

DI: 145750

Oprachtgever:

RIZA

Voedselwebanalyse en bioaccumulatie in  
vier biotopen in het Haringvliet

november 1999

wl | delft hydraulics

C23084



Rijkswaterstaat/RIZA  
Rijksinstituut voor  
Integraal Zoetwaterbeheer en  
Afwalwaterbehandeling  
Documentatie  
Postbus 17  
8200 AA Lelystad

## Voedselwebanalyse en bioaccumulatie in vier biotopen in het Haringvliet

A.N. Blauw



**wL | delft hydraulics**

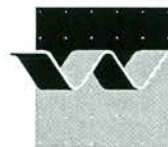

**OPDRACHTGEVER:** DG Rijkswaterstaat  
 Rijksinstituut voor Integraal Zoetwaterbeheer en Afvalwaterbehandeling/ RIZA  
 Postbus 17  
 8200 AA Lelystad

**TITEL:** Voedselwebanalyse en berekening van bioaccumulatie in vier biotopen in het Haringvliet

**SAMENVATTING:**

In het kader van het nader onderzoek naar waterbodems is behoefte aan meer inzicht in de bioaccumulatie van cadmium en PCB-153 in het Haringvliet. In een eerdere studie is al eens een analyse gemaakt van het voedselweb en de bioaccumulatie van cadmium en PCB-153 in het Haringvliet als geheel. In deze studie is de analyse verder uitgewerkt op biotoopniveau voor vier geselecteerde biotopen.

Uit de bio-accumulatieberekeningen komt naar voren dat de bio-accumulatie het sterkst optreedt in de slibrijke milieus. De blootstelling aan verontreiniging met cadmium en PCB is het hoogst in het biotoop 'diep instabiel slib'. De produktie door het voedselweb is het hoogst in het biotoop 'ondiep stabiel slib'. Beide factoren zijn van belang voor bio-accumulatie, waardoor de beide slibrijke milieus de hoogste concentraties geaccumuleerde verontreinigingen laten zien in de hogere organismen. Cadmium lijkt het sterkst te accumuleren in kuifeenden, steltlopers en kluten. PCB accumuleert het sterkst in aalscholvers.

Er zijn weinig gegevens beschikbaar over de concentraties aan verontreinigingen in de verschillende biotopen. Hierdoor kunnen de uitgevoerde berekeningen slechts als indicatief worden beschouwd voor de werkelijk optredende processen. Om een inschatting te krijgen van de invloed van deze onzekerheden op de uiteindelijke modelresultaten zijn (door coëfficiëntaanpassingen) de concentraties cadmium in chironomiden in ondiepe biotopen 10 maal verhoogd. Dit had tot gevolg dat de concentraties in vogels toenamen met een factor 3.5 tot 5.5. Ook voor PCB is een kleine gevoeligheidsanalyse uitgevoerd, waaruit bleek dat een verhoogde opname door oligochaeten met een factor 1.5 een verhoging van de accumulatie-niveaus in hogere organismen gaf tot een factor 1.3.

**REFERENTIES:** Opdrachtbon nummer 34492 WSC (29 oktober 1998)

REV.	AUTEUR	DATUM	OPMERKINGEN	REVIEW	GOEDKEURING
0	A. Blauw <i>AB</i>	19-11-99	definitief	F.J. Los <i>FL</i>	T. Schilperoort <i>TS</i>

TREFWOORDEN	INHOUD	STATUS
Haringvliet, voedselweb, bioaccumulatie biotoop	TEKST: 18 TABELLEN: 16 FIGUREN: 1 APPENDICES: 13	<input type="checkbox"/> VOORLOPIG <input type="checkbox"/> CONCEPT <input checked="" type="checkbox"/> DEFINITIEF
PROJECTNUMMER: Z2794.00		

# Inhoud

<b>1</b>	<b>Inleiding</b> .....	<b>1-1</b>
1.1	Aanleiding en doelstelling .....	1-1
1.2	Aanpak .....	1-1
1.3	Verantwoording .....	1-1
<b>2</b>	<b>Toepassing van het voedselwebmodel</b> .....	<b>2-1</b>
2.1	Opzet van de voedselwebmodellen .....	2-1
2.2	Kalibratie .....	2-1
2.3	Resultaten .....	2-2
2.4	Conclusies .....	2-5
<b>3</b>	<b>Bio-accumulatieberekeningen</b> .....	<b>3-1</b>
3.1	Opzet van de bio-accumulatiemodellen .....	3-1
3.2	Kalibratie .....	3-1
3.3	Resultaten .....	3-4
<b>4</b>	<b>Conclusies en aanbevelingen</b> .....	<b>4-1</b>
	<b>Literatuur</b> .....	<b>1</b>

## **Appendices**

- A Biomassaschattingen voor biotopen**
- B Achtergrondinformatie MC<sup>2</sup>**
- C Invoerfiles van de gekalibreerde voedselwebberekeningen**
- D Uitvoer van de gekalibreerde voedselwebberekeningen**
- E Achtergrondinformatie over CHEOPS**
- F Chemische gegevens over biotopen**
- G Omrekening van sedimentkarakteristieken naar CHEOPS invoer**
- H Algemene structuur van de CHEOPS invoerfile**
- I Invoerfiles voor CHEOPS**
- J Samengevatte ongekalibreerde resultaten**
- K Ongekalibreerde uitvoerfiles CHEOPS**
- L Gekalibreerde uitvoerfiles CHEOPS**
- M Uitvoerfiles CHEOPS met verhoogde opname**

# I Inleiding

## I.1 Aanleiding en doelstelling

In het kader van het nader onderzoek waterbodems wordt onderzoek gedaan naar de noodzaak van waterbodemsanering in onder andere het Haringvliet. In het verleden (WL, 1997) zijn berekeningen uitgevoerd om een inschatting te maken van de bio-accumulatie in het Haringvliet. Daarbij is toen geen onderscheid gemaakt in de verschillende biotopen die voorkomen in het Haringvliet, hoewel er wel biotoopspecifieke gegevens beschikbaar zijn over de voedselwebben en concentraties verontreiniging.

De doelstelling van het onderhavige project is het uitvoeren van berekeningen om de verschillen in bio-accumulatie in te schatten tussen verschillende biotopen in het Haringvliet. Dit is van belang in verband met de prioritering van bodemsaneringsmaatregelen. De berekeningen worden uitgevoerd voor cadmium en PCB-153 voor een viertal geselecteerde biotopen in het Haringvliet. Het betreft de biotopen:

- ondiep zand
- intergetijdenzone
- diep instabiel slib
- ondiep stabiel slib

De biotopen ‘diep stabiel slib’ en ‘diep zand’ worden buiten beschouwing gelaten. De voedselstromen in de voedselwebben worden berekend met het model MC<sup>2</sup>, de bio-accumulatie met het model CHEOPS. De berekeningen worden gedaan voor alle vier de biotopen en (ter vergelijking) ook van het gehele Haringvliet.

## I.2 Aanpak

Het project wordt opgesplitst in de volgende onderdelen:

1. Verzamelen van gegevens. Voor de kalibratie zijn gegevens voor 1997-1998 beschikbaar uit een studie door bureau Waardenburg (Boudewijn en Moorsel, 1996)
2. Opzetten berekeningen MC<sup>2</sup> en CHEOPS. Dit onderdeel bevat tevens de mobilisatie van beide modellen en reproduceren van de resultaten van 1997 voor het Haringvliet.
3. Uitvoeren kalibratieberekeningen in een bijeenkomst met WL en de opdrachtgever (in de persoon van dr. P.J. den Besten).
4. beknopte rapportage.

## I.3 Verantwoording

Dit project werd uitgevoerd door drs. M.B. de Vries (projectleider), ir. A.N. Blauw en drs. F.J. Los. De opdracht voor de studie werd gegeven met opdrachtbon nummer: 34492/WSC d.d. 29 oktober 1999.

## 2 Toepassing van het voedselwebmodel

### 2.1 Opzet van de voedselwebmodellen

Bij de opzet van de voedselwebmodellen voor de verschillende biotopen in het Haringvliet is in eerste instantie uitgegaan van het gekalibreerde model zoals dat was opgeleverd na de eerdere kalibratie voor het gehele Haringvliet (WL, 1997). De parameterwaarden voor het Haringvliet zonder sanering (scenario Hv0) zijn als startpunt genomen voor de kalibratie van de deelmodellen. Ten opzichte van dit totaalmodel zijn de geschatte biomassa's voor de verschillende voedselgroepen aangepast, volgens de gemeten waarden voor de biotopen zoals opgegeven in Boudewijn en Moorsel (1996). Een kopie van de gebruikte tabel uit dat rapport is weergegeven in appendix A, met een toelichting op de wijze waarop de gepresenteerde waarden zijn omgezet naar invoer voor de voedselwebmodellen. Voor de voedselgroepen fytoplankton, zoöplankton en detritus in suspensie (susdet) zijn dezelfde waarden aangehouden als voor het totaalmodel voor het Haringvliet. De aanwezige biomassa van bodemdetritus is gebaseerd op de metingen in Tabel 1.

De voedselwebberekeningen dienen als basis voor de bio-accumulatieberekeningen met CHEOPS. Voor de kalibratie van de bio-accumulatieberekeningen zijn alleen biotoopspecifieke gegevens bekend voor oligochaeten en chironomiden. Deze soortengroepen werden in de oude berekeningen samengenomen. Ten behoeve van de kalibratie van het bio-accumulatiemodel zijn de oligochaeten en chironomiden in deze nieuwe (biotoopspecifieke) voedselwebberekeningen als aparte soortengroepen behandeld. De parameterwaarden zijn in eerste instantie voor beide groepen gelijk gehouden aan de oude waarden voor oligochaeten en chironomiden samen.

### 2.2 Kalibratie

De voedselwebrelaties zijn zoveel mogelijk gelijk gehouden aan het eerder gekalibreerde model voor het Haringvliet als geheel. Tijdens de kalibratie zijn voornamelijk aanpassingen gemaakt aan de import en biomassaschattingen van detritus en de export van schelpdieren. De nieuwe biomassaschattingen voor bodemdetritus zijn gebaseerd op de metingen in Tabel 1.

Tabel 1: Meetgegevens van organisch materiaal in de bodem.

Biotoop	gehalte organisch stof (gC/m <sup>2</sup> )
diep instabiel slib	3.4
ondiep zand	0.7
ondiep stabiel slib	0.85
intergetijdenzone	0.9

De volgende veranderingen aan parameterinstellingen zijn gemaakt in het kader van de kalibratie (biomassa in 0.01 gC/m<sup>2</sup>, fluxen in 0.01 gC/m<sup>2</sup>/dag):

parameter\biotoop	totaal	zand	intergetijde	diep slib	ondiep slib
bodemdetritus	300	70	90	340	125
imp. bodemdetritus	20	5	5	25	5
imp. susp. detritus	20	10	10	10	10
imp. mollklein	-4	-1.5	-2	-2	-4.7
imp. slak	-1.1		-2	-0.1	
imp. oligochaeten	0		-0.2		
imp. chironomiden	0		-0.3		
imp. macrust	0		-0.01		

De verlaagde aanvoer van detritus in water en bodemdetritus komt overeen met de lagere gehalten aan organisch materiaal die in de deelbiotopen zijn gemeten, vergeleken met de geschatte hoeveelheid bodemdetritus in het totale Haringvliet.

Een negatieve import betekent een netto export van organismen uit het systeem, bijvoorbeeld door predatie door vogels. De modellen bleken zeer gevoelig te reageren op veranderingen aan de exportparameter. Wanneer door middel van de aanvoer van voedsel (detritus) en de export de biomassaschattingen van de organismen laag in de voedselketen goed gereproduceerd werden, waren de schattingen voor hogere organismen zoals witvis vaak ook redelijk. De biomassa's van roofvissen bleken moeilijker te kunnen worden gereproduceerd. Hierbij speelt waarschijnlijk een rol dat de biomassa van roofvissen die ondersteund wordt door een bepaald biotoop moeilijk in het veld vast te stellen is, doordat de dieren veel mobieler zijn dan de meeste bodemorganismen. Door de grote onzekerheid in de 'gemeten' biomassa van roofvissen en aal is niet doorgekalibreerd tot het model de 'gemeten' waarden kon reproduceren. Tijdens de gezamenlijke kalibratie is ervoor gekozen om de parameterwaarden van de kalibratie voor het gehele Haringvliet onveranderd aan te houden voor de roofvissen in de voedselwebmodellen voor de biotopen.

## 2.3 Resultaten

De voedselwebben die zijn berekend met de gekalibreerde deelmodellen voor de biotopen worden in het onderstaande gepresenteerd en toegelicht.

Uit Tabel 2 kan worden geconcludeerd dat de groep 'oligochaeten en chironomiden' uit de vorige voedselwebstudie voor het Haringvliet (WL, 1997) gemiddeld over het Haringvliet voornamelijk uit oligochaeten bestaat. De groepen onderin de voedselketen (zoöplankton, mollusken, schelpdieren en oligochaeten en chironomiden) worden licht onderschat, de kleinere witvissen worden overschat en de roofvissen onderschat.



Tabel 2: Berekend voedselweb voor het Haringvliet als geheel waarbij de groep oligochaeten en chironomiden uit de eerdere studie (WL, 1997) gesplitst is.

Groep	import	biomassa berekend	biomassa 'gemeten'	produktie
gesuspendeerd detritus	20	299.77	280	0
bodemdetritus	20	307.42	300	0
fytoplankton	70	277.53	280	70
zoöplankton	-2	47.08	42	3.06
kleine mollusken	-4	462.29	518	4.21
grote mollusken	0	56.94	57	0.03
oligochaeten	0	57.94	80.8	1.16
chironomiden	0	2.01	2.8	0.04
macrocrustaceaen	0	4.08	5.2	0.08
slakken	-1.1	60.3	78	1.21
kleine witvis	0	35.52	23	0.31
middelgrote witvis	0	27.2	16	0.11
grote witvis	0	57.85	61	0.23
middelgrote roofvis	0	9.37	17	0.03
grote roofvis	0	11.02	20	0.03
aal	0	14.11	11	0.03

Tabel 3: Berekend voedselweb voor het biotoop 'ondiep zand'.

Groep	import	biomassa berekend	biomassa 'gemeten'	produktie
gesuspendeerd detritus	10	283.34	280	0
bodemdetritus	5	71.77	70	0
fytoplankton	70	287.6	280	70
zoöplankton	-2	56.32	42	3.66
kleine mollusken	-1.5	152.14	142.5	1.58
grote mollusken	0	74.59	74.8	0.04
oligochaeten	0	23.27	20.4	0.47
chironomiden	0	10.49	9.2	0.21
macrocrustaceaen	0	4.59	5.2	0.09
slakken	-1.1	64.32	71.5	1.29
kleine witvis	0	37.52	32.71	0.32
middelgrote witvis	0	23.83	18.63	0.1
grote witvis	0	30.83	27.24	0.12
middelgrote roofvis	0	10.61	22.79	0.03
grote roofvis	0	6.38	13.71	0.02
aal	0	11.9	33.82	0.02

De berekende biomassa's in ondiep zand komen (Tabel 3) goed overeen met de schattingen gebaseerd op metingen voor de groepen laag in de voedselketen. De witvisbiomassa wordt iets onderschat; de roofvisbiomassa wordt onderschat met een factor 2 en de aalbiomassa wordt onderschat met een factor 3.

Tabel 4: Berekend voedselweb voor het biotoop 'intergetijdenzone'.

Groep	import	biomassa berekend	biomassa 'gemeten'	produktie
gesuspendeerd detritus	10	244.76	280	0
bodemdetritus	5	96.46	90	0
fytoplankton	70	291.5	280	70
zoöplankton	-2	41.58	42	2.7
kleine mollusken	-2	220.8	209.7	2.01
grote mollusken	0	82.7	83.8	0.04
oligochaeten	-0.2	18.59	20.4	0.37
chironomiden	-0.3	32.84	37.8	0.66
macrocrustaceaen	-0.01	2.96	5.2	0.06
slakken	-2	101.31	104.8	2.03
kleine witvis	0	21.66	19.1	0.19
middelgrote witvis	0	5.76	4.34	0.02
grote witvis	0	4.06	3.12	0.02
middelgrote roofvis	0	5.54	5.32	0.02
grote roofvis	0	1.99	1.91	0.01
aal	0	4.65	3.98	0.01

De berekende biomassa's in de intergetijdenzone (Tabel 4) komen voor alle groepen goed overeen met de biomassaschattingen op basis van metingen.

Tabel 5: Berekend voedselweb voor het biotoop 'diep instabiel slib'.

Groep	import	biomassa berekend	biomassa 'gemeten'	produktie
gesuspendeerd detritus	10	326.47	280	0
bodemdetritus	25	344.41	340	0
fytoplankton	70	300.56	280	70
zoöplankton	-2	42.82	42	2.78
kleine mollusken	-2	226.94	228	2.07
grote mollusken	0	0	0	0
oligochaeten	0	69.07	86.4	1.38
chironomiden	0	1.12	1.4	0.02
macrocrustaceaen	0	3.8	5.2	0.08
slakken	-0.1	5.64	8.8	0.11
kleine witvis	0	29.76	18.68	0.26
middelgrote witvis	0	24.98	16.27	0.1
grote witvis	0	53.38	72.69	0.21
middelgrote roofvis	0	7.78	15.51	0.02
grote roofvis	0	10.62	21.16	0.03
aal	0	12.15	4.58	0.02

De berekende biomassa's van de groepen laag in de voedselketen komen in diep instabiel slib redelijk overeen met de schattingen op basis van metingen (Tabel 5). De kleinere witvissen worden overschat en de roofvissen onderschat.

Tabel 6: Berekend voedselweb voor het biotoop 'ondiep stabiel slib'.

Groep	import	biomassa berekend	biomassa 'gemeten'	produktie
gesuspendeerd detritus	10	192.96	280	0
bodemdetritus	5	144.25	125	0
fytoplankton	70	250.09	280	70
zoöplankton	-2	59	42	3.83
kleine mollusken	-4.7	527.04	537.2	4.8
grote mollusken	0	37.75	39.2	0.02
oligochaeten	0	23.06	18.8	0.46
chironomiden	0	7.97	6.5	0.16
macrocrustaceen	0	3.76	5.2	0.08
slakken	-1.1	58.16	49	1.16
kleine witvis	0	43.02	43.7	0.37
middelgrote witvis	0	22.63	16.1	0.09
grote witvis	0	51.97	22.63	0.21
middelgrote roofvis	0	10.02	19.77	0.03
grote roofvis	0	8.56	16.89	0.03
aal	0	16.34	29.8	0.03

De biomassa's op basis van metingen van de groepen laag in de voedselketen worden in ondiep stabiel slib met wisselend succes gereproduceerd (Tabel 6). De witvissen worden licht overschat en de roofvissen en aal onderschat.

## 2.4 Conclusies

De berekende voedselwebben komen over het algemeen goed overeen met de biomassaschattingen voor de biotopen op basis van de metingen door bureau Waardenburg (Boudewijn en Moorsel, 1996). De afwijkingen tussen model en 'metingen' zijn het grootst voor de ecologische groepen hoger in de voedselketen. De biomassa van witvissen wordt vaak overschat terwijl de biomassa van roofvissen en aal meestal juist onderschat wordt. Deze tendens is ook terug te vinden in het oorspronkelijke voedselwebmodel voor het Haringvliet als geheel (WL, 1997). Deze structurele afwijkingen pleiten voor structurele aanpassingen aan de parameterwaarden die de graas van roofvissen op witvissen sturen.

Bij de vergelijking van de voedselwebben voor de verschillende biotopen is het opvallend dat het biotoop met de hoogste detritusconcentraties (diep slib) niet de hoogste biomassa's aan schelpdieren wordt gevonden. De hoogste biomassa van lagere organismen (macrofauna, schelpdieren en zoöplankton) worden gevonden in het biotoop ondiep stabiel slib. Deze organismen vormen de basis van de voedselketen. In ondiep stabiel slib is deze basis bijna even groot als gemiddeld voor het gehele Haringvliet. De verklaring voor het feit dat gemiddeld over het gehele Haringvliet meer biomassa is gemeten dan voor ieder van de 4 onderscheiden biotopen is dat het biotoop met de hoogste biomassa: diep stabiel slib, buiten deze studie valt. In appendix A is te zien dat juist in dat biotoop zeer hoge concentraties kleine mollusken (= kleine bivalven), slakken (= gastropoden) en oligochaeten gevonden zijn.

In Tabel 7 wordt een overzicht gegeven van de totale biomassa aan de basis en hogerop in de voedselketen in de verschillende biotopen. Ondanks de veel hogere biomassa aan de basis van de voedselketen in ondiep stabiel slib is de visproductie niet hoger dan in de andere biotopen. Bij de kalibratie is dit fenomeen gereproduceerd door de hoge exportterm voor kleine mollusken, waardoor de geëxporteerde schelpdierbiomassa niet beschikbaar is voor de groei van vissen. In het intergetijdenzone zijn de visbiomassa's veel lager dan op grond van de beschikbaarheid van lagere organismen verwacht kan worden. Het feit dat dit biotoop een gedeelte van de tijd droog staat en dan dus geen vissen kan herbergen kan hierbij een rol spelen, evenals een verhoogde graasdruk door vogels tijdens droogval en een verhoogde sterfte van organismen door de wisselende omstandigheden. In de kalibratie komt deze verminderde beschikbaarheid van lagere organismen voor vissen tot uitdrukking in verhoogde exporttermen voor vrijwel alle lagere organismen. Ook uit Figuur 1 blijkt dat ondiep slib het meest produktieve milieu is voor de lagere organismen. De visbiomassa is in alle biotopen in dezelfde orde van grootte, behalve in de intergetijdenzone.

Tabel 7: Overzicht van gemeten en berekende totale biomassa aan de basis van de voedselketen (macrofauna, zoöplankton en schelpdieren) en vissen.

berekend:	totaal	zand	intergetijden	diep slib	ondiep slib
totale biomassa	932	515	541	521	847
biomassa basis	795	399	508	376	728
visbiomassa	137	115	34	144	119
gemeten:					
totale biomassa	846	507	544	488	869
biomassa basis	705	398	505	362	733
visbiomassa	141	109	39	127	136

Figuur 1: Produktie door voedselgroepen in de verschillende biotopen

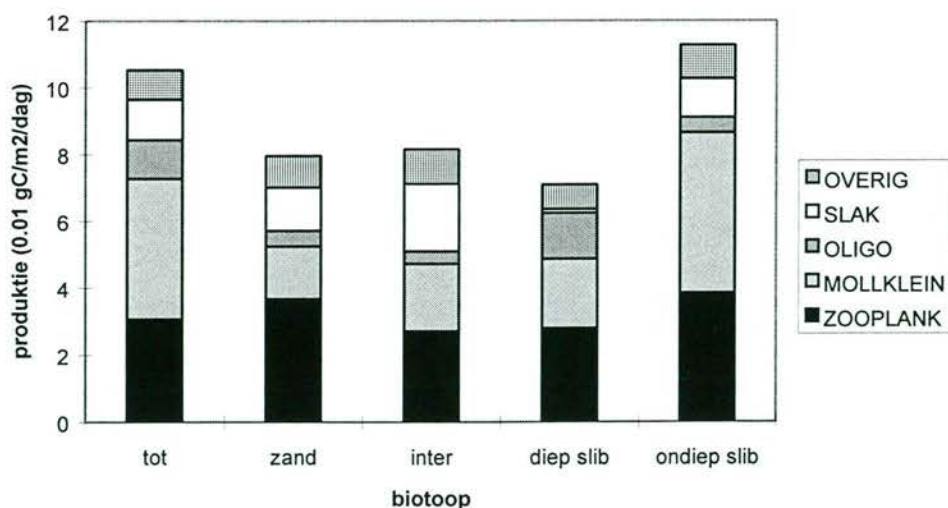

## 3 Bio-accumulatieberekeningen

### 3.1 Opzet van de bio-accumulatiemodellen

Bij de opzet van de bio-accumulatiemodellen voor de vier biotopen in het Haringvliet is (evenals bij de voedselwebmodellen) uitgegaan van het totaalmodel voor het Haringvliet zonder sanering, uit de eerdere studie (WL, 1997). Op basis van specifieke gegevens voor de biotopen zijn nieuwe concentraties berekend in het water, geadsorbeerd aan detritus in suspensie, geadsorbeerd aan bodemdetritus en in het poriewater. De gebruikte gegevens staan in appendix F, de berekende concentraties staan in Tabel 8.

Tabel 8: Ingevoerde concentraties aan verontreinigingen in water en geadsorbeerd aan detritus in de verschillende biotopen.

	Ondiep zand		intergetijdenzone		diep instabiel slib		ondiep slib	
	Cd	PCB <sub>153</sub>	Cd	PCB <sub>153</sub>	Cd	PCB <sub>153</sub>	Cd	PCB <sub>153</sub>
water	0.04	0.121	0.04	0.121	0.04	0.121	0.04	0.121
detritus in water	5	227	5	227	5	227	5	227
poriewater	0.062	0.098	0.035	0.092	0.098	0.124	0.049	0.069
bodemdetritus	7.692	183.3	4.372	172.2	12.19	232.3	6.135	129.4

De concentraties in Tabel 8 zijn berekend met een spreadsheet zoals staat afgebeeld in appendix G. De berekening is verschillend voor cadmium en PCB153. Cadmium adsorbeert voornamelijk aan fijn anorganisch slib, terwijl PCB153 voornamelijk aan organisch materiaal adsorbeert. Voor cadmium wordt aangenomen dat alle cadmium in het sediment geadsorbeerd is aan de fractie kleiner dan 63  $\mu$ , waaronder ook de organische fractie. Vervolgens wordt de concentratie geadsorbeerd aan bodemdetritus gelijkgesteld aan de fractie geadsorbeerd aan anorganisch slib. Voor PCB wordt aangenomen dat alle PCB in het sediment geadsorbeerd is aan organisch materiaal. De concentraties in poriewater nemen lineair toe met de concentraties geadsorbeerd aan organisch materiaal.

In diep slib komen de hoogste concentraties aan fijn slib en organisch materiaal voor en de hoogste concentraties cadmium en PCB. In ondiep zand komen de laagste concentraties voor van slib, organisch materiaal en cadmium en PCB.

Voor de bio-accumulatieberekeningen zijn de nieuwe gekalibreerde voedselwebresultaten (zie hoofdstuk 2) gebruikt, waaraan evenals in de vorige studie (WL, 1997) enkele vogels zijn toegevoegd.

### 3.2 Kalibratie

Voor de kalibratie zijn alleen biotoopspecifieke gegevens beschikbaar voor oligochaeten en chironomiden. De beschikbare gegevens zijn weergegeven in Tabel 9 en Tabel 10.

Tabel 9: Biotootspecifieke gegevens over bioaccumulatie van cadmium (mg/kg ww) in oligochaeten en chironomiden in het Haringvliet (IVM, 1996, IVM, 1999, Reinhold et al. 1999).

	Hollands Diep, diepe delen	ondiep zand	intergetijden zone	diep instabiel slib	ondiep slib
oligochaeten	0.09	0.05		0.05	0.04
--droogw oligo	11.7%	17.4%		18.2%	17.4%
chironomiden	0.07		0.35 (data BrabB.)	0.12 (data HD)	2.1
--droogw chir	10%		11.8%	11.8%	11.8%

De concentraties cadmium in oligochaeten is redelijk constant op 0.05 mg/kg ww over de verschillende biotopen in het Haringvliet. In het Hollands Diep worden 2 maal hogere waarden gevonden. De metingen voor chironomiden vertonen een grote spreiding. De enige meting in het Haringvliet betreft het ondiepe slib. De concentratie daar is circa een factor 20 keer hoger dan de gemeten waarden in het Hollands Diep en de Brabantse Biesbosch en een factor 50 keer hoger dan in oligochaeten in hetzelfde biotoop.

Tabel 10: Biotootspecifieke gegevens over bioaccumulatie van PCB153 ( $\mu\text{g}/\text{kg}$  ww) in oligochaeten en chironomiden in het Haringvliet (IVM, 1996, IVM, 1999, Reinhold et al. 1999).

	Hollands Diep, diepe delen	ondiep zand	intergetijden zone	diep instabiel slib	ondiep slib
oligochaeten	22.4	13.4		23.8	19.0
--vet%oligo	2.0%	2.0%		2.0%	2.0%
chironomiden	16-30 (gem: 23)		10 (data BrabB)		13
--vet% chir	1.0%		1.0%		1.0%

Voor de berekeningen van de gehalten PCB-153 op versgewichtbasis (tabel 10) zijn eerst de gehalten op vetbasis gemiddeld en is vervolgens met een vast vetpercentage omgerekend naar gehalten op versgewichtbasis (gemeten waarden gemiddeld: 2% voor oligochaeten en 1% voor chironomiden). De gehalten PCB in oligochaeten zijn in slibrijke biotopen circa 2 maal hoger dan in het zandige biotoop. Dit zou verklaard kunnen worden uit de hogere blootstelling aan PCB's in de slibrijke biotopen. In ondiep slib is de gemeten concentratie in oligochaeten 1.5 maal zo hoog als in chironomiden. PCB wordt via passieve opname opgenomen, doordat het een lipofiele stof is. Het hogere vetgehalte van de oligochaeten zou een verklaring kunnen zijn voor de hogere concentratie in oligochaeten ten opzichte van chironomiden in hetzelfde biotoop. Om hierover meer zekerheid te krijgen zijn meer gegevens nodig.

In overeenstemming met Tabel 10 is het vetgehalte in oligochaeten verhoogd van 1% naar 2%. Het vetgehalte van chironomiden is gehandhaafd op 1%. Het vetgehalte heeft alleen effect op de bioaccumulatie van PCB's, en niet op cadmium. Het vetgehalte speelt alleen een rol voor de passieve opname van bijvoorbeeld organische microverontreinigingen. Met de bovenstaande aanpassing en de nieuwe voedselwebben zijn de eerste CHEOPS-berekeningen uitgevoerd. De resultaten van deze berekeningen staan in appendix J en K.

## Cadmium

De concentraties cadmium (zie Tabel 11) in oligochaeten zijn in de ondiepe biotopen van dezelfde orde grootte als de metingen in ondiepe biotopen, maar wel tot circa 1.5 maal te hoog (gemeten: 0.04-0.05, berekend: 0.04-0.07). In diep instabiel slib zijn de berekende concentraties ruim 2 maal te hoog (berekend: 0.12, gemeten: 0.05). De berekende cadmiumconcentraties in chironomiden in ondiep slib zijn daarentegen circa 35 maal lager dan de metingen in ondiep slib in het Haringvliet. De gemeten concentraties in diepe biotopen in het Hollands Diep liggen wel in dezelfde orde grootte, maar gezien de grote spreiding tussen de metingen in de verschillende biotopen en systemen geeft dit alleen aan dat de berekende waarde binnen de gemeten range van concentraties ligt.

De hoge berekende concentraties cadmium in diep slib komen voort uit de hogere blootstelling in dit biotoop (zie paragraaf 3.1). Het is niet duidelijk waarom de concentratie in oligochaeten in de metingen even hoog is als in de andere biotopen, hoewel er hogere concentraties in het sediment zijn gemeten.

Tabel 11: Concentraties cadmium in chironomiden en oligochaeten (mg/kg ww) voor de kalibratie (tussen haakjes staan de gemeten waarden).

Parameter\biotoop	totaal	ondiep zand	intergetijde	diep slib	ondiep slib
oligochaeten	0.09	0.07 (0.05)	0.04	0.12 (0.05)	0.06 (0.04)
chironomiden	0.09	0.07	0.04	0.12	0.06 (2.1)

Om de berekende concentraties dichter in de buurt te brengen bij de gemeten waarden zijn de volgende aanpassingen aan de coëfficiënten gemaakt:

- verlaging van de extractie-efficiëntie uit water en voedsel door oligochaeten van 0.005 naar 0.003.
- verhoging van de extractie-efficiëntie uit water en voedsel door chironomiden van 0.005 naar 0.05 in de ondiepe biotopen: ondiep zand, intergetijdenzone en ondiep stabiel slib.

Het is niet duidelijk waarom de concentratie cadmium in chironomiden in ondiep slib in het Haringvliet zoveel hoger is dan in het Hollands Diep en de Brabantse Biesbosch. Het is onwaarschijnlijk dat de verschillen veroorzaakt worden door het gedrag van de chironomiden zelf. Hoogstwaarschijnlijk is de blootstelling op de monsterlocaties verhoogd. Vanwege de onzekerheden over de oorzaak en de betekenis van deze hoge meting is door een coëfficiëntaanpassing getracht de concentraties in chironomiden in het model te verhogen, zonder te proberen het verklarende mechanisme voor de verhoogde concentraties te modelleren. Er is alleen geanalyseerd wat de effecten van een dergelijk hoge concentratie voor organismen hoger in de voedselketen zou betekenen. Er zijn daarom sommen gemaakt waarin de extractie-efficiëntie uit water en voedsel door chironomiden verhoogd is van 0.005 naar 0.05, maar ook sommen waarin deze aanpassing niet is gemaakt.

## PCB<sub>153</sub>

De eerste resultaten van de berekeningen voor de bio-accumulatie van PCB kwamen redelijk goed overeen met de gemeten waarden. De berekende concentraties in oligochaeten in ondiep slib waren echter circa een factor 1.5 te laag.

Tabel 12: Concentraties PCB<sub>153</sub> in chironomiden en oligochaeten (µg/kg ww) voor de kalibratie, waarbij het vetgehalte van oligochaeten nog gelijk is aan dat in chironomiden (tussen haakjes staan de gemeten waarden).

Parameter\biotoop	totaal	ondiep zand	intergetijde	diep slib	ondiep slib
oligochaeten	23	17 (13.4)	17	22 (23.8)	13 (19)
chironomiden	23	17	17	22	13 (13)

Oligochaeten nemen PCB's voor het belangrijkste deel op via hun voedsel (zie appendix K). Om de effecten in te schatten van de hoge concentraties in oligochaeten in ondiep stabiel slib zijn ook berekeningen gemaakt met een verhoogde extractie-efficiëntie van PCB uit voedsel van 0.02 naar 0.03 in alle biotopen.

### 3.3 Resultaten

De resultaten van de bio-accumulatieberekeningen voor de verschillende biotopen staan in appendix L en M. De resulterende concentraties aan cadmium en PCB in de verschillende groepen staan samengevat in Tabel 13 tot en met Tabel 16.

Tabel 13: Berekende concentraties cadmium (mg/kg ww) met de extractie-efficiëntie uit water en voedsel voor chironomiden op de uitgangswaarde van 0.005 en voor oligochaeten op 0.003 in alle biotopen (tussen haakjes staan de gemeten waarden).

Parameter\biotoop	totaal	ondiep zand	intergetijde	diep slib	ondiep slib
zoöplankton	0.013	0.013	0.013	0.013	0.013
kleine mollusken	0.190	0.163	0.170	0.200	0.178
grote mollusken	0.127	0.127	0.127	0.125	0.127
oligochaeten	0.052	0.043 (0.05)	0.027	0.073 (0.05)	0.038 (0.04)
chironomiden	0.087	0.072	0.044	0.122	0.063 (2.1)
macrocrustaceen	0.126	0.073	0.074	0.155	0.113
slakken	0.170	0.150	0.085	0.238	0.120
kleine witvis	0.007	0.007	0.007	0.007	0.007
middelgrote witvis	0.008	0.008	0.006	0.010	0.015
grote witvis	0.048	0.041	0.024	0.067	0.045
middelgrote roofvis	0.004	0.004	0.004	0.004	0.004
grote roofvis	0.005	0.005	0.005	0.005	0.005
aal	0.023	0.023	0.022	0.023	0.023
kuifeend	0.116	0.100	0.104	0.123	0.109
aalscholver	0.004	0.003	0.003	0.004	0.006
fuut	0.003	0.003	0.003	0.003	0.003
steltloper	0.090	0.076	0.060	0.113	0.111
kluut	0.071	0.058	0.036	0.098	0.101
visdiefje	0.004	0.004	0.004	0.004	0.004



De verlaging van de extractie-efficiënties door oligochaeten heeft de overeenkomst tussen de gemeten en berekende waarden duidelijk verbeterd. Op grond van deze berekeningen kan geconcludeerd worden dat de kuifeend, de steltloper en de kluut de hoogste concentraties cadmium accumuleren en dat de bio-accumulatie van cadmium het sterkst optreedt in de biotopen 'diep instabiel slib' en 'ondiep stabiel slib'.

Tabel 14: Berekende concentraties PCB<sub>153</sub> (µg/kg ww) met de extractie uit voedsel voor oligochaeten op de uitgangswaarde van 0.02 en een vetgehalte in oligochaeten van 2% (tussen haakjes staan de gemeten concentraties).

Parameter\biotoop	totaal	ondiep zand	intergetijde	diep slib	ondiep slib
zoöplankton	5	5	5	5	5
kleine mollusken	30	23	23	30	25
grote mollusken	6	6	6	5	6
oligochaeten	24	18 (13.4)	17	23 (23.8)	13 (19)
chironomiden	23	17	17	22	13 (13)
macrocrustaceen	90	59	67	87	67
slakken	24	19	18	24	13
kleine witvis	34	18	23	33	18
middelgrote witvis	57	42	37	59	73
grote witvis	238	176	155	233	156
middelgrote roofvis	35	22	23	35	26
grote roofvis	54	34	36	55	40
aal	434	231	124	446	245
kuifeend	249	192	193	249	205
aalscholver	3460	2430	2120	3600	3910
fuut	824	452	576	811	433
steltloper	325	245	239	318	201
kluut	430	321	310	417	237
visdiefje	691	380	484	681	364

De verhoging van het vetpercentage in oligochaeten heeft maar weinig effect. De hoogste accumulatie-niveaus van PCB-153 worden bereikt in aalscholvers in slibrijke biotopen.

Tabel 15: Berekende concentraties cadmium (mg/kg ww) met verhoogde extractie-efficiëntie uit water en voedsel voor chironomiden (0.05 i.p.v. 0.005) in ondiepe biotopen (tussen haakjes staan de gemeten waarden), [tussen vierkante haken staan de waarden uit Tabel 13].

Parameter\biotoop	totaal	ondiep zand	intergetijde	diep slib	ondiep slib
zoöplankton	0.013	0.013	0.013	0.013	0.013
kleine mollusken	0.190	0.163	0.170	0.200	0.178
grote mollusken	0.127	0.127	0.127	0.125	0.127
oligochaeten	0.052	0.043 (0.05)	0.027	0.073 (0.05)	0.038 (0.04)
chironomiden	0.087	0.721	0.441	0.122	0.626 (2.1)
macrocrustaceen	0.126	0.073	0.074	0.155	0.113
slakken	0.170	0.150	0.085	0.238	0.120
kleine witvis	0.007	0.007	0.008	0.007	0.007
middelgrote witvis	0.008	0.009	0.008	0.010	0.015
grote witvis	0.048	0.042	0.026	0.067	0.046
middelgrote roofvis	0.004	0.004	0.004	0.004	0.004
grote roofvis	0.005	0.005	0.005	0.005	0.005

Parameter\biotoop	totaal	ondiep zand	intergetijde	diep slib	ondiep slib
aal	0.023	0.023	0.022	0.023	0.023
kuifeend	0.116	0.100	0.104	0.123	0.109
aalscholver	0.004	0.004	0.004	0.004	0.006
fuut	0.003	0.003	0.004	0.003	0.003
steltloper	0.090	0.325 [.086]	0.212 [.066]	0.113	0.543 [.129]
kluut	0.071	0.387 [.072]	0.236 [.044]	0.098	0.671 [.125]
visdiefje	0.004	0.004	0.004	0.004	0.004

De verhoogde opname van cadmium door chironomiden in ondiepe biotopen heeft geleid tot 10 maal hogere concentraties in chironomiden. Dit heeft voor de vogels in deze biotopen tot gevolg dat de accumulatie-niveaus in kluten toenemen met circa een factor 5.4 in alle ondiepe biotopen. De concentraties in steltlopers nemen in ondiep slib meer toe (factor 4.2) dan in ondiep zand en de intergetijdenzone (circa factor 3.5).

Tabel 16: Berekende concentraties PCB<sub>153</sub> (µg/kg ww) met een verhoogde extractie uit voedsel voor oligochaeten van 0.02 naar 0.03 (tussen haakjes staan de gemeten waarden), [tussen vierkante haken staan de waarden uit Tabel 14].

Parameter\biotoop	totaal	ondiep zand	intergetijde	diep slib	ondiep slib
zoöplankton	5	5	5	5	5
kleine mollusken	30	23	23	30	25
grote mollusken	6	6	6	5	6
oligochaeten	36	27 (13.4)	26	35 (23.8)	20 (19)
chironomiden	23	17	17	22	13 (13)
macrocrustaceen	90	59	67	87	67
slakken	24	19	18	24	13
kleine witvis	43 [34]	20 [18]	25 [23]	43 [33]	19 [18]
middelgrote witvis	69 [57]	48 [42]	40 [37]	76 [59]	78 [73]
grote witvis	249 [238]	182 [176]	159 [155]	246 [233]	157 [156]
middelgrote roofvis	43 [35]	24 [22]	24 [23]	45 [35]	28 [26]
grote roofvis	67 [54]	37 [34]	38 [36]	70 [55]	43 [40]
aal	459 [434]	239 [231]	129 [124]	475 [446]	250 [245]
kuifeend	249	192	193	249	205
aalscholver	4160 [3460]	2730 [2430]	2290 [2120]	4520 [3600]	4190 [3910]
fuut	1060 [824]	488 [452]	618 [576]	1050 [811]	471 [433]
steltloper	388 [325]	291 [245]	284 [239]	378 [318]	235 [201]
kluut	538 [430]	402 [321]	388 [310]	521 [417]	297 [237]
visdiefje	886 [691]	409 [380]	519 [484]	878 [681]	395 [364]

Wanneer de extractie-efficiëntie van oligochaeten voor PCB's uit voedsel verhoogd wordt van 0.02 naar 0.03 worden de gemeten PCB-concentraties in oligochaeten in ondiep stabiel slib beter gereproduceerd. De concentraties in de overige biotopen worden echter overschat. Als gevolg van de verhoging nemen de concentraties in alle vogels toe met een factor variërend tussen 1 en 1.3.

## 4 Conclusies en aanbevelingen

### Kalibratie van roofvisbiomassa

Door aanpassingen aan de beschikbaarheid van detritus en de export van organismen konden de voedselwebben voor de afzonderlijke biotopen redelijk goed worden gereproduceerd. Met de oorspronkelijke parameterwaarden voor fysiologische processen en voedselkeuze bleek een structurele onderschatting op te treden van de roofvisbiomassa en een overschatting van de witvisbiomassa, die ook al in het oorspronkelijke model van het Haringvliet zat. Het verdient aanbeveling om de parameterwaarden voor vissen nader te analyseren en eventueel te kalibreren.

### Verschillen tussen biotopen

Uit de bio-accumulatieberekeningen komt naar voren dat de bio-accumulatie het sterkst optreedt in de slibrijke milieus. Cadmium lijkt het sterkst te accumuleren in kuifeenden, steltlopers en kluten. PCB accumuleert het sterkst in aalscholvers. De blootstelling aan verontreiniging met cadmium en PCB is het hoogst in het biotoop 'diep instabiel slib'. De productie door het voedselweb is het hoogst in het biotoop 'ondiep stabiel slib' (zie ook hoofdstuk 3). Beide factoren zijn van belang voor bio-accumulatie, waardoor de beide slibrijke milieus de hoogste concentraties geaccumuleerde verontreinigingen laten zien in de hogere organismen. De meeste hogere organismen (vissen en vogels) zijn niet gebonden aan één deelbiotoop. Voor de inschatting, in welke mate de verschillende deelbiotopen bijdragen aan de totale bioaccumulatie in de vis- en vogelpopulaties is ook van belang welk deel van hun voedsel ze per biotoop vergaren. In de huidige berekeningen is de consumptie door vogels voor alle biotopen gelijk gehouden. Door hierin meer differentiatie aan te brengen zou het belang van verschillende deelbiotopen voor de totale bioaccumulatie beter zichtbaar worden.

### Waarde van de modelresultaten

Er zijn weinig gegevens beschikbaar over de concentraties aan verontreinigingen in de verschillende biotopen. Hierdoor kunnen de uitgevoerde berekeningen slechts als indicatief worden beschouwd voor de werkelijk optredende processen. Aanbevolen wordt om meer metingen te verzamelen van de accumulatie-niveaus in verschillende organismen om daarmee de berekeningen beter te onderbouwen en zonodig te kalibreren. Vooral concentraties in weinig mobiele organismen zijn bruikbaar als indicatie over de blootstelling en bioaccumulatie van vogels per deelbiotoop. Om een inschatting te krijgen van de invloed van de huidige onzekerheden op de uiteindelijke modelresultaten zijn, bij wijze van gevoeligheidsanalyse, aanvullende berekeningen met andere parameter-instellingen uitgevoerd.

## Literatuur

Bakema, A.H., Rip, W.J., Haan, M.W. de and F.J. Los, Quantifying the Food webs of Lake Bleiswijkse Zoom and Lake Zwemlust, *Hydrobiologica* 200/201, 1990, pp 487 - 495.

Boudewijn, T.J., G.W.N.M. Moorsel, 1996

Onderbouwing voedselwebmodellen voor Haringvliet en Brabantse Biesbosch. Rapport Bureau Waardenburg nr. 96.40, in opdracht van Rijkswaterstaat RIZA.

IVM, 1999.

Bepaling van microverontreinigingen in monsters uit bioaccumulatietesten met sedimenten uit de Zuidrand.

IVM, 1996.

Biomonitoring van microverontreinigingen in het Hollandsch Diep, de Dordtsche Biesbosch en de Brabantse Biesbosch.

Los, F.J., A.H. Bakema, 1988

The general ecomodel: analyse en toepassing als balansmodel. DBW/RIZA/WL.

Reinhold et al., 1999.

Accumulation of microcontaminants from sediment to larvae and adult chironomids, and the risks for the pond bat (*Myotis dasycymene*). *Journal of Aquatic Ecology*, submitted.

WL, 1997

MER-Haringvlietsluizen Voedselwebanalyse en berekeningen van bio-accumulatie, werkdocument, WL-rapport Z2202, in opdracht van Rijkswaterstaat, Directie Zuid-Holland.

WL, 1989

MC<sup>2</sup>, een balansmodel voor ecosystemen, beschrijving en handleiding voor gebruik. WL-rapport: T483, in opdracht van Rijkswaterstaat RIZA

# **A Biomassaschattingen voor biotopen**

Tabel 45. Overzicht van de berekening van de totale biomassa in gC in het Haringvliet. Voor de berekening is een gewogen gemiddelde gebruikt waarbij rekening is gehouden met de oppervlakte van de onderscheiden habitats.

	habitat	oppervlakte in ha	diepte	dichtheid gC/m <sup>2</sup> of gC/m <sup>3</sup>	biomassa in gC totaal	per m <sup>2</sup>
Fytoplankton	Haringvliet-west	n.v.t.	?	0,3748		
	Haringvliet-oost	n.v.t.	?	0,426		
	totaal					
Zooplankton	Haringvliet-west	n.v.t.	?	0,047		
	Haringvliet-oost	n.v.t.	?	0,076		
	totaal					
bodemfauna						
Chironomiden	diep stabiel slib	3155		0,007	220850	
	diep instabiel slib	2476		0,014	346640	
	diep zand	741		0,010	74100	
	ondiep slib	1228		0,065	798200	
	ondiep zand	661		0,092	608120	
	intergetijdengebied	90		0,378	340200	
	totaal				2388110	0,0286
Oligochaeten	diep stabiel slib	3155		1,161	36629550	
	diep instabiel slib	2476		0,864	21392640	
	diep zand	741		0,606	4490460	
	ondiep slib	1228		0,188	2308640	
	ondiep zand	661		0,204	1348440	
	intergetijdengebied	90		1,451	1305900	
	totaal				67475630	0,8080
Kleine bivalven = moiklein	diep stabiel slib	3155		8,53	269121500	
	diep instabiel slib	2476		2,28	56452800	
	diep zand	741		4,02	29788200	
	ondiep slib	1228		5,372	65968160	
	ondiep zand	661		1,425	9419250	
	intergetijdengebied	90		2,097	1887300	
	totaal				432637210	5,1807
Grote bivalven = mollgroot	diep stabiel slib	3155		0,828	26123400	
	diep instabiel slib	2476		0	0	
	diep zand	741		1,470	10892700	
	ondiep slib	1228		0,392	4813760	
	ondiep zand	661		0,748	4944280	
	intergetijdengebied	90		0,838	754200	
	totaal				47528340	0,5691
Gastropoden = slak	diep stabiel slib	3155		1,521	47987550	
	diep instabiel slib	2476		0,088	2178880	
	diep zand	741		0,457	3386370	
	ondiep slib	1228		0,490	6017200	
	ondiep zand	661		0,715	4726150	
	intergetijdengebied	90		1,048	943200	
	totaal				65239350	0,7812

Tabel 45 (vervolg)

	habitat	oppervlakte in ha	diepte	dichtheid gC/m <sup>2</sup> of gC/m <sup>3</sup>	biomassa in gC totaal	per m <sup>2</sup>
Kleine vis	diep	6372		0,1868	11902896	
	ondiep slib	1228		0,4370	5366360	
	ondiep zand	661		0,3271	2162131	
	intergetijdengebied	90		0,1910	171900	
	totaal				19603287	0,2347
Mid niet-roofvis	diep	6372		0,1627	10367244	
	ondiep slib	1228		0,1610	1977080	
	ondiep zand	661		0,1863	1231443	
	intergetijdengebied	90		0,0434	39060	
	totaal				13614827	0,1630
Groot niet-roofvis	diep	6372		0,7269	46318068	
	ondiep slib	1228		0,2263	2778964	
	ondiep zand	661		0,2724	1800564	
	intergetijdengebied	90		0,0312	28080	
	totaal				50925676	0,6098
Mid roofvis	diep	6372		0,1551	9882972	
	ondiep slib	1228		0,1977	2427756	
	ondiep zand	661		0,2279	1506419	
	intergetijdengebied	90		0,0532	47880	
	totaal				13865027	0,1660
groot roofvis	diep	6372		0,2116	13483152	
	ondiep slib	1228		0,1689	2074092	
	ondiep zand	661		0,1371	906231	
	intergetijdengebied	90		0,0191	17190	
	totaal				16480665	0,1973
Aal	diep	6372		0,0458	2918376	
	ondiep slib	1228		0,2980	3659440	
	ondiep zand	661		0,3382	2235502	
	intergetijdengebied	90		0,0398	35820	
	totaal				8849138	0,1060

# B Achtergrondinformatie MC<sup>2</sup>

Als achtergrondinformatie over de werking van MC<sup>2</sup> zijn kopieën van twee documenten bijgevoegd:

- een hoofdstuk uit de beschrijving en handleiding van MC<sup>2</sup> (WL, 1989)
- een publicatie van een project waarin MC<sup>2</sup> eerder is toegepast (Bakema et al., 1990).



## 2.0 KORTE BESCHRIJVING VAN HET MODEL

### 2.1 INLEIDING

In dit hoofdstuk wordt een kort overzicht van de benodigde invoergegevens voor MC<sup>2</sup> gegeven en van de belangrijkste stappen die in het model worden doorlopen. In het volgende hoofdstuk wordt dieper ingegaan op de werking van het model. In het laatste hoofdstuk tenslotte wordt een beknopte handleiding voor gebruik van het model gegeven aan de hand van een voorbeeld.

### 2.2 INVOER

#### 2.2.1 Structuur van het voedselweb

De basis van MC<sup>2</sup> wordt gevormd door de specificatie van het voedselweb van het te bestuderen systeem. Kwalitatief wordt het voedselweb gespecificeerd door de relaties tussen de verschillende soorten op te geven: 'wie eet wie' (figuur 1). Indien gewenst kunnen verschillende soorten worden samengevoegd tot 'functionele ecologische groepen' of kortweg 'ecogroepen'. Dit zal in veel gevallen nodig zijn om het aantal te onderscheiden groepen enigszins beperkt te houden. Bovendien zijn de eigenschappen voor alle aanwezige soorten in een systeem vaak onvoldoende bekend, maar kunnen wel redelijke aannamen of schattingen gedaan worden voor groepen van soorten.

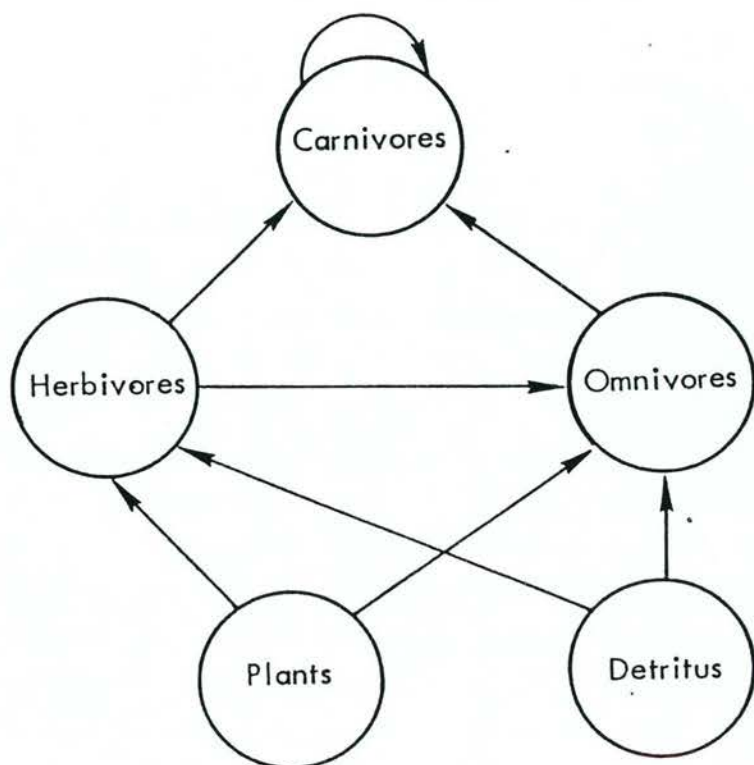

Figuur 1.  
Een voorbeeld van een voedselweb

### 2.2.2 Biomassa's

De gemeten biomassa's van de verschillende soorten vormen na het opstellen van de balansvergelijkingen de initiële schattingen, waarvoor het model tracht een sluitende balans op te stellen. Wanneer het niet mogelijk is voor de gemeten biomassa's een sluitende balans op te stellen berekent het model de dichtstbijzijnde biomassaverdeling die wel aan de balansvergelijkingen voldoet.

De eenheid waarin de biomassa's uitgedrukt worden is in principe vrij te kiezen. Oorspronkelijk werd gewerkt met asvrij drooggewicht, later zijn echter ook berekeningen op koolstof-basis uitgevoerd. Wanneer men met drooggewicht of zelfs natgewicht zou willen werken dienen wel de gebruikte coëfficiënten op dezelfde basis te worden berekend. Voor asvrij drooggewicht en koolstof zullen de verschillen in de coëfficiënten in de meeste gevallen erg klein zijn.

Ook de 'schaling' van de eenheid (per meer, per m<sup>2</sup>, per liter) is vrij te kiezen. Om vergelijking tussen verschillende systemen te vergemakkelijken verdient een eenheid als g/m<sup>2</sup> of g/l de voorkeur.

In de voorbeeld-toepassing is als eenheid kg asvrij drooggewicht per meer gekozen. In het vervolg wordt overigens ook over biomassa gesproken. Hier wordt steeds asvrij drooggewicht mee bedoeld.

### 2.2.3 Import- en export-snelheden

Naast de biomassa's zijn de import- en exportsnelheden van de verschillende ecogroepen (voor de planten de produktiesnelheid) de belangrijkste variabelen. Deze import- en exportsnelheden kunnen konstant zijn (een vaste hoeveelheid gevangen vis bijvoorbeeld), of evenredig met de aanwezige biomassa (migratie, transport met de waterbeweging).

Aangezien alle ecogroepen energie verbruiken, is een netto energie-import (biomassa-import) noodzakelijk voor het in stand houden van het ecosysteem. Meestal levert de primaire produktie hieraan de grootste bijdrage.

### 2.2.4 Coëfficiënten

Om de voedselwebrelaties kwantitatief vast te leggen moeten van de verschillende ecogroepen drie eigenschappen worden gespecificeerd, te weten:

- de hoeveelheid voedsel die zij dagelijks op moeten nemen (netto, dus zonder de fractie die als faeces het lichaam verlaat)
- de fractie hiervan die wordt gebruikt voor groei en reproductie en de fractie die gebruikt wordt voor respiratie
- de fecale fractie, i.e. de fractie van de biomassa van de ecogroep die als faeces het lichaam verlaat van de ecogroep waardoor hij opgegeten wordt

Wanneer deze eigenschappen van de ecogroepen zijn gespecificeerd, is het mogelijk voor het gehele systeem balansvergelijkingen op te stellen.

## 2.3 OPSTELLEN VAN DE BALANSVERGELIJKINGEN

De balansvergelijkingen zijn van de volgende vorm: de hoeveelheid biomassa van een ecogroep die verdwijnt door predatie

minus de hoeveelheid biomassa van die ecogroep die ontstaat door groei en reproductie, moet gelijk zijn aan de importsnelheid minus de exportsnelheid van de ecogroep. Voor ieder van de ecogroepen ontstaat zo een balansvergelijking:

$$\frac{d A}{d t} = \text{groei} + \text{reproductie} + \text{import} - \text{predatie} - \text{export} \quad (1)$$

waarbij:

A is de biomassa van de ecogroep

Om de verschillende voedselstromen te modelleren, worden de ecogroepen in het model onderverdeeld in verschillende frakties, op basis van de verschillende soorten voedsel die een ecogroep gebruikt. Deze frakties worden hier verder aangeduid met de term 'voedselgroepen'. Iedere ecogroep is dus opgebouwd uit minstens een, maar meestal meerdere, van deze voedselgroepen. Zo wordt van de ecogroep omnivoren uit figuur 1 de biomassa verdeeld in twee voedselgroepen, namelijk een hoeveelheid omnivorenbiomassa die leeft van het eten van detritus en een hoeveelheid omnivorenbiomassa die leeft van het eten van planten. Deze onderverdeling wordt gemaakt om technische redenen, waarop later nog teruggekomen wordt.

Overigens houdt deze onderverdeling niet in dat een omnivoor niet zowel detritus als herbivoren zou kunnen eten. De verdeling is in termen van biomassa, en niet van individuen.

## 2.4 HET VINDEN VAN EEN OPLOSSING

Aangezien de ecogroepen opgedeeld zijn in verschillende voedselgroepen (een voor iedere voedselbron of pijl in figuur 1), bevatten deze balansvergelijkingen echter nog niet genoeg informatie om het systeem vast te leggen. Er zijn in voedselwebrelaties als in figuur 1 namelijk altijd meer pijlen (voedselgroepen) dan ecogroepen aanwezig. Er zijn daardoor vele combinaties van biomassa's voor de verschillende ecogroepen die voldoen aan de balansvergelijkingen.

Bij het opstellen van een sluitende massabalans wordt uit de mogelijke biomassaverdelingen diegene gekozen die zo dicht mogelijk bij de initiële schattingen ligt, verkregen uit de metingen. De hiervoor gevolgde procedure wordt beschreven in het volgende hoofdstuk.

## Quantifying the food webs of Lake Bleiswijkse Zoom and Lake Zwemlust

A. H. Bakema<sup>1</sup>, W. J. Rip<sup>2</sup>, M. W. de Haan<sup>3</sup> & F. J. Los<sup>4</sup>

<sup>1</sup>Delft Hydraulics, P.O. Box 177, 2600 MH Delft, The Netherlands; Present address: National Institute of Public Health and Environmental Protection, P.O. Box 1, 3720 BA Bilthoven, The Netherlands;

<sup>2</sup>Provincial Waterboard of Utrecht, P.O. Box 80300, 3508 TH Utrecht, The Netherlands; <sup>3</sup>Institute for Inland Water Management and Waste Water Treatment, P.O. Box 17, 8200 AA Lelystad, The Netherlands; <sup>4</sup>Delft Hydraulics, P.O. Box 177, 2600 MH Delft, The Netherlands

*Key words:* modelling, food web, biomanipulation, trophic level

### Abstract

Data on biomass levels from two lakes in The Netherlands, Lake Bleiswijkse Zoom and Lake Zwemlust, on which biomanipulation experiments are being carried out, were related with some physiological properties of the species present at different trophic levels. These properties include the daily ration and metabolic fraction of heterotrophic species, natural mortality rate and autolysis fraction of primary producers, mineralisation rate of detritus, and digestibility of all species. Mean biomass levels during the year were calculated directly from measurements. These combined data were used to see if a consistent description of the food web could be produced, by letting a computer model search for a balanced food web that corresponds most closely to the measurements. The computer model relates the present biomass of species at different trophic levels, by constructing balance equations for the amount of biomass present at each trophic level, using the physiological properties of the species. Results include estimates of production levels, diet composition and detritus production for species at all trophic levels.

For both manipulated lakes, using this technique it was possible to produce a consistent, quantitative description of the major flows of biomass between groups of species at different trophic levels. For the untreated part of Lake Bleiswijkse Zoom some inconsistencies in the constructed description of the food web remained unsolved.

### Introduction

Constructing a quantitative description of the flows of biomass between the different trophic levels of a food web contributes to a better understanding of the functioning of an aquatic ecosystem. Such a description relates measurements on different species and singles out the most important flows of biomass in the system. This approach was first used by Odum (1957) for the

Silver Springs ecosystem in Florida. In view of the crucial role that food-relations seem to play in biomanipulation, it was felt that producing such quantitative descriptions for Lake Bleiswijkse Zoom and lake Zwemlust, two lakes in The Netherlands on which biomanipulation experiments are being carried out (Meijer *et al.*, 1989; Van Donk *et al.*, 1989), could help in the interpretation of the collected data, by offering a different way to view these data.

Although quantitative food web descriptions have been produced for a variety of ecosystems, they are very time-consuming to produce. The computer program MC<sup>2</sup> (Mass balance Construction by Computer) was specifically designed to facilitate the construction of such a description. Using measured biomass levels and some autecological information on the species present at different trophic levels, the program automatically calculates the biomass levels, and the fluxes of biomass between the trophic levels, for which the food web is balanced, i.e. for which there are no large increases or decreases of biomass levels from year to year. Since extensive monitoring programmes are being carried out in Lake Bleiswijk (Meijer *et al.*, 1989) and Lake Zwemlust (Van Donk *et al.*, 1989), no separate measurements were necessary to obtain information on the biomass levels. The program MC<sup>2</sup> was, therefore, applied using existing data, to yield some more information on the relationship between measured data from different trophic levels.

## Study sites and methods

### *The study sites*

This study focuses on two small lakes in The Netherlands, Lake Zwemlust and Lake Bleiswijkse Zoom (or Lake Bleiswijk), on which biomanipulation experiments have been carried out (Meijer *et al.*, 1989, Van Donk *et al.*, 1989). Lake Zwemlust has an area of *ca* 1.5 ha, with a mean depth of 1.5 m (maximum depth 2.5 m). The lake is used for recreational purposes (swimming) by the community of the neighbouring villages. From the mid-sixties onwards Secchi depth of L. Zwemlust has been very low, between 0.1 and 0.3 m, because of massive blooms of green and bluegreen algae (*Microcystis aeruginosa*). In March 1987 the lake was drained empty, and all fish (mostly bream, *Abramis brama*) were removed by seine- and electro-fishing. After this operation the lake was stocked with 1600 0<sup>+</sup> pike (*Esox lucius*) and 140 rudd (*Scardinius erythrophthalmus*). Also, seedlings of

*Chara globularis* and roots of *Nuphar lutea* were introduced (Van Donk *et al.*, 1989).

Lake Bleiswijk has a mean depth of 1.1 m. The lake is very popular for sportfishing. It consists of two parts, Galgje (3.1 ha) and Zeeltje (11.3 ha), which are connected to each other at the dam site. This dam was made between the two parts in 1987, to allow exchange of water and plankton, but not fish. In Galgje all planktivorous fish and 85% of benthivorous fish were removed, and this part of the lake was stocked with 0<sup>+</sup> pikeperch (*Stizostedion lucioperca*). Macrophytes (mainly Characeae) became abundant within two months although they were not introduced artificially as in lake Zwemlust. Both the treated part (Galgje) and the untreated part (Zeeltje) have been monitored for physico-chemical and biological data. The existence of a treated and untreated lake next to each other provides the opportunity to assess the effect of the operation more clearly.

Biomass measurements were carried out throughout the year 1988 at regular intervals in both Lake Zwemlust and Lake Bleiswijk. Measurements on individual species were not always available. For this analysis the measurements were lumped together to obtain data on groups of species like phytoplankton, zoobenthos, zooplankton, molluscs, macrophytes, piscivorous fish and non-piscivorous fish. The average biomass of these groups in the lakes has been calculated for the year 1988. For the phytoplankton the yearly primary production was calculated from primary production measurements during summer, using a conversion based on Van Liere & Breebaert (1987) for lake Bleiswijk. The macrophytes primary production was estimated at 5% of the biomass per day. This relatively high value corresponds to the clear water and small depth of the manipulated lakes.

For Lake Bleiswijk a more extensive description of the biomanipulation operation and of the original data and the methods used is given in Meijer *et al.* (1989) and Meijer *et al.* (1990), and for Lake Zwemlust in Van Donk *et al.* (1989), Gulati (1989) and Ozimek *et al.* (1990). For both lakes, part of the data are still unpublished.

## Methods

In most ecosystems the year-to-year change in biomass of the species is small in comparison with the increase of biomass corresponding to growth, reproduction and import, and the decrease in biomass caused by natural mortality, predation or emigration. Therefore, any loss to the biomass of a species will, on average, be counterbalanced by a gain. Thus, it is possible to construct a balance equation for each ecological group, in which all gains and losses to the biomass of that group are summed up. This summation of all gains and losses will then be equal to zero for each ecological group.

At the same time, all organisms need a regular supply of energy to maintain their metabolic needs. For heterotrophic species this energy is often consumed in the form of biomass of other species. Through these food relations, the balance equations for the different groups are coupled, since growth of one species occurs through consumption of another. The resulting set of coupled balance equations can be used to check the consistency of our measurements of the ecosystem, or to find missing information on one group from data on other groups. This procedure is followed in the computer program MC<sup>2</sup>, that is an adapted version of a program developed by Bigelow *et al.* (1977). The program automatically creates the balance equations for the ecological groups and calculates a biomass distribution for which the result is indeed equal to zero.

In nearly all cases the possible number of balanced solutions is infinitely large. MC<sup>2</sup> selects from this set of solutions the one that is closest to the measured biomass for the various groups. The method used is a least squares optimization, weighted by dividing the squared differences (between measured and balanced biomasses) by the measured biomass values. Theoretically it is possible that the measured biomasses for all groups are equal to the balanced biomasses. In nearly all cases, however, there will be differences. These differences may then be judged (either statistically or by 'sound judgement') on their significance. If the balanced solution is close to the

measured biomasses, our conception of the ecosystem structure is considered to be consistent with the measurements. In this case the result of this exercise is a 'best guess' of all the major biomass flows in the ecosystem. If large differences between the measured and the balanced biomass distribution exist, an analysis of their origin may lead to new insights in the functioning of the ecosystem. Finally, of course, it is possible that the differences are large, but cannot be explained adequately at present.

To construct the balance equations, the program uses some physiological parameters of the ecological groups. One such parameter is the faecal fraction (the fraction of the biomass that will become faeces when this group is consumed by another group), that needs to be specified for all ecological groups. For heterotrophic groups their daily ration (net food uptake per unit of body weight per day) and their metabolic fraction (the fraction of the net food uptake used for respiration) are also needed. For primary producers the mortality rate and the fraction autolysis need to be specified, and for detritus the mineralisation rate is needed. The values for these parameters are based on Los & Bakema (1988), with the following modifications: the daily ration of the zooplankton was set to  $0.8 \text{ d}^{-1}$  (based on Gulati *et al.*, 1982, and on Van Donk *et al.*, 1989), and the faecal fraction of the phytoplankton was set to 0.5 and now matches that of the macrophytes. The values used for these parameters are summarized in Table 1.

For the calculations the biomass measurements of the ecological groups have been converted to ash free dry weight (AFDW), using conversions based on Jorgensen (1979) and Los & Bakema (1988). All biomass levels are expressed in  $\text{g AFDW m}^{-2}$  and all primary production rates in  $\text{g AFDW m}^{-2} \text{ year}^{-1}$ , to facilitate comparison of biomass and production in the different lakes. Yearlings of piscivorous fish are assumed not to be piscivorous, and were put in the same group as planktivorous fish and benthivorous fish. These yearly mean biomass data are summarized in Table 2.

Table 1. Parameters used to describe the ecological groups.

a. Heterotrophic species	Daily ration (g g <sup>-1</sup> d <sup>-1</sup> )	Faecal fraction (-)	Metabolic fraction (-)
Zooplankton	0.80	0.2	0.6
Zoobenthos	0.12	0.2	0.6
Mollusca	0.05	0.2	0.6
Non-piscivorous fish	0.045	0.2	0.9
Piscivorous fish	0.015	0.2	0.9
b. Primary producers	Mortality rate (d <sup>-1</sup> )	Faecal fraction (-)	Autolysis fraction (-)
Phytoplankton	0-0.1	0.5	0.33
Macrophytes	0.05	0.5	0.1
c. Detritus	Mineralisation rate (d <sup>-1</sup> )	Faecal fraction (-)	
Suspended detritus	0.05	0.5	
Bottom detritus	0.05	0.5	

## Results and discussion

The biomasses of the organisms at different levels that form a balanced food web, as calculated by MC<sup>2</sup>, are discussed for each lake separately.

### Lake Zwemlust

In general there seems to be a good agreement between balanced and measured biomass, except

for the zoobenthos (Table 2). The calculated food web is depicted in Fig. 1. The balanced phytoplankton biomass matches the measured biomass. The primary production of the phytoplankton was based on Van Donk *et al.* (1989) and N-limitation of the phytoplankton during the summer of 1988 is, therefore, implicitly accounted for. Since the natural mortality rate of the phytoplankton was set to zero, all loss of phytoplankton biomass must be caused by grazing. The zooplankton accounts for 99% of this grazing, the

Table 2. Measured (M) and balanced (B) biomass (g AFDW m<sup>-2</sup>) for all sites.

Ecological group	Zwemlust		Bleiswijk treated		Bleiswijk untreated		+ fishing B
	M	B	M	B	M	B	
Phytoplankton	1.95	1.95	2.60	2.60	10.00	10.58	10.26
Macrophytes	18.75	17.66	30.00	28.54	0.60	0.57	0.56
Susp. detritus	-	2.23	5.40	5.95	20.50	18.82	18.18
Bottom detritus	-	16.17	-	22.05	-	4.92	4.79
Zooplankton	2.15	1.66	0.89	1.66	0.91	0.58	0.61
Zoobenthos	1.16	0.63	3.50	3.53	2.10	3.84	3.99
Mollusca	-	-	0.64	0.73	0.01	0.02	0.02
Fish, non-piscivores	0.88	1.15	4.60	4.22	12.80	6.47	12.44
Fish, piscivores	0.32	0.30	0.60	1.10	0.77	1.69	0.77



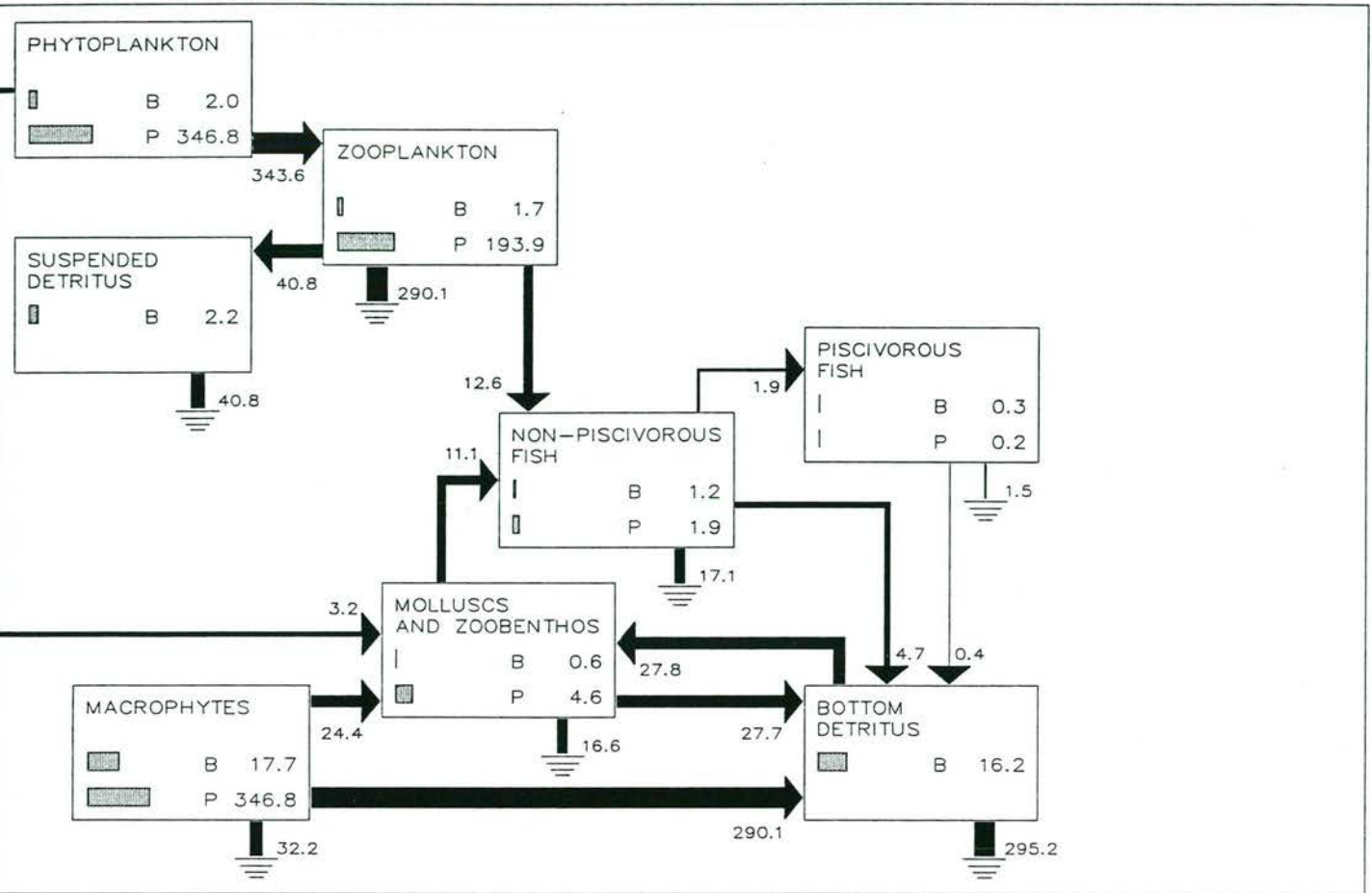

Fig. 1. Quantified balanced food web Lake Zwemlust. Biomass (B) is expressed in g AFDW m<sup>-2</sup> production (P) and flows of biomass in g AFDW m<sup>-2</sup> year<sup>-1</sup>. Biomass of suspended and bottom detritus have been calibrated. The area of the rectangles and the thickness of the arrows correspond to the calculated values (logarithmically scaled). Arrows and rectangles are differently scaled. The losses out of the system represent autolysis (for primary producers), respiration (for heterotrophs) and mineralisation (for detritus).

remaining 1% being caused by the zoobenthos (chironomids).

The macrophytes are important in this food web, both as the main source of the bottom detritus, the main food source for the zoobenthos, and as a direct food for the molluscs (here also included in the zoobenthos, since in the measured biomass levels no distinction was made between zoobenthos and molluscs). The effect of the macrophytes on the nutrient balance has been accounted for indirectly in these calculations, as they are the primary cause for the nitrogen limitation of the phytoplankton (Van Donk *et al.*, 1989; Van Donk, in press; Ozimek *et al.* submitted). For both suspended and bottom detritus, no data were available. The values calculated by MC<sup>2</sup> optimize the fit between the measured and

balanced biomass values for the other groups. As a result the biomass values of the detritus cover only the part that is actively involved in the food web. The inedible, refractory detritus is, therefore, specifically excluded. For the bottom detritus this may lead to a difference between the calculated value and the value derived from the organic matter content of the lake bottom. Since no measured data are available, this aspect has not yet been evaluated. The balanced biomass of the zooplankton is somewhat lower than the measured biomass. According to the balance calculations the food of the zooplankton constitutes 40% phytoplankton, 39% suspended detritus and 21% other zooplankton. In Fig. 1 only the net flows are depicted. For the zoobenthos the measured biomass is twice as high as the one

derived from the balance calculations. The measured value includes the molluscs that feed on the macrophytes, as noted earlier. The daily rations for molluscs and zoobenthos are different, however (Table 1). Changing the daily ration of the combined group from  $0.12 \text{ d}^{-1}$  (the value for zoobenthos) to  $0.05 \text{ d}^{-1}$  (the value for molluscs) gives a balanced biomass of  $1.06 \text{ g m}^{-2}$  for the zoobenthos, which is very close to the measured value of  $1.16 \text{ g m}^{-2}$ . Then the balanced biomass of the planktivorous fish and benthivorous fish becomes  $1.01 \text{ g m}^{-2}$ , which is very similar to the measured value. The effect on the other groups is negligible. However, since the percentage of molluscs is unknown, we used 0.12 as the value for the combined group.

The balanced biomass of the planktivorous fish and benthivorous fish, a few per cent of which consists of yearlings of the piscivores, is already close to the measured values. Roughly half their food consists of zoobenthos, the other half of zooplankton. The balanced biomass of the piscivores is almost equal to the measured value.

In general the biomasses of the ecological groups as calculated for the balanced food web closely resemble the measured values, and the existing deviations can partly be explained by the lumping of the zoobenthos and molluscs into one group. The close agreement between calculated and measured biomass values increases our confidence in the calculated values for the flows.

### *Lake Bleiswijk*

For the treated part of Lake Bleiswijk (Galgje) the balanced biomass of most groups is very close to the measurements (Table 2). Exceptions are the zooplankton and the piscivorous fish, for which groups the balanced biomasses are much higher than the measured ones. The calculated balanced food web is shown in Fig. 2.

The balanced biomasses of both phytoplankton and macrophytes closely match the measured values. Again, the influence of the macrophytes on algal growth, through nitrogen limitation or allelopathy (Meijer *et al.*, 1989), is only indirectly

accounted for through the primary production of the phytoplankton, that was specified as input.

The zooplankton biomass calculated using the balance equations is almost twice the measured value. The cause of this deviation is unknown to us; there appears to be an inconsistency in either the measurements or in the physiological parameters used. In fact, according to Meijer *et al.* (1989), the measured biomass value might be an underestimate due to non-representative sampling between the macrophytes as well as migration of zooplankton to near-bottom layers where sampling is rather difficult (Pers. comm. R. D. Gulati).

For both the treated and the untreated part of Lake Bleiswijk the biomass of suspended detritus has been roughly estimated from the ash-free dry weight of the total suspended solids minus the algal biomass, and therefore only the estimate for bottom detritus is missing. The balanced value for the suspended detritus is close to the estimate. The higher calculated value for bottom detritus compared with that in Lake Zwemlust, is mainly caused by the relatively higher macrophyte biomass and correspondingly higher production of bottom detritus.

For both parts of Lake Bleiswijk the measurements for molluscs and zoobenthos could be separated; therefore both groups are distinguished in the balance studies of the food web. The zoobenthos biomass is much higher than in Lake Zwemlust, which is consistent with the higher value for the bottom detritus that is the main food source for the zoobenthos. The balanced and measured values are quite comparable. This is true also for molluscs. The balanced biomass for the planktivorous fish and benthivorous fish in Galgje is slightly lower than the measured value. Food of these fish constitutes 71% zoobenthos, 22% zooplankton and 6% molluscs. The higher percentage of zoobenthos reflects their higher biomass in this lake compared with lake Zwemlust. Also the biomass of the planktivorous fish and benthivorous fish itself is much higher in Galgje than in Lake Zwemlust. For the piscivores the balanced biomass is much higher than the measured biomass. This is probably caused by

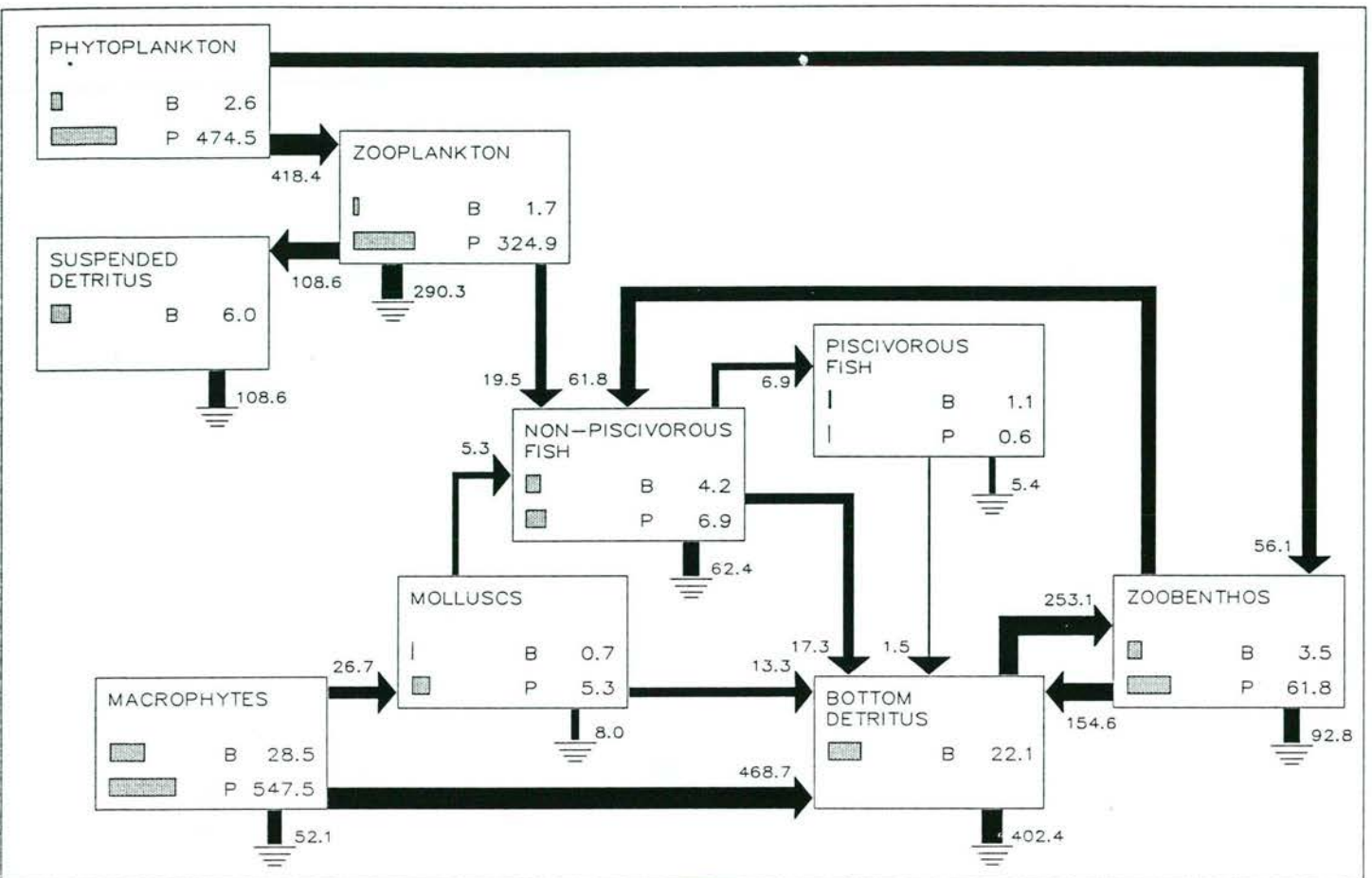

Fig. 2. Quantified balanced food web of the treated part (Galge) of Lake Bleiswijk. Biomass of bottom detritus has been calibrated. Legend as in Fig. 1.

the presence of a number of large cyprinids, production of which in the balance calculations is assumed to be available to the piscivores. In reality however, they are too large to be preyed upon.

It is concluded that despite the overall agreement between the balanced and the measured biomasses for the treated part of Lake Bleiswijk, the deviations for the zooplankton and the piscivores in the lake can only be partly explained, and the measured biomass for zooplankton is much lower than their biomass in the balanced food web.

For Zeeltje, the untreated part of Lake Bleiswijk, the results of the balance calculations deviate greatly from the measured values (Table 2). The calculated balanced food web is shown in Fig. 3. Deviations are largest for the two fish groups. While biomass of piscivorous fish is

overestimated, the biomass of their prey, the planktivorous fish and benthivorous fish, is underestimated. This could be partly due to the occurrence of large cyprinids, as in the lake's treated part. Since the differences are large, the cause may also lie in the intensive fishery, especially on the planktivores and on the benthivores. The fishing seems to have two major effects: 1) introduction of artificial fish food into the lake and 2) removal of the fish itself. The amount of fish food a fisherman uses ranges from a few hundred grams to several kilograms (AFDW) per day while the amount of fish caught per day per fisherman ranges from one kg to several kg fresh weight (0.2–1.0 kg AFDW). Since reasonably accurate measurement of neither the total input of fish food nor the total fish output by fishing is available, the balance calculations were used to test what values can be derived from the observed

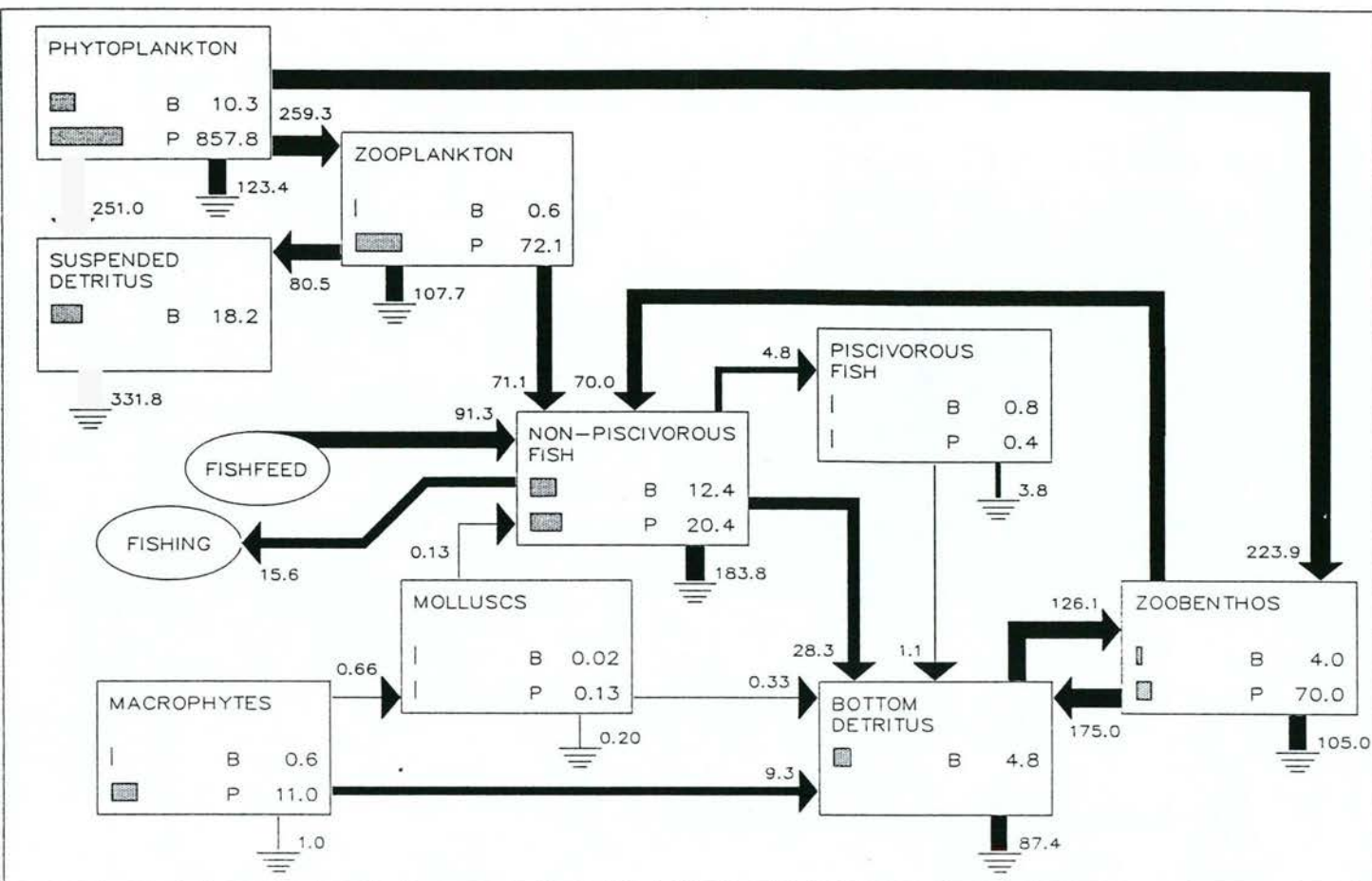

Fig. 3. Quantified balanced food web of the untreated part (Zeeltje) of Lake Bleiswijk. Input of fish food and output of fish and the biomass of bottom detritus have been calibrated. Legend as in Fig. 1.

biomass levels (see last column of Table 2). The input of fish food calculated was  $0.25 \text{ g AFDW m}^{-2} \text{ d}^{-1}$  or  $28.3 \text{ kg AFDW d}^{-1}$  for the whole lake, and the output of fish was  $0.04 \text{ g AFDW m}^{-2} \text{ d}^{-1}$  or  $4.8 \text{ kg AFDW d}^{-1}$  for the whole lake (Fig. 3). These values seem to fall within a realistic range. Balanced and measured biomass levels now correspond very closely, except for the biomass of the zoobenthos for which the biomass in the balanced food web is much higher than the measured value. The amount of phytoplankton consumed by the zoobenthos in the balanced food web also still seems unrealistically high (Table 3).

The calculations do show that fishing in Lake Bleiswijk may strongly influence the ecosystem functioning. However, the impact on the balance calculations of the occurrence of large cyprinids relative to the influence of fishing, cannot be evaluated at present.

## Conclusions

For the two treated lakes, namely Lake Zwemlust and Lake Galgje, it has been possible to quantify a balanced food web, that closely corresponds to the biomass measurements, without adapting any of the parameters that specify the various ecological groups. Most remaining deviations from the measurements are small or can be explained adequately. For the untreated part of Lake Bleiswijk, it was necessary to include the effect of fishing to reproduce the measured biomass values. Despite this, inconsistencies in the food web remain. By relating the existing data on Lake Zwemlust and Lake Bleiswijk with some autecological data, the method provides a new view on these data and offers a 'best guess' of most flows of biomass through the food web.

## Acknowledgements

We are grateful for having been able to use data collected by the Limnological Institute, the Organisation for Improvement of the Inland Fisheries, the Provincial Waterboard of Utrecht and the Institute for Inland Water Management and Waste Water Treatment. We also like to thank Dr. E. Van Donk, Drs M.-L. Meijer and Drs J. J. Brinkman for their useful suggestions during preparation of the manuscript.

## References

- Bakema, A. H., 1989. MC<sup>2</sup>, een balansmodel voor ecosystemen. Beschrijving en handleiding voor gebruik. Delft Hydraulics Report T483.00, 32 pp.
- Bigelow, J. H., J. C. de Haven, C. Dzitzer, P. Eilers & J. H. C. Peeters, 1977. Protecting an estuary from floods – A policy analysis of the Oosterschelde, Volume III: Assessment of long-run ecological balances. Report R-2121/3-NETH. The Rand Corporation, Santa Monica.
- Gulati, R. D., 1989. Structure and feeding activities of zooplankton community in lake Zwemlust, in the two years after biomanipulation. *Hydrobiol. Bull.* 23: 35–49.
- Gulati, R. D., K. Siewertsen & G. Postema, 1982. The zooplankton, its community structure, food and feeding, and role in the ecosystem of lake Vechten. *Hydrobiologia* 95: 127–163.
- Jorgensen, S. E. (Ed.), 1979. Handbook of Environmental Data and ecological parameters. Int. Soc. Ecol. Modelling, Copenhagen.
- Los, F. J. & A. H. Bakema, 1988. Het General Ecomodel, analyse en toepassing als balansmodel. Delft Hydraulics Report T248, 91 pp.
- Meijer, M.-L., A. J. P. Raat & R. W. Doef, 1989. Restoration by biomanipulation of Lake Bleiswijkse Zoom, first results. *Hydrobiol. Bull.* 23: 49–57.
- Meijer, M.-L., M. W. de Haan, A. W. Breukelaar, H. Buiteveld, 1990. Is reduction of the benthivorous fish an important cause of high transparency following biomanipulation in shallow lakes? *Hydrobiologia* 200/201: 303–315.
- Odum, H. T., 1957. Trophic structure and productivity of Silver Springs, Florida. *Ecol. Monogr.* 27: 55–112.
- Ozimek, T., R. D. Gulati & E. Van Donk, 1990. Can macrophytes be useful in biomanipulation of lakes? The Lake Zwemlust example. *Hydrobiologia* 200/201: 399–407.
- Van Donk, E., R. D. Gulati & M. P. Grimm, 1989. Food web manipulation in lake Zwemlust: positive and negative effects during the first two years. *Hydrobiol. Bull.* 23: 19–34.
- Van Donk, E. (in press). Changes in community structure and growth limitation of phytoplankton due to top-down food web manipulation. *Verh. int. Ver. Limnol.*, Vol. 25.
- Van Liere, L. & L. Breebaart, 1987. Waterkwaliteits Onderzoek Loosdrechtse Plassen Basisgegevens 1986. WOL Report 1987–4.

# **C Invoerfiles van de gekalibreerde voedselwebberekeningen**

## Haringvliet totaal:

Ecogroups 16	Type	Daily ration	Fecal fraction	Metabolic rate	Biomass	Import rate	Migration rate
SUSDET	DETRIT	0.15	0.7	1	280	20	0
BOTDET	DETRIT	0.05	0.9	1	300	20	0
FYTOPLANK	PHOTOS	0.2	0.6	0.33	280	70	0
ZOOPLANK	HETERO	0.1	0.2	0.35	42	-2	0
MOLLKLEIN	HETERO	0.035	0.2	0.74	518	-4	0
MOLLGROOT	HETERO	0.002	0.2	0.74	57	0	0
OLIGO	HETERO	0.08	0.2	0.75	80.8	0	0
CHIRONO	HETERO	0.08	0.2	0.75	2.8	0	0
MACRUST	HETERO	0.08	0.2	0.75	5.2	0	0
SLAK	HETERO	0.08	0.2	0.75	78	-1.1	0
KLEIN	HETERO	0.043	0.2	0.8	23	0	0
MIDWIT	HETERO	0.02	0.2	0.8	16	0	0
GROOTWIT	HETERO	0.02	0.2	0.8	61	0	0
MIDROOF	HETERO	0.015	0.2	0.8	17	0	0
GROOTROOF	HETERO	0.015	0.2	0.8	20	0	0
AAL	HETERO	0.02	0.2	0.9	11	0	0

## Ondiep zand:

Ecogroups 16	Type	Daily ration	Fecal fraction	Metabolic rate	Biomass	Import rate	Migration rate
SUSDET	DETRIT	0.15	0.7	1	280	10	0
BOTDET	DETRIT	0.05	0.9	1	70	5	0
FYTOPLANK	PHOTOS	0.2	0.6	0.33	280	70	0
ZOOPLANK	HETERO	0.1	0.2	0.35	42	-2	0
MOLLKLEIN	HETERO	0.04	0.2	0.74	142.5	-1.5	0
MOLLGROOT	HETERO	0.002	0.2	0.74	74.8	0	0
OLIGO	HETERO	0.08	0.2	0.75	20.4	0	0
CHIRONO	HETERO	0.08	0.2	0.75	9.2	0	0
MACRUST	HETERO	0.08	0.2	0.75	5.2	0	0
SLAK	HETERO	0.08	0.2	0.75	71.5	-1.1	0
KLEIN	HETERO	0.043	0.2	0.8	32.71	0	0
MIDWIT	HETERO	0.02	0.2	0.8	18.63	0	0
GROOTWIT	HETERO	0.02	0.2	0.8	27.24	0	0
MIDROOF	HETERO	0.015	0.2	0.8	22.79	0	0
GROOTROOF	HETERO	0.015	0.2	0.8	13.71	0	0
AAL	HETERO	0.02	0.2	0.9	33.82	0	0

## Intergetijdenzone:

Ecogroups 16	Type	Daily ration	Fecal fraction	Metabolic rate	Biomass	Import rate	Migration rate
SUSDET	DETRIT	0.15	0.7	1	280	10	0
BOTDET	DETRIT	0.05	0.9	1	90	5	0
FYTOPLANK	PHOTOS	0.2	0.6	0.33	280	70	0
ZOOPLANK	HETERO	0.1	0.2	0.35	42	-2	0
MOLLKLEIN	HETERO	0.035	0.2	0.74	209.7	-2	0
MOLLGROOT	HETERO	0.002	0.2	0.74	83.8	0	0
OLIGO	HETERO	0.08	0.2	0.75	20.4	-0.2	0
CHIRONO	HETERO	0.08	0.2	0.75	37.8	-0.3	0
MACRUST	HETERO	0.08	0.2	0.75	5.2	-0.01	0
SLAK	HETERO	0.08	0.2	0.75	104.8	-2	0
KLEIN	HETERO	0.043	0.2	0.8	19.1	0	0
MIDWIT	HETERO	0.02	0.2	0.8	4.34	0	0
GROOTWIT	HETERO	0.02	0.2	0.8	3.12	0	0
MIDROOF	HETERO	0.015	0.2	0.8	5.32	0	0
GROOTROOF	HETERO	0.015	0.2	0.8	1.91	0	0
AAL	HETERO	0.02	0.2	0.9	3.98	0	0

## Diep instabiel slib:

Ecogroups 16	Type	Daily ration	Fecal fraction	Metabolic rate	Biomass	Import rate	Migration rate
SUSDET	DETRIT	0.15	0.7	1	280	10	0
BOTDET	DETRIT	0.05	0.9	1	340	25	0
FYTOPLANK	PHOTOS	0.2	0.6	0.33	280	70	0
ZOOPLANK	HETERO	0.1	0.2	0.35	42	-2	0
MOLLKLEIN	HETERO	0.035	0.2	0.74	228	-2	0
MOLLGROOT	HETERO	0.002	0.2	0.74	0	0	0
OLIGO	HETERO	0.08	0.2	0.75	86.4	0	0
CHIRONO	HETERO	0.08	0.2	0.75	1.4	0	0
MACRUST	HETERO	0.08	0.2	0.75	5.2	0	0
SLAK	HETERO	0.08	0.2	0.75	8.8	-0.1	0
KLEIN	HETERO	0.043	0.2	0.8	18.68	0	0
MIDWIT	HETERO	0.02	0.2	0.8	16.27	0	0
GROOTWIT	HETERO	0.02	0.2	0.8	72.69	0	0
MIDROOF	HETERO	0.015	0.2	0.8	15.51	0	0
GROOTROOF	HETERO	0.015	0.2	0.8	21.16	0	0
AAL	HETERO	0.02	0.2	0.9	4.58	0	0



## Ondiep stabiel slib:

Ecogroups 16	Type	Daily ration	Fecal fraction	Metabolic rate	Biomass	Import rate	Migration rate
SUSDET	DETRIT	0.15	0.7	1	280	10	0
BOTDET	DETRIT	0.05	0.9	1	125	5	0
FYTOPLANK	PHOTOS	0.2	0.6	0.33	280	70	0
ZOOPLANK	HETERO	0.1	0.2	0.35	42	-2	0
MOLLKLEIN	HETERO	0.035	0.2	0.74	537.2	-4.7	0
MOLLGROOT	HETERO	0.002	0.2	0.74	39.2	0	0
OLIGO	HETERO	0.08	0.2	0.75	18.8	0	0
CHIRONO	HETERO	0.08	0.2	0.75	6.5	0	0
MACRUST	HETERO	0.08	0.2	0.75	5.2	0	0
SLAK	HETERO	0.08	0.2	0.75	49	-1.1	0
KLEIN	HETERO	0.043	0.2	0.8	43.7	0	0
MIDWIT	HETERO	0.02	0.2	0.8	16.1	0	0
GROOTWIT	HETERO	0.02	0.2	0.8	22.63	0	0
MIDROOF	HETERO	0.015	0.2	0.8	19.77	0	0
GROOTROOF	HETERO	0.015	0.2	0.8	16.89	0	0
AAL	HETERO	0.02	0.2	0.9	29.8	0	0

Invoerfile met voedselpreferenties (\*.fwb) is gelijk voor alle biotopen:

Predator	Prey	Type of detritus	Preference
	41		
SUSDET	SUSDET	SUSDET	1
BOTDET	BOTDET	BOTDET	1
FYTOPLANK	FYTOPLANK	SUSDET	1
ZOOPLANK	SUSDET	SUSDET	1
ZOOPLANK	FYTOPLANK	SUSDET	1
MOLLKLEIN	SUSDET	BOTDET	0.3
MOLLKLEIN	BOTDET	BOTDET	0.7
MOLLKLEIN	FYTOPLANK	BOTDET	0.1
MOLLGROOT	FYTOPLANK	BOTDET	1
MOLLGROOT	SUSDET	BOTDET	1
MOLLGROOT	MOLLGROOT	BOTDET	1
OLIG_CHIR	SUSDET	BOTDET	0.01
OLIG_CHIR	BOTDET	BOTDET	0.99
MACRUST	BOTDET	BOTDET	0.8
MACRUST	SUSDET	BOTDET	0.2
SLAK	BOTDET	BOTDET	1
KLEIN	ZOOPLANK	SUSDET	4
KLEIN	OLIG_CHIR	SUSDET	1
KLEIN	MACRUST	SUSDET	1
MIDWIT	ZOOPLANK	SUSDET	0.001
MIDWIT	MOLLKLEIN	SUSDET	0.05
MIDWIT	SLAK	SUSDET	0.11
MIDWIT	OLIG_CHIR	SUSDET	0.9
MIDWIT	MACRUST	SUSDET	0.1
MIDWIT	BOTDET	SUSDET	0.8
GROOTWIT	OLIG_CHIR	SUSDET	0.05
GROOTWIT	ZOOPLANK	SUSDET	0.0001
GROOTWIT	MOLLKLEIN	SUSDET	0.001
GROOTWIT	SLAK	SUSDET	0.01
GROOTWIT	MACRUST	SUSDET	0.01
GROOTWIT	BOTDET	SUSDET	0.8
MIDROOF	KLEIN	SUSDET	1
MIDROOF	MIDWIT	SUSDET	1
GROOTROOF	KLEIN	SUSDET	1
GROOTROOF	MIDWIT	SUSDET	1
AAL	KLEIN	SUSDET	1
AAL	MIDWIT	SUSDET	1
AAL	GROOTWIT	SUSDET	1
AAL	MIDROOF	SUSDET	1
AAL	GROOTROOF	SUSDET	1
AAL	AAL	SUSDET	1

# **D**   **Uitvoer van de gekalibreerde voedselwebberekeningen**

**gehele Haringvliet**  
**file: Ref4.out**

Ecogroup	Import	Biomass	Estimate	Product.
SUSDET	20.00	299.77	280.00	.00
BOTDET	20.00	307.42	300.00	.00
FYTOPLANK	70.00	277.53	280.00	70.00
ZOOPLANK	-2.00	47.08	42.00	3.06
MOLLKLEIN	-4.00	462.29	518.00	4.21
MOLLGROOT	.00	56.94	57.00	.03
OLIGO	.00	57.94	80.80	1.16
CHIRONO	.00	2.01	2.80	.04
MACRUST	.00	4.08	5.20	.08
SLAK	-1.10	60.30	78.00	1.21
KLEIN	.00	35.52	23.00	.31
MIDWIT	.00	27.20	16.00	.11
GROOTWIT	.00	57.85	61.00	.23
MIDROOF	.00	9.37	17.00	.03
GROOTROOF	.00	11.02	20.00	.03
AAL	.00	14.11	11.00	.03

Name	Ecogroup	Feeding on	Biomass	Flow	Detritus	Respirat
1	: SUSDET	SUSDET	299.77	44.96613	.00000	.00000
2	: BOTDET	BOTDET	307.42	15.37082	.00000	.00000
3	: FYTOPLANK	FYTOPLANK	277.53	55.50634	37.18925	.00000
4	: ZOOPLANK	SUSDET	20.74	6.91256	4.83879	.72582
5	: ZOOPLANK	FYTOPLANK	26.34	6.58469	3.95082	.92186
6	: MOLLKLEIN	SUSDET	203.29	23.71758	16.60231	5.26530
7	: MOLLKLEIN	BOTDET	170.08	59.52710	53.57439	4.40501
8	: MOLLKLEIN	FYTOPLANK	88.92	7.78017	4.66810	2.30293
9	: MOLLGROOT	FYTOPLANK	25.76	.12880	.07728	.03812
10	: MOLLGROOT	SUSDET	19.34	.12891	.09024	.02862
11	: MOLLGROOT	MOLLGROOT	11.84	.02961	.00592	.01753
12	: OLIGO	SUSDET	1.58	.42130	.29491	.09479
13	: OLIGO	BOTDET	56.36	45.09029	40.58126	3.38177
14	: CHIRONO	SUSDET	.05	.01460	.01022	.00328
15	: CHIRONO	BOTDET	1.95	1.56253	1.40628	.11719
16	: MACRUST	BOTDET	2.41	1.92638	1.73375	.14448
17	: MACRUST	SUSDET	1.67	.44548	.31183	.10023
18	: SLAK	BOTDET	60.30	48.23768	43.41391	3.61783
19	: KLEIN	ZOOPLANK	19.71	1.05961	.21192	.67815
20	: KLEIN	OLIGO	13.92	.74845	.14969	.47901
21	: KLEIN	CHIRONO	.48	.02594	.00519	.01660
22	: KLEIN	MACRUST	1.40	.07502	.01500	.04802
23	: MIDWIT	ZOOPLANK	.01	.00020	.00004	.00013
24	: MIDWIT	MOLLKLEIN	7.09	.17730	.03546	.11347
25	: MIDWIT	SLAK	2.41	.06031	.01206	.03860
26	: MIDWIT	OLIGO	11.23	.28063	.05613	.17961
27	: MIDWIT	CHIRONO	.39	.00972	.00194	.00622
28	: MIDWIT	MACRUST	.14	.00357	.00071	.00229
29	: MIDWIT	BOTDET	5.93	1.18575	1.06717	.09486
30	: GROOTWIT	OLIGO	5.19	.12977	.02595	.08306
31	: GROOTWIT	CHIRONO	.18	.00450	.00090	.00288
32	: GROOTWIT	ZOOPLANK	.01	.00016	.00003	.00010
33	: GROOTWIT	MOLLKLEIN	1.18	.02952	.00590	.01889
34	: GROOTWIT	SLAK	1.83	.04563	.00913	.02921
35	: GROOTWIT	MACRUST	.12	.00297	.00059	.00190
36	: GROOTWIT	BOTDET	49.35	9.86985	8.88286	.78959
37	: MIDROOF	KLEIN	6.88	.12895	.02579	.08253
38	: MIDROOF	MIDWIT	2.49	.04667	.00933	.02987
39	: GROOTROOF	KLEIN	8.09	.15170	.03034	.09709
40	: GROOTROOF	MIDWIT	2.93	.05491	.01098	.03514
41	: AAL	KLEIN	.99	.02479	.00496	.01785

---

42	:	AAL	MIDWIT	.29	.00722	.00144	.00520
43	:	AAL	GROOTWIT	9.26	.23141	.04628	.16661
44	:	AAL	MIDROOF	1.12	.02810	.00562	.02023
45	:	AAL	GROOTROOF	1.32	.03306	.00661	.02380
46	:	AAL	AAL	1.13	.02822	.00564	.02032

**ondiep zand**  
**file: Zand4.out**

Ecogroup	Import	Biomass	Estimate	Product.
SUSDET	10.00	283.34	280.00	.00
BOTDET	5.00	71.77	70.00	.00
FYTOPLANK	70.00	287.60	280.00	70.00
ZOOPLANK	-2.00	56.32	42.00	3.66
MOLLKLEIN	-1.50	152.14	142.50	1.58
MOLLGROOT	.00	74.59	74.80	.04
OLIGO	.00	23.27	20.40	.47
CHIRONO	.00	10.49	9.20	.21
MACRUST	.00	4.59	5.20	.09
SLAK	-1.10	64.32	71.50	1.29
KLEIN	.00	37.52	32.71	.32
MIDWIT	.00	23.83	18.63	.10
GROOTWIT	.00	30.83	27.24	.12
MIDROOF	.00	10.61	22.79	.03
GROOTROOF	.00	6.38	13.71	.02
AAL	.00	11.90	33.82	.02

Name	Ecogroup	Feeding on	Biomass	Flow	Detritus	Respirat
1	: SUSDET	SUSDET	283.34	42.50154	.00000	.00000
2	: BOTDET	BOTDET	71.77	3.58828	.00000	.00000
3	: FYTOPLANK	FYTOPLANK	287.60	57.52083	38.53896	.00000
4	: ZOOPLANK	SUSDET	23.76	7.92136	5.54495	.83174
5	: ZOOPLANK	FYTOPLANK	32.55	8.13786	4.88272	1.13930
6	: MOLLKLEIN	SUSDET	91.58	12.21125	8.54787	2.71090
7	: MOLLKLEIN	BOTDET	18.83	7.53256	6.77931	.55741
8	: MOLLKLEIN	FYTOPLANK	41.72	4.17243	2.50346	1.23504
9	: MOLLGROOT	FYTOPLANK	33.77	.16887	.10132	.04999
10	: MOLLGROOT	SUSDET	25.30	.16866	.11806	.03744
11	: MOLLGROOT	MOLLGROOT	15.51	.03879	.00776	.02296
12	: OLIGO	SUSDET	2.28	.60684	.42479	.13654
13	: OLIGO	BOTDET	20.99	16.79508	15.11557	1.25963
14	: CHIRONO	SUSDET	1.03	.27367	.19157	.06158
15	: CHIRONO	BOTDET	9.47	7.57425	6.81683	.56807
16	: MACRUST	BOTDET	1.25	.99718	.89746	.07479
17	: MACRUST	SUSDET	3.34	.89174	.62422	.20064
18	: SLAK	BOTDET	64.32	51.45321	46.30789	3.85899
19	: KLEIN	ZOOPLANK	30.88	1.65973	.33195	1.06223
20	: KLEIN	OLIGO	3.55	.19089	.03818	.12217
21	: KLEIN	CHIRONO	1.60	.08609	.01722	.05510
22	: KLEIN	MACRUST	1.49	.08003	.01601	.05122
23	: MIDWIT	ZOOPLANK	.02	.00048	.00010	.00031
24	: MIDWIT	MOLLKLEIN	2.93	.07333	.01467	.04693
25	: MIDWIT	SLAK	4.80	.11997	.02399	.07678
26	: MIDWIT	OLIGO	8.21	.20516	.04103	.13130
27	: MIDWIT	CHIRONO	3.70	.09252	.01850	.05921
28	: MIDWIT	MACRUST	.29	.00732	.00146	.00469
29	: MIDWIT	BOTDET	3.88	.77572	.69815	.06206
30	: GROOTWIT	OLIGO	2.77	.06935	.01387	.04438
31	: GROOTWIT	CHIRONO	1.25	.03127	.00625	.02002
32	: GROOTWIT	ZOOPLANK	.01	.00029	.00006	.00019
33	: GROOTWIT	MOLLKLEIN	.36	.00892	.00178	.00571
34	: GROOTWIT	SLAK	2.65	.06636	.01327	.04247
35	: GROOTWIT	MACRUST	.18	.00446	.00089	.00285
36	: GROOTWIT	BOTDET	23.60	4.71982	4.24784	.37759
37	: MIDROOF	KLEIN	8.10	.15190	.03038	.09722
38	: MIDROOF	MIDWIT	2.51	.04700	.00940	.03008
39	: GROOTROOF	KLEIN	4.87	.09138	.01828	.05848
40	: GROOTROOF	MIDWIT	1.51	.02827	.00565	.01810

---

41	:	AAL	KLEIN	3.18	.07940	.01588	.05717
42	:	AAL	MIDWIT	.80	.02005	.00401	.01443
43	:	AAL	GROOTWIT	4.93	.12330	.02466	.08878
44	:	AAL	MIDROOF	1.27	.03182	.00636	.02291
45	:	AAL	GROOTROOF	.77	.01914	.00383	.01378
46	:	AAL	AAL	.95	.02380	.00476	.01714

**intergetijdenzone**  
**file: Inter4.out**

Ecogroup	Import	Biomass	Estimate	Product.
SUSDET	10.00	244.76	280.00	.00
BOTDET	5.00	96.46	90.00	.00
FYTOPLANK	70.00	291.50	280.00	70.00
ZOOPLANK	-2.00	41.58	42.00	2.70
MOLLKLEIN	-2.00	220.80	209.70	2.01
MOLLGROOT	.00	82.70	83.80	.04
OLIGO	-.20	18.59	20.40	.37
CHIRONO	-.30	32.84	37.80	.66
MACRUST	-.01	2.96	5.20	.06
SLAK	-2.00	101.31	104.80	2.03
KLEIN	.00	21.66	19.10	.19
MIDWIT	.00	5.76	4.34	.02
GROOTWIT	.00	4.06	3.12	.02
MIDROOF	.00	5.54	5.32	.02
GROOTROOF	.00	1.99	1.91	.01
AAL	.00	4.65	3.98	.01

Name	Ecogroup	Feeding on	Biomass	Flow	Detritus	Respirat
1	: SUSDET	SUSDET	244.76	36.71361	.00000	.00000
2	: BOTDET	BOTDET	96.46	4.82304	.00000	.00000
3	: FYTOPLANK	FYTOPLANK	291.50	58.29933	39.06055	.00000
4	: ZOOPLANK	SUSDET	16.57	5.52222	3.86555	.57983
5	: ZOOPLANK	FYTOPLANK	25.01	6.25305	3.75183	.87543
6	: MOLLKLEIN	SUSDET	121.16	14.13476	9.89433	3.13792
7	: MOLLKLEIN	BOTDET	39.53	13.83711	12.45340	1.02395
8	: MOLLKLEIN	FYTOPLANK	60.11	5.25997	3.15598	1.55695
9	: MOLLGROOT	FYTOPLANK	37.53	.18764	.11259	.05554
10	: MOLLGROOT	SUSDET	27.97	.18647	.13053	.04140
11	: MOLLGROOT	MOLLGROOT	17.20	.04300	.00860	.02546
12	: OLIGO	SUSDET	.91	.24182	.16928	.05441
13	: OLIGO	BOTDET	17.68	14.14699	12.73229	1.06102
14	: CHIRONO	SUSDET	1.60	.42711	.29898	.09610
15	: CHIRONO	BOTDET	31.23	24.98678	22.48810	1.87401
16	: MACRUST	BOTDET	1.30	1.04304	.93873	.07823
17	: MACRUST	SUSDET	1.65	.44127	.30889	.09929
18	: SLAK	BOTDET	101.31	81.05115	72.94604	6.07884
19	: KLEIN	ZOOPLANK	13.07	.70254	.14051	.44963
20	: KLEIN	OLIGO	2.48	.13320	.02664	.08525
21	: KLEIN	CHIRONO	5.22	.28073	.05615	.17967
22	: KLEIN	MACRUST	.89	.04771	.00954	.03054
23	: MIDWIT	ZOOPLANK	.00	.00006	.00001	.00004
24	: MIDWIT	MOLLKLEIN	.35	.00866	.00173	.00554
25	: MIDWIT	SLAK	.78	.01959	.00392	.01254
26	: MIDWIT	OLIGO	1.28	.03195	.00639	.02045
27	: MIDWIT	CHIRONO	2.51	.06285	.01257	.04023
28	: MIDWIT	MACRUST	.04	.00106	.00021	.00068
29	: MIDWIT	BOTDET	.79	.15763	.14186	.01261
30	: GROOTWIT	OLIGO	.27	.00667	.00133	.00427
31	: GROOTWIT	CHIRONO	.52	.01311	.00262	.00839
32	: GROOTWIT	ZOOPLANK	.00	.00002	.00000	.00001
33	: GROOTWIT	MOLLKLEIN	.03	.00065	.00013	.00042
34	: GROOTWIT	SLAK	.27	.00669	.00134	.00428
35	: GROOTWIT	MACRUST	.02	.00040	.00008	.00025
36	: GROOTWIT	BOTDET	2.96	.59201	.53281	.04736
37	: MIDROOF	KLEIN	4.90	.09188	.01838	.05880
38	: MIDROOF	MIDWIT	.64	.01202	.00240	.00769
39	: GROOTROOF	KLEIN	1.76	.03299	.00660	.02111
40	: GROOTROOF	MIDWIT	.23	.00432	.00086	.00276
41	: AAL	KLEIN	2.46	.06140	.01228	.04421



---

42	:	AAL	MIDWIT	.27	.00668	.00134	.00481
43	:	AAL	GROOTWIT	.65	.01625	.00325	.01170
44	:	AAL	MIDROOF	.66	.01662	.00332	.01197
45	:	AAL	GROOTROOF	.24	.00597	.00119	.00430
46	:	AAL	AAL	.37	.00930	.00186	.00669

**diep instabiel slib**  
**file: Dpslib4.out**

Ecogroup	Import	Biomass	Estimate	Product.
SUSDET	10.00	326.47	280.00	.00
BOTDET	25.00	344.41	340.00	.00
FYTOPLANK	70.00	300.56	280.00	70.00
ZOOPLANK	-2.00	42.82	42.00	2.78
MOLLKLEIN	-2.00	226.94	228.00	2.07
MOLLGROOT	.00	.00	.00	.00
OLIGO	.00	69.07	86.40	1.38
CHIRONO	.00	1.12	1.40	.02
MACRUST	.00	3.80	5.20	.08
SLAK	-.10	5.64	8.80	.11
KLEIN	.00	29.76	18.68	.26
MIDWIT	.00	24.98	16.27	.10
GROOTWIT	.00	53.38	72.69	.21
MIDROOF	.00	7.78	15.51	.02
GROOTROOF	.00	10.62	21.16	.03
AAL	.00	12.15	4.58	.02

Name	Ecogroup	Feeding on	Biomass	Flow	Detritus	Respirat
1	: SUSDET	SUSDET	326.47	48.97119	.00000	.00000
2	: BOTDET	BOTDET	344.41	17.22069	.00000	.00000
3	: FYTOPLANK	FYTOPLANK	300.56	60.11208	40.27509	.00000
4	: ZOOPLANK	SUSDET	18.31	6.10341	4.27239	.64086
5	: ZOOPLANK	FYTOPLANK	24.51	6.12853	3.67712	.85799
6	: MOLLKLEIN	SUSDET	98.71	11.51641	8.06149	2.55664
7	: MOLLKLEIN	BOTDET	85.26	29.84053	26.85648	2.20820
8	: MOLLKLEIN	FYTOPLANK	42.96	3.75939	2.25564	1.11278
9	: MOLLGROOT	FYTOPLANK	.00	.00000	.00000	.00000
10	: MOLLGROOT	SUSDET	.00	.00000	.00000	.00000
11	: MOLLGROOT	MOLLGROOT	.00	.00000	.00000	.00000
12	: OLIGO	SUSDET	2.05	.54707	.38295	.12309
13	: OLIGO	BOTDET	67.02	53.61620	48.25458	4.02122
14	: CHIRONO	SUSDET	.03	.00886	.00621	.00199
15	: CHIRONO	BOTDET	1.09	.86878	.78190	.06516
16	: MACRUST	BOTDET	2.16	1.73023	1.55721	.12977
17	: MACRUST	SUSDET	1.64	.43695	.30586	.09831
18	: SLAK	BOTDET	5.64	4.51125	4.06013	.33834
19	: KLEIN	ZOOPLANK	14.57	.78325	.15665	.50128
20	: KLEIN	OLIGO	13.67	.73491	.14698	.47034
21	: KLEIN	CHIRONO	.22	.01191	.00238	.00762
22	: KLEIN	MACRUST	1.29	.06928	.01386	.04434
23	: MIDWIT	ZOOPLANK	.01	.00018	.00004	.00011
24	: MIDWIT	MOLLKLEIN	2.21	.05514	.01103	.03529
25	: MIDWIT	SLAK	.28	.00702	.00140	.00449
26	: MIDWIT	OLIGO	17.21	.43035	.08607	.27542
27	: MIDWIT	CHIRONO	.28	.00697	.00139	.00446
28	: MIDWIT	MACRUST	.14	.00355	.00071	.00227
29	: MIDWIT	BOTDET	4.85	.96944	.87249	.07755
30	: GROOTWIT	OLIGO	8.65	.21617	.04323	.13835
31	: GROOTWIT	CHIRONO	.14	.00350	.00070	.00224
32	: GROOTWIT	ZOOPLANK	.01	.00016	.00003	.00010
33	: GROOTWIT	MOLLKLEIN	.40	.00997	.00199	.00638
34	: GROOTWIT	SLAK	.23	.00577	.00115	.00369
35	: GROOTWIT	MACRUST	.13	.00321	.00064	.00205
36	: GROOTWIT	BOTDET	43.83	8.76531	7.88878	.70122
37	: MIDROOF	KLEIN	5.59	.10476	.02095	.06705
38	: MIDROOF	MIDWIT	2.20	.04121	.00824	.02637
39	: GROOTROOF	KLEIN	7.62	.14292	.02858	.09147
40	: GROOTROOF	MIDWIT	3.00	.05622	.01124	.03598
41	: AAL	KLEIN	.33	.00821	.00164	.00591

---

42	:	AAL	MIDWIT	.10	.00248	.00050	.00178
43	:	AAL	GROOTWIT	8.54	.21351	.04270	.15373
44	:	AAL	MIDROOF	.93	.02335	.00467	.01682
45	:	AAL	GROOTROOF	1.27	.03186	.00637	.02294
46	:	AAL	AAL	.97	.02430	.00486	.01749

## ondiep stabiel slib

file: Stslib4.out

Ecogroup	Import	Biomass	Estimate	Product.
SUSDET	10.00	192.96	280.00	.00
BOTDET	5.00	144.25	125.00	.00
FYTOPLANK	70.00	250.09	280.00	70.00
ZOOPLANK	-2.00	59.00	42.00	3.83
MOLLKLEIN	-4.70	527.04	537.20	4.80
MOLLGROOT	.00	37.75	39.20	.02
OLIGO	.00	23.06	18.80	.46
CHIRONO	.00	7.97	6.50	.16
MACRUST	.00	3.76	5.20	.08
SLAK	-1.10	58.16	49.00	1.16
KLEIN	.00	43.02	43.70	.37
MIDWIT	.00	22.63	16.10	.09
GROOTWIT	.00	51.97	22.63	.21
MIDROOF	.00	10.02	19.77	.03
GROOTROOF	.00	8.56	16.89	.03
AAL	.00	16.34	29.80	.03

Name	Ecogroup	Feeding on	Biomass	Flow	Detritus	Respirat
1	: SUSDET	SUSDET	192.96	28.94405	.00000	.00000
2	: BOTDET	BOTDET	144.25	7.21237	.00000	.00000
3	: FYTOPLANK	FYTOPLANK	250.09	50.01701	33.51140	.00000
4	: ZOOPLANK	SUSDET	24.37	8.12366	5.68656	.85298
5	: ZOOPLANK	FYTOPLANK	34.63	8.65661	5.19397	1.21193
6	: MOLLKLEIN	SUSDET	241.87	28.21806	19.75264	6.26441
7	: MOLLKLEIN	BOTDET	156.71	54.84704	49.36234	4.05868
8	: MOLLKLEIN	FYTOPLANK	128.46	11.24058	6.74435	3.32721
9	: MOLLGROOT	FYTOPLANK	17.16	.08580	.05148	.02540
10	: MOLLGROOT	SUSDET	12.74	.08493	.05945	.01885
11	: MOLLGROOT	MOLLGROOT	7.85	.01963	.00393	.01162
12	: OLIGO	SUSDET	.37	.09869	.06909	.02221
13	: OLIGO	BOTDET	22.69	18.14995	16.33496	1.36125
14	: CHIRONO	SUSDET	.13	.03412	.02389	.00768
15	: CHIRONO	BOTDET	7.84	6.27525	5.64773	.47064
16	: MACRUST	BOTDET	2.68	2.14045	1.92641	.16053
17	: MACRUST	SUSDET	1.08	.28807	.20165	.06482
18	: SLAK	BOTDET	58.16	46.52419	41.87177	3.48931
19	: KLEIN	ZOOPLANK	34.13	1.83445	.36689	1.17405
20	: KLEIN	OLIGO	5.64	.30322	.06064	.19406
21	: KLEIN	CHIRONO	1.95	.10484	.02097	.06709
22	: KLEIN	MACRUST	1.30	.06992	.01398	.04475
23	: MIDWIT	ZOOPLANK	.01	.00026	.00005	.00017
24	: MIDWIT	MOLLKLEIN	3.51	.08781	.01756	.05620
25	: MIDWIT	SLAK	1.77	.04423	.00885	.02831
26	: MIDWIT	OLIGO	5.01	.12527	.02505	.08017
27	: MIDWIT	CHIRONO	1.73	.04331	.00866	.02772
28	: MIDWIT	MACRUST	.14	.00354	.00071	.00226
29	: MIDWIT	BOTDET	10.45	2.09019	1.88117	.16722
30	: GROOTWIT	OLIGO	1.31	.03266	.00653	.02091
31	: GROOTWIT	CHIRONO	.45	.01129	.00226	.00723
32	: GROOTWIT	ZOOPLANK	.00	.00012	.00002	.00008
33	: GROOTWIT	MOLLKLEIN	.33	.00824	.00165	.00528
34	: GROOTWIT	SLAK	.75	.01887	.00377	.01208
35	: GROOTWIT	MACRUST	.07	.00166	.00033	.00106
36	: GROOTWIT	BOTDET	49.05	9.81021	8.82919	.78482
37	: MIDROOF	KLEIN	8.00	.15005	.03001	.09603
38	: MIDROOF	MIDWIT	2.02	.03782	.00756	.02421
39	: GROOTROOF	KLEIN	6.84	.12819	.02564	.08204
40	: GROOTROOF	MIDWIT	1.72	.03231	.00646	.02068
41	: AAL	KLEIN	3.67	.09175	.01835	.06606

---

42	:	AAL	MIDWIT	.82	.02038	.00408	.01467
43	:	AAL	GROOTWIT	8.31	.20786	.04157	.14966
44	:	AAL	MIDROOF	1.20	.03006	.00601	.02164
45	:	AAL	GROOTROOF	1.03	.02568	.00514	.01849
46	:	AAL	AAL	1.31	.03267	.00653	.02352

# **E**    **Achtergrondinformatie over CHEOPS**

Als achtergrondinformatie over CHEOPS zijn kopieën van twee documenten bijgevoegd:

1.    een korte samenvatting van de gebruikte formuleringen
2.    een folder over CHEOPS

## CHEOPS

De berekening van de inwendige concentratie is gebaseerd op vergelijking (1) waarin alle termen die bijdragen aan de inwendige concentratie (zowel positief als negatief), zijn meegenomen.

$$\frac{dC}{dt} = (k_0 + k_1) \times a \times C_v + k_2 \times b \times C_w - (k_3 + k_4 + k_5 + k_1) \times C \quad (1)$$

waarin:

C =	concentratie in het organisme	µg/g
C <sub>v</sub> =	concentratie in het voedsel	µg/g
C <sub>w</sub> =	concentratie in het water	µg/l
m =	biomassa organisme	g
k <sub>0</sub> =	snelheidscoëfficiënt voor totale respiratie	d <sup>-1</sup>
k <sub>1</sub> =	snelheidscoëfficiënt voor groei	d <sup>-1</sup>
k <sub>2</sub> =	snelheidscoëfficiënt voor opname uit water	l/g.d
k <sub>3</sub> =	populatie-turnover snelheid	d <sup>-1</sup>
k <sub>4</sub> =	uitscheidingsnelheid ('echte eliminatie')	d <sup>-1</sup>
k <sub>5</sub> =	omzettingssnelheid (metabolisme)	d <sup>-1</sup>
a =	extractie-efficiëntie van de stof uit het voedsel	-
b =	biologisch beschikbare fractie c.q. extractie-efficiëntie	-

Indien een steady-state benadering wordt gekozen, wordt de evenwichtsconcentratie (C<sub>e</sub>) weergegeven door vergelijking 2.

$$C_e = \frac{(k_0 + k_1) \times a \times C_v + k_2 \times b \times C_w}{k_3 + k_4 + k_5 + k_1} \quad (2)$$

Voor een gedetailleerde beschrijving van de verschillende processen wordt verwezen naar de gebruikershandleiding van CHEOPS (WL | Delft Hydraulics, 1990).

Hieronder wordt een overzicht gegeven van de invoerparameters in CHEOPS die in de steady-state benadering van belang zijn voor een specifieke stof (zoals bijvoorbeeld kwik).

Parameter	omschrijving	eenheid
a	extractie-efficiëntie van de stof uit het voedsel	-
b	biologisch beschikbare fractie c.q. extractie-efficiëntie	-
C <sub>w</sub>	concentratie in het water	µg/l
F <sub>a</sub>	gewichtsfractie adsorberende pool in organisme	-
K	partiticoëfficiënt van de stof	l/gOct
k <sub>2</sub>	snelheidscoëfficiënt voor opname uit water	d <sup>-1</sup>
k <sub>4</sub>	uitscheidingsnelheid ('echte eliminatie')	d <sup>-1</sup>
k <sub>5</sub>	omzettingssnelheid (metabolisme)	d <sup>-1</sup>

Alle overige parameters zijn van belang voor de voedselfluxen tussen de verschillen de voedselgroepen (predator - prooi) en zijn onafhankelijk van de gemodelleerde toxische stof.



# Assessment of bio-accumulation of micropollutants with CHEOPS/UPTAQE

---

## introduction

CHEOPS stands for Cumulation of HEavy metals and Organic PollutantS. The model calculates the accumulation of toxicants in aquatic organisms. Uptake of toxicants through the foodchain and uptake of toxicants from the water is taken into account. The model can generate a steady-state, a quasi dynamic or a fully dynamic solution for the bio-accumulation in the ecosystem. Necessary water quality data may be generated by estimation or using output from dynamic or steady state water quality models.

The model generates quantitative data from the relation between exposition on different levels in the ecosystem and bio-accumulation. This knowledge gives insight in the importance of accumulation via the foodchain for modelled chemicals and modelled (top)predators.

---

## keywords

bio-accumulation, organic micropollutants, heavy metals, foodweb, modelling

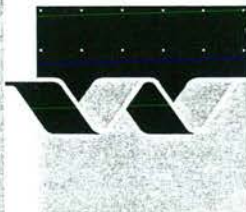

p.o. box 177  
2600 mh delft  
the netherlands

telephone +31 15 2569353  
telefax +31 15 2619674

**delft hydraulics**

## processes and model structure

Aquatic organisms are exposed to dissolved and adsorbed fractions of chemicals. The amount and type of exposure depends on the ambient water and bottom quality and on the behaviour of the organism. This means that pelagic or benthic living organisms may be exposed to different concentrations of toxicants.

The behaviour of modelled organisms is described by characteristic knowledge of its physiology and feeding habits. Furthermore, it is necessary to quantify water and bottom qualities and pollutant-specific data governing uptake and elimination rates. With this knowledge the model calculates the uptake of toxicants from food and water as well as elimination of the toxicant by the organism (See figure 1). The model calculates internal concentrations going from the bottom to the top of the foodchain. This result, as well as information about feeding behaviour (predator-prey relations), is used to calculate internal concentrations on successive higher trophic levels.

The model is designed to function in a menustructure, allowing the user to develop his own foodchain structure(s) and change every possible parameter from within a menu. Options are presented to choose between steady-state or (semi) dynamic calculation of bio-accumulation. Furthermore, it is possible to choose forcing functions or measured time-series for water quality data.

Figure 1  
Modelled uptake and elimination processes.

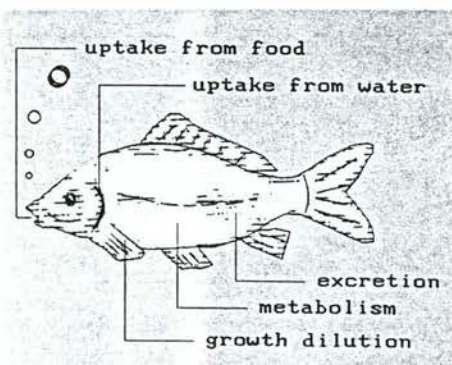
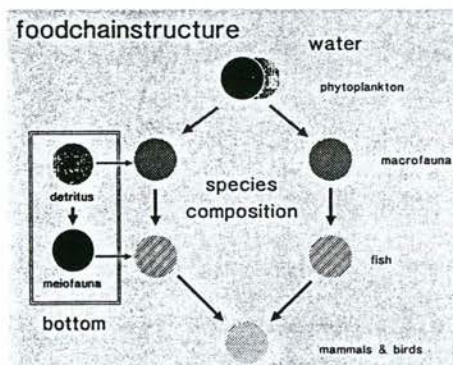

Figure 2  
North Sea foodweb with predator-prey relations.



## field of application

The model has been developed to study the relations between water quality and bio-accumulation of organic pollutants in fresh-water ecosystems. From there extensions have been made to include the kinetics of the accumulation of heavy metals in the model. The model has been used to study the fate of Hexachlorobenzene (HCB) and Polychlorinated Biphenyls (PCB) in a Dutch fresh-water lake. Recently, due to the general model formulations, it was applied to assess the transfer of heavy metals (Cadmium and Mercury), PCBs, HCB and pesticides (g-HCH) through a North Sea foodchain. Furthermore the accumulation of PCB's by grey seals in the Dutch Wadden Sea was studied (See figures 3, 4 and 5). In general, a coupling to steady-state or dynamic water quality models was used to generate the necessary exposure concentrations. Results of the model studies are used by governmental institutions to assess the impact of changing water and bottom quality on the levels of contamination through the foodchain for loading-reduction policy scenarios.

## schematization

The model set-up does not allow a schematization in either direction. In principle, organisms are exposed to a concentration on one geographical location. It is possible to use concentration time-series for this location to study time-related behaviour of accumulation and elimination. When immediate steady-state is assumed, the model can cope with water quality datasets describing a steady-state situation for any amount of locations. This set-up was used for applications of the model to the North Sea, where it generated steady-state accumulation data for thousands of grid-cells. Another important part of the model is the schematization of the foodchain. This schematization can be changed by the user but is considered constant during a model-run. Information needed for the construction of a foodchain has to be based on a yearly mean description of predator-prey relations of the modelled organisms (See figure 2).

## principles

The equilibrium concentration of a toxicant in organisms is a result of the ratio between uptake and elimination rates. The model allows the user to choose between two principles of uptake and elimination. The first possibility is to use passive uptake and elimination kinetics for relevant toxicants. In this case, the bio-accumulation is governed by the lipophilicity of the toxicant and the lipidcontent of the organisms. In all other cases uptake and elimination are based on active processes, for which the extraction efficiency and the rate of elimination govern the resulting level of accumulation. Depending on the application, the user may choose to use a steady-state solution, a semi-dynamic solution or a full dynamic solution. The choice between these possible types of solutions depends on the accessible field-data for water quality and calibration. Another decisive factor is the ratio of residence time in an aquatic system to the time needed for the organisms to reach an equilibrium. If the most simple solution is used, the model assumes constant water quality and non-varying physiology for the modelled organisms.

Figure 3  
Model calibration for cadmium in a North Sea foodweb.

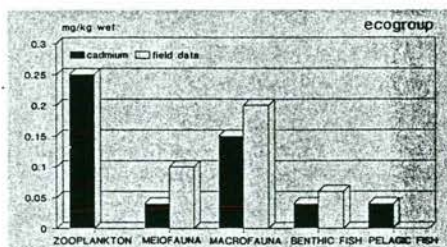

Figure 4  
Model calibration for PCB153 in a North Sea foodweb.

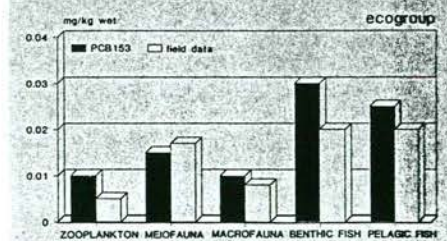
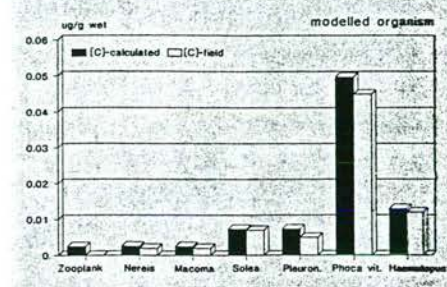

Figure 5  
Calibration for PCB138 in a Wadden Sea foodweb, including Seal.



## general formulation

The calculation of the internal concentration is based on the identification and quantification of a limited number of processes. These processes are included in a differential equation, that can be used to calculate concentration changes in time. If a steady-state solution is used, the value of this equation is in principle set to zero.

The following equation is used in the model. In general it is stated that:

$$dC/dt = (k_0 + k_1).a.C_v + k_2.b.C_w - k_3.C - k_4.C - k_5.C - k_1.C \quad (1)$$

with:

- C – concentration toxicant in the organism  $\mu\text{g/g}$
- $C_v$  – concentration toxicant in the food  $\mu\text{g/g}$
- $C_w$  – concentration toxicant in the water  $\mu\text{g/l}$
- m – biomass organism g
- $k_0$  – total respiration rate d-1
- $k_1$  – growth rate d-1
- $k_2$  – ventilation volume rate l/g.d
- $k_3$  – population turnover rate d-1
- $k_4$  – excretion rate d-1
- $k_5$  – metabolic rate d-1
- a – extraction-efficiency for toxicant from food (-)
- b – extraction-efficiency for toxicant from water (-)
- dC – concentration change  $\mu\text{g/g}$
- dt – timestep d

For a steady-state solution the equilibrium concentration [Ce] is calculated as follows:

$$C_e = \frac{(k_0 + k_1).a.C_v + k_2.b.C_w}{k_3 + k_4 + k_5 + k_1} \quad (2)$$

in which  $k_3 + k_4 + k_5 + k_1$  represent the total elimination rate E.

If the theoretical equilibrium concentration [Ce] and the total elimination rate E is known, only a start concentration [C0] is needed to construct a theoretical curve that expresses the relation between time lapsed and accumulated concentration. In formula:

$$C_t = (C_0 - C_e).e^{(-E.t)} + C_e \quad (3)$$

## validation and quality assurance

The model is presently applied and calibrated for a wide range of toxicants (e.g. cadmium, mercury, hexachlorobenzene, PCBs, PAHs and lindane). The model was applied in studies about the Dutch Lake IJssel, the river Rhine, the North Sea and the Wadden Sea. In combination with other models, UPTAQE/CHEOPS is used for the analysis of management scenarios for the North Sea (figure 6). This operational modelling framework deals with the complete cause-effect chain from loading of toxicants to accumulation in organisms (figures 7 and 8). In this project the model is applied for a broad range of toxicants including calibration on field data as a very important item. The model is documented and comes with a user manual.

## computer resources

The model is implemented on an MS-DOS Personal Computer. Its source code is programmed in FORTRAN77. Model performance improves with the use of a co-processor but this is not imperative. Included graphical software may use VGA, EGA or Hercules graphic modes.

Figure 6  
Modelling framework  
Management North Sea  
(MANS).

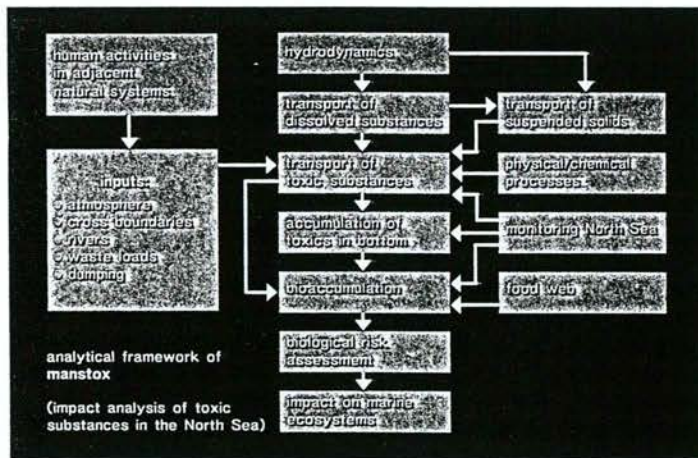
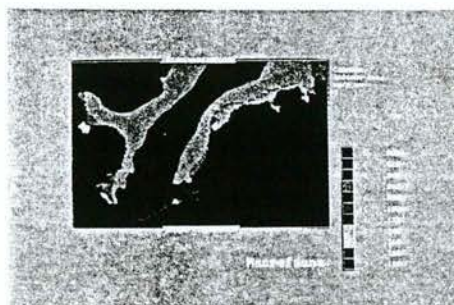
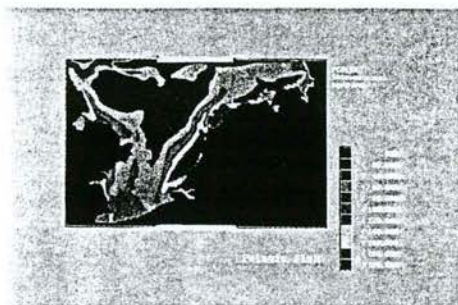

Figure 7  
Accumulation of  
Cadmium in macrofauna  
in the North Sea.

Figure 8  
Accumulation of  
PCB513 in pelagic fish  
in the North Sea.



## extensions

The model CHEOPS is embedded in a menu driven Monte-Carlo generator. This extension (called SSENS) may be used to study the sensitivity of the model results for uncertainty in input variables. Free combinations of uncertain variables (including variable feeding behaviour) may be chosen. The Monte-Carlo generator exerts a given number of model runs and the results are presented in a graphical presentation of variability of model calculations. A linear multiple regression procedure is implemented to assess the relative importance of varying input variables.

This extension uses the same computer resources and is fully documented.

## references

- Bruggeman, W. A. (DBW/RIZA), de Vries, D. J. (WL) and de Vries, M.B. (WL), 1989. Modelling the Fate of organic Micropollutants in Surface Water, Sediment and Aquatic Organisms. H2O, 22(7): 204-211 (Dutch).
- DELFT HYDRAULICS, 1990. Manual UPTAQE/CHEOPS (Dutch).
- Dekker, E. A., Goossens, H. and Nauta, T. A., 1990. Modelling organic Micropollutants in the North Sea, 523, DELFT HYDRAULICS, May 1990 (Dutch).
- RWS and SIBAS, 1988. MANS – Management Analysis North Sea, summary report. RWS, February 1988.
- Vries, D. J. de, and de Vries, M. B., 1988. Modelling the Fate of HCB and PCBs in Lake Ketel and Lake IJssel. Report on Investigations, T250, DELFT HYDRAULICS (English).
- Vries, M. B. de (DH), en Pieters, H. (RIVO), 1989. Accumulation of Heavy Metals in Organisms; Bio-accumulation of Mercury in Pike-Perch, Data-analysis for the Lakes IJsselmeer, Ketelmeer and Markermeer. Report on Investigations, T250, DELFT HYDRAULICS (Dutch).

# **F Chemische gegevens over biotopen**

## Invoer t.b.v. kalibratie CHEOPS voor Haringvliet (huidige situatie)

Parameter / locatie	Diep slib	Ondiep slib	Ondiep zand	Intergetijdenzone
[Cd] in sed mg/kg	5.4	1.0	0.3	0.8
[PCB-153] in sed µg/kg	15.8	2.2	1.1	3.1
% OS in sed *	6.8	1.7	0.6	1.8
% < 63 µm in sed	44.3	16.3	3.9	18.3
% OC in zwev stof	7.7	7.7	7.7	7.7
% 63m in zwev stof	63	63	63	63
[Cd] in zwev stof mg/kg	5.0	5.0	5.0	5.0
[PCB-153] in zw st µg/kg	19.0	19.0	19.0	19.0

# **G Omrekening van sedimentkarakteristieken naar CHEOPS invoer**





# **H** Algemene structuur van de **CHEOPS** invoerfile

**(Toelichting in vette letters)**

MER Haringvliet, huidige situatie

PCB153 6.510 1

[stof] [partitievoëfficiënt [type\_berekening:  
in water: Kow] 1=organische microverontr.,  
2 = metalen]

5

PELAGIC DISS -99.00 .121  
[dummy] [concentratie opgelost in water]

BENTHIC DISS -99.00 .127  
[dummy] [concentratie opgelost in poriewater]

FYTOPLANK .1500 227.  
[ratio\_drooggewicht/natgewicht] [conc. geads. aan algen mg/kg]

SUSDET .1500 227.  
[ratio\_drooggew./natgew.] [conc. geads. aan detritus in water mg/kg]

BOTDET .1500 239.  
[ratio\_drooggew./natgew.] [conc. geads. aan bodemdetritus mg/kg]

18	:	[resp]	[groei]	[conversie eff.]	[dw/ww]	[koolstof/dw]
ZOOPANK		.0350	.0650	.3500	.1500	.4000
MOLLKLEIN		.0259	.0091	.1900	.1500	.4000
MOLLGROOT		.0015	.0005	.4000	.1500	.4000
OLIG_CHIR		.0600	.0200	.1018	.1500	.4000
MACRUST		.0600	.0200	.1372	.1500	.4000
SLAK		.0600	.0200	.1000	.1500	.4000
KLEIN		.0344	.0086	.8000	.2500	.4000
MIDWIT		.0160	.0040	.3596	.2500	.4000
GROOTWIT		.0160	.0040	.1199	.2500	.4000
MIDROOF		.0120	.0030	.8000	.2500	.4000
GROOTROOF		.0120	.0030	.8000	.2500	.4000
AAL		.0180	.0020	.8000	.3300	.4000
KUIFEEND		.3000	.0014	.8000	.2500	.4000
AALSCH		.1100	.0002	.8000	.2500	.4000
FUUT		.2000	.0003	.8000	.2500	.4000
STELTLOP		.5000	.0015	.8000	.2500	.4000
KLUUT		.2000	.0003	.8000	.2500	.4000
VISDIEFJE		.5000	.0015	.8000	.2500	.4000

: [type org] [CR] [lipide conc.] [gem. gew. ind.  
org. 2x]

ZOOPANK	1 f	1.000	.014	.001	.001
MOLLKLEIN	1 i	.200 c	.024	.015	.015
MOLLGROOT	1 l	.100 l	.015	.500	.500
OLIG_CHIR	1 t	.010 e	.010	.015	.015

MACRUST	1	.010	a	.015	.015	.015	
SLAK	1	.010	r	.017	.015	.015	
KLEIN	2	v	.000	a	.010	7.000	7.000
MIDWIT	2	i	.000	c	.021	98.000	98.000
GROOTWIT	2	s	.000	e	.026	500.000	500.000
MIDROOF	2	.000		.007	98.000	98.000	
GROOTROOF	2	.000	r	.013	500.000	500.000	
AAL	2	.000	a	.183	100.000	100.000	
KUIFEEND	3	v	.000	t	.050	900.000	900.000
AALSCH	3	o	.000	e	.129	2430.000	2430.000
FUUT	3	g	.000		.050	1200.000	1200.000
STELTLOP	3	e	.000		.050	225.000	225.000
KLUUT	3	l	.000		.050	360.000	360.000
VISDIEFJE	3	s	.000		.050	125.000	125.000

: [extractie uit: [water] [voedsel] [opname eff. O2] [habitat:  
1= in water,  
2 = in bodem]

ZOOPLANK	.1000	.100	.7500	1	
MOLLKLEIN	.1000	.100	.7500	1	
MOLLGROOT	.1000	.100	.7500	1	
OLIG_CHIR	.1000	.020	.7500	2	
MACRUST	.1000	.100	.7500	1	
SLAK	.1000	.020	.7500	2	
KLEIN	.6000	.6000	.7500	1-	water
MIDWIT	.6000	.2000	.7500	1	
GROOTWIT	.6000	.2000	.7500	1	organismen
MIDROOF	.6000	.6000	.7500	1	
GROOTROOF	.6000	.6000	.7500	1	
AAL	.6000	.2000	.7500	1	
KUIFEEND	.0000	.0700	.7500	1	
AALSCH	.0000	.2000	.7500	1	
FUUT	.0000	.2000	.7500	1	
STELTLOP	.0000	.0700	.7500	1	
KLUUT	.0000	.0700	.7500	1	
VISDIEFJE	.0000	.2000	.7500	1-	

	[extractie] halfwaardetijd	[verduunning ] door turnover populatie	[meta ] bolisme 1/dag	[conc. op t = 0]	[max. biom. t = ~]
ZOOPLANK	1.000	7.000	.000	.002	.01400
MOLLKLEIN	100.000	730.000	.000	.003	.03800
MOLLGROOT	100.000	730.000	.000	.002	.06000
OLIG_CHIR	25.000	365.000	.000	.003	.01000
MACRUST	200.000	730.000	.000	.003	.03800
SLAK	100.000	365.000	.000	.003	.03800
KLEIN	50.000	365.000	.000	.008	.06400
MIDWIT	75.000	730.000	.000	.013	.07500
GROOTWIT	100.000	1460.000	.000	.005	.07500
MIDROOF	75.000	730.000	.000	.008	.08300

GROOTROOF	100.000	1460.000	.000	.003	-9.00000
AAL	200.000	9999.000	.000	.042	.90900
KUIFEEND	365.000	1095.000	.002	.240	.40000
AALSCH	365.000	1095.000	.000	.045	2.00000
FUUT	365.000	1095.000	.001	.056	-9.00000
STELTLOP	365.000	1095.000	.002	.056	-9.00000
KLUUT	365.000	1095.000	.001	.056	-9.00000
VISDIEFJE	365.000	1095.000	.002	.056	-9.00000

	temperatuurcoeff: [resp]	[groei]	[ademhaling]	[ampl.variatie]	[t max. biom.]
ZOOPLANK	.0639	.0639	.0300	.0000	90.0000
MOLLKLEIN	.0639	.0639	.0300	.0000	90.0000
MOLLGROOT	.0639	.0639	.0300	.0000	90.0000
OLIG_CHIR	.0639	.0639	.0300	.0000	90.0000
MACRUST	.0639	.0639	.0300	.0000	90.0000
SLAK	.0639	.0639	.0300	.0000	90.0000
KLEIN	.0639	.0639	.0300	.0000	90.0000
MIDWIT	.0639	.0639	.0300	.0000	90.0000
GROOTWIT	.0639	.0639	.0300	.0000	90.0000
MIDROOF	.0639	.0639	.0300	.0000	90.0000
GROOTROOF	.0639	.0639	.0300	.0000	90.0000
AAL	.0000	.0000	.0000	.0000	90.0000
KUIFEEND	.0000	.0000	.0000	.0000	90.0000
AALSCH	.0000	.0000	.0000	.0000	90.0000
FUUT	.0000	.0000	.0000	.0000	90.0000
STELTLOP	.0000	.0000	.0000	.0000	90.0000
KLUUT	.0000	.0000	.0000	.0000	90.0000
VISDIEFJE	.0000	.0000	.0000	.0000	90.0000

48

dieet fracties uit mc2, gecorrigeerd met spreadsheet

ZOOPLANK	SUSDET	0.44
ZOOPLANK	FYTOPLANK	0.56
MOLLKLEIN	SUSDET	0.24
MOLLKLEIN	BOTDET	0.44
MOLLKLEIN	FYTOPLANK	0.32
MOLLGROOT	FYTOPLANK	0.45
MOLLGROOT	SUSDET	0.34
MOLLGROOT	MOLLGROOT	0.21
OLIG_CHIR	SUSDET	0.03
OLIG_CHIR	BOTDET	0.97
MACRUST	BOTDET	0.59
MACRUST	SUSDET	0.41
SLAK	BOTDET	1.00
KLEIN	ZOOPLANK	0.51
KLEIN	OLIG_CHIR	0.45
KLEIN	MACRUST	0.04
MIDWIT	ZOOPLANK	0.00
MIDWIT	MOLLKLEIN	0.21
MIDWIT	SLAK	0.07

MIDWIT	OLIG_CHIR	0.54
MIDWTI	MACRUST	0.00
MIDWIT	BOTDET	0.18
GROOTWIT	OLIG_CHIR	0.14
GROOTWIT	ZOOPLANK	0.00
GROOTWIT	MOLLKLEIN	0.02
GROOTWIT	SLAK	0.03
GROOTWIT	MACRUST	0.00
GROOTWIT	BOTDET	0.81
MIDROOF	KLEIN	0.74
MIDROOF	MIDWIT	0.26
GROOTROOF	KLEIN	0.74
GROOTROOF	MIDWIT	0.26
AAL	KLEIN	0.07
AAL	MIDWIT	0.02
AAL	GROOTWIT	0.66
AAL	MIDROOF	0.08
AAL	GROOTROOF	0.09
AAL	AAL	0.08
KUIFEEND	MOLLKLEIN	1.000
AALSCH	MIDWIT	.780
AALSCH	MIDROOF	.150
AALSCH	KLEIN	.050
AALSCH	AAL	.020
FUUT	KLEIN	1.000
STELTLOP	OLIG_CHIR	.500
STELTLOP	MOLLKLEIN	.500
KLUUT	OLIG_CHIR	1.000
VISDIEFJE	KLEIN	1.000

8	zie blz. 24 van handleiding:
2.650	omrekeningsfactor C naar O2
8.500	conc. O2 in water
10.000	watertemperatuur
365.000	
0.000	
.000	
.000	
.000	

hv0p [dummy]

.000 365.000 4.000 8.000

[starttijden ed alleen voor dynamische berekeningen]

# I Invoerfiles voor CHEOPS

Cadmium in gehele Haringvliet  
file: Refcad.chp

MER Haringvliet, huidige situatie  
cadmium -999.000 2

5

PELAGIC DISS -99.00 .400E-01  
BENTHIC DISS -99.00 .69E-01  
FYTOPLANK .1500 5.00  
SUSDET .1500 5.00  
BOTDET .1500 8.7

19

ZOPLANK	.0350	.0650	.3491	.1500	.4000
MOLLKLEIN	.0259	.0091	.1777	.1500	.4000
MOLLGROOT	.0015	.0005	.3964	.1500	.4000
OLIGO	.0600	.0200	.1018	.1500	.4000
CHIRONO	.0600	.0200	.1018	.1500	.4000
MACRUST	.0600	.0200	.1374	.1500	.4000
SLAK	.0600	.0200	.1000	.1500	.4000
KLEIN	.0344	.0086	.8000	.2500	.4000
MIDWIT	.0160	.0040	.3641	.2500	.4000
GROOTWIT	.0160	.0040	.1205	.2500	.4000
MIDROOF	.0120	.0030	.8000	.2500	.4000
GROOTROOF	.0120	.0030	.8000	.2500	.4000
AAL	.0180	.0020	.8000	.3300	.4000
KUIFEEND	.3000	.0014	.8000	.2500	.4000
AALSCH	.1100	.0002	.8000	.2500	.4000
FUUT	.2000	.0003	.8000	.2500	.4000
STELTLOP	.5000	.0015	.8000	.2500	.4000
KLUUT	.2000	.0003	.8000	.2500	.4000
VISDIEFJE	.5000	.0015	.8000	.2500	.4000

ZOPLANK	1	1.000	.014	.001	.001
MOLLKLEIN	1	.200	.024	.015	.015
MOLLGROOT	1	.100	.015	.500	.500
OLIGO	1	.010	.010	.015	.015
CHIRONO	1	.010	.010	.015	.015
MACRUST	1	.010	.015	.015	.015
SLAK	1	.010	.017	.015	.015
KLEIN	2	.000	.010	7.000	7.000
MIDWIT	2	.000	.021	98.000	98.000
GROOTWIT	2	.000	.026	500.000	500.000
MIDROOF	2	.000	.007	98.000	98.000
GROOTROOF	2	.000	.013	500.000	500.000
AAL	2	.000	.183	100.000	100.000
KUIFEEND	3	.000	.050	900.000	900.000
AALSCH	3	.000	.129	2430.000	2430.000
FUUT	3	.000	.050	1200.000	1200.000
STELTLOP	3	.000	.050	225.000	225.000

KLUUT	3	.000	.050	360.000	360.000
VISDIEFJE	3	.000	.050	125.000	125.000

ZOPLANK	.0050	.0050	.7500	1
MOLLKLEIN	.0050	.0050	.7500	1
MOLLGROOT	.0050	.0050	.7500	1
OLIGO	.0030	.0030	.7500	2
CHIRONO	.0050	.0050	.7500	2
MACRUST	.0050	.0050	.7500	1
SLAK	.0050	.0050	.7500	2
KLEIN	.0050	.0050	.7500	1
MIDWIT	.0050	.0020	.7500	1
GROOTWIT	.0050	.0020	.7500	1
MIDROOF	.0050	.0050	.7500	1
GROOTROOF	.0050	.0050	.7500	1
AAL	.0050	.0020	.7500	1
KUIFEEND	.0000	.0050	.7500	1
AALSCH	.0000	.0050	.7500	1
FUUT	.0000	.0050	.7500	1
STELTLOP	.0000	.0050	.7500	1
KLUUT	.0000	.0050	.7500	1
VISDIEFJE	.0000	.0050	.7500	1

ZOPLANK	1.000	7.000	.000	.002	.01400
MOLLKLEIN	100.000	730.000	.000	.003	.03800
MOLLGROOT	100.000	730.000	.000	.002	.06000
OLIGO	25.000	365.000	.000	.003	.01000
CHIRONO	25.000	365.000	.000	.003	.01000
MACRUST	200.000	730.000	.000	.003	.03800
SLAK	100.000	365.000	.000	.003	.03800
KLEIN	50.000	365.000	.000	.008	.06400
MIDWIT	75.000	730.000	.000	.013	.07500
GROOTWIT	100.000	1460.000	.000	.005	.07500
MIDROOF	75.000	730.000	.000	.008	.08300
GROOTROOF	100.000	1460.000	.000	.003	-9.00000
AAL	200.000	9999.000	.000	.042	.90900
KUIFEEND	365.000	1095.000	.000	.240	.40000
AALSCH	365.000	1095.000	.000	.045	2.00000
FUUT	365.000	1095.000	.000	.056	-9.00000
STELTLOP	365.000	1095.000	.000	.056	-9.00000
KLUUT	365.000	1095.000	.000	.056	-9.00000
VISDIEFJE	365.000	1095.000	.000	.056	-9.00000

ZOPLANK	.0639	.0639	.0300	.0000	90.0000
MOLLKLEIN	.0639	.0639	.0300	.0000	90.0000
MOLLGROOT	.0639	.0639	.0300	.0000	90.0000
OLIGO	.0639	.0639	.0300	.0000	90.0000
CHIRONO	.0639	.0639	.0300	.0000	90.0000
MACRUST	.0639	.0639	.0300	.0000	90.0000
SLAK	.0639	.0639	.0300	.0000	90.0000
KLEIN	.0639	.0639	.0300	.0000	90.0000

MIDWIT	.0639	.0639	.0300	.0000	90.0000
GROOTWIT	.0639	.0639	.0300	.0000	90.0000
MIDROOF	.0639	.0639	.0300	.0000	90.0000
GROOTROOF	.0639	.0639	.0300	.0000	90.0000
AAL	.0000	.0000	.0000	.0000	90.0000
KUIFEEND	.0000	.0000	.0000	.0000	90.0000
AALSCH	.0000	.0000	.0000	.0000	90.0000
FUUT	.0000	.0000	.0000	.0000	90.0000
STELTLOP	.0000	.0000	.0000	.0000	90.0000
KLUUT	.0000	.0000	.0000	.0000	90.0000
VISDIEFJE	.0000	.0000	.0000	.0000	90.0000

55

ZOOPLANK	SUSDET	0.44
ZOOPLANK	FYTOPLANK	0.56
MOLLKLEIN	SUSDET	0.24
MOLLKLEIN	BOTDET	0.44
MOLLKLEIN	FYTOPLANK	0.32
MOLLGROOT	FYTOPLANK	0.45
MOLLGROOT	SUSDET	0.34
MOLLGROOT	MOLLGROOT	0.21
OLIGO	SUSDET	0.03
OLIGO	BOTDET	0.97
CHIRONO	SUSDET	0.03
CHIRONO	BOTDET	0.97
MACRUST	BOTDET	0.59
MACRUST	SUSDET	0.41
SLAK	BOTDET	1.00
KLEIN	ZOOPLANK	0.50
KLEIN	OLIGO	0.44
KLEIN	CHIRONO	0.02
KLEIN	MACRUST	0.04
MIDWIT	ZOOPLANK	0.00
MIDWIT	MOLLKLEIN	0.21
MIDWIT	SLAK	0.07
MIDWIT	OLIGO	0.53
MIDWIT	CHIRONO	0.02
MIDWIT	MACRUST	0.00
MIDWIT	BOTDET	0.17
GROOTWIT	OLIGO	0.14
GROOTWIT	CHIRONO	0.00
GROOTWIT	ZOOPLANK	0.00
GROOTWIT	MOLLKLEIN	0.02
GROOTWIT	SLAK	0.03
GROOTWIT	MACRUST	0.00
GROOTWIT	BOTDET	0.81
MIDROOF	KLEIN	0.74
MIDROOF	MIDWIT	0.26
GROOTROOF	KLEIN	0.74
GROOTROOF	MIDWIT	0.26
AAL	KLEIN	0.07

AAL	MIDWIT	0.02
AAL	GROOTWIT	0.66
AAL	MIDROOF	0.08
AAL	GROOTROOF	0.09
AAL	AAL	0.08
KUIFEEND	MOLLKLEIN	1.000
AALSCH	MIDWIT	.780
AALSCH	MIDROOF	.150
AALSCH	KLEIN	.050
AALSCH	AAL	.020
FUUT	KLEIN	1.000
STELTLOP	OLIGO	.40
STELTLOP	CHIRONO	.40
STELTLOP	MOLLKLEIN	.20
KLUUT	OLIGO	0.50
KLUUT	CHIRONO	0.50
VISDIEFJE	KLEIN	1.000

8

2.650
8.500
10.000
365.000
0.000
.000
.000
.000
hv0c
.000
365.000
4.000
8.000



Cadmium in ondiep zand  
file: Za6cad.chp

MER Haringvliet, huidige situatie  
cadmium -999.000 2

5  
PELAGIC DISS -99.00 .400E-01  
BENTHIC DISS -99.00 .62E-01  
FYTOPLANK .1500 5.00  
SUSDET .1500 5.00  
BOTDET .1500 7.692

19  
ZOOPLANK .0350 .0650 .3507 .1500 .4000  
MOLLKLEIN .0296 .0104 .2545 .1500 .4000  
MOLLGROOT .0015 .0005 .3964 .1500 .4000  
OLIGO .0600 .0200 .1070 .1500 .4000  
CHIRONO .0600 .0200 .1070 .1500 .4000  
MACRUST .0600 .0200 .1944 .1500 .4000  
SLAK .0600 .0200 .1000 .1500 .4000  
KLEIN .0344 .0086 .8000 .2500 .4000  
MIDWIT .0160 .0040 .3739 .2500 .4000  
GROOTWIT .0160 .0040 .1258 .2500 .4000  
MIDROOF .0120 .0030 .8000 .2500 .4000  
GROOTROOF .0120 .0030 .8000 .2500 .4000  
AAL .0180 .0020 .8000 .3300 .4000  
KUIFEEND .3000 .0014 .8000 .2500 .4000  
AALSCH .1100 .0002 .8000 .2500 .4000  
FUUT .2000 .0003 .8000 .2500 .4000  
STELTLOP .5000 .0015 .8000 .2500 .4000  
KLUUT .2000 .0003 .8000 .2500 .4000  
VISDIEFJE .5000 .0015 .8000 .2500 .4000

ZOOPLANK 1 1.000 .014 .001 .001  
MOLLKLEIN 1 .200 .024 .015 .015  
MOLLGROOT 1 .100 .015 .500 .500  
OLIGO 1 .010 .010 .015 .015  
CHIRONO 1 .010 .010 .015 .015  
MACRUST 1 .010 .015 .015 .015  
SLAK 1 .010 .017 .015 .015  
KLEIN 2 .000 .010 7.000 7.000  
MIDWIT 2 .000 .021 98.000 98.000  
GROOTWIT 2 .000 .026 500.000 500.000  
MIDROOF 2 .000 .007 98.000 98.000  
GROOTROOF 2 .000 .013 500.000 500.000  
AAL 2 .000 .183 100.000 100.000  
KUIFEEND 3 .000 .050 900.000 900.000  
AALSCH 3 .000 .129 2430.000 2430.000  
FUUT 3 .000 .050 1200.000 1200.000

STELTLOP 3 .000 .050 225.000 225.000  
KLUUT 3 .000 .050 360.000 360.000  
VISDIEFJE 3 .000 .050 125.000 125.000

ZOOPLANK .0050 .0050 .7500 1  
MOLLKLEIN .0050 .0050 .7500 1  
MOLLGROOT .0050 .0050 .7500 1  
OLIGO .0030 .0030 .7500 2  
CHIRONO .0050 .0050 .7500 2  
MACRUST .0050 .0050 .7500 1  
SLAK .0050 .0050 .7500 2  
KLEIN .0050 .0050 .7500 1  
MIDWIT .0050 .0020 .7500 1  
GROOTWIT .0050 .0020 .7500 1  
MIDROOF .0050 .0050 .7500 1  
GROOTROOF .0050 .0050 .7500 1  
AAL .0050 .0020 .7500 1  
KUIFEEND .0000 .0050 .7500 1  
AALSCH .0000 .0050 .7500 1  
FUUT .0000 .0050 .7500 1  
STELTLOP .0000 .0050 .7500 1  
KLUUT .0000 .0050 .7500 1  
VISDIEFJE .0000 .0050 .7500 1

ZOOPLANK 1.000 7.000 .000 .002 .01400  
MOLLKLEIN 100.000 730.000 .000 .003 .03800  
MOLLGROOT 100.000 730.000 .000 .002 .06000  
OLIGO 25.000 365.000 .000 .003 .01000  
CHIRONO 25.000 365.000 .000 .003 .01000  
MACRUST 200.000 730.000 .000 .003 .03800  
SLAK 100.000 365.000 .000 .003 .03800  
KLEIN 50.000 365.000 .000 .008 .06400  
MIDWIT 75.000 730.000 .000 .013 .07500  
GROOTWIT 100.000 1460.000 .000 .005 .07500  
MIDROOF 75.000 730.000 .000 .008 .08300  
GROOTROOF 100.000 1460.000 .000 .003 -9.00000  
AAL 200.000 9999.000 .000 .042 .90900  
KUIFEEND 365.000 1095.000 .000 .240 .40000  
AALSCH 365.000 1095.000 .000 .045 2.00000  
FUUT 365.000 1095.000 .000 .056 -9.00000  
STELTLOP 365.000 1095.000 .000 .056 -9.00000  
KLUUT 365.000 1095.000 .000 .056 -9.00000  
VISDIEFJE 365.000 1095.000 .000 .056 -9.00000

ZOOPLANK .0639 .0639 .0300 .0000 90.0000  
MOLLKLEIN .0639 .0639 .0300 .0000 90.0000  
MOLLGROOT .0639 .0639 .0300 .0000 90.0000  
OLIGO .0639 .0639 .0300 .0000 90.0000  
CHIRONO .0639 .0639 .0300 .0000 90.0000  
MACRUST .0639 .0639 .0300 .0000 90.0000  
SLAK .0639 .0639 .0300 .0000 90.0000

KLEIN	.0639	.0639	.0300	.0000	90.0000
MIDWIT	.0639	.0639	.0300	.0000	90.0000
GROOTWIT	.0639	.0639	.0300	.0000	90.0000
MIDROOF	.0639	.0639	.0300	.0000	90.0000
GROOTROOF	.0639	.0639	.0300	.0000	90.0000
AAL	.0000	.0000	.0000	.0000	90.0000
KUIFEEND	.0000	.0000	.0000	.0000	90.0000
AALSCH	.0000	.0000	.0000	.0000	90.0000
FUUT	.0000	.0000	.0000	.0000	90.0000
STELTLOP	.0000	.0000	.0000	.0000	90.0000
KLUUT	.0000	.0000	.0000	.0000	90.0000
VISDIEFJE	.0000	.0000	.0000	.0000	90.0000

55

ZOOPLANK	SUSDET	0.42
ZOOPLANK	FYTOPLANK	0.58
MOLLKLEIN	SUSDET	0.60
MOLLKLEIN	BOTDET	0.12
MOLLKLEIN	FYTOPLANK	0.27
MOLLGROOT	FYTOPLANK	0.45
MOLLGROOT	SUSDET	0.34
MOLLGROOT	MOLLGROOT	0.21
OLIGO	SUSDET	0.10
OLIGO	BOTDET	0.90
CHIRONO	SUSDET	0.10
CHIRONO	BOTDET	0.90
MACRUST	BOTDET	0.27
MACRUST	SUSDET	0.73
SLAK	BOTDET	1.00
KLEIN	ZOOPLANK	0.82
KLEIN	OLIGO	0.09
KLEIN	CHIRONO	0.04
KLEIN	MACRUST	0.04
MIDWIT	ZOOPLANK	0.00
MIDWIT	MOLLKLEIN	0.12
MIDWIT	SLAK	0.20
MIDWIT	OLIGO	0.34
MIDWIT	CHIRONO	0.16
MIDWIT	MACRUST	0.01
MIDWIT	BOTDET	0.16
GROOTWIT	OLIGO	0.09
GROOTWIT	CHIRONO	0.04
GROOTWIT	ZOOPLANK	0.00
GROOTWIT	MOLLKLEIN	0.01
GROOTWIT	SLAK	0.09
GROOTWIT	MACRUST	0.01
GROOTWIT	BOTDET	0.77
MIDROOF	KLEIN	0.76
MIDROOF	MIDWIT	0.24
GROOTROOF	KLEIN	0.76
GROOTROOF	MIDWIT	0.24

AAL	KLEIN	0.27
AAL	MIDWIT	0.07
AAL	GROOTWIT	0.41
AAL	MIDROOF	0.11
AAL	GROOTROOF	0.06
AAL	AAL	0.08
KUIFEEND	MOLLKLEIN	1.00
AALSCH	MIDWIT	.780
AALSCH	MIDROOF	.150
AALSCH	KLEIN	.050
AALSCH	AAL	.020
FUUT	KLEIN	1.00
STELTLOP	OLIGO	.40
STELTLOP	CHIRONO	.40
STELTLOP	MOLLKLEIN	.20
KLUUT	OLIGO	0.50
KLUUT	CHIRONO	0.50
VISDIEFJE	KLEIN	1.00

8

2.650

8.500

10.000

365.000

0.000

.000

.000

.000

hv0c

.000 365.000 4.000 8.000

Cadmium in intergetijdenzone  
file: In6cad.chp

MER Haringvliet, huidige situatie  
cadmium -999.000 2

5

PELAGIC DISS -99.00 .400E-01  
BENTHIC DISS -99.00 .35E-01  
FYTOPLANK .1500 5.00  
SUDET .1500 5.00  
BOTDET .1500 4.372

19

ZOPLANK	.0350	.0650	.3531	.1500	.4000
MOLLKLEIN	.0259	.0091	.2326	.1500	.4000
MOLLGROOT	.0015	.0005	.3965	.1500	.4000
OLIGO	.0600	.0200	.1034	.1500	.4000
CHIRONO	.0600	.0200	.1034	.1500	.4000
MACRUST	.0600	.0200	.1595	.1500	.4000
SLAK	.0600	.0200	.1000	.1500	.4000
KLEIN	.0344	.0086	.8000	.2500	.4000
MIDWIT	.0160	.0040	.4085	.2500	.4000
GROOTWIT	.0160	.0040	.1311	.2500	.4000
MIDROOF	.0120	.0030	.8000	.2500	.4000
GROOTROOF	.0120	.0030	.8000	.2500	.4000
AAL	.0180	.0020	.8000	.3300	.4000
KUIFEEND	.3000	.0014	.8000	.2500	.4000
AALSCH	.1100	.0002	.8000	.2500	.4000
FUUT	.2000	.0003	.8000	.2500	.4000
STELTLOP	.5000	.0015	.8000	.2500	.4000
KLUUT	.2000	.0003	.8000	.2500	.4000
VISDIEFJE	.5000	.0015	.8000	.2500	.4000

ZOPLANK	1	1.000	.014	.001	.001
MOLLKLEIN	1	.200	.024	.015	.015
MOLLGROOT	1	.100	.015	.500	.500
OLIGO	1	.010	.010	.015	.015
CHIRONO	1	.010	.010	.015	.015
MACRUST	1	.010	.015	.015	.015
SLAK	1	.010	.017	.015	.015
KLEIN	2	.000	.010	7.000	7.000
MIDWIT	2	.000	.021	98.000	98.000
GROOTWIT	2	.000	.026	500.000	500.000
MIDROOF	2	.000	.007	98.000	98.000
GROOTROOF	2	.000	.013	500.000	500.000
AAL	2	.000	.183	100.000	100.000
KUIFEEND	3	.000	.050	900.000	900.000
AALSCH	3	.000	.129	2430.000	2430.000
FUUT	3	.000	.050	1200.000	1200.000
STELTLOP	3	.000	.050	225.000	225.000

KLUUT	3	.000	.050	360.000	360.000
VISDIEFJE	3	.000	.050	125.000	125.000

ZOPLANK	.0050	.0050	.7500	1
MOLLKLEIN	.0050	.0050	.7500	1
MOLLGROOT	.0050	.0050	.7500	1
OLIGO	.0030	.0030	.7500	2
CHIRONO	.0050	.0050	.7500	2
MACRUST	.0050	.0050	.7500	1
SLAK	.0050	.0050	.7500	2
KLEIN	.0050	.0050	.7500	1
MIDWIT	.0050	.0020	.7500	1
GROOTWIT	.0050	.0020	.7500	1
MIDROOF	.0050	.0050	.7500	1
GROOTROOF	.0050	.0050	.7500	1
AAL	.0050	.0020	.7500	1
KUIFEEND	.0000	.0050	.7500	1
AALSCH	.0000	.0050	.7500	1
FUUT	.0000	.0050	.7500	1
STELTLOP	.0000	.0050	.7500	1
KLUUT	.0000	.0050	.7500	1
VISDIEFJE	.0000	.0050	.7500	1

ZOPLANK	1.000	7.000	.000	.002	.01400
MOLLKLEIN	100.000	730.000	.000	.003	.03800
MOLLGROOT	100.000	730.000	.000	.002	.06000
OLIGO	25.000	365.000	.000	.003	.01000
CHIRONO	25.000	365.000	.000	.003	.01000
MACRUST	200.000	730.000	.000	.003	.03800
SLAK	100.000	365.000	.000	.003	.03800
KLEIN	50.000	365.000	.000	.008	.06400
MIDWIT	75.000	730.000	.000	.013	.07500
GROOTWIT	100.000	1460.000	.000	.005	.07500
MIDROOF	75.000	730.000	.000	.008	.08300
GROOTROOF	100.000	1460.000	.000	.003	-9.00000
AAL	200.000	9999.000	.000	.042	.90900
KUIFEEND	365.000	1095.000	.000	.240	.40000
AALSCH	365.000	1095.000	.000	.045	2.00000
FUUT	365.000	1095.000	.000	.056	-9.00000
STELTLOP	365.000	1095.000	.000	.056	-9.00000
KLUUT	365.000	1095.000	.000	.056	-9.00000
VISDIEFJE	365.000	1095.000	.000	.056	-9.00000

ZOPLANK	.0639	.0639	.0300	.0000	90.0000
MOLLKLEIN	.0639	.0639	.0300	.0000	90.0000
MOLLGROOT	.0639	.0639	.0300	.0000	90.0000
OLIGO	.0639	.0639	.0300	.0000	90.0000
CHIRONO	.0639	.0639	.0300	.0000	90.0000
MACRUST	.0639	.0639	.0300	.0000	90.0000
SLAK	.0639	.0639	.0300	.0000	90.0000
KLEIN	.0639	.0639	.0300	.0000	90.0000

MIDWIT	.0639	.0639	.0300	.0000	90.0000
GROOTWIT	.0639	.0639	.0300	.0000	90.0000
MIDROOF	.0639	.0639	.0300	.0000	90.0000
GROOTROOF	.0639	.0639	.0300	.0000	90.0000
AAL	.0000	.0000	.0000	.0000	90.0000
KUIFEEND	.0000	.0000	.0000	.0000	90.0000
AALSCH	.0000	.0000	.0000	.0000	90.0000
FUUT	.0000	.0000	.0000	.0000	90.0000
STELTLOP	.0000	.0000	.0000	.0000	90.0000
KLUUT	.0000	.0000	.0000	.0000	90.0000
VISDIEFJE	.0000	.0000	.0000	.0000	90.0000

55

ZOOPLANK	SUSDET	0.40
ZOOPLANK	FYTOPLANK	0.60
MOLLKLEIN	SUSDET	0.55
MOLLKLEIN	BOTDET	0.18
MOLLKLEIN	FYTOPLANK	0.27
MOLLGROOT	FYTOPLANK	0.45
MOLLGROOT	SUSDET	0.34
MOLLGROOT	MOLLGROOT	0.21
OLIGO	SUSDET	0.05
OLIGO	BOTDET	0.95
CHIRONO	SUSDET	0.05
CHIRONO	BOTDET	0.95
MACRUST	BOTDET	0.44
MACRUST	SUSDET	0.56
SLAK	BOTDET	1.00
KLEIN	ZOOPLANK	0.60
KLEIN	OLIGO	0.11
KLEIN	CHIRONO	0.24
KLEIN	MACRUST	0.04
MIDWIT	ZOOPLANK	0.00
MIDWIT	MOLLKLEIN	0.06
MIDWIT	SLAK	0.14
MIDWIT	OLIGO	0.22
MIDWIT	CHIRONO	0.44
MIDWIT	MACRUST	0.01
MIDWIT	BOTDET	0.14
GROOTWIT	OLIGO	0.07
GROOTWIT	CHIRONO	0.13
GROOTWIT	ZOOPLANK	0.00
GROOTWIT	MOLLKLEIN	0.01
GROOTWIT	SLAK	0.07
GROOTWIT	MACRUST	0.00
GROOTWIT	BOTDET	0.73
MIDROOF	KLEIN	0.88
MIDROOF	MIDWIT	0.12
GROOTROOF	KLEIN	0.88
GROOTROOF	MIDWIT	0.12
AAL	KLEIN	0.53

AAL	MIDWIT	0.06
AAL	GROOTWIT	0.14
AAL	MIDROOF	0.14
AAL	GROOTROOF	0.05
AAL	AAL	0.08
KUIFEEND	MOLLKLEIN	1.00
AALSCH	MIDWIT	.780
AALSCH	MIDROOF	.150
AALSCH	KLEIN	.050
AALSCH	AAL	.020
FUUT	KLEIN	1.00
STELTLOP	OLIGO	.40
STELTLOP	CHIRONO	.40
STELTLOP	MOLLKLEIN	.20
KLUUT	OLIGO	0.50
KLUUT	CHIRONO	0.50
VISDIEFJE	KLEIN	1.00

8

2.650
8.500
10.000
365.000
0.000
.000
.000
.000
hv0c
.000
365.000
4.000
8.000

Cadmium in diep instabiel slib  
file: Ds6cad.chp

MER Haringvliet, huidige situatie  
cadmium -999.000 2

5

PELAGIC DISS -99.00 .400E-01  
BENTHIC DISS -99.00 .98E-01  
FYTOPLANK .1500 5.00  
SUSDET .1500 5.00  
BOTDET .1500 12.19

19

ZOPLANK	.0350	.0650	.3501	.1500	.4000
MOLLKLEIN	.0259	.0091	.1761	.1500	.4000
MOLLGROOT	.0015	.0005	.3963	.1500	.4000
OLIGO	.0600	.0200	.1020	.1500	.4000
CHIRONO	.0600	.0200	.1020	.1500	.4000
MACRUST	.0600	.0200	.1403	.1500	.4000
SLAK	.0600	.0200	.1000	.1500	.4000
KLEIN	.0344	.0086	.8000	.2500	.4000
MIDWIT	.0160	.0040	.3392	.2500	.4000
GROOTWIT	.0160	.0040	.1186	.2500	.4000
MIDROOF	.0120	.0030	.8000	.2500	.4000
GROOTROOF	.0120	.0030	.8000	.2500	.4000
AAL	.0180	.0020	.8000	.3300	.4000
KUIFEEND	.3000	.0014	.8000	.2500	.4000
AALSCH	.1100	.0002	.8000	.2500	.4000
FUUT	.2000	.0003	.8000	.2500	.4000
STELTLOP	.5000	.0015	.8000	.2500	.4000
KLUUT	.2000	.0003	.8000	.2500	.4000
VISDIEFJE	.5000	.0015	.8000	.2500	.4000

ZOPLANK	1	1.000	.014	.001	.001
MOLLKLEIN	1	.200	.024	.015	.015
MOLLGROOT	1	.100	.015	.500	.500
OLIGO	1	.010	.010	.015	.015
CHIRONO	1	.010	.010	.015	.015
MACRUST	1	.010	.015	.015	.015
SLAK	1	.010	.017	.015	.015
KLEIN	2	.000	.010	7.000	7.000
MIDWIT	2	.000	.021	98.000	98.000
GROOTWIT	2	.000	.026	500.000	500.000
MIDROOF	2	.000	.007	98.000	98.000
GROOTROOF	2	.000	.013	500.000	500.000
AAL	2	.000	.183	100.000	100.000
KUIFEEND	3	.000	.050	900.000	900.000
AALSCH	3	.000	.129	2430.000	2430.000
FUUT	3	.000	.050	1200.000	1200.000
STELTLOP	3	.000	.050	225.000	225.000

KLUUT	3	.000	.050	360.000	360.000
VISDIEFJE	3	.000	.050	125.000	125.000

ZOPLANK	.0050	.0050	.7500	1
MOLLKLEIN	.0050	.0050	.7500	1
MOLLGROOT	.0050	.0050	.7500	1
OLIGO	.0030	.0030	.7500	2
CHIRONO	.0050	.0050	.7500	2
MACRUST	.0050	.0050	.7500	1
SLAK	.0050	.0050	.7500	2
KLEIN	.0050	.0050	.7500	1
MIDWIT	.0050	.0020	.7500	1
GROOTWIT	.0050	.0020	.7500	1
MIDROOF	.0050	.0050	.7500	1
GROOTROOF	.0050	.0050	.7500	1
AAL	.0050	.0020	.7500	1
KUIFEEND	.0000	.0050	.7500	1
AALSCH	.0000	.0050	.7500	1
FUUT	.0000	.0050	.7500	1
STELTLOP	.0000	.0050	.7500	1
KLUUT	.0000	.0050	.7500	1
VISDIEFJE	.0000	.0050	.7500	1

ZOPLANK	1.000	7.000	.000	.002	.01400
MOLLKLEIN	100.000	730.000	.000	.003	.03800
MOLLGROOT	100.000	730.000	.000	.002	.06000
OLIGO	25.000	365.000	.000	.003	.01000
CHIRONO	25.000	365.000	.000	.003	.01000
MACRUST	200.000	730.000	.000	.003	.03800
SLAK	100.000	365.000	.000	.003	.03800
KLEIN	50.000	365.000	.000	.008	.06400
MIDWIT	75.000	730.000	.000	.013	.07500
GROOTWIT	100.000	1460.000	.000	.005	.07500
MIDROOF	75.000	730.000	.000	.008	.08300
GROOTROOF	100.000	1460.000	.000	.003	-9.00000
AAL	200.000	9999.000	.000	.042	.90900
KUIFEEND	365.000	1095.000	.000	.240	.40000
AALSCH	365.000	1095.000	.000	.045	2.00000
FUUT	365.000	1095.000	.000	.056	-9.00000
STELTLOP	365.000	1095.000	.000	.056	-9.00000
KLUUT	365.000	1095.000	.000	.056	-9.00000
VISDIEFJE	365.000	1095.000	.000	.056	-9.00000

ZOPLANK	.0639	.0639	.0300	.0000	90.0000
MOLLKLEIN	.0639	.0639	.0300	.0000	90.0000
MOLLGROOT	.0639	.0639	.0300	.0000	90.0000
OLIGO	.0639	.0639	.0300	.0000	90.0000
CHIRONO	.0639	.0639	.0300	.0000	90.0000
MACRUST	.0639	.0639	.0300	.0000	90.0000
SLAK	.0639	.0639	.0300	.0000	90.0000
KLEIN	.0639	.0639	.0300	.0000	90.0000

MIDWIT	.0639	.0639	.0300	.0000	90.0000
GROOTWIT	.0639	.0639	.0300	.0000	90.0000
MIDROOF	.0639	.0639	.0300	.0000	90.0000
GROOTROOF	.0639	.0639	.0300	.0000	90.0000
AAL	.0000	.0000	.0000	.0000	90.0000
KUIFEEND	.0000	.0000	.0000	.0000	90.0000
AALSCH	.0000	.0000	.0000	.0000	90.0000
FUUT	.0000	.0000	.0000	.0000	90.0000
STELTLOP	.0000	.0000	.0000	.0000	90.0000
KLUUT	.0000	.0000	.0000	.0000	90.0000
VISDIEFJE	.0000	.0000	.0000	.0000	90.0000

55

ZOOPLANK	SUSDET	0.43
ZOOPLANK	FYTOPLANK	0.57
MOLLKLEIN	SUSDET	0.43
MOLLKLEIN	BOTDET	0.38
MOLLKLEIN	FYTOPLANK	0.19
MOLLGROOT	FYTOPLANK	0.00
MOLLGROOT	SUSDET	0.00
MOLLGROOT	MOLLGROOT	0.00
OLIGO	SUSDET	0.03
OLIGO	BOTDET	0.97
CHIRONO	SUSDET	0.03
CHIRONO	BOTDET	0.97
MACRUST	BOTDET	0.57
MACRUST	SUSDET	0.43
SLAK	BOTDET	1.00
KLEIN	ZOOPLANK	0.49
KLEIN	OLIGO	0.46
KLEIN	CHIRONO	0.01
KLEIN	MACRUST	0.04
MIDWIT	ZOOPLANK	0.00
MIDWIT	MOLLKLEIN	0.09
MIDWIT	SLAK	0.01
MIDWIT	OLIGO	0.69
MIDWIT	CHIRONO	0.01
MIDWIT	MACRUST	0.01
MIDWIT	BOTDET	0.19
GROOTWIT	OLIGO	0.16
GROOTWIT	CHIRONO	0.00
GROOTWIT	ZOOPLANK	0.00
GROOTWIT	MOLLKLEIN	0.01
GROOTWIT	SLAK	0.00
GROOTWIT	MACRUST	0.00
GROOTWIT	BOTDET	0.82
MIDROOF	KLEIN	0.72
MIDROOF	MIDWIT	0.28
GROOTROOF	KLEIN	0.72
GROOTROOF	MIDWIT	0.28
AAL	KLEIN	0.03

AAL	MIDWIT	0.01
AAL	GROOTWIT	0.70
AAL	MIDROOF	0.08
AAL	GROOTROOF	0.10
AAL	AAL	0.08
KUIFEEND	MOLLKLEIN	1.00
AALSCH	MIDWIT	.780
AALSCH	MIDROOF	.150
AALSCH	KLEIN	.050
AALSCH	AAL	.020
FUUT	KLEIN	1.00
STELTLOP	OLIGO	.40
STELTLOP	CHIRONO	.40
STELTLOP	MOLLKLEIN	.20
KLUUT	OLIGO	0.50
KLUUT	CHIRONO	0.50
VISDIEFJE	KLEIN	1.00

8

2.650
8.500
10.000
365.000
0.000
.000
.000
.000
hv0c
.000
365.000
4.000
8.000

**Cadmium in ondiep stabiel slib**  
file: Ss6cad.chp

MER Haringvliet, huidige situatie  
cadmium -999.000 2

5  
PELAGIC DISS -99.00 .400E-01  
BENTHIC DISS -99.00 .49E-01  
FYTOPLANK .1500 5.00  
SUSDET .1500 5.00  
BOTDET .1500 6.135

19  
ZOOPLANK .0350 .0650 .3516 .1500 .4000  
MOLLKLEIN .0259 .0091 .1956 .1500 .4000  
MOLLGROOT .0015 .0005 .3966 .1500 .4000  
OLIGO .0600 .0200 .1011 .1500 .4000  
CHIRONO .0600 .0200 .1011 .1500 .4000  
MACRUST .0600 .0200 .1237 .1500 .4000  
SLAK .0600 .0200 .1000 .1500 .4000  
KLEIN .0344 .0086 .8000 .2500 .4000  
MIDWIT .0160 .0040 .1890 .2500 .4000  
GROOTWIT .0160 .0040 .1052 .2500 .4000  
MIDROOF .0120 .0030 .8000 .2500 .4000  
GROOTROOF .0120 .0030 .8000 .2500 .4000  
AAL .0180 .0020 .8000 .3300 .4000  
KUIFEEND .3000 .0014 .8000 .2500 .4000  
AALSCH .1100 .0002 .8000 .2500 .4000  
FUUT .2000 .0003 .8000 .2500 .4000  
STELTLOP .5000 .0015 .8000 .2500 .4000  
KLUUT .2000 .0003 .8000 .2500 .4000  
VISDIEFJE .5000 .0015 .8000 .2500 .4000

ZOOPLANK 1 1.000 .014 .001 .001  
MOLLKLEIN 1 .200 .024 .015 .015  
MOLLGROOT 1 .100 .015 .500 .500  
OLIGO 1 .010 .010 .015 .015  
CHIRONO 1 .010 .010 .015 .015  
MACRUST 1 .010 .015 .015 .015  
SLAK 1 .010 .017 .015 .015  
KLEIN 2 .000 .010 7.000 7.000  
MIDWIT 2 .000 .021 98.000 98.000  
GROOTWIT 2 .000 .026 500.000 500.000  
MIDROOF 2 .000 .007 98.000 98.000  
GROOTROOF 2 .000 .013 500.000 500.000  
AAL 2 .000 .183 100.000 100.000  
KUIFEEND 3 .000 .050 900.000 900.000  
AALSCH 3 .000 .129 2430.000 2430.000  
FUUT 3 .000 .050 1200.000 1200.000  
STELTLOP 3 .000 .050 225.000 225.000

KLUUT 3 .000 .050 360.000 360.000  
VISDIEFJE 3 .000 .050 125.000 125.000

ZOOPLANK .0050 .0050 .7500 1  
MOLLKLEIN .0050 .0050 .7500 1  
MOLLGROOT .0050 .0050 .7500 1  
OLIGO .0030 .0030 .7500 2  
CHIRONO .0050 .0050 .7500 2  
MACRUST .0050 .0050 .7500 1  
SLAK .0050 .0050 .7500 2  
KLEIN .0050 .0050 .7500 1  
MIDWIT .0050 .0020 .7500 1  
GROOTWIT .0050 .0020 .7500 1  
MIDROOF .0050 .0050 .7500 1  
GROOTROOF .0050 .0050 .7500 1  
AAL .0050 .0020 .7500 1  
KUIFEEND .0000 .0050 .7500 1  
AALSCH .0000 .0050 .7500 1  
FUUT .0000 .0050 .7500 1  
STELTLOP .0000 .0050 .7500 1  
KLUUT .0000 .0050 .7500 1  
VISDIEFJE .0000 .0050 .7500 1

ZOOPLANK 1.000 7.000 .000 .002 .01400  
MOLLKLEIN 100.000 730.000 .000 .003 .03800  
MOLLGROOT 100.000 730.000 .000 .002 .06000  
OLIGO 25.000 365.000 .000 .003 .01000  
CHIRONO 25.000 365.000 .000 .003 .01000  
MACRUST 200.000 730.000 .000 .003 .03800  
SLAK 100.000 365.000 .000 .003 .03800  
KLEIN 50.000 365.000 .000 .008 .06400  
MIDWIT 75.000 730.000 .000 .013 .07500  
GROOTWIT 100.000 1460.000 .000 .005 .07500  
MIDROOF 75.000 730.000 .000 .008 .08300  
GROOTROOF 100.000 1460.000 .000 .003 -9.00000  
AAL 200.000 9999.000 .000 .042 .90900  
KUIFEEND 365.000 1095.000 .000 .240 .40000  
AALSCH 365.000 1095.000 .000 .045 2.00000  
FUUT 365.000 1095.000 .000 .056 -9.00000  
STELTLOP 365.000 1095.000 .000 .056 -9.00000  
KLUUT 365.000 1095.000 .000 .056 -9.00000  
VISDIEFJE 365.000 1095.000 .000 .056 -9.00000

ZOOPLANK .0639 .0639 .0300 .0000 90.0000  
MOLLKLEIN .0639 .0639 .0300 .0000 90.0000  
MOLLGROOT .0639 .0639 .0300 .0000 90.0000  
OLIGO .0639 .0639 .0300 .0000 90.0000  
CHIRONO .0639 .0639 .0300 .0000 90.0000  
MACRUST .0639 .0639 .0300 .0000 90.0000  
SLAK .0639 .0639 .0300 .0000 90.0000  
KLEIN .0639 .0639 .0300 .0000 90.0000

MIDWIT	.0639	.0639	.0300	.0000	90.0000
GROOTWIT	.0639	.0639	.0300	.0000	90.0000
MIDROOF	.0639	.0639	.0300	.0000	90.0000
GROOTROOF	.0639	.0639	.0300	.0000	90.0000
AAL	.0000	.0000	.0000	.0000	90.0000
KUIFEEND	.0000	.0000	.0000	.0000	90.0000
AALSCH	.0000	.0000	.0000	.0000	90.0000
FUUT	.0000	.0000	.0000	.0000	90.0000
STELTLOP	.0000	.0000	.0000	.0000	90.0000
KLUUT	.0000	.0000	.0000	.0000	90.0000
VISDIEFJE	.0000	.0000	.0000	.0000	90.0000

55

ZOOPLANK	SUSDET	0.41
ZOOPLANK	FYTOPLANK	0.59
MOLLKLEIN	SUSDET	0.46
MOLLKLEIN	BOTDET	0.30
MOLLKLEIN	FYTOPLANK	0.24
MOLLGROOT	FYTOPLANK	0.45
MOLLGROOT	SUSDET	0.34
MOLLGROOT	MOLLGROOT	0.21
OLIGO	SUSDET	0.02
OLIGO	BOTDET	0.98
CHIRONO	SUSDET	0.02
CHIRONO	BOTDET	0.98
MACRUST	BOTDET	0.71
MACRUST	SUSDET	0.29
SLAK	BOTDET	1.00
KLEIN	ZOOPLANK	0.79
KLEIN	OLIGO	0.13
KLEIN	CHIRONO	0.05
KLEIN	MACRUST	0.03
MIDWIT	ZOOPLANK	0.00
MIDWIT	MOLLKLEIN	0.16
MIDWIT	SLAK	0.08
MIDWIT	OLIGO	0.22
MIDWIT	CHIRONO	0.08
MIDWIT	MACRUST	0.01
MIDWIT	BOTDET	0.46
GROOTWIT	OLIGO	0.03
GROOTWIT	CHIRONO	0.01
GROOTWIT	ZOOPLANK	0.00
GROOTWIT	MOLLKLEIN	0.01
GROOTWIT	SLAK	0.01
GROOTWIT	MACRUST	0.00
GROOTWIT	BOTDET	0.94
MIDROOF	KLEIN	0.80
MIDROOF	MIDWIT	0.20
GROOTROOF	KLEIN	0.80
GROOTROOF	MIDWIT	0.20
AAL	KLEIN	0.22

AAL	MIDWIT	0.05
AAL	GROOTWIT	0.51
AAL	MIDROOF	0.07
AAL	GROOTROOF	0.06
AAL	AAL	0.08
KUIFEEND	MOLLKLEIN	1.00
AALSCH	MIDWIT	.780
AALSCH	MIDROOF	.150
AALSCH	KLEIN	.050
AALSCH	AAL	.020
FUUT	KLEIN	1.00
STELTLOP	OLIGO	.800
STELTLOP	CHIRONO	.800
STELTLOP	MOLLKLEIN	.200
KLUUT	OLIGO	1.00
KLUUT	CHIRONO	1.00
VISDIEFJE	KLEIN	1.00

8

2.650
8.500
10.000
365.000
0.000
.000
.000
.000
hv0c
.000
365.000
4.000
8.000



PCB in gehele Haringvliet  
file: Re6pcb.chp

MER Haringvliet, huidige situatie

PCB153 6.510 1

5

PELAGIC DISS -99.00 .121  
BENTHIC DISS -99.00 .127  
FYTOPLANK .1500 227.  
SUSDET .1500 227.  
BOTDET .1500 239.

19

ZOOPLANK	.0350	.0650	.3491	.1500	.4000
MOLLKLEIN	.0259	.0091	.1777	.1500	.4000
MOLLGROOT	.0015	.0005	.3964	.1500	.4000
OLIGO	.0600	.0200	.1018	.1500	.4000
CHIRONO	.0600	.0200	.1018	.1500	.4000
MACRUST	.0600	.0200	.1374	.1500	.4000
SLAK	.0600	.0200	.1000	.1500	.4000
KLEIN	.0344	.0086	.8000	.2500	.4000
MIDWIT	.0160	.0040	.3641	.2500	.4000
GROOTWIT	.0160	.0040	.1205	.2500	.4000
MIDROOF	.0120	.0030	.8000	.2500	.4000
GROOTROOF	.0120	.0030	.8000	.2500	.4000
AAL	.0180	.0020	.8000	.3300	.4000
KUIFEEND	.3000	.0014	.8000	.2500	.4000
AALSCH	.1100	.0002	.8000	.2500	.4000
FUUT	.2000	.0003	.8000	.2500	.4000
STELTLOP	.5000	.0015	.8000	.2500	.4000
KLUUT	.2000	.0003	.8000	.2500	.4000
VISDIEFJE	.5000	.0015	.8000	.2500	.4000

ZOOPLANK	1	1.000	.014	.001	.001
MOLLKLEIN	1	.200	.024	.015	.015
MOLLGROOT	1	.100	.015	.500	.500
OLIGO	1	.010	.020	.015	.015
CHIRONO	1	.010	.010	.015	.015
MACRUST	1	.010	.015	.015	.015
SLAK	1	.010	.017	.015	.015
KLEIN	2	.000	.010	7.000	7.000
MIDWIT	2	.000	.021	98.000	98.000
GROOTWIT	2	.000	.026	500.000	500.000
MIDROOF	2	.000	.007	98.000	98.000
GROOTROOF	2	.000	.013	500.000	500.000
AAL	2	.000	.183	100.000	100.000
KUIFEEND	3	.000	.050	900.000	900.000
AALSCH	3	.000	.129	2430.000	2430.000
FUUT	3	.000	.050	1200.000	1200.000
STELTLOP	3	.000	.050	225.000	225.000

KLUUT	3	.000	.050	360.000	360.000
VISDIEFJE	3	.000	.050	125.000	125.000

ZOOPLANK	.1000	.100	.7500	1
MOLLKLEIN	.1000	.100	.7500	1
MOLLGROOT	.1000	.100	.7500	1
OLIGO	.1000	.020	.7500	2
CHIRONO	.1000	.020	.7500	2
MACRUST	.1000	.100	.7500	1
SLAK	.1000	.020	.7500	2
KLEIN	.6000	.6000	.7500	1
MIDWIT	.6000	.2000	.7500	1
GROOTWIT	.6000	.2000	.7500	1
MIDROOF	.6000	.6000	.7500	1
GROOTROOF	.6000	.6000	.7500	1
AAL	.6000	.2000	.7500	1
KUIFEEND	.0000	.0700	.7500	1
AALSCH	.0000	.2000	.7500	1
FUUT	.0000	.2000	.7500	1
STELTLOP	.0000	.0700	.7500	1
KLUUT	.0000	.0700	.7500	1
VISDIEFJE	.0000	.2000	.7500	1

ZOOPLANK	1.000	7.000	.000	.002	.01400
MOLLKLEIN	100.000	730.000	.000	.003	.03800
MOLLGROOT	100.000	730.000	.000	.002	.06000
OLIGO	25.000	365.000	.000	.003	.01000
CHIRONO	25.000	365.000	.000	.003	.01000
MACRUST	200.000	730.000	.000	.003	.03800
SLAK	100.000	365.000	.000	.003	.03800
KLEIN	50.000	365.000	.000	.008	.06400
MIDWIT	75.000	730.000	.000	.013	.07500
GROOTWIT	100.000	1460.000	.000	.005	.07500
MIDROOF	75.000	730.000	.000	.008	.08300
GROOTROOF	100.000	1460.000	.000	.003	-9.00000
AAL	200.000	9999.000	.000	.042	.90900
KUIFEEND	365.000	1095.000	.002	.240	.40000
AALSCH	365.000	1095.000	.000	.045	2.00000
FUUT	365.000	1095.000	.001	.056	-9.00000
STELTLOP	365.000	1095.000	.002	.056	-9.00000
KLUUT	365.000	1095.000	.001	.056	-9.00000
VISDIEFJE	365.000	1095.000	.002	.056	-9.00000

ZOOPLANK	.0639	.0639	.0300	.0000	90.0000
MOLLKLEIN	.0639	.0639	.0300	.0000	90.0000
MOLLGROOT	.0639	.0639	.0300	.0000	90.0000
OLIGO	.0639	.0639	.0300	.0000	90.0000
CHIRONO	.0639	.0639	.0300	.0000	90.0000
MACRUST	.0639	.0639	.0300	.0000	90.0000
SLAK	.0639	.0639	.0300	.0000	90.0000
KLEIN	.0639	.0639	.0300	.0000	90.0000

MIDWIT	.0639	.0639	.0300	.0000	90.0000
GROOTWIT	.0639	.0639	.0300	.0000	90.0000
MIDROOF	.0639	.0639	.0300	.0000	90.0000
GROOTROOF	.0639	.0639	.0300	.0000	90.0000
AAL	.0000	.0000	.0000	.0000	90.0000
KUIFEEND	.0000	.0000	.0000	.0000	90.0000
AALSCH	.0000	.0000	.0000	.0000	90.0000
FUUT	.0000	.0000	.0000	.0000	90.0000
STELTLOP	.0000	.0000	.0000	.0000	90.0000
KLUUT	.0000	.0000	.0000	.0000	90.0000
VISDIEFJE	.0000	.0000	.0000	.0000	90.0000

55

ZOOPLANK	SUSDET	0.44
ZOOPLANK	FYTOPLANK	0.56
MOLLKLEIN	SUSDET	0.44
MOLLKLEIN	BOTDET	0.37
MOLLKLEIN	FYTOPLANK	0.190
MOLLGROOT	FYTOPLANK	0.45
MOLLGROOT	SUSDET	0.34
MOLLGROOT	MOLLGROOT	0.21
OLIGO	SUSDET	0.03
OLIGO	BOTDET	0.97
CHIRONO	SUSDET	0.03
CHIRONO	BOTDET	0.97
MACRUST	BOTDET	0.59
MACRUST	SUSDET	0.41
SLAK	BOTDET	1.00
KLEIN	ZOOPLANK	0.50
KLEIN	OLIGO	0.44
KLEIN	CHIRONO	0.02
KLEIN	MACRUST	0.04
MIDWIT	ZOOPLANK	0.00
MIDWIT	MOLLKLEIN	0.21
MIDWIT	SLAK	0.07
MIDWIT	OLIGO	0.53
MIDWIT	CHIRONO	0.02
MIDWIT	MACRUST	0.0001
MIDWIT	BOTDET	0.17
GROOTWIT	OLIGO	0.14
GROOTWIT	CHIRONO	0.0001
GROOTWIT	ZOOPLANK	0.0001
GROOTWIT	MOLLKLEIN	0.02
GROOTWIT	SLAK	0.03
GROOTWIT	MACRUST	0.0001
GROOTWIT	BOTDET	0.81
MIDROOF	KLEIN	0.74
MIDROOF	MIDWIT	0.26
GROOTROOF	KLEIN	0.74
GROOTROOF	MIDWIT	0.26
AAL	KLEIN	0.07

AAL	MIDWIT	0.02
AAL	GROOTWIT	0.66
AAL	MIDROOF	0.08
AAL	GROOTROOF	0.09
AAL	AAL	0.08
KUIFEEND	MOLLKLEIN	1.00
AALSCH	MIDWIT	.780
AALSCH	MIDROOF	.150
AALSCH	KLEIN	.050
AALSCH	AAL	.020
FUUT	KLEIN	1.00
STELTLOP	OLIGO	.40
STELTLOP	CHIRONO	.40
STELTLOP	MOLLKLEIN	.20
KLUUT	OLIGO	0.5
KLUUT	CHIRONO	0.5
VISDIEFJE	KLEIN	1.00

8

2.650  
8.500  
10.000  
365.000  
0.000  
.000  
.000  
.000

hv0p

.000 365.000 4.000 8.000

PCB in ondiep zand  
file: Za6pcb.chp

MER Haringvliet, huidige situatie

PCB153 6.510 1

5

PELAGIC DISS -99.00 .121  
BENTHIC DISS -99.00 .098  
FYTOPLANK .1500 227.  
SUSDET .1500 227.  
BOTDET .1500 183.

19

ZOOPLANK	.0350	.0650	.3507	.1500	.4000
MOLLKLEIN	.0296	.0104	.2545	.1500	.4000
MOLLGROOT	.0015	.0005	.3964	.1500	.4000
OLIGO	.0600	.0200	.1070	.1500	.4000
CHIRONO	.0600	.0200	.1070	.1500	.4000
MACRUST	.0600	.0200	.1944	.1500	.4000
SLAK	.0600	.0200	.1000	.1500	.4000
KLEIN	.0344	.0086	.8000	.2500	.4000
MIDWIT	.0160	.0040	.3739	.2500	.4000
GROOTWIT	.0160	.0040	.1258	.2500	.4000
MIDROOF	.0120	.0030	.8000	.2500	.4000
GROOTROOF	.0120	.0030	.8000	.2500	.4000
AAL	.0180	.0020	.8000	.3300	.4000
KUIFEEND	.3000	.0014	.8000	.2500	.4000
AALSCH	.1100	.0002	.8000	.2500	.4000
FUUT	.2000	.0003	.8000	.2500	.4000
STELTLOP	.5000	.0015	.8000	.2500	.4000
KLUUT	.2000	.0003	.8000	.2500	.4000
VISDIEFJE	.5000	.0015	.8000	.2500	.4000

ZOOPLANK	1	1.000	.014	.001	.001
MOLLKLEIN	1	.200	.024	.015	.015
MOLLGROOT	1	.100	.015	.500	.500
OLIGO	1	.010	.020	.015	.015
CHIRONO	1	.010	.010	.015	.015
MACRUST	1	.010	.015	.015	.015
SLAK	1	.010	.017	.015	.015
KLEIN	2	.000	.010	7.000	7.000
MIDWIT	2	.000	.021	98.000	98.000
GROOTWIT	2	.000	.026	500.000	500.000
MIDROOF	2	.000	.007	98.000	98.000
GROOTROOF	2	.000	.013	500.000	500.000
AAL	2	.000	.183	100.000	100.000
KUIFEEND	3	.000	.050	900.000	900.000
AALSCH	3	.000	.129	2430.000	2430.000
FUUT	3	.000	.050	1200.000	1200.000
STELTLOP	3	.000	.050	225.000	225.000

KLUUT	3	.000	.050	360.000	360.000
VISDIEFJE	3	.000	.050	125.000	125.000

ZOOPLANK	.1000	.100	.7500	1
MOLLKLEIN	.1000	.100	.7500	1
MOLLGROOT	.1000	.100	.7500	1
OLIGO	.1000	.020	.7500	2
CHIRONO	.1000	.020	.7500	2
MACRUST	.1000	.100	.7500	1
SLAK	.1000	.020	.7500	2
KLEIN	.6000	.6000	.7500	1
MIDWIT	.6000	.2000	.7500	1
GROOTWIT	.6000	.2000	.7500	1
MIDROOF	.6000	.6000	.7500	1
GROOTROOF	.6000	.6000	.7500	1
AAL	.6000	.2000	.7500	1
KUIFEEND	.0000	.0700	.7500	1
AALSCH	.0000	.2000	.7500	1
FUUT	.0000	.2000	.7500	1
STELTLOP	.0000	.0700	.7500	1
KLUUT	.0000	.0700	.7500	1
VISDIEFJE	.0000	.2000	.7500	1

ZOOPLANK	1.000	7.000	.000	.002	.01400
MOLLKLEIN	100.000	730.000	.000	.003	.03800
MOLLGROOT	100.000	730.000	.000	.002	.06000
OLIGO	25.000	365.000	.000	.003	.01000
CHIRONO	25.000	365.000	.000	.003	.01000
MACRUST	200.000	730.000	.000	.003	.03800
SLAK	100.000	365.000	.000	.003	.03800
KLEIN	50.000	365.000	.000	.008	.06400
MIDWIT	75.000	730.000	.000	.013	.07500
GROOTWIT	100.000	1460.000	.000	.005	.07500
MIDROOF	75.000	730.000	.000	.008	.08300
GROOTROOF	100.000	1460.000	.000	.003	-9.00000
AAL	200.000	9999.000	.000	.042	.90900
KUIFEEND	365.000	1095.000	.002	.240	.40000
AALSCH	365.000	1095.000	.000	.045	2.00000
FUUT	365.000	1095.000	.001	.056	-9.00000
STELTLOP	365.000	1095.000	.002	.056	-9.00000
KLUUT	365.000	1095.000	.001	.056	-9.00000
VISDIEFJE	365.000	1095.000	.002	.056	-9.00000

ZOOPLANK	.0639	.0639	.0300	.0000	90.0000
MOLLKLEIN	.0639	.0639	.0300	.0000	90.0000
MOLLGROOT	.0639	.0639	.0300	.0000	90.0000
OLIGO	.0639	.0639	.0300	.0000	90.0000
CHIRONO	.0639	.0639	.0300	.0000	90.0000
MACRUST	.0639	.0639	.0300	.0000	90.0000
SLAK	.0639	.0639	.0300	.0000	90.0000
KLEIN	.0639	.0639	.0300	.0000	90.0000

MIDWIT	.0639	.0639	.0300	.0000	90.0000
GROOTWIT	.0639	.0639	.0300	.0000	90.0000
MIDROOF	.0639	.0639	.0300	.0000	90.0000
GROOTROOF	.0639	.0639	.0300	.0000	90.0000
AAL	.0000	.0000	.0000	.0000	90.0000
KUIFEEND	.0000	.0000	.0000	.0000	90.0000
AALSCH	.0000	.0000	.0000	.0000	90.0000
FUUT	.0000	.0000	.0000	.0000	90.0000
STELTLOP	.0000	.0000	.0000	.0000	90.0000
KLUUT	.0000	.0000	.0000	.0000	90.0000
VISDIEFJE	.0000	.0000	.0000	.0000	90.0000

55

ZOOPLANK	SUSDET	0.42
ZOOPLANK	FYTOPLANK	0.58
MOLLKLEIN	SUSDET	0.60
MOLLKLEIN	BOTDET	0.12
MOLLKLEIN	FYTOPLANK	0.27
MOLLGROOT	FYTOPLANK	0.45
MOLLGROOT	SUSDET	0.34
MOLLGROOT	MOLLGROOT	0.21
OLIGO	SUSDET	0.10
OLIGO	BOTDET	0.90
CHIRONO	SUSDET	0.10
CHIRONO	BOTDET	0.90
MACRUST	BOTDET	0.27
MACRUST	SUSDET	0.73
SLAK	BOTDET	1.00
KLEIN	ZOOPLANK	0.82
KLEIN	OLIGO	0.09
KLEIN	CHIRONO	0.04
KLEIN	MACRUST	0.04
MIDWIT	ZOOPLANK	0.00
MIDWIT	MOLLKLEIN	0.12
MIDWIT	SLAK	0.20
MIDWIT	OLIGO	0.34
MIDWIT	CHIRONO	0.16
MIDWIT	MACRUST	0.01
MIDWIT	BOTDET	0.16
GROOTWIT	OLIGO	0.09
GROOTWIT	CHIRONO	0.04
GROOTWIT	ZOOPLANK	0.00
GROOTWIT	MOLLKLEIN	0.01
GROOTWIT	SLAK	0.09
GROOTWIT	MACRUST	0.01
GROOTWIT	BOTDET	0.77
MIDROOF	KLEIN	0.76
MIDROOF	MIDWIT	0.24
GROOTROOF	KLEIN	0.76
GROOTROOF	MIDWIT	0.24
AAL	KLEIN	0.27

AAL	MIDWIT	0.07
AAL	GROOTWIT	0.41
AAL	MIDROOF	0.11
AAL	GROOTROOF	0.06
AAL	AAL	0.08
KUIFEEND	MOLLKLEIN	1.00
AALSCH	MIDWIT	.780
AALSCH	MIDROOF	.150
AALSCH	KLEIN	.050
AALSCH	AAL	.020
FUUT	KLEIN	1.00
STELTLOP	OLIGO	.40
STELTLOP	CHIRONO	.40
STELTLOP	MOLLKLEIN	.20
KLUUT	OLIGO	0.50
KLUUT	CHIRONO	0.50
VISDIEFJE	KLEIN	1.00

8

2.650
8.500
10.000
365.000
0.000
.000
.000
.000

hv0p

.000	365.000	4.000	8.000
------	---------	-------	-------

PCB in intergetijdenzone  
file: In6pcb.chp

MER Haringvliet, huidige situatie  
PCB153 6.510 1

5

PELAGIC DISS	-99.00	.121
BENTHIC DISS	-99.00	.092
FYTOPLANK	.1500	227.
SUSDET	.1500	227.
BOTDET	.1500	172.

19

ZOOPLANK	.0350	.0650	.3531	.1500	.4000
MOLLKLEIN	.0259	.0091	.2326	.1500	.4000
MOLLGROOT	.0015	.0005	.3965	.1500	.4000
OLIGO	.0600	.0200	.1034	.1500	.4000
CHIRONO	.0600	.0200	.1034	.1500	.4000
MACRUST	.0600	.0200	.1595	.1500	.4000
SLAK	.0600	.0200	.1000	.1500	.4000
KLEIN	.0344	.0086	.8000	.2500	.4000
MIDWIT	.0160	.0040	.4085	.2500	.4000
GROOTWIT	.0160	.0040	.1311	.2500	.4000
MIDROOF	.0120	.0030	.8000	.2500	.4000
GROOTROOF	.0120	.0030	.8000	.2500	.4000
AAL	.0180	.0020	.8000	.3300	.4000
KUIFEEND	.3000	.0014	.8000	.2500	.4000
AALSCH	.1100	.0002	.8000	.2500	.4000
FUUT	.2000	.0003	.8000	.2500	.4000
STELTLOP	.5000	.0015	.8000	.2500	.4000
KLUUT	.2000	.0003	.8000	.2500	.4000
VISDIEFJE	.5000	.0015	.8000	.2500	.4000

ZOOPLANK	1	1.000	.014	.001	.001
MOLLKLEIN	1	.200	.024	.015	.015
MOLLGROOT	1	.100	.015	.500	.500
OLIGO	1	.010	.020	.015	.015
CHIRONO	1	.010	.010	.015	.015
MACRUST	1	.010	.015	.015	.015
SLAK	1	.010	.017	.015	.015
KLEIN	2	.000	.010	7.000	7.000
MIDWIT	2	.000	.021	98.000	98.000
GROOTWIT	2	.000	.026	500.000	500.000
MIDROOF	2	.000	.007	98.000	98.000
GROOTROOF	2	.000	.013	500.000	500.000
AAL	2	.000	.183	100.000	100.000
KUIFEEND	3	.000	.050	900.000	900.000
AALSCH	3	.000	.129	2430.000	2430.000
FUUT	3	.000	.050	1200.000	1200.000
STELTLOP	3	.000	.050	225.000	225.000

KLUUT	3	.000	.050	360.000	360.000
VISDIEFJE	3	.000	.050	125.000	125.000

ZOOPLANK	.1000	.100	.7500	1
MOLLKLEIN	.1000	.100	.7500	1
MOLLGROOT	.1000	.100	.7500	1
OLIGO	.1000	.020	.7500	2
CHIRONO	.1000	.020	.7500	2
MACRUST	.1000	.100	.7500	1
SLAK	.1000	.020	.7500	2
KLEIN	.6000	.6000	.7500	1
MIDWIT	.6000	.2000	.7500	1
GROOTWIT	.6000	.2000	.7500	1
MIDROOF	.6000	.6000	.7500	1
GROOTROOF	.6000	.6000	.7500	1
AAL	.6000	.2000	.7500	1
KUIFEEND	.0000	.0700	.7500	1
AALSCH	.0000	.2000	.7500	1
FUUT	.0000	.2000	.7500	1
STELTLOP	.0000	.0700	.7500	1
KLUUT	.0000	.0700	.7500	1
VISDIEFJE	.0000	.2000	.7500	1

ZOOPLANK	1.000	7.000	.000	.002	.01400
MOLLKLEIN	100.000	730.000	.000	.003	.03800
MOLLGROOT	100.000	730.000	.000	.002	.06000
OLIGO	25.000	365.000	.000	.003	.01000
CHIRONO	25.000	365.000	.000	.003	.01000
MACRUST	200.000	730.000	.000	.003	.03800
SLAK	100.000	365.000	.000	.003	.03800
KLEIN	50.000	365.000	.000	.008	.06400
MIDWIT	75.000	730.000	.000	.013	.07500
GROOTWIT	100.000	1460.000	.000	.005	.07500
MIDROOF	75.000	730.000	.000	.008	.08300
GROOTROOF	100.000	1460.000	.000	.003	-9.00000
AAL	200.000	9999.000	.000	.042	.90900
KUIFEEND	365.000	1095.000	.002	.240	.40000
AALSCH	365.000	1095.000	.000	.045	2.00000
FUUT	365.000	1095.000	.001	.056	-9.00000
STELTLOP	365.000	1095.000	.002	.056	-9.00000
KLUUT	365.000	1095.000	.001	.056	-9.00000
VISDIEFJE	365.000	1095.000	.002	.056	-9.00000

ZOOPLANK	.0639	.0639	.0300	.0000	90.0000
MOLLKLEIN	.0639	.0639	.0300	.0000	90.0000
MOLLGROOT	.0639	.0639	.0300	.0000	90.0000
OLIGO	.0639	.0639	.0300	.0000	90.0000
CHIRONO	.0639	.0639	.0300	.0000	90.0000
MACRUST	.0639	.0639	.0300	.0000	90.0000
SLAK	.0639	.0639	.0300	.0000	90.0000
KLEIN	.0639	.0639	.0300	.0000	90.0000

MIDWIT	.0639	.0639	.0300	.0000	90.0000
GROOTWIT	.0639	.0639	.0300	.0000	90.0000
MIDROOF	.0639	.0639	.0300	.0000	90.0000
GROOTROOF	.0639	.0639	.0300	.0000	90.0000
AAL	.0000	.0000	.0000	.0000	90.0000
KUIFEEND	.0000	.0000	.0000	.0000	90.0000
AALSCH	.0000	.0000	.0000	.0000	90.0000
FUUT	.0000	.0000	.0000	.0000	90.0000
STELTLOP	.0000	.0000	.0000	.0000	90.0000
KLUUT	.0000	.0000	.0000	.0000	90.0000
VISDIEFJE	.0000	.0000	.0000	.0000	90.0000

55

ZOOPLANK	SUSDET	0.40
ZOOPLANK	FYTOPLANK	0.60
MOLLKLEIN	SUSDET	0.55
MOLLKLEIN	BOTDET	0.18
MOLLKLEIN	FYTOPLANK	0.27
MOLLGROOT	FYTOPLANK	0.45
MOLLGROOT	SUSDET	0.34
MOLLGROOT	MOLLGROOT	0.21
OLIGO	SUSDET	0.05
OLIGO	BOTDET	0.95
CHIRONO	SUSDET	0.05
CHIRONO	BOTDET	0.95
MACRUST	BOTDET	0.44
MACRUST	SUSDET	0.56
SLAK	BOTDET	1.00
KLEIN	ZOOPLANK	0.60
KLEIN	OLIGO	0.11
KLEIN	CHIRONO	0.24
KLEIN	MACRUST	0.04
MIDWIT	ZOOPLANK	0.00
MIDWIT	MOLLKLEIN	0.06
MIDWIT	SLAK	0.14
MIDWIT	OLIGO	0.22
MIDWIT	CHIRONO	0.44
MIDWIT	MACRUST	0.01
MIDWIT	BOTDET	0.14
GROOTWIT	OLIGO	0.07
GROOTWIT	CHIRONO	0.13
GROOTWIT	ZOOPLANK	0.00
GROOTWIT	MOLLKLEIN	0.01
GROOTWIT	SLAK	0.07
GROOTWIT	MACRUST	0.00
GROOTWIT	BOTDET	0.73
MIDROOF	KLEIN	0.88
MIDROOF	MIDWIT	0.12
GROOTROOF	KLEIN	0.88
GROOTROOF	MIDWIT	0.12
AAL	KLEIN	0.53

AAL	MIDWIT	0.06
AAL	GROOTWIT	0.14
AAL	MIDROOF	0.14
AAL	GROOTROOF	0.05
AAL	AAL	0.08
KUIFEEND	MOLLKLEIN	1.00
AALSCH	MIDWIT	.780
AALSCH	MIDROOF	.150
AALSCH	KLEIN	.050
AALSCH	AAL	.020
FUUT	KLEIN	1.00
STELTLOP	OLIGO	.40
STELTLOP	CHIRONO	.40
STELTLOP	MOLLKLEIN	.20
KLUUT	OLIGO	0.50
KLUUT	CHIRONO	0.50
VISDIEFJE	KLEIN	1.00

8

2.650
8.500
10.000
365.000
0.000
.000
.000
.000

hv0p

.000	365.000	4.000	8.000
------	---------	-------	-------

PCB in diep instabiel slib  
file: Ds6pcb.chp

MER Haringvliet, huidige situatie  
PCB153 6.510 1

5

PELAGIC DISS	-99.00	.121
BENTHIC DISS	-99.00	.124
FYTOPLANK	.1500	227.
SUSDET	.1500	227.
BOTDET	.1500	232.

19

ZOOPLANK	.0350	.0650	.3501	.1500	.4000
MOLLKLEIN	.0259	.0091	.1761	.1500	.4000
MOLLGROOT	.0015	.0005	.3963	.1500	.4000
OLIGO	.0600	.0200	.1020	.1500	.4000
CHIRONO	.0600	.0200	.1020	.1500	.4000
MACRUST	.0600	.0200	.1403	.1500	.4000
SLAK	.0600	.0200	.1000	.1500	.4000
KLEIN	.0344	.0086	.8000	.2500	.4000
MIDWIT	.0160	.0040	.3392	.2500	.4000
GROOTWIT	.0160	.0040	.1186	.2500	.4000
MIDROOF	.0120	.0030	.8000	.2500	.4000
GROOTROOF	.0120	.0030	.8000	.2500	.4000
AAL	.0180	.0020	.8000	.3300	.4000
KUIFEEND	.3000	.0014	.8000	.2500	.4000
AALSCH	.1100	.0002	.8000	.2500	.4000
FUUT	.2000	.0003	.8000	.2500	.4000
STELTLOP	.5000	.0015	.8000	.2500	.4000
KLUUT	.2000	.0003	.8000	.2500	.4000
VISDIEFJE	.5000	.0015	.8000	.2500	.4000

ZOOPLANK	1	1.000	.014	.001	.001
MOLLKLEIN	1	.200	.024	.015	.015
MOLLGROOT	1	.100	.015	.500	.500
OLIGO	1	.010	.020	.015	.015
CHIRONO	1	.010	.010	.015	.015
MACRUST	1	.010	.015	.015	.015
SLAK	1	.010	.017	.015	.015
KLEIN	2	.000	.010	7.000	7.000
MIDWIT	2	.000	.021	98.000	98.000
GROOTWIT	2	.000	.026	500.000	500.000
MIDROOF	2	.000	.007	98.000	98.000
GROOTROOF	2	.000	.013	500.000	500.000
AAL	2	.000	.183	100.000	100.000
KUIFEEND	3	.000	.050	900.000	900.000
AALSCH	3	.000	.129	2430.000	2430.000
FUUT	3	.000	.050	1200.000	1200.000
STELTLOP	3	.000	.050	225.000	225.000

KLUUT	3	.000	.050	360.000	360.000
VISDIEFJE	3	.000	.050	125.000	125.000

ZOOPLANK	.1000	.100	.7500	1
MOLLKLEIN	.1000	.100	.7500	1
MOLLGROOT	.1000	.100	.7500	1
OLIGO	.1000	.020	.7500	2
CHIRONO	.1000	.020	.7500	2
MACRUST	.1000	.100	.7500	1
SLAK	.1000	.020	.7500	2
KLEIN	.6000	.6000	.7500	1
MIDWIT	.6000	.2000	.7500	1
GROOTWIT	.6000	.2000	.7500	1
MIDROOF	.6000	.6000	.7500	1
GROOTROOF	.6000	.6000	.7500	1
AAL	.6000	.2000	.7500	1
KUIFEEND	.0000	.0700	.7500	1
AALSCH	.0000	.2000	.7500	1
FUUT	.0000	.2000	.7500	1
STELTLOP	.0000	.0700	.7500	1
KLUUT	.0000	.0700	.7500	1
VISDIEFJE	.0000	.2000	.7500	1

ZOOPLANK	1.000	7.000	.000	.002	.01400
MOLLKLEIN	100.000	730.000	.000	.003	.03800
MOLLGROOT	100.000	730.000	.000	.002	.06000
OLIGO	25.000	365.000	.000	.003	.01000
CHIRONO	25.000	365.000	.000	.003	.01000
MACRUST	200.000	730.000	.000	.003	.03800
SLAK	100.000	365.000	.000	.003	.03800
KLEIN	50.000	365.000	.000	.008	.06400
MIDWIT	75.000	730.000	.000	.013	.07500
GROOTWIT	100.000	1460.000	.000	.005	.07500
MIDROOF	75.000	730.000	.000	.008	.08300
GROOTROOF	100.000	1460.000	.000	.003	-9.00000
AAL	200.000	9999.000	.000	.042	.90900
KUIFEEND	365.000	1095.000	.002	.240	.40000
AALSCH	365.000	1095.000	.000	.045	2.00000
FUUT	365.000	1095.000	.001	.056	-9.00000
STELTLOP	365.000	1095.000	.002	.056	-9.00000
KLUUT	365.000	1095.000	.001	.056	-9.00000
VISDIEFJE	365.000	1095.000	.002	.056	-9.00000

ZOOPLANK	.0639	.0639	.0300	.0000	90.0000
MOLLKLEIN	.0639	.0639	.0300	.0000	90.0000
MOLLGROOT	.0639	.0639	.0300	.0000	90.0000
OLIGO	.0639	.0639	.0300	.0000	90.0000
CHIRONO	.0639	.0639	.0300	.0000	90.0000
MACRUST	.0639	.0639	.0300	.0000	90.0000
SLAK	.0639	.0639	.0300	.0000	90.0000
KLEIN	.0639	.0639	.0300	.0000	90.0000

MIDWIT	.0639	.0639	.0300	.0000	90.0000
GROOTWIT	.0639	.0639	.0300	.0000	90.0000
MIDROOF	.0639	.0639	.0300	.0000	90.0000
GROOTROOF	.0639	.0639	.0300	.0000	90.0000
AAL	.0000	.0000	.0000	.0000	90.0000
KUIFEEND	.0000	.0000	.0000	.0000	90.0000
AALSCH	.0000	.0000	.0000	.0000	90.0000
FUUT	.0000	.0000	.0000	.0000	90.0000
STELTLOP	.0000	.0000	.0000	.0000	90.0000
KLUUT	.0000	.0000	.0000	.0000	90.0000
VISDIEFJE	.0000	.0000	.0000	.0000	90.0000

55

ZOOPLANK	SUSDET	0.43
ZOOPLANK	FYTOPLANK	0.57
MOLLKLEIN	SUSDET	0.43
MOLLKLEIN	BOTDET	0.38
MOLLKLEIN	FYTOPLANK	0.19
MOLLGROOT	FYTOPLANK	0.00
MOLLGROOT	SUSDET	0.00
MOLLGROOT	MOLLGROOT	0.00
OLIGO	SUSDET	0.03
OLIGO	BOTDET	0.97
CHIRONO	SUSDET	0.03
CHIRONO	BOTDET	0.97
MACRUST	BOTDET	0.57
MACRUST	SUSDET	0.43
SLAK	BOTDET	1.00
KLEIN	ZOOPLANK	0.49
KLEIN	OLIGO	0.46
KLEIN	CHIRONO	0.01
KLEIN	MACRUST	0.04
MIDWIT	ZOOPLANK	0.00
MIDWIT	MOLLKLEIN	0.09
MIDWIT	SLAK	0.01
MIDWIT	OLIGO	0.69
MIDWIT	CHIRONO	0.01
MIDWIT	MACRUST	0.01
MIDWIT	BOTDET	0.19
GROOTWIT	OLIGO	0.16
GROOTWIT	CHIRONO	0.00
GROOTWIT	ZOOPLANK	0.00
GROOTWIT	MOLLKLEIN	0.01
GROOTWIT	SLAK	0.00
GROOTWIT	MACRUST	0.00
GROOTWIT	BOTDET	0.82
MIDROOF	KLEIN	0.72
MIDROOF	MIDWIT	0.28
GROOTROOF	KLEIN	0.72
GROOTROOF	MIDWIT	0.28
AAL	KLEIN	0.03

AAL	MIDWIT	0.01
AAL	GROOTWIT	0.70
AAL	MIDROOF	0.08
AAL	GROOTROOF	0.10
AAL	AAL	0.08
KUIFEEND	MOLLKLEIN	1.00
AALSCH	MIDWIT	.780
AALSCH	MIDROOF	.150
AALSCH	KLEIN	.050
AALSCH	AAL	.020
FUUT	KLEIN	1.00
STELTLOP	OLIGO	.40
STELTLOP	CHIRONO	.40
STELTLOP	MOLLKLEIN	.20
KLUUT	OLIGO	0.50
KLUUT	CHIRONO	0.50
VISDIEFJE	KLEIN	1.00

8

2.650
8.500
10.000
365.000
0.000
.000
.000
.000

hv0p

.000	365.000	4.000	8.000
------	---------	-------	-------



PCB in ondiep stabiel slib  
file: Ss6pcb.chp

MER Haringvliet, huidige situatie  
PCB153 6.510 1

5

PELAGIC DISS -99.00 .121  
BENTHIC DISS -99.00 .069  
FYTOPLANK .1500 227.  
SUSDET .1500 227.  
BOTDET .1500 129.

19

ZOPLANK	.0350	.0650	.3516	.1500	.4000
MOLLKLEIN	.0259	.0091	.1956	.1500	.4000
MOLLGROOT	.0015	.0005	.3966	.1500	.4000
OLIGO	.0600	.0200	.1011	.1500	.4000
CHIRONO	.0600	.0200	.1011	.1500	.4000
MACRUST	.0600	.0200	.1237	.1500	.4000
SLAK	.0600	.0200	.1000	.1500	.4000
KLEIN	.0344	.0086	.8000	.2500	.4000
MIDWIT	.0160	.0040	.1890	.2500	.4000
GROOTWIT	.0160	.0040	.1052	.2500	.4000
MIDROOF	.0120	.0030	.8000	.2500	.4000
GROOTROOF	.0120	.0030	.8000	.2500	.4000
AAL	.0180	.0020	.8000	.3300	.4000
KUIFEEND	.3000	.0014	.8000	.2500	.4000
AALSCH	.1100	.0002	.8000	.2500	.4000
FUUT	.2000	.0003	.8000	.2500	.4000
STELTLOP	.5000	.0015	.8000	.2500	.4000
KLUUT	.2000	.0003	.8000	.2500	.4000
VISDIEFJE	.5000	.0015	.8000	.2500	.4000

ZOPLANK	1	1.000	.014	.001	.001
MOLLKLEIN	1	.200	.024	.015	.015
MOLLGROOT	1	.100	.015	.500	.500
OLIGO	1	.010	.020	.015	.015
CHIRONO	1	.010	.010	.015	.015
MACRUST	1	.010	.015	.015	.015
SLAK	1	.010	.017	.015	.015
KLEIN	2	.000	.010	7.000	7.000
MIDWIT	2	.000	.021	98.000	98.000
GROOTWIT	2	.000	.026	500.000	500.000
MIDROOF	2	.000	.007	98.000	98.000
GROOTROOF	2	.000	.013	500.000	500.000
AAL	2	.000	.183	100.000	100.000
KUIFEEND	3	.000	.050	900.000	900.000
AALSCH	3	.000	.129	2430.000	2430.000
FUUT	3	.000	.050	1200.000	1200.000
STELTLOP	3	.000	.050	225.000	225.000

KLUUT	3	.000	.050	360.000	360.000
VISDIEFJE	3	.000	.050	125.000	125.000

ZOPLANK	.1000	.100	.7500	1
MOLLKLEIN	.1000	.100	.7500	1
MOLLGROOT	.1000	.100	.7500	1
OLIGO	.1000	.020	.7500	2
CHIRONO	.1000	.020	.7500	2
MACRUST	.1000	.100	.7500	1
SLAK	.1000	.020	.7500	2
KLEIN	.6000	.6000	.7500	1
MIDWIT	.6000	.2000	.7500	1
GROOTWIT	.6000	.2000	.7500	1
MIDROOF	.6000	.6000	.7500	1
GROOTROOF	.6000	.6000	.7500	1
AAL	.6000	.2000	.7500	1
KUIFEEND	.0000	.0700	.7500	1
AALSCH	.0000	.2000	.7500	1
FUUT	.0000	.2000	.7500	1
STELTLOP	.0000	.0700	.7500	1
KLUUT	.0000	.0700	.7500	1
VISDIEFJE	.0000	.2000	.7500	1

ZOPLANK	1.000	7.000	.000	.002	.01400
MOLLKLEIN	100.000	730.000	.000	.003	.03800
MOLLGROOT	100.000	730.000	.000	.002	.06000
OLIGO	25.000	365.000	.000	.003	.01000
CHIRONO	25.000	365.000	.000	.003	.01000
MACRUST	200.000	730.000	.000	.003	.03800
SLAK	100.000	365.000	.000	.003	.03800
KLEIN	50.000	365.000	.000	.008	.06400
MIDWIT	75.000	730.000	.000	.013	.07500
GROOTWIT	100.000	1460.000	.000	.005	.07500
MIDROOF	75.000	730.000	.000	.008	.08300
GROOTROOF	100.000	1460.000	.000	.003	-9.00000
AAL	200.000	9999.000	.000	.042	.90900
KUIFEEND	365.000	1095.000	.002	.240	.40000
AALSCH	365.000	1095.000	.000	.045	2.00000
FUUT	365.000	1095.000	.001	.056	-9.00000
STELTLOP	365.000	1095.000	.002	.056	-9.00000
KLUUT	365.000	1095.000	.001	.056	-9.00000
VISDIEFJE	365.000	1095.000	.002	.056	-9.00000

ZOPLANK	.0639	.0639	.0300	.0000	90.0000
MOLLKLEIN	.0639	.0639	.0300	.0000	90.0000
MOLLGROOT	.0639	.0639	.0300	.0000	90.0000
OLIGO	.0639	.0639	.0300	.0000	90.0000
CHIRONO	.0639	.0639	.0300	.0000	90.0000
MACRUST	.0639	.0639	.0300	.0000	90.0000
SLAK	.0639	.0639	.0300	.0000	90.0000
KLEIN	.0639	.0639	.0300	.0000	90.0000

MIDWIT	.0639	.0639	.0300	.0000	90.0000
GROOTWIT	.0639	.0639	.0300	.0000	90.0000
MIDROOF	.0639	.0639	.0300	.0000	90.0000
GROOTROOF	.0639	.0639	.0300	.0000	90.0000
AAL	.0000	.0000	.0000	.0000	90.0000
KUIFEEND	.0000	.0000	.0000	.0000	90.0000
AALSCH	.0000	.0000	.0000	.0000	90.0000
FUUT	.0000	.0000	.0000	.0000	90.0000
STELTLOP	.0000	.0000	.0000	.0000	90.0000
KLUUT	.0000	.0000	.0000	.0000	90.0000
VISDIEFJE	.0000	.0000	.0000	.0000	90.0000

55

ZOOPLANK	SUSDET	0.41
ZOOPLANK	FYTOPLANK	0.59
MOLLKLEIN	SUSDET	0.46
MOLLKLEIN	BOTDET	0.30
MOLLKLEIN	FYTOPLANK	0.24
MOLLGROOT	FYTOPLANK	0.45
MOLLGROOT	SUSDET	0.34
MOLLGROOT	MOLLGROOT	0.21
OLIGO	SUSDET	0.02
OLIGO	BOTDET	0.98
CHIRONO	SUSDET	0.02
CHIRONO	BOTDET	0.98
MACRUST	BOTDET	0.71
MACRUST	SUSDET	0.29
SLAK	BOTDET	1.00
KLEIN	ZOOPLANK	0.79
KLEIN	OLIGO	0.13
KLEIN	CHIRONO	0.05
KLEIN	MACRUST	0.03
MIDWIT	ZOOPLANK	0.00
MIDWIT	MOLLKLEIN	0.16
MIDWIT	SLAK	0.08
MIDWIT	OLIGO	0.22
MIDWIT	CHIRONO	0.08
MIDWIT	MACRUST	0.01
MIDWIT	BOTDET	0.46
GROOTWIT	OLIGO	0.03
GROOTWIT	CHIRONO	0.01
GROOTWIT	ZOOPLANK	0.00
GROOTWIT	MOLLKLEIN	0.01
GROOTWIT	SLAK	0.01
GROOTWIT	MACRUST	0.00
GROOTWIT	BOTDET	0.94
MIDROOF	KLEIN	0.80
MIDROOF	MIDWIT	0.20
GROOTROOF	KLEIN	0.80
GROOTROOF	MIDWIT	0.20
AAL	KLEIN	0.22

AAL	MIDWIT	0.05
AAL	GROOTWIT	0.51
AAL	MIDROOF	0.07
AAL	GROOTROOF	0.06
AAL	AAL	0.08
KUIFEEND	MOLLKLEIN	1.00
AALSCH	MIDWIT	.780
AALSCH	MIDROOF	.150
AALSCH	KLEIN	.050
AALSCH	AAL	.020
FUUT	KLEIN	1.00
STELTLOP	OLIGO	.40
STELTLOP	CHIRONO	.40
STELTLOP	MOLLKLEIN	.20
KLUUT	OLIGO	0.50
KLUUT	CHIRONO	0.50
VISDIEFJE	KLEIN	1.00

8

2.650

8.500

10.000

365.000

0.000

.000

.000

.000

hv0p

.000 365.000 4.000 8.000

# **J** **Samengevatte ongekalibreerde resultaten**

## Ongekalibreerde resultaten voor cadmium (mg/kg natgewicht):

parameter\biotoop	totaal	zand	intergetijde	diep slib	ondiep slib
zoöplankton	0.013	0.013	0.013	0.013	0.013
kleine mollusken	0.192	0.163	0.170	0.200	0.178
grote mollusken	0.127	0.127	0.127	0.125	0.127
oligochaeten	0.087	0.072	0.044	0.122	0.063
chironomiden	0.087	0.072	0.044	0.122	0.063
macrocrustaceen	0.126	0.073	0.074	0.155	0.113
slakken	0.170	0.150	0.085	0.238	0.120
kleine witvis	0.007	0.007	0.007	0.008	0.007
middelgrote witvis	0.008	0.008	0.006	0.010	0.015
grote witvis	0.049	0.041	0.024	0.067	0.046
middelgrote roofvis	0.004	0.004	0.004	0.004	0.004
grote roofvis	0.005	0.005	0.005	0.005	0.005
aal	0.023	0.023	0.022	0.023	0.023
kuifeend	0.117	0.100	0.104	0.123	0.109
aalscholver	0.004	0.003	0.003	0.004	0.006
fuut	0.003	0.003	0.003	0.003	0.003
steltloper	0.104	0.087	0.067	0.132	0.082
kluut	0.088	0.073	0.045	0.123	0.063
visdiefje	0.004	0.004	0.004	0.004	0.004

Ongekalibreerde resultaten voor PCB ( $\mu\text{g}/\text{kg}$  natgewicht):

parameter\biotoop	totaal	zand	intergetijde	diep slib	ondiep slib
zoöplankton	5	5	5	5	5
kleine mollusken	30	23	23	30	25
grote mollusken	6	6	6	5	6
oligochaeten	23	17	17	22	13
chironomiden	23	17	17	22	13
macrocrustaceen	90	59	67	87	67
slakken	24	19	18	24	13
kleine witvis	33	18	23	32	18
middelgrote witvis	56	42	37	58	72
grote witvis	237	176	155	232	156
middelgrote roofvis	34	22	22	34	25
grote roofvis	53	34	35	54	40
aal	432	230	123	444	245
kuifeend	250	192	193	249	205
aalscholver	3400	2410	2100	3520	3890
fuut	803	449	573	790	430
steltloper	320	241	235	312	198
kluut	420	314	303	407	232
visdiefje	674	377	481	663	361

# **K** Ongekalibreerde uitvoerfiles **CHEOPS**

**Haringvliet als geheel**  
**file: Re4cad.out**

; Let op: steady-state berekening, geen uitvoer naar (

[Rekentype]

Rekt=FLUX-type

[Lokatie]

Locn=MER Haringvliet, huidige

[Stofnaam]

stofn=cadmium

[aantal\_org]

norg= 19

[naam\_org]

1=ZOOPLANK

2=MOLLKLEIN

3=MOLLGROOT

4=OLIGO

5=CHIRONO

6=MACRUST

7=SLAK

8=KLEIN

9=MIDWIT

10=GROOTWIT

11=MIDROOF

12=GROOTROOF

13=AAL

14=KUIFEEND

15=AALSCH

16=FUUT

17=STELTLOP

18=KLUUT

19=VISDIEFJE

[Eenheden]

w=Waterkwaliteit in ug/l en ug/g dw

o=Accumulatie in organismen in ug/g ww

b=bioaccumulatiefactor in l/g

f=opnamefluxen in ug/g.d

[conc-abio]

1= .400E-01

2= .690E-01

3= 5.00

4= 5.00

5= 8.70

[conc-accu]

1= .132E-01

2= .192

3= .127

4= .873E-01

5= .873E-01

6= .126

7= .170

8= .740E-02

9= .846E-02

10= .486E-01

11= .416E-02

12= .537E-02

13= .227E-01

14= .117

15= .363E-02

16= .311E-02

17= .104

18= .883E-01

19= .392E-02

[bio-accu]

1= .331

2= 4.79

3= 3.17

4= 1.27

5= 1.27

6= 3.14

7= 2.46

8= .185

9= .211

10= 1.22

11= .104

12= .134

13= .568

14= 2.94

15= .909E-01

16= .777E-01

17= 2.60

18= 2.21

19= .980E-01

[food-flux]

1= .780E-03

2= .711E-03

3= .113E-04

4= .368E-02

5= .368E-02

6= .228E-02

7= .379E-02

8= .169E-04

9= .428E-04

10= .433E-03

11= .523E-06  
12= .523E-06  
13= .231E-05  
14= .462E-03  
15= .993E-05  
16= .881E-05  
17= .419E-03  
18= .356E-03  
19= .158E-04  
[water-flux]  
1= .103E-01  
2= .207E-02  
3= .103E-02  
4= .178E-03  
5= .178E-03  
6= .103E-03  
7= .178E-03  
8= .146E-03  
9= .680E-04  
10= .680E-04  
11= .510E-04  
12= .510E-04  
13= .123E-03  
14= .000  
15= .000  
16= .000  
17= .000  
18= .000  
19= .000  
[tot-flux]  
1= .703E-01  
2= .256  
3= .109E-01  
4= .954  
5= .954  
6= .957  
7= .955  
8= .103  
9= .387  
10= .864  
11= .102E-01  
12= .102E-01  
13= .183E-01  
14= 1.00  
15= 1.00  
16= 1.00  
17= 1.00

18= 1.00  
19= 1.00  
[biomag]  
1= .124E-02  
2= .494E-01  
3= .222E-02  
4= .647E-01  
5= .647E-01  
6= .112  
7= .124  
8= .887E-02  
9= .609E-02  
10= .234E-01  
11= .551E-02  
12= .711E-02  
13= .903E-02  
14= .368  
15= .458  
16= .420  
17= .576  
18= .607  
19= .529  
[biocon]  
1= .308  
2= 3.56  
3= 3.13  
4= .585E-01  
5= .585E-01  
6= .136  
7= .111  
8= .166  
9= .130  
10= .165  
11= .103  
12= .133  
13= .558  
14= .000  
15= .000  
16= .000  
17= .000  
18= .000  
19= .000  
[half-elim]  
1= .822  
2= 47.6  
3= 83.7  
4= 15.6

5= 15.6  
6= 36.4  
7= 29.5  
8= 31.3  
9= 52.7  
10= 66.9  
11= 55.8  
12= 72.0  
13= 125.  
14= 175.  
15= 253.  
16= 244.  
17= 171.  
18= 171.  
19= 171.

**Haringvliet als geheel.**

**File: Re4pcb.out**

[Rekertype]

Rekt=KOW -type

[Lokatie]

Locn=MER Haringvliet, huidige

[Stofnaam]

stofn=PCB153

[aantal\_org]

norg= 19

[naam\_org]

1=ZOOPLANK

2=MOLLKLEIN

3=MOLLGROOT

4=OLIGO

5=CHIRONO

6=MACRUST

7=SLAK

8=KLEIN

9=MIDWIT

10=GROOTWIT

11=MIDROOF

12=GROOTROOF

13=AAL

14=KUIFEEND

15=AALSCH

16=FUUT

17=STELTLOP

18=KLUUT

19=VISDIEFJE

[Eenheden]

w=Waterkwaliteit in ug/l en ug/g dw

o=Accumulatie in organismen in ug/g ww

b=bioaccumulatiefactor in l/g

f=opnamefluxen in ug/g.d

[conc-abio]

1= .121

2= .127

3= 227.

4= 227.

5= 239.

[conc-accu]

1= 5.12

2= 29.9

3= 6.09

4= 23.0



5= 23.0  
6= 90.2  
7= 24.4  
8= 32.6  
9= 55.5  
10= 237.  
11= 33.8  
12= 53.1  
13= 432.  
14= 250.  
15= .340E+04  
16= 803.  
17= 320.  
18= 420.  
19= 674.  
[bio-accu]  
1= 42.3  
2= 247.  
3= 50.3  
4= 181.  
5= 181.  
6= 745.  
7= 192.  
8= 270.  
9= 459.  
10= .196E+04  
11= 279.  
12= 439.  
13= .357E+04  
14= .207E+04  
15= .281E+05  
16= .664E+04  
17= .264E+04  
18= .347E+04  
19= .557E+04  
[food-flux]  
1= .709  
2= .499  
3= .103E-01  
4= .409  
5= .409  
6= 1.49  
7= .417  
8= .655  
9= .356  
10= 1.35  
11= .315

12= .315  
13= 1.12  
14= 1.01  
15= 2.83  
16= 1.55  
17= 1.32  
18= 1.32  
19= 2.79  
[water-flux]  
1= .625  
2= .125  
3= .625E-01  
4= .656E-02  
5= .656E-02  
6= .625E-02  
7= .656E-02  
8= .530E-01  
9= .247E-01  
10= .247E-01  
11= .185E-01  
12= .185E-01  
13= .448E-01  
14= .000  
15= .000  
16= .000  
17= .000  
18= .000  
19= .000  
[tot-flux]  
1= .531  
2= .800  
3= .142  
4= .984  
5= .984  
6= .996  
7= .985  
8= .925  
9= .935  
10= .982  
11= .945  
12= .945  
13= .961  
14= 1.00  
15= 1.00  
16= 1.00  
17= 1.00  
18= 1.00

19= 1.00  
[biomag]  
1= .800E-01  
2= .686  
3= .307E-01  
4= .633  
5= .633  
6= 2.56  
7= .669  
8= 1.08  
9= 1.16  
10= 4.16  
11= .827  
12= 1.30  
13= 1.86  
14= 5.02  
15= 60.1  
16= 24.6  
17= 7.87  
18= 10.9  
19= 20.7  
[biocon]  
1= 19.8  
2= 49.5  
3= 43.2  
4= 2.87  
5= 2.87  
6= 3.12  
7= 2.97  
8= 20.2  
9= 29.7  
10= 35.1  
11= 15.5  
12= 24.3  
13= 137.  
14= .000  
15= .000  
16= .000  
17= .000  
18= .000  
19= .000  
[half-elim]  
1= 2.65  
2= 33.1  
3= 57.7  
4= 38.3  
5= 38.3

6= 41.7  
7= 39.7  
8= 31.8  
9= 101.  
10= 119.  
11= 69.8  
12= 110.  
13= 256.  
14= 171.  
15= 828.  
16= 357.  
17= 167.  
18= 220.  
19= 167.

**Cadmium in ondiep zand**

**file: Za4cad.out**

; Let op: steady-state berekening, geen uitvoer naar (

[Rekentype]

Rekt=FLUX-type

[Lokatie]

Locn=MER Haringvliet, huidige

[Stofnaam]

stofn=cadmium

[aantal\_org]

norg= 19

[naam\_org]

1=ZOOPLANK

2=MOLLKLEIN

3=MOLLGROOT

4=OLIGO

5=CHIRONO

6=MACRUST

7=SLAK

8=KLEIN

9=MIDWIT

10=GROOTWIT

11=MIDROOF

12=GROOTROOF

13=AAL

14=KUIFEEND

15=AALSCH

16=FUUT

17=STELTLOP

18=KLUUT

19=VISDIEFJE

[Eenheden]

w=Waterkwaliteit in ug/l en ug/g dw

o=Accumulatie in organismen in ug/g ww

b=bioaccumulatiefactor in l/g

f=opnamefluxen in ug/g.d

[conc-abio]

1= .400E-01

2= .620E-01

3= 5.00

4= 5.00

5= 7.69

[conc-accu]

1= .132E-01

2= .163

3= .127

4= .721E-01

5= .721E-01

6= .732E-01

7= .150

8= .698E-02

9= .787E-02

10= .407E-01

11= .416E-02

12= .537E-02

13= .226E-01

14= .100E+00

15= .341E-02

16= .293E-02

17= .867E-01

18= .729E-01

19= .369E-02

[bio-accu]

1= .331

2= 4.08

3= 3.17

4= 1.16

5= 1.16

6= 1.83

7= 2.43

8= .174

9= .197

10= 1.02

11= .104

12= .134

13= .564

14= 2.50

15= .853E-01

16= .733E-01

17= 2.17

18= 1.82

19= .924E-01

[food-flux]

1= .777E-03

2= .452E-03

3= .113E-04

4= .302E-02

5= .302E-02

6= .128E-02

7= .335E-02

8= .753E-05

9= .351E-04

10= .352E-03

11= .490E-06  
12= .490E-06  
13= .140E-05  
14= .393E-03  
15= .932E-05  
16= .830E-05  
17= .349E-03  
18= .294E-03  
19= .149E-04

[water-flux]

1= .103E-01  
2= .207E-02  
3= .103E-02  
4= .160E-03  
5= .160E-03  
6= .103E-03  
7= .160E-03  
8= .146E-03  
9= .680E-04  
10= .680E-04  
11= .510E-04  
12= .510E-04  
13= .123E-03  
14= .000  
15= .000  
16= .000  
17= .000  
18= .000  
19= .000

[tot-flux]

1= .700E-01  
2= .179  
3= .109E-01  
4= .950  
5= .950  
6= .926  
7= .954  
8= .490E-01  
9= .341  
10= .838  
11= .952E-02  
12= .952E-02  
13= .112E-01  
14= 1.00  
15= 1.00  
16= 1.00  
17= 1.00

18= 1.00  
19= 1.00

[biomag]

1= .123E-02  
2= .370E-01  
3= .222E-02  
4= .615E-01  
5= .615E-01  
6= .789E-01  
7= .124  
8= .887E-02  
9= .593E-02  
10= .224E-01  
11= .551E-02  
12= .711E-02  
13= .903E-02  
14= .368  
15= .458  
16= .420  
17= .576  
18= .607  
19= .529

[biocon]

1= .308  
2= 3.35  
3= 3.13  
4= .585E-01  
5= .585E-01  
6= .136  
7= .111  
8= .166  
9= .130  
10= .165  
11= .103  
12= .133  
13= .558  
14= .000  
15= .000  
16= .000  
17= .000  
18= .000  
19= .000

[half-elim]

1= .822  
2= 44.7  
3= 83.7  
4= 15.6

5= 15.6  
6= 36.4  
7= 29.5  
8= 31.3  
9= 52.7  
10= 66.9  
11= 55.8  
12= 72.0  
13= 125.  
14= 175.  
15= 253.  
16= 244.  
17= 171.  
18= 171.  
19= 171.

**PCB153 in ondiep zand**  
**file: Za4pcb.out**

[Rekentype]  
Rekt=KOW -type  
[Lokatie]  
Locn=MER Haringvliet, huidige  
[Stofnaam]  
stofn=PCB153  
[aantal\_org]  
norg= 19  
[naam\_org]  
1=ZOOPLANK  
2=MOLLKLEIN  
3=MOLLGROOT  
4=OLIGO  
5=CHIRONO  
6=MACRUST  
7=SLAK  
8=KLEIN  
9=MIDWIT  
10=GROOTWIT  
11=MIDROOF  
12=GROOTROOF  
13=AAL  
14=KUIFEEND  
15=AALSCH  
16=FUUT  
17=STELTLOP  
18=KLUUT  
19=VISDIEFJE  
[Eenheden]  
w=Waterkwaliteit in ug/l en ug/g dw  
o=Accumulatie in organismen in ug/g ww  
b=bioaccumulatiefactor in l/g  
f=opnamefluxen in ug/g.d  
[conc-abio]  
1= .121  
2= .980E-01  
3= 227.  
4= 227.  
5= 183.  
[conc-accu]  
1= 5.11  
2= 23.0  
3= 6.09  
4= 17.2

5= 17.2  
6= 58.7  
7= 18.7  
8= 18.2  
9= 41.5  
10= 176.  
11= 21.6  
12= 33.9  
13= 230.  
14= 192.  
15= .241E+04  
16= 449.  
17= 241.  
18= 314.  
19= 377.  
[bio-accu]  
1= 42.2  
2= 190.  
3= 50.3  
4= 176.  
5= 176.  
6= 485.  
7= 190.  
8= 151.  
9= 343.  
10= .145E+04  
11= 178.  
12= 280.  
13= .190E+04  
14= .159E+04  
15= .199E+05  
16= .371E+04  
17= .199E+04  
18= .259E+04  
19= .312E+04  
[food-flux]  
1= .705  
2= .376  
3= .103E-01  
4= .305  
5= .305  
6= .965  
7= .319  
8= .343  
9= .260  
10= .996  
11= .195

12= .195  
13= .575  
14= .775  
15= 2.00  
16= .868  
17= .995  
18= .983  
19= 1.56  
[water-flux]  
1= .625  
2= .125  
3= .625E-01  
4= .506E-02  
5= .506E-02  
6= .625E-02  
7= .506E-02  
8= .530E-01  
9= .247E-01  
10= .247E-01  
11= .185E-01  
12= .185E-01  
13= .448E-01  
14= .000  
15= .000  
16= .000  
17= .000  
18= .000  
19= .000  
[tot-flux]  
1= .530  
2= .750  
3= .142  
4= .984  
5= .984  
6= .994  
7= .984  
8= .866  
9= .913  
10= .976  
11= .913  
12= .913  
13= .928  
14= 1.00  
15= 1.00  
16= 1.00  
17= 1.00  
18= 1.00

19= 1.00  
[biomag]  
1= .796E-01  
2= .524  
3= .307E-01  
4= .603  
5= .603  
6= 1.81  
7= .669  
8= 1.08  
9= 1.13  
10= 3.98  
11= .827  
12= 1.30  
13= 1.86  
14= 5.02  
15= 60.1  
16= 24.6  
17= 7.87  
18= 10.9  
19= 20.7  
[biocon]  
1= 19.8  
2= 47.4  
3= 43.2  
4= 2.87  
5= 2.87  
6= 3.12  
7= 2.97  
8= 20.2  
9= 29.7  
10= 35.1  
11= 15.5  
12= 24.3  
13= 137.  
14= .000  
15= .000  
16= .000  
17= .000  
18= .000  
19= .000  
[half-elim]  
1= 2.65  
2= 31.6  
3= 57.7  
4= 38.3  
5= 38.3

6= 41.7  
7= 39.7  
8= 31.8  
9= 101.  
10= 119.  
11= 69.8  
12= 110.  
13= 256.  
14= 171.  
15= 828.  
16= 357.  
17= 167.  
18= 220.  
19= 167.

**Cadmium in intergetijdzone**

file: In4cad.out

Let op: steady-state berekening, geen uitvoer naar (

[Rekentype]

Rekt=FLUX-type

[Lokatie]

Locn=MER Haringvliet, huidige

[Stofnaam]

stofn=cadmium

[aantal\_org]

norg= 19

[naam\_org]

1=ZOOPLANK

2=MOLLKLEIN

3=MOLLGROOT

4=OLIGO

5=CHIRONO

6=MACRUST

7=SLAK

8=KLEIN

9=MIDWIT

10=GROOTWIT

11=MIDROOF

12=GROOTROOF

13=AAL

14=KUIFEEND

15=AALSCH

16=FUUT

17=STELTLOP

18=KLUUT

19=VISDIEFJE

[Eenheden]

w=Waterkwaliteit in ug/l en ug/g dw

o=Accumulatie in organismen in ug/g ww

b=bioaccumulatiefactor in l/g

f=opnamefluxen in ug/g.d

[conc-abio]

1= .400E-01

2= .350E-01

3= 5.00

4= 5.00

5= 4.37

[conc-accu]

1= .132E-01

2= .170

3= .127

4= .441E-01

5= .441E-01

6= .736E-01

7= .854E-01

8= .703E-02

9= .649E-02

10= .243E-01

11= .416E-02

12= .537E-02

13= .224E-01

14= .104

15= .292E-02

16= .295E-02

17= .665E-01

18= .446E-01

19= .372E-02

[bio-accu]

1= .331

2= 4.25

3= 3.17

4= 1.26

5= 1.26

6= 1.84

7= 2.44

8= .176

9= .162

10= .608

11= .104

12= .134

13= .561

14= 2.61

15= .730E-01

16= .738E-01

17= 1.66

18= 1.11

19= .930E-01

[food-flux]

1= .772E-03

2= .401E-03

3= .113E-04

4= .186E-02

5= .186E-02

6= .129E-02

7= .191E-02

8= .856E-05

9= .171E-04

10= .183E-03



11= .474E-06  
12= .474E-06  
13= .642E-06  
14= .410E-03  
15= .798E-05  
16= .836E-05  
17= .268E-03  
18= .180E-03  
19= .150E-04  
[water-flux]  
1= .103E-01  
2= .207E-02  
3= .103E-02  
4= .904E-04  
5= .904E-04  
6= .103E-03  
7= .904E-04  
8= .146E-03  
9= .680E-04  
10= .680E-04  
11= .510E-04  
12= .510E-04  
13= .123E-03  
14= .000  
15= .000  
16= .000  
17= .000  
18= .000  
19= .000  
[tot-flux]  
1= .695E-01  
2= .162  
3= .109E-01  
4= .954  
5= .954  
6= .926  
7= .955  
8= .554E-01  
9= .201  
10= .729  
11= .922E-02  
12= .922E-02  
13= .517E-02  
14= 1.00  
15= 1.00  
16= 1.00  
17= 1.00

18= 1.00  
19= 1.00  
[biomag]  
1= .123E-02  
2= .377E-01  
3= .222E-02  
4= .637E-01  
5= .637E-01  
6= .962E-01  
7= .124  
8= .887E-02  
9= .543E-02  
10= .215E-01  
11= .551E-02  
12= .711E-02  
13= .903E-02  
14= .368  
15= .458  
16= .420  
17= .576  
18= .607  
19= .529  
[biocon]  
1= .308  
2= 3.56  
3= 3.13  
4= .585E-01  
5= .585E-01  
6= .136  
7= .111  
8= .166  
9= .130  
10= .165  
11= .103  
12= .133  
13= .558  
14= .000  
15= .000  
16= .000  
17= .000  
18= .000  
19= .000  
[half-elim]  
1= .822  
2= 47.6  
3= 83.7  
4= 15.6

5= 15.6  
6= 36.4  
7= 29.5  
8= 31.3  
9= 52.7  
10= 66.9  
11= 55.8  
12= 72.0  
13= 125.  
14= 175.  
15= 253.  
16= 244.  
17= 171.  
18= 171.  
19= 171.

**PCB in intergetijdenzone**  
**file: In4pcb.out**

[Reketype]  
Rekt=KOW -type  
[Lokatie]  
Locn=MER Haringvliet, huidige  
[Stofnaam]  
stofn=PCB153  
[aantal\_org]  
norg= 19  
[naam\_org]  
1=ZOOPLANK  
2=MOLLKLEIN  
3=MOLLGROOT  
4=OLIGO  
5=CHIRONO  
6=MACRUST  
7=SLAK  
8=KLEIN  
9=MIDWIT  
10=GROOTWIT  
11=MIDROOF  
12=GROOTROOF  
13=AAL  
14=KUIFEEND  
15=AALSCH  
16=FUUT  
17=STELTLOP  
18=KLUUT  
19=VISDIEFJE  
[Eenheden]  
w=Waterkwaliteit in ug/l en ug/g dw  
o=Accumulatie in organismen in ug/g ww  
b=bioaccumulatiefactor in l/g  
f=opnamefluxen in ug/g.d  
[conc-abio]  
1= .121  
2= .920E-01  
3= 227.  
4= 227.  
5= 172.  
[conc-accu]  
1= 5.09  
2= 23.1  
3= 6.09  
4= 16.6

5= 16.6  
6= 67.4  
7= 17.5  
8= 23.3  
9= 36.6  
10= 155.  
11= 22.4  
12= 35.3  
13= 123.  
14= 193.  
15= .210E+04  
16= 573.  
17= 235.  
18= 303.  
19= 481.  
[bio-accu]  
1= 42.1  
2= 191.  
3= 50.3  
4= 181.  
5= 181.  
6= 557.  
7= 191.  
8= 192.  
9= 303.  
10= .128E+04  
11= 186.  
12= 291.  
13= .102E+04  
14= .159E+04  
15= .174E+05  
16= .473E+04  
17= .194E+04  
18= .250E+04  
19= .397E+04  
[food-flux]  
1= .701  
2= .356  
3= .103E-01  
4= .295  
5= .295  
6= 1.11  
7= .300  
8= .452  
9= .226  
10= .872  
11= .203

12= .203  
13= .288  
14= .778  
15= 1.75  
16= 1.11  
17= .970  
18= .948  
19= 1.99  
[water-flux]  
1= .625  
2= .125  
3= .625E-01  
4= .475E-02  
5= .475E-02  
6= .625E-02  
7= .475E-02  
8= .530E-01  
9= .247E-01  
10= .247E-01  
11= .185E-01  
12= .185E-01  
13= .448E-01  
14= .000  
15= .000  
16= .000  
17= .000  
18= .000  
19= .000  
[tot-flux]  
1= .529  
2= .740  
3= .142  
4= .984  
5= .984  
6= .994  
7= .984  
8= .895  
9= .902  
10= .973  
11= .917  
12= .917  
13= .865  
14= 1.00  
15= 1.00  
16= 1.00  
17= 1.00  
18= 1.00

19= 1.00  
[biomag]  
1= .791E-01  
2= .524  
3= .307E-01  
4= .624  
5= .624  
6= 2.20  
7= .669  
8= 1.08  
9= 1.04  
10= 3.82  
11= .827  
12= 1.30  
13= 1.86  
14= 5.02  
15= 60.1  
16= 24.6  
17= 7.87  
18= 10.9  
19= 20.7  
[biocon]  
1= 19.8  
2= 49.5  
3= 43.2  
4= 2.87  
5= 2.87  
6= 3.12  
7= 2.97  
8= 20.2  
9= 29.7  
10= 35.1  
11= 15.5  
12= 24.3  
13= 137.  
14= .000  
15= .000  
16= .000  
17= .000  
18= .000  
19= .000  
[half-elim]  
1= 2.65  
2= 33.1  
3= 57.7  
4= 38.3  
5= 38.3

6= 41.7  
7= 39.7  
8= 31.8  
9= 101.  
10= 119.  
11= 69.8  
12= 110.  
13= 256.  
14= 171.  
15= 828.  
16= 357.  
17= 167.  
18= 220.  
19= 167.

**Cadmium in diep instabiel slib**

**file: Ds4cad.out**

; Let op: steady-state berekening, geen uitvoer naar (

[Reketype]

Rekt=FLUX-type

[Lokatie]

Locn=MER Haringvliet, huidige

[Stofnaam]

stofn=cadmium

[aantal\_org]

norg= 19

[naam\_org]

1=ZOOPLANK

2=MOLLKLEIN

3=MOLLGROOT

4=OLIGO

5=CHIRONO

6=MACRUST

7=SLAK

8=KLEIN

9=MIDWIT

10=GROOTWIT

11=MIDROOF

12=GROOTROOF

13=AAL

14=KUIFEEND

15=AALSCH

16=FUUT

17=STELTLOP

18=KLUUT

19=VISDIEFJE

[Eenheden]

w=Waterkwaliteit in ug/l en ug/g dw

o=Accumulatie in organismen in ug/g ww

b=bioaccumulatiefactor in l/g

f=opnamefluxen in ug/g.d

[conc-abio]

1= .400E-01

2= .980E-01

3= 5.00

4= 5.00

5= 12.2

[conc-accu]

1= .132E-01

2= .200

3= .125

4= .122

5= .122

6= .155

7= .238

8= .767E-02

9= .101E-01

10= .668E-01

11= .417E-02

12= .538E-02

13= .229E-01

14= .123

15= .424E-02

16= .322E-02

17= .132

18= .123

19= .406E-02

[bio-accu]

1= .331

2= 5.01

3= 3.13

4= 1.24

5= 1.24

6= 3.87

7= 2.43

8= .192

9= .254

10= 1.67

11= .104

12= .134

13= .572

14= 3.07

15= .106

16= .805E-01

17= 3.30

18= 3.08

19= .102

[food-flux]

1= .778E-03

2= .837E-03

3= .000

4= .512E-02

5= .512E-02

6= .283E-02

7= .531E-02

8= .227E-04

9= .649E-04

10= .621E-03

11= .570E-06  
12= .570E-06  
13= .326E-05  
14= .483E-03  
15= .116E-04  
16= .912E-05  
17= .532E-03  
18= .496E-03  
19= .164E-04

[water-flux]

1= .103E-01  
2= .207E-02  
3= .103E-02  
4= .253E-03  
5= .253E-03  
6= .103E-03  
7= .253E-03  
8= .146E-03  
9= .680E-04  
10= .680E-04  
11= .510E-04  
12= .510E-04  
13= .123E-03

14= .000  
15= .000  
16= .000  
17= .000  
18= .000  
19= .000

[tot-flux]

1= .701E-01  
2= .288  
3= .000  
4= .953  
5= .953  
6= .965  
7= .955  
8= .135  
9= .489  
10= .901  
11= .111E-01  
12= .111E-01  
13= .257E-01  
14= 1.00  
15= 1.00  
16= 1.00  
17= 1.00

18= 1.00  
19= 1.00

[biomag]

1= .124E-02  
2= .498E-01  
3= .222E-02  
4= .645E-01  
5= .645E-01  
6= .109  
7= .124  
8= .887E-02  
9= .654E-02  
10= .238E-01  
11= .551E-02  
12= .711E-02  
13= .903E-02  
14= .368  
15= .458  
16= .420  
17= .576  
18= .607  
19= .529

[biocon]

1= .308  
2= 3.56  
3= 3.13  
4= .585E-01  
5= .585E-01  
6= .136  
7= .111  
8= .166  
9= .130  
10= .165  
11= .103  
12= .133  
13= .558  
14= .000  
15= .000  
16= .000  
17= .000  
18= .000  
19= .000

[half-elim]

1= .822  
2= 47.6  
3= 83.7  
4= 15.6

5= 15.6  
6= 36.4  
7= 29.5  
8= 31.3  
9= 52.7  
10= 66.9  
11= 55.8  
12= 72.0  
13= 125.  
14= 175.  
15= 253.  
16= 244.  
17= 171.  
18= 171.  
19= 171.

**PCB in diep instabiel slib**  
**file: Ds4pcb.out**

[Rekentype]  
Rekt=KOW -type  
[Lokatie]  
Locn=MER Haringvliet, huidige  
[Stofnaam]  
stofn=PCB153  
[aantal\_org]  
norg= 19  
[naam\_org]  
1=ZOOPLANK  
2=MOLLKLEIN  
3=MOLLGROOT  
4=OLIGO  
5=CHIRONO  
6=MACRUST  
7=SLAK  
8=KLEIN  
9=MIDWIT  
10=GROOTWIT  
11=MIDROOF  
12=GROOTROOF  
13=AAL  
14=KUIFEEND  
15=AALSCH  
16=FUUT  
17=STELTLOP  
18=KLUUT  
19=VISDIEFJE  
[Eenheden]  
w=Waterkwaliteit in ug/l en ug/g dw  
o=Accumulatie in organismen in ug/g ww  
b=bioaccumulatiefactor in l/g  
f=opnamefluxen in ug/g.d  
[conc-abio]  
1= .121  
2= .124  
3= 227.  
4= 227.  
5= 232.  
[conc-accu]  
1= 5.12  
2= 29.8  
3= 5.23  
4= 22.3

5= 22.3  
6= 86.7  
7= 23.7  
8= 32.1  
9= 57.8  
10= 232.  
11= 34.4  
12= 54.0  
13= 444.  
14= 249.  
15= .352E+04  
16= 790.  
17= 312.  
18= 407.  
19= 663.  
[bio-accu]  
1= 42.3  
2= 246.  
3= 43.2  
4= 180.  
5= 180.  
6= 717.  
7= 191.  
8= 265.  
9= 478.  
10= .192E+04  
11= 284.  
12= 447.  
13= .367E+04  
14= .206E+04  
15= .291E+05  
16= .653E+04  
17= .258E+04  
18= .336E+04  
19= .548E+04  
[food-flux]  
1= .707  
2= .496  
3= .000  
4= .396  
5= .396  
6= 1.43  
7= .405  
8= .643  
9= .372  
10= 1.32  
11= .321

12= .321  
13= 1.15  
14= 1.00  
15= 2.93  
16= 1.53  
17= 1.29  
18= 1.28  
19= 2.74  
[water-flux]  
1= .625  
2= .125  
3= .625E-01  
4= .640E-02  
5= .640E-02  
6= .625E-02  
7= .640E-02  
8= .530E-01  
9= .247E-01  
10= .247E-01  
11= .185E-01  
12= .185E-01  
13= .448E-01  
14= .000  
15= .000  
16= .000  
17= .000  
18= .000  
19= .000  
[tot-flux]  
1= .531  
2= .799  
3= .000  
4= .984  
5= .984  
6= .996  
7= .984  
8= .924  
9= .938  
10= .982  
11= .946  
12= .946  
13= .963  
14= 1.00  
15= 1.00  
16= 1.00  
17= 1.00  
18= 1.00



19= 1.00  
[biomag]  
1= .797E-01  
2= .692  
3= .307E-01  
4= .632  
5= .632  
6= 2.50  
7= .669  
8= 1.08  
9= 1.25  
10= 4.22  
11= .827  
12= 1.30  
13= 1.86  
14= 5.02  
15= 60.1  
16= 24.6  
17= 7.87  
18= 10.9  
19= 20.7  
[biocon]  
1= 19.8  
2= 49.5  
3= 43.2  
4= 2.87  
5= 2.87  
6= 3.12  
7= 2.97  
8= 20.2  
9= 29.7  
10= 35.1  
11= 15.5  
12= 24.3  
13= 137.  
14= .000  
15= .000  
16= .000  
17= .000  
18= .000  
19= .000  
[half-elim]  
1= 2.65  
2= 33.1  
3= 57.7  
4= 38.3  
5= 38.3

6= 41.7  
7= 39.7  
8= 31.8  
9= 101.  
10= 119.  
11= 69.8  
12= 110.  
13= 256.  
14= 171.  
15= 828.  
16= 357.  
17= 167.  
18= 220.  
19= 167.

**Cadmium in ondiep stabiel slib**  
**file: Ss4cad.out**

; Let op: steady-state berekening, geen uitvoer naar (

[Rekentype]

Rekt=FLUX-type

[Lokatie]

Locn=MER Haringvliet, huidige

[Stofnaam]

stofn=cadmium

[aantal\_org]

norg= 19

[naam\_org]

1=ZOOPLANK

2=MOLLKLEIN

3=MOLLGROOT

4=OLIGO

5=CHIRONO

6=MACRUST

7=SLAK

8=KLEIN

9=MIDWIT

10=GROOTWIT

11=MIDROOF

12=GROOTROOF

13=AAL

14=KUIFEEND

15=AALSCH

16=FUUT

17=STELTLOP

18=KLUUT

19=VISDIEFJE

[Eenheden]

w=Waterkwaliteit in ug/l en ug/g dw

o=Accumulatie in organismen in ug/g ww

b=bioaccumulatiefactor in l/g

f=opnamefluxen in ug/g.d

[conc-abio]

1= .400E-01

2= .490E-01

3= 5.00

4= 5.00

5= 6.14

[conc-accu]

1= .132E-01

2= .178

3= .127

4= .626E-01

5= .626E-01

6= .113

7= .120

8= .701E-02

9= .146E-01

10= .455E-01

11= .417E-02

12= .538E-02

13= .226E-01

14= .109

15= .582E-02

16= .294E-02

17= .823E-01

18= .633E-01

19= .371E-02

[bio-accu]

1= .331

2= 4.46

3= 3.17

4= 1.28

5= 1.28

6= 2.84

7= 2.45

8= .175

9= .365

10= 1.14

11= .104

12= .134

13= .566

14= 2.74

15= .146

16= .736E-01

17= 2.06

18= 1.58

19= .928E-01

[food-flux]

1= .775E-03

2= .521E-03

3= .113E-04

4= .264E-02

5= .264E-02

6= .205E-02

7= .267E-02

8= .817E-05

9= .123E-03

10= .401E-03

11= .581E-06  
12= .581E-06  
13= .181E-05  
14= .430E-03  
15= .159E-04  
16= .834E-05  
17= .332E-03  
18= .255E-03  
19= .150E-04  
[water-flux]  
1= .103E-01  
2= .207E-02  
3= .103E-02  
4= .127E-03  
5= .127E-03  
6= .103E-03  
7= .127E-03  
8= .146E-03  
9= .680E-04  
10= .680E-04  
11= .510E-04  
12= .510E-04  
13= .123E-03  
14= .000  
15= .000  
16= .000  
17= .000  
18= .000  
19= .000  
[tot-flux]  
1= .698E-01  
2= .201  
3= .109E-01  
4= .954  
5= .954  
6= .952  
7= .955  
8= .530E-01  
9= .645  
10= .855  
11= .113E-01  
12= .113E-01  
13= .144E-01  
14= 1.00  
15= 1.00  
16= 1.00  
17= 1.00

18= 1.00  
19= 1.00  
[biomag]  
1= .123E-02  
2= .449E-01  
3= .222E-02  
4= .651E-01  
5= .651E-01  
6= .124  
7= .124  
8= .887E-02  
9= .117E-01  
10= .268E-01  
11= .551E-02  
12= .711E-02  
13= .903E-02  
14= .368  
15= .458  
16= .420  
17= .576  
18= .607  
19= .529  
[biocon]  
1= .308  
2= 3.56  
3= 3.13  
4= .585E-01  
5= .585E-01  
6= .136  
7= .111  
8= .166  
9= .130  
10= .165  
11= .103  
12= .133  
13= .558  
14= .000  
15= .000  
16= .000  
17= .000  
18= .000  
19= .000  
[half-elim]  
1= .822  
2= 47.6  
3= 83.7  
4= 15.6

5= 15.6  
6= 36.4  
7= 29.5  
8= 31.3  
9= 52.7  
10= 66.9  
11= 55.8  
12= 72.0  
13= 125.  
14= 175.  
15= 253.  
16= 244.  
17= 171.  
18= 171.  
19= 171.

**PCB in ondiep stabiel slib**  
**file: Ss4pcb.out**

[Rekentype]  
Rekt=KOW -type  
[Lokatie]  
Locn=MER Haringvliet, huidige  
[Stofnaam]  
stofn=PCB153  
[aantal\_org]  
norg= 19  
[naam\_org]  
1=ZOOPLANK  
2=MOLLKLEIN  
3=MOLLGROOT  
4=OLIGO  
5=CHIRONO  
6=MACRUST  
7=SLAK  
8=KLEIN  
9=MIDWIT  
10=GROOTWIT  
11=MIDROOF  
12=GROOTROOF  
13=AAL  
14=KUIFEEND  
15=AALSCH  
16=FUUT  
17=STELTLOP  
18=KLUUT  
19=VISDIEFJE  
[Eenheden]  
w=Waterkwaliteit in ug/l en ug/g dw  
o=Accumulatie in organismen in ug/g ww  
b=bioaccumulatiefactor in l/g  
f=opnamefluxen in ug/g.d  
[conc-abio]  
1= .121  
2= .690E-01  
3= 227.  
4= 227.  
5= 129.  
[conc-accu]  
1= 5.10  
2= 24.5  
3= 6.09

4= 12.7  
5= 12.7  
6= 67.4  
7= 13.2  
8= 17.5  
9= 72.2  
10= 156.  
11= 25.4  
12= 39.9  
13= 245.  
14= 205.  
15= .389E+04  
16= 430.  
17= 198.  
18= 232.  
19= 361.  
[bio-accu]  
1= 42.2  
2= 202.  
3= 50.3  
4= 184.  
5= 184.  
6= 557.  
7= 191.  
8= 144.  
9= 597.  
10= .129E+04  
11= 210.  
12= 330.  
13= .202E+04  
14= .169E+04  
15= .321E+05  
16= .355E+04  
17= .163E+04  
18= .192E+04  
19= .298E+04  
[food-flux]  
1= .704  
2= .385  
3= .103E-01  
4= .226  
5= .226  
6= 1.11  
7= .225  
8= .326  
9= .471  
10= .878

11= .232  
12= .232  
13= .615  
14= .826  
15= 3.24  
16= .831  
17= .817  
18= .727  
19= 1.49  
[water-flux]  
1= .625  
2= .125  
3= .625E-01  
4= .356E-02  
5= .356E-02  
6= .625E-02  
7= .356E-02  
8= .530E-01  
9= .247E-01  
10= .247E-01  
11= .185E-01  
12= .185E-01  
13= .448E-01  
14= .000  
15= .000  
16= .000  
17= .000  
18= .000  
19= .000  
[tot-flux]  
1= .530  
2= .755  
3= .142  
4= .984  
5= .984  
6= .994  
7= .984  
8= .860  
9= .950  
10= .973  
11= .926  
12= .926  
13= .932  
14= 1.00  
15= 1.00  
16= 1.00  
17= 1.00

18= 1.00  
19= 1.00  
[biomag]  
1= .794E-01  
2= .623  
3= .307E-01  
4= .638  
5= .638  
6= 2.84  
7= .669  
8= 1.08  
9= 2.24  
10= 4.76  
11= .827  
12= 1.30  
13= 1.86  
14= 5.02  
15= 60.1  
16= 24.6  
17= 7.87  
18= 10.9  
19= 20.7  
[biocon]  
1= 19.8  
2= 49.5  
3= 43.2  
4= 2.87  
5= 2.87  
6= 3.12  
7= 2.97  
8= 20.2  
9= 29.7  
10= 35.1  
11= 15.5  
12= 24.3  
13= 137.  
14= .000  
15= .000  
16= .000  
17= .000  
18= .000  
19= .000  
[half-elim]  
1= 2.65  
2= 33.1  
3= 57.7  
4= 38.3

5= 38.3  
6= 41.7  
7= 39.7  
8= 31.8  
9= 101.  
10= 119.  
11= 69.8  
12= 110.  
13= 256.  
14= 171.  
15= 828.  
16= 357.  
17= 167.  
18= 220.  
19= 167.

# **L**   **Gekalibreerde uitvoerfiles** **CHEOPS**

**Cadmium in gehele Haringvliet**

file: Re6cad.out

; Let op: steady-state berekening, geen uitvoer naar (

[Rekentype]

Rekt=FLUX-type

[Lokatie]

Locn=MER Haringvliet, huidige

[Stofnaam]

stofn=cadmium

[aantal\_org]

norg= 19

[naam\_org]

1=ZOOPLANK

2=MOLLKLEIN

3=MOLLGROOT

4=OLIGO

5=CHIRONO

6=MACRUST

7=SLAK

8=KLEIN

9=MIDWIT

10=GROOTWIT

11=MIDROOF

12=GROOTROOF

13=AAL

14=KUIFEEND

15=AALSCH

16=FUUT

17=STELTLOP

18=KLUUT

19=VISDIEFJE

[Eenheden]

w=Waterkwaliteit in ug/l en ug/g dw

o=Accumulatie in organismen in ug/g ww

b=bioaccumulatiefactor in l/g

f=opnamefluxen in ug/g.d

[conc-abio]

1= .400E-01

2= .690E-01

3= 5.00

4= 5.00

5= 8.70

[conc-accu]

1= .132E-01

2= .190

3= .127

4= .524E-01

5= .873E-01

6= .126

7= .170

8= .718E-02

9= .827E-02

10= .484E-01

11= .416E-02

12= .537E-02

13= .227E-01

14= .116

15= .356E-02

16= .301E-02

17= .901E-01

18= .707E-01

19= .380E-02

[bio-accu]

1= .331

2= 4.74

3= 3.17

4= .759

5= 1.27

6= 3.14

7= 2.46

8= .179

9= .207

10= 1.21

11= .104

12= .134

13= .568

14= 2.91

15= .890E-01

16= .753E-01

17= 2.25

18= 1.77

19= .950E-01

[food-flux]

1= .780E-03

2= .684E-03

3= .113E-04

4= .221E-02

5= .368E-02

6= .228E-02

7= .379E-02

8= .119E-04

9= .403E-04

10= .431E-03



11= .508E-06  
12= .508E-06  
13= .230E-05  
14= .457E-03  
15= .973E-05  
16= .854E-05  
17= .363E-03  
18= .285E-03  
19= .153E-04  
[water-flux]  
1= .103E-01  
2= .207E-02  
3= .103E-02  
4= .107E-03  
5= .178E-03  
6= .103E-03  
7= .178E-03  
8= .146E-03  
9= .680E-04  
10= .680E-04  
11= .510E-04  
12= .510E-04  
13= .123E-03  
14= .000  
15= .000  
16= .000  
17= .000  
18= .000  
19= .000  
[tot-flux]  
1= .703E-01  
2= .249  
3= .109E-01  
4= .954  
5= .954  
6= .957  
7= .955  
8= .751E-01  
9= .372  
10= .864  
11= .987E-02  
12= .987E-02  
13= .183E-01  
14= 1.00  
15= 1.00  
16= 1.00  
17= 1.00

18= 1.00  
19= 1.00  
[biomag]  
1= .124E-02  
2= .494E-01  
3= .222E-02  
4= .388E-01  
5= .647E-01  
6= .112  
7= .124  
8= .887E-02  
9= .609E-02  
10= .234E-01  
11= .551E-02  
12= .711E-02  
13= .903E-02  
14= .368  
15= .458  
16= .420  
17= .576  
18= .607  
19= .529  
[biocon]  
1= .308  
2= 3.56  
3= 3.13  
4= .351E-01  
5= .585E-01  
6= .136  
7= .111  
8= .166  
9= .130  
10= .165  
11= .103  
12= .133  
13= .558  
14= .000  
15= .000  
16= .000  
17= .000  
18= .000  
19= .000  
[half-elim]  
1= .822  
2= 47.6  
3= 83.7  
4= 15.6

5= 15.6  
6= 36.4  
7= 29.5  
8= 31.3  
9= 52.7  
10= 66.9  
11= 55.8  
12= 72.0  
13= 125.  
14= 175.  
15= 253.  
16= 244.  
17= 171.  
18= 171.  
19= 171.

**Cadmium in ondiep zand**  
**file: Za6cad.out**

; Let op: steady-state berekening, geen uitvoer naar (

[Rekertype]

Rekt=FLUX-type

[Lokatie]

Locn=MER Haringvliet, huidige

[Stofnaam]

stofn=cadmium

[aantal\_org]

norg= 19

[naam\_org]

1=ZOOPLANK

2=MOLLKLEIN

3=MOLLGROOT

4=OLIGO

5=CHIRONO

6=MACRUST

7=SLAK

8=KLEIN

9=MIDWIT

10=GROOTWIT

11=MIDROOF

12=GROOTROOF

13=AAL

14=KUIFEEND

15=AALSCH

16=FUUT

17=STELTLOP

18=KLUUT

19=VISDIEFJE

[Eenheden]

w=Waterkwaliteit in ug/l en ug/g dw

o=Accumulatie in organismen in ug/g ww

b=bioaccumulatiefactor in l/g

f=opnamefluxen in ug/g.d

[conc-abio]

1= .400E-01

2= .620E-01

3= 5.00

4= 5.00

5= 7.69

[conc-accu]

1= .132E-01

2= .163

3= .127

4= .433E-01  
5= .721E-01  
6= .732E-01  
7= .150  
8= .694E-02  
9= .777E-02  
10= .406E-01  
11= .416E-02  
12= .537E-02  
13= .226E-01  
14= .100E+00  
15= .338E-02  
16= .292E-02  
17= .756E-01  
18= .583E-01  
19= .367E-02  
[bio-accu]  
1= .331  
2= 4.08  
3= 3.17  
4= .698  
5= 1.16  
6= 1.83  
7= 2.43  
8= .174  
9= .194  
10= 1.02  
11= .104  
12= .134  
13= .564  
14= 2.50  
15= .844E-01  
16= .729E-01  
17= 1.89  
18= 1.46  
19= .919E-01  
[food-flux]  
1= .777E-03  
2= .452E-03  
3= .113E-04  
4= .181E-02  
5= .302E-02  
6= .128E-02  
7= .335E-02  
8= .669E-05  
9= .338E-04  
10= .351E-03

11= .486E-06  
12= .486E-06  
13= .140E-05  
14= .393E-03  
15= .923E-05  
16= .826E-05  
17= .305E-03  
18= .235E-03  
19= .148E-04  
[water-flux]  
1= .103E-01  
2= .207E-02  
3= .103E-02  
4= .961E-04  
5= .160E-03  
6= .103E-03  
7= .160E-03  
8= .146E-03  
9= .680E-04  
10= .680E-04  
11= .510E-04  
12= .510E-04  
13= .123E-03  
14= .000  
15= .000  
16= .000  
17= .000  
18= .000  
19= .000  
[tot-flux]  
1= .700E-01  
2= .179  
3= .109E-01  
4= .950  
5= .950  
6= .926  
7= .954  
8= .438E-01  
9= .332  
10= .838  
11= .945E-02  
12= .945E-02  
13= .112E-01  
14= 1.00  
15= 1.00  
16= 1.00  
17= 1.00

18= 1.00

19= 1.00

[biomag]

1= .123E-02

2= .370E-01

3= .222E-02

4= .369E-01

5= .615E-01

6= .789E-01

7= .124

8= .887E-02

9= .593E-02

10= .224E-01

11= .551E-02

12= .711E-02

13= .903E-02

14= .368

15= .458

16= .420

17= .576

18= .607

19= .529

[biocon]

1= .308

2= 3.35

3= 3.13

4= .351E-01

5= .585E-01

6= .136

7= .111

8= .166

9= .130

10= .165

11= .103

12= .133

13= .558

14= .000

15= .000

16= .000

17= .000

18= .000

19= .000

[half-elim]

1= .822

2= 44.7

3= 83.7

4= 15.6

5= 15.6

6= 36.4

7= 29.5

8= 31.3

9= 52.7

10= 66.9

11= 55.8

12= 72.0

13= 125.

14= 175.

15= 253.

16= 244.

17= 171.

18= 171.

19= 171.

**Cadmium in intergetijdenzone**

file: In6cad.out

; Let op: steady-state berekening, geen uitvoer naar (

[Rekentype]

Rekt=FLUX-type

[Lokatie]

Locn=MER Haringvliet, huidige

[Stofnaam]

stofn=cadmium

[aantal\_org]

norg= 19

[naam\_org]

1=ZOOPLANK

2=MOLLKLEIN

3=MOLLGROOT

4=OLIGO

5=CHIRONO

6=MACRUST

7=SLAK

8=KLEIN

9=MIDWIT

10=GROOTWIT

11=MIDROOF

12=GROOTROOF

13=AAL

14=KUIFEEND

15=AALSCH

16=FUUT

17=STELTLOP

18=KLUUT

19=VISDIEFJE

[Eenheden]

w=Waterkwaliteit in ug/l en ug/g dw

o=Accumulatie in organismen in ug/g ww

b=bioaccumulatiefactor in l/g

f=opnamefluxen in ug/g.d

[conc-abio]

1= .400E-01

2= .350E-01

3= 5.00

4= 5.00

5= 4.37

[conc-accu]

1= .132E-01

2= .170

3= .127

4= .265E-01

5= .441E-01

6= .736E-01

7= .854E-01

8= .700E-02

9= .645E-02

10= .243E-01

11= .416E-02

12= .537E-02

13= .224E-01

14= .104

15= .291E-02

16= .294E-02

17= .597E-01

18= .357E-01

19= .370E-02

[bio-accu]

1= .331

2= 4.25

3= 3.17

4= .756

5= 1.26

6= 1.84

7= 2.44

8= .175

9= .161

10= .607

11= .104

12= .134

13= .561

14= 2.61

15= .727E-01

16= .735E-01

17= 1.49

18= .892

19= .926E-01

[food-flux]

1= .772E-03

2= .401E-03

3= .113E-04

4= .111E-02

5= .186E-02

6= .129E-02

7= .191E-02

8= .793E-05

9= .166E-04

10= .183E-03

11= .472E-06  
12= .472E-06  
13= .640E-06  
14= .410E-03  
15= .794E-05  
16= .832E-05  
17= .241E-03  
18= .144E-03  
19= .149E-04

[water-flux]

1= .103E-01  
2= .207E-02  
3= .103E-02  
4= .542E-04  
5= .904E-04  
6= .103E-03  
7= .904E-04  
8= .146E-03  
9= .680E-04  
10= .680E-04  
11= .510E-04  
12= .510E-04  
13= .123E-03

14= .000  
15= .000  
16= .000  
17= .000  
18= .000  
19= .000

[tot-flux]

1= .695E-01  
2= .162  
3= .109E-01  
4= .954  
5= .954  
6= .926  
7= .955  
8= .515E-01  
9= .196  
10= .729  
11= .918E-02  
12= .918E-02  
13= .516E-02  
14= 1.00  
15= 1.00  
16= 1.00  
17= 1.00

18= 1.00  
19= 1.00

[biomag]

1= .123E-02  
2= .377E-01  
3= .222E-02  
4= .382E-01  
5= .637E-01  
6= .962E-01  
7= .124  
8= .887E-02  
9= .543E-02  
10= .215E-01  
11= .551E-02  
12= .711E-02  
13= .903E-02  
14= .368  
15= .458  
16= .420  
17= .576  
18= .607  
19= .529

[biocon]

1= .308  
2= 3.56  
3= 3.13  
4= .351E-01  
5= .585E-01  
6= .136  
7= .111  
8= .166  
9= .130  
10= .165  
11= .103  
12= .133  
13= .558  
14= .000  
15= .000  
16= .000  
17= .000  
18= .000  
19= .000

[half-elim]

1= .822  
2= 47.6  
3= 83.7  
4= 15.6

5= 15.6  
6= 36.4  
7= 29.5  
8= 31.3  
9= 52.7  
10= 66.9  
11= 55.8  
12= 72.0  
13= 125.  
14= 175.  
15= 253.  
16= 244.  
17= 171.  
18= 171.  
19= 171.

**Cadmium in diep instabiel slib**  
**file: Ds6cad.out**

; Let op: steady-state berekening, geen uitvoer naar (

[Rekentype]

Rekt=FLUX-type

[Lokatie]

Locn=MER Haringvliet, huidige

[Stofnaam]

stofn=cadmium

[aantal\_org]

norg= 19

[naam\_org]

1=ZOOPLANK

2=MOLLKLEIN

3=MOLLGROOT

4=OLIGO

5=CHIRONO

6=MACRUST

7=SLAK

8=KLEIN

9=MIDWIT

10=GROOTWIT

11=MIDROOF

12=GROOTROOF

13=AAL

14=KUIFEEND

15=AALSCH

16=FUUT

17=STELTLOP

18=KLUUT

19=VISDIEFJE

[Eenheden]

w=Waterkwaliteit in ug/l en ug/g dw

o=Accumulatie in organismen in ug/g ww

b=bioaccumulatiefactor in l/g

f=opnamefluxen in ug/g.d

[conc-abio]

1= .400E-01

2= .980E-01

3= 5.00

4= 5.00

5= 12.2

[conc-accu]

1= .132E-01

2= .200

3= .125

4= .730E-01  
5= .122  
6= .155  
7= .238  
8= .734E-02  
9= .978E-02  
10= .665E-01  
11= .416E-02  
12= .537E-02  
13= .229E-01  
14= .123  
15= .411E-02  
16= .308E-02  
17= .113  
18= .984E-01  
19= .389E-02  
[bio-accu]  
1= .331  
2= 5.01  
3= 3.13  
4= .745  
5= 1.24  
6= 3.87  
7= 2.43  
8= .183  
9= .244  
10= 1.66  
11= .104  
12= .134  
13= .572  
14= 3.07  
15= .103  
16= .771E-01  
17= 2.83  
18= 2.46  
19= .971E-01  
[food-flux]  
1= .778E-03  
2= .837E-03  
3= .000  
4= .307E-02  
5= .512E-02  
6= .283E-02  
7= .531E-02  
8= .154E-04  
9= .601E-04  
10= .618E-03

11= .546E-06  
12= .546E-06  
13= .324E-05  
14= .483E-03  
15= .112E-04  
16= .873E-05  
17= .456E-03  
18= .397E-03  
19= .157E-04  
[water-flux]  
1= .103E-01  
2= .207E-02  
3= .103E-02  
4= .152E-03  
5= .253E-03  
6= .103E-03  
7= .253E-03  
8= .146E-03  
9= .680E-04  
10= .680E-04  
11= .510E-04  
12= .510E-04  
13= .123E-03  
14= .000  
15= .000  
16= .000  
17= .000  
18= .000  
19= .000  
[tot-flux]  
1= .701E-01  
2= .288  
3= .000  
4= .953  
5= .953  
6= .965  
7= .955  
8= .956E-01  
9= .469  
10= .901  
11= .106E-01  
12= .106E-01  
13= .256E-01  
14= 1.00  
15= 1.00  
16= 1.00  
17= 1.00



18= 1.00  
19= 1.00  
[biomag]  
1= .124E-02  
2= .498E-01  
3= .222E-02  
4= .387E-01  
5= .645E-01  
6= .109  
7= .124  
8= .887E-02  
9= .654E-02  
10= .238E-01  
11= .551E-02  
12= .711E-02  
13= .903E-02  
14= .368  
15= .458  
16= .420  
17= .576  
18= .607  
19= .529  
[biocon]  
1= .308  
2= 3.56  
3= 3.13  
4= .351E-01  
5= .585E-01  
6= .136  
7= .111  
8= .166  
9= .130  
10= .165  
11= .103  
12= .133  
13= .558  
14= .000  
15= .000  
16= .000  
17= .000  
18= .000  
19= .000  
[half-elim]  
1= .822  
2= 47.6  
3= 83.7  
4= 15.6

5= 15.6  
6= 36.4  
7= 29.5  
8= 31.3  
9= 52.7  
10= 66.9  
11= 55.8  
12= 72.0  
13= 125.  
14= 175.  
15= 253.  
16= 244.  
17= 171.  
18= 171.  
19= 171.

**Cadmium in ondiep stabiel slib**

file: S6cad.out

; Let op: steady-state berekening, geen uitvoer naar (

[Rekentye]

Rekt=FLUX-type

[Lokatie]

Locn=MER Haringvliet, huidige

[Stofnaam]

stofn=cadmium

[aantal\_org]

norg= 19

[naam\_org]

1=ZOOPLANK

2=MOLLKLEIN

3=MOLLGROOT

4=OLIGO

5=CHIRONO

6=MACRUST

7=SLAK

8=KLEIN

9=MIDWIT

10=GROOTWIT

11=MIDROOF

12=GROOTROOF

13=AAL

14=KUIFEEND

15=AALSCH

16=FUUT

17=STELTLOP

18=KLUUT

19=VISDIEFJE

[Eenheden]

w=Waterkwaliteit in ug/l en ug/g dw

o=Accumulatie in organismen in ug/g ww

b=bioaccumulatiefactor in l/g

f=opnamefluxen in ug/g.d

[conc-abio]

1= .400E-01

2= .490E-01

3= 5.00

4= 5.00

5= 6.14

[conc-accu]

1= .132E-01

2= .178

3= .127

4= .375E-01

5= .626E-01

6= .113

7= .120

8= .696E-02

9= .145E-01

10= .454E-01

11= .417E-02

12= .538E-02

13= .226E-01

14= .109

15= .578E-02

16= .292E-02

17= .111

18= .101

19= .368E-02

[bio-accu]

1= .331

2= 4.46

3= 3.17

4= .766

5= 1.28

6= 2.84

7= 2.45

8= .174

9= .362

10= 1.14

11= .104

12= .134

13= .566

14= 2.74

15= .145

16= .731E-01

17= 2.78

18= 2.53

19= .921E-01

[food-flux]

1= .775E-03

2= .521E-03

3= .113E-04

4= .158E-02

5= .264E-02

6= .205E-02

7= .267E-02

8= .711E-05

9= .122E-03

10= .400E-03

11= .577E-06  
12= .577E-06  
13= .181E-05  
14= .430E-03  
15= .158E-04  
16= .828E-05  
17= .448E-03  
18= .408E-03  
19= .149E-04

[water-flux]

1= .103E-01  
2= .207E-02  
3= .103E-02  
4= .759E-04  
5= .127E-03  
6= .103E-03  
7= .127E-03  
8= .146E-03  
9= .680E-04  
10= .680E-04  
11= .510E-04  
12= .510E-04  
13= .123E-03  
14= .000  
15= .000  
16= .000  
17= .000  
18= .000  
19= .000

[tot-flux]

1= .698E-01  
2= .201  
3= .109E-01  
4= .954  
5= .954  
6= .952  
7= .955  
8= .464E-01  
9= .642  
10= .855  
11= .112E-01  
12= .112E-01  
13= .144E-01  
14= 1.00  
15= 1.00  
16= 1.00  
17= 1.00

18= 1.00  
19= 1.00

[biomag]

1= .123E-02  
2= .449E-01  
3= .222E-02  
4= .391E-01  
5= .651E-01  
6= .124  
7= .124  
8= .887E-02  
9= .117E-01  
10= .268E-01  
11= .551E-02  
12= .711E-02  
13= .903E-02  
14= .368  
15= .458  
16= .420  
17= .576  
18= .607  
19= .529

[biocon]

1= .308  
2= 3.56  
3= 3.13  
4= .351E-01  
5= .585E-01  
6= .136  
7= .111  
8= .166  
9= .130  
10= .165  
11= .103  
12= .133  
13= .558  
14= .000  
15= .000  
16= .000  
17= .000  
18= .000  
19= .000

[half-elim]

1= .822  
2= 47.6  
3= 83.7  
4= 15.6

5= 15.6  
6= 36.4  
7= 29.5  
8= 31.3  
9= 52.7  
10= 66.9  
11= 55.8  
12= 72.0  
13= 125.  
14= 175.  
15= 253.  
16= 244.  
17= 171.  
18= 171.  
19= 171.

**PCB<sub>153</sub> in gehele Haringvliet**  
**file: Re6pcb.out**

[Rekentype]

Rekt=KOW -type

[Lokatie]

Loen=MER Haringvliet, huidige

[Stofnaam]

stofn=PCB153

[aantal\_org]

norg= 19

[naam\_org]

1=ZOOPLANK

2=MOLLKLEIN

3=MOLLGROOT

4=OLIGO

5=CHIRONO

6=MACRUST

7=SLAK

8=KLEIN

9=MIDWIT

10=GROOTWIT

11=MIDROOF

12=GROOTROOF

13=AAL

14=KUIFEEND

15=AALSCH

16=FUUT

17=STELTLOP

18=KLUUT

19=VISDIEFJE

[Eenheden]

w=Waterkwaliteit in ug/l en ug/g dw

o=Accumulatie in organismen in ug/g ww

b=bioaccumulatiefactor in l/g

f=opnamefluxen in ug/g.d

[conc-abio]

1= .121

2= .127

3= 227.

4= 227.

5= 239.

[conc-accu]

1= 5.12

2= 29.8

3= 6.09

4= 24.1

5= 23.0  
6= 90.2  
7= 24.4  
8= 33.5  
9= 56.6  
10= 238.  
11= 34.5  
12= 54.3  
13= 434.  
14= 249.  
15= .346E+04  
16= 824.  
17= 325.  
18= 430.  
19= 691.  
[bio-accu]  
1= 42.3  
2= 246.  
3= 50.3  
4= 190.  
5= 181.  
6= 745.  
7= 192.  
8= 277.  
9= 467.  
10= .197E+04  
11= 285.  
12= 448.  
13= .359E+04  
14= .206E+04  
15= .286E+05  
16= .681E+04  
17= .269E+04  
18= .355E+04  
19= .571E+04  
[food-flux]  
1= .709  
2= .497  
3= .103E-01  
4= .409  
5= .409  
6= 1.49  
7= .417  
8= .673  
9= .363  
10= 1.36  
11= .323

12= .323  
13= 1.12  
14= 1.01  
15= 2.88  
16= 1.59  
17= 1.34  
18= 1.35  
19= 2.86  
[water-flux]  
1= .625  
2= .125  
3= .625E-01  
4= .656E-02  
5= .656E-02  
6= .625E-02  
7= .656E-02  
8= .530E-01  
9= .247E-01  
10= .247E-01  
11= .185E-01  
12= .185E-01  
13= .448E-01  
14= .000  
15= .000  
16= .000  
17= .000  
18= .000  
19= .000  
[tot-flux]  
1= .531  
2= .799  
3= .142  
4= .984  
5= .984  
6= .996  
7= .985  
8= .927  
9= .936  
10= .982  
11= .946  
12= .946  
13= .962  
14= 1.00  
15= 1.00  
16= 1.00  
17= 1.00  
18= 1.00

19= 1.00  
[biomag]  
1= .800E-01  
2= .686  
3= .307E-01  
4= .663  
5= .633  
6= 2.56  
7= .669  
8= 1.08  
9= 1.16  
10= 4.16  
11= .827  
12= 1.30  
13= 1.86  
14= 5.02  
15= 60.1  
16= 24.6  
17= 7.87  
18= 10.9  
19= 20.7  
[biocon]  
1= 19.8  
2= 49.5  
3= 43.2  
4= 3.00  
5= 2.87  
6= 3.12  
7= 2.97  
8= 20.2  
9= 29.7  
10= 35.1  
11= 15.5  
12= 24.3  
13= 137.  
14= .000  
15= .000  
16= .000  
17= .000  
18= .000  
19= .000  
[half-elim]  
1= 2.65  
2= 33.1  
3= 57.7  
4= 40.1  
5= 38.3

6= 41.7  
7= 39.7  
8= 31.8  
9= 101.  
10= 119.  
11= 69.8  
12= 110.  
13= 256.  
14= 171.  
15= 828.  
16= 357.  
17= 167.  
18= 220.  
19= 167.

PCB<sub>153</sub> in ondiep zand  
file: Za6pcb.out

[Rekentye]

Rekt=KOW -type

[Lokatie]

Locn=MER Haringvliet, huidige

[Stofnaam]

stofn=PCB153

[aantal\_org]

norg= 19

[naam\_org]

1=ZOOPLANK

2=MOLLKLEIN

3=MOLLGROOT

4=OLIGO

5=CHIRONO

6=MACRUST

7=SLAK

8=KLEIN

9=MIDWIT

10=GROOTWIT

11=MIDROOF

12=GROOTROOF

13=AAL

14=KUIFEEND

15=AALSCH

16=FUUT

17=STELTLOP

18=KLUUT

19=VISDIEFJE

[Eenheden]

w=Waterkwaliteit in ug/l en ug/g dw

o=Accumulatie in organismen in ug/g ww

b=bioaccumulatiefactor in l/g

f=opnamefluxen in ug/g.d

[conc-abio]

1= .121

2= .980E-01

3= 227.

4= 227.

5= 183.

[conc-accu]

1= 5.11

2= 23.0

3= 6.09

4= 18.0

5= 17.2

6= 58.7

7= 18.7

8= 18.4

9= 42.1

10= 176.

11= 21.8

12= 34.2

13= 231.

14= 192.

15= .243E+04

16= 452.

17= 245.

18= 321.

19= 380.

[bio-accu]

1= 42.2

2= 190.

3= 50.3

4= 184.

5= 176.

6= 485.

7= 190.

8= 152.

9= 348.

10= .146E+04

11= 180.

12= 283.

13= .191E+04

14= .159E+04

15= .201E+05

16= .374E+04

17= .202E+04

18= .265E+04

19= .314E+04

[food-flux]

1= .705

2= .376

3= .103E-01

4= .305

5= .305

6= .965

7= .319

8= .346

9= .264

10= .999

11= .197  
12= .197  
13= .577  
14= .775  
15= 2.03  
16= .874  
17= 1.01  
18= 1.01  
19= 1.57

[water-flux]

1= .625  
2= .125  
3= .625E-01  
4= .506E-02  
5= .506E-02  
6= .625E-02  
7= .506E-02  
8= .530E-01  
9= .247E-01  
10= .247E-01  
11= .185E-01  
12= .185E-01  
13= .448E-01  
14= .000  
15= .000  
16= .000  
17= .000  
18= .000  
19= .000

[tot-flux]

1= .530  
2= .750  
3= .142  
4= .984  
5= .984  
6= .994  
7= .984  
8= .867  
9= .914  
10= .976  
11= .914  
12= .914  
13= .928  
14= 1.00  
15= 1.00  
16= 1.00  
17= 1.00

18= 1.00

19= 1.00

[biomag]

1= .796E-01  
2= .524  
3= .307E-01  
4= .631  
5= .603  
6= 1.81  
7= .669  
8= 1.08  
9= 1.13  
10= 3.98  
11= .827  
12= 1.30  
13= 1.86  
14= 5.02  
15= 60.1  
16= 24.6  
17= 7.87  
18= 10.9  
19= 20.7

[biocon]

1= 19.8  
2= 47.4  
3= 43.2  
4= 3.00  
5= 2.87  
6= 3.12  
7= 2.97  
8= 20.2  
9= 29.7  
10= 35.1  
11= 15.5  
12= 24.3  
13= 137.  
14= .000  
15= .000  
16= .000  
17= .000  
18= .000  
19= .000

[half-elim]

1= 2.65  
2= 31.6  
3= 57.7  
4= 40.1



5= 38.3  
6= 41.7  
7= 39.7  
8= 31.8  
9= 101.  
10= 119.  
11= 69.8  
12= 110.  
13= 256.  
14= 171.  
15= 828.  
16= 357.  
17= 167.  
18= 220.  
19= 167.

**PCB<sub>153</sub> in intergetijdenzone**  
**file: In6pcb.out**

[Rekentype]  
Rekt=KOW -type  
[Lokatie]  
Locn=MER Haringvliet, huidige  
[Stofnaam]  
stofn=PCB153  
[aantal\_org]  
norg= 19  
[naam\_org]  
1=ZOOPLANK  
2=MOLLKLEIN  
3=MOLLGROOT  
4=OLIGO  
5=CHIRONO  
6=MACRUST  
7=SLAK  
8=KLEIN  
9=MIDWIT  
10=GROOTWIT  
11=MIDROOF  
12=GROOTROOF  
13=AAL  
14=KUIFEEND  
15=AALSCH  
16=FUUT  
17=STELTLOP  
18=KLUUT  
19=VISDIEFJE  
[Eenheden]  
w=Waterkwaliteit in ug/l en ug/g dw  
o=Accumulatie in organismen in ug/g ww  
b=bioaccumulatiefactor in l/g  
f=opnamefluxen in ug/g.d  
[conc-abio]  
1= .121  
2= .920E-01  
3= 227.  
4= 227.  
5= 172.  
[conc-accu]  
1= 5.09  
2= 23.1  
3= 6.09

4= 17.4  
5= 16.6  
6= 67.4  
7= 17.5  
8= 23.4  
9= 36.9  
10= 155.  
11= 22.6  
12= 35.5  
13= 124.  
14= 193.  
15= .212E+04  
16= 576.  
17= 239.  
18= 310.  
19= 484.  
[bio-accu]  
1= 42.1  
2= 191.  
3= 50.3  
4= 189.  
5= 181.  
6= 557.  
7= 191.  
8= 194.  
9= 305.  
10= .128E+04  
11= 187.  
12= 293.  
13= .102E+04  
14= .159E+04  
15= .175E+05  
16= .476E+04  
17= .197E+04  
18= .256E+04  
19= .400E+04  
[food-flux]  
1= .701  
2= .356  
3= .103E-01  
4= .295  
5= .295  
6= 1.11  
7= .300  
8= .455  
9= .228  
10= .874

11= .205  
12= .205  
13= .289  
14= .778  
15= 1.76  
16= 1.11  
17= .986  
18= .970  
19= 2.00  
[water-flux]  
1= .625  
2= .125  
3= .625E-01  
4= .475E-02  
5= .475E-02  
6= .625E-02  
7= .475E-02  
8= .530E-01  
9= .247E-01  
10= .247E-01  
11= .185E-01  
12= .185E-01  
13= .448E-01  
14= .000  
15= .000  
16= .000  
17= .000  
18= .000  
19= .000  
[tot-flux]  
1= .529  
2= .740  
3= .142  
4= .984  
5= .984  
6= .994  
7= .984  
8= .896  
9= .903  
10= .973  
11= .917  
12= .917  
13= .866  
14= 1.00  
15= 1.00  
16= 1.00  
17= 1.00

18= 1.00  
19= 1.00  
[biomag]  
1= .791E-01  
2= .524  
3= .307E-01  
4= .653  
5= .624  
6= 2.20  
7= .669  
8= 1.08  
9= 1.04  
10= 3.82  
11= .827  
12= 1.30  
13= 1.86  
14= 5.02  
15= 60.1  
16= 24.6  
17= 7.87  
18= 10.9  
19= 20.7  
[biocon]  
1= 19.8  
2= 49.5  
3= 43.2  
4= 3.00  
5= 2.87  
6= 3.12  
7= 2.97  
8= 20.2  
9= 29.7  
10= 35.1  
11= 15.5  
12= 24.3  
13= 137.  
14= .000  
15= .000  
16= .000  
17= .000  
18= .000  
19= .000  
[half-elim]  
1= 2.65  
2= 33.1  
3= 57.7  
4= 40.1

5= 38.3  
6= 41.7  
7= 39.7  
8= 31.8  
9= 101.  
10= 119.  
11= 69.8  
12= 110.  
13= 256.  
14= 171.  
15= 828.  
16= 357.  
17= 167.  
18= 220.  
19= 167.

PCB<sub>153</sub> in diep instabiel slib  
file: Ds6pcb.out

[Rekentype]

Rekt=KOW -type

[Lokatie]

Locn=MER Haringvliet, huidige

[Stofnaam]

stofn=PCB153

[aantal\_org]

norg= 19

[naam\_org]

1=ZOOPLANK

2=MOLLKLEIN

3=MOLLGROOT

4=OLIGO

5=CHIRONO

6=MACRUST

7=SLAK

8=KLEIN

9=MIDWIT

10=GROOTWIT

11=MIDROOF

12=GROOTROOF

13=AAL

14=KUIFEEND

15=AALSCH

16=FUUT

17=STELTLOP

18=KLUUT

19=VISDIEFJE

[Eenheden]

w=Waterkwaliteit in ug/l en ug/g dw

o=Accumulatie in organismen in ug/g ww

b=bioaccumulatiefactor in l/g

f=opnamefluxen in ug/g.d

[conc-abio]

1= .121

2= .124

3= 227.

4= 227.

5= 232.

[conc-accu]

1= 5.12

2= 29.8

3= 5.23

4= 23.4

5= 22.3

6= 86.7

7= 23.7

8= 33.0

9= 59.3

10= 233.

11= 35.3

12= 55.4

13= 446.

14= 249.

15= .360E+04

16= 811.

17= 318.

18= 417.

19= 681.

[bio-accu]

1= 42.3

2= 246.

3= 43.2

4= 189.

5= 180.

6= 717.

7= 191.

8= 272.

9= 490.

10= .193E+04

11= 291.

12= 458.

13= .369E+04

14= .206E+04

15= .298E+05

16= .671E+04

17= .263E+04

18= .344E+04

19= .563E+04

[food-flux]

1= .707

2= .496

3= .000

4= .396

5= .396

6= 1.43

7= .405

8= .662

9= .382

10= 1.33

11= .330  
12= .330  
13= 1.16  
14= 1.00  
15= 3.00  
16= 1.57  
17= 1.31  
18= 1.31  
19= 2.81  
[water-flux]  
1= .625  
2= .125  
3= .625E-01  
4= .640E-02  
5= .640E-02  
6= .625E-02  
7= .640E-02  
8= .530E-01  
9= .247E-01  
10= .247E-01  
11= .185E-01  
12= .185E-01  
13= .448E-01  
14= .000  
15= .000  
16= .000  
17= .000  
18= .000  
19= .000  
[tot-flux]  
1= .531  
2= .799  
3= .000  
4= .984  
5= .984  
6= .996  
7= .984  
8= .926  
9= .939  
10= .982  
11= .947  
12= .947  
13= .963  
14= 1.00  
15= 1.00  
16= 1.00  
17= 1.00

18= 1.00  
19= 1.00  
[biomag]  
1= .797E-01  
2= .692  
3= .307E-01  
4= .662  
5= .632  
6= 2.50  
7= .669  
8= 1.08  
9= 1.25  
10= 4.22  
11= .827  
12= 1.30  
13= 1.86  
14= 5.02  
15= 60.1  
16= 24.6  
17= 7.87  
18= 10.9  
19= 20.7  
[biocon]  
1= 19.8  
2= 49.5  
3= 43.2  
4= 3.00  
5= 2.87  
6= 3.12  
7= 2.97  
8= 20.2  
9= 29.7  
10= 35.1  
11= 15.5  
12= 24.3  
13= 137.  
14= .000  
15= .000  
16= .000  
17= .000  
18= .000  
19= .000  
[half-elim]  
1= 2.65  
2= 33.1  
3= 57.7  
4= 40.1

5= 38.3  
6= 41.7  
7= 39.7  
8= 31.8  
9= 101.  
10= 119.  
11= 69.8  
12= 110.  
13= 256.  
14= 171.  
15= 828.  
16= 357.  
17= 167.  
18= 220.  
19= 167.

PCB<sub>153</sub> in ondiep stabiel slib  
file: Ss6pcb.out

[Rekentype]  
Rekt=KOW -type  
[Lokatie]  
Locn=MER Haringvliet, huidige  
[Stofnaam]  
stofn=PCB153  
[aantal\_org]  
norg= 19  
[naam\_org]  
1=ZOOPLANK  
2=MOLLKLEIN  
3=MOLLGROOT  
4=OLIGO  
5=CHIRONO  
6=MACRUST  
7=SLAK  
8=KLEIN  
9=MIDWIT  
10=GROOTWIT  
11=MIDROOF  
12=GROOTROOF  
13=AAL  
14=KUIFEEND  
15=AALSCH  
16=FUUT  
17=STELTLOP  
18=KLUUT  
19=VISDIEFJE  
[Eenheden]  
w=Waterkwaliteit in ug/l en ug/g dw  
o=Accumulatie in organismen in ug/g ww  
b=bioaccumulatiefactor in l/g  
f=opnamefluxen in ug/g.d  
[conc-abio]  
1= .121  
2= .690E-01  
3= 227.  
4= 227.  
5= 129.  
[conc-accu]  
1= 5.10  
2= 24.5  
3= 6.09

4= 13.3  
5= 12.7  
6= 67.4  
7= 13.2  
8= 17.6  
9= 72.7  
10= 156.  
11= 25.6  
12= 40.2  
13= 245.  
14= 205.  
15= .391E+04  
16= 433.  
17= 201.  
18= 237.  
19= 364.  
[bio-accu]  
1= 42.2  
2= 202.  
3= 50.3  
4= 193.  
5= 184.  
6= 557.  
7= 191.  
8= 146.  
9= 601.  
10= .129E+04  
11= 211.  
12= 332.  
13= .203E+04  
14= .169E+04  
15= .324E+05  
16= .358E+04  
17= .166E+04  
18= .196E+04  
19= .301E+04  
[food-flux]  
1= .704  
2= .385  
3= .103E-01  
4= .226  
5= .226  
6= 1.11  
7= .225  
8= .329  
9= .474  
10= .879

11= .234  
12= .234  
13= .616  
14= .826  
15= 3.26  
16= .838  
17= .829  
18= .744  
19= 1.50  
[water-flux]  
1= .625  
2= .125  
3= .625E-01  
4= .356E-02  
5= .356E-02  
6= .625E-02  
7= .356E-02  
8= .530E-01  
9= .247E-01  
10= .247E-01  
11= .185E-01  
12= .185E-01  
13= .448E-01  
14= .000  
15= .000  
16= .000  
17= .000  
18= .000  
19= .000  
[tot-flux]  
1= .530  
2= .755  
3= .142  
4= .984  
5= .984  
6= .994  
7= .984  
8= .861  
9= .951  
10= .973  
11= .927  
12= .927  
13= .932  
14= 1.00  
15= 1.00  
16= 1.00  
17= 1.00

18= 1.00

19= 1.00

[biomag]

1= .794E-01

2= .623

3= .307E-01

4= .667

5= .638

6= 2.84

7= .669

8= 1.08

9= 2.24

10= 4.76

11= .827

12= 1.30

13= 1.86

14= 5.02

15= 60.1

16= 24.6

17= 7.87

18= 10.9

19= 20.7

[biocon]

1= 19.8

2= 49.5

3= 43.2

4= 3.00

5= 2.87

6= 3.12

7= 2.97

8= 20.2

9= 29.7

10= 35.1

11= 15.5

12= 24.3

13= 137.

14= .000

15= .000

16= .000

17= .000

18= .000

19= .000

[half-elim]

1= 2.65

2= 33.1

3= 57.7

4= 40.1

5= 38.3

6= 41.7

7= 39.7

8= 31.8

9= 101.

10= 119.

11= 69.8

12= 110.

13= 256.

14= 171.

15= 828.

16= 357.

17= 167.

18= 220.

19= 167.



# **M** Uitvoerfiles CHEOPS met verhoogde opname

Cadmium in gehele Haringvliet

file: Rescad.out

: Let op: steady-state berekening, geen uitvoer naar (

[Rekentype]

Rekt=FLUX-type

[Lokatie]

Locn=MER Haringvliet, huidige

[Stofnaam]

stof=cadmium

[aantal\_org]

norg= 19

[nam\_org]

1=ZOOPLANK

2=MOLLKLEIN

3=MOLLGROOT

4=OLIGO

5=CHIRONO

6=MACRUST

7=SLAK

8=KLEIN

9=MIDWIT

10=GROOTWIT

11=MIDROOF

12=GROOTROOF

13=AL

14=KUIFEEND

15=AALSCH

16=FUUT

17=STELTLOP

18=KLUUT

19=VISDIEFJE

[Eenheden]

w=Waerkerkwaaliteit in ug/l en ug/g dw

o=Accumulatie in organismen in ug/g ww

b=biocaccumulatiefactor in lg

f=opnamefluxen in ug/g.d

[conc-abio]

1= .400E-01

2= .690E-01

3= 5.00

4= 5.00

5= 8.70

[conc-accu]

1= .132E-01

2= .190

3= .127

4= .524E-01

5= .873E-01

6= .126

7= .170

8= .718E-02

9= .827E-02

10= .484E-01

11= .416E-02

12= .537E-02

13= .227E-01

14= .116

15= .356E-02

16= .301E-02

17= .901E-01

18= .707E-01

19= .380E-02

[bio-accu]

1= .331

2= 4.74

3= 3.17

4= .759

5= 1.27

6= 3.14

7= 2.46

8= .179

9= .207

10= 1.21

11= .104

12= .134

13= .568

14= 2.91

15= .890E-01

16= .753E-01

17= 2.25

18= 1.77

19= .950E-01

[food-flux]

1= .780E-03

2= .684E-03

3= .113E-04

4= .221E-02

5= .368E-02

6= .228E-02

7= .379E-02

8= .119E-04

9= .403E-04

10= .431E-03

11= .508E-06  
12= .508E-06  
13= .230E-05  
14= .457E-03  
15= .973E-05  
16= .854E-05  
17= .363E-03  
18= .285E-03  
19= .153E-04  
[water-flux]  
1= .103E-01  
2= .207E-02  
3= .103E-02  
4= .107E-03  
5= .178E-03  
6= .103E-03  
7= .178E-03  
8= .146E-03  
9= .680E-04  
10= .680E-04  
11= .510E-04  
12= .510E-04  
13= .123E-03  
14= .000  
15= .000  
16= .000  
17= .000  
18= .000  
19= .000  
[tot-flux]  
1= .703E-01  
2= .249  
3= .109E-01  
4= .954  
5= .954  
6= .957  
7= .955  
8= .751E-01  
9= .372  
10= .864  
11= .987E-02  
12= .987E-02  
13= .183E-01  
14= 1.00  
15= 1.00  
16= 1.00  
17= 1.00

18= 1.00  
19= 1.00  
[biomag]  
1= .124E-02  
2= .494E-01  
3= .222E-02  
4= .388E-01  
5= .647E-01  
6= .112  
7= .124  
8= .887E-02  
9= .609E-02  
10= .234E-01  
11= .551E-02  
12= .711E-02  
13= .903E-02  
14= .368  
15= .458  
16= .420  
17= .576  
18= .607  
19= .529  
[biocon]  
1= .308  
2= 3.56  
3= 3.13  
4= .351E-01  
5= .585E-01  
6= .136  
7= .111  
8= .166  
9= .130  
10= .165  
11= .103  
12= .133  
13= .558  
14= .000  
15= .000  
16= .000  
17= .000  
18= .000  
19= .000  
[half-elim]  
1= .822  
2= 47.6  
3= 83.7  
4= 15.6

5= 15.6  
6= 36.4  
7= 29.5  
8= 31.3  
9= 52.7  
10= 66.9  
11= 55.8  
12= 72.0  
13= 125.  
14= 175.  
15= 253.  
16= 244.  
17= 171.  
18= 171.  
19= 171.

**Cadmium in ondiep zand**  
**file: ZaScad.out**

; Let op: steady-state berekening, geen uitvoer naar (

[Reketype]

Rekt=FLUX-type

[Lokatie]

Locn=MER Haringvliet, huidige

[Stofnaam]

stofn=cadmium

[aantal\_org]

norg= 19

[naam\_org]

1=ZOOPLANK

2=MOLLKLEIN

3=MOLLGROOT

4=OLIGO

5=CHIRONO

6=MACRUST

7=SLAK

8=KLEIN

9=MIDWIT

10=GROOTWIT

11=MIDROOF

12=GROOTROOF

13=AAL

14=KUIFEEND

15=AALSCH

16=FUUT

17=STELTLOP

18=KLUUT

19=VISDIEFJE

[Eenheden]

w=Waterkwaliteit in ug/l en ug/g dw

o=Accumulatie in organismen in ug/g ww

b=bioaccumulatiefactor in l/g

f=opnamefluxen in ug/g.d

[conc-abio]

1= .400E-01

2= .620E-01

3= 5.00

4= 5.00

5= 7.69

[conc-accu]

1= .132E-01

2= .163

3= .127

4= .433E-01  
5= .721  
6= .732E-01  
7= .150  
8= .733E-02  
9= .880E-02  
10= .416E-01  
11= .416E-02  
12= .537E-02  
13= .226E-01  
14= .100E+00  
15= .375E-02  
16= .308E-02  
17= .325  
18= .387  
19= .388E-02  
[bio-accu]  
1= .331  
2= 4.08  
3= 3.17  
4= .698  
5= 11.6  
6= 1.83  
7= 2.43  
8= .183  
9= .220  
10= 1.04  
11= .104  
12= .134  
13= .564  
14= 2.50  
15= .938E-01  
16= .769E-01  
17= 8.12  
18= 9.66  
19= .969E-01  
[food-flux]  
1= .777E-03  
2= .452E-03  
3= .113E-04  
4= .181E-02  
5= .302E-01  
6= .128E-02  
7= .335E-02  
8= .151E-04  
9= .473E-04  
10= .361E-03

11= .523E-06  
12= .523E-06  
13= .144E-05  
14= .393E-03  
15= .103E-04  
16= .871E-05  
17= .131E-02  
18= .156E-02  
19= .156E-04  
[water-flux]  
1= .103E-01  
2= .207E-02  
3= .103E-02  
4= .961E-04  
5= .160E-02  
6= .103E-03  
7= .160E-03  
8= .146E-03  
9= .680E-04  
10= .680E-04  
11= .510E-04  
12= .510E-04  
13= .123E-03  
14= .000  
15= .000  
16= .000  
17= .000  
18= .000  
19= .000  
[tot-flux]  
1= .700E-01  
2= .179  
3= .109E-01  
4= .950  
5= .950  
6= .926  
7= .954  
8= .939E-01  
9= .410  
10= .842  
11= .102E-01  
12= .102E-01  
13= .115E-01  
14= 1.00  
15= 1.00  
16= 1.00  
17= 1.00

18= 1.00

19= 1.00

[biomag]

1= .123E-02

2= .370E-01

3= .222E-02

4= .369E-01

5= .615

6= .789E-01

7= .124

8= .887E-02

9= .593E-02

10= .224E-01

11= .551E-02

12= .711E-02

13= .903E-02

14= .368

15= .458

16= .420

17= .576

18= .607

19= .529

[biocon]

1= .308

2= 3.35

3= 3.13

4= .351E-01

5= .585

6= .136

7= .111

8= .166

9= .130

10= .165

11= .103

12= .133

13= .558

14= .000

15= .000

16= .000

17= .000

18= .000

19= .000

[half-elim]

1= .822

2= 44.7

3= 83.7

4= 15.6

5= 15.6

6= 36.4

7= 29.5

8= 31.3

9= 52.7

10= 66.9

11= 55.8

12= 72.0

13= 125.

14= 175.

15= 253.

16= 244.

17= 171.

18= 171.

19= 171.

**Cadmium in intergetijdenzone**

file: In5cad.out

; Let op: steady-state berekening, geen uitvoer naar (

[Rekentype]

Rekt=FLUX-type

[Lokatie]

Locn=MER Haringvliet, huidige

[Stofnaam]

stofn=cadmium

[aantal\_org]

norg= 19

[naam\_org]

1=ZOOPLANK

2=MOLLKLEIN

3=MOLLGROOT

4=OLIGO

5=CHIRONO

6=MACRUST

7=SLAK

8=KLEIN

9=MIDWIT

10=GROOTWIT

11=MIDROOF

12=GROOTROOF

13=AAL

14=KUIFEEND

15=AALSCH

16=FUUT

17=STELTLOP

18=KLUUT

19=VISDIEFJE

[Eenheden]

w=Waterkwaliteit in ug/l en ug/g dw

o=Accumulatie in organismen in ug/g ww

b=bioaccumulatiefactor in l/g

f=opnamefluxen in ug/g.d

[conc-abio]

1= .400E-01

2= .350E-01

3= 5.00

4= 5.00

5= 4.37

[conc-accu]

1= .132E-01

2= .170

3= .127

4= .265E-01

5= .441

6= .736E-01

7= .854E-01

8= .841E-02

9= .804E-02

10= .261E-01

11= .417E-02

12= .538E-02

13= .224E-01

14= .104

15= .350E-02

16= .353E-02

17= .212

18= .236

19= .445E-02

[bio-accu]

1= .331

2= 4.25

3= 3.17

4= .756

5= 12.6

6= 1.84

7= 2.44

8= .210

9= .201

10= .653

11= .104

12= .134

13= .561

14= 2.61

15= .876E-01

16= .883E-01

17= 5.30

18= 5.91

19= .111

[food-flux]

1= .772E-03

2= .401E-03

3= .113E-04

4= .111E-02

5= .186E-01

6= .129E-02

7= .191E-02

8= .389E-04

9= .373E-04

10= .202E-03

11= .569E-06  
12= .569E-06  
13= .713E-06  
14= .410E-03  
15= .958E-05  
16= .100E-04  
17= .855E-03  
18= .953E-03  
19= .179E-04  
[water-flux]  
1= .103E-01  
2= .207E-02  
3= .103E-02  
4= .542E-04  
5= .904E-03  
6= .103E-03  
7= .904E-04  
8= .146E-03  
9= .680E-04  
10= .680E-04  
11= .510E-04  
12= .510E-04  
13= .123E-03  
14= .000  
15= .000  
16= .000  
17= .000  
18= .000  
19= .000  
[tot-flux]  
1= .695E-01  
2= .162  
3= .109E-01  
4= .954  
5= .954  
6= .926  
7= .955  
8= .210  
9= .354  
10= .748  
11= .111E-01  
12= .111E-01  
13= .574E-02  
14= 1.00  
15= 1.00  
16= 1.00  
17= 1.00

18= 1.00  
19= 1.00  
[biomag]  
1= .123E-02  
2= .377E-01  
3= .222E-02  
4= .382E-01  
5= .637  
6= .962E-01  
7= .124  
8= .887E-02  
9= .543E-02  
10= .215E-01  
11= .551E-02  
12= .711E-02  
13= .903E-02  
14= .368  
15= .458  
16= .420  
17= .576  
18= .607  
19= .529  
[biocon]  
1= .308  
2= 3.56  
3= 3.13  
4= .351E-01  
5= .585  
6= .136  
7= .111  
8= .166  
9= .130  
10= .165  
11= .103  
12= .133  
13= .558  
14= .000  
15= .000  
16= .000  
17= .000  
18= .000  
19= .000  
[half-elim]  
1= .822  
2= 47.6  
3= 83.7  
4= 15.6



5= 15.6  
6= 36.4  
7= 29.5  
8= 31.3  
9= 52.7  
10= 66.9  
11= 55.8  
12= 72.0  
13= 125.  
14= 175.  
15= 253.  
16= 244.  
17= 171.  
18= 171.  
19= 171.

**Cadmium in diep instabiel slib**  
**file: DsScad.out**

; Let op: steady-state berekening, geen uitvoer naar (

[Rekentype]

Rekt=FLUX-type

[Lokatie]

Locn=MER Haringvliet, huidige

[Stofnaam]

stofn=cadmium

[aantal\_org]

norg= 19

[naam\_org]

1=ZOOPLANK

2=MOLLKLEIN

3=MOLLGROOT

4=OLIGO

5=CHIRONO

6=MACRUST

7=SLAK

8=KLEIN

9=MIDWIT

10=GROOTWIT

11=MIDROOF

12=GROOTROOF

13=AAL

14=KUIFEEND

15=AALSCH

16=FUUT

17=STELTLOP

18=KLUUT

19=VISDIEFJE

[Eenheden]

w=Waterkwaliteit in ug/l en ug/g dw

o=Accumulatie in organismen in ug/g ww

b=bioaccumulatiefactor in l/g

f=opnamefluxen in ug/g.d

[conc-abio]

1= .400E-01

2= .980E-01

3= 5.00

4= 5.00

5= 12.2

[conc-accu]

1= .132E-01

2= .200

3= .125

4= .730E-01  
5= .122  
6= .155  
7= .238  
8= .734E-02  
9= .978E-02  
10= .665E-01  
11= .416E-02  
12= .537E-02  
13= .229E-01  
14= .123  
15= .411E-02  
16= .308E-02  
17= .113  
18= .984E-01  
19= .389E-02  
[bio-accu]  
1= .331  
2= 5.01  
3= 3.13  
4= .745  
5= 1.24  
6= 3.87  
7= 2.43  
8= .183  
9= .244  
10= 1.66  
11= .104  
12= .134  
13= .572  
14= 3.07  
15= .103  
16= .771E-01  
17= 2.83  
18= 2.46  
19= .971E-01  
[food-flux]  
1= .778E-03  
2= .837E-03  
3= .000  
4= .307E-02  
5= .512E-02  
6= .283E-02  
7= .531E-02  
8= .154E-04  
9= .601E-04  
10= .618E-03

11= .546E-06  
12= .546E-06  
13= .324E-05  
14= .483E-03  
15= .112E-04  
16= .873E-05  
17= .456E-03  
18= .397E-03  
19= .157E-04  
[water-flux]  
1= .103E-01  
2= .207E-02  
3= .103E-02  
4= .152E-03  
5= .253E-03  
6= .103E-03  
7= .253E-03  
8= .146E-03  
9= .680E-04  
10= .680E-04  
11= .510E-04  
12= .510E-04  
13= .123E-03  
14= .000  
15= .000  
16= .000  
17= .000  
18= .000  
19= .000  
[tot-flux]  
1= .701E-01  
2= .288  
3= .000  
4= .953  
5= .953  
6= .965  
7= .955  
8= .956E-01  
9= .469  
10= .901  
11= .106E-01  
12= .106E-01  
13= .256E-01  
14= 1.00  
15= 1.00  
16= 1.00  
17= 1.00

18= 1.00  
19= 1.00  
[biomag]  
1= .124E-02  
2= .498E-01  
3= .222E-02  
4= .387E-01  
5= .645E-01  
6= .109  
7= .124  
8= .887E-02  
9= .654E-02  
10= .238E-01  
11= .551E-02  
12= .711E-02  
13= .903E-02  
14= .368  
15= .458  
16= .420  
17= .576  
18= .607  
19= .529  
[biocon]  
1= .308  
2= 3.56  
3= 3.13  
4= .351E-01  
5= .585E-01  
6= .136  
7= .111  
8= .166  
9= .130  
10= .165  
11= .103  
12= .133  
13= .558  
14= .000  
15= .000  
16= .000  
17= .000  
18= .000  
19= .000  
[half-elim]  
1= .822  
2= 47.6  
3= 83.7  
4= 15.6

5= 15.6  
6= 36.4  
7= 29.5  
8= 31.3  
9= 52.7  
10= 66.9  
11= 55.8  
12= 72.0  
13= 125.  
14= 175.  
15= 253.  
16= 244.  
17= 171.  
18= 171.  
19= 171.

**Cadmium in ondiep stabiel slib**

file: Ss5cad.out

; Let op: steady-state berekening, geen uitvoer naar (

[Rekentype]

Rekt=FLUX-type

[Lokatie]

Locn=MER Haringvliet, huidige

[Stofnaam]

stofn=cadmium

[aantal\_org]

norg= 19

[naam\_org]

1=ZOOPLANK

2=MOLLKLEIN

3=MOLLGROOT

4=OLIGO

5=CHIRONO

6=MACRUST

7=SLAK

8=KLEIN

9=MIDWIT

10=GROOTWIT

11=MIDROOF

12=GROOTROOF

13=AAL

14=KUIFEEND

15=AALSCH

16=FUUT

17=STELTLOP

18=KLUUT

19=VISDIEFJE

[Eenheden]

w=Waterkwaliteit in ug/l en ug/g dw

o=Accumulatie in organismen in ug/g ww

b=bioaccumulatiefactor in l/g

f=opnamefluxen in ug/g.d

[conc-abio]

1= .400E-01

2= .490E-01

3= 5.00

4= 5.00

5= 6.14

[conc-accu]

1= .132E-01

2= .178

3= .127

4= .375E-01

5= .626

6= .113

7= .120

8= .738E-02

9= .154E-01

10= .457E-01

11= .417E-02

12= .538E-02

13= .226E-01

14= .109

15= .611E-02

16= .310E-02

17= .543

18= .671

19= .391E-02

[bio-accu]

1= .331

2= 4.46

3= 3.17

4= .766

5= 12.8

6= 2.84

7= 2.45

8= .184

9= .384

10= 1.14

11= .104

12= .135

13= .566

14= 2.74

15= .153

16= .775E-01

17= 13.6

18= 16.8

19= .976E-01

[food-flux]

1= .775E-03

2= .521E-03

3= .113E-04

4= .158E-02

5= .264E-01

6= .205E-02

7= .267E-02

8= .163E-04

9= .133E-03

10= .403E-03

11= .611E-06  
12= .611E-06  
13= .183E-05  
14= .430E-03  
15= .167E-04  
16= .877E-05  
17= .219E-02  
18= .270E-02  
19= .157E-04

[water-flux]

1= .103E-01  
2= .207E-02  
3= .103E-02  
4= .759E-04  
5= .127E-02  
6= .103E-03  
7= .127E-03  
8= .146E-03  
9= .680E-04  
10= .680E-04  
11= .510E-04  
12= .510E-04  
13= .123E-03  
14= .000  
15= .000  
16= .000  
17= .000  
18= .000  
19= .000

[tot-flux]

1= .698E-01  
2= .201  
3= .109E-01  
4= .954  
5= .954  
6= .952  
7= .955  
8= .100  
9= .663  
10= .856  
11= .119E-01  
12= .119E-01  
13= .146E-01  
14= 1.00  
15= 1.00  
16= 1.00  
17= 1.00

18= 1.00  
19= 1.00  
[biomag]  
1= .123E-02  
2= .449E-01  
3= .222E-02  
4= .391E-01  
5= .651  
6= .124  
7= .124  
8= .887E-02  
9= .117E-01  
10= .268E-01  
11= .551E-02  
12= .711E-02  
13= .903E-02  
14= .368  
15= .458  
16= .420  
17= .576  
18= .607  
19= .529

[biocon]

1= .308  
2= 3.56  
3= 3.13  
4= .351E-01  
5= .585  
6= .136  
7= .111  
8= .166  
9= .130  
10= .165  
11= .103  
12= .133  
13= .558  
14= .000  
15= .000  
16= .000  
17= .000  
18= .000  
19= .000  
[half-elim]  
1= .822  
2= 47.6  
3= 83.7  
4= 15.6

5= 15.6  
6= 36.4  
7= 29.5  
8= 31.3  
9= 52.7  
10= 66.9  
11= 55.8  
12= 72.0  
13= 125.  
14= 175.  
15= 253.  
16= 244.  
17= 171.  
18= 171.  
19= 171.

PCB<sub>153</sub> in gehele Haringvliet  
file: Re5pcb.out

[Rekentype]  
Rekt=KOW -type  
[Lokatie]  
Locn=MER Haringvliet, huidige  
[Stofnaam]  
stofn=PCB153  
[aantal\_org]  
norg= 19  
[naam\_org]  
1=ZOOPLANK  
2=MOLLKLEIN  
3=MOLLGROOT  
4=OLIGO  
5=CHIRONO  
6=MACRUST  
7=SLAK  
8=KLEIN  
9=MIDWIT  
10=GROOTWIT  
11=MIDROOF  
12=GROOTROOF  
13=AAL  
14=KUIFEEND  
15=AALSCH  
16=FUUT  
17=STELTLOP  
18=KLUUT  
19=VISDIEFJE  
[Eenheden]  
w=Waterkwaliteit in ug/l en ug/g dw  
o=Accumulatie in organismen in ug/g ww  
b=bioaccumulatiefactor in l/g  
f=opnamefluxen in ug/g.d  
[conc-abio]  
1= .121  
2= .127  
3= 227.  
4= 227.  
5= 239.  
[conc-accu]  
1= 5.12  
2= 29.8  
3= 6.09

4= 36.0  
5= 23.0  
6= 90.2  
7= 24.4  
8= 42.9  
9= 68.8  
10= 249.  
11= 42.9  
12= 67.4  
13= 459.  
14= 249.  
15= .416E+04  
16= .106E+04  
17= 388.  
18= 538.  
19= 886.  
[bio-accu]  
1= 42.3  
2= 246.  
3= 50.3  
4= 283.  
5= 181.  
6= 745.  
7= 192.  
8= 354.  
9= 568.  
10= .206E+04  
11= 355.  
12= 557.  
13= .380E+04  
14= .206E+04  
15= .344E+05  
16= .872E+04  
17= .320E+04  
18= .444E+04  
19= .732E+04  
[food-flux]  
1= .709  
2= .497  
3= .103E-01  
4= .613  
5= .409  
6= 1.49  
7= .417  
8= .877  
9= .447  
10= 1.42

11= .405  
12= .405  
13= 1.19  
14= 1.01  
15= 3.46  
16= 2.04  
17= 1.60  
18= 1.68  
19= 3.66  
[water-flux]  
1= .625  
2= .125  
3= .625E-01  
4= .656E-02  
5= .656E-02  
6= .625E-02  
7= .656E-02  
8= .530E-01  
9= .247E-01  
10= .247E-01  
11= .185E-01  
12= .185E-01  
13= .448E-01  
14= .000  
15= .000  
16= .000  
17= .000  
18= .000  
19= .000  
[tot-flux]  
1= .531  
2= .799  
3= .142  
4= .989  
5= .984  
6= .996  
7= .985  
8= .943  
9= .948  
10= .983  
11= .956  
12= .956  
13= .964  
14= 1.00  
15= 1.00  
16= 1.00  
17= 1.00

18= 1.00

19= 1.00

[biomag]

1= .800E-01

2= .686

3= .307E-01

4= .994

5= .633

6= 2.56

7= .669

8= 1.08

9= 1.16

10= 4.16

11= .827

12= 1.30

13= 1.86

14= 5.02

15= 60.1

16= 24.6

17= 7.87

18= 10.9

19= 20.7

[biocon]

1= 19.8

2= 49.5

3= 43.2

4= 3.00

5= 2.87

6= 3.12

7= 2.97

8= 20.2

9= 29.7

10= 35.1

11= 15.5

12= 24.3

13= 137.

14= .000

15= .000

16= .000

17= .000

18= .000

19= .000

[half-elim]

1= 2.65

2= 33.1

3= 57.7

4= 40.1

5= 38.3

6= 41.7

7= 39.7

8= 31.8

9= 101.

10= 119.

11= 69.8

12= 110.

13= 256.

14= 171.

15= 828.

16= 357.

17= 167.

18= 220.

19= 167.



PCB<sub>153</sub> in ondiep zand  
file: Za5pcb.out

[Rekentype]

Rekt=KOW -type

[Lokatie]

Locn=MER Haringvliet, huidige

[Stofnaam]

stofn=PCB153

[aantal\_org]

norg= 19

[naam\_org]

1=ZOOPLANK

2=MOLLKLEIN

3=MOLLGROOT

4=OLIGO

5=CHIRONO

6=MACRUST

7=SLAK

8=KLEIN

9=MIDWIT

10=GROOTWIT

11=MIDROOF

12=GROOTROOF

13=AAL

14=KUIFEEND

15=AALSCH

16=FUUT

17=STELTLOP

18=KLUUT

19=VISDIEFJE

[Eenheden]

w=Waterkwaliteit in ug/l en ug/g dw

o=Accumulatie in organismen in ug/g ww

b=bioaccumulatiefactor in l/g

f=opnamefluxen in ug/g.d

[conc-abio]

1= .121

2= .980E-01

3= 227.

4= 227.

5= 183.

[conc-accu]

1= 5.11

2= 23.0

3= 6.09

4= 26.9

5= 17.2

6= 58.7

7= 18.7

8= 19.8

9= 47.7

10= 182.

11= 23.8

12= 37.4

13= 239.

14= 192.

15= .273E+04

16= 488.

17= 291.

18= 402.

19= 409.

[bio-accu]

1= 42.2

2= 190.

3= 50.3

4= 274.

5= 176.

6= 485.

7= 190.

8= 164.

9= 395.

10= .150E+04

11= 197.

12= 309.

13= .198E+04

14= .159E+04

15= .226E+05

16= .403E+04

17= .241E+04

18= .332E+04

19= .338E+04

[food-flux]

1= .705

2= .376

3= .103E-01

4= .458

5= .305

6= .965

7= .319

8= .377

9= .303

10= 1.03

11= .217  
12= .217  
13= .599  
14= .775  
15= 2.27  
16= .943  
17= 1.20  
18= 1.26  
19= 1.69

[water-flux]

1= .625  
2= .125  
3= .625E-01  
4= .506E-02  
5= .506E-02  
6= .625E-02  
7= .506E-02  
8= .530E-01  
9= .247E-01  
10= .247E-01  
11= .185E-01  
12= .185E-01  
13= .448E-01  
14= .000  
15= .000  
16= .000  
17= .000  
18= .000  
19= .000

[tot-flux]

1= .530  
2= .750  
3= .142  
4= .989  
5= .984  
6= .994  
7= .984  
8= .877  
9= .925  
10= .977  
11= .921  
12= .921  
13= .930  
14= 1.00  
15= 1.00  
16= 1.00  
17= 1.00

18= 1.00  
19= 1.00  
[biomag]  
1= .796E-01  
2= .524  
3= .307E-01

4= .946  
5= .603  
6= 1.81  
7= .669  
8= 1.08  
9= 1.13  
10= 3.98  
11= .827  
12= 1.30  
13= 1.86  
14= 5.02  
15= 60.1  
16= 24.6  
17= 7.87  
18= 10.9  
19= 20.7

[biocon]

1= 19.8  
2= 47.4  
3= 43.2  
4= 3.00  
5= 2.87  
6= 3.12  
7= 2.97  
8= 20.2  
9= 29.7  
10= 35.1  
11= 15.5  
12= 24.3  
13= 137.  
14= .000  
15= .000  
16= .000  
17= .000  
18= .000  
19= .000

[half-elim]

1= 2.65  
2= 31.6  
3= 57.7  
4= 40.1

5= 38.3  
6= 41.7  
7= 39.7  
8= 31.8  
9= 101.  
10= 119.  
11= 69.8  
12= 110.  
13= 256.  
14= 171.  
15= 828.  
16= 357.  
17= 167.  
18= 220.  
19= 167.

**PCB<sub>153</sub> in intergetijdenzone**  
**file: In5pcb.out**

[Rekentype]  
Rekt=KOW -type  
[Lokatie]  
Locn=MER Haringvliet, huidige  
[Stofnaam]  
stofn=PCB153  
[aantal\_org]  
norg= 19  
[naam\_org]  
1=ZOOPLANK  
2=MOLLKLEIN  
3=MOLLGROOT  
4=OLIGO  
5=CHIRONO  
6=MACRUST  
7=SLAK  
8=KLEIN  
9=MIDWIT  
10=GROOTWIT  
11=MIDROOF  
12=GROOTROOF  
13=AAL  
14=KUIFEEND  
15=AALSCH  
16=FUUT  
17=STELTLOP  
18=KLUUT  
19=VISDIEFJE  
[Eenheden]  
w=Waterkwaliteit in ug/l en ug/g dw  
o=Accumulatie in organismen in ug/g ww  
b=bioaccumulatiefactor in l/g  
f=opnamefluxen in ug/g.d  
[conc-abio]  
1= .121  
2= .920E-01  
3= 227.  
4= 227.  
5= 172.  
[conc-accu]  
1= 5.09  
2= 23.1  
3= 6.09

4= 25.9  
5= 16.6  
6= 67.4  
7= 17.5  
8= 25.1  
9= 40.2  
10= 159.  
11= 24.1  
12= 37.9  
13= 129.  
14= 193.  
15= .229E+04  
16= 618.  
17= 284.  
18= 388.  
19= 519.  
[bio-accu]  
1= 42.1  
2= 191.  
3= 50.3  
4= 282.  
5= 181.  
6= 557.  
7= 191.  
8= 208.  
9= 332.  
10= .131E+04  
11= 200.  
12= 313.  
13= .106E+04  
14= .159E+04  
15= .189E+05  
16= .511E+04  
17= .234E+04  
18= .320E+04  
19= .429E+04  
[food-flux]  
1= .701  
2= .356  
3= .103E-01  
4= .442  
5= .295  
6= 1.11  
7= .300  
8= .492  
9= .251  
10= .897

11= .220  
12= .220  
13= .302  
14= .778  
15= 1.91  
16= 1.19  
17= 1.17  
18= 1.21  
19= 2.14  
[water-flux]  
1= .625  
2= .125  
3= .625E-01  
4= .475E-02  
5= .475E-02  
6= .625E-02  
7= .475E-02  
8= .530E-01  
9= .247E-01  
10= .247E-01  
11= .185E-01  
12= .185E-01  
13= .448E-01  
14= .000  
15= .000  
16= .000  
17= .000  
18= .000  
19= .000  
[tot-flux]  
1= .529  
2= .740  
3= .142  
4= .989  
5= .984  
6= .994  
7= .984  
8= .903  
9= .910  
10= .973  
11= .922  
12= .922  
13= .871  
14= 1.00  
15= 1.00  
16= 1.00  
17= 1.00

18= 1.00  
19= 1.00  
[biomag]  
1= .791E-01  
2= .524  
3= .307E-01  
4= .979  
5= .624  
6= 2.20  
7= .669  
8= 1.08  
9= 1.04  
10= 3.82  
11= .827  
12= 1.30  
13= 1.86  
14= 5.02  
15= 60.1  
16= 24.6  
17= 7.87  
18= 10.9  
19= 20.7  
[biocon]  
1= 19.8  
2= 49.5  
3= 43.2  
4= 3.00  
5= 2.87  
6= 3.12  
7= 2.97  
8= 20.2  
9= 29.7  
10= 35.1  
11= 15.5  
12= 24.3  
13= 137.  
14= .000  
15= .000  
16= .000  
17= .000  
18= .000  
19= .000  
[half-elim]  
1= 2.65  
2= 33.1  
3= 57.7  
4= 40.1

5= 38.3  
6= 41.7  
7= 39.7  
8= 31.8  
9= 101.  
10= 119.  
11= 69.8  
12= 110.  
13= 256.  
14= 171.  
15= 828.  
16= 357.  
17= 167.  
18= 220.  
19= 167.

PCB<sub>153</sub> in diep instabiel slib  
file: Ds5pcb.out

[Rekentype]

Rekt=KOW -type

[Lokatie]

Locn=MER Haringvliet, huidige

[Stofnaam]

stofn=PCB153

[aantal\_org]

norg= 19

[naam\_org]

1=ZOOPLANK

2=MOLLKLEIN

3=MOLLGROOT

4=OLIGO

5=CHIRONO

6=MACRUST

7=SLAK

8=KLEIN

9=MIDWIT

10=GROOTWIT

11=MIDROOF

12=GROOTROOF

13=AAL

14=KUIFEEND

15=AALSCH

16=FUUT

17=STELTLOP

18=KLUUT

19=VISDIEFJE

[Eenheden]

w=Waterkwaliteit in ug/l en ug/g dw

o=Accumulatie in organismen in ug/g ww

b=bioaccumulatiefactor in l/g

f=opnamefluxen in ug/g.d

[conc-abio]

1= .121

2= .124

3= 227.

4= 227.

5= 232.

[conc-accu]

1= 5.12

2= 29.8

3= 5.23

4= 34.9

5= 22.3

6= 86.7

7= 23.7

8= 42.5

9= 75.8

10= 246.

11= 44.8

12= 70.3

13= 475.

14= 249.

15= .452E+04

16= .105E+04

17= 378.

18= 521.

19= 878.

[bio-accu]

1= 42.3

2= 246.

3= 43.2

4= 281.

5= 180.

6= 717.

7= 191.

8= 351.

9= 627.

10= .204E+04

11= 370.

12= 581.

13= .393E+04

14= .206E+04

15= .373E+05

16= .864E+04

17= .312E+04

18= .431E+04

19= .725E+04

[food-flux]

1= .707

2= .496

3= .000

4= .595

5= .396

6= 1.43

7= .405

8= .869

9= .495

10= 1.41

11= .424  
12= .424  
13= 1.24  
14= 1.00  
15= 3.76  
16= 2.02  
17= 1.56  
18= 1.63  
19= 3.63

[water-flux]

1= .625  
2= .125  
3= .625E-01  
4= .640E-02  
5= .640E-02  
6= .625E-02  
7= .640E-02  
8= .530E-01  
9= .247E-01  
10= .247E-01  
11= .185E-01  
12= .185E-01  
13= .448E-01

14= .000  
15= .000  
16= .000  
17= .000  
18= .000  
19= .000

[tot-flux]

1= .531  
2= .799  
3= .000  
4= .989  
5= .984  
6= .996  
7= .984  
8= .942  
9= .953  
10= .983  
11= .958  
12= .958  
13= .965  
14= 1.00  
15= 1.00  
16= 1.00  
17= 1.00

18= 1.00  
19= 1.00  
[biomag]  
1= .797E-01  
2= .692  
3= .307E-01  
4= .992

5= .632  
6= 2.50  
7= .669  
8= 1.08  
9= 1.25  
10= 4.22  
11= .827  
12= 1.30  
13= 1.86  
14= 5.02  
15= 60.1  
16= 24.6  
17= 7.87  
18= 10.9  
19= 20.7

[biocon]

1= 19.8  
2= 49.5  
3= 43.2  
4= 3.00  
5= 2.87  
6= 3.12  
7= 2.97  
8= 20.2  
9= 29.7  
10= 35.1  
11= 15.5  
12= 24.3  
13= 137.  
14= .000  
15= .000  
16= .000  
17= .000  
18= .000  
19= .000

[half-elim]

1= 2.65  
2= 33.1  
3= 57.7  
4= 40.1

5= 38.3  
6= 41.7  
7= 39.7  
8= 31.8  
9= 101.  
10= 119.  
11= 69.8  
12= 110.  
13= 256.  
14= 171.  
15= 828.  
16= 357.  
17= 167.  
18= 220.  
19= 167.

PCB<sub>153</sub> in ondiep stabiel slib  
file: Ss5pcb.out

[Reketype]  
Rekt=KOW -type  
[Lokatie]  
Locn=MER Haringvliet, huidige  
[Stofnaam]  
stofn=PCB153  
[aantal\_org]  
norg= 19  
[naam\_org]  
1=ZOOPLANK  
2=MOLLKLEIN  
3=MOLLGROOT  
4=OLIGO  
5=CHIRONO  
6=MACRUST  
7=SLAK  
8=KLEIN  
9=MIDWIT  
10=GROOTWIT  
11=MIDROOF  
12=GROOTROOF  
13=AAL  
14=KUIFEEND  
15=AALSCH  
16=FUUT  
17=STELTLOP  
18=KLUUT  
19=VISDIEFJE  
[Eenheden]  
w=Waterkwaliteit in ug/l en ug/g dw  
o=Accumulatie in organismen in ug/g ww  
b=bioaccumulatiefactor in l/g  
f=opnamefluxen in ug/g.d  
[conc-abio]  
1= .121  
2= .690E-01  
3= 227.  
4= 227.  
5= 129.  
[conc-accu]  
1= 5.10  
2= 24.5  
3= 6.09



4= 19.9  
5= 12.7  
6= 67.4  
7= 13.2  
8= 19.1  
9= 78.1  
10= 157.  
11= 27.5  
12= 43.1  
13= 250.  
14= 205.  
15= .419E+04  
16= 471.  
17= 235.  
18= 297.  
19= 395.  
[bio-accu]  
1= 42.2  
2= 202.  
3= 50.3  
4= 288.  
5= 184.  
6= 557.  
7= 191.  
8= 158.  
9= 646.  
10= .130E+04  
11= 227.  
12= 357.  
13= .206E+04  
14= .169E+04  
15= .347E+05  
16= .389E+04  
17= .194E+04  
18= .245E+04  
19= .327E+04  
[food-flux]  
1= .704  
2= .385  
3= .103E-01  
4= .339  
5= .226  
6= 1.11  
7= .225  
8= .362  
9= .511  
10= .888

11= .253  
12= .253  
13= .628  
14= .826  
15= 3.49  
16= .911  
17= .972  
18= .931  
19= 1.63  
[water-flux]  
1= .625  
2= .125  
3= .625E-01  
4= .356E-02  
5= .356E-02  
6= .625E-02  
7= .356E-02  
8= .530E-01  
9= .247E-01  
10= .247E-01  
11= .185E-01  
12= .185E-01  
13= .448E-01  
14= .000  
15= .000  
16= .000  
17= .000  
18= .000  
19= .000  
[tot-flux]  
1= .530  
2= .755  
3= .142  
4= .990  
5= .984  
6= .994  
7= .984  
8= .872  
9= .954  
10= .973  
11= .932  
12= .932  
13= .933  
14= 1.00  
15= 1.00  
16= 1.00  
17= 1.00

18= 1.00  
19= 1.00  
[biomag]  
1= .794E-01  
2= .623  
3= .307E-01  
4= 1.00  
5= .638  
6= 2.84  
7= .669  
8= 1.08  
9= 2.24  
10= 4.76  
11= .827  
12= 1.30  
13= 1.86  
14= 5.02  
15= 60.1  
16= 24.6  
17= 7.87  
18= 10.9  
19= 20.7  
[biocon]  
1= 19.8  
2= 49.5  
3= 43.2  
4= 3.00  
5= 2.87  
6= 3.12  
7= 2.97  
8= 20.2  
9= 29.7  
10= 35.1  
11= 15.5  
12= 24.3  
13= 137.  
14= .000  
15= .000  
16= .000  
17= .000  
18= .000  
19= .000  
[half-elim]  
1= 2.65  
2= 33.1  
3= 57.7  
4= 40.1

5= 38.3  
6= 41.7  
7= 39.7  
8= 31.8  
9= 101.  
10= 119.  
11= 69.8  
12= 110.  
13= 256.  
14= 171.  
15= 828.  
16= 357.  
17= 167.  
18= 220.  
19= 167.

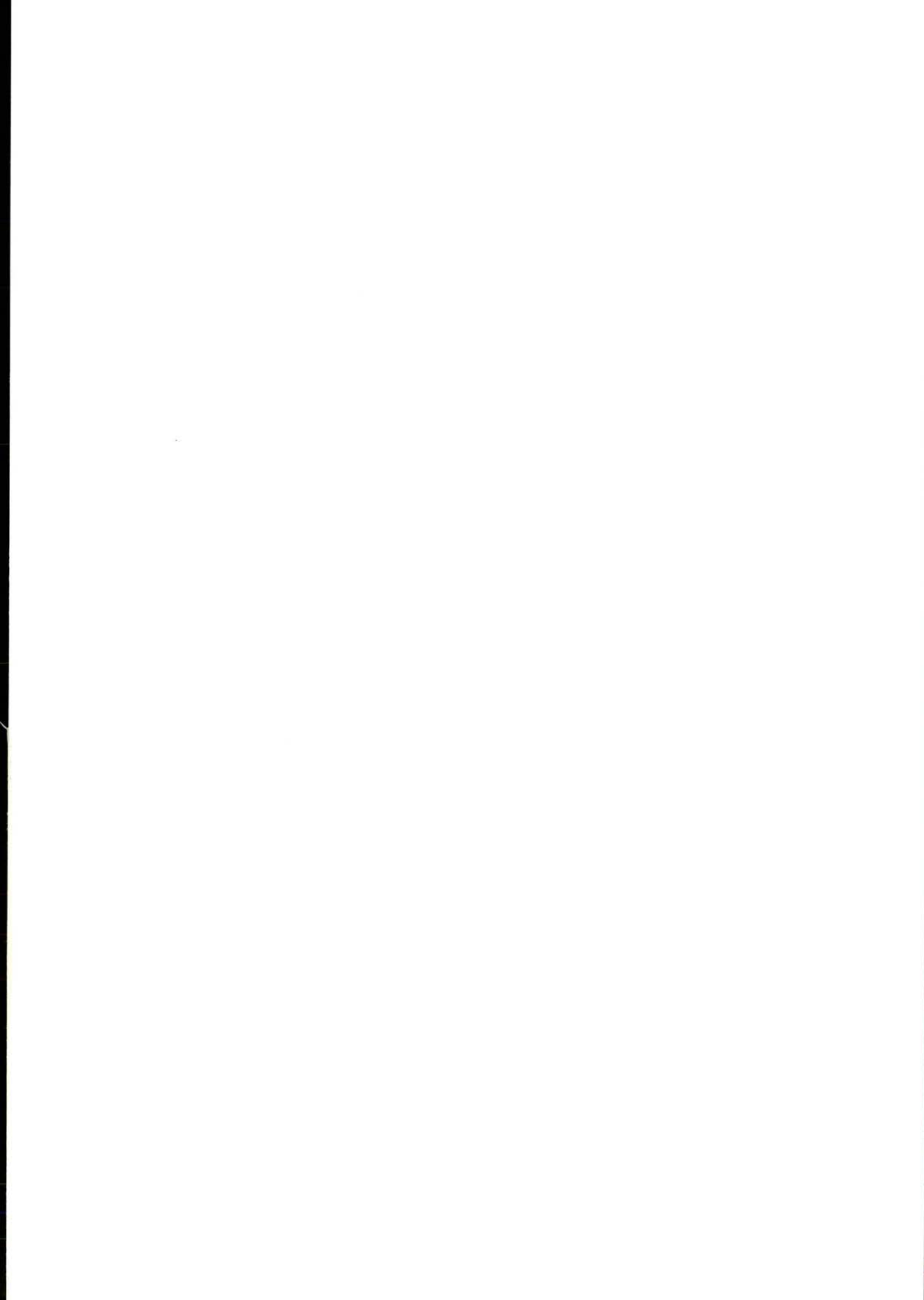



## **wL | delft hydraulics**

Rotterdamseweg 185  
postbus 177  
2600 MH Delft  
telefoon 015 285 85 85  
telefax 015 285 85 82  
e-mail [info@wldelft.nl](mailto:info@wldelft.nl)  
internet [www.wldelft.nl](http://www.wldelft.nl)

Rotterdamseweg 185  
p.o. box 177  
2600 MH Delft  
The Netherlands  
telephone +31 15 285 85 85  
telefax +31 15 285 85 82  
e-mail [info@wldelft.nl](mailto:info@wldelft.nl)  
internet [www.wldelft.nl](http://www.wldelft.nl)

