

# CENTERPIECE™



Centerpiece™ shown with Ceres® Seating.

## CENTERPIECE™

With Centerpiece in your office, your commitment to quality is front and center. Made with hand-selected veneers and skilled craftsmanship, this collection offers a range of desk configurations and storage solutions that let you tackle any job with efficiency and style. Designed to support any work style, including sit-to-stand, Centerpiece is available in a variety of finishes, with glass door and handle options that let your private office reflect your personal style.

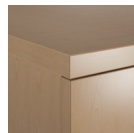

## FEATURES

- Top grade veneer combined with an advanced finish process provides exceptional depth, clarity, and durability.
- From filing cabinets and bookcases to stack-on storage, wall-mounted units and more, Centerpiece has storage to fit your needs.
- Distinct, easy to grasp handles are available in two designs — Beam or Bridge.

# VENEER ORDERING/DESIGN INFORMATION

## STYLING

- Lustrous finish provides exceptional depth, clarity, and durability.
- Clean, uninterrupted lines and precise fits; no gaps.
- All end, modesty, and back panels, as well as drawer and door fronts, feature vertical grain.
- Formal, full height modesty panels on factory-configured (i.e., built-up; assembled) desks, credenzas, and returns.
- Drawer and door fronts over end panels.
- Top-between-end panels (behind door fronts) on stack-on and wall mount storage, and 68 $\frac{1}{4}$ "H & 81 $\frac{1}{4}$ "H storage and combination storage cabinets, wardrobes, and towers.
- Option choices include:
  - Handle design
  - Worksurface grommet
  - Wood or frosted doors on overhead storage
  - Finish (worksurface/chassis/drawer front/door as single option)

## CONSTRUCTION

- Chassis & Pedestal Construction
  - All wood pedestals are made with veneer end panels and fronts which are constructed with  $\frac{3}{4}$ " thick balanced 3-ply panels.
  - End panels are connected with an inset top, back, and bottom cross-tie which is made of  $\frac{1}{16}$ " thick 45lb particleboard. Panels are secured with cam fasteners in conjunction with pressed hardwood biscuits that are adhered with PVA (white polyvinyl acetate) glue.
  - A threaded steel glide plate is attached to the inset bottom panel on the pedestal to provide a durable connection between the glide and the bottom of the pedestal.
  - Steel glide plates are attached to single end panels with screws. End panels are pre-bored to accept the stem of the glide.
- Overhead / Storage Construction
  - All wood panels are constructed with  $\frac{3}{4}$ " thick balanced 3-ply panels.
  - Top, end, and bottom panels are secured with cam fasteners in conjunction with pressed hardwood biscuits that are adhered with PVA (white polyvinyl acetate) glue.
  - All units have inset back panels; backs are unfinished and covered gator-ply material.
  - Back panels are connected using pocket bores and wood screws.
  - Stack-on storage attaches to worksurface with double-sided adhesive tape.

- Wall mount cabinets are mounted to the wall with a spade and "z" bracket attachment method. Steel barrel nuts and spade brackets are securely mounted through the back of wall mount cabinets.
- All units ship with a "z" bracket. This bracket is mounted to the wall by field installers.
- Wall mount cabinet attachment requires individual cabinets be secured by a minimum of two wall mounting locations/studs.
- The cabinets are designed for interior and perimeter walls that are constructed with wood or metal studs. Installers are responsible for selecting and supplying appropriate fasteners for all conditions.
- The HON Company is not responsible for any liabilities resulting from wall mounted cabinets that are not properly installed per instructions.
- Hinges
  - Units with doors include 95° self-closing hinges. Hinges are adjustable.
- Filing
  - The file hanging system is an integral part of the drawer.
  - A highly durable black plastic extrusion is securely fastened into a route on the top of the drawer.
  - The extrusion, coupled with steel rails, allow side to side and front to back filing in file and lateral drawers.
  - The plastic extrusion was designed to promote optimum filing capacity within the drawer while providing a reliable and maintenance free filing system.
- Aluminum Frame Frosted Glass Doors
  - Extruded aluminum mitered frame is clear anodized silver aluminum.
  - Frame is  $\frac{7}{8}$ " thick and 1 $\frac{3}{4}$ " high. Frosted glass is inset within the frame.
  - All frosted glass should be cleaned with a soft lint free cloth and non-ammonia based cleaner only.
- Height Adjustable Worksurfaces
  - Worksurfaces are actual widths. A 1" clearance gap is required for any height adjustable top on all sides.
  - Moving worksurfaces can collide with other components. It is important to ensure free range of motion prior to operating the table.
  - Adjacent worksurfaces need to be self supporting. A wall mount bracket may be used.

# CENTERPIECE™ VENEER ORDERING/DESIGN INFORMATION

## MATERIALS

- Veneer and Finish
  - Natural veneer is subject to nature's quality control. Each species will exhibit difference in grain pattern and tone. This is to be expected and, in fact, contributes to the beauty and individuality of each product. Flat Cut veneers emphasize the variations of wood by exhibiting cathedrals in the grain pattern. Worksurfaces, desktops, and table tops are protected by an advanced UV-cured finish coating in an open pore low sheen finish, applied by state-of-the-art finishing equipment. The finish meets the EPA's stringent requirements for VOC emissions and air quality. Cured in a specially designed ultra-violet oven, the finish fuses to the wood, forming a durable shield that provides a high level of scratch, stain, chemical, and heat resistance, plus a high level of clarity. Regular dusting and occasional cleaning are recommended to maintain your wood finish. To clean, dampen a soft cloth with lukewarm water and gently wipe the wood in the direction of the grain. A mild solution of Murphy's oil soap and water may also be used. Avoid cleaners with oil, waxes, or silicones as they may create a hazy look.
  - Wood owes its inherent beauty to variations in color, grain, and texture; therefore, these variations are not considered defects. There may be minor variations from one piece of furniture to the next even though they are ordered and finished at the same time. Exposure to light and the aging process will cause a darkening of natural wood products. Light finishes on wood products do not mask the natural characteristics of wood. The HON Company does not guarantee the exact matching of grain, pattern, and color. Finishes do not cover any of the natural characteristics of the wood, including nature's colorations and pitch pockets. Merchandise will not be replaced because of these natural variations.
- All exposed surfaces utilize select plain sliced Cherry, Maple, or Walnut veneers. Veneers are carefully selected and slip-matched to assure balance and consistency.
- Finish process provides exceptional depth, clarity, durability, and chemical-resistance throughout the life of the product.
- Eight rich finishes to choose from — Bourbon Cherry, Cognac, Harvest, Mahogany, Mocha, Natural Maple, Pinnacle, and Shaker Cherry.
- Tops / Worksurfaces
  - 1 $\frac{3}{16}$ " thick balanced 3-ply panels with 45lb. particleboard substrate
  - Flat edge detail
  - $\frac{3}{32}$ " thick natural solid external hardwood band on the user sides

	$\frac{3}{32}$ " Softened Edge	1mm Square Edge
Desk Tops	User & Approach	Ends
Extension Tops	User & Approach	Ends
Runoff Tops	User & Approach	Ends
Bridge Tops	User	Back and Ends
Credenza Tops	User	Back and Ends
Return Tops	User	Back and Ends

- Tops connect to the chassis with wood screws through the inset top panel of the pedestals and steel angle brackets.

## SUSTAINABILITY

- LEED EQ compliant finishes.
- Open pore low sheen water base UV finish on writable worksurfaces.
- Low-emitting, low sheen, solvent based conversion varnish finish on non-writing surfaces.
- 19.43% Post-Consumer content and 56.23% Pre-Consumer content; overall recycled content of 47.54% (based on ANSI/BIFMA M7.1-2011 standard private office freestanding casegoods workstation system configurations A2.2.5).

## PRODUCT AND PACKAGE TESTING

- Meets or exceeds ANSI/BIFMA and ISTA performance standards.

## DRAWER SPECIFICATIONS

- Drawers
  - All drawers are 5-sided construction, which allows easy drawer alignment or replacement of drawer fronts. Drawer fronts are attached with screws for easy removal.
  - Drawer fronts feature matched veneer within each pedestal set.
  - The drawers are miterfold construction and are fastened together with dowel joinery for maximum drawer strength.
  - The drawer side material is 3-ply 12mm vinyl-wrapped particleboard in a natural cherry color.
  - The bottom material is a 3-ply substrate consisting of vinyl-wrapped high-density fiberboard core.
  - Optional pencil tray is available for order.
- Drawer Slides
  - Box and file drawers feature full extension, precision steel ball bearing suspensions for a smooth, quiet range of motion; the slides are load rated for 100 lbs.
  - Fully progressive action with dampened start/stop.
  - Lateral file suspensions are load rated for 150 lbs and include an anti-tip mechanism that prevents more than one drawer from being opened at the same time.

# VENEER ORDERING/DESIGN INFORMATION

- Suspensions are silver, steel, roll-formed, zinc plated, and high-grade.
- All suspensions are warranted for the lifetime of the product.

## LEVELING GLIDES

- Glides provide 1½” of vertical leveling adjustment to compensate for uneven floors. Glide bottom is durable non-rust nylon.

## CORE REMOVABLE LOCKS

- Satin (silver) face locks are standard on desk, credenza, return, stack-on and wall mount storage with doors, mobile pedestal, bookcase hutch with door, lateral file, bookcase with lateral file, storage cabinet with lateral file, wardrobe, wardrobe/storage cabinet, storage tower, and modular pedestal models. Each pedestal is independently locked.
- Locks are factory installed. Lock is option SA.
- On individual models that have multiple locks, such as a double pedestal desk and storage tower, the locks are keyed alike.
- Models with hinged door below the worksurface do not lock. This includes: Hinged Door Full Storage Credenza, Modular Hinged Door Pedestal, and Hinged Door Cabinets.
- Glass doors do not lock.
- Hinged doors on 5 high laterals do not lock.
- Keying
  - Keying is random from the factory.
  - Locks feature a removable cylinder (core) that can be interchanged as needed; allows all furniture pieces within an individual workstation to be accessed with one key for convenience, and allows locks to be differentiated between workstations and offices for security. Makes re-keying quick and easy.
  - For field installable lock core kits, specify HF27S (satin) or HF27B (black) plus the key number.

## CORD MANAGEMENT

- Capabilities include optional worksurface grommets.
- Desks specified with worksurface grommets include cutout in kneewell side of pedestal(s) to route and hide cords.
- Under worksurface wire managers are sold separately. These units hide and route cords horizontally around a station.
- Grommet
  - 2-piece round plastic grommet. Grommet cap is inset in a plastic sleeve. Sleeve measures 3” outside dimension x 1” thick.
  - Cap has two cord access holes. Black plastic finish only.
  - Component can be replaced with grommet-mount power hub (HGRMTAC) or power/USB hub (HGRMTUSB2).

Product	Number of Grommets	Grommet(s) Location
Desks	2	Back Left and Right
Credenza	1	Back Center
Return	1	Back Corner Opposite of Pedestal
Bridge	1	Back Center
Peninsula	1	User Side Back Corner
Modular Worksurface	1	Back Left, Back Center, or Back Right

## ACCESSORIES

- Veneer center drawer (HVPACCD26)
- Pencil tray (HVPPT15)
- Lock kits:
  - Removable lock core (HF27B) - black - for stack-on and wall mounted storage with locking doors only
  - Removable lock core (HF27S) - satin - for stack-on and wall mounted storage with locking doors only
- Cord management:
  - Field installable grommets (HFLDGRMT3, HFLDGRMT4, HFLDGRMT)
  - Cable troughs (HCTROUGH17/HCTROUGH1710, HCTROUGH36/HCTROUGH3610)
- Electric accessories (sized to replace worksurface grommet):
  - Power hub, 3” diameter grommet mount (HGRMTAC)
  - Power/USB hub, 3” diameter grommet mount (HGRMTUSB2)
  - 4” x 8” Rectangle Grommet/Pop-up Port (HTPWRGROM1) for rectangle conference table tops
- Lighting:
  - Task lights for stack-on and wall mounted storage (HH870960, HH870942, HH870930)
  - LED task lights for stack-on and wall mounted storage (HLED17AS, HLED31AS, HLED17A, HLED31A, HLED17AUO, HLED31AUO, HLEDOSA)
  - Desktop task lights (HLED1, HLED10C, HLED2)
- Computer accessories:
  - Keyboard platforms (H2516, H2107, H1706, H4022, HE4022, H4028, H4029)
  - Monitor arms (H5210, H5220)
- Mobile Pedestal Cushion (HPSEAT24ND)



# CENTERPIECE™ VENEER ORDERING/SPECIFICATION INFORMATION

## WORKSURFACE / TOP EDGE DETAIL

Designator	Profile	
G	Flat, square	

## DRAWER / DOOR DECORATIVE HANDLES

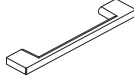
- Two handle style options, each available in silver.
- Distinct, easy to grasp designs.
- Handles are metal.
- The hole spacing is 128mm.
- The handle style has to be specified on drawer fronts (desk/credenza/return, mobile and modular pedestals), lateral file drawer fronts, the doors of the storage cabinet, storage/file cabinet, storage cabinet/lateral file, wardrobe/storage cabinet, wardrobe/bookcase, and storage tower.
- NOTE: Decorative handles are not used on the doors of stack-on storage units or wall mounted storage cabinets.

Designator	Handle Style	
A	Beam	
D	Bridge	

## CORD MANAGEMENT GROMMETS

- Grommets — 3" round, black.

## LOCK FINISH

- Locks — Satin face (for field installable lock kit, use model HF27S).

## SILVER COLORWAY

- The following finish options are coordinating silver colorways: Satin, Satin Nickel, and Matte Chrome.

## VENEER FINISHES / SPECIES

- All exposed surfaces utilize select plain sliced Cherry, Maple, or Walnut veneers.
- These veneers are carefully selected and slip-matched to assure balance and consistency.

Finish	Wood Species
◆ Bourbon Cherry (H)	Cherry
◆ Cognac (COGN)	Cherry
◆ Harvest (C)	Maple
◆ Mahogany (N)	Walnut
◆ Mocha (MOCH)	Cherry
◆ Natural Maple (D)	Maple
◆ Pinnacle (PINC)	Walnut
◆ Shaker Cherry (F)	Cherry

◆◆◆ For lead time information see page 21.



Icon Legend on page 21

# CENTERPIECE™ Typicals

QTY	DESCRIPTION	MODEL	LIST PRICE	PRICE EXTENSION
1	<b>Table Desk with Four Metal Legs</b> 72"W x 36"D x 29½"H	HVPTDR3672-WW	\$2,475	\$2,475
1	<b>Rectangle Worksurface</b> 90"W x 24"D	HVPMWR2490-W	\$930	\$930
1	<b>Pedestal, Box/Box/File</b> 15½"W x 24"D x 28"H	HVPMPW2415-3W	\$1,187	\$1,187
1	<b>Pedestal, File/File</b> 15½"W x 24"D x 28"H	HVPMPW2415-2W	\$1,187	\$1,187
1	<b>Credenza Modesty Panel</b> 90"W	HVPMCF90-W	\$640	\$640
1	<b>Stack-on Storage</b> 90"W x 15"D x 52½"H	HVPSMC2H90-WG	\$4,559	\$4,559
1	<b>Storage Tower, Right</b> 24"W x 24"D x 81¼"H	HVPUTC6H24R-WW	\$4,581	\$4,581
1	<b>Storage Tower, Left</b> 24"W x 24"D x 81¼"H	HVPUTC6H24L-WW	\$4,581	\$4,581
<b>TOTAL:</b>			<b>\$20,140</b>	

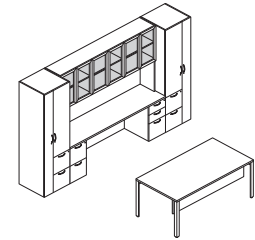

**TABLE DESK/CREDENZA/STORAGE**

**138"W x 108"D**

QTY	DESCRIPTION	MODEL	LIST PRICE	PRICE EXTENSION
1	<b>Double Pedestal Desk, Rectangle Top</b> 72"W x 36"D x 29½"H	HVPDRO3672-32WW	\$3,047	\$3,047
1	<b>Credenza with Kneespace, File/File</b> 72"W x 24"D x 29½"H	HVPDPC2472-22WW	\$2,843	\$2,843
1	<b>Stack-on Storage</b> 72"W x 15"D x 39½"H	HVPSMC1H72-WW	\$2,656	\$2,656
<b>TOTAL:</b>			<b>\$8,546</b>	

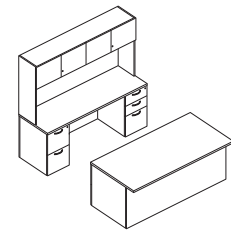

**DESK/CREDENZA/STORAGE**

**72"W x 108"D**

QTY	DESCRIPTION	MODEL	LIST PRICE	PRICE EXTENSION
1	<b>Double Pedestal Desk, Rectangle Top</b> 72"W x 36"D x 29½"H	HVPDRO3672-32WW	\$3,047	\$3,047
1	<b>Rectangle Worksurface</b> 108"W x 24"D	HVPMWR24108-W	\$1,281	\$1,281
2	<b>Storage Cabinet Pedestal</b> 36"W x 24"D x 28"H	HVPMPW2436-5W	\$1,356	\$2,712
1	<b>Credenza Modesty Panel</b> 108"W	HVPMCF108-W	\$968	\$968
1	<b>Bookcase Hutch, Right</b> 18"W x 15"D x 52½"H	HVPSTF2H18R-WW	\$1,535	\$1,535
1	<b>Bookcase Hutch, Left</b> 18"W x 15"D x 52½"H	HVPSTF2H18L-WW	\$1,535	\$1,535
1	<b>Stack-on Storage</b> 72"W x 15"D x 52½"H	HVPSMC2H72-WW	\$3,287	\$3,287
<b>TOTAL:</b>			<b>\$14,365</b>	

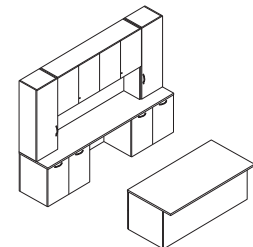

**DESK/CREDENZA/STORAGE**

**108"W x 108"D**

# CENTERPIECE™

## Typicals



Icon Legend on page 21

QTY	DESCRIPTION	MODEL	LIST PRICE	PRICE EXTENSION
1	<b>P-Shape Peninsula, Right, 1/2 Modesty</b> 72"W x 30/42"D x 29 1/8"H	HVPXBH3072-WW	\$2,450	\$2,450
1	<b>Bridge</b> 48"W x 24"D x 29 1/8"H	HVPBRG2448-WW	\$954	\$954
1	<b>Single Pedestal Credenza, Left, File/File</b> 72"W x 24"D x 29 1/8"H	HVPSPC2472L-2WW	\$2,389	\$2,389
1	<b>Mobile Pedestal, Box/File</b> 15 1/2"W x 21 3/4"D x 22 1/8"H	HVPMPD2415-6WW	\$1,317	\$1,317
1	<b>Pedestal Seat Cushion</b> 15"W x 22 1/8"D x 2"H	HPSEAT24ND	\$180	\$180
1	<b>Stack-on Storage</b> 72"W x 15"D x 39 1/8"H	HVPSMC1H72-WG	\$2,816	\$2,816
1	<b>Storage Tower, Left</b> 24"W x 24"D x 68 1/4"H	HVPUTC5H24L-WW	\$4,006	\$4,006
<b>TOTAL:</b>			<b>\$14,112</b>	

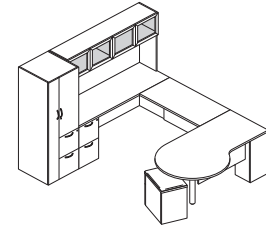

**"U" WORKSTATION WITH PENINSULA**  
96"W x 114"D

QTY	DESCRIPTION	MODEL	LIST PRICE	PRICE EXTENSION
1	<b>Single Pedestal Desk, Right, Rectangle Top</b> 72"W x 36"D x 29 1/8"H	HVPDRO3672R-3WW	\$2,750	\$2,750
1	<b>Bridge</b> 48"W x 24"D x 29 1/8"H	HVPBRG2448-WW	\$954	\$954
1	<b>Single Pedestal Credenza, Left, Lateral File</b> 72"W x 24"D x 29 1/8"H	HVPCLF2472L-4WW	\$2,822	\$2,822
1	<b>Stack-on Storage</b> 72"W x 15"D x 39 1/8"H	HVPSMC1H72-WW	\$2,656	\$2,656
1	<b>Wardrobe, Left</b> 16"W x 24"D x 68 1/4"H	HVPCLS5H15L-WW	\$2,287	\$2,287
<b>TOTAL:</b>			<b>\$11,469</b>	

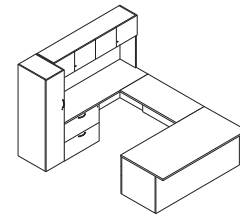

**"U" WORKSTATION WITH DESK**  
72"W x 108"D

QTY	DESCRIPTION	MODEL	LIST PRICE	PRICE EXTENSION
1	<b>P-Shape Peninsula, Left, 1/2 Modesty</b> 72"W x 30/42"D x 29 1/8"H	HVPXDH3072-WW	\$2,450	\$2,450
1	<b>Bridge</b> 48"W x 24"D x 29 1/8"H	HVPBRG2448-WW	\$954	\$954
1	<b>Rectangle Worksurface</b> 102"W x 24"D	HVPMWR24102-W	\$1,112	\$1,112
1	<b>Multi File Pedestal, Right</b> 30"W x 24"D x 28"H	HVPMPW2430-MFRW	\$1,487	\$1,487
1	<b>End Panel</b> 3/4"W x 23 1/8"D	HVPMEP24-W	\$321	\$321
1	<b>Credenza Modesty Panel</b> 102"W	HVPMCF102-W	\$808	\$808
1	<b>Pedestal, Box/Box/File</b> 15 1/16"W x 24"D x 28"H	HVPMPW2415-3W	\$1,187	\$1,187
1	<b>Stack-on Storage</b> 72"W x 15"D x 52 1/16"H	HVPSMC2H72-WG	\$3,520	\$3,520
1	<b>Bookcase Hutch, Open</b> 30"W x 15"D x 52 1/16"H	HVPSTN2H30-WN	\$1,586	\$1,586
<b>TOTAL:</b>			<b>\$13,425</b>	

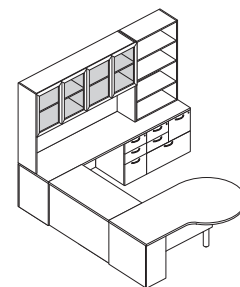

**"U" WORKSTATION WITH PENINSULA**  
102"W x 114"D



Icon Legend on page 21

# CENTERPIECE™ Typicals

DESKS

QTY	DESCRIPTION	MODEL	LIST PRICE	PRICE EXTENSION
1	<b>Rectangle Worksurface</b> 102"W x 24"D	HVPMWR24102-W	\$1,112	\$1,112
1	<b>Multi File Pedestal, Left</b> 30"W x 24"D x 28"H	HVPMPW2430-MFLW	\$1,487	\$1,487
1	<b>End Panel</b> ¾"W x 23⅞"D	HVPMEP24-W	\$321	\$321
1	<b>Credenza Modesty Panel</b> 102"W	HVPMCF102-W	\$808	\$808
1	<b>Return, Right, File/File</b> 60"W x 24"D x 29⅞"H	HVPRTN2460R-2WW	\$2,061	\$2,061
1	<b>Stack-on Storage</b> 72"W x 15"D x 52⅞"H	HVPSMC2H72-WW	\$3,287	\$3,287
1	<b>Bookcase Hutch, Open</b> 30"W x 15"D x 52⅞"H	HVPSTN2H30-WN	\$1,586	\$1,586
1	<b>Wardrobe/Cabinet</b> 36"W x 24"D x 81¼"H	HVPCLD6H30-DW	\$4,481	\$4,481
<b>TOTAL:</b>			<b>\$15,143</b>	

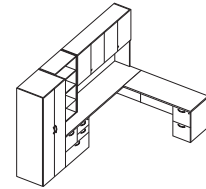

**"L" WORKSTATION**  
138"W x 84"D

QTY	DESCRIPTION	MODEL	LIST PRICE	PRICE EXTENSION
1	<b>Storage Tower, Left</b> 24"W x 24"D x 68¼"H	HVPUTC5H24L-WW	\$4,006	\$4,006
1	<b>Single Pedestal Credenza, Left, File/File</b> 72"W x 24"D x 29⅞"H	HVSPC2472L-2WW	\$2,389	\$2,389
1	<b>Rectangle Worksurface</b> 54"W x 24"D	HVPMWR2454-W	\$643	\$643
1	<b>Pedestal, Box/Box/File</b> 15⅞"W x 24"D x 28"H	HVPMPW2415-3W	\$1,187	\$1,187
1	<b>Return Modesty Panel</b> 54"W	HVPMRF54-W	\$462	\$462
1	<b>Wall Mount Storage</b> 72"W x 15"D x 14⅞"H	HVPWMC1H72L-WW	\$2,473	\$2,473
1	<b>Round Top</b> 42" Diameter	HVPTRD42-W	\$1,462	\$1,462
1	<b>Disc Base</b> 24" Diameter	HVPMDISC24-LD	\$889	\$889
<b>TOTAL:</b>			<b>\$13,511</b>	

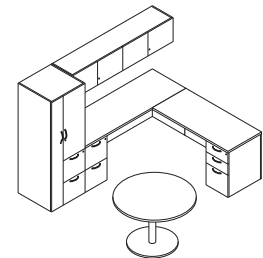

**"L" WORKSTATION**  
108"W x 108"D

QTY	DESCRIPTION	MODEL	LIST PRICE	PRICE EXTENSION
1	<b>Rectangle Worksurface</b> 90"W x 24"D	HVPMWR2490-W	\$930	\$930
1	<b>Multi File Pedestal, Right</b> 30"W x 24"D x 28"H	HVPMPW2430-MFRW	\$1,487	\$1,487
1	<b>End Panel</b> ¾"W x 23⅞"D	HVPMEP24-W	\$321	\$321
1	<b>Credenza Modesty Panel</b> 90"W	HVPMCF90-W	\$640	\$640
1	<b>Bullet Runoff, Left, with Column Leg</b> 54"W x 30"D x 29⅞"H	HVPRRH3054L-WW	\$1,212	\$1,212
1	<b>Wall Mount Storage</b> 90"W x 15"D x 27⅞"H	HVPWMC2H90-WW	\$3,996	\$3,996
1	<b>Wardrobe/Cabinet</b> 36"W x 24"D x 81¼"H	HVPCLD6H30-DW	\$4,481	\$4,481
<b>TOTAL:</b>			<b>\$13,067</b>	

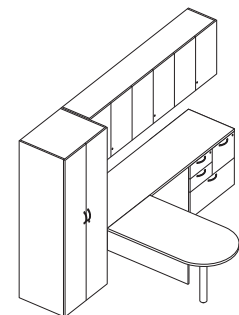

**STORAGE WALL WITH  
CONFERENCE RUNOFF**  
126"W x 78"D



# CENTERPIECE™

## Desks

GSA SIN 711-8

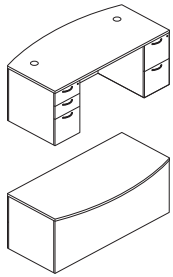

Icon Legend on page 21

**DESCRIPTION****Double Pedestal Desk — Bow Top**

72"W x 36"D x 29½"H

**MODEL****HVPDBO3672-32WW****SHIP WEIGHT**

430

**CUBE**

54.3

**LIST PRICE****\$3655**

NOTES: 6" conference overhang on approach side. Pedestal depth is 6" less than top depth. Single piece modesty panels. Kneespace between double pedestals on 72"W desks is 42".

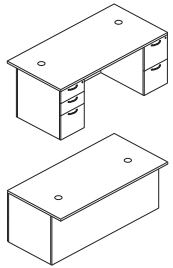
**Double Pedestal Desk — Rectangle Top**

72"W x 36"D x 29½"H

**HVPDRO3672-32WW**

435

54.3

**\$3047**

NOTES: 6" conference overhang on approach side. Pedestal depth is 6" less than top depth. Single piece modesty panels. Kneespace between double pedestals on 72"W desks is 42".

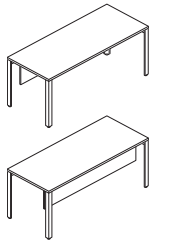
**Table Desk with Four Metal Legs**

72"W x 36"D x 29½"H

**HVPTDR3672-WW**

180

7.6

**\$2475**

72"W x 30"D x 29½"H

**HVPTDR3072-WW**

172

6.5

**\$2347**

NOTES: Horizontal, side-to-side grain direction. Includes 1/2 modesty panel. 6" conference overhang on approach side. Four metal legs; available in black (P) or silver (PR6).

**NOTES:**

- Drawers operate on high quality steel ball-bearing suspensions to ensure quiet, smooth, long-lasting operation.
- Full extension box and file drawers allow complete and easy access to all contents.
- Filing capabilities for 72"W desks are front-to-back letter filing and side-to-side letter or legal filing.
- File drawers standard with hangrails.
- See page 73 for veneer center drawer.
- For removable lock core kits, see model HF27S on page 73.

**HOW TO SPECIFY**

Select Model Number	Select Edge Profile	Select Handle	Select Grommet	Select Finish
<b>G</b> Square Edge	<b>A</b> Beam in Silver <b>D</b> Bridge in Silver	<b>GP</b> Grommet(s) Black <b>X</b> No Grommet	<b>H</b> Bourbon Cherry <b>COGN</b> Cognac <b>C</b> Harvest <b>N</b> Mahogany <b>MOCH</b> Mocha <b>D</b> Natural Maple <b>PINC</b> Pinnacle <b>F</b> Shaker Cherry	
HVPDBO3672-32WW	G	A	X	N
HVPDRO3672-32WW	G	A	X	N

Select Model Number	Select Edge Profile	Select Leg Color	Select Finish
<b>G</b> Square Edge	<b>PR6</b> Silver <b>P</b> Black	<b>H</b> Bourbon Cherry <b>COGN</b> Cognac <b>C</b> Harvest <b>N</b> Mahogany <b>MOCH</b> Mocha <b>D</b> Natural Maple <b>PINC</b> Pinnacle <b>F</b> Shaker Cherry	
HVPTDR3672-WW	G	P	PINC

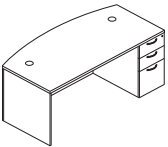
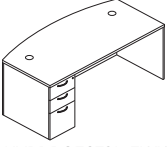
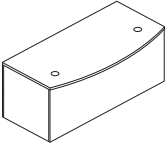
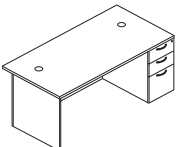
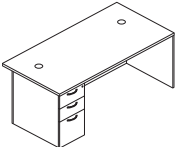
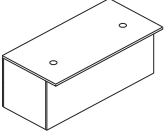

	DESCRIPTION	MODEL	SHIP WEIGHT	CUBE	LIST PRICE
 <i>HVPDBO3672R-3WW shown</i>	<b>Single Pedestal Desk — Bow Top</b> 72"W x 36"D x 29½"H, Right 72"W x 36"D x 29½"H, Left	<b>HVPDBO3672R-3WW</b>	285	43.7	<b>\$3196</b>
		<b>HVPDBO3672L-3WW</b>	285	54.3	<b>\$3196</b>
 <i>HVPDBO3672L-3WW shown</i>					
					
  	<b>Single Pedestal Desk — Rectangle Top</b> 72"W x 36"D x 29½"H, Right (shown) 72"W x 30"D x 29½"H, Right 66"W x 30"D x 29½"H, Right  72"W x 36"D x 29½"H, Left (shown) 72"W x 30"D x 29½"H, Left 66"W x 30"D x 29½"H, Left  NOTES: 30"D desks have a flush modesty panel; no overhang on approach-side.	<b>HVPDRO3672R-3WW</b>	290	54.3	<b>\$2750</b>
		<b>HVPDRF3072R-3WW</b>	300	36.4	<b>\$2608</b>
		<b>HVPDRF3066R-3WW</b>	280	33.4	<b>\$2522</b>
		<b>HVPDRO3672L-3WW</b>	290	54.3	<b>\$2750</b>
		<b>HVPDRF3072L-3WW</b>	300	46.0	<b>\$2608</b>
		<b>HVPDRF3066L-3WW</b>	280	42.3	<b>\$2522</b>

**NOTES:**

- Right pedestal desk to be specified with left pedestal return or bridge and left pedestal credenza.
- Left pedestal desk to be specified with right pedestal return or bridge and right pedestal credenza.
- Kneespace between end panel and pedestal:  
 66" width desk = 51"  
 72" width desk = 57"
- See page 73 for veneer center drawer.
- For removable lock core kits, see model HF27S on page 73.

**HOW TO SPECIFY**

Select Model Number	Select Edge Profile	Select Handle	Select Grommet	Select Finish
<b>G</b> Square Edge	<b>A</b> Beam in Silver <b>D</b> Bridge in Silver	<b>GP</b> Grommet(s) Black <b>X</b> No Grommet	<b>H</b> Bourbon Cherry <b>COGN</b> Cognac <b>C</b> Harvest <b>N</b> Mahogany	<b>MOCH</b> Mocha <b>D</b> Natural Maple <b>PINC</b> Pinnacle <b>F</b> Shaker Cherry
HVPDBO3672R-3WW	G	D	GP	D

# CENTERPIECE™

## Peninsulas

GSA SIN 711-8



Icon Legend on page 21

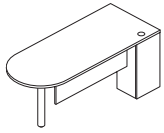

HVPXRH3072R-WW shown

**DESCRIPTION****Peninsula with 1/2 Modesty Panel**

72"W x 30"D x 29 1/8"H, Bullet Shape with Support Column, Right  
72"W x 30"D x 29 1/8"H, Bullet Shape with Support Column, Left

72"W x 30/42"D x 29 1/8"H, P-Shape with Support Column, Right  
72"W x 30/42"D x 29 1/8"H, P-Shape with Support Column, Left

**MODEL****SHIP WEIGHT****CUBE****LIST PRICE****HVPXRH3072R-WW**

150

36.4

**\$1983****HVPXRH3072L-WW**

150

36.4

**\$1983****HVPXBH3072-WW**

154

46.0

**\$2450****HVPXDH3072-WW**

154

46.0

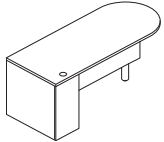
**\$2450**

HVPXRH3072L-WW shown

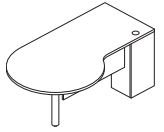

HVPXBH3072-WW shown

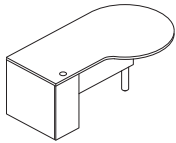

HVPXDH3072-WW shown

**NOTES:**

- Available in bullet or P-shaped tops.
- Right peninsula for use with left pedestal return or bridge and left pedestal credenza.
- Left peninsula for use with right pedestal return or bridge and right pedestal credenza.
- 1/2-height modesty panel.
- 6" conference overhang on approach side.
- Peninsulas include metal support column; available in black or silver.



**HOW TO SPECIFY**

Select Model Number	Select Edge Profile	Select Grommet	Select Column Color	Select Finish
	<b>G</b> Square Edge	<b>GP</b> Grommet(s) Black <b>X</b> No Grommet	<b>PR6</b> Silver <b>P</b> Black	<b>H</b> Bourbon Cherry <b>COGN</b> Cognac <b>C</b> Harvest <b>N</b> Mahogany <b>MOCH</b> Mocha <b>D</b> Natural Maple <b>PINC</b> Pinnacle <b>F</b> Shaker Cherry
HVPXRH3072R-WW	G	X	PR6	F

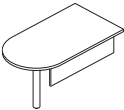

Icon Legend on page 21

# CENTERPIECE™ Conference Runoffs

	DESCRIPTION	MODEL	SHIP WEIGHT	CUBE	LIST PRICE	
 HVPRRH3054R-WW shown	<b>Bullet Conference Runoff with 1/2 Modesty Panel</b> 60"W x 30"D x 29 1/8"H, with Support Column, Right 54"W x 30"D x 29 1/8"H, with Support Column, Right	<b>HVPRRH3060R-WW</b> <b>HVPRRH3054R-WW</b>	54 49	5.4 4.9	<b>\$1281</b> <b>\$1212</b>	
	60"W x 30"D x 29 1/8"H, with Support Column, Left 54"W x 30"D x 29 1/8"H, with Support Column, Left	<b>HVPRRH3060L-WW</b> <b>HVPRRH3054L-WW</b>	54 49	5.4 4.9	<b>\$1281</b> <b>\$1212</b>	
	 HVPRRH3054L-WW shown	<b>Rectangle Conference Runoff with 1/2 Modesty Panel</b> 60"W x 30"D x 29 1/8"H, with Metal Legs, Right 54"W x 30"D x 29 1/8"H, with Metal Legs, Right	<b>HVPRRL3060R-WW</b> <b>HVPRRL3054R-WW</b>	60 55	5.4 4.9	<b>\$1467</b> <b>\$1419</b>
		60"W x 30"D x 29 1/8"H, with Metal Legs, Left 54"W x 30"D x 29 1/8"H, with Metal Legs, Left	<b>HVPRRL3060L-WW</b> <b>HVPRRL3054L-WW</b>	60 55	5.4 4.9	<b>\$1467</b> <b>\$1419</b>

**NOTES:**

- Worksurface extension solution attaches perpendicular to credenzas.
- Bullet and rectangle worksurface shapes.
- Vertical, front-to-back grain direction on worksurface.
- 3" diameter metal support column included with bullet worksurface.
- Two metal support legs included with rectangle worksurface.
- Column and legs available in black or silver.
- Units ship unassembled, field assembly required.
- Conference runoffs include worksurface connection bracket.

## HOW TO SPECIFY

<b>Select Model Number</b>  HVPRRH3060R-WW	<b>Select Edge Profile</b> G Square Edge	<b>Select Column/Leg Color</b> PR6 Silver P Black	<b>Select Finish</b> H Bourbon Cherry COGN Cognac C Harvest N Mahogany MOCH Mocha D Natural Maple PINC Pinnacle F Shaker Cherry
HVPRRH3060R-WW	G	P	MOCH

# CENTERPIECE™

## Credenzas

GSA SIN 711-8

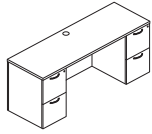

Icon Legend on page 21

**DESCRIPTION**

**Credenza with Kneespace**  
72"W x 24"D x 29½"H

**MODEL****HVPDPC2472-22WW****SHIP WEIGHT**

280

**CUBE**

37.6

**LIST PRICE****\$2843**

NOTES: For use behind a desk or as a stand-alone storage piece. Four locking file drawers, 2-left, 2-right. 60" and 66"W sizes can be specified using modular components.

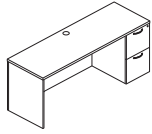

HVPSPC2472R-2WW shown

**Single Pedestal Credenza**

72"W x 24"D x 29½"H, Right  
66"W x 24"D x 29½"H, Right

**HVPSPC2472R-2WW**

275

37.6

**\$2389****HVPSPC2466R-2WW**

255

34.6

**\$2241**

72"W x 24"D x 29½"H, Left  
66"W x 24"D x 29½"H, Left

**HVPSPC2472L-2WW**

275

37.6

**\$2389****HVPSPC2466L-2WW**

255

34.6

**\$2241**

NOTES: Primary use is as part of a U-shaped workstation with a single pedestal desk and a bridge. Two locking file drawers. Modular component options include sizes wider than 72" and box/box/file pedestal storage.

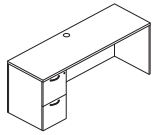

HVPCLF2472L-4WW shown

**Credenza with Lateral File**

84"W x 24"D x 29½"H, Right  
78"W x 24"D x 29½"H, Right  
72"W x 24"D x 29½"H, Right

**HVPCLF2484R-4WW**

345

43.6

**\$3164****HVPCLF2478R-4WW**

330

40.7

**\$2942****HVPCLF2472R-4WW**

315

37.6

**\$2822**

84"W x 24"D x 29½"H, Left  
78"W x 24"D x 29½"H, Left  
72"W x 24"D x 29½"H, Left

**HVPCLF2484L-4WW**

345

43.7

**\$3164****HVPCLF2478L-4WW**

330

40.7

**\$2942****HVPCLF2472L-4WW**

315

37.6

**\$2822**

NOTES: Primary use is as part of a U-shaped workstation with a single pedestal desk and a bridge. Storage file measures 30"W. T-Support included with 84"W size; for unsupported worksurface span greater than 48"W. Modular options include components for credenza with 36"W lateral file.

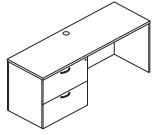

HVPCLF2472L-4WW shown

**Credenza with Two Lateral Files**

72"W x 24"D x 29½"H  
60"W x 24"D x 29½"H

**HVPFSC2472-44WW**

310

37.6

**\$3801****HVPFSC2460-44WW**

240

31.6

**\$3421**

NOTES: Four locking lateral file drawers, 2-left, 2-right.

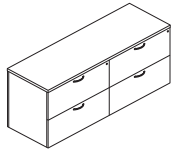

HVPFSC2472-44WW shown

**Credenza with Two Storage Cabinets**

72"W x 24"D x 29½"H  
60"W x 24"D x 29½"H

**HVPFSC2472-55WW**

280

37.6

**\$2955****HVPFSC2460-55WW**

210

31.6

**\$2659**

NOTES: Two side-by-side cabinets. Hinged doors; doors do not lock.

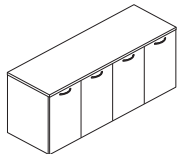

HVPFSC2472-55WW shown

**NOTES:**

- Drawers operate on high quality steel ball-bearing suspensions to ensure quiet, smooth, long-lasting operation.
- Full extension drawers allow complete and easy access to all contents.
- File drawers standard with hangrails.
- For removable lock core kits, see model HF27S on page 73.

❗ The credenza models listed on this page have an unfinished back panel; they are intended for use against a wall. For a finished back panel, specify credenzas using modular components.

**HOW TO SPECIFY**

Select Model Number	Select Edge Profile	Select Handle	Select Grommet	Select Finish
<b>H</b> V P D P C 2 4 7 2 - 2 2 W W	<b>G</b> Square Edge	<b>A</b> Beam in Silver <b>D</b> Bridge in Silver	<b>GPC</b> Grommet Black <b>X</b> No Grommet Do NOT specify for models: HVPFSC2472-44WW, HVPFSC2460-44WW, HVPFSC2472-55WW, HVPFSC2460-55WW	<b>H</b> Bourbon Cherry <b>COGN</b> Cognac <b>C</b> Harvest <b>N</b> Mahogany <b>MOCH</b> Mocha <b>D</b> Natural Maple <b>PINC</b> Pinnacle <b>F</b> Shaker Cherry



	DESCRIPTION	MODEL	SHIP WEIGHT	CUBE	LIST PRICE
 HVPRTN2460R-2WW shown	<b>Return</b>				
	60"W x 24"D x 29½"H, Right	<b>HVPRTN2460R-2WW</b>	235	31.6	<b>\$2061</b>
	54"W x 24"D x 29½"H, Right	<b>HVPRTN2454R-2WW</b>	220	28.6	<b>\$1995</b>
	48"W x 24"D x 29½"H, Right	<b>HVPRTN2448R-2WW</b>	205	25.6	<b>\$1938</b>
	42"W x 24"D x 29½"H, Right	<b>HVPRTN2442R-2WW</b>	190	22.6	<b>\$1888</b>
 HVPRTN2460L-2WW shown	60"W x 24"D x 29½"H, Left	<b>HVPRTN2460L-2WW</b>	235	31.6	<b>\$2061</b>
	54"W x 24"D x 29½"H, Left	<b>HVPRTN2454L-2WW</b>	220	28.6	<b>\$1995</b>
	48"W x 24"D x 29½"H, Left	<b>HVPRTN2448L-2WW</b>	205	25.6	<b>\$1938</b>
	42"W x 24"D x 29½"H, Left	<b>HVPRTN2442L-2WW</b>	190	22.6	<b>\$1888</b>

**NOTES:**

- Right returns to be specified with left pedestal desks and peninsulas.
- Left returns to be specified with right pedestal desks and peninsulas.
- Worksurface has vertical, front-to-back grain direction.
- Finished back panel is standard on both factory-configured models and returns built with modular components.
- 66" and 72"W sizes, and alternative storage configurations, can be specified using modular components.
- Returns standard with two file drawers; handrails included.
- Returns include worksurface connection bracket.
- For removable lock core kits, see model HF27S on page 73.

## HOW TO SPECIFY

<p><b>Select Model Number</b></p> <p>H V P R T N 2 4 6 0 R - 2 W W .</p>	<p><b>Select Edge Profile</b></p> <p>G Square Edge</p> <p>G .</p>	<p><b>Select Handle</b></p> <p>A Beam in Silver D Bridge in Silver</p> <p>D .</p>	<p><b>Select Grommet</b></p> <p>GP Grommet Black X No Grommet</p> <p>GP .</p>	<p><b>Select Finish</b></p> <table border="0"> <tr> <td>H Bourbon Cherry</td> <td>MOCH Mocha</td> </tr> <tr> <td>COGN Cognac</td> <td>D Natural Maple</td> </tr> <tr> <td>C Harvest</td> <td>PINC Pinnacle</td> </tr> <tr> <td>N Mahogany</td> <td>F Shaker Cherry</td> </tr> </table> <p>D</p>	H Bourbon Cherry	MOCH Mocha	COGN Cognac	D Natural Maple	C Harvest	PINC Pinnacle	N Mahogany	F Shaker Cherry
H Bourbon Cherry	MOCH Mocha											
COGN Cognac	D Natural Maple											
C Harvest	PINC Pinnacle											
N Mahogany	F Shaker Cherry											

# CENTERPIECE™ Bridges

GSA SIN 711-8



Icon Legend on page 21

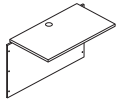

HVPBRG2442-WW shown

**DESCRIPTION**

**Bridge with Full Modesty Panel**  
48"W x 24"D x 29 1/8"H  
42"W x 24"D x 29 1/8"H

**MODEL**

**HVPBRG2448-WW**  
**HVPBRG2442-WW**

**SHIP WEIGHT**

75  
67

**CUBE**

4.4  
3.9

**LIST PRICE**

**\$954**  
**\$915**

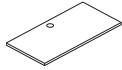

HVPBRX2448-WW shown

**Bridge with No Modesty Panel**  
48"W x 24"D x 29 1/8"H  
42"W x 24"D x 29 1/8"H

**HVPBRX2448-WW**  
**HVPBRX2442-WW**

75  
67

4.4  
3.9

**\$758**  
**\$719**

**NOTES:**

- Available with full modesty panel or with no modesty panel.
- Worksurface has vertical, front-to-back grain direction to align with desk and credenza grain.
- Finished back panel.
- Modesty panel units ship unassembled, field assembly required.
- Bridges include worksurface connection brackets.

## HOW TO SPECIFY

<p><b>Select Model Number</b></p> <p>H V P B R G 2 4 4 8 - W W .</p>	<p><b>Select Edge Profile</b></p> <p>G Square Edge</p> <p>G .</p>	<p><b>Select Grommet</b></p> <p>GP Grommet Black X No Grommet</p> <p>GP .</p>	<p><b>Select Finish</b></p> <table border="0"> <tr> <td>H</td><td>Bourbon Cherry</td> <td>MOCH</td><td>Mocha</td> </tr> <tr> <td>COGN</td><td>Cognac</td> <td>D</td><td>Natural Maple</td> </tr> <tr> <td>C</td><td>Harvest</td> <td>PINC</td><td>Pinnacle</td> </tr> <tr> <td>N</td><td>Mahogany</td> <td>F</td><td>Shaker Cherry</td> </tr> </table> <p>C</p>	H	Bourbon Cherry	MOCH	Mocha	COGN	Cognac	D	Natural Maple	C	Harvest	PINC	Pinnacle	N	Mahogany	F	Shaker Cherry
H	Bourbon Cherry	MOCH	Mocha																
COGN	Cognac	D	Natural Maple																
C	Harvest	PINC	Pinnacle																
N	Mahogany	F	Shaker Cherry																



Icon Legend on page 21

# CENTERPIECE™ Stack-on Storage

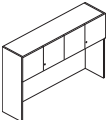
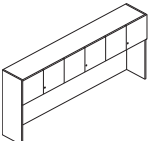
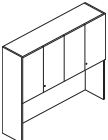
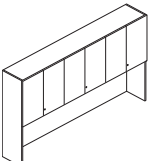
	DESCRIPTION	MODEL	SHIP WEIGHT	CUBE	LIST PRICE
 HVPSMC1H60-WW shown	<b>Stack-on Storage — Wood Doors — 39”H</b>				
	96”W x 14 <sup>3</sup> / <sub>4</sub> ”D x 39 <sup>1</sup> / <sub>8</sub> ”H — 6 Doors	<b>HVPSMC1H96-WW</b>	210	42.8	<b>\$3723</b>
	90”W x 14 <sup>3</sup> / <sub>4</sub> ”D x 39 <sup>1</sup> / <sub>8</sub> ”H — 6 Doors	<b>HVPSMC1H90-WW</b>	199	40.2	<b>\$3398</b>
	84”W x 14 <sup>3</sup> / <sub>4</sub> ”D x 39 <sup>1</sup> / <sub>8</sub> ”H — 6 Doors	<b>HVPSMC1H84-WW</b>	187	37.6	<b>\$3102</b>
	78”W x 14 <sup>3</sup> / <sub>4</sub> ”D x 39 <sup>1</sup> / <sub>8</sub> ”H — 4 Doors	<b>HVPSMC1H78-WW</b>	170	35.0	<b>\$2833</b>
	72”W x 14 <sup>3</sup> / <sub>4</sub> ”D x 39 <sup>1</sup> / <sub>8</sub> ”H — 4 Doors	<b>HVPSMC1H72-WW</b>	159	32.4	<b>\$2656</b>
 HVPSMC1H90-WW shown	66”W x 14 <sup>3</sup> / <sub>4</sub> ”D x 39 <sup>1</sup> / <sub>8</sub> ”H — 4 Doors	<b>HVPSMC1H66-WW</b>	147	29.8	<b>\$2482</b>
	60”W x 14 <sup>3</sup> / <sub>4</sub> ”D x 39 <sup>1</sup> / <sub>8</sub> ”H — 4 Doors	<b>HVPSMC1H60-WW</b>	135	27.2	<b>\$2316</b>
	<b>Stack-on Storage — Wood Doors — 52”H</b>				
	90”W x 14 <sup>3</sup> / <sub>4</sub> ”D x 52 <sup>1</sup> / <sub>16</sub> ”H — 6 Doors	<b>HVPSMC2H90-WW</b>	302	52.5	<b>\$4212</b>
	84”W x 14 <sup>3</sup> / <sub>4</sub> ”D x 52 <sup>1</sup> / <sub>16</sub> ”H — 6 Doors	<b>HVPSMC2H84-WW</b>	280	49.1	<b>\$3842</b>
	78”W x 14 <sup>3</sup> / <sub>4</sub> ”D x 52 <sup>1</sup> / <sub>16</sub> ”H — 4 Doors	<b>HVPSMC2H78-WW</b>	255	45.7	<b>\$3506</b>
 HVPSMC2H60-WW shown	72”W x 14 <sup>3</sup> / <sub>4</sub> ”D x 52 <sup>1</sup> / <sub>16</sub> ”H — 4 Doors	<b>HVPSMC2H72-WW</b>	240	42.3	<b>\$3287</b>
	66”W x 14 <sup>3</sup> / <sub>4</sub> ”D x 52 <sup>1</sup> / <sub>16</sub> ”H — 4 Doors	<b>HVPSMC2H66-WW</b>	225	39.0	<b>\$3066</b>
	60”W x 14 <sup>3</sup> / <sub>4</sub> ”D x 52 <sup>1</sup> / <sub>16</sub> ”H — 4 Doors	<b>HVPSMC2H60-WW</b>	210	35.6	<b>\$2861</b>
	 HVPSMC2H90-WW shown				

**NOTES:**

- Available with wood or aluminum frame frosted glass doors.
- Wood door models are standard with locks; lock finish is satin. Frosted door units do not lock.
- Doors equipped with self-closing hinges; hinges are adjustable.
- Two height options, single (42<sup>1</sup>/<sub>4</sub>”H) and double (55<sup>5</sup>/<sub>8</sub>”H).
- Double height cabinets include standard fixed shelf.
- Inside dimensions (width varies with cabinet): 1 high standard - D = 13<sup>3</sup>/<sub>16</sub>”, H = 12<sup>1</sup>/<sub>4</sub>”; 2 high standard - D = 13<sup>3</sup>/<sub>16</sub>”, H = 25<sup>1</sup>/<sub>8</sub>”.
- Distance from bottom of cabinet to worksurface is 24<sup>1</sup>/<sub>2</sub>” on all units.
- Connect to worksurface with double-sided adhesive tape.
- Lighting options available. See page 77.
- 2” diameter pass-through hole in back panel to route task light cord.
- Units have an unfinished back and are intended for use against a wall.
- Ship assembled.
- See page 55 for tackboards.

**HOW TO SPECIFY**

<p><b>Select Model Number</b></p> <p>H V P S M C 1 H 9 6 - W W .</p>	<p><b>Select Lock</b></p> <p>SA Satin Do NOT specify on models with frosted doors</p> <p>S A .</p>	<p><b>Select Finish</b></p> <table border="0"> <tr> <td>H</td><td>Bourbon Cherry</td> <td>MOCH</td><td>Mocha</td> </tr> <tr> <td>COGN</td><td>Cognac</td> <td>D</td><td>Natural Maple</td> </tr> <tr> <td>C</td><td>Harvest</td> <td>PINC</td><td>Pinnacle</td> </tr> <tr> <td>N</td><td>Mahogany</td> <td>F</td><td>Shaker Cherry</td> </tr> </table> <p>N</p>	H	Bourbon Cherry	MOCH	Mocha	COGN	Cognac	D	Natural Maple	C	Harvest	PINC	Pinnacle	N	Mahogany	F	Shaker Cherry
H	Bourbon Cherry	MOCH	Mocha															
COGN	Cognac	D	Natural Maple															
C	Harvest	PINC	Pinnacle															
N	Mahogany	F	Shaker Cherry															



# CENTERPIECE™ Stack-on Storage

GSA SIN 711-8



Icon Legend on page 21

**DESCRIPTION**

**MODEL**

**SHIP WEIGHT**

**CUBE**

**LIST PRICE**

**Stack-on Storage — Frosted Doors/Silver Frame — 39”H**  
 90”W x 14<sup>3</sup>/<sub>4</sub>”D x 39<sup>1</sup>/<sub>8</sub>”H — 6 Doors  
 72”W x 14<sup>3</sup>/<sub>4</sub>”D x 39<sup>1</sup>/<sub>8</sub>”H — 4 Doors  
 60”W x 14<sup>3</sup>/<sub>4</sub>”D x 39<sup>1</sup>/<sub>8</sub>”H — 4 Doors

<b>HVPSMC1H90-WG</b>	199	40.2	<b>\$3648</b>
<b>HVPSMC1H72-WG</b>	159	32.4	<b>\$2816</b>
<b>HVPSMC1H60-WG</b>	135	27.2	<b>\$2437</b>

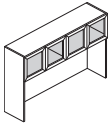

HVPSMC1H60-WG shown

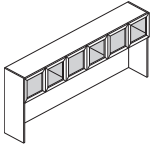

HVPSMC1H90-WG shown

**Stack-on Storage — Frosted Doors/Silver Frame — 52”H**  
 90”W x 14<sup>3</sup>/<sub>4</sub>”D x 52<sup>1</sup>/<sub>16</sub>”H — 6 Doors  
 72”W x 14<sup>3</sup>/<sub>4</sub>”D x 52<sup>1</sup>/<sub>16</sub>”H — 4 Doors  
 60”W x 14<sup>3</sup>/<sub>4</sub>”D x 52<sup>1</sup>/<sub>16</sub>”H — 4 Doors

<b>HVPSMC2H90-WG</b>	302	52.5	<b>\$4559</b>
<b>HVPSMC2H72-WG</b>	240	42.3	<b>\$3520</b>
<b>HVPSMC2H60-WG</b>	210	35.6	<b>\$3044</b>

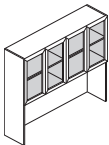

HVPSMC2H60-WG shown

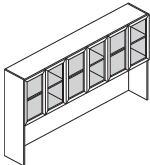

HVPSMC2H90-WG shown

**NOTES:**

- Available with wood or aluminum frame frosted glass doors.
- Wood door models are standard with locks; lock finish is satin. Frosted door units do not lock.
- Doors equipped with self-closing hinges; hinges are adjustable.
- Two height options, single (42<sup>1</sup>/<sub>4</sub>”H) and double (55<sup>5</sup>/<sub>8</sub>”H).
- Double height cabinets include standard fixed shelf.
- Inside dimensions (width varies with cabinet): 1 high standard - D = 13<sup>3</sup>/<sub>16</sub>”, H = 12<sup>1</sup>/<sub>4</sub>”; 2 high standard - D = 13<sup>3</sup>/<sub>16</sub>”, H = 25<sup>1</sup>/<sub>8</sub>”.
- Distance from bottom of cabinet to worksurface is 24<sup>1</sup>/<sub>2</sub>” on all units.
- Connect to worksurface with double-sided adhesive tape.
- Lighting options available. See page 77.
- 2” diameter pass-through hole in back panel to route task light cord.
- Units have an unfinished back and are intended for use against a wall.
- Ship assembled.
- See page 55 for tackboards.

**HOW TO SPECIFY**

<p><b>Select Model Number</b></p> <p>H V P S M C 1 H 9 0 - W G .</p>	<p><b>Select Lock</b></p> <p>SA Satin                  Do NOT specify on models with frosted doors</p> <p>S A .</p>	<p><b>Select Finish</b></p> <table border="0"> <tr> <td><b>H</b> Bourbon Cherry</td> <td><b>MOCH</b> Mocha</td> </tr> <tr> <td><b>COGN</b> Cognac</td> <td><b>D</b> Natural Maple</td> </tr> <tr> <td><b>C</b> Harvest</td> <td><b>PINC</b> Pinnacle</td> </tr> <tr> <td><b>N</b> Mahogany</td> <td><b>F</b> Shaker Cherry</td> </tr> </table> <p>N</p>	<b>H</b> Bourbon Cherry	<b>MOCH</b> Mocha	<b>COGN</b> Cognac	<b>D</b> Natural Maple	<b>C</b> Harvest	<b>PINC</b> Pinnacle	<b>N</b> Mahogany	<b>F</b> Shaker Cherry
<b>H</b> Bourbon Cherry	<b>MOCH</b> Mocha									
<b>COGN</b> Cognac	<b>D</b> Natural Maple									
<b>C</b> Harvest	<b>PINC</b> Pinnacle									
<b>N</b> Mahogany	<b>F</b> Shaker Cherry									



	DESCRIPTION	MODEL	SHIP WEIGHT	CUBE	LIST PRICE
	<b>Tackboard for use with Stack-on Storage</b>				
	47 <sup>3</sup> / <sub>32</sub> "W x 5 <sup>1</sup> / <sub>8</sub> "D x 23 <sup>7</sup> / <sub>8</sub> "H - for 96"W (qty. 2)	<b>HVPTKS96</b>	34	6.8	<b>\$512</b>
	88 <sup>3</sup> / <sub>16</sub> "W x 5 <sup>1</sup> / <sub>8</sub> "D x 23 <sup>7</sup> / <sub>8</sub> "H - for 90"W	<b>HVPTKS90</b>	32	6.4	<b>\$480</b>
	82 <sup>3</sup> / <sub>16</sub> "W x 5 <sup>1</sup> / <sub>8</sub> "D x 23 <sup>7</sup> / <sub>8</sub> "H - for 84"W	<b>HVPTKS84</b>	30	6.0	<b>\$447</b>
	76 <sup>3</sup> / <sub>16</sub> "W x 5 <sup>1</sup> / <sub>8</sub> "D x 23 <sup>7</sup> / <sub>8</sub> "H - for 78"W	<b>HVPTKS78</b>	29	5.6	<b>\$414</b>
	70 <sup>3</sup> / <sub>16</sub> "W x 5 <sup>1</sup> / <sub>8</sub> "D x 23 <sup>7</sup> / <sub>8</sub> "H - for 72"W	<b>HVPTKS72</b>	27	5.1	<b>\$382</b>
	64 <sup>3</sup> / <sub>16</sub> "W x 5 <sup>1</sup> / <sub>8</sub> "D x 23 <sup>7</sup> / <sub>8</sub> "H - for 66"W	<b>HVPTKS66</b>	25	4.7	<b>\$350</b>
58 <sup>3</sup> / <sub>16</sub> "W x 5 <sup>1</sup> / <sub>8</sub> "D x 23 <sup>7</sup> / <sub>8</sub> "H - for 60"W	<b>HVPTKS60</b>	23	4.3	<b>\$337</b>	

**NOTES:**

- Tackboards include latch and hook tape for attachment to stack-on storage back panel.
- Available in HON Group panel fabric grades A and B.

! Upcharges may apply to different fabric grades.

**HOW TO SPECIFY**

<b>Select Model Number</b>	<b>Select Fabric</b>
	See pages 35-36
H V P T K S 9 6 .	A P N 1 5

# CENTERPIECE™

## Wall Mount Storage

GSA SIN 711-8



Icon Legend on page 21

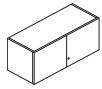

HVPWMC1H36-WW shown

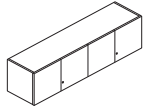

HVPWMC1H60-WW shown

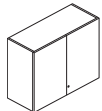

HVPWMC2H36-WW shown

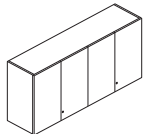

HVPWMC2H60-WW shown

**DESCRIPTION****Wall Mount Storage — Wood Doors — 14<sup>3</sup>/<sub>4</sub>"H**

108"W x 14<sup>3</sup>/<sub>4</sub>"D x 14<sup>1</sup>/<sub>6</sub>"H — 6 Doors  
 102"W x 14<sup>3</sup>/<sub>4</sub>"D x 14<sup>1</sup>/<sub>6</sub>"H — 6 Doors  
 96"W x 14<sup>3</sup>/<sub>4</sub>"D x 14<sup>1</sup>/<sub>6</sub>"H — 6 Doors  
 90"W x 14<sup>3</sup>/<sub>4</sub>"D x 14<sup>1</sup>/<sub>6</sub>"H — 6 Doors  
 84"W x 14<sup>3</sup>/<sub>4</sub>"D x 14<sup>1</sup>/<sub>6</sub>"H — 6 Doors  
 78"W x 14<sup>3</sup>/<sub>4</sub>"D x 14<sup>1</sup>/<sub>6</sub>"H — 4 Doors  
 72"W x 14<sup>3</sup>/<sub>4</sub>"D x 14<sup>1</sup>/<sub>6</sub>"H — 4 Doors  
 66"W x 14<sup>3</sup>/<sub>4</sub>"D x 14<sup>1</sup>/<sub>6</sub>"H — 4 Doors  
 60"W x 14<sup>3</sup>/<sub>4</sub>"D x 14<sup>1</sup>/<sub>6</sub>"H — 4 Doors  
 36"W x 14<sup>3</sup>/<sub>4</sub>"D x 14<sup>1</sup>/<sub>6</sub>"H — 2 Doors

**MODEL**

**HVPWMC1H108-WW**  
**HVPWMC1H102-WW**  
**HVPWMC1H96-WW**  
**HVPWMC1H90-WW**  
**HVPWMC1H84-WW**  
**HVPWMC1H78-WW**  
**HVPWMC1H72-WW**  
**HVPWMC1H66-WW**  
**HVPWMC1H60-WW**  
**HVPWMC1H36-WW**

**SHIP WEIGHT****CUBE****LIST PRICE**

158 20.2 **\$3414**  
 149 19.1 **\$3289**  
 142 18.0 **\$3168**  
 135 16.9 **\$2996**  
 126 15.8 **\$2810**  
 115 14.7 **\$2636**  
 105 13.6 **\$2473**  
 94 12.5 **\$2309**  
 85 11.4 **\$2158**  
 53 7.1 **\$1445**

**Wall Mount Storage — Wood Doors — 27<sup>5</sup>/<sub>8</sub>"H**

90"W x 14<sup>3</sup>/<sub>4</sub>"D x 27<sup>5</sup>/<sub>8</sub>"H — 6 Doors  
 84"W x 14<sup>3</sup>/<sub>4</sub>"D x 27<sup>5</sup>/<sub>8</sub>"H — 6 Doors  
 78"W x 14<sup>3</sup>/<sub>4</sub>"D x 27<sup>5</sup>/<sub>8</sub>"H — 4 Doors  
 72"W x 14<sup>3</sup>/<sub>4</sub>"D x 27<sup>5</sup>/<sub>8</sub>"H — 4 Doors  
 66"W x 14<sup>3</sup>/<sub>4</sub>"D x 27<sup>5</sup>/<sub>8</sub>"H — 4 Doors  
 60"W x 14<sup>3</sup>/<sub>4</sub>"D x 27<sup>5</sup>/<sub>8</sub>"H — 4 Doors  
 36"W x 14<sup>3</sup>/<sub>4</sub>"D x 27<sup>5</sup>/<sub>8</sub>"H — 2 Doors

**HVPWMC2H90-WW**  
**HVPWMC2H84-WW**  
**HVPWMC2H78-WW**  
**HVPWMC2H72-WW**  
**HVPWMC2H66-WW**  
**HVPWMC2H60-WW**  
**HVPWMC2H36-WW**

237 29.3 **\$3996**  
 218 27.4 **\$3690**  
 201 25.5 **\$3383**  
 186 23.6 **\$3056**  
 167 21.7 **\$2852**  
 150 19.8 **\$2662**  
 93 12.3 **\$1773**

**NOTES:**

- Available with wood or aluminum frame frosted glass doors.
- Wood door models are standard with locks; lock finish is satin. Frosted door units do not lock.
- For removable lock core kits, see model HF27S on page 73.
- Doors equipped with self-closing hinges; hinges are adjustable.
- Single-height 14<sup>1</sup>/<sub>6</sub>" and double-height 27<sup>5</sup>/<sub>8</sub>".
- Double-height cabinets include standard fixed shelf.
- Inside dimensions (width varies with cabinet): 1 high standard - D = 13<sup>3</sup>/<sub>16</sub>", H = 12<sup>1</sup>/<sub>4</sub>"; 2 high standard - D = 13<sup>3</sup>/<sub>16</sub>", H = 25<sup>1</sup>/<sub>8</sub>".
- For task lights, see page 77.
- Units have an unfinished back.
- Connect to wall with steel spade and "z" clip method; mounted to the wall by field installers.

- ⚠ Wall mount cabinet attachment requires individual cabinets be secured by a minimum of two wall mounting locations/studs.
- ⚠ The cabinets are designed for interior and perimeter walls that are constructed with wood or metal studs. Installers are responsible for selecting and supplying appropriate fasteners for all conditions.
- ⚠ HON Company is not responsible for any liabilities resulting from wall mounted cabinets that are not properly installed.

**HOW TO SPECIFY**

Select Model Number	Select Lock	Select Finish
HVPWMC1H108-WW	SA Satin Do NOT specify on models with frosted doors	H Bourbon Cherry COGN Cognac C Harvest N Mahogany MOCH Mocha D Natural Maple PINC Pinnacle F Shaker Cherry
	SA	PINC



# CENTERPIECE™

## Wall Mount Storage

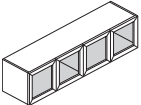
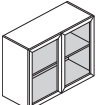
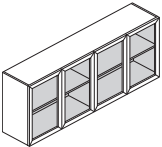
	DESCRIPTION	MODEL	SHIP WEIGHT	CUBE	LIST PRICE
 HVPWMC1H36-WG shown	<b>Wall Mount Storage — Frosted Doors/Silver Frame — 14<sup>3</sup>/<sub>4</sub>"H</b> 108"W x 14 <sup>3</sup> / <sub>4</sub> "D x 14 <sup>11</sup> / <sub>16</sub> "H — 6 Doors 90"W x 14 <sup>3</sup> / <sub>4</sub> "D x 14 <sup>11</sup> / <sub>16</sub> "H — 6 Doors 72"W x 14 <sup>3</sup> / <sub>4</sub> "D x 14 <sup>11</sup> / <sub>16</sub> "H — 4 Doors 60"W x 14 <sup>3</sup> / <sub>4</sub> "D x 14 <sup>11</sup> / <sub>16</sub> "H — 4 Doors 36"W x 14 <sup>3</sup> / <sub>4</sub> "D x 14 <sup>11</sup> / <sub>16</sub> "H — 2 Doors	HVPWMC1H108-WG	158	20.2	<b>\$3665</b>
		HVPWMC1H90-WG	135	16.9	<b>\$3196</b>
		HVPWMC1H72-WG	105	13.6	<b>\$2609</b>
		HVPWMC1H60-WG	94	11.4	<b>\$2257</b>
		HVPWMC1H36-WG	53	7.1	<b>\$1460</b>
 HVPWMC1H60-WG shown	<b>Wall Mount Storage — Frosted Doors/Silver Frame — 27<sup>5</sup>/<sub>8</sub>"H</b> 90"W x 14 <sup>3</sup> / <sub>4</sub> "D x 27 <sup>5</sup> / <sub>8</sub> "H — 6 Doors 72"W x 14 <sup>3</sup> / <sub>4</sub> "D x 27 <sup>5</sup> / <sub>8</sub> "H — 4 Doors 60"W x 14 <sup>3</sup> / <sub>4</sub> "D x 27 <sup>5</sup> / <sub>8</sub> "H — 4 Doors 36"W x 14 <sup>3</sup> / <sub>4</sub> "D x 27 <sup>5</sup> / <sub>8</sub> "H — 2 Doors	HVPWMC2H90-WG	237	29.3	<b>\$4317</b>
		HVPWMC2H72-WG	186	23.6	<b>\$3264</b>
		HVPWMC2H60-WG	150	19.8	<b>\$2820</b>
		HVPWMC2H36-WG	93	12.3	<b>\$1824</b>
 HVPWMC2H36-WG shown	<b>Wall Mount Storage — Frosted Doors/Silver Frame — 27<sup>5</sup>/<sub>8</sub>"H</b> 90"W x 14 <sup>3</sup> / <sub>4</sub> "D x 27 <sup>5</sup> / <sub>8</sub> "H — 6 Doors 72"W x 14 <sup>3</sup> / <sub>4</sub> "D x 27 <sup>5</sup> / <sub>8</sub> "H — 4 Doors 60"W x 14 <sup>3</sup> / <sub>4</sub> "D x 27 <sup>5</sup> / <sub>8</sub> "H — 4 Doors 36"W x 14 <sup>3</sup> / <sub>4</sub> "D x 27 <sup>5</sup> / <sub>8</sub> "H — 2 Doors	HVPWMC2H90-WG	237	29.3	<b>\$4317</b>
		HVPWMC2H72-WG	186	23.6	<b>\$3264</b>
 HVPWMC2H72-WG shown	<b>Wall Mount Storage — Frosted Doors/Silver Frame — 27<sup>5</sup>/<sub>8</sub>"H</b> 90"W x 14 <sup>3</sup> / <sub>4</sub> "D x 27 <sup>5</sup> / <sub>8</sub> "H — 6 Doors 72"W x 14 <sup>3</sup> / <sub>4</sub> "D x 27 <sup>5</sup> / <sub>8</sub> "H — 4 Doors 60"W x 14 <sup>3</sup> / <sub>4</sub> "D x 27 <sup>5</sup> / <sub>8</sub> "H — 4 Doors 36"W x 14 <sup>3</sup> / <sub>4</sub> "D x 27 <sup>5</sup> / <sub>8</sub> "H — 2 Doors	HVPWMC2H60-WG	150	19.8	<b>\$2820</b>
		HVPWMC2H36-WG	93	12.3	<b>\$1824</b>

**NOTES:**

- Available with wood or aluminum frame frosted glass doors.
  - Wood door models are standard with locks; lock finish is satin. Frosted door units do not lock.
  - For removable lock core kits, see model HF27S on page 73.
  - Doors equipped with self-closing hinges; hinges are adjustable.
  - Single-height 14<sup>11</sup>/<sub>16</sub>" and double-height 27<sup>5</sup>/<sub>8</sub>".
  - Double-height cabinets include standard fixed shelf.
  - Inside dimensions (width varies with cabinet): 1 high standard - D = 13<sup>3</sup>/<sub>16</sub>", H = 12<sup>1</sup>/<sub>4</sub>"; 2 high standard - D = 13<sup>3</sup>/<sub>16</sub>", H = 25<sup>1</sup>/<sub>8</sub>".
  - For task lights, see page 77.
  - Units have an unfinished back.
  - Connect to wall with steel spade and "z" clip method; mounted to the wall by field installers.
- ⚠ Wall mount cabinet attachment requires individual cabinets be secured by a minimum of two wall mounting locations/studs.
- ⚠ The cabinets are designed for interior and perimeter walls that are constructed with wood or metal studs. Installers are responsible for selecting and supplying appropriate fasteners for all conditions.
- ⚠ HON Company is not responsible for any liabilities resulting from wall mounted cabinets that are not properly installed.

**HOW TO SPECIFY**

<b>Select Model Number</b>  HVPWMC1H108-WG	<b>Select Lock</b>  SA Satin Do NOT specify on models with frosted doors	<b>Select Finish</b>  H Bourbon Cherry    MOCH Mocha COGN Cognac        D Natural Maple C Harvest            PINC Pinnacle N Mahogany         F Shaker Cherry
HVPWMC1H108-WG	SA	PINC

# CENTERPIECE™

## Tackboards

GSA SIN 711-8

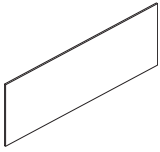

Icon Legend on page 21

**DESCRIPTION****Tackboard for use with Wall Mount Storage**

72"W x 5/8"D x 24 3/8"H  
 48"W x 5/8"D x 24 3/8"H  
 42"W x 5/8"D x 24 3/8"H  
 36"W x 5/8"D x 24 3/8"H  
 30"W x 5/8"D x 24 3/8"H

**MODEL**

**HVPTKW72**  
**HVPTKW48**  
**HVPTKW42**  
**HVPTKW36**  
**HVPTKW30**

**SHIP WEIGHT**

30  
 28  
 26  
 24  
 16

**CUBE**

5.8  
 5.4  
 4.9  
 4.5  
 2.8

**LIST PRICE**

**\$382**  
**\$325**  
**\$307**  
**\$275**  
**\$275**

**NOTES:**

- For 60" Wall Mount Storage use Tackboard HVPTKW30 x 2
- For 66" Wall Mount Storage use Tackboard HVPTKW30 and HVPTKW36
- For 72" Wall Mount Storage use Tackboard HVPTKW72
- For 78" Wall Mount Storage use Tackboard HVPTKW36 and HVPTKW42
- For 84" Wall Mount Storage use Tackboard HVPTKW42 x 2
- For 90" Wall Mount Storage use Tackboard HVPTKW30 x 3
- For 96" Wall Mount Storage use Tackboard HVPTKW48 x 2
- For 102" Wall Mount Storage use Tackboard HVPTKW36 x 2 and HVPTKW30
- For 108" Wall Mount Storage use Tackboard HVPTKW36 x 3

**NOTES:**

- Available in HON Group panel fabric grades A and B.
- Easy to install; includes mounting hardware.

**!** Upcharges may apply to different fabric grades.

**HOW TO SPECIFY**

Select  
Model Number

Select  
Fabric

See pages 35-36

H V P T K W 7 2 .

A P N 1 5

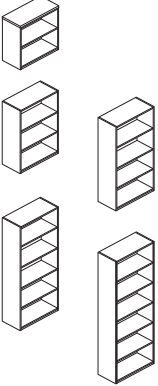
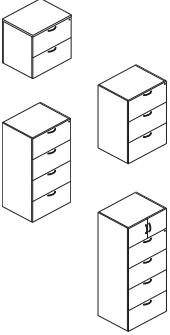
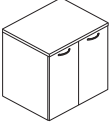

	DESCRIPTION	MODEL	SHIP WEIGHT	CUBE	LIST PRICE
	<b>Mobile Pedestal, Box/File</b> 15½"W x 21¾"D x 22½"H  NOTES: Rolls easily on four casters (2 locking and 2 non-locking) to provide convenient, flexible placement of personal storage needs. Box and file locking storage drawers; interchangeable core removable lock makes re-keying quick and easy. Seat cushion model HPSEAT24ND is optional. Cushion adds 1" to the height of the pedestal. Unit with cushion will fit below 29½"H worksurfaces. Ship fully assembled.	<b>HVPMPD2415-6WW</b>	91	5.7	<b>\$1317</b>
	<b>Bookcase</b> 30½"W x 14½"D x 29½"H, 2 Shelves 30"W x 14"D x 41½"H, 3 Shelves 30"W x 14"D x 55¾"H, 4 Shelves 30"W x 14"D x 68¼"H, 5 Shelves 30"W x 14"D x 81¼"H, 6 Shelves  36½"W x 14½"D x 29½"H, 2 Shelves 36"W x 14"D x 41½"H, 3 Shelves 36"W x 14"D x 55¾"H, 4 Shelves 36"W x 14"D x 68¼"H, 5 Shelves 36"W x 14"D x 81¼"H, 6 Shelves  NOTES: All shelves are fixed. 6-shelf (81¼"H) bookcase must be attached to wall. 2-shelf models have a 1⅜" thick top; 3-, 4-, 5-, and 6-shelf models have a ¾" top. All units have an unfinished back. Ship fully assembled.	<b>HVPBKN2H30-WW</b> <b>HVPBKN3H30-WW</b> <b>HVPBKN4H30-WW</b> <b>HVPBKN5H30-WW</b> <b>HVPBKN6H30-WW</b>  <b>HVPBKN2H36-WW</b> <b>HVPBKN3H36-WW</b> <b>HVPBKN4H36-WW</b> <b>HVPBKN5H36-WW</b> <b>HVPBKN6H36-WW</b>	74 101 127 152 212  94 121 152 177 237	10.5 14.5 19.0 23.1 27.4  12.5 17.1 22.4 27.3 32.3	<b>\$1081</b> <b>\$1165</b> <b>\$1481</b> <b>\$1737</b> <b>\$1995</b>  <b>\$1135</b> <b>\$1329</b> <b>\$1650</b> <b>\$1920</b> <b>\$2092</b>
	<b>Lateral File</b> 30½"W x 24"D x 29½"H, 2 Drawers 30"W x 24"D x 41½"H, 3 Drawers 30"W x 24"D x 55¾"H, 4 Drawers 30"W x 24"D x 68¼"H, 4 Drawers, 1 Cabinet  36½"W x 24"D x 29½"H, 2 Drawers 36"W x 24"D x 41½"H, 3 Drawers 36"W x 24"D x 55¾"H, 4 Drawers 36"W x 24"D x 68¼"H, 4 Drawers, 1 Cabinet  NOTES: Available with two-, three-, and four-drawers, plus four-drawers with a storage cabinet. Mechanical interlock inhibits the extension of more than one drawer from opening at a time. Includes counterweight to inhibit tipping. Drawers lock; interchangeable core removable lock makes re-keying quick and easy. Doors on 68¼"H do not lock. 2-drawer models have a 1⅜" thick top; 3- and 4-drawer models and the 4-drawer cabinet have a ¾" top. All units have an unfinished back. Ship fully assembled.	<b>HVPLFS2H30-4WW</b> <b>HVPLFS3H30-4WW</b> <b>HVPLFS4H30-4WW</b> <b>HVPLFS5H30-4WW</b>  <b>HVPLFS2H36-4WW</b> <b>HVPLFS3H36-4WW</b> <b>HVPLFS4H36-4WW</b> <b>HVPLFS5H36-4WW</b>	156 201 58 291  179 230 281 332	16.6 23.0 30.0 36.7  19.7 27.2 35.5 43.3	<b>\$1728</b> <b>\$2398</b> <b>\$4105</b> <b>\$2685</b>  <b>\$1988</b> <b>\$2991</b> <b>\$4614</b> <b>\$3075</b>
	<b>Storage Cabinet</b> 30½"W x 24"D x 29½"H 36½"W x 24"D x 29½"H  NOTES: Includes one fixed shelf. Doors do not lock. All units have an unfinished back. Ship fully assembled.	<b>HVPSCF2430-5WW</b> <b>HVPSCF2436-5WW</b>	123 143	16.6 19.6	<b>\$1482</b> <b>\$1526</b>

HVPSCF2430-5WW shown

**NOTES:**

- Full extension drawers allow complete and easy access to all contents.
- File drawers standard with hangrails.
- For removable lock core kits, see model HF27S on page 73.
- Bookcases, lateral files, and storage cabinets have an unfinished back panel; they are intended for use against a wall.

**HOW TO SPECIFY**

Select Model Number	Select Edge Profile	Select Handle	Select Finish
HVPMPD2415-6WW	G	A	F

**Select Edge Profile**

**G** Square Edge  
 Only specify for models  
 HVPMPD2415-6WW,  
 HVPBKN2H30-WW,  
 HVPBKN2H36-WW,  
 HVPLFS2H30-4WW,  
 HVPLFS2H36-4WW

**Select Handle**

**A** Beam in Silver  
**D** Bridge in Silver  
 Do NOT specify on bookcase models.

**Select Finish**

**H** Bourbon Cherry  
**COGN** Cognac  
**C** Harvest  
**N** Mahogany  
**MOCH** Mocha  
**D** Natural Maple  
**PINC** Pinnacle  
**F** Shaker Cherry

# CENTERPIECE™

## Storage

GSA SIN 711-8

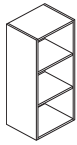

Icon Legend on page 21

**DESCRIPTION****Bookcase Hutch — Open — No Door(s)**

18"W x 14"D x 39½"H  
 30"W x 14"D x 39½"H  
 36"W x 14"D x 39½"H

18"W x 14"D x 52½"H  
 30"W x 14"D x 52½"H  
 36"W x 14"D x 52½"H

NOTES: 39½"H unit has two shelves; 52½"H unit has three shelves. Shelves are fixed. Secures to worksurface with double-sided adhesive tape. Units have an unfinished back and are intended for use against a wall. Ship assembled.

**MODEL****SHIP WEIGHT****CUBE****LIST PRICE**

**HVPSTN1H18-WN** 56 8.7 **\$937**  
**HVPSTN1H30-WN** 92 13.7 **\$1269**  
**HVPSTN1H36-WN** 100 16.1 **\$1366**

**HVPSTN2H18-WN** 70 11.3 **\$1172**  
**HVPSTN2H30-WN** 97 17.8 **\$1586**  
**HVPSTN2H36-WN** 111 21.1 **\$1706**

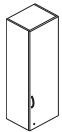

HVPSTF2H18R-WW shown



HVPSTF2H18L-WW shown

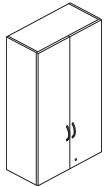

HVPSTF2H30-WW shown

**Bookcase Hutch — Wood Door(s)**

18"W x 14¾"D x 52½"H, Hinged Right  
 18"W x 14¾"D x 52½"H, Hinged Left

30"W x 14¾"D x 52½"H  
 36"W x 14¾"D x 52½"H

NOTES: 3 fixed shelves. Secures to worksurface with double-sided adhesive tape. Standard with lock in satin (SA) finish. Units have an unfinished back and are intended for use against a wall. Ship assembled.

**HVPSTF2H18R-WW** 90 11.8 **\$1535**  
**HVPSTF2H18L-WW** 90 11.8 **\$1535**

**HVPSTF2H30-WW** 126 18.6 **\$1839**  
**HVPSTF2H36-WW** 146 22.0 **\$1995**

**NOTES:**

- For removable lock core kits, see model HF27S on page 73.
- ! Models on this page have an unfinished back and are intended for use against a wall.

**HOW TO SPECIFY**

Select Model Number	Select Handle	Select Finish
HVPSTF2H18R-WW	A Beam in Silver D Bridge in Silver Do NOT specify for Open Bookcase Hutch models	H Bourbon Cherry COGN Cognac C Harvest N Mahogany MOCH Mocha D Natural Maple PINC Pinnacle F Shaker Cherry
	A	H



**DESCRIPTION**

**MODEL**

**SHIP WEIGHT**

**CUBE**

**LIST PRICE**

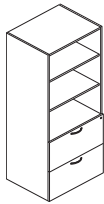

HVPSBD5H30-WN shown

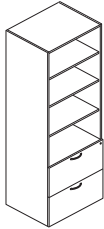

HVPSBD6H30-WN shown

**Bookcase with Lateral File**

30"W x 24"D x 68¼"H  
30"W x 24"D x 81¼"H

**HVPSBD5H30-WN**  
**HVPSBD6H30-WN**

282  
328

36.7  
43.3

**\$3463**  
**\$3964**

NOTES: Open bookcase above two lateral file drawers. Two height options. Shelves are fixed. Locking drawers; interchangeable core removable locks make re-keying quick and easy. All units have an unfinished back. Ship fully assembled.

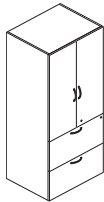

HVPSBD5H30-WW shown

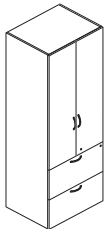

HVPSBD6H30-WW shown

**Storage Cabinet with Lateral File**

30"W x 24"D x 68¼"H  
30"W x 24"D x 81¼"H

**HVPSBD5H30-WW**  
**HVPSBD6H30-WW**

297  
343

36.7  
43.3

**\$3747**  
**\$4215**

NOTES: Hinged door cabinet above two lateral file drawers. Two height options. Cabinet on 68¼"H includes two shelves; 81¼"H has three shelves. Shelves are fixed. Locking doors and drawers; interchangeable core removable locks make re-keying quick and easy. All units have an unfinished back. Ship fully assembled.

**NOTES:**

- For removable lock core kits, see model HF27S on page 73.
- ! Models on this page have an unfinished back and are intended for use against a wall.

**HOW TO SPECIFY**

<p><b>Select Model Number</b></p> <p>H V P S B D 5 H 3 0 - W N .</p>	<p><b>Select Handle</b></p> <p><b>A</b> Beam in Silver <b>D</b> Bridge in Silver Do NOT specify for Open Bookcase Hutch models</p> <p>A .</p>	<p><b>Select Finish</b></p> <table border="0"> <tr> <td><b>H</b> Bourbon Cherry</td> <td><b>MOCH</b> Mocha</td> </tr> <tr> <td><b>COGN</b> Cognac</td> <td><b>D</b> Natural Maple</td> </tr> <tr> <td><b>C</b> Harvest</td> <td><b>PINC</b> Pinnacle</td> </tr> <tr> <td><b>N</b> Mahogany</td> <td><b>F</b> Shaker Cherry</td> </tr> </table> <p>H</p>	<b>H</b> Bourbon Cherry	<b>MOCH</b> Mocha	<b>COGN</b> Cognac	<b>D</b> Natural Maple	<b>C</b> Harvest	<b>PINC</b> Pinnacle	<b>N</b> Mahogany	<b>F</b> Shaker Cherry
<b>H</b> Bourbon Cherry	<b>MOCH</b> Mocha									
<b>COGN</b> Cognac	<b>D</b> Natural Maple									
<b>C</b> Harvest	<b>PINC</b> Pinnacle									
<b>N</b> Mahogany	<b>F</b> Shaker Cherry									



# CENTERPIECE™

## Storage

GSA SIN 711-8



Icon Legend on page 21

**DESCRIPTION****Wardrobe**

15<sup>9</sup>/<sub>16</sub>"W x 24"D x 68<sup>1</sup>/<sub>4</sub>"H, Hinged Right  
15<sup>9</sup>/<sub>16</sub>"W x 24"D x 68<sup>1</sup>/<sub>4</sub>"H, Hinged Left

**MODEL****SHIP WEIGHT****CUBE****LIST PRICE****HVPCLS5H15R-WW**

121

20.8

**\$2287****HVPCLS5H15L-WW**

121

20.8

**\$2287**

18<sup>1</sup>/<sub>8</sub>"W x 24"D x 81<sup>1</sup>/<sub>4</sub>"H, Hinged Right (shown)  
18<sup>1</sup>/<sub>8</sub>"W x 24"D x 81<sup>1</sup>/<sub>4</sub>"H, Hinged Left

**HVPCLS6H18R-WW**

158

28.5

**\$2606****HVPCLS6H18L-WW**

158

28.5

**\$2606**

NOTES: Doors have lock; interchangeable core removable lock makes re-keying quick and easy. 68<sup>1</sup>/<sub>4</sub>"H unit has a coat rod. 81<sup>1</sup>/<sub>4</sub>"H size includes coat rod and 1 fixed shelf. All units have an unfinished back. Ship fully assembled.

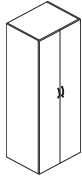
**Wardrobe/Storage Cabinet**

30"W x 24"D x 68<sup>1</sup>/<sub>4</sub>"H  
30"W x 24"D x 81<sup>1</sup>/<sub>4</sub>"H (shown)

**HVPCLD5H30-DW**

238

36.7

**\$3638****HVPCLD6H30-DW**

286

43.3

**\$4481**

NOTES: Mixed storage design features a wardrobe closet on the left and storage cabinet with shelves on the right. Two height options. 68<sup>1</sup>/<sub>4</sub>"H unit has wardrobe and four 15"W shelves. 81<sup>1</sup>/<sub>4</sub>"H size includes wardrobe and six 15"W shelves. All shelves are fixed. Doors have lock; interchangeable core removable lock makes re-keying quick and easy. Units have an unfinished back. Ship fully assembled.

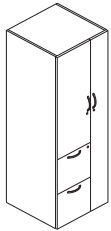
**Storage Tower**

24"W x 24"D x 68<sup>1</sup>/<sub>4</sub>"H, Wardrobe Hinged Right, Cabinet and File/File Left (shown)  
24"W x 24"D x 68<sup>1</sup>/<sub>4</sub>"H, Wardrobe Hinged Left, Cabinet and File/File Right

**HVPUTC5H24R-WW**

269

30.0

**\$4006****HVPUTC5H24L-WW**

269

30.0

**\$4006**

24"W x 24"D x 81<sup>1</sup>/<sub>4</sub>"H, Wardrobe Hinged Right, Cabinet and File/File Left  
24"W x 24"D x 81<sup>1</sup>/<sub>4</sub>"H, Wardrobe Hinged Left, Cabinet and File/File Right

**HVPUTC6H24R-WW**

317

32.9

**\$4581****HVPUTC6H24L-WW**

317

32.9

**\$4581**

NOTES: Versatile design includes a wardrobe closet, storage cabinet, and two file drawers. Two height options. Wardrobe has full-height door and contains coat rod. Cabinet on 68<sup>1</sup>/<sub>4</sub>"H includes two shelves; 81<sup>1</sup>/<sub>4</sub>"H has three shelves. Shelves are fixed. Locking doors and drawers; interchangeable core removable locks make re-keying quick and easy. All units have an unfinished back. Ship fully assembled.

**NOTES:**

- For removable lock core kits, see model HF27S on page 73.

! Models on this page have an unfinished back and are intended for use against a wall.

**HOW TO SPECIFY**

Select Model Number	Select Handle	Select Finish
HVPCLS5H15R-WW	A Beam in Silver D Bridge in Silver	H Bourbon Cherry COGN Cognac C Harvest N Mahogany MOCH Mocha D Natural Maple PINC Pinnacle F Shaker Cherry
	D	C



Icon Legend on page 21

# CENTERPIECE™

## Components — Worksurfaces

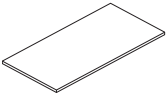
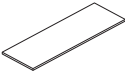
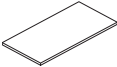
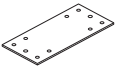
	DESCRIPTION	MODEL	SHIP WEIGHT	CUBE	LIST PRICE
	<b>Modular Desk Worksurface — Rectangle — Horizontal Woodgrain</b>				
	72"W x 30"D	<b>HVPDWRA3072-W</b>	67	6.0	<b>\$803</b>
	66"W x 30"D	<b>HVPDWRA3066-W</b>	61	5.5	<b>\$780</b>
	60"W x 30"D	<b>HVPDWRA3060-W</b>	56	5.0	<b>\$734</b>
	54"W x 30"D	<b>HVPDWRA3054-W</b>	50	4.5	<b>\$718</b>
	48"W x 30"D	<b>HVPDWRA3048-W</b>	45	4.0	<b>\$690</b>
	NOTES: Horizontal, side-to-side grain direction. Component tops do not include a flat bracket to connect adjoining worksurfaces; model HVPMDWBRK must be ordered separately. Can be used with 23½"D modular support pedestal. Grommets should not be specified over modular pedestals. Unsupported spans greater than 48"W require a T-Support. 48"-72"W x 30"D tops can be used with the Coordinate™ Height Adjustable Base.				
 HVPMWR2472-W shown	<b>Modular Credenza and Return Worksurface — Rectangle — Horizontal Woodgrain</b>				
	108"W x 24"D	<b>HVPMWR24108-W</b>	78	7.8	<b>\$1281</b>
	102"W x 24"D	<b>HVPMWR24102-W</b>	72	7.4	<b>\$1112</b>
	96"W x 24"D	<b>HVPMWR2496-W</b>	68	7.0	<b>\$975</b>
	90"W x 24"D	<b>HVPMWR2490-W</b>	64	6.5	<b>\$930</b>
	84"W x 24"D	<b>HVPMWR2484-W</b>	60	6.1	<b>\$882</b>
	78"W x 24"D	<b>HVPMWR2478-W</b>	56	5.7	<b>\$812</b>
	72"W x 24"D	<b>HVPMWR2472-W</b>	52	5.3	<b>\$743</b>
	66"W x 24"D	<b>HVPMWR2466-W</b>	48	4.9	<b>\$712</b>
	60"W x 24"D	<b>HVPMWR2460-W</b>	44	4.4	<b>\$688</b>
	54"W x 24"D	<b>HVPMWR2454-W</b>	39	4.0	<b>\$643</b>
	48"W x 24"D	<b>HVPMWR2448-W</b>	35	3.6	<b>\$602</b>
	42"W x 24"D	<b>HVPMWR2442-W</b>	30	3.2	<b>\$561</b>
	36"W x 24"D	<b>HVPMWR2436-W</b>	26	2.7	<b>\$546</b>
	30"W x 24"D	<b>HVPMWR2430-W</b>	22	2.3	<b>\$525</b>
	NOTES: Horizontal, side-to-side grain direction. Component tops do not include a flat bracket to connect adjoining worksurfaces; model HVPMDWBRK must be ordered separately. Grommets should not be specified over modular pedestals. Unsupported spans greater than 48"W require a T-Support. 48"-72"W x 24"D tops can be used with the Coordinate™ Height Adjustable Base.				
 HVPDWRA2448V-W shown	<b>Modular Credenza, Return, and Bridge Worksurface — Rectangle — Vertical Woodgrain</b>				
	48"W x 30"D	<b>HVPDWRA3048V-W</b>	30	3.2	<b>\$690</b>
	48"W x 24"D	<b>HVPDWRA2448V-W</b>	26	2.7	<b>\$602</b>
	42"W x 24"D	<b>HVPDWRA2442V-W</b>	22	2.3	<b>\$561</b>
	NOTES: Vertical, front-to-back grain direction. Component tops do not include a flat bracket to connect adjoining worksurfaces; model HVPMDWBRK must be ordered separately. Unsupported spans greater than 48"W require a T-Support. Grommets should not be specified over modular pedestals. 48"W tops can be used with the Coordinate™ Height Adjustable Base.				
	<b>Modular Worksurface Connection Bracket</b>				
	16½"W x 3¼"D x ½"H	<b>HVPWBRK</b>	2	0.3	<b>\$71</b>
	NOTES: Flat brackets to connect adjoining worksurfaces. Component tops do not include a connection bracket; model HVPMDWBRK must be ordered separately. No need to specify. <b>SPECIFYING EXAMPLE: HVPWBRK</b>				

**NOTES:**

- For worksurface supports and pedestals, see pages 63-69.
- 48"-72"W x 24"-30"D tops can be used with the Coordinate™ Height Adjustable Base (see page 66).

- ! Unsupported spans of greater than 48"W require a T-Support.
- ! Worksurface connection bracket sold separately — see model HVPWBRK above.

**HOW TO SPECIFY**

<b>Select Model Number</b>	<b>Select Edge Profile</b>	<b>Select Grommet</b>	<b>Select Finish</b>
	<b>G</b> Square Edge	<b>GPL</b> Grommet Black Left <b>GPC</b> Grommet Black Center <b>GPR</b> Grommet Black Right <b>X</b> No Grommet	<b>H</b> Bourbon Cherry <b>COGN</b> Cognac <b>C</b> Harvest <b>N</b> Mahogany <b>MOCH</b> Mocha <b>D</b> Natural Maple <b>PINC</b> Pinnacle <b>F</b> Shaker Cherry
HVPDWRA3072-W	G	GPC	C

# CENTERPIECE™

## Components — Modesty Panels

GSA SIN 711-8

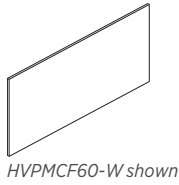

Icon Legend on page 21

**DESCRIPTION****Modular Credenza Modesty Panel**

For 108"W  
For 102"W  
For 96"W  
For 90"W  
For 84"W  
For 78"W  
For 72"W  
For 66"W  
For 60"W

**MODEL**

**HVPMCF108-W**  
**HVPMCF102-W**  
**HVPMCF96-W**  
**HVPMCF90-W**  
**HVPMCF84-W**  
**HVPMCF78-W**  
**HVPMCF72-W**  
**HVPMCF66-W**  
**HVPMCF60-W**

**SHIP WEIGHT**

53  
50  
47  
44  
41  
38  
35  
32  
29

**CUBE**

8.9  
8.4  
8.0  
7.5  
7.0  
6.5  
6.0  
5.5  
5.1

**LIST PRICE**

**\$968**  
**\$808**  
**\$702**  
**\$640**  
**\$581**  
**\$555**  
**\$527**  
**\$500**  
**\$475**

NOTES: For use in modular credenza applications only. Widths 60"-108". Provide approach-side kneespace privacy for user seated at credenza. Formal, full-length, 27<sup>5</sup>/<sub>16</sub>"H panel extends from the underside of the worksurface to the floor. Veneer finish on both sides.

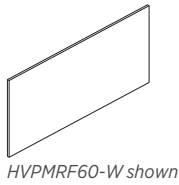
**Modular Return Modesty Panel**

For 72"W  
For 66"W  
For 60"W  
For 54"W  
For 48"W  
For 42"W

**HVPMRF72-W**  
**HVPMRF66-W**  
**HVPMRF60-W**  
**HVPMRF54-W**  
**HVPMRF48-W**  
**HVPMRF42-W**

35  
32  
29  
26  
23  
20

6.0  
5.6  
5.1  
4.6  
4.1  
3.6

**\$527**  
**\$500**  
**\$487**  
**\$462**  
**\$440**  
**\$418**

NOTES: For use in modular return applications only. Widths 42"-72". Provide approach-side kneespace privacy for user seated at return. Formal, full-length, 27<sup>5</sup>/<sub>16</sub>"H panel extends from the underside of the worksurface to the floor. Veneer finish on both sides.

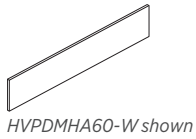
**10" Hanging Modesty Panel**

For 72"W  
For 66"W  
For 60"W  
For 54"W  
For 48"W

**HVPDMHA72-W**  
**HVPDMHA66-W**  
**HVPDMHA60-W**  
**HVPDMHA54-W**  
**HVPDMHA48-W**

13  
12  
11  
9  
8

1.9  
1.8  
1.6  
1.4  
1.2

**\$619**  
**\$595**  
**\$563**  
**\$534**  
**\$507**

NOTES: For use with 48"-72"W rectangle worksurfaces. Compatible with worksurfaces supported by the Coordinate™ Height Adjustable Electric Base. Secures to underside of worksurface; includes attachment hardware. Veneer finish on both sides.

**NOTES:**

- Provide approach-side kneespace privacy for user.
- ! Modular modesty panels have veneer finish on both the user and approach sides.



**HOW TO SPECIFY**

<b>Select Model Number</b>	<b>Select Finish</b>								
	<table border="0"> <tr> <td><b>H</b> Bourbon Cherry</td> <td><b>MOCH</b> Mocha</td> </tr> <tr> <td><b>COGN</b> Cognac</td> <td><b>D</b> Natural Maple</td> </tr> <tr> <td><b>C</b> Harvest</td> <td><b>PINC</b> Pinnacle</td> </tr> <tr> <td><b>N</b> Mahogany</td> <td><b>F</b> Shaker Cherry</td> </tr> </table>	<b>H</b> Bourbon Cherry	<b>MOCH</b> Mocha	<b>COGN</b> Cognac	<b>D</b> Natural Maple	<b>C</b> Harvest	<b>PINC</b> Pinnacle	<b>N</b> Mahogany	<b>F</b> Shaker Cherry
<b>H</b> Bourbon Cherry	<b>MOCH</b> Mocha								
<b>COGN</b> Cognac	<b>D</b> Natural Maple								
<b>C</b> Harvest	<b>PINC</b> Pinnacle								
<b>N</b> Mahogany	<b>F</b> Shaker Cherry								
H V P M C F 1 0 8 - W .	N								

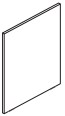
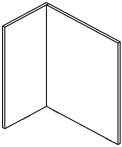
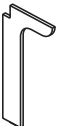

Icon Legend on page 21

# CENTERPIECE™ Components — Supports

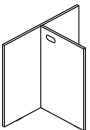
	DESCRIPTION	MODEL	SHIP WEIGHT	CUBE	LIST PRICE
	<b>End Panel</b> ¾"W x 23⅝"D x 28"H NOTES: Required for use with a full, 27⅝"H modesty panel.	<b>HVPMEP24-W</b>	11	0.3	<b>\$321</b>
	<b>L-Shaped End Panel</b> 15⅞"W x 23⅝"D x 28"H NOTES: Intended to be used in no modesty panel applications. Non-handed design.	<b>HVPMLS24-W</b>	25	1.6	<b>\$527</b>
	<b>Support Brace</b> ¾"W x 12"D x 28"H NOTES: Intermediate support required when a worksurface with a modesty panel has an unsupported span of greater than 48"W.	<b>HVPMSP12-W</b>	9	0.1	<b>\$176</b>
	<b>T-Support Brace</b> 8"W x 23¾"D x 28"H NOTES: Intermediate support required when a worksurface without a modesty panel has an unsupported span of greater than 48"W.	<b>HVPMSP13-W</b>	9	0.6	<b>\$319</b>
	<b>T-Shaped End Panel</b> 29⅞"W x 18"D x 28"H NOTES: T-Support can be used as an end support in peninsula-type applications or as a worksurface junction support.	<b>HVPMJS24-W</b>	20	2.2	<b>\$496</b>

**NOTES:**

- ¾", L- and T-Shaped end panels support the end of a component worksurface where there is no modular pedestal.

## HOW TO SPECIFY

<p><b>Select Model Number</b></p>	<p><b>Select Finish</b></p> <table border="0"> <tr> <td><b>H</b> Bourbon Cherry</td> <td><b>MOCH</b> Mocha</td> </tr> <tr> <td><b>COGN</b> Cognac</td> <td><b>D</b> Natural Maple</td> </tr> <tr> <td><b>C</b> Harvest</td> <td><b>PINC</b> Pinnacle</td> </tr> <tr> <td><b>N</b> Mahogany</td> <td><b>F</b> Shaker Cherry</td> </tr> </table>	<b>H</b> Bourbon Cherry	<b>MOCH</b> Mocha	<b>COGN</b> Cognac	<b>D</b> Natural Maple	<b>C</b> Harvest	<b>PINC</b> Pinnacle	<b>N</b> Mahogany	<b>F</b> Shaker Cherry
<b>H</b> Bourbon Cherry	<b>MOCH</b> Mocha								
<b>COGN</b> Cognac	<b>D</b> Natural Maple								
<b>C</b> Harvest	<b>PINC</b> Pinnacle								
<b>N</b> Mahogany	<b>F</b> Shaker Cherry								
<p>H V P M E P 2 4 - W .</p>	<p>F</p>								

# CENTERPIECE™

## Components — Supports

OPEN MARKET



Icon Legend on page 21

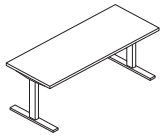

Base shown with work surface attached.

**DESCRIPTION****Coordinate™ Height Adjustable Base – 2 Stage**

24"D Feet and Worksurface Brackets

**MODEL****HHAB2S2L****SHIP WEIGHT**

63

**CUBE**

2.4

**LIST PRICE****\$860**

NOTES: **AVAILABLE FEBRUARY 2018.** Base is a dual motor 2-stage design with standard anti-collision. Legs raise from 25 $\frac{5}{8}$ " to 45 $\frac{1}{4}$ ". Base telescopes to accommodate any rectangular work surface between 24"D x 48"W and 36"D x 72"W. Supports weight capacity of 250 lbs. (excluding work surface weight). See page 767 for Voi® Worksurfaces. See page 767 for Systems Worksurfaces. For Height Adjustable Base Accessories see pages 765-766. Foundation™, Systems, Voi®, 10500, and Preside® all have worksurfaces within this range.

! When attaching a Keyboard Tray, remember to also specify a Keyboard Spacer Kit (HKBS).

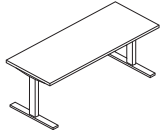

Base shown with work surface attached.

**Coordinate™ Height Adjustable Base – 3 Stage**

24"D Feet and Worksurface Brackets

**HHAB3S2L**

67

2.4

**\$960**

NOTES: **AVAILABLE FEBRUARY 2018.** Base is a dual motor 3-stage design with standard anti-collision. Legs raise from 21 $\frac{5}{8}$ " to 47 $\frac{3}{4}$ ". Base telescopes to accommodate any rectangular work surface between 24"D x 48"W and 36"D x 72"W. Supports weight capacity of 250 lbs. (excluding work surface weight). Foundation™, Systems, Voi®, 10500, and Preside® all have worksurfaces within this range.

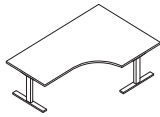

Base shown with work surface attached.

**Coordinate™ 3-Leg Height Adjustable Base – 3 Stage**

24"D Feet and Worksurface Brackets

**HHAB3S3L**

97

3.6

**\$1625**

NOTES: **AVAILABLE FEBRUARY 2018.** Base is a three motor 3-stage design with standard anti-collision. Legs raise from 21 $\frac{5}{8}$ " to 47 $\frac{3}{4}$ ". Base telescopes to accommodate work surfaces between 24"D x 48"W<sup>1</sup> x 60"W<sup>2</sup> and 30"D x 72"W<sup>1</sup> x 72"W<sup>2</sup>. Base can be arranged to accommodate 120 degree work surfaces. Supports weight capacity of 330 lbs. (excluding work surface weight). Can be used with 120 degree work surface models.

! When using two work surfaces, a flat bracket is required. Bracket purchased separately — HHN831124, HHN831130 — see page 574.

**NOTES:**

- Comes standard with one-touch, four memory controller with digital display; no specification needed, available in black finish only.
- **HON 5-Year Limited Warranty.**

**HOW TO SPECIFY**

<b>Select Model Number</b>	<b>Select Finish</b>
HHAB2S2L	P8L Nickel
HHAB2S2L	P8L

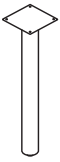
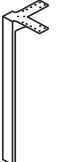
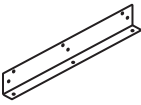

# CENTERPIECE™ Components — Supports

	DESCRIPTION	MODEL	SHIP WEIGHT	CUBE	LIST PRICE
	<b>Support Column</b> 3" Diameter NOTES: Available in powder coat black or silver.	<b>HVPCOLUMN3</b>	7	0.6	<b>\$187</b>
	<b>Table Leg</b> 2¼"W x 2¼"D x 28"H NOTES: Light scale metal support. Available in powder coat black or silver. <b>The Centerpiece™ leg can be used to support 10500 Series™ and Concinnity™ worksurfaces, however approximately ⅜" of the threaded insert on the leveling glides will be visible due to the difference in the height of the offerings.</b>	<b>HVPLEGMTL-LD</b>	5	0.5	<b>\$213</b>
 <i>HVPWLBK24 shown</i>	<b>Worksurface Wall Mount Bracket</b> For 30" For 24" NOTES: Can be used in place of an end panel to support a worksurface. Cannot be used as a support when placing a stack-on storage unit on worksurface over bracket; must have two full-sized floor supports when using stack-on storage. Finish option not required. <b>SPECIFYING EXAMPLE: HVPWLBK30</b>	<b>HVPWLBK30</b> <b>HVPWLBK24</b>	2 2	0.3 0.3	<b>\$79</b> <b>\$73</b>

## HOW TO SPECIFY

<b>Select Model Number</b>  HVPCOLUMN3	<b>Select Column Color</b> PR6 Silver P Black  PR6
<b>Select Model Number</b>  HVPLEGMTL-LD	<b>Select Leg Color</b> PR6 Silver P Black  P

# CENTERPIECE™

## Components — Pedestals

GSA SIN 711-8



Icon Legend on page 21



HVPMPW2415-3W shown

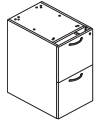

HVPMPW2415-2W shown

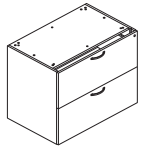

HVPMPW2436-4W shown

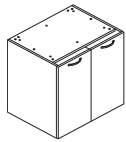
**DESCRIPTION****15<sup>11</sup>/<sub>16</sub>" W Pedestals**

15<sup>11</sup>/<sub>16</sub>" W x 24" D x 28" H, Box/Box/File  
15<sup>11</sup>/<sub>16</sub>" W x 24" D x 28" H, File/File

**MODEL**

**HVPMPW2415-3W**  
**HVPMPW2415-2W**

**SHIP WEIGHT**

100  
100

**CUBE**

7.5  
7.5

**LIST PRICE**

**\$1187**  
**\$1187**

NOTES: Non-handed, interchangeable design reconfigures easily. For use under 24" and 30" D rectangle worksurfaces; when used to support a 30" D top, there is a 6" approach-side overhang. Drawers lock; interchangeable core removable lock makes re-keying quick and easy. File drawers include hangrails to accept folders in letter or legal size. 15<sup>11</sup>/<sub>16</sub>" W pedestals are designed to be used with the modular desk, credenza, and return worksurface and modesty panel sizes listed on pages 55-56, and the 15" W pedestal back panel. The smallest component top size is 30" W. There is not a 15<sup>11</sup>/<sub>16</sub>" W x 24" D top for a stand-alone pedestal application. Pedestals are not fully enclosed and require a component top/worksurface and modesty panel or a pedestal back, both of which must be ordered separately. Ship fully assembled.

**Lateral File Pedestal**

30" W x 24" D x 28" H  
36" W x 24" D x 28" H

**HVPMPW2430-4W**  
**HVPMPW2436-4W**

160  
190

13.4  
11.7

**\$1312**  
**\$1491**

NOTES: Two locking file drawers; drawers include hangrails to accept folders in letter or legal size. For use under 24" D rectangle worksurface. Includes counterweight to inhibit tipping. Drawers lock; interchangeable core removable lock makes re-keying quick and easy. Top and back are open and require top and back panel components — ordered separately. Ship fully assembled.

**Storage Cabinet Pedestal**

30" W x 24" D x 28" H  
36" W x 24" D x 28" H

**HVPMPW2430-5W**  
**HVPMPW2436-5W**

145  
175

13.4  
15.9

**\$1177**  
**\$1356**

NOTES: Hinged door cabinet includes one fixed shelf. For use under 24" D rectangle worksurface. Doors do not lock. Top and back are open and require top and back panel components — ordered separately. Ship fully assembled.

**NOTES:**

- For removable lock core kits, see model HF27S on page 73.

! Pedestals are not fully enclosed and require a component top/worksurface and modesty panel or pedestal back, both of which must be ordered separately.

**HOW TO SPECIFY**

Select Model Number	Select Handle	Select Finish
HVPMPW2415-3W	A Beam in Silver D Bridge in Silver	H Bourbon Cherry COGN Cognac C Harvest N Mahogany MOCH Mocha D Natural Maple PINC Pinnacle F Shaker Cherry
	A	PINC

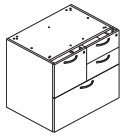

HVPMPW2430-MFLW shown

**DESCRIPTION**

**Multi File Pedestal**

31½"W x 24"D x 28"H, Top File Drawer, Right  
31½"W x 24"D x 28"H, Top File Drawer, Left

**MODEL**

**HVPMPW2430-MFRW**  
**HVPMPW2430-MFLW**

**SHIP WEIGHT**

160  
160

**CUBE**

13.8  
13.8

**LIST PRICE**

**\$1487**  
**\$1487**

NOTES: Versatile four drawer design features one lateral file, one vertical file, and two drawers for supplies. Units are handed left or right by top vertical file drawer location in relation to user. Designed to be used with the credenza, and return worksurface and modesty panel sizes listed on pages 55-56. There is not a 31½"W x 24"D top for a stand-alone pedestal application. Drawers lock; interchangeable core removable lock makes re-keying quick and easy. Top and back are open and require top and back panel components — ordered separately. Ship fully assembled.



HVPMBP15-W shown

**Pedestal Back Panel**

For 15"W  
For 30"W  
For Multi File  
For 36"W

**HVPMBP15-W**  
**HVPMBP30-W**  
**HVPMBP30-MFW**  
**HVPMBP36-W**

7  
14  
14  
17

1.5  
2.7  
2.8  
3.1

**\$326**  
**\$346**  
**\$346**  
**\$375**

NOTES: Veneer finished panel encloses the rear of modular support pedestals, which come standard with an open, unfinished back. 15" model for use with box/box/file or file/file pedestal. 30" model for use with lateral file or hinged door pedestal. 36" model for use with lateral file or hinged door pedestal. MF model for use with multi file pedestal.

! Pedestal back panels have veneer finish on the user approach side.

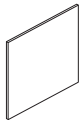

HVPMBP30-W shown

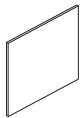

HVPMBP30-MFW shown



**Filler Strip**

7½"W x ¾"D

**HVPMPF-W**

1

0.8

**\$59**

NOTES: Suggested to be used when pedestal, without a finished back panel, is positioned against a wall; strip fills gap between pedestal and wall.

## HOW TO SPECIFY

<p><b>Select Model Number</b></p> <p>HVPMPW2430-MFRW</p>	<p><b>Select Handle</b></p> <p>A Beam in Silver D Bridge in Silver</p> <p>A</p>	<p><b>Select Finish</b></p> <table border="0"> <tr> <td>H</td><td>Bourbon Cherry</td> <td>MOCH</td><td>Mocha</td> </tr> <tr> <td>COGN</td><td>Cognac</td> <td>D</td><td>Natural Maple</td> </tr> <tr> <td>C</td><td>Harvest</td> <td>PINC</td><td>Pinnacle</td> </tr> <tr> <td>N</td><td>Mahogany</td> <td>F</td><td>Shaker Cherry</td> </tr> </table> <p>PINC</p>	H	Bourbon Cherry	MOCH	Mocha	COGN	Cognac	D	Natural Maple	C	Harvest	PINC	Pinnacle	N	Mahogany	F	Shaker Cherry
H	Bourbon Cherry	MOCH	Mocha															
COGN	Cognac	D	Natural Maple															
C	Harvest	PINC	Pinnacle															
N	Mahogany	F	Shaker Cherry															

<p><b>Select Model Number</b></p> <p>HVPMBP15-W</p> <p>HVPMPF-W</p>	<p><b>Select Finish</b></p> <table border="0"> <tr> <td>H</td><td>Bourbon Cherry</td> <td>MOCH</td><td>Mocha</td> </tr> <tr> <td>COGN</td><td>Cognac</td> <td>D</td><td>Natural Maple</td> </tr> <tr> <td>C</td><td>Harvest</td> <td>PINC</td><td>Pinnacle</td> </tr> <tr> <td>N</td><td>Mahogany</td> <td>F</td><td>Shaker Cherry</td> </tr> </table> <p>MOCH</p> <p>MOCH</p>	H	Bourbon Cherry	MOCH	Mocha	COGN	Cognac	D	Natural Maple	C	Harvest	PINC	Pinnacle	N	Mahogany	F	Shaker Cherry
H	Bourbon Cherry	MOCH	Mocha														
COGN	Cognac	D	Natural Maple														
C	Harvest	PINC	Pinnacle														
N	Mahogany	F	Shaker Cherry														



# CENTERPIECE™ Conference Tables

GSA SIN AS NOTED



Icon Legend on page 21

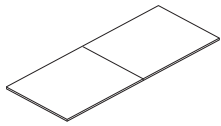

HVPTRT48120-W shown  
SIN 711-8

**DESCRIPTION**

**Rectangle Conference Table Top**  
144"W x 48"D — 2 pieces  
120"W x 48"D — 2 pieces  
96"W x 48"D — 1 piece

NOTES: Grain direction — 96"W x 48"D — long grain (end-to-end), 120"W x 48"D — short grain (side-to-side), 144"W x 48"D — short grain (side-to-side). Model HTPWRGROM1 must be specified separately when tops are ordered with "G1" cutout for grommets — 96"W x 48"D — specify (1) HTPWRGROM1, 120"W x 48"D — specify (2) HTPWRGROM1, 144"W x 48"D — specify (2) HTPWRGROM1.

**MODEL**

**SHIP WEIGHT**

**CUBE**

**LIST PRICE**

<b>HVPTRT48144-W</b>	320	19.5	<b>\$3749</b>
<b>HVPTRT48120-W</b>	290	16.3	<b>\$3006</b>
<b>HVPTRT4896-W</b>	260	13.2	<b>\$2309</b>

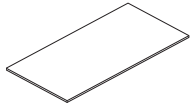

HVPTRT4896-W shown  
SIN 711-8

**Pop-up Port**

- Fits into 4" x 8" cutout.
- Specify G1 cutout in table top.
- Pop-up Port provides three power ports and one blank data receptacle.
- Sits flush with worksurface when closed.
- Finish is anodized aluminum.
- Includes 6' cord with three-prong plug.

NOTES: For additional information see page 918.

**HTPWRGROM1**

5

0.3

**\$352**



SIN 711-11



HVPTRD42-W shown  
SIN 711-8

**Round Top**

48" Diameter  
42" Diameter  
36" Diameter

NOTES: When grommet option is specified, 3" diameter black grommet is included and positioned in middle of top. For 3" grommet mount options, see the power hub (HGRMTAC) and power/USB hub (HGRMTUSB2) models on page 77.

**HVPTRD48-W**

80

6.8

**\$1741**

**HVPTRD42-W**

70

5.3

**\$1462**

**HVPTRD36-W**

60

4.0

**\$1281**

**NOTES:**

- Tops and bases are ordered separately and shipped in separate cartons.
- Occasional Tables are shown on page 72.

! If cord grommets are specified in a rectangle table top, pop-up power port model HTPWRGROM1 must be specified and ordered separately.

! If cord grommets are specified in rectangle or round tops, the 18" Diameter cylinder base with cord management access door — model HVPWCYL18WM — must be used.

! For table bases, use listings on page 71 only.

## HOW TO SPECIFY

<p><b>Select Model Number</b></p> <p>HVPTRT48144-W</p>	<p><b>Select Edge Profile</b></p> <p>G Square Edge</p> <p>G</p>	<p><b>Select Grommet</b></p> <p>G1 4" x 8" Grommet Cutouts X No Grommet</p> <p>X</p>	<p><b>Select Finish</b></p> <p>H Bourbon Cherry COGN Cognac C Harvest N Mahogany MOCH Mocha D Natural Maple PINC Pinnacle F Shaker Cherry</p> <p>PINC</p>
--	---	--	---

<p><b>Select Model Number</b></p> <p>HVPTRD48-W</p>	<p><b>Select Edge Profile</b></p> <p>G Square Edge</p> <p>G</p>	<p><b>Select Grommet</b></p> <p>GP Grommet Black X No Grommet</p> <p>GP</p>	<p><b>Select Finish</b></p> <p>H Bourbon Cherry COGN Cognac C Harvest N Mahogany MOCH Mocha D Natural Maple PINC Pinnacle F Shaker Cherry</p> <p>COGN</p>
---	---	---	---



# CENTERPIECE™ Conference Tables

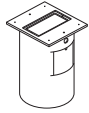

HVPWCYL18WM shown

**DESCRIPTION**

**Cylinder Base**  
18" Diameter  
18" Diameter, with Cord Management Access Door

**MODEL**

**HVPWCYL18**  
**HVPWCYL18WM**

**SHIP WEIGHT**

230.0  
230.0

**CUBE**

7.7  
7.7

**LIST PRICE**

**\$1350**  
**\$2391**

NOTES: Available with and without cord management access door. Includes 180 lbs. of ballast for stability.

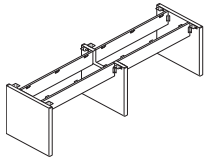

**Panel Base**

58"W x 30"D x 27 3/4"H  
82"W x 30"D x 27 3/4"H  
106"W x 30"D x 27 3/4"H

**HVPWSL4896**  
**HVPWSL48120**  
**HVPWSL48144**

108.0  
124.0  
142.0

4.1  
5.3  
5.3

**\$3521**  
**\$4393**  
**\$4612**

NOTES: Veneer panel bases feature dual support beams; field assembly required.

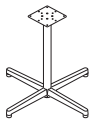

**Metal X-Base**

For 36" and 42" Round Tops  
For 48" Round Tops

**HVPBSMTL33X-LD**  
**HVPBSMTL38X-LD**

22.0  
23.0

23.3  
30.1

**\$710**  
**\$762**

NOTES: X-base column is 2 1/4" diameter.

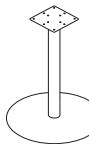

HVPMDISC24-LD shown

**Metal Disc Base**

For 36" and 42" Round Tops  
For 42" and 48" Round Tops, and Rectangle Conference Tops

**HVPMDISC18-LD**  
**HVPMDISC24-LD**

7.9  
13.0

31.0  
45.0

**\$759**  
**\$889**

NOTES: Metal disc base available with 18" and 24" bottom plate; vertical column is 4" diameter.

**NOTES:**

❗ If cord grommets are specified in rectangle or round conference table tops, the 18" Diameter cylinder base with cord management access door — model HVPWCYL18WM — must be used.

		18" Diameter Cylinder Base	18" Diameter Cylinder Base with Cord Management Access Door	2 1/4"W x 2 1/4"D x 28"H Table Leg	33"D Metal X-Base	38"D Metal X-Base	18" Diameter Disc Base	24" Diameter Disc Base	58"W Panel Base	82"W Panel Base	106"W Panel Base
		HVPWCYL18	HVPWCYL18WM	HVPLEGMTL-LD	HVPBSMTL33X-LD	HVPBSMTL38X-LD	HVPMDISC18-LD	HVPMDISC24-LD	HVPWSL4896	HVPWSL48120	HVPWSL48144
HVPTRD36-W	36" Dia Round Top	1	1	4	1		1				
HVPTRD42-W	42" Dia Round Top	1	1	4	1			1			
HVPTRD48-W	48" Dia Round Top	1	1	4		1		1			
HVPTRT4896-W	96"W x 48"D Rectangle Top — 1 piece	2	2					2	1		
HVPTRT48120-W	120"W x 48"D Rectangle Top — 2 pieces	3	3					3		1	
HVPTRT48144-W	144"W x 48"D Rectangle Top — 2 pieces	3	3					3			1

**HOW TO SPECIFY**

Select Model Number

HVPWCYL18

Select Finish

<b>H</b> Bourbon Cherry	<b>MOCH</b> Mocha
<b>COGN</b> Cognac	<b>D</b> Natural Maple
<b>C</b> Harvest	<b>PINC</b> Pinnacle
<b>N</b> Mahogany	<b>F</b> Shaker Cherry

H

Select Model Number

HVPBSMTL33X-LD

Select Leg Color

**PR6** Silver  
**P** Black

PR6

# CENTERPIECE™

## Buffet Credenza

GSA SIN 711-8



Icon Legend on page 21

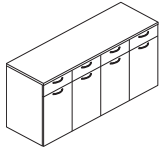

HVPCBF2474-WW shown

**DESCRIPTION**

**Buffet Credenza**  
24"W x 73<sup>3</sup>/<sub>8</sub>"D x 34<sup>3</sup>/<sub>16</sub>"H

NOTES: Worksurface positioned at buffet height for easy reach. Includes one fixed shelf behind each set of doors. Drawers and doors do not lock.

**MODEL**

HVPCBF2474-WW

**SHIP WEIGHT**

365

**CUBE**

35.1

**LIST PRICE****\$4112**

# CENTERPIECE™

## Occasional Tables

GSA SIN 711-8



Icon Legend on page 21

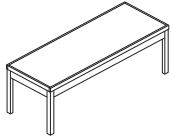

HVPTO2448L16 shown



HVPTO2424L16 shown



HVPTO2424L21 shown

**DESCRIPTION****Occasional Tables**

48"W x 24"D x 16"H, Coffee Table  
24"W x 24"D x 16"H, In-Line Table  
24"W x 24"D x 21"H, End Table

NOTES: Selection features a coffee table and two side tables. Legs are constructed of solid hardwood. Legs are attached to table with steel corner brackets and lag bolts. Metal tack glides are standard. Legs require customer attachment.

**MODEL**

HVPTO2448L16

HVPTO2424L16

HVPTO2424L21

**SHIP WEIGHT**

51

30

41

**CUBE**

15.1

8.0

10.1

**LIST PRICE****\$1517****\$1229****\$1300****HOW TO SPECIFY****Select Model Number**

HVPCBF2474-WW

**Select Edge Profile**

G Square Edge

G

**Select Handle**

A Beam in Silver  
D Bridge in Silver

D

**Select Finish**

H Bourbon Cherry  
COGN Cognac  
C Harvest  
N Mahogany  
MOCH Mocha  
D Natural Maple  
PINC Pinnacle  
F Shaker Cherry

D

**Select Model Number**







HVPTO2424L16

**Select Finish**

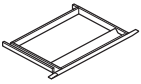
H Bourbon Cherry  
COGN Cognac  
C Harvest  
N Mahogany  
MOCH Mocha  
D Natural Maple  
PINC Pinnacle  
F Shaker Cherry

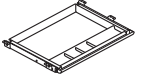
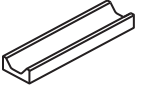
N



	DESCRIPTION	MODEL	SHIP WEIGHT	CUBE	LIST PRICE
 <b>SIN 711-8</b>  	<b>Center Drawer</b> 26"W x 22"D x 2¼"H  NOTES: Inside drawer dimensions: 20⅞"W x 11⅞"D x 1½"H. Minimum clearance for mounting: 25⅞"W x 19"D x 2¼"H. For use with desks, peninsulas, credenzas, and returns. Ball-bearing slide suspensions. Includes pencil tray. Specify finish. For additional information see page 903.	<b>HVPACCD26</b>	20.0	2.3	<b>\$501</b>
 <b>OPEN MARKET</b>	<b>Polymer Center Drawer</b> <ul style="list-style-type: none"> <li>• Color: Black.</li> <li>• Material: ABS.</li> <li>• Opening Requirements: 23"W x 16¼"D x 2"H.</li> <li>• Retracts on 16" ball bearing slides.</li> <li>• Can be used on worksurfaces with Coordinate™ Height Adjustable Bases as long as it is attached with spacer model HKBS.</li> <li>• Can store up to 25 lbs.</li> </ul> NOTES: For additional information see page 904. ⓘ Black finish only, no specification needed.	<b>HCD1</b>	7.0	0.5	<b>\$99</b>
 <b>SIN 711-8</b>  	<b>Pencil Tray</b> 12⅜"W x 3"D x 1¼"H  NOTES: Designed for use inside box drawers. <b>SPECIFYING EXAMPLE: HVPPT15</b>	<b>HVPPT15</b>	1.0	0.2	<b>\$68</b>
 <b>SIN 711-2</b> 	<b>Removable Lock Core Kit</b> Satin <ul style="list-style-type: none"> <li>• Specify quantity of each key number from 101E to 225E.</li> <li>• Includes: 1-core, 2-keys, 1-core removal tool, and instructions.</li> </ul> NOTES: If key number isn't specified, number will be at random.	<b>HF27S</b>	0.2	0.02	<b>\$29</b>

**NOTES:**

- For keyed alike locks:
  - Order standard product which will be shipped with factory installed locks and random numbered cores.
  - Order the appropriate quantity of like numbered cores required for each workstation or keyed area.
  - Simply replace the factory installed cores with the replacement cores after product has been installed.
- To install new core:
  - Lock must be in the unlocked position.
  - Insert core removal key and pull core straight out.
  - Insert new core with core removable key, hold core into lock and withdraw core removal key.
  - Retain original core for future use.
- To provide normal lead times, key numbers cannot be specified on HON products at time of order. This also eliminates need for tagging and tracking each product's lock number during installation.

**HOW TO ORDER CORE REMOVABLE LOCK KITS:**

Specify: Model Number.X  
 Key Number  
 Examples: HF27S.X121E  
 HF27S.X (Key number not specified)

NOTES: Key orders without numbers specified will be keyed at random.  
 Numbers 101E-225E are available.

**SAMPLE ORDER:**

Quantity	Model	Key Code
4	HF27S.	X121E

**HOW TO SPECIFY**

<p><b>Select Model Number</b></p> <p>H V P A C C D 2 6</p>	<p><b>Select Finish</b></p> <table border="0"> <tr> <td><b>H</b> Bourbon Cherry</td> <td><b>MOCH</b> Mocha</td> </tr> <tr> <td><b>COGN</b> Cognac</td> <td><b>D</b> Natural Maple</td> </tr> <tr> <td><b>C</b> Harvest</td> <td><b>PINC</b> Pinnacle</td> </tr> <tr> <td><b>N</b> Mahogany</td> <td><b>F</b> Shaker Cherry</td> </tr> </table> <p>C</p>	<b>H</b> Bourbon Cherry	<b>MOCH</b> Mocha	<b>COGN</b> Cognac	<b>D</b> Natural Maple	<b>C</b> Harvest	<b>PINC</b> Pinnacle	<b>N</b> Mahogany	<b>F</b> Shaker Cherry
<b>H</b> Bourbon Cherry	<b>MOCH</b> Mocha								
<b>COGN</b> Cognac	<b>D</b> Natural Maple								
<b>C</b> Harvest	<b>PINC</b> Pinnacle								
<b>N</b> Mahogany	<b>F</b> Shaker Cherry								

# CENTERPIECE™

## Accessories

OPEN MARKET

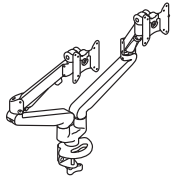

Icon Legend on page 21

**DESCRIPTION****MODEL****SHIP WEIGHT****CUBE****LIST PRICE****Dual Monitor Arm — Effortless Adjustment****H5220**

15

1.8

**\$912**

- Single mount with dual monitor adjustment.
- Effortless adjustment.
- Height adjusts from 7" to 20" for a total range of 13".
- Monitor extends 22½".
- Monitor retracts 3½" to save space.
- 360° swivel at two points with folding capabilities.
- Monitor tilts +25° to -90°.
- Enclosed cable management.
- Dual screen models allow screens to be aligned horizontally for optimal ergonomic positioning.
- Includes desk clamp or grommet mount.
- Includes VESA plate for 75 x 75mm or 100 x 100mm (converter plate for 100mm x 200mm is available separately).

Silver finish only, no specification needed.

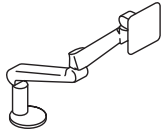
**Single Monitor Arm — Effortless Adjustment****H5210**

11

1.3

**\$510**

- Effortless adjustment.
- Height adjusts from 7" to 20" for a total range of 13".
- Monitor extends 22½".
- Monitor retracts 3½" to save space.
- 360° swivel at two points with folding capabilities.
- Monitor tilts +25° to -90°.
- Enclosed cable management.
- Includes desk clamp or grommet mount.

Silver finish only, no specification needed.

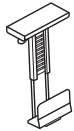
**CPU Holder****HCPU**

16

0.5

**\$236**

- Vertically mounts to underside of worksurface.
- 360° swivel.
- Supports up to 55 lbs.
- Height adjustable from 16" to 22" below worksurface.
- Width adjustable to accept units from 3¼" to 6".

Silver finish only, no specification needed.

**NOTES:**

- For additional information see page 899.

**Monitor Arms**

- Arms fold back to post to allow more desktop room.
- Arms feature double extension, allowing 20"+ of back and forth movement.
- Cable management on both pole and arm assemblies.
- Counterbalance adjustment provides stability for monitors up to 17.6 lbs per arm.
- Made of high quality aluminum alloy material.

**HOW TO SPECIFY**

Select  
Model Number

H 5 2 2 0

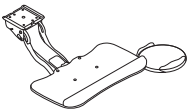
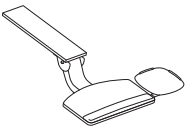
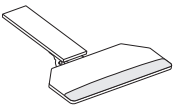

	DESCRIPTION	MODEL	SHIP WEIGHT	CUBE	LIST PRICE
	<p><b>Sit to Stand Arm with Keyboard</b></p> <ul style="list-style-type: none"> <li>• Sit to stand application.</li> <li>• No knob or lever for adjustment, simply lift into place.</li> <li>• One-hand tilt adjustment for maximum flexibility.</li> <li>• For use on surfaces 24" or deeper.</li> <li>• Height adjustment without levers.</li> <li>• +10°/-20° tilt adjustment.</li> <li>• Height adjustment 12½" (7" above and 5½" below).</li> <li>• Tilt and swivel mouse surface with gel palm rest.</li> <li>• Detachable palm rest.</li> <li>• Mouse pad can mount right or left.</li> </ul> <p>! Black finish only, no specification needed.</p>	<b>H2516</b>	17 <b>Ⓢ</b>	1.6	<b>\$565</b>
	<p><b>Articulating Arm with Convertible Keyboard</b></p> <ul style="list-style-type: none"> <li>• 21" glide track.</li> <li>• Lift and lock height adjustment.</li> <li>• Height adjustment 7" (2½" above and 4½" below track).</li> <li>• Release handle for independent tilt adjustment.</li> <li>• Tilt: +/-15°.</li> <li>• Independent tilt and swivel mousing platform.</li> <li>• Positions platform flush with worksurface.</li> <li>• 360° rotation.</li> <li>• Mouse can be used in-line, over, or forward at platform height or above.</li> <li>• Mouse can be placed at platform height or above height.</li> <li>• Left or right handed mousing; no tools required.</li> <li>• Detachable palm rest.</li> <li>• Cord management clips included.</li> </ul> <p>! Black finish only, no specification needed.</p>	<b>H2107</b>	16 <b>Ⓢ</b>	1.3	<b>\$484</b>
	<p><b>Articulating Arm with Keyboard</b></p> <ul style="list-style-type: none"> <li>• 17" glide track.</li> <li>• Spring assisted.</li> <li>• Height adjustment 6¼" (1¼" above and 5" below track).</li> <li>• Tilt: +10°/-15°.</li> <li>• 25" cut corner platform.</li> <li>• Accommodates keyboard and mouse on same level.</li> <li>• Detachable palm rest.</li> <li>• Cord management clips included.</li> </ul> <p>! Black finish only, no specification needed.</p>	<b>H1706</b>	16 <b>Ⓢ</b>	1.4	<b>\$451</b>

**NOTES:**

- For additional information see page 900.

## HOW TO SPECIFY

Select Model Number

H	2	5	1	6
---	---	---	---	---

# CENTERPIECE™

## Accessories

GSA SIN 711-2 EXCEPT AS NOTED



Icon Legend on page 21



OPEN MARKET

**DESCRIPTION**

**Back Pack Hook (10 per carton)**  
12"W x 14½"D x 1½"H

**MODEL****HCLA65****SHIP WEIGHT**

10

**CUBE**

0.1

**LIST PRICE****\$91**

NOTES: Assembly: attaches to bottom of desk with (2) screws, included. For additional information see page 914.

Available in Chrome finish only, no specification needed.

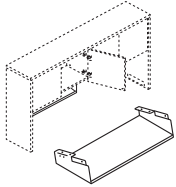
**Hanging Paper Shelf**

28½"W x 11⅞"D x 4⅝"H

**HHPS1**

7

2.9

**\$180**

NOTES: Attaches quickly and easily (screws included). Maximizes worksurface space; de-clutters desktop while placing priority communications and active project folders within easy reach. Angled design allows contents to be distinguished at a glance. Mixed material styling features strong painted metal frame with a frosted shelf.

Attaches quickly and easily to laminate stack-on and wall mount storage models (except the 36"W Voi® overhead hutch with O-legs or panel mount brackets). Not for use with 38000 Series™ and Systems.

Choose from Platinum Metallic (T1), Black (P), and Charcoal (S) paint. For additional information see page 913.

Specify: Model.Paint

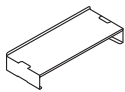
**SPECIFYING EXAMPLE: HHPS1.T1****Desktop Paper Shelf**

28½"W x 11⅞"D x 5"H

**HDPS1**

7

2.9

**\$180**

NOTES: Desktop Paper Shelf and Storage Terrace include protective, non-slip pads on the base. Paper Shelf can stack two-high. Organizer shelf provides a place and space for work-in-process and piling to keep worksurfaces neat and tidy. Convenient, scalable design with interlocking side supports allow two units to be stacked and integrated. Durable painted metal frame with a frosted shelf; mixed material styling matches hanging paper shelf.

Can also be used inside select overhead storage, including the following stack-on with clearance and hinged door models: 10500 and Valido 36", 42", 66", 72", 78"W and 10700 68⅝"W.

Choose from Platinum Metallic (T1), Black (P), and Charcoal (S) paint. For additional information see page 913.

Specify: Model.Paint

**SPECIFYING EXAMPLE: HDPS1.T1****Storage Cube**

12"W x 12"D

**HLSL1212**

1

0.3

**\$276**

NOTES: Available in the following colors: Autumn (AUTM), Citron (CITR), Flame (FLAM), Pool (POOL) and Sisal (SISL). For additional information see page 914.

**SPECIFYING EXAMPLE: HLSL1212.CITR****HOW TO SPECIFY****Select Model Number**

H L S L 1 2 1 2 .

**Select Paint Color**

**AUTM** Autumn  
**CITR** Citron  
**FLAM** Flame  
**POOL** Pool  
**SISL** Sisal

*Only specify for model HLSL1212*

C I T R



Icon Legend on page 21

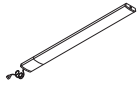

OPEN MARKET

**DESCRIPTION**

**LED Task Lights — For Stack-on and Wall Mounted Storage Cabinets**

17" LED Light with Power Supply (Single)  
31" LED Light with Power Supply (Single)

17" LED Light with Power Supply for Daisy-chain (Starter)  
31" LED Light with Power Supply for Daisy-chain (Starter)

17" LED Light with 8" Jumper Cord for Daisy-chain (Follower)  
31" LED Light with 8" Jumper Cord for Daisy-chain (Follower)

**Undercabinet Occupancy Sensor with 1" End to End Connector**

MODEL	SHIP WEIGHT	CUBE	LIST PRICE
<b>HLED17AS</b>	1.2 <b>Ⓔ</b>	0.05	<b>\$384</b>
<b>HLED31AS</b>	1.5 <b>Ⓔ</b>	0.09	<b>\$516</b>
<b>HLED17A</b>	1.0 <b>Ⓔ</b>	0.05	<b>\$422</b>
<b>HLED31A</b>	1.4 <b>Ⓔ</b>	0.09	<b>\$567</b>
<b>HLED17AUO</b>	1.0 <b>Ⓔ</b>	0.03	<b>\$344</b>
<b>HLED31AUO</b>	1.0 <b>Ⓔ</b>	0.05	<b>\$460</b>
<b>HLEDOSA</b>	0.2 <b>Ⓔ</b>	0.01	<b>\$80</b>

NOTES: To use the daisy chain application, must start with model HLED17A or HLED31A. No finish specification required. Attaches magnetically to underside of overhead storage, or attaches with provided screws or double-sided tape. Occupancy sensor attaches to a single or starter LED light and will automatically turn the light off after no motion is detected for 30 minutes. Just like all the LED light models, the occupancy sensor features a soft-touch on/off switch. LED task lights have a lifetime of 50,000 hours and have a dimmer feature that allows the user to adjust the amount of light output. For additional information see page 911.

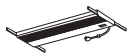

OPEN MARKET

**Recessed Task Lights — For Stack-on and Wall Mounted Storage Cabinets**

- Color: Black.
- Slim profile design.
- Mount to stack-on storage and wall mounted storage cabinets (see pages 53-54 and 56-57).
- Electronic ballast for increased energy efficiency.
- T5 bulb, included, which contains less mercury.
- 9-foot black cord and switch off right rear corner.

22<sup>1</sup>/<sub>8</sub>"W x 3<sup>1</sup>/<sub>16</sub>"D x 1<sup>1</sup>/<sub>8</sub>"H  
Chicago code version (with fused plug)  
34<sup>5</sup>/<sub>8</sub>"W x 3<sup>1</sup>/<sub>16</sub>"D x 1<sup>1</sup>/<sub>8</sub>"H  
Chicago code version (with fused plug)  
46<sup>1</sup>/<sub>2</sub>"W x 3<sup>1</sup>/<sub>16</sub>"D x 1<sup>1</sup>/<sub>8</sub>"H  
Chicago code version (with fused plug)

<b>HH870930</b>	7.0 <b>Ⓔ</b>	0.60	<b>\$211</b>
<b>HH870930CH</b>	7.0 <b>Ⓔ</b>	0.60	<b>\$275</b>
<b>HH870942</b>	10.0 <b>Ⓔ</b>	0.90	<b>\$228</b>
<b>HH870942CH</b>	10.0 <b>Ⓔ</b>	0.90	<b>\$290</b>
<b>HH870960</b>	12.0 <b>Ⓔ</b>	1.10	<b>\$246</b>
<b>HH870960CH</b>	12.0 <b>Ⓔ</b>	1.10	<b>\$308</b>

NOTES: For additional information see page 911.



SIN 711-1

**Articulating Desk Lamp**  
**Articulating Desk Lamp w/ Occupancy Sensor**

NOTES: For additional information see page 909.

<b>HLED1</b>	1.2 <b>Ⓔ</b>	6.5	<b>\$359</b>
<b>HLED1OC</b>	1.2 <b>Ⓔ</b>	6.5	<b>\$439</b>



SIN 711-1

**Task Desk Lamp**

NOTES: For additional information see page 909.

<b>HLED2</b>	0.7 <b>Ⓔ</b>	3.0	<b>\$311</b>
--------------	--------------	-----	--------------

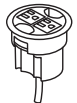

SIN 71-302

**Power Hub, 3" Grommet Mount**

- Brings the ease of plug-and-play to the desktop.
- Fits in 3" round grommet holes.
- Two grounded AC power outlets.
- Two cord pass-through holes in cap.
- Includes 6' cord with three-prong plug.
- UL Listed.

NOTES: For additional information see page 916.

ⓘ Available in black only (no color designation so use .X - Specify: HGRMTAC.X).

<b>HGRMTAC</b>	1.3	0.2	<b>\$103</b>
----------------	-----	-----	--------------

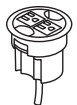

OPEN MARKET



**3" Round Power Grommet – 2 Outlets, 10' Cord**

- Includes 10' cord with three-prong plug.
- Fits in 3" round grommet holes on the following product lines: Coordinate, Huddle, Motivate, all laminate and veneer casegoods series, and Systems Worksurfaces.
- Two grounded AC power outlets.
- Field installed with Plug-and-play ease.

NOTES: Power Modules will also work with standing-height applications for 10500 Series™ and Voi® desks. Optional Memory Control allows preset worksurface heights for consistency. Ships separately. Dynamic load capacity when worksurface is moving is 300 lbs.

ⓘ Available in black finish only, no specification needed.

<b>HGRMTAC2</b>	1.5	0.2	<b>\$130</b>
-----------------	-----	-----	--------------

## HOW TO SPECIFY

Select  
Model Number

H H 8 7 0 9 3 0



# CENTERPIECE™

## Accessories

GSA SIN AS NOTED



Icon Legend on page 21

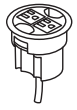

SIN 71-302

**DESCRIPTION****Power Hub, 3" Grommet Mount**

- Brings the ease of plug-and-play to the desktop.
- Fits in 3" round grommet holes.
- Two grounded AC power outlets.
- Two cord pass-through holes in cap.
- Includes 6' cord with three-prong plug.
- UL Listed.

NOTES: For additional information see page 916.

! Available in black only (no color designation so use .X - Specify: HGRMTAC.X).

**MODEL****HGRMTAC****SHIP WEIGHT**

1.3

**CUBE**

0.2

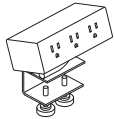
**LIST PRICE****\$103**

Model HPWRMOD3WC shown

SIN 711-2

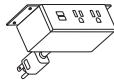

Model HPWRMOD2UWM shown

SIN 711-2

**Power Modules**

- 3 Receptacles with Worksurface Clamp
- 3 Receptacles with Under-Worksurface Mounting Bracket
- 2 Receptacles 2 USB with Worksurface Clamp
- 2 Receptacles 2 USB with Under-Worksurface Mounting Bracket
- 6' power cord with standard three-prong plug.

- Under-worksurface mounting bracket models work with any top that has a 5" x 5" square clearance.
- Worksurface clamp models work on any top with a 4" overhang.
- UL Listed.

NOTES: For additional information see page 917.

! Color finish coordinates with HON's Charcoal or White. Specify S for Charcoal or WHIT for White when ordering. Example: HPWRMOD3WC.S.

**HPWRMOD3WC**2.3 **Ⓢ**

0.2

**\$279****HPWRMOD3UWM**2.3 **Ⓢ**

0.2

**\$279****HPWRMOD2WC**2.3 **Ⓢ**

0.2

**\$447****HPWRMOD2UWM**2.3 **Ⓢ**

0.2

**\$447****Power & Data Center**

- 2 Receptacles 2 Data Accessory
- Standard with two receptacles and openings for two data ports.
- 6' power cord with standard three-prong plug.
- Fits on any worksurface with a 4" overhang.
- UL Listed.

NOTES: For additional information see page 917.

! Color finish coordinates with HON's Loft. Specify LOFT when ordering. Example: HCOMDOME2.LOFT.

**HCOMDOME2**2.5 **Ⓢ**

0.2

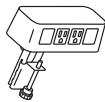
**\$266**

SIN 711-2

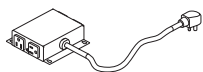

SIN 711-2

**Under Worksurface Power Module — 4 Outlets, 10' Cord**

- Includes 10' cord with three-prong plug.
- Fits in cable management troughs. See page 79.
- 4 outlets on side create easy access.

NOTES: Power Modules will also work with standing-height applications for 10500 Series™ and Voi® desks. For additional information see page 917.

! Available in black finish only, no specification needed.

**HPWRMOD2**

1.5

0.2

**\$354****Vertebrae**

NOTES: For additional information see page 920.

! Clear finish. Specify "X" for finish option.

**SPECIFYING EXAMPLE: HMPVWM28.X****HMPVWM28**

3.0

0.3

**\$200**

SIN 711-2

**HOW TO SPECIFY**

Select  
Model Number

H P W R M O D 2



	DESCRIPTION	MODEL	SHIP WEIGHT	CUBE	LIST PRICE
	<b>Cable Management Troughs</b>				
	17"W — Single	<b>HCTROUGH17</b>	2.7 <b>Ⓞ</b>	0.5	<b>\$62</b>
	17"W — 10-Pack	<b>HCTROUGH1710</b>	14.0 <b>Ⓞ</b>	0.5	<b>\$583</b>
	36"W — Single	<b>HCTROUGH36</b>	4.9 <b>Ⓞ</b>	0.9	<b>\$104</b>
	36"W — 10-Pack	<b>HCTROUGH3610</b>	30.0 <b>Ⓞ</b>	0.9	<b>\$983</b>
	<ul style="list-style-type: none"> <li>• Cable management troughs ship flat packed.</li> <li>• The troughs attach to underneath the worksurface with screws.</li> <li>• The 17"W has one wire access cut out on the user side. The 36" has two wire access cut outs. These cut outs give users access to inside the trough without having to detach it from the worksurface.</li> <li>• Color: Graphite.</li> <li>• Material: Metal.</li> <li>• TAA Compliant.</li> </ul>				

**NOTES:**

- For additional information see page 920.

## HOW TO SPECIFY

Select  
Model Number

H C T R O U G H 1 7

# CENTERPIECE™

## Accessories

OPEN MARKET

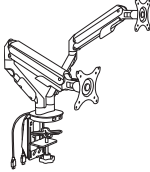
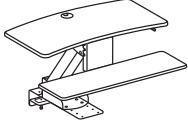
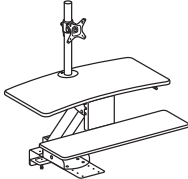
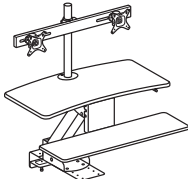

Icon Legend on page 21

	DESCRIPTION	MODEL	SHIP WEIGHT	CUBE	LIST PRICE
	<b>Coordinate™ Portable Desktop Riser</b> 31"D x 4½"-16½"H x 35"W NOTES: Available in Black (BLK) or White (WHT) finish. Desktop riser dimensions (without keyboard tray): 22"D x 4½"-16½"H x 35"W. Keyboard tray dimensions: 9"D x 30"W. Max loading capacity is 33 lbs for the desktop riser surface and 4 lbs for the keyboard tray. Easily transition from seated to standing positions throughout the workday. Sits atop an existing desk to create sit-to-stand functionality by raising the computer. Includes keyboard tray and surface for computer monitors. <b>HON 5-Year Limited Warranty.</b> ⓘ Not intended for use on mobile workstations.	<b>HBXRISER</b>	54.0	4.1	<b>\$500</b>
	<b>Dual Monitor Arm with 2 USB Ports</b> NOTES: <b>AVAILABLE FEBRUARY 2018.</b> Easy adjustment. Height adjusts to 17" tall. Monitor tilt and swivel capability. Enclosed cable management. Grommet or desktop mounting. Clean appearance. For additional information see page 899. ⓘ No specification needed.	<b>HBDMAUSB</b>	41.9	2.6	<b>\$360</b>
	<b>Coordinate™ Mounted Desktop Riser</b> NOTES: Does not include a monitor arm and is suitable for laptops and/or monitors on their original stands. ⓘ No specification needed.	<b>HS1100</b>	60.0 ⓘ	3.2	<b>\$525</b>
	<b>Coordinate™ Mounted Desktop Riser with Single Monitor Arm</b> NOTES: Includes a monitor arm for a single monitor. ⓘ No specification needed.	<b>HS1101</b>	62.0 ⓘ	3.2	<b>\$615</b>
	<b>Coordinate™ Mounted Desktop Riser with Dual Monitor Arm</b> NOTES: Includes a monitor arm for dual monitors. ⓘ No specification needed.	<b>HS1102</b>	63.0 ⓘ	3.2	<b>\$700</b>

### NOTES FOR HS1100, HS1101, HS1102:

- These products are designed to allow the user to transition from seating position to standing position throughout the workday.
- Gas-assist lever-operated mechanism with positive stop.
- Clamp mount compatible with worksurfaces depths of 20"-30". 20" is for systems only.
- Clamp requires 3.5" of clearance along back edge of worksurface.
- Black seamless worksurfaces.
- Silver powder coated metal components.
- Lowers below worksurface level on 24" and 30"D worksurfaces.
- All models contain a large primary worksurface and a smaller keyboard / mouse surface.
- Beveled edges for sleek appearance and comfort while typing.
- Monitor arms include height, width, and swivel adjustment.
- For additional information see page 906.

- Not for use under overhead storage, with flush mounted modesty panels, or worksurfaces thinner than 1".

- ⓘ Not recommended for use on mobile (castered) worksurfaces.

### MOUNTING AND COMPATIBILITY FOR HS1100, HS1101, HS1102:

- This product is intended to be installed on commercial-grade worksurfaces in good condition.
- Compatible with freestanding worksurfaces 24"-30"D or panel-supported worksurfaces 24"-30"D.
- Not for use on mobile worksurfaces.

#### Clamp Mount

Use when 3.5" minimum overhang is available

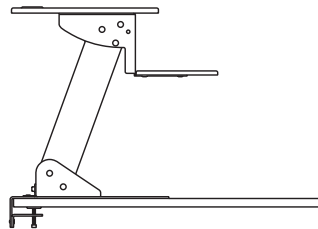

#### Screw Mount

Use when no overhang is available. Worksurface must be minimum 1" thick.

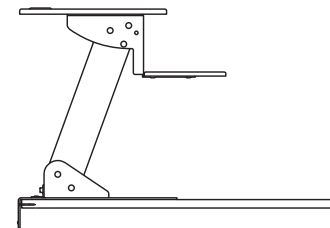

## HOW TO SPECIFY

### Select Model Number



HBXRISER.

### Select Finish

BLK Black  
WHIT White

BLK

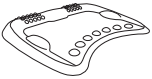
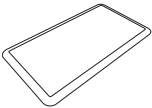
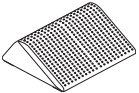

	DESCRIPTION	MODEL	SHIP WEIGHT	CUBE	LIST PRICE
	<b>Rectangle Wobble Board — Anti-Fatigue Mat</b> 18"D x 3"H x 22½"W ⓘ Available in Black (T) finish ONLY. Recommended weight capacity not to exceed 250 pounds. <b>HON 5-Year Limited Warranty.</b> <b>SPECIFYING EXAMPLE: HVL981.T</b>	<b>HVL981</b>	10.0 Ⓔ	0.9	<b>\$220</b>
	<b>Round Wobble Board — Anti-Fatigue Mat</b> 18½"D x 2⅝"H x 18½"W ⓘ Available in Black (T) finish ONLY. Recommended weight capacity not to exceed 250 pounds. <b>HON 5-Year Limited Warranty.</b> <b>SPECIFYING EXAMPLE: HVL982.T</b>	<b>HVL982</b>	5.8 Ⓔ	0.6	<b>\$190</b>
	<b>Ergonomic Anti-Fatigue Mat</b> 25"D x 2¾"H x 29⅞"W ⓘ <b>AVAILABLE FEBRUARY 2018.</b> Available in Black ONLY. No specification needed. <b>SPECIFYING EXAMPLE: HBEAFM1</b>	<b>HBEAFM1</b>	7.0	1.4	<b>\$176</b>
	<b>Rectangle Anti-Fatigue Mat</b> 20"D x ¾"H x 36"W ⓘ <b>AVAILABLE FEBRUARY 2018.</b> Available in Black ONLY. No specification needed. <b>SPECIFYING EXAMPLE: HBAFM2036</b>	<b>HBAFM2036</b>	5.4	0.4	<b>\$80</b>
	<b>Footrest — Anti-Slip Cover</b> 13¾"D x 5½"H x 16"W ⓘ Available in Black (T) finish ONLY. Recommended weight capacity not to exceed 250 pounds. <b>HON 5-Year Limited Warranty.</b> <b>SPECIFYING EXAMPLE: HVL991.T</b>	<b>HVL991</b>	7.0 Ⓔ	0.9	<b>\$65</b>

## HOW TO SPECIFY

<b>Select Model Number</b>	<b>Select Finish</b>
H V L 9 8 1 .	T Black
	T

# FEATURES OFFERED ON HON LAMINATE CASEGOODS

	10500	10700	Valido	Concinnity	94000	Voi
<b>Worksurfaces</b>						
• Scratch, stain and spill-resistant surface over durable 1/4" solid core high performance particleboard	•	•		•		•
• Scratch, stain and spill-resistant surface over extra-thick 1/2" solid core high performance particleboard			•			
• Scratch, stain and spill-resistant high gloss surface over durable 1/4" solid core high performance particleboard					•	
• Contoured hardwood accent trim		•			•	
• User-friendly waterfall-shaped edges and rounded corners improves worker comfort		•				
• Edge profile options				•		
<b>Chassis Construction</b>						
• European-designed fastening system – Precision, metal-to-metal, fasteners eliminate need for external cleats or exposed screws; enables tops or end panels to be interchanged or replaced	•	•	•	•	•	•
• Inner frame constructed using mortise and tenon joinery for superior structural strength and precisely positioning/securing the pedestal to the modesty panel; endures frequent moving/handling; ensures a longer product life cycle	•	•	•		•	
• All fasteners and dowels are positioned by computer to maintain rigorous dimensional standards	•	•	•	•	•	•
• End panels on base units and stack-ons feature PVC bottom edgebanding for added strength and to seal out moisture	•	•	•	•	•	•
<b>Drawer Construction</b>						
• Steel ball-bearing drawer suspensions for smooth, quiet, long-lasting operation	•	•	•	•	•	•
• 5-sided drawer construction for added strength and easy alignment or replacement of drawer fronts	•	•	•	•	•	•
• Full extension box and file drawers	•	•	•	•	•	•
• Hangrails provided in all file drawers for side-to-side letter, legal, A4 or EDP filing; and front-to-back for letter filing	•	•	•	•	•	•
<b>Amenities</b>						
• Conference overhang (select models) provides visitor's kneespace on approach side of desk for meetings	•	•	•	•	•	•
• Formal, full height modesty panels	•	•	•	•	•	•
• Short modesty panel option for easy access to wall electrical outlets	•	•	•	•	•	•
• Patented, side-mounted drawer handles provide good ergonomics and clean appearance	•	•				
• Antique brass drawer handles					•	
• Decorative drawer/door handle design and finish options			•	•		•
• Vertical grain direction on drawer fronts and modesty panels				•	•	•
• Upscale mixed material door options (select models) on overhead storage	•	•	•	•	•	•
• Adjustable hex leveling glides to level furniture without lifting	•	•		•	•	•
• Pullout reference/writing shelf provides additional worksurface space					•	
• Interchangeable lock cores (allow multiple units to be keyed alike)	•	•	•	•	•	•
• Central locking on desks (one lock secures all drawers)					•	
• Cord management (standard) to route and hide wires and cables	•	•	•	•	•	
• Cord management options on modular components (worksurfaces, end and modesty panels, pedestals)				•		•
<b>Configuration Options</b>						
• Components for efficient "U" and "L" shaped workstation layouts	•	•	•	•	•	•
• Peninsulas and corner units	•	•	•	•		
• Worksurfaces or shells up to 96"W	•			•		
• Standing, 42"H desking solutions	•			•		•
• Overheads sized to span multiple base units	•	•	•	•	•	•
• Reception station/transaction counter	•	•	•	•	•	
• Light scale styling, including worksurface components with O-leg supports	•			•		•
• Two-tone color options	•		•	•		•
<b>Storage Options</b>						
• 3/4 pedestals provide increased budget flexibility	•	•	•			
• Full desktop-to-floor pedestals maximize storage space	•	•	•	•	•	•
• Modular components/storage with precise, custom cabinet-like fits				•		•
• Modular shells w/ a variety of storage-pedestal solutions	•	•	•			
• Back wall storage in conventional (65") and executive (78") heights				•		
• Overheads, storage cabinets, wardrobes, lateral files, and bookcases	•	•	•	•	•	•
<b>Companion Products</b>						
• Matching conference tables	•		•	•	•	•
• Coordinating conference tables		•				
<b>Endorsements</b>						
• Meets or exceeds current ANSI/BIFMA and ISTA standards	•	•	•	•	•	•
• Meets SCS Indoor Advantage Certification (see page 19)	•	•	•	•	•	•
• level® certified in conformance with the BIFMA e3 furniture sustainability standard	•	•	•	•	•	•

# BL SERIES



**BL Laminate Executive Workstation shown with Manage® Desks.**

## BL LAMINATE

Maximum performance. Minimum price tag. Sometimes that's just what your business needs — and our BL Series fits the bill. Made with scratch- and stain-resistant laminate that stands up to heavy use, the BL Series offers straightforward styling that blends in with any office design.



## FEATURES

- Includes all the elements to create any size or type of desk configuration.
- Pull off any look with one of four attractive handle styles.
- Scratch-, spill- and stain-resistant laminate stands up to heavy use.
- Metal-to-metal fastening system for precise fit and unsurpassed durability.
- For any organization seeking maximum performance for the price.
- Desk and credenza shells ship flat and assemble in minutes.

# BL SERIES

## Bundles Typicals

Espresso  
**HBLPP3066ES**

Mahogany  
**HBLPP3066N**

Medium Cherry  
**HBLPP3066A1**

QTY	DESCRIPTION	MODEL	LIST PRICE	PRICE EXTENSION
1	Desk Shell	<b>HBL2102</b> *	\$255	\$255
1	Box / Box / File Pedestal	<b>HBL2162</b> *	\$297	\$297
1	File / File Pedestal	<b>HBL2163</b> *	\$297	\$297

\* De-emphasized. Recommend specifying Foundation™ for all future orders.

**TOTAL: \$849**

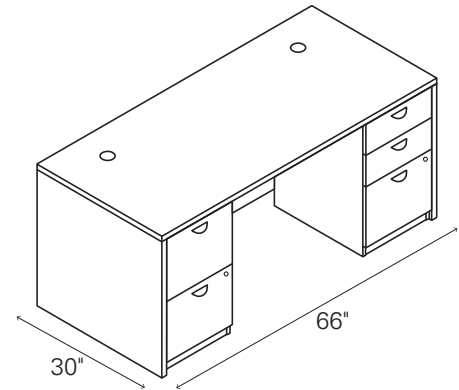

**LAMINATE DESK WITH 2 PEDESTALS**

Espresso  
**HBLP3060ES**

Mahogany  
**HBLP3060N**

Medium Cherry  
**HBLP3060A1**

QTY	DESCRIPTION	MODEL	LIST PRICE	PRICE EXTENSION
1	Desk Shell	<b>HBL2103</b> *	\$233	\$233
1	File / File Pedestal	<b>HBL2163</b> *	\$297	\$297

\* De-emphasized. Recommend specifying Foundation™ for all future orders.

**TOTAL: \$530**

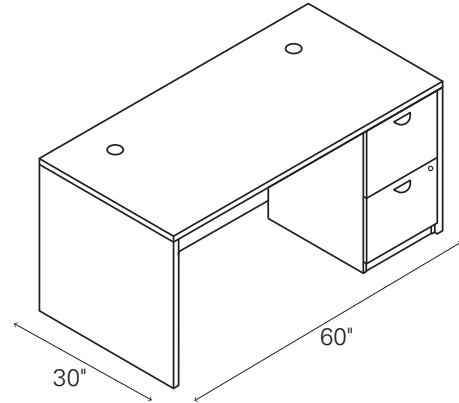

**DESK SHELL WITH 1 PEDESTAL (NON-HANDED)**

Espresso  
**HBLDCH7296ES**

Mahogany  
**HBLDCH7296N**

Medium Cherry  
**HBLDCH7296A1**

QTY	DESCRIPTION	MODEL	LIST PRICE	PRICE EXTENSION
1	Desk Shell	<b>HBL2101</b> *	\$297	\$297
1	Credenza Shell	<b>HBL2121</b> *	\$240	\$240
1	Hutch with Doors	<b>HBL2180</b> *	\$410	\$410
2	Box / Box / File Pedestal	<b>HBL2162</b> *	\$297	\$594
2	File / File Pedestal	<b>HBL2163</b> *	\$297	\$594

\* De-emphasized. Recommend specifying Foundation™ for all future orders.

**TOTAL: \$2,135**

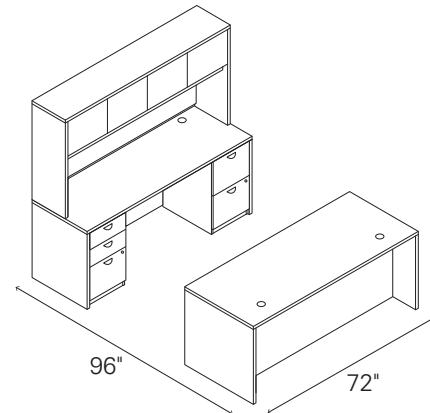

**OFFICE SUITE**

# BL SERIES Bundles Typicals

Espresso  
**HBLPP6678ES**

Mahogany  
**HBLPP6678N**

Medium Cherry  
**HBLPP6678A1**

QTY	DESCRIPTION	MODEL	LIST PRICE	PRICE EXTENSION
1	Desk Shell	<b>HBL2102</b> *	\$255	\$255
1	Return Shell	<b>HBL2145</b> *	\$185	\$185
1	Box / Box / File Pedestal	<b>HBL2162</b> *	\$297	\$297
1	File / File Pedestal	<b>HBL2163</b> *	\$297	\$297

\* De-emphasized. Recommend specifying Foundation™ for all future orders.

**TOTAL: \$1,034**

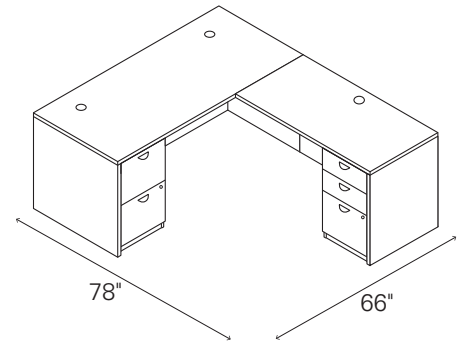

**L-STATION WITH 2 PEDESTALS (NON-HANDED)**

Espresso  
**HBLDCHL7272ES**

Mahogany  
**HBLDCHL7272N**

Medium Cherry  
**HBLDCHL7272A1**

QTY	DESCRIPTION	MODEL	LIST PRICE	PRICE EXTENSION
1	Bow Front Desk Shell	<b>HBL2111</b> *	\$333	\$333
1	Credenza Shell	<b>HBL2121</b> *	\$240	\$240
1	Hutch with Doors	<b>HBL2180</b> *	\$410	\$410
1	5-Shelf Bookcase	<b>HBL2194</b> *	\$270	\$270
1	2-Drawer Lateral File	<b>HBL2171</b> *	\$483	\$483
2	Box / Box / File Pedestal	<b>HBL2162</b> *	\$297	\$594
2	File / File Pedestal	<b>HBL2163</b> *	\$297	\$594

\* De-emphasized. Recommend specifying Foundation™ for all future orders.

**TOTAL: \$2,924**

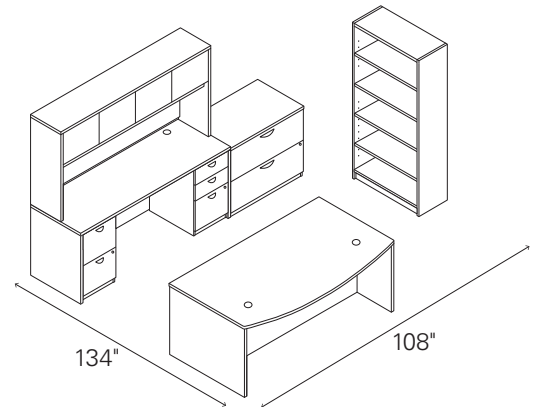

**OFFICE SUITE WITH STORAGE**

Espresso  
**HBLUPP72108ES**

Mahogany  
**HBLUPP72108N**

Medium Cherry  
**HBLUPP72108A1**

QTY	DESCRIPTION	MODEL	LIST PRICE	PRICE EXTENSION
1	Desk Shell	<b>HBL2101</b> *	\$297	\$297
1	Credenza Shell	<b>HBL2121</b> *	\$240	\$240
1	Bridge	<b>HBL2155</b> *	\$174	\$174
1	Box / Box / File Pedestal	<b>HBL2162</b> *	\$297	\$297
1	File / File Pedestal	<b>HBL2163</b> *	\$297	\$297

\* De-emphasized. Recommend specifying Foundation™ for all future orders.

**TOTAL: \$1,305**

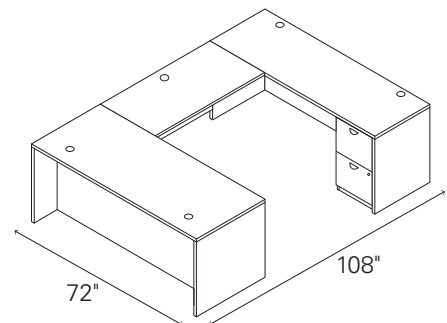

**U-STATION (NON-HANDED)**



# BL SERIES

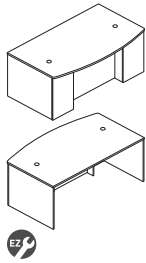

**DESCRIPTION**

**Breakfront Desk Shell with Bow Front Top**  
72"W x 42"D x 29"H

**OVERHANG**

12<sup>9</sup>/<sub>10</sub>"

**MODEL**

**HBL2111BF** \*

**SHIP WEIGHT**

156.0

**CUBE**

9.6

**LIST PRICE**

**\$415**

NOTES: Two cord management grommets in tops.

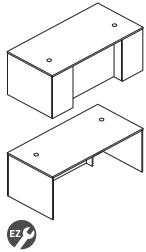

**Breakfront Desk Shell with Rectangle Top**

72"W x 36"D x 29"H

6<sup>7</sup>/<sub>10</sub>"

**HBL2101BF** \*

152.0

8.4

**\$370**

NOTES: Two cord management grommets in tops.

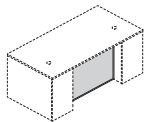

**Glass Modesty Panel**

For 72"W Breakfront Desk Shell

**HBL72BFMODG**

18.0

2.0

**\$214**

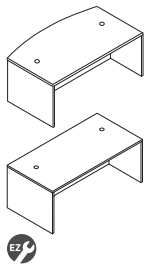

**Desk Shell**

72"W x 42"D x 29"H, Bow Top  
72"W x 36"D x 29"H, Rectangle Top  
66"W x 30"D x 29"H, Rectangle Top  
60"W x 30"D x 29"H, Rectangle Top

16<sup>1</sup>/<sub>2</sub>"  
10"  
4<sup>1</sup>/<sub>2</sub>"  
4<sup>1</sup>/<sub>2</sub>"

**HBL2111** \*  
**HBL2101** \*  
**HBL2102** \*  
**HBL2103** \*

154.0  
149.0  
116.0  
111.0

8.9  
7.7  
6.1  
5.6

**\$333**  
**\$297**  
**\$255**  
**\$233**

NOTES: Two cord management grommets in tops.



**Peninsula with End Panel**

72"W x 36"D x 29"H

**HBL2115** \*

116.0

15.0

**\$376**

NOTES: Support column available in Black only. For use in "U" or "L" configuration.

⚠ Not designed to be used freestanding.

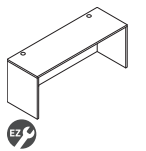

**Credenza Shell**

72"W x 24"D x 29"H  
60"W x 24"D x 29"H

**HBL2121** \*  
**HBL2123** \*

108.0  
95.5

5.5  
5.5

**\$240**  
**\$213**

NOTES: Two cord management grommets in the top and one cord pass-through grommet in the top center of modesty panel.

**NOTES:**



- Scratch- and stain-resistant thermal-fused laminate surfaces.
- Durable 1" thick tops and end panels.
- Full height modesty panels.
- Desk, credenza shells, and peninsula assemble quickly and easily.
- Breakfront design creates a high end aesthetic for private offices and executive workstations.
- Breakfront desk features fixed and adjustable shelves.
- Desk shells come standard with Black 3" round grommets.

- Recessed modesty panel design on desk shells provides overhang for visitor meetings and conferencing.
- Glass modesty replaces laminate modesty included with desk.
- Credenza shells come standard with Black grommets.
- Adjustable floor leveling glides provide 3/4" of adjustment.
- Three laminate color options — Mahogany (NN), Medium Cherry (A1A1) or Espresso (ESES).
- **HON 5-Year Limited Warranty.**

\* De-emphasized. Recommend specifying Foundation™ for all future orders.

**HOW TO SPECIFY**

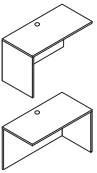
<p><b>Select Model Number</b></p> <p>H B L 2 1 1 1 B F</p>	<p><b>Select Laminate</b></p> <p><b>NN</b> Mahogany <b>A1A1</b> Medium Cherry <b>ESES</b> Espresso</p> <p>N N</p>
--	---

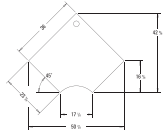
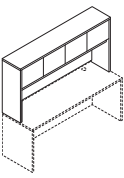
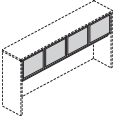
	DESCRIPTION	MODEL	SHIP WEIGHT	CUBE	LIST PRICE
	<b>Return Shell</b> 48 <sup>3</sup> / <sub>4</sub> "W x 24"D x 29"H 42 <sup>3</sup> / <sub>4</sub> "W x 24"D x 29"H	<b>HBL2145</b> * <b>HBL2146</b> *	66.0 66.0	4.6 4.6	<b>\$185</b> <b>\$170</b>
	NOTES: One cord management grommet in the top and one cord pass-through grommet in the top center of modesty panel. Return shells are non-handed.				
	<b>Bridge</b> 47 <sup>3</sup> / <sub>4</sub> "W x 24"D x 29"H	<b>HBL2155</b> *	52.9	3.7	<b>\$174</b>
	NOTES: One cord management grommet in the top and one cord pass-through grommet in the top center of modesty panel.				
	<b>Corner Unit</b> 18" x 36" x 36" x 18" x 29"H	<b>HBL42CU</b> *	114.0	5.1	<b>\$332</b>
	NOTES: Intended for use with 24"D x 29"H returns or bridges. ⓘ Not designed to be used freestanding.				
	<b>Hutch with Doors</b> 72"W x 14 <sup>5</sup> / <sub>8</sub> "D x 37 <sup>1</sup> / <sub>8</sub> "H 60"W x 14 <sup>5</sup> / <sub>8</sub> "D x 37 <sup>1</sup> / <sub>8</sub> "H	<b>HBL2180</b> * <b>HBL2183</b> *	138.2 119.0	7.6 6.6	<b>\$410</b> <b>\$372</b>
	NOTES: 72"W Hutch with four doors fits on the 72"W desk or credenza. It can also span an "L" configuration where the width of the return and the depth of the desk or credenza combined equal 72". Example: 42"W return and a 30"D desk shell. 60"W Hutch with doors fits on the 60"W desk or credenza shell.				
	<b>Glass Doors for 72" Hutch</b>	<b>HBL72HDG</b>	9.0	1.5	<b>\$275</b>

**NOTES:**

- Scratch- and stain-resistant thermal-fused laminate surfaces.
- Durable 1" thick tops and end panels.
- Full height modesty panels.
- Adjustable floor leveling glides provide 3/4" of adjustment.
- 72"W and 60"W hutches with doors include fully enclosed back with a grommet to facilitate routing cords.
- Returns, bridges, and reception stations assemble quickly and easily.
- 3" diameter grommet(s) in tops of desks to route cords; grommet cap is black.
- Return shells and bridge come standard with 3" round Black grommets.
- **HON 5-Year Limited Warranty.**

\* De-emphasized. Recommend specifying Foundation™ for all future orders.

## HOW TO SPECIFY

<p>Select Model Number</p> <p>H B L 2 1 4 5</p>	<p>Select Laminate</p> <p>                     NN Mahogany                      A1A1 Medium Cherry                      ESES Espresso                 </p> <p>NN</p>
---	--

## BL SERIES

OPEN MARKET

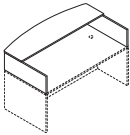
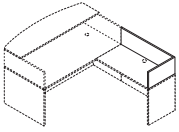
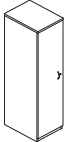

Icon Legend on page 21

	DESCRIPTION	MODEL	SHIP WEIGHT	CUBE	LIST PRICE
	<b>Reception Station with Bow Front Transaction Counter</b> 72"W x 42"D x 14"H NOTES: Can be used on 72"W x 42"D bow top and 72"W x 36"D rectangle top desks. Can be used to quickly convert existing 72"W desks and 42¼"W returns into reception stations.	<b>HBL2211</b> *	74.1 Ⓢ	5.4	<b>\$277</b>
	<b>Reception Station for Returns</b> 42¼"W x 24"D x 13"H NOTES: To be used with model HBL2211 in an "L" configuration on a 42¼" return shell. Can be used to quickly convert existing 72"W desks and 42¼"W returns into reception stations.	<b>HBL2213</b> *	23.1 Ⓢ	2.0	<b>\$119</b>
	<b>Personal Wardrobe Cabinet</b> 18"W x 24"D x 65"H NOTES: Door is non-handed and can be converted to left or right open configuration. Features coat rod, fixed shelf, and lock. Comes with metal handle in Silver finish.	<b>HBLPWC</b> *	84.0	6.1	<b>\$475</b>







**NOTES:**

- Scratch- and stain-resistant thermal-fused laminate surfaces.
- Durable 1" thick tops and end panels.
- Full height modesty panels.
- Adjustable floor leveling glides provide ¾" of adjustment.
- 72"W and 60"W hutches with doors include fully enclosed back with a grommet to facilitate routing cords.
- Returns, bridges, and reception stations assemble quickly and easily.
- 3" diameter grommet(s) in tops of desks to route cords; grommet cap is black.
- Return shells and bridge come standard with 3" round Black grommets.
- **HON 5-Year Limited Warranty.**

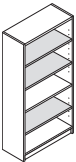
\* De-emphasized. Recommend specifying Foundation™ for all future orders.

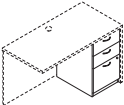
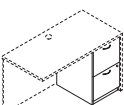
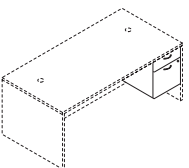
**HOW TO SPECIFY**

<b>Select Model Number</b>  H B L 2 2 1 1 .	<b>Select Laminate</b> NN Mahogany A1A1 Medium Cherry ESES Espresso  N N
---	---

	DESCRIPTION	MODEL	SHIP WEIGHT	CUBE	LIST PRICE
	<b>Bookcases — 5-Shelf</b> 32"W x 13 <sup>13</sup> / <sub>16</sub> "D x 65 <sup>3</sup> / <sub>8</sub> "H NOTES: Features three adjustable shelves and one fixed shelf.	<b>HBL2194</b> *	137.3	7.2	<b>\$270</b>
	<b>Lateral Files — 2-Drawer</b> 35 <sup>1</sup> / <sub>2</sub> "W x 22"D x 29"H NOTES: Features inner lock mechanism. Drawers lock. Removable top for use under shells. Features full extension drawers with ball-bearing suspensions.	<b>HBL2171</b> *	144.8	19.4	<b>\$483</b>
	<b>Pedestals, Box/Box/File</b> 15 <sup>5</sup> / <sub>8</sub> "W x 21 <sup>3</sup> / <sub>4</sub> "D x 27 <sup>3</sup> / <sub>4</sub> "H NOTES: Drawers lock. Not to be used freestanding. For use under shells (sold separately). Unfinished top.	<b>HBL2162</b> *	80.5	9.2	<b>\$297</b>
	<b>Pedestal, File/File</b> 15 <sup>5</sup> / <sub>8</sub> "W x 21 <sup>3</sup> / <sub>4</sub> "D x 27 <sup>3</sup> / <sub>4</sub> "H NOTES: Drawers lock. Not to be used freestanding. For use under shells (sold separately). Unfinished top.	<b>HBL2163</b> *	78.9	9.2	<b>\$297</b>
	<b>Pedestal, Box/File</b> 15 <sup>5</sup> / <sub>8</sub> "W x 21 <sup>3</sup> / <sub>4</sub> "D x 19 <sup>1</sup> / <sub>4</sub> "H NOTES: Drawers lock. Not to be used freestanding. For use under shells (sold separately). Unfinished top.	<b>HBL2164</b> *	63.3	6.8	<b>\$229</b>
	<b>Field Installed Contemporary Pull — 2-pack</b> Silver NOTES: For use on Lateral Files, Pedestals, and Personal Wardrobe Cabinets. ⓘ Silver finish only, no specification needed.	<b>HBLPCONTEMP</b>	0.1 ⓘ	0.3	<b>\$10</b>
	<b>Field Installed Bridge Pull — 2-pack</b> Silver NOTES: For use on Lateral Files, Pedestals, and Personal Wardrobe Cabinets. ⓘ Polished finish only, no specification needed.	<b>HBLPBRIDGE</b>	0.1 ⓘ	0.3	<b>\$10</b>
	<b>Field Installed Classic Pull — 2-pack</b> Black NOTES: For use on Lateral Files, Pedestals, and Personal Wardrobe Cabinets. ⓘ Black finish only, no specification needed.	<b>HBLPCLASSIC</b>	0.1 ⓘ	0.3	<b>\$10</b>

**NOTES:**

- Lateral file and pedestals ship assembled.
- Pedestals are designed to be used under the desk, credenza, and return shells.
- Drawers operate on full extension, ball-bearing suspensions to ensure smooth, quiet, long-lasting operation.
- Hangrails are included in each file drawer for side-to-side letter or legal filing, and for front-to-back letter filing.
- Lateral file and pedestals come standard with metal handle in Silver finish.
- **HON 5-Year Limited Warranty.**

\* De-emphasized. Recommend specifying Foundation™ for all future orders.

## HOW TO SPECIFY

<p>Select Model Number</p> <p>H B L 2 1 9 4</p>	<p>Select Laminate</p> <p>NN Mahogany                      A1A1 Medium Cherry                      ESES Espresso</p> <p>NN</p>
---	--

# BL SERIES

## Accessories

OPEN MARKET

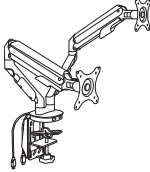
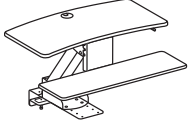
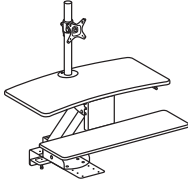
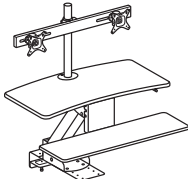
	DESCRIPTION	MODEL	SHIP WEIGHT	CUBE	LIST PRICE
	<b>Coordinate™ Portable Desktop Riser</b> 31"D x 4½"-16½"H x 35"W NOTES: Available in Black (BLK) or White (WHT) finish. Desktop riser dimensions (without keyboard tray): 22"D x 4½"-16½"H x 35"W. Keyboard tray dimensions: 9"D x 30"W. Max loading capacity is 33 lbs for the desktop riser surface and 4 lbs for the keyboard tray. Easily transition from seated to standing positions throughout the workday. Sits atop an existing desk to create sit-to-stand functionality by raising the computer. Includes keyboard tray and surface for computer monitors. <b>HON 5-Year Limited Warranty.</b> ⓘ Not intended for use on mobile workstations.	<b>HBXRISER</b>	54.0	4.1	<b>\$500</b>
	<b>Dual Monitor Arm with 2 USB Ports</b> NOTES: <b>AVAILABLE FEBRUARY 2018.</b> Easy adjustment. Height adjusts to 17" tall. Monitor tilt and swivel capability. Enclosed cable management. Grommet or desktop mounting. Clean appearance. For additional information see page 899. ⓘ No specification needed.	<b>HBDMAUSB</b>	41.9	2.6	<b>\$360</b>
	<b>Coordinate™ Mounted Desktop Riser</b> NOTES: Does not include a monitor arm and is suitable for laptops and/or monitors on their original stands. ⓘ No specification needed.	<b>HS1100</b>	60.0 ⓘ	3.2	<b>\$525</b>
	<b>Coordinate™ Mounted Desktop Riser with Single Monitor Arm</b> NOTES: Includes a monitor arm for a single monitor. ⓘ No specification needed.	<b>HS1101</b>	62.0 ⓘ	3.2	<b>\$615</b>
	<b>Coordinate™ Mounted Desktop Riser with Dual Monitor Arm</b> NOTES: Includes a monitor arm for dual monitors. ⓘ No specification needed.	<b>HS1102</b>	63.0 ⓘ	3.2	<b>\$700</b>

### NOTES FOR HS1100, HS1101, HS1102:

- These products are designed to allow the user to transition from seating position to standing position throughout the workday.
- Gas-assist lever-operated mechanism with positive stop.
- Clamp mount compatible with worksurfaces depths of 20"-30". 20" is for systems only.
- Clamp requires 3.5" of clearance along back edge of worksurface.
- Black seamless worksurfaces.
- Silver powder coated metal components.
- Lowers below worksurface level on 24" and 30"D worksurfaces.
- All models contain a large primary worksurface and a smaller keyboard / mouse surface.
- Beveled edges for sleek appearance and comfort while typing.
- Monitor arms include height, width, and swivel adjustment.
- For additional information see page 906.

- Not for use under overhead storage, with flush mounted modesty panels, or worksurfaces thinner than 1".

- ⓘ Not recommended for use on mobile (castered) worksurfaces.

### MOUNTING AND COMPATIBILITY FOR HS1100, HS1101, HS1102:

- This product is intended to be installed on commercial-grade worksurfaces in good condition.
- Compatible with freestanding worksurfaces 24"-30"D or panel-supported worksurfaces 24"-30"D.
- Not for use on mobile worksurfaces.

#### Clamp Mount

Use when 3.5" minimum overhang is available

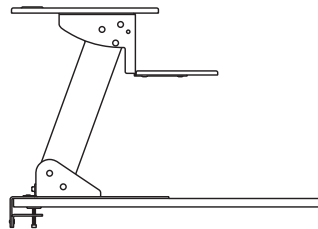

#### Screw Mount

Use when no overhang is available. Worksurface must be minimum 1" thick.

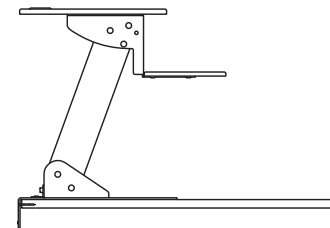

## HOW TO SPECIFY

### Select Model Number



HBXRISER.

### Select Finish

BLK Black  
WHIT White

BLK

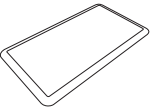
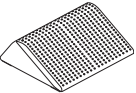

	DESCRIPTION	MODEL	SHIP WEIGHT	CUBE	LIST PRICE
	<b>Rectangle Wobble Board — Anti-Fatigue Mat</b> 18"D x 3"H x 22¼"W ⓘ Available in Black (T) finish ONLY. Recommended weight capacity not to exceed 250 pounds. <b>HON 5-Year Limited Warranty.</b> <b>SPECIFYING EXAMPLE: HVL981.T</b>	<b>HVL981</b>	10.0 Ⓔ	0.9	<b>\$220</b>
	<b>Round Wobble Board — Anti-Fatigue Mat</b> 18½"D x 2⅝"H x 18½"W ⓘ Available in Black (T) finish ONLY. Recommended weight capacity not to exceed 250 pounds. <b>HON 5-Year Limited Warranty.</b> <b>SPECIFYING EXAMPLE: HVL982.T</b>	<b>HVL982</b>	5.8 Ⓔ	0.6	<b>\$190</b>
	<b>Ergonomic Anti-Fatigue Mat</b> 25"D x 2¾"H x 29⅞"W ⓘ <b>AVAILABLE FEBRUARY 2018.</b> Available in Black ONLY. No specification needed. <b>SPECIFYING EXAMPLE: HBEAFM1</b>	<b>HBEAFM1</b>	7.0	1.4	<b>\$176</b>
	<b>Rectangle Anti-Fatigue Mat</b> 20"D x ¾"H x 36"W ⓘ <b>AVAILABLE FEBRUARY 2018.</b> Available in Black ONLY. No specification needed. <b>SPECIFYING EXAMPLE: HBAFM2036</b>	<b>HBAFM2036</b>	5.4	0.4	<b>\$80</b>
	<b>Footrest — Anti-Slip Cover</b> 13¾"D x 5½"H x 16"W ⓘ Available in Black (T) finish ONLY. Recommended weight capacity not to exceed 250 pounds. <b>HON 5-Year Limited Warranty.</b> <b>SPECIFYING EXAMPLE: HVL991.T</b>	<b>HVL991</b>	7.0 Ⓔ	0.9	<b>\$65</b>

## HOW TO SPECIFY

<p>Select Model Number</p> <p>H V L 9 8 1 . T</p>	<p>Select Finish</p> <p>T Black</p>
---	-------------------------------------

# BL SERIES Conference Tables

OPEN MARKET



Icon Legend on page 21

	DESCRIPTION	MODEL	SHIP WEIGHT	CUBE	LIST PRICE
	<b>Rectangular Conference Table with Slab Base</b> 72"W x 36"D	<b>HBLC72R</b> *	128	7.1	<b>\$318</b>
	<b>Round Conference Table with "X" Base</b> 48" Dia.	<b>HBLC48D</b> *	88	7.9	<b>\$262</b>

**NOTES:**

- Compatible with BL Casegoods series.
- Tops and bases are packaged together.
- Durable, thermal-fused laminate is scratch- and spill-resistant.
- **HON 5-Year Limited Warranty.**

\* De-emphasized. Recommend specifying Foundation™ for all future orders.

## HOW TO SPECIFY

<p><b>Select Model Number</b></p>	<p><b>Select Laminate</b></p> <p><b>A1A1</b> Medium Cherry  <b>NN</b> Mahogany  <b>ESES</b> Espresso</p>
<p>H B L C 7 2 R .</p>	<p>A 1 A 1</p>

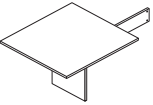
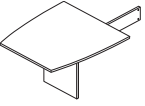
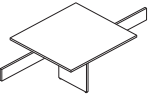

# BL SERIES Modular Conference Tables

	DESCRIPTION	MODEL	SHIP WEIGHT	CUBE	LIST PRICE
	<b>Rectangle Table End Section</b> 48"W x 44"D	<b>HBLMTO48R</b> *	97	6.4	<b>\$260</b>
	<b>Boat Table End Section</b> 48"W x 44"D	<b>HBLMTO48B</b> *	96	6.4	<b>\$260</b>
	<b>Table Adder Section</b> 48"W x 44"D NOTES: Adder Section expands tables in 48"W increments.	<b>HBLMTO48A</b> *	97	6.4	<b>\$272</b>

**NOTES:**

- Coordinates with BL Casegoods series.
  - All models include top, slab base and stretcher rails.
  - Order two end sections to create an 8' table.
  - 2mm PVC edgebanding.
  - Shapes include rectangle and boat.
  - **HON 5-Year Limited Warranty.**
- \* De-emphasized. Recommend specifying Foundation™ for all future orders.

## BL Modular Conference Table Product Reference: Sizes, Sections, Seating Capacity

Feet	Inches	# of Sections	Seating Capacity
8	96	2	6-8
12	144	3	10-12
16	192	4	14-16
20	240	5	18-20
24	288	6	22-24

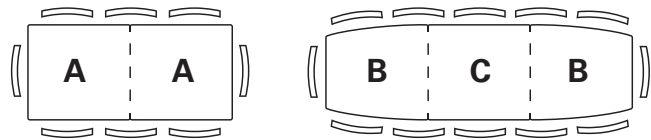

- A** – Rectangle Table End Section
- B** – Boat Table End Section
- C** – Table Adder Section

## HOW TO SPECIFY

<p><b>Select Model Number</b></p> <p>H B L M T O 4 8 R</p>	<p><b>Select Laminate</b></p> <p><b>NN</b> Mahogany <b>A1A1</b> Medium Cherry <b>ESES</b> Espresso</p> <p>N N</p>
--	---



# BL SERIES

## Occasional Tables

OPEN MARKET



Icon Legend on page 21

	DESCRIPTION	MODEL	SHIP WEIGHT	CUBE	LIST PRICE
	<b>Coffee Table</b> 42"W x 20"D x 16"H	<b>HBLH3160</b> *	24 <b>Ⓢ</b>	3.0	<b>\$241</b>
	<b>Corner Table</b> 24"W x 24"D x 20"H	<b>HBLH3170</b> *	9 <b>Ⓢ</b>	1.7	<b>\$188</b>

**NOTES:**

Square  
Edge Detail  
(Laminate)



- **HON 5-Year Limited Warranty.**
- Ideal for reception areas, lounges and offices.
- Laminate tops have a hollow core honeycomb substructure, making them extremely light weight.
- 2" thick top.
- Sleek contemporary design.
- Black laminate finish only available on the BL Series Occasional Tables.

\* De-emphasized. Recommend specifying Foundation™ for all future orders.

### HOW TO SPECIFY

<p><b>Select Model Number</b></p> <p>H B L H 3 1 6 0 . N</p>	<p><b>Select Laminate</b></p> <p>ES Espresso N Mahogany P Black</p>
--	---



Concinnity™ Executive Workstation shown with Ignition® and Grove® Seating and Flock® Tables.

## CONCINNITY™

Clean styling. Rich woodgrains. Mixed materials. A coordinated suite of components. With Concinnity, you can create an upscale look for all types of office spaces — from open to collaborative to private. Choose from a variety of desk configurations and an extensive selection of storage options to create the ideal solution to fit your footprint and your needs.



## FEATURES

- Cohesive visual signature highlighted by clean lines, vertical grain, and components that fit together like custom cabinetry.
- Modular design delivers an unbeatable combination of versatility, style, and personalization to any workspace.
- Wide array of aesthetic options, including edge profiles, handles, mixed materials, and laminate finish combinations.
- Extensive assortment of storage solutions allow users to increase functionality, maximize space and keep everything conveniently within reach.
- Products to create flat, continuous horizontal planes or multi-level, overlapping, layered surfaces.
- Standing-height workstations to support today's healthy work styles; available with adjustable or fixed height bases.

# CONCINNITY™ ORDERING INFORMATION

		Worksurfaces	Chassis	Drawer and Door Fronts	End, Modesty, and Back Panels	O-, Post-, and T-Leg Metal Legs
<b>L1 LAMINATES</b>		<b>CODES</b>				
Woodgrain	◆ Bourbon Cherry	H	•	•	•	•
	◆ Cognac	COGN	•	•	•	•
	◆ Harvest	C	•	•	•	•
	◆ Mahogany	N	•	•	•	•
	◆ Mocha	MOCH	•	•	•	•
	◆ Natural Maple	D	•	•	•	•
	◆ Pinnacle	PINC	•	•	•	•
	◆ Shaker Cherry	F	•	•	•	•
Solid	◆ Black	P	•	•	•	•
	◆ Brilliant White	WHIT	•	•	•	•
	◆ Charcoal	S	•	•	•	•
	◆ Loft	LOFT	•	•	•	•
Patterned	◆ Sheer Mesh	A5	•			
	◆ Silver Mesh	B9	•			
<b>L2 LAMINATES</b>		<b>CODES</b>				
Woodgrain	◆ Lowell Ash	LLA1	•	•	•	•
	◆ Natural Recon	LNR1	•	•	•	•
	◆ Phantom Ecrú	LPE1	•	•	•	•
	◆ Portico Teak	LPT1	•	•	•	•
	◆ Skyline Walnut	LSW1	•	•	•	•
<b>PAINTS/WORKSURFACE GROMMETS</b>		<b>CODES</b>				
Core	◆ Black	P	•			•
Metallic	◆ Platinum Metallic	T1	•			•
<b>HANDLE/LOCK FINISHES</b>		<b>CODES</b>				
Core	◆ Black	P		•		
	◆ Satin	SA		•		

◆◆◆ For lead time information see page 21.

**SILVER COLORWAY:** The following finish options are coordinating silver colorways — Satin, Satin Nickel, Matte Chrome, Platinum, and Platinum Metallic.

		Edge Profiles "B" and "Y"	Edge Profile "G"	
<b>EDGEBAND COLORS</b>		<b>CODES</b>		
Woodgrain	◆ Bourbon Cherry	H	•	
	◆ Cognac	COGN	•	
	◆ Harvest	C	•	
	◆ Lowell Ash	DL	•	
	◆ Mahogany	N	•	
	◆ Mocha	MOCH	•	
	◆ Natural Maple	D	•	
	◆ Natural Recon	NR	•	
	◆ Phantom Ecrú	PE	•	
	◆ Pinnacle	PINC	•	
	◆ Portico Teak	DP	•	
	◆ Shaker Cherry	F	•	
	◆ Skyline Walnut	SW	•	
	Solid	◆ Black	P	•
		◆ Brilliant White	WHIT	•
◆ Charcoal		S	•	
◆ Loft		LOFT	•	

Pattern laminates do not have a matching edgeband color; they are available with a woodgrain or solid color edge.

◆◆◆ For lead time information see page 21.



# CONCINNITY™ ORDERING SPECIFICATION/MODEL LOGIC

DESKS	
Double Pedestal Desk	Model   Edge Profile + Edge Color   Handle   Worksurface Grommet Finish   Worksurface Color   Chassis Color   Drawer Front Color
Single Pedestal Desk (Left & Right)	Model   Edge Profile + Edge Color   Handle   Worksurface Grommet Finish   Worksurface Color   Chassis Color   Drawer Front Color
CREDENZAS	
Credenza w/ Storage	Model   Edge Profile + Edge Color   Handle   Worksurface Grommet Finish   Worksurface Color   Chassis Color   Drawer/Door Front Color
Credenza w/ Kneespace	Model   Edge Profile + Edge Color   Handle   Worksurface Grommet Finish   Worksurface Color   Chassis Color   Drawer Front Color
Credenza w/ Lateral File (Left & Right)	Model   Edge Profile + Edge Color   Handle   Worksurface Grommet Finish   Worksurface Color   Chassis Color   Drawer Front Color
Single Pedestal Credenza (Left & Right)	Model   Edge Profile + Edge Color   Handle   Worksurface Grommet Finish   Worksurface Color   Chassis Color   Drawer Front Color
Credenzas - Low/Bench-Height	Model   Edge Profile + Edge Color   Handle   Top Color   Chassis Color   Drawer Front Color
RETURNS	
Return (Left & Right)	Model   Edge Profile + Edge Color   Handle   Worksurface Grommet Finish   Worksurface Color   Chassis Color   Drawer Front Color
BULLET PENINSULA	
Bullet Peninsula	Model   Edge Profile + Edge Color   Worksurface Color   Chassis Color
BRIDGES	
Bridge	Model   Edge Profile + Edge Color   Worksurface Grommet Finish   Worksurface Color   Chassis Color
CORNER UNITS	
Corner Unit	Model   Edge Profile + Edge Color   Worksurface Grommet Finish   Worksurface Color   Chassis Color
JETTY PENINSULAS	
Jetty Peninsula	Model   Edge Profile + Edge Color   Worksurface Grommet Finish   Worksurface Color   Chassis Color
STACK-ON STORAGE	
Stack-On Storage w/ Laminate Doors	Model   Chassis Color   Door Front Color
Stack-On Storage w/ Laminate Locking Doors	Model   Lock Finish   Chassis Color   Door Front Color
Stack-On Storage w/ Frosted Doors	Model   Chassis Color
Stack-On Storage w/ Sliding Door	Model   Chassis Color   Door Front Color
Stack-On Space Saver End Panels	Model   Laminate Color
WALL MOUNTED STORAGE	
Wall Mounted Storage w/ Laminate Doors	Model   Chassis Color   Door Front Color
Wall Mounted Storage w/ Laminate Locking Doors	Model   Lock Finish   Chassis Color   Door Front Color
Wall Mounted Storage w/ Frosted Doors	Model   Chassis Color
Wall Mounted Storage w/ Sliding Door	Model   Chassis Color   Door Front Color
BOOKCASE HUTCHES	
Bookcase Hutch - No Doors/Open	Model   Laminate Color
Bookcase Hutch w/ Laminate Doors	Model   Handle   Chassis Color   Door Front Color
Bookcase Hutch w/ Frosted Doors	Model   Laminate Color
RECEPTION STATIONS	
Reception Station	Model   Edge Profile   Edge Color   Counter Color   Chassis Color
LATERAL FILES & STORAGE CABINETS	
Lateral File	Model   Edge Profile + Edge Color   Handle   Top Color   Chassis Color   Drawer Front Color
Storage Cabinet - 78½" and 64¾"H	Model   Handle   Chassis Color   Door Front Color
Storage Cabinet - 29½"H	Model   Edge Profile + Edge Color   Handle   Top Color   Chassis Color   Door Front Color
Storage/File Cabinet - No Doors/Open	Model   Handle   Chassis Color   Drawer Front Color
Storage/File Cabinet w/ Laminate Door	Model   Handle   Chassis Color   Door & Drawer Front Color
Lateral File/Storage Cabinet	Model   Handle   Chassis Color   Door & Drawer Front Color
WARDROBES	
Wardrobe/Storage Cabinet	Model   Handle   Chassis Color   Door Front Color
Wardrobe/Bookcase	Model   Handle   Chassis Color   Door Front Color

# CONCINNITY™ ORDERING SPECIFICATION/MODEL LOGIC

<b>STORAGE TOWERS</b>	
24"W Storage Tower	Model   Handle   Chassis Color   Door & Drawer Front Color
18"W Storage Tower	Model   Handle   Chassis Color   Door Front Color
<b>BOOKCASES</b>	
Bookcase	Model   Edge Profile and Edge Color   Top Color   Chassis Color
Bookcase w/ Coat Hooks	Model   Laminate Color
<b>WORKSURFACES</b>	
Rectangle Worksurface	Model   Edge Profile + Edge Color   Grommet   Worksurface Color
Bow Worksurface	Model   Edge Profile + Edge Color   Grommet   Worksurface Color
Bullet Worksurface	Model   Edge Profile + Edge Color   Grommet   Worksurface Color
Extended Corner Worksurface	Model   Edge Profile + Edge Color   Worksurface Grommet   Worksurface Color   End Panel Color
<b>PANELS &amp; LEGS</b>	
27 <sup>7</sup> / <sub>8</sub> "H Modesty/Back Panels	Model   Grommet   Laminate Color
10"H Modesty/Back Panels	Model   Laminate Color
Full Back Panel for Pedestals - 30" & 36"W x 27 <sup>7</sup> / <sub>8</sub> "H	Model   Grommet   Laminate Color
Full Back Panel for Pedestals - 9 <sup>1</sup> / <sub>2</sub> ", 15 <sup>3</sup> / <sub>4</sub> ", & 18"W	Model   Laminate Color
Full Back Panel for Pedestals - 9 <sup>1</sup> / <sub>2</sub> " & 15 <sup>3</sup> / <sub>4</sub> "W x 40 <sup>3</sup> / <sub>8</sub> "H	Model   Laminate Color
Low Back Panel for Pedestal	Model   Laminate Color
Laminate End Panel - 1 <sup>1</sup> / <sub>8</sub> "W x 28 <sup>1</sup> / <sub>2</sub> " or 41"H	Model   Grommet   Laminate Color
Laminate End Panel - 1 <sup>1</sup> / <sub>8</sub> "W x 7"H	Model   Laminate Color
Laminate End Panel - L-Shape	Model   Grommet   Laminate Color
Laminate End Panel - T-Shape	Model   Laminate Color
Laminate End Panel - Kneespace Clearance	Model   Laminate Color
Laminate End Panel - Support Brace	Model   Laminate Color
Metal O-Leg	Model   Paint Color
<b>PEDESTALS</b>	
Pedestal - Narrow Box/Box/File	Model   Handle   Grommet   Chassis Color   Drawer Front Color
Pedestal - Narrow File/File	Model   Handle   Grommet   Chassis Color   Drawer Front Color
Pedestal - Box/Box/File	Model   Handle   Grommet   Chassis Color   Drawer Front Color
Pedestal - File/File	Model   Handle   Grommet   Chassis Color   Drawer Front Color
Pedestal - Lateral File	Model   Handle   Grommet   Chassis Color   Drawer Front Color
Pedestal - Shelf/Box/Box/Lateral File	Model   Handle   Grommet   Chassis Color   Drawer Front Color
Pedestal - Storage Cabinet	Model   Handle   Grommet   Chassis Color   Door Front Color
Pedestal - Bookcase Pedestal	Model   Grommet   Chassis Color
Pedestal - Bookcase End Support	Model   Chassis Color
Mobile Pedestal - Box/Box/File, File/File, Box/File	Model   Handle   Chassis Color   Drawer Front Color
Mobile Pedestal - 30"W Shelf/File/Storage	Model   Edge Profile + Edge Color   Handle   Top Color   Chassis Color   Drawer/Door Front Color
Pedestal Tops	Model   Edge Profile + Edge Color   Top Color
<b>ACCESSORIES</b>	
Laminate Center Drawer	Model   Laminate Color
Collaborative Desk Shelf	Model   Laminate Color
Wall Mount Markerboard	Model
Wall Mount Tackboard	Model   Fabric
Field Installable Grommet	Model
Lock Core Kit	Model

# CONCINNITY™ LAMINATE DESIGN/MATERIALS INFORMATION

## STYLING AND CONSTRUCTION

- Conventional desking or light scale components.
- Clean, uninterrupted lines and precise fits; no gaps.
- All end, modesty, and back panels, as well as drawer and door fronts, that are specified in a woodgrain color, feature vertical grain; drawer fronts are vertically-aligned, continuous grain and are matched sets.
- All desk, credenza, and return models feature full-to-the-floor pedestals to maximize storage space.
- Factory-configured (i.e., built-up; assembled) 72"W desks can be specified with breakfront or recessed modesty panels.
- Formal, full height modesty panels on factory-configured (i.e., built-up; assembled) desks, credenzas, and returns; modular components available with full or 10" modesty panels.
- Drawer and door fronts over end panels.
- Back panel-over-end panel on desks, credenzas, returns, mobile pedestals, 29½"H lateral files and storage cabinets, and full-length modesty panels for modular pedestals.
- Top-between-end panels on stack-on and wall mount storage, 66⅝"H & 79½"H storage and combination storage cabinets, wardrobes and towers.
- Option choices include:
  - Edge profile and edge color
  - Handle design
  - Handle/worksurface grommet/lock face finish
  - Worksurface color
  - Chassis color
  - Drawer front/door color
- **IMPORTANT NOTE:** Designed and sized to coordinate with 65"H Accelerate® Panels.
  - Desks, credenzas, returns, 2-drawer lateral files, and 29½"H storage cabinets, plus 35¼"H stack-on storage or bookcase hutch, are 64¾"H.
  - Additional solutions ≤65"H include the following: storage cabinet, storage/file cabinet, storage cabinet/lateral file, 18" and 36"W wardrobe/storage cabinets, wardrobe/bookcase, storage tower, and 5-shelf bookcase.

## MATERIALS

- Easy-care, scratch-, spill- and stain-resistant thermal-fused laminate (TFL) over solid core, high performance particleboard;
  - Component model thickness: 1⅛" worksurfaces and end panels; ¾" modesty panel and drawer/door fronts.
- Durable, impact-resistant banding protects edges.

- Bottom of end panels on base units and stack-ons feature edgebanding for added strength and to seal out moisture.
- HPL worksurfaces are available via special request.

## DRAWER SPECIFICATIONS

- Operate on steel ball-bearing slides to ensure smooth, quiet, long-lasting operation.
- Full extension drawers allow complete access to contents.
- Drawers feature 5-sided construction for added strength and easy alignment or replacement of drawer fronts.
- File drawers include integrated hangrails for side-to-side letter or legal filing; and front-to-back for letter filing.
- One molded black pencil tray is included in each box/box/file pedestal.
- Drawer fronts are edgebanded on all four sides.

## CORE REMOVABLE LOCKS

- All drawers/doors lock on the following products:
  - All desk, credenza, and return pedestals (NOTE: The lock is on the face of the pedestal)
  - Stack-on and wall mount storage with laminate locking doors ("LL" models)
  - Wall mount storage with sliding door
  - Mobile pedestals
  - Lateral files
  - Storage cabinets
  - Storage/file cabinet
  - Storage cabinet/lateral file
  - Wardrobe/storage cabinets
  - Storage towers
  - Modular pedestals
- On products that are equipped with two locks, the locks are keyed alike:
  - Double pedestal desks
  - Credenza with storage
  - Credenzas with kneespace
  - Low credenzas with four drawers
  - Storage and combination storage/file cabinets
  - Storage towers
  - Stack-on and wall mount storage 60" - 78"W
- Lock faces are available in black or satin.

# CONCINNITY™ LAMINATE DESIGN/MATERIALS INFORMATION

- Locks feature a removable cylinder (core) that can be interchanged as needed; allows all furniture pieces within an individual workstation to be accessed with one key for convenience, and allows locks to be differentiated between workstations and offices for security. Makes re-keying quick and easy.
  - Keyed alike cores must be ordered separately by specification of the key number. For all products, except stack-on and wall mounted storage, the removable lock core kits are HF23B for Black and HF23S for Satin (Silver).
  - EXCEPTION - IMPORTANT - NOTE: The removable lock core kit for stack-on and wall mounted storage is model HF27B (Black) or HF27S (Satin).

## CORD MANAGEMENT

- Cord management grommets and pass-through cutouts, for routing and hiding wires and cables, are standard in a pre-determined location on a number of factory-configured (i.e., built-up; assembled) products:
  - Two grommets are located in the tops of desks and credenzas; one grommet is located in the top of returns, bridges, jetty peninsulas, and corner units.
  - All desk, credenza, and return pedestals are designed with two cord pass-through grommets, one per side; end panels of single pedestal desks and single pedestal credenzas feature one cord pass-through grommet.
  - Pass-through in the sides of pedestals and end panels enable the routing of cords below the worksurface and connections between workstations.
  - A pass-through grommet, to facilitate reaching wall electrical outlets, is located in the back panels of credenza with storage, credenza with kneespace, single pedestal credenzas, credenzas with 36" lateral file, returns and bridges.
- See chart on page 104 for cord management options. Worksurfaces/tops, end and modesty panels, and pedestals can be specified with or without grommets.
- Grommets on worksurfaces are sized to accept optional grommet mount power hub (HGRMTAC) and USB (HGRMTUSB2) models.

- Grommet color/shape/size:
  - Worksurfaces, Black or Platinum, Round, 3" diameter hole with a 3½" plastic cap.
  - Back/modesty panels, Black, Round, 2½" diameter hole with a 3" plastic cap.
  - End panels and pedestal sides, Black, Half-round, 1¾" diameter hole with a 2" x 2½" plastic cap.

## LEVELING GLIDES

- Adjustable hex glides to compensate for uneven floors; allow furniture to be easily leveled without lifting the unit.
  - Glides have a 1¼" adjustable range.
  - The hex adjustment is on the foot of the glide for all products except for the 9½", 15¾", and 18"W modular pedestals, in which case it is on the top of the glide stem.

## IMPORTANT — OTHER

- Products ship fully assembled, unless otherwise noted (NOTE:  — easy-to-assemble — items are designated in the "DESCRIPTIONS").
- All models must meet or exceed ANSI/BIFMA & ISTA performance standards.
- Products covered by HON Limited Lifetime Warranty.
- Indoor Advantage™ Gold. Indoor Air Quality Certified to SCS-EC10.3-2014 v3.0.
- BIFMA level® 2 certified. Conforms to ANSI/BIFMA e32014e Furniture Sustainability Standard.



# CONCINNITY™ LAMINATE ORDERING/SPECIFICATION INFORMATION

## WORKSURFACE/TOP EDGE DETAILS

- Three options; two contoured profiles and one smooth, flat edge.
- For beaded (B) and tri-oval (V) edge shapes, tops are profiled on the user and approach sides, and flat on the ends; the flat edges allow side-by-side placement of worksurfaces without gaps. **The only exceptions are return, bridge, corner unit, extended corner worksurface, and rectangle worksurface with vertical grain models, tops on these items are profiled on the user's side and flat banded on the approach side and ends.**
  - Bookcases have profiled edge on the front, user side only.
  - The reception station transaction counter and the L-reception station with transaction counter (for the desk) models, have profiled edgeband on the approach and user sides.
  - The L-reception station with the transaction counter models, on which the counter runs around the entire perimeter of the L-configuration, have a profiled edge on the front of the transaction counter on the desk approach side only.

**Edge Options:                      Profiles                      Designator**

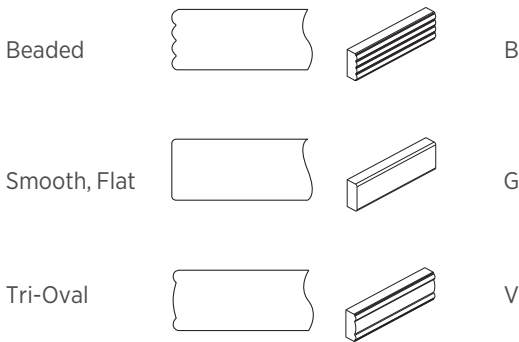

## WORKSURFACE EDGE COLORS

- Woodgrain and solid color laminates can be specified with a matching, complementary, or contrasting edgeband color; options include:
  - Matching the worksurface edge to a common worksurface, chassis, and drawer front color.
  - Matching the worksurface edge to the worksurface laminate and selecting a different laminate color for the chassis.
  - Matching the worksurface edge to the chassis laminate and selecting a different laminate color for the worksurface.
- Beaded (B) and tri-oval (V) edges are available in L1 woodgrain colors only.
- The smooth, flat (G) edge is available in woodgrain and solid colors.
- Pattern laminates do not have a matching edgeband color; the patterns are available with a woodgrain or solid color edge.

	WORKSURFACE LAMINATES	CODES	EDGE BAND OPTIONS				
			Any Woodgrain	Black (P)	Brilliant White (WHIT)	Charcoal (S)	Loft (LOFT)
Woodgrain	Bourbon Cherry	H	•	•	•	•	•
	Cognac	COGN	•	•	•	•	•
	Harvest	C	•	•	•	•	•
	Lowell Ash	LLA1	•	•	•	•	•
	Mahogany	N	•	•	•	•	•
	Mocha	MOCH	•	•	•	•	•
	Natural Maple	D	•	•	•	•	•
	Natural Recon	LNR1	•	•	•	•	•
	Phantom Ecrú	LPE1	•	•	•	•	•
	Pinnacle	PINC	•	•	•	•	•
	Portico Teak	LPT1	•	•	•	•	•
	Shaker Cherry	F	•	•	•	•	•
	Skyline Walnut	LSW1	•	•	•	•	•
Solid	Black	P	•	•	•	•	•
	Brilliant White	WHIT	•	•	•	•	•
	Charcoal	S	•	•	•	•	•
	Loft	LOFT	•	•	•	•	•
Pattern	Sheer Mesh	A5	•	•	•	•	•
	Silver Mesh	B9	•	•	•	•	•

## DRAWER/DOOR DECORATIVE HANDLES

- Three handle style options, each available in Satin or Black finish.
- Distinct, easy to grasp designs.
- Handles are metal.
- The hole spacing is 128mm.
- The handle style/finish has to be specified on drawer fronts (desk/credenza/return, mobile and modular pedestals), lateral file drawer fronts, the doors of the storage cabinet, storage/file cabinet, storage cabinet/lateral file, wardrobe/storage cabinet, wardrobe/bookcase, and storage tower.
  - NOTE: Decorative handles are not used on the doors of stack-on storage units or wall mounted storage cabinets.
  - Bookcase hatches with frosted doors are equipped with a push latch release.

Handle Options		Finish	Designator
Cylinder		Satin	A
Cylinder		Black	B
Canopy		Satin	C
Canopy		Black	D
Loop		Satin	E
Loop		Black	F

- NOTE: The Linear and Arch field installable drawer/door handle kit models can be attached using 128mm hole spacing.

## LAMINATE ORDERING/SPECIFICATION INFORMATION

### CORD MANAGEMENT GROMMETS

- Grommets are standard on desk, credenza, return, bridge, jetty peninsula, and corner unit models. Specification logic includes the grommet finish for tops; choose from Black (P) or Platinum (T1). Grommets in modesty and end panels are Black only.
- Grommets are optional on modular component worksurfaces, full-length (27<sup>7</sup>/<sub>8</sub>"H) modesty panels, end panels (1<sup>1</sup>/<sub>8</sub>", L-shaped) and the sides of support storage pedestals. On worksurfaces, choose from Black (P), Platinum (T1), or no grommet(s) (X). On modesty, end, and side panels the options are grommet Black (P) or no grommet (X).
- See cord management chart on page 104 for details.

### LOCK FINISH

- Finish is determined by, and automatically aligned with, the handle finish specified. If there is no decorative handle on the product, such as on locking stack-on or wall mount storage models, the lock finish is specified separately in the option string.
  - When specification is required, the lock finish options are Black (P) or Satin (SA).
- Removable, interchangeable lock core kits must be ordered separately:
  - For all models, except stack-on and wall mount storage, specify model HF23B (Black) or HF23S (Satin), and the specific key number required.
  - For stack-on and wall mount storage, specify model HF27B (Black) or HF27S (Satin), and the specific key number required.

### SILVER COLORWAY

- The following finish options are coordinating Silver colorways: Satin, Satin Nickel, Matte Chrome, Platinum, and Platinum Metallic.

### LAMINATE COLORS

- Palette choices include eight (13) woodgrain, four (4) solid, and two (2) pattern colors.

Woodgrain		Solid Color		Pattern	
Bourbon Cherry	H	Black	P	Sheer Mesh	A5
Cognac	COGN	Brilliant White	WHIT	Silver Mesh	B9
Harvest	C	Charcoal	S		
Lowell Ash	LLA1	Loft	LOFT		
Mahogany	N				
Mocha	MOCH				
Natural Maple	D				
Natural Recon	LNR1				
Phantom Ecru	LPE1				
Pinnacle	PINC				
Portico Teak	LPT1				
Shaker Cherry	F				
Skyline Walnut	LSW1				

- Worksurface, chassis and drawer/door fronts are specified separately to enable a single, color-matched visual, or a complementary or contrasting, multi-tone aesthetic.
- Worksurfaces/tops are available in woodgrain, solid, or pattern laminate colors.
- Chassis and drawer fronts are available in woodgrain or solid laminate colors.
- Pattern colors are available on worksurface tops only.

Worksurface		Chassis		Drawer/Door	
Bourbon Cherry	H	Bourbon Cherry	H	Bourbon Cherry	H
Cognac	COGN	Cognac	COGN	Cognac	COGN
Harvest	C	Harvest	C	Harvest	C
Lowell Ash	LLA1	Lowell Ash	LLA1	Lowell Ash	LLA1
Mahogany	N	Mahogany	N	Mahogany	N
Mocha	MOCH	Mocha	MOCH	Mocha	MOCH
Natural Maple	D	Natural Maple	D	Natural Maple	D
Natural Recon	LNR1	Natural Recon	LNR1	Natural Recon	LNR1
Phantom Ecru	LPE1	Phantom Ecru	LPE1	Phantom Ecru	LPE1
Pinnacle	PINC	Pinnacle	PINC	Pinnacle	PINC
Portico Teak	LPT1	Portico Teak	LPT1	Portico Teak	LPT1
Shaker Cherry	F	Shaker Cherry	F	Shaker Cherry	F
Skyline Walnut	LSW1	Skyline Walnut	LSW1	Skyline Walnut	LSW1
Black	P	Black	P	Black	P
Brilliant White	WHIT	Brilliant White	WHIT	Brilliant White	WHIT
Charcoal	S	Charcoal	S	Charcoal	S
Loft	LOFT	Loft	LOFT	Loft	LOFT
Sheer Mesh	A5				
Silver Mesh	B9				

- Two-tone color options allow specification of different, complementary laminate combinations:

Color #1	Color #2
Top	Chassis and Drawer Fronts
Top and Drawer Fronts	Chassis
Top and Chassis	Drawer Fronts

- Modesty panels and the backs of storage chassis that are specified in L2 laminates and wider than 60"W will ship as horizontal grain.

# CONCINNITY™ CORD MANAGEMENT

	GROMMET	# OF GROMMETS	LOCATION	CUTOUT SHAPE	MATERIAL	COLOR/FINISH
<b>BUILT-UP/FACTORY-CONFIGURED</b>						
<b>DESK</b>						
Top	Standard/Fixed Location	2	Back Left & Right	3" Round	Plastic	Black or Platinum
End Panel	Standard/Fixed Location	2 (1 per EP)	Top Back Corner	1¼" Round	Plastic	Black
Modesty/Back	Not Available	0	N/A	N/A	N/A	N/A
<b>CREDENZA</b>						
Top	Standard/Fixed Location	2	Back Left & Right	3" Round	Plastic	Black or Platinum
End Panel	Standard/Fixed Location	2 (1 per EP)	Top Back Corner	1¼" Round	Plastic	Black
Modesty/Back	Standard/Fixed Location	1	Top Center	2½" Round	Plastic	Black
<b>RETURN</b>						
Top	Standard/Fixed Location	1	Top Center	3" Round	Plastic	Black or Platinum
End Panel	Standard/Fixed Location	1	Top Back Corner	1¼" Round	Plastic	Black
Modesty/Back	Standard/Fixed Location	1	Top Center	2½" Round	Plastic	Black
<b>BRIDGE</b>						
Top	Standard/Fixed Location	1	Back Center	3" Round	Plastic	Black or Platinum
Modesty/Back	Standard/Fixed Location	1	Top Center	2½" Round	Plastic	Black
<b>BULLET PENINSULA</b>						
Top	Not Available	0				
End Panel	Not Available; Pass-Thru in Brace Panel	0				
<b>JETTY PENINSULA</b>						
Top	Standard/Fixed Location	1	Back, Approach-Side Corner	3" Round	Plastic	Black or Platinum
End Panel	Not Available; Pass-Thru Standard in Brace Panel	0				
<b>CORNER UNIT</b>						
Top	Standard/Fixed Location	1	Back Corner	3" Round	Plastic	Black or Platinum
Modesty/Back	Not Available; Pass-Thru Standard in Brace Panels	0				
Stack-on	Standard/Fixed Location	1	1¼" Side-to-Side Gap at Top or Bottom of Back Panel, Below Cabinet			
<b>MODULAR COMPONENTS – WORKSURFACES</b>						
Rectangle – 60" to 96"W	Optional – Specify: Black (P) or Platinum (TI) or None (X)	2	Back Left & Right	3" Round	Plastic	Black or Platinum
Rectangle – 30" to 54"W	Optional – Specify: Black (P) or Platinum (TI) or None (X)	1	Back Center	3" Round	Plastic	Black or Platinum
Bullet Shape	Optional – Specify: Black (P) or Platinum (TI) or None (X)	1	Centered Along EP; Over Brace Leg Cutout	3" Round	Plastic	Black or Platinum
Ext. Corner	Optional – Specify: Black (P) or Platinum (TI) or None (X)	1	Back Corner of Top and Long End Panel	3" Round	Plastic	Black or Platinum
<b>MODULAR COMPONENTS – MODESTY PANELS</b>						
Full-Length – ≥30"W	Optional – Specify: Black (P) or None (X)	1	Top Center	2½" Round	Plastic	Black
10"	No	0				
<b>MODULAR COMPONENTS – END PANELS</b>						
1½" Thick	Optional – Specify: Black (P) or None (X)	1	Top Back Corner	1¼" Round	Plastic	Black
T-Shaped	No	0				
L-Shaped	Optional – Specify: Black (P) or None (X)	1	Top or Bottom Centered	1¼" Round	Plastic	Black
<b>MODULAR COMPONENTS – STORAGE PEDESTALS</b>						
Pedestal	Optional – Specify: Black (P) or None (X)	2 (1 per EP)	Top Back Corner	1¼" Round	Plastic	Black

NOTE: If customer wants a desk, credenza, return, or bridge without grommets, they can specify modular components.

## Grommet Locations in Tops

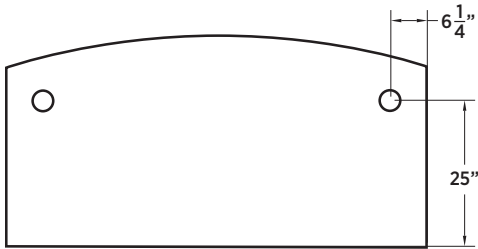

Bow Top Desks and Worksurfaces

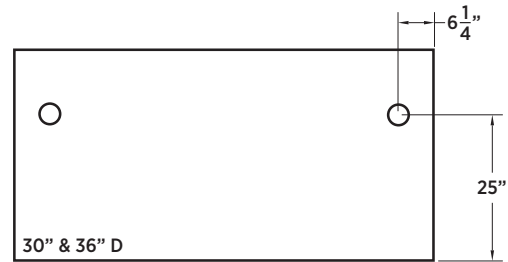

30" & 36" D  
Desks and Rectangle Worksurfaces

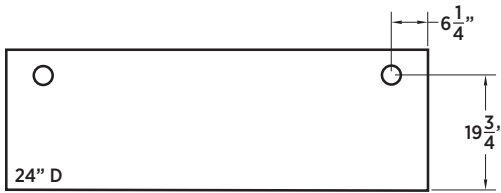

24" D  
Credenzas and Rectangle Worksurfaces

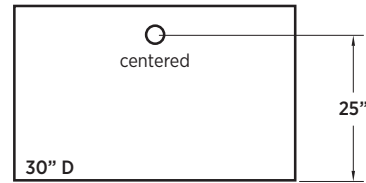

30" D  
Rectangle Worksurfaces

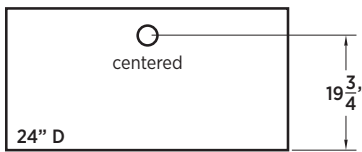

24" D  
Returns, Bridges, and Rectangle Worksurfaces

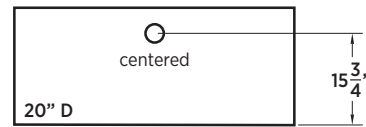

20" D  
Rectangle Worksurfaces

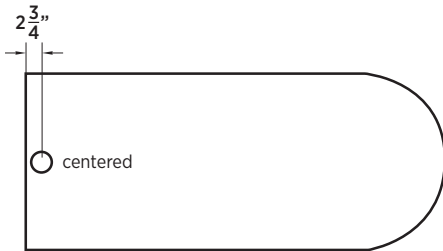

Bullet Worksurfaces

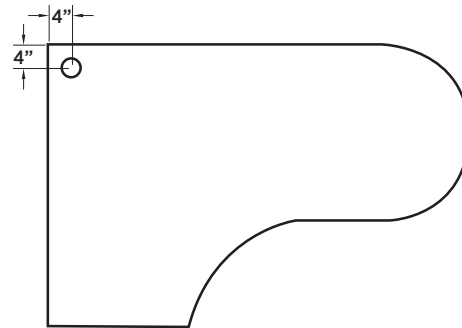

Jetty Peninsula

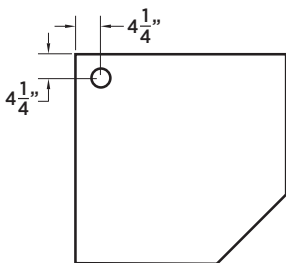

Corner Unit

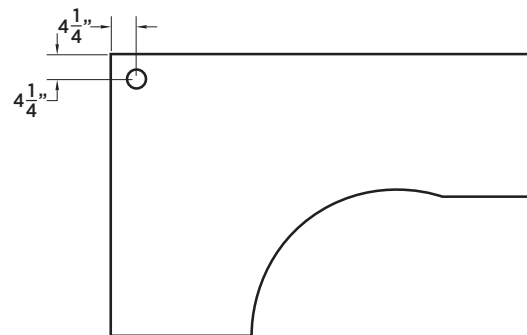

Extended Corner Worksurfaces

# CONCINNITY™

## Typicals



Icon Legend on page 21

QTY	DESCRIPTION	MODEL	LIST PRICE	PRICE EXTENSION
1	<b>Double Pedestal Desk, Bow Top, Breakfront Frosted Modesty Panel</b> 72"W x 36"D x 29½"H	HNL3672DPBBF	\$2,683	\$2,683
1	<b>Credenza with Kneespace</b> 72"W x 24"D x 29½"H	HNL2472DPK	\$1,691	\$1,691
1	<b>Wall Mount Storage, Frosted Doors with Silver Frame</b> 72"W x 15"D x 28½"H	HNL2972FD	\$2,231	\$2,231
1	<b>Storage/File Cabinet, Hinged Right</b> 18"W x 24"D x 64¾"H	HNL241865SFLR	\$1,618	\$1,618
1	<b>Storage/File Cabinet, Hinged Left</b> 18"W x 24"D x 64¾"H	HNL241865SFL	\$1,618	\$1,618
<b>TOTAL:</b>			<b>\$9,841</b>	

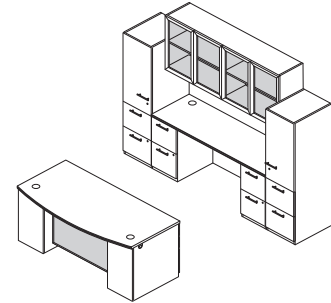
**DESK — CREDENZA — STORAGE**

QTY	DESCRIPTION	MODEL	LIST PRICE	PRICE EXTENSION
1	<b>Left Pedestal Desk, Rectangle Top, Breakfront Modesty Panel</b> 72"W x 36"D x 29½"H	HNL3672LPRB	\$1,777	\$1,777
1	<b>Rectangle Worksurface with Vertical Grain</b> 42"W x 24"D	HNLRC2442V	\$228	\$228
1	<b>Narrow File/File Pedestal</b> 9½"W x 23⅞"D x 28½"H	HNL231028PFF	\$641	\$641
1	<b>Modesty/Back Panel — Full-Length</b> 42"W x 27⅞"H	HNLMP4228	\$189	\$189
1	<b>Stack-on Storage, Sliding Door</b> 78"W x 15"D x 35¼"H	HNL3678SD	\$1,178	\$1,178
1	<b>Storage/File Cabinet, Open Shelves</b> 18"W x 24"D x 64¾"H	HNL241865SFX	\$1,536	\$1,536
<b>TOTAL:</b>			<b>\$5,549</b>	

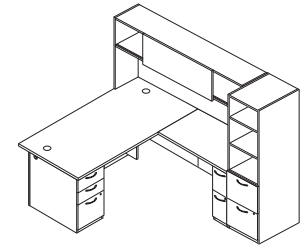
**L-WORKSTATION**

QTY	DESCRIPTION	MODEL	LIST PRICE	PRICE EXTENSION
1	<b>Rectangle Worksurface</b> 72"W x 30"D	HNLRC3072	\$394	\$394
1	<b>Narrow Box/Box/File Pedestal</b> 9½"W x 29⅞"D x 28½"H	HNL291028PBBF	\$717	\$717
1	<b>Full Back Panel — For 9½"W Pedestal</b> 9½"W x 27⅞"H	HNLPB1028	\$115	\$115
1	<b>Laminate Floating Modesty Panel</b> 36"W x 14"H	HLSL3614L	\$163	\$163
1	<b>Bookcase End Support</b> 12"W x 30"D x 28½"H	HNL123028BKE	\$471	\$471
1	<b>Rectangle Worksurface</b> 72"W x 24"D	HNLRC2472	\$327	\$327
1	<b>Shelf/Box/Box/Lateral File Pedestal</b> 36"W x 23⅞"D x 28½"H	HNL233628PSL	\$1,157	\$1,157
1	<b>Storage Cabinet Pedestal</b> 36"W x 23⅞"D x 28½"H	HNL233628PSC	\$752	\$752
1	<b>Modesty/Back Panel — Full-Length</b> 72"W x 27⅞"H	HNLMP7228	\$264	\$264
1	<b>Stack-on Storage, Sliding Door</b> 72"W x 15"D x 35¼"H	HNL3672SD	\$1,143	\$1,143
1	<b>Bookcase with Coat Hooks, 5-Shelf, Left</b> 24"W x 24"D x 64¾"H	HNL2424BK5CL	\$890	\$890
<b>TOTAL:</b>			<b>\$6,393</b>	

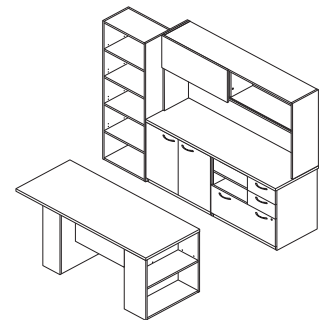
**DESK — CREDENZA — STORAGE**



Icon Legend on page 21

# CONCINNITY™ Typicals

DESKS

QTY	DESCRIPTION	MODEL	LIST PRICE	PRICE EXTENSION
1	<b>Rectangle Worksurface</b> 60"W x 24"D	HNLRC2460	\$291	\$291
1	<b>Height Adjustable Base</b>	HHAB3S2L	\$912	\$912
1	<b>Rectangle Worksurface</b> 84"W x 24"D	HNLRC2484	\$441	\$441
1	<b>End Panel, Left</b> 1½"W x 23⅞"D x 28½"H	HNL2428L	\$189	\$189
1	<b>Shelf/Box/Box/Lateral File Pedestal</b> 36"W x 23⅞"D x 28½"H	HNL233628PSL	\$1,157	\$1,157
1	<b>Modesty/Back Panel — Short</b> 84"W x 10"H	HNLMP8410	\$322	\$322
1	<b>Low Back Panel — For 28½"H Pedestal</b> 36"W x 18"H	HNLB3618	\$138	\$138
2	<b>Stack-on Storage, Frosted Doors with Silver Frame</b> 42"W x 15"D x 35¼"H	HNL3642FD	\$1,232	\$2,464
1	<b>Space Saver End Panels for Stack-on Storage</b> ¾"W x 14¼"D x 35¼"H	HNL3605SSEP	\$351	\$351
1	<b>Wardrobe/Storage Cabinet, Hinged Right</b> 18"W x 24"D x 64¾"H	HNL241865WLR	\$1,478	\$1,478

**TOTAL: \$7,743**

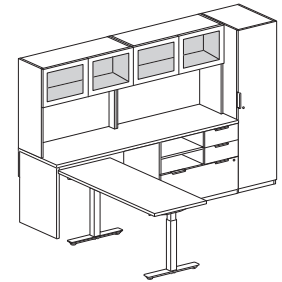

**L-WORKSTATION WITH HEIGHT-ADJUSTABLE DESK — OPEN PLAN**

QTY	DESCRIPTION	MODEL	LIST PRICE	PRICE EXTENSION
1	<b>Bullet Worksurface</b> 84"W x 30"D	HNLBU3084	\$559	\$559
1	<b>T-Shaped End Panel — For Bullet Worksurface</b> 11⅝"W x 29⅞"D x 28½"H	HNLTEP3028	\$327	\$327
1	<b>Support Column — For Bullet Worksurface</b> 4½" Diameter	HPC190X	\$148	\$148
1	<b>Bridge</b> 48"W x 24"D x 29½"H	HNL2448BF	\$415	\$415
1	<b>Rectangle Worksurface</b> 84"W x 24"D	HNLRC2484	\$441	\$441
1	<b>End Panel, Left</b> 1½"W x 23⅞"D x 28½"H	HNL2428L	\$189	\$189
1	<b>Shelf/Box/Box/Lateral File Pedestal</b> 36"W x 23⅞"D x 28½"H	HNL233628PSL	\$1,157	\$1,157
1	<b>Modesty/Back Panel — Full-Length</b> 84"W x 27⅞"H	HNLMP8428	\$322	\$322
2	<b>Stack-on Storage, Laminate Doors</b> 42"W x 15"D x 48⅝"H	HNL4942LD	\$1,122	\$2,244
1	<b>Space Saver End Panels for Stack-on Storage</b> ¾"W x 14¼"D x 48⅝"H	HNL4905SSEP	\$476	\$476

**TOTAL: \$6,278**

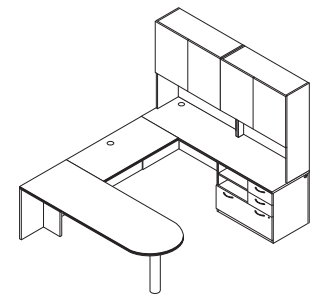

**U-WORKSTATION WITH 84" W WORKSURFACE**

QTY	DESCRIPTION	MODEL	LIST PRICE	PRICE EXTENSION
1	<b>Left Pedestal Desk, Rectangle Top, Breakfront Frosted Modesty Panel</b> 72"W x 36"D x 29½"H	HNL3672LPRBF	\$2,227	\$2,227
1	<b>Rectangle Worksurface with Vertical Grain</b> 48"W x 24"D	HNLRC2448V	\$245	\$245
1	<b>Modesty/Back Panel — Short</b> 48"W x 10"H	HNLMP4810	\$204	\$204
1	<b>Right Credenza with Lateral File</b> 72"W x 24"D x 29½"H	HNL2472RLC	\$1,473	\$1,473
1	<b>Stack-on Storage, Frosted Doors with Silver Frame</b> 72"W x 15"D x 48⅝"H	HNL4972FD	\$2,427	\$2,427
1	<b>Vertical Paper Manager</b>	HLVPM1	\$298	\$298
1	<b>Wardrobe Left, Bookcase Right</b> 36"W x 24"D x 78⅞"H	HNL243679WLBR	\$2,356	\$2,356

**TOTAL: \$9,230**

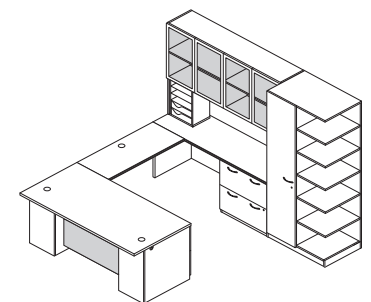

**U-WORKSTATION**

# CONCINNITY™

## Typicals



Icon Legend on page 21

QTY	DESCRIPTION	MODEL	LIST PRICE	PRICE EXTENSION
1	<b>Rectangle Worksurface</b> 72"W x 30"D	HNLRC3072	\$394	\$394
1	<b>Rectangle Worksurface with Vertical Grain</b> 42"W x 24"D	HNLRC2442V	\$228	\$228
1	<b>Height Adjustable Base, 3-Leg</b>	HHAB3S3L	\$1,565	\$1,565
1	<b>Mixed Material Floating Modesty Panel</b> 60"W x 14"H	HLSL6014MM	\$1,023	\$1,023
1	<b>Rectangle Worksurface</b> 72"W x 24"D	HNLRC2472	\$327	\$327
1	<b>End Panel, Right</b> 1½"W x 23⅝"D x 28½"H	HNLEP2428R	\$189	\$189
1	<b>Box/Box/File Pedestal</b> 15¾"W x 23⅝"D x 28½"H	HNL231628PBBF	\$663	\$663
1	<b>Low Back Panel — For 15¾"W Pedestal</b> 15¾"W x 18"H	HNLLB1618	\$117	\$117
1	<b>Modesty/Back Panel — Short</b> 72"W x 10"H	HNLMP7210	\$264	\$264
1	<b>Wall Mount Storage, Frosted Doors with Silver Frame</b> 72"W x 15"D x 15"H	HNL1572FD	\$1,675	\$1,675
1	<b>Storage/File Cabinet, Hinged Left</b> 18"W x 24"D x 64¾"H	HNL241865SFL	\$1,618	\$1,618
<b>TOTAL:</b>			<b>\$8,063</b>	

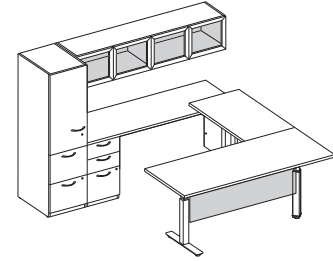

**U-WORKSTATION WITH HEIGHT-ADJUSTABLE L-WORKSURFACE**

QTY	DESCRIPTION	MODEL	LIST PRICE	PRICE EXTENSION
1	<b>Rectangle Worksurface</b> 72"W x 24"D	HNLRC2472	\$327	\$327
2	<b>O-Leg Support for 24"D Worksurface</b> 24"D x 28½"H	HLSL2428O	\$291	\$582
1	<b>External Support Channel for 72"W Worksurface</b>	HLSLZ5SC78	\$100	\$100
1	<b>Low Credenza, Drawers Left, Bookcase Right</b> 60"W x 20"D x 21½"H	HNL206021LD2	\$1,176	\$1,176
1	<b>Rectangle Worksurface</b> 54"W x 24"D	HNLRC2454	\$266	\$266
1	<b>Standing-Height O-Leg Support for 24"D Worksurface</b> 24"D x 41"H	HLSL2441O	\$390	\$390
1	<b>Narrow Box/Box/File/File Pedestal</b> 9½"W x 23⅝"D x 41"H	HNL231041PBBFF	\$1,229	\$1,229
1	<b>Full Back Panel — For 41"H Pedestal</b> 9½"W x 40⅜"H	HNLPB1041	\$128	\$128
1	<b>Storage Tower, Hinged Left</b> 18"W x 24"D x 50"H	HNL241850TLL	\$1,157	\$1,157
<b>TOTAL:</b>			<b>\$5,355</b>	

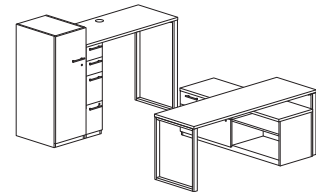

**U-WORKSTATION WITH SITTING AND STANDING-HEIGHT WORKSURFACES — OPEN PLAN**



Icon Legend on page 21

# CONCINNITY™ Typicals

QTY	DESCRIPTION	MODEL	LIST PRICE	PRICE EXTENSION
1	<b>Rectangle Worksurface</b> 72"W x 30"D	HNLRC3072	\$394	\$394
1	<b>O-Leg Support for 30"D Worksurface</b> 30"D x 28½"H	HLSL30280	\$323	\$323
1	<b>O-Leg Support over Low Credenza</b> 30"D x 7"H	HLSL3070	\$249	\$249
1	<b>External Support Channel for 72"W Worksurface</b>	HLSLZ5SC78	\$100	\$100
1	<b>Low Credenza, Drawers Right, Bookcase Left</b> 60"W x 20"D x 21½"H	HNL206021RD2	\$1,176	\$1,176
1	<b>Low Credenza, Drawers Left, Bookcase Right</b> 60"W x 20"D x 21½"H	HNL206021LD2	\$1,176	\$1,176
2	<b>Wall Mount Storage, Laminate Doors</b> 30"W x 15"D x 48⅝"H	HNL2930LD	\$761	\$1,522
1	<b>Wall Mount Storage, Frosted Doors with Silver Frame</b> 30"W x 15"D x 48⅝"H	HNL2930FD	\$1,211	\$1,211
1	<b>Wall Mount Markerboard</b> 30"W x 48⅝"H	HNL4930WB	\$212	\$212
<b>TOTAL:</b>			<b>\$6,363</b>	

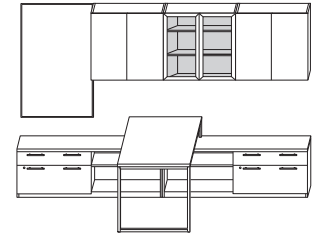

**WORKSTATION WITH  
WORKWALL – OPEN PLAN**

QTY	DESCRIPTION	MODEL	LIST PRICE	PRICE EXTENSION
3	<b>Rectangle Worksurface with Vertical Grain</b> 48"W x 24"D	HNLRC2448V	\$245	\$735
3	<b>O-Leg Support for 48"W x 24"D Worksurface</b> 24"D x 28½"H	HLSL24280	\$291	\$873
3	<b>Mixed Material Floating Modesty Panel</b> 42"W x 14"H	HLSL4214MM	\$745	\$2,235
3	<b>Rectangle Worksurface</b> 72"W x 24"D	HNLRC2472	\$327	\$981
3	<b>L-Shaped End Panel, Left</b> 15¾"W x 24"D x 28½"H	HNLLEP2428L	\$307	\$921
3	<b>Shelf/Box/Box/Lateral File Pedestal</b> 30"W x 23⅜"D x 28½"H	HNL233028PSL	\$1,135	\$3,405
3	<b>Modesty/Pedestal Back Panel</b> 30"W x 27⅞"H	HNLMP3028	\$161	\$483
3	<b>Wall Mount Storage, Frosted Doors with Silver Frame</b> 72"W x 15"D x 15"H	HNL1572FD	\$1,675	\$5,025
<b>TOTAL:</b>			<b>\$14,658</b>	

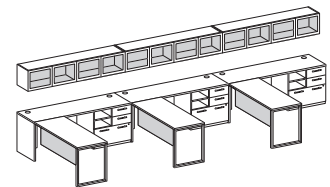

**L-WORKSTATIONS – OPEN PLAN**



# CONCINNITY™

## Typicals



Icon Legend on page 21

QTY	DESCRIPTION	MODEL	LIST PRICE	PRICE EXTENSION
1	Rectangle Worksurface with Vertical Grain 48"W x 24"D	HNLRC2448V	\$245	\$245
1	O-Leg Support for 48"W x 24"D Worksurface 24"D x 28½"H	HLSL2428O	\$291	\$291
1	Rectangle Worksurface 96"W x 24"D	HNLRC2496	\$476	\$476
1	Storage Cabinet Pedestal 36"W x 23⅞"D x 28½"H	HNL233628PSC	\$752	\$752
1	End Panel, Left 1⅞"W x 23⅞"D x 28½"H	HNLEP2428L	\$189	\$189
1	Modesty/Back Panel — Full-Length 96"W x 27⅞"H	HNLMP9628	\$399	\$399
1	Bookcase Hutch, Frosted Doors with Silver Frame 36"W x 15"D x 48⅝"H	HNL4936BHFD	\$1,590	\$1,590
1	Wall Mount Storage, Frosted Doors with Silver Frame 60"W x 15"D x 28½"H	HNL2960FD	\$2,098	\$2,098
1	Vertical Paper Manager	HLVPM1	\$298	\$298
1	Storage Tower, Wardrobe Right, Cabinet Left 24"W x 24"D x 78⅞"H	HNL242465TLR	\$2,079	\$2,079
<b>TOTAL:</b>			<b>\$8,417</b>	

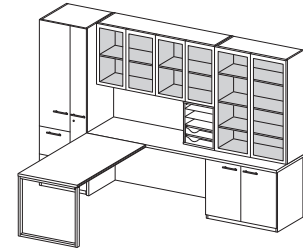

**WORKSTATION WITH WORKWALL — OPEN PLAN**

QTY	DESCRIPTION	MODEL	LIST PRICE	PRICE EXTENSION
4	Rectangle Worksurface 60"W x 24"D	HNLRC2460	\$291	\$1,164
4	Shelf/Box/Box/File Pedestal 15¾"W x 23⅞"D x 41"H	HNL231641PSBBF	\$1,398	\$5,592
4	Full Back Panel — For 15¾"W Pedestal 15¾"W x 40⅝"H	HNLPB1641	\$142	\$568
4	Narrow Box/Box/File/File Pedestal 9½"W x 23⅞"D x 41"H	HNL231041PBFF	\$1,229	\$4,916
4	Full Back Panel — For 9½"W Pedestal 9½"W x 40⅝"H	HNLPB1041	\$128	\$512
2	Above/Below Privacy Screen, Frosted 30"W x 28"H	HLSL2830	\$736	\$1,472
2	5-Shelf Bookcase with Coat Hooks, Right 24"W x 24"D x 64¾"H	HNL2424BK5CR	\$890	\$1,780
2	5-Shelf Bookcase with Coat Hooks, Left 24"W x 24"D x 64¾"H	HNL2424BK5CL	\$890	\$1,780
<b>TOTAL:</b>			<b>\$17,784</b>	

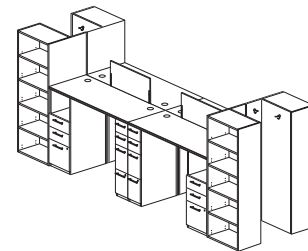

**STANDING-HEIGHT — TEAMING WORKSTATION — OPEN PLAN**



Icon Legend on page 21

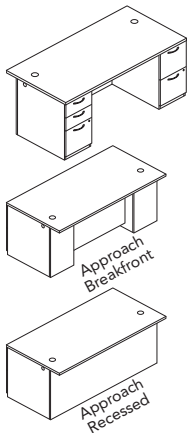
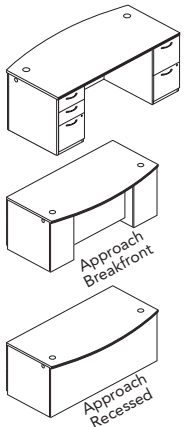

DESCRIPTION	APPROACH SIDE OVERHANG	MODEL	SHIP WEIGHT	CUBE	L1 LIST	L2 UPCHARGES			
						WORKSURFACES	CHASSIS	FRONTS	
<b>Double Pedestal Desk — Bow Top</b>									
72"W x 36"D x 29½"H, Recessed Modesty Panel	6"	<b>HNL3672DPBR</b>	298	51.8	<b>\$2149</b>	<b>\$25</b>	<b>\$40</b>	<b>\$10</b>	
72"W x 36"D x 29½"H, Breakfront Modesty Panel	6-12"	<b>HNL3672DPBB</b>	282	51.8	<b>\$2233</b>	<b>\$25</b>	<b>\$40</b>	<b>\$10</b>	
72"W x 36"D x 29½"H, Breakfront Frosted Modesty Panel	6-12"	<b>HNL3672DPBBF</b>	266	51.8	<b>\$2683</b>	<b>\$25</b>	<b>\$40</b>	<b>\$10</b>	

NOTES: For laminate center drawer, see page 171. For pull-out collaborative shelf, for desks with breakfront modesty panel, see page 171.

<b>Double Pedestal Desk — Rectangle Top</b>									
72"W x 36"D x 29½"H, Rectangle Top, Recessed Modesty Panel	6"	<b>HNL3672DPRR</b>	292	51.8	<b>\$1818</b>	<b>\$25</b>	<b>\$40</b>	<b>\$10</b>	
66"W x 30"D x 29½"H, Rectangle Top, Flush Modesty Panel		<b>HNL3066DPRF</b>	267	40.2	<b>\$1710</b>	<b>\$20</b>	<b>\$35</b>	<b>\$10</b>	
60"W x 30"D x 29½"H, Rectangle Top, Flush Modesty Panel		<b>HNL3060DPRF</b>	257	40.2	<b>\$1598</b>	<b>\$20</b>	<b>\$45</b>	<b>\$20</b>	
72"W x 36"D x 29½"H, Rectangle Top, Breakfront Modesty Panel	6-12"	<b>HNL3672DPRB</b>	287	51.8	<b>\$2023</b>	<b>\$25</b>	<b>\$40</b>	<b>\$10</b>	
72"W x 36"D x 29½"H, Rectangle Top, Breakfront Frosted Modesty Panel	6-12"	<b>HNL3672DPRBF</b>	270	51.8	<b>\$2473</b>	<b>\$25</b>	<b>\$40</b>	<b>\$10</b>	

NOTES: For laminate center drawer, see page 171. For pull-out collaborative shelf, for desks with breakfront modesty panel, see page 171.

**NOTES:**

- Feature full-to-the-floor pedestals to maximize storage space.
- Double pedestal desks have 3/2 drawer configuration (box/box/file on left pedestal, file/file on right pedestal).
- Single pedestal desks have a box/box/file pedestal.
- One molded black pencil tray is included in each box/box/file pedestal.
- 72"W models are available with Rectangle- or bow-shaped tops.
- Bow top desk models measure 36"D at the crest and 30"D along the end panels.
- Formal breakfront or recessed modesty panel.
- Breakfront desk features a floating modesty panel which can be specified in laminate or frosted material. Floating design provides space for optional pull-out collaborative shelf for visitors. See page 171.
- Recessed modesty panel design has a full-width conference overhang, providing worksurface and kneespace for guests.
- 66"W and 60"W desks have a flush modesty panel (i.e., no conference overhang).
- Two cord management grommets, for routing and hiding wires and cables, are located in desktops.
- Grommets can be replaced with optional Power (model HGRMTAC) or USB Hub (HGRMTUSB2).
- Pedestal sides and end panels are standard with pass-through grommets to enable the routing of cords below the worksurface, and connections between workstations.
- Specification logic includes the grommet finish for tops; choose from Black (P) or Platinum (T1). Side grommets on pedestal are black only.
- See "Modular Components" for cord management options. Worksurfaces/tops, end and modesty panels, and pedestals can be specified with or without grommets.
- Finish of pedestal lock(s) is determined by, and aligned with, the handle finish specified.
- Adjustable hex leveling glides.
- Ship fully assembled.

**HOW TO SPECIFY**

<b>Select Model Number</b>	<b>Select Edge Profile and Edge Color</b>	<b>Select Handle</b>	<b>Select Worksurface Grommet Finish</b>	<b>Select Worksurface Color</b>	<b>Select Chassis Color</b>	<b>Select Drawer Front Color</b>
See page 96	See page 96	<b>A</b> Cylinder – Satin <b>B</b> Cylinder – Black <b>C</b> Canopy – Satin <b>D</b> Canopy – Black <b>E</b> Loop – Satin <b>F</b> Loop – Black	<b>P</b> Black <b>T1</b> Platinum	See page 96	See page 96	See page 96
<b>HNL3672DPBR</b>	<b>BH</b>	<b>E</b>	<b>T1</b>	<b>H</b>	<b>H</b>	<b>H</b>

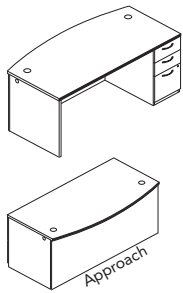

DESCRIPTION	APPROACH SIDE OVERHANG	MODEL	SHIP WEIGHT	CUBE	L1 LIST	L2 UPCHARGES		
						WORKSURFACES	CHASSIS	FRONTS
<b>Single Pedestal Desk — Bow Top</b> 72"W x 36"D x 29½"H, Right, Recessed Modesty Panel (shown)	6"	<b>HNL3672RPBR</b>	238	51.8	<b>\$1726</b>	<b>\$25</b>	<b>\$40</b>	<b>\$10</b>
72"W x 36"D x 29½"H, Left, Recessed Modesty Panel	6"	<b>HNL3672LPBR</b>	238	51.8	<b>\$1726</b>	<b>\$25</b>	<b>\$40</b>	<b>\$10</b>
72"W x 36"D x 29½"H, Right, Breakfront Modesty Panel	6-12"	<b>HNL3672RPBB</b>	237	51.8	<b>\$1946</b>	<b>\$25</b>	<b>\$40</b>	<b>\$10</b>
72"W x 36"D x 29½"H, Left, Breakfront Modesty Panel	6-12"	<b>HNL3672LPBB</b>	237	51.8	<b>\$1946</b>	<b>\$25</b>	<b>\$40</b>	<b>\$10</b>
72"W x 36"D x 29½"H, Right, Breakfront Frosted Modesty Panel	6-12"	<b>HNL3672RPBBF</b>	221	51.8	<b>\$2396</b>	<b>\$25</b>	<b>\$40</b>	<b>\$10</b>
72"W x 36"D x 29½"H, Left, Breakfront Frosted Modesty Panel	6-12"	<b>HNL3672LPBBF</b>	221	51.8	<b>\$2396</b>	<b>\$25</b>	<b>\$40</b>	<b>\$10</b>

NOTES: For laminate center drawer, see page 171. For pull-out collaborative shelf, for desks with breakfront modesty panel, see page 171.

#### NOTES:

- Feature full-to-the-floor pedestals to maximize storage space.
- Double pedestal desks have 3/2 drawer configuration (box/box/file on left pedestal, file/file on right pedestal).
- Single pedestal desks have a box/box/file pedestal.
- One molded black pencil tray is included in each box/box/file pedestal.
- 72"W models are available with Rectangle- or bow-shaped tops.
- Bow top desk models measure 36"D at the crest and 30"D along the end panels.
- Formal breakfront or recessed modesty panel.
- Breakfront desk features a floating modesty panel which can be specified in laminate or frosted material. Floating design provides space for optional pull-out collaborative shelf for visitors. See page 171.
- Recessed modesty panel design has a full-width conference overhang, providing workspace and kneespace for guests.
- 66"W and 60"W desks have a flush modesty panel (i.e., no conference overhang).
- Two cord management grommets, for routing and hiding wires and cables, are located in desktops.
- Grommets can be replaced with optional Power (model HGRMTAC) or USB Hub (HGRMTUSB2).
- Pedestal sides and end panels are standard with pass-through grommets to enable the routing of cords below the workspace, and connections between workstations.
- Specification logic includes the grommet finish for tops; choose from Black (P) or Platinum (TI). Side grommets on pedestal are black only.
- See "Modular Components" for cord management options. Worksurfaces/tops, end and modesty panels, and pedestals can be specified with or without grommets.
- Finish of pedestal lock(s) is determined by, and aligned with, the handle finish specified.
- Adjustable hex leveling glides.
- Ship fully assembled.

## HOW TO SPECIFY

Select Model Number	Select Edge Profile and Edge Color	Select Handle	Select Worksurface Grommet Finish	Select Worksurface Color	Select Chassis Color	Select Drawer Front Color
See page 96	See page 96	<b>A</b> Cylinder - Satin <b>B</b> Cylinder - Black <b>C</b> Canopy - Satin <b>D</b> Canopy - Black <b>E</b> Loop - Satin <b>F</b> Loop - Black	<b>P</b> Black <b>TI</b> Platinum	See page 96	See page 96	See page 96
H N L 3 6 7 2 R P B R .	B H .	E .	T I .	H .	H .	H .

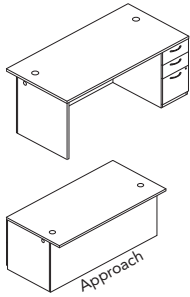

DESCRIPTION	APPROACH SIDE OVERHANG	MODEL	SHIP WEIGHT	CUBE	L1 LIST	L2 UPCHARGES		
						WORKSURFACES	CHASSIS	FRONTS
<b>Single Pedestal Desk — Rectangle Top</b> 72"W x 36"D x 29½"H, Right, Recessed Modesty Panel (shown)	6"	<b>HNL3672RPRR</b>	242	51.8	<b>\$1490</b>	<b>\$25</b>	<b>\$40</b>	<b>\$10</b>
72"W x 36"D x 29½"H, Left, Recessed Modesty Panel	6"	<b>HNL3672LPRR</b>	242	51.8	<b>\$1490</b>	<b>\$25</b>	<b>\$40</b>	<b>\$10</b>
66"W x 30"D x 29½"H, Right, Flush Modesty Panel		<b>HNL3066RPRF</b>	217	40.2	<b>\$1454</b>	<b>\$20</b>	<b>\$35</b>	<b>\$10</b>
66"W x 30"D x 29½"H, Left, Flush Modesty Panel		<b>HNL3066LPRF</b>	217	40.2	<b>\$1454</b>	<b>\$20</b>	<b>\$35</b>	<b>\$10</b>
72"W x 36"D x 29½"H, Right, Breakfront Modesty Panel	6-12"	<b>HNL3672RPRB</b>	242	51.8	<b>\$1777</b>	<b>\$25</b>	<b>\$40</b>	<b>\$10</b>
72"W x 36"D x 29½"H, Left, Breakfront Modesty Panel	6-12"	<b>HNL3672LPRB</b>	242	51.8	<b>\$1777</b>	<b>\$25</b>	<b>\$40</b>	<b>\$10</b>
72"W x 36"D x 29½"H, Right, Breakfront Frosted Modesty Panel	6-12"	<b>HNL3672RPRBF</b>	225	51.8	<b>\$2227</b>	<b>\$25</b>	<b>\$40</b>	<b>\$10</b>
72"W x 36"D x 29½"H, Left, Breakfront Frosted Modesty Panel	6-12"	<b>HNL3672LPRBF</b>	225	51.8	<b>\$2227</b>	<b>\$25</b>	<b>\$40</b>	<b>\$10</b>

NOTES: For laminate center drawer, see page 171. For pull-out collaborative shelf, for desks with breakfront modesty panel, see page 171.

**NOTES:**

- Feature full-to-the-floor pedestals to maximize storage space.
- Double pedestal desks have 3/2 drawer configuration (box/box/file on left pedestal, file/file on right pedestal).
- Single pedestal desks have a box/box/file pedestal.
- One molded black pencil tray is included in each box/box/file pedestal.
- 72"W models are available with Rectangle- or bow-shaped tops.
- Bow top desk models measure 36"D at the crest and 30"D along the end panels.
- Formal breakfront or recessed modesty panel.
- Breakfront desk features a floating modesty panel which can be specified in laminate or frosted material. Floating design provides space for optional pull-out collaborative shelf for visitors. See page 171.
- Recessed modesty panel design has a full-width conference overhang, providing worksurface and kneespace for guests.
- 66"W and 60"W desks have a flush modesty panel (i.e., no conference overhang).
- Two cord management grommets, for routing and hiding wires and cables, are located in desktops.
- Grommets can be replaced with optional Power (model HGRMTAC) or USB Hub (HGRMTUSB2).
- Pedestal sides and end panels are standard with pass-through grommets to enable the routing of cords below the worksurface, and connections between workstations.
- Specification logic includes the grommet finish for tops; choose from Black (P) or Platinum (T1). Side grommets on pedestal are black only.
- See "Modular Components" for cord management options. Worksurfaces/tops, end and modesty panels, and pedestals can be specified with or without grommets.
- Finish of pedestal lock(s) is determined by, and aligned with, the handle finish specified.
- Adjustable hex leveling glides.
- Ship fully assembled.

**HOW TO SPECIFY**

<p><b>Select Model Number</b></p>	<p><b>Select Edge Profile and Edge Color</b></p> <p>See page 96</p>	<p><b>Select Handle</b></p> <p><b>A</b> Cylinder – Satin <b>B</b> Cylinder – Black <b>C</b> Canopy – Satin <b>D</b> Canopy – Black <b>E</b> Loop – Satin <b>F</b> Loop – Black</p>	<p><b>Select Worksurface Grommet Finish</b></p> <p><b>P</b> Black <b>T1</b> Platinum</p>	<p><b>Select Worksurface Color</b></p> <p>See page 96</p>	<p><b>Select Chassis Color</b></p> <p>See page 96</p>	<p><b>Select Drawer Front Color</b></p> <p>See page 96</p>
<p><b>H N L 3 6 7 2 R P R R</b></p>	<p><b>B H</b></p>	<p><b>E</b></p>	<p><b>T 1</b></p>	<p><b>H</b></p>	<p><b>H</b></p>	<p><b>H</b></p>

# CONCINNITY™

## Peninsulas

GSA SIN AS NOTED



Icon Legend on page 21

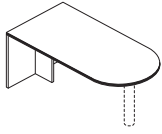

Support column sold separately

SIN 711-2



DESCRIPTION	MODEL	SHIP WEIGHT	CUBE	L1 LIST	L2 UPCHARGES	
					WORKSURFACE	CHASSIS
<b>Bullet Peninsula with End Panel</b>						
72"W x 36"D x 29½"H	<b>HNL3672BUEP</b>	131	6.6	<b>\$834</b>	<b>\$25</b>	<b>\$40</b>
72"W x 30"D x 29½"H	<b>HNL3072BUEP</b>	112	5.6	<b>\$727</b>	<b>\$20</b>	<b>\$25</b>
66"W x 30"D x 29½"H	<b>HNL3066BUEP</b>	105	5.1	<b>\$651</b>	<b>\$20</b>	<b>\$35</b>

NOTES: For use in "U" or "L" shaped furniture layouts; not to be used freestanding. Comprised of top and end/brace panels (Note: Must specify support column; sold separately). Cord routing notch in the brace panel. Adjustable hex leveling glides. For cord grommet options, see "Modular Components". Options include center drawers and modesty panels. Modesty panel is available in laminate or frosted material. Ships

Not designed to be used freestanding.

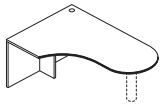
Right-hand model  
HNL4872JREP shown

Support column sold separately

SIN 711-2



DESCRIPTION	MODEL	SHIP WEIGHT	CUBE	L1 LIST	L2 UPCHARGES	
					WORKSURFACE	CHASSIS
<b>Jetty Peninsula with End Panel</b>						
72"W x 30/48"D x 29½"H, Right	<b>HNL4872JREP</b>	147	8.9	<b>\$1003</b>	<b>\$30</b>	<b>\$25</b>
72"W x 30/48"D x 29½"H, Left	<b>HNL4872JLEP</b>	147	8.9	<b>\$1003</b>	<b>\$30</b>	<b>\$25</b>
72"W x 30/42"D x 29½"H, Right	<b>HNL4272JREP</b>	134	17.0	<b>\$932</b>	<b>\$30</b>	<b>\$25</b>
72"W x 30/42"D x 29½"H, Left	<b>HNL4272JLEP</b>	134	17.0	<b>\$932</b>	<b>\$30</b>	<b>\$25</b>

NOTES: Worksurface designed and sized to efficiently serve as both a computing and conferencing space. Two sizes, 42"D and 48"D. The 48"D unit is specifically intended to be used with the 48"D extended corner modular top/back components to form a two-piece U-shaped workstation with a 42" cockpit area. For use in "U" or "L" shaped furniture layouts; not to be used freestanding. Comprised of top and end/brace panels (Note: Must specify support column; sold separately). One cord management grommet in the top; cord routing notch in the brace panel. Adjustable hex leveling glides. Field installable modesty panel is optional. Ships

Not designed to be used freestanding.

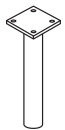

SIN 711-8

DESCRIPTION	MODEL	SHIP WEIGHT	CUBE	LIST PRICE
<b>Support Column for Bullet and Jetty Peninsulas</b> 4½" Diameter. Specify: HPC190X.P. <b>Black only.</b>	<b>HPC190X</b>	12	1.0	<b>\$148</b>
<b>Support Column for Bullet and Jetty Peninsulas</b> 4½" Diameter. Specify: HPC191X.X. <b>Available in Silver only.</b>	<b>HPC191X</b>	12	1.0	<b>\$148</b>

Support Column must be specified/ordered with Bullet and Jetty peninsulas.

## NOTES:





- See pages 158-162 for shared components.

## HOW TO SPECIFY

<b>Select Model Number</b> H N L 3 6 7 2 B U E P	<b>Select Edge Profile and Edge Color</b> See page 96 B H	<b>Select Worksurface Color</b> See page 96 H	<b>Select Chassis Color</b> See page 96 H	
<b>Select Model Number</b> H N L 4 8 7 2 J R E P	<b>Select Edge Profile and Edge Color</b> See page 96 B H	<b>Select Worksurface Grommet Finish</b> P Black T1 Platinum	<b>Select Worksurface Color</b> See page 96 H	<b>Select Chassis Color</b> See page 96 H



Icon Legend on page 21

	DESCRIPTION	MODEL	SHIP WEIGHT	CUBE	LIST PRICE BY PAINT GRADE	
					CORE	METALLICS
	<b>Post Leg Base</b> 28½" H x 2" square  NOTES: Can only be used as the outbound support in a peninsula or island extension worksurface application. Glides have 2" of adjustability. Ship 1/pack. <b>SPECIFYING EXAMPLE: HLSL28P.T1</b>	<b>HLSL28P</b>	15	1.0	<b>\$267</b>	<b>\$271</b>
	<b>Field Installable Modesty Panel for Bullet and Jetty Peninsulas, Laminate (Vertical Grain)</b> 50¼"W x ¾" Thick x 18"H  NOTES: Center drawer model H1522 can be used in conjunction with laminate modesty panel model HPC180W. Cord pass-through notch in top corner. <b>SPECIFYING EXAMPLE: HPC180W.H</b>	<b>HPC180W</b>	28 	3.6		<b>\$199</b>
	<b>Field Installable Modesty Panel for Bullet and Jetty Peninsulas, Frosted with Silver Frame</b> 50¼"W x ¾" Thick x 18"H  ⚠ Cord pass-through notch is not available on the Frosted/Silver model HPC180G. Notch is on laminate model HPC180W only. ⚠ Center drawers not designed to be used with the frosted/silver modesty panel model HPC180G.	<b>HPC180G</b>	33 	1.5		<b>\$645</b>

**NOTES:**

- See pages 158-162 for shared components.

## HOW TO SPECIFY

Select Model Number

H	L	S	L	2	8	P
---	---	---	---	---	---	---

# CONCINNITY™

## Corner Unit

GSA SIN 711-2



Icon Legend on page 21

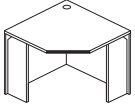

DESCRIPTION	MODEL	SHIP WEIGHT	CUBE	L1 LIST	L2 UPCHARGES	
					WORKSURFACE	CHASSIS
<b>Corner Unit</b> 24"W x 36"D x 24" x 29½"H	<b>HNL3636CU</b>	109	26.4	<b>\$878</b>	<b>\$15</b>	<b>\$20</b>
NOTES: Designed for use with 24"D returns or bridges. Can be used freestanding. Can be used with two 36"W modular returns to achieve an efficient 6' x 6' layout. One cord management grommet in the top; cord routing notches in the leg panels. The worksurface grommet can be replaced with optional power (model HGRMTAC) or USB (model HGRMTUSB2) hub. Adjustable hex leveling glides. When connected to a 42"W return or modular return, the 78"W stack-on storage unit spans the total depth dimension (78"D). When connected to a 36"W modular return, the 72"W stack-on storage unit spans the total depth dimension (72"D). <b>Edgebanding on the corner unit is profiled on the user's side and flat on the back (approach side) and ends.</b> Ships fully assembled.						

**NOTES:**

- For Extended Corner Worksurface sizes, see "Modular Components" on page 145.

**HOW TO SPECIFY**

Select  
Model Number

H N L 3 6 3 6 C U .

Select  
Edge Profile and Edge  
Color

See page 96

B H .

Select  
Worksurface Grommet  
Finish

P Black  
T1 Platinum

P .

Select  
Worksurface Color

See page 96

H .

Select  
Chassis Color

See page 96

H

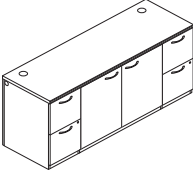
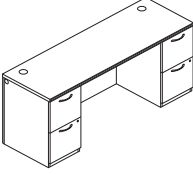
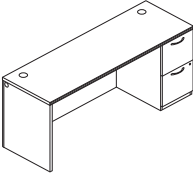
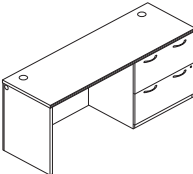

DESCRIPTION	MODEL	SHIP WEIGHT	CUBE	L1 LIST	L2 UPCHARGES		
					WORKSURFACES	CHASSIS	FRONTS
 <p><b>Credenza with Storage</b> 72"W x 24"D x 29½"H</p> <p>NOTES: For use behind a desk or as a stand-alone storage piece. Four file drawers, 2-left, 2-right and one storage cabinet with hinged doors. One adjustable shelf, which adjusts in 2½" increments, behind doors. Drawers lock. Finish of locks is determined by, and aligned with, the handle finish specified. Storage cabinet doors are non-locking. Worksurface grommets can be replaced with optional Power (model HGRMTAC) or USB (model HGRMTUSB2) hub.</p>	<b>HNL2472DPS</b>	323	35.6	<b>\$2236</b>	<b>\$20</b>	<b>\$45</b>	<b>\$40</b>
 <p><b>Credenza with Kneespace</b> 72"W x 24"D x 29½"H 66"W x 24"D x 29½"H 60"W x 24"D x 29½"H</p> <p>NOTES: For use behind a desk or as a stand-alone storage piece. Four locking file drawers, 2-left, 2-right. Finish of locks determined by, and aligned with, the handle finish specified. Worksurface grommets can be replaced with optional Power (model HGRMTAC) or USB (model HGRMTUSB2) hub.</p>	<b>HNL2472DPK</b>	247	35.6	<b>\$1691</b>	<b>\$20</b>	<b>\$40</b>	<b>\$20</b>
	<b>HNL2466DPK</b>	239	32.7	<b>\$1614</b>	<b>\$20</b>	<b>\$40</b>	<b>\$20</b>
	<b>HNL2460DPK</b>	230	29.9	<b>\$1587</b>	<b>\$20</b>	<b>\$35</b>	<b>\$20</b>
 <p><b>Credenza, Single Pedestal</b> 72"W x 24"D x 29½"H, Right 72"W x 24"D x 29½"H, Left</p> <p>NOTES: Primary use is as part of a connected U-shaped workstation with a bridge and single pedestal desk. Two locking file drawers. Finish of lock determined by, and aligned with, the handle finish specified. Worksurface grommets can be replaced with optional Power (model HGRMTAC) or USB (model HGRMTUSB2) hub. Can be used with modular or mobile pedestals.</p>	<b>HNL2472RP</b>	199	35.6	<b>\$1348</b>	<b>\$20</b>	<b>\$35</b>	<b>\$10</b>
	<b>HNL2472LP</b>	199	35.6	<b>\$1348</b>	<b>\$20</b>	<b>\$35</b>	<b>\$10</b>
 <p><b>Credenza with Lateral File</b> 72"W x 24"D x 29½"H, Right 72"W x 24"D x 29½"H, Left</p> <p>NOTES: Storage file measures 30"W (36"W can be specified using modular components). Mechanical interlock inhibits the extension of more than one drawer at a time. Finish of lock is determined by, and aligned with, the handle finish specified. Worksurface grommets can be replaced with optional Power (model HGRMTAC) or USB (model HGRMTUSB2) hub. Can be used with modular or mobile pedestals.</p>	<b>HNL2472RLC</b>	245	35.6	<b>\$1473</b>	<b>\$20</b>	<b>\$35</b>	<b>\$20</b>
	<b>HNL2472LLC</b>	245	35.6	<b>\$1473</b>	<b>\$20</b>	<b>\$35</b>	<b>\$20</b>

**NOTES:**

- Optional 72"W, 66"W and 60"W stack-on sizes maximize storage space.
- Two cord management grommets, for routing and hiding wires and cables, are located in top.
- Modesty panel and pedestal grommets are black only.
- A cord pass-through grommet is located in the sides of the pedestal and top center of the back (modesty panel) to facilitate reaching wall electrical outlets.
- Specification logic includes the grommet finish for tops; choose from Black (P) or Platinum (TI).
- Worksurfaces/tops, end and modesty panels, and pedestals can be specified with or without grommets. See "Modular Components" on page 104 for cord management options.
- For paper organizers, see page 175.

**HOW TO SPECIFY**

Select Model Number	Select Edge Profile and Edge Color	Select Handle	Select Worksurface Grommet Finish	Select Worksurface Color	Select Chassis Color	Select Drawer Front Color
See page 96	See page 96	<b>A</b> Cylinder – Satin <b>B</b> Cylinder – Black <b>C</b> Canopy – Satin <b>D</b> Canopy – Black <b>E</b> Loop – Satin <b>F</b> Loop – Black	<b>P</b> Black <b>TI</b> Platinum	See page 96	See page 96	See page 96
<b>H N L 2 4 7 2 D P S</b>	<b>B H</b>	<b>E</b>	<b>T I</b>	<b>H</b>	<b>H</b>	<b>H</b>



# CONCINNITY™

## Low Credenzas

GSA SIN AS NOTED



Icon Legend on page 21

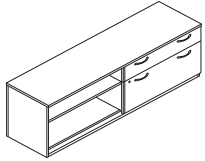

SIN 711-2

DESCRIPTION	MODEL	SHIP WEIGHT	CUBE	L1 LIST	L2 UPCHARGES		
					WORKSURFACES	CHASSIS	FRONTS
<b>Low Credenza (Bench-Height)</b> 72"W x 20"D x 21½"H, Drawers Right, Bookcase Left (shown)	<b>HNL207221RD2</b>	219	21.6	<b>\$1309</b>	<b>\$15</b>	<b>\$25</b>	<b>\$20</b>
72"W x 20"D x 21½"H, Drawers Left, Bookcase Right	<b>HNL207221LD2</b>	219	21.6	<b>\$1309</b>	<b>\$15</b>	<b>\$25</b>	<b>\$20</b>
60"W x 20"D x 21½"H, Drawers Right, Bookcase Left	<b>HNL206021RD2</b>	187	18.1	<b>\$1176</b>	<b>\$20</b>	<b>\$15</b>	<b>\$20</b>
60"W x 20"D x 21½"H, Drawers Left, Bookcase Right	<b>HNL206021LD2</b>	187	18.1	<b>\$1176</b>	<b>\$20</b>	<b>\$15</b>	<b>\$20</b>

NOTES: Combination storage design comprised of two locking drawers (1-box/supply and 1-file) plus a bookcase. File drawers include integrated hangrails for letter- or legal-sized folders. Bookcase has one adjustable shelf; adjusts in 2½" increments.

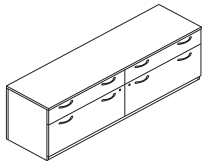

SIN 711-2

<b>Low Credenza, 2 Box/2 File</b> 72"W x 20"D x 21½"H	<b>HNL207221D4</b>	308	21.6	<b>\$1593</b>	<b>\$15</b>	<b>\$25</b>	<b>\$40</b>
60"W x 20"D x 21½"H	<b>HNL206021D4</b>	260	18.1	<b>\$1411</b>	<b>\$15</b>	<b>\$20</b>	<b>\$40</b>

NOTES: Four locking drawers (2-box/supply and 2-file). File drawers include integrated hangrails for letter- or legal-sized folders.

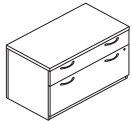

SIN 711-2

<b>Low Credenza, Box/File</b> 36"W x 20"D x 21½"H	<b>HNL203621D2</b>	143	11.8	<b>\$922</b>	<b>\$10</b>	<b>\$15</b>	<b>\$20</b>
30"W x 20"D x 21½"H	<b>HNL203021D2</b>	121	10.0	<b>\$866</b>	<b>\$10</b>	<b>\$15</b>	<b>\$20</b>

NOTES: Unit contains two drawers, one box and one lateral file.

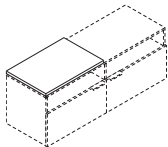

SIN 711-3

DESCRIPTION	MODEL	SHIP WEIGHT	CUBE	SHIP					
				1	2	3	4	5	6
<b>Credenza Cushion</b> 36"W x 20"D x 1"H for 72" and 36"W Low Credenzas	<b>HLSL2036CH2</b>	11	2.2	<b>\$369</b>	<b>\$407</b>	<b>\$445</b>	<b>\$484</b>	<b>\$533</b>	<b>\$583</b>
30"W x 20"D x 1"H for 60" and 30"W Low Credenzas	<b>HLSL2030CH2</b>	9	1.9	<b>\$342</b>	<b>\$378</b>	<b>\$414</b>	<b>\$450</b>	<b>\$496</b>	<b>\$543</b>

NOTES: See pages 24-34 for available fabrics.

Seat cushions are optional; HLSL2036CH2 for 72" and 36"W, HLSL2030CH2 for 60" and 30"W.

! For model HLSL2030CH2 must order two cushions to cover entire 60" Credenza surface.

**SPECIFYING EXAMPLE: HLSL2036CH2.AB10**

### NOTES:

- Versatile, space-saving solutions double as a compact storage unit and convenient bench seat.
- When combined with 29½"H worksurfaces, the 21½"H credenzas can be positioned to create multi-level, overlapping surfaces that optimize floor space, organization and display needs.
- The distinct, clean horizontal planes provide a light scale, layered look.
- Low-heights help facilitate team collaboration.
- Finish of lock(s) is determined by, and aligned with, the handle finish specified.
- Overlapping surfaces can be supported by a 28½"H or 7"H O-leg or 7"H laminate end panel.

## HOW TO SPECIFY

<b>Select Model Number</b>  H N L 2 0 7 2 2 1 R D 2 .	<b>Select Edge Profile and Edge Color</b>  See page 96  B H .	<b>Select Handle</b>  A Cylinder - Satin B Cylinder - Black C Canopy - Satin D Canopy - Black E Loop - Satin F Loop - Black  E .	<b>Select Top Color</b>  See page 96  H .	<b>Select Chassis Color</b>  See page 96  H .	<b>Select Drawer Front Color</b>  See page 96  H .
---	---	---	---	---	--

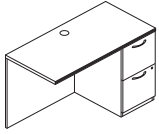

DESCRIPTION	MODEL	SHIP		L1 LIST	L2 UPCHARGES		
		WEIGHT	CUBE		WORKSURFACES	CHASSIS	FRONTS
<b>Return</b>							
48"W x 24"D x 29½"H, Right (shown)	<b>HNL2448RP</b>	141	24.8	<b>\$966</b>	<b>\$15</b>	<b>\$15</b>	<b>\$10</b>
48"W x 24"D x 29½"H, Left	<b>HNL2448LP</b>	141	24.8	<b>\$966</b>	<b>\$15</b>	<b>\$15</b>	<b>\$10</b>
42"W x 24"D x 29½"H, Right	<b>HNL2442RP</b>	132	22.0	<b>\$926</b>	<b>\$15</b>	<b>\$15</b>	<b>\$10</b>
42"W x 24"D x 29½"H, Left	<b>HNL2442LP</b>	132	22.0	<b>\$926</b>	<b>\$15</b>	<b>\$15</b>	<b>\$10</b>

NOTES: For L-shaped workstations. Connects to single pedestal desk, peninsula (bullet or jetty), or component worksurface with end panel. Drawers lock. Finish of lock is determined by, and aligned with, the handle finish specified. Formal, full-height modesty panel. One cord grommet in top for routing and hiding wires and cables. One cord pass-through grommet is located in the sides of the pedestal and top center of the back (modesty panel) to facilitate reaching wall electrical outlets. Specification logic includes the grommet finish for tops; choose from Black (P) or Platinum (TI). Modesty panel and pedestal grommets are black only. Edgebanding on 42"W and 48"W returns is profiled on the user's side and flat on the back (approach side) and ends. Woodgrain direction on worksurface runs vertical (i.e., front-to-back). Smaller and larger return sizes can be specified using modular worksurface and modesty panel components. Optional stack-on solutions maximize storage space. Ship fully assembled.

See chart on page 104 for cord management options. Worksurfaces/tops, end and modesty panels, and pedestals can be specified with or without grommets. For easy access to wall electrical outlets, options include a short (10") modesty panel or no back panel.

For paper organizers, see page 175.

## HOW TO SPECIFY

<p><b>Select Model Number</b></p>	<p><b>Select Edge Profile and Edge Color</b></p> <p>See page 96</p>	<p><b>Select Handle</b></p> <p>A Cylinder – Satin                  B Cylinder – Black                  C Canopy – Satin                  D Canopy – Black                  E Loop – Satin                  F Loop – Black</p>	<p><b>Select Worksurface Grommet Finish</b></p> <p>P Black                  TI Platinum</p>	<p><b>Select Worksurface Color</b></p> <p>See page 96</p>	<p><b>Select Chassis Color</b></p> <p>See page 96</p>	<p><b>Select Drawer Front Color</b></p> <p>See page 96</p>
<p>H N L 2 4 4 8 R P .</p>	<p>B H .</p>	<p>E .</p>	<p>T I .</p>	<p>H .</p>	<p>H .</p>	<p>H .</p>

# CONCINNITY™ Bridges

GSA SIN 711-2



Icon Legend on page 21

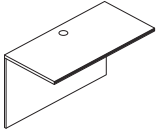

DESCRIPTION	MODEL	SHIP WEIGHT	CUBE	L1 LIST	L2 UPCHARGES		
					WORKSURFACES	CHASSIS	FRONTS
<b>Bridge</b> 48"W x 24"D x 29½"H	<b>HNL2448BF</b>	71	3.0	<b>\$415</b>	<b>\$15</b>	<b>\$15</b>	<b>N/A</b>
42"W x 24"D x 29½"H	<b>HNL2442BF</b>	62	2.5	<b>\$397</b>	<b>\$15</b>	<b>\$15</b>	<b>N/A</b>

NOTES: For U-shaped workstation layouts. Connects single pedestal desk, peninsula (bullet or jetty), or component worksurface to corner unit or to single pedestal credenza, credenza with lateral file, or rectangle worksurface. Formal, full-height modesty panel. One cord grommet in top for routing and hiding wires and cables. One cord pass-through grommet in top center of back (modesty panel).

Specification logic includes the grommet finish for tops; choose from Black (P) or Platinum (T1). Clear inside depth 22<sup>7</sup>/<sub>8</sub>"D. Edgebanding on 42"W and 48"W bridges is profiled on the user's side and flat on the back (approach side) and ends. Woodgrain direction on worksurface runs vertical (i.e., front-to-back). Additional sizes, including 30"W and 36"W for use with corner or extended corner units, as well as jetty peninsulas, can be specified using modular worksurface and modesty panel components. Ship — quick, simple assembly.

See chart on page 104 for cord management options. Worksurfaces/tops and modesty panels can be specified with or without grommets. For easy access to wall electrical outlets, options include a short (10") modesty panel or no back panel.

## HOW TO SPECIFY

Select  
Model Number

H N L 2 4 4 8 B F .

Select  
Edge Profile and Edge  
Color

See page 96

B H .

Select  
Worksurface Grommet  
Finish

P Black  
T1 Platinum

P .

Select  
Worksurface Color

See page 96

H .

Select  
Chassis Color

See page 96

H

# CONCINNITY™ STACK-ON STORAGE APPLICATIONS

## STACK-ON STORAGE APPLICATIONS

### 78"W

- Spans full-width of 78"W modular credenza or return.
- Spans total depth dimension of "L" workstation configurations comprised of:
  - 48"W return or modular return attached to a 36"D single pedestal desk with a bow front (78"D).
    - NOTE: The 36"D single pedestal desk with bow front is 30"D along end panel.
  - 48"W return or modular return attached to a 30"D single pedestal desk, modular desk, or bullet peninsula (78"D).
  - 42"W return or modular return attached to a 36"D single pedestal desk with rectangle top, modular desk, or bullet peninsula (78"D).
  - 42"W return or modular return attached to a 36" corner unit or 36"D extended corner unit (78"D).
  - 36"W modular return attached to a 42"D jetty peninsula (78"D).
  - 30"W modular return attached to a 48"D jetty peninsula (78"D).
  - 30"W modular return attached to a 48"D extended corner unit (78"D).

### 72"W

- Spans full-width of 72"W desks with rectangle top, credenzas, extended corner units, or modular desk, credenza, or return.
- Spans total depth dimension of "L" workstation configurations comprised of:
  - 48"W return or modular return attached to a 24"D single pedestal credenza or modular credenza (72"D).
  - 42"W return or modular return attached to a 36"D single pedestal desk with a bow front (72"D).
    - NOTE: The 36"D single pedestal desk with bow front is 30"D along end panel.
  - 42"W return or modular return attached to a 30"D single pedestal desk, modular desk, or bullet peninsula (72"D).
  - 36"W modular return attached to a 36"D single pedestal desk with rectangle top, modular desk, or bullet peninsula (72"D).
  - 36"W modular return attached to a 36" corner unit or 36"D extended corner unit (72"D).
  - 30"W modular return attached to a 42"D jetty peninsula (72"D).

### 66"W

- Spans full-width of 66"W desk, credenza, or modular desk, credenza, or return.
- Spans total depth dimension of "L" workstation configurations comprised of:
  - 42"W return or modular return attached to a 24"D single pedestal credenza or modular credenza (66"D).

- 36"W modular return attached to a 30"D single pedestal desk, bullet peninsula, or modular desk (66"D).
- 36"W modular return attached to a 36"D single pedestal desk with a bow front (66"D).
  - NOTE: The 36"D single pedestal desk with bow front is 30"D along end panel.
- 30"W modular return attached to a 36"D single pedestal desk with rectangle top or modular desk (66"D).
- 30"W modular return attached to a 36" corner unit (66"D).

### 60"W

- Spans full-width of 60"W desk, credenza, or modular desk, credenza, or return.
- Spans total depth dimension of "L" workstation configurations comprised of:
  - 36"W modular return attached to a 24"D single pedestal credenza or modular credenza (60"D).
  - 30"W modular return attached to a 30"D single pedestal desk or modular desk (60"D).

### 48"W

- Spans full-width of 48"W return, modular return, or modular desk or credenza.
- Spans full-depth of the 48"D jetty peninsula or extended corner unit.

### 42"W

- Spans full-width of 42"W return, modular return, or modular desk or credenza.
- Spans full-depth of 42"D jetty peninsula.

### 36"W

- Spans full-width of 36"W modular return, modular desk or credenza, two drawer lateral file, or 29½"H storage cabinet with doors.
- Spans full-depth of 36"D desks with rectangle top, bullet peninsula, extended corner unit, or 36" corner unit.

## OPTIONS INCLUDE:

- Door/Storage Options:

Door(s)	Standard-Height	Executive-Height
Laminate	•	•
Laminate Locking	•	•
Frosted/Silver	•	•
Sliding	•	•

- Available in 35¼" or 78⅛"H; when positioned on 29½"H base unit, heights respectively align with 64¾" and 78⅛"H storage- and wardrobe-type cabinets.
- Paper organizers for stack-on and wall mounted storage cabinets (see application and compatibility information on page 176).

# CONCINNITY™ STACK-ON STORAGE APPLICATIONS

- Fabric-Covered Tackboards:
  - Sized  $\frac{3}{4}$ " narrower than the stack-on storage back enclosure, allowing  $\frac{3}{8}$ " on each side to route task light cords.
  - Includes adhesive latch & hook tape for attachment to stack-on storage back panel and fasteners for wall mount applications.
  - Available in HON Group panel fabric grades A and B.
- Markerboards:
  - HL1530SOMB: 29½"W x 12½"H panel attaches to 60" and 66"W stack-on and wall mounted storage with sliding door models with double-sided tape.
  - HL1536SOMB: 35½"W x 12½"H panel attaches to 72" and 78"W stack-on and wall mounted storage with sliding door models with double-sided tape.
- Markerboards will not fit on stack-on storage laminate or laminate locking door models.
- Task Lights:
  - Attach to underside of stack-on and wall mount storage cabinets.
  - Fluorescent or LED options.
  - Tackboard and fluorescent and LED task light solutions, by model, for each stack-on storage size:

Stack-on Storage	Tackboard	Fluorescent Task Light	LED Task Light
78"W	H90057	HH870960, HH870960CH	HLED31A, HLED31AUO
72"W	H90056	HH870960, HH870960CH	HLED31A, HLED31AUO
66"W	H90055	HH870960, HH870960CH	HLED31A, HLED17AUO
60"W	H90054	HH870960, HH870960CH	HLED31A, HLED17AUO
48"W	H90053	HH870942, HH870942CH	HLED31AS
42"W	H90052	HH870942, HH870942CH	HLED31AS
36"W	H90051	HH870930, HH870930CH	HLED17AS



# CONCINNITY™ Stack-on Storage

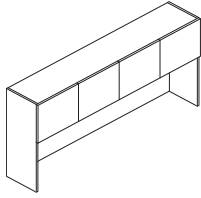

**DESCRIPTION**

**Stack-on Storage, Laminate Doors**  
 78"W x 15"D x 35¼"H — 4 doors, 2 compartments  
 72"W x 15"D x 35¼"H — 4 doors, 2 compartments  
 66"W x 15"D x 35¼"H — 4 doors, 2 compartments  
 60"W x 15"D x 35¼"H — 4 doors, 2 compartments  
 48"W x 15"D x 35¼"H — 3 doors, 2 compartments  
 42"W x 15"D x 35¼"H — 2 doors, 1 compartment  
 36"W x 15"D x 35¼"H — 2 doors, 1 compartment

MODEL	SHIP WEIGHT	CUBE	L1 LIST	L2 UPCHARGES	
				CHASSIS	FRONTS
<b>HNL3678LD</b>	173	31.8	<b>\$1229</b>	<b>\$45</b>	<b>\$20</b>
<b>HNL3672LD</b>	162	29.0	<b>\$1178</b>	<b>\$35</b>	<b>\$20</b>
<b>HNL3666LD</b>	151	26.7	<b>\$1162</b>	<b>\$35</b>	<b>\$20</b>
<b>HNL3660LD</b>	139	24.3	<b>\$1060</b>	<b>\$35</b>	<b>\$20</b>
<b>HNL3648LD</b>	117	19.6	<b>\$956</b>	<b>\$30</b>	<b>\$20</b>
<b>HNL3642LD</b>	100	18.1	<b>\$932</b>	<b>\$30</b>	<b>\$10</b>
<b>HNL3636LD</b>	88	15.3	<b>\$788</b>	<b>\$30</b>	<b>\$10</b>

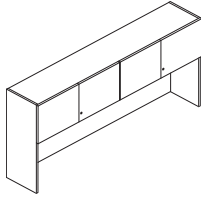

**Stack-on Storage, Laminate Locking Doors**

78"W x 15"D x 35¼"H — 4 doors, 2 compartments  
 72"W x 15"D x 35¼"H — 4 doors, 2 compartments  
 66"W x 15"D x 35¼"H — 4 doors, 2 compartments  
 60"W x 15"D x 35¼"H — 4 doors, 2 compartments  
 48"W x 15"D x 35¼"H — 3 doors, 2 compartments  
 42"W x 15"D x 35¼"H — 2 doors, 1 compartment  
 36"W x 15"D x 35¼"H — 2 doors, 1 compartment

<b>HNL3678LL</b>	173	31.8	<b>\$1309</b>	<b>\$45</b>	<b>\$20</b>
<b>HNL3672LL</b>	162	29.0	<b>\$1258</b>	<b>\$35</b>	<b>\$20</b>
<b>HNL3666LL</b>	151	26.7	<b>\$1242</b>	<b>\$35</b>	<b>\$20</b>
<b>HNL3660LL</b>	139	24.3	<b>\$1140</b>	<b>\$35</b>	<b>\$20</b>
<b>HNL3648LL</b>	117	19.6	<b>\$996</b>	<b>\$30</b>	<b>\$20</b>
<b>HNL3642LL</b>	100	18.1	<b>\$972</b>	<b>\$30</b>	<b>\$10</b>
<b>HNL3636LL</b>	88	15.3	<b>\$828</b>	<b>\$30</b>	<b>\$10</b>

! Lock available in Black (P) or Satin (SA) finish. Lock is core removable. Keyed alike cores must be ordered separately. For stack-on and wall mount storage with locking hinged doors, specify model HF27B (Black) or HF27S (Satin) and the key number, see page 177. Model HNL3648LL has one lock, which secures two of the three doors.

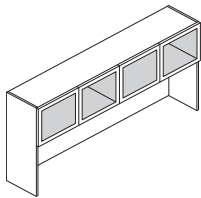

**Stack-on Storage, Frosted Doors with Silver Frame**

78"W x 15"D x 35¼"H — 4 doors, 2 compartments  
 72"W x 15"D x 35¼"H — 4 doors, 2 compartments  
 66"W x 15"D x 35¼"H — 4 doors, 2 compartments  
 60"W x 15"D x 35¼"H — 4 doors, 2 compartments  
 48"W x 15"D x 35¼"H — 3 doors, 2 compartments  
 42"W x 15"D x 35¼"H — 2 doors, 1 compartment  
 36"W x 15"D x 35¼"H — 2 doors, 1 compartment

<b>HNL3678FD</b>	153	31.8	<b>\$1829</b>	<b>\$45</b>	<b>N/A</b>
<b>HNL3672FD</b>	143	29.0	<b>\$1778</b>	<b>\$35</b>	<b>N/A</b>
<b>HNL3666FD</b>	134	26.7	<b>\$1762</b>	<b>\$35</b>	<b>N/A</b>
<b>HNL3660FD</b>	124	24.3	<b>\$1660</b>	<b>\$35</b>	<b>N/A</b>
<b>HNL3648FD</b>	104	19.6	<b>\$1406</b>	<b>\$30</b>	<b>N/A</b>
<b>HNL3642FD</b>	89	18.1	<b>\$1232</b>	<b>\$30</b>	<b>N/A</b>
<b>HNL3636FD</b>	79	15.3	<b>\$1088</b>	<b>\$30</b>	<b>N/A</b>

! Frosted/silver door units do not have a lock option.

**NOTES:**

- Convenient off-the-worksurface storage requires no additional floor space.
- 35¼"H stack-on storage models ship fully assembled.
- Fully enclosed back provides privacy; includes a 1¼", full-width pass-through for 3-prong electrical plugs; facilitates routing cords and reaching wall electrical outlets.
- Lower back panel can be attached with cord pass-through at bottom next to the worksurface or at top for close proximity to task light cord.
- Lower back panel can be removed to facilitate collaboration in teaming configurations.
- Valance hides task light.
- Vertical clearance for computer monitor is 20".
- Laminate vertical paper organizer (HLVPMI) sized to fit below storage compartments.
- Can be specified in seven widths (36", 42", 48", 60", 66", 72", and 78"W) and two heights, standard (35¼"H) or executive (48⅝"H).
- Available with laminate doors, frosted/silver doors, or sliding door.
- Doors are sized to overlap the top, end panels and light valance, to provide a clean design.
- Laminate and frosted/silver door units are equipped with self-closing, adjustable hinges.
- Laminate hinged door units are available with or without a lock.
- For tackboards, see page 127.
- For task lights, see page 178.
- For paper organizers, see page 175.

**HOW TO SPECIFY**

<p><b>Select Model Number</b></p> <p>H N L 3 6 7 2 L D</p>	<p><b>Select Chassis Color</b></p> <p>See page 96</p> <p>H</p>	<p><b>Select Door Front Color</b></p> <p>See page 96</p> <p>H</p>	
<p><b>Select Model Number</b></p> <p>H N L 3 6 7 2 L L</p>	<p><b>Select Lock Finish</b></p> <p>See page 96</p> <p>P</p>	<p><b>Select Chassis Color</b></p> <p>See page 96</p> <p>H</p>	<p><b>Select Door Front Color</b></p> <p>See page 96</p> <p>H</p>
<p><b>Select Model Number</b></p> <p>H N L 3 6 7 2 F D</p>	<p><b>Select Chassis Color</b></p> <p>See page 96</p> <p>H</p>		

# CONCINNITY™

## Stack-on Storage

GSA SIN 711-2

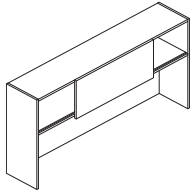

Icon Legend on page 21

**DESCRIPTION****Stack-on Storage, Sliding Door**

78"W x 15"D x 35¼"H  
 72"W x 15"D x 35¼"H  
 66"W x 15"D x 35¼"H  
 60"W x 15"D x 35¼"H  
 48"W x 15"D x 35¼"H

**MODEL**

**HNL3678SD**  
**HNL3672SD**  
**HNL3666SD**  
**HNL3660SD**  
**HNL3648SD**

**SHIP WEIGHT**

161  
 151  
 141  
 131  
 110

**CUBE**

31.8  
 29.0  
 26.7  
 24.3  
 19.6

**L1 LIST**

**\$1178**  
**\$1143**  
**\$1053**  
**\$1024**  
**\$968**

**L2 UPCHARGES**

CHASSIS	FRONTS
<b>\$45</b>	<b>\$20</b>
<b>\$35</b>	<b>\$20</b>
<b>\$35</b>	<b>\$20</b>
<b>\$35</b>	<b>\$20</b>
<b>\$30</b>	<b>\$20</b>

NOTES: Sliding door units have one door per cabinet; standard with black lock, which is located on inside vertical support panel. Lock is core removable. Keyed alike cores must be ordered separately. For stack-on and wall mount storage with sliding door, specify model HF23B (Black) and the key number, see page 177. Sliding door availability limited to select sizes.

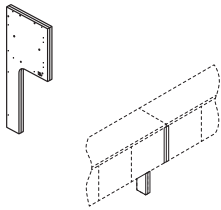
**Stack-on Space Saver End Panels**

¾"W x 14¼"D x 35¼"H

**HNL3605SSEP**

14

1.7

**\$351****\$15****N/A**

NOTES: Two field installable end panels (1-right; 1-left) for use in ganging two stack-on storage units. Combining stack-on allows users to span longer worksurfaces, including 84" (2 - 42"W), 96" (2 - 48"W), 120" (2 - 60"W), and 144" (2 - 72"W). Narrow, space-saving panel size replaces the full 15"D end panels to expand worksurface space. The 4¼" right end panel is to replace the standard 15"D right end panel on one stack-on storage unit, the 4¼" left end panel is to replace the standard 15"D left end panel on a separate, adjacent stack-on storage unit that is in linear alignment with the first unit. Kit includes: (2) narrow end panel supports; European-style fasteners; dowels; joint connector bolts with sleeve nuts (for ganging stack-on storage units). Can be used to connect up to two stack-on storage units in a line (requires 1 kit). Can be specified in a woodgrain or solid laminate color only.

**SPECIFYING EXAMPLE: HNL3605SSEP.H**

**NOTES:**

- Convenient off-the-worksurface storage requires no additional floor space.
- 35¼"H stack-on storage models ship fully assembled.
- Fully enclosed back provides privacy; includes a 1¼", full-width pass-through for 3-prong electrical plugs; facilitates routing cords and reaching wall electrical outlets.
- Lower back panel can be attached with cord pass-through at bottom next to the worksurface or at top for close proximity to task light cord.
- Lower back panel can be removed to facilitate collaboration in teaming configurations.
- Valance hides task light.
- Vertical clearance for computer monitor is 20".
- Laminate vertical paper organizer (HLVPM1) sized to fit below storage compartments.
- Can be specified in seven widths (36", 42", 48", 60", 66", 72", and 78"W) and two heights, standard (35¼"H) or executive (48⅝"H).
- Available with laminate doors, frosted/silver doors, or sliding door.
- Doors are sized to overlap the top, end panels and light valance, to provide a clean design.
- Laminate and frosted/silver door units are equipped with self-closing, adjustable hinges.
- Laminate hinged door units are available with or without a lock.
- For tackboards, see page 127.
- For task lights, see page 178.
- For paper organizers, see page 175.

**HOW TO SPECIFY****Select Model Number**

H N L 3 6 7 2 S D

**Select Chassis Color**

See page 96

H

**Select Door Front Color**

See page 96

H

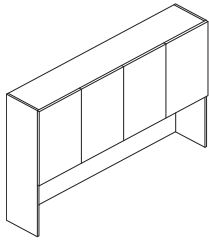
**DESCRIPTION****Stack-on Storage, Laminate Doors**

78"W x 15"D x 48 <sup>5</sup> / <sub>8</sub> "H — 4 doors, 2 compartments
72"W x 15"D x 48 <sup>5</sup> / <sub>8</sub> "H — 4 doors, 2 compartments
66"W x 15"D x 48 <sup>5</sup> / <sub>8</sub> "H — 4 doors, 2 compartments
60"W x 15"D x 48 <sup>5</sup> / <sub>8</sub> "H — 4 doors, 2 compartments
48"W x 15"D x 48 <sup>5</sup> / <sub>8</sub> "H — 3 doors, 2 compartments
42"W x 15"D x 48 <sup>5</sup> / <sub>8</sub> "H — 2 doors, 1 compartment
36"W x 15"D x 48 <sup>5</sup> / <sub>8</sub> "H — 2 doors, 1 compartment

**MODEL****SHIP WEIGHT****CUBE****L1 LIST****L2 UPCHARGES**  
**CHASSIS    FRONTS**

<b>HNL4978LD</b>	264	31.3	<b>\$1659</b>	<b>\$60</b>	<b>\$20</b>
<b>HNL4972LD</b>	243	29.1	<b>\$1527</b>	<b>\$50</b>	<b>\$20</b>
<b>HNL4966LD</b>	229	26.8	<b>\$1443</b>	<b>\$50</b>	<b>\$20</b>
<b>HNL4960LD</b>	212	24.5	<b>\$1342</b>	<b>\$50</b>	<b>\$20</b>
<b>HNL4948LD</b>	175	26.4	<b>\$1279</b>	<b>\$45</b>	<b>\$20</b>
<b>HNL4942LD</b>	149	23.2	<b>\$1122</b>	<b>\$45</b>	<b>\$20</b>
<b>HNL4936LD</b>	145	20.3	<b>\$1085</b>	<b>\$45</b>	<b>\$20</b>

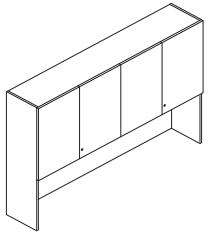
**Stack-on Storage, Laminate Locking Doors**

78"W x 15"D x 48 <sup>5</sup> / <sub>8</sub> "H — 4 doors, 2 compartments
72"W x 15"D x 48 <sup>5</sup> / <sub>8</sub> "H — 4 doors, 2 compartments
66"W x 15"D x 48 <sup>5</sup> / <sub>8</sub> "H — 4 doors, 2 compartments
60"W x 15"D x 48 <sup>5</sup> / <sub>8</sub> "H — 4 doors, 2 compartments
48"W x 15"D x 48 <sup>5</sup> / <sub>8</sub> "H — 3 doors, 2 compartments
42"W x 15"D x 48 <sup>5</sup> / <sub>8</sub> "H — 2 doors, 1 compartment
36"W x 15"D x 48 <sup>5</sup> / <sub>8</sub> "H — 2 doors, 1 compartment

<b>HNL4978LL</b>
<b>HNL4972LL</b>
<b>HNL4966LL</b>
<b>HNL4960LL</b>
<b>HNL4948LL</b>
<b>HNL4942LL</b>
<b>HNL4936LL</b>

264	31.3	<b>\$1739</b>	<b>\$60</b>	<b>\$20</b>
243	29.1	<b>\$1607</b>	<b>\$50</b>	<b>\$20</b>
229	26.8	<b>\$1523</b>	<b>\$50</b>	<b>\$20</b>
212	24.5	<b>\$1422</b>	<b>\$50</b>	<b>\$20</b>
175	26.4	<b>\$1319</b>	<b>\$45</b>	<b>\$20</b>
149	23.2	<b>\$1162</b>	<b>\$45</b>	<b>\$20</b>
145	20.3	<b>\$1125</b>	<b>\$45</b>	<b>\$20</b>

**!** Lock available in Black (P) or Satin (SA) finish. Lock is core removable. Keyed alike cores must be ordered separately. For stack-on and wall mount storage with locking hinged doors, specify model HF27B (Black) or HF27S (Satin) and the key number, see page 177. Model HNL4948LL has one lock, which secures two of the three doors.

**NOTES:**

- Convenient off-the-worksurface storage requires no additional floor space.
- 48<sup>5</sup>/<sub>8</sub>"H units have a fixed, intermittent shelf; storage space above and below the shelf is 12<sup>5</sup>/<sub>8</sub>".
- Product applications are detailed on pages 121-122.
- Fully enclosed back provides privacy; includes a 1<sup>1</sup>/<sub>4</sub>", full-width pass-through for 3-prong electrical plugs; facilitates routing cords and reaching wall electrical outlets.
- Lower back panel can be attached with cord pass-through at bottom next to the worksurface or at top for close proximity to task light cord.
- Lower back panel can be removed to facilitate collaboration in teaming configurations.
- Valance hides task light.
- Vertical clearance for computer monitor is 20".
- Laminate vertical paper organizer (HLVPM1) sized to fit below storage compartments.
- Can be specified in seven widths (36", 42", 48", 60", 66", 72", and 78"W) and two heights, standard (35<sup>1</sup>/<sub>4</sub>"H) or executive (48<sup>5</sup>/<sub>8</sub>"H).
- Available with laminate doors, frosted/silver doors, or sliding door.
- Doors are sized to overlap the top, end panels and light valance, to provide a clean design.
- Laminate and frosted/silver door units are equipped with self-closing, adjustable hinges.
- Laminate hinged door units are available with or without a lock.
- For tackboards, see page 127.
- For task lights, see page 178.
- For paper organizers, see page 175.

**HOW TO SPECIFY**

<b>Select Model Number</b> <input type="text" value="HNL4978LD"/>	<b>Select Chassis Color</b> See page 96 <input type="text" value="H"/>	<b>Select Door Front Color</b> See page 96 <input type="text" value="H"/>	
<b>Select Model Number</b> <input type="text" value="HNL4978LL"/>	<b>Select Lock Finish</b> See page 96 <input type="text" value="P"/>	<b>Select Chassis Color</b> See page 96 <input type="text" value="H"/>	<b>Select Door Front Color</b> See page 96 <input type="text" value="H"/>



# CONCINNITY™

## Stack-on Storage

GSA SIN 711-2



Icon Legend on page 21

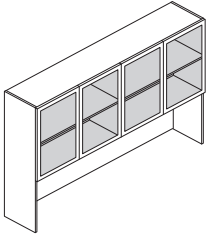

DESCRIPTION	MODEL	SHIP WEIGHT	CUBE	L1 LIST	L2 UPCHARGES	
					CHASSIS	FRONTS
<b>Stack-on Storage, Frosted Doors with Silver Frame</b>						
78"W x 15"D x 48 $\frac{5}{8}$ "H — 4 doors, 2 compartments	<b>HNL4978FD</b>	225	31.3	<b>\$2559</b>	<b>\$60</b>	<b>N/A</b>
72"W x 15"D x 48 $\frac{5}{8}$ "H — 4 doors, 2 compartments	<b>HNL4972FD</b>	207	29.1	<b>\$2427</b>	<b>\$50</b>	<b>N/A</b>
66"W x 15"D x 48 $\frac{5}{8}$ "H — 4 doors, 2 compartments	<b>HNL4966FD</b>	196	26.8	<b>\$2343</b>	<b>\$50</b>	<b>N/A</b>
60"W x 15"D x 48 $\frac{5}{8}$ "H — 4 doors, 2 compartments	<b>HNL4960FD</b>	182	24.5	<b>\$2242</b>	<b>\$50</b>	<b>N/A</b>
48"W x 15"D x 48 $\frac{5}{8}$ "H — 3 doors, 2 compartments	<b>HNL4948FD</b>	152	26.4	<b>\$1954</b>	<b>\$45</b>	<b>N/A</b>
42"W x 15"D x 48 $\frac{5}{8}$ "H — 2 doors, 1 compartment	<b>HNL4942FD</b>	128	23.2	<b>\$1572</b>	<b>\$45</b>	<b>N/A</b>
36"W x 15"D x 48 $\frac{5}{8}$ "H — 2 doors, 1 compartment	<b>HNL4936FD</b>	114	20.3	<b>\$1535</b>	<b>\$45</b>	<b>N/A</b>

Frosted/silver door units do not have a lock option.

### NOTES:

- Convenient off-the-worksurface storage requires no additional floor space.
- 48 $\frac{5}{8}$ "H units have a fixed, intermittent shelf; storage space above and below the shelf is 12 $\frac{5}{8}$ ".
- Product applications are detailed on pages 121-122.
- Fully enclosed back provides privacy; includes a 1 $\frac{1}{4}$ ", full-width pass-through for 3-prong electrical plugs; facilitates routing cords and reaching wall electrical outlets.
- Lower back panel can be attached with cord pass-through at bottom next to the worksurface or at top for close proximity to task light cord.
- Lower back panel can be removed to facilitate collaboration in teaming configurations.
- Valance hides task light.
- Vertical clearance for computer monitor is 20".
- Laminate vertical paper organizer (HLVPM1) sized to fit below storage compartments.
- Can be specified in seven widths (36", 42", 48", 60", 66", 72", and 78"W) and two heights, standard (35 $\frac{1}{4}$ "H) or executive (48 $\frac{5}{8}$ "H).
- Available with laminate doors, frosted/silver doors, or sliding door.
- Doors are sized to overlap the top, end panels and light valance, to provide a clean design.
- Laminate and frosted/silver door units are equipped with self-closing, adjustable hinges.
- Laminate hinged door units are available with or without a lock.
- For tackboards, see page 127.
- For task lights, see page 178.
- For paper organizers, see page 175.

### HOW TO SPECIFY

Select  
Model Number

Select  
Chassis Color

See page 96

H N L 4 9 7 8 F D . H

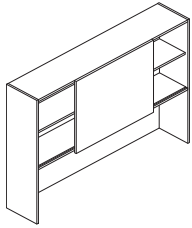

# CONCINNITY™ Stack-on Storage

**DESCRIPTION****Stack-on Storage, Sliding Door**

78"W x 15"D x 48<sup>5</sup>/<sub>8</sub>"H  
 72"W x 15"D x 48<sup>5</sup>/<sub>8</sub>"H  
 66"W x 15"D x 48<sup>5</sup>/<sub>8</sub>"H  
 60"W x 15"D x 48<sup>5</sup>/<sub>8</sub>"H  
 48"W x 15"D x 48<sup>5</sup>/<sub>8</sub>"H

**MODEL**

**HNL4978SD**   
**HNL4972SD**   
**HNL4966SD**   
**HNL4960SD**   
**HNL4948SD**

**COM****SHIP WEIGHT****CUBE****L1 LIST****L2 UPCHARGES  
CHASSIS FRONTS**

236	31.3	<b>\$1683</b>	<b>\$60</b>	<b>\$20</b>
221	29.1	<b>\$1593</b>	<b>\$50</b>	<b>\$20</b>
207	26.8	<b>\$1557</b>	<b>\$50</b>	<b>\$20</b>
192	24.5	<b>\$1372</b>	<b>\$50</b>	<b>\$20</b>
162	26.4	<b>\$1306</b>	<b>\$45</b>	<b>\$20</b>

NOTES: Sliding door units have one door per cabinet; standard with black lock, which is located on inside vertical support panel. Lock is core removable. Keyed alike cores must be ordered separately. For stack-on and wall mount storage with sliding door, specify model HF23B (Black) and the key number, see page 177. Sliding door availability limited to select sizes.

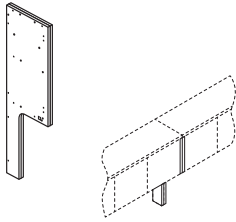
**Stack-on Space Saver End Panels**

<sup>3</sup>/<sub>4</sub>"W x 14<sup>1</sup>/<sub>4</sub>"D x 48<sup>5</sup>/<sub>8</sub>"H

**HNL4905SEP**

23

2.2

**\$476****\$15****N/A**

NOTES: Two field installable end panels (1-right; 1-left) for use in ganging two stack-on storage units. Combining stack-on allows users to span longer worksurfaces, including 84" (2 - 42"W), 96" (2 - 48"W), 120" (2 - 60"W), and 144" (2 - 72"W). Narrow, space-saving panel size replaces the full 15"D end panels to expand worksurface space. The <sup>4</sup>/<sub>4</sub>" right end panel is to replace the standard 15"D right end panel on one stack-on storage unit, the <sup>4</sup>/<sub>4</sub>" left end panel is to replace the standard 15"D left end panel on a separate, adjacent stack-on storage unit that is in linear alignment with the first unit. Kit includes: (2) narrow end panel supports; European-style fasteners; dowels; joint connector bolts with sleeve nuts (for ganging stack-on storage units). Can be used to connect up to two stack-on storage units in a line (requires 1 kit). Can be specified in a woodgrain or solid laminate color only.

**SPECIFYING EXAMPLE: HNL4905SEP.H**

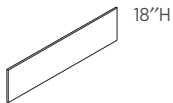

18"H

**Tackboards for use with Stack-on Storage**

75"W - for 78"W

**H90057**

3.0

13

3.2

**\$297****N/A****N/A**68<sup>3</sup>/<sub>4</sub>"W - for 72"W**H90056**

2.0

12

2.7

**\$283****N/A****N/A**62<sup>3</sup>/<sub>4</sub>"W - for 66"W**H90055**

2.0

11

2.5

**\$268****N/A****N/A**56<sup>3</sup>/<sub>4</sub>"W - for 60"W**H90054**

2.0

10

2.2

**\$236****N/A****N/A**44<sup>3</sup>/<sub>4</sub>"W - for 48"W**H90053**

2.0

8

1.8

**\$226****N/A****N/A**

39"W - for 42"W

**H90052**

2.0

7

1.6

**\$208****N/A****N/A**

33"W - for 36"W

**H90051**

1.0

6

1.4

**\$184****N/A****N/A**26<sup>3</sup>/<sub>4</sub>"W**H90050**

1.0

5

1.2

**\$184****N/A****N/A**

NOTES: Specify fabric, see pages 35-36. Upcharges may apply to premium fabric grades.

**SPECIFYING EXAMPLE: H90057.APN15**

**NOTES:**

- Convenient off-the-worksurface storage requires no additional floor space.
- 48<sup>5</sup>/<sub>8</sub>"H units have a fixed, intermittent shelf; storage space above and below the shelf is 12<sup>5</sup>/<sub>8</sub>".
- Fully enclosed back provides privacy; includes a 1<sup>1</sup>/<sub>4</sub>", full-width pass-through for 3-prong electrical plugs; facilitates routing cords and reaching wall electrical outlets.
- Lower back panel can be attached with cord pass-through at bottom next to the worksurface or at top for close proximity to task light cord.
- Lower back panel can be removed to facilitate collaboration in teaming configurations.
- Valance hides task light.
- Vertical clearance for computer monitor is 20".
- Laminate vertical paper organizer (HLVPM1) sized to fit below storage compartments.
- Can be specified in seven widths (36", 42", 48", 60", 66", 72", and 78"W) and two heights, standard (35<sup>3</sup>/<sub>4</sub>"H) or executive (48<sup>5</sup>/<sub>8</sub>"H).
- Available with laminate doors, frosted/silver doors, or sliding door.
- Doors are sized to overlap the top, end panels and light valance, to provide a clean design.
- Laminate and frosted/silver door units are equipped with self-closing, adjustable hinges.
- Laminate hinged door units are available with or without a lock.
- For tackboards, see above.
- For task lights, see page 178.
- For paper organizers, see page 175.

**HOW TO SPECIFY**

<b>Select Model Number</b> H N L 4 9 7 8 S D	<b>Select Chassis Color</b> See page 96 H	<b>Select Door Front Color</b> See page 96 H
---	---	--

# CONCINNITY™ WALL MOUNT STORAGE APPLICATIONS

- Installation (review carefully):
  - **Attachment requires individual cabinets be secured by a minimum of two (2) wall mounting locations/studs.**
  - **Designed for interior and perimeter walls that are constructed with wood or metal studs.**
  - **Attaches to wall with horizontally mounted, interlocking brackets.**
  - **The HON Company is not responsible for any liabilities resulting from wall mounted storage cabinets that are not properly installed.**
- Laminate, laminate locking, and frosted/silver door units can be specified in eight widths (30", 36", 42", 48", 60", 66", 72", and 78"W) and two heights, standard (15"H) or executive (29½"H).
- Sliding door units can be specified in five widths (48", 60", 66", 72", and 78"W) and two heights, standard (15"H) or executive (29½"H).
- Product placement can be aligned to match the height of 64¾"H or 78⅛"H storage- and wardrobe-type cabinets.
- Available with laminate doors, frosted/silver doors, or sliding door.
  - Door design overlaps end panels so that when multiple units are placed side-by-side they appear as one continuous unit.
  - Laminate and frosted/silver door units are equipped with self-closing, adjustable hinges.
  - Laminate hinged door units are available with or without a lock.
  - Lock available in Black (P) or Satin (SA).
  - Lock is core removable; keyed alike cores must be ordered separately — for overhead storage with hinged doors specify model HF27B or HF27S and the key number.
  - Frosted/silver hinged door units do not have a lock option.
  - Sliding door units have one door per cabinet; standard with black lock, which is located on inside vertical support panel. Lock is core removable; keyed alike cores must be ordered separately — for overhead storage with a sliding door specify model HF23B (Black) and the key number.
  - Laminate and frosted/silver door cabinets in 30", 36", and 42"W have two doors; 48"W has three doors; 60", 66", 72", and 78"W have four doors.
- Inside storage dimensions of 15"H cabinets:
  - 30"W = one compartment, sized 28⅜"W x 13⅜"D x 12¾"H
  - 36"W = one compartment, sized 34⅜"W x 13⅜"D x 12¾"H
  - 42"W = one compartment, sized 40⅜"W x 13⅜"D x 12¾"H
  - 48"W = two compartments, one sized 30⅝"W x 13⅜"D x 12¾"H; one sized 14⅝"W x 13⅜"D x 12¾"H
  - 60"W = two compartments, each 28⅝"W x 13⅜"D x 12¾"H
  - 66"W = two compartments, each 31⅝"W x 13⅜"D x 12¾"H
  - 72"W = two compartments, each 34⅝"W x 13⅜"D x 12¾"H
  - 78"W = two compartments, each 37⅝"W x 13⅜"D x 12¾"H
- 28½"H units have a fixed, intermittent shelf; storage space above and below the shelf is 12⅝".
- Wall mounted storage cabinets are not designed for attachment to O-leg models HLSL65OS or HLSL50OS.
- Horizontal interlocking rails are included; due to varying types of walls, installers are responsible for selecting and supplying the appropriate fasteners.
- Ship fully assembled.

# CONCINNITY™ WALL MOUNT STORAGE APPLICATIONS

## OPTIONS INCLUDE:

- Door/Storage Options:

Door(s)	Standard-Height	Executive-Height
Laminate	•	•
Laminate Locking	•	•
Frosted/Silver	•	•
Sliding	48"-78"W only	48"-78"W only

- Paper organizers for stack-on and wall mounted storage cabinets (see compatibility information on page 176).
- Fabric-Covered Tackboards:
  - Tackboards mount directly to wall using the fasteners or hook-and-loop tape provided.
  - Available in HON Group panel fabric grades A and B.
  - See compatibility cross reference below.
  - NOTE: Tackboard widths differ slightly from the wall mounted storage cabinet widths. For applications where multiple wall mounted storage units are placed side-by-side, the preferred tackboard solution may be to utilize a larger tackboard size.  
For example, H90057 = 75"W; H90056 = 68<sup>3</sup>/<sub>4</sub>"W; H90055 = 62<sup>3</sup>/<sub>4</sub>"W; H90054 = 56<sup>3</sup>/<sub>4</sub>"W.
- Markerboards:
  - HLSL1530SOMB: 29<sup>1</sup>/<sub>2</sub>"W x 12<sup>1</sup>/<sub>2</sub>"H panel attaches to 60" and 66"W stack-on and wall mounted storage with sliding door models with double-sided tape.
  - HLSL1536SOMB: 35<sup>1</sup>/<sub>2</sub>"W x 12<sup>1</sup>/<sub>2</sub>"H panel attaches to 72" and 78"W stack-on and wall mounted storage with sliding door models with double-sided tape.
- Task Lights:
  - Attach to underside of stack-on and wall mount storage cabinets.
  - Fluorescent or LED options.
  - Compatibility: Tackboard and task light solutions, by model, for each wall mounted storage cabinet size:

Wall Mounted Storage	Tackboard	Fluorescent Task Light	LED Task Light
78"W	H90057 (75"W) or qty 2 of H90052 (39"W ea.)	HH870960, HH870960CH	HLED31A, HLED31AUO
72"W	H90056 (71 <sup>1</sup> / <sub>2</sub> "W)	HH870960, HH870960CH	HLED31A, HLED31AUO
66"W	H90055 (65 <sup>15</sup> / <sub>16</sub> "W)	HH870960, HH870960CH	HLED31A, HLED17AUO
60"W	H90054 (59 <sup>15</sup> / <sub>16</sub> "W)	HH870960, HH870960CH	HLED31A, HLED17AUO
48"W	H90053 (44 <sup>3</sup> / <sub>4</sub> "W)	HH870942, HH870942CH	HLED31AS
42"W	H90052 (39"W)	HH870942, HH870942CH	HLED31AS
36"W	H90051 (33"W)	HH870930, HH870930CH	HLED17AS
30"W	H90050 (26 <sup>3</sup> / <sub>4</sub> "W)	HH870930, HH870930CH	HLED17AS

# CONCINNITY™

## Wall Mount Storage

GSA SIN 711-2

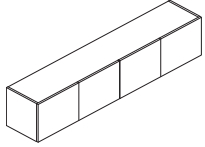

Icon Legend on page 21

**DESCRIPTION****Wall Mount Storage, Laminate Doors**

78"W x 15"D x 15"H — 4 doors, 2 compartments  
 72"W x 15"D x 15"H — 4 doors, 2 compartments  
 66"W x 15"D x 15"H — 4 doors, 2 compartments  
 60"W x 15"D x 15"H — 4 doors, 2 compartments  
 48"W x 15"D x 15"H — 3 doors, 2 compartments  
 42"W x 15"D x 15"H — 2 doors, 1 compartment  
 36"W x 15"D x 15"H — 2 doors, 1 compartment  
 30"W x 15"D x 15"H — 2 doors, 1 compartment

**MODEL****SHIP WEIGHT****CUBE****L1 LIST****L2 UPCHARGES**  
**CHASSIS    FRONTS**

<b>HNL1578LD</b>	126	17.1	<b>\$1157</b>	<b>\$35</b>	<b>\$20</b>
<b>HNL1572LD</b>	118	15.9	<b>\$1075</b>	<b>\$25</b>	<b>\$20</b>
<b>HNL1566LD</b>	109	14.6	<b>\$1024</b>	<b>\$25</b>	<b>\$20</b>
<b>HNL1560LD</b>	100	13.3	<b>\$919</b>	<b>\$25</b>	<b>\$20</b>
<b>HNL1548LD</b>	83	10.9	<b>\$829</b>	<b>\$20</b>	<b>\$20</b>
<b>HNL1542LD</b>	68	9.7	<b>\$783</b>	<b>\$20</b>	<b>\$10</b>
<b>HNL1536LD</b>	60	8.4	<b>\$715</b>	<b>\$20</b>	<b>\$10</b>
<b>HNL1530LD</b>	51	7.2	<b>\$660</b>	<b>\$20</b>	<b>\$10</b>

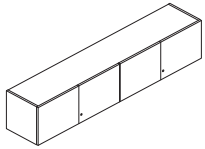
**Wall Mount Storage, Laminate Locking Doors**

78"W x 15"D x 15"H — 4 doors, 2 compartments  
 72"W x 15"D x 15"H — 4 doors, 2 compartments  
 66"W x 15"D x 15"H — 4 doors, 2 compartments  
 60"W x 15"D x 15"H — 4 doors, 2 compartments  
 48"W x 15"D x 15"H — 3 doors, 2 compartments  
 42"W x 15"D x 15"H — 2 doors, 1 compartment  
 36"W x 15"D x 15"H — 2 doors, 1 compartment  
 30"W x 15"D x 15"H — 2 doors, 1 compartment

<b>HNL1578LL</b>	126	17.1	<b>\$1237</b>	<b>\$35</b>	<b>\$20</b>
<b>HNL1572LL</b>	118	15.9	<b>\$1155</b>	<b>\$25</b>	<b>\$20</b>
<b>HNL1566LL</b>	109	14.6	<b>\$1104</b>	<b>\$25</b>	<b>\$20</b>
<b>HNL1560LL</b>	100	13.3	<b>\$999</b>	<b>\$25</b>	<b>\$20</b>
<b>HNL1548LL</b>	83	10.9	<b>\$869</b>	<b>\$20</b>	<b>\$20</b>
<b>HNL1542LL</b>	68	9.7	<b>\$823</b>	<b>\$20</b>	<b>\$10</b>
<b>HNL1536LL</b>	60	8.4	<b>\$755</b>	<b>\$20</b>	<b>\$10</b>
<b>HNL1530LL</b>	51	7.2	<b>\$700</b>	<b>\$20</b>	<b>\$10</b>

! Lock available in Black (P) or Satin (SA) finish. Lock is core removable. Keyed alike cores must be ordered separately. For stack-on and wall mount storage with locking hinged doors, specify model HF27B (Black) or HF27S (Satin) and the key number, see page 177. Model HNL1548LL has one lock, which secures two of the three doors.

**NOTES:**

- Convenient off-the-worksurface storage requires no additional floor space.
- Available with laminate doors, frosted/silver doors, or sliding door.
- Doors are sized to overlap the top, end panels and light valance, to provide a clean design.
- Laminate and frosted/silver door units are equipped with self-closing, adjustable hinges.
- Laminate hinged door units are available with or without a lock.
- For tackboards, see page 133.
- For task lights, see page 178.
- For paper organizers, see page 175.
- **IMPORTANT: See installation guidelines at top of page 128.**

**HOW TO SPECIFY****Select Model Number**

H N L 1 5 7 8 L D

**Select Chassis Color**

See page 96

H

**Select Door Front Color**

See page 96

H

**Select Model Number**

H N L 1 5 7 8 L L

**Select Lock Finish**

See page 96

P

**Select Chassis Color**

See page 96

H

**Select Door Front Color**

See page 96

H



# CONCINNITY™ Wall Mount Storage

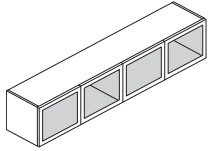

**DESCRIPTION**

**Wall Mount Storage, Frosted Doors with Silver Frame**

- 78"W x 15"D x 15"H — 4 doors, 2 compartments
- 72"W x 15"D x 15"H — 4 doors, 2 compartments
- 66"W x 15"D x 15"H — 4 doors, 2 compartments
- 60"W x 15"D x 15"H — 4 doors, 2 compartments
- 48"W x 15"D x 15"H — 3 doors, 2 compartments
- 42"W x 15"D x 15"H — 2 doors, 1 compartment
- 36"W x 15"D x 15"H — 2 doors, 1 compartment
- 30"W x 15"D x 15"H — 2 doors, 1 compartment

**MODEL**

**SHIP WEIGHT    CUBE    L1 LIST    L2 UPCHARGES  
CHASSIS    FRONTS**

<b>HNL1578FD</b>	106	17.1	<b>\$1757</b>	<b>\$35</b>	<b>N/A</b>
<b>HNL1572FD</b>	99	15.9	<b>\$1675</b>	<b>\$25</b>	<b>N/A</b>
<b>HNL1566FD</b>	92	14.6	<b>\$1624</b>	<b>\$25</b>	<b>N/A</b>
<b>HNL1560FD</b>	85	13.3	<b>\$1519</b>	<b>\$25</b>	<b>N/A</b>
<b>HNL1548FD</b>	71	10.9	<b>\$1279</b>	<b>\$20</b>	<b>N/A</b>
<b>HNL1542FD</b>	57	9.7	<b>\$1083</b>	<b>\$20</b>	<b>N/A</b>
<b>HNL1536FD</b>	50	8.4	<b>\$1015</b>	<b>\$20</b>	<b>N/A</b>
<b>HNL1530FD</b>	43	7.2	<b>\$960</b>	<b>\$20</b>	<b>N/A</b>

❗ Frosted door models do not have a lock option.

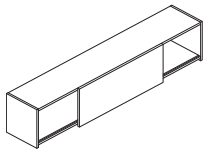

**Wall Mount Storage, Sliding Door**

- 78"W x 15"D x 15"H
- 72"W x 15"D x 15"H
- 66"W x 15"D x 15"H
- 60"W x 15"D x 15"H
- 48"W x 15"D x 15"H

<b>HNL1578SD</b>	114	17.1	<b>\$1127</b>	<b>\$35</b>	<b>\$20</b>
<b>HNL1572SD</b>	107	15.9	<b>\$1034</b>	<b>\$25</b>	<b>\$20</b>
<b>HNL1566SD</b>	99	14.6	<b>\$963</b>	<b>\$25</b>	<b>\$20</b>
<b>HNL1560SD</b>	91	13.3	<b>\$875</b>	<b>\$25</b>	<b>\$20</b>
<b>HNL1548SD</b>	76	10.9	<b>\$819</b>	<b>\$20</b>	<b>\$20</b>

NOTES: One door per unit. Standard with black lock, which is located on the inside vertical support panel. Lock is core removable. Keyed alike cores must be ordered separately. For stack-on and wall mount storage with sliding door, specify model HF23B (Black) and the key number, see page 177.

**NOTES:**

- Convenient off-the-worksurface storage requires no additional floor space.
- Available with laminate doors, frosted/silver doors, or sliding door.
- Doors are sized to overlap the top, end panels and light valance, to provide a clean design.
- Laminate and frosted/silver door units are equipped with self-closing, adjustable hinges.
- Laminate hinged door units are available with or without a lock.
- For tackboards, see page 133.
- For task lights, see page 178.
- For paper organizers, see page 175.
- **IMPORTANT: See installation guidelines at top of page 128.**

## HOW TO SPECIFY

<p><b>Select Model Number</b></p> <div style="border: 1px solid black; display: flex; justify-content: space-between; align-items: center; padding: 2px;"> <span>H</span><span>N</span><span>L</span><span>1</span><span>5</span><span>7</span><span>8</span><span>F</span><span>D</span> </div>	<p><b>Select Chassis Color</b></p> <p>See page 96</p> <div style="border: 1px solid black; display: flex; justify-content: space-between; align-items: center; padding: 2px;"> <span>H</span> </div>	
<p><b>Select Model Number</b></p> <div style="border: 1px solid black; display: flex; justify-content: space-between; align-items: center; padding: 2px;"> <span>H</span><span>N</span><span>L</span><span>1</span><span>5</span><span>7</span><span>8</span><span>S</span><span>D</span> </div>	<p><b>Select Chassis Color</b></p> <p>See page 96</p> <div style="border: 1px solid black; display: flex; justify-content: space-between; align-items: center; padding: 2px;"> <span>H</span> </div>	<p><b>Select Door Front Color</b></p> <p>See page 96</p> <div style="border: 1px solid black; display: flex; justify-content: space-between; align-items: center; padding: 2px;"> <span>H</span> </div>

# CONCINNITY™

## Wall Mount Storage

GSA SIN 711-2

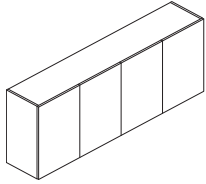

Icon Legend on page 21

**DESCRIPTION****Wall Mount Storage, Laminate Doors**

78"W x 15"D x 28½"H — 4 doors, 2 compartments  
 72"W x 15"D x 28½"H — 4 doors, 2 compartments  
 66"W x 15"D x 28½"H — 4 doors, 2 compartments  
 60"W x 15"D x 28½"H — 4 doors, 2 compartments  
 48"W x 15"D x 28½"H — 3 doors, 2 compartments  
 42"W x 15"D x 28½"H — 2 doors, 1 compartment  
 36"W x 15"D x 28½"H — 2 doors, 1 compartment  
 30"W x 15"D x 28½"H — 2 doors, 1 compartment

**MODEL****SHIP WEIGHT****CUBE****L1 LIST****L2 UPCHARGES**  
CHASSIS FRONTS

<b>HNL2978LD</b>	213	30.8	<b>\$1403</b>	<b>\$50</b>	<b>\$40</b>
<b>HNL2972LD</b>	199	28.6	<b>\$1331</b>	<b>\$40</b>	<b>\$40</b>
<b>HNL2966LD</b>	185	26.4	<b>\$1290</b>	<b>\$40</b>	<b>\$40</b>
<b>HNL2960LD</b>	170	24.1	<b>\$1198</b>	<b>\$40</b>	<b>\$40</b>
<b>HNL2948LD</b>	142	19.7	<b>\$1091</b>	<b>\$35</b>	<b>\$30</b>
<b>HNL2942LD</b>	116	17.4	<b>\$896</b>	<b>\$35</b>	<b>\$20</b>
<b>HNL2936LD</b>	101	15.2	<b>\$853</b>	<b>\$35</b>	<b>\$20</b>
<b>HNL2930LD</b>	87	12.9	<b>\$761</b>	<b>\$35</b>	<b>\$20</b>

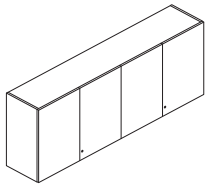
**Wall Mount Storage, Laminate Locking Doors**

78"W x 15"D x 28½"H — 4 doors, 2 compartments  
 72"W x 15"D x 28½"H — 4 doors, 2 compartments  
 66"W x 15"D x 28½"H — 4 doors, 2 compartments  
 60"W x 15"D x 28½"H — 4 doors, 2 compartments  
 48"W x 15"D x 28½"H — 3 doors, 2 compartments  
 42"W x 15"D x 28½"H — 2 doors, 1 compartment  
 36"W x 15"D x 28½"H — 2 doors, 1 compartment  
 30"W x 15"D x 28½"H — 2 doors, 1 compartment

<b>HNL2978LL</b>	213	30.8	<b>\$1483</b>	<b>\$50</b>	<b>\$40</b>
<b>HNL2972LL</b>	199	28.6	<b>\$1411</b>	<b>\$40</b>	<b>\$40</b>
<b>HNL2966LL</b>	185	26.4	<b>\$1370</b>	<b>\$40</b>	<b>\$40</b>
<b>HNL2960LL</b>	170	24.1	<b>\$1278</b>	<b>\$40</b>	<b>\$40</b>
<b>HNL2948LL</b>	142	19.7	<b>\$1131</b>	<b>\$35</b>	<b>\$30</b>
<b>HNL2942LL</b>	116	17.4	<b>\$936</b>	<b>\$35</b>	<b>\$20</b>
<b>HNL2936LL</b>	101	15.2	<b>\$893</b>	<b>\$35</b>	<b>\$20</b>
<b>HNL2930LL</b>	87	12.9	<b>\$801</b>	<b>\$35</b>	<b>\$20</b>

! Lock available in Black (P) or Satin (SA) finish. Lock is core removable. Keyed alike cores must be ordered separately. For stack-on and wall mount storage with locking hinged doors, specify model HF27B (Black) or HF27S (Satin) and the key number, see page 177. Model HNL2948LL has one lock, which secures two of the three doors.

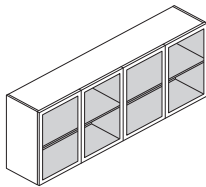
**Wall Mount Storage, Frosted Doors with Silver Frame**

78"W x 15"D x 28½"H — 4 doors, 2 compartments  
 72"W x 15"D x 28½"H — 4 doors, 2 compartments  
 66"W x 15"D x 28½"H — 4 doors, 2 compartments  
 60"W x 15"D x 28½"H — 4 doors, 2 compartments  
 48"W x 15"D x 28½"H — 3 doors, 2 compartments  
 42"W x 15"D x 28½"H — 2 doors, 1 compartment  
 36"W x 15"D x 28½"H — 2 doors, 1 compartment  
 30"W x 15"D x 28½"H — 2 doors, 1 compartment

<b>HNL2978FD</b>	174	30.8	<b>\$2303</b>	<b>\$50</b>	<b>N/A</b>
<b>HNL2972FD</b>	163	28.6	<b>\$2231</b>	<b>\$40</b>	<b>N/A</b>
<b>HNL2966FD</b>	152	26.4	<b>\$2190</b>	<b>\$40</b>	<b>N/A</b>
<b>HNL2960FD</b>	140	24.1	<b>\$2098</b>	<b>\$40</b>	<b>N/A</b>
<b>HNL2948FD</b>	118	19.7	<b>\$1766</b>	<b>\$35</b>	<b>N/A</b>
<b>HNL2942FD</b>	94	17.4	<b>\$1346</b>	<b>\$35</b>	<b>N/A</b>
<b>HNL2936FD</b>	83	15.2	<b>\$1303</b>	<b>\$35</b>	<b>N/A</b>
<b>HNL2930FD</b>	72	12.9	<b>\$1211</b>	<b>\$35</b>	<b>N/A</b>

! Frosted door models do not have a lock option.

**NOTES:**

- Convenient off-the-worksurface storage requires no additional floor space.
- Available with laminate doors, frosted/silver doors, or sliding door.
- Doors are sized to overlap the top, end panels and light valance, to provide a clean design.
- Laminate and frosted/silver door units are equipped with self-closing, adjustable hinges.
- Laminate hinged door units are available with or without a lock.
- 28½"H units have a fixed, intermittent shelf; storage space above and below the shelf is 12½".
- For tackboards, see page 133.
- For task lights, see page 178.
- For paper organizers, see page 175.
- **IMPORTANT: See installation guidelines at top of page 128.**

**HOW TO SPECIFY****Select Model Number**

H N L 2 9 7 8 L D

**Select Chassis Color**

See page 96

H

**Select Door Front Color**

See page 96

H

**Select Model Number**

H N L 2 9 7 8 L L

**Select Lock Finish**

See page 96

P

**Select Chassis Color**

See page 96

H

**Select Door Front Color**

See page 96

H

**Select Model Number**

H N L 2 9 7 8 F D

**Select Chassis Color**

See page 96

H



# CONCINNITY™

## Wall Mount Storage

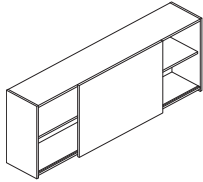

DESCRIPTION	MODEL	COM	SHIP WEIGHT	CUBE	L1 LIST	L2 UPCHARGES	
						CHASSIS	FRONTS
<b>Wall Mount Storage, Sliding Door</b>							
78"W x 15"D x 28½"H	<b>HNL2978SD</b>		189	30.8	<b>\$1459</b>	<b>\$50</b>	<b>\$40</b>
72"W x 15"D x 28½"H	<b>HNL2972SD</b>		177	28.6	<b>\$1393</b>	<b>\$40</b>	<b>\$40</b>
66"W x 15"D x 28½"H	<b>HNL2966SD</b>		165	26.4	<b>\$1360</b>	<b>\$40</b>	<b>\$40</b>
60"W x 15"D x 28½"H	<b>HNL2960SD</b>		153	24.1	<b>\$1273</b>	<b>\$40</b>	<b>\$40</b>
48"W x 15"D x 28½"H	<b>HNL2948SD</b>		129	19.7	<b>\$1116</b>	<b>\$35</b>	<b>\$30</b>

NOTES: One door per unit. Standard with black lock, which is located on the inside vertical support panel. Lock is core removable. Keyed alike cores must be ordered separately. For stack-on and wall mount storage with sliding door, specify model HF23B (Black) and the key number, see page 177.

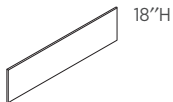

### Tackboards for use with Wall Mount Storage

75"W - for 78"W	<b>H90057</b>	3.0	13	3.2	<b>\$297</b>	N/A	N/A
68¾"W - for 72"W	<b>H90056</b>	2.0	12	2.7	<b>\$283</b>	N/A	N/A
62¾"W - for 66"W	<b>H90055</b>	2.0	11	2.5	<b>\$268</b>	N/A	N/A
56¾"W - for 60"W	<b>H90054</b>	2.0	10	2.2	<b>\$236</b>	N/A	N/A
44¾"W - for 48"W	<b>H90053</b>	2.0	8	1.8	<b>\$226</b>	N/A	N/A
39"W - for 42"W	<b>H90052</b>	2.0	7	1.6	<b>\$208</b>	N/A	N/A
33"W - for 36"W	<b>H90051</b>	1.0	6	1.4	<b>\$184</b>	N/A	N/A
26¾"W	<b>H90050</b>	1.0	5	1.2	<b>\$184</b>	N/A	N/A

NOTES: Specify fabric, see pages 35-36. Upcharges may apply to premium fabric grades.

Tackboard widths differ slightly from the wall mounted storage cabinet widths. For applications where multiple wall mounted storage units are placed side-by-side, the preferred tackboard solution may be to utilize a larger tackboard size. For example, H90057 = 75"W;

H90056 = 68¾"W; H90055 = 62¾"W; H90054 = 56¾"W.

**SPECIFYING EXAMPLE: H90057.APN15**

### NOTES:

- Convenient off-the-worksurface storage requires no additional floor space.
- Valance hides task light.
- Available with laminate doors, frosted/silver doors, or sliding door.
- Doors are sized to overlap the top, end panels and light valance, to provide a clean design.
- Laminate and frosted/silver door units are equipped with self-closing, adjustable hinges.
- Laminate hinged door units are available with or without a lock.
- 28½"H units have a fixed, intermittent shelf; storage space above and below the shelf is 12⅝".
- For tackboards, see above.
- For task lights, see page 178.
- For paper organizers, see page 175.
- **IMPORTANT: See installation guidelines at top of page 128.**

## HOW TO SPECIFY

Select  
Model Number

H N L 2 9 7 8 S D

Select  
Chassis Color

See page 96

H

Select  
Door Front Color

See page 96

H



# CONCINNITY™

## Bookcase Hutches

GSA SIN 711-2

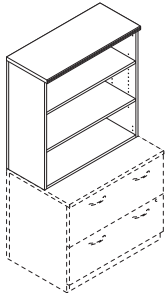

Icon Legend on page 21

**DESCRIPTION****Bookcase Hutch, No Doors/Open**

36"W x 14 1/4"D x 35 1/4"H (shown)  
30"W x 14 1/4"D x 35 1/4"H

36"W x 14 1/4"D x 48 5/8"H  
30"W x 14 1/4"D x 48 5/8"H

**MODEL****SHIP WEIGHT****CUBE****L1 LIST****L2 UPCHARGES**  
**CHASSIS    FRONTS**

**HNL3636BHxD**  
**HNL3630BHxD**

213  
199

15.3  
12.5

**\$542**  
**\$530**

**\$15**  
**\$15**

**N/A**  
**N/A**

**HNL4936BHxD**  
**HNL4930BHxD**

213  
199

125.0  
109.0

**\$686**  
**\$640**

**\$25**  
**\$25**

**N/A**  
**N/A**

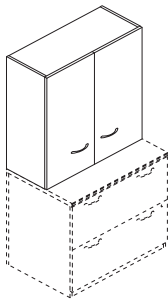
**Bookcase Hutch, Laminate Doors**

36"W x 15"D x 35 1/4"H (shown)  
30"W x 15"D x 35 1/4"H

36"W x 15"D x 48 5/8"H  
30"W x 15"D x 48 5/8"H

**HNL3636BHLD**  
**HNL3630BHLD**

213  
199

15.3  
12.5

**\$701**  
**\$658**

**\$15**  
**\$15**

**\$20**  
**\$20**

**HNL4936BHLD**  
**HNL4930BHLD**

213  
199

165.0  
142.0

**\$840**  
**\$788**

**\$25**  
**\$25**

**\$30**  
**\$30**

**NOTES:**

- Designed for use on worksurfaces, or on 30" or 36" W x 29 1/2" H lateral file or storage cabinet with doors.
- Two widths, 30" and 36"; two heights, 35 1/4" and 48 5/8".
- The 35 1/4" H unit has three shelves, two are adjustable in 1/4" increments with a total range of 17 1/2"; bottom shelf is fixed.
- The 48 5/8" H unit has four shelves, three are adjustable in 1/4" increments with a total range of 25"; bottom shelf is fixed.
- Available with laminate doors or frosted/silver doors or no doors (open).
- Door units equipped with self-closing, adjustable hinges.
- Laminate doors have decorative handles.
- Frosted door units have push/touch latch release.
- Doors are non-locking.
- To align with the top of the 35 1/4" bookcase hutch, use 64 3/4" H floor-standing storage models; to align with the top of the 48 5/8" H bookcase hutch, use 78 1/8" H models.
- Ship fully assembled.

**HOW TO SPECIFY****Select Model Number**

H N L 3 6 3 6 B H X D .

**Select Laminate Color**

See page 96

H

**Select Model Number**

H N L 3 6 3 6 B H L D .

**Select Handle**

- A Cylinder - Satin
- B Cylinder - Black
- C Canopy - Satin
- D Canopy - Black
- E Loop - Satin
- F Loop - Black

E .

**Select Chassis Color**

See page 96

H .

**Select Door Front Color**

See page 96

H



# CONCINNITY™

## Bookcase Hutches

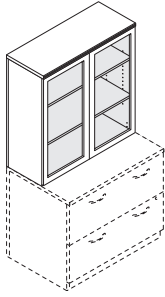

DESCRIPTION	MODEL	SHIP WEIGHT	CUBE	L1 LIST	L2 UPCHARGES	
					CHASSIS	FRONTS
<b>Bookcase Hutch, Frosted Doors with Silver Frame</b> 36"W x 15"D x 35¼"H (shown)	<b>HNL3636BHFD</b>	199	15.3	<b>\$1301</b>	<b>\$15</b>	<b>N/A</b>
36"W x 15"D x 48⅝"H	<b>HNL4936BHFD</b>	213	134.0	<b>\$1590</b>	<b>\$25</b>	<b>N/A</b>

**NOTES:**

- Designed for use on worksurfaces, or on 30" or 36"W x 29½"H lateral file or storage cabinet with doors.
- Two widths, 30" and 36"; two heights, 35¼" and 48⅝".
- The 35¼"H unit has three shelves, two are adjustable in 1¼" increments with a total range of 17½"; bottom shelf is fixed.
- The 48⅝"H unit has four shelves, three are adjustable in 1¼" increments with a total range of 25"; bottom shelf is fixed.
- Available with laminate doors or frosted/silver doors or no doors (open).
- Door units equipped with self-closing, adjustable hinges.
- Laminate doors have decorative handles.
- Frosted door units have push/touch latch release.
- Doors are non-locking.
- To align with the top of the 35¼"H bookcase hutch, use 64¾"H floor-standing storage models; to align with the top of the 48⅝"H bookcase hutch, use 78⅝"H models.
- Ship fully assembled.

**HOW TO SPECIFY**

Select  
Model Number

H N L 3 6 3 6 B H F D .

Select  
Chassis Color

See page 96

H

# CONCINNITY™

## Reception Stations

GSA SIN 711-2

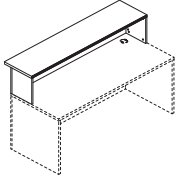

Icon Legend on page 21

**DESCRIPTION****Reception Station Counter for Desk**72"W x 17"D x 14<sup>5</sup>/<sub>8</sub>"H**MODEL****HNL1772RT****SHIP WEIGHT**

74

**CUBE**

4.3

**L1 LIST****\$512****L2 UPCHARGES****\$10****\$15**

Compatible for use on 72"W x 30" or 36"D desktops and worksurfaces. For cleanest approach-side aesthetic, use on desk built with modular components; desk comprised of either 72"W x 30"D rectangle worksurface and 72"W x 27<sup>7</sup>/<sub>8</sub>"H modesty/back panel, supported by 29<sup>1</sup>/<sub>8</sub>"D pedestal(s) and/or end panel(s), or 72"W x 36"D worksurface and 72"W x 27<sup>7</sup>/<sub>8</sub>"H modesty/back panel, supported by 35"D left and right end panels. The counter is 17"D with a 4" approach-side overhang; end panels are 12<sup>3</sup>/<sub>8</sub>"D. Ships with Transaction counter organizer (model HCOL52) is available as an option; fits under transaction counter; organizer is available in black only.

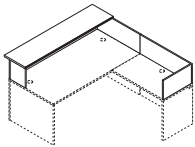
**SPECIFYING EXAMPLE: HNL1772RT.BH.H.H**

For Station with Right Return

**L-Reception Station with Transaction Counter for Desk**72"W x 88"D x 14<sup>5</sup>/<sub>8</sub>"H72"W x 82"D x 14<sup>5</sup>/<sub>8</sub>"H**HNL8472RT**

103

4.5

**\$819****\$10****\$25****HNL7872RT**

101

4.5

**\$799****\$10****\$25**

NOTES: Intended for use on desk built with modular components, for clean approach-side aesthetic, connected to a return or modular return. Layout for 78" and 84"D footprints:

- 72"W x 78"D:
  - Desk = 72"W x 30"D worksurface, 72"W x 27<sup>7</sup>/<sub>8</sub>"H modesty/back panel, supported by 29<sup>1</sup>/<sub>8</sub>"D pedestal(s) and/or end panel(s).
  - Return = 48"W x 24"D return; or 48"W x 24"D worksurface with vertical grain, 48"W x 27<sup>7</sup>/<sub>8</sub>"H modesty/back panel, supported by a 23<sup>1</sup>/<sub>8</sub>"D pedestal and/or end panel.
- 72"W x 84"D:
  - Desk = 72"W x 36"D worksurface, 72"W x 27<sup>7</sup>/<sub>8</sub>"H modesty/back panel, supported by 1-left and 1-right 35"D panel.
  - Return = 42"W x 24"D return; or 42"W x 24"D worksurface with vertical grain, 42"W x 27<sup>7</sup>/<sub>8</sub>"H modesty/back panel, supported by a 23<sup>1</sup>/<sub>8</sub>"D pedestal and/or end panel.
- 72"W x 84"D:
  - Desk = 72"W x 36"D worksurface, 72"W x 27<sup>7</sup>/<sub>8</sub>"H modesty/back panel, supported by 1-left and 1-right 35"D end panel.
  - Return = 48"W x 24"D return; or 48"W x 24"D worksurface with vertical grain, 48"W x 27<sup>7</sup>/<sub>8</sub>"H modesty/back panel, supported by a 23<sup>1</sup>/<sub>8</sub>"D pedestal and/or end panel.

Composed of 17"D transaction counter, with 4" approach-side overhang, for the desk and a vertical privacy panel extending the depth of the desk and width of the return. Ships with Transaction counter organizer (model HCOL52) is available as an option; fits under transaction counter; organizer is available in black only.

**SPECIFYING EXAMPLE: HNL8472RT.BH.H.H****NOTES:**

- Reception Station Counter for Desk, and L-Reception Station with Transaction Counter for Desk, have profiled edgeband on the approach and user sides.
- L-Reception Station with Transaction Counter for Desk and Return has profiled edgeband on front side of transaction counter on desk approach-side only.
- For L-reception station layouts where the return is not against a wall, specify return using modular components, as the modesty/back panel can be specified without a grommet. Assembled returns come standard with cord grommet in modesty/back panel.

**HOW TO SPECIFY**

Select Model Number	Select Edge Profile and Edge Color	Select Counter Color	Select Chassis Color
See page 96	See page 96	See page 96	See page 96
H N L 1 7 7 2 R T	B H	H	H

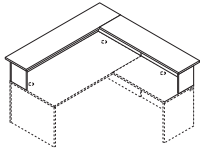

For Station with Right Return

**SIN 711-2**

DESCRIPTION	MODEL	SHIP WEIGHT	CUBE	L1 LIST	L2 UPCHARGES	
					COUNTER	CHASSIS

<b>L-Reception Station with Transaction Counter for Desk and Return</b> 76"W x 88"D x 14 <sup>5</sup> / <sub>8</sub> "H	<b>HNL8472RLT</b>	145	5.6	<b>\$981</b>	<b>\$10</b>	<b>\$25</b>
76"W x 82"D x 14 <sup>5</sup> / <sub>8</sub> "H	<b>HNL7872RLT</b>	139	5.6	<b>\$947</b>	<b>\$10</b>	<b>\$25</b>

NOTES: Intended for use on desk built with modular components, for clean approach-side aesthetic, connected to a return or modular return. Layout for 78" and 84"D footprints:

- 72"W x 78"D:
  - Desk = 72"W x 30"D worksurface, 72"W x 27<sup>7</sup>/<sub>8</sub>"H modesty/back panel, supported by 29<sup>9</sup>/<sub>8</sub>"D pedestal(s) and/or end panel(s).
  - Return = 48"W x 24"D worksurface with vertical grain, 48"W x 27<sup>7</sup>/<sub>8</sub>"H modesty/back panel, supported by a 23<sup>1</sup>/<sub>8</sub>"D pedestal and/or end panel.
- 72"W x 78"D:
  - Desk = 72"W x 36"D worksurface, 72"W x 27<sup>7</sup>/<sub>8</sub>"H modesty/back panel, supported by 1-left and 1-right 35"D panel.
  - Return = 42"W x 24"D worksurface with vertical grain, 42"W x 27<sup>7</sup>/<sub>8</sub>"H modesty/back panel, supported by a 23<sup>1</sup>/<sub>8</sub>"D pedestal and/or end panel.
- 72"W x 84"D:
  - Desk = 72"W x 36"D worksurface, 72"W x 27<sup>7</sup>/<sub>8</sub>"H modesty/back panel, supported by 1-left and 1-right 35"D end panel.
  - Return = 48"W x 24"D worksurface with vertical grain, 48"W x 27<sup>7</sup>/<sub>8</sub>"H modesty/back panel, supported by a 23<sup>1</sup>/<sub>8</sub>"D pedestal and/or end panel.

! The 17"D transaction counter, with 4" overhang, extends around the perimeter of the station, across the width of the desk, as well as along the depth of the desk and width of the return. Ships with Transaction counter organizer (model HTCOL52) is available as an option; fits under transaction counter; organizer is available in black only.

**SPECIFYING EXAMPLE: HNL8472RLT.BH.H.H**

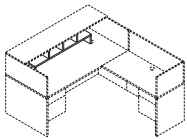

**SIN 711-8**

<b>Transaction Counter Organizer</b> 48 <sup>3</sup> / <sub>4</sub> "W x 11 <sup>1</sup> / <sub>8</sub> "D x 13"H	<b>HTCOL52</b>	24	1.1	<b>\$259</b>	<b>N/A</b>	<b>N/A</b>
--	----------------	----	-----	--------------	------------	------------

NOTES: Fits under reception station counters.

! Black only.

**SPECIFYING EXAMPLE: HTCOL52.P**

**NOTES:**

- Reception Station Counter for Desk, and L-Reception Station with Transaction Counter for Desk, have profiled edgeband on the approach and user sides.
- ! L-Reception Station with Transaction Counter for Desk and Return has profiled edgeband on front side of transaction counter on desk approach-side only.
- ! For L-reception station layouts where the return is not against a wall, specify return using modular components, as the modesty/back panel can be specified without a grommet. Assembled returns come standard with cord grommet in modesty/back panel.

## HOW TO SPECIFY

<p><b>Select Model Number</b></p> <p>H N L 8 4 7 2 R L T .</p>	<p><b>Select Edge Profile and Edge Color</b></p> <p>See page 96</p> <p>B H .</p>	<p><b>Select Counter Color</b></p> <p>See page 96</p> <p>H .</p>	<p><b>Select Chassis Color</b></p> <p>See page 96</p> <p>H</p>
--	--	--	--

# CONCINNITY™

## Mobile Pedestals

GSA SIN AS NOTED



Icon Legend on page 21



SIN 711-2

DESCRIPTION	MODEL	SHIP WEIGHT	CUBE	L1 LIST	L2 UPCHARGES		
					TOP	CHASSIS	FRONTS
<b>Mobile Pedestal — 15 3/4" W</b>							
15 3/4" W x 20 1/8" D x 28 3/8" H, Box/Box/File	<b>HNL2116MBBF</b>	69	7.4	<b>\$834</b>	<b>N/A</b>	<b>\$20</b>	<b>\$10</b>
15 3/4" W x 20 1/8" D x 28 3/8" H, File/File	<b>HNL2116MFF</b>	70	7.4	<b>\$834</b>	<b>N/A</b>	<b>\$20</b>	<b>\$10</b>
15 3/4" W x 20 1/8" D x 21 1/2" H, Box/File	<b>HNL2116MBF</b>	55	5.8	<b>\$706</b>	<b>N/A</b>	<b>\$20</b>	<b>\$10</b>

NOTES: Well suited to a variety of office layouts, including private, open floor plan, and cubicle workspaces. Design positions the center of gravity towards the back of the cabinet to inhibit tipping. All drawers lock; interchangeable core removable lock makes re-keying quick and easy. Finish of lock is determined by, and aligned with, the handle finish specified. Keyed alike cores must be ordered separately; specify model HF23B (Black) or HF23S (Satin) and specific key number required. Pedestals, excluding cushion option, are sized to be positioned under 29 1/2" H worksurfaces. Seat cushion model HLSL2016PH2 is optional. Cushion adds 1" to the height of the pedestal. Box/File unit with cushion will fit below 29 1/2" H worksurface. 3/4" thick top with flat edgeband; back inside end panel construction. Ships fully assembled.

**SPECIFYING EXAMPLE: HNL2116MBBF.E.H.H**

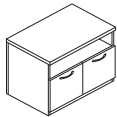

SIN 711-2

DESCRIPTION	MODEL	SHIP WEIGHT	CUBE	L1 LIST	L2 UPCHARGES TOP	L2 UPCHARGES CHASSIS	L2 UPCHARGES FRONTS
<b>Mobile Pedestal — 30" W</b>							
30" W x 20" D x 21 1/2" H, Shelf/File/Cabinet	<b>HNL2030MSFC</b>	105	10.7	<b>\$1050</b>	<b>\$10</b>	<b>\$25</b>	<b>\$15</b>

NOTES: Sized to align with 20" D x 20 1/2" H low credenzas. Open shelf over file drawer left and cabinet with door right. Design positions the center of gravity towards the back of the cabinet to inhibit tipping. Seat cushion model HLSL2030CH2 is optional. Cushion adds 1" to the height of the pedestal. 1 1/8" thick top matches low credenza design. Ships fully assembled.

**SPECIFYING EXAMPLE: HNL2030MSFC.BH.E.H.H.H**

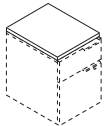

SIN 711-2 - HLSL2016PH2

SIN 711-3 - HLSL2030CH2

DESCRIPTION	MODEL	SHIP WEIGHT	CUBE	SHIP						
				1	2	3	4	5	6	
<b>Mobile Pedestal Cushion</b>										
15 7/8" W x 20" D x 1" H	<b>HLSL2016PH2</b>	6	1.1	<b>\$284</b>	<b>\$308</b>	<b>\$332</b>	<b>\$356</b>	<b>\$387</b>	<b>\$418</b>	
30" W x 20" D x 1" H	<b>HLSL2030CH2</b>	9	1.9	<b>\$342</b>	<b>\$378</b>	<b>\$414</b>	<b>\$450</b>	<b>\$496</b>	<b>\$543</b>	

NOTES: See pages 24-34 for available fabrics.

**SPECIFYING EXAMPLE: HLSL2016PH2.AB10**

### NOTES:

- Mobile pedestals roll easily on four casters to provide convenient, flexible placement of personal storage needs.
- Drawers operate on steel ball bearing suspension with full extension.
- File drawers include hangrails for side-to-side letter and legal filing; and front-to-back for letter filing.

ⓘ 28 3/8" H mobile pedestals are not designed for use with the 28 1/2" H metal O-leg due to interference caused by (1) the O-leg worksurface attachment bracket, and (2) the external support channel on the underside of a 72", 66", and 60" W rectangle worksurface supported by O-leg(s).

## HOW TO SPECIFY

<b>Select Model Number</b> H N L 2 1 1 6 M B B F .	<b>Select Handle</b> A Cylinder – Satin B Cylinder – Black C Canopy – Satin D Canopy – Black E Loop – Satin F Loop – Black E .	<b>Select Chassis Color</b> See page 96 H .	<b>Select Drawer Front Color</b> See page 96 H		
<b>Select Model Number</b> H N L 2 0 3 0 M S F C .	<b>Select Edge Profile and Edge Color</b> See page 96 B H .	<b>Select Handle</b> A Cylinder – Satin B Cylinder – Black C Canopy – Satin D Canopy – Black E Loop – Satin F Loop – Black E .	<b>Select Top Color</b> See page 96 H .	<b>Select Chassis Color</b> See page 96 H .	<b>Select Drawer/Door Front Color</b> See page 96 H

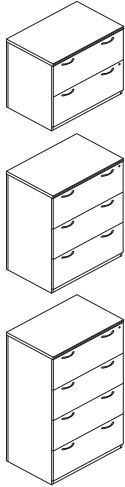

DESCRIPTION	MODEL	SHIP WEIGHT	CUBE	L1 LIST	L2 UPCHARGES		
					TOP	CHASSIS	FRONTS
<b>Lateral File</b> 36"W x 24"D x 29½"H, 2-Drawer	<b>HNL2436LD2</b>	178	18.4	<b>\$1085</b>	<b>\$15</b>	<b>\$20</b>	<b>\$20</b>
36"W x 24"D x 45½"H, 3-Drawer	<b>HNL2436LD3</b>	222	26.0	<b>\$1639</b>	<b>\$15</b>	<b>\$25</b>	<b>\$25</b>
36"W x 24"D x 59½"H, 4-Drawer	<b>HNL2436LD4</b>	276	34.3	<b>\$1977</b>	<b>\$15</b>	<b>\$30</b>	<b>\$30</b>

NOTES: Equipped with safety restraints; mechanical interlock inhibits the extension of more than one drawer at a time; counterweight positions the center of gravity towards the back of the cabinet to inhibit tipping. 24" depth aligns evenly with credenzas, returns, storage cabinet, storage/file cabinet, storage cabinet/lateral file, wardrobe/storage cabinet, wardrobe/bookcase, storage towers, and 24"D modular components. 29½"H unit is sized to accommodate 36"W stack-on storage or bookcase hutch options. Drawers lock; interchangeable core removable lock makes re-keying quick and easy. Finish of lock is determined by, and aligned with, the handle finish specified. Keyed alike cores must be ordered separately; specify model HF23B (Black) or HF23S (Satin) and specific key number required. Ship fully assembled. 30"W two-drawer size can be specified and assembled using modular components. Drawers include hangrails to accept folders in letter or legal size.

**SPECIFYING EXAMPLE: HNL2436LD2.BH.E.H.H.H**

## HOW TO SPECIFY

<p><b>Select Model Number</b></p> <p>H N L 2 4 3 6 L D 4 .</p>	<p><b>Select Edge Profile and Edge Color</b></p> <p>See page 96</p> <p>B H .</p>	<p><b>Select Handle</b></p> <p>A Cylinder – Satin                  B Cylinder – Black                  C Canopy – Satin                  D Canopy – Black                  E Loop – Satin                  F Loop – Black</p> <p>E .</p>	<p><b>Select Top Color</b></p> <p>See page 96</p> <p>H .</p>	<p><b>Select Chassis Color</b></p> <p>See page 96</p> <p>H .</p>	<p><b>Select Drawer Front Color</b></p> <p>See page 96</p> <p>H .</p>
--	--	--	--	--	---

# CONCINNITY™ Storage Cabinets

GSA SIN 711-2



Icon Legend on page 21

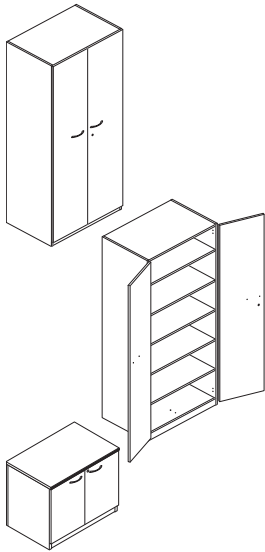

DESCRIPTION	MODEL	SHIP WEIGHT	CUBE	L1 LIST	L2 UPCHARGES		
					TOP	CHASSIS	FRONTS
<b>Storage Cabinet with Laminate Doors</b>							
36"W x 24"D x 29½"H	<b>HNL243629SC</b>	158	18.4	<b>\$966</b>	<b>\$15</b>	<b>\$20</b>	<b>\$20</b>
36"W x 24"D x 64¾"H	<b>HNL243665SC</b>	252	40.8	<b>\$2013</b>	<b>N/A</b>	<b>\$55</b>	<b>\$20</b>
36"W x 24"D x 78⅞"H (shown)	<b>HNL243679SC</b>	317	47.4	<b>\$2141</b>	<b>N/A</b>	<b>\$60</b>	<b>\$25</b>

NOTES: 29½"H size has one adjustable interior shelf. Shelf adjusts in 1¼" increments over a total range of 6¼", 64¾"H and 78⅞" have five shelves (four adjustable) and six shelves (five adjustable), respectively; shelves adjust in 2½" increments. Locking doors. 24" depth aligns evenly with credenzas, returns, lateral files, storage/file cabinet, storage cabinet/lateral file, wardrobe/storage cabinet, wardrobe/bookcase, storage tower, bookcase with coat hook, and 24"D modular components. 29½"H unit is sized to accommodate 36"W stack-on storage or bookcase hutch options. Ships fully assembled. 30"W x 24"D x 29½"H freestanding unit can be built using modular components.

**SPECIFYING EXAMPLE (29½"H): HNL243629SC.BH.E.H.H.H**  
**SPECIFYING EXAMPLE (64¾-78⅞"H): HNL243665SC.E.H.H**

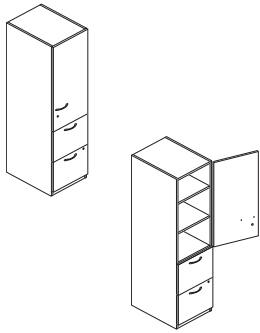

DESCRIPTION	MODEL	SHIP WEIGHT	CUBE	L1 LIST	L2 UPCHARGES		
					TOP	CHASSIS	FRONTS
<b>Storage/File Cabinet</b>							
18"W x 24"D x 64¾"H, File/File, Laminate Door Hinged Right (shown)	<b>HNL241865SFLR</b>	184	21.6	<b>\$1618</b>	<b>N/A</b>	<b>\$25</b>	<b>\$15</b>
18"W x 24"D x 64¾"H, File/File, Laminate Door Hinged Left	<b>HNL241865SFLL</b>	184	21.6	<b>\$1618</b>	<b>N/A</b>	<b>\$25</b>	<b>\$15</b>
18"W x 24"D x 64¾"H, File/File, Open Shelves	<b>HNL241865SFX</b>	169	21.6	<b>\$1536</b>	<b>N/A</b>	<b>\$25</b>	<b>\$15</b>

NOTES: Versatile unit features a storage cabinet plus two file drawers. Storage cabinet includes three shelves, two are adjustable; shelves adjust in 2½" increments. Can be specified with door hinged left, door hinged right, or no door/open shelves. File drawers operate on steel ball-bearing suspensions with full extension. File drawers include hangrails to accept folders in letter or legal size. Storage cabinet door and file drawers lock separately; the two locks are keyed alike. Unit height is designed to match desk, credenza, or return plus 35¼"H stack-on storage (= 64¾"). Ships fully assembled.

**SPECIFYING EXAMPLE (WITH DOOR): HNL241865SFLR.E.H.H**  
**SPECIFYING EXAMPLE (WITHOUT DOOR): HNL241865SFX.E.H.H**

**NOTES:**

- Interchangeable core removable lock makes re-keying quick and easy.
- Finish of lock is determined by, and aligned with, the handle finish specified.
- Keyed alike cores must be ordered separately; specify model HF23B (Black) or HF23S (Satin) and specific key number required.

## HOW TO SPECIFY

<p><b>Select Model Number</b></p> <p>See page 96</p> <p><b>H N L 2 4 3 6 2 9 S C</b></p>	<p><b>Select Edge Profile and Edge Color</b></p> <p>See page 96</p> <p><b>B H</b></p>	<p><b>Select Handle</b></p> <p>A Cylinder - Satin                  B Cylinder - Black                  C Canopy - Satin                  D Canopy - Black                  E Loop - Satin                  F Loop - Black</p> <p><b>E</b></p>	<p><b>Select Top Color</b></p> <p>See page 96</p> <p><b>H</b></p>	<p><b>Select Chassis Color</b></p> <p>See page 96</p> <p><b>H</b></p>	<p><b>Select Drawer Front Color</b></p> <p>See page 96</p> <p><b>H</b></p>
--	---	---	---	---	--

<p><b>Select Model Number</b></p> <p>See page 96</p> <p><b>H N L 2 4 3 6 6 5 S C</b></p> <p><b>H N L 2 4 1 8 6 5 S F X</b></p>	<p><b>Select Handle</b></p> <p>A Cylinder - Satin                  B Cylinder - Black                  C Canopy - Satin                  D Canopy - Black                  E Loop - Satin                  F Loop - Black</p> <p><b>E</b></p>	<p><b>Select Chassis Color</b></p> <p>See page 96</p> <p><b>H</b></p>	<p><b>Select Drawer Front Color</b></p> <p>See page 96</p> <p><b>H</b></p>
--	---	---	--



# CONCINNITY™ Storage Cabinets

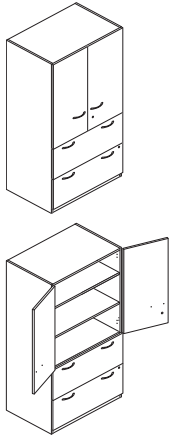

DESCRIPTION	MODEL	SHIP WEIGHT	CUBE	L1 LIST	L2 UPCHARGES		
					TOP	CHASSIS	FRONTS
<b>Storage Cabinet/Lateral File, Laminate Doors</b> 36"W x 24"D x 64¾"H	<b>HNL243665SLL</b>	328	40.8	\$2171	N/A	\$55	\$20

NOTES: Cabinet includes one fixed and two full-width adjustable shelves; adjustable shelves can be removed. Overall storage compartment measures 34"W x 22"D x 34½"H and will accommodate supplies, books and binders. Lateral file equipped with mechanical interlock to inhibit the extension of more than one drawer at a time. Lateral file drawers include hangrails to accept folders in letter or legal size. Storage cabinet and lateral file lock independently; upper lock secures cabinet; lower locks secure file drawers. Locks are keyed alike. Door hinges rotate to 94 degrees. Unit height is designed to match desk, credenza, or return plus 35¼"H stack-on storage (= 64¾"). Ships fully assembled.

**SPECIFYING EXAMPLE: HNL243665SLL.E.H.H**

**NOTES:**

- Interchangeable core removable lock makes re-keying quick and easy.
- Finish of lock is determined by, and aligned with, the handle finish specified.
- Keyed alike cores must be ordered separately; specify model HF23B (Black) or HF23S (Satin) and specific key number required.

## HOW TO SPECIFY

<p><b>Select Model Number</b></p> <p style="text-align: center;">H N L 2 4 3 6 6 5 S L L .</p>	<p><b>Select Handle</b></p> <p>A Cylinder – Satin                      B Cylinder – Black                      C Canopy – Satin                      D Canopy – Black                      E Loop – Satin                      F Loop – Black</p> <p style="text-align: center;">E .</p>	<p><b>Select Chassis Color</b></p> <p style="text-align: center;">See page 96</p> <p style="text-align: center;">H .</p>	<p><b>Select Door/Drawer Front Color</b></p> <p style="text-align: center;">See page 96</p> <p style="text-align: center;">H</p>
--	--	--	--

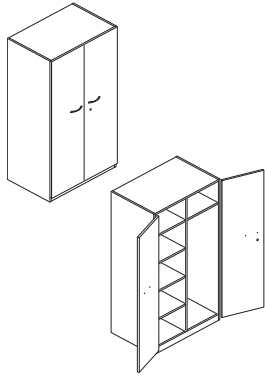

**DESCRIPTION****Wardrobe/Storage Cabinet, Laminate Doors — 36"W**36"W x 24"D x 64 $\frac{3}{4}$ "H36"W x 24"D x 78 $\frac{1}{8}$ "H**MODEL****HNL243665WL****HNL243679WL****SHIP WEIGHT**

284

303

**CUBE**

40.8

40.8

**L1 LIST****\$2356****\$2458****L2 UPCHARGES****\$55****\$60****\$20****\$25**

NOTES: Spacious design combines a cabinet with adjustable shelves and a generous personal wardrobe compartment with a coat rod and upper shelf. 64 $\frac{3}{4}$ "H and 78 $\frac{1}{8}$ "H have five shelves (four adjustable) and six shelves (five adjustable), respectively; shelves adjust in 2 $\frac{1}{2}$ " increments. One lock secures both doors. Ships fully assembled.

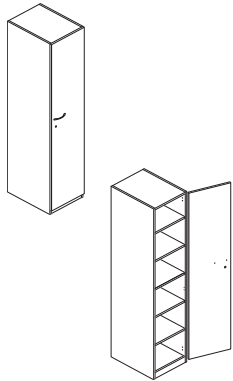
**SPECIFYING EXAMPLE: HNL243665WL.E.H.H****Wardrobe/Storage Cabinet, Laminate Door — 18"W**18"W x 24"D x 64 $\frac{3}{4}$ "H, Hinged Right18"W x 24"D x 64 $\frac{3}{4}$ "H, Hinged Left18"W x 24"D x 78 $\frac{1}{8}$ "H, Hinged Right (shown)18"W x 24"D x 78 $\frac{1}{8}$ "H, Hinged Left**HNL241865WLR****HNL241865WLL****HNL241879WLR****HNL241879WLL**

157

157

205

205

21.6

21.6

24.8

24.8

**\$1478****\$1478****\$1613****\$1613****\$25****\$25****\$30****\$30****\$15****\$15****\$20****\$20**

NOTES: Design includes coat rod and shelves. 64 $\frac{3}{4}$ "H and 78 $\frac{1}{8}$ "H have five shelves (four adjustable) and six shelves (five adjustable), respectively; shelves adjust in 2 $\frac{1}{2}$ " increments. Middle shelves can be removed to provide space for garments; coat rod can be removed for storage only applications. Lock to secure contents. Ships fully assembled.

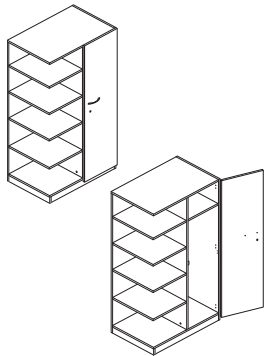
**SPECIFYING EXAMPLE: HNL241865WLR.E.H.H****Wardrobe/Bookcase, Laminate Door**36"W x 24"D x 64 $\frac{3}{4}$ "H, Wardrobe Left, Bookcase Right36"W x 24"D x 64 $\frac{3}{4}$ "H, Wardrobe Right, Bookcase Left (shown)36"W x 24"D x 78 $\frac{1}{8}$ "H, Wardrobe Left, Bookcase Right36"W x 24"D x 78 $\frac{1}{8}$ "H, Wardrobe Right, Bookcase Left**HNL243665WLBR****HNL243665WRBL****HNL243679WLBR****HNL243679WRBL**

230

230

302

302

40.8

40.8

47.4

47.4

**\$2228****\$2228****\$2356****\$2356****\$55****\$55****\$60****\$60****\$20****\$20****\$25****\$25**

NOTES: Combination closed-door wardrobe closet and open shelf bookcase. 64 $\frac{3}{4}$ "H and 78 $\frac{1}{8}$ "H bookcases have five and six fixed shelves, respectively. Locking wardrobe compartment includes a coat rod and one shelf; shelf is positioned above the coat rod. Bookcase can be accessed from front or side. Left (L) model is wardrobe on left, bookcase on right; Right (R) model is wardrobe on right, bookcase on left. Ships fully assembled.

**SPECIFYING EXAMPLE: HNL243665WRBL.E.H.H****NOTES:**

- Heights designed to match desk, credenza, or return plus 35 $\frac{1}{4}$ "H stack-on storage (= 64 $\frac{3}{4}$ "H) or 48 $\frac{5}{8}$ "H stack-on storage (= 78 $\frac{1}{8}$ "H).
- Finish of locks is determined by, and aligned with, the handle finish specified.
- Keyed alike cores must be ordered separately; specify model HF23B (Black) or HF23S (Satin) and specific key number required.

**HOW TO SPECIFY**

Select Model Number	Select Handle	Select Chassis Color	Select Door Front Color
H N L 2 4 3 6 6 5 W L .	E .	See page 96	See page 96



# CONCINNITY™ Storage Towers

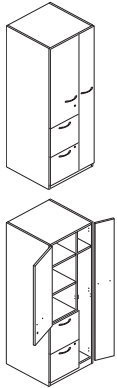

**DESCRIPTION**

**Storage Towers, Laminate Doors — 24" W**

- 24" W x 24" D x 64 3/4" H, Wardrobe Hinged Left, Cabinet Hinged Right
- 24" W x 24" D x 64 3/4" H, Wardrobe Hinged Right, Cabinet Hinged Left (shown)
- 24" W x 24" D x 78 1/8" H, Wardrobe Hinged Left, Cabinet Hinged Right
- 24" W x 24" D x 78 1/8" H, Wardrobe Hinged Right, Cabinet Hinged Left

**MODEL**

SHIP WEIGHT	CUBE	L1 LIST	L2 UPCHARGES	
			CHASSIS	FRONTS

<b>HNL242465TLL</b>	241	27.6	<b>\$2079</b>	<b>\$60</b>	<b>\$35</b>
<b>HNL242465TLR</b>	241	27.6	<b>\$2079</b>	<b>\$60</b>	<b>\$35</b>
<b>HNL242479TLL</b>	284	32.4	<b>\$2284</b>	<b>\$70</b>	<b>\$45</b>
<b>HNL242479TLR</b>	284	32.4	<b>\$2284</b>	<b>\$70</b>	<b>\$45</b>

NOTES: Versatile design includes a wardrobe closet, storage cabinet, and two file drawers, in one compact unit. Wardrobe contains a coat rod and upper shelf. 64 3/4" H and 78 1/8" H cabinets have three shelves (two adjustable) and four shelves (three adjustable), respectively; shelves adjust in 2 1/2" increments. File drawers operate on ball-bearing suspensions with full extension. File drawer design includes integrated hangrails for side-to-side letter or legal filing; and front-to-back for letter filing. Upper lock secures wardrobe closet and storage cabinet; lower lock secures file drawers; the two locks are keyed alike. Left (L) model is wardrobe hinged left, cabinet hinged right; Right (R) model is wardrobe hinged right, cabinet hinged left. Ships fully assembled.

**SPECIFYING EXAMPLE: HNL242465TLR.E.H.H**

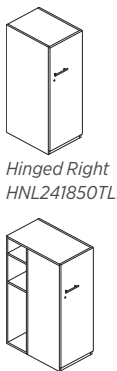

Hinged Right  
HNL241850TLR shown

Hinged Right  
HNL301850TLR shown

**Storage Towers, Laminate Door — 50" H**

- 18" W x 24" D x 50" H, Hinged Right
- 18" W x 24" D x 50" H, Hinged Left
- 18" W x 30" D x 50" H, Hinged Right
- 18" W x 30" D x 50" H, Hinged Left

<b>HNL241850TLR</b>	121	15.9	<b>\$1157</b>	<b>\$50</b>	<b>\$35</b>
<b>HNL241850TLL</b>	121	15.9	<b>\$1157</b>	<b>\$50</b>	<b>\$35</b>
<b>HNL301850TLR</b>	135	19.8	<b>\$1288</b>	<b>\$50</b>	<b>\$35</b>
<b>HNL301850TLL</b>	135	19.8	<b>\$1288</b>	<b>\$50</b>	<b>\$35</b>

NOTES: Low profile design is well-suited for open plan layouts. Can be used next to 29 1/2" H to standing, 42" H worksurfaces. Cabinet includes coat hook on back of door, perfect for jackets, sweaters, and purses. Two adjustable interior shelves, plus bottom of unit; shelves adjust in 2 1/2" increments. 30" D size has a slim side-access storage space at rear of unit with two fixed interior shelves; the lower shelf is positioned to align with a 29 1/2" H worksurface, the upper shelf with a 42" H worksurface. Hardware bag includes an extra coat hook which can be positioned on the side of the unit, below the worksurface; ideal for back packs. Left (L) model is door hinged left; Right (R) model is door hinged right. Worksurface tower bracket kit (model HSTB2W1) can be used to attach a worksurface directly to the tower. Bracket (1) eliminates the need for one end panel or O-leg support; (2) is not designed to be used as a support when a stack-on storage unit is placed over bracket. Ships fully assembled.

**SPECIFYING EXAMPLE: HNL182450TLR.E.H.H**

**NOTES:**

- Equipped with interchangeable core removable locks.
- Finish of locks is determined by, and aligned with, the handle finish specified.
- Keyed alike cores must be ordered separately; specify model HF23B (Black) or HF23S (Satin) and specific key number required.

CABINET/WARDROBE/TOWER SOLUTIONS BY SIZE			
	Low/50" H	Standard/64 3/4" H	Executive/78 1/8" H
Storage Cabinet with Doors		•	•
Storage/File Cabinet		•	
Storage Cabinet/Lateral File		•	
Wardrobe/Storage Cabinet		•	•
Wardrobe/Bookcase		•	•
Storage Tower		•	•
Storage Tower with Side Access on 30" D	•		
Bookcase with Coat Hook		•	

**HOW TO SPECIFY**

<p><b>Select Model Number</b></p>	<p><b>Select Handle</b></p> <p>A Cylinder – Satin                      B Cylinder – Black                      C Canopy – Satin                      D Canopy – Black                      E Loop – Satin                      F Loop – Black</p>	<p><b>Select Chassis Color</b></p> <p>See page 96</p>	<p><b>Select Door Front Color</b></p> <p>See page 96</p>
<p>H N L 2 4 2 4 6 5 T L R .</p>	<p>E .</p>	<p>H .</p>	<p>E .</p>

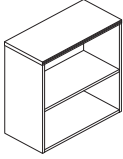

DESCRIPTION	MODEL	SHIP WEIGHT	CUBE	L1 LIST	L2 UPCHARGES	
					TOP	CHASSIS
<b>Bookcase with Adjustable Shelves</b>						
30"W x 14¼"D x 29½"H, 2-Shelf	<b>HNL1530BK2</b>	69	10.2	<b>\$522</b>	<b>\$15</b>	<b>\$15</b>
30"W x 14¼"D x 42"H, 3-Shelf	<b>HNL1530BK3</b>	95	14.1	<b>\$594</b>	<b>\$15</b>	<b>\$20</b>
30"W x 14¼"D x 52¾"H, 4-Shelf	<b>HNL1530BK4</b>	118	17.4	<b>\$676</b>	<b>\$20</b>	<b>\$25</b>
30"W x 14¼"D x 65"H, 5-Shelf	<b>HNL1530BK5</b>	143	21.1	<b>\$781</b>	<b>\$25</b>	<b>\$30</b>
30"W x 14¼"D x 78⅞"H, 6-Shelf	<b>HNL1530BK6</b>	170	25.7	<b>\$881</b>	<b>\$30</b>	<b>\$35</b>

NOTES: Profiled top edge; choose from edge detail options. Number of total and adjustable shelves:

Height	Shelves	Adjustable Shelves
29½"	2	1
42"	3	2
52¾"	4	3
65"	5	4
78⅞"	6	5

¾" thick shelves adjust in 1¼" increments. Inside shelf dimensions on all units are 28½"W x 13¼"D. Ships fully assembled.

**SPECIFYING EXAMPLE: HNL1530BK2.BH.H.H**

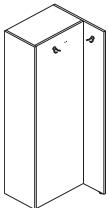
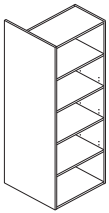

Back View

DESCRIPTION	MODEL	SHIP WEIGHT	CUBE	L1	L2
				LIST PRICE	UPCHARGE
<b>Bookcase with Coat Hooks</b>					
24"W x 24"D x 64¾"H, 5-Shelf, with Coat Hooks, Right (shown)	<b>HNL2424BK5CR</b>	133	27.6	<b>\$890</b>	<b>\$30</b>
24"W x 24"D x 64¾"H, 5-Shelf, with Coat Hooks, Left	<b>HNL2424BK5CL</b>	133	27.6	<b>\$890</b>	<b>\$30</b>

NOTES: Inside shelf dimensions are 28½"W x 13¼"D. Two out of sight coat hooks for garments are secluded behind bookcase. One end panel measures 14¼"D, the other 24"D. "R" indicates coat hook access is on the right and the full 24"D end panel on the left; for use next to credenza or return with pedestal on right. "L" indicates coat hook access is on the left and the full 24"D end panel is on the right; for use next to credenza or return with pedestal on left. Unit height is designed to match desk, credenza, or return plus 35¼"H stack-on storage (= 64¾"). ¾" thick, non-profiled top edge. Not available in two-tone laminate color combinations. Ships fully assembled.

**SPECIFYING EXAMPLE: HNL2424BK5CR.H**

## HOW TO SPECIFY

<b>Select Model Number</b> H N L 1 5 3 0 B K 2 .	<b>Select Edge Profile and Edge Color</b> See page 96 B H .	<b>Select Top Color</b> See page 96 H .	<b>Select Chassis Color</b> See page 96 H
---	---	---	---

<b>Select Model Number</b> H N L 2 4 2 4 B K 5 C R .	<b>Select Laminate</b> See page 96 H
---	--

## MODULAR COMPONENTS

- Smart, adaptable, reconfigurable assortment to maximize office layout flexibility and optimize floor space.
- Components for all popular office layouts.
- Selection allows user to choose their own workstation shape, size, and storage.
- Sizes for large and small spaces:
  - 36"D x 72"W or 84"W
  - 30"D — six sizes up to 84"W
  - 24"D — in 6" increments, from 30"W to 96"W
- Worksurfaces supported by post legs with casters provide added layout flexibility.
- Mobile desks quickly convert an office into a small conference space; desks roll easily and can be repositioned in seconds.
- Grommet options provide cord management from the top, side, and back in appropriate models.
- Broad menu of under-surface storage to enable user to specify the solution that best meets their individual needs.
  - Non-handed units can be configured to meet individual tastes and reconfigured when preferences or floor space requirements change.
  - Applications include:
    - The ability to “build” contiguous customized/personalized storage behind the desk that looks like custom architectural millwork, but at a fraction of the price. Allows for multiple storage pedestals to be configured under a single top with clean lines and no gaps.
    - Choosing the storage solution to go under desks, credenzas, and returns.

## WORKSURFACES

- Available in a variety of shapes and sizes.
- Scratch-, stain-, and spill-resistant laminate over durable 1½" solid core high performance particleboard; resists warping.
- An external support channel, for attachment under worksurfaces, is required for all unsupported spans — a distance in which there is not a vertical support (point of contact) between the underside of the worksurface and the floor — greater than 54"W.
- For tri-oval and beaded edge options on tops with horizontal grain, there is a shaped profile on the user and approach sides, and a flat edge on the ends.
- For tri-oval and beaded edge options on tops with vertical grain, there is a shaped profile on the user side and a flat edge on the approach side and the ends.
- Grommets are an option and require specification. If grommets are selected, grommets come in a pre-determined location.

- Must be specified with support components; for pedestal, end panel, column, and leg options, see “Components — Supports” listings.

## SUPPORTS

- For use with rectangle, bow, bullet, and extended corner worksurfaces.
- Available in 28½" and 41"H.
- Adjustable hex glides allow floor-standing units to be easily leveled, without lifting, to compensate for uneven floors; glides have 1¼" adjustable range on most components; 2" on O-legs.
- Bottom of laminate end panels are edgebanded for added strength and to seal out moisture.

## FOR 29½"H WORKSURFACES

- Specify from a broad assortment of solutions, including —
  - Modular Pedestals
  - Laminate end panels (must be used in conjunction with a laminate modesty panel)
  - Laminate L-shaped end panels
  - Laminate T-shaped end panels
  - Metal O-legs — for use with worksurfaces up to 78"W (when using an 84" or wider worksurface, cannot use two O-legs; must use at least one 15¾" or wider pedestal for the other support).
  - 4½" diameter metal column
  - 2" square metal post leg

## FOR 42"H WORKSURFACES

- 42", fixed standing-height workstations give users the option of changing postures from sitting to standing throughout the day to help achieve their wellness goals.
- Specify supports from —
  - Modular Pedestals
  - Laminate end panels (must be used in conjunction with a laminate modesty panel)
  - Laminate L-shaped end panels
  - Metal O-legs
- When combined with a stool-height task chair, provides users the benefit of alternating their work between a seated or standing position.
- An external support channel, for attachment under worksurfaces, is required for all unsupported spans greater than 54"W.

# CONCINNITY™ COMPONENTS

- Worksurface End Support (panel, leg, column, base, pedestal) requirements by product type are as follows —
  - Desk, peninsula, or credenza — qty. 2
  - Return — qty. 1
  - Island extension — qty. 1

## COORDINATE™ HEIGHT ADJUSTABLE BASE

- Height adjustable bases deliver a healthier style of working by allowing a seamless transition between sitting and standing throughout the day. For open, private, or training spaces.
- Frame rises from 23<sup>5</sup>/<sub>8</sub>" to 49<sup>1</sup>/<sub>4</sub>".
- Telescoping base design.
- Accommodates rectangle worksurface sizes 24" to 36"D and 48" to 72"W.
- Standard-height adjustable control included with base. Optional memory control allows preset worksurface heights for consistency — ships separately.
- Shipped complete with a pre-assembled electric motor.

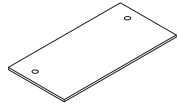

DESCRIPTION	MODEL	SHIP WEIGHT	CUBE	L1 LIST PRICE	L2 UPCHARGE
<b>Rectangle Worksurface with Horizontal Grain</b>					
84"W x 36"D	<b>HNLRC3684</b>	105	7.7	<b>\$594</b>	<b>\$30</b>
72"W x 36"D (shown)	<b>HNLRC3672</b>	90	6.7	<b>\$496</b>	<b>\$30</b>
84"W x 30"D	<b>HNLRC3084</b>	88	6.5	<b>\$476</b>	<b>\$25</b>
78"W x 30"D	<b>HNLRC3078</b>	81	6.1	<b>\$430</b>	<b>\$25</b>
72"W x 30"D	<b>HNLRC3072</b>	75	5.6	<b>\$394</b>	<b>\$20</b>
66"W x 30"D	<b>HNLRC3066</b>	69	5.2	<b>\$362</b>	<b>\$20</b>
60"W x 30"D	<b>HNLRC3060</b>	62	4.7	<b>\$339</b>	<b>\$20</b>
48"W x 30"D	<b>HNLRC3048</b>	50	3.9	<b>\$276</b>	<b>\$15</b>
96"W x 24"D	<b>HNLRC2496</b>	80	5.8	<b>\$476</b>	<b>\$30</b>
90"W x 24"D	<b>HNLRC2490</b>	75	5.5	<b>\$466</b>	<b>\$30</b>
84"W x 24"D	<b>HNLRC2484</b>	70	5.3	<b>\$441</b>	<b>\$25</b>
78"W x 24"D	<b>HNLRC2478</b>	65	4.9	<b>\$393</b>	<b>\$20</b>
72"W x 24"D	<b>HNLRC2472</b>	60	4.6	<b>\$327</b>	<b>\$20</b>
66"W x 24"D	<b>HNLRC2466</b>	55	4.2	<b>\$315</b>	<b>\$20</b>
60"W x 24"D	<b>HNLRC2460</b>	50	3.9	<b>\$291</b>	<b>\$20</b>
54"W x 24"D	<b>HNLRC2454</b>	45	3.5	<b>\$266</b>	<b>\$20</b>
48"W x 24"D	<b>HNLRC2448</b>	40	3.1	<b>\$245</b>	<b>\$15</b>
42"W x 24"D	<b>HNLRC2442</b>	35	2.8	<b>\$228</b>	<b>\$15</b>
36"W x 24"D Rectangle Worksurface/Pedestal Top	<b>HNLRC2436</b>	30	2.4	<b>\$204</b>	<b>\$15</b>
30"W x 24"D Rectangle Worksurface/Pedestal Top	<b>HNLRC2430</b>	25	2.1	<b>\$204</b>	<b>\$15</b>

NOTES: See chart on page 104 for cord management options.

- When grommets are specified for 30"D and 36"D rectangle worksurfaces, pre-drilled holes will not be included for a 4½" diameter support column.

### NOTES:

- Grain direction on all rectangle worksurfaces runs horizontal (side-to-side) except as follows: 30"W - 36"W - 42"W - 48"W - 54"W - 60"W x 24"D tops can be specified with horizontal (side-to-side) or vertical (front-to-back) grain.
- 42"W and 48"W x 20"D tops are available with vertical (front-to-back) grain only.
- 48" - 72"W x 24" - 30"D worksurfaces are compatible for use with height adjustable electric base model HHAB3S2L.
- For standing-height requirements, use worksurface with 41"H O-leg, end panel, L-shaped end panel, or pedestal supports.
- For mobile desks and tables, use post leg with casters.
- For paper organizers, see page 175.
- Attachment of above privacy screen models requires a minimum 1" clear space/overhang on the underside of worksurface.
- Attachment of above/below privacy screen models requires a minimum 2" clear space/overhang on the underside of the worksurface.
- Steel external support channel can be attached to the underside of worksurfaces that are subjected to heavier loads. Channel is recommended to provide extra support on unsupported spans of 54"W or greater or per user preference. Ordered separately from worksurface.
- If using a 54"W or 60"W floating modesty panel, it is not necessary to specify an external support channel.
- When using an external support channel under the worksurface, the depth clearance for center drawers and keyboard platforms decreases by 8".
- See "External Channel (Recommended Use)" chart on page 152.

## HOW TO SPECIFY

<b>Select Model Number</b> H N L R C 3 6 8 4	<b>Select Edge Profile and Edge Color</b> See page 96 B H	<b>Select Worksurface Grommet Finish</b> P Black T1 Platinum X No Grommet P	<b>Select Worksurface Color</b> See page 96 H
---	---	---	---

# CONCINNITY™

## Components — Worksurfaces

GSA SIN 711-2



Icon Legend on page 21

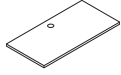

DESCRIPTION	MODEL	SHIP WEIGHT	CUBE	L1 LIST PRICE	L2 UPCHARGE
<b>Rectangle Worksurface with Vertical Grain</b>					
60"W x 24"D	<b>HNLRC2460V</b>	50	3.9	<b>\$291</b>	<b>\$20</b>
54"W x 24"D	<b>HNLRC2454V</b>	45	3.5	<b>\$266</b>	<b>\$20</b>
48"W x 24"D (shown)	<b>HNLRC2448V</b>	40	3.1	<b>\$245</b>	<b>\$15</b>
42"W x 24"D	<b>HNLRC2442V</b>	35	2.8	<b>\$228</b>	<b>\$15</b>
36"W x 24"D Rectangle Worksurface/Pedestal Top	<b>HNLRC2436V</b>	30	2.4	<b>\$204</b>	<b>\$15</b>
30"W x 24"D Rectangle Worksurface/Pedestal Top	<b>HNLRC2430V</b>	25	2.1	<b>\$204</b>	<b>\$15</b>
48"W x 20"D	<b>HNLRC2048V</b>	33	2.7	<b>\$234</b>	<b>\$10</b>
42"W x 20"D	<b>HNLRC2042V</b>	29	2.3	<b>\$215</b>	<b>\$10</b>

NOTES: Can be used in a host of applications, including as a desk, credenza, return, bridge, stationary or mobile table surface, in U- or L-shaped configurations, as part of a work wall layout with an island extension, or with the height adjustable electric base. The conference overhang dimension on the approach side of worksurfaces varies depending on the supports and modesty panels specified. Top can be positioned with a cantilevered conference overhang on one end when used with select worksurface supports, including an O-leg or 9½"W modular pedestal. For return applications in which there is an unsupported span wider than 54", such as a 72"W x 24"D worksurface supported by a 15¾"W modular pedestal (= 56¼") or a 60"W x 24"D worksurface supported by a 1½" thick end panel (= 58⅞"), use internal support panel model HNL11SUPP. For bridges wider than 54", use internal support panel HNL11SUPP. When using a 30"W, 36"W, 42"W, or 48"W rectangle worksurface as a bridge, no support legs are needed. When specifying a 84"W, 90"W, or 96"W worksurface, cannot use two O-legs for the supports. In these applications, the maximum number of supports that can be an O-leg is one; must choose from a 15¾" or wider modular pedestal for use as the additional support component. For applications requiring connection to an adjoining worksurface, two flat brackets are included with 24"D and 20"D worksurfaces that are ≤48"W; one flat bracket is included with 24"D worksurfaces that are ≥54"W. Underside of worksurface includes pilot mounting holes for O-leg, 1½" thick laminate end panel, pedestals, and flat brackets. See chart on page 104 for cord management options.

ⓘ When grommets are specified for 30"D and 36"D rectangle worksurfaces, pre-drilled holes will not be included for attachment of a 4½" diameter support column.

### NOTES:

- Grain direction on all rectangle worksurfaces runs horizontal (side-to-side) except as follows: 30"W - 36"W - 42"W - 48"W - 54"W - 60"W x 24"D tops can be specified with horizontal (side-to-side) or vertical (front-to-back) grain.
- 42"W and 48"W x 20"D tops are available with vertical (front-to-back) grain only.
- 48" - 72"W x 24" - 30"D worksurfaces are compatible for use with height adjustable electric base model HHAB3S2L.
- For standing-height requirements, use worksurface with 41"H O-leg, end panel, L-shaped end panel, or pedestal supports.
- For mobile desks and tables, use post leg with casters.
- For paper organizers, see page 175.
- ⓘ Attachment of above/below privacy screen models requires a minimum 1" clear space/overhang on the underside of worksurface.
- ⓘ Attachment of above/below privacy screen models requires a minimum 2" clear space/overhang on the underside of the worksurface.
- ⓘ Steel external support channel can be attached to the underside of worksurfaces that are subjected to heavier loads. Channel is recommended to provide extra support on unsupported spans of 54"W or greater or per user preference. Ordered separately from worksurface.
- ⓘ If using a 54"W or 60"W floating modesty panel, it is not necessary to specify an external support channel.
- ⓘ When using an external support channel under the worksurface, the depth clearance for center drawers and keyboard platforms decreases by 8".
- ⓘ See "External Channel (Recommended Use)" chart on page 152.

## HOW TO SPECIFY

<b>Select Model Number</b> H N L R C 2 4 6 0 V	<b>Select Edge Profile and Edge Color</b> See page 96 B H	<b>Select Worksurface Grommet Finish</b> P Black T1 Platinum X No Grommet P	<b>Select Worksurface Color</b> See page 96 H
---	---	---	---



# CONCINNITY™

## Components — Worksurfaces

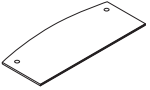
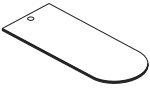
	DESCRIPTION	MODEL	SHIP WEIGHT	CUBE	L1 LIST PRICE	L2 UPCHARGE
	<b>Bow Worksurface</b>					
	84"W x 36"D 72"W x 36"D	<b>HNLBW3684</b> <b>HNLBW3672</b>	94 80	7.7 6.7	<b>\$635</b> <b>\$573</b>	<b>\$30</b> <b>\$30</b>
	NOTES: 84"W size is ideal for executive layouts or for user's who require additional worksurface space. 72"W top can be combined with different pedestal support options to allow users to personalize their storage needs. Underside of worksurface includes pilot mounting holes for 1½" and L-shaped laminate end panels, and 29⅞"D pedestals. Grain direction runs horizontal (side-to-side). See chart on page 104 for cord management options.					
	<b>Bullet Worksurface</b>					
	84"W x 30"D 78"W x 30"D 72"W x 30"D 66"W x 30"D 60"W x 30"D 48"W x 30"D	<b>HNLBU3084</b> <b>HNLBU3078</b> <b>HNLBU3072</b> <b>HNLBU3066</b> <b>HNLBU3060</b> <b>HNLBU3048</b>	84 78 72 66 60 54	6.3 6.3 5.5 5.5 4.7 3.7	<b>\$559</b> <b>\$532</b> <b>\$462</b> <b>\$441</b> <b>\$409</b> <b>\$358</b>	<b>\$25</b> <b>\$20</b> <b>\$20</b> <b>\$20</b> <b>\$20</b> <b>\$15</b>
	NOTES: Applications include U- or L-shaped peninsula configurations and island extensions. Underside of worksurface includes pilot mounting holes for O-leg, T-shaped end panel, 29⅞"D pedestals, 4½" diameter support column, and 2" square post leg. One flat bracket is packaged with each worksurface for applications requiring connection to an adjoining worksurface. Grain direction runs horizontal (side-to-side). Can be used in combination with a 15¾"W or 9½"W x 29⅞"D x 28¼"H modular pedestal to create a freestanding desk. See chart on page 104 for cord management options.					

**NOTES:**

- ❗ When specifying an 84"W size, cannot use two O-legs; must use another type of support component such as a pedestal.
- ❗ Steel external support channel can be attached to the underside of worksurfaces that are subjected to heavier loads. Channel is recommended to provide extra support on unsupported spans of 54"W or greater or per user preference. Ordered separately from worksurface.
- ❗ If using a 54"W or 60"W floating modesty panel, it is not necessary to specify an external support channel.
- ❗ When using an external support channel under the worksurface, the depth clearance for center drawers and keyboard platforms decreases by 8".
- ❗ See "External Channel (Recommended Use)" chart on page 152.

**HOW TO SPECIFY**

<b>Select Model Number</b>  <div style="border: 1px solid black; padding: 2px; display: flex; gap: 2px;"> <span>H</span><span>N</span><span>L</span><span>B</span><span>W</span><span>3</span><span>6</span><span>8</span><span>4</span> </div>	<b>Select Edge Profile and Edge Color</b> See page 96  <div style="border: 1px solid black; padding: 2px; display: flex; gap: 2px;"> <span>B</span><span>H</span> </div>	<b>Select Worksurface Grommet Finish</b>  P Black T1 Platinum X No Grommet  <div style="border: 1px solid black; padding: 2px; display: flex; gap: 2px;"> <span>P</span> </div>	<b>Select Worksurface Color</b> See page 96  <div style="border: 1px solid black; padding: 2px; display: flex; gap: 2px;"> <span>H</span> </div>
---	---	---	---



# CONCINNITY™

## Components — Worksurfaces

GSA SIN 711-2



Icon Legend on page 21

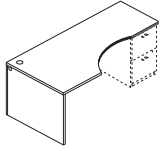

DESCRIPTION	MODEL	SHIP WEIGHT	CUBE	L1 LIST	L2 UPCHARGES	
					WORKSURFACE	END PANEL
<b>Extended Corner Worksurface</b>						
72"W x 48"D, Right	<b>HNLEC487224R</b>	130	8.9	<b>\$966</b>	<b>\$50</b>	<b>\$50</b>
72"W x 48"D, Left	<b>HNLEC487224L</b>	130	8.9	<b>\$966</b>	<b>\$50</b>	<b>\$50</b>
72"W x 36"D, Right	<b>HNLEC367224R</b>	106	6.6	<b>\$799</b>	<b>\$45</b>	<b>\$45</b>
72"W x 36"D, Left	<b>HNLEC367224L</b>	106	6.6	<b>\$799</b>	<b>\$45</b>	<b>\$45</b>

NOTES: For use in U- or L-shaped layouts. Includes top and long (47"D or 35"D) end panel components. Installation also requires modesty panel and either a 1/8" thick end panel or 15 3/4" x 23 1/8" D pedestal support for opposite end; both ordered separately. 72"W x 24/48"D or 48/24"D top is intended for use with 30/48"D or 48/30"D jetty peninsula to create a 2-piece "U" station with a curved cockpit on user's side. 72"W x 24/36"D or 36/24"D size is intended for use with 24"D returns or bridges. Underside of worksurface has pilot mounting holes for 1/8" thick end panel and 15 3/4" x 23 1/8" D modular pedestal. **Edgebanding on the extended corner worksurface is profiled on the user's side and flat on the back (approach side) and ends.** Grain direction runs horizontal (side-to-side).

- ❗ One flat bracket is packaged with each 48"D worksurface for applications requiring connection to a 48"D jetty peninsula. For 36"D extended corner worksurface, the flat bracket is shipped with the adjoining return or bridge. See chart on page 104 for cord management options. If grommet option is chosen, the worksurface component will match the color specified; the long end panel grommet color will be black.

### NOTES:

- ❗ When specifying an 84"W size, cannot use two O-legs; must use another type of support component such as a pedestal.
- ❗ Steel external support channel can be attached to the underside of worksurfaces that are subjected to heavier loads. Channel is recommended to provide extra support on unsupported spans of 54"W or greater or per user preference. Ordered separately from worksurface.
- ❗ If using a 54"W or 60"W floating modesty panel, it is not necessary to specify an external support channel.
- ❗ When using an external support channel under the worksurface, the depth clearance for center drawers and keyboard platforms decreases by 8".
- ❗ See "External Channel (Recommended Use)" chart on page 152.

### HOW TO SPECIFY

<b>Select Model Number</b> See page 96 <b>H N L E C 4 8 7 2 2 4 R</b>	<b>Select Edge Profile and Edge Color</b> See page 96 <b>B H</b>	<b>Select Worksurface Grommet Finish</b> P Black T1 Platinum X No Grommet <b>X</b>	<b>Select Worksurface Color</b> See page 96 <b>H</b>	<b>Select End Panel Color</b> See page 96 <b>H</b>
---	--	--	--	--



# CONCINNITY™ Components — Supports

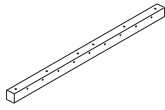

SIN 711-2

**DESCRIPTION**

**External Support Channel**

48"W for a 54" Worksurface  
54"W for a 60" Worksurface  
60"W for a 66" Worksurface  
66"W for a 72" Worksurface  
72"W for a 78" Worksurface

**MODEL**

**HLSLZ5SC60**  
**HLSLZ5SC66**  
**HLSLZ5SC72**  
**HLSLZ5SC78**  
**HLSLZ5SC84**

**SHIP WEIGHT**

6  
7  
7  
7  
12

**CUBE**

0.5  
0.5  
0.5  
0.5  
0.7

**LIST PRICE**

**\$90**  
**\$93**  
**\$100**  
**\$100**  
**\$100**

- ❗ Available in Graphite paint only.
- ❗ Attaches to underside of worksurface; required for unsupported spans greater than 54"W.
- ❗ When specifying a 54"W or 60"W Floating Modesty Panel, it is not necessary to specify an external channel.

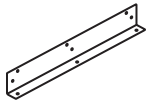

HVPWLBK24 shown

OPEN MARKET

**Worksurface Wall Mount Bracket**

For 30"  
For 24"

**HVPWLBK30**  
**HVPWLBK24**

2  
2

0.3  
0.3

**\$79**  
**\$73**

NOTES: Can be used in place of an end panel to support a worksurface. Cannot be used as a support when placing a stack-on storage unit on worksurface over bracket; must have two full-sized floor supports when using stack-on storage. Finish option not required.

**SPECIFYING EXAMPLE: HVPWLBK30**



SIN 711-3

**DESCRIPTION**

**Worksurface to Tower Bracket Kit**

18½" long bracket for attaching 24"D worksurface directly to storage tower, wardrobe/bookcase, wardrobe/storage cabinet, storage cabinet/lateral file, storage cabinet, or lateral file.

**MODEL**

**HSTB2W1**

**SHIP WEIGHT**

4

**CUBE**

0.6

**LIST PRICE BY PAINT GRADE**

**CHOICE/  
METALLICS**

**\$70**

**\$83**

**CUSTOM**

**\$94**

NOTES: Can be used in place of end panel or O-leg to support worksurfaces.

- ❗ Bracket not designed for use as a support if placing Stack-on Storage on worksurface over/above bracket. Two full-sized supports required when using Stack-on Storage.

**NOTES:**

- Use the worksurface to tower bracket kit to attach worksurfaces to Storage Tower models.
- ❗ Depending on your support combination, an external channel may be required for extra support on unsupported spans greater than 54"W.

**HOW TO SPECIFY**

Select Model Number

H L S L Z 5 S C 8 4

# CONCINNITY™ COMPONENTS

**HNL Support Options — External Channel (model HLSLZ5SCxx) - Recommended Use**

	Support Combination		Worksurface Width											
	Support 1	Support 2	30"	36"	42"	48"	54"	60"	66"	72"	78"	84"	90"	96"
O-LEG ON ONE END	O-Leg	O-Leg	NR	NR	NR	NR	60	66	72	78	84	NA	NA	NA
	O-Leg	9½"W Ped	NR	NR	NR	NR	NR	60	66	72	78	84	NA	NA
	O-Leg	End Bookcase	NA	NR	NR	NR	NR	NR	60	66	72	78	84	NA
	O-Leg	L End Panel	NR	NR	NR	NR	NR	60	66	72	78	84	NA	NA
	O-Leg	15¾"W Ped	NA	NR	NR	NR	NR	NR	NR	60	66	72	78	NA
	O-Leg	18"W Ped	NA	NA	NR	NR	NR	NR	NR	60	66	72	78	84
	O-Leg	30"W Ped	NA	NA	NA	NA	NR	NR	NR	NR	NR	60	66	72
	O-Leg	36"W Ped	NA	NA	NA	NA	NA	NR	NR	NR	NR	NR	60	66
NARROW PED	9½"W Ped	9½"W Ped	NA	NA	NR	NR	NR	NR	NR	60	66	72	78	84
	9½"W Ped	End Bookcase	NA	NA	NR	NR	NR	NR	NR	60	66	72	78	84
	9½"W Ped	L End Panel	NA	NR	NR	NR	NR	NR	60	66	72	78	84	NA
	9½"W Ped	15¾"W Ped	NA	NA	NA	NR	NR	NR	NR	NR	60	66	72	78
	9½"W Ped	18"W Ped	NA	NA	NA	NR	NR	NR	NR	NR	60	66	72	78
	9½"W Ped	30"W Ped	NA	NA	NA	NA	NA	NR	NR	NR	NR	NR	60	66
	9½"W Ped	36"W Ped	NA	NA	NA	NA	NA	NA	NR	NR	NR	NR	NR	60
END BOOKCASE PED	End Bookcase	End Bookcase	NA	NA	NR	NR	NR	NR	NR	NR	60	66	72	78
	End Bookcase	L End Panel	NA	NA	NR	NR	NR	NR	NR	60	66	72	78	84
	End Bookcase	15¾"W Ped	NA	NA	NA	NR	NR	NR	NR	NR	60	66	72	78
	End Bookcase	18"W Ped	NA	NA	NA	NR	NR	NR	NR	NR	60	66	72	78
	End Bookcase	30"W Ped	NA	NA	NA	NA	NA	NR	NR	NR	NR	NR	NR	60
	End Bookcase	36"W Ped	NA	NA	NA	NA	NA	NA	NR	NR	NR	NR	NR	NR
L END PANEL	L End Panel	L End Panel	NA	NR	NR	NR	NR	NR	60	66	72	78	84	NA
	L End Panel	15¾"W Ped	NA	NA	NR	NR	NR	NR	NR	NR	60	66	72	78
	L End Panel	18"W Ped	NA	NA	NA	NR	NR	NR	NR	NR	60	66	72	78
	L End Panel	30"W Ped	NA	NA	NA	NA	NA	NR	NR	NR	NR	NR	60	66
	L End Panel	36"W Ped	NA	NA	NA	NA	NA	NA	NR	NR	NR	NR	NR	60
TWO PEDS	15¾"W Ped	15¾"W Ped	NA	NA	NA	NA	NR	NR	NR	NR	NR	60	66	72
	15¾"W Ped	18"W Ped	NA	NA	NA	NA	NR	NR	NR	NR	NR	60	66	72
	15¾"W Ped	30"W Ped	NA	NA	NA	NA	NA	NR	NR	NR	NR	NR	NR	60
	15¾"W Ped	36"W Ped	NA	NA	NA	NA	NA	NA	NR	NR	NR	NR	NR	NR
	18"W Ped	18"W Ped	NA	NR	NA	NA	NR	NR	NR	NR	NR	NR	60	66
	18"W Ped	30"W Ped	NA	NA	NA	NR	NA	NA	NR	NR	NR	NR	NR	NR
	18"W Ped	36"W Ped	NA	NA	NA	NA	NA	NA	NR	NR	NR	NR	NR	NR
	30"W Ped	30"W Ped	NA	NA	NA	NA	NA	NR	NA	NA	NR	NR	NR	NR
	30"W Ped	36"W Ped	NA	NA	NA	NA	NA	NA	NR	NA	NA	NR	NR	NR
	36"W Ped	36"W Ped	NA	NA	NA	NA	NA	NA	NR	NA	NA	NR	NR	NR
RETURN CONFIGURATION	None	O-Leg	NR	NR	NR	NR	60	66	72	78	84	NA	NA	NA
	None	9½"W Ped	NR	NR	NR	NR	NR	60	66	72	78	84	NA	NA
	None	End Bookcase	NA	NR	NR	NR	NR	NR	60	66	72	78	84	NA
	None	L End Panel	NR	NR	NR	NR	NR	60	66	72	78	84	NA	NA
	None	15¾"W Ped	NA	NR	NR	NR	NR	NR	NR	60	66	72	78	NA
	None	18"W Ped	NA	NA	NR	NR	NR	NR	NR	60	66	72	78	84
	None	30"W Ped	NA	NA	NA	NA	NR	NR	NR	NR	NR	60	66	72
	None	36"W Ped	NA	NA	NA	NA	NA	NR	NR	NR	NR	NR	60	66

NA = Stiffener not applicable due to invalid worksurface width and support combination

NR = Applicable worksurface width and support combination, but stiffener not required

! The chart reference is to be used to complete the model number. It is not the actual length dimension of the external support channel.

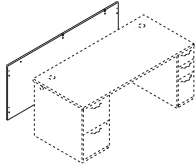
**DESCRIPTION****Modesty/Back Panels — Full-Length**

96"W x 27<sup>1</sup>/<sub>8</sub>"H  
 90"W x 27<sup>1</sup>/<sub>8</sub>"H  
 84"W x 27<sup>1</sup>/<sub>8</sub>"H  
 78"W x 27<sup>1</sup>/<sub>8</sub>"H  
 72"W x 27<sup>1</sup>/<sub>8</sub>"H  
 66"W x 27<sup>1</sup>/<sub>8</sub>"H  
 60"W x 27<sup>1</sup>/<sub>8</sub>"H  
 54"W x 27<sup>1</sup>/<sub>8</sub>"H  
 48"W x 27<sup>1</sup>/<sub>8</sub>"H  
 42"W x 27<sup>1</sup>/<sub>8</sub>"H

**MODEL****SHIP WEIGHT****CUBE****L1 LIST PRICE****L2 UPCHARGE**

**HNLMP9628**  
**HNLMP9028**  
**HNLMP8428**  
**HNLMP7828**  
**HNLMP7228**  
**HNLMP6628**  
**HNLMP6028**  
**HNLMP5428**  
**HNLMP4828**  
**HNLMP4228**

62  
58  
54  
50  
46  
42  
38  
34  
30  
26

7.2  
6.7  
6.1  
5.5  
5.3  
4.8  
4.4  
4.0  
3.6  
3.2

**\$399**  
**\$389**  
**\$322**  
**\$286**  
**\$264**  
**\$248**  
**\$225**  
**\$217**  
**\$204**  
**\$189**

**\$25**  
**\$25**  
**\$25**  
**\$20**  
**\$20**  
**\$20**  
**\$20**  
**\$15**  
**\$15**

36"W x 27<sup>1</sup>/<sub>8</sub>"H Modesty/Pedestal Back Panel

30"W x 27<sup>1</sup>/<sub>8</sub>"H Modesty/Pedestal Back Panel

**HNLMP3628**  
**HNLMP3028**

22  
18

2.8  
2.4

**\$174**  
**\$161**

**\$12**  
**\$12**

**Modesty/Back Panels — Short**

96"W x 10"H  
 90"W x 10"H  
 84"W x 10"H  
 78"W x 10"H  
 72"W x 10"H  
 66"W x 10"H  
 60"W x 10"H  
 54"W x 10"H  
 48"W x 10"H  
 42"W x 10"H  
 36"W x 10"H  
 30"W x 10"H

**HNLMP9610**  
**HNLMP9010**  
**HNLMP8410**  
**HNLMP7810**  
**HNLMP7210**  
**HNLMP6610**  
**HNLMP6010**  
**HNLMP5410**  
**HNLMP4810**  
**HNLMP4210**  
**HNLMP3610**  
**HNLMP3010**

22  
21  
20  
19  
18  
17  
16  
15  
14  
13  
12  
11

3.0  
2.8  
2.8  
2.3  
2.1  
1.9  
1.8  
1.6  
1.4  
1.3  
1.1  
0.9

**\$399**  
**\$389**  
**\$322**  
**\$286**  
**\$264**  
**\$248**  
**\$225**  
**\$217**  
**\$204**  
**\$189**  
**\$174**  
**\$161**

**\$15**  
**\$15**  
**\$15**  
**\$12**  
**\$12**  
**\$12**  
**\$12**  
**\$12**  
**\$10**  
**\$10**  
**\$10**  
**\$10**

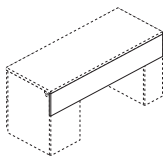

Back View

NOTES: For use with modular worksurface and support components. Component is 3/4" thick. Full-to-floor sizes can be specified with or without grommet; see chart on page 104 for cord management options. For standing-height applications, a worksurface supported by 1 1/8" thick x 41"H laminate end panel(s) and/or 41"H support pedestal(s), the recommended modesty panel length extends 27 1/8" below the underside of the top, leaving 13" of wall access; 9 1/2" and 15 3/4" W x 13"H backs are available to enclose the balance of the pedestal back. Worksurfaces supported by a 1 1/8" thick x 41"H laminate end panel and 41"H support pedestal, or by two 41"H support pedestals, can be used with a 10" modesty panel to increase the amount of wall access, however in this application the pedestal(s) should be positioned against a wall, as there is not a 30 7/8"H panel to cover the back of the pedestal that is exposed below the modesty panel. The 10"H modesty panel is not recommended for use in a standing-height shell, where both supports are 41"H laminate end panels; for this solution use the 27 1/8"H modesty panel. For standing-height applications with the worksurface supported by 41"H O-legs or L-shaped end panels, use the appropriate floating modesty panel size.

**NOTES:**

- Provide approach-side kneespace privacy for user seated at desks, credenzas, returns, and bridges.
- Full-width laminate panel can be specified in 6" increments from 30"-96"W, and in full-length (27<sup>1</sup>/<sub>8</sub>"H) or short (10"H).
- Formal, full-length, 27<sup>1</sup>/<sub>8</sub>"H models extend from the underside of the worksurface to the floor.
- 10"H sizes allow quick and easy access to wall power outlets.
- 30"W and 36"W x 27<sup>1</sup>/<sub>8</sub>"H are sized to serve as a modesty panel, or pedestal back for respective 30"W and 36"W support storage pedestal models.

- ! The full-width panel designs are specifically for use when the worksurface supports are two 1 1/8" thick end panels, two support storage pedestals, or one 1 1/8" thick end panel and one support storage pedestal; not for use with O-legs or L-shaped end panels.

**HOW TO SPECIFY**

<b>Select Model Number</b> H N L M P 7 2 2 8	<b>Select Grommet</b> P Black X No Grommet X	<b>Select Laminate Color</b> See page 96 H
---	---	--

<b>Select Model Number</b> H N L M P 7 2 1 0	<b>Select Laminate Color</b> See page 96 H
---	--

# CONCINNITY™

## Components — Modesty/Back Panels

GSA SIN 711-2

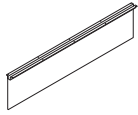

DESCRIPTION	MODEL	SHIP WEIGHT	CUBE	L1 LIST PRICE	L2 UPCHARGE
<b>Laminate Floating Modesty Panel</b>					
30"W x 14"H	<b>HLSL3014L</b>	10	0.8	<b>\$154</b>	<b>\$10</b>
36"W x 14"H	<b>HLSL3614L</b>	12	0.8	<b>\$163</b>	<b>\$10</b>
42"W x 14"H	<b>HLSL4214L</b>	14	0.8	<b>\$176</b>	<b>\$10</b>
48"W x 14"H	<b>HLSL4814L</b>	16	1.1	<b>\$193</b>	<b>\$12</b>
54"W x 14"H	<b>HLSL5414L</b>	18	1.1	<b>\$212</b>	<b>\$12</b>
60"W x 14"H	<b>HLSL6014L</b>	20	1.1	<b>\$228</b>	<b>\$12</b>

NOTES: The attachment bracket and modesty panel are packaged separately.

Specify: Model.Laminate.Paint

**SPECIFYING EXAMPLE: HLSL3014L.N.P (Black is the only paint option for this model)**

ⓘ When specifying the 54"W or 60"W Laminate Floating Modesty Panel, it is not necessary to specify an external support channel.

ⓘ 30"W and 36"W screens attach with L-brackets, not the external channel.

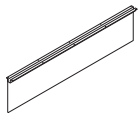

DESCRIPTION	MODEL	SHIP WEIGHT	CUBE	L1 LIST PRICE	L2 UPCHARGE
<b>Mixed Material Floating Modesty Panel</b>					
30"W x 14"H	<b>HLSL3014MM</b>	8	2.0	<b>\$621</b>	<b>N/A</b>
36"W x 14"H	<b>HLSL3614MM</b>	8	2.0	<b>\$666</b>	<b>N/A</b>
42"W x 14"H	<b>HLSL4214MM</b>	9	2.3	<b>\$745</b>	<b>N/A</b>
48"W x 14"H	<b>HLSL4814MM</b>	11	2.6	<b>\$826</b>	<b>N/A</b>
54"W x 14"H	<b>HLSL5414MM</b>	13	3.3	<b>\$896</b>	<b>N/A</b>
60"W x 14"H	<b>HLSL6014MM</b>	13	3.3	<b>\$1023</b>	<b>N/A</b>

NOTES: The attachment bracket and modesty panel are packaged separately.

Specify: Model.Mixed Material.Paint

**SPECIFYING EXAMPLE: HLSL3014MM.FT01.P (Frosted Translucent mixed material and Black paint are the only options for this model)**

ⓘ When specifying the 54"W or 60"W Mixed Material Floating Modesty Panel, it is not necessary to specify an external support channel.

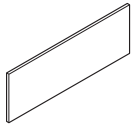

DESCRIPTION	MODEL	SHIP WEIGHT	CUBE	L1 LIST PRICE	L2 UPCHARGE
<b>Full Width/Half-Height Laminate Modesty Panel</b>					
28"W x 14"H, for use with 60" desks	<b>HLSL2814LM</b>	19	1.6	<b>\$169</b>	<b>\$10</b>
34"W x 14"H, for use with 66" desks	<b>HLSL3414LM</b>	23	1.9	<b>\$174</b>	<b>\$10</b>
40"W x 14"H, for use with 72" desks	<b>HLSL4014LM</b>	29	2.4	<b>\$182</b>	<b>\$10</b>

NOTES: Filler piece that can only be used between the following supports: two 15<sup>3</sup>/<sub>4</sub>"W modular pedestals, two 15<sup>3</sup>/<sub>4</sub>"W L-shaped end panels, or one 15<sup>3</sup>/<sub>4</sub>"W modular pedestal and one 15<sup>3</sup>/<sub>4</sub>"W L-shaped end panel. Attachment brackets included.

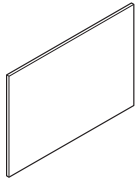

DESCRIPTION	MODEL	SHIP WEIGHT	CUBE	L1 LIST PRICE	L2 UPCHARGE
<b>Full-to-Floor/Full-Length Laminate Modesty Panel</b>					
28"W x 28 <sup>1</sup> / <sub>2</sub> "H, for use with 60" desks	<b>HLSL2828LM</b>	33	2.7	<b>\$227</b>	<b>\$12</b>
34"W x 28 <sup>1</sup> / <sub>2</sub> "H, for use with 66" desks	<b>HLSL3428LM</b>	38	3.2	<b>\$265</b>	<b>\$12</b>
40"W x 28 <sup>1</sup> / <sub>2</sub> "H, for use with 72" desks	<b>HLSL4028LM</b>	44	3.6	<b>\$281</b>	<b>\$12</b>

NOTES: Filler piece that can only be used between the following supports: two 15<sup>3</sup>/<sub>4</sub>"W modular pedestals, two 15<sup>3</sup>/<sub>4</sub>"W L-shaped end panels, or one 15<sup>3</sup>/<sub>4</sub>"W modular pedestal and one 15<sup>3</sup>/<sub>4</sub>"W L-shaped end panel. Attachment brackets included.

### NOTES:

- Floating panel options attach under worksurfaces and are available in laminate or mixed (frosted translucent) material. The modesty panel and attachment bracket are packaged separately.
- If using a 54"W or 60"W floating modesty panel, it is not necessary to specify an external support channel.
- When using a floating modesty panel under the worksurface, the depth clearance for center drawers and keyboard platforms decreases by 8".
- The full width/half-height and full-to-floor/full-length panels are filler options designed only for use on 60", 66", and 72"W x 29<sup>1</sup>/<sub>2</sub>"H, double, 15<sup>3</sup>/<sub>4</sub>"W, pedestal desks and credenzas that are specified/built with modular components.

## HOW TO SPECIFY

<b>Select Model Number</b> HLSL3014MM	<b>Select Mixed Material</b> FT01 Frosted Translucent
<b>Select Model Number</b> HLSL2814LM	<b>Select Laminate Color</b> See page 96 N

# CONCINNITY™ MODESTY/BACK PANELS

HNL Floating Modesty Panel — HSLx14L/MM — Selection Guide														
	Support Combination		Worksurface Width											
	Support 1	Support 2	30"	36"	42"	48"	54"	60"	66"	72"	78"	84"	90"	96"
O-LEG ON ONE END	O-Leg	O-Leg	NA	NA	36	42	48	54	60	60	60	NA	NA	NA
	O-Leg	9½"W Ped	NA	NA	NA	30	36	42	48	54	60	60	NA	NA
	O-Leg	End Bookcase	NA	NA	NA	30	36	42	48	54	60	60	60	NA
	O-Leg	L End Panel	NA	NA	NA	36	42	48	54	60	60	60	NA	NA
	O-Leg	15¾"W Ped	NA	NA	NA	NA	30	36	42	48	54	60	60	NA
	O-Leg	18"W Ped	NA	NA	NA	NA	30	36	42	48	54	60	60	60
	O-Leg	30"W Ped	NA	NA	NA	NA	NA	NA	30	36	42	48	54	60
	O-Leg	36"W Ped	NA	NA	NA	NA	NA	NA	NA	30	36	42	48	54
NARROW PED	9½"W Ped	9½"W Ped	NA	NA	NA	NA	30	36	42	48	54	60	60	60
	9½"W Ped	End Bookcase	NA	NA	NA	NA	30	36	42	48	54	60	60	60
	9½"W Ped	L End Panel	NA	NA	NA	NA	30	36	42	48	54	60	60	NA
	9½"W Ped	15¾"W Ped	NA	NA	NA	NA	NA	30	36	42	48	54	60	60
	9½"W Ped	18"W Ped	NA	NA	NA	NA	NA	30	36	42	48	54	60	60
	9½"W Ped	30"W Ped	NA	NA	NA	NA	NA	NA	NA	NA	30	36	48	48
	9½"W Ped	36"W Ped	NA	NA	NA	NA	NA	NA	NA	NA	30	36	42	48
END BOOKCASE PED	End Bookcase	End Bookcase	NA	NA	NA	NA	NA	30	36	42	48	54	60	60
	End Bookcase	L End Panel	NA	NA	NA	NA	30	36	36	48	54	60	60	60
	End Bookcase	15¾"W Ped	NA	NA	NA	NA	NA	30	36	42	48	54	60	60
	End Bookcase	18"W Ped	NA	NA	NA	NA	NA	NA	30	36	42	48	54	60
	End Bookcase	30"W Ped	NA	NA	NA	NA	NA	NA	NA	NA	30	36	42	48
	End Bookcase	36"W Ped	NA	NA	NA	NA	NA	NA	NA	NA	NA	30	36	42
L END PANEL	L End Panel	L End Panel	NA	NA	NA	NA	36	36	48	54	60	60	60	NA
	L End Panel	15¾"W Ped	NA	NA	NA	NA	NA	30	36	42	48	54	60	60
	L End Panel	18"W Ped	NA	NA	NA	NA	NA	30	36	42	48	54	60	60
	L End Panel	30"W Ped	NA	NA	NA	NA	NA	NA	NA	30	36	42	48	54
	L End Panel	36"W Ped	NA	NA	NA	NA	NA	NA	NA	NA	30	36	42	48
TWO PEDS	15¾"W Ped	15¾"W Ped	NA	NA	NA	NA	NA	NA	30	36	42	48	54	60
	15¾"W Ped	18"W Ped	NA	NA	NA	NA	NA	NA	30	36	36	48	54	60
	15¾"W Ped	30"W Ped	NA	NA	NA	NA	NA	NA	NA	NA	30	36	42	48
	15¾"W Ped	36"W Ped	NA	NA	NA	NA	NA	NA	NA	NA	30	36	42	48
	18"W Ped	18"W Ped	NA	NA	NA	NA	NA	NA	NA	30	36	42	48	54
	18"W Ped	30"W Ped	NA	NA	NA	NA	NA	NA	NA	NA	NA	30	36	42
	18"W Ped	36"W Ped	NA	NA	NA	NA	NA	NA	NA	NA	NA	NA	30	36
	30"W Ped	30"W Ped	NA	NA	NA	NA	NA	NA	NA	NA	NA	NA	NA	30
	30"W Ped	36"W Ped	NA	NA	NA	NA	NA	NA	NA	NA	NA	NA	NA	NA
	36"W Ped	36"W Ped	NA	NA	NA	NA	NA	NA	NA	NA	NA	NA	NA	NA
HT ADJ BASE	Height Adjustable Electric Base (model HHAB3S2L)		NA	NA	NA	42	48	54	60	60	NA	NA	NA	NA
PENINSULA	Support Column	T End Panel	NA	NA	NA	30	30	36	42	48	54	60	60	60
	Support Column	9½"W Ped	NA	NA	NA	NA	NA	30	36	42	48	54	60	60
	Support Column	15¾"W Ped	NA	NA	NA	NA	NA	NA	30	36	42	48	54	60
	Support Column	18"W Ped	NA	NA	NA	NA	NA	NA	30	36	42	48	54	60
	Support Column	30"W Ped	NA	NA	NA	NA	NA	NA	NA	NA	30	36	42	48
	Support Column	36"W Ped	NA	NA	NA	NA	NA	NA	NA	NA	NA	30	36	42
RETURN CONFIGURATION	None	O-Leg	NA	NA	36	42	48	54	60	60	60	NA	NA	NA
	None	9½"W Ped	NA	NA	NA	30	36	42	48	54	60	60	NA	NA
	None	End Bookcase	NA	NA	NA	30	36	42	48	54	60	60	60	NA
	None	L End Panel	NA	NA	36	36	42	48	54	60	60	60	NA	NA
	None	15¾"W Ped	NA	NA	NA	NA	30	36	42	48	54	60	60	NA
	None	18"W Ped	NA	NA	NA	NA	30	36	42	48	54	60	60	60
	None	30"W Ped	NA	NA	NA	NA	NA	NA	30	36	42	48	54	60
	None	36"W Ped	NA	NA	NA	NA	NA	NA	NA	30	36	42	48	60

NA = Floating Modesty Panel not applicable for use with worksurface width and support combination

# CONCINNITY™

## Components — Supports

GSA SIN 711-2

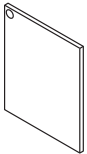
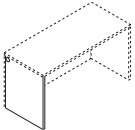
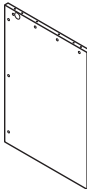

Icon Legend on page 21

	DESCRIPTION	MODEL	SHIP WEIGHT	CUBE	L1 LIST PRICE	L2 UPCHARGE
 HNLEP2428R shown	<b>1 1/8" Laminate End Panels — For 29 1/2"H</b> 1 1/8"W x 35"D x 28 1/2"H for 36"D, Right 1 1/8"W x 35"D x 28 1/2"H for 36"D, Left	<b>HNLEP3628R</b> <b>HNLEP3628L</b>	39 39	2.8 2.8	<b>\$241</b> <b>\$241</b>	<b>\$20</b> <b>\$20</b>
	1 1/8"W x 29 1/8"D x 28 1/2"H for 30"D, Right 1 1/8"W x 29 1/8"D x 28 1/2"H for 30"D, Left	<b>HNLEP3028R</b> <b>HNLEP3028L</b>	32 32	2.3 2.3	<b>\$211</b> <b>\$211</b>	<b>\$15</b> <b>\$15</b>
 HNLEP2428L shown	1 1/8"W x 23 1/8"D x 28 1/2"H for 24"D, Right 1 1/8"W x 23 1/8"D x 28 1/2"H for 24"D, Left	<b>HNLEP2428R</b> <b>HNLEP2428L</b>	22 22	1.9 1.9	<b>\$189</b> <b>\$189</b>	<b>\$10</b> <b>\$10</b>
	<b>1 1/8" Laminate End Panels — For 42"H</b> 1 1/8"W x 29 1/8"D x 41"H for 30"D, Right 1 1/8"W x 29 1/8"D x 41"H for 30"D, Left	<b>HNLEP3041R</b> <b>HNLEP3041L</b>	47 47	3.2 3.2	<b>\$240</b> <b>\$240</b>	<b>\$20</b> <b>\$20</b>
 HNLEP2441R shown	1 1/8"W x 23 1/8"D x 41"H for 24"D, Right 1 1/8"W x 23 1/8"D x 41"H for 24"D, Left	<b>HNLEP2441R</b> <b>HNLEP2441L</b>	37 37	2.6 2.6	<b>\$225</b> <b>\$225</b>	<b>\$15</b> <b>\$15</b>

NOTES: Supports the end of a component worksurface where there is no modular pedestal. 1 1/8" Laminate End Panels must be used with a full-length (27 7/8"H) or short (10"H) modesty/back panel; ordered separately, see page 153. The depth of an end panel is 3/4" less than the depth of the worksurface, to accommodate the modesty/back panel. Handed design (left and right models). Bottom of end panel is edgebanded for added strength and to seal out moisture. Applications include — For the non-pedestal end of single pedestal desks or credenzas utilizing modular storage components. For returns that do not have a modular storage pedestal to support the worksurface. For extended corner units that do not utilize a 15 3/4"W x 23 1/8"D modular storage pedestal to support the 24"D worksurface dimension. For building desk or credenza shells comprised of a worksurface top and modesty/back panel components, and left and right end panel. Available in a woodgrain or solid laminate color only. Can be specified with or without grommet; see chart on page 104 for cord management options. If grommet option is chosen, the color is black only.

**NOTES:**

❗ 1 1/8" Laminate End Panels must be used with a full-length (27 7/8"H) or short (10"H) modesty/back panel; ordered separately, see page 153.

**HOW TO SPECIFY**

<b>Select Model Number</b> <input type="text" value="HNLEP2428R"/>	<b>Select Grommet</b> <input type="radio"/> Black <input checked="" type="radio"/> No Grommet	<b>Select Laminate Color</b> <input type="text" value="H"/> See page 96
---	---	--



# CONCINNITY™ Kneespace Clearance End Panels

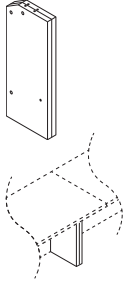

DESCRIPTION	MODEL	SHIP WEIGHT	CUBE	L1	L2
				LIST PRICE	UPCHARGE
<b>Kneespace Clearance End Panels</b> 1½"W x 11¼"D x 28½"H for 24"D, 2 pk	<b>HNLEP1128</b>	25	2.0	<b>\$215</b>	<b>\$10</b>
1½"W x 11¼"D x 41"H for 24"D, 2 pk	<b>HNLEP1141</b>	25	2.8	<b>\$264</b>	<b>\$10</b>

NOTES: Creates additional kneespace for the user. Two 1½"W x 11¼"D laminate end panels, one left, one right; sized to support two adjoining, contiguous 24"D worksurfaces. Can be specified with worksurfaces at time of installation or ordered as replacement for two side-by-side 1½"W x 23"D end panels. Available in 28½" and 41"H. Can be used to connect up to three credenzas in line (2 kits). Not designed for use with returns. Allows conversion of units currently in the field; European fasteners make installation quick and easy. Cord routing notch in top back of each panel. Includes two 1½" thick panels; European fastening hardware; flat connector bracket; self-tapping wood screws for ganging credenza to adjacent worksurface; and adjustable leveling glides. Can be specified in a woodgrain or solid laminate color only; not in a two-tone combination.

**SPECIFYING EXAMPLE: HNLEP1128.H**

## HOW TO SPECIFY

<p><b>Select Model Number</b></p> <p>HNLEP1128</p>	<p><b>Select Grommet</b></p> <p>P Black X No Grommet</p> <p>X</p>
--	---



# CONCINNITY™

## Components — Supports

GSA SIN 711-2



Icon Legend on page 21

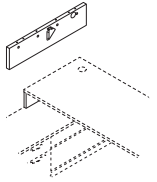

HNLEP307L shown

**DESCRIPTION****MODEL****SHIP WEIGHT****CUBE****L1 LIST PRICE****L2 UPCHARGE****Laminate End Panel — 7”H Support for Worksurfaces**

1½”W x 30”D x 7”H, Right

**HNLEP307R**

7

0.7

**\$122****\$10**

1½”W x 30”D x 7”H, Left

**HNLEP307L**

7

0.7

**\$122****\$10**

1½”W x 24”D x 7”H, Right

**HNLEP247R**

6

0.7

**\$122****\$10**

1½”W x 24”D x 7”H, Left

**HNLEP247L**

6

0.7

**\$122****\$10**

NOTES: Specifically for layered surface applications; used to support a 29½”H component worksurface over a 21½”H low credenza unit. 1½” thick. Handed design (left and right models). Includes cord routing notch. Bottom of end panel is edgebanded for added strength and to seal out moisture. Attaches to underside of worksurface via cam fasteners and L-bracket; attaches to top of low credenza with double-sided tape. Can be specified in a woodgrain or solid laminate color only. For 7”H metal O-leg support see page 160.

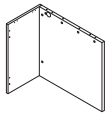
**SPECIFYING EXAMPLE: HNLEP307R.H**

HNLLEP3028R shown

**Laminate L-Shaped End Panels — For 29½”H**

15¾”W x 30”D x 28½”H, Right

**HNLLEP3028R**

38

4.3

**\$342****\$15**

15¾”W x 30”D x 28½”H, Left

**HNLLEP3028L**

38

4.3

**\$342****\$15**

15¾”W x 24”D x 28½”H, Right

**HNLLEP2428R**

32

2.8

**\$307****\$15**

15¾”W x 24”D x 28½”H, Left

**HNLLEP2428L**

32

2.8

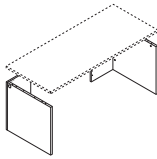
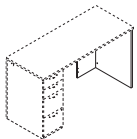
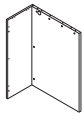
**\$307****\$15**HNLLEP3028R and  
HNLLEP3028L shown

HNLLEP3041R shown

**Laminate L-Shaped End Panels — For 42”H**

15¾”W x 30”D x 41”H, Right

**HNLLEP3041R**

55

4.3

**\$378****\$20**

15¾”W x 30”D x 41”H, Left

**HNLLEP3041L**

55

4.3

**\$378****\$20**

15¾”W x 24”D x 41”H, Right

**HNLLEP2441R**

47

2.8

**\$338****\$20**

15¾”W x 24”D x 41”H, Left

**HNLLEP2441L**

47

2.8

**\$338****\$20**

NOTES: Supports the end of a component worksurface where there is no modular pedestal. Provides easy, open access to wall electrical outlets. For configurations requiring a modesty panel, options include a laminate floating modesty panel or a mixed material floating modesty panel — see page 154. Tops and bottoms of panels are edgebanded. Two pieces; 1½” end panel and ¾” back panel. Ships ; simple assembly. Can be specified in a woodgrain or solid laminate color only; not available in a two-tone combination. See chart on page 104 for cord management options. If grommet option is chosen for the end panel, the color is black only.

**SPECIFYING EXAMPLE: HNLLEP2428R.X.H****HOW TO SPECIFY****Select Model Number**

H N L E P 3 0 7 R .

**Select Laminate Color**

See page 96

H

**Select Model Number**

H N L L E P 3 0 2 8 R .

**Select Grommet**P Black  
X No Grommet

X

**Select Laminate Color**

See page 96

H



# CONCINNITY™ Components — Supports

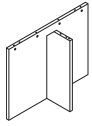

**DESCRIPTION**

**MODEL**

**SHIP WEIGHT**

**CUBE**

**L1 LIST PRICE**

**L2 UPCHARGE**

**Laminate T-Shaped End Panels — For 29½”H**

11⅝”W x 35⅞”D x 28½”H

**HNLTEP3628**

45

3.7

**\$348**

**\$20**

11⅝”W x 29⅞”D x 28½”H

**HNLTEP3028**

39

3.3

**\$327**

**\$20**

11⅝”W x 23⅞”D x 28½”H

**HNLTEP2428**

33

2.9

**\$307**

**\$20**

NOTES: Supports the end of a component worksurface where there is no modular pedestal. Available in 24”, 30”, and 36”D x 28½”H. Two 1⅝” thick pieces; one end and one brace panel. Cord routing notch in brace panel. Non-handed. Ships ; simple assembly. Can be specified in a woodgrain or solid laminate color only; not available in a two-tone combination.

**SPECIFYING EXAMPLE: HNLTEP3628.H**

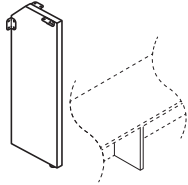

**Support Brace — For 29½”H**

1⅝”W x 10½”D x 28½”H

**HNL11SUPP**

11

0.9

**\$138**

**\$10**

NOTES: Minimizes worksurface deflection by providing added internal support under 24”D tops with an unsupported span of 54” or wider (distance for which there is no panel, leg, or pedestal support component). Not for use as an end panel. 11”D size provides kneespace clearance. Attaches with brackets to both the underside of the worksurface top and either a conventional full-length or 10” laminate modesty panel; not for use with O-leg or L-shaped end panel supports. 1⅝” thick. Cord routing notch in brace panel. Can be specified in a woodgrain or solid laminate color only.

**SPECIFYING EXAMPLE: HNL11SUPP.H**

## HOW TO SPECIFY

Select Model Number

H N L 1 1 S U P P

Select Laminate Color

See page 96

H

# CONCINNITY™

## Components — Supports

GSA SIN 711-2 EXCEPT AS NOTED

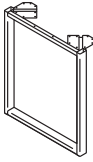
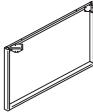
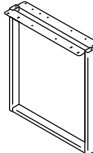
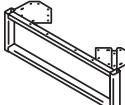
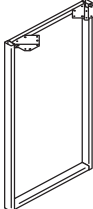
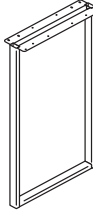

Icon Legend on page 21

	DESCRIPTION	MODEL	SHIP WEIGHT	CUBE	LIST PRICE BY PAINT GRADE	
					CORE	METALLICS
 SIN 711-3	<b>O-Leg</b> 30"D x 28½"H 24"D x 28½"H  NOTES: Ship fully assembled, 1/pack. Non-handed. IMPORTANT: The O-leg attachment bracket interferes with placement of 28¾"H mobile pedestals, preventing them from being positioned directly next to (flush with) the O-leg. Box/file mobile pedestal (model HNL2116MBF) can be positioned along side the O-leg. <b>SPECIFYING EXAMPLE: HLSL2428O.T1</b>	<b>HLSL3028O</b>	19	5.4	<b>\$323</b>	<b>\$327</b>
		<b>HLSL2428O</b>	17	3.7	<b>\$291</b>	<b>\$295</b>
	<b>Double-Depth O-Leg Support for Worksurfaces</b> 48"D x 28½"H 60"D x 28½"H  NOTES: Ship fully assembled, 1/pack. Non-handed. 48"D and 60"D sizes span back-to-back 24"D and 30"D worksurfaces, respectively.	<b>HLSL4828O</b>	18	7.0	<b>\$550</b>	<b>\$558</b>
		<b>HLSL6028O</b>	19	8.7	<b>\$612</b>	<b>\$620</b>
	<b>O-Leg Shared Support for Worksurfaces</b> 24"D x 28½"H 30"D x 28½"H  NOTES: Ship fully assembled, 1/pack. Non-handed. ! Specify paint only. <b>SPECIFYING EXAMPLE: HLSL2028SL.T1</b>	<b>HLSL2428SL</b>	17	3.7	<b>\$361</b>	<b>\$365</b>
		<b>HLSL3028SL</b>	19	5.4	<b>\$402</b>	<b>\$406</b>
	<b>O-Leg Support for Low Credenzas</b> 24"D x 7"H 30"D x 7"H  NOTES: Ship fully assembled, 1/pack. Non-handed. For 7"H laminate support see page 158. ! Specify paint only. <b>SPECIFYING EXAMPLE: HLSL2070.T1</b>	<b>HLSL2470</b>	6	1.0	<b>\$196</b>	<b>\$200</b>
		<b>HLSL3070</b>	7	1.0	<b>\$249</b>	<b>\$253</b>
	<b>Standing-Height O-Leg Support for Worksurfaces</b> 24"D x 41"H 30"D x 41"H  NOTES: Ship fully assembled, 1/pack. Non-handed.	<b>HLSL2441O</b>	16	5.3	<b>\$390</b>	<b>\$396</b>
		<b>HLSL3041O</b>	17	6.5	<b>\$436</b>	<b>\$442</b>
	<b>Standing-Height O-Leg Shared Support for Worksurfaces</b> 24"D x 41"H 30"D x 41"H  NOTES: Ship fully assembled, 1/pack. Non-handed. For use with two 24"D or 30"D worksurfaces positioned side-by-side along the depth dimension.	<b>HLSL2441SL</b>	16	5.3	<b>\$439</b>	<b>\$445</b>
		<b>HLSL3041SL</b>	17	6.5	<b>\$487</b>	<b>\$493</b>

**NOTES:**

- Open frame, metal design.
- O-leg ships fully assembled with mounting hardware.
- O-leg glides have 2" adjustability.
- Will have 6" overhang when using 30"D O-legs with a 36"D worksurface.
- Shared O-legs create a cleaner aesthetic in all applications where two legs are used side-by-side.

! O-legs may only be attached to worksurfaces, not storage units.

! O-leg installation requires 6" of clearance from the worksurface end.

! For use with worksurfaces up to 78"W. When using an 84"W or wider worksurface, cannot use two O-legs; must use one 15¾" or wider pedestal for the other support.

**HOW TO SPECIFY**Select  
Model NumberSelect  
Paint Color

See page 96

HLSL3028O.

T1



# CONCINNITY™

## Components — Supports

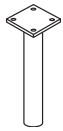

SIN 711-8

**DESCRIPTION****Support Column**4½" Diameter. Specify: HPC190X.P. **Black only.****MODEL****HPC190X****SHIP WEIGHT**

12 ☉

**CUBE**

1.0

**LIST PRICE****\$148****Support Column**4½" Diameter. Specify: HPC191X.X. **Available in Silver only.****HPC191X**

12 ☉

1.0

**\$148**

NOTES: For peninsula or island extension worksurface application.

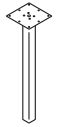

SIN 711-2

**DESCRIPTION****Post Leg Base**

28½"H x 2" square

**MODEL****HLSL28P****SHIP WEIGHT**

15

**CUBE**

1.0

**LIST PRICE BY PAINT GRADE****CORE****\$267****METALLICS****\$271**

NOTES: Can only be used as the outbound support in a peninsula or island extension worksurface application. Glides have 2" of adjustability. Ship 1/pack.

**SPECIFYING EXAMPLE: HLSL28P.T1****NOTES:**

- All bases allow tops to sit at 29½" from the floor with glides half-way seated.

**Height Adjustable Base**

- 3-Stage column design.
- Frame rises from 23¾" to 49¼" for a sit-to-stand desk option.
- Ships complete with a pre-assembled motor.
- Base telescopes to accommodate any worksurface between 48"W and 72"W.
- Accommodates rectangular worksurfaces between 24"D x 48"W and 36"D x 72"W.
- Standard height adjustable control ships with base.
- Dynamic load capacity when worksurface is moving is 300 lbs.
- Optional Memory Control allows preset worksurface heights for consistency. Ships separately.
- Silver finish matches any neutral HON paint or finish color.
- Tops and bases are ordered and sold separately.

**Post and T-Leg Bases**

- Both glides and casters attach to the foot easily without tools for assembly.
- Bases specified with casters include two locking and two non-locking casters.
- Bases specified with glides have four adjustable glides, which adjust 1".
- When post legs are used with 18"W tops, post leg to be specified with glides only.
- ! Support column must be specified for worksurfaces used as peninsulas or as an island extension.
- ! Post leg can only be used to support peninsula, not as primary supports for a top.

**HOW TO SPECIFY**Select  
Model Number

H P C 1 9 0 X

# CONCINNITY™ Components — Supports

GSA SIN AS NOTED

ABI

Icon Legend on page 21

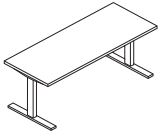

Base shown with work surface attached.

OPEN MARKET

## DESCRIPTION

**Coordinate™ Height Adjustable Base – 3 Stage**  
24”D Feet and Worksurface Brackets

## MODEL

**HHAB3S2L**

## SHIP WEIGHT

67

## CUBE

2.4

## LIST PRICE

**\$960**

NOTES: **AVAILABLE FEBRUARY 2018.** Support option for 24”, 30”, and 36”D rectangle worksurfaces. For 36”D, the base must be centered in the middle of the underside of worksurface. Worksurfaces are ordered separately, see model listing on pages 147-148.

Available in Nickel P8L finish only.

**SPECIFYING EXAMPLE: HHAB3S2L.P8L**

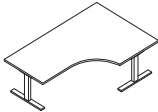

Base shown with work surface attached.

OPEN MARKET

## Coordinate™ 3-Leg Height Adjustable Base – 3 Stage

24”D Feet and Worksurface Brackets

**HHAB3S3L**

97

3.6

**\$1625**

NOTES: **AVAILABLE FEBRUARY 2018.** Supports two rectangular worksurfaces to create a height adjustable L-shaped configuration. Accepts worksurface sizes between 24”D x 48”W and 36”D x 72”W. Accommodates combined components comprising a maximum L-layout footprint of 6’ x 6’ (72”W x 72”D), examples include 72”W x 30”D with 42”W x 24”D and 72”W x 24”D with 48”W x 24”D.

Available in Nickel P8L finish only.

**SPECIFYING EXAMPLE: HHAB3S3L.P8L**

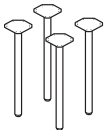

SIN 711-11



## Post Leg Base (Includes 4 Post Legs)

24”D and 30”D Worksurfaces up to 72”W

**HMBPOST**

18

2.3

**\$333**

NOTES: For 54” and 60” worksurfaces, use one external channel, centered between user and approach sides. For 66” and 72”W worksurfaces, use two external channels; if no grommets, locate the channels 3” from user and approach sides; if grommets are in the worksurface, locate channels 3” from user and 6” from approach sides.

1 3/4” diameter Post Leg Base with glide (HMBPOST.G); qty. 4; for 30” to 72”W x 24”D and 48” to 72”W x 30”D tops

1 3/4” diameter Post Leg Base with casters (HMBPOST.C); qty. 4; for 30” to 72”W x 24”D and 48” to 72”W x 30”D tops

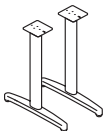

SIN 711-11



## Fixed Height T-Leg Base (Includes 2 T-legs)

For 24”D and 30”D Worksurfaces up to 72”W

**HMBTLEG24**

14

3.6

**\$395**

NOTES: Use external channel when space between the two legs is 54”W or greater. Center the channel between approach and user sides. See model listing on page 151.

Fixed Height T-Leg Base with glide (HMBTLEG24.G); qty. 2; for 24” and 30”D tops up to 72”W; adjustable glides have 1” range

Fixed Height T-Leg Base with casters (HMBTLEG24.C); qty. 2; for 24” and 30”D tops up to 72”W; two locking and two non-locking casters

## NOTES:

- All bases allow tops to sit at 29 1/2” from the floor with glides half-way seated.

### Height Adjustable Base

- 3-Stage column design.
- Frame rises from 21 5/8” to 47 5/8” for a sit-to-stand desk option.
- Ships complete with a pre-assembled motor.
- Comes standard with one-touch, four memory controller with digital display; no specification needed, available in black finish only.
- Base telescopes to accommodate any worksurface between 48”W and 72”W.
- Accommodates rectangular worksurfaces between 24”D x 48”W and 36”D x 72”W.
- Standard height adjustable control ships with base.
- Dynamic load capacity when worksurface is moving is 250 lbs.
- Nickel finish matches any neutral HON paint or finish color.
- Tops and bases are ordered and sold separately.
- For additional information see page 566.
- HON 5-Year Limited Warranty.**

### Post and T-Leg Bases

- Both glides and casters attach to the foot easily without tools for assembly.
- Bases specified with casters include two locking and two non-locking casters.
- Bases specified with glides have four adjustable glides, which adjust 1”.
- When post legs are used with 18”W tops, post leg to be specified with glides only.
- Support column must be specified for worksurfaces used as peninsulas or as an island extension.
- Post leg can only be used to support peninsula, not as primary supports for a top.

## HOW TO SPECIFY

### Select Model Number

H M B T L E G 2 4

### Select Glide/Caster Option

G Glide  
C Caster  
18”D tops are not available in Concinnity™

G

### Select Paint Color

See page 96  
\$20 upcharge per model, for Metallic paint

T 1



Icon Legend on page 21

# CONCINNITY™ Components — Privacy Screens

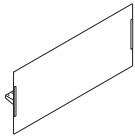

**DESCRIPTION**

**Above/Below Privacy Screen**

- 30"W x 28"H
- 36"W x 28"H
- 42"W x 28"H
- 48"W x 28"H
- 54"W x 28"H
- 60"W x 28"H

**MODEL**

- HLSL2830**
- HLSL2836**
- HLSL2842**
- HLSL2848**
- HLSL2854**
- HLSL2860**

**SHIP WEIGHT**

- 6
- 6
- 6
- 8
- 9
- 9

**CUBE**

- 6.4
- 6.4
- 6.3
- 8.2
- 8.6
- 8.6

**LIST PRICE**

- \$736**
- \$1018**
- \$1031**
- \$1098**
- \$1279**
- \$1287**

NOTES: Attachment bracket extends 2" into top and underside of worksurface. Screen is frosted translucent acrylic. All brackets are platinum (no need to specify). Extends 13" above and 13" below worksurface.

! See page 164 for the "Above-Below Privacy Screen — HLSL28xx — Selection Guide".

! Available in Frosted Translucent Acrylic ONLY HLSL2830.FT01.

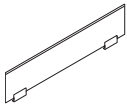

**Above Privacy Screen**

- 30"W x 13"H
- 36"W x 13"H
- 42"W x 13"H
- 48"W x 13"H
- 54"W x 13"H
- 60"W x 13"H

- HLSL1230**
- HLSL1236**
- HLSL1242**
- HLSL1248**
- HLSL1254**
- HLSL1260**

- 13
- 15
- 18
- 20
- 22
- 24

- 1.5
- 1.8
- 2.3
- 2.3
- 2.9
- 2.9

- \$251**
- \$277**
- \$310**
- \$354**
- \$379**
- \$408**

NOTES: Attachment requires 1" clear space/overhang on the underside of the worksurface. Screen is frosted glass. All brackets are platinum (no need to specify).

! Available in Frosted Glass ONLY HLSL1230.G.

! Above only privacy screen clamps onto worksurface and cannot be installed where support storage will be attached.

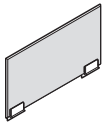

**Above Frosted Polymer (Side) Privacy Screen**

- 24"W x 13"H
- 30"W x 13"H
- 36"W x 13"H

- HLSL1224FS**
- HLSL1230FS**
- HLSL1236FS**

- 14 **Ⓞ**
- 16 **Ⓞ**
- 19 **Ⓞ**

- 1.4
- 1.6
- 1.9

- \$296**
- \$320**
- \$358**

NOTES: Attach to top and side of worksurface with adhesive banding. Platinum color brackets are intended to be attached between users sitting side-by-side. Brackets create a 1/8" separation between adjacent worksurfaces.

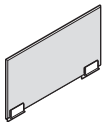

**Above Frosted Glass (Side) Privacy Screen**

- 24"W x 13"H
- 30"W x 13"H
- 36"W x 13"H

- HLSL1224GS**
- HLSL1230GS**
- HLSL1236GS**

- 16 **Ⓞ**
- 18 **Ⓞ**
- 20 **Ⓞ**

- 1.4
- 1.6
- 1.9

- \$247**
- \$267**
- \$298**

NOTES: Attach to top and side of worksurface with adhesive banding. Platinum color brackets are intended to be attached between users sitting side-by-side. Brackets create a 1/8" separation between adjacent worksurfaces.

**NOTES:**

- Ships complete with attachment brackets.
- All brackets are Platinum.
- Above Privacy Screen attaches to top of worksurface.
- Above and below privacy screen extends 13" above and 13" below the worksurface.

! Above screens must attach to edgeband and top of surface.

! Screens cannot be used with T-mold on series such as tables. Screens can only attach to edgeband. Surfaces must be cleaned prior to adhering the screen and must be left to cure for 24 hours without touching for best adhesion.

**HOW TO SPECIFY**

Select Model Number

HLSL2830 .

HLSL1230 .

Select Mixed Material

**FT01** Frosted Translucent Acrylic  
Specified for Above/Below Privacy Screens only

**G** Frosted Glass  
Specified for Above Privacy Screens only

FT01

G

Select Model Number

HLSL1224FS .

HLSL1224GS .

Select Mixed Material

**FT01** Frosted Translucent Acrylic  
Specified for Above Screen models HLSL1224FS-HLSL1236FS only

**G** Frosted Glass  
Specified for Above Screen models HLSL1224GS-HLSL1236GS only

FT01

G

# CONCINNITY™ PRIVACY SCREENS

HNL Above-Below Privacy Screen — HLSL28xx — Selection Guide															
	Support Combination		Worksurface Width												
	Support 1	Support 2	30"	36"	42"	48"	54"	60"	66"	72"	78"	84"	90"	96"	
O-LEG ON ONE END	O-Leg	O-Leg	NA	30	36	42	48	54	60	60	60	60	NA	NA	NA
	O-Leg	9½"W Ped	NA	NA	30	36	42	48	54	60	60	60	60	NA	NA
	O-Leg	End Bookcase	NA	NA	NA	30	36	42	48	54	60	60	60	60	NA
	O-Leg	L End Panel	NA	NA	NA	36	42	48	54	60	60	60	60	NA	NA
	O-Leg	15¾"W Ped	NA	NA	NA	30	36	42	48	54	60	60	60	60	NA
	O-Leg	18"W Ped	NA	NA	NA	NA	30	36	42	48	54	60	60	60	60
	O-Leg	30"W Ped	NA	NA	NA	NA	NA	NA	30	36	42	48	54	60	60
	O-Leg	36"W Ped	NA	NA	NA	NA	NA	NA	NA	30	36	42	48	54	60
NARROW PED	9½"W Ped	9½"W Ped	NA	NA	NA	NA	30	36	42	48	54	60	60	60	60
	9½"W Ped	End Bookcase	NA	NA	NA	NA	30	36	42	48	54	60	60	60	60
	9½"W Ped	L End Panel	NA	NA	NA	30	36	42	48	48	60	60	60	60	NA
	9½"W Ped	15¾"W Ped	NA	NA	NA	NA	30	36	42	48	54	60	60	60	60
	9½"W Ped	18"W Ped	NA	NA	NA	NA	30	36	42	48	54	60	60	60	60
	9½"W Ped	30"W Ped	NA	NA	NA	NA	NA	NA	NA	30	36	42	48	54	60
	9½"W Ped	36"W Ped	NA	NA	NA	NA	NA	NA	NA	NA	30	36	42	48	54
END BOOKCASE PED	End Bookcase	End Bookcase	NA	NA	NA	NA	30	36	42	48	54	60	60	60	60
	End Bookcase	L End Panel	NA	NA	NA	NA	30	36	42	48	54	60	60	60	60
	End Bookcase	15¾"W Ped	NA	NA	NA	NA	30	36	42	48	54	60	60	60	60
	End Bookcase	18"W Ped	NA	NA	NA	NA	30	36	42	48	54	60	60	60	60
	End Bookcase	30"W Ped	NA	NA	NA	NA	NA	NA	NA	30	36	42	48	54	60
	End Bookcase	36"W Ped	NA	NA	NA	NA	NA	NA	NA	NA	30	36	42	48	54
L END PANEL	L End Panel	L End Panel	NA	NA	NA	30	36	42	48	54	60	60	60	60	NA
	L End Panel	15¾"W Ped	NA	NA	NA	NA	30	36	42	48	54	60	60	60	60
	L End Panel	18"W Ped	NA	NA	NA	NA	30	36	42	48	54	60	60	60	60
	L End Panel	30"W Ped	NA	NA	NA	NA	NA	NA	NA	30	36	42	48	54	60
	L End Panel	36"W Ped	NA	NA	NA	NA	NA	NA	NA	NA	30	36	42	48	54
TWO PEDS	15¾"W Ped	15¾"W Ped	NA	NA	NA	NA	NA	NA	30	36	42	48	54	60	60
	15¾"W Ped	18"W Ped	NA	NA	NA	NA	NA	NA	30	36	42	48	54	60	60
	15¾"W Ped	30"W Ped	NA	NA	NA	NA	NA	NA	NA	NA	30	36	42	48	54
	15¾"W Ped	36"W Ped	NA	NA	NA	NA	NA	NA	NA	NA	NA	30	36	42	48
	18"W Ped	18"W Ped	NA	NA	NA	NA	NA	NA	30	36	42	48	48	60	60
	18"W Ped	30"W Ped	NA	NA	NA	NA	NA	NA	NA	NA	30	36	42	48	54
	18"W Ped	36"W Ped	NA	NA	NA	NA	NA	NA	NA	NA	NA	30	36	42	48
	30"W Ped	30"W Ped	NA	NA	NA	NA	NA	NA	NA	NA	NA	NA	30	36	42
	30"W Ped	36"W Ped	NA	NA	NA	NA	NA	NA	NA	NA	NA	NA	NA	30	36
	36"W Ped	36"W Ped	NA	NA	NA	NA	NA	NA	NA	NA	NA	NA	NA	NA	30
HT ADJ BASE	Height Adjustable Base (model HHAB3S2L)		NA	NA	NA	42	48	54	60	60	NA	NA	NA	NA	NA
RETURN CONFIGURATION	None	O-Leg	NA	30	36	42	48	54	60	60	60	60	NA	NA	NA
	None	9½"W Ped	NA	NA	30	36	42	48	54	60	60	60	60	NA	NA
	None	End Bookcase	NA	NA	NA	30	36	42	48	54	60	60	60	60	NA
	None	L End Panel	NA	NA	30	36	42	48	54	60	60	60	60	NA	NA
	None	15¾"W Ped	NA	NA	NA	30	36	36	48	54	60	60	60	60	NA
	None	18"W Ped	NA	NA	NA	NA	30	36	42	48	54	60	60	60	60
	None	30"W Ped	NA	NA	NA	NA	NA	NA	30	36	42	48	54	60	60
	None	36"W Ped	NA	NA	NA	NA	NA	NA	NA	30	36	42	48	54	60

NA = Above-Below Screen not applicable for use with worksurface width and support combination

## SUPPORT STORAGE PEDESTALS — 28½”H

- Non-handed, interchangeable design reconfigures easily.
- For use with component top and modesty/back panels or pedestal top and back panels.
  - Pedestals are not fully enclosed and require a component top/worksurface and modesty/back panel or a pedestal back, both of which must be ordered separately.
  - Pedestal’s front and side panels are finished.
- The pedestal depth dimension is less than the like-size depth of the component top, to accommodate addition of a modesty/back panel.
  - 29½”D pedestals can be used under 30” or 36”D worksurfaces; 23½”D pedestals can be used under 24” or 30”D worksurfaces.
  - When specifying a 29½”D pedestal with ¾” modesty panel under a 36”D worksurface, or a 23½”D pedestal with a ¾” modesty panel under a 30”D worksurface, there will be a 6” approach side overhang.
- Bottom of side panels are edgebanded for added strength and to seal out moisture.
- Drawers:
  - Operate on steel ball-bearing suspensions to ensure smooth, quiet, long-lasting operation; full extension allows easy access to contents.
  - Fronts are edgebanded on all four sides.
  - Feature 5-sided construction for added strength and easy alignment or replacement of drawer fronts.

- Interchangeable core removable locks are located on front of all modular storage products, except the storage cabinet.
- Finish of lock is determined by, and aligned with, the handle finish specified.
- Locks feature a removable cylinder that can be interchanged as needed; allows users to access all furniture pieces in an office with a single key for convenience and security. Makes re-keying quick and easy. Keyed alike cores must be ordered separately by specification of the key number (removable lock core kit models available in Black [model HF23B] or Satin [model HF23S]).
- Ship fully assembled.
- Chassis and drawer front colors are specified separately; can be selected with common woodgrain or solid laminate color, or with different, complementary chassis and drawer/door colors.
- See chart on page 104 for cord management options. If the pedestal grommet option is chosen, two cutouts, one per end/side panel, each with a black plastic cap, are included.

## SUPPORT STORAGE PEDESTALS — 41”H STANDING-HEIGHT

- Same as above except — not to be used freestanding; top and back are not enclosed.
  - Rear of pedestal can be enclosed with a full, 40¾”H back panel or with a 27¾”H modesty panel combined with a lower, 13”H pedestal back component. Pedestal back and modesty panel must be ordered separately.



# CONCINNITY™

## Components — Supports

GSA SIN 711-2

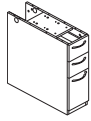

Icon Legend on page 21

**DESCRIPTION****Narrow Box/Box/File Pedestal**

9½"W x 29⅞"D x 28½"H  
9½"W x 23⅞"D x 28½"H

**MODEL**

**HNL291028PBBF**  
**HNL231028PBBF**

**SHIP WEIGHT**

64  
53

**CUBE**

10.6  
8.6

**L1 LIST**

**\$717**  
**\$641**

**L2 UPCHARGES**

**\$25**      **\$10**  
**\$20**      **\$10**

NOTES: Efficient, space saving design for smaller footprints. Three locking drawers; two box (supply) drawers, one for files. File drawer has high sides to accept hanging folders; hangrails are included for side-to-side letter or legal filing. Pedestal's top and back are open and require top and back panel components — ordered separately. See chart on page 104 for cord management options. Ships fully assembled.

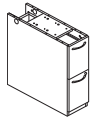
**SPECIFYING EXAMPLE: HNL291028PBBF.E.X.H.H****Narrow File/File Pedestal**

9½"W x 29⅞"D x 28½"H  
9½"W x 23⅞"D x 28½"H

**HNL291028PFF**  
**HNL231028PFF**

69  
54

10.6  
10.6

**\$717**  
**\$641**

**\$25**      **\$10**  
**\$20**      **\$10**

NOTES: Efficient, space saving design for smaller footprints. Two locking file drawers. Drawers have high sides to accept hanging folders; hangrails are included for side-to-side letter or legal filing. Pedestal's top and back are open and require top and back panel components — ordered separately. See chart on page 104 for cord management options. Ships fully assembled.

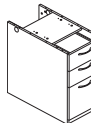
**SPECIFYING EXAMPLE: HNL291028PFF.E.X.H.H****Box/Box/File Pedestal**

15¾"W x 29⅞"D x 28½"H  
18"W x 23⅞"D x 28½"H  
15¾"W x 23⅞"D x 28½"H

**HNL291628PBBF**  
**HNL231828PBBF**  
**HNL231628PBBF**

76  
72  
69

10.6  
9.8  
8.6

**\$727**  
**\$730**  
**\$663**

**\$25**      **\$10**  
**\$20**      **\$10**  
**\$20**      **\$10**

NOTES: Three locking drawers; two box (supply) drawers, one for files. File drawer has high sides to accept hanging folders; hangrails are included for side-to-side letter or legal filing; and front-to-back for letter filing. Pedestal's top and back are open and require top and back panel components — ordered separately. See chart on page 104 for cord management options. Ships fully assembled.

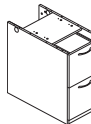
**SPECIFYING EXAMPLE: HNL291628PBBF.E.X.H.H****File/File Pedestal**

15¾"W x 29⅞"D x 28½"H  
18"W x 23⅞"D x 28½"H  
15¾"W x 23⅞"D x 28½"H

**HNL291628PFF**  
**HNL231828PFF**  
**HNL231628PFF**

78  
72  
70

10.6  
9.8  
8.6

**\$727**  
**\$730**  
**\$663**

**\$25**      **\$10**  
**\$20**      **\$10**  
**\$20**      **\$10**

NOTES: Two locking file drawers. Drawers have high sides to accept hanging folders; hangrails are included for side-to-side letter or legal filing; and front-to-back for letter filing. Pedestal's top and back are open and require top and back panel components — ordered separately. See chart on page 104 for cord management options. Ships fully assembled.

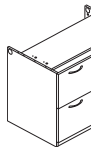
**SPECIFYING EXAMPLE: HNL291628PFF.E.X.H.H****Lateral File Pedestal**

36"W x 23⅞"D x 28½"H  
30"W x 23⅞"D x 28½"H

**HNL233628PLF**  
**HNL233028PLF**

134  
115

18.4  
15.0

**\$981**  
**\$896**

**\$40**      **\$20**  
**\$35**      **\$20**

NOTES: Two locking file drawers; drawers include hangrails to accept folders in letter or legal size. For use under 24"D rectangle worksurface. Widths can also span depth dimension of respective 30" or 36"D rectangle worksurface. Anti-tip design includes mechanical interlock to inhibit the extension of more than one drawer at a time. Pedestal's top and back are open and require top and back panel components — ordered separately. See chart on page 104 for cord management options. Ships fully assembled.

**SPECIFYING EXAMPLE: HNL233628PLF.E.X.H.H****NOTES:**

- 29⅞"D pedestals can be used under 30" or 36"D worksurfaces; 23⅞"D pedestals can be used under 24" or 30"D worksurfaces.
- Drawers operate on steel ball-bearing suspensions to ensure smooth, quiet, long-lasting operation; full extension allows easy access to contents.
- Interchangeable core removable locks allow users to access all furniture pieces in an office with a single key for convenience and security. Makes re-keying quick and easy.
- See chart on page 104 for cord management options. If the pedestal grommet option is chosen, two cutouts, one per end/side panel, each with a black plastic cap, are included.

! Pedestal tops and backs are open and require top and back panel components — ordered separately.

! 9½"W pedestals are not designed to be used independently in a stand-alone application.

**HOW TO SPECIFY**

Select Model Number	Select Handle	Select Grommet	Select Chassis Color	Select Drawer Front Color
A Cylinder – Satin B Cylinder – Black C Canopy – Satin D Canopy – Black E Loop – Satin F Loop – Black	P Black X No Grommet	See page 96	See page 96	
H N L 2 9 1 0 2 8 P B B F .	E .	X .	H .	H .



# CONCINNITY™

## Components — Supports

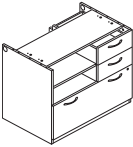
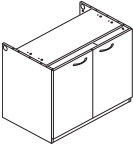
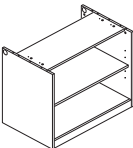
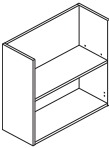
	DESCRIPTION	MODEL	SHIP WEIGHT	CUBE	L1 LIST	L2 UPCHARGES	
						CHASSIS	FRONTS
	<b>Shelf/Box/Box/Lateral File Pedestal</b>						
	36"W x 23 1/8"D x 28 1/2"H	<b>HNL233628PSL</b>	145	18.4	<b>\$1157</b>	<b>\$40</b>	<b>\$20</b>
	30"W x 23 1/8"D x 28 1/2"H	<b>HNL233028PSL</b>	126	15.0	<b>\$1135</b>	<b>\$35</b>	<b>\$20</b>
	NOTES: Versatile unit features an open shelf and three drawers; two for supplies and one for files. For use under 24"D rectangle worksurface. Widths can also span depth dimension of respective 30" or 36"D rectangle worksurface. Box (supply) drawers are located on the right and open shelves on the left. All drawers lock. Pedestal's top and back are open and require top and back panel components — ordered separately. See chart on page 104 for cord management options. Ships fully assembled.						
	<b>SPECIFYING EXAMPLE: HNL233628PSL.E.X.H.H</b>						
	<b>Storage Cabinet Pedestal</b>						
	36"W x 23 1/8"D x 28 1/2"H	<b>HNL233628PSC</b>	104	18.4	<b>\$752</b>	<b>\$40</b>	<b>\$20</b>
	30"W x 23 1/8"D x 28 1/2"H	<b>HNL233028PSC</b>	91	15.0	<b>\$727</b>	<b>\$35</b>	<b>\$20</b>
	NOTES: One adjustable shelf, which adjusts in 2 1/2" increments. For use under 24"D rectangle worksurface. Widths can also span depth dimension of respective 30" or 36"D rectangle worksurface. Doors are non-locking. Pedestal's top and back are open and require top and back panel components — ordered separately. See chart on page 104 for cord management options. Ships fully assembled.						
	<b>SPECIFYING EXAMPLE: HNL233628PSC.E.X.H.H</b>						
	<b>Bookcase Pedestal</b>						
	36"W x 23 1/8"D x 28 1/2"H	<b>HNL233628PBK</b>	82	18.4	<b>\$661</b>	<b>\$40</b>	<b>N/A</b>
	30"W x 23 1/8"D x 28 1/2"H	<b>HNL233028PBK</b>	73	15.0	<b>\$646</b>	<b>\$35</b>	<b>N/A</b>
	NOTES: Two shelves; bottom of unit plus one adjustable shelf, which adjusts in 2 1/2" increments. For use under 24"D rectangle worksurface. Widths can also span depth dimension of respective 30" or 36"D rectangle worksurface. Pedestal's top and back are open and require top and back panel components — ordered separately. See chart on page 104 for cord management options. Ships fully assembled.						
	<b>SPECIFYING EXAMPLE: HNL233628PBK.X.H</b>						
	<b>Bookcase End Support</b>						
	12"W x 36"D x 28 1/2"H	<b>HNL123628BKE</b>	48	11.0	<b>\$496</b>	<b>\$25</b>	<b>N/A</b>
	12"W x 30"D x 28 1/2"H	<b>HNL123028BKE</b>	48	10.2	<b>\$471</b>	<b>\$20</b>	<b>N/A</b>
	12"W x 24"D x 28 1/2"H	<b>HNL122428BKE</b>	41	7.4	<b>\$446</b>	<b>\$20</b>	<b>N/A</b>
	NOTES: Two shelves; bottom of unit plus one adjustable shelf, which adjusts in 1 1/4" increments. Designed to span the depth dimension of 24", 30", or 36"D rectangle worksurface; shelves can be oriented facing outwards, or inwards towards the user's kneespace. Includes fully finished back. Ships with two (2) extra L-brackets for applications requiring attachment of a laminate modesty panel; the panel brackets to the back of the bookcase end support. Modesty panel specified should be 12" less than the worksurface width. Open top; for use under worksurface only — ordered separately. Ships fully assembled.						
	<b>SPECIFYING EXAMPLE: HNL123628BKE.H</b>						

**NOTES:**

- 23 1/8"D pedestals can be used under 24" or 30"D worksurfaces.
- Drawers operate on steel ball-bearing suspensions to ensure smooth, quiet, long-lasting operation; full extension allows easy access to contents.
- Interchangeable core removable locks allow users to access all furniture pieces in an office with a single key for convenience and security. Makes re-keying quick and easy.
- See chart on page 104 for cord management options. If the pedestal grommet option is chosen, two cutouts, one per end/side panel, each with a black plastic cap, are included.

**!** Pedestal tops and backs are open and require top and back panel components — ordered separately.

**HOW TO SPECIFY**

<b>Select Model Number</b> H N L 2 3 3 6 2 8 P S L .	<b>Select Handle</b> A Cylinder – Satin B Cylinder – Black C Canopy – Satin D Canopy – Black E Loop – Satin F Loop – Black E .	<b>Select Grommet</b> P Black X No Grommet X .	<b>Select Chassis Color</b> See page 96 H .	<b>Select Drawer Front Color</b> See page 96 H
---	---	---	---	--

# CONCINNITY™

## Components — Supports

GSA SIN 711-2

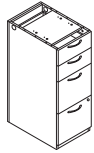

Icon Legend on page 21

**DESCRIPTION****Box/Box/File/File Pedestal**15<sup>3</sup>/<sub>4</sub>"W x 29<sup>1</sup>/<sub>8</sub>"D x 41"H15<sup>3</sup>/<sub>4</sub>"W x 23<sup>1</sup>/<sub>8</sub>"D x 41"H**MODEL****HNL291641PBBFF****HNL231641PBBFF****SHIP WEIGHT**

114

102

**CUBE**

14.7

11.9

**L1 LIST****\$1490****\$1398****L2 UPCHARGES****\$45****\$40****\$10****\$10**

NOTES: Four drawers: two box (supply) and two file. File drawer has high sides to accept hanging folders; hangrails are included for side-to-side letter or legal filing; and front-to-back for letter filing. The two box drawers do not lock. Pedestal's top and back are open and require top and back panel components — ordered separately. See chart on page 104 for cord management options. Ships fully assembled.

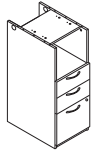
**SPECIFYING EXAMPLE: HNL291641PBBFF.E.X.H.H****Shelf/Box/Box/File Pedestal**15<sup>3</sup>/<sub>4</sub>"W x 29<sup>1</sup>/<sub>8</sub>"D x 41"H15<sup>3</sup>/<sub>4</sub>"W x 23<sup>1</sup>/<sub>8</sub>"D x 41"H**HNL291641PSBBF****HNL231641PSBBF**

99

89

14.7

11.9

**\$1490****\$1398****\$45****\$40****\$10****\$10**

NOTES: Open shelf over three drawers: two box (supply) and one file. Interior dimensions of the open storage area are: 14<sup>1</sup>/<sub>8</sub>"W x 28<sup>1</sup>/<sub>4</sub>"D x 12<sup>1</sup>/<sub>4</sub>"H for the 29<sup>1</sup>/<sub>8</sub>"D pedestal. 14<sup>1</sup>/<sub>8</sub>"W x 22<sup>1</sup>/<sub>4</sub>"D x 12<sup>1</sup>/<sub>4</sub>"H for the 23<sup>1</sup>/<sub>8</sub>"D pedestal. File drawer has high sides to accept hanging folders; hangrails are included for side-to-side letter or legal filing; and front-to-back for letter filing. All drawers lock. Pedestal's top and back are open and require top and back panel components — ordered separately. See chart on page 104 for cord management options. Ships fully assembled.

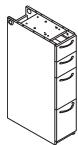
**SPECIFYING EXAMPLE: HNL291641PSBBF.E.X.H.H****Narrow Box/Box/File/File Pedestal**9<sup>1</sup>/<sub>2</sub>"W x 29<sup>1</sup>/<sub>8</sub>"D x 41"H9<sup>1</sup>/<sub>2</sub>"W x 23<sup>1</sup>/<sub>8</sub>"D x 41"H**HNL291041PBBFF****HNL231041PBBFF**

88

79

14.7

11.9

**\$1311****\$1229****\$45****\$40****\$20****\$20**

NOTES: Efficient, space saving design for smaller footprints. Four drawers: two box (supply) and two file. File drawers have high sides to accept hanging folders; hangrails are included for side-to-side letter or legal filing. When used in a double pedestal configuration under a 60" and 48"W worksurface, provides 41" and 29" of kneespace width, respectively. The two box drawers do not lock. Pedestal's top and back are open and require top and back panel components — ordered separately. See chart on page 104 for cord management options. Ships fully assembled.

**SPECIFYING EXAMPLE: HNL291041PBBFF.E.X.H.H****NOTES:**

- Pedestals for standing-height workstations.
- 29<sup>1</sup>/<sub>8</sub>"D pedestals can be used under 30" or 36"D worksurfaces; 23<sup>1</sup>/<sub>8</sub>"D pedestals can be used under 24" or 30"D worksurfaces.
- Drawers operate on steel ball-bearing suspensions to ensure smooth, quiet, long-lasting operation; full extension allows easy access to contents.
- See chart on page 104 for cord management options. If the pedestal grommet option is chosen, two cutouts, one per end/side panel, each with a black plastic cap, are included.

! Pedestal tops and backs are open and require top and back panel components — ordered separately.

! 9<sup>1</sup>/<sub>2</sub>"W pedestals are not designed to be used independently in a stand-alone application.

**HOW TO SPECIFY**

Select Model Number	Select Handle	Select Grommet	Select Chassis Color	Select Drawer Front Color
	<b>A</b> Cylinder – Satin <b>B</b> Cylinder – Black <b>C</b> Canopy – Satin <b>D</b> Canopy – Black <b>E</b> Loop – Satin <b>F</b> Loop – Black	<b>P</b> Black <b>X</b> No Grommet	See page 96	See page 96
H N L 2 9 1 6 4 1 P B B F F .	E .	X .	H .	H .



# CONCINNITY™

## Components — Pedestal Tops

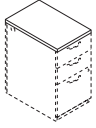

DESCRIPTION	MODEL	SHIP WEIGHT	CUBE	L1	L2
				LIST PRICE	UPCHARGE
<b>Pedestal Tops</b>					
15¾"W x 30"D	<b>HNLPT3016</b>	16	1.4	<b>\$213</b>	<b>\$10</b>
18"W x 24"D	<b>HNLPT2418</b>	15	1.3	<b>\$200</b>	<b>\$10</b>
15¾"W x 24"D	<b>HNLPT2416</b>	13	1.2	<b>\$200</b>	<b>\$10</b>

NOTES: Component is 1½" thick. Underside of top includes pilot mounting holes for pedestals. Grain direction on 15¾" and 18"W pedestal tops runs horizontal (side-to-side). Component tops for 30" and 36"W pedestals are listed with rectangle worksurface sizes. Grain direction on 30" and 36"W pedestal tops can be specified horizontal (side-to-side) or vertical (front-to-back). For tri-oval and beaded edge options, there is a shaped profile on the user and approach sides, and a flat edge on the ends.

- ⓘ For modular pedestals used in freestanding applications; not compatible when pedestal is positioned under a worksurface.
- ⓘ 9½"W pedestals are not designed to be used independently in a freestanding application, so 9½"W tops are not available to order.

## HOW TO SPECIFY

Select  
Model Number

H N L P T 3 0 1 6

Select  
Edge Profile and Edge Color

See page 96

B H

Select  
Top Color

See page 96

H

# CONCINNITY™

## Components — Pedestal Back Panels

GSA SIN 711-2

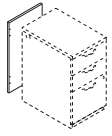
**DESCRIPTION****Full Back Panels — For 28½”H Pedestals**

18”W x 27⅞”H  
 15¾”W x 27⅞”H  
 9½”W x 27⅞”H

**MODEL**

**HNLBP1828**  
**HNLBP1628**  
**HNLBP1028**

**SHIP WEIGHT**

11  
 10  
 6

**CUBE**

1.5  
 1.3  
 0.9

**L1 LIST PRICE**

**\$138**  
**\$122**  
**\$115**

**L2 UPCHARGE**

**\$10**  
**\$10**  
**\$10**

NOTES: Encloses the rear of 28½”H modular support pedestals, which come standard with an open, unfinished back. For use when a support storage pedestal is positioned under a 29½”H worksurface and a conventional worksurface width x 27⅞”H modesty/back panel is not specified to cover the back of the pedestal. Examples of when to use a 27⅞” pedestal back include: A worksurface supported by an O-leg on one end and support pedestal on the other, with open wall access; or a worksurface with an O-leg and pedestal support flanking a floating modesty panel. Can be specified in a woodgrain or solid laminate color only. For 30” and 36”W pedestals, use the respective modesty/pedestal back panel size, see page 153.

**SPECIFYING EXAMPLE (9½”, 15¾”, 18”W): HNLBP1028.H**

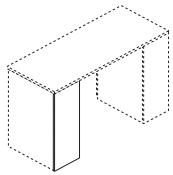

Back View

**Full Back Panels — For 41”H Pedestals**

15¾”W x 40⅜”H  
 9½”W x 40⅜”H

**HNLBP1641**  
**HNLBP1041**

15  
 9

1.8  
 1.2

**\$142**  
**\$128**

**\$15**  
**\$15**

NOTES: Encloses the rear of 41”H modular support pedestals, which come standard with an open, unfinished back. For use when a support storage pedestal is positioned under a 42”H worksurface and no full-width, 27⅞”H laminate modesty and low, 13”H pedestal back panel are specified. Examples of when to use a 40⅜” pedestal back include: A worksurface supported by an O-leg on one end and support pedestal on the other, with open wall access; or a worksurface with an O-leg and pedestal support flanking a floating modesty panel. Can be specified in a woodgrain or solid laminate color only.

**SPECIFYING EXAMPLE: HNLBP1641.H**

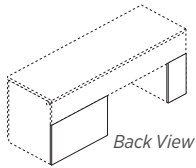

Back View

Shown with HNLB3018 and HNLB1018

**Low Back Panels — For 28½”H Pedestals**

36”W x 18”H  
 30”W x 18”H  
 18”W x 18”H  
 15¾”W x 18”H  
 9½”W x 18”H

**HNLB3618**  
**HNLB3018**  
**HNLB1818**  
**HNLB1618**  
**HNLB1018**

15  
 12  
 7  
 6  
 4

1.9  
 1.6  
 1.0  
 0.9  
 0.6

**\$138**  
**\$138**  
**\$122**  
**\$117**  
**\$109**

**\$15**  
**\$15**  
**\$15**  
**\$10**  
**\$10**

NOTES: Encloses the rear of 28½”H modular support pedestals when positioned under a 29½”H worksurface with a full-width, 10” laminate modesty panel. The modesty panel extends down from the underside of the worksurface to cover the upper back portion of the pedestal, the lower panel component encloses the remainder of the pedestal back. When used in combination, the 10” modesty and pedestal low back panels fully conceal the rear of the pedestal. The pedestal low back panel is only for use when a modular pedestal is used in conjunction with a worksurface with a 10” laminate modesty panel and the customer wants/needs to fully enclose the back section of the pedestal. Can be specified in a woodgrain or solid laminate color only.

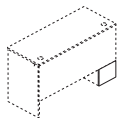

Back View

**Low Back Panels — For 41”H Pedestals**

15¾”W x 13”H  
 9½”W x 13”H

**HNLB1613**  
**HNLB1013**

4  
 3

0.7  
 0.5

**\$117**  
**\$109**

**\$10**  
**\$10**

NOTES: Encloses the rear of 41”H modular support pedestals when positioned under a 42”H worksurface with a full-width, 27⅞” laminate modesty panel. The modesty panel extends down from the underside of the worksurface to cover the upper back portion of the pedestal, the lower panel component encloses the remainder of the pedestal back. When used in combination, the 27⅞” modesty and pedestal low back panels fully conceal the rear of the pedestal. The pedestal low back panel is only for use when a modular pedestal is used in conjunction with a worksurface with a 27⅞” laminate modesty panel and the customer wants/needs to fully enclose the back section of the pedestal. Can be specified in a woodgrain or solid laminate color only.

**HOW TO SPECIFY****Select Model Number**

H N L P B 1 8 2 8 .

**Select Laminate Color**

See page 96

H

**Select Model Number**

H N L L B 3 6 1 8 .

**Select Laminate Color**

See page 96

H



Icon Legend on page 21



Refer to page 171 for Center Drawer compatibility information

SIN 711-1, 711-2, 711-11

**DESCRIPTION**

**Laminate Center Drawer**

26" x 15<sup>5</sup>/<sub>8</sub>"  
22" x 15<sup>5</sup>/<sub>8</sub>"

- 12" drawer extension (3/4).
- Inside drawer dimension for H1526: 22<sup>7</sup>/<sub>8</sub>"W x 15<sup>1</sup>/<sub>2</sub>"D x 1<sup>1</sup>/<sub>2</sub>"H.
- Inside drawer dimension for H1522: 18<sup>7</sup>/<sub>8</sub>"W x 15<sup>1</sup>/<sub>2</sub>"D x 1<sup>1</sup>/<sub>2</sub>"H.
- Minimum clearance for mounting H1526: 27<sup>1</sup>/<sub>4</sub>"W x 18<sup>1</sup>/<sub>2</sub>"D compatible with 72"W x 36"D, 66"W x 30"D, 60"W x 30"D Double Pedestal Desks, 72"W x 24"D, 66"W x 24"D, 60"W x 24"D Credenza w/Kneespace, 48"W x 24"D Return
- Minimum clearance for mounting H1522: 22<sup>3</sup>/<sub>4</sub>"W x 18<sup>1</sup>/<sub>2</sub>"D compatible with 72"W x 36"D, 66"W x 30"D, 60"W x 30"D Double Pedestal Desks, 72"W x 36"D, 66"W x 30"D Single Pedestal Desks, Bullet and P-Shaped Peninsulas, 72"W x 24"D, 66"W x 24"D, 60"W x 24"D Credenza w/Kneespace, 72"W x 24"D, 66"W x 24"D Single Pedestal Credenzas, 48"W x 24"D, 42"W x 24"D Returns

NOTES: Specify laminate for drawer. Model H1522 or H1022 can be used on peninsulas with modesty panel, model HPC180W. Laminate center drawers include pencil tray. For center drawer laminate colors, see page 96. For additional information see page 903.

**MODEL**

**SHIP WEIGHT**

**CUBE**

**LIST PRICE**

**H1526**  
**H1522**

12 **Ⓞ**  
11 **Ⓞ**

1.2  
1.1

**\$187**  
**\$173**

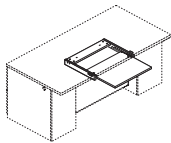

SIN 711-2

**DESCRIPTION**

**Collaborative Desk Shelf**

25"W x 23"D x 2<sup>1</sup>/<sub>2</sub>"H

NOTES: Convenient slide-out shelf on approach-side of desk provides workspace for guests. For use with 72"W x 36"D breakfront desk designs — see listings on page 111 — or with 60" or wider worksurface, supported by pedestals, and no modesty panel. Minimum clearance for mounting: 28"W x 19<sup>3</sup>/<sub>4</sub>"D. Fully extended shelf dimensions: 24"W x 19"D. Shelf extends 12<sup>3</sup>/<sub>8</sub>". <sup>3</sup>/<sub>4</sub>" thick. Not compatible on desks with under surface center drawer or keyboard platform attached. Can be specified in a woodgrain or solid laminate color only.

❗ Collaborative desk shelf for use with 72"W x 36"D breakfront, floating modesty panel desk designs or with 60" or wider worksurface, supported by pedestals, and no modesty panel.

**SPECIFYING EXAMPLE: HNLCDSEH.F.H**

**MODEL**

**SHIP WEIGHT**

**CUBE**

**L1 LIST PRICE**

**L2 UPCHARGE**

**HNLCDSEH.F**

18

1.5

**\$317**

**\$20**

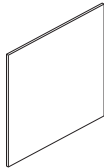

SIN 711-2

**DESCRIPTION**

**Wall Mount Tackboard**

36"W x 35<sup>1</sup>/<sub>4</sub>"H  
30"W x 35<sup>1</sup>/<sub>4</sub>"H

36"W x 48<sup>5</sup>/<sub>8</sub>"H  
30"W x 48<sup>5</sup>/<sub>8</sub>"H

NOTES: Available in HON Group panel fabric grades A and B. When positioned above 29<sup>1</sup>/<sub>2</sub>"H floor-standing storage, the sizes align with overhead storage height options. Can be positioned side-by-side with corresponding wall mount markerboard sizes. Easy to install; includes mounting hardware. Attaches to wall with horizontally mounted, interlocking Z-clip brackets. For the space directly below stack-on and wall mount storage cabinets, use the 18"H tackboard models listed on Pricer pages 127 and 133.

**SPECIFYING EXAMPLE: HNL3636TB.APN15**

**MODEL**

**SHIP WEIGHT**

**CUBE**

**LIST PRICE**

**HNL3636TB**  
**HNL3630TB**

20  
16

2.9  
2.9

**\$276**  
**\$235**

**HNL4936TB**  
**HNL4930TB**

27  
22

5.5  
3.7

**\$307**  
**\$266**

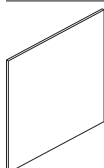

SIN 711-2

**Wall Mount Markerboard**

36"W x 35<sup>1</sup>/<sub>4</sub>"H  
30"W x 35<sup>1</sup>/<sub>4</sub>"H

36"W x 48<sup>5</sup>/<sub>8</sub>"H  
30"W x 48<sup>5</sup>/<sub>8</sub>"H

NOTES: Smooth, white, magnetic surface. Metal material produces clear graphics and cleans easily. Compatible for use with dry- or wet-erase markers. When positioned above 29<sup>1</sup>/<sub>2</sub>"H floor-standing storage, the sizes align with overhead storage height options. Can be positioned side-by-side with corresponding wall mount tackboard sizes. Easy to install; includes mounting hardware. Attaches to wall with horizontally mounted, interlocking Z-clip brackets.

**SPECIFYING EXAMPLE: HNL3636WB**

**HNL3636WB**  
**HNL3630WB**

16  
14

2.9  
2.9

**\$188**  
**\$175**

**HNL4936WB**  
**HNL4930WB**

22  
20

5.5  
3.7

**\$230**  
**\$212**

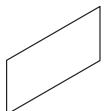

SIN 711-2

**Markerboard**

36"W x 15"D  
30"W x 15"D

NOTES: Markerboard laminate material with black edges, no frame. Adheres to laminate doors. Includes double-sided tape. No specification necessary.

**HLSL1536SOMB**  
**HLSL1530SOMB**

8  
6

1.0  
1.0

**\$163**  
**\$121**

## HOW TO SPECIFY

<p>Select Model Number</p>	<p>Select Laminate Color</p> <p>See page 96</p>
<p>H N L C D S H E L F .</p>	<p>H</p>

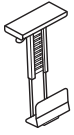
**DESCRIPTION****CPU Holder**

- Vertically mounts to underside of worksurface.
- 360° swivel.
- Supports up to 55 lbs.
- Height adjustable from 16" to 22" below worksurface.
- Width adjustable to accept units from 3¼" to 6".

NOTES: Arms fold back to post to allow more desktop room. Arms feature double extension, allowing 20"+ of back and forth movement. Cable management on both pole and arm assemblies. Counterbalance adjustment provides stability for monitors up to 17.6 lbs per arm. Made of high quality aluminum alloy material. For additional information see page 899.

! Silver finish only, no specification needed.

**MODEL****HCPU****SHIP WEIGHT**

16

**CUBE**

0.5

**LIST PRICE****\$236****Back Pack Hook (10 per carton)**

12"W x 14½"D x 1½"H

**HCLA65**

10

0.1

**\$91**

NOTES: Assembly: attaches to bottom of desk with (2) screws, included. For additional information see page 914.

! Available in Chrome finish only, no specification needed.

**HOW TO SPECIFY**

Select  
Model Number

H C P U



Icon Legend on page 21



Black only

SIN 711-8



**DESCRIPTION**

**Field Installable Grommet — For 2½” Diameter Hole**

- Intended for use in tops and end panels to route/hide cords and in modesty panels to facilitate reaching wall electrical outlets.
- Grommet is field installable.
- Requires a 2½” diameter hole saw and drill for installation (not included).
- Grommet shape is round.
- Includes grommet cap and sleeve.
- Grommet cap measures 3” diameter and includes a ¾” diameter cord access hole.
- Grommet sleeve measures 2½” O.D. x ¾” thick.
- Includes instructions to locate grommet position for desks, credenzas, returns, and bridges.

NOTES: For additional information see page 916.

! Black Finish

**SPECIFYING EXAMPLE: HFLDGRMT**

**MODEL**

**HFLDGRMT**

**SHIP WEIGHT**

0.1 Ⓢ

**CUBE**

0.01

**LIST PRICE**

**\$29**



SIN 711-8



**Field Installable Grommet — For 3” Diameter Hole**

- Intended for use in tops and end panels to route/hide cords and in modesty panels to facilitate reaching wall electrical outlets.
- Grommet is field installable.
- Requires a 3” diameter hole saw and drill for installation (not included).
- Grommet shape is round.
- Includes grommet cap and sleeve.
- Grommet outside dimensions measures 3½” diameter and includes two cord access holes.
- Grommet sleeve measures 3” O.D. x 1” thick.
- Includes instructions to locate grommet position for desks, credenzas, returns, and bridges.

NOTES: For additional information see page 916.

! Black Finish

**SPECIFYING EXAMPLE: HFLDGRMT3**

**MODEL**

**HFLDGRMT3**

**SHIP WEIGHT**

0.1 Ⓢ

**CUBE**

0.3

**LIST PRICE**

**\$29**



OPEN MARKET



**Field Installable Grommet — For 3” Diameter Hole**

- Intended for use in tops to route/hide cords.
- Requires a 3” diameter hole saw and drill for installation (not included).
- Includes grommet cap, with two access holes, and sleeve components.
- Outside dimension measures 3½” diameter.
- Sleeve hole in worksurface measures 3” O.D. x 1” thick.
- Includes instructions to locate grommet position for desks, credenzas, returns, and bridges.

! Platinum Finish

**SPECIFYING EXAMPLE: HFLDGRMT4**

**MODEL**

**HFLDGRMT4**

**SHIP WEIGHT**

0.1

**CUBE**

0.01

**LIST PRICE**

**\$29**

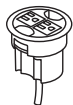

SIN 71-302

**Power Hub, 3” Grommet Mount**

- Fits in 3” round grommet holes on the following product lines: 10500, 10700, Concinnity, Coordinate, and Voi desks; Abound Worksurfaces; Huddle and Motivate tables and SmartLink.
- Two grounded AC power outlets.
- Two cord pass-through holes in cap.
- Includes 6’ cord with three-prong plug.
- Field installed; easy plug-and-play.
- UL Listed.

NOTES: For additional information see page 916.

! Available in black only (no color designation so use .X - Specify: HGRMTAC.X).

**MODEL**

**HGRMTAC**

**SHIP WEIGHT**

1.3

**CUBE**

0.2

**LIST PRICE**

**\$103**

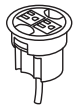

SIN 71-302



**3” Round Power Grommet – 2 Outlets, 10’ Cord**

- Includes 10’ cord with three-prong plug.
- Fits in 3” round grommet holes on the following product lines: Coordinate, Huddle, Motivate, all laminate and veneer casegoods series, and Systems Worksurfaces.
- Two grounded AC power outlets.
- Field installed with Plug-and-play ease.

NOTES: Power Modules will also work with standing-height applications for 10500 Series™ and Voi® desks. Optional Memory Control allows preset worksurface heights for consistency. Ships separately. Dynamic load capacity when worksurface is moving is 300 lbs.

! Available in black finish only, no specification needed.

**MODEL**

**HGRMTAC2**

**SHIP WEIGHT**

1.5

**CUBE**

0.2

**LIST PRICE**

**\$130**

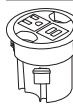

SIN 71-302

**Power/USB Hub, 3” Grommet Mount**

- One grounded AC power outlet with 2 USB ports.
- Two cord pass-through holes in cap.
- Includes 6’ cord with three-prong plug.
- Field installed; easy plug-and-play.
- UL Listed.

NOTES: For additional information see page 916.

! Available in black only (no color designation so use .X - Specify: HGRMTUSB2.X).

**MODEL**

**HGRMTUSB2**

**SHIP WEIGHT**

1.3 Ⓢ

**CUBE**

0.2

**LIST PRICE**

**\$203**

**HOW TO SPECIFY**

Select Model Number

H G R M T A C



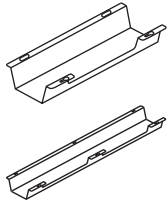

SIN 711-1

**DESCRIPTION****Cable Management Troughs**

17"W — Single  
17"W — 10-Pack  
36"W — Single  
36"W — 10-Pack

- Cable management troughs ship flat packed.
- The troughs attach to underneath the worksurface with screws.
- The 17"W has one wire access cut out on the user side. The 36" has two wire access cut outs. These cut outs give users access to inside the trough without having to detach it from the worksurface.
- Color: Graphite.
- Material: Metal.
- TAA Compliant.

NOTES: For additional information see page 920.

**MODEL****SHIP WEIGHT****CUBE****LIST PRICE**

<b>HCTROUGH17</b>	2.7 <b>Ⓢ</b>	0.5	<b>\$62</b>
<b>HCTROUGH1710</b>	14.0 <b>Ⓢ</b>	0.5	<b>\$583</b>
<b>HCTROUGH36</b>	4.9 <b>Ⓢ</b>	0.9	<b>\$104</b>
<b>HCTROUGH3610</b>	30.0 <b>Ⓢ</b>	0.9	<b>\$983</b>



OPEN MARKET

**O-Leg Cord Clips**

Clips for 28½" Worksurface O-Legs — 8-Pack  
Clips for Layering O-Legs — 4-Pack

NOTES: Wire clips work with 7" Low Credenza O-leg and 29"H Support O-leg. For additional information see page 920.

- ! Available in frosted plastic material only.

**HWMCLIPLG**0.8 **Ⓢ**

0.1

**\$90****HWMCLIPSM**0.5 **Ⓢ**

0.1

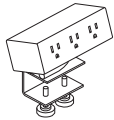
**\$58**

Model HPWRMOD3WC shown

SIN 711-2

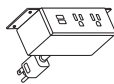

Model HPWRMOD2UWM shown

SIN 711-2

**Power Modules**

3 Receptacles with Worksurface Clamp  
3 Receptacles with Under-Worksurface Mounting Bracket  
2 Receptacles 2 USB with Worksurface Clamp  
2 Receptacles 2 USB with Under-Worksurface Mounting Bracket

- 6' power cord with standard three-prong plug.
- Under-worksurface mounting bracket models work with any top that has a 5" x 5" square clearance.
- Worksurface clamp models work on any top with a 4" overhang.
- UL Listed.

NOTES: For additional information see page 917.

- ! Color finish coordinates with HON's Charcoal or White. Specify *S* for Charcoal or *WHIT* for White when ordering. Example: HPWRMOD3WC.S.

**HPWRMOD3WC**2.3 **Ⓢ**

0.2

**\$279****HPWRMOD3UWM**2.3 **Ⓢ**

0.2

**\$279****HPWRMOD2WC**2.3 **Ⓢ**

0.2

**\$447****HPWRMOD2UWM**2.3 **Ⓢ**

0.2

**\$447****Power & Data Center**

2 Receptacles 2 Data Accessory

- Standard with two receptacles and openings for two data ports.
- 6' power cord with standard three-prong plug.
- Fits on any worksurface with a 4" overhang.
- UL Listed.

NOTES: For additional information see page 917.

- ! Color finish coordinates with HON's Loft. Specify *LOFT* when ordering. Example: HCOMDOME2.LOFT.

**HCOMDOME2**2.5 **Ⓢ**

0.2

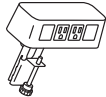
**\$266**

SIN 711-2



SIN 711-2

**Under Worksurface Power Module — 4 Outlets, 10' Cord**

- Includes 10' cord with three-prong plug.
- Fits in cable management troughs. See page 79.
- 4 outlets on side create easy access.

NOTES: Power Modules will also work with standing-height applications for 10500 Series™ and Voi® desks. For additional information see page 917.

- ! Available in black finish only, no specification needed.

**HPWRMOD2**

1.5

0.2

**\$354****Vertebrae**

NOTES: For additional information see page 920.

- ! Clear finish. Specify "X" for finish option.

**SPECIFYING EXAMPLE: HMPVWM28.X**

**HMPVWM28**

3.0

0.3

**\$200**

SIN 711-2

**HOW TO SPECIFY**

Select  
Model Number

H P W R M O D 3 W C



Icon Legend on page 21

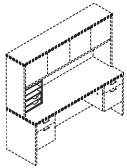

Not available in two-tone laminates  
SIN 711-8

**DESCRIPTION**

**Vertical Paper Manager**  
14<sup>7</sup>/<sub>8</sub>"W x 10<sup>7</sup>/<sub>8</sub>"D x 19<sup>3</sup>/<sub>8</sub>"H

MODEL	SHIP WEIGHT	CUBE	L1 LIST PRICE	L2 UPCHARGE
HLVPM1	27.0	2.8	\$298	\$10

NOTES: Keeps papers, files, and books neatly organized and within easy reach from a seated position. Designed for desk, credenza, and return tops. Fits under stack-on storage models. Two pullout drawers and three fixed shelves. Not available in pattern laminate colors. Ships fully assembled. For additional information see page 912.

⚠ When used in conjunction with wall mounted storage cabinets, allow 19<sup>3</sup>/<sub>4</sub>" minimum clearance above the worksurface.

**SPECIFYING EXAMPLE: HLVPM1.N**

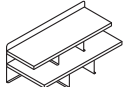

Not available in two-tone laminate



**Desktop Storage Terrace**  
26<sup>1</sup>/<sub>2</sub>"W x 12<sup>1</sup>/<sub>2</sub>"D x 10<sup>1</sup>/<sub>2</sub>"H

MODEL	SHIP WEIGHT	CUBE	L1 LIST PRICE	L2 UPCHARGE
HLDST1	24.0	1.1	\$279	\$10

NOTES: Keeps work-in-process, priority files, loose pages, and mail neatly organized and in view. Mixed material design comprised of sturdy laminate shelves with metal back and support panels. Not available in two-tone laminate combination or pattern laminate colors. Choose from Platinum Metallic (T1), Black (P), and Charcoal (S) for the metal components. Designed to be used on worksurfaces. Also sized to fit in stack-on and wall mounted storage cabinets, see compatibility chart on page 176. For additional information see page 912.

Specify: Model.Laminate.Paint

**SPECIFYING EXAMPLE: HLDST1.N.T1**

**DESCRIPTION**

**Stacked Paper Management**  
32<sup>1</sup>/<sub>2</sub>"W x 12<sup>5</sup>/<sub>8</sub>"D x 4<sup>1</sup>/<sub>4</sub>"H

MODEL	SHIP WEIGHT	CUBE	L1 LIST PRICE
HLVPM2	22.0	1.25	\$148

NOTES: Segments and organizes stack-on and wall mount storage compartments (see compatibility chart on page 176), as well as bookcase shelves. In some cases, installation may require removing the stack-on or wall mount storage doors. For additional information see page 913.

⚠ Black only.

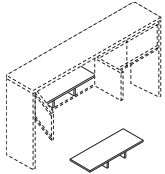

**Hanging Paper Shelf**  
28<sup>1</sup>/<sub>8</sub>"W x 11<sup>5</sup>/<sub>8</sub>"D x 4<sup>3</sup>/<sub>8</sub>"H

MODEL	SHIP WEIGHT	CUBE	L1 LIST PRICE
HHPS1	7.0	2.9	\$180

NOTES: Attaches quickly and easily (screws included). Maximizes worksurface space; de-clutters desktop while placing priority communications and active project folders within easy reach. Angled design allows contents to be distinguished at a glance. Mixed material styling features strong painted metal frame with a frosted shelf. Attaches quickly and easily to laminate stack-on and wall mount storage models (except the 36"W Voi® overhead hutch with O-legs or panel mount brackets). Not for use with 38000 Series™ and Systems.

Choose from Platinum Metallic (T1), Black (P), and Charcoal (S) paint. For additional information see page 913.

Specify: Model.Paint

**SPECIFYING EXAMPLE: HHPS1.T1**

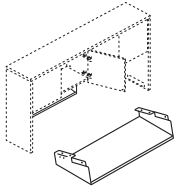

**Desktop Paper Shelf**  
28<sup>1</sup>/<sub>8</sub>"W x 11<sup>5</sup>/<sub>8</sub>"D x 5"H

MODEL	SHIP WEIGHT	CUBE	L1 LIST PRICE
HDPS1	7.0	2.9	\$180

NOTES: Desktop Paper Shelf and Storage Terrace include protective, non-slip pads on the base. Paper Shelf can stack two-high. Organizer shelf provides a place and space for work-in-process and piling to keep worksurfaces neat and tidy. Convenient, scalable design with interlocking side supports allow two units to be stacked and integrated. Durable painted metal frame with a frosted shelf; mixed material styling matches hanging paper shelf.

Can also be used inside select overhead storage, including the following stack-on with clearance and hinged door models: 10500 and Valido 36", 42", 66", 72", 78"W and 10700 68<sup>3</sup>/<sub>8</sub>"W.

Choose from Platinum Metallic (T1), Black (P), and Charcoal (S) paint. For additional information see page 913.

Specify: Model.Paint

**SPECIFYING EXAMPLE: HDPS1.T1**

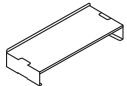

**Storage Cube**  
12"W x 12"D

MODEL	SHIP WEIGHT	CUBE	L1 LIST PRICE
HLSL1212	1.0	0.3	\$276

NOTES: Available in the following colors: Autumn (AUTM), Citron (CITR), Flame (FLAM), Pool (POOL) and Sisal (SISL). For additional information see page 914.

**SPECIFYING EXAMPLE: HLSL1212.CITR**

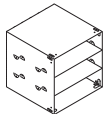

**HOW TO SPECIFY**

<p>Select Model Number</p> <p>HLVPM1 . N</p>	<p>Select Laminate Color</p> <p>See page 96</p>
--	---

# CONCINNITY™ PAPER ORGANIZER COMPATIBILITY







## PAPER ORGANIZERS FOR STACK-ON AND WALL MOUNTED STORAGE CABINETS

- Laminate vertical paper manager (HLVPM1) is designed for desk, credenza, and return tops; fits under stack-on and wall mount storage units.
- Laminate desktop storage terrace (HLDST1) for use on worksurfaces, or inside overhead storage compartments >26½"W.
- Metal desktop paper shelf (HDPS1) for use on worksurfaces, can be stacked two high, or inside overhead storage compartments >28¾"W.
- Stacked paper management (HLVPM2) can be positioned inside overhead storage cabinets >32½"W.
- Metal hanging paper shelf (HHPS1) attaches quickly and easily to the underside of stack-on and wall mounted storage models.
- For applications using the organizers inside stack-on and wall mounted storage compartments, the fit compatibility is as follows:

OUTSIDE WIDTH	INSIDE WIDTH	Stacked Paper Mgt. — 32½"W HLVPM2	Desktop Paper Shelf — 28¾"W HDPS1	Desktop Storage Terrace — 26½"W HLDST1	Hanging Paper Shelf — 28¾"W HHPS1
		Yes or No	Yes or No	Yes or No	*Qty — see NOTE
<b>STACK-ON STORAGE W/ LAM DOORS, LAM LOCKING DOORS, FROSTED DOORS</b>					
36"W	34.34	Y	Y	Y	1
42"W	40.34	Y	Y	Y	1
48"W (large compartment)	30.60	N	Y	Y	1
60"W	28.60	N	N	Y	2
66"W	31.60	N	Y	Y	2
72"W	34.60	Y	Y	Y	2
78"W	37.60	Y	Y	Y	2
<b>STACK-ON STORAGE W/ SLIDING DOOR</b>					
48"W	22.60	N	N	N	1
60"W	28.60	N	N	Y	2
66"W	31.60	N	Y	Y	2
72"W	34.60	Y	Y	Y	2
78"W	37.60	Y	Y	Y	2
<b>WALL MOUNT STORAGE W/ LAM DOORS, LAM LOCKING DOORS, FROSTED DOORS</b>					
30"W	28.35	N	N	Y	N
36"W	33.67	Y	Y	Y	1
42"W	39.67	Y	Y	Y	1
48"W (large compartment)	30.22	N	Y	Y	1
60"W	28.22	N	N	Y	2
66"W	31.22	N	Y	Y	2
72"W	34.22	Y	Y	Y	2
78"W	37.22	Y	Y	Y	2
<b>WALL MOUNT STORAGE W/ SLIDING DOOR</b>					
48"W	22.46	N	N	N	1
60"W	28.46	N	N	Y	2
66"W	31.46	N	Y	Y	2
72"W	34.46	Y	Y	Y	2
78"W	37.46	Y	Y	Y	2

\*NOTE: For model HHPS1, quantity represents the number that can be mounted side-by-side under the cabinet.



	DESCRIPTION	MODEL	SHIP WEIGHT	CUBE	LIST PRICE
  <b>SIN 711-2</b>	<b>Black Removable Lock Core Kit</b> • Specify quantity of each key number from 101E-225E. • Includes: 1-core, 2-keys, 1-core removal tool, and instructions. NOTES: If key number isn't specified, number will be at random.	<b>HF23B</b>	0.1 <b>Ⓞ</b>	0.1	<b>\$29</b>
  <b>SIN 711-3</b>	<b>Satin Removable Lock Core Kit</b> • Specify quantity of each key number from 101E-225E. • Includes: 1-core, 2-keys, 1-core removal tool, and instructions. NOTES: If key number isn't specified, number will be at random.	<b>HF23S</b>	0.1 <b>Ⓞ</b>	0.1	<b>\$36</b>
  <b>SIN 711-2</b>	<b>Removable Lock Core Kit</b> Black Satin • For stack-on and wall mounted storage laminate models (with locks) in 10500, 10700, Valido, Park Avenue Laminate, Concinnity, and 94000 Series. • Specify quantity of each key number from 101E to 225E. • Includes: 1-core, 2-keys, 1-core removal tool, and instructions. NOTES: If key number isn't specified, number will be at random.	<b>HF27B</b> <b>HF27S</b>	0.2 0.2	0.02 0.02	<b>\$29</b> <b>\$29</b>

**NOTES:**

- Interchangeable core removable locks are standard on most HON products.
- Removable lock core kits with specific key number must be ordered to facilitate keying alike in the field.
- For keyed alike locks:
  - Order standard product which will be shipped with factory installed locks and random numbered cores.
  - Order the appropriate quantity of like numbered cores required for each workstation or keyed area.
  - Simply replace the factory installed cores with the replacement cores after product has been installed.
- To install new core:
  - Lock must be in the unlocked position.
  - Insert core removal key and pull core straight out.
  - Insert new core with core removable key, hold core into lock and withdraw core removal key.
  - Retain original core for future use.
- For master key, see model HF22 on page 922.
- To provide normal lead times, key numbers cannot be specified on HON products at time of order. This also eliminates need for tagging and tracking each product's lock number during installation.

**HOW TO ORDER CORE REMOVABLE LOCK KITS:**

Specify: Model Number.X  
Key Number  
Examples: HF23S.X121E  
HF23S.X (Key number not specified)

**SAMPLE ORDER:**

Quantity	Model	Key Code
4	HF23B.	X121E

NOTES: Key orders without numbers specified will be keyed at random.  
Numbers 101E-225E are available.

**HOW TO SPECIFY**

Select Model Number

H
F
2
3
B

# CONCINNITY™

## Accessories — Task Lights

GSA SIN AS NOTED



Icon Legend on page 21

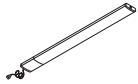

OPEN MARKET

**DESCRIPTION****MODEL****SHIP WEIGHT****CUBE****LIST PRICE****LED Task Lights — For Stack-on and Wall Mounted Storage Cabinets**

17" LED Light with Power Supply (Single)

**HLED17AS**

1.2 Ⓢ

0.05

**\$384**

31" LED Light with Power Supply (Single)

**HLED31AS**

1.5 Ⓢ

0.09

**\$516**

17" LED Light with Power Supply for Daisy-chain (Starter)

**HLED17A**

1.0 Ⓢ

0.05

**\$422**

31" LED Light with Power Supply for Daisy-chain (Starter)

**HLED31A**

1.4 Ⓢ

0.09

**\$567**

17" LED Light with 8" Jumper Cord for Daisy-chain (Follower)

**HLED17AUO**

1.0 Ⓢ

0.03

**\$344**

31" LED Light with 8" Jumper Cord for Daisy-chain (Follower)

**HLED31AUO**

1.0 Ⓢ

0.05

**\$460****Undercabinet Occupancy Sensor with 1" End to End Connector****HLEDOSA**

0.2 Ⓢ

0.01

**\$80**

NOTES: To use the daisy chain application, must start with model HLED17A or HLED31A. No finish specification required. Attaches magnetically to underside of overhead storage, or attaches with provided screws or double-sided tape. Occupancy sensor attaches to a single or starter LED light and will automatically turn the light off after no motion is detected for 30 minutes. Just like all the LED light models, the occupancy sensor features a soft-touch on/off switch. LED task lights have a lifetime of 50,000 hours and have a dimmer feature that allows the user to adjust the amount of light output. For additional information see page 911.



OPEN MARKET

**Recessed Task Lights — For Stack-on and Wall Mounted Storage Cabinets**

- Color: Black.
- Slim profile design.
- Mount to stack-on storage and wall mounted storage cabinets (see pages 123-127 and 130-133).
- Electronic ballast for increased energy efficiency.
- T5 bulb, included, which contains less mercury.
- 9-foot black cord and switch off right rear corner.

22<sup>7</sup>/<sub>8</sub>"W x 3<sup>3</sup>/<sub>16</sub>"D x 1<sup>1</sup>/<sub>8</sub>"H**HH870930**

7.0 Ⓢ

0.60

**\$211**

Chicago code version (with fused plug)

**HH870930CH**

7.0 Ⓢ

0.60

**\$275**34<sup>5</sup>/<sub>8</sub>"W x 3<sup>3</sup>/<sub>16</sub>"D x 1<sup>1</sup>/<sub>8</sub>"H**HH870942**

10.0 Ⓢ

0.90

**\$228**

Chicago code version (with fused plug)

**HH870942CH**

10.0 Ⓢ

0.90

**\$290**46<sup>1</sup>/<sub>2</sub>"W x 3<sup>3</sup>/<sub>16</sub>"D x 1<sup>1</sup>/<sub>8</sub>"H**HH870960**

12.0 Ⓢ

1.10

**\$246**

Chicago code version (with fused plug)

**HH870960CH**

12.0 Ⓢ

1.10

**\$308**

NOTES: For additional information see page 911.



SIN 711-1

**Articulating Desk Lamp****HLED1**

1.2 Ⓢ

6.5

**\$359****Articulating Desk Lamp w/ Occupancy Sensor****HLED10C**

1.2 Ⓢ

6.5

**\$439**

NOTES: For additional information see page 909.



SIN 711-1

**Task Desk Lamp****HLED2**

0.7 Ⓢ

3.0

**\$311**

NOTES: For additional information see page 909.

**HOW TO SPECIFY**Select  
Model Number

H H 8 7 0 9 3 0



Icon Legend on page 21



Refer to pages 75 and 901 for additional product information

SIN 711-1, 711-2, 711-11



DESCRIPTION	MODEL	SHIP WEIGHT	CUBE	LIST PRICE BY PAINT GRADE	
				CORE	METALLICS
Sit to Stand Arm with Convertible Keyboard Platform	H2516 OPEN MARKET	17 Ⓢ	1.6	\$565	
Articulating Arm with Convertible Keyboard Platform	H2107 OPEN MARKET	16 Ⓢ	1.3	\$484	
Articulating Arm with Keyboard Platform	H1706 OPEN MARKET	16 Ⓢ	1.4	\$451	
Slide-Away Keyboard Platform (Specify: Laminate)	H4022	10 Ⓢ	0.6	\$199	
Extended Tray Slide-Away Keyboard Platform (Specify: Laminate)	HE4022	12 Ⓢ	0.7	\$285	
Metal Keyboard and Mouse Tray (Specify paint)	H4028 OPEN MARKET	11 Ⓢ	1.5	\$144	\$154
Metal Keyboard Tray (Specify paint)	H4029 OPEN MARKET	11 Ⓢ	1.5	\$129	\$139

NOTES: For additional information see pages 900-901.

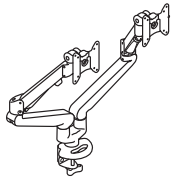

OPEN MARKET

DESCRIPTION	MODEL	SHIP WEIGHT	CUBE	LIST PRICE
<b>Dual Monitor Arm</b> Single Mount with Dual Monitor. Effortless adjustment. Range of adjustment is 13" from 6½"-19½". <ul style="list-style-type: none"> <li>• Single mount with dual monitor adjustment.</li> <li>• Monitor extends 21".</li> <li>• Monitor retracts 3½" to save space.</li> <li>• 360° swivel at two points with folding capabilities.</li> <li>• Monitor tilts +30° to -25°.</li> <li>• Enclosed cable management.</li> <li>• Dual screen models allow screens to be aligned horizontally for optimal ergonomic positioning.</li> <li>• Includes desk clamp or grommet mount.</li> </ul> ⓘ Available in Silver finish only, no specification needed. For complete monitor arm features, see page 288.	H5220	15 Ⓢ	1.8	\$912

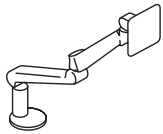

OPEN MARKET

<b>Single Monitor Arm</b> Effortless adjustment, no levers. Range of adjustment is 13" from 6½"-19½". <ul style="list-style-type: none"> <li>• Monitor extends 21".</li> <li>• Monitor retracts 3½" to save space.</li> <li>• 360° swivel at two points with folding capabilities.</li> <li>• Monitor tilts +30° to -25°.</li> <li>• Enclosed cable management.</li> <li>• Includes desk clamp or grommet mount.</li> </ul> ⓘ Silver finish only, no specification needed.	H5210	11 Ⓢ	1.3	\$510
---	-------	------	-----	-------

**NOTES:**

**Monitor Arms Only**

- Arms fold back to post to allow more desktop room.
- Arms feature double extension, allowing 20"+ of back and forth movement.
- Cable management on both pole and arm assemblies.
- Counterbalance adjustment provides stability for monitors up to 17 lbs per arm.
- Made of high quality aluminum alloy material.
- For additional information see page 899.

## HOW TO SPECIFY

Select Model Number

H 2 5 1 6

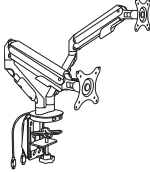
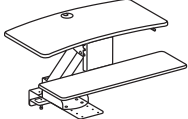
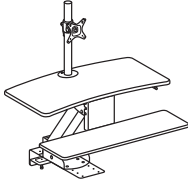
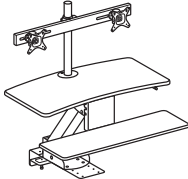

	DESCRIPTION	MODEL	SHIP WEIGHT	CUBE	LIST PRICE
	<b>Coordinate™ Portable Desktop Riser</b> 31"D x 4½"-16½"H x 35"W NOTES: Available in Black (BLK) or White (WHT) finish. Desktop riser dimensions (without keyboard tray): 22"D x 4½"-16½"H x 35"W. Keyboard tray dimensions: 9"D x 30"W. Max loading capacity is 33 lbs for the desktop riser surface and 4 lbs for the keyboard tray. Easily transition from seated to standing positions throughout the workday. Sits atop an existing desk to create sit-to-stand functionality by raising the computer. Includes keyboard tray and surface for computer monitors. <b>HON 5-Year Limited Warranty.</b> ⓘ Not intended for use on mobile workstations.	<b>HBXRISER</b>	54.0	4.1	<b>\$500</b>
	<b>Dual Monitor Arm with 2 USB Ports</b> NOTES: <b>AVAILABLE FEBRUARY 2018.</b> Easy adjustment. Height adjusts to 17" tall. Monitor tilt and swivel capability. Enclosed cable management. Grommet or desktop mounting. Clean appearance. For additional information see page 899. ⓘ No specification needed.	<b>HBDMAUSB</b>	41.9	2.6	<b>\$360</b>
	<b>Coordinate™ Mounted Desktop Riser</b> NOTES: Does not include a monitor arm and is suitable for laptops and/or monitors on their original stands. ⓘ No specification needed.	<b>HS1100</b>	60.0 ⓘ	3.2	<b>\$525</b>
	<b>Coordinate™ Mounted Desktop Riser with Single Monitor Arm</b> NOTES: Includes a monitor arm for a single monitor. ⓘ No specification needed.	<b>HS1101</b>	62.0 ⓘ	3.2	<b>\$615</b>
	<b>Coordinate™ Mounted Desktop Riser with Dual Monitor Arm</b> NOTES: Includes a monitor arm for dual monitors. ⓘ No specification needed.	<b>HS1102</b>	63.0 ⓘ	3.2	<b>\$700</b>

### NOTES FOR HS1100, HS1101, HS1102:

- These products are designed to allow the user to transition from seating position to standing position throughout the workday.
- Gas-assist lever-operated mechanism with positive stop.
- Clamp mount compatible with worksurfaces depths of 20"-30". 20" is for systems only.
- Clamp requires 3.5" of clearance along back edge of worksurface.
- Black seamless worksurfaces.
- Silver powder coated metal components.
- Lowers below worksurface level on 24" and 30"D worksurfaces.
- All models contain a large primary worksurface and a smaller keyboard / mouse surface.
- Beveled edges for sleek appearance and comfort while typing.
- Monitor arms include height, width, and swivel adjustment.
- For additional information see page 906.

- Not for use under overhead storage, with flush mounted modesty panels, or worksurfaces thinner than 1".

- ⓘ Not recommended for use on mobile (castered) worksurfaces.

### MOUNTING AND COMPATIBILITY FOR HS1100, HS1101, HS1102:

- This product is intended to be installed on commercial-grade worksurfaces in good condition.
- Compatible with freestanding worksurfaces 24"-30"D or panel-supported worksurfaces 24"-30"D.
- Not for use on mobile worksurfaces.

#### Clamp Mount

Use when 3.5" minimum overhang is available

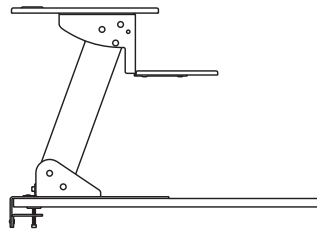

#### Screw Mount

Use when no overhang is available. Worksurface must be minimum 1" thick.

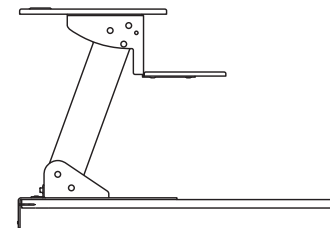

## HOW TO SPECIFY

### Select Model Number



HBXRISER.

### Select Finish

BLK Black  
WHIT White

BLK

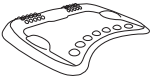
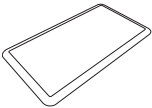
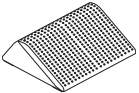

	DESCRIPTION	MODEL	SHIP WEIGHT	CUBE	LIST PRICE
	<b>Rectangle Wobble Board — Anti-Fatigue Mat</b> 18"D x 3"H x 22¼"W ⓘ Available in Black (T) finish ONLY. Recommended weight capacity not to exceed 250 pounds. <b>HON 5-Year Limited Warranty.</b> <b>SPECIFYING EXAMPLE: HVL981.T</b>	<b>HVL981</b>	10.0 Ⓔ	0.9	<b>\$220</b>
	<b>Round Wobble Board — Anti-Fatigue Mat</b> 18½"D x 2⅝"H x 18½"W ⓘ Available in Black (T) finish ONLY. Recommended weight capacity not to exceed 250 pounds. <b>HON 5-Year Limited Warranty.</b> <b>SPECIFYING EXAMPLE: HVL982.T</b>	<b>HVL982</b>	5.8 Ⓔ	0.6	<b>\$190</b>
	<b>Ergonomic Anti-Fatigue Mat</b> 25"D x 2¾"H x 29⅞"W ⓘ <b>AVAILABLE FEBRUARY 2018.</b> Available in Black ONLY. No specification needed. <b>SPECIFYING EXAMPLE: HBEAFM1</b>	<b>HBEAFM1</b>	7.0	1.4	<b>\$176</b>
	<b>Rectangle Anti-Fatigue Mat</b> 20"D x ¾"H x 36"W ⓘ <b>AVAILABLE FEBRUARY 2018.</b> Available in Black ONLY. No specification needed. <b>SPECIFYING EXAMPLE: HBAFM2036</b>	<b>HBAFM2036</b>	5.4	0.4	<b>\$80</b>
	<b>Footrest — Anti-Slip Cover</b> 13¾"D x 5½"H x 16"W ⓘ Available in Black (T) finish ONLY. Recommended weight capacity not to exceed 250 pounds. <b>HON 5-Year Limited Warranty.</b> <b>SPECIFYING EXAMPLE: HVL991.T</b>	<b>HVL991</b>	7.0 Ⓔ	0.9	<b>\$65</b>

## HOW TO SPECIFY

<b>Select Model Number</b>	<b>Select Finish</b>
H V L 9 8 1 .	T Black
	T



# FOUNDATION™



Foundation™ Executive Workstation.

## Foundation™

Create a solid starting point for your success with HON Foundation. Personalize your office suite with this versatile collection of laminate desk and storage solutions that can be combined in a variety of ways to fit any work style or space. Get the fundamentals and much more with the HON Foundation laminate collection.



## FEATURES

- The HON Foundation collection allows you to create a premium workspace at an affordable price.
- Straightforward styling blends with any office design.
- Lateral files and storage pedestals come fully assembled, and desks and credenzas assemble easily in minutes.
- Multiple storage options let you create spaces that work the way you do.
- All components feature attractive scratch- and stain-resistant laminate for an unbeatable combination of stunning beauty and rugged durability.
- Available in three beautiful woodgrain finishes.
- Three optional decorative handles to choose from.

# FOUNDATION™ Typicals

QTY	DESCRIPTION	MODEL	LIST PRICE	PRICE EXTENSION
1	Desk Shell	HLM6630	\$255	\$255
1	Box / Box / File Pedestal	HLMBBF	\$297	\$297
1	File / File Pedestal	HLMFF	\$297	\$297
<b>TOTAL:</b>				<b>\$849</b>

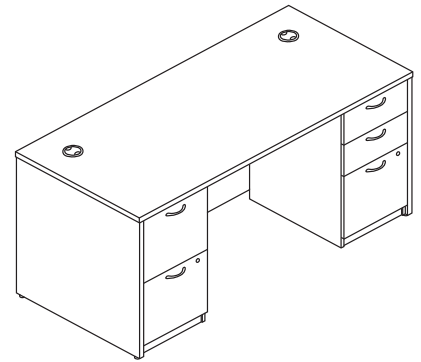

**LAMINATE DESK WITH 2 PEDESTALS**

**66" W x 30" D**

QTY	DESCRIPTION	MODEL	LIST PRICE	PRICE EXTENSION
1	Desk Shell	HLM6030	\$233	\$233
1	File / File Pedestal	HLMFF	\$297	\$297
<b>TOTAL:</b>				<b>\$530</b>

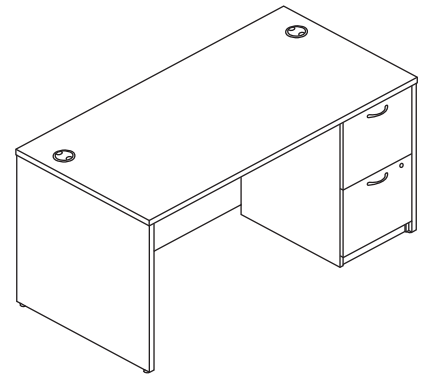

**DESK SHELL WITH 1 PEDESTAL (NON-HANDED)**

**60" W x 30" D**

QTY	DESCRIPTION	MODEL	LIST PRICE	PRICE EXTENSION
1	Desk Shell	HLM7236	\$297	\$297
1	Credenza Shell	HLM72CRD	\$240	\$240
1	Hutch with Doors	HLM72HUT	\$410	\$410
2	Box / Box / File Pedestal	HLMBBF	\$297	\$594
2	File / File Pedestal	HLMFF	\$297	\$594
<b>TOTAL:</b>				<b>\$2,135</b>

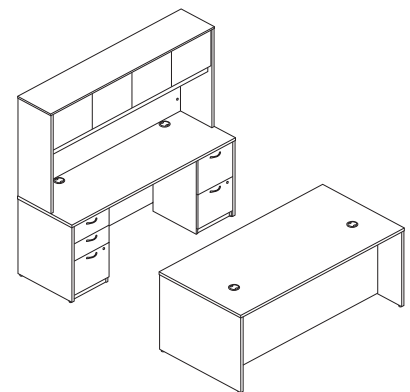

**OFFICE SUITE**

**72" W x 96" D**

# FOUNDATION™

## Typicals

QTY	DESCRIPTION	MODEL	LIST PRICE	PRICE EXTENSION
1	Desk Shell	HLM6630	\$255	\$255
1	Return Shell	HLM48RET	\$185	\$185
1	Box / Box / File Pedestal	HLMBBF	\$297	\$297
1	File / File Pedestal	HLMFF	\$297	\$297
<b>TOTAL:</b>			<b>\$1,034</b>	

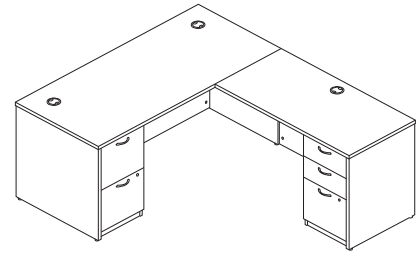

**L-STATION WITH 2 PEDESTALS (NON-HANDED)**

**66" W x 78" D**

QTY	DESCRIPTION	MODEL	LIST PRICE	PRICE EXTENSION
1	Bow Front Desk Shell	HLM7242	\$333	\$333
1	Credenza Shell	HLM72CRD	\$240	\$240
1	Hutch with Doors	HLM72HUT	\$410	\$410
1	5-Shelf Bookcase	HLM65BC	\$270	\$270
1	2-Drawer Lateral File	HMLLATF	\$483	\$483
2	Box / Box / File Pedestal	HLMBBF	\$297	\$594
2	File / File Pedestal	HLMFF	\$297	\$594
<b>TOTAL:</b>			<b>\$2,924</b>	

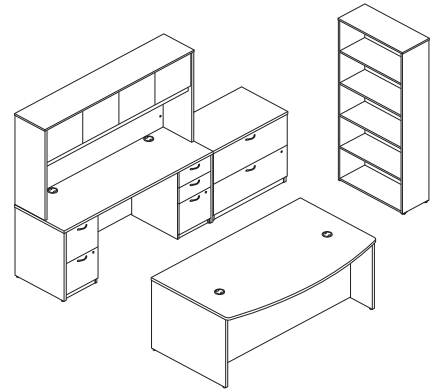

**OFFICE SUITE WITH STORAGE**

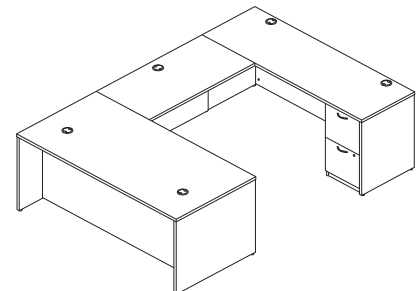

**108" W x 134" D**

QTY	DESCRIPTION	MODEL	LIST PRICE	PRICE EXTENSION
1	Desk Shell	HLM7236	\$297	\$297
1	Credenza Shell	HLM72CRD	\$240	\$240
1	Bridge	HLM48BRG	\$174	\$174
1	Box / Box / File Pedestal	HLMBBF	\$297	\$297
1	File / File Pedestal	HLMFF	\$297	\$297
<b>TOTAL:</b>			<b>\$1,305</b>	

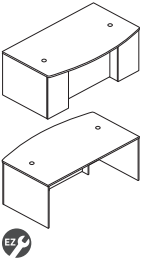
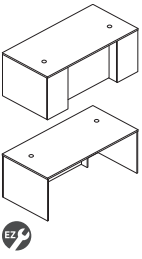
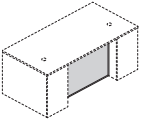
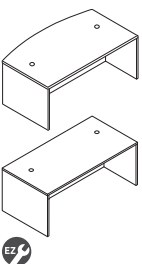

**U-STATION (NON-HANDED)**

**72" W x 108" D**

	DESCRIPTION	OVERHANG	MODEL	SHIP WEIGHT	CUBE	LIST PRICE
	<b>Breakfront Desk Shell with Bow Front Top</b> 72"W x 42"D x 29"H NOTES: Two cord management grommets in tops.	12 <sup>9</sup> / <sub>16</sub> "	<b>HLM7242BF</b>	156.2	9.6	<b>\$415</b>
	<b>Breakfront Desk Shell with Rectangle Top</b> 72"W x 36"D x 29"H NOTES: Two cord management grommets in tops.	6 <sup>7</sup> / <sub>16</sub> "	<b>HLM7236BF</b>	151.8	8.4	<b>\$370</b>
	<b>Glass Modesty Panel</b> For 72"W Breakfront Desk Shell		<b>HBL72BFMODG</b>	18.0 Ⓢ	2.0	<b>\$214</b>
	<b>Desk Shell</b> 72"W x 42"D x 29"H, Bow Top 72"W x 36"D x 29"H, Rectangle Top 72"W x 30"D x 29"H, Rectangle Top — <b>COMING SOON</b> 66"W x 30"D x 29"H, Rectangle Top 60"W x 30"D x 29"H, Rectangle Top 48"W x 30"D x 29"H, Rectangle Top — <b>COMING SOON</b> 48"W x 24"D x 29"H, Rectangle Top — <b>COMING SOON</b> NOTES: Two cord management grommets in tops.	16 <sup>1</sup> / <sub>2</sub> " 10" 4 <sup>1</sup> / <sub>2</sub> " 4 <sup>1</sup> / <sub>2</sub> " 4 <sup>1</sup> / <sub>2</sub> " 4 <sup>1</sup> / <sub>2</sub> " 4 <sup>1</sup> / <sub>2</sub> "	<b>HLM7242</b> <b>HLM7236</b> <b>HLM7230</b> <b>HLM6630</b> <b>HLM6030</b> <b>HLM4830</b> <b>HLM4824</b>	153.9 148.8 148.8 115.7 111.1 75.0 75.0	8.9 7.7 5.6 6.1 5.6 4.6 3.7	<b>\$333</b> <b>\$297</b> <b>\$295</b> <b>\$255</b> <b>\$233</b> <b>\$244</b> <b>\$234</b>
	<b>Peninsula with End Panel</b> 72"W x 36"D x 29"H NOTES: Support column available in Black only. For use in "U" or "L" configuration. ⚠ Not designed to be used freestanding.		<b>HLM72PEN</b>	116.4	15.0	<b>\$376</b>

**NOTES:**

- Scratch- and stain-resistant thermal-fused laminate surfaces.
- Durable 1" thick tops and end panels.
- Full height modesty panels.
- Desk, credenza shells, and peninsula assemble quickly and easily.
- Breakfront design creates a high end aesthetic for private offices and executive workstations.
- Breakfront desk features fixed and adjustable shelves.
- Desk shells come standard with Black 3" round grommets.
- Recessed modesty panel design on desk shells provides overhang for visitor meetings and conferencing.
- Glass modesty replaces laminate modesty included with desk.
- Adjustable floor leveling glides provide 3/4" of adjustment.
- Three laminate color options — Shaker Cherry (F), Mahogany (N) or Pinnacle (PINC).
- **HON 5-Year Limited Warranty.**

## HOW TO SPECIFY

<p><b>Select Model Number</b></p> <p>H L M 7 2 4 2 B F</p>	<p><b>Select Laminate</b></p> <p>F Shaker Cherry N Mahogany PINC Pinnacle</p> <p>F</p>
--	--

# FOUNDATION™



## DESCRIPTION

### Credenza Shell

72"W x 24"D x 29"H  
66"W x 24"D x 29"H — **COMING SOON**  
60"W x 24"D x 29"H

## MODEL

**HLM72CRD**  
**HLM66CRD**  
**HLM60CRD**

## SHIP WEIGHT

108.0  
95.5  
95.5

## CUBE

5.5  
4.8  
5.5

## LIST PRICE

**\$240**  
**\$225**  
**\$213**

NOTES: Two cord management grommets in the top and one cord pass-through grommet in the top center of modesty panel.



### Credenza Support Gable

16½"W x 27½"H

## HLMGBL

25.0

0.8

**\$65**

NOTES: **COMING SOON**. For use with HML72CRD. 1" thick.

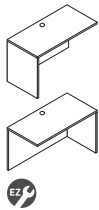

### Return Shell

48¼"W x 24"D x 29"H  
42¼"W x 24"D x 29"H  
36"W x 24"D x 29"H — **COMING SOON**  
30"W x 24"D x 29"H — **COMING SOON**

**HLM48RET**  
**HLM42RET**  
**HLM36RET**  
**HLM30RET**

66.1 Ⓢ  
66.1 Ⓢ  
66.0  
66.0

4.6  
4.1  
2.8  
2.8

**\$185**  
**\$170**  
**\$149**  
**\$144**

NOTES: One cord management grommet in the top and one cord pass-through grommet in the top center of modesty panel. Return shells are non-handed.



### Bridge

47¾"W x 24"D x 29"H  
42"W x 24"D x 29"H — **COMING SOON**  
36"W x 24"D x 29"H — **COMING SOON**

**HLM48BRG**  
**HLM42BRG**  
**HLM36BRG**

52.9 Ⓢ  
52.0  
52.0

3.7  
2.5  
2.5

**\$174**  
**\$150**  
**\$135**

NOTES: One cord management grommet in the top and one cord pass-through grommet in the top center of modesty panel.



### Corner Unit

18" x 36" x 36" x 18" x 29"H

## HLM42CU

114.4

5.1

**\$332**

NOTES: Intended for use with 24"D x 29"H returns or bridges.

ⓘ Not designed to be used freestanding.

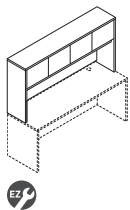
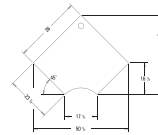

### Hutch with Doors

72"W x 14⅝"D x 37⅞"H  
66"W x 14⅝"D x 37⅞"H — **COMING SOON**  
60"W x 14⅝"D x 37⅞"H  
48"W x 14⅝"D x 37⅞"H — **COMING SOON**

**HLM72HUT**  
**HLM66HUT**  
**HLM60HUT**  
**HLM48HUT**

138.2  
127.0  
119.0  
115.0

7.6  
7.1  
6.6  
5.2

**\$410**  
**\$385**  
**\$372**  
**\$271**

NOTES: 72"W Hutch with four doors fits on the 72"W desk or credenza. It can also span an "L" configuration where the width of the return and the depth of the desk or credenza combined equal 72". Example: 42"W return and a 30"D desk shell. 60"W Hutch with doors fits on the 60"W desk or credenza shell.

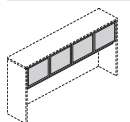

### Glass Doors for 72" Hutch

## HBL72HDG

9.0 Ⓢ

1.5

**\$275**

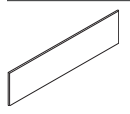

### Tackboards

72"W — for 72"W Hutch (HLM72HUT) — **COMING SOON**  
66"W — for 66"W Hutch (HLM66HUT) — **COMING SOON**  
60"W — for 60"W Hutch (HLM60HUT) — **COMING SOON**  
48"W — for 48"W Hutch (HLM48HUT) — **COMING SOON**

**HLM72TACK**  
**HLM66TACK**  
**HLM60TACK**  
**HLM48TACK**

12.0  
12.0  
10.0  
10.0

2.4  
2.2  
1.9  
1.6

**\$91**  
**\$89**  
**\$85**  
**\$80**

## NOTES:



- Credenza shells come standard with Black grommets.
- Scratch- and stain-resistant thermal-fused laminate surfaces.
- Durable 1" thick tops and end panels.
- Full height modesty panels.
- Adjustable floor leveling glides provide ¾" of adjustment.

- 72"W and 60"W hutches with doors include fully enclosed back with a grommet to facilitate routing cords.
- Returns, bridges, and reception stations assemble quickly and easily.
- 3" diameter grommet(s) in tops of desks to route cords; grommet cap is black.
- Return shells and bridge come standard with 3" round Black grommets.
- **HON 5-Year Limited Warranty.**

## HOW TO SPECIFY

<b>Select Model Number</b> H L M 7 2 C R D .	<b>Select Laminate</b> <b>F</b> Shaker Cherry <b>N</b> Mahogany <b>PINC</b> Pinnacle <b>F</b>
---	---

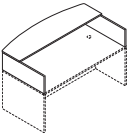
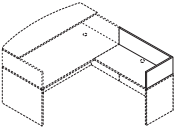

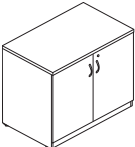
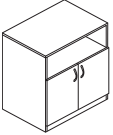
	DESCRIPTION	MODEL	SHIP WEIGHT	CUBE	LIST PRICE
	<b>Reception Station with Bow Front Transaction Counter</b> 72"W x 42"D x 14"H NOTES: Can be used on 72"W x 42"D bow top and 72"W x 36"D rectangle top desks. Can be used to quickly convert existing 72"W desks and 42¼"W returns into reception stations.	<b>HLMRECP</b>	74.1	5.4	<b>\$277</b>
	<b>Reception Station for Returns</b> 42¼"W x 24"D x 13"H NOTES: To be used with model HLMRECP in an "L" configuration on a 42¼" return shell. Can be used to quickly convert existing 72"W desks and 42¼"W returns into reception stations.	<b>HLMRECPRET</b>	23.1 Ⓢ	2.0	<b>\$119</b>
	<b>Personal Wardrobe Cabinet</b> 18"W x 24"D x 65"H NOTES: Door is non-handed and can be converted to left or right open configuration. Features coat rod, fixed shelf, and lock. Comes with metal handle in Silver finish.	<b>HLMPPWC</b>	83.6	6.1	<b>\$475</b>
	<b>Storage Cabinets</b> 36"W x 22"D x 66"H — <b>COMING SOON</b> 36"W x 22"D x 36"H — <b>COMING SOON</b> 36"W x 22"D x 29"H — <b>COMING SOON</b>	<b>HLM66CAB</b> <b>HLM36CAB</b> <b>HLM29CAB</b>	341.0 168.0 145.0	9.6 5.9 4.8	<b>\$599</b> <b>\$418</b> <b>\$341</b>
	<b>Office Cart</b> 28"W x 19½"D x 28¾"H	<b>HLMCART</b>	144.8	3.2	<b>\$292</b>

**NOTES:**

- Scratch- and stain-resistant thermal-fused laminate surfaces.
- Durable 1" thick tops and end panels.
- Full height modesty panels.
- Adjustable floor leveling glides provide ¾" of adjustment.
- 72"W and 60"W hutches with doors include fully enclosed back with a grommet to facilitate routing cords.
- Returns, bridges, and reception stations assemble quickly and easily.
- 3" diameter grommet(s) in tops of desks to route cords; grommet cap is black.
- Return shells and bridge come standard with 3" round Black grommets.
- **HON 5-Year Limited Warranty.**

## HOW TO SPECIFY

<p><b>Select Model Number</b></p> <p>H L M R E C P .</p>	<p><b>Select Laminate</b></p> <p>F Shaker Cherry                      N Mahogany                      PINC Pinnacle</p> <p>F</p>
--	--

# FOUNDATION™

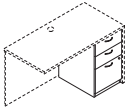
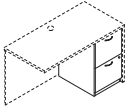
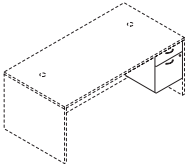
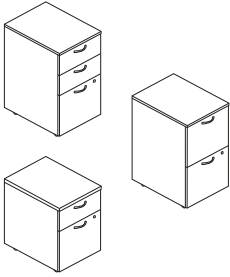

	DESCRIPTION	MODEL	SHIP WEIGHT	CUBE	LIST PRICE
	<b>Pedestals, Box/Box/File</b> 15 <sup>5</sup> / <sub>8</sub> "W x 21 <sup>3</sup> / <sub>4</sub> "D x 27 <sup>3</sup> / <sub>4</sub> "H NOTES: Drawers lock. Not to be used freestanding. For use under shells (sold separately). Unfinished top.	<b>HLMBBF</b>	80.5 Ⓢ	9.2	<b>\$297</b>
	<b>Pedestal, File/File</b> 15 <sup>5</sup> / <sub>8</sub> "W x 21 <sup>3</sup> / <sub>4</sub> "D x 27 <sup>3</sup> / <sub>4</sub> "H NOTES: Drawers lock. Not to be used freestanding. For use under shells (sold separately). Unfinished top.	<b>HLMFF</b>	78.9 Ⓢ	9.2	<b>\$297</b>
	<b>Pedestal, Box/File</b> 15 <sup>5</sup> / <sub>8</sub> "W x 21 <sup>3</sup> / <sub>4</sub> "D x 19 <sup>1</sup> / <sub>4</sub> "H NOTES: Drawers lock. Not to be used freestanding. For use under shells (sold separately). Unfinished top.	<b>HLMBF</b>	63.3 Ⓢ	6.8	<b>\$229</b>
	<b>Mobile Pedestals</b> 15 <sup>1</sup> / <sub>2</sub> "W x 26 <sup>1</sup> / <sub>2</sub> "D x 26"H, Box/Box/File — <b>COMING SOON</b> 15 <sup>1</sup> / <sub>2</sub> "W x 20 <sup>1</sup> / <sub>2</sub> "D x 26"H, File/File — <b>COMING SOON</b> 15 <sup>1</sup> / <sub>2</sub> "W x 20 <sup>1</sup> / <sub>2</sub> "D x 20"H, Box/File — <b>COMING SOON</b>	<b>HLMMBBF</b> <b>HLMMFF</b> <b>HLMMBF</b>	80.5 78.9 63.3	7.9 7.9 6.5	<b>\$334</b> <b>\$321</b> <b>\$267</b>

**NOTES:**

- Pedestals ship assembled.
- Pedestals are designed to be used under the desk, credenza, and return shells.
- Drawers operate on full extension, ball-bearing suspensions to ensure smooth, quiet, long-lasting operation.
- Hangrails are included in each file drawer for side-to-side letter or legal filing, and for front-to-back letter filing.
- Pedestals come standard with metal handle in Silver finish.
- **HON 5-Year Limited Warranty.**

## HOW TO SPECIFY

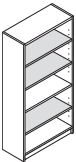
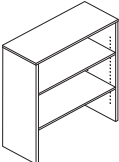
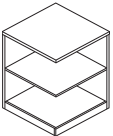
<p><b>Select Model Number</b></p> <p><b>H L M B B F</b></p>	<p><b>Select Laminate</b></p> <p><b>F</b> Shaker Cherry <b>N</b> Mahogany <b>PINC</b> Pinnacle</p> <p><b>F</b></p>
---	--

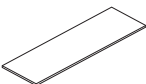
	DESCRIPTION	MODEL	SHIP WEIGHT	CUBE	LIST PRICE	
	<b>Bookcases</b> 31"W x 13"D x 72¼"H — 6-Shelf — <b>COMING SOON</b> 32"W x 13½"D x 65⅜"H — 5-Shelf 31"W x 13"D x 54¾"H — 4-Shelf — <b>COMING SOON</b> 31"W x 13"D x 42¾"H — 3-Shelf — <b>COMING SOON</b> 31"W x 13"D x 30¾"H — 2-Shelf — <b>COMING SOON</b>	<b>HLM72BC</b> <b>HLM65BC</b> <b>HLM54BC</b> <b>HLM42BC</b> <b>HLM30BC</b>	187.0 137.3 156.0 122.0 90.0	6.3 7.2 5.2 4.1 3.2	<b>\$297</b> <b>\$270</b> <b>\$219</b> <b>\$216</b> <b>\$150</b>	
	NOTES: Features three adjustable shelves and one fixed shelf.					
		<b>Open Bookcase Hutch</b> 35⅝"W x 14⅝"D x 36¾"H — <b>COMING SOON</b>	<b>HLMBCHUT</b>	103.0	3.2	<b>\$226</b>
		<b>Square Corner End Bookcase</b> 24"W x 24"D x 29"H — <b>COMING SOON</b>	<b>HLMSQBC</b>	63.0	3.7	<b>\$254</b>
		<b>Lateral Files — 2-Drawer</b> 35½"W x 22"D x 29"H NOTES: Features inner lock mechanism. Drawers lock. Removable top for use under shells. Features full extension drawers with ball-bearing suspensions.	<b>HLMLATF</b>	144.8	19.4	<b>\$483</b>
	<b>72" Top for Lateral File</b> 72"W x 22"D — <b>COMING SOON</b> NOTES: 1" thick.	<b>HLMLATTOP</b>	89.0	4.2	<b>\$113</b>	

**NOTES:**



- Lateral files ship assembled.
- Drawers operate on full extension, ball-bearing suspensions to ensure smooth, quiet, long-lasting operation.
- Hangrails are included in each file drawer for side-to-side letter or legal filing, and for front-to-back letter filing.
- Lateral files come standard with metal handle in Silver finish.
- **HON 5-Year Limited Warranty.**

## HOW TO SPECIFY

<p>Select Model Number</p> <p><b>H L M 7 2 B C</b></p>	<p>Select Laminate</p> <p><b>F</b> Shaker Cherry  <b>N</b> Mahogany  <b>PINC</b> Pinnacle</p> <p><b>F</b></p>
--	---



# FOUNDATION™

	DESCRIPTION	MODEL	SHIP WEIGHT	CUBE	LIST PRICE
	<b>Field Installed Contemporary Pull — 2-pack</b> Silver NOTES: For use on Lateral Files, Pedestals, and Personal Wardrobe Cabinets. ⓘ Silver finish only, no specification needed.	<b>HBLPCONTEMP</b>	0.4 ⓘ	0.1	<b>\$10</b>
	<b>Field Installed Bridge Pull — 2-pack</b> Silver NOTES: For use on Lateral Files, Pedestals, and Personal Wardrobe Cabinets. ⓘ Polished finish only, no specification needed.	<b>HBLPBRIDGE</b>	0.4 ⓘ	0.1	<b>\$10</b>
	<b>Field Installed Classic Pull — 2-pack</b> Black NOTES: For use on Lateral Files, Pedestals, and Personal Wardrobe Cabinets. ⓘ Black finish only, no specification needed.	<b>HBLPCLASSIC</b>	0.4 ⓘ	0.1	<b>\$10</b>

**NOTES:**

- HON 5-Year Limited Warranty.

## HOW TO SPECIFY

Select  
Model Number

H L M P C O N T E M P



# FOUNDATION™ Conference Tables

	DESCRIPTION	MODEL	SHIP WEIGHT	CUBE	LIST PRICE
	<b>Rectangular Conference Table with Slab Base</b> 72"W x 36"D	<b>HLMC72R</b>	113	9.2	<b>\$318</b>
	<b>Round Conference Table with "X" Base</b> 48" Diameter 42" Diameter — <b>COMING SOON</b> 36" Diameter — <b>COMING SOON</b>	<b>HLMC48D</b> <b>HLMC42D</b> <b>HLMC36D</b>	120 118 116	7.9 7.9 5.2	<b>\$262</b> <b>\$248</b> <b>\$236</b>

**NOTES:**

- Compatible with BL Caseloads series.
- Tops and bases are packaged together.
- Durable, thermal-fused laminate is scratch- and spill-resistant.
- **HON 5-Year Limited Warranty.**

## HOW TO SPECIFY

<p><b>Select Model Number</b></p> <p>H L M C 7 2 R .</p>	<p><b>Select Laminate</b></p> <p><b>F</b> Shaker Cherry <b>N</b> Mahogany <b>PINC</b> Pinnacle</p> <p><b>F</b></p>
--	--

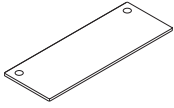
**DESCRIPTION**
**Worksurfaces for Height Adjustable Bases**

48"W x 24"D  
 60"W x 24"D  
 66"W x 24"D  
 72"W x 24"D

48"W x 30"D  
 60"W x 30"D  
 66"W x 30"D  
 72"W x 30"D

**MODEL**
**SHIP WEIGHT**
**CUBE**
**LIST PRICE**

<b>HLMW4824</b>	61	3.4	<b>\$115</b>
<b>HLMW6024</b>	75	4.2	<b>\$135</b>
<b>HLMW6624</b>	82	5.0	<b>\$147</b>
<b>HLMW7224</b>	89	5.0	<b>\$152</b>
<b>HLMW4830</b>	75	4.2	<b>\$152</b>
<b>HLMW6030</b>	92	5.1	<b>\$190</b>
<b>HLMW6630</b>	101	6.1	<b>\$206</b>
<b>HLMW7230</b>	110	6.1	<b>\$222</b>

**NOTES:**

- Add height adjustability to the Foundation™ desk line by using these worksurfaces with the height adjustable bases.
- Select from Shaker Cherry, Mahogany or Pinnacle laminates to match Foundation™ desks.
- Also compatible with Coordinate™ Height Adjustable Base on page 566.
- 1" Thick worksurfaces.
- 3" Round Grommets included.
- **HON 5-Year Limited Warranty.**

**HOW TO SPECIFY**
**Select  
Model Number**
**Select  
Laminate**

**F** Shaker Cherry  
**N** Mahogany  
**PINC** Pinnacle

H L M W 4 8 2 4 .

F

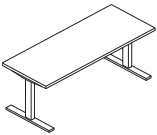
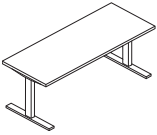
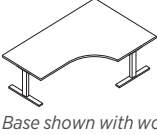

# FOUNDATION™ Height Adjustable Bases

	DESCRIPTION	MODEL	SHIP WEIGHT	CUBE	LIST PRICE
 Base shown with work surface attached.	<b>Coordinate™ Height Adjustable Base – 2 Stage</b> 24”D Feet and Worksurface Brackets  NOTES: <b>AVAILABLE FEBRUARY 2018.</b> Base is a dual motor 2-stage design with standard anti-collision. Legs raise from 25 <sup>5</sup> / <sub>8</sub> ” to 45 <sup>1</sup> / <sub>4</sub> ”. Base telescopes to accommodate any rectangular work surface between 24”D x 48”W and 36”D x 72”W. Supports weight capacity of 250 lbs. (excluding work surface weight). See page 767 for Voi® Worksurfaces. See page 767 for Systems Worksurfaces. For Height Adjustable Base Accessories see pages 765-766. Foundation™, Systems, Voi®, 10500, and Preside® all have worksurfaces within this range.	<b>HHAB2S2L</b>	63	2.4	<b>\$860</b>
 Base shown with work surface attached.	<b>Coordinate™ Height Adjustable Base – 3 Stage</b> 24”D Feet and Worksurface Brackets  NOTES: <b>AVAILABLE FEBRUARY 2018.</b> Base is a dual motor 3-stage design with standard anti-collision. Legs raise from 21 <sup>5</sup> / <sub>8</sub> ” to 47 <sup>3</sup> / <sub>4</sub> ”. Base telescopes to accommodate any rectangular work surface between 24”D x 48”W and 36”D x 72”W. Supports weight capacity of 250 lbs. (excluding work surface weight). Foundation™, Systems, Voi®, 10500, and Preside® all have worksurfaces within this range.	<b>HHAB3S2L</b>	67	2.4	<b>\$960</b>
 Base shown with work surface attached.	<b>Coordinate™ 3-Leg Height Adjustable Base – 3 Stage</b> 24”D Feet and Worksurface Brackets  NOTES: <b>AVAILABLE FEBRUARY 2018.</b> Base is a three motor 3-stage design with standard anti-collision. Legs raise from 21 <sup>5</sup> / <sub>8</sub> ” to 47 <sup>3</sup> / <sub>4</sub> ”. Base telescopes to accommodate work surfaces between 24”D x 48”W <sup>1</sup> x 60”W <sup>2</sup> and 30”D x 72”W <sup>1</sup> x 72”W <sup>2</sup> . <b>Can be used with 48” 120 degree and corner work surface models.</b> Supports weight capacity of 330 lbs. (excluding work surface weight). Can be used with 120 degree work surface models.	<b>HHAB3S3L</b>	97	3.6	<b>\$1625</b>

⚠ When attaching a Keyboard Tray, remember to also specify a Keyboard Spacer Kit (HKBS).

⚠ When using two worksurfaces, a flat bracket is required. Bracket purchased separately — HHN831124, HHN831130 — see page 574.

**NOTES:**

- Comes standard with one-touch, four memory controller with digital display; no specification needed, available in black finish only.
- **HON 5-Year Limited Warranty.**

⚠ 120 degree and corner worksurfaces are not reduced in size to provide clearance between panels.

**HOW TO SPECIFY**

<p><b>Select Model Number</b></p> <p>HHAB2S2L</p>	<p><b>Select Finish</b></p> <p>P8L Nickel</p>
---	---

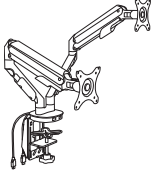
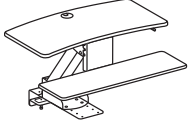
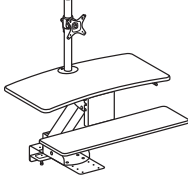
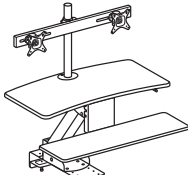
	DESCRIPTION	MODEL	SHIP WEIGHT	CUBE	LIST PRICE
	<b>Coordinate™ Portable Desktop Riser</b> 31"D x 4½"-16½"H x 35"W NOTES: Available in Black (BLK) or White (WHT) finish. Desktop riser dimensions (without keyboard tray): 22"D x 4½"-16½"H x 35"W. Keyboard tray dimensions: 9"D x 30"W. Max loading capacity is 33 lbs for the desktop riser surface and 4 lbs for the keyboard tray. Easily transition from seated to standing positions throughout the workday. Sits atop an existing desk to create sit-to-stand functionality by raising the computer. Includes keyboard tray and surface for computer monitors. <b>HON 5-Year Limited Warranty.</b> ⓘ Not intended for use on mobile workstations.	<b>HBXRISER</b>	54.0	4.1	<b>\$500</b>
	<b>Dual Monitor Arm with 2 USB Ports</b> NOTES: <b>AVAILABLE FEBRUARY 2018.</b> Easy adjustment. Height adjusts to 17" tall. Monitor tilt and swivel capability. Enclosed cable management. Grommet or desktop mounting. Clean appearance. For additional information see page 899. ⓘ No specification needed.	<b>HBDMAUSB</b>	41.9	2.6	<b>\$360</b>
	<b>Coordinate™ Mounted Desktop Riser</b> NOTES: Does not include a monitor arm and is suitable for laptops and/or monitors on their original stands. ⓘ No specification needed.	<b>HS1100</b>	60.0 ⓘ	3.2	<b>\$525</b>
	<b>Coordinate™ Mounted Desktop Riser with Single Monitor Arm</b> NOTES: Includes a monitor arm for a single monitor. ⓘ No specification needed.	<b>HS1101</b>	62.0 ⓘ	3.2	<b>\$615</b>
	<b>Coordinate™ Mounted Desktop Riser with Dual Monitor Arm</b> NOTES: Includes a monitor arm for dual monitors. ⓘ No specification needed.	<b>HS1102</b>	63.0 ⓘ	3.2	<b>\$700</b>

### NOTES FOR HS1100, HS1101, HS1102:

- These products are designed to allow the user to transition from seating position to standing position throughout the workday.
- Gas-assist lever-operated mechanism with positive stop.
- Clamp mount compatible with worksurfaces depths of 20"-30". 20" is for systems only.
- Clamp requires 3.5" of clearance along back edge of worksurface.
- Black seamless worksurfaces.
- Silver powder coated metal components.
- Lowers below worksurface level on 24" and 30"D worksurfaces.
- All models contain a large primary worksurface and a smaller keyboard / mouse surface.
- Beveled edges for sleek appearance and comfort while typing.
- Monitor arms include height, width, and swivel adjustment.
- For additional information see page 906.

- Not for use under overhead storage, with flush mounted modesty panels, or worksurfaces thinner than 1".

- ⓘ Not recommended for use on mobile (castered) worksurfaces.

### MOUNTING AND COMPATIBILITY FOR HS1100, HS1101, HS1102:

- This product is intended to be installed on commercial-grade worksurfaces in good condition.
- Compatible with freestanding worksurfaces 24"-30"D or panel-supported worksurfaces 24"-30"D.
- Not for use on mobile worksurfaces.

#### Clamp Mount

Use when 3.5" minimum overhang is available

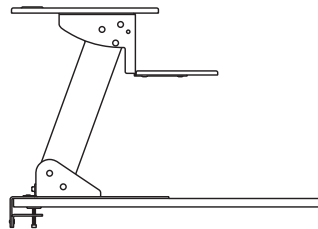

#### Screw Mount

Use when no overhang is available. Worksurface must be minimum 1" thick.

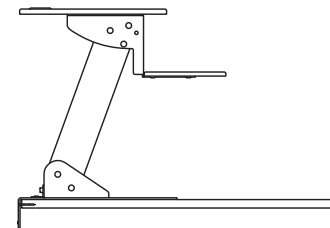

## HOW TO SPECIFY

### Select Model Number



HBXRISER.

### Select Finish

BLK Black  
WHIT White

BLK

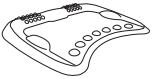
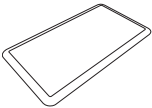
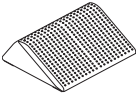

	DESCRIPTION	MODEL	SHIP WEIGHT	CUBE	LIST PRICE
	<b>Rectangle Wobble Board — Anti-Fatigue Mat</b> 18"D x 3"H x 22¼"W ⓘ Available in Black (T) finish ONLY. Recommended weight capacity not to exceed 250 pounds. <b>HON 5-Year Limited Warranty.</b> <b>SPECIFYING EXAMPLE: HVL981.T</b>	<b>HVL981</b>	10.0 Ⓔ	0.9	<b>\$220</b>
	<b>Round Wobble Board — Anti-Fatigue Mat</b> 18½"D x 2⅝"H x 18½"W ⓘ Available in Black (T) finish ONLY. Recommended weight capacity not to exceed 250 pounds. <b>HON 5-Year Limited Warranty.</b> <b>SPECIFYING EXAMPLE: HVL982.T</b>	<b>HVL982</b>	5.8 Ⓔ	0.6	<b>\$190</b>
	<b>Ergonomic Anti-Fatigue Mat</b> 25"D x 2¾"H x 29⅞"W ⓘ <b>AVAILABLE FEBRUARY 2018.</b> Available in Black ONLY. No specification needed. <b>SPECIFYING EXAMPLE: HBEAFM1</b>	<b>HBEAFM1</b>	7.0	1.4	<b>\$176</b>
	<b>Rectangle Anti-Fatigue Mat</b> 20"D x ¾"H x 36"W ⓘ <b>AVAILABLE FEBRUARY 2018.</b> Available in Black ONLY. No specification needed. <b>SPECIFYING EXAMPLE: HBAFM2036</b>	<b>HBAFM2036</b>	5.4	0.4	<b>\$80</b>
	<b>Footrest — Anti-Slip Cover</b> 13¾"D x 5½"H x 16"W ⓘ Available in Black (T) finish ONLY. Recommended weight capacity not to exceed 250 pounds. <b>HON 5-Year Limited Warranty.</b> <b>SPECIFYING EXAMPLE: HVL991.T</b>	<b>HVL991</b>	7.0 Ⓔ	0.9	<b>\$65</b>

## HOW TO SPECIFY

<p>Select Model Number</p> <p>H V L 9 8 1 . T</p>	<p>Select Finish</p> <p>T Black</p>
---	-------------------------------------

# MANAGE<sup>®</sup> SERIES



Manage<sup>®</sup> Desks shown with  
Convergence<sup>®</sup> Task Chairs.

## MANAGE

Inspired by the needs of small businesses, Manage makes it easy to, well . . . manage your workspace. Whether you're setting up a new office or expanding where you are, Manage is easy to order and install — and to reconfigure as your business needs grow and change. It's thoroughly functional, endlessly flexible, and ready to meet today's fast-paced business demands. Plus, the price is a perfect fit for small-business budgets.



## FEATURES

- Remarkable performance at an affordable price.
- Supports open plans, semi-private or private offices.
- Sturdy reinforced steel construction for strength and durability.
- Scratch-, spill- and stain-resistant laminate withstands heavy use.
- Precision metal-to-metal fasteners and wood dowels to provide easy assembly.
- Distinctive, custom-designed metal drawer handles.

# MANAGE<sup>®</sup> SERIES Laminate Desks Typicals

QTY	DESCRIPTION	MODEL	LIST PRICE	PRICE EXTENSION
1	<b>Worksurface</b> 60"W x 23½"D	HMNG60WKS	\$203	\$203
2	<b>Desk Leg (single)</b> 2¼"W x 23½"D x 28½"H	HMNGDLEG	\$86	\$172
1	<b>File Center, 2 drawer</b> 36"W x 16"D x 22"H	HMNG36FCD	\$550	\$550
1	<b>Stadium</b> 36"W x 21"D x 12½"D x 7½"H	HMNG36STDM	\$124	\$124
<b>TOTAL:</b>			<b>\$1,049</b>	

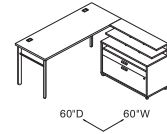

**L-STATION WITH STORAGE**  
**60"W x 60"D**

QTY	DESCRIPTION	MODEL	LIST PRICE	PRICE EXTENSION
1	<b>Worksurface</b> 72"W x 23½"D	HMNG72WKS	\$235	\$235
2	<b>Desk Leg (single)</b> 2¼"W x 23½"D x 28½"H	HMNGDLEG	\$86	\$172
1	<b>Pedestal, P/P/F</b> 15¼"W x 21½"D x 22"H	HMNG15PED	\$310	\$310
1	<b>File Center, 2 drawer</b> 30"W x 16"D x 22"H	HMNG30FCD	\$494	\$494
1	<b>File Center, open</b> 36"W x 16"D x 22"H	HMNG30FCO	\$310	\$310
<b>TOTAL:</b>			<b>\$1,521</b>	

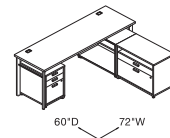

**L-STATION WITH STORAGE**  
**72"W x 60"D**

QTY	DESCRIPTION	MODEL	LIST PRICE	PRICE EXTENSION
1	<b>Worksurface</b> 60"W x 23½"D	HMNG60WKS	\$203	\$203
2	<b>Desk Leg (single)</b> 2¼"W x 23½"D x 28½"H	HMNGDLEG	\$86	\$172
1	<b>Pedestal, P/P/F</b> 15¼"W x 21½"D x 22"H	HMNG15PED	\$310	\$310
1	<b>Overhead</b> 36"W x 14½"D x 17¼"H	HMNG36OVRD	\$215	\$215
1	<b>File Center, 2 drawer</b> 36"W x 16"D x 22"H	HMNG36FCD	\$550	\$550
<b>TOTAL:</b>			<b>\$1,450</b>	

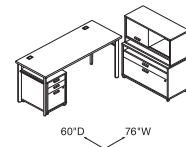

**L-STATION WITH PEDESTAL,  
STORAGE AND OVERHEAD**  
**76"W x 60"D**



# MANAGE® SERIES

## Laminate Desks Typicals

QTY	DESCRIPTION	MODEL	LIST PRICE	PRICE EXTENSION
1	<b>Worksurface</b> 60"W x 23½"D	HMNG60WKS	\$203	\$203
2	<b>Desk Leg (single)</b> 2¼"W x 23½"D x 28½"H	HMNGDLEG	\$86	\$172
1	<b>Pedestal, P/P/F</b> 15¼"W x 21½"D x 22"H	HMNG15PED	\$310	\$310
2	<b>File Center, 2 drawer</b> 30"W x 16"D x 22"H	HMNG30FCD	\$494	\$988
1	<b>Overhead</b> 60"W x 14½"D x 17¼"H	HMNG60OVRD	\$296	\$296
1	<b>Overhead Leg</b> 1¾"W x 14½"D x 16"H	HMNGOHLEG	\$108	\$108
<b>TOTAL:</b>			<b>\$2,077</b>	

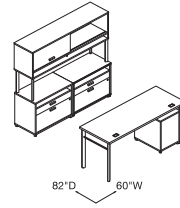

**DESK, CREDENZA WORKSTATION  
WITH OVERHEAD STORAGE**

**60"W x 82"D**

QTY	DESCRIPTION	MODEL	LIST PRICE	PRICE EXTENSION
1	<b>Worksurface</b> 72"W x 23½"D	HMNG72WKS	\$235	\$235
2	<b>Desk Leg (single)</b> 2¼"W x 23½"D x 28½"H	HMNGDLEG	\$86	\$172
1	<b>Pedestal, P/P/F</b> 15¼"W x 21½"D x 22"H	HMNG15PED	\$310	\$310
1	<b>File Center, 2 drawer</b> 30"W x 16"D x 22"H	HMNG30FCD	\$494	\$494
1	<b>File Center, open</b> 30"W x 16"D x 22"H	HMNG30FCO	\$310	\$310
1	<b>Overhead</b> 60"W x 14½"D x 17¼"H	HMNG60OVRD	\$296	\$296
1	<b>Overhead Leg</b> 1¾"W x 14½"D x 16"H	HMNGOHLEG	\$108	\$108
<b>TOTAL:</b>			<b>\$1,925</b>	

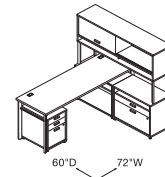

**L-STATION WITH STORAGE  
AND OVERHEAD**

**72"W x 60"D**

# MANAGE<sup>®</sup> SERIES Bundles Typical

Wheat  
**HMLDP6024W**

Chestnut  
**HMLDP6024C**

QTY	DESCRIPTION	MODEL	LIST PRICE	PRICE EXTENSION
1	Worksurface	HMNG60WKS	\$203	\$203
2	Desk Leg (single)	HMNGDLEG	\$86	\$172
1	Pedestal	HMNG15PED	\$310	\$310
<b>TOTAL:</b>			<b>\$685</b>	

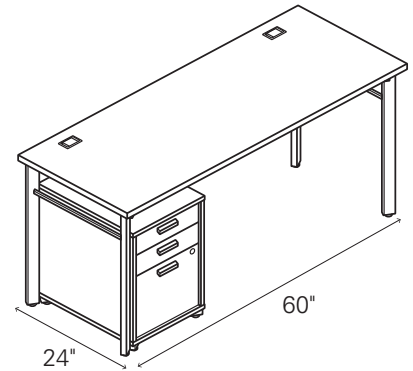
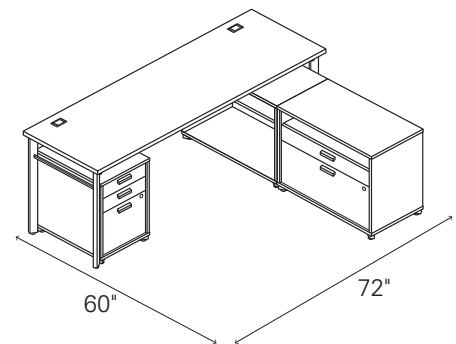

**TABLE DESK WITH PEDESTAL**

Wheat  
**HMLDPF7260W**

Chestnut  
**HMLDPF7260C**

QTY	DESCRIPTION	MODEL	LIST PRICE	PRICE EXTENSION
1	Worksurface	HMNG72WKS	\$235	\$235
2	Desk Leg (single)	HMNGDLEG	\$86	\$172
1	Pedestal	HMNG15PED	\$310	\$310
1	File Center	HMNG30FCD	\$494	\$494
1	File Center	HMNG30FCO	\$310	\$310
<b>TOTAL:</b>			<b>\$1,521</b>	



**L-STATION WITH STORAGE**

Wheat  
**HMLDF6060W**

Chestnut  
**HMLDF6060C**

QTY	DESCRIPTION	MODEL	LIST PRICE	PRICE EXTENSION
1	Worksurface	HMNG60WKS	\$203	\$203
2	Desk Leg (single)	HMNGDLEG	\$86	\$172
1	File Center	HMNG36FCD	\$550	\$550
1	Stadium	HMNG36STDM	\$124	\$124
<b>TOTAL:</b>			<b>\$1,049</b>	

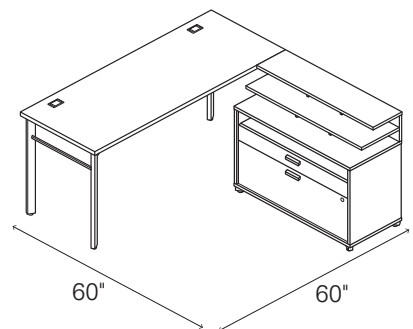

**L-STATION WITH STORAGE**

# MANAGE<sup>®</sup> SERIES

## Bundles Typicals

Wheat  
HMLDPFO7260W

Chestnut  
HMLDPFO7260C

QTY	DESCRIPTION	MODEL	LIST PRICE	PRICE EXTENSION
1	Worksurface	HMNG72WKS	\$235	\$235
2	Desk Leg (single)	HMNGDLEG	\$86	\$172
1	Pedestal	HMNG15PED	\$310	\$310
1	File Center	HMNG30FCD	\$494	\$494
1	File Center	HMNG30FCO	\$310	\$310
1	Overhead	HMNG60OVRD	\$296	\$296
1	Overhead Leg	HMNGOHLEG	\$108	\$108
<b>TOTAL:</b>			<b>\$1,925</b>	

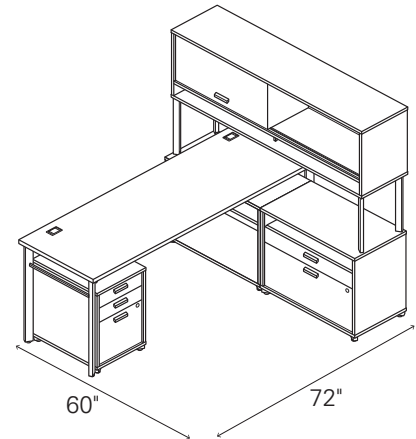

**L-STATION WITH STORAGE AND OVERHEAD**

Wheat  
HMLDPFO7660W

Chestnut  
HMLDPFO7660C

QTY	DESCRIPTION	MODEL	LIST PRICE	PRICE EXTENSION
1	Worksurface	HMNG60WKS	\$203	\$203
2	Desk Leg (single)	HMNGDLEG	\$86	\$172
1	Pedestal	HMNG15PED	\$310	\$310
1	Overhead	HMNG36OVRD	\$215	\$215
1	File Center	HMNG36FCD	\$550	\$550
<b>TOTAL:</b>			<b>\$1,450</b>	

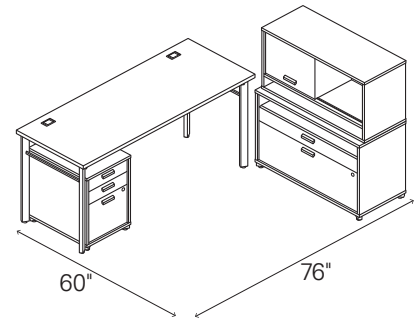

**L-STATION WITH PEDESTAL, STORAGE AND OVERHEAD**

Wheat  
HMLDPFO6082W

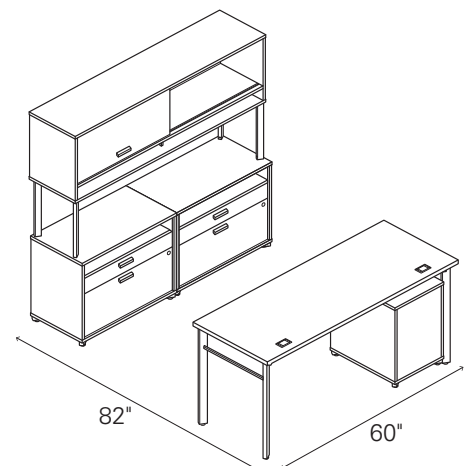

Chestnut  
HMLDPFO6082C

QTY	DESCRIPTION	MODEL	LIST PRICE	PRICE EXTENSION
1	Worksurface	HMNG60WKS	\$203	\$203
2	Desk Leg (single)	HMNGDLEG	\$86	\$172
1	Pedestal	HMNG15PED	\$310	\$310
2	File Center	HMNG30FCD	\$494	\$988
1	Overhead	HMNG60OVRD	\$296	\$296
1	Overhead Leg	HMNGOHLEG	\$108	\$108
<b>TOTAL:</b>			<b>\$2,077</b>	

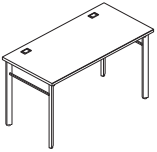

**DESK, CREDENZA WORKSTATION WITH OVERHEAD STORAGE**

# MANAGE<sup>®</sup> SERIES Laminate Desks Worksurfaces

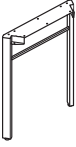
	DESCRIPTION	MODEL	SHIP WEIGHT	CUBE	LIST PRICE
 	<b>Table Desk</b> 60"W x 23½"D 48"W x 23½"D NOTES: Two cord management grommets in tops.	<b>HMNG60WKSL</b> <b>HMNG48WKSL</b>	78 59 <b>Ⓢ</b>	7.3 6.0	<b>\$361</b> <b>\$347</b>
	<b>Worksurface</b> 72"W x 23½"D 60"W x 23½"D NOTES: Two cord management grommets in tops. ⚠ Specify laminate only.	<b>HMNG72WKS</b> <b>HMNG60WKS</b>	57 47 <b>Ⓢ</b>	5.0 4.0	<b>\$235</b> <b>\$203</b>
	<b>Desk Leg</b> 2¼"W x 23½"D x 28½"H ⚠ Specify paint only. <b>SPECIFYING EXAMPLE: HMNGDLEG.A1</b>	<b>HMNGDLEG</b>	14 <b>Ⓢ</b>	2.0	<b>\$86</b>

**NOTES:**

- Non-handed desk design simplifies ordering and supports both left-handed and right-handed users.
- Worksurfaces offer 72"W or 60"W options.
- Two factory-installed steel beams reinforce the worksurface for strength and rigidity.
- 1" thick desk top provides a sturdy, durable worksurface.
- Durable, thermal-fused laminate is scratch- and spill-resistant.
- Desk legs have leveling glides to compensate for uneven floors.
- Two laminate color options – Wheat (WH) or Chestnut (C1).
- **HON 5-Year Limited Warranty.**









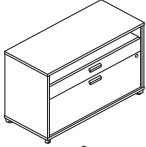
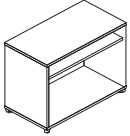

## HOW TO SPECIFY

<p><b>Select Model Number</b></p> <p>HMNG60WKSL .</p>	<p><b>Select Laminate</b></p> <p>C1 Chestnut                      WH Wheat                      Not specified for model HMNGDLEG</p> <p>C1 .</p>	<p><b>Select Paint Color</b></p> <p>A1 Ash                      Not specified for models HMNG72WKS and HMNG60WKS</p> <p>A1</p>
---	--	--

# MANAGE<sup>®</sup> SERIES

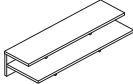
## Laminate Desks

OPEN MARKET

	DESCRIPTION	MODEL	SHIP WEIGHT	CUBE	LIST PRICE	
 	<b>File Center</b> 36"W x 16"D x 22"H, 2-drawer 30"W x 16"D x 22"H, 2-drawer 30"W x 16"D x 22"H, Open NOTES: File centers with 2-drawers feature inner lock mechanism.	<b>HMNG36FCD</b> <b>HMNG30FCD</b> <b>HMNG30FCO</b> 	92  80  50 	11.0 10.0 3.0	<b>\$550</b> <b>\$494</b> <b>\$310</b>	
		<b>Pedestals</b> 15 <sup>3</sup> / <sub>4</sub> "W x 21"D x 22"H, Pencil/Pencil/File NOTES: Pedestal includes two pencil drawers and a file drawer.	<b>HMNG15PED</b>	69 	7.0	<b>\$310</b>
	 	<b>Stadium</b> 36"W x 12 <sup>1</sup> / <sub>2</sub> "D x 7 <sup>1</sup> / <sub>2</sub> "H 30"W x 12 <sup>1</sup> / <sub>2</sub> "D x 7 <sup>1</sup> / <sub>2</sub> "H	<b>HMNG36STDM</b> <b>HMNG30STDM</b>	21  18 	1.0 1.0	<b>\$124</b> <b>\$113</b>

**NOTES:**

- Durable, thermal-fused laminate is scratch- and spill-resistant.
- File Centers with drawers and Pedestals ship fully assembled.
- Ball-bearing suspensions on drawers provide full extension and smooth, quiet access to documents.
- Choose from 36"W or 30"W File Centers with two drawers and a top opening or 30"W with one shelf.
- Pedestals feature two pencil drawers and one file drawer for a variety of storage needs.
- The Stadium model sits atop a worksurface or file center offering layered storage options.
- **HON 5-Year Limited Warranty.**

**HOW TO SPECIFY**

<b>Select Model Number</b> HMNG36FCD	<b>Select Laminate</b> C1 Chestnut WH Wheat C1	<b>Select Paint Color</b> A1 Ash A1
---	---	---

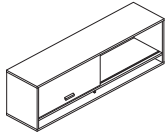

**DESCRIPTION**

**Overhead Storage**

60"W x 14½"D x 17¾"H  
36"W x 14½"D x 17¾"H

NOTES: 36" Overhead Storage can be used on top of the 36" File Center to create a low profile storage solution. Overheads feature one non-locking sliding door.

Specify: Model.Laminate.Paint

**SPECIFYING EXAMPLE: HMNG60OVRD.C1.A1**

**MODEL**

**SHIP WEIGHT**

**CUBE**

**LIST PRICE**

**HMNG60OVRD**  
**HMNG36OVRD**

80 **\$**  
60 **\$**

5.0  
2.0

**\$296**  
**\$215**



**Overhead Legs**

1¾"W x 14½"D x 16"H

NOTES: Overhead legs ship 2/carton.  
Specify paint only.

**SPECIFYING EXAMPLE: HMNGOHLEG.A1**

**HMNGOHLEG**

12 **\$**

1.0

**\$108**



**Mesh Modesty Panels**

72"W  
60"W  
48"W

**!** Available in Black Mesh fabric only, no need to specify.

**HBMP72MOD**  
**HBMP60MOD**  
**HBMP48MOD**

4 **\$**  
3 **\$**  
2 **\$**

0.3  
0.3  
0.2

**\$140**  
**\$124**  
**\$113**

**NOTES:**

- Durable, thermal-fused laminate is scratch- and spill-resistant.
- **HON 5-Year Limited Warranty.**

**HOW TO SPECIFY**

<p><b>Select Model Number</b></p> <p>HMNG60OVRD .</p>	<p><b>Select Laminate</b></p> <p>C1 Chestnut WH Wheat</p> <p>C1 .</p>	<p><b>Select Paint Color</b></p> <p>A1 Ash</p> <p>A1</p>
---	---	--

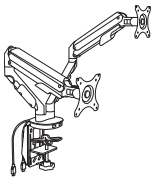
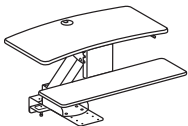
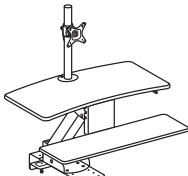
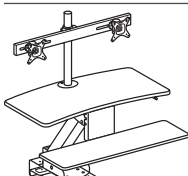
	DESCRIPTION	MODEL	SHIP WEIGHT	CUBE	LIST PRICE
	<b>Coordinate™ Portable Desktop Riser</b> 31"D x 4½"-16½"H x 35"W NOTES: Available in Black (BLK) or White (WHT) finish. Desktop riser dimensions (without keyboard tray): 22"D x 4½"-16½"H x 35"W. Keyboard tray dimensions: 9"D x 30"W. Max loading capacity is 33 lbs for the desktop riser surface and 4 lbs for the keyboard tray. Easily transition from seated to standing positions throughout the workday. Sits atop an existing desk to create sit-to-stand functionality by raising the computer. Includes keyboard tray and surface for computer monitors. <b>HON 5-Year Limited Warranty.</b> ⓘ Not intended for use on mobile workstations.	<b>HBXRISER</b>	54.0	4.1	<b>\$500</b>
	<b>Dual Monitor Arm with 2 USB Ports</b> NOTES: <b>AVAILABLE FEBRUARY 2018.</b> Easy adjustment. Height adjusts to 17" tall. Monitor tilt and swivel capability. Enclosed cable management. Grommet or desktop mounting. Clean appearance. For additional information see page 899. ⓘ No specification needed.	<b>HBDMAUSB</b>	41.9	2.6	<b>\$360</b>
	<b>Coordinate™ Mounted Desktop Riser</b> NOTES: Does not include a monitor arm and is suitable for laptops and/or monitors on their original stands. ⓘ No specification needed.	<b>HS1100</b>	60.0 ⓘ	3.2	<b>\$525</b>
	<b>Coordinate™ Mounted Desktop Riser with Single Monitor Arm</b> NOTES: Includes a monitor arm for a single monitor. ⓘ No specification needed.	<b>HS1101</b>	62.0 ⓘ	3.2	<b>\$615</b>
	<b>Coordinate™ Mounted Desktop Riser with Dual Monitor Arm</b> NOTES: Includes a monitor arm for dual monitors. ⓘ No specification needed.	<b>HS1102</b>	63.0 ⓘ	3.2	<b>\$700</b>

#### NOTES FOR HS1100, HS1101, HS1102:

- These products are designed to allow the user to transition from seating position to standing position throughout the workday.
- Gas-assist lever-operated mechanism with positive stop.
- Clamp mount compatible with worksurfaces depths of 20"-30". 20" is for systems only.
- Clamp requires 3.5" of clearance along back edge of worksurface.
- Black seamless worksurfaces.
- Silver powder coated metal components.
- Lowers below worksurface level on 24" and 30"D worksurfaces.
- All models contain a large primary worksurface and a smaller keyboard / mouse surface.
- Beveled edges for sleek appearance and comfort while typing.
- Monitor arms include height, width, and swivel adjustment.
- For additional information see page 906.

- Not for use under overhead storage, with flush mounted modesty panels, or worksurfaces thinner than 1".

- ⓘ Not recommended for use on mobile (castered) worksurfaces.

#### MOUNTING AND COMPATIBILITY FOR HS1100, HS1101, HS1102:

- This product is intended to be installed on commercial-grade worksurfaces in good condition.
- Compatible with freestanding worksurfaces 24"-30"D or panel-supported worksurfaces 24"-30"D.
- Not for use on mobile worksurfaces.

#### Clamp Mount

Use when 3.5" minimum overhang is available

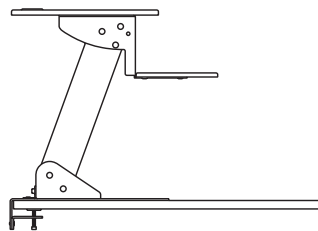

#### Screw Mount

Use when no overhang is available. Worksurface must be minimum 1" thick.

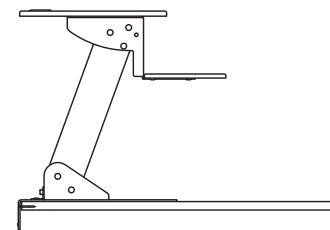

## HOW TO SPECIFY

#### Select Model Number



HBXRISER.

#### Select Finish

BLK Black  
WHIT White

BLK

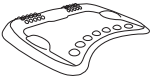
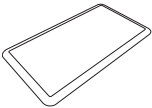
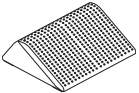

	DESCRIPTION	MODEL	SHIP WEIGHT	CUBE	LIST PRICE
	<b>Rectangle Wobble Board — Anti-Fatigue Mat</b> 18"D x 3"H x 22¼"W ⓘ Available in Black (T) finish ONLY. Recommended weight capacity not to exceed 250 pounds. <b>HON 5-Year Limited Warranty.</b> <b>SPECIFYING EXAMPLE: HVL981.T</b>	<b>HVL981</b>	10.0 Ⓔ	0.9	<b>\$220</b>
	<b>Round Wobble Board — Anti-Fatigue Mat</b> 18½"D x 2⅝"H x 18½"W ⓘ Available in Black (T) finish ONLY. Recommended weight capacity not to exceed 250 pounds. <b>HON 5-Year Limited Warranty.</b> <b>SPECIFYING EXAMPLE: HVL982.T</b>	<b>HVL982</b>	5.8 Ⓔ	0.6	<b>\$190</b>
	<b>Ergonomic Anti-Fatigue Mat</b> 25"D x 2¾"H x 29⅞"W ⓘ <b>AVAILABLE FEBRUARY 2018.</b> Available in Black ONLY. No specification needed. <b>SPECIFYING EXAMPLE: HBEAFM1</b>	<b>HBEAFM1</b>	7.0	1.4	<b>\$176</b>
	<b>Rectangle Anti-Fatigue Mat</b> 20"D x ¾"H x 36"W ⓘ <b>AVAILABLE FEBRUARY 2018.</b> Available in Black ONLY. No specification needed. <b>SPECIFYING EXAMPLE: HBAFM2036</b>	<b>HBAFM2036</b>	5.4	0.4	<b>\$80</b>
	<b>Footrest — Anti-Slip Cover</b> 13¾"D x 5½"H x 16"W ⓘ Available in Black (T) finish ONLY. Recommended weight capacity not to exceed 250 pounds. <b>HON 5-Year Limited Warranty.</b> <b>SPECIFYING EXAMPLE: HVL991.T</b>	<b>HVL991</b>	7.0 Ⓔ	0.9	<b>\$65</b>

## HOW TO SPECIFY

<p>Select Model Number</p> <p>H V L 9 8 1 . T</p>	<p>Select Finish</p> <p>T Black</p>
---	-------------------------------------



# NOTES



Valido® shown with Preside® Conference Table, HON® Occasional Tables, Flock® and Ignition® seating.

## VALIDO®

Valido knows how to make them. Impeccable design. Quality craftsmanship. A tailored, signature style that lasts. With precision-machined edges and more than 100 different surface combinations, Valido lets you create a custom-built look with an executive edge. And thanks to a variety of flexible component options — plus high-quality laminate that resists scratches, stains, spills and wear — Valido is the very definition of form meeting function.



## FEATURES

- Formal 1½-thick worksurfaces are finished with an elegant, ribbon-edge detail.
- Multiple storage options let you create spaces that work the way you do.
- Valido components are designed to fit, form and grow into every area and any space.
- Metal-to-metal fastening system for precise fit and unsurpassed durability.
- Available in durable mix-and-match laminates, including wood-grain, solid, and pattern colors.
- Four decorative handle options to choose from.

# VALIDO® ORDERING INFORMATION

## LAMINATE FINISHES AVAILABILITY — VALIDO®

L1 LAMINATES		CODES
Woodgrain	◆ Bourbon Cherry	HH
	◆ Cognac	COGNCOGN
	◆ Harvest	CC
	◆ Mahogany	NN
	◆ Mocha	MOCHMOCH
	◆ Natural Maple	DD
	◆ Pinnacle	PINCPINC
	◆ Shaker Cherry	FF
Solid	◆ Black	PP
	◆ Brilliant White	WHITWHIT
	◆ Charcoal	SS
Patterned Top	◆ Grey Tigris	L6(*)
	◆ Sheer Mesh	A5(*)
	◆ Silver Mesh	B9(*)
	◆ Canyon Zephyr	K9(*)
	◆ Desert Zephyr	K8(*)

Must specify both top and edgeband options for worksurfaces. First laminate designator is for the worksurface color, the second is for the edge color. SPECIFYING EXAMPLE: H11592.NN

(\*) Patterned top laminates are available with the following base/edgebanding laminate selection: C, COGN, D, F, H, MOCH, N, P, PINC, S, or WHIT. Edgebanding will match base laminate selected.

SPECIFYING EXAMPLE: H11592.L6N

The following Valido products are not available as two-tone and require only one color code:

- Modular pedestals — box/file, box/box/file, file/file, lateral file, multi file, and cabinet.

◆◆◆ For lead time information see page 21.

### Edge Option:



Ribbon Edge "A"

### Handle Options:



**Sweep Designator**  
Black  
Satin Nickel      A  
C

4 5/8"W

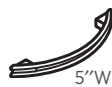

**Crescent Designator**  
Black  
Satin Nickel      D  
F

5"W

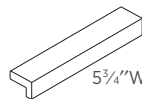

**Linear**  
Black  
Matte Chrome      G  
J

5 3/4"W

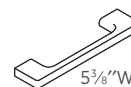

**Arch**  
Black  
Matte Chrome      K  
M

5 3/8"W

### Patterned Top

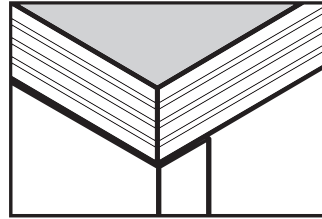

### Edgeband Around Top / Laminate Base

- Edgebanding on patterned laminates matches the laminate base selected.
- LAMINATE DESKS  
SPECIFY: Model Number.  
Laminate  
EXAMPLE: H11596.NN
- WORKSURFACES  
SPECIFY: Model Number.  
Top Laminate  
Edgeband
- All specifications in this publication are based on the latest product information available at the time of print.

! Tops with a patterned color are not available with a matching edgeband.

## LAMINATE FINISHES AVAILABILITY – VALIDO®

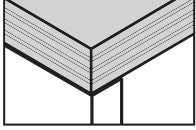
Two-Tone Laminate Top / Edgebanding	
	
L1 LAMINATES	CODES
◆ Black/Brilliant White	PWHIT
◆ Black/Charcoal	PS
◆ Bourbon Cherry/Black	HP
◆ Bourbon Cherry/Brilliant White	HWHIT
◆ Bourbon Cherry/Charcoal	HS
◆ Brilliant White/Black	WHITP
◆ Brilliant White/Bourbon Cherry	WHITH
◆ Brilliant White/Charcoal	WHITS
◆ Brilliant White/Cognac	WHITCOGN
◆ Brilliant White/Harvest	WHITC
◆ Brilliant White/Mahogany	WHITN
◆ Brilliant White/Mocha	WHITMOCH
◆ Brilliant White/Natural Maple	WHITD
◆ Brilliant White/Pinnacle	WHITPINC
◆ Brilliant White/Shaker Cherry	WHITF
◆ Charcoal/Black	SP
◆ Charcoal/Brilliant White	SWHIT
◆ Cognac/Black	COGNP
◆ Cognac/Brilliant White	COGNWHIT
◆ Cognac/Charcoal	COGNS
◆ Harvest/Black	CP
◆ Harvest/Brilliant White	CWHIT
◆ Harvest/Charcoal	CS
◆ Mahogany/Black	NP
◆ Mahogany/Brilliant White	NWHIT
◆ Mahogany/Charcoal	NS
◆ Mocha/Black	MOCHP
◆ Mocha/Brilliant White	MOCHWHIT
◆ Mocha/Charcoal	MOCHS
◆ Natural Maple/Black	DP
◆ Natural Maple/Brilliant White	DWHIT
◆ Natural Maple/Charcoal	DS
◆ Pinnacle/Black	PINCP
◆ Pinnacle/Brilliant White	PINCWHIT
◆ Pinnacle/Charcoal	PINCS
◆ Shaker Cherry/Black	FP
◆ Shaker Cherry/Brilliant White	FWHIT
◆ Shaker Cherry/Charcoal	FS

### Laminate Base

Two-tone laminates: Top and edgebanding are the same, base is different laminate color.

- Edgebanding on two-tone laminates matches top, base is a different laminate color.
- A complete selection of Conference Room and Occasional Tables is shown under Tables on pages 764-765, 767-768, 771, and 790-812.
- LAMINATE DESKS  
SPECIFY: Model Number.  
Laminate  
EXAMPLE: H11596.HP
- **All specifications in this publication are based on the latest product information available at the time of print.**

◆◆◆ For lead time information see page 21.



Components used are listed on pages 213-235. Order components individually. Other configurations are possible, including various sizes of some components.

QTY	DESCRIPTION	MODEL	LIST PRICE	PRICE EXTENSION
1	<b>Double Pedestal Desk - 2/2</b> 72"W x 36"D x 29½"H	H11593	\$1,613	\$1,613
1	<b>Credenza with Kneespace - 2/2</b> 72"W x 24"D x 29½"H	H11543	\$1,496	\$1,496
1	<b>Stack-on Storage</b> 72"W x 14⅝"D x 37½"H	H11534	\$1,160	\$1,160
2	<b>Vertical Paper Manager</b>	HLVPM1	\$298	\$596
<b>TOTAL:</b>				<b>\$4,865</b>

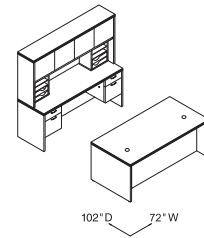

**DESK/CRENZEA**  
**72"W x 102"D**

QTY	DESCRIPTION	MODEL	LIST PRICE	PRICE EXTENSION
1	<b>Double Pedestal Bow Top Desk - 2/2</b> 72"W x 36"D x 29½"H	H11595	\$1,762	\$1,762
1	<b>Credenza with Kneespace - 2/2</b> 72"W x 24"D x 29½"H	H115900	\$1,858	\$1,858
1	<b>Stack-on Storage</b> 72"W x 14⅝"D x 37½"H	H11534	\$1,160	\$1,160
1	<b>Personal Wardrobe/Storage Cabinet, Left</b> 18"W x 24"D x 67"H	H115296L	\$1,598	\$1,598
1	<b>Storage/File Cabinet, Right</b> 18"W x 24"D x 67"H	H115297R	\$1,849	\$1,849
<b>TOTAL:</b>				<b>\$8,227</b>

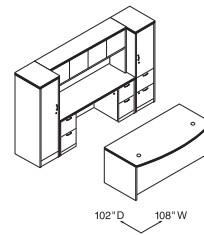

**DESK/CRENZEA**  
**108"W x 102"D**

QTY	DESCRIPTION	MODEL	LIST PRICE	PRICE EXTENSION
1	<b>Single Pedestal Desk, Left - B/F</b> 72"W x 36"D x 29½"H	H11586L	\$1,371	\$1,371
1	<b>Return, Right - B/F</b> 48"W x 24"D x 29½"H	H11515R	\$998	\$998
1	<b>Stack-on Storage</b> 48"W x 14⅝"D x 37½"H	H115323	\$943	\$943
1	<b>Square End Cap Bookshelf</b> 24"W x 24"D x 29½"H	H115525R	\$675	\$675
<b>TOTAL:</b>				<b>\$3,987</b>

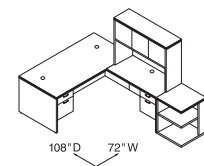

**"L" WORKSTATION**  
**72"W x 108"D**

QTY	DESCRIPTION	MODEL	LIST PRICE	PRICE EXTENSION
1	<b>Single Pedestal Desk, Left - B/F</b> 66"W x 30"D x 29½"H	H11584L	\$1,282	\$1,282
1	<b>Return, Right - B/F</b> 48"W x 24"D x 29½"H	H11515R	\$998	\$998
1	<b>Stack-on Storage</b> 78"W x 14⅝"D x 37½"H	H115327	\$1,292	\$1,292
1	<b>Vertical Paper Manager</b>	HLVPM1	\$298	\$298
1	<b>End Cap Bookshelf</b> 24"W x 24"D x 29½"H	H115520	\$685	\$685
1	<b>End Cap Bookshelf</b> 15"W x 15"D x 37½"H	H115523	\$606	\$606
<b>TOTAL:</b>				<b>\$5,161</b>

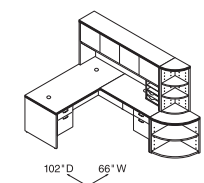

**"L" WORKSTATION**  
**66"W x 102"D**



Icon Legend on page 21

Components used are listed on pages 213-235. Order components individually. Other configurations are possible, including various sizes of some components.

QTY	DESCRIPTION	MODEL	LIST PRICE	PRICE EXTENSION
1	<b>Single Pedestal Desk, Right - B/F</b> 72"W x 36"D x 29½"H	H11585R	\$1,371	\$1,371
1	<b>Bridge</b> 47"W x 24"D x 29½"H	H11570	\$453	\$453
1	<b>Credenza with 36" Lateral, Left</b> 72"W x 24"D x 29½"H	H11548L	\$1,604	\$1,604
1	<b>Stack-on Storage</b> 72"W x 14⅝"D x 37½"H	H11534	\$1,160	\$1,160
1	<b>Storage Cabinet/Lateral File</b> 36"W x 24"D x 67"H	H115293	\$2,397	\$2,397
<b>TOTAL:</b>			<b>\$6,985</b>	

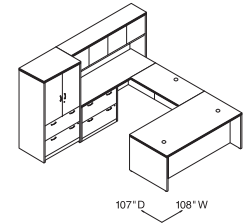

**"U" WORKSTATION**  
108"W x 107"D

QTY	DESCRIPTION	MODEL	LIST PRICE	PRICE EXTENSION
1	<b>Single Full Pedestal Bow Front Desk</b> 72"W x 36"D x 29½"H	H115893R	\$1,923	\$1,923
1	<b>Bridge</b> 42"W x 24"D x 29½"H	H11560	\$434	\$434
1	<b>Left Single Full Pedestal Credenza</b> 72"W x 24"D x 29½"H	H115904L	\$1,529	\$1,529
1	<b>Stack-on Storage</b> 72"W x 14⅝"D x 37½"H	H11534	\$1,160	\$1,160
1	<b>Vertical Paper Manager</b>	HLVPM1	\$298	\$298
1	<b>Personal Wardrobe/Storage Cabinet</b> 36"W x 24"D x 67"H	H11530	\$2,341	\$2,341
<b>TOTAL:</b>			<b>\$7,685</b>	

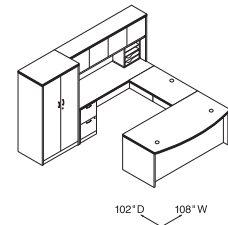

**"U" WORKSTATION**  
108"W x 102"D

QTY	DESCRIPTION	MODEL	LIST PRICE	PRICE EXTENSION
1	<b>Single Pedestal Bow Front Desk, Right - B/F</b> 72"W x 36"D x 29½"H	H11587R	\$1,552	\$1,552
1	<b>Bridge</b> 36"W x 24"D x 29½"H	H115599	\$434	\$434
1	<b>36" Corner Unit</b>	H115811	\$810	\$810
1	<b>Return, Left</b>	H11512L	\$986	\$986
1	<b>Stack-on Storage</b> 78"W x 14⅝"D x 37½"H	H115327	\$1,292	\$1,292
1	<b>Vertical Paper Manager</b>	HLVPM1	\$298	\$298
1	<b>Personal Storage Tower</b> 24"W x 24"D x 67"H	H115301R	\$2,341	\$2,341
<b>TOTAL:</b>			<b>\$7,713</b>	

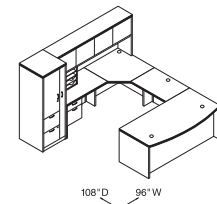

**"U" WORKSTATION**  
102"W x 108"D

QTY	DESCRIPTION	MODEL	LIST PRICE	PRICE EXTENSION
1	<b>Extended Corner Unit, Left</b> 24"D x 72"W x 36"D x 24"W x 29½"H	H115816L	\$1,176	\$1,176
1	<b>Box/Box/File Mobile Pedestal</b> 15⅝"W x 22¾"D x 28"H	H115102	\$844	\$844
1	<b>Stack-on Storage</b> 72"W x 14⅝"D x 37½"H	H11534	\$1,160	\$1,160
1	<b>Vertical Paper Manager</b>	HLVPM1	\$298	\$298
1	<b>Return Shell (with Full Modesty Panel)</b> 48"W x 24"D x 29½"H	H11561	\$618	\$618
1	<b>File/File Mobile Pedestal</b> 15⅝"W x 22¾"D x 28"H	H115104	\$844	\$844
<b>TOTAL:</b>			<b>\$4,940</b>	

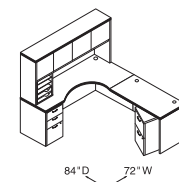

**MODULAR "L" WORKSTATION**  
72"W x 84"D



Components used are listed on pages 213-235. Order components individually. Other configurations are possible, including various sizes of some components.

QTY	DESCRIPTION	MODEL	LIST PRICE	PRICE EXTENSION
1	<b>Jetty Peninsula, Left</b> 72"W x 42"/30"D x 29½"H	H115202L	\$1,253	\$1,253
1	<b>File/File Mobile Pedestal</b> 15⅝"W x 22¾"D x 28"H	H115104	\$844	\$844
1	<b>Return Shell</b> 72"W x 24"D x 29½"H	H115686	\$808	\$808
1	<b>Multi File Pedestal</b> 36"W x 20"D x 28"H	H11505	\$1,263	\$1,263
2	<b>Wall Mounted Storage Cabinet</b> 42"W x 14⅝"D x 18⅞"H	H115382	\$888	\$1,776
1	<b>Wall Mounted Storage Cabinet</b> 30"W x 14⅝"D x 18⅞"H	H115380	\$784	\$784
1	<b>End Cap Bookshelf</b> 24"W x 24"D x 29½"H	H115520	\$685	\$685
<b>TOTAL:</b>			<b>\$7,413</b>	

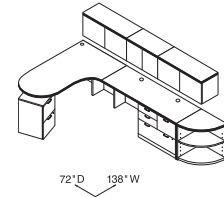

**MODULAR "L" WORKSTATION**  
**138" W x 72" D**

QTY	DESCRIPTION	MODEL	LIST PRICE	PRICE EXTENSION
1	<b>Storage/File Cabinet, Left</b> 18"W x 24"D x 67"H	H115298L	\$1,849	\$1,849
1	<b>Return Shell</b> 72"W x 24"D x 29½"H	H115686	\$808	\$808
1	<b>File/File Modular Pedestal</b> 15⅝"W x 22¾"D x 28"H	H11504	\$689	\$689
1	<b>Mobile Printer/Fax Cart</b> 20"W x 19⅞"D x 14⅞"H	H105679	\$397	\$397
1	<b>Stack-on Storage</b> 72"W x 14⅝"D x 37½"H	H11534	\$1,160	\$1,160
1	<b>Vertical Paper Manager</b>	HLVPM1	\$298	\$298
1	<b>36" Corner Unit</b>	H115811	\$810	\$810
1	<b>Stack-on Storage</b> 36"W x 14⅝"D x 37½"H	H115321	\$777	\$777
1	<b>Return Shell</b> 60"W x 24"D x 29½"H	H115684	\$755	\$755
1	<b>Multi File Pedestal</b> 36"W x 20"D x 28"H	H11505	\$1,263	\$1,263
<b>TOTAL:</b>			<b>\$8,806</b>	

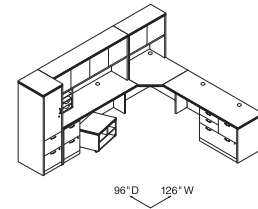

**MODULAR "L" CORNER WORKSTATION**  
**126" W x 96" D**

QTY	DESCRIPTION	MODEL	LIST PRICE	PRICE EXTENSION
1	<b>Boomerang Peninsula, Left</b> 72"W x 42"/30"D x 29½"H	H115204L	\$1,253	\$1,253
1	<b>Box/Box/File Mobile Pedestal</b> 15⅝"W x 22¾"D x 28"H	H115102	\$844	\$844
1	<b>Bridge</b> 30"W x 24"D x 29½"H	H115598	\$434	\$434
1	<b>Extended Corner Unit, Right</b> 24"W x 36"D x 72"W x 24"D x 29½"H	H115815R	\$1,176	\$1,176
1	<b>File/File Modular Pedestal</b> 15⅝"W x 22¾"D x 28"H	H11504	\$689	\$689
1	<b>Stack-on Storage</b> 72"W x 14⅝"D x 37½"H	H11534	\$1,160	\$1,160
1	<b>Storage/File Cabinet, Right</b> 18"W x 24"D x 67"H	H115297R	\$1,849	\$1,849
1	<b>End Cap Bookshelf</b> 24"W x 24"D x 29½"H	H115524	\$1,090	\$1,090
<b>TOTAL:</b>			<b>\$8,495</b>	

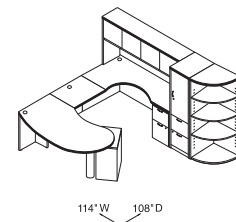

**MODULAR "U" WORKSTATION**  
**114" W x 108" D**



Icon Legend on page 21

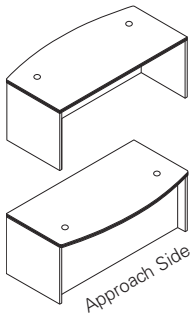

Model H11596 shown

**DESCRIPTION**

**Desk Shell (with Full Modesty Panel)**

72"W x 36"D x 29½"H, Bow Top (end panels 30"D)
72"W x 36"D x 29½"H, Rectangle Top
72"W x 30"D x 29½"H, Rectangle Top
66"W x 30"D x 29½"H, Rectangle Top
60"W x 30"D x 29½"H, Rectangle Top
48"W x 30"D x 29½"H, Rectangle Top (1 grommet)

INSIDE DIMENSIONS	FULL WIDTH OVERHANG	MODEL	SHIP WEIGHT	SHIP CUBE	LIST PRICE
69½"W x 24⅝"D	10½"	<b>H11596</b>	218	5.8	<b>\$959</b>
69½"W x 24⅝"D	10½"	<b>H11594</b>	239	5.8	<b>\$919</b>
69½"W x 24⅝"D	4½"	<b>H11592</b>	206	6.6	<b>\$857</b>
63½"W x 24⅝"D	4½"	<b>H11579</b>	194	4.5	<b>\$808</b>
57½"W x 24⅝"D	4½"	<b>H11578</b>	182	4.1	<b>\$774</b>
45½"W x 24⅝"D	4½"	<b>H11598</b>	154	4.0	<b>\$731</b>

NOTES: See page 233 for optional center drawers.

**NOTES:**

- Non-handed desk, credenza, and return shells, combined with a variety of under-the-worksurface storage solutions, maximize office layout flexibility. Shells and pedestals can be reconfigured quickly and easily when user preferences or space needs change.
- Tops are abrasion- and stain-resistant laminate over extra-thick 1½" solid core high-performance particleboard; resists warping.
- "Ribbon" edge profile; shape is on all four sides.
- Full height modesty panels.
- Cord management grommets, for routing and hiding wires and cables, are located in the tops of desk and return shells.
- 3" round worksurface grommet can be replaced with optional Power Hub (model HGRMTAC) or Power/USB Hub (model HGRMTUSB2) to bring the ease of plug-and-play to the desktop. See page 237.
- Credenza shells have a cord pass-through grommet in the top center of the modesty panel.
- The narrow design of the kneespace clearance end panel kits replace full end panels to provide added kneespace.
- Adjustable hex leveling glides allow floor-standing furniture to be easily leveled; glides have ¼" adjustable range.
- For conference table options, see the Preside® table tops and bases on pages 846-851. Order edge option "K".
- See pages 216-217 for modular storage components.

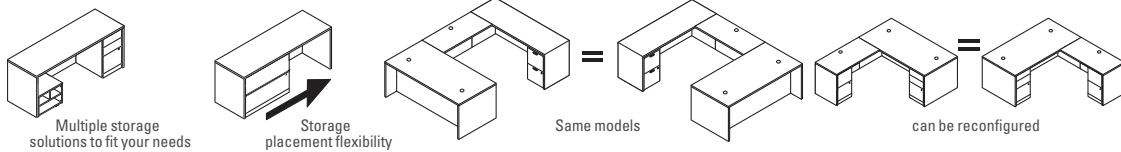

**HOW TO SPECIFY**

<p><b>Select Model Number</b></p> <p>H 1 1 5 9 6 .</p>	<p><b>Select Edge Profile</b></p> <p>See page 208</p> <p>A .</p>	<p><b>Select Laminate</b></p> <p>See pages 208-209</p> <p>NN</p>
--	--	--



# VALIDO® Modular Credenzas

GSA SIN 711-2



Icon Legend on page 21

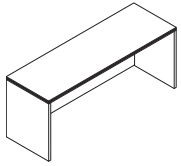

Model H11541 shown

**DESCRIPTION****24"D Credenza Shell (with Full Modesty Panel)**

72"W x 24"D x 29½"H  
66"W x 24"D x 29½"H  
60"W x 24"D x 29½"H  
48"W x 24"D x 29½"H  
42¼"W x 24"D x 29½"H

**INSIDE DIMENSIONS**

69½"W x 22¾"D  
63½"W x 22¾"D  
57½"W x 22¾"D  
45½"W x 22¾"D  
39¾"W x 22¾"D

**MODEL**

**H11541**  
**H11542**  
**H11564**  
**H115692**  
**H115691**

**SHIP WEIGHT**

169  
159  
148  
135  
118

**CUBE**

4.5  
4.2  
3.8  
2.8  
3.4

**LIST PRICE**

**\$808**  
**\$786**  
**\$755**  
**\$710**  
**\$675**

NOTES: Cord pass-through grommet in top center of modesty panel. See pages 225-226 for optional stack-on storage.

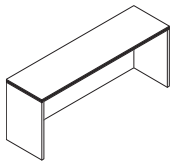
**20"D Credenza Shell (with Full Modesty Panel)**

72"W x 20"D x 29½"H  
66"W x 20"D x 29½"H  
60"W x 20"D x 29½"H

69½"W x 18¾"D  
66"W x 20"D x 29½"H  
57½"W x 18¾"D

**H115581**  
**H115582**  
**H115583**

154  
145  
135

5.3  
4.8  
4.4

**\$765**  
**\$742**  
**\$715**

NOTES: Cord pass-through grommet in top center of modesty panel. See pages 225-226 for optional stack-on storage.

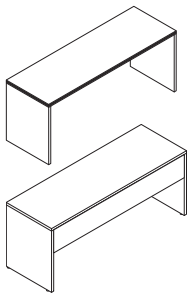
**24"D Credenza Shell (with 10" Modesty Panel)**

72"W x 24"D x 29½"H  
66"W x 24"D x 29½"H  
60"W x 24"D x 29½"H  
48"W x 24"D x 29½"H  
42¼"W x 24"D x 29½"H

69½"W x 22¾"D  
63½"W x 22¾"D  
57½"W x 22¾"D  
45½"W x 22¾"D  
39¾"W x 22¾"D

**H11541X**   
**H11542X**   
**H11564X**   
**H115692X**   
**H115691X**

162  
124  
120  
107  
98

5.0  
4.0  
4.0  
4.0  
4.0

**\$808**  
**\$786**  
**\$755**  
**\$710**  
**\$675**

**20"D Credenza Shell (with 10" Modesty Panel)**

72"W x 20"D x 29½"H  
66"W x 20"D x 29½"H  
60"W x 20"D x 29½"H

69½"W x 18¾"D  
63½"W x 18¾"D  
57½"W x 18¾"D

**H115581X**  
**H115582X**  
**H115583X**

124  
117  
110

4.6  
4.2  
3.8

**\$765**  
**\$742**  
**\$715**

NOTES: Makes reaching wall electrical outlets quick and easy. Provides more than 18" of clearance. See pages 225-226 for optional stack-on storage.



Not available in two-tone laminate

**Kneespace Clearance End Panel Kits (field installable)**

1⅞"W x 11¼"D x 28⅞"H

**H105098**

13

0.9

**\$198**

For use at either end of Valido, 10500 or 10700 Series™ 24"D Credenza Shells (with full or 10" modesty panel) or non-pedestal end of single pedestal credenzas or credenzas with lateral files.

1⅞"W x 17¼"D x 28⅞"H

**H105099**

11

0.8

**\$207**

For use at either end of Valido, 10500 or 10700 Series™ 30"D Desk Shells or non-pedestal end of 30"D single pedestal desks.

Kits include: (1) support panel; European fastening hardware; flat connector bracket; joint connector bolts with sleeve nuts (for ganging credenza to adjacent worksurface); and adjustable leveling glides. Allows conversion of units currently in the field.

NOTES: Can be used to connect up to three 24"D credenzas or 30"D desks in line (requires 4 kits).

Not designed to be used freestanding. Not designed to be used with returns, 36"D desks or desk shells.

**SPECIFYING EXAMPLE: H105098.N****NOTES:**

- Non-handed desk, credenza, and return shells, combined with a variety of under-the-worksurface storage solutions, maximize office layout flexibility. Shells and pedestals can be reconfigured quickly and easily when user preferences or space needs change.
- Tops are abrasion- and stain-resistant laminate over extra-thick 1½" solid core high-performance particleboard; resists warping.
- "Ribbon" edge profile; shape is on all four sides.
- Cord management grommets, for routing and hiding wires and cables, are located in the tops of desk and return shells.
- Credenza shells have a cord pass-through grommet in the top center of the modesty panel.
- The narrow design of the kneespace clearance end panel kits replace full end panels to provide added kneespace.
- Adjustable hex leveling glides allow floor-standing furniture to be easily leveled; glides have ¾" adjustable range.
- Credenza Shells available with Full or 10" Modesty Panel options.
- For conference table options, see the Preside® table tops and bases on pages 846-851. Order edge option "K".
- See pages 216-217 for modular storage components.

**HOW TO SPECIFY****Select Model Number**

H 1 1 5 4 1 .

**Select Edge Profile**

See page 208

A .

**Select Laminate**

See pages 208-209

N N



Icon Legend on page 21

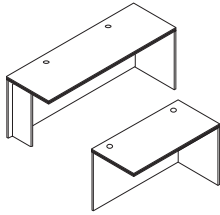

Model H115686 shown

**DESCRIPTION****24" D Return Shell (with Full Modesty Panel)**

72"W x 24"D x 29½"H, (w/support; 2 grommets)
60"W x 24"D x 29½"H, (w/support; 2 grommets)
48"W x 24"D x 29½"H, (1 grommet)
42"W x 24"D x 29½"H, (1 grommet)
36"W x 24"D x 29½"H, (1 grommet)
30"W x 24"D x 29½"H, (1 grommet)

**INSIDE DIMENSIONS**

67"W x 22¾"D
55"W x 22¾"D
47"W x 22¾"D
41"W x 22¾"D
34¾"W x 22¾"D
28¾"W x 22¾"D

**MODEL**

<b>H115686</b>
<b>H115684</b>
<b>H11561</b>
<b>H115681</b>
<b>H115680</b>
<b>H11568</b>

**SHIP WEIGHT**

161
142
97
97
91
78

**CUBE**

5.4
4.9
3.2
2.5
3.2
2.8

**LIST PRICE**

<b>\$808</b>
<b>\$755</b>
<b>\$618</b>
<b>\$605</b>
<b>\$605</b>
<b>\$561</b>

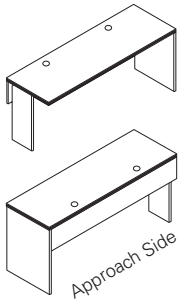
**24" D Return Shell (with 10" Modesty Panel)**

72"W x 24"D x 29½"H
60"W x 24"D x 29½"H
48"W x 24"D x 29½"H
42"W x 24"D x 29½"H
36"W x 24"D x 29½"H
30"W x 24"D x 29½"H

67"W x 22¾"D
55"W x 22¾"D
47"W x 22¾"D
41"W x 22¾"D
34¾"W x 22¾"D
28¾"W x 22¾"D

<b>H115686X</b>
<b>H115684X</b>
<b>H11561X</b>
<b>H115681X</b>
<b>H115680X</b>
<b>H11568X</b>

124
108
90
80
76
65

5.0
4.0
3.0
3.0
3.0
2.8

<b>\$808</b>
<b>\$755</b>
<b>\$618</b>
<b>\$605</b>
<b>\$605</b>
<b>\$561</b>

NOTES: Shells are non-handed. No pre-drilled grommet in modesty panel (field installable grommet included). Wood-grain direction on modesty/back panel runs vertical on 30"W-60"W sizes and horizontal on 72"W unit. 36"W return shell can be used to achieve an efficient 6' x 6' footprint when connected to either a 72"W x 36"D single pedestal desk, desk shell, or peninsula, or when two are connected to a 36"W corner unit model H115811. 30"W return shell can be used to accomplish a 5' x 5' footprint when connected to a 60"W x 30"D desk shell or peninsula. See pages 225-226 for optional stack-on storage.

**NOTES:**

- Non-handed desk, credenza, and return shells, combined with a variety of under-the-worksurface storage solutions, maximize office layout flexibility. Shells and pedestals can be reconfigured quickly and easily when user preferences or space needs change.
- Tops are abrasion- and stain-resistant laminate over extra-thick 1½" solid core high-performance particleboard; resists warping.
- "Ribbon" edge profile; shape is on all four sides.
- Cord management grommets, for routing and hiding wires and cables, are located in the tops of desk and return shells.
- Credenza shells have a cord pass-through grommet in the top center of the modesty panel.
- The narrow design of the kneespace clearance end panel kits replace full end panels to provide added kneespace.
- Adjustable hex leveling glides allow floor-standing furniture to be easily leveled; glides have ¾" adjustable range.
- Credenza Shells available with Full or 10" Modesty Panel options.
- For conference table options, see the Preside® table tops and bases on pages 846-851. Order edge option "K".
- For work-in-process paper management tools, see page 234.
- See pages 216-217 for modular storage components.

**HOW TO SPECIFY****Select Model Number**

H 1 1 5 6 8 6

**Select Edge Profile**

See page 208

A

**Select Laminate**

See pages 208-209

NN

# VALIDO® Laminate Modular Components

GSA SIN 711-2



Icon Legend on page 21

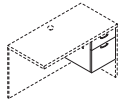

Not available in two-tone laminate

**DESCRIPTION****Box/File Pedestal (with core removable lock)**15<sup>5</sup>/<sub>8</sub>"W x 22<sup>3</sup>/<sub>4</sub>"D x 17<sup>3</sup>/<sub>4</sub>"H**MODEL****H11501****SHIP WEIGHT**

57

**CUBE**

5.5

**LIST PRICE****\$532**

NOTES: For use under 24"D, 30"D and 36"D desk, credenza and return shells. Hangrails included. Lock can be positioned on either the right or left side. Attaches to underside of worksurface top. **Unfinished top and back.**

⚠ Not designed to be used freestanding.

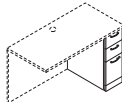

Not available in two-tone laminate

**Narrow Box/Box/File Pedestal — floor-standing**9<sup>1</sup>/<sub>2</sub>"W x 22<sup>3</sup>/<sub>4</sub>"D x 28"H**H115093**

61

5.6

**\$679**

NOTES: For use under 24"D, 30"D and 36"D modular desk, credenza and return shells. Unfinished top and back.

⚠ Handle choices for this model are the Sweep, Crescent and Arch designs only. The linear handle (options "G" and "J") is not available on this product as the width of the component interferes with lock on the drawer face.

⚠ Not designed to be used freestanding.

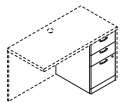

Not available in two-tone laminate

**Box/Box/File Pedestal (with core removable lock) — floor-standing**15<sup>5</sup>/<sub>8</sub>"W x 22<sup>3</sup>/<sub>4</sub>"D x 28"H — for use under 24"D, 30"D and 36"D desk, credenza and return shells**H11502**

90

8.4

**\$689**15<sup>5</sup>/<sub>8</sub>"W x 18<sup>3</sup>/<sub>4</sub>"D x 28"H — for use under 20"D, 24"D, 30"D and 36"D desk, credenza and return shells**H115012**

73

7.0

**\$650**

NOTES: Top box drawer does not lock. Hangrails included. **Unfinished top and back.**

⚠ Not designed to be used freestanding.

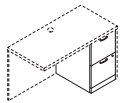

Not available in two-tone laminate

**File/File Pedestal (with core removable lock) — floor-standing**15<sup>5</sup>/<sub>8</sub>"W x 22<sup>3</sup>/<sub>4</sub>"D x 28"H — for use under 24"D, 30"D and 36"D desk, credenza and return shells**H11504**

85

8.4

**\$689**15<sup>5</sup>/<sub>8</sub>"W x 18<sup>3</sup>/<sub>4</sub>"D x 28"H — for use under 20"D, 24"D, 30"D and 36"D desk, credenza and return shells**H115014**

72

7.0

**\$650**

NOTES: Hangrails included. **Unfinished top and back.**

⚠ Not designed to be used freestanding.

**NOTES:**

- Pedestals can be reconfigured quickly and easily when user preferences or space needs change.
- File drawers accept hanging folders in letter or legal size.
- Narrow pedestal features a compact design that is ideal for use in U- and L-shaped layouts for smaller spaces, such as a 5' x 8' U-shaped workstation or a 5' x 5' L-shaped workstation.
- Pedestal drawers operate on full-extension, ball-bearing suspensions to ensure smooth quiet, long-lasting operation.
- Handle options shown on page 208.
- Pedestal sides are notched to enable the routing of cords and cables.
- Mobile pedestals shown on page 229, work well in a variety of configurations.
- Pedestal models ship assembled unless designated .
- Modular pedestals to be used with 24"D, 30"D and 36"D Modular Shells.
- Pedestal models not designed to be used freestanding.
- See pages 213-215 for desk, credenza and return shells.

**HOW TO SPECIFY****Select Model Number**

H 1 1 5 0 1

**Select Handle Option**

Linear handles "G" and "J" not available on model H115093

See page 208

C

**Select Laminate**

See pages 208-209

N

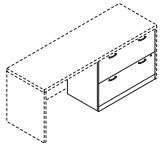

Not available in two-tone laminate

**DESCRIPTION**

**Lateral File Pedestal (with core removable lock) — floor-standing**

36"W x 20"D x 28"H — for use under 24"D, 30"D and 36"D desk, credenza and return shells

**MODEL**

**H11503**

**SHIP WEIGHT**

127

**CUBE**

15.6

**LIST PRICE**

**\$1059**

NOTES: Hangrails included. **Unfinished top and back.** Mechanical interlock inhibits extension of more than one drawer at a time.

⚠ Not designed to be used freestanding.

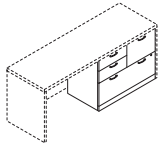

Not available in two-tone laminate

**Multi File Pedestal (with core removable lock) — floor-standing**

36"W x 20"D x 28"H — for use under 24"D, 30"D and 36"D desk, credenza and return shells

**H11505**

155

15.6

**\$1263**

NOTES: Versatile four drawer unit features one lateral file drawer, one vertical file drawer, and two box drawers. Box drawers do not lock. Hangrails included. **Unfinished top and back.** Mechanical interlock in lateral drawer inhibits extension of more than one drawer at a time.

⚠ Not designed to be used freestanding.

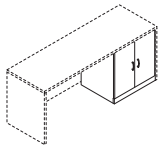

Not available in two-tone laminate

**Cabinet Pedestal — floor-standing**

26"W x 21¼"D x 28"H — for use under 24"D, 30"D and 36"D desk, credenza and return shells

**H11508**

78

12.2

**\$768**

NOTES: One adjustable shelf at 2½" increments. Doors are non-locking. **Unfinished top and back.**

⚠ Not designed to be used freestanding.

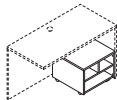

SIN 711-8



**Mobile Printer/Fax Cart**

20"W x 19⅞"D x 14⅞"H

**H105679**

52

2.9

**\$397**

NOTES: Holds laser printers, inkjet printers or fax machines. Ideal for limited space. Low profile cart stores conveniently and easily under desks and workstations. Interior compartment shelving is Black. Four casters. 1⅞" thick top with flat, non-profiled edge.

**SPECIFYING EXAMPLE: H105679.NN**

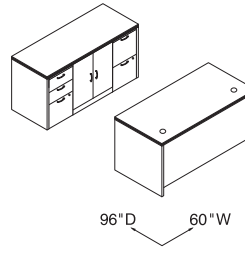
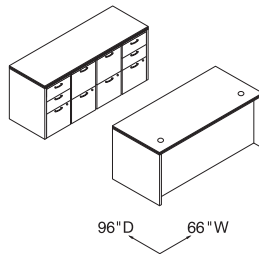

- 1 - H11579
- 1 - H11542
- 2 - H115102
- 2 - H115104

- 1 - H11578
- 1 - H11564
- 1 - H11502
- 1 - H11504
- 1 - H11508

**NOTES:**

- Pedestals can be reconfigured quickly and easily when user preferences or space needs change.
- See page 208 for handle design/finish options.
- File drawers accept hanging folders in letter or legal size.
- Pedestal drawers operate on full extension, ball-bearing suspensions to ensure smooth quiet, long-lasting operation.
- Pedestal sides are notched to enable the routing of cords and cables.
- Mobile pedestals shown on page 229, work well in a variety of configurations.
- Pedestal models ship assembled unless designated
- See pages 213-215 for desk, credenza and return shells.

**HOW TO SPECIFY**

Select Model Number

**H 1 1 5 0 3**

Select Handle Option

See page 208  
Not specified for model H105679

**C**

Select Laminate

See pages 208-209

**N**

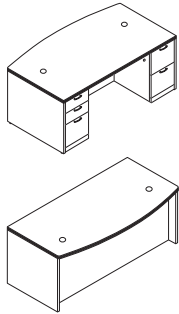
**DESCRIPTION****Double Pedestal Desk, 3/2**

72"W x 36"D x 29½"H, Bow Top	10½"	<b>H115899</b>	362	52.2	<b>\$2193</b>
72"W x 36"D x 29½"H, Rectangle Top	10½"	<b>H115890</b>	370	52.2	<b>\$2086</b>
66"W x 30"D x 29½"H, Rectangle Top	4½"	<b>H115891</b>	312	40.9	<b>\$2006</b>
60"W x 30"D x 29½"H, Rectangle Top	4½"	<b>H115892</b>	303	37.3	<b>\$1905</b>

NOTES: All drawers lock. Two worksurface grommets to route/hide cords. See page 233 for optional center drawers. Bow top model measures 36"D at the crest and 30" along the end panels.

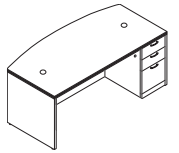
**Single Pedestal Desk, Bow Top**

72"W x 36"D x 29½"H, Right	10½"	<b>H115893R</b>	308	52.2	<b>\$1923</b>
72"W x 36"D x 29½"H, Left	10½"	<b>H115894L</b>	308	52.2	<b>\$1923</b>

NOTES: Box/box/file drawer configuration. Drawers lock. Two worksurface grommets to route/hide cords. See page 233 for optional center drawers. Bow top model measures 36"D at the crest and 30" along the end panels.

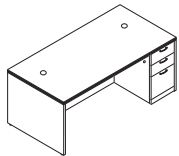
**Single Pedestal Desk, Rectangle Top**

72"W x 36"D x 29½"H, Right	10½"	<b>H115895R</b>	316	52.2	<b>\$1800</b>
66"W x 30"D x 29½"H, Right	4½"	<b>H115897R</b>	269	40.9	<b>\$1634</b>
72"W x 36"D x 29½"H, Left	10½"	<b>H115896L</b>	316	52.2	<b>\$1800</b>
66"W x 30"D x 29½"H, Left	4½"	<b>H115898L</b>	269	40.9	<b>\$1634</b>

NOTES: Box/box/file drawer configuration. Drawers lock. Two worksurface grommets to route/hide cords. See page 233 for optional center drawers.

**NOTES:**

- Full pedestal design provides a more formal styling aesthetic and maximizes storage space.
- Drawers in pedestal extend from underside of worksurface to the floor.
- Tops are abrasion- and stain-resistant laminate over extra-thick 1½" solid core high-performance particleboard; resists warping.
- 3" round worksurface grommet can be replaced with optional Power Hub (model HGRMTAC) or Power/USB Hub (model HGRMTUSB2) to bring the ease of plug-and-play to the desktop. See page 237.
- Recessed modesty panel design facilitates conferencing. See approach side illustration at left.
- Full height modesty panels.
- Drawers operate on full extension, ball-bearing suspensions to ensure smooth, quiet, long-lasting operation.
- See page 208 for handle design/finish options.
- File drawer design includes integrated hangrails for side-to-side letter or legal filing; and front-to-back for letter filing.
- All drawers are 5-sided construction, which allows easy drawer alignment or replacement of drawer fronts.
- Desk, credenza and return models ship assembled.
- For conference table options, see the Preside® table tops and bases on pages 846-851. Order edge option "K".
- See pages 222-238 for shared components.

**HOW TO SPECIFY**

<b>Select Model Number</b>	<b>Select Edge Profile</b>	<b>Select Handle Option</b>	<b>Select Laminate</b>
See page 208	See page 208	See page 208	See pages 208-209
H 1 1 5 8 9 9 .	A .	C .	NN

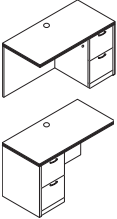
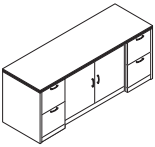
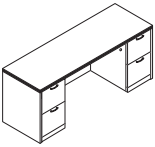
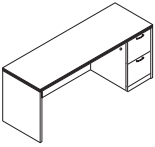

# VALIDO® Laminate Wood Desks — Full Pedestals

	DESCRIPTION	FULL WIDTH OVERHANG	MODEL	SHIP WEIGHT	CUBE	LIST PRICE
	<b>Return, File/File</b>					
	48"W x 24"D x 29½"H, Right		<b>H115905R</b>	168	24.9	<b>\$1194</b>
	42"W x 24"D x 29½"H, Right		<b>H115907R</b>	159	20.5	<b>\$1181</b>
	48"W x 24"D x 29½"H, Left		<b>H115906L</b>	168	24.9	<b>\$1194</b>
	42"W x 24"D x 29½"H, Left		<b>H115908L</b>	159	20.5	<b>\$1181</b>
	NOTES: Return is for use with single pedestal desks, desk shells, peninsulas or corner units. Drawers lock. One worksurface grommet and one cord pass-through grommet in top center of modesty panel to reach wall electrical outlets. See pages 225-226 for optional stack-on storage.					
	<b>Credenza with Doors</b>					
72"W x 24"D x 29½"H	3½"	<b>H115909</b>	340	36.0	<b>\$2184</b>	
	NOTES: All drawers lock. Doors are non-locking. One cord pass-through grommet in top center of modesty panel. Includes a fixed shelf located at the bottom of the center storage area. No intermittent shelf. See pages 225-226 for optional stack-on storage.					
	<b>Credenza with Kneespace — 2/0/2</b>					
	72"W x 24"D x 29½"H	3½"	<b>H115900</b>	296	36.0	<b>\$1858</b>
	66"W x 24"D x 29½"H	3½"	<b>H115901</b>	286	31.6	<b>\$1768</b>
	60"W x 24"D x 29½"H	3½"	<b>H115902</b>	257	28.8	<b>\$1712</b>
	NOTES: All drawers lock. One cord pass-through grommet in top center of modesty panel. See pages 225-226 for optional stack-on storage.					
	! Not designed to be used with Valido/11500 Series 24"D modular or mobile pedestals.					
	<b>Single Pedestal Credenza, File/File</b>					
	72"W x 24"D x 29½"H, Right (shown)	3½"	<b>H115903R</b>	251	36.0	<b>\$1529</b>
	72"W x 24"D x 29½"H, Left	3½"	<b>H115904L</b>	251	36.0	<b>\$1529</b>
	NOTES: Drawers lock. One cord pass-through grommet in top center of modesty panel. See pages 225-226 for optional stack-on storage.					
	! Not designed to be used with Valido/11500 Series 24"D modular or mobile pedestals.					

**NOTES:**

- Full pedestal design provides a more formal styling aesthetic and maximizes storage space.
- Drawers in pedestal extend from underside of worksurface to the floor.
- Tops are abrasion- and stain-resistant laminate over extra-thick 1½" solid core high-performance particleboard; resists warping.
- Recessed modesty panel design facilitates conferencing. See approach side illustration at left.
- Full height modesty panels.
- Drawers operate on full extension, ball-bearing suspensions to ensure smooth, quiet, long-lasting operation.
- See page 208 for handle design/finish options.
- File drawer design includes integrated hangrails for side-to-side letter or legal filing; and front-to-back for letter filing.
- All drawers are 5-sided construction, which allows easy drawer alignment or replacement of drawer fronts.
- Valido® 18¾"D modular and mobile pedestals can be positioned under credenza with kneespace and single pedestal credenza models.
- Desk, credenza and return models ship assembled.
- For conference table options, see the Preside® table tops and bases on pages 846-851. Order edge option "K".
- See pages 222-238 for shared components.

**HOW TO SPECIFY**

<b>Select Model Number</b> H 1 1 5 9 0 5 R .	<b>Select Edge Profile</b> See page 208 A .	<b>Select Handle Option</b> See page 208 C .	<b>Select Laminate</b> See pages 208-209 N N
---	---	--	--

# VALIDO® Laminate Wood Desks — 3/4 Pedestals

GSA SIN 711-2

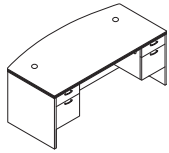

Icon Legend on page 21

**DESCRIPTION****Double Pedestal Desk, 2-2**

72"W x 36"D x 29½"H, Bow Top	10½"	<b>H11595</b>	356	52.2	<b>\$1762</b>
72"W x 36"D x 29½"H, Rectangle Top	10½"	<b>H11593</b>	364	52.2	<b>\$1613</b>
66"W x 30"D x 29½"H, Rectangle Top	4½"	<b>H11571</b>	304	40.9	<b>\$1540</b>
60"W x 30"D x 29½"H, Rectangle Top	4½"	<b>H11573</b>	288	37.3	<b>\$1452</b>

NOTES: All drawers lock. Two worksurface grommets to route/hide cords. See page 233 for optional center drawers.

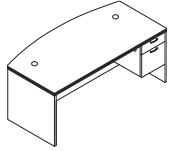
**Single Pedestal Desk, Bow Top**

72"W x 36"D x 29½"H, Right	10½"	<b>H11587R</b>	264	52.9	<b>\$1552</b>
72"W x 36"D x 29½"H, Left	10½"	<b>H11588L</b>	264	52.9	<b>\$1552</b>

NOTES: Drawers lock. Two worksurface grommets to route/hide cords. See page 233 for optional center drawers. Bow top models measure 36"D at the crest and 30"D along the end panels.

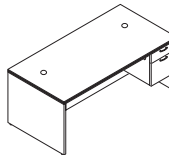
**Single Pedestal Desk, Rectangle Top**

72"W x 36"D x 29½"H, Right	10½"	<b>H11585R</b>	303	52.2	<b>\$1371</b>
66"W x 30"D x 29½"H, Right	4½"	<b>H11583R</b>	247	40.9	<b>\$1282</b>
72"W x 36"D x 29½"H, Left	10½"	<b>H11586L</b>	303	52.2	<b>\$1371</b>
66"W x 30"D x 29½"H, Left	4½"	<b>H11584L</b>	247	40.9	<b>\$1282</b>

NOTES: Drawers lock. Two worksurface grommets to route/hide cords. See page 233 for optional center drawers.

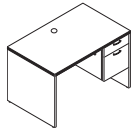
**Small Office Desk**

48"W x 30"D x 29½"H

4½"

**H11585R**

183

30.0

**\$1034**

NOTES: Small footprint makes this desk ideal for limited space. Drawers lock. One cord grommet in top for routing and hiding wires and cables. 3/4 length modesty panel facilitates reaching wall electrical outlets. Optional stack-on storage model H115323 maximizes storage space; see pages 225-226 for additional stack-on storage models.

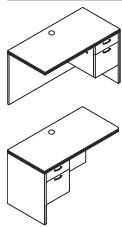
**Return, Box/File**

48"W x 24"D x 29½"H, Right	<b>H11515R</b>	158	24.9	<b>\$998</b>
42"W x 24"D x 29½"H, Right	<b>H11511R</b>	146	20.5	<b>\$986</b>
48"W x 24"D x 29½"H, Left	<b>H11516L</b>	158	24.9	<b>\$998</b>
42"W x 24"D x 29½"H, Left	<b>H11512L</b>	146	20.5	<b>\$986</b>

NOTES: Return is for use with single pedestal desks, desk shells, peninsulas or corner units. Drawers lock. One worksurface grommet and one cord pass-through grommet in top center of modesty panel to reach wall electrical outlets. See pages 225-226 for optional stack-on storage.

ⓘ Not designed to be used freestanding.

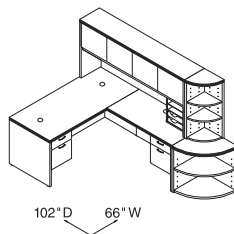

H11584L  
H11515R  
H115327  
H115520  
H115523  
HLVPM1

102"D 66"W

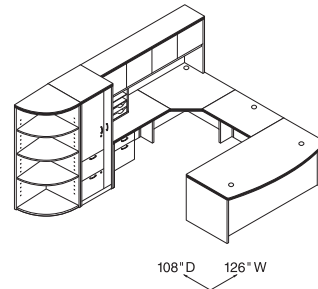

H11587R  
H115598  
H115811 H115524  
H11516L H115327  
H115301 HLVPM1

108"D 126"W

**NOTES:**

- For components that can be shared with Valido/11500 Series, see pages 222-238.
- Tops are abrasion- and stain-resistant laminate over extra-thick 1½" solid core high-performance particleboard; resists warping.
- 3/4 pedestal design increases budget flexibility.
- Formal, full height modesty panels.
- 3" round worksurface grommet can be replaced with optional Power Hub (model HGRMTAC) or Power/USB Hub (model HGRMTUSB2) to bring the ease of plug-and-play to the desktop. See page 237.
- All drawers are 5-sided construction, which allows easy drawer alignment or replacement of drawer fronts.
- The small foot print of the Small Office Desk is ideal for limited space.

- Drawers operate on full extension, ball-bearing suspensions to ensure smooth, quiet, long-lasting operation.
- See page 208 for handle design/finish options.
- Center drawers conveniently store writing instruments, paper and other miscellaneous items. Includes pencil tray. See page 233.
- File drawer design includes integrated hangrails for side-to-side letter or legal filing; and front-to-back for letter filing.
- Desk, credenza and return models ship assembled.
- See pages 225-226 for optional stack-on storage.
- For conference table options, see the Preside® table tops and bases on pages 846-851. Order edge option "K".

**HOW TO SPECIFY**

<b>Select Model Number</b>	<b>Select Edge Profile</b>	<b>Select Handle Option</b>	<b>Select Laminate</b>
See page 208	See page 208	See page 208	See pages 208-209
H 1 1 5 9 5 .	A .	C .	NN

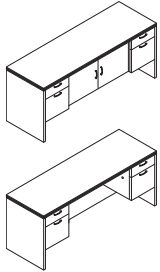

**DESCRIPTION**

**Credenza with Doors**  
72"W x 24"D x 29½"H

**FULL WIDTH OVERHANG**     **MODEL**     **SHIP WEIGHT**     **CUBE**     **LIST PRICE**

3½"     **H11544**     294     36.0     **\$1776**

NOTES: Includes one fixed shelf at the bottom of the center storage area. All drawers lock. Doors are non-locking.

**Credenza with Kneespace**

72"W x 24"D x 29½"H  
66"W x 24"D x 29½"H  
60"W x 24"D x 29½"H

3½"     **H11543**     259     36.0     **\$1496**  
3½"     **H11566**     249     31.6     **\$1452**  
3½"     **H11565**     239     28.8     **\$1399**

NOTES: One cord pass-through grommet in top center of modesty panel to reach wall electrical outlets. All drawers lock. See pages 225-226 for optional stack-on storage.

⚠ Not designed to be used with Valido/11500 Series 24"D modular or mobile pedestals.

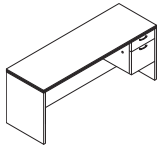

**Credenza, Single Pedestal, Box/File**

72"W x 24"D x 29½"H, Right (shown)  
72"W x 24"D x 29½"H, Left

3½"     **H11545R**     228     36.0     **\$1253**  
3½"     **H11546L**     228     36.0     **\$1253**

NOTES: One cord pass-through grommet in top center of modesty panel to reach wall electrical outlets. Drawers lock. See pages 225-226 for optional stack-on storage.

⚠ Not designed to be used with Valido/11500 Series 24"D modular or mobile pedestals.

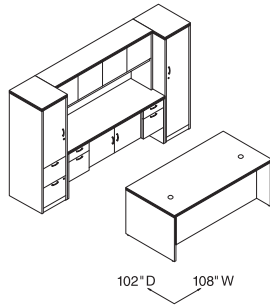

H11593  
H11544  
H115295R  
H115298L  
H11534

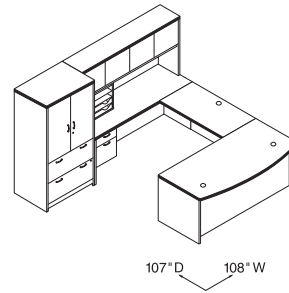

H11587R  
H11570  
H11546L  
H11534  
H115293  
HLVPM1

**NOTES:**

- For components that can be shared with Valido/11500 Series, see pages 222-238.
- Tops are abrasion- and stain-resistant laminate over extra-thick 1½" solid core high-performance particleboard; resists warping.
- Formal, full height modesty panels.
- Cord management grommets, for routing and hiding wires and cables, are located in the tops of desks, returns, bridges and corner units.
- All drawers are 5-sided construction, which allows easy drawer alignment or replacement of drawer fronts.
- Drawers operate on full extension, ball-bearing suspensions to ensure smooth, quiet, long-lasting operation.
- See page 208 for handle design/finish options.
- File drawer design includes integrated hangrails for side-to-side letter or legal filing; and front-to-back for letter filing.
- For conference table options, see the Preside® table tops and bases on pages 846-851. Order edge option "K".

**HOW TO SPECIFY**

<p><b>Select Model Number</b></p> <p>H 1 1 5 4 4 .</p>	<p><b>Select Edge Profile</b></p> <p>See page 208</p> <p>A .</p>	<p><b>Select Handle Option</b></p> <p>See page 208</p> <p>C .</p>	<p><b>Select Laminate</b></p> <p>See pages 208-209</p> <p>N N</p>
--	--	---	---



# VALIDO®

## Shared Components & Accessories

GSA SIN 711-2

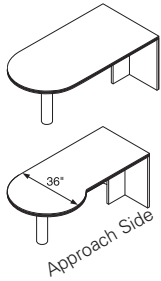

Icon Legend on page 21

**DESCRIPTION****Peninsula w/End Panel**

72"W x 36"D x 29½"H  
66"W x 30"D x 29½"H  
60"W x 30"D x 29½"H

**MODEL**

**H11521**  
**H11522**  
**H11523**

**SHIP WEIGHT**

171  
142  
119

**CUBE**

15.1  
11.8  
11.4

**LIST PRICE**

**\$972**  
**\$888**  
**\$825**

**P-shaped Peninsula w/End Panel**

72"W x 30/36"D x 29½"H, Right (shown)  
72"W x 36/30"D x 29½"H, Left

**H11525R**  
**H11526L**

163  
163

13.4  
13.4

**\$1081**  
**\$1081**

NOTES: Use for "U" or "L" configuration. 60"W ideal for smaller spaces. Cord routing notch in brace panel. Accept field installable modesty panel model H10528 (see page 223). See page 233 for optional center drawers. Peninsulas ship complete with end panel and support column. Support column is black.

ⓘ Not designed to be used freestanding.

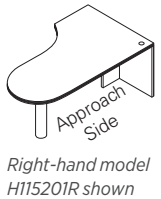
**Jetty Peninsula w/End Panel**

72"W x 30/42"D x 29½"H, Right (shown)  
72"W x 42/30"D x 29½"H, Left

**H115201R**  
**H115202L**

179  
179

16.9  
16.9

**\$1253**  
**\$1253**

NOTES: For use in "U" or "L" configuration. Designed and sized to efficiently serve as both a computing and conferencing space. One cord management grommet in the top; cord routing notch in brace panel. Jetty units manufactured on or after 10/24/2005 accept field installable modesty panel H10528 (see page 223). Peninsulas ship complete with end panel and support column. Support column is black.

ⓘ Not designed to be used freestanding.

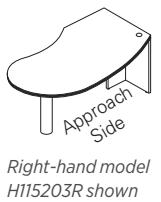
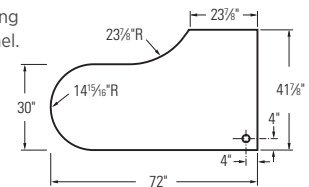
**Boomerang Peninsula w/End Panel**

72"W x 30/42"D x 29½"H, Right (shown)  
72"W x 42/30"D x 29½"H, Left

**H115203R**  
**H115204L**

176  
176

16.9  
16.9

**\$1253**  
**\$1253**

NOTES: For use in "U" or "L" configuration. Designed and sized to efficiently serve as both a computing and conferencing space. One cord management grommet in the top; cord routing notch in brace panel. Accepts field installable modesty panel H10528 (see page 223). Peninsulas ship complete with end panel and support column. Support column is black.

ⓘ Not designed to be used freestanding.

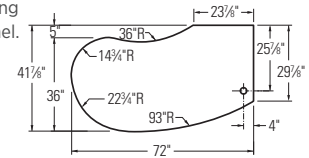
**NOTES:**

- Shared components shown on this page can be used with modular components shown on pages 213-217, full pedestal models shown on pages 218-219, and 3/4 pedestal models shown on pages 220-221.
- Mobile pedestals shown on page 229 work well in a variety of configurations.
- Peninsulas ship complete with end panel and black 4½" diameter support column. For a silver support column option, please see model HPC191X on page 317 (ordered separately).
- Jetty, Boomerang and Rudder peninsulas are designed and sized to efficiently serve as both a computing and conferencing space.
- Adjustable hex leveling glides allow floor-standing furniture to be easily leveled; glides have ¾" adjustable range.
- For conference table options, see the Preside® table tops and bases on pages 846-851. Order edge option "K".
- See pages 222-238 for shared components.

**HOW TO SPECIFY****Select Model Number**

H 1 1 5 2 1 .

**Select Edge Profile**

See page 208







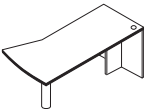

A .

**Select Laminate**

See pages 208-209

N N



	DESCRIPTION	MODEL	SHIP WEIGHT	CUBE	LIST PRICE
 	<b>Rudder Peninsula w/End Panel</b> 72"W x 30/38"D x 29½"H, Right 72"W x 38/30"D x 29½"H, Left NOTES: Use for "U" or "L" configuration. One cord management grommet in the top; cord routing notch in the brace panel. Support column is black.	<b>H115205R</b> <b>H115206L</b>	168 168	16.8 16.8	<b>\$1183</b> <b>\$1183</b>
	 Not designed to be used freestanding.				
 <b>SIN 711-8</b>	<b>Field Installable Modesty Panel for Peninsulas</b> 50¼"W x ¾"Thick x 18"H NOTES: Center drawer model H1522 can be used in conjunction with modesty panel. Laminate Modesty Panel has a cord pass-through notch in top corner.	<b>H10528</b>	25	1.3	<b>\$177</b>
	 Not designed to be used on jetty peninsulas manufactured prior to 10/24/2005. <b>SPECIFYING EXAMPLE: H10528.N</b>				
	<b>Field Installable Modesty Panel for Bullet, Jetty and Boomerang Peninsulas, Frosted with Silver Frame</b> 50¼"W x ¾"Thick x 18"H NOTES: For use on 72"W peninsulas. Frosted/silver modesty panel HPC180G can be used with Valido, 10700, 10600 and 10500 Series™ peninsula models. Cord pass-through notch is not available on the Frosted/Silver model HPC180G. Notch is on laminate model H10528 only.	<b>HPC180G</b>	33 	1.5	<b>\$645</b>
	 Center drawers not designed to be used with the frosted/silver modesty panel model HPC180G.				

**NOTES:**

- Shared components shown on this page can be used with modular components shown on pages 213-217, full pedestal models shown on pages 218-219, and 3/4 pedestal models shown on pages 220-221.
- Mobile pedestals shown on page 229 work well in a variety of configurations.
- Peninsulas ship complete with end panel and black 4½" diameter support column. For a silver support column option, please see model HPC191X on page 317 (ordered separately).
- Jetty, Boomerang and Rudder peninsulas are designed and sized to efficiently serve as both a computing and conferencing space.
- Adjustable hex leveling glides allow floor-standing furniture to be easily leveled; glides have ¾" adjustable range.
- For conference table options, see the Preside® table tops and bases on pages 846-851. Order edge option "K".
- See pages 222-238 for shared components.

**HOW TO SPECIFY**

<p><b>Select Model Number</b></p> <p>H 1 1 5 2 0 5 R .</p>	<p><b>Select Edge Profile</b></p> <p>See page 208</p> <p>A .</p>	<p><b>Select Laminate</b></p> <p>See pages 208-209</p> <p>N N</p>
--	--	---

# VALIDO®

## Shared Components & Accessories

GSA SIN 711-2



Icon Legend on page 21

**DESCRIPTION****MODEL****SHIP WEIGHT****CUBE****LIST PRICE****Bridge (Single Ped. Desk, Desk Shell or Peninsula, to Corner Unit, Single Ped. Credenza or Credenza Shell)**

47"W x 24"D x 29½"H, (Clear inside depth = 21⅞"D)

**H11570**

86

3.2

**\$453**

42"W x 24"D x 29½"H, (Clear inside depth = 21⅞"D)

**H11560**

81

2.9

**\$434**

36"W x 24"D x 29½"H, (Clear inside depth = 21⅞"D) (see notes below)

**H115599**

69

2.9

**\$434**

30"W x 24"D x 29½"H, (Clear inside depth = 21⅞"D) (see notes below)

**H115598**

57

2.2

**\$434**

47"W x 20"D x 29½"H, (Clear inside depth = 17⅞"D) (see notes below)

**H115699**

70

3.2

**\$434**

42"W x 20"D x 29½"H, (Clear inside depth = 17⅞"D) (see notes below)

**H115698**

62

2.9

**\$414**

NOTES: One worksurface grommet and one grommet in top and in top center of modesty panel. Grommet can be replaced with optional Power Hub or Power/USB Hub for easy plug-and-play (see page 237). Kneespace of desk limited to 2¼"W if bridge is used with 66"W single pedestal desk. H115599 is for use with corner or extended corner units or jetty or boomerang peninsulas. H115598 is for use with corner or extended corner units. H115699 and H115698 are for use with single pedestal desks, desk shells or peninsulas (excluding jetty and boomerang).

Specify: Model.Edge.Laminate

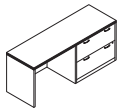
**SPECIFYING EXAMPLE: H11570.A.NN****Credenza with 36" Lateral (with core removable locks)**

72"W x 24"D x 29½"H, Right (shown)

**H11547R**

264

36.0

**\$1604**

72"W x 24"D x 29½"H, Left

**H11548L**

264

36.0

**\$1604**

NOTES: Includes hangrails. Mechanical interlock inhibits the extension of more than one drawer at a time. See pages 225-226 for optional stack-on storage.

⚠ Not designed to be used with Valido/11500 Series 24"D modular or mobile pedestals.

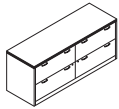
**Credenza with two Lateral Files (with core removable locks)**

72"W x 24"D x 29½"H

**H115491**

330

36.0

**\$2249**

NOTES: 4 locking drawers. Each lock secures 2 drawers. Includes hangrails; mechanical interlock inhibits the extension of more than one drawer at a time. If side-by-side drawers are opened or closed simultaneously, one drawer may interfere with the other. See pages 225-226 for optional stack-on storage.

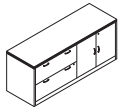
**Credenza with Lateral File, left and Storage Cabinet, right (with core removable locks)**

72"W x 24"D x 29½"H

**H115492**

323

36.0

**\$2040**

NOTES: Includes hangrails; mechanical interlock inhibits the extension of more than one drawer at a time. Storage cabinet locks and includes one adjustable interior shelf. Shelf adjusts in ¼" increments with a total range of 6¼"H. See pages 225-226 for optional stack-on storage.

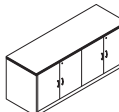
**Credenza w/Two Storage Cabinets**

72"W x 24"D x 29½"H

**H115493**

320

35.6

**\$1809**

NOTES: Each storage cabinet has one interior shelf which adjusts in ¼" increments over a total range of 5". Each cabinet locks independently. Locks are keyed alike. For optional stack-on storage, see pages 225-226 for additional stack-on storage models.

**NOTES:**

- Shared components shown on this page can be used with modular components shown on pages 213-217, full pedestal models shown on pages 218-219, and 3/4 pedestal models shown on pages 220-221.
- Mobile pedestals shown on page 229 work well in a variety of configurations.
- Locking units equipped with interchangeable core removable locks.
- File drawers accept hanging folders in letter or legal size.
- See page 208 for handle design/finish options.
- Adjustable hex leveling glides allow floor-standing furniture to be easily leveled; glides have ¾" adjustable range.
- See pages 222-238 for shared components.

⚠ Keyed alike cores must be ordered separately — see page 922.

**HOW TO SPECIFY****Select Model Number**

H 1 1 5 4 7 R .

**Select Edge Profile**

See page 208

A .

**Select Handle Option**

See page 208

Not specified on Bridge models

C .

**Select Laminate**

See pages 208-209

N N



Icon Legend on page 21

# VALIDO®

## Shared Components & Accessories

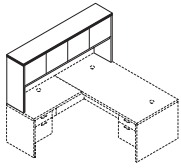
**DESCRIPTION**

**Stack-on Storage for an "L" Workstation**  
78"W x 14<sup>5</sup>/<sub>8</sub>"D x 37<sup>1</sup>/<sub>2</sub>"H

**MODEL SHIP WEIGHT CUBE LIST PRICE**

**H115327** 209 17.6 **\$1292**

**Stack-on Storage for an "L" Workstation, Locking**  
78"W x 14<sup>5</sup>/<sub>8</sub>"D x 37<sup>1</sup>/<sub>2</sub>"H

**H115327K** 209 17.6 **\$1372**

NOTES: Spans the total depth dimension of configurations comprised of: 48"W return or return shell attached to a 30"D single pedestal desk, desk shell or peninsula (78"D); 42"W return or return shell attached to a 36"D single pedestal desk, desk shell or peninsula (78"D). 42"W return or return shell attached to a 36" corner unit (78"D); or 42"W curved return attached to 36" curved corner unit (78"D). Use back enclosure model H105857 and tackboard model H90057 (see page 227). Use task light models HH870960, or HH870960CH (see page 532). For vertical paper manager model HLVPM1, see page 234.

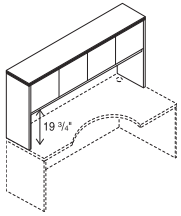
**Stack-on Storage (See page 227 for Back Enclosures and Fabric Tackboards)**

72"W x 14<sup>5</sup>/<sub>8</sub>"D x 37<sup>1</sup>/<sub>2</sub>"H, 4 doors (Use Task Light model HH870960, see page 236) **H11534**  
66"W x 14<sup>5</sup>/<sub>8</sub>"D x 37<sup>1</sup>/<sub>2</sub>"H, 4 doors (Use Task Light model HH870960, see page 236) **H11533**  
60"W x 14<sup>5</sup>/<sub>8</sub>"D x 37<sup>1</sup>/<sub>2</sub>"H, 4 doors (Use Task Light model HH870960, see page 236) **H115324**  
48"W x 14<sup>5</sup>/<sub>8</sub>"D x 37<sup>1</sup>/<sub>2</sub>"H, 3 doors (Use Task Light model HH870942, see page 236) **H115323**  
42"W x 14<sup>5</sup>/<sub>8</sub>"D x 37<sup>1</sup>/<sub>2</sub>"H, 2 doors (Use Task Light model HH870942, see page 236) **H115322**  
36"W x 14<sup>5</sup>/<sub>8</sub>"D x 37<sup>1</sup>/<sub>2</sub>"H, 2 doors (Use Task Light model HH870930, see page 236) **H115321**

195 16.9 **\$1160**  
184 15.3 **\$1133**  
172 14.0 **\$1085**  
148 11.3 **\$943**  
141 4.0 **\$811**  
107 3.5 **\$777**

**Stack-on Storage, Locking (See page 227 for Back Enclosures and Fabric Tackboards)**

72"W x 14<sup>5</sup>/<sub>8</sub>"D x 37<sup>1</sup>/<sub>2</sub>"H, 4 doors (Use Task Light model HH870960, see page 236) **H11534K**  
66"W x 14<sup>5</sup>/<sub>8</sub>"D x 37<sup>1</sup>/<sub>2</sub>"H, 4 doors (Use Task Light model HH870960, see page 236) **H11533K**  
60"W x 14<sup>5</sup>/<sub>8</sub>"D x 37<sup>1</sup>/<sub>2</sub>"H, 4 doors (Use Task Light model HH870960, see page 236) **H115324K**  
48"W x 14<sup>5</sup>/<sub>8</sub>"D x 37<sup>1</sup>/<sub>2</sub>"H, 3 doors (Use Task Light model HH870942, see page 236) **H115323K**  
42"W x 14<sup>5</sup>/<sub>8</sub>"D x 37<sup>1</sup>/<sub>2</sub>"H, 2 doors (Use Task Light model HH870942, see page 236) **H115322K**  
36"W x 14<sup>5</sup>/<sub>8</sub>"D x 37<sup>1</sup>/<sub>2</sub>"H, 2 doors (Use Task Light model HH870930, see page 236) **H115321K**

195 16.9 **\$1240**  
184 15.3 **\$1213**  
172 14.0 **\$1165**  
148 11.3 **\$983**  
141 4.0 **\$851**  
107 3.5 **\$817**

NOTES: Models H11534 and H11534K can be used for "L" configuration comprised of 30"D desk, desk shell or peninsula and 42"W return or return shell. Model H115323K has one lock which secures two of the three doors. For vertical paper manager, see page 234.

**NOTES:**

- Shared components shown on this page can be used with modular components shown on pages 213-217, full pedestal models shown on pages 218-219, and 3/4 pedestal models shown on pages 220-221.
- Stack-on storage models are equipped with self-closing, adjustable hinged doors and valance to hide task light.
- For work-in-process paper management tools, see page 234.
- See pages 222-238 for shared components.

❗ Removable lock core kit for stack-on and wall mount storage is model HF27B, see page 922.

❗ The HON Company is not responsible for any liabilities resulting from wall mounted storage cabinets that are not properly installed.

**HOW TO SPECIFY**

<b>Select Model Number</b> <div style="display: flex; gap: 5px;"> <div style="border: 1px solid black; padding: 2px 5px;">H</div> <div style="border: 1px solid black; padding: 2px 5px;">1</div> <div style="border: 1px solid black; padding: 2px 5px;">1</div> <div style="border: 1px solid black; padding: 2px 5px;">5</div> <div style="border: 1px solid black; padding: 2px 5px;">3</div> <div style="border: 1px solid black; padding: 2px 5px;">4</div> </div>	<b>Select Edge Profile</b> See page 208 <div style="display: flex; gap: 5px;"> <div style="border: 1px solid black; padding: 2px 5px;">A</div> </div>	<b>Select Laminate</b> See pages 208-209 <div style="display: flex; gap: 5px;"> <div style="border: 1px solid black; padding: 2px 5px;">N</div> <div style="border: 1px solid black; padding: 2px 5px;">N</div> </div>
---	---	--

# VALIDO® Shared Components & Accessories

GSA SIN 711-2

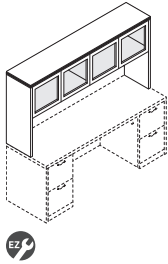
**DESCRIPTION****MODEL SHIP WEIGHT CUBE LIST PRICE****Stack-on Storage for an "L" Workstation, Frosted Doors with Silver Frame**78"W x 14<sup>5</sup>/<sub>8</sub>"D x 37<sup>1</sup>/<sub>2</sub>"H, 4 doors (Use Task Light model HH870960, see page 236)**H115327G** 210 18.4 **\$1892**

NOTES: Spans the total depth dimension of configurations comprised of: 48"W return or return shell attached to a 30"D single pedestal desk, desk shell or peninsula (78"D); 42"W return or return shell attached to a 36"D single pedestal desk or desk shell with a rectangle top, or to a peninsula (78"D); 42"W return or return shell attached to a 36" corner unit (78"D); 42"W curved return attached to 36" curved corner unit (78"D); or 36"W return shell attached to a jetty peninsula (78"D). Use back enclosure model 105857 and tackboard model 90057. Use task light models H870960 or H870960CH. For vertical paper manager model HLVP1, see page 234.

**Stack-on Storage, w/Frosted Doors with Silver Frame**72"W x 14<sup>5</sup>/<sub>8</sub>"D x 37<sup>1</sup>/<sub>2</sub>"H, 4 doors (Use Task Light model HH870960, see page 236)**H11534G** 196 17.0 **\$1760**66"W x 14<sup>5</sup>/<sub>8</sub>"D x 37<sup>1</sup>/<sub>2</sub>"H, 4 doors (Use Task Light model HH870960, see page 236)**H11533G** 185 15.6 **\$1733**60"W x 14<sup>5</sup>/<sub>8</sub>"D x 37<sup>1</sup>/<sub>2</sub>"H, 4 doors (Use Task Light model HH870960, see page 236)**H115324G** 173 14.2 **\$1685**48"W x 14<sup>5</sup>/<sub>8</sub>"D x 37<sup>1</sup>/<sub>2</sub>"H, 3 doors (Use Task Light model HH870942, see page 236)**H115323G** 148 11.5 **\$1393**42"W x 14<sup>5</sup>/<sub>8</sub>"D x 37<sup>1</sup>/<sub>2</sub>"H, 2 doors (Use Task Light model HH870942, see page 236)**H115322G** 141 4.1 **\$1111**36"W x 14<sup>5</sup>/<sub>8</sub>"D x 37<sup>1</sup>/<sub>2</sub>"H, 2 doors (Use Task Light model HH870930, see page 236)**H115321G** 107 4.1 **\$1077**

NOTES: For respective desk, credenza or return widths. Model 11534 can be used for "L" configuration comprised of a 42"W return or return shell attached to a 30"D single pedestal desk, desk shell or peninsula (72"); 36"W return shell attached to a 36"D single pedestal desk, desk shell or peninsula (72"); or 30"W return shell attached to a jetty peninsula (72"). Back enclosures, tackboards for use with back enclosures and task lights are available as options. See vertical paper manager model HLVP1 on page 234.

Stack-on Storage models H115327G, H11534G, H11533G and H115324G use task light model HH870960. Models H115323G and H115322G use task light model H870942 and model H115321G uses task light model HH870930. All task lights can be found on page 236.

**Stack-on Storage Clearance End Panel Kit**1<sup>1</sup>/<sub>8</sub>"W x 4<sup>5</sup>/<sub>8</sub>"-14<sup>5</sup>/<sub>8</sub>"D x 36"H**H105349** 29 3.4 **\$340**

Two field installable end panels (1-right; 1-left) for use in ganging two 10500 or Valido® Series stack-on storage units. See page 334.

NOTES: Can be used to connect up to two stack-on storage units in a line (requires 1 kit). Not available in two-tone laminate.

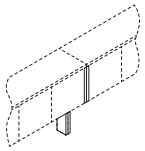
**SPECIFYING EXAMPLE: H105349.N****NOTES:**

- Shared components shown on this page can be used with modular components shown on pages 213-217, full pedestal models shown on pages 218-219, and 3/4 pedestal models shown on pages 220-221.
- Stack-on storage models are equipped with self-closing, adjustable hinged doors and valance to hide task light.
- For work-in-process paper management tools, see page 234.
- See pages 222-238 for shared components.

! Removable lock core kit for stack-on and wall mount storage is model HF27B, see page 922.

! The HON Company is not responsible for any liabilities resulting from wall mounted storage cabinets that are not properly installed.

**HOW TO SPECIFY**Select  
Model Number

H 1 1 5 3 2 7 G .

Select  
Edge Profile

See page 208

A .

Select  
Laminate

See pages 208-209

N N



# Shared Components & Accessories

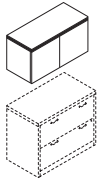

**DESCRIPTION**

**Wall Mounted Storage Cabinet**

30"W x 14<sup>5</sup>/<sub>8</sub>"D x 18<sup>7</sup>/<sub>8</sub>"H, 2 doors  
(Use Task Light model HH870930, see page 236)  
36"W x 14<sup>5</sup>/<sub>8</sub>"D x 18<sup>7</sup>/<sub>8</sub>"H, 2 doors  
(Use Task Light model HH870930, see page 236)  
42"W x 14<sup>5</sup>/<sub>8</sub>"D x 18<sup>7</sup>/<sub>8</sub>"H, 2 doors  
(Use Task Light model HH870942, see page 236)  
48"W x 14<sup>5</sup>/<sub>8</sub>"D x 18<sup>7</sup>/<sub>8</sub>"H, 3 doors  
(Use Task Light model HH870942, see page 236)

MODEL	COM	SHIP WEIGHT	CUBE	LIST PRICE
H115380		77	8.7	\$784
H115381		92	10.2	\$825
H115382		103	11.7	\$888
H115383		121	14.0	\$958

**Wall Mounted Storage Cabinet, Locking**

30"W x 14<sup>5</sup>/<sub>8</sub>"D x 18<sup>7</sup>/<sub>8</sub>"H, 2 doors  
(Use Task Light model HH870930, see page 236)  
36"W x 14<sup>5</sup>/<sub>8</sub>"D x 18<sup>7</sup>/<sub>8</sub>"H, 2 doors  
(Use Task Light Model HH870930, see page 236)  
42"W x 14<sup>5</sup>/<sub>8</sub>"D x 18<sup>7</sup>/<sub>8</sub>"H, 2 doors  
(Use Task Light Model HH870942, see page 236)  
48"W x 14<sup>5</sup>/<sub>8</sub>"D x 18<sup>7</sup>/<sub>8</sub>"H, 3 doors  
(Use Task Light Model HH870942, see page 236)

H115380K		77	8.7	\$824
H115381K		92	10.2	\$865
H115382K		103	11.7	\$928
H115383K		121	14.0	\$998

NOTES: Horizontal interlocking rails are included; due to varying types of walls, installers are responsible for selecting and supplying the appropriate fasteners. Tackboard widths differ slightly from wall mounted storage cabinet widths. For applications where multiple wall mounted storage cabinets are placed side-by-side, the preferred tackboard solution may be to utilize a larger tackboard size. For example, H90057 = 75"W; H90056 = 68<sup>3</sup>/<sub>4</sub>"W; H90055 = 62<sup>3</sup>/<sub>4</sub>"W; H90054 = 56<sup>3</sup>/<sub>4</sub>"W. For paper organizer tools, see pages 234-235.

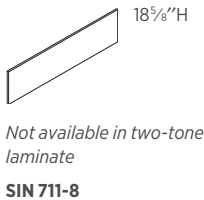

**Back Enclosure for Stack-on Storage**

75<sup>3</sup>/<sub>4</sub>"W - for 78"W model #H115327  
69<sup>3</sup>/<sub>4</sub>"W - for 72"W model #H11534  
63<sup>3</sup>/<sub>4</sub>"W - for 66"W model #H11533  
57<sup>3</sup>/<sub>4</sub>"W - for 60"W model #H115324  
45<sup>3</sup>/<sub>4</sub>"W - for 48"W model #H115323  
39<sup>3</sup>/<sub>4</sub>"W - for 42"W model #H115322  
33<sup>3</sup>/<sub>4</sub>"W - for 36"W model #H115321

H105857		39	1.4	\$244
H105856		33	1.3	\$224
H105855		31	1.3	\$208
H105854		29	1.3	\$199
H105853		23	0.9	\$199
H105852		21	0.9	\$190
H105851		18	0.9	\$179

NOTES: Non-tackable. Specify laminate.  
**SPECIFYING EXAMPLE: H105857.N**

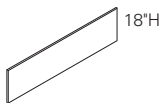

**Tackboards for use with Stack-on Back Enclosures**

75"W - for 78"W model #H115327 Hutch with #H105857 Enclosure  
68<sup>3</sup>/<sub>4</sub>"W - for 72"W model #H11534 Hutch with #H105856 Enclosure  
62<sup>3</sup>/<sub>4</sub>"W - for 66"W model #H11533 Hutch with #H105855 Enclosure  
56<sup>3</sup>/<sub>4</sub>"W - for 60"W model #H115324 Hutch with #H105854 Enclosure  
44<sup>3</sup>/<sub>4</sub>"W - for 48"W model #H115323 Hutch with #H105853 Enclosure  
39"W - for 42"W model #H115322 Hutch with #H105852 Enclosure  
33"W - for 36"W model #H115321 Hutch with #H105851 Enclosure

H90057	3.0	13	3.2	\$297
H90056	2.0	12	2.7	\$283
H90055	2.0	11	2.5	\$268
H90054	2.0	10	2.2	\$236
H90053	2.0	8	1.8	\$226
H90052	2.0	7	1.6	\$208
H90051	1.0	6	1.4	\$184

NOTES: Specify fabric, see pages 35-36. Upcharges may apply to premium fabric grades.

❗ Back Enclosures must be ordered separately.  
**SPECIFYING EXAMPLE: H90057.APN15**

**NOTES:**

- Shared components shown on this page can be used with modular components shown on pages 213-217, full pedestal models shown on pages 218-219, and 3/4 pedestal models shown on pages 220-221.
- Back enclosure features full-width 1<sup>1</sup>/<sub>8</sub>" slot at the bottom to facilitate routing cords and reaching wall electrical outlets.
- Tackboard is sized <sup>3</sup>/<sub>4</sub>" narrower than stack-on storage back enclosure, allowing <sup>3</sup>/<sub>8</sub>" on each side to route task light cord.
- Wall mounted storage cabinet attachment requires individual cabinets be secured by a minimum of two wall mounting locations/studs.
- Wall mounted storage cabinets are designed for interior and perimeter walls that are constructed with wood or metal studs.
- Wall attachment methodology: horizontally mounted, interlocking brackets.
- Wall mounted storage cabinet door design overlaps end panels so that when multiple units are placed side-by-side they appear as one continuous unit.
- See pages 222-238 for shared components.

❗ Removable lock core kit for stack-on and wall mount storage is model HF27B, see page 922.

❗ The HON Company is not responsible for any liabilities resulting from wall mounted storage cabinets that are not properly installed.

## HOW TO SPECIFY

<p>Select Model Number</p> <p>H 1 1 5 3 8 0 .</p>	<p>Select Edge Profile</p> <p>See page 208</p> <p>A .</p>	<p>Select Laminate</p> <p>See pages 208-209</p> <p>NN</p>
---	---	---

# VALIDO® Shared Components & Accessories

GSA SIN 711-2



Icon Legend on page 21

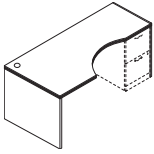

Right-hand model  
H115815R shown

## DESCRIPTION

### Extended Corner Unit

24"W x 36"D x 72"W x 24"D x 29½"H, Right (shown)  
24"D x 72"W x 36"D x 24"W x 29½"H, Left

NOTES: Can be used freestanding. One grommet in top and in modesty panel. Accept Valido/11500 Series modular or mobile pedestals. See pages 225-226 for optional stack-on storage.

ⓘ Designed to be used with returns or bridges.

**SPECIFYING EXAMPLE: H115815R.A.NN**

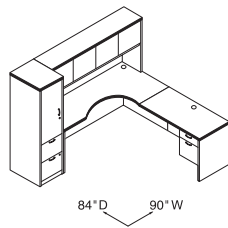
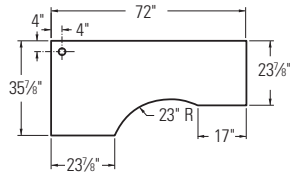

H115298L  
H115816L  
H11534  
H11515R

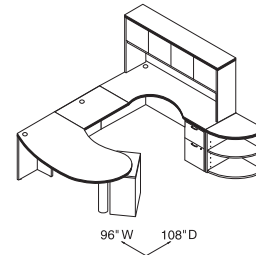

H115103  
H115204L  
H115598  
H115815R  
H115104  
H11534  
H115520

MODEL	SHIP WEIGHT	CUBE	LIST PRICE
<b>H115815R</b>	203	7.0	<b>\$1176</b>
<b>H115816L</b>	203	7.0	<b>\$1176</b>

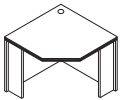

### Corner Unit

24" x 36" x 36" x 24" x 29½"H

NOTES: Can be used freestanding.

ⓘ Designed to be used with 24"D x 29½"H returns or bridges.

**SPECIFYING EXAMPLE: H115811.A.NN**

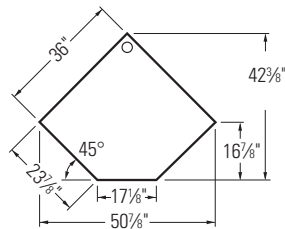

<b>H115811</b>	141	3.1	<b>\$810</b>
----------------	-----	-----	--------------

## NOTES:

- Shared components shown on this page can be used with modular components shown on pages 213-217, full pedestal models shown on pages 218-219, and 3/4 pedestal models shown on pages 220-221.
- Mobile pedestals, shown on page 229, work well in a variety of configurations.
- Extended corner units (H115815R and H115816L) can be used with 36"W return shell (H115680) to achieve a 6' x 6' layout.
- 36" corner unit (H115811) can be used with two 36"W return shells (H115680) to achieve a 6' x 6' layout.
- For conference table options, see the Preside® table tops and bases on pages 846-851. Order edge option "K".
- For work-in-process paper management tools, see pages 234-235.
- See pages 222-238 for shared components.

## HOW TO SPECIFY

Select  
Model Number

H 1 1 5 8 1 7 R .

Select  
Edge Profile

See page 208

A .

Select  
Laminate

See pages 208-209

NN



	DESCRIPTION	MODEL	SHIP WEIGHT	CUBE	LIST PRICE
	<b>Mobile Pedestal (with core removable lock) — Box/Box/File</b> 15 <sup>3</sup> / <sub>4</sub> "W x 22 <sup>3</sup> / <sub>4</sub> "D x 28 <sup>3</sup> / <sub>8</sub> "H — use freestanding or under 24"D, 30"D and 36"D modular shells NOTES: Top box drawer does not lock.	<b>H115102</b>	121	8.4	<b>\$844</b>
	<b>Mobile Pedestal (with core removable lock) — File/File</b> 15 <sup>3</sup> / <sub>4</sub> "W x 22 <sup>3</sup> / <sub>4</sub> "D x 28 <sup>3</sup> / <sub>8</sub> "H — use freestanding or under 24"D, 30"D and 36"D modular shells	<b>H115104</b>	121	8.4	<b>\$844</b>
	<b>Mobile Pedestal (with core removable lock) — Box/File</b> 15 <sup>3</sup> / <sub>4</sub> "W x 18 <sup>3</sup> / <sub>4</sub> "D x 21 <sup>1</sup> / <sub>8</sub> "H — use freestanding or under 20"D, 24"D, 30"D and 36"D modular shells	<b>H115106</b>	68	5.8	<b>\$705</b>
	<b>Mobile Pedestal — Shelf/Box/File</b> 15 <sup>3</sup> / <sub>4</sub> "W x 18 <sup>3</sup> / <sub>4</sub> "D x 28 <sup>3</sup> / <sub>8</sub> "H — use freestanding or under 20"D, 24"D, 30"D and 36"D modular shells NOTES: All mobile pedestals have a 1 <sup>1</sup> / <sub>8</sub> " thick top with flat, non-profiled edge. <b>SPECIFYING EXAMPLE: H115102.C.NN</b>	<b>H115109</b>	76	7.3	<b>\$775</b>
	<b>Lateral File (with core removable lock)</b> 36"W x 24"D x 29 <sup>1</sup> / <sub>2</sub> "H — two drawer	<b>H115690</b>	199	18.4	<b>\$1183</b>
	36"W x 20"D x 29 <sup>1</sup> / <sub>2</sub> "H — two drawer	<b>H11563</b>	177	15.6	<b>\$1126</b>
	36"W x 20"D x 45 <sup>1</sup> / <sub>2</sub> "H — three drawer	<b>H11517</b>	247	23.2	<b>\$1712</b>
	36"W x 20"D x 59 <sup>1</sup> / <sub>8</sub> "H — four drawer	<b>H11516</b>	312	31.0	<b>\$2387</b>
	NOTES: Includes hangrails, mechanical interlock, and in H11563 and H115690, a counterweight. Stack-on storage (H115321) and bookcase hutch (H115292) can be used with H11563 and H115690. Interlock inhibits the extension of more than one drawer from opening at a time. 24"D two-drawer model aligns with the depth of 24"D credenzas and returns. <b>SPECIFYING EXAMPLE: H11563.A.C.NN</b>				
	<b>Storage Cabinet with Doors (with core removable lock)</b> 36"W x 24"D x 29 <sup>1</sup> / <sub>2</sub> "H	<b>H115290</b>	176	18.4	<b>\$1017</b>
	36"W x 20"D x 29 <sup>1</sup> / <sub>2</sub> "H	<b>H115291</b>	154	15.0	<b>\$873</b>
	NOTES: Includes one adjustable shelf. Shelf adjusts in 1/4" increments with a total range of 6 3/4"H. Stack-on storage (H115321) and bookcase hutch (H115292) can be used with H115290 or H115291. 24"D model aligns with the depth of 24"D credenzas and returns. <b>SPECIFYING EXAMPLE: H115291.A.C.NN</b>				
	<b>Bookcase Hutch (for use with lateral file models H11563 or H115690 or storage cabinet with door models H115291 or H115290)</b> 36"W x 14 <sup>3</sup> / <sub>8</sub> "D x 37 <sup>1</sup> / <sub>2</sub> "H	<b>H115292</b>	108	3.8	<b>\$681</b>
	NOTES: Cord pass-through gap behind shelves and a 1 <sup>1</sup> / <sub>8</sub> "H full-width cord management slot at the bottom of the back panel to facilitate routing cords and reaching wall electrical outlets. When placed on top of 29 <sup>1</sup> / <sub>2</sub> "H base unit the total height (67"H) matches the height of credenzas with stack-on storage and the height of the wardrobe/storage cabinets and storage cabinet/lateral file. Two shelves are adjustable in 1/4" increments with a total range of 17 <sup>1</sup> / <sub>2</sub> "H. <b>SPECIFYING EXAMPLE: H115292.A.NN</b>				

**NOTES:**

- For additional components that can be shared with Valido/11500 Series, see pages 222-238.
- Drawers operate on full extension, ball-bearing suspensions to ensure smooth, quiet, long-lasting operation.
- Versatile mobile pedestals work well in a variety of configurations. Can be used freestanding or under modular shells. 1<sup>1</sup>/<sub>8</sub>" thick top with a square, non-profiled edge.
- 24"D two drawer lateral file and 24"D storage cabinet with door models align with 24"D credenzas and returns, credenza and return shells as well as wardrobe/storage cabinets to provide linear layout continuity.
- Mobile printer/fax cart shown on page 217 is ideal for limited space.
- File drawer design includes integrated hangrails for side-to-side letter or legal filing; and front-to-back for letter filing.
- Adjustable hex leveling glides allow floor-standing furniture to be easily leveled; glides have 3/4" adjustable range.
- For conference table options, see the Preside® table tops and bases on pages 846-851. Order edge option "K".

**HOW TO SPECIFY**

<b>Select Model Number</b> H 1 1 5 6 3	<b>Select Edge Profile</b> See page 208 Not specified for models H115102, H115103 and H115104 A	<b>Select Handle Option</b> See page 208 Not specified for models H115292, H115520, H115523 and H115524 C	<b>Select Laminate</b> See pages 208-209 NN
---	--	--	---



# VALIDO®

## Shared Components & Accessories

GSA SIN 711-2



Icon Legend on page 21

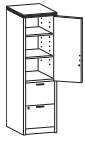

Right-hand model  
H115297R shown

**DESCRIPTION****Storage/File Cabinet (with core removable locks)**

18"W x 24"D x 67"H, Hinged Right (shown)  
18"W x 24"D x 67"H, Hinged Left

**MODEL**

**H115297R**  
**H115298L**

**SHIP WEIGHT**

262  
262

**CUBE**

22.7  
22.7

**LIST PRICE**

**\$1849**  
**\$1849**

NOTES: Versatile unit features a storage cabinet and two file drawers. Storage cabinet includes three shelves, two are adjustable in 2½" increments. Door hinged left or right models available. File drawers operate on ball-bearing suspensions with full extension. File drawers have high sides to accept hanging folders in letter or legal size. Drawers standard with hangrails. Both the storage cabinet and the file drawers are equipped with an interchangeable core removable lock. Unit height is designed to match credenza or return plus stack-on storage height.



Doors open 110 degrees from  
closed position.

**Storage Cabinet/Lateral File (with core removable lock)**

36"W x 24"D x 67"H

**H115293**

373

41.0

**\$2397**

NOTES: Storage cabinet is standard with one fixed and two full-width adjustable shelves in top compartment; adjustable shelves can be removed. Overall storage compartment measures 31¼"W x 22"D x 36⅝"H and will accommodate supplies, books and binders, as well as business machines and electronic equipment. Cord pass-through gap behind shelves and grommet in back of cabinet to facilitate routing cords and reaching wall electrical outlets. Two drawer lateral file on bottom. Lateral file comes with mechanical interlock and hangrails. Cabinet and lateral file lock independently. Unit height is designed to match credenza or return plus stack-on storage height.



Doors open 110 degrees from  
closed position.

**Storage Cabinet w/Doors (with core removable lock)**

36"W x 24"D x 67"H

**H115299**

349

41.0

**\$2141**

NOTES: Large capacity storage area includes five, full-width (side-to-side) shelves; three are adjustable in 2½" increments. Unit height matches credenza or return plus stack-on storage height.

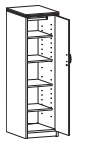

Right-hand model  
H115295R shown

**Personal Wardrobe/Storage Cabinet (with core removable lock)**

18"W x 24"D x 67"H, Hinged Right (shown)  
18"W x 24"D x 67"H, Hinged Left

**H115295R**  
**H115296L**

227  
227

22.9  
22.9

**\$1598**  
**\$1598**

NOTES: Unit is standard with four adjustable shelves, coat rod, and core removable lock. Shelves adjust in 2½" increments. Unit height is designed to match credenza or return plus stack-on storage height. Cabinet can be used as a wardrobe by removing four adjustable shelves. Coat rod can be removed from cabinet for storage only applications.

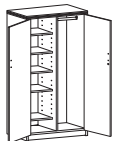

Doors open 110 degrees from  
closed position.

**Personal Wardrobe/Storage Cabinet (with core removable lock)**

36"W x 24"D x 67"H

**H11530**

349

41.0

**\$2341**

NOTES: Spacious design is standard with four adjustable shelves (one shelf is fixed), coat rod and core removable lock which locks both doors. Shelves adjust in 2½" increments. Unit height is designed to match credenza or return plus stack-on storage height.

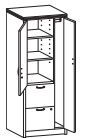

Right-hand model  
H115301R shown

**Personal Storage Tower (with core removable locks)**

24"W x 24"D x 67"H, Wardrobe Hinged Right, Storage Cabinet Hinged  
Left (shown)  
24"W x 24"D x 67"H, Wardrobe Hinged Left, Storage Cabinet Hinged  
Right

**H115301R**

304

27.9

**\$2341****H115302L**

304

27.9

**\$2341**

NOTES: Spacious design includes a wardrobe closet, storage cabinet, and two file drawers in one compact unit. Wardrobe closet contains a coat rod. Storage cabinet includes three shelves, two are adjustable in 2½" increments. Door hinged left or right models available. File drawers operate on ball-bearing suspensions with full extension. File drawers have high sides to accept hanging folders in letter or legal size. Drawers standard with hangrails. Equipped with interchangeable core removable locks. Upper lock secures storage cabinet and wardrobe closet doors; lower lock secures file drawers. Unit height is designed to match credenza or return plus stack-on storage height.

**NOTES:**

- Adjustable hex leveling glides allow floor-standing furniture to be easily leveled; glides have ¾" adjustable range.
- Locking units equipped with interchangeable core removable locks.
- For conference table options, see the Preside® table tops and bases on pages 846-851. Order edge option "K".
- See pages 222-238 for shared components.

ⓘ Keyed alike cores must be ordered separately — see model HF23B on page 922.

**HOW TO SPECIFY**

Select  
Model Number

H 1 1 5 2 9 7 R .

Select  
Edge Profile

See page 208

A .

Select  
Handle Option

See page 208

C .

Select  
Laminate

See pages 208-209

NN



H11552 shown

**DESCRIPTION****Bookcase**

36"W x 13<sup>1</sup>/<sub>8</sub>"D x 29<sup>5</sup>/<sub>8</sub>"H, 2-Shelf  
 36"W x 13<sup>1</sup>/<sub>8</sub>"D x 43<sup>3</sup>/<sub>8</sub>"H, 3-Shelf  
 36"W x 13<sup>1</sup>/<sub>8</sub>"D x 57<sup>1</sup>/<sub>8</sub>"H, 4-Shelf  
 36"W x 13<sup>1</sup>/<sub>8</sub>"D x 71"H, 5-Shelf

**MODEL**

**H11552**  
**H11553**  
**H11554**  
**H11555**

**SHIP WEIGHT**

94  
 126  
 160  
 191

**CUBE**

10.2  
 15.6  
 20.3  
 25.3

**LIST PRICE**

**\$585**  
**\$684**  
**\$815**  
**\$919**

NOTES: Fixed shelves. Inside shelf dimensions on all units is 33<sup>3</sup>/<sub>4</sub>"W x 12"D x 13"H. No assembly required.

**SPECIFYING EXAMPLE: H11552.A.NN**

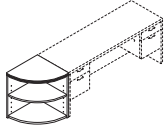
**End Cap Bookshelf**

24"W x 24"D x 29<sup>1</sup>/<sub>2</sub>"H

**H115520**

87

2.6

**\$685**

(2 shelves, 1 fixed, 1 adjustable. Adjusts in 2<sup>1</sup>/<sub>2</sub>" increments with a total range of 10"H)

NOTES: Unit is freestanding. Designed to be positioned at the end of 24"D credenzas and returns. Holds books and personal items.

**SPECIFYING EXAMPLE: H115520.A.NN**

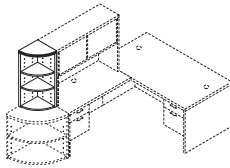
**End Cap Bookshelf**

15"W x 15"D x 37<sup>1</sup>/<sub>2</sub>"H

**H115523**

54

2.2

**\$606**

(3 shelves, 1 fixed, 2 adjustable. Adjusts in 2<sup>1</sup>/<sub>2</sub>" increments with a total range of 25"H)

NOTES: Unit is designed to be positioned at the end of stack-on storage and on top of model H115520. Combined height of models H115520 and H115523 matches credenza plus stack-on storage height. Can be used freestanding.

**SPECIFYING EXAMPLE: H115523.A.NN**

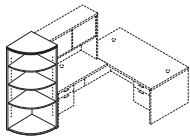
**End Cap Bookshelf**

24"W x 24"D x 67"H

**H115524**

167

4.8

**\$1090**

NOTES: Designed to be positioned at the end of 24"D credenzas with stack-on storage, 24"D returns with stack-on storage, 24"D storage/file cabinet, 24"D storage cabinet/lateral file, 24"D wardrobe/storage cabinets, or the 24"D personal storage tower. Unit has four shelves, three are adjustable in 2<sup>1</sup>/<sub>2</sub>" increments, with a total range of 45"H; bottom shelf is fixed.

**SPECIFYING EXAMPLE: H115524.A.NN**

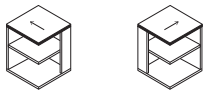

Model H115525R Model H115526L

**Square End Cap Bookshelf — 2-Fixed Shelves**

24"W x 24"D x 29<sup>1</sup>/<sub>2</sub>"H, Right  
 24"W x 24"D x 29<sup>1</sup>/<sub>2</sub>"H, Left

**H115525R**

98

3.7

**\$675****H115526L**

98

3.7

**\$675**

**SPECIFYING EXAMPLE: H115525R.A.NN**

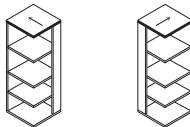

Model H115527R Model H115528L

**Square End Cap Bookshelf — 4-Fixed Shelves**

24"W x 24"D x 67"H, Right  
 24"W x 24"D x 67"H, Left

**H115527R**

178

11.4

**\$1044****H115528L**

178

11.4

**\$1044**

**SPECIFYING EXAMPLE: H115527R.A.NN**

NOTES: Units are freestanding. Designed to be positioned next to 24"D models or as a corner bookcase.

End cap, left: grain direction on top aligns with grain direction on tops of left pedestal returns and left credenza models or when positioned to the left side of credenzas with doors or kneespace models.

End cap, right: grain direction on top aligns with grain direction on tops of right pedestal returns and right credenza models or when positioned to the right side of credenzas with doors or kneespace models.

**NOTES:**

- Choose from square or rounded versions of the end cap bookshelves.
- End cap bookshelf units are ideal for books, photos and mementos.
- End Cap Bookcases are designed to be positioned at the end of 24"D credenzas and returns.
- Adjustable hex leveling glides allow floor-standing furniture to be easily leveled; glides have <sup>3</sup>/<sub>4</sub>" adjustable range.
- End cap bookshelf units are ideal for books, photos and mementos.
- For conference table options, see the Preside® table tops and bases on pages 846-851. Order edge option "K".
- See pages 222-238 for shared components.

**HOW TO SPECIFY**

Select  
Model Number

H 1 1 5 5 2 7 R .

Select  
Edge Profile

See page 208

A .

Select  
Laminate

See pages 208-209

NN

# VALIDO®

## Shared Components & Accessories

GSA SIN 711-2 EXCEPT AS NOTED

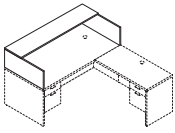
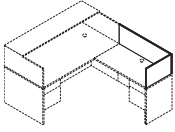
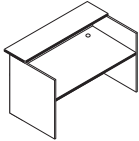
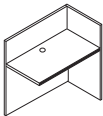
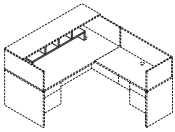

Icon Legend on page 21

	DESCRIPTION	MODEL	SHIP WEIGHT	CUBE	LIST PRICE
	<b>Reception Station with Transaction Counter for 72"W x 36"D Desk, or Desk Shell, with rectangle top</b> 72"W x 36"D x 14 <sup>5</sup> / <sub>8</sub> "H	<b>H115720</b>	100	3.0	<b>\$651</b>
	NOTES: For desk tops without grommets, see field installable grommet kit, model HFLDGRMT or HFLDGRMT3 on page 236. Transaction counter organizer (HTCOL52) fits under/inside of transaction counter (see below).				
	<b>Reception Station for 42"W x 24"D Return or Return Shell</b> 42"W x 24"D x 13"H	<b>H105722</b>	21	1.0	<b>\$239</b>
	<b>Reception Station for 48"W x 24"D Return or Return Shell</b> 48"W x 24"D x 13"H	<b>H105721</b>	25	3.6	<b>\$272</b>
	NOTES: For return tops without grommets, see field installable grommet kit, model HFLDGRMT or HFLDGRMT3 on page 236. ⚠ Not available in two tone laminate.				
	<b>Reception Desk Shell</b> 72"W x 39 <sup>7</sup> / <sub>8</sub> "D x 44 <sup>1</sup> / <sub>2</sub> "H	<b>H115724</b>	328	16.8	<b>\$1305</b>
	NOTES: Non-handed design. Integrated 18 <sup>5</sup> / <sub>8</sub> "D transaction counter with a 4" full-width overhang. Two cord management grommets in top for routing and hiding wires and cables. Transaction counter organizer (HTCOL52) fits under/inside of transaction counter.				
	<b>Reception Return Shell</b> 42"W x 24"D x 43 <sup>5</sup> / <sub>8</sub> "H	<b>H115726</b>	140	16.8	<b>\$848</b>
	NOTES: Non-handed design. Attaches to reception desk shell to form an L-shaped workstation. One cord management grommet in top for routing and hiding wires and cables. Wood-grain on approach side is vertical to match grain direction on end panels of reception desk.				
	<b>Transaction Counter Organizer</b> 48 <sup>3</sup> / <sub>4</sub> "W x 11 <sup>1</sup> / <sub>8</sub> "D x 13"H	<b>HTCOL52</b>	24	1.1	<b>\$259</b>
	NOTES: Fits under reception station with transaction counter model H115720 or reception desk shell H115724. ⚠ Black only.				

**NOTES:**

- Two welcoming reception station designs to choose from — stack-on enclosure or full-to-floor shell.
- See pages 222-238 for shared components.

**HOW TO SPECIFY**

<b>Select Model Number</b> H 1 1 5 7 2 4	<b>Select Edge Profile</b> See page 208 A	<b>Select Laminate</b> See pages 208-209 N N
---	---	--



Icon Legend on page 21

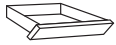

Refer to page 171 for Center Drawer compatibility information

SIN 711-1, 711-2, 711-11



**DESCRIPTION**

**Angled Wood Center Drawer**

26" x 15<sup>3</sup>/<sub>8</sub>"  
22" x 15<sup>3</sup>/<sub>8</sub>"

**MODEL**

**H1526**  
**H1522**

**SHIP WEIGHT**

12.0 Ⓢ  
11.0 Ⓢ

**CUBE**

1.2  
1.1

**LIST PRICE**

**\$187**  
**\$173**

NOTES: Specify laminate for drawer. For additional information see page 903.

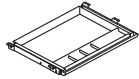

OPEN MARKET

**Polymer Center Drawer**

- Color: Black.
- Material: ABS.
- Opening Requirements: 23"W x 16<sup>1</sup>/<sub>4</sub>"D x 2"H.
- Retracts on 16" ball bearing slides.
- Can be used on worksurfaces with Coordinate™ Height Adjustable Bases as long as it is attached with spacer model HKBS.
- Can store up to 25 lbs.

**HCD1**

7.0

0.5

**\$99**

NOTES: For additional information see page 904.

! Black finish only, no specification needed.

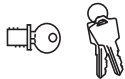

SIN 711-2



**Black Removable Lock Core Kit** — see page 922.

**HF23B**

0.1 Ⓢ

0.1

**\$29**

NOTES: Lock with a removable cylinder that can be interchanged as needed; allows users to access all furniture pieces in an office with a single key for convenience and security.

Makes re-keying quick and easy. For use in all Valido® Series product lock cores, except the stack-on and wall mounted storage "K" models. For the latter, use lock core kit model HF27B.

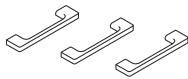
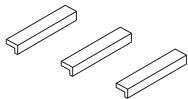

SIN 711-8



**Field Installable Drawer/Door Handle Kits (fit Valido® 96mm hole spacing)**

Linear, Black, 2-pack  
Linear, Matte Chrome, 2-pack

**HLINEARA2**  
**HLINEARC2**

0.4 Ⓢ  
0.4 Ⓢ

0.3  
0.3

**\$51**  
**\$51**

Linear, Black, 3-pack  
Linear, Matte Chrome, 3-pack

**HLINEARA3**  
**HLINEARC3**

0.5 Ⓢ  
0.5 Ⓢ

0.3  
0.3

**\$59**  
**\$59**

NOTES: The Linear and Arch handles attach using the same 96mm hole spacing as the Valido® Sweep and Crescent handles. The Linear handle is not recommended for use on the Valido® Narrow/Box/Box/File Modular Pedestal — model H115093.

Arch, Black, 2-pack  
Arch, Matte Chrome, 2-pack

**HARCHA2**  
**HARCHC2**

0.4 Ⓢ  
0.4 Ⓢ

0.3  
0.3

**\$51**  
**\$51**

Arch, Black, 3-pack  
Arch, Matte Chrome, 3-pack

**HARCHA3**  
**HARCHC3**

0.5 Ⓢ  
0.5 Ⓢ

0.3  
0.3

**\$59**  
**\$59**

! Must be ordered with a configurable end product. If ordered separately, not on GSA contract.

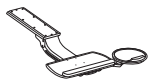

Refer to pages 75 and 901 for additional product information

SIN 711-1, 711-2, 711-11



DESCRIPTION	MODEL	SHIP WEIGHT	CUBE	LIST PRICE BY PAINT GRADE	
				CORE	METALLICS
<b>Sit to Stand Arm with Convertible Keyboard Platform</b>	<b>H2516 OPEN MARKET</b>	17 Ⓢ	1.6		<b>\$565</b>
<b>Articulating Arm with Convertible Keyboard Platform</b>	<b>H2107 OPEN MARKET</b>	16 Ⓢ	1.3		<b>\$484</b>
<b>Articulating Arm with Keyboard Platform</b>	<b>H1706 OPEN MARKET</b>	16 Ⓢ	1.4		<b>\$451</b>
<b>Slide-Away Keyboard Platform</b> (Specify: Laminate)	<b>H4022</b>	10 Ⓢ	0.6		<b>\$199</b>
<b>Extended Tray Slide-Away Keyboard Platform</b> (Specify: Laminate)	<b>HE4022</b>	12 Ⓢ	0.7		<b>\$285</b>
<b>Metal Keyboard and Mouse Tray</b> (Specify paint)	<b>H4028 OPEN MARKET</b>	11 Ⓢ	1.5		<b>\$144</b> <b>\$154</b>
<b>Metal Keyboard Tray</b> (Specify paint)	<b>H4029 OPEN MARKET</b>	11 Ⓢ	1.5		<b>\$129</b> <b>\$139</b>

NOTES: For additional information see pages 585-901.

**NOTES:**

- Linear and Arch field installable handles attach using Valido® 96mm (approx. 3<sup>3</sup>/<sub>4</sub>"") hole spacing. No drilling required.
- Center drawers ideal for pens, pencils and other miscellaneous storage. Feature ball-bearing slide suspension.
- For conference table options, see the Preside® table tops and bases on pages 846-851. Order edge option "K".

# VALIDO®

## Shared Components & Accessories

GSA SIN 711-2 EXCEPT AS NOTED



Icon Legend on page 21

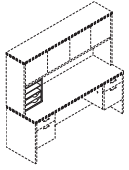

Not available in two-tone laminates

SIN 711-8

**DESCRIPTION****Vertical Paper Manager**14 $\frac{7}{8}$ "W x 10 $\frac{7}{8}$ "D x 19 $\frac{1}{16}$ "H**MODEL****HLVPM1****SHIP WEIGHT**

27

**CUBE**

2.8

**LIST PRICE****\$298**

NOTES: Keeps papers, files, and books neatly organized and within easy reach from a seated position. Designed for desk, credenza, and return tops. Fits under stack-on storage models. Two pullout drawers and three fixed shelves. Not available in pattern laminate colors. Ships fully assembled. For additional information see page 912.

ⓘ When used in conjunction with wall mounted storage cabinets, the top of the wall mounted storage cabinets must be positioned a minimum of 68 $\frac{3}{8}$ " above the floor.

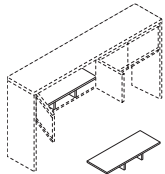
**SPECIFYING EXAMPLE: HLVPM1.N****Stacked Paper Management**32 $\frac{1}{2}$ "W x 12 $\frac{5}{8}$ "D x 4 $\frac{1}{4}$ "H**HLVPM2**

22

1.25

**\$148**

NOTES: Segments and organizes stack-on and wall mount storage compartments, as well as bookcase shelves. Unit can be used in Models H115327, H11534, H115322, H115321, H115382 and H115381. In some cases, installation may require removing the stack-on or wall mount storage doors. For additional information see page 913.

ⓘ Black (P) only.

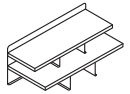

Not available in two-tone laminate

**Desktop Storage Terrace**26 $\frac{1}{2}$ "W x 12 $\frac{1}{2}$ "D x 10 $\frac{1}{2}$ "H**HLDST1**

24

1.1

**\$279**

NOTES: Keeps work-in-process, priority files, loose pages, and mail neatly organized and in view. Mixed material design comprised of sturdy laminate shelves with metal back and support panels. Not available in two-tone laminate combination or pattern laminate colors. Choose from Platinum Metallic (T1), Black (P), and Charcoal (S) for the metal components.

Sized to fit in stack-on and wall mounted storage cabinets in 10500, 10700, Valido, 94000, Park Avenue Laminate, and 38000 Series. Fits in Voi stack-on and overhead cabinets except for 48"W or smaller sliding door models. For additional information see page 912.

Specify: Model.Laminate.Paint

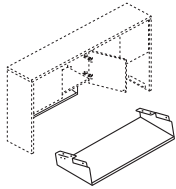
**SPECIFYING EXAMPLE: HLDST1.N.T1****Hanging Paper Shelf**28 $\frac{1}{16}$ "W x 11 $\frac{1}{16}$ "D x 4 $\frac{5}{16}$ "H**HHPS1**

7

2.9

**\$180**

NOTES: Maximizes worksurface space; de-clutters desktop while placing priority communications and active project folders within easy reach. Angled design allows contents to be distinguished at a glance. Mixed material styling features strong painted metal frame with a frosted shelf.

Attaches quickly and easily to stack-on and wall mount storage models in the following series: 10500, 10700, Valido, Park Avenue Laminate, 94000, and Voi (except the 36"W overhead hutch with O-legs or panel mount brackets). Not for use with 38000 Series.

Choose from Platinum Metallic (T1), Black (P), and Charcoal (S) paint. For additional information see page 913.

Specify: Model.Paint

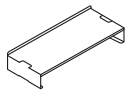
**SPECIFYING EXAMPLE: HHPS1.T1****Desktop Paper Shelf**28 $\frac{1}{16}$ "W x 11 $\frac{5}{16}$ "D x 5"H**HDPS1**

7

2.9

**\$180**

NOTES: Organizer shelf provides a place and space for work-in-process and piling to keep worksurfaces neat and tidy. Convenient, scalable design with interlocking side supports allow two units to be stacked and integrated. Durable painted metal frame with a frosted shelf; mixed material styling matches hanging paper shelf.

Can also be used inside select overhead storage, including the following stack-on with hinged door models: 10500 and Valido 36", 42", 66", 72", 78"W and 10700 68 $\frac{5}{8}$ "W.

Choose from Platinum Metallic (T1), Black (P), and Charcoal (S) paint. For additional information see page 913.

Specify: Model.Paint

**SPECIFYING EXAMPLE: HDPS1.T1****Storage Cube**

12"W x 12"D

**HLSL1212**

1

0.3

**\$276**

NOTES: Available in the following colors: Autumn (AUTM), Citron (CITR), Flame (FLAM), Pool (POOL) and Sisal (SISL). For additional information see page 914.

**SPECIFYING EXAMPLE: HLSL1212.CITR****HOW TO SPECIFY**

Select  
Model Number

H L V P M 1 .





Select  
Laminate

See pages 208-209

N

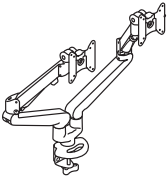
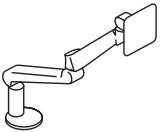
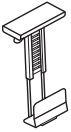

Icon Legend on page 21

	DESCRIPTION	MODEL	SHIP WEIGHT	CUBE	LIST PRICE
	<p><b>Dual Monitor Arm</b> Single Mount with Dual Monitor effortless adjustment. Range of adjustment is 13" from 6½"-19½".</p> <p>NOTES: Available in Silver only, no specification needed. For complete monitor arm features, see page 288. For additional information see page 899.</p>	<b>H5220</b>	15 Ⓢ	1.8	<b>\$912</b>
	<p><b>Single Monitor Arm</b> Effortless adjustment, no levers. Range of adjustment is 13" from 6½"-19½".</p>	<b>H5210</b>	11 Ⓢ	1.3	<b>\$510</b>
	<p><b>CPU Holder</b></p> <ul style="list-style-type: none"> <li>Vertically mounts to underside of worksurface.</li> <li>360° swivel.</li> <li>Supports up to 55 lbs.</li> <li>Height adjustable from 16" to 22" below worksurface.</li> <li>Width adjustable to accept units from 3¼" to 6".</li> </ul> <p>NOTES: Arms fold back to post to allow more desktop room. Arms feature double extension, allowing 20"+ of back and forth movement. Cable management on both pole and arm assemblies. Counterbalance adjustment provides stability for monitors up to 17.6 lbs per arm. Made of high quality aluminum alloy material. For additional information see page 899.</p> <p>⚠ Silver finish only, no specification needed.</p>	<b>HCPU</b>	16 Ⓢ	0.5	<b>\$236</b>
   	<p><b>Back Pack Hook (10 per carton)</b> 12"W x 14½"D x 1½"H</p> <p>NOTES: Assembly: attaches to bottom of desk with (2) screws, included. For additional information see page 914.</p> <p>⚠ Available in Chrome finish only, no specification needed.</p>	<b>HCLA65</b>	10 Ⓢ	0.1	<b>\$91</b>

**HOW TO SPECIFY**

Select Model Number

H 5 2 1 0

# VALIDO®

## Shared Components & Accessories

GSA SIN AS NOTED



Icon Legend on page 21

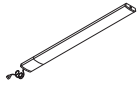

OPEN MARKET

**DESCRIPTION****LED Task Lights**

17" LED Light with Power Supply (Single)

31" LED Light with Power Supply (Single)

17" LED Light with Power Supply for Daisy-chain (Starter)

31" LED Light with Power Supply for Daisy-chain (Starter)

17" LED Light with 8" Jumper Cord for Daisy-chain (Follower)

31" LED Light with 8" Jumper Cord for Daisy-chain (Follower)

**Undercabinet Occupancy Sensor with 1" End to End Connector**

NOTES: To use the daisy chain application, must start with model HLED17A or HLED31A. No finish specification required. Attaches magnetically to underside of overhead storage, or attaches with provided screws or double-sided tape. Occupancy sensor attaches to a single or starter LED light and will automatically turn the light off after no motion is detected for 30 minutes. Just like all the LED light models, the occupancy sensor features a soft-touch on/off switch. LED task lights have a lifetime of 50,000 hours and have a dimmer feature that allows the user to adjust the amount of light output. For additional information see page 911.

**MODEL****SHIP WEIGHT****CUBE****LIST PRICE****HLED17AS**

1.2 Ⓢ

0.05

**\$384****HLED31AS**

1.5 Ⓢ

0.09

**\$516****HLED17A**

1.0 Ⓢ

0.05

**\$422****HLED31A**

1.4 Ⓢ

0.09

**\$567****HLED17AUO**

1.0 Ⓢ

0.03

**\$344****HLED31AUO**

1.0 Ⓢ

0.05

**\$460****HLEDOSA**

0.2 Ⓢ

0.01

**\$80**

Refer to page 77

OPEN MARKET

**Recessed Task Light**

46½"W x 3¼"D x 1⅞"H for Models H115327, H11534, H11533 and H115324

34⅝"W x 3⅞"D x 1⅞"H for Models H115323, H115322, H115382 and H115383

22⅞"W x 3⅞"D x 1⅞"H for Models H115321, H115380 and H115381

NOTES: For additional information see page 911.

**HH870960**

12.0 Ⓢ

1.1

**\$246****HH870942**

10.0 Ⓢ

0.9

**\$228****HH870930**

7.0 Ⓢ

0.6

**\$211****LED Task Lights****Articulating Desk Lamp****Articulating Desk Lamp w/ Occupancy Sensor**

NOTES: For additional information see page 909.

**HLED1**

1.2 Ⓢ

6.5

**\$359****HLED1OC**

1.2 Ⓢ

6.5

**\$439**

SIN 711-1

**Task Desk Lamp**

NOTES: For additional information see page 909.

**HLED2**

0.7 Ⓢ

3.0

**\$311**

SIN 711-1



Black only

SIN 711-8

**Field Installable Grommet**

• Grommet is field installable.

• Grommet shape is round.

• Includes grommet cap and sleeve.

• Grommet cap measures 3" diameter and includes a ¾" diameter cord access hole.

• Grommet sleeve measures 2½" O.D. x ¾" thick.

• Includes instructions to locate grommet position for desks, credenzas, returns and bridges.

NOTES: For additional information see page 916.

! Designed to be used in top and end panels to route/hide cords, and in modesty panels to facilitate reaching wall electrical outlets.

! Black Finish

! Requires a 2½" diameter hole saw and drill for installation (not included).

**HFLDGRMT**

0.1 Ⓢ

0.01

**\$29**

SIN 711-8

**Field Installable Grommet**

• Grommet is field installable.

• Grommet shape is round.

• Includes grommet cap and sleeve.

• Grommet outside dimensions measure 3½" diameter and includes two cord access holes.

• Grommet sleeve measures 3" O.D. x 1" thick.

• Includes instructions to locate grommet position for desks, credenzas, returns and bridges.

NOTES: For additional information see page 916.

! Designed to be used in top and end panels to route/hide cords, and in modesty panels to facilitate reaching wall electrical outlets.

! Black Finish

! Requires a 3" diameter hole saw and drill for installation (not included).

**HFLDGRMT3**

0.1 Ⓢ

0.3

**\$29****NOTES:**

• See pages 222-238 for shared components.

**HOW TO SPECIFY**Select  
Model NumberSelect  
Color

Available in Black (P) only

H H 8 7 0 9 6 0 .

P

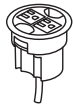

SIN 71-302

**DESCRIPTION**

**MODEL**

**SHIP WEIGHT**

**CUBE**

**LIST PRICE**

**Power Hub, 3" Grommet Mount**

**HGRMTAC**

1.3

0.2

**\$103**

- Fits in 3" round grommet holes on the following product lines: 10500, 10700, Concinnity, Coordinate, and Voi desks; Abound Worksurfaces; Huddle and Motivate tables and SmartLink.
- Two grounded AC power outlets.
- Includes 6' cord with three-prong plug.
- Two cord pass-through holes in cap.
- Field installed; easy plug-and-play.
- UL Listed.

NOTES: For additional information see page 916.

ⓘ Available in black only (no color designation so use .X - Specify: HGRMTAC.X).

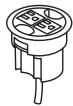

SIN 71-302



**3" Round Power Grommet - 2 Outlets, 10' Cord**

**HGRMTAC2**

1.5

0.2

**\$130**

- Includes 10' cord with three-prong plug.
- Fits in 3" round grommet holes on the following product lines: Coordinate, Huddle, Motivate, all laminate and veneer casegoods series, and Systems Worksurfaces.
- Two grounded AC power outlets.
- Field installed with Plug-and-play ease.

NOTES: Power Modules will also work with standing-height applications for 10500 Series™ and Voi® desks. Optional Memory Control allows preset worksurface heights for consistency. Ships separately. Dynamic load capacity when worksurface is moving is 300 lbs.

ⓘ Available in black finish only, no specification needed.

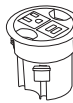

SIN 71-302

**Power/USB Hub, 3" Grommet Mount**

**HGRMTUSB2**

1.3 ⓘ

0.02

**\$203**

- One grounded AC power outlet with 2 USB ports.
- Two cord pass-through holes in cap.
- Includes 6' cord with three-prong plug.
- Field installed; easy plug-and-play.
- UL Listed.

NOTES: For additional information see page 916.

ⓘ Available in black only (no color designation so use .X - Specify: HGRMTUSB2.X).

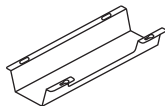

SIN 711-1

**Cable Management Troughs**

17"W - Single

**HCTROUGH17**

2.7 ⓘ

0.5

**\$62**

17"W - 10-Pack

**HCTROUGH1710**

14.0 ⓘ

0.5

**\$583**

36"W - Single

**HCTROUGH36**

4.9 ⓘ

0.9

**\$104**

36"W - 10-Pack

**HCTROUGH3610**

30.0 ⓘ

0.9

**\$983**

- Cable management troughs ship flat packed.
- The troughs attach to underneath the worksurface with screws.
- The 17"W has one wire access cut out on the user side. The 36" has two wire access cut outs. These cut outs give users access to inside the trough without having to detach it from the worksurface.
- Color: Graphite.
- Material: Metal.
- TAA Compliant.

NOTES: For additional information see page 920.

**HOW TO SPECIFY**

Select Model Number

H G R M T A C



# VALIDO® Shared Components & Accessories

GSA SIN 711-2



Icon Legend on page 21

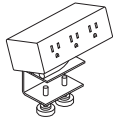

Model HPWRMOD3WC shown

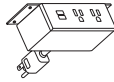

Model HPWRMOD2UWM shown

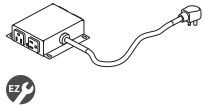
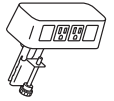
**DESCRIPTION****MODEL****SHIP WEIGHT****CUBE****LIST PRICE****Power Modules**

- 3 Receptacles with Worksurface Clamp
- 3 Receptacles with Under-Worksurface Mounting Bracket
- 2 Receptacles 2 USB with Worksurface Clamp
- 2 Receptacles 2 USB with Under-Worksurface Mounting Bracket
- 6' power cord with standard three-prong plug.
- Under-worksurface mounting bracket models work with any top that has a 5" x 5" square clearance.
- Worksurface clamp models work on any top with a 4" overhang.
- UL Listed.

**HPWRMOD3WC**

2.3 Ⓢ

0.2

**\$279****HPWRMOD3UWM**

2.3 Ⓢ

0.2

**\$279****HPWRMOD2WC**

2.3 Ⓢ

0.2

**\$447****HPWRMOD2UWM**

2.3 Ⓢ

0.2

**\$447**

- Color finish coordinates with HON's Charcoal or White. *Specify S for Charcoal or WHIT for White when ordering.*  
Example: HPWRMOD3WC.S.

**Power & Data Center**

- 2 Receptacles 2 Data Accessory
- Standard with two receptacles and openings for two data ports.
- 6' power cord with standard three-prong plug.
- Fits on any worksurface with a 4" overhang.
- UL Listed.

**HCOMDOME2**

2.5 Ⓢ

0.2

**\$266**

- Color finish coordinates with HON's Loft. *Specify LOFT when ordering.* Example: HCOMDOME2.LOFT.

**Under Worksurface Power Module — 4 Outlets, 10' Cord****HPWRMOD2**

1.5

0.2

**\$354**

- Includes 10' cord with three-prong plug.
- Fits in cable management troughs. See page 79.
- 4 outlets on side create easy access.

NOTES: Power Modules will also work with standing-height applications for 10500 Series™ and Voi® desks.

- Available in black finish only, no specification needed.

**Vertebrae****HMPVWM28**

3.0

0.3

**\$200**

- Clear finish. Specify "X" for finish option.  
**SPECIFYING EXAMPLE: HMPVWM28.X**

**NOTES:**

- For additional information see pages 917 and 920.

**HOW TO SPECIFY**Select  
Model Number

H P W R M O D 3 W C

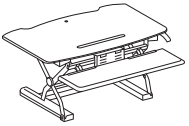
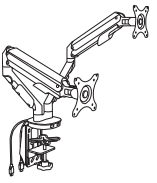
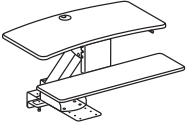
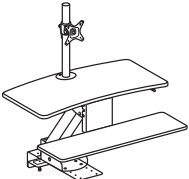
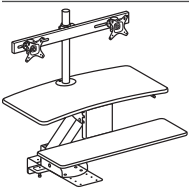
	DESCRIPTION	MODEL	SHIP WEIGHT	CUBE	LIST PRICE
	<p><b>Coordinate™ Portable Desktop Riser</b> 31"D x 4½"-16½"H x 35"W</p> <p>NOTES: Available in Black (BLK) or White (WHT) finish. Desktop riser dimensions (without keyboard tray): 22"D x 4½"-16½"H x 35"W. Keyboard tray dimensions: 9"D x 30"W. Max loading capacity is 33 lbs for the desktop riser surface and 4 lbs for the keyboard tray. Easily transition from seated to standing positions throughout the workday. Sits atop an existing desk to create sit-to-stand functionality by raising the computer. Includes keyboard tray and surface for computer monitors. <b>HON 5-Year Limited Warranty.</b></p> <p>⚠ Not intended for use on mobile workstations.</p>	<b>HBXRISER</b>	54.0	4.1	<b>\$500</b>
	<p><b>Dual Monitor Arm with 2 USB Ports</b></p> <p>NOTES: <b>AVAILABLE FEBRUARY 2018.</b> Easy adjustment. Height adjusts to 17" tall. Monitor tilt and swivel capability. Enclosed cable management. Grommet or desktop mounting. Clean appearance. For additional information see page 899.</p> <p>⚠ No specification needed.</p>	<b>HBDMAUSB</b>	41.9	2.6	<b>\$360</b>
	<p><b>Coordinate™ Mounted Desktop Riser</b></p> <p>NOTES: Does not include a monitor arm and is suitable for laptops and/or monitors on their original stands.</p> <p>⚠ No specification needed.</p>	<b>HS1100</b>	60.0 Ⓢ	3.2	<b>\$525</b>
	<p><b>Coordinate™ Mounted Desktop Riser with Single Monitor Arm</b></p> <p>NOTES: Includes a monitor arm for a single monitor.</p> <p>⚠ No specification needed.</p>	<b>HS1101</b>	62.0 Ⓢ	3.2	<b>\$615</b>
	<p><b>Coordinate™ Mounted Desktop Riser with Dual Monitor Arm</b></p> <p>NOTES: Includes a monitor arm for dual monitors.</p> <p>⚠ No specification needed.</p>	<b>HS1102</b>	63.0 Ⓢ	3.2	<b>\$700</b>

**NOTES FOR HS1100, HS1101, HS1102:**

- These products are designed to allow the user to transition from seating position to standing position throughout the workday.
- Gas-assist lever-operated mechanism with positive stop.
- Clamp mount compatible with worksurfaces depths of 20"-30". 20" is for systems only.
- Clamp requires 3.5" of clearance along back edge of worksurface.
- Black seamless worksurfaces.
- Silver powder coated metal components.
- Lowers below worksurface level on 24" and 30"D worksurfaces.
- All models contain a large primary worksurface and a smaller keyboard / mouse surface.
- Beveled edges for sleek appearance and comfort while typing.
- Monitor arms include height, width, and swivel adjustment.
- For additional information see page 906.

- Not for use under overhead storage, with flush mounted modesty panels, or worksurfaces thinner than 1".

⚠ Not recommended for use on mobile (castered) worksurfaces.

**MOUNTING AND COMPATIBILITY FOR HS1100, HS1101, HS1102:**

- This product is intended to be installed on commercial-grade worksurfaces in good condition.
- Compatible with freestanding worksurfaces 24"-30"D or panel-supported worksurfaces 24"-30"D.
- Not for use on mobile worksurfaces.

**Clamp Mount**

Use when 3.5" minimum overhang is available

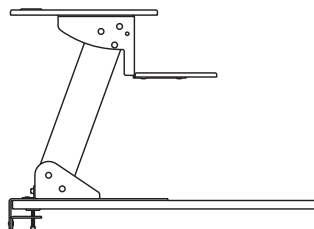

**Screw Mount**

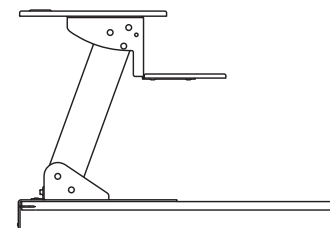

Use when no overhang is available. Worksurface must be minimum 1" thick.



**HOW TO SPECIFY**

<p>Select Model Number</p> <p><b>HBXRISER.</b></p>	<p>Select Finish</p> <p><b>BLK</b> Black <b>WHIT</b> White</p> <p><b>BLK</b></p>
--	--

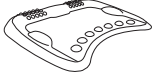
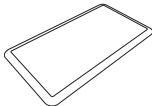
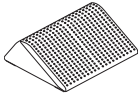

	DESCRIPTION	MODEL	SHIP WEIGHT	CUBE	LIST PRICE
	<b>Rectangle Wobble Board — Anti-Fatigue Mat</b> 18"D x 3"H x 22½"W ⓘ Available in Black (T) finish ONLY. Recommended weight capacity not to exceed 250 pounds. <b>HON 5-Year Limited Warranty.</b> <b>SPECIFYING EXAMPLE: HVL981.T</b>	<b>HVL981</b>	10.0 Ⓢ	0.9	<b>\$220</b>
	<b>Round Wobble Board — Anti-Fatigue Mat</b> 18½"D x 2½"H x 18½"W ⓘ Available in Black (T) finish ONLY. Recommended weight capacity not to exceed 250 pounds. <b>HON 5-Year Limited Warranty.</b> <b>SPECIFYING EXAMPLE: HVL982.T</b>	<b>HVL982</b>	5.8 Ⓢ	0.6	<b>\$190</b>
	<b>Ergonomic Anti-Fatigue Mat</b> 25"D x 2¾"H x 29⅞"W ⓘ <b>AVAILABLE FEBRUARY 2018.</b> Available in Black ONLY. No specification needed. <b>SPECIFYING EXAMPLE: HBEAFM1</b>	<b>HBEAFM1</b>	7.0	1.4	<b>\$176</b>
	<b>Rectangle Anti-Fatigue Mat</b> 20"D x ¾"H x 36"W ⓘ <b>AVAILABLE FEBRUARY 2018.</b> Available in Black ONLY. No specification needed. <b>SPECIFYING EXAMPLE: HBAFM2036</b>	<b>HBAFM2036</b>	5.4	0.4	<b>\$80</b>
	<b>Footrest — Anti-Slip Cover</b> 13¾"D x 5½"H x 16"W ⓘ Available in Black (T) finish ONLY. Recommended weight capacity not to exceed 250 pounds. <b>HON 5-Year Limited Warranty.</b> <b>SPECIFYING EXAMPLE: HVL991.T</b>	<b>HVL991</b>	7.0 Ⓢ	0.9	<b>\$65</b>

## HOW TO SPECIFY

Select  
Model Number

H V L 9 8 1 .

Select  
Finish

T Black

T



Voi® shown with Ignition® Seating.

**VOI®**

Voi gets you. Your needs. Your style. Your environment. Voi packs a lot of functionality into a little space, so you can maximize yours. Plus, versatile Voi integrates easily with a variety of spaces, systems — even open plans. Solidly built and strikingly designed, Voi combines classic warmth and contemporary cool with an extensive variety of laminates, colors, components and configurations. So you can create a sophisticated, professional look that is uniquely yours.



**FEATURES**

- Big. Small. Functional. Adaptable. Voi has multiple options to meet your storage needs and available space.
- To create an office look that's uniquely yours, mix things up — with tasteful modesty panels, stylish storage cubes and mixed surface materials.
- Refined scale. Layered workspaces. Together they help streamline your office to create small-footprint spaces that work BIG.
- With so many configurations and combinations, Voi® makes it easy to create a stylish, unified look across your entire office.

# VOI® ORDERING INFORMATION

			Voi® Worksurfaces	Chassis/Cabinet	Drawer/Door Fronts	Grommets	Cubes/Drawer Organizer	O-Legs, Post Legs, Brackets, Shared Legs	Pulls	Laminate End Panels, Layering Shelves and Modesty Panels
<b>L1 LAMINATES</b>		<b>CODES</b>								
Woodgrain	◆ Bourbon Cherry	H	•	•	•					•
	◆ Cognac	COGN	•	•	•					•
	◆ Harvest	C	•	•	•					•
	◆ Mahogany	N	•	•	•					•
	◆ Mocha	MOCH	•	•	•					•
	◆ Natural Maple	D	•	•	•					•
	◆ Pinnacle	PINC	•	•	•					•
	◆ Shaker Cherry	F	•	•	•					•
Patterned	◆ Sheer Mesh*	A5	•							
	◆ Silver Mesh**	B9	•							
Solid	◆ Black	P	•	•	•					•
	◆ Brilliant White	WHIT	•	•	•					•
	◆ Charcoal	S	•	•	•					•
	◆ Loft	LOFT	•	•	•					•
<b>L2 LAMINATES***</b>		<b>CODES</b>								
Woodgrain	◆ Lowell Ash	LLA1	•	•	•					•
	◆ Natural Recon	LNRI	•	•	•					•
	◆ Phantom Ecru	LPE1	•	•	•					•
	◆ Portico Teak	LPT1	•	•	•					•
	◆ Skyline Walnut	LSW1	•	•	•					•
<b>PAINTS / GROMMETS</b>		<b>CODES</b>								
Core	◆ Black	P				•	•	•		
	◆ Charcoal	S						•		
	◆ Greige	T5				•		•		
	◆ Light Gray	Q						•		
	◆ Loft	LOFT						•		
	◆ Muslin	T3						•		
	◆ Putty	L						•		
	◆ Shadow	SHDW						•		
Cube	◆ Autumn	AUTM					•			
	◆ Citron	CITR					•			
	◆ Flame	FLAM					•			
	◆ Pool	POOL					•			
	◆ Sisal	SISL					•			
Metallic	◆ Brilliant White	WHIT				•		•	•	
	◆ Champagne Metallic	T4						•	•	
	◆ Platinum Metallic	T1				•		•	•	

\* Sheer Mesh laminate will have Muslin Edgeband.  
 \*\* Silver Mesh laminate will have Loft Edgeband.  
 \*\*\* Storage chassis that are specified in L2 laminates and are longer than 60"W will ship with back panels that are horizontal grain.

◆◆◆ For lead time information see page 21.

			Voi® Worksurfaces
<b>EDGE BAND</b>		<b>CODES</b>	
◆	Bourbon Cherry	H	•
◆	Brilliant White	WHIT	•
◆	Cognac	COGN	•
◆	Harvest	C	•
◆	Loft	LOFT	•
◆	Lowell Ash	DL	•
◆	Mahogany	N	•
◆	Mocha	MOCH	•
◆	Muslin	T	•
◆	Natural Maple	D	•
◆	Natural Recon	NR	•
◆	Phantom Ecru	PE	•
◆	Pinnacle	PINC	•
◆	Portico Teak	DP	•
◆	Shadow	SHDW	•
◆	Shaker Cherry	F	•
◆	Skyline Walnut	SW	•

◆◆◆ For lead time information see page 21.

WORKSURFACE LAMINATES	CODES	EDGE BAND OPTIONS						
		Matching Edge	Brilliant White (WHIT)	Loft (LOFT)	Muslin (T)	Shadow (SHDW)	Black (P)	Charcoal (S)
Black	P							•
Bourbon Cherry	H	•			•			
Brilliant White	WHIT		•					
Charcoal	S							•
Cognac	COGN	•	•		•			
Harvest	C	•	•		•			
Loft	LOFT			•				
Lowell Ash	LLA1	•	•	•	•			
Mahogany	N	•		•		•		
Mocha	MOCH	•	•		•			
Natural Maple	D	•	•	•	•			
Natural Recon	LNRI	•	•	•	•			
Phantom Ecru	LPE1	•	•	•	•			
Pinnacle	PINC	•	•		•			
Portico Teak	LPT1	•	•	•	•			
Shaker Cherry	F	•	•	•	•	•		
Sheer Mesh	A5					•		
Silver Mesh	B9			•				
Skyline Walnut	LSW1	•	•	•	•			



Icon Legend on page 21

QTY	DESCRIPTION	MODEL	LIST PRICE	PRICE EXTENSION
1	<b>External Channel</b> 54"W	HLSLZ5SC66	\$93	\$93
1	<b>Rectangle Worksurface</b> 24"D x 66"W	HLSLR2466	\$350	\$350
1	<b>Low credenza (Right hand drawers)</b> 60"W x 20"D x 21½"H	HLSL2060LR2	\$1,177	\$1,177
1	<b>Layering shelf</b> 60"W x 14½"D x 5½"H	HLSL1460LS	\$334	\$334
2	<b>O-Leg Support for Worksurface (1 pack)</b> 24"D x 28½"H	HLSL24280	\$291	\$582
1	<b>Overhead Cabinet with Wall Bracket with One Sliding Door</b> 60"W x 14¼"D x 14"H	HLSL1460S	\$1,219	\$1,219
<b>TOTAL:</b>			<b>\$3,755</b>	

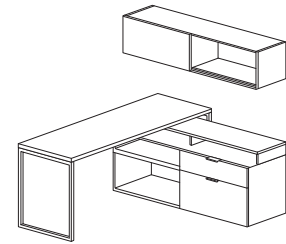

**SMALL FOOTPRINT**

**66" x 60"**

QTY	DESCRIPTION	MODEL	LIST PRICE	PRICE EXTENSION
4	<b>External Channel</b> 48"W	HLSLZ5SC60	\$90	\$360
2	<b>Accelerate® Raceway Panels</b> 42½"H x 60"W	HETP4260FP	\$394	\$788
2	<b>Accelerate® Raceway Panels</b> 50"H x 60"W	HETP5060FP	\$439	\$878
2	<b>Electrical Power Harness, 3-1 &amp; 2-2</b> 60"W	HH871260	\$194	\$388
4	<b>Duplex Receptacle Circuit 3, 3-1</b>	HH871503	\$37	\$148
1	<b>Power In-feed</b>	HH879072	\$206	\$206
2	<b>Low credenza (Right hand drawers)</b> 60"W x 20"D x 21½"H	HLSL2060LR2	\$1,177	\$2,354
2	<b>Low credenza (Left hand drawers)</b> 60"W x 20"D x 21½"H	HLSL2060LL2	\$1,177	\$2,354
4	<b>Credenza Cushion</b> 20"W x 30"D x 1"H	HLSL2030CH2	\$342	\$1,368
4	<b>O-Leg Support for Worksurface (1 pack)</b> 30"D x 28½"H	HLSL24280	\$291	\$1,164
2	<b>Left O-Leg to panel bracket</b>	HLSLPBL	\$91	\$182
2	<b>Right O-Leg to panel bracket</b>	HLSLPBR	\$91	\$182
4	<b>Accelerate® Top Cap 60"W</b>	HETC60	\$73	\$292
2	<b>Accelerate® Variable Height Finishing Kit</b>	HECVH07P	\$46	\$92
2	<b>Accelerate® Finished End Cover 50"H</b>	HEFEC50P	\$50	\$100
2	<b>Accelerate® Finished End Cover 42½"H</b>	HEFEC42P	\$47	\$94
1	<b>Accelerate® "X" Connector</b> 50"H	HEC50PX	\$129	\$129
4	<b>O-Leg Support for Worksurface</b> 24"D x 7"H	HLSL2470	\$196	\$784
4	<b>Rectangle Worksurface</b> 24"D x 60"W	HLSLR2460	\$322	\$1,288
<b>TOTAL:</b>			<b>\$13,151</b>	

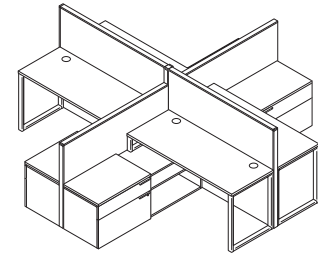

**OPEN PLAN**

**120" x 120"**

# VOI® Laminate Typicals



Icon Legend on page 21

QTY	DESCRIPTION	MODEL	LIST PRICE	PRICE EXTENSION
4	Rectangle Worksurface 24"D x 72"W	HLSLR2472	\$361	\$1,444
2	Low credenza (Right hand drawers) 60"W x 20"D x 21½"H	HLSL2060LR2	\$1,177	\$2,354
2	Low credenza (Left hand drawers) 60"W x 20"D x 21½"H	HLSL2060LL2	\$1,177	\$2,354
4	O-Leg Support for Worksurface (1 pack) 24"D x 28½"H	HLSL24280	\$291	\$1,164
4	Overhead Cabinet - Sliding 72"W x 14¼"D x 14"H	HLSL1472S	\$1,289	\$5,156
4	Stack-on Storage Panel Mounted Bracket (3 pack)	HLSLPMB	\$119	\$476
4	Storage Cube 12" x 12"	HLSL1212	\$276	\$1,104
4	Mixed Material Floating Modesty Panel 42"W x 14"H	HLSL4214MM	\$745	\$2,980
6	Abound® Panel Frame 65"H x 24"W	HRVF6524P	\$256	\$1,536
4	Abound® Power/Data Fabric Tile 60"H x 24"W	HRVT6024E	\$213	\$852
8	Abound® Fabric Tile 60"H x 24"W	HRVT6024T	\$152	\$1,216
2	Abound® Panel Frame 65"H x 48"W	HRVF6548P	\$292	\$584
4	Abound® Fabric Tile 60"H x 48"W	HRVT6048T	\$237	\$948
4	Finished End Painted 65"	HRVC65PF	\$90	\$360
2	"T" Connector Painted 65"	HRVC65PT	\$148	\$296
1	Power In-feed	HH879072	\$206	\$206
4	Duplex Receptacle Circuit 1	HH873504	\$37	\$148
6	Duplex Receptacle Circuit 2	HH873502	\$37	\$222
6	Duplex Receptacle Circuit 3	HH873503	\$37	\$222
4	Electrical Power Harness, 3-1 & 2-2 24"W	HH871224	\$185	\$740
1	Electrical Pass-Thru Power Harness, 3-1 & 2-2 96"W	HH871096	\$184	\$184
2	Electrical Power Harness, 3-1 & 2-2 48"W	HH871248	\$194	\$388
1	Up to 30" Vertical Jump 66"	HH871366	\$124	\$124
1	Electrical Mounting Brackets (Pk of 12)	HH8988EBN	\$56	\$56
4	Worksurface Bracket Kit	HWSB2	\$41	\$164
1	Abound® Top Cap 96"W	HRVTC96	\$116	\$116
6	Abound® Top Cap 24"W	HRVTC24	\$32	\$192
<b>TOTAL:</b>			<b>\$25,586</b>	

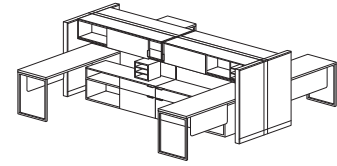

**OPEN PLAN**  
**144'' x 144''**

QTY	DESCRIPTION	MODEL	LIST PRICE	PRICE EXTENSION
4	External Channel 60"W	HLSLZ55C72	\$100	\$400
4	Rectangle Worksurface 24"D x 72"W	HLSLR2472	\$361	\$1,444
2	O-Leg Shared Support for Low Credenzas	HLSL2475L	\$244	\$488
4	O-Leg Support for Worksurface (1 pack) 24"D x 28½"H	HLSL24280	\$291	\$1,164
2	Low credenza (Right hand drawers) 60"W x 20"D x 21½"H	HLSL2060LR2	\$1,177	\$2,354
2	Low credenza (Left hand drawers) 60"W x 20"D x 21½"H	HLSL2060LL2	\$1,177	\$2,354
2	Above/Below Privacy Screen 60"W x 28½"H	HLSL2860	\$1,287	\$2,574
<b>TOTAL:</b>			<b>\$10,778</b>	

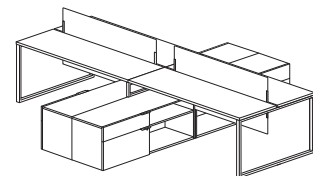

**OPEN PLAN**  
**144'' x 120''**



Icon Legend on page 21

VOI®

# Laminate Typicals

DESKS

QTY	DESCRIPTION	MODEL	LIST PRICE	PRICE EXTENSION
1	<b>Personal Storage Tower (Left handed)</b> 24"W x 24"D x 65"H	HLSLW446LP	\$2,404	\$2,404
2	<b>Lateral File</b> 30"W x 24"D x 28½"H	HLSL2430L	\$1,090	\$2,180
1	<b>Rectangle Worksurface</b> 24"D x 60"W	HLSLR2460	\$322	\$322
1	<b>Rectangle Worksurface</b> 30"D x 72"W	HLSLR3072	\$431	\$431
1	<b>Rectangle Worksurface</b> 24"D x 54"W	HLSLR2454	\$296	\$296
2	<b>O-Leg Support for Worksurface (1 pack)</b> 30"D x 28½"H	HLSL30280	\$323	\$646
2	<b>Overhead Cabinet with Wall Bracket with One Sliding Door</b> 72"W x 14¼"D x 13"H	HLSL1472S	\$1,439	\$2,878
2	<b>Storage Cube</b> 12" x 12"	HLSL1212	\$276	\$552
1	<b>External Channel</b> 60"W	HLSLZ5SC72	\$100	\$100
<b>TOTAL:</b>			<b>\$9,809</b>	

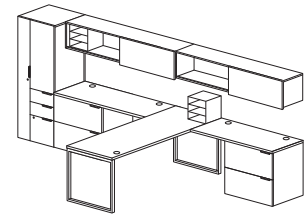

**OPEN PLAN**  
**168" x 72"**

QTY	DESCRIPTION	MODEL	LIST PRICE	PRICE EXTENSION
2	<b>External Channel</b> 60"W	HLSLZ5SC72	\$100	\$200
2	<b>Rectangle Worksurface</b> 24"D x 72"W	HLSLR2472	\$361	\$722
2	<b>Low credenza (2 file drawers and open top)</b> 72"W x 20"D x 21½"H	HLSL2072LD2	\$1,356	\$2,712
1	<b>Overhead Cabinet with One Sliding Door</b> 72"W x 14¼"D x 14"H	HLSL1472S	\$1,289	\$1,289
1	<b>Shelf for Stack-on Storage</b> 72"W	HLSL72S	\$273	\$273
1	<b>O-Leg Stack-on Storage Support (2 pack)</b> 65"H	HLSL65OS	\$430	\$430
4	<b>O-Leg Support for Worksurface (1 pack)</b> 24"D x 28½"H	HLSL24280	\$291	\$1,164
1	<b>Credenza Cushion</b> 20"W x 36"D x 1"H	HLSL2036CH2	\$369	\$369
1	<b>Storage Cube</b> 12" x 12"	HLSL1212	\$276	\$276
<b>TOTAL:</b>			<b>\$7,435</b>	

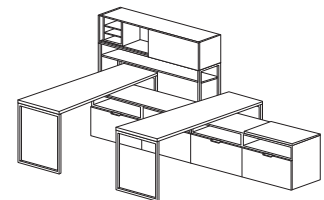

**SEMI PRIVATE**  
**144" x 72"**

QTY	DESCRIPTION	MODEL	LIST PRICE	PRICE EXTENSION
1	<b>Tower (Right hand drawers/Left hand door)</b> 24"W x 20"D x 65"H, Left	HLSLW046L	\$2,016	\$2,016
1	<b>Layering shelf</b> 60"W x 14½"D x 5½"H	HLSL1460LS	\$334	\$334
1	<b>Rectangle Worksurface</b> 30"D x 72"W	HLSLR3072	\$431	\$431
1	<b>Mixed Material Floating Modesty Panel</b> 42"W x 14"H	HLSL4214MM	\$745	\$745
2	<b>O-Leg Support for Worksurface (1 pack)</b> 30"D x 28½"H	HLSL30280	\$323	\$646
1	<b>Low credenza (2 file/2 box)</b> 60"W x 20"D x 21½"H	HLSL2060LD4	\$1,373	\$1,373
1	<b>Low credenza (Open/Right hand drawers)</b> 60"W x 20"D x 21½"H	HLSL2060LR2	\$1,177	\$1,177
1	<b>Credenza Cushion</b> 20"W x 30"D x 1"H	HLSL2030CH2	\$342	\$342
<b>TOTAL:</b>			<b>\$7,064</b>	

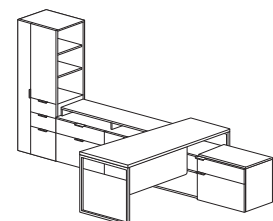

**PRIVATE OFFICE**  
**144" x 72"**



# VOI® Laminate Typicals



Icon Legend on page 21

QTY	DESCRIPTION	MODEL	LIST PRICE	PRICE EXTENSION
1	<b>External Channel</b> 54"W	HLSLZ55C66	\$93	\$93
1	<b>Rectangle Worksurface</b> 24"D x 66"W	HLSLR2466	\$350	\$350
1	<b>Low credenza (2 file/2 box)</b> 60"W x 20"D x 21½"H	HLSL2060LD4	\$1,373	\$1,373
2	<b>O-Leg Support for Worksurface (1 pack)</b> 24"D x 28½"H	HLSL24280	\$291	\$582
1	<b>Overhead Cabinet with 4 Doors</b> 60"W x 14¼"D x 14"H	HLSL1460D	\$1,069	\$1,069
1	<b>O-Leg Support for Overhead Cabinet</b> 14⅝"D x 20½"H for 65"H Overhead Cabinet	HLSL650S	\$430	\$430
<b>TOTAL:</b>			<b>\$3,897</b>	

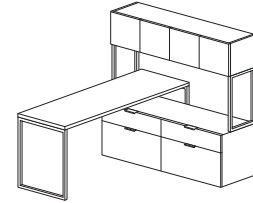

**SMALL FOOTPRINT**  
66" x 60"

QTY	DESCRIPTION	MODEL	LIST PRICE	PRICE EXTENSION
1	<b>Box/Box/File Pedestal Support</b> 30"D x 28"H	HLSL3028B	\$790	\$790
1	<b>Rectangle Worksurface</b> 36"D x 72"W	HLSLR3672	\$561	\$561
1	<b>End Panel Support</b> 24"D x 28½"H	HLSL2428E	\$186	\$186
1	<b>End Panel Support</b> 30"D x 28½"H	HLSL3028E	\$198	\$198
1	<b>Rectangle Worksurface</b> 20"D x 42"W	HLSLR2042	\$240	\$240
1	<b>Rectangle Worksurface</b> 24"D x 72"W	HLSLR2472	\$361	\$361
1	<b>Mixed Material Floating Modesty Panel</b> 42"W x 14"H	HLSL4214MM	\$745	\$745
1	<b>Lateral File</b> 36"W x 24"D x 28½"H	HLSL2430L	\$1,090	\$1,090
1	<b>Overhead Cabinet - Metal Frame, Glass Doors</b> 72"W x 14¼"D x 14"H	HLSL1472M	\$2,115	\$2,115
1	<b>Storage Cube</b> 12" x 12"	HLSL1212	\$276	\$276
<b>TOTAL:</b>			<b>\$6,562</b>	

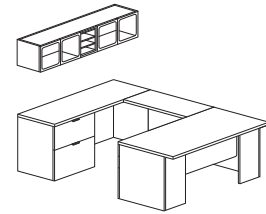

**PRIVATE OFFICE**  
102" x 72"

QTY	DESCRIPTION	MODEL	LIST PRICE	PRICE EXTENSION
1	<b>External Channel</b> 54"W	HLSLZ55C66	\$93	\$93
1	<b>Rectangle Worksurface</b> 24"D x 66"W	HLSLR2466	\$350	\$350
1	<b>Low credenza (Right hand drawers)</b> 60"W x 20"D x 21½"H	HLSL2060LR2	\$1,177	\$1,177
2	<b>O-Leg Support for Worksurface (1 pack)</b> 24"D x 28½"H	HLSL24280	\$291	\$582
1	<b>Overhead Cabinet with One Sliding Door</b> 60"W x 14¼"D x 14"H	HLSL1460S	\$1,069	\$1,069
1	<b>O-Leg Support for Overhead Cabinet</b> 14⅝"D x 20½"H for 65"H Overhead Cabinet	HLSL650S	\$430	\$430
<b>TOTAL:</b>			<b>\$3,701</b>	

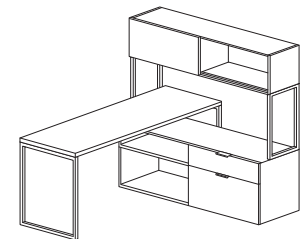

**SMALL FOOTPRINT**  
66" x 60"



Icon Legend on page 21

QTY	DESCRIPTION	MODEL	LIST PRICE	PRICE EXTENSION
1	<b>External Channel</b> 48"W	HLSLZ5SC60	\$90	\$90
1	<b>Rectangle Worksurface</b> 30"D x 72"W	HLSLR3072	\$431	\$431
1	<b>Rectangle Worksurface</b> 20"D x 72"W	HLSLR2072	\$359	\$359
1	<b>Low credenza (2 file drawers)</b> 60"W x 20"D x 21½"H	HLSL2060LD2	\$1,287	\$1,287
1	<b>Overhead Cabinet - Metal Frame, Glass Doors</b> 72"W x 14¼"D x 14"H	HLSL1472M	\$1,965	\$1,965
1	<b>O-Leg Stack-on Storage Support (2 pack)</b> 65"H	HLSL65OS	\$430	\$430
1	<b>O-Leg Support for Worksurface (1 pack)</b> 20"D x 28½"H	HLSL2028O	\$267	\$267
2	<b>O-Leg Support for Worksurface (1 pack)</b> 30"D x 28½"H	HLSL3028O	\$323	\$646
1	<b>Box/Box/File Pedestal Support</b> 20"D x 28½"H	HLSL2028B	\$634	\$634
1	<b>Mixed Material Floating Modesty Panel</b> 60"W x 14"H	HLSL6014MM	\$1,023	\$1,023
1	<b>Storage Cube</b> 12" x 12"	HLSL1212	\$276	\$276
<b>TOTAL:</b>			<b>\$7,408</b>	

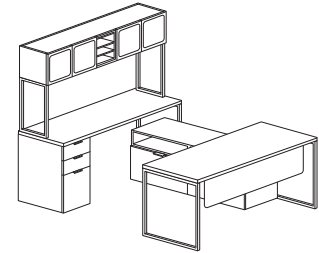

**PRIVATE OFFICE**  
92" x 72"

QTY	DESCRIPTION	MODEL	LIST PRICE	PRICE EXTENSION
1	<b>External Channel</b> 54"W	HLSLZ5SC54	\$85	\$85
1	<b>Rectangle Worksurface</b> 24"D x 66"W	HLSLR2466	\$350	\$350
1	<b>Low credenza (Right hand drawers)</b> 60"W x 20"D x 21½"H	HLSL2060LR2	\$1,177	\$1,177
1	<b>Layering shelf</b> 60"W x 14½"D x 5½"H	HLSL1460LS	\$334	\$334
2	<b>O-Leg Support for Worksurface (1 pack)</b> 24"D x 28½"H	HLSL2428O	\$291	\$582
<b>TOTAL:</b>			<b>\$2,528</b>	

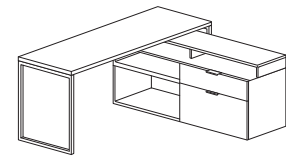

**SMALL FOOTPRINT**  
66" x 60"

# VOI® Bundles Typicals



Icon Legend on page 21

**VT6030MB**

Worksurface is Silver Mesh, Mobile Pedestal is Harvest, O-Leg Supports and grommets are Platinum Metallic.

QTY	DESCRIPTION	MODEL	LIST PRICE	PRICE EXTENSION
1	Rectangle Worksurface with External Support Channel	HLSLR3060W*	\$435	\$435
2	O-Leg Support for Worksurface	HLSL3028O	\$327	\$654
1	Mobile Pedestal	HLSL2016MP2	\$745	\$745
<b>TOTAL:</b>			<b>\$1,834</b>	

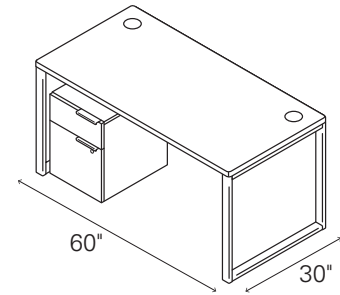
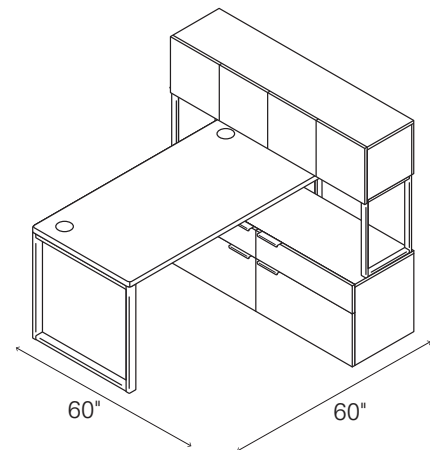

**TABLE DESK WITH MOBILE PEDESTAL  
(NON-HANDED)**

**VS6060L1B**

Worksurface is Silver Mesh, Low Credenza and Overhead Cabinet are Harvest, O-Leg Supports and grommets are Platinum Metallic.

QTY	DESCRIPTION	MODEL	LIST PRICE	PRICE EXTENSION
1	Rectangle Worksurface with External Support Channel	HLSLR3060W*	\$435	\$435
2	O-Leg Support for Worksurface	HLSL3028O	\$327	\$654
1	Low Credenza, 2 File/2 Box	HLSL2060LD4	\$1,373	\$1,373
1	Overhead Cabinet with 4 Doors	HLSL1460D	\$1,069	\$1,069
1	O-Leg Support for Overhead Cabinet (Pair)	HLSL650S	\$434	\$434
<b>TOTAL:</b>			<b>\$3,965</b>	



**SMALL FOOTPRINT L-STATION  
(NON-HANDED)**

**VS6060L6B**

Worksurface is Silver Mesh, Low Credenza and Layering Shelf are Harvest, O-Leg Supports and grommets are Platinum Metallic.

QTY	DESCRIPTION	MODEL	LIST PRICE	PRICE EXTENSION
1	Rectangle Worksurface with External Support Channel	HLSLR3060W*	\$435	\$435
2	O-Leg Support for Worksurface	HLSL3028O	\$327	\$654
1	Low Credenza, Right-hand Drawers	HLSL2060LR2	\$1,177	\$1,177
1	Layering Shelf	HLSL1460LS	\$334	\$334
<b>TOTAL:</b>			<b>\$2,600</b>	

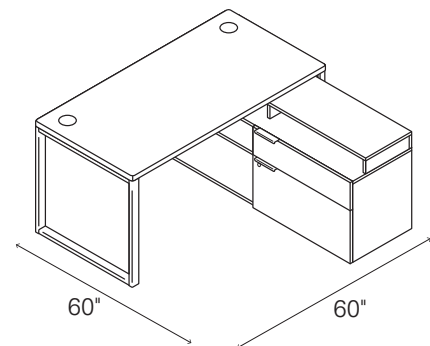

**SMALL FOOTPRINT L-STATION  
(RIGHT HANDED, LOW CREDENZA)**

\*Worksurface model **HLSLR3060W** can only be ordered with bundles.



Icon Legend on page 21

# VOI® Bundles Typicals

DESKS

## VS6060L4B

Worksurface is Silver Mesh, Low Credenza and Layering Shelf are Harvest, O-Leg Supports and grommets are Platinum Metallic.

QTY	DESCRIPTION	MODEL	LIST PRICE	PRICE EXTENSION
1	Rectangle Worksurface with External Support Channel	HLSLR3060W*	\$435	\$435
2	O-Leg Support for Worksurface	HLSL30280	\$327	\$654
1	Low Credenza, Left-hand Drawers	HLSL2060LL2	\$1,177	\$1,177
1	Layering Shelf	HLSL1460LS	\$334	\$334
<b>TOTAL:</b>			<b>\$2,600</b>	

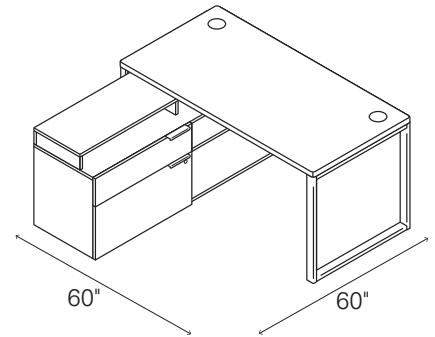

**SMALL FOOTPRINT L-STATION  
(LEFT HANDED, LOW CREDENZA)**

## VS6060L5B

Worksurface is Silver Mesh, Low Credenza and Overhead Cabinet are Harvest, O-Leg Supports and grommets are Platinum Metallic.

QTY	DESCRIPTION	MODEL	LIST PRICE	PRICE EXTENSION
1	Rectangle Worksurface with External Support Channel	HLSLR3060W*	\$435	\$435
2	O-Leg Support for Worksurface	HLSL30280	\$327	\$654
1	Low Credenza, Right-hand Drawers	HLSL2060LR2	\$1,177	\$1,177
1	Overhead Cabinet with 4 Doors	HLSL1460D	\$1,069	\$1,069
1	O-Leg Support for Overhead Cabinet (Pair)	HLSL650S	\$434	\$434
<b>TOTAL:</b>			<b>\$3,769</b>	

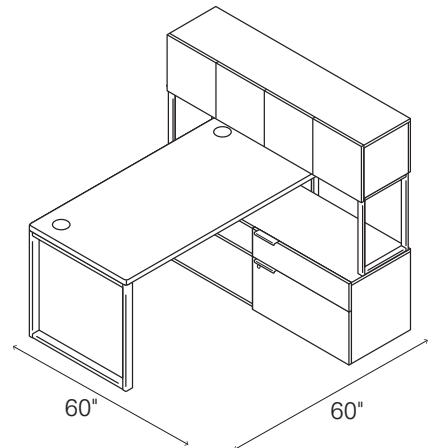

**SMALL FOOTPRINT L-STATION  
(RIGHT HANDED, LOW CREDENZA)**

## VS6060L3B

Worksurface is Silver Mesh, Low Credenza and Overhead Cabinet are Harvest, O-Leg Supports and grommets are Platinum Metallic.

QTY	DESCRIPTION	MODEL	LIST PRICE	PRICE EXTENSION
1	Rectangle Worksurface with External Support Channel	HLSLR3060W*	\$435	\$435
2	O-Leg Support for Worksurface	HLSL30280	\$327	\$654
1	Low Credenza, Left-hand Drawers	HLSL2060LL2	\$1,177	\$1,177
1	Overhead Cabinet with 4 Doors	HLSL1460D	\$1,069	\$1,069
1	O-Leg Support for Overhead Cabinet (Pair)	HLSL650S	\$434	\$434
<b>TOTAL:</b>			<b>\$3,769</b>	

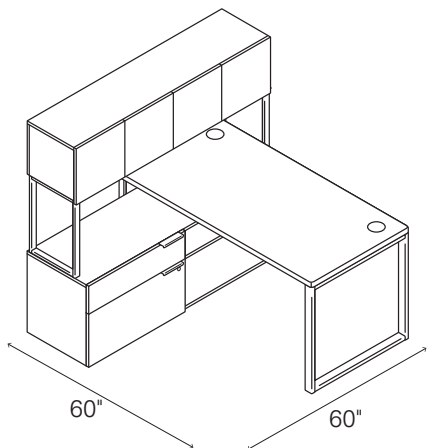

**SMALL FOOTPRINT L-STATION  
(LEFT HANDED, LOW CREDENZA)**

\*Worksurface model HLSLR3060W can only be ordered with bundles.

# VOI® Bundles Typicals



Icon Legend on page 21

## VC7272L1B2

Worksurfaces and Overhead Cabinet are Brilliant White, Support Pedestal is Harvest, O-Leg Supports and grommets are Platinum Metallic.

QTY	DESCRIPTION	MODEL	LIST PRICE	PRICE EXTENSION
1	Rectangle Worksurface with External Support Channel	HLSLR3072W*	\$506	\$506
1	Rectangle Worksurface	HLSLR2042	\$240	\$240
2	O-Leg Support for Worksurface	HLSL3028O	\$327	\$654
1	Support Pedestal, Box/Box/File	HLSL2028B	\$634	\$634
1	Overhead Cabinet with 4 Doors/Cubbie	HLSL1472D	\$1,289	\$1,289
1	O-Leg Support for Overhead Cabinet (Pair)	HLSL650S	\$434	\$434
<b>TOTAL:</b>			<b>\$3,757</b>	

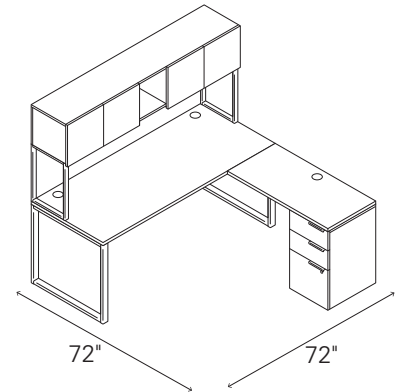

**CONTEMPORARY L-STATION  
(NON-HANDED)**

## VS6060L2B

Worksurface is Silver Mesh, Low Credenza and Layering Shelf are Harvest, O-Leg Supports and grommets are Platinum Metallic.

QTY	DESCRIPTION	MODEL	LIST PRICE	PRICE EXTENSION
1	Rectangle Worksurface with External Support Channel	HLSLR3060W*	\$435	\$435
2	O-Leg Support for Worksurface	HLSL3028O	\$327	\$654
1	Low Credenza, 2 File/2 Box	HLSL2060LD4	\$1,373	\$1,373
1	Layering Shelf	HLSL1460LS	\$334	\$334
<b>TOTAL:</b>			<b>\$2,796</b>	

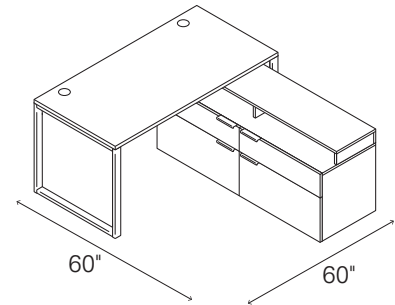

**SMALL FOOTPRINT L-STATION  
(LOW CREDENZA, LAYERING SHELF)  
(NON-HANDED)**

## VC7292U2B2

Worksurfaces and Overhead Cabinet are Brilliant White, Low Credenza and Support Pedestal are Harvest, O-Leg Supports and grommets are Platinum Metallic.

QTY	DESCRIPTION	MODEL	LIST PRICE	PRICE EXTENSION
1	Rectangle Worksurface with External Support Channel	HLSLR3072W*	\$506	\$506
1	Rectangle Worksurface with External Support Channel	HLSLR2072W*	\$431	\$431
2	O-Leg Support for Worksurface	HLSL3028O	\$327	\$654
1	O-Leg Support for Worksurface	HLSL2028O	\$271	\$271
1	Support Pedestal, Box/Box/File	HLSL2028B	\$634	\$634
1	Overhead Cabinet with 4 Doors/Cubbie	HLSL1472D	\$1,289	\$1,289
1	O-Leg Support for Overhead Cabinet (Pair)	HLSL650S	\$434	\$434
1	Low Credenza, 2 File/2 Box	HLSL2060LD4	\$1,373	\$1,373
<b>TOTAL:</b>			<b>\$5,592</b>	

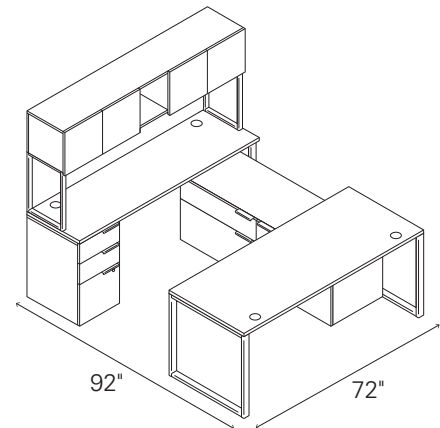

**CONTEMPORARY U-STATION  
(LOW CREDENZA, OVERHEAD CABINET)  
(NON-HANDED)**

\*Worksurface models **HLSLR3072W**, **HLSLR3060W** and **HLSLR2072W** can only be ordered with bundles.



Icon Legend on page 21

# VOI® Bundles Typicals

## VC7260L2B

Worksurface is Silver Mesh, Low Credenza is Harvest, O-Leg Supports and grommets are Platinum Metallic.

QTY	DESCRIPTION	MODEL	LIST PRICE	PRICE EXTENSION
1	Rectangle Worksurface with External Support Channel	HLSLR3072W*	\$506	\$506
2	O-Leg Support for Worksurface	HLSL30280	\$327	\$654
1	Low Credenza, 2 File/2 Box	HLSL2060LD4	\$1,373	\$1,373
<b>TOTAL:</b>			<b>\$2,533</b>	

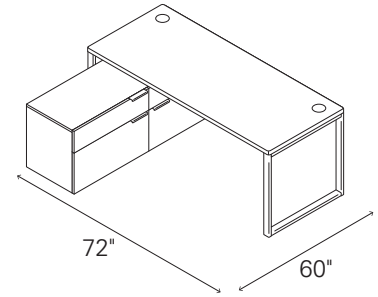

**CONTEMPORARY L-STATION  
(NON-HANDED)**

## VC7292U1B2

Worksurfaces and Overhead Cabinet are Brilliant White, Support Pedestal is Harvest, O-Leg Supports and grommets are Platinum Metallic.

QTY	DESCRIPTION	MODEL	LIST PRICE	PRICE EXTENSION
1	Rectangle Worksurface with External Support Channel	HLSLR3072W*	\$506	\$506
1	Rectangle Worksurface with External Support Channel	HLSLR2072W*	\$431	\$431
1	Rectangle Worksurface	HLSLR2042	\$240	\$240
2	O-Leg Support for Worksurface	HLSL30280	\$327	\$654
1	O-Leg Support for Worksurface	HLSL20280	\$271	\$271
1	Overhead Cabinet with 4 Doors/Cubbie	HLSL1472D	\$1,289	\$1,289
1	O-Leg Support for Overhead Cabinet (Pair)	HLSL650S	\$434	\$434
1	Support Pedestal, Box/Box/File	HLSL2028B	\$634	\$634
<b>TOTAL:</b>			<b>\$4,459</b>	

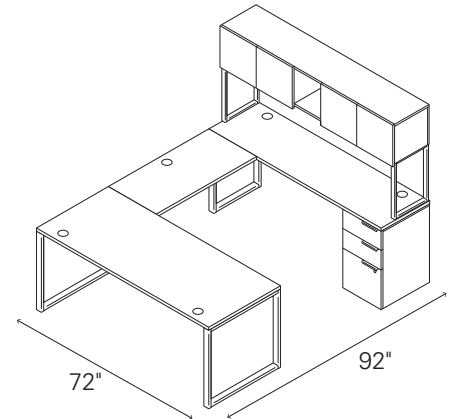

**CONTEMPORARY U-STATION  
(NON-HANDED)**

\*Worksurface models **HLSLR3072W** and **HLSLR2072W** can only be ordered with bundles.

# VOI® SPECIFYING/DESIGN GUIDE

This Specifying Guide is designed to walk you through the steps when choosing the Voi desks elements that will meet your particular workplace needs. From private office to open plan, there are endless combinations that will fit your style and need.

Regardless of the application, Voi presents an integrated, unified aesthetic for the entire workplace.

The step-by-step instructions make it easy to specify elements that personalize workspaces and achieve the right mix of functionality and style.

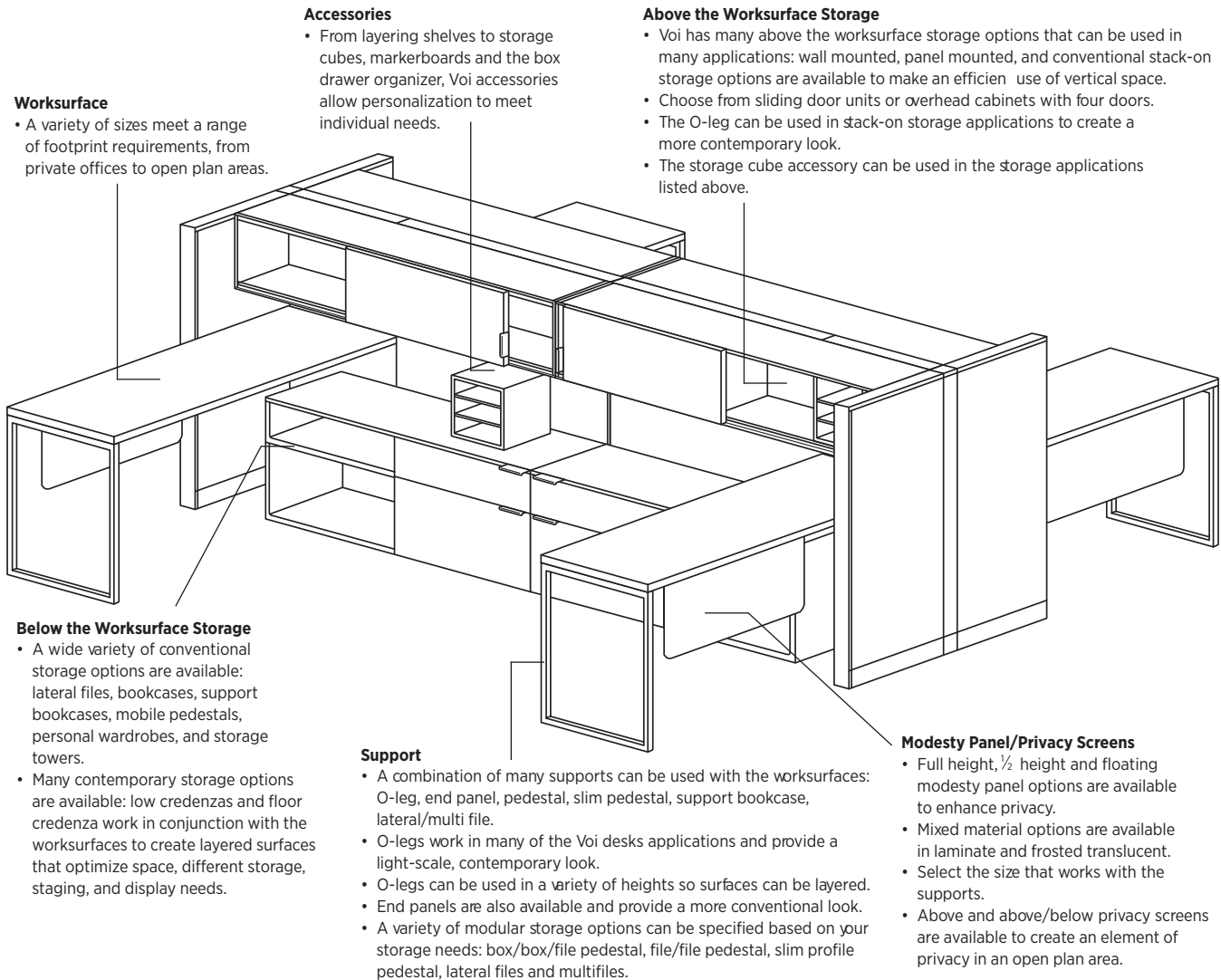

### Worksurface

- A variety of sizes meet a range of footprint requirements, from private offices to open plan areas.

### Accessories

- From layering shelves to storage cubes, markerboards and the box drawer organizer, Voi accessories allow personalization to meet individual needs.

### Above the Worksurface Storage

- Voi has many above the worksurface storage options that can be used in many applications: wall mounted, panel mounted, and conventional stack-on storage options are available to make an efficient use of vertical space.
- Choose from sliding door units or overhead cabinets with four doors.
- The O-leg can be used in stack-on storage applications to create a more contemporary look.
- The storage cube accessory can be used in the storage applications listed above.

### Below the Worksurface Storage

- A wide variety of conventional storage options are available: lateral files, bookcases, support bookcases, mobile pedestals, personal wardrobes, and storage towers.
- Many contemporary storage options are available: low credenzas and floor credenza work in conjunction with the worksurfaces to create layered surfaces that optimize space, different storage, staging, and display needs.

### Support

- A combination of many supports can be used with the worksurfaces: O-leg, end panel, pedestal, slim pedestal, support bookcase, lateral/multi file.
- O-legs work in many of the Voi desks applications and provide a light-scale, contemporary look.
- O-legs can be used in a variety of heights so surfaces can be layered.
- End panels are also available and provide a more conventional look.
- A variety of modular storage options can be specified based on your storage needs: box/box/file pedestal, file/file pedestal, slim profile pedestal, lateral files and multfiles.

### Modesty Panel/Privacy Screens

- Full height, ½ height and floating modesty panel options are available to enhance privacy.
- Mixed material options are available in laminate and frosted translucent.
- Select the size that works with the supports.
- Above and above/below privacy screens are available to create an element of privacy in an open plan area.

## Steps for specification:

1. Select the right worksurface.  
Choose the worksurface shape and size that best fits your office layout.

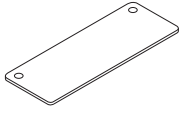

**Rectangle Worksurface**  
 Depths: 20", 24", 30", 36"  
 Widths: 36", 42", 48", 54",  
 60", 66", 72", 84"

2. Select the supports.  
Countless combinations of support options meet a variety of support and storage needs.

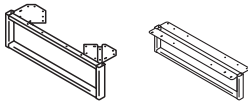

**O-Leg and Shared Support for Low Credenza**  
 20"D x 7"H, 24"D x 7"H, 30"D x 7"H  
 7"H only O-legs attach to worksurface and sit on top of credenzas.

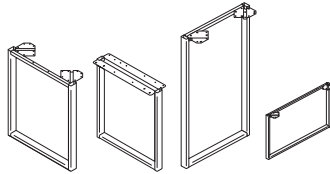

**O-Leg and Shared Support for Worksurfaces**  
 20"D x 28½"H, 24"D x 28½"H, 30"D x 28½"H  
 28½"H, 24"D x 41"H, 30"D x 41"H, 48"D x 28½"H,  
 60"D x 28½"H O-legs provide support for the worksurface.

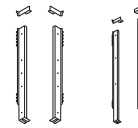

**O-Leg-to-Panel Attachment Bracket**  
 Left handed bracket (quantity 1)  
 Right handed bracket (quantity 1)

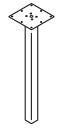

**Post Leg**  
 28½"H, 2" square

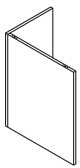

**End Panel Support**  
 16"W x 20"D x 28½"H,  
 16"W x 24"D x 28½"H,  
 16"W x 30"D x 28½"H

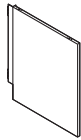

**Laminate End Panel Support With Panel Attachment Bracket**  
 24"D x 28½"H, 30"D x 28"H

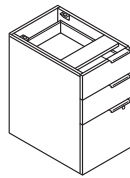

**B/B/F Standard and Power-Ready Pedestals**  
 16"W x 20"D x 28½"H,  
 16"W x 24"D x 28½"H,  
 16"W x 30"D x 28½"H

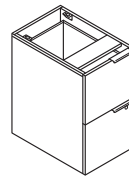

**F/F Standard and Power-Ready Pedestals**  
 16"W x 20"D x 28½"H,  
 16"W x 24"D x 28½"H,  
 16"W x 30"D x 28½"H

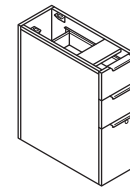

**B/B/F Standard Slim Profile Pedestals**  
 9½"W x 24"D x 28½"H,  
 9½"W x 30"D x 28½"H

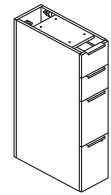

**Standing-Height Pedestals**  
 9½"W x 24"D x 41"H,  
 9½"W x 30"D x 41"H

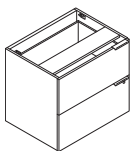

**2 Drawer Standard and Power-Ready Lateral with Pulls**  
 30"W x 24"D x 28½"H

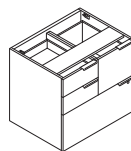

**Multi-Drawer Standard File Center**  
 30"W x 24"D x 28½"H

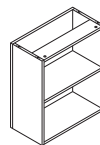

**Bookcase Support**  
 30"W x 12"D x 28½"H,  
 24"W x 12"D x 28½"H

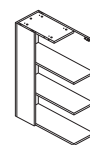

**Standing-Height Support Storage**  
 12"W x 30"D x 41"H,  
 12"W x 24"D x 41"H

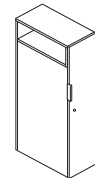

**Standing-Height Towers**  
 12"W x 30"D x 50"H,  
 12"W x 24"D x 50"H

### Tips

- When using an O-leg in open plan, panel supported, applications, you must specify an O-leg to panel attachment bracket separately (available in 28"H and 41"H).
- Bookcase Support can only be used exterior facing.
- Telescoping ball-bearing slides used on box and file drawers. Lateral drawers use a progressive ball-bearing slide.
- When specifying a 30"D support on a 36"D worksurface, there will be a 6" overhang.
- All modular pedestals have an easy attach method to the worksurface for quick assembly.
- Pass-thru openings in the sides of the Power-Ready Pedestals and Lateral Files allow hardwire conduit to run under the worksurfaces, through the case in a continuous run.
- One double-depth O-leg can replace two regular O-legs in teaming applications.
- Shared O-legs create cleaner aesthetic where two legs are used side-by-side.
- 2" adjustable glides on O-leg supports.
- Standing-Height Support Pedestals bottom two file drawers are locking.
- Standing-Height Bookcase Support contains easy-access, fixed storage shelves.



# VOI® SPECIFYING/DESIGN GUIDE

3. Select the modesty panel/privacy screen that works in conjunction with the supports you have specified.

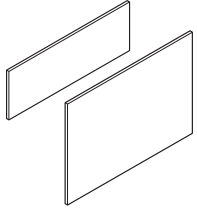

**14”H Full Width/  
Half-height  
Laminate Modesty  
Panel**  
28”, 34”, 40”W  
(Modesty Size)  
**28”H Full-to-Floor/  
Full-Length  
Laminate Modesty  
Panel**  
28”, 34”, 40”W  
(Modesty Size)

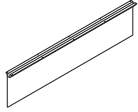

**Laminate Floating  
Modesty Panel**  
30”W x 14”H, 36”W x  
14”H, 42”W x 14”H,  
48”W x 14”H, 54”W x  
14”H, 60”W x 14”H

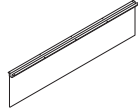

**Mixed Material  
Floating Modesty  
Panel**  
30”W x 14”H, 36”W x  
14”H, 42”W x 14”H,  
48”W x 14”H, 54”W x  
14”H, 60”W x 14”H  
Available in Frosted  
Translucent only

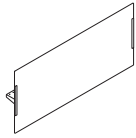

**Above/Below  
Privacy Screen**  
30”W x 28”H, 36”W  
x 28”H, 42”W x 28”H,  
48”W x 28”H, 54”W  
x 28”H, 60”W x 28”H  
Available in Frosted  
Translucent only

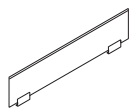

**Above Privacy  
Screen**  
30”W x 13”H, 36”W x  
13”H, 42”W x 13”H,  
48”W x 13”H, 54”W x  
13”H, 60”W x 13”H  
Available in Frosted  
Glass only

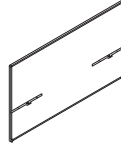

**Above/Below Fabric  
Screen**  
36”W x 35”H, 42”W  
x 35”H, 48”W x 35”H,  
54”W x 35”H, 60”W  
x 35”H, 66”W x 35”H,  
72”W x 35”H

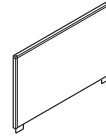

**Above Fabric Screen**  
20”W x 20”H, 20”W  
x 13”H, 24”W x 20”H,  
24”W x 13”H, 30”W x  
20”H, 30”W x 13”H,  
36”W x 20”H, 36”W  
x 13”H

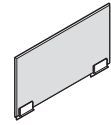

**Above Polymer or  
Glass (Side) Screen**  
20”W x 13”H, 24”W x  
13”H, 30”W x 13”H,  
36”W x 13”H

**Tips**

- Mixed material and laminate floating modesty panels create a lighter scale look by attaching to the top of the worksurface.
- Choose from a variety of materials to create your desired look.
- Laminate modesty panels to create a more conventional look.
- 54”W and 60”W Floating Modesty panels eliminate the need for an external channel.
- Above Privacy Screens provide a division between two worksurfaces and create a division of space in an open plan area.
- Modesty panels cannot be used as a support.
- See modesty panel chart to choose proper modesty size depending on support options.

4. Select Above the Worksurface Storage (Stack-on Storage) or Overhead Cabinets

Select the above the worksurface storage that meets your storage criteria, choose from overhead cabinets, panel mounted storage, conventional or contemporary stack-on storage.

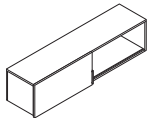

**14 1/4”D x 14”H Shared Overhead  
Cabinet with One Sliding Door**  
60”, 72”

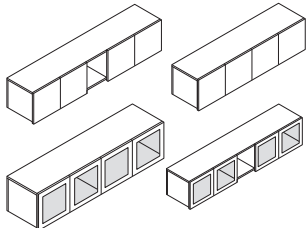

**14 1/4” Overhead Cabinet with 4 Laminate  
Doors with or without Cubbie or 4 Frosted  
Metal Doors with or without Cubbie**  
36”, 42”, 48” and 60” with 4 Laminate or  
Frosted Doors  
60”, 66”, 72” and 78” with Laminate or  
Frosted Doors and Cubbie

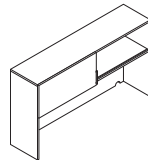

**14 1/4”D x 35”H Stack-on Storage,  
Built-up, with Sliding Doors**  
72”W only

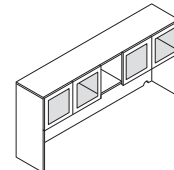

**14 1/4”D x 35”H Stack-on Storage, Built-up,  
4 Frosted Metal Doors with Cubbie**  
72”W only with Laminate or Frosted Doors  
and Cubbie

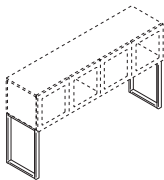

**O-Leg Support for Overhead  
Cabinet**  
50”-14 1/8”D x 5 1/2”H  
65”-14 1/8”D x 20 1/2”H

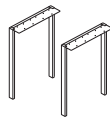

**Post Legs for Shared Storage**  
14”H and 22”H

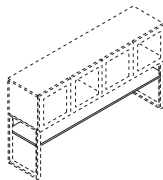

**Steel Shelf for Stack-on  
Storage**  
72”W, 66”W, 60”W



**Tackboard for Overhead  
Cabinet Applications  
Tackboard for Built-up  
Stack-on Storage**  
72”W only

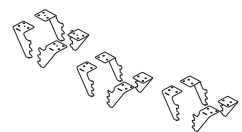

**Panel Mount Bracket for  
Shared Overhead**  
Abound and Accelerate

**Tips**

- Select sliding or hinged doors.
- Specify O-leg separately for a contemporary look.
- Optional storage shelf works in conjunction with the O-leg design to provide additional storage space. Only works with 65”H O-legs.
- O-legs come in two sizes to make a 50”H or 65”H stack-on storage unit.
- Wall-mount brackets carry a \$150 upcharge and are specified in the model ordering logic.
- Use shared overhead and attachments in small footprint applications.
- Shared overhead must be ordered as left or right to determine open storage location.
- Shared overhead panel mount brackets and overhead post legs allow overhead to span over all panels systems or run down the spine wall, centered on top of the panel.
- Use the 65”H for a more conventional design. 65”H and 50”H aligns with Abound and Accelerate.
- Stack-on Storage must be placed over two full-height supports. Cannot be placed over non-supported sections such as returns using a flat bracket or tower-to-worksurface bracket.
- If the end panel conventional look is preferred, order the built-up stack-on storage models.
- There are two types of tackboards for use on Overhead Cabinet and Stack-on Storage.

5. Select the right storage.

Choose from a variety of below the worksurface, as well as traditional, storage options.

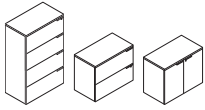

**Laterals and Storage Cabinet**

2-Drawer Lateral, 4-Drawer Lateral, Storage Cabinet

36"W x 24"D x 29½"H, 36"W x 20"D x 29½"H,  
36"W x 24"D x 57"H, 36"W x 20"D x 57"H,  
36"W x 24"D x 29½"H, 36"W x 20"D x 29½"H

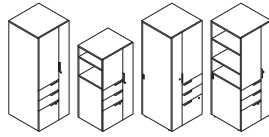

**Storage Towers**

18"W x 20"D, 18"W x 24"D, 24"W x 20"D, 24"W x  
24"D, 50"H and 65"H

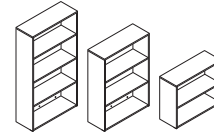

**Bookshelves**

36"W x 13"D x 29½"H (2 Shelf)  
36"W x 13"D x 50"H (3 Shelf)  
36"W x 13"D x 65"H (4 Shelf)



**Bookcase Hutch  
without Doors**

36"W x 14"D x 35"H

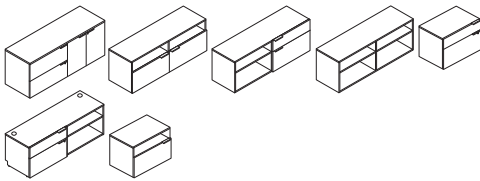

**Credenzas (Standard and Power Ready)**

Credenza: 24"D x 72"W x 29½"H

Low Credenzas: 20"D x 21½"H x 30", 36", 60", 72"W

Low Credenzas with a variety of door/drawer options

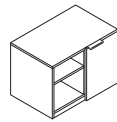

**Mobile Credenza**

30"W x 20"D x 21½"H

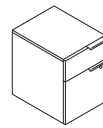

**Mobile Pedestal**

15¾"W x 20¼"D x 21⅙"H

**Tips**

- Small credenza models can be used in small footprint applications.
- Can use pedestal or credenza seat cushions on smaller credenza models.
- Low credenzas work in conjunction with worksurface 7" O-leg designed to create a unique layering design.
- Bookcase/laterals and other conventional storage components provide additional storage space.
- Must specify chassis and drawer front color separately.
- Low Credenzas, Laterals and Mobile Pedestals have seat cushions to create additional seating in the workspace.
- Storage and Personal Tower models offer conventional storage as well as wardrobes with a coat rod.
- Using a seat cushion with a power-ready credenza will cover one grommet.
- Specify appropriate power pack for credenza length.
- A worksurface-to-tower bracket kit allows the attachment of worksurfaces to Storage and Personal Tower models.
- Telescoping ball-bearing slides used on box and file drawers. Lateral drawers use a progressive ball-bearing slide.
- Cannot route software power through lockable storage units.

6. Select Accessories to add color, additional storage and organization to your workspace.

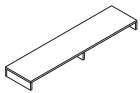

**Layering Shelf**

60"W x 14¼"D x 5½"H  
72"W x 14¼"D x 5½"H

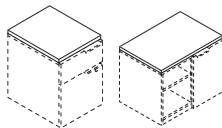

**Seat Cushion for Credenzas and Mobile  
Credenza/Pedestal  
Pedestal Cushion**

15⅞"W x 20"D x 2"H

**Credenza Cushion**

20"W x 30"D x 2"H, 20"W x 36"D x 2"H

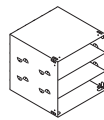

**Storage Cube**

12" x 12"

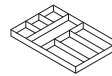

**Drawer Organizer**

12"W x 14½"D x 1½"H

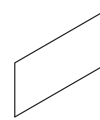

**Markerboard for Shared Overhead**

30"W x 15"D for use with 60"W Shared Overhead  
36"W x 15"D for use with 72"W Shared Overhead

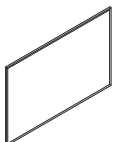

**Markerboard**

48"W x 31"H

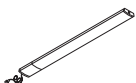

**LED Task Light**

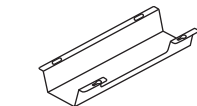

**Cable Management Trough**

17"W

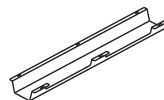

**Cable Management Trough**

36"W

**Tips**

- Choose from five bright Storage Cube colors for a colorful design element while providing additional storage.
- Use the Drawer Organizer to keep small items in order. Also offered in the same bright Storage Cube colors.
- Layering shelves are great for filing and piling or in conjunction with the lower credenza.
- Optimize shared overhead capabilities by adding the Markerboard for Shared Overhead.

# VOI® SPECIFYING/DESIGN GUIDE

## VOI® AND SYSTEMS INTEGRATION

### Worksurface Applications

Either Voi or Systems worksurfaces can be used with Voi in an open plan application. There are several support options:

- A. Completely panel supported.
- B. Combination of panel supported and another worksurface support such as:
  - Bookcase support
  - Pedestal (Brigade®, Flagship®, Contain®, or Voi®)
  - Systems open leg
  - Voi O-leg
  - End panel (Systems or Voi)
  - Tower to worksurface bracket
  - Support column
  - Systems round post leg
  - Voi post leg
- C. Freestanding:
  - Bookcase support
  - Two pedestals (Brigade®, Flagship®, Contain®, or Voi®)
  - Two Voi O-legs
  - One Voi O-leg and one Voi O-leg support for lower credenzas
  - Two end panels (metal or Voi)—requires metal or Voi modesty panel

### Additional application guidelines for worksurfaces:

- Systems worksurfaces are available with grommets or no grommets.
- When Voi lower credenzas are used along the spine wall and are placed adjacent to the wing wall, one electrical/data cutout on the wing wall will be blocked.
- When Voi credenzas are used along the wing wall and are placed adjacent to the spine wall, one electrical/data cutout on the spine wall will be blocked.
- When the Voi O-leg support for credenzas is used, it is recommended to also panel attach the worksurface with the worksurface anti-dislodgement bracket kit HWSA2.
- When the Voi O-leg support is used with panels, it is recommended to also panel attach the O-leg to the panel with the O-leg to panel bracket kit HLSPPBL (left) and/or HLSPBR (right). This bracket will provide additional workstation rigidity.
- When the Voi end panel support is used with panels, it is recommended to use the end panel support with panel bracket model. This model will provide additional workstation rigidity.
- The worksurface to tower bracket kit, HSTB2W1, will work with Voi towers, Voi worksurfaces, and systems worksurfaces.

### Application Guidelines—Combination of Panel Supported and Another Worksurface Support

- For applications where 1) the worksurface is perpendicular to the spine wall; 2) the worksurface is panel supported off the spine wall; and 3) there are Voi credenzas placed under the worksurface along the spine: there is not enough clearance to use standard worksurface cantilevers to attach the worksurface to the spine. Use the worksurface anti-dislodgement bracket kit HWSA2 to panel attach the worksurface in lieu of cantilevers.

### Panel Mounted Stack-on Storage Applications

- The Voi stack-on storage cabinets can be used on Abound and Accelerate as panel mounted overheads.
- The sliding door stack-on storage units are available in 36", 42", 48" widths in addition to 60", 66", 72", and 78" widths.
- The 4 door stack-on storage units are only available in 36", 42", 48", 60", 66", 72", and 78" widths.
- The storage units require a storage to panel bracket kit, model HLSPMB. This model includes one left hand, one right hand, and one center bracket. The brackets are available in all Core and Choice/Metallic paint colors.
- The storage cabinets do not have off modular capabilities.
- For proper installation and support, the storage units must follow the following specification rules:
  - There should be a storage unit of the same construction on each side of a given panel.
  - The storage units on opposite sides of a given panel should be in the same location vertically and horizontally.
  - Only one storage unit per panel, per side.
  - The wing panel adjacent to the spine wall needs to be the same height as the spine wall.

Contact HON's Integrated Design Services team with specification questions.

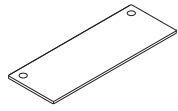

DESCRIPTION	MODEL	SHIP WEIGHT	CUBE	LIST PRICE BY LAMINATE GRADE	
				L1	L2
<b>Rectangle Worksurfaces</b>					
36"W x 20"D	<b>HLSLR2036</b>	40	2.2	<b>\$216</b>	<b>\$226</b>
42"W x 20"D	<b>HLSLR2042</b>	46	2.6	<b>\$240</b>	<b>\$250</b>
48"W x 20"D	<b>HLSLR2048</b>	52	2.9	<b>\$259</b>	<b>\$269</b>
54"W x 20"D	<b>HLSLR2054</b>	64	3.5	<b>\$291</b>	<b>\$306</b>
60"W x 20"D	<b>HLSLR2060</b>	70	3.5	<b>\$320</b>	<b>\$335</b>
66"W x 20"D	<b>HLSLR2066</b>	76	4.2	<b>\$348</b>	<b>\$363</b>
72"W x 20"D	<b>HLSLR2072</b>	82	4.2	<b>\$359</b>	<b>\$374</b>
36"W x 24"D	<b>HLSLR2436</b>	47	2.6	<b>\$227</b>	<b>\$242</b>
42"W x 24"D	<b>HLSLR2442</b>	54	3.0	<b>\$254</b>	<b>\$269</b>
48"W x 24"D	<b>HLSLR2448</b>	61	3.4	<b>\$275</b>	<b>\$290</b>
54"W x 24"D	<b>HLSLR2454</b>	68	4.2	<b>\$296</b>	<b>\$316</b>
60"W x 24"D	<b>HLSLR2460</b>	75	4.2	<b>\$322</b>	<b>\$342</b>
66"W x 24"D	<b>HLSLR2466</b>	82	5.0	<b>\$350</b>	<b>\$370</b>
72"W x 24"D	<b>HLSLR2472</b>	89	5.0	<b>\$361</b>	<b>\$381</b>
84"W x 24"D	<b>HLSLR2484</b>	103	5.7	<b>\$533</b>	<b>\$558</b>

**NOTES:**

- Systems worksurfaces can be used with all Voi components.
- Worksurfaces are abrasion- and stain-resistant laminate over durable 1/8" solid core high performance particleboard: resists wrapping.
- There is one 3" grommet in 36"W and 42"W worksurfaces and two in 48"W-84"W worksurfaces.
- One flat bracket ships with each worksurface.
- When attaching tops to panels, refer to Systems section of this pricer.
- Square edge detail.
- When using a floating modesty panel or an external channel under the worksurface, the depth clearance for keyboard trays and center drawers decreases by 8". See accessory matrix in accessory section of the pricer.
- 3" Power Hub model HGRMTAC can be interchanged with 3" standard grommet.
- ! Voi® worksurfaces cannot be used with Abode™ Desks components.
- ! Grommets in worksurfaces must be specified. If grommets are specified, grommets come in predetermined location.
- ! Edgeband option only on all Voi worksurfaces. For edgeband options, see matrix on page 258.
- ! When specifying an 84" Worksurface, cannot use two O-legs, must use at least one additional support such as a pedestal or lateral file.
- ! When using a worksurface as a bridge, no additional supports are needed. One support is required for returns, two supports are required for desks and credenzas.
- ! Lateral file or multi-files must be used with surfaces 24"D and 60"W or greater.
- ! Depending on your support combination, an external channel may be required for extra support on unsupported spans greater than 54"W. Please see the matrix on page 259 for more details.
- ! If using a 54"W or 60"W floating modesty, it is not necessary to spec an external channel.
- ! When attaching worksurfaces to panels, one or more of the following are required: anti-dislodgement brackets, end panel, support leg and/or cantilevers. Cantilevers and anti-dislodgement brackets must be ordered separately when attaching worksurfaces to panels.
- ! A return worksurface is considered 48"W or shorter. Longer returns cannot be supported by a flat bracket only.

**HOW TO SPECIFY**

<b>Select Model Number</b>  <div style="border: 1px solid black; padding: 2px; display: inline-block;">HLSLR2036</div>	<b>Select Worksurface Laminate and Edge Color</b> See page 242  <div style="border: 1px solid black; padding: 2px; display: inline-block;">NN</div>	<b>Select Grommet Option and Color</b> <b>X</b> No Grommet    If choosing the grommet option <b>G</b> Grommet        Select Grommet Color <b>P</b> Black Grommet <b>WHIT</b> Brilliant White Grommet <b>T5</b> Greige Grommet <b>T1</b> Platinum Grommet  <div style="border: 1px solid black; padding: 2px; display: inline-block;">GT5</div>
--	--	--

# VOI® Laminate Worksurfaces — Rectangle

GSA SIN 711-2

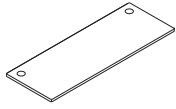
**DESCRIPTION****Rectangle Worksurfaces**

36"W x 30"D  
42"W x 30"D  
48"W x 30"D  
54"W x 30"D  
60"W x 30"D  
66"W x 30"D  
72"W x 30"D  
84"W x 30"D

60"W x 36"D  
66"W x 36"D  
72"W x 36"D

MODEL	SHIP WEIGHT	CUBE	LIST PRICE BY LAMINATE GRADE	
			L1	L2
<b>HLSLR3036</b>	58	3.2	<b>\$259</b>	<b>\$274</b>
<b>HLSLR3042</b>	67	3.7	<b>\$280</b>	<b>\$295</b>
<b>HLSLR3048</b>	75	4.2	<b>\$296</b>	<b>\$311</b>
<b>HLSLR3054</b>	84	5.1	<b>\$330</b>	<b>\$350</b>
<b>HLSLR3060</b>	92	5.1	<b>\$369</b>	<b>\$389</b>
<b>HLSLR3066</b>	101	6.1	<b>\$397</b>	<b>\$417</b>
<b>HLSLR3072</b>	110	6.1	<b>\$431</b>	<b>\$451</b>
<b>HLSLR3084</b>	127	7.0	<b>\$589</b>	<b>\$614</b>
<b>HLSLR3660</b>	110	6.1	<b>\$462</b>	<b>\$487</b>
<b>HLSLR3666</b>	120	7.2	<b>\$500</b>	<b>\$525</b>
<b>HLSLR3672</b>	130	7.2	<b>\$561</b>	<b>\$586</b>

**NOTES:**

- Systems worksurfaces can be used with all Voi components.
- Worksurfaces are abrasion- and stain-resistant laminate over durable 1½" solid core high performance particleboard: resists wrapping.
- There is one 3" grommet in 36"W and 42"W worksurfaces and two in 48"W-84"W worksurfaces.
- One flat bracket ships with each worksurface.
- When attaching tops to panels, refer to Systems section of this pricer.
- Square edge detail.
- When using a floating modesty panel or an external channel under the worksurface, the depth clearance for keyboard trays and center drawers decreases by 8". See accessory matrix in accessory section of the pricer.
- 3" Power Hub model HGRMTAC can be interchanged with 3" standard grommet.

- ! Voi® worksurfaces cannot be used with Abode™ Desks components.
- ! Grommets in worksurfaces must be specified. If grommets are specified, grommets come in predetermined location.
- ! Edgeband option only on all Voi worksurfaces.
- ! When specifying an 84" Worksurface, cannot use two O-legs, must use at least one additional support such as a pedestal or lateral file.

- ! When using a worksurface as a bridge, no additional supports are needed. One support is required for returns, two supports are required for desks and credenzas.
- ! Lateral file or multi-files must be used with surfaces 24"D and 60"W or greater.
- ! Depending on your support combination, an external channel may be required for extra support on unsupported spans greater than 54"W. Please see page 259 for models and a matrix to aid in specifying.
- ! If using a 54"W or 60"W floating modesty, it is not necessary to spec an external channel.
- ! When attaching worksurfaces to panels, one or more of the following are required: anti-dislodgement brackets, end panel, support leg and/or cantilevers. Cantilevers and anti-dislodgement brackets must be ordered separately when attaching worksurfaces to panels.
- ! A return worksurface is considered 48"W or shorter. Longer returns cannot be supported by a flat bracket only.

WORKSURFACE LAMINATES	CODES	EDGE BAND OPTIONS						
		Matching Edge	Brilliant White (WHIT)	Loft (LOFT)	Muslin (T)	Shadow (SHDW)	Black (P)	Charcoal (S)
Black	P							
Bourbon Cherry	H	•	•		•			
Brilliant White	WHIT		•					
Charcoal	S							•
Cognac	COGN	•	•		•			
Harvest	C	•	•		•			
Loft	LOFT			•				
Lowell Ash	LLA1	•	•	•	•			
Mahogany	N	•		•		•		
Mocha	MOCH	•	•		•			
Natural Maple	D	•	•	•	•			
Natural Recon	LNRI	•	•	•	•			
Phantom Ecru	LPE1	•	•	•	•			
Pinnacle	PINC	•	•		•			
Portico Teak	LPTI	•	•	•	•			
Shaker Cherry	F	•	•	•	•	•		
Sheer Mesh	A5				•			
Silver Mesh	B9			•				
Skyline Walnut	LSW1	•	•	•	•			

**HOW TO SPECIFY****Select Model Number**

HLSLR3036

**Select Worksurface Laminate and Edge Color**

See page 242

NN

**Select Grommet Option and Color**

- X No Grommet
  - G Grommet
- If choosing the grommet option  
Select Grommet Color
- P Black Grommet
  - WHIT Brilliant White Grommet
  - T5 Greige Grommet
  - T1 Platinum Grommet

GT5

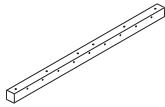
**DESCRIPTION****External Support Channel**

42"W for a 54" Worksurface  
 48"W for a 60" Worksurface  
 54"W for a 66" Worksurface  
 60"W for a 72" Worksurface  
 72"W for an 84" Worksurface

! Available in Graphite paint only.

! When specifying panel-hung worksurfaces, specify external channel as if supported by two O-legs via selection chart.

! When specifying a 54"W or 60"W Floating Modesty Panel, it is not necessary to specify an external channel.

**MODEL****SHIP WEIGHT****CUBE****LIST PRICE**

<b>HLSLZ5SC54</b>	5	0.5	<b>\$85</b>
<b>HLSLZ5SC60</b>	6	0.5	<b>\$90</b>
<b>HLSLZ5SC66</b>	7	0.5	<b>\$93</b>
<b>HLSLZ5SC72</b>	7	0.5	<b>\$100</b>
<b>HLSLZ5SC84</b>	12	0.7	<b>\$100</b>

**EXTERNAL CHANNEL SELECTION GUIDE**

Support Combination		Worksurface Width for Rectangle, Wedge, and Saddle				
Support 1	Support 2	84 in	72 in	66 in	60 in	54 in
O-Leg	O-Leg	NA	HLSLZ5SC72	HLSLZ5SC66	HLSLZ5SC60	HLSLZ5SC54
O-Leg	Slim Profile Pedestal	HLSLZ5SC84	HLSLZ5SC66	HLSLZ5SC60	HLSLZ5SC54	NA
O-Leg	Bookcase	HLSLZ5SC72	HLSLZ5SC66	HLSLZ5SC60	HLSLZ5SC54	NA
O-Leg	Pedestal	HLSLZ5SC72	HLSLZ5SC60	HLSLZ5SC54	NA	NA
O-Leg	End-Panel	HLSLZ5SC84	HLSLZ5SC60	HLSLZ5SC54	NA	NA
Slim Profile Pedestal	Slim Profile Pedestal	HLSLZ5SC72	HLSLZ5SC60	HLSLZ5SC54	NA	NA
Slim Profile Pedestal	Bookcase	HLSLZ5SC72	HLSLZ5SC60	HLSLZ5SC54	NA	NA
Slim Profile Pedestal	Pedestal	HLSLZ5SC66	HLSLZ5SC54	NA	NA	NA
Slim Profile Pedestal	End-Panel	HLSLZ5SC66	HLSLZ5SC54	NA	NA	NA
Pedestal	Bookcase	HLSLZ5SC66	HLSLZ5SC54	NA	NA	NA
End-Panel	Bookcase	HLSLZ5SC66	HLSLZ5SC54	NA	NA	NA
Bookcase	Bookcase	HLSLZ5SC66	HLSLZ5SC54	NA	NA	NA
End-Panel	End-Panel	HLSLZ5SC60	NA	NA	NA	NA
Pedestal	Pedestal	HLSLZ5SC60	NA	NA	NA	NA
Pedestal	End-Panel	HLSLZ5SC60	NA	NA	NA	NA
O-Leg	Lateral/Multifile	HLSLZ5SC54	NA	NA	NA	NA
Bookcase	Lateral/Multifile	NA	NA	NA	NA	NA
Slim Profile Pedestal	Lateral/Multifile	NA	NA	NA	NA	NA
Pedestal	Lateral/Multifile	NA	NA	NA	NA	NA
End-Panel	Lateral/Multifile	NA	NA	NA	NA	NA

\*All Rudder worksurfaces use external channel model HLSLZ5SC60.

**HOW TO SPECIFY**

Select  
Model Number

H L S L Z 5 S C 8 4 .

Select  
Paint

P

# VOI® Worksurface Supports

GSA SIN 711-2

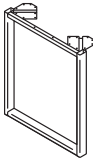
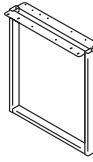
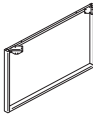
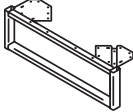
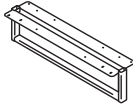

Icon Legend on page 21

	DESCRIPTION	MODEL	SHIP WEIGHT	CUBE	LIST PRICE BY PAINT GRADE	
					CORE	METALLICS
	<b>O-Leg Support for Worksurfaces</b>					
	20"D x 28½"H	<b>HLSL2028O</b>	15	3.7	<b>\$267</b>	<b>\$271</b>
	24"D x 28½"H	<b>HLSL2428O</b>	17	3.7	<b>\$291</b>	<b>\$295</b>
	30"D x 28½"H	<b>HLSL3028O</b>	19	5.4	<b>\$323</b>	<b>\$327</b>
	NOTES: Ship fully assembled, 1/pack. Non-handed. ! Specify paint only. <b>SPECIFYING EXAMPLE: HLSL2028O.T1</b>					
	<b>O-Leg Shared Support for Worksurfaces</b>					
	20"D x 28½"H	<b>HLSL2028SL</b>	15	3.7	<b>\$321</b>	<b>\$325</b>
	24"D x 28½"H	<b>HLSL2428SL</b>	17	3.7	<b>\$361</b>	<b>\$365</b>
	30"D x 28½"H	<b>HLSL3028SL</b>	19	5.4	<b>\$402</b>	<b>\$406</b>
	NOTES: Ship fully assembled, 1/pack. Non-handed. ! Specify paint only. <b>SPECIFYING EXAMPLE: HLSL2028SL.T1</b>					
	<b>Double-Depth O-Leg Support for Worksurfaces</b>					
	48"D x 28½"H	<b>HLSL4828O</b>	18	7.0	<b>\$550</b>	<b>\$558</b>
	60"D x 28½"H	<b>HLSL6028O</b>	19	8.7	<b>\$612</b>	<b>\$620</b>
	NOTES: Ship fully assembled, 1/package. Non-handed.					
	<b>O-Leg Support for Low Credenzas</b>					
	20"D x 7"H	<b>HLSL207O</b>	5	1.0	<b>\$180</b>	<b>\$184</b>
	24"D x 7"H	<b>HLSL247O</b>	6	1.0	<b>\$196</b>	<b>\$200</b>
	30"D x 7"H	<b>HLSL307O</b>	7	1.0	<b>\$249</b>	<b>\$253</b>
	NOTES: Ship fully assembled, 1/pack. Non-handed. ! Specify paint only. <b>SPECIFYING EXAMPLE: HLSL207O.T1</b>					
	<b>O-Leg Shared Support for Low Credenzas</b>					
	20"D x 7"H	<b>HLSL207SL</b>	5	1.0	<b>\$225</b>	<b>\$229</b>
	24"D x 7"H	<b>HLSL247SL</b>	6	1.0	<b>\$244</b>	<b>\$248</b>
	30"D x 7"H	<b>HLSL307SL</b>	7	1.0	<b>\$309</b>	<b>\$313</b>
	NOTES: Ship fully assembled, 1/pack. Non-handed. ! Specify paint only. <b>SPECIFYING EXAMPLE: HLSL207SL.T1</b>					

**NOTES:**





- A variety of pedestals, end panels, and O-legs can be combined to create a conventional or contemporary desk.
- O-leg ships fully assembled with mounting hardware.
- Shared O-Legs create a cleaner aesthetic in all applications where two legs are used side-by-side.
- Shared O-Leg bracket will span both worksurfaces to provide the same support with the look of a single O-leg.
- Will have a 6" overhang when using 30" worksurface supports with a 36"D worksurface.
- Glides on O-Leg Support for Worksurfaces and Post Leg Base have 2" of adjustability. No glides on 7"H O-leg. Glides on end panels have 1¼" adjustability.

! O-legs may only be attached to worksurfaces, not storage units.

**HOW TO SPECIFY**

<b>Select Model Number</b>	<b>Select Paint Color</b>
HLSL2028O	T1
	See page 242

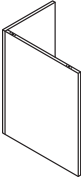

	DESCRIPTION	MODEL	SHIP WEIGHT	CUBE	LIST PRICE BY PAINT GRADE	
					CORE	METALLICS
	<b>Post Leg Base</b> 28½"H x 2" square ! Post leg cannot be used on primary worksurface with an O-leg as the other support. ! Post leg can only be used to support peninsula, not as primary supports for a top.	<b>HLSL28P</b>	15	1.0	<b>\$267</b>	<b>\$271</b>
	<b>28½"H O-Leg-to-Panel Attachment Bracket</b> 28½"H Left handed bracket (quantity 1) 28½"H Right handed bracket (quantity 1) NOTES: Used to connect Voi O-Leg to a systems panel for additional workstation rigidity. Bracket designed to work with edgeband worksurfaces only. Brackets are handed, come one per package and include self-tapping screws. Specify paint.	<b>HLSLPBL</b> <b>HLSLPBR</b>	3  3 	0.4 0.4	<b>\$91</b> <b>\$91</b>	<b>\$95</b> <b>\$95</b>
	<b>Standing-Height O-Leg to Panel Attachment Bracket</b> 41"H Left-hand Bracket 41"H Right-hand Bracket NOTES: 1/package. Brackets are handed as shown above. To be used with 41"H O-legs shown above (HLSL2441O and HLSL3041O).	<b>HLSLSPBL</b> <b>HLSLSPBR</b>	6 6	1.0 1.0	<b>\$116</b> <b>\$116</b>	<b>\$120</b> <b>\$120</b>
	<b>End Panel Support</b> 16"W x 20"D x 28½"H 16"W x 24"D x 28½"H 16"W x 30"D x 28½"H NOTES: Ship in two pieces. Non-handed.	<b>HLSL2028E</b> <b>HLSL2428E</b> <b>HLSL3028E</b>	39 44 50	3.2 3.7 4.2	<b>\$172</b> <b>\$186</b> <b>\$198</b>	<b>\$182</b> <b>\$196</b> <b>\$208</b>

**NOTES:**

- A variety of pedestals, end panels, and O-legs can be combined to create a conventional or contemporary desk.
- O-leg ships fully assembled with mounting hardware.
- Shared O-Legs create a cleaner aesthetic in all applications where two legs are used side-by-side.
- The bracket on the O-leg will span both worksurfaces to provide the same support with the look of a single O-leg.
- Voi square support column is interchangeable with the Systems worksurface round support column: HCNLEG29.
- Will have a 6" overhang when using 30" worksurface supports with a 36"D worksurface.
- Glides on O-Leg Support for Worksurfaces and Post Leg Base have 2" of adjustability. No glides on 7"H O-leg. Glides on end panels have 1/4" adjustability.
- ! O-legs may only be attached to worksurfaces, not storage units.
- ! Post leg can only be used to support peninsula, not as primary supports for a top.

**HOW TO SPECIFY**

<b>Select Model Number</b> HLSL2028E	<b>Select Laminate</b> See page 242 H
---	---

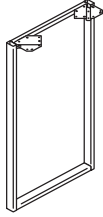

**DESCRIPTION****Standing-Height O-Leg Support for Worksurfaces**

24"D x 41"H

30"D x 41"H

**MODEL****HLSL2441O****HLSL3041O****SHIP WEIGHT**

16

17

**CUBE**

5.3

6.5

**LIST PRICE BY PAINT GRADE****CORE****\$390****\$436****METALLICS****\$396****\$442**

NOTES: Ship fully assembled, 1/package. Non-handed.

Coordinate™ Power Modules will work with standing-height applications for 10500™ and Voi® desks. Please see Coordinate™ Accessories Stand-Alone Pricer pages for more information.

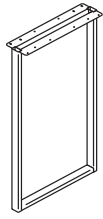
**Standing-Height O-Leg Shared Support for Worksurfaces**

24"D x 41"H

30"D x 41"H

**HLSL2441SL****HLSL3041SL**

16

17

5.3

6.5

**\$439****\$487****\$445****\$493**

NOTES: Ship fully assembled, 1/package. Non-handed.

Coordinate™ Power Modules will work with standing-height applications for 10500™ and Voi® desks. Please see Coordinate™ Accessories Stand-Alone Pricer pages for more information.

**Standing-Height O-Leg to Panel Attachment Bracket**

41"H Left-hand Bracket

41"H Right-hand Bracket

**HLSLSPBL****HLSLSPBR**

6

6

1.0

1.0

**\$116****\$116****\$120****\$120**

NOTES: 1/package. Brackets are handed as shown above. To be used with 41"H O-legs shown above (HLSL2441O and HLSL3041O).

**NOTES:**

- O-leg glides have 2" adjustability.
- O-Leg to Panel Attachment Brackets are used to connect Voi® O-Legs to a systems panel for additional worksurface rigidity.

! O-legs may only be attached to worksurfaces, not storage units.

**HOW TO SPECIFY****Select Model Number**

HLSL2441O

**Select Paint Color**

See page 242

T1

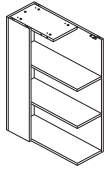
**DESCRIPTION****Standing-Height Bookcase Support**

12"W x 30"D x 41"H - Left  
12"W x 30"D x 41"H - Right

**MODEL**

**HLSL3041BCL**  
**HLSL3041BCR**

**SHIP WEIGHT**

73  
73

**CUBE**

3.7  
3.7

**L1 LIST**

**\$647**  
**\$647**

**L2 UPCHARGES**

**\$30**    **N/A**  
**\$30**    **N/A**

12"W x 24"D x 41"H - Left  
12"W x 24"D x 41"H - Right

**HLSL2441BCL**  
**HLSL2441BCR**

57  
57

2.8  
2.8

**\$543**  
**\$543**

**\$25**    **N/A**  
**\$25**    **N/A**

! Cannot use grommet worksurfaces with Standing-Height Support Storage.

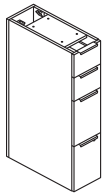
**Standing-Height Support Pedestals — Box/Box/File/File**

9½"W x 24"D x 41"H  
9½"W x 30"D x 41"H

**HLSL2441S**  
**HLSL3041S**

94  
113

11.9  
14.7

**\$1363**  
**\$1416**

**\$40**    **\$20**  
**\$45**    **\$20**

NOTES: Top two drawers are non-locking.

! Cannot use grommet worksurfaces with Standing-Height Support Storage.

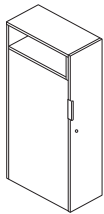
**Standing-Height Side Access Storage Tower**

12"W x 24"D x 50"H - Left  
12"W x 24"D x 50"H - Right

**HLSLW1224L**  
**HLSLW1224R**

100  
100

11.0  
11.0

**\$1243**  
**\$1243**

**\$35**    **\$20**  
**\$35**    **\$20**

12"W x 30"D x 50"H - Left  
12"W x 30"D x 50"H - Right

**HLSLW1230L**  
**HLSLW1230R**

121  
121

13.6  
13.6

**\$1296**  
**\$1296**

**\$35**    **\$20**  
**\$35**    **\$20**

**NOTES:**

- Tower includes coat hook on back of door.
- Chassis and drawer front panels can be specified separately.
- Tower door is locking. Ships with one handle.
- Support Pedestals bottom file drawers will lock, top box drawers will not.
- Standing-Height Bookcases and Pedestals will have 6" overhang when using 30"D support storage with a 36"D worksurface.
- Use the worksurface to tower bracket kit model HSTB2W1 on page 284 to attach worksurfaces to the Storage Tower models.
- ! Bookcase can only mount with open side facing underneath the worksurface.
- ! Pedestals ship fully assembled but must attach to a worksurface with a quick release bracket, provided. Pedestals are non-handed and are interchangeable.
- ! Locking units equipped with HON "One Key" interchangeable core removable locks. Keyed alike core must be ordered separately.

**HOW TO SPECIFY**

Select Model Number	Select Chassis Laminate	Select Drawer Front Laminate	Select Pull Color
See page 242	See page 242	See page 242	See page 242
HLSL2441S	N	N	T4

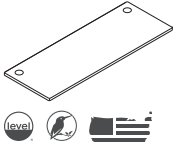
	DESCRIPTION	MODEL	SHIP WEIGHT	CUBE	LIST PRICE BY LAMINATE GRADE	
					L1	L2
	<b>Rectangle Worksurfaces</b>					
	48"W x 24"D	<b>HLSLR2448</b>	61	3.4	<b>\$275</b>	<b>\$290</b>
	54"W x 24"D	<b>HLSLR2454</b>	68	4.2	<b>\$296</b>	<b>\$316</b>
	60"W x 24"D	<b>HLSLR2460</b>	75	4.2	<b>\$322</b>	<b>\$342</b>
	66"W x 24"D	<b>HLSLR2466</b>	82	5.0	<b>\$350</b>	<b>\$370</b>
	72"W x 24"D	<b>HLSLR2472</b>	89	5.0	<b>\$361</b>	<b>\$381</b>

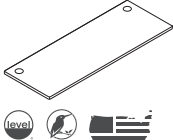
	<b>Rectangle Worksurfaces</b>					
	48"W x 30"D	<b>HLSLR3048</b>	75	4.2	<b>\$296</b>	<b>\$311</b>
	54"W x 30"D	<b>HLSLR3054</b>	84	5.1	<b>\$330</b>	<b>\$350</b>
	60"W x 30"D	<b>HLSLR3060</b>	92	5.1	<b>\$369</b>	<b>\$389</b>
	66"W x 30"D	<b>HLSLR3066</b>	101	6.1	<b>\$397</b>	<b>\$417</b>
	72"W x 30"D	<b>HLSLR3072</b>	110	6.1	<b>\$431</b>	<b>\$451</b>

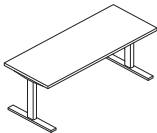
	DESCRIPTION	MODEL	SHIP WEIGHT	CUBE	LIST PRICE
 <p>Base shown with worksurface attached.</p>	<b>Coordinate™ Height Adjustable Base – 2 Stage</b> 24"D Feet and Worksurface Brackets	<b>HHAB2S2L</b>	63	2.4	<b>\$860</b>
	NOTES: <b>AVAILABLE FEBRUARY 2018.</b> Base is a dual motor 2-stage design with standard anti-collision. Legs raise from 25 $\frac{5}{8}$ " to 45 $\frac{1}{4}$ ". Base telescopes to accommodate any rectangular worksurface between 24"D x 48"W and 36"D x 72"W. Supports weight capacity of 250 lbs. (excluding worksurface weight). See page 767 for Voi® Worksurfaces. See page 767 for Systems Worksurfaces. For Height Adjustable Base Accessories see pages 765-766. Foundation™, Systems, Voi®, 10500, and Preside® all have worksurfaces within this range.				
	ⓘ When attaching a Keyboard Tray, remember to also specify a Keyboard Spacer Kit (HKBS).				

## OPEN MARKET

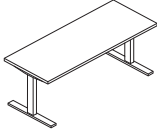

 <p>Base shown with worksurface attached.</p>	<b>Coordinate™ Height Adjustable Base – 3 Stage</b> 24"D Feet and Worksurface Brackets	<b>HHAB3S2L</b>	67	2.4	<b>\$960</b>
	NOTES: <b>AVAILABLE FEBRUARY 2018.</b> Base telescopes to accommodate any rectangular worksurface between 24"D x 48"W and 36"D x 72"W. Supports weight capacity of 250 lbs. (excluding worksurface weight). Foundation™, Systems, Voi®, 10500, and Preside® all have worksurfaces within this range. Base is a dual motor 3-stage design with standard anti-collision. Legs raise from 21 $\frac{5}{8}$ " to 47 $\frac{3}{4}$ ".				

## OPEN MARKET



## NOTES:

**Coordinate™ Height Adjustable Bases**

- Comes standard with one-touch, four memory controller with digital display; no specification needed, available in black finish only.
- **HON 5-Year Limited Warranty.**

## HOW TO SPECIFY

<b>Select Model Number</b> HLSLR2448	<b>Select Worksurface Laminate and Edge Color</b> See page 242 NN	<b>Select Grommet Option and Color</b> X No Grommet G Grommet If choosing the grommet option Select Grommet Color P Black Grommet WHIT Brilliant White Grommet T5 Greige Grommet T1 Platinum Grommet GT5
---	---	---



# Laminate Support/Support Pedestals

VOI®

DESKS

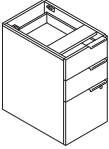
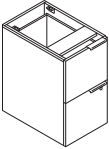
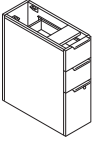
	DESCRIPTION	MODEL	SHIP WEIGHT	CUBE	L1 LIST	L2 UPCHARGES	
						CHASSIS	FRONTS
	<b>Support Pedestals — Box/Box/File</b>						
	16"W x 20"D x 28½"H	<b>HLSL2028B</b>	73	7.3	<b>\$634</b>	<b>\$15</b>	<b>\$10</b>
	16"W x 24"D x 28½"H	<b>HLSL2428B</b>	85	8.5	<b>\$701</b>	<b>\$20</b>	<b>\$10</b>
	16"W x 30"D x 28½"H	<b>HLSL3028B</b>	105	10.5	<b>\$790</b>	<b>\$25</b>	<b>\$10</b>
	NOTES: Top box drawer does not lock.						
	<b>Support Pedestals — File/File</b>						
	16"W x 20"D x 28½"H	<b>HLSL2028F</b>	72	7.3	<b>\$634</b>	<b>\$15</b>	<b>\$10</b>
	16"W x 24"D x 28½"H	<b>HLSL2428F</b>	84	8.5	<b>\$701</b>	<b>\$20</b>	<b>\$10</b>
	16"W x 30"D x 28½"H	<b>HLSL3028F</b>	104	10.5	<b>\$790</b>	<b>\$25</b>	<b>\$10</b>
	NOTES: Unit is locking.						
	<b>Slim Profile Pedestals — Box/Box/File</b>						
	9½"W x 24"D x 28½"H	<b>HLSL2428S</b>	69	6.9	<b>\$696</b>	<b>\$20</b>	<b>\$10</b>
	9½"W x 30"D x 28½"H	<b>HLSL3028S</b>	56	5.6	<b>\$764</b>	<b>\$25</b>	<b>\$10</b>
	NOTES: Top box drawer does not lock. ! Grommet will be located under Slim Pedestal when attached.						



**NOTES:**

- A variety of pedestals, end panels, and O-legs can be combined to create a conventional or contemporary desk.
- Chassis and drawer front woodgrain and solid laminates are specified separately (see SIF options below).
- Will have a 6" overhang when using 30" worksurface supports with a 36"D worksurface.
- File drawers accept hanging folders in letter or legal size.
- Multiple handle locations possible per customer preference.
- Ships with one handle per drawer.
- Drawer Organizer model HSLDRWORG works with box drawers.
- Box and file drawers operate on ball-bearing suspension with full extension.
- Adjustable hex leveling glides allow floor-standing furniture to be easily leveled without lifting the unit; glides have 1/4" adjustable range.
- ! Pedestals ship fully assembled but must attach to a worksurface with a quick release bracket, provided. Pedestals are non-handed and are interchangeable.
- ! Locking units equipped with HON "One Key" interchangeable core removable locks. Keyed alike core must be ordered separately.

**HOW TO SPECIFY**

<b>Select Model Number</b> HLSL2028B	<b>Select Chassis Laminate</b> See page 242 N	<b>Select Drawer Front Laminate</b> See page 242 N	<b>Select Pull Color</b> P Black T4 Champagne T1 Platinum WHIT White T4	<b>Select Grommet Color</b> P Black Specified for Power-Ready models only P
---	---	--	--	--

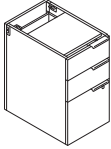
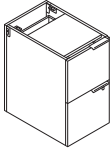
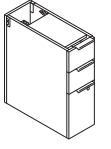

	DESCRIPTION	MODEL	SHIP WEIGHT	CUBE	L1 LIST	L2 UPCHARGES	
						CHASSIS	FRONTS
	<b>Power-Ready Support Pedestal — Box/Box/File</b>						
	16"W x 20"D x 28½"H	<b>HLSL2028BPWR</b>	73	7.3	<b>\$734</b>	<b>\$15</b>	<b>\$10</b>
	16"W x 24"D x 28½"H	<b>HLSL2428BPWR</b>	86	8.5	<b>\$772</b>	<b>\$20</b>	<b>\$10</b>
	16"W x 30"D x 28½"H	<b>HLSL3028BPWR</b>	105	10.5	<b>\$861</b>	<b>\$25</b>	<b>\$10</b>
	NOTES: Top box drawer does not lock.						
	<b>Power-Ready Support Pedestal — File/File</b>						
	16"W x 20"D x 28½"H	<b>HLSL2028FPWR</b>	72	7.3	<b>\$734</b>	<b>\$15</b>	<b>\$10</b>
	16"W x 24"D x 28½"H	<b>HLSL2428FPWR</b>	85	8.5	<b>\$772</b>	<b>\$20</b>	<b>\$10</b>
	16"W x 30"D x 28½"H	<b>HLSL3028FPWR</b>	104	10.5	<b>\$861</b>	<b>\$25</b>	<b>\$10</b>
	NOTES: Unit is locking.						
	<b>Power-Ready, Slim Profile Support Pedestal — Box/Box/File</b>						
	9½"W x 24"D x 28½"H	<b>HLSL2428SPWR</b>	56	5.6	<b>\$769</b>	<b>\$20</b>	<b>\$10</b>
	9½"W x 30"D x 28½"H	<b>HLSL3028SPWR</b>	69	6.9	<b>\$836</b>	<b>\$25</b>	<b>\$10</b>
	NOTES: Top box drawer does not lock.  Grommet will be located under Slim Pedestal when attached.						

**NOTES:**

- A variety of pedestals, end panels, and O-legs can be combined to create a conventional or contemporary desk.
- Chassis and drawer front woodgrain and solid laminates are specified separately (see SIF options below).
- Will have a 6" overhang when using 30" worksurface supports with a 36"D worksurface.
- Pass-thru openings in the sides of support pedestals allow hardwire conduit to run under worksurfaces, through the case in a continuous run. Black grommets included on both sides for a finished look.
- File drawers accept hanging folders in letter or legal size.
- Multiple handle locations possible per customer preference.
- Ships with one handle per drawer.
- Drawer Organizer model HLSLDRWORG works with box drawers.
- Box and file drawers operate on ball-bearing suspension with full extension.
- Adjustable hex leveling glides allow floor-standing furniture to be easily leveled without lifting the unit; glides have 1/4" adjustable range.

 Pedestals ship fully assembled but must attach to a worksurface with a quick release bracket, provided. Pedestals are non-handed and are interchangeable.



 Locking units equipped with HON "One Key" interchangeable core removable locks. Keyed alike core must be ordered separately.

**HOW TO SPECIFY**

Select Model Number	Select Chassis Laminate	Select Drawer Front Laminate	Select Pull Color	Select Grommet Color
	See page 242	See page 242	<b>P</b> Black <b>T4</b> Champagne <b>T1</b> Platinum <b>WHIT</b> White	<b>P</b> Black Specified for Power-Ready models only
<b>HLSL2028BPWR</b>	<b>N</b>	<b>N</b>	<b>T4</b>	<b>P</b>

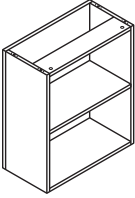

# Laminate Support/Support Storage

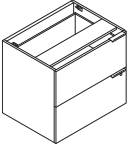
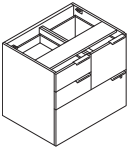
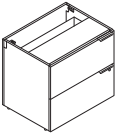
	DESCRIPTION	MODEL	SHIP WEIGHT	CUBE	L1 LIST	L2 UPCHARGES	
						CHASSIS	FRONTS
 <p><b>SIN 711-2</b></p> 	<b>Bookcase Support</b> 24"W x 12"D x 28½"H 30"W x 12"D x 28½"H	<b>HLSL24OBC</b> <b>HLSL30OBC</b>	60 75	3.0 3.0	<b>\$471</b> <b>\$493</b>	<b>\$20</b> <b>\$25</b>	N/A N/A
		<b>Lateral File — 2 Drawer</b> 31⅜"W x 24"D x 28½"H NOTES: Unit is locking.	<b>HLSL2430L</b>	121	15.6	<b>\$1090</b>	<b>\$35</b>
	<b>Multi File Lateral File</b> 31⅜"W x 24"D x 28½"H NOTES: Box drawers do not lock.	<b>HLSL2430MF</b>	163	15.6	<b>\$1293</b>	<b>\$35</b>	<b>\$20</b>
	<b>Power-Ready Lateral File, 2 Drawers</b> 31⅜"W x 24"D x 28½"H NOTES: Unit is locking.	<b>HLSL2430LPWR</b>	121	15.6	<b>\$1161</b>	<b>\$35</b>	<b>\$20</b>

**NOTES:**

- Ships with one handle per drawer on all units.
  - A variety of pedestals, end panels, and O-legs can be combined to create a conventional or contemporary desk.
  - Will have a 6" overhang when using 30" worksurface supports with a 36"D worksurface.
  - Bookcase can only mount exterior facing under a worksurface.
  - Chassis and drawer front woodgrain and solid laminates are specified separately (see SIF options below).
  - File drawers accept hanging folders in letter or legal size.
  - Multiple handle locations possible per customer preference.
  - Storage accessory model HLSLDRWORG works with box doors.
  - Standard box drawers operate on ball-bearing suspension with full extension. File, lateral, and wide box drawers operate on ball-bearing suspension with full extension.
  - Adjustable hex leveling glides allow floor-standing furniture to be easily leveled without lifting the unit; glides have 2" adjustable range.
  - When using two lateral files, a 60" worksurface cannot be used, a 66" worksurface must be specified, which will show a gap.
- ! A single multi-file or lateral file must be specified under a worksurface 60"W or wider.
- ! Locking units equipped with HON "One Key" interchangeable core removable locks. Keyed alike core must be ordered separately.

## HOW TO SPECIFY

<p><b>Select Model Number</b></p> <p>H L S L 2 4 3 0 L .</p>	<p><b>Select Chassis Laminate</b></p> <p>See page 242</p> <p>N .</p>	<p><b>Select Laminate</b></p> <p>See page 242</p> <p>N .</p>	<p><b>Select Pull Color</b></p> <p>P Black                      T4 Champagne                      T1 Platinum                      WHIT White</p> <p>T 4 .</p>	<p><b>Select Grommet Color</b></p> <p>P Black                      Specified for Power-Ready models only</p> <p>P</p>
--	--	--	--	---

# VOI® Modesty Panels

GSA SIN 711-2



Icon Legend on page 21

	DESCRIPTION	MODEL	SHIP WEIGHT	CUBE	LIST PRICE BY LAMINATE GRADE	
					L1	L2
	<b>Full Width/Half-height Laminate Modesty Panel</b>					
	28"W x 14"H, for use with 60" desks	<b>HL3L2814LM</b>	19	1.6	<b>\$169</b>	<b>\$179</b>
	34"W x 14"H, for use with 66" desks	<b>HL3L3414LM</b>	23	1.9	<b>\$174</b>	<b>\$184</b>
	40"W x 14"H, for use with 72" desks	<b>HL3L4014LM</b>	29	2.4	<b>\$182</b>	<b>\$192</b>
	NOTES: Three sizes available for 60", 66" and 72" desks. Can only be used when using end panels and pedestals for support.					
	<b>Full-to-Floor/Full-Length Laminate Modesty Panel</b>					
	28"W x 28½"H, for use with 60" desks	<b>HL3L2828LM</b>	33	2.7	<b>\$227</b>	<b>\$239</b>
	34"W x 28½"H, for use with 66" desks	<b>HL3L3428LM</b>	38	3.2	<b>\$265</b>	<b>\$277</b>
	40"W x 28½"H, for use with 72" desks	<b>HL3L4028LM</b>	44	3.6	<b>\$281</b>	<b>\$293</b>
	NOTES: Three sizes available for 60", 66" and 72" desks. Can only be used when using end panels and pedestals for support.					
	<b>Laminate Floating Modesty Panel</b>					
	30"W x 14"H	<b>HL3L3014L</b>	10	0.8	<b>\$154</b>	<b>\$164</b>
	36"W x 14"H	<b>HL3L3614L</b>	12	0.8	<b>\$163</b>	<b>\$173</b>
	42"W x 14"H	<b>HL3L4214L</b>	14	0.8	<b>\$176</b>	<b>\$186</b>
	48"W x 14"H	<b>HL3L4814L</b>	16	1.1	<b>\$193</b>	<b>\$205</b>
	54"W x 14"H	<b>HL3L5414L</b>	18	1.1	<b>\$212</b>	<b>\$224</b>
	60"W x 14"H	<b>HL3L6014L</b>	20	1.1	<b>\$228</b>	<b>\$240</b>
NOTES: The attachment bracket and modesty panel are packaged separately. Specify: Model.Laminate.Paint <b>SPECIFYING EXAMPLE: HL3L3014L.N (Black is the only paint option for this model)</b>						
ⓘ When specifying the 54"W or 60"W Laminate Floating Modesty Panel, it is not necessary to specify an external channel.						
ⓘ 30"W and 36"W screens attach with L-brackets, not the external channel.						

**NOTES:**

- Full width laminate modesty panel (14"H) and full width/full-length laminate modesty panels are designed to work with 60", 66", & 72" desks.
- Laminate and frosted translucent laminate are available options on modesty panels.
- Full height and half height laminate modesty panels can only be used when specifying a pedestal and/or end panel.

**HOW TO SPECIFY**

<b>Select Model Number</b> HL3L2814LM . N	<b>Select Laminate</b> See page 242
--	--



Icon Legend on page 21

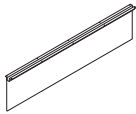

**DESCRIPTION**

**Mixed Material Floating Modesty Panel**

- 30"W x 14"H
- 36"W x 14"H
- 42"W x 14"H
- 48"W x 14"H
- 54"W x 14"H
- 60"W x 14"H

**MODEL**

- HLSL3014MM**
- HLSL3614MM**
- HLSL4214MM**
- HLSL4814MM**
- HLSL5414MM**
- HLSL6014MM**

**SHIP WEIGHT**

- 8
- 8
- 9
- 11
- 13
- 13

**CUBE**

- 2.0
- 2.0
- 2.3
- 2.6
- 3.3
- 3.3

**LIST PRICE**

- \$621**
- \$666**
- \$745**
- \$826**
- \$896**
- \$1023**

NOTES: The attachment bracket and modesty panel are packaged separately.

Specify: Model.Mixed Material.Paint

**SPECIFYING EXAMPLE: HLSL3014MM.FT01.P (Frosted Translucent mixed material and Black paint are the only options for this model)**

**!** When specifying the 54"W or 60"W Mixed Material Floating Modesty Panel, it is not necessary to specify an external channel.

**NOTES:**

- Full width laminate modesty panel (14"H) and full width/full-length laminate modesty panels are designed to work with 60", 66", & 72" desks.
- Laminate and frosted translucent laminate are available options on modesty panels.
- Full height and half height laminate modesty panels can only be used when specifying a pedestal and/or end panel.

**FLOATING MODESTY SELECTION GUIDE**

Support Combination		Top Size								
Support 1	Support 2	84 in	72 in	66 in	60 in	54 in	48 in	42 in	36 in	30 in
O-Leg	O-Leg	NA	HLSL6014	HLSL5414	HLSL4814	HLSL4214	HLSL3614	HLSL3014	NA	NA
O-Leg	Slim Profile Pedestal	HLSL6014	HLSL5414	HLSL4814	HLSL4214	HLSL3614	HLSL3014	NA	NA	NA
O-Leg	Bookcase	HLSL6014	HLSL5414	HLSL4814	HLSL4214	HLSL3614	HLSL3014	NA	NA	NA
O-Leg	Pedestal	HLSL6014	HLSL4814	HLSL4214	HLSL3614	HLSL3014	NA	NA	NA	NA
O-Leg	End-Panel	HLSL6014	HLSL4814	HLSL4214	HLSL3614	HLSL3014	NA	NA	NA	NA
Slim Profile Pedestal	Slim Profile Pedestal	HLSL6014	HLSL4814	HLSL4214	HLSL3614	HLSL3014	NA	NA	NA	NA
Slim Profile Pedestal	Bookcase	HLSL6014	HLSL4814	HLSL4214	HLSL3614	HLSL3014	NA	NA	NA	NA
Slim Profile Pedestal	Pedestal	HLSL5414	HLSL4214	HLSL3614	HLSL3014	NA	NA	NA	NA	NA
Slim Profile Pedestal	End-Panel	HLSL5414	HLSL4214	HLSL3614	HLSL3014	NA	NA	NA	NA	NA
Pedestal	Bookcase	HLSL5414	HLSL4214	HLSL3614	HLSL3014	NA	NA	NA	NA	NA
End-Panel	Bookcase	HLSL5414	HLSL4214	HLSL3614	HLSL3014	NA	NA	NA	NA	NA
Bookcase	Bookcase	HLSL5414	HLSL4214	HLSL3614	HLSL3014	NA	NA	NA	NA	NA
End-Panel	End-Panel	HLSL4814	HLSL3614	HLSL3014	NA	NA	NA	NA	NA	NA
Pedestal	Pedestal	HLSL4814	HLSL3614	HLSL3014	NA	NA	NA	NA	NA	NA
Pedestal	End-Panel	HLSL4814	HLSL3614	HLSL3014	NA	NA	NA	NA	NA	NA
O-Leg	Lateral/Multifile	HLSL4214	HLSL3614	HLSL3014	NA	NA	NA	NA	NA	NA
Bookcase	Lateral/Multifile	HLSL3614	NA	NA	NA	NA	NA	NA	NA	NA
Slim Profile Pedestal	Lateral/Multifile	HLSL3614	NA	NA	NA	NA	NA	NA	NA	NA
Pedestal	Lateral/Multifile	HLSL3014	NA	NA	NA	NA	NA	NA	NA	NA
End-Panel	Lateral/Multifile	HLSL3014	NA	NA	NA	NA	NA	NA	NA	NA

**HOW TO SPECIFY**

<p><b>Select Model Number</b></p> <p>HLSL3014MM.</p>	<p><b>Select Mixed Material</b></p> <p>FT01 Frosted Translucent</p> <p>FT01</p>
--	---



# VOI® Privacy Screens

GSA SIN 711-2

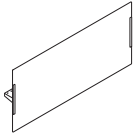

Icon Legend on page 21

**DESCRIPTION****Above/Below Privacy Screen**

30"W x 28"H  
36"W x 28"H  
42"W x 28"H  
48"W x 28"H  
54"W x 28"H  
60"W x 28"H

**MODEL**

**HLSL2830**  
**HLSL2836**  
**HLSL2842**  
**HLSL2848**  
**HLSL2854**  
**HLSL2860**

**SHIP WEIGHT**

6  
6  
6  
8  
9  
9

**CUBE**

6.4  
6.4  
6.3  
8.2  
8.6  
8.6

**LIST PRICE**

**\$736**  
**\$1018**  
**\$1031**  
**\$1098**  
**\$1279**  
**\$1287**

NOTES: Attachment bracket extends 2" into the worksurface. Brackets are Platinum only, no need to specify.

❗ Available in Frosted Translucent Acrylic ONLY HLSL2830.FT01.

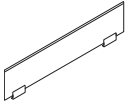
**Above Privacy Screen**

30"W x 13"H  
36"W x 13"H  
42"W x 13"H  
48"W x 13"H  
54"W x 13"H  
60"W x 13"H

**HLSL1230**  
**HLSL1236**  
**HLSL1242**  
**HLSL1248**  
**HLSL1254**  
**HLSL1260**

13  
15  
18  
20  
22  
24

1.5  
1.8  
2.3  
2.3  
2.9  
2.9

**\$251**  
**\$277**  
**\$310**  
**\$354**  
**\$379**  
**\$408**

NOTES: Bracket is Platinum only, no need to specify.

❗ Available in Frosted Glass ONLY HLSL1230.G.

❗ Above only privacy screen clamps onto worksurface and cannot be installed where support storage will be attached.

**NOTES:**

- Ships complete with attachment brackets.
- Voi® Privacy Screens can be used on the HON Height Adjustable Base.
- All brackets are Platinum.
- Above Privacy Screen attaches to top of worksurface.
- Above and below privacy screen extends 13" above and 13" below the worksurface.

**ABOVE-BELOW PRIVACY SCREEN SELECTION GUIDE**

Support Combination		Top Size								
Support 1	Support 2	84 in	72 in	66 in	60 in	54 in	48 in	42 in	36 in	30 in
O-Leg	O-Leg	NA	HLSL2860	HLSL2854	HLSL2848	HLSL2842	HLSL2836	HLSL2830	NA	NA
O-Leg	Slim Profile Pedestal	HLSL2860	HLSL2854	HLSL2848	HLSL2842	HLSL2836	HLSL2830	NA	NA	NA
O-Leg	Bookcase	HLSL2860	HLSL2854	HLSL2848	HLSL2842	HLSL2836	HLSL2830	NA	NA	NA
O-Leg	Pedestal	HLSL2860	HLSL2848	HLSL2842	HLSL2836	HLSL2830	NA	NA	NA	NA
O-Leg	End-Panel	HLSL2860	HLSL2848	HLSL2842	HLSL2836	HLSL2830	NA	NA	NA	NA
Slim Profile Pedestal	Slim Profile Pedestal	HLSL2860	HLSL2848	HLSL2842	HLSL2836	HLSL2830	NA	NA	NA	NA
Slim Profile Pedestal	Bookcase	HLSL2860	HLSL2848	HLSL2842	HLSL2836	HLSL2830	NA	NA	NA	NA
Slim Profile Pedestal	Pedestal	HLSL2854	HLSL2842	HLSL2836	HLSL2830	NA	NA	NA	NA	NA
Slim Profile Pedestal	End-Panel	HLSL2854	HLSL2842	HLSL2836	HLSL2830	NA	NA	NA	NA	NA
Pedestal	Bookcase	HLSL2854	HLSL2842	HLSL2836	HLSL2830	NA	NA	NA	NA	NA
End-Panel	Bookcase	HLSL2854	HLSL2842	HLSL2836	HLSL2830	NA	NA	NA	NA	NA
Bookcase	Bookcase	HLSL2854	HLSL2842	HLSL2836	HLSL2830	NA	NA	NA	NA	NA
End-Panel	End-Panel	HLSL2848	HLSL2836	HLSL2830	NA	NA	NA	NA	NA	NA
Pedestal	Pedestal	HLSL2848	HLSL2836	HLSL2830	NA	NA	NA	NA	NA	NA
Pedestal	End-Panel	HLSL2848	HLSL2836	HLSL2830	NA	NA	NA	NA	NA	NA
O-Leg	Lateral/Multifile	HLSL2842	HLSL2836	HLSL2830	NA	NA	NA	NA	NA	NA
Bookcase	Lateral/Multifile	HLSL2836	NA	NA	NA	NA	NA	NA	NA	NA
Slim Profile Pedestal	Lateral/Multifile	HLSL2836	NA	NA	NA	NA	NA	NA	NA	NA
Pedestal	Lateral/Multifile	HLSL2830	NA	NA	NA	NA	NA	NA	NA	NA
End-Panel	Lateral/Multifile	HLSL2830	NA	NA	NA	NA	NA	NA	NA	NA

**HOW TO SPECIFY****Select Model Number**

HLSL2830.

HLSL1230.

**Select Mixed Material****FT01** Frosted Translucent Acrylic

Specified for Above/Below Privacy Screens only

**G** Frosted Glass

Specified for Above Privacy Screens only

FT01

G

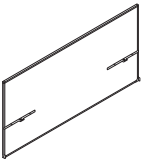
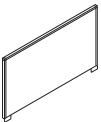

	DESCRIPTION	MODEL	SHIP WEIGHT	CUBE	CORE LIST PRICE BY CODE	
					A	B
	<b>Above/Below Fabric Privacy Screen</b>					
	36"W x 35"H	<b>HL3635TS</b>	21	3.8	<b>\$798</b>	<b>\$823</b>
	42"W x 35"H	<b>HL4235TS</b>	27	4.4	<b>\$839</b>	<b>\$864</b>
	48"W x 35"H	<b>HL4835TS</b>	33	6.0	<b>\$895</b>	<b>\$930</b>
	54"W x 35"H	<b>HL5435TS</b>	39	6.0	<b>\$934</b>	<b>\$969</b>
	60"W x 35"H	<b>HL6035TS</b>	45	6.0	<b>\$993</b>	<b>\$1036</b>
	66"W x 35"H	<b>HL6635TS</b>	51	7.4	<b>\$1046</b>	<b>\$1089</b>
72"W x 35"H	<b>HL7235TS</b>	57	7.4	<b>\$1092</b>	<b>\$1135</b>	
NOTES: Brackets are Platinum only, no need to specify. Above/Below privacy screens must be ordered the same width as the worksurface it is being used with to properly attach.						
	<b>Above Fabric (Side) Privacy Screen</b>					
	20"W x 20"H	<b>HL2020TS</b>	13 Ⓞ	1.4	<b>\$308</b>	<b>\$315</b>
	24"W x 20"H	<b>HL2024TS</b>	15 Ⓞ	1.4	<b>\$317</b>	<b>\$325</b>
	30"W x 20"H	<b>HL2030TS</b>	17 Ⓞ	1.9	<b>\$333</b>	<b>\$344</b>
	36"W x 20"H	<b>HL2036TS</b>	19 Ⓞ	2.2	<b>\$368</b>	<b>\$381</b>
	20"W x 13"H	<b>HL1220TS</b>	11 Ⓞ	1.1	<b>\$289</b>	<b>\$295</b>
	24"W x 13"H	<b>HL1224TS</b>	13 Ⓞ	1.1	<b>\$294</b>	<b>\$300</b>
	30"W x 13"H	<b>HL1230TS</b>	15 Ⓞ	1.6	<b>\$308</b>	<b>\$315</b>
	36"W x 13"H	<b>HL1236TS</b>	17 Ⓞ	1.9	<b>\$327</b>	<b>\$335</b>
	NOTES: Brackets are Platinum only, no need to specify. Brackets intended to be attached between users sitting side-by-side, and will create 1/8" separation between worksurfaces.					

**NOTES:**

- Above privacy screens are intended to be attached between users sitting side-by-side but will create 1/8" spacing between the worksurfaces. Please consider stack up if using in a panel-wrapped application.
- Ships complete with attachment brackets.
- All brackets are Platinum.
- Above Privacy Screen attaches to top and side of worksurface with adhesive banding.
- Lower attachment brackets may be shifted to attach to support components.
- Above/Below privacy screen extends 20" above and 13" below worksurface.
- ❗ Screens cannot be used with T-mold on series such as tables. Screens can only attach to edgeband. Surfaces must be cleaned prior to adhering the screen and must be left to cure for 24 hours without touching for best adhesion.
- ❗ Above/Below Fabric Privacy Screens can attach to worksurfaces that are either O-leg supported on both sides, or worksurfaces that are supported by a support pedestal on one side and an O-leg on the other. They cannot be attached to worksurfaces supported by support pedestals on both sides, unless additional hardware is specified.
- ❗ Above screens must attach to edgeband and top of surface.
- ❗ Above/Below privacy screens must be ordered the same width as the worksurface it is being used with to properly attach.
- ❗ Shared O-legs should not be used with Above/Below Fabric privacy screens.

**HOW TO SPECIFY**

<b>Select Model Number</b>	<b>Select Fabric</b>
See pages 35-36	See pages 35-36
HL3635TS	PN15

# VOI® Privacy Screens

GSA SIN 711-2

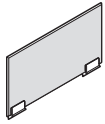

Icon Legend on page 21

**DESCRIPTION****Above Frosted Polymer (Side) Privacy Screen**

20"W x 13"H

24"W x 13"H

30"W x 13"H

36"W x 13"H

**MODEL****HLSL1220FS****HLSL1224FS****HLSL1230FS****HLSL1236FS****SHIP WEIGHT**12 **Ⓞ**14 **Ⓞ**16 **Ⓞ**19 **Ⓞ****CUBE**

1.3

1.4

1.6

1.9

**LIST PRICE****\$278****\$296****\$320****\$358**

NOTES: Brackets are Platinum only, no need to specify. Brackets intended to be attached between users sitting side-by-side, and will create 1/8" separation between workspaces.

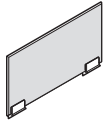
**Above Frosted Glass (Side) Privacy Screen**

20"W x 13"H

24"W x 13"H

30"W x 13"H

36"W x 13"H

**HLSL1220GS****HLSL1224GS****HLSL1230GS****HLSL1236GS**13 **Ⓞ**16 **Ⓞ**18 **Ⓞ**20 **Ⓞ**

1.3

1.4

1.6

1.9

**\$232****\$247****\$267****\$298**

NOTES: Brackets are Platinum only, no need to specify. Brackets intended to be attached between users sitting side-by-side, and will create 1/8" separation between workspaces.

**NOTES:**

- Above privacy screens are intended to be attached between users sitting side-by-side but will create 1/8" spacing between the workspaces. Please consider stack up if using in a panel-wrapped application.
  - Ships complete with attachment brackets.
  - All brackets are Platinum.
  - Above Privacy Screen attaches to top and side of worksurface with adhesive banding.
  - Lower attachment brackets may be shifted to attach to support components.
  - Above/Below privacy screen extends 20" above and 13" below worksurface.
- ⓘ Screens cannot be used with T-mold on series such as tables. Screens can only attach to edgeband. Surfaces must be cleaned prior to adhering the screen and must be left to cure for 24 hours without touching for best adhesion.

**HOW TO SPECIFY****Select  
Model Number**

HLSL1220FS

HLSL1220GS

**Select  
Mixed Material****FT01** Frosted Translucent Acrylic

Specified for Above Screen models HLSL1220FS-HLSL1236FS only

**G** Frosted Glass

Specified for Above Screen models HLSL1220GS-HLSL1236GS only

FT01

G

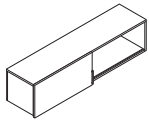

**DESCRIPTION**

**Overhead Cabinet with One Sliding Door**

36"W x 14¼"D x 14"H  
 42"W x 14¼"D x 14"H  
 48"W x 14¼"D x 14"H  
 60"W x 14¼"D x 14"H  
 66"W x 14¼"D x 14"H  
 72"W x 14¼"D x 14"H  
 78"W x 14¼"D x 14"H

MODEL	SHIP WEIGHT	CUBE	L1 LIST	L2 UPCHARGES	
				CABINET	DOOR
<b>HLSL1436S</b>	39	9.7	<b>\$919</b>	<b>\$25</b>	<b>\$20</b>
<b>HLSL1442S</b>	48	9.7	<b>\$964</b>	<b>\$25</b>	<b>\$20</b>
<b>HLSL1448S</b>	57	12.1	<b>\$993</b>	<b>\$25</b>	<b>\$20</b>
<b>HLSL1460S</b>	69	13.3	<b>\$1069</b>	<b>\$30</b>	<b>\$25</b>
<b>HLSL1466S</b>	83	14.6	<b>\$1180</b>	<b>\$30</b>	<b>\$25</b>
<b>HLSL1472S</b>	95	15.9	<b>\$1289</b>	<b>\$35</b>	<b>\$25</b>
<b>HLSL1478S</b>	105	18.5	<b>\$1402</b>	<b>\$35</b>	<b>\$25</b>

**NOTES:**

- Sliding door overhead does not ship with a pull — door overhangs chassis to slide.

**HOW TO SPECIFY**

<p><b>Select Model Number</b></p> <p>H L S L 1 4 7 8 S</p>	<p><b>Select Cabinet Laminate</b></p> <p>See page 242</p> <p>N</p>	<p><b>Select Door Laminate</b></p> <p>See page 242</p> <p>N</p>	<p><b>Specify Bracket Option</b></p> <p>X No Bracket                  W Wall Bracket (\$150 upcharge)</p> <p>W</p>
--	--	---	--

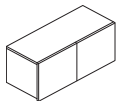

**DESCRIPTION**

**Overhead Cabinet with Doors**

36"W x 14¼"D x 14"H, 2 doors  
 42"W x 14¼"D x 14"H, 2 doors  
 48"W x 14¼"D x 14"H, 3 doors  
 60"W x 14¼"D x 14"H, 4 doors

MODEL	SHIP WEIGHT	CUBE	L1 LIST	L2 UPCHARGES	
				CABINET	DOOR
<b>HLSL1436D</b>	39	9.7	<b>\$775</b>	<b>\$25</b>	<b>\$20</b>
<b>HLSL1442D</b>	48	9.7	<b>\$862</b>	<b>\$25</b>	<b>\$20</b>
<b>HLSL1448D</b>	57	12.1	<b>\$957</b>	<b>\$25</b>	<b>\$30</b>
<b>HLSL1460D</b>	115	13.3	<b>\$1069</b>	<b>\$30</b>	<b>N/A</b>

❗ 2-Door and 3-Door Overhead Cabinet with Doors models HLSL1436D–HLSL1448D available in laminate only. The 60" model HLSL1460D is available in all door finish options—see "Select Door Material for 2/3/4 Door Models" below.

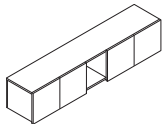

**Overhead Cabinet with 4 Doors/Cubbies**

66"W x 14¼"D x 14"H with 6" Cubbie  
 72"W x 14¼"D x 14"H with 12" Cubbie  
 78"W x 14¼"D x 14"H with 18" Cubbie

<b>HLSL1466D</b>	126	14.6	<b>\$1180</b>	<b>\$30</b>	<b>N/A</b>
<b>HLSL1472D</b>	139	15.9	<b>\$1289</b>	<b>\$35</b>	<b>N/A</b>
<b>HLSL1478D</b>	153	18.5	<b>\$1402</b>	<b>\$35</b>	<b>N/A</b>

NOTES: Doors available in laminate or mixed materials.

**NOTES:**

- All Overhead Cabinets shown above can be used as a wall mount, panel mount or stack-on storage with O-leg.
- Tackboards are available for wall mount storage applications and conventional stack-on. Use wall mount tackboards when using O-leg supports.
- 5½"H and 20½"H O-legs can be purchased to create stack-on storage. Heights line up with Abound® and Accelerate® panels.
- Overhead cabinets with four doors are available in laminate or mixed materials.
- Wall mount brackets specified with unit. Brackets attach to case horizontally.
- For all color specifying combinations, see matrix on page 242.
- Storage cases accept binder height items.
- Storage cube fits inside stack-on storage or overhead cabinet units to provide paper management.
- For panel mounted applications, brackets and hardware are ordered separately, see pages 529-530. Brackets attach to panel and case is screwed into brackets. Two brackets needed for 60" unit; three brackets needed for 66" and larger.

❗ Stack-on Storage must be placed over two full-height supports. Cannot be placed over non-supported sections such as returns using a flat bracket or tower-to-worksurface bracket.

❗ Overhead units do not lock.

**HOW TO SPECIFY**

<p><b>Select Model Number</b></p> <p>H L S L 1 4 6 0 D</p>	<p><b>Select Cabinet Laminate</b></p> <p>See page 242</p> <p>N</p>	<p><b>Select Door Material for 2/3/4 Door Models</b></p> <p>Upcharges for door selection: 4-Door</p> <p><b>TIG</b> Platinum Polymer with Frosted glass \$315  <b>TIFT01</b> Platinum with Frosted Translucent Acrylic \$360</p> <p>Also available in laminate doors. See page 242.                  Not specified for models HLSL1436D–HLSL1448D. These models are available in laminate only.</p> <p>T I G</p>	<p><b>Select Bracket Option</b></p> <p>X No Bracket                  W Wall Bracket (\$150 upcharge)</p> <p>X</p>
--	--	---	---

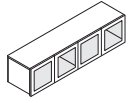
**DESCRIPTION**

**Overhead Cabinet with 4 Frosted, Metal Frame Doors**  
60"W x 14¼"D x 14"H

**MODEL****HLSL1460M****SHIP WEIGHT**

115

**CUBE**

11.4

**LIST PRICE BY LAMINATE GRADE****L1****\$1744****L2****\$1774**

! Must specify an X or W for attachment bracket option below.

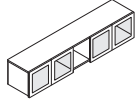
**Overhead Cabinet with 4 Frosted, Metal Frame Doors**

78"W x 14¼"D x 14"H with 18" Cubbie  
72"W x 14¼"D x 14"H with 12" Cubbie  
66"W x 14¼"D x 14"H with 6" Cubbie

**HLSL1478M**

153

14.7

**HLSL1472M**

139

13.6

**HLSL1466M**

126

12.5

**\$2076****\$2111****\$1965****\$2000****\$1854****\$1884**

! Must specify an X or W for attachment bracket option below.

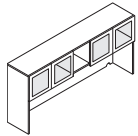
**Stack-on Storage, Built-up with 4 Frosted Doors with Metal Frame with Cubbies**

72"W x 14¼"D x 35"H with 12" Cubbie

**HLSL1472MB**

165

30.4

**\$2070****\$2115**

NOTES: Ships complete with Back Enclosure and laminate End Panels. Ships factory assembled.

! Does not require bracket specification.

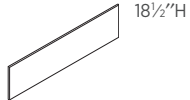
**DESCRIPTION****MODEL****SHIP WEIGHT****CUBE****A****B**

18½"H

**Tackboard for Wall Mount Overhead Cabinets**

For 78"W

**HLSL78TW**

13

1.4

**\$354****\$366**

For 72"W

**HLSL72TW**

12

1.4

**\$337****\$349**

For 66"W

**HLSL66TW**

11

1.4

**\$322****\$334**

For 60"W

**HLSL60TW**

10

1.1

**\$286****\$298**

For 48"W

**HLSL48TW**

13

1.4

**\$249****\$259**

For 42"W

**HLSL42TW**

12

1.4

**\$232****\$242**

For 36"W

**HLSL36TW**

11

1.4

**\$218****\$228****SPECIFYING EXAMPLE: HLSL48TW.DB30****NOTES:**

- Overhead and Stack-on storage units do not lock.
- Use O-Leg Support models for Overhead Cabinets. See page 276.
- Storage cube fits inside stack-on storage or wall mount units to provide paper management. See page 276.
- Storage cubes are available in the following colors: Autumn (AUTM), Citron (CITR), Flame (FLAM), Pool (POOL) and Sisal (SISL).

! Stack-on Storage must be placed over two full-height supports. Cannot be placed over non-supported sections such as returns using a flat bracket or tower-to-worksurface bracket.

**HOW TO SPECIFY**

Select Model Number	Select Cabinet Laminate	Select Door Material	Select Bracket Option
HL SL 14 60 M	See page 242	<b>TIG</b> Platinum Metal Doors with Frosted Glass (no upcharge) <b>TIFT01</b> Platinum Metal Doors with Frosted Translucent Acrylic (\$43 upcharge)	<b>X</b> No Bracket <b>W</b> Wall Bracket (\$150 upcharge) Not specified for models HL SL1460MB, HL SL1478MB, HL SL1472MB, HL SL1466MB
N		TIG	X

# Laminate Shared Overhead Storage Components

	DESCRIPTION	MODEL	SHIP WEIGHT	CUBE	L1 LIST	L2 UPCHARGES	
						CABINET	DOOR
	<b>Shared Overhead Storage — Left</b>						
	60"W x 17"D x 14"H 72"W x 17"D x 14"H	<b>HLSSL1760SOL</b> <b>HLSSL1772SOL</b>	115 139	14.8 17.0	<b>\$1176</b> <b>\$1417</b>	<b>\$20</b> <b>\$25</b>	<b>\$40</b> <b>\$40</b>
	<b>Shared Overhead Storage — Right</b>						
	60"W x 17"D x 14"H 72"W x 17"D x 14"H	<b>HLSSL1760SOR</b> <b>HLSSL1772SOR</b>	115 139	14.8 17.0	<b>\$1176</b> <b>\$1417</b>	<b>\$20</b> <b>\$25</b>	<b>\$40</b> <b>\$40</b>
	DESCRIPTION	MODEL	SHIP WEIGHT	CUBE	LIST PRICE BY PAINT GRADE		
	<b>Post Legs for Shared Storage</b>				CORE	METALLICS	
	14"H Post Legs 22"H Post Legs	<b>HLSSL140SPL</b> <b>HLSSL220SPL</b>	10 <b>Ⓔ</b> 13 <b>Ⓔ</b>	1.1 3.7	<b>\$311</b> <b>\$345</b>	<b>\$315</b> <b>\$349</b>	
NOTES: 14"H post legs on worksurfaces will span 35"H panel or shorter. 14"H post legs on low credenzas will span 30"H panel or shorter. 22"H post legs on worksurfaces will span 50"H panel or shorter. 22"H post legs on low credenzas will span 35"H panel or shorter. Specify paint. <b>SPECIFYING EXAMPLE: HLSSL140SPL.T4</b>							
	<b>Panel Mount Bracket for Shared Overhead</b>						
	Panel Mount Bracket for Overhead Storage — Accelerate®	<b>HLSLPMBSOA</b>	4 <b>Ⓔ</b>	0.1	<b>\$124</b>	<b>\$128</b>	
	Panel Mount Bracket for Overhead Storage — Abound®	<b>HLSLPMBSOB</b>	4 <b>Ⓔ</b>	0.1	<b>\$124</b>	<b>\$128</b>	
	Panel Mount Bracket for Overhead Storage — Accelerate®/Abound® 42½"H panels only	<b>HLSLPMBSO42</b>	4 <b>Ⓔ</b>	0.1	<b>\$116</b>	<b>\$120</b>	
NOTES: Specify paint. <b>SPECIFYING EXAMPLE: HLSLPMBSOA.T4</b>							
	<b>Markerboard for Shared Storage</b>						
	30"W x 13"H for use with 60"W Shared Overhead 36"W x 13"H for use with 72"W Shared Overhead	<b>HLSSL1530SOMB</b> <b>HLSSL1536SOMB</b>	6 <b>Ⓔ</b> 8 <b>Ⓔ</b>	1.0 1.0	<b>\$121</b> <b>\$163</b>		
NOTES: No specification necessary.							

**NOTES:**

- Overall case depth is 19"D including the sliding door.
- Use Shared Overhead and attachments in small footprint applications.
- Sliding door is 15"H, providing a 1" valance below the case which can be used as a finger pull if desired.
- Shared Overhead panel mount brackets and overhead post legs allow overhead to span over all panels systems or run down the spine wall, centered on top of the panel.
- Post legs can attach to all low credenza models and all worksurface models.
- Markerboard insert is markerboard laminate with black edges, no frame.

ⓘ Shared Overhead must be ordered as left or right to determine open storage location.

ⓘ Overhead units do not lock.

## HOW TO SPECIFY

<p><b>Select Model Number</b></p> <p>HLSSL1760SOL .</p>	<p><b>Select Chassis Laminate</b></p> <p>See page 242</p> <p>N .</p>	<p><b>Select Door Front Laminate</b></p> <p>See page 242</p> <p>N</p>
<p><b>Select Model Number</b></p> <p>HLSSL140SPL .</p> <p>HLSLPMBSOA .</p>	<p><b>Select Paint Color</b></p> <p>See page 242</p> <p>T4</p> <p>T4</p>	

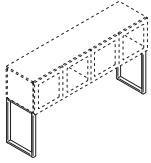

SIN 711-3

**DESCRIPTION****O-Leg Support for Overhead Cabinet**

Ships 2/pack  
14 $\frac{1}{8}$ "D x 20 $\frac{1}{2}$ "H  
14 $\frac{1}{8}$ "D x 5 $\frac{1}{2}$ "H

**MODEL**

**HLSL650S**  
**HLSL500S**

**SHIP WEIGHT**

8  
6

**CUBE**

1.1  
1.0

**LIST PRICE BY PAINT GRADE****CORE**

**\$430**  
**\$358**

**METALLICS**

**\$434**  
**\$362**

NOTES: 20 $\frac{1}{2}$ "H legs used to reach 65"H when overhead storage is stacked on top of a worksurface. 5 $\frac{1}{2}$ "H legs used to reach 50"H when overhead storage is stacked on top of a worksurface. O-leg ships fully assembled with mounting hardware. O-legs can be used with all overhead cabinet models. See pages 273 and 274.

- ⚠ Not for use on Shared Overhead Storage, use post leg models on page 275.
- ⚠ Stack-on Storage must be placed over two full-height supports. Cannot be placed over non-supported sections such as returns using a flat bracket or tower-to-worksurface bracket.

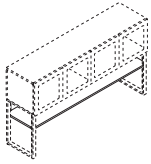
**Steel Shelf for Stack-on Storage**

78"W  
72"W  
66"W  
60"W

**HLSL78S**  
**HLSL72S**  
**HLSL66S**  
**HLSL60S**

35  
29  
24  
20

5.9  
3.4  
3.4  
2.9

**\$292**  
**\$273**  
**\$253**  
**\$242**

**\$296**  
**\$277**  
**\$257**  
**\$246**

NOTES: Works with O-leg only. Shelves can only be used with 65"H O-leg application.

- ⚠ Installation required for steel shelf onto Stack-on Storage.
- ⚠ Stack-on Storage must be placed over two full-height supports. Cannot be placed over non-supported sections such as returns using a flat bracket or tower-to-worksurface bracket.

**SPECIFY PAINT: HLSL78S.T5**

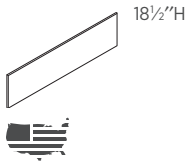
18 $\frac{1}{2}$ "H**DESCRIPTION****Tackboard for Overhead Cabinet Applications**

For 78"W  
For 72"W  
For 66"W  
For 60"W  
For 48"W  
For 42"W  
For 36"W

**MODEL**

**HLSL78TW**  
**HLSL72TW**  
**HLSL66TW**  
**HLSL60TW**  
**HLSL48TW**  
**HLSL42TW**  
**HLSL36TW**

**SHIP WEIGHT**

13  
12  
11  
10  
13  
12  
11

**CUBE**

1.4  
1.4  
1.4  
1.1  
1.4  
1.4  
1.4

**A**

**\$354**  
**\$337**  
**\$322**  
**\$286**  
**\$249**  
**\$232**  
**\$218**

**B**

**\$366**  
**\$349**  
**\$334**  
**\$298**  
**\$259**  
**\$242**  
**\$228**

NOTES: Specify fabric, see pages 35-36. Upcharges may apply to premium fabric grades.

**SPECIFYING EXAMPLE: HLSL78TW.DB30**

**DESCRIPTION****Storage Cube**

12"W x 12"D

**MODEL**

**HLSL1212**

**SHIP WEIGHT**

1

**CUBE**

0.3

**LIST PRICE**

**\$276**

NOTES: Storage Cubes are available in the following colors: Autumn (AUTM), Citron (CITR), Flame (FLAM), Pool (POOL) and Sisal (SISL). For additional information see page 914.

**SPECIFYING EXAMPLE: HLSL1212.CITR**

**HOW TO SPECIFY**

Select  
Model Number

Select  
Paint Color

See page 242

HLSL650S.T1

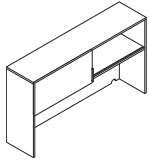

DESCRIPTION	MODEL	SHIP WEIGHT	CUBE	L1 LIST	L2 UPCHARGES	
					CABINET	DOOR
<b>Stack-on Storage, Built-up, with Sliding Doors</b> 72"W x 14¼"D x 35"H NOTES: Ships complete with Back Enclosure and laminate End Panels. Ships factory assembled.	<b>HLSL1472SB</b>	139	30.4	<b>\$1402</b>	<b>\$45</b>	<b>\$20</b>

## HOW TO SPECIFY

### Select Model Number

H L S L 1 4 7 2 S B .

### Select Cabinet Laminate

See page 242  
L2 (\$45 upcharge)

N .

### Select Door Laminate

See page 242  
L2 (\$20 upcharge)

N

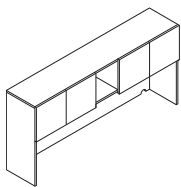

DESCRIPTION	MODEL	SHIP WEIGHT	CUBE	L1 LIST	L2 UPCHARGES	
					CABINET	DOOR
<b>Stack-on Storage, Built-up, with 4 Doors/Cubbies</b> 72"W x 14¼"D x 35"H with 12" Cubbie NOTES: Ships complete with Back Enclosure and laminate End Panels. Ships factory assembled.	<b>HLSL1472DB</b>	144	30.4	<b>\$1402</b>	<b>\$45</b>	<b>N/A</b>

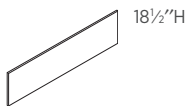

DESCRIPTION	MODEL	SHIP WEIGHT	CUBE	A	B
				<b>Tackboard for Built-up Stack-on Storage</b> For 72" NOTES: For a complete listing of fabrics available for Tackboards, see pages 35-36. <b>SPECIFYING EXAMPLE: HLSL78TE.DB30</b>	<b>HLSL7265TE</b>

### NOTES:

- Storage cube fits inside stack-on storage or wall mount units to provide paper management.
- Overhead and Stack-on storage units do not lock.
- Storage Cubes are available in the following colors: Autumn (AUTM), Citron (CITR), Flame (FLAM), Pool (POOL) and Sisal (SISL).
- ❶ Tackboards are available for Built-up models only. Tackboards cannot be added to O-leg supported units.
- ❷ Stack-on Storage must be placed over two full-height supports. Cannot be placed over non-supported sections such as returns using a flat bracket or tower-to-worksurface bracket.

## HOW TO SPECIFY

### Select Model Number

H L S L 1 4 7 2 D B .

### Select Cabinet Chassis Laminate

See page 242  
L2 (\$45 upcharge)

N .

### Select Door Material for 4-Door Models

Upcharges for door selection: 4-Door

<b>T1G</b> Platinum Polymer with Frosted glass	\$315
<b>T1FT01</b> Platinum with Frosted Translucent Acrylic Laminate Grade L2	\$360
	\$40

Also available in laminate doors. See page 242.

T 1 G



# VOI® Laminate Low Credenzas

GSA SIN 711-3



Icon Legend on page 21

	DESCRIPTION	MODEL	SHIP WEIGHT	CUBE	L1 LIST	L2 UPCHARGES	
						CHASSIS	FRONTS
	<b>Low Credenza, 2 File/2 Box</b> 72"W x 20"D x 21½"H 60"W x 20"D x 21½"H	<b>HLSL2072LD4</b>	230	21.9	<b>\$1507</b>	<b>\$40</b>	<b>\$40</b>
	NOTES: Unit is locking.	<b>HLSL2060LD4</b>	190	18.9	<b>\$1373</b>	<b>\$35</b>	<b>\$40</b>
	<b>Low Credenza, 2 File Drawers, Open Top</b> 72"W x 20"D x 21½"H 60"W x 20"D x 21½"H	<b>HLSL2072LD2</b>	200	21.9	<b>\$1356</b>	<b>\$40</b>	<b>\$30</b>
	NOTES: Unit is non-locking.	<b>HLSL2060LD2</b>	160	18.9	<b>\$1287</b>	<b>\$35</b>	<b>\$30</b>
	<b>Low Credenza, Left Hand Drawers</b> 72"W x 20"D x 21½"H 60"W x 20"D x 21½"H	<b>HLSL2072LL2</b>	200	21.9	<b>\$1396</b>	<b>\$40</b>	<b>\$20</b>
	NOTES: Unit is locking.	<b>HLSL2060LL2</b>	160	18.9	<b>\$1177</b>	<b>\$35</b>	<b>\$20</b>
	<b>Low Credenza, Right Hand Drawers</b> 72"W x 20"D x 21½"H 60"W x 20"D x 21½"H	<b>HLSL2072LR2</b>	200	21.9	<b>\$1396</b>	<b>\$40</b>	<b>\$20</b>
	NOTES: Unit is locking.	<b>HLSL2060LR2</b>	160	18.9	<b>\$1177</b>	<b>\$35</b>	<b>\$20</b>
	<b>Low Credenza, Open</b> 72"W x 20"D x 21½"H 60"W x 20"D x 21½"H	<b>HLSL2072LDO</b>	170	21.9	<b>\$1185</b>	<b>\$40</b>	<b>N/A</b>
	<b>SPECIFYING EXAMPLE: HLSL2072LDO.Z (model.chassis only)</b>	<b>HLSL2060LDO</b>	130	18.9	<b>\$984</b>	<b>\$35</b>	<b>N/A</b>
	<b>Low Credenza, 4 Storage Doors</b> 72"W x 20"D x 21½"H 60"W x 20"D x 21½"H	<b>HLSL2072S4</b>	190	21.9	<b>\$1496</b>	<b>\$40</b>	<b>\$40</b>
	NOTES: Unit is locking.	<b>HLSL2060S4</b>	160	18.9	<b>\$1284</b>	<b>\$35</b>	<b>\$40</b>

**NOTES:**

- Worksurfaces with 7" O-legs, may be placed upon low credenzas to create layering.
- Chassis and drawer fronts woodgrains and solid laminates are specified separately (see SIF options below).
- File drawers accept hanging folders in letter or legal size.
- Multiple handle locations possible per customer preference.
- Seat cushions are available for low credenzas and mobile pedestals (specify separately).
- Storage accessory model HLSLDRWORG works with box doors.
- Layering shelf works with low credenzas to provide additional storage areas.
- File, lateral, and wide box drawers operate on ball-bearing suspension with full extension.
- Adjustable hex leveling glides allow floor-standing furniture to be easily leveled without lifting the unit; glides have 1/4" adjustable range.
- Ships with one handle per drawer on all units.

⚠ Locking units equipped with HON "One Key" interchangeable core removable locks. Keyed alike core must be ordered separately.

**HOW TO SPECIFY**

<b>Select Model Number</b> HLSL2072LD4	<b>Select Chassis Laminate</b> See page 242 N	<b>Select Drawer Front Laminate</b> See page 242 N	<b>Select Pull Color</b> P Black T4 Champagne T1 Platinum WHIT White Not specified for Open Credenza models HLSL2072LDO, HLSL2060LDO T4
---	---	--	---

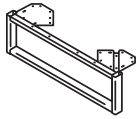

**DESCRIPTION**

**7" O-Leg Support for Worksurfaces**

30"D x 7"H

24"D x 7"H

20"D x 7"H

Specify: Model.Paint HL3070.T1.

NOTES: 7" O-Leg Support to be placed upon Low Credenza models to support worksurfaces. Ship 1/pack.

MODEL	SHIP WEIGHT	CUBE	LIST PRICE BY PAINT GRADE	
			CORE	METALLICS
HL3070	7	1.0	\$249	\$253
HL2470	6	1.0	\$196	\$200
HL2070	5	1.0	\$180	\$184

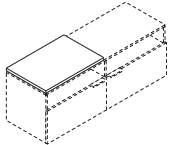

**DESCRIPTION**

**Credenza Cushion**

20"W x 36"D x 1"H for 72" Credenzas

20"W x 30"D x 1"H for 60" Credenzas

NOTES: See pages 24-34 for available fabrics.

**SPECIFYING EXAMPLE: HL2036CH2.AB10**

MODEL	SHIP WEIGHT	CUBE	1	2	3	4	5	6
HL2036CH2	11	2.2	\$369	\$407	\$445	\$484	\$533	\$583
HL2030CH2	9	1.9	\$342	\$378	\$414	\$450	\$496	\$543

**NOTES:**

- Worksurfaces with 7" O-legs, may be placed upon low credenzas to create layering.
- Chassis and drawer fronts woodgrains and solid laminates are specified separately (see SIF options on preceding page).
- Seat cushions are available for low credenzas and mobile pedestals (specify separately).
- Storage accessory model HL3DRWORG works with box doors.
- Layering shelf works with low credenzas to provide additional storage areas.
- File, lateral, and wide box drawers operate on ball-bearing suspension with full extension.
- Adjustable hex leveling glides allow floor-standing furniture to be easily leveled without lifting the unit; glides have 1/4" adjustable range.
- Ships with one handle per drawer on all units.

**HOW TO SPECIFY**

<p>Select Model Number</p> <p>HL3070.T1</p>	<p>Select Paint Color</p> <p>See page 242</p>
---	---

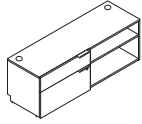
**DESCRIPTION****Power-Ready Low Credenza — Left Hand Drawers, Open Right**

72"W x 20"D x 21½"H

60"W x 20"D x 21½"H

NOTES: Unit is locking.

**MODEL****HLSL2072LL2PWR****HLSL2060LL2PWR****SHIP WEIGHT**

200

160

**CUBE**

21.9

18.9

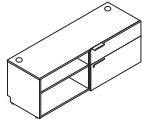
**L1 LIST****\$1573****\$1352****L2 UPCHARGES****\$40****\$35****\$20****\$20****Power-Ready Low Credenza — Right Hand Drawers, Open Left**

72"W x 20"D x 21½"H

60"W x 20"D x 21½"H

NOTES: Unit is locking.

**HLSL2072LR2PWR****HLSL2060LR2PWR**

200

160

21.9

18.9

**\$1573****\$1352****\$40****\$35****\$20****\$20****NOTES:**

- Worksurfaces with 7" O-legs, may be placed upon low credenzas to create layering.
  - Chassis and drawer front woodgrains and solid laminates are specified separately (see SIF options below).
  - Metal channel behind credenzas allow cords to run through the case in a continuous run. Also allows cords to run vertically to the worksurface or terminate as a power source in the credenza top. Grommets included for a finished look.
  - File drawers accept hanging folders in letter or legal size.
  - Multiple handle locations possible per customer preference.
  - Ships with one handle per drawer.
  - File, lateral, and wide box drawers operate on ball-bearing suspension with full extension.
  - Drawer Organizer model HLSDRWORG works with box drawers.
  - Adjustable hex leveling glides allow floor-standing furniture to be easily leveled without lifting the unit; glides have 1/4" adjustable range.
- ! Locking units equipped with HON "One Key" interchangeable core removable locks. Keyed alike core must be ordered separately.

**HOW TO SPECIFY**

Select Model Number	Select Chassis Laminate	Select Drawer Front Laminate	Select Pull Color	Select Grommet Color
	See page 242	See page 242	<b>P</b> Black <b>T4</b> Champagne <b>T1</b> Platinum <b>WHIT</b> White	<b>P</b> Black <b>WHIT</b> Brilliant White <b>T5</b> Greige <b>T1</b> Platinum
HLSL2072LL2PWR	N	N	T4	T5

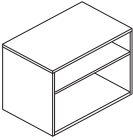
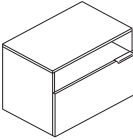

Icon Legend on page 21

	DESCRIPTION	MODEL	SHIP WEIGHT	CUBE	L1 LIST	L2 UPCHARGES	
						CHASSIS	FRONTS
	<b>Low Credenza — Open</b>						
	30"W x 20"D x 21½"H 36"W x 20"D x 21½"H	<b>HLSL2030LDO</b> <b>HLSL2036LDO</b>	65 85	9.8 12.0	<b>\$814</b> <b>\$839</b>	<b>\$25</b> <b>\$30</b>	<b>N/A</b> <b>N/A</b>
	<b>Low Credenza — Open Top, File Drawer</b>						
	30"W x 20"D x 21½"H 36"W x 20"D x 21½"H	<b>HLSL2030LD1</b> <b>HLSL2036LD1</b>	75 95	9.8 12.0	<b>\$904</b> <b>\$932</b>	<b>\$25</b> <b>\$30</b>	<b>\$15</b> <b>\$15</b>
	<b>Low Credenza — 1 File Drawer, 1 Box Drawer</b>						
	30"W x 20"D x 21½"H 36"W x 20"D x 21½"H NOTES: Unit is locking.	<b>HLSL2030LD2</b> <b>HLSL2036LD2</b>	80 100	9.8 12.0	<b>\$1005</b> <b>\$1035</b>	<b>\$25</b> <b>\$30</b>	<b>\$20</b> <b>\$20</b>

**NOTES:**

- Worksurfaces with 7" O-legs, may be placed upon low credenzas to create layering.
- File drawers accept hanging folders in letter or legal size.
- Multiple handle locations possible per customer preference.
- Post legs on Shared Overhead are compatible to attach to low credenzas.
- Storage accessory model HLSLDRWORG works with box doors.
- File, lateral, and wide box drawers operate on ball-bearing suspension with full extension.
- Utilize in small footprint applications.
- Adjustable hex leveling glides allow floor-standing furniture to be easily leveled without lifting the unit; glides have 1/4" adjustable range.
- Ships with one handle per drawer on all units.

ⓘ Locking units equipped with HON "One Key" interchangeable core removable locks. Keyed alike core must be ordered separately.

**HOW TO SPECIFY**

<p><b>Select Model Number</b></p> <p>HLSL2030LDO .</p>	<p><b>Select Chassis Laminate</b></p> <p>See page 242</p> <p>N .</p>	<p><b>Select Drawer Front Laminate</b></p> <p>See page 242</p> <p>Not specified for Open Credenza models HLSL2030LDO, HLSL2036LDO</p> <p>N .</p>	<p><b>Select Pull Color</b></p> <p><b>P</b> Black <b>T4</b> Champagne <b>T1</b> Platinum <b>WHIT</b> White</p> <p>Not specified for Open Credenza models HLSL2030LDO, HLSL2036LDO</p> <p>T4</p>
--	--	--	---

# VOI® Laminate Mobile Storage

GSA SIN AS NOTED



Icon Legend on page 21

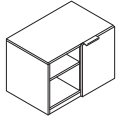

SIN 711-3

DESCRIPTION	MODEL	SHIP WEIGHT	CUBE	L1 LIST	L2 UPCHARGES	
					CHASSIS	FRONTS
<b>Mobile Credenza</b> 30"W x 20"D x 21½"H NOTES: Unit is non-locking.	HLSL2030MCO	80	9.8	\$1288	\$25	\$10

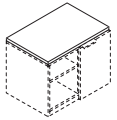

SIN 711-3

DESCRIPTION	MODEL	SHIP WEIGHT	CUBE	L2 UPCHARGES					
				1	2	3	4	5	6
<b>Credenza Cushion</b> 20"W x 30"D x 1"H for 60" Credenzas NOTES: See pages 24-34 for available fabrics. <b>SPECIFYING EXAMPLE: HLSL2030CH2.AB10</b>	HLSL2030CH2	9	1.9	\$342	\$378	\$414	\$450	\$496	\$543

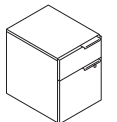

SIN 711-2

DESCRIPTION	MODEL	SHIP WEIGHT	CUBE	L1 LIST	L2 UPCHARGES	
					CHASSIS	FRONTS
<b>Mobile Pedestal</b> 15¾"W x 20⅞"D x 21⅞"H NOTES: Unit is locking.	HLSL2016MP2	65	5.7	\$745	\$20	\$10

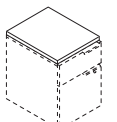

SIN 711-2

DESCRIPTION	MODEL	SHIP WEIGHT	CUBE	L2 UPCHARGES					
				1	2	3	4	5	6
<b>Mobile Pedestal Cushion</b> 15¾"W x 20"D x 1"H for Pedestals NOTES: See pages 24-34 for available fabrics. <b>SPECIFYING EXAMPLE: HLSL2016PH2.AB10</b>	HLSL2016PH2	6	1.1	\$284	\$308	\$332	\$356	\$387	\$418

**NOTES:**

- Chassis and drawer fronts woodgrains and solid laminates are specified separately (see SIF options below).
- File drawers accept hanging folders in letter or legal size.
- Multiple handle locations possible per customer preference.
- Seat cushions are available for low credenzas, floor credenzas, and mobile pedestals (specify separately).
- Storage accessory model HLSDRWORG works with box doors.
- Standard box drawers operate on ball-bearing suspension with full extension. File drawers operate on ball-bearing suspension with full extension.
- Ships with one handle per drawer on all units.

! Locking units equipped with HON "One Key" interchangeable core removable locks. Keyed alike core must be ordered separately.

**HOW TO SPECIFY**

<b>Select Model Number</b> HLSL2030MCO	<b>Select Chassis Laminate</b> See page 242 N	<b>Select Drawer Front Laminate</b> See page 242 N	<b>Select Pull Color</b> P Black T4 Champagne T1 Platinum WHIT White T4
---	---	--	--

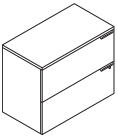
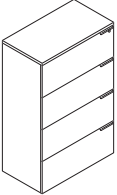
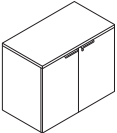
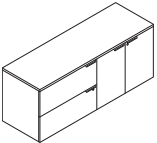
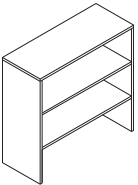

Icon Legend on page 21

	DESCRIPTION	MODEL	SHIP WEIGHT	CUBE	L1 LIST	L2 UPCHARGES	
						CHASSIS	FRONTS
	<b>2-Drawer Lateral Files</b> 36"W x 24"D x 29½"H 36"W x 20"D x 29½"H	<b>HLSL2436L2</b>	305	29.8	<b>\$1182</b>	<b>\$35</b>	<b>\$20</b>
		<b>HLSL2036L2</b>	170	15.7	<b>\$1060</b>	<b>\$30</b>	<b>\$20</b>
	<b>4-Drawer Lateral Files</b> 36"W x 24"D x 57"H 36"W x 20"D x 57"H	<b>HLSL2436L4</b>	366	35.9	<b>\$1682</b>	<b>\$45</b>	<b>\$30</b>
		<b>HLSL2036L4</b>	204	18.3	<b>\$1579</b>	<b>\$40</b>	<b>\$30</b>
	<b>Storage Cabinet</b> 36"W x 24"D x 29½"H 36"W x 20"D x 29½"H	<b>HLSL2436SC</b>	150	18.3	<b>\$895</b>	<b>\$35</b>	<b>\$20</b>
		<b>HLSL2036SC</b>	147	15.7	<b>\$841</b>	<b>\$30</b>	<b>\$20</b>
	<b>Lateral/Storage Cabinet Credenza</b> 72"W x 24"D x 29½"H	<b>HLSL2472LC</b>	300	35.6	<b>\$2433</b>	<b>\$45</b>	<b>\$30</b>
	<b>Bookcase Hutch (no doors)</b> 36"W x 14"D x 35"H NOTES: Bookcase Hutch model works with Storage Cabinet and Lateral File models shown above. ! Specify: Chassis laminate only.	<b>HLSL1436BH</b>	125	3.7	<b>\$646</b>	<b>\$20</b>	<b>N/A</b>

**NOTES:**

- Ships with one handle per drawer on all units.
- All models shown below are locking.
- Chassis and drawer fronts woodgrains and solid laminates are specified separately (see SIF options below).
- File drawers accept hanging folders in letter or legal size.
- Multiple handle locations possible per customer preference.
- Adjustable hex leveling glides allow floor-standing furniture to be easily leveled without lifting the unit; glides have 1/4" adjustable range.

! Locking units equipped with HON "One Key" interchangeable core removable locks. Keyed alike core must be ordered separately.

**HOW TO SPECIFY**

<b>Select Model Number</b>  HLSL2036L2 . N .	<b>Select Chassis Laminate</b> See page 242  N .	<b>Select Drawer Front Laminate</b> See page 242 Not specified for model HLSL1436BH  N .	<b>Select Pull Color</b>  P Black T4 Champagne T1 Platinum WHIT White Not specified for Bookcase Hutch model HLSL1436BH  T4
--	---	--	---

# VOI® Laminate Storage Towers

GSA SIN 711-2 EXCEPT AS NOTED



Icon Legend on page 21

	DESCRIPTION	MODEL	SHIP WEIGHT	CUBE	L1 LIST	L2 UPCHARGES	
						CHASSIS	FRONTS
	<b>24"W x 20"D Storage Tower — Right Hand Drawers, Left Hand Door</b>						
	24"W x 20"D x 50"H, Left	<b>HLSLW045L</b>	167	17.4	<b>\$1768</b>	<b>\$50</b>	<b>\$35</b>
	24"W x 20"D x 65"H, Left	<b>HLSLW046L</b>	200	22.5	<b>\$2016</b>	<b>\$55</b>	<b>\$35</b>
	<b>24"W x 20"D Storage Tower — Left Hand Drawers, Right Hand Door</b>						
	24"W x 20"D x 50"H, Right	<b>HLSLW045R</b>	167	17.4	<b>\$1768</b>	<b>\$50</b>	<b>\$35</b>
	24"W x 20"D x 65"H, Right	<b>HLSLW046R</b>	200	22.5	<b>\$2016</b>	<b>\$55</b>	<b>\$35</b>
	<b>24"W x 24"D Storage Tower — Right Hand Drawers, Left Hand Door</b>						
	24"W x 24"D x 50"H, Left	<b>HLSLW445L</b>	200	20.7	<b>\$1915</b>	<b>\$55</b>	<b>\$35</b>
	24"W x 24"D x 65"H, Left	<b>HLSLW446L</b>	240	27.8	<b>\$2123</b>	<b>\$60</b>	<b>\$35</b>
	<b>24"W x 24"D Storage Tower — Left Hand Drawers, Right Hand Door</b>						
	24"W x 24"D x 50"H, Right	<b>HLSLW445R</b>	200	20.7	<b>\$1915</b>	<b>\$55</b>	<b>\$35</b>
	24"W x 24"D x 65"H, Right	<b>HLSLW446R</b>	240	27.8	<b>\$2123</b>	<b>\$60</b>	<b>\$35</b>
	<b>24"W x 24"D Personal Storage Tower</b>						
	24"W x 24"D x 65"H, Right	<b>HLSLW446LP</b>	250	27.8	<b>\$2404</b>	<b>\$60</b>	<b>\$35</b>
	24"W x 24"D x 65"H, Right	<b>HLSLW446RP</b>	250	27.8	<b>\$2404</b>	<b>\$60</b>	<b>\$35</b>

	DESCRIPTION	MODEL	SHIP WEIGHT	CUBE	LIST PRICE BY PAINT GRADE CHOICE/		
					CORE	METALLICS	CUSTOM
 SIN 711-3	<b>Worksurface to Tower Bracket Kit</b>						
	Bracket to attach storage towers or pedestal to worksurfaces.	<b>HSTB2W1</b>	4	0.6	<b>\$70</b>	<b>\$83</b>	<b>\$94</b>
	NOTES: Can be used in place of end panel or O-leg to support worksurfaces.						
	⚠ Bracket cannot be used as a support when placing Stack-on Storage on worksurface over bracket. Must use two full-sized supports when using Stack-on Storage.						

**NOTES:**

- Use the worksurface to tower bracket kit to attach worksurfaces to Storage Towers models shown above.
- Chassis and drawer fronts woodgrains and solid laminates are specified separately (see SIF options below).
- File drawers accept hanging folders in letter or legal size.
- Wardrobe, middle box drawer and file drawer are locking.
- Standard box drawers operate on ball-bearing suspension with full extension. File, lateral, and wide box drawers operate on ball-bearing suspension with full extension.
- Ships with one handle per drawer on all units.
- Adjustable hex leveling glides allow floor-standing furniture to be easily leveled without lifting the unit; glides have 1/4" adjustable range.
- Wardrobe/storage cabinet includes coat rod.
- Wardrobes contain easy access side storage shelves.

⚠ Locking units equipped with HON "One Key" interchangeable core removable locks. Keyed alike core must be ordered separately.

**HOW TO SPECIFY**

<b>Select Model Number</b>	<b>Select Chassis Laminate</b>	<b>Select Drawer Front Laminate</b>	<b>Select Pull Color</b>
See page 242	See page 242	See page 242	
HL SLW045L	N	N	P Black T4 Champagne T1 Platinum WHIT White



Icon Legend on page 21

# Laminate Storage Towers

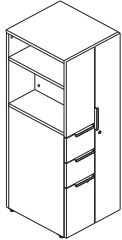

**DESCRIPTION**

**MODEL**

**SHIP WEIGHT**

**CUBE**

**L1 LIST**

**L2 UPCHARGES**  
**CHASSIS    FRONTS**

**18''W x 20''D Storage Towers — Right Hand Drawers, Left Hand Door**

18''W x 20''D x 50''H, Left  
18''W x 20''D x 65''H, Left

**HLSLW085L**  
**HLSLW086L**

139  
167

13.4  
17.3

**\$1592**  
**\$1818**

**\$45**  
**\$50**

**\$35**  
**\$35**

**18''W x 20''D Storage Towers — Left Hand Drawers, Right Hand Door**

18''W x 20''D x 50''H, Right  
18''W x 20''D x 65''H, Right

**HLSLW085R**  
**HLSLW086R**

139  
167

13.4  
17.3

**\$1592**  
**\$1818**

**\$45**  
**\$50**

**\$35**  
**\$35**

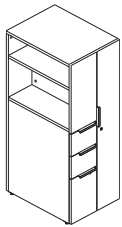

**18''W x 24''D Storage Towers — Right Hand Drawers, Left Hand Door**

18''W x 24''D x 50''H, Left  
18''W x 24''D x 65''H, Left

**HLSLW485L**  
**HLSLW486L**

167  
200

15.8  
21.5

**\$1811**  
**\$2019**

**\$50**  
**\$55**

**\$35**  
**\$35**

**18''W x 24''D Storage Towers — Left Hand Drawers, Right Hand Door**

18''W x 24''D x 50''H, Right  
18''W x 24''D x 65''H, Right

**HLSLW485R**  
**HLSLW486R**

167  
200

15.8  
21.5

**\$1811**  
**\$2019**

**\$50**  
**\$55**

**\$35**  
**\$35**

**NOTES:**

- Ships with one handle per drawer on all units.
- Chassis and drawer fronts woodgrains and solid laminates are specified separately (see SIF options below).
- File drawers accept hanging folders in letter or legal size.
- Standard box drawers operate on ball-bearing suspension with full extension. File and box drawers operate on ball-bearing suspension with full extension.
- Adjustable hex leveling glides allow floor-standing furniture to be easily leveled without lifting the unit; glides have 1/4" adjustable range.
- Wardrobe/storage cabinet includes coat rod.
- Wardrobes contain easy access side storage shelves.
- Wardrobe, middle box drawer and file drawer are locking.
- ! Locking units equipped with HON "One Key" interchangeable core removable locks. Keyed alike core must be ordered separately.
- ! Worksurface-to-tower bracket cannot be used as a support when placing Stack-on Storage on worksurface over bracket. Must use two full-sized supports when using Stack-on Storage.

**HOW TO SPECIFY**

<p><b>Select Model Number</b></p> <p>HL SLW085L</p>	<p><b>Select Chassis Laminate</b></p> <p>See page 242</p> <p>N</p>	<p><b>Select Door/Drawer Front Laminate</b></p> <p>See page 242</p> <p>N</p>	<p><b>Select Pull Color</b></p> <p>P Black T4 Champagne T1 Platinum WHIT White</p> <p>T4</p>
---	--	--	--



# VOI® Laminate Bookcases

GSA SIN 711-3



Icon Legend on page 21

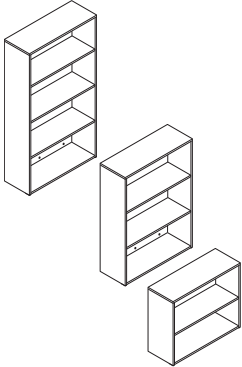

DESCRIPTION	MODEL	SHIP WEIGHT	CUBE	LIST PRICE BY LAMINATE GRADE	
				L1	L2
<b>Bookcase</b> 36"W x 13"D x 29½"H, 2-Shelf	<b>HLSL1336B2</b>	90	10.7	<b>\$513</b>	<b>\$528</b>
36"W x 13"D x 50"H, 3-Shelf	<b>HLSL1336B3</b>	122	17.3	<b>\$661</b>	<b>\$681</b>
36"W x 13"D x 65"H, 4-Shelf	<b>HLSL1336B4</b>	156	22.2	<b>\$778</b>	<b>\$803</b>

NOTES: Bookcases available in 2, 3 and 4 shelf models. Adjustable glides allow bookcases to be easily leveled. Glides have 1/4" of adjustability.

## HOW TO SPECIFY

Select Model Number

HLSL1336B2



Select Laminate

See page 242

N

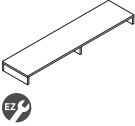

Icon Legend on page 21

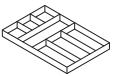
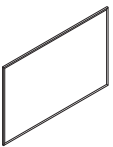
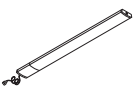
	DESCRIPTION	MODEL	SHIP WEIGHT	CUBE	L1 LIST PRICE	L2 UPCHARGE
	<b>Layering Shelf</b>					
	72"W x 14½"D x 5½"H 60"W x 14½"D x 5½"H	<b>HLSL1472LS</b> <b>HLSL1460LS</b>	50 39	4.6 1.3	<b>\$400</b> <b>\$334</b>	<b>\$10</b> <b>\$10</b>
	NOTES: Layering shelf works with lower credenzas to provide additional storage areas. For additional information see page 912. ! Layering Shelves cannot be stacked. ! Cannot add a hutch on top of a layering shelf.					
	<b>Storage Cube</b>					
	12"W x 12"D	<b>HLSL1212</b>	1.0	0.3		<b>\$276</b>
	NOTES: Storage Cubes and Drawer Organizers are available in the following colors: Autumn (AUTM), Citron (CITR), Flame (FLAM), Pool (POOL) and Sisal (SISL). For additional information see page 914. <b>SPECIFYING EXAMPLE: HLSL1212.CITR</b>					
	<b>Drawer Organizer</b>					
	12"W x 14½"D x 1½"H	<b>HLSLDRWORG</b>	1.0	0.5		<b>\$143</b>
	NOTES: Storage Cubes and Drawer Organizers are available in the following colors: Autumn (AUTM), Citron (CITR), Flame (FLAM), Pool (POOL) and Sisal (SISL). For additional information see page 914. <b>SPECIFYING EXAMPLE: HLSLDRWORG.POOL</b>					
	<b>Markerboard</b>					
	48"W x 31"H	<b>HLSL4831MB</b>	44.0	3.4		<b>\$612</b>
	NOTES: No specification required. For additional information see page 915.					
 <p>OPEN MARKET</p>	<b>LED Task Lights</b>					
	17" LED Light with Power Supply (Single)	<b>HLED17AS</b>	1.2	0.05		<b>\$384</b>
	31" LED Light with Power Supply (Single)	<b>HLED31AS</b>	1.5	0.09		<b>\$516</b>
	17" LED Light with Power Supply for Daisy-chain (Starter)	<b>HLED17A</b>	1.0	0.05		<b>\$422</b>
	31" LED Light with Power Supply for Daisy-chain (Starter)	<b>HLED31A</b>	1.4	0.09		<b>\$567</b>
	17" LED Light with 8" Jumper Cord for Daisy-chain (Follower)	<b>HLED17AUO</b>	1.0	0.03		<b>\$344</b>
	31" LED Light with 8" Jumper Cord for Daisy-chain (Follower)	<b>HLED31AUO</b>	1.0	0.05		<b>\$460</b>
	<b>Undercabinet Occupancy Sensor with 1" End to End Connector</b>	<b>HLEDOSA</b>	0.2	0.01		<b>\$80</b>
	NOTES: To use the daisy chain application, must start with model HLED17A or HLED31A. No finish specification required. Attaches magnetically to underside of overhead storage, or attaches with provided screws or double-sided tape. Occupancy sensor attaches to a single or starter LED light and will automatically turn the light off after no motion is detected for 30 minutes. Just like all the LED light models, the occupancy sensor features a soft-touch on/off switch. LED task lights have a lifetime of 50,000 hours and have a dimmer feature that allows the user to adjust the amount of light output. For additional information see page 911.					

## HOW TO SPECIFY

<p>Select Model Number</p> <p>H L S L 1 4 7 2 L S .</p>	<p>Select Laminate</p> <p>See page 242 L2 (\$10 upcharge)</p> <p>N</p>
---	--

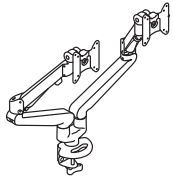
**DESCRIPTION****MODEL SHIP WEIGHT CUBE LIST PRICE****Dual Monitor Arm — Effortless Adjustment****H5220 15 9 1.8 \$912**

- Single mount with dual monitor adjustment.
- Effortless adjustment.
- Height adjusts from 7" to 20" for a total range of 13".
- Monitor extends 22½".
- Monitor retracts 3½" to save space.
- 360° swivel at two points with folding capabilities.
- Monitor tilts +25° to -90°.
- Enclosed cable management.
- Dual screen models allow screens to be aligned horizontally for optimal ergonomic positioning.
- Includes desk clamp or grommet mount.
- Includes VESA plate for 75 x 75mm or 100 x 100mm (converter plate for 100mm x 200mm is available separately).

! Silver finish only, no specification needed.

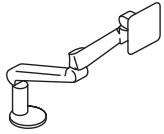
**Single Monitor Arm — Effortless Adjustment****H5210 11 9 1.3 \$510**

- Effortless adjustment.
- Height adjusts from 7" to 20" for a total range of 13".
- Monitor extends 22½".
- Monitor retracts 3½" to save space.
- 360° swivel at two points with folding capabilities.
- Monitor tilts +25° to -90°.
- Enclosed cable management.
- Includes desk clamp or grommet mount.

! Silver finish only, no specification needed.

**CPU Holder****HCPU 16 9 0.5 \$236**

- Vertically mounts to underside of worksurface.
- 360° swivel.
- Supports up to 55 lbs.
- Height adjustable from 16" to 22" below worksurface.
- Width adjustable to accept units from 3¼" to 6".

! Silver finish only, no specification needed.

**NOTES:**

- For additional information see page 899.

**Monitor Arms**

- Arms fold back to post to allow more desktop room.
- Arms feature double extension, allowing 20"+ of back and forth movement.
- Cable management on both pole and arm assemblies.
- Counterbalance adjustment provides stability for monitors up to 17.6 lbs per arm.
- Made of high quality aluminum alloy material.

**HOW TO SPECIFY**

Select  
Model Number

H 5 2 2 0



Icon Legend on page 21

**DESCRIPTION**

**MODEL SHIP WEIGHT CUBE LIST PRICE**

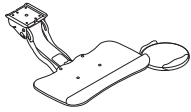

**Sit to Stand Arm with Keyboard**

- Sit to stand application.
- No knob or lever for adjustment, simply lift into place.
- One-hand tilt adjustment for maximum flexibility.
- For use on surfaces 24" or deeper.
- Height adjustment without levers.
- +10°/-20° tilt adjustment.
- Height adjustment 12½" (7" above and 5½" below).
- Tilt and swivel mouse surface with gel palm rest.
- Detachable palm rest.
- Mouse pad can mount right or left.

**H2516 17 1.6 \$565**

! Black finish only, no specification needed.

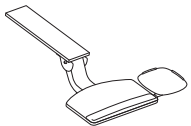

**Articulating Arm with Convertible Keyboard**

- 21" glide track.
- Lift and lock height adjustment.
- Height adjustment 7" (2½" above and 4½" below track).
- Release handle for independent tilt adjustment.
- Tilt: +/-15°.
- Independent tilt and swivel mousing platform.
- Positions platform flush with worksurface.
- 360° rotation.
- Mouse can be used in-line, over, or forward at platform height or above.
- Mouse can be placed at platform height or above height.
- Left or right handed mousing; no tools required.
- Detachable palm rest.
- Cord management clips included.

**H2107 16 1.3 \$484**

! Black finish only, no specification needed.

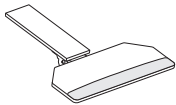

**Articulating Arm with Keyboard**

- 17" glide track.
- Spring assisted.
- Height adjustment 6¼" (1¼" above and 5" below track).
- Tilt: +10°/-15°.
- 25" cut corner platform.
- Accommodates keyboard and mouse on same level.
- Detachable palm rest.
- Cord management clips included.

**H1706 16 1.4 \$451**

! Black finish only, no specification needed.

**NOTES:**

- For additional information see page 900.

Voi® Worksurface with Accessory Selection Guide			Grommet & External Channel			
Accessory Type	Model	Clearance	20"D	24"D	30"D	36"D
CPU Holder	HCPU	13½"	N	Y	Y	Y
Keyboard Tray	H2516	24"	N	N	N	Y
Keyboard Tray	H2107	21¼"	N	N	Y	Y
Keyboard Tray	H1706	17¼"	N	N	Y	Y
Laminate Center Drawer	H1522	18½"	N	N	Y	Y
Laminate Center Drawer	H1526	18½"	N	N	Y	Y
Metal Center Drawer	HD2	20¼"	N	N	Y	Y
Metal Center Drawer	HD8	20¼"	N	N	Y	Y
Keyboard Tray	H4022	17"	N	N	Y	Y
Keyboard Tray	HE4022	17"	N	N	Y	Y
Keyboard Tray	H4028	15"	N	Y	Y	Y
Keyboard Tray	H4029	15"	N	Y	Y	Y

**HOW TO SPECIFY**

Select Model Number

H 2 5 1 6



OPEN MARKET

**DESCRIPTION**

**Back Pack Hook (10 per carton)**  
12"W x 14½"D x 1½"H

**MODEL****HCLA65****SHIP WEIGHT**

10

**CUBE**

0.1

**LIST PRICE****\$91**

NOTES: Assembly: attaches to bottom of desk with (2) screws, included. For additional information see page 914.

Available in Chrome finish only, no specification needed.

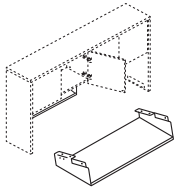
**Hanging Paper Shelf**

28½"W x 11⅞"D x 4⅝"H

**HHPS1**

7

2.9

**\$180**

NOTES: Attaches quickly and easily (screws included). Maximizes worksurface space; de-clutters desktop while placing priority communications and active project folders within easy reach. Angled design allows contents to be distinguished at a glance. Mixed material styling features strong painted metal frame with a frosted shelf.

Attaches quickly and easily to laminate stack-on and wall mount storage models (except the 36"W Voi® overhead hutch with O-legs or panel mount brackets). Not for use with 38000 Series™ and Systems.

Choose from Platinum Metallic (T1), Black (P), and Charcoal (S) paint. For additional information see page 913.

Specify: Model.Paint

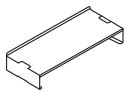
**SPECIFYING EXAMPLE: HHPS1.T1****Desktop Paper Shelf**

28½"W x 11⅞"D x 5"H

**HDPS1**

7

2.9

**\$180**

NOTES: Desktop Paper Shelf and Storage Terrace include protective, non-slip pads on the base. Paper Shelf can stack two-high. Organizer shelf provides a place and space for work-in-process and piling to keep worksurfaces neat and tidy. Convenient, scalable design with interlocking side supports allow two units to be stacked and integrated. Durable painted metal frame with a frosted shelf; mixed material styling matches hanging paper shelf.

Can also be used inside select overhead storage, including the following stack-on with clearance and hinged door models: 10500 and Valido 36", 42", 66", 72", 78"W and 10700 68⅝"W.

Choose from Platinum Metallic (T1), Black (P), and Charcoal (S) paint. For additional information see page 913.

Specify: Model.Paint

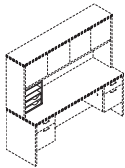
**SPECIFYING EXAMPLE: HDPS1.T1**

Not available in two-tone laminates

SIN 711-8

**Vertical Paper Manager**

14⅞"W x 10⅞"D x 19⅜"H

**HLVPM1**

27

2.8

**\$298**

NOTES: Keeps papers, files, and books neatly organized and within easy reach from a seated position. Designed for desk, credenza, and return tops. Fits under stack-on storage models. Two pullout drawers and three fixed shelves. Not available in pattern laminate colors. Ships fully assembled. For additional information see page 912.

When used in conjunction with wall mounted storage cabinets, the top of the wall mounted storage cabinets must be positioned a minimum of 68⅜" above the floor.

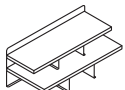
**SPECIFYING EXAMPLE: HLVPM1.N**

Not available in two-tone laminate

**Desktop Storage Terrace**

26½"W x 12½"D x 10½"H

**HLDST1**

24

1.1

**\$299**

NOTES: Keeps work-in-process, priority files, loose pages, and mail neatly organized and in view. Mixed material design comprised of sturdy laminate shelves with metal back and support panels. Not available in two-tone laminate combination or pattern laminate colors. Choose from Platinum Metallic (T1), Black (P), and Charcoal (S) for the metal components.

Sized to fit in stack-on and wall mounted storage cabinets in 10500, 10700, Valido, 94000, Park Avenue Laminate, and 38000 Series. Fits in Voi stack-on and overhead cabinets except for 48"W or smaller sliding door models. For additional information see page 912.

Specify: Model.Laminate.Paint



**SPECIFYING EXAMPLE: HLDST1.N.T1****HOW TO SPECIFY**

Select  
Model Number

H C L A 6 5

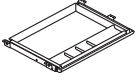
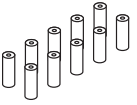

Icon Legend on page 21

	DESCRIPTION	MODEL	SHIP WEIGHT	CUBE	LIST PRICE
 Refer to page 171 for Center Drawer compatibility information SIN 711-1, 711-2, 711-11 	<b>Angled Wood Center Drawer</b> 26" x 15 <sup>3</sup> / <sub>8</sub> " 22" x 15 <sup>3</sup> / <sub>8</sub> " NOTES: Specify laminate for drawer. Ideal for pens, pencils and other miscellaneous storage. Feature ball-bearing slide suspension. For additional information see page 903.	<b>H1526</b> <b>H1522</b>	12 Ⓞ 11 Ⓞ	1.2 1.1	<b>\$187</b> <b>\$173</b>
	<b>Polymer Center Drawer</b> <ul style="list-style-type: none"> <li>• Color: Black.</li> <li>• Material: ABS.</li> <li>• Opening Requirements: 23"W x 16<sup>1</sup>/<sub>4</sub>"D x 2"H.</li> <li>• Retracts on 16" ball-bearing slides.</li> <li>• Can be used on worksurfaces with Coordinate™ Height Adjustable Bases as long as it is attached with spacer model HKBS.</li> <li>• Can store up to 25 lbs.</li> </ul> NOTES: For additional information see page 904. ⓘ Black finish only, no specification needed.	<b>HCD1</b>	7	0.5	<b>\$99</b>
 OPEN MARKET	<b>Keyboard Spacer</b> <ul style="list-style-type: none"> <li>• For use when attaching a keyboard tray to Coordinate™ and Voi® or Systems Worksurface with an external channel.</li> <li>• The kit includes ten cylinder spacers and ten screws.</li> <li>• Spacers are 3/4"W x 2<sup>1</sup>/<sub>8</sub>"H.</li> <li>• Specify one kit per keyboard tray.</li> </ul> NOTES: For additional information see page 900.	<b>HKBS</b>	1 Ⓞ	0.8	<b>\$83</b>
 OPEN MARKET					

**HOW TO SPECIFY**

Select Model Number

H
C
D
1

**DESCRIPTION****Articulating Desk Lamp****Articulating Desk Lamp w/ Occupancy Sensor**

- Color: Matte Silver.
- Full-range dimming from 10% to 100%.
- Designed for 50,000 hours of life.
- Occupancy sensor is built into the head of the lamp and will automatically shut the lamp off after 6 minutes of undetected movement.
- Base swivel is 180 degrees.
- Uses only 5 watts of energy.
- Light comes with a silver 9' 4" power cord.
- Base diameter is 7.5".
- 3500K Color Temperature.
- 80 Color Rendering Index.
- TAA Compliant.

**MODEL****SHIP WEIGHT****CUBE****LIST PRICE****HLED1**

1.2 Ⓢ

6.5

**\$359****HLED1OC**

1.2 Ⓢ

6.5

**\$439****Task Desk Lamp**

- Color: Brushed Nickel.
- Full-range dimming from 10% to 100%.
- Designed for 50,000 hours of life.
- Lamp is 15.83" tall.
- Desk lamp does not articulate at base. The pivoting head provides custom positioning, as it can be twisted 360 degrees.
- Uses only 5 watts of energy.
- Light comes with a silver 9' 4" power cord.
- Base diameter is 6.7".
- 3500K Color Temperature.
- 80 Color Rendering Index.
- TAA Compliant.

**HLED2**

0.7 Ⓢ

3.0

**\$311****NOTES:**

- For additional information see page 909.

**HOW TO SPECIFY**

Select  
Model Number

H L E D 1

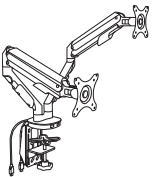
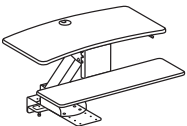
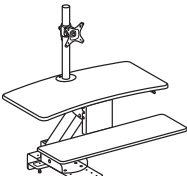
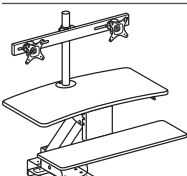
	DESCRIPTION	MODEL	SHIP WEIGHT	CUBE	LIST PRICE
	<p><b>Coordinate™ Portable Desktop Riser</b> 31"D x 4½"-16½"H x 35"W</p> <p>NOTES: Available in Black (BLK) or White (WHT) finish. Desktop riser dimensions (without keyboard tray): 22"D x 4½"-16½"H x 35"W. Keyboard tray dimensions: 9"D x 30"W. Max loading capacity is 33 lbs for the desktop riser surface and 4 lbs for the keyboard tray. Easily transition from seated to standing positions throughout the workday. Sits atop an existing desk to create sit-to-stand functionality by raising the computer. Includes keyboard tray and surface for computer monitors. <b>HON 5-Year Limited Warranty.</b></p> <p>⚠ Not intended for use on mobile workstations.</p>	<b>HBXRISER</b>	54.0	4.1	<b>\$500</b>
	<p><b>Dual Monitor Arm with 2 USB Ports</b></p> <p>NOTES: <b>AVAILABLE FEBRUARY 2018.</b> Easy adjustment. Height adjusts to 17" tall. Monitor tilt and swivel capability. Enclosed cable management. Grommet or desktop mounting. Clean appearance. For additional information see page 899.</p> <p>⚠ No specification needed.</p>	<b>HBDMAUSB</b>	41.9	2.6	<b>\$360</b>
	<p><b>Coordinate™ Mounted Desktop Riser</b></p> <p>NOTES: Does not include a monitor arm and is suitable for laptops and/or monitors on their original stands.</p> <p>⚠ No specification needed.</p>	<b>HS1100</b>	60.0 Ⓢ	3.2	<b>\$525</b>
	<p><b>Coordinate™ Mounted Desktop Riser with Single Monitor Arm</b></p> <p>NOTES: Includes a monitor arm for a single monitor.</p> <p>⚠ No specification needed.</p>	<b>HS1101</b>	62.0 Ⓢ	3.2	<b>\$615</b>
	<p><b>Coordinate™ Mounted Desktop Riser with Dual Monitor Arm</b></p> <p>NOTES: Includes a monitor arm for dual monitors.</p> <p>⚠ No specification needed.</p>	<b>HS1102</b>	63.0 Ⓢ	3.2	<b>\$700</b>

**NOTES FOR HS1100, HS1101, HS1102:**

- These products are designed to allow the user to transition from seating position to standing position throughout the workday.
- Gas-assist lever-operated mechanism with positive stop.
- Clamp mount compatible with worksurfaces depths of 20"-30". 20" is for systems only.
- Clamp requires 3.5" of clearance along back edge of worksurface.
- Black seamless worksurfaces.
- Silver powder coated metal components.
- Lowers below worksurface level on 24" and 30"D worksurfaces.
- All models contain a large primary worksurface and a smaller keyboard / mouse surface.
- Beveled edges for sleek appearance and comfort while typing.
- Monitor arms include height, width, and swivel adjustment.
- For additional information see page 906.

- Not for use under overhead storage, with flush mounted modesty panels, or worksurfaces thinner than 1".

⚠ Not recommended for use on mobile (castered) worksurfaces.

**MOUNTING AND COMPATIBILITY FOR HS1100, HS1101, HS1102:**

- This product is intended to be installed on commercial-grade worksurfaces in good condition.
- Compatible with freestanding worksurfaces 24"-30"D or panel-supported worksurfaces 24"-30"D.
- Not for use on mobile worksurfaces.

**Clamp Mount**

Use when 3.5" minimum overhang is available

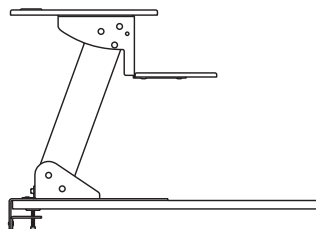

**Screw Mount**

Use when no overhang is available. Worksurface must be minimum 1" thick.

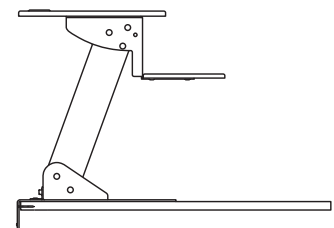



**HOW TO SPECIFY**

<p>Select Model Number</p> <p>HBXRISER.</p>	<p>Select Finish</p> <p>BLK Black WHIT White</p> <p>BLK</p>
---	---



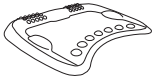
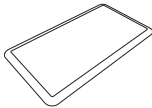
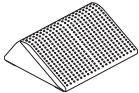

	DESCRIPTION	MODEL	SHIP WEIGHT	CUBE	LIST PRICE
	<b>Rectangle Wobble Board — Anti-Fatigue Mat</b> 18"D x 3"H x 22¼"W ⓘ Available in Black (T) finish ONLY. Recommended weight capacity not to exceed 250 pounds. <b>HON 5-Year Limited Warranty.</b> <b>SPECIFYING EXAMPLE: HVL981.T</b>	<b>HVL981</b>	10.0 ⓘ	0.9	<b>\$220</b>
	<b>Round Wobble Board — Anti-Fatigue Mat</b> 18½"D x 2½"H x 18½"W ⓘ Available in Black (T) finish ONLY. Recommended weight capacity not to exceed 250 pounds. <b>HON 5-Year Limited Warranty.</b> <b>SPECIFYING EXAMPLE: HVL982.T</b>	<b>HVL982</b>	5.8 ⓘ	0.6	<b>\$190</b>
	<b>Ergonomic Anti-Fatigue Mat</b> 25"D x 2¾"H x 29⅞"W ⓘ <b>AVAILABLE FEBRUARY 2018.</b> Available in Black ONLY. No specification needed. <b>SPECIFYING EXAMPLE: HBEAFM1</b>	<b>HBEAFM1</b>	7.0	1,4	<b>\$176</b>
	<b>Rectangle Anti-Fatigue Mat</b> 20"D x ¾"H x 36"W ⓘ <b>AVAILABLE FEBRUARY 2018.</b> Available in Black ONLY. No specification needed. <b>SPECIFYING EXAMPLE: HBAFM2036</b>	<b>HBAFM2036</b>	5.4	0.4	<b>\$80</b>
	<b>Footrest — Anti-Slip Cover</b> 13¾"D x 5½"H x 16"W ⓘ Available in Black (T) finish ONLY. Recommended weight capacity not to exceed 250 pounds. <b>HON 5-Year Limited Warranty.</b> <b>SPECIFYING EXAMPLE: HVL991.T</b>	<b>HVL991</b>	7.0 ⓘ	0.9	<b>\$65</b>

## HOW TO SPECIFY

Select  
Model Number



H V L 9 8 1 .

Select  
Finish

T Black

T

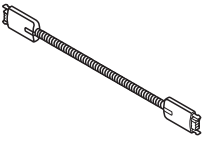
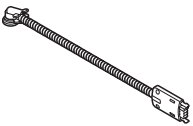

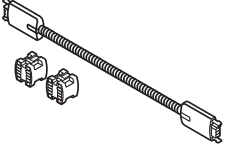
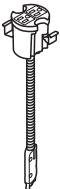
	DESCRIPTION	MODEL	SHIP WEIGHT	CUBE	LIST PRICE
	<b>Electrical Power Jumper</b>				
	12" Jumper	HMAJUMP12	0.5 <b>Ⓔ</b>	0.2	\$75
	18" Jumper	HMAJUMP18	0.8 <b>Ⓔ</b>	0.2	\$84
	24" Jumper	HMAJUMP24	1.0 <b>Ⓔ</b>	0.2	\$90
	30" Jumper	HMAJUMP30	1.0 <b>Ⓔ</b>	0.2	\$98
	36" Jumper	HMAJUMP36	1.5 <b>Ⓔ</b>	0.2	\$102
	42" Jumper	HMAJUMP42	1.8 <b>Ⓔ</b>	0.2	\$115
	48" Jumper	HMAJUMP48	2.0 <b>Ⓔ</b>	0.2	\$125
	54" Jumper	HMAJUMP54	2.3 <b>Ⓔ</b>	0.2	\$139
	60" Jumper	HMAJUMP60	2.5 <b>Ⓔ</b>	0.2	\$149
	66" Jumper	HMAJUMP66	2.8 <b>Ⓔ</b>	0.2	\$158
	72" Jumper	HMAJUMP72	3.0 <b>Ⓔ</b>	0.2	\$165
	84" Jumper	HMAJUMP84	3.5 <b>Ⓔ</b>	0.2	\$178
	96" Jumper	HMAJUMP96	4.0 <b>Ⓔ</b>	0.2	\$196
	108" Jumper	HMAJUMP108	4.5 <b>Ⓔ</b>	0.2	\$208
120" Jumper	HMAJUMP120	5.0 <b>Ⓔ</b>	0.2	\$223	
132" Jumper	HMAJUMP132	5.5 <b>Ⓔ</b>	0.2	\$234	
144" Jumper	HMAJUMP144	6.0 <b>Ⓔ</b>	0.2	\$248	
<b>!</b> No color options. Specify X when ordering. Example: HMAJUMP12.X.					
	<b>Power In-Feed</b>				
	6' Metal Conduit Power In-feed	HMAINFEE72	1.6 <b>Ⓔ</b>	0.3	\$152
	13' Metal Conduit Power In-feed	HMAINFEE156	3.5 <b>Ⓔ</b>	0.3	\$216
<b>!</b> No color options. Specify X when ordering. Example: HMAINFEE72.X.					
	6' Sealtight Power In-Feed	HMAINFEE72ST	1.6 <b>Ⓔ</b>	0.3	\$126
	<b>!</b> No color options. Specify P when ordering. Example: HMAINFEE72ST.P.				
	<b>Credenza Power Packs</b>				
	For 60" Credenza 36" Jumper and two four-way splitters	HMACREDPK60	0.3 <b>Ⓔ</b>	0.9	\$132
	For 72" Credenza 48" Jumper and two four-way splitters	HMACREDPK72	0.3 <b>Ⓔ</b>	1.2	\$142
<b>!</b> No color options. Specify X when ordering. Example: HMACREDPK60.X.					
	<b>Hardwire Power Hub</b>				
	Circuit 1 Hardwired 3" Power Hub grommet for worksurface	HGRMTAC1HW34	8.0 <b>Ⓔ</b>	0.9	\$145
	Circuit 1 Hardwired 3" Power Hub grommet for low and floor credenza	HGRMTAC1HW26	8.0 <b>Ⓔ</b>	0.9	\$145
	Circuit 2 Hardwired 3" Power Hub grommet for worksurface	HGRMTAC2HW34	8.0 <b>Ⓔ</b>	0.9	\$145
	Circuit 2 Hardwired 3" Power Hub grommet for low and floor credenza	HGRMTAC2HW26	8.0 <b>Ⓔ</b>	0.9	\$145
NOTES: Includes black grommet housing.					
<b>!</b> Available in Black only. Specify P when ordering. Example: HGRMTAC1HW34.P.					

**NOTES:**

- Specify with power-ready casegoods.
- Includes all mounting hardware.
- In-Feeds work with a power pole, wall in-feed, or a floor core.
- In-Feed to be installed by certified electrician.
- UL 183 Listed to be exposed.
- Credenza Power Packs have three open connection points on each end (splitters).
- A/C Grommets are available in two lengths and two circuits for use with Low Credenzas or the grommet cutout on a worksurface.

**HOW TO SPECIFY**











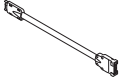

<b>Select Model Number</b> H M A J U M P 1 2 .	<b>Select Color</b> X P Black
H G R M T A C 1 H W 3 4 .	P

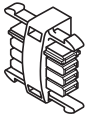
# VOI® Hardwire Electrical Components

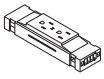
GSA SIN 711-2



Icon Legend on page 21

	DESCRIPTION	MODEL	SHIP WEIGHT	CUBE	LIST PRICE
	<b>Electrical Connectors</b>				
	4-Way Splitter — Single Pack	<b>HMASPLIT</b>	1.0 	0.2	<b>\$44</b>
	4-Way Splitter — 5-Pack 2"W x 2"D	<b>HMASPLITBP5</b>	2.5 	0.2	<b>\$188</b>
	8-Wire to 4-Wire Connector 48"W	<b>HMA8TO4CON</b>	1.4 	0.2	<b>\$165</b>
	Duplex Receptacle Connector 2"W	<b>HMAADCON</b>	1.4 	0.2	<b>\$35</b>
	 Electrical connector models are available in Black only. <i>Specify with a .P.</i>				
	<b>Duplex Receptacles</b>				
	Circuit 1 Duplex Receptacle — Single Pack	<b>HMAADPLEX1</b>	1.4 	0.2	<b>\$67</b>
	Circuit 1 Duplex Receptacle — 5-Pack 6"W x 2"D x 1"H	<b>HMAADPLEX1BP5</b>	3.5 	0.2	<b>\$304</b>
	Circuit 2 Duplex Receptacle — Single Pack	<b>HMAADPLEX2</b>	1.4 	0.2	<b>\$67</b>
	Circuit 2 Duplex Receptacle — 5-Pack 6"W x 2"D x 1"H	<b>HMAADPLEX2BP5</b>	3.5 	0.2	<b>\$304</b>
 Available in Black only. <i>Specify P when ordering. Example: HMAADPLEX1.P.</i>					

## HOW TO SPECIFY





Select  
Model Number

Select  
Color

P Black

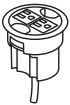
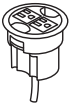
H M A S P L I T . P



	DESCRIPTION	MODEL	SHIP WEIGHT	CUBE	LIST PRICE
 <b>SIN 71-302</b>	<p><b>Softwire Power Hub, 3" Grommet Mount</b></p> <ul style="list-style-type: none"> <li>Fits in 3" round grommet holes</li> <li>Field installed with Plug-and-play ease</li> <li>Two grounded AC power outlets</li> <li>Includes 6' cord with three-prong plug</li> </ul> <p>NOTES: For additional information see page 916.</p> <p>ⓘ Available in Black only. Specify X when ordering. Example: HGRMTAC.X.</p>	<b>HGRMTAC</b>	1.3	0.2	<b>\$103</b>
 <b>SIN 71-302</b> 	<p><b>3" Round Power Grommet - 2 Outlets, 10' Cord</b></p> <ul style="list-style-type: none"> <li>Includes 10' cord with three-prong plug.</li> <li>Fits in 3" round grommet holes on the following product lines: Coordinate, Huddle, Motivate, all laminate and veneer casegoods series, and Systems Worksurfaces.</li> <li>Two grounded AC power outlets.</li> <li>Field installed with Plug-and-play ease.</li> </ul> <p>NOTES: Power Modules will also work with standing-height applications for 10500 Series™ and Voi® desks. Optional Memory Control allows preset worksurface heights for consistency. Ships separately. Dynamic load capacity when worksurface is moving is 300 lbs.</p> <p>ⓘ Available in black finish only, no specification needed.</p>	<b>HGRMTAC2</b>	1.5	0.2	<b>\$130</b>
 <b>SIN 71-302</b>	<p><b>Power/USB Hub, 3" Grommet Mount</b></p> <ul style="list-style-type: none"> <li>One grounded AC power outlet with 2 USB ports.</li> <li>Two cord pass-through holes in cap.</li> <li>Includes 6' cord with three-prong plug.</li> <li>Field installed; easy plug-and-play.</li> <li>UL Listed.</li> </ul> <p>NOTES: For additional information see page 916.</p> <p>ⓘ Available in black only (no color designation so use .X - Specify: HGRMTUSB2.X).</p>	<b>HGRMTUSB2</b>	1.3 ⓘ	0.2	<b>\$203</b>
 <b>SIN 711-11</b>	<p><b>Data Grommet</b></p> <p>Blank grommet kit that includes adapters for a variety of manufacturers jacks and couplers.</p> <ul style="list-style-type: none"> <li>Fits in existing 3" round grommet housing</li> </ul> <p>NOTES: For additional information see page 916.</p> <p>ⓘ Available in Black only. Specify P when ordering. Example: HGRMTDATA.P.</p>	<b>HGRMTDATA</b>	0.2	0.2	<b>\$16</b>

## HOW TO SPECIFY

Select Model Number

H G R M T A C



OPEN MARKET

**DESCRIPTION****O-Leg Cord Clips**

Clips for 28½" Worksurface O-Legs — 8-Pack  
Clips for Stack-on Storage, Hutch and Layering O-Legs — 4-Pack

**MODEL**

**HWMCLIPLG**  
**HWMCLIPSM**

**SHIP WEIGHT**

0.8 **Ⓢ**  
0.5 **Ⓢ**

**CUBE**

0.1  
0.1

**LIST PRICE**

**\$90**  
**\$58**

NOTES: Wire clips work with 7" Low Credenza O-leg and 29"H Support O-leg. Wire clips also work with the 50" and 65" Hutch O-legs. For additional information see page 920.

⚠ Available in frosted plastic material only.

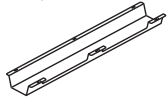
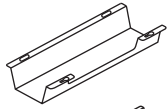

SIN 711-1

**Cable Management Troughs**

17"W — Single  
17"W — 10-Pack  
36"W — Single  
36"W — 10-Pack

**HCTROUGH17**  
**HCTROUGH1710**  
**HCTROUGH36**  
**HCTROUGH3610**

2.7 **Ⓢ**  
14.0 **Ⓢ**  
4.9 **Ⓢ**  
30.0 **Ⓢ**

0.5  
0.5  
0.9  
0.9

**\$62**  
**\$583**  
**\$104**  
**\$983**

- Cable management troughs ship flat packed.
- The troughs attach to underneath the worksurface with screws.
- The 17"W has one wire access cut out on the user side. The 36" has two wire access cut outs. These cut outs give users access to inside the trough without having to detach it from the worksurface.
- Color: Graphite.
- Material: Metal.
- TAA Compliant.

NOTES: For additional information see page 920.



Specify paint color for  
HH870070, not available in  
Putty

SIN 711-11

**Power Pole — w/o Receptacles**

10'5"

**HH870070**

14.0

0.5

**\$390**

⚠ Specify paint; not available in Putty (L), **Platinum Metallic (T1)**, and **Champagne Metallic (T4)**.



SIN 711-8

**Field Installable Grommet****HFLDGRMT3**0.1 **Ⓢ**

0.3

**\$29**

- Intended for use in tops and end panels to route/hide cords and in modesty panels to facilitate reaching wall electrical outlets.
- Grommet is field installable.
- Grommet shape is round.
- Includes grommet cap and sleeve.
- Grommet outside dimensions measure 3½" diameter and includes two cord access holes.
- Grommet sleeve measures 3" O.D. x 1" thick.
- Includes instructions to locate grommet position for desks, credenzas, returns and bridges.

NOTES: For additional information see page 916.



- ⚠ Black Finish
- ⚠ Requires a 3" diameter hole saw and drill for installation (not included).
- ⚠ Not for use with credenzas, pedestals, laterals or towers.

**HOW TO SPECIFY**

Select  
Model Number

H W M C L I P L G

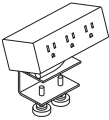
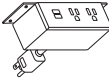
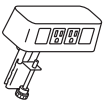
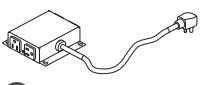

	DESCRIPTION	MODEL	SHIP WEIGHT	CUBE	LIST PRICE
 Model HPWRMOD3WC shown	<b>Power Modules</b>				
	3 Receptacles with Worksurface Clamp	<b>HPWRMOD3WC</b>	2.3 Ⓢ	0.2	<b>\$279</b>
	3 Receptacles with Under-Worksurface Mounting Bracket	<b>HPWRMOD3UWM</b>	2.3 Ⓢ	0.2	<b>\$279</b>
	2 Receptacles 2 USB with Worksurface Clamp	<b>HPWRMOD2WC</b>	2.3 Ⓢ	0.2	<b>\$447</b>
 Model HPWRMOD2UWM shown	2 Receptacles 2 USB with Under-Worksurface Mounting Bracket	<b>HPWRMOD2UWM</b>	2.3 Ⓢ	0.2	<b>\$447</b>
	<ul style="list-style-type: none"> <li>• 6' power cord with standard three-prong plug.</li> <li>• Under-worksurface mounting bracket models work with any top that has a 5" x 5" square clearance.</li> <li>• Worksurface clamp models work on any top with a 4" overhang.</li> <li>• UL Listed.</li> </ul> <p>❗ Color finish coordinates with HON's Charcoal or White. Specify <i>S</i> for Charcoal or <i>WHIT</i> for White when ordering. Example: HPWRMOD3WC.S.</p>				
	<b>Power &amp; Data Center</b>				
	2 Receptacles 2 Data Accessory	<b>HCOMDOME2</b>	2.5 Ⓢ	0.2	<b>\$266</b>
 	<b>Under Worksurface Power Module — 4 Outlets, 10' Cord</b>	<b>HPWRMOD2</b>	1.5	0.2	<b>\$354</b>
	<ul style="list-style-type: none"> <li>• Includes 10' cord with three-prong plug.</li> <li>• Fits in cable management troughs. See page 79.</li> <li>• 4 outlets on side create easy access.</li> </ul> <p>NOTES: Power Modules will also work with standing-height applications for 10500 Series™ and Voi® desks.</p> <p>❗ Available in black finish only, no specification needed.</p>				
	<b>Vertebrae</b>	<b>HMPVWM28</b>	3.0	0.3	<b>\$200</b>
	<ul style="list-style-type: none"> <li>• Clear finish. Specify "X" for finish option.</li> </ul> <p><b>SPECIFYING EXAMPLE: HMPVWM28.X</b></p>				

**NOTES:**

- For additional information see pages 917 and 920.

**HOW TO SPECIFY**

Select  
Model Number

H P W R M O D 3 W C

# NOTES

# 10500 SERIES™



## 10500 SERIES™

Endlessly adaptable and unexpectedly affordable, our refreshed 10500 Series offers truly lasting value. The versatile new design and options give you an even wider range of layout possibilities and the flexibility to maximize footprints — even smaller ones. And with more ways to customize your personal storage, the 10500 Series simply gives you more for less.



## FEATURES

- The 10500 Series' fresh new aesthetic includes airy O-Legs and frosted modesty panels.
- Available in 22 durable mix-and-match laminates, including new textured styles.
- With so many convenient and compact storage options, even the smallest footprints feel big.
- The versatile 10500 Series™ offers a variety of components to accommodate any size workspace.
- Support today's healthy work styles by offering the choice of sitting or standing while working, with storage options that fit your needs.



# 10500 SERIES™ ORDERING INFORMATION

## LAMINATE FINISHES AVAILABILITY — 10500 SERIES™

L1 LAMINATES		CODES
Woodgrain	◆ Bourbon Cherry	HH
	◆ Cognac	COGNCOGN
	◆ Harvest	CC
	◆ Mahogany	NN
	◆ Mocha	MOCHMOCH
	◆ Natural Maple	DD
	◆ Pinnacle	PINCPINC
	◆ Shaker Cherry	FF
Solid	◆ Black	PP
	◆ Brilliant White	WHITWHIT
	◆ Charcoal	SS
	◆ Loft	LOFT
Patterned Top	◆ Grey Tigris	L6(*)
	◆ Sheer Mesh	A5(*)
	◆ Silver Mesh	B9(*)
	◆ Canyon Zephyr	K9(*)
	◆ Desert Zephyr	K8(*)
L2 LAMINATES		CODES
Woodgrain	◆ Lowell Ash	LLA1
	◆ Natural Recon	LNRI
	◆ Phantom Ecreu	LPE1
	◆ Portico Teak	LPT1
	◆ Skyline Walnut	LSW1

Must specify both top and edgeband options for worksurfaces. First laminate designator is for the worksurface color, the second is for the edge color.  
**SPECIFYING EXAMPLE: H105B3072.NN**

(\*) Patterned top laminates are available with the following base/edgebanding laminate selection: C, COGN, D, F, H, LOFT, MOCH, N, P, PINC, S, or WHIT.  
Edgebanding will match base laminate selected.

**SPECIFYING EXAMPLE: H105413.L6N**

The following 10500 Series™ products are not available as two-tone and require only one color code:

- Modular pedestals — box/file, box/box/file, file/file, lateral file, multi file, and cabinet (also applies to Valido/11500 Series).
- Access strip and end panel kits
- Modesty panel for peninsulas
- Back enclosures
- Wall mounted open shelf
- Reception stations for return
- T-shaped end panels
- L-shaped end panels

◆◆◆ For lead time information see page 21.

### Patterned Top

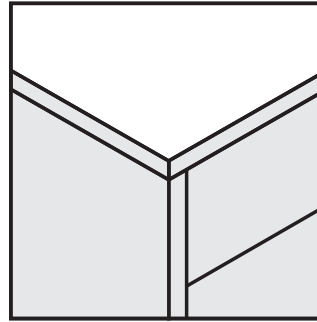

### Edgeband Around Top / Laminate Base

- Edgebanding on patterned laminates matches the laminate base selected.
- For 10500 Series™ worksurface models, the finish specification options include matching the top and edgeband colors or choosing a two-tone combination.
- LAMINATE DESKS  
SPECIFY: Model Number.  
Laminate
- EXAMPLE: H105413.NN
- WORKSURFACES  
SPECIFY: Model Number.  
Top Laminate  
Edgeband
- **All specifications in this publication are based on the latest product information available at the time of print.**

❗ Tops with a patterned color are not available with a matching edgeband.

# 10500 SERIES™ ORDERING INFORMATION

## LAMINATE FINISHES AVAILABILITY — 10500 SERIES™

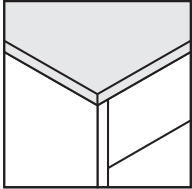
Two-Tone Laminate Top / Edgebanding	
	
L1 LAMINATES	CODES
◆ Black/Brilliant White	PWHIT
◆ Black/Charcoal	PS
◆ Black/Loft	PLOFT
◆ Bourbon Cherry/Black	HP
◆ Bourbon Cherry/Brilliant White	HWHIT
◆ Bourbon Cherry/Charcoal	HS
◆ Bourbon Cherry/Loft	HLOFT
◆ Brilliant White/Black	WHITP
◆ Brilliant White/Bourbon Cherry	WHITH
◆ Brilliant White/Charcoal	WHITS
◆ Brilliant White/Cognac	WHITCOGN
◆ Brilliant White/Harvest	WHITC
◆ Brilliant White/Loft	WHITLOFT
◆ Brilliant White/Mahogany	WHITN
◆ Brilliant White/Mocha	WHITMOCH
◆ Brilliant White/Natural Maple	WHITD
◆ Brilliant White/Pinnacle	WHITPINC
◆ Brilliant White/Shaker Cherry	WHITF
◆ Charcoal/Black	SP
◆ Charcoal/Brilliant White	SWHIT
◆ Charcoal/Loft	SLOFT
◆ Cognac/Black	COGNP
◆ Cognac/Brilliant White	COGNWHIT
◆ Cognac/Charcoal	COGNS
◆ Cognac/Loft	COGHLOFT
◆ Harvest/Black	CP
◆ Harvest/Brilliant White	CWHIT
◆ Harvest/Charcoal	CS
◆ Harvest/Loft	CLOFT
◆ Loft/Black	LOFTP
◆ Loft/Brilliant White	LOFTWHIT
◆ Loft/Charcoal	LOFTS
◆ Mahogany/Black	NP
◆ Mahogany/Brilliant White	NWHIT
◆ Mahogany/Charcoal	NS
◆ Mahogany/Loft	NLOFT
◆ Mocha/Black	MOCHP
◆ Mocha/Brilliant White	MOCHWHIT
◆ Mocha/Charcoal	MOCHS
◆ Mocha/Loft	MOCHLOFT
◆ Natural Maple/Black	DP
◆ Natural Maple/Brilliant White	DWHIT
◆ Natural Maple/Charcoal	DS
◆ Natural Maple/Loft	DLOFT
◆ Pinnacle/Black	PINCP
◆ Pinnacle/Brilliant White	PINCWHIT
◆ Pinnacle/Charcoal	PINCS
◆ Pinnacle/Loft	PINCLOFT
◆ Shaker Cherry/Black	FP
◆ Shaker Cherry/Brilliant White	FWHIT
◆ Shaker Cherry/Charcoal	FS
◆ Shaker Cherry/Loft	FLOFT

L2 LAMINATES		CODES
Two-Tone Top/Base	◆ Brilliant White/Lowell Ash	WHITLLA1
	◆ Brilliant White/Natural Recon	WHITLNR1
	◆ Brilliant White/Phantom Ecu	WHITLPE1
	◆ Brilliant White/Portico Teak	WHITLPT1
	◆ Brilliant White/Skyline Walnut	WHITLSW1
	◆ Lowell Ash/Black	LLA1P
	◆ Lowell Ash/Brilliant White	LLA1WHIT
	◆ Lowell Ash/Charcoal	LLA1S
	◆ Lowell Ash/Loft	LLA1LOFT
	◆ Natural Recon/Black	LNR1P
	◆ Natural Recon/Brilliant White	LNR1WHIT
	◆ Natural Recon/Charcoal	LNR1S
	◆ Natural Recon/Loft	LNR1LOFT
	◆ Phantom Ecu/Black	LPE1P
	◆ Phantom Ecu/Brilliant White	LPE1WHIT
	◆ Phantom Ecu/Charcoal	LPE1S
	◆ Phantom Ecu/Loft	LPE1LOFT
	◆ Portico Teak/Black	LPT1P
	◆ Portico Teak/Brilliant White	LPT1WHIT
	◆ Portico Teak/Charcoal	LPT1S
◆ Portico Teak/Loft	LPT1LOFT	
◆ Skyline Walnut/Black	LSW1P	
◆ Skyline Walnut/Brilliant White	LSW1WHIT	
◆ Skyline Walnut/Charcoal	LSW1S	
◆ Skyline Walnut/Loft	LSW1LOFT	

### Laminate Base

Two-tone laminates: Top and edgebanding are the same, base is different laminate color.

The following 10500 Series™ products are not available as two-tone. They are one color and require only one color code:

- Modular pedestals — box/file, box/box/file, file/file, lateral file, multi file, and cabinet (also applies to Valido/11500 Series).
- Access strip and end panel kits
- Back enclosures
- Wall mounted open shelf
- Reception stations for return
- T-shaped end panels
- L-shaped end panels

Storage chassis that are specified in L2 laminates and are longer than 60"W will ship with back panels that are horizontal grain.

- Edgebanding on two-tone laminates matches top, base is a different laminate color.
- A complete selection of Conference Room and Occasional Tables is shown under Tables on pages 764-765, 767-768, 771, and 790-812.
- LAMINATE DESKS  
SPECIFY: Model Number.  
Laminate  
EXAMPLE: H10596.HP
- **All specifications in this publication are based on the latest product information available at the time of print.**

◆ ◆ ◆ For lead time information see page 21.

# 10500 SERIES™

## Typicals



Icon Legend on page 21

Components used are listed on pages 310-352. Order components individually. Other configurations are possible, including various sizes of some components.

QTY	DESCRIPTION	MODEL	LIST PRICE	PRICE EXTENSION
1	<b>Double Pedestal Desk - 2/2</b> 72"W x 36"D x 29½"H	H10593	\$1,319	\$1,319
1	<b>Credenza with Kneespace - 2/0/2</b> 72"W x 24"D x 29½"H	H10543	\$1,176	\$1,176
<b>TOTAL:</b>			<b>\$2,495</b>	

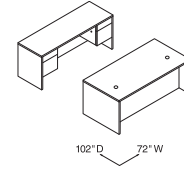

**DESK CRENDENZA WORKSTATION**  
**72"W x 102"D**

QTY	DESCRIPTION	MODEL	LIST PRICE	PRICE EXTENSION
1	<b>Double Pedestal Bow Top Desk - 2/2</b> 72"W x 36"D x 29½"H	H10595	\$1,480	\$1,480
1	<b>Credenza with Kneespace - 2/0/2</b> 72"W x 24"D x 29½"H	H10543	\$1,176	\$1,176
1	<b>Stack-on Storage</b> 72"W x 14⅝"D x 37⅞"H	H10534	\$958	\$958
<b>TOTAL:</b>			<b>\$3,614</b>	

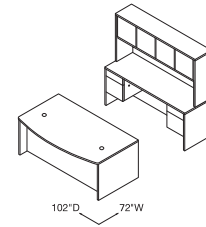

**DESK CRENDENZA WORKSTATION**  
**72"W x 102"D**

QTY	DESCRIPTION	MODEL	LIST PRICE	PRICE EXTENSION
1	<b>Double Pedestal Desk - 2/2</b> 72"W x 36"D x 29½"H	H10593	\$1,319	\$1,319
1	<b>Credenza with Doors</b> 72"W x 24"D x 29½"H	H10544	\$1,434	\$1,434
1	<b>Stack-on PC Organizer</b> 72"W x 14⅝"D x 22"H	H105388	\$772	\$772
<b>TOTAL:</b>			<b>\$3,525</b>	

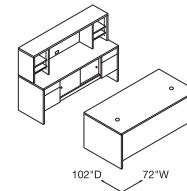

**DESK CRENDENZA WORKSTATION**  
**72"W x 102"D**

QTY	DESCRIPTION	MODEL	LIST PRICE	PRICE EXTENSION
1	<b>Curved Return Left, B/F</b> 42"W x 18-24"D x 29½"H	H105818L	\$793	\$793
1	<b>Curved Corner Unit</b> 18" x 36" x 36" x 18" x 29½"H	H105810	\$732	\$732
1	<b>Curved Return, Right - B/F</b> 42"W x 18-24"D x 29½"H	H105817R	\$793	\$793
<b>TOTAL:</b>			<b>\$2,318</b>	

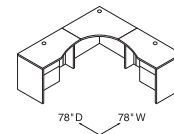

**CURVED CORNER AND RETURNS**  
**78"W x 78"D**

QTY	DESCRIPTION	MODEL	LIST PRICE	PRICE EXTENSION
1	<b>Single Pedestal Desk, Left - B/F</b> 66"W x 30"D x 29½"H	H10584L	\$985	\$985
1	<b>Return, Right - B/F</b> 42"W x 24"D x 29½"H	H10511R	\$776	\$776
1	<b>Stack-on Storage</b> 72"W x 14⅝"D x 37⅞"H	H10534	\$958	\$958
<b>TOTAL:</b>			<b>\$2,719</b>	

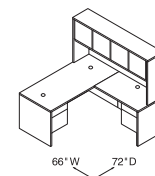

**DESK "L" WORKSTATION - RIGHT**  
**66"W x 72"D**



Icon Legend on page 21

# 10500 SERIES™ Typicals

Components used are listed on pages 310-352. Order components individually. Other configurations are possible, including various sizes of some components.

QTY	DESCRIPTION	MODEL	LIST PRICE	PRICE EXTENSION
1	<b>Single Pedestal Desk, Left - B/F</b> 72"W x 36"D x 29½"H	H10586L	\$1,120	\$1,120
1	<b>Bridge</b> 47"W x 24"D x 29½"H	H10570	\$344	\$344
1	<b>Single Pedestal Credenza, Right - B/F</b> 72"W x 24"D x 29½"H	H10545R	\$969	\$969
1	<b>Stack-on Storage</b> 72"W x 14⅝"D x 37⅞"H	H10534	\$958	\$958
<b>TOTAL:</b>			<b>\$3,391</b>	

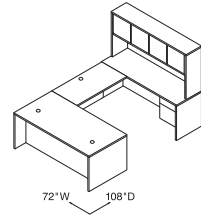

**DESK "U" WORKSTATION**  
**72"W x 108"D**

QTY	DESCRIPTION	MODEL	LIST PRICE	PRICE EXTENSION
1	<b>Peninsula with End Panel</b> 72"W x 36"D x 29½"H	H10521	\$831	\$831
1	<b>Bridge</b> 42"W x 24"D x 29½"H	H10560	\$331	\$331
1	<b>Extended Corner Unit, Left</b> 72"W x 24"-36"D x 29½"H	H105816L	\$1,018	\$1,018
1	<b>Mobile Pedestal - B/B/F</b> 15¾"W x 22¾"D x 28"H	H105102	\$809	\$809
1	<b>Stack-on Storage</b> 72"W x 14⅝"D x 37⅞"H	H10534	\$958	\$958
1	<b>Storage Cabinet/Lateral File</b> 36"W x 24"D x 66⅝"H	H105293	\$2,161	\$2,161
<b>TOTAL:</b>			<b>\$6,108</b>	

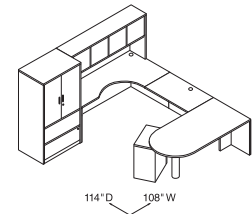

**PENINSULA "U" WORKSTATION - LEFT**  
**108"W x 114"D**

QTY	DESCRIPTION	MODEL	LIST PRICE	PRICE EXTENSION
1	<b>Single Pedestal Desk, Right - B/F</b> 72"W x 36"D x 29½"H	H10585R	\$1,120	\$1,120
1	<b>Return Shell</b> 36"W x 24"D x 29½"H	H105680	\$466	\$466
<b>TOTAL:</b>			<b>\$1,586</b>	

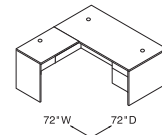

**DESK AND RETURN 6' X 6' WORKSTATION**  
**72"W x 72"D**

QTY	DESCRIPTION	MODEL	LIST PRICE	PRICE EXTENSION
1	<b>Rudder Peninsula with End Panel, Right</b> 72"W x 30/38"D x 29½"H	H105205R	\$1,055	\$1,055
1	<b>Return, Left - F/F</b> 42"W x 24"D x 29½"H	H105908L	\$892	\$892
1	<b>Stack-on Storage</b> 72"W x 14⅝"D x 37⅞"H	H10534	\$958	\$958
<b>TOTAL:</b>			<b>\$2,905</b>	

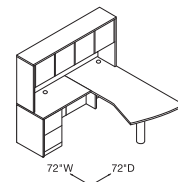

**PENINSULA "L" WORKSTATION**  
**72"W x 72"D**

# 10500 SERIES™

## Typicals



Icon Legend on page 21

Components used are listed on pages 310-352. Order components individually. Other configurations are possible, including various sizes of some components.

QTY	DESCRIPTION	MODEL	LIST PRICE	PRICE EXTENSION
1	<b>Return, Left - B/F</b> 42"W x 24"D x 29½"H	H10512L	\$776	\$776
1	<b>Corner Unit</b> 24" x 36" x 36" x 24" x 29½"H	H105811	\$732	\$732
1	<b>Return, Right - B/F</b> 42"W x 24"D x 29½"H	H10511R	\$776	\$776
1	<b>Stack-on Storage</b> 78"W x 14⅝"D x 37⅞"H	H105327	\$1,085	\$1,085
<b>TOTAL:</b>			<b>\$3,369</b>	

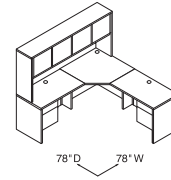

**CORNER UNIT AND RETURNS**  
78"W x 78"D

QTY	DESCRIPTION	MODEL	LIST PRICE	PRICE EXTENSION
1	<b>Single Full Pedestal Desk, Right - B/B/F</b> 72"W x 36"D x 29½"H	H105895R	\$1,291	\$1,291
1	<b>Bridge</b> 47"W x 24"D x 29½"H	H10570	\$344	\$344
1	<b>Single Full Pedestal Credenza, Left - F/F</b> 72"W x 24"D x 29½"H	H105904L	\$1,148	\$1,148
1	<b>Stack-on Storage</b> 72"W x 14⅝"D x 37⅞"H	H10534	\$958	\$958
<b>TOTAL:</b>			<b>\$3,741</b>	

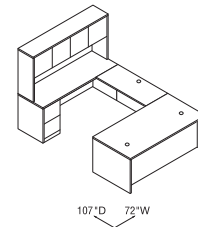

**"U" WORKSTATION WITH FULL PEDESTALS**  
72"W x 107"D

QTY	DESCRIPTION	MODEL	LIST PRICE	PRICE EXTENSION
1	<b>Double Full Pedestal Desk - 3/2</b> 72"W x 36"D x 29½"H	H105890	\$1,614	\$1,614
1	<b>Credenza with Kneespace - 2/0/2</b> 72"W x 24"D x 29½"H	H105900	\$1,415	\$1,415
1	<b>Stack-on Storage, Frosted Doors with Silver Frame</b> 72"W x 14⅝"D x 37⅞"H	H10534G	\$1,558	\$1,558
<b>TOTAL:</b>			<b>\$4,587</b>	

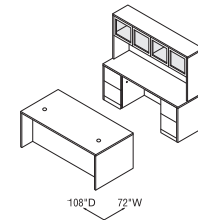

**DESK/CREDENZA/STACK-ON STORAGE WITH FROSTED DOORS**  
72"W x 108"D

QTY	DESCRIPTION	MODEL	LIST PRICE	PRICE EXTENSION
1	<b>Peninsula with End Panel</b> 72"W x 36"D x 29½"H	H10521	\$831	\$831
1	<b>Bridge</b> 47"W x 24"D x 29½"H	H10570	\$344	\$344
1	<b>Credenza with Lateral, Right</b> 72"W x 24"D x 29½"H	H10547R	\$1,328	\$1,328
1	<b>Stack-on Storage</b> 72"W x 14⅝"D x 37⅞"H	H10534	\$958	\$958
1	<b>Wardrobe/Storage Cabinet w/Doors</b> 36"W x 24"D x 66⅝"H	H10530	\$2,161	\$2,161
1	<b>Mobile Pedestal - B/B/F</b> 15¾"W x 22¾"D x 28"H	H105102	\$809	\$809
<b>TOTAL:</b>			<b>\$6,431</b>	

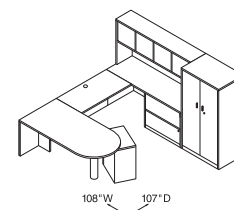

**DESK "U" WORKSTATION - RIGHT**  
108"W x 107"D



Icon Legend on page 21

# 10500 SERIES™ Bundles Typicals

Mahogany  
**H105LL7284N**

Harvest  
**H105LL7284C**

QTY	DESCRIPTION	MODEL	LIST PRICE	PRICE EXTENSION
1	Left Pedestal Desk	H10586L	\$1,120	\$1,120
1	Right Return	H10515R	\$793	\$793
<b>TOTAL:</b>			<b>\$1,913</b>	

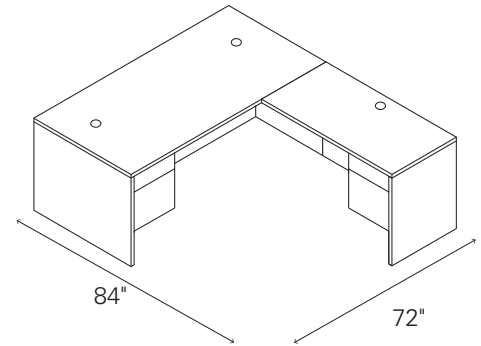

**L-STATION (LEFT DESK/RIGHT RETURN)**

Mahogany  
**H105LR7284N**

Harvest  
**H105LR7284C**

QTY	DESCRIPTION	MODEL	LIST PRICE	PRICE EXTENSION
1	Right Pedestal Desk	H10585R	\$1,120	\$1,120
1	Left Return	H10516L	\$793	\$793
<b>TOTAL:</b>			<b>\$1,913</b>	

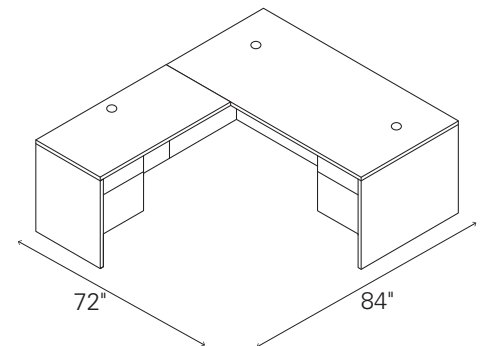

**L-STATION (RIGHT DESK/LEFT RETURN)**

Mahogany  
**H105LLH7284N**

Harvest  
**H105LLH7284C**

QTY	DESCRIPTION	MODEL	LIST PRICE	PRICE EXTENSION
1	Left Pedestal Desk	H10586L	\$1,120	\$1,120
1	Right Return	H10515R	\$793	\$793
1	Stack-on Storage	H105323	\$805	\$805
<b>TOTAL:</b>			<b>\$2,718</b>	

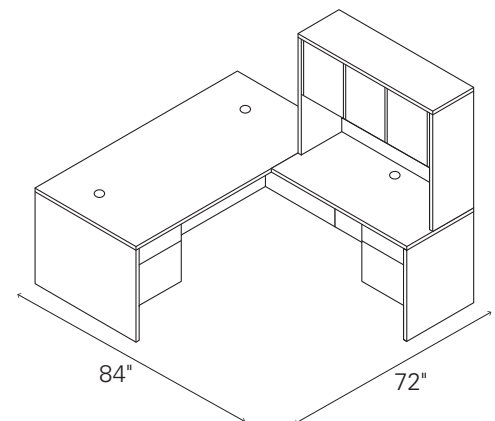

**L-STATION WITH STACK-ON STORAGE  
(LEFT DESK/RIGHT RETURN)**

# 10500 SERIES™

## Bundles Typicals



Icon Legend on page 21

Mahogany  
H105LRH7284N

Harvest  
H105LRH7284C

QTY	DESCRIPTION	MODEL	LIST PRICE	PRICE EXTENSION
1	Right Pedestal Desk	H10585R	\$1,120	\$1,120
1	Left Return	H10516L	\$793	\$793
1	Stack-on Storage	H105323	\$805	\$805
<b>TOTAL:</b>			<b>\$2,718</b>	

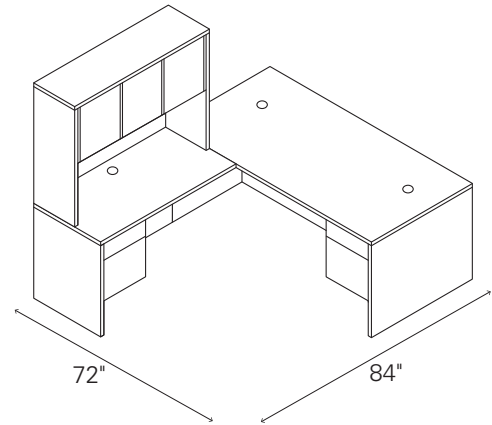

**L-STATION WITH STACK-ON STORAGE  
(RIGHT DESK/LEFT RETURN)**

Mahogany  
H105ULH72108N

Harvest  
H105ULH72108C

QTY	DESCRIPTION	MODEL	LIST PRICE	PRICE EXTENSION
1	Left Pedestal Desk	H10586L	\$1,120	\$1,120
1	Right Pedestal Credenza	H10545R	\$969	\$969
1	Bridge	H10570	\$344	\$344
1	Stack-on Storage	H10534	\$958	\$958
<b>TOTAL:</b>			<b>\$3,391</b>	

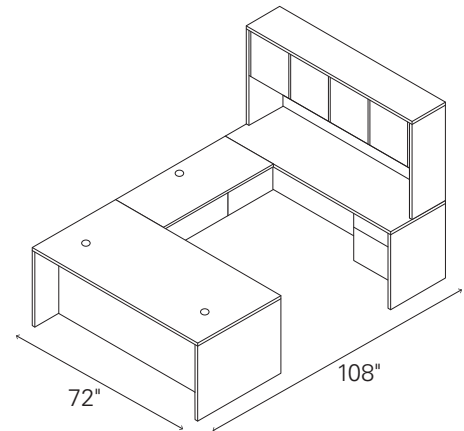

**U-STATION WITH STACK-ON STORAGE  
(LEFT DESK/RIGHT CREDENZA)**

Mahogany  
H105URH72108N

Harvest  
H105URH72108C

QTY	DESCRIPTION	MODEL	LIST PRICE	PRICE EXTENSION
1	Right Pedestal Desk	H10585R	\$1,120	\$1,120
1	Left Pedestal Credenza	H10546L	\$969	\$969
1	Bridge	H10570	\$344	\$344
1	Stack-on Storage	H10534	\$958	\$958
<b>TOTAL:</b>			<b>\$3,391</b>	

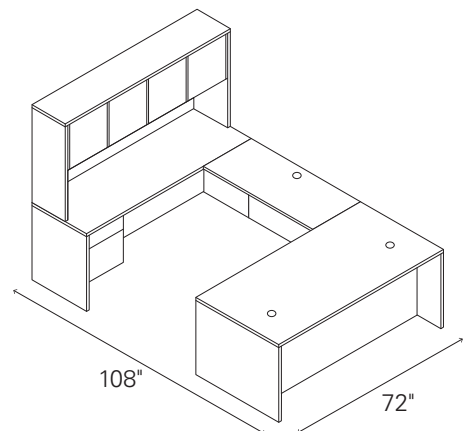

**U-STATION WITH STACK-ON STORAGE  
(RIGHT DESK/LEFT CREDENZA)**



Icon Legend on page 21

# 10500 SERIES™ Bundles Typicals

DESKS

Mahogany  
**H105DLH7298N**

Harvest  
**H105DLH7298C**

QTY	DESCRIPTION	MODEL	LIST PRICE	PRICE EXTENSION
1	Double Pedestal Desk	H10593	\$1,319	\$1,319
2	Bookcase Hutch	H105292	\$540	\$1,080
1	2-Drawer Lateral File	H10563	\$922	\$922
1	Storage Cabinet with Doors	H105291	\$740	\$740
<b>TOTAL:</b>			<b>\$4,061</b>	<b>\$4,061</b>

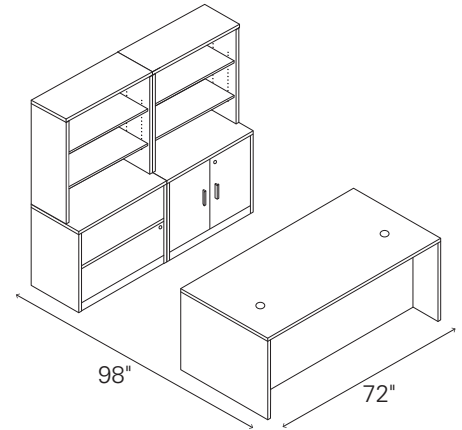

**STORAGE WORKSTATION**

Mahogany  
**H105DCH6098N**

Harvest  
**H105DCH6098C**

QTY	DESCRIPTION	MODEL	LIST PRICE	PRICE EXTENSION
1	Double Pedestal Desk	H10573	\$1,111	\$1,111
1	Double Pedestal Credenza	H10565	\$1,111	\$1,111
1	Stack-on Storage	H105324	\$894	\$894
<b>TOTAL:</b>			<b>\$3,116</b>	<b>\$3,116</b>

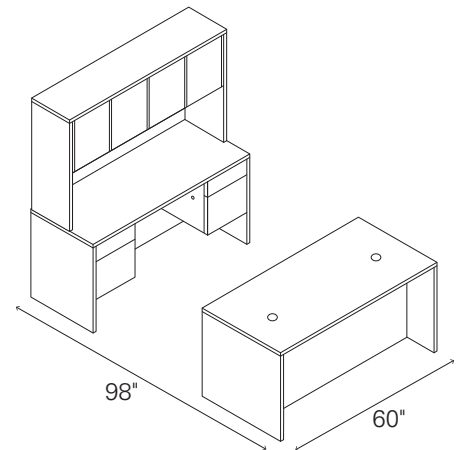

**DESK CREDENZA STACK-ON #1**

Mahogany  
**H105DCH7298N**

Harvest  
**H105DCH7298C**

QTY	DESCRIPTION	MODEL	LIST PRICE	PRICE EXTENSION
1	Double Pedestal Desk	H10593	\$1,319	\$1,319
1	Double Pedestal Credenza	H10543	\$1,176	\$1,176
1	Stack-on Storage	H10534	\$958	\$958
<b>TOTAL:</b>			<b>\$3,453</b>	<b>\$3,453</b>

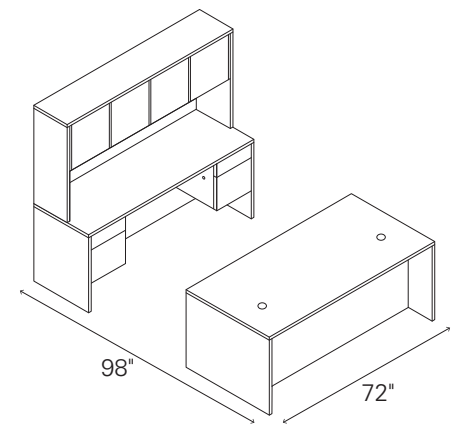

**DESK CREDENZA STACK-ON #2**



# 10500 SERIES™

## Laminate Modular Components

GSA SIN 711-8



Icon Legend on page 21

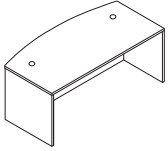

Model H10596 shown

DESCRIPTION	INSIDE DIMENSIONS	FULL WIDTH OVERHANG	MODEL	SHIP WEIGHT	CUBE	LIST PRICE BY LAMINATE GRADE	
						L1	L2
<b>Desk Shell (with full modesty panel and 2 grommets)</b>							
72"W x 36"D x 29½"H, Bow Top (end panels 30"D)	69½"W x 24⅝"D	10½"	<b>H10596</b>	192	6.9	<b>\$848</b>	<b>\$898</b>
72"W x 36"D x 29½"H, Rectangle Top	69½"W x 24⅝"D	10½"	<b>H10594</b>	209	6.9	<b>\$765</b>	<b>\$815</b>
72"W x 30"D x 29½"H, Rectangle Top	69½"W x 24⅝"D	4½"	<b>H10592</b>	182	5.8	<b>\$725</b>	<b>\$765</b>
66"W x 30"D x 29½"H, Rectangle Top	63½"W x 24⅝"D	4½"	<b>H10579</b>	172	5.4	<b>\$687</b>	<b>\$727</b>
60"W x 30"D x 29½"H, Rectangle Top	57½"W x 24⅝"D	4½"	<b>H10578</b>	161	5.0	<b>\$638</b>	<b>\$678</b>
48"W x 30"D x 29½"H, Rectangle Top (1 grommet)	45½"W x 24⅝"D	4½"	<b>H10598</b>	141	5.0	<b>\$593</b>	<b>\$623</b>
NOTES: See page 352 for optional center drawers.							
<b>Desk Shell (with 10"H modesty panel and 2 grommets)</b>							
72"W x 36"D x 29½"H, Bow Top (end panels 30"D)	69½"W x 24⅝"D	10½"	<b>H10596X</b>	155	6.1	<b>\$848</b>	<b>\$898</b>
72"W x 36"D x 29½"H, Rectangle Top	69½"W x 24⅝"D	10½"	<b>H10594X</b>	153	6.1	<b>\$765</b>	<b>\$815</b>
72"W x 30"D x 29½"H, Rectangle Top	69½"W x 24⅝"D	4½"	<b>H10592X</b>	143	5.1	<b>\$725</b>	<b>\$765</b>
66"W x 30"D x 29½"H, Rectangle Top	63½"W x 24⅝"D	4½"	<b>H10579X</b>	134	4.7	<b>\$687</b>	<b>\$727</b>
60"W x 30"D x 29½"H, Rectangle Top	57½"W x 24⅝"D	4½"	<b>H10578X</b>	125	4.4	<b>\$638</b>	<b>\$678</b>
48"W x 30"D x 29½"H, Rectangle Top (1 grommet)	45½"W x 24⅝"D	4½"	<b>H10598X</b>	115	4.4	<b>\$593</b>	<b>\$623</b>
NOTES: Makes reaching wall electrical outlets quick and easy. Provides more than 18" of clearance. See pages 334-335 for optional stack-on storage and page 352 for optional center drawers.							

**NOTES:**

- Non-handed desk, credenza, and return shells, combined with a variety of under-the-worksurface storage solutions, maximize office layout flexibility. Products can be reconfigured quickly and easily when user preferences or space needs change.
- For under-surface storage options, see pages 323-325.
- For additional components see pages 330-352.
- Tops and end panels are abrasion- and stain-resistant laminate over durable 1⅝" solid core high-performance particleboard; resists warping.
- Cord management grommets, for routing and hiding wires and cables, are located in the tops of desks and return shells.
- 3" round worksurface grommet can be replaced with optional Power Hub (model HGRMTAC) or Power/USB Hub (model HGRMTUSB2) to bring the ease of plug-and-play to the desktop. See page 351.
- Adjustable hex leveling glides allow floor-standing furniture to be easily leveled without lifting the unit; glides have ¾" adjustable range.
- For standing, 42"H shells, see page 313.

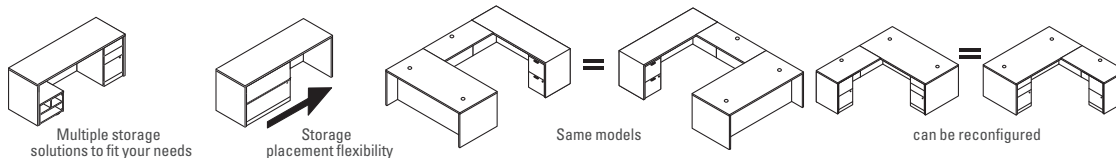
**HOW TO SPECIFY**
**Select  
Model Number**

H 1 0 5 9 6 .

**Select  
Laminate Top and Chassis Color**

See pages 302-303

N N



# 10500 SERIES™ Laminate Modular Components

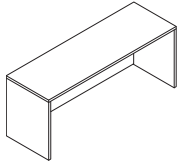

DESCRIPTION	INSIDE DIMENSIONS	MODEL	SHIP WEIGHT	CUBE	LIST PRICE BY LAMINATE GRADE	
					L1	L2
<b>Credenza Shell (with full modesty panel)</b>						
72"W x 24"D x 29½"H	69½"W x 22¾"D	<b>H10541</b>	153	5.6	<b>\$659</b>	<b>\$699</b>
66"W x 24"D x 29½"H	63½"W x 22¾"D	<b>H10542</b>	144	5.1	<b>\$645</b>	<b>\$685</b>
60"W x 24"D x 29½"H	57½"W x 22¾"D	<b>H10564</b>	135	4.7	<b>\$603</b>	<b>\$638</b>
48"W x 24"D x 29½"H	45½"W x 22¾"D	<b>H105692</b>	124	3.9	<b>\$578</b>	<b>\$608</b>
42¼"W x 24"D x 29½"H	39¾"W x 22¾"D	<b>H105691</b>	110	3.8	<b>\$558</b>	<b>\$588</b>
72"W x 20"D x 29½"H	69½"W x 18¾"D	<b>H105581</b>	138	5.6	<b>\$623</b>	<b>\$658</b>
66"W x 20"D x 29½"H	63½"W x 18¾"D	<b>H105582</b>	130	5.1	<b>\$607</b>	<b>\$642</b>
60"W x 20"D x 29½"H	57½"W x 18¾"D	<b>H105583</b>	122	4.7	<b>\$576</b>	<b>\$606</b>

NOTES: Cord pass-through in top center of modesty panel. See pages 334-335 for optional stack-on storage.

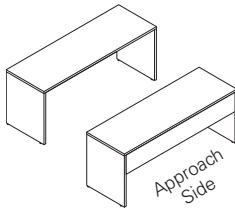

DESCRIPTION	INSIDE DIMENSIONS	MODEL	SHIP WEIGHT	CUBE	LIST PRICE BY LAMINATE GRADE	
					L1	L2
<b>Credenza Shell (with 10" H modesty panel)</b>						
72"W x 24"D x 29½"H	69½"W x 22¾"D	<b>H10541X</b>	114	4.8	<b>\$659</b>	<b>\$699</b>
66"W x 24"D x 29½"H	63½"W x 22¾"D	<b>H10542X</b>	107	4.4	<b>\$645</b>	<b>\$685</b>
60"W x 24"D x 29½"H	57½"W x 22¾"D	<b>H10564X</b>	105	4.0	<b>\$603</b>	<b>\$638</b>
48"W x 24"D x 29½"H	45½"W x 22¾"D	<b>H105692X</b>	95	3.8	<b>\$578</b>	<b>\$608</b>
42¼"W x 24"D x 29½"H	39¾"W x 22¾"D	<b>H105691X</b>	87	3.8	<b>\$558</b>	<b>\$588</b>
72"W x 20"D x 29½"H	69½"W x 18¾"D	<b>H105581X</b>	107	4.8	<b>\$623</b>	<b>\$658</b>
66"W x 20"D x 29½"H	63½"W x 18¾"D	<b>H105582X</b>	101	4.4	<b>\$607</b>	<b>\$642</b>
60"W x 20"D x 29½"H	57½"W x 18¾"D	<b>H105583X</b>	96	4.0	<b>\$576</b>	<b>\$606</b>

NOTES: Makes reaching wall electrical outlets quick and easy. Provides more than 18" of clearance. See pages 334-335 for optional stack-on storage.



Not available in two-tone laminate

DESCRIPTION	MODEL	SHIP WEIGHT	CUBE	L1	L2
				LIST PRICE	UPCHARGE
<b>Kneespace Clearance End Panel Kits (field installable)</b>					
1½"W x 11¼"D x 28½"H	<b>H105098</b>	13	0.9	<b>\$198</b>	<b>\$10</b>
For use at either end of 10500, 10700 or Valido Series® 24"D Credenza Shells (with full or 10" modesty panel) or non-pedestal end of single pedestal credenzas or credenzas with lateral files.					
1½"W x 17¼"D x 28½"H	<b>H105099</b>	11	0.8	<b>\$207</b>	<b>\$10</b>
For use at either end of 10500, 10700 or Valido Series® 30"D Desk Shells or non-pedestal end of 30"D single pedestal desks.					
Kits include: (1) support panel; European fastening hardware; flat connector bracket; joint connector bolts with sleeve nuts (for ganging credenza to adjacent worksurface); and adjustable leveling glides. Allows conversion of units currently in the field.					
NOTES: Can be used to connect up to three 24"D credenzas or 30"D desks in line (requires 4 kits).					
⚠ Not designed to be used freestanding. Not designed to be used with returns, 36"D desks or desk shells.					
<b>SPECIFYING EXAMPLE: H105098.N</b>					

## NOTES:

- Non-handed desk, credenza, and return shells, combined with a variety of under-the-worksurface storage solutions, maximize office layout flexibility. Products can be reconfigured quickly and easily when user preferences or space needs change.
- For 78", 84", 90", and 96"W credenza shells, see page 312.
- For under-surface storage options, see pages 323-325.
- Tops and end panels are abrasion- and stain-resistant laminate over durable 1/8" solid core high-performance particleboard; resists warping.
- For additional components see pages 330-352.
- For work-in-process paper management tools, see pages 346-347.
- Cord management grommets, for routing and hiding wires and cables, are located in the tops of desks and return shells.
- Credenza shells have a cord pass-through grommet in the top center of the modesty panel.
- Kneespace Clearance End Panel Kit model H105098, can be used to create "L" configurations with leg clearance, by connecting credenzas to single pedestal desks or credenzas, desk or credenza shells, corners, extended corners or peninsulas.
- Adjustable hex leveling glides allow floor-standing furniture to be easily leveled without lifting the unit; glides have 3/4" adjustable range.

## HOW TO SPECIFY

<b>Select Model Number</b> <input type="text" value="H10541"/>	<b>Select Laminate Top and Chassis Color</b> See pages 302-303 <input type="text" value="NN"/>
---	--

# 10500 SERIES™

## Laminate Modular Components

GSA SIN 711-8



Icon Legend on page 21

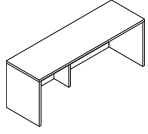

DESCRIPTION	INSIDE DIMENSIONS	MODEL	SHIP WEIGHT	CUBE	LIST PRICE BY LAMINATE GRADE	
					L1	L2
<b>Credenza Shell (with full modesty panel)</b>						
96"W x 24"D x 29½"H	93½"	<b>H105413</b>	215	7.0	<b>\$940</b>	<b>\$995</b>
90"W x 24"D x 29½"H	87½"	<b>H105412</b>	202	6.6	<b>\$914</b>	<b>\$964</b>
84"W x 24"D x 29½"H	81½"	<b>H105411</b>	189	6.2	<b>\$810</b>	<b>\$860</b>
78"W x 24"D x 29½"H	75½"	<b>H105410</b>	176	5.8	<b>\$788</b>	<b>\$833</b>

NOTES: Larger sizes can be used in conjunction with a 10500 Series rectangle- or bullet-shaped worksurface, supported by an end panel, column or leg, to achieve a space efficient work wall configuration. Shells wider than 72" include an internal, 10½"D vertical support leg. The internal leg can be removed if it is replaced with a 10500 Series 28"H modular pedestal that is adjusted to support the credenza shell top. Cord pass-through in top center of modesty panel. See pages 334-335 for optional stack-on storage and the stack-on storage end panel kit (model H105349).

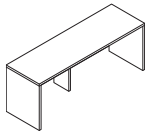

<b>Credenza Shell (with 10"H modesty panel)</b>						
96"W x 24"D x 29½"H	93½"	<b>H105413X</b>	163	6.1	<b>\$940</b>	<b>\$995</b>
90"W x 24"D x 29½"H	87½"	<b>H105412X</b>	152	5.7	<b>\$914</b>	<b>\$964</b>
84"W x 24"D x 29½"H	81½"	<b>H105411X</b>	141	5.4	<b>\$810</b>	<b>\$860</b>
78"W x 24"D x 29½"H	75½"	<b>H105410X</b>	130	5.0	<b>\$788</b>	<b>\$833</b>

NOTES: Makes reaching wall electrical outlets quick and easy. Provides more than 18" of clearance. Larger sizes can be used in conjunction with a 10500 Series rectangle- or bullet-shaped worksurface, supported by an end panel, column or leg, to achieve a space efficient work wall configuration. Shells wider than 72" include an internal, 10½"D vertical support leg. The internal leg can be removed if it is replaced with a 10500 Series 28"H modular pedestal that is adjusted to support the credenza shell top. See pages 334-335 for optional stack-on storage and the stack-on storage end panel kit (model H105349).

**NOTES:**

- Non-handed desk, credenza, and return shells, combined with a variety of under-the-worksurface storage solutions, maximize office layout flexibility. Products can be reconfigured quickly and easily when user preferences or space needs change.
- For under-surface storage options, see pages 323-325.
- For additional components see pages 330-352.
- Tops and end panels are abrasion- and stain-resistant laminate over durable 1½" solid core high-performance particleboard; resists warping.
- Credenza shells have a cord pass-through grommet in the top center of the modesty panel.
- Kneespace Clearance End Panel Kit model H105098, can be used to create "L" configurations with leg clearance, by connecting credenzas to single pedestal desks or credenzas, desk or credenza shells, corners, extended corners or peninsulas.
- Adjustable hex leveling glides allow floor-standing furniture to be easily leveled without lifting the unit; glides have ¾" adjustable range.

**HOW TO SPECIFY**
**Select Model Number**

H 1 0 5 4 1 3 .

**Select Laminate Top and Chassis Color**

See pages 302-303

N N



Icon Legend on page 21

# 10500 SERIES™

## Laminate Modular Components

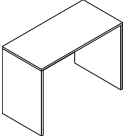
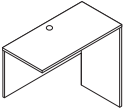
	DESCRIPTION	INSIDE DIMENSIONS	MODEL	SHIP WEIGHT	CUBE	LIST PRICE BY LAMINATE GRADE	
						L1	L2
	<b>Standing-Height Desk Shell</b>						
	60"W x 30"D x 42"H	57½"W x 24½"D x 41⅝"H	<b>H105397</b>	185	6.2	<b>\$793</b>	<b>\$833</b>
	60"W x 24"D x 42"H	57½"W x 22¾"D x 41⅝"H	<b>H105393</b>	154	5.1	<b>\$731</b>	<b>\$771</b>
	48"W x 24"D x 42"H	45⅞"W x 22¾"D x 41⅝"H	<b>H105392</b>	143	4.2	<b>\$684</b>	<b>\$719</b>
	NOTES: Fixed height surface is 42"H. When combined with a stool-height task chair, provides users the benefit of alternating their work between a seated or standing position without the additional cost of an adjustable-height mechanism. Short, 22⅝" modesty panel provides over 18" of wall access; makes reaching wall electrical outlets quick and easy. Box/File Pedestal (H10501) attaches to the underside of the worksurface top to position supplies and files within easy reach.						
	<b>Standing-Height Return Shell</b>						
	48"W x 24"D x 42"H	47"W x 22¾"D x 41⅝"H	<b>H105663</b>	96	3.1	<b>\$574</b>	<b>\$609</b>
	NOTES: Non-handed design. Attaches to sit/stand desk shells to form an L-shaped workstation. Short, 22⅝" modesty panel makes reaching wall electrical outlets quick and easy. One cord management grommet in top for routing and hiding wires and cables. Grommet can be replaced with optional Power Hub (model HGRMTAC). Box/File Pedestal (H10501) attaches to the underside of the worksurface top to position supplies and files within easy reach.						

**NOTES:**

- 42"H shells help support a healthy work style by allowing users to switch between sitting and standing.
- Non-handed desk and return shells maximize office layout flexibility. Products can be reconfigured quickly and easily when user preferences or space needs change.
- Tops and end panels are abrasion- and stain-resistant laminate over durable 1⅝" solid core high-performance particleboard; resists warping.
- For additional components see pages 330-352.
- Mobile pedestals, shown on page 341, work well in a variety of applications and configurations.
- Adjustable hex leveling glides allow floor-standing furniture to be easily leveled without lifting the unit; glides have ¾" adjustable range.

**HOW TO SPECIFY**

<b>Select Model Number</b> H 1 0 5 3 9 7 .	<b>Select Laminate Top and Chassis Color</b> See pages 302-303 N N
---	--

# 10500 SERIES™

## Laminate Modular Components

GSA SIN 711-8



Icon Legend on page 21

Model H105686  
shown

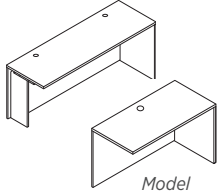

Model  
H105686  
shown

DESCRIPTION	INSIDE DIMENSIONS	MODEL	SHIP WEIGHT	CUBE	LIST PRICE BY LAMINATE GRADE	
					L1	L2
<b>Return Shell (with full modesty panel)</b>						
72"W x 24"D x 29½"H, (w/support; 2 grommets)	67"W x 22¾"D	<b>H105686</b>	145	5.4	<b>\$659</b>	<b>\$699</b>
60"W x 24"D x 29½"H, (w/support; 2 grommets)	55"W x 22¾"D	<b>H105684</b>	129	4.4	<b>\$603</b>	<b>\$638</b>
48"W x 24"D x 29½"H, (1 grommet)	47"W x 22¾"D	<b>H10561</b>	86	3.7	<b>\$496</b>	<b>\$526</b>
42"W x 24"D x 29½"H, (1 grommet)	41"W x 22¾"D	<b>H105681</b>	89	2.5	<b>\$466</b>	<b>\$496</b>
36"W x 24"D x 29½"H, (1 grommet)	34⅞"W x 22¾"D	<b>H105680</b>	83	3.2	<b>\$466</b>	<b>\$491</b>
30"W x 24"D x 29½"H, (1 grommet)	28⅞"W x 22¾"D	<b>H10568</b>	69	2.6	<b>\$445</b>	<b>\$470</b>

NOTES: Shells are non-handed. No pre-drilled grommet in modesty panel (field installable grommet included). Wood-grain direction on modesty/back panel runs vertical on 30"W-60"W sizes and horizontal on 72"W unit. 36"W return shell can be used to achieve a 6' x 6' L-shaped footprint when connected to either a 72"W x 36"D single pedestal desk, desk shell, or peninsula, or when two are connected to 36"W corner unit model H105811. 30"W return shell can be used to accomplish a 5' x 5' L-shaped footprint when connected to a 60"W x 30"D desk shell or peninsula. See pages 334-335 for optional stack-on storage.

ⓘ Not designed to attach to corner units manufactured prior to 5/24/99.

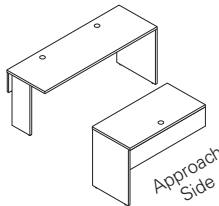

Approach  
Side

<b>Return Shell (with 10"H modesty panel)</b>						
72"W x 24"D x 29½"H, (w/support; 2 grommets)	67"W x 22¾"D	<b>H105686X</b>	106	4.6	<b>\$659</b>	<b>\$699</b>
60"W x 24"D x 29½"H, (w/support; 2 grommets)	55"W x 22¾"D	<b>H105684X</b>	93	3.9	<b>\$603</b>	<b>\$638</b>
48"W x 24"D x 29½"H, (1 grommet)	47"W x 22¾"D	<b>H10561X</b>	78	3.1	<b>\$496</b>	<b>\$526</b>
42"W x 24"D x 29½"H, (1 grommet)	41"W x 22¾"D	<b>H105681X</b>	69	3.8	<b>\$466</b>	<b>\$496</b>
36"W x 24"D x 29½"H, (1 grommet)	34⅞"W x 22¾"D	<b>H105680X</b>	67	3.8	<b>\$466</b>	<b>\$491</b>
30"W x 24"D x 29½"H, (1 grommet)	28⅞"W x 22¾"D	<b>H10568X</b>	56	2.6	<b>\$445</b>	<b>\$470</b>

NOTES: Makes reaching wall electrical outlets quick and easy. Provides more than 18" of clearance. See pages 334-335 for optional stack-on storage.

### NOTES:

- Non-handed desk, credenza, and return shells, combined with a variety of under-the-worksurface storage solutions, maximize office layout flexibility. Products can be reconfigured quickly and easily when user preferences or space needs change.
- For additional components see pages 330-352.
- Tops and end panels are abrasion- and stain-resistant laminate over durable 1⅞" solid core high-performance particleboard; resists warping.
- Cord management grommets, for routing and hiding wires and cables, are located in the tops of desks and return shells.
- Adjustable hex leveling glides allow floor-standing furniture to be easily leveled without lifting the unit; glides have ¾" adjustable range.
- 36"W and 30"W return shells enable L-shaped layouts for smaller spaces.
- One cord management grommet in tops of Return Shell models, H10568 and H10568X, is used for routing and hiding wires and cables. The 3" round grommet can be replaced with optional Power Hub or Power/USB Hub — see page 351.

### HOW TO SPECIFY

Select  
Model Number

H 1 0 5 6 8 6 .

Select  
Laminate Top and Chassis Color

See pages 302-303

N N



# 10500 SERIES™ Worksurfaces

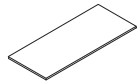

SIN 711-8

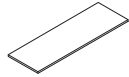

SIN 711-8



SIN 711-8

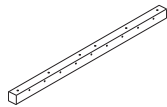

SIN 711-2

DESCRIPTION	MODEL	SHIP WEIGHT	CUBE	LIST PRICE BY LAMINATE GRADE	
				L1	L2
<b>Rectangle Worksurface</b>					
72"W x 30"D	H105R3072	83	6.1	\$381	\$401
66"W x 30"D	H105R3066	76	6.1	\$353	\$373
60"W x 30"D	H105R3060	69	5.2	\$330	\$350
48"W x 30"D	H105R3048	55	4.1	\$270	\$285
72"W x 24"D	H105R2472	66	4.9	\$323	\$343
66"W x 24"D	H105R2466	61	4.9	\$313	\$333
60"W x 24"D	H105R2460	55	4.2	\$294	\$314
48"W x 24"D	H105R2448	44	3.4	\$249	\$264
42"W x 24"D	H105R2442	39	3.0	\$226	\$241

NOTES: Underside of rectangle worksurfaces includes pilot mounting holes for end panels, support columns, post and O-legs, and height adjustable base. Applications for 24"D worksurfaces include desks, credenzas, returns, and bridges. For above privacy screen sizes, see page 270.

DESCRIPTION	MODEL	SHIP WEIGHT	CUBE	L1	L2
<b>Bullet Worksurface</b>					
72"W x 30"D	H105B3072	79	6.1	\$394	\$414
66"W x 30"D	H105B3066	73	6.1	\$373	\$393
60"W x 30"D	H105B3060	66	5.2	\$355	\$375

NOTES: Underside includes pilot mounting holes for T-shaped end panels and support columns.

! When specifying 60"W Floating Modesty Panel, it is not necessary to specify an external channel.

DESCRIPTION	MODEL	SHIP WEIGHT	CUBE	LIST PRICE
<b>External Support Channel</b>				
60"W	HLSLZ5SC72	7	0.5	\$100
54"W	HLSLZ5SC66	7	0.5	\$93
48"W	HLSLZ5SC60	6	0.5	\$90
42"W	HLSLZ5SC54	5	0.5	\$85

NOTES: Steel channel can be attached to the underside of worksurfaces that are subjected to heavier loads. Channel is recommended for unsupported spans of 54"W or greater or per user preference. When using an external support channel under the worksurface, the depth clearance for center drawers and keyboard platforms decreases by 8". See chart below for support channel compatibility information.

! Specify: Model.P (black only)

! When specifying a 54"W or 60"W Floating Modesty Panel, it is not necessary to specify an external channel.

**NOTES:**

- Easy-care, scratch-, spill- and stain-resistant laminate over 1/8" solid core high-performance particleboard.
- Grain direction on all worksurfaces runs horizontal.
- Versatile component tops combine with under-surface support options to form freestanding desks or credenzas, U- or L-shaped configurations, or work wall layouts with an island extension.
- One flat bracket ships with each worksurface for applications requiring connection to an adjoining worksurface.
- For end panels, legs, columns and bases, see the Worksurface Supports listing on pages 316-317.
- When using a floating modesty panel or an external channel under the worksurface, the depth clearance for keyboard trays and center drawers decreases by 8". See accessory matrix in accessory section of the pricer.

! Worksurfaces are subject to slight bowing. The magnitude of the deflection is dependent upon the weight, placement, and duration of the load.

! When using a worksurface as a bridge, no additional supports are needed. One support is required for returns, two supports are required for desks and credenzas.

! External channel support is recommended for extended unsupported spans or heavily loaded worksurfaces. See above and below for details.

EXTERNAL SUPPORT CHANNEL (recommended use)				
Support Combination		Rectangle Worksurface Width		
Support 1	Support 2	72 in	66 in	60 in
O-Leg	O-Leg	HLSLZ5SC72	HLSLZ5SC66	HLSLZ5SC60
O-Leg	L-Shaped End Panel	HLSLZ5SC60	HLSLZ5SC54	HLSLZ5SC48
O-Leg	4 1/2" Diameter Support Column	NA	NA	NA
O-Leg	2" Square Post Leg	NA	NA	NA
L-Shaped End Panel	L-Shaped End Panel	NA	NA	NA
L-Shaped End Panel	4 1/2" Diameter Support Column	NA	NA	NA
L-Shaped End Panel	2" Square Post Leg	NA	NA	NA
T-Shaped End Panel	O-Leg	HLSLZ5SC60	HLSLZ5SC54	HLSLZ5SC48
T-Shaped End Panel	L-Shaped End Panel	NA	NA	NA
T-Shaped End Panel	4 1/2" Diameter Support Column	NA	NA	NA
T-Shaped End Panel	2" Square Post Leg	NA	NA	NA

**HOW TO SPECIFY**

<p><b>Select Model Number</b></p> <p>H 1 0 5 R 3 0 7 2</p>	<p><b>Select Worksurface Laminate and Edge Color</b></p> <p>See pages 302-303</p> <p>N N</p>
--	--

# 10500 SERIES™

## Worksurface Supports

GSA SIN 711-8



Icon Legend on page 21

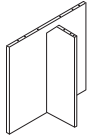

Not available in  
two-tone laminate

**DESCRIPTION****T-shaped End Panel**11<sup>3</sup>/<sub>8</sub>"W x 29<sup>7</sup>/<sub>8</sub>"D x 28<sup>1</sup>/<sub>2</sub>"H11<sup>3</sup>/<sub>8</sub>"W x 23<sup>7</sup>/<sub>8</sub>"D x 28<sup>1</sup>/<sub>2</sub>"H**MODEL****H10530TEP****H10524TEP****SHIP WEIGHT**

45

38

**CUBE**

3.7

3.2

**LIST PRICE BY LAMINATE GRADE****L1****\$250****\$235****L2****\$262****\$247**

NOTES: Non-handed. For use with 30"D and 24"D 10500 Series worksurfaces. Two 1<sup>1</sup>/<sub>8</sub>" thick pieces; one end and one brace panel. Cord routing notch in brace panel. Simple assembly.

ⓘ Not designed to be used freestanding.

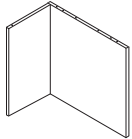

Not available in  
two-tone laminate

**L-shaped End Panel**15<sup>3</sup>/<sub>4</sub>"W x 29<sup>7</sup>/<sub>8</sub>"D x 28<sup>1</sup>/<sub>2</sub>"H15<sup>3</sup>/<sub>4</sub>"W x 23<sup>7</sup>/<sub>8</sub>"D x 28<sup>1</sup>/<sub>2</sub>"H**H10530LEP****H10524LEP**

49

43

4.1

3.7

**\$272****\$254****\$284****\$266**

NOTES: Non-handed. 29<sup>7</sup>/<sub>8</sub>"D for use with 30"D worksurfaces; 23<sup>7</sup>/<sub>8</sub>"D for use with 24"D worksurfaces. Design facilitates easy, open access to wall electrical outlets. Two pieces; 1<sup>1</sup>/<sub>8</sub>" end panel and 3<sup>1</sup>/<sub>4</sub>" back panel. 10500 Series modular and mobile pedestals fit flush to the end panel. Simple assembly.

ⓘ Not designed to be used freestanding.

**NOTES:**

- Adjustable hex leveling glides allow floor-standing furniture to be easily leveled without lifting the unit; glides have 3/4" adjustable range.

ⓘ Support column must be specified for worksurfaces used as peninsulas or as an island extension.

ⓘ Laminate L- and T-shaped end panels can be specified as one color only; not available in two-tone laminate combination or in a pattern laminate.

30"D Rectangle Worksurface Support Options				
Product Application	Support Combination		Support Model Numbers for 72"W, 66"W, or 60"W Worksurfaces	Support Model Numbers for 48"W or 42"W Worksurfaces
	Support 1	Support 2		
Desk or Credenza	O-Leg	O-Leg	HLSL30280 (2)	HLSL30280 (2)
	O-Leg	L-Shaped End Panel	HLSL30280 / HH10530LEP	HLSL30280 / H10530LEP
	L-Shaped End Panel	L-Shaped End Panel	H10530LEP (2)	H10530LEP (2)
	T-Shaped End Panel	O-Leg	H10530TEP / HLSL30280	H10530TEP / HLSL30280
	T-Shaped End Panel	L-Shaped End Panel	H10530TEP / H10530LEP	H10530TEP / H10530LEP
Peninsula for U- or L-Configuration; Not Freestanding	O-Leg	4 <sup>1</sup> / <sub>2</sub> " Diameter Support Column	HLSL30280 / HPC190X-191X	NA
	O-Leg	2" Square Post Leg	HLSL30280 / HLSL28P	NA
	L-Shaped End Panel	4 <sup>1</sup> / <sub>2</sub> " Diameter Support Column	H10530LEP / HPC190X-191X	NA
	L-Shaped End Panel	2" Square Post Leg	H10530LEP / HLSL28P	NA
	T-Shaped End Panel	4 <sup>1</sup> / <sub>2</sub> " Diameter Support Column	H10530TEP / HPC190X-191X	NA
	T-Shaped End Panel	2" Square Post Leg	H10530TEP / HLSL28P	NA
Desk, Credenza, or Freestanding Return or Bridge	Adjustable Height Base - Electric		HHAB3S2L	HHAB3S2L (48"W min.)
Return (requires one support)	O-Leg	—	HLSL30280	HLSL30280
	L-Shaped End Panel	—	H10530LEP	H10530LEP
Island Extension (requires one support)	O-Leg	—	HLSL30280	HLSL30280
	4 <sup>1</sup> / <sub>2</sub> " Diameter Support Column	—	HPC190X or HPC191X	HPC190X or HPC191X
	2" Square Post Leg	—	HLSL28P	HLSL28P

**HOW TO SPECIFY**

<b>Select Model Number</b>	<b>Select Laminate</b>
H 1 0 5 3 0 T E P	See pages 302-303
N	



# 10500 SERIES™ Worksurface Supports

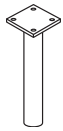

SIN 711-8

**DESCRIPTION**

**Support Column for 10500 Series Rectangle and Bullet Worksurfaces**  
 4½" Diameter  
 For **Black**, specify HPC190X.P.  
 For **Silver**, specify HPC191X.X.

MODEL	SHIP WEIGHT	CUBE	LIST PRICE
HPC190X	12 Ⓞ	1.0	\$148
HPC191X	12 Ⓞ	1.0	\$148

NOTES: Can only be used as the outbound support in a peninsula or island extension worksurface application. Glides have ¾" adjustable range.

! Support column must be specified for worksurfaces used as peninsulas or as an island extension.



SIN 711-2

**DESCRIPTION**

**Post Leg Base**  
 28½"H x 2" square

MODEL	SHIP WEIGHT	CUBE	LIST PRICE BY PAINT GRADE	
			CORE	METALLICS
HLSL28P	15	1.0	\$267	\$271

NOTES: Can only be used as the outbound support in a peninsula or island extension worksurface application. Glides have 2" of adjustability. Ship 1/pack.

! Post leg can only be used to support peninsula, not as primary supports for a top.

**SPECIFYING EXAMPLE: HLSL28P.T1**

24"D Rectangle Worksurface Support Options				
Product Application	Support Combination		Support Model Numbers for 72"W, 66"W, or 60"W Worksurfaces	Support Model Numbers for 48"W or 42"W Worksurfaces
	Support 1	Support 2		
Desk or Credenza	O-Leg	O-Leg	HLSL24280 (2)	HLSL24280 (2)
	O-Leg	L-Shaped End Panel	HLSL24280 / H10524LEP	HLSL24280 / H10524LEP
	L-Shaped End Panel	L-Shaped End Panel	H10524LEP (2)	H10524LEP (2)
	T-Shaped End Panel	O-Leg	H10524TEP / HLSL24280	H10524TEP / HLSL24280
	T-Shaped End Panel	L-Shaped End Panel	H10524TEP / H10524LEP	H10524TEP / H10524LEP
Peninsula for U- or L-Configuration; Not Freestanding	O-Leg	4½" Diameter Support Column	HLSL24280 / HPC190X-191X	NA
	O-Leg	2" Square Post Leg	HLSL24280 / HLSL28P	NA
	L-Shaped End Panel	4½" Diameter Support Column	H10524LEP / HPC190X-191X	NA
	L-Shaped End Panel	2" Square Post Leg	H10524LEP / HLSL28P	NA
	T-Shaped End Panel	4½" Diameter Support Column	H10524TEP / HPC190X-191X	NA
Desk, Credenza, or Freestanding Return or Bridge	Adjustable Height Base - Electric		HHAB3S2L	HHAB3S2L (48"W min.)
Return (requires one support)	O-Leg	—	HLSL24280	HLSL24280
	L-Shaped End Panel	—	H10524LEP	H10524LEP
	T-Shaped End Panel	—	H10524TEP	H10524TEP
	4½" Diameter Support Column	—	HPC190X or HPC191X	HPC190X or HPC191X
	2" Square Post Leg	—	HLSL28P	HLSL28P
Island Extension (requires one support)	O-Leg	—	HLSL24280	HLSL24280
	4½" Diameter Support Column	—	HPC190X or HPC191X	HPC190X or HPC191X
	2" Square Post Leg	—	HLSL28P	HLSL28P

72"W, 66"W, or 60"W x 30"D Bullet Worksurface Support Options			
Product Application	Support Combination		Support Model Numbers
	Support 1	Support 2	
Peninsula for U- or L-Configuration; Not Freestanding	O-Leg	4½" Diameter Support Column	HLSL30280 / HPC190X or HPC191X
	O-Leg	2" Square Post Leg	HLSL30280 / HLSL28P
	L-Shaped End Panel	4½" Diameter Support Column	H10524LEP / HPC190X or HPC191X
	L-Shaped End Panel	2" Square Post Leg	H10524LEP / HLSL28P
	T-Shaped End Panel	4½" Diameter Support Column	H10524TEP / HPC190X or HPC191X
	T-Shaped End Panel	2" Square Post Leg	H10524TEP / HLSL28P
Island Extension	4½" Diameter Support Column	—	HPC190X or HPC191X
	2" Square Post Leg	—	HLSL28P

## HOW TO SPECIFY

<p><b>Select Model Number</b></p> <p>H P C 1 9 0 X .</p>	<p><b>Select Paint Color</b></p> <p>T 1</p> <p>See page 242</p>
--	---



# 10500 SERIES™ Worksurface Supports

GSA SIN AS NOTED



Icon Legend on page 21

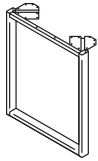

SIN 711-3

**DESCRIPTION****O-Leg**

30"D x 28½"H  
24"D x 28½"H

**MODEL**

**HLSL30280**  
**HLSL24280**

**SHIP WEIGHT**

19.0  
17.0

**CUBE**

5.4  
3.7

**LIST PRICE BY PAINT GRADE****CORE**

**\$323**  
**\$291**

**METALLICS**

**\$327**  
**\$295**

NOTES: Ship fully assembled with mounting hardware, 1/pack. Non-handed. O-leg glides have 2" adjustability. For shared components such as modesty panels and privacy screens see pages 268-270. O-leg installation requires 6" of clearance from the worksurface end. For standing-height O-leg sizes, see page 318. Shared O-legs create a cleaner aesthetic in all applications where two legs are used side-by-side. Will have 6" overhang when using 30"D O-legs with a 36"D worksurface.

IMPORTANT: The O-leg attachment bracket interferes with placement of 10500 Series modular pedestals and 28½"H mobile pedestals, preventing them from being positioned directly next to (flush with) the O-leg. Box/file mobile pedestal (model H105106) and mobile printer/fax cart model (H105679) can be positioned along side the O-leg.

! O-legs may only be attached to worksurfaces, not storage units.

**SPECIFYING EXAMPLE: HLSL24280.T1**

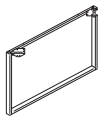

SIN 711-2

**Double-Depth O-Leg Support for Worksurfaces**

48"D x 28½"H  
60"D x 28½"H

**HLSL48280**  
**HLSL60280**

18.0  
19.0

7.0  
8.7

**\$550**  
**\$612**

**\$558**  
**\$620**

NOTES: Ship fully assembled with mounting hardware, 1/package. Non-handed. 48"D and 60"D sizes span back-to-back 24"D and 30"D worksurfaces, respectively. O-leg glides have 2" adjustability. For shared components such as modesty panels and privacy screens see pages 268-270. O-leg installation requires 6" of clearance from the worksurface end. For standing-height O-leg sizes, see page 318. Shared O-legs create a cleaner aesthetic in all applications where two legs are used side-by-side. Will have 6" overhang when using 30"D O-legs with a 36"D worksurface.

! O-legs may only be attached to worksurfaces, not storage units.

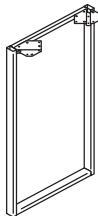

SIN 711-2

**Standing-Height O-Leg Support for Worksurfaces**

24"D x 41"H  
30"D x 41"H

**HLSL24410**  
**HLSL30410**

16.0  
17.0

5.3  
6.5

**\$390**  
**\$436**

**\$396**  
**\$442**

NOTES: Ship fully assembled with mounting hardware, 1/package. Non-handed. O-leg glides have 2" adjustability. For shared components such as modesty panels and privacy screens see pages 268-270. O-leg installation requires 6" of clearance from the worksurface end. For standing-height O-leg sizes, see page 318. Shared O-legs create a cleaner aesthetic in all applications where two legs are used side-by-side. Will have 6" overhang when using 30"D O-legs with a 36"D worksurface.

Coordinate™ Power Modules will work with standing-height applications for 10500™ and Voi® desks. Please see Coordinate™ Accessories Stand-Alone Pricer pages for more information.

! O-legs may only be attached to worksurfaces, not storage units.

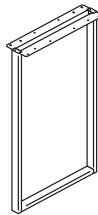

SIN 711-2

**Standing-Height O-Leg Shared Support for Worksurfaces**

24"D x 41"H  
30"D x 41"H

**HLSL2441SL**  
**HLSL3041SL**

16.0  
17.0

5.3  
6.5

**\$439**  
**\$487**

**\$445**  
**\$493**

NOTES: Ship fully assembled with mounting hardware, 1/package. Non-handed. For use with two 24"D or 30"D worksurfaces positioned side-by-side along the depth dimension. O-leg glides have 2" adjustability. For shared components such as modesty panels and privacy screens see pages 268-270. O-leg installation requires 6" of clearance from the worksurface end. For standing-height O-leg sizes, see page 318. Shared O-legs create a cleaner aesthetic in all applications where two legs are used side-by-side. Will have 6" overhang when using 30"D O-legs with a 36"D worksurface.

Coordinate™ Power Modules will work with standing-height applications for 10500™ and Voi® desks. Please see Coordinate™ Accessories Stand-Alone Pricer pages for more information.

! O-legs may only be attached to worksurfaces, not storage units.



OPEN MARKET

**O-Leg Cord Clips**

Clips for 28½" Worksurface O-Legs — 8-Pack

**HWMCLPLG**

0.8 Ⓞ

0.1

**\$90**

**N/A**

NOTES: Wire clips work with 7" Low Credenza O-leg and 29"H Support O-leg. Wire clips also work with the 50" and 65" Hutch O-legs. For additional information see page 920.

! Available in frosted plastic material only.

**HOW TO SPECIFY****Select Model Number**

HLSL30280

**Select Paint Color**

See page 242

T1



# 10500 SERIES™ Worksurface Supports

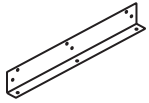

HVPWLBK24 shown

OPEN MARKET

**DESCRIPTION**

**Worksurface Wall Mount Bracket**  
For 30"  
For 24"

**MODEL**

**HVPWLBK30**  
**HVPWLBK24**

**SHIP WEIGHT**

2  
2

**CUBE**

0.3  
0.3

**LIST PRICE**

**\$79**  
**\$73**

NOTES: Can be used in place of an end panel or O-leg to support a worksurface. Cannot be used as a support when placing a stack-on storage unit on worksurface over bracket; must have two full-sized floor supports when using stack-on storage. Finish option not required.

**SPECIFYING EXAMPLE: HVPWLBK30**



SIN 711-3

**DESCRIPTION**

**Worksurface to Tower Bracket Kit**  
18½" long bracket for attaching 24"D worksurface directly to storage tower, wardrobe/bookcase, wardrobe/storage cabinet, storage cabinet/lateral file, storage cabinet, or lateral file.

**MODEL**

**HSTB2W1**

**SHIP WEIGHT**

4

**CUBE**

0.6

**LIST PRICE BY PAINT GRADE**

**CHOICE/  
CORE METALLICS CUSTOM**

**\$70**

**\$83**

**\$94**

NOTES: Can be used in place of end panel or O-leg to support worksurfaces.

! Bracket not designed for use as a support if placing Stack-on Storage on worksurface over/above bracket. Two full-sized supports required when using Stack-on Storage.

**NOTES:**

- O-leg glides have 2" adjustability.
- For shared components such as modesty panels and privacy screens see pages 268-270.
- O-leg ships fully assembled with mounting hardware.
- O-leg installation requires 6" of clearance from the worksurface end.
- For standing-height O-leg sizes, see page 318.
- Shared O-legs create a cleaner aesthetic in all applications where two legs are used side-by-side.
- Will have 6" overhang when using 30"D O-legs with a 36"D worksurface.

! O-legs may only be attached to worksurfaces, not storage units.

## HOW TO SPECIFY

Select Model Number

HVPWLBK30

# 10500 SERIES™ Components — Supports

GSA SIN AS NOTED

ABI

Icon Legend on page 21

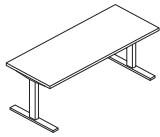

Base shown with work surface attached.

OPEN MARKET

## DESCRIPTION

**Coordinate™ Height Adjustable Base – 3 Stage**  
24"D Feet and Worksurface Brackets

MODEL

SHIP WEIGHT

CUBE

LIST PRICE

HHAB3S2L

67.0

2.4

\$960

NOTES: **AVAILABLE FEBRUARY 2018.** Base is a dual motor 3-stage design with standard anti-collision. Legs raise from 21 $\frac{5}{8}$ " to 47 $\frac{3}{4}$ ". Base telescopes to accommodate any rectangular work surface between 24"D x 48"W and 36"D x 72"W. Supports weight capacity of 250 lbs. (**excluding work surface weight**). Foundation™, Systems, Voi®, 10500, and Preside® all have work surfaces within this range. Comes standard with one-touch, four memory controller with digital display; no specification needed, available in black finish only. UL Certified. **HON 5-Year Limited Warranty.**

! Coordinate bases available in White (PTW3) finish as a standard special. Contact IDS for details.

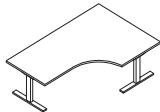

Base shown with work surface attached.

OPEN MARKET

## Coordinate™ 3-Leg Height Adjustable Base – 3 Stage

24"D Feet and Worksurface Brackets

HHAB3S3L

97.0

3.6

\$1625

NOTES: **AVAILABLE FEBRUARY 2018.** Base is a three motor 3-stage design with standard anti-collision. Legs raise from 21 $\frac{5}{8}$ " to 47 $\frac{3}{4}$ ". Base telescopes to accommodate work surfaces between 24"D x 48"W<sup>1</sup> x 60"W<sup>2</sup> and 30"D x 72"W<sup>1</sup> x 72"W<sup>2</sup>. Base can be arranged to accommodate 120 degree work surfaces. Supports weight capacity of 330 lbs. (**excluding work surface weight**). Can be used with 120 degree work surface models. Comes standard with one-touch, four memory controller with digital display; no specification needed, available in black finish only. UL Certified. **HON 5-Year Limited Warranty.**

! Coordinate bases available in White (PTW3) finish as a standard special. Contact IDS for details.

! When using two work surfaces, a flat bracket is required. Bracket purchased separately – HHN831124, HHN831130 – see page 574.

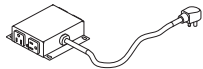

SIN 711-2



## Under Worksurface Power Module – 4 Outlets, 10' Cord

HPWRMOD2

1.5

0.2

\$354

- Includes 10' cord with three-prong plug.
- Fits in cable management troughs. See page 79.
- 4 outlets on side create easy access.

NOTES: Power Modules will also work with standing-height applications for 10500 Series™ and Voi® desks. For additional information see page 917.

! Available in black finish only, no specification needed.

## DESCRIPTION

MODEL

SHIP WEIGHT

CUBE

LIST PRICE BY LAMINATE GRADE

L1

L2

### Rectangle Worksurface

72"W x 30"D

H105R3072

83

6.1

\$381

\$401

66"W x 30"D

H105R3066

76

6.1

\$353

\$373

60"W x 30"D

H105R3060

69

5.2

\$330

\$350

48"W x 30"D

H105R3048

55

4.1

\$270

\$285

72"W x 24"D

H105R2472

66

4.9

\$323

\$343

66"W x 24"D

H105R2466

61

4.9

\$313

\$333

60"W x 24"D

H105R2460

55

4.2

\$294

\$314

48"W x 24"D

H105R2448

44

3.4

\$249

\$264

42"W x 24"D

H105R2442

39

3.0

\$226

\$241

NOTES: Underside of rectangle work surfaces includes pilot mounting holes for end panels, support columns, post and O-legs, and height adjustable base. Applications for 24"D work surfaces include desks, credenzas, returns, and bridges. The 42"W x 24"D size is not compatible with Height Adjustable Base model HHAB3S2L; it can however, be used in combination with the 72"W x 30"D work surface on 3-Leg Height Adjustable Base model HHAB3S3L. For above privacy screen sizes, see page 270.

## NOTES:

- Height Adjustable Base is a 3-stage column design.
- Frame rises from 21 $\frac{5}{8}$ " to 47 $\frac{3}{8}$ " for a sit-to-stand desk option.
- Height Adjustable Bases shipped complete with a pre-assembled motor.
- Base telescopes to accommodate any work surface between 48"W and 72"W.
- Height Adjustable Base accommodates rectangular work surfaces between 24"D x 48"W and 36"D x 72"W. Systems, Voi®, 10500, and Preside® all have work surfaces within this range.

- Comes standard with one-touch, four memory controller with digital display; no specification needed, available in black finish only.
- Standard height adjustable control ships with base.
- Dynamic load capacity when work surface is moving is 250 lbs.
- Silver finish matches any neutral HON paint or finish color.

## HOW TO SPECIFY

Select  
Model Number

Select  
Laminate

See pages 302-303

H 1 0 5 R 3 0 7 2

N N



# 10500 SERIES™ Shared Components

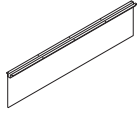

DESCRIPTION	MODEL	SHIP WEIGHT	CUBE	LIST PRICE BY LAMINATE GRADE	
				L1	L2
<b>Laminate Floating Modesty Panel</b>					
30"W x 14"H	<b>HLSL3014L</b>	10	0.8	<b>\$154</b>	<b>\$164</b>
36"W x 14"H	<b>HLSL3614L</b>	12	0.8	<b>\$163</b>	<b>\$173</b>
42"W x 14"H	<b>HLSL4214L</b>	14	0.8	<b>\$176</b>	<b>\$186</b>
48"W x 14"H	<b>HLSL4814L</b>	16	1.1	<b>\$193</b>	<b>\$205</b>
54"W x 14"H	<b>HLSL5414L</b>	18	1.1	<b>\$212</b>	<b>\$224</b>
60"W x 14"H	<b>HLSL6014L</b>	20	1.1	<b>\$228</b>	<b>\$240</b>

NOTES: The attachment bracket and modesty panel are packaged separately.

Specify: Model.Laminate.Paint

**SPECIFYING EXAMPLE: HLSL3014L.N.P (Black is the only paint option for this model)**

❗ When specifying the 54"W or 60"W Laminate Floating Modesty Panel, it is not necessary to specify an external channel.

❗ 30"W and 36"W screens attach with L-brackets, not the external channel.

## NOTES:

- Laminate or mixed material floating modesty panels options are available for attachment under 10500 Series worksurfaces. The modesty panel and attachment bracket are packaged separately.
- If using a 54"W or 60"W floating modesty panel, it is not necessary to specify an external support channel under the worksurface.
- When using a floating modesty panel under the worksurface, the depth clearance for center drawers and keyboard platforms decreases by 8".

FLOATING MODESTY PANELS - MODEL SELECTION GUIDE						
Support Combination		Rectangle Worksurface Width				
Support 1	Support 2	72 in	66 in	60 in	48 in	42 in
O-Leg	O-Leg	HLSL6014	HLSL5414	HLSL4814	HLSL3614	HLSL3014
O-Leg	L-Shaped End Panel	HLSL4814	HLSL4214	HLSL3614	NA	NA
O-Leg	4½" Diameter Support Column	HLSL4814	HLSL4814	HLSL4814	HLSL3614	HLSL3014
O-Leg	2" Square Post Leg	HLSL4814	HLSL4814	HLSL4814	HLSL3614	HLSL3014
L-Shaped End Panel	L-Shaped End Panel	HLSL3614	HLSL3014	NA	NA	NA
L-Shaped End Panel	4½" Diameter Support Column	HLSL3614	HLSL3614	HLSL3614	NA	NA
L-Shaped End Panel	2" Square Post Leg	HLSL3614	HLSL3614	HLSL3614	NA	NA
T-Shaped End Panel	O-Leg	HLSL5414	HLSL4814	HLSL4214	HLSL3014	NA
T-Shaped End Panel	L-Shaped End Panel	HLSL3614	HLSL3014	NA	NA	NA
T-Shaped End Panel	4½" Diameter Support Column	HLSL3614	HLSL3014	NA	NA	NA
T-Shaped End Panel	2" Square Post Leg	HLSL3614	HLSL3014	NA	NA	NA

Support Combination		Bullet Worksurface Width		
Support 1	Support 2	72 in	66 in	60 in
O-Leg	4½" Diameter Support Column	HLSL4814	HLSL4814	HLSL4814
O-Leg	2" Square Post Leg	HLSL4814	HLSL4814	HLSL4814
L-Shaped End Panel	4½" Diameter Support Column	HLSL3614	HLSL3614	HLSL3614
L-Shaped End Panel	2" Square Post Leg	HLSL3614	HLSL3614	HLSL3614
T-Shaped End Panel	4½" Diameter Support Column	HLSL3614	HLSL3614	HLSL3614
T-Shaped End Panel	2" Square Post Leg	HLSL3614	HLSL3614	HLSL3614

## HOW TO SPECIFY

Select  
Model Number

H L S L 3 0 1 4 L .

Select  
Laminate

See pages 302-303

N

# 10500 SERIES™

## Shared Components

GSA SIN 711-2

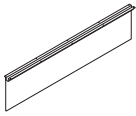

Icon Legend on page 21

**DESCRIPTION****Mixed Material Floating Modesty Panel**

30"W x 14"H

36"W x 14"H

42"W x 14"H

48"W x 14"H

54"W x 14"H

60"W x 14"H

**MODEL****HLSL3014MM****HLSL3614MM****HLSL4214MM****HLSL4814MM****HLSL5414MM****HLSL6014MM****SHIP WEIGHT**

8

8

9

11

13

13

**CUBE**

2.0

2.0

2.3

2.6

3.3

3.3

**LIST PRICE****\$621****\$666****\$745****\$826****\$896****\$1023**

NOTES: The attachment bracket and modesty panel are packaged separately.

Specify: Model.Mixed Material.Paint

**SPECIFYING EXAMPLE: HLSL3014MM.FT01.P (Frosted Translucent mixed material and Black paint are the only options for this model)**

! When specifying the 54"W or 60"W Mixed Material Floating Modesty Panel, it is not necessary to specify an external channel.

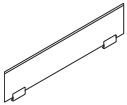
**Above Privacy Screen**

30"W x 13"H

36"W x 13"H

42"W x 13"H

48"W x 13"H

54"W x 13"H

60"W x 13"H

**HLSL1230****HLSL1236****HLSL1242****HLSL1248****HLSL1254****HLSL1260**

13

15

18

20

22

24

1.5

1.8

2.3

2.3

2.9

2.9

**\$251****\$277****\$310****\$354****\$379****\$408**

NOTES: Ships complete with attachment bracket. Bracket is Platinum only, no need to specify. Attaches to top of rectangle worksurfaces; requires a minimum overhang of 1½".

! Available in Frosted Glass ONLY HLSL1230.G.

! Above only privacy screen clamps onto worksurface and cannot be installed where support storage will be attached.

**NOTES:**

- Laminate or mixed material floating modesty panels options are available for attachment under 10500 Series worksurfaces. The modesty panel and attachment bracket are packaged separately.
- If using a 54"W or 60"W floating modesty panel, it is not necessary to specify an external support channel under the worksurface.
- When using a floating modesty panel under the worksurface, the depth clearance for center drawers and keyboard platforms decreases by 8".
- See charts on previous page.

**HOW TO SPECIFY**Select  
Model Number

HLSL3014MM.

Select  
Mixed Material

FT01 Frosted Translucent

FT01



# 10500 SERIES™

## Laminate Modular Components

### LIST PRICE BY LAMINATE GRADE

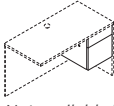
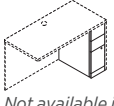
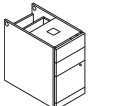
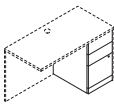
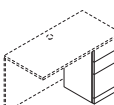
	DESCRIPTION	MODEL	SHIP WEIGHT	CUBE	LIST PRICE BY LAMINATE GRADE	
					L1	L2
 Not available in two-tone laminate	<b>Box/File Pedestal (with core removable lock)</b> 15 $\frac{5}{8}$ "W x 22 $\frac{3}{4}$ "D x 17 $\frac{3}{4}$ "H — for use under 24"D, 30"D and 36"D desk, credenza and return shells  NOTES: Attaches to underside of worksurface top. Lock can be positioned on either the right or left side. File drawer includes integrated hangrails for letter- or legal-sized folders. Not for use under 20"D shells. ⓘ Not designed to be used freestanding. Unfinished top and back.	<b>H10501</b>	57	5.5	<b>\$495</b>	<b>\$515</b>
 Not available in two-tone laminate	<b>Narrow Box/Box/File Pedestal (with core removable lock) — floor-standing</b> 9 $\frac{1}{2}$ "W x 22 $\frac{3}{4}$ "D x 28"H — for use under 24"D, 30"D and 36"D desk, credenza and return shells  NOTES: Space-saving design supports smaller footprints. Middle box drawer and file drawer lock; top box drawer does not lock. File drawer includes integrated hangrails for side-to-side letter or legal filing. Not for use under 20"D shells. ⓘ Not designed to be used freestanding. Unfinished top and back.	<b>H105093</b>	61	5.6	<b>\$640</b>	<b>\$665</b>
 Not available in two-tone laminate	<b>Box/Box/File Pedestal — floor-standing</b> 15 $\frac{5}{8}$ "W x 28 $\frac{3}{4}$ "D x 28"H — for use under 10500 Series 30"D worksurfaces supported by 29 $\frac{7}{8}$ "D L-shaped end panel model H10530LEP  NOTES: Top box drawer does not lock. File drawer includes integrated hangrails for letter- or legal-sized folders. Not for use under shells, per "Inside Dimensions" listings. ⓘ Not designed to be used freestanding. Unfinished top and back.	<b>H105062</b>	105	10.5	<b>\$704</b>	<b>\$734</b>
 Not available in two-tone laminate	<b>Box/Box/File Pedestal (with core removable lock) — floor-standing</b> 15 $\frac{5}{8}$ "W x 22 $\frac{3}{4}$ "D x 28"H — for use under 24"D, 30"D and 36"D desk, credenza and return shells or worksurface supported by 23 $\frac{7}{8}$ "D L-shaped end panel(s)  NOTES: Top box drawer does not lock. File drawer includes integrated hangrails for letter- or legal-sized folders. Not for use under 20"D shells. ⓘ Not designed to be used freestanding. Unfinished top and back.	<b>H10502</b>	90	8.4	<b>\$650</b>	<b>\$675</b>
 Not available in two-tone laminate	<b>Box/Box/File Pedestal (with core removable lock) — floor-standing</b> 15 $\frac{5}{8}$ "W x 18 $\frac{3}{4}$ "D x 28"H — for use under 20"D, 24"D, 30"D and 36"D desk, credenza and return shells  NOTES: Top box drawer does not lock. File drawer includes integrated hangrails for letter- or legal-sized hanging folders. ⓘ Not designed to be used freestanding. Unfinished top and back.	<b>H105012</b>	73	7.3	<b>\$613</b>	<b>\$633</b>

#### NOTES:

- Pedestals can be reconfigured quickly and easily when user preferences or space needs change.
- Locking units equipped with interchangeable core removable locks.
- Pedestal models ship assembled unless designated ☞.
- Mobile pedestals shown on page 341, work well in a variety of configurations.
- Narrow Pedestal features a compact design that is ideal for use in U- and L-shaped layouts for smaller spaces such as a 5' x 8' U-shaped workstation or a 5' x 5' L-shaped workstation.
- 10500 Series™ modular pedestals are for use with desk, credenza and return shells (see pages 310-314), as well as L-shaped end panels (page 316).
- ⓘ Keyed alike cores must be ordered separately — see model HF23B on page 922 — makes re-keying quick and easy.
- ⓘ Access strip (filler) required when box/box file, file/file, and or pencil/media/file pedestals are configured side-by-side to allow access for opening the drawers.
- ⓘ Access strip is required when CPU storage pedestal is used next to B/F, B/B/F, or F/F or P/M/F pedestals (finger pull is on side of door front). See above.
- ⓘ Modular pedestals can be specified as one color only; not available in two-tone laminate combination or in a pattern laminate.

## HOW TO SPECIFY

<b>Select Model Number</b> <input type="text" value="H105093"/>	<b>Select Laminate Chassis Color</b> See pages 302-303 <input type="text" value="N"/>
--	---



# 10500 SERIES™

## Laminate Modular Components

GSA SIN 711-8

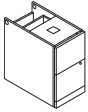
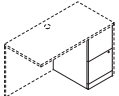
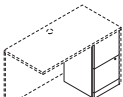

Icon Legend on page 21

	DESCRIPTION	MODEL	SHIP WEIGHT	CUBE	LIST PRICE BY LAMINATE GRADE	
					L1	L2
 <p>Not available in two-tone laminate</p>	<p><b>File/File Pedestal — floor-standing</b> 15<math>\frac{5}{8}</math>"W x 28<math>\frac{3}{4}</math>"D x 28"H — for use under 10500 Series 30"D worksurfaces supported by 29<math>\frac{7}{8}</math>"D L-shaped end panel model H10530LEP</p> <p>NOTES: File drawer includes integrated hangrails for letter- or legal-sized folders. Not for use under shells, per "Inside Dimensions" listings.</p> <p>⚠ Not designed to be used freestanding. Unfinished top and back.</p>	<b>H105064</b>	104	10.5	<b>\$704</b>	<b>\$734</b>
 <p>Not available in two-tone laminate</p>	<p><b>File/File Pedestal (with core removable lock) — floor-standing</b> 15<math>\frac{5}{8}</math>"W x 22<math>\frac{3}{4}</math>"D x 28"H — for use under 24"D, 30"D and 36"D desk, credenza and return shells or worksurface supported by 23<math>\frac{7}{8}</math>"D L-shaped end panel(s)</p> <p>NOTES: File drawers include integrated hangrails for letter- or legal-sized folders. Not for use under 20"D shells.</p> <p>⚠ Not designed to be used freestanding. Unfinished top and back.</p>	<b>H10504</b>	85	8.2	<b>\$650</b>	<b>\$675</b>
 <p>Not available in two-tone laminate</p>	<p><b>File/File Pedestal (with core removable lock) — floor-standing</b> 15<math>\frac{5}{8}</math>"W x 18<math>\frac{3}{4}</math>"D x 28"H — for use under 20"D, 24"D, 30"D and 36"D desk, credenza and return shells</p> <p>NOTES: File drawers include integrated hangrails for letter- or legal-sized folders.</p> <p>⚠ Not designed to be used freestanding. Unfinished top and back.</p>	<b>H105014</b>	72	7.3	<b>\$613</b>	<b>\$633</b>
 <p>Not available in two-tone laminate</p>	<p><b>Access Strip (Filler)</b> 1<math>\frac{1}{8}</math>"W x 20<math>\frac{1}{2}</math>"D x 28"H</p> <p>NOTES: For use under 24"D, 30"D and 36"D desk, credenza or return shells when B/B/F, F/F, and or P/M/F pedestals are configured side-by-side or when CPU storage is used next to B/F, B/B/F, or F/F pedestals. Not required when pedestals are used in conjunction with lateral file pedestals, multi file pedestals or cabinet pedestal. Not sized for use with 20"D modular shells.</p> <p>NOTE: See pages 310-314 for desk, credenza and return shells.</p>	<b>H10524</b>	21	0.9	<b>\$165</b>	<b>\$175</b>

**NOTES:**

- Pedestals can be reconfigured quickly and easily when user preferences or space needs change.
- Locking units equipped with interchangeable core removable locks.
- Pedestal models ship assembled unless designated .
- Mobile pedestals shown on page 341, work well in a variety of configurations.
- Narrow Pedestal features a compact design that is ideal for use in U- and L-shaped layouts for smaller spaces such as a 5' x 8' U-shaped workstation or a 5' x 5' L-shaped workstation.
- 10500 Series™ modular pedestals are for use with desk, credenza and return shells (see pages 310-314), as well as L-shaped end panels (page 316).
- ⚠ Keyed alike cores must be ordered separately — see model HF23B on page 922 — makes re-keying quick and easy.
- ⚠ Access strip (filler) required when box/box file, file/file, and or pencil/media/file pedestals are configured side-by-side to allow access for opening the drawers.
- ⚠ Access strip is required when CPU storage pedestal is used next to B/F, B/B/F, or F/F or P/M/F pedestals (finger pull is on side of door front). See above.
- ⚠ Modular pedestals can be specified as one color only; not available in two-tone laminate combination or in a pattern laminate.

**HOW TO SPECIFY**







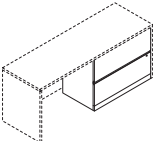

Select  
Model Number

H 1 0 5 0 4 .

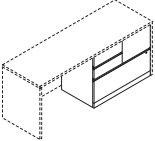
Select  
Laminate Chassis Color

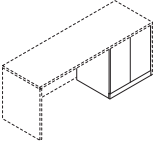

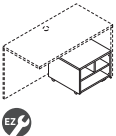
See pages 302-303

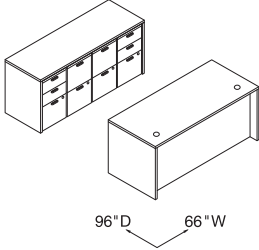
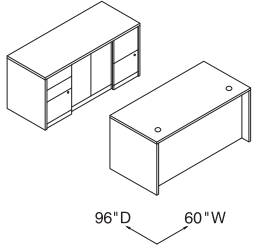
N

	DESCRIPTION	MODEL	SHIP WEIGHT	CUBE	LIST PRICE BY LAMINATE GRADE		
					L1	L2	
 Not available in two-tone laminate	<b>Lateral File Pedestal (with core removable lock) — floor-standing</b> 36"W x 20"D x 28"H — for use under 24"D, 30"D and 36"D desk, credenza and return shells	<b>H10503</b>	127	15.6	<b>\$988</b>	<b>\$1028</b>	
NOTES: Drawers include integrated hangrails for letter- or legal-sized folders. Mechanical interlock inhibits extension of more than one drawer at a time. Not for use under 20"D shells.							
 Not designed to be used freestanding. Unfinished top and back.							
 Not available in two-tone laminate	<b>Multi File Pedestal (with core removable lock) — floor-standing</b> 36"W x 20"D x 28"H — for use under 24"D, 30"D and 36"D desk, credenza and return shells	<b>H10505</b>	155	15.6	<b>\$1184</b>	<b>\$1224</b>	
NOTES: Versatile four drawer unit features a lateral file, vertical file, and two box drawers. Box drawers do not lock. File drawers include integrated hangrails for letter- or legal-sized folders. Mechanical interlock in lateral drawer inhibits extension of more than one drawer at a time. Not for use under 20"D shells.							
 Not designed to be used freestanding. Unfinished top and back.							
 Not available in two-tone laminate	<b>Cabinet Pedestal — floor-standing</b> 26"W x 21¼"D x 28"H — for use under 24"D, 30"D and 36"D desk, credenza and return shells	<b>H10508</b>	78	12.2	<b>\$736</b>	<b>\$776</b>	
NOTES: One adjustable shelf at 2½" increments. Doors are non-locking. Not for use under 20"D shells.							
 Not designed to be used freestanding. Unfinished top and back.							
 	<b>Mobile Printer/Fax Cart</b> 20"W x 19⅞"D x 14⅞"H — for use under 24"D, 30"D and 36"D desk, credenza and return shells	<b>H105679</b>	52	2.9	<b>\$397</b>	<b>\$417</b>	
NOTES: Holds laser printers, inkjet printers or fax machines. Ideal for limited space. Low profile cart stores conveniently and easily under desks and workstations. Interior compartment shelving is Black. Four casters. Specify laminate top and chassis color. Not for use under 20"D shells.							
<b>SPECIFYING EXAMPLE: H105679.NN</b>							
 <p>96"D 66"W</p>		1 - H10579 1 - H10542 2 - H105102 2 - H105104		 <p>96"D 60"W</p>			1 - H10578 1 - H10564 1 - H10502 1 - H10504 1 - H10508

**NOTES:**

- Pedestals can be reconfigured quickly and easily when user preferences or space needs change.
- File drawers accept hanging folders in letter or legal size.
- Mobile pedestals shown on page 341, work well in a variety of configurations.
- Locking units equipped with interchangeable core removable locks.
- Pedestal models ship assembled unless designated .
- See pages 310-314 for desk, credenza and return shells.

-  Keyed alike cores must be ordered separately — see model HF23B on page 922 — makes re-keying quick and easy.
-  Access strip (filler) required when box/box file, file/file, and or pencil/media/file pedestals are configured side-by-side to allow access for opening the drawers.
-  Access strip is required when CPU storage pedestal is used next to B/F, B/B/F, F/F or P/M/F pedestals (finger pull is on side of door front). See page 323.

**HOW TO SPECIFY**

<p><b>Select Model Number</b></p> <p>H 1 0 5 0 3 . N</p>	<p><b>Select Laminate Chassis Color</b></p> <p>See pages 302-303</p>
--	--



# 10500 SERIES™

## Laminate Wood Desks — Full Pedestals

GSA SIN 711-8



Icon Legend on page 21

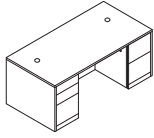

DESCRIPTION	FULL WIDTH OVERHANG	MODEL	SHIP WEIGHT	CUBE	LIST PRICE BY LAMINATE GRADE	
					L1	L2
<b>Double Pedestal Desk</b>						
72"W x 36"D x 29½"H, Bow Top, 3/2	10½"	<b>H105899</b>	315	50.9	<b>\$1771</b>	<b>\$1851</b>
72"W x 36"D x 29½"H, Rectangle Top, 3/2	10½"	<b>H105890</b>	340	50.9	<b>\$1614</b>	<b>\$1689</b>
66"W x 30"D x 29½"H, Rectangle Top, 3/2	4½"	<b>H105891</b>	290	39.4	<b>\$1503</b>	<b>\$1568</b>
60"W x 30"D x 29½"H, Rectangle Top, 3/2	4½"	<b>H105892</b>	278	35.9	<b>\$1413</b>	<b>\$1473</b>

NOTES: All drawers lock. Two cord grommets in top for routing and hiding wires and cables. Bow top models measure 36"D at crest and 30"D along the end panels. See page 346 for optional center drawers.

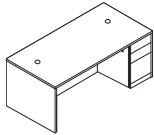

DESCRIPTION	FULL WIDTH OVERHANG	MODEL	SHIP WEIGHT	CUBE	LIST PRICE BY LAMINATE GRADE	
					L1	L2
<b>Single Pedestal Desk</b>						
72"W x 36"D x 29½"H, Bow Top, Right	10½"	<b>H105893R</b>	292	50.9	<b>\$1451</b>	<b>\$1521</b>
72"W x 36"D x 29½"H, Rectangle Top, Right	10½"	<b>H105895R</b>	278	50.9	<b>\$1291</b>	<b>\$1361</b>
66"W x 30"D x 29½"H, Rectangle Top, Right	4½"	<b>H105897R</b>	226	39.4	<b>\$1165</b>	<b>\$1220</b>
72"W x 36"D x 29½"H, Bow Top, Left	10½"	<b>H105894L</b>	292	50.9	<b>\$1451</b>	<b>\$1521</b>
72"W x 36"D x 29½"H, Rectangle Top, Left	10½"	<b>H105896L</b>	278	50.9	<b>\$1291</b>	<b>\$1361</b>
66"W x 30"D x 29½"H, Rectangle Top, Left	4½"	<b>H105898L</b>	226	39.4	<b>\$1165</b>	<b>\$1220</b>

NOTES: Box/box/file drawers. Drawers lock. Two cord grommets in top for routing and hiding wires and cables. Bow top models measure 36"D at crest and 30"D along the end panels. See page 346 for optional center drawers.

### NOTES:

- Factory-configured desks, credenzas and returns ship fully assembled for ease and speed of installation.
- Full-to-floor pedestals maximize storage space.
- Smooth, flat edges provide a clean look.
- Tops are easy-care, scratch-, spill- and stain-resistant laminate over 1⅞" solid core high-performance particleboard.
- 3" round cord management grommets, for routing and hiding wires and cables, are located in the tops of desks, returns, bridges, and corner units. Grommet cutout accepts optional Power Hub (model HGRMTAC) or Power/USB Hub (model HGRMTUSB2) — see page 351.
- For work-in-process paper management tools, see pages 346-347.
- Drawers operate on full extension, ball-bearing suspensions to ensure smooth, quiet, long-lasting operation.
- File drawer design includes integrated hangrails for side-to-side letter or legal filing; and front-to-back for letter filing.
- For field installable decorative handle options, see page 349.
- All drawers are five-sided construction for added strength and easy alignment or replacement of drawer fronts.
- Center drawers conveniently store writing instruments, paper and other miscellaneous items. Includes pencil tray. See page 352.

### HOW TO SPECIFY

Select  
Model Number

H 1 0 5 8 9 9 .

Select  
Laminate Top and Chassis Color

See pages 302-303

N N



# 10500 SERIES™

## Laminate Wood Desks — Full Pedestals

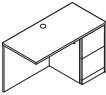
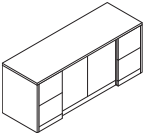
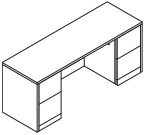
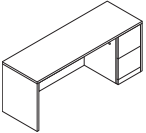
	DESCRIPTION	FULL WIDTH OVERHANG	MODEL	SHIP WEIGHT	CUBE	LIST PRICE BY LAMINATE GRADE	
						L1	L2
	<b>Return, file/file</b>						
	48"W x 24"D x 29½"H, Right		<b>H105905R</b>	167	24.2	<b>\$912</b>	<b>\$952</b>
	42"W x 24"D x 29½"H, Right		<b>H105907R</b>	147	21.4	<b>\$892</b>	<b>\$932</b>
	48"W x 24"D x 29½"H, Left		<b>H105906L</b>	167	24.2	<b>\$912</b>	<b>\$952</b>
	42"W x 24"D x 29½"H, Left		<b>H105908L</b>	147	21.4	<b>\$892</b>	<b>\$932</b>
	NOTES: Return is for use with single pedestal desks, desk shells, peninsulas or corner units. One worksurface grommet and one cord pass-through grommet in top center of modesty panel to reach wall electrical outlets. Drawers lock. Not to be used freestanding. Will not attach to Corner Units manufactured prior to 5/24/99. See pages 334-335 for optional Stack-on Storage.						
	<b>Credenza with Doors</b>						
	72"W x 24"D x 29½"H	3½"	<b>H105909</b>	323	34.8	<b>\$1671</b>	<b>\$1736</b>
	NOTES: All drawers lock. Doors are non-locking. Includes a fixed shelf located at the bottom of the center storage area. No intermittent shelf. See pages 334-335 for optional Stack-on Storage.						
	<b>Credenza with Kneespace, file/file</b>						
	72"W x 24"D x 29½"H	3½"	<b>H105900</b>	274	34.8	<b>\$1415</b>	<b>\$1475</b>
	66"W x 24"D x 29½"H	3½"	<b>H105901</b>	262	32.0	<b>\$1402</b>	<b>\$1462</b>
	60"W x 24"D x 29½"H	3½"	<b>H105902</b>	248	29.2	<b>\$1350</b>	<b>\$1405</b>
	NOTES: All drawers lock. One cord pass-through grommet in top center of modesty panel to reach wall electrical outlets. Not designed for use with 24"D modular or mobile pedestals. See pages 334-335 for optional Stack-on Storage.						
	<b>Single Pedestal Credenza, file/file</b>						
	72"W x 24"D x 29½"H, Right (shown)	3½"	<b>H105903R</b>	226	34.8	<b>\$1148</b>	<b>\$1203</b>
	72"W x 24"D x 29½"H, Left	3½"	<b>H105904L</b>	226	34.8	<b>\$1148</b>	<b>\$1203</b>
	NOTES: Drawers lock. One cord pass-through grommet in top center of modesty panel to reach wall electrical outlets. Not designed for use with 24"D modular or mobile pedestals. See pages 334-335 for optional Stack-on Storage.						

**NOTES:**

- Factory-configured desks, credenzas and returns ship fully assembled for ease and speed of installation.
  - Formal, full-length modesty panels.
  - Tops are easy-care, scratch-, spill- and stain-resistant laminate over 1/8" solid core high-performance particleboard.
  - 3" round cord management grommets, for routing and hiding wires and cables, are located in the tops of desks, returns, bridges, and corner units. Grommet cutout accepts optional Power Hub (model HGRMTAC) or Power/USB Hub (model HGRMTUSB2) — see page 351.
  - Drawers operate on full extension, ball-bearing suspensions to ensure smooth, quiet, long-lasting operation.
  - All drawers are five-sided construction for added strength and easy alignment or replacement of drawer fronts.
  - File drawer design includes integrated hangrails for side-to-side letter or legal filing; and front-to-back for letter filing.
  - For field installable decorative handle options, see page 349.
  - 10500 Series™ 18¾"D modular and mobile pedestals can be positioned under credenza with kneespace and single pedestal credenza models.
- ! Keyed alike cores must be ordered separately — see model HF23B on page 922 — makes re-keying quick and easy.

**HOW TO SPECIFY**

<b>Select Model Number</b> H 1 0 5 9 0 5 R .	<b>Select Laminate Top and Chassis Color</b> See pages 302-303 N N
---	--

# 10500 SERIES™

## Laminate Wood Desks — 3/4 Pedestals

GSA SIN 711-8



Icon Legend on page 21

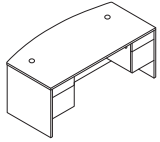

DESCRIPTION	FULL WIDTH OVERHANG	MODEL	SHIP WEIGHT	CUBE	LIST PRICE BY LAMINATE GRADE	
					L1	L2
<b>Double Pedestal Desk</b>						
72"W x 36"D x 29½"H, Bow Top, 2-2	10½"	<b>H10595</b>	300	52.9	<b>\$1480</b>	<b>\$1560</b>
72"W x 36"D x 29½"H, Rectangle Top, 2-2	10½"	<b>H10593</b>	320	52.9	<b>\$1319</b>	<b>\$1394</b>
66"W x 30"D x 29½"H, Rectangle Top, 2-2	4½"	<b>H10571</b>	286	40.9	<b>\$1207</b>	<b>\$1272</b>
60"W x 30"D x 29½"H, Rectangle Top, 2-2	4½"	<b>H10573</b>	271	37.4	<b>\$1111</b>	<b>\$1171</b>

NOTES: All drawers lock. Two cord grommets in top for routing and hiding wires and cables. Bow top models measure 36"D at crest and 30"D along the end panels. See page 352 for optional center drawers.

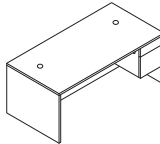

<b>Single Pedestal Desk</b>						
72"W x 36"D x 29½"H, Bow Top, Right	10½"	<b>H10587R</b>	238	52.9	<b>\$1277</b>	<b>\$1347</b>
72"W x 36"D x 29½"H, Rectangle Top, Right	10½"	<b>H10585R</b>	279	52.9	<b>\$1120</b>	<b>\$1185</b>
66"W x 30"D x 29½"H, Rectangle Top, Right	4½"	<b>H10583R</b>	229	41.0	<b>\$985</b>	<b>\$1040</b>
72"W x 36"D x 29½"H, Bow Top, Left	10½"	<b>H10588L</b>	238	52.9	<b>\$1277</b>	<b>\$1347</b>
72"W x 36"D x 29½"H, Rectangle Top, Left	10½"	<b>H10586L</b>	279	52.9	<b>\$1120</b>	<b>\$1185</b>
66"W x 30"D x 29½"H, Rectangle Top, Left	4½"	<b>H10584L</b>	229	41.0	<b>\$985</b>	<b>\$1040</b>

NOTES: Box/file drawers. Drawers lock. Two cord grommets in top for routing and hiding wires and cables. Bow top models measure 36"D at crest and 30"D along the end panels. See page 352 for optional center drawers.

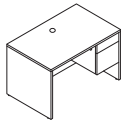

<b>Small Office Desk</b>						
48"W x 30"D x 29½"H, 3/4 Pedestal, Right box/file	4½"	<b>H105885R</b>	168	30.5	<b>\$874</b>	<b>\$914</b>

NOTES: Small footprint makes this desk ideal for limited space. Drawers lock. One cord grommet in top for routing and hiding wires and cables. 3/4 height modesty panel facilitates reaching wall electrical outlets. Optional stack-on storage model H105323 maximizes storage space; see page 334.

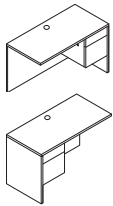

<b>Return, box/file</b>						
48"W x 24"D x 29½"H, Right		<b>H10515R</b>	147	25.6	<b>\$793</b>	<b>\$833</b>
42"W x 24"D x 29½"H, Right		<b>H10511R</b>	138	20.5	<b>\$776</b>	<b>\$816</b>
48"W x 24"D x 29½"H, Left		<b>H10516L</b>	147	25.6	<b>\$793</b>	<b>\$833</b>
42"W x 24"D x 29½"H, Left		<b>H10512L</b>	138	20.5	<b>\$776</b>	<b>\$816</b>

NOTES: Return is for use with single pedestal desks, desk shells, peninsulas or corner units. One worksurface grommet and one cord pass-through grommet in top center of modesty panel to reach wall electrical outlets. Drawers lock. See pages 334-335 for optional stack-on storage.

⚠ Not designed to be used freestanding. Will not attach to Corner Units manufactured prior to 5/24/99.

### NOTES:

- For components that can be shared with 10500 Series™, see pages 330-352.
- Tops and end panels are abrasion- and stain-resistant laminate over durable 1½" solid core high-performance particleboard; resists warping.
- Formal, full height modesty panels.
- 3/4 pedestal design increases budget flexibility.
- 3" round cord management grommets, for routing and hiding wires and cables, are located in the tops of desks, returns, bridges, and corner units. Grommet cutout accepts optional Power Hub (model HGRMTAC) or Power/USB Hub (model HGRMTUSB2) — see page 351.
- All drawers are 5-sided construction, which allows easy drawer alignment or replacement of drawer fronts.
- Drawers operate on full extension, ball-bearing suspensions to ensure smooth, quiet, long-lasting operation.
- File drawer design includes integrated hangrails for side-to-side letter or legal filing; and front-to-back for letter filing.
- For field installable decorative handle options, see page 349.
- Desk, credenza, and return models ship assembled.
- See stack-on storage and stack-on PC organizer options on pages 333-335.
- Use with Above Worksurface Privacy Screens. See page 321.
- Mobile table quickly provides additional worksurface space, see page 331.

### HOW TO SPECIFY

Select Model Number

H 1 0 5 9 5 .

Select Laminate Top and Chassis Color

See pages 302-303

N N



# 10500 SERIES™

## Laminate Wood Desks — 3/4 Pedestals

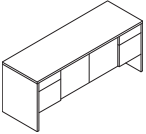
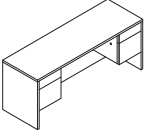
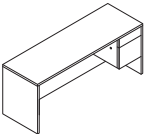
	DESCRIPTION	FULL WIDTH OVERHANG	MODEL	SHIP WEIGHT	CUBE	LIST PRICE BY LAMINATE GRADE	
						L1	L2
	<b>Credenza with Doors</b> 72"W x 24"D x 29½"H NOTES: All drawers lock. Doors are non-locking. Includes a fixed shelf located at the bottom of the center storage area. No intermittent shelf. See pages 334-335 for optional stack-on storage.	3½"	<b>H10544</b>	278	36.0	<b>\$1434</b>	<b>\$1499</b>
	<b>Credenza with Kneespace — box/file</b> 72"W x 24"D x 29½"H 66"W x 24"D x 29½"H 60"W x 24"D x 29½"H NOTES: All drawers lock. One cord pass-through grommet in top center of modesty panel to reach wall electrical outlets. ⓘ Not designed to be used with 24"D modular or mobile pedestals.	3½" 3½" 3½"	<b>H10543</b> <b>H10566</b> <b>H10565</b>	243 234 229	36.3 33.4 28.8	<b>\$1176</b> <b>\$1164</b> <b>\$1111</b>	<b>\$1236</b> <b>\$1224</b> <b>\$1166</b>
	<b>Single Pedestal Credenza — box/file</b> 72"W x 24"D x 29½"H, Right (shown) 72"W x 24"D x 29½"H, Left NOTES: Drawers lock. One cord pass-through grommet in top center of modesty panel to reach wall electrical outlets. See page 334 for optional stack-on storage. ⓘ Not designed to be used with 24"D modular or mobile pedestals.	3½" 3½"	<b>H10545R</b> <b>H10546L</b>	212 212	36.0 36.0	<b>\$969</b> <b>\$969</b>	<b>\$1024</b> <b>\$1024</b>

**NOTES:**

- For components that can be shared with 10500 Series™, see pages 330-352.
- Tops and end panels are abrasion- and stain-resistant laminate over durable 1½" solid core high-performance particleboard; resists warping.
- Formal, full height modesty panels.
- 3/4 pedestal design increases budget flexibility.
- 3" round cord management grommets, for routing and hiding wires and cables, are located in the tops of desks, returns, bridges, and corner units. Accepts optional Power Hub Grommet model HGRMTAC — page 351.
- All drawers are 5-sided construction, which allows easy drawer alignment or replacement of drawer fronts.
- Drawers operate on full extension, ball-bearing suspensions to ensure smooth, quiet, long-lasting operation.
- File drawer design includes integrated hangrails for side-to-side letter or legal filing; and front-to-back for letter filing.
- For field installable decorative handle options, see page 349.
- Desk, credenza, and return models ship assembled.
- See stack-on storage and stack-on PC organizer options on pages 333-335.
- Use with Above Worksurface Privacy Screens. See page 321.
- Mobile table quickly provides additional worksurface space, see page 331.

**HOW TO SPECIFY**

<b>Select Model Number</b> H 1 0 5 4 4 . N N	<b>Select Laminate Top and Chassis Color</b> See pages 302-303
---	---

# 10500 SERIES™

## Shared Components & Accessories

GSA SIN 711-8

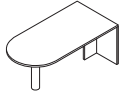

Icon Legend on page 21

**DESCRIPTION****Peninsula w/End Panel**

72"W x 36"D x 29½"H  
 72"W x 30"D x 29½"H  
 66"W x 30"D x 29½"H  
 60"W x 30"D x 29½"H

**MODEL****SHIP WEIGHT****CUBE****LIST PRICE BY LAMINATE GRADE****L1****L2**

**H10521**  
**H105209**  
**H10522**  
**H10523**

150  
 130  
 125  
 100

15.1  
 12.8  
 11.8  
 10.7

**\$831**  
**\$761**  
**\$766**  
**\$717**

**\$876**  
**\$806**  
**\$811**  
**\$762**

NOTES: Use for "U" or "L" configuration. 60"W size ideal for smaller spaces. Cord routing notch in brace panel. Accepts field installable modesty panel model H10528. Accepts center drawer model H1526 and H1522. Model H1522 can be used in conjunction with the laminate modesty panel model H10528. Round support column is black.

ⓘ Not designed to be used freestanding.

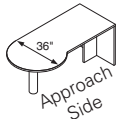

72"W x 30/36"D x 29½"H, P-shaped Right (shown)  
 72"W x 36/30"D x 29½"H, P-shaped Left

**H10525R**  
**H10526L**

142  
 142

13.4  
 13.4

**\$972**  
**\$972**

**\$1017**  
**\$1017**

NOTES: Use for "U" or "L" configuration. Cord routing notch in brace panel. Accept field installable modesty panel model H10528 (see page 331). See page 352 for optional center drawers. Round support column is black.

ⓘ Not designed to be used freestanding.

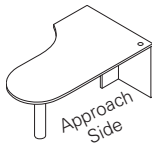

Right-hand model  
 H105201R shown

**Jetty Peninsula w/End Panel**

72"W x 30/42"D x 29½"H, Right (shown)  
 72"W x 42/30"D x 29½"H, Left

**H105201R**  
**H105202L**

156  
 156

16.9  
 16.9

**\$1079**  
**\$1079**

**\$1134**  
**\$1134**

NOTES: For use in "U" or "L" configuration. Designed and sized to efficiently serve as both a computing and conferencing space. One cord management grommet in the top; cord routing notch in brace panel. Round support column is black.

ⓘ Not designed to be used freestanding. Jetty units manufactured on or after 10/24/2005 accept field installable modesty panel H10528 (see page 331).

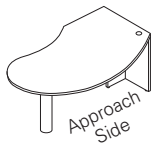
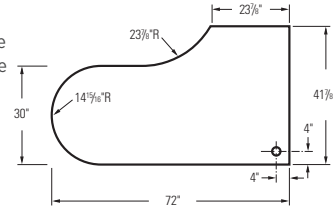

Right-hand model  
 H105203R shown

**Boomerang Peninsula w/End Panel**

72"W x 30/42"D x 29½"H, Right (shown)  
 72"W x 42/30"D x 29½"H, Left

**H105203R**  
**H105204L**

152  
 152

16.9  
 16.9

**\$1079**  
**\$1079**

**\$1134**  
**\$1134**

NOTES: For use in "U" or "L" configuration. Designed and sized to efficiently serve as both a computing and conferencing space. One cord management grommet in the top; cord routing notch in brace panel. Round support column is black.

ⓘ Not designed to be used freestanding. Accept field installable modesty panel H10528 (see page 331).

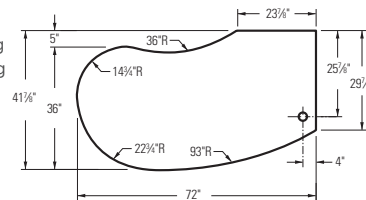
**NOTES:**

- Shared components shown on this page can be used with modular components shown on pages 310-325, full pedestal models shown on pages 326-327 and 3/4 pedestal models shown on pages 328-329.
- Jetty, boomerang and rudder peninsulas are designed and sized to efficiently serve as both a computing and conferencing space.
- Peninsulas ship complete with end panel and black 4½" diameter support column. For a silver support column option, please see model HPC191X on page 317 (ordered separately).
- Mobile pedestals shown on page 341 work well in a variety of configurations.
- Adjustable hex leveling glides allow floor-standing furniture to be easily leveled without lifting the unit; glides have ¾" adjustable range.
- See pages 330-352 for shared components.

**HOW TO SPECIFY****Select Model Number**

H 1 0 5 2 5 R .

**Select Laminate Top and Chassis Color**

See pages 302-303

N N



Icon Legend on page 21

# 10500 SERIES™ Shared Components & Accessories

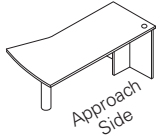

Model H105205R shown



DESCRIPTION	MODEL	SHIP WEIGHT	CUBE	LIST PRICE BY LAMINATE GRADE	
				L1	L2
<b>Rudder Peninsula with End Panel</b> 72"W x 30/38"D x 29½"H, Right (shown)	<b>H105205R</b>	142	15.8	<b>\$1055</b>	<b>\$1100</b>
72"W x 30/38"D x 29½"H, Left	<b>H105206L</b>	142	15.8	<b>\$1055</b>	<b>\$1100</b>

NOTES: Use for "U" or "L" configuration. One cord management grommet in top; cord routing notch in brace panel. 30"D along end panel. Round support column is black.

⚠ Not designed to be used freestanding.



DESCRIPTION	MODEL	SHIP WEIGHT	CUBE	L1	L2
<b>Field Installable Laminate Modesty Panel for Peninsulas</b> 50¼"W x ¾"Thick x 18"H	<b>H10528</b>	25	1.3	<b>\$177</b>	<b>\$187</b>

NOTES: Center drawer model H1522 can be used in conjunction with the laminate modesty panel. Laminate modesty panel has a cord pass-through notch in top corner.

⚠ Not compatible with Peninsula models H10525R, H10526L, H10621, H10721, H10722 manufactured prior to 12/1/2001 or jetty models H105201R and H105202L manufactured prior to 10/24/2005.

**SPECIFYING EXAMPLE: H10528.N**



DESCRIPTION	MODEL	SHIP WEIGHT	CUBE	LIST PRICE
<b>Field Installable Modesty Panel, Frosted with Silver Frame</b> 50¼"W x ¾"Thick x 18"H — for use on 72"W peninsulas	<b>HPC180G</b>	33 Ⓞ	1.5	<b>\$645</b>

⚠ Center drawers not designed to be used with the frosted/silver modesty panel. Cord pass-through notch is not available on the Frosted/Silver model HPC180G. Notch is on laminate model H10528 only.

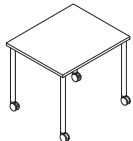

DESCRIPTION	MODEL	SHIP WEIGHT	CUBE	LIST PRICE BY LAMINATE GRADE	
				L1	L2
<b>Mobile Table</b> 36"W x 30"D x 29½"H	<b>H105T3036C</b>	56	11.0	<b>\$606</b>	<b>\$621</b>
30"W x 24"D x 29½"H	<b>H105T2430C</b>	42	7.1	<b>\$543</b>	<b>\$555</b>

NOTES: Rectangle-shaped top. Versatile design quickly provides additional worksurface space; ideal for work-in-process, meetings, and special projects. Choose from two sizes to align with either 30" and 36"D or 24" and 30"D worksurfaces. Roll easily on 4 casters; 2 locking, 2 non-locking. Top and legs ship together in one carton. Simple assembly. Paint options for post leg are Black (P), Charcoal (S), Brilliant White (WHIT), and Platinum Metallic (TI). Easy-care, scratch-, spill- and stain-resistant laminate over 1/8" solid core high-performance particleboard.

Specify: Model.Worksurface Laminate.Edge Color.Base Paint Color

**SPECIFYING EXAMPLE: H105T3036C.N.N.S**

**NOTES:**  
**Panels**

- Shared components shown on this page can be used with modular components shown on pages 310-325, full pedestal models shown on pages 326-327 and 3/4 pedestal models shown on pages 328-329.
- Jetty, boomerang and rudder peninsulas are designed and sized to efficiently serve as both a computing and conferencing space.
- Peninsulas ship complete with end panel and black 4½" diameter support column. For a silver support column option, please see model HPC191X on page 317 (ordered separately).
- Mobile pedestals shown on page 341 work well in a variety of configurations.
- Adjustable hex leveling glides allow floor-standing furniture to be easily leveled without lifting the unit; glides have ¾" adjustable range.
- See pages 330-352 for shared components.

**HOW TO SPECIFY**

<p><b>Select Model Number</b></p> <p>H 1 0 5 2 0 5 R .</p>	<p><b>Select Laminate Top and Chassis Color</b></p> <p>See pages 302-303</p> <p>N N</p>		
<p><b>Select Model Number</b></p> <p>H 1 0 5 T 3 0 3 6 C .</p>	<p><b>Select Worksurface Laminate</b></p> <p>See pages 302-303</p> <p>N .</p>	<p><b>Select Edge Color</b></p> <p>See pages 302-303</p> <p>N .</p>	<p><b>Select Base Paint Color</b></p> <p>S Charcoal</p> <p>S</p>

# 10500 SERIES™

## Shared Components & Accessories

GSA SIN 711-8



Icon Legend on page 21

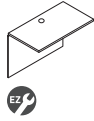

DESCRIPTION	MODEL	SHIP WEIGHT	CUBE	LIST PRICE BY LAMINATE GRADE	
				L1	L2
<b>Bridge (Single Ped. Desk, Desk Shell, or Peninsula, to Corner Unit, Single Ped. Credenza or Credenza Shell)</b>					
47"W x 24"D x 29½"H (Clear inside depth = 21⅞"D)	<b>H10570</b>	76	2.8	<b>\$344</b>	<b>\$374</b>
42"W x 24"D x 29½"H (Clear inside depth = 21⅞"D)	<b>H10560</b>	72	2.6	<b>\$331</b>	<b>\$361</b>
<b>Bridge (for use with Corner or Extended Corner Units or Jetty or Boomerang Peninsulas)</b>					
36"W x 24"D x 29½"H (Clear inside depth = 21⅞"D)	<b>H105599</b>	61	2.6	<b>\$331</b>	<b>\$361</b>
<b>Bridge (for use with Corner or Extended Corner Units)</b>					
30"W x 24"D x 29½"H (Clear inside depth = 21⅞"D)	<b>H105598</b>	50	1.9	<b>\$331</b>	<b>\$361</b>
NOTES: One cord grommet in top; one pass-through grommet in top center of modesty panel. Grommet can be replaced with optional Power Hub or Power/USB Hub for easy plug-and-play (see page 351). Kneespace of desk limited to 24¾"W if bridge is used with 66"W single pedestal desk.					
! Not designed to attach to corner units manufactured prior to 5/24/99.					
<b>Bridge (Single Ped. Desk, Desk Shell, or Peninsula to Single Ped. Credenza or Credenza Shell)</b>					
47"W x 20"D x 29½"H (Clear inside depth = 17⅞"D)	<b>H105699</b>	61	2.8	<b>\$331</b>	<b>\$361</b>
42"W x 20"D x 29½"H (Clear inside depth = 17⅞"D)	<b>H105698</b>	54	2.6	<b>\$307</b>	<b>\$337</b>
NOTES: One cord grommet in top; one pass-through grommet in top center of modesty panel.					
! Models H105699 and H105698 cannot be connected to corner or extended corner units or to the jetty or boomerang peninsulas, due to the 20"D "hook-up".					

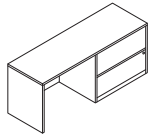

<b>Credenza with 36" Lateral (with core removable lock)</b>					
72"W x 24"D x 29½"H, Right (shown)	<b>H10547R</b>	248	35.6	<b>\$1328</b>	<b>\$1388</b>
72"W x 24"D x 29½"H, Left	<b>H10548L</b>	248	35.6	<b>\$1328</b>	<b>\$1388</b>
NOTES: One cord pass-through grommet in top center of modesty panel. Includes hangrails. Mechanical interlock inhibits the extension of more than one drawer at a time. Accepts optional stack-on storage model H10534 (page 334) or PC Organizer model H105388 (page 333).					
! Not designed to be used with 10500 Series™ 24"D modular or mobile pedestals.					

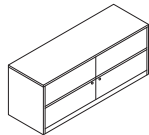

<b>Credenza with two Lateral Files (4 locking drawers. Each core removable lock secures 2 drawers)</b>					
72"W x 24"D x 29½"H	<b>H105491</b>	314	34.7	<b>\$1917</b>	<b>\$1992</b>
NOTES: Includes hangrails; mechanical interlock inhibits the extension of more than one drawer at a time. If side-by-side drawers are opened or closed simultaneously, one drawer may interfere with the other. Two locks (keyed alike). Accepts optional stack-on storage model H10534 (page 334) or PC Organizer model H105388 (page 333).					

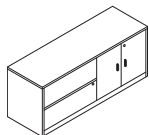

<b>Credenza with Lateral File, left and Storage Cabinet, right (with core removable locks)</b>					
72"W x 24"D x 29½"H	<b>H105492</b>	307	34.7	<b>\$1677</b>	<b>\$1752</b>
NOTES: Includes hangrails; mechanical interlock inhibits the extension of more than one drawer at a time. Storage cabinet locks and includes one adjustable interior shelf. Shelf adjusts in ¼" increments with a total range of 5"H. Two locks (keyed alike). Accepts optional stack-on storage model H10534 (page 334) or PC Organizer model H105388 (page 333).					

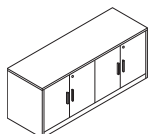

<b>Credenza with Two Storage Cabinets (with core removable locks)</b>					
72"W x 24"D x 29½"H	<b>H105493</b>	302	34.8	<b>\$1563</b>	<b>\$1638</b>
NOTES: Each storage cabinet has one interior shelf which adjusts in ¼" increments over a total range of 5". Each cabinet locks independently; locks are keyed alike. Accepts optional stack-on storage model H10534 (page 334) or PC Organizer model H105388 (page 333).					

**NOTES:**

- Shared components shown on this page and the next can be used with modular components shown on pages 310-325 and 3/4 pedestal models shown on pages 328-329.
- Locking units equipped with interchangeable core removable locks.
- File drawers accept hanging folders in letter or legal size.
- Mobile pedestals shown on page 341 work well in a variety of configurations.
- Work Organizer models accept 3-ring binders and organizer model HTC0L52. See page 345.
- See stack-on storage and organizer options for desks, credenzas and returns, pages 333-335.
- See pages 330-352 for shared components.

! Keyed alike cores must be ordered separately — see model HF23B on page 922.

**HOW TO SPECIFY**

<b>Select Model Number</b>	<b>Select Laminate Top and Chassis Color</b>
See pages 302-303	See pages 302-303
H 1 0 5 7 0 .	N N



# 10500 SERIES™

## Shared Components & Accessories

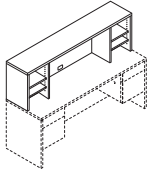

**DESCRIPTION**

**Stack-on PC Organizer**

72"W x 14<sup>5</sup>/<sub>8</sub>"D x 22"H (for 72"W desks, credenzas and shells)  
 60"W x 14<sup>5</sup>/<sub>8</sub>"D x 22"H (for 60"W desks, credenzas and shells)

MODEL	SHIP WEIGHT	CUBE	LIST PRICE BY LAMINATE GRADE	
			L1	L2
<b>H105388</b>	124	5.0	<b>\$772</b>	<b>\$807</b>
<b>H105386</b>	111	4.3	<b>\$715</b>	<b>\$750</b>

NOTES: Features two adjustable paper management shelves both left and right; shelves are adjustable in 1/4" increments. Shelves keep papers, files, and books within easy reach from a seated position. One cord management grommet located in the bottom center of the back panel. Design allows 20<sup>3</sup>/<sub>4</sub>" of vertical clearance for computer equipment.

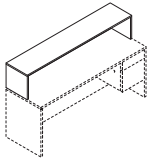

**Work Organizer (shell only)**

72"W x 14<sup>5</sup>/<sub>8</sub>"D x 14<sup>1</sup>/<sub>8</sub>"H (for 72"W unit)  
 66"W x 14<sup>5</sup>/<sub>8</sub>"D x 14<sup>1</sup>/<sub>8</sub>"H (for 66"W unit)

<b>H10537</b>	73	2.9	<b>\$398</b>	<b>\$428</b>
<b>H10536</b>	68	2.7	<b>\$379</b>	<b>\$409</b>

NOTES: Space below counter accepts 3-ring binders and organizer model HTC0L52. See page 345.

**NOTES:**

- Shared components shown on the previous page and on this page can be used with modular components shown on pages 310-325 and 3/4 pedestal models shown on pages 328-329.
- Mobile pedestals shown on page 341 work well in a variety of configurations.
- See stack-on storage and organizer options for desks, credenzas and returns, pages 333-335.
- See pages 330-352 for shared components.
- Locking units equipped with interchangeable core removable locks.
- ! Keyed alike cores must be ordered separately — see model HF23B on page 922.

**HOW TO SPECIFY**

<p>Select Model Number</p> <p>H 1 0 5 3 8 8 .</p>	<p>Select Laminate Top and Chassis Color</p> <p>See pages 302-303</p> <p>N N</p>
---	--



# 10500 SERIES™

## Shared Components & Accessories

GSA SIN 711-8



Icon Legend on page 21

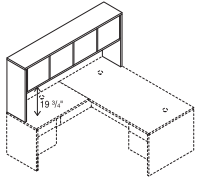

DESCRIPTION	MODEL	SHIP WEIGHT	CUBE	LIST PRICE BY LAMINATE GRADE	
				L1	L2
<b>Stack-on Storage for an "L" Workstation</b> 78"W x 14 <sup>5</sup> / <sub>8</sub> "D x 37 <sup>1</sup> / <sub>8</sub> "H	<b>H105327</b>	198	17.6	<b>\$1085</b>	<b>\$1150</b>
<b>Stack-on Storage for an "L" Workstation, Locking</b> 78"W x 14 <sup>5</sup> / <sub>8</sub> "D x 37 <sup>1</sup> / <sub>8</sub> "H	<b>H105327K</b>	198	17.6	<b>\$1165</b>	<b>\$1230</b>

NOTES: Spans the total depth dimension of configurations comprised of: 48"W return or return shell attached to a 30"D single pedestal desk, desk shell or peninsula (78"D); 42"W return or return shell attached to a 36"D single pedestal desk or desk shell with a rectangle top, or to a peninsula (78"D). 42"W return or return shell attached to a 36" corner unit (78"D); or 42"W curved return attached to 36" curved corner unit (78"D). Use back enclosure model H105857 and tackboard model H90057. Use task light models HH870960 or HH870960CH (see page 532). For vertical paper manager model HLVPM1, see page 346.

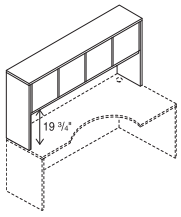

<b>Stack-on Storage</b> 72"W x 14 <sup>5</sup> / <sub>8</sub> "D x 37 <sup>1</sup> / <sub>8</sub> "H, 4 doors (Use Task Light HH870960, see page 339)	<b>H10534</b>	185	17.1	<b>\$958</b>	<b>\$998</b>
66"W x 14 <sup>5</sup> / <sub>8</sub> "D x 37 <sup>1</sup> / <sub>8</sub> "H, 4 doors (Use Task Light HH870960, see page 339)	<b>H10533</b>	175	15.3	<b>\$932</b>	<b>\$987</b>
60"W x 14 <sup>5</sup> / <sub>8</sub> "D x 37 <sup>1</sup> / <sub>8</sub> "H, 4 doors (Use Task Light HH870960, see page 339)	<b>H105324</b>	164	14.0	<b>\$894</b>	<b>\$949</b>
48"W x 14 <sup>5</sup> / <sub>8</sub> "D x 37 <sup>1</sup> / <sub>8</sub> "H, 3 doors (Use Task Light HH870942, see page 339)	<b>H105323</b>	141	11.3	<b>\$805</b>	<b>\$850</b>
42"W x 14 <sup>5</sup> / <sub>8</sub> "D x 37 <sup>1</sup> / <sub>8</sub> "H, 2 doors (Use Task Light HH870942, see page 339)	<b>H105322</b>	135	4.0	<b>\$659</b>	<b>\$704</b>
36"W x 14 <sup>5</sup> / <sub>8</sub> "D x 37 <sup>1</sup> / <sub>8</sub> "H, 2 doors (Use Task Light HH870930, see page 339)	<b>H105321</b>	102	3.5	<b>\$623</b>	<b>\$653</b>
<b>Stack-on Storage, Locking</b> 72"W x 14 <sup>5</sup> / <sub>8</sub> "D x 37 <sup>1</sup> / <sub>8</sub> "H, 4 doors (Use Task Light HH870960, see page 339)	<b>H10534K</b>	185	17.1	<b>\$1038</b>	<b>\$1093</b>
66"W x 14 <sup>5</sup> / <sub>8</sub> "D x 37 <sup>1</sup> / <sub>8</sub> "H, 4 doors (Use Task Light HH870960, see page 339)	<b>H10533K</b>	175	15.3	<b>\$1012</b>	<b>\$1067</b>
60"W x 14 <sup>5</sup> / <sub>8</sub> "D x 37 <sup>1</sup> / <sub>8</sub> "H, 4 doors (Use Task Light HH870960, see page 339)	<b>H105324K</b>	164	14.0	<b>\$974</b>	<b>\$1029</b>
48"W x 14 <sup>5</sup> / <sub>8</sub> "D x 37 <sup>1</sup> / <sub>8</sub> "H, 3 doors (Use Task Light HH870942, see page 339)	<b>H105323K</b>	141	11.3	<b>\$845</b>	<b>\$890</b>
42"W x 14 <sup>5</sup> / <sub>8</sub> "D x 37 <sup>1</sup> / <sub>8</sub> "H, 2 doors (Use Task Light HH870942, see page 339)	<b>H105322K</b>	135	4.0	<b>\$699</b>	<b>\$744</b>
36"W x 14 <sup>5</sup> / <sub>8</sub> "D x 37 <sup>1</sup> / <sub>8</sub> "H, 2 doors (Use Task Light HH870930, see page 339)	<b>H105321K</b>	102	3.5	<b>\$663</b>	<b>\$703</b>

NOTES: For use on respective desk, credenza or return widths. Model H10534 can be used for "L" configuration comprised of 30"D desk, desk shell or peninsula and 42"W return or return shell; or a 36"D desk, desk shell, peninsula, or corner unit and 36"W return shell. Model H115323K has one lock which secures two of the three doors. See vertical paper manager model HLVPM1 on page 346.

**NOTES:**

- Shared components shown on this page and the next can be used with modular components shown on pages 310-325 and 3/4 pedestal models shown on pages 328-329.
- Rich wood-grain laminate and frosted doors with silver frames adds a contemporary mixed materials option to the 10500 Series™.
- Stack-on storage models are equipped with self-closing, adjustable hinged doors and valance to hide task light.
- See page 337 for stack-on storage back enclosures and tackboards, and page 339 for task lights.
- For work-in-process paper management tools, see pages 346-347.
- See pages 330-352 for shared components.
- **Removable lock core kit for locking stack-on storage is model HF27B. See page 922.**

**HOW TO SPECIFY****Select Model Number**

Add suffix "K" to Model Number for Lock. \$80 upcharge.

H 1 0 5 3 2 7 .

**Select Laminate Top and Chassis Color**

See pages 302-303

N N

# 10500 SERIES™

## Shared Components & Accessories

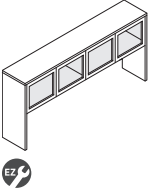
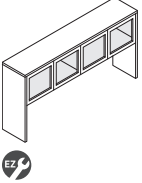
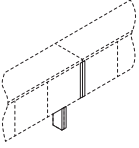
	DESCRIPTION	MODEL	SHIP WEIGHT	CUBE	LIST PRICE BY LAMINATE GRADE	
					L1	L2
	<b>Stack-on Storage for an "L" Workstation, Frosted Doors with Silver Frame</b> 78"W x 14 <sup>5</sup> / <sub>8</sub> "D x 37 <sup>1</sup> / <sub>8</sub> "H	<b>H105327G</b>	198	17.3	<b>\$1685</b>	<b>\$1735</b>
	NOTES: Spans the total depth dimension of configurations comprised of: 48"W return or return shell attached to a 30"D single pedestal desk, desk shell or peninsula (78"D); 42"W return or return shell attached to a 36"D single pedestal desk or desk shell with a rectangle top, or to a peninsula (78"D). 42"W return or return shell attached to a 36" corner unit (78"D); 42"W curved return attached to 36" curved corner unit (78"D); or 36"W return shell attached to a jetty peninsula (78"D). Use back enclosure model 105857 and tackboard model 90057. Use task light models H870960 or H870960CH. For vertical paper manager model HLVPM1, see page 346.					
	<b>Stack-on Storage, Frosted Doors with Silver Frame</b> 72"W x 14 <sup>5</sup> / <sub>8</sub> "D x 37 <sup>1</sup> / <sub>8</sub> "H, 4 doors (Use Task Light HH870960, see page 339)	<b>H10534G</b>	185	15.9	<b>\$1558</b>	<b>\$1598</b>
	66"W x 14 <sup>5</sup> / <sub>8</sub> "D x 37 <sup>1</sup> / <sub>8</sub> "H, 4 doors (Use Task Light HH870960, see page 339)	<b>H10533G</b>	175	14.6	<b>\$1532</b>	<b>\$1572</b>
	60"W x 14 <sup>5</sup> / <sub>8</sub> "D x 37 <sup>1</sup> / <sub>8</sub> "H, 4 doors (Use Task Light HH870960, see page 339)	<b>H105324G</b>	164	13.3	<b>\$1494</b>	<b>\$1534</b>
	48"W x 14 <sup>5</sup> / <sub>8</sub> "D x 37 <sup>1</sup> / <sub>8</sub> "H, 3 doors (Use Task Light HH870942, see page 339)	<b>H105323G</b>	141	10.8	<b>\$1255</b>	<b>\$1285</b>
	42"W x 14 <sup>5</sup> / <sub>8</sub> "D x 37 <sup>1</sup> / <sub>8</sub> "H, 2 doors (Use Task Light HH870942, see page 339)	<b>H105322G</b>	135	3.6	<b>\$959</b>	<b>\$989</b>
	36"W x 14 <sup>5</sup> / <sub>8</sub> "D x 37 <sup>1</sup> / <sub>8</sub> "H, 2 doors (Use Task Light HH870930, see page 339)	<b>H105321G</b>	102	3.1	<b>\$923</b>	<b>\$948</b>
	NOTES: For respective desk, credenza or return widths. Model 10534 can be used for "L" configuration comprised of a 42"W return or return shell attached to a 30"D single pedestal desk, desk shell or peninsula (72"); 36"W return shell attached to a 36"D single pedestal desk, desk shell or peninsula (72"); or 30"W return shell attached to a jetty peninsula (72"). Back enclosures, tackboards for use with back enclosures and task lights are available as options. See vertical paper manager model HLVPM1 on page 346.					
	<b>Stack-on Storage Clearance End Panel Kit</b> 1 <sup>1</sup> / <sub>8</sub> "W x 4 <sup>5</sup> / <sub>8</sub> -14 <sup>5</sup> / <sub>8</sub> "D x 36"H	<b>H105349</b>	29	3.4	<b>\$340</b>	<b>\$355</b>
	Two field installable end panels (1-right; 1-left) for use in ganging two 10500 or Valido® Series stack-on storage units. Narrow design replaces the full 14 <sup>5</sup> / <sub>8</sub> "D end panels to expand worksurface space. The narrow right end panel replaces the standard 14 <sup>5</sup> / <sub>8</sub> "D right end panel on one stack-on storage unit, the narrow left end panel replaces the standard 14 <sup>5</sup> / <sub>8</sub> "D left end panel on a separate, adjacent stack-on storage unit that is in linear alignment with the first unit. Kit includes: (2) narrow end panel supports; European-style fasteners; dowels; joint connector bolts with sleeve nuts (for ganging stack-on storage units).					
	NOTES: Can be used to connect up to two stack-on storage units in a line (requires 1 kit). Not available in two-tone laminate.					
	<b>SPECIFYING EXAMPLE: H105349.N</b>					

**NOTES:**

- Shared components shown on the previous page and on this page can be used with modular components shown on pages 310-325 and 3/4 pedestal models shown on pages 328-329.
- Rich wood-grain laminate and frosted doors with silver frames adds a contemporary mixed materials option to the 10500 Series™.
- Stack-on storage models are equipped with self-closing, adjustable hinged doors and valance to hide task light.
- See page 337 for stack-on storage back enclosures and tackboards, and page 339 for task lights.
- For work-in-process paper management tools, see pages 346-347.
- See pages 330-352 for shared components.
- **Removable lock core kit for locking stack-on storage is model HF27B. See page 922.**

**HOW TO SPECIFY**
**Select Model Number**

Add suffix "K" to Model Number for Lock. \$80 upcharge.

H 1 0 5 3 2 7 G .

**Select Laminate Top and Chassis Color**

See pages 302-303

N N

# 10500 SERIES™

## Shared Components & Accessories

GSA SIN 711-8

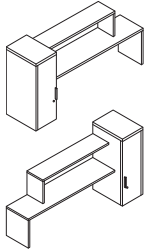

Icon Legend on page 21

**DESCRIPTION**

**Stack-on Cabinet, Left, Open Shelves, Right**  
**Stack-on Cabinet, Right, Open Shelves, Left**

Overall measures: 72"W x 20"D x 37<sup>1</sup>/<sub>8</sub>"H  
 Cabinet measures: 13<sup>1</sup>/<sub>2</sub>"W x 19<sup>7</sup>/<sub>8</sub>"D x 37<sup>1</sup>/<sub>8</sub>"H

NOTES: Closed door locking cabinet combines with open shelves for a clean look. Cabinet has 3 shelves (two are adjustable) and a core removable lock to secure contents. The clearance between the worksurface and underside of the lower shelf is 18<sup>5</sup>/<sub>8</sub>". Top shelf is 45"W x 11"D, bottom shelf is 58<sup>1</sup>/<sub>2</sub>"W x 14"D; space between the shelves is 12<sup>1</sup>/<sub>4</sub>". Some assembly required; cabinet is fully assembled; simple shelf attachment. For two-tone color combinations, the first color designator defines the top of the storage cabinet(s), the second designator defines the color of the cabinet vertical panels and the open (exterior) shelves.

**MODEL****SHIP WEIGHT****CUBE****LIST PRICE BY LAMINATE GRADE****L1****L2**

**H105314L**  
**H105313R**

149  
 149

11.9  
 11.9

**\$1048**  
**\$1048**

**\$1098**  
**\$1098**

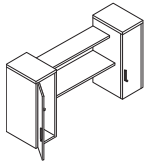
**Stack-on Cabinets with Open Shelves, Center****H105319**

218

20.3

**\$1666****\$1746**

Overall measures: 72"W x 20"D x 37<sup>1</sup>/<sub>8</sub>"H  
 Cabinet measures: 13<sup>1</sup>/<sub>2</sub>"W x 19<sup>7</sup>/<sub>8</sub>"D x 37<sup>1</sup>/<sub>8</sub>"H

NOTES: Contemporary, light scale design blends open and closed storage. Features two locking cabinets bridged by two open shelves. The clearance between the worksurface and underside of the lower shelf is 18<sup>5</sup>/<sub>8</sub>". Top shelf is 45"W x 11"D, bottom shelf is 45"W x 14"D; space between the shelves is 12<sup>1</sup>/<sub>4</sub>". Some assembly required; cabinets are fully assembled; simple shelf attachment. For two-tone color combinations, the first color designator defines the top of the storage cabinet(s), the second designator defines the color of the cabinet vertical panels and the open (exterior) shelves.

**NOTES:**

- Stack-on models above are sized to fit on 72" desk, credenza, return, or desk with return worksurfaces.
- Easy-care, scratch-, spill- and stain-resistant laminate over 1/8" solid core high-performance particleboard.
- Cabinets have three shelves, two are adjustable.
- Removable lock core kit for the cabinet models above is HF23B. See page 922.
- Back of cabinet door has a convenient double coat hook; the lower peg is for jackets and lighter items, the upper peg for heavier coats and bags.
- Open shelves display books, photos, and mementos, shelves are fixed height; top shelf is 3/4" thick, lower shelf is 1/8".
- Task light can be attached to underside of the bottom shelf.

**HOW TO SPECIFY****Select Model Number**

H 1 0 5 3 1 4 L .

**Select Cabinet Top and Chassis Color**

See pages 302-303

H H .

**Select Open Shelf Laminate**

L1

**H** Bourbon Cherry  
**COGN** Cognac  
**C** Harvest  
**N** Mahogany  
**MOCH** Mocha  
**D** Natural Maple  
**PINC** Pinnacle  
**F** Shaker Cherry  
**P** Black  
**S** Charcoal  
**WHIT** Brilliant White

L2

**LLA1** Lowell Ash  
**LNRI** Natural Recon  
**LPE1** Phantom Ecu  
**LPT1** Portico Teak  
**LSW1** Skyline Walnut

H



Icon Legend on page 21

# 10500 SERIES™ Shared Components & Accessories

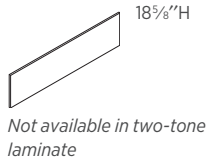

DESCRIPTION	MODEL	SHIP WEIGHT	CUBE	LIST PRICE BY LAMINATE GRADE	
				L1	L2
<b>Back Enclosure for Stack-on Storage</b>					
75 3/4"W - for 78"W model #H105327/H105327K/H105327G	<b>H105857</b>	39	1.4	<b>\$244</b>	<b>\$254</b>
69 3/4"W - for 72"W model #H10534/H10534K/H10534G	<b>H105856</b>	33	1.3	<b>\$224</b>	<b>\$234</b>
63 3/4"W - for 66"W model #H10533/H10533K/H10533G	<b>H105855</b>	31	1.3	<b>\$208</b>	<b>\$218</b>
57 3/4"W - for 60"W model #H105324/H105324K/H105324G	<b>H105854</b>	29	1.3	<b>\$199</b>	<b>\$209</b>
45 3/4"W - for 48"W model #H105323/H105323K/H105323G	<b>H105853</b>	23	0.9	<b>\$199</b>	<b>\$209</b>
39 3/4"W - for 42"W model #H105322/H105322K/H105322G	<b>H105852</b>	21	0.9	<b>\$190</b>	<b>\$200</b>
33 3/4"W - for 36"W model #H105321/H105321K/H105321G	<b>H105851</b>	18	0.9	<b>\$179</b>	<b>\$189</b>

NOTES: Non-tackable.  
SPECIFYING EXAMPLE: **H105857.N**

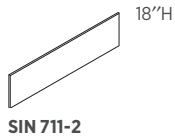

DESCRIPTION	MODEL	COM	SHIP WEIGHT	CUBE	LIST PRICE
<b>Tackboards for use with Stack-on Back Enclosures (Back Enclosures must be ordered separately.)</b>					
75"W - for 78"W model #H105327 Hutch with #H105857 Enclosure	<b>H90057</b>	3.0	13	3.2	<b>\$297</b>
68 3/4"W - for 72"W model #H10534 Hutch with #H105856 Enclosure	<b>H90056</b>	2.0	12	2.7	<b>\$283</b>
62 3/4"W - for 66"W model #H10533 Hutch with #H105855 Enclosure	<b>H90055</b>	2.0	11	2.5	<b>\$268</b>
56 3/4"W - for 60"W model #H105324 Hutch with #H105854 Enclosure	<b>H90054</b>	2.0	10	2.2	<b>\$236</b>
44 3/4"W - for 48"W model #H105323 Hutch with #H105853 Enclosure	<b>H90053</b>	2.0	8	1.8	<b>\$226</b>
39"W - for 42"W model #H105322 Hutch with #H105852 Enclosure	<b>H90052</b>	2.0	7	1.6	<b>\$208</b>
33"W - for 36"W model #H105321 Hutch with #H105851 Enclosure	<b>H90051</b>	1.0	6	1.4	<b>\$184</b>
26 3/4"W	<b>H90050</b>	1.0	5	1.2	<b>\$184</b>

NOTES: Specify fabric, see pages 35-36. Upcharges may apply to premium fabric grades.  
SPECIFYING EXAMPLE: **H90057.APN15**

**NOTES:**

- When connected to the stack-on storage unit, back enclosure features full-width 1 1/8" slot at the bottom to facilitate routing cords and reaching wall electrical outlets.
- Tackboard is sized 3/4" narrower than stack-on storage back enclosure, allowing 3/8" on each side to route task light cord.
- Tackboard includes adhesive tape to secure to back enclosure and hardware for wall attachment.
- See pages 330-352 for shared components.

## HOW TO SPECIFY

<p>Select Model Number</p> <p><b>H 1 0 5 8 5 7 . N</b></p>	<p>Select Laminate Top and Chassis Color</p> <p>See pages 302-303</p> <p><b>N</b></p>
--	---

# 10500 SERIES™

## Shared Components & Accessories

GSA SIN 711-8

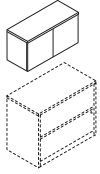

DESCRIPTION	MODEL	SHIP		LIST PRICE BY LAMINATE GRADE	
		WEIGHT	CUBE	L1	L2
<b>Wall Mounted Storage Cabinet</b> 30"W x 14 <sup>5</sup> / <sub>8</sub> "D x 18 <sup>1</sup> / <sub>2</sub> "H, 2 doors (Use task light model HH870930, see page 339)	<b>H105380</b>	73	8.7	<b>\$660</b>	<b>\$695</b>
36"W x 14 <sup>5</sup> / <sub>8</sub> "D x 18 <sup>1</sup> / <sub>2</sub> "H, 2 doors (Use task light model HH870930, see page 339)	<b>H105381</b>	87	10.2	<b>\$708</b>	<b>\$743</b>
42"W x 14 <sup>5</sup> / <sub>8</sub> "D x 18 <sup>1</sup> / <sub>2</sub> "H, 2 doors (Use task light model HH870942, see page 339)	<b>H105382</b>	97	11.7	<b>\$778</b>	<b>\$813</b>
48"W x 14 <sup>5</sup> / <sub>8</sub> "D x 18 <sup>1</sup> / <sub>2</sub> "H, 3 doors (Use task light model HH870942, see page 339)	<b>H105383</b>	114	13.2	<b>\$832</b>	<b>\$867</b>
<b>Wall Mounted Storage Cabinet, Locking</b> 30"W x 14 <sup>5</sup> / <sub>8</sub> "D x 18 <sup>1</sup> / <sub>2</sub> "H, 2 doors (Use task light model HH870930, see page 339)	<b>H105380K</b>	73	8.7	<b>\$700</b>	<b>\$735</b>
36"W x 14 <sup>5</sup> / <sub>8</sub> "D x 18 <sup>1</sup> / <sub>2</sub> "H, 2 doors (Use task light model HH870930, see page 339)	<b>H105381K</b>	87	10.2	<b>\$748</b>	<b>\$783</b>
42"W x 14 <sup>5</sup> / <sub>8</sub> "D x 18 <sup>1</sup> / <sub>2</sub> "H, 2 doors (Use task light model HH870942, see page 339)	<b>H105382K</b>	97	11.7	<b>\$818</b>	<b>\$853</b>
48"W x 14 <sup>5</sup> / <sub>8</sub> "D x 18 <sup>1</sup> / <sub>2</sub> "H, 3 doors (Use task light model HH870942, see page 339)	<b>H105383K</b>	114	13.2	<b>\$872</b>	<b>\$907</b>

NOTES: Horizontal interlocking rails are included; due to varying types of walls, installers are responsible for selecting and supplying the appropriate fasteners. Tackboard widths differ slightly from wall mounted storage cabinet widths. For applications where multiple wall mounted storage cabinets are placed side-by-side, the preferred tackboard solution may be to utilize a larger tackboard size. For wall mounted storage cabinets with frosted doors, see page 339.

**SPECIFYING EXAMPLE: H105380.NN**  
**If Specifying with Lock Option: H105380K.NN**

**NOTES:**

- Tackboard is sized <sup>3</sup>/<sub>4</sub>" narrower than stack-on storage back enclosure, allowing <sup>3</sup>/<sub>8</sub>" on each side to route task light cord.
- Wall attachment methodology: horizontally mounted, interlocking brackets.
- Wall mounted storage cabinet door design overlaps end panels so that when multiple units are placed side-by-side they appear as one continuous unit.
- Wall mounted storage cabinets available with laminate doors, locking laminate doors or frosted doors.
- Removable lock core kit for locking stack-on and wall mounted storage is model HF27B. See page 922.
- See pages 330-352 for shared components.

- ! Wall mounted storage cabinet attachment requires individual cabinets be secured by a minimum of two wall mounting locations/studs.
- ! Wall mounted storage cabinets are designed for interior and perimeter walls that are constructed with wood or metal studs.
- ! The HON Company is not responsible for any liabilities resulting from wall mounted storage cabinets that are not properly installed.

**HOW TO SPECIFY**

Select  
Model Number

Select  
Laminate Top and Chassis Color

See pages 302-303

H 1 0 5 3 8 0 K . N N



Icon Legend on page 21

# 10500 SERIES™ Storage

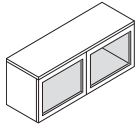

DESCRIPTION	MODEL	SHIP WEIGHT	CUBE	LIST PRICE BY LAMINATE GRADE	
				L1	L2
<b>Wall Mounted Storage Cabinet, Frosted Doors with Silver Frame</b>					
30"W x 14 <sup>5</sup> / <sub>8</sub> "D x 17 <sup>1</sup> / <sub>2</sub> "H	<b>H105380G</b>	73.0	9.1	<b>\$960</b>	<b>\$985</b>
36"W x 14 <sup>5</sup> / <sub>8</sub> "D x 17 <sup>1</sup> / <sub>2</sub> "H	<b>H105381G</b>	87.0	10.7	<b>\$1008</b>	<b>\$1033</b>
42"W x 14 <sup>5</sup> / <sub>8</sub> "D x 17 <sup>1</sup> / <sub>2</sub> "H	<b>H105382G</b>	97.0	12.3	<b>\$1078</b>	<b>\$1103</b>
48"W x 14 <sup>5</sup> / <sub>8</sub> "D x 17 <sup>1</sup> / <sub>2</sub> "H	<b>H105383G</b>	114.0	13.9	<b>\$1282</b>	<b>\$1307</b>

NOTES: Door design overlaps end panels so that when multiple units are placed side-by-side they appear as one continuous unit. Product placement can be aligned to match the height of storage cabinets, wardrobes and towers. Equipped with self-closing, adjustable side-hinged doors. The 30", 36", and 42"W units have two doors; the 48"W has three doors. Frosted door units do not have a lock option. Wall attachment methodology: horizontally mounted, interlocking brackets.

Tackboard widths differ slightly from wall mounted storage cabinet widths. For applications where multiple wall mounted storage cabinets are placed side-by-side, the preferred tackboard width may be to utilize a larger tackboard size.

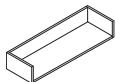

Not available in two-tone laminate



DESCRIPTION	MODEL	SHIP WEIGHT	CUBE	LIST PRICE BY LAMINATE GRADE	
				L1	L2
<b>Wall Mounted Open Shelf</b>					
30"W x 9 <sup>7</sup> / <sub>8</sub> "D x 4 <sup>3</sup> / <sub>4</sub> "H	<b>H105360</b>	12.0	0.8	<b>\$228</b>	<b>\$243</b>
36"W x 9 <sup>7</sup> / <sub>8</sub> "D x 4 <sup>3</sup> / <sub>4</sub> "H	<b>H105361</b>	14.0	0.8	<b>\$240</b>	<b>\$255</b>
42"W x 9 <sup>7</sup> / <sub>8</sub> "D x 4 <sup>3</sup> / <sub>4</sub> "H	<b>H105362</b>	16.0	0.8	<b>\$264</b>	<b>\$284</b>
48"W x 9 <sup>7</sup> / <sub>8</sub> "D x 4 <sup>3</sup> / <sub>4</sub> "H	<b>H105363</b>	18.0	1.2	<b>\$292</b>	<b>\$312</b>

NOTES: Ideal for books, photographs, and mementos up to 9"D. Two attachment orientation options, open ended shelf or shelf with book ends. Available in wood-grain or solid color laminates only. No patterns. No two-tone combinations. Simple assembly.

**SPECIFYING EXAMPLE: H105363.N**

**NOTES:**

- Easy-care, scratch-, spill- and stain-resistant laminate over solid core high-performance particleboard.
- Stacked paper management (model HLVPM2), which is 32<sup>1</sup>/<sub>2</sub>"W, is compatible with the 30"W and 36"W wall mounted storage cabinets.
- ! Wall mounted storage cabinet attachment requires individual cabinets be secured by a minimum of two wall mounting locations/studs.
- ! Wall mounted storage cabinets are designed for interior and perimeter walls that are constructed with wood or metal studs.
- ! The HON Company is not responsible for any liabilities resulting from wall mounted storage cabinets that are not properly installed.



OPEN MARKET

DESCRIPTION	MODEL	SHIP WEIGHT	CUBE	LIST PRICE
<b>LED Task Lights</b>				
17" LED Light with Power Supply (Single)	<b>HLED17AS</b>	1.2 Ⓞ	0.05	<b>\$384</b>
31" LED Light with Power Supply (Single)	<b>HLED31AS</b>	1.5 Ⓞ	0.09	<b>\$516</b>
17" LED Light with Power Supply for Daisy-chain (Starter)	<b>HLED17A</b>	1.0 Ⓞ	0.05	<b>\$422</b>
31" LED Light with Power Supply for Daisy-chain (Starter)	<b>HLED31A</b>	1.4 Ⓞ	0.09	<b>\$567</b>
17" LED Light with 8" Jumper Cord for Daisy-chain (Follower)	<b>HLED17AUO</b>	1.0 Ⓞ	0.03	<b>\$344</b>
31" LED Light with 8" Jumper Cord for Daisy-chain (Follower)	<b>HLED31AUO</b>	1.0 Ⓞ	0.05	<b>\$460</b>
<b>Undercabinet Occupancy Sensor with 1" End to End Connector</b>	<b>HLEDOSA</b>	0.2 Ⓞ	0.01	<b>\$80</b>

NOTES: To use the daisy chain application, must start with model HLED17A or HLED31A. No finish specification required. Attaches magnetically to underside of overhead storage, or attaches with provided screws or double-sided tape. Occupancy sensor attaches to a single or starter LED light and will automatically turn the light off after no motion is detected for 30 minutes. Just like all the LED light models, the occupancy sensor features a soft-touch on/off switch. LED task lights have a lifetime of 50,000 hours and have a dimmer feature that allows the user to adjust the amount of light output. For additional information see page 911.



Refer to page 77

OPEN MARKET

<b>Recessed Task Light</b> , 46 <sup>1</sup> / <sub>2</sub> "W x 3 <sup>1</sup> / <sub>8</sub> "D, for Models H105327, H10534, H10533 and H105324	<b>HH870960</b>	12.0 Ⓞ	1.1	<b>\$246</b>
<b>Recessed Task Light</b> , 34 <sup>5</sup> / <sub>8</sub> "W x 3 <sup>1</sup> / <sub>8</sub> "D, for Models H105323, H105322, H105382 and H105383	<b>HH870942</b>	10.0 Ⓞ	0.9	<b>\$228</b>
<b>Recessed Task Light</b> , 22 <sup>7</sup> / <sub>8</sub> "W x 3 <sup>1</sup> / <sub>8</sub> "D, for Models H10531, H105321, H105320, H105380 and H105381	<b>HH870930</b>	7.0 Ⓞ	0.6	<b>\$211</b>

NOTES: For additional information see page 911.

## HOW TO SPECIFY

<p>Select Model Number</p> <p>H 1 0 5 3 8 3 G .</p>	<p>Select Laminate Top and Chassis Color</p> <p>See pages 302-303</p> <p>H H</p>
---	--

# 10500 SERIES™ Shared Components & Accessories

GSA SIN 711-8



Icon Legend on page 21

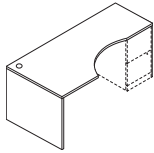

Right-hand model  
H105815R shown



**DESCRIPTION**

**Extended Corner Unit**

24"W x 36"D x 72"W x 24"D x 29½"H, Right (shown)  
24"D x 72"W x 36"D x 24"W x 29½"H, Left

MODEL	SHIP WEIGHT	CUBE
<b>H105815R</b>	184	7.0
<b>H105816L</b>	184	7.0

**LIST PRICE BY LAMINATE GRADE**

L1	L2
<b>\$1018</b>	<b>\$1063</b>
<b>\$1018</b>	<b>\$1063</b>

NOTES: Intended for use with returns or bridges. Can be used freestanding. The 17" user side dimension is designed to accommodate 10500 Series™ modular or mobile pedestals up to 15¾"W. One grommet in top and one cord pass-through grommet in modesty panel. See pages 333-337 for optional stack-ons and tackboards. Extended corner units (H105815R and H105816L) can be used with 36"W return shell (H105680) to achieve a 6' x 6' layout.

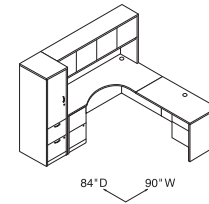
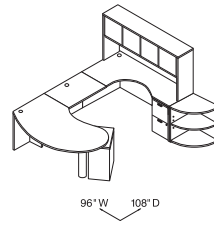
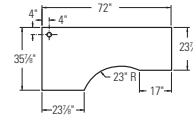

H105204L  
H105102  
H105598  
H105815R  
H105104  
H10534  
H105520

H105298L  
H105816L  
H10504  
H10534  
H10515R

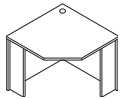

**Corner Unit**

24" x 36" x 36" x 24" x 29½"H

**H105811**

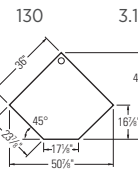

NOTES: Intended for use with 24"D x 29½"H returns or bridges. Can be used freestanding. 36" corner unit (H105811) can be used with two 36"W return shells (H105680) to achieve a 6' x 6' layout.

⚠ Not designed to attach to returns or bridges manufactured prior to 5/24/99.

130 3.1

**\$732 \$767**

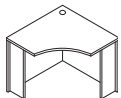

**Curved Corner Unit**

18" x 36" x 36" x 18" x 29½"H

**H105810**

NOTES: Can be used freestanding.

⚠ Designed to be used with curved returns only.

128 5.4

**\$732 \$767**

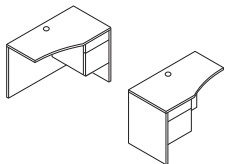

**Curved Return — box/file**

42"W x 18-24"D x 29½"H, Right  
42"W x 24-18"D x 29½"H, Left

**H105817R**  
**H105818L**

134 20.5  
134 20.5

**\$793 \$833**  
**\$793 \$833**

NOTES: Pedestal locks. One cord grommet in top; one pass-through grommet in top center of modesty panel. H105327 stack-on storage (78"W) can be used to span corner unit and return. H105322 stack-on storage (42"W) can be used on return. See page 334.

⚠ Designed to be used with curved corner unit only.  
⚠ Not designed to be used freestanding.

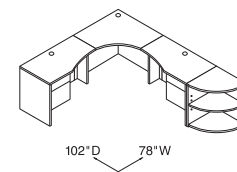
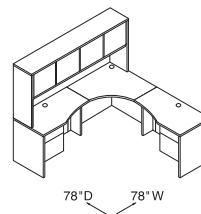

H105818L  
H105810  
H105327  
H105817R

H105818  
H105810  
H105817R  
H105520

**NOTES:**

- Shared components shown on this page can be used with modular components shown on pages 310-325 and 3/4 pedestal models shown on pages 328-329.
- Mobile pedestals, shown on page 341, work well in a variety of configurations.
- End cap bookshelf units are ideal for books and personal items — see page 344.
- For work-in-process paper management tools, see pages 346-347.
- For 10500 Series™ matching occasional tables, use the H80191, H80192, and H80193 on page 348.
- For conference table options, see the Preside® table tops and bases on pages 846-851.
- Mobile table quickly provides additional worksurface space, see page 331.
- See pages 330-352 for shared components.





**HOW TO SPECIFY**

<b>Select Model Number</b>	<b>Select Laminate Top and Chassis Color</b>
	See pages 302-303
H 1 0 5 8 1 5 R .	N N



# 10500 SERIES™

## Shared Components & Accessories

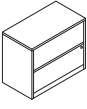
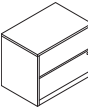
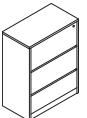
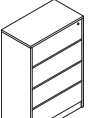
	DESCRIPTION	MODEL	SHIP WEIGHT	CUBE	LIST PRICE BY LAMINATE GRADE	
					L1	L2
	<b>Box/Box/File Mobile Pedestal (with core removable lock)</b> 15 <sup>3</sup> / <sub>4</sub> "W x 22 <sup>3</sup> / <sub>4</sub> "D x 28 <sup>3</sup> / <sub>8</sub> "H — use freestanding or under 24"D, 30"D and 36"D modular shells NOTES: Top box drawer does not lock. File drawer includes hangrails.	<b>H105102</b>	121	8.5	<b>\$809</b>	<b>\$849</b>
	<b>File/File Mobile Pedestal (with core removable lock)</b> 15 <sup>3</sup> / <sub>4</sub> "W x 22 <sup>3</sup> / <sub>4</sub> "D x 28 <sup>3</sup> / <sub>8</sub> "H — use freestanding or under 24"D, 30"D and 36"D modular shells NOTES: File drawers include hangrails.	<b>H105104</b>	121	8.4	<b>\$809</b>	<b>\$849</b>
	<b>Box/File Mobile Pedestal (with core removable lock)</b> 15 <sup>3</sup> / <sub>4</sub> "W x 18 <sup>7</sup> / <sub>8</sub> "D x 21 <sup>7</sup> / <sub>8</sub> "H — use freestanding or under 20"D, 24"D, 30"D and 36"D modular shells	<b>H105106</b>	65	5.8	<b>\$677</b>	<b>\$707</b>
	<b>Shelf/Box/File Mobile Pedestal (with core removable lock)</b> 15 <sup>3</sup> / <sub>4</sub> "W x 18 <sup>7</sup> / <sub>8</sub> "D x 28 <sup>3</sup> / <sub>8</sub> "H — use freestanding or under 20"D, 24"D, 30"D and 36"D modular shells NOTES: Interior dimensions of the open storage area of the Shelf/Box/File model are 14 <sup>1</sup> / <sub>8</sub> "W x 16 <sup>3</sup> / <sub>4</sub> "D x 6 <sup>5</sup> / <sub>8</sub> "H.	<b>H105109</b>	73	7.3	<b>\$745</b>	<b>\$785</b>
	<b>Lateral File (with core removable lock)</b> 36"W x 20"D x 29 <sup>1</sup> / <sub>2</sub> "H — two drawer 36"W x 24"D x 29 <sup>1</sup> / <sub>2</sub> "H — two drawer 36"W x 20"D x 45 <sup>1</sup> / <sub>2</sub> "H — three drawer 36"W x 20"D x 59 <sup>1</sup> / <sub>8</sub> "H — four drawer NOTES: Includes hangrails, mechanical interlock and in H10563 and H105690, a counterweight. Stack-on storage (H105321) and bookcase hutch (H105292) can be used with H10563 and H105690. Interlock inhibits the extension of more than one drawer from opening at a time. Model H105690 aligns with 24"D credenzas and returns.	<b>H10563</b>	170	15.6	<b>\$922</b>	<b>\$972</b>
		<b>H105690</b>	191	17.6	<b>\$969</b>	<b>\$1024</b>
		<b>H10517</b>	240	23.2	<b>\$1515</b>	<b>\$1580</b>
		<b>H10516</b>	305	31.0	<b>\$1997</b>	<b>\$2067</b>

**NOTES:**

- For additional components that can be shared with 10500 Series™, see pages 330-352.
- Mobile pedestals feature clean styling with hidden casters. Versatile designs roll easily and work well in a variety of configurations. Can be used freestanding, under modular shells, or with 10500 Series™ component worksurfaces and supports.
- 24"D lateral file, storage cabinet, and bookcase models align evenly with credenzas and returns to provide linear layout continuity.
- At 45<sup>1</sup>/<sub>2</sub>"H, the three-drawer lateral file can be used as a standing-height worksurface or to support office equipment.
- Drawers operate on full extension, ball-bearing suspensions to ensure smooth, quiet, long-lasting operation.
- File drawer design includes integrated hangrails for side-to-side letter or legal filing; and front-to-back for letter filing.
- Mobile printer/fax cart shown on page 325 is ideal for limited space.

**HOW TO SPECIFY**

<b>Select Model Number</b> <input type="text" value="H105102"/>	<b>Select Laminate Top and Chassis Color</b> See pages 302-303 <input type="text" value="NN"/>
--	--



# 10500 SERIES™

## Shared Components & Accessories

GSA SIN 711-8

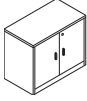
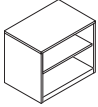
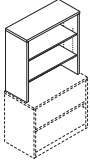

Icon Legend on page 21

	DESCRIPTION	MODEL	SHIP WEIGHT	CUBE	LIST PRICE BY LAMINATE GRADE	
					L1	L2
	<b>Storage Cabinet with Doors (with core removable lock)</b>					
	36"W x 20"D x 29½"H 36"W x 24"D x 29½"H	<b>H105291</b> <b>H105290</b>	147 168	15.0 17.6	<b>\$740</b> <b>\$878</b>	<b>\$790</b> <b>\$933</b>
	NOTES: Includes one adjustable shelf. Shelf adjusts in 1¼" increments with a total range of 6¼"H. Stack-on storage (H105321), and bookcase hutch (H105292) can be used with H105291 or H105290. Model H105290 aligns with 24"D credenzas and returns.					
	<b>Bookcase</b>					
	36"W x 24"D x 29½"H, 2-Shelf, 1-Adjustable	<b>H105531</b>	102	18.4	<b>\$717</b>	<b>\$732</b>
	NOTES: Adjustable shelf is 22"D and adjusts in 1¼" increments, with a total range of 5". 24" depth aligns evenly with 24"D credenzas, credenza shells, returns, return shells, and wardrobe/storage cabinets to provide linear layout continuity. Adjustable leveling glides. Accommodates the 36"W stack-on storage or bookcase hutch. Ships fully assembled.					
	<b>Bookcase Hutch (for use with lateral file models H10563/H105690, storage cabinet models H105291/H105290, and bookcase model H105531)</b>					
	36"W x 14⅝"D x 37⅞"H	<b>H105292</b>	103	3.6	<b>\$540</b>	<b>\$555</b>
	NOTES: Cord pass-through gap behind shelves and a 1⅞"H full-width cord management slot at the bottom of the back panel. Two shelves are adjustable in 1¼" increments with a total range of 17½"H.					

**NOTES:**

- For additional components that can be shared with 10500 Series™, see pages 330-352.
- Versatile mobile pedestals roll easily and work well in a variety of configurations. Can be used freestanding, under modular shells, or with 10500 Series™ component worksurfaces and supports.
- 24"D lateral file, storage cabinet, and bookcase models align evenly with credenzas and returns to provide linear layout continuity.
- Mobile printer/fax cart shown on page 325 is ideal for limited space.

**HOW TO SPECIFY**



<b>Select Model Number</b>	<b>Select Laminate Top and Chassis Color</b>
	See pages 302-303
H 1 0 5 2 9 1 .	N N



Icon Legend on page 21

# 10500 SERIES™

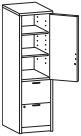
## Shared Components & Accessories

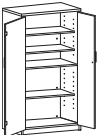
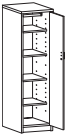
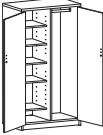
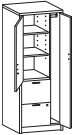
	DESCRIPTION	MODEL	SHIP WEIGHT	CUBE	LIST PRICE BY LAMINATE GRADE	
					L1	L2
 Right-hand model H105297R shown	<b>Storage/File Cabinet (with core removable locks)</b>					
	18"W x 24"D x 66 $\frac{5}{8}$ "H, Hinged Right (shown)	<b>H105297R</b>	258	22.7	<b>\$1604</b>	<b>\$1679</b>
	18"W x 24"D x 66 $\frac{5}{8}$ "H, Hinged Left	<b>H105298L</b>	258	22.7	<b>\$1604</b>	<b>\$1679</b>
	NOTES: Versatile unit features a storage cabinet and two file drawers. Storage cabinet includes three shelves, two are adjustable in 2 $\frac{1}{2}$ " increments. Door hinged left or right models available. File drawers operate on ball-bearing suspensions with full extension. File drawers have high sides to accept hanging folders in letter or legal size. Drawers standard with hangrails. Both the storage cabinet and the file drawers are equipped with a HON "One Key" interchangeable core removable lock. Unit height is designed to match credenza or return plus stack-on storage height.					
 Doors open 110 degrees from closed position.	<b>Storage Cabinet/Lateral File (with core removable lock)</b>					
	36"W x 24"D x 66 $\frac{5}{8}$ "H	<b>H105293</b>	365	41.0	<b>\$2161</b>	<b>\$2261</b>
	NOTES: Storage cabinet is standard with one fixed and two full-width adjustable shelves in top compartment; adjustable shelves can be removed. Overall storage compartment measures 31 $\frac{1}{4}$ "W x 22"D x 36 $\frac{1}{8}$ "H and will accommodate supplies, books and binders, as well as business machines and electronic equipment. Cord pass-through gap behind shelves and grommet in back of the cabinet to facilitate routing cords and reaching wall electrical outlets. Two drawer lateral file on bottom. Lateral file comes with mechanical interlock and hangrails. Cabinet and lateral file lock independently. Unit height is designed to match credenza or return plus stack-on storage height.					
 Doors open 110 degrees from closed position.	<b>Storage Cabinet with Full-width Shelves (with core removable lock)</b>					
	36"W x 24"D x 66 $\frac{5}{8}$ "H	<b>H105299</b>	341	39.6	<b>\$2017</b>	<b>\$2117</b>
	NOTES: Large storage area includes five, full-width (side-to-side) shelves; three are adjustable in 2 $\frac{1}{2}$ " increments. Unit height matches credenza or return plus stack-on storage height.					
 Right-hand model H105295R shown	<b>Personal Wardrobe/Storage Cabinet (with core removable lock)</b>					
	18"W x 24"D x 66 $\frac{5}{8}$ "H, Hinged Right (shown)	<b>H105295R</b>	223	22.9	<b>\$1453</b>	<b>\$1528</b>
	18"W x 24"D x 66 $\frac{5}{8}$ "H, Hinged Left	<b>H105296L</b>	223	22.9	<b>\$1453</b>	<b>\$1528</b>
	NOTES: Unit is standard with four adjustable shelves, coat rod, and core removable lock. Shelves adjust in 2 $\frac{1}{2}$ " increments. Cabinet can be used as a wardrobe by removing four adjustable shelves. Coat rod can be removed from cabinet for storage only applications. Unit height is designed to match credenza or return plus stack-on storage height.					
 Doors open 110 degrees from closed position.	<b>Personal Wardrobe/Storage Cabinet (with core removable lock)</b>					
	36"W x 24"D x 66 $\frac{5}{8}$ "H	<b>H10530</b>	341	41.0	<b>\$2161</b>	<b>\$2173</b>
	NOTES: Spacious design is standard with four adjustable shelves (one shelf is fixed), coat rod and core removable lock which locks both doors. Shelves adjust in 2 $\frac{1}{2}$ " increments. Unit height is designed to match credenza or return plus stack-on storage height.					
 Right-hand model H105301R shown	<b>Personal Storage Tower (with core removable locks)</b>					
	24"W x 24"D x 66 $\frac{5}{8}$ "H, wardrobe Hinged Right, storage cabinet Hinged Left (shown)	<b>H105301R</b>	299	27.9	<b>\$2030</b>	<b>\$2125</b>
	24"W x 24"D x 66 $\frac{5}{8}$ "H, wardrobe Hinged Left, storage cabinet Hinged Right	<b>H105302L</b>	299	27.9	<b>\$2030</b>	<b>\$2125</b>
	NOTES: Spacious design includes a wardrobe closet, storage cabinet, and two file drawers in one compact unit. Wardrobe closet contains a coat rod. Storage cabinet includes three shelves, two are adjustable in 2 $\frac{1}{2}$ " increments. Door hinged left or right models available. File drawers operate on ball-bearing suspensions with full extension. File drawers have high sides to accept hanging folders in letter or legal size. Drawers standard with hangrails. Equipped with HON "One Key" interchangeable core removable locks. Upper lock secures storage cabinet and wardrobe closet doors; lower lock secures file drawers. Unit height is designed to match credenza or return plus stack-on storage height.					

**NOTES:**

- Broad family of storage components takes organization way beyond the confines of a desk drawer.
- Locking units equipped with interchangeable core removable locks.
- Adjustable hex leveling glides allow floor-standing furniture to be easily leveled without lifting the unit; glides have  $\frac{3}{4}$ " adjustable range.
- See pages 330-352 for shared components.

🔑 Keyed alike cores must be ordered separately — see model HF23B on page 922 — makes re-keying quick and easy.

**HOW TO SPECIFY**

<b>Select Model Number</b>	<b>Select Laminate Top and Chassis Color</b>
See pages 302-303	See pages 302-303
H 1 0 5 2 9 7 R .	N N

# 10500 SERIES™

## Shared Components & Accessories

GSA SIN 711-8



Icon Legend on page 21



H105532 shown

DESCRIPTION	MODEL	SHIP WEIGHT	CUBE	LIST PRICE BY LAMINATE GRADE	
				L1	L2
<b>Bookcase</b>					
2 Shelf, 36"W x 13 <sup>1</sup> / <sub>8</sub> "D x 29 <sup>5</sup> / <sub>8</sub> "H	<b>H105532</b>	90	11.0	<b>\$449</b>	<b>\$464</b>
3 Shelf, 36"W x 13 <sup>1</sup> / <sub>8</sub> "D x 43 <sup>3</sup> / <sub>8</sub> "H	<b>H105533</b>	122	15.6	<b>\$570</b>	<b>\$590</b>
4 Shelf, 36"W x 13 <sup>1</sup> / <sub>8</sub> "D x 57 <sup>1</sup> / <sub>8</sub> "H	<b>H105534</b>	156	20.2	<b>\$673</b>	<b>\$698</b>
5 Shelf, 36"W x 13 <sup>1</sup> / <sub>8</sub> "D x 71"H	<b>H105535</b>	187	25.1	<b>\$782</b>	<b>\$812</b>

NOTES: Fixed shelves. Inside shelf dimensions on all units is 33<sup>3</sup>/<sub>4</sub>"W x 12"D x 13"H. No assembly required.

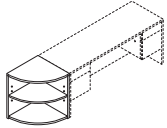

<b>End Cap Bookshelf (2 shelves, 1 fixed, 1 adjustable. Adjusts in 2<sup>1</sup>/<sub>2</sub>" increments with a total range of 10"H)</b>					
24"W x 24"D x 29 <sup>1</sup> / <sub>2</sub> "H	<b>H105520</b>	84	2.6	<b>\$571</b>	<b>\$586</b>

NOTES: Unit is freestanding. Designed to be positioned at the end of 24"D credenzas and returns. Ideal for books, photos, plants and mementos.

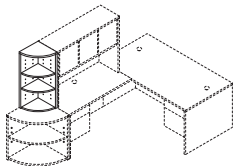

<b>End Cap Bookshelf (3 shelves, 1 fixed, 2 adjustable. Adjusts in 2<sup>1</sup>/<sub>2</sub>" increments with a total range of 25"H)</b>					
15"W x 15"D x 37 <sup>1</sup> / <sub>8</sub> "H	<b>H105523</b>	53	2.2	<b>\$491</b>	<b>\$506</b>

NOTES: Unit is designed to be positioned at the end of stack-on storage and on top of model H105520. Combined height of models H105520 and H105523 matches credenza or return plus stack-on storage height. Can be used freestanding.

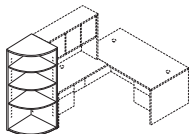

<b>End Cap Bookshelf</b>					
24"W x 24"D x 66 <sup>5</sup> / <sub>8</sub> "H	<b>H105524</b>	164	4.8	<b>\$952</b>	<b>\$977</b>

NOTES: Designed to be positioned at the end of 24"D credenzas with stack-on storage, 24"D returns with stack-on storage, 24"D storage/file cabinet, 24"D storage cabinet/lateral file, 24"D wardrobe/storage cabinets, or the 24"D personal storage tower. Unit has four shelves, three are adjustable in 2<sup>1</sup>/<sub>2</sub>" increments, with a total range of 45"H; bottom shelf is fixed.

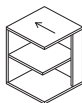

Model H105525R

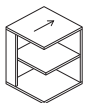

Model H105526L

<b>Square End Cap Bookshelf — 2-Fixed Shelves</b>					
24"W x 24"D x 29 <sup>1</sup> / <sub>2</sub> "H, Right	<b>H105525R</b>	92	3.6	<b>\$566</b>	<b>\$581</b>
24"W x 24"D x 29 <sup>1</sup> / <sub>2</sub> "H, Left	<b>H105526L</b>	92	3.6	<b>\$566</b>	<b>\$581</b>

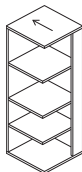

Model H105527R

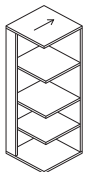

Model H105528L

<b>Square End Cap Bookshelf — 4-Fixed Shelves</b>					
24"W x 24"D x 66 <sup>5</sup> / <sub>8</sub> "H, Right	<b>H105527R</b>	172	5.9	<b>\$909</b>	<b>\$934</b>
24"W x 24"D x 66 <sup>5</sup> / <sub>8</sub> "H, Left	<b>H105528L</b>	172	5.9	<b>\$909</b>	<b>\$934</b>

NOTES: Units are freestanding. Designed to be positioned next to 24"D models or as a corner bookcase.

End cap, left: grain direction on top aligns with grain direction on tops of left pedestal returns and left credenza models or when positioned to the left side of credenzas with doors or kneespace models.

End cap, right: grain direction on top aligns with grain direction on tops of right pedestal returns and right credenza models or when positioned to the right side of credenzas with doors or kneespace models.



### NOTES:

- For 36"W x 24"D x 29<sup>1</sup>/<sub>2</sub>"H two-shelf bookcase, to align evenly with credenzas and returns, see page 342.

## HOW TO SPECIFY

Select  
Model Number

H 1 0 5 5 3 2 .

Select  
Laminate Top and Chassis Color

See pages 302-303

N N



# 10500 SERIES™

## Shared Components & Accessories

	DESCRIPTION	MODEL	SHIP WEIGHT	CUBE	LIST PRICE BY LAMINATE GRADE	
					L1	L2
	<b>Reception Station with Transaction Counter, for 72" W x 36" D Desk, or Desk Shell, with rectangle top</b> 72" W x 36" D x 14 1/4" H	<b>H105720</b>	92	3.0	<b>\$477</b>	<b>\$512</b>
	NOTES: For desk tops without grommets, see field installable grommet kit, model HFLDGRMT on page 351. Transaction counter organizer (HTCOL52) fits under/inside of transaction counter (see below).					
	<b>Reception Station for 42" W x 24" D Return or Return Shell</b> 42" W x 24" D x 13" H	<b>H105722</b>	2	1.0	<b>\$239</b>	<b>\$259</b>
	<b>Reception Station for 48" W x 24" D Return or Return Shell</b> 48" W x 24" D x 13" H	<b>H105721</b>	25	3.6	<b>\$272</b>	<b>\$292</b>
	NOTES: For return tops without grommets, see field installable grommet kit, model HFLDGRMT on page 351. Not available in two-tone laminate. Designed specifically for use with Reception Station with Transaction Counter, model H105720. <b>SPECIFYING EXAMPLE: H105722.N</b>					
	DESCRIPTION	MODEL	SHIP WEIGHT	CUBE	LIST PRICE	
	<b>Transaction Counter Organizer</b> 48 3/4" W x 11 1/8" D x 13" H	<b>HTCOL52</b>	24	1.1	<b>\$259</b>	
	NOTES: Fits under reception station with transaction counter model H105720 reception desk shell (H105724), and work organizer models H10537 and H10536. <b>Black only.</b> <b>SPECIFYING EXAMPLE: HTCOL52.P</b>					
	DESCRIPTION	MODEL	SHIP WEIGHT	CUBE	LIST PRICE BY LAMINATE GRADE	
					L1	L2
	<b>Reception Desk Shell, with rectangle top</b> 72" W x 39 7/8" D x 44 7/16" H	<b>H105724</b>	294	17.0	<b>\$1020</b>	<b>\$1075</b>
	NOTES: Non-handed design. Integrated 18 5/8" D transaction counter with a 4" full-width overhang. Two cord management grommets in top for routing and hiding wires and cables. Transaction counter organizer model TCOL52 fits under/inside transaction counter. When a two-tone color combination is specified, the first designator defines the transaction countertop and the desk worksurface.					
	<b>Reception Station Return Shell</b> 42" W x 24 3/8" D x 42 15/16" H	<b>H105726</b>	131	17.0	<b>\$710</b>	<b>\$745</b>
	NOTES: Non-handed design for use with reception desk shell. One cord management grommet in top for routing and hiding wires and cables. Woodgrain on approach side is vertical to match grain direction on end panels of reception station desk. Designed specifically for use with Reception Desk Shell, model H105724.					
	<b>Transaction Counter for Reception Desk</b> 66" W x 14 5/8" D x 14 1/4" H	<b>H105729</b>	100	4.2	<b>\$593</b>	<b>\$618</b>
	NOTES: Off-the-worksurface solution designed for use with 72" W or 66" W desks or desk shells with a 1 1/8" thick rectangle top and a full-width conference (approach-side) overhang of 4 1/2" D minimum. Choose from two height options at time of installation; 13 1/8" H (upper position) or 5 1/2" H (lower position) above the desktop. Attaches easily and securely without any drilling or double-sided tape on the worksurface. Grain direction: side-to-side on countertop; horizontal on approach and users side vertical panel.					

**NOTES:**

- Three welcoming reception station designs to choose from — stack-on enclosure, full-to-floor shell, or front-suspended counter.
- Versatile mobile office table is ideal for additional worksurface space, meetings, and special projects. See page 331.
- For 10500 Series™ matching reception area furniture, see Occasional Tables on page 348.
- See pages 330-352 for shared components.

**HOW TO SPECIFY**

<b>Select Model Number</b>	<b>Select Laminate Top and Chassis Color</b>
	See pages 302-303
H 1 0 5 7 2 0 .	N N

# 10500 SERIES™

## Shared Components & Accessories

GSA SIN 711-2 EXCEPT AS NOTED



Icon Legend on page 21

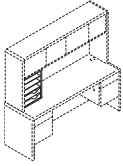

Not available in  
two-tone laminate

SIN 711-8



DESCRIPTION	MODEL	SHIP WEIGHT	CUBE	LIST PRICE BY LAMINATE GRADE	
				L1	L2
<b>Vertical Paper Manager</b> 14 $\frac{7}{8}$ "W x 10 $\frac{7}{8}$ "D x 19 $\frac{3}{8}$ "H  NOTES: Keeps papers, files, and books neatly organized and within easy reach from a seated position. Designed for desk, credenza, and return tops. Fits under stack-on storage models. Two pullout drawers and three fixed shelves. Unit can also be used with 10700 Series™, Valido®, Park Avenue Collection® Laminate and 94000 Series™. When used in conjunction with wall mounted storage cabinets, the top of the wall mounted storage cabinets must be positioned a minimum of 68" above the floor. For additional information see page 912. <b>SPECIFYING EXAMPLE: HLVPM1.N</b>	HLVPM1	27	2.8	\$298	\$308

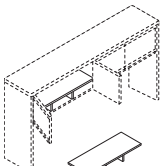

DESCRIPTION	MODEL	SHIP WEIGHT	CUBE	LIST PRICE
<b>Stacked Paper Management</b> 32 $\frac{1}{2}$ "W x 12 $\frac{3}{8}$ "D x 4 $\frac{1}{4}$ "H  NOTES: Segments and organizes stack-on and wall mount storage compartments, as well as bookcase shelves. In some cases, installation may require removing the stack-on or wall mount storage doors. For additional information see page 913. <b>!</b> Black only.	HLVPM2	22	1.25	\$148

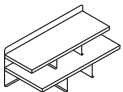

Not available in  
two-tone laminate



DESCRIPTION	MODEL	SHIP WEIGHT	CUBE	LIST PRICE BY LAMINATE GRADE	
				L1	L2
<b>Desktop Storage Terrace</b> 26 $\frac{1}{2}$ "W x 12 $\frac{1}{2}$ "D x 10 $\frac{1}{2}$ "H  NOTES: Keeps work-in-process, priority files, loose pages, and mail neatly organized and in view. Mixed material design comprised of sturdy laminate shelves with metal back and support panels. Not available in two-tone laminate combination or pattern laminate colors. Choose from Platinum Metallic (T1), Black (P), and Charcoal (S) for the metal components. Sized to fit in stack-on and wall mounted storage cabinets in 10500, 10700, Valido, 94000, Park Avenue Laminate, and 38000 Series. Fits in Voi stack-on and overhead cabinets except for 48"W or smaller sliding door models. For additional information see page 912. Specify: Model.Laminate.Paint <b>SPECIFYING EXAMPLE: HLDST1.N.T1</b>	HLDST1	24	1.1	\$279	\$289



Refer to page 171 for  
Center Drawer compatibility  
information

SIN 711-1, 711-2, 711-11

DESCRIPTION	MODEL	SHIP WEIGHT	CUBE	LIST PRICE
<b>Angled Wood Center Drawer</b> 26" x 15 $\frac{3}{8}$ " 22" x 15 $\frac{3}{8}$ "  NOTES: Specify laminate for drawer. Model H1522 can be used on peninsulas with modesty panel, model H10528. For additional information see page 903.	H1526	12	1.2	\$187
	H1522	11	1.1	\$173

**NOTES:**

- For 10500 Series™ matching Occasional Tables, see page 348.
- Vertical paper manager designed for desk, credenza, and return tops. Fits under stack-on storage.
- Stacked paper management segments and organizes stack-on and wall mount storage compartments, as well as bookcase shelves. Unit can be used in models H105327, H10534, H105322, H105321, H105382 and H105381.
- Desktop Storage Terrace is for use on the tops of 29 $\frac{1}{2}$ "H desks, credenzas, and returns.
- Desktop Storage Terrace features six storage sections plus top display shelf.
- Desktop Storage Terrace includes protective, non-slip pads on the base.
- See pages 330-352 for shared components.

**!** In some cases, installation of Stacked Paper Management may require removing the stack-on or wall mount storage doors.







**HOW TO SPECIFY**

<b>Select Model Number</b>  H L V P M 1 . N	<b>Select Laminate</b> See pages 302-303
---	---

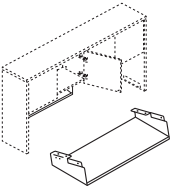

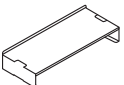
# 10500 SERIES™

## Shared Components & Accessories

	DESCRIPTION	MODEL	SHIP WEIGHT	CUBE	LIST PRICE
 	<b>Hanging Paper Shelf</b> 28 <sup>1</sup> / <sub>16</sub> "W x 11 <sup>7</sup> / <sub>16</sub> "D x 4 <sup>5</sup> / <sub>16</sub> "H NOTES: Maximizes worksurface space; de-clutters desktop while placing priority communications and active project folders within easy reach. Angled design allows contents to be distinguished at a glance. Mixed material styling features strong painted metal frame with a frosted shelf. Attaches quickly and easily to stack-on and wall mount storage models in the following series: 10500, 10700, Valido, Park Avenue Laminate, 94000, and Voi (except the 36"W overhead hutch with O-legs or panel mount brackets). Not for use with 38000 Series. Choose from Platinum Metallic (T1), Black (P), and Charcoal (S) paint. Specify: Model.Paint <b>SPECIFYING EXAMPLE: HHPS1.T1</b>	<b>HHPS1</b>	7	2.9	<b>\$180</b>
 	<b>Desktop Paper Shelf</b> 28 <sup>1</sup> / <sub>16</sub> "W x 11 <sup>5</sup> / <sub>16</sub> "D x 5"H NOTES: Organizer shelf provides a place and space for work-in-process and piling to keep worksurfaces neat and tidy. Convenient, scalable design with interlocking side supports allow two units to be stacked and integrated. Durable painted metal frame with a frosted shelf; mixed material styling matches hanging paper shelf. Can also be used inside select overhead storage, including the following stack-on with hinged door models: 10500 and Valido 36", 42", 66", 72", 78"W and 10700 68 <sup>5</sup> / <sub>16</sub> "W. Choose from Platinum Metallic (T1), Black (P), and Charcoal (S) paint. Specify: Model.Paint <b>SPECIFYING EXAMPLE: HDPS1.T1</b>	<b>HDPS1</b>	7	2.9	<b>\$180</b>
  	<b>Storage Cube</b> 12"W x 12"D NOTES: Available in the following colors: Autumn (AUTM), Citron (CITR), Flame (FLAM), Pool (POOL) and Sisal (SISL). For additional information see page 914. <b>SPECIFYING EXAMPLE: HL1212.CITR</b>	<b>HL1212</b>	1	0.3	<b>\$276</b>

**NOTES:**

- For 10500 Series™ matching Occasional Tables, see page 348.
- Desktop Paper Shelf includes protective, non-slip pads on the base.
- Paper Shelf can stack two-high.
- Hanging Paper Shelf attaches quickly and easily (screws included).
- See pages 330-352 for shared components.
- For additional information see page 913.

**HOW TO SPECIFY**

<b>Select Model Number</b> HHPS1	<b>Select Paint Color</b> See page 242 T1
-------------------------------------	---

# 10500 Series™ Laminate Occasional Tables

GSA SIN 711-11

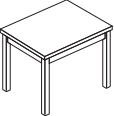

Icon Legend on page 21

	DESCRIPTION	MODEL	SHIP WEIGHT	CUBE	LIST PRICE
	<b>Coffee Table</b> 48"W x 20"D x 16"H	<b>H80191</b>	48 <b>Ⓢ</b>	3.4	<b>\$442</b>
	<b>Corner Table</b> 24"W x 24"D x 20"H	<b>H80192</b>	35 <b>Ⓢ</b>	2.1	<b>\$382</b>
	<b>End Table</b> 24"W x 20"D x 20"H	<b>H80193</b>	29 <b>Ⓢ</b>	1.8	<b>\$364</b>

**Laminate Occasional Tables (H80191, H80192 and H80193)**

Woodgrain	Solid	Patterned	Two-Tone	
Bourbon Cherry (HH) Cognac (COGNCOGN) Harvest (CC) Mahogany (NN) Mocha (MOCHMOCH) Natural Maple (DD) Pinnacle (PINCPINC) Shaker Cherry (FF)	Black (PP) Brilliant White (WHITWHIT) Charcoal (SS)	Canyon Zephyr (K9) Desert Zephyr (K8) Grey Tigris (L6*) Sheer Mesh (A5) Silver Mesh (B9)  *Select edge/apron/leg color Black (P) Bourbon Cherry (H) Brilliant White (WHIT) Charcoal (S) Cognac (COGN) Harvest (C) Mahogany (N) Mocha (MOCH) Natural Maple (D) Pinnacle (PINC) Shaker Cherry (F)	Black/Brilliant White (PWHIT) Black/Charcoal (PS) Bourbon Cherry/Black (HP) Bourbon Cherry/Brilliant White (HWHIT) Bourbon Cherry/Charcoal (HS) Brilliant White/Black (WHITP) Brilliant White/Bourbon Cherry (WHITH) Brilliant White/Charcoal (WHITS) Brilliant White/Cognac (WHITCOGN) Brilliant White/Harvest (WHITC) Brilliant White/Mahogany (WHITN) Brilliant White/Mocha (WHITMOCH) Brilliant White/Natural Maple (WHITD) Brilliant White/Pinnacle (WHITPINC) Brilliant White/Shaker Cherry (WHITF) Charcoal/Black (SP) Charcoal/Brilliant White (SWHIT) Cognac/Black (COGNP) Cognac/Brilliant White (COGNWHIT)	Cognac/Charcoal (COGNS) Harvest/Black (CP) Harvest/Brilliant White (CWHIT) Harvest/Charcoal (CS) Mahogany/Black (NP) Mahogany/Brilliant White (NWHIT) Mahogany/Charcoal (NS) Mocha/Black (MOCHP) Mocha/Brilliant White (MOCHWHIT) Mocha/Charcoal (MOCHS) Natural Maple/Black (DP) Natural Maple/Brilliant White (DWHIT) Natural Maple/Charcoal (DS) Pinnacle/Black (PINCP) Pinnacle/Brilliant White (PINCWHIT) Pinnacle/Charcoal (PINCS) Shaker Cherry/Black (FP) Shaker Cherry/Brilliant White (FWHIT) Shaker Cherry/Charcoal (FS)

**NOTES:**

- Durable material and construction make laminate occasional tables ideal for high traffic areas such as lobbies, reception rooms and lounges. Versatile design is also well suited to private offices.
- Tables accommodate lamps, magazines, telephones, plants, laptops and more.
- Coffee, Corner and End Tables feature top-over-apron styling with square corner detail, which complements many interiors and furniture designs.
- Tops are abrasion- and stain-resistant laminate over 1/8" thick solid core high-performance particleboard.
- For 10500 Series™ mobile tables, see page 331.
- See pages 330-352 for shared components.

**HOW TO SPECIFY**

<b>Select Model Number</b>	<b>Select Laminate</b>
See above	See above
H 8 0 1 9 1 .	N N
H 8 0 1 9 1 .	L 6 N

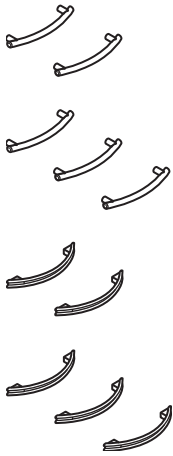

# 10500 Series™ Shared Components & Accessories

**DESCRIPTION****Field Installable Drawer/Door Handle Kits**

Sweep Black, 2-pack  
Sweep Satin Nickel, 2-pack

Sweep Black, 3-pack  
Sweep Satin Nickel, 3-pack

Crescent Black, 2-pack  
Crescent Satin Nickel, 2-pack

Crescent Black, 3-pack  
Crescent Satin Nickel, 3-pack

**MODEL****SHIP WEIGHT****CUBE****LIST PRICE****HSWEEPA2**0.4 **Ⓔ**

0.3

**\$39****HSWEEPC2**0.4 **Ⓔ**

0.3

**\$39****HSWEEPA3**0.5 **Ⓔ**

0.3

**\$51****HSWEEPC3**0.5 **Ⓔ**

0.3

**\$51****HCRESCENTA2**0.4 **Ⓔ**

0.3

**\$39****HCRESCENTC2**0.4 **Ⓔ**

0.3

**\$39****HCRESCENTA3**0.5 **Ⓔ**

0.3

**\$51****HCRESCENTC3**0.5 **Ⓔ**

0.3

**\$51**

NOTES: Handles are for purchase and field installation on 10500 or 10700 Series™ desks, credenzas, returns, and lateral files, as well as for the modular pedestals used with 10700 and 10500.

Applications include:

- box/file and file/file pedestals = one 2-pack per pedestal
- box/box/file and pencil/media/file pedestals = one 3-pack per pedestal
- two drawer lateral file = two 2-packs per unit
- four drawer lateral file = four 2-packs per unit

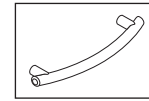
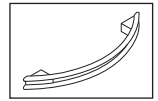
**Sweep Handle****Crescent Handle**

The hole spacing for the Sweep and Crescent handles is 96mm (approx. 3¾"). Important note: effective January 1, 2007, the holes used for the black drawer/door handle that comes standard on several HON 10500 and 10700 Series™ products, including mobile pedestals, storage cabinet with doors, storage/file cabinet, storage cabinet/lateral file, personal wardrobe/storage cabinets, and personal storage towers, will accept the Sweep and Crescent handles. Units manufactured prior to January 1, 2007, have 64mm (approx. 2½") hole spacing and will not accept the Sweep and Crescent handles. Instructions include mounting hardware and paper template.

**!** Must be ordered with a configurable end product. If ordered separately, not on GSA contract.

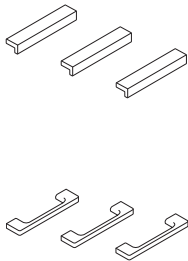
**Field Installable Drawer/Door Handle Kits**

Linear, Black, 2-pack  
Linear, Matte Chrome, 2-pack

Linear, Black, 3-pack  
Linear, Matte Chrome, 3-pack

Specify Linear handles in black to coordinate with 10500 Series™ models that ship standard with a decorative handle, such as mobile pedestals, storage cabinets and wardrobes.

**HLINEARA2**0.4 **Ⓔ**

0.3

**\$51****HLINEARC2**0.4 **Ⓔ**

0.3

**\$51****HLINEARA3**0.5 **Ⓔ**

0.3

**\$59****HLINEARC3**0.5 **Ⓔ**

0.3

**\$59****HARCHA2**0.4 **Ⓔ**

0.3

**\$51****HARCHC2**0.4 **Ⓔ**

0.3

**\$51****HARCHA3**0.5 **Ⓔ**

0.3

**\$59****HARCHC3**0.5 **Ⓔ**

0.3

**\$59**

NOTES: Handles are for purchase and field installation on 10500 or 10700 Series™ desks, credenzas, returns, lateral files and modular pedestals. Instructions include mounting hardware and paper template for drilling holes.

Applications include:

- box/file and file/file pedestals = one 2-pack per pedestal
- box/box/file and pencil/media/file pedestals = one 3-pack per pedestal
- two drawer lateral file = two 2-packs per unit
- four drawer lateral file = four 2-packs per unit

The Linear and Arch handles can be attached using 96mm (approx. 3¾") or 128mm (approx. 5") hole spacing. Important note: effective January 1, 2007, the holes used for the black drawer/door handle that comes standard on several HON 10500 and 10700 Series™ products, including mobile pedestals, storage cabinet with doors, storage/file cabinet, storage cabinet/lateral file, personal wardrobe/storage cabinets, and personal storage towers, will accept the Linear and Arch handles. Units manufactured prior to January 1, 2007, have 64mm (approx. 2½") hole spacing and will not accept the Linear and Arch handles.

**!** Must be ordered with a configurable end product. If ordered separately, not on GSA contract.

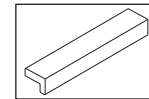
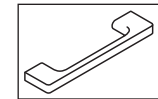
**Linear Handle****Arch Handle****NOTES:**

- Field Installable Drawer/Door Handle Kits for use on 10500 Series™ desks, credenzas, returns and lateral files.
- Metal template, for field installation of the Linear, Arch, Sweep and Crescent decorative handles, on 10500 and 10700 Series™ drawer fronts, can be ordered through HON Customer Support. Hardware Pack 251-0251. Order SPLH-SYST-DRKNB.M263164.
- See pages 330-352 for shared components.

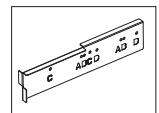
**HOW TO SPECIFY**

Select  
Model Number

H S W E E P A 2



# 10500 SERIES™

## Shared Components & Accessories

GSA SIN AS NOTED

ABI

Icon Legend on page 21

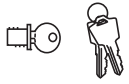

SIN 711-2, SIN 711-3

**DESCRIPTION**
**Black Removable Lock Core Kit**  
**Satin Removable Lock Core Kit**

- Specify quantity of each key number from 101E-225E.
- Includes: 1-core, 2-keys, 1-core removal tool, and instructions.

NOTES: Lock with a removable cylinder that can be interchanged as needed; allows users to access all furniture pieces in an office with a single key for convenience and security. Makes re-keying quick and easy. For use in all 10500 Series™ product lock cores, except the stack-on and wall mounted storage "K" models. For the latter use model HF27B or HF27S, listed below.

**MODEL****SHIP WEIGHT****CUBE****LIST PRICE****HF23B**

0.1 Ⓞ

0.1

**\$29****HF23S**

0.1 Ⓞ

0.1

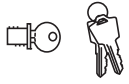
**\$36**

OPEN MARKET

**Removable Lock Core Kit**Black  
Satin**HF27B**

0.2

0.02

**\$29****HF27S**

0.2

0.02

**\$29**

- For stack-on and wall mounted storage laminate models (with locks) in 10500, 10700, Valido, Park Avenue Laminate, Concinnity, and 94000 Series.

- Specify quantity of each key number from 101E to 225E.
- Includes: 1-core, 2-keys, 1-core removal tool, and instructions.

NOTES: If key number isn't specified, number will be at random.

**NOTES:**

- See pages 330-352 for shared components.
- For master key, see model HF22 on page 922.

**HOW TO ORDER CORE REMOVABLE LOCK KITS:**

Specify: Model Number.X  
Key Number

Examples: HF23S.X121E

HF23S.X (Key number not specified)

NOTES: Key orders without numbers specified will be keyed at random.

Numbers 101E-225E are available.

**SAMPLE ORDER:**

Quantity	Model	Key Code
4	HF23B.	X121E

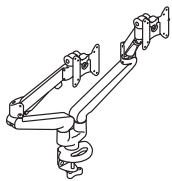

OPEN MARKET

**DESCRIPTION****Dual Monitor Arm**

Single Mount with Dual Monitor effortless adjustment. Range of adjustment is 13" from 6½"-19½".

NOTES: All Keyboards available in Silver only, no specification needed. For complete monitor arm features, see page 288. For additional information see page 899.

**MODEL****SHIP WEIGHT****CUBE****LIST PRICE****H5220**

15.0 Ⓞ

1.8

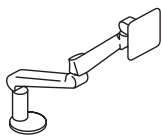
**\$912**

OPEN MARKET

**Single Monitor Arm**

Effortless adjustment, no levers. Range of adjustment is 13" from 6½"-19½".

**H5210**

11.0 Ⓞ

1.3

**\$510****HOW TO SPECIFY**







Select  
Model Number

H F 2 3 B



Icon Legend on page 21

# 10500 Series™ Shared Components & Accessories

	DESCRIPTION	MODEL	SHIP WEIGHT	CUBE	LIST PRICE
	<p><b>Field Installable Grommet</b></p> <ul style="list-style-type: none"> <li>Intended for use in tops and end panels to route/hide cords and in modesty panels to facilitate reaching wall electrical outlets.</li> <li>Grommet is field installable.</li> <li>Grommet shape is round.</li> <li>Includes grommet cap and sleeve.</li> <li>Grommet cap measures 3" diameter and includes a 3/4" diameter cord access hole.</li> <li>Grommet sleeve measures 2 1/2" O.D. x 3/4" thick.</li> <li>Includes instructions to locate grommet position for desks, credenzas, returns and bridges.</li> </ul> <p>NOTES: For additional information see page 916.</p> <ul style="list-style-type: none"> <li>❗ Black Finish</li> <li>❗ Requires a 2 1/2" diameter hole saw and drill for installation (not included).</li> </ul>	<b>HFLDGRMT</b>	0.1 <b>Ⓢ</b>	0.01	<b>\$29</b>
	<p><b>Field Installable Grommet</b></p> <ul style="list-style-type: none"> <li>Intended for use in tops and end panels to route/hide cords and in modesty panels to facilitate reaching wall electrical outlets.</li> <li>Grommet is field installable.</li> <li>Grommet shape is round.</li> <li>Includes grommet cap and sleeve.</li> <li>Grommet outside dimensions measure 3 1/2" diameter and includes two cord access holes.</li> <li>Grommet sleeve measures 3" O.D. x 1" thick.</li> <li>Includes instructions to locate grommet position for desks, credenzas, returns and bridges.</li> </ul> <p>NOTES: For additional information see page 916.</p> <ul style="list-style-type: none"> <li>❗ Black Finish</li> <li>❗ Requires a 3" diameter hole saw and drill for installation (not included).</li> </ul>	<b>HFLDGRMT3</b>	0.1 <b>Ⓢ</b>	0.3	<b>\$29</b>
 <p><b>SIN 71-302</b></p>	<p><b>Power Hub, 3" Grommet Mount</b></p> <ul style="list-style-type: none"> <li>Brings the ease of plug-and-play to the desktop.</li> <li>Fits in 3" round grommet holes in 10500 Series™ desks, credenzas and returns; not compatible with 10500 Series™ 2 1/2" round grommets.</li> <li>Two grounded AC power outlets.</li> <li>Two cord pass-through holes in cap.</li> <li>Includes 6' cord with three-prong plug.</li> <li>For field installation.</li> <li>UL Listed.</li> </ul> <p>NOTES: For additional information see page 916.</p> <ul style="list-style-type: none"> <li>❗ Available in Black only (no color designation – Specify: HGRMTAC.X).</li> </ul>	<b>HGRMTAC</b>	1.3	0.2	<b>\$103</b>
 <p><b>SIN 71-302</b></p> 	<p><b>3" Round Power Grommet – 2 Outlets, 10' Cord</b></p> <ul style="list-style-type: none"> <li>Includes 10' cord with three-prong plug.</li> <li>Fits in 3" round grommet holes on the following product lines: Coordinate, Huddle, Motivate, all laminate and veneer casegoods series, and Systems Worksurfaces.</li> <li>Two grounded AC power outlets.</li> <li>Field installed with Plug-and-play ease.</li> </ul> <p>NOTES: Power Modules will also work with standing-height applications for 10500 Series™ and Voi® desks. Optional Memory Control allows preset worksurface heights for consistency. Ships separately. Dynamic load capacity when worksurface is moving is 300 lbs.</p> <ul style="list-style-type: none"> <li>❗ Available in black finish only, no specification needed.</li> </ul>	<b>HGRMTAC2</b>	1.5	0.2	<b>\$130</b>
 <p><b>SIN 71-302</b></p>	<p><b>Power/USB Hub, 3" Grommet Mount</b></p> <ul style="list-style-type: none"> <li>Brings the ease of plug-and-play to the desktop.</li> <li>Fits in 3" round grommet holes in 10500 Series™ desks, credenzas and returns; not compatible with 10500 Series™ 2 1/2" round grommets.</li> <li>One grounded AC power outlet with 2 USB ports.</li> <li>Two cord pass-through holes in cap.</li> <li>Includes 6' cord with three-prong plug.</li> <li>For field installation.</li> <li>UL Listed.</li> </ul> <p>NOTES: For additional information see page 916.</p> <ul style="list-style-type: none"> <li>❗ Available in black only (no color designation so use .X – Specify: HGRMTUSB2.X).</li> </ul>	<b>HGRMTUSB2</b>	1.3 <b>Ⓢ</b>	0.02	<b>\$203</b>

**NOTES:**

- See pages 330-352 for shared components.

## HOW TO SPECIFY

Select Model Number

H	F	L	D	G	R	M	T
---	---	---	---	---	---	---	---

# 10500 SERIES™

## Shared Components & Accessories

GSA SIN AS NOTED

ABI

Icon Legend on page 21



SIN 711-1

**DESCRIPTION**

**Articulating Desk Lamp**  
**Articulating Desk Lamp w/ Occupancy Sensor**

NOTES: For additional information see page 909.

! Silver finish only, no specification needed.

**MODEL**

**HLED1**  
**HLED10C**

**SHIP WEIGHT**

1.2 Ⓢ  
 1.2 Ⓢ

**CUBE**

6.5  
 6.5

**LIST PRICE**

**\$359**  
**\$439**



SIN 711-1

**Task Desk Lamp**

NOTES: For additional information see page 909.

! Brushed nickel finish only, no specification needed.

**HLED2**

0.7 Ⓢ

3.0

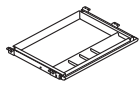
**\$311**

OPEN MARKET

**Polymer Center Drawer**

- Color: Black.
- Material: ABS.
- Opening Requirements: 23"W x 16¼"D x 2"H.
- Retracts on 16" ball bearing slides.
- Can be used on worksurfaces with Coordinate™ Height Adjustable Bases as long as it is attached with spacer model HKBS.
- Can store up to 25 lbs.

NOTES: For additional information see page 904.

! Black finish only, no specification needed.

**HCD1**

7.0

0.5

**\$99**

OPEN MARKET

**CPU Holder**

- Vertically mounts to underside of worksurface.
- 360° swivel.
- Supports up to 55 lbs.
- Height adjustable from 16" to 22" below worksurface.
- Width adjustable to accept units from 3¼" to 6".

NOTES: For additional information see page 408.

! Silver finish only, no specification needed.

**HCPU**

16.0 Ⓢ

0.5

**\$236**

OPEN MARKET

**Back Pack Hook (10 per carton)**

12"W x 14½"D x 1½"H

NOTES: Assembly: attaches to bottom of desk with (2) screws, included. For additional information see page 914.

! Available in Chrome finish only, no specification needed.

**HCLA65**

10.0 Ⓢ

0.1

**\$91**

Refer to pages 75 and 901 for additional product information

SIN 711-1, 711-2, 711-11

**DESCRIPTION**

**Sit to Stand Arm with Convertible Keyboard Platform**  
**Articulating Arm with Convertible Keyboard Platform**  
**Articulating Arm with Keyboard Platform**  
**Slide-Away Keyboard Platform** (Specify: Laminate)  
**Extended Tray Slide-Away Keyboard Platform**  
 (Specify: Laminate)  
**Metal Keyboard and Mouse Tray** (Specify paint)  
**Metal Keyboard Tray** (Specify paint)

NOTES: For additional information see pages 900-901.

**MODEL**

**H2516 OPEN MARKET**  
**H2107 OPEN MARKET**  
**H1706 OPEN MARKET**  
**H4022**  
**HE4022**  
**H4028 OPEN MARKET**  
**H4029 OPEN MARKET**

**SHIP WEIGHT CUBE**

17 Ⓢ 1.6  
 16 Ⓢ 1.3  
 16 Ⓢ 1.4  
 10 Ⓢ 0.6  
 12 Ⓢ 0.7

**LIST PRICE BY PAINT GRADE**

**CORE METALLICS**  
**\$565**  
**\$484**  
**\$451**  
**\$199**  
**\$285**  
**\$144** **\$154**  
**\$129** **\$139**

**NOTES:**

- See pages 330-352 for shared components.

**HOW TO SPECIFY**

Select  
Model Number

HLED1

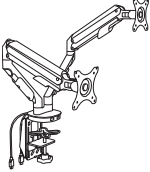
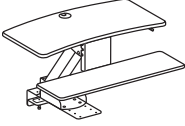
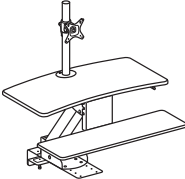
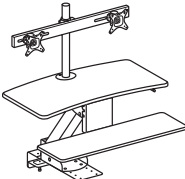
	DESCRIPTION	MODEL	SHIP WEIGHT	CUBE	LIST PRICE
	<b>Coordinate™ Portable Desktop Riser</b> 31"D x 4½"-16½"H x 35"W NOTES: Available in Black (BLK) or White (WHT) finish. Desktop riser dimensions (without keyboard tray): 22"D x 4½"-16½"H x 35"W. Keyboard tray dimensions: 9"D x 30"W. Max loading capacity is 33 lbs for the desktop riser surface and 4 lbs for the keyboard tray. Easily transition from seated to standing positions throughout the workday. Sits atop an existing desk to create sit-to-stand functionality by raising the computer. Includes keyboard tray and surface for computer monitors. <b>HON 5-Year Limited Warranty.</b> ⓘ Not intended for use on mobile workstations.	<b>HBXRISER</b>	54.0	4.1	<b>\$500</b>
	<b>Dual Monitor Arm with 2 USB Ports</b> NOTES: <b>AVAILABLE FEBRUARY 2018.</b> Easy adjustment. Height adjusts to 17" tall. Monitor tilt and swivel capability. Enclosed cable management. Grommet or desktop mounting. Clean appearance. For additional information see page 899. ⓘ No specification needed.	<b>HBDMAUSB</b>	41.9	2.6	<b>\$360</b>
	<b>Coordinate™ Mounted Desktop Riser</b> NOTES: Does not include a monitor arm and is suitable for laptops and/or monitors on their original stands. ⓘ No specification needed.	<b>HS1100</b>	60.0 ⓘ	3.2	<b>\$525</b>
	<b>Coordinate™ Mounted Desktop Riser with Single Monitor Arm</b> NOTES: Includes a monitor arm for a single monitor. ⓘ No specification needed.	<b>HS1101</b>	62.0 ⓘ	3.2	<b>\$615</b>
	<b>Coordinate™ Mounted Desktop Riser with Dual Monitor Arm</b> NOTES: Includes a monitor arm for dual monitors. ⓘ No specification needed.	<b>HS1102</b>	63.0 ⓘ	3.2	<b>\$700</b>

**NOTES FOR HS1100, HS1101, HS1102:**

- These products are designed to allow the user to transition from seating position to standing position throughout the workday.
- Gas-assist lever-operated mechanism with positive stop.
- Clamp mount compatible with worksurfaces depths of 20"-30". 20" is for systems only.
- Clamp requires 3.5" of clearance along back edge of worksurface.
- Black seamless worksurfaces.
- Silver powder coated metal components.
- Lowers below worksurface level on 24" and 30"D worksurfaces.
- All models contain a large primary worksurface and a smaller keyboard / mouse surface.
- Beveled edges for sleek appearance and comfort while typing.
- Monitor arms include height, width, and swivel adjustment.
- For additional information see page 906.

- Not for use under overhead storage, with flush mounted modesty panels, or worksurfaces thinner than 1".

ⓘ Not recommended for use on mobile (castered) worksurfaces.

**MOUNTING AND COMPATIBILITY FOR HS1100, HS1101, HS1102:**

- This product is intended to be installed on commercial-grade worksurfaces in good condition.
- Compatible with freestanding worksurfaces 24"-30"D or panel-supported worksurfaces 24"-30"D.
- Not for use on mobile worksurfaces.

**Clamp Mount**

Use when 3.5" minimum overhang is available

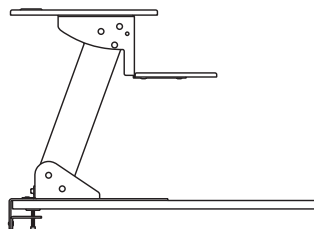

**Screw Mount**

Use when no overhang is available. Worksurface must be minimum 1" thick.

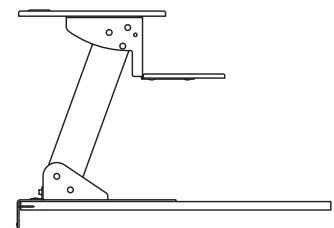

**HOW TO SPECIFY**

<p>Select Model Number</p> <p>HBXRISER.</p>	<p>Select Finish</p> <p>BLK Black WHIT White</p> <p>BLK</p>
---	---



# 10500 SERIES™

## Accessories

OPEN MARKET

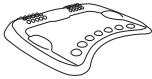
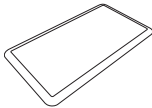
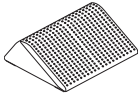

Icon Legend on page 21

	DESCRIPTION	MODEL	SHIP WEIGHT	CUBE	LIST PRICE
	<b>Rectangle Wobble Board — Anti-Fatigue Mat</b> 18"D x 3"H x 22½"W ⓘ Available in Black (T) finish ONLY. Recommended weight capacity not to exceed 250 pounds. <b>HON 5-Year Limited Warranty.</b> <b>SPECIFYING EXAMPLE: HVL981.T</b>	<b>HVL981</b>	10.0 <b>Ⓔ</b>	0.9	<b>\$220</b>
	<b>Round Wobble Board — Anti-Fatigue Mat</b> 18½"D x 2½"H x 18½"W ⓘ Available in Black (T) finish ONLY. Recommended weight capacity not to exceed 250 pounds. <b>HON 5-Year Limited Warranty.</b> <b>SPECIFYING EXAMPLE: HVL982.T</b>	<b>HVL982</b>	5.8 <b>Ⓔ</b>	0.6	<b>\$190</b>
	<b>Ergonomic Anti-Fatigue Mat</b> 25"D x 2¾"H x 29⅞"W ⓘ <b>AVAILABLE FEBRUARY 2018.</b> Available in Black ONLY. No specification needed. <b>SPECIFYING EXAMPLE: HBEAFM1</b>	<b>HBEAFM1</b>	7.0	1.4	<b>\$176</b>
	<b>Rectangle Anti-Fatigue Mat</b> 20"D x ¾"H x 36"W ⓘ <b>AVAILABLE FEBRUARY 2018.</b> Available in Black ONLY. No specification needed. <b>SPECIFYING EXAMPLE: HBAFM2036</b>	<b>HBAFM2036</b>	5.4	0.4	<b>\$80</b>
	<b>Footrest — Anti-Slip Cover</b> 13¾"D x 5½"H x 16"W ⓘ Available in Black (T) finish ONLY. Recommended weight capacity not to exceed 250 pounds. <b>HON 5-Year Limited Warranty.</b> <b>SPECIFYING EXAMPLE: HVL991.T</b>	<b>HVL991</b>	7.0 <b>Ⓔ</b>	0.9	<b>\$65</b>

### HOW TO SPECIFY

Select  
Model Number

H V L 9 8 1 .

Select  
Finish

T Black

T



# 10700 SERIES™



10700 Series™ Teaming Workstations shown with Ignition® and Flock® Seating.

## 10700 SERIES™

Talk about a high achiever! The versatile 10700 Series offers a wide selection of layout configurations — making it easy to get the clean, cohesive look your office needs. Designed to withstand frequent moving and reconfiguration, the 10700 Series boasts contract grade high-pressure laminate and a durable inner-frame construction. Whatever the look you go for, this all-around performer is a smart choice.



## FEATURES

- Contoured, solid wood accents and waterfall-shaped edges combine form and function for lasting comfort.
- Make the most of both large and small spaces with flexible storage options that work well together.
- With a variety of mixed materials to choose from, you can customize your look to perfectly match your aesthetic.
- Available in eight woodgrain patterns, our laminate desks are the definition of scratch-, spill- and stain-resistant durability.

# 10700 SERIES™ ORDERING INFORMATION

## LAMINATE FINISHES AVAILABILITY — 10700 SERIES™

	L1 LAMINATES	CODES
Woodgrain	◆ Bourbon Cherry	HH
	◆ Cognac	COGNCOGN
	◆ Harvest	CC
	◆ Mahogany	NN
	◆ Mocha	MOCHMOCH
	◆ Natural Maple	DD
	◆ Pinnacle	PINCPINC
	◆ Shaker Cherry	FF

◆◆◆ For lead time information see page 21.

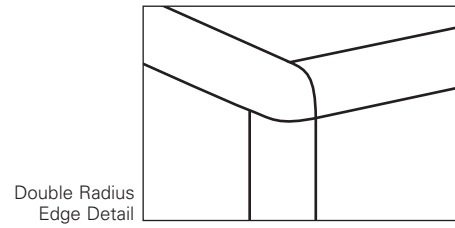



# 10700 SERIES™

## Typicals



Icon Legend on page 21

Components used are listed on pages 364-385. Order components individually. Other configurations are possible, including various sizes of some components.

QTY	DESCRIPTION	MODEL	LIST PRICE	PRICE EXTENSION
1	<b>Double Pedestal Desk – 2/2</b> 60"W x 30"D x 29½"H	H10771	\$1,229	\$1,229
1	<b>Credenza with Kneespace – 2/0/2</b> 60"W x 24"D x 29½"H	H10765	\$1,172	\$1,172
<b>TOTAL:</b>			<b>\$2,401</b>	

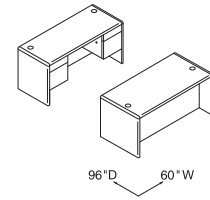

**DESK WORKSTATION**  
**60"W x 96"D**

QTY	DESCRIPTION	MODEL	LIST PRICE	PRICE EXTENSION
1	<b>Corner Unit</b> 24" x 36" x 36" x 24" x 29½"H	H107811	\$1,075	\$1,075
1	<b>Return, Right – B/F</b> 48"W x 24"D x 29½"H	H10715R	\$813	\$813
1	<b>Return, Left – B/F</b> 48"W x 24"D x 29½"H	H10716L	\$813	\$813
1	<b>Stack-on Storage</b> 44½"W x 14½"D x 37½"H	H107313	\$958	\$958
<b>TOTAL:</b>			<b>\$3,659</b>	

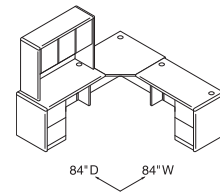

**CORNER "L" WORKSTATION**  
**84"W x 84"D**

QTY	DESCRIPTION	MODEL	LIST PRICE	PRICE EXTENSION
1	<b>Single Pedestal Desk, Left – B/F</b> 72"W x 36"D x 29½"H	H10786L	\$1,210	\$1,210
1	<b>Bridge</b> 47"W x 24"D x 29½"H	H10770	\$367	\$367
1	<b>Credenza with Lateral, Right</b> 72"W x 24"D x 29½"H	H10747R	\$1,461	\$1,461
1	<b>Stack-on Storage</b> 68½"W x 14½"D x 37½"H	H10734	\$1,089	\$1,089
<b>TOTAL:</b>			<b>\$4,127</b>	

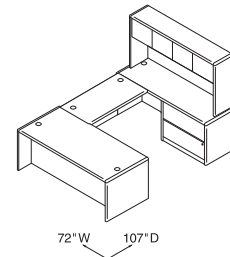

**DESK "U" WORKSTATION – RIGHT**  
**72"W x 107"D**

QTY	DESCRIPTION	MODEL	LIST PRICE	PRICE EXTENSION
1	<b>Double Pedestal Desk – 3/2</b> 72"W x 36"D x 29½"H	H10799	\$1,872	\$1,872
1	<b>Credenza with Storage</b> 72"W x 24"D x 29½"H	H10742	\$1,872	\$1,872
<b>TOTAL:</b>			<b>\$3,744</b>	

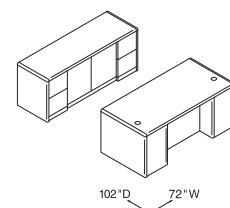

**DESK WORKSTATION WITH  
STORAGE CRENZNA**  
**72"W x 102"D**



Icon Legend on page 21

# 10700 SERIES™ Typicals

Components used are listed on pages 364-385. Order components individually. Other configurations are possible, including various sizes of some components.

QTY	DESCRIPTION	MODEL	LIST PRICE	PRICE EXTENSION
1	<b>Double Pedestal Desk – 3/2</b> 72"W x 36"D x 29½"H	H10799	\$1,872	\$1,872
1	<b>Credenza with Kneespace – 2/0/2</b> 72"W x 24"D x 29½"H	H10741	\$1,614	\$1,614
1	<b>Stack-on Storage</b> 68⅝"W x 14⅝"D x 37⅞"H	H10734	\$1,089	\$1,089
1	<b>Wardrobe/Storage Cabinet, Right</b> 18"W x 24"D x 66⅝"H	H107295R	\$1,654	\$1,654
<b>TOTAL:</b>			<b>\$6,229</b>	

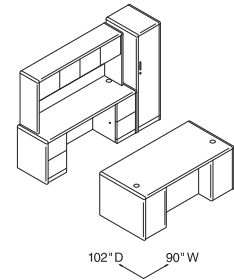

**DESK WORKSTATION**  
**90"W x 102"D**

QTY	DESCRIPTION	MODEL	LIST PRICE	PRICE EXTENSION
1	<b>Peninsula</b> 72"W x 36"D x 29½"H	H10721	\$1,195	\$1,195
1	<b>Return, Left – F/F</b> 42"W x 24"D x 29½"H	H107192L	\$981	\$981
1	<b>Stack-on Storage</b> 74⅝"W x 14⅝"D x 37⅞"H	H107318	\$1,195	\$1,195
<b>TOTAL:</b>			<b>\$3,371</b>	

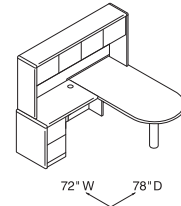

**PENINSULA "L" WORKSTATION – LEFT**  
**72"W x 78"D**

QTY	DESCRIPTION	MODEL	LIST PRICE	PRICE EXTENSION
1	<b>Single Pedestal Desk, Right – B/B/F</b> 66"W x 30"D x 29½"H	H10701R	\$1,484	\$1,484
1	<b>Return, Left – F/F</b> 48"W x 24"D x 29½"H	H10712L	\$993	\$993
1	<b>Stack-on Storage</b> 74⅝"W x 14⅝"D x 37⅞"H	H107318	\$1,195	\$1,195
1	<b>2-Drawer Lateral File</b> 36"W x 24"D x 29½"H	H107690	\$1,084	\$1,084
<b>TOTAL:</b>			<b>\$4,756</b>	

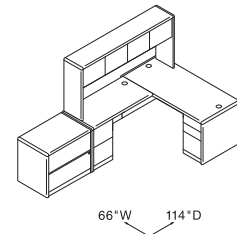

**DESK "L" WORKSTATION – LEFT**  
**66"W x 114"D**

QTY	DESCRIPTION	MODEL	LIST PRICE	PRICE EXTENSION
1	<b>Peninsula</b> 72"W x 36"D x 29½"H	H10721	\$1,195	\$1,195
1	<b>Bridge</b> 47"W x 24"D x 29½"H	H10770	\$367	\$367
1	<b>Credenza Shell with Full Modesty Panel</b> 72"W x 24"D x 29½"H	H107817	\$812	\$812
1	<b>Multi File Pedestal</b> 36"W x 20"D x 28"H	H10505	\$1,184	\$1,184
1	<b>Stack-on Storage</b> 68⅝"W x 14⅝"D x 37⅞"H	H10734	\$1,089	\$1,089
<b>TOTAL:</b>			<b>\$4,647</b>	

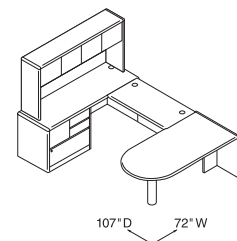

**PENINSULA "U" WORKSTATION – LEFT**  
**72"W x 107"D**

# 10700 SERIES™

## Typicals



Icon Legend on page 21

Components used are listed on pages 364-385. Order components individually. Other configurations are possible, including various sizes of some components.

QTY	DESCRIPTION	MODEL	LIST PRICE	PRICE EXTENSION
1	<b>Single Pedestal Desk, Left - B/B/F</b> 72"W x 36"D x 29½"H	H10788L	\$1,614	\$1,614
1	<b>Bridge</b> 47"W x 24"D x 29½"H	H10770	\$367	\$367
1	<b>Single Pedestal Credenza, Right - F/F</b> 72"W x 24"D x 29½"H	H10707R	\$1,321	\$1,321
1	<b>Stack-on Storage</b> 68⅝"W x 14⅝"D x 37⅞"H	H10734	\$1,089	\$1,089
1	<b>Wardrobe/Storage Cabinet, Right</b> 18"W x 24"D x 66⅝"H	H107295R	\$1,654	\$1,654
<b>TOTAL:</b>			<b>\$6,045</b>	

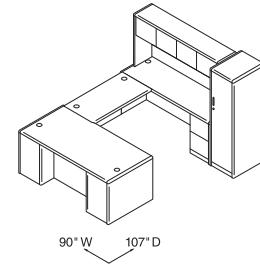

**DESK "U" WORKSTATION - RIGHT**

**90" W x 107" D**

QTY	DESCRIPTION	MODEL	LIST PRICE	PRICE EXTENSION
1	<b>Return Shell, Left</b> 36"W x 24"D x 29½"H	H107802L	\$546	\$546
1	<b>Corner Unit</b> 24" x 36" x 36" x 24" x 29½"H	H107811	\$1,075	\$1,075
1	<b>Return Shell, Right</b> 36"W x 24"D x 29½"H	H107801R	\$546	\$546
1	<b>Stack-on Storage</b> 68⅝"W x 14⅝"D x 37⅞"H	H10734	\$1,089	\$1,089
1	<b>Mobile Pedestal - B/B/F</b> 15¾"W x 22¾"D x 28"H	H105102	\$809	\$809
1	<b>Mobile Pedestal - F/F</b> 15¾"W x 22¾"D x 28"H	H105104	\$809	\$809
<b>TOTAL:</b>			<b>\$4,874</b>	

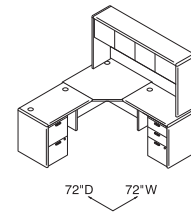

**CORNER 6' X 6' WORKSTATION**

**72" W x 72" D**

QTY	DESCRIPTION	MODEL	LIST PRICE	PRICE EXTENSION
1	<b>Desk Shell</b> 66"W x 30"D x 29½"H	H107826	\$870	\$870
1	<b>Credenza Shell</b> 66"W x 24"D x 29½"H	H107816	\$757	\$757
2	<b>Mobile Pedestal - B/B/F</b> 15¾"W x 22¾"D x 28"H	H105102	\$809	\$1,618
2	<b>Mobile Pedestal - F/F</b> 15¾"W x 22¾"D x 28"H	H105104	\$809	\$1,618
<b>TOTAL:</b>			<b>\$4,863</b>	

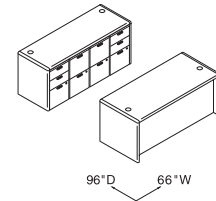

**MODULAR DESK AND CREDEZA**

**66" W x 96" D**

QTY	DESCRIPTION	MODEL	LIST PRICE	PRICE EXTENSION
1	<b>Peninsula</b> 66"W x 30"D x 29½"H	H10722	\$1,044	\$1,044
1	<b>Bridge</b> 42"W x 24"D x 29½"H	H10760	\$352	\$352
1	<b>Corner Unit</b> 24" x 36" x 36" x 24" x 29½"H	H107811	\$1,075	\$1,075
1	<b>Return Shell, Right</b> 42"W x 24"D x 29½"H	H107803R	\$546	\$546
1	<b>Mobile Pedestal - B/B/F</b> 15¾"W x 22¾"D x 28"H	H105102	\$809	\$809
1	<b>Mobile Pedestal - F/F</b> 15¾"W x 22¾"D x 28"H	H105104	\$809	\$809
1	<b>Stack-on Storage</b> 74⅝"W x 14⅝"D x 37⅞"H	H107318	\$1,195	\$1,195
<b>TOTAL:</b>			<b>\$5,830</b>	

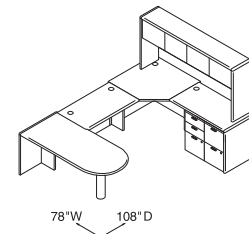

**PENINSULA "U" WITH  
MODULAR COMPONENTS**

**78" W x 108" D**



Icon Legend on page 21

# 10700 SERIES™ Bundles Typicals

Mahogany  
**H107LL7284N**

QTY	DESCRIPTION	MODEL	LIST PRICE	PRICE EXTENSION
1	Left Pedestal Desk	H10786L	\$1,210	\$1,210
1	Right Return	H10715R	\$813	\$813
<b>TOTAL:</b>			<b>\$2,023</b>	

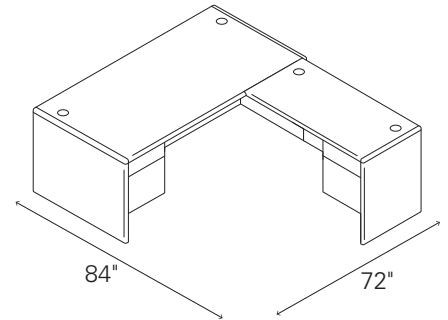

**L-STATION (LEFT DESK, RIGHT RETURN)**

Mahogany  
**H107LR7284N**

QTY	DESCRIPTION	MODEL	LIST PRICE	PRICE EXTENSION
1	Right Pedestal Desk	H10785R	\$1,210	\$1,210
1	Left Return	H10716L	\$813	\$813
<b>TOTAL:</b>			<b>\$2,023</b>	

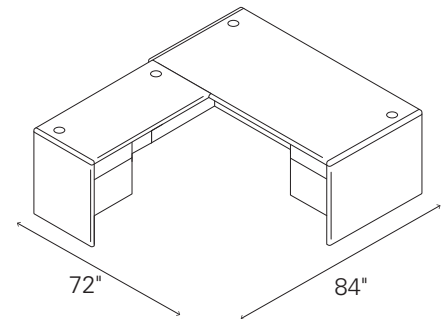

**L-STATION (RIGHT DESK, LEFT RETURN)**

Mahogany  
**H107UL72108N**

QTY	DESCRIPTION	MODEL	LIST PRICE	PRICE EXTENSION
1	Left Pedestal Desk	H10786L	\$1,210	\$1,210
1	Right Pedestal Credenza	H10745R	\$1,061	\$1,061
1	Bridge	H10770	\$367	\$367
<b>TOTAL:</b>			<b>\$2,638</b>	

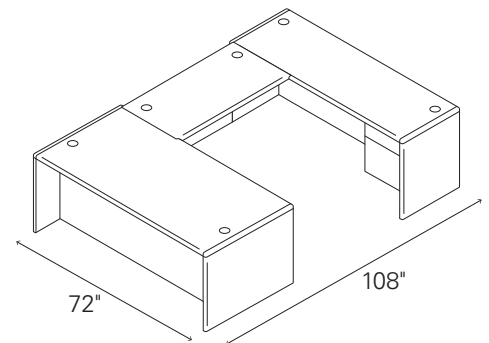

**U-STATION (LEFT DESK, RIGHT CREDENZA)**

# 10700 SERIES™

## Bundles Typicals



Icon Legend on page 21

Mahogany  
H107UR72108N

QTY	DESCRIPTION	MODEL	LIST PRICE	PRICE EXTENSION
1	Right Pedestal Desk	H10785R	\$1,210	\$1,210
1	Left Pedestal Credenza	H10746L	\$1,061	\$1,061
1	Bridge	H10770	\$367	\$367
<b>TOTAL:</b>			<b>\$2,638</b>	

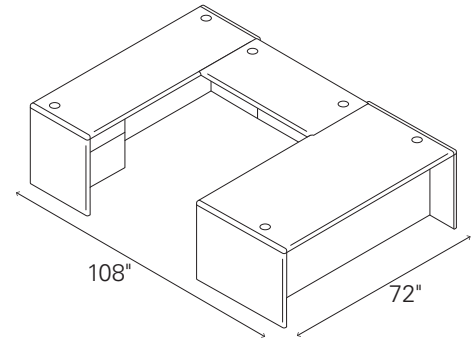

**U-STATION (RIGHT DESK, LEFT CREDENZA)**

Mahogany  
H107LLH7284N

QTY	DESCRIPTION	MODEL	LIST PRICE	PRICE EXTENSION
1	Left Pedestal Desk	H10786L	\$1,210	\$1,210
1	Right Return	H10715R	\$813	\$813
1	Stack-on Storage	H107313	\$958	\$958
<b>TOTAL:</b>			<b>\$2,981</b>	

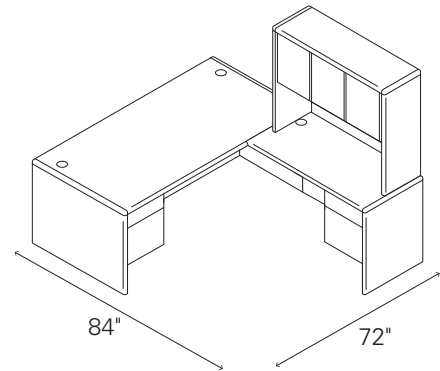

**L-STATION WITH STACK-ON STORAGE  
(LEFT DESK, RIGHT RETURN)**

Mahogany  
H107LRH7284N

QTY	DESCRIPTION	MODEL	LIST PRICE	PRICE EXTENSION
1	Right Pedestal Desk	H10785R	\$1,210	\$1,210
1	Left Return	H10716L	\$813	\$813
1	Stack-on Storage	H107313	\$958	\$958
<b>TOTAL:</b>			<b>\$2,981</b>	

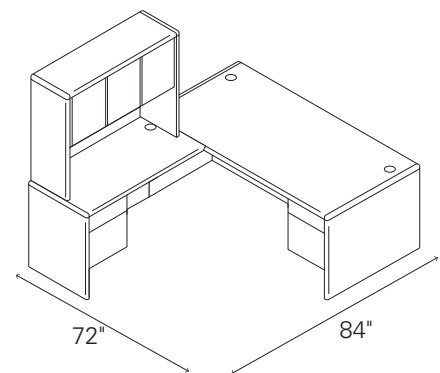

**L-STATION WITH STACK-ON STORAGE  
(RIGHT DESK, LEFT RETURN)**



Icon Legend on page 21

# 10700 SERIES™ Bundles Typicals

DESKS

Mahogany  
**H107ULH72108N**

QTY	DESCRIPTION	MODEL	LIST PRICE	PRICE EXTENSION
1	Left Pedestal Desk	<b>H10786L</b>	\$1,210	\$1,210
1	Right Pedestal Credenza	<b>H10745R</b>	\$1,061	\$1,061
1	Bridge	<b>H10770</b>	\$367	\$367
1	Stack-on Storage	<b>H10734</b>	\$1,089	\$1,089
<b>TOTAL:</b>			<b>\$3,727</b>	<b>\$3,727</b>

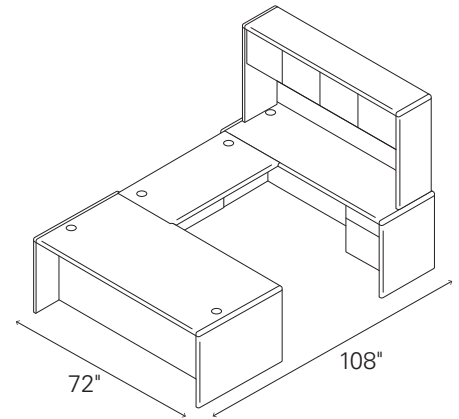

**U-STATION WITH STACK-ON STORAGE  
(LEFT DESK, RIGHT CREDENZA)**

Mahogany  
**H107URH72108N**

QTY	DESCRIPTION	MODEL	LIST PRICE	PRICE EXTENSION
1	Right Pedestal Desk	<b>H10785R</b>	\$1,210	\$1,210
1	Left Pedestal Credenza	<b>H10746L</b>	\$1,061	\$1,061
1	Bridge	<b>H10770</b>	\$367	\$367
1	Stack-on Storage	<b>H10734</b>	\$1,089	\$1,089
<b>TOTAL:</b>			<b>\$3,727</b>	<b>\$3,727</b>

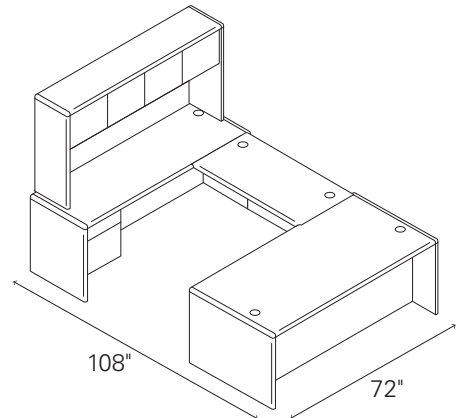

**U-STATION WITH STACK-ON STORAGE  
(RIGHT DESK, LEFT CREDENZA)**

# 10700 SERIES™

## Laminate Modular Components

GSA SIN 711-8



Icon Legend on page 21

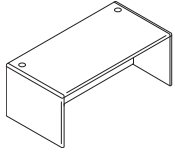

DESCRIPTION	INSIDE DIMENSIONS	FULL WIDTH OVERHANG	MODEL	SHIP WEIGHT	CUBE	LIST PRICE
<b>Desk Shell w/Full Modesty Panel</b>						
72"W x 36"D x 29½"H	69½"W x 24⅝"D	1½"	<b>H107827</b>	213	7.0	<b>\$983</b>
72"W x 30"D x 29½"H	69½"W x 24⅝"D	4½"	<b>H107829</b>	167	4.7	<b>\$873</b>
66"W x 30"D x 29½"H	63½"W x 24⅝"D	4½"	<b>H107826</b>	175	5.5	<b>\$870</b>
60"W x 30"D x 29½"H	57½"W x 24⅝"D	4½"	<b>H107825</b>	164	5.0	<b>\$752</b>
48"W x 30"D x 29½"H	45½"W x 24⅝"D	4½"	<b>H107824</b>	143	5.0	<b>\$731</b>

NOTES: Can be used freestanding or connected to a 42"W return shell to achieve a space efficient 6' x 6' L-shaped workstation layout. Accepts stack-on storage models H10734, H10734K or H10734G. See page 384 for optional center drawers.

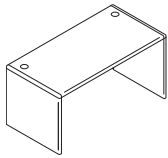

<b>Desk Shell w/10" Modesty Panel</b>						
60"W x 30"D x 29½"H	57½"W x 24⅝"D	4½"	<b>H107825X</b>	161	4.0	<b>\$752</b>

NOTES: Makes reaching wall electrical outlets quick and easy. Provides more than 18" of clearance. Can be used freestanding or connected to a 30"W return shell to achieve a compact 5' x 5' L-shaped workstation layout. Accepts stack-on storage models H10732, H10732K. See page 384 for optional center drawers.

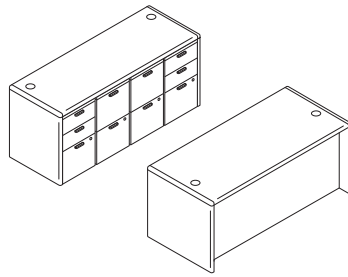

96"D 66"W

1 – H107826  
1 – H107816  
2 – H105102  
2 – H105104

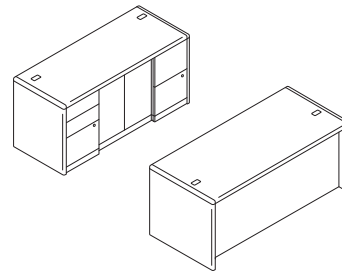

96"D 60"W

1 – H107825  
1 – H107815  
1 – H10508  
1 – H10504  
1 – H10502

! All 10700 Series™ grommets on desk, credenza, credenza shell, return, return shell, bridge and corner unit worksurfaces changed from rectangle-shaped to round, effective November, 2011.

### NOTES:

- Desk, credenza, and return shells, combined with a variety of under-the-worksurface storage solutions, maximize office layout flexibility. Products can be reconfigured quickly and easily when user preferences or space needs change.
- Worksurfaces and end panels feature contract-grade scratch, stain and spill resistant laminate over durable 1⅛" solid core high-performance particleboard; resists warping.
- Contoured hardwood trim; stained to match laminate.
- User friendly waterfall-shaped edges and round corners.
- 3" round cord management grommets, for routing and hiding wires and cables, are located in the tops of desk, credenza, and return shells. Grommets also serve as anchor points for stack-on storage and organizers.
- Grommet can be replaced with optional Power Hub or Power/USB Hub for easy plug-and-play. See page 386.
- Shells utilize 10500 Series™ mobile pedestals or modular pedestals. See pages 323-325.
- See pages 368-369 for modular storage components.

### HOW TO SPECIFY

Select Model Number

H 1 0 7 8 2 7 .

Select Laminate

See page 357



N N



Icon Legend on page 21

# 10700 SERIES™

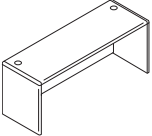
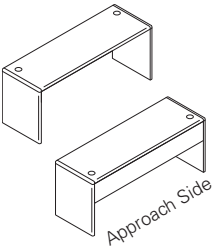
## Laminate Modular Components

	DESCRIPTION	INSIDE DIMENSIONS	MODEL	SHIP WEIGHT	CUBE	LIST PRICE
	<b>Credenza Shell w/Full Modesty Panel</b>					
	72"W x 24"D x 29½"H	69½"W x 22¾"D	<b>H107817</b>	156	6.0	<b>\$812</b>
	66"W x 24"D x 29½"H	63½"W x 22¾"D	<b>H107816</b>	145	5.5	<b>\$757</b>
	60"W x 24"D x 29½"H	57½"W x 22¾"D	<b>H107815</b>	133	5.0	<b>\$715</b>
	72"W x 20"D x 29½"H	69½"W x 18¾"D	<b>H107837</b>	140	5.3	<b>\$794</b>
	66"W x 20"D x 29½"H	63½"W x 18¾"D	<b>H107836</b>	132	4.8	<b>\$740</b>
	60"W x 20"D x 29½"H	57½"W x 18¾"D	<b>H107835</b>	127	3.8	<b>\$702</b>
	NOTES: One cord pass-through grommet in top center of modesty panel to reach wall electrical outlets. See pages 376-377 for optional stack-on storage.					
	<b>Credenza Shell w/10"H Modesty Panel</b>					
	72"W x 24"D x 29½"H	69½"W x 22¾"D	<b>H107817X</b>	127	6.0	<b>\$812</b>
	66"W x 24"D x 29½"H	63½"W x 22¾"D	<b>H107816X</b>	121	5.5	<b>\$757</b>
	60"W x 24"D x 29½"H	57½"W x 22¾"D	<b>H107815X</b>	115	5.0	<b>\$715</b>
	NOTES: Makes reaching wall electrical outlets quick and easy. Provides more than 18" of clearance. See pages 376-377 for optional stack-on storage.					
	<b>Kneespace Clearance End Panel Kits (field installable)</b>					
	1½"W x 11¼"D x 28⅝"H		<b>H105098</b>	13	0.9	<b>\$198</b>
	For use at either end of 10700, 10500 or Valido Series® 24"D Credenza Shells (with full or 10" modesty panel) or non-pedestal end of single pedestal credenzas or credenzas with lateral files.					
	1⅝"W x 17¼"D x 28⅝"H		<b>H105099</b>	11	0.8	<b>\$207</b>
	For use at either end of 10700, 10500 or Valido Series® 30"D Desk Shells or non-pedestal end of 30"D single pedestal desks.					
	Kits include: (1) support panel; European fastening hardware; flat connector bracket; joint connector bolts with sleeve nuts (for ganging credenza to adjacent worksurface); and adjustable leveling glides. Allows conversion of units currently in the field.					
	NOTES: Can be used to connect up to three 24"D credenzas or 30"D desks in line (requires 4 kits).					
	⚠ Not designed to be used freestanding. Not designed to be used with returns, 36"D desks or desk shells.					
	<b>SPECIFYING EXAMPLE: H105098.N</b>					

Not available in two-tone laminate

**NOTES:**

- Desk, credenza, and return shells, combined with a variety of under-the-worksurface storage solutions, maximize office layout flexibility. Products can be reconfigured quickly and easily when user preferences or space needs change.
- Worksurfaces and end panels feature contract-grade scratch, stain and spill resistant laminate over durable 1/8" solid core high-performance particleboard; resists warping.
- Contoured hardwood trim; stained to match laminate.
- User friendly waterfall-shaped edges and rounded corners.
- Formal, full height or 10" modesty panels.
- Cord management grommets, for routing and hiding wires and cables, are located in the tops of desk, credenza, and return shells. Grommets also serve as anchor points for stack-on storage and organizers.
- Shells utilize 10500 Series™ mobile pedestals or modular pedestals. See pages 323-325.
- See pages 368-369 for modular storage components.

**HOW TO SPECIFY**

<b>Select Model Number</b>	<b>Select Laminate</b>
	See page 357
H 1 0 7 8 1 7 .	N N



# 10700 SERIES™

## Laminate Modular Components

GSA SIN 711-8



Icon Legend on page 21

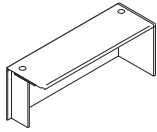

Model H10772R shown

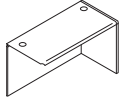

Model H107805R shown

DESCRIPTION	INSIDE DIMENSIONS	MODEL	SHIP WEIGHT	CUBE	LIST PRICE
<b>Right Return Shell w/Full Modesty Panel</b>					
72"W x 24"D x 29½"H, Right (w/support; 2 grommets)	62"W x 22⅜"D	<b>H10772R</b>	145	5.6	<b>\$812</b>
60"W x 24"D x 29½"H, Right (w/support; 2 grommets)	50"W x 22⅜"D	<b>H107807R</b>	129	4.7	<b>\$715</b>
48"W x 24"D x 29½"H, Right (2 grommets)	47"W x 22¾"D	<b>H107805R</b>	100	4.0	<b>\$572</b>
42"W x 24"D x 29½"H, Right (2 grommets)	41"W x 22¾"D	<b>H107803R</b>	95	3.5	<b>\$546</b>
36"W x 24"D x 29½"H, Right (2 grommets)	34¾"W x 22⅜"D	<b>H107801R</b>	83	3.4	<b>\$546</b>
30"W x 24"D x 29½"H (1 grommet)	28¾"W x 22¾"D	<b>H107725R</b>	69	2.4	<b>\$530</b>
<b>Left Return Shell w/Full Modesty Panel</b>					
72"W x 24"D x 29½"H, Left (w/support; 2 grommets)	62"W x 22⅜"D	<b>H107728L</b>	145	5.6	<b>\$812</b>
60"W x 24"D x 29½"H, Left (w/support; 2 grommets)	50"W x 22⅜"D	<b>H107808L</b>	129	4.7	<b>\$715</b>
48"W x 24"D x 29½"H, Left (2 grommets)	47"W x 22¾"D	<b>H107806L</b>	100	4.0	<b>\$572</b>
42"W x 24"D x 29½"H, Left (2 grommets)	41"W x 22¾"D	<b>H107804L</b>	95	3.5	<b>\$546</b>
36"W x 24"D x 29½"H, Left (2 grommets)	34¾"W x 22⅜"D	<b>H107802L</b>	83	3.4	<b>\$546</b>
30"W x 24"D x 29½"H (1 grommet)	28¾"W x 22¾"D	<b>H107726L</b>	69	2.4	<b>\$530</b>

NOTES: One cord pass-through grommet in top center of modesty panel to reach wall electrical outlets. Wood-grain direction on modesty/back panel runs vertical on 30"W-60"W sizes and horizontal on 72"W unit. Stack-on model H10734 is sized to be used on the 72"W return shell. Stack-on model H10732 will work on the 60"W return shell. Stack-on storage model H107313 fits on the 48"W return shell. Stack-on storage model H10734 will work on a 36"W return shell attached to the 36" corner unit; attaches to the return shell through the grommet hole and to the corner unit via double-sided tape. 36"W return shell can be used to achieve a 6' x 6' footprint when connected to either a 72"W x 36"D single pedestal desk, desk shell or peninsula, or when two are connected to a 36" corner unit model H107811.

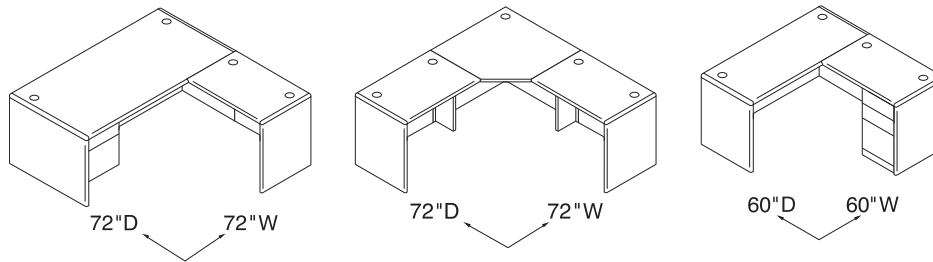

! All 10700 Series™ grommets on desk, credenza, credenza shell, return, return shell, bridge and corner unit worksurfaces changed from rectangle-shaped to round, effective November, 2011.

### NOTES:

- Worksurfaces and end panels feature contract-grade scratch, stain and spill resistant laminate over durable 1½" solid core high-performance particleboard; resists warping.
- Contoured hardwood trim; stained to match laminate.
- User friendly waterfall-shaped edges and rounded corners.
- Formal, full height or 10" modesty panels.
- Cord management grommets, for routing and hiding wires and cables, are located in the tops of desk, credenza, and return shells. Grommets also serve as anchor points for stack-on storage and organizers.
- For work-in-process paper management tools, see page 383.
- For conference table options, see the Preside® table tops and bases on pages 846-851.
- Shells utilize 10500 Series™ mobile pedestals or modular pedestals. See pages 323-325.
- See pages 368-369 for modular storage components.

### HOW TO SPECIFY

Select Model Number	Select Laminate
H 1 0 7 7 2 7 R .	See page 357 N N



# 10700 SERIES™ Laminate Modular Components

	DESCRIPTION	INSIDE DIMENSIONS	MODEL	SHIP WEIGHT	CUBE	LIST PRICE
	<b>Right Return Shell w/10" H Modesty Panel</b>					
	72"W x 24"D x 29½"H, Right (w/support; 2 grommets)	62"W x 22 <sup>13</sup> / <sub>16</sub> "D	<b>H107727RX</b>	113	5.6	<b>\$812</b>
	60"W x 24"D x 29½"H, Right (w/support; 2 grommets)	50"W x 22 <sup>13</sup> / <sub>16</sub> "D	<b>H107807RX</b>	105	4.7	<b>\$715</b>
	48"W x 24"D x 29½"H, Right (2 grommets)	47"W x 22 <sup>3</sup> / <sub>4</sub> "D	<b>H107805RX</b>	81	4.0	<b>\$572</b>
	42"W x 24"D x 29½"H, Right (2 grommets)	41"W x 22 <sup>3</sup> / <sub>4</sub> "D	<b>H107803RX</b>	78	3.5	<b>\$546</b>
	36"W x 24"D x 29½"H, Right (2 grommets)	34 <sup>3</sup> / <sub>4</sub> "W x 22 <sup>13</sup> / <sub>16</sub> "D	<b>H107801RX</b>	69	3.4	<b>\$546</b>
	<b>Left Return Shell w/10" H Modesty Panel</b>					
	72"W x 24"D x 29½"H, Left (w/support; 2 grommets)	62"W x 22 <sup>13</sup> / <sub>16</sub> "D	<b>H107728LX</b>	113	5.6	<b>\$812</b>
	60"W x 24"D x 29½"H, Left (w/support; 2 grommets)	50"W x 22 <sup>13</sup> / <sub>16</sub> "D	<b>H107808LX</b>	105	4.7	<b>\$715</b>
	48"W x 24"D x 29½"H, Left (2 grommets)	47"W x 22 <sup>3</sup> / <sub>4</sub> "D	<b>H107806LX</b>	81	4.0	<b>\$572</b>
	42"W x 24"D x 29½"H, Left (2 grommets)	41"W x 22 <sup>3</sup> / <sub>4</sub> "D	<b>H107804LX</b>	78	3.5	<b>\$546</b>
	36"W x 24"D x 29½"H, Left (2 grommets)	34 <sup>3</sup> / <sub>4</sub> "W x 22 <sup>13</sup> / <sub>16</sub> "D	<b>H107802LX</b>	69	3.4	<b>\$546</b>

NOTES: Makes reaching wall electrical outlets quick and easy. Provides more than 18" of clearance.

	<b>Non-Handed Return Shell w/10" H Modesty Panel</b>					
	30"W x 20"D x 29½"H	28 <sup>3</sup> / <sub>4</sub> "W x 18 <sup>3</sup> / <sub>4</sub> "D	<b>H107270X</b>	47	2.4	<b>\$506</b>

NOTES: Makes reaching wall electrical outlets quick and easy; provides more than 18" of clearance. Ideal for smaller spaces. Connects to single pedestal desks and credenzas, peninsulas, or desk or credenza shells. Designed to fit over 10500 Series™ mobile pedestal models H105106 (box/file) or H105109 (shelf/box/file) and modular pedestal models H105012 (box/box/file) or H105014 (file/file).

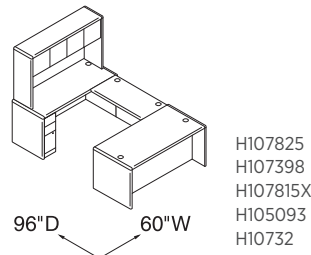
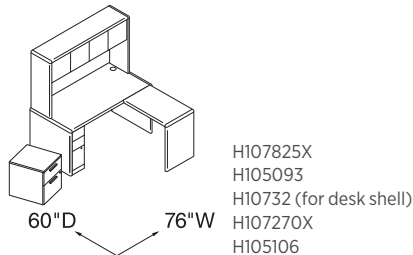

! All 10700 Series™ grommets on desk, credenza, credenza shell, return, return shell, bridge and corner unit worksurfaces changed from rectangle-shaped to round, effective November, 2011.

## NOTES:

- Worksurfaces and end panels feature contract-grade scratch, stain and spill resistant laminate over durable 1½" solid core high-performance particleboard; resists warping.
- Contoured hardwood trim; stained to match laminate.
- User friendly waterfall-shaped edges and rounded corners.
- Formal, full height or 10" modesty panels.
- 3" round cord management grommets, for routing and hiding wires and cables, are located in the tops of desk, credenza, and return shells. Grommets also serve as anchor points for stack-on storage and organizers.
- Grommet can be replaced with optional Power Hub or Power/USB Hub for easy plug-and-play. See page 386.
- For conference table options, see the Preside® table tops and bases on pages 846-851.
- Shells utilize 10500 Series™ mobile pedestals or modular pedestals. See pages 323-325.
- See pages 368-369 for modular storage components.

## HOW TO SPECIFY

<b>Select Model Number</b> <input type="text" value="H107727RX"/>	<b>Select Laminate</b> See page 357 <input type="text" value="NN"/>
--	---

# 10700 SERIES™

## Laminate Modular Components

GSA SIN 711-8

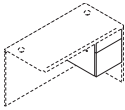
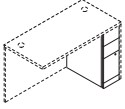
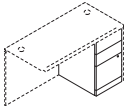
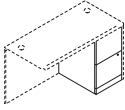
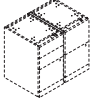

Icon Legend on page 21

	DESCRIPTION	MODEL	SHIP WEIGHT	CUBE	LIST PRICE
	<p><b>Box/File Pedestal (with core removable lock)</b> 15<math>\frac{3}{8}</math>"W x 22<math>\frac{3}{4}</math>"D x 17<math>\frac{3}{4}</math>"H — for use under 24"D, 30"D and 36"D desk, credenza and return shells</p> <p>NOTES: Hangrails included. Lock can be positioned on either the right or left side. Attaches to underside of worksurface top. Not for use under 20"D shells.</p> <p>ⓘ Not designed to be used freestanding. Unfinished top and back.</p>	<b>H10501</b>	57	5.5	<b>\$495</b>
	<p><b>Narrow Box/Box/File Pedestal (with core removable lock) — floor-standing</b> 9<math>\frac{1}{2}</math>"W x 22<math>\frac{3}{4}</math>"D x 28"H — for use under 24"D, 30"D and 36"D desk, credenza and return shells</p> <p>NOTES: Compact design is ideal for use in U- and L-shaped layouts for smaller spaces such as 5' x 8' U-workstation or a 5' x 5' L-workstation. Middle box drawer and file drawer lock; top box drawer does not lock. File drawer includes integrated hangrails for side-to-side letter or legal filing. Field installable handle choices for this model are the Sweep, Crescent, and Arch only. Not for use with 20"D shells.</p> <p>ⓘ Not designed to be used freestanding; unfinished top and back.</p>	<b>H105093</b>	61	5.6	<b>\$640</b>
	<p><b>Box/Box/File Pedestal (with core removable lock) — floor-standing</b> 15<math>\frac{3}{8}</math>"W x 22<math>\frac{3}{4}</math>"D x 28"H — for use under 24"D, 30"D and 36"D desk, credenza and return shells</p> <p>NOTES: Top box drawer does not lock. Hangrails included. Not for use under 20"D shells.</p> <p>ⓘ Not designed to be used freestanding. Unfinished top and back.</p>	<b>H10502</b>	90	8.4	<b>\$650</b>
	<p><b>File/File Pedestal (with core removable lock) — floor-standing</b> 15<math>\frac{3}{8}</math>"W x 22<math>\frac{3}{4}</math>"D x 28"H — for use under 24"D, 30"D and 36"D desk, credenza and return shells</p> <p>NOTES: Hangrails included. Not for use under 20"D shells.</p> <p>ⓘ Not designed to be used freestanding. Unfinished top and back.</p>	<b>H10504</b>	85	8.2	<b>\$650</b>
	<p><b>Access Strip (Filler)</b> 1<math>\frac{1}{8}</math>"W x 20<math>\frac{1}{2}</math>"D x 28"H</p> <p>NOTES: For use with B/B/F, F/F, and or P/M/F pedestals configured side-by-side or when CPU storage is used next to B/F, B/B/F, or F/F pedestals. Not required when pedestals are used in conjunction with lateral file pedestal, multi file pedestal or cabinet pedestal. Not for use under 20"D shells.</p> <p>ⓘ All 10700 Series™ grommets on desk, credenza, credenza shell, return, return shell, bridge and corner unit worksurfaces changed from rectangle-shaped to round, effective November, 2011.</p>	<b>H10524</b>	21	0.9	<b>\$165</b>

**NOTES:**

- Pedestals can be reconfigured quickly and easily when user preferences or space needs change.
- Pedestal models ship assembled unless designated .
- Locking units equipped with interchangeable core removable locks.
- See pages 364-367 for modular desk, credenza and return shells.
- ⓘ Keyed alike cores must be ordered separately — see page 922.
- ⓘ Pedestals are not designed to be used freestanding. Unfinished top and back.
- ⓘ Access strip (filler) required when full height pedestals are configured side-by-side to allow access for opening the drawers.
- ⓘ Access strip is required when CPU storage pedestal is used next to B/F, B/B/F, or F/F pedestals (finger pull is on side of door front).

**HOW TO SPECIFY**

<b>Select Model Number</b>	<b>Select Laminate</b>
	See page 357
H 1 0 5 0 1	N

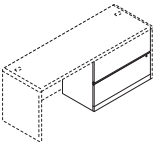
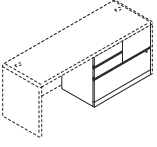
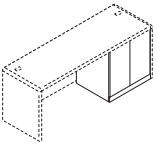
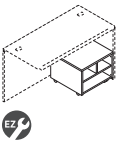

# 10700 SERIES™ Laminate Modular Components

	DESCRIPTION	MODEL	SHIP WEIGHT	CUBE	LIST PRICE
	<p><b>Lateral File Pedestal (with core removable lock) – floor-standing</b> 36"W x 20"D x 28"H — for use under 24"D, 30"D and 36"D desk, credenza and return shells</p> <p>NOTES: Designed for use with credenza or return shells. Hangrails included. Mechanical interlock inhibits extension of more than one drawer at a time. Not for use under 20"D shells.</p> <p>⚠ Not designed to be used freestanding. Unfinished top and back.</p>	<b>H10503</b>	127	15.6	<b>\$988</b>
	<p><b>Multi File Pedestal (with core removable lock) – floor-standing</b> 36"W x 20"D x 28"H — for use under 24"D, 30"D and 36"D desk, credenza and return shells</p> <p>NOTES: Designed for use with credenza or return shells. Versatile four drawer unit features one lateral file drawer, one vertical file drawer, and two box drawers. Box drawers do not lock. Hangrails included. Mechanical interlock in lateral drawer inhibits extension of more than one drawer at a time. Not for use under 20"D shells.</p> <p>⚠ Not designed to be used freestanding. Unfinished top and back.</p>	<b>H10505</b>	155	15.6	<b>\$1184</b>
	<p><b>Cabinet Pedestal – floor-standing</b> 26"W x 21¼"D x 28"H — for use under 24"D, 30"D and 36"D desk, credenza and return shells</p> <p>NOTES: One adjustable shelf at 2½" increments. For use with credenza or return shells. Doors are non-locking. Not for use under 20"D shells.</p> <p>⚠ Not designed to be used freestanding. Unfinished top and back.</p>	<b>H10508</b>	78	12.2	<b>\$736</b>
	<p><b>Mobile Printer/Fax Cart</b> 20"W x 19⅞"D x 14⅞"H</p> <p>NOTES: Holds laser printers, inkjet printers or fax machines. Ideal for limited space. Low profile cart stores conveniently and easily under desks and workstations. Interior compartment shelving is Black. Four casters. Not for use under 20"D shells. <b>Flat edge profile on top.</b></p> <p><b>SPECIFYING EXAMPLE: H105679.NN</b></p> <p>⚠ All 10700 Series™ grommets on desk, credenza, credenza shell, return, return shell, bridge and corner unit worksurfaces changed from rectangle-shaped to round, effective November, 2011.</p>	<b>H105679</b>	52	2.9	<b>\$397</b>

**NOTES:**

- Pedestals can be reconfigured quickly and easily when user preferences or space needs change.
- Locking units equipped with interchangeable core removable locks.
- See pages 364-367 for modular desk, credenza and return shells.
- ⚠ Keyed alike cores must be ordered separately — see HF23B on page 922.
- ⚠ Pedestals are not designed to be used freestanding. Unfinished top and back.
- ⚠ Access strip (filler) required when full height pedestals are configured side-by-side to allow access for opening the drawers.
- ⚠ Access strip is required when CPU storage pedestal is used next to B/F, B/B/F, or F/F pedestals (finger pull is on side of door front). See page 368.

**HOW TO SPECIFY**

<b>Select Model Number</b> <input type="text" value="H10503"/>	<b>Select Laminate</b> See page 357 <input type="text" value="N"/>
---	--

# 10700 SERIES™

## Laminate Wood Desks — Full Pedestals

GSA SIN 711-8



Icon Legend on page 21

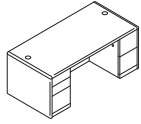

DESCRIPTION	RECESSED MODESTY PANEL	MODEL	SHIP WEIGHT	CUBE	LIST PRICE
<b>Double Pedestal Desk w/Wood-Grain Breakfront Modesty Panel — 3/2</b>					
72"W x 36"D x 29½"H	10½"	<b>H10799</b>	371	52.9	<b>\$1872</b>
66"W x 30"D x 29½"H	4½"	<b>H10774</b>	313	40.9	<b>\$1805</b>
60"W x 30"D x 29½"H	4½"	<b>H10773</b>	305	37.3	<b>\$1718</b>
NOTES: All drawers lock. Two worksurface grommets to route/hide cords. See page 384 for optional center drawers.					

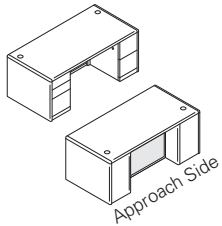

<b>Double Pedestal Desk w/Frosted Breakfront Modesty Panel — 3/2</b>					
72"W x 36"D x 29½"H	10½"	<b>H10799G</b>	366	51.8	<b>\$2322</b>
NOTES: All drawers lock. Two worksurface grommets to route/hide cords. See page 384 for optional center drawers.					

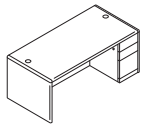

<b>Single Pedestal Desk w/Wood-Grain Breakfront Modesty Panel — Box/box/file</b>					
72"W x 36"D x 29½"H, Right	10½"	<b>H10787R</b>	317	52.9	<b>\$1614</b>
66"W x 30"D x 29½"H, Right	4½"	<b>H10701R</b>	270	40.9	<b>\$1484</b>
72"W x 36"D x 29½"H, Left	10½"	<b>H10788L</b>	317	52.9	<b>\$1614</b>
66"W x 30"D x 29½"H, Left	4½"	<b>H10702L</b>	270	40.9	<b>\$1484</b>
NOTES: Drawers lock. Two worksurface grommets to route/hide cords. See page 384 for optional center drawers.					

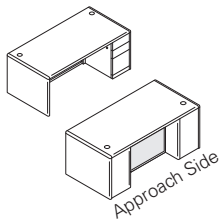

<b>Single Pedestal Desk w/Frosted Breakfront Modesty Panel — Box/box/file</b>					
72"W x 36"D x 29½"H, Right	10½"	<b>H10787RG</b>	313	51.8	<b>\$2064</b>
72"W x 36"D x 29½"H, Left	10½"	<b>H10788LG</b>	313	51.8	<b>\$2064</b>
NOTES: Drawers lock. Two worksurface grommets to route/hide cords. See page 384 for optional center drawers.					

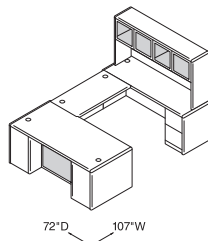

H10788L  
H10770  
H10707R  
H10734G

! All 10700 Series™ grommets on desk, credenza, credenza shell, return, return shell, bridge and corner unit worksurfaces changed from rectangle-shaped to round, effective November, 2011.

### NOTES:

- Worksurfaces and end panels feature contract-grade scratch, stain and spill resistant high-pressure laminate over durable 1/8" solid core high-performance particleboard.
- Contoured hardwood trim; stained to match laminate.
- User friendly waterfall-shaped edges.
- Full-to-floor pedestals maximize storage space.
- Breakfront modesty panel design on full height pedestal desks. See approach side illustration above.
- Grommet can be replaced with optional Power Hub or Power/USB Hub for easy plug-and-play. See page 386.
- All drawers are 5-sided construction, which allows easy drawer alignment or replacement of drawer fronts.
- File drawer design includes integrated handrails for side-to-side letter or legal filing; and front-to-back for letter filing.
- Adjustable hex leveling glides allow floor-standing furniture to be easily leveled without lifting the unit; glides have 3/4" adjustable range.
- Desk, credenza, and return models ship assembled; ready to set in place.
- See pages 374-386 for shared components.

### HOW TO SPECIFY

<b>Select Model Number</b>	<b>Select Laminate</b>
H 1 0 7 9 9 .	See page 357
N N	



# 10700 SERIES™

## Laminate Wood Desks — Full Pedestals

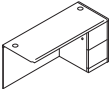
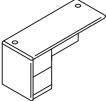
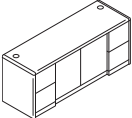
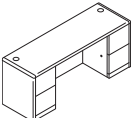
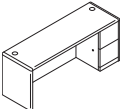
	DESCRIPTION	RECESSED MODESTY PANEL	MODEL	SHIP WEIGHT	CUBE	LIST PRICE
	<b>Return — Right file/file (2 grommets)</b>					
	60"W x 24"D x 29½"H		<b>H10709R</b>	176	29.7	<b>\$1147</b>
	48"W x 24"D x 29½"H		<b>H10711R</b>	158	24.9	<b>\$993</b>
	42"W x 24"D x 29½"H		<b>H107191R</b>	150	22.1	<b>\$981</b>
	NOTES: Drawers lock. Two worksurface grommets to route/hide cords and one cord pass-through grommet in top center of modesty panel. See pages 376-377 for optional stack-on storage.					
	⚠ Not designed to be used freestanding.					
	<b>Return — Left file/file (2 grommets)</b>					
	60"W x 24"D x 29½"H		<b>H10710L</b>	176	29.7	<b>\$1147</b>
	48"W x 24"D x 29½"H		<b>H10712L</b>	158	24.9	<b>\$993</b>
	42"W x 24"D x 29½"H		<b>H107192L</b>	150	22.1	<b>\$981</b>
	NOTES: Drawers lock. Two worksurface grommets to route/hide cords and one cord pass-through grommet in top center of modesty panel. See pages 376-377 for optional stack-on storage.					
	⚠ Not designed to be used freestanding.					
	<b>Credenza with Doors</b>					
	72"W x 24"D x 29½"H	3½"	<b>H10742</b>	314	36.0	<b>\$1872</b>
	NOTES: All drawers lock. Doors are non-locking. Two worksurface grommets to route/hide cords and one pass-through grommet in top center of modesty panel. Includes a fixed shelf located at the bottom of the center storage area. No intermittent shelf. See pages 376-377 for optional stack-on storage.					
	<b>Credenza with Kneespace — 2/0/2</b>					
	72"W x 24"D x 29½"H	3½"	<b>H10741</b>	280	36.0	<b>\$1614</b>
	66"W x 24"D x 29½"H	3½"	<b>H10768</b>	270	33.4	<b>\$1519</b>
	60"W x 24"D x 29½"H	3½"	<b>H10767</b>	241	28.8	<b>\$1476</b>
	NOTES: All drawers lock. Two worksurface grommets to route/hide cords and one pass-through grommet in top center of modesty panel. See pages 376-377 for optional stack-on storage.					
	⚠ Not designed to be used with 24"D modular or mobile pedestals.					
	<b>Single Pedestal Credenza, File/File</b>					
	72"W x 24"D x 29½"H, Right	3½"	<b>H10707R</b>	235	36.3	<b>\$1321</b>
	66"W x 24"D x 29½"H, Right	3½"	<b>H10705R</b>	225	33.4	<b>\$1299</b>
	72"W x 24"D x 29½"H, Left	3½"	<b>H10708L</b>	235	36.3	<b>\$1321</b>
	66"W x 24"D x 29½"H, Left	3½"	<b>H10706L</b>	225	33.4	<b>\$1299</b>
	NOTES: Drawers lock. Two worksurface grommets to route/hide cords and one cord pass-through grommet in top center of modesty panel. See pages 376-377 for optional stack-on storage.					
	⚠ Not designed to be used with 24"D modular or mobile pedestals.					
	⚠ All 10700 Series™ grommets on desk, credenza, credenza shell, return, return shell, bridge and corner unit worksurfaces changed from rectangle-shaped to round, effective November, 2011.					

**NOTES:**

- Worksurfaces and end panels feature contract-grade scratch, stain and spill resistant high-pressure laminate over durable 1/8" solid core high-performance particleboard.
- Contoured hardwood trim; stained to match laminate.
- User friendly waterfall-shaped edges.
- Full-to-floor pedestals maximize storage space.
- Breakfront modesty panel design on full height pedestal desks. See approach side illustration on page 370.
- Cord management grommets serve as anchor points for stack-on storage and organizers.
- All drawers are 5-sided construction, which allows easy drawer alignment or replacement of drawer fronts.
- File drawer design includes integrated hangrails for side-to-side letter or legal filing; and front-to-back for letter filing.
- Adjustable hex leveling glides allow floor-standing furniture to be easily leveled without lifting the unit; glides have 3/4" adjustable range.
- Desk, credenza, and return models ship assembled; ready to set in place.
- For work-in-process paper management tools, see page 383.
- See pages 374-386 for shared components.

**HOW TO SPECIFY**

<b>Select Model Number</b>	<b>Select Laminate</b>
	See page 357
H 1 0 7 0 9 R .	N N

# 10700 SERIES™

## Laminate Wood Desks — 3/4 Pedestals

GSA SIN 711-8

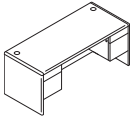
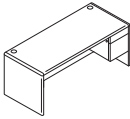
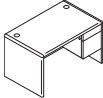
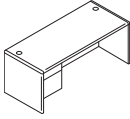
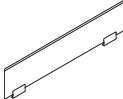

Icon Legend on page 21

	DESCRIPTION	FULL WIDTH OVERHANG	MODEL	SHIP WEIGHT	CUBE	LIST PRICE
	<b>Double Pedestal Desk, 2-2</b>					
	72"W x 36"D x 29½"H	10½"	<b>H10791</b>	340	52.9	<b>\$1460</b>
	66"W x 30"D x 29½"H	4½"	<b>H10775</b>	290	40.9	<b>\$1395</b>
	60"W x 30"D x 29½"H	4½"	<b>H10771</b>	266	37.4	<b>\$1229</b>
	NOTES: All drawers lock. Two worksurface grommets to route/hide cords. See page 384 for optional center drawers.					
	<b>Single Pedestal Desk, Right box/file</b>					
	72"W x 36"D x 29½"H	10½"	<b>H10785R</b>	279	52.9	<b>\$1210</b>
	66"W x 30"D x 29½"H	4½"	<b>H10783R</b>	239	41.0	<b>\$1103</b>
	NOTES: Drawers lock. Two worksurface grommets to route/hide cords. See page 384 for optional center drawers.					
	<b>Small Office Desk, 3/4 Pedestal, Right box/file</b>					
	48"W x 30"D x 29½"H		<b>H107885R</b>	191	30.2	<b>\$1012</b>
	NOTES: Footprint is ideal for limited space. Drawers lock. Two cord management grommets in the top. 3/4 height modesty panel facilitates reaching wall electrical outlets. Optional stack-on storage model H107313 maximizes storage space. See page 384 for optional center drawers.					
	<b>Single Pedestal Desk, Left box/file</b>					
	72"W x 36"D x 29½"H	10½"	<b>H10786L</b>	279	52.9	<b>\$1210</b>
	66"W x 30"D x 29½"H	4½"	<b>H10784L</b>	239	41.0	<b>\$1103</b>
	NOTES: Drawers lock. Two worksurface grommets to route/hide cords. See page 384 for optional center drawers.					
<p>! All 10700 Series™ grommets on desk, credenza, credenza shell, return, return shell, bridge and corner unit worksurfaces changed from rectangle-shaped to round, effective November, 2011.</p>						
	<b>Above Privacy Screen</b>					
	30"W x 13"H		<b>HLSL1230</b>	13	1.5	<b>\$251</b>
	36"W x 13"H		<b>HLSL1236</b>	15	1.8	<b>\$277</b>
	42"W x 13"H		<b>HLSL1242</b>	18	2.3	<b>\$310</b>
	48"W x 13"H		<b>HLSL1248</b>	20	2.3	<b>\$354</b>
	54"W x 13"H		<b>HLSL1254</b>	22	2.9	<b>\$379</b>
60"W x 13"H		<b>HLSL1260</b>	24	2.9	<b>\$408</b>	
	NOTES: Ships complete with attachment bracket. Bracket is Platinum only, no need to specify. Attaches to top of rectangle worksurfaces; requires a minimum overhang of 1½".					
	! Available in Frosted Glass ONLY HLSL1230.G.					
	! Above only privacy screen clamps onto worksurface and cannot be installed where support storage will be attached.					

**NOTES:**

- Worksurfaces and end panels feature contract-grade scratch, stain and spill resistant high-pressure laminate over durable 1½" solid core high-performance particleboard.
- Contoured hardwood trim; stained to match laminate.
- User friendly waterfall-shaped edges and rounded corners.
- 3/4 pedestal design increases budget flexibility.
- Formal, full height modesty panels.
- Drawers operate on full extension, ball-bearing suspensions to ensure smooth, quiet, long-lasting operation.
- All drawers are 5-sided construction, which allows easy drawer alignment or replacement of drawer fronts.
- File drawer design includes integrated hangrails for side-to-side letter or legal filing; and front-to-back for letter filing.
- Grommet can be replaced with optional Power Hub or Power/USB Hub for easy plug-and-play. See page 386.
- Adjustable hex leveling glides allow floor-standing furniture to be easily leveled without lifting the unit; glides have ¾" adjustable range.
- Desk, credenza, and return models ship assembled; ready to set in place.
- Center drawers conveniently store writing instruments, paper and other miscellaneous items. Includes pencil tray. See page 384.
- See pages 374-386 for shared components.

**HOW TO SPECIFY**

<b>Select Model Number</b>	<b>Select Laminate</b>
	See page 357
H 1 0 7 9 1 .	N N



# 10700 SERIES™

## Laminate Wood Desks — 3/4 Pedestals

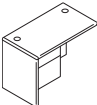
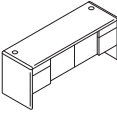
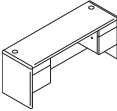
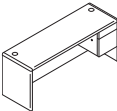
	DESCRIPTION	FULL WIDTH OVERHANG	MODEL	SHIP WEIGHT	CUBE	LIST PRICE
 Model H10717R shown	<b>Return — Right box/file (2 grommets)</b>					
	60"W x 24"D x 29½"H		<b>H10717R</b>	173	29.7	<b>\$921</b>
	48"W x 24"D x 29½"H		<b>H10715R</b>	147	25.3	<b>\$813</b>
	42"W x 24"D x 29½"H		<b>H107193R</b>	136	22.1	<b>\$792</b>
	NOTES: Drawers lock. Two worksurface grommets and one cord pass-through grommet in top center of modesty panel. See pages 376-377 for optional stack-on storage.					
	⚠ Not designed to be used freestanding.					
 Model H10716L shown	<b>Return — Left box/file (2 grommets)</b>					
	60"W x 24"D x 29½"H		<b>H10718L</b>	173	29.7	<b>\$921</b>
	48"W x 24"D x 29½"H		<b>H10716L</b>	147	25.3	<b>\$813</b>
	42"W x 24"D x 29½"H		<b>H107194L</b>	136	22.1	<b>\$792</b>
	NOTES: Drawers lock. Two worksurface grommets and one cord pass-through grommet in top center of modesty panel to reach wall electrical outlets. See pages 376-377 for optional stack-on storage.					
	⚠ Not designed to be used freestanding.					
	<b>Credenza with Doors</b>	3½"	<b>H10744</b>	278	36.0	<b>\$1473</b>
	72"W x 24"D x 29½"H					
	NOTES: All drawers lock. Hinged doors are non-locking. Two worksurface grommets and one cord pass-through grommet in top center of modesty panel to reach wall electrical outlets. Includes a fixed shelf located at the bottom of the center storage area. No intermittent shelf. See pages 376-377 for optional stack-on storage.					
	<b>Credenza with Kneespace</b>					
	72"W x 24"D x 29½"H	3½"	<b>H10743</b>	243	36.3	<b>\$1313</b>
	66"W x 24"D x 29½"H	3½"	<b>H10766</b>	234	33.4	<b>\$1227</b>
	60"W x 24"D x 29½"H	3½"	<b>H10765</b>	229	28.8	<b>\$1172</b>
	NOTES: Drawers lock. Two worksurface grommets and one cord pass-through grommet in top center of modesty panel to reach wall electrical outlets. See pages 376-377 for optional stack-on storage.					
	⚠ Not designed to be used with 24"D modular or mobile pedestals.					
	<b>Single Pedestal Credenza, Box/File</b>					
	72"W x 24"D x 29½"H, Right	3½"	<b>H10745R</b>	212	36.0	<b>\$1061</b>
	66"W x 24"D x 29½"H, Right	3½"	<b>H10763R</b>	203	33.4	<b>\$1044</b>
	72"W x 24"D x 29½"H, Left	3½"	<b>H10746L</b>	212	36.0	<b>\$1061</b>
	66"W x 24"D x 29½"H, Left	3½"	<b>H10764L</b>	203	33.4	<b>\$1044</b>
	NOTES: Drawers lock. Two worksurface grommets and one cord pass-through grommet in top center of modesty panel to reach wall electrical outlets. See pages 376-377 for optional stack-on storage.					
	⚠ Not designed to be used with 24"D modular or mobile pedestals.					
	⚠ All 10700 Series™ grommets on desk, credenza, credenza shell, return, return shell, bridge and corner unit worksurfaces changed from rectangle-shaped to round, effective November, 2011.					

**NOTES:**

- Worksurfaces and end panels feature contract-grade scratch, stain and spill resistant high-pressure laminate over durable 1½" solid core high-performance particleboard.
- Contoured hardwood trim; stained to match laminate.
- User friendly waterfall-shaped edges and rounded corners.
- 3/4 pedestal design increases budget flexibility.
- Formal, full height modesty panels.
- Cord management grommets also serve as anchor points for stack-on storage and organizers.
- All drawers are 5-sided construction, which allows easy drawer alignment or replacement of drawer fronts.
- File drawer design includes integrated hangrails for side-to-side letter or legal filing; and front-to-back for letter filing.
- Adjustable hex leveling glides allow floor-standing furniture to be easily leveled without lifting the unit; glides have ¾" adjustable range.
- Desk, credenza, and return models ship assembled; ready to set in place.
- For work-in-process paper management tools, see page 383.
- See pages 374-386 for shared components.

**HOW TO SPECIFY**

<b>Select Model Number</b>	<b>Select Laminate</b>
	See page 357
H 1 0 7 4 5 R .	N N



# 10700 SERIES™

## Shared Components and Accessories

GSA SIN 711-8

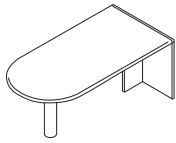

Icon Legend on page 21

**DESCRIPTION****MODEL****SHIP WEIGHT****CUBE****LIST PRICE****Peninsula w/End Panel and Steel Support Column**

72"W x 36"D x 29½"H  
66"W x 30"D x 29½"H

**H10721**

150

15.1

**\$1195****H10722**

125

11.8

**\$1044**

NOTES: Use for "U" or "L" configuration. Cord routing notch in brace panel. Round support column is black. Peninsula models H10721 and H10722 ship complete with end panel and black 4½" diameter support column. For a silver support column option, please see model HPC191X on page 317 (ordered separately).

ⓘ Not designed to be used freestanding.

**Peninsula Desk w/End Panel and Wood Support Column**

72"W x 30"D x 29½"H  
60"W x 30"D x 29½"H

**H10724**

167

14.6

**\$1034****H10726**

161

10.7

**\$958**

NOTES: Designed for use in "U" or "L" configurations, or to be used in combination with bookcase with adjustable shelves (model H107569).

60"W x 30"D size can be used to achieve a space efficient 5' x 5' L-shaped workstation (when connected to a 30"W return shell) or 5' x 8' U-shaped workstation (when used with a 42"W x 20"D bridge and 60"W credenza shell). Cord routing notch in brace panel. The wood support column component ships fully assembled.

ⓘ Not designed to be used freestanding.

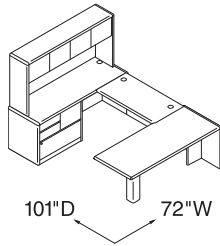
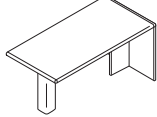
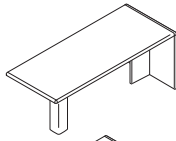

101"D 72"W

H10721  
H10770  
H107817  
H10505  
H10734

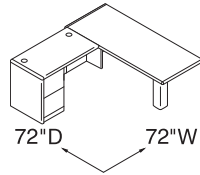

72"D 72"W

H10724  
H107192L

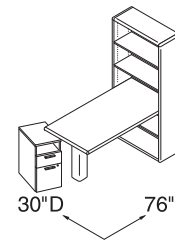

30"D 76"W

H10726  
H107569  
H105109

**Field Installable Laminate Modesty Panel**

50¼"W x ¾"Thick x 18"H

**H10528**

25

1.3

**\$177**

NOTES: Center drawer model H1522 can be used in conjunction with modesty panel. Cord pass-through notch in top corner of modesty panel. See page 384 for optional center drawers.

ⓘ Not designed to attach to peninsulas manufactured prior to 12/1/2001.

**SPECIFYING EXAMPLE: H10528.N**

**Field Installable Modesty Panel, Frosted with Silver Frame**

50¼"W x ¾"Thick x 18"H — for use on 72"W peninsulas

**HPC180G**

33 ⓘ

1.5

**\$645**

ⓘ Center drawers not designed to be used with the frosted/silver modesty panel.

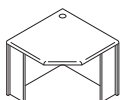
**Corner Unit**

24" x 36" x 36" x 24" x 29½"H - (1 grommet in top)  
Works with 24"D x 29½"H returns or bridges.

**H107811**

136

4.2

**\$1075**

NOTES: Support legs feature cutouts for routing cords.  
Can be used freestanding.

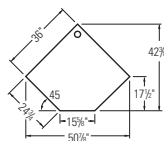
**NOTES:**

- Shared components on this page can be used with modular, full pedestal, and 3/4 pedestal models shown on pages 364-373.
- Multi file is a versatile four drawer unit featuring two box drawers, one file drawer, and one lateral file drawer with mechanical interlock.
- Cord management grommets, for routing and hiding wires and cables, are located in the tops of desks, credenzas, and returns. Grommets also serve as anchor points for stack-on storage and organizers.
- Cord pass-through grommet located in the back/modesty panel of returns, bridges and credenzas, facilitates reaching wall electrical outlets.
- All drawers are 5-sided construction, which allows easy drawer alignment or replacement of drawer fronts.
- Locking units equipped with interchangeable core removable locks.
- Stack-on storage attaches with two removable mounting brackets.
- Adjustable hex leveling glides allow floor-standing furniture to be easily leveled without lifting the unit; glides have ¾" adjustable range.
- See pages 374-386 for shared components.

ⓘ Keyed alike cores must be ordered separately — see page 922.

**HOW TO SPECIFY**







Select  
Model Number

H 1 0 7 2 1 .

Select  
Laminate

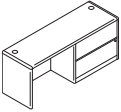
See page 357

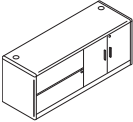
N N

	DESCRIPTION	FULL WIDTH OVERHANG	MODEL	SHIP WEIGHT	CUBE	LIST PRICE
 	<b>Bridge (Single Ped. Desk, Desk Shell or Peninsula to Corner Unit or Single Ped. Credenza or Credenza Shell)</b>					
	47"W x 24"D x 29½"H, (Clear inside depth = 22¾"D)		<b>H10770</b>	81	2.5	<b>\$367</b>
	42"W x 24"D x 29½"H, (Clear inside depth = 22¾"D)		<b>H10760</b>	69	2.6	<b>\$352</b>
	36"W x 24"D x 29½"H, (Clear inside depth = 22¾"D) (for use with Corner Units)		<b>H10751</b>	64	2.5	<b>\$350</b>
	47"W x 20"D x 29½"H, (Clear inside depth = 18¾"D)		<b>H107399</b>	68	2.8	<b>\$352</b>
	42"W x 20"D x 29½"H, (Clear inside depth = 18¾"D)		<b>H107398</b>	56	2.6	<b>\$342</b>
	NOTES: Two cord grommets in top; one cord pass-through grommet in top center of modesty panel. Grommets can be replaced with optional Power Hub or Power/USB Hub for easy plug-and-play (see page 386). Kneespace of desk limited to 24¾"W if bridge is used with 66"W single pedestal desk.					
 	<b>Credenza with 36" Lateral (with core removable lock) – 2 cord grommets in top</b>					
	72"W x 24"D x 29½"H, Right	3½"	<b>H10747R</b>	247	36.0	<b>\$1461</b>
	72"W x 24"D x 29½"H, Left	3½"	<b>H10748L</b>	247	36.0	<b>\$1461</b>
	NOTES: One cord pass-through grommet in top center of modesty panel. Mechanical interlock inhibits the extension of more than one drawer at a time. Optional stack-on models H10734, H10734K, and H10734G maximize storage space.					
	! Not designed to be used with 24"D modular or mobile pedestals.					
 	<b>Credenza with Lateral File, Left and Storage Cabinet, Right</b>					
	72"W x 24"D x 29½"H	3½"	<b>H107492</b>	307	35.6	<b>\$1812</b>
	NOTES: Lateral file is equipped with mechanical interlock to inhibit the extension of more than one drawer at a time. Storage cabinet has one adjustable interior shelf which adjusts in 1¼" increments over a range of 5". Drawers and doors lock separately; the two locks are keyed alike. Can be used with optional stack-on storage. See page 376 for Stack-on Storage models H10734/H10734K/H10734G.					

**NOTES:**

- Cord management grommets, for routing and hiding wires and cables, are located in the tops of desks, credenzas, and returns. Grommets also serve as anchor points for stack-on storage and organizers.
- Cord pass-through grommet located in the back/modesty panel of returns, bridges and credenzas, facilitates reaching wall electrical outlets.
- All drawers are 5-sided construction, which allows easy drawer alignment or replacement of drawer fronts.
- Locking units equipped with interchangeable core removable locks.
- Stack-on storage attaches with two removable mounting brackets.
- Adjustable hex leveling glides allow floor-standing furniture to be easily leveled without lifting the unit; glides have ¾" adjustable range.
- See pages 374-386 for shared components.

**HOW TO SPECIFY**

<b>Select Model Number</b>	<b>Select Laminate</b>
See page 357	See page 357
H 1 0 7 7 0 .	N N

# 10700 SERIES™

## Shared Components and Accessories

GSA SIN 711-8

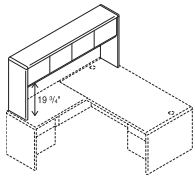

Icon Legend on page 21

**DESCRIPTION****Stack-on Storage for "L" Workstation**

74<sup>5</sup>/<sub>8</sub>"W x 14<sup>5</sup>/<sub>8</sub>"D x 37<sup>1</sup>/<sub>8</sub>"H  
(Use Task Light model H870960, see page 385)

**Stack-on Storage for "L" Workstation, Locking**

74<sup>5</sup>/<sub>8</sub>"W x 14<sup>5</sup>/<sub>8</sub>"D x 37<sup>1</sup>/<sub>8</sub>"H  
(Use Task Light model H870960, see page 385)

NOTES: Spans the total depth dimension of configurations comprised of: 48"W return or return shell attached to a 30"D single pedestal desk, desk shell or peninsula (78"D); 42"W return or return shell attached to a 36"D single pedestal desk, desk shell or peninsula (78"D) or 42"W return or return shell attached to a 36"W corner unit (78"D). Attaches to desk, peninsula, or corner unit via double-sided tape, and to return through grommet hole. Inside storage consists of two compartments each 34<sup>3</sup>/<sub>4</sub>"W x 12<sup>1</sup>/<sub>8</sub>"D x 12"H. Use back enclosure model H107358 and tackboard model H90035. For vertical paper manager, see page 383.

**MODEL****SHIP WEIGHT****CUBE****LIST PRICE****H107318**

198

15.8

**\$1195****H107318K**

198

15.8

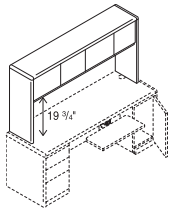
**\$1275****Stack-on Storage**

68<sup>5</sup>/<sub>8</sub>"W x 14<sup>5</sup>/<sub>8</sub>"D x 37<sup>1</sup>/<sub>8</sub>"H, 4 doors (For 72"W Credenza)

62<sup>5</sup>/<sub>8</sub>"W x 14<sup>5</sup>/<sub>8</sub>"D x 37<sup>1</sup>/<sub>8</sub>"H, 4 doors (For 66"W Credenza)

56<sup>5</sup>/<sub>8</sub>"W x 14<sup>5</sup>/<sub>8</sub>"D x 37<sup>1</sup>/<sub>8</sub>"H, 4 doors (For 60"W Credenza or Return)

44<sup>5</sup>/<sub>8</sub>"W x 14<sup>5</sup>/<sub>8</sub>"D x 37<sup>1</sup>/<sub>8</sub>"H, 3 doors (For 48"W Return or 48"W Small Office Desk)

**Stack-on Storage, Locking**

68<sup>5</sup>/<sub>8</sub>"W x 14<sup>5</sup>/<sub>8</sub>"D x 37<sup>1</sup>/<sub>8</sub>"H, 4 doors (For 72"W Credenza)

62<sup>5</sup>/<sub>8</sub>"W x 14<sup>5</sup>/<sub>8</sub>"D x 37<sup>1</sup>/<sub>8</sub>"H, 4 doors (For 66"W Credenza)

56<sup>5</sup>/<sub>8</sub>"W x 14<sup>5</sup>/<sub>8</sub>"D x 37<sup>1</sup>/<sub>8</sub>"H, 4 doors (For 60"W Credenza or Return)

44<sup>5</sup>/<sub>8</sub>"W x 14<sup>5</sup>/<sub>8</sub>"D x 37<sup>1</sup>/<sub>8</sub>"H, 3 doors (For 48"W Return or 48"W Small Office Desk)

NOTES: Inside storage for H10734, H10733 and H10732 contains two compartments each sized: 32<sup>1</sup>/<sub>2</sub>"W, 28<sup>3</sup>/<sub>4</sub>"W, 25<sup>3</sup>/<sub>4</sub>"W respectively x 12<sup>7</sup>/<sub>8</sub>"D x 12"H. H107313 has 3 doors. Inside storage for H107313 contains two compartments: right side 12<sup>7</sup>/<sub>8</sub>"W, left side 26<sup>3</sup>/<sub>4</sub>"W respectively x 12<sup>7</sup>/<sub>8</sub>"D x 12"H. Stack-ons attach through grommet holes on the worksurfaces of desks, credenzas and returns. Model 10734 can be used for "L" configuration comprised of 30"D desk, desk shell or peninsula and 42"W return or return shell; or a 36"D desk, desk shell, peninsula or corner unit and 36"W return shell. Model H107313K has one lock which secures two of the three doors. For task light and vertical paper manager, see pages 383 and 385.

**H10734**

175

16.0

**\$1089****H10733**

168

14.4

**\$1074****H10732**

161

13.0

**\$1044****H107313**

147

10.3

**\$958****H10734K**

175

16.0

**\$1169****H10733K**

168

14.4

**\$1154****H10732K**

161

13.0

**\$1124****H107313K**

147

10.3

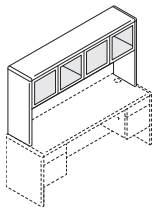
**\$998****Stack-on Storage w/Frosted Doors w/Silver Frame**

68<sup>5</sup>/<sub>8</sub>"W x 14<sup>5</sup>/<sub>8</sub>"D x 37<sup>1</sup>/<sub>8</sub>"H

**H10734G**

185

16.2

**\$1689**

NOTES: Rich wood-grain laminate and contemporary frosted doors with silver frames add a sleek mixed materials option to 10700 Series™. Accepts back enclosure model H10738, tackboard for use with back enclosure model H90034, task light HH870960 and vertical paper manager HVLPM1. Frosted door models are non-locking.

**NOTES:**

- Shared components on this page can be used with modular, full pedestal, and 3/4 pedestal models shown on pages 364-373.
- Stack-on storage models are equipped with self closing, adjustable hinged doors, and valance to hide task light.
- When spanning the total depth of an L-workstation, stack-on storage attaches to the desk, peninsula or corner unit via double-sided tape, and to the return through the grommet hole.
- Stack-on storage end panels are .
- Stack-on storage and organizers attach with two removable mounting brackets, except for "L" workstation unit.
- Stacked paper management segments and organizes stack-on storage compartments and bookcase shelves. Unit can be used in stack-on storage models H107318 and H10734. See HLVPM2 on page 383.
- Vertical paper manager keeps papers, files, and books neatly organized and within easy reach from a seated position. Fits under stack-on storage models. See page 383.
- See pages 374-386 for shared components.

 Upcharges may apply to premium tackboard fabric grades.

 Removable lock core kit for locking stack-on storage is model HF27B. See page 922.

**HOW TO SPECIFY**

<b>Select Model Number</b>	<b>Select Laminate</b>
	See page 357
H 1 0 7 3 4 .	N N



	DESCRIPTION	MODEL	COM	SHIP WEIGHT	CUBE	LIST PRICE
<p>18 5/8" H</p>	<b>Back Enclosure for Stack-on Storage</b>					
	72 1/4" W - for 74 5/8" W model #H107318/H107318K	<b>H107358</b>		34	1.3	<b>\$244</b>
	66 1/4" W - for 68 5/8" W model #H10734/H10734K	<b>H10738</b>		31	1.3	<b>\$224</b>
	60 1/4" W - for 62 5/8" W model #H10733/H10733K	<b>H10737</b>		29	1.3	<b>\$208</b>
	54 1/4" W - for 56 5/8" W model #H10732/H10732K	<b>H10736</b>		27	1.3	<b>\$199</b>
	42 1/4" W - for 44 5/8" W model #H107313/H107313K	<b>H107353</b>		22	0.9	<b>\$199</b>
	NOTES: Non-tackable. Specify laminate. Features full width 1 1/8" slot at bottom to facilitate routing cords and reaching wall electrical outlets. H10738 can also be used with H10634 and H94234 stack-ons.					
<p>18" H</p> <p>SIN 711-2</p>	<b>Tackboards for use with Stack-on Back Enclosures (Back Enclosures must be ordered separately.)</b>					
	71 1/2" W - for 74 5/8" W model #H107318/H107318K Hutch with #H107358 Enclosure	<b>H90035</b>	2.0	13	2.8	<b>\$297</b>
	65 1/4" W - for 68 5/8" W model #H10734/H10734K Hutch with #H10738 Enclosure	<b>H90034</b>	2.0	11	2.0	<b>\$283</b>
	59 1/4" W - for 62 5/8" W model #H10733/H10733K Hutch with #H10737 Enclosure	<b>H90033</b>	2.0	10	1.8	<b>\$268</b>
	53 1/4" W - for 56 5/8" W model #H10732/H10732K Hutch with #H10736 Enclosure	<b>H90032</b>	2.0	9	1.8	<b>\$236</b>
	41 1/2" W - for 44 5/8" W model #H107313/H107313K Hutch with #H107353 Enclosure	<b>H90031</b>	2.0	7	1.7	<b>\$226</b>
	NOTES: Tackboards are sized 3/4" narrower than respective stack-on storage back enclosure, allowing 3/8" each side to route task light cords. Specify fabric selection from pages 35-36. Board is attached using latch & hook tape provided. H90034 can also be used with H10738 on H10634 and H94234 stack-ons. <b>SPECIFYING EXAMPLE: H90035.APN15</b>					

**NOTES:**

- Shared components on this page can be used with modular, full pedestal, and 3/4 pedestal models shown on pages 364-373.
- Stacked paper management segments and organizes stack-on storage compartments and bookcase shelves. Unit can be used in stack-on storage models H107318 and H10734. See HLVPM2 on page 383.
- Vertical paper manager keeps papers, files, and books neatly organized and within easy reach from a seated position. Fits under stack-on storage models. See page 383.
- See pages 374-386 for shared components.

ⓘ Upcharges may apply to premium tackboard fabric grades.

**HOW TO SPECIFY**

<p>Select Model Number</p>	<p>Select Laminate</p> <p>See page 357</p>
<p>H 1 0 7 3 5 8 .</p>	<p>N</p>

# 10700 SERIES™

## Shared Components and Accessories

GSA SIN 711-8



Icon Legend on page 21

	DESCRIPTION	MODEL	SHIP WEIGHT	CUBE	LIST PRICE
	<b>Box/Box/File Mobile Pedestal (with core removable lock)</b> 15 <sup>3</sup> / <sub>4</sub> "W x 22 <sup>3</sup> / <sub>4</sub> "D x 28 <sup>3</sup> / <sub>8</sub> "H — use freestanding or under 24"D, 30"D and 36"D modular shells NOTES: Top box drawer does not lock. File drawer includes hangrails.	<b>H105102</b>	121	8.5	<b>\$809</b>
	<b>File/File Mobile Pedestal (with core removable lock)</b> 15 <sup>3</sup> / <sub>4</sub> "W x 22 <sup>3</sup> / <sub>4</sub> "D x 28 <sup>3</sup> / <sub>8</sub> "H — use freestanding or under 24"D, 30"D and 36"D modular shells NOTES: File drawers include hangrails.	<b>H105104</b>	121	8.4	<b>\$809</b>
	<b>Box/File Mobile Pedestal (with core removable lock)</b> 15 <sup>3</sup> / <sub>4</sub> "W x 18 <sup>7</sup> / <sub>8</sub> "D x 21 <sup>1</sup> / <sub>8</sub> "H — use freestanding or under 20"D, 24"D, 30"D and 36"D modular shells	<b>H105106</b>	65	5.8	<b>\$677</b>
	<b>Shelf/Box/File Mobile Pedestal (with core removable lock)</b> 15 <sup>3</sup> / <sub>4</sub> "W x 18 <sup>7</sup> / <sub>8</sub> "D x 28 <sup>3</sup> / <sub>8</sub> "H — use freestanding or under 20"D, 24"D, 30"D and 36"D modular shells NOTES: Interior dimensions of the open storage area of the Shelf/Box/File model are 14 <sup>1</sup> / <sub>8</sub> "W x 16 <sup>3</sup> / <sub>4</sub> "D x 6 <sup>5</sup> / <sub>8</sub> "H.	<b>H105109</b>	73	7.3	<b>\$745</b>
	<b>Lateral File (with core removable lock)</b> 36"W x 24"D x 29 <sup>1</sup> / <sub>2</sub> "H — two drawer — matches depth of credenzas and returns 36"W x 20"D x 29 <sup>1</sup> / <sub>2</sub> "H — two drawer 36"W x 20"D x 45 <sup>1</sup> / <sub>2</sub> "H — three drawer 36"W x 20"D x 59 <sup>1</sup> / <sub>8</sub> "H — four drawer NOTES: Includes hangrails, mechanical interlock and, in H10762 and H107690, a counterweight. Interlock inhibits the extension of more than one drawer from opening at a time. 24"D size aligns evenly with 24"D credenzas, credenza shells, returns, return shells, and wardrobe/storage cabinets to provide linear layout continuity.	<b>H107690</b>	191	18.6	<b>\$1084</b>
		<b>H10762</b>	168	15.6	<b>\$1044</b>
		<b>H107698</b>	240	23.2	<b>\$1607</b>
		<b>H107699</b>	296	31.0	<b>\$2218</b>
	<b>Lateral File w/Open Shelf (with core removable lock)</b> 36"W x 20"D x 29 <sup>1</sup> / <sub>2</sub> "H NOTES: Open storage area measures 33 <sup>5</sup> / <sub>8</sub> "W x 18"D x 12"H; accommodates books or binders, as well as business machines and electronic equipment. Also sized to accept optional stacked paper management model HLVPM2. Drawer design includes integrated hangrails for folders. Accepts bookcase hutch H107292.	<b>H107697</b>	220	15.7	<b>\$909</b>
	<b>Storage Cabinet with doors (with core removable lock)</b> 36"W x 20"D x 29 <sup>1</sup> / <sub>2</sub> "H NOTES: One adjustable interior shelf.	<b>H107291</b>	144	15.0	<b>\$845</b>
	<b>Storage Cabinet with Doors (with core removable lock)</b> 36"W x 24"D x 29 <sup>1</sup> / <sub>2</sub> "H — matches depth of credenzas and returns NOTES: One adjustable interior shelf. 24"D size aligns evenly with 24"D credenzas, credenza shells, returns, return shells, and wardrobe/storage cabinets to provide linear layout continuity.	<b>H107290</b>	162	18.6	<b>\$929</b>
	<b>Bookcase Hutch</b> 32 <sup>5</sup> / <sub>8</sub> "W x 14 <sup>5</sup> / <sub>8</sub> "D x 37 <sup>1</sup> / <sub>8</sub> "H NOTES: For use with Lateral Files (H10762, H107690, H107697) and Storage Cabinets (H107291, H107290). Cord pass-through gap behind shelves and a 1 <sup>1</sup> / <sub>8</sub> " full-width cord management slot at the bottom of the back panel to facilitate routing cords and reaching wall electrical outlets. When placed on a 29 <sup>1</sup> / <sub>2</sub> "H base unit, the total 66 <sup>5</sup> / <sub>8</sub> "H matches the height of credenzas with stack-on storage and the height of the wardrobe/storage cabinet. Two shelves are adjustable in 1 <sup>1</sup> / <sub>4</sub> " increments.	<b>H107292</b>	93	5.1	<b>\$626</b>

**NOTES:**

- Shared components on this page can be used with modular, full pedestal, and 3/4 pedestal models shown on pages 364-373.
- Broad family of storage components takes organization way beyond the confines of a desk drawer.
- Mobile pedestal tops have smooth, flat edges. Units are standard with counterweight and four 2" diameter, non-locking casters.
- Locking units equipped with interchangeable core removable locks.
- Mobile pedestals, lateral files, storage cabinets, and bookcases ship assembled.
- See pages 374-386 for shared components.

ⓘ Keyed alike cores must be ordered separately — see model HF23B on page 922 — makes re-keying quick and easy.

**HOW TO SPECIFY**

<b>Select Model Number</b>	<b>Select Laminate</b>
See page 357	See page 357
H 1 0 5 1 0 2 .	N N

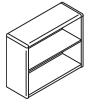
**DESCRIPTION****Bookcase w/Fixed Shelves**

36"W x 13<sup>1</sup>/<sub>8</sub>"D x 29<sup>5</sup>/<sub>8</sub>"H, 2-Shelf  
 36"W x 13<sup>1</sup>/<sub>8</sub>"D x 43<sup>3</sup>/<sub>8</sub>"H, 3-Shelf  
 36"W x 13<sup>1</sup>/<sub>8</sub>"D x 57<sup>1</sup>/<sub>8</sub>"H, 4-Shelf  
 36"W x 13<sup>1</sup>/<sub>8</sub>"D x 71"H, 5-Shelf

**MODEL****SHIP WEIGHT****CUBE****LIST PRICE****H10752**

90

10.9

**\$578****H10753**

122

15.6

**\$698****H10754**

156

20.3

**\$786****H10755**

187

25.3

**\$930**

NOTES: 36"W models with finished back. No assembly required. Ready to set in place.

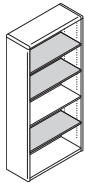
**Bookcase w/Adjustable Shelves**32<sup>3</sup>/<sub>8</sub>"W x 13<sup>1</sup>/<sub>8</sub>"D x 71"H, 5-Shelf**H107569**

170

25.1

**\$918**NOTES: 32<sup>3</sup>/<sub>8</sub>"W design with five shelves; two fixed, three adjustable. Shelves adjust in 2<sup>1</sup>/<sub>2</sub>" increments. Finished back. Can be used in combination with peninsula desk models H10724 or H10726. No assembly required. Ready to set in place.*Shaded shelves are adjustable.***NOTES:**

- Shared components on this page can be used with modular, full pedestal, and 3/4 pedestal models shown on pages 364-373.
- Broad family of storage components takes organization way beyond the confines of a desk drawer.
- Conventional bookcase designs ship fully assembled to ease and speed installation.
- See pages 374-386 for shared components.

**HOW TO SPECIFY**Select  
Model Number

H 1 0 7 5 2 .

Select  
Laminate

See page 357

N N

# 10700 SERIES™

## Shared Components and Accessories

GSA SIN 711-8



Icon Legend on page 21



Doors open 110 degrees from closed position.

**DESCRIPTION****Storage Cabinet (with core removable lock)**36"W x 24"D x 66 $\frac{5}{8}$ "H**MODEL****H107299****SHIP WEIGHT**

341

**CUBE**

41.0

**LIST PRICE****\$2047**

NOTES: Large storage area includes five, full-width (side-to-side) shelves; three are adjustable in 2 $\frac{1}{2}$ " increments. Unit height is designed to match credenza or return plus stack-on height (66 $\frac{5}{8}$ ").

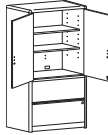

Doors open 110 degrees from closed position.

**Storage Cabinet/Lateral File (with core removable lock)**36"W x 24"D x 66 $\frac{5}{8}$ "H**H107293**

365

41.0

**\$2250**

NOTES: Storage cabinet is standard with one fixed and two full-width adjustable shelves in top compartment; adjustable shelves can be removed. Overall storage compartment measures 31 $\frac{1}{4}$ "W x 22"D x 36 $\frac{1}{8}$ "H and will accommodate supplies, books and binders, as well as business machines and electronic equipment. Cord pass-through gap behind shelves and grommet in back of the cabinet to facilitate routing cords and reaching wall electrical outlets. Two drawer lateral file on bottom. Cabinet and lateral file lock independently.

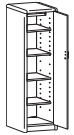

Right-hand model H107295R shown.

**Wardrobe/Storage Cabinet (with core removable lock)**18"W x 24"D x 66 $\frac{5}{8}$ "H, with coat rod and 4 adjustable shelves, Hinged Right**H107295R**

225

22.9

**\$1654**18"W x 24"D x 66 $\frac{5}{8}$ "H, with coat rod and 4 adjustable shelves, Hinged Left**H107296L**

225

22.9

**\$1654**

NOTES: Unit is standard with four adjustable shelves, coat rod, and core removable lock. Shelves adjust in 2 $\frac{1}{2}$ " increments. Unit height is designed to match credenza or return plus stack-on storage height. Cabinet can be used as a wardrobe by removing four adjustable shelves. Coat rod can be removed from cabinet for storage only applications.

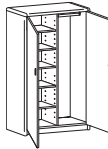

Doors open 110 degrees from closed position.

**Personal Wardrobe/Storage Cabinet (with core removable lock)**36"W x 24"D x 66 $\frac{5}{8}$ "H**H10730**

335

40.6

**\$2235**

NOTES: Spacious design is standard with four adjustable shelves (one shelf is fixed), coat rod and core removable lock which locks both doors. Shelves adjust in 2 $\frac{1}{2}$ " increments. Unit height is designed to match credenza or return plus stack-on storage height.

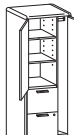

Right-hand model H107301R shown.

**Personal Storage Towers**24"W x 24"D x 66 $\frac{5}{8}$ "H, Wardrobe Hinged Right, Storage Cabinet Hinged Left**H107301R**

299

27.8

**\$2122**24"W x 24"D x 66 $\frac{5}{8}$ "H, Wardrobe Hinged Left, Storage Cabinet Hinged Right**H107302L**

299

27.8

**\$2122**

NOTES: Spacious design includes a wardrobe closet, storage cabinet, and two file drawers in one compact unit. Wardrobe closet contains a coat rod. Storage cabinet includes three shelves, two are adjustable in 2 $\frac{1}{2}$ " increments. Door hinged left or right models available. File drawers operate on ball-bearing suspensions with full extension. File drawers have high sides to accept hanging folders in letter or legal size. Drawers standard with hangrails. Equipped with interchangeable core removable locks. Upper lock secures storage cabinet and wardrobe closet doors; lower lock secures file drawers. Unit height is designed to match credenza or return plus stack-on storage height.

**NOTES:**

- Broad family of storage components takes storage way beyond the confines of a desk drawer.
- The 18"W wardrobe/storage cabinet can be used as wardrobe by removing some or all of the adjustable shelves, coat rod can be removed for storage only.
- Locking units equipped with interchangeable core removable locks.
- See pages 374-386 for shared components.

! Keyed alike cores must be ordered separately — see model HF23B on page 922 — makes re-keying quick and easy.

**HOW TO SPECIFY**







Select  
Model Number

H 1 0 7 2 9 3 .

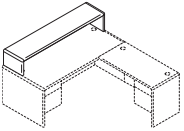
Select  
Laminate

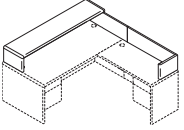
See page 357

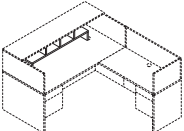
N N

	DESCRIPTION	MODEL	SHIP WEIGHT	CUBE	LIST PRICE
 	<b>Reception Station/Transaction Counter</b> 68 $\frac{5}{8}$ "W x 14 $\frac{5}{8}$ "D x 14 $\frac{1}{4}$ "H Intended for use with H10700 72"W double and single pedestal desk models and 72"W desk shells.  NOTES: Cord management grommets on desktops serve as anchor points. Transaction counter organizer (HTCOL52) fits under/inside of transaction counter.	<b>H107720</b>	76	3.2	<b>\$608</b>
 	<b>Reception Station for an "L" Workstation</b> 68 $\frac{5}{8}$ "W x 75 $\frac{5}{8}$ "D x 14 $\frac{1}{4}$ "H Intended for use with a 72"W x 36"D left single pedestal desk or modular desk shell with a 42"W x 24"D right pedestal return or modular right return shell.  Intended for use with a 72"W x 36"D right single pedestal desk or modular desk shell with a 42"W x 24"D left pedestal return or modular left return shell.  NOTES: Cord management grommets on desktop and return serves as the anchor points for the reception station for return.	<b>H107721R</b>	108	4.3	<b>\$875</b>
 	<b>Transaction Counter Organizer</b> 48 $\frac{3}{4}$ "W x 11 $\frac{1}{8}$ "D x 13"H Fits under Transaction Counter Models H107720, H107721R and H107722L. <b>!</b> Black only. <b>SPECIFYING EXAMPLE: HTCOL52.P</b>	<b>HTCOL52</b>	24	1.1	<b>\$259</b>
 <i>Base sold separately.</i>	<b>42" Diameter Table Top</b>  NOTES: Underside of top features a factory-installed template. The template, which is trilingual, facilitates assembly of the base to the top by designating the specific attachment location for multiple base designs. Bases attach to the top with self drilling screws, no drilling is required. All top + base models are 29 $\frac{1}{2}$ "H. For Base Options see Preside® Table Base pages 848-851. <b>!</b> Requires specification of a support base model shown on pages 848-851. <b>SPECIFYING EXAMPLE: H107242.N</b>	<b>H107242</b>	58	4.1	<b>\$585</b>

**NOTES:**

- "L" Reception station includes components for both the reception/transaction counter for desk and the reception station for return.
- Round table design is well suited to a variety of applications, including use in private or open plan offices.
- See pages 374-386 for shared components.

**HOW TO SPECIFY**

<b>Select Model Number</b> H 1 0 7 7 2 0	<b>Select Laminate</b> See page 357 N N
---	---



# 10700 SERIES™

## Shared Components and Accessories

GSA SIN 711-8

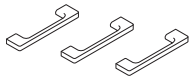
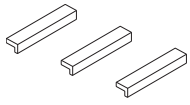

Icon Legend on page 21

**DESCRIPTION****Field Installable Drawer/Door Handle Kits**

Linear, Black, 2-pack

Linear, Matte Chrome, 2-pack

Linear, Black, 3-pack

Linear, Matte Chrome, 3-pack

Specify Linear handles in black to coordinate with 10700 or 10500 Series™ models that ship standard with a decorative handle, such as mobile pedestals, storage cabinets and wardrobes.

Arch, Black, 2-pack

Arch, Matte Chrome, 2-pack

Arch, Black, 3-pack

Arch, Matte Chrome, 3-pack

NOTES: Handles are for purchase and field installation on 10700 or 10500 Series™ desks, credenzas, returns, lateral files and modular pedestals. Instructions include mounting hardware and paper template for drilling holes.

Applications include:

- box/file and file/file pedestals = one 2-pack per pedestal
- box/box/file and pencil/media/file pedestals = one 3-pack per pedestal
- two drawer lateral file = two 2-packs per unit
- four drawer lateral file = four 2-packs per unit

The Linear and Arch handles can be attached using 96mm (approx. 3¾") or 128mm (approx. 5") hole spacing. Important note: effective January 1, 2007, the holes used for the black drawer/door handle that comes standard on several HON 10700 or 10500 Series™ products, including mobile pedestals, storage cabinet with doors, storage/file cabinet, storage cabinet/lateral file, personal wardrobe/storage cabinets, and personal storage towers, will accept the Linear and Arch handles. Units manufactured prior to January 1, 2007, have 64mm (approx. 2½") hole spacing and will not accept the Linear and Arch handles.

! **Must be ordered with a configurable end product. If ordered separately, not on GSA contract.**

**MODEL****SHIP WEIGHT****CUBE****LIST PRICE****HLINEARA2**0.4 **Ⓢ**

0.3

**\$51****HLINEARC2**0.4 **Ⓢ**

0.3

**\$51****HLINEARA3**0.5 **Ⓢ**

0.3

**\$59****HLINEARC3**0.5 **Ⓢ**

0.3

**\$59****HARCHA2**0.4 **Ⓢ**

0.3

**\$51****HARCHC2**0.4 **Ⓢ**

0.3

**\$51****HARCHA3**0.5 **Ⓢ**

0.3

**\$59****HARCHC3**0.5 **Ⓢ**

0.3

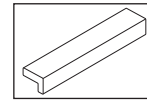
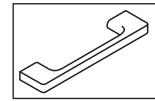
**\$59****Linear Handle****Arch Handle****Field Installable Drawer/Door Handle Kits**

Sweep Black, 2-pack

Sweep Satin Nickel, 2-pack

Sweep Black, 3-pack

Sweep Satin Nickel, 3-pack

Crescent Black, 2-pack

Crescent Satin Nickel, 2-pack

Crescent Black, 3-pack

Crescent Satin Nickel, 3-pack

NOTES: Handles are for purchase and field installation on 10700 or 10500 Series™ desks, credenzas, returns, and lateral files, as well as for the modular pedestals used with 10700 and 10500.

Applications include:

- box/file and file/file pedestals = one 2-pack per pedestal
- box/box/file and pencil/media/file pedestals = one 3-pack per pedestal
- two drawer lateral file = two 2-packs per unit
- four drawer lateral file = four 2-packs per unit

The hole spacing for the Sweep and Crescent handles is 96mm (approx. 3¾"). Important note: effective January 1, 2007, the holes used for the black drawer/door handle that comes standard on several HON 10700 or 10500 Series™ products, including mobile pedestals, storage cabinet with doors, storage/file cabinet, storage cabinet/lateral file, personal wardrobe/storage cabinets, and personal storage towers, will accept the Sweep and Crescent handles. Units manufactured prior to January 1, 2007, have 64mm (approx. 2½") hole spacing and will not accept the Sweep and Crescent handles. Instructions include mounting hardware and paper template.

! **Must be ordered with a configurable end product. If ordered separately, not on GSA contract.**

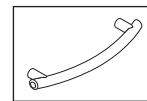
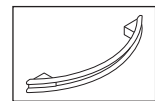
**Sweep Handle****Crescent Handle****NOTES:**

- Field Installable Drawer/Door Handle Kits for use on 10700 Series™ desks, credenzas, returns, lateral files and storage cabinets.
- Metal template, for field installation of the Linear, Arch, Sweep and Crescent decorative handles, on 10700 and 10500 Series™ drawer fronts, can be ordered through HON Customer Support. Specify as SPLH-SYST-DRKNB.M263164.
- See pages 374-386 for shared components.

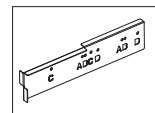
**HOW TO SPECIFY**

Select  
Model Number

H L I N E A R A 2



Icon Legend on page 21

# 10700 SERIES™ Shared Components and Accessories

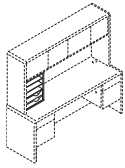

SIN 711-8



**DESCRIPTION**

**Vertical Paper Manager**  
14<sup>7</sup>/<sub>8</sub>"W x 10<sup>7</sup>/<sub>8</sub>"D x 19<sup>1</sup>/<sub>16</sub>"H

**MODEL SHIP WEIGHT CUBE LIST PRICE**

**HLVPM1 27 2.8 \$298**

NOTES: Keeps papers, files, and books neatly organized and within easy reach from a seated position. Designed for desk, credenza, and return tops. Fits under stack-on storage models. Two pullout drawers and three fixed shelves. Vertical paper manager designed for desk, credenza, and return tops. Fits under stack-on storage. For additional information see page 912.

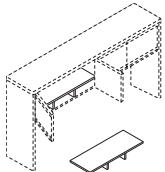

**Stacked Paper Management**

32<sup>1</sup>/<sub>2</sub>"W x 12<sup>5</sup>/<sub>8</sub>"D x 4<sup>1</sup>/<sub>4</sub>"H

**HLVPM2 22 1.25 \$148**

NOTES: Segments and organizes stack-on and wall mount storage compartments, as well as bookcase shelves. In some cases, installation may require removing the stack-on or wall mount storage doors. For additional information see page 913.

! Black only.

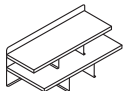

Not available in two-tone laminate



**Desktop Storage Terrace**

26<sup>1</sup>/<sub>2</sub>"W x 12<sup>1</sup>/<sub>2</sub>"D x 10<sup>1</sup>/<sub>2</sub>"H

**HLDST1 24 1.1 \$279**

NOTES: Keeps work-in-process, priority files, loose pages, and mail neatly organized and in view. Mixed material design comprised of sturdy laminate shelves with metal back and support panels. Not available in two-tone laminate combination or pattern laminate colors. Choose from Platinum Metallic (TI), Black (P), and Charcoal (S) for the metal components.

Sized to fit in stack-on and wall mounted storage cabinets in 10500, 10700, Valido, 94000, Park Avenue Laminate, and 38000 Series. Fits in Voi stack-on and overhead cabinets except for 48"W or smaller sliding door models. For additional information see page 912.

Specify: Model.Laminate.Paint

**SPECIFYING EXAMPLE: HLDST1.N.TI**

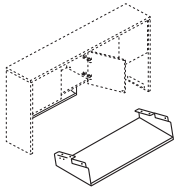

**Hanging Paper Shelf**

28<sup>1</sup>/<sub>16</sub>"W x 11<sup>7</sup>/<sub>16</sub>"D x 4<sup>5</sup>/<sub>16</sub>"H

**HHPST1 7 2.9 \$180**

NOTES: Maximizes worksurface space; de-clutters desktop while placing priority communications and active project folders within easy reach. Angled design allows contents to be distinguished at a glance. Mixed material styling features strong painted metal frame with a frosted shelf.

Attaches quickly and easily to stack-on and wall mount storage models in the following series: 10500, 10700, Valido, Park Avenue Laminate, 94000, and Voi (except the 36"W overhead hutch with O-legs or panel mount brackets). Not for use with 38000 Series.

Choose from Platinum Metallic (TI), Black (P), and Charcoal (S) paint. For additional information see page 899.

Specify: Model.Paint

**SPECIFYING EXAMPLE: HHPST1.TI**

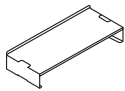

**Desktop Paper Shelf**

28<sup>1</sup>/<sub>16</sub>"W x 11<sup>5</sup>/<sub>16</sub>"D x 5"H

**HDPS1 7 2.9 \$180**

NOTES: Organizer shelf provides a place and space for work-in-process and piling to keep worksurfaces neat and tidy. Convenient, scalable design with interlocking side supports allow two units to be stacked and integrated. Durable painted metal frame with a frosted shelf; mixed material styling matches hanging paper shelf.

Can also be used inside select overhead storage, including the following stack-on with hinged door models: 10500 and Valido 36", 42", 66", 72", 78"W and 10700 68<sup>5</sup>/<sub>8</sub>"W.

Choose from Platinum Metallic (TI), Black (P), and Charcoal (S) paint. For additional information see page 913.

Specify: Model.Paint

**SPECIFYING EXAMPLE: HDPS1.TI**

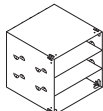

**Storage Cube**

12"W x 12"D

**HLSL1212 1 0.3 \$276**

NOTES: Available in the following colors: Autumn (AUTM), Citron (CITR), Flame (FLAM), Pool (POOL) and Sisal (SISL). For additional information see page 914.

**SPECIFYING EXAMPLE: HLSL1212.CITR**

**NOTES:**

- See pages 374-386 for shared components.

**HOW TO SPECIFY**

<b>Select Model Number</b>	<b>Select Laminate</b>
	See page 357
HLVPM1	N

# 10700 SERIES™

## Shared Components and Accessories

GSA SIN 711-2 EXCEPT AS NOTED



Icon Legend on page 21



Refer to page 171 for Center Drawer compatibility information

SIN 711-1, 711-2, 711-11

**DESCRIPTION****Angled Wood Center Drawer**

26" x 15<sup>3</sup>/<sub>8</sub>"  
22" x 15<sup>3</sup>/<sub>8</sub>"

**MODEL****SHIP WEIGHT****CUBE****LIST PRICE****H1526**

12.0

1.2

**\$187****H1522**

11.0

1.1

**\$173**

NOTES: Center drawers ideal for pens, pencils and other miscellaneous storage. Feature ball-bearing slide suspension. Compatibility (where to use) information is detailed on page 171. Specify laminate for drawer. Model H1522 or H1022 can be used on peninsulas with modesty panel, model H10528. For additional information see page 903.

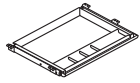

OPEN MARKET

**Polymer Center Drawer**

- Color: Black.
- Material: ABS.
- Opening Requirements: 23"W x 16<sup>1</sup>/<sub>4</sub>"D x 2"H.
- Retracts on 16" ball bearing slides.
- Can be used on worksurfaces with Coordinate™ Height Adjustable Bases as long as it is attached with spacer model HKBS.
- Can store up to 25 lbs.

NOTES: For additional information see page 904.

Black finish only, no specification needed.

**HCD1**

7.0

0.5

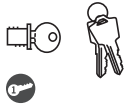
**\$99****Black Removable Lock Core Kit** — see page 922.**HF23B**

0.1

0.1

**\$29**

NOTES: Lock with a removable cylinder that can be interchanged as needed; allows users to access all furniture pieces in an office with a single key for convenience and security. Makes re-keying quick and easy.

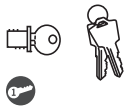
**Removable Lock Core Kit**

Black

**HF27B**

0.2

0.02

**\$29**

- For stack-on and wall mounted storage laminate models (with locks) in 10500, 10700, Valido, Park Avenue Laminate, Concinnity, and 94000 Series.
- Specify quantity of each key number from 101E to 225E.
- Includes: 1-core, 2-keys, 1-core removal tool, and instructions.

NOTES: If key number isn't specified, number will be at random.



OPEN MARKET

**Back Pack Hook (10 per carton)**12"W x 14<sup>1</sup>/<sub>2</sub>"D x 1<sup>1</sup>/<sub>2</sub>"H**HCLA65**

10.0

0.1

**\$91**

NOTES: Assembly: attaches to bottom of desk with (2) screws, included. For additional information see page 914.

Available in Chrome finish only, no specification needed.

**NOTES:**

- For master key, see model HF22 on page 922.
- See pages 374-386 for shared components.

**HOW TO SPECIFY**

<b>Select Model Number</b>	<b>Select Laminate</b>
	See page 357
H 1 5 2 6 .	N N

# 10700 SERIES™

## Shared Components and Accessories



Refer to pages 75 and 901 for additional product information

SIN 711-1, 711-2, 711-11



DESCRIPTION	MODEL	SHIP WEIGHT CUBE		LIST PRICE BY PAINT GRADE	
				CORE	METALLICS
Sit to Stand Arm with Convertible Keyboard Platform	H2516 OPEN MARKET	17 Ⓢ	1.6	\$565	
Articulating Arm with Convertible Keyboard Platform	H2107 OPEN MARKET	16 Ⓢ	1.3	\$484	
Articulating Arm with Keyboard Platform	H1706 OPEN MARKET	16 Ⓢ	1.4	\$451	
Slide-Away Keyboard Platform (Specify: Laminate)	H4022	10 Ⓢ	0.6	\$199	
Extended Tray Slide-Away Keyboard Platform (Specify: Laminate)	HE4022	12 Ⓢ	0.7	\$285	
Metal Keyboard and Mouse Tray (Specify paint)	H4028 OPEN MARKET	11 Ⓢ	1.5	\$144	\$154
Metal Keyboard Tray (Specify paint)	H4029 OPEN MARKET	11 Ⓢ	1.5	\$129	\$139
Corner Sleeve — Square Edge (22½" leading edge x 18"D) Specify paint color.	H51206	10 Ⓢ	1.5	\$143	\$153

NOTES: For additional information see pages 900-902.



SIN 711-1

DESCRIPTION	MODEL	SHIP WEIGHT	CUBE	LIST PRICE
LED Task Lights				
Articulating Desk Lamp	HLED1	1.2 Ⓢ	6.5	\$359
Articulating Desk Lamp w/ Occupancy Sensor	HLED10C	1.2 Ⓢ	6.5	\$439

NOTES: For additional information see page 909.



SIN 711-1

Task Desk Lamp	HLED2	0.7 Ⓢ	3.0	\$311
----------------	-------	-------	-----	-------

NOTES: For additional information see page 909.



OPEN MARKET

DESCRIPTION	MODEL	SHIP WEIGHT	CUBE	LIST PRICE
LED Task Lights — for Stack-on Storage Models				
17" LED Light with Power Supply (Single)	HLED17AS	1.2 Ⓢ	0.05	\$384
31" LED Light with Power Supply (Single)	HLED31AS	1.5 Ⓢ	0.09	\$516
17" LED Light with Power Supply for Daisy-chain (Starter)	HLED17A	1.0 Ⓢ	0.05	\$422
31" LED Light with Power Supply for Daisy-chain (Starter)	HLED31A	1.4 Ⓢ	0.09	\$567
17" LED Light with 8" and 30" Jumper Cord for Daisy-chain (Follower)	HLED17AUO	1.0 Ⓢ	0.03	\$344
31" LED Light with 8" and 30" Jumper Cord for Daisy-chain (Follower)	HLED31AUO	1.0 Ⓢ	0.05	\$460
Undercabinet Occupancy Sensor with 1" End to End Connector	HLEDOSA	0.2 Ⓢ	0.01	\$80

NOTES: To use the daisy chain application, must start with model HLED17A or HLED31A. No finish specification required. Attaches magnetically to underside of overhead storage, or attaches with provided screws or double-sided tape. Occupancy sensor attaches to a single or starter LED light and will automatically turn the light off after no motion is detected for 30 minutes. Just like all the LED light models, the occupancy sensor features a soft-touch on/off switch. LED task lights have a lifetime of 30,000 hours and have a dimmer feature that allows the user to adjust the amount of light output. For additional information see page 911.

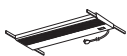

Refer to page 77

OPEN MARKET

Task Light — for Stack-on Storage Models				
46½"W x 3⅜"D x 1⅞"H, for models H107318, H10734, H10733 or H10732	HH870960	12.0 Ⓢ	1.1	\$246
34⅝"W x 3⅜"D x 1⅞"H, for model H107313	HH870942	10.0 Ⓢ	0.9	\$228

NOTES: Task light and Chicago Code models see page 532. For additional information see page 911.

### NOTES:

- Task lights are designed for use with stack-on storage and wall mounted storage cabinets.
- Task lights feature a new slim profile and electronic ballast for increased energy efficiency.
- Task lights include a T5 bulb which contains less mercury.

# 10700 SERIES™

## Shared Components and Accessories

GSA SIN 711-8 EXCEPT AS NOTED

ABI

Icon Legend on page 21

**DESCRIPTION****MODEL****SHIP WEIGHT****CUBE****LIST PRICE****Field Installable Grommet****HFLDGRMT**

0.1 Ⓢ

0.01

**\$29**

- Intended for use in tops and end panels to route/hide cords and in modesty panels to facilitate reaching wall electrical outlets.
- Grommet is field installable.
- Grommet shape is round.
- Includes grommet cap and sleeve.
- Grommet cap measures 3" diameter and includes a 3/4" diameter cord access hole.
- Grommet sleeve measures 2 1/2" O.D. x 3/4" thick.
- Includes instructions to locate grommet position for desks, credenzas, returns and bridges.

! Black Finish

! Requires a 2 1/2" diameter hole saw and drill for installation (not included).

**Field Installable Grommet****HFLDGRMT3**

0.1 Ⓢ

0.3

**\$29**

- Intended for use in tops and end panels to route/hide cords and in modesty panels to facilitate reaching wall electrical outlets.
- Grommet is field installable.
- Grommet shape is round.
- Includes grommet cap and sleeve.
- Grommet outside dimensions measure 3 1/2" diameter and includes two cord access holes.
- Grommet sleeve measures 3" O.D. x 1" thick.
- Includes instructions to locate grommet position for desks, credenzas, returns and bridges.

! Black Finish

! Requires a 3" diameter hole saw and drill for installation (not included).

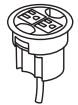
**SIN 71-302****Power Hub, 3" Grommet Mount****HGRMTAC**

1.3

0.2

**\$103**

- Two grounded AC power outlets.
- Two cord pass-through holes in cap.
- Includes 6' cord with three-prong plug.

! Available in Black only (no color designation - Specify: HGRMTAC.X).

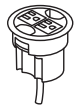
**SIN 71-302****3" Round Power Grommet - 2 Outlets, 10' Cord****HGRMTAC2**

1.5

0.2

**\$130**

- Includes 10' cord with three-prong plug.
- Fits in 3" round grommet holes on the following product lines: Coordinate, Huddle, Motivate, all laminate and veneer casegoods series, and Systems Worksurfaces.
- Two grounded AC power outlets.
- Field installed with Plug-and-play ease.

NOTES: Power Modules will also work with standing-height applications for 10500 Series™ and Voi® desks. Optional Memory Control allows preset worksurface heights for consistency. Ships separately. Dynamic load capacity when worksurface is moving is 300 lbs.

! Available in black finish only, no specification needed.

**SIN 71-302****Power/USB Hub, 3" Grommet Mount****HGRMTUSB2**

1.3 Ⓢ

0.02

**\$203**

- One grounded AC power outlet with 2 USB ports.
- Two cord pass-through holes in cap.
- Includes 6' cord with three-prong plug.

! Available in black only (no color designation so use .X - Specify: HGRMTUSB2.X).

**NOTES:**

- The power and power/USB hub models bring the ease of plug-and-play to the desktop.
- Models HFLDGRMT3, HGRMTAC, and HGRMTUSB2 fit in 3" round grommet holes in 10700 Series™ desks, credenzas, and returns; not compatible with 10700 products with rectangle-shaped grommets.
- For additional information see page 916.

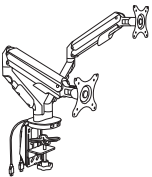
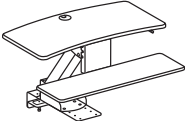
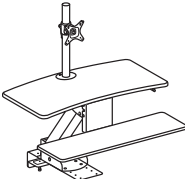
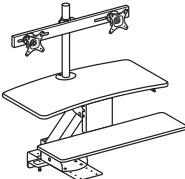
	DESCRIPTION	MODEL	SHIP WEIGHT	CUBE	LIST PRICE
	<p><b>Coordinate™ Portable Desktop Riser</b> 31"D x 4½"-16½"H x 35"W</p> <p>NOTES: Available in Black (BLK) or White (WHT) finish. Desktop riser dimensions (without keyboard tray): 22"D x 4½"-16½"H x 35"W. Keyboard tray dimensions: 9"D x 30"W. Max loading capacity is 33 lbs for the desktop riser surface and 4 lbs for the keyboard tray. Easily transition from seated to standing positions throughout the workday. Sits atop an existing desk to create sit-to-stand functionality by raising the computer. Includes keyboard tray and surface for computer monitors. <b>HON 5-Year Limited Warranty.</b></p> <p>⚠ Not intended for use on mobile workstations.</p>	<b>HBXRISER</b>	54.0	4.1	<b>\$500</b>
	<p><b>Dual Monitor Arm with 2 USB Ports</b></p> <p>NOTES: <b>AVAILABLE FEBRUARY 2018.</b> Easy adjustment. Height adjusts to 17" tall. Monitor tilt and swivel capability. Enclosed cable management. Grommet or desktop mounting. Clean appearance. For additional information see page 899.</p> <p>⚠ No specification needed.</p>	<b>HBDMAUSB</b>	41.9	2.6	<b>\$360</b>
	<p><b>Coordinate™ Mounted Desktop Riser</b></p> <p>NOTES: Does not include a monitor arm and is suitable for laptops and/or monitors on their original stands.</p> <p>⚠ No specification needed.</p>	<b>HS1100</b>	60.0 Ⓢ	3.2	<b>\$525</b>
	<p><b>Coordinate™ Mounted Desktop Riser with Single Monitor Arm</b></p> <p>NOTES: Includes a monitor arm for a single monitor.</p> <p>⚠ No specification needed.</p>	<b>HS1101</b>	62.0 Ⓢ	3.2	<b>\$615</b>
	<p><b>Coordinate™ Mounted Desktop Riser with Dual Monitor Arm</b></p> <p>NOTES: Includes a monitor arm for dual monitors.</p> <p>⚠ No specification needed.</p>	<b>HS1102</b>	63.0 Ⓢ	3.2	<b>\$700</b>

**NOTES FOR HS1100, HS1101, HS1102:**

- These products are designed to allow the user to transition from seating position to standing position throughout the workday.
- Gas-assist lever-operated mechanism with positive stop.
- Clamp mount compatible with worksurfaces depths of 20"-30". 20" is for systems only.
- Clamp requires 3.5" of clearance along back edge of worksurface.
- Black seamless worksurfaces.
- Silver powder coated metal components.
- Lowers below worksurface level on 24" and 30"D worksurfaces.
- All models contain a large primary worksurface and a smaller keyboard / mouse surface.
- Beveled edges for sleek appearance and comfort while typing.
- Monitor arms include height, width, and swivel adjustment.
- For additional information see page 906.

- Not for use under overhead storage, with flush mounted modesty panels, or worksurfaces thinner than 1".

⚠ Not recommended for use on mobile (castered) worksurfaces.

**MOUNTING AND COMPATIBILITY FOR HS1100, HS1101, HS1102:**

- This product is intended to be installed on commercial-grade worksurfaces in good condition.
- Compatible with freestanding worksurfaces 24"-30"D or panel-supported worksurfaces 24"-30"D.
- Not for use on mobile worksurfaces.

**Clamp Mount**

Use when 3.5" minimum overhang is available

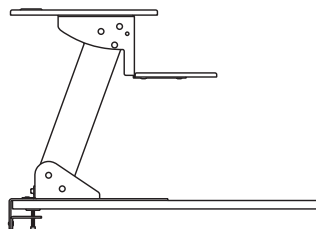

**Screw Mount**

Use when no overhang is available. Worksurface must be minimum 1" thick.

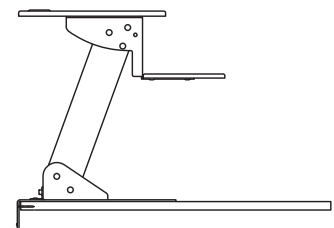

**HOW TO SPECIFY**

<p><b>Select Model Number</b></p> <p>HBXRISER.</p>	<p><b>Select Finish</b></p> <p>BLK Black WHIT White</p> <p>BLK</p>
--	--



# 10700 SERIES™

## Accessories

OPEN MARKET

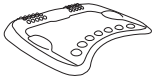
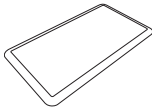
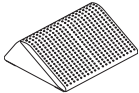

Icon Legend on page 21

	DESCRIPTION	MODEL	SHIP WEIGHT	CUBE	LIST PRICE
	<b>Rectangle Wobble Board — Anti-Fatigue Mat</b> 18"D x 3"H x 22½"W ⓘ Available in Black (T) finish ONLY. Recommended weight capacity not to exceed 250 pounds. <b>HON 5-Year Limited Warranty.</b> <b>SPECIFYING EXAMPLE: HVL981.T</b>	<b>HVL981</b>	10.0 <b>Ⓔ</b>	0.9	<b>\$220</b>
	<b>Round Wobble Board — Anti-Fatigue Mat</b> 18½"D x 2½"H x 18½"W ⓘ Available in Black (T) finish ONLY. Recommended weight capacity not to exceed 250 pounds. <b>HON 5-Year Limited Warranty.</b> <b>SPECIFYING EXAMPLE: HVL982.T</b>	<b>HVL982</b>	5.8 <b>Ⓔ</b>	0.6	<b>\$190</b>
	<b>Ergonomic Anti-Fatigue Mat</b> 25"D x 2¾"H x 29⅞"W ⓘ <b>AVAILABLE FEBRUARY 2018.</b> Available in Black ONLY. No specification needed. <b>SPECIFYING EXAMPLE: HBEAFM1</b>	<b>HBEAFM1</b>	7.0	1.4	<b>\$176</b>
	<b>Rectangle Anti-Fatigue Mat</b> 20"D x ¾"H x 36"W ⓘ <b>AVAILABLE FEBRUARY 2018.</b> Available in Black ONLY. No specification needed. <b>SPECIFYING EXAMPLE: HBAFM2036</b>	<b>HBAFM2036</b>	5.4	0.4	<b>\$80</b>
	<b>Footrest — Anti-Slip Cover</b> 13¾"D x 5½"H x 16"W ⓘ Available in Black (T) finish ONLY. Recommended weight capacity not to exceed 250 pounds. <b>HON 5-Year Limited Warranty.</b> <b>SPECIFYING EXAMPLE: HVL991.T</b>	<b>HVL991</b>	7.0 <b>Ⓔ</b>	0.9	<b>\$65</b>

### HOW TO SPECIFY

Select  
Model Number

H V L 9 8 1 .

Select  
Finish

T Black

T

# 94000 SERIES™



## 94000 SERIES™

Confident. Accomplished. Your office speaks volumes about you, and the 94000 Series says all the right things. Exceptionally crafted and solidly engineered, it's finished with warm, durable mahogany laminate — a timeless example of classic beauty and executive elegance.

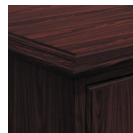

## FEATURES

- Traditional furniture design features solid wood trim and plinth style bases.
- From gleaming brass fixtures to raised accent moldings, details make this desk a standout.
- Our comprehensive selection makes it easy to create a complete executive look.
- It's all about the amenities — like pull out writing surfaces for extra room when you need it and central locking center drawers on all desks.



# 94000 SERIES™

## Typicals



Icon Legend on page 21

Components used are listed on pages 392-397. Order components individually. Other configurations are possible, including various sizes of some components.

QTY	DESCRIPTION	MODEL	LIST PRICE	PRICE EXTENSION
1	<b>Double Pedestal Desk</b> 72"W x 36"D x 29½"H	H94271	\$2,219	\$2,219
1	<b>Credenza with Kneespace</b> 72"W x 24"D x 29½"H	H94243	\$1,851	\$1,851
1	<b>Stack-on Storage</b> 70"W x 16⅞"D x 37"H	H94234	\$1,335	\$1,335
<b>TOTAL:</b>			<b>\$5,405</b>	

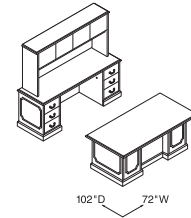

**DESK WORKSTATION**  
72"W x 102"D

QTY	DESCRIPTION	MODEL	LIST PRICE	PRICE EXTENSION
1	<b>Double Pedestal Desk</b> 72"W x 36"D x 29½"H	H94271	\$2,219	\$2,219
1	<b>Credenza with Doors</b> 72"W x 24"D x 29½"H	H94244	\$2,139	\$2,139
1	<b>Hutch with Wire Mesh Doors</b> 70"W x 16⅞"D x 48¾"H	H94235	\$2,482	\$2,482
<b>TOTAL:</b>			<b>\$6,840</b>	

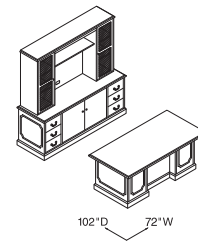

**DESK WORKSTATION**  
72"W x 102"D

QTY	DESCRIPTION	MODEL	LIST PRICE	PRICE EXTENSION
1	<b>Laminate Rectangle Top with Traditional Edge Detail</b> 72"W x 36"D	HTLC3672T	\$1,014	\$1,014
1	<b>Laminate Traditional Panel Base</b> 29½"H with HTLC3672T Top	HTLT72	\$708	\$708
1	<b>Credenza with Doors</b> 72"W x 24"D x 29½"H	H94244	\$2,139	\$2,139
1	<b>Stack-on Storage</b> 70"W x 16⅞"D x 37"H	H94234	\$1,335	\$1,335
<b>TOTAL:</b>			<b>\$5,196</b>	

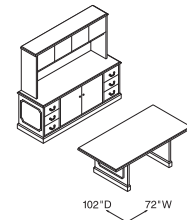

**TABLE WORKSTATION**  
72"W x 102"D

QTY	DESCRIPTION	MODEL	LIST PRICE	PRICE EXTENSION
1	<b>Single Pedestal Desk, Left</b> 66"W x 30"D x 29½"H	H94284L	\$1,824	\$1,824
1	<b>Right Return – box/file</b> 48"W x 24"D x 29½"H	H94215R	\$1,245	\$1,245
<b>TOTAL:</b>			<b>\$3,069</b>	

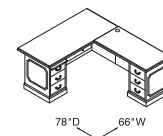

**DESK "L" WORKSTATION – RIGHT**  
66"W x 78"D



Icon Legend on page 21

# 94000 SERIES™ Typicals

Components used are listed on pages 392-397. Order components individually. Other configurations are possible, including various sizes of some components.

QTY	DESCRIPTION	MODEL	LIST PRICE	PRICE EXTENSION
1	<b>Single Pedestal Desk, Right</b> 66"W x 30"D x 29½"H	H94283R	\$1,824	\$1,824
1	<b>Left Return - box/file</b> 48"W x 24"D x 29½"H	H94216L	\$1,245	\$1,245
1	<b>Stack-on-Storage</b> 76"W x 16⅞"D x 37"H	H94237	\$1,390	\$1,390
<b>TOTAL:</b>			<b>\$4,459</b>	

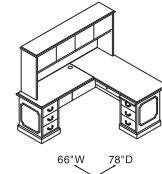

**DESK "L" WORKSTATION - LEFT**  
**66"W x 78"D**

QTY	DESCRIPTION	MODEL	LIST PRICE	PRICE EXTENSION
1	<b>Single Pedestal Desk, Left</b> 72"W x 36"D x 29½"H	H94286L	\$1,941	\$1,941
1	<b>Bridge</b> 48"W x 24"D x 29½"H	H94270	\$731	\$731
1	<b>Single Pedestal Credenza, Right</b> 72"W x 24"D x 29½"H	H94245R	\$1,600	\$1,600
1	<b>Stack-on Storage</b> 70"W x 16⅞"D x 37"H	H94234	\$1,335	\$1,335
<b>TOTAL:</b>			<b>\$5,607</b>	

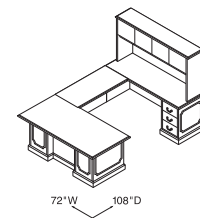

**DESK "U" WORKSTATION - RIGHT**  
**72"W x 108"D**

QTY	DESCRIPTION	MODEL	LIST PRICE	PRICE EXTENSION
1	<b>Single Pedestal Desk, Right</b> 72"W x 36"D x 29½"H	H94285R	\$1,941	\$1,941
1	<b>Bridge</b> 48"W x 24"D x 29½"H	H94270	\$731	\$731
1	<b>Credenza w/Lateral, Left</b> 72"W x 24"D x 29½"H	H94248L	\$1,818	\$1,818
1	<b>Stack-on Storage w/Glass Doors</b> 70"W x 16⅞"D x 37"H	H94236	\$1,786	\$1,786
<b>TOTAL:</b>			<b>\$6,276</b>	

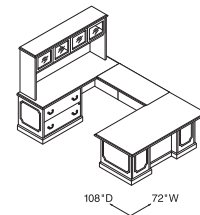

**DESK "U" WORKSTATION - LEFT**  
**72"W x 108"D**

# 94000 SERIES™

## Laminate Wood Desks

GSA SIN 711-8

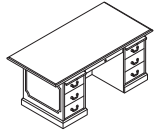

Icon Legend on page 21

**DESCRIPTION****Double Pedestal Desk 2-2 — Box/File**

72"W x 36"D x 29½"H

7"

**H94271**

307

52.9

**\$2219**

NOTES: 7" conference overhang on approach side (provides kneespace for visitors), and a 6¾" conference overhang on each end. Convenient pull out writing shelf above pedestal provides added workspace. Center drawer features central locking (locks all drawers).

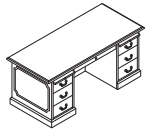
**Double Pedestal Desk 2-2 — Box/File**

66"W x 30"D x 29½"H

1"

**H94276**

340

42.8

**\$2161**

60"W x 30"D x 29½"H

1"

**H94251**

284

39.0

**\$2088**

NOTES: Convenient pull out writing shelf above pedestal provides added workspace. Center drawer features central locking (locks all drawers).

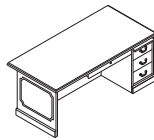
**Single Pedestal Desk — Box/File**

72"W x 36"D x 29½"H, Right

7"

**H94285R**

275

54.0

**\$1941**

66"W x 30"D x 29½"H, Right

1"

**H94283R**

233

42.8

**\$1824**

72"W x 36"D x 29½"H, Left

7"

**H94286L**

275

54.0

**\$1941**

66"W x 30"D x 29½"H, Left

1"

**H94284L**

233

42.8

**\$1824**

NOTES: Convenient pull out writing shelf above pedestal provides added workspace. Center drawer features central locking (locks all drawers).

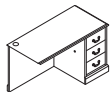

Model H94215R shown

**Return — Box/File**

48"W x 24"D x 29½"H, Right

**H94215R**

154

24.9

**\$1245**

42"W x 24"D x 29½"H, Right

**H94211R**

146

22.1

**\$1153**

48"W x 24"D x 29½"H, Left

**H94216L**

154

24.9

**\$1245**

42"W x 24"D x 29½"H, Left

**H94212L**

146

22.1

**\$1153**

NOTES: Drawers lock. One round cord grommet in the top. One cord pass-through grommet in the modesty panel to facilitate reaching wall electrical outlets.

⚠ Not designed to be used freestanding.

**NOTES:**

- 18th century elegance, 21st century engineering.
- Traditional furniture applications include state and local government, military bases, banks, and attorney offices.
- Tops are premium abrasion- and stain-resistant high pressure, high-gloss laminate over durable 1½" solid core high-performance particleboard.
- Solid wood edge profile.
- Antique brass drawer pulls; hand-applied raised decorative molding, and plinth style base.
- Pullout reference/writing shelf is standard on all desk pedestals.
- Desk, credenza, and return drawers are 5-sided construction, which allows easy drawer alignment or replacement of drawer fronts.
- Center drawer on desks equipped with built-in pencil tray and central locking (locks all drawers).
- Drawers operate on full extension, ball-bearing suspensions to ensure smooth, quiet, long-lasting operation.
- File drawer design includes integrated hangrails for side-to-side letter or legal filing; and front-to-back for letter filing.
- Locking units equipped with interchangeable core removable locks.
- 94000 Series™ products produced after 10/26/98 have been improved with a thicker top. Joining with older products before that date may cause misalignment.
- Adjustable hex leveling glides allow floor-standing furniture to be easily leveled without lifting the unit; glides have ¾" adjustable range.

⚠ Keyed alike cores must be ordered separately — see model HF23B on page 922 — makes re-keying quick and easy.

**HOW TO SPECIFY**

<b>Select Model Number</b>	<b>Select Laminate</b>
H 9 4 2 7 1	NN Mahogany
	NN

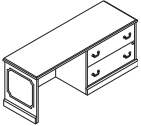
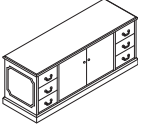
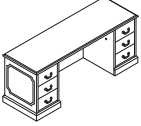

# 94000 SERIES™ Laminate Wood Desks

	DESCRIPTION	MODEL	SHIP WEIGHT	CUBE	LIST PRICE
 	<b>Bridge (single ped. desk to single ped. credenza or credenza with lateral)</b> 48"W x 24"D x 29½"H, (clear inside depth is 22½"D) 42"W x 24"D x 29½"H, (clear inside depth is 22½"D)	<b>H94270</b> <b>H94260</b>	85 76	4.3 4.3	<b>\$731</b> <b>\$675</b>
	NOTES: One cord pass-through grommet in top center of modesty panel to facilitate reaching wall electrical outlets. Kneespace of desk is limited to 24¾"W if bridge is used with 66"W single pedestal desk.				
 Model H94245R shown	<b>Credenza, Single Pedestal — Box/File</b> 72"W x 24"D x 29½"H, Right 72"W x 24"D x 29½"H, Left	<b>H94245R</b> <b>H94246L</b>	230 230	36.0 36.0	<b>\$1600</b> <b>\$1600</b>
	NOTES: Drawers lock. One cord pass-through grommet in top center of modesty panel to facilitate reaching wall electrical outlets. See pages 394-395 for optional Overhead Hutch and Stack-on Storage.				
 Model H94247R shown	<b>Credenza with 36" Lateral</b> 72"W x 24"D x 29½"H, Right 72"W x 24"D x 29½"H, Left	<b>H94247R</b> <b>H94248L</b>	239 239	36.0 36.0	<b>\$1818</b> <b>\$1818</b>
	NOTES: Lateral file drawers lock. See pages 394-395 for optional Overhead Hutch and Stack-on Storage.				
 Model H94244 shown	<b>Credenza with Doors — Box/File</b> 72"W x 24"D x 29½"H	<b>H94244</b>	313	36.0	<b>\$2139</b>
	NOTES: All drawers lock. Doors are non-locking. One removable shelf (38¾"W x 13¾"D). Shelf is not adjustable. See pages 394-395 for optional Overhead Hutch and Stack-on Storage.				
 Model H94243 shown	<b>Credenza with Kneespace — Box/File</b> 72"W x 24"D x 29½"H	<b>H94243</b>	253	36.0	<b>\$1851</b>
	NOTES: All drawers lock. One cord pass-through grommet in top center of modesty panel to facilitate reaching wall electrical outlets. See pages 394-395 for optional Overhead Hutch and Stack-on Storage.				

**NOTES:**

- 18th century elegance, 21st century engineering.
- Tops are premium abrasion- and stain-resistant high pressure, high-gloss laminate over durable 1½" solid core high-performance particleboard.
- Solid wood edge profile.
- Antique brass drawer pulls; hand-applied raised decorative molding, and plinth style base.
- Pullout reference/writing shelf is standard on all desk pedestals.
- Desk, credenza, and return drawers are 5-sided construction, which allows easy drawer alignment or replacement of drawer fronts.
- Center drawer on desks equipped with built-in pencil tray and central locking (locks all drawers).
- Drawers operate on full extension, ball-bearing suspensions to ensure smooth, quiet, long-lasting operation.
- File drawer design includes integrated hangrails for side-to-side letter or legal filing; and front-to-back for letter filing.
- Locking units equipped with interchangeable core removable locks.
- 94000 Series™ products produced after 10/26/98 have been improved with a thicker top. Joining with older products before that date may cause misalignment.
- Adjustable hex leveling glides allow floor-standing furniture to be easily leveled without lifting the unit; glides have ¾" adjustable range.

ⓘ Keyed alike cores must be ordered separately — see model HF23B on page 922 — makes re-keying quick and easy.

**HOW TO SPECIFY**

<b>Select Model Number</b> <input type="text" value="H"/> <input type="text" value="9"/> <input type="text" value="4"/> <input type="text" value="2"/> <input type="text" value="4"/> <input type="text" value="5"/> <input type="text" value="R"/>	<b>Select Laminate</b> <input type="text" value="NN"/>
--	---

# 94000 SERIES™

## Laminate Wood Desks

GSA SIN 711-8

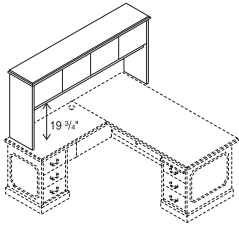

Icon Legend on page 21

**DESCRIPTION****Stack-on Storage for 78" D "L" Shaped Workstation**

76"W x 16 1/8"D x 37"H (Accepts Back Enclosure H107358, Fabric Tackboard H90035 and Task Light HH870960.)

**MODEL****H94237****SHIP WEIGHT**

198

**CUBE**

18.4

**LIST PRICE****\$1390****Stack-on Storage for 78" D "L" Shaped Workstation, Locking**

76"W x 16 1/8"D x 37"H (Accepts Back Enclosure H107358, Fabric Tackboard H90035 and Task Light HH870960.)

**H94237K**

198

18.4

**\$1470**

NOTES: Spans the total dimension of "L" shaped layouts comprised of a 48"W return attached to a 30"D single pedestal desk (78"D); or a 42"W return attached to 36"D single pedestal desk (78"D). For vertical paper manager model HLVPM1, see page 397.

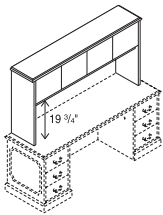
**Stack-on Storage**

70"W x 16 1/8"D x 37"H (Accepts Back Enclosure H10738, Fabric Tackboard H90034 and Task Light HH870960.)

**H94234**

175

18.0

**\$1335****Stack-on Storage, Locking**

70"W x 16 1/8"D x 37"H (Accepts Back Enclosure H10738, Fabric Tackboard H90034 and Task Light HH870960.)

**H94234K**

175

18.0

**\$1415**

NOTES: For use on 72"W credenza models or on 72"D "L" shaped workstations comprised of a 30"D single pedestal desk and a 42"W return. Inside storage contains two compartments each sized: 31 3/4"W x 12 1/8"D x 12"H. Vertical paper manager, model HLVPM1, fits under stack-on storage. See page 397.

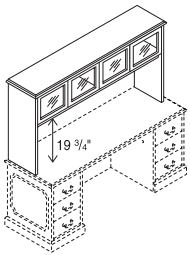
**Stack-on Storage with Glass Doors**

70"W x 16 1/8"D x 37"H (Accepts Back Enclosure H10738 and Fabric Tackboard H90034.) (Use Task Light HH870960, see page 395)

**H94236**

171

18.0

**\$1786**

NOTES: Elegant wood-framed, clear glass door design. For use on 72"W credenza models or on 72"D "L" shaped workstations comprised of a 30"D single pedestal desk and a 42"W return. No lock option for glass doors. For vertical paper manager model HLVPM1, see page 397.

**NOTES:**

- Stack-on storage equipped with self-closing, adjustable hinged doors.
- Stack-on storage design includes valance to hide task light.
- Vertical paper manager keeps papers, files and books organized and within easy reach from a seated position. Fits under stack-on storage models. See page 397.
- Stacked paper management segments and organizes stack-on storage compartments and bookcase shelves. Unit can be used in models H94327, H94234 and H94236. In some cases, installation may require removing the stack-on storage doors. See page 383.
- For a variety of work-in-process paper management tools, see pages 346-347.
- Overhead Hutch features one cord pass-through grommet located in bottom center of back panel.
- Overhead Hutch is not designed to accept task light.
- Removable lock core kit for locking stack-on storage is model HF27B. See page 922.

**HOW TO SPECIFY****Select Model Number**

H 9 4 2 3 7 .

**Select Laminate**







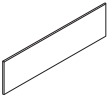

NN Mahogany

N N

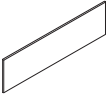

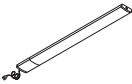
Icon Legend on page 21

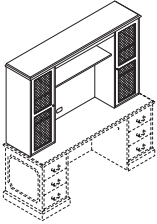
# 94000 SERIES™ Laminate Wood Desks

	DESCRIPTION	MODEL	COM	SHIP WEIGHT	CUBE	LIST PRICE
 18 <sup>5</sup> / <sub>8</sub> "H 	<b>Back Enclosure for Stack-on Storage</b> 76"W model #H94237 70"W model #H94234 or H94236	<b>H107358</b> <b>H10738</b>		34.0 31.0	1.30 1.30	<b>\$244</b> <b>\$224</b>
	NOTES: Specify laminate with a single designator. Non-tackable surface. Feature full width 1 <sup>1</sup> / <sub>8</sub> " slot at bottom to facilitate routing cords and reaching wall electrical outlets. <b>SPECIFYING EXAMPLE: H107358.N</b>					
 18"H 	<b>Tackboards for use with Stack-on Storage Back Enclosures (Back Enclosures must be ordered separately.)</b> 71 <sup>1</sup> / <sub>2</sub> "W for 76"W model #H94237 Stack-on with #H107358 Enclosure 65 <sup>15</sup> / <sub>16</sub> "W for 70"W model #H94234 or H94236 Stack-on with #H10738 Enclosure	<b>H90035</b> <b>H90034</b>	2.0 2.0	13.0 11.0	2.80 2.00	<b>\$297</b> <b>\$283</b>
	NOTES: Specify fabric selection from pages 35-36. Upcharges may apply to premium fabric grades. Tackboards are sized <sup>3</sup> / <sub>4</sub> " narrower than respective stack-on storage back enclosure, allowing <sup>3</sup> / <sub>8</sub> " each side to route task light cords. Attached to back enclosure using latch & hook tape provided. <b>SPECIFYING EXAMPLE: H930035.APNI5</b>					
 <b>OPEN MARKET</b>	<b>LED Task Lights — For Stack-on and Wall Mounted Storage Cabinets</b> 17" LED Light with Power Supply (Single) 31" LED Light with Power Supply (Single)	<b>HLED17AS</b> <b>HLED31AS</b>		1.2 Ⓢ 1.5 Ⓢ	0.05 0.09	<b>\$384</b> <b>\$516</b>
	NOTES: No finish specification required. Attaches magnetically to underside of overhead storage, or attaches with provided screws or double-sided tape. Occupancy sensor attaches to a single or starter LED light and will automatically turn the light off after no motion is detected for 30 minutes. Just like all the LED light models, the occupancy sensor features a soft-touch on/off switch. LED task lights have a lifetime of 50,000 hours and have a dimmer feature that allows the user to adjust the amount of light output. For additional information see page 911.					
 Refer to page 77 <b>OPEN MARKET</b>	<b>Recessed Task Light</b> 46 <sup>1</sup> / <sub>2</sub> "W x 3 <sup>1</sup> / <sub>16</sub> "D for Models H94234, H94234K, H94236, H94237 and H94237K. Chicago code version (with fused plug)	<b>HH870960</b> <b>HH870960CH</b>		12.0 Ⓢ 12.0 Ⓢ	1.10 1.10	<b>\$246</b> <b>\$308</b>
	NOTES: For additional information see page 911.					
 	<b>Overhead Hutch w/Wire Mesh Doors</b> 70"W x 16 <sup>1</sup> / <sub>8</sub> "D x 48 <sup>3</sup> / <sub>4</sub> "H	<b>H94235</b>		260.0	43.30	<b>\$2482</b>
	NOTES: Each side storage compartment contains: 1-lower opening 16 <sup>1</sup> / <sub>4</sub> "W x 13 <sup>1</sup> / <sub>16</sub> "D x 15 <sup>7</sup> / <sub>8</sub> "H and 2-upper openings 16 <sup>1</sup> / <sub>4</sub> "W x 13 <sup>1</sup> / <sub>16</sub> "D x 14 <sup>3</sup> / <sub>8</sub> "H. Clearance for computer, etc.: 32 <sup>15</sup> / <sub>16</sub> "W x 12 <sup>5</sup> / <sub>8</sub> "D x 31 <sup>3</sup> / <sub>4</sub> "H. No lock option for mesh doors. ⓘ 14 <sup>3</sup> / <sub>4</sub> "H center shelf does not adjust. Not designed to accept task light.					

**NOTES:**

- Stack-on storage equipped with self-closing, adjustable hinged doors.
- Stack-on storage design includes valance to hide task light.
- Vertical paper manager keeps papers, files and books organized and within easy reach from a seated position. Fits under stack-on storage models. See page 397.
- Stacked paper management segments and organizes stack-on storage compartments and bookcase shelves. Unit can be used in models H94327, H94234 and H94236. In some cases, installation may require removing the stack-on storage doors. See page 383.
- For a variety of work-in-process paper management tools, see pages 346-347.
- Overhead Hutch features one cord pass-through grommet located in bottom center of back panel.

- ⓘ Overhead Hutch is not designed to accept task light.
- ⓘ Removable lock core kit for locking stack-on storage is model HF27B. See page 922.

## HOW TO SPECIFY

<p><b>Select Model Number</b></p> <p>H 9 4 2 3 5 .</p>	<p><b>Select Laminate</b></p> <p>NN Mahogany</p> <p>NN</p>
--	--



# 94000 SERIES™

## Laminate Wood Desks

GSA SIN 711-8

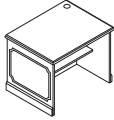
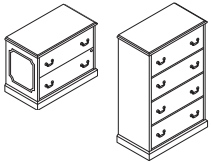
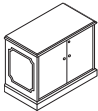
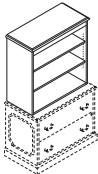
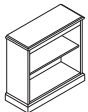

Icon Legend on page 21

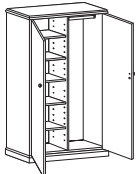
	DESCRIPTION	MODEL	SHIP WEIGHT	CUBE	LIST PRICE
	<b>Computer Work Table with cord grommet</b> 36"W x 30"D x 29½"H NOTES: One removable shelf (32⅓⅙"W x 12⅝⅙"D).	<b>H94226</b>	130	23.8	<b>\$1009</b>
	<b>Lateral Files (with core removable lock)</b> 37½"W x 20½"D x 29½"H — two drawer 37½"W x 20½"D x 59⅞"H — four drawer NOTES: High capacity file storage. Includes hangrails; mechanical interlock inhibits the extension of more than one drawer at a time. Two drawer design is equipped with a counterweight.	<b>H94223</b> <b>H94229</b>	172 300	17.7 34.0	<b>\$1278</b> <b>\$2193</b>
	<b>Storage Cabinet (with core removable lock)</b> 37½"W x 20½"D x 29½"H NOTES: Bookcase hutch H94210 can be used with H94291. One adjustable shelf, adjusts in 1¼" increments.	<b>H94291</b>	165	16.7	<b>\$1146</b>
	<b>Bookcase Hutch</b> 35¾"W x 14⅝⅙"D x 37"H, (3 shelves; 2 adjustable, includes bottom of unit) Designed to be used on model H94223 lateral file or model H94291 storage cabinet. NOTES: One cord pass-through grommet located at bottom center of back panel. Two adjustable shelves, adjust in 1¼" increments.	<b>H94210</b>	95	14.0	<b>\$855</b>
	<b>Bookcase</b> 35¾"W x 14⅝⅙"D x 35½"H, 2-Shelf 35¾"W x 14⅝⅙"D x 49⅝⅙"H, 3-Shelf 35¾"W x 14⅝⅙"D x 64"H, 4-Shelf 35¾"W x 14⅝⅙"D x 78¼"H, 5-Shelf NOTES: Fixed shelves.	<b>H94221</b> <b>H94222</b> <b>H94224</b> <b>H94225</b>	100 130 160 200	14.8 20.6 26.3 32.3	<b>\$799</b> <b>\$895</b> <b>\$1015</b> <b>\$1113</b>
	<b>Bookcase with Glass Doors</b> 35¾"W x 14⅝⅙"D x 49⅝⅙"H NOTES: Upscale design brings order, utility and a touch of elegance to the traditional office. Wood-framed, clear glass doors with hinges provide easy access to interior. Three fixed shelves provide spacious storage. Shelf measures 32¾"W x 11¾"D. Bookcase with glass doors brings order, utility and a touch of elegance to the traditional office. <b>!</b> Doors are not designed to lock.	<b>H94220</b>	155	20.6	<b>\$1428</b>
	<b>Storage Cabinet/Lateral File (with core removable lock)</b> 37½"W x 24"D x 66½"H NOTES: Standard with one fixed and two full-width adjustable shelves in top compartment; adjustable shelves can be removed. Overall storage compartment measures 33¾"W x 22"D x 36⅞"H and will accommodate supplies, books and binders, as well as business machines and electronic equipment. Cord pass-through gap behind shelves and grommet in back of the cabinet to facilitate routing cords and reaching wall electrical outlets. Two drawer lateral file on bottom. Lateral file comes with mechanical interlock and hangrails. Cabinet and lateral file lock independently. Unit height is designed to match credenza or return plus stack-on storage height or the two drawer lateral file or storage cabinet plus the bookcase hutch height (66½"H).	<b>H94435</b>	355	44.4	<b>\$2338</b>
<i>Doors open 110 degrees from closed position.</i>					
	<b>Personal Wardrobe/Storage Cabinet (with core removable lock)</b> 37½"W x 24"D x 66½"H NOTES: Spacious design is standard with four adjustable shelves (one shelf is fixed) plus a generous wardrobe section with a coat rod. Shelves adjust in 2½" increments. One lock secures both doors. Unit height is designed to match credenza plus stack-on storage height or the two drawer lateral file or storage cabinet plus the bookcase hutch height (66½"H). Personal wardrobe/storage cabinet is standard with four adjustable shelves (one shelf is fixed) plus a generous wardrobe section with a coat rod.	<b>H94430</b>	351	44.4	<b>\$2298</b>

**NOTES:**

- File drawers accommodate letter and legal width side-to-side filing, and letter-width front-to-back filing; use hanging folders with a maximum overall height of 9⅜".
- Adjustable hex leveling glides allow floor-standing furniture to be easily leveled without lifting the unit; glides have ¾" adjustable range.
- For conference table options, see the Preside® table tops and bases on pages 846-851. Order edge option "T" for 94000 Desks edge compatibility.
- Removable lock core kit - HF23B - allows multiple units to be keyed alike. See page 922.









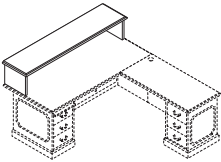

**HOW TO SPECIFY**

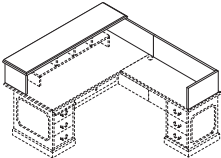
<b>Select Model Number</b>	<b>Select Laminate</b>
<input type="text" value="H"/> <input type="text" value="9"/> <input type="text" value="4"/> <input type="text" value="2"/> <input type="text" value="2"/> <input type="text" value="6"/>	<input type="text" value="NN"/>

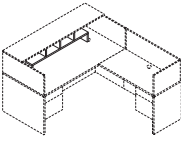

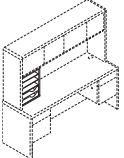
Icon Legend on page 21

# 94000 SERIES™ Laminate Wood Desks

	DESCRIPTION	MODEL	SHIP WEIGHT	CUBE	LIST PRICE
 	<b>Reception Station/Transaction Counter</b> 71 <sup>3</sup> / <sub>4</sub> "W x 16 <sup>1</sup> / <sub>8</sub> "D x 14 <sup>1</sup> / <sub>4</sub> "H Designed for use with 72"W single pedestal desk models H94285R or H94286L. NOTES: Reception station/transaction counter has traditional-styled decorative molding on the approach side.	<b>H94720</b>	75	2.6	<b>\$833</b>
	<b>Reception Station for an "L" Workstation</b> 71 <sup>3</sup> / <sub>4</sub> "W x 82 <sup>3</sup> / <sub>4</sub> "D x 14 <sup>1</sup> / <sub>4</sub> "H Designed for use with 72"W single pedestal desk H94286L and 48"W return H94215R (shown) Designed for use with 72"W single pedestal desk H94285R and 48"W return H94216L NOTES: Reception station for "L" workstation includes components for both the reception/transaction counter for desk and the reception station for return.	<b>H94721R</b> <b>H94722L</b>	100	4.0	<b>\$1008</b> <b>\$1008</b>
 Model H94721R shown 	<b>Transaction Counter Organizer</b> 48 <sup>3</sup> / <sub>4</sub> "W x 11 <sup>1</sup> / <sub>8</sub> "D x 13"H Fits under Transaction Counter on models H94720, H94721R and H94722L. NOTES: Transaction Counter Organizer model HTCOL52 fits under/inside of transaction counter. ! Black only. <b>SPECIFYING EXAMPLE: HTCOL52.P</b>	<b>HTCOL52</b>	24	1.1	<b>\$259</b>
 	<b>Vertical Paper Manager</b> 14 <sup>7</sup> / <sub>8</sub> "W x 10 <sup>7</sup> / <sub>8</sub> "D x 19 <sup>1</sup> / <sub>16</sub> "H NOTES: Keeps papers, files, and books neatly organized and within easy reach from a seated position. Designed for desk, credenza, and return tops. Fits under stack-on storage models. Two pullout drawers and three fixed shelves. NOTES: For additional information see page 912. <b>SPECIFYING EXAMPLE: HLVPM1.N</b>	<b>HLVPM1</b>	27	2.8	<b>\$298</b>
 Not available in two-tone laminate	<b>Angled Wood Center Drawer</b> 26" x 15 <sup>5</sup> / <sub>8</sub> " 22" x 15 <sup>5</sup> / <sub>8</sub> " NOTES: Specify laminate. For additional information see page 903. <b>SPECIFYING EXAMPLE: H1526.N</b>	<b>H1526</b> <b>H1522</b>	12  11 	1.2 1.1	<b>\$187</b> <b>\$173</b>
 Refer to page 171 for Center Drawer compatibility information <b>SIN 711-1, 711-2, 711-11</b>					

**NOTES:**

- For conference table options, see the Preside® table tops and bases on pages 846-851. Order edge option "T" for 94000 Desks edge compatibility.

## HOW TO SPECIFY

<b>Select Model Number</b> H 9 4 7 2 0	<b>Select Laminate</b> NN Mahogany
---	---------------------------------------



# 94000 SERIES™

## Accessories

GSA SIN AS NOTED

ABI

Icon Legend on page 21

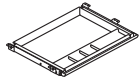

OPEN MARKET

**DESCRIPTION****Polymer Center Drawer**

- Color: Black.
- Material: ABS.
- Opening Requirements: 23"W x 16¼"D x 2"H.
- Retracts on 16" ball bearing slides.
- Can be used on worksurfaces with Coordinate™ Height Adjustable Bases as long as it is attached with spacer model HKBS.
- Can store up to 25 lbs.

NOTES: For additional information see page 904.

! Black finish only, no specification needed.

**MODEL****HCD1****SHIP WEIGHT**

7.0

**CUBE**

0.5

**LIST PRICE****\$99**

Refer to pages 75 and 901 for additional product information

SIN 711-1, 711-2, 711-11

**Sit to Stand Arm with Convertible Keyboard Platform****H2516 OPEN MARKET**

17.0 \$

1.6

**\$565****Articulating Arm with Convertible Keyboard Platform****H2107 OPEN MARKET**

16.0 \$

1.3

**\$484****Articulating Arm with Keyboard Platform****H1706 OPEN MARKET**

16.0 \$

1.4

**\$451****Slide-Away Keyboard Platform** (Specify: Laminate)**H4022**

10.0 \$

0.6

**\$199****Extended Tray Slide-Away Keyboard Platform** (Specify: Laminate)**HE4022**

12.0 \$

0.7

**\$285**

NOTES: For additional information see pages 900-901.

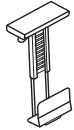

OPEN MARKET

**CPU Holder**

- Vertically mounts to underside of worksurface.
- 360° swivel.
- Supports up to 55 lbs.
- Height adjustable from 16" to 22" below worksurface.
- Width adjustable to accept units from 3¼" to 6".

NOTES: For additional information see page 899.

! Silver finish only, no specification needed.

**HCPU**

16.0 \$

0.5

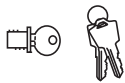
**\$236**

SIN 711-2

**Black Removable Lock Core Kit (for laminate products)****HF23B**

0.1 \$

0.1

**\$29**

- Specify quantity of each key number from 101E-225E.
- Includes: 1-core, 2-keys, 1-core removal tool, and instructions.

NOTES: If key number isn't specified, number will be at random. Core matches manufactured lock on laminate product but can be used with metal casegoods product.

**NOTES:**

- For conference table options, see the Preside® table tops and bases on pages 846-851. Order edge option "T" for 94000 Desks edge compatibility.

**HOW TO SPECIFY**

Select  
Model Number

H C D 1

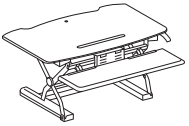
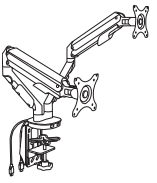
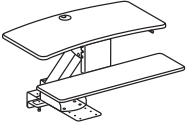
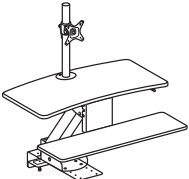
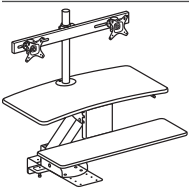
	DESCRIPTION	MODEL	SHIP WEIGHT	CUBE	LIST PRICE
	<p><b>Coordinate™ Portable Desktop Riser</b> 31"D x 4½"-16½"H x 35"W</p> <p>NOTES: Available in Black (BLK) or White (WHT) finish. Desktop riser dimensions (without keyboard tray): 22"D x 4½"-16½"H x 35"W. Keyboard tray dimensions: 9"D x 30"W. Max loading capacity is 33 lbs for the desktop riser surface and 4 lbs for the keyboard tray. Easily transition from seated to standing positions throughout the workday. Sits atop an existing desk to create sit-to-stand functionality by raising the computer. Includes keyboard tray and surface for computer monitors. <b>HON 5-Year Limited Warranty.</b></p> <p>⚠ Not intended for use on mobile workstations.</p>	<b>HBXRISER</b>	54.0	4.1	<b>\$500</b>
	<p><b>Dual Monitor Arm with 2 USB Ports</b></p> <p>NOTES: <b>AVAILABLE FEBRUARY 2018.</b> Easy adjustment. Height adjusts to 17" tall. Monitor tilt and swivel capability. Enclosed cable management. Grommet or desktop mounting. Clean appearance. For additional information see page 899.</p> <p>⚠ No specification needed.</p>	<b>HBDMAUSB</b>	41.9	2.6	<b>\$360</b>
	<p><b>Coordinate™ Mounted Desktop Riser</b></p> <p>NOTES: Does not include a monitor arm and is suitable for laptops and/or monitors on their original stands.</p> <p>⚠ No specification needed.</p>	<b>HS1100</b>	60.0 Ⓢ	3.2	<b>\$525</b>
	<p><b>Coordinate™ Mounted Desktop Riser with Single Monitor Arm</b></p> <p>NOTES: Includes a monitor arm for a single monitor.</p> <p>⚠ No specification needed.</p>	<b>HS1101</b>	62.0 Ⓢ	3.2	<b>\$615</b>
	<p><b>Coordinate™ Mounted Desktop Riser with Dual Monitor Arm</b></p> <p>NOTES: Includes a monitor arm for dual monitors.</p> <p>⚠ No specification needed.</p>	<b>HS1102</b>	63.0 Ⓢ	3.2	<b>\$700</b>

**NOTES FOR HS1100, HS1101, HS1102:**

- These products are designed to allow the user to transition from seating position to standing position throughout the workday.
- Gas-assist lever-operated mechanism with positive stop.
- Clamp mount compatible with worksurfaces depths of 20"-30". 20" is for systems only.
- Clamp requires 3.5" of clearance along back edge of worksurface.
- Black seamless worksurfaces.
- Silver powder coated metal components.
- Lowers below worksurface level on 24" and 30"D worksurfaces.
- All models contain a large primary worksurface and a smaller keyboard / mouse surface.
- Beveled edges for sleek appearance and comfort while typing.
- Monitor arms include height, width, and swivel adjustment.
- For additional information see page 906.

- Not for use under overhead storage, with flush mounted modesty panels, or worksurfaces thinner than 1".

⚠ Not recommended for use on mobile (castered) worksurfaces.

**MOUNTING AND COMPATIBILITY FOR HS1100, HS1101, HS1102:**

- This product is intended to be installed on commercial-grade worksurfaces in good condition.
- Compatible with freestanding worksurfaces 24"-30"D or panel-supported worksurfaces 24"-30"D.
- Not for use on mobile worksurfaces.

**Clamp Mount**

Use when 3.5" minimum overhang is available

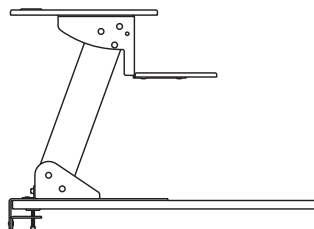

**Screw Mount**

Use when no overhang is available. Worksurface must be minimum 1" thick.

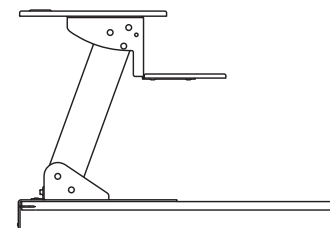

**HOW TO SPECIFY**

<p><b>Select Model Number</b></p> <p>HBXRISER.</p>	<p><b>Select Finish</b></p> <p>BLK Black WHIT White</p> <p>BLK</p>
--	--



# 94000 SERIES™

## Accessories

OPEN MARKET

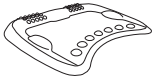
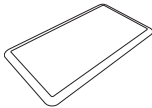
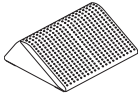

Icon Legend on page 21

	DESCRIPTION	MODEL	SHIP WEIGHT	CUBE	LIST PRICE
	<b>Rectangle Wobble Board — Anti-Fatigue Mat</b> 18"D x 3"H x 22½"W ⓘ Available in Black (T) finish ONLY. Recommended weight capacity not to exceed 250 pounds. <b>HON 5-Year Limited Warranty.</b> <b>SPECIFYING EXAMPLE: HVL981.T</b>	<b>HVL981</b>	10.0 Ⓢ	0.9	<b>\$220</b>
	<b>Round Wobble Board — Anti-Fatigue Mat</b> 18½"D x 2½"H x 18½"W ⓘ Available in Black (T) finish ONLY. Recommended weight capacity not to exceed 250 pounds. <b>HON 5-Year Limited Warranty.</b> <b>SPECIFYING EXAMPLE: HVL982.T</b>	<b>HVL982</b>	5.8 Ⓢ	0.6	<b>\$190</b>
	<b>Ergonomic Anti-Fatigue Mat</b> 25"D x 2¾"H x 29⅞"W ⓘ <b>AVAILABLE FEBRUARY 2018.</b> Available in Black ONLY. No specification needed. <b>SPECIFYING EXAMPLE: HBEAFM1</b>	<b>HBEAFM1</b>	7.0	1.4	<b>\$176</b>
	<b>Rectangle Anti-Fatigue Mat</b> 20"D x ¾"H x 36"W ⓘ <b>AVAILABLE FEBRUARY 2018.</b> Available in Black ONLY. No specification needed. <b>SPECIFYING EXAMPLE: HBAFM2036</b>	<b>HBAFM2036</b>	5.4	0.4	<b>\$80</b>
	<b>Footrest — Anti-Slip Cover</b> 13¾"D x 5½"H x 16"W ⓘ Available in Black (T) finish ONLY. Recommended weight capacity not to exceed 250 pounds. <b>HON 5-Year Limited Warranty.</b> <b>SPECIFYING EXAMPLE: HVL991.T</b>	<b>HVL991</b>	7.0 Ⓢ	0.9	<b>\$65</b>

### HOW TO SPECIFY

Select  
Model Number

H V L 9 8 1 .

Select  
Finish

T Black

T



# NOTES



Mentor® Double Pedestal Desk with Volt® Task Chair and Brigade® Bookcases.

## MENTOR®

Users appreciate the clean lines and rounded corners of the Mentor desk from HON. Stylish detailing and soft edges create an attractive, contemporary desk that's very user-friendly. Performance and durability make Mentor ideal for use in intensive environments. Featuring central locking drawers and integrated wire management, Mentor works hard for hard-working professionals.



## FEATURES

- Durable baked enamel finish will hold up beautifully under years of daily use.
- Functional features like central locking center drawers and integrated wire management.
- Sturdy steel construction and heavy-duty reinforced frames.
- Mentor's performance and durability make it ideal for intensive use environments.
- Half-round legs and radius top corners are excellent for high-traffic areas.
- Arch drawer handles match Flagship® laterals, pedestals and towers.

# MENTOR® ORDERING INFORMATION

## MENTOR® FINISHES AVAILABILITY

L1 LAMINATES		CODES
Woodgrain	◆ Bourbon Cherry	H
	◆ Cognac	COGN
	◆ Harvest	C
	◆ Mahogany	N
	◆ Mocha	MOCH
	◆ Natural Maple	D
	◆ Shaker Cherry	F
Solid	◆ Black	P
	◆ Brilliant White	WHIT
	◆ Charcoal	S
	◆ Loft	LOFT
	◆ Whitestone	K4
Patterned	◆ Sheer Mesh*	A5
	◆ Silver Mesh*	B9
	◆ Steel Mesh*	A9
	◆ Canyon Zephyr	K9
	◆ Desert Zephyr	K8
	◆ Shadow Zephyr	K1
	◆ Gray*	G2
	◆ Grey Tigris	L6
◆ White	G1	
PAINTS		CODES
Core	◆ Black	P
	◆ Charcoal	S
	◆ Greige	T5
	◆ Light Gray	Q
	◆ Loft	LOFT
	◆ Muslin	T3
	◆ Putty	L
	◆ Shadow	SHDW

- STEEL DESKS  
SPECIFY: Model Number.  
Top Laminate  
Paint Color  
EXAMPLE: H88976.NS

\* **Noted Patterned** laminate colors will have the following pre-set edgeband colors:

Sheer Mesh	Muslin
Silver Mesh	Loft
Steel Mesh	Charcoal
Gray	Charcoal

◆◆◆ For lead time information see page 21.

## ColorCorrect<sup>®</sup> CHOICE COLORS

		Mentor <sup>®</sup> 
	PAINTS	CODES
Haworth <sup>®</sup>	◆ Beige	D1
	◆ Chalk <sup>1</sup>	T3
	◆ Charcoal	D2
	◆ Graphite	D5
	◆ Putty	D6
	◆ Sand	D3
	◆ Smoke	D7
Herman Miller <sup>®</sup>	◆ Inner Tone	J2
	◆ Inner Tone Light	J5
	◆ Light Tone	J6
	◆ Medium Tone	H8
	◆ Slate Gray	H7
Knoll <sup>®</sup>	◆ Jet Black <sup>2</sup>	P
	◆ Medium Gray	K1
	◆ Pumice	K4
	◆ Soft Gray	K3
	◆ Taupe	K5
Steelcase <sup>®</sup>	◆ Black <sup>3</sup>	P
	◆ Cream	K6
	◆ Grey Value 1	K9
	◆ Midnight	K7
	◆ Tan Value 1	K8

<sup>1</sup> Haworth Chalk is the same as HON Muslin. When ordering this color use the HON Muslin paint code T3.

<sup>2</sup> Knoll Jet Black is the same as HON Black. When ordering this color use the HON Black paint code P.

<sup>3</sup> Steelcase Black is the same as HON Black. When ordering this color use the HON Black paint code P.

NOTES: Choice color selections do not require a customer approval. The colors can be ordered with the HON paint code noted above.

Pricing for eligible product is listed on the individual list pricer pages under the column Choice/Metallic column.

No minimum order is required for Choice Colors.

Refer to page 17 for detailed information on the ColorCorrect<sup>®</sup> Program.

### Custom Paint Colors

Custom Paint Colors require a special request submitted within MyProjects. Refer to page 17 for detailed information regarding Custom Paints.

◆◆◆ For lead time information see page 21.



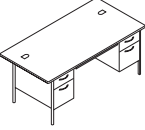
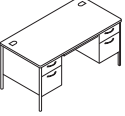
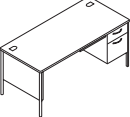
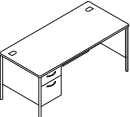
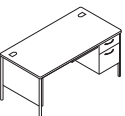
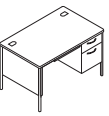

	DESCRIPTION	MODEL	SHIP WEIGHT	CUBE	LIST PRICE
	<b>Double Pedestal Desk with Center Drawer (6" overhang on 3 sides) — 2/2</b> 72"W x 36"D x 29½"H, Chrome Leg and Pull NOTES: Model H88976 requires Model H386560N 60"W Stack-on as top of desk extends over end panels.	<b>H88976</b>	203	37.7	<b>\$1519</b>
	<b>Double Pedestal Desk with Center Drawer — 2/2</b> 60"W x 30"D x 29½"H, Chrome Leg and Pull	<b>H88962</b>	178	26.7	<b>\$1258</b>
	<b>Single Pedestal Desk with Center Drawer – Right, box/file</b> 66"W x 30"D x 29½"H, Chrome Leg and Pull	<b>H88265R</b>	162	29.2	<b>\$1143</b>
	<b>Single Pedestal Desk with Center Drawer – Left, box/file</b> 66"W x 30"D x 29½"H, Chrome Leg and Pull	<b>H88266L</b>	162	29.2	<b>\$1143</b>
	<b>Single Pedestal Desk with Center Drawer – Right, box/file</b> 60"W x 30"D x 29½"H, Chrome Leg and Pull	<b>H88263R</b>	145	26.7	<b>\$1085</b>
	<b>Single Pedestal Desk with Center Drawer – Right, box/file</b> 48"W x 30"D x 29½"H, Chrome Leg and Pull	<b>H88251R</b>	130	21.6	<b>\$1027</b>

**NOTES:**

- Leg available in Chrome.
- Attractive radius leg design and arched drawer pulls.
- Legs ship unattached.
- 3/4 height modesty panels.
- Rounded edge desk top with soft feel-vinyl edge.
- Wire management grommets in desk tops and pedestals.
- Laminate tops are constructed of 1½" thick particleboard.
- 13½" deep, central locking center drawer equipped with HON "One Key" interchangeable lock cores.
- High-sided file drawers accept hanging files without hangrails. Spring-loaded follower blocks are standard.
- 3/4 extension box drawers with one divider provide 20" deep filing capacity.
- Reinforced double "O" frame inner structure keeps desk solid and sturdy for years of use.
- 90% extension triple-tied cradles on all file drawers provide 21" deep filing capacity.
- Vinyl edge and grommets match specified chassis color.
- All interior drawer bodies are gray, pre-painted steel.

ⓘ Keyed alike cores must be ordered separately — see page 922.

**HOW TO SPECIFY****Select Model Number**

H 8 8 9 7 6 .

**Select Laminate**

See page 404

N .

**Select Paint Color**

See pages 404-405

S



Icon Legend on page 21

	DESCRIPTION	MODEL	SHIP WEIGHT	CUBE	LIST PRICE
	<b>Double Pedestal Credenza with Kneespace, box/file (non-locking)</b> 60"W x 24"D x 29½"H, Chrome Leg and Pull	<b>H88231</b>	149	21.8	<b>\$1242</b>
	<b>Return, Right, box/file (non-locking)</b> 42"W x 24"D x 29½"H, Chrome Leg and Pull	<b>H88235R</b>	92	15.5	<b>\$798</b>
	<b>Return, Left, box/file (non-locking)</b> 42"W x 24"D x 29½"H, Chrome Leg and Pull	<b>H88236L</b>	92	15.5	<b>\$798</b>

**NOTES:**

- Leg available in Chrome.
- Attractive radius leg design and arched drawer pulls.
- Legs ship unattached.
- ¾ height modesty panels.
- Rounded edge desk top with soft feel-vinyl edge.
- Wire management grommets in desk tops and pedestals.
- Laminate tops are constructed of 1½" thick particleboard.
- High-sided file drawers accept hanging files without hangrails. Spring-loaded follower blocks are standard.
- ¾ extension box drawers with one divider provide 20" deep filing capacity.
- Reinforced double "O" frame inner structure keeps desk solid and sturdy for years of use.
- 90% extension triple-tied cradles on all file drawers provide 21" deep filing capacity.
- Vinyl edge and grommets match specified chassis color.
- All interior drawer bodies are gray, pre-painted steel.

## HOW TO SPECIFY

<p><b>Select Model Number</b></p> <p>H 8 8 2 3 1</p>	<p><b>Select Laminate</b></p> <p>See page 404</p> <p>N</p>	<p><b>Select Paint Color</b></p> <p>See pages 404-405</p> <p>S</p>
--	--	--

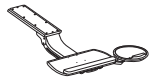

Refer to page 75 for additional product information

SIN 711-1, 711-2



## DESCRIPTION

**Sit to Stand Arm with Convertible Keyboard Platform**  
**Articulating Arm with Convertible Keyboard Platform**  
**Articulating Arm with Keyboard Platform**

## MODEL

**H2516 OPEN MARKET**  
**H2107 OPEN MARKET**  
**H1706 OPEN MARKET**

## SHIP WEIGHT

17.0 **Ⓢ**  
 16.0 **Ⓢ**  
 16.0 **Ⓢ**

## CUBE

1.6  
 1.3  
 1.4

## LIST PRICE

**\$565**  
**\$484**  
**\$451**

NOTES: For additional information see page 900.



OPEN MARKET

## 360° Swivel CPU Holder

- Vertically mounts to underside of worksurface.
- 360° swivel.
- Supports up to 55 lbs.
- Height adjustable from 16" to 22" below worksurface.
- Width adjustable to accept units from 3¼" to 6".

**HCPU**

16.0 **Ⓢ**

0.5

**\$236**

NOTES: For additional information see page 899.

! Silver only

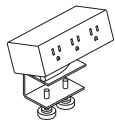

Model HPWRMOD3WC shown

SIN 711-2



## Power Modules

3 Receptacles with Worksurface Clamp  
 2 Receptacles 2 USB with Worksurface Clamp

**HPWRMOD3WC**

2.3 **Ⓢ**

0.2

**\$279**

- 6' power cord with standard three-prong plug.
- Under-worksurface mounting bracket models work with any top that has a 5" x 5" square clearance.
- Worksurface clamp models work on any top with a 4" overhang.
- UL Listed.

**HPWRMOD2WC**

2.3 **Ⓢ**

0.2

**\$447**

NOTES: For additional information see page 917.

! Color finish coordinates with HON's Charcoal or White. Specify *S* for Charcoal or *WHIT* for White when ordering.  
 Example: HPWRMOD3WC.S.

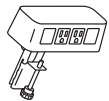

SIN 711-2



## Power & Data Center

- 2 Receptacles 2 Data Accessory
- Standard with two receptacles and openings for two data ports.
  - 6' power cord with standard three-prong plug.
  - Fits on any worksurface with a 4" overhang.
  - UL Listed.

**HCOMDOME2**

2.5 **Ⓢ**

0.2

**\$266**

NOTES: For additional information see page 917.

! Color finish coordinates with HON's Loft. Specify *LOFT* when ordering. Example: HCOMDOME2.LOFT.



SIN 711-2



## Vertebrae

NOTES: For additional information see page 920.

! Clear finish. Specify "X" for finish option.

**SPECIFYING EXAMPLE: HMPVWM28.X**

**HMPVWM28**

3.0

0.3

**\$200**



SIN 711-2



## Storage Cube

12"W x 12"D

**HLSL1212**

1.0

0.3

**\$276**

NOTES: Available in the following colors: Autumn (AUTM), Citron (CITR), Flame (FLAM), Pool (POOL) and Sisal (SISL). For additional information see page 914.

**SPECIFYING EXAMPLE: HLSL1212.CITR**

## HOW TO SPECIFY

Select  
Model Number

H P W R M O D 3 W C

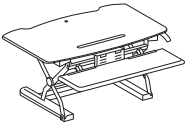
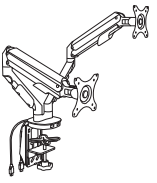
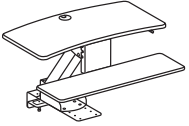
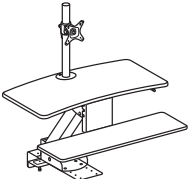
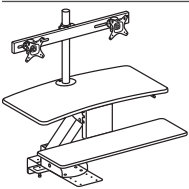
	DESCRIPTION	MODEL	SHIP WEIGHT	CUBE	LIST PRICE
	<p><b>Coordinate™ Portable Desktop Riser</b> 31"D x 4½"-16½"H x 35"W</p> <p>NOTES: Available in Black (BLK) or White (WHT) finish. Desktop riser dimensions (without keyboard tray): 22"D x 4½"-16½"H x 35"W. Keyboard tray dimensions: 9"D x 30"W. Max loading capacity is 33 lbs for the desktop riser surface and 4 lbs for the keyboard tray. Easily transition from seated to standing positions throughout the workday. Sits atop an existing desk to create sit-to-stand functionality by raising the computer. Includes keyboard tray and surface for computer monitors. <b>HON 5-Year Limited Warranty.</b></p> <p>⚠ Not intended for use on mobile workstations.</p>	<b>HBXRISER</b>	54.0	4.1	<b>\$500</b>
	<p><b>Dual Monitor Arm with 2 USB Ports</b></p> <p>NOTES: <b>AVAILABLE FEBRUARY 2018.</b> Easy adjustment. Height adjusts to 17" tall. Monitor tilt and swivel capability. Enclosed cable management. Grommet or desktop mounting. Clean appearance. For additional information see page 899.</p> <p>⚠ No specification needed.</p>	<b>HBDMAUSB</b>	41.9	2.6	<b>\$360</b>
	<p><b>Coordinate™ Mounted Desktop Riser</b></p> <p>NOTES: Does not include a monitor arm and is suitable for laptops and/or monitors on their original stands.</p> <p>⚠ No specification needed.</p>	<b>HS1100</b>	60.0 Ⓢ	3.2	<b>\$525</b>
	<p><b>Coordinate™ Mounted Desktop Riser with Single Monitor Arm</b></p> <p>NOTES: Includes a monitor arm for a single monitor.</p> <p>⚠ No specification needed.</p>	<b>HS1101</b>	62.0 Ⓢ	3.2	<b>\$615</b>
	<p><b>Coordinate™ Mounted Desktop Riser with Dual Monitor Arm</b></p> <p>NOTES: Includes a monitor arm for dual monitors.</p> <p>⚠ No specification needed.</p>	<b>HS1102</b>	63.0 Ⓢ	3.2	<b>\$700</b>

**NOTES FOR HS1100, HS1101, HS1102:**

- These products are designed to allow the user to transition from seating position to standing position throughout the workday.
- Gas-assist lever-operated mechanism with positive stop.
- Clamp mount compatible with worksurfaces depths of 20"-30". 20" is for systems only.
- Clamp requires 3.5" of clearance along back edge of worksurface.
- Black seamless worksurfaces.
- Silver powder coated metal components.
- Lowers below worksurface level on 24" and 30"D worksurfaces.
- All models contain a large primary worksurface and a smaller keyboard / mouse surface.
- Beveled edges for sleek appearance and comfort while typing.
- Monitor arms include height, width, and swivel adjustment.
- For additional information see page 906.

- Not for use under overhead storage, with flush mounted modesty panels, or worksurfaces thinner than 1".

⚠ Not recommended for use on mobile (castered) worksurfaces.

**MOUNTING AND COMPATIBILITY FOR HS1100, HS1101, HS1102:**

- This product is intended to be installed on commercial-grade worksurfaces in good condition.
- Compatible with freestanding worksurfaces 24"-30"D or panel-supported worksurfaces 24"-30"D.
- Not for use on mobile worksurfaces.

**Clamp Mount**

Use when 3.5" minimum overhang is available

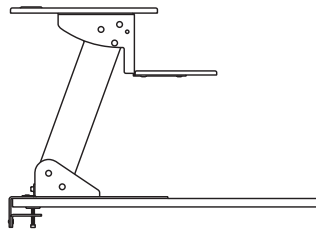

**Screw Mount**

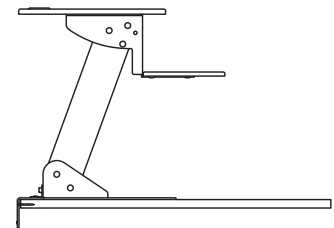

Use when no overhang is available. Worksurface must be minimum 1" thick.



**HOW TO SPECIFY**

<p><b>Select Model Number</b></p> <p>HBXRISER.</p>	<p><b>Select Finish</b></p> <p>BLK Black WHIT White</p> <p>BLK</p>
--	--

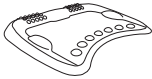
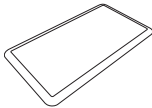
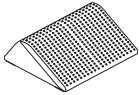

	DESCRIPTION	MODEL	SHIP WEIGHT	CUBE	LIST PRICE
	<b>Rectangle Wobble Board — Anti-Fatigue Mat</b> 18"D x 3"H x 22½"W ⓘ Available in Black (T) finish ONLY. Recommended weight capacity not to exceed 250 pounds. <b>HON 5-Year Limited Warranty.</b> <b>SPECIFYING EXAMPLE: HVL981.T</b>	<b>HVL981</b>	10.0 <b>Ⓔ</b>	0.9	<b>\$220</b>
	<b>Round Wobble Board — Anti-Fatigue Mat</b> 18½"D x 2½"H x 18½"W ⓘ Available in Black (T) finish ONLY. Recommended weight capacity not to exceed 250 pounds. <b>HON 5-Year Limited Warranty.</b> <b>SPECIFYING EXAMPLE: HVL982.T</b>	<b>HVL982</b>	5.8 <b>Ⓔ</b>	0.6	<b>\$190</b>
	<b>Ergonomic Anti-Fatigue Mat</b> 25"D x 2¾"H x 29⅞"W ⓘ <b>AVAILABLE FEBRUARY 2018.</b> Available in Black ONLY. No specification needed. <b>SPECIFYING EXAMPLE: HBEAFM1</b>	<b>HBEAFM1</b>	7.0	1.4	<b>\$176</b>
	<b>Rectangle Anti-Fatigue Mat</b> 20"D x ¾"H x 36"W ⓘ <b>AVAILABLE FEBRUARY 2018.</b> Available in Black ONLY. No specification needed. <b>SPECIFYING EXAMPLE: HBAFM2036</b>	<b>HBAFM2036</b>	5.4	0.4	<b>\$80</b>
	<b>Footrest — Anti-Slip Cover</b> 13¾"D x 5½"H x 16"W ⓘ Available in Black (T) finish ONLY. Recommended weight capacity not to exceed 250 pounds. <b>HON 5-Year Limited Warranty.</b> <b>SPECIFYING EXAMPLE: HVL991.T</b>	<b>HVL991</b>	7.0 <b>Ⓔ</b>	0.9	<b>\$65</b>

## HOW TO SPECIFY

Select  
Model Number

H V L 9 8 1 .

Select  
Finish

T Black

T

# METRO CLASSIC



Metro Classic Desk shown with Ignition® Seating.

## METRO CLASSIC

The Metro Classic is a forward-thinking flashback that marries '60s styling with today's technology. This handsomely built collection offers excellent performance for the price — with best-in-class construction, easy-care laminate tops, built-in wire management and more. If you're looking for iconic style that lasts, you'll find it in Metro Classic.



## FEATURES

- Retro-styled, but with up-to-date amenities, this classic reflects the enduring Modernist office designs of the 1960s.
- With tubular steel legs painted to match the desk body, Metro Classic gives you a clean look from top to bottom.
- Pedestals feature Tru-Fit mitered drawer fronts for precision alignment when closed.
- Contract-grade, multi-ply laminate stands up to scratches, spills, stains and boiling liquids.
- Recessed plastic drawer handles are color-matched to HON core paint colors.
- All drawers lock by securing the center drawer; lock core can be changed as security needs require.

# METRO CLASSIC ORDERING INFORMATION

## METRO CLASSIC FINISHES AVAILABILITY

L1 LAMINATES		CODES
Woodgrain	◆ Bourbon Cherry	H
	◆ Cognac	COGN
	◆ Harvest	C
	◆ Mahogany	N
	◆ Mocha	MOCH
	◆ Natural Maple	D
	◆ Shaker Cherry	F
Solid	◆ Black	P
	◆ Brilliant White	WHIT
	◆ Charcoal	S
	◆ Loft	LOFT
	◆ Whitestone	K4
Patterned	◆ Sheer Mesh*	A5
	◆ Silver Mesh*	B9
	◆ Steel Mesh*	A9
	◆ Canyon Zephyr	K9
	◆ Desert Zephyr	K8
	◆ Shadow Zephyr	K1
	◆ Gray*	G2
	◆ Grey Tigris	L6
◆ White	G1	
PAINTS		CODES
Core	◆ Black	P
	◆ Charcoal	S
	◆ Greige	T5
	◆ Light Gray	Q
	◆ Loft	LOFT
	◆ Muslin	T3
	◆ Putty	L
	◆ Shadow	SHDW

- STEEL DESKS

SPECIFY: Model Number.  
Top Laminate  
Paint Color  
EXAMPLE: HP3276.NS

\* **Noted Patterned** laminate colors will have the following pre-set edgeband colors:

Sheer Mesh	Muslin
Silver Mesh	Loft
Steel Mesh	Charcoal
Gray	Charcoal



◆◆◆ For lead time information see page 21.



Icon Legend on page 21

# METRO CLASSIC

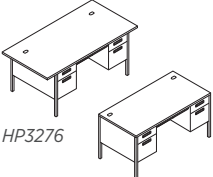
## Steel Desks

	DESCRIPTION	MODEL	SHIP WEIGHT	CUBE	LIST PRICE
 <p>HP3276</p> <p>HP3262</p>	<b>Double Pedestal — 2/2 (locking)</b> 72"W x 36"D x 29½"H (6" overhang on 3 sides) NOTES: HP3276 requires Model H386560N 60"W Stack-on as top of desk extends over end panels. 60"W x 30"D x 29½"H (Non-Locking, 24"D chassis) (6" overhang on approach side only) 60"W x 30"D x 29½"H (locking)	<b>HP3276</b>  <b>HP3261</b>  <b>HP3262</b>	218  165  186	37.7  26.7  26.7	<b>\$1490</b>  <b>\$1044</b>  <b>\$1217</b>
	<b>Single Pedestal (locking)</b> 66"W x 30"D x 29½"H — 2R 66"W x 30"D x 29½"H — 2L  48"W x 30"D x 29½"H — 2R	<b>HP3265R</b> <b>HP3266L</b>  <b>HP3251R</b>	167 167  142	29.2 29.2  21.6	<b>\$1123</b> <b>\$1123</b>  <b>\$1001</b>
	<b>Return, Right — box/file (non-locking)</b> 42"W x 24"D x 29½"H	<b>HP3235R</b>	95	15.5	<b>\$786</b>
	<b>Return, Left — box/file (non-locking)</b> 42"W x 24"D x 29½"H	<b>HP3236L</b>	95	15.5	<b>\$786</b>

**NOTES:**

- Wire grommets in desk and credenza tops accept 38000 Series™ Stack-on Units.
- 3/4 height modesty panels.
- Legs shipped unattached.
- Color of pulls and grommets match paint selection for core colors.
- "Tru-fit" mitered drawer fronts for better visual alignment.
- Color of legs match paint selection.
- Central locking center drawer standard, with HON "One Key" interchangeable lock cores.
- High-sided file drawers accept hanging files without hangrails. Spring-loaded follower blocks standard.
- 90% extension triple-tied cradles on all file drawers.
- 3/4 extension box drawers with one divider standard.
- Reinforced, double "O" frame inner structure keeps desk solid and sturdy for years of use.
- All interior drawer bodies are gray pre-painted steel.

! Keyed alike cores ordered separately — see page 922.

**HOW TO SPECIFY**

<b>Select Model Number</b>  HP3276	<b>Select Laminate</b> See page 412 Not specified for models H386566N, H386560N and H386548N  N	<b>Select Paint Color</b> See page 412  S
--	---	--



# METRO CLASSIC

## Steel Desks

GSA SIN 711-2 EXCEPT AS NOTED

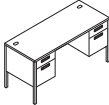
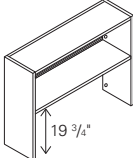
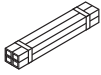
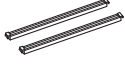

Icon Legend on page 21

	DESCRIPTION	MODEL	SHIP WEIGHT	CUBE	LIST PRICE
	<b>Credenza w/Kneespace — 2/2 (non-locking)</b> 60"W x 24"D x 29½"H Accommodates optional HD2 or HD8 center drawer. NOTES: Non-locking.	<b>HP3231</b>	165.0	21.8	<b>\$1217</b>
	<b>Stack-on Full Clearance w/o doors</b> 66"W x 13½"D x 34¾"H 60"W x 13½"D x 34¾"H 48"W x 13½"D x 34¾"H NOTES: Interior is 12¾"H. Specify: Paint color. For additional 38000 Series™ Stack-on accessory items, see pages 438-439. HP3276 requires Model H386566N 60"W Stack-on as top of desk extends over end panels.	<b>H386566N</b> <b>H386560N</b> <b>H386548N</b>	68.0 64.0 53.0	6.3 5.7 4.7	<b>\$776</b> <b>\$720</b> <b>\$657</b>
	<b>Chrome Leg Packs — Field Installable</b> 4 pk-29½"H	<b>HC14</b>	7.2	0.2	<b>\$118</b>
	<b>Double-Rail Hanging File Racks — 2 Pack (for side-to-side)</b> ! Gray only	<b>H519495</b>	0.5	0.5	<b>\$31</b>

**NOTES:**

- Wire grommets in desk and credenza tops accept 38000 Series™ Stack-on Units.
- ¾ height modesty panels.
- Legs shipped unattached.
- Color of pulls and grommets match paint selection for core colors.
- "Tru-fit" mitered drawer fronts for better visual alignment.
- Color of legs match paint selection.
- Central locking center drawer standard, with HON "One Key" interchangeable lock cores.
- High-sided file drawers accept hanging files without hangrails. Spring-loaded follower blocks standard.
- 90% extension triple-tied cradles on all file drawers.
- ¾ extension box drawers with one divider standard.
- Reinforced, double "O" frame inner structure keeps desk solid and sturdy for years of use.
- All interior drawer bodies are gray pre-painted steel.

! Keyed alike cores ordered separately — see page 922.

**HOW TO SPECIFY****Select Model Number**

HP3231

**Select Laminate**

See page 412

Not specified for models H386566N, H386560N and H386548N



N

**Select Paint Color**

See page 412

S

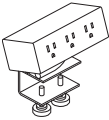
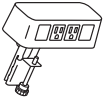

	DESCRIPTION	MODEL	SHIP WEIGHT	CUBE	LIST PRICE
 Model HPWRMOD3WC shown	<b>Power Modules</b> 3 Receptacles with Worksurface Clamp 2 Receptacles 2 USB with Worksurface Clamp	<b>HPWRMOD3WC</b> <b>HPWRMOD2WC</b>	2.3 Ⓢ 2.3 Ⓢ	0.2 0.2	<b>\$279</b> <b>\$447</b>
	<ul style="list-style-type: none"> <li>• 6' power cord with standard three-prong plug.</li> <li>• Under-worksurface mounting bracket models work with any top that has a 5" x 5" square clearance.</li> <li>• Worksurface clamp models work on any top with a 4" overhang.</li> <li>• UL Listed.</li> </ul> <p>! Color finish coordinates with HON's Charcoal or White. Specify <i>S</i> for Charcoal or <i>WHIT</i> for White when ordering.                      Example: HPWRMOD3WC.S.</p>				
	<b>Power &amp; Data Center</b> 2 Receptacles 2 Data Accessory	<b>HCOMDOME2</b>	2.5 Ⓢ	0.2	<b>\$266</b>
	<ul style="list-style-type: none"> <li>• Standard with two receptacles and openings for two data ports.</li> <li>• 6' power cord with standard three-prong plug.</li> <li>• Fits on any worksurface with a 4" overhang.</li> <li>• UL Listed.</li> </ul> <p>! Color finish coordinates with HON's Loft. Specify <i>LOFT</i> when ordering. Example: HCOMDOME2.LOFT.</p>				
	<b>Vertebrae</b>	<b>HMPVWM28</b>	3.0	0.3	<b>\$200</b>
	<p>! Clear finish. Specify "X" for finish option.  <b>SPECIFYING EXAMPLE: HMPVWM28.X</b></p>				

**NOTES:**

- For additional information see pages 917 and 920.

## HOW TO SPECIFY

Select Model Number

H	P	W	R	M	O	D	3	W	C
---	---	---	---	---	---	---	---	---	---

# METRO CLASSIC

## Accessories

GSA SIN AS NOTED

ABI

Icon Legend on page 21

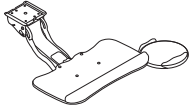

OPEN MARKET

**DESCRIPTION****Sit to Stand Arm with Keyboard**

- Sit to stand application.
- No knob or lever for adjustment, simply lift into place.
- One-hand tilt adjustment for maximum flexibility.
- For use on surfaces 24" or deeper.
- Height adjustment without levers.
- +10°/-20° tilt adjustment.
- Height adjustment 12½" (7" above and 5½" below).
- Tilt and swivel mouse surface with gel palm rest.
- Detachable palm rest.
- Mouse pad can mount right or left.

NOTES: For additional information see page 900.

! Black finish only, no specification needed.

**MODEL****H2516****SHIP WEIGHT**

17 Ⓢ

**CUBE**

1.6

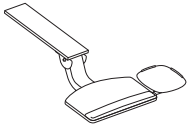
**LIST PRICE****\$565**

OPEN MARKET

**Articulating Arm with Convertible Keyboard**

- 21" glide track.
- Lift and lock height adjustment.
- Height adjustment 7" (2½" above and 4½" below track).
- Release handle for independent tilt adjustment.
- Tilt: +/-15°.
- Independent tilt and swivel mousing platform.
- Positions platform flush with worksurface.
- 360° rotation.
- Mouse can be used in-line, over, or forward at platform height or above.
- Mouse can be placed at platform height or above height.
- Left or right handed mousing; no tools required.
- Detachable palm rest.
- Cord management clips included.

NOTES: For additional information see page 900.

! Black finish only, no specification needed.

**H2107**

16 Ⓢ

1.3

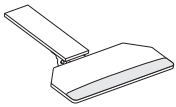
**\$484**

OPEN MARKET

**Articulating Arm with Keyboard**

- 17" glide track.
- Spring assisted.
- Height adjustment 6¼" (1¼" above and 5" below track).
- Tilt: +10°/-15°.
- 25" cut corner platform.
- Accommodates keyboard and mouse on same level.
- Detachable palm rest.
- Cord management clips included.

NOTES: For additional information see page 900.

! Black finish only, no specification needed.

**H1706**

16 Ⓢ

1.4

**\$451**

OPEN MARKET

**CPU Holder**

- Vertically mounts to underside of worksurface.
- 360° swivel.
- Supports up to 55 lbs.
- Height adjustable from 16" to 22" below worksurface.
- Width adjustable to accept units from 3¼" to 6".

NOTES: For additional information see page 899.

! Silver finish only, no specification needed.

**HCPU**

16 Ⓢ

0.5

**\$236**

SIN 711-2

**Storage Cube**

12"W x 12"D

NOTES: Available in the following colors: Autumn (AUTM), Citron (CITR), Flame (FLAM), Pool (POOL) and Sisal (SISL). For additional information see page 914.

**SPECIFYING EXAMPLE: HLSSL1212.CITR****HLSSL1212**

1

0.3

**\$276****HOW TO SPECIFY**Select  
Model Number

H 2 5 1 6

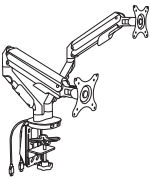
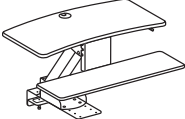
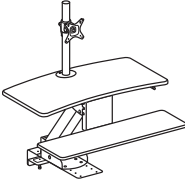
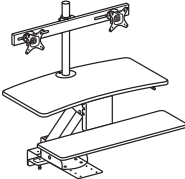
	DESCRIPTION	MODEL	SHIP WEIGHT	CUBE	LIST PRICE
	<p><b>Coordinate™ Portable Desktop Riser</b> 31"D x 4½"-16½"H x 35"W</p> <p>NOTES: Available in Black (BLK) or White (WHT) finish. Desktop riser dimensions (without keyboard tray): 22"D x 4½"-16½"H x 35"W. Keyboard tray dimensions: 9"D x 30"W. Max loading capacity is 33 lbs for the desktop riser surface and 4 lbs for the keyboard tray. Easily transition from seated to standing positions throughout the workday. Sits atop an existing desk to create sit-to-stand functionality by raising the computer. Includes keyboard tray and surface for computer monitors. <b>HON 5-Year Limited Warranty.</b></p> <p>⚠ Not intended for use on mobile workstations.</p>	<b>HBXRISER</b>	54.0	4.1	<b>\$500</b>
	<p><b>Dual Monitor Arm with 2 USB Ports</b></p> <p>NOTES: <b>AVAILABLE FEBRUARY 2018.</b> Easy adjustment. Height adjusts to 17" tall. Monitor tilt and swivel capability. Enclosed cable management. Grommet or desktop mounting. Clean appearance. For additional information see page 899.</p> <p>⚠ No specification needed.</p>	<b>HBDMAUSB</b>	41.9	2.6	<b>\$360</b>
	<p><b>Coordinate™ Mounted Desktop Riser</b></p> <p>NOTES: Does not include a monitor arm and is suitable for laptops and/or monitors on their original stands.</p> <p>⚠ No specification needed.</p>	<b>HS1100</b>	60.0 Ⓢ	3.2	<b>\$525</b>
	<p><b>Coordinate™ Mounted Desktop Riser with Single Monitor Arm</b></p> <p>NOTES: Includes a monitor arm for a single monitor.</p> <p>⚠ No specification needed.</p>	<b>HS1101</b>	62.0 Ⓢ	3.2	<b>\$615</b>
	<p><b>Coordinate™ Mounted Desktop Riser with Dual Monitor Arm</b></p> <p>NOTES: Includes a monitor arm for dual monitors.</p> <p>⚠ No specification needed.</p>	<b>HS1102</b>	63.0 Ⓢ	3.2	<b>\$700</b>

**NOTES FOR HS1100, HS1101, HS1102:**

- These products are designed to allow the user to transition from seating position to standing position throughout the workday.
- Gas-assist lever-operated mechanism with positive stop.
- Clamp mount compatible with worksurfaces depths of 20"-30". 20" is for systems only.
- Clamp requires 3.5" of clearance along back edge of worksurface.
- Black seamless worksurfaces.
- Silver powder coated metal components.
- Lowers below worksurface level on 24" and 30"D worksurfaces.
- All models contain a large primary worksurface and a smaller keyboard / mouse surface.
- Beveled edges for sleek appearance and comfort while typing.
- Monitor arms include height, width, and swivel adjustment.
- For additional information see page 906.

- Not for use under overhead storage, with flush mounted modesty panels, or worksurfaces thinner than 1".

⚠ Not recommended for use on mobile (castered) worksurfaces.

**MOUNTING AND COMPATIBILITY FOR HS1100, HS1101, HS1102:**

- This product is intended to be installed on commercial-grade worksurfaces in good condition.
- Compatible with freestanding worksurfaces 24"-30"D or panel-supported worksurfaces 24"-30"D.
- Not for use on mobile worksurfaces.

**Clamp Mount**

Use when 3.5" minimum overhang is available

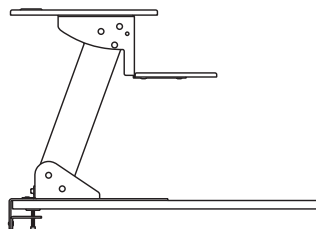

**Screw Mount**

Use when no overhang is available. Worksurface must be minimum 1" thick.

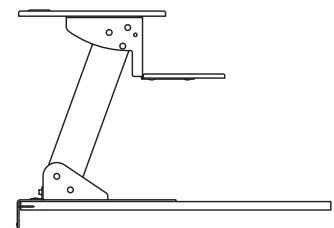

**HOW TO SPECIFY**

<p><b>Select Model Number</b></p> <p>HBXRISER.</p>	<p><b>Select Finish</b></p> <p>BLK Black WHIT White</p> <p>BLK</p>
--	--



# METRO CLASSIC

## Accessories

OPEN MARKET

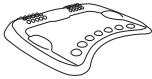
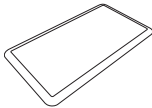
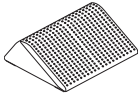

Icon Legend on page 21

	DESCRIPTION	MODEL	SHIP WEIGHT	CUBE	LIST PRICE
	<b>Rectangle Wobble Board — Anti-Fatigue Mat</b> 18"D x 3"H x 22½"W ⓘ Available in Black (T) finish ONLY. Recommended weight capacity not to exceed 250 pounds. <b>HON 5-Year Limited Warranty.</b> <b>SPECIFYING EXAMPLE: HVL981.T</b>	<b>HVL981</b>	10.0 <b>Ⓔ</b>	0.9	<b>\$220</b>
	<b>Round Wobble Board — Anti-Fatigue Mat</b> 18½"D x 2½"H x 18½"W ⓘ Available in Black (T) finish ONLY. Recommended weight capacity not to exceed 250 pounds. <b>HON 5-Year Limited Warranty.</b> <b>SPECIFYING EXAMPLE: HVL982.T</b>	<b>HVL982</b>	5.8 <b>Ⓔ</b>	0.6	<b>\$190</b>
	<b>Ergonomic Anti-Fatigue Mat</b> 25"D x 2¾"H x 29⅞"W ⓘ <b>AVAILABLE FEBRUARY 2018.</b> Available in Black ONLY. No specification needed. <b>SPECIFYING EXAMPLE: HBEAFM1</b>	<b>HBEAFM1</b>	7.0	1.4	<b>\$176</b>
	<b>Rectangle Anti-Fatigue Mat</b> 20"D x ¾"H x 36"W ⓘ <b>AVAILABLE FEBRUARY 2018.</b> Available in Black ONLY. No specification needed. <b>SPECIFYING EXAMPLE: HBAFM2036</b>	<b>HBAFM2036</b>	5.4	0.4	<b>\$80</b>
	<b>Footrest — Anti-Slip Cover</b> 13¾"D x 5½"H x 16"W ⓘ Available in Black (T) finish ONLY. Recommended weight capacity not to exceed 250 pounds. <b>HON 5-Year Limited Warranty.</b> <b>SPECIFYING EXAMPLE: HVL991.T</b>	<b>HVL991</b>	7.0 <b>Ⓔ</b>	0.9	<b>\$65</b>

### HOW TO SPECIFY

Select  
Model Number

H V L 9 8 1 .

Select  
Finish

T Black

T

# 34000 SERIES



34000 Series shown with 500 Series Lateral and Volt® Seating.

## 34000 SERIES

The 34000 Series gets high marks in the classroom — or any environment requiring a heavy-duty metal desk that knows how to look good. The square Chrome legs and brushed Aluminum handles look clean and uncomplicated. The Tru-Fit mitered drawer fronts line up perfectly every time. Desk models offer central locking, so all the drawers can be secured with the turn of a single key. And with HON's best-in-class construction, 34000 Series will stand up to years of use.



## FEATURES

- Legs are Chrome for a contemporary accent.
- Pedestals feature Tru-Fit mitered drawer fronts that align precisely when closed.
- All drawers lock by securing the center drawer; lock core can be changed as security needs require.
- Contract-grade, multi-ply laminate worksurface stands up to scratches, spills, stains and boiling liquids.
- Brushed Aluminum drawer handles match HON vertical file handles.

# 34000 SERIES ORDERING INFORMATION

## 34000 SERIES FINISHES AVAILABILITY

L1 LAMINATES		CODES
Woodgrain	◆ Bourbon Cherry	H
	◆ Cognac	COGN
	◆ Harvest	C
	◆ Mahogany	N
	◆ Mocha	MOCH
	◆ Natural Maple	D
	◆ Shaker Cherry	F
Solid	◆ Black	P
	◆ Brilliant White	WHIT
	◆ Charcoal	S
	◆ Loft	LOFT
	◆ Whitestone	K4
Patterned	◆ Sheer Mesh*	A5
	◆ Silver Mesh*	B9
	◆ Steel Mesh*	A9
	◆ Canyon Zephyr	K9
	◆ Desert Zephyr	K8
	◆ Shadow Zephyr	K1
	◆ Gray*	G2
	◆ Grey Tigris	L6
	◆ White	G1
PAINTS		CODES
Core	◆ Black	P
	◆ Charcoal	S
	◆ Greige	T5
	◆ Light Gray	Q
	◆ Loft	LOFT
	◆ Muslin	T3
	◆ Putty	L
	◆ Shadow	SHDW

- STEEL DESKS  
SPECIFY: Model Number.  
Top Laminate  
Paint Color  
EXAMPLE: H34962.NS

\* **Noted Patterned** laminate colors will have the following pre-set edgeband colors:



Sheer Mesh	Muslin
Silver Mesh	Loft
Steel Mesh	Charcoal
Gray	Charcoal

◆◆◆ For lead time information see page 21.

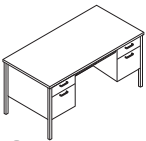
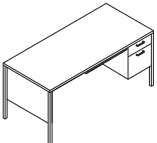
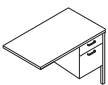

Icon Legend on page 21

# 34000 SERIES Steel Desks

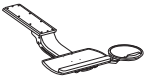
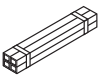
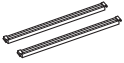
	DESCRIPTION	MODEL	SHIP WEIGHT	CUBE	LIST PRICE
	<b>Double Pedestal — 2/2 (locking)</b> 60"W x 30"D x 29½"H	<b>H34962</b>	162.0	26.7	<b>\$1151</b>
	<b>Single Pedestal, box/file (locking)</b> 66"W x 30"D x 29½"H, Right 66"W x 30"D x 29½"H, Left 48"W x 30"D x 29½"H, Right 45¼"W x 24"D x 29½"H, Right	<b>H34973R</b> <b>H34974L</b> <b>H34251</b> <b>H34002R</b>	161.0 161.0 115.0 83.0	29.2 29.2 21.6 16.6	<b>\$994</b> <b>\$994</b> <b>\$877</b> <b>\$750</b>
	<b>Return, Box/File (non-locking)</b> 42"W x 24"D x 29½"H, Right 42"W x 24"D x 29½"H, Left  NOTES: Returns are for use with 66"W Single Pedestal Desks.	<b>H34834R</b> <b>H34835L</b>	89.0 89.0	15.5 15.5	<b>\$660</b> <b>\$660</b>
	<b>Credenza with Kneespace — 2/2 (non-locking)</b> 60"W x 24"D x 29½"H <b>! Accommodates optional HD2 or HD8 center drawer.</b>	<b>H34480</b>	160.0	21.8	<b>\$1156</b>
	<b>Sit to Stand Arm with Convertible Keyboard Platform</b> <b>Articulating Arm with Convertible Keyboard Platform</b> <b>Articulating Arm with Keyboard Platform</b>  NOTES: For additional information see page 900.  Refer to page 75 for additional product information	<b>H2516 OPEN MARKET</b> <b>H2107 OPEN MARKET</b> <b>H1706 OPEN MARKET</b>	17.0 <b>Ⓢ</b> 16.0 <b>Ⓢ</b> 16.0 <b>Ⓢ</b>	1.6 1.3 1.4	<b>\$565</b> <b>\$484</b> <b>\$451</b>
	<b>Chrome Leg Packs — Field Installable</b> 4 pk-29½"H	<b>HC14</b>	7.2 <b>Ⓢ</b>	0.2	<b>\$118</b>
	<b>Double-Rail Hanging File Racks — 2 Pack (for side-to-side)</b> <b>! Gray only</b>	<b>H519495</b>	0.5	0.5	<b>\$31</b>

**NOTES:**

- "Tru-fit" mitered drawer fronts for better visual alignment.
- 3/4 height modesty panels.
- Chrome legs shipped unattached.
- Laminate tops.
- Central locking center drawer standard, with HON "One Key" interchangeable lock cores.
- 90% extension triple-tied cradles on all file drawers.
- High-sided file drawers accept hanging files without hangrails. Spring-loaded follower blocks standard.
- 3/4 extension box drawers with one divider standard.
- Reinforced, double "O" frame inner structure keeps desk solid and sturdy for years of use.
- All interior drawer bodies are gray, pre-painted steel.

**! Keyed-alike cores ordered separately — see page 922.**

## HOW TO SPECIFY

<p><b>Select Model Number</b></p> <p>H 3 4 9 6 2</p>	<p><b>Select Laminate</b></p> <p>See page 420</p> <p>N</p>	<p><b>Select Paint Color</b></p> <p>See page 420</p> <p>S</p>
--	--	---



# 34000 SERIES

## Accessories

GSA SIN AS NOTED

ABI

Icon Legend on page 21

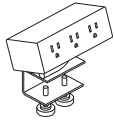

Model HPWRMOD3WC shown

SIN 711-2

**DESCRIPTION****Power Modules**

3 Receptacles with Worksurface Clamp

2 Receptacles 2 USB with Worksurface Clamp

- 6' power cord with standard three-prong plug.

- Under-worksurface mounting bracket models work with any top that has a 5" x 5" square clearance.

- Worksurface clamp models work on any top with a 4" overhang.

- UL Listed.

NOTES: For additional information see page 917.

! Color finish coordinates with HON's Charcoal or White. Specify *S* for Charcoal or *WHIT* for White when ordering.  
Example: HPWRMOD3WC.S.

**MODEL****SHIP WEIGHT****CUBE****LIST PRICE****HPWRMOD3WC**

2.3 Ⓢ

0.2

**\$279****HPWRMOD2WC**

2.3 Ⓢ

0.2

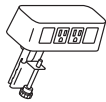
**\$447**

SIN 711-2

**Power & Data Center**

2 Receptacles 2 Data Accessory

- Standard with two receptacles and openings for two data ports.

- 6' power cord with standard three-prong plug.

- Fits on any worksurface with a 4" overhang.

- UL Listed.

NOTES: For additional information see page 917.

! Color finish coordinates with HON's Loft. Specify *LOFT* when ordering. Example: HCOMDOME2.LOFT.

**HCOMDOME2**

2.5 Ⓢ

0.2

**\$266**

SIN 711-2

**Vertebrae**

NOTES: For additional information see page 920.

! Clear finish. Specify "X" for finish option.

**SPECIFYING EXAMPLE: HMPVWM28.X****HMPVWM28**

3.0

0.3

**\$200**

OPEN MARKET

**CPU Holder**

- Vertically mounts to underside of worksurface.

- 360° swivel.

- Supports up to 55 lbs.

- Height adjustable from 16" to 22" below worksurface.

- Width adjustable to accept units from 3¼" to 6".

NOTES: For additional information see page 899.

! Silver finish only, no specification needed.

**HCPU**

16.0 Ⓢ

0.5

**\$236**

SIN 711-2

**Storage Cube**

12"W x 12"D

NOTES: Available in the following colors: Autumn (AUTM), Citron (CITR), Flame (FLAM), Pool (POOL) and Sisal (SISL). For additional information see page 914.

**SPECIFYING EXAMPLE: HLSSL1212.CITR****HLSSL1212**

1.0

0.3

**\$276****HOW TO SPECIFY**Select  
Model Number

H P W R M O D 3 W C

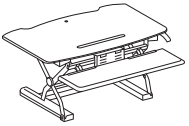
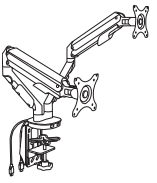
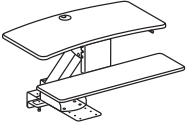
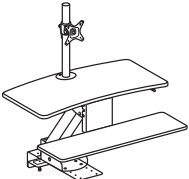
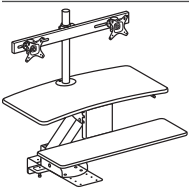
	DESCRIPTION	MODEL	SHIP WEIGHT	CUBE	LIST PRICE
	<p><b>Coordinate™ Portable Desktop Riser</b> 31"D x 4½"-16½"H x 35"W</p> <p>NOTES: Available in Black (BLK) or White (WHT) finish. Desktop riser dimensions (without keyboard tray): 22"D x 4½"-16½"H x 35"W. Keyboard tray dimensions: 9"D x 30"W. Max loading capacity is 33 lbs for the desktop riser surface and 4 lbs for the keyboard tray. Easily transition from seated to standing positions throughout the workday. Sits atop an existing desk to create sit-to-stand functionality by raising the computer. Includes keyboard tray and surface for computer monitors. <b>HON 5-Year Limited Warranty.</b></p> <p>⚠ Not intended for use on mobile workstations.</p>	<b>HBXRISER</b>	54.0	4.1	<b>\$500</b>
	<p><b>Dual Monitor Arm with 2 USB Ports</b></p> <p>NOTES: <b>AVAILABLE FEBRUARY 2018.</b> Easy adjustment. Height adjusts to 17" tall. Monitor tilt and swivel capability. Enclosed cable management. Grommet or desktop mounting. Clean appearance. For additional information see page 899.</p> <p>⚠ No specification needed.</p>	<b>HBDMAUSB</b>	41.9	2.6	<b>\$360</b>
	<p><b>Coordinate™ Mounted Desktop Riser</b></p> <p>NOTES: Does not include a monitor arm and is suitable for laptops and/or monitors on their original stands.</p> <p>⚠ No specification needed.</p>	<b>HS1100</b>	60.0 Ⓢ	3.2	<b>\$525</b>
	<p><b>Coordinate™ Mounted Desktop Riser with Single Monitor Arm</b></p> <p>NOTES: Includes a monitor arm for a single monitor.</p> <p>⚠ No specification needed.</p>	<b>HS1101</b>	62.0 Ⓢ	3.2	<b>\$615</b>
	<p><b>Coordinate™ Mounted Desktop Riser with Dual Monitor Arm</b></p> <p>NOTES: Includes a monitor arm for dual monitors.</p> <p>⚠ No specification needed.</p>	<b>HS1102</b>	63.0 Ⓢ	3.2	<b>\$700</b>

**NOTES FOR HS1100, HS1101, HS1102:**

- These products are designed to allow the user to transition from seating position to standing position throughout the workday.
- Gas-assist lever-operated mechanism with positive stop.
- Clamp mount compatible with worksurfaces depths of 20"-30". 20" is for systems only.
- Clamp requires 3.5" of clearance along back edge of worksurface.
- Black seamless worksurfaces.
- Silver powder coated metal components.
- Lowers below worksurface level on 24" and 30"D worksurfaces.
- All models contain a large primary worksurface and a smaller keyboard / mouse surface.
- Beveled edges for sleek appearance and comfort while typing.
- Monitor arms include height, width, and swivel adjustment.
- For additional information see page 906.

- Not for use under overhead storage, with flush mounted modesty panels, or worksurfaces thinner than 1".

⚠ Not recommended for use on mobile (castered) worksurfaces.

**MOUNTING AND COMPATIBILITY FOR HS1100, HS1101, HS1102:**

- This product is intended to be installed on commercial-grade worksurfaces in good condition.
- Compatible with freestanding worksurfaces 24"-30"D or panel-supported worksurfaces 24"-30"D.
- Not for use on mobile worksurfaces.

**Clamp Mount**

Use when 3.5" minimum overhang is available

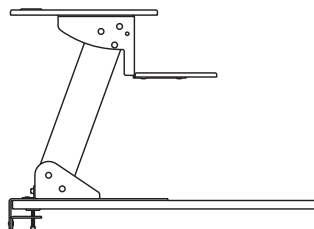

**Screw Mount**

Use when no overhang is available. Worksurface must be minimum 1" thick.

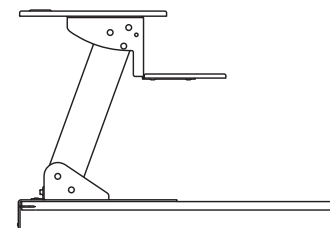

**HOW TO SPECIFY**

<p><b>Select Model Number</b></p> <p>HBXRISER.</p>	<p><b>Select Finish</b></p> <p>BLK Black WHIT White</p> <p>BLK</p>
--	--



# 34000 SERIES

## Accessories

OPEN MARKET

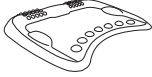
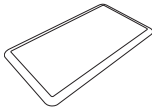
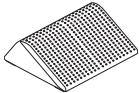

Icon Legend on page 21

	DESCRIPTION	MODEL	SHIP WEIGHT	CUBE	LIST PRICE
	<b>Rectangle Wobble Board — Anti-Fatigue Mat</b> 18"D x 3"H x 22½"W ⓘ Available in Black (T) finish ONLY. Recommended weight capacity not to exceed 250 pounds. <b>HON 5-Year Limited Warranty.</b> <b>SPECIFYING EXAMPLE: HVL981.T</b>	<b>HVL981</b>	10.0 <b>Ⓔ</b>	0.9	<b>\$220</b>
	<b>Round Wobble Board — Anti-Fatigue Mat</b> 18½"D x 2½"H x 18½"W ⓘ Available in Black (T) finish ONLY. Recommended weight capacity not to exceed 250 pounds. <b>HON 5-Year Limited Warranty.</b> <b>SPECIFYING EXAMPLE: HVL982.T</b>	<b>HVL982</b>	5.8 <b>Ⓔ</b>	0.6	<b>\$190</b>
	<b>Ergonomic Anti-Fatigue Mat</b> 25"D x 2¾"H x 29⅞"W ⓘ <b>AVAILABLE FEBRUARY 2018.</b> Available in Black ONLY. No specification needed. <b>SPECIFYING EXAMPLE: HBEAFM1</b>	<b>HBEAFM1</b>	7.0	1.4	<b>\$176</b>
	<b>Rectangle Anti-Fatigue Mat</b> 20"D x ¾"H x 36"W ⓘ <b>AVAILABLE FEBRUARY 2018.</b> Available in Black ONLY. No specification needed. <b>SPECIFYING EXAMPLE: HBAFM2036</b>	<b>HBAFM2036</b>	5.4	0.4	<b>\$80</b>
	<b>Footrest — Anti-Slip Cover</b> 13¾"D x 5½"H x 16"W ⓘ Available in Black (T) finish ONLY. Recommended weight capacity not to exceed 250 pounds. <b>HON 5-Year Limited Warranty.</b> <b>SPECIFYING EXAMPLE: HVL991.T</b>	<b>HVL991</b>	7.0 <b>Ⓔ</b>	0.9	<b>\$65</b>

### HOW TO SPECIFY

<b>Select Model Number</b> H V L 9 8 1 .	<b>Select Finish</b> T Black
---	---------------------------------

# 38000 SERIES™



38000 Series™ Station shown with Solve® Seating.

## 38000 SERIES™

The 38000 Series is America's best-selling steel desk — and with good reason. Rugged good looks. Precision engineering. Best-in-class construction. This modular collection blends designer touches like stylish, high-pressure laminate with useful details like cord-management. Which makes the 38000 Series the ideal desk solution for any organization seeking premium performance for a moderate price.



## FEATURES

- Our steel construction is best in class — so it stands up to heavy use and frequent relocation.
- Integrated wire management and optional power hub accommodate today's electronic office.
- Pedestals feature Tru-Fit mitered drawer fronts for precision alignment when closed.
- Curved, waterfall-shaped edge profile provides a comfortable typing surface.
- Premium, multi-ply laminate worksurface stands up to scratches, spills and stains, and holds up under heavy use.
- Steel ball-bearing drawer suspensions operate easily and quietly.
- Cord management provides access to wall outlets, and allows cords to run through the or between components.

# 38000 SERIES™ ORDERING INFORMATION

## 38000 SERIES™ FINISHES AVAILABILITY

		38000 Series™	38000 Stack-on Hutch
L1 LAMINATES		CODES	
Woodgrain	◆ Bourbon Cherry	H	•
	◆ Cognac	COGN	•
	◆ Harvest	C	•
	◆ Mahogany	N	•
	◆ Mocha	MOCH	•
	◆ Natural Maple	D	•
	◆ Pinnacle	PINC	•
Solid	◆ Shaker Cherry	F	•
	◆ Black	P	•
	◆ Brilliant White	WHIT	•
	◆ Charcoal	S	•
	◆ Loft	LOFT	•
Patterned	◆ Whitestone	K4	•
	◆ Sheer Mesh*	A5	•
	◆ Silver Mesh*	B9	•
	◆ Steel Mesh*	A9	•
	◆ Canyon Zephyr	K9	•
	◆ Desert Zephyr	K8	•
	◆ Shadow Zephyr	K1	•
	◆ Gray*	G2	•
	◆ Grey Tigris	L6	•
◆ White	G1	•	
PAINTS		CODES	
Core	◆ Black	P	• •
	◆ Charcoal	S	• •
	◆ Greige	T5	• •
	◆ Light Gray	Q	• •
	◆ Loft	LOFT	• •
	◆ Muslin	T3	• •
	◆ Putty	L	• •
	◆ Shadow	SHDW	• •
Choice/ Metallic	◆ Brilliant White	WHIT	• •
	◆ Champagne Metallic	T4	• •
	◆ Platinum Metallic	T1	• •

\* Noted **Patterned** laminate colors will have the following pre-set edgeband colors:

Sheer Mesh	Muslin
Silver Mesh	Loft
Steel Mesh	Charcoal
Gray	Charcoal

◆◆◆ For lead time information see page 21.

- STEEL DESKS  
SPECIFY: Model Number.  
Top Laminate  
Paint Color  
EXAMPLE: H38934.NS
- 38000 TACKBOARDS  
(Fabric listed on pages 35-36)  
SPECIFY: Model Number  
Fabric Style.  
Color Code  
Paint Color  
EXAMPLE: HT72.CE18.P

# 38000 SERIES™ ORDERING INFORMATION

## ColorCorrect® CHOICE COLORS

			38000 Series™ ②	38000 Stack-on Hutch ③
PAINTS		CODES		
Haworth®	◆ Beige	D1	•	•
	◆ Chalk <sup>1</sup>	T3	•	•
	◆ Charcoal	D2	•	•
	◆ Graphite	D5	•	•
	◆ Putty	D6	•	•
	◆ Sand	D3	•	•
	◆ Smoke	D7	•	•
Herman Miller®	◆ Inner Tone	J2	•	•
	◆ Inner Tone Light	J5	•	•
	◆ Light Tone	J6	•	•
	◆ Medium Tone	H8	•	•
	◆ Slate Gray	H7	•	•
Knoll®	◆ Jet Black <sup>2</sup>	P	•	•
	◆ Medium Gray	K1	•	•
	◆ Pumice	K4	•	•
	◆ Soft Gray	K3	•	•
	◆ Taupe	K5	•	•
Steelcase®	◆ Black <sup>3</sup>	P	•	•
	◆ Cream	K6	•	•
	◆ Grey Value 1	K9	•	•
	◆ Midnight	K7	•	•
	◆ Tan Value 1	K8	•	•

<sup>1</sup> Haworth Chalk is the same as HON Muslin. When ordering this color use the HON Muslin paint code T3.

<sup>2</sup> Knoll Jet Black is the same as HON Black. When ordering this color use the HON Black paint code P.

<sup>3</sup> Steelcase Black is the same as HON Black. When ordering this color use the HON Black paint code P.

NOTES: Choice color selections do not require a customer approval. The colors can be ordered with the HON paint code noted above.

Pricing for eligible product is listed on the individual list pricer pages under the column Choice/Metallic column.

No minimum order is required for Choice Colors.

Refer to page 17 for detailed information on the ColorCorrect® Program.

### Custom Paint Colors

Custom Paint Colors require a special request submitted within MyProjects. Refer to page 17 for detailed information regarding Custom Paints.

◆◆◆ For lead time information see page 21.

# 38000 SERIES™

## Typicals — 3/4 Height Pedestals



Icon Legend on page 21

Components used are listed on pages 432-439. Order components individually. Other configurations are possible, including various sizes of some components.

QTY	DESCRIPTION	MODEL	LIST PRICE	PRICE EXTENSION
1	<b>Double Pedestal Desk</b> 72"W x 36"D x 29½"H	H38180	\$1,744	\$1,744
1	<b>Credenza with Kneespace</b> 72"W x 24"D x 29½"H	H38854	\$1,514	\$1,514
<b>TOTAL:</b>			<b>\$3,258</b>	

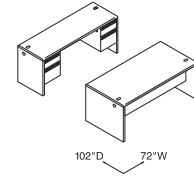

**DESK WORKSTATION WITH CREDEZA**  
72"W x 102"D

QTY	DESCRIPTION	MODEL	LIST PRICE	PRICE EXTENSION
1	<b>Single Pedestal Desk</b> 72"W x 36"D x 29½"H	H38293R	\$1,554	\$1,554
1	<b>Stack-on Storage w/o Doors</b> 72½"W x 13½"D x 34¾"H	H386572N	\$820	\$820
1	<b>Bridge</b> 48"W x 24"D x 37⅞"H	H38210	\$522	\$522
1	<b>Flipper Doors</b> 2@36"W x 15"H	H387215	\$509	\$509
1	<b>Single Pedestal Credenza</b> 72"W x 24"D x 29½"H	H38855L	\$1,290	\$1,290
<b>TOTAL:</b>			<b>\$4,695</b>	

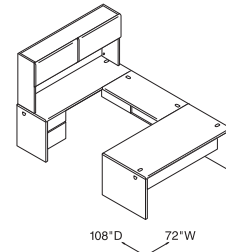

**DESK "U" WORKSTATION**  
72"W x 108"D

QTY	DESCRIPTION	MODEL	LIST PRICE	PRICE EXTENSION
1	<b>Single Pedestal Desk</b> 72"W x 36"D x 29½"H	H38293R	\$1,554	\$1,554
1	<b>Stack-on Storage w/o Doors</b> 72½"W x 13½"D x 34¾"H	H386572N	\$820	\$820
1	<b>Left, Return, box/file</b> 60"W x 24"D x 29½"H	H38218L	\$1,032	\$1,032
1	<b>Flipper Doors</b> 2@36"W x 15"H	H387215	\$509	\$509
<b>TOTAL:</b>			<b>\$3,915</b>	

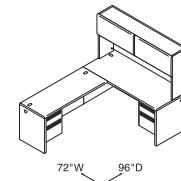

**DESK "L" WORKSTATION**  
72"W x 96"D

QTY	DESCRIPTION	MODEL	LIST PRICE	PRICE EXTENSION
1	<b>Peninsula with Full End Panel</b> 70"W x 36"D x 29½"H	H38941	\$1,214	\$1,214
1	<b>Stack-on Storage w/o Doors</b> 72½"W x 13½"D x 34¾"H	H386572N	\$820	\$820
1	<b>Bridge</b> 42"W x 24"D x 29½"H	H38220	\$497	\$497
1	<b>Flipper Doors</b> 2@36"W x 15"H	H387215	\$509	\$509
1	<b>Single Pedestal Credenza, Left</b> 72"W x 24"D x 29½"H	H38855L	\$1,290	\$1,290
<b>TOTAL:</b>			<b>\$4,330</b>	

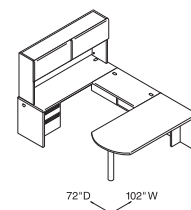

**PENINSULA "U" WORKSTATION**  
72"W x 102"D



Icon Legend on page 21

# 38000 SERIES™ Typicals — Modular

Components used are listed on pages 432-439. Order components individually. Other configurations are possible, including various sizes of some components.

QTY	DESCRIPTION	MODEL	LIST PRICE	PRICE EXTENSION
1	<b>Shell Desk</b> 72"W x 36"D x 29½"H	H38934	\$1,057	\$1,057
1	<b>Flagship Mobile Pedestal – file/file</b> 15"W x 22⅞"D x 28"H	H18823R	\$672	\$672
1	<b>Return Shell, Left</b> 48"W x 24"D x 29½"H	H38944L	\$736	\$736
1	<b>Standard Height Mobile Pedestal – box/box/file</b> 15"W x 16⅞"D x 28"H	H18717R	\$625	\$625
<b>TOTAL:</b>			<b>\$3,090</b>	

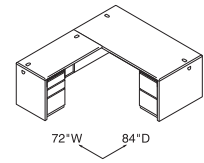

**MODULAR DESK WORKSTATION**  
84"W x 72"D

QTY	DESCRIPTION	MODEL	LIST PRICE	PRICE EXTENSION
1	<b>Shell Desk</b> 72"W x 36"D x 29½"H	H38934	\$1,057	\$1,057
1	<b>Flagship Mobile Pedestal – file/file</b> 15"W x 22⅞"D x 28"H	H18823R	\$672	\$672
1	<b>Bridge</b> 48"W x 24"D x 29½"H	H38210	\$522	\$522
1	<b>Shell Desk</b> 72"W x 24"D x 29½"H	H38925	\$1,023	\$1,023
1	<b>Standard Height Mobile Pedestal – box/box/file</b> 15"W x 16⅞"D x 28"H	H18717R	\$625	\$625
1	<b>Stack-on Storage w/o Doors</b> 72⅝"W x 13½"D x 34¾"H	H386572N	\$820	\$820
<b>TOTAL:</b>			<b>\$4,719</b>	

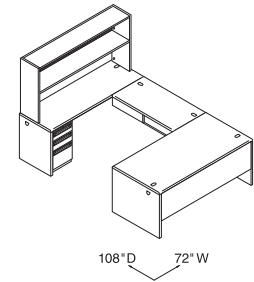

**MODULAR DESK "U" WORKSTATION**  
72"W x 108"D

QTY	DESCRIPTION	MODEL	LIST PRICE	PRICE EXTENSION
1	<b>Corner Unit</b>	H38928	\$1,187	\$1,187
1	<b>Peninsula with End Panel</b> 70"W x 36"D x 29½"H	H38941	\$1,214	\$1,214
1	<b>Bridge</b> 42"W x 24"D x 29½"H	H38220	\$497	\$497
1	<b>Shell Return, Right</b> 72"W x 24"D x 29½"H	H38947R	\$980	\$980
1	<b>Flagship Lateral File</b> 30"W x 18"D x 28"H	H9170R	\$873	\$873
1	<b>Stack-on Storage w/o Doors</b> 72⅝"W x 13½"D x 34¾"H	H386572N	\$820	\$820
1	<b>Flipper Doors</b> 2@36"W x 15"H	H387215	\$509	\$509
<b>TOTAL:</b>			<b>\$6,080</b>	

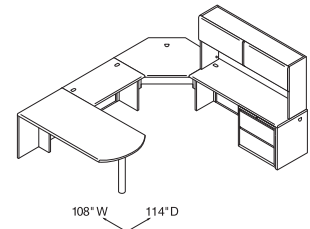

**PENINSULA "U" WORKSTATION**  
108"W x 114"D

QTY	DESCRIPTION	MODEL	LIST PRICE	PRICE EXTENSION
1	<b>Corner Unit</b>	H38928	\$1,187	\$1,187
1	<b>Shell Return, Left</b> 72"W x 24"D x 29½"H	H38948L	\$980	\$980
1	<b>Standard Height Mobile Pedestal – box/box/file</b> 15"W x 16⅞"D x 28"H	H18717R	\$625	\$625
1	<b>Stack-on Storage w/o Doors</b> 72⅝"W x 13½"D x 34¾"H	H386572N	\$820	\$820
1	<b>Flipper Doors</b> 2@36"W x 15"H	H387215	\$509	\$509
1	<b>Shell Return – Right</b> 72"W x 24"D x 29½"H	H38947R	\$980	\$980
1	<b>Standard Height Mobile Pedestal – file/file</b> 15"W x 16⅞"D x 28"H	H18817R	\$625	\$625
<b>TOTAL:</b>			<b>\$5,726</b>	

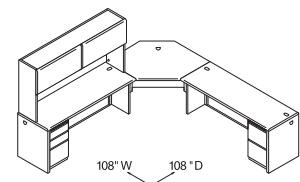

**CORNER UNIT WITH RETURNS  
WORKSTATION**  
108"W x 108"D



# 38000 SERIES™ Bundles Typicals



Icon Legend on page 21

Mahogany/Charcoal  
**H38LL7284NS**

Harvest/Putty  
**H38LL7284CL**

QTY	DESCRIPTION	MODEL	LIST PRICE	PRICE EXTENSION
1	Left Pedestal Desk	<b>H38294L</b>	\$1,554	\$1,554
1	Right Return	<b>H38215R</b>	\$940	\$940
<b>TOTAL:</b>			<b>\$2,494</b>	

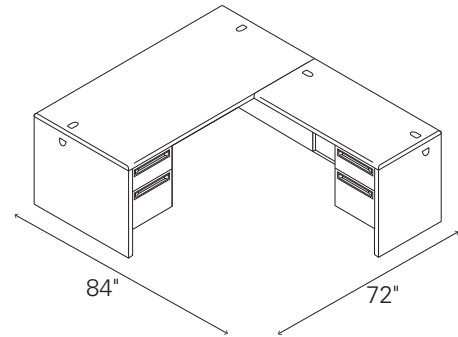

**L-STATION (LEFT DESK/RIGHT RETURN)**

Mahogany/Charcoal  
**H38LR7284NS**

Harvest/Putty  
**H38LR7284CL**

QTY	DESCRIPTION	MODEL	LIST PRICE	PRICE EXTENSION
1	Right Pedestal Desk	<b>H38293R</b>	\$1,554	\$1,554
1	Left Return	<b>H38216L</b>	\$940	\$940
<b>TOTAL:</b>			<b>\$2,494</b>	

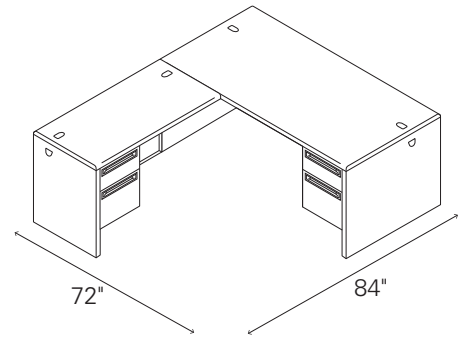

**L-STATION (RIGHT DESK/LEFT RETURN)**

Mahogany/Charcoal  
**H38URH72108NS2**

Harvest/Putty  
**H38URH72108CL2**

QTY	DESCRIPTION	MODEL	LIST PRICE	PRICE EXTENSION
1	Single Pedestal Desk, Right	<b>H38293R</b>	\$1,554	\$1,554
1	Single Pedestal Credenza, Left	<b>H38855L</b>	\$1,290	\$1,290
1	Hutch without Doors	<b>H386572N</b>	\$820	\$820
1	Flipper Doors, Pair	<b>H387215</b>	\$509	\$509
1	Bridge	<b>H38210</b>	\$522	\$522
<b>TOTAL:</b>			<b>\$4,695</b>	

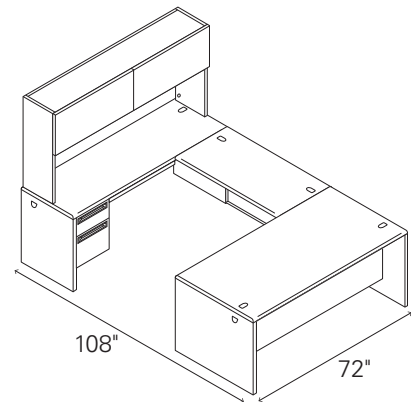

**U-STATION WITH HUTCH  
(RIGHT DESK/LEFT CREDENZA)**



Icon Legend on page 21

# 38000 SERIES™ Bundles Typicals

DESKS

Mahogany/Charcoal  
**H38ULH72108NS2**

Harvest/Putty  
**H38ULH72108CL2**

QTY	DESCRIPTION	MODEL	LIST PRICE	PRICE EXTENSION
1	Single Pedestal Desk, Left	<b>H38294L</b>	\$1,554	\$1,554
1	Single Pedestal Credenza, Right	<b>H38856R</b>	\$1,290	\$1,290
1	Hutch without Doors	<b>H386572N</b>	\$820	\$820
1	Flipper Doors, Pair	<b>H387215</b>	\$509	\$509
1	Bridge	<b>H38210</b>	\$522	\$522
<b>TOTAL:</b>				<b>\$4,695</b>

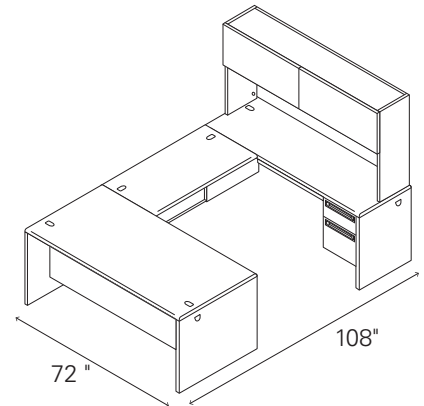

**U-STATION WITH HUTCH  
(LEFT DESK/RIGHT CREDENZA)**

Mahogany/Charcoal  
**H38DCH6096NS2**

Harvest/Putty  
**H38DCH6096CL2**

QTY	DESCRIPTION	MODEL	LIST PRICE	PRICE EXTENSION
1	Double Pedestal Desk	<b>H38155</b>	\$1,491	\$1,491
1	Double Pedestal Credenza	<b>H38852</b>	\$1,455	\$1,455
1	Hutch without Doors	<b>H386560N</b>	\$720	\$720
1	Flipper Doors, Pair	<b>H386015</b>	\$483	\$483
<b>TOTAL:</b>				<b>\$4,149</b>

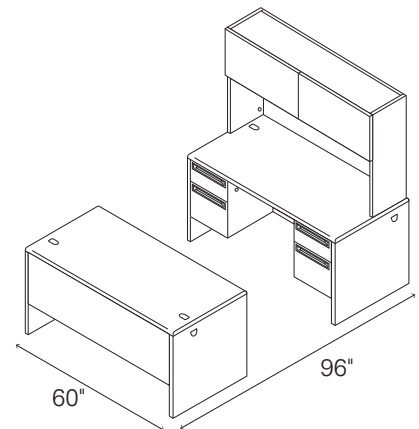

**WORKSTATION**



# 38000 SERIES™

## Steel Desks — 3/4 Pedestals

GSA SIN 711-2

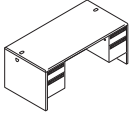
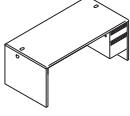

Icon Legend on page 21

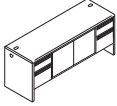
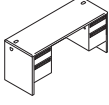
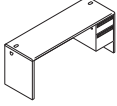
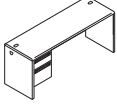
	DESCRIPTION	FULL WIDTH OVERHANG	MODEL	SHIP WEIGHT	CUBE	LIST PRICE BY PAINT GRADE		
						CORE	CHOICE/ METALLICS	CUSTOM
	<b>Double Pedestal — 2/2 w/Locks</b>	6"						
	72"W x 36"D x 29½"H — 2R		<b>H38180</b>	256	51.7	<b>\$1744</b>	<b>\$1818</b>	<b>\$1889</b>
	66"W x 30"D x 29½"H		<b>H38170</b>	224	40.1	<b>\$1669</b>	<b>\$1743</b>	<b>\$1814</b>
	60"W x 30"D x 29½"H		<b>H38155</b>	217	36.6	<b>\$1491</b>	<b>\$1565</b>	<b>\$1636</b>
	<b>Single Pedestal w/Lock</b>	6"						
	72"W x 36"D x 29½"H — 2R		<b>H38293R</b>	214	51.7	<b>\$1554</b>	<b>\$1628</b>	<b>\$1699</b>
	66"W x 30"D x 29½"H — 2R		<b>H38291R</b>	181	40.1	<b>\$1432</b>	<b>\$1506</b>	<b>\$1577</b>
	48"W x 30"D x 29½"H — 2R	<b>H38251</b>	155	29.6	<b>\$1267</b>	<b>\$1341</b>	<b>\$1412</b>	
	72"W x 36"D x 29½"H — 2L	<b>H38294L</b>	214	51.7	<b>\$1554</b>	<b>\$1628</b>	<b>\$1699</b>	
	66"W x 30"D x 29½"H — 2L	<b>H38292L</b>	181	40.1	<b>\$1432</b>	<b>\$1506</b>	<b>\$1577</b>	
	48"W x 30"D x 29½"H — 2L		<b>H38252L</b>	155	29.6	<b>\$1267</b>	<b>\$1341</b>	<b>\$1412</b>
	<b>Flush Return — box/file w/Lock</b>							
	60"W x 24"D x 29½"H — 2R		<b>H38217R</b>	138	30.1	<b>\$1032</b>	<b>\$1077</b>	<b>\$1121</b>
	48"W x 24"D x 29½"H — 2R		<b>H38215R</b>	124	24.1	<b>\$940</b>	<b>\$985</b>	<b>\$1029</b>
	60"W x 24"D x 29½"H — 2L		<b>H38218L</b>	138	30.1	<b>\$1032</b>	<b>\$1077</b>	<b>\$1121</b>
	48"W x 24"D x 29½"H — 2L		<b>H38216L</b>	124	24.1	<b>\$940</b>	<b>\$985</b>	<b>\$1029</b>
	NOTES: Returns have 2 grommets each in worksurface top and full height modesty panel.							
	<b>Credenza w/Doors w/Locks</b>		<b>H38853</b>	230	35.6	<b>\$1645</b>	<b>\$1719</b>	<b>\$1790</b>
	72"W x 24"D x 29½"H							
	NOTES: Pedestals lock.							
	<b>Credenza w/Kneespace w/Locks</b>							
	72"W x 24"D x 29½"H		<b>H38854</b>	172	35.6	<b>\$1514</b>	<b>\$1588</b>	<b>\$1659</b>
	Kneespace: 39¾"W							
	66"W x 24"D x 29½"H		<b>H38851</b>	166	32.7	<b>\$1481</b>	<b>\$1555</b>	<b>\$1626</b>
	Kneespace: 33¾"W							
60"W x 24"D x 29½"H		<b>H38852</b>	154	29.8	<b>\$1455</b>	<b>\$1529</b>	<b>\$1600</b>	
	Kneespace: 27¾"W							
	NOTES: Pedestals lock.							
	<b>Single Pedestal Credenza — 2R w/Lock</b>							
	72"W x 24"D x 29½"H		<b>H38856R</b>	159	35.6	<b>\$1290</b>	<b>\$1364</b>	<b>\$1435</b>
	66"W x 24"D x 29½"H		<b>H38858R</b>	153	32.7	<b>\$1196</b>	<b>\$1270</b>	<b>\$1341</b>
	NOTES: Pedestal locks.							
	<b>Single Pedestal Credenza — 2L w/Lock</b>							
	72"W x 24"D x 29½"H		<b>H38855L</b>	159	35.6	<b>\$1290</b>	<b>\$1364</b>	<b>\$1435</b>
	66"W x 24"D x 29½"H		<b>H38857L</b>	153	32.7	<b>\$1196</b>	<b>\$1270</b>	<b>\$1341</b>
	NOTES: Pedestal locks.							

**NOTES:**

- 3/4 height modesty panels unless noted.
- Color of pulls and grommets match paint selection for core colors.
- One pencil tray standard per unit except returns.
- Laminate particleboard tops feature attractive, radius edges on front and rear edges of desks. Returns and bridges have radius front and flat rear edge to match the side edge it attaches to.
- Wire grommets standard in all tops.
- Wire grommets in end panels allow cable connections between desks.
- "Tru-fit" mitered drawer fronts for better visual alignment.
- Optional center drawer features steel ball-bearing suspension.
- High-sided file drawers accept hanging files without hangrails.
- Spring-loaded follower blocks standard.
- Three-part full extension steel ball-bearing suspension on all file drawers for full access to interior contents.
- Box drawers feature two-part, ¾" extension steel ball-bearing suspension.
- Baked enamel finish over rust-inhibiting phosphate pre-treatment.
- See page 434 for 38000 Series™ shared components.

**HOW TO SPECIFY**Select  
Model Number

H 3 8 1 8 0 .

Select  
Laminate

See page 426

N .

Select  
Paint Color

See pages 426-427

S



Icon Legend on page 21

# 38000 SERIES™ Modular Desks

**LIST PRICE BY PAINT GRADE**

DESCRIPTION	INSIDE SHELL DIMENSIONS	FULL WIDTH OVERHANG	MODEL	SHIP WEIGHT	CUBE	CHOICE/			
						CORE	METALLICS	CUSTOM	
<b>Desk Shell</b>									
72"W x 36"D x 29½"H	69½"W x 28¾"D	6"	<b>H38934</b>	134	7.1	\$1057	\$1131	\$1202	
72"W x 30"D x 29½"H	69½"W x 28¾"D		<b>H38935</b>	118	6.0	\$1028	\$1102	\$1173	
66"W x 30"D x 29½"H	63½"W x 28¾"D		<b>H38933</b>	108	6.0	\$1013	\$1087	\$1158	
60"W x 30"D x 29½"H	57½"W x 28¾"D		<b>H38932</b>	103	5.1	\$963	\$1037	\$1108	
48"W x 30"D x 29½"H	45½"W x 28¾"D		<b>H38931</b>	89	5.1	\$890	\$964	\$1035	
72"W x 24"D x 29½"H	69½"W x 22¾"D		<b>H38925</b>	99	5.0	\$1023	\$1097	\$1168	
66"W x 24"D x 29½"H	63½"W x 22¾"D		<b>H38923</b>	95	5.0	\$978	\$1052	\$1123	
60"W x 24"D x 29½"H	57½"W x 22¾"D		<b>H38922</b>	89	4.2	\$930	\$1004	\$1075	
48"W x 24"D x 29½"H	45½"W x 22¾"D		<b>H38921</b>	83	4.2	\$871	\$945	\$1016	
<b>Return</b>									
72"W x 24"D x 29½"H, Right	69½"W x 22¾"D (2 grommets)		<b>H38947R</b>	87	6.0	\$980	\$1025	\$1069	
60"W x 24"D x 29½"H, Right	57½"W x 22¾"D (2 grommets)		<b>H38945R</b>	80	5.1	\$879	\$924	\$968	
48"W x 24"D x 29½"H, Right	45½"W x 22¾"D (2 grommets)		<b>H38943R</b>	71	4.2	\$736	\$781	\$825	
42"W x 24"D x 29½"H, Right	39½"W x 22¾"D (2 grommets)		<b>H38949R</b>	65	4.2	\$685	\$730	\$774	
72"W x 24"D x 29½"H, Left	69½"W x 22¾"D (2 grommets)		<b>H38948L</b>	87	6.0	\$980	\$1025	\$1069	
60"W x 24"D x 29½"H, Left	57½"W x 22¾"D (2 grommets)		<b>H38946L</b>	80	5.1	\$879	\$924	\$968	
48"W x 24"D x 29½"H, Left	45½"W x 22¾"D (2 grommets)		<b>H38944L</b>	71	4.2	\$736	\$781	\$825	
42"W x 24"D x 29½"H, Left	39½"W x 22¾"D (2 grommets)		<b>H38950L</b>	65	4.2	\$685	\$730	\$774	

NOTES: Modular returns feature full height modesty panels.  
 Not designed to be used freestanding.

**NOTES:**

- 38000 Series™ Modular Desks offers designer styling, configuration flexibility and storage versatility.
- Create both individual managerial stations and task-oriented work areas.
- Designed with adaptability for today's electronic office.
- Color of pulls and grommets match paint selection for core colors.
- Wire grommets standard in all tops, except peninsulas.
- Wire grommets in end panels allow cable connections between desks.
- Optional center drawer features steel ball-bearing suspension.
- For components that can be shared with 38000 Series™, see page 434.
- 3/4 height modesty panels unless noted.
- Ability to use all HON laterals and pedestals.

**Recommended Pedestal Options:**

38000 Series™	36" Deep Desk			30" Deep Desk			24" Deep Desk		
	Ability to Attach	Ability to Use Wire Port	Ability to Attach Hutch	Ability to Attach	Ability to Use Wire Port	Ability to Attach Hutch	Ability to Attach	Ability to Use Wire Port	Ability to Attach Hutch
Contain®, Flagship® or Brigade® Pedestals	•	•	•	•	•	•	•	•	•
16¾"D Hanging Pedestal	•	•	•	•	•	•	•	•	•
22⅞"D Hanging Pedestal	•	•	•	•	•	•	•	•	•
16¾"D Freestanding or Mobile	•	•	•	•	•	•	•	•	•
22⅞"D Freestanding or Mobile	•	•	•	•	•	•	•	•	•
28⅞"D Freestanding or Mobile	•	•	•	•	•	•	•	•	•

Use of a pedestal spacer or 28"H standard height pedestals will block wire access from the grommet to the kneespace area.

NOTES: Stack-on units can be attached regardless of pedestal configuration.

**Personalize Your Storage Needs With These Possible Solutions:**

Use coordinating HON components such as Pedestals shown on page 699 and Lateral Files shown on pages 701-702 and 661-669.

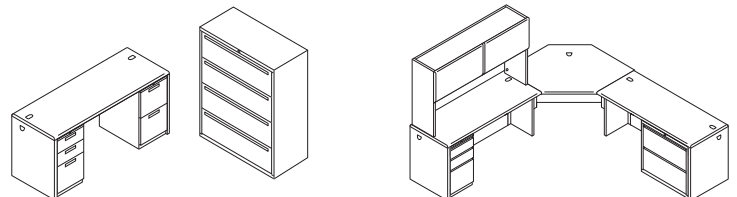

**HOW TO SPECIFY**

<p><b>Select Model Number</b></p> <p>H 3 8 9 3 4</p>	<p><b>Select Laminate</b></p> <p>See page 426</p> <p>N</p>	<p><b>Select Paint Color</b></p> <p>See pages 426-427</p> <p>S</p>
--	--	--











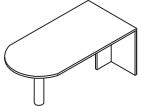



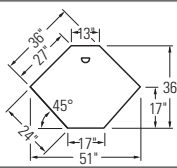
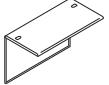





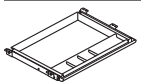

# 38000 SERIES™

## Shared Components and Accessories

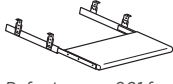
GSA SIN 711-2 EXCEPT AS NOTED



Icon Legend on page 21

	DESCRIPTION	MODEL	SHIP WEIGHT	CUBE	LIST PRICE BY PAINT GRADE			
					CORE	CHOICE/ METALLICS	CUSTOM	
  	<b>Peninsula with Support Column and End Panel</b> 70"W x 36"D x 29½"H 70"W x 30"D x 29½"H 66"W x 30"D x 29½"H	<b>H38941</b> <b>H38942</b> <b>H38966</b>	136.0 130.0 117.0	15.5 13.2 13.2	<b>\$1214</b> <b>\$1153</b> <b>\$1121</b>	<b>\$1259</b> <b>\$1198</b> <b>\$1166</b>	<b>\$1303</b> <b>\$1242</b> <b>\$1210</b>	
	NOTES: Use to create "L" configuration with a Return or "U" configuration with a Bridge and Credenza, Desk or Corner Unit.  Not designed to be used freestanding.							
	<b>Corner Unit</b> 24" x 36" x 36" x 24" x 29½"H Leading edge is 17"W; leading edge to rear edge is 36"D.		<b>H38928</b>	85.0	7.4	<b>\$1187</b>	<b>\$1261</b>	<b>\$1332</b>
  	<b>Bridge</b> 48"W x 24"D x 29½"H 42"W x 24"D x 29½"H NOTES: Full height modesty panel.	<b>H38210</b> <b>H38220</b>	54.0  50.0 	4.2 4.2	<b>\$522</b> <b>\$497</b>	<b>\$540</b> <b>\$515</b>	<b>\$555</b> <b>\$530</b>	
 Refer to page 904 <b>SIN 711-1, 711-2, 711-11</b> 	<b>Metal Center Drawers with core removable locks</b> 24¾"W x 14¾"D for H38180, H38170, H38155 19"W x 14¾"D for H38293R, H38294L, H38291R, H38292L NOTES: For additional information see page 904. Specify: Paint color.	<b>HD8</b> <b>HD2</b>	12.0  9.0 	1.2 1.0	<b>\$234</b> <b>\$234</b>	<b>\$244</b> <b>\$244</b>	<b>\$252</b> <b>\$252</b>	
 <b>OPEN MARKET</b>	<b>Polymer Center Drawer</b> <ul style="list-style-type: none"> <li>Color: Black.</li> <li>Material: ABS.</li> <li>Opening Requirements: 23"W x 16¼"D x 2"H.</li> <li>Retracts on 16" ball bearing slides.</li> <li>Can be used on worksurfaces with Coordinate™ Height Adjustable Bases as long as it is attached with spacer model HKBS.</li> <li>Can store up to 25 lbs.</li> </ul> NOTES: For additional information see page 904.  Black finish only, no specification needed.	<b>HCD1</b>	7.0	0.5	<b>\$99</b>			
 Refer to page 902 	<b>Corner Sleeve — Square Edge</b> 22½" leading edge x 18"D NOTES: For additional information see page 902. Specify: Paint color.	<b>H51206</b>	10.0 	1.5	<b>\$143</b>	<b>\$153</b>	<b>\$160</b>	
 Refer to page 901 for additional product information <b>SIN 711-1, 711-2, 711-11</b> 	<b>Slide-Away Keyboard Platform</b> (Specify: Laminate) <b>Metal Keyboard and Mouse Tray</b> (Specify paint) <b>Metal Keyboard Tray</b> (Specify paint) NOTES: For additional information see page 901.	<b>H4022</b> <b>H4028</b> <b>OPEN MARKET</b> <b>H4029</b> <b>OPEN MARKET</b>	10.0  11.0   11.0 	0.6 1.5  1.5	<b>\$199</b> <b>\$144</b>  <b>\$129</b>	 <b>\$154</b>  <b>\$139</b>		
 <b>SIN 711-3</b> 	<b>Double-Rail Hanging File Racks — 2 Pack</b> <b>(for side-to-side)</b>	<b>H519495</b>	0.5	0.5	<b>\$31</b>			

**NOTES:**

- Full end panel legs have neat, contemporary appearance.
- ¾ height modesty panels unless noted.
- Our broadest selection of components, including components for "U" and "L" workstation arrangements.
- All worksurfaces shown are particleboard.
- Color of grommets match paint selection for core colors.
- 38000 Series™ Stack-on units and accessories listed on pages 434-439.

**HOW TO SPECIFY**
**Select Model Number**

**Select Laminate**

See page 426

**Select Paint Color**

See pages 426-427

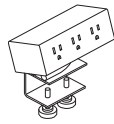

Model HPWRMOD3WC shown

SIN 711-2

**DESCRIPTION****Power Modules**

3 Receptacles with Worksurface Clamp

2 Receptacles 2 USB with Worksurface Clamp

- 6' power cord with standard three-prong plug.
- Under-worksurface mounting bracket models work with any top that has a 5" x 5" square clearance.
- Worksurface clamp models work on any top with a 4" overhang.
- UL Listed.

NOTES: For additional information see page 917.

! Color finish coordinates with HON's Charcoal or White. Specify *S* for Charcoal or *WHIT* for White when ordering.  
Example: HPWRMOD3WC.S.

**MODEL****SHIP WEIGHT****CUBE****LIST PRICE****HPWRMOD3WC**

2.3 Ⓢ

0.2

**\$279****HPWRMOD2WC**

2.3 Ⓢ

0.2

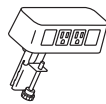
**\$447**

SIN 711-2

**Power & Data Center**

2 Receptacles 2 Data Accessory

- Standard with two receptacles and openings for two data ports.
- 6' power cord with standard three-prong plug.
- Fits on any worksurface with a 4" overhang.
- UL Listed.

NOTES: For additional information see page 917.

! Color finish coordinates with HON's Loft. Specify *LOFT* when ordering. Example: HCOMDOME2.LOFT.

**HCOMDOME2**

2.5 Ⓢ

0.2

**\$266**

SIN 711-2

**Vertebrae**

NOTES: For additional information see page 920.

! Clear finish. Specify "X" for finish option.

**SPECIFYING EXAMPLE: HMPVWM28.X****HMPVWM28**

3.0

0.3

**\$200**

OPEN MARKET

**CPU Holder**

- Vertically mounts to underside of worksurface.
- 360° swivel.
- Supports up to 55 lbs.
- Height adjustable from 16" to 22" below worksurface.
- Width adjustable to accept units from 3¼" to 6".

NOTES: For additional information see page 899.

! Silver finish only, no specification needed.

**HCPU**

16.0 Ⓢ

0.5

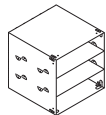
**\$236**

SIN 711-2

**Storage Cube**

12"W x 12"D

NOTES: Available in the following colors: Autumn (AUTM), Citron (CITR), Flame (FLAM), Pool (POOL) and Sisal (SISL). For additional information see page 914.

**SPECIFYING EXAMPLE: HLSL1212.CITR****HLSL1212**

1.0

0.3

**\$276****HOW TO SPECIFY**Select  
Model Number

H P W R M O D 3 W C

# 38000 SERIES™

## Accessories

OPEN MARKET

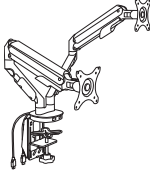
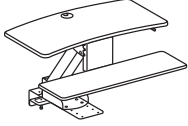
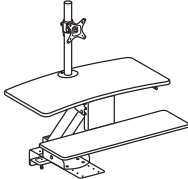
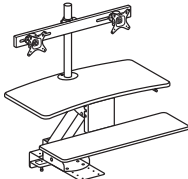
	DESCRIPTION	MODEL	SHIP WEIGHT	CUBE	LIST PRICE
	<b>Coordinate™ Portable Desktop Riser</b> 31"D x 4½"-16½"H x 35"W NOTES: Available in Black (BLK) or White (WHT) finish. Desktop riser dimensions (without keyboard tray): 22"D x 4½"-16½"H x 35"W. Keyboard tray dimensions: 9"D x 30"W. Max loading capacity is 33 lbs for the desktop riser surface and 4 lbs for the keyboard tray. Easily transition from seated to standing positions throughout the workday. Sits atop an existing desk to create sit-to-stand functionality by raising the computer. Includes keyboard tray and surface for computer monitors. <b>HON 5-Year Limited Warranty.</b> ⓘ Not intended for use on mobile workstations.	<b>HBXRISER</b>	54.0	4.1	<b>\$500</b>
	<b>Dual Monitor Arm with 2 USB Ports</b> NOTES: <b>AVAILABLE FEBRUARY 2018.</b> Easy adjustment. Height adjusts to 17" tall. Monitor tilt and swivel capability. Enclosed cable management. Grommet or desktop mounting. Clean appearance. For additional information see page 899. ⓘ No specification needed.	<b>HBDMAUSB</b>	41.9	2.6	<b>\$360</b>
	<b>Coordinate™ Mounted Desktop Riser</b> NOTES: Does not include a monitor arm and is suitable for laptops and/or monitors on their original stands. ⓘ No specification needed.	<b>HS1100</b>	60.0 ⓘ	3.2	<b>\$525</b>
	<b>Coordinate™ Mounted Desktop Riser with Single Monitor Arm</b> NOTES: Includes a monitor arm for a single monitor. ⓘ No specification needed.	<b>HS1101</b>	62.0 ⓘ	3.2	<b>\$615</b>
	<b>Coordinate™ Mounted Desktop Riser with Dual Monitor Arm</b> NOTES: Includes a monitor arm for dual monitors. ⓘ No specification needed.	<b>HS1102</b>	63.0 ⓘ	3.2	<b>\$700</b>

### NOTES FOR HS1100, HS1101, HS1102:

- These products are designed to allow the user to transition from seating position to standing position throughout the workday.
- Gas-assist lever-operated mechanism with positive stop.
- Clamp mount compatible with worksurfaces depths of 20"-30". 20" is for systems only.
- Clamp requires 3.5" of clearance along back edge of worksurface.
- Black seamless worksurfaces.
- Silver powder coated metal components.
- Lowers below worksurface level on 24" and 30"D worksurfaces.
- All models contain a large primary worksurface and a smaller keyboard / mouse surface.
- Beveled edges for sleek appearance and comfort while typing.
- Monitor arms include height, width, and swivel adjustment.
- For additional information see page 906.

- Not for use under overhead storage, with flush mounted modesty panels, or worksurfaces thinner than 1".

- ⓘ Not recommended for use on mobile (castered) worksurfaces.

### MOUNTING AND COMPATIBILITY FOR HS1100, HS1101, HS1102:

- This product is intended to be installed on commercial-grade worksurfaces in good condition.
- Compatible with freestanding worksurfaces 24"-30"D or panel-supported worksurfaces 24"-30"D.
- Not for use on mobile worksurfaces.

#### Clamp Mount

Use when 3.5" minimum overhang is available

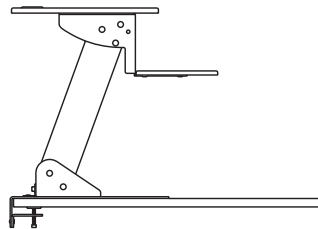

#### Screw Mount

Use when no overhang is available. Worksurface must be minimum 1" thick.

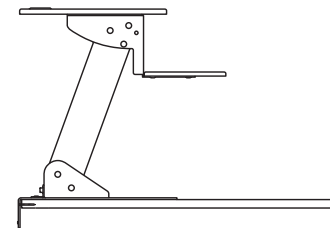

## HOW TO SPECIFY

### Select Model Number



HBXRISER.

### Select Finish

BLK Black  
WHIT White

BLK

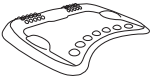
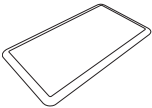
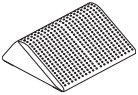

	DESCRIPTION	MODEL	SHIP WEIGHT	CUBE	LIST PRICE
	<b>Rectangle Wobble Board — Anti-Fatigue Mat</b> 18"D x 3"H x 22¼"W ⓘ Available in Black (T) finish ONLY. Recommended weight capacity not to exceed 250 pounds. <b>HON 5-Year Limited Warranty.</b> <b>SPECIFYING EXAMPLE: HVL981.T</b>	<b>HVL981</b>	10.0 Ⓔ	0.9	<b>\$220</b>
	<b>Round Wobble Board — Anti-Fatigue Mat</b> 18½"D x 2⅝"H x 18½"W ⓘ Available in Black (T) finish ONLY. Recommended weight capacity not to exceed 250 pounds. <b>HON 5-Year Limited Warranty.</b> <b>SPECIFYING EXAMPLE: HVL982.T</b>	<b>HVL982</b>	5.8 Ⓔ	0.6	<b>\$190</b>
	<b>Ergonomic Anti-Fatigue Mat</b> 25"D x 2¾"H x 29⅞"W ⓘ <b>AVAILABLE FEBRUARY 2018.</b> Available in Black ONLY. No specification needed. <b>SPECIFYING EXAMPLE: HBEAFM1</b>	<b>HBEAFM1</b>	7.0	1.4	<b>\$176</b>
	<b>Rectangle Anti-Fatigue Mat</b> 20"D x ¾"H x 36"W ⓘ <b>AVAILABLE FEBRUARY 2018.</b> Available in Black ONLY. No specification needed. <b>SPECIFYING EXAMPLE: HBAFM2036</b>	<b>HBAFM2036</b>	5.4	0.4	<b>\$80</b>
	<b>Footrest — Anti-Slip Cover</b> 13¾"D x 5½"H x 16"W ⓘ Available in Black (T) finish ONLY. Recommended weight capacity not to exceed 250 pounds. <b>HON 5-Year Limited Warranty.</b> <b>SPECIFYING EXAMPLE: HVL991.T</b>	<b>HVL991</b>	7.0 Ⓔ	0.9	<b>\$65</b>

## HOW TO SPECIFY

<p>Select Model Number</p> <p>H V L 9 8 1 . T</p>	<p>Select Finish</p> <p>T Black</p>
---	-------------------------------------



# 38000 SERIES™

## Steel Stack-on Units

GSA SIN 711-2

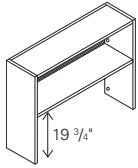

Icon Legend on page 21

**DESCRIPTION****Stack-on Full Clearance w/o doors**

72"W x 13½"D x 34¾"H

66"W x 13½"D x 34¾"H

60"W x 13½"D x 34¾"H

48"W x 13½"D x 34¾"H

NOTES: Interior is 12¾"H.

Specify: Paint color.

**MODEL****SHIP WEIGHT****CUBE****LIST PRICE BY PAINT GRADE****CHOICE/****CORE****METALLICS****CUSTOM****H386572N**

72

6.8

**\$820****\$871****\$920****H386566N**

68

6.3

**\$776****\$827****\$876****H386560N**

64

5.7

**\$720****\$771****\$820****H386548N**

53

4.7

**\$657****\$708****\$820****HOW TO SPECIFY****Select Model Number****Select Paint Color**

See pages 426-427

H 3 8 6 5 7 2 N .

P

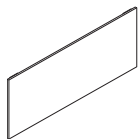
**DESCRIPTION****Front Flipper Doors**

2 @ 36"W x 15"H, Flipper Doors for 72"W Stack-on

2 @ 33"W x 15"H, Flipper Doors for 66"W Stack-on

2 @ 30"W x 15"H, Flipper Doors for 60"W Stack-on

1 @ 48"W x 15"H, Flipper Door for 48"W Stack-on

Specify: Paint color.

**MODEL****SHIP WEIGHT****CUBE****LIST PRICE BY PAINT GRADE****CHOICE/****CORE****METALLICS****CUSTOM****H387215**

19

0.9

**\$509****\$527****\$553****H386615**

17

0.9

**\$498****\$516****\$542****H386015**

16

0.9

**\$483****\$501****\$527****H384815**

12

0.5

**\$292****\$310****\$336****NOTES:**

- Flipper doors are standard with a core removable lock located on the underside of stack-on shelf.
- Many Stack-on sizes available, from 48" to 72" wide.
- Equipped with HON "One Key" interchangeable core removable locks.
- Stack-on units attach to worksurface with double stick tape or with screws provided.
- Stack-ons also compatible with Abode™, Mentor®, Metro Classic, and 66000 Series Computer Furniture.
- Cabinet/door combination kits available for field installation.
- Two dividers standard with every stack-on.
- Color of grommets match paint selection for core colors.

! Keyed alike cores must be ordered separately — see page 922.

! Stack-on Units not designed to be used on Corner Units.

**HOW TO SPECIFY****Select Model Number****Select Lock Option**

L Lock  
 X Omit Lock  
 (deduct \$20)

See page 922 for omit lock ordering instructions

**Select Paint Color**

See pages 426-427

H 3 8 7 2 1 5 .

L .

P



# 38000 SERIES™ Steel Stack-on Units



DESCRIPTION	MODEL	SHIP WEIGHT	CUBE	LIST PRICE BY PAINT GRADE		
				CORE	CHOICE/ METALLICS	CUSTOM
<b>Shelf Dividers — package of 6</b> Specify: Paint color. Shelf dividers can only be used on stack-ons manufactured after 7/3/2000.	H38SHFDV	3	0.2	\$131	\$142	\$150

## HOW TO SPECIFY

Select Model Number  H 3 8 S H F D V .	Select Paint Color See pages 426-427  P
---	---

# 38000 SERIES™

## Steel Stack-on Units

GSA SIN AS NOTED



Icon Legend on page 21

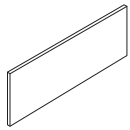

SIN 711-2

**DESCRIPTION****Tackboard for Stack-on — 19<sup>3</sup>/<sub>8</sub>"H**

72"W  
66"W  
60"W  
48"W

**MODEL**

**HT72ND**  
**HT66ND**  
**HT60ND**  
**HT48ND**

**SHIP WEIGHT**

26.0  
24.0  
22.0  
18.0

**CUBE**

2.3  
2.1  
1.9  
1.5

**LIST PRICE**

**\$461**  
**\$443**  
**\$429**  
**\$382**

Specify: Model.Fabric.Paint. Upcharges may apply to premium fabric grades.

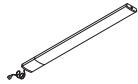

OPEN MARKET

**LED Task Lights**

17" LED Light with Power Supply (Single)  
31" LED Light with Power Supply (Single)

**HLED17AS**  
**HLED31AS**

1.2 Ⓢ  
1.5 Ⓢ

0.05  
0.09

**\$384**  
**\$516**

17" LED Light with Power Supply for Daisy-chain (Starter)  
31" LED Light with Power Supply for Daisy-chain (Starter)

**HLED17A**  
**HLED31A**

1.0 Ⓢ  
1.4 Ⓢ

0.05  
0.09

**\$422**  
**\$567**

17" LED Light with 8" Jumper Cord for Daisy-chain (Follower)  
31" LED Light with 8" Jumper Cord for Daisy-chain (Follower)

**HLED17AUO**  
**HLED31AUO**

1.0 Ⓢ  
1.0 Ⓢ

0.03  
0.05

**\$344**  
**\$460**

**Undercabinet Occupancy Sensor with 1" End to End Connector****HLEDOSA**

0.2 Ⓢ

0.01

**\$80**

NOTES: To use the daisy chain application, must start with model HLED17A or HLED31A. No finish specification required. Attaches magnetically to underside of overhead storage, or attaches with provided screws or double-sided tape. Occupancy sensor attaches to a single or starter LED light and will automatically turn the light off after no motion is detected for 30 minutes. Just like all the LED light models, the occupancy sensor features a soft-touch on/off switch. LED task lights have a lifetime of 50,000 hours and have a dimmer feature that allows the user to adjust the amount of light output. For additional information see page 911.

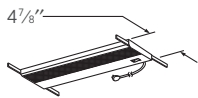

Refer to page 77

OPEN MARKET

**Recessed Task Light for use under 72", 66" and 60"W Stack-on or Open Shelf**46<sup>1</sup>/<sub>2</sub>"W x 3<sup>1</sup>/<sub>16</sub>"D x 1<sup>1</sup>/<sub>8</sub>"H**HH870960**

12.0 Ⓢ

1.1

**\$246**

NOTES: For additional information see page 911.

**Recessed Task Light for use under 48"W Stack-on or Open Shelf**34<sup>5</sup>/<sub>8</sub>"W x 3<sup>1</sup>/<sub>16</sub>"D x 1<sup>1</sup>/<sub>8</sub>"H**HH870942**

10.0 Ⓢ

0.9

**\$228**

NOTES: For additional information see page 911.



SIN 711-1

**Articulating Desk Lamp****Articulating Desk Lamp w/ Occupancy Sensor****HLED1**

1.2 Ⓢ

6.5

**\$359****HLED10C**

1.2 Ⓢ

6.5

**\$439**

NOTES: For additional information see page 909.



SIN 711-1

**Task Desk Lamp****HLED2**

0.7 Ⓢ

3.0

**\$311**

NOTES: For additional information see page 909.

**NOTES:**

- See specifying information above for Choice/Metallic paint and pages 17, 426 and 427 for Custom Paint ordering instructions.
- Tackboards feature painted steel backs and can be installed in the field.

**HOW TO SPECIFY**Select  
Model Number

H T 7 2 N D .

Select  
Fabric Color

See pages 35-36

A P N 1 5 .

Select  
Paint Color

See pages 426-427

P