



# User Manual

## Full HD 180-Degree Outdoor Wi-Fi Cam

DCS-2670L

---

# Preface

D-Link reserves the right to revise this publication and to make changes in the content hereof without obligation to notify any person or organization of such revisions or changes. Information in this document may become obsolete as our services and websites develop and change.

## Manual Revisions

Revision	Date	Description
1.00	06/01/2017	A1 release with firmware version 1.00

## Trademarks

D-Link and the D-Link logo are trademarks or registered trademarks of D-Link Corporation or its subsidiaries in the United States or other countries. All other company or product names mentioned herein are trademarks or registered trademarks of their respective companies.

Apple®, Apple logo®, Safari®, iPhone®, iPad®, iPod touch® and Macintosh® are trademarks of Apple Inc., registered in the U.S. and other countries. App Store<sup>SM</sup> is a service mark of Apple Inc. Chrome<sup>TM</sup> browser, Google Play<sup>TM</sup> and Android<sup>TM</sup> are trademarks of Google Inc. Internet Explorer®, Windows® and the Windows logo are trademarks of the Microsoft group of companies.

Copyright © 2017 D-Link Corporation.

All rights reserved. This publication may not be reproduced, in whole or in part, without prior expressed written permission from D-Link Corporation.

### ErP Power Usage

This device is an Energy Related Product (ErP) designed to be always on. If it is not needed during certain periods of time, it can be unplugged to save energy.

---

# Table of Contents

<b>Product Overview.....</b>	<b>4</b>	Time and Date.....	36
Package Contents.....	4	Event Setup.....	37
System Requirements.....	5	SD Card.....	44
Introduction.....	6	Advanced.....	45
Features.....	6	ICR and IR.....	45
Hardware Overview.....	7	HTTPS.....	46
Front View.....	7	Access List.....	47
Rear View.....	8	Maintenance.....	48
Wireless Installation Considerations.....	9	Admin.....	48
Installation.....	10	System.....	49
Mobile App Setup.....	11	Firmware Upgrade.....	50
mydlink.....	13	Status.....	51
Mounting the Camera.....	14	Device Info.....	51
Waterproofing Your Camera.....	16	Log.....	52
<b>Configuration.....</b>	<b>18</b>	Help.....	53
Accessing the Web Configuration Utility.....	18	<b>Troubleshooting.....</b>	<b>54</b>
Live Video.....	19	<b>Technical Specifications.....</b>	<b>56</b>
Setup.....	21	<b>Regulatory Information.....</b>	<b>58</b>
Setup Wizard.....	21		
Network Setup.....	26		
Wireless Setup.....	29		
Dynamic DNS.....	30		
Image Setup.....	31		
Audio and Video.....	33		
Motion Detection.....	34		
Sound Detection.....	35		

# Product Overview

## Package Contents



DCS-2670L Full HD 180-Degree Outdoor Wi-Fi Cam



Waterproof Cable Connector



Power Adapter

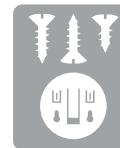

Camera Base and Mounting Kit



Ethernet Cable



Quick Installation Guide

If any of the above items are missing, please contact your reseller.

**Note:** Using a power supply with a different voltage than the one included with your product will cause damage and void the warranty for this product.

## System Requirements

<b>Network Requirements</b>	<ul style="list-style-type: none"><li>• 10/100 Ethernet network or a 802.11n/g/b wireless network</li><li>• An Internet connection</li><li>• A router connected to your broadband modem</li></ul>
<b>mydlink Lite App Requirements</b>	<ul style="list-style-type: none"><li>• An iPhone, iPad, iPod touch, or Android smartphone or tablet (please refer to the mobile app's store page to check whether your device is compatible)</li></ul>
<b>mydlink Website Requirements</b>	<p>A computer with:</p> <ul style="list-style-type: none"><li>• Internet Explorer 8 or higher</li><li>• Firefox 12 or higher</li><li>• Safari 6 or higher</li><li>• Chrome 20 or higher</li></ul> <p><b>Note:</b> Make sure you have the latest version of Java installed. Visit <a href="http://www.java.com">www.java.com</a> to download the latest version.</p>

# Introduction

The DCS-2670L Full HD 180-Degree Outdoor Wi-Fi Cam boasts a ultra-wide 180° lens that easily captures your entire room in high-quality 1080p. Its IP65 certification, three-axis adjustment, wireless network connectivity, and built-in night vision let you watch over your home or small office at all times and under any lighting conditions. Rounding out the solution is the free mydlink™ Lite app, which pushes notifications to your mobile device in case of an event and lets you quickly view live streams no matter where you are.

## Features

### **180° Wide-Angle Lens**

The DCS-2670L provides whole-room coverage with a 180° wide-angle lens, eliminating the need for multiple cameras to cover a single room. Built-in de-warping technology automatically corrects the image for you.

### **1080p Full HD Video**

The 1080p Full HD sensor provides crisp detail and clarity for high-quality snapshots and video.

### **IP65-Certified for Waterproof Installations**

The DCS-2670L has the toughness to withstand wet conditions in both indoor or outdoor environments.\*

### **Comprehensive Day/Night Surveillance**

The built-in infrared LEDs enable night-time viewing of up to 10 meters (32.8 feet) in complete darkness. The microSD card slot allows the camera to record snapshots and video directly to onboard storage for a complete surveillance solution.

### **Wireless N Connectivity**

The DCS-2670L uses high-speed Wireless N to connect to your wireless router, and is compatible with 802.11n/g.

### **mydlink™ Lite App Support for Your Mobile Device**

Setup is easy via the in-app setup wizard, and you can receive instant notifications and view live streams from anywhere using your mobile device.

### **mydlink Web Portal**

Using a standard web browser, you can manage the DCS-2670L via the mydlink website, so you can access your DCS-2670L anytime, anywhere in the world.

**\*Note:** Due to its IP65 rating, we recommend that you install your device under a roof or shelter.

## Hardware Overview Front View



1	<b>IR LEDs</b>	Illuminate the camera's field of view in low light environments.
2	<b>Power Connector</b>	Plug in the included power adapter to this connector.
3	<b>Ethernet Connector</b>	Use an Ethernet cable for a wired connection to your network.
4	<b>Light Sensor</b>	The IR-Cut sensor monitors lighting conditions and switches between color and infrared modes accordingly.
5	<b>180° Camera Lens</b>	Provides a wide-angle view and streams/records video of your environment.
6	<b>Status LEDs</b>	Indicates the camera's current status.
7	<b>Microphone</b>	Records audio from the camera's environment.

## Rear View

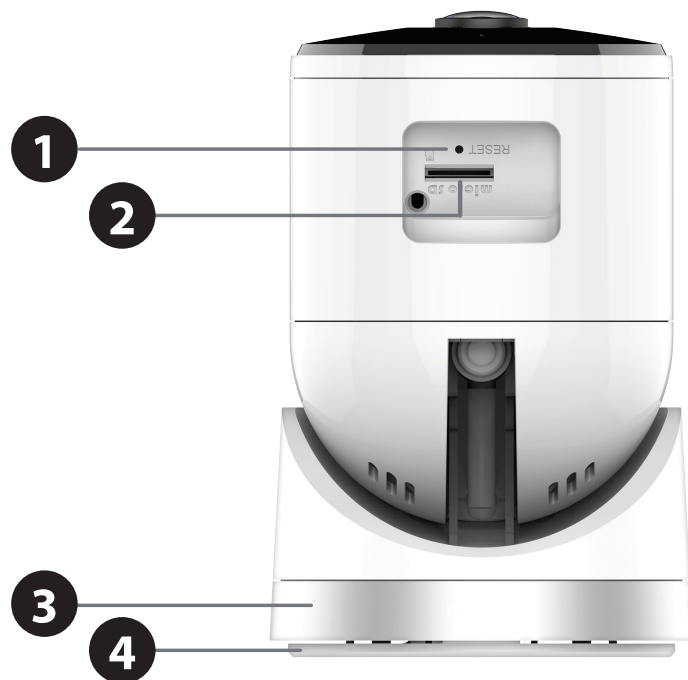

1	<b>Reset Button</b>	Press and hold this button for 10 seconds to reset the camera.
2	<b>microSD Card Slot</b>	Insert a microSD card to record videos and images to the card.
3	<b>Camera Base</b>	Rotate the camera base until you achieve your desired viewing angle.
4	<b>Baseplate</b>	Use the baseplate to easily mount the camera to the surface of your choice.



# Wireless Installation Considerations

The DCS-2670L connects to your network using a wireless connection from anywhere within the operating range of your wireless network. However, the number, thickness and location of walls, ceilings, or other objects that the wireless signals must pass through, may limit the range. Typical ranges vary depending on the types of materials and background RF (radio frequency) noise in your home or business. The key to maximizing wireless range is to follow these basic guidelines:

1. Minimize the number of walls and ceilings between your camera and other network devices (such as your Network Camera) - each wall or ceiling can reduce your camera's range from 3-90 feet (1-30 meters).
2. Be aware of the direct line between network devices. A wall that is 1.5 feet thick (.5 meters), at a 45-degree angle appears to be almost 3 feet (1 meter) thick. At a 2-degree angle, it looks over 42 feet (14 meters) thick. Position your devices so that the signal will travel straight through a wall or ceiling (instead of at an angle) for better reception.
3. Building materials make a difference. A solid metal door or aluminum studs may weaken the wireless signal. Try to position your access points, wireless routers, and other networking devices where the signal passes through drywall or open doorways. Materials and objects such as glass, steel, metal, walls with insulation, water (fish tanks), mirrors, file cabinets, brick, and concrete will degrade your wireless signal.
4. Keep your product at least 3-6 feet or 1-2 meters away from electrical devices or appliances that generate RF noise.
5. If you are using 2.4 GHz cordless phones or other radio frequency sources (such as microwave ovens), your wireless connection may degrade dramatically or drop completely. Make sure your 2.4 GHz phone base is as far away from your wireless devices as possible. The base transmits a signal even if the phone is not in use.

# Installation

You will need to connect the power adapter and an Ethernet cable before you can set up and use your camera. Follow the steps below to set up your DCS-2670L.

## Step 1: Connect the Ethernet Cable and the Plug

Use an Ethernet cable and plug it into the camera. Connect the other end into an available LAN port on your router. Connect one end of the included power adapter to the back of the camera.

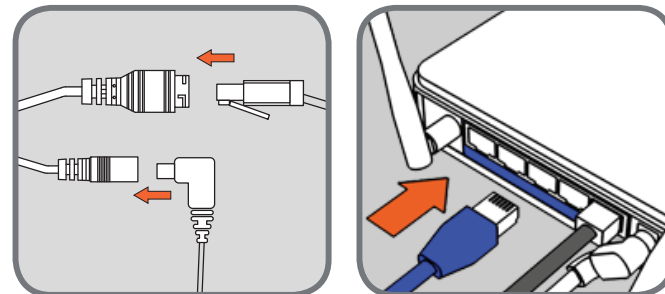

## Step 2: Plug the Power Adapter to a Wall Outlet

Plug the other end of the power adapter to a wall outlet to power on your camera.

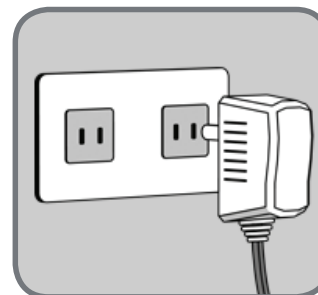

## Mobile App Setup

After installing the hardware, you can configure your camera through the mydlink Lite mobile app. On your mobile device, download mydlink Lite by searching for **mydlink Lite** in the App Store or Google Play.



Launch the mydlink Lite app and create a new account or sign in to your existing account. Follow the onscreen instructions to set up your camera.

## Section 2: Installation

---

To connect your camera to your network wirelessly, follow the instructions below.

### Step 1:

Once your camera is set up, select your camera and tap the **Settings** button.

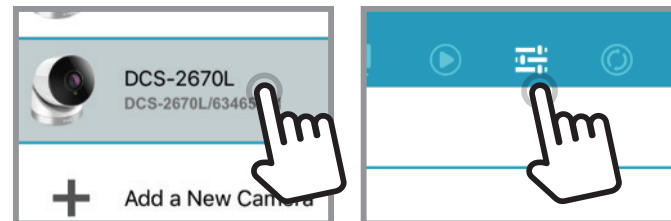

### Step 2:

Select Wi-Fi Setting and "Enable Wi-Fi connection".

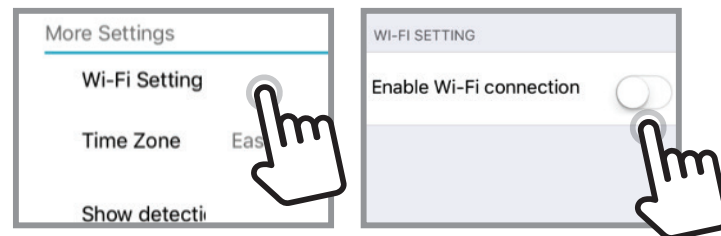

### Step 3:

Select your wireless network and enter your password, then tap **Apply**.

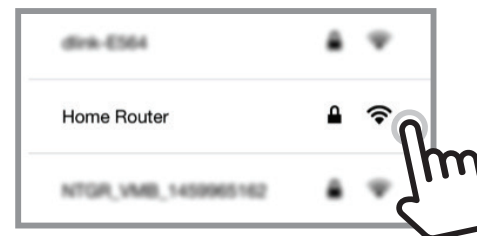

### Step 4:

You can now disconnect the Ethernet cable and move the camera to your preferred location.

# mydlink

After registering your camera with a mydlink account, you will be able to remotely access your camera from the [www.mydlink.com](http://www.mydlink.com) website. After signing in to your mydlink account, you will see a screen similar to the following:

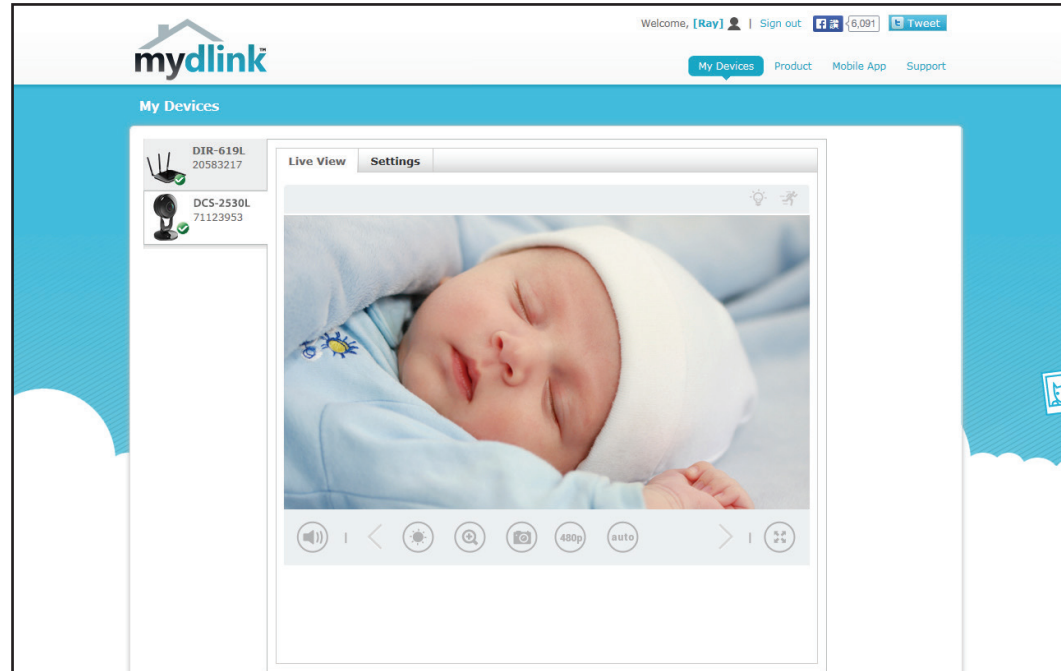

For more details on using your camera with mydlink, go to the **Support** section of the mydlink website and check the **User Manual** section for your product to find the latest guides for your camera's mydlink features.

## Mounting the Camera

To mount your camera on a wall or ceiling, please follow the steps below. It is recommended that you configure the camera before mounting.

### Step 1:

Place the baseplate where you want to position the camera and use a pencil to mark the holes. You can use the large holes for a removable installation, or the small holes for a fixed one. Make sure the lock arrow on the plate is pointing down.

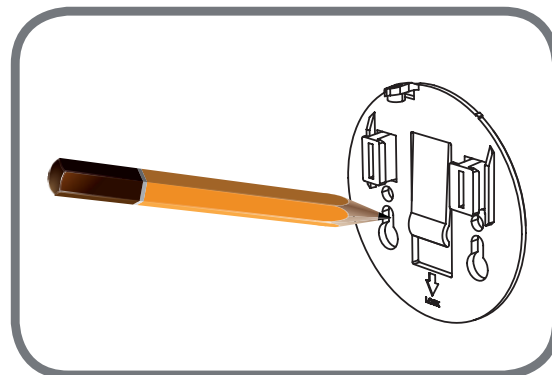

### Step 2:

Depending on the material of the wall or ceiling, use proper tools to drill holes 25 mm deep with a 6 mm drill bit where you marked. If the wall is made out of concrete, drill the holes first, then insert the plastic anchors to support the screws.

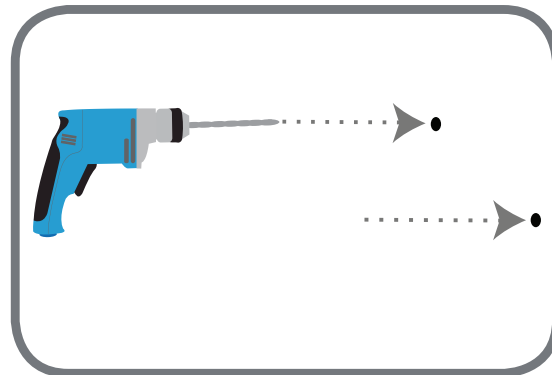

### Step 3:

Place the baseplate over the holes that are in the wall. Make sure to align the baseplate holes with the holes in the wall. Use the supplied screws to attach the baseplate to the surface of the wall.

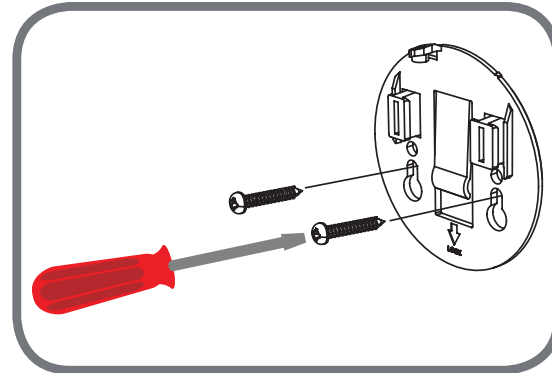

## Section 2: Installation

### Step 4:

Place the camera over the baseplate and align the nub with the hole on the camera. Attach the camera by sliding it in the direction of the arrow. Then screw the baseplate to the camera body.

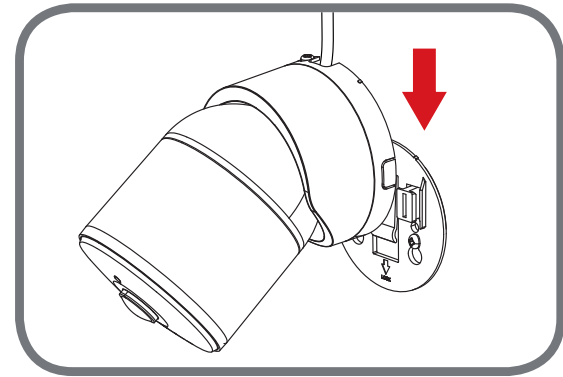

### Step 5:

Once the camera is secured to the baseplate, use a screwdriver to fasten the screw next to the hole at the back of the camera body.

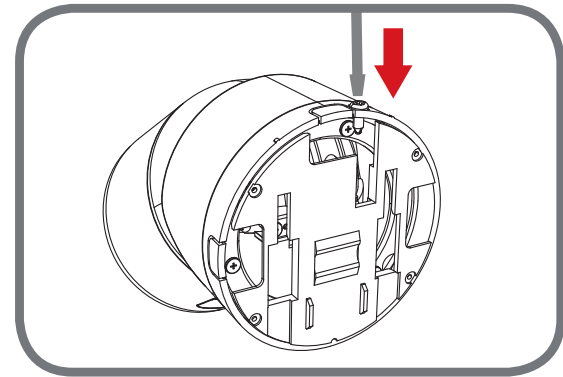

### Step 6:

Adjust the angles via the camera body and rotate the silver base until you achieve your desired viewing angle.

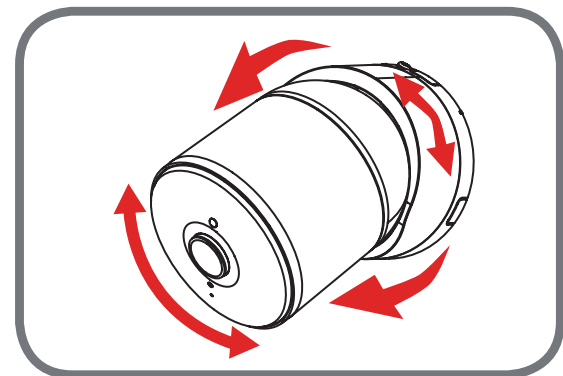

## Waterproofing Your Camera

After configuring your camera, follow the instructions below to prevent water from entering the camera's Ethernet and Power Cable connections.

### Waterproofing your connectors when using Wi-Fi:

**Step 1:**

Plug the power adapter into the dongle.

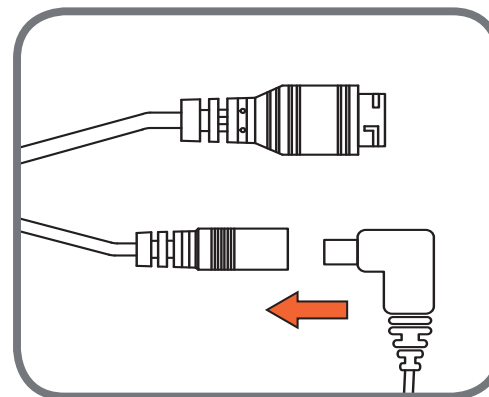

**Step 2:**

To waterproof the Ethernet socket, align the cap according to the thread and twist it clockwise to seal it.

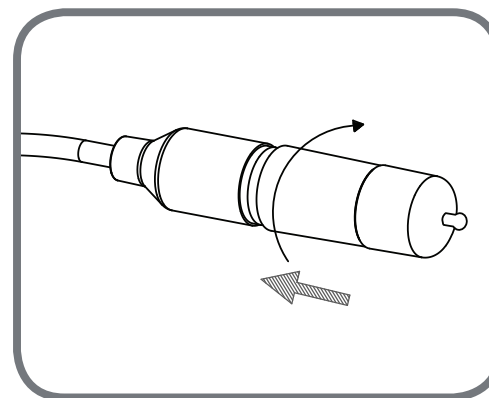

**Note:** Due to its IP65 rating we recommend that you install your device under a roof or a shelter to protect the Power and Ethernet connections from water seepage. However, the cables and connections need to be located away from all potential water hazards.



### Waterproofing your connectors using electrical tape:

If you are using an Ethernet connection, follow the instructions below to prevent water from entering the camera's Ethernet and power cable connectors.

#### Step 1:

Connect the power and Ethernet cables to their sockets.

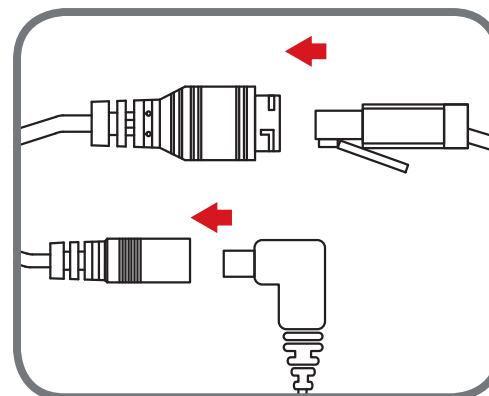

#### Step 2:

Wind waterproof tape, such as butyl rubber or vinyl tape, around the individual cables and connectors in a half-overlapping manner then wrap all the connectors together. Be sure to cover all of the connectors and any unsheathed cables.

**Note:** Butyl rubber tape should be wrapped by stretching the tape to about twice its length, and wrapping it around the cable. Failure to stretch the tape sufficiently will result in insufficient waterproofing performance.

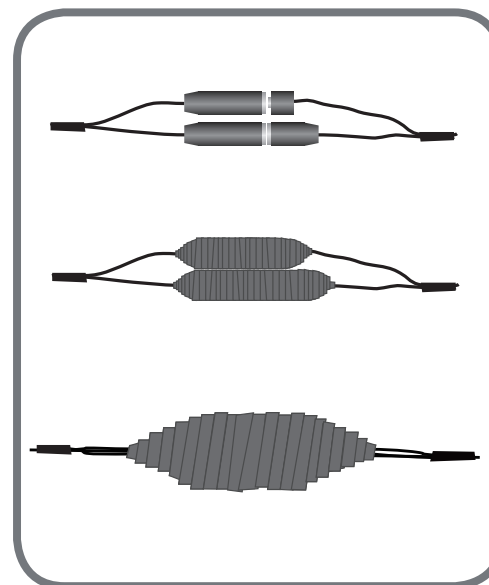

# Configuration

## Accessing the Web Configuration Utility

After completing the setup wizard in the mydlink Lite app, you are ready to use your camera. The camera's built-in Web configuration utility is designed to allow you to easily access and configure your DCS-2670L. Once it is set up, enter the IP address of your camera into a web browser, such as Internet Explorer®. To log in, use the User name **admin** and the password you created in the Installation Wizard. If you did not create a password, you will be prompted to create one. Initially, you can log in using the default password, which is blank. After entering your new password, click **OK**.

**Note:** If you are directly connecting your PC to the camera, or if you are using the camera on a closed network, the default IP is **192.168.0.20**.

Please make sure that you have the latest version of Java application installed on your computer to ensure proper operation when viewing the video in Java mode. The Java application can be downloaded at no cost from Sun's web site (<http://www.java.com>).

When you connect to the home page of your camera, you may be prompted to download ActiveX. If you want to use ActiveX to view your video images instead of Java, then you must download ActiveX.

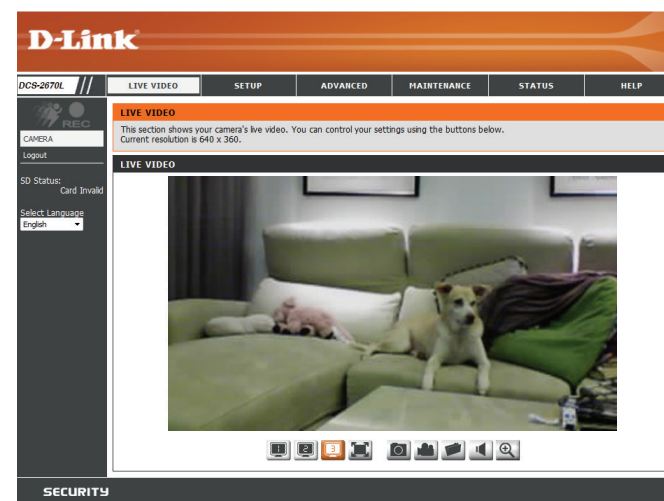
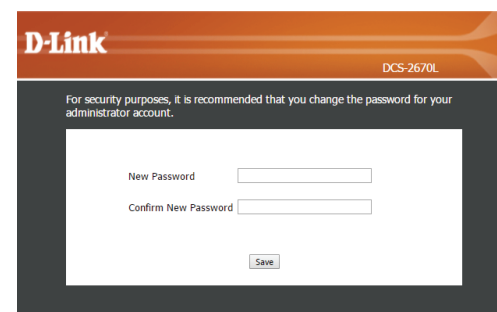
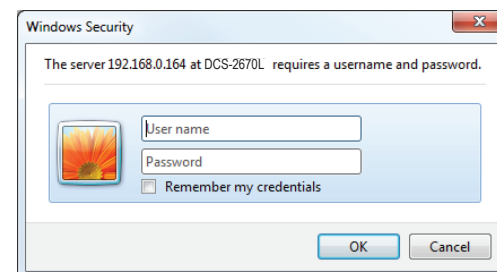









# Live Video

The Live Video page lets you view the live video stream from your camera.

Please make sure that you have the latest version of Java installed on your computer to ensure proper operation when viewing the video in Java mode. The Java application can be downloaded free from Sun's web site (<http://www.java.com>).

The screenshot shows the D-Link web interface for the DCS-2670L camera. The top navigation bar includes the D-Link logo and menu items: LIVE VIDEO (selected), SETUP, ADVANCED, MAINTENANCE, STATUS, and HELP. The left sidebar contains a 'CAMERA' section with a 'REC' indicator, a 'Logout' button, 'SD Status: Card Invalid', and a 'Select Language' dropdown menu set to 'English'. The main content area is titled 'LIVE VIDEO' and contains a text box stating: 'This section shows your camera's live video. You can control your settings using the buttons below. Current resolution is 640 x 360.' Below this is a live video stream showing a dog sitting on a green sofa. At the bottom of the video player are several control icons: a play button, a stop button, a refresh button, a camera icon, a microphone icon, a speaker icon, and a volume icon. The bottom status bar of the interface displays the word 'SECURITY'.

## Section 3: Configuration

Icon	Button Name	Function
	Event Trigger Indicator	This indicator will change color when a trigger event occurs, such as when motion or sound is detected.
	Recording Indicator	When a recording is in progress, this indicator will change color.
	Profiles	Use these buttons to switch between video profiles. Refer to <b>Audio and Video</b> on page 33 for more information on setting up profiles.
	Full Screen	Switches to a full screen view of the camera video.
	Snapshot	Takes a snapshot of the image currently displayed on the screen and saves it to the hard drive in the folder specified using the Storage folder button.
	Video Recording	Triggers the camera's recording function. This will record the video displayed on the screen and saves it to the hard drive in the folder specified using the Storage folder button.
	Storage Folder	Sets the storage folder for snapshots and video recordings.
	Speaker	Sends the audio received from the camera's microphone through to the PC's speakers.
	Magnify	Use this button to zoom in on the live view stream.

# Setup Setup Wizard

This section allows you to begin setup wizards which will guide you through the process of getting your camera's various functions configured. If you want to adjust the settings manually, you may skip the wizards and adjust settings manually as needed.

**Internet Connection Setup Wizard:** You may choose to configure your camera's Internet connection by using the Internet Connection Setup Wizard that includes step-by-step instructions. Please refer to **Internet Connection Setup Wizard** on page 22 for more details.

**Manual Internet Connection Setup:** If you would rather manually set up the camera's Internet connection, you can refer to **Network Setup** on page 26 which provides more details on the information required.

**Motion Detection Setup Wizard:** You may choose to configure motion detection by using the Motion Detection Setup Wizard that includes step-by-step instructions. Please refer to **Motion Detection Setup Wizard** on page 24 for more details.

**Manual Motion Detection Setup:** If you would rather manually set up the camera's motion detection features, you can refer to **Motion Detection** on page 34 which provides more details on the information required.

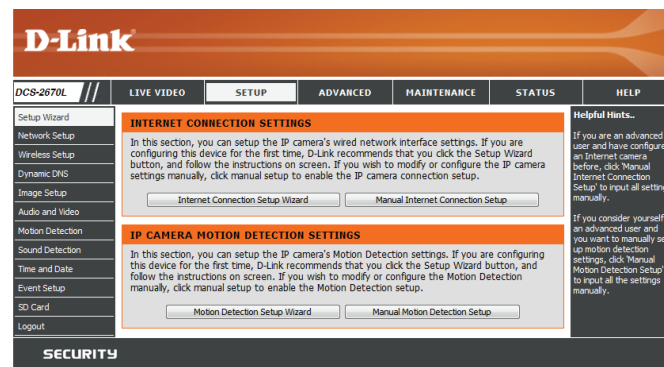

# Internet Connection Setup Wizard

This wizard will guide you through a step-by-step process to configure your new D-Link Camera and connect the camera to the Internet. Click **Next** to continue.

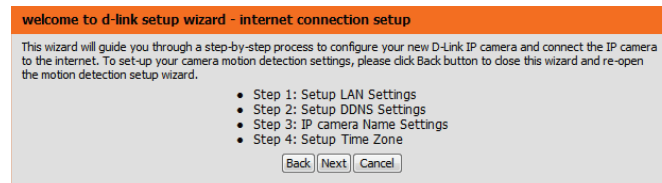

Select how the camera will connect to the Internet.

**If your camera is connected to a router, or you are unsure how your camera will connect to the Internet, select DHCP.**

Select **Static IP Client** if your Internet Service Provider has provided you with connection settings, or if you wish to set a static address within your home network. Enter the correct configuration information and click **Next** to continue.

If you are using PPPoE, select **Enable PPPoE** and enter your user name and password.

Click **Next** to continue.

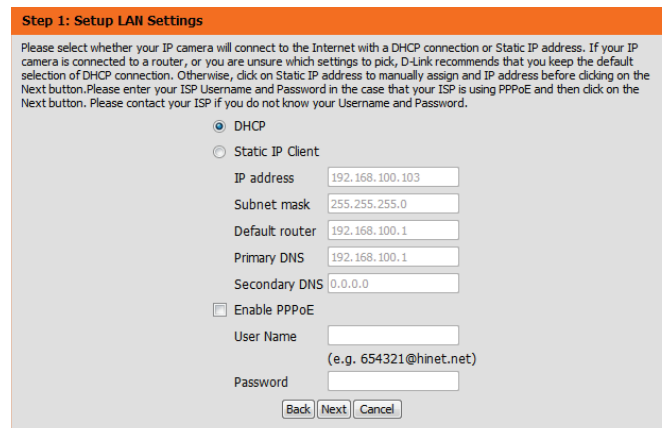

## Section 3: Configuration

If you have a Dynamic DNS account and would like the camera to update your IP address automatically, Select **Enable DDNS** and enter your host information. Click **Next** to continue.

**Step 2: Setup DDNS Settings**

If you have a Dynamic DNS account and would like the IP camera to update your IP address automatically, enable DDNS and enter in your host information below. Please click on the Next button to continue.

Enable DDNS

Server Address  <<

Host Name

User Name

Password

Verify Password

Timeout  (hours)

Enter a name for your camera and click **Next** to continue.

**Step 3: IP camera Name Settings**

D-Link recommends that you rename your IP camera for easy accessibility. You can then identify and connect to your IP camera via this name. Please assign a name of your choice before clicking on the Next button.

IP camera Name

Configure the correct time to ensure that all events will be triggered as scheduled. Click **Next** to continue.

**Step 4: Setup Time Zone**

Please configure the correct time to ensure that all events are triggered, captured and scheduled at the correct time and day and then click on the Next button.

Time Zone

Enable Daylight Saving

If you have selected DHCP, you will see a summary of your settings, including the camera's IP address. Please write down all of this information as you will need it in order to access your camera.

Click **Apply** to save your settings.

**Step 5: Setup complete**

Below is a summary of your IP camera settings. Click on the Back button to review or modify settings or click on the Apply button if all settings are correct. It is recommended to note down these settings in order to access your IP camera on the network or via your web browser.

IP Address	DHCP
IP camera Name	DCS-2670L
Time Zone	(GMT+08:00) Taipei
DDNS	Disable
PPPoE	Disable

# Motion Detection Setup Wizard

This wizard will guide you through a step-by-step process to configure your camera's motion detection functions.

Click **Next** to continue.

### Step 1

This step will allow you to enable or disable motion detection, specify the detection sensitivity, and adjust the camera's ability to detect movement.

You may specify whether the camera should capture a snapshot or a video clip when motion is detected.

Refer to **Motion Detection** on page 34 for information about how to configure motion detection.

### Step 2

This step allows you to enable motion detection based on a customized schedule. Specify the days and hours to enable motion detection. You may also choose to always record whenever motion is detected.

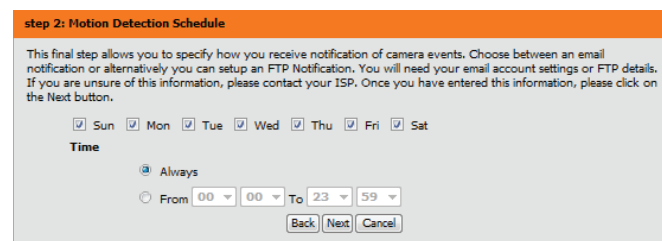
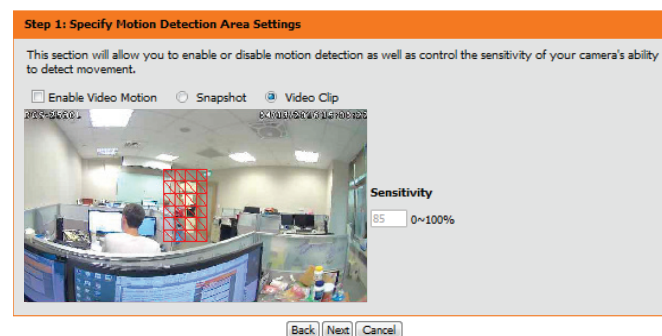
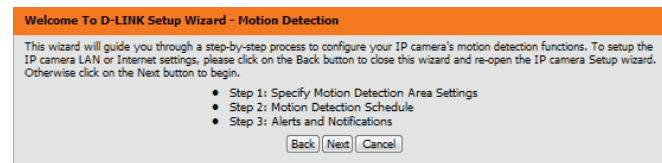



## Section 3: Configuration

### Step 3

This step allows you to specify how you will receive event notifications from your camera. You may choose not to receive notifications, or to receive notifications via e-mail.

Please enter the relevant information for your e-mail account.

Click **Next** to continue.

**Step 3: Alerts and Notification**

This final step allows you to specify how you receive notification of camera events. Choose between an email notification. You will need your email account settings. If you are unsure of this information, please contact your ISP. Once you have entered this information, please click on the Next button.

Do not notify me

Email

Sender email address	<input type="text" value="test@test.com"/>
Recipient email address	<input type="text" value="test@test.com"/>
Server address	<input type="text" value="test@test.com"/>
User name	<input type="text"/>
Password	<input type="password"/>
Port	<input type="text" value="25"/>

This server requires a secure connection (StartTLS)

### Step 4

You have completed the Motion Detection Wizard.

Please verify your settings and click **Apply** to save them.

**Step 4: Setup Complete**

You have completed your IP camera setup. Please click the Back button if you want to review or modify your settings or click on the Apply button to save and apply your settings.

Motion Detection :	Disable
EVENT :	Video Clip
Schedule Day :	Sun , Mon , Tue , Wed , Thu , Fri , Sat ,
Schedule Time :	Always
Alerts and Notification :	Do not notify me

Please wait a few moments while the camera saves your settings and restarts.

**Step 4: Setup Complete**

You have completed your IP camera setup. Please click the Back button if you want to review or modify your settings or click on the Apply button to save and apply your settings.

Changes saved.IP camera's network is restarting, please wait for 6 seconds ...

# Network Setup

Use this section to configure the network connections for your camera. All relevant information must be entered accurately. After making your changes, click the **Save Settings** button for them to take effect.

**LAN Settings:** This section lets you configure settings for your local area network.

**DHCP:** Select this connection if you have a DHCP server running on your network and would like your camera to obtain an IP address automatically.

**Static IP Client:** If your network uses a fixed routes, you may need to obtain a fixed IP address from your network administrator for your camera. A static IP address may simplify access to your camera in the future.

**IP Address:** Enter the IP address that the camera will use on your network. You may need to get this information from your network administrator.

**Subnet Mask:** Enter the subnet mask that your camera will use on the network. The default value is "255.255.255.0." This is used to determine if the destination is part of the same subnet.

**Default Router:** Enter the address of the router or gateway your camera will use on the network. The gateway is used to forward frames to destinations in a different subnet. Invalid gateway settings may cause transmissions to a different subnet to fail.

**Primary DNS:** Enter the primary domain name server that translates names to IP addresses.

**Secondary DNS:** Enter the secondary domain name server used to back up the Primary DNS.

**Enable UPnP Presentation:** Enabling this setting allows your camera to be configured as a UPnP device on your network.

**D-Link**

DCS-2670L // LIVE VIDEO SETUP ADVANCED MAINTENANCE STATUS HELP

Setup Wizard  
Network Setup  
Wireless Setup  
Dynamic DNS  
Image Setup  
Audio and Video  
Motion Detection  
Sound Detection  
Time and Date  
Event Setup  
SD Card  
Logout

**Helpful Hints...**

**DHCP:** Select DHCP Connection if you are running a DHCP server on your network and would like an IP address assigned to your IP camera automatically.

**UPnP:** Enabling UPnP settings will allow you to configure your IP camera as an UPnP device in the network.

**PPPoE Setting:** If you use the IP camera to connect directly to the Internet, you will need to enter the username and password, which were given to you when you set up your account with your Internet Service Provider. If the camera is behind a router or a gateway, you do not need to configure this setting.

**HTTP:** HTTP Port is the port you allocate in order to connect to the IP camera via a standard web browser.

**HTTPS:** HTTPS Port in a IP camera connects it with a PC via a secure web browser.

**RTSP:** RTSP Port is the port you allocate in order to connect to a IP camera by using streaming mobile device(s), such as a mobile phone or PDA.

**CoS (Class of Service):** Coarsely-grained traffic control based on the L2 protocol. Class of Service technologies do not guarantee a level of service in terms of bandwidth and delivery time, they offer a "best-effort".

**QoS (Quality of Service):** Finely-grained traffic control, a resource reservation control mechanism. Quality of service guarantees are important if the network capacity is insufficient, especially for real-time streaming multimedia applications.

**Enable IPv6:** Select this option and save to enable IPv6 setting. Please note that this only works if your network environment and hardware equipment support IPv6. The browser should be Microsoft® Internet Explorer 6.5, Mozilla Firefox 3.0 or above. When IPv6 is enabled, by default, the Network Camera will listen to

**NETWORK SETUP**  
You can configure your LAN and Internet settings here.  
Save Settings Don't Save Settings

**LAN SETTINGS**

DHCP  
 Static IP Client

IP address: 192.168.100.103  
Subnet mask: 255.255.255.0  
Default router: 192.168.100.1  
Primary DNS: 192.168.100.1  
Secondary DNS: 0.0.0.0

Enable UPnP presentation  
 Enable UPnP port forwarding  
Forwarding Port: 1024 [Test]  
Forwarding Status: UPnP forwarding is inactive

**HTTP**  
HTTP port: 80  
Access name for stream1: video1.mjpeg  
Access name for stream2: video2.mjpeg  
Access name for stream3: video3.mjpeg

**HTTPS**  
HTTPS port: 443

**RTSP**  
Authentication: Digest  
RTSP port: 554  
Access name for stream1: live1.sdp  
Access name for stream2: live2.sdp  
Access name for stream3: live3.sdp

**COS SETTINGS**  
 Enable CoS  
VLAN ID: 1 [0-4095]  
Live video: 0  
Live audio: 0  
Event/Alarm: 0  
Management: 0

**QoS SETTINGS**  
 Enable QoS  
Live video: 0  
Live audio: 0  
Event/Alarm: 0  
Management: 0

## Section 3: Configuration

**Enable UPnP Port Forwarding:** Enabling this setting allows the camera to add port forwarding entries into the router automatically on a UPnP capable network.

**HTTP Port:** Enter the port to use for HTTP access to the camera. The default port number is 80.

**Access Name for Stream 1~3:** Enter a name to use for HTTP streaming access. The default name is video#.mjpeg, where # is the number of the stream.

**HTTPS Port:** Enter the port to use for HTTPS access to the camera. You may use a PC with a secure browser to connect to the HTTPS port of the camera. The default port number is 443.

**RTSP Port:** Enter the port number to use for RTSP streaming to mobile devices. The default port number is 554. You may specify the address of a particular stream. For instance, live1.sdp can be accessed at rtsp://x.x.x.x/live1.sdp where the x.x.x.x represents the IP address of your camera.

**Enable CoS:** Enabling CoS allows you to specify the Class of Service for different types of traffic so you can prioritize their transmission on your network. CoS helps provide prioritization for Layer 2 traffic.

**Enable QoS:** Enabling QoS allows you to specify the Quality of Service for different types of traffic so you can prioritize their transmission on your network. QoS helps provide prioritization for Layer 3 traffic. If the camera is connected to a router that itself implements QoS, the router's settings will override the QoS settings of the camera.

**Enable IPv6:** Select Enable IPv6 to automatically get an IPv6 address from your router. If you have a static or fixed IP from your network administrator,

The screenshot displays the configuration interface for the camera, organized into several sections:

- LAN SETTINGS:** Includes radio buttons for DHCP (selected) and Static IP Client. Fields for IP address (192.168.100.103), Subnet mask (255.255.255.0), Default router (192.168.100.1), Primary DNS (192.168.100.1), and Secondary DNS (0.0.0.0). Checkboxes for 'Enable UPnP presentation' (checked) and 'Enable UPnP port forwarding' (unchecked). A 'Forwarding Port' field (1024) and a 'Test' button are present. The 'Forwarding Status' is 'UPnP forwarding is inactive'.
- HTTP:** 'HTTP port' field (80). 'Access name for stream1' (video1.mjpeg), 'Access name for stream2' (video2.mjpeg), and 'Access name for stream3' (video3.mjpeg).
- HTTPS:** 'HTTPS port' field (443).
- RTSP:** 'Authentication' dropdown (Digest). 'RTSP port' field (554). 'Access name for stream1' (live1.sdp), 'Access name for stream2' (live2.sdp), and 'Access name for stream3' (live3.sdp).
- COS SETTINGS:** 'Enable CoS' checkbox (unchecked). 'VLAN ID' field (1) with a range indicator [0~4095]. 'Live video', 'Live audio', 'Event/Alarm', and 'Management' dropdown menus, all set to 0.

## Section 3: Configuration

select Static IP address and enter the information provided by your ISP or network administrator.

**Enable Multicast for stream:** The DCS-2670L allows you to multicast each of the available streams via a group address and lets you specify the TTL value for each stream. Enter the ports and TTL settings you wish to use if you do not want to use the defaults.

**Enable Bonjour:** Enable this to allow other network devices to connect to this camera using the Bonjour protocol.

**Bonjour Name:** Enter a name to use to identify this camera through Bonjour.

### QOS SETTINGS

Enable QoS

Live video	0
Live audio	0
Event/Alarm	0
Management	0

### IPV6

Enable IPv6

Manually setup the IP address

Optional IP address / Prefix length:  /

Optional default router:

Optional primary DNS:

### MULTICAST

Enable multicast for stream 1

Multicast group address	<input type="text" value="239.1.1.1"/>
Multicast video port	<input type="text" value="6550"/>
Multicast RTCP video port	<input type="text" value="6551"/>
Multicast audio port	<input type="text" value="6552"/>
Multicast RTCP audio port	<input type="text" value="6553"/>
Multicast TTL [1~255]	<input type="text" value="64"/>

Enable multicast for stream 2

Multicast group address	<input type="text" value="239.1.1.2"/>
Multicast video port	<input type="text" value="6554"/>
Multicast RTCP video port	<input type="text" value="6555"/>
Multicast audio port	<input type="text" value="6556"/>
Multicast RTCP audio port	<input type="text" value="6557"/>
Multicast TTL [1~255]	<input type="text" value="64"/>

Enable multicast for stream 3

Multicast group address	<input type="text" value="239.1.1.3"/>
Multicast video port	<input type="text" value="6558"/>
Multicast RTCP video port	<input type="text" value="6559"/>
Multicast audio port	<input type="text" value="6560"/>
Multicast RTCP audio port	<input type="text" value="6561"/>
Multicast TTL [1~255]	<input type="text" value="64"/>

### BONJOUR SETTINGS

Enable Bonjour

Bonjour Name:  32 characters maximum  
(Characters you may use in a Bonjour Name: "upper or lower case letters", "numbers" and "hyphens".)

## Wireless Setup

This section allows you to set up and configure the wireless settings on your camera.

**Site Survey:** The drop down menu lists all the wireless networks that the camera was able to detect. Click **Rescan** to scan for wireless networks again.

**SSID:** Type in an SSID name to connect the camera to a wireless network.

**Wireless Mode:** This shows the current wireless mode being used by the camera.

**Channel:** In Ad-Hoc wireless mode, you can select the wireless channel you wish the camera to operate on.

**Authentication:** For security, you can choose **Open**, **Shared**, or **WPA-PSK / WPA2-PSK**. Select the same encryption method that is being used by your wireless device/router.

**Encryption:** Select **Shared**, **WPA-PSK**, or **WPA2-PSK** as **Open** is not recommended for security purposes.

**Key:** Enter the key(password) for your wireless network.

Click the **Save Settings** button to save your changes.

The screenshot shows the D-Link web interface for the DCS-2670L camera. The main navigation bar includes 'LIVE VIDEO', 'SETUP', 'ADVANCED', 'MAINTENANCE', 'STATUS', and 'HELP'. The 'SETUP' menu is expanded to show 'WIRELESS SETUP'. The 'WIRELESS CONFIGURATION' section includes the following fields and options:

- Site Survey:** A dropdown menu labeled '===SSID List===', a 'Rescan' button, and a text input field.
- SSID:** A text input field.
- Wireless Mode:** A dropdown menu set to 'Infrastructure'.
- Channel:** A dropdown menu set to 'Auto'.
- Authentication:** A dropdown menu set to 'Open'.
- Encryption:** A dropdown menu set to 'Disable'.
- Default Key:** A dropdown menu set to '1'.
- Key 1, Key 2, Key 3, Key 4:** Four password input fields, each with a masked '\*\*\*\*\*' value.

At the bottom of the configuration section, there is a note: '(5 or 13 ASCII, 10 or 26 HEX characters)'. Below the fields are 'Save Settings' and 'Don't Save Settings' buttons. On the right side, there is a 'Helpful Hints...' sidebar with the following text:

**Helpful Hints...**  
You may choose which wireless network for the connection using the pull-down menu of Site Survey or enter the SSID manually.

**SSID (Service Set Identifier)** is the name of your wireless network, such as Default, Conference, My network, and etc.

**Authentication**  
**Open:** This option makes the camera visible to all devices on the network. No encryption is provided.  
**Shared:** Allows communication only with other devices that have the identical WEP (Wired Equivalent Privacy) settings.

**WPA-PSK, WPA2-PSK:** Both modes will require you to input a pre-shared Key for the connection that is held between the camera and the wireless device.

# Dynamic DNS

If your Internet Service provider only provides you with a dynamic IP address, DDNS allows you to access your camera remotely using a domain name. To do this, you will need to have an account with one of the DDNS services listed in the drop-down box on this page.

**Enable DDNS:** Select this checkbox to enable the DDNS function.

**Server Address:** Select your Dynamic DNS provider from the drop-down menu or enter the server address manually.

**Host Name:** Enter the host name of the DDNS server.

**User Name:** Enter the user name or e-mail used to connect to your DDNS account.

**Password:** Enter the password used to connect to your DDNS account. Enter it again in the Verify Password field.

**Timeout:** Enter the DNS timeout values you wish to use.

**Status:** This indicates the connection status, which is automatically determined by the system.

The screenshot shows the D-Link DCS-2670L web interface. The top navigation bar includes 'LIVE VIDEO', 'SETUP', 'ADVANCED', 'MAINTENANCE', 'STATUS', and 'HELP'. The 'SETUP' tab is active, and the 'Dynamic DNS' option is selected in the left sidebar. The main content area is titled 'DYNAMIC DNS' and contains the following text: 'The Dynamic DNS feature allows you to use a domain name that you have purchased (www.yourdomain.com) to access your IP camera with a dynamically assigned IP address. Most broadband Internet service providers assign dynamic (changing) IP addresses. By using a DDNS service, you can enter your domain name to connect to your IP camera no matter what your IP address is. Sign up for D-Link's Free DDNS service at [www.DLinkDDNS.com](http://www.DLinkDDNS.com).' Below this text are two buttons: 'Save Settings' and 'Don't Save Settings'. The 'DYNAMIC DNS SETTING' section includes: 'Enable DDNS' (checkbox), 'Server Address' (text field with a dropdown menu showing 'www.dlinkdns.com'), 'Host Name' (text field), 'User Name' (text field), 'Password' (text field), 'Verify Password' (text field), 'Timeout' (text field with '24' and '(hours)'), and 'Status' (displaying 'Inactive'). At the bottom of this section are 'Save Settings' and 'Don't Save Settings' buttons. A 'Helpful Hints...' sidebar on the right explains that Dynamic DNS is useful for users with dynamic IP addresses and allows for remote access using a domain name.

# Image Setup

In this section, you can configure the video image settings for your camera.

**Enable Privacy Mask Setting:** The Privacy Mask setting allows you to specify up to 3 rectangular areas on the camera's image to be blocked/excluded from recordings and snapshots.

You may click and drag the mouse cursor over the camera image to draw a mask area. Right clicking on the camera image brings up the following menu options:

- **Disable All:** Disables all mask areas
- **Enable All:** Enables all mask areas
- **Reset All:** Clears all mask areas.

**Mirror:** This will mirror the image horizontally.

**Flip:** This will flip the image vertically. If the camera is installed upside down, **Flip** and **Mirror** should both be checked.

**Anti Flicker:** Select the frequency used by your power lines to avoid interference or distortion.

**White Balance:** Use the drop-down box to change white balance settings to help balance colors for different environments. You can choose from **Auto**, **Outdoor**, **Indoor**, and **Fluorescent**.

**Exposure Mode:** Changes the exposure mode. Use the drop-down box to set the camera for **Outdoor**, **Indoor**, or **Night** environments, or set to **Moving** to capture moving objects. The **Low Noise** option will focus on creating a high-quality picture with reduced noise when monitoring low-light environments. You can also create 3 different custom exposure modes that let you set the minimum and maximum shutter speeds. The **Max Gain** setting will allow you to control the maximum amount of gain to apply to brighten the picture.

The screenshot shows the D-Link DCS-2670L web interface. The top navigation bar includes 'LIVE VIDEO', 'SETUP', 'ADVANCED', 'MAINTENANCE', 'STATUS', and 'HELP'. The 'SETUP' tab is active, and the 'IMAGE SETUP' sub-tab is selected. A message states: 'Changes to your IP camera settings are made immediately.' Below this, the 'LIVE VIDEO' section shows a camera feed with a 'Privacy Mask' overlay. The 'IMAGE SETTINGS' section contains the following controls:

- Mirror:  On  Off
- Flip:  On  Off
- Anti Flicker:  60 Hz  50 Hz
- White Balance: Auto (dropdown)
- Exposure Mode: Auto (dropdown) Max Gain: 36 dB
- Denoise: 1 (dropdown)
- Brightness: 100 (slider)
- Contrast: 100 (slider)
- Saturation: 100 (slider)
- Sharpness: 100 (slider)
- WDR Level: 2 (dropdown)

A 'Reset Default' button is located at the bottom of the settings section. On the right side, there are 'Helpful Hints' for Privacy Mask, Mirror, Flip, Anti Flicker, White Balance, Exposure Mode, Max Gain, Denoise, and Brightness.

## Section 3: Configuration

**Denoise:** This setting controls the amount of noise reduction that will be applied to the picture.

**Brightness:** Adjust this setting to compensate for backlit subjects.

**Contrast:** Adjust this setting to alter the color intensity/strength.

**Saturation:** This setting controls the amount of coloration, from grayscale to fully saturated.

**Sharpness:** Specify how much sharpening to apply to the image.

**WDR Level:** You can select the strength of Wide Dynamic Range from this drop-down menu to enhance dark and bright areas of your image.

**Reset Default:** Click this button to reset the image settings to the factory defaults.

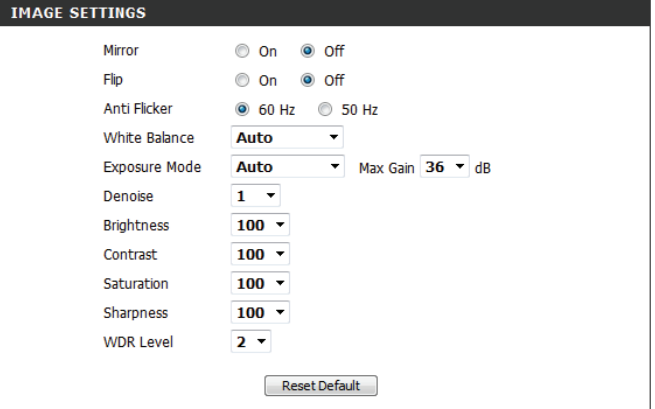

The screenshot displays the 'IMAGE SETTINGS' menu with the following options and values:

- Mirror:  On  Off
- Flip:  On  Off
- Anti Flicker:  60 Hz  50 Hz
- White Balance: Auto
- Exposure Mode: Auto Max Gain: 36 dB
- Denoise: 1
- Brightness: 100
- Contrast: 100
- Saturation: 100
- Sharpness: 100
- WDR Level: 2

A 'Reset Default' button is located at the bottom right of the settings panel.



## Audio and Video

You may configure up to three video profiles with different settings for your camera for your computer and mobile displays. This allows for better usability when using different devices for management. After making your changes, click the **Save Settings** button for them to take effect.

**Mode:** Set the video codec to be used to **JPEG** or **H.264**.

**Frame Size:** Frame size determines the total capture resolution the camera will use when viewing and recording video. Higher resolutions provide better video quality, but will require more bandwidth.

**Maximum Frame Rate:** A higher frame rate provides smoother motion for videos, and requires more bandwidth. Lower frame rates will result in stuttering motion, and require less bandwidth. Please note that if 1920 x 1080 is selected as your frame size, your maximum frame rate will be 30 frames per second.

**Video Quality:** This limits the maximum frame rate, which can be combined with the **Fixed quality** option to optimize the bandwidth utilization and video quality. If fixed bandwidth utilization is desired regardless of the video quality, choose **Constant bit rate** and select the desired bandwidth.

**Constant Bit Rate:** The bits per second (BPS) will affect the bit rate of the video recorded by the camera. Higher bit rates result in higher video quality.

**Fixed Quality:** Select the image quality level for the camera to try to maintain. High quality levels will result in increased bit rates.

**Audio In Off:** Checking this will mute the audio picked up by the built-in microphone.

**Audio In Gain Level:** Specify how much gain to add to the audio picked up by the built-in microphone.

The screenshot shows the D-Link web interface for the DCS-2670L camera. The 'AUDIO AND VIDEO' section is active, displaying three video profiles and audio settings. The 'AUDIO AND VIDEO' header includes a 'Save Settings' button and a 'Don't Save Settings' button. The 'VIDEO PROFILE 1' section shows Mode: H264, Frame size: 1920x1080, Maximum frame rate: 30, Video quality: Constant bit rate (2M), and Fixed quality: Excellent. The 'VIDEO PROFILE 2' section shows Mode: H264, Frame size: 1280x720, Maximum frame rate: 30, Video quality: Constant bit rate (1M), and Fixed quality: Excellent. The 'VIDEO PROFILE 3' section shows Mode: H264, Frame size: 640x360, Maximum frame rate: 15, Video quality: Constant bit rate (512K), and Fixed quality: Excellent. The 'AUDIO SETTINGS' section shows 'Audio in off' checked and 'Audio in gain level' set to 5. A 'Save' button is located at the bottom right of the settings area. The 'Helpful Hints...' section on the right provides additional information about frame size, frame rate, and video quality settings.

## Motion Detection

Motion detection enables the camera to monitor the video feed for movement. You can specify what part of the image to monitor for motion and adjust the sensitivity settings. For more details, refer to **Event Setup** on page 37. After making your changes, click the **Save Settings** button for them to take effect.

**Enable Video Motion:** Select this box to enable the motion detection feature of your camera.

**Note:** If you do not draw an area to monitor for motion, motion will not be detected by the camera.

**Sensitivity:** Specifies how sensitive motion detection will be from 0% to 100%. A low sensitivity setting means that there must be large changes between two images in order to detect motion, and a high sensitivity setting means that even small changes will cause motion to be detected.

**Draw Motion Area:** Use your mouse to click and drag on the areas that you would like to monitor for motion.

**Erase Motion Area:** To erase a motion detection area, simply click on the red square that you wish to remove.

Right click on the camera image to bring up the following menu options:

**Select All:** Draws a motion detection area over the entire screen.

**Clear All:** Clears any motion detection areas that have been drawn.

**Restore:** Restores the previously specified motion detection areas.

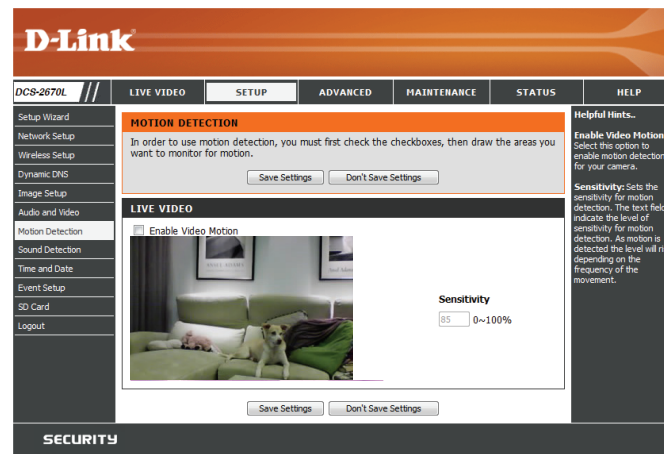

# Sound Detection

Sound detection enables the camera to monitor the environment for loud sounds. You may set the volume threshold used to determine whether sound was detected or not. If this option is selected, the trigger by option under **Video Clip, Snapshot, or SD Recording** should also be selected. For more details, refer to **Event Setup** on page 37. After making your changes, click the **Save Settings** button for them to take effect.

**Sound Detection:** Select this box to enable the sound detection feature of your camera.

**Detection Level:** Specify the volume level that a sound must exceed in order to trigger the sound detection feature. The lower the number, the more sensitive the camera will be to sound.

The screenshot displays the D-Link web interface for the DCS-2670L camera. The top navigation bar includes 'LIVE VIDEO', 'SETUP', 'ADVANCED', 'MAINTENANCE', 'STATUS', and 'HELP'. The 'SETUP' menu is expanded, showing options like 'Setup Wizard', 'Network Setup', 'Wireless Setup', 'Dynamic DNS', 'Image Setup', 'Audio and Video', 'Motion Detection', 'Sound Detection', 'Time and Date', 'Event Setup', 'SD Card', and 'Logout'. The 'Sound Detection' section is active, showing a checkbox for 'Sound Detection' which is checked. Below it, the 'Detection Level' is set to 70. A bar chart shows sound levels over time, with the y-axis labeled 'dB' ranging from -40 to 100. The chart shows several peaks, with the highest reaching approximately 85 dB. The x-axis is labeled 'Time'. The interface also includes 'Save Settings' and 'Don't Save Settings' buttons. A 'Helpful Hints...' section on the right provides additional information: 'Sound Detection: Sound Detection detects sound events using the microphone on the camera.' and 'Detection Level: Set this Detection Level of sound detection algorithm to trigger sound events. Lower Detection Level makes small sound easier to be detected.'

## Time and Date

This section allows you to automatically or manually configure, update, and maintain the internal system clock for your camera. After making your changes, click the **Save Settings** button for them to take effect.

**Time Zone:** Select your time zone from the drop-down menu.

**Enable Daylight Saving:** Select this to enable Daylight Saving Time.

**Auto Daylight Saving:** Select this option to allow your camera to configure the Daylight Saving settings automatically.

**Set Date and Time Manually:** Selecting this option allows you to configure the Daylight Saving date and time manually.

**Offset:** Sets the amount of time to be added or removed when Daylight Saving is enabled.

**Start Time / End Time:** Set the date and time to start using and stop using daylight saving.

**Synchronize with NTP Server:** Enable this feature to obtain time automatically from a Network Time Protocol (NTP) server.

**NTP Server:** Network Time Protocol (NTP) synchronizes the DCS-2670L with an Internet time server. Choose the one that is closest to your location.

**Set Date and Time Manually:** This option allows you to set the time and date manually.

**Copy Your Computer's Time Settings:** This will synchronize the time information from your PC.

The screenshot shows the D-Link DCS-2670L web interface. The main navigation bar includes 'LIVE VIDEO', 'SETUP', 'ADVANCED', 'MAINTENANCE', 'STATUS', and 'HELP'. The left sidebar lists various setup options, with 'Time and Date' selected. The main content area is titled 'TIME AND DATE' and contains the following sections:

- TIME AND DATE:** A message stating 'You can set the current time for the IP camera.' with 'Save Settings' and 'Don't Save Settings' buttons.
- TIME CONFIGURATION:**
  - Time Zone: (GMT+08:00) Taipei
  - Enable Daylight Saving
  - Auto Daylight Saving
  - Set date and time manually
    - Offset: +02:00
    - Start time: Month 1, Week 1, Day of week Sunday, Hour 0, Minutes 0
    - End time: Month 1, Week 1, Day of week Sunday, Hour 0, Minutes 0
- AUTOMATIC TIME CONFIGURATION:**
  - Synchronize with NTP Server
  - NTP Server: ntp1.dlink.com << Select NTP Server >>
- SET DATE AND TIME MANUALLY:**
  - Set date and time manually
  - Year: 2017, Month: 3, Day: 22
  - Hour: 16, Minute: 18, Second: 35
  - Copy Your Computer's Time Settings button

At the bottom of the page, there is a 'SECURITY' section. On the right side, there is a 'Helpful Hints...' section with additional information about time zones and daylight saving.

# Event Setup

The DCS-2670L has a comprehensive Event system that lets you configure the camera to perform certain actions when an event occurs. For example, when motion is detected, you can have snapshots sent to an e-mail address. You can also configure the camera to take regular video recordings according to a schedule you define. Detailed information for the following steps can be found at **Add Server** on page 38, **Add Media** on page 39, and **Add Event** on page 41.

### Step 1: Select your destination Server and Media type

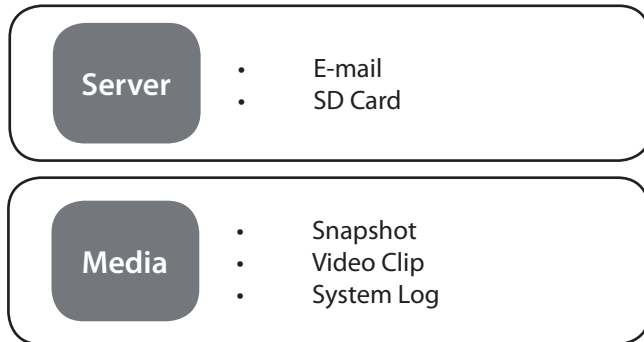

### Step 2: Select your Trigger event and Action

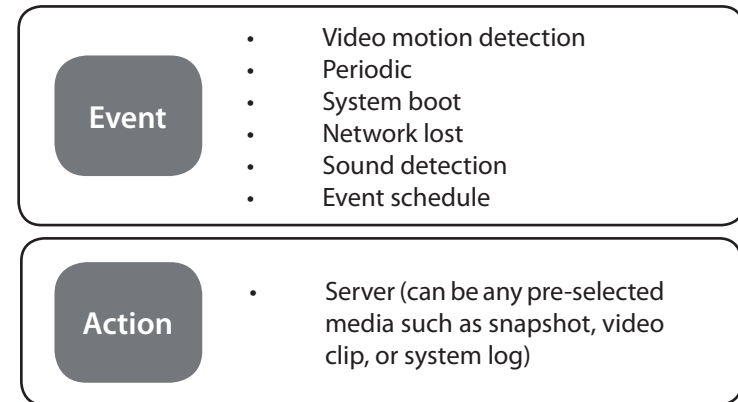

When an event is triggered:

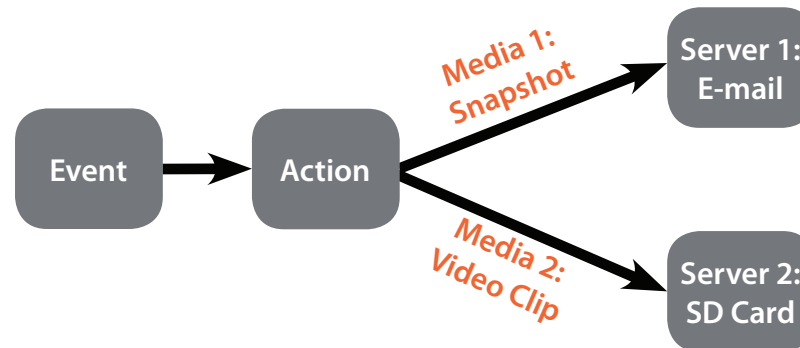

## Section 3: Configuration

The Event Setup page includes 4 different sections.

- Server
- Media
- Event
- Recording

1. To add a new server, media, event, or recording item, click **Add**. A screen will appear and allow you to update the fields accordingly.
2. To delete the selected item from the server, media, event, or recording drop-down menus, click the **Delete** button next to it.
3. Click on an item to edit it.

### Add Server

You can configure up to five servers (destinations) to save snapshots and/or video to. After making your changes, click the **Save Settings** button for them to take effect.

**Server Name:** Enter the name for the server.

**E-mail:** If you want to use an e-mail address for your server, select this and enter the settings for your target e-mail account. You can ask your email service provider for the server address and port settings. After you've filled these fields out, click the **Test** button to make sure the system is working correctly.

**SD Card:** Select this to use an inserted microSD card as your server.

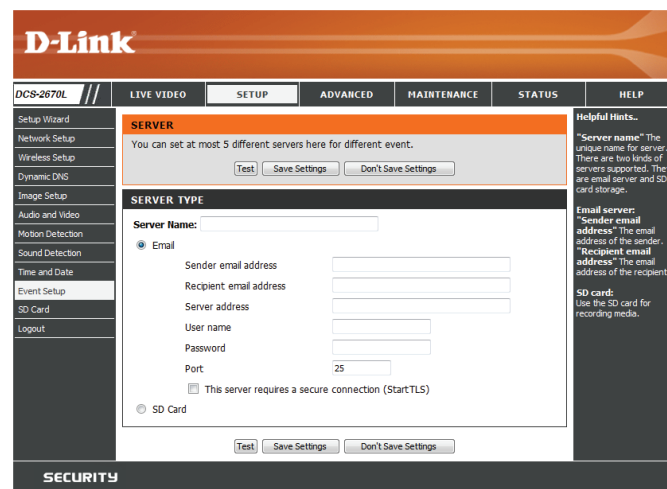
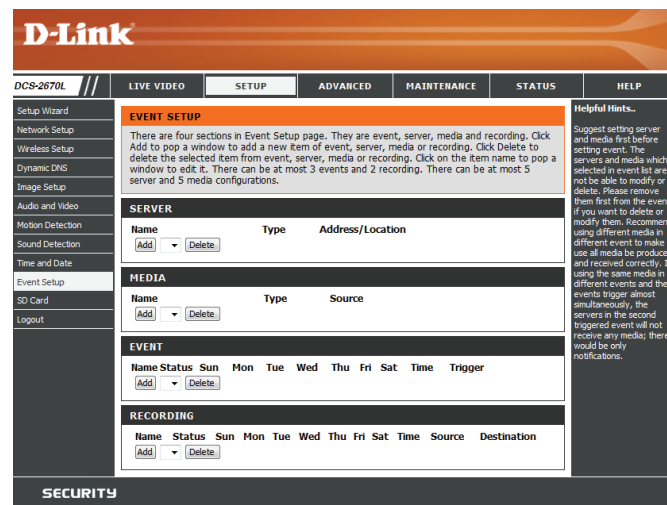

## Add Media

There are three types of media: **Snapshot**, **Video Clip**, and **System Log**. After making your changes, click the **Save Settings** button for them to take effect.

**Media Name:** Enter a unique name for the media you want to create.

**Snapshot:** Select this option to set the media type to snapshots.

**Source:** Set the video profile to use as the media source. Refer to **Audio and Video** on page 33 for more information on video profiles.

**Send pre-event image(s) [0~4]:** Set the number of pre-event images to take. Pre-event images are images taken before the main event snapshot is taken.

**Send post-event image(s) [0~7]:** Set the number of post-event images to take. Post-event images are images taken after the main event snapshot is taken. You can set up to seven post-event images to be taken.

For example:

If both the Send pre-event images and Send post-event images are set to four, a total of 9 images are generated after a trigger is activated.

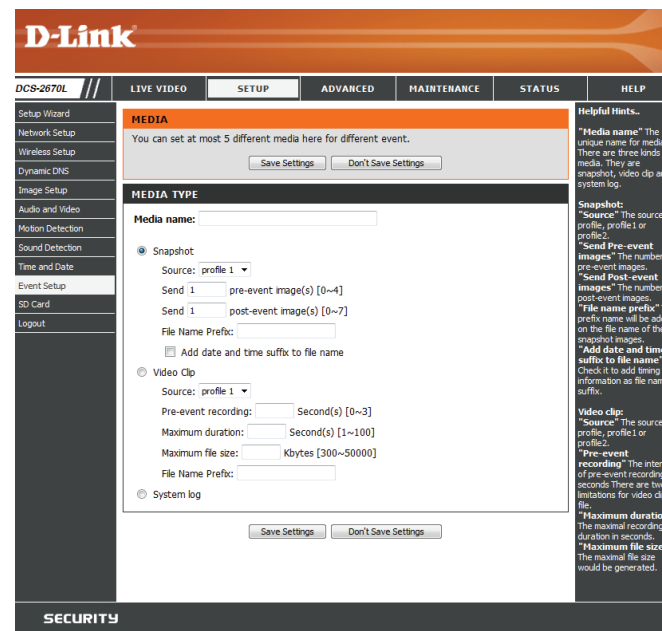
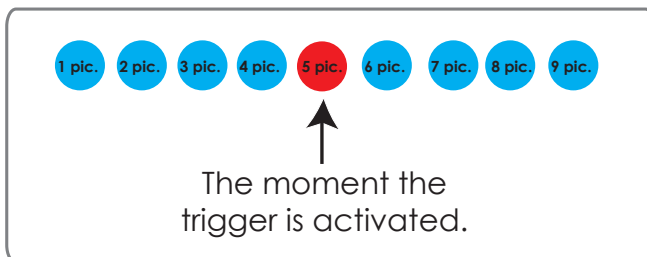

## Section 3: Configuration

**File name prefix:** Enter the prefix to add to the saved file name.

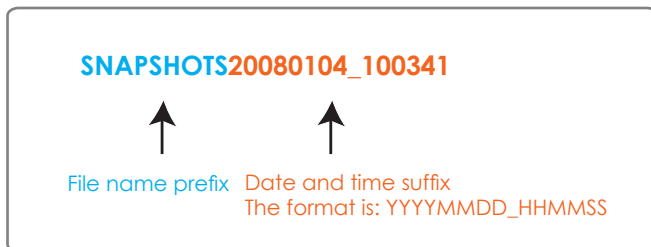

**Add date and time suffix to file name:** Check this to add the date and time the snapshot was recorded as a file name suffix.

**Video clip:** Select this option to set the media type to video clips.

**Source:** Set the video profile to use as the media source. Refer to **Audio and Video** on page 33 for more information on video profiles.

**Pre-event recording:** This sets how many seconds to record before the main event video clip starts. You can record up to 4 seconds of pre-event video.

**Maximum duration:** Set the maximum length of video to record for your video clips.

**Maximum file size:** Set the maximum file size to record for your video clips.

**File Name Prefix:** This is the prefix that will be added to the filename of saved video clips.

**System log:** Select this option to set the media type to system logs. This will send the system log, but will not record any snapshots or video.

**MEDIA TYPE**

Media name:

Snapshot

Source: profile 1

Send  pre-event image(s) [0~4]

Send  post-event image(s) [0~7]

File Name Prefix:

Add date and time suffix to file name

Video Clip

Source: profile 1

Pre-event recording:  Second(s) [0~3]

Maximum duration:  Second(s) [1~100]

Maximum file size:  Kbytes [300~50000]

File Name Prefix:

System log

Save Settings    Don't Save Settings



## Add Event

Create and schedule up to three events with their own settings here. After making your changes, click the **Save Settings** button for them to take effect.

**Event name:** Enter a name for the event.

**Enable this event:** Select this box to activate this event.

**Priority:** Set the priority for this event. The event with higher priority will be executed first.

**Delay:** Specify the delay time before allowing this event to be triggered again. This is used for both motion detection events and digital input triggers.

**Trigger:** Specify the input type that triggers the event.

**Video Motion Detection:** Selecting this will trigger the event when motion is detected during live video monitoring. Make sure you have enabled motion detection and specified what part of the image to monitor for motion. For more details, refer to **Motion Detection** on page 34.

**Periodic:** Selecting this will trigger the event in specified intervals. The trigger interval unit is in minutes.

**System Boot:** Selecting this will trigger an event when the system boots up.

**Network Lost:** Selecting this will trigger an event when the camera's connection to the network is lost.

**Event Schedule:** Specify when you want to monitor for this event. Select which days to monitor for this event, then select **Always** or enter the time interval to monitor for the specified event.

**Action:** If you have created Server and Media entries, you will see them appear here. Select which Server you want to send to and which Media you want the camera to send.

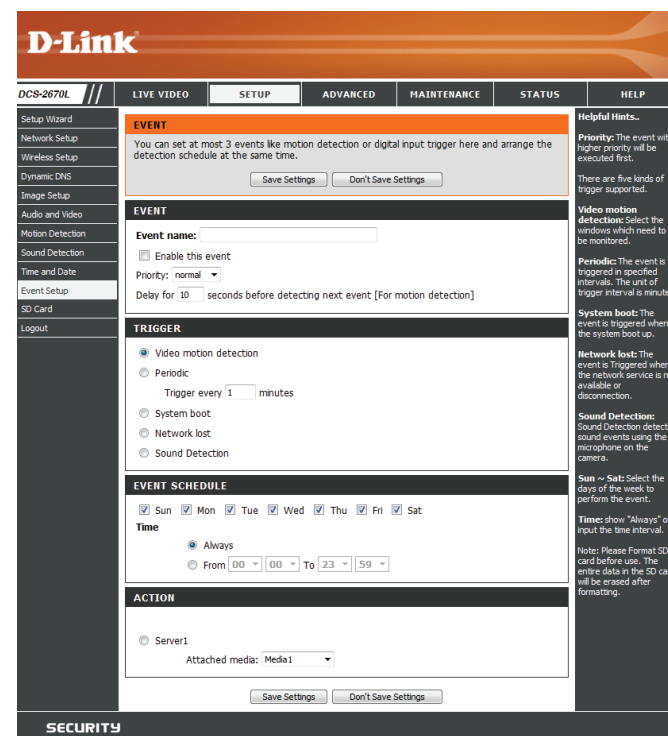

## Add Recording

Here you can configure and schedule a regular video recording. After making your changes, click the **Save Settings** button for them to take effect.

**Recording entry name:** Enter a name for the recording.

**Enable this recording:** Select this to enable this recording.

**Priority:** Set the priority for this recording. A recording with a higher priority will be the one used if two recordings will happen at the same time.

**Source:** Select the video profile to use as the recording source.

**Recording schedule:** Use the checkboxes to set which days to record video on. Select **Always** to record for the entire day, or select **From** and specify the period of time you want to record using the drop-down menus.

**Destination:** Select the Server to save the recording file to. If you created a server entry for the microSD card slot, you can select **SD** to save to it.

**Total cycling recording size:** Specify the amount of disk space to use for this recording (between 200 MB and 2 TB). When this space is full, the oldest recordings will be deleted to make room for new recordings. For example, if each recording file is 6 MB, and the total cycling recording size is 600 MB, then the camera will record 100 files in the specified destination. After that, the oldest file will be deleted to make space for new ones.

Please note that if the amount of free disk space is not enough, the recording will stop. Before you set up this option, please make sure your storage drive has enough free space. Also, it is recommended that you do not save other files in the same folder as your recording files.

**D-Link**

DCS-2670L // LIVE VIDEO SETUP ADVANCED MAINTENANCE STATUS HELP

**RECORDING**

You can setup schedule recording to network storage with your specify week day and time period.

Save Settings Don't Save Settings

**RECORDING**

Recording entry name:

Enable this recording

Priority: normal

Source: profile 1

**RECORDING SCHEDULE**

Sun  Mon  Tue  Wed  Thu  Fri  Sat

Time

Always

From 00:00 To 23:59

**RECORDING SETTINGS**

Destination: None

Total cycling recording size: 1000 Mbytes [200~2000000]

Size of each file for recording: 10 Mbytes

Time of each file for recording: 10 seconds

File Name Prefix:

Save Settings Don't Save Settings

**Helpful Hints...**

**Recording:** Enable this option if you want to upload the recording to a shared folder on the network.

**Recording schedule:** Select the day(s) according to when you want the IP camera to make a video clip.

**Always:** This enables the IP camera to make video clips continuously.

**From:** The time range specified for the video clip.

**Total cycling recording size:** Please enter the maximum amount of storage that can be used for recording on the media. Files will be written to storage cyclically (eg. oldest files will be overwritten if necessary) so that the total recording size does not exceed this value.

**Note:** Please Format SD card before use. The entire data in the SD card will be erased after formatting.

**SECURITY**

## Section 3: Configuration

---

**Size of each file for recording:** If this is selected, files will be separated based on the file size you specify.

**Time of each file for recording:** If this is selected, files will be separated based on the maximum length you specify.

**File Name Prefix:** The prefix name will be added to the file name of the recording file(s).

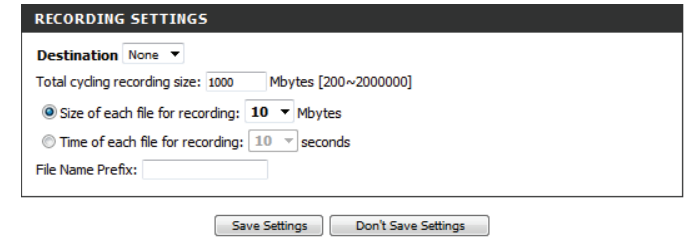

The screenshot shows a configuration window titled "RECORDING SETTINGS". It contains the following elements:

- Destination:** A dropdown menu currently set to "None".
- Total cycling recording size:** A text input field containing "1000" followed by "Mbytes [200~2000000]".
- Size of each file for recording:** A radio button that is selected, followed by a dropdown menu set to "10" and the text "Mbytes".
- Time of each file for recording:** A radio button that is unselected, followed by a dropdown menu set to "10" and the text "seconds".
- File Name Prefix:** An empty text input field.
- Buttons:** Two buttons at the bottom right: "Save Settings" and "Don't Save Settings".

## SD Card

Here you may browse and manage the recorded files which are stored on the microSD card. Video is stored in the Video folder, and snapshots are stored in the Picture folder. You can play back video and view snapshots by clicking on the appropriate folder, then clicking on the file you want to view.

**Files Per Page:** Use the drop-down menu to specify how many files to show per page. To change pages, use the drop-down menu on the right.

**Refresh:** Click this to refresh the file and folder information from the microSD card.

**Format SD Card:** Click this icon to automatically format the microSD card and create the Video and Picture folders.

**Deleting Files and Folders:** To delete files and folders, click on the checkbox next to the files or folders you want to delete, then click the **OK** button.

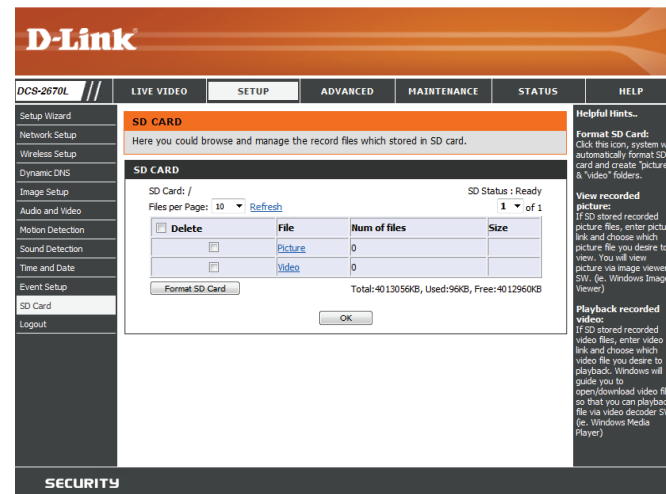

# Advanced

## ICR and IR

Here you can configure the ICR and IR settings. The IR (Infrared) Cut-Removable (ICR) filter can be disengaged for increased sensitivity in low light environments. After making your changes, click the **Save Settings** button for them to take effect.

**Automatic:** The Day/Night mode is set automatically. You can use the **Sensitivity** drop-down box to set when the camera will switch to Night mode. The text box to the right shows which lighting conditions are currently being detected by the camera for reference. You can refresh this status by clicking the **Refresh** button.

**Day Mode:** Day mode enables the IR Cut Filter.

**Night Mode:** Night mode disables the IR Cut Filter.

**Schedule Mode:** Set up the Day/Night mode using a schedule. The camera will enter Day mode at the starting time and return to Night mode at the ending time.

**IR Light Control:** The camera can enable or disable the IR (infrared) light according to your preferences. This setting provides additional controls depending on your specific application.

**Off:** The IR light will always be off.

**On:** The IR light will always be on.

**Sync with ICR:** The IR light will turn on when the ICR filter is disabled (night mode).

**Schedule:** The IR light will turn on or off according to the schedule that you specify below.

**D-Link**

DCS-2670L // LIVE VIDEO SETUP **ADVANCED** MAINTENANCE STATUS HELP

ICR and IR

**ICR AND IR**

An IR(Infrared) Cut-Removable(ICR) filter can be disengaged from the image path for increased sensitivity in low light environments. The ICR filter will automatically engage depending on the ambient light, allowing the camera to be effective in day/night environments.

- Select the Day/Night from the radio button. The available options are Automatic, Schedule mode, Day mode and Night mode.
- The default value is Automatic.

Light Sensor Sensitivity  
Light sensor sensitivity has Low, Medium, and High three different levels. You may get current camera light illumination by clicking Refresh button to set proper level of Light sensor sensitivity. For example, when level sets at High less than 30lux, camera will switch Day & Night mode to Night mode.

IR Light  
The built-in IR light illuminators will be activated automatically or manually so as to supplement the low light situation without additional equipment.

Save Settings Don't Save Settings

**ICR**

Removable IR-Cut filter trigger condition:

Automatic Sensitivity: Medium: <20lux over 30 lux Refresh

Day mode

Night mode

Schedule mode

Day mode(24hr)  
From 00 00 To 23 59

**IR LIGHT**

IR Light Control Highest

Off

On

Sync. With ICR

Schedule

IR Light Control On(24hr)  
From 00 00 To 23 59

Save Settings Don't Save Settings

Helpful Hints...

**ICR and IR:**

**Automatic:** The day/night mode is set automatically. It is normally set in the Day mode and changes to the Night mode in a dark place.

**Day mode:** The Day mode means disable the IR Cut Filter.

**Night mode:** The Night mode means enable the IR Cut Filter.

**Schedule mode:** Set the Day/Night mode using the schedule. Fill in the time so the Day/Night mode is normally set to Day mode and it enters the Day mode at the start time and returns to the Night mode at the end time.

**IR Light Control:** In poor light conditions, open IR Light Control to automatically turn on the light to enable you to take clear picture. The IR Light Control has 4 options: Off, On, Sync. with ICR, and Schedule. Off: This option disable the IR Light Control. On: The system automatically opens the IR Light Control to enable a camera to take clear images in poor light conditions. Sync with ICR: In this option, the IR Light Control will open automatically and follow the ICR setting. Schedule: In this option, you have to customize the setting to set the time period you want. Please set the Start time and the End time of your chosen schedule.

SECURITY

# HTTPS

This page allows you to install and activate an HTTPS certificate for encrypted access to your camera. After making your changes, click the **Save Settings** button for them to take effect.

**Enable HTTPS** Enable HTTPS connections. You will need to create a certificate using **Secure Connection:** the settings below.

**Create Certificate Method:** Choose the way the certificate should be created. Three options are available:

- Create a self-signed certificate automatically
- Create a self-signed certificate manually
- Create a certificate request and install

**Status:** Displays the details of the SSL certificate that is being used.

**Note:**

The certificate cannot be removed while HTTPS is still enabled. To remove the certificate, you must first uncheck **Enable HTTPS secure connection**.

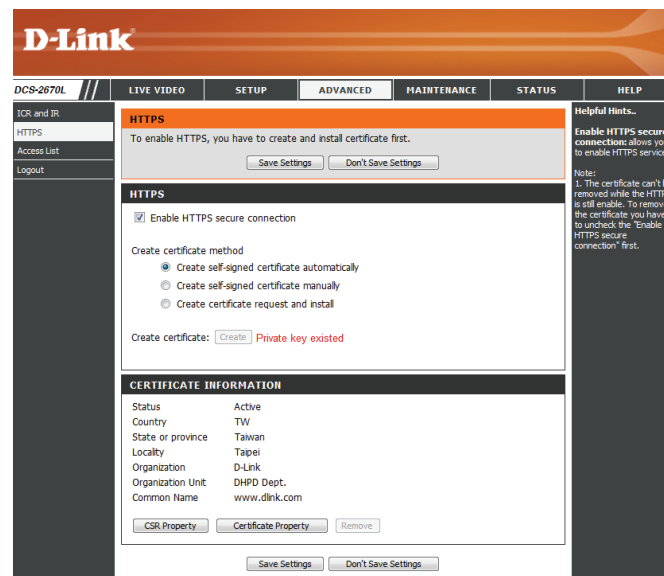

## Access List

Here you can set access permissions for users to view your DCS-2670L.

**Allow list:** The list of IP addresses that have access rights to the camera.

**Note:** When adding entries to the Allow list, make sure the first entry includes the IP address of the computer or device you are using to access the camera. Otherwise, you may be blocked from accessing the camera after adding the entry to the Allow list.

**Start IP address:** The starting IP address of the IP address range for the devices (such as a computer) that have permission to access the video of the camera.

**End IP address:** The ending IP address of the IP address range for the devices (such as a computer) that have permission to access the video of the camera. Click **Add** to save your changes.

**Note:** You can create seven entries for both the Allow list and the Deny list.

**Delete allow list:** Select an entry to remove from the Allow List, then click **Delete**.

**Deny list:** The list of IP addresses that have no access rights to the camera.

**Delete deny list:** Select an entry to remove from the Deny List, then click **Delete**.

**Note:** All addresses in the Deny List will be denied access, even if they are also in the Allow List.

The screenshot shows the D-Link DCS-2670L web interface. The top navigation bar includes 'LIVE VIDEO', 'SETUP', 'ADVANCED', 'MAINTENANCE', 'STATUS', and 'HELP'. The 'ADVANCED' tab is selected, leading to the 'ACCESS LIST' configuration page. The page title is 'ACCESS LIST' and the subtitle is 'Here you can set access permissions for users to view your IP camera.' Below the subtitle, there are two main sections: 'ALLOW LIST' and 'DENY LIST'. Each section has input fields for 'Start IP address' and 'End IP address', a dropdown menu for 'Delete allow list' (or 'Delete deny list'), and 'Add' and 'Delete' buttons. A 'Helpful Hints...' sidebar on the right provides definitions for 'Start IP Address', 'End IP Address', 'Delete Allow List', and 'Delete Deny List'.

# Maintenance Admin

You may modify the name and administrator password of your camera, as well as manage the user accounts for accessing the camera. You may also use this section to create a unique name and configure the On-Screen Display (OSD) settings for your camera.

**Admin Password Setting:** Set a new password for the administrator account.

**Add User Account:** Add a new user account.

**User Name:** Enter the user name for the new account.

**New Password:** Enter the password for the new account.

**User List:** All the existing user accounts will be displayed here. You may delete accounts included in the list, but you may want to reserve at least one as a guest account.

**IP Camera Name:** Create a unique name for your camera that will be added to the file name prefix when creating a snapshot or a video clip.

**Enable OSD:** Select this option to enable the On-Screen Display feature for your camera, which shows the camera name, date, and time on the camera's video.

**Label:** Enter a label for the camera, which will be shown on the OSD when it is enabled.

**LED:** You may specify whether or not to illuminate the status LED on the camera.

**D-Link**

DCS-2670L // LIVE VIDEO SETUP ADVANCED MAINTENANCE STATUS HELP

Admin  
System  
Firmware Upgrade  
Logout

**ADMIN**  
Here you can change the administrator's password for your IP camera as well as add and/or delete user account(s). You can configure the information, such as IP camera's name and time via this page. You can also enable the OSD (On-Screen Display) feature in order to display the IP camera name and time stamp for your video recordings.

**ADMIN PASSWORD SETTING**

New Password  63 characters maximum  
Retype Password

**ADD USER ACCOUNT**

User Name  5 users maximum  
New Password  63 characters maximum  
Retype Password

**USER LIST**

User Name -- User list --

**DEVICE SETTING**

IP Camera Name DCS-2670L 16 characters maximum  
 Enable OSD  
Label DCS-2670L 16 characters maximum

**LED**

LED  On  Off

**Helpful Hints...**  
Enabling OSD, the IP camera name and time will be displayed on the video screen for the user.  
For security purposes, it is recommended that you change the password for your administrator account. Be sure to write down the new password to avoid having to reset the IP camera in the event that it is forgotten.  
LED: In the rear panel of your camera there is a LED beside the network adapter. ON: The LED will flash a light to indicate if the network is working or not. OFF: No light will show, for this option is turn off.

**SECURITY**



# System

In this section, you may backup, restore and reset the camera configuration, or reboot the camera.

**Save To Local Hard Drive:** You may save your current camera configuration as a file on your computer.

**Load From Local Hard Drive:** Locate a pre-saved configuration by clicking **Browse** and then restore the pre-defined settings to your camera by clicking **Load Configuration**.

**Restore to Factory Defaults:** You may reset your camera and restore the factory settings by clicking **Restore Factory Defaults**.

**Reboot Device:** This will restart your camera.

**Enable Schedule Reboot:** If you want your camera to reboot on a regular schedule, check the **Enable Schedule Reboot** checkbox, then select the days and time you want the camera to reboot.

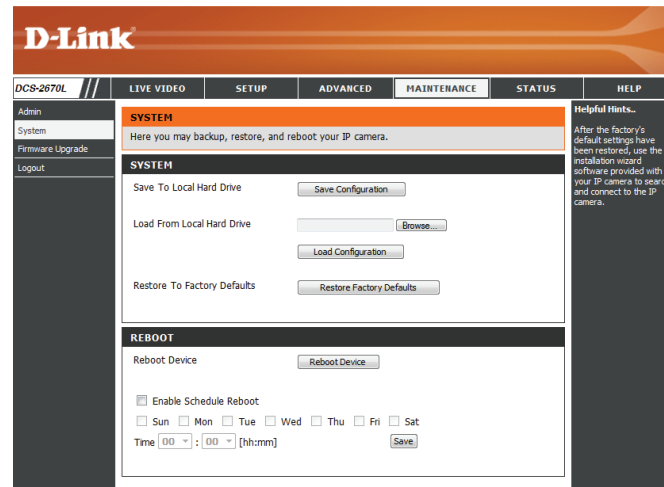

# Firmware Upgrade

The camera's current firmware version will be displayed on this screen. You may visit the D-Link Support Website to check for the latest available firmware version.

To upgrade the firmware on your DCS-2670L, please download and save the latest firmware version from the D-Link Support Page to your local hard drive. Locate the file on your local hard drive by clicking the **Browse** button. Select the file and click the **Upload** button to start upgrading the firmware.

**Current Firmware Version:** Displays the detected firmware version.

**Current Product Name:** Displays the camera model name.

**File Path:** Locate the file (upgraded firmware) on your hard drive by clicking **Browse**.

**Upload:** Uploads the new firmware to your camera.

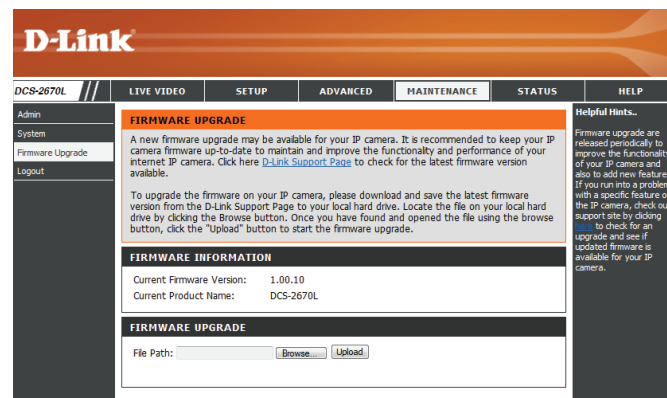

# Status Device Info

This page displays detailed information about your device and network connection.

The screenshot shows the D-Link web interface for the DCS-2670L camera. The top navigation bar includes 'LIVE VIDEO', 'SETUP', 'ADVANCED', 'MAINTENANCE', 'STATUS', and 'HELP'. The 'STATUS' tab is active, and the 'Device Info' sub-tab is selected. The main content area is titled 'DEVICE INFO' and contains a message: 'All of your network connection details are displayed on this page. The firmware version is also displayed here.' Below this is an 'INFORMATION' section with the following details:

IP Camera Name	DCS-2670L
Time & Date	Wed Mar 22 16:35:28 2017
Firmware Version	1.00.10
Hardware Version	A
MAC Address	B0:C5:54:17:D6:3D
IP Address	192.168.100.103
IP Subnet Mask	255.255.255.0
Default Gateway	192.168.100.1
Primary DNS	192.168.100.1
Secondary DNS	0.0.0.0
PPPoE	Disable
DDNS	Disable
Agent Version	2.1.0-b67

On the right side, there is a 'Helpful Hints..' section with the text: 'This page displays all the information about the IP camera and network settings.'

# Log

This page displays the log information of your camera. You may download the information by clicking **Download**. You may also click **Clear** to delete the saved log information.

The screenshot shows the D-Link web interface for the DCS-2670L camera. The top navigation bar includes 'LIVE VIDEO', 'SETUP', 'ADVANCED', 'MAINTENANCE', 'STATUS', and 'HELP'. The 'STATUS' tab is active, and the 'Log' option is selected in the left sidebar. The main content area is titled 'SYSTEM LOG' and contains a description: 'The system log records IP camera events that have occurred.' Below this is a 'CURRENT LOG' section with a list of 20 events. At the bottom of the log list are buttons for 'First Page', 'Previous 20', 'Next 20', 'Clear', and 'Download'. A 'Helpful Hints..' section on the right provides instructions on how to save and clear the log.

DCS-2670L	LIVE VIDEO	SETUP	ADVANCED	MAINTENANCE	STATUS	HELP
Device Info						<b>Helpful Hints..</b> You can save the log to your local hard IP camera by clicking the Download button, and you can clear the log by clicking on the Clear button.
Log	<b>SYSTEM LOG</b> The system log records IP camera events that have occurred.					
Logout	<b>CURRENT LOG</b> <ol style="list-style-type: none"> <li>2017/03/22 16:26:29 admin from 192.168.100.101 Set event type 1 ; Trigger : Motion Detection.</li> <li>2017/03/22 16:00:16 admin login Ok from 192.168.100.101</li> <li>2017/03/21 14:05:55 admin login Ok from 192.168.100.101</li> <li>2017/03/21 14:05:05 network port connected.</li> <li>2017/03/21 14:04:56 network port disconnected.</li> <li>2017/03/21 14:03:53 network port connected.</li> <li>2017/03/21 14:03:34 system power on.</li> <li>2017/03/20 16:21:17 network port connected.</li> <li>2017/03/20 16:20:59 system power on.</li> <li>2017/03/20 14:06:33 admin from 192.168.0.176 set IRLed strength from 100 to 100.</li> <li>2017/03/20 14:06:33 admin from 192.168.0.176 set IRCut mode from Night to Auto.</li> <li>2017/03/20 14:06:13 admin from 192.168.0.176 set IRLed strength from 100 to 100.</li> <li>2017/03/20 14:06:13 admin from 192.168.0.176 set IRCut mode from Auto to Night.</li> <li>2017/03/20 14:03:11 system change admin password.</li> <li>2017/03/20 14:02:47 admin login Ok from 192.168.0.176</li> <li>2017/03/20 14:02:07 network port connected.</li> <li>2017/03/20 14:01:43 system power on.</li> <li>2017/03/20 13:07:39 SD card removed.</li> <li>2017/03/20 13:07:27 admin login Ok from 10.10.0.121</li> <li>2017/03/20 13:06:59 network port connected.</li> </ol>					
	First Page Previous 20 Next 20 Clear Download					

# Help

This page provides helpful information regarding camera operation.

The screenshot shows the D-Link DCS-2670L web interface. At the top is the D-Link logo. Below it is a navigation bar with tabs for LIVE VIDEO, SETUP, ADVANCED, MAINTENANCE, STATUS, and HELP. The HELP tab is selected. On the left side, there is a sidebar with 'Help' and 'Logout' links. The main content area is titled 'HELP' and contains a list of links for each menu item: LIVE VIDEO (Camera), SETUP (Setup Wizard, Network Setup, Wireless Setup, Dynamic DNS, Image Setup, Audio and Video, Motion Detection, Sound Detection, Time and Date, Event Setup, SD Card), ADVANCED (ICR and IR, HTTPS, Access List), MAINTENANCE (Admin, System, Firmware Upgrade), and STATUS (Device Info, Log). At the bottom of the page, there is a 'SECURITY' section.

DCS-2670L	LIVE VIDEO	SETUP	ADVANCED	MAINTENANCE	STATUS	HELP
Help Logout	<b>HELP</b> <ul style="list-style-type: none"><li>LIVE VIDEO</li><li>SETUP</li><li>MAINTENANCE</li><li>ADVANCED</li><li>STATUS</li></ul>	<b>LIVE VIDEO</b> <ul style="list-style-type: none"><li>Camera</li></ul>	<b>SETUP</b> <ul style="list-style-type: none"><li>Setup Wizard</li><li>Network Setup</li><li>Wireless Setup</li><li>Dynamic DNS</li><li>Image Setup</li><li>Audio and Video</li><li>Motion Detection</li><li>Sound Detection</li><li>Time and Date</li><li>Event Setup</li><li>SD Card</li></ul>	<b>ADVANCED</b> <ul style="list-style-type: none"><li>ICR and IR</li><li>HTTPS</li><li>Access List</li></ul>	<b>MAINTENANCE</b> <ul style="list-style-type: none"><li>Admin</li><li>System</li><li>Firmware Upgrade</li></ul>	<b>STATUS</b> <ul style="list-style-type: none"><li>Device Info</li><li>Log</li></ul>

**SECURITY**

# Troubleshooting

## 1. What can I do if I forget the password for my camera's web configuration interface?

If you forget your password, you will need to perform a factory reset of your camera. This process will change all your settings back to the factory defaults. It is therefore recommended that you make a record of the password for future reference.

To reset your camera, please use an unfolded paperclip to press and hold the RESET button for at least 10 seconds while your camera is plugged in.

## 2. Why don't the LEDs light up?

The power supply might be faulty. Confirm that you are using the provided DC 5 V power supply for this network camera. Verify that the power supply is correctly connected. If the camera is functioning normally, the LEDs may have been disabled. See **Admin** on page 48 for information about how to enable the LEDs.

## 3. Why is the camera's network connection unreliable?

There might be a problem with the network cable. To confirm that the cables are working, PING the address of a known device on the network. If the cabling is OK and your network is reachable, you should receive a reply similar to the following (...bytes = 32 time = 2 ms).

Another possible problem may be that the network device such as a hub or switch utilized by the Network Camera is not functioning properly. Please confirm the power for the devices are well connected and functioning properly.

If you are using a wireless connection to connect the camera, be aware of the range limitations of the wireless N standard. Most wireless N devices have a maximum indoor range of around 70 metres (230 feet). Also be aware that obstacles such as walls, floors, doors and other solid objects can have an adverse effect on signal range.

## 4. Why does a series of broad vertical white lines appear through out the image?

It could be that the image sensor has become overloaded when it has been exposed to bright light such as direct exposure to sunlight or halogen lights. Reposition the camera into a more shaded area immediately, as prolonged exposure to bright lights will damage the sensor.

### **5. The camera is producing noisy images. How can I solve the problem?**

The video images might be noisy if the camera is used in a very low light environment. Try switching to night mode if you are consistently monitoring a low light area.

### **6. The images are poor quality, how can I improve the image quality?**

You may also need to check your image settings to make sure the brightness, contrast, and other settings are set properly. For more, refer to **Image Setup** on page 31.

### **7. Why are no images available through the Web browser?**

ActiveX might be disabled. If you are viewing the images from Internet Explorer make sure ActiveX has been enabled in the Internet Options menu. You may also need to change the security settings on your browser to allow the ActiveX plug-in to be installed. Also, check that you have the latest version of Java installed. Java can be downloaded from <http://www.java.com>

If you are using Internet Explorer with a version number 6 or lower, then you will need to upgrade your Web browser software in order to view the streaming video transmitted by the Network Camera.

# Technical Specifications

Camera		
Camera Hardware Profile	<ul style="list-style-type: none"> <li>• 1/2.7" 2-Megapixel progressive CMOS sensor</li> <li>• Minimum illumination:                             <ul style="list-style-type: none"> <li>• Color mode: 0.5 lux</li> <li>• B/W mode (LEDs off): 0.1 lux</li> <li>• B/W mode (LEDs on): 0 lux</li> </ul> </li> <li>• Minimum object distance 30 cm</li> <li>• Lens focal length: 1.5 mm ± 3%</li> </ul>	<ul style="list-style-type: none"> <li>• Aperture: F2.0</li> <li>• Angle of view (16:9):                             <ul style="list-style-type: none"> <li>• Horizontal: 180°</li> </ul> </li> <li>• Mounting angle:                             <ul style="list-style-type: none"> <li>• Vertical: 0° to 90°</li> <li>• Horizontal: 0° to 180°</li> </ul> </li> </ul>
Camera Housing	<ul style="list-style-type: none"> <li>• IP65 compliant weatherproof housing<sup>3</sup></li> </ul>	
Image Features	<ul style="list-style-type: none"> <li>• Digital zoom</li> <li>• Built-in microphone</li> <li>• Configurable image size, quality, frame rate, and bit rate</li> <li>• Wide Dynamic Range (WDR)</li> </ul>	<ul style="list-style-type: none"> <li>• Time stamp and text overlays</li> <li>• Configurable motion detection windows</li> <li>• Configurable brightness</li> </ul>
Video Compression	<ul style="list-style-type: none"> <li>• Simultaneous H.264 format compression</li> <li>• H.264 multicast streaming</li> </ul>	<ul style="list-style-type: none"> <li>• JPEG for still images</li> </ul>
Video Resolution	<ul style="list-style-type: none"> <li>• 16:9</li> <li>• 1920 x 1080 at up to 30 fps; 1280 x 720, 800 x 448, 640 x 360 at up to 30 fps</li> </ul>	
Audio Support	<ul style="list-style-type: none"> <li>• AAC (32 kbps)</li> </ul>	<ul style="list-style-type: none"> <li>• G.711 (128 kbps)</li> </ul>
Connectivity	<ul style="list-style-type: none"> <li>• 802.11n/g/b wireless with WPA/WPA2 encryption</li> <li>• 10/100BASE-TX Fast Ethernet port</li> <li>• Maximum data rate of 300 Mbps (PHY rate)<sup>1</sup></li> </ul>	<ul style="list-style-type: none"> <li>• microSD/SDHC/SDXC card slot, accepts cards up to 128 GB</li> </ul>
Network		
Network Protocols	<ul style="list-style-type: none"> <li>• IPv6, IPv4, ARP, TCP, UDP, ICMP</li> <li>• DHCP client</li> <li>• NTP client (D-Link)</li> <li>• DNS client</li> <li>• DDNS client (D-Link)</li> <li>• SMTP client</li> </ul>	<ul style="list-style-type: none"> <li>• HTTP server</li> <li>• HTTPS (for configuration)</li> <li>• uPnP port forwarding</li> <li>• ONVIF</li> <li>• RTP/RTSP/RTCP</li> <li>• Bonjour</li> </ul>
Security Features	<ul style="list-style-type: none"> <li>• Administrator and user group protection</li> <li>• Password authentication</li> </ul>	<ul style="list-style-type: none"> <li>• HTTP and RTSP digest encryption</li> </ul>



# Appendix A: Technical Specifications

System Integration		
System Requirements for mydlink Portal Web Management <sup>4</sup>	<ul style="list-style-type: none"> <li>Operating System: Windows 10/8/7 or Mac OS X 10.7 or higher</li> </ul>	<ul style="list-style-type: none"> <li>Browser: Internet Explorer 8, Firefox 12, Chrome 20<sup>2</sup>, or Safari 6 or higher</li> </ul>
Event Management	<ul style="list-style-type: none"> <li>Motion detection</li> <li>Sound level detection</li> <li>Scheduled recording</li> </ul>	<ul style="list-style-type: none"> <li>Event notification and snapshot/video clip uploads to mobile device</li> </ul>
Remote Management	<ul style="list-style-type: none"> <li>Configuration interface accessible via a web browser</li> </ul>	
Mobile Support	<ul style="list-style-type: none"> <li>mydlink Lite mobile app for iPhone, iPad, iPod touch, and Android</li> </ul>	
Physical		
Weight	<ul style="list-style-type: none"> <li>360 grams (12.7 ounces) ± 5%</li> </ul>	
Power Adapter	<ul style="list-style-type: none"> <li>Input: 100 to 240 V AC, 50/60 Hz</li> </ul>	<ul style="list-style-type: none"> <li>Output: 5 V DC 1.2 A</li> </ul>
Power Consumption	<ul style="list-style-type: none"> <li>Maximum: 5 watts ± 5%</li> </ul>	
Temperature	<ul style="list-style-type: none"> <li>Operating: -25 to 45 °C (-13 to 113 °F)</li> </ul>	<ul style="list-style-type: none"> <li>Storage: -20 to 70 °C (-4 to 158 °F)</li> </ul>
Humidity	<ul style="list-style-type: none"> <li>Operating: 20% to 80% non-condensing</li> </ul>	<ul style="list-style-type: none"> <li>Storage: 5% to 95% non-condensing</li> </ul>
Certifications	<ul style="list-style-type: none"> <li>CE</li> <li>CE LVD</li> <li>FCC</li> </ul>	<ul style="list-style-type: none"> <li>ICES</li> <li>RCM</li> </ul>
Dimensions Diagram	<p>The diagram illustrates the physical dimensions of the device in two views. The front view shows a circular lens with a diameter of 75.7 mm and a total height of 89.5 mm. The side view shows a depth of 69 mm and a base width of 102.1 mm. The device has a rounded top and a flat base with a mounting bracket.</p>	

# Regulatory Information

## Federal Communication Commission Interference Statement

This equipment has been tested and found to comply with the limits for a Class B digital device, pursuant to Part 15 of the FCC Rules. These limits are designed to provide reasonable protection against harmful interference in a residential installation. This equipment generates, uses and can radiate radio frequency energy and, if not installed and used in accordance with the instructions, may cause harmful interference to radio communications. However, there is no guarantee that interference will not occur in a particular installation. If this equipment does cause harmful interference to radio or television reception, which can be determined by turning the equipment off and on, the user is encouraged to try to correct the interference by one of the following measures:

- Reorient or relocate the receiving antenna.
- Increase the separation between the equipment and receiver.
- Connect the equipment into an outlet on a circuit different from that to which the receiver is connected.
- Consult the dealer or an experienced radio/TV technician for help.

## Non-modifications Statement:

Any changes or modifications not expressly approved by the party responsible for compliance could void the user's authority to operate this equipment.

## Caution:

This device complies with Part 15 of the FCC Rules. Operation is subject to the following two conditions:

- (1) This device may not cause harmful interference, and
- (2) this device must accept any interference received, including interference that may cause undesired operation.

This device and its antenna(s) must not be co-located or operating in conjunction with any other antenna or transmitter except in accordance with FCC multi-transmitter product procedures. For product available in the USA/Canada market, only channel 1~11 can be operated. Selection of other channels is not possible.

## Note:

The country code selection is for non-USA models only and is not available to all USA models. Per FCC regulations, all WiFi product marketed in the USA must be fixed to USA operational channels only.

### **IMPORTANT NOTICE:**

#### **FCC Radiation Exposure Statement**

This equipment complies with FCC radiation exposure limits set forth for an uncontrolled environment. This equipment should be installed and operated with minimum distance 20 cm between the radiator and your body.

#### **Innovation, Science and Economic Development Canada (ISED) Statement:**

This Class B digital apparatus complies with Canadian ICES-003.

Cet appareil numérique de la classe B est conforme à la norme NMB-003 du Canada.

#### **Innovation, Science and Economic Development Canada (ISED) Statement:**

This device complies with ISED licence-exempt RSS standard(s). Operation is subject to the following two conditions:

- (1) this device may not cause interference, and
- (2) this device must accept any interference, including interference that may cause undesired operation of the device.

Le présent appareil est conforme aux CNR d'ISED applicables aux appareils radio exempts de licence. L'exploitation est autorisée aux deux conditions suivantes :

- (1) l'appareil ne doit pas produire de brouillage, et
- (2) l'utilisateur de l'appareil doit accepter tout brouillage radioélectrique subi, même si le brouillage est susceptible d'en compromettre le fonctionnement.

#### **Radiation Exposure Statement**

This equipment complies with ISED radiation exposure limits set forth for an uncontrolled environment. This equipment should be installed and operated with minimum distance 20 cm between the radiator and your body.

#### **Déclaration d'exposition aux radiations**

Cet équipement est conforme aux limites d'exposition aux rayonnements ISED établies pour un environnement non contrôlé. Cet équipement doit être installé et utilisé avec un minimum de 20 cm de distance entre la source de rayonnement et votre corps.