

OCT 26 1960

U.S. DEPARTMENT OF COMMERCE
NATIONAL BUREAU OF STANDARDS

**SCREW-THREAD STANDARDS
FOR FEDERAL SERVICES
1957**

Amends in part H28 (1944) (and in part its 1950 Supplement)

HANDBOOK H28 (1957)—Part III

THE NATIONAL BUREAU OF STANDARDS

Functions and Activities

The functions of the National Bureau of Standards are set forth in the Act of Congress, March 3, 1901, as amended by Congress in Public Law 619, 1950. These include the development and maintenance of the national standards of measurement and the provision of means and methods for making measurements consistent with these standards; the determination of physical constants and properties of materials; the development of methods and instruments for testing materials, devices, and structures; advisory services to government agencies on scientific and technical problems; invention and development of devices to serve special needs of the Government; and the development of standard practices, codes, and specifications. The work includes basic and applied research, development, engineering, instrumentation, testing, evaluation, calibration services, and various consultation and information services. Research projects are also performed for other government agencies when the work relates to and supplements the basic program of the Bureau or when the Bureau's unique competence is required. The scope of activities is suggested by the listing of divisions and sections on the inside of the back cover.

Publications

The results of the Bureau's work take the form of either actual equipment and devices or published papers. These papers appear either in the Bureau's own series of publications or in the journals of professional and scientific societies. The Bureau itself publishes three periodicals available from the Government Printing Office: The Journal of Research, published in four separate sections, presents complete scientific and technical papers; the Technical News Bulletin presents summary and preliminary reports on work in progress; and Basic Radio Propagation Predictions provide data for determining the best frequencies to use for radio communications throughout the world. There are also five series of nonperiodical publications: Monographs, Applied Mathematics Series, Handbooks, Miscellaneous Publications, and Technical Notes.

Information on the Bureau's publications can be found in NBS Circular 460, Publications of the National Bureau of Standards (\$1.25) and its Supplement (\$1.50), available from the Superintendent of Documents, Government Printing Office, Washington 25, D.C.

NATIONAL BUREAU OF STANDARDS HANDBOOK H28 (1957)

SCREW-THREAD STANDARDS FOR FEDERAL SERVICES 1957

PART III

ACME, STUB ACME, AND BUTTRESS THREADS

ROLLED THREADS FOR SCREW SHELLS OF ELECTRIC LAMP
HOLDERS AND UNASSEMBLED LAMP BASES

MICROSCOPE OBJECTIVE AND NOSEPIECE THREADS

SURVEYING INSTRUMENT MOUNTING THREADS

PHOTOGRAPHIC EQUIPMENT THREADS

ISO METRIC THREADS; MISCELLANEOUS THREADS

CLASS 5 INTERFERENCE-FIT THREADS, TRIAL STANDARD

WRENCH OPENINGS



Amends in part H28 (1944) (and in part its 1950 Supplement)

[Issued October 7, 1960]

Foreword

This volume is the third of a series of three into which the 1957 edition of NBS Handbook H28 is divided.

Part I, published in September 1957, includes standards for screw threads which are commonly applied to bolts, screws, nuts, and other similar fasteners. Such threads are variously designated as Unified, American, American National, and Unified Miniature threads.

Part II, published in November 1959, includes standards for the following: pipe threads, including Dryseal pipe threads; gas cylinder valve outlet and inlet threads; hose coupling, including fire-hose coupling threads; and hose connections for welding equipment.

Handbook H28 (1944) and the 1950 Supplement thereto are superseded by Parts I, II, and III of Handbook H28 (1957) and the Federal Specifications listed in appendix 6 of Part I of H28 (1957).

A Supplement to the 1957 Handbook is in preparation, in order to make available revisions that have been developed subsequent to publication. These pertain primarily to the Unified thread standards.

ARCHIBALD T. MCPHERSON, *Chairman,*
Interdepartmental Screw Thread Committee.

PERSONNEL OF THE INTERDEPARTMENTAL SCREW THREAD COMMITTEE

Representing the Department of Defense:

MR. ALDEN W. McDANIEL, Mechanical and Engineering Programs Branch, Standardization Division, Armed Forces Supply Support Center, Department of Defense, Washington 25, D.C.

Representing the Department of the Army:

MR. EUGENE VON LOESCH, Research and Development Division, Office of the Chief of Engineers, Department of the Army, Washington 25, D.C.

MR. M. L. FRUECHTENICHT, Gage Laboratory, Frankford Arsenal, Ordnance Corps, Department of the Army, Philadelphia 37, Pa.

Representing the Department of the Navy:

MR. JAMES W. JENKINS, Metallurgical and Mechanical Branch, Research Division (Code 343), Bureau of Ships, Department of the Navy, Washington 25, D.C.

MR. J. E. WALTER, Engineering Department, U.S. Naval Weapons Plant, Washington 25, D.C.

Representing the Department of the Air Force:

MR. JOSEPH W. EVANS, WWDPF, Wright Air Development Division, Wright-Patterson Air Force Base, Ohio.

MR. FRANCIS L. CALKINS, WWDXSS, Wright Air Development Division, Wright-Patterson Air Force Base, Ohio.

Representing the Department of Commerce:

DR. ARCHIBALD T. MCPHERSON, chairman, Associate Director, National Bureau of Standards, Washington 25, D.C.

MR. IRVIN H. FULLMER, secretary, Chief, Engineering Metrology Section, Metrology Division, National Bureau of Standards, Washington 25, D.C.

Liaison Representatives of Sectional Committees Organized Under the Procedure of the American Standards Association and Sponsored by The American Society of Mechanical Engineers and the Society of Automotive Engineers, Inc., or the American Gas Association:

MR. RICHARD B. BELFORD, Technical Adviser, Industrial Fasteners Institute, 1517 Terminal Tower, Cleveland 13, Ohio. (Member of ASA Committees B1 and B18.)

MR. H. C. ERDMAN, Technical Adviser to Pres., The National Screw & Manufacturing Co., 2440 E. 75th St., Cleveland 4, Ohio. (Member of ASA Committees B1 and B18.)

MR. ERNEST S. HELDMANN, Chief Engineer, Holo-Krome Screw Corp., 31 Brooks St., Hartford 10, Conn. (Representing ASA Committee B18.)

MR. RUSSELL F. HOLMES, Technical Assistant, Engineering Standards Section, General Motors Technical Center, General Motors Corp., Detroit 2, Mich. (Member of ASA Committees B1 and B2.)

MR. MILTON A. SCHULTHEIS, Staff Engineer, Hughes Aircraft Co., Bldg. 6, Mail Sta. T2057, Culver City, Calif. (Member of ASA Committee B1.)

MR. FRANK TISCH, Voi-Shan Manufacturing Co., division of Voi-Shan Industries, Inc., 8463 Higuera St., Culver City, Calif. (Member of ASA Committee B1.)

MR. W. G. WALTERMIRE, Chief Products Engineer, The Lamson & Sessions Company, 5000 Tideman Rd., Cleveland 9, Ohio. (Member of ASA Committees B1, B2, and B18.)

APPROVAL BY THE SECRETARIES OF DEFENSE AND COMMERCE

The accompanying Handbook H28 (1957), Part III, on screw-thread standards for Federal Services, submitted by the Interdepartmental Screw Thread Committee, is hereby approved for use by the Departments of Defense and Commerce.

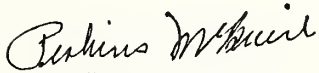

For the
Secretary of Defense



Secretary of Commerce

Contents

	Page		Page
Foreword.....	ii	SECTION XVIII. Photographic equipment threads.....	41
Personnel of the Interdepartmental Screw Thread Committee.....	ii	1. Tripod connections for American cameras; ¼—20UNC—1A/1B threads (PH3.6).....	41
Approval by the Secretaries of Defense and Commerce.....	iii	2. Tripod connections for European cameras; ¾—16UNC—1A/1B (PH3.7).....	42
SECTION XII. Acme threads.....	1	3. Threads for attaching mounted lenses to photographic equipment (PH3.10).....	42
1. General and historical.....	1	4. Attachment threads for lens accessories (PH3.12).....	42
2. Specifications for Acme form of thread.....	1	5. Shutter cable release tip and socket with taper (European) thread (PH3.23).....	45
3. Standard Acme thread series.....	4	6. Shutter cable release tip and socket with straight (American) thread (PH3.24).....	45
4. Classification and tolerances, Acme threads.....	4	SECTION XIX. Miscellaneous threads.....	45
5. Limits of size, Acme threads.....	6	1. 60° stub threads.....	45
6. Thread designations.....	7	2. Modified square threads.....	45
7. Gages for Acme threads.....	10	3. Threads for dairy sanitary fittings.....	46
(a) Gage tolerances.....	10	4. Glass bottle and jar threads.....	46
(b) Gages for external threads.....	10	Appendix 10. Wrench openings.....	47
(c) Gages for internal threads.....	17	Appendix 11. Class 5 interference-fit threads, Trial American Standard.....	48
(d) Concentricity.....	18	1. Introduction.....	48
SECTION XIII. Stub Acme threads.....	18	2. Scope.....	48
1. General and historical.....	18	3. Design and application data.....	48
2. Specifications for Stub Acme form of thread.....	18	4. Tables of dimensions, torques, and interferences.....	52
3. Standard Stub Acme thread series.....	19	5. Extension of the standard.....	52
4. Classification and tolerances, standard Stub Acme threads.....	19	Appendix 12. The tightening of threaded fasteners to proper tension.....	52
5. Limits of size, standard Stub Acme threads.....	20	1. Micrometer method.....	52
6. Thread designations.....	21	2. "Feel" method.....	53
7. Alternative Stub Acme threads.....	22	3. Torque measurement method.....	53
8. Gages for Stub Acme threads.....	25	4. Angular turn of nut method.....	53
(a) Gage tolerances.....	25	5. Use of special devices for controlling tension.....	53
(b) Gages for external threads.....	26	6. Bibliography.....	53
(c) Gages for internal threads.....	27	Appendix 13. Three-wire method of measurement of pitch diameter of 29° Acme, 29° Stub Acme, and Buttress threads.....	54
(d) Concentricity.....	27	1. Acme and Stub Acme threads.....	54
(e) Gage dimensions.....	27	(a) Single-start external threads.....	54
SECTION XIV. National Buttress threads.....	27	(b) Multiple-start external threads.....	55
1. Historical.....	27	(c) Limitations of three-wire measurement of external threads.....	59
2. General.....	28	2. Buttress threads.....	59
3. Specifications.....	28	3. Bibliography on measurement of pitch diameter by means of wires.....	60
4. Thread designations.....	32	Appendix 14. Metric screw-thread standards.....	61
5. Gaging.....	33	1. ISO thread profiles.....	61
6. British standard Buttress thread.....	34	2. Standard series for ISO metric threads.....	62
SECTION XV. American Standard rolled threads for screw shells of electric lamp holders and for screw shells of unassembled lamp bases.....	34	3. Designations for ISO metric threads.....	62
1. Form of thread.....	34		
2. Thread series.....	34		
3. Gages.....	35		
SECTION XVI. Microscope objective and nose-piece threads, 0.800—36AMO.....	36		
1. General and historical.....	36		
2. Specifications.....	36		
3. Gage dimensions.....	38		
4. British standard for microscope objective and nose-piece threads.....	38		
SECTION XVII. Surveying instrument mounting threads.....	40		
1. General and historical.....	40		
2. Specifications.....	40		
3. Gage dimensions.....	40		

Tables

	Page
Table XII. 1.—Basic dimensions, general purpose Acme threads.....	2
Table XII. 2.—Basic dimensions, centralizing Acme threads.....	3
Table XII. 3.—Acme threads series, basic diameters and thread data.....	4
Table XII. 4.—Tolerances and allowances (minimum clearances) for major and minor diameters, Acme thread series.....	5
Table XII. 5.—Pitch diameter allowances for Acme threads.....	6
Table XII. 6.—Pitch diameter tolerances for Acme screw threads, classes 2G and 2C.....	7
Table XII. 7.—Pitch diameter tolerances for Acme screw threads, classes 3G, 3C, and 5C.....	8
Table XII.8.—Pitch diameter tolerances for Acme screw threads, classes 4G, 4C, and 6C.....	9
Table XII.9.—Formulas for diameters, Acme thread classes.....	10
Table XII.10.—Limits of size and tolerances, Acme general purpose thread series, classes 2G, 3G, and 4G.....	11
Table XII.11.—Limits of size and tolerances, Acme centralizing thread series, classes 2C, 3C, and 4C.....	13
Table XII.12.—Limits of size and tolerances, Acme centralizing thread series, classes 5C and 6C.....	14
Table XII.13.—Tolerances for “go” and “not go” thread and plain gages, Acme threads.....	17
Table XII.14.—Pitch diameter compensation for adjusted lengths of “go” ring gages for general purpose and centralizing threads.....	17
Table XIII.1.—Standard Stub Acme thread form, basic dimensions.....	19
Table XIII.2.—Standard Stub Acme thread series, basic diameters and thread data.....	21
Table XIII.3.—Tolerances and allowances for major and minor diameters, Stub Acme threads.....	22
Table XIII.4.—Pitch diameter allowances for Stub Acme threads.....	22
Table XIII.5.—Limits of size and tolerances, standard Stub Acme thread series.....	23
Table XIII.6.—Modified Form 1 Stub Acme thread form, basic dimensions.....	25
Table XIII.7.—Modified Form 2 Stub Acme thread form, basic dimensions.....	25
Table XIII.8.—Tolerances for “go” and “not go” thread gages, Stub Acme threads.....	26
Table XIII.9.—Tolerances for plain gages, Stub Acme threads.....	26
Table XIV. 1.—Basic dimensions for Buttress threads.....	30
Table XIV. 2.—Tolerances on Buttress threads, class 3 (close).....	30
Table XIV. 3.—Tolerances on Buttress threads, class 2 (medium).....	30
Table XIV. 4.—Tolerances on Buttress threads, class 1 (free).....	31
Table XIV. 5.—Allowances on external Buttress threads, all classes.....	31
Table XIV. 6.—Numerical data for British Standard form Buttress threads.....	34
Table XV. 1.—American Standard rolled threads for lamp base screw shells before assembly.....	35
Table XV. 2.—American Standard rolled threads for lamp holder screw shells.....	35
Table XVI. 1.—Symbols, formulas, and basic and design dimensions, 0.800—36AMO.....	37
Table XVI. 2.—Limits of size and tolerances, 0.800—36AMO.....	37
Table XVI. 3.—Recommended gage dimensions for microscope objective and nose-piece thread, 0.800—36AMO.....	39
Table XVI. 4.—Limits of size for the British microscope objective and nosepiece thread.....	39
Table XVII. 1.—Limits of size, tolerances, and allowances; surveying instrument mounting threads.....	40
Table XVII. 2.—Recommended gage dimensions for surveying instrument mounting threads.....	41
Table XVIII. 1.—Limits of size, tolerances, and lengths of threads for attaching mounted lenses to photographic equipment, class 3A/3B UNS.....	43
Table XVIII. 2.—Limits of size and tolerances for preferred attachment threads for lens accessories, 36 tpi, class 2, NS.....	44
Table XVIII. 3.—Limits of size and tolerances for secondary attachment threads for lens accessories, 36 tpi, class 2, NS.....	44
Table XIX. 1.—Basic dimensions of 60° stub threads.....	46
Table 10.1.—Standard wrench openings.....	47
Table 11.1.—Limits of size, external threads, class 5.....	50
Table 11.2.—Limits of size, internal threads, class 5.....	50
Table 11.3.—Interferences, lengths of engagement, and torques, class 5.....	51
Table 13.1.—Wire sizes and constants, single-start Acme and Stub-Acme threads (29°).....	54
Table 13.2.—Values for wire measurements of single-start standard Acme threads (29°).....	55
Table 13.3.—Values for wire measurements of single-start standard Stub Acme threads (29°).....	56
Table 13.4.—Values of $(1 + \operatorname{cosec} \alpha')$ for $\alpha = 14^\circ 30'$ and lead angles from 0° to 5°	56
Table 13.5.—Best wire diameters and constants for large lead angles, 1-in. axial pitch Acme and Stub Acme threads (29°).....	57
Table 13.6.—Wire sizes and constants, single-start Buttress threads (7°, 45°).....	60
Table 14.1.—ISO metric screw threads for general use, 0.25 to 300 mm diameter.....	63
Table 14.2.—ISO metric screw threads for screws, bolts, and nuts, 0.25 to 39 mm diameter.....	65

Figures

	Page
Figure XII.1.—General purpose Acme thread form.....	2
Figure XII.2.—Centralizing Acme thread form.....	3
Figure XII.3.—Illustration of allowances, tolerances, and crest clearances, general purpose Acme threads, classes 2G, 3G, and 4G.....	12
Figure XII.4.—Illustration of allowances, tolerances, and crest clearances, centralizing Acme threads, classes 2C, 3C, and 4C.....	15
Figure XII.5.—Illustration of allowances, tolerances, and crest clearances, centralizing Acme threads, classes 5C and 6C.....	16
Figure XIII.1.—Standard Stub Acme form of thread.....	20
Figure XIII.2.—Illustration of allowances, tolerances, and crest clearances for Stub Acme threads.....	24
Figure XIII.3.—Modified Form 1 Stub Acme thread with basic height of 0.375 pitch.....	25
Figure XIII.4.—Modified Form 2 Stub Acme thread with basic height of 0.25 pitch.....	25
Figure XIV.1.—Form of Buttress thread having 7° pressure flank and 45° clearance flank.....	29
Figure XIV.2.—Illustration of tolerances, allowances, and root truncations, Buttress threads.....	31
Figure XIV.3.—British Standard form of Buttress thread.....	34
Figure XV.1.—Illustration of thread form, allowance, and tolerances, American Standard rolled threads for screw shells of electric lamp holders and lamp bases.....	35
Figure XVI.1.—Typical arrangement of microscope objective and nosepiece.....	36
Figure XVI.2.—Disposition of tolerances, allowances, and crest clearances for 0.800—36AMO thread.....	38
Figure XVI.3.—Basic form of Whitworth thread.....	39
Figure XVII.1.—Surveying instrument tripod head and base plate.....	40
Figure XVIII.1.—Tripod screw, ¼—20 UNC—1A.....	41
Figure XVIII.2.—Tripod socket in camera, ¼—20 UNC—1B.....	41
Figure XVIII.3.—Spacer for use on tripod with 0.340 in. length screw, ¼—20 UNC—1B.....	42
Figure XVIII.4.—Tripod screw, ⅜—16 UNC—1A.....	42
Figure XVIII.5.—Tripod socket in camera, ⅜—16 UNC—1B.....	42
Figure XVIII.6.—Adapter; ⅜—16 UNC—1A external thread, ¼—20 UNC—1B internal thread.....	42
Figure XVIII.7.—Length, pilot, and undercut of attachment threads for lens accessories.....	44
Figure XVIII.8.—Shutter cable release tip with taper (European) thread (50 tpi).....	45
Figure XVIII.9.—Thread details for shutter cable release tip and socket with taper (European) thread (50 tpi).....	45
Figure XVIII.10.—Shutter cable release tip with straight (American) thread.....	45
Figure XVIII.11.—Open type shutter cable socket with straight (American) thread.....	45
Figure XIX.1.—Modified square thread (10° included angle) basic proportions.....	46
Figure 11.1.—Illustrations showing maximum and minimum interferences, class 5 threads.....	49
Figure 12.1.—Effective length applicable in elongation formula.....	53
Figure 12.2.—Drilling for elongation determination when one end is not accessible.....	53
Figure 13.1.—Basis of lead angle correction for external thread.....	59
Figure 13.2.—Diameters of “best” and “maximum” thread wires for Buttress threads.....	60
Figure 14.1.—ISO basic profile for inch and metric screw threads.....	61
Figure 14.2.—ISO design profile of external and internal threads with an allowance for inch and metric screw threads.....	62
Figure 14.3.—ISO design profile of external and internal threads without an allowance for inch and metric screw threads.....	62

1957 HANDBOOK OF SCREW-THREAD STANDARDS FOR FEDERAL SERVICES, PART III

As Approved 1960

SECTION XII. ACME THREADS¹

1. GENERAL AND HISTORICAL

When formulated prior to 1895, Acme threads were intended to replace square threads and a variety of threads of other forms used chiefly for the purpose of producing traversing motions on machines, tools, etc. Acme threads are now extensively used for a variety of purposes. This section provides for two general applications of Acme threads, namely, general purpose and centralizing.²

The three classes of general purpose threads have clearances on all diameters for free movement and may be used in assemblies with the internal thread rigidly fixed and movement of the external thread in a direction perpendicular to its axis limited by its bearing or bearings. The five classes of centralizing threads have a limited clearance at the major diameters of the external and internal threads, so that a bearing at the major diameter maintains approximate alinement of the thread axis and prevents wedging on the flanks of the thread. For any combination of the five classes of threads covered in this section some end play or backlash will result. This is unavoidable for interchangeable product. When backlash or end play is objectionable, some mechanical means should be provided to eliminate the condition. The following practices have been successfully used:

(a) The internally threaded member is split parallel with the axis and adjusted and lapped to fit the externally threaded member;

(b) the internally threaded member is tapped first and the externally threaded member is milled, ground, or otherwise machined to fit the internally threaded member;

(c) the internally threaded member is split perpendicular to the axis, and the two parts are adjusted to bear on opposite flanks of the thread of the externally threaded member.

In any case, sufficient end play must be left to provide a close running fit.

In addition to limits of size for the standard series of diameters and pitches of Acme threads, tables of pitch diameter tolerances provide for a wide choice of diameters for a given standard pitch, and by use of the formulas for diameter and pitch increments shown in tables XII.6, XII.7, and XII.8, pp. 7, 8, and 9, the pitch diameter tol-

erances for special diameters and pitches can be determined for each class. Formulas and data for use with special threads are also provided in table XII.5, p. 6, for pitch diameter allowances on external threads, and in table XII.4, p. 5, for major and minor diameter allowances and tolerances.

Multiple threads should be considered when fast relative motion is required.

While threads for valve operation may be made to this standard, this application is highly specialized and these data should not be used without consultation with the valve manufacturer.

2. SPECIFICATIONS FOR ACME FORM OF THREAD

1. **ANGLE OF THREAD.**—The angle between the flanks of the thread measured in an axial plane shall be 29°. The line bisecting this 29° angle shall be perpendicular to the axis of the thread.

2. **PITCH OF THREAD.**—The pitch of a thread is the distance, measured parallel to its axis, between corresponding points on adjacent thread forms.

3. **HEIGHT OF THREAD.**—The basic height of the thread shall be equal to one-half of the pitch.

4. **THICKNESS OF THREAD.**—The basic thickness of the thread at a diameter smaller by one-half the pitch than the basic major diameter shall be equal to one-half of the pitch.

5. **ALLOWANCE (MINIMUM CLEARANCE) AT MAJOR AND MINOR DIAMETERS.**—(a) *General purpose threads.*—A minimum diametrical clearance is provided at the minor diameter of all external threads by establishing the maximum minor diameter 0.020 in. below the basic minor diameter for 10 threads per inch (tpi) and coarser, and 0.010 in. for finer pitches.

A minimum diametrical clearance at the major diameter is obtained by establishing the minimum major diameter of the internal thread 0.020 in. above the basic major diameter for 10 tpi and coarser, and 0.010 in. for finer pitches.

(b) *Centralizing threads.*—A minimum diametrical clearance is provided at the minor diameter of all external threads by establishing the maximum minor diameter 0.020 in. below the basic minor diameter for 10 tpi and coarser, and 0.010 in. for finer pitches. A minimum diametrical clearance for the fillet is provided at the minor diameter by establishing the minimum minor diameter of the internal thread 0.1*p* greater than the basic minor diameter.

A minimum diametrical clearance at the major diameter is obtained by establishing the minimum major diameter of the internal thread $0.001\sqrt{D}$ above the basic major diameter.

¹ This section is in substantial agreement with American Standards Association publication ASA B1.5, "Acme Screw Threads," which is published by the ASME, 29 W. 39th St., New York 18, N.Y. The latest revision should be consulted when referring to this ASA document.

² Stub Acme threads are covered in section XIII, p. 18.

6. CHAMFERS AND FILLETS.—(a) *General purpose threads.*—External threads may have the crest corners chamfered at an angle of 45° with the axis to a maximum depth of $0.0667p$. This corresponds to a maximum width of chamfer flat of $0.0945p$.

(b) *Centralizing threads.*—External threads shall have the crest corners chamfered at an angle of 45° with the axis to a minimum depth of $0.05p$ and a maximum depth of $0.0667p$. This corresponds to a minimum width of chamfer flat of $0.0707p$ and a maximum width of $0.0945p$. (See table XII.2, cols. 6 and 7.)

External threads for classes 2C, 3C, and 4C may have a fillet at the minor diameter not greater than $0.1p$ and for classes 5C and 6C the minimum fillet shall be $0.07p$, and the maximum fillet $0.1p$.

Internal threads of all classes may have a fillet at the major diameter not greater than $0.06p$.

7. BASIC DIMENSIONS.—(a) *General.*—For general purpose threads, the basic thread form dimensions for the most generally used pitches are given in table XII.1; the basic thread form is symmetrical and is illustrated in figure XII.1.

For centralizing threads, the basic dimensions for the most generally used pitches are given in

table XII.2; the basic thread form is symmetrical and is illustrated in figure XII.2.

TABLE XII.1—Basic dimensions, general purpose Acme threads

Threads per inch, n	Pitch, p	Height of thread (basic), $h=0.5p$	Total height of thread, $h_s=h+0.5$ allowance ^a	Thread thickness (basic), $t=0.5p$	Width of flat at:	
					Crest of internal thread (basic), $F_{cn}=0.3707p$	Root of internal thread, $F_{rn}=0.3707p-0.259 \times$ allowance ^a
1	2	3	4	5	6	7
	<i>in.</i>	<i>in.</i>	<i>in.</i>	<i>in.</i>	<i>in.</i>	<i>in.</i>
16	0.06250	0.03125	0.0362	0.03125	0.0232	0.0206
14	.07143	.03571	.0407	.03571	.0265	.0239
12	.08333	.04167	.0467	.04167	.0309	.0283
10	.10000	.05000	.0600	.05000	.0371	.0319
8	.12500	.06250	.0725	.06250	.0463	.0411
6	.16667	.08333	.0933	.08333	.0618	.0566
5	.20000	.10000	.1100	.10000	.0741	.0689
4	.25000	.12500	.1350	.12500	.0927	.0875
3	.33333	.16667	.1767	.16667	.1236	.1184
2½	.40000	.20000	.2100	.20000	.1483	.1431
2	.50000	.25000	.2600	.25000	.1853	.1802
1½	.66667	.33333	.3433	.33333	.2471	.2419
1¼	.75000	.37500	.3850	.37500	.2780	.2728
1	1.00000	.50000	.5100	.50000	.3707	.3655

^a For allowance, see table XII.4, col. 3.

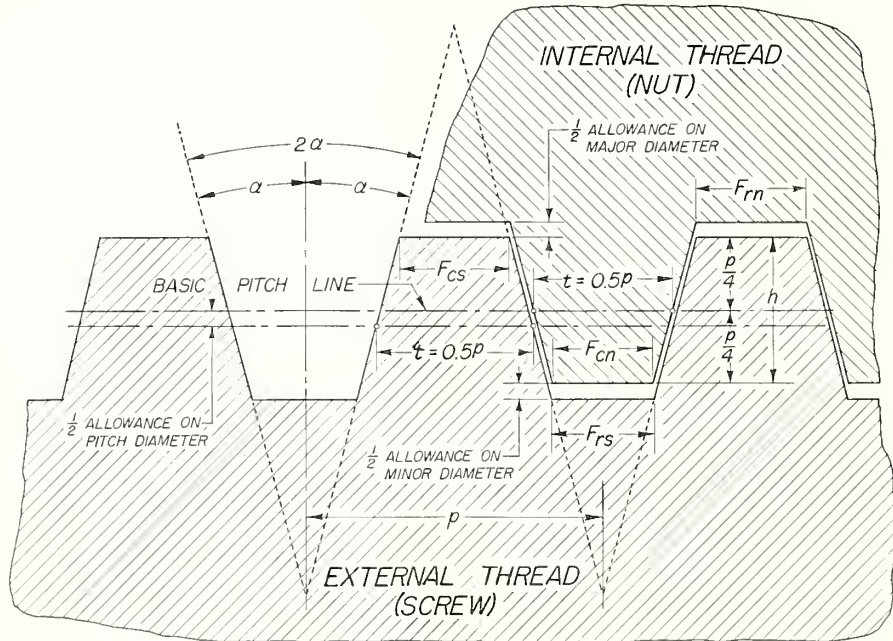

FIGURE XII.1.—General purpose Acme thread form.

NOTATION

- $2\alpha=29^\circ$
- $\alpha=14^\circ30'$
- p =pitch
- n =number of threads per inch
- N =number of turns per inch
- h =basic height of thread= $0.5p$
- t =thickness of thread= $0.5p$
- $F_{cn}=0.3707p$ =basic width of flat of crest of internal thread
- $F_{cs}=0.3707p$ =basic width of flat of crest of external thread
- $F_{rn}=0.3707p-0.259 \times$ (major-diameter allowance on internal thread)
- $F_{rs}=0.3707p-0.259 \times$ (minor-diameter allowance on external thread—pitch-diameter allowance on external thread).

TABLE XII.2—Basic dimensions, centralizing Acme threads

Threads per inch, n	Pitch, p	Height of thread (basic), $h=0.5p$	Total height of thread (all external threads) $h_s=h+0.5$ allowance ^a	Thread thickness (basic), $t=0.5p$	45° chamfer crest of centralizing external threads		Max fillet radius, root of centralizing tapped hole, $0.06p$	Fillet radius at minor diameter of centralizing screws	
					Min depth, $0.05p$	Min width of chamfer flat, $0.0707p$		Min (classes 5 and 6 only), $0.07p$	Max (all classes), $0.10p$
1	2	3	4	5	6	7	8	9	10
16.....	<i>in.</i> 0.06250	<i>in.</i> 0.03125	<i>in.</i> 0.0362	<i>in.</i> 0.03125	<i>in.</i> 0.0031	<i>in.</i> 0.0044	<i>in.</i> 0.0040	<i>in.</i> 0.0044	<i>in.</i> 0.0062
14.....	0.07143	0.03571	0.0407	0.03571	0.0036	0.0050	0.0040	0.0050	0.0071
12.....	0.08333	0.04167	0.0467	0.04167	0.0042	0.0060	0.0050	0.0058	0.0083
10.....	0.10000	0.05000	0.0600	0.05000	0.0050	0.0070	0.0060	0.0070	0.0100
8.....	0.12500	0.06250	0.0725	0.06250	0.0062	0.0090	0.0075	0.0088	0.0125
6.....	0.16667	0.08333	0.0933	0.08333	0.0083	0.0120	0.0100	0.0117	0.0167
5.....	0.20000	0.10000	0.1100	0.10000	0.0100	0.0140	0.0120	0.0140	0.0200
4.....	0.25000	0.12500	0.1350	0.12500	0.0125	0.0180	0.0150	0.0175	0.0250
3.....	0.33333	0.16667	0.1767	0.16667	0.0167	0.0240	0.0200	0.0233	0.0333
2½.....	0.40000	0.20000	0.2100	0.20000	0.0200	0.0280	0.0240	0.0280	0.0400
2.....	0.50000	0.25000	0.2600	0.25000	0.0250	0.0350	0.0300	0.0350	0.0500
1½.....	0.66667	0.33333	0.3433	0.33333	0.0330	0.0470	0.0400	0.0467	0.0667
1⅓.....	0.75000	0.37500	0.3850	0.37500	0.0380	0.0530	0.0450	0.0525	0.0750
1.....	1.00000	0.50000	0.5100	0.50000	0.0500	0.0710	0.0600	0.0700	0.1000

^a For allowance, see table XII.4, col. 3.

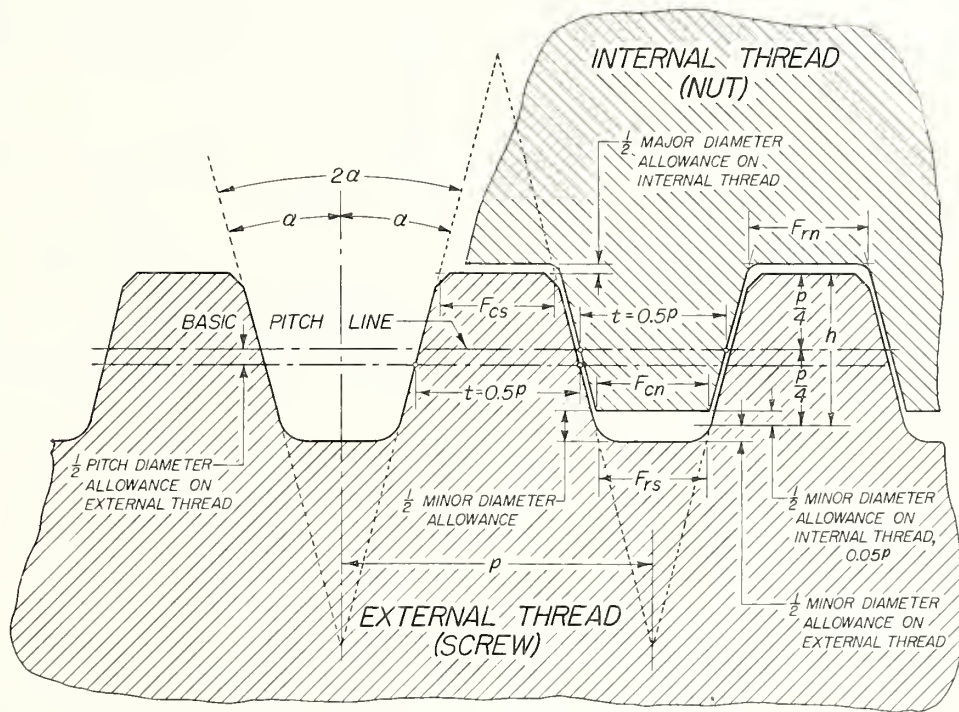

FIGURE XII.2.—Centralizing Acme thread form.

NOTATION

$2\alpha=29^\circ$

$\alpha=14^\circ 30'$

p =pitch

n =number of threads per inch

N =number of turns per inch

h =basic height of thread= $0.5p$

t =thickness of thread= $0.5p$

$F_{cn}=0.3707p$ =basic width of flat of crest of internal thread

$F_{cs}=0.3707p$ =basic width of flat of crest of external thread

$F_{rn}=0.3707p-0.259 \times$ (major-diameter allowance on internal thread)

$F_{rs}=0.3707p-0.259 \times$ (minor-diameter allowance on external thread—pitch-diameter allowance on external thread).

F_{rn} and F_{rs} are measured from the intersections of the straight flanks and roots.

(b) *Special requirements (deviations from nominal diameter).*—Applications requiring special machining processes resulting in a basic diameter other than the nominal diameters shown in table XII.3, column 1, shall have allowances and tolerances in accordance with table XII.4, footnote a; table XII.5; and tabulated tolerances, tables XII.6, XII.7, and XII.8.

(c) *Special diameters.*—Special diameters not shown in table XII.3 or not divisible by $\frac{1}{16}$, shall show the actual basic major diameter in decimals on drawings, specifications, and tools.

3. STANDARD ACME THREAD SERIES³

There has been selected a series of diameters and associated pitches of Acme threads listed in table XII.3 which is recommended as preferred.

³ When Acme centralizing threads are produced in single units or in very small quantities (and principally in sizes larger than the range of commercial taps and dies) where the manufacturing process employs cutting tools (such as lathe cutting), it may be economically advantageous and therefore desirable to have the centralizing control of the mating threads located at the *minor diameters*.

Particularly under the above-mentioned type of manufacturing, the advantages cited for minor diameter centralizing control over centralizing control at the major diameters of the mating threads are:

(1) Greater ease and faster checking of machined thread dimensions. It is much easier to measure the minor diameter (root) of the external thread and the mating minor diameter (crest or bore) of the internal thread than it is to determine the major diameter (root) of the internal thread and the major diameter (crest or turn) of the external thread;

(2) better manufacturing control of the machined size due to greater ease of checking;

(3) lower manufacturing costs.

TABLE XII.3—Acme thread series, basic diameters and thread data

Identification		Basic diameters						Thread data									
Nominal sizes (all classes)	Threads per inch, <i>n</i>	General purpose, all classes, and centralizing, classes 2C, 3C, and 4C			Centralizing, classes 5C and 6C			Pitch, <i>p</i>	Thread thickness at pitch line, <i>t</i> =0.5 <i>p</i>	Basic height of thread, <i>h</i> =0.5 <i>p</i>	Basic width of flat, <i>F</i> =0.3707 <i>p</i>	Lead angle at basic pitch diameter				Shear area, class 3G ^a	Stress area, class 3G ^b
		Major diameter, <i>D</i>	Pitch diameter, <i>E</i> =(<i>D</i> - <i>h</i>)	Minor diameter, <i>K</i> =(<i>D</i> -2 <i>h</i>)	Major diameter, <i>P</i> =(<i>D</i> -0.025√ <i>D</i>)	Pitch diameter, <i>E</i> =(<i>B</i> - <i>h</i>)	Minor diameter, <i>K</i> =(<i>B</i> -2 <i>h</i>)					General purpose, all classes, and centralizing classes 2C, 3C, and 4C, λ	Centralizing classes 5C and 6C, λ				
1	2	3	4	5	6	7	8	9	10	11	12	13	14	15	16		
<i>in.</i>		<i>in.</i>	<i>in.</i>	<i>in.</i>	<i>in.</i>	<i>in.</i>	<i>in.</i>	<i>in.</i>	<i>in.</i>	<i>in.</i>	<i>in.</i>	<i>deg min</i>	<i>deg min</i>	<i>sq in.</i>	<i>sq in.</i>		
$\frac{1}{4}$	16	0.2500	0.2188	0.1875	0.06250	0.03125	0.03125	0.0232	5 12	0.350	0.0285		
$\frac{5}{16}$	14	.3125	.2768	.241107143	.03571	.03571	.0265	4 42451	.0474		
$\frac{3}{8}$	12	.3750	.3333	.291708333	.04167	.04167	.0309	4 33545	.0699		
$\frac{7}{16}$	12	.4375	.3958	.354208333	.04167	.04167	.0309	3 50660	.1022		
$\frac{1}{2}$	10	.5000	.4500	.4000	0.4823	0.4323	0.3823	.10000	.05000	.05000	.0371	4 3	4 13	.749	.1287		
.....		
$\frac{5}{8}$	8	.6250	.5625	.5000	.6052	.5427	.4802	.12500	.06250	.06250	.0463	4 3	4 12	.941	.2043		
$\frac{3}{4}$	6	.7500	.6667	.5833	.7284	.6451	.5617	.16667	.08333	.08333	.0618	4 33	4 42	1.108	.2848		
$\frac{7}{8}$	6	.8750	.7917	.7083	.8516	.7683	.6849	.16667	.08333	.08333	.0618	3 50	3 57	1.339	.4150		
1.....	5	1.0000	.9000	.8000	.9750	.8750	.7750	.20000	.10000	.10000	.0741	4 3	4 10	1.519	.5354		
.....		
$1\frac{1}{8}$	5	1.1250	1.0250	.9250	1.0985	.9985	.8985	.20000	.10000	.10000	.0741	3 33	3 39	1.751	.709		
$1\frac{1}{4}$	5	1.2500	1.1500	1.0500	1.2220	1.1220	1.0220	.20000	.10000	.10000	.0741	3 10	3 15	1.983	.907		
$1\frac{3}{8}$	4	1.3750	1.2500	1.1250	1.3457	1.2207	1.0957	.25000	.12500	.12500	.0927	3 39	3 44	2.139	1.059		
$1\frac{1}{2}$	4	1.5000	1.3750	1.2500	1.4694	1.3444	1.2194	.25000	.12500	.12500	.0927	3 19	3 23	2.372	1.298		
.....		
$1\frac{3}{4}$	4	1.7500	1.6250	1.5000	1.7169	1.5919	1.4669	.25000	.12500	.12500	.0927	2 48	2 52	2.837	1.851		
2.....	4	2.0000	1.8750	1.7500	1.9646	1.8396	1.7146	.25000	.12500	.12500	.0927	2 26	2 29	3.301	2.501		
$2\frac{1}{4}$	3	2.2500	2.0833	1.9167	2.2125	2.0458	1.8792	.33333	.16667	.16667	.1236	2 55	2 58	3.643	3.049		
$2\frac{1}{2}$	3	2.5000	2.3333	2.1667	2.4605	2.2938	2.1272	.33333	.16667	.16667	.1236	2 36	2 39	4.110	3.870		
$2\frac{3}{4}$	3	2.7500	2.5833	2.4167	2.7085	2.5418	2.3752	.33333	.16667	.16667	.1236	2 21	2 23	4.577	4.788		
.....		
3.....	2	3.0000	2.7500	2.5000	2.9567	2.7067	2.4567	.50000	.25000	.25000	.1853	3 19	3 22	4.786	5.27		
$3\frac{1}{2}$	2	3.5000	3.2500	3.0000	3.4532	3.2032	2.9532	.50000	.25000	.25000	.1853	2 48	2 51	5.73	7.50		
4.....	2	4.0000	3.7500	3.5000	3.9500	3.7000	3.4500	.50000	.25000	.25000	.1853	2 26	2 28	6.67	10.12		
$4\frac{1}{2}$	2	4.5000	4.2500	4.0000	4.4470	4.1970	3.9470	.50000	.25000	.25000	.1853	2 9	2 10	7.60	13.13		
5.....	2	5.0000	4.7500	4.5000	4.9441	4.6941	4.4441	.50000	.25000	.25000	.1853	1 55	1 56	8.54	16.53		

^a Per inch length of engagement of the external thread in line with the minor diameter crests of the internal thread. Computed from this formula: Shear area = $\pi K_n [0.5 + n \tan 14\frac{1}{2}^\circ (E_s - K_n)]$. Figures given are the minimum shear area based on max K_n and min E_s .

^b Figures given are the minimum stress area based on the mean of the minimum minor and pitch diameters of the external thread.

These diameters and pitches have been carefully selected to meet the present needs with the fewest number of items, in order to reduce to a minimum the inventory of both tools and gages.

4. CLASSIFICATION AND TOLERANCES, ACME THREADS

There are established herein three classes of threads for general purpose and five classes for centralizing Acme threads, as follows:

Type of thread	Class of thread				
	2G	3G	4G	5C	6C
General purpose.....	2C	3C	4C	5C	6C
Centralizing.....

These classes, together with the accompanying specifications, are for the purpose of assuring the interchangeable manufacture of Acme threaded parts. Each user is free to select the classes best adapted to his particular needs. It is suggested that external and internal threads of the same class be used together for either general purpose or centralizing assemblies. If less backlash or end play than provided by class 2 is desired, classes 3 and 4 are provided for both general purpose and centralizing threads, and classes 5C and 6C for centralizing threads only.

All classes of general purpose external and internal threads may be used interchangeably. The requirement for a centralizing fit is that the sum of the major-diameter tolerance plus the major-diameter allowance on the internal thread, and the major-diameter tolerance on the external thread, shall equal or be less than the pitch-diameter allowance on the external thread. A class 2C external thread, which has a larger pitch diameter allowance than either a class 3C or 4C external thread, can be used interchangeably with classes 2C, 3C, or 4C internal threads and fulfill this requirement. Similarly, a class 3C external thread can be used interchangeably with classes 3C or 4C internal threads, but only a class 4C internal thread can be used with a class 4C external thread. Classes 5C and 6C external and internal threads can be used interchangeably. The average backlash for any cross combination will be between the values for backlash when both members are class 5C and when both members are class 6C.

1. BASIC DIAMETERS.—The maximum major diameter of the external thread is basic and is

the nominal major diameter for all classes except classes 5C and 6C. The maximum major diameter of all class 5C and 6C external threads is the basic major diameter, B , established by subtracting $0.025\sqrt{D}$ from the nominal diameter, D . The minimum pitch diameter of the internal thread is basic for all classes and equal to the basic major diameter minus the basic depth of thread, $0.5p$. The basic minor diameter is equal to the basic major diameter minus twice the basic thread depth, p . The minimum minor diameter of the general purpose internal thread is basic. The minimum minor diameter of the centralizing internal thread is $0.1p$ above basic.

2. LENGTH OF ENGAGEMENT.—The tolerances specified herein are applicable to lengths of engagement not exceeding twice the nominal major diameter.

3. TOLERANCES.—(a) The tolerances specified represent the extreme variations allowed on the product. They are such as to produce interchangeability and maintain a high grade of product.

TABLE XII.4.—Tolerances and allowances (minimum clearances) for major and minor diameters, Acme thread series (max major diameter of external thread D , basic. Basic thread height, $h=0.5 p$.)

Size ^a	Threads per inch, n ^b	Allowances from basic major and minor diameters, all classes				Tolerance on minor diam, all internal threads, plus $0.05p$ ^f	Tolerance on major diameter, plus on internal, minus on external threads							
		All external threads		Internal thread			General Purpose		Centralizing					
		Minor diameter, minus ^c	Major diameter, plus ^c	Major diameter, plus $0.0010\sqrt{D}$	Minor diameter, plus $0.1p$		All classes		Class 2C	Classes 3C and 5C		Classes 4C and 6C		
							External thread, $0.05p$	Internal thread ^e	External and internal threads, $0.0035\sqrt{D}$	External thread, $0.0015\sqrt{D}$	Internal thread, $0.0035\sqrt{D}$	External thread, $0.0010\sqrt{D}$	Internal thread, $0.0020\sqrt{D}$	
1	2	3	4	5	6	7	8	9	10	11	12	13	14	
<i>in.</i>		<i>in.</i>	<i>in.</i>	<i>in.</i>	<i>in.</i>	<i>in.</i>	<i>in.</i>	<i>in.</i>	<i>in.</i>	<i>in.</i>	<i>in.</i>	<i>in.</i>	<i>in.</i>	<i>in.</i>
1/4	16	0.010	0.010			0.0050	0.0050	0.010						
5/16	14	.010	.010			.0050	.0050	.010						
3/8	12	.010	.010			.0050	.0050	.010						
7/16	12	.010	.010			.0050	.0050	.010						
1/2	10	.020	.020	0.0007	0.0100	.0050	.0050	.020	0.0025	0.0011	0.0025	0.0007	0.0014	
5/8	8	.020	.020	.0008	.0125	.0062	.0062	.020	.0028	.0012	.0028	.0008	.0016	
3/4	6	.020	.020	.0009	.0167	.0083	.0083	.020	.0030	.0013	.0030	.0009	.0017	
7/8	6	.020	.020	.0009	.0167	.0083	.0083	.020	.0033	.0014	.0033	.0009	.0019	
1	5	.020	.020	.0010	.0200	.0100	.0100	.020	.0035	.0015	.0035	.0010	.0020	
1 1/8	5	.020	.020	.0011	.0200	.0100	.0100	.020	.0037	.0016	.0037	.0011	.0021	
1 1/4	5	.020	.020	.0011	.0200	.0100	.0100	.020	.0039	.0017	.0039	.0011	.0022	
1 3/8	4	.020	.020	.0012	.0250	.0125	.0125	.020	.0041	.0018	.0041	.0012	.0023	
1 1/2	4	.020	.020	.0012	.0250	.0125	.0125	.020	.0043	.0018	.0043	.0012	.0024	
1 3/4	4	.020	.020	.0013	.0250	.0125	.0125	.020	.0046	.0020	.0046	.0013	.0026	
2	4	.020	.020	.0014	.0250	.0125	.0125	.020	.0049	.0021	.0049	.0014	.0028	
2 1/4	3	.020	.020	.0015	.0333	.0167	.0167	.020	.0052	.0022	.0052	.0015	.0030	
2 1/2	3	.020	.020	.0016	.0333	.0167	.0167	.020	.0055	.0024	.0055	.0016	.0032	
2 3/4	3	.020	.020	.0017	.0333	.0167	.0167	.020	.0058	.0025	.0058	.0017	.0033	
3	2	.020	.020	.0017	.0500	.0250	.0250	.020	.0061	.0026	.0061	.0017	.0035	
3 1/2	2	.020	.020	.0019	.0500	.0250	.0250	.020	.0065	.0028	.0065	.0019	.0037	
4	2	.020	.020	.0020	.0500	.0250	.0250	.020	.0070	.0030	.0070	.0020	.0040	
4 1/2	2	.020	.020	.0021	.0500	.0250	.0250	.020	.0074	.0032	.0074	.0021	.0042	
5	2	.020	.020	.0022	.0500	.0250	.0250	.020	.0078	.0034	.0078	.0022	.0045	

^a Values for intermediate diameters should be calculated from the formulas in column headings, but ordinarily may be interpolated.

^b Intermediate pitches take the values of the next coarser pitch listed.

^c Values are 0.020 in. for 10 tpi and coarser, and 0.010 in. for finer pitches.

^d The minimum clearance at the major diameter between the internal and external thread is equal to col. 5.

^e The minimum clearance at the minor diameter between the centralizing internal and external thread is the sum of the values in cols. 3 and 6.

^f To avoid a complicated formula and still provide an adequate tolerance, the pitch factor is used as a base, with the minimum tolerance value set at 0.005 in.

NOTE.—The maximum angular play of a centralizing internal thread, one diameter long, on its external thread for the maximum major diameter clearance is 1° or less.

Tolerance on minor diameter of all external threads is $1.5 \times$ pitch-diameter tolerance.

TABLE XII.5.—Pitch-diameter allowances for Acme threads

Nominal size range ^a		Pitch-diameter allowances on external ^b threads, general purpose and centralizing		
Above	To and including	Classes 2G, 2C, and 5C; 0.008√D	Classes 3G, 3C, and 6C; 0.006√D	Classes 4G and 4C; 0.004√D
1	2	3	4	5
<i>in.</i>	<i>in.</i>	<i>in.</i>	<i>in.</i>	<i>in.</i>
0-----	3/16	0.0024	0.0018	0.0012
3/16-----	5/16	.0040	.0030	.0020
5/16-----	7/16	.0049	.0037	.0024
7/16-----	9/16	.0057	.0042	.0028
9/16-----	1 1/16	.0063	.0047	.0032
1 1/16-----	1 3/16	.0069	.0052	.0035
1 3/16-----	1 5/16	.0075	.0056	.0037
1 5/16-----	1 7/16	.0080	.0060	.0040
1 7/16-----	1 9/16	.0085	.0064	.0042
1 9/16-----	1 11/16	.0089	.0067	.0045
1 11/16-----	1 13/16	.0094	.0070	.0047
1 13/16-----	1 15/16	.0098	.0073	.0049
1 15/16-----	1 7/8	.0105	.0079	.0052
1 7/8-----	2 1/8	.0113	.0085	.0057
2 1/8-----	2 3/8	.0120	.0090	.0060
2 3/8-----	2 5/8	.0126	.0095	.0063
2 5/8-----	2 7/8	.0133	.0099	.0066
2 7/8-----	3 1/4	.0140	.0105	.0070
3 1/4-----	3 3/4	.0150	.0112	.0075
3 3/4-----	4 1/4	.0160	.0120	.0080
4 1/4-----	4 3/4	.0170	.0127	.0085
4 3/4-----	5 1/2	.0181	.0136	.0091

^a The values in columns 3, 4, and 5 are to be used for any size within the corresponding range shown in columns 1 and 2. These values are calculated from the mean of columns 1 and 2. It is recommended that the sizes given in table XII.3 be used whenever possible.

^b An increase of 10 percent in the allowance is recommended for each inch, or fraction thereof, that the length of engagement exceeds two diameters.

(b) The tolerances on diameters of the internal threads shall be applied plus from the minimum sizes to above the minimum sizes.

(c) The tolerances on diameters of the external threads shall be applied minus from the maximum sizes to below the maximum sizes.

(d) The pitch-diameter tolerances (which control thread thickness) for an external or internal thread of a given class are the same. The pitch-diameter tolerances for the product include lead and angle deviations.

Pitch diameter tolerances for all classes and for various practicable combinations of diameter and pitch, are given in tables XII.6, XII.7, and XII.8. The relative proportions of the pitch diameter tolerances are: classes 2, 3.0; classes 3 and 5, 1.4; and classes 4 and 6, 1.0.

(e) The tolerances on the major and minor diameters of the external and internal threads are listed in table XII.4 and are based on the following formulas, which are to be used for special threads:

Tolerances on major and minor diameters of external and internal threads

Type of thread	Major diameter		Minor diameter	
	External thread	Internal thread	External thread	Internal thread
General purpose (all classes)-----	0.05p ^a (Min = 0.005 in.)	{ 0.020 in. for 10 tpi and coarser; 0.010 in. for finer pitches	} 1.5×pitch diameter tolerance	} 0.05p ^a (Min = 0.005 in.)
Centralizing { Class 2C----- Classes 3C and 5C----- Classes 4C and 6C-----	0.0035√D----- 0.0015√D----- 0.0010√D-----	0.0035√D----- 0.0035√D----- 0.0020√D-----		

^a To avoid a complicated formula and still provide an adequate tolerance, the pitch factor is used as a base, with the minimum tolerance value set at 0.005 in.

4. ALLOWANCES (MINIMUM CLEARANCES).—Allowances applied to the pitch diameter of the external thread for all classes, general purpose and centralizing, are given in table XII.5. These pitch diameter allowances are equal to the sum of the allowance on major diameter, column 4, table XII.4, and the sum of the tolerances on external and internal threads, columns 10 to 14, inclusive, table XII.4, for general purpose and centralizing, plus an additional amount of 0.002√D in. for classes 5C and 6C. This is the minimum pitch diameter allowance that is required to maintain the centralizing fit and minimum end play of 0.0005√D in. for classes 5C and 6C.

For centralizing fits, when the product has a length of engagement greater than the standard length of the thread ring gage as shown in table XII.14, column 3, p. 17, and lead deviations not exceeding the values shown at the bottom of that table, and when “go” thread ring gages of these lengths are to be used, the maximum pitch diameter of the external thread shall be decreased by the amount shown in table XII.14, column 5. If the lead deviations in the product are greater than indicated, the allowance for the ring gage stated in column 5 should be increased proportionately. However, if methods of gaging the external thread are to be used which will detect angle deviation and cumulative lead deviation, the pitch diameter of the external thread shall be below the tabular maximum pitch diameter of the external thread by an amount sufficient to compensate for the measured deviations.

An increase of 10 percent in the allowance is recommended for each inch, or fraction thereof, that the length of engagement exceeds two diameters.

5. FORMULAS FOR DIAMETERS.—The formulas for the major, pitch, and minor diameters are given in table XII.9.

5. LIMITS OF SIZE, ACME THREADS

Limits of size for *general purpose* Acme threads of the preferred series of diameters and pitches are given in table XII.10. The application of these limits is illustrated in figure XII.3.

Limits of size for *centralizing* Acme threads of the preferred series of diameters and pitches are given in tables XII.11 and XII.12. The application of these limits is illustrated in figures XII.4 and XII.5.

6. THREAD DESIGNATIONS

The following abbreviations are recommended for use on drawings and in specifications, and on tools and gauges:

- ACME=Acme threads,
- G=general purpose,
- C=centralizing,
- LH=left-hand.

Examples of designations:

Right-hand Acme threads:

- 1 3/4-4 ACME-2G=General purpose class 2G Acme threads; major diameter 1 3/4 in., pitch 0.2500 in., single, right-hand.
- 2 7/8-0.4p-0.8L-ACME-3G=General purpose class 3G Acme threads; major diameter 2 7/8 in., pitch 0.4 in., lead 0.8 in., double, right-hand.

Left-hand Acme threads:

- 1 3/4-4 ACME-2G-LH
- 2 7/8-0.4p-0.8L-ACME-3G-LH
- 1 3/4-6 ACME-4C-LH
- 2 7/8-0.4p-0.8L-ACME-3C-LH
- 2 1/2-0.3333p-0.6667L-ACME-5C-LH

TABLE XII.6.—Pitch diameter tolerances for Acme screw threads, classes 2G and 2C

Threads per inch, <i>n</i>	Pitch increment, 0.030 √1/ <i>n</i>	Pitch diameter tolerances for nominal diameters of: ^a										
		1/4 in.	5/16 in.	3/8 in.	7/16 in.	1/2 in.	5/8 in.	3/4 in.	7/8 in.	1 in.	1 1/8 in.	1 1/4 in.
16	<i>in.</i> 0.00750	<i>in.</i> 0.0105	<i>in.</i> 0.0109	<i>in.</i> 0.0112	<i>in.</i> 0.0115	<i>in.</i> 0.0117	<i>in.</i> 0.0122	<i>in.</i> 0.0127	<i>in.</i> 0.0136	<i>in.</i> 0.0140	<i>in.</i> 0.0150	<i>in.</i> 0.0154
14	0.00802	0.0114	0.0117	0.0120	0.0123	0.0128	0.0132	0.0139	0.0143	0.0147	0.0155	0.0162
12	0.00866	0.0123	0.0126	0.0129	0.0133	0.0134	0.0142	0.0147	0.0151	0.0158	0.0170	0.0186
10	0.00949	0.0132	0.0135	0.0137	0.0148	0.0154	0.0158	0.0162	0.0174	0.0182	0.0194	0.0217
8	0.01061											
6	0.01225											
5	0.01342											
4	0.01500											
3	0.01732											
2 1/2	0.01897											
2	0.02121											
1 1/2	0.02449											
1 1/8	0.02598											
1	0.03000											
Diameter increment, 0.006 √ <i>D</i>		0.00300	0.00335	0.00367	0.00397	0.00424	0.00474	0.00520	0.00561	0.00600	0.00636	0.00671

Threads per inch, <i>n</i>	Pitch increment, 0.030 √1/ <i>n</i>	Pitch diameter tolerances for nominal diameters of: ^a										
		1 3/8 in.	1 1/2 in.	1 3/4 in.	2 in.	2 1/4 in.	2 1/2 in.	2 3/4 in.	3 in.	3 1/2 in.	4 in.	4 1/2 in.
16	<i>in.</i> 0.00750	<i>in.</i> 0.0165	<i>in.</i> 0.0168	<i>in.</i> 0.0174	<i>in.</i> 0.0191	<i>in.</i> 0.0212	<i>in.</i> 0.0229	<i>in.</i> 0.0245	<i>in.</i> 0.0249	<i>in.</i> 0.0254	<i>in.</i> 0.0262	<i>in.</i> 0.0270
14	0.00802	0.0176	0.0180	0.0185	0.0207	0.0224	0.0240	0.0254	0.0262	0.0270	0.0285	0.0307
12	0.00866	0.0193	0.0196	0.0202	0.0219	0.0235	0.0249	0.0262	0.0270	0.0285	0.0302	0.0324
10	0.00949	0.0205	0.0208	0.0214	0.0229	0.0244	0.0258	0.0270	0.0285	0.0294	0.0307	0.0324
8	0.01061	0.0220	0.0223	0.0229	0.0235	0.0240	0.0245	0.0249	0.0254	0.0262	0.0270	0.0285
6	0.01225	0.0247	0.0253	0.0258	0.0263	0.0268	0.0273	0.0278	0.0283	0.0288	0.0294	0.0300
5	0.01342	0.0269	0.0275	0.0280	0.0285	0.0290	0.0295	0.0300	0.0305	0.0310	0.0315	0.0320
4	0.01500	0.0297	0.0302	0.0307	0.0312	0.0317	0.0322	0.0327	0.0332	0.0337	0.0342	0.0347
3	0.01732											
2 1/2	0.01897											
2	0.02121											
1 1/2	0.02449											
1 1/8	0.02598											
1	0.03000											
Diameter increment, 0.006 √ <i>D</i>		0.00704	0.00735	0.00794	0.00849	0.00900	0.00949	0.00995	0.01039	0.01122	0.01200	0.01273

^a The equivalent tolerance on thread thickness is 0.259 times the pitch diameter tolerance. For an intermediate nominal diameter, apply the pitch diameter tolerance for the next larger nominal diameter given in this table.

NOTE.—The pitch diameter tolerances shown equal the sum of the pitch increment and the diameter increment.

TABLE XII.7.—Pitch diameter tolerances for Acme screw threads, classes 3G, 3C, and 5C

Threads per inch, n	Pitch increment, $0.014\sqrt{1/n}$	Pitch diameter tolerances for nominal diameters of: ^a											
		¼ in.	⅝ in.	¾ in.	⅞ in.	1 in.	1 ⅛ in.	1 ¼ in.	1 ½ in.	1 ¾ in.	2 in.	2 ¼ in.	
16	<i>in.</i> 0.00350	<i>in.</i> 0.0049	<i>in.</i> 0.0051	<i>in.</i> 0.0052	<i>in.</i> 0.0054	<i>in.</i> 0.0055	<i>in.</i> 0.0057	<i>in.</i> 0.0059	<i>in.</i> 0.0064	<i>in.</i> 0.0065	<i>in.</i> 0.0070	<i>in.</i> 0.0072	<i>in.</i> 0.0076
14	.00374		.0053	.0055	.0056	.0057	.0060	.0062					
12	.00404			.0058	.0059	.0060	.0062	.0065	.0067			0.0070	0.0072
10	.00443			.0061	.0063	.0064	.0066	.0068	.0070			.0074	.0076
8	.00495					.0069	.0072	.0074	.0076			.0079	.0081
6	.00572							.0081	.0083			.0087	.0088
5	.00626								.0089			.0092	.0094
4	.00700											.0100	.0101
3	.00808												
2½	.00885												
2	.00990												
1½	.01143												
1¼	.01212												
1	.01400												
Diameter increment, $0.0028\sqrt{D}$		0.00140	0.00157	0.00171	0.00185	0.00198	0.00221	0.00242	0.00262	0.00280	0.00297	0.00313	0.00333

Threads per inch, n	Pitch increment, $0.014\sqrt{1/n}$	Pitch diameter tolerances for nominal diameters of: ^a											
		1 ⅝ in.	1 ¾ in.	1 ⅞ in.	2 in.	2 ¼ in.	2 ½ in.	2 ¾ in.	3 in.	3 ½ in.	4 in.	4 ½ in.	5 in.
16	<i>in.</i> 0.00350	<i>in.</i>	<i>in.</i>	<i>in.</i>	<i>in.</i>	<i>in.</i>	<i>in.</i>	<i>in.</i>	<i>in.</i>	<i>in.</i>	<i>in.</i>	<i>in.</i>	<i>in.</i>
14	.00374												
12	.00404												
10	.00443	0.0077	0.0079	0.0081									
8	.00495	.0082	.0084	.0086	0.0089								
6	.00572	.0090	.0091	.0094	.0097	0.0099							
5	.00626	.0095	.0097	.0100	.0102	.0104							
4	.00700	.0103	.0104	.0107	.0110	.0112	0.0107	0.0114	0.0116	0.0118	0.0122	0.0126	
3	.00808		.0115	.0118	.0120	.0123	.0125	.0127	.0129	.0133	.0137	0.0140	0.0143
2½	.00885			.0126	.0128	.0131	.0133	.0135	.0137	.0141	.0145	.0148	.0151
2	.00990				.0139	.0141	.0143	.0145	.0147	.0151	.0155	.0158	.0162
1½	.01143									.0163	.0167	.0170	.0174
1¼	.01212									.0170	.0174	.0177	.0181
1	.01400									.0192	.0196	.0199	.0203
Diameter increment, $0.0028\sqrt{D}$		0.00328	0.00343	0.00370	0.00396	0.00420	0.00443	0.00464	0.00485	0.00524	0.00560	0.00594	0.00626

^a The equivalent tolerance on thread thickness is 0.259 times the pitch diameter tolerance. For an intermediate nominal diameter, apply the pitch diameter tolerance for the next larger nominal diameter given in this table.

NOTE.—The pitch diameter tolerances shown equal the sum of the pitch increment and the diameter increment.

TABLE XII.8.—Pitch diameter tolerances for Acme screw threads, classes 4G, 4C, and 6C

Threads per inch, n	Pitch increment, $0.010\sqrt{1/n}$	Pitch diameter tolerances for nominal diameters of: ^a											
		¼ in.	⅜ in.	½ in.	⅝ in.	¾ in.	⅞ in.	1 in.	1 ¼ in.	1 ½ in.	1 ¾ in.	2 in.	
16	<i>in.</i> 0.00250	<i>in.</i> 0.0035	<i>in.</i> 0.0036	<i>in.</i> 0.0037	<i>in.</i> 0.0038	<i>in.</i> 0.0039	<i>in.</i> 0.0041	<i>in.</i> 0.0042	<i>in.</i> 0.0044	<i>in.</i> 0.0045	<i>in.</i> 0.0047	<i>in.</i> 0.0049	<i>in.</i> 0.0051
14	.00267	.0038	.0039	.0040	.0041	.0042	.0043	.0044	.0045	.0046	.0047	.0048	.0049
12	.00289		.0041	.0042	.0043	.0044	.0045	.0046	.0047	.0048	.0049	.0050	.0051
10	.00316		.0044	.0045	.0046	.0047	.0048	.0049	.0050	.0051	.0052	.0053	.0054
8	.00354					.0050	.0051	.0053	.0054	.0055	.0057	.0058	.0058
6	.00408							.0058	.0060	.0061	.0062	.0063	.0063
5	.00447								.0063	.0065	.0066	.0067	.0067
4	.00500										.0071	.0072	.0072
3	.00577												
2½	.00632												
2	.00707												
1½	.00816												
1¼	.00866												
1	.01000												
Diameter increment, $0.002\sqrt{D}$		0.00100	0.00112	0.00122	0.00132	0.00141	0.00158	0.00173	0.00187	0.00200	0.00212	0.00224	0.00241

Threads per inch, n	Pitch increment, $0.010\sqrt{1/n}$	Pitch diameter tolerances for nominal diameters of: ^a											
		1 ⅜ in.	1 ½ in.	1 ¾ in.	2 in.	2 ¼ in.	2 ½ in.	2 ¾ in.	3 in.	3 ½ in.	4 in.	4 ½ in.	5 in.
16	<i>in.</i> 0.00250	<i>in.</i>	<i>in.</i>	<i>in.</i>	<i>in.</i>	<i>in.</i>	<i>in.</i>	<i>in.</i>	<i>in.</i>	<i>in.</i>	<i>in.</i>	<i>in.</i>	<i>in.</i>
14	.00267												
12	.00289												
10	.00316	0.0055	0.0056	0.0058									
8	.00354	.0059	.0060	.0062	0.0064								
6	.00408	.0064	.0065	.0067	.0069	0.0071							
5	.00447	.0068	.0069	.0071	.0073	.0075	0.0076						
4	.00500	.0073	.0074	.0076	.0078	.0080	.0082	0.0083	0.0085	0.0087	0.0090		
3	.00577			.0084	.0086	.0088	.0089	.0091	.0092	.0095	.0098	0.0100	0.0102
2½	.00632			.0090	.0092	.0093	.0095	.0096	.0098	.0101	.0103	.0106	.0108
2	.00707				.0099	.0101	.0102	.0104	.0105	.0108	.0111	.0113	.0115
1½	.00816								.0116	.0119	.0122	.0124	.0126
1¼	.00866								.0121	.0124	.0127	.0129	.0131
1	.01000								.0137	.0140	.0142	.0144	.0145
Diameter increment, $0.002\sqrt{D}$		0.00235	0.00245	0.00265	0.00283	0.00300	0.00316	0.00332	0.00346	0.00374	0.00400	0.00424	0.00447

^a The equivalent tolerance on thread thickness is 0.259 times the pitch diameter tolerance. For an intermediate nominal diameter, apply the pitch diameter tolerance for the next larger nominal diameter given in this table.

NOTE.—The pitch diameter tolerances shown equal the sum of the pitch increment and the diameter increment.

TABLE XII.9.—Formulas for diameters, Acme thread classes

	Classes 2G, 3G, 4G Classes 2C, 3C, 4C	Classes 5C, 6C
1	2	3
EXTERNAL THREADS		
Major dia: Basic (max) =	D	$B (= D - 0.025 \sqrt{D})$
Min =	$D - \text{tol from table XII.4, cols 8, 10, 11, or 13}$	$B - \text{tol from table XII.4, cols 11 or 13}$
Pitch dia: Max =	Int min pitch dia—allow from table XII.5, cols 3, 4, or 5	Int min pitch dia—allow from table XII.5, cols 3 or 4
Min =	Ext max pitch dia—tol from tables XII.6, XII.7, or XII.8	Ext max pitch dia—tol from tables XII.7 or XII.8
Minor dia: Max =	$D - p$ —allow from table XII.4, col 3	$B - p$ —allow from table XII.4, col 3
Min =	Ext max minor dia— $1.5 \times$ pitch dia tol from tables XII.6, XII.7, or XII.8	Ext max minor dia— $1.5 \times$ pitch dia tol from tables XII.7 or XII.8
INTERNAL THREADS		
Major dia: Min =	$D + \text{allow from table XII.4, cols 4 or 5}$	$B + \text{allow from table XII.4, col 5}$
Max =	Int min major dia+tol from table XII.4, cols 9, 10, 12, or 14	Int min major dia+tol from table XII.4, cols 12 or 14
Pitch dia: Basic (min) =	$D - 0.5p$	$B - 0.5p$
Max =	Int min pitch dia+tol from tables XII.6, XII.7, or XII.8	Int min pitch dia+tol from table XII.7 or XII.8
Minor dia: Basic =	$D - p$	$B - p$
Min =	$D - p$ (for classes 2G, 3G, 4G)	$B - p + 0.1p$
	$D - p + 0.1p$ (for classes 2C, 3C, 4C)	
Max =	Int min minor dia+tol from table XII.4, col 7	Int min minor dia+tol from table XII.4, col 7

D = Nominal size or diameter.
 B = Basic diameter (for classes 5C and 6C)
 p = Pitch

7. GAGES FOR ACME THREADS

Gages representing both product limits, or adequate gaging instruments for thread elements, are necessary for the proper inspection of Acme threads. The dimensions of “go” and “not go” gages should be in accordance with the principles: (a) that the maximum-metal limit or “go” gage should check simultaneously as many elements as possible, and that a minimum-metal limit or “not go” thread gage can effectively check but one element; and (b) that permissible variations in the gages be kept within the extreme product limits.

(a) GAGE TOLERANCES

Tolerances for the thread elements of “go” and “not go” thread gages for Acme threads are as specified below.

1. TOLERANCES ON PITCH DIAMETER.—The pitch diameter tolerances for gages for classes 2G and 2C external and internal threads are given in table XII.13, column 2, and for gages for classes 3G, 3C, 4G, 4C, 5C, and 6C external and internal threads in table XII.13, column 3.

2. TOLERANCES ON MAJOR AND MINOR DIAMETERS.—The major and minor diameter tolerances for Acme thread gages are given in table XII.13, column 4.

3. TOLERANCES ON LEAD.—The variation in lead of all Acme thread gages for classes 3, 4, 5, and 6 product shall not exceed 0.0002 inch between any two threads not farther apart than one inch. However, the cumulative error in lead shall not exceed 0.0003 in. for gages with a length over 1 to 3 in., inclusive; or 0.0004 in. for gages with a length over 3 to 5 in., inclusive; or 0.0006 in. for gages with a length over 5 to 10 in., inclusive. For gages for class 2 product, 0.0001 in. shall be added to the above values. For multiple threads, the cumulative tolerance for pitch and lead shall be multiplied by 1.5.

4. TOLERANCES ON ANGLE OF THREAD.—The tolerances on angle of thread, as specified in table XII.13, column 5, for the various pitches are tolerances on one-half the included angle. This insures that the bisector of the included angle will be perpendicular to the axis of the thread within proper limits. The equivalent deviation from the true thread form caused by such irregularities as convex or concave sides of thread, or slight projections on the thread form, should not exceed the tolerances permitted on angle of thread.

(b) GAGES FOR EXTERNAL THREADS

1. “GO” THREAD RING OR THREAD SNAP GAGE.—(a) Major diameter.—The major diameter of the “go” thread ring or thread snap gage shall clear a diameter greater by 0.01 in. than the maximum major diameter of the external thread.

(b) Pitch diameter.—The pitch diameter shall fit the maximum-metal limit thread setting plug gage.

(c) Minor diameter.—For general purpose external threads, the minor diameter of the “go” thread ring gage shall be the same as the maximum minor diameter of the external thread plus 0.005 in. for pitches finer than 10 tpi, and plus 0.010 in. for 10 tpi and coarser, to allow for possible deviations in concentricity of the pitch and minor diameters of the product. The tolerance shall be applied minus.

For centralizing external threads, the minor diameter of the “go” thread ring gage shall be less than the minimum minor diameter of the internal thread by the amount of the allowance on pitch diameter, table XII.5, columns 3 to 5. The tolerance (table XII.13, col. 4) shall be applied minus.

(d) Length.—The length of the “go” thread ring or thread snap gage should approximate the length of engagement (see footnote to table XII.14) but should not exceed the length specified in table XII.14, col. 3.

2. MAXIMUM-METAL LIMIT THREAD SETTING PLUG FOR “GO” THREAD RING OR SNAP GAGES.—(a) Major diameter.—The major diameter of the basic-crest maximum-metal limit thread setting

TABLE XII.10.—Limits of size and tolerances, Acme general purpose thread series, classes 2G, 3G, and 4G

Size limits and tolerances		Nominal diameter, <i>D</i> , inches																								
		Threads per inch ^a																								
		1/4	5/16	3/8	7/16	1/2	5/8	3/4	7/8	1	1 1/8	1 1/4	1 3/8	1 1/2	1 3/4	2	2 1/4	2 1/2	2 3/4	3	3 1/2	4	4 1/2	5		
EXTERNAL THREADS		Classes 2G, 3G, and 4G, ^b																								
		major diameter																								
Classes 2G, 3G, and 4G, minor diameter		in.																								
		in.																								
Class 2G, minor diameter		in.																								
		in.																								
Class 3G, minor diameter		in.																								
		in.																								
Class 4G, minor diameter		in.																								
		in.																								
Class 2G, pitch diameter		in.																								
		in.																								
Class 3G, pitch diameter		in.																								
		in.																								
Class 4G, pitch diameter		in.																								
		in.																								
INTERNAL THREADS		Classes 2G, 3G, and 4G, major diameter																								
		in.																								
Classes 2G, 3G, and 4G, minor diameter		in.																								
		in.																								
Class 2G, pitch diameter		in.																								
		in.																								
Class 3G, pitch diameter		in.																								
		in.																								
Class 4G, pitch diameter		in.																								
		in.																								

^a The selection of threads per inch is arbitrary and is intended for the purpose of establishing a standard.
^b These dimensions correspond to tolerances on major diameter of external thread and minor diameter of internal thread equal to 0.05 *p*.

INTERNAL THREAD (NUT)

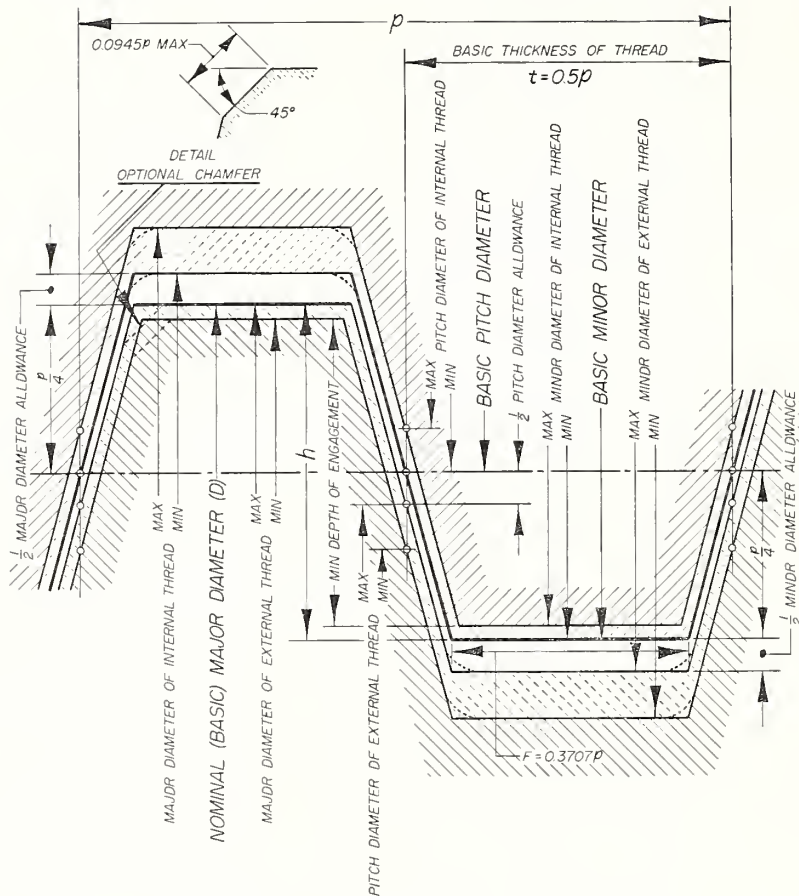

EXTERNAL THREAD (SCREW)

FIGURE XII.3.—Illustration of allowances, tolerances, and crest clearances, general purpose Acme threads, classes 2G, 3G, and 4G.

NOTATION

p = pitch,
 h = basic thread height.
 Heavy lines show basic size.

plug gage shall be the same as the maximum major diameter of the external thread. The gage tolerance (table XII.13, col. 4) shall be applied plus. The major diameter of the truncated maximum-metal limit thread setting plug gage shall be smaller by one-third of the basic thread depth ($=p/6$) than the maximum major diameter of the external thread. The gage tolerance (table XII.13, col. 4) shall be applied minus.

(b) *Pitch diameter.*—The pitch diameter of the maximum-metal limit thread setting plug for all external threads shall be the same as the maximum pitch diameter of the external thread. However, if the product length of engagement exceeds the length of the ring gage, table XII.14, column 3, the pitch diameter of the maximum-metal limit thread setting plug shall be less than the maximum pitch diameter of the external thread by the amount stated in table XII.14, column 5. The gage tolerance (table XII.13, col. 2 and 3) shall be

applied minus.

(c) *Minor diameter.*—The minor diameter shall be cleared below the minimum minor diameter of the “go” thread ring gage.

(d) *Length.*—The length of the maximum-metal limit thread setting plug gage should approximate the length of the “go” thread ring or thread snap gage.

3. “GO” PLAIN RING OR SNAP GAGE FOR MAJOR DIAMETER.—The diameter of the “go” plain ring gage, or gaging dimension of the “go” plain snap gage, shall be the same as the maximum major diameter of the external thread. The class Z tolerances given in footnote of table XII.13 shall be applicable to gages for centralizing threads. Tolerances given in table XII.13, column 4, shall be applicable to gages for general purpose threads. The tolerances shall be applied minus.

4. “NOT GO” THREAD RING OR THREAD

TABLE XII.11.—Limits of size and tolerances, Acme centralizing thread series, classes 2C, 3C, and 4C

Size limits and tolerances		Nominal diameter, <i>D</i>																	
		½	¾	1	1¼	1½	1¾	1¾	2	2¼	2½	3	3½	4	4½	5			
EXTERNAL THREADS																			
Classes 2C, 3C, and 4C, major diameter	Max. <i>D</i>	<i>in.</i> 0.5000	<i>in.</i> 0.6250	<i>in.</i> 0.7500	<i>in.</i> 0.8750	<i>in.</i> 1.0000	<i>in.</i> 1.1250	<i>in.</i> 1.2500	<i>in.</i> 1.3750	<i>in.</i> 1.5000	<i>in.</i> 1.7500	<i>in.</i> 2.0000	<i>in.</i> 2.5000	<i>in.</i> 3.0000	<i>in.</i> 3.5000	<i>in.</i> 4.0000	<i>in.</i> 4.5000	<i>in.</i> 5.0000	
Class 2C, major diameter	(Min. (Tol.4975 .0025	.6222 .0028	.7470 .0030	.8717 .0033	.9965 .0035	1.1213 .0037	1.2461 .0039	1.3709 .0041	1.4957 .0043	1.7454 .0046	1.9951 .0049	2.2448 .0052	2.4945 .0055	2.7442 .0058	3.9930 .0070	4.4926 .0074	4.9922 .0078	
Class 3C, major diameter	(Min. (Tol.4989 .0011	.6238 .0012	.7487 .0013	.8736 .0014	.9985 .0015	1.1234 .0016	1.2483 .0017	1.3732 .0018	1.4982 .0018	1.7480 .0020	1.9979 .0021	2.2478 .0022	2.4976 .0024	2.7475 .0025	3.9970 .0028	4.4968 .0032	4.9966 .0034	
Class 4C, major diameter	(Min. (Tol.4983 .0007	.6242 .0008	.7491 .0009	.8741 .0009	.9990 .0010	1.1239 .0011	1.2489 .0011	1.3738 .0012	1.4988 .0012	1.7487 .0013	1.9986 .0014	2.2485 .0015	2.4984 .0016	2.7483 .0017	3.9980 .0020	4.4979 .0021	4.9978 .0022	
Classes 2C, 3C, and 4C, minor diameter	Max.3800	.4800	.5833	.6833	.7800	.9050	1.0300	1.1050	1.2300	1.4800	1.7300	1.9800	2.1467	2.3967	2.9800	3.4800	4.4800	
Class 2C, minor diameter	(Min.3594	.4570	.5371	.6015	.7059	.8753	.9998	1.0719	1.1965	1.4456	1.6948	1.8572	2.0358	2.3266	2.9814	3.4302	4.4281	
Class 3C, minor diameter	(Min.3704	.4693	.5511	.6158	.7064	.8912	1.0159	1.0896	1.2144	1.4640	1.7136	1.8783	2.1279	2.3776	2.9574	3.4568	4.4558	
Class 4C, minor diameter	(Min.3731	.4723	.5546	.6194	.7103	.8951	1.0199	1.0940	1.2188	1.4685	1.7183	1.8835	2.1333	2.3831	2.9638	3.4634	4.4627	
Class 2C, pitch diameter	(Max. (Tol.4443 .0306	.5562 .0408	.6598 .0508	.7842 .0624	.8920 .0763	.9967 .0919	1.1210 .1074	1.2456 .1241	1.3702 .1433	1.5012 .1633	1.7511 .1841	2.0010 .2055	2.2509 .2273	2.5008 .2497	2.7507 .2721	3.7340 .3708	4.2330 .4191	4.9378 .4839
Class 3C, pitch diameter	(Max. (Tol.4458 .0064	.5578 .0072	.6615 .0081	.7861 .0088	.8940 .0093	1.0186 .0092	1.1433 .0094	1.2680 .0103	1.3930 .0103	1.5283 .0104	1.6641 .0107	1.8005 .0110	1.9374 .0123	2.0748 .0123	2.2122 .0147	2.7395 .0151	3.2388 .0158	4.2373 .0162
Class 4C, pitch diameter	(Max. (Tol.4472 .0046	.5593 .0051	.6632 .0058	.7880 .0060	.8960 .0065	1.0208 .0066	1.1455 .0067	1.2703 .0073	1.3953 .0073	1.5301 .0074	1.6654 .0076	1.8015 .0078	1.9385 .0088	2.0765 .0088	2.2145 .0105	2.7420 .0111	3.2415 .0113	4.2415 .0115
INTERNAL THREADS																			
Classes 2C, 3C, and 4C, major diameter	Min.5007	.6258	.7509	.8759	1.0010	1.1261	1.2511	1.3762	1.5012	1.7513	2.0014	2.2515	2.5016	2.7517	3.5019	4.0020	5.0022	
Classes 2C and 3C, major diameter	(Max. (Tol.5032 .0025	.6283 .0028	.7534 .0030	.8784 .0033	1.0035 .0035	1.1286 .0037	1.2537 .0039	1.3788 .0041	1.5039 .0043	1.7540 .0046	2.0041 .0049	2.2542 .0052	2.5043 .0055	2.7544 .0058	3.5047 .0061	4.0048	5.0051	
Class 4C, major diameter	(Max. (Tol.5021 .0014	.6274 .0016	.7526 .0017	.8778 .0019	1.0030 .0020	1.1282 .0021	1.2533 .0022	1.3785 .0023	1.5036 .0024	1.7539 .0026	2.0042 .0028	2.2545 .0030	2.5048 .0032	2.7550 .0033	3.5056 .0037	4.0057	5.0067	
Classes 2C, 3C, and 4C, minor diameter	(Min.4100	.5125	.6000	.7250	.8200	.9450	1.0700	1.1500	1.2750	1.5250	1.7750	1.9500	2.0900	2.4500	2.5500	3.5500	4.5500	
Class 2C, pitch diameter	(Max. (Tol.4150 .0050	.5187 .0062	.6062 .0068	.7313 .0083	.8300 .0088	.9550 .0100	1.0800 .0100	1.1625 .0125	1.2875 .0125	1.5375 .0125	1.7875 .0125	1.9627 .0125	2.1627 .0167	2.4627 .0167	2.5750 .0250	3.5750	4.5750	
Class 3C, pitch diameter	(Min. (Tol.4500 .0137	.5625 .0154	.6667 .0174	.7917 .0194	.9000 .0194	1.0250 .0198	1.1500 .0201	1.2500 .0220	1.3500 .0223	1.4750 .0223	1.6479 .0229	1.8000 .0235	1.9500 .0263	2.1000 .0268	2.7500 .0316	3.2500	4.2500	
Class 4C, pitch diameter	(Min. (Tol.4500 .0064	.5697 .0072	.6667 .0081	.7917 .0094	.9000 .0091	1.0250 .0092	1.1500 .0094	1.2500 .0103	1.3500 .0104	1.4750 .0107	1.6479 .0110	1.8000 .0123	1.9500 .0125	2.1000 .0127	2.7500 .0167	3.2500	4.2500	
Class 4C, pitch diameter	(Min. (Tol.4500 .0046	.5676 .0051	.6667 .0058	.7917 .0060	.9000 .0065	1.0250 .0066	1.1500 .0067	1.2500 .0073	1.3500 .0074	1.4750 .0076	1.6479 .0078	1.8000 .0088	1.9500 .0088	2.1000 .0091	2.7500 .0105	3.2500	4.2500	

^a The selection of threads per inch is arbitrary and is intended for the purpose of establishing a standard.

TABLE XII.12.—Limits of size and tolerances, Acme centralizing thread series, classes 5C and 6C

Nominal diameter, D																		
Threads per inch ^a																		
	1/2	5/8	3/4	7/8	1	1 1/8	1 1/4	1 3/8	1 1/2	1 3/4	2	2 1/4	2 1/2	3	3 1/2	4	4 1/2	5
EXTERNAL THREADS																		
Classes 5C and 6C, major diameter.....	<i>in.</i>	<i>in.</i>	<i>in.</i>	<i>in.</i>	<i>in.</i>	<i>in.</i>	<i>in.</i>	<i>in.</i>	<i>in.</i>	<i>in.</i>	<i>in.</i>	<i>in.</i>	<i>in.</i>	<i>in.</i>	<i>in.</i>	<i>in.</i>	<i>in.</i>	<i>in.</i>
Max. <i>D</i>	0.4823	0.6052	0.7283	0.8516	0.9750	1.0985	1.2220	1.3457	1.4694	1.5931	1.7169	1.8406	1.9643	2.0880	2.2117	2.3354	2.4591	2.5828
Min. <i>D</i>4812	.6040	.7270	.8502	.9735	1.0969	1.2203	1.3439	1.4676	1.5913	1.7149	1.8385	1.9621	2.0857	2.2093	2.3329	2.4565	2.5801
Tol. <i>D</i>0011	.0012	.0013	.0014	.0015	.0016	.0017	.0018	.0018	.0018	.0020	.0021	.0022	.0022	.0022	.0022	.0022	.0022
Classes 5C, major diameter.....	<i>in.</i>	<i>in.</i>	<i>in.</i>	<i>in.</i>	<i>in.</i>	<i>in.</i>	<i>in.</i>	<i>in.</i>	<i>in.</i>	<i>in.</i>	<i>in.</i>	<i>in.</i>	<i>in.</i>	<i>in.</i>	<i>in.</i>	<i>in.</i>	<i>in.</i>	<i>in.</i>
Max. <i>D</i>4816	.6044	.7274	.8507	.9740	1.0974	1.2209	1.3445	1.4682	1.5919	1.7156	1.8392	1.9629	2.0865	2.2101	2.4337	2.4573	2.4809
Min. <i>D</i>4807	.6035	.7265	.8498	.9731	1.0965	1.2199	1.3435	1.4672	1.5909	1.7146	1.8382	1.9619	2.0855	2.2091	2.4327	2.4563	2.4799
Tol. <i>D</i>0007	.0008	.0009	.0009	.0010	.0011	.0011	.0012	.0012	.0013	.0013	.0014	.0015	.0016	.0017	.0017	.0019	.0021
Classes 5C and 6C, minor diameter.....	<i>in.</i>	<i>in.</i>	<i>in.</i>	<i>in.</i>	<i>in.</i>	<i>in.</i>	<i>in.</i>	<i>in.</i>	<i>in.</i>	<i>in.</i>	<i>in.</i>	<i>in.</i>	<i>in.</i>	<i>in.</i>	<i>in.</i>	<i>in.</i>	<i>in.</i>	<i>in.</i>
Max. <i>d</i>3623	.4602	.5416	.6649	.7464	.8677	1.0020	1.0757	1.1994	1.3231	1.4469	1.5706	1.6943	1.8180	1.9417	2.0654	2.1891	2.3128
Min. <i>d</i>3527	.4495	.5294	.6527	.7342	.8547	.9879	1.0603	1.1838	1.3073	1.4308	1.5543	1.6778	1.8013	1.9248	2.0483	2.1718	2.2953
Tol. <i>d</i>0096	.0097	.0098	.0097	.0096	.0095	.0094	.0093	.0092	.0091	.0090	.0089	.0088	.0087	.0086	.0085	.0084	.0083
Classes 5C, minor diameter.....	<i>in.</i>	<i>in.</i>	<i>in.</i>	<i>in.</i>	<i>in.</i>	<i>in.</i>	<i>in.</i>	<i>in.</i>	<i>in.</i>	<i>in.</i>	<i>in.</i>	<i>in.</i>	<i>in.</i>	<i>in.</i>	<i>in.</i>	<i>in.</i>	<i>in.</i>	<i>in.</i>
Max. <i>d</i>4266	.5294	.6322	.7350	.8378	.9406	1.0434	1.1462	1.2490	1.3518	1.4546	1.5574	1.6602	1.7630	1.8658	1.9686	2.0714	2.1742
Min. <i>d</i>4257	.5285	.6313	.7341	.8369	.9397	1.0425	1.1453	1.2481	1.3509	1.4537	1.5565	1.6593	1.7621	1.8649	1.9677	2.0705	2.1733
Tol. <i>d</i>0009	.0009	.0009	.0009	.0009	.0009	.0009	.0009	.0009	.0009	.0009	.0009	.0009	.0009	.0009	.0009	.0009	.0009
Classes 6C, minor diameter.....	<i>in.</i>	<i>in.</i>	<i>in.</i>	<i>in.</i>	<i>in.</i>	<i>in.</i>	<i>in.</i>	<i>in.</i>	<i>in.</i>	<i>in.</i>	<i>in.</i>	<i>in.</i>	<i>in.</i>	<i>in.</i>	<i>in.</i>	<i>in.</i>	<i>in.</i>	<i>in.</i>
Max. <i>d</i>4281	.5309	.6337	.7365	.8393	.9421	1.0449	1.1477	1.2505	1.3533	1.4561	1.5589	1.6617	1.7645	1.8673	1.9701	2.0729	2.1757
Min. <i>d</i>4272	.5300	.6328	.7356	.8384	.9412	1.0440	1.1468	1.2496	1.3524	1.4552	1.5580	1.6608	1.7636	1.8664	1.9692	2.0720	2.1748
Tol. <i>d</i>0009	.0009	.0009	.0009	.0009	.0009	.0009	.0009	.0009	.0009	.0009	.0009	.0009	.0009	.0009	.0009	.0009	.0009
INTERNAL THREADS																		
Classes 5C and 6C, major diameter.....	<i>in.</i>	<i>in.</i>	<i>in.</i>	<i>in.</i>	<i>in.</i>	<i>in.</i>	<i>in.</i>	<i>in.</i>	<i>in.</i>	<i>in.</i>	<i>in.</i>	<i>in.</i>	<i>in.</i>	<i>in.</i>	<i>in.</i>	<i>in.</i>	<i>in.</i>	<i>in.</i>
Max. <i>D</i>4830	.6060	.7292	.8525	.9760	1.0996	1.2231	1.3469	1.4706	1.5943	1.7180	1.8417	1.9654	2.0891	2.2128	2.3365	2.4602	2.5839
Min. <i>D</i>4821	.6051	.7283	.8516	.9750	1.0985	1.2220	1.3457	1.4694	1.5931	1.7169	1.8406	1.9643	2.0880	2.2117	2.3354	2.4591	2.5828
Tol. <i>D</i>0009	.0009	.0009	.0009	.0009	.0009	.0009	.0009	.0009	.0009	.0009	.0009	.0009	.0009	.0009	.0009	.0009	.0009
Classes 5C, major diameter.....	<i>in.</i>	<i>in.</i>	<i>in.</i>	<i>in.</i>	<i>in.</i>	<i>in.</i>	<i>in.</i>	<i>in.</i>	<i>in.</i>	<i>in.</i>	<i>in.</i>	<i>in.</i>	<i>in.</i>	<i>in.</i>	<i>in.</i>	<i>in.</i>	<i>in.</i>	<i>in.</i>
Max. <i>D</i>4834	.6064	.7296	.8529	.9764	1.0999	1.2234	1.3472	1.4709	1.5946	1.7183	1.8420	1.9657	2.0894	2.2131	2.3368	2.4605	2.5842
Min. <i>D</i>4825	.6054	.7286	.8519	.9754	1.0989	1.2224	1.3462	1.4699	1.5936	1.7173	1.8410	1.9647	2.0884	2.2121	2.3358	2.4595	2.5832
Tol. <i>D</i>0009	.0009	.0009	.0009	.0009	.0009	.0009	.0009	.0009	.0009	.0009	.0009	.0009	.0009	.0009	.0009	.0009	.0009
Classes 6C, major diameter.....	<i>in.</i>	<i>in.</i>	<i>in.</i>	<i>in.</i>	<i>in.</i>	<i>in.</i>	<i>in.</i>	<i>in.</i>	<i>in.</i>	<i>in.</i>	<i>in.</i>	<i>in.</i>	<i>in.</i>	<i>in.</i>	<i>in.</i>	<i>in.</i>	<i>in.</i>	<i>in.</i>
Max. <i>d</i>3627	.4606	.5420	.6653	.7468	.8681	1.0024	1.0761	1.1998	1.3235	1.4473	1.5710	1.6947	1.8184	1.9421	2.0658	2.1895	2.3132
Min. <i>d</i>3531	.4500	.5309	.6542	.7357	.8570	.9902	1.0639	1.1876	1.3113	1.4350	1.5587	1.6824	1.8061	1.9298	2.0535	2.1772	2.3009
Tol. <i>d</i>0096	.0097	.0098	.0097	.0096	.0095	.0094	.0093	.0092	.0091	.0090	.0089	.0088	.0087	.0086	.0085	.0084	.0083
Classes 5C and 6C, minor diameter.....	<i>in.</i>	<i>in.</i>	<i>in.</i>	<i>in.</i>	<i>in.</i>	<i>in.</i>	<i>in.</i>	<i>in.</i>	<i>in.</i>	<i>in.</i>	<i>in.</i>	<i>in.</i>	<i>in.</i>	<i>in.</i>	<i>in.</i>	<i>in.</i>	<i>in.</i>	<i>in.</i>
Max. <i>d</i>4267	.5295	.6323	.7351	.8379	.9407	1.0435	1.1463	1.2491	1.3519	1.4547	1.5575	1.6603	1.7631	1.8659	1.9687	2.0715	2.1743
Min. <i>d</i>4258	.5286	.6314	.7342	.8370	.9398	1.0426	1.1454	1.2482	1.3510	1.4538	1.5566	1.6594	1.7622	1.8650	1.9678	2.0706	2.1734
Tol. <i>d</i>0009	.0009	.0009	.0009	.0009	.0009	.0009	.0009	.0009	.0009	.0009	.0009	.0009	.0009	.0009	.0009	.0009	.0009
Classes 5C, minor diameter.....	<i>in.</i>	<i>in.</i>	<i>in.</i>	<i>in.</i>	<i>in.</i>	<i>in.</i>	<i>in.</i>	<i>in.</i>	<i>in.</i>	<i>in.</i>	<i>in.</i>	<i>in.</i>	<i>in.</i>	<i>in.</i>	<i>in.</i>	<i>in.</i>	<i>in.</i>	<i>in.</i>
Max. <i>d</i>4271	.5299	.6327	.7355	.8383	.9411	1.0439	1.1467	1.2495	1.3523	1.4551	1.5579	1.6607	1.7635	1.8663	1.9691	2.0719	2.1747
Min. <i>d</i>4262	.5290	.6318	.7346	.8374	.9402	1.0430	1.1458	1.2486	1.3514	1.4542	1.5570	1.6598	1.7626	1.8654	1.9682	2.0710	2.1738
Tol. <i>d</i>0009	.0009	.0009	.0009	.0009	.0009	.0009	.0009	.0009	.0009	.0009	.0009	.0009	.0009	.0009	.0009	.0009	.0009
Classes 6C, minor diameter.....	<i>in.</i>	<i>in.</i>	<i>in.</i>	<i>in.</i>	<i>in.</i>	<i>in.</i>	<i>in.</i>	<i>in.</i>	<i>in.</i>	<i>in.</i>	<i>in.</i>	<i>in.</i>	<i>in.</i>	<i>in.</i>	<i>in.</i>	<i>in.</i>	<i>in.</i>	<i>in.</i>
Max. <i>d</i>4285	.5313	.6341	.7369	.8397	.9425	1.0453	1.1481	1.2509	1.3537	1.4565	1.5593	1.6621	1.7649	1.8677	1.9705	2.0733	2.1761
Min. <i>d</i>4276	.5304	.6332	.7360	.8388	.9416	1.0444	1.1472	1.2500	1.3528	1.4556	1.5584	1.6612	1.7640	1.8668	1.9696	2.0724	2.1752
Tol. <i>d</i>0009	.0009	.0009	.0009	.0009	.0009	.0009	.0009	.0009	.0009	.0009	.0009	.0009	.0009	.0009	.0009	.0009	.0009

^a The selection of threads per inch is arbitrary and is intended for the purpose of establishing a standard.

INTERNAL THREAD (NUT)

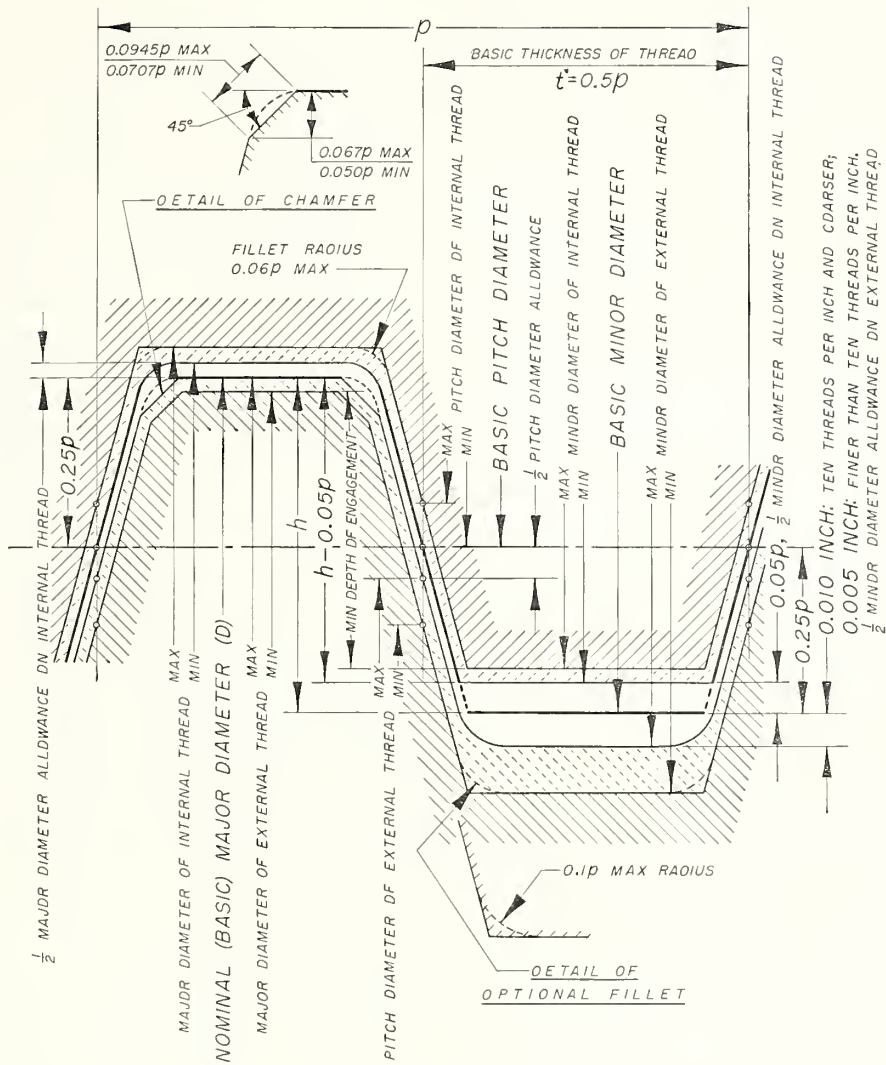

EXTERNAL THREAD (SCREW)

FIGURE XII.4.—Illustration of allowances, tolerances, and crest clearances, centralizing Acme threads, classes 2C, 3C, and 4C.

NOTATION

p = pitch
 h = basic thread height.
 Heavy lines show basic size.

SNAP GAGE.—(a) *Major diameter.*—The major diameter of the “not go” thread ring or thread snap gage shall clear a diameter greater by 0.01 in. than the maximum major diameter of the external thread. The clearance cut may have 0.435 p maximum width between intersections with the flanks of the thread.

(b) *Pitch diameter.*—The pitch diameter shall fit the minimum-metal limit thread setting plug gage.

(c) *Minor diameter.*—The minor diameter shall be the basic minor diameter of the internal thread plus $p/4$, with the tolerance (table XII.13,

col. 4) applied plus. If the value for minimum minor diameter determined by the formula is greater than the minimum pitch diameter of the external thread, the minimum minor diameter of the gage shall be specified as the minimum pitch diameter of the external thread.

(d) *Length.*—The length of the “not go” thread ring or thread snap gage should approximate 3 pitches (see footnote to table XII.14). When a multiple thread is involved, the “not go” thread ring or snap gage shall be of such length as to provide at least 1 full turn of thread.

5. THREAD SETTING PLUG FOR “NOT Go”

INTERNAL THREAD (NUT)

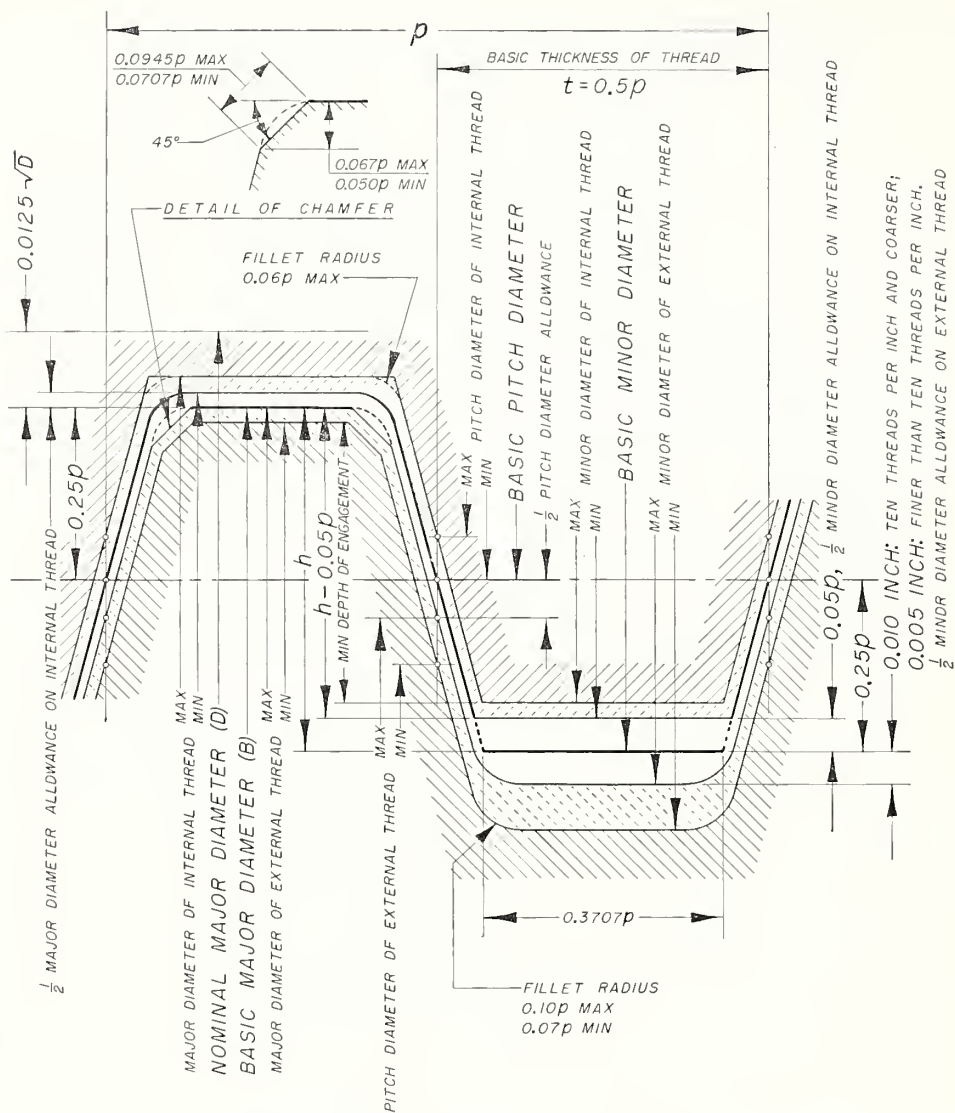

EXTERNAL THREAD (SCREW)

FIGURE XII.5.—Illustration of allowances, tolerances, and crest clearances, centralizing Acme threads, classes 5C and 6C.

NOTATION

p = pitch
 h = basic thread height
 Heavy lines show basic form.

THREAD RING OR THREAD SNAP GAGE.—(a) *Major diameter.*—The major diameter of the basic-crest minimum-metal limit thread setting plug gage shall be the same as the maximum major diameter of the external thread. The gage tolerance (table XII.13, col. 4) shall be applied plus. The major diameter of the truncated minimum-metal limit thread setting plug gage shall be truncated one-third basic thread depth ($=p/6$) smaller than the maximum major diameter of the

external thread. The gage tolerance (table XII.13, col. 4) shall be applied minus.

(b) *Pitch diameter.*—The pitch diameter shall be the same as the minimum pitch diameter of the external thread, with the tolerance applied plus.

(c) *Minor diameter.*—The minor diameter shall be cleared below the minimum minor diameter of the “not go” thread ring gage.

(d) *Length.*—The length shall be at least equal

to the length of the "not go" thread ring or thread snap gage.

6. "NOT GO" PLAIN SNAP GAGE FOR MAJOR DIAMETER.—The gaging dimension of the "not go" plain snap gage shall be the same as the minimum major diameter of the external thread. Class Z tolerances given in footnote of table XII.13 shall be applicable to gages for centralizing threads. Tolerances given in table XII.13, column 4, shall be applicable to gages for general purpose threads. The gage tolerance shall be applied plus.

(c) GAGES FOR INTERNAL THREADS

1. "GO" THREAD PLUG GAGE, GENERAL PURPOSE THREADS.—(a) Major diameter.—The major diameter of the "go" thread plug gage for general purpose threads shall be equal to the minimum major diameter of the internal thread minus 0.005 in. for pitches finer than 10 tpi, and minus 0.010 in. for 10 tpi and coarser, to allow for possible deviations in concentricity of the pitch and major diameters of the product. The gage tolerance (table XII.13, col. 4) shall be applied plus.

TABLE XII.13.—Tolerances for "go" and "not go" thread and plain gages, Acme threads

Threads per inch ^a	Tolerance on pitch ^b diameter		Tolerance ^c on major and minor diameters	Tolerance on half angle of thread
	Classes 2G and 2C	Classes 3G, 3C, 4G, 4C, 5C, and 6C		
1	2	3	4	5
	<i>in.</i>	<i>in.</i>	<i>in.</i>	<i>deg min</i> ±
16.....	0.0006	0.0005	0.001	0 10
14.....	.0006	.0005	.001	0 10
12.....	.0006	.0006	.001	0 10
10.....	.0007	.0006	.002	0 10
8.....	.0008	.0007	.002	0 8
6.....	.0009	.0007	.002	0 8
5.....	.0010	.0008	.002	0 8
4.....	.0011	.0008	.002	0 8
3.....	.0013	.0008	.002	0 6
2½.....	.0014	.0009	.002	0 6
2.....	.0015	.0010	.002	0 6
1½.....	.0018	.0010	.002	0 5
1⅓.....	.0018	.0010	.002	0 5
1.....	.0021	.0010	.002	0 5

^a Intermediate pitches take the tolerances of the next coarser pitch listed in the table.

^b These pitch diameter tolerances for thread gages are not cumulative; that is, they do not include tolerances on lead and on half angle. Lead tolerances are given in par. 7(a) 3, p. 10.

^c These tolerances are applicable to all gages except the "go" and "not go" thread plug gages for major diameter of all classes of centralizing internal threads, and for "go" and "not go" plain ring or snap gages for major diameter of centralizing external threads. For these gages the tolerances are class Z, as follows:

Size range		Class Z tolerance
Above	To and including	
<i>in.</i>	<i>in.</i>	<i>in.</i>
0.029	0.825	0.00010
0.825	1.510	.00012
1.510	2.510	.00016
2.510	4.510	.00020
4.510	6.510	.00025

(b) Pitch diameter.—The pitch diameter shall be equal to the minimum (basic) pitch diameter of the internal thread with the tolerance (table XII.13, col. 2 and 3) applied plus.

(c) Minor diameter.—The minor diameter shall clear a diameter less by 0.01 in. than the minimum minor diameter of the internal thread.

(d) Length.—The length of the "go" thread plug gage should approximate the length of engagement (see footnote to table XII.14) but shall not exceed twice the nominal major diameter unless specifically requested.

2. "GO" THREAD PLUG GAGE, CENTRALIZING THREADS.—(a) Major diameter.—The major diameter of the "go" thread plug gage for centralizing threads shall be the same as the minimum

TABLE XII.14.—Pitch diameter compensation for adjusted lengths of "go" ring gages for general purpose and centralizing threads

Nominal major diameter of external thread		Length of "go" ring gage	Maximum amount 2 diameters length of engagement exceeds length of gage	Maximum amount pitch diameter of "go" ring shall be less than maximum pitch diameter of external thread
Above	To and including			
1	2	3	4	5
<i>in.</i>	<i>in.</i>	2 diameters.	<i>in.</i>	<i>in.</i>
0.....	1	0	0	0
1.....	1¼	2 in.....	¼	0.0012
1½.....	1¾	2 in.....	½	.0012
1¾.....	1⅞	2 in.....	¾	.0015
2.....	2	2 in.....	1	.0015
2½.....	2½	2 in.....	1½	.0015
3.....	3	2 in.....	2	.0019
3½.....	3½	2 in.....	2	.0019
4.....	4	2½ in.....	2½	.0019
4½.....	4½	2½ in.....	3	.0019
5.....	5	3 in.....	3	.0019
5½.....	5½	3 in.....	5	.0027
6.....	6	3 in.....	7	.0039

NOTE.—The above compensation is based on a length of engagement not exceeding two diameters and a lead deviation in the product not exceeding the following values (in inch):

- 0.0003 in length of ½ in. or less.
- 0.0004 in length over ½ to 1½ in.
- 0.0005 in length over 1½ to 3 in.
- 0.0007 in length over 3 to 6 in.
- 0.0010 in length over 6 to 10 in.

The principles have been established in the foregoing requirements that "go" gages should approximate the length of engagement, and "not go" gages should be three pitches long. For reasons of economy or limitations in gage manufacture or use, it may be desirable to modify these principles to: (1) Take advantage of the economies of using standard blanks, as listed in the latest issue of CSS, Gage Blanks, wherever they may be utilized successfully. (2) Avoid too cumbersome ring gages as well as excessively expensive gages by limiting the length of "go" thread ring gages to maximum lengths given in col. 3 above. (3) Avoid excessively cumbersome thread plug gages by limiting maximum length to two diameters wherever possible. (4) Take full advantage of modern equipment for producing and checking accurate leads, particularly where long engagements are involved, thus permitting the use of standard or moderate length thread plug, thread ring, or thread snap gages. Alternatively, of course, instruments might be used for checking diameters and angles independently.

Should a "go" gage shorter than the length of engagement be chosen, independent means should be used to measure lead deviation in product. The maximum metal condition must be reduced to assure free assembly of product, if the lead deviation in the length of engagement, δp , so determined, exceeds $0.259G$, where G is the product pitch diameter allowance. The required amount of change in pitch diameter, ΔE , of the product (minus on external thread, plus on internal thread) accordingly is: $\Delta E = 3.867 \left(1 - \frac{L_g}{L_e}\right) \delta p$, where L_g is the length of the gage and L_e is the length of engagement. When instruments are used for checking diameter it is a simple matter to make this allowance. When thread plug and ring gages are used, the allowance is sometimes increased a fixed amount, as outlined in the above table. This arbitrarily reduces the tolerance on diameter.

major diameter of the internal thread with a plus tolerance (class Z, footnote of table XII.13). Both corners at the crest shall be chamfered equally at an angle of 45° , leaving a width of flat at crest of $0.28p$, $+0.00$, $-0.02p$.

(b) *Pitch diameter, minor diameter, and length.*—The pitch diameter, minor diameter, and length of gage shall be the same as those given in 1(b), 1(c), and 1(d) above.

3. "NOT GO" THREAD PLUG GAGE FOR PITCH DIAMETER OF ALL INTERNAL THREADS.—(a) *Major diameter.*—The major diameter of the "not go" thread plug gage shall be equal to the maximum (basic) major diameter of the external thread minus $p/4$, with the tolerance (table XII.13, col. 4) applied minus.

(b) *Pitch diameter.*—The pitch diameter shall be the same as the maximum pitch diameter of the internal thread, with the tolerance (table XII.13, col. 2 and 3) applied minus.

(c) *Minor diameter.*—The minor diameter shall clear a diameter less by 0.01 in. than the minimum minor diameter of the internal thread. The clearance cut may have $0.435p$ maximum width between intersections with the flanks of the thread.

(d) *Length.*—The length of the "not go" thread plug gage should approximate 3 pitches (see footnote to table XII.14). When a multiple thread is involved, the "not go" thread plug gage shall be of such length as to provide at least 1 full turn of the thread.

4. "NOT GO" THREAD PLUG GAGE FOR MAJOR DIAMETER OF CENTRALIZING INTERNAL THREAD.—The major diameter shall be equal to the maximum major diameter of the internal thread. The tolerance shall be class Z (footnote of table XII.13), applied minus. The included angle of the thread shall be 29° . The pitch diameter shall be the maximum pitch diameter of the class 4C centralizing *external thread* (for centralizing internal threads, classes 2C, 3C, and 4C) or the maximum pitch diameter of the class 6C centralizing *external thread* (for centralizing internal threads, classes 5C and 6C), with a minus tolerance of twice that given in table XII.13, column 3. The crest corners shall be chamfered 45° equally to leave a central crest flat not more than $0.24p$ wide. The approximate depth of chamfer is $0.07p$. The minor diameter shall clear a diameter less by 0.01 in. than the minimum minor diameter of the internal thread. The length should approximate $3p$ (see footnote to table XII.14). When a multiple thread is involved, the "not go" gage shall be of such length as to provide at least 1 full turn of thread.

5. "GO" PLAIN PLUG GAGE FOR MINOR DIAMETER OF INTERNAL THREAD.—The diameter of the "go" plain plug gage shall be the same as the minimum minor diameter of the internal thread. The gage tolerance shall be class Z (footnote of table XII.13), applied plus. The gage length shall be in accordance with the latest revision of Commercial Standard CSS, Gage Blanks.

6. "NOT GO" PLAIN PLUG FOR MINOR DIAMETER OF INTERNAL THREAD.—The diameter of the "not go" plain plug gage shall be the same as the maximum minor diameter of the internal thread. The gage tolerance shall be class Z (footnote of table XII.13), applied minus. The gage length shall be in accordance with the latest revision of CSS.

(d) CONCENTRICITY

Methods of securing concentricity between major and pitch diameters of external or internal threads must be determined for each individual application.

SECTION XIII. STUB ACME THREADS⁴

1. GENERAL AND HISTORICAL

When formulated prior to 1895, regular Acme threads were intended to replace square threads and a variety of threads of other forms used chiefly for the purpose of producing traversing motions on machines, tools, etc. Acme threads are now extensively used for a variety of purposes.

Section XII, p. 1, provides information and data pertaining to the use of the regular standard Acme thread form. The Stub Acme thread came into being early in the 1900's. Its use has been generally confined to those unusual applications where a coarse-pitch thread of shallow depth is required due to mechanical or metallurgical considerations.

While threads for valve operation may be made to this standard, this application is highly specialized and these data should not be used without consultation with the valve manufacturer.

2. SPECIFICATIONS FOR THE STUB ACME FORM OF THREAD

1. *ANGLE OF THREAD.*—The angle between the flanks of the thread measured in an axial plane shall be 29° . The line bisecting this 29° angle shall be perpendicular to the axis of the thread.

2. *PITCH OF THREAD.*—The pitch of a thread is the distance, measured parallel to its axis, between corresponding points on adjacent thread forms.

3. *HEIGHT OF THREAD.*—The basic height of Stub Acme threads shall be as follows:

Standard Stub Acme	$0.3p$,
Modified Form 1 Stub Acme	$0.375p$,
Modified Form 2 Stub Acme	$0.25p$.

4. *THICKNESS OF THREAD.*—The basic thickness of the thread at a diameter smaller by the basic height of thread (for which see previous paragraph) than the basic major diameter, shall be $0.5p$.

5. *ALLOWANCE (MINIMUM CLEARANCE) AT MAJOR AND MINOR DIAMETERS.* A minimum diametrical clearance is provided at the minor diameter of all Stub Acme thread assemblies by

⁴ This section is in substantial agreement with American Standards Association publication ASA B1.8, "Stub Acme Screw Threads," which is published by the ASME, 29 W. 39th St., New York 18, N.Y. The latest revision should be consulted when referring to this ASA document.

establishing the maximum minor diameter of external threads 0.020 in. below the basic minor diameter on 10 tpi and coarser, and 0.010 in. below the basic minor diameter for finer pitches.

A minimum diametrical clearance at the major diameter is obtained by establishing the minimum major diameter of the internal thread 0.020 in. above the basic major diameter for 10 tpi and coarser, and 0.010 in. above the basic major diameter for finer pitches.

6. BASIC THREAD FORM DIMENSIONS.—The basic dimensions of the standard Stub Acme thread form for the most generally used pitches are given in table XIII.1. The basic thread form is symmetrical and is illustrated in figure XIII.1.

TABLE XIII.1.—Standard Stub Acme thread form, basic dimensions

Threads per inch, <i>n</i>	Pitch, <i>p</i>	Height of thread (basic), $h=0.3p$	Total height of thread, $h_s=h+\frac{1}{2}$ allowance ^a	Thread thickness (basic), $t=p/2$	Width of flat at:	
					Crest of internal thread (basic), $F_{c_n}=0.4224p$	Root of internal thread, $F_{r_n}=0.4224p-0.259 \times \text{allowance } ^a$
1	2	3	4	5	6	7
16	<i>in.</i> 0.06250	<i>in.</i> 0.01875	<i>in.</i> 0.0238	<i>in.</i> 0.03125	<i>in.</i> 0.0264	<i>in.</i> 0.0238
14	0.07143	0.02143	0.0264	0.03571	0.0302	0.0276
12	0.08333	0.02500	0.0300	0.04167	0.0352	0.0326
10	0.10000	0.03000	0.0400	0.05000	0.0422	0.0370
9	0.11111	0.03333	0.0433	0.05556	0.0469	0.0417
8	0.12500	0.03750	0.0475	0.06250	0.0528	0.0476
7	0.14286	0.04286	0.0529	0.07143	0.0603	0.0551
6	0.16667	0.05000	0.0600	0.08333	0.0704	0.0652
5	0.20000	0.06000	0.0700	0.10000	0.0845	0.0793
4	0.25000	0.07500	0.0850	0.12500	0.1056	0.1004
3½	0.28571	0.08571	0.0957	0.14286	0.1207	0.1155
3	0.33333	0.10000	0.1100	0.16667	0.1408	0.1356
2½	0.40000	0.12000	0.1300	0.20000	0.1690	0.1638
2	0.50000	0.15000	0.1600	0.25000	0.2112	0.2060
1½	0.66667	0.20000	0.2100	0.33333	0.2816	0.2764
1¼	0.75000	0.22500	0.2350	0.37500	0.3168	0.3116
1	1.00000	0.30000	0.3100	0.50000	0.4224	0.4172

^a Allowance is shown in table XIII.3, col. 3.

(a) *Special requirements, deviations from nominal diameter.*—Applications requiring special machining processes resulting in a basic diameter less than the nominal shown in table XIII.2, column 1, shall have allowances and tolerances in accordance with footnote b, table XIII.3; table XIII.4; and tabulated tolerances, table XIII.5.

(b) *Special diameters.*—Special diameters not shown in table XIII.2 and not divisible by 1/16 shall show the actual basic major diameter in decimals on drawings, specifications, and tools.

3. STANDARD STUB ACME THREAD SERIES

There has been selected a series of diameters and associated pitches of standard Stub Acme threads listed in table XIII.2, which is recom-

mended as preferred. These diameters and pitches have been carefully selected to meet the present needs with the fewest number of items, in order to reduce to a minimum the inventory of both tools and gages.

4. CLASSIFICATION AND TOLERANCES, STANDARD STUB ACME THREADS

There is established herein only one class of thread for general usage. This class corresponds to the class 2G (General Purpose) of section XII. If a fit having less backlash is required, the tolerances and allowances for general purpose threads shown in tables XII.3, XII.4, XII.5, XII.6, and XII.8, pp. 4 to 9, may be used to determine the limits of size for mating threads.

1. **BASIC DIAMETERS.**—The maximum major diameter of the external thread is the basic (nominal) major diameter. The minimum pitch diameter of the internal thread is basic and equal to the basic major diameter minus the basic height of thread. The basic minor diameter is the minimum minor diameter of the internal thread and is equal to the basic major diameter minus twice the basic thread height.

2. **LENGTH OF ENGAGEMENT.**—The tolerances specified herein are applicable to lengths of engagement not exceeding twice the nominal major diameter.

3. **TOLERANCES.**—The tolerances specified are such as to assure interchangeability and maintain a high grade of product.

The tolerances on diameters of internal threads shall be applied plus from the minimum sizes to above the minimum sizes.

The tolerances on diameters of external threads shall be applied minus from the maximum sizes to below the maximum sizes.

The pitch-diameter (or thread-thickness) tolerances for an external or an internal thread are the same. Pitch diameter tolerances are the same as those given in table XII.6, p. 7.

The pitch-diameter (or thread-thickness) tolerances for the product include lead and angle deviations.

The tolerances on the major and minor diameters of external and internal threads for use with special threads are listed in table XIII.3 and are based on the following formulas:

Major diameter tolerance		Minor diameter tolerance	
External thread	Internal thread	External thread	Internal thread
0.05 <i>p</i> . (Min=0.005 in.). ^a	1.0×pitch (diameter tolerance). ^b	1.0×pitch (diameter tolerance). ^b	0.05 <i>p</i> . (Min=0.005 in.). ^a

^a To avoid a complicated formula and still provide an adequate tolerance, the pitch factor is used as a base, with the minimum tolerance value set at 0.005 in.

^b For use only where the major diameter of the internal thread and the minor diameter of the external thread must be controlled, such as on thin-walled components. Pitch-diameter tolerances for various practicable combinations of diameter and pitch are given in table XII.6, p. 7.

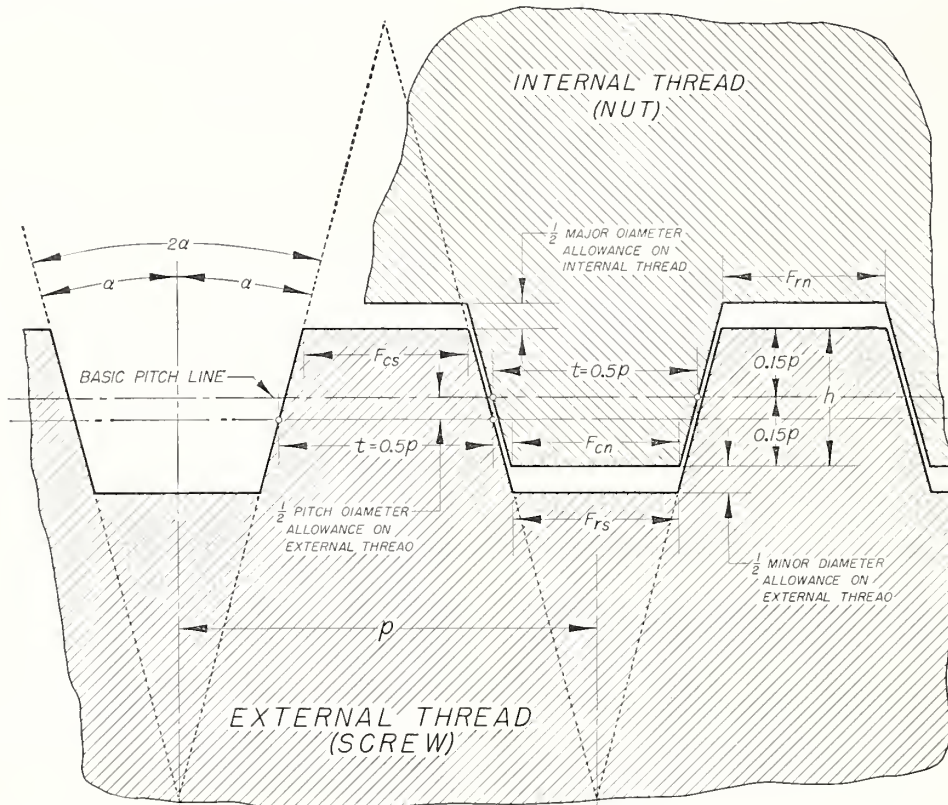

FIGURE XIII.1.—Standard Stub Acme form of thread.

NOTATION

- $2\alpha = 29^\circ$
- $\alpha = 14^\circ 30'$
- $p =$ pitch
- $n =$ number of threads per inch
- $N =$ number of turns per inch
- $h = 0.3p =$ basic height of thread
- $F_{cn} = 0.4224p =$ basic width of flat of crest of internal thread
- $F_{cs} = 0.4224p =$ basic width of flat of crest of external thread
- $F_{rn} = 0.4224p = 0.259 \times$ (major diameter allowance on internal thread)
- $F_{rs} = 0.4224p = 0.259 \times$ (minor diameter allowance on external thread)

4. ALLOWANCES (MINIMUM CLEARANCES).—Allowances applied to the pitch diameter of the external thread are based on the major diameter and are given in table XIII.4.

When the product has a length of engagement greater than the standard length of thread ring gage as shown in table XII.14, col. 3, p. 17, and lead deviations not exceeding values shown in the footnote to that table, and when “go” thread ring gages of these lengths are to be used, the maximum pitch diameter of the external thread shall be decreased by the amount shown in table XII.14, col. 5. If the lead deviations in the product are greater than indicated, the allowance for the ring gage stated in col. 5 should be increased proportionately. However, if methods of gaging the external thread are to be used that will detect

angle deviation and cumulative lead deviation, the pitch diameter of the thread shall be below the tabular maximum pitch diameter by an amount sufficient to compensate for the measured deviations.

An increase of 10 percent in the allowance is recommended for each inch, or fraction thereof, that the length of engagement exceeds two diameters.

5. LIMITS OF SIZE, STANDARD STUB ACME THREADS

Limits of size for Stub Acme threads of the preferred series of diameters and pitches are given in table XIII.5. The application of these limits

is illustrated in figure XIII.2. The values in table XIII.5 are based on the following formulas:

External Threads (Screws)

- (Basic) Max major diam=Nominal size or diameter, D .
- Min major diam=Ext max major diam minus tolerance from table XIII.3, col 6.
- Max pitch diam=Int min pitch diam minus allowance from table XIII.4, col 3.
- Min pitch diam=Ext max pitch diam minus tolerance from table XII.6, p. .
- Max minor diam=Int min minor diam minus allowance from table XIII.3, col 4.
- Min minor diam=Ext max minor diam minus tolerance from table XIII.3, col 7.

Internal Threads (Nuts)

- Min major diam=Ext max major diam plus allowance from table XIII.3, col 3.
- Max major diam=Int min major diam plus tolerance from table XIII.3, col 7.
- (Basic) Min pitch diam=Ext max major diam minus basic height of thread from table XIII.2, col 8.

(Basic)

- Max pitch diam=Int min pitch diam plus tolerance from table XII.6, p. 7.
- Min minor diam=Ext max major diam minus 2 times basic height of thread from table XIII.2, col 8.
- Max minor diam=Int min minor diam plus tolerance from table XIII.3, col 5.

6. THREAD DESIGNATIONS

Standard Stub Acme threads shall be designated as shown below on drawings and in specifications, and on tools and gages:

Right-hand thread:

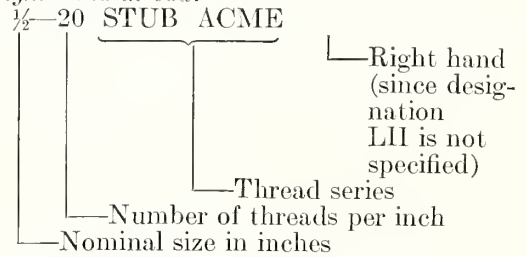

Left-hand thread:

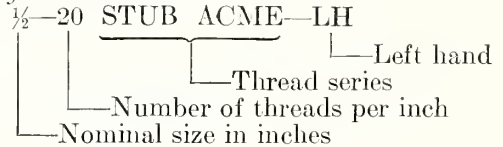

TABLE XIII.2.—Standard Stub Acme thread series, basic diameters and thread data

Nominal sizes	Threads per inch, n	Basic diameters			Thread data				
		Major diameter, D	Pitch diameter, $E = D - h$	Minor diameter, $K = D - 2h$	Pitch, p	Thread thickness at pitch line, $t = p/2$	Basic height of thread, $h = 0.3p$	Basic width of flat, $F = 0.4224p$	Lead angle at basic pitch diameter, λ
1	2	3	4	5	6	7	8	9	10
<i>in.</i>		<i>in.</i>	<i>in.</i>	<i>in.</i>	<i>in.</i>	<i>in.</i>	<i>in.</i>	<i>in.</i>	<i>deg min</i>
1/4	16	0.2500	0.2312	0.2125	0.06250	0.03125	0.01875	0.0264	4 54
5/16	14	.3125	.2911	.2696	.07143	.03572	.02143	.0302	4 28
3/8	12	.3750	.3500	.3250	.08333	.04167	.02500	.0352	4 20
7/16	12	.4375	.4125	.3875	.08333	.04167	.02500	.0352	3 41
1/2	10	.5000	.4700	.4400	.10000	.05000	.03000	.0422	3 52
5/8	8	.6250	.5875	.5500	.12500	.06250	.03750	.0528	3 52
3/4	6	.7500	.7000	.6500	.16667	.08333	.05000	.0704	4 20
7/8	6	.8750	.8250	.7750	.16667	.08333	.05000	.0704	3 41
1	5	1.0000	.9400	.8800	.20000	.10000	.06000	.0845	3 52
1 1/8	5	1.1250	1.0650	1.0050	.20000	.10000	.06000	.0845	3 25
1 1/4	5	1.2500	1.1900	1.1300	.20000	.10000	.06000	.0845	3 4
1 3/8	4	1.3750	1.3000	1.2250	.25000	.12500	.07500	.1056	3 30
1 1/2	4	1.5000	1.4250	1.3500	.25000	.12500	.07500	.1056	3 12
1 3/4	4	1.7500	1.6750	1.6000	.25000	.12500	.07500	.1056	2 43
2	4	2.0000	1.9250	1.8500	.25000	.12500	.07500	.1056	2 22
2 1/4	3	2.2500	2.1500	2.0500	.33333	.16667	.10000	.1408	2 50
2 1/2	3	2.5000	2.4000	2.3000	.33333	.16667	.10000	.1408	2 32
2 3/4	3	2.7500	2.6500	2.5500	.33333	.16667	.10000	.1408	2 18
3	2	3.0000	2.8500	2.7000	.50000	.25000	.15000	.2112	3 12
3 1/2	2	3.5000	3.3500	3.2000	.50000	.25000	.15000	.2112	2 43
4	2	4.0000	3.8500	3.7000	.50000	.25000	.15000	.2112	2 22
4 1/2	2	4.5000	4.3500	4.2000	.50000	.25000	.15000	.2112	2 6
5	2	5.0000	4.8500	4.7000	.50000	.25000	.15000	.2112	1 53

7. ALTERNATIVE STUB ACME THREADS

Recognizing the fact that the standard Stub Acme thread form may not provide a generally acceptable thread system to meet the requirements of all applications, basic data for two of the other commonly used forms are tabulated in tables XIII.6 and XIII.7. These threads are identified as Modified Form 1 Stub Acme Thread (shown on fig. XIII.3) and Modified Form 2 Stub Acme Thread (shown on fig. XIII.4). Wherever practicable, however, the standard Stub Acme Thread form should be used.

In applying the foregoing data to special designs, the allowances and tolerances can be taken directly from tables XIII.3, XIII.4, and XII.6, p. 7 for standard Stub Acme threads. Therefore the major diameter and basic thread thickness at pitch line for both external and internal threads will be the same as for the standard form as shown

in tables XIII.2 and XIII.5. The pitch diameter and minor diameter will vary from the data shown in tables XIII.2 and XIII.5; for modified form 1, the pitch and minor diameters will be smaller than similar values for the standard form, and for modified form 2 the pitch and minor diameters will be larger than those dimensions for the standard forms.

These threads shall be designated as shown below on drawings and in specifications, and on tools and gages:

Right-hand thread:

$\frac{1}{2}$ —20 STUB ACME M1
 $\frac{1}{2}$ —20 STUB ACME M2

 Modified Form 1
 Modified Form 2

Left-hand thread:

$\frac{1}{2}$ —20 STUB ACME M1—LH
 $\frac{1}{2}$ —20 STUB ACME M2—LH

TABLE XIII.3.—Tolerances and allowances for major and minor diameters, Stub Acme threads ^a

Size ^b	Threads per inch, <i>n</i>	Allowances from basic major and minor diameters		Tolerance ^c on minor diameter, all internal threads, plus 0.05 <i>p</i>	Tolerance ^c on major diameter, all external threads, minus 0.05 <i>p</i>	Tolerance on ^f major diameter, plus on all internal threads; also tolerance on minor diameter, minus on all external threads, =1.0×P.D. tol.
		Major ^e diam, all internal threads plus	Minor ^d diam, all external threads minus			
1	2	3	4	5	6	7
<i>in.</i>		<i>in.</i>	<i>in.</i>	<i>in.</i>	<i>in.</i>	<i>in.</i>
$\frac{1}{4}$ -----	16	0.010	0.010	0.0050	0.0050	0.0105
$\frac{5}{16}$ -----	14	.010	.010	.0050	.0050	.0114
$\frac{3}{8}$ -----	12	.010	.010	.0050	.0050	.0123
$\frac{7}{16}$ -----	12	.010	.010	.0050	.0050	.0126
$\frac{1}{2}$ -----	10	.020	.020	.0050	.0050	.0137
$\frac{5}{8}$ -----	8	.020	.020	.0062	.0062	.0154
$\frac{3}{4}$ -----	6	.020	.020	.0083	.0083	.0174
$\frac{7}{8}$ -----	6	.020	.020	.0083	.0083	.0179
1-----	5	.020	.020	.0100	.0100	.0194
$1\frac{1}{8}$ -----	5	.020	.020	.0100	.0100	.0198
$1\frac{1}{4}$ -----	5	.020	.020	.0100	.0100	.0201
$1\frac{3}{8}$ -----	4	.020	.020	.0125	.0125	.0220
$1\frac{1}{2}$ -----	4	.020	.020	.0125	.0125	.0223
$1\frac{3}{4}$ -----	4	.020	.020	.0125	.0125	.0229
2-----	4	.020	.020	.0125	.0125	.0235
$2\frac{1}{4}$ -----	3	.020	.020	.0167	.0167	.0263
$2\frac{1}{2}$ -----	3	.020	.020	.0167	.0167	.0268
$2\frac{3}{4}$ -----	3	.020	.020	.0167	.0167	.0273
3-----	2	.020	.020	.0250	.0250	.0316
$3\frac{1}{2}$ -----	2	.020	.020	.0250	.0250	.0324
4-----	2	.020	.020	.0250	.0250	.0332
$4\frac{1}{2}$ -----	2	.020	.020	.0250	.0250	.0339
5-----	2	.020	.020	.0250	.0250	.0346

^a Pitch-diameter tolerances for various practicable combinations of diameter and pitch are given in table XII.6, p. 7.

^b For an intermediate size, the tolerances and deviations for the next larger size given in this table shall apply.

^c The minimum clearance at the major diameter between the internal and external threads is equal to column 3.

^d The minimum clearance at the minor diameter between the internal and external threads is equal to column 4.

^e To avoid a complicated formula and still provide an adequate tolerance, the pitch factor is used as a base, with the minimum tolerance value set at 0.005 in.

^f For use only where the major diameter of the internal thread and the minor diameter of the external thread must be controlled, such as on thin-walled components.

TABLE XIII.4.—Pitch diameter allowances for Stub Acme threads

Nominal size range ^a		Pitch diameter ^b allowances on external threads, 0.008√ <i>D</i>
Above	To and including	
1	2	3
<i>in.</i>	<i>in.</i>	<i>in.</i>
0-----	$\frac{3}{16}$	0.0024
$\frac{3}{16}$ -----	$\frac{5}{16}$.0040
$\frac{5}{16}$ -----	$\frac{7}{16}$.0049
$\frac{7}{16}$ -----	$\frac{9}{16}$.0057
$\frac{9}{16}$ -----	$1\frac{1}{16}$.0063
$1\frac{1}{16}$ -----	$1\frac{3}{16}$.0069
$1\frac{3}{16}$ -----	$1\frac{5}{16}$.0075
$1\frac{5}{16}$ -----	$1\frac{7}{16}$.0080
$1\frac{7}{16}$ -----	$1\frac{9}{16}$.0085
$1\frac{9}{16}$ -----	$1\frac{11}{16}$.0089
$1\frac{11}{16}$ -----	$1\frac{13}{16}$.0094
$1\frac{13}{16}$ -----	$1\frac{15}{16}$.0098
$1\frac{15}{16}$ -----	$1\frac{7}{8}$.0105
$1\frac{7}{8}$ -----	$1\frac{1}{2}$.0113
$1\frac{1}{2}$ -----	$1\frac{3}{4}$.0120
$1\frac{3}{4}$ -----	2	.0126
2 -----	$2\frac{1}{4}$.0133
$2\frac{1}{4}$ -----	$2\frac{1}{2}$.0140
$2\frac{1}{2}$ -----	$2\frac{3}{4}$.0150
$2\frac{3}{4}$ -----	3	.0160
3 -----	$3\frac{1}{4}$.0170
$3\frac{1}{4}$ -----	$3\frac{1}{2}$.0181

^a The values in column 3 are to be used for any nominal size within the range shown in cols 1 and 2. These values are calculated from the mean of the range.

It is recommended that the nominal sizes given in table XIII.2 be used whenever possible.

^b An increase of 10 percent in the allowance is recommended for each inch, or fraction thereof, that the length of engagement exceeds two diameters.

INTERNAL THREAD (NUT)

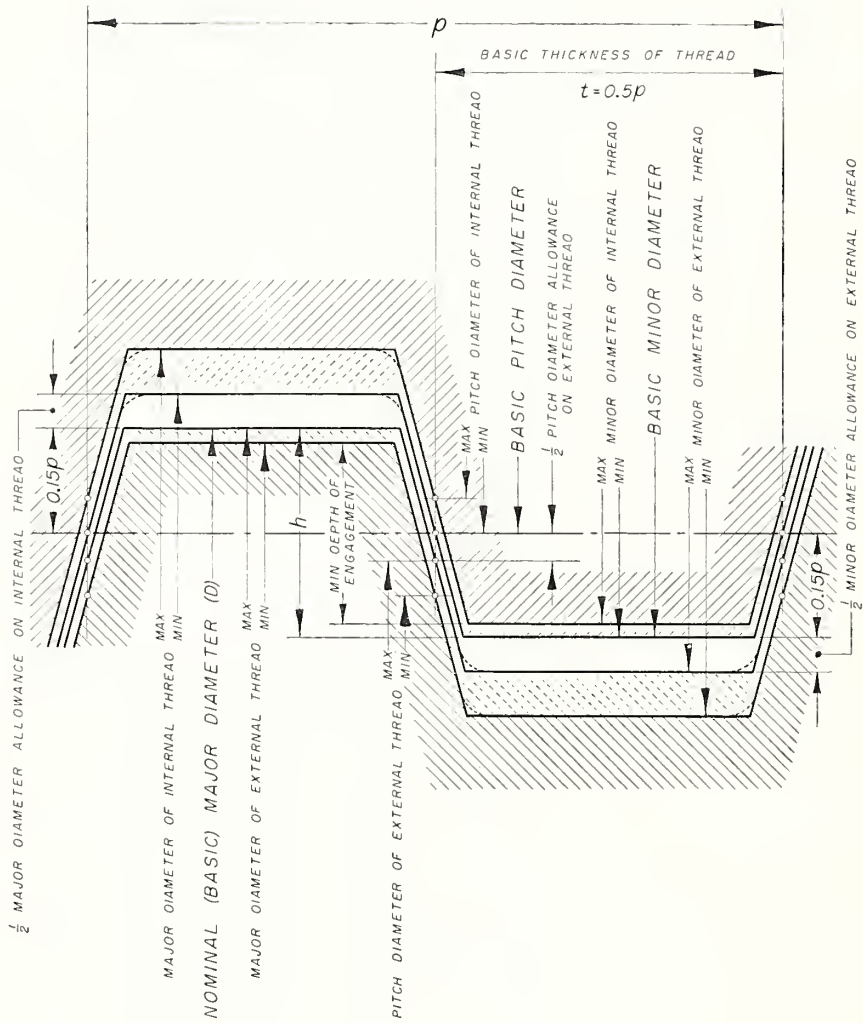

EXTERNAL THREAD (SCREW)

FIGURE XIII.2.—Illustration of allowances, tolerances, and crest clearances for Stub Acme threads.

NOTATION

p = pitch
 h = basic thread height

TABLE XIII.6.—Modified Form 1 Stub Acme thread form, basic dimensions

Threads per inch, <i>n</i>	Pitch, <i>p</i>	Height of thread (basic), $h=0.375p$	Total height of thread, $h_s=h+\frac{1}{2}$ allowance ^a	Thread thickness (basic), $t=p/2$	Width of flat at crest of internal thread (basic), $F_{en}=0.4030p$
1	2	3	4	5	6
16	.06250	.02344	.0284	.03125	.0252
14	.07143	.02679	.0318	.03572	.0288
12	.08333	.03125	.0363	.04167	.0336
10	.10000	.03750	.0475	.05000	.0403
9	.11111	.04167	.0517	.05556	.0448
8	.12500	.04688	.0569	.06250	.0504
7	.14286	.05357	.0636	.07143	.0576
6	.16667	.06250	.0725	.08333	.0672
5	.20000	.07500	.0850	.10000	.0806
4	.25000	.09375	.1038	.12500	.1008
3½	.28571	.10714	.1171	.14286	.1151
3	.33333	.12500	.1350	.16667	.1343
2½	.40000	.15000	.1600	.20000	.1612
2	.50000	.18750	.1975	.25000	.2015
1½	.66667	.25000	.2600	.33333	.2687
1¼	.75000	.28125	.2913	.37500	.3023
1	1.00000	.37500	.3850	.50000	.4030

^a Allowance is shown in table XIII.3, column 4.

TABLE XIII.7.—Modified Form 2 Stub Acme thread form, basic dimensions

Threads per inch, <i>n</i>	Pitch, <i>p</i>	Height of thread (basic), $h=0.250p$	Total height of thread, $h_s=h+\frac{1}{2}$ allowance ^a	Thread thickness (basic), $t=p/2$	Width of flat at crest of internal thread (basic), $F_{en}=0.4353p$
1	2	3	4	5	6
16	.06250	.01563	.0206	.03125	.0272
14	.07143	.01786	.0229	.03571	.0311
12	.08333	.02083	.0258	.04167	.0363
10	.10000	.02500	.0350	.05000	.0435
9	.11111	.02778	.0378	.05556	.0484
8	.12500	.03125	.0413	.06250	.0544
7	.14286	.03571	.0457	.07143	.0622
6	.16667	.04167	.0517	.08333	.0726
5	.20000	.05000	.0600	.10000	.0871
4	.25000	.06250	.0725	.12500	.1088
3½	.28571	.07143	.0814	.14286	.1244
3	.33333	.08333	.0933	.16667	.1451
2½	.40000	.10000	.1100	.20000	.1741
2	.50000	.12500	.1350	.25000	.2177
1½	.66667	.16667	.1767	.33333	.2902
1¼	.75000	.18750	.1975	.37500	.3265
1	1.00000	.25000	.2600	.50000	.4353

^a Allowance is shown in table XIII.3, column 4.

8. GAGES FOR STUB ACME THREADS

Gages representing both product limits, or adequate gaging instruments for thread elements, are necessary for the proper inspection of Stub Acme threads. The dimensions of “go” and “not go” gages should be in accordance with the principles:

(a) that the maximum-metal limit, or “go,” gage should check simultaneously as many elements as possible, and that a minimum-metal limit or “not go” thread gage can effectively check but one element; and (b) that permissible variations in the gages be kept within the extreme product limits.

(a) GAGE TOLERANCES

Tolerances for the thread elements of “go” and “not go” thread gages for Stub Acme threads are as specified below.

1. TOLERANCES ON PITCH DIAMETER.—The pitch diameter tolerances for gages for external and internal threads are given in table XIII.8, col. 2.

2. TOLERANCES ON MAJOR AND MINOR DIAMETERS.—The major and minor diameter tolerances for Stub Acme thread gages are given in table XIII.8, col. 3.

3. TOLERANCES ON LEAD.—The variation in lead of all Stub Acme thread gages shall not exceed 0.0003 in. between any 2 threads not farther apart than 1 in. However, the cumulative deviation in lead shall not exceed 0.0004 in. for gages with a length over 1 to 3 in., inclusive; or 0.0005 in., for gages with a length over 3 to 5 in., inclusive; or 0.0007 in., for gages with a length over 5 to 10 in., inclusive. For multiple threads the cumulative tolerance for any length of gage shall be obtained by multiplying by 1.5 the above tolerance applicable to that length.

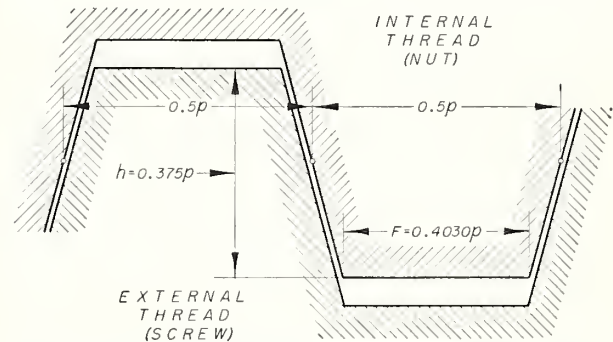

FIGURE XIII.3.—Modified Form 1 Stub Acme thread with basic height of 0.375 pitch.

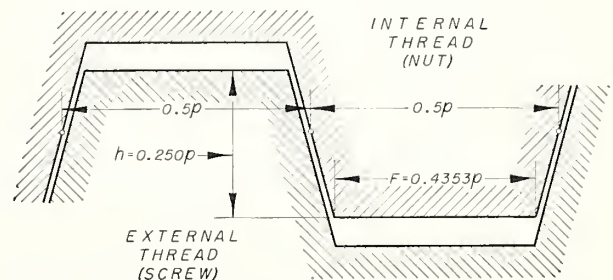

FIGURE XIII.4.—Modified Form 2 Stub Acme thread with basic height of 0.25 pitch.

TABLE XIII.8.—Tolerances for “go” and “not go” thread gages, Stub Acme threads

Threads per inch ^a	Tolerances on pitch diameter ^b	Tolerance on major and minor diameters	Tolerance on half angle of thread
1	2	3	4
	<i>in.</i>	<i>in.</i>	<i>minutes</i>
16.....	0.0006	0.001	10
14.....	.0006	.001	10
12.....	.0006	.001	10
10.....	.0007	.002	10
9.....	.0008	.002	10
8.....	.0008	.002	8
7.....	.0009	.002	8
6.....	.0009	.002	8
5.....	.0010	.002	8
4.....	.0011	.002	8
3½.....	.0013	.002	8
3.....	.0013	.002	6
2½.....	.0014	.002	6
2.....	.0015	.002	6
1½.....	.0018	.002	5
1¼.....	.0018	.002	5
1.....	.0021	.002	5

^a Intermediate pitches take the tolerances of the next coarser pitch listed in this table.

^b These pitch diameter tolerances for thread gages are not cumulative, that is, they do not include tolerances on lead and on half angle.

4. TOLERANCES ON ANGLE OF THREADS.—The tolerances on angle of thread, as specified in table XIII.8, col. 4 for the various pitches, are tolerances on one-half the included angle. This insures that the bisector of the included angle will be perpendicular to the axis of the thread within proper limits. The equivalent deviation from the true thread form caused by such irregularities as convex or concave sides of the thread, or slight projections on the thread form, should not exceed the tolerances permitted on angle of thread.

(b) GAGES FOR EXTERNAL THREADS

1. “GO” THREAD RING OR THREAD SNAP GAGE.—(a) *Major diameter.*—The major diameter of the “go” thread ring or snap gage shall clear a diameter greater by 0.01 in. than the maximum major diameter of the external thread.

(b) *Pitch diameter.*—The pitch diameter shall fit the maximum-metal limit thread setting plug gage.

(c) *Minor diameter.*—The minor diameter shall be the same as the maximum minor diameter of the external thread plus 0.005 in. for pitches finer than 10 tpi and plus 0.010 in. for 10 tpi and coarser. The tolerance shall be applied minus.

(d) *Length.*—The length shall approximate the length of engagement but shall not exceed the length specified in table XII.14, col. 3, p. 17.

2. MAXIMUM-METAL LIMIT THREAD SETTING PLUG FOR “GO” THREAD RING OR SNAP GAGES.—

(a) *Major diameter.*—The major diameter of the maximum-metal limit thread setting plug shall be the same as the maximum major diameter of the external thread. The gage tolerance shall be applied plus.

(b) *Pitch diameter.*—The pitch diameter shall be the same as the maximum pitch diameter of the external thread, except when modified in accord-

ance with table XII.14, p. 17.

(c) *Minor diameter.*—The minor diameter shall be cleared below the minimum minor diameter of the “go” thread ring or snap gage.

(d) *Length.*—The length shall approximate the length of the “go” thread ring or snap gage.

3. “GO” PLAIN RING OR SNAP GAGE FOR MAJOR DIAMETER.—The diameter of the “go” plain ring gage, or the gaging dimension of the “go” plain snap gage, shall be the same as the maximum major diameter of the external thread. Tolerances are shown in table XIII.9, col. 4, and shall be applied minus.

4. “NOT GO” THREAD RING OR THREAD SNAP GAGE.—(a) *Major diameter.*—The major diameter of the “not go” thread ring or thread snap gage shall clear a diameter greater by 0.010 in. than the maximum major diameter of the external thread.

(b) *Pitch diameter.*—The pitch diameter shall fit the minimum-metal limit thread setting plug gage.

(c) *Minor diameter.*—The minor diameter shall be the basic minor diameter of the internal thread plus 0.15p, with the tolerance applied plus.

TABLE XIII.9.—Tolerances for plain gages, Stub Acme threads

Size range		Tolerances for plain plug gages	Tolerances for plain ring and snap gages
Above	To and including		
1	2	3	4
<i>in.</i>	<i>in.</i>	<i>in.</i>	<i>in.</i>
0.500	0.525	0.00010	0.00020
.825	1.510	.00012	.00024
1.510	2.510	.00016	.00032
2.510	4.510	.00020	.00040
4.510	5.000	.00025	.00050

(d) *Length.*—The length shall approximate three pitches except that, for multiple threads, the length shall provide at least one full turn of thread.

5. MINIMUM-METAL THREAD SETTING PLUG FOR “NOT GO” THREAD RING OR SNAP GAGE.—

(a) *Major diameter.*—The major diameter of the minimum-metal limit thread setting plug shall be the same as the maximum major diameter of the external thread. The gage tolerance shall be applied plus.

(b) *Pitch diameter.*—The pitch diameter shall be the same as the minimum pitch diameter of the external thread, with the tolerance applied plus.

(c) *Minor diameter.*—The minor diameter shall be cleared below the minimum minor diameter of the “not go” thread gage.

(d) *Length.*—The length shall be at least equal to the length of the “not go” thread ring or snap gage.

6. “NOT GO” PLAIN SNAP GAGE FOR MAJOR DIAMETER.—The gaging dimension of the “not go” plain snap gage shall be the same as the minimum major diameter of the external thread. Tolerances are shown in table XIII.9, col. 4, and shall be applied plus.

1. "GO" THREAD PLUG GAGE.—(a) *Major diameter*.—The major diameter of the "go" thread plug gage shall be equal to the minimum major diameter of the internal thread minus 0.005 in. for pitches finer than 10 tpi, and minus 0.010 in. for 10 tpi and coarser. The tolerance (table XIII.8, col. 3) shall be applied plus.

(b) *Pitch diameter*.—The pitch diameter shall be equal to the minimum (basic) pitch diameter of the internal thread, with the tolerance (table XIII.8, col. 2) applied plus.

(c) *Minor diameter*.—The minor diameter shall clear a diameter smaller by 0.010 in. than the minimum minor diameter of the internal thread.

(d) *Length*.—The length shall approximate the length of engagement (see footnote to table XII.14, p. 17) but shall not exceed twice the nominal major diameter, unless otherwise specified.

2. "NOT GO" THREAD PLUG GAGE FOR PITCH DIAMETER OF INTERNAL THREAD.—(a) *Major diameter*.—The major diameter of the "not go" thread plug gage shall be equal to the maximum (basic) major diameter of the external thread minus 0.15 μ with the tolerance (table XIII.8, col. 3) applied minus.

(b) *Pitch diameter*.—The pitch diameter shall be the same as the maximum pitch diameter of the internal thread, with the tolerance (table XIII.8, col. 2) applied minus.

(c) *Minor diameter*.—The minor diameter shall clear a diameter less by 0.01 in. than the minimum minor diameter of the internal thread.

(d) *Length*.—The length shall approximate three pitches, except that for multiple threads the length shall provide at least one full turn of thread.

3. "GO" PLAIN PLUG GAGE FOR MINOR DIAMETER OF INTERNAL THREAD.—The diameter of the "go" plain plug gage shall be the same as the minimum minor diameter of the internal thread. The gage tolerance shall be applied plus. (See table XIII.9, col. 3.) The gage length shall be in accordance with the latest revision of Commercial Standard CSS, Gage Blanks.

4. "NOT GO" PLAIN PLUG GAGE FOR MINOR DIAMETER OF INTERNAL THREAD.—The diameter of the "not go" plain plug gage shall be the same as the maximum minor diameter of the internal thread. The gage tolerance shall be applied minus. (See table XIII.9, col. 3.) The gage length shall be in accordance with the latest revision of CSS, Gage Blanks.

(d) CONCENTRICITY

When a special check of the concentricity between the major, pitch, and minor diameters of an external or internal thread is required, the method of checking this concentricity must be devised for each individual application.

(e) GAGE DIMENSIONS

It is recommended that wherever possible the general dimensions of the gages be in accordance with the latest revision of CSS, Gage Blanks.

1. HISTORICAL

Although the Buttress thread was described as early as March, 1888 in the *Journal of The Franklin Institute*, it was so little used that its national standardization was not undertaken until after the Combined Conservation Committee in early 1942 reviewed the standardization status of items needed in the war effort. Formerly each application of the Buttress thread was treated individually and the form it took depended on the experience of the designer and the manufacturing equipment available.

At the American-British-Canadian conference in New York, called by the Combined Conservation Committee in November, 1943, Buttress threads were discussed and it was agreed that a basic profile should be established for this thread, that the Interdepartmental Screw Thread Committee (ISTC) of the War, Navy, and Commerce Departments should collect data on current practice of American producers, and that the American Standards Association should distribute the data for comment from industries using Buttress threads. As the Military Departments needed Buttress and other special types of threads, the War Production Board in February, 1944, arranged with the ASA to establish a General War Committee on Screw Threads.

In April 1944, F. E. Richardson, then with the Aeronautical Board and a member of the ASA War Committee on Screw Threads, collected information on Buttress threads and presented it at a joint meeting of the BI Sectional Committee on the Standardization and Unification of Screw Threads, the Interdepartmental Screw Thread Committee, and the General ASA War Committee on Screw Threads. The data disclosed that the pressure flank angle, measured in an axial plane, ranged from 0 to more than 15° from the normal to the axis, and the clearance flank angle ranged from 30 to 55°. The ISTC decided to develop a proposed Buttress thread form having a pressure flank angle of 7°, which closely approaches the static angle of friction for well-lubricated steel surfaces in contact, and a clearance flank angle of 45°.

At the American-British-Canadian conference in London, August and September, 1944, sponsored by the Combined Production and Resources Board, the British proposed a Buttress thread of 7.5° pressure flank angle and a 45° clearance flank angle. The United States' proposal was the ISTC's recommendation of a 7° by 45° thread profile. The British agreed to prepare and circulate a draft specification for a Buttress thread having a 7° pressure flank angle, a 45° clearance

⁵ This section is in substantial agreement with American Standards Association publication ASA B1.9, Buttress Screw Threads, which is published by the ASME, 29 W. 39th Street, New York 18, N.Y. The latest revision should be consulted when referring to this ASA document.

flank angle, and a basic depth of thread engagement of $0.4p$. It was also agreed that the specification should include recommended relationship of pitch to diameter and appropriate tables of clearances and tolerances for such relationships.

The 1944 edition of Handbook H28 published the ISTC's recommendation of a basic Buttress thread form which had a crest flat in the internal thread (nut) twice that of the external thread (screw), and a thread engagement depth of approximately $0.56p$. In November, 1944, the ASA War Subcommittee on Buttress Threads was established and after reviewing the British draft of April, 1945, this committee felt that because of the distortion tendency of thin wall tubing, a greater basic depth of thread engagement than $0.4p$ was desirable, especially since the minimum depth of thread engagement is necessarily less than $0.4p$ by one-half the sum of the allowance and the tolerances on minor diameter of internal thread and major diameter of external thread. Therefore, the July, 1945 draft of the War Standard was based on a basic depth of thread engagement of $0.5p$.

Another American-British-Canadian conference sponsored by the Combined Production and Resources Board was held in Ottawa, Canada, September and October, 1945. Here the British proposal of April, 1945, with an alternate design of 0° pressure flank angle and a clearance flank angle of 52° , was reviewed and compared with the American proposal of July, 1945. Learning that the British had had considerable favorable experience on thin wall tubing with Buttress threads having $0.4p$ basic depth of thread engagement, it was decided that the American standard might adopt this basis. Accord was also reached on preferred diameters and pitches, thread dimension tolerances and allowances, and on having each standard include in its appendix an alternate thread of 0° pressure flank angle. Further, each country agreed to publish the standard in conformance with their respective formats.

In April, 1946, buttress threads were assigned to Subcommittee No. 3 of the Sectional Committee on the Standardization and Unification of Screw Threads, B1, and the committee membership was enlarged. This committee prepared and circulated in 1948 to members of the B1 committee, a draft of a proposed standard based on the British proposal with a basic thread depth of $0.4p$. The comments included so many objections to the shallow depth of thread that in 1949 the committee decided to base the next draft on a thread having $0.6p$ engagement depth. The committee also voted not to include in the appendix of the American standard, data for a buttress thread having 0° pressure flank angle as it was evident that this was only one of several modifications that might be needed for special applications.

The next American-British-Canadian conference was called at the request of the Director of Defense Mobilization and held in New York in June, 1952. The British Standard 1657; 1950 for Buttress

Threads which is based on a thread engagement depth of $0.4p$ and the American draft of September, 1951, based on thread engagement depth of $0.6p$ were reviewed. It was concluded that the applications for buttress threads are so varied that threads with either engagement depth ($0.4p$ or $0.6p$) might be preferred for particular design requirements. It was recommended that the next printing of the British standard and the forthcoming American standard include the essential details of the other country's standards in appendixes. ASA B1.9-1953, Buttress Screw Threads, was issued in conformance with this recommendation.

2. GENERAL

The Buttress form of thread has certain advantages in applications involving exceptionally high stresses in one direction only, along the thread axis. As the thrust side of the thread is made very nearly perpendicular to the thread axis, the radial component of the thrust is reduced to a minimum. On account of the small radial thrust, this form of thread is particularly applicable where tubular members are screwed together. Examples of actual applications are the breech mechanisms of large guns and airplane propeller hubs.

As the use of buttress threads applies mainly to specially designed components, it has been considered that no useful purpose would be served by introducing a recommended diameter-pitch series.

In selecting the form of thread recommended as standard, manufacture by the thread milling or grinding processes has been taken into consideration. Wherever possible it is recommended that the form of thread and tolerances contained in this section be used.

3. SPECIFICATIONS

1. SCOPE.—This section relates to threads of buttress form and provides:

- (a) a standard form of thread,
- (b) tables of preferred diameters and preferred pitches,
- (c) a formula for calculating pitch diameter tolerances,
- (d) tolerances for major and minor diameters,
- (e) a system of allowances between mating parts, and
- (f) recommended methods of gaging.

2. DEFINITIONS.—The pressure flank is that which takes the thrust or load in an assembly. The clearance flank is that which does not take the thrust or load in an assembly.

3. BASIC FORM OF THREAD.—The basic form of the buttress thread is shown in figure XIV.1, and has the following characteristics:

- (a) a pressure flank angle, measured in an axial plane, of 7° from the normal to the axis;
- (b) a clearance flank angle, measured in an axial plane, of 45° ;

(c) equal truncations at the crests of the internal and external threads such that the basic depth of engagement (assuming no allowance) is equal to $0.6p$;

(d) equal radii at the roots of the internal and external threads tangential to the pressure flank and the clearance flank.

4. PREFERRED DIAMETER SERIES.—It is recommended that the nominal major diameters of buttress threads be selected wherever possible from the following geometric (20) series:

INCHES				
1/2	1 1/8	2 1/2	5 1/2	12
9/16	1 1/4	2 3/4	6	14
5/8	1 3/8	3	7	16
1 1/16	1 1/2	3 1/2	8	18
3/4	1 3/4	4	9	20
7/8	2	4 1/2	10	22
1	2 1/4	5	11	24

5. PREFERRED PITCH SERIES.—It is recommended that the pitches of buttress threads be selected from the following geometric (10) series:

Threads per inch		
20	6	2
16	5	1 1/2
12	4	1 1/4
10	3	1
8	2 1/2	

The following suggestions are made regarding suitable associations of diameters and pitches:

Diameter range	Associated pitches
<i>in.</i>	<i>tpi</i>
From 1/2 to 1 1/16	20, 16, 12
Over 1 1/16 to 1	16, 12, 10
Over 1 to 1 1/2	16, 12, 10, 8, 6
Over 1 1/2 to 2 1/2	16, 12, 10, 8, 6, 5, 4
Over 2 1/2 to 4	16, 12, 10, 8, 6, 5, 4
Over 4 to 6	12, 10, 8, 6, 5, 4, 3
Over 6 to 10	10, 8, 6, 5, 4, 3, 2 1/2, 2
Over 10 to 16	10, 8, 6, 5, 4, 3, 2 1/2, 2, 1 1/2, 1 1/4
Over 16 to 24	8, 6, 5, 4, 3, 2 1/2, 2, 1 1/2, 1 1/4, 1

Basic dimensions for each of the foregoing pitches are given in table XIV.1.

6. TOLERANCES.—Tolerances on external threads shall be minus, and on internal threads shall be plus.

(a) Tolerances on pitch diameter.—The following formula is used for determining pitch diameter tolerances:

Class 2 (medium) pitch diameter:

$$PD \text{ tolerance} = 0.002\sqrt[3]{D} + 0.00278\sqrt{L_e} + 0.00854\sqrt{p}$$

where

D = major diameter of thread,

L_e = length of engagement,

p = pitch of thread.

It is to be borne in mind that this formula relates specifically to class 2 (medium) tolerances. Class 3 (close) tolerances are 2/3 of class 2 (medium) tolerances, and class 1 (free) tolerances are 1 1/2 times class 2 (medium) tolerances.

If the length of engagement is taken as $10p$, the formula can be further simplified to:

$$PD \text{ tolerance} = 0.002\sqrt[3]{D} + 0.0173\sqrt{p}$$

Using this formula, pitch diameter tolerances for various combinations of pitch and diameter are given in tables XIV.2, XIV.3, and XIV.4.

(b) Tolerances on major diameter of external thread and minor diameter of internal thread.—As each of these diameters may be used as a datum

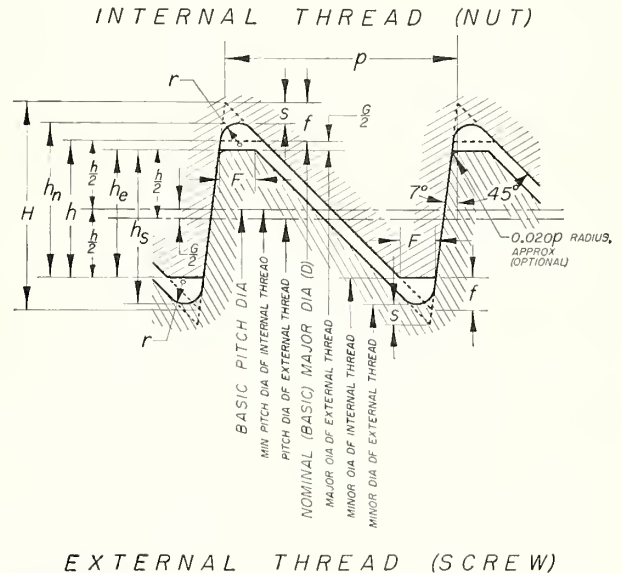

FIGURE XIV.1.—Form of Buttress thread having 7° pressure flank and 45° clearance flank.

NOTATION		Min material
Max material (basic)		
Nominal major diameter	D	(see footnote)
Height of sharp-V thread	$H = 0.89064p$	
Basic height of thread	$h = 0.6p$	
Root radius	$r = 0.07141p$	Min $r = 0.0357p$
Root truncation	$s = 0.08261p$	Min $s = \text{Max } s/2 = 0.0413p$
Allowance	G	
Depth of engagement	$h_e = h - G/2$	Min $h_e = \text{Max } h_e - [1/2 \text{ tol. on major diam external thread (screw)} + 1/2 \text{ tol. on minor diam internal thread (nut).}]$
Crest truncation	$f = 0.14532p$	
Crest width	$\bar{F} = 0.16316p$	
Major diameter of internal thread (nut)	$D_n = D + 0.12542p$	Max $D_n = \text{Max pitch diam of internal thread (nut)} + 0.80803p$
Minor diameter of external thread (screw)	$K_e = D - 1.32542p - G$	Min $K_e = \text{Min pitch diam of external thread (screw)} - 0.80803p$
Height of thread of internal thread (nut)	$h_n = 0.66271p$	
Height of thread of external thread (screw)	$h_e = 0.66271p$	

NOTE: The formulas for "Min material" given above apply when an adequate wall thickness is provided beyond the roots of the threads. For Buttress threads on relatively thin-walled tubing the root truncation $s = 0.08261p$ may be taken as the minimum truncation and the maximum truncation recommended is $0.08261p + G/2$. This will give max $D_n = \text{max pitch diam of internal thread (nut)} + 0.72542p$ and min $K_e = \text{min pitch diam of external thread (screw)} - 0.72542p$. In order to avoid contact between the crest corners of "go" thread gages and the maximum root radius, the crest corners on the pressure flank of "go" thread gages should be bevelled a radial distance approximately equal to $G/2$.

TABLE XIV.1.—Basic dimensions for Buttress threads ^a

Threads per inch	Pitch,	Basic height of thread,	Height of sharp V thread,	Crest truncation,	Height of thread,	Root truncation,	Root radius,	Width of flat at crest,
	p	$h=0.6p$	$H=0.89064p$	$f=0.14532p$	h_1 or $h_2=0.66271p$	$s=0.08261p$	$r=0.07141p$	$F=0.16316p$
1	2	3	4	5	6	7	8	9
20	<i>in.</i> 0.0500	<i>in.</i> 0.0300	<i>in.</i> 0.0445	<i>in.</i> 0.0973	<i>in.</i> 0.0331	<i>in.</i> 0.0041	<i>in.</i> 0.0036	<i>in.</i> 0.0082
16	0.0625	0.0375	0.0557	0.0991	0.0414	0.0052	0.0045	0.0102
12	0.0833	0.0500	0.0742	0.121	0.0552	0.0069	0.0059	0.0136
10	0.1000	0.0600	0.0891	0.145	0.0663	0.0083	0.0071	0.0163
8	0.1250	0.0750	0.1113	0.182	0.0828	0.0103	0.0089	0.0204
6	0.1667	0.1000	0.1484	0.242	0.1105	0.0138	0.0119	0.0271
5	0.2000	0.1200	0.1781	0.291	0.1325	0.0165	0.0143	0.0326
4	0.2500	0.1500	0.2227	0.363	0.1657	0.0207	0.0179	0.0408
3	0.3333	0.2000	0.2969	0.484	0.2209	0.0275	0.0238	0.0543
2½	0.4000	0.2400	0.3563	0.581	0.2651	0.0330	0.0286	0.0653
2	0.5000	0.3000	0.4453	0.727	0.3314	0.0413	0.0357	0.0816
1½	0.6667	0.4000	0.5938	0.969	0.4418	0.0551	0.0476	0.1088
1¼	0.8000	0.4800	0.7125	1.163	0.5302	0.0661	0.0572	0.1305
1	1.0000	0.6000	0.8906	1.453	0.6627	0.0826	0.0714	0.1632

^a Symbols are shown on figure XIV.1.

TABLE XIV.2.—Tolerances on Buttress threads, class 3 (close)

Major diameter	Preferred diameters	Threads per inch														Tol on major dia of ext thread and minor dia of int thread
		20	16	12	10	8	6	5	4	3	2½	2	1½	1¼	1	
		Tolerance on pitch diameter, external and internal threads														
<i>in.</i> ½ to 1¼	<i>in.</i> ½, ¾, 5⁄8, 1¼	<i>in.</i> 0.0037	<i>in.</i> 0.0040	<i>in.</i> 0.0044	<i>in.</i> 0.0049	<i>in.</i> 0.0055	<i>in.</i> 0.0061	<i>in.</i> 0.0068	<i>in.</i> 0.0074	<i>in.</i> 0.0089	<i>in.</i> 0.0100	<i>in.</i> 0.0108	<i>in.</i> 0.0126	<i>in.</i> 0.0135	<i>in.</i> 0.0152	<i>in.</i> 0.0030
1¼ to 1	¾, ⅞, 1	0.0042	0.0046	0.0051	0.0058	0.0064	0.0071	0.0077	0.0093	0.0104	0.0113	0.0130	0.0139	0.0152	0.0030	
1 to 1½	1⅜, 1¼, 1⅝, 1½	0.0043	0.0048	0.0051	0.0058	0.0064	0.0071	0.0077	0.0093	0.0104	0.0113	0.0130	0.0139	0.0152	0.0030	
1½ to 2½	1¾, 2, 2¼, 2½	0.0046	0.0050	0.0053	0.0058	0.0064	0.0071	0.0077	0.0093	0.0104	0.0113	0.0130	0.0139	0.0152	0.0030	
2½ to 4	2¾, 3, 3½, 4	0.0049	0.0053	0.0056	0.0064	0.0070	0.0074	0.0080	0.0089	0.0100	0.0108	0.0126	0.0135	0.0152	0.0030	
4 to 6	4½, 5, 5½, 6	0.0056	0.0059	0.0064	0.0070	0.0074	0.0078	0.0084	0.0093	0.0104	0.0113	0.0130	0.0139	0.0152	0.0030	
6 to 10	7, 8, 9, 10	0.0063	0.0067	0.0074	0.0078	0.0083	0.0089	0.0098	0.0108	0.0113	0.0130	0.0139	0.0152	0.0165	0.0030	
10 to 16	11, 12, 14, 16	0.0068	0.0072	0.0078	0.0083	0.0089	0.0098	0.0108	0.0113	0.0130	0.0139	0.0152	0.0165	0.0178	0.0030	
16 to 24	18, 20, 22, 24	0.0077	0.0083	0.0088	0.0094	0.0103	0.0109	0.0118	0.0130	0.0139	0.0152	0.0165	0.0178	0.0191	0.0030	

TABLE XIV.3.—Tolerances on Buttress threads, class 2 (medium)

Major diameter	Diameter increment, $\sqrt[3]{D}$	Preferred diameters	Threads per inch														Tol on major dia of ext thread and minor dia of int thread
			20	16	12	10	8	6	5	4	3	2½	2	1½	1¼	1	
			Tolerance on pitch diameter, external and internal threads														
<i>in.</i> ½ to 1¼	<i>in.</i> 0.00168	<i>in.</i> ½, ¾, 5⁄8, 1¼	<i>in.</i> 0.0056	<i>in.</i> 0.0060	<i>in.</i> 0.0067	<i>in.</i> 0.0074	<i>in.</i> 0.0083	<i>in.</i> 0.0092	<i>in.</i> 0.0103	<i>in.</i> 0.0112	<i>in.</i> 0.0134	<i>in.</i> 0.0149	<i>in.</i> 0.0162	<i>in.</i> 0.0188	<i>in.</i> 0.0202	<i>in.</i> 0.0227	<i>in.</i> 0.0040
1¼ to 1	0.00189	¾, ⅞, 1	0.0062	0.0069	0.0074	0.0083	0.0092	0.0103	0.0112	0.0134	0.0149	0.0162	0.0188	0.0202	0.0227	0.0040	
1 to 1½	0.00215	1⅜, 1¼, 1⅝, 1½	0.0065	0.0071	0.0076	0.0083	0.0092	0.0103	0.0112	0.0134	0.0149	0.0162	0.0188	0.0202	0.0227	0.0040	
1½ to 2½	0.00252	1¾, 2, 2¼, 2½	0.0068	0.0075	0.0080	0.0086	0.0096	0.0103	0.0112	0.0134	0.0149	0.0162	0.0188	0.0202	0.0227	0.0040	
2½ to 4	0.00296	2¾, 3, 3½, 4	0.0073	0.0080	0.0084	0.0091	0.0100	0.0107	0.0116	0.0134	0.0149	0.0162	0.0188	0.0202	0.0227	0.0040	
4 to 6	0.00342	4½, 5, 5½, 6	0.0084	0.0089	0.0095	0.0105	0.0112	0.0121	0.0134	0.0149	0.0162	0.0188	0.0202	0.0227	0.0040		
6 to 10	0.00400	7, 8, 9, 10	0.0095	0.0101	0.0109	0.0111	0.0117	0.0127	0.0140	0.0149	0.0162	0.0188	0.0202	0.0227	0.0040		
10 to 16	0.00470	11, 12, 14, 16	0.0102	0.0108	0.0118	0.0124	0.0134	0.0147	0.0156	0.0164	0.0177	0.0196	0.0209	0.0227	0.0040		
16 to 24	0.00543	18, 20, 22, 24	0.0115	0.0125	0.0132	0.0141	0.0154	0.0164	0.0177	0.0196	0.0209	0.0227	0.0240	0.0253	0.0040		
Pitch increment	0.0173 $\sqrt[3]{p}$		0.00387	0.00432	0.00499	0.00547	0.00612	0.00706	0.00774	0.00865	0.00999	0.01094	0.01223	0.01413	0.01547	0.01730	

TABLE XIV.4.—Tolerances on Buttress threads, class 1 (free)

Major diameter	Preferred diameters	Threads per inch														Tol on major dia of ext thread and minor dia of int thread
		20	16	12	10	8	6	5	4	3	2½	2	1½	1¼	1	
		Tolerance on pitch diameter, external and internal threads														
<i>in.</i>	<i>in.</i>	<i>in.</i>	<i>in.</i>	<i>in.</i>	<i>in.</i>	<i>in.</i>	<i>in.</i>	<i>in.</i>	<i>in.</i>	<i>in.</i>	<i>in.</i>	<i>in.</i>	<i>in.</i>	<i>in.</i>	<i>in.</i>	
½ to 1¼	½, ¾, 5⁄8, 1¼	0.0083	0.0090	0.0067	0.0111										0.0050	
1¼ to 1	¾, 7⁄8, 1		0.0093	0.0104	0.0104										0.0050	
1 to 1½	1½, 1¼, 1¾, 1½			0.0107	0.0114	0.0124	0.0138								0.0060	
1½ to 2½	1¾, 2, 2¼, 2½			0.0113	0.0120	0.0130	0.0144	0.0154	0.0168						0.0060	
2½ to 4	2¾, 3, 3½, 4			0.0119	0.0126	0.0136	0.0150	0.0160	0.0174						0.0060	
4 to 6	4½, 5, 5½, 6				0.0133	0.0143	0.0157	0.0167	0.0181	0.0201					0.0080	
6 to 10	7, 8, 9, 10				0.0142	0.0152	0.0166	0.0176	0.0190	0.0210	0.0224	0.0243			0.0100	
10 to 16	11, 12, 14, 16					0.0162	0.0176	0.0187	0.0200	0.0220	0.0235	0.0254	0.0282	0.0303	0.0110	
16 to 24	18, 20, 22, 24					0.0173	0.0187	0.0197	0.0211	0.0231	0.0246	0.0265	0.0293	0.0314	0.0341	

for measurement of thread angles and pitch they should be held to close limits; see tables XIV.2, XIV.3, and XIV.4.

(c) Tolerances on minor diameter of external thread and major diameter of internal thread.—It will be sufficient in most instances to state only the maximum minor diameter of the external thread and the minimum major diameter of the internal thread without any tolerance. However, the root truncation from a sharp v should not be greater than 0.0826p or less than 0.0413p.

7. MINIMUM CLEARANCES FOR EASY ASSEMBLY.—An allowance (clearance) should be provided on all buttress external threads in order to secure easy assembly of parts. The amount of the allowance should be deducted from the nominal major, pitch, and minor diameters of the external member in order to determine the maximum metal condition.

The minimum internal thread diameters will be basic.

The recommended allowance is the same for all three classes of thread and is equal to the class 3 (close) pitch diameter tolerance as calculated under par. 6(a), p. 29. The allowances for various combinations of pitch and diameter are given in table XIV.5.

The disposition of allowances and tolerances is indicated in figure XIV.2.

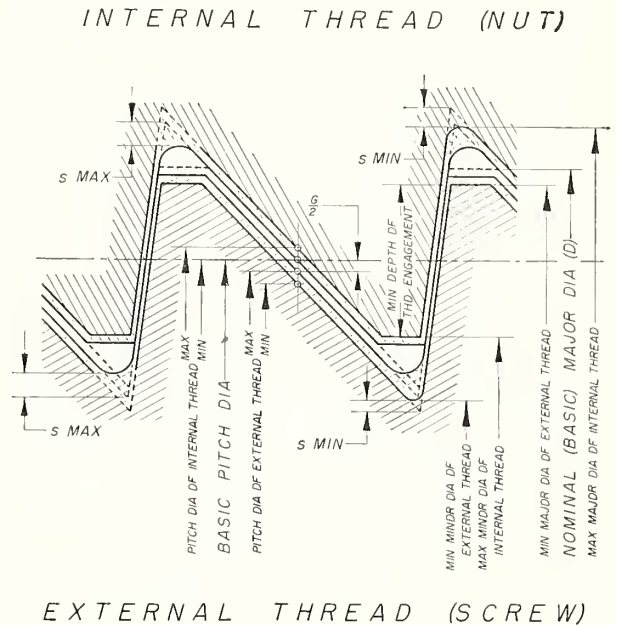

FIGURE XIV.2.—Illustration of tolerances, allowances, and root truncations, Buttress threads.

$$\frac{G}{2} = \frac{1}{2} \text{ pitch diameter allowance on external thread}$$

$$s = \text{root truncation}$$

TABLE XIV.5.—Allowances on external Buttress threads, all classes

Major diameter	Preferred diameters	Threads per inch													
		20	16	12	10	8	6	5	4	3	2½	2	1½	1¼	1
		Allowance on major, minor, and pitch diameters													
<i>in.</i>	<i>in.</i>	<i>in.</i>	<i>in.</i>	<i>in.</i>	<i>in.</i>	<i>in.</i>	<i>in.</i>	<i>in.</i>	<i>in.</i>	<i>in.</i>	<i>in.</i>	<i>in.</i>	<i>in.</i>	<i>in.</i>	
½ to 1¼	½, ¾, 5⁄8, 1¼	0.0037	0.0040	0.0044											
1¼ to 1	¾, 7⁄8, 1		0.0042	0.0046	0.0049										
1 to 1½	1½, 1¼, 1¾, 1½		0.0043	0.0048	0.0051	0.0055	0.0061								
1½ to 2½	1¾, 2, 2¼, 2½		0.0046	0.0050	0.0053	0.0058	0.0064	0.0068	0.0074						
2½ to 4	2¾, 3, 3½, 4		0.0049	0.0053	0.0056	0.0061	0.0067	0.0071	0.0077						
4 to 6	4½, 5, 5½, 6			0.0056	0.0059	0.0064	0.0070	0.0074	0.0080	0.0089					
6 to 10	7, 8, 9, 10				0.0063	0.0067	0.0074	0.0078	0.0084	0.0093	0.0100	0.0108			
10 to 16	11, 12, 14, 16				0.0068	0.0072	0.0078	0.0083	0.0089	0.0098	0.0104	0.0113	0.0126	0.0135	
16 to 24	18, 20, 22, 24					0.0077	0.0083	0.0088	0.0094	0.0103	0.0109	0.0118	0.0130	0.0139	0.0152

Example:

2.080—4 class 2 Buttress thread (2.080 dia., 4 tpi)

h = Basic thread height = 0.1500 (table XIV.1)

$h_n = h_s$ = Height of thread in internal thread (nut) and external thread (screw) = 0.66271 p = 0.1657 (table XIV.1)

G = Pitch diameter allowance = 0.0074 (table XIV.5)

Tolerance on pitch diameter of both external and internal thread = 0.0112 (table XIV.3)

Tolerance on major diameter of external and minor diameter of internal thread = 0.005 (table XIV.3)

Internal Thread (nut or tapped hole)

Basic major diameter = D = 2.0800

Min pitch diameter = $D - h$ = 1.9300

Max pitch diameter = $D - h + PD$ tol. = 1.9412

Min minor diameter = $D - 2h$ = 1.7800

Max minor diameter = $D - 2h +$ minor diameter tol. = 1.7850

Min major diameter = $D - 2h + 2h_n$ = 2.1114

External Thread (screw)

Max major diameter = $D - G$ = 2.0726

Min major diameter = $D - G -$ major diameter tol. = 2.0676

Max pitch diameter = $D - h - G$ = 1.9226

Min pitch diameter = $D - h - G - PD$ tol. = 1.9114

Max minor diameter = $D - G - 2h_s$ = 1.7412

8. IDENTIFICATION OF LEADING FLANK.—In specifying or ordering product, threading tools, or gages with Buttress threads, it is important to clearly indicate whether the pressure flank (7°) or the clearance flank (45°) is the leading flank. The leading flank is the one which, when the thread is about to be assembled with a mating thread, faces the mating thread. If a Buttress screw is designed to push, the pressure flank will be the leading flank on both screw and nut, and if designed to pull, the clearance flank will be the leading flank.

4. THREAD DESIGNATIONS

The following abbreviations and symbols are recommended for use on drawings, tools, gages, and in specifications:

N Butt = National Buttress form of thread specified in this section;

(\leftarrow) indicates that internal member (screw) is to push; pressure flank of thread the leading flank;

\leftarrow (indicates that internal member (screw) is to pull; clearance flank of thread the leading flank;

LH indicates a left-hand thread; no symbol is used to indicate a right-hand thread;

p = pitch;

L = lead.

The complete symbol for indicating a particular size of buttress thread shall consist of the nominal

diameter (basic major diameter of the internal thread), number of threads per inch, the symbol indicating whether screw is to push or pull, the abbreviation N BUTT, and finally the class number.

If the thread is multiple start, both the lead and pitch should be shown instead of the number of threads per inch.

Examples:

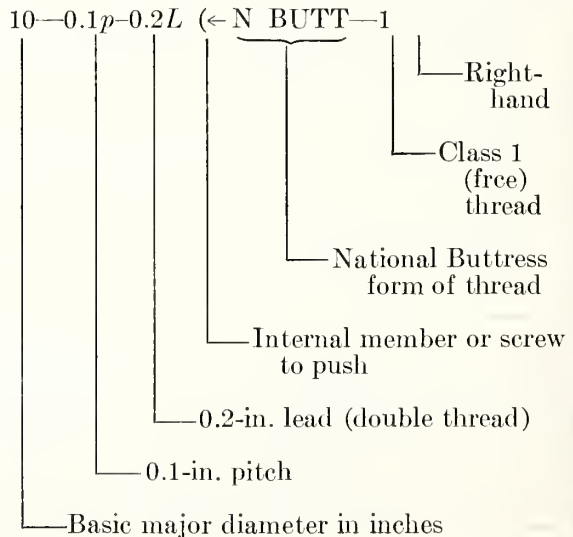
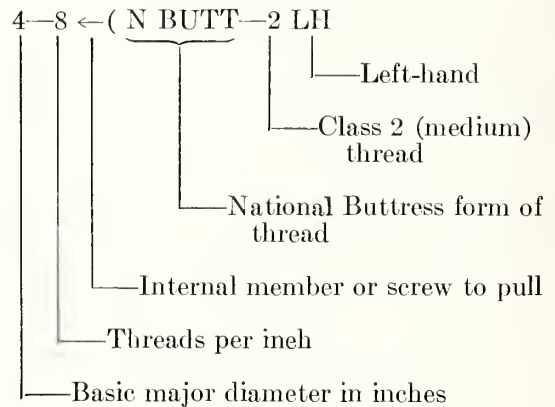
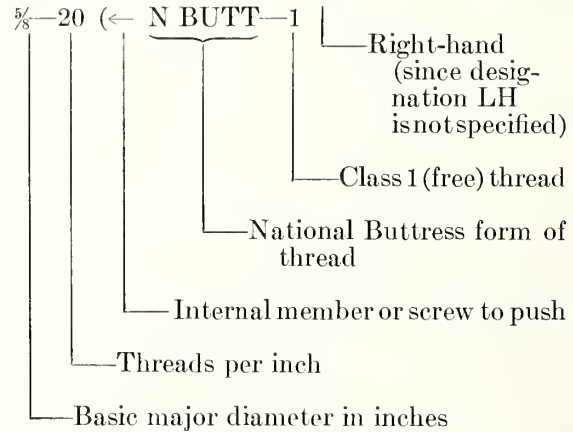

5. GAGING

1. GENERAL.—Buttress threads are employed for thrust purposes and it is essential to obtain as large a contact area as practicable between the pressure flanks of the threads of mating components. Therefore differences in the angle of the pressure flanks and of lead in the length of engagement of mating components should be kept as small as possible. The clearance flank at 45° will normally clear, and differences in the angles of the clearance flanks of the product is of lesser importance. However, measuring the pitch diameter of Buttress thread gages presents some difficulty because of the wide difference between the angle of the pressure flank and the angle of the clearance flank. The clearance flank at 45° has a greater effect on the pitch diameter measurements than the 7° pressure flank, therefore the clearance flank angle on thread gages must be held to a tolerance at least as close as the tolerance on the pressure flanks and *best size* wires should be used. Products that are a snug fit in or on "go" thread gages described below will interchange. If there is any difference in the thread angles or lead of the product and the mated "go" gages used, the diametrical clearance space between the assembled product threads will be greater than the minimum clearance (allowance) specified in table XIV.5. If excessive clearance (looseness) is objectionable, then the angle of the clearance flank as well as the pressure flank must be held to close limits.

If the quantities required are small and *best size* wires are used to determine the pitch diameter of taps and screws in lieu of thread gages, then the angle of the clearance flank as well as the pressure flank must be held within close limits to secure interchangeable product.

2. RECOMMENDED GAGING PRACTICE.—(a) *For external threads:*

(1) "go" and "not go" snap or plain ring gages for major diameter;

(2) "go" thread ring gage having pitch diameter equal to maximum pitch diameter of external thread, major diameter greater than maximum major diameter of external thread, and minor diameter equal to minimum minor diameter of internal thread;

(3) "not go" thread ring or thread snap gage having pitch diameter equal to minimum pitch diameter of external thread, major diameter greater than maximum major diameter of external thread, and minor diameter $0.35p$ less than minimum pitch diameter of external thread;

(4) measurement of pitch by an accepted method, reading at intervals and over the whole length of engagement;

(5) measurement of the angles of both flanks either by direct optical projection, or by means of suitable templates.

(b) *For internal threads:*

(1) "go" thread plug gage having pitch diameter equal to minimum pitch diameter of internal

thread, major diameter equal to maximum major diameter of external thread, and minor diameter less than minimum minor diameter of internal thread;

(2) "not go" thread plug gage having pitch diameter equal to maximum pitch diameter of internal thread, major diameter $0.35p$ greater than maximum pitch diameter of internal thread, and minor diameter less than minimum minor diameter of internal thread;

(3) measurement of pitch as for external threads;

(4) measurement of the angles of both flanks by optical projection from casts of the thread;

(5) "go" and "not go" plain plug gages for minor diameter.

(c) *Width of root relief:*

A width of relief at root of $p/6$ is recommended for "go" plugs and rings and $p/4$ for "not go" plugs and rings. This relief should be located so that the shoulders formed at intersection of relief and thread flanks will be approximately equidistant from the pitch line.

3. PITCH DIAMETER EQUIVALENTS FOR PITCH AND ANGLE DEVIATIONS.—(a) *Pitch deviations.*—A deviation in the pitch of a Buttress thread virtually increases the pitch diameter of an external thread and decreases the pitch diameter of an internal thread.

If δp represents the maximum deviation in the axial displacement (pitch deviation) between any two points on a Buttress thread within the length of engagement, the corresponding virtual increase in the pitch diameter of the external thread (or decrease for the internal thread) is given by the expression:

Virtual change in pitch diameter equals

$$\Delta E_p = \frac{2\delta p}{\tan 45^\circ + \tan 7^\circ} = 1.781 \delta p$$

(b) *Flank angle deviations.*—A deviation in one or both of the flank angles virtually increases the pitch diameter of an external thread and decreases the pitch diameter of an internal thread.

If $\delta\alpha_1$ and $\delta\alpha_2$ (in degrees) represent the deviations present in the two flanks (45° and 7° , respectively) of a Buttress thread, the corresponding virtual change in pitch diameter is given by the following formula:

$$\Delta E_\alpha = 0.6p \left[\frac{\pm \tan (7^\circ \pm \delta\alpha_2) \mp \tan 7^\circ}{\tan (7^\circ \pm \delta\alpha_2) + \tan 45^\circ} + \frac{\pm \tan (45^\circ \pm \delta\alpha_1) \mp \tan 45^\circ}{\tan (45^\circ \pm \delta\alpha_1) + \tan 7^\circ} \right]$$

The values of ΔE_α obtained by the above formula, do not differ greatly for plus and minus values for $\delta\alpha_1$ and $\delta\alpha_2$, when $\delta\alpha_1$ and $\delta\alpha_2$ are one degree or less, and the following formula, in which the signs are disregarded, gives values closely approx-

imating the values obtained by the above formula:

$$\Delta E_{\alpha} = p [0.009 \delta\alpha_2 + 0.019 \delta\alpha_1]$$

where $\delta\alpha_1$ and $\delta\alpha_2$ are in degrees or fractions of a degree.

6. BRITISH STANDARD BUTTRESS THREAD

The Buttress thread covered in British Standard 1657:1950 Buttress Threads, published by the British Standards Institution, has a basic depth of thread of $0.4p$, instead of the $0.6p$ depth, which is the basis of the thread covered by this section. However, the two standards are in agreement as to the preferred pitch series and the preferred diameter series, except that this section includes diameters from $\frac{1}{2}$ to $\frac{7}{8}$ in. not included in the British Standard. Both standards use the same formulas for the pitch diameter tolerances and allowances for the three classes common to both standards. In the British Standard, the tolerance on major and minor diameters is the same as the pitch diameter tolerance (for the same class), but provision is made for smaller tolerances where the crest surfaces of screw or nut are used as datum surfaces, or the resulting reduction in depth of engagement has to be limited.

The American Committee does not consider it advisable to encourage for regular use certain combinations of the larger diameters with fine pitches covered in the British Standard. However, pitch diameter tolerances for such combinations when required can be determined by use of the diameter and pitch increments given in table XIV.3. With these exceptions, the tables for pitch diameter tolerances and allowances for sizes over one in. are in agreement with tables XIV.2, XIV.3, XIV.4, and XIV.5 in this section. The form of thread recommended in the British Standard is shown in figure XIV.3 and the numerical data for the British form in table XIV.6.

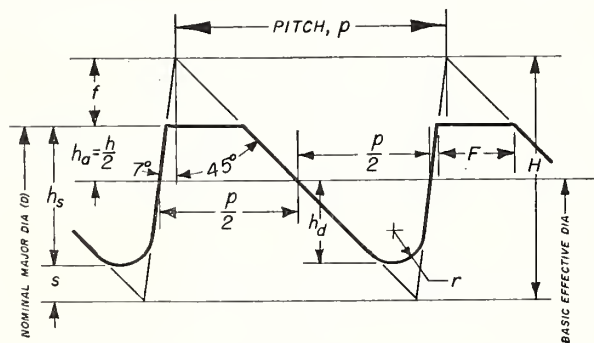

FIGURE XIV.3.—British Standard form of Buttress thread.

(Heavy line indicates basic form.)

NOTATION

Height of sharp V thread.....	$H=0.89064p$	Height of dedendum.....	$h_d=0.30586p$
Basic height of thread.....	$h=0.4p$	Root radius.....	$r=0.12055p$
Height of external thread (screw).....	$h_s=0.50586p$	Root truncation.....	$s=0.13946p$
Height of addendum.....	$h_o=h/2=0.2p$	Crest width.....	$F=0.27544p$
		Crest truncation.....	$f=0.24532p$

TABLE XIV.6.—Numerical data for British Standard form Buttress thread

(Basic depth of thread= $0.4p$. See fig. XIV.3)

Threads per inch	Pitch, p	h	H	f	h_s	$2h_d$	s	r	F
1	2	3	4	5	6	7	8	9	10
	<i>in.</i>	<i>in.</i>	<i>in.</i>	<i>in.</i>	<i>in.</i>	<i>in.</i>	<i>in.</i>	<i>in.</i>	<i>in.</i>
20	0.0500	0.0200	0.0445	0.0123	0.0253	0.0306	0.0070	0.0060	0.0138
16	0.0625	0.0250	0.0557	0.0153	0.0316	0.0382	0.0087	0.0075	0.0172
12	0.0833	0.0333	0.0742	0.0204	0.0421	0.0510	0.0116	0.0100	0.0230
10	0.1000	0.0400	0.0891	0.0245	0.0506	0.0612	0.0140	0.0121	0.0275
8	0.1250	0.0500	0.1113	0.0307	0.0632	0.0765	0.0174	0.0151	0.0344
6	0.1667	0.0667	0.1484	0.0409	0.0843	0.1020	0.0233	0.0201	0.0459
5	0.2000	0.0800	0.1781	0.0491	0.1012	0.1223	0.0279	0.0241	0.0551
4	0.2500	0.1000	0.2227	0.0613	0.1265	0.1529	0.0349	0.0301	0.0689
3	0.3333	0.1333	0.2969	0.0818	0.1686	0.2039	0.0465	0.0402	0.0918
2½	0.4000	0.1600	0.3563	0.0981	0.2023	0.2447	0.0558	0.0482	0.1102
2	0.5000	0.2000	0.4453	0.1227	0.2529	0.3059	0.0697	0.0603	0.1377
1½	0.6667	0.2667	0.5938	0.1635	0.3372	0.4078	0.0930	0.0804	0.1836
1¼	0.8000	0.3200	0.7125	0.1963	0.4047	0.4894	0.1116	0.0964	0.2204
1	1.0000	0.4000	0.8906	0.2453	0.5059	0.6117	0.1395	0.1206	0.2754

SECTION XV. AMERICAN STANDARD ROLLED THREADS FOR SCREW SHELLS OF ELECTRIC LAMP HOLDERS AND SCREW SHELLS OF UNASSEMBLED LAMP BASES⁶

The specifications given herein for American Standard rolled threads for screw shells of electric lamp holders and for screw shells of unassembled lamp bases, with the exception of the more recently adopted intermediate size, were originally published in 1915 in Bulletin No. 1474 of The American Society of Mechanical Engineers entitled "Rolled Threads for Screw Shells of Electric Sockets and Lamp Bases," which was a report of the ASME Committee on Standardization of Special Threads for Fixtures and Fittings.

1. FORM OF THREAD

The thread form is composed of two circular segments tangent to each other and of equal radii, as shown in figure XV.1.

2. THREAD SERIES

The sizes for which standard dimensions and tolerances have been adopted are designated as follows: "miniature, candelabra, intermediate, medium, and mogul."

The thread designations, threads per inch, radii of thread form, and diameter limits of size for these sizes of lamp base screw shells, which are used on lamp bases, fuse plugs, attachment plugs, and similar devices, are given in table XV.1.

The corresponding designations, dimensions, and limits of size for lamp holder screw shells, which are used in electric sockets, receptacles, and similar devices, are given in table XV.2.

⁶ This standard, in substantially the same form, has been adopted by the American Standards Association. It is published as ASA C81.1, "Rolled Threads for Screw Shells of Electric Lamp Holders and for Screw Shells of Unassembled Lamp Bases," by the ASME, 29 West 39th St., New York 18, N.Y. The latest revision should be consulted when referring to this ASA document.

3. GAGES

Gages are necessary to control dimensions in manufacture and to insure interchangeability and proper assembly.

(a) GAGING OF LAMP BASE SCREW SHELLS.—

(1) *Working gages.*—For each size of lamp base screw shell there should be provided for control in manufacture, “go” and “not go” threaded ring gages to govern the minor diameter and thread form, and “go” and “not go” plain ring gages to govern major diameter.

(2) *Inspection gages.*—For purposes of inspection in the final acceptance of the product, a “go” thread ring gage governing minor diameter and thread form and a “not go” plain ring gage governing major diameter are sufficient.

(b) GAGING OF LAMP HOLDER SCREW SHELLS.—

(1) *Working gages.*—For each size of lamp holder screw shell there should be provided, for control in manufacture, “go” and “not go” thread plug gages to govern the major diameter and thread form, and “go” and “not go” plain plug gages to govern minor diameter.

(2) *Inspection gages.*—For the final acceptance of the product, a “go” thread plug gage governing the major diameter and thread form, and a “not go” plain plug gage governing minor diameter are sufficient.

(c) **TOLERANCES ON GAGES.**—Manufacturing tolerances on inspection or working gages shall be as follows:

LAMP BASE SCREW SHELL

“Go” thread ring gage, maximum thread size to minus 0.0003 in.

“Not go” thread ring gage, minimum thread

INTERNAL THREAD LAMP HOLDER SCREW SHELL

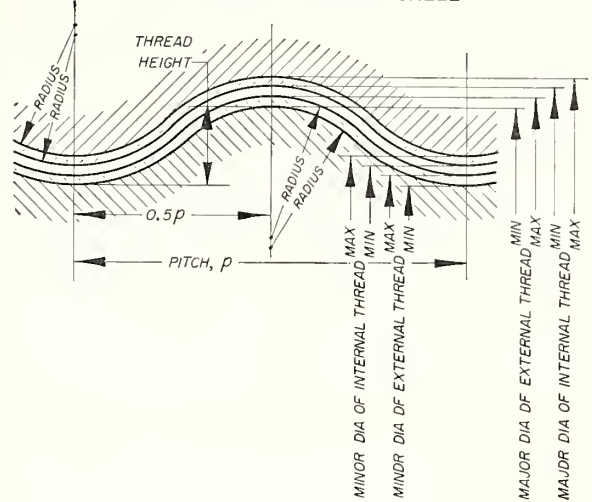

EXTERNAL THREAD BASE SCREW SHELL

FIGURE XV.1.—Illustration of thread form, allowance, and tolerances, American Standard rolled threads for screw shells of electric lamp holders and lamp bases.

size to plus 0.0003 in.

“Go” plain ring gage, maximum major diameter to minus 0.0002 in.

“Not go” plain ring gage, minimum major diameter to plus 0.0002 in.

LAMP HOLDER SCREW SHELL

“Go” thread plug gage, minimum thread size to plus 0.0003 in.

TABLE XV.1.—American Standard rolled threads for lamp base screw shells before assembly

Thread designation	Threads per inch	Pitch	Height of thread	Radius	Major diameter		Minor diameter	
					Maximum	Minimum	Maximum	Minimum
1	2	3	4	5	6	7	8	9
Miniature lamp base thd.....	14	<i>in.</i> 0.07143	<i>in.</i> 0.020	<i>in.</i> 0.0210	<i>in.</i> 0.375	<i>in.</i> 0.370	<i>in.</i> 0.335	<i>in.</i> 0.330
Candelabra lamp base thd.....	10	.10000	.025	.0312	.465	.400	.415	.410
Intermediate lamp base thd.....	9	.11111	.027	.0353	.651	.645	.597	.591
Medium lamp base thd.....	7	.14286	.033	.0470	1.037	1.031	.971	.965
Mogul lamp base thd.....	4	.25000	.050	.0906	1.555	1.545	1.455	1.445

TABLE XV.2.—American Standard rolled threads for lamp holder screw shells

Thread designation	Threads per inch	Pitch	Height of thread	Radius	Major diameter		Minor diameter	
					Minimum	Maximum	Minimum	Maximum
1	2	3	4	5	6	7	8	9
Miniature lamp holder thd.....	14	<i>in.</i> 0.07143	<i>in.</i> 0.020	<i>in.</i> 0.0210	<i>in.</i> 0.3775	<i>in.</i> 0.3835	<i>in.</i> 0.3375	<i>in.</i> 0.3435
Candelabra lamp holder thd.....	10	.10000	.025	.0312	.470	.476	.420	.426
Intermediate lamp holder thd.....	9	.11111	.027	.0353	.657	.664	.603	.610
Medium lamp holder thd.....	7	.14286	.033	.0470	1.045	1.053	.979	.987
Mogul lamp holder thd.....	4	.25000	.050	.0906	1.565	1.577	1.465	1.477

"Not go" thread plug gage, maximum thread size to minus 0.0003 in.

"Go" plain plug gage, minimum minor diameter to plus 0.0002 in.

"Not go" plain plug gage, maximum minor diameter to minus 0.0002 in.

CHECK GAGES FOR LAMP BASE SCREW SHELL GAGES

Thread check plug for "go" thread ring gage, maximum thread size to minus 0.0003 in.

Thread check plug for "not go" thread ring gage, minimum thread size to plus 0.0003 in.

SECTION XVI. MICROSCOPE OBJECTIVE AND NOSEPIECE THREADS, 0.800—36AMO⁷

1. GENERAL AND HISTORICAL

The standardization of the microscope objective and nosepiece threads is one of the projects toward unification of screw thread standards among inch-using countries. In Great Britain, the Royal Microscopical Society had established standards for microscope objective threads in 1858, based on the Whitworth screw thread system, which were subsequently used throughout the world. The history of this standard is in the *Transactions of the Society*: 1858, p. 39; 1859, p. 92; 1896, pp. 389, 487; 1911, p. 175; 1915, p. 230; 1924, p. 266; and 1936, p. 377.

In practice, American manufacturers of this thread have always employed modifications of the Whitworth form because of their preference for flat crests, such modified threads being completely interchangeable with the RMS threads. At the Conference on Unification of Engineering Standards held in Ottawa in 1945, the American Delegation presented ASA Paper B1/57 and A.O. Drawing ED-95 giving limits of size for a truncated Whitworth thread. Since a thread form with rounded crest is preferred in Great Britain for optical instruments, it was recommended that the title of this document be amended to read, "Proposed Permitted Truncation and Tolerances for RMS Thread."

On the basis of this proposal a draft of a proposed American Standard, dated April, 1948, was circulated to the B1 Sectional Committee membership for comment. In conformity with comments received, a revised draft, dated October, 1954, was approved by Subcommittee No. 4 on Instrument Screw Threads and subsequently submitted to the Sectional Committee for approval. Final approval as an American Standard was given on January 7, 1958, by ASA.

This section covers the thread used for mounting the microscope objective to the nosepiece. A typical arrangement is shown in figure XVI.1.

⁷ This section is in substantial agreement with American Standards Association publication ASA B1.11, "Microscope Objective Threads," which is published by the ASME, 29 W. 39th St., New York 18, N.Y. The latest revision should be consulted when referring to this ASA document.

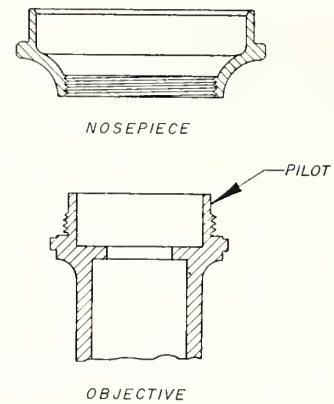

FIGURE XVI.1.—Typical arrangement of microscope objective and nosepiece.

This thread is recommended also for other optical assemblies of microscopes and associated apparatus, such as photomicrographic equipment. The thread is based on, and intended to be interchangeable with, the thread introduced and adopted many years ago by the Royal Microscopical Society of Great Britain and generally known as the "RMS thread." This thread has become almost universally accepted as the basic standard for microscope objective and nosepiece threads. Formal recognition, however, has been extremely limited.

Experience has established that the principal attributes of a good fit for microscope objective and nosepiece threads are:

(a) Adequate clearance to afford protection against binding due to the presence of foreign particles or small thread crest damage.

(b) Sufficient depth of thread engagement to assure security in the short lengths of engagement commonly encountered.

(c) Allowances for limited eccentricities so that centralization and squareness of the objective are not influenced by such deviations in manufacture.

The need for the above characteristics stems principally from the inherent longevity of optical equipment and the repeated uses to which objectives and nosepiece threads are subjected.

2. SPECIFICATIONS

1. FORM OF THREAD.—This section covers only one nominal size of thread which has a basic major diameter of 0.800 in. and 36 tpi. Because of its British origin, the basic thread possesses the British Standard Whitworth form, having an included angle of 55° and rounded crests and roots. The thread is of the single-start type. Symbols, formulas, and basic and design dimensions for the threads are given in table XVI.1.

2. ALLOWANCES.—Positive allowances (minimum clearances) are provided on the pitch, major,

TABLE XVI.1.—Symbols, formulas, and basic and design dimensions, 0.800—36 AMO

	Symbol	Formula	Dimension
Basic thread form			
Half angle of thread.....	α	-----	27°30'
Included angle of thread.....	2α	-----	55°00'
Number of threads per inch.....	n	-----	36
Pitch.....	p	$1/n$	0.027778 in.
Height of fundamental triangle.....	H	$0.960491p$.026680 in.
Height of basic thread.....	h_b	$.640327p$.0178 in.
Radius at crest and root of British Standard Whitworth basic thread (not used).	r	$.137329p$.0038 in.
Design thread form			
Height of truncated Whitworth thread.....	k	$h_b - U = 0.566410p$	0.0157 in.
Width of flat at crest.....	F_c	$0.243624p$.0068 in.
Width of flat at root.....	F_r	$.166667p$.0046 in.
Basic truncation of crest from basic Whitworth form.	U	$.073917p$.00205 in.
Basic and design sizes			
Major diameter, nominal and basic.	D	-----	0.800 in.
Major diameter of internal (nosepiece) thread.	D_n	D	.800 in.
Major diameter of external (objective) thread. ^a	D_e	$D - 2U - G$.7941 in.
Pitch diameter, basic.....	E	$D - h_b$.7822 in.
Pitch diameter of internal (nosepiece) thread.....	E_n	$D - h_b$.7822 in.
Pitch diameter of external (objective) thread. ^b	E_e	$D - h_b - G$.7804 in.
Minor diameter, basic.....	K	$D - 2h_b$.7644 in.
Minor diameter of internal (nosepiece) thread.....	K_n	$D - 2K$.7685 in.
Minor diameter of external (objective) thread. ^a	K_e	$D - 2h_b - G$.7626 in.
Allowance at pitch diameter ^{a, b}	G	-----	.0018 in.

^a An allowance equal to that on the pitch diameter is also provided on the major and minor diameters of the external (objective) thread for additional clearance and centralizing.
^b Allowance (minimum clearance) on pitch diameter is the same as on British RMS thread.

and minor diameters of the external (objective) thread. The allowance on the pitch diameter is 0.0018 in., the value established by the British Royal Microscopical Society in 1924 and now widely regarded as a basic requirement. The same allowance is also applied on both the major and minor diameters.

Where interchangeability with product having full-form Whitworth threads is not required the allowances on the major and minor diameters of the external (objective) thread are not necessary,

since the forms at the root and crest of the truncated internal (nosepiece) thread provide the desired clearances. In such cases, either both limits or only the maximum limit of the major and minor diameters may be increased by the amount of the allowance. Benefits are derived principally from changes in the major diameter where increasing both limits improves the depth of thread engagement, and increasing only the maximum limit grants a larger manufacturing tolerance.

However, unless such deviations are specifically covered in purchase negotiations, it is to be assumed that the threads will be supplied in accordance with the tables in this section.

3. TOLERANCES.—In accordance with standard practice, tolerances on the internal (nosepiece) thread shall be applied plus from the basic (design) size and tolerances on the external (objective) thread shall be applied minus from its design (maximum material) size.

The pitch diameter tolerances for the external and internal thread are the same and include both lead and angle deviations. They are derived from the RMS standard of 1924 and are the same as for the current British RMS thread.

The tolerance on the major diameter of the external thread and the tolerance on the minor diameter of the internal thread are the minimum values which experience has demonstrated to be practicable. Adequate depth of thread engagement is thereby assured.

All tolerances are given in table XVI.2.

4. LENGTHS OF ENGAGEMENT.—The tolerances specified herein are applicable to lengths of engagement ranging from 1/8 to 3/8 in. (approximately 15 to 50 percent of the basic diameter). Lengths of engagement exceeding these limits are seldom employed and, consequently, are not provided for in this section.

For microscope objective and nosepiece assemblies, the length of engagement most generally employed is 1/8 in.

5. PILOT ON OBJECTIVE THREAD.—A pilot (plain portion) shall be provided at the leading end of the objective thread for ease of assembly with the nosepiece thread. The diameter of the pilot shall not exceed 0.7626 in. (See fig. XVI.1.)

TABLE XVI.2.—Limits of size and tolerances, 0.800—36 AMO

Diameter	External (objective) thread					Internal (nosepiece) thread				
	Maximum		Minimum		Tolerance	Minimum		Maximum		Tolerance
1	2	3	4	5	6	7	8	9	10	11
Major.....	<i>in.</i> 0.7941	<i>mm</i> 20.170	<i>in.</i> 0.7911	<i>mm</i> 20.094	<i>in.</i> 0.0030	<i>in.</i> 0.8000	<i>mm</i> 20.320	<i>in.</i> ^b 0.8092	<i>mm</i> ^b 20.554	<i>in.</i> -----
Pitch.....	.7804	19.822	.7774	19.746	.0030	.7822	19.868	.7852	19.944	0.0030
Minor.....	.7626	19.370	^a .7552	^a 19.182	-----	.7685	19.520	.7715	19.596	.0030

^a Extreme minimum minor diameter produced by a new threading tool having a minimum flat of $p/12$ ($=0.0023$ in.). This minimum diameter is not controlled by gages but by the form of the threading tool.
^b Extreme maximum major diameter produced by a new threading tool having a minimum flat of $p/20$ ($=0.0014$ in.). This maximum diameter is not controlled by gages but by the form of the threading tool.

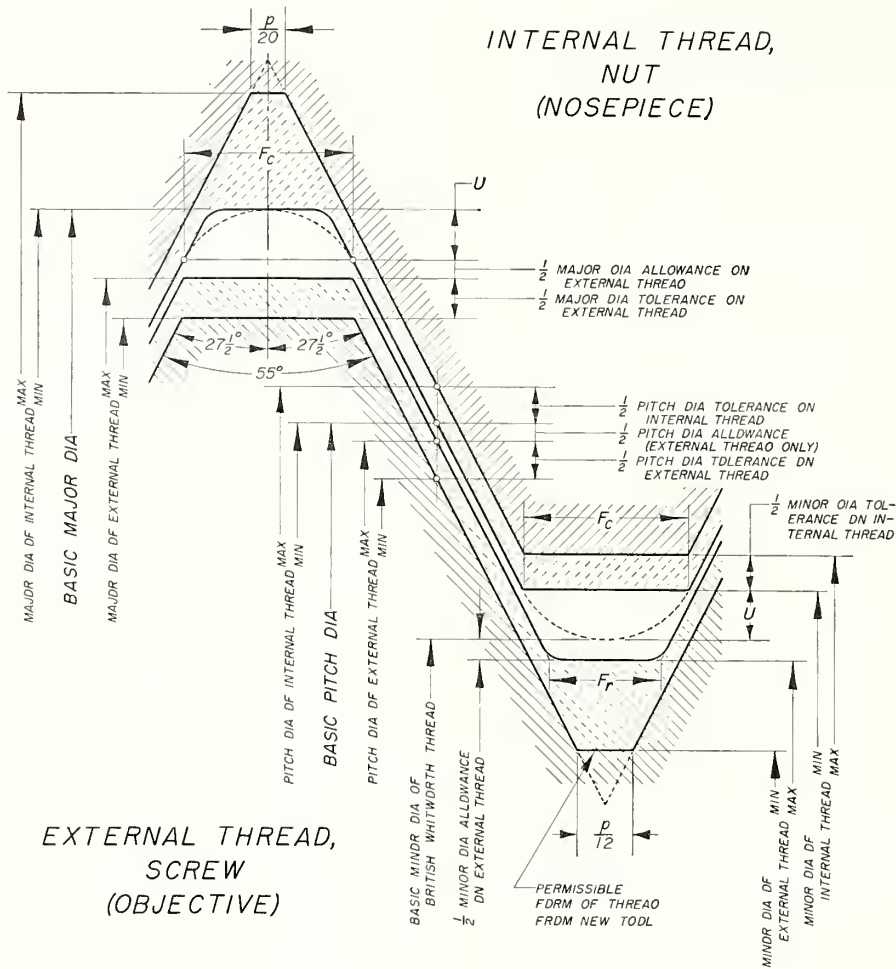

FIGURE XVI.2.—Disposition of tolerances, allowances, and crest clearances for 0.800—36 AMO thread.

See table XVI.1 for interpretation of symbols.

6. LIMITS OF SIZE.—The limits of size for both the external and internal thread are given in table XVI.2. Their application is illustrated in figure XVI.2.

7. THREAD DESIGNATION.—This thread is to be designated on engineering drawings, in specifications, and on tools and gages by the symbol “AMO” preceded by the basic major diameter in inches and the number of threads per inch, as given below:

0.800—36AMO.

3. GAGE DIMENSIONS

Recommended gage dimensions are listed in table XVI.3.

4. BRITISH STANDARD FOR MICROSCOPE OBJECTIVE AND NOSEPIECE THREADS

The British and American threads are the same with the following exceptions:

The British thread has a basic and design thread form as shown in figure XVI.3 whereas the American thread has truncated crests and roots as shown in figure XVI.2. The limits of size of the British thread are given in table XVI.4.

The length of thread on the British objective is 0.125 in. (3.175 mm.) whereas the lengths of engagement for the American thread may range from $\frac{1}{8}$ to $\frac{3}{8}$ in. However, the length of engagement most generally employed for the American thread is $\frac{1}{8}$ in.

TABLE XVI.3.—Recommended gage dimensions for microscope objective and nosepiece thread, 0.800—36 AMO

Dimension symbol	Description	Formula	Dimension
EXTERNAL (OBJECTIVE) THREAD			
"GO" SETTING THREAD PLUG GAGE (A—GO)			
D_e Max.....	Major diameter, maximum	D_e Max.....	in. 0.7941
D_e Min.....	Major diameter, minimum	D_e Max -0.0004.....	.7937
E_e Max.....	Pitch diameter, maximum	E_e Max.....	.7804
E_e Min.....	Pitch diameter, minimum	E_e Max -0.0002.....	.7802
"NOT GO" SETTING THREAD PLUG GAGE (A—NOT GO)			
D_e Min.....	Major diameter, minimum	D_e Max.....	.7941
D_e Max.....	Major diameter, maximum	D_e Min +0.0004.....	.7945
E_e Min.....	Pitch diameter, minimum	E_e Min.....	.7774
E_e Max.....	Pitch diameter, maximum	E_e Min +0.0002.....	.7776
"GO" THREAD RING GAGE			
E_e Max.....	Pitch diameter, maximum	E_e Max "Go" A Plug.....	.7804
E_e Min.....	Pitch diameter, minimum	E_e Min "Go" A Plug.....	.7802
K_g Max.....	Minor diameter, maximum	D_n Min -2 h_b7644
K_g Min.....	Minor diameter, minimum	K_g Max -0.0004.....	.7640
"NOT GO" THREAD RING GAGE			
E_e Min.....	Pitch diameter, minimum	E_e Min "Not Go" A Plug.....	.7774
E_e Max.....	Pitch diameter, maximum	E_e Max "Not Go" A Plug.....	.7776
K_g Min.....	Minor diameter, minimum	E_e Min - $p/3$7681
K_g Max.....	Minor diameter, maximum	K_g Min +0.0004.....	.7685
INTERNAL (NOSEPIECE) THREAD			
"GO" THREAD PLUG GAGE			
D_g Min.....	Major diameter, minimum	D_g Min.....	0.8000
D_g Max.....	Major diameter, maximum	D_g Min +0.0004.....	.8004
E_g Min.....	Pitch diameter, minimum	E_g Min.....	.7822
E_g Max.....	Pitch diameter, maximum	E_g Min +0.0002.....	.7824
"NOT GO" THREAD PLUG GAGE			
D_g Max.....	Major diameter, maximum	E_n Max + $p/3$7945
D_g Min.....	Major diameter, minimum	D_g Max -0.0004.....	.7941
E_g Max.....	Pitch diameter, maximum	E_n Max.....	.7852
E_g Min.....	Pitch diameter, minimum	E_g Max -0.0002.....	.7850
Tolerance on lead.....			±0.0002 in.
Tolerance on half-angle of thread.....			±0 deg 20 min

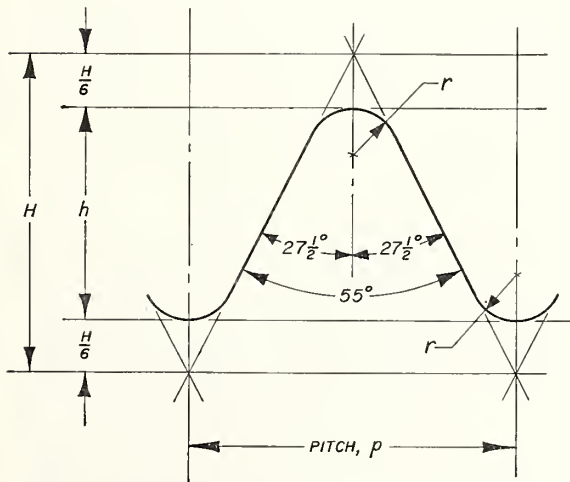

FIGURE XVI.3.—Basic form of Whitworth thread.

$$H = 0.960491p$$

$$h = 2/3H = 0.640327p$$

$$H/6 = 0.160082p$$

$$r = 0.137329p$$

TABLE XVI.4.—Limits of size for the British microscope objective and nosepiece thread

Diameter	External (objective) thread				Internal (nosepiece) thread			
	Maximum		Minimum		Minimum		Maximum	
1	2	3	4	5	6	7	8	9
Major.....	in. 0.7982	mm 20.274	in. 0.7952	mm 20.198	in. 0.8000	mm 20.320	in. 0.7852	mm 19.944
Simple effective.....	.7804	19.822	.7774	19.746	.7822	19.868	.7674	19.416
Minor.....	.7626	19.3707644	19.416	.7674	19.492

SECTION XVII. SURVEYING INSTRUMENT MOUNTING THREADS⁸

1. GENERAL AND HISTORICAL

In 1927 a manufacturers' subcommittee working with the Division of Simplified Practice of the National Bureau of Standards prepared a specification for a tripod thread having a 60° thread angle and a nominal diameter of 3½ inches, 8 threads per inch. This thread was considered suitable for use with transits having horizontal limbs 4½ inches or more in diameter at the edge of graduation, and also for all engineers' levels. It was considered for adoption as a commercial standard, but as all the makers of surveying instruments did not agree to its adoption, it does not have this official status at the present time. However, on March 6, 1958 Subcommittee No. 4 on Miniature, Microscope Objective, and Surveying Instrument Threads of ASA Sectional Committee B1, passed a resolution recommending that this thread be adopted as an American Standard. The dimensions of this thread were first circulated in 1927 as NBS Drawing B-1180.

1. SCOPE.—This section covers the nominal dimensions and limits of size of the threaded portions of the base plate and the tripod head used for securing a surveying instrument to its tripod or other base of support.

2. DEFINITIONS.—(a) *Surveying instrument*.—The term "surveying instrument" shall be deemed to apply to transits, levels, and similar types of apparatus most commonly used when mounted on a tripod.

(b) *Tripod head*.—The tripod head is that portion of the tripod or other means of support to which the surveying instrument is affixed when in use. (See fig. XVII.1.)

(c) *Base plate*.—The base plate is that portion of the surveying instrument which contains the thread used for fastening it to the tripod head. (See fig. XVII.1.)

2. SPECIFICATIONS

1. FORM OF THREAD.—The form of thread profile shall be the American National form as shown in appendix 1 of Part I of Handbook H28.

2. DIMENSIONS.—The thread shall have a basic major diameter of 3½ in. and 8 threads per inch. The thread dimensions are shown in table XVII.1.

The tripod head and base plate shall be in accordance with the dimensions shown on figure XVII.1.

3. DESIGNATION.—As the limits of size and tolerances do not correspond to a standard Unified or American National thread class, in accordance

with standard practice the thread designation is: "3½—8 SPECIAL FORM, 60° thread" followed by all limits of size.

3. GAGE DIMENSIONS

Recommended gage dimensions are listed in table XVII.2.

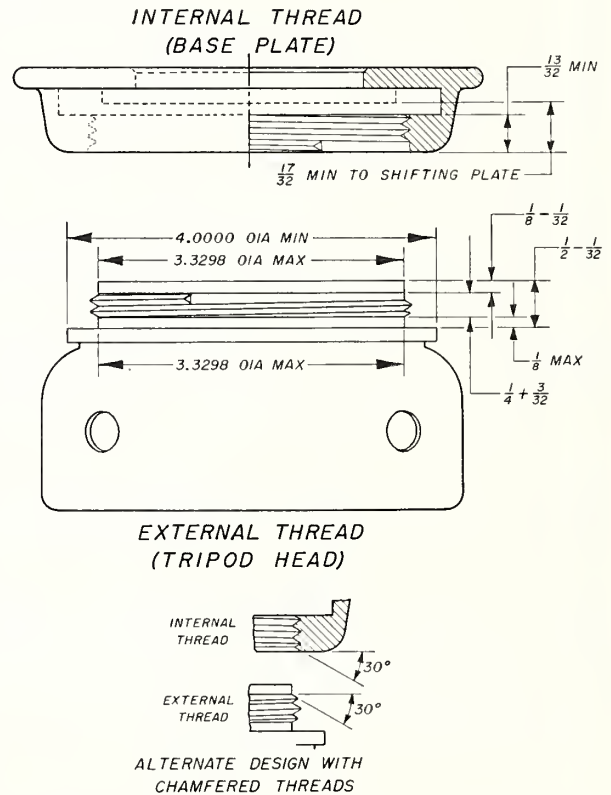

FIGURE XVII.1.—Surveying instrument tripod head and base plate.

See table XVII.1 for thread dimensions.

TABLE XVII.1.—Limits of size, tolerances, and allowances, surveying instrument mounting threads

Diameter	Tripod head (external) thread				Base plate (internal) thread		
	Maximum	Minimum	Tolerance	Allowance	Minimum	Maximum	Tolerance
1	2	3	4	5	6	7	8
Major.....	<i>in.</i> 3.4966	<i>in.</i> 3.4804	<i>in.</i> 0.0162	<i>in.</i> 0.0034	<i>in.</i> 3.5090	<i>in.</i> 3.4232	<i>in.</i> 0.0044
Pitch.....	3.4154	3.4110	.0044	.0034	3.4188	3.3792	0.0044
Minor.....	3.3432	3.3298	.0134	.0215	3.3647		.0145

⁸ This section is in substantial agreement with the March 1948 proposed draft of the American Standards Association bearing the same title. This thread is specified in Federal Specification GG-T-621, Transits one-minute; and transit tripods.

TABLE XVII.2.—Recommended gage dimensions for surveying instrument mounting threads

TRIPOD HEAD (EXTERNAL) THREAD		
	"Go" setting thread plug gage	"Not go" setting thread plug gage
Major diameter, max.....	in. 3.4966	in. 3.4811
Major diameter, min.....	3.4959	3.4804
Pitch diameter, max.....	3.4154	3.4114
Pitch diameter, min.....	3.4150	3.4110
"Go" thread ring gage		
Pitch diameter, max.....	in. 3.4154	in. 3.4114
Pitch diameter, min.....	3.4150	3.4110
Minor diameter, max.....	3.3647	3.3910
Minor diameter, min.....	3.3640	3.3917
BASE PLATE (INTERNAL) THREAD		
	"Go" thread plug gage	"Not go" thread plug gage ^a
Major diameter, max.....	in. 3.5007	in. 3.4736
Major diameter, min.....	3.5000	3.4729
Pitch diameter, max.....	3.4192	3.4232
Pitch diameter, min.....	3.4188	3.4228

Tolerance on lead: ± 0.0004 in.
Tolerance on half-angle of thread: $\pm 0^\circ 5$ min.

^a It will be noted that the "not go" thread plug gage is truncated on the major diameter below the corresponding dimension of the "go" plug gage. This is to insure noninterference of the "not go" gage at the major diameter.

SECTION XVIII. PHOTOGRAPHIC EQUIPMENT THREADS⁹

1. TRIPOD CONNECTIONS FOR AMERICAN CAMERAS; $\frac{1}{4}$ -20 UNC-1A/1B THREADS (PH3.6)⁹

1. SCOPE.—This subsection describes the screw commonly used on American photographic tripods, and the corresponding threaded socket in cameras, in sufficient detail to promote the interchangeability of cameras on tripods. It is not intended to prescribe design except for the dimensions affecting interchangeability. For this reason, the screw and socket specified herein indicate two of many possible general designs.

2. TRIPOD SCREW.—The tripod screw shall be in accordance with figure XVIII.1. The screw shall have $\frac{1}{4}$ -20 UNC-1A threads in accordance with part I, section III.

⁹ The material included in this section is in substantial agreement with the following American Standards Association publications:

- PH3.6 Tripod Connections for American Cameras $\frac{1}{4}$ -in.-20 thread. See above.
- PH3.7 Tripod Connections for Heavy-Duty or European Cameras $\frac{3}{8}$ -in.-16 Thread with Adapter for $\frac{1}{4}$ -in.-20 Tripod Screws. See p. 42.
- PH3.10 Threads for Attaching Mounted Lenses to Photographic Equipment. See p. 42.
- PH3.12 Attachment Threads for Lens Accessories. See p. 42.
- PH3.23 Shutter Cable Release Tip and Socket With Taper (European) Thread. See p. 45.
- PH3.24 Shutter Cable Release Tip and Socket With Straight (American) Thread. See p. 45.

These standards are published by the American Standards Association, Inc., 10 E. 40th St., New York 16, N.Y. The latest revisions should be consulted when referring to these ASA documents.

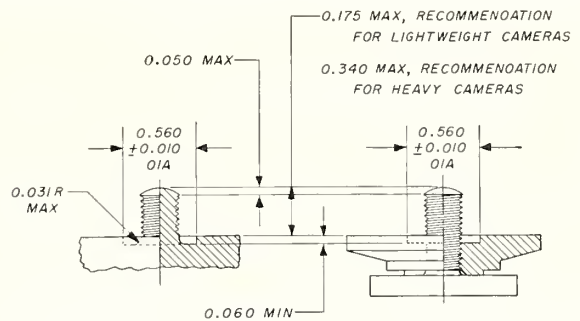

FIGURE XVIII.1.—Tripod screw, $\frac{1}{4}$ -20 UNC-1A.

The undercut in the tripod top around the base of the screw provides clearance for the flange found around the tripod socket in some cameras. The dimensions, including thread dimensions, include all plating or other finish.

The thread dimensions are:

	Max	Min
Major diameter.....	0.2489 in.	0.2367 in.
Pitch diameter.....	.2164	.2108
Minor diameter.....	.1876	-----

3. TRIPOD SOCKET IN CAMERA.¹⁰—The tripod socket in the camera shall be in accordance with figure XVIII.2. The socket shall have $\frac{1}{4}$ -20 UNC-1B threads in accordance with part I, section III.

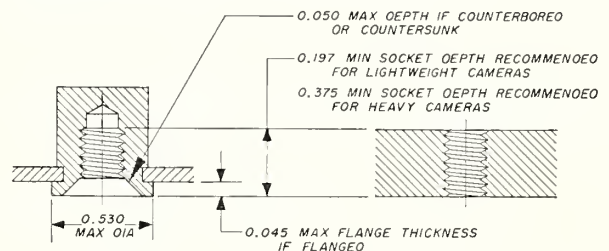

FIGURE XVIII.2.—Tripod socket in camera, $\frac{1}{4}$ -20 UNC-1B.

It is recommended that a clear area, free from obstructions, at least 2 in. in diameter, surround the socket in the camera. The dimensions, including thread dimensions, include all plating or other finish.

The thread dimensions are:

	Min	Max
Major diameter.....	0.2500 in.	-----
Pitch diameter.....	.2175	0.2248 in.
Minor diameter.....	.196	.207

4. SPACER.—On tripods having a screw 0.340 in. long, it is recommended that a spacer be supplied for use with cameras having shallow sockets. The spacer shall be in accordance with figure XVIII.3. The threads shall be as specified in the preceding paragraph for the tripod socket.

5. HEAVY-DUTY APPLICATIONS.—For heavy-duty applications, it is recommended that the tripod connections shown in the following subsection be used.

¹⁰ It is recognized that some nonstandard tripod screws (probably as a result of plating build-up over threads machined to standard tolerances) have been made oversize. Where accommodation of such a nonstandard screw has been considered important, $\frac{1}{4}$ -in. sockets have been produced to the following dimensions:

	Min	Max
Major diameter.....	0.266 in.	-----
Pitch diameter.....	.233	0.237 in.
Minor diameter.....	.211	.217

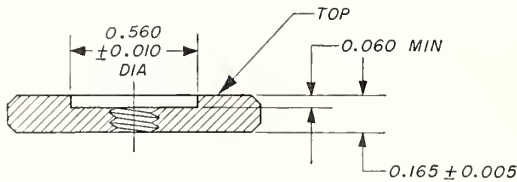

FIGURE XVIII.3.—Spacer for use on tripod with 0.340-in. length screw, 1/4—20 UNC—1B.

The outside diameter of the spacer shall conform to that of the tripod head.

2. TRIPOD CONNECTIONS FOR EUROPEAN CAMERAS (HEAVY-DUTY APPLICATIONS); 3/8—16 UNC—1A/1B THREADS (PH3.7⁹)

1. SCOPE.—This subsection describes the screw used on some European photographic tripods, the corresponding threaded socket in cameras, and the bushing to adapt American tripods to European cameras, in sufficient detail to promote the interchangeability of cameras on tripods. It is not intended to prescribe design except for the dimensions effecting interchangeability. For this reason, the screw and socket specified herein indicate two of many possible general designs.

2. TRIPOD SCREW.—The tripod screw shall be in accordance with figure XVIII.4. The screw shall have 3/8—16 UNC—1A threads in accordance with part I, Section III. The thread dimensions are:

	Max	Min
Major diameter.....	0.3737 in.	0.3595 in.
Pitch diameter.....	.3331	.3266
Minor diameter.....	.2970	-----

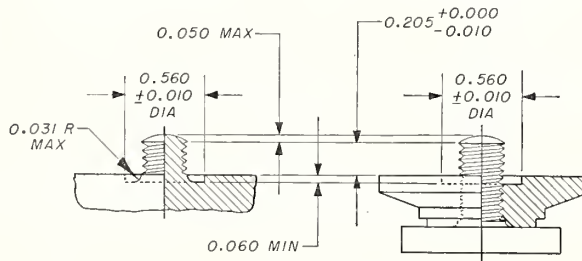

FIGURE XVIII.4.—Tripod screw, 3/8—16 UNC—1A

The undercut in the tripod top around the base of the screw provides clearance for the flange found around the tripod socket in some cameras. The dimensions, including thread dimensions, include all plating or other finish.

3. TRIPOD SOCKET IN CAMERA.—The tripod socket in the camera shall be in accordance with figure XVIII.5. The socket shall have 3/8—16 UNC—1B threads in accordance with part I, section III. The thread dimensions are:

	Min	Max
Major diameter.....	0.3750 in.	-----
Pitch diameter.....	.3344	0.3429 in.
Minor diameter.....	.307	.321

4. ADAPTER.—To adapt a tripod having a screw with a 1/4—20 UNC—1A thread as specified in subsection 1, above, to a camera having a tripod socket with a 3/8—16 UNC—1B thread, a threaded bushing as shown in figure XVIII.6 is recom-

mended. The bushing shall have a 3/8—16 UNC—1A external thread as specified in paragraph 2 of this subsection and a 1/4—20 UNC—1B internal thread as specified in paragraph 3 of subsection 1, page 41.

5. For the dimensions of the 1/4—20 tripod screws and sockets used on American cameras, see subsection 1 on page 41.

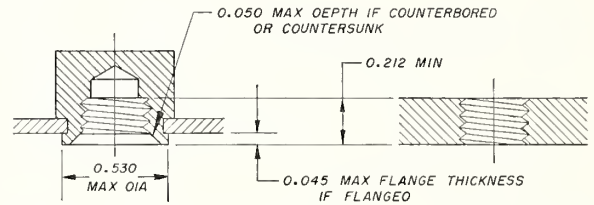

FIGURE XVIII.5.—Tripod socket in camera, 3/8—16 UNC—1B.

It is recommended that a clear area, free from obstructions, at least 2 in. in diameter, surround the socket in the camera. The dimensions, including thread dimensions, include all plating or other finish.

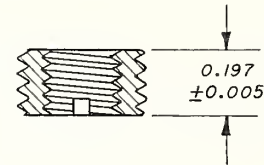

FIGURE XVIII.6.—Adapter; 3/8—16 UNC—1A external thread, 1/4—20 UNC—1B internal thread.

The dimensions, including thread dimensions, include all plating or other finish.

3. THREADS FOR ATTACHING MOUNTED LENSES TO PHOTOGRAPHIC EQUIPMENT (PH3.10⁹)

1. SCOPE.—This subsection consists of the specifications for the threads used for attaching mounted lenses to photographic equipment, for example, for attaching lens barrels to lens boards as in the case where flanges are employed.

2. THREAD FORM.—The Unified form of thread profile as specified in section III, part I, shall be used.

3. LIMITS OF SIZE, TOLERANCES, AND LENGTHS OF THREADS.—The limits of size, tolerances, and lengths of the threads in common usage for attaching mounted lenses to photographic equipment are listed in table XVIII.1. For sizes larger than shown in table XVIII.1, see footnote a to the table. The dimensions given in this table are not intended to preclude the use of threads specified by the Royal Microscopical Society.

4. ATTACHMENT THREADS FOR LENS ACCESSORIES (PH3.12⁹)

1. SCOPE.—This subsection consists of the specifications for the attachment threads for lens accessories. The lens accessories have an external thread which mates with an internal thread in the lens mount.

TABLE XVIII.1.—Limits of size, tolerances, and lengths of threads for threads for attaching mounted lenses to photographic equipment, classes 3A/3B, UNS^a

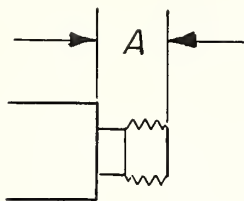

Nominal size and threads per inch	External thread, 3A ^b						Internal thread, 3B ^b						Maximum length from shoulder to end of external thread, A (Seesketch)
	Major diameter		Pitch diameter			Minor diameter	Minor diameter		Pitch diameter			Major diameter	
	Max	Min	Max	Min	Tolerance	Max	Min	Max	Min	Max	Tolerance	Min	
1	2	3	4	5	6	7	8	9	10	11	12	13	14
$1\frac{1}{8}$ -48	<i>in.</i> 0.5000	<i>in.</i> 0.4955	<i>in.</i> 0.4865	<i>in.</i> 0.4843	<i>in.</i> 0.0022	<i>in.</i> 0.4744	<i>in.</i> 0.4774	<i>in.</i> 0.4795	<i>in.</i> 0.4865	<i>in.</i> 0.4894	<i>in.</i> 0.0029	<i>in.</i> 0.5000	<i>in.</i> 0.156
$5\frac{1}{8}$ -32 ^c	.6250	.6190	.6047	.6020	.0027	.5867	.5910	.5969	.6047	.6082	.0035	.6250	.115
$3\frac{1}{4}$ -32 ^c	.7500	.7440	.7297	.7270	.0027	.7117	.7160	.7219	.7297	.7333	.0036	.7500	.156
$7\frac{1}{8}$ -32 ^c	.8750	.8690	.8547	.8520	.0027	.8367	.8410	.8469	.8547	.8583	.0036	.8750	.156
1-32 ^c	1.0000	.9940	.9797	.9769	.0028	.9617	.9660	.9719	.9797	.9834	.0037	1.0000	.160
$1\frac{1}{8}$ -32	1.1250	1.1190	1.1047	1.1019	.0028	1.0867	1.0912	1.0941	1.1047	1.1084	.0037	1.1250	.187
$1\frac{1}{4}$ -32	1.2500	1.2440	1.2297	1.2268	.0029	1.2117	1.2162	1.2191	1.2297	1.2335	.0038	1.2500	.187
$1\frac{3}{8}$ -32	1.3750	1.3690	1.3547	1.3518	.0029	1.3367	1.3412	1.3441	1.3547	1.3585	.0038	1.3750	.187
$1\frac{1}{2}$ -32	1.5000	1.4940	1.4797	1.4767	.0030	1.4617	1.4662	1.4691	1.4797	1.4836	.0039	1.5000	.187
$1\frac{3}{4}$ -32	1.7500	1.7440	1.7297	1.7266	.0031	1.7117	1.7162	1.7191	1.7297	1.7337	.0040	1.7500	.218
2-24	2.0000	1.9928	1.9729	1.9694	.0035	1.9489	1.9549	1.9584	1.9729	1.9774	.0045	2.0000	.218
$2\frac{1}{4}$ -24	2.2500	2.2428	2.2229	2.2194	.0035	2.1989	2.2049	2.2084	2.2229	2.2274	.0045	2.2500	.218
$2\frac{1}{2}$ -24	2.5000	2.4928	2.4729	2.4693	.0036	2.4489	2.4549	2.4584	2.4729	2.4775	.0046	2.5000	.250
$2\frac{3}{4}$ -24	2.7500	2.7428	2.7229	2.7193	.0036	2.6989	2.7049	2.7084	2.7229	2.7275	.0046	2.7500	.250
3-24	3.0000	2.9928	2.9729	2.9692	.0037	2.9489	2.9549	2.9584	2.9729	2.9777	.0048	3.0000	.250
$3\frac{1}{2}$ -24	3.5000	3.4928	3.4729	3.4692	.0037	3.4489	3.4549	3.4584	3.4729	3.4778	.0049	3.5000	.275

^a Larger sizes than shown in the table may be specified by increments of $\frac{1}{2}$ in., such larger sizes to have 24 threads per inch. Limits of size and tolerances for these larger sizes are to be calculated in accordance with table IV.13 of part I (class 3A/3B threads). The limits of size are to include plating, lacquer, or other finish.

^b Values shown are based on table IV.13 of part I. The limits of size are to include plating, lacquer, or other finish.

^c These are standard sizes of the Unified 32-thread series as given in tables 1 and 2.1 of ASA B1.1-1960. The standard designation for these is "UN."

2. **THREAD FORM.**—The American National thread form as specified in appendix 1, part I, shall be used. An example of the thread designation is as follows: 0.5906–36 NS–2.

3. **PITCH.**—All threads covered by this subsection shall have a pitch of 0.705555 mm (0.027778 in.). This is equivalent to 36 tpi.

4. **THREAD SIZE.**—The basic major diameters for these threads are shown in tables XVIII.2 and XVIII.3

5. **LENGTH OF THREADS.**—See figure XVIII.7 for the length of the threaded portion of the lens accessory, the length of the pilot, and the undercut of the thread.

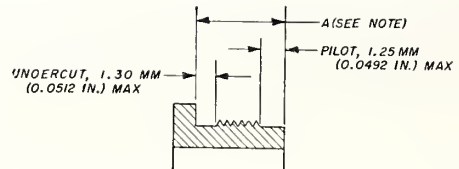

FIGURE XVIII.7.—Length, pilot, and undercut of attachment threads for lens accessories.

The length of the threaded portion of the lens accessory, dimension A, shall be 4.25 ± 0.10 mm (0.1673 ± 0.004 in.) for all sizes up to and including 45.5 mm (1.7913 in.) in diameter, and 4.75 ± 0.10 mm (0.1870 ± 0.004 in.) for larger sizes.

TABLE XVIII.2.—Basic major diameters of threads ^a

Preferred standard		Secondary standard	
mm	in.	mm	in.
15.0	0.5906	12.0	0.4724
18.0	.7087	13.5	.5315
19.5	.7677	16.5	.6496
22.0	.8661	20.5	.8071
23.5	.9252	25.0	.9843
26.5	1.0433	28.0	1.1024
30.0	1.1811	31.0	1.2205
34.5	1.3583	32.5	1.2795
39.5	1.5551	33.5	1.3189
		36.5	1.4370
		38.0	1.4961
		42.5	1.6732
		45.5	1.7913
		48.5	1.9094
		51.5	2.0276
		54.5	2.1457
		57.0	2.2441

^a Larger sizes (62.0 mm, 67.0 mm, etc.) are to be by increments of 5.0 mm (0.1969 in.).

TABLE XVIII.3.—Basic major diameters of threads for retaining rings for series designation of filters ^a

Series designation	Major diameter	
	mm	in.
IV	23.5	0.9252
V	33.346	1.3128
VI	44.346	1.7459
VII	54.346	2.1396
VIII	66.846	2.6317
IX	87.0	3.4252

^a Series is that specified by American Standard specification PH3.17, Photographic Filter Sizes.

5. SHUTTER CABLE RELEASE TIP AND SOCKET WITH TAPER (EUROPEAN) THREAD (PH3.23⁹)

1. SCOPE.—This subsection consists of the thread specifications for the shutter cable release tip and socket with taper (European) thread.

2. THREAD.—The American National thread form as specified in part I of Handbook H28 shall be used. The thread shall be 50 tpi and shall be adapted for taper tolerances that are the same as for a class 2. The thread dimensions are shown on figures XVIII.8 and XVIII.9.

3. SHUTTER CABLE RELEASE TIP AND SOCKET WITH STRAIGHT (AMERICAN) THREAD.—For the thread specifications of the shutter cable release tip and socket with straight (American) thread, see subsection 6 immediately following.

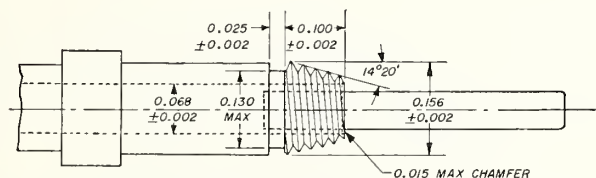

FIGURE XVIII.8.—Shutter cable release tip with taper (European) thread (50 tpi).

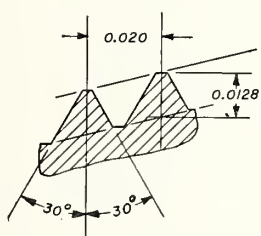

FIGURE XVIII.9.—Thread details for shutter cable release tip and socket with taper (European) thread (50 tpi).

6. SHUTTER CABLE RELEASE TIP AND SOCKET WITH STRAIGHT (AMERICAN) THREAD (PH3.24⁹)

1. SCOPE.—This subsection consists of the thread specifications for the shutter cable release tip and socket with straight (American) thread.

2. THREAD.—The thread shall be No. 5 (.125)—44 NF-2 in accordance with part I of Handbook H28. The thread dimensions are shown in figures XVIII.10 and XVIII.11.

3. SHUTTER CABLE RELEASE TIP AND SOCKET WITH TAPER (EUROPEAN) THREAD.—For the thread specifications of the shutter cable release tip and socket with taper (European) thread, see subsection 5 immediately preceding this subsection.

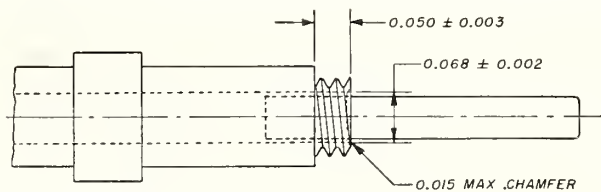

FIGURE XVIII.10.—Shutter cable release tip with straight (American) thread.

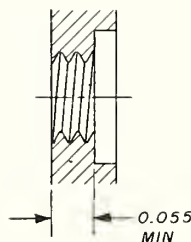

FIGURE XVIII.11.—Open type shutter cable socket with straight (American) thread.

SECTION XIX. MISCELLANEOUS THREADS

1. 60° STUB THREADS

The angle between the flanks of the thread is 60°. The threads are truncated top and bottom, have a basic height of $0.433p$, a basic thickness of $0.50p$, and are symmetrical about a line perpendicular to the axis of the screw. Basic dimensions of the 60° stub thread are given in table XIX.1. In accordance with standard practice this thread is designated as follows, for example: "1 $\frac{1}{8}$ —9 SPECIAL FORM, 60° thread," followed by all limits of size.

2. MODIFIED SQUARE THREADS

The angle between the flanks of the thread is 10°. The threads are truncated top and bottom, have a basic height of $0.50p$, a basic thread thickness of $0.50p$, and are symmetrical about a line perpendicular to the axis of the external thread. The angle of 10° results in a thread which is the equivalent of a "square thread" in so far as all practical considerations are concerned, and yet is capable of economical production. This thread form is illustrated in figure XIX.1. In accordance with standard practice this thread is designated as follows, for example: "1 $\frac{1}{4}$ —6 SPECIAL FORM, 10° thread," followed by all limits of size.

Multiple thread milling cutters and ground thread taps should not be specified for modified square threads of steep lead angle without consulting the cutting tool manufacturer.

3. THREADS FOR DAIRY SANITARY FITTINGS

Drawings showing threaded "3A" standard sanitary fittings for dairy applications are available from the Dairy Industries Supply Association, 1145 19th St., N.W., Washington 6, D.C. These are Acme threads, 8 tpi.

4. GLASS BOTTLE AND JAR THREADS

Industry standard glass finishes, including standard thread profiles and pitches, for bottles and jars are presented on drawings available from the Glass Container Manufacturers Institute, Inc., 1625 K St., N.W., Washington 6, D.C.

TABLE XIX.1.—Basic dimensions of 60° stub threads

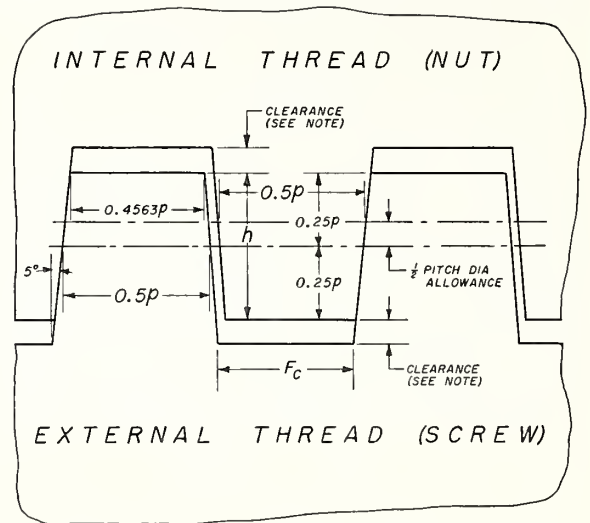
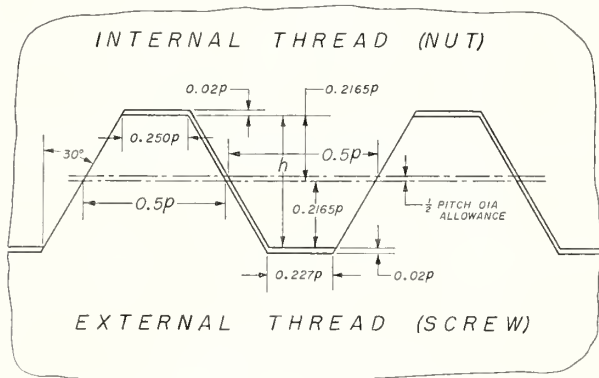

FIGURE XIX.1.—Modified square thread (10° included angle), basic proportions.

- p = pitch in inches
- h (basic height of thread) = $0.5p$
- H (total height of thread) = $0.5p + \text{clearance}$
- t (thickness of thread) = $0.5p$
- F_c (flat at root of thread) = $0.4563p - 0.17 \times \text{clearance}$
- F (basic width of flat at crest of thread) = $0.4563p$

NOTE.—A clearance should be added to h to produce extra height, thus avoiding interference with threads of mating parts at minor or major diameters. The amount of this clearance must be determined from the application of the thread assembly.

Threads per inch	Pitch, p	Height of thread (basic), $h=0.433p$	Total ^a height of thread, $(h+0.02p)$	Thread thickness (basic), $t=0.5p$	Width of flat at	
					Crest of screw (basic), $F=0.250p$	Root of screw $F_c=0.227p$
1	2	3	4	5	6	7
16	.06250	.0271	.0283	.0313	.0156	.0142
14	.07143	.0309	.0324	.0357	.0179	.0162
12	.08333	.0361	.0378	.0417	.0208	.0189
10	.10000	.0433	.0453	.0500	.0250	.0227
9	.11111	.0481	.0503	.0556	.0278	.0252
8	.12500	.0541	.0566	.0625	.0313	.0284
7	.14286	.0619	.0647	.0714	.0357	.0324
6	.16667	.0722	.0755	.0833	.0417	.0378
5	.20000	.0866	.0906	.1000	.0500	.0454
4	.25000	.1083	.1133	.1250	.0625	.0567

^a A clearance of at least 0.02p is added to h to produce extra height, thus avoiding interference with threads of mating part at minor or major diameters.

APPENDIX 10. WRENCH OPENINGS

TABLE 10.1.—Standard wrench openings

Nominal size of wrench, also basic or maximum width across flats of bolt and screw heads and nuts			Allowance between bolt heads or nuts and jaws of wrench			Wrench openings			Nuts			Bolts and screws			Nuts
									Finished hex, hex-jam, hex-slotted, hex-thick slotted, and hex-castle	Regular square, hex, hex-jam, semi-fin. hex, hex-jam, and hex-slotted	Heavy square, hex, hex-jam, semi-fin. hex, hex-jam, and hex-slotted	Finished and regular bolts, square, hex, semi-fin. hex, hex head cap screws	Heavy bolts, hex, semi-fin. hex, and finished hex	Lag bolts, square	Set screws, square
						Min.	Tol.	Max.							
1	2	3	4	5	6	7	8	9	10	11	12	13			
<i>in.</i>	<i>in.</i>	<i>mm</i>	<i>in.</i>	<i>in.</i>	<i>in.</i>	<i>in.</i>	<i>in.</i>	<i>in.</i>	<i>in.</i>	<i>in.</i>	<i>in.</i>	<i>in.</i>	<i>in.</i>		
5/32	0.1562	3.969	0.002	0.158	0.005	.0163									
3/16	.1875	4.762	.002	.190	.005	.195									
7/32	.2187	5.556	.002	.220	.005	.225									
1/4	.2500	6.350	.002	.252	.005	.257									
9/32	.2812	7.144	.002	.283	.005	.288									
5/16	.3125	7.937	.003	.316	.006	.322									
11/32	.3438	8.731	.003	.347	.006	.353									
3/8	.3750	9.525	.003	.378	.006	.384									
7/16	.4375	11.112	.003	.440	.006	.446									
1/2	.5000	12.700	.004	.504	.006	.510									
9/16	.5625	14.287	.004	.566	.007	.573									
5/8	.6250	15.875	.004	.629	.007	.636									
11/16	.6875	17.462	.004	.692	.007	.699									
3/4	.7500	19.050	.005	.755	.008	.763									
13/16	.8125	20.637	.005	.818	.008	.826									
7/8	.8750	22.225	.005	.880	.008	.888									
15/16	.9375	23.812	.006	.944	.009	.953									
1	1.0000	25.400	.006	1.006	.009	1.015									
1 1/16	1.0625	26.988	.006	1.068	.009	1.077									
1 1/8	1.1250	28.575	.007	1.132	.010	1.142									
1 1/4	1.2500	31.750	.007	1.257	.010	1.267									
1 3/16	1.3125	33.338	.008	1.320	.011	1.331									
1 3/8	1.3750	34.925	.008	1.383	.011	1.394									
1 1/2	1.4375	36.512	.008	1.446	.011	1.457									
1 5/8	1.5000	38.100	.008	1.508	.012	1.520									
1 3/4	1.6250	41.275	.009	1.634	.012	1.646									
1 7/8	1.6875	42.862	.009	1.696	.012	1.708									
1 15/16	1.8125	46.038	.010	1.822	.013	1.835									
1 7/8	1.8750	47.625	.010	1.885	.013	1.898									
2	2.0000	50.800	.011	2.011	.014	2.025									
2 1/16	2.0625	52.388	.011	2.074	.014	2.088									
2 1/8	2.1875	55.562	.012	2.200	.015	2.215									
2 1/4	2.2500	57.150	.012	2.262	.015	2.277									
2 3/8	2.3750	60.325	.013	2.388	.016	2.404									
2 1/2	2.4375	61.912	.013	2.450	.016	2.466									
2 3/4	2.5625	65.088	.014	2.576	.017	2.593									
2 5/8	2.6250	66.675	.014	2.639	.017	2.656									
2 3/4	2.7500	69.850	.014	2.766	.017	2.783									
2 7/8	2.8125	71.438	.015	2.827	.018	2.845									
2 15/16	2.9375	74.612	.016	2.954	.019	2.973									
3	3.0000	76.200	.016	3.016	.019	3.035									
3 1/16	3.1250	79.375	.017	3.142	.020	3.162									
3 3/8	3.3750	85.725	.018	3.393	.021	3.414									
3 1/2	3.5000	88.900	.019	3.518	.022	3.540									
3 3/4	3.7500	95.250	.020	3.770	.023	3.793									
3 7/8	3.8750	98.425	.020	3.895	.023	3.918									
4 1/8	4.1250	104.78	.022	4.147	.025	4.172									
4 1/4	4.2500	107.95	.022	4.272	.025	4.297									
4 1/2	4.5000	114.30	.024	4.524	.026	4.550									
4 5/8	4.6250	117.48	.024	4.649	.027	4.676									
4 3/4	4.8750	123.82	.025	4.900	.028	4.928									
5	5.0000	127.00	.026	5.026	.029	5.055									
5 1/4	5.2500	133.35	.027	5.277	.030	5.307									
5 3/8	5.3750	136.52	.028	5.403	.031	5.434									
5 1/2	5.6250	142.88	.029	5.654	.032	5.686									
5 3/4	5.7500	146.05	.030	5.780	.033	5.813									
6	6.0000	152.40	.031	6.031	.034	6.065									
6 1/8	6.1250	155.58	.032	6.157	.035	6.192									

^a Regular square only.

Wrenches shall be marked with the "Nominal size of wrench" which is equal to the basic or maximum width across flats of the corresponding bolt head or nut.

Allowance (minimum clearance) between maximum width across flats of nut or bolt head and jaws of wrench equals (1.005 W + 0.001). Tolerance on wrench opening = plus (0.005 W + 0.004 from minimum). (W equals nominal size of wrench.)

This standard is in general agreement with Appendix 1 of American Standard ASA B18.2, "Square and Hexagon Bolts and Nuts," published by The American Society of Mechanical Engineers, 29 W. 39th St., New York 18, N.Y. The latest revision should be consulted when referring to such standards.

APPENDIX 11. CLASS 5 INTERFERENCE-FIT THREADS, TRIAL AMERICAN STANDARD

1. INTRODUCTION

Interference-fit threads are threads in which the externally threaded member is larger than the internally threaded member when both members are in a free state and which, when assembled, become the same size and develop a high resistance to any applied unscrewing torque through elastic compression, plastic movement of material, or both. By custom, these threads are designated class 5.

The standards previously published in this handbook were helpful in stabilizing design; however, in spite of restrictive tolerance, loosening or breakage of externally threaded members has been all too frequent. They also established minimum and maximum torque values, the validity of which has been generally accepted in service for the past 20 years.

This trial standard¹ is based on 10 years of research, testing, and field study, and represents the first attempt to establish an American standard for interference fit threads. It is predicated on the following conclusions which have been drawn from the research and field experience:

(1) Materials of the external and internal interference fit threads compress elastically during assembly and when assembled.

(2) During driving, plastic flow of materials occurs, resulting in either an increase of the external thread major diameter, or a decrease in the internal thread minor diameter, or both.

(3) Relieving the external thread major diameter and the internal thread minor diameter to make allowance for plastic flow eliminates the main causes of seizing, galling, and abnormally high and erratic driving torques.

(4) Such reliefs require an increase in the pitch diameter interference in order to obtain driving torques within the range previously established. (In driving studs, it was found that the minimum driving torque should be about 50 percent of the torque required to break loose a properly tightened nut.)

(5) Lubricating only the internal thread results in more uniform torques than lubricating only the external thread and is almost as beneficial as lubricating both external and internal threads.

(6) For threads having truncated profile, torques increase directly as the pitch diameter interference for low interferences, but torques soon become practically constant and increase little, if at all, with increases of interference. Obviously, for uniformity of driving torques, it is desirable to work with greater interferences.

(7) Comparatively large pitch diameter interferences can be tolerated provided that the external thread major diameter and internal thread minor diameter are adequately relieved, and proper lubrication is used during assembly.

(8) Driving torque increases directly with turns of engagement. (For thin wall applications, it may be desirable to use longer engagement rather than large pitch diameter interference to obtain desired driving torque.)

(9) Studs should be driven to a predetermined depth. "Bottoming" or "shouldering" should be avoided. "Bottoming," which is engagement of the threads of the stud with the incomplete threads at the bottom of a shallow drilled and tapped hole causes the stud to stop suddenly, thus inviting failure in torsional shear. "Shouldering," which is the practice of driving the stud until the thread runout engages with the top threads of the hole, creates radial compressive stresses and upward bulging of the material at the top of the hole. This results in erratic variations in free stud length after driving.

As application experience is gained by users of this

standard, it is urged that results, good or bad, be reported to the Industrial Fasteners Institute, 1517 Terminal Tower, Cleveland, Ohio, with copy to Standards Department, The American Society of Mechanical Engineers, 29 West 39th Street, New York 18, N.Y. Future adjustments to the standard will be based largely on such field reports.

2. SCOPE

This trial standard¹ provides dimensional tables for external and internal interference fit (class 5) threads of modified Unified form in the coarse thread series, sizes $\frac{1}{4}$ to $1\frac{1}{2}$ in. It is intended that designs conforming with this standard will provide adequate torque conditions which fall within the limits shown in table 11.3. These torque limits are the same as those in H28(1944) and the 1950 Supplement. The minimum torques are intended to be sufficient to ensure that externally threaded members will not loosen in service; the maximum torques establish a limit below which seizing, galling or torsional failure of the externally threaded components is unlikely. See figure 11.1 for conditions of fit.

3. DESIGN AND APPLICATION DATA

Following are conditions of usage and inspection on which satisfactory application of products made to dimensions in tables 11.1, 11.2, and 11.3 are predicated.

1. **THREAD DESIGNATIONS.**—(a) The following thread designations provide a means of distinguishing the Trial American Standard class 5 threads of this standard from the tentative class 5 and alternate class 5 threads specified previously in Handbook H28. It also distinguishes between external and internal Trial American Standard class 5 threads.

(b) Trial class 5 external threads are designated as follows:

NC5 HF —For driving in hard ferrous material of hardness over 160 BHN.

NC5 CSF —For driving in copper alloy and soft ferrous material of 160 BHN or less.

NC5 ONF —For driving in other nonferrous material (nonferrous materials other than copper alloys), any hardness.

(c) Trial class 5 internal threads are designated as follows:

NC5 IF —Entire ferrous material range.

NC5 INF —Entire nonferrous material range.

2. **STUDS.**—(a) *Inspection.*—Since angle and lead deviations are not as critical factors as in free fitting screw threads, the controlling element for class 5 threaded products is pitch diameter. This element can be satisfactorily checked by an optical comparator, a thread micrometer, or thread snap gages having anvils that are not affected by lead or angle. For rapid and convenient control in mass production, the use of "go" and "not go" snap gages is recommended. Ring gages may be used, but their use is not primarily recommended. The "not go" ring gage shall stop at $1\frac{1}{2}$ turns or less engagement in order to maintain minimum pitch diameter interference. *W* thread setting plugs shall be used for all gages, and tolerances shall be applied within the product limits. The maximum major diameter of the truncated portion of the truncated setting plug should be equal to the minimum major diameter of the stud thread. If the threads are zinc, cadmium, or copper plated, limits are applicable before plating.

(b) *Points.*—Points of externally threaded components should be chamfered or otherwise reduced to a diameter below the minimum minor diameter of the thread.

(c) *Workmanship.*—Studs should be free from excessive nicks, burrs, chips, grit, or other extraneous material before driving.

3. **STUD MATERIALS.**—The length of engagement, depth of thread engagement, and pitch diameter limits in tables 11.1, 11.2, and 11.3 are designed to produce adequate torque conditions when heat-treated medium-carbon steel studs, ASTM A-325 (SAE grade 5) or better, are used. In many applications, case-carburized studs and unheat-treated medium-carbon steel studs, SAE grade 4, are satisfactory. SAE grades 1, 2, and 8 may be desirable under

¹ This trial standard is identical in all technical features with the current draft standard developed by Subcommittee No. 10 of ASA Sectional Committee B1 on the Standardization and Unification of Screw Threads.

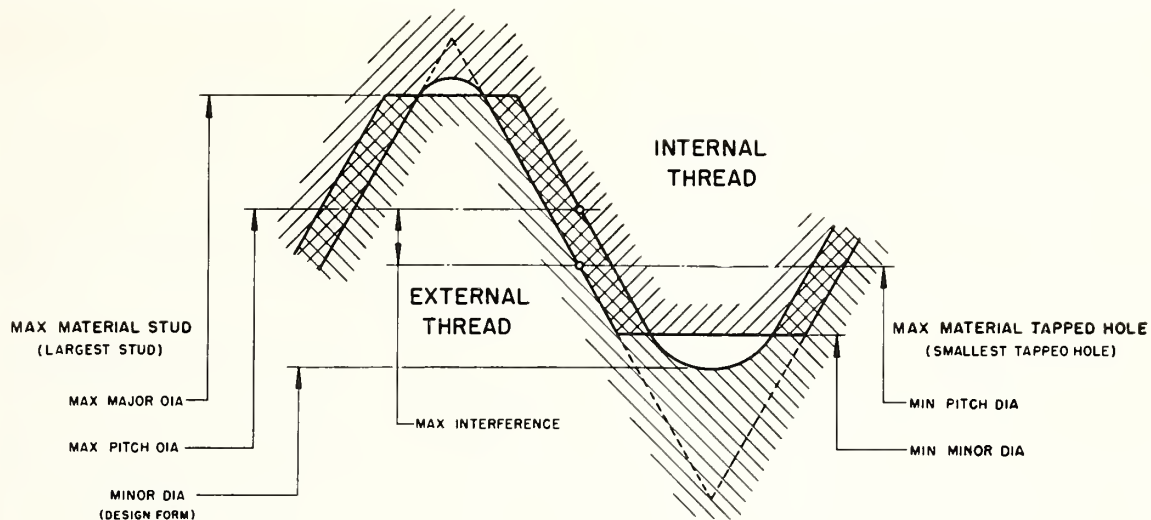

MAXIMUM INTERFERENCE

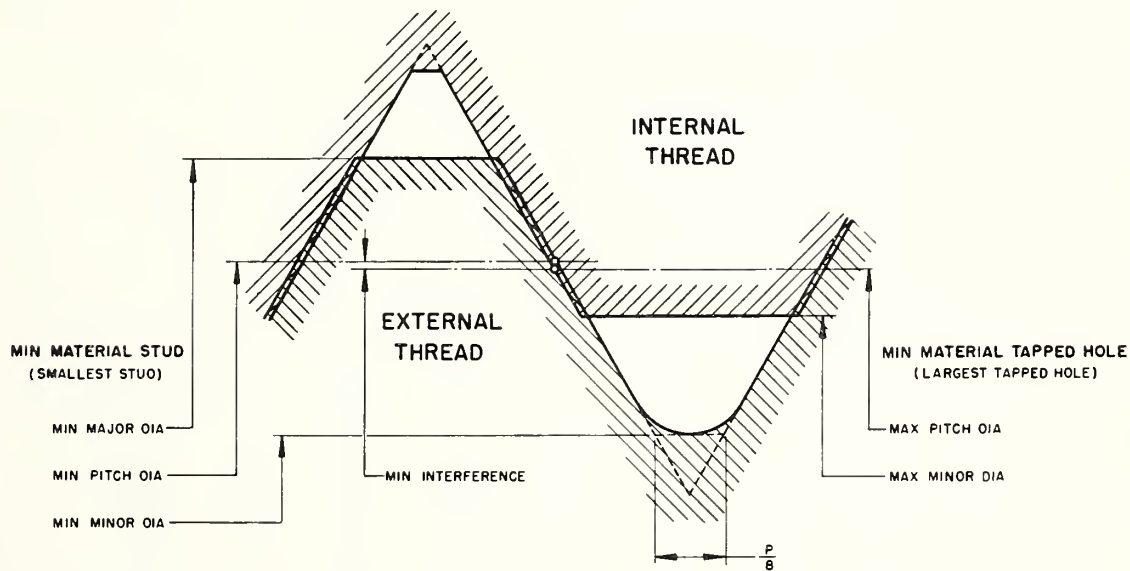

MINIMUM INTERFERENCE

FIGURE 11.1.—Illustrations showing maximum and minimum interferences, class 5 threads.

TABLE 11.1.—Limits of size, external threads, class 5^a

Sizes and threads per inch	Major diameter						Pitch diameter, design form		Minor diameter
	NC5 HF for driving in ferrous material with hardness greater than 160 Bhn, $L_e=1\frac{1}{4}$ dia		NC5 CSF for driving in brass and ferrous material with hardness equal to or less than 160 Bhn, $L_e=1\frac{1}{4}$ dia		NC5 ONF for driving in nonferrous except brass (any hardness), $L_e=2\frac{1}{2}$ dia		Max	Min	Max
	Max	Min	Max	Min	Max	Min			
1	2	3	4	5	6	7	8	9	10
	<i>in.</i>	<i>in.</i>	<i>in.</i>	<i>in.</i>	<i>in.</i>	<i>in.</i>	<i>in.</i>	<i>in.</i>	<i>in.</i>
1/4-20	0.2470	0.2408	0.2470	0.2408	0.2470	0.2408	0.2230	0.2204	0.1932
5/16-18	.3080	.3020	.3090	.3030	.3090	.3030	.2829	.2799	.2508
3/8-16	.3690	.3626	.3710	.3646	.3710	.3646	.3414	.3382	.3053
7/16-14	.4305	.4233	.4330	.4258	.4330	.4258	.3991	.3955	.3579
1/2-13	.4920	.4846	.4950	.4876	.4950	.4876	.4584	.4547	.4140
9/16-12	.5540	.5460	.5580	.5495	.5580	.5495	.5176	.5136	.4695
5/8-11	.6140	.6056	.6195	.6111	.6195	.6111	.5758	.5716	.5233
3/4-10	.7360	.7270	.7440	.7350	.7440	.7350	.6955	.6910	.6378
7/8-9	.8600	.8502	.8685	.8587	.8685	.8587	.8144	.8095	.7503
1-8	.9835	.9727	.9935	.9827	.9935	.9827	.9316	.9262	.8594
1 1/8-7	1.1070	1.0952	1.1180	1.1062	1.1180	1.1062	1.0465	1.0406	.9640
1 1/4-7	1.232	1.220	1.2430	1.2312	1.2430	1.2312	1.1715	1.1656	1.0890
1 3/8-6	1.356	1.341	1.3680	1.3558	1.3680	1.3558	1.2839	1.2768	1.1877
1 1/2-6	1.481	1.467	1.4930	1.4788	1.4930	1.4788	1.4089	1.4018	1.3127

^a This table is based on externally threaded members being steel ASTM A-325 (SAE grade 5) or better. It is for rolled, cut, or ground threads.

TABLE 11.2.—Limits of size, internal threads, class 5^a

Sizes and threads per inch	NC5 IF Ferrous material			NC5 INF Nonferrous material			Pitch diameter		Major diameter
	Minor diameter		Tap drill	Minor diameter		Tap drill	Min	Max	Min
	Min	Max		Min	Max				
1	2	3	4	5	6	7	8	9	10
	<i>in.</i>	<i>in.</i>	<i>in.</i>	<i>in.</i>	<i>in.</i>	<i>in.</i>	<i>in.</i>	<i>in.</i>	<i>in.</i>
1/4-20	0.196	0.206	1 3/64 in.	0.196	0.206	1 3/64 in.	0.2175	0.2201	0.2500
5/16-18	.252	.265	G	.252	.265	G	.2764	.2794	.3125
3/8-16	.307	.321	O	.307	.321	O	.3344	.3376	.3750
7/16-14	.374	.381	3/8	.360	.372	U	.3911	.3947	.4375
1/2-13	.431	.440	{ 11.0mm 0.4330 }	.417	.429	2 7/64	.4500	.4537	.5000
9/16-12	.488	.497	12.5mm	.472	.485	3 1/64	.5084	.5124	.5625
5/8-11	.544	.554	3 5/64	.527	.540	1 7/32	.5660	.5702	.6250
3/4-10	.661	.678	4 3/64	.642	.655	16.5mm	.6850	.6895	.7500
7/8-9	.777	.789	2 5/32	.755	.770	4 9/64	.8028	.8077	.8750
1-8	.890	.904	5 7/64	.865	.880	7/8	.9188	.9242	1.0000
1 1/8-7	1.000	1.015	1	.970	.991	6 3/64	1.0322	1.0381	1.1250
1 1/4-7	1.125	1.140	1 1/8	1.095	1.115	1 7/64	1.1572	1.1631	1.2500
1 3/8-6	1.229	1.247	1 1 5/64	1.195	1.213	1 1 5/64	1.2667	1.2738	1.3750
1 1/2-6	1.354	1.372	1 2 3/64	1.320	1.338	1 2 3/64	1.3917	1.3988	1.5000

^a This table is based on externally threaded members being steel ASTM A-325 (SAE grade 5) or better. It is for rolled, cut, or ground threads.

certain conditions. This trial standard is not intended to cover the use of studs made of stainless steel, silicon bronze, brass or similar materials. Where such materials are used, the dimensions listed herein will probably require adjustment based on pilot experimental work with the combination of materials involved.

4. HOLES.—(a) *Inspection*.—Gages in accordance with Part I, section VI, shall be used. "Go" plain plug and "go" thread plug gages should be inserted to full depth in order to detect the effect of excessive drill or tap wear at the bottom of the hole. "Not go" thread plug gages should not enter more than 1½ threads. Holes shall be clean from grit, chips, oil, or other extraneous material prior to gaging.

(b) *Countersinks*.—Holes shall be countersunk to a diameter greater than the major diameter in order to facilitate starting of the studs and to prevent raising a lip around the hole after the stud is driven.

(c) *Cleanliness*.—Holes shall be free from chips, grit, or other foreign material before driving studs.

5. LEAD AND ANGLE DEVIATIONS.—This trial standard does not provide control for lead and angle deviations. Angle and lead deviations are not normally objectionable, since they contribute to interference and this is the purpose of the class 5 thread. Experience may dictate the need for imposing some limits under certain conditions.

6. LUBRICATION.—(a) For driving in ferrous material, a good lubricant sealer should be used, particularly in the hole. A noncarbonizing type of lubricant, (such as a rubber-in-water dispersion) is suggested. The lubricant shall be applied to the hole and it may also be applied to the stud. In applying it to the hole, care must be taken so that an excess amount of lubricant will not cause the stud to be impeded by hydraulic pressure in a blind hole.

(b) When class 5 threaded products are driven in non-ferrous materials, lubrication may not be needed. Recent British research recommends the use of medium gear oil for driving in aluminum. In American research it has been observed that the minor diameter of lubricated tapped holes in nonferrous materials may tend to close in, that is be reduced in driving; whereas with an unlubricated hole the minor diameter may tend to open up in some cases.

(c) Where sealing is involved, a lubricant should be selected which is insoluble in the medium being sealed.

7. DRIVING SPEED.—This trial standard makes no recommendation for driving speed. Some opinion has been advanced that careful selection and control of driving speed is desirable to obtain optimum results with various combinations of surface hardness and roughness. Field experience with threads made to this standard may indicate what limitations should be placed on driving speeds.

8. RELATION OF DRIVING TORQUE TO LENGTH OF ENGAGEMENT.—Torques increase directly as the length of engagement. American research indicates that this increase is proportionately more rapid as size increases.

9. BREAKLOOSE TORQUES AFTER REAPPLICATION.—This trial standard does not establish recommended reapplication breakloose torques in cases where repeated usage is involved. Field experience with a large variety of sizes and materials will be needed to establish adequate values.

10. ASSEMBLY TORQUES FOR REAPPLICATION.—This trial standard does not establish assembly torques for reapplication. Field experience with a large variety of sizes and materials will be necessary to determine the torques which will insure the same performance where repeated usage is involved.

TABLE 11.3.—Interferences, lengths of engagement, and torques, class 5^a

Sizes and threads per inch	Interferences on pitch diameter		Engagement lengths, external thread lengths and tapped hole depths						Approx. torque at ¼ engagement of 1¼D in ferrous material	
	Max	Min	In brass and ferrous			In nonferrous except brass			Max	Min
			L _e ^b	T _e ^c	T _h min ^d	L _e ^b	T _e ^c	T _h min ^d		
1	2	3	4	5	6	7	8	9	10	11
¼-20	<i>in.</i> 0.0055	<i>in.</i> 0.0003	<i>in.</i> 5/16	<i>in.</i> 3/8 +.125 -.000	<i>in.</i> 3/8	<i>in.</i> 5/8	<i>in.</i> 1 1/16 +.125 -.000	<i>in.</i> 1 1/16	<i>ft-lb</i> 12	<i>ft-lb</i> 3
5/16-18	.0065	.0005	2 5/64	1 5/32 +.139 -.000	1 5/32	2 5/32	5 5/64 +.139 -.000	5 5/64	19	6
3/8-16	.0070	.0006	1 5/32	9/16 +.156 -.000	9/16	1 5/16	1 1/2 +.156 -.000	1 1/2	35	10
7/16-14	.0080	.0008	3 5/64	2 1/32 +.179 -.000	2 1/32	1 3/32	1 13/64 +.179 -.000	1 13/64	45	15
1/2-13	.0084	.0010	5/8	3/4 +.192 -.000	3/4	1 1/4	1 3/8 +.192 -.000	1 3/8	75	20
9/16-12	.0092	.0012	4 5/64	2 7/32 +.208 -.000	2 7/32	1 3/32	1 35/64 +.208 -.000	1 35/64	90	30
5/8-11	.0098	.0014	2 5/32	1 5/16 +.227 -.000	1 5/16	1 1/16	1 23/32 +.227 -.000	1 23/32	120	37
3/4-10	.0105	.0015	1 5/16	1 1/8 +.250 -.000	1 1/8	1 7/8	2 1/16 +.250 -.000	2 1/16	190	60
7/8-9	.0116	.0018	1 3/32	1 5/16 +.278 -.000	1 5/16	2 3/16	2 13/32 +.278 -.000	2 13/32	250	90
1-8	.0128	.0020	1 1/4	1 1/2 +.312 -.000	1 1/2	2 1/2	2 3/4 +.312 -.000	2 3/4	400	125
1 1/8-7	.0143	.0025	1 13/32	1 11/16 +.357 -.000	1 11/16	2 13/16	3 3/32 +.357 -.000	3 3/32	470	155
1 1/4-7	.0143	.0025	1 1/16	1 7/8 +.357 -.000	1 7/8	3 1/8	3 7/16 +.357 -.000	3 7/16	580	210
1 3/8-6	.0172	.0030	1 23/32	2 1/16 +.417 -.000	2 1/16	3 7/16	3 25/32 +.417 -.000	3 25/32	705	250
1 1/2-6	.0172	.0030	1 7/8	2 3/4 +.417 -.000	2 3/4	3 3/4	4 1/8 +.417 -.000	4 1/8	840	325

^a This table is based on externally threaded members being ASTM A-325 (SAE grade 5) or better. It is for rolled, cut, or ground threads.

^b L_e = Length of engagement.

^c T_e = External thread length.

^d T_h = Depth of full form thread in hole.

4. TABLES OF DIMENSIONS, TORQUES, AND INTERFERENCES

Tables 11.1 and 11.2 of the standard are based on engagement lengths, external thread lengths, and tapping hole depths specified in table 11.3 and in compliance with the above design and application data.

Table 11.1 contains the limits of size for external threads.

(a) For each size, it contains one set of pitch diameter limits regardless of material involved. The minimum pitch diameter is larger than the basic pitch diameter of comparable UNC series threads.

(b) For driving into brass and into ferrous materials having hardness under 160 Bhn, the length of engagement is $1\frac{1}{4}D$. For driving into other nonferrous materials, the length of engagement is $2\frac{1}{2}D$. In both cases, the minimum major diameter is approximately that of the minimum major diameter for class 2A.

(c) For driving into ferrous material of 160 Bhn and harder, the length of engagement is $1\frac{1}{4}D$; however, the maximum and minimum major diameter limits are reduced to permit plastic flow and to reduce and stabilize driving torque.

Table 11.2 contains the limits of size for internal threads.

(a) One set of pitch diameter limits is maintained for each size regardless of material.

(b) The hole minor diameter limits are the same as those of class 3 for all sizes in nonferrous materials and for sizes up to and including $\frac{3}{8}$ in. in ferrous materials.

For $\frac{7}{16}$ in. and larger sizes in ferrous materials, the minor diameters have been enlarged slightly in order to reduce driving torques, and tolerances have been adjusted.

Table 11.3 gives interferences and engagement lengths. For lengths of engagement of $1\frac{1}{4}D$, the external thread length and depth of full form threads in tapped holes are set at $1\frac{1}{2}D$ with a tolerance of plus $2\frac{1}{2}p$, minus 0. For lengths of engagement of $2\frac{1}{2}D$, the length of external thread and depth of full form thread in the tapped hole are set at $2\frac{3}{4}D$ with a tolerance of plus $2\frac{1}{2}$ pitches, minus 0.

5. EXTENSION OF THE STANDARD

1. SMALL SIZES (UNDER $\frac{1}{4}$ IN.).—By using the new principles upon which this standard is based, stud sizes may be extended downward. However, adequate data are not now (1958) available to permit setting a standard. American research indicates that on smaller sizes the main reliance for producing adequate breakloose torques should be placed on pitch diameter interference and not on increasing the length of engagement. Extension of the standard is being investigated further.

2. LARGE SIZES (OVER $1\frac{1}{2}$ IN.).—Although there is some current usage of interference fits on large size threads, adequate data is not now (1958) available to permit setting a standard on larger sizes.

3. FINE THREAD SERIES.—Use of the coarse thread series is urged unless requirements for strength of the stud make a finer pitch necessary. No research data are available now (1958) to enable the setting of a trial standard for fine thread studs having reduced major diameters. Indications are, however, that the product of the ratio:

$$\frac{\text{Class 2A UNF PD tolerance}}{\text{Class 2A UNC PD tolerance}}$$

and the following coarse thread characteristics will probably work:

- (a) stud major diameter tolerance,
- (b) stud pitch diameter tolerance,
- (c) minimum interference.

Similarly, the above principles observed in setting the pitch and major diameter limits on the fine series class 5 external thread may be followed in deriving the pitch and minor diameters of the internal thread for the fine series.

4. 8-THREAD SERIES. The 8-thread series is now (1958) being investigated.

APPENDIX 12. THE TIGHTENING OF THREADED FASTENERS TO PROPER TENSION

The effectiveness of a threaded fastener usually depends on the degree to which it is initially tightened, and in some applications the amount of prestressing within a narrow range of tension is critical. For example, sufficient tension must be produced in pipe flange bolts to exceed the longitudinal forces caused by the pressure in the piping, so that the flanged connection does not leak. The same problem is faced in tightening the nuts on the cylinder head of an engine block, so that the studs are all stressed equally and to a tension that precludes leakage. In statically loaded structures in which there is a clearance between the bolt and the members held together the clamping tension is important where rigidity of joints is desired to prevent relative motion of such members. In structures subjected to varying or alternating stresses, the range of the dynamic stress in the members varies with the bolt tension, and consequently the fatigue strength varies with the bolt tension.

Factors affecting the maintenance of bolt tension are the proportion of seating area to thread cross-section, elastic properties of the seating material, stretch of the bolt, or creep of the bolt under load. The use of washers or other springy members in a fastener assembly tends to reduce the amount of external load that can be applied to a prestressed fastener before the load becomes additive to the initial bolt tension.

In the design of bolted connections, enough experience is generally available to determine the amount of the required tension. To assure that such tension is actually induced in the bolt, screw, or stud when the joint is assembled requires a method that either directly or indirectly measures or determines the amount of tension.

In the laboratory the tension induced in a bolt by tightening the nut can be accurately determined in a tensile testing machine. In the practical application of fasteners there are five generally used methods for setting bolt tension, as follows:

1. Micrometer method, in which both ends of the bolt must be accessible to measure the change in the overall length of the bolt.
2. "Feel" method, applicable only when the desired tensile stress is just beyond the yield point of the bolt material.
3. Torque measurement methods, which require that the torque-tension relationship be established for the specific conditions of assembly.
4. Angular turn-of-the-nut method.
5. Use of special devices for controlling tension.

1. MICROMETER METHOD

When a bolt is tightened, it elongates as the tension in the bolt is increased. Since the modulus of elasticity is practically constant at 29,500,000 psi for all steels at room temperature, the following formula applies:

$$\frac{\text{Desired stress in bolt in psi}}{29,500,000} = \frac{\text{elongation in inches per inch}}{\frac{1}{2} \text{ effective length, } L_e \text{ (see g. 12.1.)}}$$

Example: For a length L_e of 5 in. and a desired stress of 45,000 psi,

$$\text{Elongation} = \frac{45,000}{29,500,000} \times 5 = 0.0076 \text{ in.}$$

To apply this method, the length of the bolt is measured by a micrometer before tightening. The bolt is then tightened until it has elongated the required amount.

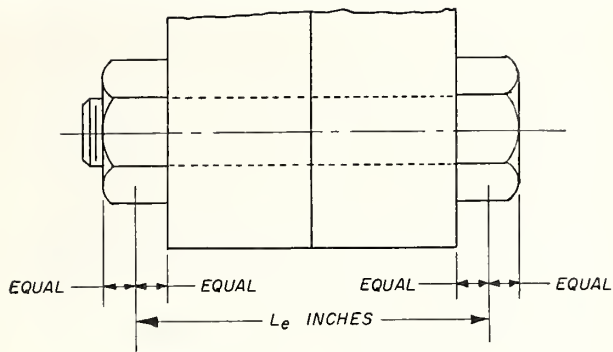

FIGURE 12.1.—Effective length applicable in elongation formula.

The micrometer method is applicable for bolts that are threaded their entire length or for bolts that are so designed that the elongation will be uniform throughout the length. This method is not practical for general use but may be used for spot checking. It may also be applicable in establishing torque-tension relationships when a tensile testing machine is not available.

2. "FEEL" METHOD

Authorities agree that when an assembly has been properly designed, the yield point of the bolt may be slightly exceeded without harmful results. When a skilled workman is tightening a nut, he can "feel" a very slight yield in the bolt when the yield point has been reached, and he stops tightening when he feels this yield.

3. TORQUE MEASUREMENT METHOD

In most applications of threaded fasteners, it is not practicable to measure directly the tension produced in each fastener during assembly. Fortunately, for many applications the tension may be controlled within satisfactory limits by applying known torques in tightening the nuts on the bolts or studs. Tests in numerous laboratories have shown that satisfactory torque-tension relationships may be established for a given set of conditions, but that the change of any one variable may alter the relationship markedly. Because of the fact that most of the applied torque is absorbed in indeterminate friction, a change in the surface roughness of the bearing surfaces or of the threads, or a change in lubrication will drastically affect the friction and thus the torque-tension relationship. Thus, it must be recognized that a given torque will not always produce a definite stress in the bolt but will probably induce a stress that lies in a stress range that is satisfactory.

The torque-tension relationship for a given set of conditions may be established by means of a torque-wrench in combination with a tensile testing machine or by the micrometer method described above. When both ends of a fastener are not accessible for measurement, if the diameter of the bolt or stud is sufficiently large an axial hole may be drilled in it, see figure 12.2. By applying a micrometer depth gage to determine the change in depth of the hole during tightening of the fastener the tension can be determined.

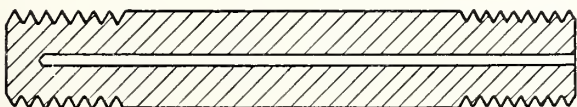

FIGURE 12.2.—Drilling for elongation determination when one end is not accessible.

4. ANGULAR TURN OF NUT METHOD

A procedure that is consistently being used in the installation of high strength bolts in structures is based on the turn-of-the-nut method. The nut is first tightened to seat the contacting surfaces firmly. It is then loosened sufficiently, if deemed necessary, to just release the bolt tension. This nut is then tightened through a specified fraction of a turn to produce the required bolt tension. The angle through which the nut should be turned will be different for each bolt size, length, material, threads per inch, and will also vary with the elastic properties of the abutting material.

5. USE OF SPECIAL DEVICES FOR CONTROLLING TENSION

There are some specialized proprietary devices available whose function is accurately to control the tension induced in the bolt. These devices are operative even when both ends of the fastener are not available for measurement. They are known as preload indicating washers, load sensitive screws, and tru-load bolts.

(a) *Preload indicating washer.*—This device consists of two concentric steel rings sandwiched between two close-tolerance, hardened steel washers. The inner ring is smaller in diameter and higher than the outer by a predetermined amount. A known preload in the bolt is indicated when the inner ring is compressed to the point where the outer ring can no longer be moved freely by means of a pin inserted into one of the peripheral holes.

(b) *Load sensitive screw.*—A screw is made load sensitive by having a special resistance-type strain gage potted axially at its center. The change in resistance of the strain gage is read on a calibrated potentiometer as actual bolt tension.

(c) *Tru-load bolt.*—The "tru-load" bolt provides a positive means for indicating the actual tensile loading on a bolt by the amount of elongation. It consists of almost any kind of bolt modified to contain a pin inserted along the axis of the bolt. The pin is in contact with the bolt only at the inner end. The pin usually is made to be flush with the bolt head surface before loading. As the bolt is loaded, the elongation produced in the bolt causes the pin surface to move below the reference surface. This change in distance is converted directly into unit stress by gaging with a calibrated dial gage.

For some applications, it may be desirable to have the indicating pin extend above the top of the bolt before tightening. When the load is applied, the pin withdraws into the bolt. The length of the pin is such that when the full load has been applied, the pin will be drawn in until it is flush with the top of the bolt. A dial depth gage reading of zero then indicates full preload.

6. BIBLIOGRAPHY

- [1] J. V. Poncelet, Frottement des vis et des écrous, *Crelles Jour.*, **2**, 293 (1827).
- [2] F. Grashof, *Theoretische Maschinenlehre*, **2**, 265 (1883). (Voss, Leipzig.)
- [3] Melvin D. Casler, Effect of initial tension in flange bolts. *Am. Mach.* **60**, 369 (1924).
- [4] H. L. Whittemore, G. W. Nusbaum, and E. O. Seaquist, The relation of torque to tension for threadlocking devices. *B. S. Jour., Res.*, **7**, 945 (1931), RP 386.
- [5] J. N. Goodier, The distribution of load on the threads of screws. *Trans. ASME*, **62**, A-10 (1940).
- [6] J. O. Almen, How tight should a bolt be? *Fasteners*, **1**, 1, 16 (1944), **1**, 2, 14 (1944).
- [7] W. C. Stewart, What torque? *Fasteners*, **1**, 4, 8 (1940).
- [8] L. H. Carr, Draw up flange bolts more uniformly. *Fasteners*, **3**, 4, 7 (1946); *Power*, Feb. 1946.
- [9] G. A. Maney, Predicting bolt tension. *Fasteners*, **3**, 5, 16 (1946).
- [10] V. E. Hillman, Engineering aspects of bolt variables. *Iron Age*, **160**, 62 (1947).

- [11] A. W. Brunot and W. G. Schmittner, Studies of the bolting of a fabricated steam chest. *Fasteners*, **3**, 5, 16 (1947).
- [12] K. H. Lenzen, Strength and clamping force of bolts. *Prod. Eng.*, **18**, 130 (1947).
- [13] M. P. Milliken, How tight is too tight? *Fasteners*, **6**, 1, 14 (1949).
- [14] W. F. Pickel, Tightening characteristics of nut and stud assemblies, *Fasteners*, **6**, 1, 10 (1949).
- [15] W. C. Stewart, Torque for bolts and nuts. *Fasteners*, **10**, 1, 12 (1955).
- [16] Walter M. Hanneman, The simultaneous measurement of torque and tension in machine screws. *Fasteners*, **12**, 2 and 3, 4 (1957).
- [17] Richard H. Skidmore, New bolt tension calibrator. *Fasteners*, **13**, 2, 7 (1958).
- [18] Richard B. Belford, A review of the use of structural fasteners for greatest economy, safety, and dependability. *Fasteners*, **14**, 2 and 3, 5 (1959).

APPENDIX 13. THREE-WIRE METHOD OF MEASUREMENT OF PITCH DIAMETER OF 29° ACME, 29° STUB ACME, AND BUTTRESS THREADS²

The computed value for the pitch diameter of a screw thread gage obtained from readings over wires will depend upon the accuracy of the measuring instrument used, the contact load, and the value of the diameter of the wires used in the computations. In order to measure the pitch diameter of a screw-thread gage to an accuracy of 0.0001 inch by means of wires, it is necessary to know the wire diameters to 0.00002 in. Accordingly, it is necessary to use a measuring instrument which reads accurately to 0.00001 in.

Variations in diameter around the wire should be determined by rotating the wire between a measuring contact and an anvil having the form of a V-groove cut on a cylinder and having the same flank angles, 14°30', as the thread to be measured. As thus measured the limit on roundness deviation shall be 0.00005 in.

To avoid a permanent deformation of the material of the wires and gages it is necessary to limit the contact load, and for consistent results a standard practice as to contact load in making wire measurements of hardened screw thread gages is necessary.

In the case of Acme threads the wire presses against the sides of the thread with a pressure of approximately twice that of the measuring instrument. This would indicate that the diameter of the wires should be measured against a hardened cylinder having a radius equal to the radius of curvature of the helical surface of the thread at the point of contact, using approximately twice the load to be used in making pitch diameter readings. As with 60° threads it is not practical to use such a variety of sizes, and it is recommended that the measurements of wire diameter be made between a flat contact and a 0.750-in. hardened and accurately finished steel cylinder. To limit the tendency of the wires to wedge in and deform the sides of an Acme thread, it is recommended that pitch diameter measurements on 8 tpi and finer be made at 1 lb. For coarser pitches and larger wires the deformation of wires and threads is less than for finer pitches. Furthermore, the coarser pitches are used on larger and heavier product, on which the pitch diameter tolerance is greater and a larger measuring load may be required to make satisfactory measurements. It is, therefore, recommended that for tpi coarser than 8, the pitch diameter be measured at 2½ lb.

The standard specification for wires and standard practice in the measurement of wires stated in H28 (1957) Part I, Appendix 4, p. 196, are applicable to wires for Acme, Stub Acme, and Buttress threads, with the above-stated exceptions as to angle of V-groove and limit on roundness.

1. ACME AND STUB ACME THREADS (29°)

The combination of small flank angle and large lead angle that is characteristic of Acme threads results in a relatively large lead-angle correction to be applied in wire measurements of pitch diameter of such threads. In the case of multiple-start threads the geometry is such that it is no longer feasible to make the usual simplifying assumptions as to the positions of contact of the wire in the thread. Accordingly, in this appendix measurements of single-start threads (with lead angles generally less than 5°) are treated as they were in the 1950 Supplement to H28 (1944), whereas for threads having lead angles greater than 5° the necessary refinements in the calculations are presented.

(a) SINGLE-START EXTERNAL THREADS

The general formula³ is:

$$E = M_w + \frac{\cot \alpha}{2n} - w(1 + \operatorname{cosec} \alpha') \quad (1)$$

in which

E = pitch diameter,
 M_w = measurement over wires,
 α = half-angle of thread,
 n = threads per inch = 1/pitch,
 w = wire diameter,
 $\alpha' = \tan^{-1}(\tan \alpha \cos \lambda)$
 λ = lead angle at pitch diameter.

For a half-angle of 14°30', formula (1) takes the form

$$E = M_w + \frac{1.933\ 357}{n} - w(1 + \operatorname{cosec} \alpha') \quad (2)$$

The diameter, w , of the wires used should be as close as practicable to the size that will contact the flanks of the thread at the pitch line, to minimize errors caused by deviations of the flank angle from nominal value. The best-size wire, to be applied only where the lead angle does not exceed approximately 5°, may be taken as

$$w_b = \frac{\sec \alpha}{2n} = \frac{0.516\ 450}{n} \quad (3)$$

for which values are tabulated in table 13.1.

TABLE 13.1.—Wire sizes and constants, single-start Acme and Stub-Acme threads (29°)

Threads per inch	Pitch, $p = \frac{1}{n}$	Wire sizes ^a		
		Best, 0.516450p	Maximum, 0.630013p	Minimum, 0.487263p
1	2	3	4	5
16	<i>in.</i> 0.06250	<i>in.</i> 0.03228	<i>in.</i> 0.04063	<i>in.</i> 0.03045
14	.07143	.03689	.04643	.03480
12	.08333	.04304	.05417	.04061
10	.10000	.05164	.06300	.04873
9	.11111	.05738	.07222	.05414
8	.12500	.06456	.08125	.06091
7	.14286	.07378	.09286	.06961
6	.16667	.08608	.10834	.08121
5	.20000	.10329	.13000	.09745
4	.25000	.12911	.16250	.12182
3½	.28571	.14756	.18572	.13922
3	.33333	.17215	.21667	.16242
2½	.40000	.20658	.26001	.19491
2	.50000	.25822	.32501	.24363
1½	.66667	.34430	.43334	.32484
1¼	.75000	.38734	.48751	.36545
1⅓	.75000	.38734	.48751	.36545
1	1.00000	.51645	.63001	.48726

^a Based on zero lead angle.

³ Equation (2), H28 (1957) Part I, p. 197.

² See Appendix 4, Part I, parts of which are applicable to this appendix.

For standard diameter-pitch combinations of Acme or Stub Acme threads, and if the best-size wire is used, the computations are simplified by the use of tables 13.2 or 13.3, thus

$$E = M_w - \text{col. 7,} \quad (4)$$

or, if E differs appreciably from the basic value given in column 3,

$$E = M_w - \text{col. 7} - 100 (\text{col. 3} - E_1) \text{ col. 8,} \quad (5)$$

where $E_1 = M_w - \text{col. 7.}$

If the measured wire diameter, w' , differs slightly (not more than 0.0003 in.) from the best size, w , shown in column 4

$$E = M_w - \text{col. 7} - 5 (w' - w) - 100 (\text{col. 3} - E_1) \text{ col. 8.} \quad (6)$$

However, the correction derived from column 8 is seldom significant in amount for standard diameter-pitch combinations.

Values of the term $(1 + \text{cosec } \alpha')$ are given in table for use when threads of other than standard diameter combinations are to be measured. Values for intermediate lead angles may be determined by interpolation.

The three-wire measurement of Stub Acme threads corresponds to that of 29° Acme threads. However, because of the shallower root on the Stub Acme threads, no smaller wire than the best-size wire given in table 13.3 shall be used. There can be instances when the best-size wire will touch the thread root. Hence, a check should always be made to ensure that the wires do not touch the thread root.

(b) MULTIPLE-START EXTERNAL THREADS

Multiple-start threads commonly have lead angles greater than 5°. In those exceptional cases that have smaller lead angles the procedures described above may be applied. For larger lead angles there are two procedures available that give almost identical results; that is the discrepancy between the values obtained for the

TABLE 13.2.—Values for wire measurements of single-start standard Acme threads (29°)

Sizes	Threads per inch	Basic pitch diameter	Best wire size, $w = \frac{0.516450}{n}$	$\frac{\cot 14^\circ 30'}{2n}$	$w(1 + \text{cosec } \alpha')$	Col. 6 minus col. 5 ^a	Change in cols. 6 and 7 per 0.01 in. change in pitch diameter (col. 3)
1	2	3	4	5	6	7	8
All general purpose and classes 2C, 3C, and 4C centralizing							
<i>in.</i>	<i>in.</i>	<i>in.</i>	<i>in.</i>	<i>in.</i>	<i>in.</i>	<i>in.</i>	<i>in.</i>
1/4	16	0.2188	0.03228	0.120835	0.161704	0.040869	0.000049
5/16	14	.2768	.03689	.138097	.184692	.046595	.000036
3/8	12	.3333	.04304	.161113	.215448	.054335	.000032
7/16	12	.3958	.04304	.161113	.215300	.054187	.000019
1/2	10	.4500	.05164	.193336	.258370	.065034	.000022
5/8	8	.5625	.06456	.241670	.323013	.081343	.000022
3/4	6	.6667	.08608	.322226	.430898	.108672	.000030
7/8	6	.7917	.08608	.322226	.430601	.108375	.000022
1	5	.9000	.10329	.386671	.516791	.130120	.000019
1 1/8	5	1.0250	.10329	.386671	.516567	.129896	.000014
1 1/4	5	1.1500	.10329	.386671	.516412	.129741	.000011
1 3/8	4	1.2500	.12911	.483339	.645744	.162405	.000014
1 1/2	4	1.3750	.12911	.483339	.645575	.162236	.000014
1 3/4	4	1.6250	.12911	.483339	.645346	.162007	.000006
2	4	1.8750	.12911	.483339	.645202	.161863	.000005
2 1/4	3	2.0833	.17215	.644452	.860541	.216089	.000007
2 1/2	3	2.3333	.17215	.644452	.860368	.215916	.000005
2 3/4	3	2.5833	.17215	.644452	.860247	.215795	.000003
3	2	2.7500	.25822	.966678	1.291149	.324471	.000010
3 1/2	2	3.2500	.25822	.966678	1.290694	.324016	.000008
4	2	3.7500	.25822	.966678	1.290403	.323725	.000004
4 1/2	2	4.2500	.25822	.966678	1.290210	.323532	.000004
5	2	4.7500	.25822	.966678	1.290075	.323395	.000003
Classes 5C and 6C centralizing							
1/2	10	.4323	.05164	.193336	.258410	.065074	.000022
5/8	8	.5427	.06456	.241670	.323057	.081387	.000022
3/4	6	.6451	.08608	.322226	.430964	.108738	.000030
7/8	6	.7683	.08608	.322226	.430653	.108427	.000022
1	5	.8750	.10329	.386671	.516846	.130175	.000019
1 1/8	5	.9985	.10329	.386671	.516606	.129935	.000015
1 1/4	5	1.1220	.10329	.386671	.516443	.129772	.000011
1 3/8	4	1.2207	.12911	.483339	.645774	.162435	.000014
1 1/2	4	1.3444	.12911	.483339	.645618	.162279	.000014
1 3/4	4	1.5919	.12911	.483339	.645366	.162027	.000006
2	4	1.8396	.12911	.483339	.645221	.161882	.000005
2 1/4	3	2.0458	.17215	.644452	.860570	.216118	.000007
2 1/2	3	2.2938	.17215	.644452	.860389	.215937	.000005
2 3/4	3	2.5418	.17215	.644452	.860260	.215808	.000003
3	2	2.7667	.25822	.966678	1.291198	.324520	.000010
3 1/2	2	3.2032	.25822	.966678	1.290733	.324055	.000008
4	2	3.7000	.25822	.966678	1.290422	.323744	.000004
4 1/2	2	4.1970	.25822	.966678	1.290229	.323551	.000004
5	2	4.6941	.25822	.966678	1.290093	.323415	.000003

^a Given to six decimal places for purposes of computation. After subtracting from M_w the final result should be rounded to four places.

TABLE 13.3.—Values for wire measurements of single-start standard Stub Acme threads (29°)

Sizes	Threads per inch	Basic pitch diameter	Best wire size, $w = \frac{0.516450}{n}$	$\cot 14^\circ 30'$ $\frac{1}{2n}$	$w(1+\operatorname{cosec}\alpha')$	Col. 6 minus col. 5 ^a	Change in cols. 6 and 7 per 0.01 in. change in pitch diameter (col. 3,
1	2	3	4	5	6	7	8
<i>in.</i>		<i>in.</i>	<i>in.</i>		<i>in.</i>		<i>in.</i>
1/4	16	0.2312	0.03228	0.120835	0.161422	0.040587	0.000044
5/16	14	.2911	.03689	.138097	.184647	.046550	.000031
3/8	12	.3500	.04304	.161113	.215407	.054294	.000025
7/16	12	.4125	.04304	.161113	.215477	.054364	.000018
1/2	10	.4700	.05164	.193336	.258329	.064993	.000021
5/8	8	.5875	.06456	.241670	.322961	.081291	.000021
3/4	6	.7000	.08608	.322226	.430800	.108574	.000030
7/8	6	.8250	.08608	.322226	.430542	.108316	.000019
1	5	.9400	.10329	.386671	.516707	.130036	.000021
1 1/8	5	1.0650	.10329	.386671	.516620	.129949	.000014
1 1/4	5	1.1900	.10329	.386671	.516356	.129685	.000014
1 3/8	4	1.3000	.12911	.483339	.645669	.162330	.000014
1 1/2	4	1.4250	.12911	.483339	.645518	.162179	.000012
1 3/4	4	1.6750	.12911	.483339	.645310	.161971	.000007
2	4	1.9250	.12911	.483339	.645178	.161839	.000005
2 1/4	3	2.1500	.17215	.644452	.860533	.216081	.000004
2 1/2	3	2.4000	.17215	.644452	.860332	.215880	.000005
2 3/4	3	2.6500	.17215	.644452	.860218	.215766	.000004
3	2	2.8500	.25822	.966678	1.291035	.324357	.000011
3 1/2	2	3.3500	.25822	.966678	1.290620	.323942	.000007
4	2	3.8500	.25822	.966678	1.290356	.323678	.000004
4 1/2	2	4.3500	.25822	.966678	1.290176	.323498	.000003
5	2	4.8500	.25822	.966678	1.290049	.323371	.000003

^a Given to six decimal places for purposes of computation. After subtracting from M_w the final result should be rounded to four places.

lead angle correction, c , is well within the possible observational error in making the measurement of pitch diameter. The methods are those of Marriner and Wood [26],⁴ based on the analytical approach of Gary [22] and of Vogel [21].

It is necessary to determine the best-wire size for the individual thread, as this size is dependent on the lead angle of the thread. This determination is simplified by extracting from table 13.5 the wire diameter (interpolating if necessary) for a 1-in. axial pitch screw and dividing by the threads per inch [15]. Thus,

$$w = w_1/n \quad (7)$$

The pitch diameter is given by formulas, as follows:

$$E = M_w - (C + c) \quad (8)$$

where E = pitch diameter

$$M_w = \text{measurement over wires}$$

$$C = w(1 + \operatorname{cosec} \alpha) - (\cot \alpha)/2n \quad (9)$$

$$= 4.993\ 929w - 1.933\ 357/n$$

$$c = 2(OP - OO) \text{ of figure 13.1} \quad (10)$$

Tabular values for $(C + c)_1$ for a 1-in. axial pitch screw are also given in table 13.5 and references [15] and [21], which should be divided by the threads per inch for a given case.

In figure 13.1 the actual points of contact of the wire with the thread flanks are at A and B. Under certain conditions a wire may contact one flank at two points, in which case it is advisable to use a ball, equal in diameter to the wire. The value of c is the same for a ball as for a wire. The conditions determining single or double contact are dealt with below.

TABLE 13.4—Values of $(1 + \operatorname{cosec} \alpha')$ for $\alpha = 14^\circ 30'$ and lead angles from 0 to 5°

Lead angle, λ	$1 + \operatorname{cosec} \alpha'$	Difference	Lead angle, λ	$1 + \operatorname{cosec} \alpha'$	Difference
1	2	3	1	2	3
<i>deg min</i>			<i>deg min</i>		
0 0	4.99393	0	2 30	4.99748	24
5	393	1	35	772	25
10	394	2	40	797	26
15	396	3	45	823	27
20	399	4	50	850	27
25	403	4	55	877	28
30	407	5	3 0	905	29
35	412	5	5	934	30
40	418	6	10	964	31
45	425	7	15	995	31
50	432	7	20	5.00026	32
55	440	8	25	058	33
30	407	9	30	091	34
35	412	10	35	125	35
40	418	11	40	160	35
45	425	11	45	195	35
50	432	11	50	231	36
55	440	12	55	268	37
1 0	449	13	0	306	38
5	459	14	4 0	306	39
10	470	15	5	345	39
15	481	15	10	384	39
20	493	16	15	424	40
25	506	17	20	465	41
30	520	17	25	507	42
35	535	18	30	550	43
40	550	18	35	593	43
45	566	19	40	637	44
50	583	19	45	682	45
55	601	19	50	728	46
2 0	620	19	55	775	47
5	639	20	0	823	48
10	659	20	5 0	871	48
15	680	21	10	920	49
20	702	22			
25	725	23			

⁴ See references listed in the bibliography at the end of this appendix.

To evaluate c

$$OP = \gamma \cos \alpha \cos \beta + \frac{w \left(\frac{l}{2\pi} \sin \beta + \gamma \sin \alpha \cos \beta \right)}{\sqrt{\gamma^2 + \left(\frac{l}{2\pi} \right)^2}} \quad (11)$$

$$OQ = R + \frac{w}{2} \operatorname{cosec} \alpha \quad (12)$$

γ = distance from contact point A to a point L on the thread axis, measured parallel to an element of the thread flank, in the axial plane containing LA .

β = (designated the "key angle" by Vogel) angle in a plane perpendicular to the thread axis between lines connecting the point O on the thread axis, to the axis of the wire (or center of the ball) and to the point of contact of the wire and thread flank, respectively.

The values of β and γ are determined by the following equations:

$$\sin \beta = \frac{w \left(\frac{l \cos \beta}{2\pi \gamma \cos \alpha} - \tan \alpha \sin \beta \right)}{\sqrt{\gamma^2 + \left(\frac{l}{2\pi} \right)^2}} \quad (13)$$

$$\gamma = \frac{R}{\cos \alpha} + \frac{\left(\frac{w}{2} \gamma \cot \alpha \right)}{\sqrt{\gamma^2 + \left(\frac{l}{2\pi} \right)^2}} + \frac{l\beta}{2\pi \sin \alpha} \quad (14)$$

These are simultaneous equations in β and γ which cannot be solved directly but can be solved by iteration. Letting $\beta = 0$, the first approximation for γ is

$$\gamma_0 = R \sec \alpha + \frac{w}{2} \cot \alpha \quad (15)$$

TABLE 13.5.—Best wire diameters and constants for large lead angles, 1-in. axial pitch Acme and Stub Acme threads (29°)

Lead angle, λ	1-start threads		2-start threads		Lead angle, λ	2-start threads		3-start threads	
	w_1	$(C+c)_1$	w_1	$(C+c)_1$		w_1	$(C+c)_1$	w_1	$(C+c)_1$
1	2	3	4	5	1	4	5	6	7
<i>deg</i>	<i>in.</i>	<i>in.</i>	<i>in.</i>	<i>in.</i>	<i>deg</i>	<i>in.</i>	<i>in.</i>	<i>in.</i>	<i>in.</i>
5.0	0.51450	0.64311	0.51443	0.64250	10.0	0.50864	0.63518	0.50847	0.63463
5.1	.51442	.64301	.51435	.64279	10.1	.50849	.63498	.50831	.63442
5.2	.51435	.64291	.51427	.64268	10.2	.50834	.63478	.50815	.63420
5.3	.51427	.64282	.51418	.64256	10.3	.50818	.63457	.50800	.63399
5.4	.51419	.64272	.51410	.64245	10.4	.50802	.63436	.50784	.63378
5.5	.51411	.64261	.51401	.64233	10.5	.50786	.63416	.50768	.63356
5.6	.51403	.64251	.51393	.64221	10.6	.50771	.63395	.50751	.63333
5.7	.51395	.64240	.51384	.64209	10.7	.50755	.63375	.50735	.63311
5.8	.51386	.64229	.51375	.64196	10.8	.50739	.63354	.50718	.63288
5.9	.51377	.64218	.51366	.64184	10.9	.50723	.63333	.50701	.63265
6.0	.51368	.64207	.51356	.64171	11.0	.50707	.63313	.50684	.63242
6.1	.51359	.64195	.51346	.64157	11.1	.50691	.63292	.50667	.63219
6.2	.51350	.64184	.51336	.64144	11.2	.50674	.63271	.50649	.63195
6.3	.51340	.64172	.51327	.64131	11.3	.50658	.63250	.50632	.63172
6.4	.51330	.64160	.51317	.64117	11.4	.50641	.63228	.50615	.63149
6.5	.51320	.64147	.51306	.64103	11.5	.50623	.63206	.50597	.63126
6.6	.51310	.64134	.51296	.64089	11.6	.50606	.63184	.50579	.63102
6.7	.51300	.64122	.51285	.64075	11.7	.50589	.63162	.50561	.63078
6.8	.51290	.64110	.51275	.64061	11.8	.50571	.63140	.50544	.63055
6.9	.51280	.64097	.51264	.64046	11.9	.50553	.63117	.50526	.63031
7.0	.51270	.64085	.51254	.64032	12.0	.50535	.63095	.50507	.63006
7.1	.51259	.64072	.51243	.64017	12.1	.50517	.63072	.50488	.62981
7.2	.51249	.64060	.51232	.64002	12.2	.50500	.63050	.50470	.62956
7.3	.51238	.64047	.51221	.63987	12.3	.50482	.63027	.50451	.62931
7.4	.51227	.64034	.51209	.63972	12.4	.50464	.63004	.50432	.62906
7.5	.51217	.64021	.51198	.63957	12.5	.50445	.62981	.50413	.62881
7.6	.51206	.64008	.51186	.63941	12.6	.50427	.62958	.50394	.62856
7.7	.51196	.63996	.51174	.63925	12.7	.50408	.62934	.50375	.62830
7.8	.51186	.63983	.51162	.63909	12.8	.50389	.62911	.50356	.62805
7.9	.51175	.63970	.51150	.63892	12.9	.50371	.62888	.50336	.62779
8.0	.51164	.63957	.51138	.63876	13.0	.50352	.62865	.50316	.62752
8.1	.51153	.63944	.51125	.63859	13.1	.50333	.62841	.50295	.62725
8.2	.51142	.63930	.51113	.63843	13.2	.50313	.62817	.50275	.62699
8.3	.51130	.63916	.51101	.63827	13.3	.50293	.62792	.50255	.62672
8.4	.51118	.63902	.51088	.63810	13.4	.50274	.62768	.50235	.62646
8.5	.51105	.63887	.51075	.63793	13.5	.50254	.62743	.50214	.62619
8.6	.51093	.63873	.51062	.63775	13.6	.50234	.62718	.50194	.62592
8.7	.51081	.63859	.51049	.63758	13.7	.50215	.62694	.50173	.62564
8.8	.51069	.63845	.51035	.63740	13.8	.50195	.62670	.50152	.62537
8.9	.51057	.63831	.51022	.63722	13.9	.50175	.62645	.50131	.62509
9.0	.51044	.63817	.51008	.63704	14.0	.50155	.62621	.50110	.62481
9.1	.51032	.63802	.50993	.63685	14.1	.50135	.62596	.50089	.62453
9.2	.51019	.63788	.50979	.63667	14.2	.50115	.62571	.50068	.62425
9.3	.51006	.63774	.50965	.63649	14.3	.50094	.62546	.50046	.62397
9.4	.50993	.63759	.50951	.63630	14.4	.50073	.62520	.50024	.62368
9.5	.50981	.63744	.50937	.63612	14.5	.50051	.62494	.50003	.62340
9.6	.50968	.63730	.50922	.63593	14.6	.50030	.62468	.49981	.62312
9.7	.50955	.63715	.50908	.63574	14.7	.50009	.62442	.49959	.62283
9.8	.50941	.63700	.50893	.63555	14.8	.49988	.62417	.49936	.62253
9.9	.50927	.63685	.50879	.63537	14.9	.49966	.62391	.49914	.62224
10.0	.50913	.63670	.50864	.63518	15.0	.49945	.62365	.49891	.62195

This approximate value of γ is entered in the right-hand side of eq (13) to obtain a new value of $\beta = \beta_1$. Then this new value of β is entered in the right-hand side of eq (14), together with the first approximation of γ to obtain a new value of $\gamma = \gamma_1$. Then γ_1 and β_1 are entered in eq (13) to obtain a new $\beta = \beta_2$. This process is repeated until the values of β and γ repeat themselves to the required degree of accuracy. Their final values are then entered in eq (11) and (12) to obtain the lead angle correction given by eq (10).

The following calculation exemplifies the process, and the result may be compared with that obtained for the same example by the Vogel method [21] or the Van Keuren method utilizing tables [15, 21].

$1\frac{1}{8}'' - 5$, 4 start 29° Acme screw thread
 $E = 1.025$, nominal,
 $l = 0.800$,

$p = 0.200$,
 $\lambda = 13.951927^\circ$,
 $w = 0.10020$ (from table 13.5, p. 57, [15, 21],
 $\alpha = 14.5^\circ$,
 $\sin \alpha = 0.25038$ 00041,
 $\cos \alpha = .96814$ 76404,
 $\tan \alpha = .25861$ 75844,
 $\cot \alpha = 3.86671$ 30949,
 $\sec \alpha = 1.03290$ 03122,
 $\operatorname{cosec} \alpha = 3.99392$ 91629,
 $1/\pi = .31830$ 98862,
 $R = .31916$ 43455,
 $l/2\pi = .12732$ 39545,
 $(l/2\pi)^2 = .01621$ 13939,
 $l/(2\pi \sin \alpha) = .50852$ 28550,
 $l/(2\pi \cos \alpha) = .13151$ 29523,
 $R/\cos \alpha = .32966$ 49520,
 $\gamma_0 = .27393$ 42429.

TABLE 13.5.—Best wire diameters and constants for large lead angles, 1-in. axial pitch Acme and Stub Acme threads (29°)—Con.

Lead angle, λ	3-start threads		4-start threads		Lead angle, λ	3-start threads		4-start threads	
	w_1	$(C+c)_1$	w_1	$(C+c)_1$		w_1	$(C+c)_1$	w_1	$(C+c)_1$
1	6	7	8	9	1	6	7	8	9
<i>deg</i>	<i>in.</i>	<i>in.</i>	<i>in.</i>	<i>in.</i>	<i>deg</i>	<i>in.</i>	<i>in.</i>	<i>in.</i>	<i>in.</i>
13.0	0.50316	0.62752	0.50297	0.62694	18.0	0.49154	0.61250	0.49109	0.61109
13.1	.50295	.62725	.50277	.62667	18.1	.49127	.61216	.49082	.61073
13.2	.50275	.62699	.50256	.62639	18.2	.49101	.61182	.49054	.61037
13.3	.50255	.62672	.50235	.62611	18.3	.49074	.61148	.49027	.61001
13.4	.50235	.62646	.50215	.62583	18.4	.49047	.61114	.48999	.60964
13.5	.50214	.62619	.50194	.62555	18.5	.49020	.61080	.48971	.60928
13.6	.50194	.62592	.50173	.62526	18.6	.48992	.61045	.48943	.60891
13.7	.50173	.62564	.50152	.62498	18.7	.48965	.61011	.48915	.60854
13.8	.50152	.62537	.50131	.62469	18.8	.48938	.60976	.48887	.60817
13.9	.50131	.62509	.50109	.62440	18.9	.48910	.60941	.48859	.60780
14.0	.50110	.62481	.50087	.62411	19.0	.48882	.60906	.48830	.60742
14.1	.50089	.62453	.50065	.62381	19.1	.48854	.60871	.48800	.60704
14.2	.50068	.62425	.50043	.62351	19.2	.48825	.60835	.48771	.60666
14.3	.50046	.62397	.50021	.62321	19.3	.48797	.60799	.48742	.60628
14.4	.50024	.62368	.49999	.62291	19.4	.48769	.60764	.48713	.60590
14.5	.50003	.62340	.49977	.62262	19.5	.48741	.60729	.48684	.60552
14.6	.49981	.62312	.49955	.62232	19.6	.48712	.60693	.48655	.60514
14.7	.49959	.62283	.49932	.62202	19.7	.48683	.60657	.48625	.60475
14.8	.49936	.62253	.49910	.62172	19.8	.48655	.60621	.48596	.60437
14.9	.49914	.62224	.49885	.62141	19.9	.48626	.60585	.48566	.60398
15.0	.49891	.62195	.49864	.62110	20.0	.48597	.60549	.48536	.60359
15.1	.49869	.62166	.49842	.62080	20.1	-----	-----	.48506	.60320
15.2	.49846	.62137	.49819	.62049	20.2	-----	-----	.48476	.60281
15.3	.49824	.62108	.49795	.62017	20.3	-----	-----	.48445	.60241
15.4	.49801	.62078	.49771	.61985	20.4	-----	-----	.48415	.60202
15.5	.49778	.62048	.49747	.61953	20.5	-----	-----	.48384	.60162
15.6	.49754	.62017	.49723	.61921	20.6	-----	-----	.48354	.60123
15.7	.49731	.61987	.49699	.61889	20.7	-----	-----	.48323	.60083
15.8	.49707	.61956	.49675	.61857	20.8	-----	-----	.48292	.60042
15.9	.49683	.61926	.49651	.61825	20.9	-----	-----	.48261	.60002
16.0	.49659	.61895	.49627	.61793	21.0	-----	-----	.48230	.59961
16.1	.49635	.61864	.49602	.61760	21.1	-----	-----	.48198	.59920
16.2	.49611	.61833	.49577	.61727	21.2	-----	-----	.48166	.59879
16.3	.49586	.61801	.49552	.61694	21.3	-----	-----	.48134	.59838
16.4	.49562	.61770	.49527	.61661	21.4	-----	-----	.48103	.59797
16.5	.49537	.61738	.49502	.61628	21.5	-----	-----	.48071	.59756
16.6	.49512	.61706	.49476	.61594	21.6	-----	-----	.48040	.59715
16.7	.49488	.61675	.49451	.61560	21.7	-----	-----	.48008	.59674
16.8	.49463	.61643	.49425	.61526	21.8	-----	-----	.47975	.59632
16.9	.49438	.61611	.49400	.61492	21.9	-----	-----	.47943	.59590
17.0	.49414	.61580	.49375	.61458	22.0	-----	-----	.47910	.59548
17.1	.49389	.61548	.49349	.61424	22.1	-----	-----	.47878	.59507
17.2	.49363	.61515	.49322	.61389	22.2	-----	-----	.47845	.59465
17.3	.49337	.61482	.49296	.61354	22.3	-----	-----	.47812	.59422
17.4	.49311	.61449	.49269	.61319	22.4	-----	-----	.47778	.59379
17.5	.49285	.61416	.49243	.61284	22.5	-----	-----	.47745	.59336
17.6	.49259	.61383	.49217	.61250	22.6	-----	-----	.47711	.59293
17.7	.49233	.61350	.49191	.61215	22.7	-----	-----	.47677	.59250
17.8	.49206	.61316	.49164	.61180	22.8	-----	-----	.47643	.59207
17.9	.49180	.61283	.49137	.61144	22.9	-----	-----	.47610	.59164
-----	-----	-----	-----	-----	23.0	-----	-----	.47577	.59121

NOTE.—This table courtesy of the Van Keuren Co.

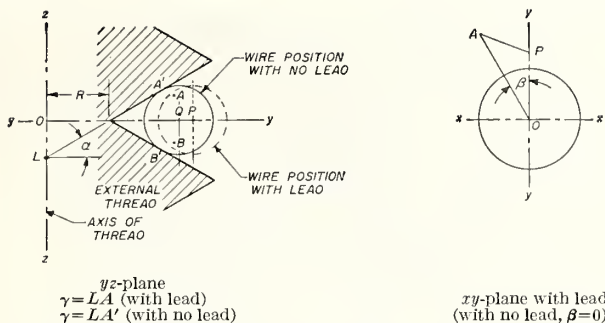

FIGURE 13.1.—Basis of lead angle correction for external thread.

$\sqrt{\gamma^2 + \left(\frac{l}{2\pi}\right)^2}$	$\sin \beta$	β (radians)	$\cos \beta$	γ
0.53865 168	0.02337 088	0.02337 301	0.99972 686	0.52978 325
.54486 850	.02226 331	.02226 515	.99975 214	.52934 621
.54441 357	.02232 647	.02232 833	.99975 073	.52936 984
.54446 655	.02232 298	.02232 483	.99975 081	.52936 853
.54446 526	.02232 317	.02232 502	.99975 081	.52936 860
.54446 5336	.02232 3160	.02232 5012	.99975 0807	.52936 8598

$$OP = 0.52483 3962$$

$$OQ = 0.51926 0196$$

$$c = 0.01114 8$$

$$2 OP = 1.04966 79 = \text{nominal measurement between centers of wires}$$

$$M_w = 2 OP + w = 1.149 868 \text{ in.} = \text{nominal measurement over wires}$$

$$M_w = 1.149 868 = \text{actual measurement over wires}$$

$$E = 1.149 868 - (C + c), \text{ (see equations 8 and 9)}$$

$$C = 4.993 929 \times 0.100 20 - 1.933 357/5 = 0.113 720$$

$$C + c = 0.113 720 + 0.011 148 = 0.124 868$$

$$E = 1.149 868 - 0.124 868 = 1.025 000 \text{ (as measured)}$$

If instead of the Marriner and Wood equations those of Vogel are applied we have

$$\sigma - \beta = \frac{\cot^2 \lambda}{\cot \beta - \frac{\tan \alpha}{\tan \lambda}} \quad (16)$$

where

$$\sigma = \frac{\pi}{2N_s}$$

N_s = number of starts

λ = lead angle at pitch line

α = half angle of thread in axial plane.

This equation may likewise be solved for β by iteration, but various short cuts are presented in reference [21], including a short, highly accurate, and nontranscendent formula for β . The value of β in the above example which satisfies this equation is 0.02232 480 radian, as compared with 0.02232 501 obtained with the Marriner and Wood formulas. The measurement to the center of the wires is given by the Vogel formula

$$2 OP = E \tan^2 \lambda (\sigma - \beta) \operatorname{cosec} \beta = 1.0496 522 \text{ in.},$$

which is 0.0000 157 smaller than the value (1.0496 679) obtained by the Marriner and Wood formulas. As this discrepancy is small compared with the possible error in measurement of M_w , either set of formulas is applicable. Also, the discrepancy between the value of $(C + c)$ by the Marriner and Wood formulas and that extracted from table 13.5 is only 0.000 018 in.

(c) LIMITATIONS ON THREE-WIRE MEASUREMENT OF EXTERNAL THREADS

When the lead angle and diameter of a thread are such that double contact of the measuring wires occurs, it will be necessary to check the pitch diameter by means of balls rather than wires.

For accurate measurement with wires single contact on each flank must occur. Measuring wires can be used if the following formula [26] is satisfied for a specific thread:

$$\tan \alpha > \frac{l}{\pi} \sqrt{1 / \left(R + \frac{w}{2} \cos \alpha \cot \alpha \right)^2 - 4/D^2}, \quad (17)$$

in which

α = half angle of thread in an axial plane

l = lead

R = distance from thread axis to sharp root (see fig. 13.1)

w = diameter of measuring wires

D = major diameter of thread

If best-size wires are used, so that contact is near the pitch line, the condition for single contact simplifies to:

$$\tan \alpha > \frac{2l}{\pi} \sqrt{\frac{1}{E^2} - \frac{1}{D^2}}. \quad (18)$$

On account of the approximate nature of the above formulas, double contact does not necessarily occur when these formulas are not satisfied. If not satisfied the following formula can be used for a more precise determination:

$$\frac{D}{2} \tan \alpha - \gamma_A \sin \alpha + \frac{l}{2\pi} (\beta_A - \beta_P) + \left(\gamma_A \sin \alpha \sin \beta_A - \frac{l}{2\pi} \cos \beta_A \right) \times \sec \beta_P \sin (\beta_A - \beta_P) > 0 \quad (19)$$

in which,

γ_A = final value for γ in the correction calculation (0.52936 8598 would be the γ_A for sample calculation, the results of which are shown above.)

β_A = final value for β in the correction calculation.

$\beta_P = \cos^{-1} (2\gamma_A \cos \alpha \cos \beta_A / D)$ and is a negative angle.

If the formula is satisfied, double contact does not occur.

2. BUTTRESS THREADS

Two optional procedures are used in determining the pitch diameter of external threads from the reading over the wires, M_w . The comparator reading M_w over the wires is checked using a gage block or combination as a master. Then, using the average diameter of the wires, w , the pitch diameter, E , is computed using the formula

$$E = M_w \frac{p}{\tan \alpha_1 \tan \alpha_2} - w \left(1 + \operatorname{cosec} \frac{\alpha_1 + \alpha_2}{2} \cos \frac{\alpha_1 - \alpha_2}{2} \right) - c. \quad (20)$$

When $\alpha_1 = 45^\circ$ and $\alpha_2 = 7^\circ$, this formula reduces to

$$E = M_w + 0.89064p - 3.15689w - c.$$

In the optional method, a reading M_D is taken over the wires placed on either side of a plain cylindrical plug gage of known diameter D . Then, the distance T between the wires as seated in the threads of the thread plug is computed by formula

$$T = D - M_D + M_w$$

and the formula for pitch diameter E becomes

$$E = T + \frac{p}{\tan \alpha_1 + \tan \alpha_2} - w \left(\operatorname{cosec} \frac{\alpha_1 + \alpha_2}{2} \cos \frac{\alpha_1 - \alpha_2}{2} - 1 \right) - c \quad (21)$$

or

$$E = T + 0.89064p - 1.15689w - c.$$

D should be slightly smaller than the major diameter of the thread plug gage to be measured.

In both formulas 20 and 21, c is a correction depending on the angle the wires make with a plane perpendicular to the axis of the thread plug gage. For all possible single-start combinations of diameters and pitches listed in tables XIV.2, XIV.3, and XIV.4, c is less than 0.0004 in. As Buttress threads are designed to avoid metal-to-metal fits in all cases, it is not essential that the absolute value of the pitch diameter be accurately determined by applying

the correction c . Accordingly, it is recommended that the wire angle correction be neglected for these combinations and all other single-start buttress thread plug gages.

However, if it is desired to take the lead-angle correction into account, the following formula to determine pitch diameter derived in reference [3] may be applied where the lead angle does not exceed 5° :

$$E = M_w + \frac{p \cos \alpha_1 \cos \alpha_2}{\sin(\alpha_1 + \alpha_2)} - w \left\{ 1 + \sqrt{(1 + \tan^2 \lambda) \cot^2 \alpha_1 + 1} - \frac{\cos \alpha_1 \sin \alpha_2}{\sin(\alpha_1 + \alpha_2)} \left[\sqrt{(1 + \tan^2 \lambda) \cot^2 \alpha_1 + 1} - \sqrt{(1 + \tan^2 \lambda) \cot^2 \alpha_2 + 1} \right] \right\} \quad (22)$$

where

α_1 = flank angle of pressure flank,
 α_2 = flank angle of trailing flank,
 λ = lead angle at pitch line.

For the $7^\circ, 45^\circ$ Buttress thread this formula becomes

$$E = M_w + 0.890643p - w \left\{ 1 + \sqrt{66.330378(1 + \tan^2 \lambda) + 1} - 0.890643 \left[\sqrt{66.330378(1 + \tan^2 \lambda) + 1} - \sqrt{\tan^2 \lambda + 1} \right] \right\} \quad (23)$$

For larger lead angles formulas may be applied that are derived in reference [22].

1. WIRE SIZES.—In order to eliminate the effect of deviations of the thread form on the calculated pitch diameter, the “best size” wires, for symmetrical threads, should contact the flanks of the thread at the pitch line. Because of the wide difference in the flank angles of a buttress thread it is impossible for the thread measuring wires to contact both flanks simultaneously at the pitch line.

A deviation in the angle α_1 of the trailing flank has approximately twice the effect on the pitch diameter calculated from readings over wires than the same angle deviation on the pressure flank angle, α_2 . For this reason it was decided that the diameter of the “best size” wire should be such that it will contact the pressure flank at a point twice the distance above the pitch line that the contact point on the trailing flank is below the pitch line. This wire diameter for flank angles $7^\circ, 45^\circ$ is given by

$$w_b = 0.54147p. \quad (24)$$

As shown in figure 13.2, the “best” size wire will contact the pressure flank of a thread of basic form $0.1944p$ below the thread crest, and the wire will project above the crest $0.1094p$. If this wire fails to project above the crest of the thread in an actual case, a larger wire must be used. For such a case the maximum wire, having a diameter of $0.61433p$, which contacts the trailing flank at the pitch line should be used. The relation of the “best” and “max” size wires to the flanks and crests of the $7^\circ, 45^\circ$ Buttress thread is shown in figure 13.2. The diameters of “best” and “max” wires and the projection above the crest of the thread are shown in table 13.6.

Because of the small pressure flank angle of 7° there may be double contact of the wire on this flank if the lead angle is more than a few degrees. Such double contact will introduce an error into the measurement of pitch diameter. Double contact is less likely with the “max” wire than with the “best” wire, as the former contacts this flank nearer the thread crest. Therefore, it is desirable in such cases to check the pitch diameter measurement obtained with “best” wires by measurement with “max” wires also. With large lead angles a further check should be made using balls instead of wires. Inconsistencies in results may indicate double contact of wires. If double contact occurs with max wires it will be necessary to make pitch diameter measurements by means of balls.

An alternative method for determining whether or not single contact occurs is to apply the Marriner and Wood [26] formula 19, p. 59, for the exact condition for single contact.

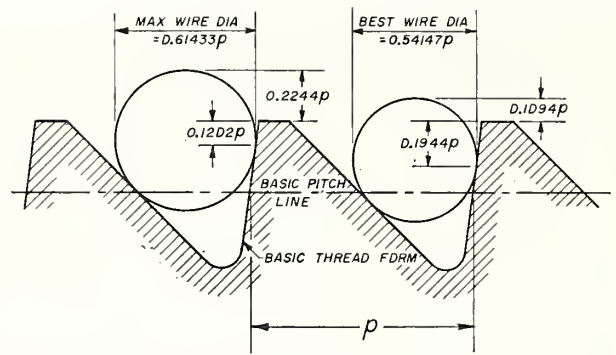

FIGURE 13.2.—Diameters of “best” and “maximum” thread wires for Buttress threads.

TABLE 13.6.—Wire sizes and constants, single-start Buttress threads ($7^\circ, 45^\circ$)

Threads per inch	Pitch, p	“Best” wire diameter, $w = 0.54147p$	Projection, $a = 0.1094p$	“Max” wire diameter, $w = 0.61433p$	Projection, $a' = 0.2244p$
	<i>in.</i>	<i>in.</i>	<i>in.</i>	<i>in.</i>	<i>in.</i>
20	0.05000	0.02707	0.0055	0.03072	0.0112
16	.06250	.03384	.0068	.03840	.0140
12	.08333	.04512	.0091	.05119	.0187
10	.10000	.05415	.0109	.06143	.0224
8	.12500	.06768	.0137	.07679	.0280
6	.16667	.09024	.0182	.10239	.0374
5	.20000	.10829	.0219	.12287	.0449
4	.25000	.13537	.0274	.15358	.0561
3	.33333	.18049	.0364	.20478	.0747
2½	.40000	.21659	.0438	.24573	.0898
2	.50000	.27074	.0547	.30716	.1122
1½	.66667	.36098	.0729	.40955	.1496
1¼	.80000	.43318	.0875	.49146	.1795
1	1.00000	.54147	.1094	.61433	.2244

3. BIBLIOGRAPHY ON MEASUREMENT OF PITCH DIAMETER BY MEANS OF WIRES

- [1] H.H. Jeffcott. Notes on screw threads, Proc. Inst. Mechanical Engineers, December 1907, 1067–1108. Reprinted in Collected Researches, The National Physical Laboratory, Vol. 5, (1909).
- [2] O. Eppenstein, Die optische Messung des Flankendurchmessers von Gewinden. Präzision, No. 25, 1922.
- [3] Derivation of the general formula for pitch diameter measured by the three-wire method. NBS Letter Circular LC 23, Appendix 1, (1923).
- [4] E. A. Limming, Normal thickness of a worm thread. Machinery (London), 21, 360 and 759 (1922); 22, 114 (1923).
- [5] E. A. Limming, Cylinders and spheres for gauging worm or screw threads. Machinery (N.Y.), 30, 466 (1924).
- [6] G. A. Tomlinson, Correction for elastic compression in the measurement of screws with small cylinders. Machinery (London) 28, 616 (1926).
- [7] G. A. Tomlinson, Correction for rake in screw thread measurement, Proc. Inst. Mechanical Engineers, December 1927, pp. 1031–1036.
- [8] G. Berndt, Die Messung konischer Gewinde. Neuss (1937).
- [9] Earle Buckingham, Pin method of measuring worms and helical gears, Machinery (N.Y.), 45, 1 (1938).
- [10] G. Berndt, Die Bestimmung des Flankendurchmessers von Gewinden mit symmetrischem Profil nach der Deridrahtmethode, Zeit. für Instrumentenkunde. 59, 439 (Nov. 1939).

- [11] N. Günther and H. Zöllner, Die Messung der Flankendurchmesser mehrgängiger Gewinde mit drei Drähten. *Feinmech. und Präz.*, **47**, 129 (1939).
- [12] G. Berndt, Die Anlagekorrekturen bei der Bestimmung des Flankendurchmessers von symmetrischen und unsymmetrischen Aussen- und Innengewinden nach der Dreidrahtmethode oder mittels zweier Kugeln. *Zeit. für Instrumentenkunde*, **60**, 14, 141, 177, 209, 237, 272, (1940); *Werkstattstechnik und Werksleiter*, **34**, 277 (1940).
- [13] D. E. Williamson, Effect of elastic modulus on measurement of thread wires, *Production Engineering and Management*, **18**, 1, (Aug. 1946).
- [14] Werner F. Vogel, The best wire for over wire measurement of general screws. The Van Keuren Co., Watertown, Mass. (Unpublished.)
- [15] H. L. Van Keuren, Tables for precise measurement of screws. *Catalog and Handbook No. 34*, The Van Keuren Co. (1948).
- [16] F. L. Litvin, Determination of the thickness of the teeth of worms and spiral-toothed wheels with the help of rollers and balls, (Unidentified Russian publication, July 6, 1950. Translation available at NBS and Van Keuren Co.).
- [17] M. Ogawa, On precision screw threads. Report of the Institute of Industrial Science, Univ. of Tokyo, **2**, No. 1, (April 1951).
- [18] Gauging and Measuring Screw Threads, Section VII, Formulae and corrections for use in the measurement of the effective diameter of parallel screw plug gauges by means of small cylinders. National Physical Laboratory, 1951.
- [19] F. Wolf, Prüfen und Messen von Gewinden. Munich (1952).
- [20] W. H. Harrison, Analysis of screw thread measurement. *Machinist*, **96**, 602 (1952).
- [21] Werner F. Vogel, New thread measuring formulas. *Catalog and Handbook No. 36*, Appendix D, The Van Keuren Co. (1955).
- [22] M. Gary, Die Berechnung der Gewinde-Anlagekorrekturen. Physikalisch-Technischen Bundesanstalt, Braunschweig, **21**, No. 4 (1955).
- [23] M. Gary, Geometrische Probleme bei der Vermessung von zylindrischen Evolventen-Schnecken und Evolventen-Schrägstirnrädern. *Konstruktion* **8**, No. 10, 412 (1956).
- [24] E. C. Varnum and S. J. Johnson, Precise formulas for overpin measurements of helical forms, Barber-Colman Co. (1957).
- [25] L. W. Nickols, Effect of differences between U.S. and British practices in measuring screw gages for Unified threads, *Machinery (Lond.)* **90**, 723 (1957).
- [26] R. S. Marriner and Mrs. J. G. Wood, Rake correction in the measurement of parallel external and internal screw threads. *Inst. of Mechanical Engineers, London*, (July 1958).

APPENDIX 14. METRIC SCREW THREAD STANDARDS

Metric-thread systems have been used in European Continental countries since 1848, particularly in France, Germany, and Switzerland. Efforts toward international unification of these systems led in 1898 to a conference in Zurich, Switzerland, which was attended by representatives from engineering societies and other technical organizations in France, Germany, Italy, the Netherlands, and Switzerland. Organizations in other countries such as the United States and Great Britain, were also invited but did not send delegates.

The Zurich Conference of 1898 adopted a system of metric threads which was practically the same as that previously developed in France by the Société d'Encour-

agement pour l'Industrie Nationale in 1894. This system became known as the "International System" and is usually designated as the "SI System" (from the French name, "Système Internationale"). This system was recommended for adoption by all countries where metric threads were used and covered a range of nominal diameters from 6 to 80 mm, inclusive, with associated (coarse) pitches. The threads were intended for use as fastening threads in machine construction and hence for application to the general types of screws, bolts, and nuts.

The need for metric coarse threads in sizes smaller than 6 mm and larger than 80 mm, and of metric fine threads, led a number of Continental European countries to extend the original SI series. However, these additional series showed differences in respect to nominal diameters, pitches, and diameter-pitch combinations. National standardizing bodies, organized in Europe during and after the first World War, made an effort to bring some order in these additional series. In 1926 the International Standards Association (ISA) was founded and one of its first technical committees dealt with metric threads.

At a conference held in Copenhagen in 1931, this committee succeeded in getting agreement in principle on five recommended series of metric threads, designated by the letters A to E. It took several more years to put the final touches on this unification plan, and ISA Bulletin 26, in which the recommended ISA series are listed, was not published until September, 1940. The original series of SI coarse threads was extended to diameters as large as 600 mm (about 24 in.), the pitch being 6 mm for all sizes above 80 mm. Therefore, the term "coarse" threads was avoided and the original SI series, with its upward and downward extensions, was designated as "ISA Series A." However, ISA Bulletin 26 and the national standards set up in accordance with it, explicitly refer to the ISA Series B to E, inclusive, as "fine threads."

The ISA became inactive in 1942 as a result of the second world war. Following the war the International Organization for Standardization (ISO) was established, and ISO/TC1, Screw Threads, held its first meeting at Paris in 1949. This technical committee subsequently developed recommendations for basic and design thread profiles, and standard series for metric and inch screw threads.

1. ISO THREAD PROFILES

The ISO basic profile for screw threads is shown on fig. 14.1. The ISO design profiles of external and internal

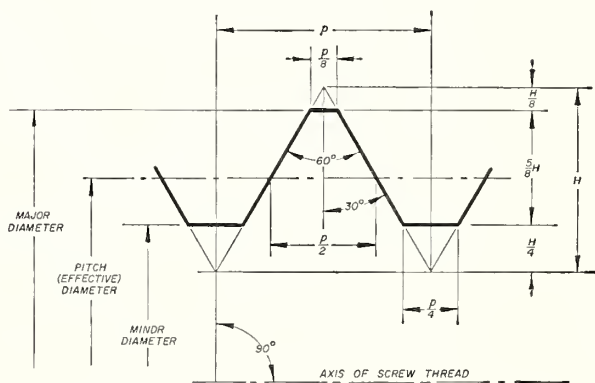

FIGURE 14.1.—ISO basic profile for inch and metric screw threads.

$$H = 0.86603p$$

$$\frac{H}{4} = 0.21651p$$

$$\frac{H}{8} = 0.10825p$$

$$\frac{5}{8}H = 0.54127p$$

The Basic Profile is the profile to which the allowances and tolerances, which define the limits of the external and internal threads, are applied.

threads, with and without an allowance, are shown on figures 14.2 and 14.3. These ISO basic and design profiles apply to inch as well as metric threads.

2. STANDARD SERIES FOR ISO METRIC THREADS

Shown in tables 14.1 and 14.2 are the standard series for ISO metric threads. Table 14.1 covers metric screw threads for general use. Table 14.2 covers metric screw threads for screws, bolts, and nuts.

3. DESIGNATIONS FOR ISO METRIC THREADS

ISO metric threads are designated by a letter followed by the size and the pitch as shown below. Where there is no indication of pitch, the coarse pitch is implied. For coarse threads with diameters up to and including 5 mm, the letter is S. For all other threads shown in the tables, the letter is M.

Examples:

M6×1 (indicates 6-mm diameter, 1-mm pitch)
S0.8 (indicates 0.8 diameter, coarse pitch).

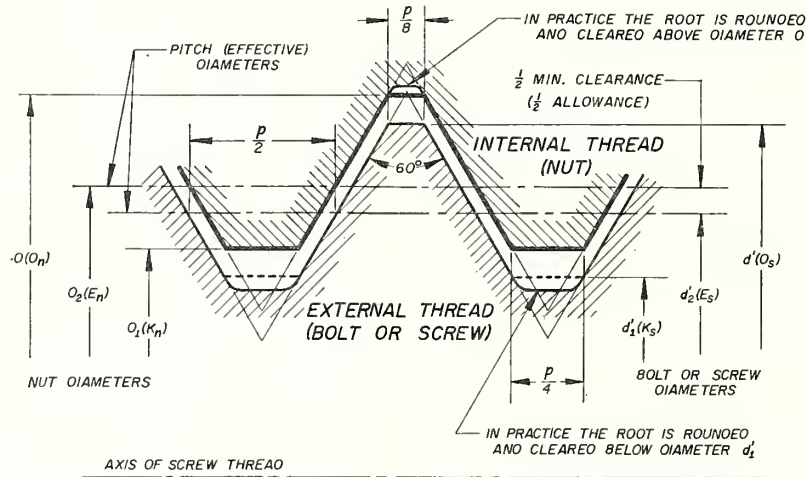

FIGURE 14.2.—ISO design profile of external and internal threads with an allowance for inch and metric screw threads.

(ISO Basic Profile shown by a thick line.)

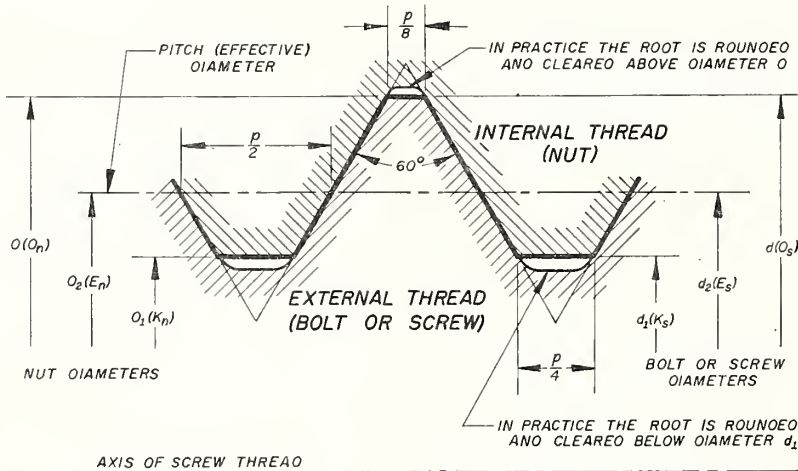

FIGURE 14.3.—ISO design profile of external and internal threads without an allowance for inch and metric screw threads.

(ISO Basic Profile shown by a thick line.)

TABLE 14.1.—ISO metric screw threads for general use, 0.25 to 300 mm diameter

Size (basic major diameter)			Basic major diameter	Pitch													
Primary	Secondary	Tertiary		Coarse	Fine												
					6	4	3	2	1.5	1.25	1	0.75	0.5	0.35	0.25	0.2	
<i>mm</i>	<i>mm</i>	<i>mm</i>	<i>in.</i>	<i>mm</i>	<i>mm</i>	<i>mm</i>	<i>mm</i>	<i>mm</i>	<i>mm</i>	<i>mm</i>	<i>mm</i>	<i>mm</i>	<i>mm</i>	<i>mm</i>	<i>mm</i>	<i>mm</i>	
0.25			0.0098	0.075													
.3			.0118	.08													
	0.35		.0138	.09													
.4			.0157	.1													
	.45		.0177	.1													
.5			.0197	.125													
	.55		.0217	.125													
.6			.0236	.15													
	.7		.0276	.175													
.8			.0315	.2													
	.9		.0354	.225													
1			.0394	.25													0.2
	1.1		.0433	.25													.2
1.2			.0472	.25													.2
	1.4		.0551	.3													.2
1.6			.0630	.35													.2
	1.8		.0709	.35													.2
2			.0787	.4												0.25	
	2.2		.0866	.45												.25	
2.5			.0984	.45											0.35		
3			.1181	.5											.35		
	3.5		.1378	.6											.35		
4			.1575	.7									0.5				
	4.5		.1772	.75									.5				
5			.1969	.8									.5				
	5.5		.2165										.5				
6			.236	1.0								0.75					
	7		.276	1.0								.75					
8			.315	1.25								.75					
	9		.354	1.25								.75					
10			.394	1.5								.75					
	11		.433	1.5								.75					
12			.472	1.75					1.5		1.25						
	14		.551	2.0					1.5		* 1.25						
	15		.591						1.5								
16			.630	2.0					1.5								
	17		.669						1.5								
	18		.709	2.5				2	1.5								
20			.787	2.5				2	1.5								
	22		.866	2.5				2	1.5								
24			.945	3.0				2	1.5								
	25		.984					2	1.5								
	26		1.02					2	1.5								
	27		1.06	3.0				2	1.5								
	28		1.10					2	1.5								
30			1.18	3.5			b (3)	2	1.5								
	32		1.26					2	1.5								
	33		1.30	3.5			b (3)	2	1.5								
36			1.38	4.0			3	2	1.5								
	38		1.42					2	1.5								
	39		1.50					2	1.5								
	40		1.54	4.0			3	2	1.5								
	42		1.57				3	2	1.5								
	45		1.65	4.5		4	3	2	1.5								
			1.77	4.5		4	3	2	1.5								
48			1.89	5.0		4	3	2	1.5								
	50		1.97			4	3	2	1.5								
	52		2.05	5.0		4	3	2	1.5								
56			2.17			4	3	2	1.5								
	55		2.20	5.5		4	3	2	1.5								
	58		2.28			4	3	2	1.5								
	60		2.36	5.5		4	3	2	1.5								
	62		2.44			4	3	2	1.5								
64			2.52	6.0		4	3	2	1.5								
	65		2.56			4	3	2	1.5								
	68		2.68	6.0		4	3	2	1.5								
	70		2.76		6	4	3	2	1.5								
72			2.83		6	4	3	2	1.5								
	75		2.95		6	4	3	2	1.5								
	76		2.99		6	4	3	2	1.5								
80			3.07					2									
	82		3.15		6	4	3	2	1.5								
	85		3.23					2									
90			3.35		6	4	3	2									
			3.54		6	4	3	2									

See footnotes at end of table.

TABLE 14.1.—ISO metric screw threads for general use, 0.25 to 300 mm diameter—Continued

Size (basic major diameter)			Basic major diameter	Pitch												
Primary	Secondary	Tertiary		Coarse	Fine											
					6	4	3	2	1.5	1.25	1	0.75	0.5	0.35	0.25	0.2
<i>mm</i>	<i>mm</i>	<i>mm</i>	<i>in.</i>	<i>mm</i>	<i>mm</i>	<i>mm</i>	<i>mm</i>	<i>mm</i>	<i>mm</i>	<i>mm</i>	<i>mm</i>	<i>mm</i>	<i>mm</i>	<i>mm</i>	<i>mm</i>	<i>mm</i>
100	95		3.74	6	4	3	2									
			3.94	6	4	3	2									
110	105		4.13	6	4	3	2									
			4.33	6	4	3	2									
	115		4.53	6	4	3	2									
				6	4	3	2									
125	120		4.72	6	4	3	2									
			4.92	6	4	3	2									
	130		5.12	6	4	3	2									
140		135	5.31	6	4	3	2									
			5.51	6	4	3	2									
				6	4	3	2									
	150		5.71	6	4	3	2									
			5.91	6	4	3	2									
160		155	6.10	6	4	3										
			6.30	6	4	3										
		165	6.50	6	4	3										
				6	4	3										
	170		6.69	6	4	3										
180			6.89	6	4	3										
			7.09	6	4	3										
		185	7.28	6	4	3										
	190		7.48	6	4	3										
				6	4	3										
200		195	7.68	6	4	3										
			7.87	6	4	3										
		205	8.07	6	4	3										
			8.27	6	4	3										
	210		8.46	6	4	3										
				6	4	3										
220			8.66	6	4	3										
		225	8.86	6	4	3										
		230	9.06	6	4	3										
		235	9.25	6	4	3										
	240		9.45	6	4	3										
				6	4	3										
250		245	9.65	6	4	3										
			9.84	6	4	3										
		255	10.04	6	4											
	260		10.24	6	4											
				6	4											
		265	10.43	6	4											
		270	10.63	6	4											
280		275	10.83	6	4											
			11.02	6	4											
				6	4											
		285	11.22	6	4											
		290	11.42	6	4											
		295	11.61	6	4											
300			11.81	6	4											

^a Pitch 1.25 of size 14 to be used only for spark plugs.

^b Pitches in parentheses not to be used unless necessary.

^c Size 35 to be used for ball bearing lock nuts.

Sizes 0.3 through 1.4 mm with coarse pitches shown are covered by Section V, Unified miniature screw threads of Handbook H28 (1957), Part I.

TABLE 14.2.—ISO metric screw threads for screws, bolts, and nuts, 0.25 to 39 mm diameter

Size (basic major diameter)		Basic major diameter	Coarse		Fine	
Primary	Secondary		Pitch	Threads per inch, approximate	Pitch	Threads per inch, approximate
<i>mm</i>	<i>mm</i>	<i>in.</i>	<i>mm</i>		<i>mm</i>	
0.25		0.0098	0.075	339		
.3		.0118	.08	318		
	0.35	.0138	.09	282		
.4		.0157	.1	254		
	.45	.0177	.1	254		
.5		.0197	.125	203		
	.55	.0217	.125	203		
.6		.0236	.15	169		
	.7	.0276	.175	145		
.8		.0315	.2	127		
	.9	.0354	.225	113		
1		.0394	.25	102		
	1.1	.0433	.25	102		
1.2		.0472	.25	102		
	1.4	.0551	.3	85		
1.6		.0630	.35	73		
	1.8	.0709	.35	73		
2		.0787	.4	64		
	2.2	.0866	.45	56		
2.5		.0984	.45	56		
3		.1181	.5	51		
	3.5	.1378	.6	42		
4		.1575	.7	36		
	4.5	.1772	.75	34		
5		.1969	.8	32		
6		.236	1.0	25		
	7	.276	1.0	25		
8		.315	1.25	20	1.0	25
10		.394	1.5	17	1.25	20
12		.472	1.75	15	1.25	20
	14	.551	2.0	13	1.5	17
16		.630	2.0	13	1.5	17
	18	.709	2.5	10	1.5	17
20		.787	2.5	10	1.5	17
	22	.866	2.5	10	1.5	17
24		.945	3.0	8	2.0	13
	27	1.06	3.0	8	2.0	13
30		1.18	3.5	7	2.0	13
	33	1.30	3.5	7	2.0	13
36		1.42	4.0	6	3.0	8
	39	1.54	4.0	6	3.0	8

Sizes 0.3 through 1.4 mm are covered by Section V, Unified miniature screw threads of Handbook H28 (1957), Part I.

INDEX

	Page		Page
A		J	
Acme screw threads.....	1	Jar threads.....	46
Allowances, Acme threads.....	6	L	
Buttress threads.....	31	Lamp base and lamp holder threads.....	34
Stub Acme threads.....	20	Lead deviations, diameter equivalent of.....	33
Angle deviations, diameter equivalent of.....	33	Leading flank.....	32
B		Lens accessory attachment threads.....	42
Best wire diameters.....	54, 60	Lens mounting threads.....	42
Bibliography, measurement of pitch diameter.....	60	Limits of size, Acme threads.....	6
Tightening of threaded fasteners.....	52	Stub Acme threads.....	20
British standard, Buttress thread.....	34	Load sensitive screw.....	53
Microscope and nosepiece thread.....	38	M	
Whitworth thread.....	36	Marking of gages.....	7, 21, 22, 32, 38
Buttress threads.....	27	Measuring load.....	54
C		Measurement of pitch diameter.....	54
Cameras, tripod connections for.....	41, 42	Metric thread standards.....	62
Centralizing Acme threads.....	1	Microscope objective and nosepiece threads.....	36
Class 5 fit for threaded studs.....	48	Multiple-start threads.....	55
Classification and tolerances, Acme threads.....	4	N	
Stub Acme threads.....	19	National Buttress threads.....	27
Compensation, pitch diameter, for adjusted gage lengths.....	17	Nosepiece threads.....	36
Concentricity.....	18, 27	P	
D		Photographic equipment threads.....	41
Dairy sanitary fittings threads.....	46	Pitch diameter, measurement of.....	54
Designations, thread, Acme.....	7	Preload indicating washer.....	53
Buttress.....	32	Pressure flank.....	28
Class 5, interference fit.....	48	R	
ISO metric.....	62	Rolled threads for electric lamp bases and lamp holders.....	34
Lamp base and lamp holder.....	34	S	
60° stub.....	45	Screw threads, Acme.....	1
Square, modified.....	45	Buttress.....	27
Stub Acme.....	21, 22	Class 5, interference fit threads.....	48
Surveying instrument mounting.....	40	Electric lamp base and lamp holder.....	34
Deviations, lead and angle.....	33	ISO metric threads.....	62
Diameter equivalent.....	33	Microscope objective and nosepiece.....	36
Of angle deviations.....	33	Photographic equipment threads.....	41
Of lead deviations.....	33	60° stub.....	45
E		Square, modified.....	45
Electric lamp base and lamp holder threads.....	34	Stub Acme.....	18
F		Stub Acme, modified.....	22
Flank, leading.....	32	Surveying instrument mounting.....	40
Trailing.....	60	Shutter cable release tip and socket.....	45
Form of thread, Acme.....	1	Studs, class 5 fit for.....	48
Buttress.....	28	T	
Electric lamp base and lamp holder.....	34	Thickness of thread.....	1, 18
ISO metric.....	61	Thread series, Acme.....	4
Stub Acme.....	18	Buttress.....	28
Formulas for diameters, Acme threads.....	10	ISO metric.....	62
Stubs Acme threads.....	21	Stub Acme.....	19
G		Tightening of threaded fasteners.....	52
Gages, Acme threads.....	10	Tolerances, Acme thread.....	5
Buttress threads.....	33	Buttress thread.....	29
Electric lamp base and lamp holder threads.....	35	Stub Acme thread.....	19
Stub Acme threads.....	25	Wires, thread measuring.....	54
Gaging practice, Buttress threads.....	33	Wrench openings.....	47
General purpose Acme threads.....	1	Torque-tension relationship.....	52
Glass bottle and jar threads.....	46	Torques, interference fit.....	51
H		Trailing flank.....	60
Historical.....	1, 18, 27, 36, 40	Tripod connections for cameras.....	41, 42
I		Tru-load bolt.....	53
Inspection, stud and tapped hole threads.....	48, 51	W	
Interference fit threads.....	48	Whitworth threads, British standard.....	36
Assembly torques.....	51	Wire measurements, limitations on.....	59
Breakloose torques.....	51	Of pitch diameter.....	54
Extension of standard.....	52	Wires, measurement of.....	54
International metric threads.....	61	Sizes of.....	54, 60
ISO metric threads.....	62	Specifications for.....	54
ISO thread profiles.....	61	Wrench openings.....	47

THE NATIONAL BUREAU OF STANDARDS

The scope of activities of the National Bureau of Standards at its major laboratories, in Washington, D.C., and Boulder, Colo., is suggested in the following listing of the divisions and sections engaged in technical work. In general, each section carries out specialized research, development, and engineering in the field indicated by its title. A brief description of the activities, and of the resultant publications, appears on the inside front cover.

WASHINGTON, D.C.

Electricity and Electronics. Resistance and Reactance. Electron Devices. Electrical Instruments. Magnetic Measurements. Dielectrics. Engineering Electronics. Electronic Instrumentation. Electrochemistry.

Optics and Metrology. Photometry and Colorimetry. Optical Instruments. Photographic Technology. Length. Engineering Metrology.

Heat. Temperature Physics. Thermodynamics. Cryogenic Physics. Rheology. Molecular Kinetics. Free Radicals Research.

Atomic Physics. Spectroscopy. Radiometry. Mass Spectrometry. Solid State Physics. Electron Physics. Atomic Physics.

Radiation Physics. Neutron Physics. Radiation Theory. Radioactivity. X-ray. High Energy Radiation. Nucleonic Instrumentation. Radiological Equipment.

Chemistry. Organic Coatings. Surface Chemistry. Organic Chemistry. Analytical Chemistry. Inorganic Chemistry. Electrodeposition. Molecular Structure and Properties of Gases. Physical Chemistry. Thermochemistry. Spectrochemistry. Pure Substances.

Mechanics. Sound. Mechanical Instruments. Fluid Mechanics. Engineering Mechanics. Mass and Scale. Capacity, Density, and Fluid Meters. Combustion Controls.

Organic and Fibrous Materials. Rubber. Textiles. Paper. Leather. Testing and Specifications. Polymer Structure. Plastics. Dental Research.

Metallurgy. Thermal Metallurgy. Chemical Metallurgy. Mechanical Metallurgy. Corrosion. Metal Physics.

Mineral Products. Engineering Ceramics. Glass. Refractories. Enameled Metals. Constitution and Microstructure.

Building Technology. Structural Engineering. Fire Protection. Air Conditioning, Heating, and Refrigeration. Floor, Roof, and Wall Coverings. Codes and Safety Standards. Heat Transfer. Concreting Materials.

Applied Mathematics. Numerical Analysis. Computation. Statistical Engineering. Mathematical Physics.

Data Processing Systems. SEAC Engineering Group. Components and Techniques. Digital Circuitry. Digital Systems. Analog Systems. Applications Engineering.

• Office of Basic Instrumentation.

• Office of Weights and Measures.

BOULDER, COLORADO

Cryogenic Engineering. Cryogenic Equipment. Cryogenic Processes. Properties of Materials. Gas Liquefaction.

Radio Propagation Physics. Upper Atmosphere Research. Ionosphere Research. Regular Prediction Services. Sun-Earth Relationships. VHF Research. Radio Warning Services. Airglow and Aurora. Radio Astronomy and Arctic Propagation.

Radio Propagation Engineering. Data Reduction Instrumentation. Radio Noise. Tropospheric Measurements. Tropospheric Analysis. Propagation-Terrain Effects. Radio-Meteorology. Lower Atmosphere Physics.

Radio Standards. High-Frequency Electrical Standards. Radio Broadcast Service. Radio and Microwave Materials. Atomic Frequency and Time Standards. Electronic Calibration Center. Microwave Circuit Standards.

Radio Communication and Systems. Low Frequency and Very Low Frequency Research. High Frequency and Very High Frequency Research. Modulation Systems. Antenna Research. Navigation Systems. Systems Analysis Field Operations.

6/27