

NBSIR 81-1656

NBS
PUBLICATIONS

NAT'L INST OF STAND & TECH



A11106 978879

NBS 30/60 MEGAHERTZ NOISE MEASUREMENT SYSTEM OPERATION AND SERVICE MANUAL

George J. Counas
Thomas H. Bremer

Electromagnetic Fields Division
National Engineering Laboratory
National Bureau of Standards
U.S. Department of Commerce
Boulder, Colorado 80303

December 1981



U.S. DEPARTMENT OF COMMERCE, Malcolm Baldrige, Secretary

NATIONAL BUREAU OF STANDARDS, Ernest Ambler, Director

QC
100
U56
81-1656
1981
c. 2

NATIONAL BUREAU
OF STANDARDS
LIBRARY

MAR 15 1982

Not Rec - Cre.

62100

1020

NO 21-226

1981

27

NBSIR 81-1656

NBS 30/60 MEGAHERTZ NOISE MEASUREMENT SYSTEM OPERATION AND SERVICE MANUAL

George J. Counas
Thomas H. Bremer

National Bureau of Standards
U.S. Department of Commerce
Boulder, Colorado 80303

December 1981

TABLE OF CONTENTS

	Page
ABSTRACT.....	1
1. INTRODUCTION.....	3
2. GENERAL THEORY OF OPERATION.....	4
A. DESCRIPTION OF MEASUREMENT SYSTEM.....	4
B. ANATOMY OF A MEASUREMENT.....	10
3. OPERATING INSTRUCTIONS.....	18
A. ADDITIONAL EQUIPMENT REQUIRED.....	18
B. GETTING STARTED.....	18
C. PREPARING THE SYSTEM FOR MEASUREMENT.....	19
1. POWER-OFF INSPECTION AND SETUP.....	19
2. POWER-ON CHECKS AND SYSTEM WARMUP.....	23
3. LOADING AND EXECUTING THE MEASUREMENT PROGRAM.....	24
D. SYSTEM TURN-OFF.....	29
4. SOFTWARE.....	30
A. GENERAL DESCRIPTION AND SUBPROGRAMS.....	30
B. MATRICES.....	34
C. EQUATIONS.....	46
5. MAINTENANCE.....	50
A. EQUIPMENT DESCRIPTION.....	50
B. SYSTEM CHECKS.....	51
C. COMPONENT DESCRIPTION AND TECHNICAL INFORMATION.....	54
1. Switch Driver Module.....	54
a) Power Supplies and Switches.....	54
b) Card 110, Decoder Card.....	54
c) Switch Driver Cards.....	60
d) 117 Output Display Card Operation and Adjustment.....	63

TABLE OF CONTENTS continued

	Page
2. 30 MHz and 60MHz PREAMPLIFIERS.....	71
3. INTERCONNECTION AND WIRING DIAGRAMS.....	73
4. PARTS LISTS.....	74
ACKNOWLEDGMENTS	99
REFERENCES.....	100
APPENDIX I.....	101

LIST OF FIGURES

	page
Figure 1. 30/60 MHz Radiometer-Illustration.....	2
Figure 2. Simplified Block Diagram of Noise Measurement System....	5
Figure 3. 30/60 MHz Radiometer-Block Diagram.....	6
Figure 4. Sample System Printout Part 1.....	11
Figure 5. Sample System Printout Part 2.....	12
Figure 6. Ambient and Cryogenic Noise Standards.....	20
Figure 7. Functional Diagram of Software Segments.....	32
Figure 8. 30/60 MHz Radiometer Block Diagram.....	55
Figure 9. 110 Decoder Card Schematic Diagram.....	56
Figure 10. Decoder Chip Truth Table.....	57
Figure 11. 110 Decoder Card Parts Placement.....	58
Figure 12. 111-114 Switch Driver Card Schematic Diagram.....	61
Figure 13. Switch Driver Card Parts Placement.....	62
Figure 14. 117 Output Display Card Schematic Diagram... ..	65
Figure 15. 117 Output Display Card Front Panel Connections.....	66
Figure 16. 117 Output Display Card Parts Placemenmt.....	67
Figure 17. 30 MHz and 60 MHz Preamplifier Schematic Diagram.....	72
Figure 18. POWER METER WIRING DIAGRAM AND SCANNER CONNECTIONS.....	75
Figure 19. NOISE STANDARDS WIRING DIAGRAM AND SCANNER CONNECTIONS... ..	76
Figure 20. System Cable Interconnection Diagram.....	77
Figure 21. Pin Connections for J104, Switch Driver Module Input....	78
Figure 22. Pin Connections for J102, Switch Driver Module Output... ..	79
Figure 23. Complete Wiring Diagram for J 102.....	80
Figure 24. J110, Decoder Card Input and Output Connector.....	81

LIST OF FIGURES continued

	Page
Figure 25. J111, Switch Driver Card Input and Output Connector.....	82
Figure 26. J112, Switch Driver Card Input and Output Connector.....	83
Figure 27. J113, Switch Driver Card Input and Output Connector.....	84
Figure 28. J114, Switch Driver Card Input and Output Connector.....	85
FIGURE 29. J117, Output Display Card Input and Output Connector.....	86

LIST OF TABLES

	Page
Table 1. LOSS CONSTANTS AND UNCERTAINTIES	21
Table 2. N Matrix Contents.....	36
Table 3. M Matrix Contents.....	41
Table 4. Z Matrix Contents.....	43
Table 5. SYSTEM CABLES--INSTRUMENTS TO SCANNER	73
Table 6. MANUFACTURER'S CODE TABLE	87
Table 7. Parts List for Switch Driver Module Components.....	91

IMPORTANT NOTICE

The specific components selected for the system were chosen on the basis of suitability, availability, and cost. They do not necessarily represent the only possible choice or even the best choice. The National Bureau of Standards states only that they were used in the system described here. Substitution of nominally equivalent components meeting the same specification should cause no difficulty; however NBS has not tested all such possible choices.

NBS 30/60 MEGAHERTZ NOISE MEASUREMENT SYSTEM

OPERATION AND SERVICE MANUAL

BY

George Counas and Tom Bremer

Electromagnetic Fields Division
National Bureau of Standards
Boulder, Colorado 80303

Calibration of coaxial noise sources at 30 and 60 MHz is now being accomplished using a total power radiometer designed to operate under computer control. Use of the IEEE 488 Instrument Bus and structured software techniques allows use and substitution of commercially available components with a minimum of hardware and software modification.

This manual addresses the general theory of operation, operating procedures, and maintenance procedures for the NBS 30/60 MHz automated noise measurement system using a commercially available desktop calculator as the controller.

Key words: Automated noise measurement system; coaxial noise sources; controller; IEEE 488 Bus; total power radiometer.

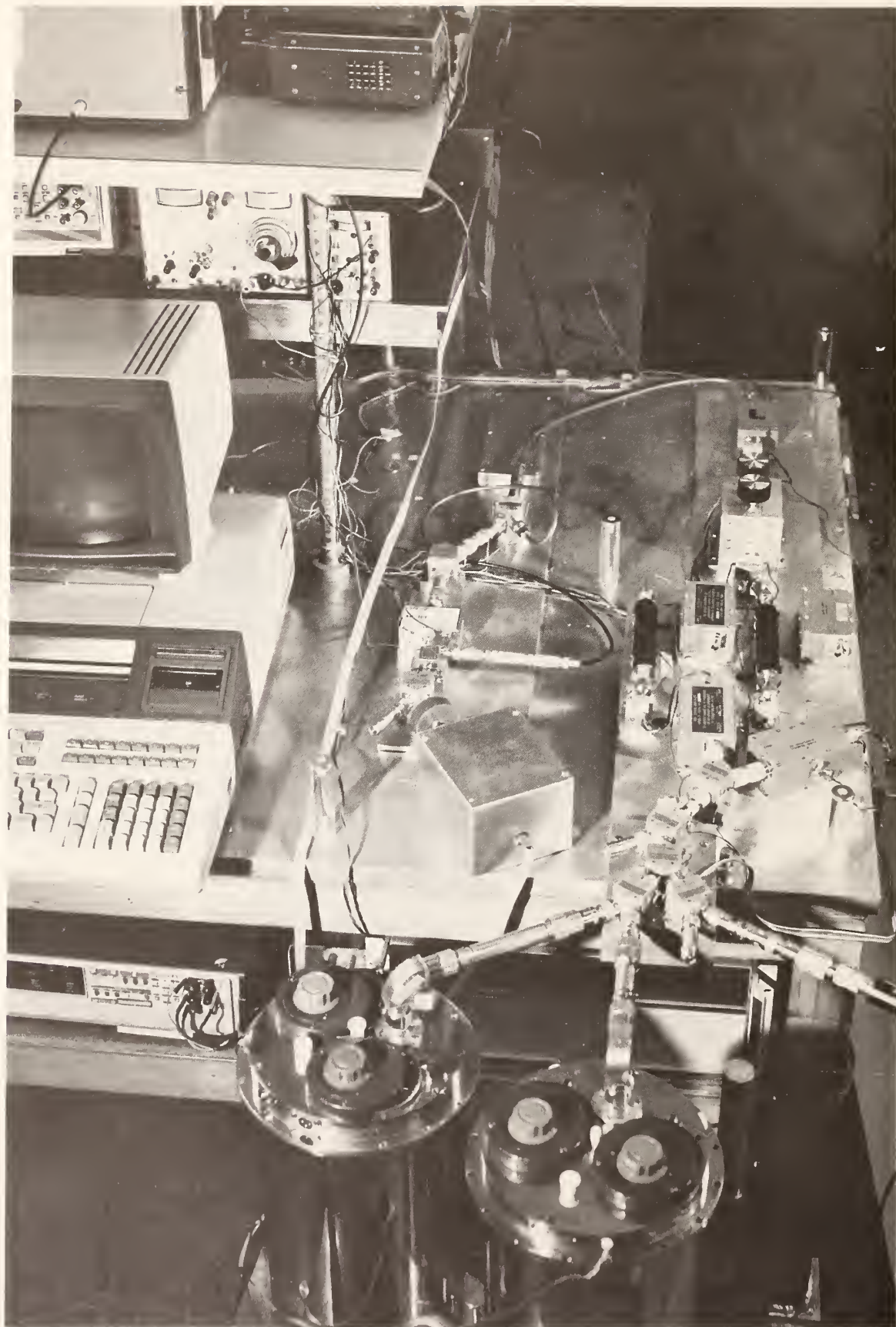

30/60 MHz RADIOMETER

FIGURE 1

1. INTRODUCTION

The use of the total power radiometer to measure noise sources requires a comparison of the unknown source with known or standard noise sources. To accomplish this with any degree of accuracy, mismatch considerations mandate either a correction for mismatch between the standards and the device under test or tuning to minimize it. Another factor which must be taken into account is noise contributed by the measurement system itself which limits system range and accuracy. This is especially true of the first amplifier noise contribution. Tuneable cryogenic and ambient noise standards plus amplifiers with high gain, low noise figure, and good input and output impedance characteristics were designed and constructed at NBS and make the measurement system described by this manual possible.

Figure 1 is a photograph of the 30/60 MHz radiometer which shows the physical layout of components, Figure 2 is a simplified block diagram showing basically how a measurement is made, and Figure 3 is a detailed block diagram of the measurement system. Figure 3, shows the general arrangement of system hardware with signal flow starting at the lower right. During a measurement sequence, the noise power from the unknown source is compared to that delivered by the system ambient and cryogenic standards. Results of this comparison are used to determine the noise temperature of the unknown source. An automated system such as this, can make large numbers of measurements in a relatively short time without operator involvement. This permits economical gathering of statistical results not previously possible.

2. GENERAL THEORY OF OPERATION

A. DESCRIPTION OF THE MEASUREMENT SYSTEM

Refer to Figure 2. This is a functional block diagram of the noise measurement system. To calibrate or find the output noise temperature of the device under test, the output noise powers of this device, the ambient standard, and the cryogenic standard are amplified, filtered, and measured in sequence. The noise temperatures of the two standards are well known. Using the noise equations detailed on page 16 of this manual, the output noise powers and noise temperatures of the two standards are compared with the output noise power of the device under test resulting in the determination of the output noise power of this device. These noise power comparisons are made by using the 30/60 Mhz radiometer system described in the following paragraphs.

For purposes of explanation, the 30/60 MHz radiometer system as shown in Figure 3, can be divided into four general parts which are: (1) the switching and noise source section, (2) the 30 or 60 MHz preamplifier section, (3) the output amplifier and power measurement section, and (4) the instrument and controller section.

The switching section provides for selection of the unknown or standard noise sources for comparison by the system. The unknown coaxial noise source is usually a noise diode network at an effective temperature of approximately 11,000 K or a load which is either heated to a temperature of approximately 376 K or cooled with liquid nitrogen to a temperature of approximately

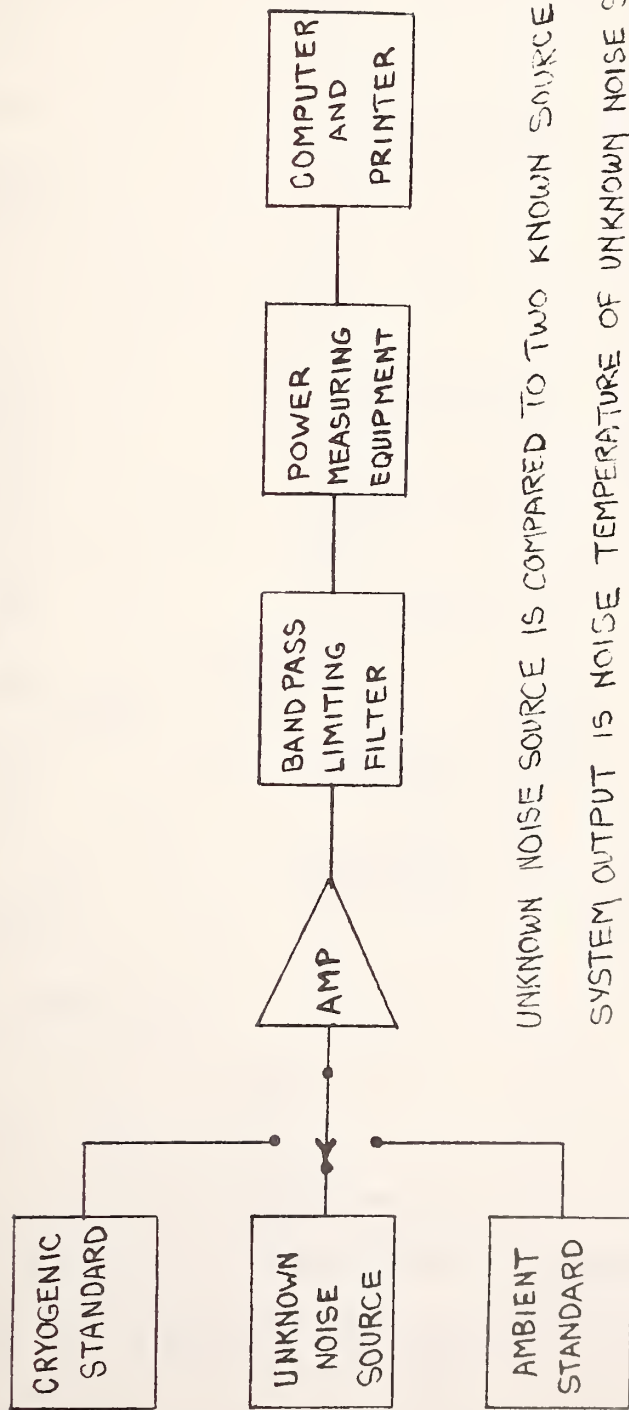

UNKNOWN NOISE SOURCE IS COMPARED TO TWO KNOWN SOURCES
 SYSTEM OUTPUT IS NOISE TEMPERATURE OF UNKNOWN NOISE SOURCE

SIMPLIFIED BLOCK DIAGRAM OF NOISE MEASUREMENT SYSTEM

FIGURE 2

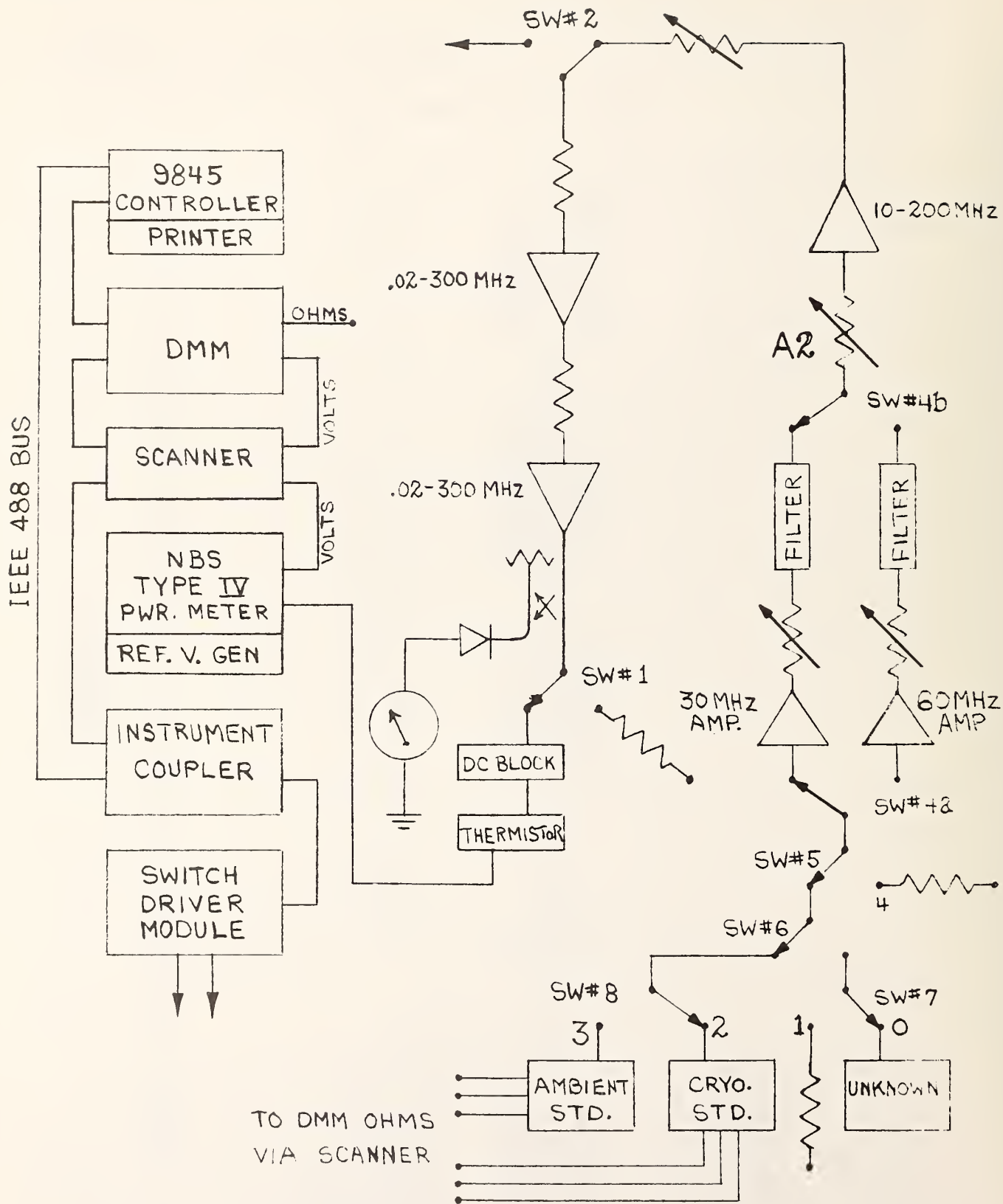

30/60 MHz RADIOMETER BLOCK DIAGRAM

FIGURE 3

77 K. The normal system range covers this region. The two noise standards used to calibrate these unknown noise sources over this range are a coaxial ambient standard and a coaxial cryogenic standard.

The ambient noise standard is a load placed in an oil bath which is allowed to come to equilibrium with room temperature. The controlled room temperature of the standards laboratory, the mass of the standard housing, and the oil bath insure slow temperature change of the load element and thus a stable noise power output. Normally, this temperature change is less than 0.05 K over an 8 hour period. The temperature of the standard is measured often enough to pick up any small temperature changes which do occur.

The cryogenic standard is similar to the ambient standard except that the load is housed in a bath of liquid nitrogen. The temperature of these loads is measured by 3-wire-platinum thermometers which are remotely read by the instrument and controller section. Both standards have tunable output ports which provide for impedance matching and are currently connected to the system with 14mm coaxial fittings and air lines. Precision adaptors are used to connect the standards and unknown noise sources to the system ports where necessary. Coaxial connector types currently accepted for the item under test include but are not limited to: precision N, GR900, APC7, and SMA.

Noise power from the item under test is amplified by either the 30 MHz preamplifier or the 60 MHz preamplifier. These

frequencies were selected to meet the needs of NBS calibration service customers. The frequency channel is remotely selected by the ganged switches at the input and output. The two channels are similar but the gain of the 30 MHz amplifier is 70 dB while that of the 60 MHz amplifier is 35 dB. The noise bandwidth of the two amplifier channels is determined by the amplifier and filter combination and is 0.77 MHz for the 30 MHz channel and 1.38 MHz for the 60 MHz channel. The system bandwidth at these frequencies is not critical as long as the input noise being amplified is constant over the bandwidth being used. The bandwidths above meet this specification. Since they have a noise figure less than 1.6 decibel, these amplifiers contribute little additional noise to that being amplified. They are not available commercially and were designed and built at NBS.

The output from the preamplifier section is amplified by three additional broadband amplifiers. The first has a bandpass of 10 to 200 MHz and the second and third have a bandpass of 0.02 to 300 MHz. All three have a gain of 30 decibels. The attenuators in this section are used to isolate components and to provide for linear operation. The output of this section is sampled through the side arm of a directional coupler to give the operator a visual indication of system power levels.

Power output is measured by using a thermistor mount connected to the output port through a DC (direct current) block. This thermistor mount in combination with an NBS Type IV Power Meter and a precision reference voltage generator is used to measure noise power.

The instrument and controller section encompasses all of the peripheral electronic equipment used to make the noise measurements including the controller, which in this case is the Hewlett Packard 9845 desktop calculator.

As shown at the left in Figure 3, the peripheral instruments are all interconnected on an IEEE 488 Bus. The instrument coupler shown connects the coaxial switch driver module to the controller. The switch driver assembly is the only instrument not compatible with the bus and so the instrument coupler, a sophisticated decoder, is used to interface the switch driver module to the controller--making it bus compatible. This switch driver module is used to control the various system switches and programmable and reference attenuator assemblies when they are used. An LED (light emitting diode) display on the front panel of the switch driver module gives a visual display of the digital code from the controller and the front panel meter indicates system output power levels. The scanner provides connection, at the proper time, of the ohmmeter section of the DMM (digital multimeter) to the platinum thermometers in the noise standard housings. Total resistance, lead resistance, and thermometer element resistance are determined. Conversion of these resistances to temperature is done by the software.

A check of system voltages is made by the DMM with proper connections made by the scanner before each measurement. Voltages checked include the 15V, 20V, 24V, and 28V switch driver and amplifier power supplies. In addition, the voltage output of the power meter is connected to the DMM through the scanner to collect output voltages which are then converted to power and

noise temperature by the software.

B. ANATOMY OF A MEASUREMENT

A brief description of a measurement sequence is as follows:

- 1) The impedance of the device to be tested is measured and input to the computer along with the connector/adaptor description and associated loss constants. Instructions for making the impedance measurements are found on page 22; the loss constants are discussed on page 18.
- 2 The temperatures of the ambient and cryogenic standards are determined and stored.
- 3) The powers from the device under test, ambient standard, and cryogenic standard are measured and the temperature of the unknown noise source is calculated. This is normally done 100 times.
- 4) At the end of the first 50 measurements, the average noise temperature of the unknown is stored along with the standard deviation, calculated system temperature, and average power measured. If the printed results are obviously erroneous (values far from nominal or with very large standard deviations), the operator can abort the measurements at this time, correct the problem, and start over. Doing this at this point saves time. If the results printed are acceptable, the cycle is then repeated starting at 2) and the 2nd 50 measurements are made. The results are again stored.
- 5) A grand average of all measurements is obtained and a summary of results is output via the system printer.

TOTAL MISMATCH ERROR IS: 16.17 K

MEASUREMENT RECAP
AND
PRELIMINARY RESULTS

FREQUENCY= 30.00 MHZ
SOURCE IMPEDANCE 49.5+J00.0 LEVEL SETTING OF A2= 8.00

TA	R OHMS	TS	R OHMS	
295.94	218.23	76.21	36.36	(1ST 50 MEASUREMENTS)
295.94	218.23	76.21	36.36	(2ND 50 MEASUREMENTS)
TX	SX	TE		
5767.77	41.69	179.36		(1ST 50 MEASUREMENTS)
5772.87	46.87	180.45		(2ND 50 MEASUREMENTS)

AVE POWER IN MILLIWATTS P1,P2,P3
 3.31 .26 .14
 SD P1,P2,P3 IN WATTS (# OF MEAS= 100.00000000) .00000740 .00000105
 .00000108

FREQUENCY = 30.MHZ

NOISE TEMPERATURE = 5770.32K +- 91.20K(BIAS) +- 13.26K (3*SEM)
 EXCESS NOISE RATIO= 12.76DB +- .06DB(BIAS+3*SEM)
 RADIOMETER SYSTEM TEMPERATURE = 180K (2.1DB NF)
 RADIOMETER GAIN = 76.4DB
 RADIOMETER NOISE BANDWIDTH= 138.00 MHZ

ERROR SUMMARY

SOURCE OF ERROR	SOURCE UNCERTAINTY	% ERROR IN NOISE TEMPERATURE
CRYOGENIC STANDARD	0.28K	.12
AMBIENT STANDARD	0.10K	.04
POWER RATIO	0.01DB	.49
MISMATCH	0.5R;1.0J OHMS	.28
NONLINEARITY	6.90E-24	.00
SWITCH ASSYMMETRY	0.002DB	.08
ADAPTOR:GR900/N	0.0001DB	0.00

LINEAR SUM OF BIAS ERRORS		1.02
3*STANDARD ERROR OF MEAN (# MEAS= 100.)		.23

LINEAR SUM OF ERRORS		1.25

CUSTOMER: CHECK STANDARD
 CUSTOMER'S STATION: NBS
 CUSTOMER'S ADDRESS: BOULDER, COLORADO 80302

SOURCE MANUFACTURER: HEWLETT PACKARD COMPANY
 SOURCE TYPE:
 SOURCE MODEL: 346B
 SOURCE SERIAL: 6000T

DATE OF CALIBRATION: JULY 10, 1981
 CALIBRATION TEST #:
 REQ OR REF #:

This summary is shown in Figure 4. The first item at the top of the page is the total mismatch error in K. This is followed by the date and time of calibration. The calibration frequency, impedance of the device under test, and system attenuator (A2) setting are printed next (documenting the A2 setting is an aid in reconstructing the measurement system power levels). Ambient standard temperature (T_a), cryogenic standard temperature (T_s), and the associated platinum thermometer resistances in ohms are then listed followed by the measured temperature of the calibrated item (T_x), the standard deviation of the measurement (S_x), and calculated system temperature (T_e). All of these parameters are listed twice, furnishing a recap for each set of 50 measurements. Average powers measured are tabulated with their associated standard deviations. P_1 , P_2 , and P_3 are the average powers measured for the device under test, the ambient standard, and the cryogenic standard respectively. Standard deviations for these powers are listed in the same order.

- 6) Figure 5 shows the final measurement results and error summary output at the end of the measurements. It simply details the results and gives a tabulation of system errors.
- 7) Finally, all information in the measurement summary, results, and error summary is stored, if desired, for future reference.

The ensuing discussion of the measurement process gives a more detailed description of how the above results were obtained. Since the coaxial noise standards are the basis for determining the noise temperature of the device under test, the error due to temperature uncertainty of these two standards must be known. The size and shape of these standards prevents a direct attachment to the measurement system, and as a result, the losses and temperature gradient in the adaptors and precision air lines used to make connection to the system were calculated and included in this temperature uncertainty.

The error attributed to these standards is listed in the error summary output by the system software and is 0.1 K for the ambient standard and 0.28 K for the cryogenic standard.

The mismatch error is due to the difference in port impedance between the device being tested and the measurement system. The error due to mismatch listed by the software is the root sum of squares of the errors determined for worst possible cases in phase and magnitude of this port impedance difference. It takes into account the impedances and the associated uncertainties of the measurement system ports, the coaxial noise standard ports, and the output port of the device under test. This error is dependent on the impedance of the device being tested and is normally between 0.1% and 0.4% of the noise temperature measured.

A vector impedance meter is used to determine the impedance of the source to be calibrated, and then the noise standards are tuned to match this impedance. The only mismatch error left to be considered, then, is the difference between the device under

test and the system measurement ports. The system ports have been measured and found to have the same impedance. The real part of this impedance was measured to be 49.5 ohms at 30 MHz and 50.5 ohms at 60 MHz. The imaginary part was measured to be 0.0 ohms at 30 MHz and 0.5 ohm at 60 MHz. The estimated uncertainty is 0.5 ohm for the real part and 1.0 ohm for the imaginary part.

In this discussion, the noise temperature of the device under test will be designated T_x , and the temperatures of the ambient and cryogenic standards will be T_a and T_s . Numeric values for T_a and T_s expressed in K are determined from the resistance values of the platinum thermometers in the ambient and cryogenic standards. As mentioned previously, this resistance is measured and read under computer control and converted to temperature by the software routines.

During a measurement, the desired port is selected and the noise power from the device connected to that port is measured under computer control using the Type IV power meter, reference voltage generator, and digital multimeter. The reference voltage output is adjusted to equal the power meter voltage with no rf power applied to the thermistor mount before the measurements begin. This zeros the instrument. (Refer to figure 3. Rf power is removed from the thermistor mount by switching system switch number 1 to its terminated port.) Power is then determined with the scanner and system switches providing the proper conditions. A normal computer controlled sequence is:

- 1) The power meter voltage (A) is measured with the rf power off.

- 2 The power meter voltage minus the reference voltage (B) is measured with the power off.
- 3) The power meter voltage minus the reference voltage (C) is measured with the rf power on.
- 4) The power meter voltage (E) is measured with the power off to check drift.
- 5) The power meter voltage minus the reference voltage (D) is again checked with the power off.
- 6) Power (P) is then obtained by:

$$P = \frac{[(A+E) - C + (B+D)/2][C - (B+D)/2]}{R_0} \quad \text{where } R_0 \text{ is the resistance of the thermistor mount (200 ohms) [1].}$$

The noise power measured from the device under test is designated P1, that from the ambient standard as P2, and that from the cryogenic standard as P3. The noise temperature of the unknown, Tx, is then determined by first finding the power ratios Y1 and Y3 and correlating them with the temperatures of the standards to find Tx:

$$Y1 = P1/P2 \tag{1}$$

$$Y3 = P3/P2 \tag{2}$$

$$Tx = Ta + (Ts - Ta)(Y1 - 1)/(Y3 - 1) \tag{3}$$

Note that because the standards are matched to the unknown, when Y1 and Y3 are calculated, only the mismatch terms between the unknown and the system are left to consider. The other terms cancel since they have been tuned to be equal. Tx is now determined and now must be corrected for any losses due to the adaptors or air lines used in connecting the unknown. Losses due to precision air lines and adaptors have been characterized and

are entered as a constant (Alpha) when the measurement begins.

The corrected temperature of Tx then, is given by:

$$\text{Corrected Tx} = (\text{Tx} - \text{Ta}) / \text{Alpha} + \text{Ta} \quad (4)$$

where L=Loss in decibels of the adaptors and
air lines used to connect the test device

$$\text{and Alpha} = 10^{(-L/10)} \quad (5)$$

In a normal calibration, the determination of Tx is made 100 times and the average of these 100 determinations is reported as is the standard deviation. Some of the other terms calculated are as follows [3] :

SYSTEM TEMPERATURE

$$\text{Te} = [\text{Ts} - (\text{Y3})(\text{Ta})] / (\text{Y3} - 1) \quad (6)$$

EXCESS NOISE RATIO dB

$$\text{ENR} = 10 \text{Log}(\text{Tx} - 290) / (290) \quad (7)$$

where 290 is a defined quantity

RADIOMETER SYSTEM TEMPERATURE

$$\text{RST} = 10 \text{Log}(1 + \text{Te}) / 290 \quad (8)$$

RADIOMETER SYSTEM GAIN

$$\text{RSG} = 10 \text{Log}[(7.244)(10^{13})(\text{P2}) / \text{Bw} / (\text{Ta} + \text{Ts})] \quad (9)$$

where Bw is the system bandwidth in MHz.

and (7.244)(10¹³) is a noise constant

The error summary in Figure 5 lists the source uncertainties on which the error calculation is based. These are the maximum errors calculated from the source listed. For example, 0.10 K is the maximum error contributed by the ambient standard.

An in depth discussion of the error calculation is outside the scope of this manual other than to state that percent error is

tabulated for each source and linearly summed. This sum is the error recorded on the test report.

3. OPERATING INSTRUCTIONS

A. ADDITIONAL EQUIPMENT REQUIRED

Besides the instruments contained in the measurement system, two additional pieces of equipment are needed to insure good measurements. These instruments are:

1. A frequency counter with at least 4 place accuracy: EIP 451D or equivalent.
2. Vector Impedance Meter: Hewlett Packard 4815A or equivalent.

B. GETTING STARTED

When an item is received for calibration, determine first that the device can be physically attached to the measurement system. If attachment is physically possible, the adaptor and/or air line combination needed to make connection should now be determined and the loss constants with the uncertainty for this combination is selected from Table 1 and recorded. Table 1 is a brief summary of common precision hardware used in making measurements. The frequency, loss constant (α), and uncertainty are listed. The α constant for a device is calculated as follows: First the loss of the device is either measured or looked up in the manufacturers specifications. Then α is calculated by raising 10 to the minus power of the loss of the device in question divided by 10. In equation form: $\text{Alpha}=(10^{(-\text{dB}/10)})$. Device input power multiplied by α is

equal to device output power. If more than one item is used, the correct loss constant (alpha term) and its uncertainty can be computed by multiplying loss constants and adding uncertainties.

C. PREPARING THE SYSTEM FOR MEASUREMENT

1. POWER-OFF INSPECTION AND SETUP

First check all cables and connections. The IEEE 488 bus cables should provide interconnection between the 9845 calculator, the scanner, the digital multimeter, and the instrument coupler. The switch driver module input jack (J110) should be connected to the instrument coupler output jack (J3).

The leads from the ambient and cryogenic standards should be securely plugged into the receptacles at the left front of the scanner. Check to make sure that the Type IV power meter and reference voltage generator are properly interconnected and that the output cable is plugged into the scanner. System wiring and interconnection diagrams are found in Section 5 of this manual.

Remove the standards and any other devices from the system measurement ports and check the system and standard connectors for damage. It is suggested that the connectors should all be cleaned with isopropyl alcohol.

Figure 6 shows the cryogenic and ambient standards as the cryogenic standard is being filled with nitrogen. Fill the small liquid nitrogen container shown in the figure with liquid nitrogen and locate the white filler cap near the tuning knobs on the top of the cryogenic standard. Remove this cap and the two



AMBIENT AND CRYOGENIC NOISE STANDARDS

FIGURE 6

FREQUENCY MHZ	CONNECTOR/ADAPTOR DESCRIPTION	LOSS CONSTANT ALPHA	ALPHA UNCERTAINTY
30	GR elbow, adaptor, 15cm air line	.99891	.00047
30	GR elbow, adaptor, 10cm air line	.99903	.00042
30	GR 15cm air line	.99952	.00021
30	GR 10cm air line	.99964	.00016
30	GR elbow	.99949	.00023
30	Adaptor-N to GR, APC7, SMA	.99985	.00010
60	GR elbow, adaptor, 15cm air line	.99843	.00067
60	GR elbow, adaptor, 10cm air line	.99986	.00060
60	GR 15cm air line	.99932	.00030
60	GR 10cm air line	.99949	.00023
60	GR elbow	.99928	.00032
60	Adaptor-N to GR, APC7, SMA	.99985	.00010

LOSS CONSTANTS AND UNCERTAINTIES
TABLE 1

white vent plugs from the standard. Using a funnel, SLOWLY pour a small amount of liquid nitrogen into the standard. After allowing several minutes for the inside of the standard to cool, add more nitrogen until the float on the top of the standard reaches the third red mark. Remove the funnel and replace the two vent caps and the filler cap.

The impedance of the item to be measured should now be determined by using the vector impedance meter. This instrument should be turned on at least one hour prior to making measurements. To save warmup time this instrument can be turned on the night before. Connect the RF OUTPUT jack on the front panel to a suitable frequency counter and set the desired calibration frequency by using the front panel RANGE SWITCH and TUNING KNOB. When the desired frequency is obtained, the instrument can be zeroed by using the PROBE CHECK on the front panel. Remove the probe from its adaptor by pulling it straight out and insert it into the PROBE CHECK receptacle. Use the MAGNITUDE ZERO and PHASE ZERO controls to get meter indications of 100 ohms and 0 degrees. Now the item can be checked by attaching the probe assembly to its output connector. If a noise diode assembly is measured, be sure to apply the voltage specified by the manufacturer (usually 28V) before making the impedance measurement. Record the impedance measured for the item. At this time, the adaptor/connector loss constant, the uncertainty of this loss constant, and the impedance of the device to be calibrated are tabulated for input to the computer during the measurement.

After the cryogenic standard reaches operating temperature,

tune the standards to the impedance value obtained for the item to be calibrated. Simply attach the probe and adaptor from the vector impedance meter to the standard ports and carefully adjust the standard tuning knobs until the same impedance values are obtained for both the standards and the unknown. Connect the ambient standard to the leftmost calibration port (port 3), the cryogenic standard to the adjacent port (port 2), and the device to be calibrated to the rightmost port (port 0). The port adjacent to port 0 (port 1) is not used at this time. Leave this port terminated at all times. Figure 1 shows the measurement system with correct devices connected to all ports. If the device under test is a noise diode network, make sure that the correct voltage is applied to it.

2. POWER-ON CHECKS AND SYSTEM WARMUP

Before any power supplies are turned on, make certain that the 30/60 preamplifier voltage switch is in the off (center) position. This switch is located on the right side of the metal table as you face the system and opposite the the two preamplifiers. Moving the switch to the up position turns on the 28 volts to the 30 MHz preamplifier and moving it to the down position applies 28 volts to the 60 MHz preamplifier.

CAUTION

DUE TO THE HIGH GAIN OF THE PREAMPLIFIERS USED WITH THIS SYSTEM MAKE SURE THE 30/60 AMPLIFIER VOLTAGE SWITCH IS IN THE OFF (CENTER) POSITION BEFORE OPENING ANY MEASUREMENT PORT. DAMAGE WHICH IS EXPENSIVE AND TIME CONSUMING TO REPAIR WILL OCCUR IF THE AMPLIFIER INPUTS ARE SUDDENLY EXPOSED TO AN OPEN CIRCUIT

CONDITION. ONE OR MORE STAGES WILL BE DESTROYED AND THE AMPLIFIER WILL HAVE TO BE RETUNED AND THE NOISE FIGURE RESTORED.

After making sure the above switch is in the off position, power-up can be accomplished in the following order:

1. Turn on the controller
2. Turn on the digital multimeter and scanner.
3. Turn on the power meter and reference voltage generator.
4. Turn on the instrument coupler and press its reset button.
5. Turn on the switch driver module and press its reset button.
6. Now turn on the 28V, 25V, 24V, and 15V supplies.
7. After all measurement ports have devices attached to them it is safe to place the 30/60 preamplifier voltage switch in the 30 MHz (up) position or the 60 MHz (down) position as required.

It is good practice to let the system warm up or cool down, as the case may be, at least 2 hours before continuing.

3. LOADING AND EXECUTING THE MEASUREMENT PROGRAM

There are two measurement programs which are used; one for 30 MHz calibrations called "30M20" and one for 60 MHz called "60M20". The programs are stored on disc and cassette tape. If it is desired to load a program from cassette, insert the program cassette in the right hand tape drive (T15) and type MASS STORAGE IS ":T15"; press Execute. Type LOAD "30M20" for example ; press

Execute. The program will now be loaded from cassette. The procedure for loading the program from disc is the same - except that the MASS STORAGE IS statement is changed to MASS STORAGE IS ":F8". The disc is placed in the left hand drive and the "LOAD 30M20" instruction when executed, loads the program from the disc.

After the program is loaded, press RUN. The system should make a series of 5 measurements as evidenced by numbers moving on the CRT display and clicking of the measurement switches. At the end of the five measurements, an average value of power at the measurement port #0 will be displayed. Adjust attenuator A2, (The precision manual step attenuator with the knobs above the plexiglass system cover) until the value of this measured power is 3 milliwatts. This is done by pressing RUN and adjusting the attenuator and then pressing RUN again to check the result. When the power level measured and displayed is 3 milliwatts consistently, press the CONT (continue) button on the 9845. The system constants should now be displayed on the screen. A listing of these constants is available in the software portion of this manual but the important thing right now, is that they are present and displayed. If this is true, press CONT again.

At this point, the program section which requests operator input is reached. The software is designed to be as friendly as possible and whenever information is requested, a prompt describing the information required is displayed and the information requested by the prompt which is currently in memory is displayed. To leave the information as is, press only the space bar followed by CONT. If a change is desired, type the

change in the same format as the sample displayed; then press Cont to go on. Information is requested by the measurement program in this order:

1. Enter the loss constant, alpha. This is the total alpha for all connectors, adaptors, and air lines used to connect the device under test.
2. Enter the uncertainty for the alpha in 1 above.
3. Enter the real and imaginary impedance of the device being tested in ohms. This is a literal representation of impedance in this form: 50.0 +J00.0. This input will be used in a printout.
- 4 Enter the real and imaginary impedance of the noise source being calibrated. This is a request for the real and imaginary parts of impedance in numeric form: 50.0,00.0. This input will be used in calculations.
5. Enter the item description.
 - a) Enter the customer's name.
 - b) Enter the customer's street address.
 - c) Enter city, state, zip.
 - d) Enter the manufacturer of the device under test.
 - e) Enter type number of device under test.
 - f) Enter model number of device under test.
 - g) Enter serial number of device under test.
 - h) Enter date of calibration.
 - i) Enter NBS Test Number
 - j) Enter reference Number

At this time the program returns to a) and the entire

description can be checked by pressing the SPACE BAR and CONT unless a change is desired. To enter corrections, simply type that line over and press CONT.

6. Enter the setting of attenuator A2. Type in the setting in dB of the manual attenuator dials.

This concludes operator entry of data. The system will now run a check of the resistance and temperature of the standards and then check the system voltages. The date, time and standard temperatures measured in degrees Kelvin will be printed. A summary of system voltages and standard resistances measured will be displayed. If everything is satisfactory, press CONT.

The system will now do a complete measurement and error analysis under computer control and print the information shown in Figures 4 and 5. While the measurements are in progress, a print of all powers measured, device temperature calculated, and the standard deviation of the measurement is printed continuously. Portions of the measurements such as power meter voltage readings are displayed on the screen in real time enabling a visual check of individual parts of the measurement. This is very helpful in finding trouble if erroneous measurements are made.

At the end of the 100 measurements and the printout of Figures 4 and 5, the program requests a data cassette to be inserted in the left hand deck and by following the instructions printed out, a complete recording of all results and device description is made. A complete catalog of the tape contents is maintained for easy access to data in the future if desired.

After the data are recorded, the software requests the operator to insert an additional 3 dB in attenuator A2 and press

run. This is a routine system linearity check and is a complete repeat of the measurement just described at a different power level. The results of the second set of measurements should closely agree with the first set. Agreement within 0.2% should be expected. The outside limit is one half of the total error printed out for the first measurement. If the outside limit is exceeded, the system should be suspected of nonlinearity and all equipment should be checked to determine the cause.

In addition, check standards (devices which can be measured to evaluate system performance) are maintained which give a good indication of measurement integrity. These standards include a noise diode "tree" which incorporates three noise sources arranged with attenuators to give three different noise power outputs. The effective noise temperatures available from this standard are approximately 11000 K, 6000 K, and 3000 K. Measurement of this standard checks system performance over a broad temperature range. A physical temperature check standard with output noise temperatures of approximately 377 K and 77 K provides a check of system performance at these temperatures. It is intended to routinely calibrate these standards and establish a control chart which will closely monitor system and standard performance. Not enough measurements have been made at the present time to establish a statistically significant chart. Measurements at this time show a total spread below 0.3%. The outside limit for measurement acceptance is estimated to be 0.5% of the measured value at this time. Measurements outside this specification indicate trouble with either the measurement system

or the standard itself.

D. SYSTEM TURN-OFF

This procedure is essentially the reverse of turn-on and should be done in the order below.

1. Turn off the preamplifier voltage with the switch located on the side of the table.
2. Carefully turn the voltage down on the noise diode power supply (if used) and turn the supply off. Remove the calibrated item and replace it with a termination to protect the measurement port.
3. Turn off the system power supplies.
4. Turn off the instrument coupler, switch driver module, digital multimeter, scanner, power meter, and reference generator.
5. Turn off the 9845 and vector impedance meter.

If the measurements are to continue soon, uncouple the cryogenic standard from port 2, and refill it with liquid nitrogen. This will sustain its internal temperature allowing measurements to resume without waiting for the standard to stabilize.

4. SOFTWARE

A. GENERAL DESCRIPTION AND SUBPROGRAMS

The measurement programs "30M20" and "60M20" are written in a structured fashion. By this it is meant that each program consists of an executive section which contains the measurement sequence and provides for the orderly gathering of information by accessing the subprograms [4]. Variables exist in the executive program and the subprograms, but are not passed between the program segments unless they are made "global" by being listed in the common declaration or in the subprogram calling statement. All subprograms used in these programs are of the multi-line function type. These subprograms are nested in the program after the executive portion, and are identified by the prefix "DEF FN...(Q)" where Q is the variable being passed between program segments. Variables passed between segments in these programs are made "global" by being listed in the common declaration at the beginning of the program and at the beginning of each subprogram as well. These common declarations must match. The value returned from the subprograms by the calling statement is a dummy variable which is not used. In these programs values are passed between segments by use of the common declaration. The advantage of this programming technique is the ease with which subprograms can be called from any point in the program without regard to the variable transfer in the calling statement (since variable transfer is through common). The drawback is that each subprogram has to have a common declaration to match the one in the main program.

The instrument subprograms are flexible and easily changed to permit a change of instruments. Because subprogram input and output variables are transferred as described above, the only changes needed to permit a change of instruments are the instrument instruction codes output on the bus to each instrument from the controller. This is necessary because few different instruments respond to exactly the same coded set of instructions. A standard instruction format for control of instrument functions does not exist at this time.

Figure 7 shows the program structure and the relationship between the executive program and the primary subprograms which are called from it. The subprograms are essentially independent of one another and require only a proper calling sequence to provide the desired output. This output will be returned to the calling program segment.

As an explanation and clarification of Figure 7, a discussion of major program segments follows:

EXECUTIVE SEGMENT provides program constants and input of needed parameters; control is then passed to EXECUTIVE SUBPROGRAM FNQ.

EXECUTIVE SUBPROGRAM FNQ is called from the EXECUTIVE SEGMENT; it directs program sequence and provides for orderly execution of program instructions. FNQ provides calls to FNE to initialize software and hardware, to FNJ to get item description, measurement parameters and port assignments, and to FNK to start measurements, compute results, print results, and store results. Return is to the EXECUTIVE SEGMENT.

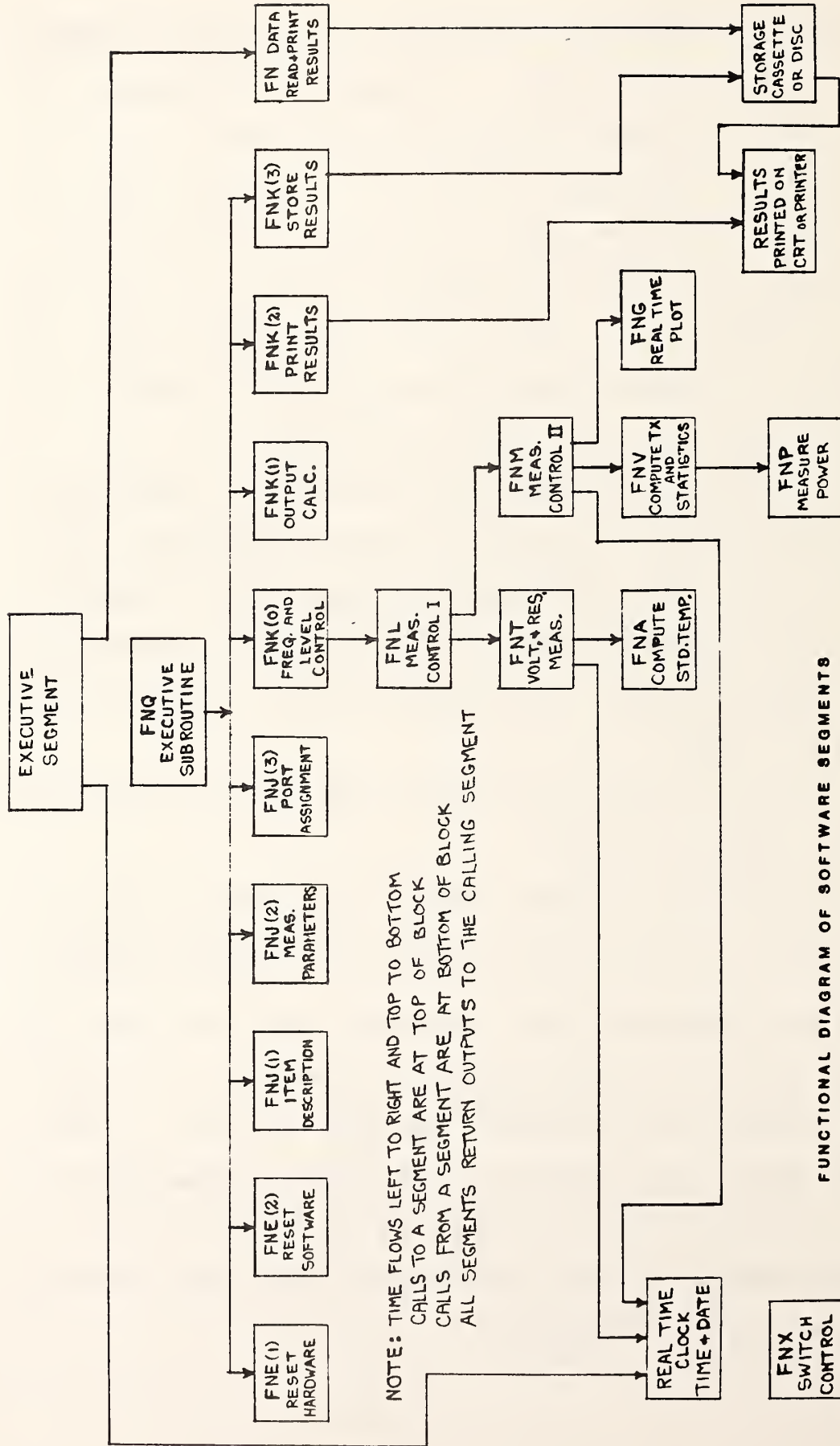

FUNCTIONAL DIAGRAM OF SOFTWARE SEGMENTS

FIGURE 7

SUBPROGRAM FNE is called from FNQ; FNE(0) performs necessary hardware reset while FNE(1) initializes the software. Return is to FNQ.

SUBPROGRAM FNJ is called from FNQ; FNJ(1) provides for input or confirmation of item under test description. FNJ(2) provides number of measurements, frequency, and system attenuator setting. FNJ(3) provides the measurement system port assignments. Return is to FNQ. SUBPROGRAM FNK is called from FNQ; FNK(0) starts measurement sequence by calling subroutine FNL and also sets up and begins filling the L, Z, and M matrices. These matrices will be covered in detail later in this section. FNK(1) performs necessary calculations for error analysis and completes filling of the L, M, and Z matrices. FNK(2) provides a call to FNVswr to get mismatch error and outputs measurement results to the printer. FNK(3) provides for storage of measurement results, temperature, pressure, and item description on tape or disc. Return is to FNQ.

SUBPROGRAM FNData is called from the EXECUTIVE SEGMENT; it provides for reading of stored data and printing of results, item description, and other information in the proper format. Return is to EXECUTIVE SEGMENT.

SUBPROGRAM FNP is called from the EXECUTIVE SEGMENT before measurements are started to enable setting of system power. Return at this time is to EXECUTIVE SEGMENT. This subprogram is also called from FNV during the measurement sequence to provide an output power determination from the device under test and the standards. Return is to FNV.

TIME from real time clock is requested by EXECUTIVE and

SUBROUTINE FNM to provide date and time information. Return is to the calling segment.

SUBPROGRAM FNL is called from FNK; it provides calls to FNT for standard resistances and system voltage check, to FNA for conversion of standard resistances to temperature in K, and to FNM to initiate measurements. Return is to FNK.

SUBPROGRAM FNM is called from FNL; it provides calls to FNV and FNG to get measurements and a real time plot of results. It also prints results and computes standard deviation. Return is to FNL.

SUBPROGRAM FNV is called from FNM; it calls FNP for power measurements and computes the value of Tx (noise temperature of item being calibrated). It also computes the standard deviation of measured quantities and averages. Return is to FNM.

SUBPROGRAM FNA is called from FNL; it provides calculated temperatures of the standards. It requires constants relating to the resistance of the platinum thermometers in the standards. Return is to FNL.

SUBPROGRAM FNVswr is called from FNK; it provides calculated mismatch error for the item under test in K. It requires impedance parameters for the item under test and the system as well as Tx, Ta, and Ts values for the measurement. Return is to FNK.

SUBPROGRAM FNX has no direct call; it provides port and frequency code to the switch driver module when required. Return is to the calling segment.

B. MATRICES

Four matrices are used to store the program constants and measurement results. They are:

1) The N matrix-- a 26 X 11 matrix which contains all system constants used in computations. These include the platinum thermometer corrections, system errors and their sources, alphas and their uncertainties, and reserved space for additional constants to be added, if necessary, in the future. Table 2 is a listing of the contents of the N matrix with descriptions of the various parameters. This matrix is automatically read from the storage medium into computer memory when the program is run.

2) The L matrix-- a 1 by 12 matrix which is used for intermediate storage of measurement results and standard values.

3) The M matrix-- a 1 by 33 matrix contains the L matrix information and, in addition, contains the measurement results, statistics, error analysis results, and standard values. Table 3 shows the contents of the M matrix.

4) The Z matrix-- a 1 by 60 matrix which is the output matrix for the measurement program. Table 4 is a listing of the Z matrix contents.

The above information concerning the various program storage registers is presented as an aid in program analysis if this is desired.

Appendix I of this manual contains a complete program listing, printout of variables used, and their location in the program.

TABLE 2
N MATRIX

<u>ELEMENT</u>	<u>FREQ</u>	<u>MHZ</u>	<u>DESCRIPTION</u>	<u>VALUE</u>
N(1,)			System #6 constants	
N(2,1)			"Hot" ambient std.	200.158
N(2,2)			"Hot" ambient std.	0.00391775
N(2,3)			"Hot" ambient std.	1.50289
N(2,4)			" Hot" ambient std.	0.12293
N(3,1)			Cryo. std. in amb. range	199.965
N(3,2)			Cryo. std. in amb. range	0.003922
N(3,3)			Cryo. std. in amb. range	1.51
N(3,4)			Cryo. std. in cryo range	0.11
N(4,*)				
N(5,*)				
N(6,1)			Cryo. std. in cryo. range	-0.00065732
N(6,2)			Cryo. std. in cryo. range	32.7792
N(6,3)			Cryo. std. in cryo. range	1.20769
N(7,1)			WCD std.	0.0
N(7,2)			WCD std.	-6.53922
N(7,3)			WCD std.	0.0210573
N(7,4)			WCD std.	65.1189
N(8,*)				
N(9,*)				

TABLE 2
N MATRIX continued

ELEMENT	FREQ MHZ	DESCRIPTION	VALUE
-----	-----	-----	-----
N(10,1)	30	"a" non-linearity	2.15 E-22
N(10,2)	30	System noise bandwidth	0.773
N(10,3)	60	"a" non-linearity	3.32 E-23
N(10,4)	60	System noise bandwidth	1.38
N(11,*)			
N(12,1)	30	Cryo. std. uncertainty K	0.22
N(12,2)	30	"Hot" amb. std uncertainty K	0.22
N(12,3)		Power ratio source (dB)	0.01
N(12,4)	30	"a" non-linearity"	2.15 E-22
N(12,7)	30,60	"switch assymetry source	0.002
N(12,8)	30,60	N term	0.00047
N(12,9)		Power to gain constant	7.244 E+13
N(13,1)	30	Real Z fixed amb. ohms	50.5
N(13,2)	30	Imag. Z fixed amb. ohms	1.0
N(13,3)	30	Mismatch error, fixed amb.	0.368651
N(13,7)	60	Cryo. std. uncertainty	0.28
N(13,8)	60	"Hot" amb. std. uncertainty	0.25
N(13,9)	60	Cryo. std. correction	0.38
N(13,10)	60	"Hot" amb. std. correction	-0.15
N(14,1)	30	Cryo. std. correction	0.26

TABLE 2
N MATRIX continued

ELEMENT	FREQ MHZ	DESCRIPTION	VALUE
-----	-----	-----	-----
N(14,2)	30	"Hot" amb. std. correction	-0.1
N(14,8)	30,60	Amb. std. correction	0.0
N(14,9)	30,60	Amb. std. uncertainty	0.1
N(15,1)	30	Sys. refl. coef. magitude	0.005
N(15,2)	30	Sys. refl. coef. (real)	-0.005
N(15,3)	30	Sys. refl. coef. (imag)	0.010
N(15,4)	30	Uncertainty for N(15,2)	0.005
N(15,5)	30	Uncertainty for N(15,3)	0.010
N(15,6)	60	Sys. refl. coef. magnitude	0.007
N(15,7)	60	Sys. refl. coef. (real)	0.495
N(15,8)	60	Sys. refl. coef. (imag)	0.005
N(15,9)	60	Uncertainty for N(15,7)	0.005
N(15,10)	60	Uncertainty for N(15,8)	0.010
N(16,*)			
N(17,*)			
N(18,*)			
N(19,*)			
N(20,*)			
N(21,*)			
N(22,*)			

TABLE 2
N MATRIX continued

ELEMENT -----	FREQ MHZ -----	DESCRIPTION -----	VALUE -----
N(23,*)			
N(24,1)	30	Total alpha of GR adapt., ell, and 15cm air line	0.99891
N(24,2)	30	Uncertainty for N(24,1)	0.00047
N(24,3)	60	Total alpha of GR adapt., ell, and 15cm air line	0.99943
N(24,4)	60	Uncertainty for N(24,3)	0.00067
N(25,1)	30	Alpha for 15cm air line	0.99952
N(25,2)	30	Uncertainty for N(25,1)	0.00021
N(25,3)	60	Alpha for 15cm air line	0.99932
N(25,4)	60	Uncertainty for N(25,2)	0.00030
N(25,6)	30	Total alpha of GR adapt., ell, and 10cm air line	0.99903
N(25,7)	30	Uncertainty for N(25,6)	0.00042
N(25,8)	60	Total alpha of GR adapt., ell, and 10cm air line	0.99986
N(25,9)	60	Uncertainty for N(25,8)	0.00060
N(26,1)	30,60	Alpha for adaptor--N to GR, APC7, or SMA	0.99985

TABLE 2
N MATRIX continued

<u>ELEMENT</u>	<u>FREQ MHZ</u>	<u>DESCRIPTION</u>	<u>VALUE</u>
N(26,2)	30,60	Uncertainty for N(26,1)	0.00010
N(26,3)	30	Alpha for GR ell	0.99949
N(26,4)	30	Uncertainty for N(26,3)	0.00023
N(26,6)	30	Alpha for GR 10cm air line	0.99964
N(26,7)	30	Uncertainty for N(26,6)	0.00016
N(26,8)	60	Alpha for GR ell	0.99928
N(26,9)	60	Uncertainty for N(26,8)	0.00032
N(26,10)	60	Alpha for GR 10cm air line	0.99949
N(26,11)	60	Uncertainty for N(26,10)	0.00022

* Note: an * in the matrix element description denotes all columns of the indicated row of the matrix.

TABLE 3
M MATRIX

ELEMENT	DESCRIPTION	PROG LOCATION
M(1,1)	Frequency F	3050
M(1,2)	# of Freq and Levels	3060
M(1,3)	L(1,1)=T2 P0=1	3070
M(1,4)	L(1,2)=T3 P0=1	3080
M(1,5)	L(1,7)=T2 P0=2	3090
M(1,6)	L(1,8)=T3 P0=2	3100
M(1,7)	L(1,3)=T1 P0=1	3110
M(1,8)	L(1,4)=S1 P0=1	3120
M(1,9)	L(1,5)=T4 P0=1	3130
M(1,10)	L(1,9)=T1 P0=2 3140	
M(1,11)	L(1,10)=S1 P0=2	3150
M(1,12)	L(1,11)=T4 P0=2	3160
M(1,13)	T1 Average = Tx	3170
M(1,14)	Standard error of mean	3450
M(1,15)	T4 or Te average	3480
M(1,16)	T2 average = Ta	3500
M(1,17)	T3 average = Ts	3520
M(1,18)	Linear sum of bias errors	3790
M(1,19)	3 times std. error of mean	3800
M(1,20)	Linear sum of errors	3810

TABLE 3
M MATRIX continued

ELEMENT -----	DESCRIPTION -----	PROG LOCATION -----
M(1,21)	Excess noise ratio of Tx (dB)	3820
M(1,22)	Bias plus 3 times std. error	3850
M(1,23)	Ambient standard error	3550
M(1,24)	Cryogenic standard error	3560
M(1,25)	Power ratio error	3680
M(1,26)	Non-linearity error	3690
M(1,27)		
M(1,28)	Standard error of mean	3460
M(1,29)	Switch assymetry error	3770
M(1,30)	L(1,6)=P2 P0=1	3170
M(1,31)	L(1,12)=P2 P0=2	3180
M(1,32)	Average power from ambient	3860
M(1,33)	Radiometer gain in dB	3620

TABLE 4
Z MATRIX

ELEMENT	DESCRIPTION	PROG LOCATION
Z(1,1)	T2 P0=1	6490
Z(1,2)	T3 P0=1	6500
Z(1,3)	T1 P0=1	6510
Z(1,4)	S1 P0=1	6520
Z(1,5)	T4 P0=1	6530
Z(1,6)	P2 P0=1	6540
Z(1,7)	T2 P0=2	6550
Z(1,8)	T3 P0=2	6560
Z(1,9)	T1 P0=2	6570
Z(1,10)	P2 P0=2	6580
Z(1,11)	T4 P0=2	6590
Z(1,12)	P2 P0=2	6600
Z(1,13)	3 times std. error (Tx)	4650
Z(1,14)	Excess noise ratio in dB (Tx)	4700
Z(1,15)	Bias plus 3 times std. error	4710
Z(1,16)	Te, radiometer sys. temp K	4740
Z(1,17)	System noise figure	4750
Z(1,18)	System gain in dB	4800
Z(1,19)	N(12,1)--s. error cryo. std.	4900
Z(1,20)	% error--cryo. std.	4910

TABLE 4
Z MATRIX continued

<u>ELEMENT</u>	<u>DESCRIPTION</u>	<u>PROG LOCATION</u>
Z(1,21)	N(14,9), ambient std. s. error	4940
Z(1,22)	% error- ambient std.	4950
Z(1,23)	N(12,3), power ratio s. error	4980
Z(1,24)	% error- power ratio	5020
Z(1,25)		
Z(1,26)	Total mismatch error K	5010
Z(1,27)	N(12,4) "a" non-linearity	5040
Z(1,28)	% error for non-linearity	5050
Z(1,29)	% error for switch assymetry	5090
Z(1,30)	Linear sum of bias errors	5170
Z(1,31)	Total # of measurements, N	5230
Z(1,32)	% Error- 3 times SEM	5240
Z(1,33)	Linear sum of errors	5280
Z(1,34)	Frequency F	4510
Z(1,35)	Calibrated Tx (average)	4630
Z(1,36)	Bias error	4640
Z(1,37)		
Z(1,38)		
Z(1,39)		
Z(1,40)		

TABLE 4
Z MATRIX continued

ELEMENT	DESCRIPTION	PROG LOCATION
Z(1,41)	Sum of sqrs T1, 2nd 50, B6	9290
Z(1,42)	Sum of T1, 2nd 50, B8	9310
Z(1,43)	Sum of sqrs T1, 1st 50, B5	9350
Z(1,44)	Sum of T1, 1st 50, B7	9360
Z(1,45)	Sum of P1 (divide by N for ave)	9520,9600
Z(1,46)	Sum of P2 (divide by N for ave)	9530,9610
Z(1,47)	Sum of P3 (divide by N for ave)	9540,9620
Z(1,48)	Sum of sqrs P1	9550,9630
Z(1,49)	Sum of sqrs P2	9560,9640
Z(1,50)	Sum of sqrs P3	9570,9650
Z(1,51)	A2 atten. setting	2690
Z(1,52)	T1	3240
Z(1,53)	T2	3250
Z(1,54)	T3	3260
Z(1,55)	N term .00047	3860,5400
Z(1,56)		
Z(1,57)	N(12,8) switch assymetry	3850
Z(1,58)		
Z(1,59)	R2 amb. std. thermometer res.	11290
Z(1,60)	R3 cryo. std. thermometer res.	11300

C. EQUATIONS

To provide a reference for the theoretical work underlying the algorithms used in the software, a summary of equations used in the software (in addition to those in part 2) is presented at this point. This summary is not intended to be self-explanatory. In the following discussion, T1 is the temperature measured for the device under test, T2 is the temperature of the ambient standard, T3 is the temperature of the cryogenic standard, and T4 is the calculated system temperature, Te. The resulting errors in T1 are reported in K.

CALCULATION OF AMBIENT STANDARD TEMPERATURE

Definition of Terms:

$$C1=200.158$$

Note: C1-C4 are constants supplied for the ambient standard platinum thermometer.

$$C2=0.00391775$$

$$C3=1.50289$$

$$C4=0.12293$$

T2=Temperature of the ambient standard in K.

R=Measured resistance of the ambient standard platinum thermometer.

Computation: (iterate to invert the Callender-Van Dusen equation.)

$$H3=(R/C1-1)/C2 \quad (1)$$

If H3 is greater than 0 set H9=0; otherwise set H9=C4.

$$G9=H3/100 \quad (2)$$

$$G8=G9-1 \quad (3)$$

If H3 is greater than 0 set H3=H3+C3*G9*G8; otherwise set

$$H3=H3+C3*G8*G9+H9*G8*G9*G9 \quad (4)$$

$$T2=H3+273.15 \text{ K} \quad (5)$$

CALCULATION OF CRYOGENIC STANDARD TEMPERATURE

Definition of Terms:

C1=-0.00065732

C2=32.7792

C3=1.20769

T3=Calculated cryogenic standard temperature in K.

R=Measured resistance of the cryogenic standard platinum thermometer.

Computation: (from a polynomial fit)

H3=C1*R^2 (6)

T3=C2+C3*R+H3 K (7)

AMBIENT STANDARD UNCERTAINTY (U) is 0.1 degree K.

at 30 and 60 MHZ.

R8=(T1-T2)/(T3-T2) (8)

where T1, T2, and T3 are the temperatures in K of the unknown device, ambient standard, and cryogenic standard respectively.

Let ES2=the error due to the ambient standard in measuring the unknown.

ES2=ABS(1-R8)*U (9)

CRYOGENIC STANDARD UNCERTAINTY (U) is 0.22 degree Kelvin at 30 MHz and is 0.28 degree K at 60 MHz.

Let ES3=Error due to the cryogenic standard uncertainty in measuring the unknown.

ES3=ABS(R8*U) (10)

UNCERTAINTY IN MEASURING POWER RATIOS is 0.01 dB.

Power factor (U) =0.0023

Let EPR=Error due to uncertainty in measuring power ratio.

$$A=1+T4/T1 \quad (11)$$

$$B=1-T2/T1 \quad (12)$$

$$C=(T3+T4)/(T3-T2) \quad (13)$$

$$EPR=ABS[U*(A-B*C)] \quad (14)$$

SYSTEM NON-LINEARITY CONSTANT (a) is $3.32 * 10^{-23}$ at 60 MHz and $2.15 * 10^{-22}$ at 30 MHz.

Bandwidth (B)= 1.38MHz at 60 MHz and 0.773MHz at 30 MHz.

Radiometer Gain in dB=G

Let ENL=Error due to system non-linearity.

$$ENL=ABS[(a)*10^{(G/10)}(B)(10^6)(T1-T3)*(T1-T2)] \quad (15)$$

UNCERTAINTY OF THE SWITCH SETTINGS IS 0.002 dB and the constant for switch assymetry is 0.00047.

Let ESA=The error due to switch assymetry.

$$A=ABS[(T1)(T3)+(T1)(T2)+(T2)(T3)/(T3-T2)] \quad (16)$$

$$ESA=A*0.00047 \quad (17)$$

SOURCE UNCERTAINTY (U) OF THE ADAPTOR/CONNECTOR LOSS is 0.0005 (0.0001dB).

Let EAL=Error due to adaptor/connector loss.

C1=Alpha for the connector adaptor combination

C2=Uncertainty for alpha.

$$C3=C1^2 \quad (18)$$

$$A=1-1/C1 \quad (19)$$

$$B=Bias Error(Linear Sum) \quad (20)$$

$$C=A*B \quad (21)$$

$$D=A*.1 \quad (22)$$

$$E=ABS[(T1-T2)/C3*(C2)] \quad (23)$$

$$EAL=B+D+E \quad (24)$$

To Calculate the OUTPUT NOISE TEMPERATURE of a Device
when an adaptor has been used in its calibration
use the following:

$$T_x = T_1 * A + T_a * (1 - A) \quad (25)$$

where T_x is the output noise temperature of the
device. T_1 is the noise temperature with the adaptor
attached, T_a is the ambient temperature in K
(the nominal value of T_a is 300 K),
and A is the alpha for the attenuation present.

$$A \text{ is calculated by: } A = 10^{(-\text{Loss dB}/10)} \quad (26)$$

STANDARD DEVIATION is calculated by:

$$S.D. = \text{Square root of } ((V - T * T / N) / (N - 1)) \quad (27)$$

where T is the sum of the individual measurements;
 V is the sum of the squares of the individual measurements,
and N is the total number of measurements.

STANDARD ERROR OF THE MEAN is given by:

$$SEM = S.D. / \text{Square root of } N \quad (28)$$

5. MAINTENANCE

A. EQUIPMENT DESCRIPTION

Since the measurement system is largely made up of commercially available equipment, operating, periodic maintenance, and troubleshooting instructions can be found in the appropriate manual supplied with the instrument. A list of the equipment presently being used, the manufacturer, and the model number follows:

IMPORTANT NOTICE

The specific components selected for use with the system were chosen on the basis of suitability, availability, and cost. They do not necessarily represent the only possible choice or even the best choice. The National Bureau of Standards states only that they were used in the system described here. Substitution of nominally equivalent components meeting the same specifications should cause no difficulty; however NBS has not tested all such possible choices.

<u>INSTRUMENT NAME</u>	<u>MANUFACTURER</u>	<u>MODEL</u>
1. Controller	Hewlett Packard Co.	9845B
2. Digital Multimeter	John F. Fluke Co.	8502A
3. Scanner	Hewlett Packard Co.	3495A
4. Instrument Coupler	ICS Electronics Corp.	4883
5. Amplifier	Aertech	A1517
6. Amplifier	Avantek	AV-4

INSTRUMENT NAME -----	MANUFACTURER -----	MODEL -----
7. Power Supplies	Power Mate Corp	BP34D
8. Preamplifier	NBS	30MHz
9. Preamplifier	NBS	60MHz
10. Noise Standard	NBS	Ambient
11. Noise Standard	NBS	Cryogenic
12. Switch Driver Module	NBS	30-60
13. Power Meter	NBS	Type IV

Technical details, schematic diagrams, and parts lists for the switch driver module and the 30 and 60 MHz preamplifiers are included in this manual. Also included are wiring diagrams and system cable information. Technical information pertaining to the ambient and cryogenic noise standards can be obtained by contacting L.D. Driver, Division 723, National Bureau of Standards, Boulder, Colorado 80302.

B. SYSTEM CHECKS

A number of checks are performed automatically in the process of making a measurement with the system and its software. These include: 1) A check of system power measurements which is made by running the system power set portion of the program at the beginning of a measurement sequence. If the power meter, reference generator, and digital multimeter are not performing adequately, this fact will be made apparent by the values displayed during this program segment. Erratic and obviously wrong power values and large variations between consecutive measurements are the usual indication of malfunction of these

instruments. System frequency and measurement port switches are also exercised during this test and defective switching can cause a substantial spread in measurement results, no change in power when a measurement port is changed, or a null to be read at one or more ports.

2) System voltage checks are made automatically before the measurement sequence begins. The values of these voltages are displayed along with the platinum thermometer resistances and noise standard temperatures. The operator must approve the displayed values before measurements continue. These checks reaffirm that the voltmeter and ohmmeter portions of the digital multimeter are working properly, that intercabling between instruments is intact, and that the system power supplies are adjusted and functioning properly.

3) Large scatter in successive readings of power and temperature taken during a calibration are an indication of erratic switch operation or poor peripheral instrument performance. Experience will dictate what this scatter should be for a given item. Three times the standard error is normally below 1 percent of the noise power measured.

In addition, system operation is verified in two other ways during a measurement sequence.

1) Measurement of the device under test at two different power levels is required and will pinpoint system non-linearity. 2) Applicable reference standards with effective noise temperatures of 11000, 6000, 3000, 377, and 77 degrees K are checked immediately before or after a device is calibrated to test system accuracy. These measurements provide an excellent check of

overall system performance. Results obtained by measurement of the reference standards are the single most important indicator of system precision and accuracy. These results will show whether or not a major failure has occurred in such a subtle manner that the failure was not detected by other checks.

If the system fails to perform properly during any of the tests, try to pinpoint the location of the trouble by logically analyzing in which test the trouble occurred, and working backwards to isolate the instrument or component responsible for the failure. For example, if a switch is intermittent, the tests outlined will give an indication of the measurement port involved (possibly a large scatter in power measured at one port). Switch operation then can be isolated to the faulty switch and/or driver card by parts substitution and in-circuit testing.

In the event that a major repair is made on the system preamplifiers or input port switches, a complete analysis of the impedance and noise figure of the radiometer "front-end" should be made and impedance parameters contained in the N-matrix changed if necessary. System linearity and bandwidth should also be re-evaluated and the constants relating to these parameters changed in the N-matrix if necessary.

Diagnostic tests of commercial units, to which faults have been isolated, can be performed by following the instructions provided in the applicable operation and service manual.

No specialized diagnostic software has been written to aid in troubleshooting the equipment because the above described tests will isolate most faults to at least the instrument level.

C. COMPONENT DESCRIPTION AND TECHNICAL INFORMATION

For commercial equipment used in the system, this information is available in manuals supplied by the manufacturer.

1. SWITCH DRIVER MODULE

This instrument is comprised of power supplies, remote switches, a decoder card, LED display, switch driver output cards, and an output display card with its associated analog meter. The output display card is the only card requiring adjustments and these are covered with the description for this card.

a) Power Supplies and Switches

The switch driver module contains one 5V power supply which supplies operating voltage for the integrated circuits on the decoder, switch driver, and output display cards. 15V and 25V drive voltages for the switches controlled by the switch driver cards are also supplied to this unit from external power supplies after passing through two remotely controlled switches. This permits the drive voltage for the system switches to be turned on and off by the controller. Also present in the unit are the positive and negative 15V supplies for the operational amplifiers on the output display card.

b) Card 110, Decoder Card.

This card uses a type 7442 decoder chip which is a BCD to decimal decoder (1 of 10). Four of these elements are used; one spare which is presently not used is supplied. Figure 10 shows the truth table for this type of decoder chip. In

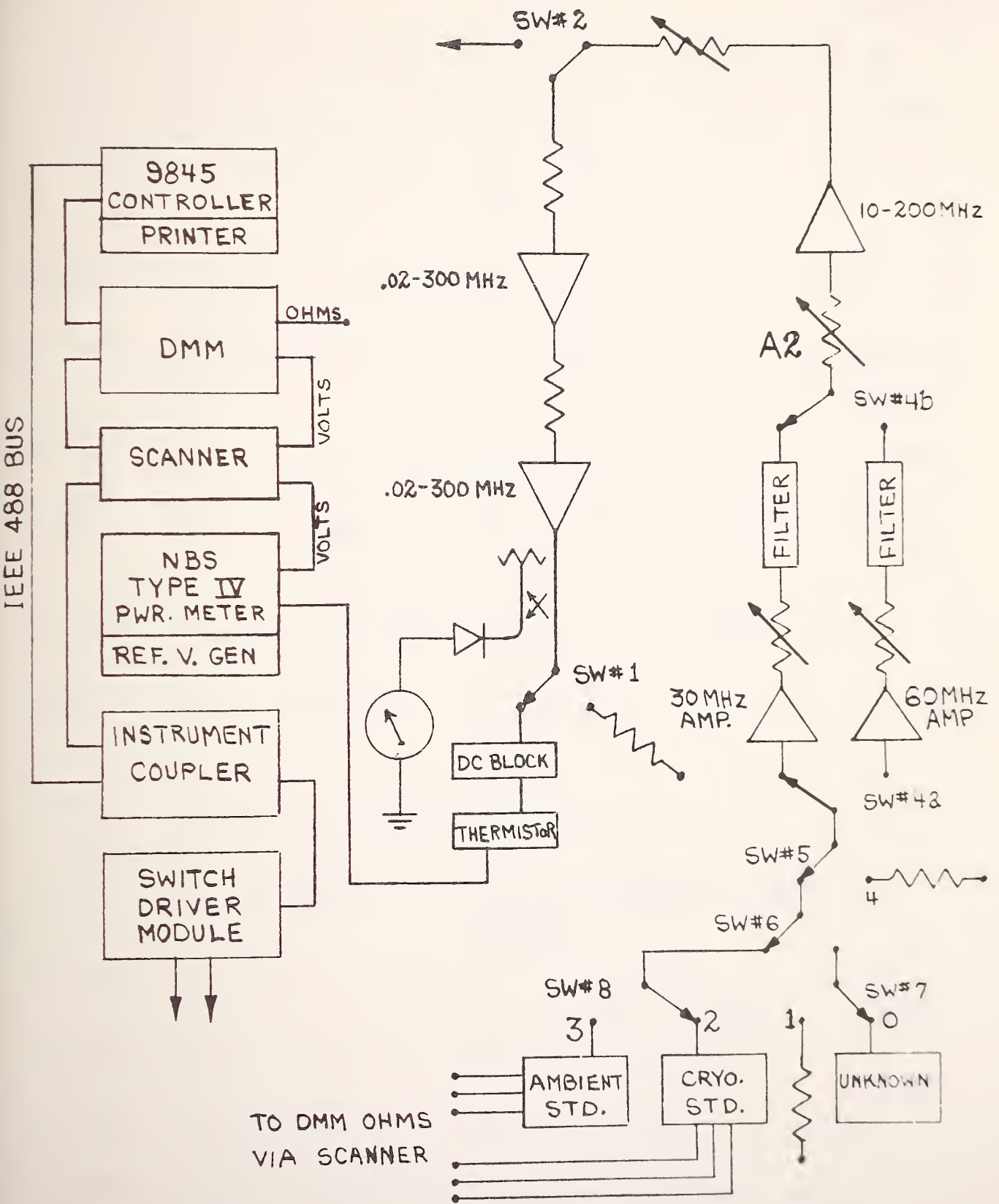

30/60 MHz RADIOMETER BLOCK DIAGRAM

FIGURE 8

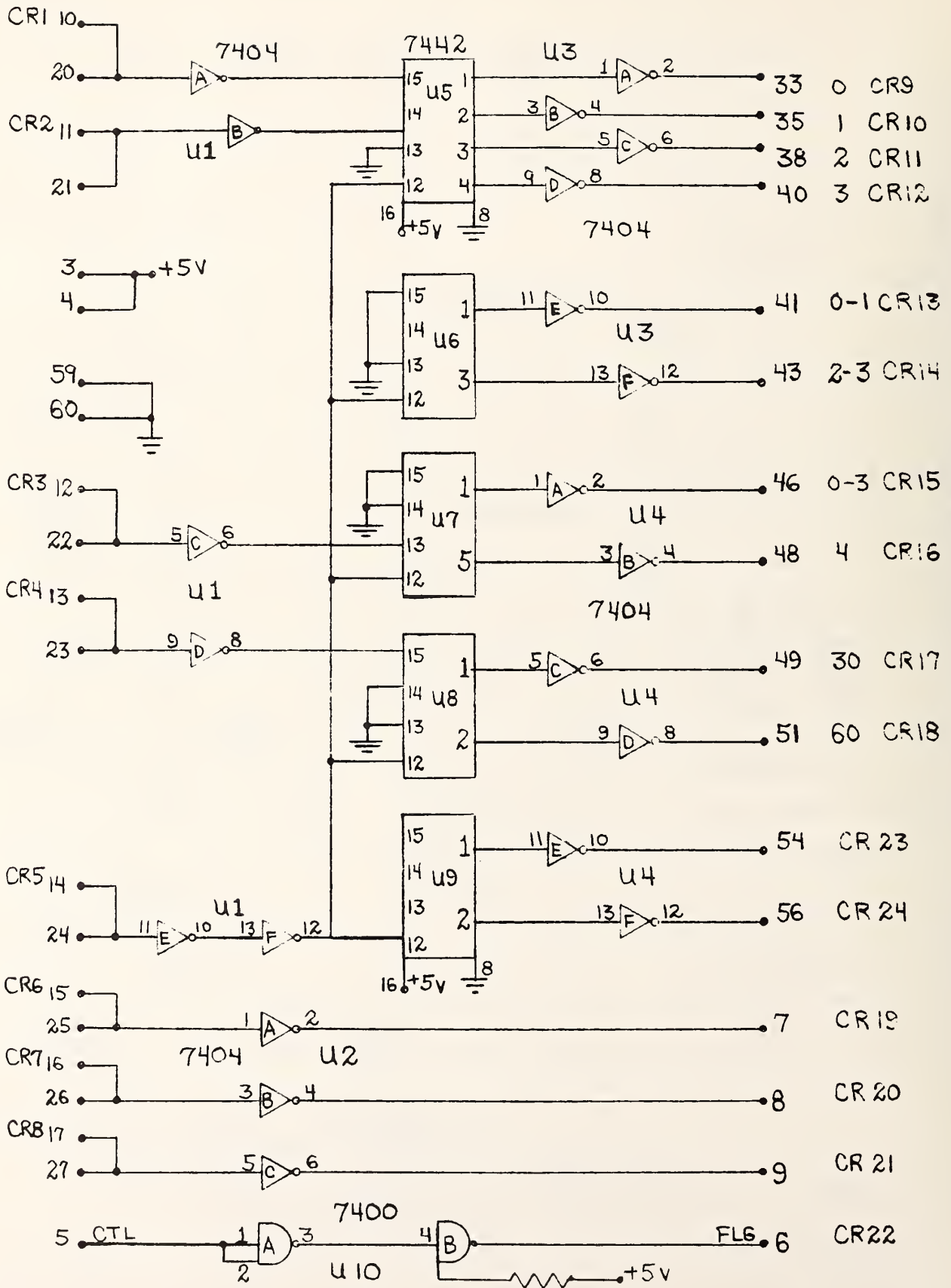

110 DECODER CARD SCHEMATIC DIAGRAM

FIGURE 9

SN7442

BCD INPUT				DECIMAL OUTPUT									
D	C	B	A	0	1	2	3	4	5	6	7	8	9
0	0	0	0	0	1	1	1	1	1	1	1	1	1
0	0	0	1	1	0	1	1	1	1	1	1	1	1
0	0	1	0	1	1	0	1	1	1	1	1	1	1
0	0	1	1	1	1	1	0	1	1	1	1	1	1
0	1	0	0	1	1	1	1	0	1	1	1	1	1
0	1	0	1	1	1	1	1	1	0	1	1	1	1
0	1	1	0	1	1	1	1	1	1	0	1	1	1
0	1	1	1	1	1	1	1	1	1	1	0	1	1
1	0	0	0	1	1	1	1	1	1	1	1	0	1
1	0	0	1	1	1	1	1	1	1	1	1	1	0
1	0	1	0	1	1	1	1	1	1	1	1	1	1
1	0	1	1	1	1	1	1	1	1	1	1	1	1
1	1	0	0	1	1	1	1	1	1	1	1	1	1
1	1	0	1	1	1	1	1	1	1	1	1	1	1
1	1	1	0	1	1	1	1	1	1	1	1	1	1
1	1	1	1	1	1	1	1	1	1	1	1	1	1

DECODER CHIP TRUTH TABLE

FIGURE 10

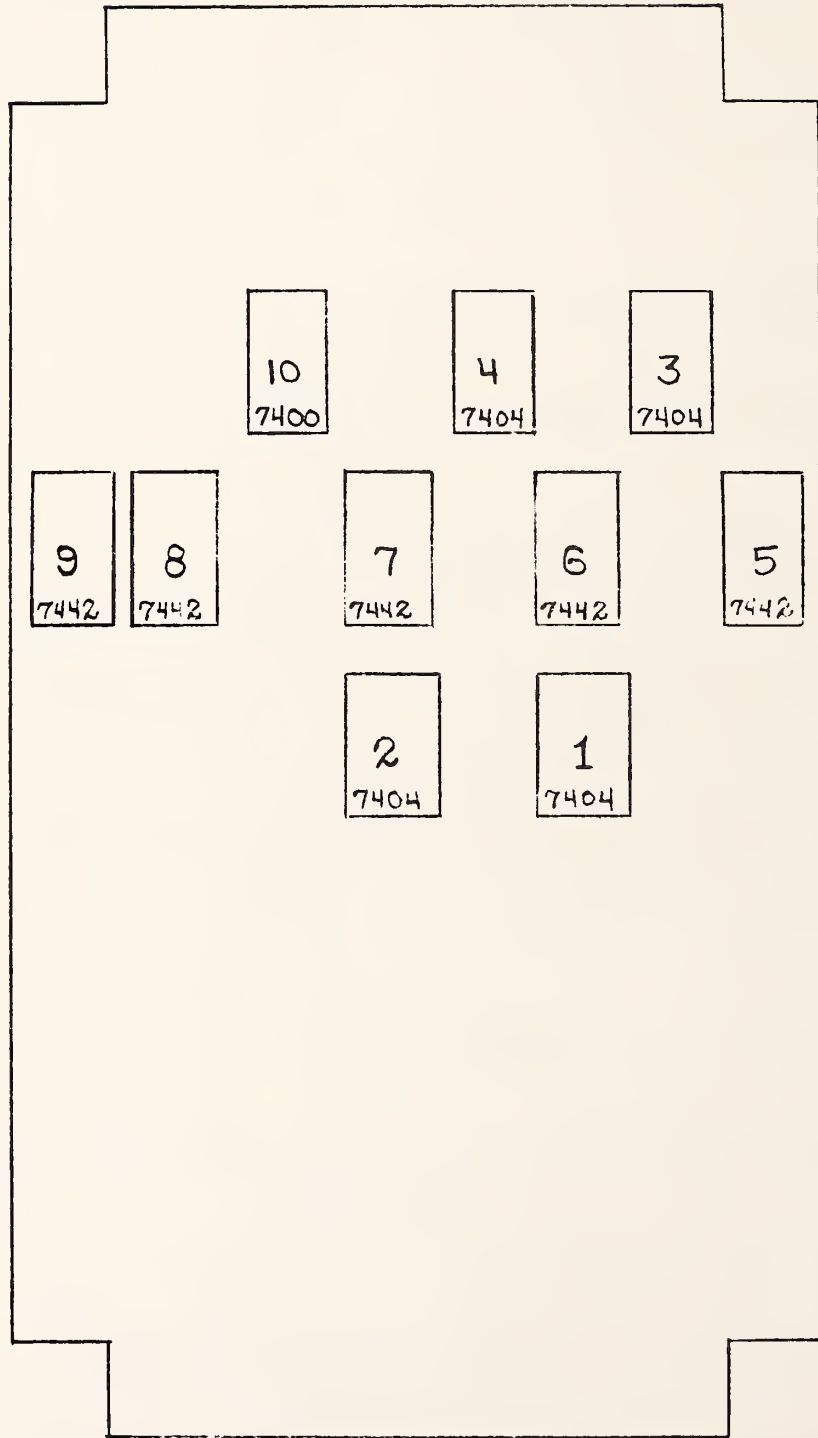

110 DECODER CARD PARTS PLACEMENT

FIGURE 11

Figure 10, the BCD (binary coded decimal) inputs labeled D, C, B, A correspond to device pin numbers 15, 14, 13, and 12 respectively. The decimal outputs listed correspond, in ascending order, to device pin numbers 1 through 11.

Inputs from the controller are sent to the decoder card via the instrument coupler. These inputs are decoded and sent to the proper switch driver card to achieve the desired switch action. Referring to Figures 8 and 9, outputs from pins 33, 35, 38, and 40 on this card control the switching of ports 0, 1, 2, and 3. Outputs from pins 41 and 43 select either the port 0-1 position or the port 2-3 position of switch #6. Outputs from pins 46 and 48 position switch #5 to connect ports 0-3 or port 4 to the remainder of the measurement system. Outputs from pins 49 and 51 select either the 30 Mhz or the 60 MHz position of switches 4a and 4b. As can be seen in Figure 9, input pin 24 on the decoder card is the "strobe" input for all of the decoder chips. This signal is used to enable the decoder output. Removing this signal provides for removing switch current without disturbing switch position. This signal is utilized in this manner to prevent heating of the switches. Outputs from pins 7 and 8 on this card are used to control the remote switches for the 15V and 25V power supplies for the switch drivers. The output from pin 9 on this card is used as a control bit for the thermistor mount switch and provides for removing current from this switch after it is properly

positioned. The output from pin 6 on this card is the return flag signal to the controller from this card.

The LED display on the front panel of the switch driver module originates on the decoder card. The upper 8 bits of the display represent the digital input bits to the decoder since a LED is connected to pins 10, 21, 12, 13, 14, 15, 16, and 17. The lower portion of the LED display is formed by connecting a LED to each of the following output pins: 33, 34, 38, 40, 41, 43, 46, 48, 49, 51, 54, 56, 7, 8, and 9. By observing the lower portion of the display, the output of the decoder card can be determined at any time.

c) Switch Driver Cards

The switch driver module uses two different switch driver designs. One is intended to use the decoder outputs to control switching. This configuration is found on cards 111, 112, and 113. The other model uses a data bit and a control bit from the controller with no decoder in between. This configuration is found on card 114. Use of this card represents a hardware update to utilize a design incorporated in new equipment now being built for other systems. Cards 111, 112, and 113 control the system measurement port and frequency switches. Referring to Figure 12, the cards are configured for the decoder input model by installing jumper wires between points B and C, and points D and E with no connection between points D and C and points A and B. There are 4 complete switch driver circuits on a card; Figure 12 shows only one of these circuits for illustration purposes with inputs and outputs for all

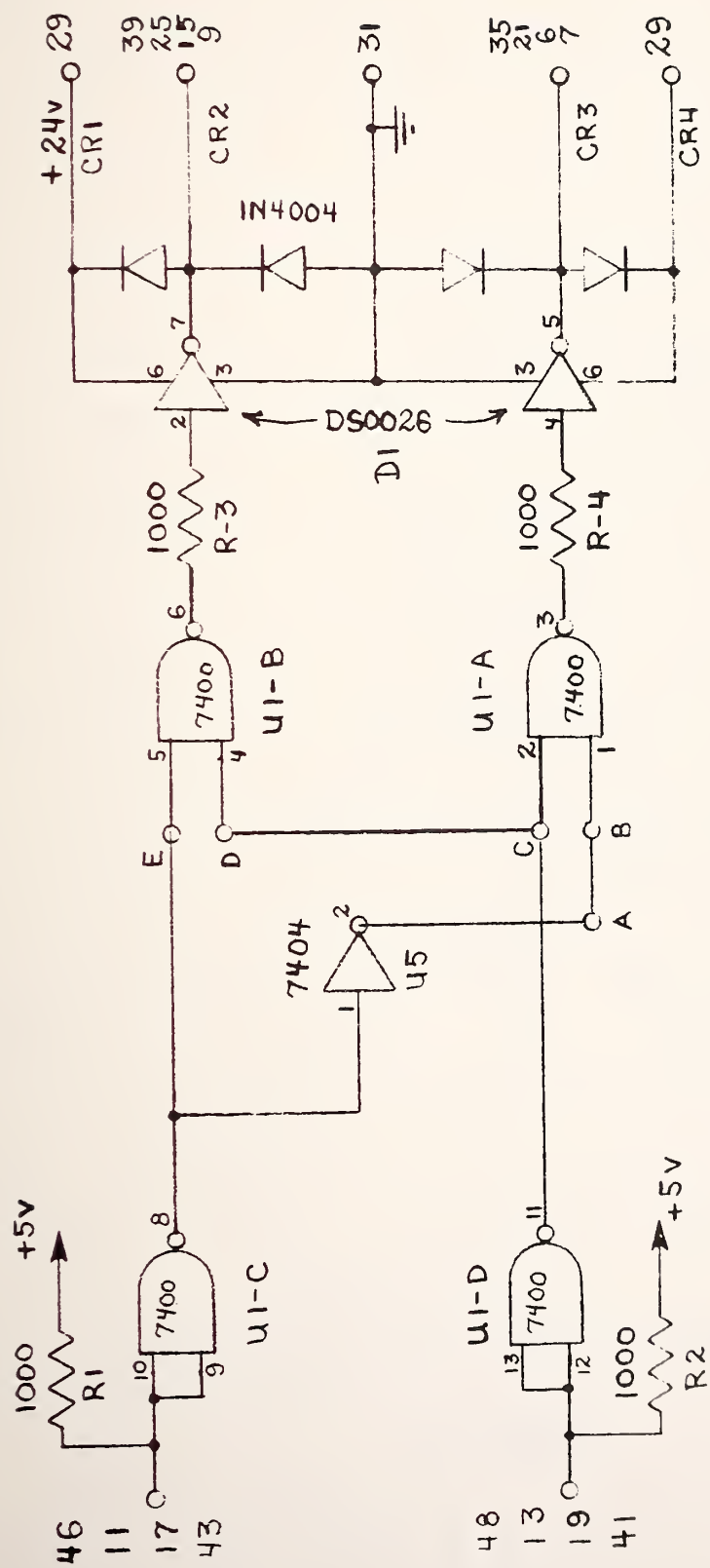

U2, U3, U4 SAME AS U1
 D2, D3 D4 SAME AS D1

WHEN DS0025 IS USED
 SHORT CIRCUIT R3 AND R4

111-114 SWITCH DRIVER CARD SCHEMATIC DIAGRAM

FIGURE 12

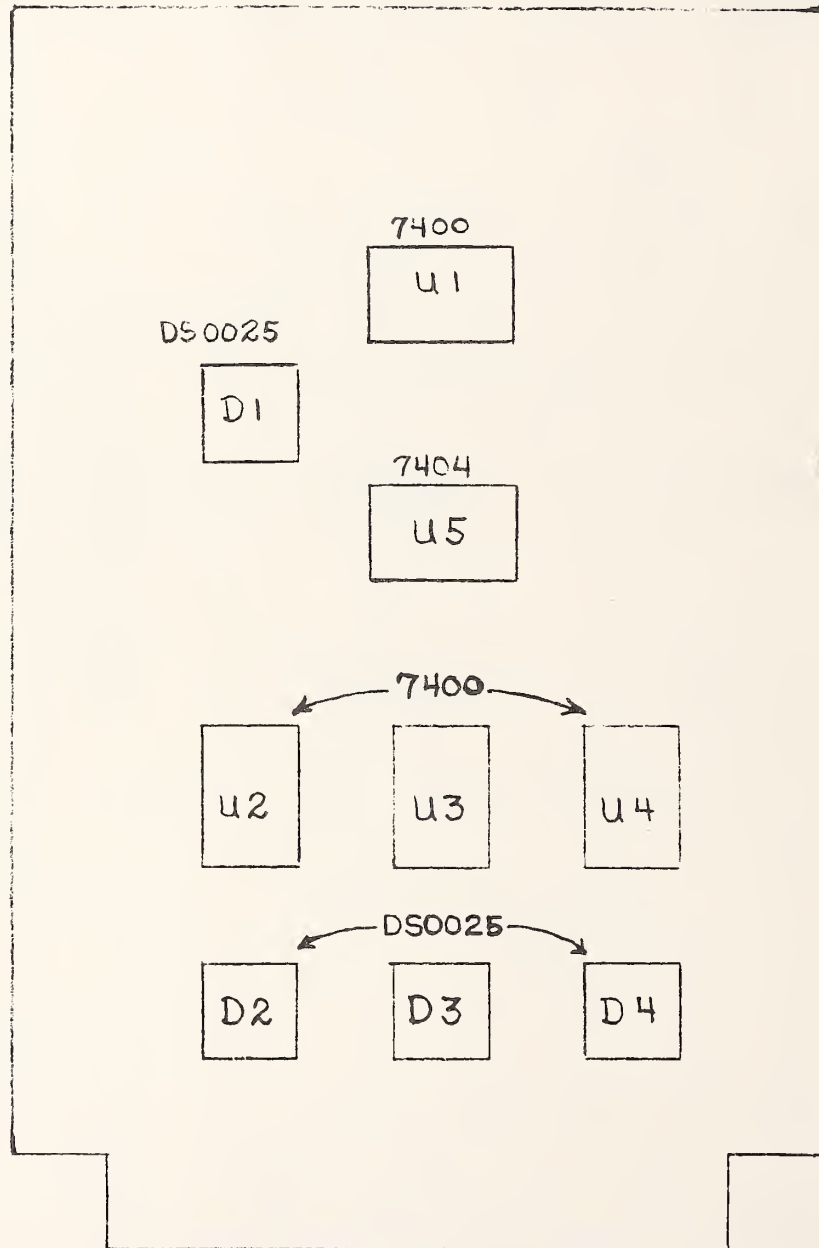

SWITCH DRIVER CARD PARTS PLACEMENT

FIGURE 13

four circuits indicated by multiple pin numbers. Inputs are in pairs and produce outputs in pairs (inputs of the proper polarity at pins 46 and 48 produce outputs of opposite polarity at pins 9 and 7). Connected to opposite sides of a switch, these outputs cause it to toggle with a change in polarity. Inputs which cause the paired outputs to have the same polarity produce a positive voltage which is applied to both sides of a switch. There is no current flow, and as a result, the switch does not toggle. The system port switches #7 and #8 are controlled by the outputs of driver card 111. The action of switches #5 and #6 is controlled by driver card 112. The frequency selection switches #4a and #4b are controlled by the output from driver card 113.

Card 114 is similar to the other switch driver cards but, as previously mentioned, is designed to operate without the decoder. To configure this card, remove the jumpers described previously and install jumpers between points A and B and points D and C.

Binary bit 7 or decimal 128 from the decoder card is used as the enabling input for the drivers on this card. It is applied to pin 19 on card 114. The source for this control bit is the controller.

d) 117 Output Display Card Operation and Adjustment

Figures 14 and 15 are the schematic diagrams for this card. The output display printed circuit card monitors the output of the diode detector. The input on pin 13 is

amplified by IC-501 and input to the overload level comparator, IC-506, through the overload-adjust potentiometer "H" (R5). If the rf power exceeds 5 milliwatts the overload comparator triggers and latches. This energizes the sonalert alarm and overvoltage LED via Pin 52. The comparator cannot be reset by pressing the reset button until the power level has been reduced to a safe level.

The incoming signal level is also processed through a series of amplifiers to the front panel RF level meter. The output of the log-amplifier, IC501, passes through a sample and hold circuit, IC-502. The output of the sample and hold circuit drives the log-amplifier, IC-504, to convert the meter reading to a dB scale. IC-503 forms a constant current source to set the zero reference of the log amplifier. The output of IC-504 is connected to the input of the meter driver amplifier, IC-505. The gain of this amplifier is switched for gains of 10, 1, and .1 to obtain meter scales of 1.0 decibel, 0.1 decibel, and 0.01 decibel. Potentiometer "D" (R14) adjusts the times 1 scale zero reference.

Adjustment of the Output Display Card

This is the only card in the switch driver module which requires adjustment. Adjustment is necessary only when the circuit has been repaired. The adjustments establish the logarithmic amplifier gain for the decibel scale on the front panel signal level meter and set the overload alarm threshold. Complete alignment requires two, 1 milliamper

117 OUTPUT DISPLAY CARD SCHEMATIC DIAGRAM

FIGURE 14

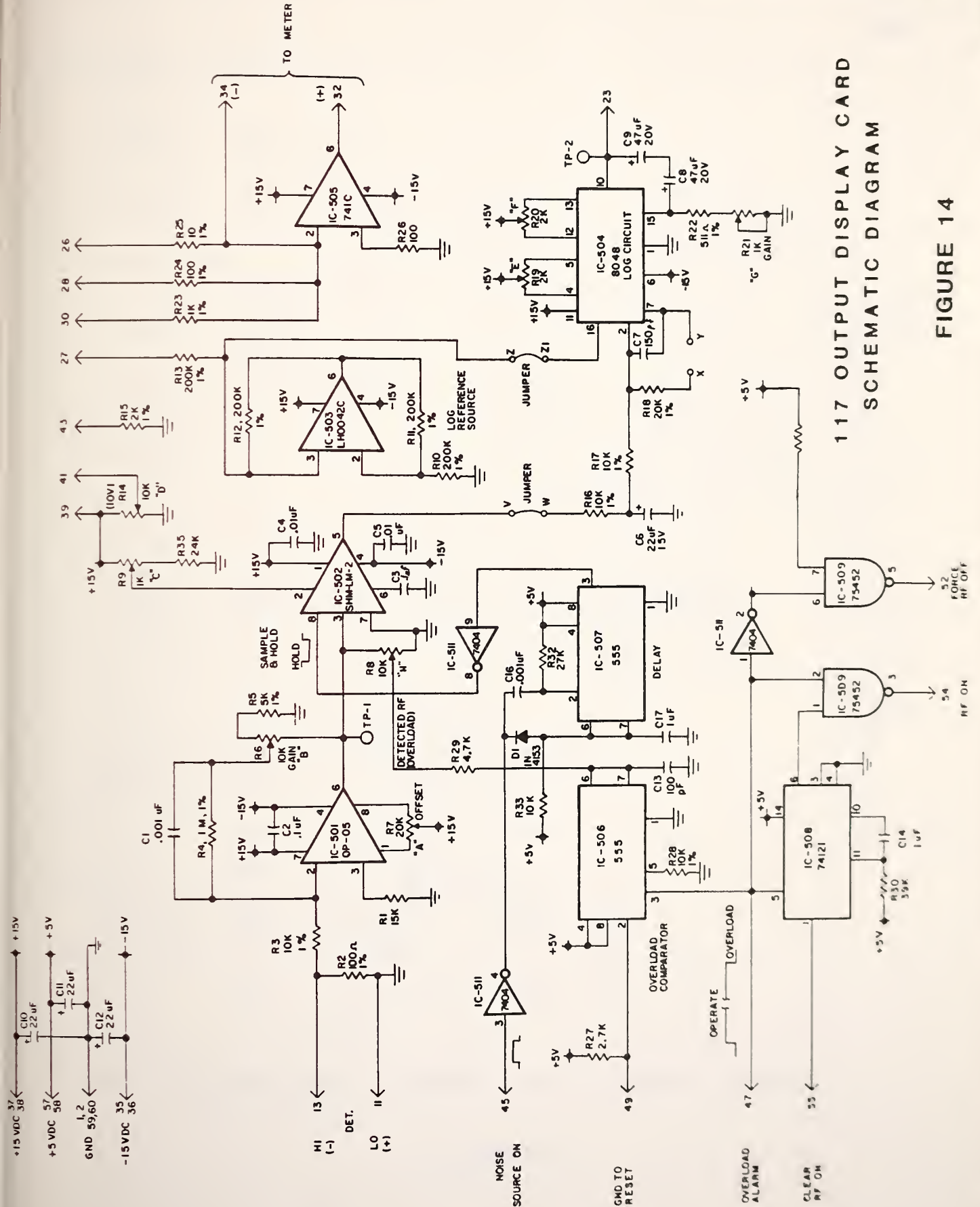

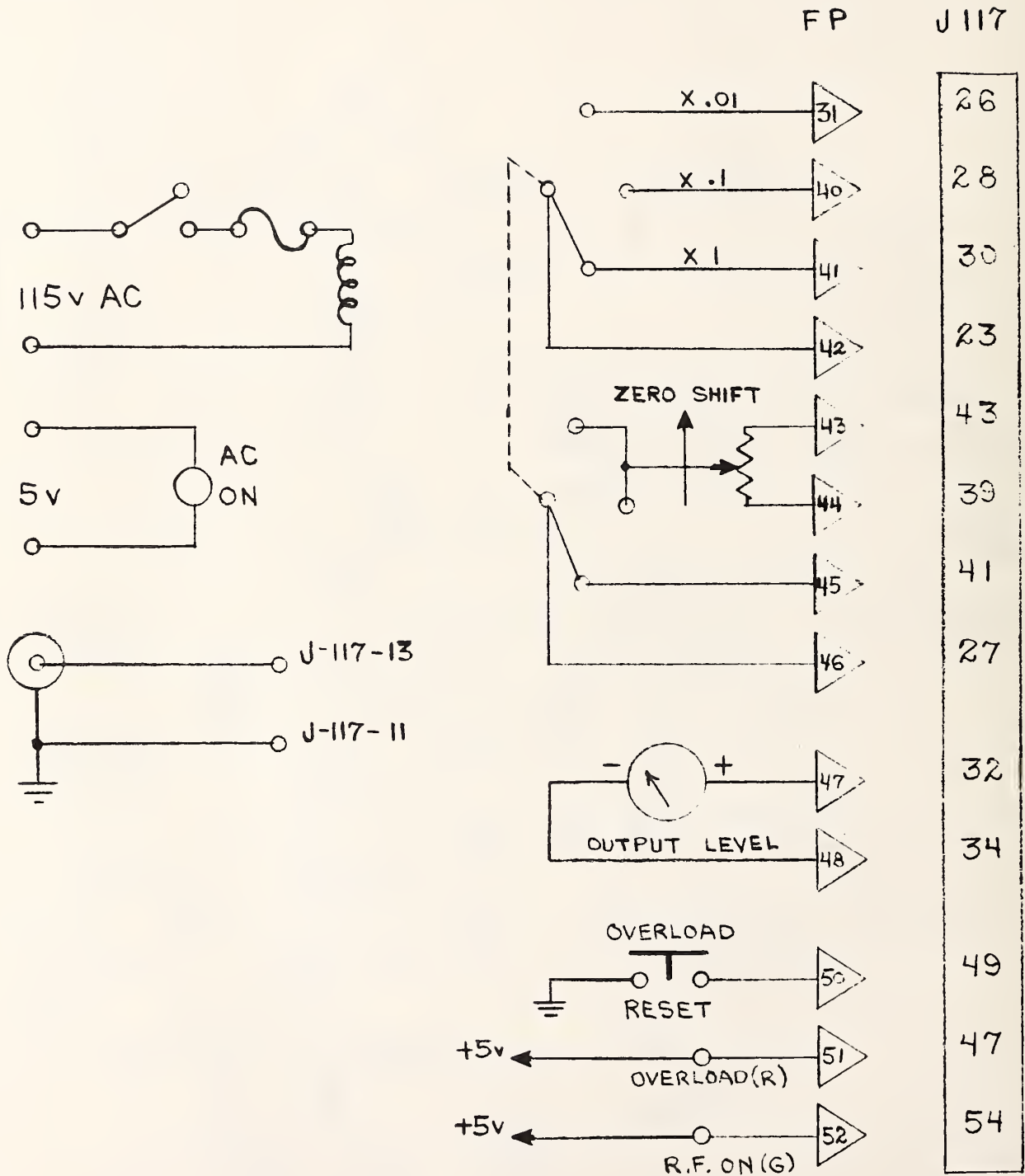

117 OUTPUT DISPLAY CARD FRONT PANEL CONNECTIONS

FIGURE 15

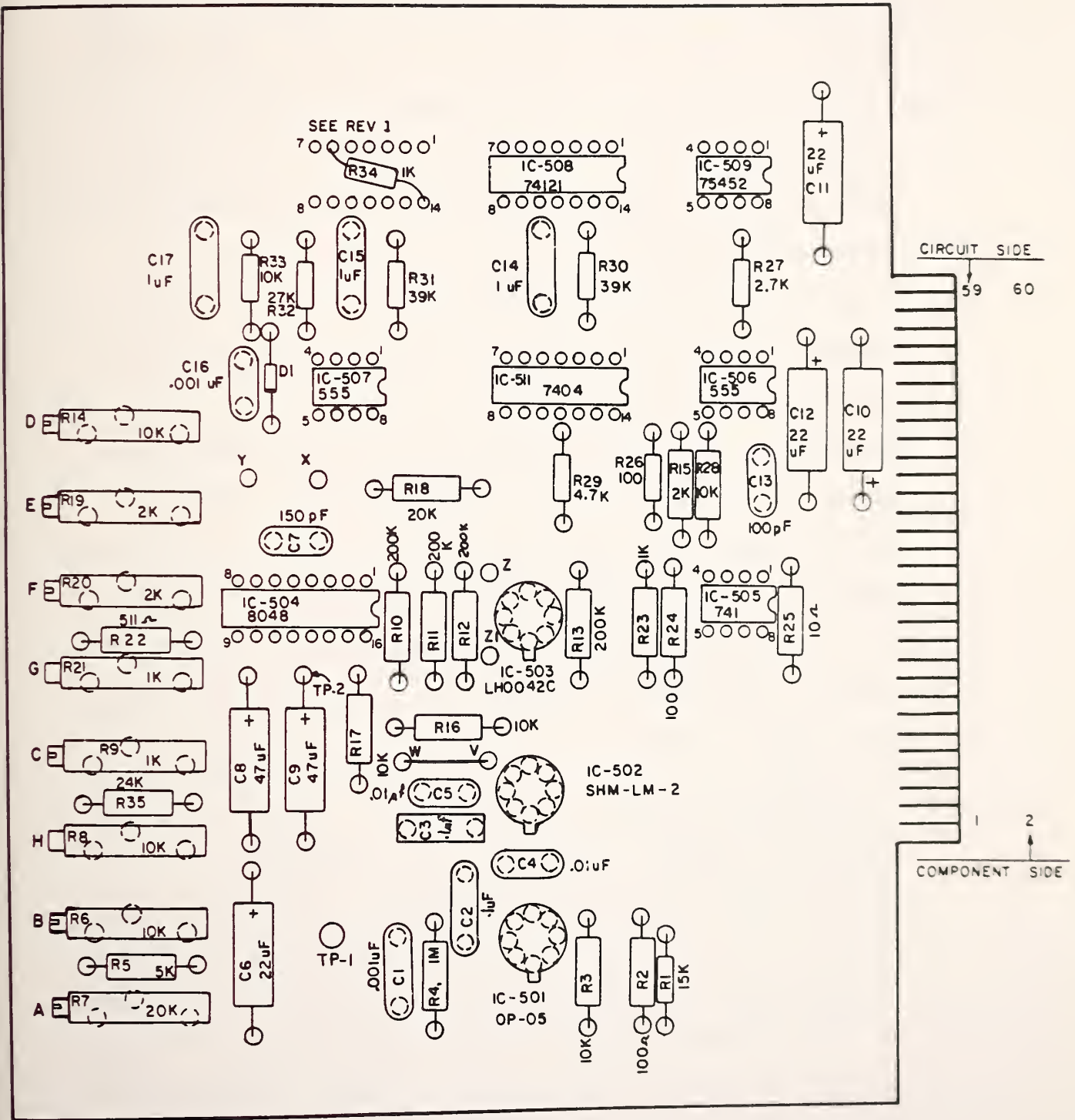

117 OUTPUT DISPLAY CARD PARTS PLACEMENT

FIGURE 16

constant current sources. Refer to Figure 14 when adjustment of the 1700 card is performed. Adjustments should be made in the following order:

1. Mount the 1700 printed circuit card on a PC extension card and remove the signal input cable from the diode detector to the front panel.
2. Connect an external voltmeter between TP 1 and ground. Adjust "A" (R7), DC offset of first amplifier, for zero on the voltmeter.
3. Connect the external voltmeter to TP V and adjust offset control, "C" (R9) for a zero reading on the voltmeter.
4. Remove the jumper from TP V to TP W. Connect a temporary jumper from TP X to TP Y. Adjust "E" (R19), DC offset of the first log-amplifier, for a zero voltmeter reading.
5. Remove the temporary jumper from TP X to TP Y. Remove the jumper from TP Z to TP Z1. Connect one +1 milliamper constant current source into TP Z1 from ground. Connect the other +1 milliamper constant current source into TP W from ground. Set both current sources to 1 milliamper. (Place two suitable current meters in series with the sources and adjust the output of the current sources to 1 milliamper on these meters). Connect the external voltmeter between TP 2 and ground. Adjust "F" (R20), the DC offset of the second stage of the log amplifier, for zero volts on the voltmeter.
6. Remove both constant current sources. Replace the jumper

from TP V to TP W. Replace the jumper between TP Z and TP Z1.

7. Connect a suitable cable between the DET IN jack on the front panel and the system diode detector output connector at one end of coaxial switch #1.

- (a) Place a diode noise standard on port 0 and apply voltage (normally 28 volts) to it.

- (b) After making sure all ports are properly terminated, turn the measurement system on.

- (c) Place the preamplifier voltage switch to the 30 MHz or up position.

- (d) Turn on all system power supplies.

- (e) Load the measurement program (30M20).

- (f) Type the following on the 9845 keyboard:

```
OUTPUT 702;"0","0","7","0"
```

```
PRESS EXECUTE
```

- (g) Remove the termination from the auxiliary port on system switch #1. Place a suitable thermistor mount on this port and connect it to an external power meter.

- (e) Set attenuator A2 for 1 milliwatt of system output power at this port.

8. Connect an external voltmeter to TP 1. Adjust "B" (R6), the first amplifier gain, for 1 volt on the voltmeter.

9. Adjust system attenuator A2 to set the external power meter reading to 2 milliwatts. Switch the meter range

- selector on the front panel to the X1 position. Adjust "D" (R14), log reference zero offset, for a zero reading on the front panel signal level meter.
10. Increase the setting of system attenuator A2 by 5 dB. Adjust "G" (R21), log-amplifier gain, for a front panel meter reading of -5 divisions. Decrease the attenuator A2 setting 10 dB and note the front panel meter reading. Touch up "G" if necessary to obtain approximately a +5 reading on the meter scale. Recheck the -5 reading.
 11. Set the input attenuator for a power level of 1 milliwatt on the power meter. Readjust "D" for a +3 reading on the front panel meter.
 12. Adjust the front panel attenuators for a 5 milliwatts (+7dBm) power indication on the power meter. Adjust "H" (R5), overload threshold adjust, clockwise until the alarm sounds. Now turn R5 1/2 turn counter-clockwise. Reduce the input power and push the reset button on the front panel. Slowly increase the power to test the alarm threshold. The alarm should be activated at the +5 milliwatt power level.
 13. Adjust attenuator A2 until the external power meter reads 2 milliwatts. Adjust "D" (R14), log reference zero offset, for a zero reading on the front panel signal level meter.

This completes the alignment of the Output Display Card. These adjustments do not affect system operation or accuracy. They do however, provide for the accurate display of system power levels.

2. 30 MHZ AND 60 MHZ PREAMPLIFIERS

Referring to Figure 17, note that essentially the same schematic diagram is used for both the 30 MHz and the 60 MHz preamplifiers. The main difference is the value of the RF chokes, L1 and L2. The values of these components in the 30 MHz amplifier are double the value of those used in the 60 MHz amplifier.

These amplifiers were very carefully built with extreme care being taken with parts selection and placement. Ground strapping is extremely important as is proper shielding. Some stock components as well as some component locations produced an inferior amplifier. For this reason, amplifier performance was checked with impedance and noise figure meters as construction progressed.

Input impedance, output impedance, and noise figure are adjustable. However, because the adjustments are interdependent, a compromise is necessary to obtain optimum tuning for both noise figure and impedance. The lowest noise figure achieved with acceptable input impedance was between 1.5 and 1.6 decibels. This noise figure was obtained while maintaining the real and imaginary parts of the input impedance as specified previously. The impedances were measured using a vector impedance meter, and the noise figure was measured using a commercial noise figure meter with a calibrated noise diode reference.

Since failure of one of these amplifiers will undoubtedly cause a long "system down time" while repairs and adjustments are made, spare amplifiers are mounted beside the two being used. If

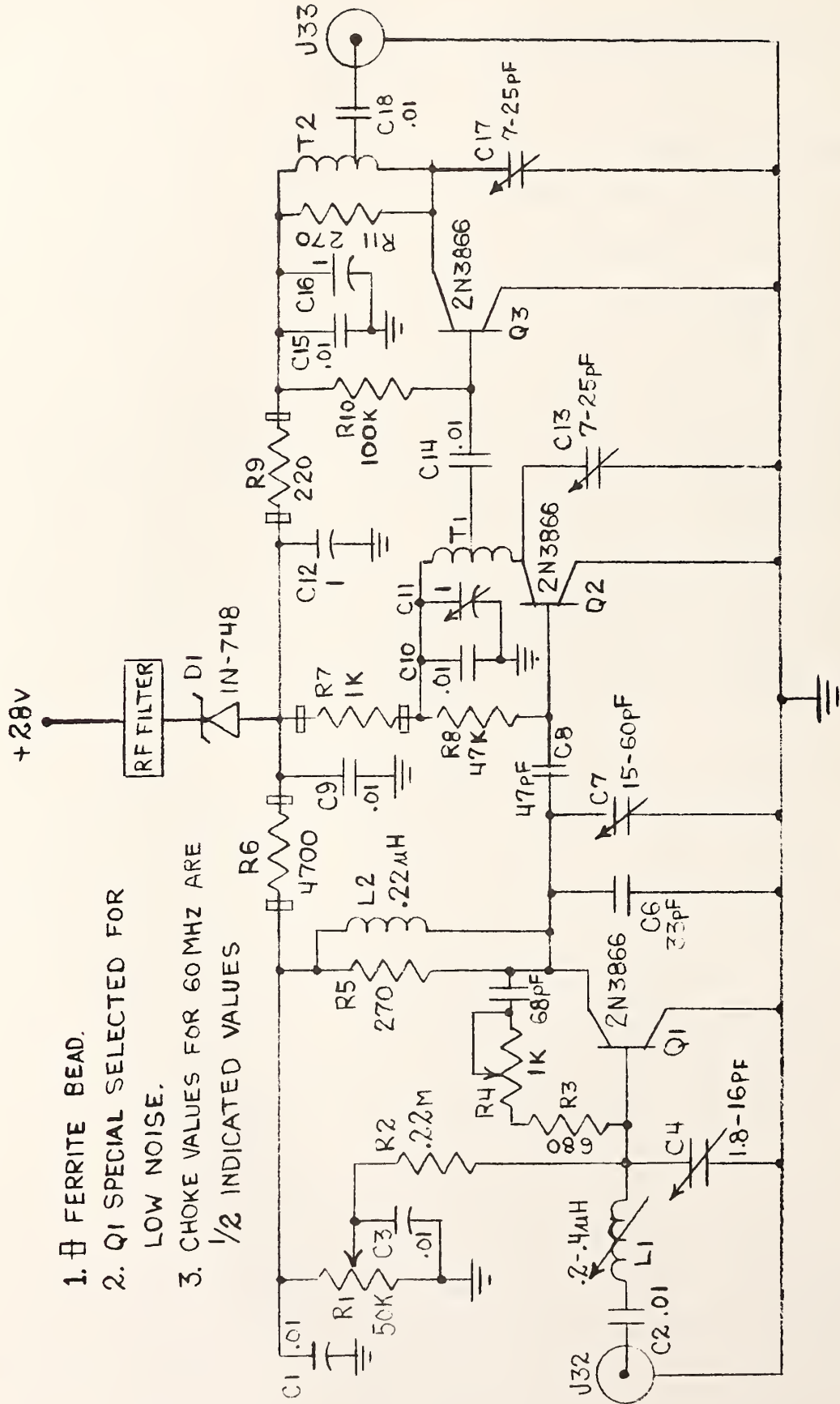

- 1. \square FERRITE BEAD.
- 2. Q1 SPECIAL SELECTED FOR LOW NOISE.
- 3. CHOKE VALUES FOR 60MHZ ARE $\frac{1}{2}$ INDICATED VALUES

30MHZ AND 60MHZ PREAMPLIFIER SCHEMATIC DIAGRAM

FIGURE 17

failure occurs, simply remove the defective amplifier and replace it with the proper spare.

3. INTERCONNECTION AND WIRING DIAGRAMS

The system interconnection cables include the IEEE 488 bus cables which connect the controller to the scanner, digital multimeter, and instrument coupler. In addition to the instrument bus interconnection cables, the equipment is coupled together by the following:

TABLE 5
SYSTEM CABLES--INSTRUMENTS TO SCANNER

Cable #	Figure #	Source	Destination
1. Cable 1	18	DC Power Supplies	Scanner
2. Cable 1A	18	Scanner	DMM Rear Panel Input Connector
3. Cable 2	18	Type IV Power Meter	Scanner
4. Cable 2a	18	Scanner	Rear Panel Input Connector
5. Cable 3	19	Ambient Standard	External Terminal Board on Scanner
7. Cable 4	19	Cryogenic Standard	External Terminal Board on Scanner
8. Cable 5	19	External Terminal Board on Scanner	DMM Front Panel Input Terminals

The cables listed in Table 5 are those directly concerned with the transfer of measurement information from the various instruments to the digital multimeter which acts as a central processing point since it measures the cable outputs and sends the measured results back to the controller on the IEEE 488 bus.

Commands from the controller are sent to the switch control module via the instrument coupler. The switch control module then controls the system switches by accessing them through the cables connected to its output jacks. Figures 20 through 28 detail the pin connections of the switch driver module input and output jacks.

An overview of all connections made to the switch driver module from the controller and within the switch driver module to the various switch driver cards is shown in Figure 20.

Figure 21 is a diagram of J104 which is the input cable from the instrument coupler to the switch driver module.

Figure 22 is a diagram of J102 which is the output jack from the switch driver module to the system switches.

Figure 23 is a wiring list for J-102 and its associated cable.

Figure 24 is a diagram showing the inputs and outputs to J-110, the decoder edge connector.

Figures 25 through 28 are diagrams of the switch driver card edge connectors J-111, J-112, J113, and J114.

4. PARTS LISTS

Information relating to the parts lists for the digital voltmeter, scanner, instrument coupler, thermistor mount, power meter, and power supplies can be obtained from the instrument manual supplied by the manufacturer. The parts lists for NBS manufactured equipment will be found in TABLE 7. Manufacturers Codes used in these parts lists are tabulated in TABLE 6.

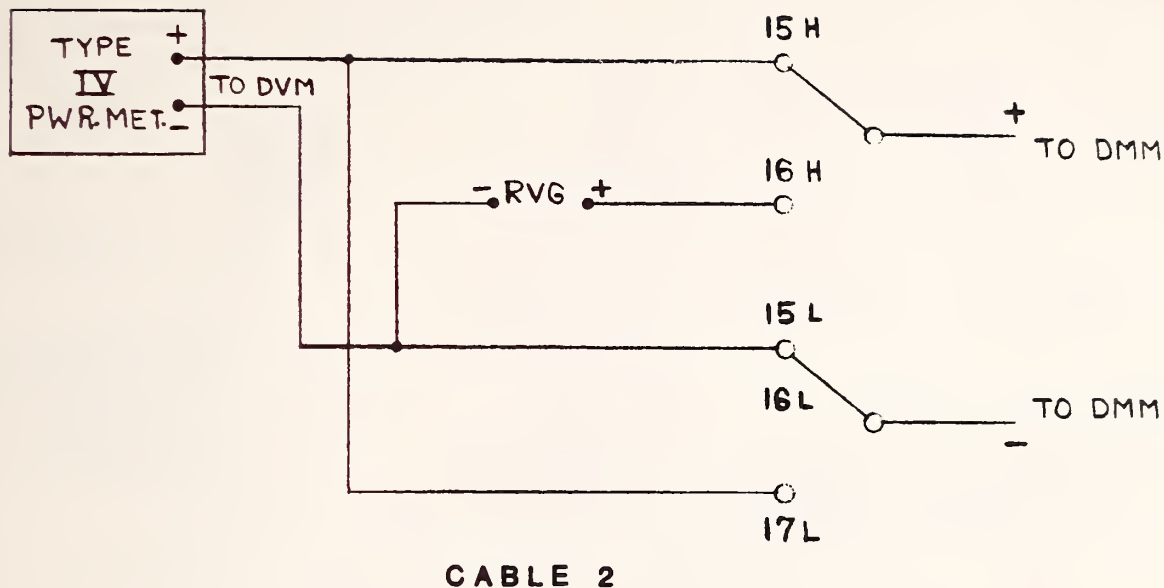

SCANNER DECADE (LOW THERMAL) CHANNELS 10-19

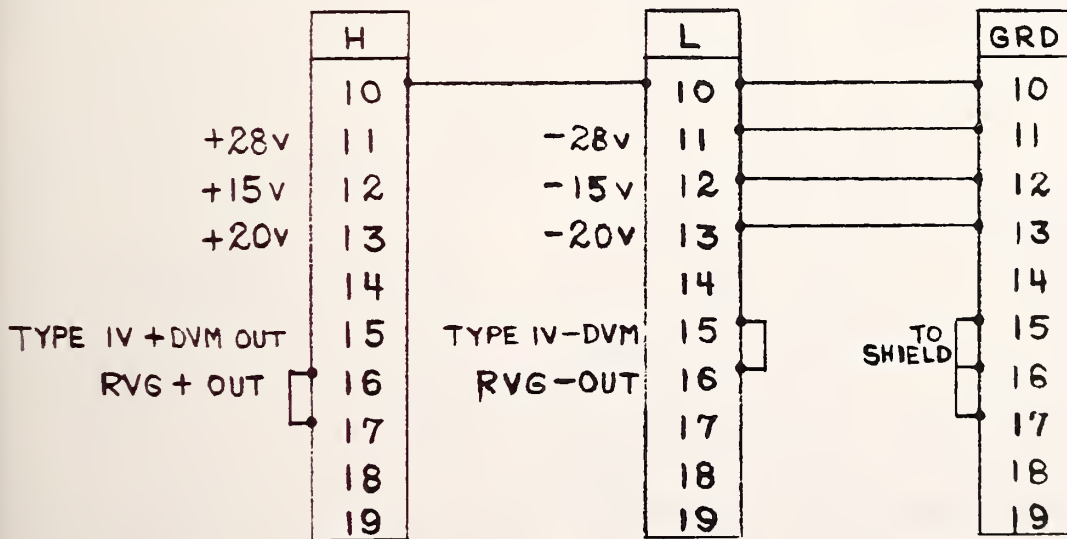

SCANNER CONNECTIONS CABLE 1 (10-13)

SCANNER CONNECTIONS CABLE 2 (15-17)

POWER METER WIRING DIAGRAM AND SCANNER CONNECTIONS

FIGURE 18

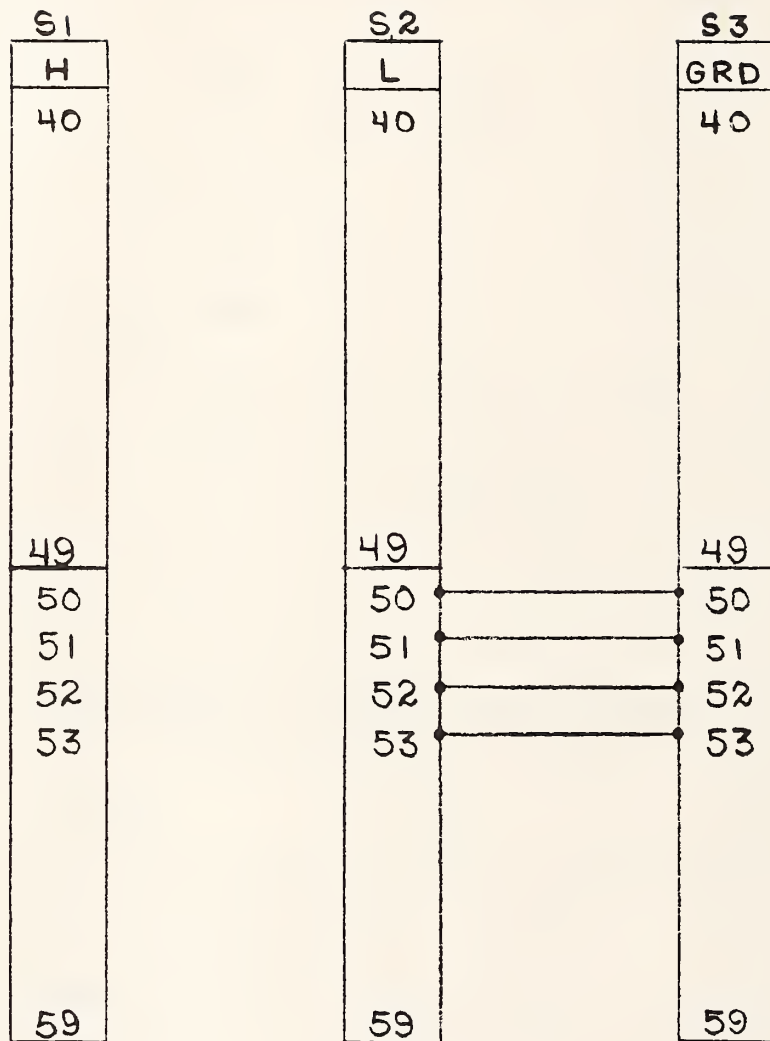

S4 OUTPUT

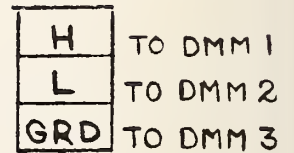

PLATINUM THERMOMETER

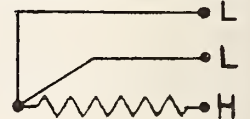

CABLE 3

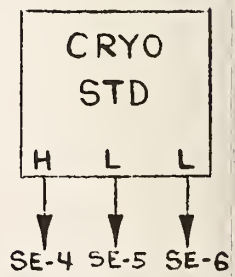
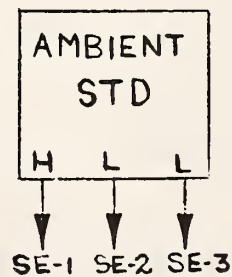
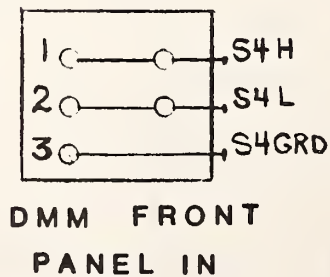
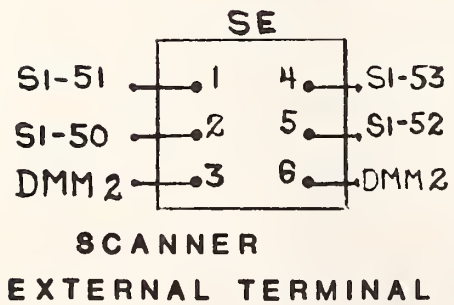

NOISE STANDARDS WIRING DIAGRAM AND SCANNER CONNECTIONS

FIGURE 19

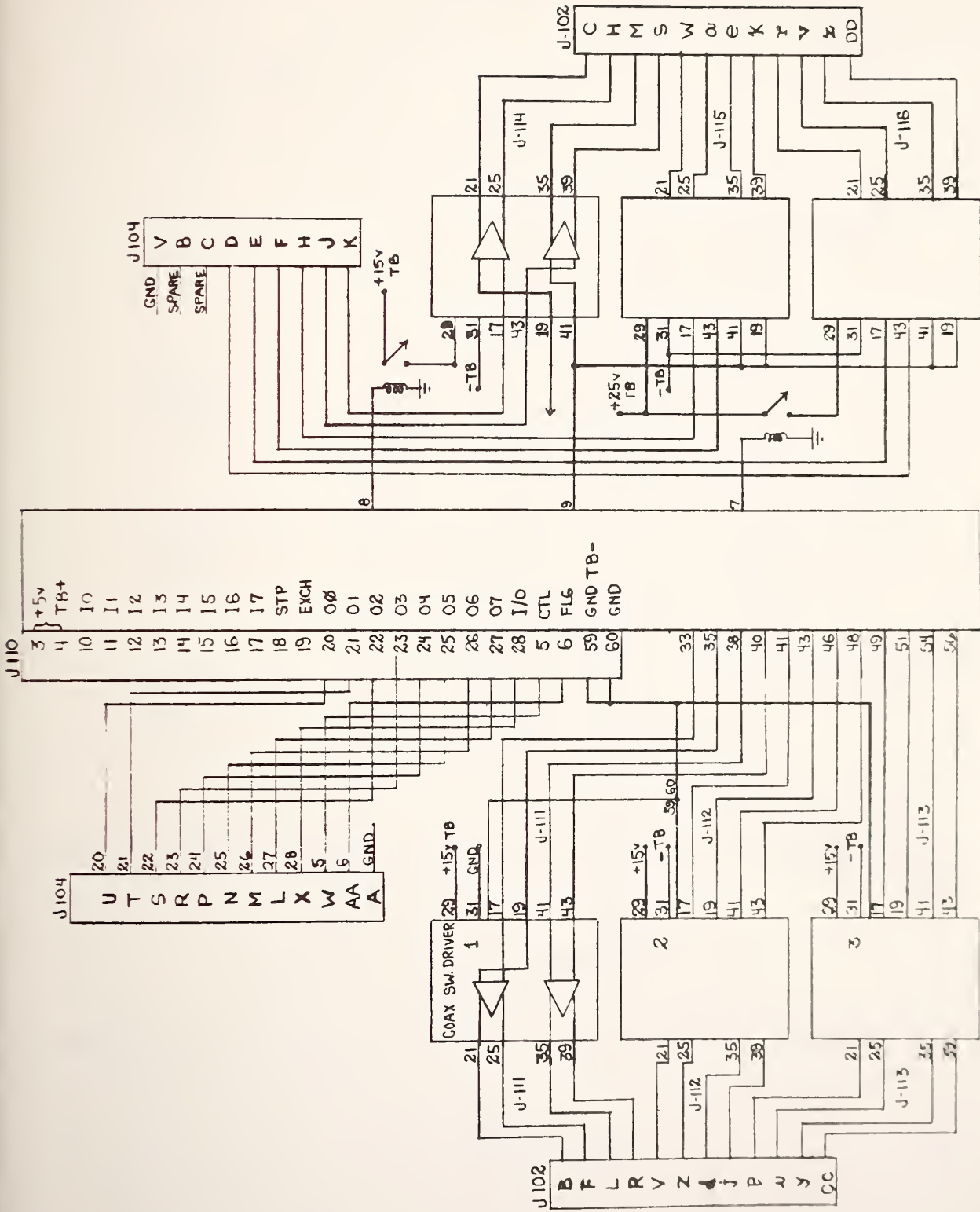

SYSTEM CABLE INTERCONNECTION DIAGRAM

FIGURE 20

J-104

GND	V	
DO 15	B	SPARE
DO 14	C	SPARE
DO 13	D	J 116-43
DO 12	E	J 116-17
DO 11	F	J 115-43
DO 10	H	J 115-17
DO 9	J	J 114-43
DO 8	K	J 114-17
DO 7	L	J 110-27
DO 6	M	J 110-26
DO 5	N	J 110-25
DO 4	P	J 110-24
DO 3	R	J 110-23
DO 2	S	J 110-22
DO 1	T	J 110-21
DO 0	U	J 110-20
PCNTL	W	J 110-5
I/O	X	J 110-28
PFLG	AA	J 110-6
GND	A	J 110-60

PIN CONNECTIONS FOR J104, SWITCH DRIVER MODULE INPUT

FIGURE 21

J102

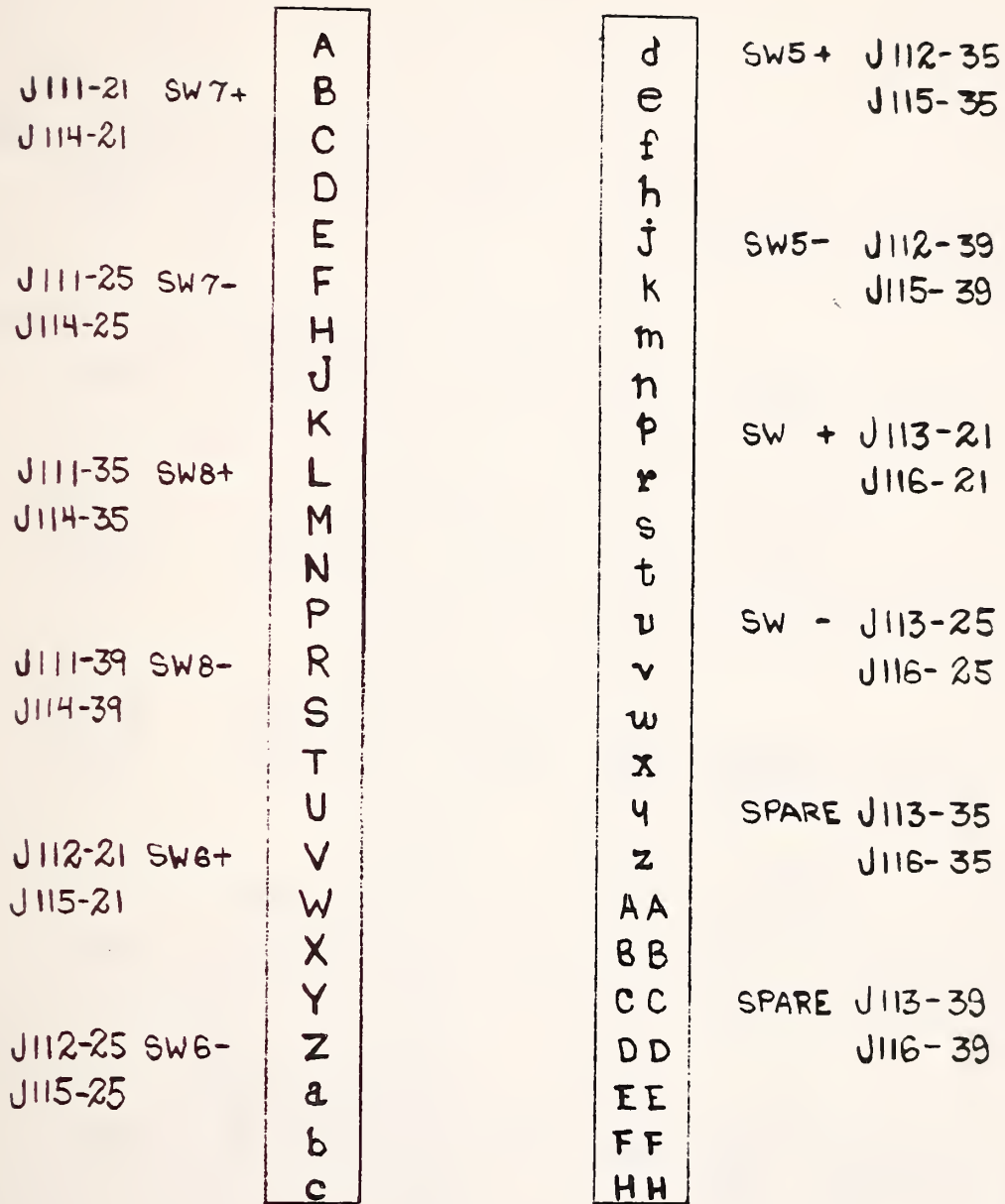

PIN CONNECTIONS FOR J102, SWITCH DRIVER MODULE OUTPUT

FIGURE 22

	A			VIO	d	J-112-35	PORT-4 SW 5
BRN	B	J-111-21	PORT-0 SW 7	VIO	e	J-115-35	2dB +
BRN	C	J-114-21	RF ON +		f		
	D				h		
	E			GRY	j	J-112-39	PORT 0-3 SW 5
RED	F	J-111-25	PORT-1 SW 7	GRY	k	J-115-39	2dB -
RED	H	J-114-25	RF ON -		m		
	J				n		
	K			WHT	p	J-113-21	60 MHz
OR	L	J-111-35	PORT-3 SW 8	WHT	r	J-116-21	4dB +
OR	M	J-114-35	REF +		s		
	N				t		
	P			BLK	u	J-113-25	30 MHz
YEL	R	J-111-39	PORT-2 SW 8	BLK	v	J-116-25	4 dB -
YEL	S	J-114-39	REF -		w		
	T				x		
	U				y	J-113-35	
GRN	V	J-112-21	TR-0-1 SW 6	BRN	z	J-116-35	8 dB +
GRN	W	J-115-21	1dB +		AA		
	X				BB		
	Y				CC	J-113-39	
BLU	Z	J-112-25	TR 2-3 SW 6	RED	DD	J-116-39	8dB -
BLU	a	J-115-25	1dB -		EE		
	b				FF		
	c				HH		

COMPLETE WIRING DIAGRAM FOR J102

FIGURE 23

J 110

	1	31	
	2	32	
+5V	}	33	J 111-17
TB+		34	
J 104 - W	5	35	J 111-19
J 104 - AA	6	36	
+ 25v SWITCH	7	37	
+ 15v SWITCH	8	38	J 111-41
J-114, 15, 16 - 41+19	9	39	
	10	40	J 111-43
	11	41	J 112-17
	12	42	
	13	43	J 112-19
	14	44	
	15	45	
	16	46	J 112-41
	17	47	
	18	48	J 112-43
	19	49	J 113-17
J 104 - U	20	50	
J 104 - T	21	51	J 113-19
J 104 - S	22	52	
J 104 - R	23	53	
J 104 - P	24	54	J 113-41
J 104 - N	25	55	
J 104 - M	26	56	J 113-43
J 104 - L	27	57	
J 104 - X	28	58	
	29	59	} -5V GND TB-
	30	60	

J 110, DECODER CARD INPUT AND OUTPUT CONNECTOR

FIGURE 24

J 111

	1	31	-15V TB
	2	32	
	3	33	
	4	34	
	5	35	J102-L
	6	36	
	7	37	
	8	38	
	9	39	J102-R
	10	40	
	11	41	J110-38
	12	42	
	13	43	J110-40
	14	44	
	15	45	
J110-33	16	46	
	17	47	
J110-35	18	48	
	19	49	
J102-B	20	50	
	21	51	
	22	52	
	23	53	
J102-F	24	54	
	25	55	
	26	56	
	27	57	
	28	58	
+15V TB	29	59	} TB GND
	30	60	

J111, SWITCH DRIVER CARD INPUT AND OUTPUT CONNECTOR

FIGURE 25

J 112

	1	31	-15 TB
	2	32	
	3	33	
	4	34	
	5	35	J 102-d
	6	36	
	7	37	
	8	38	
	9	39	J 102-j
	10	40	
	11	41	J 110-46
	12	42	
	13	43	J 110-48
	14	44	
	15	45	
J 110-41	16	46	
	17	47	
	18	48	
J 110-43	19	49	
	20	50	
J 102-V	21	51	
	22	52	
	23	53	
	24	54	
J 102-Z	25	55	
	26	56	
	27	57	
	28	58	
+15 TB	29	59	GND-TB
	30	60	GND-TB

J 112, SWITCH DRIVER CARD INPUT AND OUTPUT CONNECTOR

FIGURE 26

J113

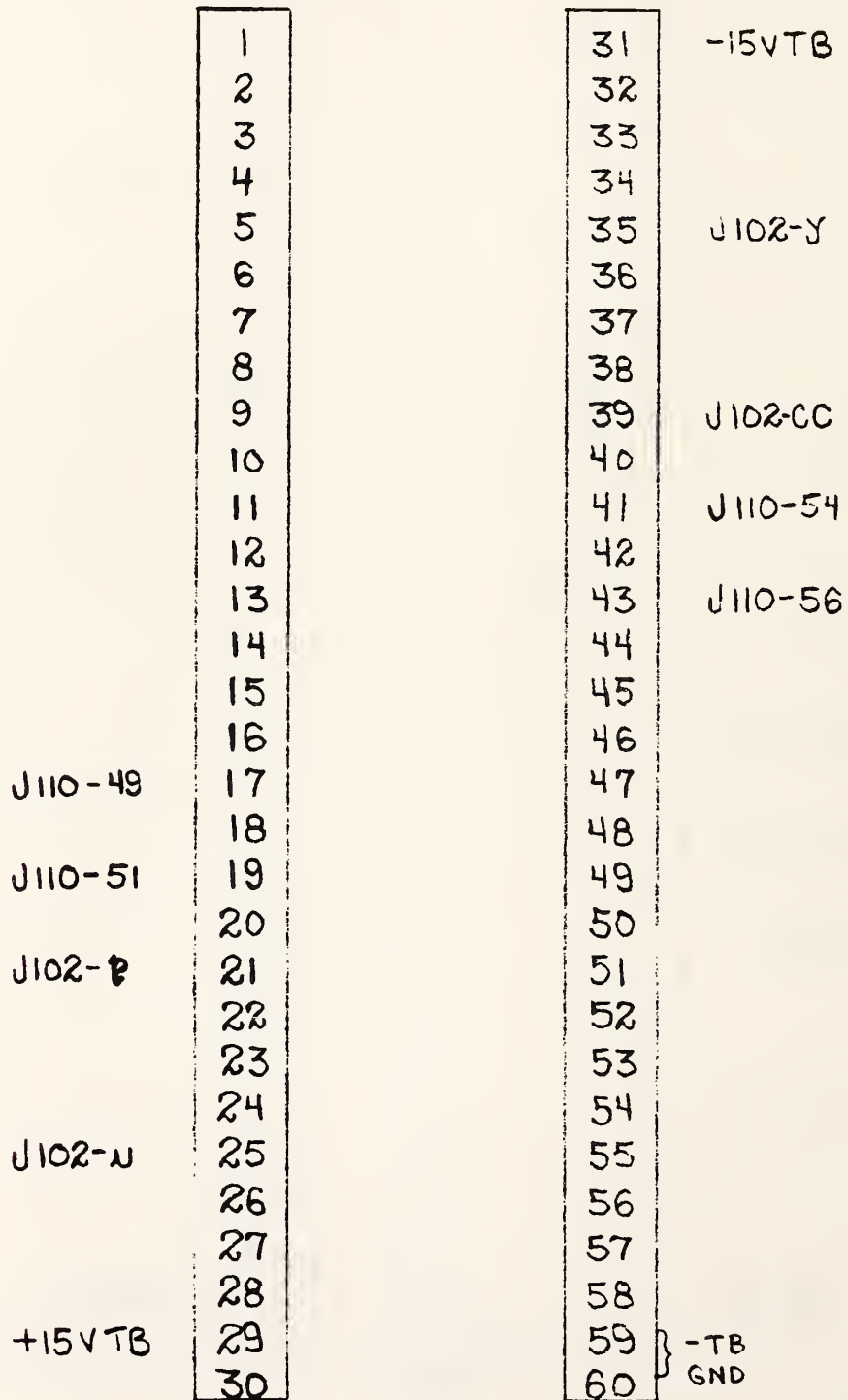

J113, SWITCH DRIVER CARD INPUT AND OUTPUT CONNECTOR

FIGURE 27

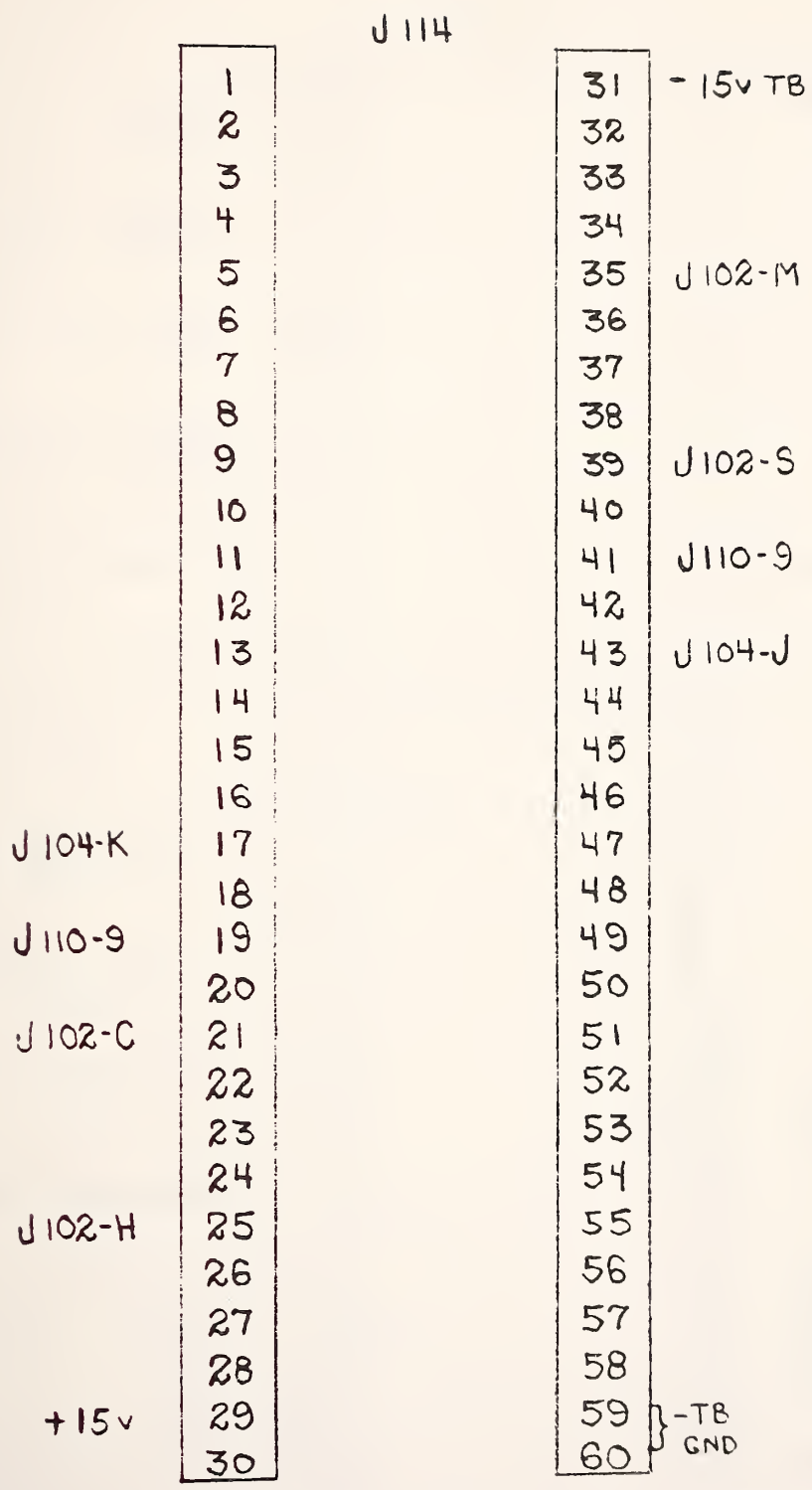

J114, SWITCH DRIVER CARD INPUT AND OUTPUT CONNECTOR

FIGURE 28

J117

ANALOG GND	1	31	
" "	2	32	FP-47
	3	33	
	4	34	FP-48
	5	35	
	6	36	-15v
	7	37	
	8	38	+15v
	9	39	FP-44
	10	40	
SHIELD XTAL DET.	11	41	FP-45
	12	42	
XTAL DET.	13	43	FP-43
	14	44	
	15	45	
	16	46	
	17	47	FP-51 LED R
	18	48	
	19	49	FP-50 RESET
	20	50	
	21	51	
	22	52	J-114-19
FP-42	23	53	
	24	54	LED-GRN FP-52
	25	55	
FP-31	26	56	
FP-46	27	57	+5v
FP-40	28	58	+5v
	29	59	GND
FP-41	30	60	"

J117, OUTPUT DISPLAY CARD INPUT AND OUTPUT CONNECTOR

FIGURE 29

TABLE 6
MANUFACTURER'S CODE TABLE

3M

3M Company, Electronics Products Division
3M Center
St. Paul, Minnesota 55101

AB

Allen-Bradley Company
1201 S. Second Street
Milwaukee, Wisconsin 53204

ALCO

Alcoswitch Division of Alco Electronic Products, Inc.
P.O. Box 1348
Lawrence, Massachusetts 01842

AMPH

Amphenol Connector Division
Bunker-Ramo Corporation
Broadview, Illinois 60153

BRNS

Bourns, Incorporated, Trimpot Division
1200 Columbia Avenue
Riverside, California 92507

BUD

Bud Radio Incorporated
4605 East 355th Street
Willoughby, Ohio 44094

TABLE 6

MANUFACTURER'S CODE TABLE continued

CORG

Corning Glass Works
Electronic Products Division
Corning, New York 14830

DATL

Datel Systems, Incorporated
1020 Turnpike Street
Canton, Massachusetts 02021

DIAL

Dialight Corporation
Division of North American Phillips Corporation
Brooklyn, New York 11237

DUNC

Duncan Electric Company, Inc.
2865 Fairview Road
Lafayette, Indiana 47902

GARY

Garry Manufacturing, Inc.
1010 Jersey Avenue
New Brunswick, New Jersey 08902

ITSL

Intersil, Incorporated
10900 North Tantau Avenue
Cupertino, California 95014

TABLE 6

MANUFACTURER'S CODE TABLE continued

MODT

Modutec, Incorporated
18 Marshall Street
Norwalk, Connecticut 06854

MONO

Precision Monolithics, Inc.
1500 Space Drive
Santa Clara, California 95050

MOT

Motorala Semiconductor Products, Incorporated
2002 West 10th Place
Tempe, Arizona 85281

NATL

National Semiconductor Corp.
2900 Semiconductor Drive
Santa Clara, California 95051

NBS

National Bureau of Standards
325 Broadway
Boulder, Colorado 80302

SAMT

Samtec, Incorporated
2652 Charlestown Road
New Albany, Indiana 47150

TABLE C

MANUFACTURER'S CODE TABLE continued

SCBE

Scanbe Canosa Industries
3445 Fletcher Avenue
El Monte, California 91731

SEAC

Seacor, Incorporated
598 Broadway
Norwood, New Jersey 07648

SPRG

Sprague Electric Company
418 Marshall Street
North Adams, Massachusetts 012147

THER

Thermalloy Inc.
2021 West Valley View
Dallas, Texas 75234

TABLE 7

PARTS LIST FOR SWITCH DRIVER MODULE COMPONENTS continued

SWITCH DRIVER CARD (111, 112, 113, 114)

Category 1-----Resistors-----				
R1	4ea	Resistor, Carbon, 0.25W 5%,1K	AB	FSN 5905-681-6462
R2	4ea	Resistor, Carbon, 0.25W 5%,1K	AB	FSN 5905-681-6462
R3	4ea	Resistor, Carbon, 0.25W 5%,1K	AB	FSN 5905-681-6462
R4	4ea	Resistor, Carbon, 0.25W 5%,1K	AB	FSN 5905-681-6462
Category 4-----Diodes-----				
CR1	4ea	Diode Rectifier	MOTO	1N4004
CR2	4ea	Diode Rectifier	MOTO	1N4004
CR3	4ea	Diode Rectifier	MOTO	1N4004
CR4	4ea	Diode Rectifier	MOTO	1N4004
Category 5-----Integrated Circuits-----				
U1	4ea	I. C. Quad Nand Gate	TI	SN7400N
U2	1ea	I. C. Hex Inverter	TI	SN7404N
U3	2ea	I. C. Mos Memory Clock Driver NATL		DS0025C
U4	2ea	I. C. Mos Memory Clock Driver NATL		DS0025C
Category 6-----Connectors-----				
	5ea	14 Pin DIP Socket	THER	8204-NF-414-1
	4ea	8 Pin DIP Socket	THER	8204-NF-408-1

TABLE 7

PARTS LIST FOR SWITCH DRIVER MODULE COMPONENTS continued

OUTPUT DISPLAY CARD (117)

Category 1		-----Resistors-----		
R1	1ea	Resistor, Carbon, 0.25W, 5%, 15K	AB	CB
R2	2ea	Resistor, MF, 0.25W, 1%, .1K	CORG	NC5
R3	4ea	Resistor, MF, 0.25W, 1%, 10K	CORG	NC5
R4	1ea	Resistor, MF, 0.25W, 1%, 1000K	CORG	NC5
R5	1ea	Resistor, MF, 0.25W, 1%, 5.1K	CORG	NC5
R6	3ea	Resistor, Var, Trim, CERMET, 10K	BRNS	3006W-1-103
R7	1ea	Resistor, Var, Trim, CERMET, 20K	BRNS	3006W-1-203
R8		Same as R6		
R9	2ea	Resistor, Var, Trim, CERMET, 1K	BRNS	3006W-1-102
R10	4ea	Resistor, MF, 0.25W, 1%, 200K	CORG	NC5
R11	Same as R10			
R12	Same as R10			
R13	Same as R10			
R14	Same as R6			
R15	1ea	Resistor, MF, 0.25W, 1%, 2K	CORG	NC5
R16	Same as R3			
R17	Same as R3			
R18	1ea	Resistor, MF, 0.25W, 1%, 20K	CORG	NC5
R19	2ea	Resistor, Var, Trim, CERMET, 2K	BRNS	300-62-1-202
R20	Same as R19			
R21	Same as R9			

TABLE 7

PARTS LIST FOR SWITCH DRIVER MODULE COMPONENTS continued

OUTPUT DISPLAY CARD (117)

R22	1ea	Resistor, MF, 0.25W, 1%, 511K	CORG	NC5
R23	1ea	Resistor, MF, 0.25W, 1%, 1K	CORG	NC5
R24		Same as R2		
R25	1ea	Resistor, MF, 0.25W, 1%, .01K	CORG	NC5
R26	1ea	Resistor, Carbon, 0.25W, 5%, .1K	AB	CB
R27	1ea	Resistor, Carbon, 0.25W, 5%, 2.7K	AB	CB
R28		Same as R3		
R29	1ea	Resistor, Carbon, 0.25W, 5%, 4.7K	AB	CB
R30	2ea	Resistor, Carbon, 0.25W, 5%, 39K	AB	CB
R31		Same as R30		
R32	1ea	Resistor, Carbon, 0.25W, 5%, 27K	AB	CB
R33	1ea	Resistor, Carbon, 0.25W, 5%, 10K	AB	CB
R34	1ea	Resistor, Carbon, 0.25W, 5%, 1K	AB	CB
R35	1ea	Resistor, Carbon, 0.25W, 5%, 24.3K	AB	CB

Catagory No. 2-----Capacitors-----

C1	2ea	Capacitor, Disc, .001UF		
C2	1ea	Capacitor, Disc, Ceramic, .1UF		
C3	1ea	Capacitor, Polycarbonate, .1UIF	SEAC	CMK
C4	2ea	Capacitor, Disk, .01UF		
C5		Same as C4		
C6	4ea	Capacitor, Tant, 35V, 22UF		
C7	1ea	Capacitor, DIP, Mica, 150PF		

TABLE 7

PARTS LIST FOR SWITCH DRIVER MODULE COMPONENTS continued

OUTPUT DISPLAY CARD (117)

Category 2-----Capacitors-----

C8	2e	Capacitor, Tant, 20V, 47UF		
C9		Same as C8		
C10		Same as C6		
C11		Same as C6		
C12		Same as C6		
C13	1ea	Capacitor, DIP, Mica, 100PF		
C14	3ea	Capacitor, HI-K MONO, 50V, 1UF		SPRG 5C023105X025053
C15		Same as C14		
C16		Same as C1		
C17		Same as C14		

Category 4-----Diodes-----

D1	1ea	Diode, Silicon, 100V	MOT	1N4153
----	-----	----------------------	-----	--------

Category 5-----Integrated Circuits-----

IC1	1ea	I. C. Op Amp	MONO	OP-05C
IC2	1ea	I. C. Sample and Hold	DATL	SHM-LM-2 I
C3	1ea	I. C. FET, Op Amp	NATL	LH0042C I
C4	1ea	I. C. Log Amp	ITSL	ICL 8048ECBE
IC5	1ea	I. C. Op Amp	NATL	LM741C
IC6	2ea	I. C. Timer	NATL	LM 555
IC7		Same as IC6		
IC8	1ea	I. C. One Shot	TI	SN74121N

TABLE 7

PARTS LIST FOR SWITCH DRIVER MODULE COMPONENTS continued

OUTPUT DISPLAY CARD (117)

Catagory 5-----Integrated Circuits-----				
IC9	1ea	I. C. Nand Drive	TI	SN7552N
IC11	1ea	I. C. Hex Inverter	TI	SN74LS04N
Catagory 7-----Terminals-----				
K1	2ea	Socket, Round, DIP, 8Pin	SANT	
K2	1ea	Socket, Dual, In-line, DIP	SANT	IC-316-SGG
K3		Same as K1		
J1	2ea	Jack, Jumper, IC, 1Pin	GARY	AA-C
J2		Same as J1		
T1	1ea	Term, Test Point, 1Pin	GARY	AA-C
Catagory 10-----Hardware-----				
B1		PC Brd, RF Process Ckt	NBS	PC-500

TABLE 7

PARTS LIST FOR SWITCH DRIVER MODULE COMPONENTS continued

Front Panel and Chassis

Catagory 1-----Resistors-----				
R1	1ea	Resistor, Var, 10 Turn, 10K	DUNC	3253
Catagory 3-----Diodes-----				
D1	1ea	LED, Green	DIAL	9173
D2	1ea	LED, Red	DIAL	550-0506
Catagory 6-----Connectors-----				
J1	1ea	Connector, Panel, BNC	AMPH	U6 492/U
J102	1ea	Connector, Amp, 50 Pin	AMPH	AMP200277 2
J104	1ea	Same as J102		
J110	6ea	Edge Connector, PC, 50 Pin	AMPH	261-100302
J111		Same as J110		
J112		Same as J110		
J113		Same as J110		
J114		Same as J110		
J117		Same as J110		
Catagory 8-----Switches-----				
S1	1ea	Switch, AC Power, Toggle	ALCO	MST 105D
S2	1ea	Switch, Push Button	ALCO	MSP 105F
S3	1ea	Switch, Rotary, 3Pole	ALCO	MRB-3-3

TABLE 7

PARTS LIST FOR SWITCH DRIVER MODULE COMPONENTS continued

Front Panel and Chassis

Category 9-----Meters-----

11	lea	Meter,	Panel,	0	Center,	1.5Ma	MODT	25DMA1.5U
----	-----	--------	--------	---	---------	-------	------	-----------

Category 10-----Hardware-----

	Plate,	Front	Panel	7"X9"		BUD	91F36
--	--------	-------	-------	-------	--	-----	-------

	Card	Cage				SCBE	60047A
--	------	------	--	--	--	------	--------

Category 10-----Hardware-----

	Fuseholder					Littlefuse	342001
--	------------	--	--	--	--	------------	--------

Category 11-----Miscellaneous-----

	Power	Supply	5V,	1A		Standard	SPS/15
--	-------	--------	-----	----	--	----------	--------

ACKNOWLEDGMENTS

The existence of this measurement system is the result of a joint effort involving cooperation of many people over a long period of time. These include: Gerome Reeve for the original system design, Lanny D. Driver for development of the ambient and cryogenic coaxial standards, Lanny D. Driver and David F. Wait for the original software model, John P. Wakefield for the switch driver module design and software tie-in, and William Daywitt who was largely responsible for the theory, error modeling, and analysis.

REFERENCES:

- [1] Larsen, N.T.; NBS Type IV Power Meter Operation and Maintenance Manual; NBSIR 77-866, Oct. 1977.
- [2] Larsen, N.T.; A New Self-Balancing D.C. Substitution RF Power Meter IEEE Transactions on Instrumentation and Measurement; Vol. IM-25, No. 4, pp. 343-347, Dec. 1976.
- [3] Miller, C.K.S., Daywitt W.C., and Arthur M.G.; Noise Standards, Measurements, and Receiver Noise Definitions; Proceedings of the IEEE, Vol 55, No. 6, June 1967.
- [4] Wait D.F.; Earth Terminal Measurement System Operations Manual; NBSIR 78-879, April 1978.
- [5] Wakefield, J.P.; Earth Terminal Measurement System Maintenance Manual; NBSIR 78-895, April 1978.

APPENDIX I

PROGRAM LISTING AND VARIABLE CROSS REFERENCE TABLE

This is a listing of program "30M20" arranged to allow easy reference to the main program and associated subprogram segments. Each segment listing is followed by the cross reference table for the variables referenced. Except for frequency dependent program constants, this program listing is identical to that for "60M20". Line numbers referenced for variables apply to both programs.

1 SEPT 1981
30M20

```

1      ! THIS VERSION IS JULY101981 VS
10     ! 30RAD
20     ! 30RAD   30 MHZ CONSTANTS IN THIS VERSION
30     ! RE-STORE "30M20"      !MARCH26 1981 1100
31     !
32     !
33     !
34     !
35     !
40     OPTION BASE 1
50     COM File,Flag
60     COM Q6,Q7,Q8,Q9,R2,R3,L,R,A6,A7,A8,A9,Z1,I2,N3,N8,N,F,F0,W
70     COM SHORT F(4),L(8,20),N(32,33),N(26,11)
80     COM D#[80],P#[100],INTEGER D(6,75),N0,X#[80]
90     COM C#[100],G#[100],R#[100],B#[10],H#[100],Q#[50],V#[100]
100    COM A#[100],Z2,Z3,Z4,Z5,T1,S1,T4,T2,T3,Z6,F7,T7,T8,T9,P9,X6,X7,X8,X9
110    COM Q1,Q2,Q3,Q5,E2,Z(1,100),B5,B6,B7,B8,C1,R5,P1,P2,P3,P4,V2,Pout#
120    COM P5,P6,P7,P8,W1,W2,W3,W4,W5,W6,T5,T6,E7,J8,I6,S,I5,X3,P0,I,C2,Mismatch
130    COM Real,Imag
140    DIM Z#[100]
150    Ptest=0
160    Ipause=0
170    FOR K=1 TO 5
171    ! Q=FNT(Q)
172    ! Q=FNK(3)
173    Q=FNData(Q)
174    GOTO 220
180    Q=FNp(Q)
190    PRINTER IS 16
200    PRINT P1*1000,P2*1000,P3*1000
210    Ptest=Ptest+P1
220    NEXT K
230    P1=Ptest/(K-1)
240    PRINT "AVERAGE POWER AT PORT 0 IS ";P1*1000;"MILLIWATTS"
250    PAUSE
251    MASS STORAGE IS ":F8,1"
260    C1=.99949      ! THIS IS ALPHA OF GR900/N ADAPTER
270    C2=.00010     ! THIS IS UNCERTAINTY OF THIS ADAPTER ALPHA
280    R5=16
290    H#[1,10]="GR900/N"
300    H#[11,20]="47.0+J00.0"
310    Real=47
320    Imag=.00001
330    Printer=0
340    File=0+.15
350    PRINTER IS 0
360    PRINTER IS 16
370    ! CREATE "NFILE:F8",40
380    ! ASSIGN #1 TO "NFILE"
390    ! PRINT #1;N(*),END
400    ! ASSIGN #1 TO *
410    ASSIGN #2 TO "NFILE"
420    READ #2;N(*)
430    ASSIGN #2 TO *
440    MAT PRINT N
450    PRINTER IS 16
460    DISP "STOP--CHECK N MAT PRESS CONT TO GO ON"
470    ! PAUSE
480    Z#="30/60 MHZ AUTOMATED NOISE MEASUREMENT SYSTEM <D 1-M -4><T1-T1 >"
490    V#="EXECUTIVE PROGRAM      VERSION GJC 2-45 MAR 81      ETMS #6.11"
500    PRINT TAB(15),Z#
510    Q=FNS(1)

```

-104-

```
520 PRINT TAB(7),V$
530 Q=FNS(4)
540 PRINT "ENTER ALPHA FOR CONNECTOR/ADAPTOR COMBINATION USED ON UNKNOWN PORT"
550 C1=FNN(C1)
560 PRINT "ENTER UNCERTAINTY FOR ADAPTER COMBINATION USED"
570 C2=FNN(C2)
580 Q=FNS(1)
590 P#=H#[1,10]
600 I2=2
610 PRINT "ENTER ADAPTER USED TO CONNECT DEVICE UNDER TEST"
620 Q=FNO(1)
630 H#[1,10]=P$
640 Q=FNS(1)
650 P#=H#[11,20]
660 PRINT "ENTER REAL AND IMAGINARY SOURCE IMPEDANCE IN THIS FORM"
670 Q=FNO(1)
680 H#[11,20]=P$
690 PRINT "ENTER REAL PART OF THE SOURCE IMPEDANCE"
700 Real=FNN(Real)
710 PRINT "ENTER THE IMAGINARY PART OF THE SOURCE IMPEDANCE"
720 Imag=FNN(Imag)
730 PRINT C1;C2;H#[1,10];H#[11,20];Real;Imag
740 F=30
750 Z7=3
760 K9=0
770 Q5=10000
780 D9=1
790 Z8=0
800 PRINT TAB(7),V$
810 Q=FNS(4)
820 ! OUTPUT 9;"S11,04,09,35,50" ! RESET TIME HERE
830 OUTPUT 9;"R"
840 ENTER 9;P$
850 PRINT TAB(15),P$;":1981"
860 Q=FNS(2)+FNE(0)+FNE(1)
870 IMAGE "IF HARDWARE HANGS UP",/,/,,"(1)STOP+STOP",/,,"(2)KEY0",/,,"(3)0 RESTR"
880 ! PRINT USING 440
890 Q=FNO(1)
900 Q=FNO(10)
```

MAIN

C1	*	260	550	550	730				
C2	*	270	570	570	730				
D9		780							
F	*	740							
File	*	340							
H#	*	290	300	590	630	650	680	730	730
I2	*	600							
Imag	*	320	720	720	730				
Ipause		160							
K		170	220	230					
K9		760							
NC	*	420	440						

P#	*	590	630	650	680	840	850			
P1	*	200	210	230	240					
P2	*	200								
P3	*	200								
Printer		330								
Ptest		150	210	210	230					
Q		173	173	180	180	510	530	580	620	640
670	810	860	890							
			900							
Q5	*	770								
R5	*	280								
Real	*	310	700	700	730					
V#	*	490	520	800						
Z#		140	480	500						
Z7		750								
Z8		790								

```

910 DEF FNQ(Q)
920   OPTION BASE 1
930   COM File,Flag
940   COM Q6,Q7,Q8,Q9,R2,R3,L,R,A6,A7,A8,A9,Z1,I2,N3,N8,N,F,F0,W
950   COM SHORT F(4),L(*),M(32,33),N(26,11)
960   COM D#[80],P#[100],INTEGER D(6,75),N0,X#[80]
970   COM C#[100],G#[100],R#[100],B#[10],H#[100],Q#[50],V#[100]
980   COM A#[100],Z2,Z3,Z4,Z5,T1,S1,T4,T2,T3,Z6,F7,T7,T8,T9,P9,X6,X7,X8,X9
990   COM Q1,Q2,Q3,Q5,E2,Z(1,100),B5,B6,B7,B8,C1,R5,P1,P2,P3,P4,V2,Pout#
1000  COM P5,P6,P7,P8,W1,W2,W3,W4,W5,W6,T5,T6,E7,J8,I6,S,IS,X3,P0,I,C2,Mismatch
1010  COM Real,Imag
1020  Branch=0
1030  PRINT Q
1040  ON Branch GOTO 1280,1300,1300,2380,1310,1340,2400,1350,1370,1090
1050  IF (Branch>=1) AND (Branch<=10) THEN ON Branch GOTO 1280,1300,1300,2380,13
10,1340,2400,1350,1370
1060  RETURN Q
1070  FNEND
1080  GOTO 1110
1090  Z1=Z2=Z3=Z4=Z5=Z6=0
1100  Flag(5)=0
1110  REM THIS IS THE MAIN TRAP
1120  Q=FN8(2)
1130  Q=FN9(1)
1140  K6=1
1150  REM NOISE SOURCE CALIBRATION
1160  Z1=0
1170  Q=FNJ(1)+FNJ(2)+FNJ(3)
1180  GOTO 1230
1190  Z2=0
1200  Q=FNJ(2)
1210  GOTO 1120
1220  Z3=0
1230  Q=FNK(0)+FNK(1)+FNK(2)+FNK(3)+FNCheck(1)
1240  PRINT "END OF MEASUREMENT SEQUENCE -PRESS RUN TO REPEAT"
1250  PAUSE
1260  GOTO 310
1270  RETURN Q
1280  ! CONTINUE
1290  RETURN Q
1300  PRINT "CONNECT UNKNOWN TO PORT";Q7
1310  PRINT "CONNECT AMBIENT TO PORT";Q8
1320  PRINT "CONNECT STANDARD TO PORT";Q9
1330  RETURN Q
1340  ! CONTINUE
1350  ! CONTINUE
1360  RETURN Q
1370  ! CONTINUE
1380  RETURN Q
1390  FNEND

```

FNQ<

Branch	1020	1040	1050	1050	1050				
Flag<	1100								
K6	1140								
Q	910	1020	1030	1060	1120	1130	1170	1200	1230
Q7	*	1300							
Q8	*	1310							

Q9	*	1320	
Z1	*	1090	1160
Z2	*	1090	1190
Z3	*	1090	1220
Z4	*	1090	
Z5	*	1090	
Z6	*	1090	

```

1400 DEF FNE(Q)
1410 OPTION BASE 1
1420 COM File,Flag
1430 COM Q6,Q7,Q8,Q9,R2,R3,L,R,A6,A7,A8,A9,Z1,I2,N3,N8,N,F,F0,W
1440 COM SHORT F(4),L(*),M(32,33),N(26,11)
1450 COM D#[80],P#[100],INTEGER D(6,75),N0,X#[80]
1460 COM C#[100],G#[100],R#[100],B#[10],H#[100],Q#[50],V#[100]
1470 COM A#[100],Z2,Z3,Z4,Z5,T1,S1,T4,T2,T3,Z6,F7,T7,T8,T9,P9,X6,X7,X8,X9
1480 COM Q1,Q2,Q3,Q5,E2,Z(1,100),B5,B6,B7,B8,C1,R5,P1,P2,P3,P4,V2,Pout#
1490 COM P5,P6,P7,P8,W1,W2,W3,W4,W5,W6,T5,T6,E7,J8,I6,S,I5,X3,P0,I,C2,Mismatch
1500 COM Real,Imag
1510 IF Q THEN 1580
1520 REM THIS INITIALIZES THE HARDWARE (FNE0)
1530 Flag(1)=0
1540 Flag(5)=0
1550 Q=FNO(8)
1560 PRINT "HARDWARE INITIALIZED"
1570 RETURN 0
1580 REM THIS INITIALIZES THE SOFTWARE (FNE1)
1590 Q=I=N=N3=N8=P=L0=F0=I0=I1=I2=K6=Z1=Z2=Z3=0
1600 Q7=0
1610 Q8=1
1620 Q9=2
1630 A7=A8=A9=6
1640 PRINT "SOFTWARE INITIALIZED"
1650 RETURN 0
1660 FNEND

```

FNE(

A7	*	1630		
A8	*	1630		
A9	*	1630		
F0	*	1590		
Flag(1530	1540	
I	*	1590		
I0		1590		
I1		1590		
I2	*	1590		
K6		1590		
L0		1590		
N	*	1590		
N3	*	1590		
N8	*	1590		
P		1590		
Q		1400	1510	1550 1590
Q7	*	1600		

Q8	*	1610
Q9	*	1620
Z1	*	1590
Z2	*	1590
Z3	*	1590

```
1670 DEF FNJ(Q)                                !!(FNJ)
1680 OPTION BASE 1
1690 COM File,Flag
1700 COM Q6,Q7,Q8,Q9,R2,R3,L,R,A6,A7,A8,A9,Z1,I2,N3,N8,N,F,F0,W
1710 COM SHORT F(4),L(*),M(32,33),N(26,11)
1720 COM D#[100],P#[100],INTEGER D(6,75),N0,X#[100]
1730 COM C#[100],G#[100],R#[100],B#[10],H#[100],Q#[50],V#[100]
1740 COM A#[100],Z2,Z3,Z4,Z5,T1,S1,T4,T2,T3,Z6,F7,T7,T8,T9,P9,X6,X7,X8,X912
1750 COM Q1,Q2,Q3,Q5,E2,Z(1,100),B5,B6,B7,B8,C1,R5,P1,P2,P3,P4,V2,Pout#
1760 COM P5,P6,P7,P8,W1,W2,W3,W4,W5,W6,T5,T6,E7,J8,I6,S,I5,X3,P0,I,C2,Mismatch
1770 COM Real,Imag
1780 Branch=0
1790 ! CONTINUE
1800 IF (Branch<=1) AND (Branch<=4) THEN ON Branch GOTO 1810,2470,2680
1810 IF Z1=2 THEN 2470
1820 Q=FNS(2)
1830 PRINT "CUSTOMER?(Q=BY,SP=NO)";
1840 P#=C#[1,29]
1850 IF I2=0 THEN 1920
1860 DISP "NOW: ";P#;
1870 LINPUT Q#
1880 IF Q#="0" THEN 2430
1890 IF Q#=" " THEN 1980
1900 C#[1,29]=Q#
1910 GOTO 1990
1920 DISP "NOW: ";P#
1930 I0=FNB(2)+FNS(1)+FNW(50)
1940 LINPUT Q#
1950 IF Q#="0" THEN 2430
1960 IF Q#=" " THEN 1980
1970 C#[1,29]=Q#
1980 Q=FNS(1)
1990 PRINT "CUST'S ADDRESS--STREET ?";
2000 P#=C#[30,69]
2010 Q=FNO(1)
2020 C#[30,69]=P#
2030 Q=FNS(1)
2040 PRINT "CUST'S ADDRESS?--CITY,STATE,ZIP ?";
2050 P#=C#[70,99]
2060 Q=FNO(2)
2070 C#[70,99]=P#
2080 Q=FNS(1)
2090 PRINT "SOURCE MANUFTR?";
2100 P#=G#[1,39]
2110 Q=FNO(3)
2120 G#[1,39]=P#
2130 Q=FNS(1)
2140 PRINT "SOURCE TYPE ? ";
2150 P#=G#[40,79]
2160 Q=FNO(4)
2170 G#[40,79]=P#
2180 Q=FNS(1)
2190 PRINT "SOURCE MODL # ?";
2200 P#=G#[80,89]
2210 Q=FNO(5)
2220 G#[80,89]=P#
2230 Q=FNS(1)
2240 PRINT "SOURCE SER. # ?";
2250 P#=G#[90,99]
2260 Q=FNO(6)
2270 G#[90,99]=P#
2280 Q=FNS(1)
2290 PRINT "DATE OF CALIBRATION"
2300 P#=R#[1,19]
```

```

2310 Q=FNO(7)
2320 R#[1,19]=P#
2330 Q=FNS(1)
2340 PRINT "CALIB. TEST # ?";
2350 P#=R#[20,39]
2360 Q=FNO(7)
2370 R#[20,39]=P#
2380 Q=FNS(1)
2390 PRINT "REQ OR REF # ? ";
2400 P#=R#[40,69]
2410 Q=FNO(9)
2420 R#[40,69]=P#
2430 I2=1
2440 Z1=Z1+1
2450 Q=FNS(2)+FNB(1)
2460 RETURN 0
2470 REM GET PARAMETERS SUBROUTINE (FNJ2)
2480 IF Z2 THEN 2680
2490 Q=FNS(2)
2500 ! DISP "NUMBER OF FREQUENCIES DESIRED ?";
2510 F0=1
2520 ! DISP "NUMBER OF LEVELS PER FREQUENCY ?";
2530 L0=1
2540 FOR I0=1 TO F0
2550 F(I0)=F
2560 NEXT I0
2570 Q=FNS(1)
2580 P#="ENTER VALUE OF ATEN A2"
2590 PRINT P#
2600 R5=FNN(R5)
2610 P#=" LEVEL SETTING A2="
2620 N3=5
2630 N8=5
2640 Z(1,51)=R5
2650 Z2=1
2660 Q=FNS(2)+FNB(1)
2670 RETURN 0
2680 REM PORT ASSIGNMENT SUBROUTINE (FNJ3)
2690 IF Z3=1 THEN 2810
2700 Q=FNS(2)
2710 PRINT "*****NORMAL PORT ASSIGNMENTS*****"
2720 Q=FNS(2)
2730 Q7=0
2740 PRINT "UNKNOWN CONNECTED TO PORT";Q7
2750 Q8=3
2760 PRINT "AMBIENT CONNECTED TO PORT";Q8
2770 Q9=2
2780 PRINT "STANDARD CONNECTED TO PORT";Q9
2790 Q=FNS(2)
2800 Z3=1
2810 Q=FNS(2)+FNB(1)
2820 RETURN 0
2830 FNEND

```

FNJ(

Branch	1700	1800	1900	1900	1900	2000	2020	2050	2070
C#	*	1840	1900	1970	2000	2020	2050	2070	
F	*	2550							
F(*	2550							

```

2840 DEF FNK(Q)                                !!!(FNK0)
2850   OPTION BASE 1
2860   COM File,Flag
2870   COM Q6,Q7,Q8,Q9,R2,R3,L,R,A6,A7,A8,A9,Z1,I2,N3,N8,N,F,F0,W
2880 COM SHORT F(4),L(*),M(32,33),N(26,11)
2890 COM D#[80],F#[100],INTEGER D(6,75),N0,X#[80]
2900 COM C#[100],G#[100],R#[100],B#[10],H#[100],Q#[50],V#[100]
2910 COM A#[100],Z2,Z3,Z4,Z5,T1,S1,T4,T2,T3,Z6,F7,T7,T8,T9,P9,X6,X7,X8,X9
2920 COM Q1,Q2,Q3,Q5,E2,Z(1,100),B5,B6,B7,B8,C1,R5,P1,P2,P3,P4,V2,Pout#
2930 COM P5,P6,P7,P8,W1,W2,W3,W4,W5,W6,T5,T6,E7,J8,I6,S,I5,X3,P0,I,C2,Mismatch
2940 COM Real,Imag
2950   Branch=Q+1
2960   ON Branch GOTO 2980,3310,3920,5520
2970 !!! FREQUENCY SUBROUTINE                (FNK0)
2980 FOR F9=1 TO F0
2990 F=F(F9)
3000 Q=FNL(1)
3010 L0=1
3020 I0=0
3030 FOR I1=F9*L0-L0+1 TO F9*L0
3040 I0=I0+1
3050 M(I1,1)=F
3060 M(I1,2)=I1
3070 M(I1,3)=L(I0,1)
3080 M(I1,4)=L(I0,2)
3090 M(I1,5)=L(I0,7)
3100 M(I1,6)=L(I0,8)
3110 M(I1,7)=L(I0,3)
3120 M(I1,8)=L(I0,4)
3130 M(I1,9)=L(I0,5)
3140 M(I1,10)=L(I0,9)
3150 M(I1,11)=L(I0,10)
3160 M(I1,12)=L(I0,11)
3170 M(I1,30)=L(I0,6)
3180 M(I1,31)=L(I0,12)
3190 NEXT I1
3200 NEXT F9
3210 T2=(M(1,3)+M(1,5))/2
3220 T3=(M(1,4)+M(1,6))/2
3230 T1=(M(1,7)+M(1,10))/2
3240 Z(1,52)=T1
3250 Z(1,53)=T2
3260 Z(1,54)=T3
3270 Q=FNS(4)
3280 Z4=1
3290 Q=FNS(2)+FNB(1)
3300 RETURN 0
3310 !!! NUMBER CRUNCHER SUBROUTINE          (FNK1)
3320 L0=1
3330 F0=1
3340 R9=F0*L0
3350 FOR I9=1 TO R9
3360 T8=B8+B7
3370 T1=(M(I9,7)+M(I9,10))/2
3380 M(I9,13)=T1
3390 N=N8*N3*2
3400 N9=N
3410 T7=B5+B6
3420 T8=T8*T8/N
3430 S1=(T7-T8)/(N-1)
3440 S1=SQR(S1)
3450 M(I9,14)=S1/SQR(N)
3460 M(I9,28)=S1/SQR(N)
3470 T4=(M(I9,9)+M(I9,12))/2

```

```

3480 M(I9,15)=T4
3490 T2=(M(I9,3)+M(I9,5))/2
3500 M(I9,16)=T2
3510 T3=(M(I9,4)+M(I9,6))/2
3520 M(I9,17)=T3
3530 R8=(T1-T2)/(T3-T2+1E-6)
3540 ! !!!!!!!!!!!!!!!!!!!!!!!!!!!!!!!!!!!!!TEMP IS FOR 30 MHZ N(14,9)
3550 M(I9,23)=ABS(1-R8)*N(14,9)
3560 M(I9,24)=ABS(R8)*N(12,1)
3570 M(I9,32)=M(I9,30)+M(I9,31)/2
3580 Q=M(I9,32)
3590 ! !!!!!!!!!!!!!!!!!!!!!!!!!!!!!!!!!!!!! ! BANDWIDTH W IS FOR 30 MHZ
3600 W=.773
3610 Q=N(12,9)*Q/W/(T2+T4)
3620 M(I9,33)=10*LGT(Q)
3630 Q=.0023
3640 Q0=1+Z(1,16)/Z(1,52) !1+ TE/TX
3650 Q1=1-Z(1,53)/Z(1,52) !1-TA/TX
3660 Q2=(Z(1,54)+Z(1,16))/(Z(1,54)-Z(1,53)) !TS+TE/TS-TA)
3670 Q3=Z(1,52)*(Q0-Q1*Q2)
3680 M(I9,25)=Q*Q3
3690 M(I9,26)=N(10,1)*10^(M(1,33)/10)*N(10,2)*(T1-T3)*(T1-T2)
3700 Q=T2/T1+ABS((1-T2/T1)/(1-T3/T2)+1E-6)
3710 Q=ABS(1-T2/T1)+1.7*Q
3720 Z(1,57)=N(12,8)
3730 Z(1,55)=N(12,7)
3740 Q3=T1*T3+T1*T2+T3*T2
3750 Q3=Q3/(T3-T2)
3760 Q3=ABS(Q3*N(12,8))
3770 M(1,29)=Q3
3780 Q=M(I9,23)+M(I9,24)+M(I9,25)
3790 M(I9,18)=Q+M(I9,26)+M(I9,29)
3800 M(I9,19)=3*M(I9,28)
3810 M(I9,20)=M(I9,18)+M(I9,19)
3820 M(I9,21)=10*LGT(ABS((T1-290+1E-6)/290))
3830 Q2=(M(1,19)+M(1,18))/(T1-290)
3840 Q3=ABS(1+Q2)
3850 M(I9,22)=10*LGT(Q3)
3860 M(I9,32)=(M(I9,30)+M(I9,31))/2
3870 NEXT I9
3880 Z5=1
3890 Q=FNB(2)
3900 RETURN 0
3910 ! FNK2
3920 Q=FNVswr(Q)
3930 PRINTER IS 0
3940 Z(1,26)=Mismatch
3950 E7=M(1,18)+Mismatch
3960 E6=1-1/Q1
3970 E1=E6*(E7/M(1,13))
3980 E2=E6*.0005
3990 C9=C1*C1
4000 E0=(M(1,13)-M(1,3))/C9*(C2/T1)
4010 E3=ABS(E1)+ABS(E2)+ABS(E0)
4020 E3=ABS(E3)
4030 V$="*****"
4040 L0=1
4050 ! PRINT V$
4060 I8=0
4070 FOR I9=1 TO F0
4080 FOR J9=1 TO L0
4090 I8=I8+1
4100 Q1=FNS(3)
4110 PRINT Z$
4120 A$="-----"

```

```

4130 Q1=FNS(1)
4140 N9=N3*NS*2
4150 ! PRINT PAGE
4160 PRINT TAB(6),A$
4170 Q=FNS(10)
4180 PRINT TAB(23);"MEASUREMENT RECAP"
4190 PRINT TAB(30);"AND"
4200 PRINT TAB(22);"PRELIMINARY RESULTS"
4210 Q=FNS(5)
4220 PRINT TAB(6);"FREQUENCY=";M(1,1);"MHZ"
4230 PRINT TAB(6);"SOURCE IMPEDANCE";H#[11,20],"          LEVEL SETTING OF A2=";R5
4240 PRINT TAB(6);A$
4250 PRINT TAB(10);"TA";TAB(20),"R OHMS";TAB(34);"TS";TAB(45);"R OHMS"
4260 PRINT TAB(6);" -----"
4270 FIXED 2
4280 PRINT TAB(8);M(1,3);TAB(20);Z(1,59);TAB(32);M(1,4);TAB(45);Z(1,60);"          "
; "1ST 50 MEASUREMENTS"
4290 PRINT TAB(8);M(1,5);TAB(20);Z(1,59);TAB(32);M(1,6);TAB(45);Z(1,60);"          "
; "2ND 50 MEASUREMENTS)"
4300 PRINT TAB(6);A$
4310 PRINT TAB(11);"TX";TAB(21);"SX";TAB(34);"TE"
4320 PRINT TAB(6);" -----"
4330 PRINT TAB(8);M(1,7);TAB(20);M(1,8);TAB(32);M(1,9);"          "; "(1ST 50 MEASURE
MENTS)"
4340 PRINT TAB(8);M(1,10);TAB(20);M(1,11);TAB(32);M(1,12);"          "; "(2ND 50 MEAS
UREMENTS)"
4350 PRINT
4360 PRINT TAB(6);A$
4370 PRINT
4380 STANDARD
4390 N9=N8*N3*2
4400 PRINT TAB(6);"AVE POWER IN MILLIWATTS P1,P2,P3"
4410 PRINT TAB(6);Z(1,45)/N9*1000;Z(1,46)/N9*1000;Z(1,47)/N9*1000
4420 S1=SQR((Z(1,48)-Z(1,45)*Z(1,45)/N9)/(N9-1))
4430 S2=SQR((Z(1,49)-Z(1,46)*Z(1,46)/N9)/(N9-1))
4440 S3=SQR((Z(1,50)-Z(1,47)*Z(1,47)/N9)/(N9-1))
4450 Z(1,31)=N9
4460 PRINT TAB(6);"SD P1,P2,P3 [# OF MEAS=";Z(1,31);"]";S1;S2;S3
4470 PRINT TAB(6);A$
4480 Q=FNS(20)
4490 ! PAGE
4500 PRINT USING 4520;M(I8,1)
4510 Z(1,34)=M(1,1)
4520 IMAGE 25X,"FREQUENCY =",M3D.D,"MHZ"
4530 PRINT
4540 PRINT Z$
4550 Q1=FNS(1)
4560 E4=100*E3/M(1,13)
4570 E5=E3+Mismatch
4580 M2=100*(M1/M(1,13))
4590 M5=E4+M2
4600 M(1,18)=M(1,18)+E5
4610 PRINT USING 4620;M(I8,13),M(I8,18),M(I8,19)
4620 IMAGE 10X,"NOISE TEMPERATURE =",M5D.2D,"K +- ",M3D.2D,"K(BIAS) +- ",M3D.2D,"
K (3*SEM)"
4621 Q2=(M(1,18)+M(1,19))/(T1-290)
4622 Q3=ABS(1+Q2)
4623 M(1,22)=10*LGT(Q3)
4630 Z(1,35)=M(1,13)
4640 Z(1,36)=M(1,18)
4650 Z(1,13)=M(1,19)
4660 IF T1<220 THEN 4690
4670 PRINT USING 4680;M(I8,21),M(I8,22)
4680 IMAGE 10X,"EXCESS NOISE RATIO=",M3D.2D ,"DB +- ",MD.2D ,"DB(BIAS+3*SEM)"
4690 Q1=FNS(1)

```



```
4700 Z(1,14)=M(1,21)
4710 Z(1,15)=M(1,22)
4720 PRINT USING 4730;M(I8,15),10*LGT(1+M(I8,15)/290)
4730 IMAGE 10X,"RADIOMETER SYSTEM TEMPERATURE =",4D,"K (",4D.D,"DB NF)"
4740 Z(1,16)=M(1,15)
4750 Z(1,17)=10*LGT(1+M(1,15)/290)
4760 PRINT USING 4770;M(I8,33)
4770 IMAGE 10X,"RADIOMETER GAIN =",M4D.1D,"DB"
4780 Z(1,56)=.773
4790 PRINT "          RADIOMETER NOISE BANDWIDTH=";Z(1,56);"MHZ"
4800 Z(1,18)=M(1,33)
4810 Q1=FNS(3)
4820 PRINT TAB(28),"ERROR SUMMARY"
4830 Q1=FNS(1)
4840 PRINT TAB(5),"SOURCE OF ERROR";TAB(35),"SOURCE";TAB(50),"% ERROR IN"
4850 PRINT TAB(34),"UNCERTAINTY";TAB(55),"NOISE TEMPERATURE"
4860 !          CONSTANTS FOR TEMP ARE 30 MHZ
4870 Q1=FNS(1)
4880 PRINT USING 4890;N(12,1);100*M(I8,24)/M(I8,13)
4890 IMAGE 6X,"CRYOGENIC STANDARD",10X,M2.2D,"K",16X,M4D.2D
4900 Z(1,19)=N(12,1)
4910 Z(1,20)=100*M(1,24)/M(1,13)
4920 PRINT USING 4930;N(14,9),100*M(I8,23)/M(I8,13)
4930 IMAGE 6X,"AMBIENT STANDARD",12X,M2.2D,"K",16X,M4D.2D
4940 Z(1,21)=N(14,9)
4950 Z(1,22)=100*M(1,23)/M(1,13)
4960 PRINT USING 4970;N(12,3),100*M(I8,25)/M(I8,13)
4970 IMAGE 6X,"POWER RATIO",17X,M2.2D,"DB",15X,M4D.2D
4980 Z(1,23)=N(12,3)
4990 PRINT USING 5000;100*Mismatch/M(I8,13)
5000 IMAGE 6X,"MISMATCH",21X,"0.5R;1.0J OHMS",7X,M4D.2D
5010 Z(1,26)=Mismatch
5020 Z(1,24)=100*M(1,25)/M(1,13)
5030 PRINT USING 5060;N(10,3),100*M(I8,26)/M(I8,13)
5040 Z(1,27)=N(12,4)
5050 Z(1,28)=100*M(1,26)/M(1,13)
5060 IMAGE 6X,"NONLINEARITY",16X,M1D.2DE,12X,M5D.2D
5070 PRINT USING 5080;Z(1,55),100*M(I8,29)/M(I8,13)
5080 IMAGE 6X,"SWITCH ASSYMETRY",12X,M2.3D,"DB",12X,M6D.2D
5090 Z(1,29)=100*M(1,29)/M(I8,13)
5110 Adapter=100*E3/Z(1,35)
5120 PRINT USING 5130;H#[1,10],100*E3/Z(1,35)
5130 IMAGE 6X,"ADAPTER:",10A,11X,"0.0001DB",11X,M6D.2D
5140 PRINT TAB(6),A#
5150 PRINT USING 5160;100*M(I8,18)/M(I8,13)
5160 IMAGE 6X,"LINEAR SUM OF BIAS ERRORS",24X,M5D.2D
5170 Z(1,30)=100*M(1,18)/M(I8,13)
5180 PRINT USING 5190;N9,100*M(I8,19)/M(I8,13)
5190 IMAGE 5X,"3*STANDARD ERROR OF MEAN ( # MEAS="M3D.,")",10X,M4D.2D
5200 Q=100*M(I8,18)/M(I8,13)
5210 Q1=100*M(I8,19)/M(I8,13)
5220 M(I8,20)=Q+Q1
5230 Z(1,31)=N
5240 Z(1,32)=100*M(I8,19)/M(I8,13)
5250 PRINT TAB(6),A#
5260 PRINT USING 5270;M(I8,20)
5270 IMAGE 6X,"LINEAR SUM OF ERRORS",31X,M3D.2D
5280 Z(1,33)=M(1,20)
5290 Q1=FNS(1)
5300 PRINT TAB(6),A#
5310 NEXT J9
5320 NEXT I9
5330 PRINT
5340 PRINT
5350 PRINT TAB(6),"CUSTOMER:";TAB(30),C#[1,29]
5360 PRINT TAB(6),"CUSTOMER'S STATION:";TAB(30),C#[30,69]
```

```

5370 PRINT TAB(6),"CUSTOMER'S ADDRESS:";TAB(30),C#[70,99]
5380 PRINT
5390 PRINT TAB(6),"SOURCE MANUFACTURER:";TAB(30),G#[1,39]
5400 PRINT TAB(6),"SOURCE TYPE:";TAB(30),G#[40,79]
5410 PRINT TAB(6),"SOURCE MODEL:";TAB(30),G#[80,89]
5420 PRINT TAB(6),"SOURCE SERIAL:";TAB(30),G#[90,99]
5430 PRINT
5440 PRINT TAB(6),"DATE OF CALIBRATION:";TAB(30),R#[1,19]
5450 PRINT TAB(6),"CALIBRATION TEST #:";TAB(30),R#[20,39]
5460 PRINT TAB(6),"REQ OR REF #:";TAB(30),R#[40,69]
5470 PRINT
5480 Q=FNS(10)
5490 Z6=1
5500 Q=FNB(1)
5510 RETURN 0
5520 ! !! STORE DATA SUBROUTINE (FNK3)
5530 MASS STORAGE IS ":T14"
5531 PRINTER IS 16
5540 LINPUT "PLACE DATA CASSETTE IN T14 AND PRESS SPACE BAR AND CONT",A#
5550 PRINT "ENTER FILE NAME--30-1 FOR EXAMPLE"
5560 LINPUT F#
5570 CREATE F#,6,220
5580 LINPUT "TEMPERATURE?",H#[21,30]
5590 LINPUT "PRESSURE MM MERCURY",H#[31,40]
5600 ASSIGN #1 TO F#
5610 PRINT #1;H#[1,40],Z(*),C#[1,100],G#[1,100],R#[1,100]
5620 ASSIGN #2 TO F#
5630 READ #2;H#[1,40],Z(*)
5640 DISP H#[1,100],Z(*)
5650 MASS STORAGE IS ":F8"
5660 Q=FNS(1)
5670 Q=FNCHECK(0)
5680 PAUSE
5690 RETURN 0
5700 ! FNLO
5710 !
5720 !

```

FNKK

A#	*	4120	4160	4240	4300	4360	4470	5140	5250	5
300	5540									
Adapter		5110								
B5	*	3410								
B6	*	3410								
B7	*	3360								
B8	*	3360								
Branch		2950	2960							
C#	*	5350	5360	5370	5610					
C1	*	3960	3990	3990						
C2	*	4000								
C9		3990	4000							
E0		4000	4010							

E1			3970	4010											
E2			*	3980	4010										
E3			4010	4020	4020	4560	4570	5110	5120						
E4			4560	4590											
E5			4570	4600											
E6			3960	3970	3980										
E7			*	3950	3970										
F			*	2990	3050										
F\$			5560	5570	5600	5620									
F<			*	2990											
F0			*	2980	3330	3340	4070								
F9			2980	2990	3030	3030	3200								
G\$			*	5390	5400	5410	5420	5610							
H\$			*	4230	5120	5580	5590	5610	5630	5640					
I0			3020	3040	3040	3070	3080	3090	3100	3110	3120				
	3130	3140	3150	3160											
				3170	3180										
I1			3030	3050	3060	3060	3070	3080	3090	3100	3110				
	3120	3130	3140	3150											
				3160	3170	3180	3190								
I8			4060	4090	4090	4500	4610	4610	4610	4670	4670				
	4720	4720	4760	4880											
				4880	4920	4920	4960	4960	4990	5030	5030	5			
070	5070	5090	5150												
				5150	5170	5180	5180	5200	5200	5210	5210	5			
220	5240	5240	5260												
I9			3350	3370	3370	3380	3450	3460	3470	3470	3480				
	3490	3490	3500	3510											
				3510	3520	3550	3560	3570	3570	3570	3580	3			
620	3680	3690	3780												
				3780	3780	3790	3790	3790	3800	3800	3810	3			
810	3810	3820	3850												
				3860	3860	3860	3870	4070	5320						
J9			4080	5310											
L<			*	3070	3080	3090	3100	3110	3120	3130	3140	3			
150	3160	3170	3180												
L0			3010	3030	3030	3030	3320	3340	4040	4080					
M<			*	3050	3060	3070	3080	3090	3100	3110	3120	3			
130	3140	3150	3160												
				3170	3180	3210	3210	3220	3220	3230	3230	3			
370	3370	3380	3450												
				3460	3470	3470	3480	3490	3490	3500	3510	3			
510	3520	3550	3560												
				3570	3570	3570	3580	3620	3680	3690	3690	3			

770	3780	3780	3780									
			3790	3790	3790	3800	3800	3810	3810	3810	3	
820	3830	3830	3850									
			3860	3860	3860	3950	3970	4000	4000	4220	4	
280	4280	4290	4290									
			4330	4330	4330	4340	4340	4340	4500	4510	4	
560	4580	4600	4600									
			4610	4610	4610	4621	4621	4623	4630	4640	4	
650	4670	4670	4700									
			4710	4720	4720	4740	4750	4760	4800	4880	4	
880	4910	4910	4920									
			4920	4950	4950	4960	4960	4990	5020	5020	5	
030	5030	5050	5050									
			5070	5070	5090	5090	5150	5150	5170	5170	5	
180	5180	5200	5200									
			5210	5210	5220	5240	5240	5260	5280			
M1			4580									
M2			4580	4590								
M5			4590									
Mismatch			*	3940	3950	4570	4990	5010				
N			*	3390	3400	3420	3430	3450	3460	5230		
N(*	3550	3560	3610	3690	3690	3720	3730	3760	4
880	4900	4920	4940									
			4960	4980	5030	5040						
N3			*	3390	4140	4390						
N8			*	3390	4140	4390						
N9			3400	4140	4390	4410	4410	4410	4420	4420	4430	
4430	4440	4440	4450									
			5180									
Q			2840	2950	3000	3270	3290	3580	3610	3610	3620	
3630	3680	3700	3710									
			3710	3780	3790	3890	3920	3920	4170	4210	4	
480	5200	5220	5480									
			5500	5660	5670	5670						
Q0			3640	3670								
Q1			*	3650	3670	4100	4130	4550	4690	4810	4830	4
870	5210	5220	5290									
Q2			*	3660	3670	3830	3840	4621	4622			
Q3			*	3670	3680	3740	3750	3750	3760	3760	3770	3
840	3850	4622	4623									
R4			*	5440	5450	5460	5610					
R5			*	4230								
R8			3530	3550	3560							
R9			3340	3350								
S1			*	3430	3440	3440	3450	3460	4420	4460		

```

5730 DEF FNL(Q)
5740 REM MULTI-LEVEL SUBROUTINE (FNL0)
5750 OPTION BASE 1
5760 COM File,Flag
5770 COM Q6,Q7,Q8,Q9,R2,R3,L,R,A6,A7,A8,A9,Z1,I2,N3,N8,N,F,F0,W
5780 COM SHORT F(4),L(*),M(32,33),N(26,11)
5790 COM D#[80],P#[100],INTEGER D(6,75),N0,X#[80]
5800 COM C#[100],G#[100],R#[100],B#[10],H#[100],Q#[50],V#[100]
5810 COM A#[100],Z2,Z3,Z4,Z5,T1,S1,T4,T2,T3,Z6,F7,T7,T8,T9,P9,X6,X7,X8,X9
5820 COM Q1,Q2,Q3,Q5,E2,Z(1,100),B5,B6,B7,B8,C1,R5,P1,P2,P3,P4,V2,Pout$
5830 COM P5,P6,P7,P8,W1,W2,W3,W4,W5,W6,T5,T6,E7,J8,I6,S,I5,X3,P0,I,C2,Mismatch
5840 COM Real,Imag
5850 PRINTER IS 0
5860 Q=FNS(4)
5870 FOR P0=1 TO 2
5880 Q=FNT(Q)
5890 ON P0 GOTO 5900,5920
5900 PRINT "PRESS CONTINUE IF OK , PRESS RUN TO REDO EVERTHING"
5910 PAUSE
5920 X6=2
5930 T2=FNA(Q)
5940 PRINTER IS 0
5950 A$="Ta"
5960 X6=3
5970 ! IF HOT AMB IS USED INSTEAD OF CRYO MAKE CHNGE HERE (X6=2)
5980 ! R=R3
5990 PRINTER IS 0
6000 T3=FNA(Q)
6010 PRINTER IS 16
6020 PRINT "X6,T3,R3,T2,R2",X6;T3;R3;T2;R2
6030 PRINTER IS 0
6040 IF X6>2 THEN 6080
6050 T3=T3+N(14,2)
6060 PRINTER IS 0
6070 GOTO 6090
6080 T3=T3+N(14,1)
6090 PRINT "TS=";T3
6100 PRINT A$;T2
6110 REM LEVEL LOOP
6120 N=N3*N8*2
6130 L0=1
6140 FOR L=1 TO L0
6150 ! Q=FNO(7)
6160 Q=FNM(Q)
6170 L(L,6*P0-5)=T2
6180 L(L,6*P0-4)=T3
6190 L(L,6*P0-3)=T1
6200 L(L,6*P0-2)=S1
6210 L(L,6*P0-1)=T4
6220 L(L,6*P0)=P2
6230 NEXT L
6240 Q=FNS(3)
6250 NEXT P0
6260 Q=FNS(4)
6270 REM PRELIMINARY RESULTS
6280 A$="-----"
6290 ! !!!PAGE
6300 GOTO 6480
6310 PRINTER IS 0
6320 Q=FNS(11)
6330 PRINT TAB(23),"MEASUREMENT RECAP"
6340 PRINT TAB(30),"AND"
6350 PRINT TAB(22),"PRELIMINARY RESULTS"
6360 Q=FNS(7)

```

```

6370 PRINT TAB(6),"FREQUENCY=";F;"MHZ"
6380 PRINT TAB(6),"SOURCE IMPEDANCE";TAB(23),H#[11,20];TAB(38),"LEVEL SETTING O
F R2=";R5
6390 PRINT TAB(6),A#
6400 Q=FNS(2)
6410 PRINT TAB(10),"TA";TAB(20),"R OHMS";TAB(34),"TS";TAB(44),"R OHMS"
6420 PRINT TAB(6)," ----- "
6430 FIXED 2
6440 PRINT TAB(8),Z(1,1);TAB(20),Z(1,59);TAB(32),Z(1,2);TAB(44),Z(1,60)
6450 PRINT TAB(8),Z(1,7);TAB(20),Z(1,59);TAB(32),Z(1,8);TAB(44),Z(1,60)
6460 PRINT TAB(6),A#
6470 GOTO 6630
6480 FOR L=1 TO L0
6490 Z(L,1)=L(1,1)
6500 Z(L,2)=L(1,2)
6510 Z(L,3)=L(L,3)
6520 Z(L,4)=L(L,4)
6530 Z(L,5)=L(L,5)
6540 Z(L,6)=L(L,6)
6550 Z(L,7)=L(L,7)
6560 Z(L,8)=L(L,8)
6570 Z(L,9)=L(L,9)
6580 Z(L,10)=L(L,10)
6590 Z(L,11)=L(L,11)
6600 Z(L,12)=L(L,12)
6610 NEXT L
6620 GOTO 6310
6630 PRINT TAB(11),"TX";TAB(21),"SX";TAB(34),"TE"
6640 PRINT TAB(6)," ----- "
6650 PRINT TAB(8),Z(1,3);TAB(20),Z(1,4);TAB(32),Z(1,5)
6660 PRINT TAB(8),Z(1,9);TAB(20),Z(1,10);TAB(32),Z(1,11)
6670 PRINT
6680 PRINT TAB(6),A#
6690 PRINT
6700 STANDARD
6710 N9=Z(1,31)
6720 PRINT TAB(6),"AVE POWER IN MILLIWATTS P1,P2,P3"
6730 PRINT TAB(6),Z(1,45)/N*1000,Z(1,46)/N*1000,Z(1,47)/N*1000
6740 S1=SQR((Z(1,48)-Z(1,45)*Z(1,45)/N)/(N-1))
6750 S2=SQR((Z(1,49)-Z(1,46)*Z(1,46)/N)/(N-1))
6760 S3=SQR((Z(1,50)-Z(1,47)*Z(1,47)/N)/(N-1))
6770 PRINT TAB(6),"SD P1,P2,P3 (# OF MEAS=";N;");S1;S2;S3
6780 PRINT TAB(6),A#
6790 Q=FNS(20)
6800 PRINT TAB(6),A#
6810 PRINT
6820 PRINT " END OF MEASUREMENT PRESS CONTINUE FOR FULL REPORT"
6830 PAUSE
6840 RETURN 0
6850 FNEND
6860 !
6870 ! EDITED FOR 9845
6880 ! !!!!!SUBROUTINES OUTSIDE OF MAIN PROGRAM STRUCTURE START HERE!!!!!!
6890 !

```

FNL(

A#	*	5950	6100	6280	6390	6460	6680	6780	6800		
F	*	6370									
H#	*	6380									
L	*	6140	6170	6180	6190	6200	6210	6220	6230	6	
480	6490	6500	6510	6510	6520	6520	6530	6530	6540	6550	6

550	6560	6560	6570								
			6570	6580	6580	6590	6590	6600	6600	6610	
LC			* 6170	6180	6190	6200	6210	6220	6490	6500	6
510	6520	6530	6540								
			6550	6560	6570	6580	6590	6600			
L0			6130	6140	6480						
N			* 6120	6730	6730	6730	6740	6740	6750	6750	6
760	6760	6770									
NC			* 6050	6080							
N3			* 6120								
N8			* 6120								
N9			6710								
P0			* 5870	5890	6170	6180	6190	6200	6210	6220	6
250											
P2			* 6220								
Q			5730	5860	5880	5880	5930	6000	6160	6160	6240
6260	6320	6360	6400								
			6790								
R2			* 6020								
R3			* 6020								
R5			* 6380								
S1			* 6200	6740	6770						
S2			6750	6770							
S3			6760	6770							
T1			* 6190								
T2			* 5930	6020	6100	6170					
T3			* 6000	6020	6050	6050	6080	6080	6090	6180	
T4			* 6210								
X6			* 5920	5960	6020	6040					
ZC			* 6440	6440	6440	6440	6450	6450	6450	6450	6
490	6500	6510	6520								
			6530	6540	6550	6560	6570	6580	6590	6600	6
650	6650	6650	6660								
			6660	6660	6710	6730	6730	6730	6740	6740	6
740	6750	6750	6750								
			6760	6760	6760						

```
6890 DEF FND(Q)  
6900 IF Q THEN 6920  
6910 RETURN FNX(68)+FNX(67)+FNX(63)+FNX(81)+FNX(33)  
6920 Q=FNX(68)+FNX(28)+FNX(102)+FNW(460)+FNR(2)+FNR(2)  
6930 V=FNX(68)+FNX(29)+FNX(103)+FNW(550)+FNR(2)+FNX(111)+FNX(27)+FNW(100)  
6940 RETURN 0  
6950 FNEND
```

FND<

```
.  
Q          6890   6900   6920  
V          6930
```

```

6960 DEF FNP(Q)                !!(FNP)    MOD VS JAN 16 1981    GJC
6970 ! TEST OF NEW MANIFOLD STARTED NOV 21
6980 ! ! THIS VERSION HAS CODE TO ACCOMODATE BAD PROG ATTEN!!!!!!!!!!!!!!!!!!!!!!!!!!!!
!!!!!!!!!!!!!!!!!!!!!!!!!!!!!!!!!!!!!!!!!!!!!!!!!!!!!!!!!!!!!!!!!!!!!!!!!!!!!!!!!!!!
6990 OPTION BASE 1
7000 COM File,Flag
7010 COM Q6,Q7,Q8,Q9,R2,R3,L,R,A6,A7,A8,A9,Z1,I2,N3,N8,N,F,F0,W
7020 COM SHORT F(4),L(*),M(32,33),N(26,11)
7030 COM D#[80],F#[100],INTEGER D(6,75),N0,X#[80]
7040 COM C#[100],G#[100],R#[100],B#[10],H#[100],Q#[50],V#[100]
7050 COM A#[100],Z2,Z3,Z4,Z5,T1,S1,T4,T2,T3,Z6,F7,T7,T8,T9,P9,X6,X7,X8,X9
7060 COM Q1,Q2,Q3,Q5,E2,Z(1,100),B5,B6,B7,B8,C1,R5,P1,P2,P3,P4,V2,Pout$
7070 COM P5,P6,P7,P8,W1,W2,W3,W4,W5,W6,T5,T6,E7,J8,I6,S,I5,X3,P0,I,C2,Mismatch
7080 COM Real,Imag
7090 ! OUTPUT 701;"*" !RESET FLUKE
7100 DIM Po(6)
7110 PRINTER IS 16
7120 Q=0
7130 Pout$="0"                !Q=FNX(Q7)
7140 OUTPUT 702;"0","0","7",Pout$ ! 0000 0000 0111 XXXX SETFREQ+PORT
7150 WAIT 50
7160 OUTPUT 702;"0","0",">","Pout$"!CONTROL
7170 ! PRINT "PORT #",Pout$
7180 WAIT 150
7190 OUTPUT 709;"C" !CLEAR SCANNER
7200 OUTPUT 709;15 !CHANNEL 15
7210 OUTPUT 701;"VR1F2T2S5?" !VOLTS FILTER #SA
7220 ! WAIT 600
7230 ENTER 701;V0 !VALUE OF BRIDGE POWER OFF
7240 ! PRINT "BRIDGE PWR OFF=";V0
7250 ! OUTPUT 709;16 !CHANNEL 16
7260 ! WAIT 300
7270 ! OUTPUT 701;"VRF2S5?" !OUTPUT FLUKE
7280 ! ENTER 701;V1 !VALUE OF REF
7290 ! PRINT "VALUE OF REF=";V1
7300 ! PAUSE
7310 OUTPUT 709;17
7320 WAIT 300
7330 OUTPUT 701;"VR0F2T2S5?"
7340 ! WAIT 600
7350 ENTER 701;V3 !BRIDGE -REF WITH NO POWER
7360 PRINT "BRIDGE -REF NO PWR=";V3
7370 FOR Loop=1 TO 3
7380 ON Loop GOTO 7390,7430,7490
7390 Pout$="0"                ! Q=FNX(Q8)
7400 ! PRINT "PAUSE 1",Pout$
7410 ! PAUSE
7420 GOTO 7500
7430 Pout$="3"                ! Q=FNX(Q8)
7440 ! PRINT "PAUSE2",Pout$
7450 ! PAUSE
7460 GOTO 7500
7470 ! PRINT "PAUSE 3",Pout$
7480 ! PAUSE
7490 Pout$="2"                ! Q=FNX(Q9)
7500 OUTPUT 702;"0","1","7",Pout$ !0000 0001 0111 XXXX
7510 WAIT 50
7520 OUTPUT 702;"0","1",">","Pout$ !0000 0001 1000 XXXX
7530 WAIT 150
7540 OUTPUT 701;"VR0F2T2S5?" !OUTPUT FLUKE
7550 ! WAIT 600
7560 ENTER 701;V4 !ENTER BRIDGE -REF WITH POWER
7570 PRINT "BRIDGE -REF PWR=";V4
7580 Po(Loop)=V4

```

V3	7350	7360	7760
V4	7560	7570	7580
V5	7660	7670	7760
V6	7720	7730	7740

```
7930 DEF FNB(Q)                !!(FNB)
7940   OPTION BASE 1
7950   COM File,Flag
7960   COM Q6,Q7,Q8,Q9,R2,R3,L,R,A6,A7,A8,A9,Z1,I2,N3,N8,N,F,F0,W
7970   COM SHORT F(4),L(*),M(32,33),N(26,11)
7980   COM D#[80],P#[100],INTEGER I(6,75),N0,X#[80]
7990   COM C#[100],G#[100],R#[100],B#[10],H#[100],Q#[50],V#[100]
8000   COM A#[100],Z2,Z3,Z4,Z5,T1,S1,T4,T2,T3,Z6,F7,T7,T8,T9,P9,X6,X7,X8,X9
8010   COM Q1,Q2,Q3,Q5,E2,Z(1,100),B5,B6,B7,B8,C1,R5,P1,P2,P3,P4,V2,Pout#
8020   COM P5,P6,P7,P8,W1,W2,W3,W4,W5,W6,T5,T6,E7,J8,I6,S,I5,X3,P0,I,C2,Mismatch
8030   COM Real,Imag
8040   FOR I=1 TO Q
8050     BEEP
8060     WRIT ABS(100*(I-4))
8070     NEXT I
8080     RETURN 0
8090   FNEND
```

FNB(

I	*	8040	8060	8070
Q		7930	8040	

```

8100 DEF FNN(Q)                                !!(FNN)
8110     OPTION BASE 1
8120     COM File,Flag
8130     COM Q6,Q7,Q8,Q9,R2,R3,L,R,A6,A7,A8,A9,Z1,I2,N3,N8,N,F,F0,W
8140     COM SHORT F(4),L(*),M(32,33),N(26,11)
8150     COM D#[80],P#[100],INTEGER D(6,75),N0,X#[80]
8160     COM C#[100],G#[100],R#[100],B#[10],H#[100],Q#[50],V#[100]
8170     COM A#[100],Z2,Z3,Z4,Z5,T1,S1,T4,T2,T3,Z6,F7,T7,T8,T9,P9,X6,X7,X8,X9
8180     COM Q1,Q2,Q3,Q5,E2,Z(1,100),B5,B6,B7,B8,C1,R5,P1,P2,P3,P4,V2,Pout#
8190     COM P5,P6,P7,P8,W1,W2,W3,W4,W5,W6,T5,T6,E7,J8,I6,S,I5,X3,P0,I,C2,Mismatch
8200     COM Real,Imag
8210     DISP "< =NC>:";Q;
8220     LINPUT B#
8230     IF B#[1,1]=" " THEN 8250
8240     RETURN VAL(B#)
8250     RETURN Q
8260     FNEND

```

FNN<

B#	*	8220	8230	8240
Q		8100	8210	8250

```

8270 DEF FNI(Q)                                !!(FNI)
8280 A$="- - -----#####0000"
8290 A$=A$[4*Q-3,4*Q]
8300 A$[5]=A$
8310 A$[9]=A$
8320 IMAGE M2D.1D
8330 PRINT USING 8320;A$,A$,A$,A$,A$
8340 RETURN 0
8350 FNEND

```

FNI

A\$			*	8280	8290	8290	8300	8300	8310	8310	8330	8
330	8330	8330		8330								
Q				8270	8290	8290						

8360 DEF FNW(Q)
8370 WAIT Q
8380 RETURN 0
8390 FNEND

!!(FNW)

FNW<

Q

8360 8370

```
8400 DEF FNS(Q)                                !!(FNS)
8410 OPTION BASE 1
8420 COM File,Flag
8430 COM Q6,Q7,Q8,Q9,R2,R3,L,R,A6,A7,A8,A9,Z1,I2,N3,N8,N,F,F0,W
8440 COM SHORT F(4),L(*),M(32,33),N(26,11)
8450 COM D#[80],P#[100],INTEGER D(6,75),N0,X#[80]
8460 COM C#[100],G#[100],R#[100],B#[10],H#[100],Q#[50],V#[100]
8470 COM A#[100],Z2,Z3,Z4,Z5,T1,S1,T4,T2,T3,Z6,F7,T7,T8,T9,P9,X6,X7,X8,X9
8480 COM Q1,Q2,Q3,Q5,E2,Z(1,100),B5,B6,B7,B8,C1,R5,P1,P2,P3,P4,V2,Pout$
8490 COM P5,P6,P7,P8,W1,W2,W3,W4,W5,W6,T5,T6,E7,J8,I6,S,I5,X3,P0,I,C2,Mismatch
8500 COM Real,Imag
8510 FOR I=1 TO Q
8520 PRINT
8530 NEXT I
8540 RETURN 0
8550 FNEND
```

FNS<

```
I          *      8510      8530
Q          8400      8510
```

```

8560 DEF FNO(Q)                                !!(FNO)
8570 OPTION BASE 1
8580 COM File,Flag
8590 COM Q6,Q7,Q8,Q9,R2,R3,L,R,A6,A7,A8,A9,Z1,I2,N3,N8,N,F,F0,W
8600 COM SHORT F(4),L(*),M(32,33),N(26,11)
8610 COM I#[80],P#[100],INTEGER I(6,75),N0,X#[80]
8620 COM C#[100],G#[100],R#[100],B#[10],H#[100],Q#[50],V#[100]
8630 COM A#[100],Z2,Z3,Z4,Z5,T1,S1,T4,T2,T3,Z6,F7,T7,T8,T9,P9,X6,X7,X8,X9
8640 COM Q1,Q2,Q3,Q5,E2,Z(1,100),B5,B6,B7,B8,C1,R5,P1,P2,P3,P4,V2,Pout#
8650 COM P5,P6,P7,P8,W1,W2,W3,W4,W5,W6,T5,T6,E7,J8,I6,S,I5,X3,P0,I,C2,Mismatch
8660 COM Real,Imag
8670 IF I2=0 THEN 8730
8680 DISP "(=NC)NOW: ";P#;
8690 INPUT Q#
8700 IF Q#=" " THEN 8780
8710 P#=Q#
8720 GOTO 8780
8730 DISP "(=NC)NOW: ";P#
8740 I0=FNS(1)+FNW(50)
8750 INPUT Q#
8760 IF Q#=" " THEN 8780
8770 P#=Q#
8780 RETURN Q
8790 FNEND

```

FNO(

I0		8740					
I2	*	8670					
P#	*	8680	8710	8730	8770		
Q		8560	8780				
Q#	*	8690	8700	8710	8750	8760	8770

```

8800 DEF FNM(Q)
8810   OPTION BASE 1
8820   COM File,Flag
8830   COM Q6,Q7,Q8,Q9,R2,R3,L,R,A6,A7,A8,A9,Z1,I2,N3,N8,N,F,F0,W
8840   COM SHORT F(4),L(*),M(32,33),N(26,11)
8850   COM D#[80],P#[100],INTEGER D(6,75),N0,X#[80]
8860   COM C#[100],G#[100],R#[100],B#[10],H#[100],Q#[50],V#[100]
8870   COM A#[100],Z2,Z3,Z4,Z5,T1,S1,T4,T2,T3,Z6,F7,T7,T8,T9,P9,X6,X7,X8,X9
8880   COM Q1,Q2,Q3,Q5,E2,Z(1,100),B5,B6,B7,B8,C1,R5,P1,P2,P3,P4,V2,Pout#
8890   COM F5,P6,P7,P8,W1,W2,W3,W4,W5,W6,T5,T6,E7,J8,I6,S,I5,X3,P0,I,C2,Mismatch
8900   COM Real,Imag
8910   PRINT
8920   OUTPUT 9;"R"
8930   ENTER 9;P#
8940   PRINT TAB(20),"DATE:";P#[1,2];"-";P#[4,5];"-1981";"      TIME:";P#[7,14]
8950   PRINT
8960   X5=1
8970   E8=500
8980   Z9=T7=T8=T9=P7=P8=P9=0
8990   W4=W5=W6=0
9000   FOR J8=1 TO N8+1
9010     Q=J8
9020     T1=FNV(Q)+FNG(Q)
9030     IF J8>1 THEN 9050
9040     GOTO 9150
9050     T1=T1*N3
9060     T8=T8+T1
9070     T9=T9+T4
9080     T7=T7+V2
9090     P7=P7+P4
9100     P8=P8+P5
9110     P9=P9+P6
9120     W4=W4+W1
9130     W5=W5+W2
9140     W6=W6+W3
9150   NEXT J8
9160   T1=T8/(N8*N3)
9170   T4=T9/N8
9180   S1=SQR((T7-T8*T8/(N8*N3))/(N8*N3-1))
9190   IF P0=1 THEN 9250
9200   B6=T7
9210   Z(1,41)=B6
9220   B8=T8
9230   Z(1,42)=B8
9240   GOTO 9310
9250   B5=T7
9260   B7=T8
9270   Z(1,43)=B5
9280   Z(1,42)=B7
9290   ! REM B5 AND B6=SUM OF SQRS-B7 AND B8=SUM OF T1
9300   PRINTER IS 0
9310   PRINT "          TX AVE          STD DEV          TE"
9320   PRINT
9330   PRINT USING 9340;T1,S1,T4
9340   IMAGE 5X,10D.D,5X,7D.2D,5X,7D.2D
9350   PRINT
9360   PRINT
9370   PRINT "P1 AVE MW=";P7/(N3*N8);"P2 AVE MW=";P8/(N3*N8);"P3 AVE MW=";P9/(N3*
N8)
9380   PRINT
9390   PRINT "STANDARD ERROR OF MEAN=";S1/SQR(N8*N3)
9400   PRINT
9410   PRINT
9420   PRINTER IS 16

```

```

9430 IF P0=2 THEN 9500
9440 Z(1,45)=P7
9450 Z(1,46)=P8
9460 Z(1,47)=P9
9470 Z(1,48)=W4
9480 Z(1,49)=W5
9490 Z(1,50)=W6
9500 IF P0=1 THEN 9590
9510 ! B5 AND B6 = SUM OF SQRS T1; B7 AND B8=SUM OF T1
9520 Z(1,45)=Z(1,45)+P7
9530 Z(1,46)=Z(1,46)+P8
9540 Z(1,47)=Z(1,47)+P9
9550 Z(1,48)=Z(1,48)+W4
9560 Z(1,49)=Z(1,49)+W5
9570 Z(1,50)=Z(1,50)+W6
9580 Q=FNB(1)
9590 Z8=1
9600 ! !DISP"ANOTHER ROUND"
9610 IF Z8=0 THEN 8980
9620 GOTO 9630
9630 RETURN 0
9640 FNEND
9650 ! !!!!!!!!!!!!!!!!!!!!!CUT 7 NOV 24 1980 0830 !!!!!!!!!!!!!!!!!!!!!!!!!!!!!

```

FNMC

B5	*	9250	9270							
B6	*	9200	9210							
B7	*	9260	9280							
B8	*	9220	9230							
E8		8970								
J8	*	9000	9010	9030	9150					
N3	*	9050	9160	9180	9180	9370	9370	9370	9390	
N8	*	9000	9160	9170	9180	9180	9370	9370	9370	9
390										
P#	*	8930	8940	8940	8940					
P0	*	9190	9430	9500						
P4	*	9090								
P5	*	9100								
P6	*	9110								
P7	*	8980	9090	9090	9370	9440	9520			
P8	*	8930	9100	9100	9370	9450	9530			
P9	*	8980	9110	9110	9370	9460	9540			
Q		8800	9010	9020	9020	9580				
S1	*	9180	9330	9390						
T1	*	9020	9050	9050	9060	9160	9330			

```

9660 DEF FNV(Q)
9670   OPTION BASE 1
9680   COM File,Flag
9690   COM Q6,Q7,Q8,Q9,R2,R3,L,R,A6,A7,A8,A9,Z1,I2,N3,N8,N,F,F0,W
9700   COM SHORT F(4),L(*),M(32,33),N(26,11)
9710   COM D#[80],P#[100],INTEGER I(6,75),N0,X#[80]
9720   COM C#[100],G#[100],R#[100],E#[10],H#[100],Q#[50],V#[100]
9730   COM A#[100],Z2,Z3,Z4,Z5,T1,S1,T4,T2,T3,Z6,F7,T7,T8,T9,P9,X6,X7,X8,X9
9740   COM Q1,Q2,Q3,Q5,E2,Z(1,100),E5,E6,E7,E8,C1,R5,P1,P2,P3,P4,V2,Pout#
9750   COM P5,P6,P7,P8,W1,W2,W3,W4,W5,W6,T5,T6,E7,J8,I6,S,I5,X3,P0,I,C2,Mismatch
9760   COM Real,Imag
9770 T1=T4=V2=P4=P5=P6=W1=W2=W3=0
9780 X5=1
9790 E8=1000
9800 PRINTER IS 0
9810 FOR Z2=1 TO N3
9820 J5=1
9830 ! Qo=FNV(Q7)
9840 ! Q=1
9850 ! P1=FNV(Q)
9860 ! J5=2
9870 ! Qone=FNV(Q8)
9880 ! Q=2
9890 ! P2=FNV(Q)
9900 ! J5=3
9910 ! Qtwo=FNV(Q9)
9920 ! Q=3
9930 ! P3=FNV(Q)
9940 ! Po=FNV(Q)
9950 Q=FNV(Q)
9960 ! PRINT "PAUSE AFTER RETURN FROM FNV:4462"
9970 ! PRINT "THIS IS P1,P2,P3";P1,P2,P3
9980 ! PAUSE
9990 X5=1
10000 Y1=P1/P2
10010 Y3=P3/P2
10020 X8=T2+(T3-T2)*(Y1-1)/(Y3-1)
10030 T6=X8-T2
10040 T5=T6/C1
10050 T5=T2+T5
10060 X8=T5
10070 IF X5=0 THEN 10110
10080 PRINTER IS 0
10090 PRINT X8;P1*1000;P2*1000;P3*1000
10100 GOTO 10130
10110 PRINTER IS 0
10120 PRINT X8
10130 IF J8=1 THEN 10200
10140 GOTO 10200
10150 E8=10000
10160 E6=X8-E7
10170 IF ABS(E6)<=E8 THEN 10200
10180 DISP "DEV EXCEEDS MAX--REDO LAST TEMP"
10190 GOTO 9820
10200 T1=T1+X8
10210 T4=T4+(T3-Y3*T2)/(Y3-1)
10220 V2=V2+X8*X8
10230 P4=P4+P1
10240 P5=P5+P2
10250 P6=P6+P3
10260 W1=W1+P1*P1
10270 W2=W2+P2*P2
10280 W3=W3+P3*P3
10290 NEXT Z2

```

```

10300 T4=T4/N3
10310 S=SQR((V2-T1*T1/N3)/(N3-1))
10320 T1=T1/N3
10330 E7=T1
10340 RETURN T1
10350 FNEND

```

FNVC

C1	*	10040								
E6		10160	10170							
E7	*	10160	10330							
E8		9790	10150	10170						
J5		9820								
J8	*	10130								
N3	*	9810	10300	10310	10310	10320				
P1	*	10000	10090	10230	10260	10260				
P2	*	10000	10010	10090	10240	10270	10270			
P3	*	10010	10090	10250	10280	10280				
P4	*	9770	10230	10230						
P5	*	9770	10240	10240						
P6	*	9770	10250	10250						
Q		9660	9950							
S	*	10310								
T1 340	*	9770	10200	10200	10310	10310	10320	10320	10330	10
T2	*	10020	10020	10030	10050	10210				
T3	*	10020	10210							
T4	*	9770	10210	10210	10300	10300				
T5	*	10040	10050	10050	10060					
T6	*	10030	10040							
V2	*	9770	10220	10220	10310					
W1	*	9770	10260	10260						
W2	*	9770	10270	10270						
W3	*	9770	10280	10280						
X5		9780	9990	10070						
X8 220	*	10020	10030	10060	10090	10120	10160	10200	10220	10

Y1	10000	10020		
Y3	10010	10020	10210	10210
Z2	*	9810	10290	

```

10360 DEF FNG(Q)
10370 OPTION BASE 1
10380 COM File,Flag
10390 COM Q6,Q7,Q8,Q9,R2,R3,L,R,A6,A7,A8,A9,Z1,I2,N3,N8,N,F,F0,W
10400 COM SHORT F(4),L(*),M(32,33),N(26,11)
10410 COM D#[80],P#[100],INTEGER D(6,75),N0,X#[80]
10420 COM C#[100],G#[100],R#[100],B#[10],H#[100],Q#[50],V#[100]
10430 COM A#[100],Z2,Z3,Z4,Z5,T1,S1,T4,T2,T3,Z6,F7,T7,T8,T9,P9,X6,X7,X8,X9
10440 COM Q1,Q2,Q3,Q5,E2,Z(1,100),B5,B6,B7,B8,C1,R5,P1,P2,P3,P4,V2,Pout#
10450 COM P5,P6,P7,P8,W1,W2,W3,W4,W5,W6,T5,T6,E7,J8,I6,S,I5,X3,P0,I,C2,Mismatch
10460 COM Real,Imag
10470 PRINTER IS 0
10480 IF J8>1 THEN 10830
10490 I6=T1
10500 ! PRINT "ENTER SCALE DESIRED"
10510 ! INPUT Q5
10520 ! GO TO 8485
10530 Q5=100
10540 I5=Q5/25
10550 IMAGE 5X,"TX(K) =",M7D.,"SIG(K) =",M5D.
10560 IMAGE /,/,,/
10570 D9=1
10580 Q=FNS(2)
10590 PRINT "A2 SETTING=";R5;"DB"
10600 PRINT F;"MHZ"
10610 PRINT USING 10560
10620 IMAGE 17X,"# OF PTS IN AVE =",M3D
10630 IMAGE 7X,"UNIT =",M9D.D," KELVINS",/
10640 PRINT USING 10620;N3
10650 PRINT USING 10630;I5
10660 PRINT
10670 IF Q5>=10 THEN 10720
10680 PRINT USING 10710;-Q5,-3*Q5/5,-Q5/5,Q5/5,3*Q5/5,Q5
10690 GOTO 10730
10700 IMAGE 4X,M5D ,4X,M5D ,4X,M5D ,4X,M5D ,4X,M5D ,4X,M5D ," KELVINS"
10710 IMAGE 5X,M1DE,4X,M1DE,4X,M1DE,4X,M1DE,4X,M1DE,4X,M1DE," KELVINS"
10720 PRINT USING 10700;-Q5,-3*Q5/5,-Q5/5,Q5/5,3*Q5/5,Q5
10730 A#="!...!...!...!...!...!...!...!...!...!...!"
10740 PRINT TAB(8),A#
10750 IMAGE "#/TIME",21X,"ZERO=",M5D ," KELVINS",16X,"TX(K) ",3X,"SIG(K)"
10760 IF (T1>=100) AND (T1<=1E5) THEN 10800
10770 PRINT USING 10780;I6
10780 IMAGE "#/TIME",21X,"ZERO=",M1D.2DE," KELVINS",15X,"TX(K) ",3X,"SIG(K)"
10790 GOTO 10820
10800 PRINTER IS 0
10810 PRINT USING 10750;I6
10820 RETURN 0
10830 I6=T1
10840 IMAGE M3D ,4X
10850 PRINTER IS 0
10860 PRINT USING 10840;J8-1
10870 X3=INT((T1-I6)/I5)+25
10880 X4=INT(S/I5)
10890 IF X3>0 THEN 10920
10900 PRINT "<---";TAB(51),
10910 GOTO 11080
10920 IF X3<50 THEN 10950
10930 PRINT TAB(47),"--->";
10940 GOTO 11080
10950 X3=X3
10960 IF (X3-X4>0) AND (X3+X4<50) THEN 10980
10970 GOTO 11000
10980 PRINT TAB(X3-X4),"!";TAB(X3),"+";TAB(X3+X4),"!";TAB(51),
10990 GOTO 11080

```

```

11000 IF (X3-X4>0) AND (X3<50) THEN 11020
11010 GOTO 11040
11020 PRINT TAB(X3-X4), "!"; TAB(X3), "+"; TAB(51),
11030 GOTO 11080
11040 IF (X3>0) AND (X3+X4<50) THEN 11070
11050 PRINT TAB(X3), "X"; TAB(51),
11060 GOTO 11080
11070 PRINT TAB(X3), "+"; TAB(X3+X4), "!"; TAB(51),
11080 IF (T1>=100) AND (T1<=1E5) THEN 11120
11090 IMAGE 2X, MID.2DE, 2X, MID.2DE
11100 PRINT USING 11090; T1, S
11110 GOTO 11160
11120 PRINT USING 11130; T1, S
11130 IMAGE 2X, M5D, 2X, M5D
11140 IF (J8-1)/20-INT((J8-1)/20)>0 THEN 11160
11150 PRINT TAB(8), A#
11160 RETURN 0
11170 FNEND

```

FNGL

A#			*	10730	10740	11150													
D9				10570															
F			*	10600															
I5			*	10540	10650	10870	10880												
I6			*	10490	10770	10810	10830	10870											
J8			*	10480	10860	11140	11140												
N3			*	10640															
Q				10360	10580														
Q5			*	10530	10540	10670	10680	10680	10680	10680	10680	10680	10680	10680	10				
680	10720	10720		10720															
				10720	10720	10720													
R5			*	10590															
S			*	10880	11100	11120													
T1			*	10490	10760	10760	10830	10870	11080	11080	11100	11							
120																			
X3			*	10870	10890	10920	10950	10950	10960	10960	10980	10							
980	10980	11000		11000															
				11020	11020	11040	11040	11050	11070	11070									
X4				10880	10960	10960	10980	10980	11000	11020	11040	11070							

```
11180 DEF FNA(Q)
11190 OPTION BASE 1
11200 COM File,Flag
11210 COM Q6,Q7,Q8,Q9,R2,R3,L,R,A6,A7,A8,A9,Z1,I2,N3,N8,N,F,F0,W
11220 COM SHORT F(4),L(*),M(32,33),N(26,11)
11230 COM D#[80],P#[100],INTEGER D(6,75),N0,X#[80]
11240 COM C#[100],G#[100],R#[100],E#[10],H#[100],Q#[50],V#[100]
11250 COM A#[100],Z2,Z3,Z4,Z5,T1,S1,T4,T2,T3,Z6,F7,T7,T8,T9,P9,X6,X7,X8,X9
11260 COM Q1,Q2,Q3,Q5,E2,Z(1,100),B5,B6,B7,B8,C1,R5,P1,P2,P3,P4,V2,Pout#
11270 COM P5,P6,P7,P8,W1,W2,W3,W4,W5,W6,T5,T6,E7,J8,I6,S,I5,X3,P0,I,C2,Mismatch
11280 COM Real,Imag
11290 Z(1,59)=R2
11300 Z(1,60)=R3
11310 PRINTER IS 16
11320 PRINT "FNA",X6,Z9
11330 IF X6>1 THEN 11370
11340 DISP "BULB PRESS(MM)=";
11350 INPUT H6
11360 GOTO 11590
11370 IF N(X6,1)>>0 THEN 11460
11380 DISP "R0=";
11390 INPUT N(X6,1)
11400 DISP "ALPHA=";
11410 INPUT N(X6,2)
11420 DISP "DELTA=";
11430 INPUT N(X6,3)
11440 DISP "BETA=";
11450 INPUT N(X6,4)
11460 IF X6>2 THEN 11850
11470 H4=R2
11480 PRINT "9526 X6,H4,R2",X6,H4,R2
11490 IF H4<50 THEN 11630
11500 H6=N(X6,1)
11510 H7=N(X6,2)
11520 H3=(H4/H6-1)/H7
11530 H8=N(X6,3)
11540 IF H3>0 THEN 11570
11550 H9=N(X6,4)
11560 GOTO 11690
11570 H9=0
11580 GOTO 11690
11590 H5=N(7,2)*H6*H6
11600 H5=N(7,3)*H6+H5+N(7,4)
11610 H5=H5-273.15
11620 GOTO 9815
11630 H5=N(6,1)*H4*H4
11640 H5=N(6,2)+N(6,3)*H4+H5
11650 H5=H5
11660 T3=H5
11670 PRINTER IS 0
11680 RETURN T3
11690 H5=H3
11700 PRINT
11710 FOR J9=1 TO 5
11720 G9=H5/100
11730 G8=G9-1
11740 IF H5>0 THEN 11770
11750 H5=H3+H8*G8*G9+H9*G8*G9*G9*G9
11760 GOTO 11790
11770 H5=H5+H8*G9*G8
11780 H5=H3+H8*G9*G8
11790 NEXT J9
11800 PRINTER IS 0
11810 T2=H5+273.15
```

```

11820 PRINT "AMBIENT STD",T2
11830 PRINTER IS 0
11840 RETURN T2
11850 H4=R3
11860 IF H4<50 THEN 11630
11870 H6=N(X6,1)
11880 H7=N(X6,2)
11890 H3=(H4/H6-1)/H7
11900 IF H3>0 THEN 11930
11910 H9=N(X6,4)
11920 GOTO 11940
11930 H9=0
11940 H5=H3
11950 FOR J9=1 TO 5
11960 G9=H5/100
11970 G8=G9-1
11980 IF H5>0 THEN 12010
11990 H5=H3+H8*G8*G9+H9*G8*G9*G9
12000 GOTO 12020
12010 H5=H3+H8*G9*G8
12020 NEXT J9
12030 T3=H5
12040 PRINT "AMBIENT CRYO",T3
12050 PRINTER IS 0
12060 RETURN T3+273.15
12070 FNEND

```

FNAC

G8		11730	11750	11750	11770	11780	11970	11990	11990	12010
G9		11720	11730	11750	11750	11750	11750	11770	11780	11960
11970	11990	11990	11990							
			12010							
H3		11520	11540	11690	11750	11780	11890	11900	11940	11990
12010										
H4		11470	11480	11490	11520	11630	11630	11640	11850	11860
11890										
H5		11590	11600	11600	11610	11610	11630	11640	11640	11650
11650	11660	11690	11720							
			11740	11750	11770	11770	11780	11810	11940	11960
980	11990	12010	12030							
H6		11350	11500	11520	11590	11590	11600	11870	11890	
H7		11510	11520	11880	11890					
H8		11530	11750	11770	11780	11990	12010			
H9		11550	11570	11750	11910	11930	11990			
J9		11710	11790	11950	12020					
NC		*	11370	11390	11410	11430	11450	11500	11510	11530
550	11590	11600	11600							
			11630	11640	11640	11870	11880	11910		
Q		11180								
R2		*	11290	11470	11480					

```

12080 DEF FNT(Q)
12090 OUTPUT 9;"R"
12100 ENTER 9;P$
12110 OUTPUT 709;50
12120 WAIT 250
12130 OUTPUT 701;"*"
12140 OPTION BASE 1
12150 COM File,Flag
12160 COM Q6,Q7,Q8,Q9,R2,R3,L,R,A6,A7,A8,A9,Z1,I2,N3,N8,N,F,F0,W
12170 COM SHORT F(4),L(*),M(32,33),N(26,11)
12180 COM D#[80],P#[100],INTEGER I(6,75),N0,X#[80]
12190 COM C#[100],G#[100],R#[100],B#[10],H#[100],Q#[50],V#[100]
12200 COM A#[100],Z2,Z3,Z4,Z5,T1,S1,T4,T2,T3,Z6,F7,T7,T8,T9,P9,X6,X7,X8,X9
12210 COM Q1,Q2,Q3,Q5,E2,Z(1,100),B5,B6,B7,B8,C1,R5,P1,P2,P3,P4,V2,Pout#
12220 COM P5,P6,P7,P8,W1,W2,W3,W4,W5,W6,T5,T6,E7,J8,I6,S,I5,X3,P0,I,C2,Mismatch
12230 COM Real,Imag
12240 ! 801030 GJC SUBROUTINE TO READ RESISTANCE OF PLATINUM THERMOMETERS AND VO
LTAGES
12250 PRINTER IS 16
12260 OUTPUT 9;"R"
12270 ENTER 9;Y$
12280 PRINT Y$
12290 ! OUTPUT 9;"S10,30,11,37,50"
12300 ! STOP
12310 OUTPUT 709;50
12320 WAIT 250
12330 OUTPUT 701;"*"
12340 OUTPUT 701;"ZH2?"
12350 ENTER 701;R0
12360 PRINTER IS 0
12370 OUTPUT 709;51
12380 WAIT 250
12390 OUTPUT 701;"Z ?"
12400 ENTER 701;R1
12410 OUTPUT 709;50
12420 WAIT 250
12430 OUTPUT 701;"K",","
12440 OUTPUT 701;"Z", "?"
12450 ENTER 701;Rthree
12460 OUTPUT 709;51
12470 WAIT 250
12480 OUTPUT 701;"K"
12490 OUTPUT 701;"ZP?"
12500 ENTER 701;R2
12510 !
12520 R2=R2-.022
12530 !
12540 OUTPUT 709;52
12550 WAIT 250
12560 OUTPUT 701;"*"
12570 OUTPUT 701;"Z?"
12580 ENTER 701;R7
12590 OUTPUT 701;"K,"
12600 OUTPUT 709;53
12610 OUTPUT 701;"Z?"
12620 ENTER 701;Rfive
12630 OUTPUT 701;"ZP?"
12640 ENTER 701;R3
12650 !
12660 R3=R3-.026-.045+.035
12670 !
12680 OUTPUT 709;C
12690 OUTPUT 701;"*"
12691 PRINTER IS 0

```

```
12692 PRINT R2,R3
12694 PRINTER IS 16
12695 RETURN 0
12700 OUTPUT 709;10
12710 OUTPUT 701;"VKFH0?"
12720 ENTER 701;V0
12730 OUTPUT 701;"VPFH4?"
12740 ENTER 701;V0
12750 OUTPUT 709;11
12760 OUTPUT 701;"VP0FH0?"
12770 ENTER 701;V1
12780 OUTPUT 701;"VPFH0?"
12790 ENTER 701;V1
12800 OUTPUT 709;12
12810 OUTPUT 701;"VPFH0?"
12820 ENTER 701;V2
12830 OUTPUT 709;13
12840 OUTPUT 701;"VPFH0?"
12850 ENTER 701;V3
12860 OUTPUT 709;C
12870 OUTPUT 709;13
12880 OUTPUT 701;"VPHF0?"
12890 ENTER 701;V4
12900 PRINTER IS 0
12910 PRINT
12920 OUTPUT 9;"R"
12930 ENTER 9;Y$
12940 PRINT
12950 PRINT
12960 PRINT "DATE AND TIME:";Y$,"      YEAR  1981      FREQ=";F;"MHZ"
12970 PRINT
12980 PRINT
12990 IMAGE 1X,"AMBIENT LEAD RESISTANCE",25X,DDD.DDD,5X,"CHANNEL 50"
13000 IMAGE 1X,"AMBIENT LEAD RESISTANCE+PLATINUM THERMOMETER",4X,DDD.DDD,5X,"CHA
NNEL 51"
13010 IMAGE 1X,"AMBIENT THERMOMETER RESISTANCE",18X,DDD.DDD,5X,"CHANNEL 51-50"
13020 IMAGE 1X,"CRYO LEAD RESISTANCE",28X,DDD.DDD,5X,"CHANNEL 52"
13030 IMAGE 1X,"CRYO LEAD RESISTANCE +PLATINUM THERMOMETER",6X,DDD.DDD,5X,"CHANN
EL53"
13040 IMAGE 1X,"CRYO THERMOMETER RESISTANCE",21X,DDD.DDD,5X,"CHANNEL 53-52"
13050 PRINTER IS 16
13060 PRINT USING 12990;R0
13070 PRINT USING 13000;R1
13080 PRINTER IS 0
13090 PRINT USING 13010;R2
13100 PRINTER IS 16
13110 PRINT USING 13020;R7
13120 PRINT USING 13030;Rfive
13130 PRINTER IS 0
13140 PRINT USING 13040;R3
13150 ! IMAGE 1X,"VOLTMETER ZERO CHECK ",28X,DD.DDD,5X,"CHANNEL 10"
13160 IMAGE 1X,"28 VOLT SUPPLY",35X,DD.DDD,5X,"CHANNEL 11"
13170 IMAGE 1X,"15 VOLT SUPPLY",35X,DD.DDD,5X,"CHANNEL 12"
13180 IMAGE 1X,"20 VOLT SUPPLY",35X,DD.DDD,5X,"CHANNEL 13"
13190 PRINTER IS 16
13200 ! PRINT USING 780;V0
13210 PRINT USING 13160;V1
13220 PRINT USING 13170;V2
13230 PRINT USING 13180;V3
13240 RETURN 0
13250 FNEHD
```

FNT<

C	12680	12860			
F	* 12960				
P\$	* 12100				
Q	12080	12695			
R0	12350	13060			
R1	12400	13070			
R2	* 12500	12520	12520	12692	13090
R3	* 12640	12660	12660	12692	13140
R7	12580	13110			
Rfive	12620	13120			
Rthree	12450				
V0	12720	12740			
V1	12770	12790	13210		
V2	* 12820	13220			
V3	12850	13230			
V4	12890				
Y\$	12270	12280	12930	12960	

```
13260 DEF FN(X)
13270 OPTION BASE 1
13280 COM File,Flag
13290 COM Q6,Q7,Q8,Q9,R2,R3,L,R,A6,A7,A8,A9,Z1,I2,N3,N8,N,F,F0,W
13300 COM SHORT F(4),L(*),M(32,33),N(26,11)
13310 COM D#[80],P#[100],INTEGER D(6,75),N0,X#[80]
13320 COM C#[100],G#[100],R#[100],B#[10],H#[100],Q#[50],V#[100]
13330 COM A#[100],Z2,Z3,Z4,Z5,T1,S1,T4,T2,T3,Z6,F7,T7,T8,T9,P9,X6,X7,X8,X9
13340 COM Q1,Q2,Q3,Q5,E2,Z(1,100),B5,B6,B7,B8,C1,R5,P1,P2,P3,P4,V2,Pout#
13350 COM P5,P6,P7,P8,W1,W2,W3,W4,W5,W6,T5,T6,E7,J8,I6,S,I5,X3,P0,I,C2,Mismatch
13360 COM Real,Imag
13370 PRINTER IS 16
13380 PRINT "CALIBRATION FREQ";F
13390 F1=(F-30)/30
13400 K9=0
13410 K7=0
13420 PRINT "0";Q
13430 Q=Q+1
13440 PRINT "Q+1";Q
13450 ON F1+1 GOTO 13460,13470
13460 GOTO 13600
13470 ON Q GOTO 13480,13500,13520,13540
13480 Pout#="8"
13490 GOTO 13550
13500 Pout#="9"
13510 GOTO 13550
13520 Pout#=":"
13530 GOTO 13550
13540 Pout#=";"
13550 Strobe#="1"
13560 Svolt#="7"
13570 Sclear#=">"
13580 Zout#="0"
13590 GOTO 13690
13600 ON Q GOTO 13610,13630,13650,13670
13610 Pout#="0"
13620 GOTO 13690
13630 Pout#="1"
13640 GOTO 13690
13650 Pout#="2"
13660 GOTO 13690
13670 Pout#="3"
13680 PRINTER IS 16
13690 PRINT "PAUSE 11365";Pout#,Svolt#,Sclear#
13700 OUTPUT 702;Zout#,Zout#,Svolt#,Pout#
13710 ! !!!!!!!!!!!!!!!!!!!!!!!PAUSE
13720 WAIT 250
13730 ! OUTPUT 702;Zout#,Zout#,Sclear#,Pout#
13740 ! PRINT "PAUSE 11386";Sclear#
13750 WAIT 250
13760 Q=Q-1
13770 PRINTER IS 0
13780 RETURN 0
13790 FNEND
13800 END
13810 ! ALL SUBS RUN CHECK OK FINAL VS: 1-14-81
13820 ! Q=FNvsur(0)
13830 ! PRINT "T1,T2,T3";T1;T2;T3;"FREQUENCY=30MHZ"
13840 ! ALL SUBS RUN CHECK OK FINAL VS: 1-14-81
13850 ! 30 MHZ CONSTANTS
13860 ! OPTION BASE 1
13870 ! COM File,Flag
13880 ! COM Q6,Q7,Q8,Q9,R2,R3,L,R,A6,A7,A8,A9,Z1,I2,N3,N8,N,F,F0,W
13890 ! COM SHORT F(4),L(8,20),M(32,33),N(26,11)
```

```

13900 ! COM D#[80],P#[100],INTEGER D(6,75),N0,X#[80]
13910 ! COM C#[100],G#[100],R#[100],B#[10],H#[100],Q#[50],V#[100]
13920 ! COM A#[100],Z2,Z3,Z4,Z5,T1,S1,T4,T2,T3,Z6,F7,T7,T8,T9,P9,X6,X7,X8,X9
13930 ! COM Q1,Q2,Q3,Q5,E2,Z(1,100),B5,B6,B7,B8,C1,R5,P1,P2,P3,P4,V2,Pout#
13940 ! COM P5,P6,P7,P8,W1,W2,W3,W4,W5,W6,T5,T6,E7,J8,I6,S,I5,X3,P0,I
13950 ! COM Real,Imag
13960 ! Real=R=52
13970 ! Imag=1
13980 ! T1=11000
13990 ! T2=296.00
14000 ! T3=76.00
14010 ! PRINT "T1,T2,T3";T1;T2;T3;"FREQUENCY=30MHZ"

```

FNXC

```

F          * 13380 13390

F1         13390 13450

K7         13410

K9         13400

Pout#     * 13480 13500 13520 13540 13610 13630 13650 13670 13
690 13700

Q          13260 13410 13420 13430 13430 13440 13470 13600 13760
13760

Sclear#   13570 13690

Strobe#   13550

Smolts#   13560 13690 13700

Zout#     13580 13700 13700

```

```

14020 DEF FNvswr(Q) ! 30 MHZ VS 3-2-81 GJC
14030 OPTION BASE 1
14040 COM File,Flag
14050 COM Q6,Q7,Q8,Q9,R2,R3,L,R,A6,A7,A8,A9,Z1,I2,N3,N8,N,F,F0,W
14060 COM SHORT F(4),L(8,20),M(32,33),N(26,11)
14070 COM D#[80],P#[100],INTEGER D(6,75),N0,X#[80]
14080 COM C#[100],G#[100],R#[100],B#[10],H#[100],Q#[50],V#[100]
14090 COM A#[100],Z2,Z3,Z4,Z5,T1,S1,T4,T2,T3,Z6,F7,T7,T8,T9,P9,X6,X7,X8,X9
14100 COM Q1,Q2,Q3,Q5,E2,Z(1,100),B5,B6,B7,B8,C1,R5,P1,P2,P3,P4,V2,Pout$
14110 COM P5,P6,P7,P8,W1,W2,W3,W4,W5,W6,T5,T6,E7,J8,I6,S,I5,X3,P0,I,C2,Mismatch
14120 COM Real,Imag
14130 DIM Di(60),I(60),Mi(60),Ni(60),Ei(60),Ci(60),Zi(60),Gi#[100]
14140 ! !!!!!!!!!!!!!!!!!!!!!!!!!!!!!!!!!!!!!!!!!!!!!!!!!!!!!!!!!!!!!!!!!FNG
14150 PRINT T1,T2,T3;"FREQ=30MHZ"
14160 X=Real
14170 Y=Imag
14180 Qzero=(X+50)^2+Y^2
14190 Qone=Qzero*Qzero
14200 G1=(X^2-2500+Y^2)/Qzero
14210 G2=100*Y/Qzero
14220 Qthr=100*ABS((X+50)^2-Y^2)*.5
14230 G3=(Qthr+ABS(200*Y*(X+50)*1))/Qone
14240 Qfour=200*ABS(Y*(X+50))*1
14250 Qeight=(X+50)^2
14260 Qseven=Y^2
14270 Qfive=100*ABS(Qeight-Qseven)*1
14280 G4=(Qfour+Qfive)/Qone
14290 ! GOTO 7309
14300 PRINT "Y";Y,"R";X
14310 PRINT
14320 PRINT
14330 PRINT " G'";" G'";" DG'";"
      DG'/"
14340 PRINT G1,G2,G3,G4
14350 PRINT
14360 PRINT
14370 G5=((X-50)^2+Y^2)/Qzero
14380 Qfive=200*(X^2-2500-Y^2)*.5
14390 Qfive=ABS(Qfive)
14400 G6=(Qfive+400*ABS(X*Y)*1)/Qone
14410 PRINT " GAMMA SQ"," D GAMMA SQ"
14420 PRINT G5,G6
14430 PRINT
14440 Zone=X/50
14450 Ztwo=Y/50
14460 Zzero=SQR((X^2+Y^2)/2500)
14470 G7=(Zzero^2-1)/(Zzero^2+1+2*Zone)
14480 G8=2*Ztwo/(Zzero^2+1+2*Z1)
14490 G9=SQR(G7*G7+G8*G8)
14500 Znine=(G8/G9)^2
14510 A1=ATH(G8/G9/SQR(1-Znine+.00000001))
14520 PRINT "GAMMA R";" GAMMA I";" GAMMA MAG";"
      ANGLE"
14530 PRINT G7,G8,G9,A1
14540 DISP T1,T2,T3
14550 Tfive=T1*T3
14560 Tsix=T1*T2
14570 Tseven=T3*T2
14580 Teight=T3-T2
14590 Tzero=T2-T3
14600 Tnine=T1-T2
14610 Cone=88.1
14620 ! CHECK CONSTANTS USED IN THIS ROUTINE
14630 Ctwo=80.2

```

```

14640 Cthree=9.8
14650 Cfour=5.8
14660 H=-.005
14670 H1=0
14680 H2=.005
14690 Ri=.162
14700 Rone=.186
14710 Pone=G1
14720 Ptwo=G2
14730 Pthree=G3
14740 Pfour=G4
14750 Y=1
14760 F9=0
14770 GOTO 16210
14780 !!!!!!!!!!!!!!!!!!!!!!!!!!!!!FND
14790 Index=2
14800 T=1
14810 FOR L=0 TO 3
14820 GOTO 14860
14830 I2=I1=I7=I8=Ptwo
14840 D3=D4=D5=D6=Pone
14850 GOTO 14900
14860 I1=I2=Ptwo+Pfour
14870 I7=I8=Ptwo-Pfour
14880 D3=D4=Pone+Pthree
14890 D5=D6=Pone-Pthree
14900 D1=D7=Pone+L*Pthree/3
14910 D2=D8=Pone-L*Pthree/3
14920 I3=I5=Ptwo+L*Pfour/3
14930 I4=I6=Ptwo-L*Pfour/3
14940 ! PRINT L,I5;I6;I7
14950 Di(L+1)=D1
14960 IF L=0 THEN 14980
14970 Di(L+4)=D2
14980 Di(L+8)=D3
14990 IF L=0 THEN 15010
15000 Di(L+11)=D4
15010 Di(L+15)=D5
15020 IF L=0 THEN 15040
15030 Di(L+18)=D6
15040 Di(L+22)=D7
15050 IF L=0 THEN 15070
15060 Di(L+25)=D8
15070 I(L+1)=I1
15080 IF L=0 THEN 15100
15090 I(L+4)=I2
15100 I(L+8)=I3
15110 IF L=0 THEN 15130
15120 I(L+11)=I4
15130 I(L+15)=I5
15140 IF L=0 THEN 15160
15150 I(L+18)=I6
15160 I(L+22)=I7
15170 IF L=0 THEN 15190
15180 I(L+25)=I8
15190 NEXT L
15200 IF Y=51 THEN 16570 !!!!!!!!!!!!!!!!!!!!!RETURN FNC1
15210 IF Y=52 THEN 16820 !!!!!!!!!!!!!!!!!!!!!RETURN TO FNC2
15220 IF Y=3 THEN 16050 !!!!!!!!!!!!!!!!!!!!!RETURN TO FNH Y=3
15230 IF Y=8 THEN 17050
15240 !!!!!!!!!!!!!!!!!!!!!!!!!!!!!!!!!!!!!!!!!!!!!FNM
15250 FOR Q=1 TO 28
15260 Wzero=SQR(Di(Q)*Di(Q)+I(Q)*I(Q))
15270 Wzero=1-Wzero*Wzero
15280 Wone=1-H2*H2

```

```
15290 Wtwo=(1-H*Di(Q)+H1*I(Q))^2
15300 Wthree=(H*I(Q)+H1*Di(Q))^2
15310 Wfour=Wzero*None/(Wtwo+Wthree)
15320 Mi(Q)=Wfour
15330 NEXT Q
15340 PRINT
15350 ! !!!!!!!!!!!!!!!!!!!!!!!!!!!!!!!!!!!!!!!!!!!!!!!!!!!!!!!!!!!!!FNN
15360 FOR Q=1 TO 28
15370 V1=(Ri+Di(Q))^2+(Rone+I(Q))^2
15380 V2=(1-H*Di(Q)+H1*I(Q))^2+(H*I(Q)+H1*Di(Q))^2
15390 Ni(Q)=Cone+Ctwo*(V1/V2)
15400 NEXT Q
15410 GOTO 16280
15420 ! !!!!!!!!!!!!!!!!!!!!!!!!!!!!!!!!!!!!!!!!!!!!!!!!!!!!!!!!!!!!!FNO
15430 IF F9=0 THEN 15460
15440 M1=M2=M3=Mi(1)
15450 Ni1=Ni2=Ni3
15460 K=1
15470 FOR Q=1 TO 28
15480 IF F9=1 THEN 15570
15490 IF K=1 THEN 15520
15500 IF K=2 THEN 15600
15510 IF K=3 THEN 15650
15520 Ni1=Ni(Q)
15530 Ni2=Ni3=Ni(1)
15540 M1=Mi(Q)
15550 M2=M3=Mi(1)
15560 GOTO 15690
15570 M1=M2=M3=Mi(1)
15580 Ni1=Ni2=Ni3=Ni(Q)
15590 GOTO 15690
15600 Ni2=Ni(Q)
15610 Ni1=Ni3=Ni(1)
15620 M2=Mi(Q)
15630 M1=M3=Mi(1)
15640 GOTO 15690
15650 M3=Mi(Q)
15660 M1=M2=Mi(1)
15670 Ni3=Ni(Q)
15680 Ni1=Ni2=Ni(1)
15690 E0=Tfive*(M3-M1)+Tsix*(M1-M2)+Tseven*(M2-M3)
15700 Z9=Tnine*(Ni3-Ni2)+Tzero*(Ni1-Ni2)
15710 Ei(Q)=(E0+Z9)/Teight
15720 NEXT Q
15730 E9=0
15740 E=Ei(1)
15750 FOR Q=1 TO 28
15760 E1=Ei(Q)
15770 IF ABS(E-E1)<E9 THEN 15790
15780 E9=ABS(E-E1)
15790 NEXT Q
15800 IF K=1 THEN 15830
15810 IF K=2 THEN 15870
15820 IF K=3 THEN 15910
15830 S1=E9
15840 E1=Ei(1)
15850 K=K+1
15860 GOTO 15470
15870 S2=E9
15880 E1=E(1)
15890 K=K+1
15900 GOTO 15470
15910 S3=E9
15920 E1=E(1)
15930 K=K+1
```

```

15940 IF Y=5 THEN 16440
15950 IF Y=51 THEN 16710
15960 IF Y=52 THEN 16960
15970 IF Y=8 THEN 17110
15980 GOTO 16300
15990 ! !!!!!!!!!!!!!!!!!!!!!!!!!!!!!!!!!!!!!!!!!!!!!!!!!!!!!!!!!!!!!!!!!FNNH
16000 Pone=H
16010 Ptwo=H1
16020 Pthree=.005
16030 Pfour=.01
16040 IF Y=3 THEN GOTO 14780      !!!!!!!!!!!!!!!!!!!Q=FND(Q)
16050 FOR Q=1 TO 28
16060 Wzero=SQR(G1*G1+G2*G2)
16070 Wzero=1-Wzero*Wzero
16080 Temp=SQR(Di(Q)*Di(Q)+I(Q)*I(Q))
16090 Wone=1-Temp*Temp
16100 Wtwo=(1-Di(Q)*G1+I(Q)*G2)^2
16110 Wthree=(Di(Q)*G2+I(Q)*G1)^2
16120 Wfour=Wzero*Wone/(Wtwo+Wthree)
16130 Mi(Q)=Wfour
16140 V1=(Ri+G1)^2+(Rone+G2)^2
16150 V2=(1-H*G1+H1*G2)^2+(H*G2+H1*G1)^2
16160 Ni(Q)=Cone+Ctwo*(V1/V2)
16170 NEXT Q
16180 IF Y=3 THEN 16410          !!RETURN FROM FNN Y=3
16190 Y=0
16200 GOTO 14160
16210 ! !!RETURN #1 FROM FNG
16220 Pone=G1
16230 Ptwo=G2
16240 Pthree=G3
16250 Pfour=G4
16260 Y=1
16270 GOTO 14780                !Q=FND(1)+FNM(1)+FNN(1)
16280 Y=2
16290 GOTO 15420                ! Q=FND(Q)
16300 Y=3                        !RETURN FROM FND
16310 Qone=S1
16320 Qtwo=S2
16330 Qthree=S3
16340 ! SET FOR FNN HERE
16350 Pone=H
16360 Ptwo=H1
16370 Pthree=.005
16380 Pfour=.01
16390 GOTO 15990                !Q=FNN(1)
16400 ! Y=4                      !RETURN FROM FNN
16410 Y=4                        !RETURN FROM FNN
16420 Y=5
16430 GOTO 15420                !Q=FND(1)
16440 Qfour=S1
16450 Qfive=S2
16460 Qsix=S3
16470 Index=4
16480 F9=1
16490 IF Index>4 THEN 16750     !ON INDEX GO TO FNC(INDEX)
16500 ! !!!!!!!!!!!!!!!!!!!!!!!!!!!!!!!!!!!!!!!!!!!!!!!!!!!!!!!!!!!!!!!!!Q=FNC1
16510 Pone=Ctwo
16520 Ptwo=0
16530 Pthree=7.28
16540 Pfour=0
16550 Y=51
16560 GOTO 14780                !FND(1)
16570 FOR Q=1 TO 28
16580 Wzero=SQR(G1*G1+G2*G2)

```



```

16590 Wzero=1-Wzero^2
16600 Wone=1-H2*H2
16610 Wtwo=(1-H*G1+H*G2)^2
16620 Wthree=(H*G2+H1*G1)^2
16630 Wfour=Wzero*Wone/(Wtwo+Wthree)
16640 Mi(Q)=Wfour
16650 V1=(Ri+G1)^2+(Rone+G2)^2
16660 V2=(1-H*G1+H*G2)^2+(H*G2+H1*G1)^2
16670 V3=V1/V2
16680 Ni(Q)=Cone+Di(Q)*V3
16690 NEXT Q
16700 GOTO 15420          ! Q= FNO(Q)
16710 Y=6                ! RETURN FNO
16720 Qseven=S1
16730 Qeight=S2
16740 Qnine=S3
16750 ! !!!!!!!!!!!!!!!!!!!!!!!!!!!!!!!!!!!!!!!!!!!!! FNC2
16760 Y=52
16770 Pone=.3282
16780 Ptwo=.0262
16790 Pthree=.031
16800 Pfour=.065
16810 GOTO 14780          ! Q=FND1
16820 FOR Q=1 TO 28      ! RETURN FND
16830 V1=(Di(Q)+G1)^2+(I(Q)+G2)^2
16840 V2=(1-H*G1+H1*G2)^2+(H*G2+H1*G1)^2
16850 Ni(Q)=Cone+Ctwo*(V1/V2)
16860 Wzero=1-Wzero^2
16870 Wone=1-H2*H2
16880 Wtwo=(1-H*G1+H1*G2)^2
16890 Wthree=(H*G2+H1*G1)^2
16900 Wfour=Wzero*Wone/(Wtwo+Wthree)
16910 Mi(Q)=Wfour
16920 NEXT Q
16930 F9=1
16940 Y=52
16950 GOTO 15420          ! Q=FNO
16960 U1=S1                ! RETURN FNO
16970 U2=S2
16980 U3=S3
16990 Y=8
17000 Pone=H
17010 Ptwo=H1
17020 Pthree=.005
17030 Pfour=.01
17040 GOTO 14780          !Q=FND
17050 V1=(Ri+G1)^2+(Rone+G2)^2          !RETURN FND
17060 FOR Q=1 TO 28
17070 V2=(1-Di(Q)*G1+I(Q)*G2)^2+Di(Q)*G2+(I(Q)*G1)^2
17080 Ni(Q)=Cone+Ctwo*(V1/V2)
17090 F9=1
17100 GOTO 15420          !Q=FNO
17110 U4=S1                ! RETURN FNO
17120 U5=S2
17130 U6=S3
17140 PRINTER IS 0
17150 PRINT "DGX,DGA,DGS:",Qone,Qtwo,Qthree
17160 PRINT "DGHX,DGHA,DGHS:",Qfour,Qfive,Qsix
17170 PRINT "DT2N1,DT2N2,DT2N3:",Qseven,Qeight,Qnine
17180 PRINT "DSN1,DSN2,DSN3:",U1,U2,U3
17190 PRINT "DS11N1,DS11N2,DS11N3:",U4,U5,U6
17200 PRINT
17210 PRINT PAGE
17220 Mismatch=SQR(Qone^2+Qtwo^2+Qthree^2+Qfour^2+Qfive^2+Qsix^2+Qseven+U1+U4)
17221 FIXED 2

```

17230 PRINT "SUMMATION OF MISMATCH ERRORS=(RSS)";Mismatch
17240 RETURN Q
17250 FNEND

FNVSURC

R1	14510	14530								
Cfour	14650									
DiC	14130									
Cone	14610	15390	16160	16680	16850	17080				
Cthree	14640									
Ctwo	14630	15390	16160	16510	16850	17080				
D1	14900	14950								
D2	14910	14970								
D3	14840	14880	14980							
D4	14840	14880	15000							
D5	14840	14890	15010							
D6	14840	14890	15030							
D7	14900	15040								
D8	14910	15060								
DiC	14130	14950	14970	14980	15000	15010	15030	15040	15060	
15260	15260	15290	15300							
		15370	15380	15380	16080	16080	16100	16110	16680	16
830	17070	17070								
E	15740	15770	15780							
EC	15880	15920								
E0	15690	15710								
E1	15760	15770	15780	15840	15880	15920				
E9	15730	15770	15780	15830	15870	15910				
EiC	14130	15710	15740	15760	15840					
F9	14760	15430	15480	16480	16930	17090				
G1	14200	14340	14710	16060	16060	16100	16110	16140	16150	
16150	16220	16580	16580							
		16610	16620	16650	16660	16660	16830	16840	16840	15
880	16890	17050	17070							
		17070								
G2	14210	14340	14720	16060	16060	16100	16110	16140	16150	
16150	16230	16580	16580							
		16610	16620	16650	16660	16660	16830	16840	16840	16
880	16890	17050	17070							
		17070								

G3			14230	14340	14730	16240					
G4			14280	14340	14740	16250					
G5			14370	14420							
G6			14400	14420							
G7			14470	14490	14490	14530					
G8			14480	14490	14490	14500	14510	14530			
G9			14490	14500	14510	14530					
Gi\$			14130								
H			14660	15290	15300	15380	15380	16000	16150	16150	16350
16610	16610	16620	16660								
				16660	16660	16840	16840	16880	16890	17000	
H1			14670	15290	15300	15380	15380	16010	16150	16150	16360
16620	16660	16840	16840								
				16880	16890	17010					
H2			14680	15280	15280	16600	16600	16870	16870		
I(14130	15070	15090	15100	15120	15130	15150	15160	15180
15260	15260	15290	15300								
				15370	15380	15380	16080	16080	16100	16110	16830
070	17070										17
I1			14830	14860	15070						
I2			*	14830	14860	15090					
I3			14920	15100							
I4			14930	15120							
I5			*	14920	15130						
I6			*	14930	15150						
I7			14830	14870	15160						
I8			14830	14870	15180						
Imag			*	14170							
Index			14790	16470	16490						
K			15460	15490	15500	15510	15800	15810	15820	15850	15850
15890	15890	15930	15930								
L			*	14810	14900	14910	14920	14930	14950	14960	14970
980	14990	15000	15010								14
				15020	15030	15040	15050	15060	15070	15080	15090
100	15110	15120	15130								15
				15140	15150	15160	15170	15180	15190		
M1			15440	15540	15570	15630	15660	15690	15690		
M2			15440	15550	15570	15620	15660	15690	15690		
M3			15440	15550	15570	15630	15650	15690	15690		

Mic		14130	15320	15440	15540	15550	15570	15620	15630	15650
15660	16130	16640	16910							
Mismatch		* 17220	17230							
Nic		14130	15390	15520	15530	15580	15600	15610	15670	15680
16160	16680	16850	17080							
Ni1		15450	15520	15580	15610	15680	15700			
Ni2		15450	15530	15580	15600	15680	15700	15700		
Ni3		15450	15530	15580	15610	15670	15700			
Pfour		14740	14860	14870	14920	14930	16030	16250	16380	16540
16800	17030									
Pone		14710	14840	14880	14890	14900	14910	16000	16220	16350
16510	16770	17000								
Pthree		14730	14880	14890	14900	14910	16020	16240	16370	16530
16790	17020									
Ptwo		14720	14830	14860	14870	14920	14930	16010	16230	16360
16520	16780	17010								
Q		14020	15250	15260	15260	15260	15260	15290	15290	15300
15300	15320	15330	15360							
			15370	15370	15380	15380	15380	15380	15390	15400
470	15520	15540	15580							15
			15600	15620	15650	15670	15710	15720	15750	15760
790	16050	16080	16080							15
			16080	16080	16100	16100	16110	16110	16130	16160
170	16570	16640	16680							16
			16680	16690	16820	16830	16830	16850	16910	16920
060	17070	17070	17070							17
			17070	17080	17240					
Qeight		14250	14270	16730	17170					
Qfive		14270	14280	14380	14390	14390	14400	16450	17160	17220
Qfour		14240	14280	16440	17160	17220				
Qnine		16740	17170							
Qone		14190	14230	14280	14400	16310	17150	17220		
Qseven		14260	14270	16720	17170	17220				
Qsix		16460	17160	17220						
Qthr		14220	14230							
Qthree		16330	17150	17220						
Qtwo		16320	17150	17220						
Qzero		14180	14190	14190	14200	14210	14370			
Real		* 14160								
Ri		14690	15370	16140	16650	17050				
Rone		14700	15370	16140	16650	17050				

S1	*	15830	16310	16440	16720	16960	17110			
S2		15870	16320	16450	16730	16970	17120			
S3		15910	16330	16460	16740	16980	17130			
T		14800								
T1	*	14150	14540	14550	14560	14600				
T2	*	14150	14540	14560	14570	14580	14590	14600		
T3	*	14150	14540	14550	14570	14580	14590			
Teight		14580	15710							
Temp		16080	16090	16090						
Tfive		14550	15690							
Tnine		14600	15700							
Tseven		14570	15690							
Tsix		14560	15690							
Tzero		14590	15700							
U1		16960	17180	17220						
U2		16970	17180							
U3		16980	17180							
U4		17110	17190	17220						
U5		17120	17190							
U6		17130	17190							
V1		15370	15390	16140	16160	16650	16670	16830	16850	17050
17080										
V2	*	15380	15390	16150	16160	16660	16670	16840	16850	17050
070										
17080										
V3		16670	16680							
Wfour		15310	15320	16120	16130	16630	16640	16900	16910	
Wone		15280	15310	16090	16120	16600	16630	16870	16900	
Wthree		15300	15310	16110	16120	16620	16630	16890	16900	
Wtwo		15290	15310	16100	16120	16610	16630	16880	16900	
Wzero		15260	15270	15270	15270	15310	16060	16070	16070	16070
16120	16580	16590	16590							
			16630	16860	16860	16900				

960	15970	16040	14460	14750	15200	15210	15220	15230	15940	15950	15
			16180								
760	16940	16990	16190	16260	16280	16300	16410	16420	16550	16710	16
Z1			* 14480								
Z9			15700	15710							
ZiC			14130								
Znine			14500	14510							
Zone			14440	14470							
Ztwo			14450	14480							
Zzero			14460	14470	14470	14480					

```

-160-
17260 DEF FNData(Q)
17270 OPTION BASE 1
17280 COM File,Flag
17290 COM Q6,Q7,Q8,Q9,R2,R3,L,R,A6,A7,A8,A9,Z1,I2,N3,N8,N,F,F0,W
17300 COM SHORT F(4),L(8,20),M(32,33),N(26,11)
17310 COM D#[80],P#[100],INTEGER D(6,75),N0,X#[80]
17320 COM C#[100],G#[100],R#[100],B#[10],H#[100],Q#[50],V#[100]
17330 COM A#[100],Z2,Z3,Z4,Z5,T1,S1,T4,T2,T3,Z6,F7,T7,T8,T9,P9,X6,X7,X8,X9
17340 COM Q1,Q2,Q3,Q5,E2,Z(1,100),B5,B6,B7,B8,C1,R5,F1,P2,P3,P4,V2,Pout#
17350 COM P5,P6,P7,P8,W1,W2,W3,W4,W5,W6,T5,T6,E7,J8,I6,S,I5,X3,P0,I,Mismatch
17360 COM Real,Imag
17370 MASS STORAGE IS ":T14"
17380 INPUT "TAPE #,FILE NAME ",T,Q#
17390 ASSIGN #1 TO Q#
17400 READ #1;H#[1,100],Z(*),C#[1,100],G#[1,100]!,R#[1,100]
17410 ASSIGN #1 TO *
17420 REM PRELIMINARY RESULTS
17430 A#="-----"
17440 PRINTER IS 0
17442 ! PRINT PAGE
17443 FIXED 2
17444 PRINT "TOTAL MISMATCH ERROR IS: ";Z(1,26);"DEGREES KELVIN"
17446 PRINT
17460 OUTPUT 9;"R"
17470 ENTER 9;P#
17480 PRINT TAB(20),"DATE: ";P#[1,2];"-";P#[4,5];"-1981";" TIME: ";P#[7,14]
17490 PRINT
17500 PRINT TAB(6),A#
17510 PRINT TAB(6),"TAPE #: ";T,"FILE: ";Q#;TAB(50);R#[1,19]
17520 FOR I=1 TO 11
17530 PRINT
17540 NEXT I
17550 PRINT TAB(23),"MEASUREMENT RECAP"
17560 PRINT TAB(30),"AND"
17570 PRINT TAB(22),"PRELIMINARY RESULTS"
17580 FOR I=1 TO 7
17590 PRINT
17600 NEXT I
17610 Z(1,34)=30
17620 PRINT TAB(6),"FREQUENCY=";TAB(16);Z(1,34);"MHZ"
17630 PRINT TAB(6),"SOURCE IMPEDANCE";TAB(23),H#[11,20];TAB(38),"LEVEL SETTING 0
F A2=";Z(1,51)
17640 PRINT TAB(6),A#
17650 PRINT
17660 PRINT
17670 PRINT TAB(10),"TA";TAB(20),"R OHMS";TAB(34),"TS";TAB(44),"R OHMS"
17680 PRINT TAB(6),"-----"
17690 FIXED 2
17700 PRINT TAB(8),Z(1,1);TAB(20),Z(1,59);TAB(32),Z(1,2);TAB(44),Z(1,60);" (1S
T 50 MEASUREMENTS)"
17710 PRINT TAB(8),Z(1,7);TAB(20),Z(1,59);TAB(32),Z(1,8);TAB(44),Z(1,60);" (2N
D 50 MEASUREMENTS)"
17720 PRINT TAB(6),A#
17730 PRINT TAB(11),"TX";TAB(21),"SX";TAB(34),"TE"
17740 PRINT TAB(6),"-----"
17750 PRINT TAB(8),Z(1,3);TAB(20),Z(1,4);TAB(32),Z(1,5);" (1ST 50 MEASUREMENT
S)"
17760 PRINT TAB(8),Z(1,9);TAB(20),Z(1,10);TAB(32),Z(1,11);" (2ND 50 MEASUREME
NTS)"
17770 PRINT
17780 PRINT TAB(6),A#

```

```

17820 N=N9
17821 FIXED 2
17830 PRINT TAB(6),"AVE POWER IN MILLIWATTS P1,P2,P3"
17840 PRINT TAB(6),Z(1,45)/N*1000,Z(1,46)/N*1000,Z(1,47)/N*1000
17850 S1=SQR((Z(1,48)-Z(1,45)*Z(1,45)/N)/(N-1))
17860 S2=SQR((Z(1,49)-Z(1,46)*Z(1,46)/N)/(N-1))
17870 S3=SQR((Z(1,50)-Z(1,47)*Z(1,47)/N)/(N-1))
17871 FIXED 8
17880 PRINT TAB(6),"SD P1,P2,P3 IN WATTS (# OF MEAS=";Z(1,31);")";S1;S2;S3
17890 PRINT TAB(6),R#
17910 PRINT PAGE
17920 F=30
17921 FIXED 2
17930 PRINT USING 17940;F
17940 IMAGE 25X,"FREQUENCY =",M3D., "MHZ"
17950 PRINT
17960 PRINT Z#
17970 PRINT
17980 E4=100*E3/Z(1,35)
17990 E5=E3+Z(1,26)
18000 M1=Z(1,26)
18010 M2=100*(M1/Z(1,35))
18020 M5=E4+M2
18030 Z(1,36)=Z(1,36)+E5
18040 PRINT USING 18050;Z(1,35),Z(1,36),Z(1,13)
18050 IMAGE 10X,"NOISE TEMPERATURE =",M5D.2D,"K +- ",M3D.2D,"K(BIAS) +- ",M3D.2D,"K (3*SEM)"
18060 IF Z(1,52)<220 THEN 18090
18070 PRINT USING 18080;Z(1,14),Z(1,15)
18080 IMAGE 10X,"EXCESS NOISE RATIO=",M3D.2D,"DB +- ",M1D.2D,"DB(BIAS+3*SEM)"
18090 PRINT USING 18100;Z(1,16),Z(1,17)
18100 IMAGE 10X,"RADIOMETER SYSTEM TEMPERATURE =",4D,"K (< ",4D.D,"DB NF)"
18110 PRINT USING 18120;Z(1,18)
18120 IMAGE 10X,"RADIOMETER GAIN =",M2D.1D,"DB"
18121 FIXED 2
18130 PRINT " RADIOMETER NOISE BANDWIDTH=";Z(1,56);"MHZ"
18140 PRINT
18150 PRINT
18160 PRINT
18170 PRINT TAB(28),"ERROR SUMMARY"
18180 PRINT
18190 PRINT TAB(5),"SOURCE OF ERROR";TAB(35)," SOURCE";TAB(58),"% ERROR IN"
18200 PRINT TAB(34),"UNCERTAINTY";TAB(55),"NOISE TEMPERATURE"
18210 PRINT
18220 PRINT USING 18230;Z(1,19),Z(1,20)
18230 IMAGE 6X,"CRYOGENIC STANDARD",10X,M2.2D,"K",16X,M4D.2D
18240 PRINT USING 18250;Z(1,21),Z(1,22)
18250 IMAGE 6X,"AMBIENT STANDARD",12X,M2.2D,"K",16X,M4D.2D
18260 Q=.0023
18270 Q0=1+Z(1,16)/Z(1,52)
18280 Q1=1-Z(1,53)/Z(1,52)
18290 Q2=(Z(1,54)+Z(1,16))/Z(1,54)-Z(1,53)
18300 Q3=Z(1,52)*(Q0-Q1*Q2)
18310 Z(1,24)=Q3/Z(1,35)*100*Q
18320 PRINT USING 18330;Z(1,23),Z(1,24)
18330 IMAGE 6X,"POWER RATIO",17X,M2.2D,"DB",15X,M4D.2D
18340 PRINT USING 18350;100*(Z(1,26)/Z(1,35))
18350 IMAGE 6X,"MISMATCH",21X,"0.5R;1.0J OHMS",7X,M4D.2D
18360 PRINT USING 18370;Z(1,27),Z(1,28)
18370 IMAGE 6X,"NONLINEARITY",16X,M1D.2DE,12X,M5D.2D
18380 PRINT USING 18390;Z(1,55),Z(1,29)
18390 IMAGE 6X,"SWITCH ASSYMETRY",12X,M2.3D,"DB",12X,M6D.2D
18400 Adapter=100*E3/Z(1,35)
18410 PRINT USING 18420;H#[1,10],100*E3/Z(1,35)
18420 IMAGE 6X,"ADAPTER:",10A,11X,"0.0001DB",11X,M6D.2D

```

```

18430 PRINT TAB(6),A$
18440 Su=100*Z(1,26)/Z(1,35)
18450 Suu=100*E3/Z(1,35)
18460 Summ=Z(1,20)+Z(1,22)+Z(1,24)+Su+Z(1,28)+Z(1,29)+Suu
18470 Z(1,30)=Summ
18480 PRINT USING 18490;Z(1,30)
18490 IMAGE 6X,"LINEAR SUM OF BIAS ERRORS",24X,M5D.2D
18500 PRINT USING 18510;Z(1,31),Z(1,32)
18510 IMAGE 6X;"3*STANDARD ERROR OF MEAN (< # MEAS="M3D.,")", 9X,M4D.2D
18520 Z(1,33)=Z(1,30)+Z(1,32)
18530 PRINT TAB(6),A$
18540 PRINT USING 18550;Z(1,33)
18550 IMAGE 6X,"LINEAR SUM OF ERRORS",31X,M3D.2D
18560 PRINT
18570 PRINT TAB(6),A$
18580 PRINT
18590 PRINT
18600 PRINT TAB(6),"CUSTOMER:";TAB(30),C#[1,29]
18610 PRINT TAB(6),"CUSTOMER'S STATION:";TAB(30),C#[30,69]
18620 PRINT TAB(6),"CUSTOMER'S ADDRESS:";TAB(30),C#[70,99]
18630 PRINT
18640 PRINT TAB(6),"SOURCE MANUFACTURER:";TAB(30),G#[1,39]
18650 PRINT TAB(6),"SOURCE TYPE:";TAB(30),G#[40,79]
18660 PRINT TAB(6),"SOURCE MODEL:";TAB(30),G#[80,89]
18670 PRINT TAB(6),"SOURCE SERIAL:";TAB(30),G#[90,99]
18680 PRINT
18690 PRINT TAB(6),"DATE OF CALIBRATION:";TAB(30),R#[1,19]
18700 PRINT TAB(6),"CALIBRATION TEST #:";TAB(30),R#[20,39]
18710 PRINT TAB(6),"REQ OR REF #:";TAB(30),R#[40,69]
18720 PRINT
18730 Z6=1
18740 MASS STORAGE IS ":F8"
18750 PRINT PAGE
18760 RETURN 0
18770 FEND

```

FNDat a(

A\$	*	17430	17500	17640	17720	17780	17890	18430	18530	18
570										
Adapter		18400								
C\$	*	17400	18600	18610	18620					
E3		17980	17990	18400	18410	18450				
E4		17980	18020							
E5		17990	18030							
F	*	17920	17930							
G\$	*	17400	18640	18650	18660	18670				
H\$	*	17400	17630	18410						
I	*	17520	17540	17580	17600					
M1		18000	18010							
...								

N			* 17820	17840	17840	17840	17850	17850	17860	17860	17
870	17870										
N9			17810	17820							
P\$			* 17470	17480	17480	17480					
Q			17260	18260	18310						
Q\$			* 17380	17390	17510						
Q0			18270	18300							
Q1			* 18280	18300							
Q2			* 18290	18300							
Q3			* 18300	18310							
R\$			* 17510	18690	18700	18710					
S1			* 17850	17880							
S2			17860	17880							
S3			17870	17880							
Su			18440	18460							
Summ			18460	18470							
Suu			18450	18460							
T			17380	17510							
Z\$			17960								
ZC			* 17400	17444	17610	17620	17630	17700	17700	17700	17
700	17710	17710	17710								
			17710	17750	17750	17750	17760	17760	17760	17810	17
840	17840	17840	17850								
			17850	17850	17860	17860	17860	17870	17870	17870	17
880	17980	17990	18000								
			18010	18030	18030	18040	18040	18040	18060	18070	18
070	18090	18090	18110								
			18130	18220	18220	18240	18240	18270	18270	18280	18
280	18290	18290	18290								
			18290	18300	18310	18310	18320	18320	18340	18340	18
360	18360	18380	18380								
			18400	18410	18440	18440	18450	18460	18460	18460	18
460	18460	18470	18480								
			18500	18500	18520	18520	18520	18540			
Z6			* 18730								

```
18780 DEF FNCheck(Q)
18790 OPTION BASE 1
18800 COM File,Flag
18810 COM Q6,Q7,Q8,Q9,R2,R3,L,R,A6,A7,A8,A9,Z1,I2,N3,N8,N,F,F0,W
18820 COM SHORT F(4),L(8,20),M(32,33),N(26,11)
18830 COM D#[80],P#[100],INTEGER D(6,75),N0,X#[80]
18840 COM C#[100],G#[100],R#[100],B#[10],H#[100],Q#[50],V#[100]
18850 COM A#[100],Z2,Z3,Z4,Z5,T1,S1,T4,T2,T3,Z6,F7,T7,T8,T9,P9,X6,X7,X8,X9
18860 COM Q1,Q2,Q3,Q5,E2,Z(1,100),B5,B6,B7,B8,C1,R5,P1,P2,P3,P4,V2,Pout#
18870 COM P5,P6,P7,P8,W1,W2,W3,W4,W5,W6,T5,T6,E7,J8,I6,S,I5,X3,P0,I,C2,Mismatch
18880 COM Real,Imag
18890 DIM L#[200]
18900 PRINTER IS 16
18910 L#="TO CHECK LINEARITY ADD 3 DB IN MANUAL WEINSCHEL ATTEN AND PRESS RUN "
18920 PRINT L#
18930 RETURN 0
18940 FNEND
```

FNCheck(

L#	18890	18910	18920
Q	18780		

GLOBAL NAMES

* A\$		100	980	1470	1740	2910	5810	7050	8000	8170
8470	8630	8870	9730							
			10430	11250	12200	13330	14090	17330	18850	
* A6		60	940	1430	1700	2870	5770	7010	7960	8130
8430	8590	8830	9690							
			10390	11210	12160	13290	14050	17290	18810	
* A7		60	940	1430	1700	2870	5770	7010	7960	8130
8430	8590	8830	9690							
			10390	11210	12160	13290	14050	17290	18810	
* A8		60	940	1430	1700	2870	5770	7010	7960	8130
8430	8590	8830	9690							
			10390	11210	12160	13290	14050	17290	18810	
* A9		60	940	1430	1700	2870	5770	7010	7960	8130
8430	8590	8830	9690							
			10390	11210	12160	13290	14050	17290	18810	
* B\$		90	970	1460	1730	2900	5800	7040	7990	8160
8460	8620	8860	9720							
			10420	11240	12190	13320	14080	17320	18840	
* B5		110	990	1480	1750	2920	5820	7060	8010	8180
8480	8640	8880	9740							
			10440	11260	12210	13340	14100	17340	18860	
* B6		110	990	1480	1750	2920	5820	7060	8010	8180
8480	8640	8880	9740							
			10440	11260	12210	13340	14100	17340	18860	
* B7		110	990	1480	1750	2920	5820	7060	8010	8180
8480	8640	8880	9740							
			10440	11260	12210	13340	14100	17340	18860	
* B8		110	990	1480	1750	2920	5820	7060	8010	8180
8480	8640	8880	9740							
			10440	11260	12210	13340	14100	17340	18860	
* C\$		90	970	1460	1730	2900	5800	7040	7990	8160
8460	8620	8860	9720							
			10420	11240	12190	13320	14080	17320	18840	
* C1		110	990	1480	1750	2920	5820	7060	8010	8180
8480	8640	8880	9740							
			10440	11260	12210	13340	14100	17340	18860	
* C2		120	1000	1490	1760	2930	5830	7070	8020	8190
8490	8650	8890	9750							
			10450	11270	12220	13350	14110	18870		
* D\$		80	960	1450	1720	2890	5790	7030	7980	8150
8450	8610	8850	9710							
			10410	11230	12180	13310	14070	17310	18830	
* D<		80	960	1450	1720	2890	5790	7030	7980	8150
8450	8610	8850	9710							
			10410	11230	12180	13310	14070	17310	18830	

* E2		110	990	1480	1750	2920	5820	7060	8010	8180
8480	8640	8880	9740							
			10440	11260	12210	13340	14100	17340	18860	
* E7		120	1000	1490	1760	2930	5830	7070	8020	8190
8490	8650	8890	9750							
			10450	11270	12220	13350	14110	17350	18870	
* F		60	940	1430	1700	2870	5770	7010	7960	8130
8430	8590	8830	9690							
			10390	11210	12160	13290	14050	17290	18810	
* FC		70	950	1440	1710	2880	5780	7020	7970	8140
8440	8600	8840	9700							
			10400	11220	12170	13300	14060	17300	18820	
* F0		60	940	1430	1700	2870	5770	7010	7960	8130
8430	8590	8830	9690							
			10390	11210	12160	13290	14050	17290	18810	
* F7		100	980	1470	1740	2910	5810	7050	8000	8170
8470	8630	8870	9730							
			10430	11250	12200	13330	14090	17330	18850	
* File		50	930	1420	1690	2860	5760	7000	7950	8120
8420	8580	8820	9680							
			10380	11200	12150	13280	14040	17280	18800	
* Flag		50	930	1420	1690	2860	5760	7000	7950	8120
8420	8580	8820	9680							
			10380	11200	12150	13280	14040	17280	18800	
* G\$		90	970	1460	1730	2900	5800	7040	7990	8160
8460	8620	8860	9720							
			10420	11240	12190	13320	14080	17320	18840	
* H\$		90	970	1460	1730	2900	5800	7040	7990	8160
8460	8620	8860	9720							
			10420	11240	12190	13320	14080	17320	18840	
* I		120	1000	1490	1760	2930	5830	7070	8020	8190
8490	8650	8890	9750							
			10450	11270	12220	13350	14110	17350	18870	
* I2		60	940	1430	1700	2870	5770	7010	7960	8130
8430	8590	8830	9690							
			10390	11210	12160	13290	14050	17290	18810	
* I5		120	1000	1490	1760	2930	5830	7070	8020	8190
8490	8650	8890	9750							
			10450	11270	12220	13350	14110	17350	18870	
* I6		120	1000	1490	1760	2930	5830	7070	8020	8190
8490	8650	8890	9750							
			10450	11270	12220	13350	14110	17350	18870	
* Imag		130	1010	1500	1770	2940	5840	7080	8030	8200
8500	8660	8900	9760							
			10460	11280	12230	13360	14120	17360	18880	
* J8		120	1000	1490	1760	2930	5830	7070	8020	8190
8490	8650	8890	9750							
			10450	11270	12220	13350	14110	17350	18870	
* L		60	940	1430	1700	2870	5770	7010	7960	8130

8430	8590	8830	9690							
			10390	11210	12160	13290	14050	17290	18810	
* LC			70	950	1440	1710	2880	5780	7020	8140
8440	8600	8840	9700							
			10400	11220	12170	13300	14060	17300	18820	
* MC			70	950	1440	1710	2880	5780	7020	8140
8440	8600	8840	9700							
			10400	11220	12170	13300	14060	17300	18820	
* Mismatch			120	1000	1490	1760	2930	5830	7070	8190
8490	8650	8890	9750							
			10450	11270	12220	13350	14110	17350	18870	
* N			60	940	1430	1700	2870	5770	7010	8130
8430	8590	8830	9690							
			10390	11210	12160	13290	14050	17290	18810	
* NC			70	950	1440	1710	2880	5780	7020	8140
8440	8600	8840	9700							
			10400	11220	12170	13300	14060	17300	18820	
* N0			80	960	1450	1720	2890	5790	7030	8150
8450	8610	8850	9710							
			10410	11230	12180	13310	14070	17310	18830	
* N3			60	940	1430	1700	2870	5770	7010	8130
8430	8590	8830	9690							
			10390	11210	12160	13290	14050	17290	18810	
* N8			60	940	1430	1700	2870	5770	7010	8130
8430	8590	8830	9690							
			10390	11210	12160	13290	14050	17290	18810	
* P*			80	960	1450	1720	2890	5790	7030	8150
8450	8610	8850	9710							
			10410	11230	12180	13310	14070	17310	18830	
* P0			120	1000	1490	1760	2930	5830	7070	8190
8490	8650	8890	9750							
			10450	11270	12220	13350	14110	17350	18870	
* P1			110	990	1480	1750	2920	5820	7060	8180
8480	8640	8880	9740							
			10440	11260	12210	13340	14100	17340	18860	
* P2			110	990	1480	1750	2920	5820	7060	8180
8480	8640	8880	9740							
			10440	11260	12210	13340	14100	17340	18860	
* P3			110	990	1480	1750	2920	5820	7060	8180
8480	8640	8880	9740							
			10440	11260	12210	13340	14100	17340	18860	
* P4			110	990	1480	1750	2920	5820	7060	8180
8480	8640	8880	9740							
			10440	11260	12210	13340	14100	17340	18860	
* P5			120	1000	1490	1760	2930	5830	7070	8190
8490	8650	8890	9750							
			10450	11270	12220	13350	14110	17350	18870	
* P6			120	1000	1490	1760	2930	5830	7070	8190
8490	8650	8890	9750							

			10450	11270	12220	13350	14110	17350	18870	
* P7		120	1000	1490	1760	2930	5830	7070	8020	8190
8490	8650	8890	9750							
			10450	11270	12220	13350	14110	17350	18870	
* P8		120	1000	1490	1760	2930	5830	7070	8020	8190
8490	8650	8890	9750							
			10450	11270	12220	13350	14110	17350	18870	
* P9		100	980	1470	1740	2910	5810	7050	8000	8170
8470	8630	8870	9730							
			10430	11250	12200	13330	14090	17330	18850	
* Pout\$		110	990	1480	1750	2920	5820	7060	8010	8180
8480	8640	8880	9740							
			10440	11260	12210	13340	14100	17340	18860	
* Q\$		90	970	1460	1730	2900	5800	7040	7990	8160
8460	8620	8860	9720							
			10420	11240	12190	13320	14080	17320	18840	
* Q1		110	990	1480	1750	2920	5820	7060	8010	8180
8480	8640	8880	9740							
			10440	11260	12210	13340	14100	17340	18860	
* Q2		110	990	1480	1750	2920	5820	7060	8010	8180
8480	8640	8880	9740							
			10440	11260	12210	13340	14100	17340	18860	
* Q3		110	990	1480	1750	2920	5820	7060	8010	8180
8480	8640	8880	9740							
			10440	11260	12210	13340	14100	17340	18860	
* Q5		110	990	1480	1750	2920	5820	7060	8010	8180
8480	8640	8880	9740							
			10440	11260	12210	13340	14100	17340	18860	
* Q6		60	940	1430	1700	2870	5770	7010	7960	8130
8430	8590	8830	9690							
			10390	11210	12160	13290	14050	17290	18810	
* Q7		60	940	1430	1700	2870	5770	7010	7960	8130
8430	8590	8830	9690							
			10390	11210	12160	13290	14050	17290	18810	
* Q8		60	940	1430	1700	2870	5770	7010	7960	8130
8430	8590	8830	9690							
			10390	11210	12160	13290	14050	17290	18810	
* Q9		60	940	1430	1700	2870	5770	7010	7960	8130
8430	8590	8830	9690							
			10390	11210	12160	13290	14050	17290	18810	
* R		60	940	1430	1700	2870	5770	7010	7960	8130
8430	8590	8830	9690							
			10390	11210	12160	13290	14050	17290	18810	
* R\$		90	970	1460	1730	2900	5800	7040	7990	8160
8460	8620	8860	9720							
			10420	11240	12190	13320	14080	17320	18840	
* R2		60	940	1430	1700	2870	5770	7010	7960	8130
8430	8590	8830	9690							
			10390	11210	12160	13290	14050	17290	18810	

* R3			60	940	1430	1700	2870	5770	7010	7960	8130
8430	8590	8830	9690								
			10390	11210	12160	13290	14050	17290	18810		
* R5			110	990	1480	1750	2920	5820	7060	8010	8180
8480	8640	8880	9740								
			10440	11260	12210	13340	14100	17340	18860		
* Real			130	1010	1500	1770	2940	5840	7080	8030	8200
8500	8660	8900	9760								
			10460	11280	12230	13360	14120	17360	18880		
* S			120	1000	1490	1760	2930	5830	7070	8020	8190
8490	8650	8890	9750								
			10450	11270	12220	13350	14110	17350	18870		
* S1			100	980	1470	1740	2910	5810	7050	8000	8170
8470	8630	8870	9730								
			10430	11250	12200	13330	14090	17330	18850		
* T1			100	980	1470	1740	2910	5810	7050	8000	8170
8470	8630	8870	9730								
			10430	11250	12200	13330	14090	17330	18850		
* T2			100	980	1470	1740	2910	5810	7050	8000	8170
8470	8630	8870	9730								
			10430	11250	12200	13330	14090	17330	18850		
* T3			100	980	1470	1740	2910	5810	7050	8000	8170
8470	8630	8870	9730								
			10430	11250	12200	13330	14090	17330	18850		
* T4			100	980	1470	1740	2910	5810	7050	8000	8170
8470	8630	8870	9730								
			10430	11250	12200	13330	14090	17330	18850		
* T5			120	1000	1490	1760	2930	5830	7070	8020	8190
8490	8650	8890	9750								
			10450	11270	12220	13350	14110	17350	18870		
* T6			120	1000	1490	1760	2930	5830	7070	8020	8190
8490	8650	8890	9750								
			10450	11270	12220	13350	14110	17350	18870		
* T7			100	980	1470	1740	2910	5810	7050	8000	8170
8470	8630	8870	9730								
			10430	11250	12200	13330	14090	17330	18850		
* T8			100	980	1470	1740	2910	5810	7050	8000	8170
8470	8630	8870	9730								
			10430	11250	12200	13330	14090	17330	18850		
* T9			100	980	1470	1740	2910	5810	7050	8000	8170
8470	8630	8870	9730								
			10430	11250	12200	13330	14090	17330	18850		
* V#			90	970	1460	1730	2900	5800	7040	7990	8160
8460	8620	8860	9720								
			10420	11240	12190	13320	14080	17320	18840		
* V2			110	990	1480	1750	2920	5820	7060	8010	8180
8480	8640	8880	9740								
			10440	11260	12210	13340	14100	17340	18860		
* W			60	940	1430	1700	2870	5770	7010	7960	8130

8430	8590	8830	9690							
			10390	11210	12160	13290	14050	17290	18810	
* W1			120	1000	1490	1760	2930	5830	7070	8020
8490	8650	8890	9750							8190
			10450	11270	12220	13350	14110	17350	18870	
* W2			120	1000	1490	1760	2930	5830	7070	8020
8490	8650	8890	9750							8190
			10450	11270	12220	13350	14110	17350	18870	
* W3			120	1000	1490	1760	2930	5830	7070	8020
8490	8650	8890	9750							8190
			10450	11270	12220	13350	14110	17350	18870	
* W4			120	1000	1490	1760	2930	5830	7070	8020
8490	8650	8890	9750							8190
			10450	11270	12220	13350	14110	17350	18870	
* W5			120	1000	1490	1760	2930	5830	7070	8020
8490	8650	8890	9750							8190
			10450	11270	12220	13350	14110	17350	18870	
* W6			120	1000	1490	1760	2930	5830	7070	8020
8490	8650	8890	9750							8190
			10450	11270	12220	13350	14110	17350	18870	
* X*			80	960	1450	1720	2890	5790	7030	7980
8450	8610	8850	9710							8150
			10410	11230	12180	13310	14070	17310	18830	
* X3			120	1000	1490	1760	2930	5830	7070	8020
8490	8650	8890	9750							8190
			10450	11270	12220	13350	14110	17350	18870	
* X6			100	980	1470	1740	2910	5810	7050	8000
8470	8630	8870	9730							8170
			10430	11250	12200	13330	14090	17330	18850	
* X7			100	980	1470	1740	2910	5810	7050	8000
8470	8630	8870	9730							8170
			10430	11250	12200	13330	14090	17330	18850	
* X8			100	980	1470	1740	2910	5810	7050	8000
8470	8630	8870	9730							8170
			10430	11250	12200	13330	14090	17330	18850	
* X9			100	980	1470	2910	5810	7050	8000	8170
8630	8870	9730	10430							8470
			11250	12200	13330	14090	17330	18850		
* X912			1740							
* Z(110	990	1480	1750	2920	5820	7060	8010
8480	8640	8880	9740							8180
			10440	11260	12210	13340	14100	17340	18860	
* Z1			60	940	1430	1700	2870	5770	7010	7960
8430	8590	8830	9690							8130
			10390	11210	12160	13290	14050	17290	18810	
* Z2			100	980	1470	1740	2910	5810	7050	8000
8470	8630	8870	9730							8170
			10430	11250	12200	13330	14090	17330	18850	

* 23			100	980	1470	1740	2910	5810	7050	8000	8170
8470	8630	8870	9730								
			10430	11250	12200	13330	14090	17330	18850		
* 24			100	980	1470	1740	2910	5810	7050	8000	8170
8470	8630	8870	9730								
			10430	11250	12200	13330	14090	17330	18850		
* 25			100	980	1470	1740	2910	5810	7050	8000	8170
8470	8630	8870	9730								
			10430	11250	12200	13330	14090	17330	18850		
* 26			100	980	1470	1740	2910	5810	7050	8000	8170
8470	8630	8870	9730								
			10430	11250	12200	13330	14090	17330	18850		

FNA<		11180	5930	6000							
FNB<		7930	1120	1930	2450	2660	2810	3290	3890	5500	
9580											
FNCheck<		18780	1230	5670							
FND<		6890									
FNDat a<		17260	173								
FNE<		1400	860	860							
FNG<		10360	9020								
FNI<		8270									
FNJ<		1670	1170	1170	1170	1200					
FNK<		2840	1230	1230	1230	1230					
FNL<		5730	3000								
FNMC		8800	6160								
FNN<		8100	550	570	700	720	2600				
FNO<		8560	620	670	2010	2060	2110	2160	2210	2260	
2310	2360	2410									
FNPC		6960	180	9950							
FNQ<		910	890	900	1550						
FNRC		0	6920	6920	6930						
FNS<		8400	510	530	580	640	810	860	1130	1820	
1930	1980	2030	2080								
			2130	2180	2230	2280	2330	2380	2450	2490	2
570	2660	2700	2720								
			2790	2810	3270	3290	4100	4130	4170	4210	4
480	4550	4690	4810								
			4830	4870	5290	5480	5660	5860	6240	6260	6
320	6360	6400	6790								
			8740	10580							
FNT<		12080	5880								
FNVC		9660	9020								

FNVswrC		14020	3920							
FNWc		8360	1930	6920	6930	6930	8740			
FNXc		13260	6910	6910	6910	6910	6910	6920	6920	6920
6930	6930	6930	6930							
			6930							

U. S. DEPT. OF COMM. BIBLIOGRAPHIC DATA SHEET	1. PUBLICATION OR REPORT NO. NBSIR 81-1656	2. Gov't. Accession No.	3. Recipient's Accession No.
4. TITLE AND SUBTITLE NBS 30/60 Megahertz Noise Measurement System Operation and Service Manual		5. Publication Date December 1981	6. Performing Organization Code
7. AUTHOR(S) George Counas and Tom Bremer		8. Performing Organ. Report No.	
9. PERFORMING ORGANIZATION NAME AND ADDRESS NATIONAL BUREAU OF STANDARDS DEPARTMENT OF COMMERCE WASHINGTON, DC 20234		10. Project/Task/Work Unit No.	11. Contract/Grant No.
12. SPONSORING ORGANIZATION NAME AND COMPLETE ADDRESS (Street, City, State, ZIP)		13. Type of Report & Period Covered	
15. SUPPLEMENTARY NOTES <input type="checkbox"/> Document describes a computer program; SF-185, FIPS Software Summary, is attached.		14. Sponsoring Agency Code	
16. ABSTRACT (A 200-word or less factual summary of most significant information. If document includes a significant bibliography or literature survey, mention it here.) Calibration of coaxial noise sources at 30 and 60 MHz is now being accomplished using a total power radiometer designed to operate under computer control. Use of the IEEE 488 Instrument Bus and structured software techniques allows use and substitution of commercially available components with a minimum of hardware and software modification. This manual addresses the general theory of operation, operating procedures, and maintenance procedures for the NBS 30/60 MHz automated noise measurement system using a commercially available desktop calculator as the controller.			
17. KEY WORDS (six to twelve entries; alphabetical order; capitalize only the first letter of the first key word unless a proper name; separated by semicolons) Automated noise measurement system, coaxial noise sources, controller; IEEE 488 Bus; total power radiometer.			
18. AVAILABILITY <input checked="" type="checkbox"/> Unlimited <input type="checkbox"/> For Official Distribution. Do Not Release to NTIS <input type="checkbox"/> Order From Sup. of Doc., U.S. Government Printing Office, Washington, DC 20402, SD Stock No. SNO03-003- <input checked="" type="checkbox"/> Order From National Technical Information Service (NTIS), Springfield, VA. 22161		19. SECURITY CLASS (THIS REPORT) UNCLASSIFIED	21. NO. OF PRINTED PAGES 180
		20. SECURITY CLASS (THIS PAGE) UNCLASSIFIED	22. Price \$16.50

