

W-64

NATIONAL ADVISORY COMMITTEE FOR AERONAUTICS

JPL LIBRARY
CALIFORNIA INSTITUTE OF TECHNOLOGY

WARTIME REPORT

ORIGINALLY ISSUED

June 1943 as

Advance Restricted Report 3F16

FATIGUE CHARACTERISTICS OF SPOT-WELDED 24S-T ALUMINUM ALLOY

By H. W. Russell, L. R. Jackson,
H. J. Grover, and W. W. Beaver

Battelle Memorial Institute

CASE FILE
COPY



WASHINGTON

NACA WARTIME REPORTS are reprints of papers originally issued to provide rapid distribution of advance research results to an authorized group requiring them for the war effort. They were previously held under a security status but are now unclassified. Some of these reports were not technically edited. All have been reproduced without change in order to expedite general distribution.

NATIONAL ADVISORY COMMITTEE FOR AERONAUTICS

ADVANCE RESTRICTED REPORT

FATIGUE CHARACTERISTICS OF SPOT-WELDED 24S-T ALUMINUM ALLOY

By H. W. Russell, L. R. Jackson,
H. J. Grover, and W. W. Beaver

SUMMARY

The results of this investigation may be summarized as follows:

1. The static shear strength of spot welds in lap joints of 24S-T alclad increases with increasing sheet thickness for thicknesses in the range 0.025 inch to 0.032 inch. This increase in static strength of spot welds also is evident in the fatigue properties. At low stresses (long life), variations in spot-weld quality appear to be not so important as in static tests or in high stress (short life) tests.

2. The static strength-weight ratio of stiffened panel sections in which the same stiffener is used with panels of various thicknesses is found to be higher for thin sheets than for thick ones. This is in agreement with results obtained by previous investigators. The low stress (long life) fatigue strength-weight ratio, however, shows an opposite trend in the range of sheet thickness from 0.025 to 0.051 inch. The reason for this condition is that the low-stress-fatigue results follow the same trend as the start of buckling in the material, and a thicker sheet tends to raise the stress at which buckling starts.

3. The presence of unstressed "scab" sheets attached by spot welds causes slight reduction in both the static yield strength and tensile strength with considerably greater reduction in ductility. The low stress (long life) fatigue strength of the sheet does not appear to be altered to any great extent by the presence of spot welds, since, in tests of this type, failure usually occurs in the 3-inch-radius fillet joining the ends and the test section of the sample in preference to the region along the line of the spot welds.

4. Metallographic examination indicates that the portion of the spot weld subject to fatigue loading is the sharp re-entrant angle formed by the two sheets at the weld button. It appears that fatigue failures always start in this "crack." Once fatigue failures have started, however, the course of the crack depends upon the system of stresses imposed. The extent of weld penetration appears to be more important in determining fatigue strength than it is in determining static strength.

INTRODUCTION

This paper covers the study of fatigue properties of three simple but basic types of spot-welded structures made from 24S-T alclad sheet, and it is the final report on research conducted in this investigation. An advance restricted report entitled "Progress Report on Fatigue of Spot-Welded Aluminum," by H. W. Russell and L. R. Jackson, dated February 1943, (reference 1) describes the first half of the research conducted in this investigation. It was believed advisable, however, to make this present report complete in itself; so a large amount of information presented in reference 1 is also contained in this report.

The report is divided into four parts and two appendixes. The first part deals with static and dynamic tests of spot-welded lap joints loaded in tension; the second, with compression tests of stiffened panels; the third describes an investigation of tension specimens with unstressed attachments; and the fourth, a correlation of fatigue properties with the metallogurgical structure and the geometry of spot welds. Appendix I consists of a report by the Aluminum Company of America on the mechanical properties of the alclad sheet used in this investigation. In appendix II the methods used in testing the specimens are described in detail.

This investigation, on the fatigue characteristics of spot-welded joints in aluminum 24S-T alclad, which was undertaken by the Battelle Memorial Institute in May 1942, was sponsored by, and conducted with financial assistance from, the National Advisory Committee for Aeronautics.

The 24S-T alclad sheet used in this investigation was furnished by The Glenn L. Martin Company through the courtesy of Mr. S. A. Gordon; hat-shape stringer sections were furnished

by the Curtiss-Wright Corporation through the courtesy of Mr. E. S. Jenkins. The spot-welding and the X-ray examination of welds were done at the Welding Laboratory at the Rensselaer Polytechnic Institute under the direction of Doctor W. F. Hess. Tensile and pack compression tests on coupons representative of the sheet material were conducted by the Aluminum Company of America through the courtesy of Mr. R. L. Templin.

I. TESTS ON SPOT-WELDED LAP JOINTS IN TENSION

Material Used in Making Samples

Tests have been run on samples made from 24S-T alclad in three thicknesses: 0.025, 0.032, and 0.040 inch. Since primary interest is in the spot welds, the properties of the sheet material itself were studied only enough to insure that the sheet is representative of its class of material. Static tests were run in the Aluminum Research Laboratories through the courtesy of Mr. R. L. Templin. (See appendix I.) Table 1 shows the results of measurements on test coupons from the particular sheets used in making the lap joint specimens. General conclusions are that the tensile strengths, the yield strengths, and the elongations are equal to or greater than typical values for 24S-T alclad and that the differences in tensile properties are such as would be normally expected for several lots of sheet.

Spot-Welding Details, Construction of Samples, and Static Test Results

The lap joint test pieces consisted of strips 9 inches long by 5 inches wide, cut parallel to the direction of rolling and joined by a lap joint with a 1-inch overlap. For each thickness, two weld spacings, $3/4$ inch and $1\frac{1}{2}$ inches, were used. In both cases, the single line of spots was centered in the 1-inch overlap section. Figure 1 is a photograph of a typical sample.

The spot-welding on all test pieces was done at the Rensselaer Polytechnic Institute. Table 2 summarizes their information on surface treatment and on spot-welding conditions

for the sheet used to make the lap joint (and that for the unstressed attachment) fatigue test specimens. The last column of the table gives their results for tests of the static shear strength of single spot test coupons. The values compare reasonably with those given by E. C. Hartmann and G. W. Stickley: namely, 220, 305, and 430 pounds per spot for the 0.025-, the 0.032-, and the 0.040- inch sheet. (See reference 2.)

Static tests on samples of each class of the lap joint specimens were made on a 20,000-pound Baldwin Southwark testing machine, using the same grips and loading technique as for the fatigue tests. The results of these tests are given in table 3. It is evident that the rupture load in pounds per spot agrees with the values given by the Rensselaer Polytechnic Institute for tests on single spots. In general, for the wide test specimens, the failure strength in pounds per spot is smaller for the $\frac{3}{4}$ -inch spot-weld spacing than for the $1\frac{1}{2}$ -inch spacing.

Measurements on weld size, shape, spacing, and penetration have been made for several samples of both new and failed specimens and are recorded in detail in a later section of this report. The general results are these:

1. The greatest variation in weld size and spacing was found in the 0.032-inch sheet.
2. The greatest average penetration was in the 0.040-inch sheet.
3. The largest welds relative to sheet thickness were in the 0.025-inch sheet.

Methods of Fatigue Testing

The details of the methods used in running the fatigue tests are given in appendix II. As indicated therein, it is believed that load values are set and maintained to about ± 15 pounds or to 3 percent of the load, whichever is larger. Tests with electric strain gages cemented on opposite edges of samples indicate that load is the same on opposite edges within limits of 4 percent or better.

The criterion of failure is a decrease in maximum load of about 430 pounds. (Recent improvements in the cut-off

mechanism will allow this to be reduced to a drop in load of 30 pounds, if desirable, in future work.) For most of the additional data reported here, the first appearance of visible cracks in the welds has been noted by a frequent visual inspection.

Results of Fatigue Tests

Tables 4 to 9 give the results of the fatigue tests for the two weld spacings and the three sheet thicknesses used for the lap-joint samples. In each case where it was observed with reasonable accuracy, the number of cycles to first visible cracking is reported. In each case, "failure" corresponds to a drop in load of about 430 pounds. For each specimen, the general type of failure is recorded. Three types of failure occur:

1. At high loads, failure is by shear of the spot welds.
2. At lower loads, a "pulling of buttons" appears.
3. At lowest loads, failure occurs, owing to the propagation of a fatigue crack from one weld to another and so across the width of the sheet.

These three types of failure are illustrated in figures 1A, 1B, 1C, and 1D.

Figures 2 to 7 show load-life curves plotted from the data given in tables 4 to 9. Each figure shows three curves corresponding to the three ratios (0.25, 0.50, and 0.75) of minimum load to maximum load. In general, the curves have the same shape, but it will be noted that, for the 0.025-inch sheet and for the 0.032-inch sheet with $1\frac{1}{2}$ -inch spacings, there is more "scatter" than for other curves.

Discussion of Results of Fatigue Tests

Figures 8 and 9 show load-life curves for several sheet thicknesses but for a constant stress ratio of 0.25. The fatigue strength apparently increases with sheet thickness. The most noticeable feature is the "crossover" of the curves

for the 0.025-inch sheet and the 0.032-inch sheet with the $1\frac{1}{4}$ -inch weld spacing. It is believed that this is due to a variation of weld size and penetration, and this probability is discussed in some detail in the following section on Examination of Spot Welds.

Figure 10 shows, in another way, the effect of sheet thickness on strength. Strength to failure is plotted against sheet thickness for (1) static failure, (2) fatigue failure for a life of 5,000,000 cycles and for two different stress ratios, and (3) fatigue failure for one stress ratio and a life of 50,000 cycles. That the logarithmic plot gives roughly straight lines of the same slope suggests that, approximately, the "percent" increase in strength with increasing sheet thickness is the same for fatigue as for static failure.

As will be discussed later, there were more accidental weld variations in the 0.032-inch sheet than in the other two thicknesses. Figure 10 shows that this effect of weld variability is apparently more evident in the static tests and high stress fatigue tests than in the low stress fatigue tests.

Figures 11 to 13 indicate the effect of range in stress. In each figure, the amplitude of stress variation (i.e., one-half the stress range from minimum load to maximum load) is plotted against the mean load for constant life. According to J. O. Smith (reference 3), the allowable alternating stress range should diminish linearly with increase in mean load either for axial tension stresses or for shear stresses when stress raisers (as spot welds) are present. A general observation from figures 11 to 13 is that the constant life lines are concave upward. This curvature makes it difficult to extrapolate to completely reversed stress values by extending a straight line from the static ultimate value on the mean load axis through a set of points at constant life. Such lines, however, have been drawn through points at the highest stress range used (corresponding to a stress ratio of 0.25). Table 10 gives the extrapolated values for the 0.032-inch sheet and ratios of these values to the static ultimate. For comparison, corresponding values and ratios from data taken at the Aluminum Research Laboratories are given. (See reference 2.) No great significance attends the comparison since the test conditions are quite dissimilar. The Aluminum Company data are for single spot samples with alternating-current

welds tested on a rotating beam machine with completely reversed stress values. Moreover, the extrapolations used to obtain comparable values from Battelle data are believed to be unreliable.

Examination of Spot Welds

Metallographic examination of sectioned spot welds indicated that the spots were, in many cases, elliptical and there was considerable variation in weld penetration. Figure 14 shows sections along the two major axes in typical spots made in 0.025- and 0.032-inch sheet.

As indicated in the figure, it was typical that the weld dimensions in the 0.032-inch sheet showed more variation than in the 0.025-inch sheet. The weld dimensions in the 0.032-inch sheet varied over a range of about 10 percent in penetration and over a much wider range in width and length. Some unwelded spots were found. The spots spaced $1\frac{1}{2}$ inches had, in general, somewhat greater weld penetration than the ones with $3/4$ -inch spacing.

Variations in weld dimensions are reflected in fatigue results, as shown in table 11. This table brings out relations between the average weld dimensions and the fatigue records of individual samples.

The data indicate that the weld penetration is the important variable at low loads where fatigue cracks in the sheet provide the mechanism of failure. At higher loads where the welds fail in shear, the area of the weld at the faying surface is the deciding strength factor.

Figure 8 shows fatigue curves for the 0.032- and the 0.025-inch sheet plotted on the same figure for an R value of 0.25. It will be noted that the curves cross at high loads. Metallographic examination of the welds indicates that those in the 0.025-inch sheet with $1\frac{1}{2}$ -inch spacing are long with little penetration; while those in the 0.032-inch sheet were somewhat shorter but penetrate deeper - the net result is that, at high fatigue loads or under static loads, the two have nearly the same strength. (See table 3.)

At lower fatigue loads (longer life), the effect of the deeper weld penetration in the 0.032-inch sheet becomes evident,

and the welds in the 0.032-inch sheet have a longer life than in the 0.025-inch sheet.

In both the 0.032- and the 0.025-inch sheet, the fatigue cracks start at the projection of the internal alclad (see fig. 15) into the weld button and proceed fanlike directly out toward the external alclad.

Conclusions on Lap Joint Tests

1. Three types of failure were evident: shear of the spot welds at high loads, "pulling buttons" at lower loads, and propagation of fatigue cracks between the welds at still lower loads.

2. For a given sheet thickness, the samples with six spot welds $\frac{3}{4}$ inch apart had less fatigue strength in pounds per spot than had samples with four spot welds spaced $1\frac{1}{4}$ inches apart. The six spot samples had higher strength in terms of total load.

3. For a given weld spacing, the fatigue strength as well as the static tensile strength increased with sheet thickness. (Note one exception for 0.025- and 0.032-inch sheet with welds spaced $1\frac{1}{4}$ inches apart and at relatively high loads. This is believed to be due to a difference in weld quality.)

4. There is some evidence that increasing weld size or increasing weld penetration increases fatigue strength especially at low loads where failure is occasioned by propagation of a fatigue crack. At higher loads where failure is by shear through the welds, increased weld penetration appears to have less strengthening effect.

II. COMPRESSION TESTS ON STIFFENED PANELS

Materials and Test Pieces

The stiffened panels consisted of 24S-T alclad sheets $4\frac{1}{2}$ inches wide spot-welded with two rows of spots to Curtiss-Wright SS-112-32 hat-shape stringer sections. The stringer sections were made from 0.032-inch alclad 24S-T for all test pieces.

Four thicknesses of panel were used: 0.025, 0.032, 0.040, and 0.051 inch. Table 12 gives data on test coupons from the particular sheets used in making these panels and indicates normal tensile properties for the material.

Two spot spacings were tested for each panel thickness. For one, the spot spacing was $3/4$ inch except near the ends where the spots are located $1/8$, $5/8$, and $1 1/8$ inches from the ends. For the second type, spot spacings were $1 1/2$ inches except again near the ends where additional spots, spaced as described above, were inserted. Table 13 summarizes the welding conditions reported by the Rensselaer Polytechnic Institute for these compression test samples.

Figure 16 illustrates the stringer section used. According to data furnished by Curtiss-Wright, the centroidal axis of this section is 0.505 inch from the bottom of the hat, the moment of inertia around the centroidal axis is 0.0301 inch, and the area of the section is 0.162 inch. The completed panel sections were all approximately 15.83 inches long after squaring the ends. Figure 17 illustrates the complete test specimen.

Static Tests on Stiffened Panels

Table 14 summarizes the results of static compression tests on the various types of panels. In table 14, the area A is the total area of stiffener plus panel; while the area A' is the area of the stiffener plus an effective area for the panel. This effective area was computed by using an effective width of panel from the formula

$$4W = 3.4t \sqrt{E/f_c}$$

where

4W total effective width

t panel thickness, inches

E modulus for 24S-T alclad (10×10^6 lb/sq in.)

and

f_c crippling stress for stiffener alone (35,000 lb/sq in.)

Figures 18 and 19 show the stress-deflection diagrams for the various types of panel and the stiffener section. In these figures, the area used in each case for computing the stresses was the total area A of stiffener plus panel and not the effective area A' . The data in table 14 and figures 16 and 17 indicate that, as far as static strength is concerned, a better strength-weight ratio is secured through the use of thinner panels. This has been pointed out previously. (See reference 4.)

Several attempts were made to get a definite picture of the buckling pattern and to estimate the number of buckling waves in each type of stiffened panel used. There was evidence that (1) at high loads near static failure, a different pattern occurred than at the lower loads common in fatigue, and this was more evident for the larger weld spacing; (2) the pattern was affected in size (i.e., the number of buckling waves) by panel thickness but not by spot spacing. The distances between successive high spots (along a line through the center of the panel and directed lengthwise of the sheet) averaged 4.0, 3.5, 4.5, and 5.5 inches for samples with panel thicknesses of 0.025, 0.032, 0.040, and 0.051 inch, respectively. The difficulty in a more accurate evaluation of the pattern was partly that the samples were so short that the influence of end conditions (which varied somewhat) obscured details of the pattern.

Methods of Making Fatigue Tests

A description of the testing machines and of the techniques employed is given in appendix II. The precision of loading was about ± 15 pounds. The criterion of failure was the breaking of any one weld to such an extent that the panel was then completely free from its stringer. This was usually sufficient to cause a drop in load of 430 pounds or more.

Results of Fatigue Tests

The fatigue data on the stiffened panels loaded in compression are summarized in tables 15 to 18. These data are plotted as load-life curves in figures 20 and 21.

Figure 22 shows the static strength to failure, the fatigue strength at 1,000,000 cycles, the fatigue strength at 50,000 cycles, and the static buckling strength plotted against panel

thickness. In this figure, the stresses are computed by using the total area A of stiffener plus panel; the fatigue stresses are the maximum stresses at a ratio of minimum to maximum stress of 0.25. Note that, as previously mentioned, the static values indicate a better strength-weight ratio for thinner panels. The fatigue curves drawn for a life of 1,000,000 cycles are concave upward and show, like the buckling curve, increased strength for thicker panels. The fatigue curves drawn for a life of 50,000 cycles suggest increased strength with increasing panel thickness only up to a thickness of 0.032 inch. As the stress approaches the crippling stress, the strength-thickness relation approaches that for static failure. It is quite possible that a different buckling pattern appears at high loads.

Examination of Spot Welds on Stiffened Panels

Spot welds in the compression samples were similar in dimension within reasonable limits. However, each weld was from 10 to 25 percent longer along the axis parallel to the long dimension or height of the specimen than normal to this direction. Macrographs of the untested welds are shown in figure 23. As shown in figure 24, weld variations are greater in the thinner gage material.

Failure takes place in these welds in three types of cracking patterns, two of which are illustrated in figures 25 and 26. The other type failure takes place at the most highly stressed point which occurs as a rupture along the faying surface of the weld, presumably in tension.

Next to this break, a crack pattern is formed which seems influenced by both bending and fatigue. This appears at the internal alclad protrusion into the weld, follows the shell of the weld for a way, and then turns directly outward to the external alclad. This sort of crack generally propagates itself in the thinner of the two sheets (figs. 27-a and 25).

Farthest away from the total breaks is the third type of failure. This is illustrated in figure 26. Here a crack appears, traveling into the center of the weld. The location of this crack is between the equiaxed and dendritic zones in the thicker sheet near the geometrical center of the joint.

In thinner gages, fatigue cracks, similar to those found in tensile samples, were observed in the compression specimens. (See fig. 28.)

Sectioning normal and parallel to the direction of application of stress showed no fundamental differences in the phenomena observed. Sometimes cracks appeared in one direction and sometimes in the other. Differences here could not be investigated fully because of the impossibility of sectioning the same spot two ways.

Figure 29 shows the formation of fatigue cracks at the alclad protrusion of a weld which was quite a distance from the zone of complete failure. This weld is cracking along the brittle eutectic line at the perimeter of the spot weld.

Conclusions from Tests on Stiffened Panels

1. Several crack patterns were found in welds of failed specimens. The variation seems to depend upon the position of the weld examined with reference to the location of failure. Examination of the welds suggests that both tension and shear stresses were present in the welds.
2. The static crippling stress values decrease with increasing panel thickness and are lower for $1\frac{1}{4}$ -inch weld spacing than for $\frac{3}{4}$ -inch spacing. The stress at which buckling begins, however, increases panel thickness.
3. As if influenced largely by the buckling stresses, the fatigue stress corresponding to a life of 1,000,000 cycles increases with increasing panel thickness. For fatigue failure at a life of 50,000 cycles, the dependence on thickness seems to be between that for longer life and that for static failure.

III. TESTS ON TENSION SAMPLES WITH UNSTRESSED ATTACHMENTS

Materials, Test Pieces, and Static Tests

Unstressed attachment-type tension fatigue test samples were made from 24S-T alclad in three thicknesses: 0.025, 0.032, and 0.040 inch. Table 19 gives data on test coupons from the particular sheets used in making these test pieces and indicates the normal properties of the sheet.

The samples originally consisted of pieces 17 inches long by 5 inches wide, each having a 1-inch strip of the same thickness

sheet* fastened by a single row of spot welds across a center line in a direction perpendicular to the axis of loading. Two spot-weld spacings, $\frac{3}{4}$ inch and $1\frac{1}{2}$ inches, were used for each thickness. Since early tests indicated that the unstressed attachment did not weaken the sheet so much as did the holes drilled in either end for fastening in the grips, the center section had to be reduced. Figure 30 shows the final form of test piece adopted. Note that the reduction in section deleted two of the original spot welds, so that four welds were left for the $\frac{3}{4}$ -inch spacing, and 2 welds for the $1\frac{1}{2}$ -inch spacing.

The spot-welding conditions and tests on single spot samples made at the Rensselaer Polytechnic Institute are given in table 2.

Static tension tests were made on a 20,000-pound Baldwin Southwark testing machine. The speed of testing was 0.01 inch per minute within the range of the recorder and 0.06 inch per minute (beyond yield point) to failure. Stress-strain curves were taken for each type of sample but show no effect of the attachment piece except for the low yield stress. Table 20 shows the results of these static tests. In each case, static failure was by a break across the line of welds.

Fatigue Tests on Samples with Unstressed Attachments

The fatigue tests were run, using the same technique as for the lap joint samples. There was no question as to a criterion of failure since, in virtually every case, failure was a complete break and the load dropped to zero, so that the automatic cut-off stopped machine and counter.

Early runs were made on samples with a $1\frac{1}{2}$ -inch-radius fillet. Since several failures occurred in the fillet or so near it as to be influenced by its stress concentration, the radius was increased to 3 inches, which is nearly as large as is reasonable for the size of the original strip and for the size end needed for the grips used.

*By an error, some of the 0.025-in. samples had strips of 0.032-in. sheet attached. Such samples are noted in the tables of results. There is no evidence that this affected the fatigue results.

Tables 21, 22, and 23 give the results of the fatigue tests which were all run at a ratio of minimum stress to maximum stress of 0.25. Figures 31 and 32 show the load-life curves plotted from these data. In these figures, it will be noted that, at high loads giving lifetimes less than 100,000 cycles, the samples broke along or near to the line of welds. At lower loads and longer lifetimes, the samples usually failed in the fillet region. Apparently, for low loads, the stress concentration due to the welds was less than that caused by the fillet. It should be noted that, as indicated in the following section, some of the samples failing in the fillet region has incipient fatigue cracks along the welds.

Figure 33 compares the strength-thickness relations for (1) static failure, (2) fatigue failure at 10,000 cycles (failures through the spot welds), and (3) fatigue failure at 300,000 cycles (failure in the fillet region). Little influence of weld spacing is apparent except that, for failures at 10,000 cycles, the samples with four welds ($3/4$ -in. spacing) seem stronger than those with two welds ($1\frac{1}{2}$ -in. spacing).

Metallographic Examination of Spot Welds

in Unstressed Attachments

The variation of penetration and size of spot welds in the unstressed attachments is shown in figure 34. The welds in this group have the same dimensions as the others investigated for the tension and compression samples.

Fatigue cracks are started in the unstressed attachments at the same place as in all the other types of samples (i.e., the protrusion of the alclad into the weld). Instead of proceeding through the dendritic region, however, as in the lap-jointed samples, the cracks follow the perimeter of the spot weld (see figs. 34a and 35) or, if the alclad protrusion is excessive (see fig. 34b), even bend back into this zone.

Fatigue nuclei appear in the unstressed attachments, even in the samples in which failure occurred outside of the welds. In figure 36a, the formation of a small crack is shown in a sample which failed outside the weld zone. Failure took place in the stressed sheet rather than in the unstressed attachments.

Conclusions

1. In static and in high stress fatigue tests, failure always occurs along the line of welds in preference to failure in the 3-inch radius fillet joining the ends of the test pieces with the center test section. This indicates that, under these loading conditions, the stress concentration produced by the spots is higher than that produced by the fillet.

2. In low stress (long life) fatigue tests, failure always occurs in the fillet in preference to the line of spot welds. This indicates that, under low loads, the stress concentration imposed by the fillet is higher than that produced by the welds.

3. In view of the results above, it appears that spot welds in scab sheets do not seriously weaken the material on which they are formed, so far as fatigue strength is concerned.

IV. CORRELATION OF FATIGUE PROPERTIES WITH METALLURGICAL STRUCTURE AND GEOMETRY OF SPOT WELDS

On the three types of samples investigated, lap joints, stiffened panels, and unstressed attachments, it was observed that the fatigue cracks propagated themselves through different structural regions in the spot weld under the various stressing conditions present in each type of specimen.

The inception of fatigue failure occurs in most cases at the projection of the internal alclad into the weld slug. A nucleus forms here. This protrusion is a mechanical notch surrounded by a material of low strength (2S cladding - tensile strength 13,000 lb/sq in.). Furthermore, the notch effect may be intensified by piping, by oxide accumulation, or by forcing the sheets apart by blown metal ("spitting"). As all these effects can, and mostly do, occur at the alclad protrusion, inception of failure is usually located at this point.

Factors opposing failure at the alclad junction in the weld are severe scratches on the alclad outside of the weld, but in a highly stressed region, coupled with tight bonding of the cladding on the faying surfaces just outside of the weld in the corona region (mechanically bonded ring around weld slug).

To secure a bond sufficiently tight to prevent rupturing in fatigue, the pressure which must be used is usually enough to indent severely the outside surface of the spot. This will cause failure in a line from the notch caused by the electrode indentation to a scratch in the alclad in the plane of the weld interface. This type of failure is rare with modern welding practice, as severe indentation is avoided.

The fatigue crack, once started, may propagate in a number of directions, depending on the nature and the extent of the stresses applied. Cracking can, therefore, take place in the equiaxed-grained center area, the surrounding dendritic region, or the heat-treated area around the once-molten weld slug.

Under heavy shear fatigue loads, failure takes place within the equiaxed-grained center area along the interface of the weld, but, for lighter loads, the crack travels normal to this direction through the dendritic region to the outer alclad. There is some evidence (see lap joint tests) that a greater amount of dendritic structure, as found in spot welds with much penetration, improves fatigue resistance. The dendritic region, containing the most ductile metal in the slug, is apparently more resistant to crack propagation than the surrounding wrought dural structure.

Under tension fatigue, as observed in the unstressed attachments, the cracks follow the edge of the weld until the distance between the outer surface and the crack is very short and the crack breaks through. The region at the shell of the weld is quite brittle as incipient melting of the material next to the weld pool, solid solution melting along grain boundaries, and intrusion of a copper-rich eutectic from the weld pool has taken place in this area.

Spot welds in 24S-T alclad are not very strong in tension, as the ratio of static tension to shear is only 0.29. (See reference 5.) This ratio, which is given as a measure of ductility in spot welds, is low for 24S-T alclad because of the brittle zone surrounding the weld, which has also been shown subject to crack propagation in tension fatigue. (See unstressed attachment section.)

In general, it can be said that welds with the greatest penetrations, amount of dendritic structure, and diameter possible, will prove strongest under dynamic loading. It has been found that static shear strength increases with increased

diameter but decreases with increased penetration. (See reference 4.)

$$\text{Shear strength} = \frac{13,000 \text{ diameter}^2}{\text{penetration}^{0.66}}$$

The penetration effect, however, seems more important in fatigue than it is for static shear strength, as greater penetration appears to lengthen spot-weld life under dynamic loading.

Battelle Memorial Institute,
Columbus, Ohio, March 1, 1943.

APPENDIX I

TESTS OF ALCLAD 24S-T SHEET

SUBMITTED BY BATTELLE MEMORIAL INSTITUTE*

(NACA SPOT-WELD FATIGUE INVESTIGATION)

By C. R. Buckles

Introduction

As part of the spot-weld fatigue investigation for the National Advisory Committee for Aeronautics, the Battelle Memorial Institute is determining the fatigue strength of some spot-welded structural specimens of alclad 24S-T sheet. In accordance with an agreement by the Aluminum Company of America to assist in the material control tests of the items used in the preparation of fatigue specimens tested recently, Dr. H. W. Russell submitted test coupons from the sheet used.

*This appendix is a report prepared by the Aluminum Company of America on the properties of the sheet material used in the investigation.

The object of these tests was to determine the tensile and compressive properties of the alclad 24S-T sheet used in the preparation of some spot-welded structural specimens tested in fatigue at the Battelle Memorial Institute.

Material

The material submitted consisted of duplicate test coupons 1 inch by 8 inches in size cut longitudinally from each of 55 pieces of sheet, as follows:

Identification symbol	Sheet thickness (in.)
376645-12-A to -C	0.040
-11-A to -R	.032
-8-A to -N	.032
-7-A to -O	.025
-10-A to -E	.025

Procedure

Tensile test specimens were machined from one of each pair of the test coupons submitted and were tested, using the 1000- and 2000-pound ranges of an Amsler 20,000-pound capacity universal testing machine (type 10 SZBDA). In each of the five groups, a tensile stress-strain test was made on at least one specimen, using the Huggenberger tensometers with a 0.5-inch gage length. The yield strengths of the remaining tensile specimens were determined, using a Tomplin autographic extensometer. (See reference 6.) In all tests, the yield strength was determined at 0.2 percent offset.

A compressive stress-strain test was made on one specimen from each of the five groups, using the test coupon corresponding to the one on which a tensile stress-strain test had been made. Each compressive test was made in the Montgomery-Templin single-thickness fixture for testing sheet. (See reference 7.) The tests were made, using the 5000-pound range of a 50,000-pound capacity Southwark-Tate-Emery universal testing machine (ser. no. 50-TE-162), and strains were measured with Huggenberger tensometers (2000X) with 0.5-inch gage length. The yield strength was determined at 0.2 percent offset.

Discussion

The results of the individual tensile and compressive tests are found in tables, figures, and data. Stress-strain curves in tension and compression for one sample from each of the five groups of sheet are shown in figures 1 to 3. The tensile and compressive stress-strain curves for corresponding samples were grouped together to show direct comparisons, and each figure contains the curves for one thickness of sheet.

The results of the tensile tests are summarized in table I. This table shows the maximum, average, and minimum values obtained for each of the five groups tested and also the number of tests in each group. All the material was found to meet the requirements of Federal Specification No. QQ-A-362 as far as tensile properties are concerned. In fact, all the tensile strengths and yield strengths exceeded the published typical values for Alcoa alclad 24S-T sheet, and the average values for each group were at least equal to the published typical values for Alcoa alclad 24S-RT sheet. (See reference 8.) The elongations generally were equal to the published typical value for Alcoa alclad 24S-T sheet and considerably above the typical values for Alcoa alclad 24S-RT sheet.

The results of the tensile and the compressive stress-strain tests are summarized in table II. As shown in this table, the ratio of the compressive yield strength to the tensile yield strength of the samples tested ranged from a maximum of 0.89 to a minimum of 0.82, the average being 0.85. This average value is about 4 percent higher than the value of 0.82 published in ANC-5. (See reference 9.)

Conclusions

From the tests which have been made on longitudinal specimens from the samples of alclad 24S-T sheet submitted by the Battelle Memorial Institute, the following conclusions seem warranted:

1. The tensile strengths and the yield strengths of each sample exceeded the typical values for Alcoa alclad 24S-T sheet. The elongations were about equal to the typical values.
2. The differences in the tensile properties of each group of samples tested were differences which normally would be expected among several lots of alclad 24S-T sheet.
3. The average ratio of compressive yield strength to tensile yield strength was approximately 0.85.

December 24, 1942.

TABLE I
RESULTS OF TENSILE TESTS OF ALCLAD 24S-T SHEET
FOR BATTELLE MEMORIAL INSTITUTE

(P. T. No. 110942-E)

Specimens Marked	Nominal Thickness, in.	Number of Tests		Tensile Strength, psi	Yield Strength (Offset=0.2%), psi	Elongation in 2 in., per cent
376645-12-W	0.040	3	Maximum	68 900	53 900	17.0
			Average	67 830	52 570	16.8
			Minimum	67 000	51 300	16.5
376645-11-W	0.032	18	Maximum	68 400	51 900	20.0
			Average	67 170	50 750	18.4
			Minimum	65 500	49 700	16.0
376645-8-W	0.032	14	Maximum	68 500	51 800	20.5
			Average	66 640	50 090	18.9
			Minimum	64 500	47 400	16.0
376645-7-W	0.025	15	Maximum	68 200	55 100	19.0
			Average	67 550	52 810	17.5
			Minimum	65 900	49 000	16.0
376645-10-W	0.025	5	Maximum	67 400	53 100	18.0
			Average	66 840	51 620	17.6
			Minimum	65 300	50 000	17.0

W indicates specimens cut with-grain.

TABLE II

RESULTS OF TENSILE AND COMPRESSIVE STRESS-STRAIN TESTS
OF ALCLAD 24S-T SHEET FOR BATTELLE MEMORIAL INSTITUTE

(P. T. No. 110942-E)

Specimens Marked	Nominal Thickness, in.	Tensile Strength, psi	Tensile Yield Strength (Offset=0.2%), psi	Elongation in 2 in., per cent	Compressive Yield Strength (Offset=0.2%), psi	Ratio $\frac{CYS(W)}{TYS(W)}$
376645-12-W-B	0.040	67 000	52 500	17.0	44 900	0.86
376645-11-W-B	0.032	66 900	51 500	16.0	42 000	0.82
376645-8-W-A	0.032	65 800	47 900	19.0	42 600	0.89
376645-7-W-B	0.025	68 000	54 200	16.5	45 700	0.84
376645-10-W-A	0.025	65 300	51 400	17.5	44 000	0.86
Average						<hr/> 0.854

ALUMINUM COMPANY OF AMERICA
 Aluminum Research Laboratories
 New Kensington, Pa.

W-64

Physical Test No. - 110942-E Alloy & Temper- Alclad 24S-T Form- Sheet
 Chemical Test No. - Nominal Size- .040 in.
 Order No. - Prob. 129 (J.O.9-6682-A) Actual Size - As noted
 Received from- Battelle Memorial Institute Date 11-9-42

Tension Test Data

Specimen Marked	Dimensions Inches	Tensile Strength		Yield Strength (Offset=0.2%)		Elongation in 2 in.	
		Lb.	PSI	Lb.	PSI	In.	%
376645- 12-W-A	.0385x.502 (.0193)	1330	68900	990	51300	0.34	17.0
B	.0392x.502 (.0197)	1320	67000	---	52500	0.34	17.0
C	.0407x.502 (.0204)	1380	67600	1100	53900	0.33	16.5
Average			67830		52570		16.8

Specimens cut with grain.
 Ref: Memorandum by G.W.S.,
 November 7, 1942

Tested by C.K.W.-C.R.B. Date 11-24-42

Checked by J.B. Date 12-19-42

Approved by R.L.Templin Date 12-28-42

Aluminum Research Laboratories

New Kensington, Pa.

Physical Test No.- 110942-E Alloy & Temper-Alclad 24S-T Form-Sheet

Chemical Test No.- Nominal Size .032 in.

Order No.- Prob.129(J.O. 9-6682-A) Actual Size As noted.

Received from- Battelle Memorial Institute Date 11-9-42

Tension Test Data

Specimen Marked	Dimensions Inches	Tensile Strength		Yield Strength (Offset=0.2%)		Elongation in 2 in.	
		Lb.	PSI.	Lb.	PSI.	In.	%
376645- 11-W-A	.0303x.502 (.0152)	1020	67100	755	49700	0.40	20.0
B	.0313x.502 (.0157)	1050	66900	---	51500	0.32	16.0
C	.0309x.502 (.0155)	1060	68400	805	51900	0.34	17.0
D	.0312x.503 (.0157)	1060	67500	800	51000	0.37	18.5
E	.0313x.502 (.0157)	1060	67500	780	49700	0.38	19.0
F	.0305x.502 (.0153)	1040	68000	770	50300	0.38	19.0
G	.0307x.503 (.0154)	1045	67900	785	51000	0.36	18.0
H	.0314x.503 (.0158)	1055	66800	785	49700	0.38	19.0
I	.0305x.503 (.0153)	1005	65700	765	50000	0.34	17.0
J	.0310x.503 (.0146)	1050	67300	800	51300	0.40	20.0
K	.0306x.503 (.0154)	1045	67900	795	51600	0.36	18.0
L	.0305x.503 (.0153)	1030	67300	770	50300	0.36	18.0
M	.0315x.503 (.0158)	1055	66800	795	50300	0.38	19.0
N.	.0311x.503 (.0156)	1045	67000	795	51000	0.38	19.0
O	.0304x.503 (.0153)	1030	67300	775	50700	0.36	18.0
P	.0308x.503 (.0155)	1045	67400	805	51900	0.36	18.0
Q	.0309x.503 (.0155)	1035	66800	795	51300	0.38	19.0
R	.0326x.503 (.0164)	1075	65500	825	50300	0.36	18.0
Average			67170		50750		18.4

Specimens cut with grain.

Approved by R. L. Templin
Date Dec. 28, 1942

Tested by C.K.W.-C.R.B. Date 11-24-42

Checked by J.B. Date 12-19-42

W-64

ALUMINUM COMPANY OF AMERICA

Aluminum Research Laboratories

New Kensington, Pa.

Physical Test No. 110942-E Alloy & Temper- Alclad 24S-T Form-Sheet

Chemical Test No. Nominal Size .032 in.

Order No. Prob.129(J.O.9-6682-A) Actual Size As noted

Received from Battelle Memorial Institute Date 11-9-42

Tension Test Data

Specimen Marked	Dimensions Inches	Tensile Strength		Yield Strength (Offset=0.2%)		Elongation in 2 in.	
		Lb.	PSI.	Lb.	PSI.	In.	%
376645	.0314x.503						
8-W-A	(.0158)	1040	65800	---	47900	0.38	19.0*
	.0311x.503						
B	(.0156)	1035	66300	800	51300	0.38	19.0
	.0322x.503						
C	(.0162)	1065	65700	800	49400	0.36	18.0
	.0328x.503						
D	(.0165)	1105	67000	855	51800	0.38	19.0
	.0309x.503						
E	(.0155)	1000	64500	735	47400	0.41	20.5
	.031x.504						
F	(.0158)	1050	66500	800	50600	0.36	18.0
	.0306x.504						
G	(.0154)	1030	66900	790	51300	0.38	19.0
	.0301x.504						
H	(.0152)	1010	66400	730	48000	0.38	19.0
	.0312x.504						
I	(.0157)	1060	67500	775	49400	0.37	18.5
	.0305x.504						
J	(.0154)	1025	66600	790	51300	0.32	16.0
	.0312x.504						
K	(.0157)	1060	67500	805	51300	0.40	20.0
	.0301x.504						
L	(.0152)	1010	66400	750	49300	0.38	19.0
	.0398x.504						
M	(.0150)	1010	67300	765	51000	0.38	19.0
	.0306x.504						
N	(.0154)	1055	68500	790	51300	0.40	20.0
Average			66640		50090		18.9

Specimens cut with grain.
*Broke through Huggenberger
tensometer marks.

Tested by C.K.W.-C.R.B. Date 11-24-42

Checked by J.B. Date 12-19-42

Approved by R.L.Templin Date Dec.28'42

W-64

Aluminum Research Laboratories

New Kensington, Pa.

Physical Test No.- 110942-E Alloy & Temper-Alclad 24S-T Form- SheetChemical Test No.- Nominal Size- .025 in.Order No.- Prob. 129 (J.O. 9-6682-A) Actual Size- As notedReceived from Battelle Memorial Institute Date- 11-9-42

Tensile Test Data

Specimen Marked	Dimensions Inches	Tensile Strength		Yield Strength (Offset=0.2%)		Elongation in 2 in.	
		Lb.	PSI.	Lb.	PSI.	In.	%
376645- 7-W-A	.0266x.504 (.0134)	883	659000	657	49000	0.34	17.0
B	.0253x.506 (.0128)	871	68000	---	54200	0.33	16.5
C	.0252x.504 (.0127)	855	67300	653	51400	0.36	18.0
D	.0253x.504 (.0128)	850	66400	698	54500	0.32	16.0
E	.0245x.504 (.0123)	833	67700	645	52400	0.35	17.5
F	.0255x.504 (.0129)	872	67600	670	51900	0.36	18.0
G	.0253x.504 (.0128)	873	68200	705	55100	0.36	18.0
H	.0262x.504 (.0132)	886	67100	700	53000	0.32	16.0
I	.0252x.505 (.0127)	864	68000	655	51600	0.36	18.0
J	.0253x.505 (.0128)	866	67700	663	51800	0.36	18.0
K	.0251x.505 (.0127)	861	67800	660	52000	0.36	18.0
L	.0251x.505 (.0127)	864	68000	690	54300	0.33	16.5
M	.0248x.505 (.0125)	849	67900	658	52600	0.38	19.0
N	.0247x.505 (.0125)	847	67800	675	54000	0.36	18.0
O	.0255x.505 (.0129)	875	67800	700	54300	0.35	17.5
Average			67550		52810		17.5

Specimens cut with grain.

Tested by C.K.W.-C.R.B. Date 11-24-42Checked by J.B. Date 12-19-42Approved by R.L. Templin Date 12-28-42

W-50-10

ALUMINUM COMPANY OF AMERICA
 Aluminum Research Laboratories
 New Kensington, Pa.

Physical Test No.- 110942-E Alloy & Temper- Alclad 24S-T Form- Sheet
 Chemical Test No. Nominal Size .025 in.
 Order No. Prob. 129 (J.O. 9-6682-A) Actual Size As noted
 Received from Battelle Memorial Institute Date 11-9-42

Tension Test Data

Specimen Marked	Dimensions Inches	Tensile Strength		Yield Strength (Offset=0.2%)		Elongation in 2 in.	
		Lb.	PSI.	Lb.	PSI.	In.	%
376645-10-W-A	.0256x.503 (.0129)	843	65300	---	51400	0.35	17.5
B	.0246x.503 (.0124)	830	66900	648	52300	0.35	17.5
C	.0255x.502 (.0128)	862	67300	640	50000	0.36	18.0
D	.0234x.503 (.0118)	794	67300	605	51300	0.36	18.0
E	.0256x.503 (.0129)	869	67400	685	53100	0.34	17.0
Average			66840		51620		17.6

Specimens cut with grain.

Tested by C.K.W.-C.R.B. Date 11-24-42

Checked by J. B. Date 12-19-42

Approved by R.L. Templin Date 12-28-42

W-94

ALUMINUM COMPANY OF AMERICA
Aluminum Research Laboratories
New Kensington, Pa.

Physical Test No.- 110942-E Alloy & Temper- Alclad 24S-T Form- Sheet
 Chemical Test No.- Nominal Size- .040 in, .032 in, & .025 in.
 Order No.- Prob. 129 (J.O. 9-6682-A) Actual Size- As noted
 Received from- Battelle Memorial Institute Date 11-9-42

Kind of data: Compression Test.

Specimen Marked	Nominal Thickness in.	Dimensions of Spec. in.	Length of Spec. in.	No. of Pieces in Spec.	Yield Strength (Set=0.2%) psi
376645-12-W-B	.040	.0390x.626 (.0244)	2.630	1	44900
376645-11-W-B	.032	.0312x.626 (.0195)	2.630	1	42000
376645-8-W-A	.032	.0316x.625 (.0198)	2.630	1	42600
376645-7-W-B	.025	.0253x.626 (.0158)	2.630	1	45700
376645-10-W-A	.025	.0251x.625 (.0157)	2.630	1	44000

Specimens cut with grain.

Tested by C.K.W.-C.R.B. Date 12-3-42

Checked by J.B. Date 12-19-42

Approved by R. L. Templin Date 12-28-42

APPENDIX II

APPARATUS, CALIBRATION, AND TEST METHODS

Description of the Fatigue Testing Machine

The tests reported here have been run on a Krouse fatigue testing machine of 10,000 pounds maximum load capacity. The machine can accommodate independently two specimens at one time. A photograph of the machine (fig. 37) shows one sample loaded in tension and indicates clearly the main features of loading.

The variable load is applied by the loading lever A actuated by the cam C the eccentricity of which on the driving pulley B can be adjusted to any desired value. The member transmitting the force to the specimen is guided by a parallelogram system of four steel plate fulcrums D which produce straight-line motion and direct loading of the sample. The machine is of the constant deflection type. The average value of the load can be adjusted by the loading screw E.

The static load value is obtained by measuring the bending of a fixed length of the loading lever A by means of the dial gage on the "gage bar" F. The relation between dial readings (relative to a reading with zero load) and load values is given by a calibration curve. This calibration was obtained (at the factory) by dead weights applied to the lower specimen holder for low loads and by a proving ring in place of the specimen for high loads. In practice, dial deflections are recorded for maximum and minimum loads as the cam B is rotated slowly by hand and the corresponding load values will be termed herein after the "static load values."

The machine is equipped with two mechanical counters G so geared to the driving shaft as to record one count for each hundred cycles of applied stress. The counters have a common drive, but each may be reset to zero to correspond to the start of a run upon its particular sample. A cut-off H is designed to stop the motor and, hence, also the counters, when the load drops either by yielding or failure of the sample.

Important considerations in running any sample include (1) clamping the sample so as to insure axial loading, (2)

adjusting and determining the values of the loads applied, and (3) determining the number of cycles to failure. The precautions that have been taken in each of these three respects will now be discussed in some detail.

Clamping the Sample

a) Tension samples. - Samples tested in tension were held in grips as shown in figure 37. In preparation, the sample was marked for the centers of the three bolt holes in each end by a steel template. The holes were then drilled $47/64$ inch and the center hole at each end reamed to final size ($3/4$ in.). The sample was then mounted in the grips, using only a center bolt at each end. With a moderate applied load (about 100 lb) on the sample, the remaining holes were reamed to size through the hardened sleeves in the grip bolt holes. After these holes were cleaned out, the remaining bolts were inserted. This procedure was designed to attain axial loading.

b) Compression samples. - Figure 38 shows the compression grips used for the samples described later in this report. A is a platen to which was clamped the 5- by 5-inch surface ground steel plate B. The small plates, C and D, were used to prevent slipping of the end of the sample. In practice, plate C was kept fixed so that, when the panel of the compression sample was against C, the center of mass of the sample was on the axis of loading. Plate D was tightened against the hat-shape stiffener of each sample.

Shims (visible at E in fig. 38) were placed between A and B so that the face of B for the bottom compression plate was perpendicular to the loading axis. With a sample standing on the bottom plate, shims were adjusted for the upper grip so its surface B rested evenly upon the top of the sample.

To avoid twisting the sample while adjusting the load, a rod was inserted in the disk A and held manually during the adjustment. Later, a clamp, designed to be fastened on the supporting columns, was constructed. This clamp may be seen above the upper compression grip in the photograph of figure 37.

Measuring the Load

A method for measurement of loads while the machine is running, using electrical resistance-type strain gages, was developed.

The principle of the measuring method is to apply an audio frequency current to a Wheatstone type bridge one arm of which is an SR-4 type A-1 gage mounted either on the test specimen in which it is desired to measure strains or on a "weigh-bar" in series with the specimen. The periodic strain in the test piece or "weigh-bar" varies the resistance of the gage. This variation in resistance modulates the audio frequency signal being applied to the bridge. The bridge is balanced by means of a slide wire. A cathode ray oscilloscope is used as a null-point indicator.

Figure 39 is a wiring diagram of the equipment and figure 40 is a photograph of the assembly showing the various parts in place. In figure 39, the parts illustrated are as follows:

The signal source. - "A" is a Hewlett Packard Model 200 A audio oscillator. While this oscillator can provide frequencies from 35 to 35,000 cycles, it is being used at a constant frequency of 750 cycles. This frequency can be conveniently filtered so as to eliminate 60-cycle pickup.

"B" is a shielded isolating transformer with input and output impedance selected to match the oscillator and bridge, respectively. The transformer is a United Transformer Company type LS141 transformer.

"The Bridge." - "C" is a "dummy" type A-1 gage mounted on a strip of material similar to the "weigh-bar" or test piece on which is mounted a similar gage "D." These gages have an approximate resistance of 120 ohms and the "dummy" gage is mounted as close to the measuring gage as possible in order to secure temperature compensation. These two elements form two arms of the bridge. The other two arms are made up of resistance elements E, F, G, H, I, J, and K, which are selected to make roughly a 1:1 ratio with the SR-4 elements.

Resistances E, F, and R form a resistance combination of approximately 146 ohms. Resistances I, K, and the decade box J form a variable resistance combination which can be varied to suit the particular gages (C and D) being used, so that when the slide wire G is set at zero, the bridge is balanced for zero strain on D. The slide wire G is a Leeds & Northrup Kolrausch type slide wire which is divided into 1000 divisions. The sensitivity of the bridge is such that one division on the slide wire corresponds to a resistance change of about 0.0009 ohm in gage "D." This change in resistance is equivalent approximately to a strain of 4×10^{-6} inches per inch.

On account of stray capacitance, it is necessary to insert some capacity in one arm of the bridge in order to obtain a balance. This capacitance is shown at "T" in figure 39 and has a range of 40 to 1000 μf . T is shown in arm C; it can be inserted, however, in any other arm, as required, to obtain a balance.

The detector and null-point indicator. - The various parts of the detector circuit are "L," a high quality shielded type 87A11 Stancor isolating transformer which matches the impedance of the bridge to the amplifier M. This amplifier is a David Bogen Company type E14 amplifier having a variable gain from 0 to 125 db. The amplified signal is then passed through two filters, N and P, designed to select the band from 500 to 1000 cycles, and the filtered wave is shown on the oscilloscope.

N is a General Radio type 830B, 500-cycle high pass filter, and P is a General Radio type 930E, 1000-cycle low pass filter. Q is a DuMont type 163 oscillograph. All leads connecting the various portions of the equipment are in shielded cables and the shields of all cables and transformers are grounded.

Several tests were made with the strain gage "D" on the sample itself and the dummy gage "C" on an unstrained sample nearby. It is time-consuming to use a new gage with each sample; moreover, a gage on the sample is subject to error at high loads when the sample is yielding. On the other hand, a weigh-bar in series with the sample offers difficulties in mounting of the sample. Hence, some member of the machine itself which would show appreciable strain proportional to the load was sought.

A convenient arrangement proved to be this: Gage "D" was mounted on the plate fulcrum K (fig. 37), while "C" was mounted at M. Thus, "C" served as temperature compensator to D, and also, since M is in tension when K is in compression and vice versa, the arrangement offers reasonable sensitivity despite the relatively small strains in these plate fulcrums. It should be noted that the strain in gage "D" caused by bending of K is largely compensated by a strain of gage "C," owing to concurrent bending of M. Except at extremely low loads (less than 50 lb), the readings of the slide wire in the bridge circuit are linear with corresponding values of static load. Dynamic readings with this gage arrangement, moreover, give values agreeing with those obtained by using a strain gage on the specimen itself. (The slight discrepancies at low loads can be eliminated by an arrangement wherein "D" consists of two strain gages mounted upon opposite sides of plate K and wired in series, while "C" is a similar arrangement upon plate M.)

One reason for the reproducibility (usually better than 1 percent) of dynamic load values obtained with the electric strain gages concerns the calibration method adopted. As an example, suppose it is desired to obtain dynamic values for some particular loading. The cam is turned by hand, and readings of the dial gage and of the slide wire are recorded for maximum load, for minimum load, and for two or three loads in between these. This affords a calibration curve for the strain gage. Now the Krouse gage bar is removed, the motor is started, and dynamic values for maximum and minimum load are read from the slide wire. The machine is now stopped and the calibration repeated. Thus, any shift in the strain gage calibration caused, for example, by lack of complete temperature compensation, is noted. If such a shift is appreciable (which occurs only when the strain gage circuit has been turned on recently and has not reached equilibrium), the readings are all repeated.

Many tests by the method described above indicate that the "dynamic throw" (max. load minus min. load when the machine is running) is about 15 percent greater than the "static throw" (difference between max. and min. loads when the cam is slowly turned by hand). That this throw increase is due to inertia of the moving loading lever was confirmed by tests with a series of strain gages mounted along the top of the loading lever (at N, O, P, etc., in fig. 37). The

gage at N showed such a dynamic increase, the one at Q showed little difference between dynamic throw and static throw, while gages at P, Q, and R showed static throws more than dynamic throws. These observations are readily understood if, because of inertia, the bending of the center line of the loading lever is along the lines sketched in figure 41. In such a case, the strain at N would be greater for static deflections. The point Q is at the place where the strain is the same for both static and dynamic conditions.

All the tests that have been tried indicate that, with the calibration method used, strain gages on the plate fulcrums K and M are satisfactory. The graph plotted in figure 42 indicates that the dynamic throw is directly proportional to the static throw for a wide range in mean load and for specimens varying widely in stiffness. The points shown on the graph were obtained for (1) a stiffened aluminum panel (type D) loaded in compression, (2) a cast iron pipe about 5 inches in diameter and $\frac{3}{16}$ inch in wall thickness loaded in compression, (3) a steel plate about 15 inches long and 2.00 inches by 0.093 inch in cross section loaded in tension, and (4) a spot-welded 0.040 inch sheet of aluminum with welds $\frac{3}{4}$ inch apart loaded in tension. It will be noted that the experimental points fall upon a straight line with consistency. A similar calibration curve was made for the right-hand side of the machine. It should be noted, since it does not appear upon the graph, that the dynamic mean load had, within experimental error, the same value as the static mean load.

In view of the consistency of points for such plots, it seems justifiable to adopt a graph such as figure 42 as a calibration curve. If the desired dynamic throw is known, the corresponding static throw is obtained from the calibration curve and the loading is done statically.

Measuring the Number of Cycles to Failure

The fatigue testing machine was originally equipped with electrically operated counters. Difficulties with these resulted in having them replaced by the mechanical counters already mentioned. These later counters are now operating satisfactorily.

The cut-off (which stops the machine when a test piece fails) consists of a microswitch operated by a change in the deflection of the center of the loading lever with a change in the maximum load. The motion available is only about $3\frac{1}{2}$ thousandths of an inch for a change in maximum load of 100 pounds. With the present arrangement, the switch can be made to operate for a motion of 0.015 inch corresponding to a change in load of 430 pounds. The consistency of this "criterion of failure" is, of course, better than this in the sense that cut-off occurs at nearly the same (within about 80 lb) decrease in load for all samples.

The Routine Adopted for Fatigue Tests

In order to treat all samples consistently, a routine procedure of loading and checking samples has been established. Each sample is inspected for rough edges or visible flaws. The pertinent dimensions of each sample are recorded. From data obtained on previous tests, a load designed to give a desired point on the S-N curve is selected. If the dynamic throw assigned is known, the static values at which the machine should be set are computed by using the dynamic throw calibration graph (fig. 42) for the particular machine. By use of the calibration constant furnished with the machine, the dial readings to which the load is to be set are computed.

The sample is then placed in the clamps, with the precautions already noted, and the loading screw and the cam eccentricity are adjusted until the desired dial readings (within $1/3$ dial division - corresponding to about 10 lb) are obtained. Now the machine is run for 1000 cycles, during which the mean load often decreases. The load is checked and, if necessary, restored to its original value. The machine is started and, after the cut-off adjustment has been checked, is left running.

All machines are checked frequently. A check includes a counter reading, reading of maximum and minimum load, a check on the cut-off adjustment, and careful visual examination of the sample.

REFERENCES

1. Russell, H. W., and Jackson, L. R.: Progress Report on Fatigue of Spot-Welded Aluminum. NACA A.R.R., Feb. 1943.
2. Hartmann, E. C., and Stickley, G. W.: Summary of Results of Tests Made by Aluminum Research Laboratories of Spot-Welded Joints and Structural Elements. T.N. No. 869, NACA, 1942.
3. Smith, James O.: The Effect of Range of Stress on the Fatigue Strength of Metals. Univ. of Ill. Bul. 334, vol. 39, no. 26, 1942.
4. Crockett, Harold B.: Predicting Stiffener and Stiffened Panel Crippling Stresses. Jour. Aeron. Sci., vol. 9, Nov. 1942, pp. 501-509.
5. Hess, W. F., Wyant, R. A., and Averbach, B. L.: Examination of Spot Welds in Alclad 24S-T. The Welding Jour., July 1942, pp. 350-351-S.
6. Templin, R. L.: An Automatic Autographic Extensometer for Use in Tension Tests of Materials. Proc., A.S.T.M., vol. 32, pt. II, 1932, p. 783.
7. Paul, D. A., Howell, F. M., and Grieshaber, H. E.: Comparison of Stress-Strain Curves Obtained by Single-Thickness and Pack Methods. T.N. No. 819, NACA, 1941.
8. Anon.: Alcoa Aluminum and Its Alloys, (1942 ed.) Aluminum Co. of Am.
9. Anon.: Strength of Aircraft Elements. ANC-5, Oct. 1940 (rev. ed.) Table 1-1, pp. 1-27.

TABLE 1. SUMMARY OF RESULTS OF TESTS ON 24S-T ALCLAD
USED FOR LAP JOINT SAMPLES*

Thickness of Sheet	Tensile Strength (psi)	Tensile Yield Strength (Offset 0.2%) (psi)	Elongation (in 2 in.) %	Compressive Yield Strength (Offset 0.2%) (psi)
.025"	Min. 65,900	49,000	16.0	45,700**
	Max. 68,200	54,500	19.0	
	Ave. 67,550	52,810	17.5	
.032"	Min. 64,500	47,400	16.0	42,600**
	Max. 68,500	51,800	20.0	
	Ave. 66,640	50,090	18.9	
.040"	*** 67,830	52,570	16.5	44,900

* Tests were made at Aluminum Company Laboratories. A complete copy of their report is given in the Appendix. The values quoted above were selected from data on test coupons from the particular sheets used in making the lap joint samples.

** Compressive Yield Strength is result for 1 sample.

***No sample of the .040" sheet actually used for the lap joint specimens was measured; the values given are average values for .040" sheet used for compression samples and for unstressed attachment samples.

TABLE 2. WELDING CONDITIONS ON SPOTWELD LAP JOINT AND UNSTRESSED ATTACHMENT SAMPLES

Type of Specimen	Secondary Current (2)			Electrode Tips		Electrode Pressure				Surface Treatment		Shear Strength Single Spot Lbs.
	Peak Amperes	Time in Millisec. (1)				Welding Pressure Lbs.	Forging Pressure		Paint Removal and De-grease	Removing Oxide		
		To Peak	Total	Upper	Lower		Max. Value Lbs.	Time from Peak Current Millisec. To Start To Max.				
Lap Joints 0.040"	41,800	18.5	67.5	4"R Dome	4"R Dome	1600	2400	9	22	Navy Spec. C-67-6	R. P.I. Sol.#10	602
Lap Joints and Unstressed Attachments 0.032"	21,600	17	66.3	2½"R Dome	2½"R Dome	600	1800	17	37.4	Navy Spec. C-67-6	R.P.I. Sol.#10	347
Lap Joints and Unstressed Attachments 0.025"	38,700	7	53	4"R Dome	4"R Dome	600	1800	0	11	Navy Spec. C-67-6	R.P.I. Sol.#10	328
Unstressed Attachments 0.040"	25,500	16.2	71.3	2½"R Dome	2½"R Dome	600	1800	16.2	32.4	Navy Spec. C-67-6	R.P.I. Sol.#10	470

(1) Total time from start of welding current until decay to 10%.

(2) Condenser Discharge type of welding.

TABLE 3. STATIC TESTS ON LAP JOINT SAMPLES

Sample No.	Thickness of Sheet	No. Spots	Spot Spacing	Rupture Load (Lbs.)	Rupture Load (Lbs./Spot)
1A-26	.025"	4	$1\frac{1}{4}$ "	1332	333
1A-30	.025"	4	$1\frac{1}{4}$ "	1352	338
1A-21	.025"	6	$3/4$ "	1908	318
1A-22	.025"	6	$3/4$ "	1848	308
2GI33	.032"	4	$1\frac{1}{4}$ "	1240	310
2GI31	.032"	4	$1\frac{1}{4}$ "	1260	315
2N33	.032"	6	$3/4$ "	1920	320
2N31	.032"	6	$3/4$ "	1980	330
5A1	.040"	4	$1\frac{1}{4}$ "	2400	600
3A9	.040"	4	$1\frac{1}{4}$ "	2460	615
3A27	.040"	6	$3/4$ "	3540	590
3A30	.040"	6	$3/4$ "	3590	598

Note: In all cases, failure was by shear through spot.

TABLE 4. FATIGUE DATA ON LAP JOINTS OF 0.025" ALCLAD 24 S-T WITH 4 SPOTWELDS SPACED 1 1/4" APART

Sample No.	Total Max. Load Lbs.	Max. Load Lbs./Spot	Ratio		Cycles to First Observ- ed Cracking	Cycles To Failure	Type of Break
			Min.Stress	Max.Stress			
1A7	400	100	.25		2,317,500	2,372,600	Pulled buttons & fatigue crack.
1B13	440	110	.25			1,017,500	" " " " "
1A9	500	125	.25			90,100	" " " " "
1A5	500	125	.25		197,800	695,800	" " " " "
1A33	600	150	.25		67,000	78,100	Fatigue crack.
1A2	600	150	.25			521,800	" "
1A18	660	165	.25			34,200	Pulled buttons, also sheared.
1A3	720	180	.25			13,100	Pulled buttons.
1A4	880	220	.25			6,300	
1A1	1000	250	.25			3,700	Shear.
1A24	220	55	.50			58,000	Did not fail.
Reloaded	880	220	.50			4,300	Pulled buttons.
1A17	340	85	.50		3,734,300	5,930,400	Fatigue cracks.
1A22	400	100	.50		5,687,800	8,300,300	Fatigue cracks & pulled buttons.
1AE19	440	110	.50		629,800	927,100	Fatigue cracks chiefly, also pulled buttons.
1A6	500	250	.50			12,800	Pulled buttons mostly, some shear.
1B14	520	130	.50		1,651,700	2,992,600	Pulled buttons, also fatigue crack.
1A16	600	150	.50			70,600	Pulled buttons.
1A23	720	180	.50			25,700	" "
1B15	740	185	.50		79,100	95,000	Fatigue cracks & pulled buttons.
1A29	480	120	.75			>10,759,800	Did not fail.
Reloaded	1040	260	.75			700	Pulled buttons.
1A28	600	150	.75			756,300	Fatigue cracks indication of pulling buttons.
1AE11	740	185	.75		413,500	820,800	Fatigue crack and pulling buttons.
1AE21	800	200	.75		140,900	222,500	Pulling buttons & fatigue cracks.
1AE10	1040	260	.75			73,700	Fatigue cracks.

4-64

TABLE 5. FATIGUE DATA ON LAP JOINTS OF 0.025" ALCLAD 24 S-T WITH 6 SPOTWELDS SPACED 3/4" APART

Sample Number	Total Max. Load Lbs.	Max. Load Lbs./Spot	Ratio		Cycles to First Observed Cracking	Cycles to Failure	Type of Break
			Min.Stress	Max.Stress			
1A-18	.444	74	.25			>9,010,900	Pulled buttons during reloading.
1AD-6	510	85	.25	1,000,000		2,530,900	Fatigue cracks.
1AD-4	570	95	.25	1,000,000		1,318,500	" "
1AC-3	660	110	.25	351,000		467,700	" "
1A-31	750	125	.25	223,000		485,000	Chiefly fatigue cracks.
1A-10	810	135	.25	---		182,900	" " " of buttons.
1AC-2	840	140	.25	---		108,600	Chiefly fatigue cracks, some pulling/
1C -8	960	160	.25	16,100		35,200	Pulled buttons.
1A-32	1020	170	.25	---		23,200	" "
1A-25	1140	190	.25	---		8,100	
1A-30	1200	200	.25	---		500	Shear.
1A -5	510	85	.50	7,227,600		8,553,100	Fatigue crack.
1CD-9	570	95	.50			2,640,900	" "
1CD-7	690	115	.50	280,000		683,000	" "
1A-19	690	115	.50	290,000		594,300	" "
1A-23	780	130	.50	340,000		770,300	" "
1A-26	900	150	.50			135,000	Between pulling buttons & fatigue crack.
1A-12	960	160	.50			44,300	Buttons pulled.
1A-28	1020	170	.50			16,700	" "
1A-24	1020	170	.50			16,200	" "
1A-17	1080	180	.50			39,700	" "
1A-13	810	135	.75	7,600,000		>11,771,400	Failed during reloading.
1A-15	960	160	.75	623,700		1,068,000	Fatigue crack.
1A-14	960	160	.75	348,200		483,100	" "
1A-16	1050	175	.75			290,800	" "
1A-11	1200	200	.75			166,500	" "

TABLE 6. FATIGUE DATA ON LAP JOINTS OF 0.032" ALCLAD 24 S-T WITH 4 SPOTWELDS SPACED 1 1/4" APART

42

Sample Number	Total Max. Load Lbs.	Max. Load Lbs./Spot	Ratio		Cycles to First Observed Cracking.	Cycles to Failure	Type of Break
			Min. Stress	Max. Stress			
2E1	460	115	.25		5,442,900	6,621,200	Fatigue crack.
2H22	500	125	.25		338,300	1,295,500	" "
2HI30	520	130	.25		266,000	863,400	" "
2H23	560	140	.25		599,200	1,119,300	" "
2F17	640	160	.25		210,000	227,500	Fatigue crack (shear failure?)
2G15	700	175	.25		67,000	69,500	Shear.
2G1-32	760	190	.25		----	46,600	Shear and pulling buttons.
2EF7	840	210	.25			3,800	Shear.
2E5	880	220	.25			2,800	Shear.
2E6	920	230	.25			6,750	Shear.
2EF8	1000	250	.25			1,250	Shear.
2HI26	1040	260	.25			1,100	Shear.
2H24	520	130	.50		1,838,600	3,171,100	Fatigue cracks.
2HI27	600	150	.50		427,000	886,400	Fatigue cracks.
2E3	640	160	.50		678,900	1,193,500	" "
2G14	720	180	.50		177,000	326,200	Fatigue cracks and pulling buttons.
2EG20	800	200	.50		52,400	71,500	Pulled buttons.
2E2	840	210	.50		----	22,500	" "
2F18	880	220	.50			27,400	Fatigue cracks.
2HI29	900	225	.50		----	26,800	Pulled buttons.
2EF9	960	240	.50			28,200	" "
2EF12	1080	270	.50			4,500	Shear.
2EG21	600	150	.75			>10,275,200	Did not fail.
Reloaded	800	200	.75			57,600	Fatigue cracks.
2F16	680	170	.75		1,126,000	1,959,600	" "
2EF10	800	200	.75		125,000	549,500	" "
2E4	900	225	.75		141,800	174,400	" "
2HI28	1000	250	.75		142,700	338,200	" "
2HI25	1040	260	.75			119,900	Pulled buttons.
2EG19	1080	270	.75			168,000	" "

NACA

W-64

TABLE 7. FATIGUE DATA ON LAP JOINTS OF 0.032" ALCLAD 24S-T WITH 6 SPOTWELDS SPACED 3/4" APART

Sample Number	Total Max. Load Lbs.	Max. Load Lbs./Spct	Ratio		Cycles to First Observed Cracking.	Cycles to Failure	Type of Break
			Min. Stress	Max. Stress			
2LN21	540	90	.25			>10,642,300	Did not fail.
Reload	840	140	.25			768,200	Fatigue crack.
2JL9	570	95	.25		732,800	1,503,400	Fatigue crack.
2KL5	690	115	.25		854,000	1,089,000	Fatigue crack.
2JK17	750	125	.25		350,300	776,000	Fatigue crack.
2MN29	810	135	.25		225,000	439,000	Fatigue crack.
2GI2	930	155	.25		293,100	296,200	Fatigue crack.
2N32	1050	175	.25		75,100	119,800	Fatigue and pulled buttons.
2LN20	1200	200	.25		----	9,700	Shear
2M26	1320	220	.25		----	9,900	Pulled buttons.
2LN19	690	115	.50			>10,596,000	Did not fail.
Reload	960	160	.50		847,700	896,300	
2M25	750	125	.50		558,800	1,000,500	Fatigue crack.
2Jk15	810	135	.50		301,100	735,700	" "
2JL8	930	155	.50		29,300	346,300	" "
2JK14	1050	175	.50		93,000	221,900	Pulled button, fatigue.
2G11	1110	185	.50		79,300	150,300	Fatigue crack.
2LM23	1200	200	.50			22,800	Pulled button, shear.
2JK11	1260	210	.50		70,000	113,500	Pulled buttons.
2JK16	1380	230	.50			34,350	Fatigue cracks.
2LN28	780	130	.75		2,208,900	7,043,800	Fatigue crack.
2MN30	900	150	.75		1,571,600	3,222,500	" "
2JK10	1050	175	.75		622,800	1,441,400	" "
2JK18	1200	200	.75		226,400	618,100	" "
2LM24	1380	230	.75		116,800	150,000	" "
2M27	1560	260	.75			47,200	Pulled buttons and shear.

TABLE 8. FATIGUE DATA ON LAP JOINTS OF 0.040" ALCLAD 24 S-T WITH 4 SPOTWELDS SPACED $1\frac{1}{4}$ " APART

Sample Number	Total Max. Load Lbs.	Max. Load Lbs./Spot	Ratio	Cycles to First Observed Cracking	Cycles to Failure	Type of Break
			Min. Stress Max. Stress			
3A25	600	150	0.25		>5,942,100	Did not fail.
3A25(Reload)	1200	300	0.25		113,000	Fatigue crack.
3A23	700	175	0.25		1,309,200	Fatigue crack.
3A19	800	200	0.25	420,000	779,600	" "
3A33	880	220	0.25	454,200	539,200	" "
3A29	1000	250	0.25	189,750	346,800	" "
3A31	1040	260	0.25	100,000	291,400	" "
3A14	1200	300	0.25		25,200	Shear.
3A13	1500	375	0.25		3,600	"
3A15	1620	405	0.25		1,000	"
3A26	700	175	0.50		>15,320,000	Did not fail.
3A26(Reload)	1200	300	0.50	66,400	183,600	Fatigue crack.
3A21	800	200	0.50	515,500	1,964,500	" "
3A32	880	220	0.50	331,600	1,109,000	" "
3A27	900	225	0.50	279,800	897,000	" "
3A20	1000	250	0.50	152,100	1,053,000	" "
3A17	1200	300	0.50	73,300	196,500	" "
3A18	1400	350	0.50	60,000	72,200	" "
3A22	1600	400	0.50		8,000	" "
3A28	800	200	0.75	2,188,000	6,784,600	Fatigue crack.
3A11	950	237	0.75	1,453,700	2,984,600	" "
3A10	1000	250	0.75		2,373,700	" "
3A24	1000	250	0.75		>3,200,000	Did not fail.
3A24(Reload)	1600	400	0.75	200,000	1,380,000	Fatigue crack.
3A8	1100	275	0.75	489,000	842,300	" "
3A7	1200	300	0.75	1,152,300*	1,761,600	" "
3A5	1400	350	0.75	684,300	936,000	" "
3A2	1600	400	0.75		533,300	" "
3A4	2000	500	0.75	220,000	277,000	" "
3A6	2200	550	0.75		41,200	" "

TABLE 9. FATIGUE DATA ON LAP JOINT OF 0.040" ALCLAD 24 S-T WITH 6 SPOTWELDS SPACED 3/4" APART

Sample Number	Total Max. Load Lbs.	Max. Load Lbs./Spot	Ratio		Cycles to First Observed Cracking.	Cycles to Failure	Type of Break
			Min. Stress	Max. Stress			
3A25	690	115	0.25			>10,753,000	Did not fail
Reloaded	1800	300	0.25			11,100	Pulled buttons.
3AB7	720	120	0.25			2,124,000	Fatigue cracks.
3A24	775	129	0.25			2,973,500	" "
3A23	900	150	0.25	135,900		257,400	" "
3A22	900	150	0.25			638,000	" "
3A2	1050	175	0.25			176,400	" "
3A29	1050	175	0.25			261,000	" "
3A3	1200	200	0.25	129,300		216,000	" "
3AB8	1320	220	0.25	98,500		153,900	" "
3A1	1500	250	0.25	94,200		126,000	" "
3AB10	1560	260	0.25	76,000		104,600	" "
3A5	1800	300	0.25			16,600	Pulled buttons.
3A4	2100	350	0.25			3,400	Shear.
3AB11	900	150	0.50			5,127,000	Shear.
3AB12	1050	175	0.50			1,039,400	Fatigue cracks.
3AB33	1350	225	0.50	174,700		223,400	" "
3A31	1650	275	0.50			31,200	Pulled buttons.
3A32	1650	275	0.50			87,000	Fatigue cracks and pulled buttons.
3A26	1800	300	0.50			68,000	Fatigue crack.
3A28	2100	350	0.50			31,700	" "
3AB9	2400	400	0.50			7,100	Shear.
3A18	1200	200	0.75			10,517,600	Fatigue cracks.
3A21	1350	225	0.75			2,950,000	" "
3A16	1500	250	0.75			490,000	" "
3A20	1650	275	0.75			1,000,400	" "
3A15	1800	300	0.75	318,000		593,000	" "
3A13	2100	350	0.75			387,400	" "
3A8	2400	400	0.75			143,000	Shear.
3A14	2700	450	0.75			205,800	Fatigue cracks.
3A17	3000	500	0.75	88,000		107,600	Shear
3A19	3300	550	0.75			4,100	"

NACA

TABLE 10. EXTRAPOLATED VALUES OF REVERSED STRESS FOR 0.032" ALCLAD 24 S-T

Weld Spacing Inches	Reversed Stress (Lbs./Spot) at Varied Lifetimes						Static Ultimate (Lbs./Spot)
	50,000 Cycles		500,000 Cycles		5,000,000 Cycles		
	Stress	R.***	Stress	R.	Stress	R.	
1 1/4*	106	0.340	70	0.224	59	0.189	312
3/4*	108	0.332	68	0.209	43	0.132	325
Single Spot Reversed Stress**	70	0.184	40	0.105	30	0.079	381

* Values reversed stresses extrapolated (see Figure 11).

** From tests by Hartman and Stickley (see Reference 2).

*** $R = \frac{\text{stress given lifetime}}{\text{static ultimate}}$

TABLE 11. RELATIONS BETWEEN WELD DIMENSIONS AND FATIGUE DATA FOR 0.032" - 0.025" GAGE MATERIAL

Sample Number	Average Length of Spot (Axis in Direction of Testing)	Width of Spot (Axis Normal to Direction of Testing)	Average Penetration of Spot		Maximum Load/Spot	Ratio	Cycles	Location of Point on SN Curve	Spot Spacing	Gage
			%	"						
1A-7 (4)	0.145"	0.140"	44%	.022"	100#	0.25	2,372,600	On curve.	1 1/4"	0.025"
1A-4(4)	0.150"	0.140"	44%	.022"	220#	0.25	6,300	On curve.	1 1/4"	0.025"
1AD6(6)	0.157"	0.141"	36%	.018"	85#	0.25	2,530,900	On curve.	3/4"	0.025"
1A-25 (6)	0.145"	0.136"	40%	.020"	190#	0.25	8,100	On curve	3/4"	0.025"
2H-23(4)	0.134"	0.128"	55%	.035"	140#	0.25	1,119,300	On curve	1 1/4"	0.032"
2E5(4)	0.122"	0.123"	50%	.032"	220#	0.25	2,800	Below curve.	1 1/4"	0.032"
2KL-5(6)	0.129"	0.122"	48%	.031"	115#	0.25	1,089,000	On curve.	3/4"	0.032"
2LN-19(6) Reload	0.131"	0.134"	53%	.034"	115# 160#	0.50 0.50	10,596,000+ 896,300	High	3/4"	0.032"
1A-31(6)	0.144"	0.181"	45%	.023"	125#	0.25	485,500	High	3/4"	0.025"
1A-2(4)	0.150"	0.139"	58%	.029"	150#	0.25	550,000	High	1 1/4"	0.025"

TABLE 12. SUMMARY OF RESULTS OF TESTS ON 24S-T ALCLAD
USED FOR COMPRESSION SAMPLES*

Thickness of Sheet	Tensile Strength (psi)	Tensile Yield Strength (Offset 0.2%) (psi)	Elongation (in 2 in.) %	Compression Yield Strength (Offset 0.2%) (psi)
.025"	Min. 65,300	51,400	17.5	44,000**
	Max. 67,300	50,000	18.0	
	Ave. 66,500	51,233	17.7	
.032"	Min. 66,800	49,700	19.0	42,000**
	Max. 68,400	51,900	17.0	
	Ave. 67,510	50,600	18.3	
.040"	68,900	51,300	17.0	44,900

* Tests were made at Aluminum Company Laboratories. A complete copy of their report is given in the appendix. The values quoted above were selected from data on test coupons from the particular sheets used in making compression samples.

**Compression yield strength is result for 1 sample.

N-64

TABLE 13. WELDING CONDITIONS FOR STIFFENED PANEL SAMPLES

Gauge ⁴ Inches	Secondary Current ³			Electrode Tips		Electrode Pressure				Surface Treatment		Shear Strength Single-Spot Specimen Lbs.
	Peak Value Amps.	Time in Milli-Sec.				Welding Pressure Lbs.	Forging Pressure		Paint Removing and Degreasing	Removing Oxide		
		To Peak	Time ¹	Max. Value Lbs.	Time for Peak Current In Milli-seconds		To Start	To Max.				
0.032Sr	30,400	16	62	2½" R	¼" x 10°	800	2400	12	110	Acetone & Trichlor Ethylene Vapor	R.P.I. Solution No. 4	460
0.032p1				Dome	Flat							
0.032Sr 0.051p1	32,400	16	62	2½" R Dome	¼" x 10° Flat	800	2400	12	110	"	"	505
0.032Sr(2)	37,200	17	61	2½" R	5/16" x 10°	800	2400	8	49	Navy Spec. C-67-C	R.P.I. Solution No. 10	492
0.040p1				Dome	Flat							
0.032Sr 0.025p1	24,600	18.6	69.0	2½" R Dome	5/16" x 10° Flat	600	1800	0	39	"	"	410

1. Total time from start of welding current until decay to 10%.
2. 1 cracked weld others sound.
3. Condenser discharge type of welder.
4. Sr - stringer
p1 - panel

TABLE 14. STATIC COMPRESSION TESTS ON STIFFENED PANELS

Panel Thickness (Inches)	Weld Spacing (Inches)	Area A (sq.in.)	4 W (Inches)	Area A ¹ (sq.in.)	Average Buckling Load P (Lbs.)	Average Buckling Stress P./A.	Crippling Load P ₂ (Lbs.)	Crippling Stress P ₂ /A	Crippling Stress P ₂ /A ¹
Stiffener Alone	--	.162	--	--	--	--	5,680	34,400	--
0.025	.75	.275	1.436	.198	1,750	6,360	8,400	30,500	42,300
0.025	1.25	.275	1.436	.198	1,750	6,360	7,950	28,900	40,100
0.032	.75	.306	1.84	.221	2,950	9,630	9,020	29,500	40,800
0.032	1.25	.306	1.84	.221	2,950	9,630	8,300	27,100	37,600
0.040	.75	.342	2.30	.254	3,900	11,400	10,445	30,500	41,100
0.040	1.25	.342	2.30	.254	3,900	11,400	8,640	25,200	34,000
0.051	.75	.391	2.92	.311	4,600	11,800	11,160	28,500	35,900
0.051	1.25	.391	2.92	.311	4,600	11,800	9,520	24,400	30,600

TABLE 15. COMPRESSION FATIGUE RESULTS ON 0.025" ALCLAD 24ST STIFFENED PANELS

$$\text{Ratio } \frac{\text{min. stress}}{\text{max. stress}} = .25$$

Sample	Max.Load(Lbs.)	Spot Spacing	Cycles to failure	Type of break
L6	2500	1 1/4"	6,602,600	Failed - welds pulled
L9	2700	1 1/4"	1,524,600	" 1 weld pulled loose
L8	2800	1 1/4"	210,000	" 1 weld popped, 1 cracked
L3	3100	1 1/4"	598,100	Failed
L5	3300	1 1/4"	100,700	" 1 weld pulled
L2	3500	1 1/4"	6,500	" 1 weld pulled
L7	4000	1 1/4"	100	" 3 welds separated
K5	2500	3/4"	2,742,200	Failed - 1 weld pulled
K7	3200	3/4"	847,000	" Welds pulled
K1	3600	3/4"	714,800	" Welds pulled
*K3	4000	3/4"	7,000	" While adjusting cut-off 1 weld, possibly not sound, pulled
K8	4500	3/4"	302,200	Failed - 1 weld popped
K9	5100	3/4"	11,400	" 1 weld, possibly not good, pulled
K10	5600	3/4"	4,600	Failed - 2 welds

* For K-3 the ratio, owing to an error, was 0.394 instead of 0.250.

TABLE 16. COMPRESSION FATIGUE RESULTS ON 0.032"
24S-T ALCLAD STIFFENED PANELS

Sample Number	Max. Load Lbs.	Cycles to Failure	Ratio		Spot Spacing Inches	Remarks
			Min.Load	Max.Load		
A6	7218	63,600	.25		3/4	
A10	6498	144,000	.25		"	
A3	6000	167,900	.25		"	
A5	5496	252,900	.25		"	
A2	4500	812,400	.25		"	
A7	3996	815,200	.25		"	
A8	3498	20,000,000	.25		"	Did not fail.
A8(reloaded)	3996	1,202,420	.25		"	
B9	5500	3,140	.25		1 1/4	
B5	5000	58,000	.25		"	
B10	4450	104,000	.25		"	
B2	4080	62,000	.25		"	
B6	3980	309,600	.25		"	
B1	3525	1,530,000	.25		"	
B7	3500	31,200	.25		"	
B8	3300	2,127,600	.25		"	
B4	2550	22,000,000	.25		"	Did not fail.
B4(reloaded)	3500	7,500,000	.25		"	

M-64

TABLE 17. COMPRESSION FATIGUE RESULTS ON 0.040" ALCLAD 24 S-T STIFFENED PANELS

Sample	Max. Load Lbs.	Spot Spacing	Ratio 0.25	Min. Stress	Type of Break	
				Max. Stress		
			Cycles to Failure			
G2	3400	3/4"	9,496,700		Did not fail Two welds popped.	
Reloaded	8000	3/4"	95,500			
G3	4700	3/4"	714,500		Failed through the one cracked weld in sample. 2 welds broke	
G8	5200	3/4"	682,100			
G9	5600	3/4"	455,300			
G5	6000	3/4"	213,700			
G1	6500	3/4"	294,400			
G10	8500	3/4"	58,000			
G6	9200	3/4"	34,400			
H8	3200	1 1/4"	>10,179,900			Weld pulled
Reloaded	6000	1 1/4"	78,500			Did not fail
H1	3600	1 1/4"	7,539,700			Two welds popped.
H5	4000	1 1/4"	1,156,000		Failed in center welds.	
H9	4500	1 1/4"	524,000		Weld pulled.	
H2	5000	1 1/4"	61,900		" "	
H3	5600	1 1/4"	200,000		" "	
H7	6200	1 1/4"	34,800		" "	

TABLE 18. COMPRESSION FATIGUE RESULTS ON 0.051"
24S-T ALCLAD STIFFENED PANELS

Sample Number	Max. Load Lbs.	Cycles to Failure	Ratio		Spot Spacing Inches
			Min. Load	Max. Load	
C9	9350	11,700	.175		3/4
C3	8500	169,800	.25		"
C4	8275	220,000	.170		"
C2	7626	263,700	.173		"
C6	7600	217,000	.164		"
C10	6900	165,000	.162		"
C5	6750	1,500,000	.250		"
C7	6500	4,000,000 (did not fail)	.200		"
D7	7250	900	.25		1 1/4
D2	7000	66,000	.25		"
D1	7000	66,800	.25		"
D8	6500	290,000	.25		"
D4	6500	42,600	.25		"
D3	6500	22,000	.25		"
D6	6250	638,000	.25		"
D9	6000	10,558,600	.25		"

NACA

TABLE 19. SUMMARY OF RESULTS OF TESTS ON 24S-T ALCLAD
USED FOR UNSTRESSED ATTACHMENT SAMPLES*

Thickness of Sheet	Tensile Strength (psi)	Tensile Yield Strength (Offset 0.2%) (psi)	Elongation (in 2 in.) %	Compression Yield Strength (Offset 0.2%) (psi)
.025"	Min. 65,300	50,000	17.5	44,000**
	Max. 67,400	53,100	18.0	
	Ave. 66,840	51,620	17.6	
.032"	Min. 65,500	49,700	16.0	42,000**
	Max. 68,400	51,900	20.0	
	Ave. 67,170	50,750	18.4	
.040"	Min. 67,000	51,300	16.5	44,900**
	Max. 68,900	53,900	17.0	
	Ave. 67,830	52,570	16.8	

* Tests were made at Aluminum Company Laboratories. A complete copy of their report is given in the appendix. The values quoted above were selected from data on test coupons from the particular sheets used in making unstressed attachment samples.

**Compression yield strength is result for 1 sample.

D-6-M

TABLE 20. STATIC TENSION TEST ON UNSTRESSED ATTACHMENTS

Sample	Number Welds	Gauge	Yield Load (Lbs)	Breaking Load (Lbs)	Yield (p.s.i.)	Ultimate p.s.i.	Elongation (%)
4A28	4	.025	3,800	4,660	50,700	62,100	7
4B30	4	.025	--	4,470	--	59,500	7
4G10	2	.025	3,800	4,310	50,700	57,300	5
5P22	2	.032	4,600	5,220	47,900	54,400	6
5J30	4	.032	4,500	5,210	46,800	56,600	5
6C27	2	.040	5,800	7,280	48,300	60,600	7
6B26	4	.040	6,175	7,000	51,500	58,400	5
All failed across the line of spotwelds.							

TABLE 21. TENSION FATIGUE TEST ON 24 S-T ALCLAD SHEET 3" x .025" UNSTRESSED ATTACHMENT, 2 SPOTWELDS 1 $\frac{1}{4}$ " SPACED. $R \frac{\text{Min.Stress}}{\text{Max.Stress}} = 0.25$

Sample	Max. Load Lbs.	Cycles to failure	Type of Break
4B13	1200	>10,604,500	Did not fail.
Reloaded	2500	123,600	Failed in sheet just below welds.
4C28	1600	370,005	Failed 2".
4C9	2200	219,800	Failed in fillet.
4B11	3000	41,300	Failed through line of welds.
4D22	3500	69,000	" " " " "
4C25	3700	4,700	Failed. One weld cracked.

TENSION FATIGUE TEST ON 24 S-T ALCLAD SHEET 3" x .025" UNSTRESSED ATTACHMENT, 4 SPOTWELDS 3/4" SPACED R = 0.25

4C4	1800	407,400	Failed in fillet.
4A19	2100	153,200	Cracked 1 $\frac{1}{2}$ " while load being pulled up.
4B12*	2400	142,300	Failed in fillet.
4C2 *	2600	79,300	Failed in bottom fillet.
4B24	2700	96,300	Failed on top radius.
4B26*	3200	57,800	Failed in welds.
4C1*	3600	16,900	Failed just below welds.
4B25*	4000	22,000	Failed at fillet edge.
4C3*	4100	12,700	Failed in weld.
4A21	1500	9,493,200	Did not fail
Reloaded	2400	53,400	Failed in fillet

* Unstressed attachment on these samples was .032".

W-64

TABLE 22. TENSION FATIGUE TEST ON 24 S-T ALCLAD SHEET 3" x .032" UNSTRESSED
ATTACHMENT R = .25 $\frac{\text{Min. Stress}}{\text{Max. Stress}}$

Sample	Max. Load Lbs.	Cycles to Failure	Type of Break.
2 spot welds $1\frac{1}{4}$ " spacings			
5P19	2000	520,300	Failed 1-5/8"
5K25	2400	300,100	Failed in fillet.
5M28	2800	213,900	Failed 1-3/4".
5O9	3300	62,500	Failed through welds.
5R31	4000	70,100	" " "
5N6	4600	39,900	" " "
5P18	5000	6,700	" " "
4 spot welds $3\frac{1}{4}$ " spacings			
5K27	1900	>9,787,600	
5J24	2000	2,032,900	Failed through welds.
5J23	2400	930,100	" " "
5J21	2600	317,700	Failed 2".
5I26	2600	295,600	Failed 1-3/4".
5K28	3000	369,300	Failed in fillet.
5K31	4000	65,000	Failed- 2 right welds on rear of sheet cracked.
5J29	4500	6,500	Failed in line of welds.

M-G-4

TABLE 23. TENSION FATIGUE TEST ON 24 S-T ALCLAD SHEET 3" x .040"
UNSTRESSED ATTACHMENT R $\frac{\text{Min. Stress}}{\text{Max. Stress}} = .25$

Sample	Max. Load Lbs.	Cycles to Failure	Type of Break
2 spotwelds $1\frac{1}{4}$ " spacings			
6A4	2300	3,096,500	Failed through welds.
6C32	2500	1,049,000	Failed 1-3/4".
6A3	4000	223,200	Failed $1\frac{1}{2}$ ".
6C28	5000	74,500	Failed. Crack in weld.
6B2	6000	5,800	Failed through weld.
4 spotwelds $3\frac{1}{4}$ " spacings			
6C27	2400	3,879,400	Failed through welds.
6B21	3000	620,850	Failed $1\frac{1}{2}$ ".
6C30	3800	143,800	Failed through welds.
6B25	4000	54,300	Failed across welds.
6B22	4200	203,500	Failed in fillet.
6C32	5000	32,900	Failed by shearing sheet through line of welds.
6C28	6000	48,700	Failed across welds.
6C31	6000	22,000	Failed through all welds.
6B23	6400	9,100	Failed through welds.

NACA

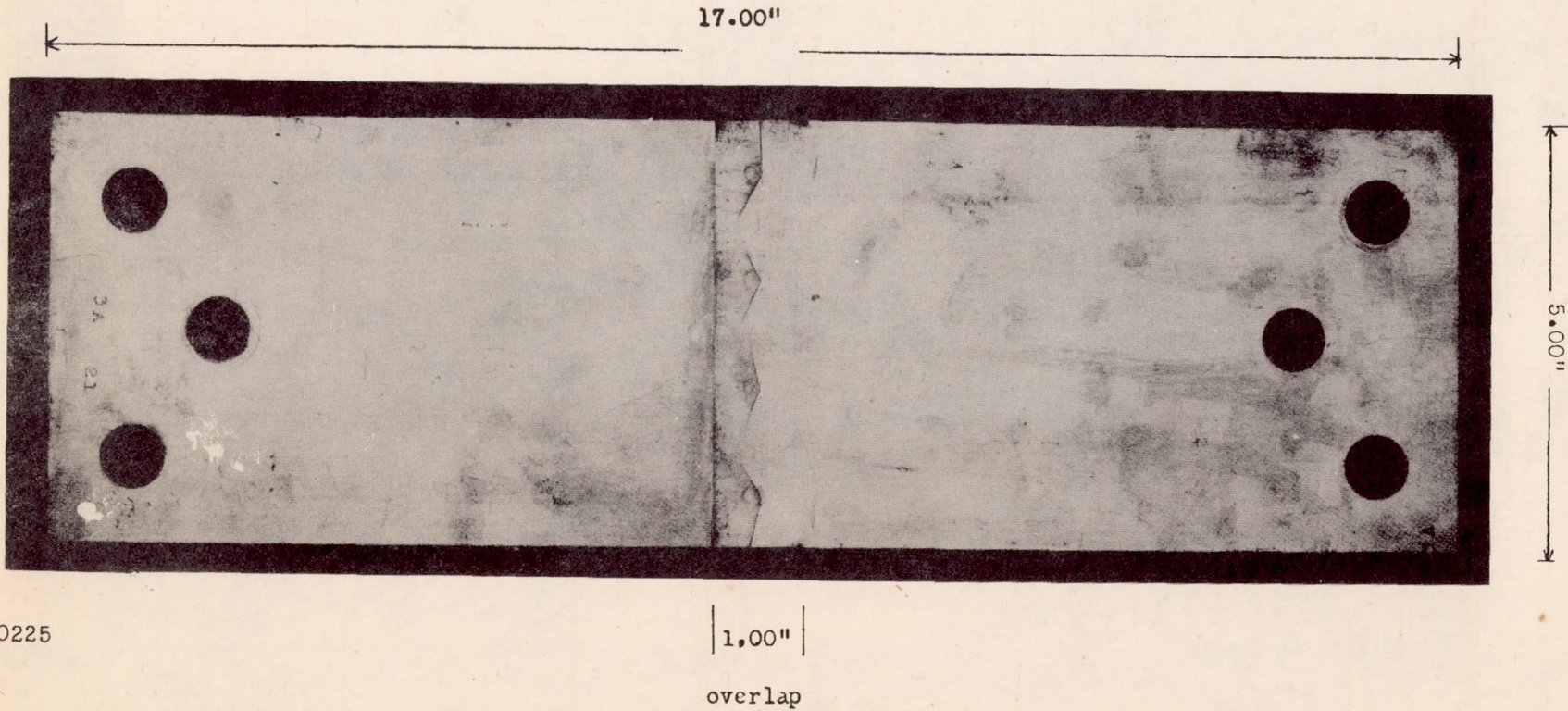

20225

Figure 1. Typical Lap Joint Tension Fatigue Sample
(Note failure by propagation of fatigue crack.)

Fig. 1

W-64

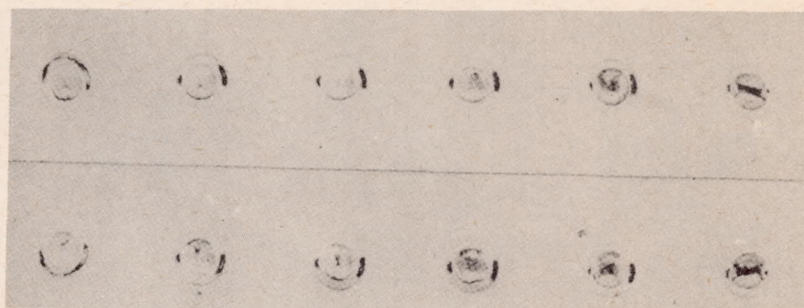

18074
1X

Figure 1A

Sample showing shear type failure through spots. Sample 3A - 4 (6).

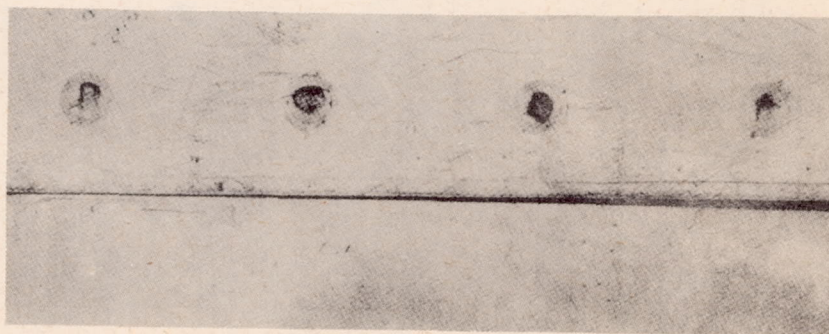

8070
1X

Figure 1B

Sample 3A - 14 (4) illustrating "button pulling" type of failure.

W-64

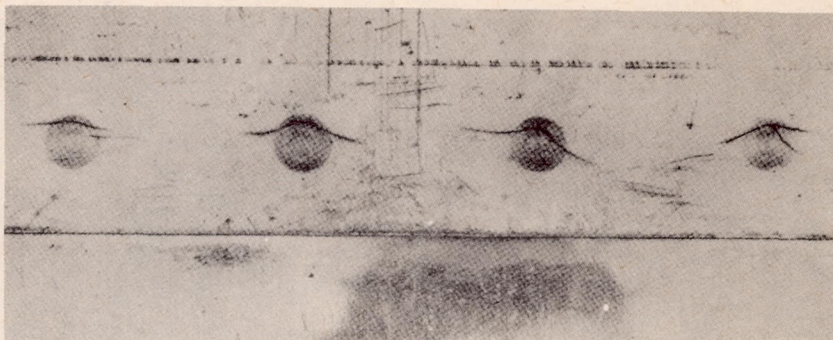

18071
1X

Figure 1C

Sample 3A - 29 (4) illustrating
beginning of fatigue cracks at top
of welds.

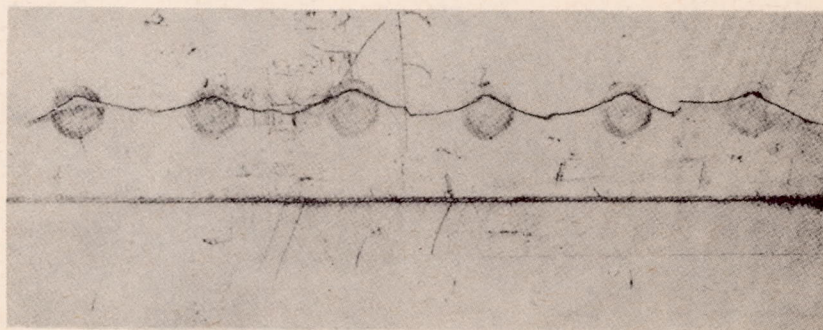

18072
1X

Figure 1D

Sample 3A - 29 (6) showing
propagation of fatigue cracks.

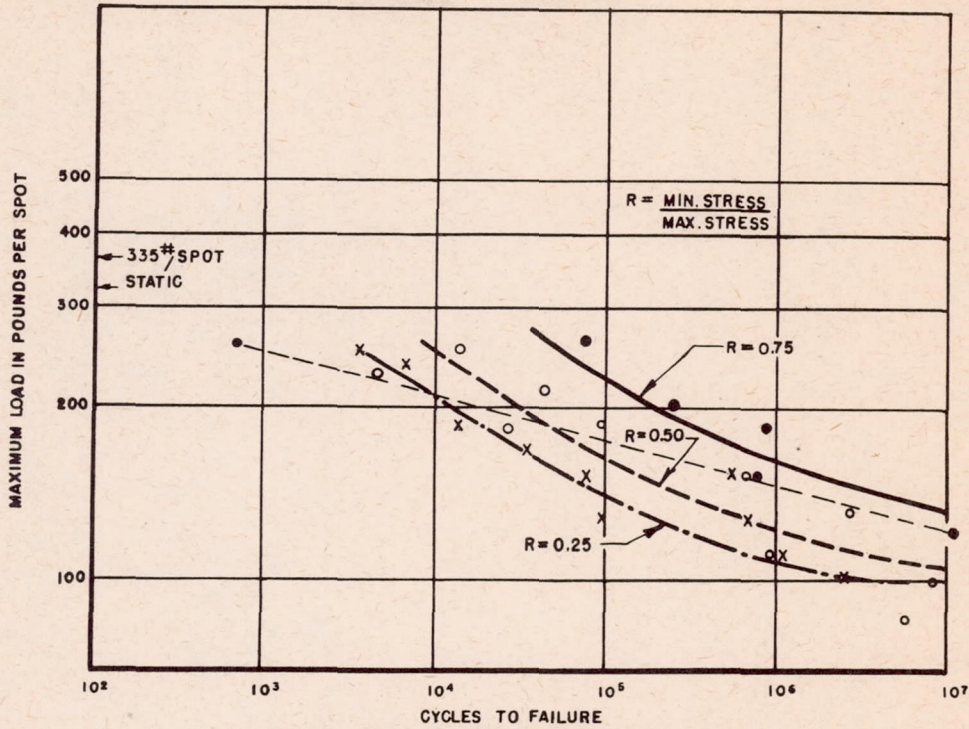

FIG. 2 FATIGUE CURVES FOR LAP JOINTS OF 0.025 ALCLAD 24 ST SHEET 4 SPOT WELDS $\frac{1}{4}$ " SPACED

20239

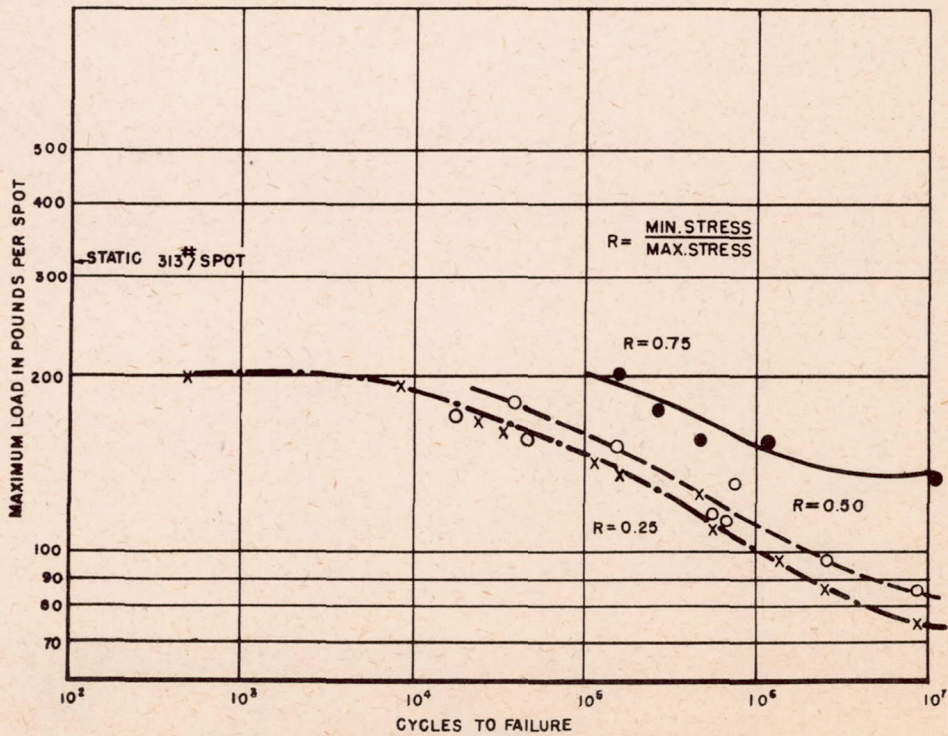

FIG. 3 FATIGUE CURVES FOR LAP JOINTS OF 0.025 ALCLAD 24 ST. SHEET 6 SPOT WELDS $\frac{3}{4}$ " SPACED

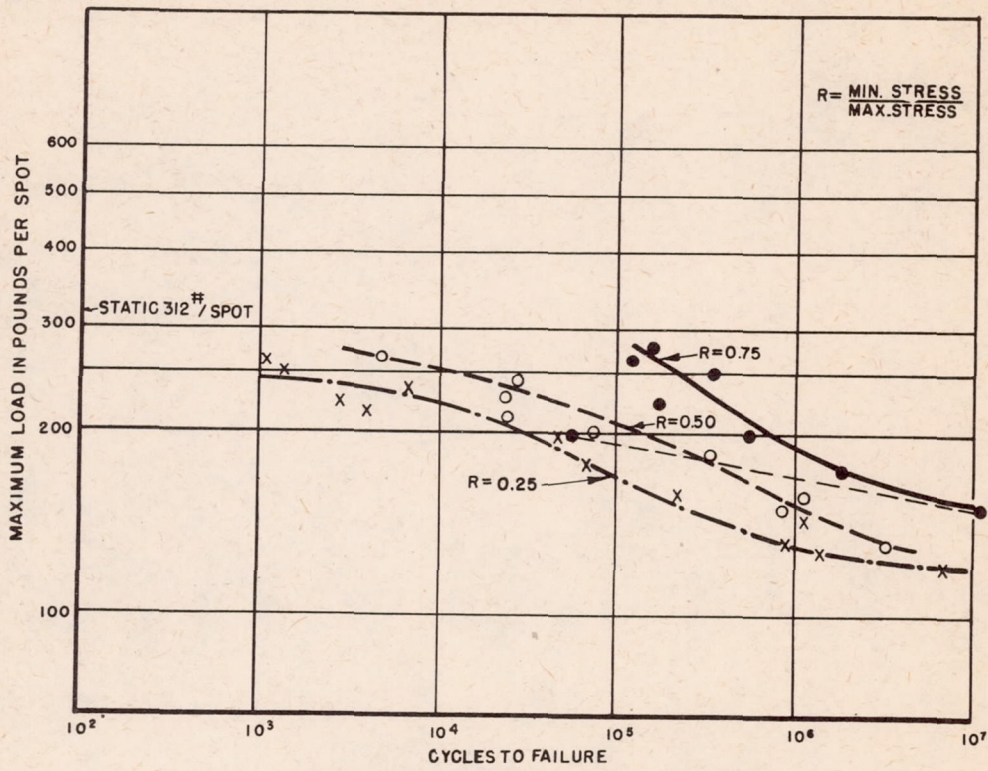

FIG. 4 FATIGUE CURVES FOR LAP JOINTS OF 0.032 ALCLAD 24 ST. SHEET 4 SPOT WELDS 1/4" SPACED

20241

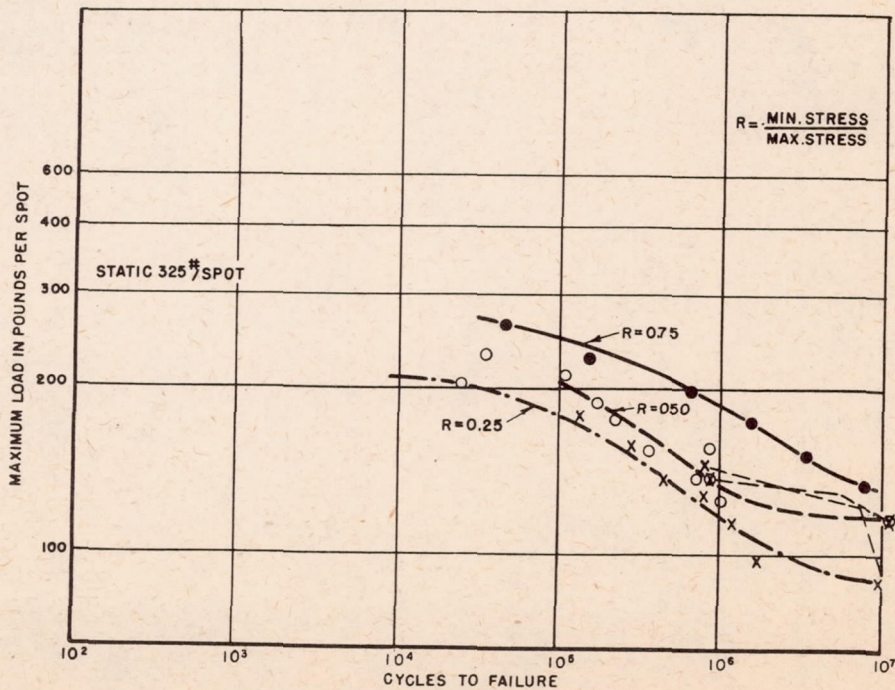

FIG. 5 FATIGUE CURVES FOR LAP JOINTS OF 0.032 ALCLAD 24 ST. SHEET 6 SPOT WELDS 3/4" SPACED

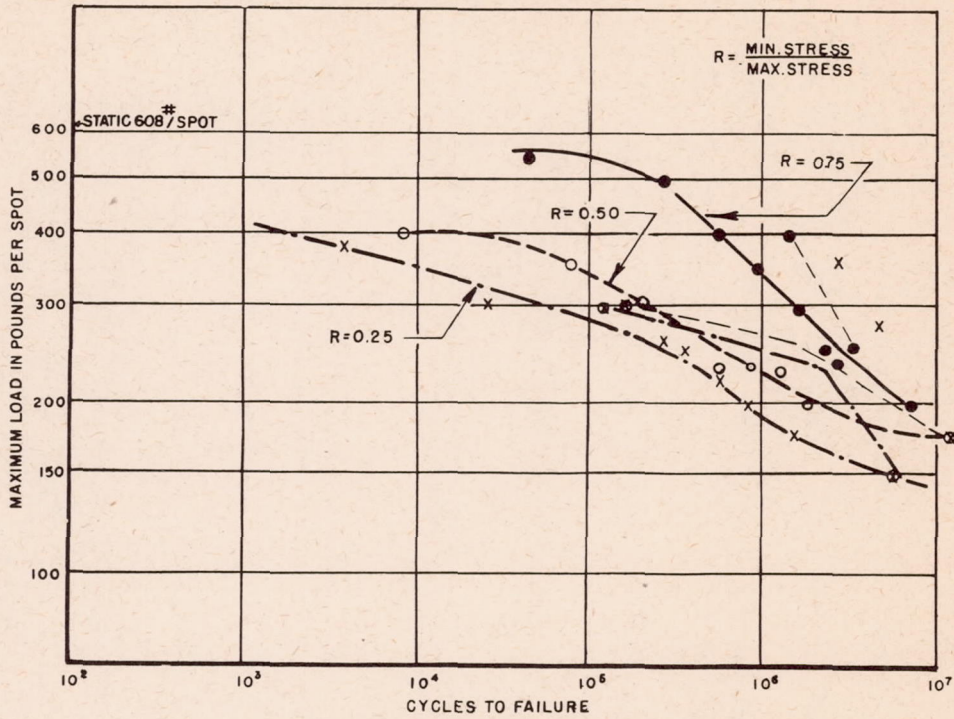

FIG. 6 FATIGUE CURVES FOR LAP JOINTS OF 0.040 ALCLAD 24 ST.
SHEET 4 SPOT WELD 1/4" SPACED 20243

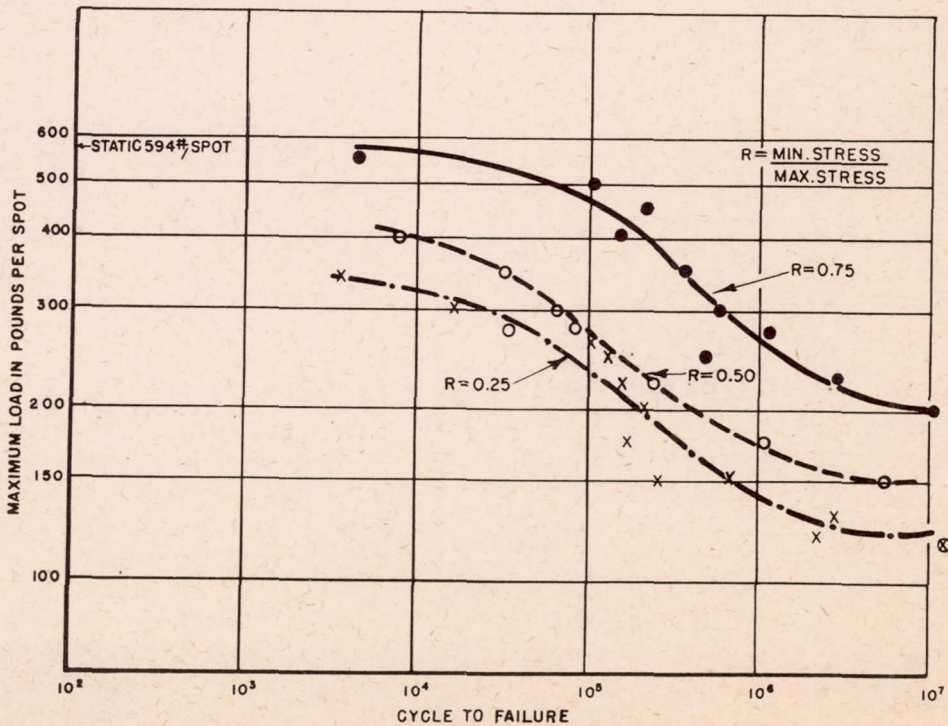

FIG. 7 FATIGUE CURVES FOR LAP JOINTS OF 0.040 ALCLAD 24 ST.
SHEET 6 SPOT WELDS 3/4" SPACED

W-64

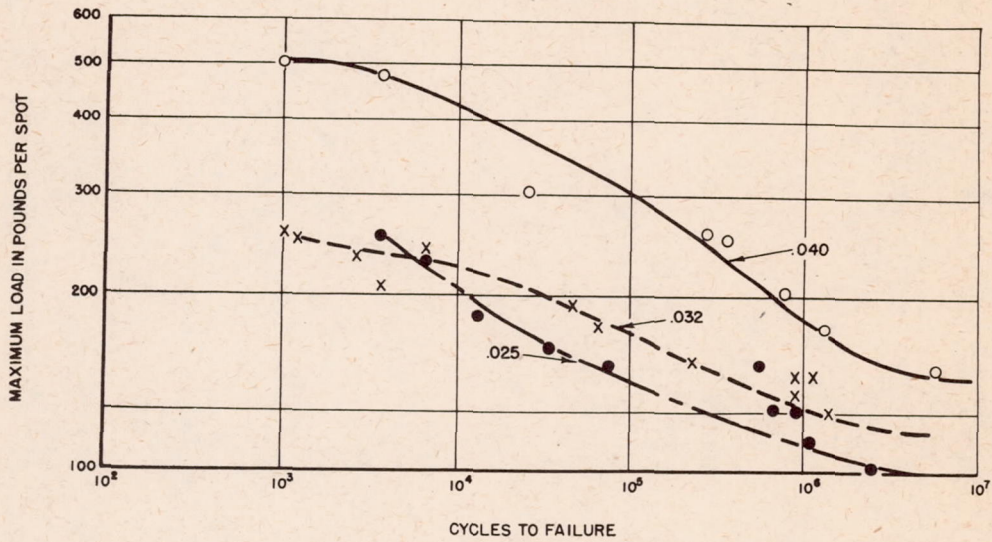

FIG. 8 - FATIGUE CURVES FOR LAP JOINTS OF ALCLAD 24 - ST. SHEET 4 SPOT WELDS 1 1/4" SPACED. RATIO .25.

20245

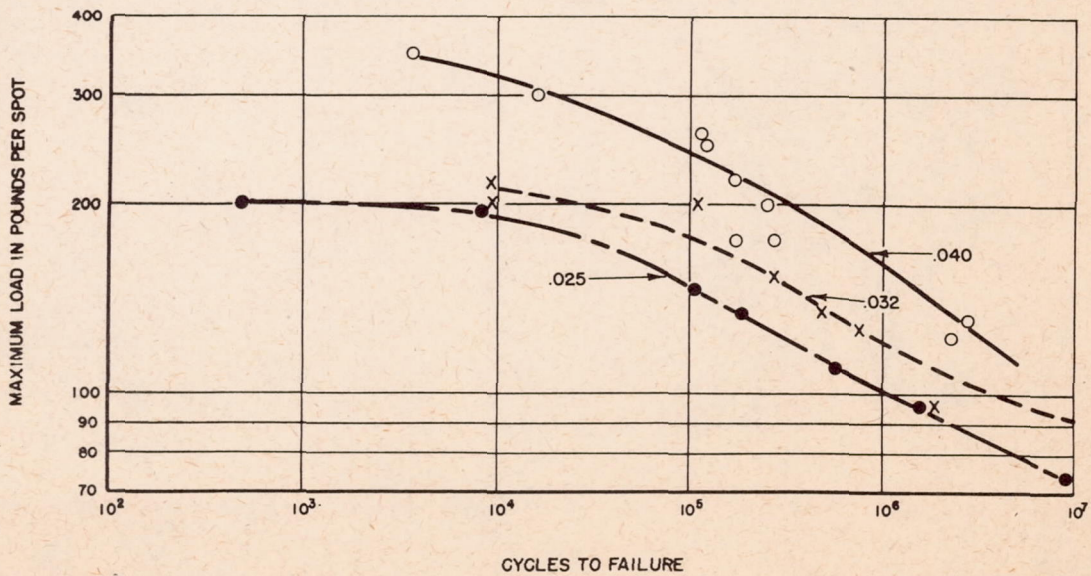

FIG. 9 - FATIGUE CURVES FOR LAP JOINTS OF ALCLAD 24 - ST. SHEET 6 SPOT WELDS 3/4" SPACED RATIO .25

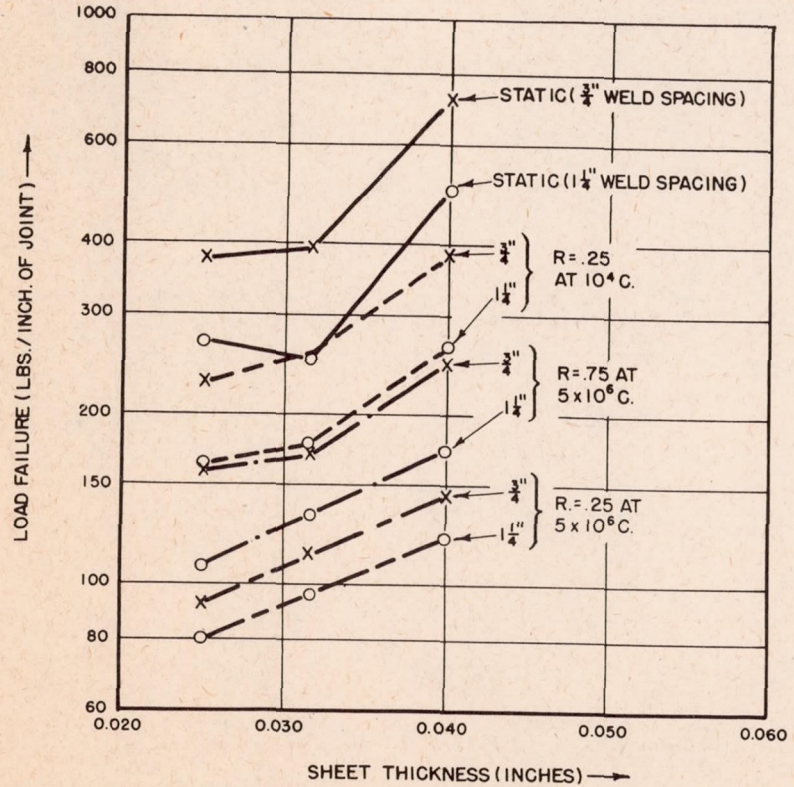

FIG. 10-EFFECT OF SHEET THICKNESS ON STRENGTH FOR SPOT-WELDED LAP JOINT SAMPLES.

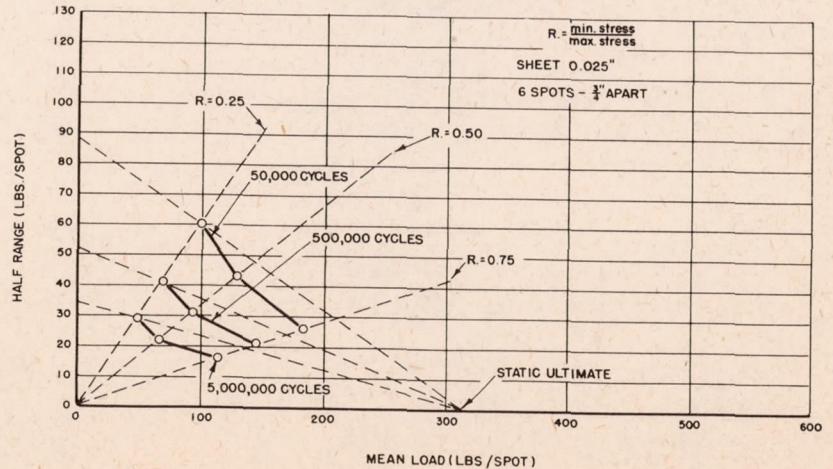
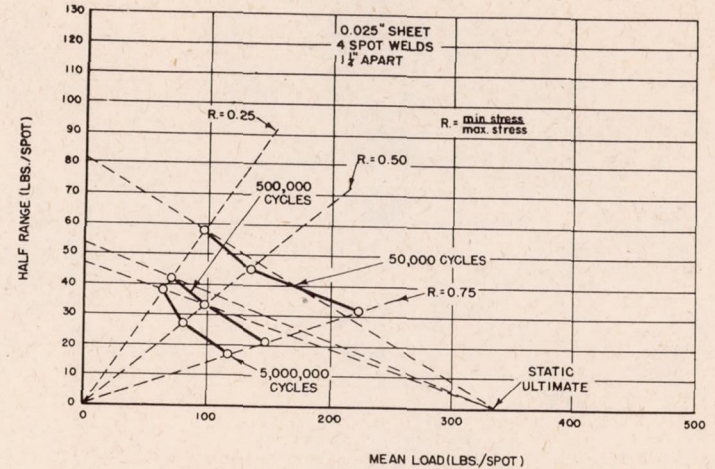

FIG. 11-EFFECT OF MEAN LOAD ON RANGE OF STRESS FOR SPOT WELDED LAP JOINTS OF 0.025" ALCLAD 24-ST

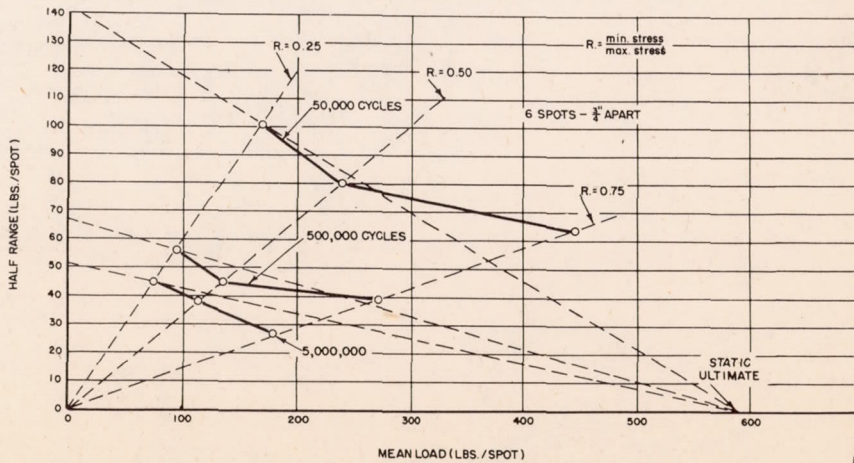
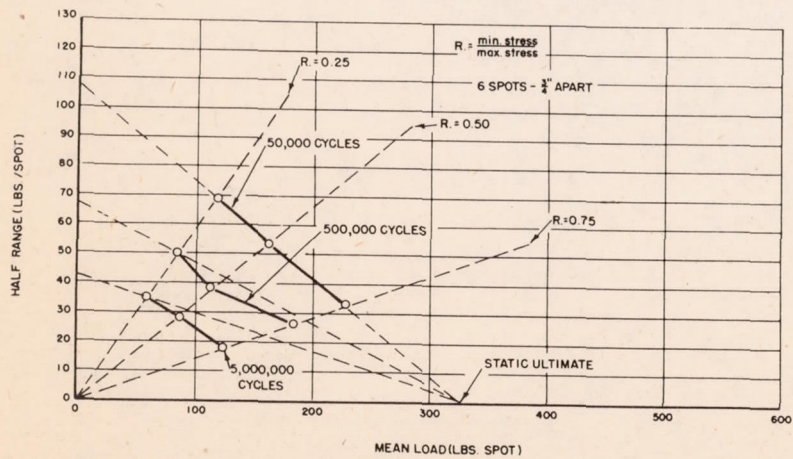
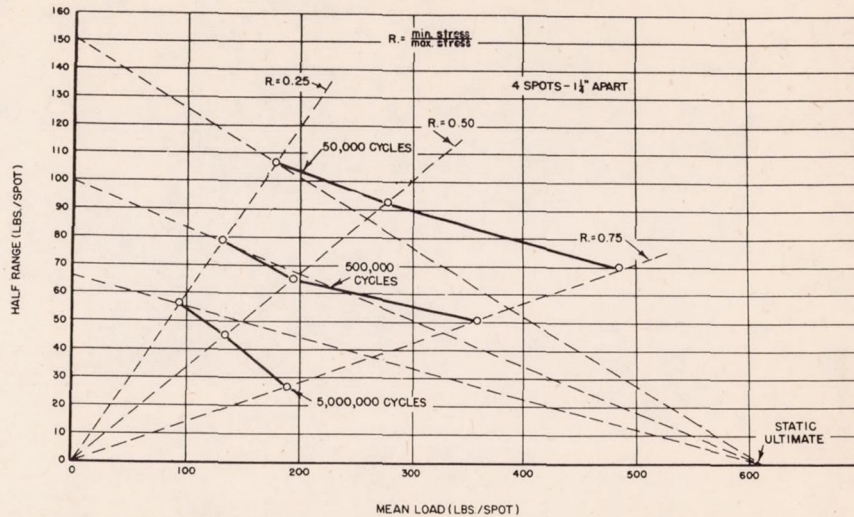
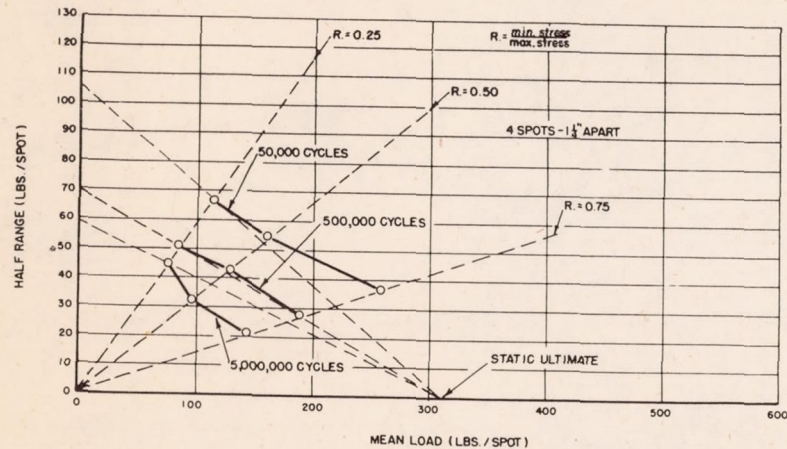
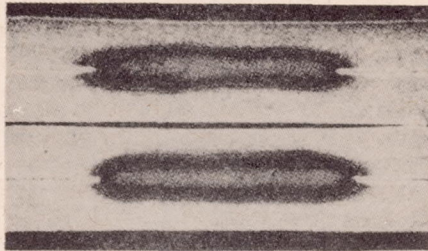

FIG 12 - EFFECT OF MEAN LOAD ON RANGE OF STRESS FOR SPOT WELDED LAP JOINTS OF 0.032" ALCLAD 24-ST

FIG 13 - EFFECT OF MEAN LOAD ON RANGE OF STRESS FOR SPOT WELDED LAP JOINTS OF 0.040" ALCLAD 24 - S1

NACA

Figs. 14,15



Keller's Etch 20386
10X

(a) 0.025"-0.025"
4 Welds, 1 $\frac{1}{4}$ " spacing.

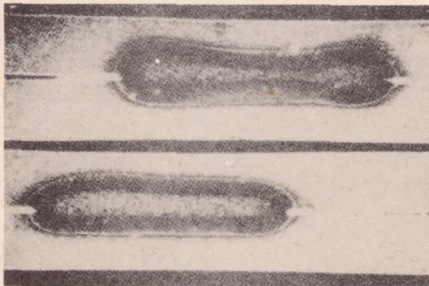

Keller's Etch 20385
10X

(b) 0.032"-0.032"
4 Welds, 1 $\frac{1}{4}$ " spacing.

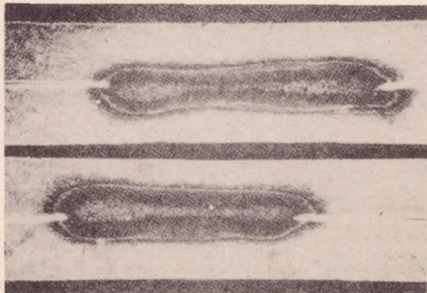

Keller's Etch 20387
10X

(c) 0.032"-0.032"
6 Welds, 3/4" spacing.

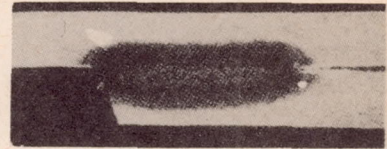

Keller's Etch 20399
10X

(a) 2LN19 6 Welds, 3/4" Spacing
0.032"-0.032"

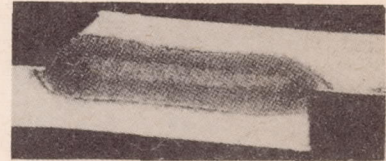

Keller's Etch 20392
10X

(b) 2H23 4 Welds, 1 $\frac{1}{4}$ " Spacing
0.032"-0.032"

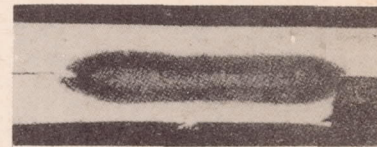

Keller's Etch 20392
10X

(c) 1A7 4 Welds, 1 $\frac{1}{4}$ " Spacing
0.025"-0.025"



Keller's Etch 20399
10X

(d) 1AD6 6 Welds, 3/4" Spacing
0.025"-0.025"

Figure 14.

Spotwelds in Tensile Samples

Figure 15.

Spotwelds in Fatigue Tensile Samples

W-64

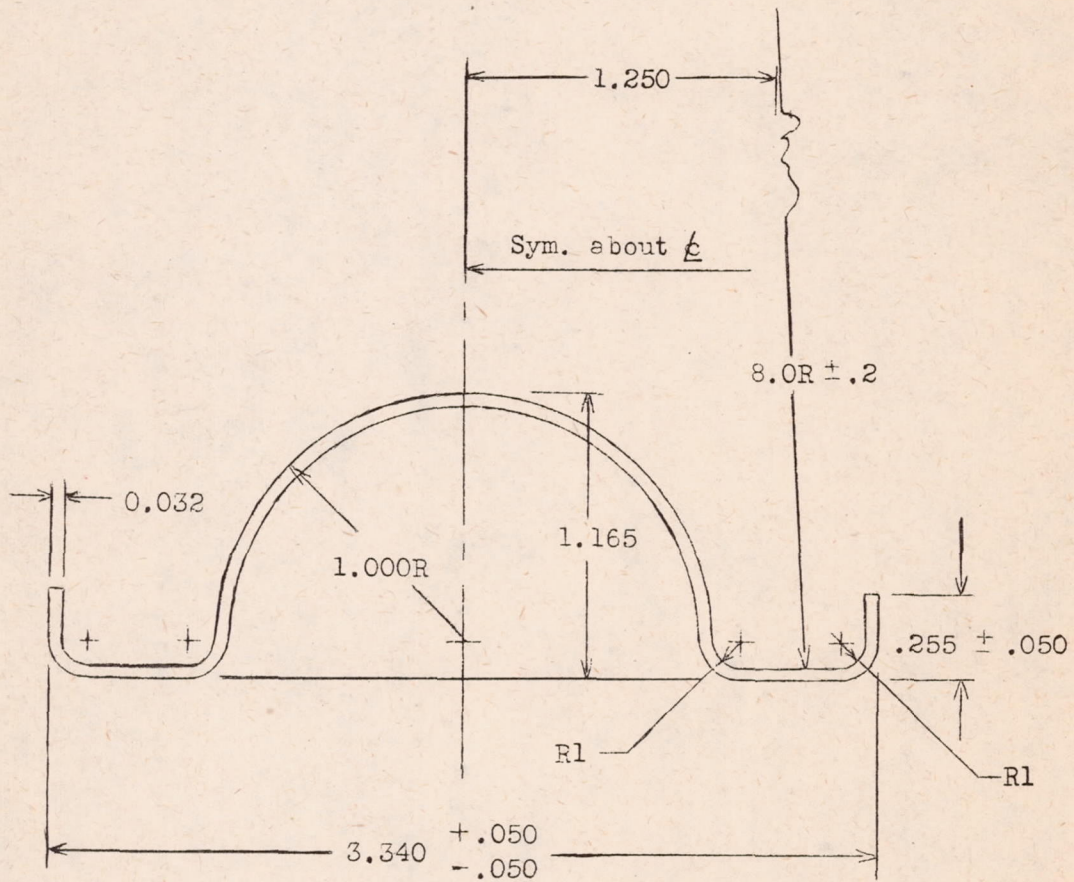

Figure 16.- Dimensions of Curtiss-Wright hat-shaped stiffener.

NACA

Fig. 17

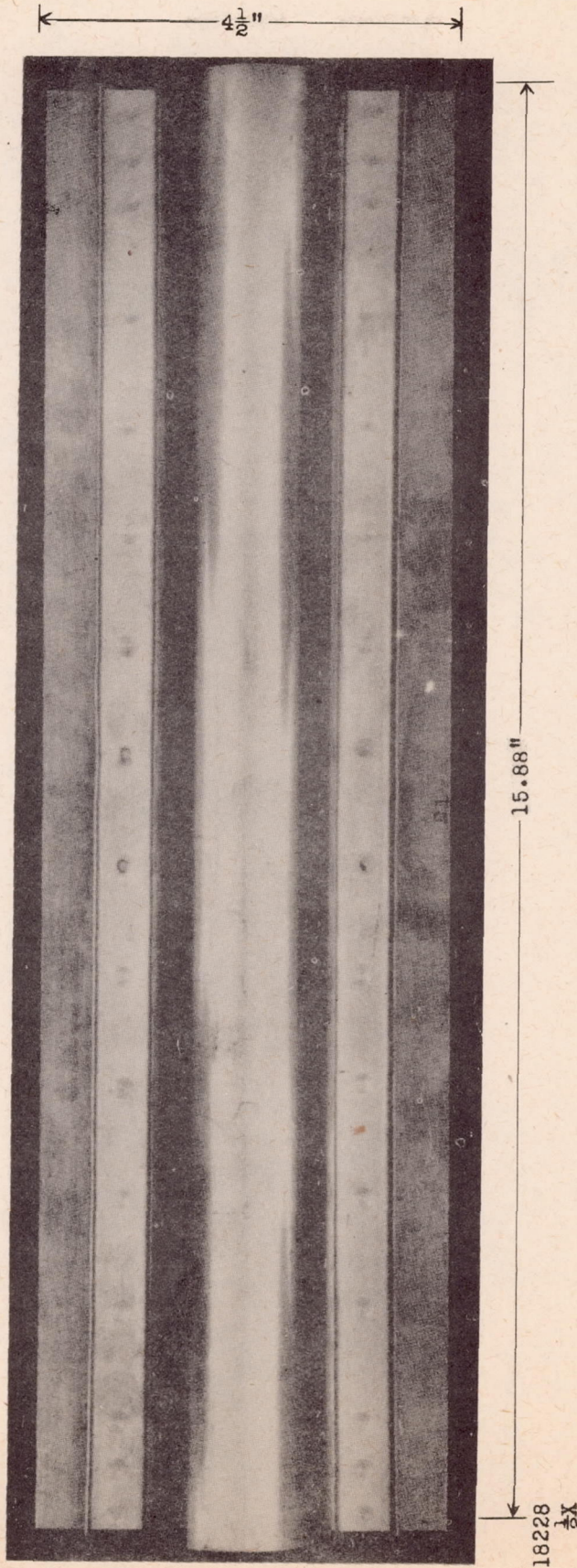

Figure 17. A Typical Stiffened Panel Sample
(Note the failure by "pulling buttons").

W-64

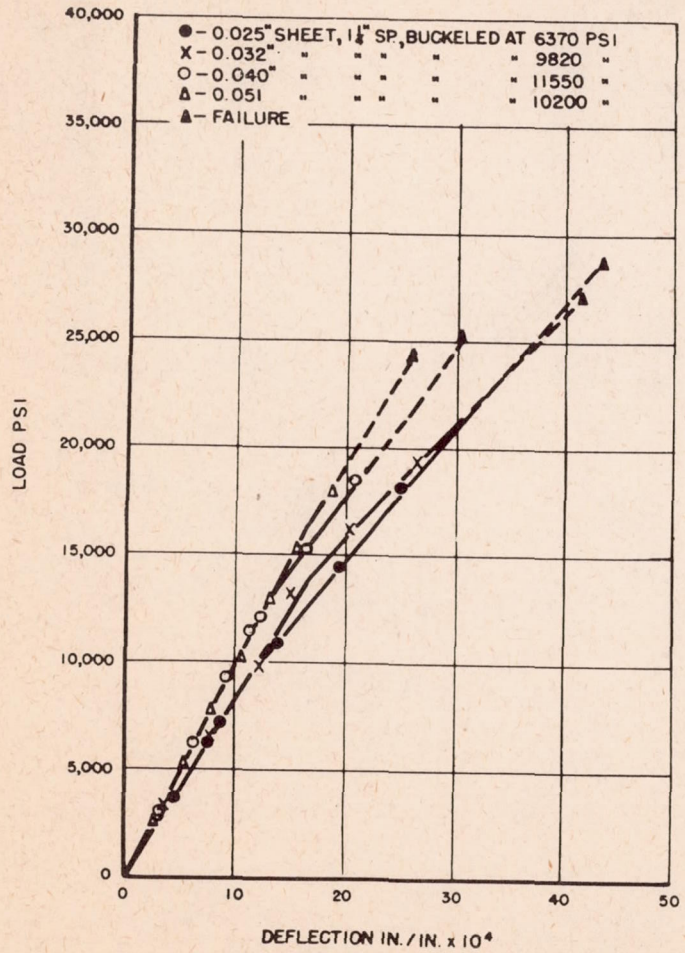

FIG. 18 - STRESS-DEFLECTION TESTS ON STIFFENED PANELS WITH 1 1/4" SPOT SPACING.

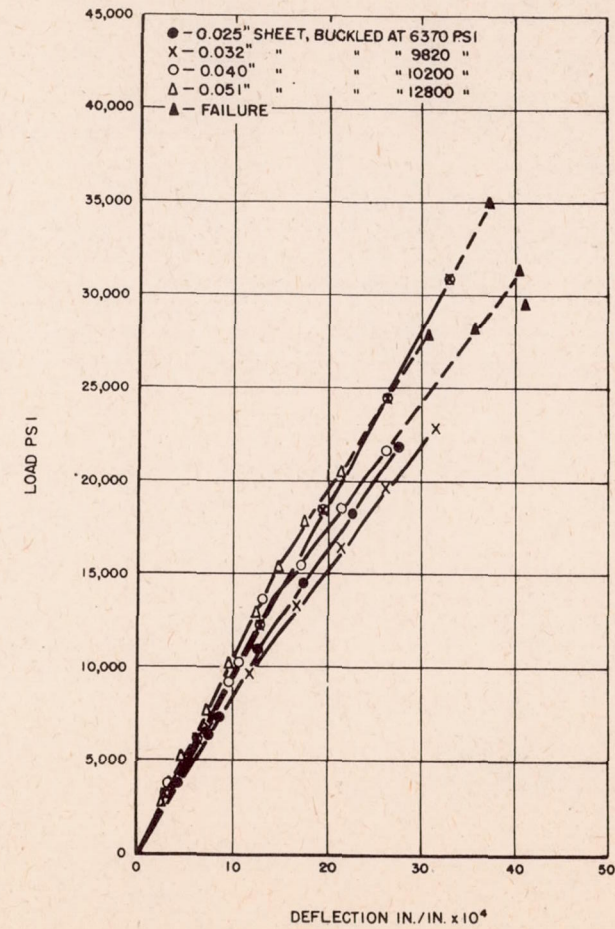

FIG. 19 - STRESS DEFLECTION TESTS ON STIFFENED PANELS WITH 3/4" SPOT SPACING.

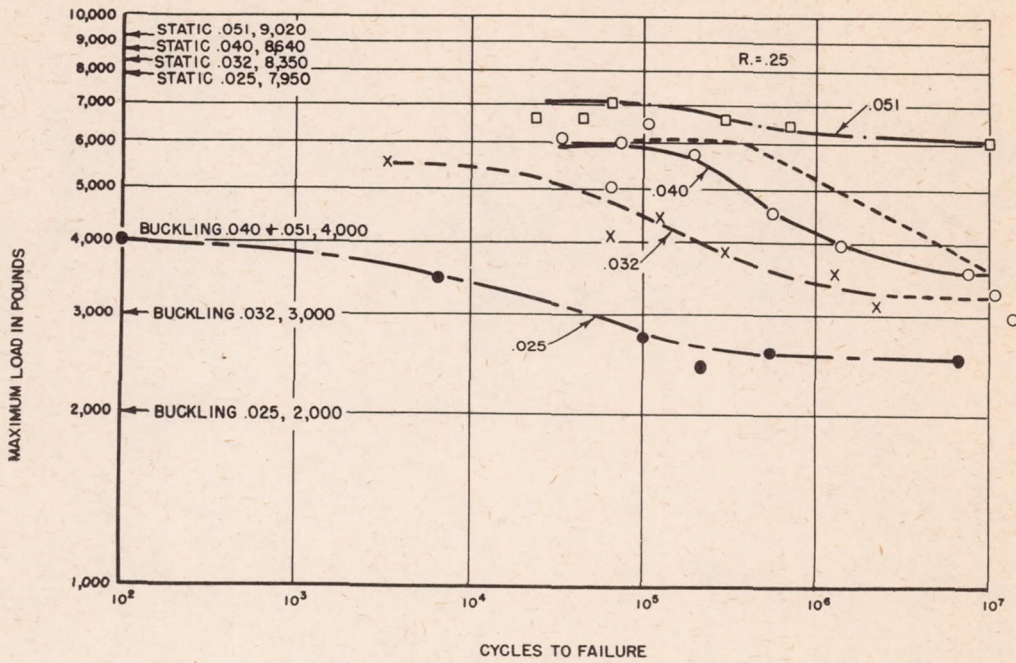

FIG. 20-FATIGUE CURVES FOR STIFFENED PANELS LOADED IN COMPRESSION, SPOT WELD SPACING $1\frac{1}{4}$ "

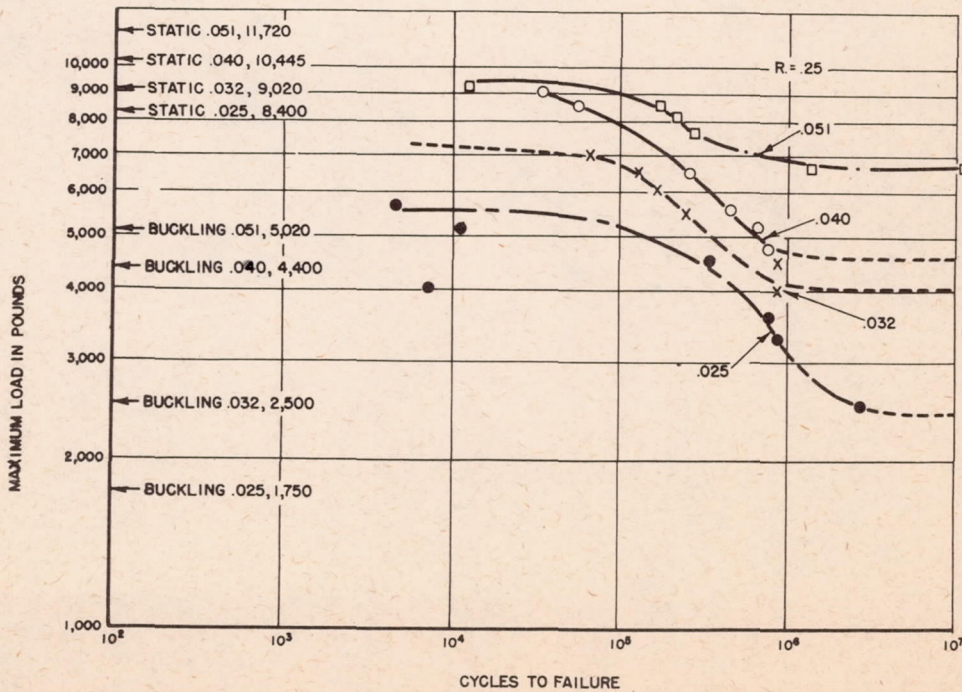

FIG. 21-FATIGUE CURVES FOR STIFFENED PANELS LOADED IN COMPRESSION, SPOT WELD SPACING $\frac{3}{4}$ "

W-64

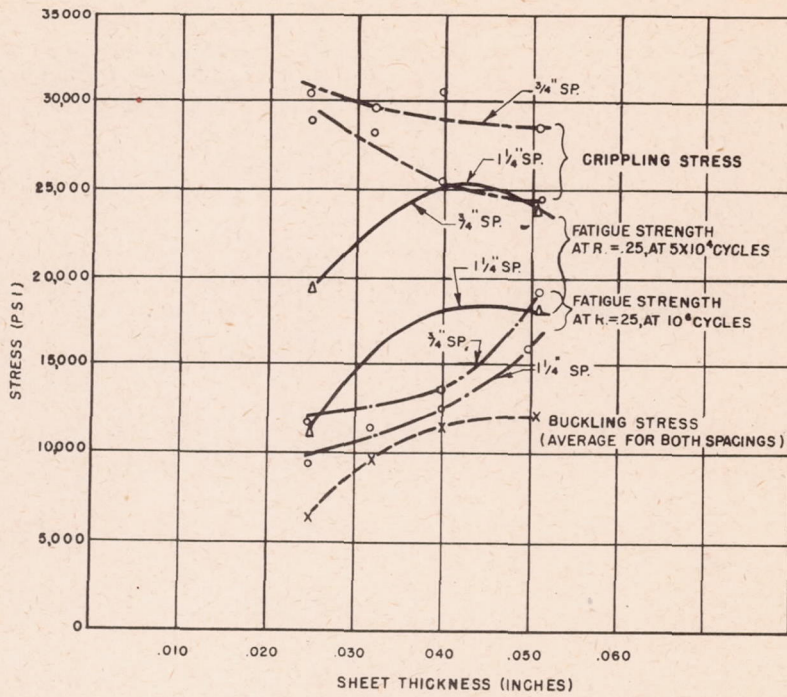

FIG. 22 COMPARISON OF FATIGUE AND STATIC STRENGTHS OF STIFFENED PANELS

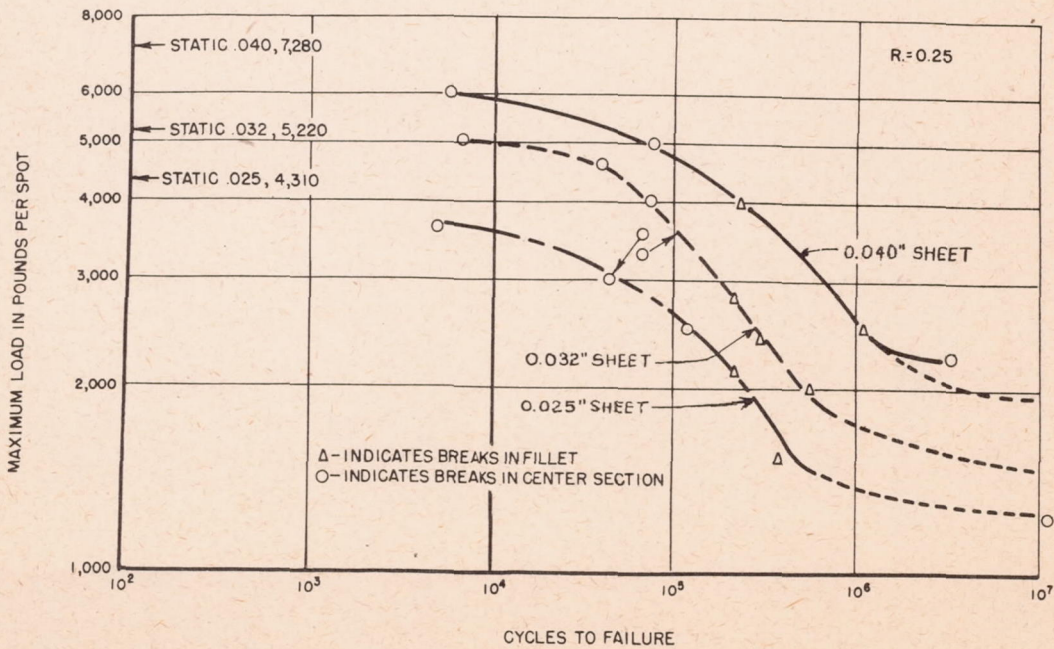
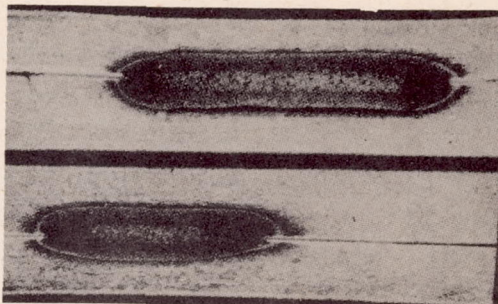

FIG. 31 - FATIGUE CURVES FOR UNSTRESSED ATTACHMENTS 24 - ST ALCLAD 1 1/4" SPOT SPACING.

W-64



Keller's Etch 20390
10X

- (a) H2- Longitudinal 0.032"-0.040"
- H2- Transverse 0.032"-0.040"

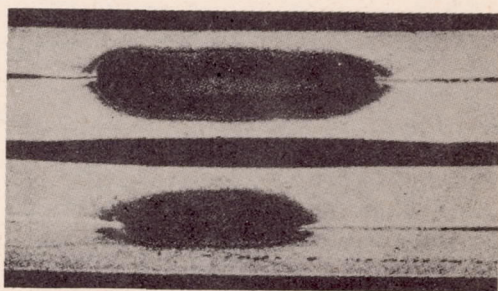

Keller's Etch 20391
10X

- (b) L3- Longitudinal 0.032"-0.025"
- L3- Transverse 0.032"-0.025"

Figure 23.

Typical Spotwelds in Stiffened Panel Section

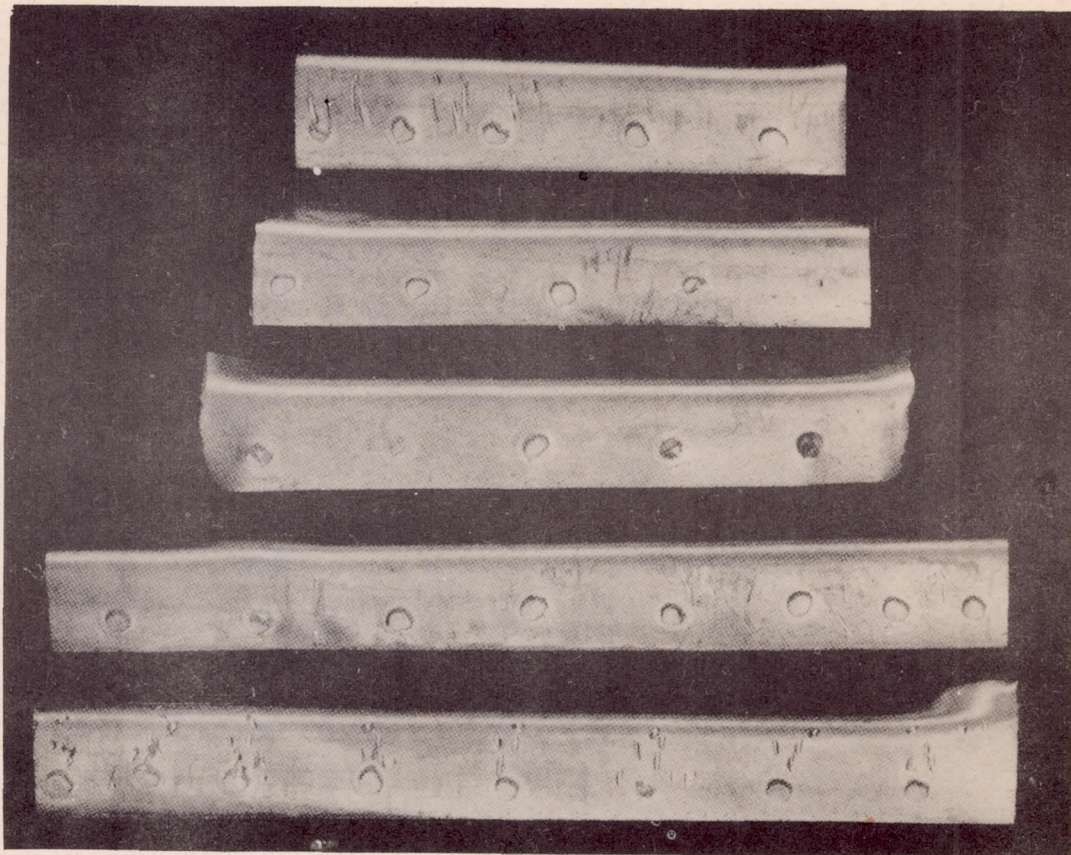

19949
1X

Figure 24.

Sample K-3, 0.025"-0.032" showing
weld variation and elliptical shaped
welds in thin gage compression samples.

W-64

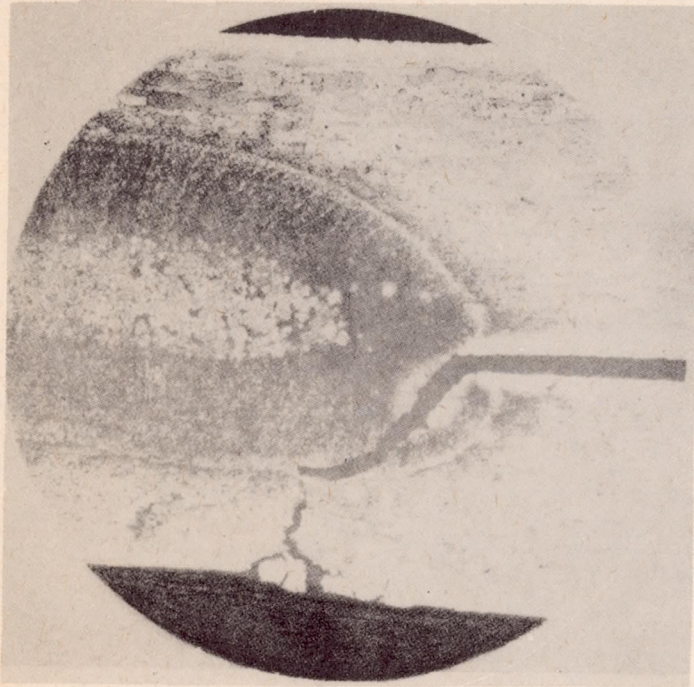

Keller's Etch

20394
50X

L-3 Longitudinal
0.032"-0.025" Compression Sample.

Figure 25.

Crack Propagation into Thinner Sheet

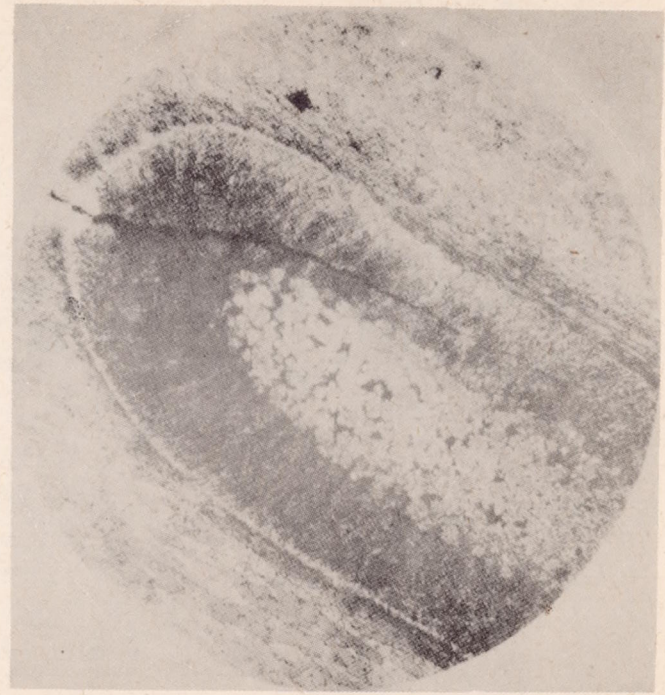

Keller's Etch

20398
50X

G-10 Longitudinal
0.032"-0.040" Compression Sample.

Figure 26.

Crack Propagation into Dendritic Zone

W-64

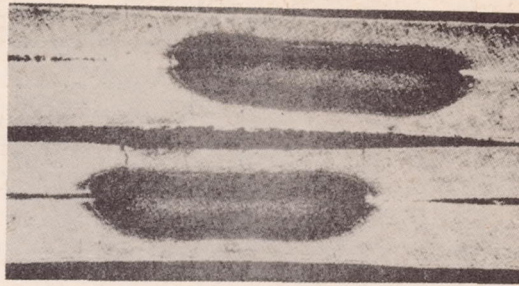

Keller's Etch 20384
10X

(a) L3 Transverse 0.032"-0.025"
L3 Longitudinal 0.032"-0.025"

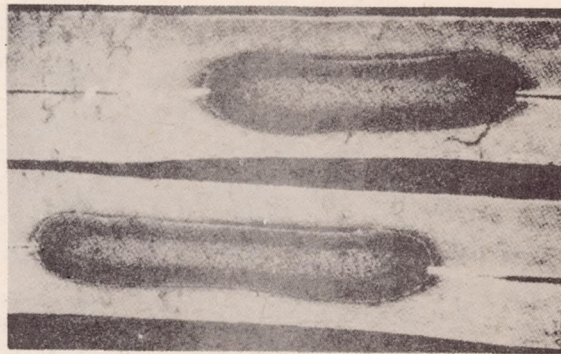

Keller's Etch 20383
10X

(b) G10 Transverse 0.032"-0.040"
G10 Longitudinal 0.032"-0.040"

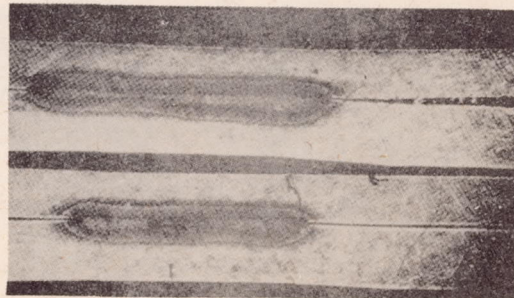

Keller's Etch 20382
10X

(c) K9 Longitudinal 0.032"-0.025"
K9 Transverse 0.032"-0.025"

Figure 27.

Appearance of Fatigue Cracks in Spotwelds

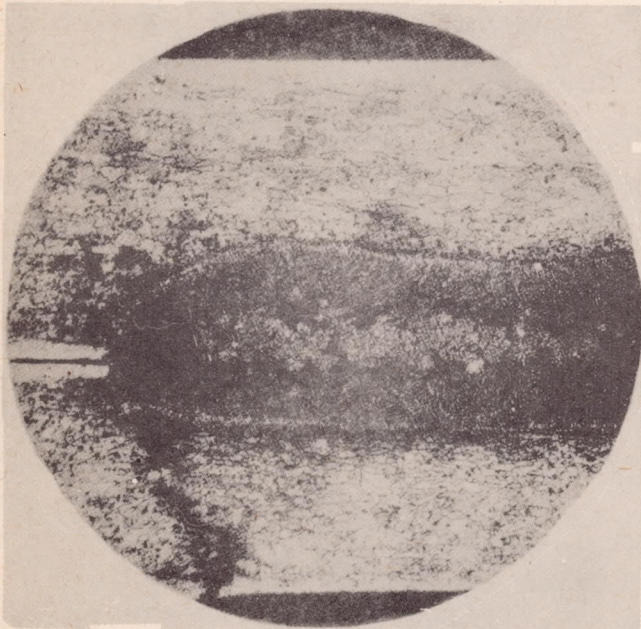

Keller's Etch 20396
50X

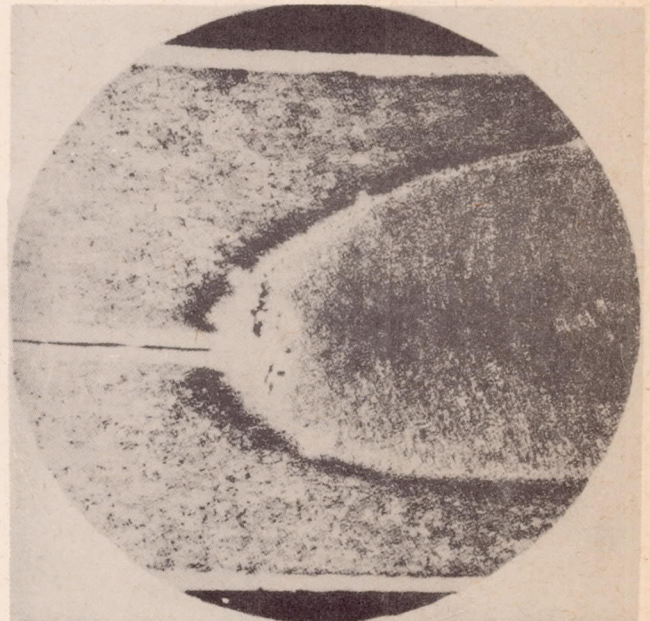

Keller's Etch 20381
50X

(a)

K-9 Transverse
0.032"-0.025" compression sample.

Figure 28.

Crack Propagation Similar to
That Occurring in Lap Weld Sections.

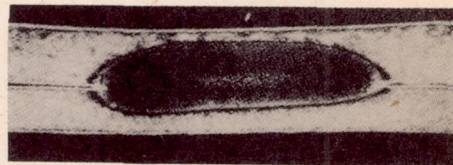

Keller's Etch 20395
10X

(b)

Figure 29.

Fatigue Cracks Starting

L-3 Transverse
0.032"-0.025" compression sample.

NACA

Fig. 30

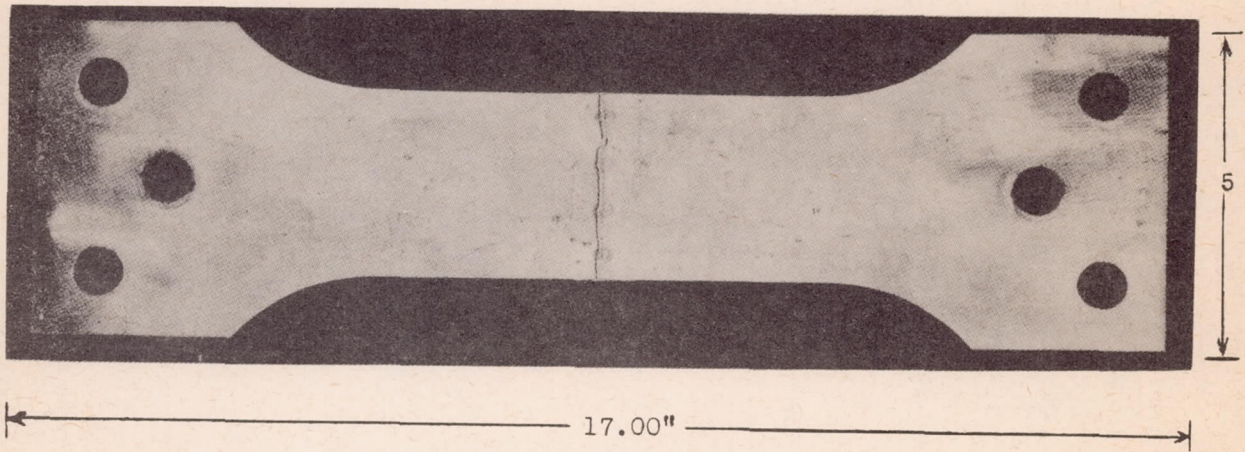

20224
 $\frac{1}{4}X$

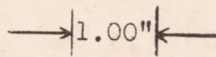
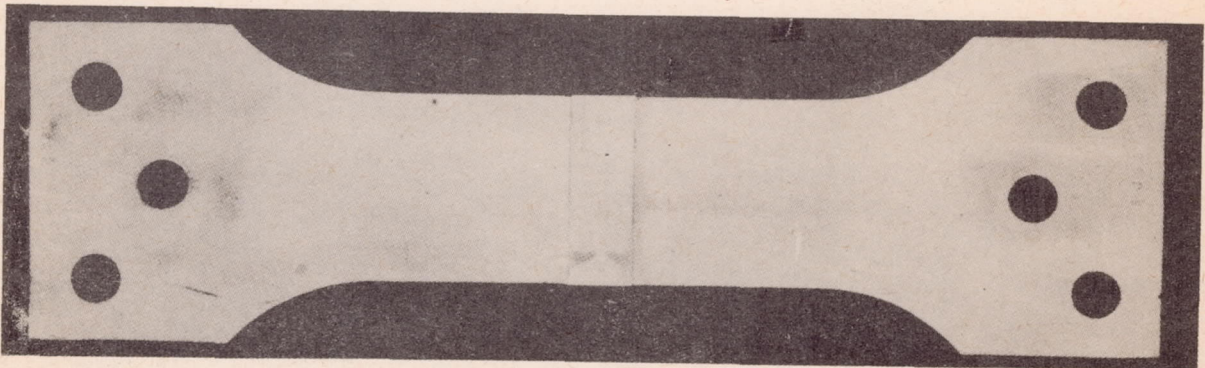

attachment

20224
 $\frac{1}{4}X$

Figure 30

Typical unstressed attachment
tension fatigue sample.
(Note failure through line of welds.)

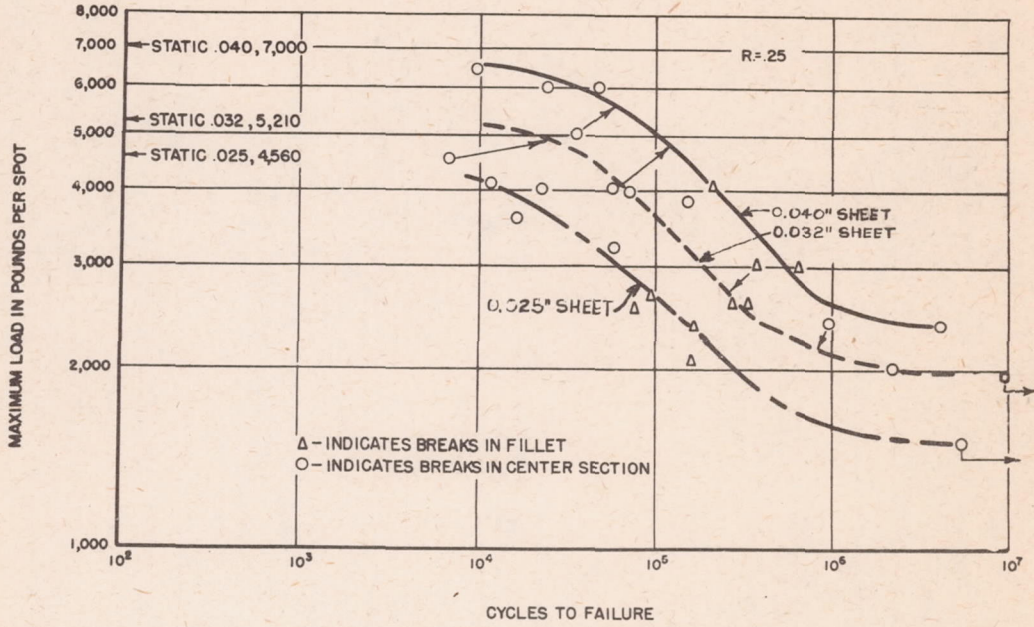

FIG. 32 - FATIGUE CURVES FOR UNSTRESSED ATTACHMENTS 24-ST. ALCLAD $\frac{3}{8}$ " SPOT SPACING.

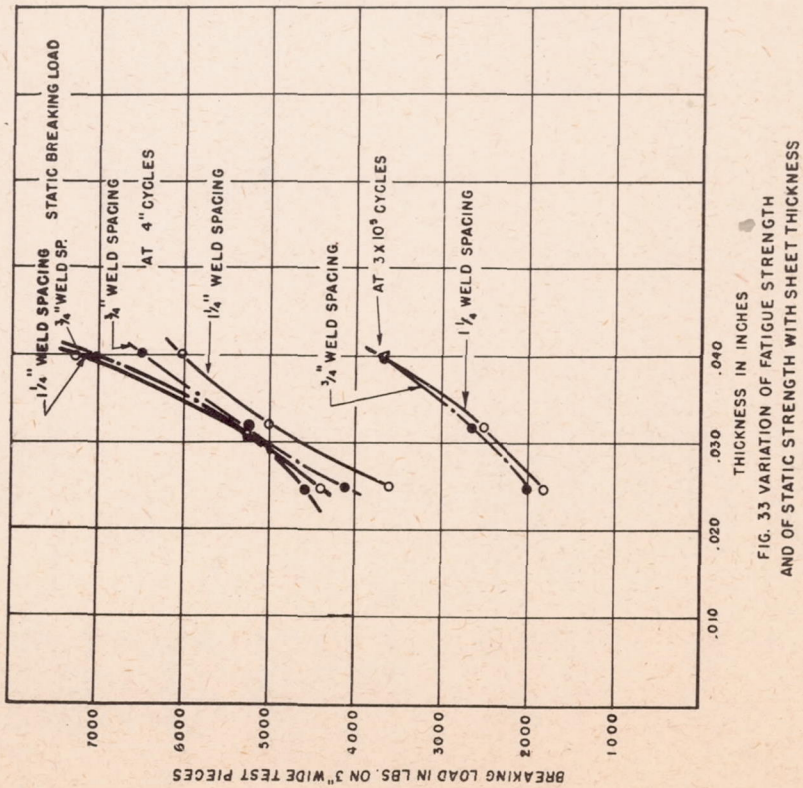
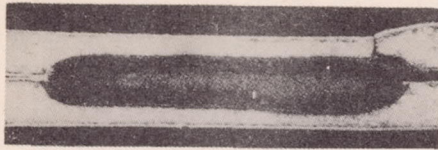

FIG. 33 VARIATION OF FATIGUE STRENGTH AND OF STATIC STRENGTH WITH SHEET THICKNESS

NACA

Figs. 34,35



Keller's Etch 20388
10X

(a) 4c25
0.025"-0.025"
49,300 p.s.i.

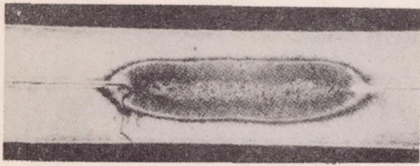

Keller's Etch 20388
10X

(b) 5K31
0.032"-0.032"
41,600 p.s.i.

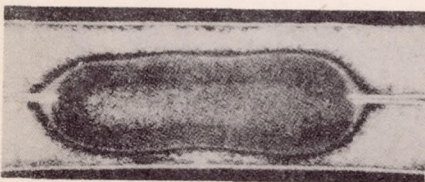

Keller's Etch 20389
10X

(c) 6B21
0.040"-0.040"
25,000 p.s.i.

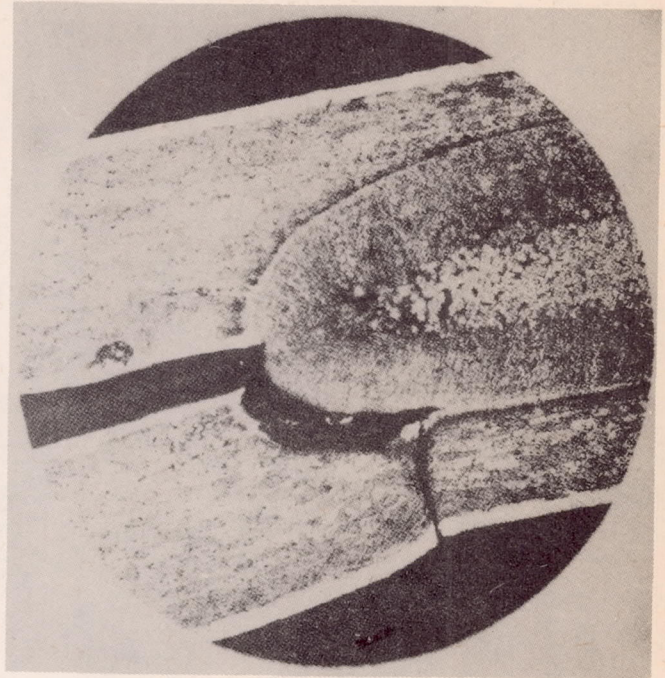

Keller's Etch

20393
50X

Figure 35

4C25
0.025"-0.025"
49,300 p.s.i.

Figure 34.

Welds and Fatigue Failures
in Unstressed Attachments

2-64

NACA

Fig. 36

Note
fatigue
nucleus
→

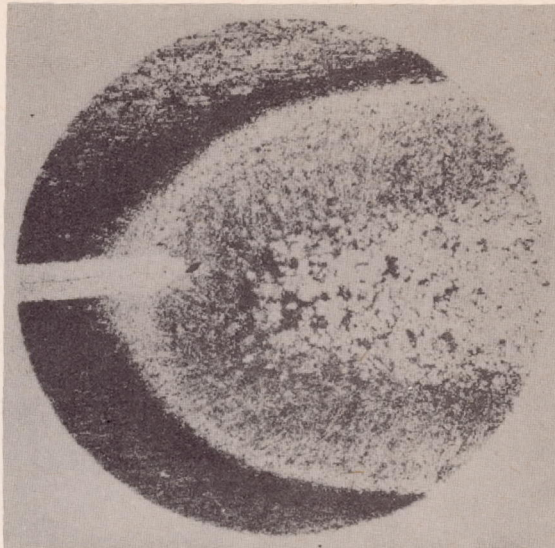

Failure
outside weld
zone.

Keller's Etch

20380

50X

(a) 6B21
0.040"-0.040"
25,000 p.s.i.



Keller's Etch

20397

50X

(b) 4D22 (total failure on other end of weld)
0.025"-0.025"
46,600 p.s.i.

Figure 35.

W-6A

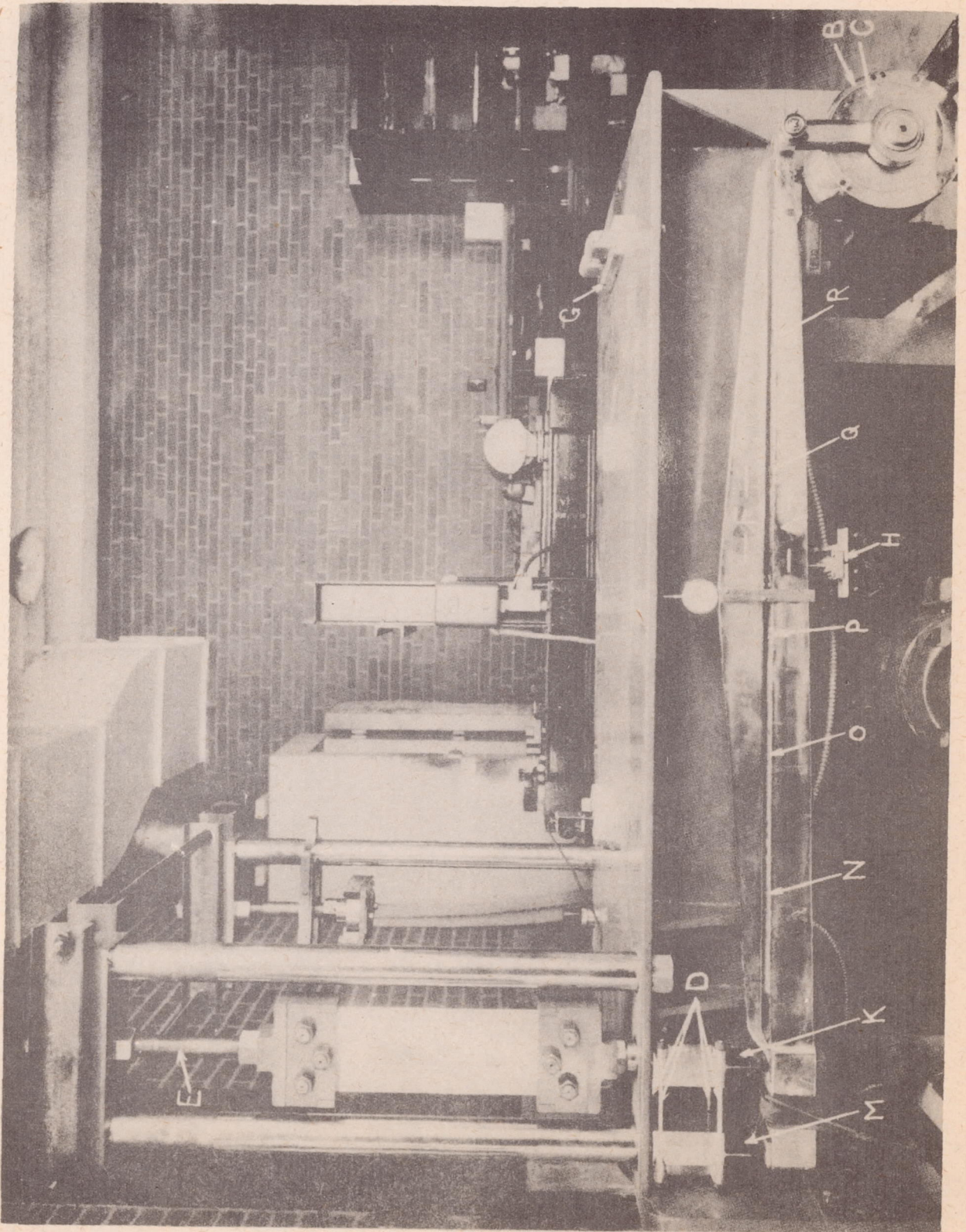

Figure 37. The Fatigue Testing Machine

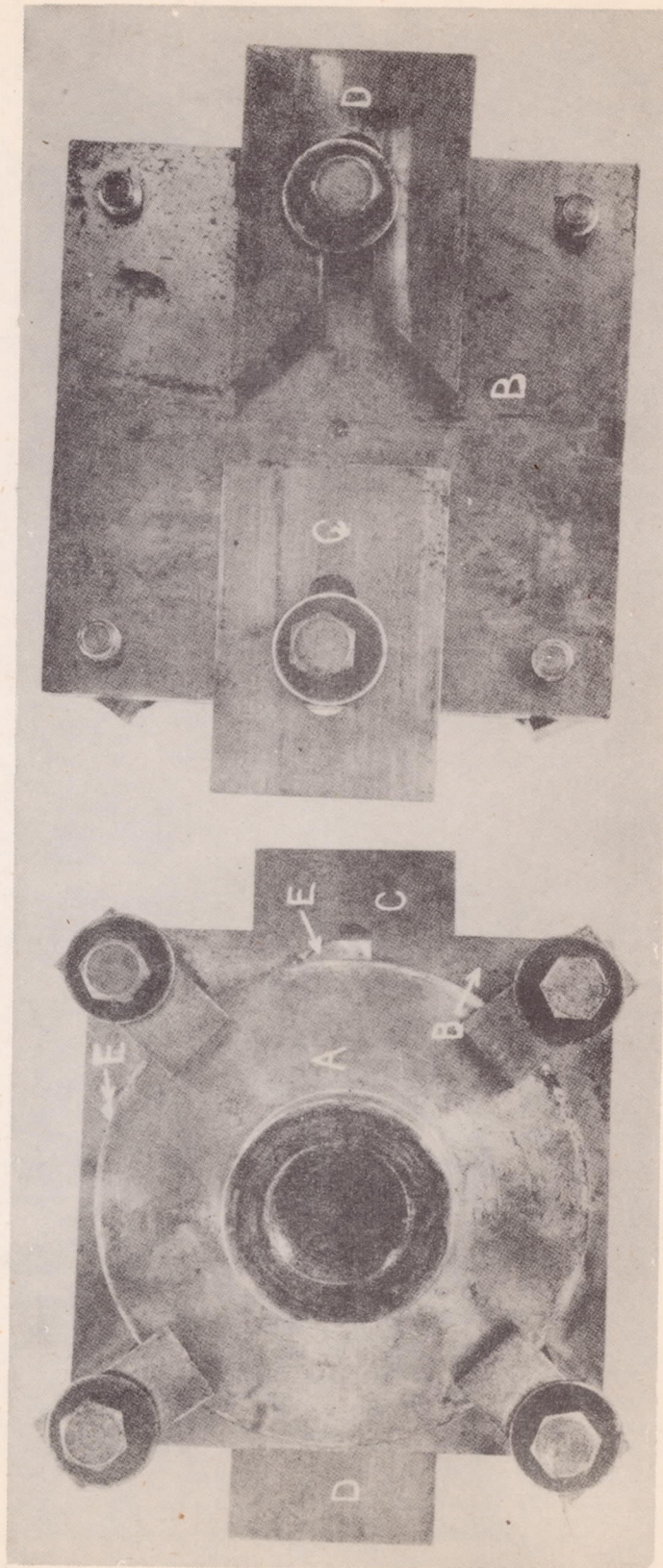

Figure 38. Grips for compression samples.

W-64

W-64

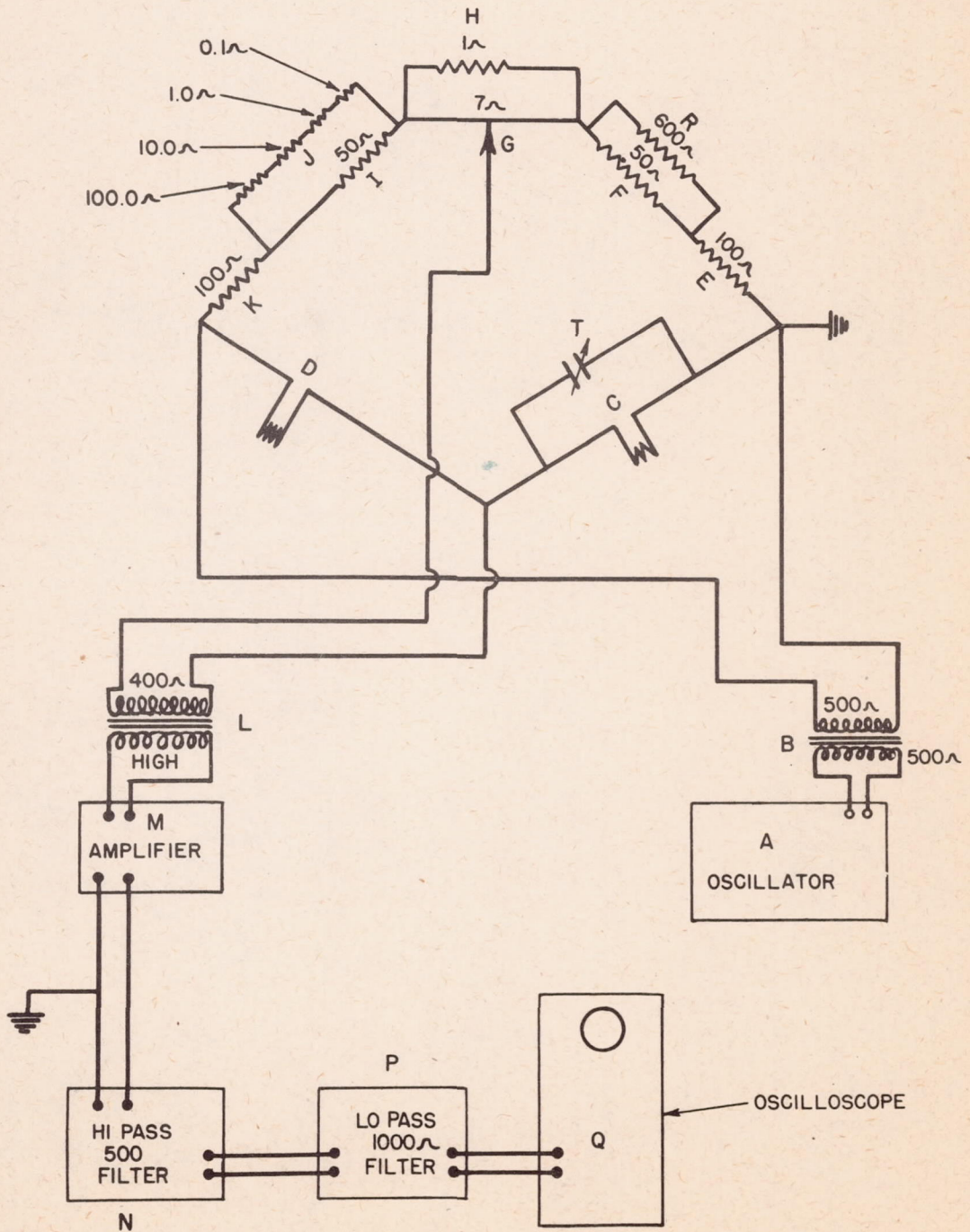

FIGURE 39-WIRING DIAGRAM OF STRAIN MEASURING BRIDGE

Oscilloscope
Q

Slide Wire
G

(Connections
to gages.)

Amplifier M

Oscillator A

17303

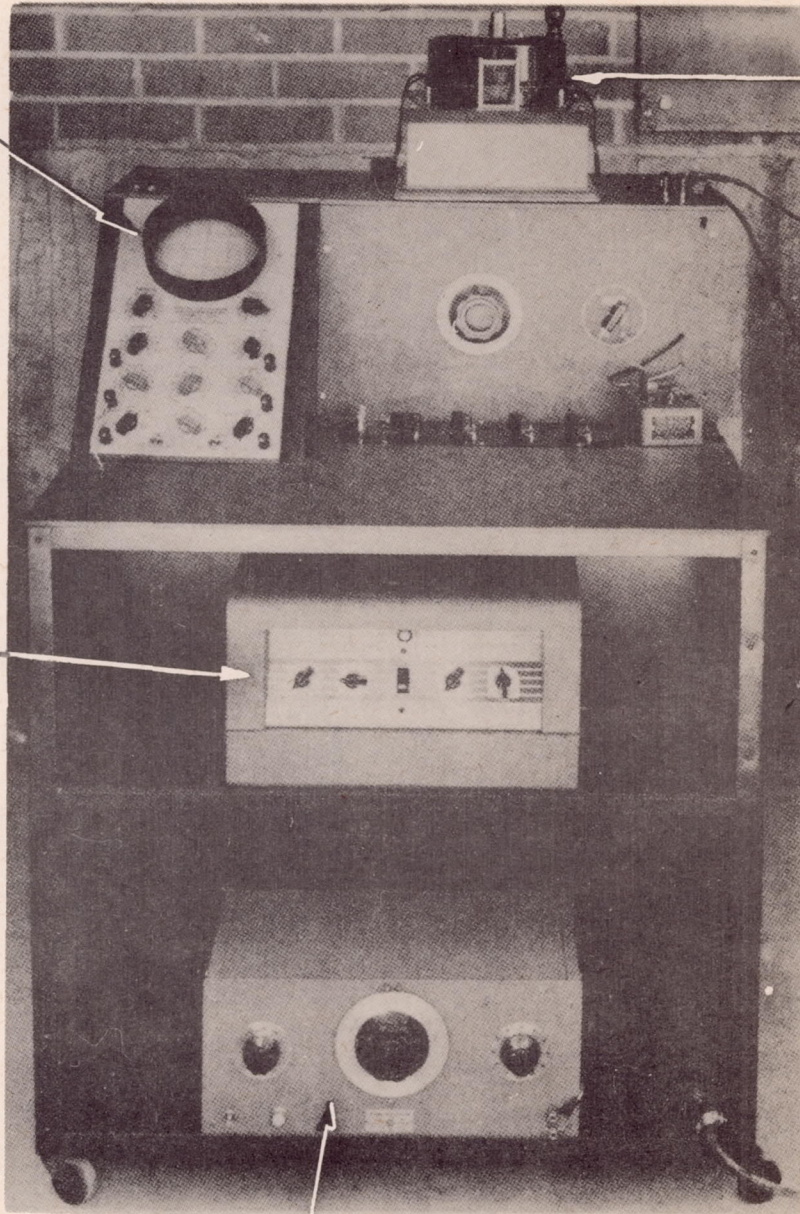

4-6-54

Figure 40.

Photograph of strain analysis equipment for use in making dynamic measurements with SR-4 strain gages.

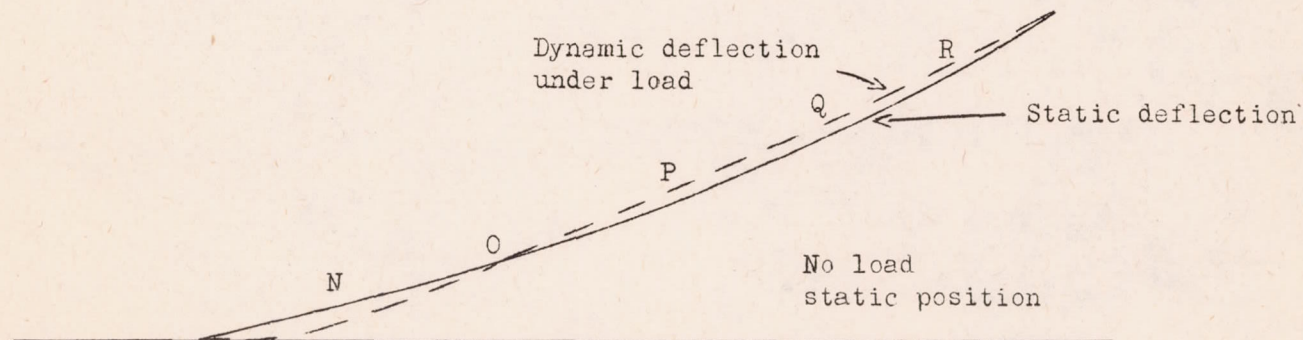

Figure 41.- Deflection of center line of loading lever (the deflection is greatly exaggerated to indicate the effect of inertia. Points N, O, P, Q, R are points of attachment of strain gages mentioned in the text).

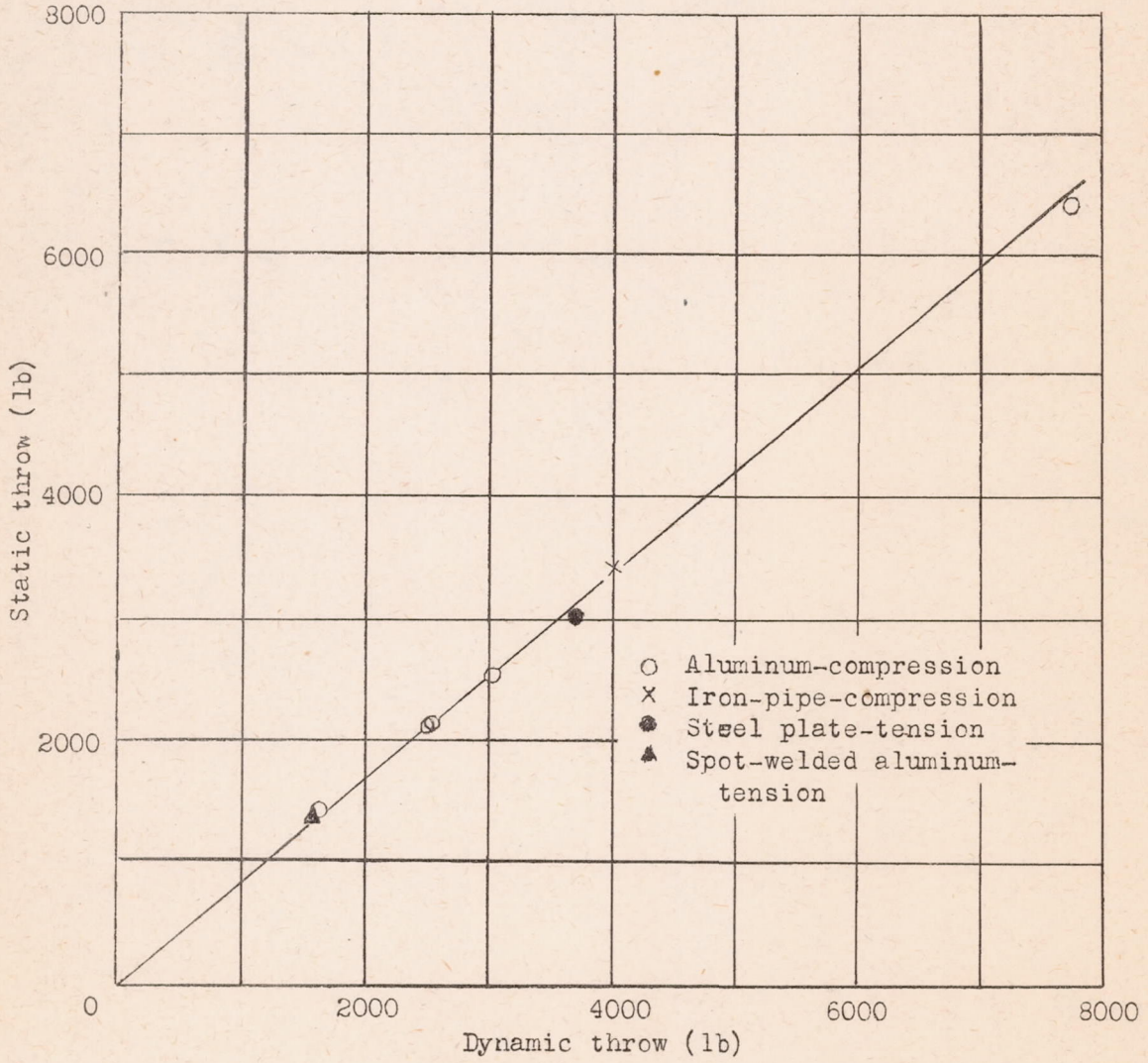

Figure 42.- Calibration for dynamic throw (left hand side - machine P-18)