

FILE COPY
NO. 5

TEE



FILE COPY
NO. 2

NATIONAL ADVISORY COMMITTEE FOR AERONAUTICS

REPORT No. 257

PRESSURE DISTRIBUTION OVER A WING AND TAIL RIB OF A VE-7 AND OF A TS AIRPLANE IN FLIGHT

By J. W. CROWLEY, Jr.

THIS DOCUMENT ON LOAN FROM THE FILES OF

NATIONAL ADVISORY COMMITTEE FOR AERONAUTICS
LANGLEY AERONAUTICAL LABORATORY
LANGLEY FIELD, HAMPTON, VIRGINIA

RETURN TO THE ABOVE ADDRESS.

REQUESTS FOR PUBLICATIONS SHOULD BE ADDRESSED
AS FOLLOWS:

NATIONAL ADVISORY COMMITTEE FOR AERONAUTICS
1724 F STREET, N.W.,
WASHINGTON 25, D.C.



~~JOSEPH S. AMES COLLECTION~~

~~FILE COPY~~

To be returned to
the files of the National
Advisory Committee
for Aeronautics
Washington, D. C.

UNITED STATES
GOVERNMENT PRINTING OFFICE
WASHINGTON

1927

AERONAUTICAL SYMBOLS

1. FUNDAMENTAL AND DERIVED UNITS

	Symbol	Metric		English	
		Unit	Symbol	Unit	Symbol
Length-----	<i>l</i>	meter-----	m	foot (or mile)-----	ft. (or mi.)
Time-----	<i>t</i>	second-----	sec	second (or hour)-----	sec. (or hr.)
Force-----	<i>F</i>	weight of one kilogram-----	kg	weight of one pound	lb.
Power-----	<i>P</i>	kg/m/sec-----		horsepower-----	HP.
Speed-----		km/hr-----		mi./hr-----	M. P. H.
		m/sec-----		ft./sec-----	f. p. s.

2. GENERAL SYMBOLS, ETC.

<p><i>W</i>, Weight, = mg</p> <p><i>g</i>, Standard acceleration of gravity = 9.80665 m/sec.² = 32.1740 ft./sec.²</p> <p><i>m</i>, Mass, = $\frac{W}{g}$</p> <p>ρ, Density (mass per unit volume). Standard density of dry air, 0.12497 (kg-m⁻³ sec.²) at 15° C and 760 mm = 0.002378 (lb.- ft.⁻³ sec.²).</p> <p>Specific weight of "standard" air, 1.2255 kg/m³ = 0.07651 lb./ft.³</p>	<p>mk^2, Moment of inertia (indicate axis of the radius of gyration, <i>k</i>, by proper sub- script).</p> <p><i>S</i>, Area.</p> <p><i>S_w</i>, Wing area, etc.</p> <p><i>G</i>, Gap.</p> <p><i>b</i>, Span.</p> <p><i>c</i>, Chord length.</p> <p><i>b/c</i>, Aspect ratio.</p> <p><i>f</i>, Distance from <i>c. g.</i> to elevator hinge.</p> <p>μ, Coefficient of viscosity.</p>
---	--

3. AERODYNAMICAL SYMBOLS

<p><i>V</i>, True air speed.</p> <p><i>q</i>, Dynamic (or impact) pressure = $\frac{1}{2} \rho V^2$</p> <p><i>L</i>, Lift, absolute coefficient $C_L = \frac{L}{qS}$</p> <p><i>D</i>, Drag, absolute coefficient $C_D = \frac{D}{qS}$</p> <p><i>C</i>, Cross-wind force, absolute coefficient $C_C = \frac{C}{qS}$</p> <p><i>R</i>, Resultant force. (Note that these coeffi- cients are twice as large as the old co- efficients <i>L_C</i>, <i>D_C</i>.)</p> <p><i>i_w</i>, Angle of setting of wings (relative to thrust line).</p> <p><i>i_t</i>, Angle of stabilizer setting with reference to to thrust line.</p>	<p>γ, Dihedral angle.</p> <p>$\frac{Vl}{\rho \mu}$, Reynolds Number, where <i>l</i> is a linear dimension. e. g., for a model airfoil 3 in. chord, 100 mi./hr. normal pressure, 0° C: 255,000 and at 15° C., 230,000; or for a model of 10 cm chord 40 m/sec, corresponding numbers are 299,000 and 270,000.</p> <p><i>C_p</i>, Center of pressure coefficient (ratio of distance of <i>C. P.</i> from leading edge to chord length).</p> <p>β, Angle of stabilizer setting with reference to lower wing, = (<i>i_t</i> - <i>i_w</i>).</p> <p>α, Angle of attack.</p> <p>ϵ, Angle of downwash.</p>
---	--

REPORT No. 257

**PRESSURE DISTRIBUTION
OVER A WING AND TAIL RIB OF A VE-7 AND
OF A TS AIRPLANE IN FLIGHT**

**By J. W. CROWLEY, Jr.
Langley Memorial Aeronautical Laboratory**

1

JOSEPH S. AMES COLLECTION.

NATIONAL ADVISORY COMMITTEE FOR AERONAUTICS

3341 NAVY BUILDING, WASHINGTON, D. C.

[An independent Government establishment, created by act of Congress approved March 3, 1915, for the supervision and direction of the scientific study of the problems of flight. It consists of twelve members who are appointed by the President, all of whom serve as such without compensation]

CHARLES D. WALCOTT, Sc. D., *Chairman*,
Secretary, Smithsonian Institution, Washington, D. C.
DAVID W. TAYLOR, D. Eng., *Secretary*,
Washington, D. C.
JOSEPH S. AMES, Ph. D., *Chairman, Executive Committee*,
Director, Physical Laboratory, Johns Hopkins University, Baltimore, Md.
GEORGE K. BURGESS, Sc. D.,
Director, Bureau of Standards, Washington, D. C.
JOHN F. CURRY, Major, United States Army,
Chief, Engineering Division, Air Service, Dayton, Ohio.
WILLIAM F. DURAND, Ph. D.,
Professor of Mechanical Engineering, Stanford University, Calif.
EMORY S. LAND, Captain, United States Navy,
Bureau of Aeronautics, Navy Department, Washington, D. C.
CHARLES F. MARVIN, M. E.,
Chief, United States Weather Bureau, Washington, D. C.
WILLIAM A. MOFFETT, Rear Admiral, United States Navy,
Chief, Bureau of Aeronautics, Navy Department, Washington, D. C.
MASON M. PATRICK, Major General, United States Army,
Chief of Air Service, War Department, Washington, D. C.
S. W. STRATTON, Sc. D.,
President, Massachusetts Institute of Technology, Cambridge, Mass.
ORVILLE WRIGHT, B. S.,
Dayton, Ohio.

EXECUTIVE COMMITTEE

JOSEPH S. AMES, *Chairman*.
DAVID W. TAYLOR, *Secretary*.

GEORGE K. BURGESS.	MASON M. PATRICK.*
JOHN F. CURRY.	S. W. STRATTON.
EMORY S. LAND.	CHARLES D. WALCOTT.
CHARLES F. MARVIN.	ORVILLE WRIGHT.
WILLIAM A. MOFFETT.	
GEORGE W. LEWIS, <i>Director of Aeronautical Research</i> .	
JOHN F. VICTORY, <i>Assistant Secretary</i> .	

REPORT No. 257

PRESSURE DISTRIBUTION OVER A WING AND TAIL RIB OF A VE-7 AND OF A TS AIRPLANE IN FLIGHT

By J. W. CROWLEY, JR.

SUMMARY

This investigation was made by the National Advisory Committee for Aeronautics at Langley Field, to determine the pressure distribution over a rib of the wing and over a rib of the horizontal tail surface of an airplane in flight and to obtain information as to the time correlation of the loads occurring on these ribs. Two airplanes, VE-7 and TS, were selected in order to obtain the information for a thin and a thick wing section. In each case the pressure distribution was recorded for the full range of angle of attack in level flight and throughout violent maneuvers. Particular attention was given to the high and low angle of attack conditions. The results show: (a) That the present rib load specifications in use by the Army Air Corps and the Bureau of Aeronautics, Navy Department, are in fair agreement with the loads actually occurring in flight, but could be slightly improved; (b) that there appears to be no definite sequence in which wing and tail surface ribs reach their respective maximum loads in different maneuvers; (c) that in accelerated flight, at air speeds less than or equal to 60 per cent of the maximum speed, the accelerations measured agree very closely with the theoretically possible maximum accelerations. In maneuvers at higher air speeds the observed accelerations were smaller than those theoretically possible.

INTRODUCTION

The subject of load distribution on an airplane in accelerated flight is of the utmost importance for design purposes and is particularly so at the present time inasmuch as the high speeds and large accelerations occurring with the present airplanes make it advisable to improve the loading specifications and computation methods. Considerable work has been done previously on the subject of pressure distribution, but the knowledge of the loads in accelerated flight is still very incomplete. Wind tunnel tests have been devoted to steady flight conditions, and the previous flight work, while including both accelerated and steady flight, has not been extensive enough. In order to improve the present loading requirements, considerable additional investigation is necessary.

The present investigation was conducted primarily to determine the rib loads of the wing and of the horizontal tail surface in level and accelerated flight and the time correlation of these loads. It actually consisted of two series of tests—first, on the VE-7 training airplane with R. A. F. 15 wings and, secondly, on the TS fighter with U. S. A. 27 wings, neither airplane being in any way changed so as to affect the performance characteristics. On each airplane the pressure distribution over a rib of the upper wing and over a rib of the horizontal stabilizer and elevator was measured. Certain peculiarities, especially in the *C. P.* location, which was found in the first series of tests (VE-7 airplane) made it desirable on the second series (TS airplane) to investigate a rib of the lower wing also. The ribs chosen were located as far as possible from the slip stream and from the aileron, and where an upper and lower wing rib was investigated they were located in the same vertical plane. The tail surface rib locations were also chosen with the idea of keeping as far as possible from the fuselage and from the tip and at the same time maintaining a chord of somewhat near the average chord of the tail surface.

the front cowling. At each station the orifices were attached directly opposite each other on the top and bottom of the rib and each pair was connected to the opposite sides of the same manometer capsule. The readings thus obtained on each capsule represent the resultant pressure normal to the chord line at a station, no attempt being made to record the pressures on the upper and lower surfaces separately. To avoid any permanent mutilation of the airplanes, false ribs with special cap strips (fig. 2) were used to which the orifices were attached. These false ribs were inserted at the positions shown in Figures 3 and 4. The orifices were installed so as to present a perfectly smooth surface, and the entire system was checked for possible leaks at frequent intervals throughout the tests. Figures 5, 6, and 7 are photographs of the orifice installation.

Besides the manometer, the following N. A. C. A. standard instruments were used on all the tests: Single component accelerometer (Reference 2); recording air-speed meter (Reference 3); recording yaw meter (Reference 4); and an electric contact making chronometer (Reference 5).

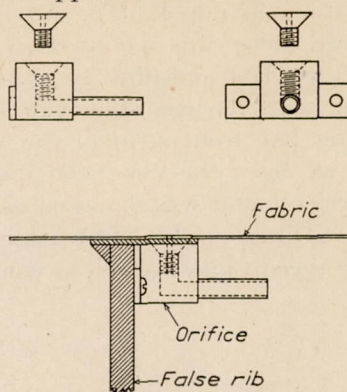

FIG. 2.—Type of orifice used and method of attachment

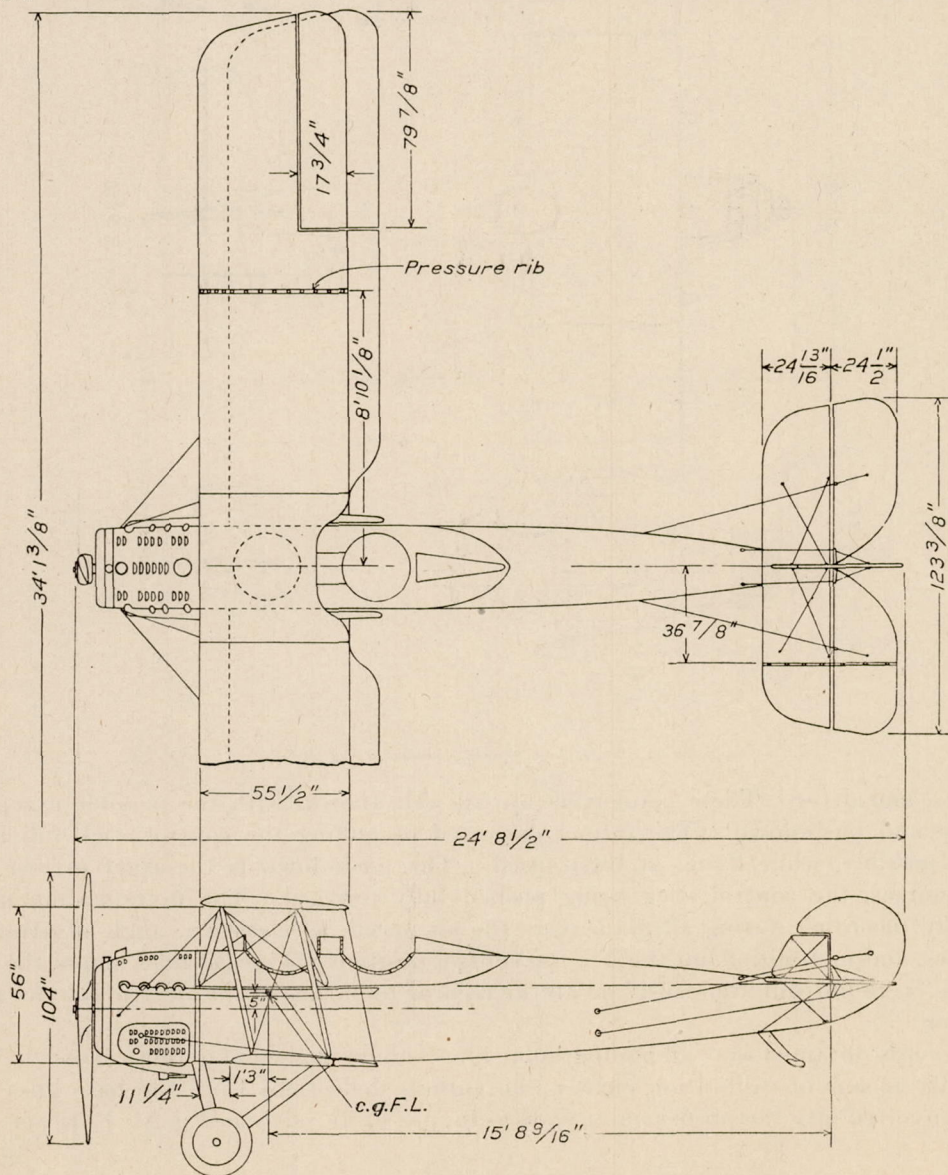

FIG. 3.—VE-7 airplane, showing location of false ribs

In addition to the above, on the tests on the TS airplane, an N. A. C. A. control position recorder (Reference 6) was used. All of the instruments have been described in previous publications as noted. The swiveling Pitot-static tube used in connection with the recording air-speed meter was mounted on a boom extending forward of the left outer bay forward strut of the VE-7 and directly on the left forward strut of the TS. The yaw head used in connection with the recording yaw meter was mounted on a boom extending forward of the right outer bay front strut of the VE-7 and similarly mounted on the left front strut of the TS. In all cases the yaw head was mounted to measure angle of attack. In both airplanes the accelerometer was mounted as close as possible to the center of gravity of the airplane.

The scope of the test covers level flight at approximately 10 M. P. H., increments throughout the speed range, as well as continuous records of accelerated flight during rolls, loops, pull-ups,

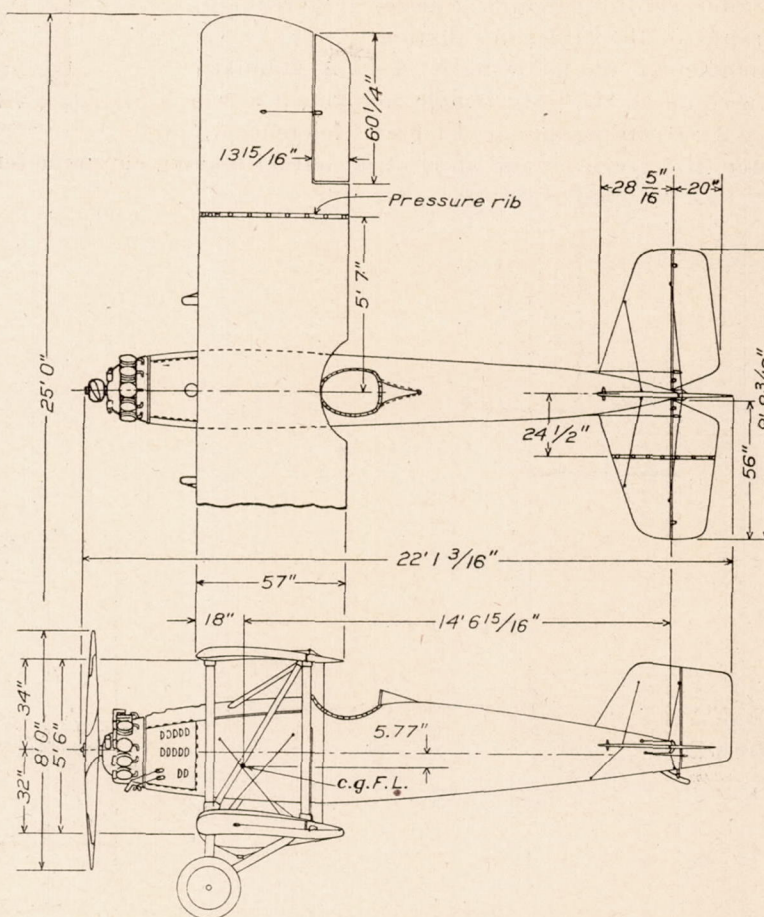

FIG. 4.—TS airplane, showing location of false ribs

push-downs, and dives. These maneuvers are all well known, with the possible exception of the pull-up and push-down. The former consisted of pulling the control stick full back as rapidly as possible, while flying at high speed. The push-down is the exact reverse of the above maneuver, the control stick being pushed fully forward. The investigation included continuously recording during all maneuvers the air speed, acceleration, angle of attack, and rib pressures, and in addition, on the TS, the control position. Vertical lines across the record, timing lines, were put simultaneously on all the records by means of the electric contact making chronometer.

The records obtained were all photographic films similar in general to those shown in Figures 8 to 11. By means of calibration curves, the various deflections from the base lines on the films are converted into the proper units, such as lb. per sq. ft., air speed in M. P. H., etc. The

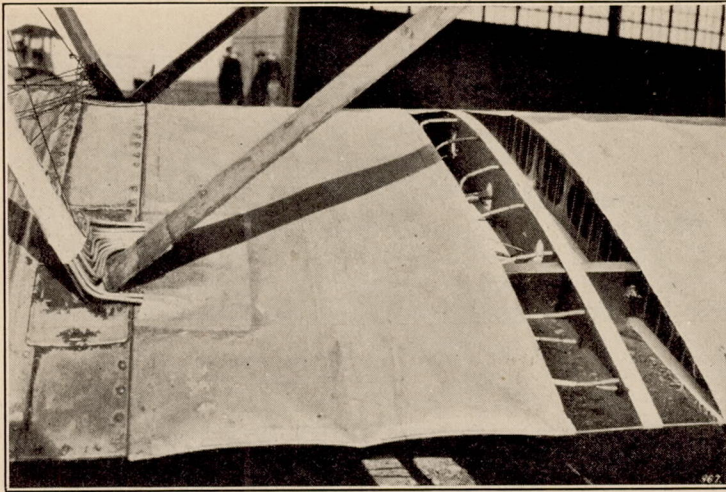

FIG. 5.—View showing orifice installation in wing

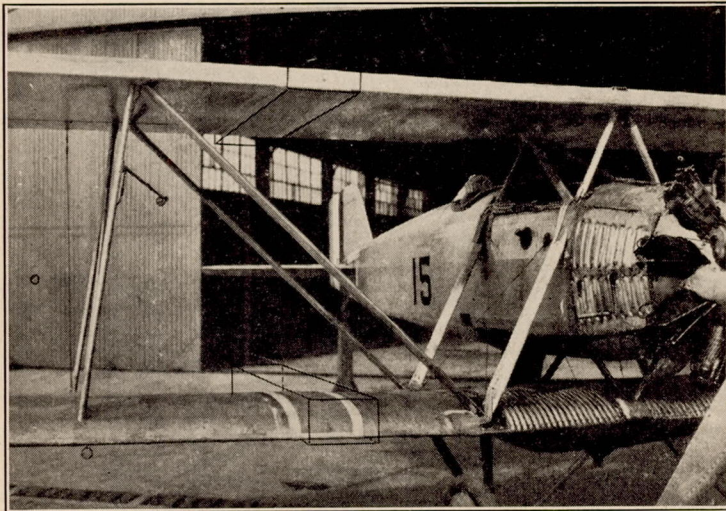

FIG. 6.—View showing finished orifice installation in wing

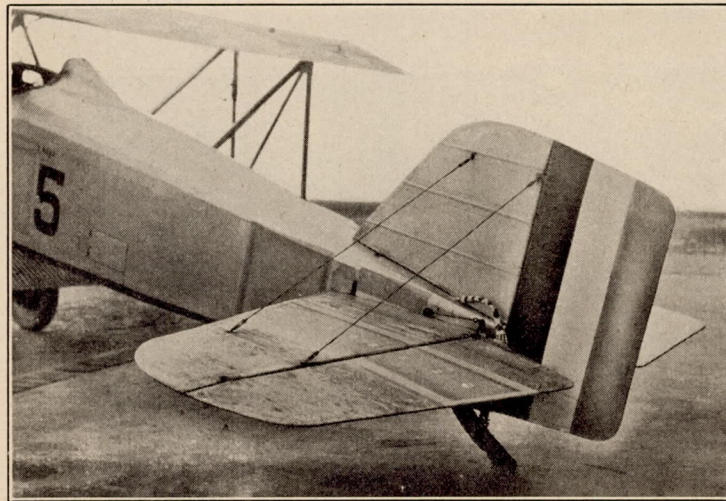

FIG. 7.—View showing finished orifice installation in tail surfaces of the TS-7 airplane

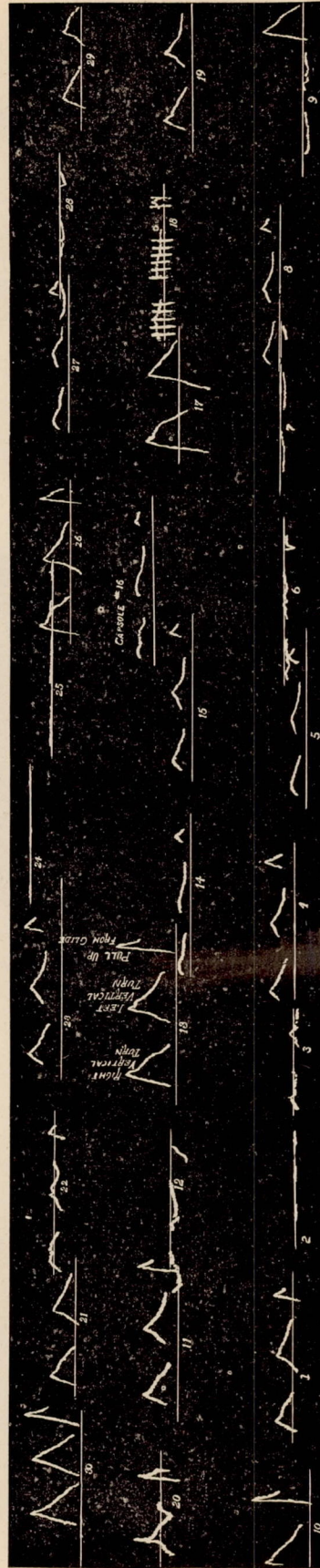

FIG. 8.—Multiple manometer record. Pressure distribution test on TS airplane

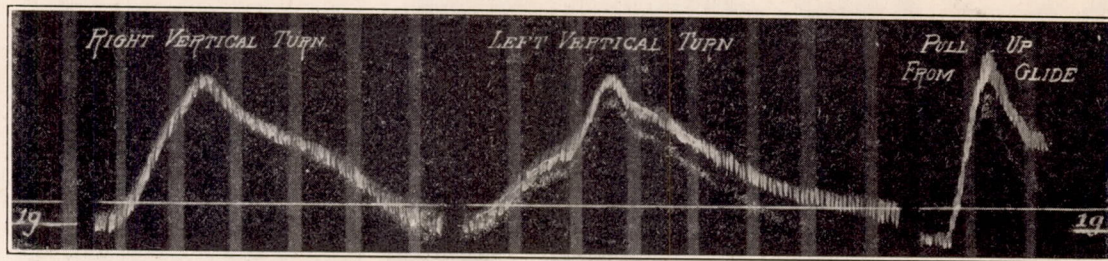

FIG. 9.—Accelerometer record. Pressure distribution test on TS airplane

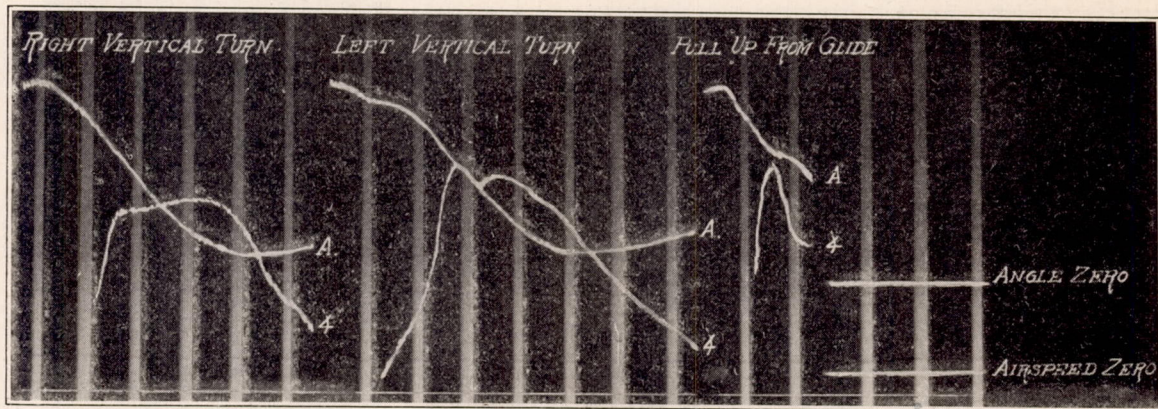

FIG. 10.—Air speed and angle of attack record. Pressure distribution test on TS airplane

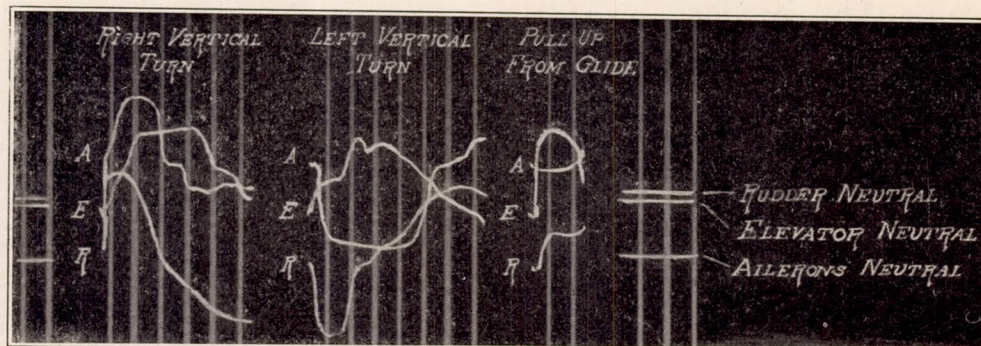

FIG. 11.—Control position record. Pressure distribution test on TS airplane

records were read at short-time intervals for each entire run, the proper synchronization of different records being obtained by means of the timing lines. These data were tabulated and the recorded normal pressures on the wing rib were plotted on the chord line, similar to those shown in Figures 13a to 13f.

The instantaneous load curves were planimetered, and from this the rib loads, centers of pressure, moments about the leading edge, and normal force coefficients were determined. The normal force coefficient is the coefficient of lift perpendicular to the chord line, and is obtained from the expression:

$$C_{N_F} = \frac{L}{\frac{1}{2} \rho V^2}$$

Where L is the specific load found by planimetering the various distribution curves, and $\frac{1}{2} \rho V^2$ the dynamic pressure measured by the Pitot-static head. The various quantities enumerated, together with some of the original data read from the photographic records, were plotted against time, thus forming a complete time-history of each maneuver investigated (fig. 13). The loads as plotted on the time-history curves are the average loads along the chord in lb./sq. ft. Wing and tail-plane moments are given in inch pounds per foot of span.

In plotting loads on the elevator, this surface is shown in a neutral position at all times, whereas in reality, it is at a varying angle. There is a slight error in the tail-moment curves on account of this angle of the resultant elevator force being disregarded.

PRECISION

The estimated precision of the measurements is as follows:

1. Air speed.....	±1 M. P. H.
2. Acceleration.....	±0.1 g
3. Control position.....	±0.5°
4. Time synchronization.....	±0.1 second
5. Individual normal pressures.....	±2 per cent

In estimating the precision of the pressure measurements it is assumed that the errors introduced by the orifice and the inherent instrument errors are negligible. This is very probably true because care was taken to install the orifices flush with the surface of the ribs and the manometer was calibrated at frequent intervals throughout the tests. The pressure loss in the tubing is also small. A recent series of laboratory and flight tests conducted at the Langley Memorial Aeronautical Laboratory on the pressure loss in transmitting air pressure through tubes (Reference 7) has provided the basis of the above estimate of precision of the pressures. In the case of the loads, centers of pressure, moments and normal force coefficients, which are determined from an integration of the normal pressures along the rib, there is a possibility of further error. However, since the different sources of error cancel each other partially it can be assumed that these are exact to ±3 per cent.

The measurement of angle of attack in accelerated flight was unsuccessful. This was probably due to the change of air flow in such flights and also to the fact that the angle of attack varies over the whole chord and span to some extent in all maneuvers. For this reason the angle of attack has been included in only a few of the curves and, except in the level flights, it should be regarded as the general trend of the angle rather than a specific value to be used in any calculations or comparisons. In level flight the angle of attack is precise to ±0.5°.

DISCUSSION OF RESULTS

The results of this investigation are given in Tables I and II and in Figures 12 to 37. Table I contains the pressure measured at each station for each increment of air speed in level flight and for each interval of time in all the maneuvers. In Table II are given, for both the wing and tail surface, the load, normal force coefficient, and the center of pressure location or the moment about the leading edge (all of which are determined from an integration of the pressures along the rib) together with the air speed, acceleration, and control position. These values are also

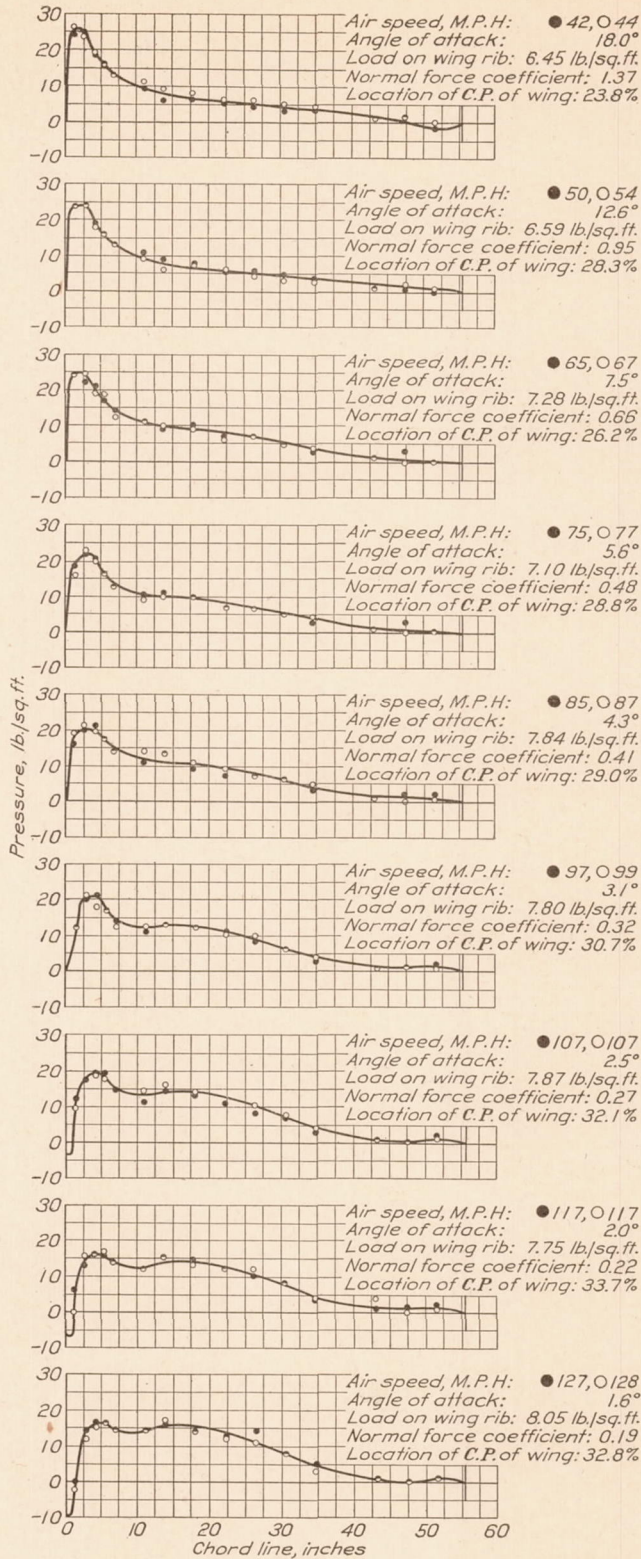

FIG. 12.—Pressure distribution on VE-7 airplane in level flight

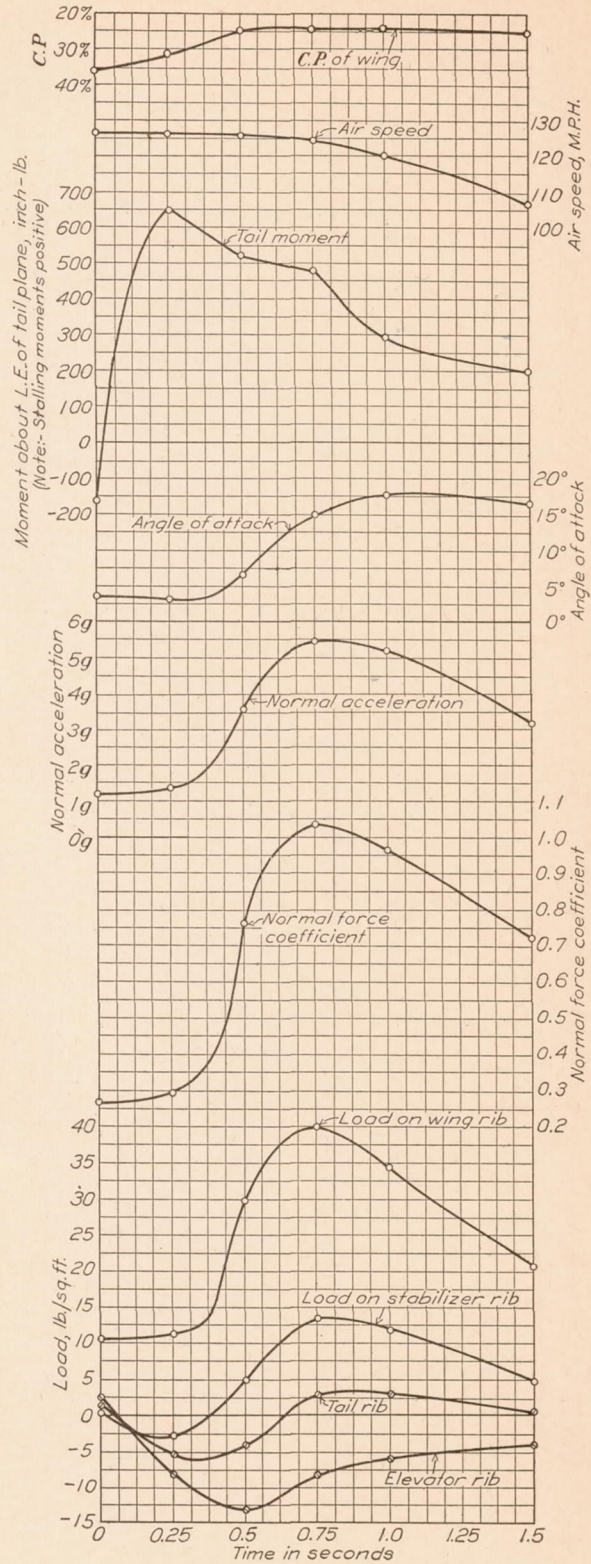

FIG. 13.—VE-7 airplane in a "pull-up" at 126 M. P. H.

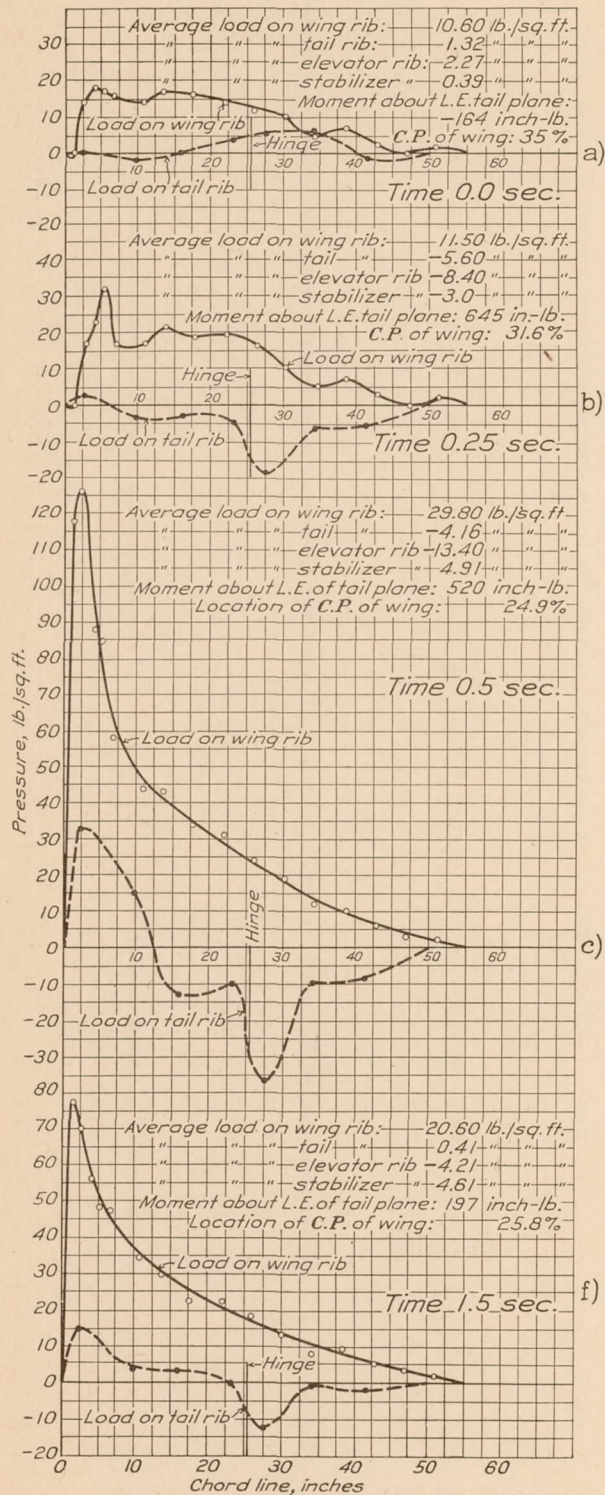

Fig. 13a, b, c, and f.—Pressure distribution on a VE-7 airplane in a "pull-up" at 126 M. P. H. for various intervals of time

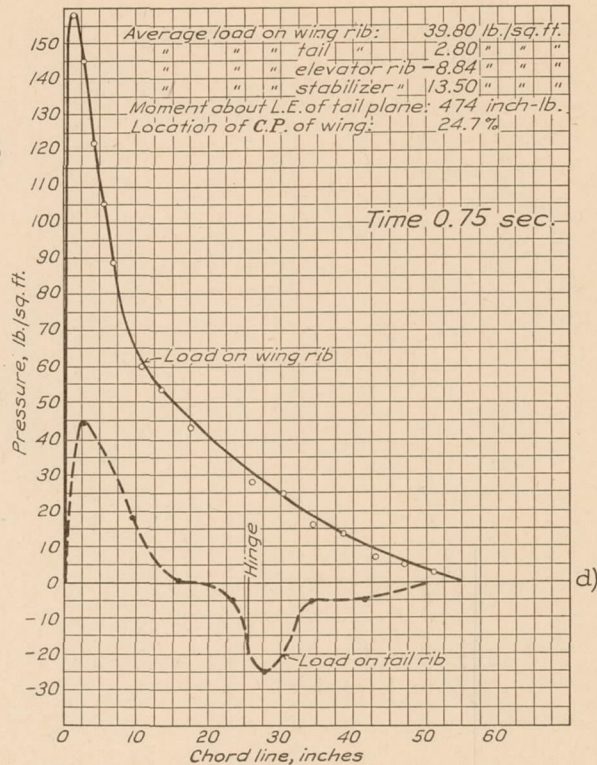

Fig. 13d.—Pressure distribution on VE-7 airplane in a "pull-up" at 126 M. P. H. for interval of 0.75 second

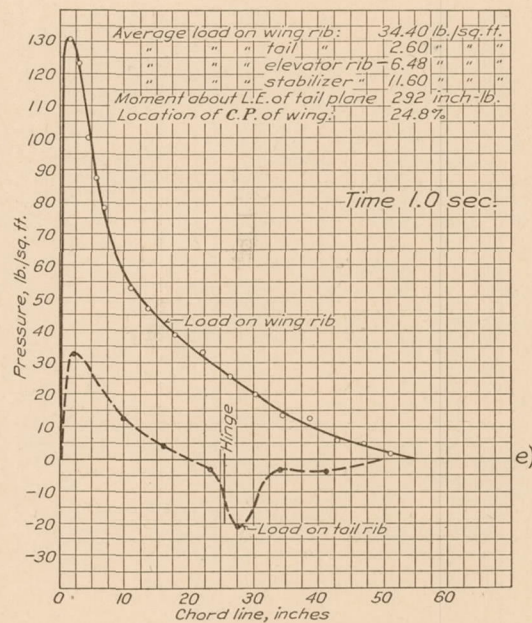

Fig. 13e.—Pressure distribution on VE-7 airplane in a "pull-up" at 126 M. P. H. for interval of 1.0 second

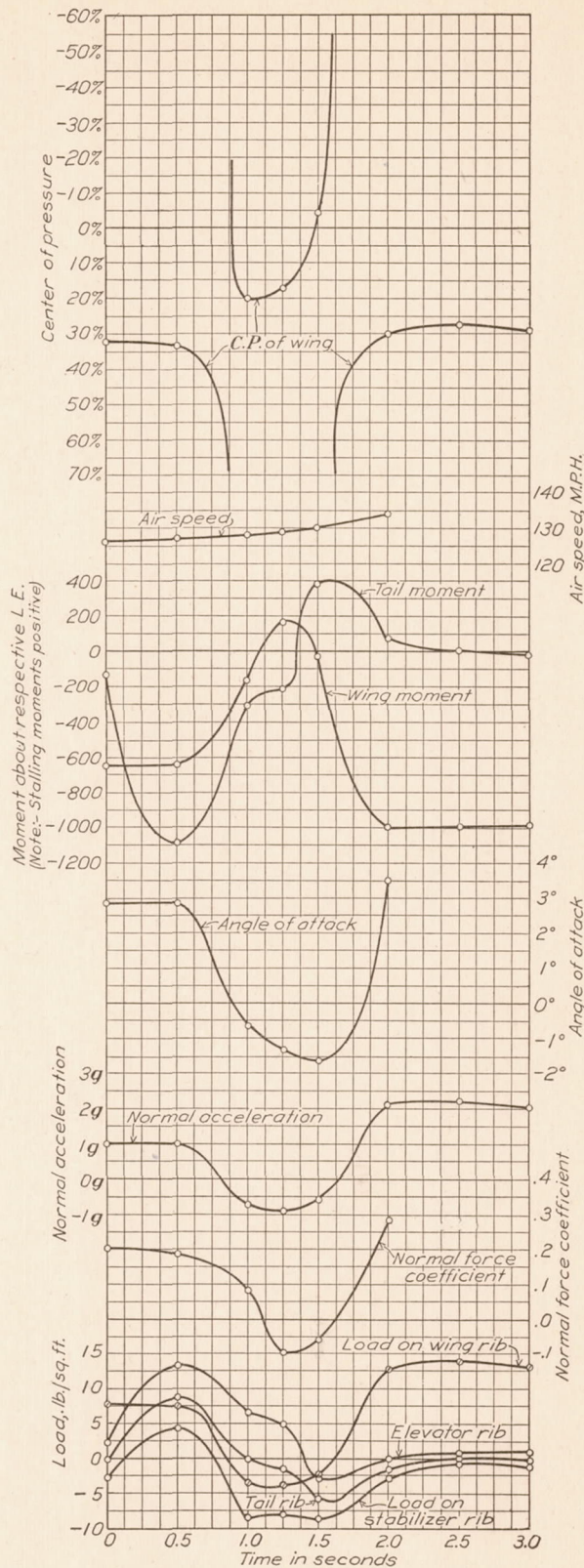

Fig. 14.—VE-7 airplane in a no lift condition (push-down) at high speed

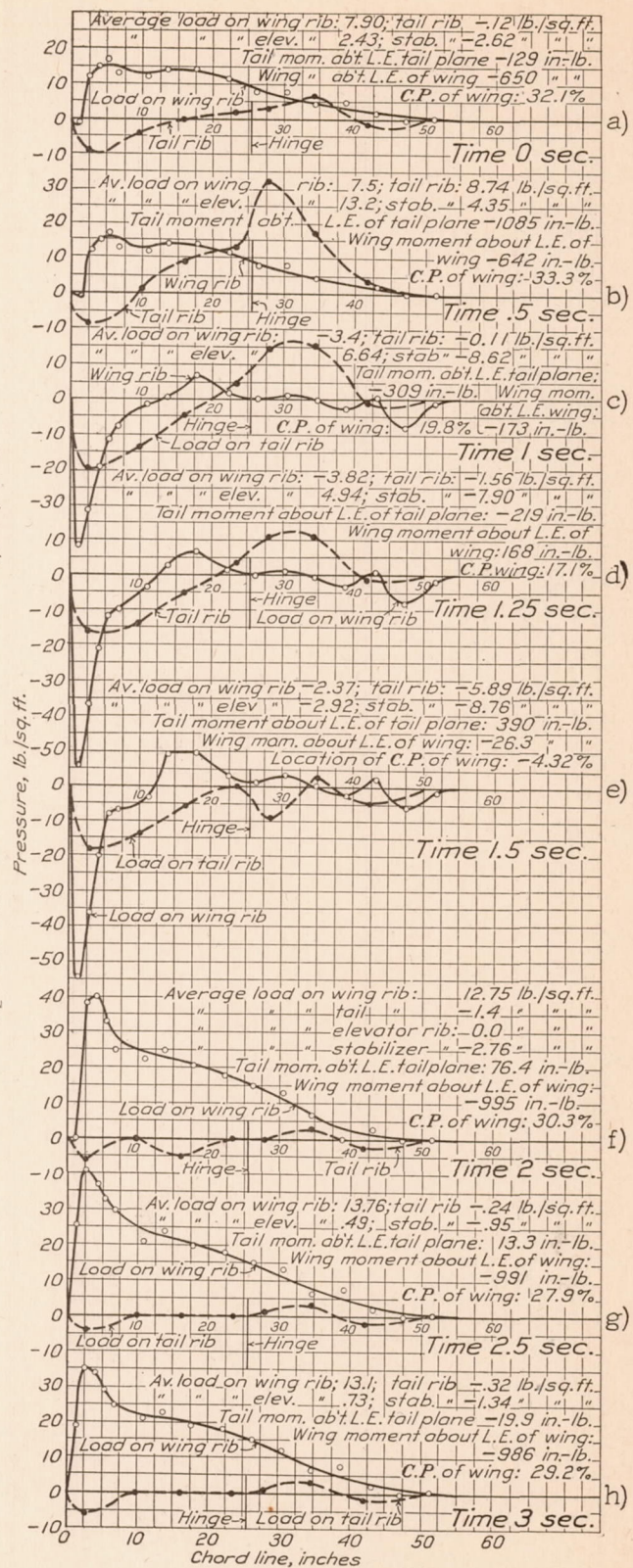

Fig. 14a, b, c, d, e, f, g, and h.—Pressure distribution on VE-7 airplane in a no lift condition at high speed for various intervals of time

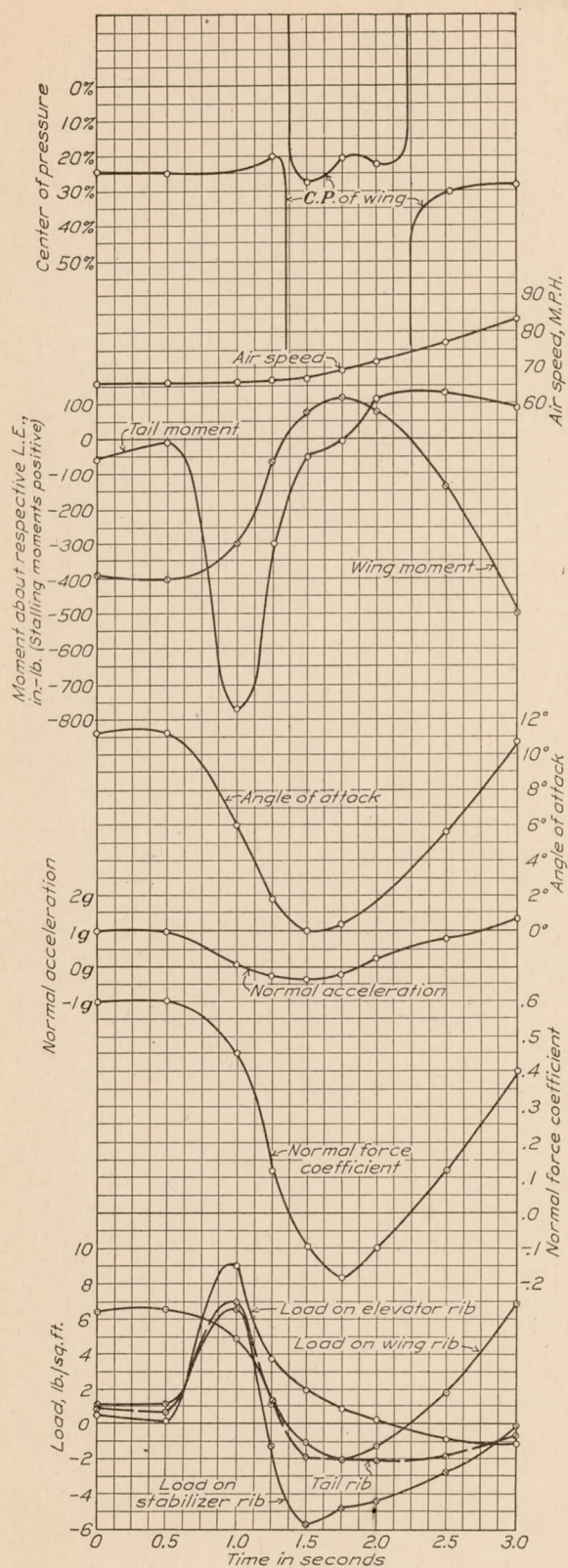

FIG. 15.—VE-7 airplane in a no lift condition (push-down) at low speed

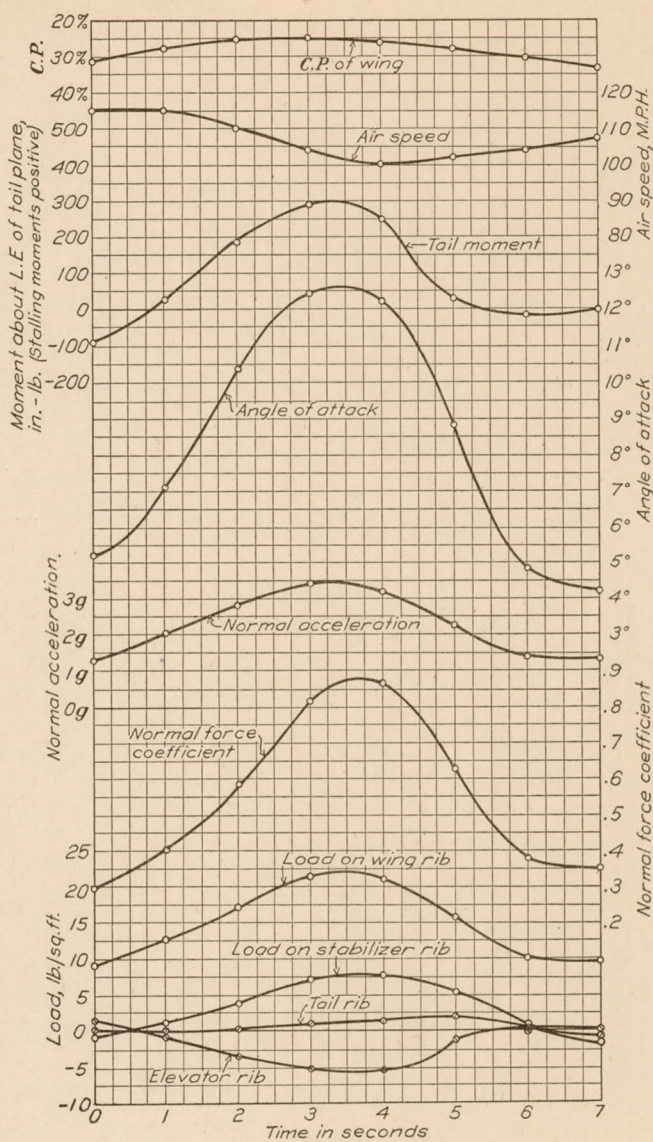

FIG. 16.—VE-7 airplane in a right turn

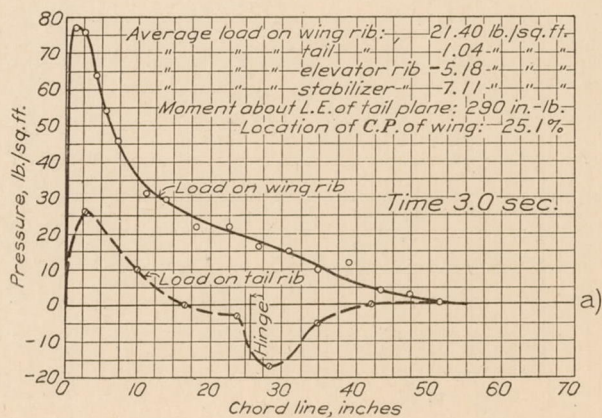

FIG. 16a.—Pressure distribution on VE-7 airplane in a right turn. Maximum wing loading

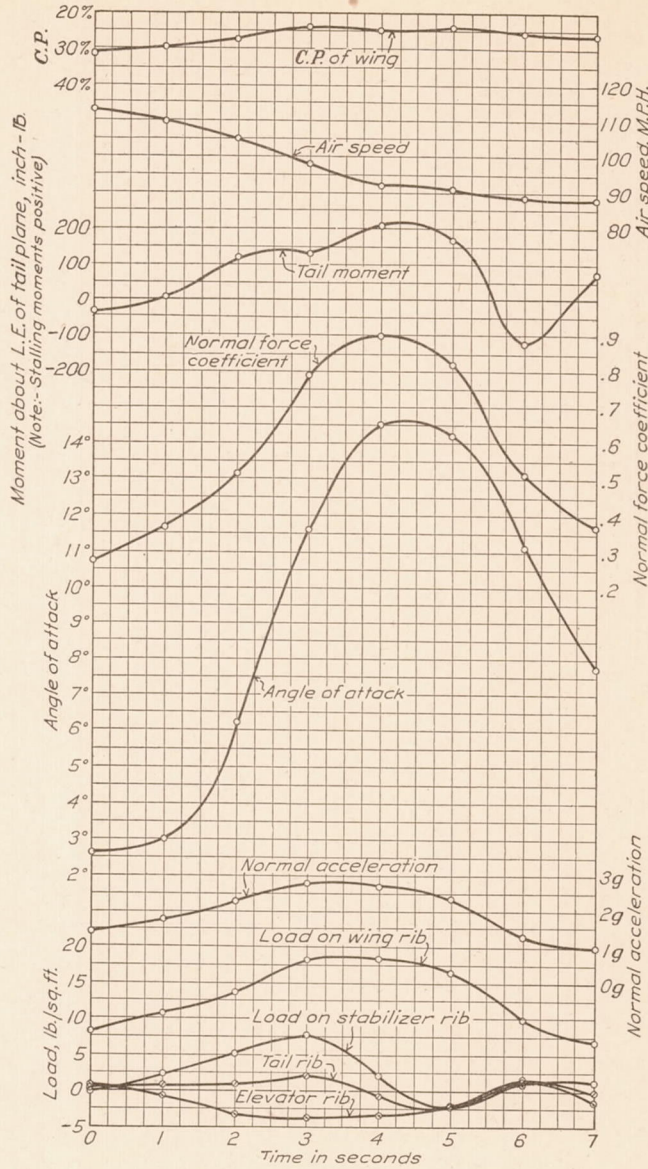

Fig. 17.—VE-7 airplane in a left turn

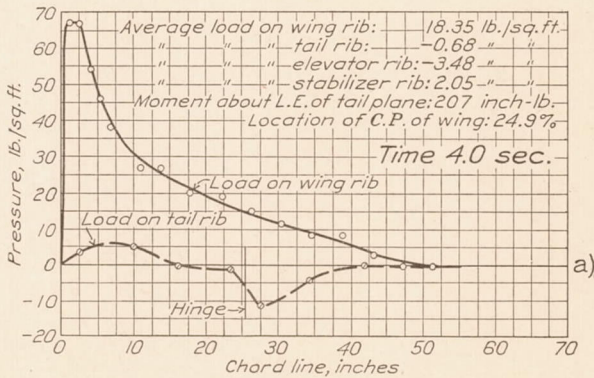

Fig. 17a.—Pressure distribution on VE-7 airplane in a left turn. Maximum wing load

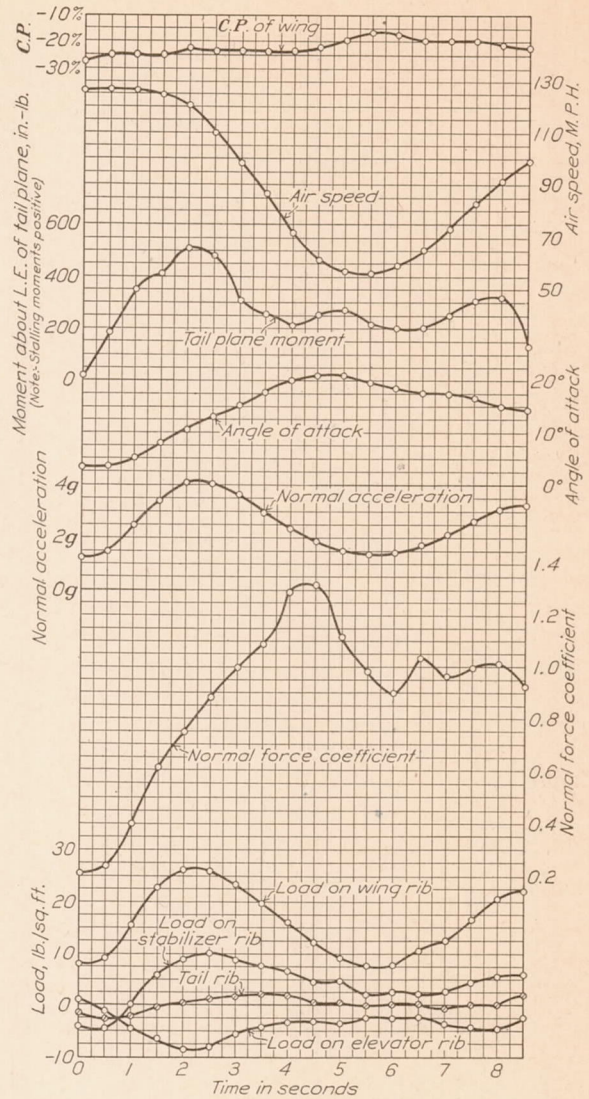

Fig. 18.—VE-7 airplane in a loop

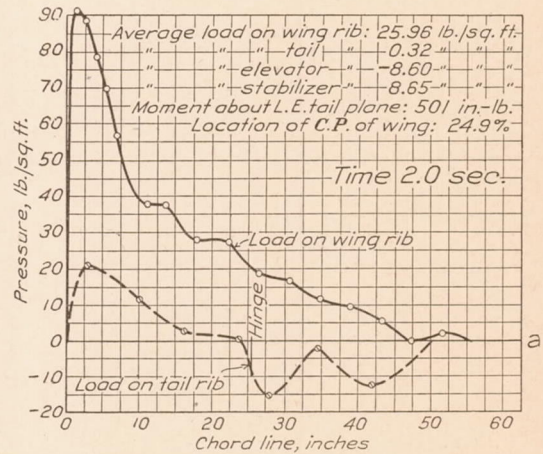

Fig. 18a.—Pressure distribution on VE-7 airplane in a loop. Maximum wing load

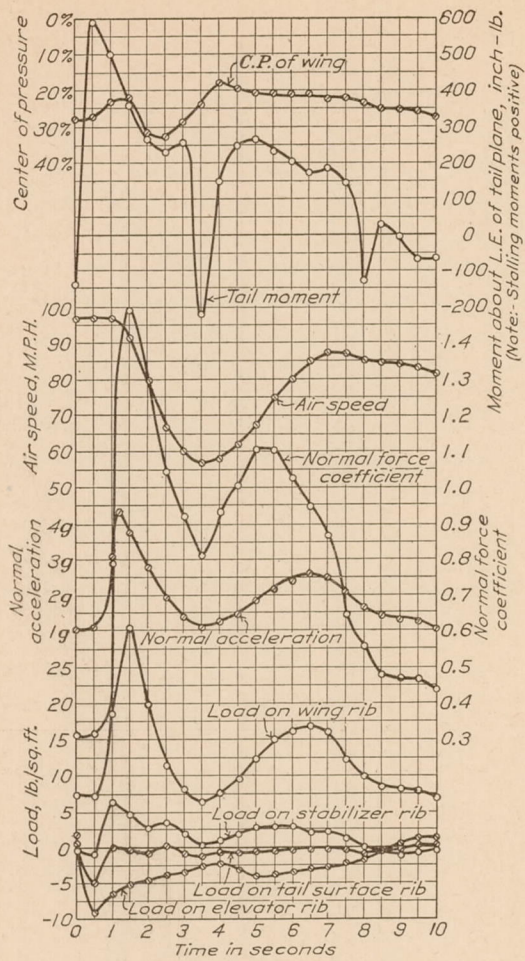

Fig. 19.—VE-7 airplane in a right roll

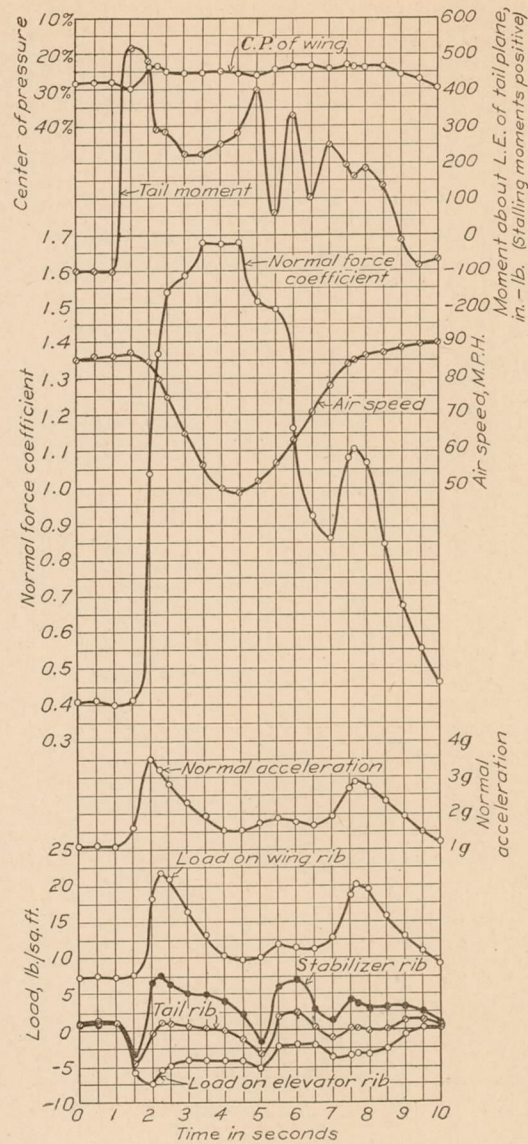

Fig. 20.—VE-7 airplane in a left roll

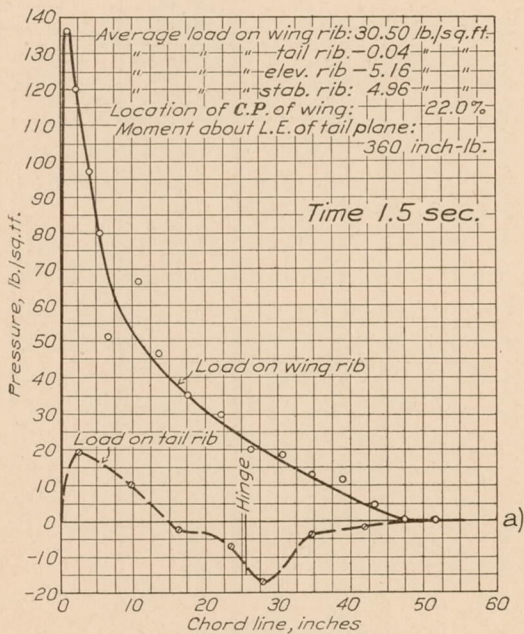

Fig. 19a.—Pressure distribution on VE-7 airplane in a right roll. Maximum wing load

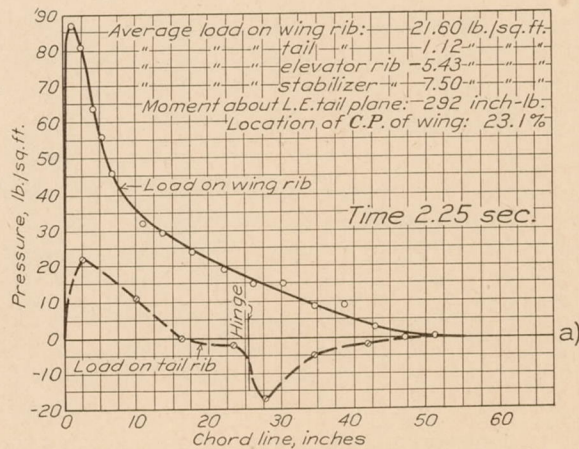

Fig. 20a.—Pressure distribution on VE-7 airplane in a left roll. Maximum wing load

tabulated for each air-speed increment in level flight and each time interval of the maneuvers. In the past there has been some uncertainty concerning the moment acting on the wing when the *C. P.* approaches infinity. This has been remedied in this paper. In all such cases the moment has been determined in addition to the *C. P.* location. Three different kinds of curves showing the results are plotted: (a) Those showing the pressure distribution along the rib (figs. 12, 13a to 13f, etc.), which will be referred to hereinafter simply as pressure curves; (b) those representing a time history of the variables measured throughout a maneuver (figs. 13, 14, etc.); and (c) those showing a comparison of the loads obtained in flight with those specified for static load tests by the Army Air Corps and the Bureau of Aeronautics, Navy Department (figs. 29 to 36). There were a large number of pressure curves plotted to obtain the information necessary for the time histories, but only those of special interest are given in this report. The pressure curves for the pull-ups and push-downs are included complete, as these maneuvers give rise to the maximum loadings for the high and low angle of attack conditions, respectively, and these curves are also examples of the typical stages through which the rib loading builds up. For the other maneuvers only the pressure curve showing the largest load in each maneuver has been inserted.

In addition to the above, a curve is given showing the theoretical accelerations compared to those actually obtained (fig. 37).

Since the tables are rather extensive, another table has been added summing up the maximum average loads, maximum resultant pressures, and maximum normal force coefficients encountered, as follows:

TABLE III

	Maximum average positive load	Maximum average negative load	Maximum positive resultant pressure	Maximum negative resultant pressure	Maximum <i>C_{NF}</i>
	<i>Lb./sq. ft.</i>	<i>Lb./sq. ft.</i>	<i>Lb./sq. ft.</i>	<i>Lb./sq. ft.</i>	
VE-7 airplane:					
Wing rib.....	39.8	-3.8	158	-54	1.679
Tail rib.....	8.7	-5.9	44	-37	
Elevator rib.....	13.2	-13.4	32	-37	
Stabilizer rib.....	13.5	-8.8	44	-20	
TS airplane:					
Upper wing rib.....	52.3		164	-96.0	1.853
Lower wing rib.....	38.2		100	-129.5	1.770
Tail rib.....	2.3	-17.7	40	-53.0	
Elevator rib.....	17.7	-19.0	40	-37.0	
Stabilizer rib.....	7.9	-19.3	33	-53.0	

As previously stated, one of the two main objects of this investigation was to obtain some data as to the time correlation of the loads occurring on the wing and tail surfaces. This has been accomplished as the time-history curves indicate. A study of the results obtained shows that at least in so far as can be determined from an investigation of a single rib, there is no definite sequence in which the wing and tail ribs reach their maximum loads in different maneuvers. In general, the loads on the elevator start to build up sooner than the wing loads, but the latter appear to build up more rapidly and as a result may reach their maximum simultaneously with the tail loads or even before the tail loads.

The second main objective in the investigation was to determine the distribution of load on a wing rib and on a tail surface rib to check the rules for specifying rib loads for design purposes. Once again it should be pointed out that since only single ribs were investigated, the results can not be entirely conclusive. Figures 29 to 36 show the comparison of the rib loadings specified by the Army Air Corps (Reference 8) and the Bureau of Aeronautics, Navy Department (Reference 9), with those measured in these tests, the worst positive and negative loadings measured being given. It will be noted in general that the loadings for the high angle of attack condition are in fairly good agreement, the Navy specified loads more closely simulating the flight loads. In the low angle of attack condition there is a considerably greater discrepancy in the comparison, the Navy loading again agreeing better with the flight loads. The Army

specified loading in Figures 32, 33, and 34 is the loading for medium angle of attack condition, but is the loading used for low angle of attack as well and is therefore comparable to the flight tests and Navy low angle of attack loads. The Army loading to be applicable to low angle of attack, as shown particularly by the loads measured on the TS airplanes (figs. 33 and 34), should include a negative load on the leading edge. It will also be noted in these figures that there is a considerable difference in the pressure distribution on the two wings investigated in the low angle of attack condition. This indicates the desirability to further investigate the pressure distribution on other wing sections before suggesting a distribution satisfactorily applicable to all types of commonly used wing sections. Wind tunnel tests are now in preparation to find the characteristic distribution on several other standard wing sections. The specified total load on the horizontal tail surfaces (figs. 35 and 36) is much larger than was found in any of the maneuvers, but because of the irregularity of the tail surface load, some of the local loads exceeded the specified slightly.

The center of pressure location at high angle of attack is very interesting. On the VE-7, where only the upper wing was investigated, the *C. P.* location in level flight agrees with monoplane wind tunnel tests of the wing section, but in accelerated flight the measured *C. P.* is farther forward by approximately 4 per cent of the chord. On the TS, where both the upper and lower wings were measured, in level flight the *C. P.* location of the upper wing again agrees very closely with wind tunnel tests, but on the lower wing is about 1 per cent of the chord farther forward. In accelerated flight the *C. P.* of the upper wing is 2 per cent forward of tunnel results while the lower *C. P.* is 2 per cent back. (NOTE:—The comparisons of wind tunnel and flight center of pressure locations were made for the same normal force coefficient.) This variation is not at all serious with respect to rib design, but may be so with respect to the distribution of load between spars and with respect to the design of lift trusses. If, as is indicated here, there is a change in *C. P.* location caused by accelerations in flight the use of the usual wing section data for wing design might be dangerous. The present tests are not complete enough to definitely establish this. The variation of *C. P.* over the span might vary considerably so that the average *C. P.* location is farther back than found here, as was the case in a previous pressure distribution experiment (Reference 10). The problem warrants further and more complete research, which is at present in progress.

To determine the possible effect of engine power and slip stream on the loads experienced, pull-ups were made with "power on" and "power off" at the same air speed (figs. 22 and 23). The results show that while the same acceleration was obtained in each, the wing rib loads in the pull-up with "power off" exceeded those obtained in the "power on" condition. This seeming contradiction is explained by the fact that the rib investigated was outside of the slip stream and the "power on" flight, because of the slip stream, produces a larger loading on the portion of the wing in the slip stream with a consequent decrease on the portion outside. Thus, while the total loading for these two flights was equal, the distribution along the span was different in such a manner that the "power off" flight showed the largest wing rib load at the rib investigated. The "power on" flight indicates a much lower air speed drop between the start of the maneuver and point of maximum load.

Since it is easy to compute the theoretically possible maximum acceleration on an airplane when pulled up suddenly, it was considered of value to compare the theoretical and actual accelerations of each of the airplanes used. The flight tests were extended to include a series of pull-ups from level flight at speeds ranging from about 60 M. P. H., to the maximum speed. The actual accelerations were measured by the accelerometer and the theoretical calculated from the expression:

$$A = \frac{V^2}{V_s^2} \text{ (Reference 11),}$$

where A is the acceleration in terms of g ,
 V_s is the minimum speed,
 V is the speed at the pull-up.

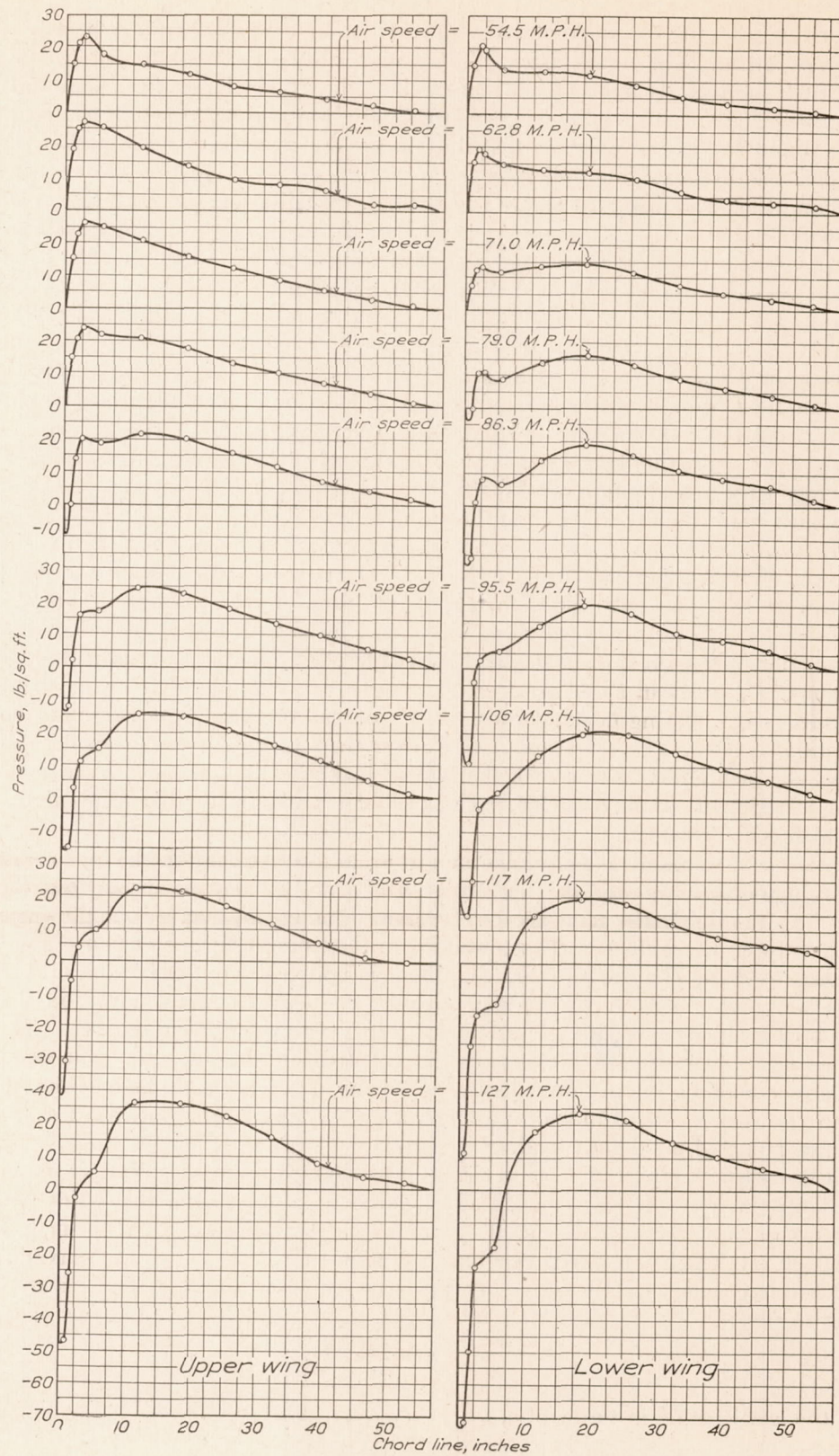

FIG. 21.—Pressure distribution on a TS airplane in level flight

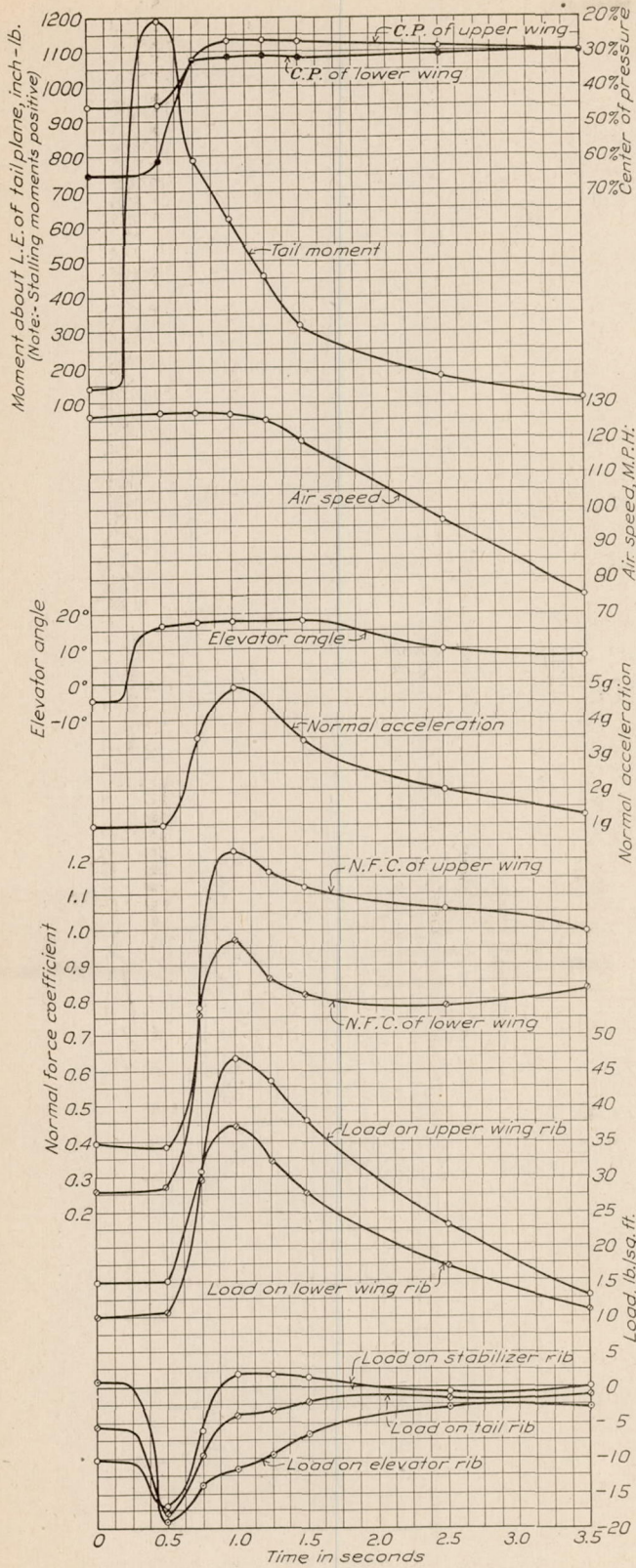

Fig. 22.—TS airplane in a "pull-up" with power on at 127 M. P. H.

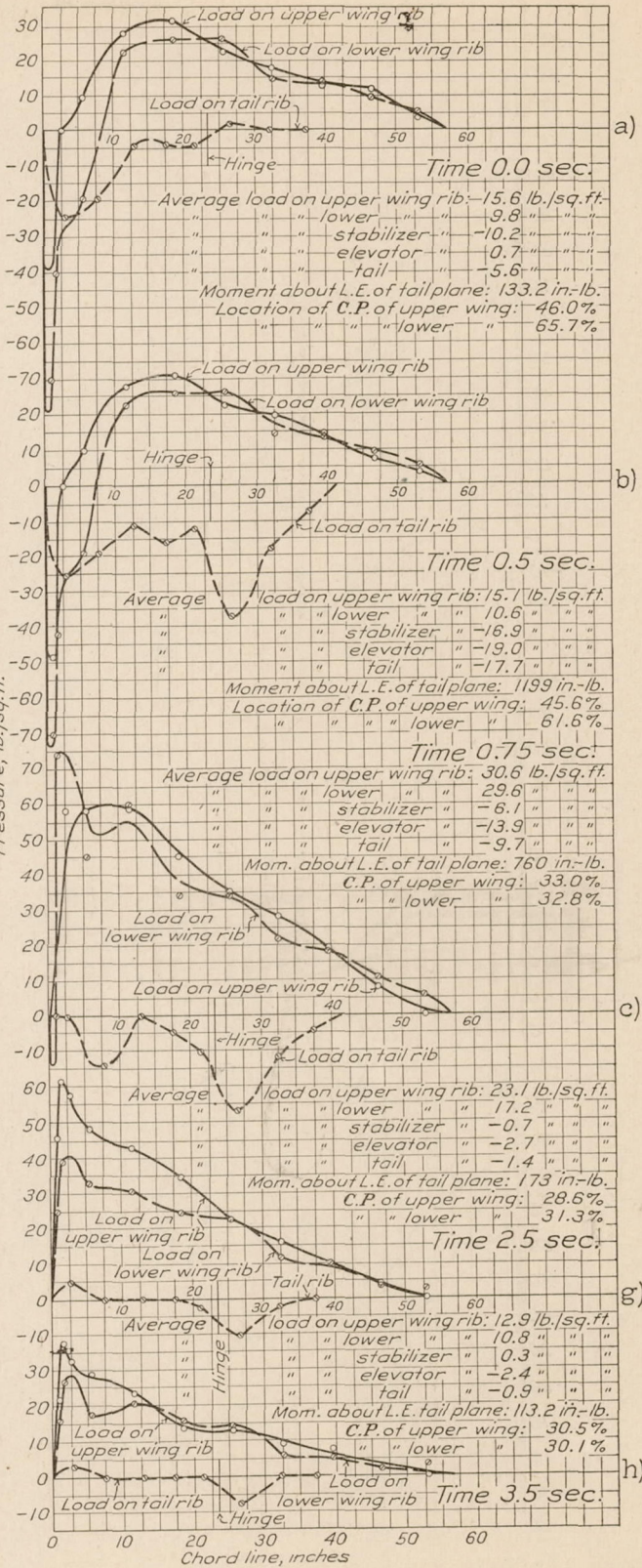

Fig. 22a, b, c, g, and h.—Pressure distribution on TS airplane in a "pull-up" with power on at 127 M. P. H. for various intervals of time

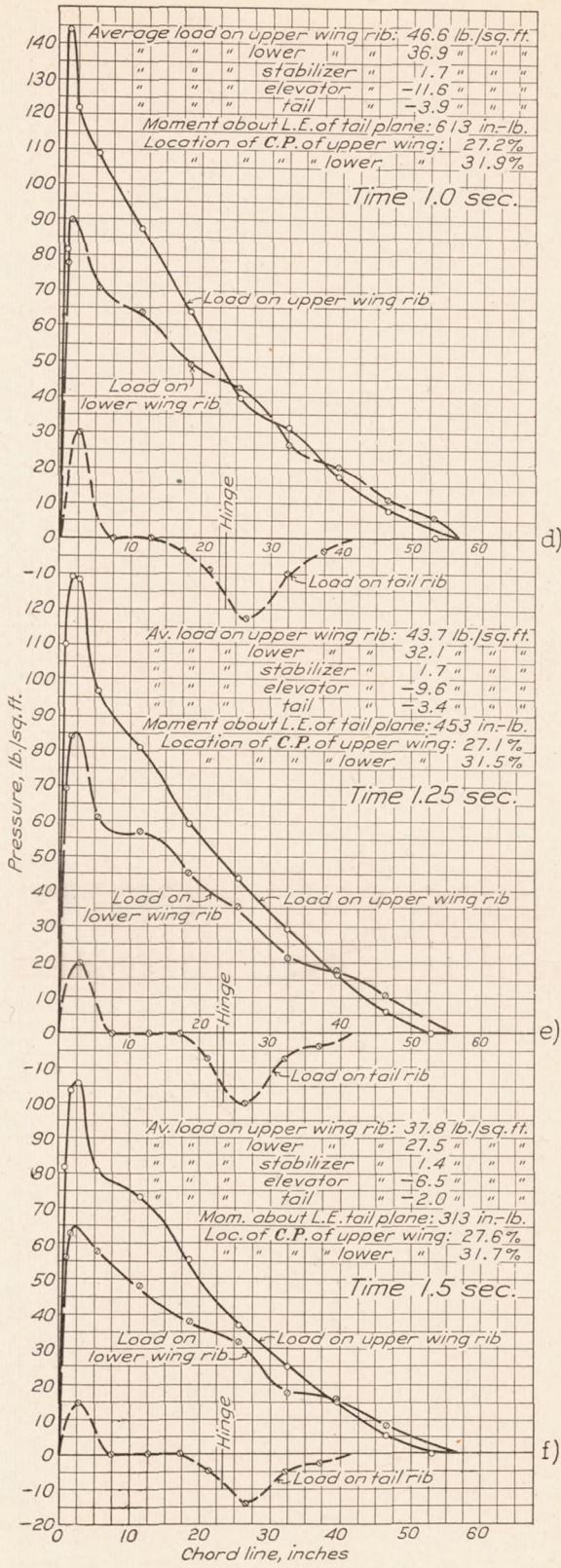

FIG. 22d, e, and f.—Pressure distribution on a “pull-up” with power on at 127 M. P. H. for various intervals of time

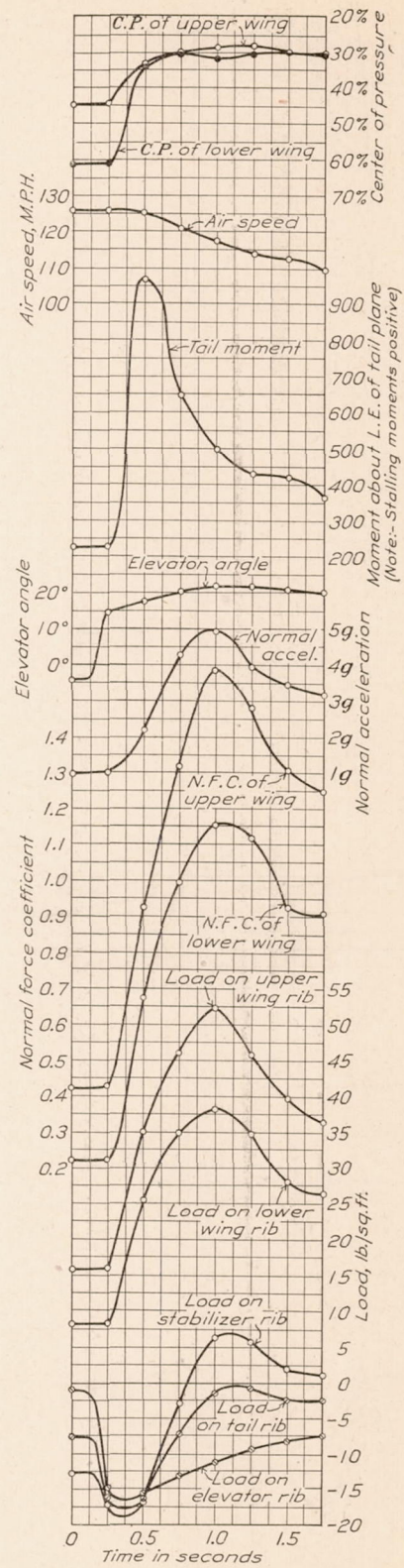

FIG. 23.—TS airplane in a “pull-up” with power off at 125 M. P. H.

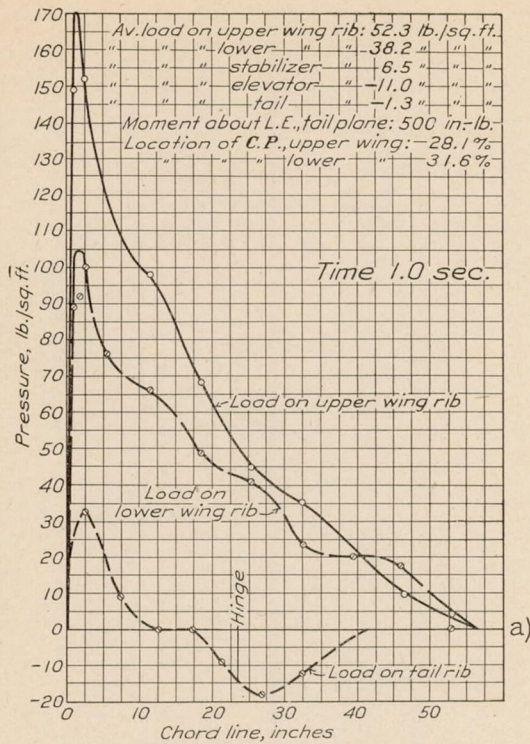

FIG. 23a.—Pressure distribution on a TS airplane in a "pull-up" with power off at 125 M. P. H. Maximum load, upper and lower wings

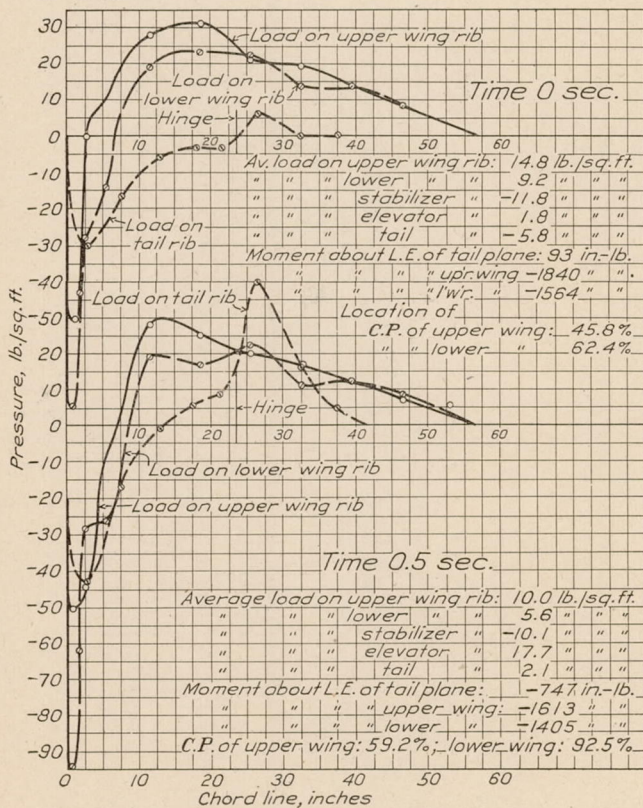

FIG. 24a and b.—Pressure distribution on TS airplane in a no lift condition (push-down) at high speed for various intervals of time

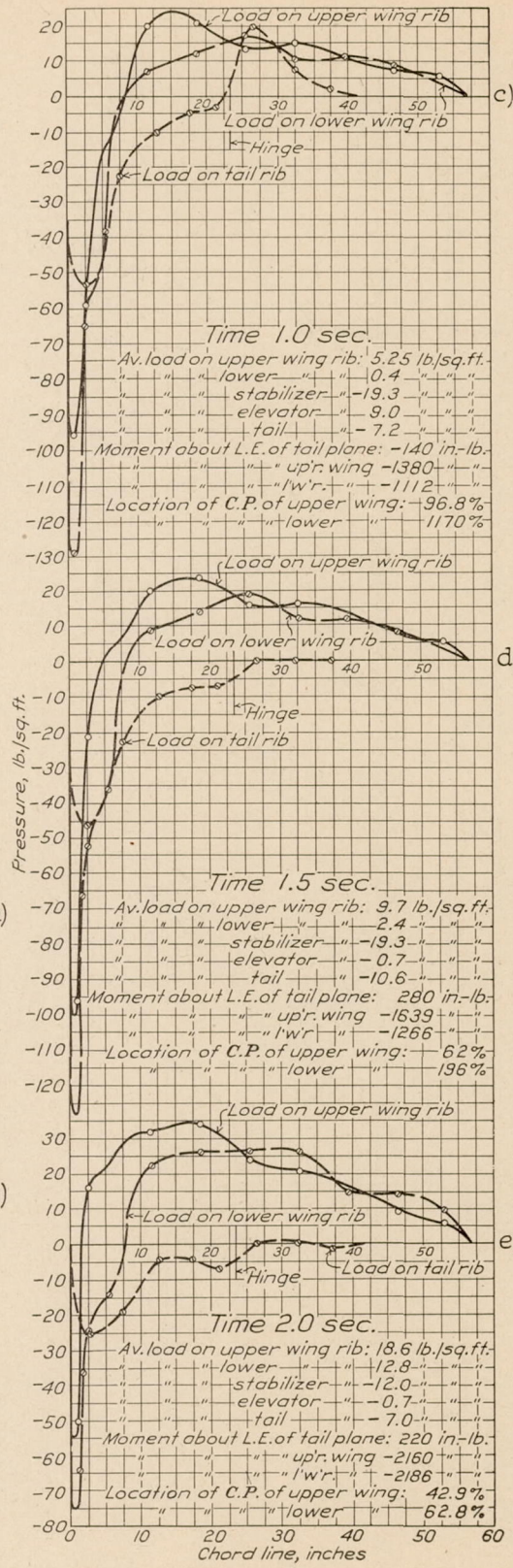

FIG. 24c, d, and e.—Pressure distribution on TS airplane in a no lift condition (push-down) at high speed for various intervals of time

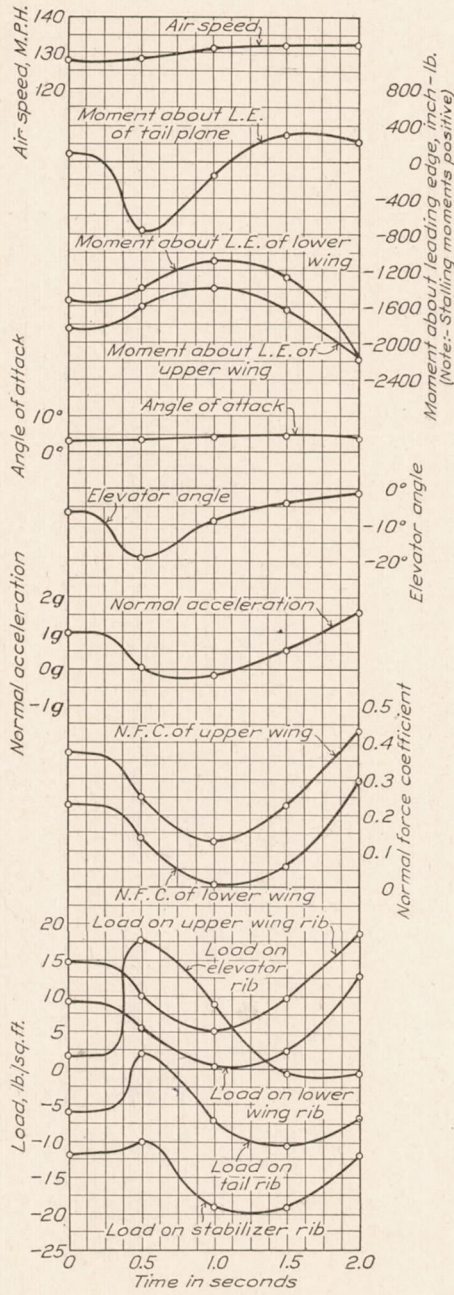

FIG. 24.—TS airplane in a no lift condition (push-down) at high speed

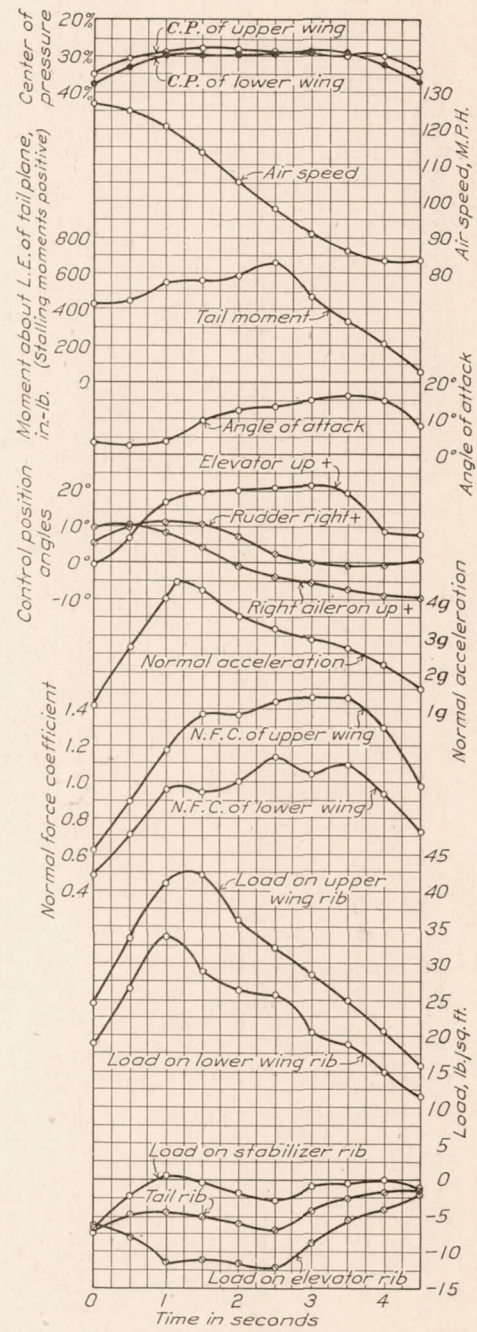

FIG. 25.—TS airplane in a right turn

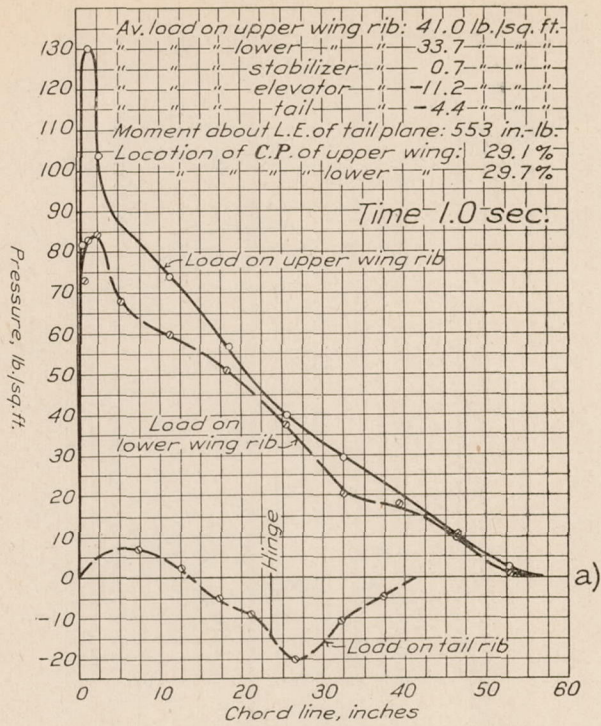

Fig. 25a.—Pressure distribution on TS airplane in a right turn. Maximum load lower wing

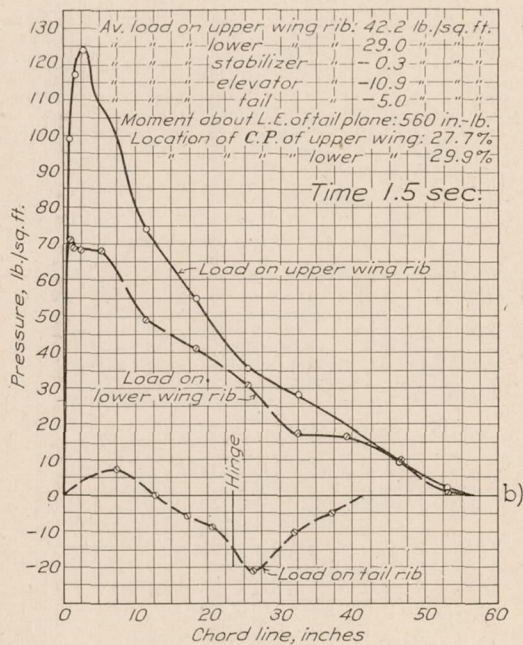

Fig. 25b.—Pressure distribution on TS airplane in a right turn. Maximum load upper wing

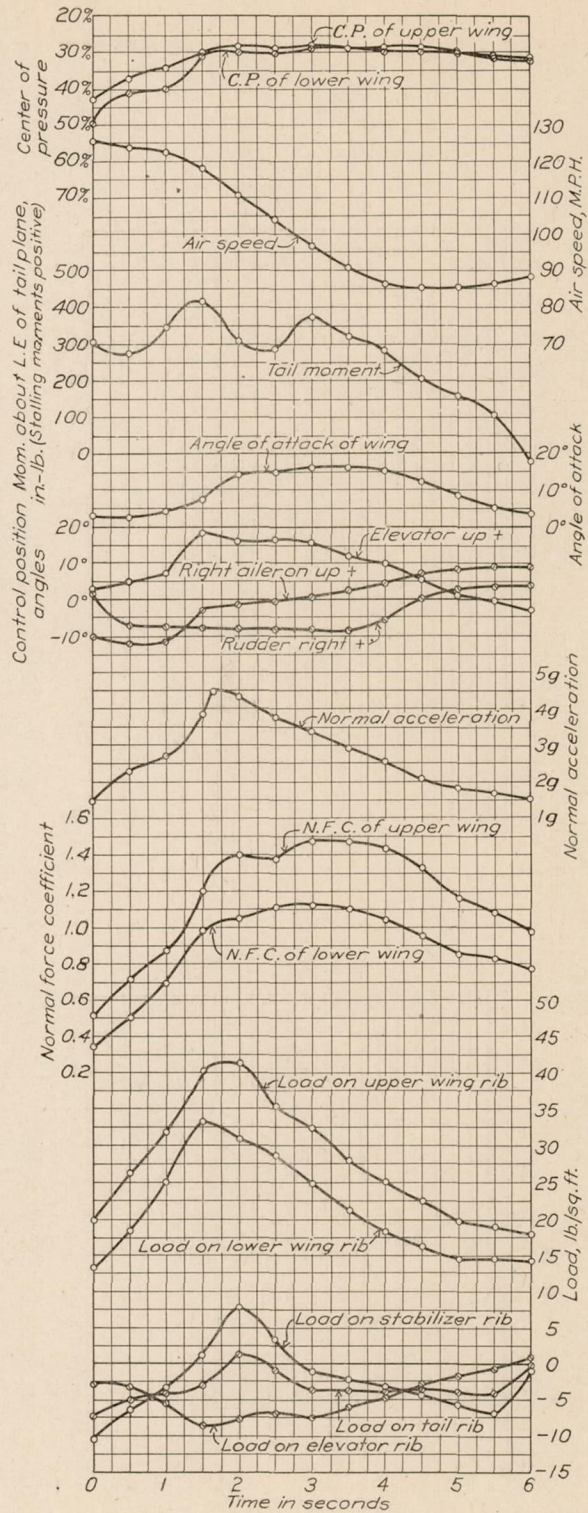

Fig. 26.—TS airplane in 1st turn

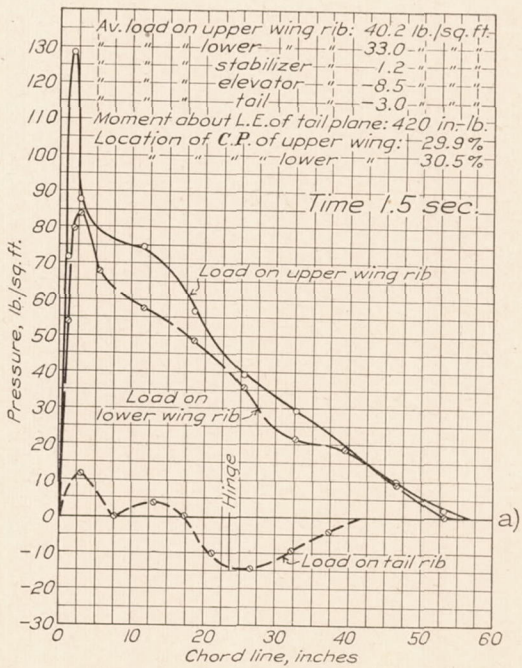
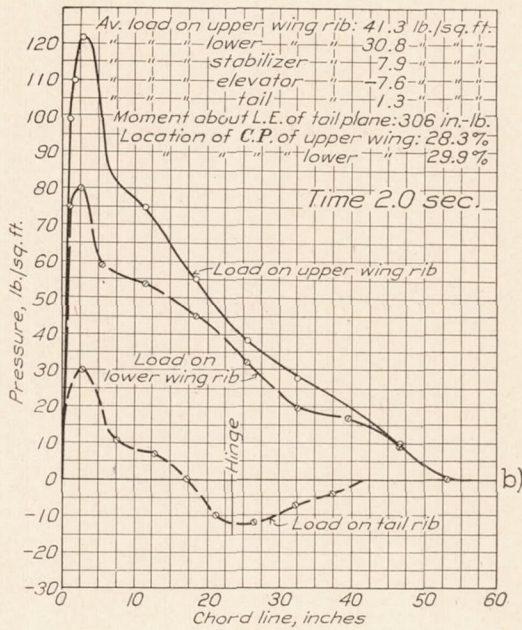

FIG. 26a and b.—Pressure distribution on TS airplane in a left turn. Maximum loads, (a) lower, (b) upper wing

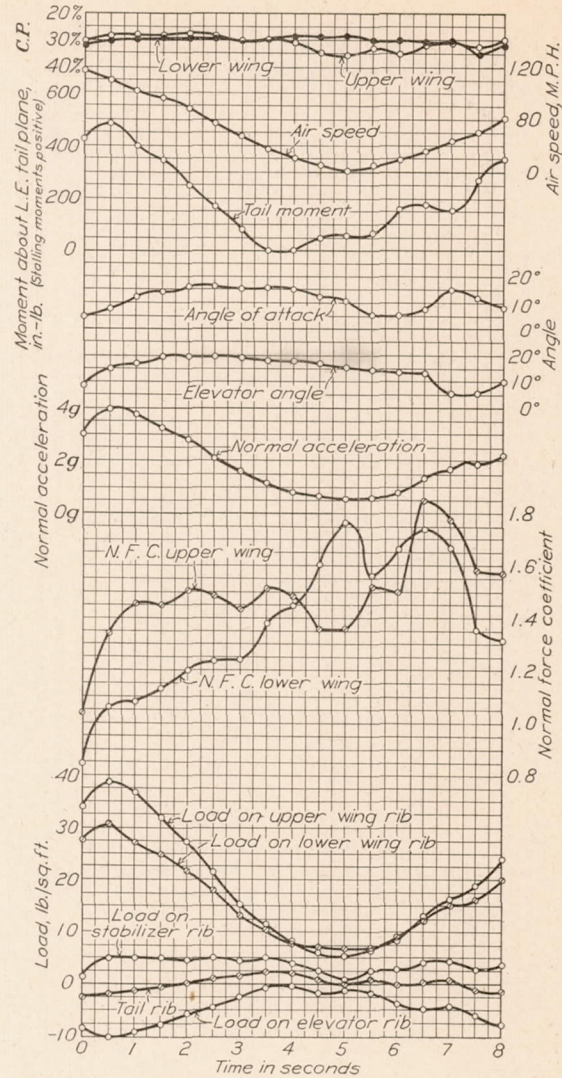

FIG. 27.—TS airplane in a loop

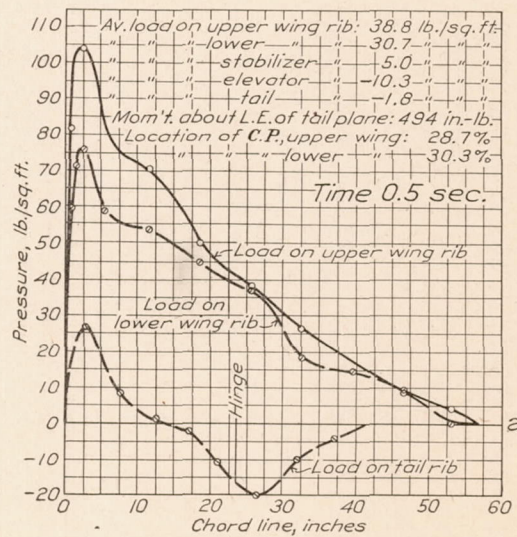

FIG. 27a.—Pressure distribution on TS airplane in a loop. Maximum loads, upper and lower wings

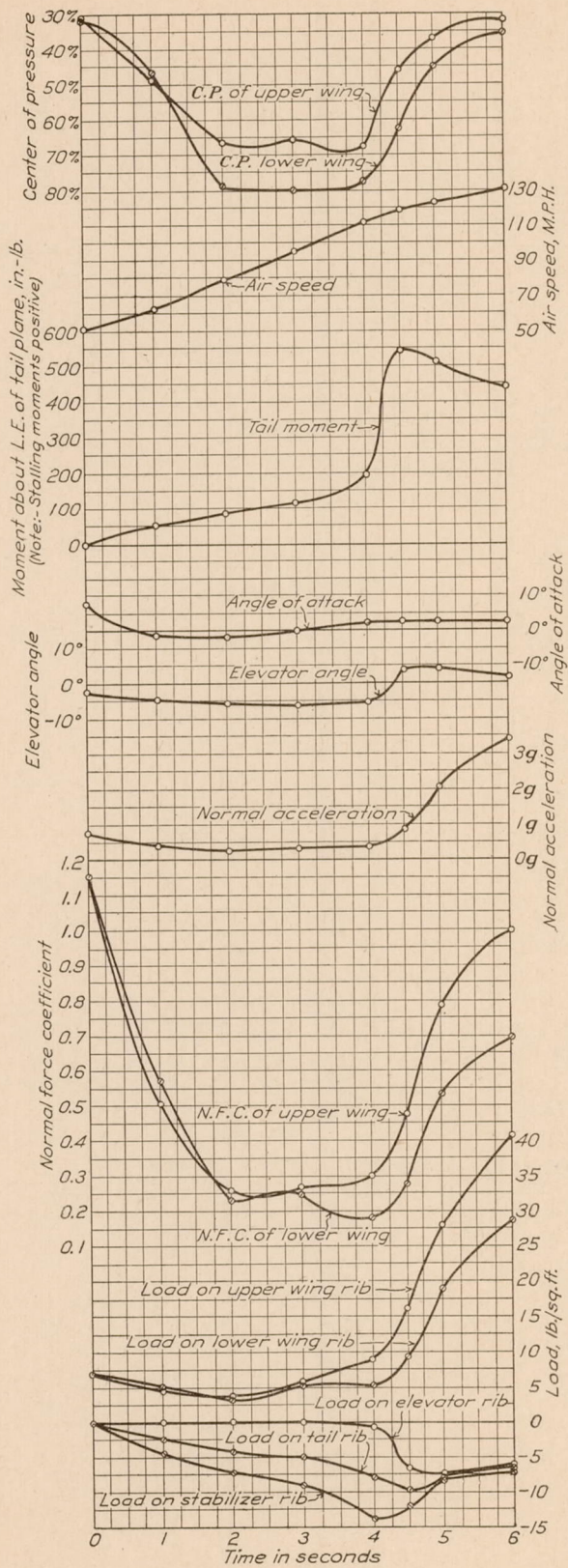

FIG. 28.—TS airplane in a dive

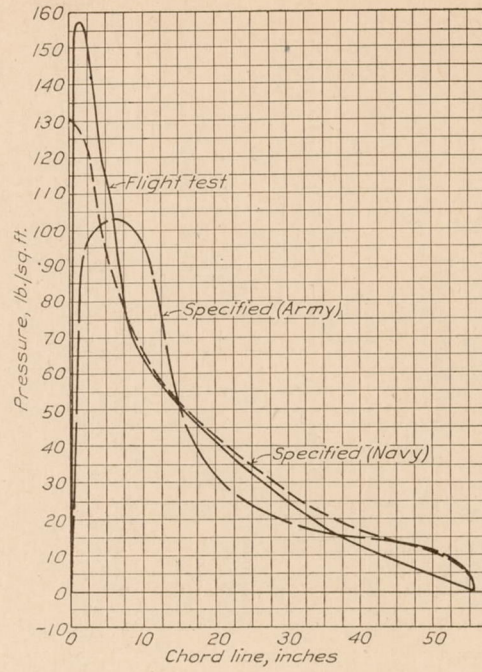

FIG. 29.—Maximum loading encountered on upper wing of VE-7 compared with specified static test loads

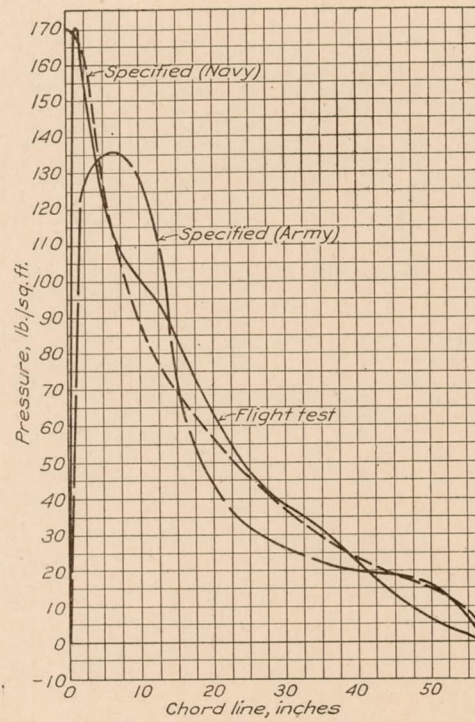

FIG. 30.—Maximum loading encountered on upper wing of TS compared with specified static test loads

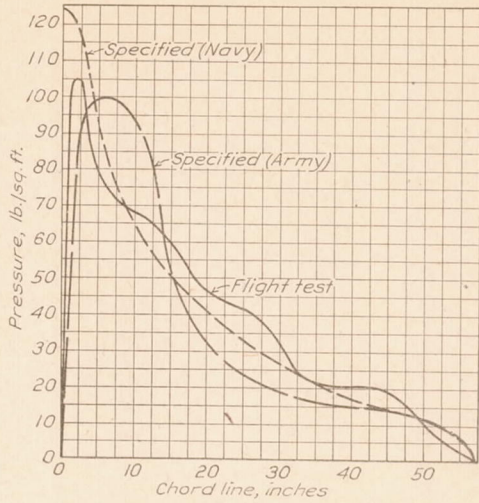

FIG. 31.—Maximum loading encountered on lower wing of TS compared with specified static test loads

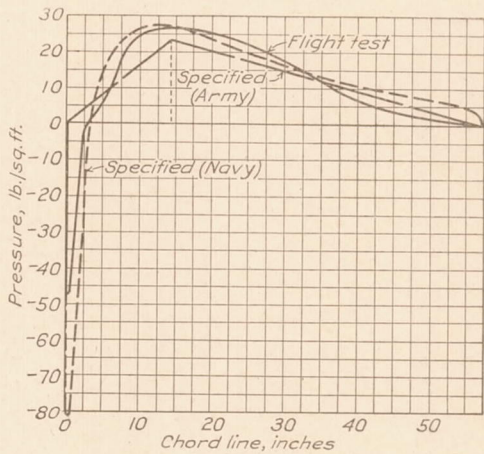

FIG. 33.—Low incidence (angle of attack) load on TS upper wing compared with medium incidence static test load specified by Army Air Corps and low incidence static test load specified by Bureau of Aeronautics, Navy Department

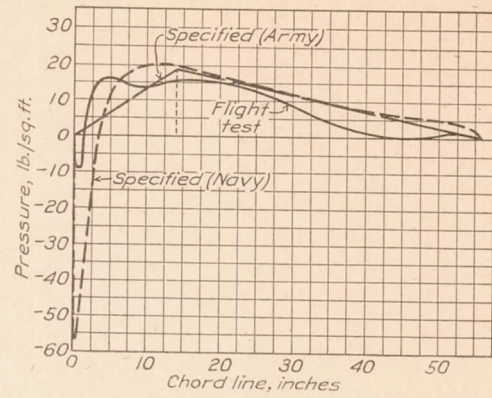

FIG. 32.—Low incidence (angle of attack) load on VE-7 upper wing compared with medium incidence static test load specified by Army Air Corps and low incidence static test load specified by Bureau of Aeronautics, Navy Department

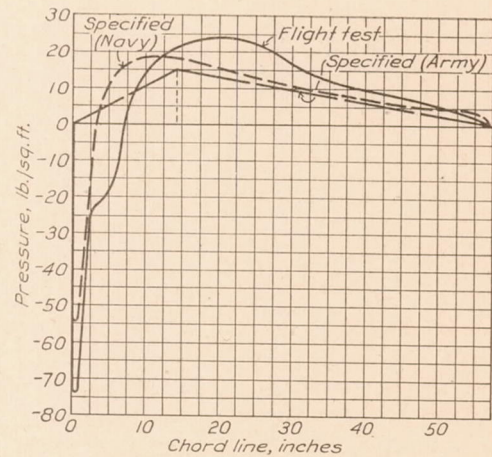

FIG. 34.—Low incidence (angle of attack) load on TS lower wing compared with medium incidence static test load specified by Army Air Corps and low incidence static test load specified by Bureau of Aeronautics, Navy Department

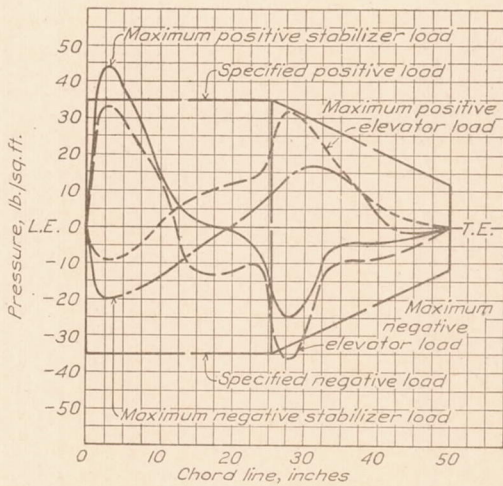

FIG. 35.—Maximum load on horizontal tail surfaces of VE-7 compared with static test load specified by Army Air Corps

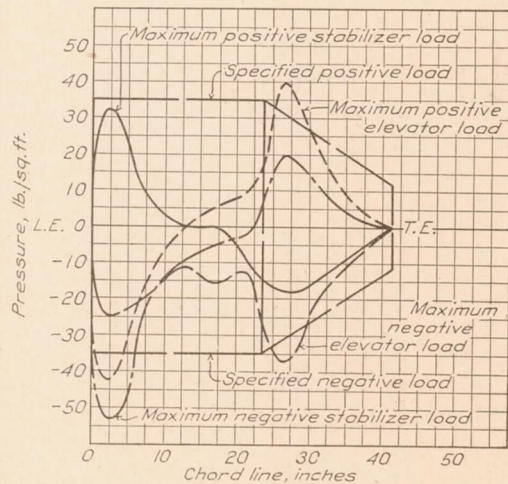

FIG. 36.—Maximum load on horizontal tail surfaces of TS compared with static test load specified by Army Air Corps

The accelerations are plotted for comparison in Figure 37. Uncertainty as to the exact value of V_s makes the computed values liable to some error. It appears though that on these two airplanes it is possible to obtain the theoretical maximum accelerations in flight below and up to speeds that are approximately 60 per cent of the maximum speed in level flight and that "power on" and "power off" does not affect this. In all cases the control stick was pulled full back practically instantaneously. The falling off of the actual accelerations from the theoretical at higher speeds must be due to lack of maneuverability and there may be derived therefrom a maneuverability factor.

In attempting to obtain the no lift or low angle of attack conditions in flight, several maneuvers were attempted before the push-down was decided upon. The most promising method of passing through zero lift apparently was in a dive at high speeds. However, it was found

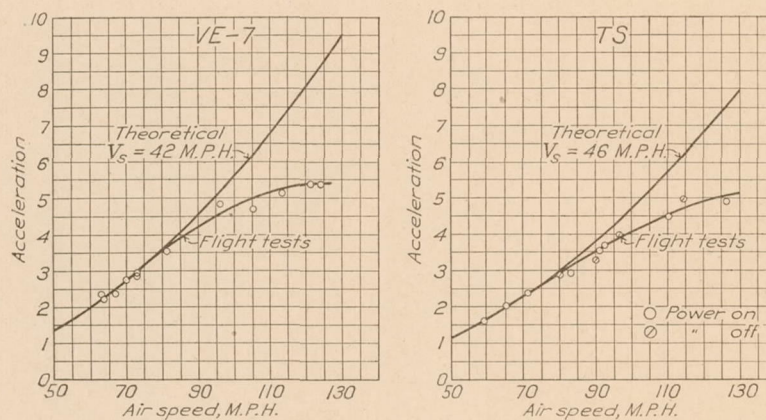

Fig. 37.—Theoretical accelerations compared with accelerations obtained in flight

that neither airplane had sufficient elevator control to reach the desired attitude, i. e., partly over on the back in a dive. A second method employed, that of "hanging" on the top of a slow loop, gave the desired result, but at such a low air speed that the pressure readings were very small and consequently indeterminate. The push-down method proved entirely satisfactory, the negative accelerations obtained indicating conclusively that the no lift condition was obtained and at the same time the air speed was large enough to eliminate the error caused by small pressure readings.

In some of the time-history figures of maneuvers made at low speeds, such as the loops, it will be noted that the shape of the normal force coefficient curves appears to be erratic. This is because at low air speeds the accuracy of the pressure measurements is poor and also because the errors of integrating the load curves, when the load is small, introduces a large percentage error in these results.

REFERENCES

1. NORTON, F. H., and BROWN, W. G. The Pressure Distribution Over the Horizontal Tail Surfaces of an Airplane—III. N. A. C. A. Technical Report No. 148. 1922.
2. NORTON, F. H., and WARNER, E. P. Accelerometer Design. N. A. C. A. Technical Report No. 100. 1921.
3. NORTON, F. H. N. A. C. A. Recording Airspeed Meter. N. A. C. A. Technical Note No. 64. 1921.
4. FREEMAN, R. G. Air Flow Investigation for Location of Angle of Attack Head on a JN4H Airplane. N. A. C. A. Technical Note No. 222. 1925.
5. BROWN, W. G. The Synchronization of N. A. C. A. Flight Records. N. A. C. A. Technical Note No. 117. 1922.

6. NORTON, F. H. N. A. C. A. Control Position Recorder. N. A. C. A. Technical Note No. 97. 1922.
7. CARROLL, T., and MIXON, R. E. The Effect of Tube Length upon the Recorded Pressures from a Pair of Static Orifices in a Wing Panel. N. A. C. A. Technical Note No. 251.
8. ENGINEERING DIVISION, ARMY AIR CORPS. Handbook of Instructions for Airplane Designers. 1925.
9. BUREAU OF CONSTRUCTION AND REPAIR, NAVY DEPARTMENT. Load Distribution for Wing Rib Tests. April 1, 1921. (SD-19.) General Specifications for the Design of Airplanes for the U. S. Navy. April 1, 1926. (SD-24B.)
10. NORTON, F. H. Pressure Distribution Over the Wings of an MB-3 Airplane in Flight. N. A. C. A. Technical Report No. 193. 1924.
11. DOOLITTLE, J. H. Accelerations in Flight. N. A. C. A. Technical Report No. 203. 1925.

TABLE I
PRESSURE IN POUNDS PER SQUARE FOOT ON VE-7 AIRPLANE

Station No.....	Wing																Tail surface						
	1	2	3	4	5	6	7	8	9	10	11	12	13	14	15	16	1	2	3	4	5	6	7
Level flight																							
Air speed (M. P. H):																							
42.....	24	24	18	16	13	9	6	6	5	4	3	3	-----	1	1.5	-2							
44.....	26	24	19	16	13	11	9	8	6	6	5	4	-----	1	1.5	0							
50.....	24	24	19	16	13	11	9	8	6	6	5	4	-----	1	1	0							
54.....	24	24	18	16	13	9	6	7	6	4	3	3	-----	1	2	1							
65.....	24	22	21	17	14	11	9	10	7	7	5	3	-----	1	3	.5							
67.....	24	24.5	19	19	12.5	10.5	10	9	6	7	5	4	-----	1	0	0							
75.....	19	22	21	17	13	11	11	10	7	7	5	3	-----	1	3	1							
77.....	16	23	20	17	13	9	10	10	7	7	5	4	-----	1	2	.5							
85.....	16	20	21	17	14	11	13	9	7	7	6	3	-----	1	2	1.5							
87.....	19	21	19	17	14	14	13	11	9	7	6	4.5	-----	1	0	.5							
97.....	12	20	21	17	14	11	13	12	11	8	6	3	-----	1	1	1.5							
99.....	12	21	18	17	12.5	12.5	13	12	10	10	6	4	-----	1	0	.5							
107.....	9	17	18	17	14	14	15.5	13.5	11	10	7.5	4	-----	1	0	1							
107.....	12	17	19	19	14	11	14	13	11	8	7	3	-----	1	0	2							
117.....	0	15.5	16	17	14	12.5	15.5	13.5	12.5	12	8	4	-----	1	0	1							
117.....	6	13	16	16	14	12	15	14	12	10	8	3	-----	1	1	1.5							
127.....	0	14	16	16	14	14	15.5	14	12.5	14	8	5	-----	1	0	1							
128.....	-2	12	15	16	14	14	17	15	12	11	8	3	-----	1	0	1							
Pull-up																							
Time (seconds):																							
0.....	0	14	18	17	16	14	17	16	14	12	10	4.5	7	2	0	1.5	0	-2	0	3	5	6	-1.5
0.25.....	0	16	22	32	16	16	21	18	19	16	10	4.5	7	3	0	1.5	2	-4	-3.5	-5	-19	-6.5	-5.5
0.50.....	118	126	88	85	58	44	43	34	31	24	19	12	10	6	3	2	33	15	-13	-10	-37	-10	-9
0.75.....	158	145	122	105	89	60	53.5	43	39	28	24.5	16	14	7	5	2.5	44	18	0	-5	-25	-5	-5
1.00.....	132	124	101	88	79	54	47.5	39	33.5	26	20.5	14	13	6	5	2	33	13	4	-3	-21	-3	-4
1.50.....	77	70	56	48	47	34	29.5	22	22	18	13	8	9	5	3	1.5	14	3	3	-1	-13	-1	-2
Push-down—high speed																							
0.....	-1	12	15	17	13	12	14	14	11.5	8	8	4.5	5	2	0	.25	-9	-4	0	2	3	7	-1.5
0.50.....	-1	12	15	17	13	12	14	14	11.5	8	8	4.5	5	2	0	.25	-9	1	9	13	32	17	3.5
1.00.....	-42	-32	-20	-12	-8	-2	0	6.5	1.5	0	1	-5	-3	0	-8	-1.5	-20	-14	-5	4	14	15	-1.5
1.25.....	-54	-37	-21	-12	-10	-3.5	2.5	6.5	1.5	0	1	-5	-3	1	-8	-1.75	-16	-14	-5	3	10.5	11	-1.5
1.50.....	-54	-36	-20	-8	-7	-3.5	9	9	2.5	1	3	0	-3	2	-6	-1.75	-18	-14	-6	0	-9	2	-5
2.00.....	0	38	40	33	25	22.5	25	20.5	18	15	13	7	0	3	0	0	-6	0	-5	0	0	3	-2
2.50.....	26	41	37	33	30	21	24	20	18	15	13	6.5	7.5	2	0	.5	-4	0	0	0	1	3	-2
3.00.....	19	35	34	29	25	21	22.5	19	18	15	12	6.5	7.5	2	0	.5	-6	0	0	0	1	3	-2

PRESSURE DISTRIBUTION OF AN AIRPLANE IN FLIGHT

TABLE I—Continued
PRESSURE IN POUNDS PER SQUARE FOOT ON THE VE-7 AIRPLANE—Continued

Station No.	Wing																Tail surface						
	1	2	3	4	5	6	7	8	9	10	11	12	13	14	15	16	1	2	3	4	5	6	7
	Push-down—low speed																						
Time (seconds)—Contd.	19	23	18	14	13	11	9	9	6	6	4	3	3	1	0	0	2	1	1.5	0	0	1	-.5
0.....	19	23	18	14	13	11	9	9	6	6	4	3	3	1	0	0	2	1	1.5	0	0	1	-.5
0.50.....	16	18	18	10	8	9	6.5	8	5	6	2	1	0	0	0	0	2	1	1.5	0	0	1	-.5
1.00.....	0	0	9	0	0	3	4	5	2	3	1	0	-1	0	-2	-1.5	-14	0	5	9	17.5	8	4.5
1.25.....	-10	-9	0	-8	-8	0	0	2	0	2	0	0	-1	0	-3	-2	-16	-7	-2.5	10	9	4	1
1.50.....	-16	-10	-7	-6	-8	0	-2	2	-1	0	0	0	-1	0	-3	-2	-12	-7	-2.5	0	3	4	0
1.75.....	-14	-9	-6	-4	-4	0	0	3	0	-2	1	1	0	1	-3	-2	-7	-7	-2.5	0	2	2	-.5
2.00.....	-2	0	3	8	2	3	4	6	2	0	3	3	3	1	-2	-1.5	-4	-4	-1.5	-1	-3	0	-1
2.50.....	19	20	19	17	13	11	9	10	6	4	5.5	4	3	1	0	0	0	0	0	-1	-3	0	-1
3.00.....																							
	Right turn																						
0.....	12	24	23	21	16	12	17	13	12.5	9	8.5	4.5	7	3	0	0	-3	0	0	0	1.5	3	0
1.00.....	30	41	34	31	27	21	20	15	12	10.5	5.5	9	3	0	0	0	2	3	0	0	-7	2	0
2.00.....	52	59	48	42	36	27	25	18	19	14	13	7	10	3	0	.5	14	6	0	0	-2	-13	0
3.00.....	77	76	64	54	46	31	29.5	22	22	16	15	10	11.5	4	3	.5	26	10	0	-3	-17	-5	0
4.00.....	72	72	62	50	44	27	28	21	20	16	15	9	11.5	4	3	.5	24	10	0	-3	-15	-5	0
5.00.....	38	49	48	36	32	19	24	20	16	15	12	7	10	4	3	.5	16	8	0	-2	-5	0	0
6.00.....	14	26	25	19	18	12	15.5	13	12.5	11	8.5	4.5	9	3	3	.5	0	3	0	0	-3	2	0
7.00.....	9	23	22	17	18	12	15.5	13	12.5	11	8.5	4.5	9	2	3	.5	-8	0	0	0	-3	2	0
	Left turn																						
0.....	8	19	18	18.5	15	12.5	14	12	12.5	9	6	4.5	5	2	0	0	0	0	0	0	0	1	0
1.00.....	19	29	26	24	20	16	17	15	14	10.5	9	6	7	2	0	0	6	3	1.5	0	-3	0	0
2.00.....	36	42	36	32	25	19.5	21	17	16	13	11.5	7	8.5	3	0	0	14	6	3	-1	-11	-2	0
3.00.....	62	65	54	46	38	27	27	20	19	15	11.5	8.5	8.5	3	0	0	21	8	3	-1	-11	-4	0
4.00.....	67	67	54	46	38	27	27	20	19	15	11.5	8.5	8.5	3	0	0	4	5	0	-1	-11	-4	0
5.00.....	57	56	50	44	37	24	22	17	16	14	10	7	7	2	0	0	-9	1.5	-2.5	0	-7	-2	0
6.00.....	26	33	28	24	22	14	15	11	11	10.5	8	4.5	5	.5	0	0	-1	1.5	1.5	1	3	3	0
7.00.....	14	23	19	18.5	15	9.5	11.2	9	7	8	5	2.5	5	0	0	0	0	1.5	1.5	1	-3	-3	0
	Loop																						
0.....	0	16	19	21	14	12.5	15	15	12	10	8	4	3	3	-6	1	-14	-4	-2.5	3	2	6	-5
0.50.....	2	22	25	24	16	14	15	18	12	12	10	4.5	3	3	-6	1	-12	-4	-3.5	2	0	4	-7
1.00.....	38	53	49	41	28	22.5	21	22	18	15	13	8.5	7	4	-2	1.5	0	1	-2.5	1	-9	1	-8
1.50.....	75	80	70	58	46	29	34	28	24	19	15	9	10	6	0	2	16	6	2	0	-13	0	-12
2.00.....	92	89	79	70	57	37	37	28	28	19	17	12	10	6	0	2	21	12	3	1	-15	-2	-12
2.50.....	92	89	76	68	57	37	37	26	27	19	17	12	10	6	3	2	24	13	2	2	-15	-3	-12
3.00.....	87	81	66	64	53	35.5	34	23	23	16	15	10	10	4	5	2	26	13	0	-3	-17	-3	-3
3.50.....	74	68	53	52	44	29	26.5	20	20	15	13	9	9	3	3	1.5	23	11	0	-4	-15	-2	-2
4.00.....	60	58	43	39	34	24	22	15	18	12	11	8.5	7	3	0	1.5	21	11	-1	-3	-13	-2	-1.5
4.50.....	43	41	32	30	25	17.5	17	11	12	10	7.5	6.5	7	3	0	1	19	8	-2.5	-3	-13	-1	-1.5
5.00.....	36	34	28	24	18	14	11	10	11	5	5	5.5	5	2	-4	.5	19	6	-3.5	-4	-13	-1	-1.5
5.50.....	31	28	25	21	18	11	10	9	7	4	4	4	3	2	-6	.5	12	4	-2.5	-3	-11	0	-1.5
6.00.....	30	29	25	23	18	11	10	10	6	6	5	4.5	3	3	-6	.5	10	3	-1	-2	-9	0	-1.5
6.50.....	40	37	36	30	24	16	13	13	10	6	6	5.5	5	4	-6	1	10	3	-1	-2	-9	0	-1.5
7.00.....	52	49	43	35	29	21	17	14	12	8	7.5	6.5	7	4	-4	1	10	4	-1	-3	-13	-1	-2
7.50.....	64	61	53	46	34	26	22	18	16	12	10	7	7	4	-4	1.5	14	6	0	-4	-13	-2	-2
8.00.....	80	74	62	56	44	29	28	21.5	19	14	13	10	9	6	-2	1.8	18	8	0	-3	-15	-2	-3
8.50.....	85	76	68	58	49	30.5	31	23	23	18	13	10	10	6	0	2	18	8	0	0	-9	0	-1.5

		Right roll																					
0.00	9	19	18	17	14	14	13	11	8.5	8	6	4	3	1	0	0	-3	0	-1.5	3	0	5	-5
0.50	12	19	18	17	16	14	13	11	8.5	7	6	4	3	1	0	0	-3	0	-1.5	3	0	5	-6
1.00	82	58	62	39	38	37	26.5	19	19	14	14	12.5	8.5	2	0	0	32	12	-1.5	-12	-35	-5	-3.5
1.50	136	120	97	80	51	66	46	35	29.5	20	18	18	11.5	4.5	0	0	19	10	-2.5	-7	-17	-4	-2
2.00	50	44	35	38	45	29	34	25	22	16	14	11	13	14	5	3	14	6	-3.5	-4	-15	-4	-1.5
2.50	16	19	17	24	20	14	25	13	11	12	11	7	7.5	6	0	0	14	6	-2.5	-3	-13	-3	-1.5
3.00	16	19	15	17	16	14	14	11	8.5	10	7.5	4.5	2	2	1	1	9	3	-3.5	-2	-13	-2	-1.5
3.50	24	17	14	14	11	12.5	10	9	6	7	5	4	2	1	-1	-1.5	7	1	-2.5	-2	-11	-1	0
4.00	36	33	25	21	18	14	10	9	6	7	5	3	0	0	-1	-2	9	1	-2.5	-1	-9	-1	0
4.50	40	40	31	26	22	16	13	11	8.5	7	6	4	2	0	-1	-2	11	1	-2.5	-1	-11	-2	-1.5
5.00	50	50	37	31	29	22.5	17	13	10	10	7.5	5	4	1	-1	-1.5	12	4	-2.5	-1	-13	-2.5	-1
5.50	64	60.5	46	39	34	27	19	16	14	11	10	6	5	1	-1	-1	11	4	-2.5	-1	-13	-3	-1
6.00	67	64	48	44	38	27	22.5	18	15	12	10	6	5	1	-1	-1	11	4	-2.5	-1	-13	-2.5	-1
6.50	70	67	53	44	38	27	24	19	15	12	10	5	5	1	0	0	9	3	-2.5	-1	-11	-2.5	-1
7.00	62	62	48	44	34	26	22.5	19	14	11	10	5	5	2	0	0	7	5	-2.5	0	-9	-2	-1
7.50	46	44	40	35	28	21	17	18	11	8	9	4.5	4	1	0	0	4	3	-2.5	0	-7	-1	-1.5
8.00	33	34	31	28	23.5	17.5	14	15	10	8	6.5	3.5	3	.5	0	0	0	0	-2.5	1	-7	0	-1.5
8.50	24	26	25	22	18	14	14	13	8.5	7	5.5	3.5	3	.5	0	0	-1	1	-2.5	1	-5	1	0
9.00	21	28	25	21	18	12.5	13	12	8.5	7	5.5	3.5	3	.5	0	0	-3	0	-2.5	1	-3	2	0
9.50	19	28	23	21	16	12.5	13	12	8.5	7	5.5	3.5	3	.5	0	0	-3	.5	-1.5	1.5	0	3	0
10.00	14	21	19	17	14	11	11.5	11	8.5	7	5.5	3.5	3	.5	0	0	-3	1	-1.5	2	0	4	0
		Left roll																					
0.00	12	22	20	17	14	11	11.5	11	8.5	8	6	3	3	1	0	.5	0	1	0	3	0	3	0
0.50	14	22	20	17	16	12	11.5	11	8.5	8	6	3	3	1	0	.5	0	1	0	3	0	3	0
1.00	12	22	20	17	14	11	11.5	11	8.5	8	6	3	3	1	0	1	0	1	0	3	0	3	0
1.50	12	22	20	15	14	11	11.5	11	8.5	8	6	5	3	1	0	1	0	-6	-6	-25	-3	3	-4
2.00	74	75	49	48	42	22	25	17	17.5	15	11	10	9	3	0	1	28	5	0	-2	-21	-5	-3
2.25	87	81	64	56	46	32	29.5	24	19	15	15	9	9	3	0	0	22	11	0	-2	-17	-5	-2
2.50	79	68	60	56	44	32	28	24	19	14	15	8	7	3	0	.5	21	8	0	-2	-15	-4	-2
3.00	60	53	48	42	34	27	22	20	15	12	12	6	7	3	0	.5	18	6	0	-2	-13	-3	-1.5
3.50	48	44	38	33	28	21	17	18	12	10	10	5	5	2	0	.5	16	6	0	-2	-13	-3	-1.5
4.00	36	35	31	26	22	17.5	13	12	10	8	7	4.5	5	1	0	.5	12	6	0	-2	-13	-3	-1.5
4.50	33	34	26	22	20	16	11.5	13	10	8	6	4.5	5	1	0	.5	6	6	0	-2	-15	-3	-1.5
5.00	35	37	29	26	22	16	13	13	10	8	6	4.5	5	1	0	.5	-6	3	-3.5	-2	-17	-4	-2
5.50	46	46	35	31	25	19	14	13	10	10	7	4.5	5	1	0	.5	16	6	4	-2	-11	-3	2
6.00	48	44	35	31	25	19	14	13	10	10	7	4.5	5	1	0	.5	12	12	5.5	-2	-9	0	0
6.50	41	41	34	28	25	17.5	14	16	10	10	7	6	5	2	0	.5	7	6	0	-2	-9	-1	0
7.00	48	47	38	31	28	19	14	20	10	10	7	6	5	2	0	.5	7	1	-1	-2	-11	-3	1
7.50	81	70	51	46	42	24	22	23	17.5	11	11	8	7	3	0	.5	16	5	0	-2	-11	-4	1
7.66	81	75	60	51	45	32	28	23	19	14	13	8	7	3	0	.5	12	5	0	-2	-11	-3	1
8.00	75	70	60	50	42	32	25	20	17.5	14	12	7	7	3	0	.5	9	5	0	0	-11	-3	1
8.50	58	59	51	42	36	26	22	17	16.5	12	11	6	7	2	0	.5	9	3	0	0	-9	-2	1
9.00	38	46	40	32	20	19.5	16	14	11	10	9	5	5	1	0	.5	4	3	0	2	-2	0	2
9.50	24	33	32	26	24	17.5	15	13	12.5	10	9	4.5	3	1	0	.5	4	3	0	2	0	2	1
10.00	16	26	23	21	18	12	13	12	11	8	8	3.5	3	1	0	.5	0	1	0	2	0	2	1

PRESSURE DISTRIBUTION OF AN AIRPLANE IN FLIGHT

TABLE I—Continued
 PRESSURE IN POUNDS PER SQUARE FOOT ON THE TS AIRPLANE

Station No.	Upper wing											Lower wing											Tail surface							
	1	2	3	4	5	6	7	8	9	10	11	1	2	3	4	5	6	7	8	9	10	11	1	2	3	4	5	6	7	8
Level flight																														
Air speed (M. P. H.):																														
54.5	15	21	23	18	15	12	8	6.5	4	2	0.5	15	20.5	20	14	13.5	12	9	5.5	3.5	2.5	1.5								
62.8	19	25	27	25.5	19	13.5	9.5	8	6.5	2	2	15	19	18	14.5	13	12	10	6	4	3	2								
71.0	16	23	26.5	25	21	16	12.5	9	6	3	1	8	12.5	13	12	13.5	14	11.5	8	5	3	1.5								
79.0	15	21	24	22	21	18	13.5	10.5	7.5	4.5	1.5	0	11	11	9	14	16	13	9	6	4	1.5								
86.3	0	14	20	19	21.5	20	16	12	7.5	4.5	2	-16	1	8	6.5	14	18.5	15.5	11	8	6	2								
95.5	-12	2	16	17.5	24.5	23	18	13.5	10	6	3	-29.5	-4	2.5	5.5	13	19.5	17	11	9	6	2								
106.0	-15	3	11	15	26	25	21	16.5	12	6	2	-36	-25	-3	2	13	20	20	14	10	6	2								
117.0	-31	-6	4	9.5	22	21.5	17	11.5	6	1.5	0	-59	-26	-16.5	-13	14	19	18	12	7.5	5	3.5								
127.0	-47	-26	-3	5	26	25.5	22	15.5	8	3.5	2	-72	-50	-24	-18	17.5	23	21	14.5	10	6.5	3.5								
Pull-up—power on																														
Time (seconds):																														
0			0	10	28	31	22.5	18	12.5	11.5	3.5	-70	-40																	
0.50	-48		0	10	28	31	22.5	19.5	14	7	3.5	-70	-42																	
0.75	0		58	58	59	45	34.5	28	19	8	0	0	74																	
1.00	82	144	122	109	87.5	64	39.5	31	17.3	7.5	0	78	90																	
1.25	110	129	128	97	81	59	43.5	29.5	16.5	6.5	0	69	84																	
1.50	82	104	106	81	73.5	55.5	37	25	15	5.5	0	56	63																	
2.50	46	62	58	48	43	35	22.5	16	10	4	0	25	39																	
3.50	22	38	33	29	24	14	13.5	9	7.7	2	0	16	27																	
Pull-up—power off																														
0	-40	-12	0		29	30	24	19.5		7.5	5.5		-48	-28	-16	19	26.5	22.5	12.2	12.5	5.5	0	-31.5	-16.5	-4.5	-6	-5	-4	0	
0.25	-40	-12	0		29	30	24	19.5		7.5	5.5		-48	-28	-16	19	26.5	22.5	12.2	12.5	5.5	0	-30	-20	-5.5	-9	-13	-35	-15	
0.50			68		64.5	55	39.5	28		9.5	4		42	48	38	36.5	47	34	17.5	18	8.5	0	-36	-20	-5.5	-9	-12	-31	-15.5	
0.75	92	104	104		86	66	46	32.5		10	4		94	76	76	48	54	41	20.5	21	10	0	0	-2	0	0	-10	-23	-14	
1.00	149		152		98	68	44.8	35.5		9.5	4		89	92	100	76	66	49	41	23.5	20	17.5	0	33	9	0	0	-9	-18	-12.5
1.25	109	128	143		88	64	42	29.5		8.5	4		78	93	66	69	47	37.5	20.5	18	10	6	28	7.5	0	0	-9	-16	-10.5	
1.50	82	108	111		75	57	37	28		8	4		65	80	54	55	39	32.5	17.5	17	7.5	0	25	-4	0	0	-9	-12	-9	
1.75	72	98	94		67	50	33	26.5	17	8	4		56	68	50	51	39	29	16.5	14.5	7.5	0	14	0	0	0	-7	-11	-9	
Push-down																														
0	-50		0		28	31	21	19.2		8.5		-74	-43	-28	-14	19	23	22.3	13.4	13.5	8.3		-30	-16.5	-5.5	-3.2	-3.5	6	0	0
0.50	-50		-44		28	25	20	16.4		7	5.5	-94	-62	-28	-26	19	17	22.3	11.3	12.3	8.3		-43	-16.5	-5	5.5	8.5	40	15.5	4.4
1.00	-96		-59		20	21	13.3	15		7	5.5	-129		-65	-38	7	12	17	10.2	11	8.3		-53	-22.5	-9.8	-4.7	-3.5	19.4	7	1.8
1.50	-96		-21		20	24	16	16.4		8	5.5		-66	-52	-36	9	14	19	12.2	12.3	8.3		-46	-22.5	-9.8	-7.5	-7	0	0	0
2.00	-50		16		32	34	23.8	20.6		9	5.5	-64	-36	-24	-14	-22.5	26	26	26	14.3	13.5	9.3	-25	-19	-4.5	-4.7	-7	0	0	-1.6
Right turn																														
0	0		40		43	40	29	22		8.5	2	-21	0	28	17	40	38	27.5	16.5	12.4	7.5	0		-15	-1.4	-5	-7	-9	-7	-3.5
0.50	36	100	67		59	48	37	26.5		9.5	2	26	56	60	35	48	43	34	18.5	15.7	9.3	0		0	0	-5	-7	-12	-9	-4.5
1.00	82	131	104		74	57	39.5	29.5		9.5	2	73	83	84	68	60	51	37.5	20.5	18	10	0		7.5	2.5	-5	-9	-20	-10.5	-5
2.00	82	117	124		74	55	35.5	28		9	2	71	69	68	68	49	41	30.5	17.5	16.8	10	0		7.5	0	-6	-9	-21	-10.5	-5
2.50	82	95	106		63	47	30.5	23.5		8.5	2	62	68	64	57	44	38	27.5	14.5	14.7	9.3	0		3.5	-5	-6	-10	-21	-10.5	-4.5
3.00	62	86	88		55.5	42	29	22		8.5	2	56	61	60	52	50	34	26	11.3	12.4	7.5	0		0	-5	-5	-9	-18	-10.5	-3.5
3.50	58	76	79		49	37	26.5	20.5		8.5	2	50	61	52	44	35	32	22.5	11.3	10	4.5	0		3.5	0	-3	-7	-16	-9	-3.5
4.00	30	69	69		43	32	24	18		8	2	44	50	44	40	33	28	20.5	10.3	10	3.5	0		5.5	0	-4	-5	-9	-7	-3.5
4.50	30	38	54		36	27	20	15		7	2	24	29	28	26	26	25	19	10.3	10	4.5	0		3.5	0	-2	-4	-5	-5	-2.5
12	12	24	30		28	24	17	13.5		6.5	2	0	14	15	14	21	21	17	9.2	10	4.5	0		0	0	-2	-2	-2	-2	-2

Left turn																												
0.00	-28	0	12	36	38	28	22	10	5.5	-53	-28	0	-1.2	26	30	26	15.5	15.8	8.4	0	-19	-12.5	-4.5	-5	-9	-2	-2	-3.5
0.50	0	38	36	48	43	33	25	10.5	4	-12	0	17	14	35	34	29	17.5	17	9.3	0	-10	-9	-2.5	-2	-10	-3	-2	-3.5
1.00	30	58	58	56	50	34.5	28	10.5	4	0	24	30	31	40	39	30.5	28.5	29	9.3	0	0	-4	-1.4	-2	-10	-7	-7	-3.5
1.50	72	129	88	75	57	39.5	29.5	10	2	54	80	84	68	58	49	36	21.5	19	9.3	0	12	0	4	0	-10	-14	-9	-4
2.00	98	110	122	75	55	38	28	9	0	75	80	59	54	45	32.5	19.5	17	9.3	0	30	10.5	7	0	-10	-12	-7	-4	
2.50	82	110	100	65	46	32	25	8	0	62	71	80	59	48	41	30.5	17.5	15.7	8.4	0	15	6	4	0	-7	-12	-9	-1
3.00	72	95	100	57	41	29	22	7	0	56	61	68	47	42	35	26	15.5	12.4	5.5	0	4	0	0	0	-7	-12	-9	-1
3.50	62	84	81	50	37	25	19.5	6.5	0	46	54	60	40	35	30	24	14.4	11	3.5	0	0	-2	0	0	-7	-11	-7	-1
4.00	52	72	72	45	34	21	16.5	6	0	38	45	48	35	29	28	20.5	11.2	10	3.5	0	-3	-6	0	0	-7	-9	-5	-2
4.50	47	62	64	40	31	18.5	15	5.5	0	32	36	44	28	28	26	17	9.2	9	3.5	0	-10	-7.5	0	0	-5	-5	-2	-2.5
5.00	36	50	52	36	28	17	15	5.5	0	23	28	40	24	26	24	17	9.2	7.5	3.5	0	-18	-7.5	0	0	-4	-2	0	-2.5
5.50	30	46	48	34	28	17	15	5.5	0	18	26	40	24	26	24	17	9.2	9	3.5	0	-24	-7.5	0	0	-2	0	0	-2
6.00	23	38	42	32	28	17	15	5.5	0	12	24	36	19	26	24	17	9.2	9	3.5	0	0	-4	0	0	0	4	0	-1
Loop																												
0.00	58	77	65	47	35	26.5	9	4	32	54	60	50	51	41	34	20.7	14.7	9.3	0	20	0	0	-1.7	-10.5	-14	-9	-3.5	
0.50	82	104	71	50	38.2	26.5	8.5	4	60	71	76	59	54	45	37.5	18.5	14.7	9.3	0	27	9.4	1.6	-1.7	-10.5	-19.6	-9	-3.5	
1.00	76	98	102	67	48	33	25	7.5	4	62	71	72	56	46	41	27.5	16.5	14.7	8.4	0	25	11	1.6	-1.7	-10.5	-16	-9	-3.5
1.50	72	86	89	60	41	30.5	22	6	4	60	64	64	50	45	36	25.8	15.3	13.5	6.5	0	23	11	1.6	-1.7	-10.5	-14	-6.5	-3.5
2.00	66	72	79	50	34	25	18	5	4	56	60	52	42	38	30	22.5	14.4	12.3	5.5	0	20	11	1.6	0	-8.6	-10	-6.5	-2.5
2.50	52	55	62	40	27	20	15	4	4	56	50	44	35	31	25	17	11.3	11	4.5	0	19	11	1.6	0	-7	-7	-4.5	-1
3.00	36	36	38	28	19	13.4	10.7	3.2	4	32	38	32	26	23	19	12	7.2	9	3.5	0	17	9.4	1.6	0	-5	-5	-2	0
3.50	30	29	27	21	14	12	7.8	2.7	2	24	26	28	21	20	14	8.6	6	8	2.7	0	15	9.4	1.6	0	-2	-1	-1	0
4.00	24	22	20	15	10	6.8	6.5	2.2	2	20	22	24	14	17	10	7	5	4	1.8	0	14	7.5	1.6	0	-2	0	-1	0
4.50	12	14	14	11	8	5.5	5	2.2	2	14	17	20	12	15	8	7	5	2.5	1.8	0	12	4	1.6	0	-3.6	-1	-2	0
5.00	0	10	10	10	8	5.5	5	2.2	2	12	14	20	12	15	8	7	5	2.5	1.8	0	14	3.5	1.6	0	-3.6	-1.6	-2	0
5.50	0	10	12	11	9	5.5	5	2.2	2	12	14	20	12	15	8	7	5	4	1.8	0	11	3.5	1.6	0	-3.6	-3	-2	0
6.00	12	14	18	15	12	8	7.8	3.2	2	14	17	24	14	17	12	10.5	6	5.3	2.7	0	14	3.5	1.6	0	-3.6	-7	-4.5	0
6.50	24	29	30	23	16	12	10.7	3.6	2	21	29	28	24	23	15	14	8.2	8	3.5	0	15	7.5	1.6	0	-3.6	-8	-6.5	0
7.00	30	40	42	30	21	14.5	13.5	4	2	30	38	40	28	28	21	17	10.3	9	4.5	0	17	9.4	1.6	0	-3.6	-8	-4.5	0
7.50	36	43	44	36	27	18.5	15	5	2	38	36	36	28	30	23	19	12	10	4.5	0	19	3.5	1.6	-2	-5	-8	-7	-1.6
8.00	47	60	60	44	32	22.5	18	6	2	42	45	40	40	37	28	24	14.3	11	5.5	0	22	3.5	1.6	0	-7	-14	-9	-1.6
Dive																												
0.00	7	18	13	10	5.5	5	2.2	0	10	15	20	12	13	8	7	4	5.2	2.7	0	0	0	0	0	0	0	0	0	0
1.00	-9	0	7	8	5.5	5	3	0	-10	-2	4	0	11	8	7	5	6.5	3.5	0	-10	-7.5	0	0	0	0	0	0	0
2.00	-28	-14	7	9	6.8	8	4	2	-38	-23	-16	-10	9	8	8.5	6	7.5	5.5	0	-17.5	-12.5	-3.5	-2	0	0	0	0	0
3.00	-55	-16	13	15	12	10.8	6	5.5	-56	-35	-20	-16	13	12	14	18	10	6.5	0	-25	-14	-4.5	-3.5	0	0	0	0	0
4.00	-70	-16	17	21	16	15	7	7	-74	-48	-32	-21	15	17	17	10.2	12.5	7.5	0	-34.5	-18	-6.5	-5	-7	0	0	0	0
4.50	-42	0	30	29	22.5	19	8.5	7	-69	-51	-32	-12	19	25	26	14.5	14.5	8.2	0	-17.5	-18	-8.5	-7.5	-7	-12	-6.5	-6.5	
5.00	0	40	38	53	43	33	26.5	10.5	7	-27	0	0	18	31	36	32.5	19.5	19	9.2	0	-8	-14	-3.5	-5	-8.5	-14	-6.5	-2.5
6.00	40	70	77	75	51	50	29.5	12	9	7	27	28	33	51	56	39	22.7	21	10.2	0	-6.5	-10.5	-2.5	-3	-10.5	-10.5	-6.5	-2.5

PRESSURE DISTRIBUTION OF AN AIRPLANE IN FLIGHT

TABLE II
VE-7 AIRPLANE

Air speed (M.P.H.)	Normal accelera- tion (in terms of <i>g</i>)	Upper wing			Angle of attack (degrees)
		Average load (lb./ sq. ft.)	<i>C_{NF}</i>	Center of pressure (per cent chord)	
Level flight					
42	1	6.5	1.370	23.8	18
44					
50	1	6.6	.950	28.3	12.6
54					
65	1	7.3	.660	26.2	7.5
67					
75	1	7.1	.480	28.8	5.6
77					
85	1	7.8	.410	29.0	4.3
87					
97	1	7.8	.320	30.7	3.1
99					
107	1	7.9	.270	32.1	2.5
117	1	7.7	.220	33.7	2.0
127	1	8.0	.190	32.8	1.6
128					

Time (seconds)	Air speed (M.P.H.)	Normal accelera- tion (in terms of <i>g</i>)	Upper wing			Tail surface			
			Average load (lb./ sq. ft.)	<i>C_{NF}</i>	Moment about leading edge (in. lb.)	Average load on stabilizer (lb./ sq. ft.)	Average load on elevator (lb./ sq. ft.)	Average load on tail (lb./ sq. ft.)	Moment about leading edge (in. lb.)
Push-down—high speed									
0	126	1.00	7.9	0.203	-650	-2.6	2.4	-0.1	-129
.50	127	1.03	7.5	.189	-642	4.3	13.2	8.7	-1085
1.00	128	-.75	-3.4	.084	-173	-8.6	6.6	-.1	-309
1.25	129	-.90	-3.8	-.093	168	-7.9	4.9	-1.5	-219
1.50	130	-.60	-2.4	-.057	-26	-8.8	-2.9	-5.8	390
2.00	134	2.10	12.8	.288	-995	-2.7	0	-1.4	76
2.50		2.20	13.8		-991	-.9	.5	-.2	13
3.00		2.05	13.1		-986	-1.3	.7	-.3	-20
Push-down—low speed									
0	66	1.00	6.3	0.593	-393	1.1	.5	.8	-60
.50	66	1.00	6.4	.601	-407	1.1	.2	.6	-13
1.00	66	-.05	4.8	.451	-299	6.5	8.9	7.0	-766
1.25	66.5	-.25	1.2	.115	-64	-1.3	3.6	1.1	-297
1.50	67	-.35	-1.1	-.097	77	-5.7	1.9	-1.9	-50
1.75	69	-.20	-2.1	-.180	111	-4.8	.8	-2.0	-10
2.00	72	.25	-1.2	-.096	70	-4.4	.2	-2.1	110
2.50	77	.80	1.8	.127	-143	-2.7	-.9	-1.8	125
3.00	83	1.35	6.9	.404	-496	-.2	-1.1	-.6	83

Time (seconds)	Air speed (M.P.H.)	Normal accelera- tion (in terms of <i>g</i>)	Upper wing			Tail surface			
			Average load (lb./ sq. ft.)	<i>C_{NF}</i>	Center of pressure (per cent chord)	Average load on stabilizer (lb./ sq. ft.)	Average load on elevator (lb./ sq. ft.)	Average load on tail (lb./ sq. ft.)	Moment about leading edge (in. lb.)
Pull-up									
0	126	1.10	10.6	0.269	35.0	0.4	2.3	1.3	-164
.25	126	1.25	11.5	.292	31.6	-3	-8.4	-5.6	645
.50	125	3.50	29.8	.766	24.9	4.9	-13.4	-4.1	520
.75	124	5.40	39.8	1.040	24.7	13.5	-8.3	2.8	474
1.00	120	5.10	34.4	.965	24.8	11.6	-6.4	2.6	292
1.50	107	3.15	20.6	.726	25.8	4.6	-4.2	.4	197
Right turn									
0	115	1.30	9.4	0.295	31.7	-.6	1.5	.4	-90
1	115	2.05	12.8	.403	28.1	1.3	-.6	.3	26
2	110	2.80	17.1	.584	25.9	4.0	-3.3	.5	186
3	104	3.45	21.4	.820	25.1	7.1	-5.2	1.0	290
4	100	3.20	20.8	.863	26.7	7.8	-5.3	1.3	246
5	102	2.25	15.7	.628	28.3	5.4	-1.3	2.0	30
6	104	1.40	9.8	.376	30.4	.8	0	.4	-16
7	107	1.35	9.7	.350	33.3	-1.7	.1	-.8	0

TABLE II—Continued
VE-7 AIRPLANE—Continued

Time (seconds)	Air speed (M.P.H.)	Normal acceleration (in terms of <i>g</i>)	Upper wing			Tail surface			
			Average load (lb./sq. ft.)	<i>C_{NP}</i>	Center of pressure (per cent chord)	Average load on stabilizer (lb./sq. ft.)	Average load on elevator (lb./sq. ft.)	Average load on tail (lb./sq. ft.)	Moment about leading edge (in. lb.)
Left turn									
0	113	1.45	8.4	0.274	31.4	0	.9	.4	-33
1	110	1.80	10.8	.368	29.5	2.4	-.6	.8	13
2	105	2.30	13.7	.517	27.4	5.1	-3.2	1.0	120
3	98	2.80	18.2	.790	24.1	7.6	-3.6	2.0	130
4	92	2.70	18.3	.900	24.9	2.0	-3.5	-.7	207
5	91	2.35	16.3	.819	24.0	-2.2	-2.0	-2.1	170
6	89	1.30	9.7	.511	25.8	.8	1.5	1.2	-124
7	88	1.00	6.8	.366	26.5	1.2	-1.5	-.2	76
Loop									
0	126	1.20	7.8	0.204	29.4	-4.0	1.0	-1.7	20
.5	126	1.40	8.9	.232	28.1	-4.5	-1.2	-2.9	181
1.0	126	2.45	15.3	.397	27.8	-.1	-4.5	-2.2	348
1.5	124	3.35	22.6	.605	25.9	5.6	-6.4	-.5	407
2.0	120	4.05	26.0	.744	24.9	8.7	-8.6	.3	501
2.5	109.5	4.00	25.6	.876	25.1	10.0	-8.0	1.0	476
3.0	98	3.60	23.2	.991	25.2	8.6	-5.7	1.5	305
3.5	86	2.90	19.4	1.080	25.8	7.5	-4.5	1.8	252
4.0	71.5	2.30	16.0	1.285	25.4	6.3	-3.5	1.5	210
4.5	61	1.80	11.8	1.310	25.7	4.2	-3.4	.4	254
5.0	57	1.45	8.8	1.110	22.4	4.3	-3.7	.2	269
5.5	57	1.40	8.8	.980	18.3	2.0	-2.7	-.4	212
6.0	56	1.30	7.5	.892	21.4	2.2	-2.8	-.3	200
6.5	59	1.40	7.5	1.028	23.0	2.1	-2.5	-.2	200
7.0	65	1.70	10.5	.958	24.4	2.3	-3.9	-.7	256
7.5	73	2.05	12.4	.992	22.6	4.0	-4.5	-.3	308
8.0	82.5	2.55	16.4	1.005	24.4	5.4	-4.8	.1	322
8.5	91.5	3.05	20.5	.919	25.4	5.8	-2.2	1.8	136
8.5	90	3.20	22.0						
Right roll									
0	97	1.05	7.5	0.317	27.9	-.3	1.7	.6	-133
.5	97	1.10	7.4	.314	27.6	-.9	-9.1	-4.9	584
1.0	97	3.10	18.6	.792	23.0	6.5	-6.4	.1	500
1.5	91.5	3.80	30.5	1.495	22.0	4.9	-5.1	0	360
2.0	79	2.80	19.8	1.294	31.6	2.9	-4.6	-.8	266
2.5	67	1.95	11.5	1.045	32.9	3.6	-3.7	0	250
3.0	60	1.40	8.1	.922	28.6	1.9	-3.5	-.8	256
3.5	57	1.10	6.4	.815	24.0	.5	-2.6	-1.0	-219
4.0	58	1.25	7.7	.938	17.9	1.0	-2.3	-.6	150
4.5	62	1.45	9.5	1.006	19.6	1.8	-3.1	-.6	249
5.0	67.5	1.85	12.3	1.105	20.9	2.9	-4.0	-.5	262
5.5	75	2.20	15.1	1.101	10.9	2.8	-3.8	-.5	232
6.0	80	2.40	16.1	1.025	21.1	2.8	-3.6	-.4	203
6.5	85	2.60	16.8	.946	21.1	2.1	-3.0	-.4	173
7.0	87	2.50	16.0	.865	22.3	2.1	-2.9	-.4	186
7.5	87	2.10	12.0	.649	22.2	1.1	-2.0	-.4	143
8.0	85	1.65	9.9	.559	23.4	-.1	-1.8	-.9	-126
8.5	84.5	1.40	8.3	.479	25.2	-.5	-.5	-.4	30
9.0	84	1.30	8.1	.471	25.4	-1.1	.2	-.4	-7
9.5	83	1.25	7.9	.468	25.6	-.8	1.3	.2	-70
10.0	81.5	1.05	7.1	.439	27.1	-.6	1.2	.3	-66
Left roll									
0	85	1.10	7.3	0.412	27.6	.9	1.1	1.0	-101
.5	86	1.10	7.5	.419	27.7	.9	1.1	1.0	-101
1.0	86	1.05	7.2	.402	27.6	.9	1.1	1.0	-101
1.5	87	1.60	7.7	.416	29.6	-3.2	-5.9	-4.6	514
2.0	84.5	3.45	18.1	1.040	23.6	6.6	-7.4	-.4	480
2.25	79.5	3.20	21.6	1.368	23.1	7.5	-5.4	1.1	292
2.5	74.5	2.80	20.8	1.541	25.0	6.3	-4.9	.8	286
3.0	65	2.30	16.3	1.583	25.3	5.1	-4.1	.6	226
3.5	56.5	1.90	13.1	1.679	25.4	4.8	-4.2	.3	226
4.0	50	1.50	10.2	1.673	24.9	3.9	-4.2	-.1	253
4.5	48.5	1.50	9.6	1.679	25.6	2.1	-4.4	-1.1	282
5.0	52	1.70	10.0	1.515	25.9	-1.6	-5.2	-3.4	397
5.5	57	1.85	11.8	1.494	24.3	5.8	-2.3	1.8	63
6.0	63	1.75	11.3	1.165	23.2	6.8	-2.1	2.4	332
6.5	70.5	1.65	11.2	.926	23.1	2.8	-2.1	.4	107
7.0	78	1.90	12.7	.862	24.0	1.4	-3.7	-1.1	252
7.5	84	2.65	18.6	1.082	23.0	4.1	-3.6	.3	196
7.7	85	2.85	20.0	1.105	23.3	3.6	-3.2	.2	166
8.0	86.5	2.70	19.5	1.071	23.8	3.2	-3.4	-.1	187
8.5	87	2.30	15.6	.848	23.5	3.2	-2.7	.2	140
9.0	88.5	1.90	12.9	.675	25.6	3.2	-.6	1.3	-10
9.5	89.5	1.45	10.9	.559	26.9	2.5	.3	1.4	-80
10.0	90.0	1.20	9.1	.466	29.2	.9	.5	.7	-66

TABLE II—Continued
TS AIRPLANE

Air speed (M. P. H.)	Normal acceleration (in terms of <i>g</i>)	Upper wing			Lower wing			Angle of attack (degrees)
		Average load (lb./sq. ft.)	<i>C_{NP}</i>	Center of pressure (per cent chord)	Average load (lb./sq. ft.)	<i>C_{NP}</i>	Center of pressure (per cent chord)	
Level flight								
54.5	1	8.2	1.210	29.0	8.1	1.199	28.4	10.95
62.7	1	10.7	1.175	29.8	8.6	.945	31.4	8.3
71	1	12.0	1.039	29.2	8.8	.760	35.4	5.9
79	1	12.3	.845	32.0	9.0	.617	37.6	4
86.7	1	12.3	.711	36.1	9.5	.549	42.3	2.48
95.5	1	13.3	.631	38.5	9.2	.436	46.5	1
106	1	14.5	.541	39.5	9.2	.343	53.0	-1.45
117	1	10.0	.304	41.7	6.7	.204	61.3	-1.5
127	1	11.8	.301	43.7	7.8	.199	67.3	-1.8

Time (seconds)	Air speed (M. P. H.)	Normal acceleration (in terms of <i>g</i>)	Upper wing			Lower wing			Tail surface				
			Average load (lb./sq. ft.)	<i>C_{NP}</i>	Moment about leading edge (in lb.)	Average load (lb./sq. ft.)	<i>C_{NP}</i>	Moment about leading edge (in lb.)	Average load on stabilizer (lb./sq. ft.)	Average load on elevator (lb./sq. ft.)	Average load on tail (lb./sq. ft.)	Moment about leading edge (in lb.)	Elevator angle (degrees)
Push-down													
0	128	1.00	14.8	0.373	-1,840	9.2	0.230	-1,564	-11.8	1.8	-5.8	93	-6.5
.50	128.5	.05	10.00	.248	-1,613	5.6	.139	-1,405	-10.1	17.7	2.1	-747	-19
1.00	131.5	-.15	5.3	.124	-1,380	.4	.009	-1,112	-19.3	9.0	-7.2	-140	-9
1.50	132	.55	9.7	.225	-1,639	2.4	.055	-1,266	-19.3	-.7	-10.6	280	-4
2.00	132.5	1.55	18.6	.429	-2,160	12.8	.295	-2,186	-12.0	-.7	-7.0	220	-1.5

Time (seconds)	Air speed (M. P. H.)	Normal acceleration (in terms of <i>g</i>)	Upper wing			Lower wing			Tail surface						
			Average load (lb./sq. ft.)	<i>C_{NP}</i>	Center of pressure (per cent chord)	Average load (lb./sq. ft.)	<i>C_{NP}</i>	Center of pressure (per cent chord)	Average load on stabilizer (lb./sq. ft.)	Average load on elevator (lb./sq. ft.)	Average load on tail (lb./sq. ft.)	Moment about leading edge (in lb.)	Elevator angle (degrees)	Rudder angle (degrees)	Aileron angle (degrees)
Pull-up—power on															
0	126	1.00	15.0	0.412	46.0	9.8	0.258	65.7	-10.2	.7	-5.6	133	-5		
.50	126.5	1.00	15.1	.387	45.6	10.6	.272	61.6	-16.9	-19.0	-17.7	1,199	16		
.75	127	3.45	30.6	.779	33.0	29.6	.754	32.8	-6.1	-13.9	-9.7	760	16.5		
1.00	126	4.90	46.6	1.225	27.2	36.9	.966	31.9	1.7	-11.6	-3.9	613	18		
1.25	124.5	4.35	43.4	1.160	27.1	32.1	.858	31.5	1.7	-9.6	-3.4	453	18		
1.50	119	3.40	37.8	1.119	27.6	27.5	.814	31.7	1.4	-6.5	-2.0	313	18		
2.50	96.5	2.00	23.1	1.057	28.6	17.2	.786	31.3	-.7	-2.7	-1.4	173	9		
3.50	75	1.25	12.9	.993	30.5	10.8	.832	30.1	.3	-2.5	-.9	113	7.5		
Pull-up—power off															
0	126	1.00	16.1	.427	44.2	8.5	.226	61.0	-12.6	-.7	-7.4	226	-4		
.25	126	1.00	16.1	.427	44.2	8.5	.226	61.0	-17.0	-14.6	-16.0	226	15		
.50	125	2.2	35.0	.929	33.0	25.6	.679	34.2	-16.6	-15.5	-16.2	965	18		
.75	121	4.3	46.2	1.317	29.5	34.9	.995	31.2	-2.7	-13.0	-7.0	646	20.5		
1.00	117.5	4.95	52.3	1.585	28.1	38.2	1.157	31.6	6.5	-11.0	-1.3	500	22		
1.25	114	3.95	45.7	1.480	27.8	34.6	1.120	30.3	5.8	-9.2	-.6	426	22		
1.50	112.5	3.45	39.4	1.305	29.7	27.9	.924	29.7	2.0	-8.3	-2.3	419	21		
1.75	109.5	3.15	36.1	1.250	29.8	26.2	.908	31.0	1.2	-7.4	-2.3	366	20.5		

TABLE II—Continued
TS AIRPLANE—Continued

Time (seconds)	Air speed (M. P. H.)	Normal acceleration (in terms of <i>g</i>)	Upper wing			Lower wing			Tail surface						
			Average load (lb./sq. ft.)	<i>C_{NP}</i>	Center of pressure (per cent chord)	Average load (lb./sq. ft.)	<i>C_{NP}</i>	Center of pressure (per cent chord)	Average load on stabilizer (lb./sq. ft.)	Average load on elevator (lb./sq. ft.)	Average load on tail (lb./sq. ft.)	Moment about leading edge (in lb.)	Elevator angle (degrees)	Rudder angle (degrees)	Aileron angle (degrees)
Right turn															
0.	127	1.15	24.5	.624	35.2	19.1	.486	37.6	-7.0	-6.3	-6.7	433	0	5.5	10
.50 . . .	125	2.75	33.4	.894	31.3	26.5	.709	33.3	-2.2	-7.8	-4.7	447	7	10.5	11
1.00 . . .	120.5	4.05	41.0	1.170	29.1	33.7	.960	29.7	-7	-11.2	-4.4	553	17	11.5	8.5
1.50 . . .	113.5	4.30	42.2	1.375	27.7	28.9	.944	29.9	-3	-10.9	-5.0	560	19.5	11.0	4.5
2.00 . . .	105.5	3.55	35.8	1.363	28.2	26.4	1.005	29.3	-1.7	-11.4	-5.9	593	20	7.5	-1
2.50 . . .	98	3.25	32.2	1.439	28.8	25.6	1.142	29.3	-2.9	-12.1	-6.9	660	20.5	2.5	-4
3.00 . . .	91	2.90	28.4	1.456	29.9	20.4	1.046	28.5	-9	-8.7	-4.2	460	21.5	0	-5.5
3.50 . . .	86	2.65	25.0	1.455	30.4	18.7	1.090	29.1	-5	-5.6	-2.6	320	19	-1	-7
4.00 . . .	83.5	2.20	20.6	1.282	30.4	14.9	.925	32.8	0	-4.0	-1.7	206	8.5	-1	-9
4.50 . . .	83.5	1.55	15.7	.978	34.4	11.5	.718	37.6	-9	-1.8	-1.4	60	8	1	-9.5
Left turn															
0.	126	1.45	20.0	.520	42.8	13.4	.348	49.2	-10.3	-2.7	-7.0	313	3	2	-10
.5	124	2.30	26.4	.716	37.0	18.5	.502	41.0	-6.2	-3.1	-4.9	280	5	-7	-11.5
1.0 . . .	123	2.70	31.7	.870	34.2	25.1	.690	40.0	-3.3	-5.4	-4.1	353	7	-7.5	-11.5
1.5 . . .	118.5	3.85	40.2	1.200	29.9	33.0	.985	30.5	1.2	-8.5	-3.0	420	18.5	-7.5	-2.5
2.0 . . .	111	4.35	41.3	1.393	28.3	30.8	1.040	29.9	7.9	-7.6	1.3	306	16	-8	-1.5
2.5 . . .	104.5	3.75	35.3	1.372	28.6	28.5	1.109	30.3	3.6	-6.7	-8	293	17	-8	0
3.0 . . .	97	3.40	32.4	1.468	27.7	24.7	1.118	28.8	-1.0	-7.4	-3.7	386	16	-8	1
3.5 . . .	91	2.90	27.9	1.450	28.8	21.1	1.096	28.6	-2.1	-6.0	-3.7	320	12	-8	2.5
4.0 . . .	86.5	2.55	24.8	1.425	28.4	18.1	1.040	29.8	-3.2	-4.7	-4.0	293	10	5.5	4.5
4.5 . . .	85.5	2.10	22.4	1.327	28.6	16.1	.954	29.8	-4.3	-2.9	-3.7	207	5.5	5	7.5
5.0 . . .	85.5	1.80	19.6	1.160	30.1	14.3	.845	29.9	-5.6	-1.8	-4.0	160	1.5	3	8.5
5.5 . . .	86.5	1.70	18.8	1.080	30.9	14.4	.827	31.3	-6.7	-7	-4.1	113	0	3.5	9
6.0 . . .	88.5	1.55	17.8	.978	31.4	14.0	.769	32.3	-1.0	.9	-2	-20	-2.5	4	9
Loop															
0.	117.5	3.00	34.1	1.040	30.8	27.7	.845	32.0	1.4	-8.3	-2.4	434	8.5		
.5	110.5	3.95	38.8	1.342	28.7	30.7	1.062	30.3	5.0	-10.3	-1.8	494	15		
1.0 . . .	102	3.75	36.7	1.459	28.1	27.2	1.080	29.9	5.1	-9.0	-1.0	400	17		
1.5 . . .	97	3.25	31.9	1.444	28.6	25.0	1.130	29.1	5.0	-7.6	-5	361	19.5		
2.0 . . .	88	2.85	27.4	1.505	27.7	21.8	1.199	29.7	4.6	-5.6	.2	247	19.5		
2.5 . . .	77.5	2.10	21.6	1.483	28.7	18.0	1.236	29.1	5.1	-4.5	1.0	173	19.5		
3.0 . . .	68	1.65	15.2	1.428	30.6	13.2	1.239	30.5	4.4	-2.5	1.5	87	19		
3.5 . . .	57.5	1.15	11.4	1.512	29.9	10.4	1.380	29.9	5.0	-7	2.3	0	18		
4.0 . . .	51	.80	8.1	1.483	31.1	7.9	1.448	28.9	3.9	-4	2.0	0	18		
4.5 . . .	45	.65	6.0	1.359	35.0	7.1	1.608	28.9	2.6	-1.6	.9	50	17		
5.0 . . .	41	.55	5.3	1.360	36.0	6.9	1.770	28.3	.9	-1.1	0	67	15.5		
5.5 . . .	45	.60	6.7	1.518	33.2	6.9	1.561	30.4	2.6	-1.6	.8	67	14.5		
6.0 . . .	50	.75	8.2	1.500	35.4	9.1	1.666	30.0	2.9	-3.8	0	160	13.5		
6.5 . . .	56	1.35	13.0	1.853	31.9	12.2	1.740	30.9	4.1	-4.7	.3	173	13.5		
7.0 . . .	64	1.65	16.2	1.780	31.5	15.2	1.670	30.6	4.6	-4.3	.8	153	5.5		
7.5 . . .	70	1.85	18.9	1.580	32.9	16.2	1.355	35.4	2.9	-6.0	-1.0	280	5.5		
8.0 . . .	81.5	2.20	24.1	1.571	29.8	20.2	1.319	30.9	3.8	-7.6	-1.3	347	10		
Dive															
0.	52	.75	6.9	1.154	31.2	6.9	1.154	31.9	0	0	0	0	-2.5		
1.0 . . .	63	.40	4.6	.506	48.5	5.2	.571	46.5	-4.3	0	-2.4	53	-4.5		
2.0 . . .	79.5	.25	3.7	.254	66.3	3.3	.227	78.4	-7.3	0	-4.3	86	-6		
3.0 . . .	95.5	.30	5.7	.268	65.8	5.3	.249	79.5	-9.1	0	-5.1	113	-6		
4.0 . . .	111	.35	8.8	.299	67.7	5.3	.180	78.0	-13.7	-7	-8.0	193	-5.5		
4.5 . . .	119	.85	16.1	.473	46.5	9.3	.273	62.7	-12.0	-6.7	-9.8	540	3.5		
5.0 . . .	122.5	2.05	28.2	.786	37.1	19.0	.529	45.1	-8.2	-7.4	-7.9	507	3.5		
6.0 . . .	130	3.40	41.0	.994	32.3	28.6	.693	36.0	-7.3	-6.3	-6.6	440	1.5		

ADDITIONAL COPIES
OF THIS PUBLICATION MAY BE PROCURED FROM
THE SUPERINTENDENT OF DOCUMENTS
GOVERNMENT PRINTING OFFICE
WASHINGTON, D. C.
AT
15 CENTS PER COPY
△

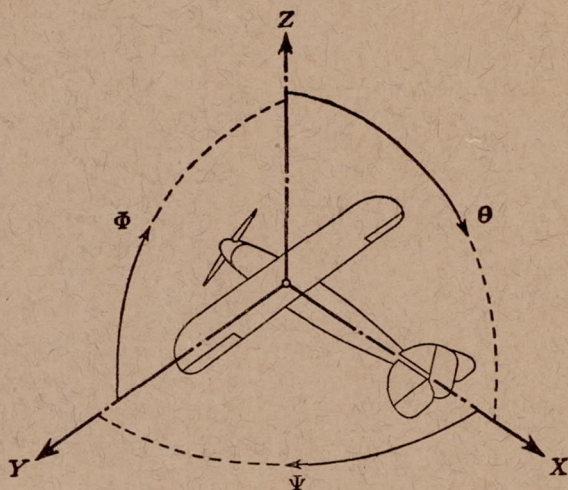

Positive directions of axes and angles (forces and moments) are shown by arrows

Axis		Force (parallel to axis) symbol	Moment about axis			Angle		Velocities	
Designation	Sym- bol		Designa- tion	Sym- bol	Positive direction	Designa- tion	Sym- bol	Linear (compo- nent along axis)	Angular
Longitudinal.....	X	X	rolling.....	L	Y → Z	roll.....	Φ	u	p
Lateral.....	Y	Y	pitching.....	M	Z → X	pitch.....	θ	v	q
Normal.....	Z	Z	yawing.....	N	X → Y	yaw.....	Ψ	w	r

Absolute coefficients of moment

$$C_L = \frac{L}{qbS} \quad C_M = \frac{M}{qcS} \quad C_N = \frac{N}{qfS}$$

Angle of set of control surface (relative to neu-
tral position), δ . (Indicate surface by proper
subscript.)

4. PROPELLER SYMBOLS

D , Diameter.
 p_e , Effective pitch
 p_g , Mean geometric pitch.
 p_s , Standard pitch.
 p_v , Zero thrust.
 p_t , Zero torque.
 p/D , Pitch ratio.
 V' , Inflow velocity.
 V_s , Slip stream velocity.

T , Thrust.
 Q , Torque.
 P , Power.

(If "coefficients" are introduced all
units used must be consistent.)

η , Efficiency = $T V/P$.
 n , Revolutions per sec., r. p. s.
 N , Revolutions per minute., R. P. M.

$$\Phi, \text{ Effective helix angle} = \tan^{-1} \left(\frac{V}{2\pi r n} \right)$$

5. NUMERICAL RELATIONS

1 HP = 76.04 kg/m/sec. = 550 lb./ft./sec.
 1 kg/m/sec. = 0.01315 HP.
 1 mi./hr. = 0.44704 m/sec.
 1 m/sec. = 2.23693 mi./hr.

1 lb. = 0.4535924277 kg.
 1 kg = 2.2046224 lb.
 1 mi. = 1609.35 m = 5280 ft.
 1 m = 3.2808333 ft