

NASA-CR-170410
19840009106

Airloads Research Study

Volume II: Airload Coefficients Derived From Wind Tunnel Data

M. D. Bartlett, T. F. Feltz, A. D. Olsen, Jr., D. B. Smith, and
P. F. Wildermuth

Contract NAS4-2769
January 1984

LIBRARY COPY

FEB 14 1984

LANGLEY RESEARCH CENTER
LIBRARY, NASA
HAMPTON, VIRGINIA



Airloads Research Study

Volume II: Airload Coefficients Derived From Wind Tunnel Data

M. D. Bartlett, T. F. Feltz, A. D. Olsen, Jr., D. B. Smith, and P. F. Wildermuth
Rockwell International, Los Angeles Division, Los Angeles, California 90009

Prepared for
Ames Research Center
Dryden Flight Research Facility
Edwards, California
under Contract NAS4-2769

1984



National Aeronautics and
Space Administration

Ames Research Center

Dryden Flight Research Facility
Edwards, California 93523

N84-17174[#]

This Page Intentionally Left Blank

CONTENTS

| Section | Page |
|--|------|
| SUMMARY | 1 |
| INTRODUCTION | 1 |
| AIRCRAFT DESCRIPTION | 2 |
| Fuselage | 2 |
| Wing | 4 |
| Nacelle | 4 |
| Horizontal Stabilizer | 5 |
| Vertical Stabilizer | 5 |
| Stability and Control Augmentation System | 6 |
| STRUCTURAL LOADS DATA DERIVED FROM WIND TUNNEL TESTS | 7 |
| METHODS AND RESULTS | 9 |
| REFERENCES | 13 |
| APPENDIX A. SYMBOLS | 22 |
| APPENDIX B. RIGID AIRLOAD COEFFICIENTS AT LOAD REFERENCE POINTS - $M=0.85$, $\Lambda_W=67.5^\circ$ | 26 |
| APPENDIX C. NET RIGID AIRLOAD COEFFICIENTS FOR FLIGHT CONDITIONS | 36 |
| APPENDIX D. FIGURES USING ENGINEERING UNITS | 42 |
| APPENDIX E. RIGID AIRLOAD COEFFICIENTS AT LOAD REFERENCE POINTS - $M=1.20$, $\Lambda_W=67.5^\circ$ | 57 |
| APPENDIX F. RIGID AIRLOAD COEFFICIENTS AT LOAD REFERENCE POINTS - $M=0.95$, $\Lambda_W=67.5^\circ$ | 66 |

CONTENTS (Concluded)

| Section | | Page |
|------------|--|------|
| APPENDIX G | RIGID AIRLOAD COEFFICIENTS AT LOAD REFERENCE POINTS - $M=0.70$, $\Lambda_W=67.5^\circ$ | 75 |
| APPENDIX H | RIGID AIRLOAD COEFFICIENTS AT LOAD REFERENCE POINTS - $M=1.60$, $\Lambda_W=67.5^\circ$ | 84 |
| APPENDIX J | RIGID AIRLOAD COEFFICIENTS AT LOAD REFERENCE POINTS - $M=2.20$, $\Lambda_W=67.5^\circ$ | 93 |

LIST OF ILLUSTRATIONS

| Figure | Title | Page |
|--------|---|------|
| 1 | B-1 aircraft | 15 |
| 2 | Structural breakdown | 16 |
| 3 | Wind tunnel pressure loads model | 17 |
| 4 | Unit additional span load distribution on wing - centerbody $\Lambda_W = 67.5^\circ$, $M = 0.85$ | 18 |
| 5 | Unit additional chordwise load distribution on wing - centerbody $\Lambda_W = 67.5^\circ$, $M = 0.85$ | 19 |
| 6 | Normalized pressure distribution | 20 |
| 7 | Flight control surfaces. | 21 |
| B-1 | Component rigid airload coefficient reference points, $\Lambda_W = 67.5^\circ$ | 35 |
| D-1 | General arrangement - RDT&E A/C-1 and -2 | 43 |
| D-2 | Fuselage structure diagram (B-1) (-55B). | 47 |
| D-3 | Wing-structure diagram, outer (-55B). | 49 |
| D-4 | Structural arrangement - nacelle external compression inlet (RDT&E). | 51 |
| D-5 | Horizontal stabilizer - STRL arrangement (42-1/2° LE sweep) | 53 |
| D-6 | Vertical stabilizer structural arrangement | 55 |

LIST OF TABLES

| Table | Title | Page |
|-------|---|------|
| I | Aerodynamic Effects Applicable to Component Loads. | 14 |
| B-I | Wing Coefficients at X _{RS} 354 for 0.85M and $\Lambda_W = 67.5^\circ$ | 27 |
| B-II | Horizontal Tail Coefficients at BP 10.75 for 0.85M and $\Lambda_W = 67.5^\circ$ | 28 |
| B-III | Vertical Tail Coefficients at WL 136.56 for 0.85M and $\Lambda_W = 67.5^\circ$ | 29 |
| B-IV | Forward Fuselage Coefficients at FS 528.5 for 0.85M and $\Lambda_W = 67.5^\circ$ | 30 |
| B-V | Aft Fuselage Coefficients at FS 1337.5 for 0.85M and $\Lambda_W = 67.5^\circ$ | 31 |
| B-VI | Vertical Tail Coefficients at WL 75.0 for 0.85M and $\Lambda_W = 67.5^\circ$ | 32 |
| B-VII | Load Coefficients Data Card Listing - M=0.85 | 33 |
| E-I | Wing Coefficients at X _{RS} 354 for 1.20M and $\Lambda_W = 67.5^\circ$ | 58 |
| E-II | Horizontal Tail Coefficients at BP 10.75 for 1.20M and $\Lambda_W = 67.5^\circ$ | 59 |
| E-III | Vertical Tail Coefficients at WL 136.56 for 1.20M and $\Lambda_W = 67.5^\circ$ | 60 |
| E-IV | Forward Fuselage Coefficients at FS 528.5 for 1.20M and $\Lambda_W = 67.5^\circ$ | 61 |
| E-V | Aft Fuselage Coefficients at FS 1337.5 for 1.20M and $\Lambda_W = 67.5^\circ$ | 62 |
| E-VI | Vertical Tail Coefficients at WL 75.0 for 1.20M and $\Lambda_W = 67.5^\circ$ | 63 |
| E-VII | Load Coefficients Data Card Listing - M=1.20 | 64 |
| F-I | Wing Coefficients at X _{RS} 354 for 0.95M and $\Lambda_W = 67.5^\circ$ | 67 |
| F-II | Horizontal Tail Coefficients at BP 10.75 for 0.95M and $\Lambda_W = 67.5^\circ$ | 68 |
| F-III | Vertical Tail Coefficients at WL 136.56 for 0.95M and $\Lambda_W = 67.5^\circ$ | 69 |
| F-IV | Forward Fuselage Coefficients at FS 528.5 for 0.95M and $\Lambda_W = 67.5^\circ$ | 70 |
| F-V | Aft Fuselage Coefficients at FS 1337.5 for 0.95M and $\Lambda_W = 67.5^\circ$ | 71 |
| F-VI | Vertical Tail Coefficients at WL 75.0 for 0.95M and $\Lambda_W = 67.5^\circ$ | 72 |
| F-VII | Load Coefficients Data Card Listing - M = 0.95 | 73 |

LIST OF TABLES (Concluded)

| Table | | Page |
|-------|---|------|
| G-I | Wing Coefficients at X_{RS} 354 for 0.70M and $\Lambda_W = 67.5^\circ$ | 76 |
| G-II | Horizontal Tail Coefficients at BP 10.75 for 0.70M and $\Lambda_W = 67.5^\circ$ | 77 |
| G-III | Vertical Tail Coefficients at WL 136.56 for 0.70M and $\Lambda_W = 67.5^\circ$ | 78 |
| G-IV | Forward Fuselage Coefficients at FS 528.5 for 0.70M and $\Lambda_W = 67.5^\circ$ | 79 |
| G-V | Aft Fuselage Coefficients at FS 1337.5 for 0.70M and $\Lambda_W = 67.5^\circ$ | 80 |
| G-VI | Vertical Tail Coefficients at WL 75.0 for 0.70M and $\Lambda_W = 67.5^\circ$ | 81 |
| G-VII | Load Coefficients Data Card Listing | 82 |
| H-I | Wing Coefficients at X_{RS} 354 for 1.60M and $\Lambda_W = 67.5^\circ$ | 85 |
| H-IIH | Horizontal Tail Coefficients at BP 10.75 for 1.60M and $\Lambda_W = 67.5^\circ$ | 86 |
| H-III | Vertical Tail Coefficients at WL 136.56 for 1.60M and $\Lambda_W = 67.5^\circ$ | 87 |
| H-IV | Forward Fuselage Coefficients at FS 528.5 for 1.60M and $\Lambda_W = 67.5^\circ$ | 88 |
| H-V | Aft Fuselage Coefficients at FS 1337.5 for 1.60M and $\Lambda_W = 67.5^\circ$ | 89 |
| H-VI | Vertical Tail Coefficients at WL 75.0 for 1.60M and $\Lambda_W = 67.5^\circ$ | 90 |
| H-VII | Load Coefficients Data Card Listing | 91 |
| J-I | Wing Coefficients at X_{RS} 354 for 2.20M and $\Lambda_W = 67.5^\circ$ | 94 |
| J-II | Horizontal Tail Coefficients at BP 10.75 for 2.20M and $\Lambda_W = 67.5^\circ$ | 95 |
| J-III | Vertical Tail Coefficients at WL 136.56 for 2.20M and $\Lambda_W = 67.5^\circ$ | 96 |
| J-IV | Forward Fuselage Coefficients at FS 528.5 for 2.20M and $\Lambda_W = 67.5^\circ$ | 97 |
| J-V | Aft Fuselage Coefficients at FS 1337.5 for 2.20M and $\Lambda_W = 67.5^\circ$ | 98 |
| J-VI | Vertical Tail Coefficients at WL 75.0 for 2.20M and $\Lambda_W = 67.5^\circ$ | 99 |
| J-VII | Load Coefficients Data Card Listing | 100 |

This Page Intentionally Left Blank

AIRLOADS RESEARCH STUDY

AIRLOAD COEFFICIENTS DERIVED FROM WIND TUNNEL DATA

By M. Bartlett, T.F. Feltz, A.D. Olsen Jr., D.B. Smith, and P.F. Wildermuth
External Structural Loads

SUMMARY

This report describes the development of the B-1 aircraft rigid wind tunnel data for use in subsequent tasks of the Airloads Research Study (ARS). The basic intent of the overall ARS program is to utilize flight data acquired during B-1 aircraft test flights, perform analyses of these data beyond the scope of Air Force requirements, and prepare research reports that will add to the technology base for future transport aircraft. Efforts are scheduled as distinct tasks with separate reports for each task.

During this contract phase, existing programs and data from the Rockwell International external structural loads files data bank were used to generate coefficients of rigid airload shear, bending moment, and torsion at specific component reference stations for each of the aircraft aerodynamic effects. Typical aerodynamic effects for each component include those due to alpha equals zero, alpha, beta, etc. The coefficient data are presented in slope intercept form. The data presented in this report are for the B-1 aircraft with the aircraft in various wing sweep configurations at selected mach numbers.

INTRODUCTION

The B-1 aircraft No. 2 (figure 1) is being utilized to conduct the airloads survey flight test program. This aircraft has undergone extensive ground testing to calibrate the strain gages utilized in the airload survey. A comprehensive wind tunnel test program has been conducted to obtain basic force data and pressure distribution data for both subsonic and supersonic speeds. The aircraft provides a reasonable simulation of a future transport aircraft since it has a speed capability in excess of mach 2.0 and employs a large flexible structure (figure 2).

The airloads data gathered from the flight, ground, and wind tunnel tests can be utilized in the evaluation of recently developed NASA computer programs, such as NASTRAN and FLEXSTAB, to enhance the analytical techniques of predicting aeroelastic response of large flexible aircraft.

AIRCRAFT DESCRIPTION

The B-1 aircraft is a prototype, long-range supersonic bomber with the capability of high-speed flight at low altitude. Configuration dimensions and general arrangement are presented in figure D-1. The aircraft utilizes a blended wing-body concept with variable-sweep wings, a single vertical stabilizer with a three-section (upper, intermediate, and lower) rudder, and horizontal stabilizers which operate independently to provide both pitch and roll control. The variable sweep (15 to 67.5 degrees) wing, equipped with slats, spoilers (which also function as speed brakes), and flaps, provides the aircraft with a highly versatile operating envelope. Canted vanes, mounted on each side of the forward fuselage, are part of the structural mode control system which reduces structural bending oscillations in the vertical and lateral axes.

The aircraft is powered by four YF101-GE-100 dual-rotor augmented turbo-fan engines in the 30,000-pound-thrust class. The engines are mounted in twin nacelles below the wing, approximately at the left and right wing pivot points. For supersonic speeds, an air induction control system varies the internal geometry of the nacelle inlet ducts to maintain the required airflow to the engines for all flight conditions.

Fuel is carried in integral tanks in the fuselage, wing carry-through, and wing outer panels. The fuel system is pressurized and inerted by nitrogen. Fuel transfer sequencing is automatic and provides center-of-gravity control. The aircraft has both in-flight and single-point refueling capabilities.

Fuselage

The fuselage (figure D-2) is constructed primarily of aluminum alloy materials arranged in a semimonocoque skin-frame longeron type of construction. Titanium is used in the wing carry-through, nacelle, and tail support structure, and for various other structures where high load concentrations exist and on the aft fuselage skins where high temperatures and acoustic levels are prevalent. Dielectric materials such as polyimide quartz and fiber glass are used for radomes and antenna covers.

The fuselage structure is fabricated in six major sections and then mated together prior to attaching wings, empennage, landing gears, and nacelles. The following functional description of each section will provide a better understanding of the overall fuselage and its relationship to most of the air vehicle subsystems.

The crew module assembly provides a sealed enclosure with crewmember provisions and is an ejectable unit for emergency escape. The structure is capable of pressurization for a 2,439 meter (8,000 feet) altitude environment and incorporates a clear vision windshield designed to bird-proof requirements, additional crew windows, an entry door, and an emergency exit hatch for ingress and egress. The floor structure supports crew seating and ejection rocket loads. An unpressurized section aft of the crew quarters houses the escape system parachutes and provides support for the stabilizing fins. Two sets of deployable mechanical stabilizing spoilers are hinged in the side panel framework and at the lower forward edge of the module. Structural ties to the forward fuselage are severed by explosive charges for emergency escape.

The forward fuselage section includes the nose radome, a forward avionics compartment, an in-flight refueling receptacle, the nose gear well and support structure, a central avionics compartment, a section of the forward fuel tank, a Doppler radome, an environmental control system equipment bay, and the crew entry stairladder structure and mechanism installation. The section also includes many other items of equipment such as antennas and pressure sensing devices. Left and right structural mode control fin surfaces are mounted on this section. Many large and small access doors are provided due to the high density of equipment installations in this assembly.

The forward intermediate section houses the forward and center weapons bays. Major bulkheads located between the two bays and at each end of the bays provide support for the rotary weapons launchers. The aft bulkhead location also forms a part of the wing carry-through section. The forward bulkhead is also a closeout for the forward fuselage section. Large integral fuel tanks are incorporated into the forward intermediate fuselage structure immediately outboard of the weapons bays. A systems routing tunnel occupies the upper structure area between longerons. Provisions for avionics are incorporated in the side fairing area, consisting of equipment bays, antennas, and radomes. Provisions for external stores pylons, wing sweep actuation components, and flap and slat drive mechanisms are also incorporated in the forward intermediate fuselage section.

The aft intermediate fuselage consists of the main gear well and the aft weapons bay. It incorporates a flight controls mixer compartment and a fuel tank above the main gear well. The gear uplock support structure is located in the mixer compartment. Avionics provisions are made in the compartment between the wheel wells and in the structural compartments outboard of the wheels. Bulkheads at the forward and aft end of the weapons bay support the weapons bay rotary weapons launcher. As in the forward intermediate fuselage, fuel is stored outboard of the weapons bay. A double support frame for the aft portion of the nacelle extends outboard to the centerline beam of the nacelle. This support is approximately midway between weapons bay

bulkheads. The upper centerline longeron and the lower outboard longerons are located and constructed so as to provide a high stiffness to weight ratio. The upper centerline longeron extends forward into the wing carry-through section and aft to the vertical stabilizer front spar.

The aft fuselage is a semimonocoque structure and consists of the aft fuel tank area, the dorsal area, the aft avionic bay, and the tail cone. The tank area is closed in the forward and aft end by bulkheads. The forward bulkhead separates the aft fuel tank from the aft weapons bay. The aft bulkhead closes the tank and provides mounting support structure for the horizontal tail spindle fitting and the aft avionic bay. The dorsal area is a dry tunnel space which houses flight control cables and hardware and provides for the routing of the electrical conduits.

Wing

The wing consists of the wing pivot, outer wing panel, flaps, slats, and spoilers. (See figure D-3.) The wing pivot consists of the pin, bearings, and inboard and outboard lugs with provisions for attachment to the wing carry-through fuselage section and the wing outer panel.

The wing outer panel consists of a structural box with leading edge slats, trailing edge flaps, and spoilers over the flap leading edge. The outer wing is mounted on pivot bearings whose supporting lugs are mechanically attached to the wing covers. Provisions for integral fuel containment are provided in the outboard wing structural box. Access is provided for sealing, inspection, servicing, and replacement of fuel system components. Control surfaces on the wings include flaps, slats, and spoilers. The flaps are aft of the wing rear spar and are mounted on rollers between curved tracks. Flap actuating jack-screws are located in the midbay of the flap panels. Segmented leading edge slats are provided. Each segment is supported on tracks mounted on rollers attached to the fixed leading edge structure. Segmented wing spoilers are aft of the wing rear spar and above the flaps.

Nacelle

The nacelle is constructed of aluminum alloy, titanium alloy, and stainless steel and fiber glass laminates. Structural type is semimonocoque with skins, frames, longerons, and a honeycomb sandwich duct. (See figure D-4.) Each nacelle is fabricated in two major sections, the forward section and the engine compartment.

The forward section consists of the inlet section, the duct assembly, the ramps, and the center beam. The inlet section consists of the center splitter wedge and the upper and lower leading edges. Portions of the upper and lower leading edges are porous for boundary layer control. The duct assemblies consist of engine air intake ducts supported by frames and stringers and covered with an external skin. In the forward area, the duct wall is covered with aluminum-machined skin. The intermediate and aft duct walls are covered with fiber glass honeycomb sandwich. The inboard wall of the duct is made up of a fixed duct and movable ramps which provide for a variable geometry system for air induction control. The center beam consists of four main longerons, interconnecting shear panels, appropriate frames, and the forward nacelle attach point, and is the primary vertical bending member of the nacelle.

The engine compartment consists of the principal firewall bulkhead, the structure between the two engines, the primary engine attach points, and the aft nacelle attach points. Large hinged engine access doors are provided to complete the engine enclosure. Construction is frame, skin, and longeron.

The nacelle is attached to the air vehicle at four points. The forward attach point is a single fitting on the top of the centerbeam structure which is connected to the wing pivot pin through a ball joint. The other three attach points are in the engine section in line with the rear engine support. They consist of links, two vertical and one horizontal, which connect the nacelle to the heavy support frame extending from the aft intermediate fuselage.

Horizontal Stabilizer

The horizontal stabilizer (figure D-5) consists of left- and right-hand slab panels attached to a steel spindle projecting out of the aft fuselage stub structure. Both left- and right-hand panels rotate on bearings and are independently controlled in order for the stabilizer to provide pitch and roll control of the air vehicle. Each panel consists of a main structural box, a leading edge assembly, a trailing edge assembly, a tip assembly, an aerodynamics chord plane seal at the inboard end, and an air seal around the spindle.

Vertical Stabilizer

The vertical stabilizer consists of the main box structure, leading edge assembly, tip assembly, and trailing edge structure. (See figure D-6.) The main box assembly supports the two upper rudder segments. Routing tunnels are provided in enclosed areas of the main box structure for electrical and cooling lines required to support avionics and antenna equipment located in the

tip and leading edge components. The rudder consists of three segments. The upper two segments are attached to the vertical stabilizer through power hinge fittings and actuated by hydraulic motors in the horizontal stabilizer actuator fairing. The lower rudder segment is supported by conventional hinge fittings and actuated by linear actuators between the rudder and aft fuselage structure.

The vertical stabilizer is attached to the aft fuselage principally through a double shear attachment provided on the horizontal stabilizer spindle fitting. The vertical stabilizer is mechanically attached to the spindle fitting by close-tolerance, high-strength bolts.

Stability and Control Augmentation System

The stability and control augmentation system (SCAS) provides desired damping and maneuver control. The SCAS transforms pilot pitch and lateral stick displacements and aircraft motion about the pitch and roll axis into symmetrical and antisymmetrical horizontal stabilizer displacements. Similarly, the yaw SCAS employs lower rudder displacement for aircraft motion about the yaw axis.

STRUCTURAL LOADS DATA DERIVED FROM WIND TUNNEL TESTS

The basic B-1 rigid aerodynamic data have been obtained from 7,255 wind tunnel test hours involving 14 wind tunnels and 17 models, including those for force measurement, high lift, pressure loads, rotary derivative, spin tests, etc. Data used for structural load analyses are derived from these tests.

The pressure loads wind tunnel model is shown in figure 3. Pressure measurements were obtained by 346 flush static-pressure taps on the top and bottom of both wings and left side of the fuselage (including the wing hood area), the bottom of the left nacelle, the left and right sides of the right nacelle, the top and bottom of the left horizontal tail, and the left side of the vertical tail, including the rudder. Typical wing unit additional lift distribution ($C_L = 1.0$ due to α) and the corresponding normalized ($c_l = 1.0$ due to α) chordwise pressure distributions derived from the pressure model test data are shown in figures 4 and 5. The pressure distribution shown in figure 6 was obtained using the data of figures 4 and 5 and normalizing the distributions to produce a wingload equal to unity.

The foregoing data sources and other pressure data contained in the Rockwell External Structural Loads Group's files were used to establish a basic data bank. The pressure data consist of wind tunnel data in the form of spanwise and chordwise distributions versus angle of attack and/or angle of sideslip. Force coefficient data and force data derived from pressure data that are obtained from two separate sources usually do not match. The force coefficients computed by integrating the pressure distributions vary slightly in magnitude and center of pressure from the measured data of the force model. The data taken from the force model were considered more accurate, and the pressure distributions were adjusted to match the force data.

While complete aircraft data are available, it is more convenient (from an external load point of view) to use force coefficient and load distribution data on the individual aircraft components. Data are available on the five basic components; i.e., wing, horizontal tail, vertical tail, rudder, and fuselage. The rudder data are separated into two parts: one for the upper rudder, and one for the lower rudder. The individual component force data reside on a basic data disk pack and may be accessed directly. The pressure distribution data have been converted to "unit" grid loading. This was done by interpolating a pressure map in-the-small and integrating over each grid area. These data also reside on disk and may be directly accessed. The type of data stored represents the basic data for various aerodynamic effects.

Force and load distribution information for each component are available for the following aerodynamic effects:

- (1) Alpha equals zero ($\alpha = 0$)
- (2) Angle of attack (α)
- (3) Angle of sideslip (β)
- (4) Symmetric and antisymmetric control surface deflections (δ_H , δ'_H , δ_{SP} , δ_R)
- (5) Pitch, roll, and yaw rate effects (Q,P,R)
- (6) Typical cross-coupling terms such as change in sideslip due to change in angle of attack

The multiplicity of aerodynamic effects results from the use and the arrangement of the aircraft movable and control surfaces which are shown in figure 7. The B-1 arrangement features the following:

- (a) Blended wing-body concept with variable-sweep wings
- (b) All-movable horizontal stabilizers for longitudinal and lateral control and trim
- (c) Spoilers for additional lateral control and for use as speed brakes
- (d) Single vertical stabilizer with rudders for directional control and trim
- (e)* Canted movable vanes on the forebody for structural mode control (vertical and lateral) to produce improved ride quality
- (f) Wing flaps and slats to provide improved lift for takeoff and landing

The data, as stored on disk, may be used to generate component loads for a complete aircraft flight condition. Distributed load conditions are obtained by applying the appropriate factors to each basic unit loading distribution and summing to obtain a complete set of net aircraft grid loads.

Existing programs and basic aircraft component data from the data bank are used to generate a coefficient of shear (C_{V_i}), bending moment (C_{B_i}), and

torsion (C_{T_i}) at component reference stations for each aircraft aerodynamic effect (i). These coefficient data are obtained in slope intercept form for use in equations to obtain net rigid airload coefficients for a given flight condition.

METHODS AND RESULTS

Coefficients of rigid airload shear, bending moment, and torsion are developed at selected airframe stations for the B-1 configuration with selected wing leading edge sweep positions (Λ_W) and selected mach numbers, using the aerodynamic data and methods described as follows.

The force data and the corresponding unit grid load distributions for each component and aerodynamic effect which reside on the Rockwell data bank disk are utilized. The force coefficient data are based on a fixed-wing reference area, S_{REF} , semi span, $b_{REF}/2$, and mean aerodynamic chord, \bar{C}_{REF} , which are used for all wing sweep positions. This reference geometry corresponds to the wing geometry when the wing leading sweep angle (Λ_W) is 15 degrees. The summation of the unit grid loads on each individual component equals unity, and the grid loads are normalized using the pressure distribution over the individual component and its actual geometry. The normal force coefficient for the individual component, C_{V_j} , based on the individual component area, S_j , is determined using the wind tunnel normal force coefficient, C_{N_j} , based on the reference area, S_{REF} , as follows:

$$C_{V_j} = C_{N_j} \left(\frac{S_{REF}}{S_j} \right) \quad (1)$$

Values of unit shear, bending moment, and torsion, V_{uj} , B_{uj} , and T_{uj} , respectively, at any station along the component were obtained by integration of the unit grid load distribution. The values of shear, bending moment, and torsion coefficients $C_{V_{ij}}$, $C_{B_{ij}}$ and $C_{T_{ij}}$ for each aerodynamic effect (i) on the component (j) were then determined as follows using the individual component S_j , $b_j/2$, and \bar{C}_j values:

Let: V_{ij} , B_{ij} , T_{ij} = The values of shear, bending moment, and torsion

S_{REF} , $b_{REF}/2$, \bar{C}_{REF} = Wind tunnel data reference area, semispan, and MAC (for $\Lambda_W = 15^\circ$).

$C'_{V_{ij}}$, $C'_{B_{ij}}$, $C'_{T_{ij}}$ = Shear, bending moment, and torsion coefficient based on S_{REF} , $b_{REF}/2$, and \bar{C}_{REF}

$$V_{ij} = C_{N_{ij}} q S_{REF} V_{U_{ij}} \quad (2)$$

$$C'_{V_{ij}} = \frac{V_{ij}}{q S_{REF}} = C_{N_{ij}} V_{U_{ij}} \quad (3)$$

$$C_{V_{ij}} = C'_{V_{ij}} \left(\frac{S_{REF}}{S_j} \right) = V_{U_{ij}} \left(\frac{C_{N_{ij}} S_{REF}}{S_j} \right) \quad (4)$$

$$B_{ij} = C_{N_{ij}} q S_{REF} B_{U_{ij}} \quad (5)$$

$$C'_{B_{ij}} = \frac{B_{ij}}{q S_{REF} (b_{REF}/2)} = \left(\frac{C_{N_{ij}}}{b_{REF}/2} \right) B_{U_{ij}} \quad (6)$$

$$C_{B_{ij}} = C'_{B_{ij}} \left[\frac{S_{REF} (b_{REF}/2)}{S_j (b_j/2)} \right] = B_{U_{ij}} \left[\frac{C_{N_{ij}} S_{REF}}{S_j (b_j/2)} \right] \quad (7)$$

$$T_{ij} = C_{N_{ij}} q S_{REF} T_{U_{ij}} \quad (8)$$

$$C'_{T_{ij}} = \left(\frac{T_{ij}}{q S_{REF} \bar{C}_{REF}} \right) = \left(\frac{C_{N_{ij}}}{\bar{C}_{REF}} \right) T_{U_{ij}} \quad (9)$$

$$C_{T_{ij}} = C'_{T_{ij}} \left(\frac{S_{REF} \bar{C}_{REF}}{S_j \bar{C}_j} \right) = T_{U_{ij}} \left(\frac{C_{N_{ij}} S_{REF}}{S_j \bar{C}_j} \right) \quad (10)$$

NOTE: For wing and horizontal tail, all coefficients ($C_{N_{ij}}$, $C_{V_{ij}}$, $C_{B_{ij}}$, $C_{T_{ij}}$, etc) are for one side.

Table I presents the individual aerodynamic effects which are applicable to wing, horizontal tail, vertical tail, forward fuselage, and aft fuselage components. Shear, bending moment, and torsion coefficients have been calculated at one station on each of the preceding listed components.

Appendix A presents a list of symbols used in this report and their definition and units where applicable. Figure B-1, of appendix B, presents the location of the reference points for which load coefficients have been determined.

The resulting coefficients of rigid airload shear, bending moment, and torsion at each component station for each of the applicable aerodynamic effects listed in table I are presented in the appendixes for the various mach numbers along with their applicable areas, semispans, and mean aerodynamic chords.

Several of the aerodynamic effects must be combined to obtain the net rigid airload coefficients for a given flight condition. The equations in appendix C present the method of combining the aerodynamic effects at each of the stations. Refer to the list of symbols (appendix A) and appendix B for the definition of symbols and dimensional data.

Some anomalies in the equations of appendix C should be explained at this point. Aircraft sideslip (β) produces an asymmetric load distribution on the wing. To accommodate this, the asymmetric distribution was separated into an equivalent symmetric and antisymmetric part such that when added together produces the asymmetric load distribution. The force data are also treated in this manner. The sideslip also produces a cross-coupling effect and varies with changes in angle of attack. This method of treatment can be seen by examining the equations. Due to the asymmetric type of load distribution exhibited by some aerodynamic effects, C_V , C_B , and C_T are given for both the left and right sides for the wing and horizontal tail.

The fuselage has both vertical and lateral load distributions, and separate C_V and C_B equations are presented. The net airload coefficient equations for the aft fuselage include the airload on the aft fuselage and the airloads on the horizontal and vertical tail surfaces.

The rigid airload coefficients of tables B-I through B-VI for mach 0.85 and sweep 67.5 degrees are prepared in punched card form, as will all subsequent rigid airload coefficients for the various mach number-wing sweep combinations. The data cards have been formatted to be compatible with the NASA DFRC Cyber 73-28 computer. A listing of the data cards is presented for mach 0.85 (table B-VII), and will be presented in subsequent appendixes for all subsequent mach number-wing sweep combinations.

The total block of data cards contains 12 descriptive title cards. Ninety data cards follow the 12 descriptive title cards. The data cards are in six groups of 15 cards each. Each group represents the rigid airload coefficients for one of the five stations where loads will be measured during the B-1 flight loads survey plus the vertical tail root station. Each data card contains a sequence number which is explained in the descriptive title cards, C_V , C_B , C_T , and an aerodynamic effect description for each set of C_V , C_B , C_T . The filler cards provide space for up to 15 aerodynamic effects at each of the six reference stations.

The suggested format for reading the rigid aerodynamic coefficient cards into the NASA DFRC Cyber 73-28 computer is as follows:

- Descriptive title cards (12 cards)

Format (8A10)

- Rigid aerodynamic coefficient data cards (90 cards)

Format (I10, 3E10.2, 4A10)

ACKNOWLEDGMENT

Mr. R. Celniker is recognized for his important contributions as program manager during the early parts of the study.

REFERENCES

1. Rockwell International Report TFD-72-1017, "B-1 Rigid Aerodynamic Data for Stability and Control, Status at Air Vehicle DVR (As Revised to Present Final Preflight Data)," 25 November 1975.
2. Rockwell International Report TFD-73-960, "B-1 Aerodynamic Force, Moment and Load Distributions," 12 September 1975.
3. Rockwell International Report NA-71-522, "Transonic Wind Tunnel Test of the 0.036 Scale B-1 Pressure Loads Model," (TWT 236), 22 June 1971.

TABLE I.- AERODYNAMIC EFFECTS APPLICABLE TO COMPONENT LOADS

| Effect | Wing | Horiz tail | Vert tail | Fwd fus | Aft fus |
|---|------|------------|-----------|---------|---------|
| $\alpha = 0$ | X | X | | X | X |
| α | X | X | | X | X |
| $\dot{\alpha}$ | X | X | | | |
| β | | X | | X | X |
| δ_H (sym horiz tail defl) | | X | | | |
| δ'_H (anti sym horiz tail defl) | | X | X | | X |
| δ_{Sp} (spoiler defl) | X | X | X | | |
| δ_{Sp} c/o (horiz tail carryover) | | X | | | |
| δ_{RJ} (upper rudder defl) | | | X | | |
| δ_{RL} (lower rudder defl) | | | X | | X |
| P (damping in roll) | X | X | X | X | X |
| Q (damping in pitch) | X | X | | | |
| R (damping in yaw) | | | X | | |
| $\beta\alpha = 0$ A/S (wing) | X | | | | |
| $\beta\alpha = 0$ Sym (wing) | X | | | | |
| $\beta\alpha$ A/S (wing) | X | | | | |
| $\beta\alpha$ Sym (wing) | X | | | | |
| $\beta\alpha = 0$ (vert tail) | | | X | | |
| $\beta\alpha$ (vert tail) | | | X | | |
| $\beta\alpha = 0$ c/o (aft fus carryover) | | | | | X |
| $\beta\alpha$ c/o (aft fus carryover) | | | | | X |

X = Applicable aerodynamic effect

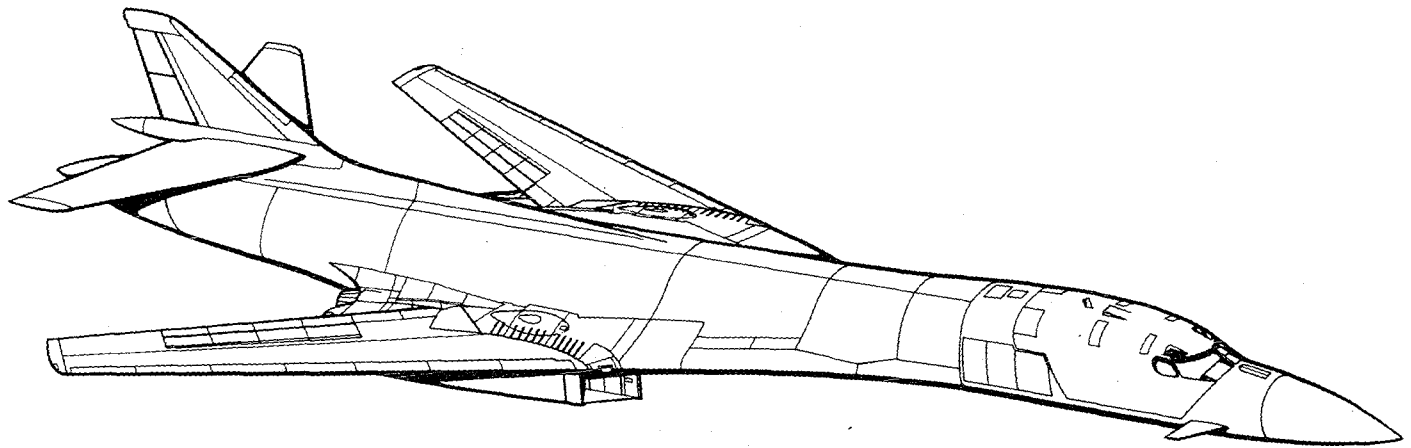

Figure 1. - B-1 aircraft.

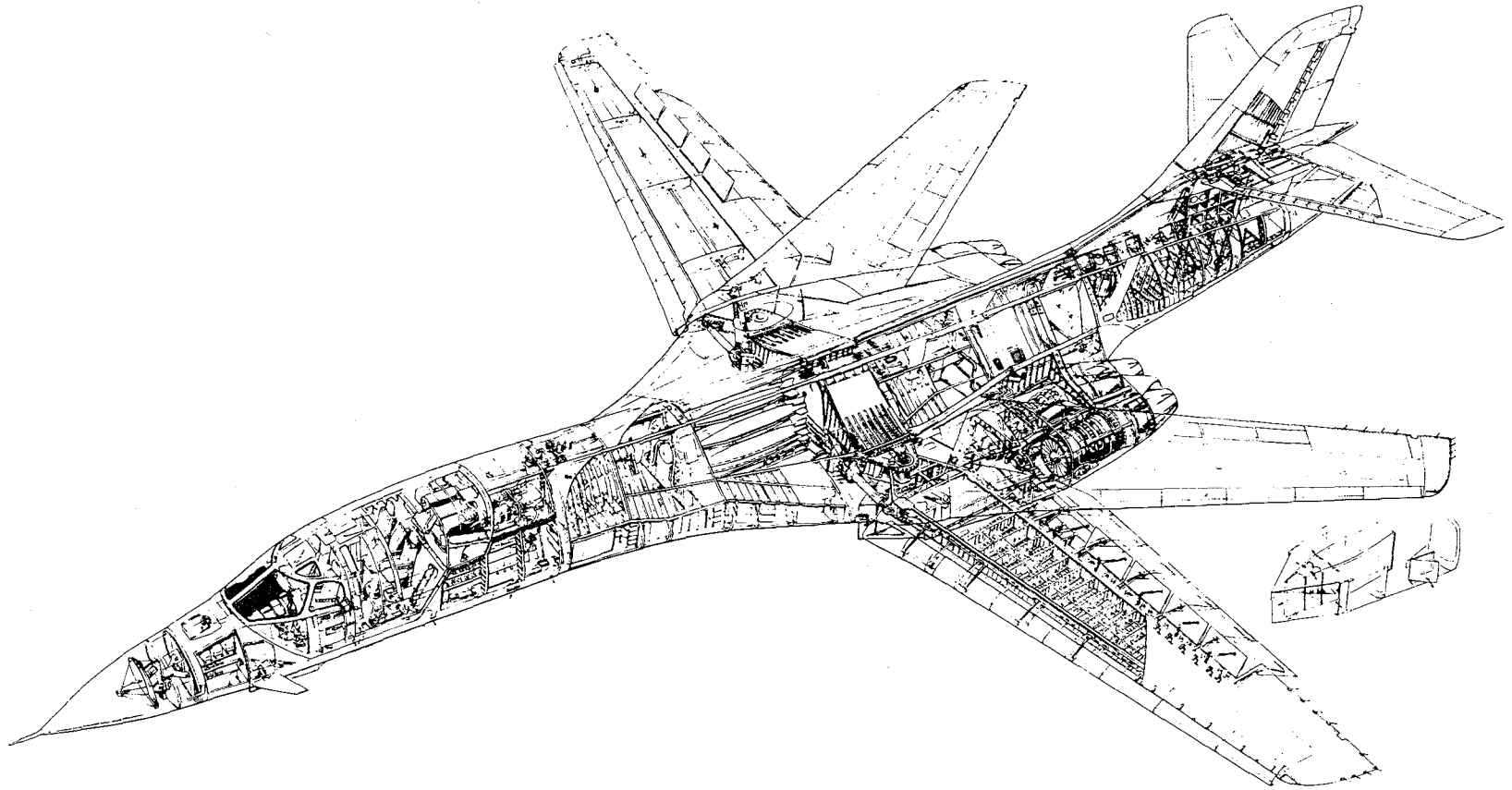

Figure 2. - Structural breakdown.

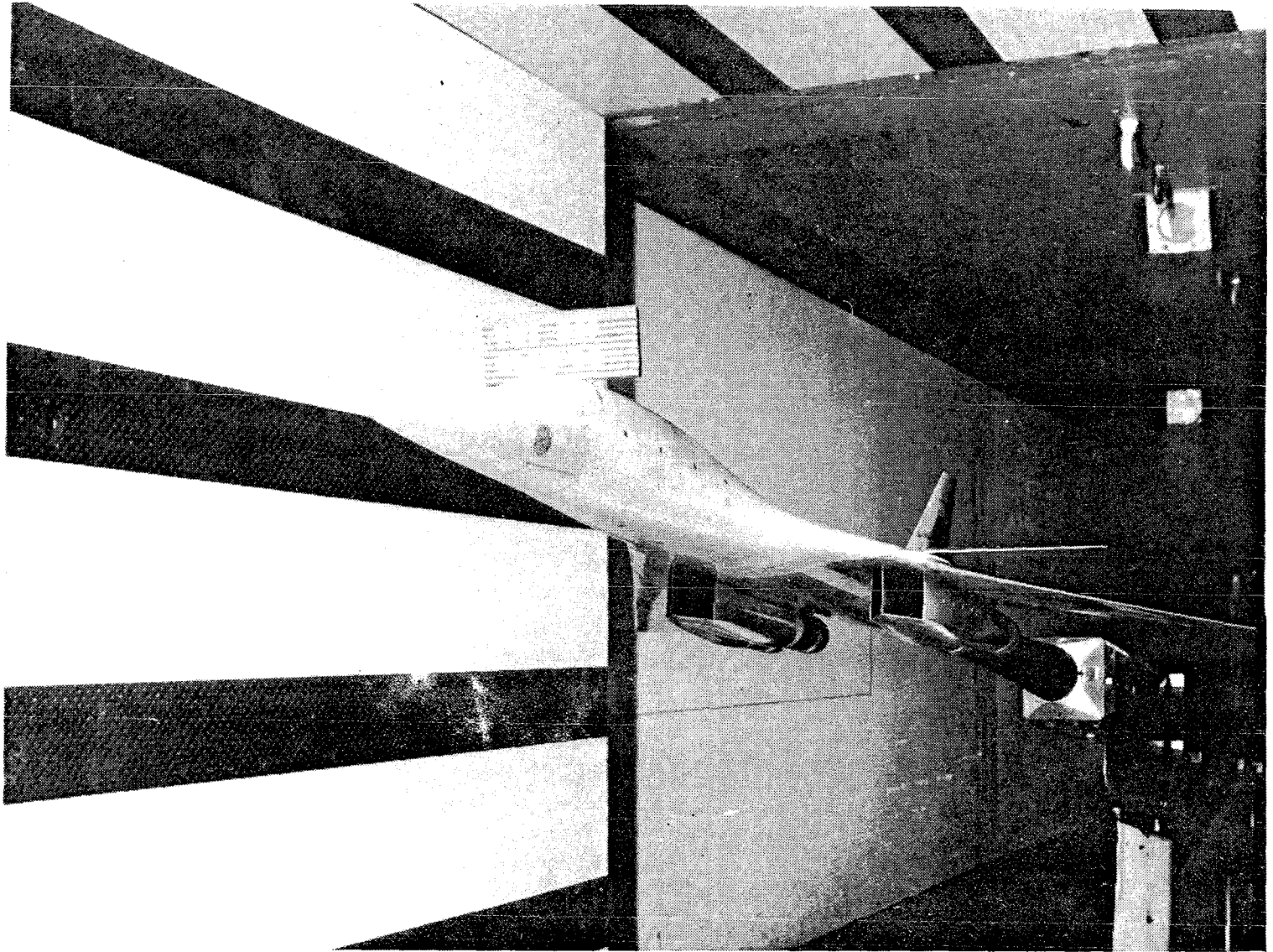

Figure 3.- Wind tunnel pressure loads model.

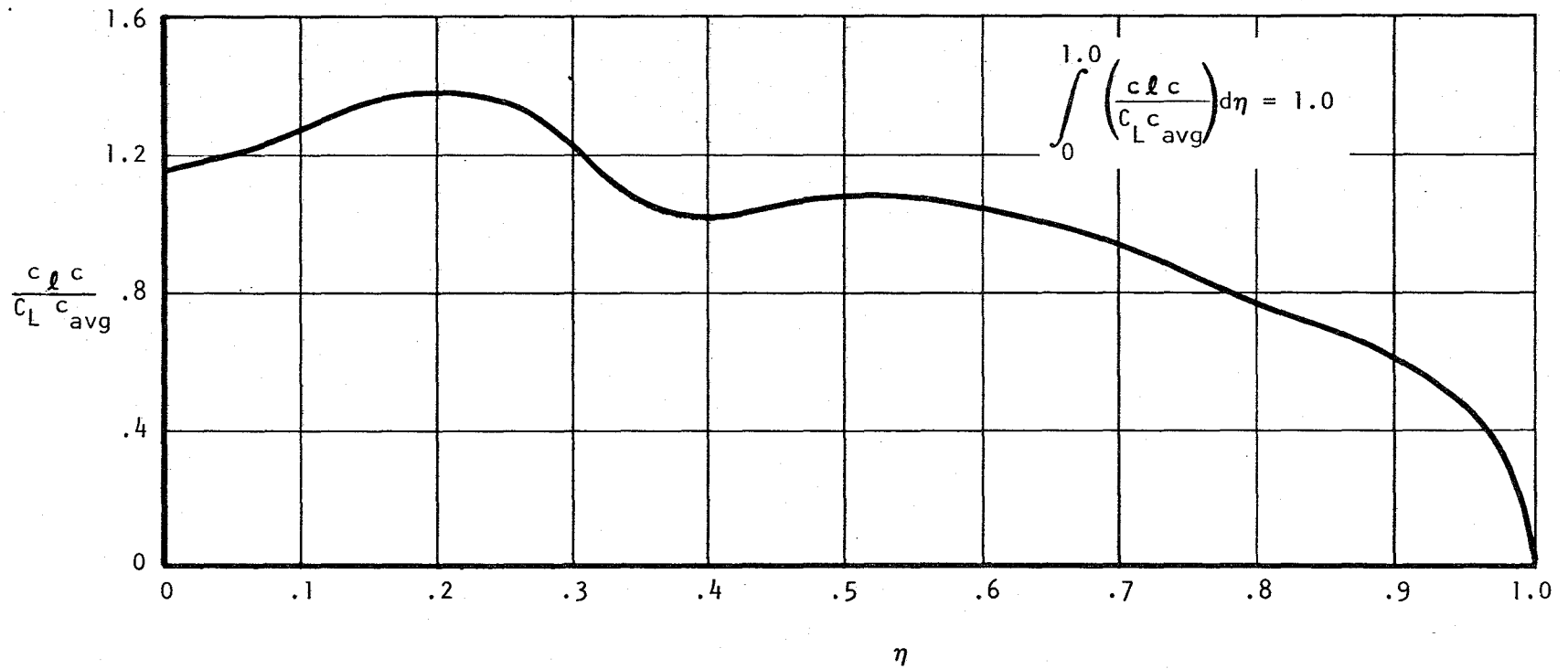

Figure 4.- Unit additional span load distribution on wing - centerbody $\Lambda_W = 67.5^\circ$, $M = 0.85$.

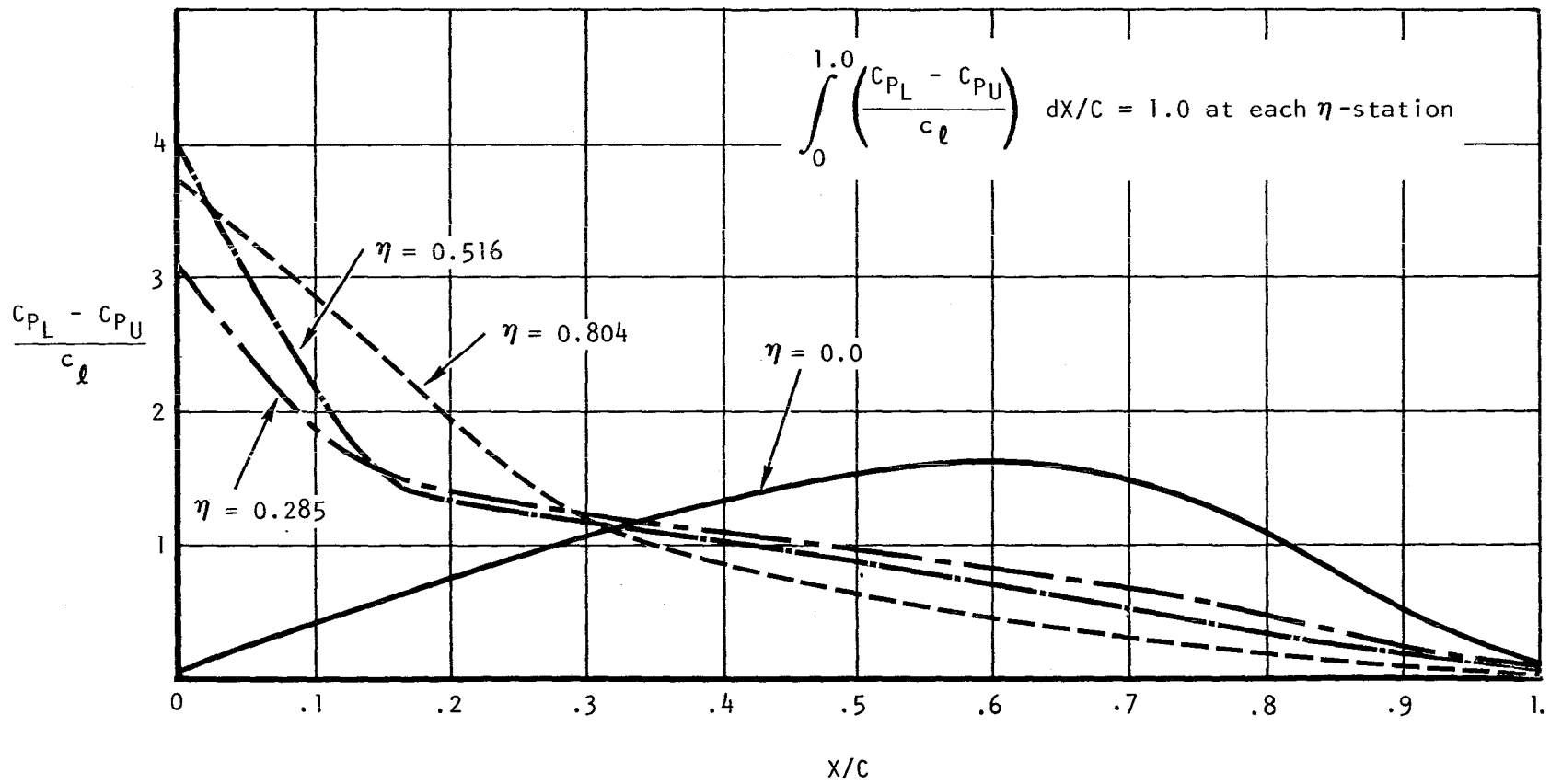

Figure 5.- Unit additional chordwise load distribution on wing-centerbody $\Lambda_W = 67.5^\circ$, $M = 0.85$.

WING PRESSURE PLOT 67.5 DEGREES SWEEP

RIGID DIST 55B WING M = .85 SW=67.5 ADDITIONAL SYM

128

Z SCALE
ZMAX = 4.59×10^{-05}
ZMIN = -8.77×10^{-09}
1 INCH = 2.02×10^{-05}

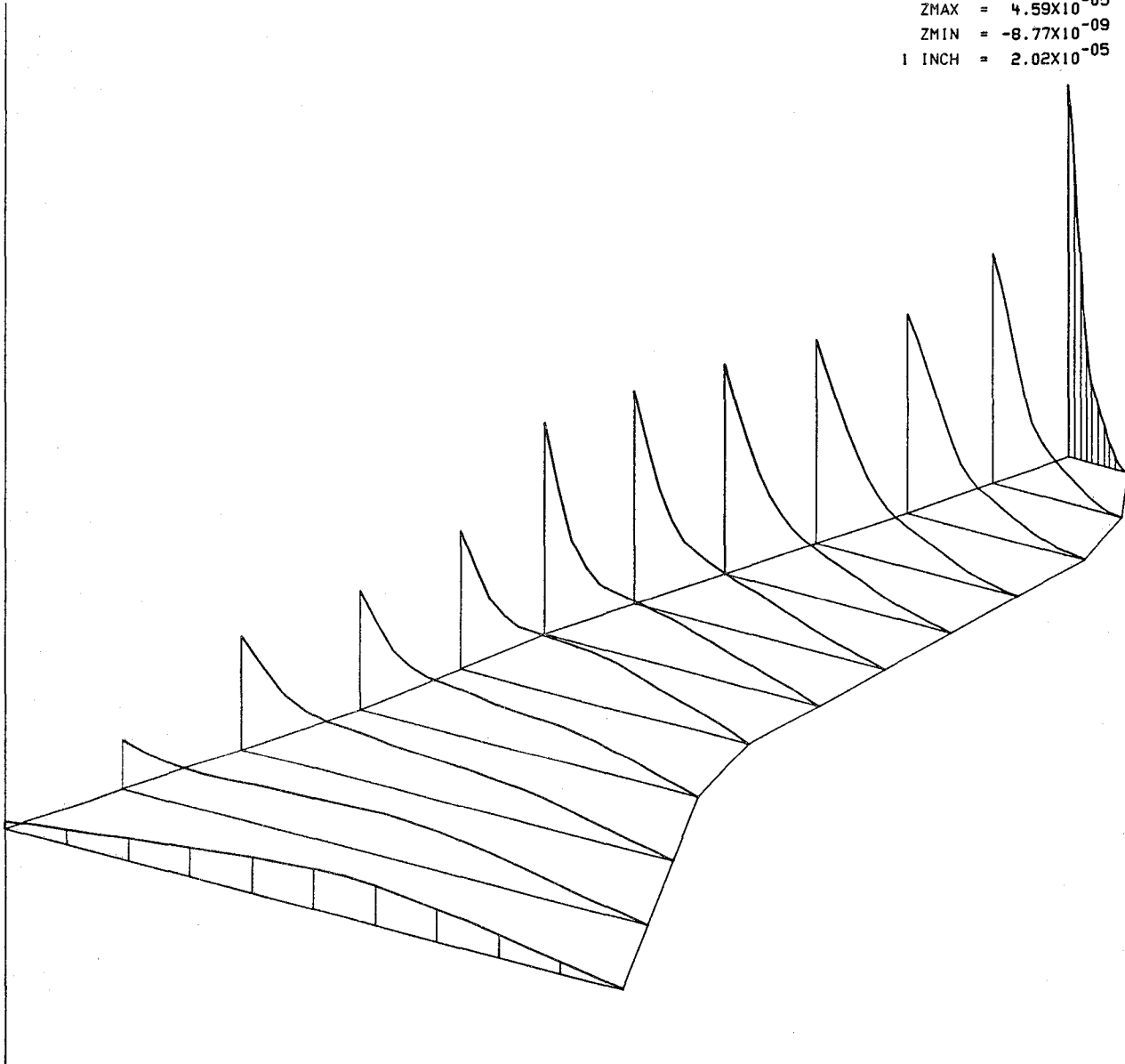

Figure 6.- Normalized pressure distribution.

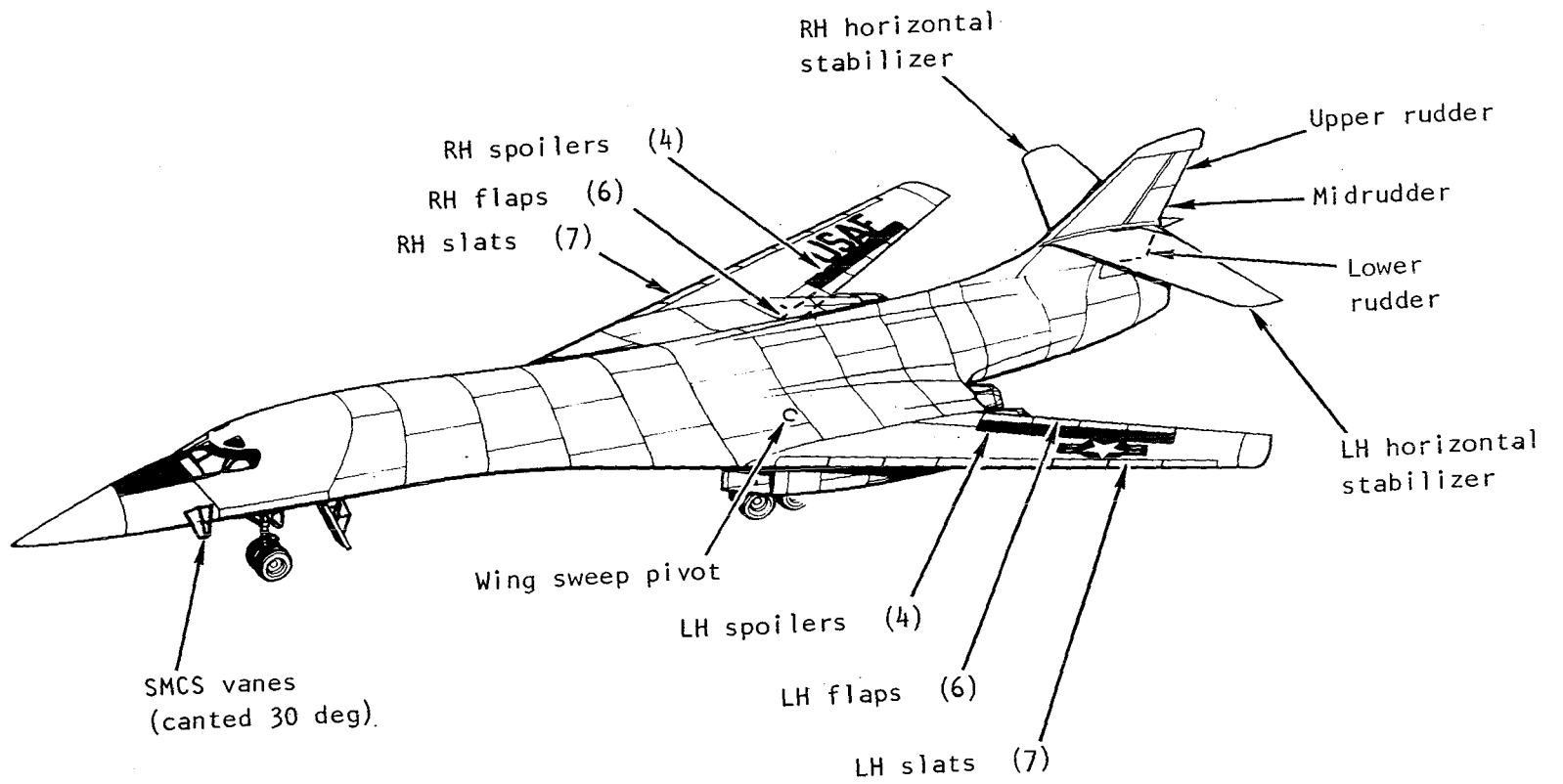

Figure 7. - Flight control surfaces.

APPENDIX A

SYMBOLS

| | | |
|--------------------------------------|---|-----------------------|
| Λ_W | wing sweep angle | degrees |
| q | dynamic pressure | lb/ft ² |
| S_j, S_{REF} | component area, reference area | ft ² |
| $b_j/2, b_{REF}/2$ | component semispan, reference semispan | in. |
| \bar{C}_j, \bar{C}_{REF} | mean aerodynamic chord, reference mean aerodynamic chord (MAC) | in. |
| C_{V_j} | normal force coefficient based on component area | |
| C_{N_j} | normal force coefficient based on reference area | |
| $V_{u_j}, B_{u_j}, T_{u_j}$ | unit shear, bending moment, and torsion on component j | lb, in.-lb, in.-lb |
| $V_{i_j}, B_{i_j}, T_{i_j}$ | Shear, bending moment, and torsion on component j due to aerodynamic effect i | lb, in.-lb, in.-lb |
| $C_{V_{ij}}, C_{B_{ij}}, C_{T_{ij}}$ | coefficient of shear, bending moment, and torsion on component j based on aerodynamic effect i using component area, semispan, and MAC | |

| | | |
|---|---|-------------|
| $C'_{V_{ij}}, C'_{B_{ij}}, C'_{T_{ij}}$ | coefficient of shear, bending moment, and torsion on component j based on aerodynamic effect i using reference area, semispan, and MAC | |
| α | angle of attack, + nose up | degrees |
| $\dot{\gamma}$ | rate of sink, + nose up | degrees/sec |
| β | angle of yaw, + nose left | degrees |
| P | rolling velocity, + left wing up | degrees/sec |
| Q | pitching velocity, + nose up | degrees/sec |
| R | yawing velocity, + nose right | degrees/sec |
| δ_H | horizontal tail deflection, + leading edge up | degrees |
| δ'_H | differential horizontal tail deflection, + δ'_H produces a plus rolling moment (left wing up) | degrees |
| δ_{sp} | spoiler deflection + when right spoilers deflected | degrees |
| $\delta_{sp_{c/o}}$ | effect of spoiler deflection on horizontal tail + when right spoilers deflected | degrees |
| δ_{RU} | deflection of upper segment of rudder, + trailing edge left | degrees |

| | | | |
|-----------------------|-----|---|-----------------|
| δ_{RL} | | deflection of lower segment of rudder, + trailing edge left | degrees |
| $*\beta_{\alpha} = 0$ | A/S | effect of β on wing, anti-symmetric contribution, + nose left | degrees |
| $*\beta_{\alpha}$ | A/S | effect of β and α on wing, anti-symmetric contribution, + nose left, + nose up | degrees-degrees |
| $*\beta_{\alpha} = 0$ | Sym | effect of β on wing, symmetric contribution, + nose left | degrees |
| $*\beta_{\alpha}$ | Sym | effect of β and α on wing, symmetric contribution, + nose left, + nose up | degrees-degrees |
| $\beta_{\alpha} = 0$ | c/o | effect of β on aft fuselage, + nose left | degrees |
| β_{α} | c/o | effect of β and α on aft fuselage, + nose left, + nose up | degrees-degrees |

*The explanation as to why the aerodynamic effects are divided into antisymmetric and symmetric parts is found in the methods and results paragraphs of this report.

A - airplane

c_l - section lift coefficient

c - section chord

C_{avg} - average surface chord

η - fraction of semispan

C_p - pressure coefficient

L - lower surface

U - upper surface

APPENDIX B

RIGID AIRLOAD COEFFICIENTS AT LOAD REFERENCE POINTS ($M = 0.85$)

The location of the load reference points where the rigid airload coefficients have been determined are presented in figure B-1. All of these stations, with the exception of the vertical tail root (VTR), are the stations where loads will be measured during the B-1 flight loads survey program.

The rigid airload coefficients were determined for each of the applicable aerodynamic effects listed in table I and are presented in tables B-I through B-VI. These coefficients were determined using equations 4, 7, and 10. The component applicable reference areas, semispans, and mean aerodynamic chords are listed in the coefficient tables.

TABLE B-I. - WING COEFFICIENTS AT X_{RS} 354 FOR 0.85M AND $\Lambda_W = 67.5^\circ$

$$S_W = 1946.0 \text{ ft}^2$$

$$b_W/2 = 820.08 \text{ in.}$$

$$\bar{C}_W = 184.05 \text{ in.}$$

Coefficients are applicable to either left or right wing.

| Effect | C_{VZ} (shear) | C_{BX} (moment) | C_{TY} (torsion) |
|-----------------------|---------------------|----------------------|-----------------------|
| $\alpha = 0$ | .024108 | .006613 | .000163 |
| α | .009900 | .002424 | .000861 |
| $\dot{\alpha}$ | .005085 | .001245 | .000442 |
| δ_{SP} | -.000357 | -.000089 | .000019 |
| P | -.002572 | -.000748 | -.000147 |
| Q | .043629 | .012035 | -.000375 |
| $\beta\alpha = 0$ A/S | -.001022 | -.000189 | .000088 |
| $\beta\alpha$ A/S | -.000234 | -.000056 | -.000018 |
| $\beta\alpha = 0$ Sym | .000058 | -.000008 | .000041 |
| $\beta\alpha$ Sym | -.000099 | -.000025 | -.000005 |

C_{VZ} , + Up and perpendicular to the wing reference plane.

C_{BX} , + Tip up and about an axis perpendicular to the wing load reference line (0.36c line)*.

C_{TY} , + Leading edge up and about the wing load reference line (0.36c line)*.

*The wing load reference line passes through the pivot (at X_{RS} 139.515, Y_{RS} -49.845) and the load reference point (at X_{RS} 354, Y_{RS} -38.248).

TABLE B-II. - HORIZONTAL TAIL COEFFICIENTS AT BP 10.75

FOR 0.85M AND $\Lambda_W = 67.5^\circ$

$$S_{HT} = 238.77 \text{ ft}^2$$

$$b_{HT}/2 = 259.03 \text{ in.}$$

$$\bar{C}_{HT} = 149.38 \text{ in.}$$

Coefficients are applicable to either left or right horizontal tail.

| Effect | C_{VZ} (shear) | C_{BX} (moment) | C_{TY} (torsion) |
|---------------------|---------------------|----------------------|-----------------------|
| $\alpha = 0$ | -.167555 | -.066791 | .029355 |
| α | .042901 | .018742 | -.013642 |
| δ_H | .077595 | .033898 | -.024675 |
| $\dot{\alpha}$ | .248221 | .108438 | -.078933 |
| β | -.008687 | -.002984 | .001240 |
| δ'_H | .027446 | .012417 | -.008247 |
| δ_{SP} (Sym) | -.000717 | -.000352 | .000269 |
| δ_{SP} (a/s) | .000268 | .000179 | -.000164 |
| P | -.002504 | -.001927 | .002056 |
| Q | .495028 | .214383 | -.204014 |

C_{VZ} , + Up and perpendicular to the airplane water plane.

C_{BX} , + Tip up and about an axis parallel to the longitudinal axis.

C_{TY} , + Leading edge up and about an axis perpendicular to the plane of symmetry.

TABLE B-III. - VERTICAL TAIL COEFFICIENTS AT WL 136.56
 FOR 0.85M AND $\Lambda_W = 67.5^\circ$

$$S_{VT} = 247.4 \text{ ft}^2$$

$$b_{VT}/2 = 206.76 \text{ in.}$$

$$\bar{C}_{VT} = 188.95 \text{ in.}$$

Coefficients are applicable on the upper vertical tail (UVT).

| Effect | C_{VY} (shear) | C_{BX} (moment) | C_{TZ} (torsion) |
|-------------------|---------------------|----------------------|-----------------------|
| $\beta\alpha = 0$ | -.030790 | -.009622 | .000175 |
| $\beta\alpha$ | -.000847 | -.000265 | .000048 |
| δ'_H | -.013635 | -.003621 | .000784 |
| δ_{SP} | -.000226 | -.000067 | -.000002 |
| δ_{RU} | .014456 | .004492 | -.004046 |
| δ_{RL} | 0 | 0 | 0 |
| P | -.003048 | -.001124 | .000367 |
| R | .024764 | .007752 | -.002350 |

C_{VY} , + To the right and normal to the plane of symmetry.

C_{BX} , + Tip to the right and about an axis parallel to the longitudinal axis.

C_{TZ} , + Leading edge right and about an axis perpendicular to the water plane.

TABLE B-IV.- FORWARD FUSELAGE COEFFICIENTS
 AT FS 528.5 FOR 0.85M AND $\Lambda_W = 67.5^\circ$

$$S_{FF} = S_{REF} = 1946.0 \text{ ft}^2$$

$$b_{FF}/2 = b_{REF}/2 = 820.08 \text{ in.}$$

$$\bar{C}_{FF} = \bar{C}_{REF} = 184.05 \text{ in.}$$

Coefficients are based on the airloads on the fuselage forward of FS 528.5.

| Effect | C_{VZ} (shear) | C_{BY} (moment) | C_{VY} (shear) | C_{BZ} (moment) | C_{TX} (torsion) |
|--------------|---------------------|----------------------|---------------------|----------------------|-----------------------|
| $\alpha = 0$ | 0.006532 | -0.000068 | - | - | - |
| α | 0.001730 | 0.000553 | - | - | - |
| P | - | - | 0.000168 | 0.000044 | 0.000026 |
| β | - | - | -0.002047 | -0.000684 | -0.000356 |

C_{VZ} , + Up and normal to the water plane.

C_{BY} , + Nose up and about an axis perpendicular to the plane of symmetry.

C_{VY} , + To the right and normal to the plane of symmetry.

C_{BZ} , + Nose right and about an axis perpendicular to the water plane.

C_{TX} , + Left wing up and about an axis parallel to the longitudinal axis.

TABLE B-V.- AFT FUSELAGE COEFFICIENTS AT
FS 1337.5 FOR 0.85M AND $\Lambda_W = 67.5^\circ$

$$S_{AF} = S_{REF} = 1946.0 \text{ ft}^2$$

$$b_{AF}/2 = b_{REF}/2 = 820.08 \text{ in.}$$

$$\bar{C}_{AF} = \bar{C}_{REF} = 184.05 \text{ in.}$$

Coefficients are based on the airloads on the fuselage aft of FS 1337.5 and do not include the airloads on the empennage. (Refer to appendix C for equations which include the airloads on the empennage.)

| Effect | C_{VZ} (shear) | C_{BY} (moment) | C_{VY} (shear) | C_{BZ} (moment) | C_{TX} (torsion) |
|-----------------------|---------------------|----------------------|---------------------|----------------------|-----------------------|
| $\alpha = 0$ | 0.009376 | 0.003220 | - | - | - |
| α | -0.000181 | -0.000052 | - | - | - |
| $\beta\alpha = 0$ c/o | - | - | -0.001670 | -0.000241 | -0.000290 |
| $\beta\alpha$ c/o | - | - | -0.000046 | -0.000007 | -0.000008 |
| δ'_H | - | - | 0.000910 | 0.000239 | 0.000158 |
| δ_{RL} | - | - | 0.000153 | 0.000021 | 0.000027 |
| P | - | - | 0.000541 | 0.000133 | 0.000094 |
| B | - | - | -0.000334 | -0.000068 | -0.000058 |

C_{VZ} , + Up and normal to the water plane.

C_{BY} , + Aft end up and about an axis perpendicular to the plane of symmetry.

C_{VY} , + To the right and normal to the plane of symmetry.

C_{BZ} , + Aft end right and about an axis perpendicular to the water plane.

C_{TX} , + Left wing up and about an axis parallel to the longitudinal axis.

TABLE B-VI. - VERTICAL TAIL COEFFICIENTS AT WL 75.0
FOR 0.85M AND $\Lambda_W = 67.5^\circ$

$$S_{VT} = 247.4 \text{ ft}^2$$

$$b_{VT}/2 = 206.76 \text{ in.}$$

$$\bar{c}_{VT} = 188.95 \text{ in.}$$

Coefficients are at the vertical tail root (VTR) and are for use in the equations in Appendix C for the determination of the net airloads coefficients for the aft fuselage point at FS 1337.5.

| Effect | C_{VY} (shear) | C_{BX} (moment) | C_{TZ} (torsion) |
|-------------------|---------------------|----------------------|-----------------------|
| $\beta\alpha = 0$ | -.046314 | -.020655 | .007677 |
| $\beta\alpha$ | -.001274 | -.000568 | .000211 |
| δ'_H | -.007260 | -.007032 | .003313 |
| δ_{SP} | -.000310 | -.000142 | .000035 |
| δ_{RU} | .014473 | .008801 | -.007605 |
| δ_{RL} | .006167 | .000570 | -.000897 |
| P | -.002933 | -.002042 | .001309 |
| R | .037307 | .016997 | -.007621 |

C_{VY} , + To the right and normal to the plane at symmetry.

C_{BX} , + Tip to the right and about an axis parallel to the plane of symmetry.

C_{TZ} , + Leading edge right and about an axis perpendicular to the water plane.

TABLE B-VII. - LOAD COEFFICIENTS DATA CARD LISTING

NASA ARS CASE 1 M=.85 S_w=67.5 WIND TUNNEL DATA RICID
 NSEQ(1)=SEQUENCE NUMBER
 1XX - WING AT XRS 354.0
 3XX - HORIZONTAL TAIL AT BF 10.75
 3XX - VERTICAL TAIL AT WL 136.56
 4XX - VERTICAL TAIL AT WL 75.0
 5XX - FORWARD FUSELAGE AT FS 528.5
 6XX - AFT FUSELAGE AT FS 1337.5

CV(I) - COEFFICIENT OF SHEAR EACH EFFECT
 CB(I) - COEFFICIENT OF BENDING MOMENT EACH EFFECT
 CT(I) - COEFFICIENT OF TORSION EACH EFFECT

TITLE(I) - DESCRIPTIVE TITLE EACH EFFECT

| SEQ NO. | CV | CB | CT | TITLE | TYPE | WING | FUSELAGE | TAIL | TOTAL |
|---------|-----------|-----------|-----------|----------------------|------|------|----------|------|-------|
| 101 | 24108E-01 | 66133E-12 | 16330E-03 | ALPHA = 0 | M | H | S | W | 67.5 |
| 102 | 99303E-02 | 24244E-12 | 86100E-03 | ALPHA | M | H | S | W | 67.5 |
| 103 | 50853E-02 | 12455E-12 | 44200E-03 | ALPHA DOT | M | H | S | W | 67.5 |
| 104 | 35700E-02 | 89000E-14 | 19000E-04 | DELTA SPOILER | M | H | S | W | 67.5 |
| 105 | 25720E-02 | 74600E-13 | 14700E-03 | ROLL VELOCITY P | M | H | S | W | 67.5 |
| 106 | 43629E-01 | 12033E-01 | 37500E-03 | PITCH VELOCITY Q | M | H | S | W | 67.5 |
| 107 | 10220E-02 | 18900E-13 | 88000E-04 | BETA ALPHA ZERO A/S | M | H | S | W | 67.5 |
| 108 | 23400E-03 | 56000E-14 | 12000E-04 | BETA ALPHA A/S | M | H | S | W | 67.5 |
| 109 | 58000E-04 | 80000E-15 | 41000E-04 | BETA ALPHA ZERO SYN | M | H | S | W | 67.5 |
| 110 | 99000E-04 | 25000E-14 | 50000E-05 | BETA ALPHA SYN | M | H | S | W | 67.5 |
| 111 | 0.0 | 0.0 | 0.0 | FILLER | M | H | S | W | 67.5 |
| 112 | 0.0 | 0.0 | 0.0 | FILLER | M | H | S | W | 67.5 |
| 113 | 0.0 | 0.0 | 0.0 | FILLER | M | H | S | W | 67.5 |
| 114 | 0.0 | 0.0 | 0.0 | FILLER | M | H | S | W | 67.5 |
| 115 | 0.0 | 0.0 | 0.0 | FILLER | M | H | S | W | 67.5 |
| 201 | 16756E+00 | 66791E-11 | 29355E-01 | ALPHA = 0 | M | H | S | W | 67.5 |
| 202 | 42901E-01 | 18742E-11 | 13642E-01 | ALPHA | M | H | S | W | 67.5 |
| 203 | 77595E-01 | 33899E-11 | 24675E-01 | DELTA H | M | H | S | W | 67.5 |
| 204 | 24822E+00 | 10844E-10 | 78533E-01 | ALPHA DOT | M | H | S | W | 67.5 |
| 205 | 66870E-02 | 29847E-12 | 12400E-02 | BETA | M | H | S | W | 67.5 |
| 206 | 27446E-01 | 12417E-11 | 82470E-02 | DELTA H PRIME | M | H | S | W | 67.5 |
| 207 | 71700E-03 | 35200E-13 | 26900E-03 | DELTA SPOILER SYN | M | H | S | W | 67.5 |
| 208 | 26800E-03 | 17900E-13 | 16400E-03 | DELTA SPOILER A/S | M | H | S | W | 67.5 |
| 209 | 25840E-03 | 19270E-12 | 25560E-02 | ROLL VELOCITY P | M | H | S | W | 67.5 |
| 210 | 49503E+00 | 21438E-10 | 28401E+00 | PITCH VELOCITY Q | M | H | S | W | 67.5 |
| 211 | 0.0 | 0.0 | 0.0 | FILLER | M | H | S | W | 67.5 |
| 212 | 0.0 | 0.0 | 0.0 | FILLER | M | H | S | W | 67.5 |
| 213 | 0.0 | 0.0 | 0.0 | FILLER | M | H | S | W | 67.5 |
| 214 | 0.0 | 0.0 | 0.0 | FILLER | M | H | S | W | 67.5 |
| 215 | 0.0 | 0.0 | 0.0 | FILLER | M | H | S | W | 67.5 |
| 301 | 30790E-01 | 96220E-12 | 17500E-03 | BETA ALPHA = 0 | M | H | S | W | 67.5 |
| 302 | 84700E-03 | 26500E-13 | 48000E-04 | BETA ALPHA | M | H | S | W | 67.5 |
| 303 | 13635E-03 | 36210E-12 | 78400E-03 | DELTA H PRIME | M | H | S | W | 67.5 |
| 304 | 22600E-03 | 67000E-14 | 20000E-05 | DELTA SPOILER | M | H | S | W | 67.5 |
| 305 | 14456E-01 | 44920E-12 | 40460E-02 | DELTA RUD UP | M | H | S | W | 67.5 |
| 306 | 0.0 | 0.0 | 0.0 | DELTA RUD LOW | M | H | S | W | 67.5 |
| 307 | 33480E-02 | 11240E-12 | 36700E-03 | ROLL VELOC P | M | H | S | W | 67.5 |
| 308 | 24764E-01 | 77520E-12 | 23500E-02 | YAW VELOC R | M | H | S | W | 67.5 |
| 309 | 0.0 | 0.0 | 0.0 | FILLER | M | H | S | W | 67.5 |
| 310 | 0.0 | 0.0 | 0.0 | FILLER | M | H | S | W | 67.5 |
| 311 | 0.0 | 0.0 | 0.0 | FILLER | M | H | S | W | 67.5 |
| 312 | 0.0 | 0.0 | 0.0 | FILLER | M | H | S | W | 67.5 |
| 313 | 0.0 | 0.0 | 0.0 | FILLER | M | H | S | W | 67.5 |
| 314 | 0.0 | 0.0 | 0.0 | FILLER | M | H | S | W | 67.5 |
| 315 | 0.0 | 0.0 | 0.0 | FILLER | M | H | S | W | 67.5 |
| 401 | 46314E-01 | 20665E-11 | 76770E-02 | BETA ALPHA = 0 WL 75 | M | H | S | W | 67.5 |
| 402 | 12740E-02 | 56800E-13 | 21100E-03 | BETA ALPHA WL 75 | M | H | S | W | 67.5 |
| 403 | 12600E-02 | 70322E-12 | 32130E-02 | DELTA H PRIME WL 75 | M | H | S | W | 67.5 |
| 404 | 31000E-03 | 14200E-13 | 35000E-04 | DELTA SPOILER WL 75 | M | H | S | W | 67.5 |
| 405 | 14473E-01 | 88010E-12 | 76500E-02 | DELTA RUD UP WL 75 | M | H | S | W | 67.5 |
| 406 | 16170E-02 | 57000E-13 | 89700E-03 | DELTA RUD LOW WL 75 | M | H | S | W | 67.5 |
| 407 | 29330E-02 | 20420E-12 | 13090E-02 | ROLL VELOC P WL 75 | M | H | S | W | 67.5 |
| 408 | 37307E-01 | 16997E-11 | 76210E-02 | YAW VELOC R WL 75 | M | H | S | W | 67.5 |
| 409 | 0.0 | 0.0 | 0.0 | FILLER | M | H | S | W | 67.5 |
| 410 | 0.0 | 0.0 | 0.0 | FILLER | M | H | S | W | 67.5 |
| 411 | 0.0 | 0.0 | 0.0 | FILLER | M | H | S | W | 67.5 |
| 412 | 0.0 | 0.0 | 0.0 | FILLER | M | H | S | W | 67.5 |
| 413 | 0.0 | 0.0 | 0.0 | FILLER | M | H | S | W | 67.5 |
| 414 | 0.0 | 0.0 | 0.0 | FILLER | M | H | S | W | 67.5 |
| 415 | 0.0 | 0.0 | 0.0 | FILLER | M | H | S | W | 67.5 |
| 501 | 65320E-02 | 68000E-14 | 0.0 | ALPHA = 0 (VERTICAL) | M | H | S | W | 67.5 |
| 502 | 17300E-03 | 55300E-13 | 0.0 | ALPHA (VERTICAL) | M | H | S | W | 67.5 |
| 503 | 16800E-03 | 44000E-14 | 26000E-04 | ROLL VEL P (LATERAL) | M | H | S | W | 67.5 |
| 504 | 20470E-02 | 68400E-13 | 35600E-03 | BETA (LATERAL) | M | H | S | W | 67.5 |
| 505 | 0.0 | 0.0 | 0.0 | FILLER | M | H | S | W | 67.5 |
| 506 | 0.0 | 0.0 | 0.0 | FILLER | M | H | S | W | 67.5 |
| 507 | 0.0 | 0.0 | 0.0 | FILLER | M | H | S | W | 67.5 |
| 508 | 0.0 | 0.0 | 0.0 | FILLER | M | H | S | W | 67.5 |
| 509 | 0.0 | 0.0 | 0.0 | FILLER | M | H | S | W | 67.5 |
| 510 | 0.0 | 0.0 | 0.0 | FILLER | M | H | S | W | 67.5 |
| 511 | 0.0 | 0.0 | 0.0 | FILLER | M | H | S | W | 67.5 |
| 512 | 0.0 | 0.0 | 0.0 | FILLER | M | H | S | W | 67.5 |
| 513 | 0.0 | 0.0 | 0.0 | FILLER | M | H | S | W | 67.5 |
| 514 | 0.0 | 0.0 | 0.0 | FILLER | M | H | S | W | 67.5 |
| 515 | 0.0 | 0.0 | 0.0 | FILLER | M | H | S | W | 67.5 |

TABLE B-VII. - Concluded

| | | | | | | | |
|-----|------------|------------|------------|-----------------------|---|----|------|
| 601 | .93760E-02 | .32200E-02 | 0. | ALPHA=0 (VERTICAL) | M | .8 | 57.5 |
| 602 | .18100E-03 | .52000E-04 | 0. | ALPHA (VERTICAL) | M | .8 | 57.5 |
| 603 | .16700E-02 | .24100E-03 | .29000E-03 | BETA ALPHA C/O (LAT) | M | .8 | 57.5 |
| 604 | .46000E-04 | .70000E-05 | .80000E-05 | BETA ALPHA C/O (LAT) | M | .8 | 57.5 |
| 605 | .91300E-03 | .23900E-03 | .15800E-03 | DELTA H PRIME (LAT) | M | .8 | 57.5 |
| 606 | .15300E-03 | .21000E-03 | .27000E-04 | DELTA RUDDER LCAER(L) | M | .8 | 57.5 |
| 607 | .54100E-03 | .13300E-03 | .94000E-04 | ROLL VELOCITY P (LAT) | M | .8 | 57.5 |
| 608 | .33400E-03 | .68000E-04 | .58000E-04 | BETA (LATERAL) | M | .8 | 57.5 |
| 609 | 0. | 0. | 0. | FILLER | M | .8 | 57.5 |
| 610 | 0. | 0. | 0. | FILLER | M | .8 | 57.5 |
| 611 | 0. | 0. | 0. | FILLER | M | .8 | 57.5 |
| 612 | 0. | 0. | 0. | FILLER | M | .8 | 57.5 |
| 613 | 0. | 0. | 0. | FILLER | M | .8 | 57.5 |
| 614 | 0. | 0. | 0. | FILLER | M | .8 | 57.5 |
| 615 | 0. | 0. | 0. | FILLER | M | .8 | 57.5 |

LW, RW - left and right wing at X_{RS} 354.0:

| | |
|----------------------|----------------------|
| BP \pm 240.672 in. | X_{RS} 354.00 in. |
| FS 1161.365 in. or | Y_{RS} -38.248 in. |
| WL 9.075 | Z_{RS} 4.370 in. |

LHT, RHT - left and right horizontal tail:

| |
|--------------------|
| BP \pm 10.75 in. |
| FS 1582.0 in. |
| WL 126.0 in. |

UVT - upper vertical tail:

| |
|---------------|
| WL 136.56 in. |
| FS 1582.0 in. |
| BP 0.0 in. |

VTR - vertical tail root:

| |
|----------------|
| WL 75.0 in. |
| FS 1535.56 in. |
| BP 0.0 in. |

FF - forward fuselage:

| |
|--------------|
| FS 528.5 in. |
| WL 32.0 in. |
| BP 0.0 in. |

AF - aft fuselage: FS 0.0

| | |
|---------------|--------|
| FS 1337.5 in. | WL 0.0 |
| WL 34.0 in. | |
| BP 0.0 in. | |

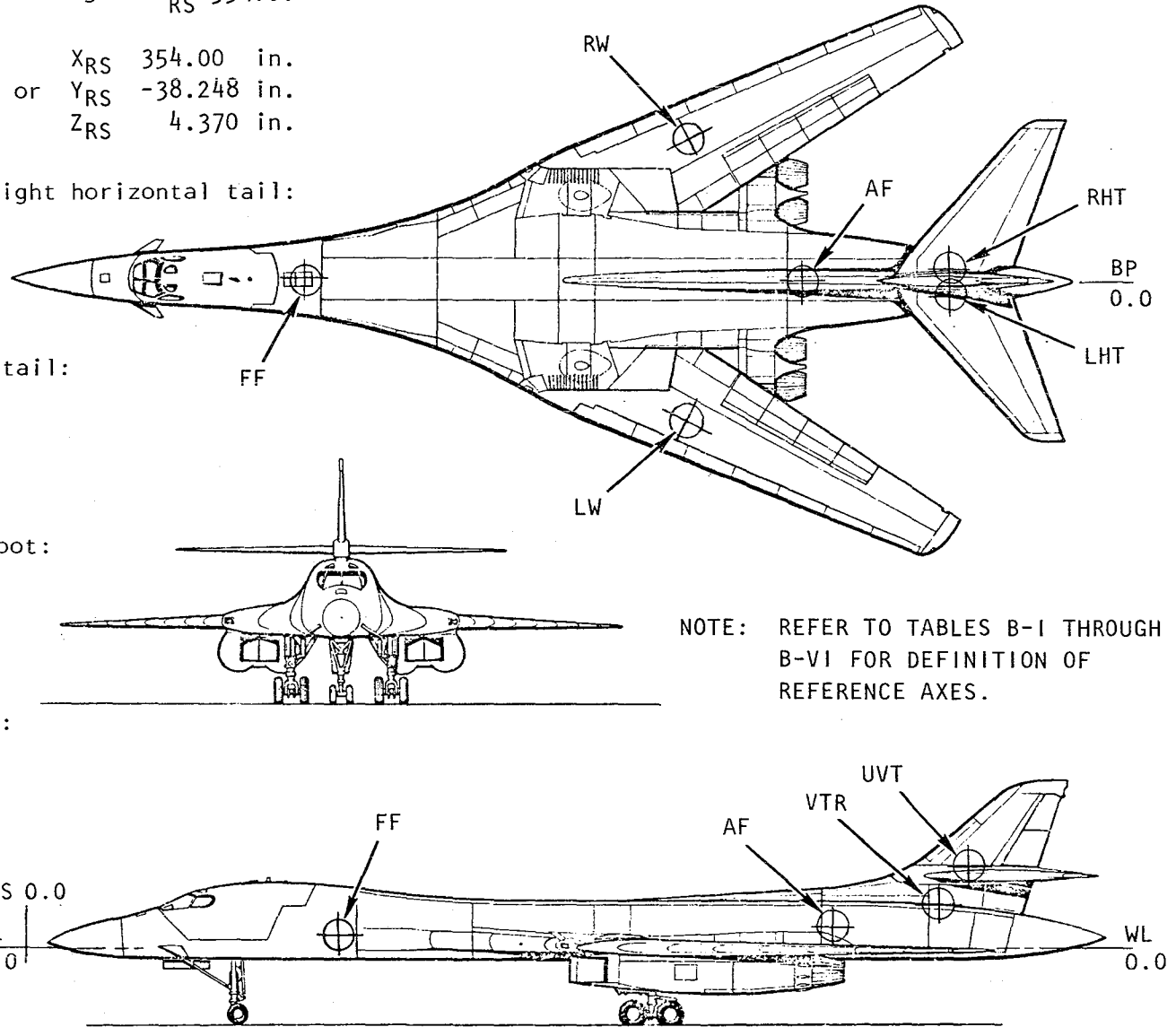

NOTE: REFER TO TABLES B-I THROUGH B-VI FOR DEFINITION OF REFERENCE AXES.

Figure B-1. - Component rigid airload coefficient reference points, $\Lambda_w = 67.5$ degrees.

APPENDIX C

NET RIGID AIRLOAD COEFFICIENTS FOR FLIGHT CONDITIONS

When it is desired to obtain the component net rigid airload coefficients for a flight condition, several of the individual aerodynamic effects must be combined. Equations which are applicable to each load reference point are presented in this appendix. These equations utilize the coefficient data and geometry data of tables B-I through B-VI.

Particular care should be exercised in the application of the dimensional units for certain terms in the equations. Refer to the list of symbols (appendix A) and appendix B for the definition of symbols, their units, and dimensions.

For example:

$b/2$ and \bar{C} are in inches.

Area, S , is in square feet.

Velocity, V , is in feet/second.

α , β , δ_H , δ'_H , δ_{SP} , and δ_{RL} are in degrees.

P , Q , R , and $\dot{\alpha}$ are in degrees/second.

Equations for Wing Station X_{RS} 354

Equations C1 and C2 are generalized equations for the net rigid airload coefficients C_{VZ} , C_{BX} , and C_{TY} at the left and right wing stations, respectively. The individual values of C_{VZ} , C_{BX} , and C_{TY} for each aerodynamic effect, applicable to the $\Lambda_w = 67.5^\circ$ and $M = 0.85$ condition, are presented in table B-I.

$$\begin{aligned}
C_{VBT_{LW}} = & C_{VBT_{\alpha=0}} + C_{VBT_{\alpha}} + C_{VBT_{\alpha}} \left(\frac{\alpha \bar{C}_W}{2V} \right) - C_{VBT_{\delta_{SP}}} \delta_{SP_{LW}} \\
& + C_{VBT_P} \left(\frac{Pb_W}{2V} \right) + C_{VBT_Q} \left(\frac{QC_W}{2V} \right) \\
& + \left[C_{VBT_{\beta\alpha=0}} + C_{VBT_{\beta\alpha=0}} + \left(C_{VBT_{\beta\alpha_{SYM}}} + C_{VBT_{\beta\alpha_{A/S}}} \right) \alpha \right] \beta \quad (C1)
\end{aligned}$$

$$\begin{aligned}
C_{VBT_{RW}} = & C_{VBT_{\alpha=0}} + C_{VBT_{\alpha}} + C_{VBT_{\alpha}} \left(\frac{\alpha \bar{C}_W}{2V} \right) + C_{VBT_{\delta_{SP}}} \delta_{SP_{RW}} \\
& - C_{VBT_P} \left(\frac{Pb_W}{2V} \right) + C_{VBT_Q} \left(\frac{QC_W}{2V} \right) \\
& + \left[C_{VBT_{\beta\alpha=0}} - C_{VBT_{\beta\alpha=0}} + \left(C_{VBT_{\beta\alpha_{SYM}}} - C_{VBT_{\beta\alpha_{A/S}}} \right) \alpha \right] \beta \quad (C2)
\end{aligned}$$

Equations for Horizontal Tail Station BP 10.75

Equations C3 and C4 are generalized equations for the net rigid airload coefficients C_{VZ} , C_{BX} , and C_{TY} at the left and right stations, respectively. The individual values of C_{VZ} , C_{BX} , and C_{TY} for each aerodynamic effect, applicable to the $\Lambda_W = 67.5^\circ$ and 0.85 M condition, are presented in table B-II.

$$\begin{aligned}
C_{VBT_{LHT}} &= C_{VBT_{\alpha=0}} + C_{VBT_{\alpha}}^{\alpha} + C_{VBT_{\delta_H}}^{\delta_H} + C_{VBT_{\alpha}}^{\dot{\alpha} \bar{C}_{HT}} \left(\frac{\dot{\alpha} \bar{C}_{HT}}{2V} \right) \\
&+ C_{VBT_{\delta'_H}}^{\delta'_H} + C_{VBT_{\beta}}^{\beta} - C_{VBT_{\delta_{SP}}}^{\delta_{SP}} \delta_{SP_L} + C_{VBT_{\delta_{SP_{c/o}}}}^{\delta_{SP_{c/o}}} \delta_{SP_R} \\
&+ C_{VBT_P} \left(\frac{Pb_{HT}}{2V} \right) + C_{VBT_Q} \left(\frac{QC_{HT}}{2V} \right)
\end{aligned} \tag{C3}$$

$$\begin{aligned}
C_{VBT_{RHT}} &= C_{VBT_{\alpha=0}} + C_{VBT_{\alpha}}^{\alpha} + C_{VBT_{\delta_H}}^{\delta_H} + C_{VBT_{\alpha}}^{\dot{\alpha} \bar{C}_{HT}} \left(\frac{\dot{\alpha} \bar{C}_{HT}}{2V} \right) \\
&- C_{VBT_{\delta'_H}}^{\delta'_H} - C_{VBT_{\beta}}^{\beta} + C_{VBT_{\delta_{SP}}}^{\delta_{SP}} \delta_{SP_R} - C_{VBT_{\delta_{SP_{c/o}}}}^{\delta_{SP_{c/o}}} \delta_{SP_L} \\
&- C_{VBT_P} \left(\frac{Pb_{HT}}{2V} \right) + C_{VBT_Q} \left(\frac{QC_{HT}}{2V} \right)
\end{aligned} \tag{C4}$$

Equations for Vertical Tail Station WL 136.56

Equation C5 is a generalized equation for the net rigid airload coefficients C_{VY} , C_{BX} , and C_{TZ} at WL 136.56. The individual values of C_{VY} , C_{BX} , and C_{TZ} for each aerodynamic effect, applicable to the $\Lambda_W = 67.5^\circ$ and 0.85M condition, are presented in table B-III.

$$\begin{aligned}
C_{VBT_{VT}} &= \left[C_{VBT_{\beta\alpha=0}} + C_{VBT_{\beta\alpha}}^{\alpha} \right] \beta + C_{VBT_{\delta'_H}}^{\delta'_H} \\
&+ C_{VBT_{\delta_{SP}}}^{\delta_{SP}} (\delta_{SP_R} + \delta_{SP_L}) + C_{VBT_{\delta_{RU}}}^{\delta_{RU}} \\
&+ C_{VBT_{\delta_{RL}}}^{\delta_{RL}} + C_{VBT_P} \left(\frac{Pb_{VT}}{2V} \right) + C_{VBT_R} \left(\frac{Rb_{VT}}{2V} \right)
\end{aligned} \tag{C5}$$

Equations for Forward Fuselage Station FS 528.5

Equations C6 through C10 are for the net rigid airload coefficients C_{VZ} , C_{BY} , C_{VY} , C_{BZ} , and C_{TX} at FS 528.5. The individual values of C_{VZ} , C_{BY} , C_{VY} , C_{BZ} , and C_{TX} for each aerodynamic effect, applicable to the $\Lambda_W = 67.5^\circ$ and 0.85M condition, are presented in table B-IV.

$$C_{VZ_{FF}} = C_{VZ_{\alpha=0}} + C_{VZ_{\alpha}} \quad (C6)$$

$$C_{BY_{FF}} = C_{BY_{\alpha=0}} + C_{BY_{\alpha}} \quad (C7)$$

$$C_{VY_{FF}} = C_{VY_{\beta}} + C_{VY_P} \left(\frac{Pb_{FF}}{2V} \right) \quad (C8)$$

$$C_{BZ_{FF}} = C_{BZ_{\beta}} + C_{BZ_P} \left(\frac{Pb_{FF}}{2V} \right) \quad (C9)$$

$$C_{TX_{FF}} = C_{TX_{\alpha=0}} + C_{TX_{\alpha}} + C_{TX_{\beta}} + C_{TX_P} \left(\frac{Pb_{FF}}{2V} \right) \quad (C10)$$

Equations for Aft Fuselage Station FS 1337.5

Equations C11 through C15 are for the net rigid airload coefficients C_{VZ} , C_{BY} , C_{VY} , C_{BZ} , and C_{TX} at FS 1337.5. The net coefficients include the airload on the fuselage, aft of FS 1337.5, and the airloads on the horizontal and vertical tail surfaces. The empennage airloads are included by using the horizontal and vertical tail root loads and their transfer distances to FS 1337.5. In the equations that follow, the numbers subscripting the brackets, { }, denote the table number or the equation number from which the coefficients within the brackets are obtained; i.e.,

{ }_{BV} denotes coefficients are from table B-V

{ }_{C3,C4} denotes coefficients obtained using equations C3 and C4.

$$C_{VZ_{AF}} = \left\{ C_{VZ_{\alpha=0}} + C_{VZ_{\alpha}} \right\}_{B-V} + \left\{ \left(C_{VZ_{LHT}} + C_{VZ_{RHT}} \right) \left(\frac{S_{HT}}{S_{AF}} \right) \right\}_{C3,C4} \quad (C11)$$

$$C_{BY_{AF}} = \left\{ C_{BY_{\alpha=0}} + C_{BY_{\alpha}} \right\}_{B-V} + \left\{ \left(C_{VZ_{LHT}} + C_{VZ_{RHT}} \right) \left(\frac{\Delta X_{HT} S_{HT}}{S_{AF} b_{AF}/2} \right) - \left(C_{TY_{LHT}} + C_{TY_{RHT}} \right) \left(\frac{S_{HT} \bar{C}_{HT}}{S_{AF} b_{AF}/2} \right) \right\}_{C3,C4} \quad (C12)$$

$$C_{VY_{AF}} = \left\{ \left(C_{VY_{\beta\alpha=0_{c/o}}} + C_{VY_{\beta\alpha_{c/o}}} \right) \beta + C_{VY_{\delta'_H}} \delta'_H + C_{VY_{\delta_{RL}}} \delta_{RL} + C_{VY_P} \left(\frac{Pb_{AF}}{2V} \right) + C_{VY_{\beta}} \right\}_{B-V} + \left\{ C_{VY_{VTR}} \left(\frac{S_{VT}}{S_{AF}} \right) \right\}_{C5,B-VI*} \quad (C13)$$

$$C_{BZ_{AF}} = \left\{ \left(C_{BZ_{\beta\alpha=0_{c/o}}} + C_{BZ_{\beta\alpha_{c/o}}} \right) \beta + C_{BZ_{\delta'_H}} \delta'_H + C_{BZ_{\delta_{RL}}} \delta_{RL} + C_{BZ_P} \left(\frac{Pb_{AF}}{2V} \right) + C_{BZ_{\beta}} \right\}_{B-V} + \left\{ C_{VY_{VTR}} \left(\frac{\Delta X_{VTR} S_{VT}}{S_{AF} b_{AF}/2} \right) - C_{TZ_{VTR}} \left(\frac{S_{VT} \bar{C}_{VT}}{S_{AF} b_{AF}/2} \right) \right\}_{C5,B-VI*} \quad (C14)$$

*Use equation C5 with coefficients from table B-VI.

$$\begin{aligned}
C_{TX_{AF}} = & \left\{ C_{TX_{\alpha=0}} + C_{TX_{\alpha}} + \left(C_{TX_{\beta\alpha=0}} + C_{TX_{\beta\alpha}} \right) \right\} \beta \\
& + C_{TX_{\delta'_H}} \delta'_H + C_{TX_{\delta_{RL}}} \delta_{RL} + C_{TX_P} \left(\frac{Pr_{AF}/2}{2V} \right) + C_{TX_{\beta}} \left. \right\}_{B-V} \\
& + \left\{ \left(C_{VZ_{LHT}} - C_{VZ_{RHT}} \right) \left(\frac{\Delta Y_{RHT} S_{HT}}{S_{AF} \bar{C}_{AF}} \right) \right. \\
& + \left. \left(C_{BX_{LHT}} - C_{BX_{RHT}} \right) \left(\frac{S_{HT} b_{HT}/2}{S_{AF} \bar{C}_{AF}} \right) \right\} C3, C4 \\
& + \left\{ C_{VY_{VTR}} \left(\frac{\Delta Z_{VTR} S_{VT}}{S_{AF} \bar{C}_{AF}} \right) + C_{BX_{VTR}} \left(\frac{S_{VT} b_{VT}/2}{S_{AF} \bar{C}_{AF}} \right) \right\} C5, B-VI^*
\end{aligned} \tag{C15}$$

Moment Transfer Arms ΔX_{HT} , ΔY_{HT} , ΔX_{VTR} , and ΔZ_{VTR}

The aft fuselage coefficients are determined at a point at FS 1337.5, WL 34, and BP 0.0. The left and right horizontal tail root coefficients are determined at points at FS 1582, WL 136.56, and BP ± 10.75 . The vertical tail root coefficients are determined at a point at FS 1535.56, WL 75, and BP 0.0. The corresponding moment transfer arms are then as follows:

$$\Delta X_{HT} = 1582.0 - 1337.5 = 244.50 \text{ in.}$$

$$\Delta Y_{RHT} = -\Delta Y_{LHT} = 10.75 \text{ in.}$$

$$\Delta X_{VTR} = 1535.56 - 1337.5 = 198.06 \text{ in.}$$

$$\Delta Z_{VTR} = 75.0 - 34.0 = 41.0 \text{ in.}$$

*Use equation C5 with coefficients from table B-VI.

APPENDIX D

FIGURES USING ENGINEERING UNITS

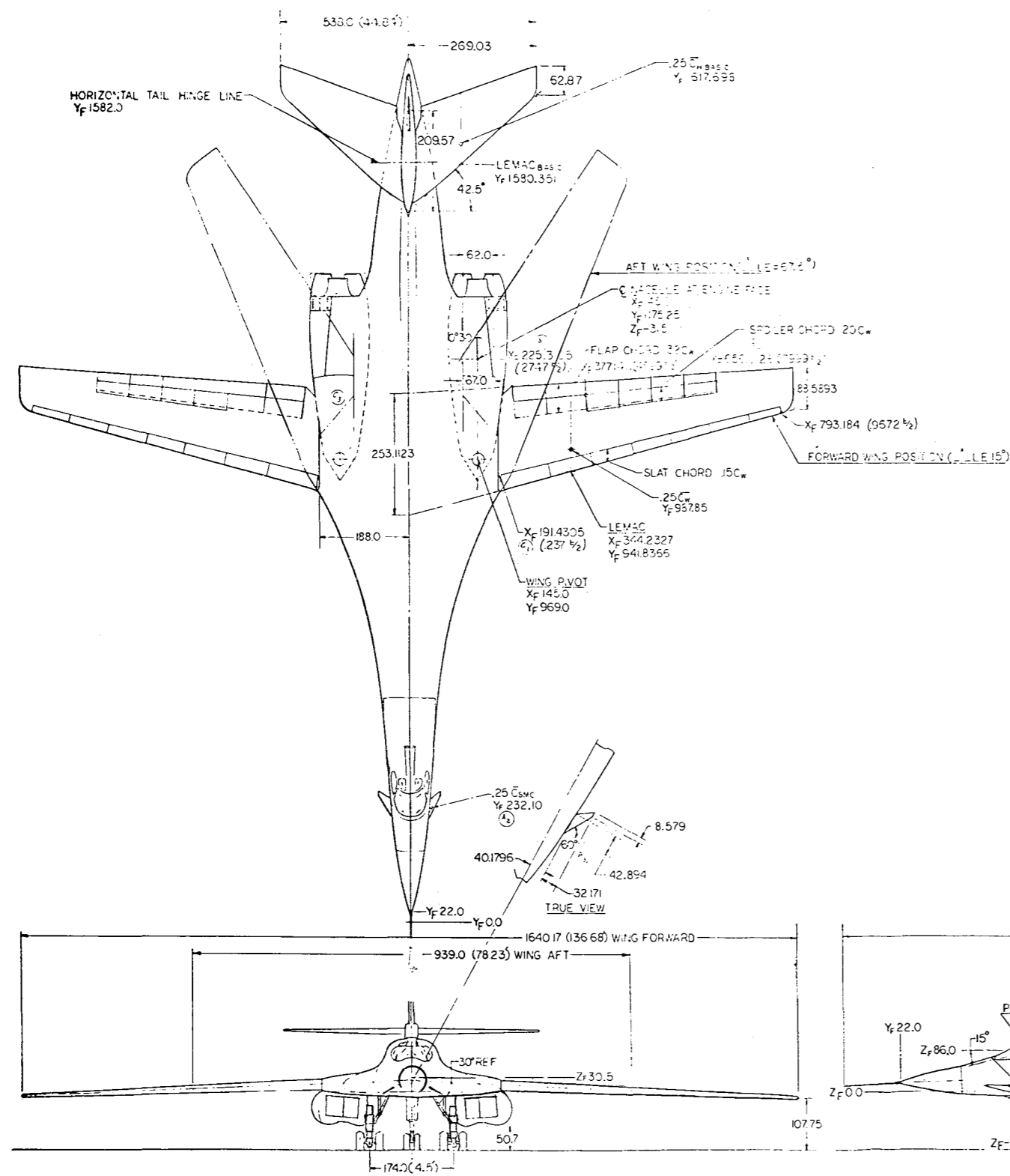

GEOMETRIC DATA

| ITEM | WING | HORIZONTAL TAIL TOTAL | VERTICAL TAIL TOTAL | STRUCTURAL NODE CONTROL |
|--------------------|------------------------------------|-----------------------|---------------------|-------------------------|
| AREA ~ SQ. FT. | 1940.0 (1848 (REF)) | 509.0 | 247.4 | 11.5 |
| ASPECT RATIO | 9.6 | 3.14 | 3.95 | 1.2 |
| TAPER RATIO | 35 | — | 30 | 20 |
| THICKNESS RATIO | REF: LINES DRAWING NA69-1902 DB-24 | REF: MDID 214 | REF: MDID 214 | .05 |
| AIRFOIL SECTION | REF: LINES DRAWING NA69-1902 DB-24 | REF: MDID 214 | REF: MDID 214 | 65A008 |
| LEADING EDGE SWEPT | 180° | 67.5° | 42.5° | 45° AT .25C |
| DIHEDRAL ANGLE | -1.94° | — | 0° | -30.0° |
| INCIDENCE ANGLE | — | — | — | DEFL ± 20.0° |
| MAC LENGTH INCHES | 14.253 | 149.385 | 188.954 | 29.55 |
| MAC LOCATION | 344.2327 | 110.373 | 84.825 | 12.50 TRUE |

CONTROL SURFACE DATA

| ITEM | FLAP | SPOILER | SLAT | RUDDER | HORIZ TAIL |
|----------------|----------------|--------------------|---------|---------------------------|---------------|
| TYPE | SINGLE-SLOTTED | UPPER SURFACE ONLY | POWERED | — | ALL MOVABLE |
| AREA - SQ FEET | 310.35 | 115.0 | 187.62 | 60.6 | 474.5 |
| DEFLECTION | 25° | 0° TO 70° UP | 20.0° | FLAP ON 125° FLAP UP 130° | PRESET TO 15° |

LANDING GEAR DATA

| ITEM | MAIN | AUXILIARY |
|----------------------------|--------------------------|-----------------|
| TIRE SIZE & TYPE | C44.5x5.0-21 TWIN TANDEM | 35x11.5-16 TWIN |
| PLY RATING | 24 | 24 |
| ROLLING RADIUS - INCHES | 15.4 | 14.79 |
| FLAT RADIUS - INCHES | 13.6 | 11.3 |
| STRUT-TOTAL STROKE - IN | 16.5 | 22.0 |
| STRUT-STATIC TO COMPRESSED | 3.5 | 7.0 |

PROPULSION DATA

FOUR 100% SIZE GENERAL ELECTRIC YF121 - GE - 100 ENGINES
2-D VARIABLE RAMP INLETS-CAPTURE AREA=1441 SQ. IN. PER ENGINE

WEIGHT DATA

| | | |
|--------------------------|--------|---------------------|
| AIRCRAFT EMPTY WEIGHT | ~ LB = | SEE SDW CODE II B-7 |
| DESIGN USEFUL LOAD | ~ LB = | SEE SDW CODE II B-7 |
| DESIGN GROSS WEIGHT-TAXI | ~ LB = | 360,000 |
| MAXIMUM GROSS WEIGHT | ~ LB = | 391,000 |

REVISIONS

| NO. | DATE | DESCRIPTION | BY | APP'D |
|-----|---------|----------------|----|-------|
| 1 | 10/1/52 | INITIAL DESIGN | | |
| 2 | 10/1/52 | REVISED | | |
| 3 | 10/1/52 | REVISED | | |
| 4 | 10/1/52 | REVISED | | |
| 5 | 10/1/52 | REVISED | | |
| 6 | 10/1/52 | REVISED | | |
| 7 | 10/1/52 | REVISED | | |
| 8 | 10/1/52 | REVISED | | |
| 9 | 10/1/52 | REVISED | | |
| 10 | 10/1/52 | REVISED | | |

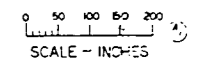

GENERAL ARRANGEMENT THREE VIEW ROTAE A/1 TO 1 & 2

| |
|---------|
| 1002C-1 |
|---------|

Figure D-1.- General arrangement - RDT&E A/C-1 and -2.

This Page Intentionally Left Blank

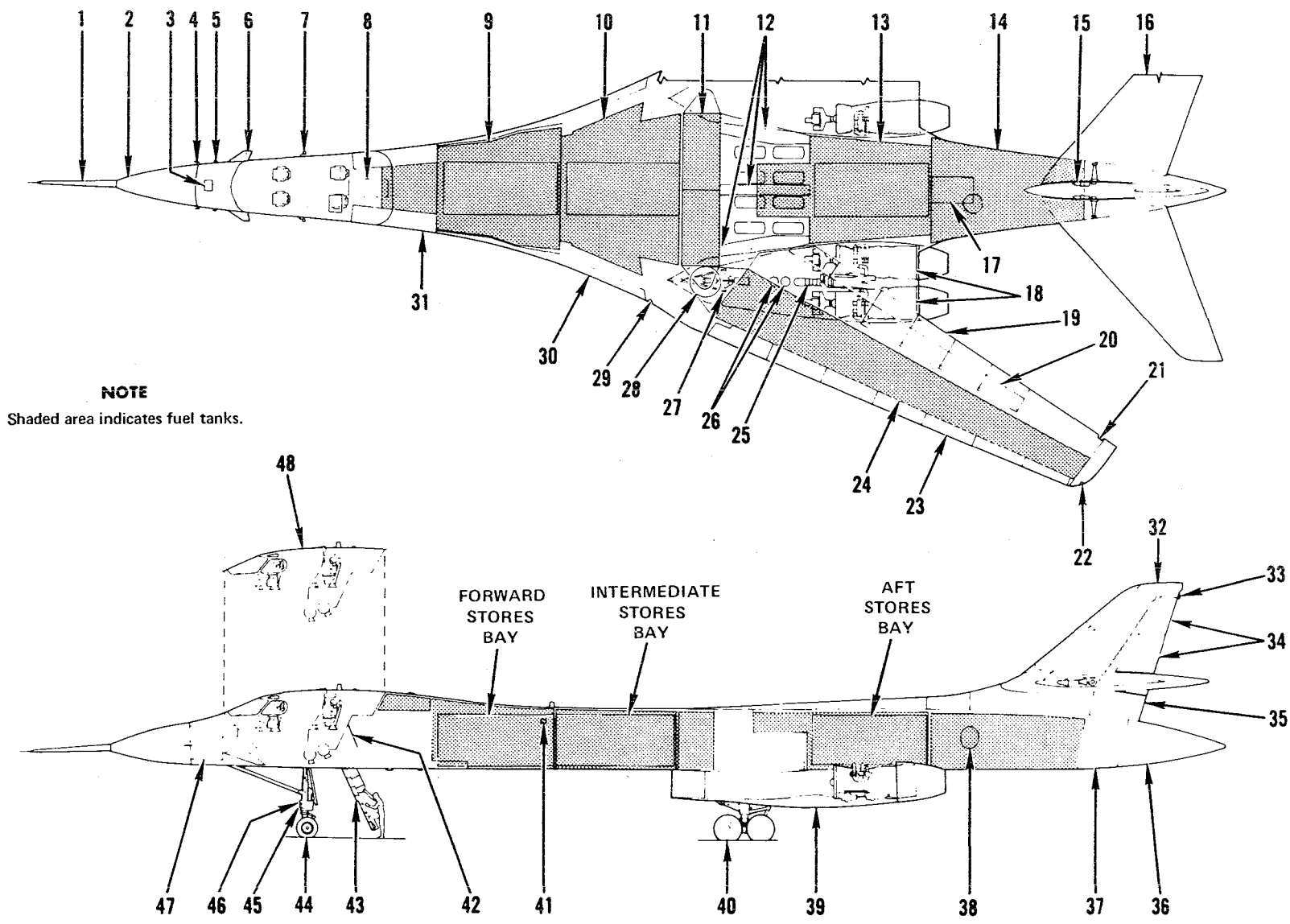
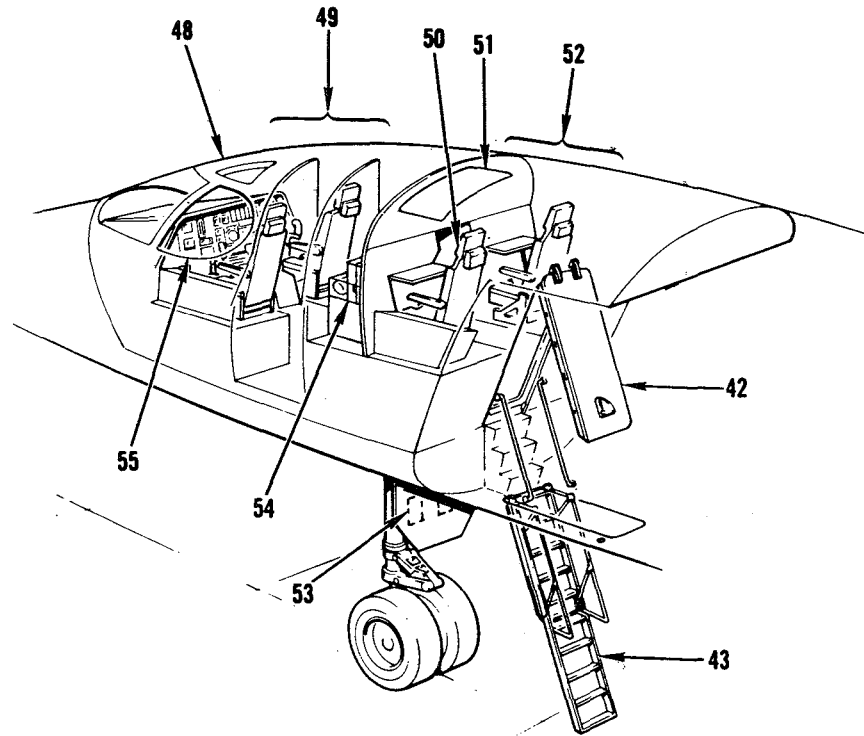

Figure D-1.- Continued.

1. PITOT-STATIC BOOM (WITH AOA AND SIDESLIP VANES)
2. FORWARD RADOME
3. AERIAL REFUEL RECEPTACLE
4. PITOT-STATIC PROBE *
5. TOTAL TEMPERATURE PROBE *
6. STRUCTURAL MODE CONTROL SYSTEM VANE *
7. ANGLE-OF-ATTACK VANE *
8. CREW ENTRY WAY
9. FORWARD FUSELAGE FUEL TANK (TANK NO. 1)
10. FORWARD INTERMEDIATE FUSELAGE FUEL TANK (TANK NO. 2)
11. MAIN FUEL TANKS
12. MAIN WHEEL WELL EQUIPMENT (INTERMEDIATE AVIONICS) COMPARTMENT
13. AFT INTERMEDIATE FUSELAGE FUEL TANK (TANK NO. 3)
14. AFT FUSELAGE FUEL TANK (TANK NO. 4)
15. HORIZONTAL STABILIZER ACTUATOR *
16. HORIZONTAL STABILIZER
17. FLIGHT CONTROLS MIXER BAY
18. ENGINES *
19. FLAPS (6) *
20. SPOILERS/SPEED BRAKES (4) *
21. FUEL JETTISON OUTLET *
22. POSITION LIGHT *
23. SLATS (7) *
24. WING FUEL TANK *
25. APU *
26. HYDRAULIC RESERVOIRS *
27. INLET RAMP MECHANISM *
28. WING PIVOT
29. SUPPLEMENTAL POSITION AND ANTICOLLISION LIGHT *
30. WING GLOVE AVIONICS COMPARTMENT *
31. CENTRAL AVIONICS COMPARTMENT
32. VERTICAL STABILIZER
33. TAIL/ANTICOLLISION LIGHT
34. UPPER AND INTERMEDIATE RUDDERS
35. LOWER RUDDER
36. AFT RADOME
37. AFT AVIONICS COMPARTMENT
38. LN₂ DEWAR
39. ENGINE NACELLE *
40. MAIN LANDING GEAR *
41. AERIAL REFUEL/WING INSPECTION LIGHT *
42. ENTRY DOOR
43. ENTRY LADDER
44. NOSE LANDING GEAR
45. LANDING/TAXI LIGHT
46. LANDING LIGHTS (2)
47. FORWARD AVIONICS COMPARTMENT
48. EJECTABLE CREW MODULE
49. FORWARD CREW STATIONS
50. CREW SEAT (4) †
51. ESCAPE HATCH (SEVERABLE)
52. AFT CREW STATIONS
53. CONTROLS FOR ENTRY LADDER, APU, AND MAIN GEAR DOORS
54. SURVIVAL EQUIPMENT
55. SIDE WINDOW (SEVERABLE) *



* Both Sides (L and R)

† Right aft seat temporarily removed

B 11048

Figure D-1.- Concluded.

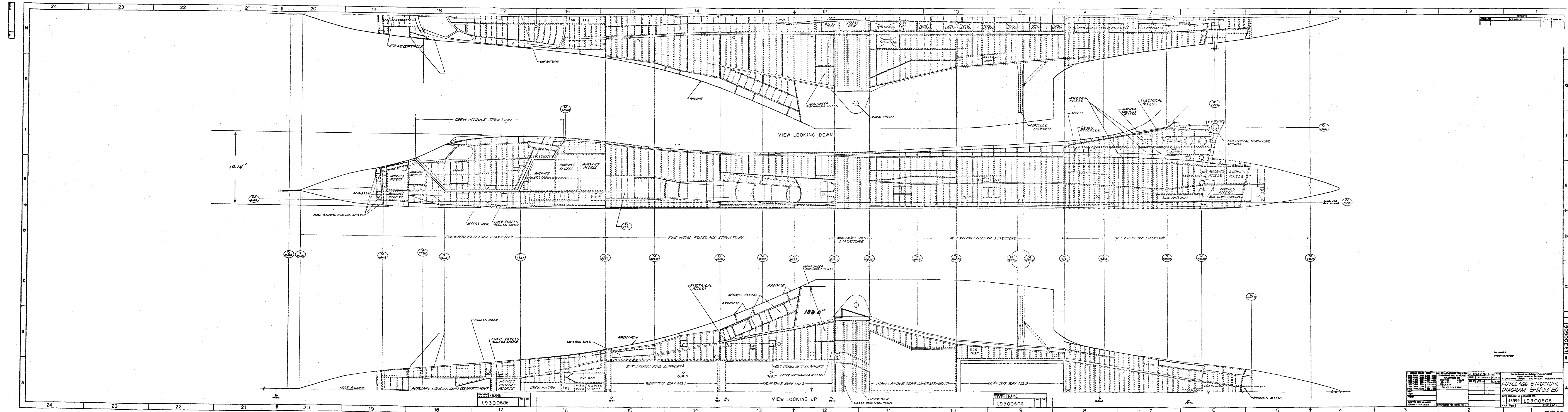

Figure D-2.- Fuselage structure diagram (B-1) (-55B).

This Page Intentionally Left Blank

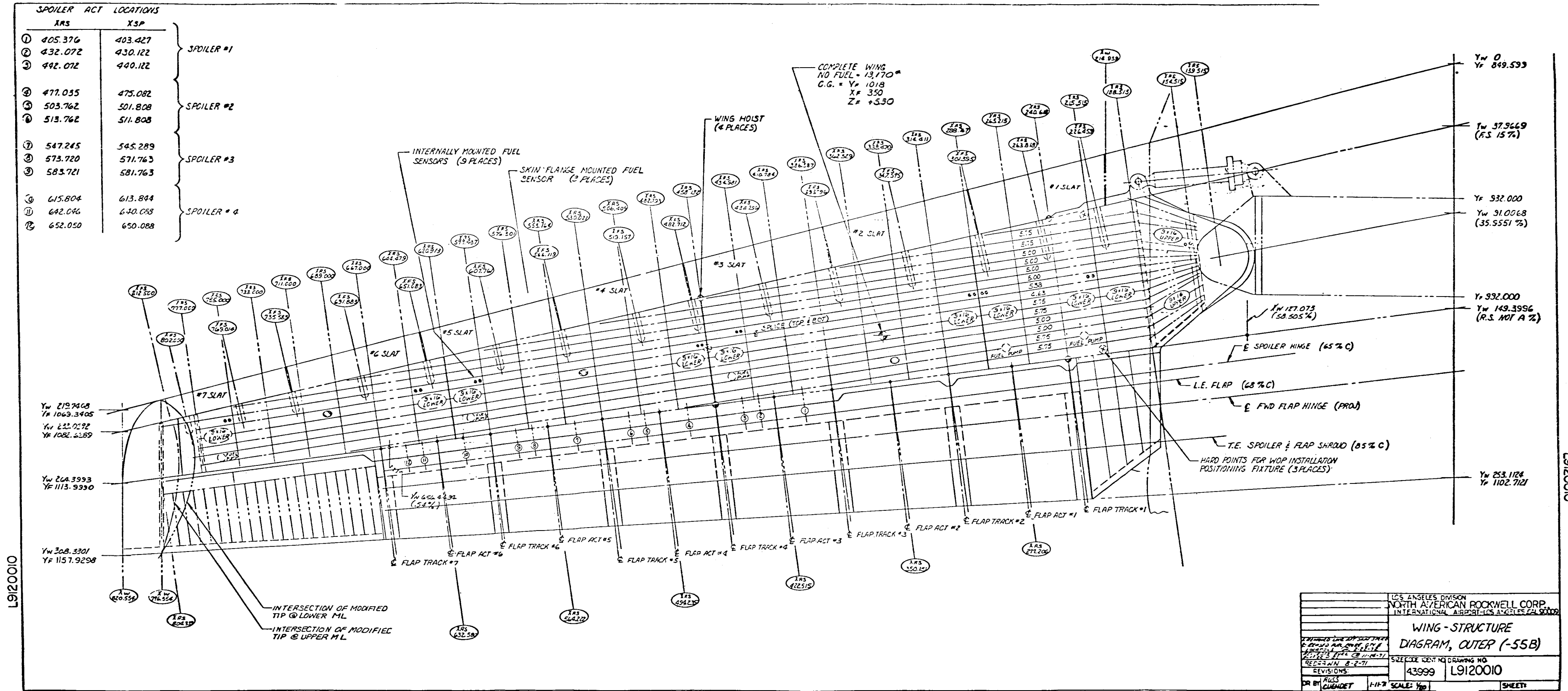
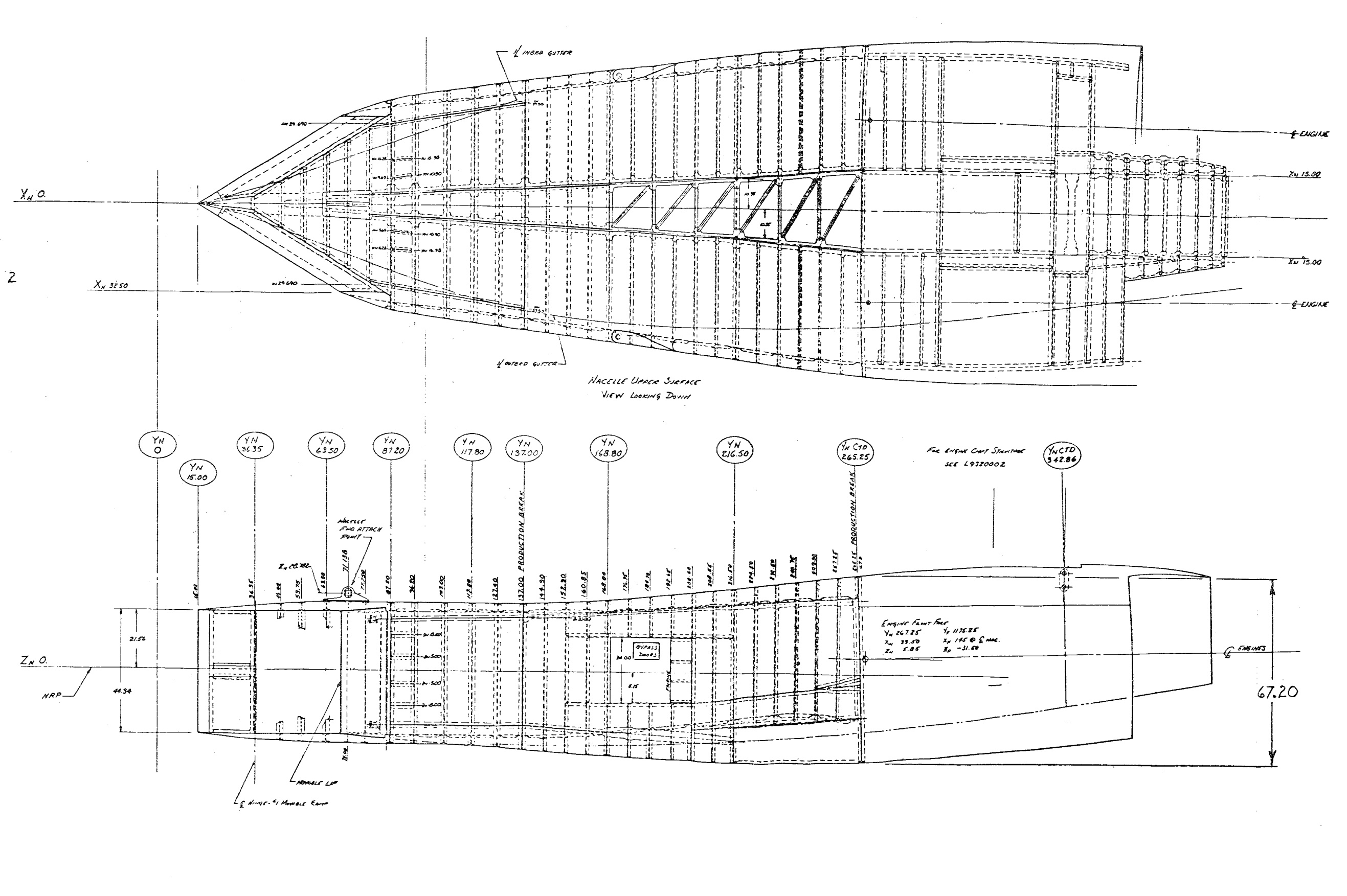
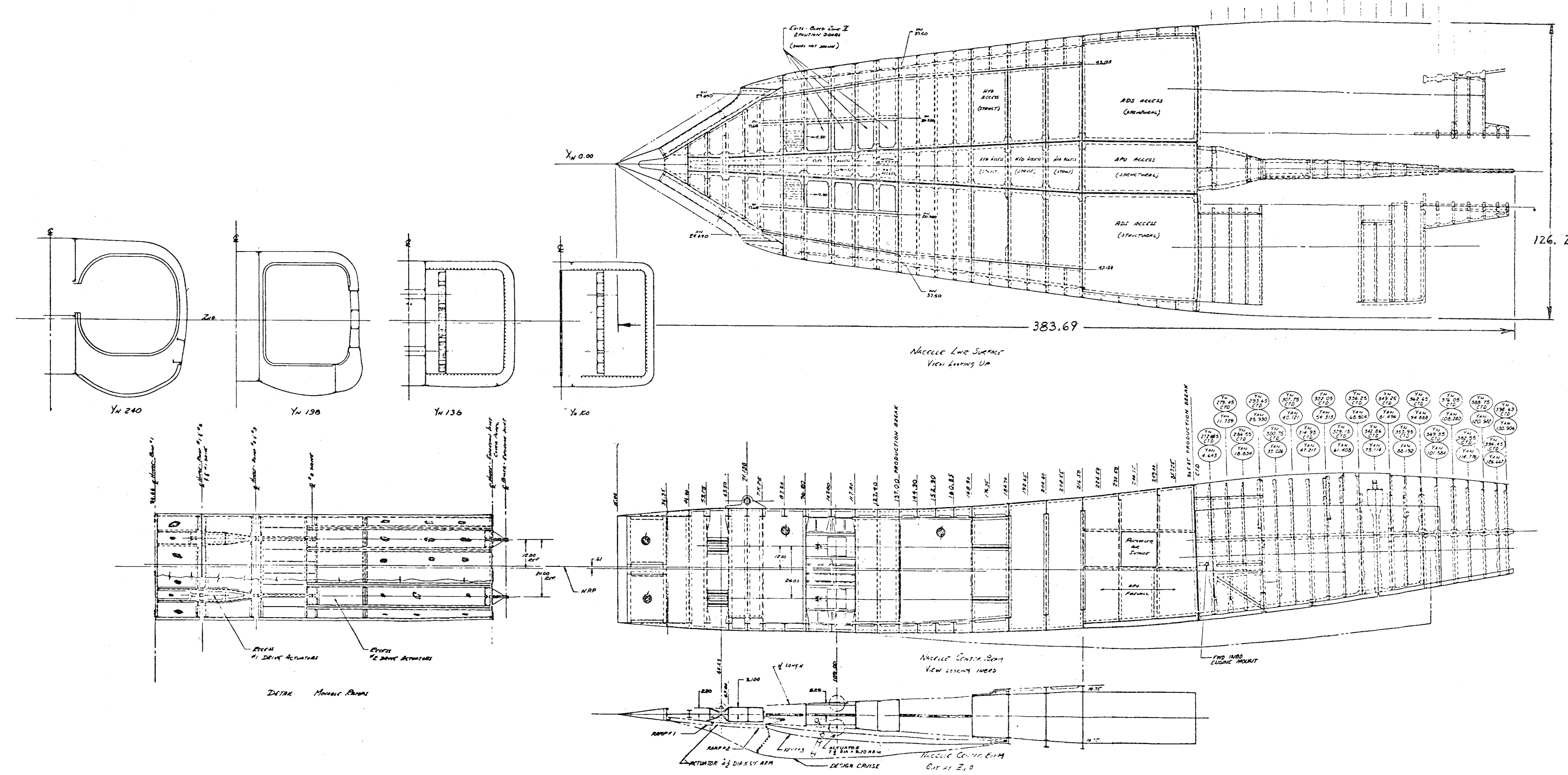

Figure D-3. - Wing-structure diagram, outer (-55B).

This Page Intentionally Left Blank



REVISIONS

| | |
|---|--|
| A | REVISED FRAMES 12,140 THRU 130,100 TO 126,200 TO 132,600. NACELLE PRODUCTION BEAM LOCATED AT 115.24. BULK HEADS LOCATED AT 115.24. BULK HEAD LOCATED AT 115.24. BULK HEAD LOCATED AT 115.24. |
| B | REVISED FRAMES 12,140 THRU 130,100 TO 126,200 TO 132,600. NACELLE PRODUCTION BEAM LOCATED AT 115.24. BULK HEADS LOCATED AT 115.24. BULK HEAD LOCATED AT 115.24. BULK HEAD LOCATED AT 115.24. |

Figure D-4.- Structural arrangement - nacelle external compression inlet (RDT&E).

This Page Intentionally Left Blank

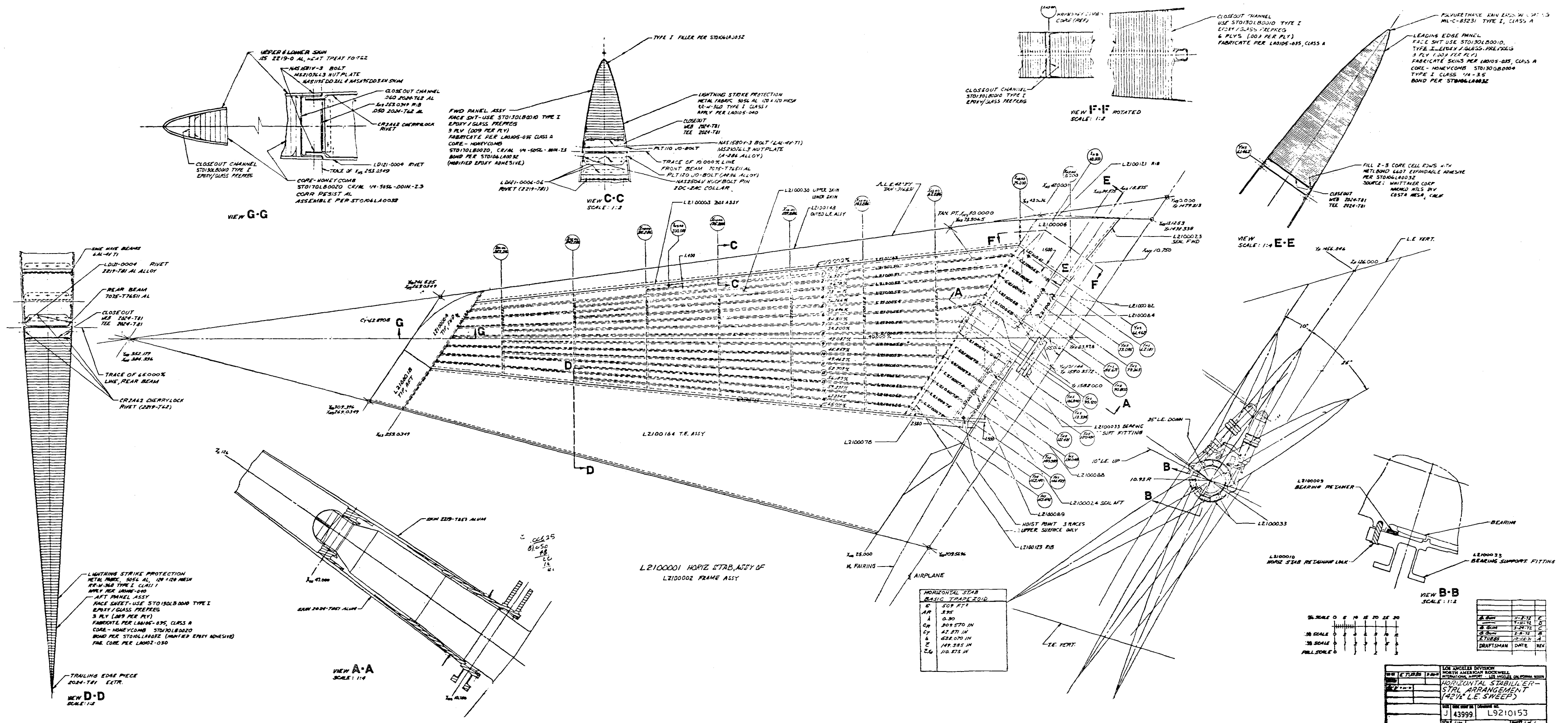

Figure D-5.- Horizontal stabilizer - STRL arrangement (42-1/2° LE sweep)

This Page Intentionally Left Blank

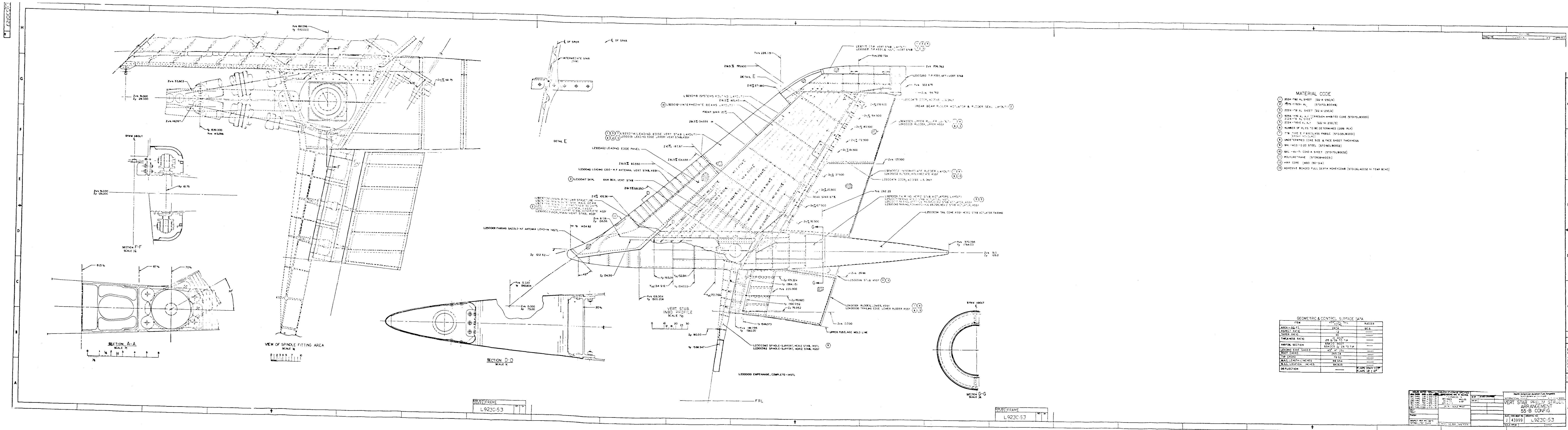

Figure D-6. Vertical stabilizer structural arrangement.

This Page Intentionally Left Blank

APPENDIX E

RIGID AIRLOAD COEFFICIENTS AT LOAD REFERENCE POINTS ($M = 1.20$)

The location of the load reference points where the rigid airload coefficients have been determined are presented in figure B-1. All of these stations, with the exception of the vertical tail root (VTR), are the stations where loads will be measured during the B-1 flight loads survey program.

The rigid airload coefficients were determined for each of the applicable aerodynamic effects listed in table I and are presented in tables E-I through E-VI. These coefficients were determined using equations 4, 7, and 10. The component applicable reference areas, semispans, and mean aerodynamic chords are listed in the coefficient tables.

Notes in appendix C which apply to tables B-I through B-VI for $m = 0.85$ data apply correspondingly to tables E-I through E-VI for $m = 1.20$ data.

TABLE E-I. - WING COEFFICIENTS AT X_{RS} 354 FOR 1.20M AND $\Lambda_W = 67.5^\circ$

$$S_W = 1946.0 \text{ ft}^2$$

$$b_W/2 = 820.08 \text{ in.}$$

$$\bar{C}_W = 184.05 \text{ in.}$$

Coefficients are applicable to either left or right wing.

| Effect | C_{VZ} (shear) | C_{BX} (moment) | C_{TY} (torsion) |
|-----------------------|---------------------|----------------------|-----------------------|
| $\alpha = 0$ | .029213 | .008831 | -.003133 |
| α | .012051 | .003229 | .000584 |
| $\dot{\alpha}$ | 0 | 0 | 0 |
| δ_{SP} | -.000290 | -.000057 | .000034 |
| P | -.003232 | -.000955 | -.000223 |
| Q | .042987 | .012062 | -.001284 |
| $\beta\alpha = 0$ A/S | -.000759 | -.000167 | .000149 |
| $\beta\alpha$ A/S | -.000226 | -.000058 | -.000025 |
| $\beta\alpha = 0$ Sym | .000311 | .000119 | -.000174 |
| $\beta\alpha$ Sym | .000008 | .000005 | -.000011 |

C_{VZ} , + Up and perpendicular to the wing reference plane.

C_{BX} , + Tip up and about an axis perpendicular to the wing load reference line (0.36c line)*.

C_{TY} , + Leading edge up and about the wing load reference line (0.36c line)*.

* The wing load reference line passes through the pivot (at X_{RS} 139.515, Y_{RS} -49.845) and the load reference point (at X_{RS} 354, Y_{RS} -38.248)

TABLE E-II. - HORIZONTAL TAIL COEFFICIENTS AT BP 10.75

FOR 1.20M AND $\Lambda_w = 67.5^\circ$

$$S_{HT} = 238.77 \text{ ft}^2$$

$$b_{HT}/2 = 259.03 \text{ in.}$$

$$\bar{C}_{HT} = 149.38 \text{ in.}$$

Coefficients are applicable to either left or right horizontal tail.

| Effect | C_{VZ} (shear) | C_{BX} (moment) | C_{TY} (torsion) |
|---------------------|---------------------|----------------------|-----------------------|
| $\alpha = 0$ | -.136182 | -.049482 | .051116 |
| α | .042237 | .018920 | -.019427 |
| δ_H | .060513 | .027107 | -.027833 |
| $\dot{\alpha}$ | .233930 | .104789 | -.107545 |
| β | -.017738 | -.006993 | .004648 |
| δ'_H | .049585 | .022735 | -.022025 |
| δ_{SP} (Sym) | -.000750 | -.000317 | .000369 |
| δ_{SP} (a/s) | .000277 | .000145 | -.000168 |
| P | -.002479 | -.002088 | .002313 |
| Q | .552160 | .254971 | -.297065 |

C_{VZ} , + Up and perpendicular to the airplane water plane.

C_{BX} , + Tip up and about an axis parallel to the longitudinal axis.

C_{TY} , + Leading edge up and about an axis perpendicular to the plane of symmetry.

TABLE E-III. - VERTICAL TAIL COEFFICIENTS AT WL 136.56
 FOR 1.20M AND $\Lambda_W = 67.5^\circ$

$$S_{VT} = 247.4 \text{ ft}^2$$

$$b_{VT}/2 = 206.76 \text{ in.}$$

$$\bar{C}_{VT} = 188.95 \text{ in.}$$

Coefficients are applicable on the upper vertical tail (UVT).

| Effect | C_{VY} (shear) | C_{BX} (moment) | C_{TZ} (torsion) |
|-------------------|---------------------|----------------------|-----------------------|
| $\beta\alpha = 0$ | -.034484 | -.010927 | .003146 |
| $\beta\alpha$ | -.001115 | -.000354 | .000102 |
| δ'_H | -.003032 | -.000800 | .000464 |
| δ_{SP} | -.000270 | -.000089 | .000023 |
| δ_{RU} | .009663 | .002854 | -.003830 |
| δ_{RL} | 0 | 0 | 0 |
| P | -.003995 | -.001461 | .000756 |
| R | .032297 | .010244 | -.005596 |

C_{VY} , + To the right and normal to the plane of symmetry.

C_{BX} , + Tip to the right and about an axis parallel to the longitudinal axis.

C_{TZ} , + Leading edge right and about an axis perpendicular to the water plane.

TABLE E-IV. - FORWARD FUSELAGE COEFFICIENTS
 AT FS 528.5 FOR 1.20M AND $\Lambda_W = 67.5^\circ$

$$S_{FF} = 1946.0 \text{ ft}^2$$

$$b_{FF}/2 = 820.08 \text{ in.}$$

$$\bar{C}_{FF} = 184.05 \text{ in.}$$

Coefficients are based on the airloads on the fuselage forward of FS 528.5.

| Effect | C_{VZ} (shear) | C_{BY} (moment) | C_{VY} (shear) | C_{BZ} (moment) | C_{TX} (torsion) |
|--------------|---------------------|----------------------|---------------------|----------------------|-----------------------|
| $\alpha = 0$ | .00317 | -.000822 | | | |
| α | .00188 | .000605 | | | |
| P | | | .00014 | .00004 | .00002 |
| β | | | -.00571 | -.00166 | -.00099 |

C_{VZ} , + Up and normal to the water plane.

C_{BY} , + Nose up and about an axis perpendicular to the plane of symmetry.

C_{VY} , + To the right and normal to the plane of symmetry.

C_{BZ} , + Nose right and about an axis perpendicular to the water plane.

C_{TX} , + Left wing up and about an axis parallel to the longitudinal axis.

TABLE E-V. - AFT FUSELAGE COEFFICIENTS AT
FS 1337.5 FOR 1.20M AND $\Lambda_W = 67.5^\circ$

$$S_{AF} = S_{REF} = 1946.0 \text{ ft}^2$$

$$b_{AF}/2 = b_{REF}/2 = 820.08 \text{ in.}$$

$$\bar{c}_{AF} = \bar{c}_{REF} = 184.05 \text{ in.}$$

Coefficients are based on the airloads on the fuselage aft of FS 1337.5 and do not include the airloads on the empennage. (Refer to Appendix C for equations which include the airloads on the empennage.)

| Effect | C_{VZ} (shear) | C_{BY} (moment) | C_{VY} (shear) | C_{BZ} (moment) | C_{TX} (torsion) |
|-------------------------------|---------------------|----------------------|---------------------|----------------------|-----------------------|
| $\alpha = 0$ | .00530 | .002173 | | | |
| α | -.00046 | -.000118 | | | |
| $\beta\alpha = 0 \text{ c/o}$ | | | -.00211 | -.00030 | -.00037 |
| $\beta\alpha \text{ c/o}$ | | | -.00007 | -.00001 | -.00001 |
| δ'_H | | | .00022 | .00006 | .00004 |
| δ_{RL} | | | .00009 | .00001 | .00002 |
| P | | | .00044 | .00011 | .00008 |
| β | | | -.00168 | -.00034 | -.00029 |

C_{VZ} , + Up and normal to the water plane.

C_{BY} , + Aft end up and about an axis perpendicular to the plane of symmetry.

C_{VY} , + To the right and normal to the plane of symmetry.

C_{BZ} , + Aft end right and about an axis perpendicular to the water plane.

C_{TX} , + Left wing up and about an axis parallel to the longitudinal axis.

TABLE E-VI. - VERTICAL TAIL COEFFICIENTS AT WL 75.0
FOR 1.20M AND $\Lambda_W = 67.5^\circ$

$$S_{VT} = 247.4 \text{ ft}^2$$

$$b_{VT}/2 = 206.76 \text{ in.}$$

$$\bar{c}_{VT} = 188.95 \text{ in.}$$

Coefficients are at the vertical tail root (VTR) and are for use in the equations in Appendix C for the determination of the net airloads coefficients for the aft fuselage point at FS 1337.5.

| Effect | C_{VY} (shear) | C_{BX} (moment) | C_{TZ} (torsion) |
|-------------------|---------------------|----------------------|-----------------------|
| $\beta\alpha = 0$ | -.053487 | -.023324 | .010230 |
| $\beta\alpha$ | -.001730 | -.000755 | .000331 |
| δ'_H | -.002353 | -.001621 | .001072 |
| δ_{SP} | -.000349 | -.000177 | .000079 |
| δ_{RU} | .009675 | .005734 | -.006210 |
| δ_{RL} | .003878 | .000352 | -.001119 |
| P | -.003700 | -.002645 | .002065 |
| R | .047596 | .022154 | -.013930 |

C_{VY} , + To the right and normal to the plane at symmetry.

C_{BX} , + Tip to the right and about an axis parallel to the plane of symmetry.

C_{TZ} , + Leading edge right and about an axis perpendicular to the water plane.

TABLE E-VII. - LOAD COEFFICIENTS DATA CARD LISTING

| NASA ARS CASE 2 M=1.20 SW=67.5 WIND TUNNEL DATA RIGID | | MSEQ(I)-SEQUENCE NUMBER | | TITLE | |
|---|------------|-------------------------|------------|----------------------|--------|
| SEQ NO. | CV | CB | CT | TITLE | |
| 101 | .29213E-01 | .8831E-02 | .3133E-02 | ALPHA = 0 | M=1.20 |
| 102 | .12051E-01 | .3229E-02 | .5840E-03 | ALPHA | M=1.20 |
| 103 | .0000E+00 | .0000E+00 | .0000E+00 | ALPHA DOT | M=1.20 |
| 104 | .29000E-03 | .5700E-03 | .3400E-04 | DELTA SPOILER | M=1.20 |
| 105 | .32320E-02 | .9550E-03 | .2230E-03 | ROLL VELOC P | M=1.20 |
| 106 | .42987E-01 | .1226E-03 | .1284E-02 | PITCH VELOC G | M=1.20 |
| 107 | .75900E-03 | .1670E-03 | .1490E-03 | BETA ALPHA ZERC A/S | M=1.20 |
| 108 | .22600E-03 | .5800E-03 | .2500E-04 | BETA ALPHA ZERC A/S | M=1.20 |
| 109 | .31100E-03 | .1190E-03 | .1740E-03 | BETA ALPHA ZERC SYM | M=1.20 |
| 110 | .80000E-05 | .5000E-05 | .1100E-04 | BETA ALPHA SYM | M=1.20 |
| 111 | .0000E+00 | .0000E+00 | .0000E+00 | FILLER | M=1.20 |
| 112 | .0000E+00 | .0000E+00 | .0000E+00 | FILLER | M=1.20 |
| 113 | .0000E+00 | .0000E+00 | .0000E+00 | FILLER | M=1.20 |
| 114 | .0000E+00 | .0000E+00 | .0000E+00 | FILLER | M=1.20 |
| 115 | .0000E+00 | .0000E+00 | .0000E+00 | FILLER | M=1.20 |
| 201 | .13618E+00 | .4948E-01 | .5111E-01 | ALPHA = 0 | M=1.20 |
| 202 | .42237E-01 | .1892E-01 | .1942E-01 | ALPHA | M=1.20 |
| 203 | .60330E-01 | .2710E-01 | .2780E-01 | DELTA F | M=1.20 |
| 204 | .23333E+00 | .1047E-01 | .1075E-01 | ALPHA DOT | M=1.20 |
| 205 | .17738E-01 | .6993E-02 | .4648E-02 | BETA | M=1.20 |
| 206 | .49585E-01 | .2273E-01 | .2202E-01 | DELTA H PRIME | M=1.20 |
| 207 | .75000E-03 | .1170E-01 | .3690E-02 | DELTA SPOILER SYM | M=1.20 |
| 208 | .27700E-03 | .1450E-01 | .1680E-02 | DELTA SPOILER A/S | M=1.20 |
| 209 | .24798E-02 | .2000E-02 | .2313E-02 | ROLL VELOCITY P | M=1.20 |
| 210 | .55216E+00 | .2549E+00 | .2970E+00 | PITCH VELOCITY G | M=1.20 |
| 211 | .0000E+00 | .0000E+00 | .0000E+00 | FILLER | M=1.20 |
| 212 | .0000E+00 | .0000E+00 | .0000E+00 | FILLER | M=1.20 |
| 213 | .0000E+00 | .0000E+00 | .0000E+00 | FILLER | M=1.20 |
| 214 | .0000E+00 | .0000E+00 | .0000E+00 | FILLER | M=1.20 |
| 215 | .0000E+00 | .0000E+00 | .0000E+00 | FILLER | M=1.20 |
| 301 | .54484E-01 | .1092E-01 | .3146E-02 | BETA ALPHA = 0 136. | M=1.20 |
| 302 | .11150E-01 | .3854E-01 | .1520E-01 | BETA ALPHA | M=1.20 |
| 303 | .30330E-02 | .2000E-01 | .4640E-02 | DELTA F PRIME | M=1.20 |
| 304 | .27600E-03 | .2300E-01 | .2300E-02 | DELTA SPOILER | M=1.20 |
| 305 | .96630E-02 | .2854E-01 | .5833E-02 | DELTA RUD UP | M=1.20 |
| 306 | .0000E+00 | .0000E+00 | .0000E+00 | DELTA RUD LOW | M=1.20 |
| 307 | .39950E-02 | .1461E-01 | .7560E-03 | ROLL VELOC P | M=1.20 |
| 308 | .32297E-01 | .10244E-01 | .55960E-02 | YAW VELOC R | M=1.20 |
| 309 | .0000E+00 | .0000E+00 | .0000E+00 | FILLER | M=1.20 |
| 310 | .0000E+00 | .0000E+00 | .0000E+00 | FILLER | M=1.20 |
| 311 | .0000E+00 | .0000E+00 | .0000E+00 | FILLER | M=1.20 |
| 312 | .0000E+00 | .0000E+00 | .0000E+00 | FILLER | M=1.20 |
| 313 | .0000E+00 | .0000E+00 | .0000E+00 | FILLER | M=1.20 |
| 314 | .0000E+00 | .0000E+00 | .0000E+00 | FILLER | M=1.20 |
| 315 | .0000E+00 | .0000E+00 | .0000E+00 | FILLER | M=1.20 |
| 401 | .53480E-01 | .2330E-01 | .1023E-01 | BETA ALPHA = 0 WL 75 | M=1.20 |
| 402 | .17300E-01 | .7550E-01 | .3318E-01 | BETA ALPHA | M=1.20 |
| 403 | .23330E-01 | .1621E-01 | .1720E-01 | DELTA H PRIME | M=1.20 |
| 404 | .34900E-03 | .1770E-01 | .7900E-02 | DELTA SPOILER | M=1.20 |
| 405 | .96750E-02 | .5734E-01 | .6210E-02 | DELTA RUD UP | M=1.20 |
| 406 | .38780E-02 | .2800E-01 | .1119E-01 | DELTA RUD LOW | M=1.20 |
| 407 | .47596E-01 | .2854E-01 | .2305E-01 | ROLL VELOC P WL 75 | M=1.20 |
| 408 | .0000E+00 | .2154E-01 | .1593E-01 | YAW VELOC R WL 75 | M=1.20 |
| 409 | .0000E+00 | .0000E+00 | .0000E+00 | FILLER | M=1.20 |
| 410 | .0000E+00 | .0000E+00 | .0000E+00 | FILLER | M=1.20 |
| 411 | .0000E+00 | .0000E+00 | .0000E+00 | FILLER | M=1.20 |
| 412 | .0000E+00 | .0000E+00 | .0000E+00 | FILLER | M=1.20 |
| 413 | .0000E+00 | .0000E+00 | .0000E+00 | FILLER | M=1.20 |
| 414 | .0000E+00 | .0000E+00 | .0000E+00 | FILLER | M=1.20 |
| 415 | .0000E+00 | .0000E+00 | .0000E+00 | FILLER | M=1.20 |
| 501 | .31700E-02 | .2220E-01 | .2000E-01 | ALPHA (VERTICAL) | M=1.20 |
| 502 | .14800E-02 | .6050E-01 | .9500E-02 | ALPHA (VERTICAL) | M=1.20 |
| 503 | .14000E-03 | .4000E-01 | .2000E-01 | ROLL VELOC (LATERAL) | M=1.20 |
| 504 | .57100E-02 | .1660E-01 | .9500E-03 | BETA (LATERAL) | M=1.20 |
| 505 | .0000E+00 | .0000E+00 | .0000E+00 | FILLER | M=1.20 |
| 506 | .0000E+00 | .0000E+00 | .0000E+00 | FILLER | M=1.20 |
| 507 | .0000E+00 | .0000E+00 | .0000E+00 | FILLER | M=1.20 |
| 508 | .0000E+00 | .0000E+00 | .0000E+00 | FILLER | M=1.20 |
| 509 | .0000E+00 | .0000E+00 | .0000E+00 | FILLER | M=1.20 |
| 510 | .0000E+00 | .0000E+00 | .0000E+00 | FILLER | M=1.20 |
| 511 | .0000E+00 | .0000E+00 | .0000E+00 | FILLER | M=1.20 |
| 512 | .0000E+00 | .0000E+00 | .0000E+00 | FILLER | M=1.20 |
| 513 | .0000E+00 | .0000E+00 | .0000E+00 | FILLER | M=1.20 |
| 514 | .0000E+00 | .0000E+00 | .0000E+00 | FILLER | M=1.20 |
| 515 | .0000E+00 | .0000E+00 | .0000E+00 | FILLER | M=1.20 |

TABLE E-VII. - Concluded

| | | | | | | | | | | | |
|-----|--------|------|--------|------|--------|------------------------|---|-------|---|---|------|
| 609 | .53300 | E-02 | .21730 | E-02 | 0. | ALPHA (VERTICAL) | M | =1.20 | S | H | 67.5 |
| 609 | .46000 | E-03 | .11860 | E-03 | 0. | ALPHA (VERTICAL) | M | =1.20 | S | H | 67.5 |
| 609 | .21130 | E-02 | .30000 | E-02 | .37700 | BETA ALPHA C/O (LAT) | M | =1.20 | S | H | 67.5 |
| 609 | .76000 | E-04 | .10000 | E-04 | .10000 | BETA ALPHA C/O (LAT) | M | =1.20 | S | H | 67.5 |
| 609 | .22000 | E-03 | .60000 | E-03 | .40000 | DELTA F PRIME (LAT) | M | =1.20 | S | H | 67.5 |
| 609 | .90000 | E-04 | .10000 | E-04 | .20000 | DELTA RUDDER LOWER (L) | M | =1.20 | S | H | 67.5 |
| 609 | .44000 | E-03 | .11000 | E-03 | .80000 | ROLL VELOCITY P (LAT) | M | =1.20 | S | H | 67.5 |
| 609 | .16800 | E-02 | .34000 | E-02 | .29000 | BETA (LATERAL) | M | =1.20 | S | H | 67.5 |
| 610 | 0. | 0. | 0. | 0. | 0. | FILLER | M | =1.20 | S | H | 67.5 |
| 611 | 0. | 0. | 0. | 0. | 0. | FILLER | M | =1.20 | S | H | 67.5 |
| 612 | 0. | 0. | 0. | 0. | 0. | FILLER | M | =1.20 | S | H | 67.5 |
| 613 | 0. | 0. | 0. | 0. | 0. | FILLER | M | =1.20 | S | H | 67.5 |
| 614 | 0. | 0. | 0. | 0. | 0. | FILLER | M | =1.20 | S | H | 67.5 |

APPENDIX F

RIGID AIRLOAD COEFFICIENTS AT LOAD REFERENCE POINTS (M = 0.95)

The location of the load reference points where the rigid airload coefficients have been determined are presented in figure B-1. All of these stations, with the exception of the vertical tail root (VTR), are the stations where loads will be measured during the B-1 flight loads survey program.

The rigid airload coefficients were determined for each of the applicable aerodynamic effects listed in table I and are presented in tables F-I through F-VI. These coefficients were determined using equations 4, 7, and 10. The component applicable reference areas, semispans and mean aerodynamic chords are listed in the coefficient tables.

Notes in appendix C which apply to tables B-1 through B-VI for M = 0.85 data apply correspondingly to tables F-I through F-VI for M = 0.95 data.

TABLE F-I. - WING COEFFICIENTS AT X_{RS} 354 FOR 0.95M AND $\Lambda_W = 67.5^\circ$

$$S_W = 1946.0 \text{ ft}^2$$

$$b_W/2 = 820.08 \text{ in.}$$

$$\bar{C}_W = 184.05 \text{ in.}$$

Coefficients are applicable to either left or right wing.

| Effect | C_{VZ} (shear) | C_{BX} (moment) | C_{TY} (torsion) |
|-----------------------|---------------------|----------------------|-----------------------|
| $\alpha = 0$ | .024057 | .006690 | -.001643 |
| α | .011027 | .002776 | .000772 |
| $\dot{\alpha}$ | .005623 | .001417 | .000394 |
| δ_{SP} | -.000423 | -.000111 | .000023 |
| P | -.002636 | -.000768 | -.000144 |
| Q | .046712 | .012751 | -.000662 |
| $\beta\alpha = 0$ A/S | -.001134 | -.000210 | .000139 |
| $\beta\alpha$ A/S | -.000044 | -.000011 | -.000002 |
| $\beta\alpha = 0$ Sym | .000034 | -.000001 | .000037 |
| $\beta\alpha$ Sym | -.000081 | -.000019 | -.000004 |

C_{VZ} , + Up and perpendicular to the wing reference plane.

C_{BX} , + Tip up and about an axis perpendicular to the wing load reference line (0.36c line)*.

C_{TY} , + Leading edge up and about the wing load reference line (0.36c line)*.

*The wing load reference line passes through the pivot (at X_{RS} 139.515, Y_{RS} -49.845) and the load reference point (at X_{RS} 354, Y_{RS} -38.248).

TABLE F-II. - HORIZONTAL TAIL COEFFICIENTS AT BP 10.75

FOR 0.95M AND $\Lambda_W = 67.5^\circ$

$$S_{HT} = 238.77 \text{ ft}^2$$

$$b_{HT}/2 = 259.03 \text{ in.}$$

$$\bar{C}_{HT} = 149.38 \text{ in.}$$

Coefficients are applicable to either left or right horizontal tail.

| Effect | C_{VZ} (shear) | C_{BX} (moment) | C_{TY} (torsion) |
|---------------------|---------------------|----------------------|-----------------------|
| $\alpha = 0$ | -.183421 | -.067341 | .041001 |
| α | .047131 | .020727 | -.015855 |
| δ_H | .080854 | .035558 | -.027200 |
| $\dot{\alpha}$ | .262472 | .115430 | -.088298 |
| β | -.020459 | -.007027 | .002921 |
| δ'_H | .021919 | .010001 | -.006959 |
| δ_{SP} (Sym) | -.000556 | -.000273 | .000209 |
| δ_{SP} (a/s) | .000258 | .000173 | -.000169 |
| P | -.002591 | -.002002 | .002197 |
| Q | .551849 | .239192 | -.239063 |

C_{VZ} , + Up and perpendicular to the airplane water plane.

C_{BX} , + Tip up and about an axis parallel to the longitudinal axis.

C_{TY} , + Leading edge up and about an axis perpendicular to the plane of symmetry.

TABLE F-III. - VERTICAL TAIL COEFFICIENTS AT WL 136.56
 FOR 0.95M AND $\Lambda_W = 67.5^\circ$

$$S_{VT} = 247.4 \text{ ft}^2$$

$$b_{VT}/2 = 206.76 \text{ in.}$$

$$\bar{C}_{VT} = 188.95 \text{ in.}$$

Coefficients are applicable on the upper vertical tail (UVT).

| Effect | C_{VY} (shear) | C_{BX} (moment) | C_{TZ} (torsion) |
|-------------------|---------------------|----------------------|-----------------------|
| $\beta\alpha = 0$ | -.034024 | -.011054 | -.001739 |
| $\beta\alpha$ | -.001155 | -.000359 | .000056 |
| δ'_H | -.007446 | -.001977 | .000428 |
| δ_{SP} | -.000252 | -.000074 | -.000003 |
| δ_{RU} | .013436 | .004109 | -.004354 |
| δ_{RL} | 0 | 0 | 0 |
| P | -.003124 | -.001146 | .000371 |
| R | .026671 | .008325 | -.002780 |

- C_{VY} , + To the right and normal to the plane of symmetry.
- C_{BX} , + Tip to the right and about an axis parallel to the longitudinal axis.
- C_{TZ} , + Leading edge right and about an axis perpendicular to the water plane.

TABLE F-IV. - FORWARD FUSELAGE COEFFICIENTS
 AT FS 528.5 FOR 0.95M AND $\Lambda_W = 67.5^\circ$

$$S_{FF} = 1946.0 \text{ ft}^2$$

$$b_{FF}/2 = 820.08 \text{ in.}$$

$$\bar{c}_{FF} = 184.05 \text{ in.}$$

Coefficients are based on the airloads on the fuselage forward of FS 528.5.

| Effect | C_{VZ} (shear) | C_{BY} (moment) | C_{VY} (shear) | C_{BZ} (moment) | C_{TX} (torsion) |
|--------------|---------------------|----------------------|---------------------|----------------------|-----------------------|
| $\alpha = 0$ | .005325 | .000111 | | | |
| α | .002413 | .000685 | | | |
| P | | | .000159 | .000042 | .000025 |
| β | | | -.004258 | -.001424 | -.000740 |

C_{VZ} , + Up and normal to the water plane.

C_{BY} , + Nose up and about an axis perpendicular to the plane of symmetry.

C_{VY} , + To the right and normal to the plane of symmetry.

C_{BZ} , + Nose right and about an axis perpendicular to the water plane.

C_{TX} , + Left wing up and about an axis parallel to the longitudinal axis.

TABLE F-V. - AFT FUSELAGE COEFFICIENTS AT
FS 1337.5 FOR 0.95M AND $\Lambda_W = 67.5^\circ$

$$S_{AF} = S_{REF} = 1946.0 \text{ ft}^2$$

$$b_{AF}/2 = b_{REF}/2 = 820.08 \text{ in.}$$

$$\bar{C}_{AF} = \bar{C}_{REF} = 184.05 \text{ in.}$$

Coefficients are based on the airloads on the fuselage aft of FS 1337.5 and do not include the airloads on the empennage. (Refer to Appendix C for equations which include the airloads on the empennage.)

| Effect | C_{VZ} (shear) | C_{BY} (moment) | C_{VY} (shear) | C_{BZ} (moment) | C_{TX} (torsion) |
|-----------------------|---------------------|----------------------|---------------------|----------------------|-----------------------|
| $\alpha = 0$ | .005241 | .001425 | | | |
| α | .000020 | .000056 | | | |
| $\beta\alpha = 0$ c/o | | | -.001738 | -.000251 | -.000302 |
| $\beta\alpha$ c/o | | | -.000051 | -.000007 | -.000009 |
| δ'_H | | | .000165 | .0000434 | .0000286 |
| δ_{RL} | | | .000187 | .000013 | .000032 |
| P | | | .000513 | .000126 | .000089 |
| β | | | -.000695 | -.000141 | -.000121 |

C_{VZ} , + Up and normal to the water plane.

C_{BY} , + Aft end up and about an axis perpendicular to the plane of symmetry.

C_{VY} , + To the right and normal to the plane of symmetry.

C_{BZ} , + Aft end right and about an axis perpendicular to the water plane.

C_{TX} , + Left wing up and about an axis parallel to the longitudinal axis.

TABLE F-VI. - VERTICAL TAIL COEFFICIENTS AT WL 75.0
FOR 0.95M AND $\Lambda_w = 67.5^\circ$

$$S_{VT} = 247.4 \text{ ft}^2$$

$$b_{VT}/2 = 206.76 \text{ in.}$$

$$\bar{c}_{VT} = 188.95 \text{ in.}$$

Coefficients are at the vertical tail root (VTR) and are for use in the equations in Appendix C for the determination of the net airloads coefficients for the aft fuselage point at FS 1337.5.

| Effect | C_{yy} (shear) | C_{BX} (moment) | C_{TZ} (torsion) |
|-------------------|---------------------|----------------------|-----------------------|
| $\beta\alpha = 0$ | -.050813 | -.023234 | .007872 |
| $\beta\alpha$ | -.001650 | -.000755 | .000256 |
| δ'_H | -.003964 | -.003839 | .001809 |
| δ_{SP} | -.000346 | -.000159 | .000039 |
| δ_{RU} | .013450 | .008112 | -.007662 |
| δ_{RL} | .004877 | .000445 | -.001115 |
| P | -.002999 | -.000274 | .001379 |
| R | .039919 | .018250 | -.008767 |

C_{yy} , + To the right and normal to the plane at symmetry.

C_{BX} , + Tip to the right and about an axis parallel to the plane of symmetry.

C_{TZ} , + Leading edge right and about an axis perpendicular to the water plane.

TABLE F-VII. - LOAD COEFFICIENTS DATA CARD LISTING

| NASA ARS CASE 3 M=0.95 SW=67.5 WIND TUNNEL DATA RIGID | | | | | | | | | |
|---|------------------------------------|------------|------------|----------------------|---|-------|-------|-------|-------|
| NSFC(I) | SEQUENCE | NUMBER | 1XX | 2XX | 3XX | 4XX | 5XX | 6XX | TITLE |
| CV(I) | COEFFICIENT OF SHEAR EACH EFFECT | | | | COEFFICIENT OF BENDING MOMENT EACH EFFECT | | | | TITLE |
| CB(I) | COEFFICIENT OF TORSION EACH EFFECT | | | | COEFFICIENT OF TORSION EACH EFFECT | | | | TITLE |
| CT(I) | DESCRIPTIVE | | | | DESCRIPTIVE | | | | TITLE |
| SEQ NO. | CV | CB | CT | TITLE | TITLE | TITLE | TITLE | TITLE | TITLE |
| 101 | 0000000000 | 0000000000 | 0000000000 | ALPHA = C | ALPHA = C | | | | 67.5 |
| 102 | 0000000000 | 0000000000 | 0000000000 | ALPHA DOT | ALPHA DOT | | | | 67.5 |
| 103 | 0000000000 | 0000000000 | 0000000000 | DELTA SPOILER | DELTA SPOILER | | | | 67.5 |
| 104 | 0000000000 | 0000000000 | 0000000000 | ROLL VELOCITY P | ROLL VELOCITY P | | | | 67.5 |
| 105 | 0000000000 | 0000000000 | 0000000000 | PITCH VELOCITY C | PITCH VELOCITY C | | | | 67.5 |
| 106 | 0000000000 | 0000000000 | 0000000000 | BETA ALPHA ZERO A/S | BETA ALPHA ZERO A/S | | | | 67.5 |
| 107 | 0000000000 | 0000000000 | 0000000000 | BETA ALPHA A/S | BETA ALPHA A/S | | | | 67.5 |
| 108 | 0000000000 | 0000000000 | 0000000000 | BETA ALPHA ZERO SYM | BETA ALPHA ZERO SYM | | | | 67.5 |
| 109 | 0000000000 | 0000000000 | 0000000000 | BETA ALPHA SYM | BETA ALPHA SYM | | | | 67.5 |
| 110 | 0000000000 | 0000000000 | 0000000000 | FILLER | FILLER | | | | 67.5 |
| 111 | 0000000000 | 0000000000 | 0000000000 | FILLER | FILLER | | | | 67.5 |
| 112 | 0000000000 | 0000000000 | 0000000000 | FILLER | FILLER | | | | 67.5 |
| 113 | 0000000000 | 0000000000 | 0000000000 | FILLER | FILLER | | | | 67.5 |
| 114 | 0000000000 | 0000000000 | 0000000000 | FILLER | FILLER | | | | 67.5 |
| 115 | 0000000000 | 0000000000 | 0000000000 | FILLER | FILLER | | | | 67.5 |
| 201 | 0000000000 | 0000000000 | 0000000000 | ALPHA = G | ALPHA = G | | | | 67.5 |
| 202 | 0000000000 | 0000000000 | 0000000000 | ALPHA | ALPHA | | | | 67.5 |
| 203 | 0000000000 | 0000000000 | 0000000000 | DELTA H | DELTA H | | | | 67.5 |
| 204 | 0000000000 | 0000000000 | 0000000000 | ALPHA DOT | ALPHA DOT | | | | 67.5 |
| 205 | 0000000000 | 0000000000 | 0000000000 | BETA | BETA | | | | 67.5 |
| 206 | 0000000000 | 0000000000 | 0000000000 | DELTA H PRIME | DELTA H PRIME | | | | 67.5 |
| 207 | 0000000000 | 0000000000 | 0000000000 | DELTA SPOILER SYM | DELTA SPOILER SYM | | | | 67.5 |
| 208 | 0000000000 | 0000000000 | 0000000000 | DELTA SPOILER A/S | DELTA SPOILER A/S | | | | 67.5 |
| 209 | 0000000000 | 0000000000 | 0000000000 | ROLL VELOCITY P | ROLL VELOCITY P | | | | 67.5 |
| 210 | 0000000000 | 0000000000 | 0000000000 | PITCH VELOCITY C | PITCH VELOCITY C | | | | 67.5 |
| 211 | 0000000000 | 0000000000 | 0000000000 | FILLER | FILLER | | | | 67.5 |
| 212 | 0000000000 | 0000000000 | 0000000000 | FILLER | FILLER | | | | 67.5 |
| 213 | 0000000000 | 0000000000 | 0000000000 | FILLER | FILLER | | | | 67.5 |
| 214 | 0000000000 | 0000000000 | 0000000000 | FILLER | FILLER | | | | 67.5 |
| 301 | 0000000000 | 0000000000 | 0000000000 | BETA ALPHA=0 | BETA ALPHA=0 | | | | 67.5 |
| 302 | 0000000000 | 0000000000 | 0000000000 | BETA ALPHA | BETA ALPHA | | | | 67.5 |
| 303 | 0000000000 | 0000000000 | 0000000000 | DELTA H PRIME | DELTA H PRIME | | | | 67.5 |
| 304 | 0000000000 | 0000000000 | 0000000000 | DELTA SPOILER | DELTA SPOILER | | | | 67.5 |
| 305 | 0000000000 | 0000000000 | 0000000000 | DELTA RUD LP | DELTA RUD LP | | | | 67.5 |
| 306 | 0000000000 | 0000000000 | 0000000000 | DELTA RUD LOW | DELTA RUD LOW | | | | 67.5 |
| 307 | 0000000000 | 0000000000 | 0000000000 | ROLL VELOC P | ROLL VELOC P | | | | 67.5 |
| 308 | 0000000000 | 0000000000 | 0000000000 | YAW VELOC R | YAW VELOC R | | | | 67.5 |
| 309 | 0000000000 | 0000000000 | 0000000000 | FILLER | FILLER | | | | 67.5 |
| 310 | 0000000000 | 0000000000 | 0000000000 | FILLER | FILLER | | | | 67.5 |
| 311 | 0000000000 | 0000000000 | 0000000000 | FILLER | FILLER | | | | 67.5 |
| 312 | 0000000000 | 0000000000 | 0000000000 | FILLER | FILLER | | | | 67.5 |
| 313 | 0000000000 | 0000000000 | 0000000000 | FILLER | FILLER | | | | 67.5 |
| 314 | 0000000000 | 0000000000 | 0000000000 | FILLER | FILLER | | | | 67.5 |
| 401 | 0000000000 | 0000000000 | 0000000000 | BETA ALPHA=0 WL 75 | BETA ALPHA=0 WL 75 | | | | 67.5 |
| 402 | 0000000000 | 0000000000 | 0000000000 | BETA ALPHA WL 75 | BETA ALPHA WL 75 | | | | 67.5 |
| 403 | 0000000000 | 0000000000 | 0000000000 | DELTA H PRIME WL 75 | DELTA H PRIME WL 75 | | | | 67.5 |
| 404 | 0000000000 | 0000000000 | 0000000000 | DELTA SPOILER WL 75 | DELTA SPOILER WL 75 | | | | 67.5 |
| 405 | 0000000000 | 0000000000 | 0000000000 | DELTA RUD LP WL 75 | DELTA RUD LP WL 75 | | | | 67.5 |
| 406 | 0000000000 | 0000000000 | 0000000000 | DELTA RUD LOW WL 75 | DELTA RUD LOW WL 75 | | | | 67.5 |
| 407 | 0000000000 | 0000000000 | 0000000000 | ROLL VELOC P WL 75 | ROLL VELOC P WL 75 | | | | 67.5 |
| 408 | 0000000000 | 0000000000 | 0000000000 | YAW VELOC R WL 75 | YAW VELOC R WL 75 | | | | 67.5 |
| 409 | 0000000000 | 0000000000 | 0000000000 | FILLER | FILLER | | | | 67.5 |
| 410 | 0000000000 | 0000000000 | 0000000000 | FILLER | FILLER | | | | 67.5 |
| 411 | 0000000000 | 0000000000 | 0000000000 | FILLER | FILLER | | | | 67.5 |
| 412 | 0000000000 | 0000000000 | 0000000000 | FILLER | FILLER | | | | 67.5 |
| 413 | 0000000000 | 0000000000 | 0000000000 | FILLER | FILLER | | | | 67.5 |
| 414 | 0000000000 | 0000000000 | 0000000000 | FILLER | FILLER | | | | 67.5 |
| 501 | 0000000000 | 0000000000 | 0000000000 | ALPHA=0 (VERTICAL) | ALPHA=0 (VERTICAL) | | | | 67.5 |
| 502 | 0000000000 | 0000000000 | 0000000000 | ALPHA (VERTICAL) | ALPHA (VERTICAL) | | | | 67.5 |
| 503 | 0000000000 | 0000000000 | 0000000000 | ROLL VEL P (LATERAL) | ROLL VEL P (LATERAL) | | | | 67.5 |
| 504 | 0000000000 | 0000000000 | 0000000000 | BETA (LATERAL) | BETA (LATERAL) | | | | 67.5 |
| 505 | 0000000000 | 0000000000 | 0000000000 | FILLER | FILLER | | | | 67.5 |
| 506 | 0000000000 | 0000000000 | 0000000000 | FILLER | FILLER | | | | 67.5 |
| 507 | 0000000000 | 0000000000 | 0000000000 | FILLER | FILLER | | | | 67.5 |
| 508 | 0000000000 | 0000000000 | 0000000000 | FILLER | FILLER | | | | 67.5 |
| 509 | 0000000000 | 0000000000 | 0000000000 | FILLER | FILLER | | | | 67.5 |
| 510 | 0000000000 | 0000000000 | 0000000000 | FILLER | FILLER | | | | 67.5 |

TABLE F-VII. - Concluded

| | | | | | | | | | | | |
|-----|--------|------|------|------|----|-----------------------|---|---|---|---|------|
| 601 | .52410 | E-02 | .142 | E-02 | 0. | ALPHA=C (VERTICAL) | M | 0 | 9 | 5 | 67.5 |
| 602 | .23806 | E-04 | .566 | E-04 | 0. | ALPHA (VERTICAL) | M | 0 | 9 | 5 | 67.5 |
| 603 | .17383 | E-02 | .251 | E-02 | 0. | BETA ALPHA C/O (LAT) | M | 0 | 9 | 5 | 67.5 |
| 604 | .51000 | E-04 | .700 | E-04 | 0. | BETA ALPHA C/O (LAT) | M | 0 | 9 | 5 | 67.5 |
| 605 | .16538 | E-03 | .434 | E-03 | 0. | DELTA H PRIME (LAT) | M | 0 | 9 | 5 | 67.5 |
| 606 | .18766 | E-03 | .125 | E-03 | 0. | DELTA RUD LOW (LAT) | M | 0 | 9 | 5 | 67.5 |
| 607 | .51350 | E-03 | .125 | E-03 | 0. | ROLL VELOCITY P (LAT) | M | 0 | 9 | 5 | 67.5 |
| 608 | .69500 | E-03 | .141 | E-03 | 0. | BETA (LATERAL) | M | 0 | 9 | 5 | 67.5 |
| 609 | 0. | 0. | 0. | 0. | 0. | FILLER | M | 0 | 9 | 5 | 67.5 |
| 610 | 0. | 0. | 0. | 0. | 0. | FILLER | M | 0 | 9 | 5 | 67.5 |
| 611 | 0. | 0. | 0. | 0. | 0. | FILLER | M | 0 | 9 | 5 | 67.5 |
| 612 | 0. | 0. | 0. | 0. | 0. | FILLER | M | 0 | 9 | 5 | 67.5 |
| 613 | 0. | 0. | 0. | 0. | 0. | FILLER | M | 0 | 9 | 5 | 67.5 |
| 614 | 0. | 0. | 0. | 0. | 0. | FILLER | M | 0 | 9 | 5 | 67.5 |
| 615 | 0. | 0. | 0. | 0. | 0. | FILLER | M | 0 | 9 | 5 | 67.5 |

APPENDIX G

RIGID AIRLOAD COEFFICIENTS AT LOAD REFERENCE POINTS ($M = 0.70$, $\Lambda_W = 67.5^\circ$)

The location of the load reference points where the rigid airload coefficients have been determined are presented in figure B-1. All of these stations, with the exception of the vertical tail root (VTR), are the stations where loads will be measured during the B-1 Flight Loads Survey program.

The rigid airload coefficients were determined for each of the applicable aerodynamic effects listed in table I and are presented in tables G-I through G-VI. These coefficients were determined using equations 4, 7, 10. The component applicable reference areas, semispans and mean aerodynamic chords are listed in the coefficient tables.

Notes in appendix C which apply to tables B-I through B-VI for $M = 0.85$ data apply correspondingly to tables G-I through G-VI for $M = 0.70$ data.

TABLE G-I.- WING COEFFICIENTS AT X_{RS} 354 FOR 0.70M AND $\Lambda_W = 67.5^\circ$

$$S_W = 1946.0 \text{ ft}^2$$

$$b_W/2 = 820.08 \text{ in.}$$

$$\bar{C}_W = 184.05 \text{ in.}$$

Coefficients are applicable to either left or right wing.

| Effect | C_{VZ} (shear) | C_{BX} (moment) | C_{TY} (torsion) |
|-----------------------|---------------------|----------------------|-----------------------|
| $\alpha = 0$ | .023524 | .006454 | -.000230 |
| α | .009244 | .002305 | .000802 |
| $\dot{\alpha}$ | .009745 | .002674 | -.000095 |
| δSP | -.000313 | -.000090 | .000015 |
| P | -.002725 | -.000793 | -.000155 |
| Q | .051001 | .014226 | -.000442 |
| $\beta\alpha = 0$ A/S | -.000958 | -.001894 | .000075 |
| $\beta\alpha$ A/S | -.000045 | -.000012 | .0 |
| $\beta\alpha = 0$ Sym | -.000236 | -.000212 | .000194 |
| $\beta\alpha$ Sym | .0 | .0 | .0 |

C_{VZ} , + Up and perpendicular to the wing reference plane.

C_{BX} , + Tip up and about an axis perpendicular to the wing load reference line (0.36c line)*.

C_{TY} , + Leading edge up and about the wing load reference line (0.36c line)*.

*The wing load reference line passes through the pivot (at X_{RS} 354, Y_{RS} -49.845) and the load reference point (at X_{RS} 354, Y_{RS} -38.248).

TABLE G-II.- HORIZONTAL TAIL COEFFICIENTS AT BP 10.75

FOR 0.70M and $\Lambda_W = 67.5^\circ$

$$S_{HT} = 238.77 \text{ ft}^2$$

$$b_{HT}/2 = 259.03 \text{ in.}$$

$$\bar{C}_{HT} = 149.38 \text{ in.}$$

Coefficients are applicable to either left or right horizontal tail.

| Effect | C_{VZ} (shear) | C_{BX} (moment) | C_{TY} (torsion) |
|-------------------|---------------------|----------------------|-----------------------|
| $\alpha = 0$ | -.143910 | -.056550 | .032218 |
| α | .035424 | .015469 | -.011257 |
| δH | .067285 | .029383 | -.021382 |
| $\dot{\alpha}$ | .220850 | .096446 | -.070184 |
| β | -.008436 | -.003358 | .002594 |
| $\delta'H$ | .041890 | .018841 | -.012397 |
| δSP (Sym) | -.000533 | -.000268 | .000207 |
| δSP (a/s) | .000122 | .000082 | -.000075 |
| P | -.002649 | -.001954 | .002038 |
| Q | .446420 | .212330 | -.197940 |

C_{VZ} , + Up and perpendicular to the airplane water plane.

C_{BX} , + Tip up and about an axis parallel to the longitudinal axis.

C_{TY} , + Leading edge up and about an axis perpendicular to the plane of symmetry.

TABLE G-III.- VERTICAL TAIL COEFFICIENTS AT WL 136.56

FOR 0.70M AND $\Lambda_W = 67.5^\circ$

$$S_{VT} = 247.4 \text{ ft}^2$$

$$b_{VT}/2 = 206.76 \text{ in.}$$

$$\bar{C}_{VT} = 188.95 \text{ in.}$$

Coefficients are applicable on the upper vertical tail (UVT).

| Effect | C_{VY} (shear) | C_{BX} (moment) | C_{TZ} (torsion) |
|-------------------|---------------------|----------------------|-----------------------|
| $\beta\alpha = 0$ | -.032845 | -.005120 | .004908 |
| $\beta\alpha$ | -.000569 | -.000089 | .000085 |
| $\delta'H$ | -.006205 | -.000857 | .000966 |
| δSP | -.000172 | -.000025 | .000020 |
| δUR | .015006 | .002245 | -.003670 |
| δRL | .0 | .0 | .0 |
| P | -.003054 | -.000565 | .000558 |
| R | .023071 | .003618 | -.003816 |

C_{VY} , + To the right and normal to the plane of symmetry.

C_{BX} , + Tip to the right and about an axis parallel to the longitudinal axis.

C_{TZ} , + Leading edge right and about an axis perpendicular to the water plane.

TABLE G-IV.- FORWARD FUSELAGE COEFFICIENTS
 AT FS 528.5 FOR 0.70M AND $\Lambda_W = 67.5^\circ$

$$S_{FF} = 1946.0 \text{ ft}^2$$

$$b_{FF}/2 = 820.08 \text{ in.}$$

$$\bar{C}_{FF} = 184.05 \text{ in.}$$

Coefficients are based on the airloads on the fuselage forward of FS 528.5.

| Effect | C_{VZ} (shear) | C_{BY} (moment) | C_{VY} (shear) | C_{BZ} (moment) | C_{TX} (torsion) |
|--------------|---------------------|----------------------|---------------------|----------------------|-----------------------|
| $\alpha = 0$ | .002696 | -.000086 | | | |
| α | .001980 | .00030 | | | |
| P | | | .000175 | .000023 | .000014 |
| β | | | -.003466 | -.000579 | -.000301 |

C_{VZ} , + Up and normal to the water plane.

C_{BY} , + Nose up and about an axis perpendicular to the plane of symmetry.

C_{VY} , + To the right and normal to the plane of symmetry.

C_{BZ} , + Nose right and about an axis perpendicular to the water plane.

C_{TX} , + Left wing up and about an axis parallel to the longitudinal axis.

TABLE G-V.- AFT FUSELAGE COEFFICIENTS AT
FS 1337.5 FOR 0.70M AND $\Lambda_W = 67.5^\circ$

$$S_{AF} = S_{REF} = 1946.0 \text{ ft}^2$$

$$b_{AF}/2 = b_{REF}/2 = 820.08 \text{ in.}$$

$$\bar{c}_{AF} = \bar{c}_{REF} = 184.05 \text{ in.}$$

Coefficients are based on the airloads on the fuselage aft of FS1337.5 and do not include the airloads on the empennage. (Refer to Appendix C for equations which include the airloads on the empennage.)

| Effect | C_{VZ} (shear) | C_{BY} (moment) | C_{VY} (shear) | C_{BZ} (moment) | C_{TY} (torsion) |
|-------------------------------|---------------------|----------------------|---------------------|----------------------|-----------------------|
| $\alpha = 0$ | .004896 | .000736 | | | |
| α | .000029 | .000004 | | | |
| $\beta\alpha = 0 \text{ c/o}$ | | | -.002010 | -.000145 | -.000175 |
| $\beta\alpha \text{ c/o}$ | | | -.000034 | .0 | .0 |
| $\delta'H$ | | | .000722 | .000095 | .000063 |
| $\delta'RL$ | | | .000229 | .000016 | .000020 |
| P | | | .000565 | .000069 | .000049 |
| β | | | -.000672 | -.000068 | -.000058 |

C_{VZ} , + Up and normal to the ater plane.

C_{BY} , + Aft end up and about an axis perpendicular to the plane of symmetry.

C_{VY} , + To the right and normal to the plane of symmetry.

C_{BZ} , + Aft end right and about an axis perpendicular to the water plane.

C_{TX} , + Left wing up and about an axis parallel to the longitudinal axis.

TABLE G-VI.- VERTICAL TAIL COEFFICIENTS AT WL 75.0

FOR 0.70M AND $\Lambda_W = 67.5^\circ$

$$S_{VT} = 247.4 \text{ ft}^2$$

$$b_{VT}/2 = 206.76 \text{ in.}$$

$$\bar{C}_{VT} = 188.95 \text{ in.}$$

Coefficients are at the vertical tail root (VTR) and are for use in the equations in Appendix C for the determination of the new airloads coefficients for the aft fuselage point at FS 1337.5.

| Effect | C_{VY} (shear) | C_{BX} (moment) | C_{TZ} (torsion) |
|-------------------|---------------------|----------------------|-----------------------|
| $\beta\alpha = 0$ | .047194 | .010863 | -.003861 |
| $\beta\alpha$ | .000818 | .000188 | -.000067 |
| $\delta'H$ | -.033366 | -.001653 | .000789 |
| δSP | -.000236 | -.000054 | .000013 |
| δRU | .015024 | .004481 | -.003673 |
| δRL | .004649 | .000214 | -.000300 |
| P | -.002981 | -.001028 | .000631 |
| R | .035102 | .007946 | -.003282 |

C_{VY} , + To the right and normal to the plane at symmetry.

C_{BX} , + Tip to the right and about an axis parallel to the plane of symmetry.

C_{TZ} , + Leading edge right and about an axis perpendicular to the water plane.

TABLE G-VII.- LOAD COEFFICIENT DATA CARD LISTING

NASA ARS CASE 4 M=0.70 SW=67.5 WIND TUNNEL DATA RIGID
 NSFG(I) SEQUENCE NUMBER 1XX - WING AT XRS 354.
 2XX - HORIZONTAL TAIL AT BP 10.75
 3XX - VERTICAL TAIL AT WL 136.56
 4XX - VERTICAL TAIL AT WL 75.0
 5XX - FORWARD FUSELAGE AT FS 528.5
 6XX - AFT FUSELAGE AT FS 1337.5

CV(I) - COEFFICIENT OF SHEAR EACH EFFECT
 CB(I) - COEFFICIENT OF BENDING MOMENT EACH EFFECT
 CT(I) - COEFFICIENT OF TORSION EACH EFFECT

| SEQ. NO. | CV | CB | CT | TITLE | |
|----------|-----------|-----------|-----------|-----------------------|-------------------|
| 101 | 0.023524 | 0.006454 | -0.000230 | ALPHA = 0 | M = .70 SW = 67.5 |
| 102 | 0.009244 | 0.002305 | 0.000802 | ALPHA | M = .70 SW = 67.5 |
| 103 | 0.009745 | 0.002674 | -0.000095 | ALPHA DOT | M = .70 SW = 67.5 |
| 104 | -0.000313 | -0.000090 | 0.000015 | DELTA SPOILER | M = .70 SW = 67.5 |
| 105 | -0.002725 | -0.000793 | -0.000155 | ROLL VELOCITY P | M = .70 SW = 67.5 |
| 106 | 0.051001 | 0.014226 | -0.000442 | PITCH VELOCITY Q | M = .70 SW = 67.5 |
| 107 | -0.000958 | -0.001894 | 0.000075 | BETA ALPHA ZERO A/S | M = .70 SW = 67.5 |
| 108 | -0.000045 | -0.000012 | 0.0 | BETA ALPHA A/S | M = .70 SW = 67.5 |
| 109 | -0.000236 | -0.000212 | 0.000194 | BETA ALPHA ZERO SYM | M = .70 SW = 67.5 |
| 110 | 0.0 | 0.0 | 0.0 | BETA ALPHA SYM | M = .70 SW = 67.5 |
| 111 | 0.0 | 0.0 | 0.0 | FILLER | M = .70 SW = 67.5 |
| 112 | 0.0 | 0.0 | 0.0 | FILLER | M = .70 SW = 67.5 |
| 113 | 0.0 | 0.0 | 0.0 | FILLER | M = .70 SW = 67.5 |
| 114 | 0.0 | 0.0 | 0.0 | FILLER | M = .70 SW = 67.5 |
| 115 | 0.0 | 0.0 | 0.0 | FILLER | M = .70 SW = 67.5 |
| 201 | -0.143910 | -0.056550 | 0.032218 | ALPHA = 0 | M = .70 SW = 67.5 |
| 202 | 0.035424 | 0.015469 | -0.011257 | ALPHA | M = .70 SW = 67.5 |
| 203 | 0.067285 | 0.029383 | -0.021382 | DELTA H | M = .70 SW = 67.5 |
| 204 | 0.220850 | 0.096446 | -0.070184 | ALPHA DOT | M = .70 SW = 67.5 |
| 205 | -0.006436 | -0.003358 | 0.002594 | BETA | M = .70 SW = 67.5 |
| 206 | 0.041890 | 0.018841 | -0.012397 | DELTA H PRIME | M = .70 SW = 67.5 |
| 207 | -0.000533 | -0.000268 | 0.000207 | DELTA SPOILER SYM | M = .70 SW = 67.5 |
| 208 | 0.000122 | 0.000062 | -0.000075 | DELTA SPOILER A/S | M = .70 SW = 67.5 |
| 209 | -0.002649 | -0.001954 | 0.002038 | ROLL VELOCITY P | M = .70 SW = 67.5 |
| 210 | 0.466420 | 0.212330 | -0.197940 | PITCH VELOCITY Q | M = .70 SW = 67.5 |
| 211 | 0.0 | 0.0 | 0.0 | FILLER | M = .70 SW = 67.5 |
| 212 | 0.0 | 0.0 | 0.0 | FILLER | M = .70 SW = 67.5 |
| 213 | 0.0 | 0.0 | 0.0 | FILLER | M = .70 SW = 67.5 |
| 214 | 0.0 | 0.0 | 0.0 | FILLER | M = .70 SW = 67.5 |
| 215 | 0.0 | 0.0 | 0.0 | FILLER | M = .70 SW = 67.5 |
| 301 | -0.032845 | -0.005120 | 0.004908 | BETA ALPHA=0 136.56M | M = .70 SW = 67.5 |
| 302 | -0.000569 | -0.000089 | 0.000065 | BETA ALPHA 136.56M | M = .70 SW = 67.5 |
| 303 | -0.006205 | -0.000857 | 0.000966 | DELTA H PRIME 136.56M | M = .70 SW = 67.5 |
| 304 | -0.000172 | -0.000025 | 0.000020 | DELTA SPOILER 136.56M | M = .70 SW = 67.5 |
| 305 | 0.015006 | 0.002245 | -0.003670 | DELTA RUD UP 136.56M | M = .70 SW = 67.5 |
| 306 | 0.0 | 0.0 | 0.0 | DELTA RUD LOW 136.56M | M = .70 SW = 67.5 |
| 307 | -0.003654 | -0.000565 | 0.000558 | ROLL VELOC P 136.56M | M = .70 SW = 67.5 |
| 308 | 0.023071 | 0.003618 | -0.003816 | YAW VELOC R 136.56M | M = .70 SW = 67.5 |
| 309 | 0.0 | 0.0 | 0.0 | FILLER | M = .70 SW = 67.5 |
| 310 | 0.0 | 0.0 | 0.0 | FILLER | M = .70 SW = 67.5 |
| 311 | 0.0 | 0.0 | 0.0 | FILLER | M = .70 SW = 67.5 |
| 312 | 0.0 | 0.0 | 0.0 | FILLER | M = .70 SW = 67.5 |
| 313 | 0.0 | 0.0 | 0.0 | FILLER | M = .70 SW = 67.5 |
| 314 | 0.0 | 0.0 | 0.0 | FILLER | M = .70 SW = 67.5 |
| 315 | 0.0 | 0.0 | 0.0 | FILLER | M = .70 SW = 67.5 |
| 401 | 0.047194 | 0.010863 | -0.003861 | BETA ALPHA=0 WL 75M | M = .70 SW = 67.5 |

TABLE G-VII. Concluded

| | | | | | | |
|-----|-----------|-----------|-----------|-----------------------|--------------|-----------|
| 402 | 0.000818 | 0.000188 | -0.000067 | BETA ALPHA | WL 75M = .70 | SW = 67.5 |
| 403 | -0.033366 | -0.001653 | 0.000789 | DELTA H PRIME | WL 75M = .70 | SW = 67.5 |
| 404 | -0.000236 | -0.000054 | 0.000013 | DELTA SPOILER | WL 75M = .70 | SW = 67.5 |
| 405 | 0.015024 | 0.004481 | -0.003673 | DELTA RUD UP | WL 75M = .70 | SW = 67.5 |
| 406 | 0.004649 | 0.000214 | -0.000300 | DELTA RUD LOW | WL 75M = .70 | SW = 67.5 |
| 407 | -0.002981 | -0.001028 | 0.000631 | ROLL VELOC P | WL 75M = .70 | SW = 67.5 |
| 408 | 0.035102 | 0.007946 | -0.003282 | YAW VELOC R | WL 75M = .70 | SW = 67.5 |
| 409 | 0.0 | 0.0 | 0.0 | FILLER | M = .70 | SW = 67.5 |
| 410 | 0.0 | 0.0 | 0.0 | FILLER | M = .70 | SW = 67.5 |
| 411 | 0.0 | 0.0 | 0.0 | FILLER | M = .70 | SW = 67.5 |
| 412 | 0.0 | 0.0 | 0.0 | FILLER | M = .70 | SW = 67.5 |
| 413 | 0.0 | 0.0 | 0.0 | FILLER | M = .70 | SW = 67.5 |
| 414 | 0.0 | 0.0 | 0.0 | FILLER | M = .70 | SW = 67.5 |
| 415 | 0.0 | 0.0 | 0.0 | FILLER | M = .70 | SW = 67.5 |
| 501 | 0.002959 | -0.000086 | 0.0 | ALPHA=0 (VERTICAL) | M = .70 | SW = 67.5 |
| 502 | 0.001980 | 0.000300 | 0.0 | ALPHA (VERTICAL) | M = .70 | SW = 67.5 |
| 503 | 0.000175 | 0.000023 | 0.000014 | ROLL VEL P (LATERAL) | M = .70 | SW = 67.5 |
| 504 | -0.003466 | -0.000579 | -0.000301 | BETA (LATERAL) | M = .70 | SW = 67.5 |
| 505 | 0.0 | 0.0 | 0.0 | FILLER | M = .70 | SW = 67.5 |
| 506 | 0.0 | 0.0 | 0.0 | FILLER | M = .70 | SW = 67.5 |
| 507 | 0.0 | 0.0 | 0.0 | FILLER | M = .70 | SW = 67.5 |
| 508 | 0.0 | 0.0 | 0.0 | FILLER | M = .70 | SW = 67.5 |
| 509 | 0.0 | 0.0 | 0.0 | FILLER | M = .70 | SW = 67.5 |
| 510 | 0.0 | 0.0 | 0.0 | FILLER | M = .70 | SW = 67.5 |
| 511 | 0.0 | 0.0 | 0.0 | FILLER | M = .70 | SW = 67.5 |
| 512 | 0.0 | 0.0 | 0.0 | FILLER | M = .70 | SW = 67.5 |
| 513 | 0.0 | 0.0 | 0.0 | FILLER | M = .70 | SW = 67.5 |
| 514 | 0.0 | 0.0 | 0.0 | FILLER | M = .70 | SW = 67.5 |
| 515 | 0.0 | 0.0 | 0.0 | FILLER | M = .70 | SW = 67.5 |
| 601 | 0.004896 | 0.000736 | 0.0 | ALPHA=0 (VERTICAL) | M = .70 | SW = 67.5 |
| 602 | 0.000029 | 0.000004 | 0.0 | ALPHA (VERTICAL) | M = .70 | SW = 67.5 |
| 603 | -0.002010 | -0.000145 | -0.000175 | BETA ALPHA=0 C/O LATM | M = .70 | SW = 67.5 |
| 604 | -0.000034 | 0.0 | 0.0 | BETA ALPHA C/O (LAT) | M = .70 | SW = 67.5 |
| 605 | 0.000722 | 0.000095 | 0.000063 | DELTA H PRIME (LAT) | M = .70 | SW = 67.5 |
| 606 | 0.000229 | 0.000016 | 0.000020 | DELTA RUD LOW (LAT) | M = .70 | SW = 67.5 |
| 607 | 0.000565 | 0.000069 | 0.000049 | ROLL VELOCITY P LAT | M = .70 | SW = 67.5 |
| 608 | -0.000672 | -0.000068 | -0.000058 | BETA (LATERAL) | M = .70 | SW = 67.5 |
| 609 | 0.0 | 0.0 | 0.0 | FILLER | M = .70 | SW = 67.5 |
| 610 | 0.0 | 0.0 | 0.0 | FILLER | M = .70 | SW = 67.5 |
| 611 | 0.0 | 0.0 | 0.0 | FILLER | M = .70 | SW = 67.5 |
| 612 | 0.0 | 0.0 | 0.0 | FILLER | M = .70 | SW = 67.5 |
| 613 | 0.0 | 0.0 | 0.0 | FILLER | M = .70 | SW = 67.5 |
| 614 | 0.0 | 0.0 | 0.0 | FILLER | M = .70 | SW = 67.5 |
| 615 | 0.0 | 0.0 | 0.0 | FILLER | M = .70 | SW = 67.5 |

APPENDIX H

RIGID AIRLOAD COEFFICIENTS AT LOAD REFERENCE POINTS ($M = 1.60$, $\Lambda_W = 67.5^\circ$)

The location of the load reference points where the rigid airload coefficients have been determined are presented in figure B-1. All of these stations, with the exception of the vertical tail root (VTR), are the stations where loads will be measured during the B-1 Flight Loads Survey program.

The rigid airload coefficients were determined for each of the applicable aerodynamic effects listed in table I and are presented in tables H-I through H-VI. These coefficients were determined using equations 4, 7, and 10. The component applicable reference areas, semispans and mean aerodynamic chords are listed in the coefficient tables.

Notes in appendix C which apply to tables B-I through B-VI for $M = 0.85$ data apply correspondingly to tables H-I through H-VI for $M = 1.60$ data.

TABLE H-I.- WING COEFFICIENTS AT X_{RS} 354 FOR 1.60M AND $\Lambda_W = 67.5^\circ$

$$S_W = 1946.0 \text{ ft}^2$$

$$b_W/2 = 820.08 \text{ in.}$$

$$\bar{C}_W = 184.05 \text{ in.}$$

Coefficients are applicable to either left or right wing.

| Effect | C_{VZ} (shear) | C_{BX} (moment) | C_{TY} (torsion) |
|-----------------------|---------------------|----------------------|-----------------------|
| $\alpha = 0$ | .020939 | .006560 | -.002288 |
| α | .010702 | .003193 | .000306 |
| $\dot{\alpha}$ | .0 | .0 | .0 |
| δSP | -.000148 | -.000030 | .000020 |
| P | -.002472 | -.000757 | -.000063 |
| Q | .035134 | .010720 | -.002668 |
| $\beta\alpha = 0$ A/S | -.000619 | -.000151 | .000291 |
| $\beta\alpha$ A/S | -.000454 | -.000115 | -.000038 |
| $\beta\alpha = 0$ Sym | .000045 | .0 | -.000135 |
| $\beta\alpha$ Sym | .000025 | .000025 | -.000051 |

C_{VZ} , + Up and perpendicular to the wing reference plane.

C_{BX} , + Tip up and about an axis perpendicular to the wing load reference line (0.36c line)*.

C_{TY} , + Leading edge up and about the wing load reference line (0.36c line)*.

*The wing load reference line passes through the pivot (at X_{RS} 139.515, X_{RS} -49.845) and the load reference point (at X_{RS} 354, Y_{RS} -38.248).

TABLE H-II.- HORIZONTAL TAIL COEFFICIENTS AT BP 10.75
 FOR 1.60M AND $\Lambda_W = 67.5^\circ$

$$S_{HT} = 238.77 \text{ ft}^2$$

$$b_{HT}/2 = 259.03 \text{ in.}$$

$$\bar{c}_{HT} = 149.38 \text{ in.}$$

Coefficients are applicable to either left or right horizontal tail.

| Effect | C_{VZ} (shear) | C_{BX} (moment) | C_{TY} (torsion) |
|-------------------|---------------------|----------------------|-----------------------|
| $\alpha = 0$ | -.082380 | -.028675 | .029277 |
| α | .020148 | .009443 | -.010049 |
| δH | .038529 | .017524 | -.019050 |
| $\dot{\alpha}$ | .119250 | .061051 | -.063703 |
| β | -.020150 | -.007246 | .003210 |
| $\delta'H$ | .017256 | .007993 | -.008290 |
| δSP (Sym) | -.000386 | -.000168 | .000195 |
| δSP (a/s) | .000147 | .000077 | -.000090 |
| P | -.002359 | -.001922 | .002119 |
| Q | .393370 | .183300 | -.219810 |

C_{VZ} , + Up and perpendicular to the airplane water plane.

C_{BX} , + Tip up and about an axis parallel to the longitudinal axis.

C_{TY} , + Leading edge up and about an axis perpendicular to the plane of symmetry.

TABLE H-III.- VERTICAL TAIL COEFFICIENTS AT WL 136.56
 FOR 1.60M AND $\Lambda_W = 67.5^\circ$

$$S_{VT} = 247.4 \text{ ft}^2$$

$$b_{VT}/2 = 206.76 \text{ in.}$$

$$\bar{C}_{VT} = 188.95 \text{ in.}$$

Coefficients are applicable on the upper vertical tail (UVT).

| Effect | C_{VY} (shear) | C_{BX} (moment) | C_{TZ} (torsion) |
|-------------------|---------------------|----------------------|-----------------------|
| $\beta\alpha = 0$ | -.034658 | -.005487 | .006545 |
| $\beta\alpha$ | -.000953 | -.000151 | .000180 |
| $\delta'H$ | -.002820 | -.000123 | .000583 |
| δSP | -.000122 | -.000020 | .000020 |
| δUR | .005500 | .000825 | .001954 |
| δRL | .0 | .0 | .0 |
| P | -.004395 | -.000856 | .001090 |
| R | .031527 | .005128 | -.006678 |

C_{VY} , + To the right and normal to the plane of symmetry.

C_{BX} , + Tip to the right and about an axis parallel to the longitudinal axis.

C_{TZ} , + Leading edge right and about an axis perpendicular to the water plane.

TABLE H-IV.- FORWARD FUSELAGE COEFFICIENTS
 AT FS 528.5 FOR 1.60M AND $\Lambda_W = 67.5^\circ$

$$S_{FF} = 1946.0 \text{ ft}^2$$

$$b_{FF}/2 = 820.08 \text{ in.}$$

$$\bar{C}_{FF} = 184.05 \text{ in.}$$

Coefficients are based on the airloads on the fuselage forward of FS 528.5.

| Effect | C_{VZ} (shear) | C_{BY} (moment) | C_{VY} (shear) | C_{BZ} (moment) | C_{TX} (torsion) |
|--------------|---------------------|----------------------|---------------------|----------------------|-----------------------|
| $\alpha = 0$ | .000481 | -.001118 | | | |
| α | .001812 | .000256 | | | |
| P | | | .001221 | .000088 | .000106 |
| β | | | -.004710 | -.000340 | -.000409 |

C_{VX} , + Up and normal to the water plane.

C_{BY} , + Nose up and about an axis perpendicular to the plane of symmetry.

C_{VY} , + To the right and normal to the plane of symmetry.

C_{BZ} , + Nose right and about an axis perpendicular to the water plane.

C_{TX} , + Left wing up and about an axis parallel to the longitudinal axis.

TABLE H-V. AFT FUSELAGE COEFFICIENTS AT
FS 1337.5 FOR 1.60M and $\Lambda_W = 67.5^\circ$

$$S_{AF} = S_{REF} = 1946.0 \text{ ft}^2$$

$$b_{AF}/2 = b_{REF}/2 = 820.08 \text{ in.}$$

$$\bar{C}_{AF} = \bar{C}_{REF} = 184.05 \text{ in.}$$

Coefficients are based on the airloads on the fuselage aft of FS1337.5 and do not include the airloads on the empennage. (Refer to Appendix C for equations which include the airloads on the empennage.)

| Effect | C_{VZ} (shear) | C_{BY} (moment) | C_{VY} (shear) | C_{BZ} (moment) | C_{TY} (torsion) |
|-------------------------------|---------------------|----------------------|---------------------|----------------------|-----------------------|
| $\alpha = 0$ | .005458 | .001981 | | | |
| α | .0 | .0 | | | |
| $\beta\alpha = 0 \text{ c/o}$ | | | -.002300 | -.000166 | -.000200 |
| $\beta\alpha \text{ c/o}$ | | | -.000070 | .0 | .0 |
| $\delta'H$ | | | -.000803 | -.000105 | -.000070 |
| $\delta'RL$ | | | .000018 | .0 | .0 |
| P | | | .000340 | .000042 | .000030 |
| β | | | -.001170 | -.000119 | -.000102 |

C_{VZ} , + Up and normal to the water plane.

C_{BY} , + Aft end up and about an axis perpendicular to the plane of symmetry.

C_{VY} , + To the right and normal to the plane of symmetry.

C_{BZ} , + Aft end right and about an axis perpendicular to the water plane.

C_{TX} , + Left wing up and about an axis parallel to the longitudinal axis.

TABLE H-VI.- VERTICAL TAIL COEFFICIENTS AT WL 75.0
 FOR 1.60M and $\Lambda_W = 67.5^\circ$

$$S_{VT} = 247.4 \text{ ft}^2$$

$$b_{VT}/2 = 206.76 \text{ in.}$$

$$\bar{C}_{VT} = 188.95 \text{ in.}$$

Coefficients are at the vertical tail root (VTR) and are for use in the equations in Appendix C for the determination of the new airloads coefficients for the aft fuselage point at FS 1337.5.

| Effect | C_{VY} (shear) | C_{BX} (moment) | C_{TZ} (torsion) |
|--------------------|---------------------|----------------------|-----------------------|
| $\beta \alpha = 0$ | .053847 | .011700 | -.006195 |
| $\beta \alpha$ | -.001471 | -.000322 | .000170 |
| $\delta 'H$ | -.002021 | -.000480 | .000468 |
| δSP | -.000157 | -.000040 | .000018 |
| δRU | .005506 | .001645 | -.001956 |
| δRL | .002729 | .000121 | -.000521 |
| P | -.003603 | -.001475 | .001220 |
| R | .047887 | .011025 | -.007172 |

C_{VY} , + To the right and normal to the plane at symmetry.

C_{BX} , + Tip to the right and about an axis parallel to the plane of symmetry.

C_{TZ} , + Leading edge right and about an axis perpendicular to the water plane.

TABLE H-VII.- LOAD COEFFICIENTS DATA CARD LISTING

NASA ARS CASE 5 M=1.6 SW=67.5 WIND TUNNEL DATA RIGID

| SEQ. NO. | CV | CB | CT | TITLE | |
|----------|-----------|-----------|-----------|-----------------------|-------------------|
| 101 | 0.020939 | 0.006560 | -0.002288 | ALPHA = 0 | M = 1.6 SW = 67.5 |
| 102 | 0.010702 | 0.003193 | 0.000306 | ALPHA | M = 1.6 SW = 67.5 |
| 103 | 0.0 | 0.0 | 0.0 | ALPHA DGT | M = 1.6 SW = 67.5 |
| 104 | -0.000148 | -0.000030 | 0.000020 | DELTA SPOILER | M = 1.6 SW = 67.5 |
| 105 | -0.002472 | -0.000757 | -0.000063 | ROLL VELOCITY P | M = 1.6 SW = 67.5 |
| 106 | 0.035134 | 0.010720 | -0.002668 | PITCH VELOCITY Q | M = 1.6 SW = 67.5 |
| 107 | -0.000619 | -0.000151 | 0.000291 | BETA ALPHA=0 A/S | M = 1.6 SW = 67.5 |
| 108 | -0.000454 | -0.000115 | -0.000038 | BETA ALPHA A/S | M = 1.6 SW = 67.5 |
| 109 | 0.000045 | 0.0 | -0.000135 | BETA ALPHA=0 SYM | M = 1.6 SW = 67.5 |
| 110 | 0.000025 | 0.000025 | -0.000051 | BETA ALPHA SYM | M = 1.6 SW = 67.5 |
| 111 | 0.0 | 0.0 | 0.0 | FILLER | M = 1.6 SW = 67.5 |
| 112 | 0.0 | 0.0 | 0.0 | FILLER | M = 1.6 SW = 67.5 |
| 113 | 0.0 | 0.0 | 0.0 | FILLER | M = 1.6 SW = 67.5 |
| 114 | 0.0 | 0.0 | 0.0 | FILLER | M = 1.6 SW = 67.5 |
| 115 | 0.0 | 0.0 | 0.0 | FILLER | M = 1.6 SW = 67.5 |
| 201 | -0.082380 | -0.028675 | 0.029277 | ALPHA = 0 | M = 1.6 SW = 67.5 |
| 202 | 0.020148 | 0.009443 | -0.010049 | ALPHA | M = 1.6 SW = 67.5 |
| 203 | 0.038529 | 0.017524 | -0.019050 | DELTA H | M = 1.6 SW = 67.5 |
| 204 | 0.119250 | 0.061051 | -0.063703 | ALPHA DGT | M = 1.6 SW = 67.5 |
| 205 | -0.020150 | -0.007246 | 0.005210 | BETA | M = 1.6 SW = 67.5 |
| 206 | 0.017250 | 0.007993 | -0.008290 | DELTA H PRIME | M = 1.6 SW = 67.5 |
| 207 | -0.000386 | -0.000168 | 0.000195 | DELTA SPOILER SYM | M = 1.6 SW = 67.5 |
| 208 | 0.000147 | 0.000077 | -0.000090 | DELTA SPOILER A/S | M = 1.6 SW = 67.5 |
| 209 | -0.002359 | -0.001922 | 0.002119 | ROLL VELOCITY P | M = 1.6 SW = 67.5 |
| 210 | 0.393370 | 0.183300 | -0.219810 | PITCH VELOCITY Q | M = 1.6 SW = 67.5 |
| 211 | 0.0 | 0.0 | 0.0 | FILLER | M = 1.6 SW = 67.5 |
| 212 | 0.0 | 0.0 | 0.0 | FILLER | M = 1.6 SW = 67.5 |
| 213 | 0.0 | 0.0 | 0.0 | FILLER | M = 1.6 SW = 67.5 |
| 214 | 0.0 | 0.0 | 0.0 | FILLER | M = 1.6 SW = 67.5 |
| 215 | 0.0 | 0.0 | 0.0 | FILLER | M = 1.6 SW = 67.5 |
| 301 | -0.034658 | -0.005467 | 0.006545 | BETA ALPHA=0 136.56M | M = 1.6 SW = 67.5 |
| 302 | -0.000953 | -0.000151 | 0.000160 | BETA ALPHA 136.56M | M = 1.6 SW = 67.5 |
| 303 | -0.002820 | -0.000123 | 0.000583 | DELTA H PRIME 136.56M | M = 1.6 SW = 67.5 |
| 304 | -0.000122 | -0.000020 | 0.000020 | DELTA SPOILER 136.56M | M = 1.6 SW = 67.5 |
| 305 | 0.005500 | 0.000825 | 0.001954 | DELTA RUD UP 136.56M | M = 1.6 SW = 67.5 |
| 306 | 0.0 | 0.0 | 0.0 | DELTA RUD LUD 136.56M | M = 1.6 SW = 67.5 |
| 307 | -0.004395 | -0.000856 | 0.001090 | ROLL VELOC P 136.56M | M = 1.6 SW = 67.5 |
| 308 | 0.031527 | 0.005128 | -0.006678 | PITCH VELOC Q 136.56M | M = 1.6 SW = 67.5 |
| 309 | 0.0 | 0.0 | 0.0 | FILLER | M = 1.6 SW = 67.5 |
| 310 | 0.0 | 0.0 | 0.0 | FILLER | M = 1.6 SW = 67.5 |
| 311 | 0.0 | 0.0 | 0.0 | FILLER | M = 1.6 SW = 67.5 |
| 312 | 0.0 | 0.0 | 0.0 | FILLER | M = 1.6 SW = 67.5 |
| 313 | 0.0 | 0.0 | 0.0 | FILLER | M = 1.6 SW = 67.5 |
| 314 | 0.0 | 0.0 | 0.0 | FILLER | M = 1.6 SW = 67.5 |
| 315 | 0.0 | 0.0 | 0.0 | FILLER | M = 1.6 SW = 67.5 |
| 401 | 0.053487 | 0.011700 | -0.006195 | BETA ALPHA=0 WL 75M | M = 1.6 SW = 67.5 |

TABLE H-VII. Concluded

| | | | | | |
|-----|-----------|-----------|-----------|-----------------------|------------------------|
| 402 | -0.001471 | -0.000322 | 0.000170 | BETA ALPHA | WL 75M = 1.6 SW = 67.5 |
| 403 | -0.002021 | -0.000480 | 0.000468 | DELTA H PRIME | WL 75M = 1.6 SW = 67.5 |
| 404 | -0.000157 | -0.000040 | 0.000018 | DELTA SPOILER | WL 75M = 1.6 SW = 67.5 |
| 405 | 0.000506 | 0.001645 | -0.001956 | DELTA RUD UP | WL 75M = 1.6 SW = 67.5 |
| 406 | 0.002729 | 0.000121 | -0.000521 | DELTA RUD LOW | WL 75M = 1.6 SW = 67.5 |
| 407 | -0.003003 | -0.001475 | 0.001220 | ROLL VELOC P | WL 75M = 1.6 SW = 67.5 |
| 408 | 0.047887 | 0.011025 | -0.007172 | YAW VELOC R | WL 75M = 1.6 SW = 67.5 |
| 409 | 0.0 | 0.0 | 0.0 | FILLER | M = 1.6 SW = 67.5 |
| 410 | 0.0 | 0.0 | 0.0 | FILLER | M = 1.6 SW = 67.5 |
| 411 | 0.0 | 0.0 | 0.0 | FILLER | M = 1.6 SW = 67.5 |
| 412 | 0.0 | 0.0 | 0.0 | FILLER | M = 1.6 SW = 67.5 |
| 413 | 0.0 | 0.0 | 0.0 | FILLER | M = 1.6 SW = 67.5 |
| 414 | 0.0 | 0.0 | 0.0 | FILLER | M = 1.6 SW = 67.5 |
| 415 | 0.0 | 0.0 | 0.0 | FILLER | M = 1.6 SW = 67.5 |
| 501 | 0.000481 | -0.001118 | 0.0 | ALPHA=0 (VERTICAL) | M = 1.6 SW = 67.5 |
| 502 | 0.001812 | 0.000256 | 0.0 | ALPHA (VERTICAL) | M = 1.6 SW = 67.5 |
| 503 | 0.001221 | 0.000088 | 0.000106 | BETA ALPHA=0 C/O LATM | M = 1.6 SW = 67.5 |
| 504 | -0.004710 | -0.000340 | -0.000409 | BETA (LATERAL) | M = 1.6 SW = 67.5 |
| 505 | 0.0 | 0.0 | 0.0 | FILLER | M = 1.6 SW = 67.5 |
| 506 | 0.0 | 0.0 | 0.0 | FILLER | M = 1.6 SW = 67.5 |
| 507 | 0.0 | 0.0 | 0.0 | FILLER | M = 1.6 SW = 67.5 |
| 508 | 0.0 | 0.0 | 0.0 | FILLER | M = 1.6 SW = 67.5 |
| 509 | 0.0 | 0.0 | 0.0 | FILLER | M = 1.6 SW = 67.5 |
| 510 | 0.0 | 0.0 | 0.0 | FILLER | M = 1.6 SW = 67.5 |
| 511 | 0.0 | 0.0 | 0.0 | FILLER | M = 1.6 SW = 67.5 |
| 512 | 0.0 | 0.0 | 0.0 | FILLER | M = 1.6 SW = 67.5 |
| 513 | 0.0 | 0.0 | 0.0 | FILLER | M = 1.6 SW = 67.5 |
| 514 | 0.0 | 0.0 | 0.0 | FILLER | M = 1.6 SW = 67.5 |
| 515 | 0.0 | 0.0 | 0.0 | FILLER | M = 1.6 SW = 67.5 |
| 601 | 0.005458 | 0.001981 | 0.0 | ALPHA=0 (VERTICAL) | M = 1.6 SW = 67.5 |
| 602 | 0.0 | 0.0 | 0.0 | ALPHA (VERTICAL) | M = 1.6 SW = 67.5 |
| 603 | -0.002300 | -0.000160 | -0.000200 | BETA ALPHA=0 C/O LATM | M = 1.6 SW = 67.5 |
| 604 | -0.000070 | 0.0 | 0.0 | BETA ALPHA C/O (LAT) | M = 1.6 SW = 67.5 |
| 605 | -0.000803 | -0.000105 | -0.000070 | DELTA H PRIME (LAT) | M = 1.6 SW = 67.5 |
| 606 | 0.000018 | 0.0 | 0.0 | DELTA RUD LOW (LAT) | M = 1.6 SW = 67.5 |
| 607 | 0.000340 | 0.000042 | 0.000030 | ROLL VELOCITY P LAT | M = 1.6 SW = 67.5 |
| 608 | -0.001170 | -0.000119 | -0.000102 | BETA (LATERAL) | M = 1.6 SW = 67.5 |
| 609 | 0.0 | 0.0 | 0.0 | FILLER | M = 1.6 SW = 67.5 |
| 610 | 0.0 | 0.0 | 0.0 | FILLER | M = 1.6 SW = 67.5 |
| 611 | 0.0 | 0.0 | 0.0 | FILLER | M = 1.6 SW = 67.5 |
| 612 | 0.0 | 0.0 | 0.0 | FILLER | M = 1.6 SW = 67.5 |
| 613 | 0.0 | 0.0 | 0.0 | FILLER | M = 1.6 SW = 67.5 |
| 614 | 0.0 | 0.0 | 0.0 | FILLER | M = 1.6 SW = 67.5 |
| 615 | 0.0 | 0.0 | 0.0 | FILLER | M = 1.6 SW = 67.5 |

APPENDIX J

RIGID AIRLOAD COEFFICIENTS AT LOAD REFERENCE POINTS ($M = 2.20$, $\Lambda_W = 67.5^\circ$)

The location of the load reference points where the rigid airload coefficients have been determined are presented in figure B-1. All of these stations, with the exception of the vertical tail root (VTR), are the stations where loads will be measured during the B-1 Flight Loads Survey program.

The rigid airload coefficients were determined for each of the applicable aerodynamic effects listed in table I and are presented in tables J-I through J-VI. These coefficients were determined using equations 4, 7, and 10. The component applicable reference areas, semispans and mean aerodynamic chords are listed in the coefficient tables.

Notes in appendix C which apply to tables B-I through B-VI for $M = 0.85$ data apply correspondingly to tables J-I through J-VI for $M = 2.20$ data.

TABLE J-I.- WING COEFFICIENTS AT X_{RS} 354 FOR 2.20M AND $\Lambda_W = 67.5^\circ$

$$S_W = 1946.0 \text{ ft}^2$$

$$b_W/2 = 820.08 \text{ in.}$$

$$\bar{C}_W = 184.05 \text{ in.}$$

Coefficients are applicable to either left or right wing.

| Effect | C_{VZ} (shear) | C_{BX} (moment) | C_{TY} (torsion) |
|-----------------------|---------------------|----------------------|-----------------------|
| $\alpha = 0$ | .018800 | .005150 | -.003918 |
| α | .009300 | .002617 | -.000384 |
| $\dot{\alpha}$ | .0 | .0 | .0 |
| δSP | -.000097 | -.000020 | .000016 |
| P | -.002083 | -.000648 | -.000036 |
| Q | .025344 | .008402 | -.003291 |
| $\beta\alpha = 0$ A/S | -.000743 | -.000127 | .000291 |
| $\beta\alpha$ A/S | .000055 | .000011 | .0 |
| $\beta\alpha = 0$ Sym | -.000164 | -.000116 | -.000036 |
| $\beta\alpha$ Sym | -.000179 | -.000054 | .000058 |

C_{VZ} , + Up and perpendicular to the wing reference plane.

C_{BX} , + Tip up and about an axis perpendicular to the wing load reference line (0.36c line)*.

C_{TY} , + Leading edge up and about the wing load reference line (0.36c line)*.

*The wing load reference line passes through the pivot (at X_{RS} 139.515, Y_{RS} -49.845) and the load reference point (at X_{RS} 354, Y_{RS} -38.248).

TABLE J-II.- HORIZONTAL TAIL COEFFICIENTS AT BP 10.75

FOR 2.20M AND $\Lambda_W = 67.5^\circ$

$$S_{HT} = 238.77 \text{ ft}^2$$

$$b_{HT}/2 = 259.03 \text{ in.}$$

$$\bar{C}_{HT} = 149.38 \text{ in.}$$

Coefficients are applicable to either left or right horizontal tail.

| Effect | C_{VZ} (shear) | C_{BX} (moment) | C_{TY} (torsion) |
|-------------------|---------------------|----------------------|-----------------------|
| $\alpha = 0$ | -.062590 | -.020695 | .022117 |
| α | .018928 | .009394 | -.010369 |
| δH | .025820 | .011969 | -.012889 |
| $\dot{\alpha}$ | .048821 | .024229 | -.026745 |
| β | .0 | .0 | .0 |
| $\delta'H$ | .023039 | .010680 | -.011501 |
| δSP (Sym) | -.000089 | -.000039 | .000045 |
| δSP (a/s) | .000034 | .000018 | -.000020 |
| P | -.002071 | -.001590 | .001867 |
| Q | .254600 | .111350 | -.144600 |

C_{VZ} , + Up and perpendicular to the airplane water plane.

C_{BX} , + Tip up and about an axis parallel to the longitudinal axis.

C_{TY} , + Leading edge up and about an axis perpendicular to the plane of symmetry.

TABLE J-III.- VERTICAL TAIL COEFFICIENTS AT WL 136.56

FOR 2.20M AND $\Lambda_W = 67.5^\circ$

$$S_{VT} = 247.4 \text{ ft}^2$$

$$b_{VT}/2 = 206.76 \text{ in.}$$

$$\bar{C}_{VT} = 188.95 \text{ in.}$$

Coefficients are applicable on the upper vertical tail (UVT).

| Effect | C_{VY} (shear) | C_{BX} (moment) | C_{TZ} (torsion) |
|--------------------|---------------------|----------------------|-----------------------|
| $\beta \alpha = 0$ | -.023927 | -.003838 | .004513 |
| $\beta \alpha$ | -.000489 | -.000078 | .000092 |
| $\delta 'H$ | -.001865 | -.000081 | .000386 |
| δSP | -.000091 | -.000015 | .000015 |
| δUR | .003299 | .000499 | -.001192 |
| δRL | .0 | .0 | .0 |
| P | -.003896 | -.000788 | .000983 |
| R | .018237 | .002966 | -.004283 |

C_{VY} , + To the right and normal to the plane of symmetry.

C_{BX} , + Tip to the right and about an axis parallel to the longitudinal axis.

C_{TZ} , + Leading edge right and about an axis perpendicular to the water plane.

TABLE J-IV. - FORWARD FUSELAGE COEFFICIENTS
 AT FS 528.5 FOR 2.20M AND $\Lambda_W = 67.5^\circ$

$$S_{FF} = 1946.0 \text{ ft}^2$$

$$b_{FF}/2 = 820.08 \text{ in.}$$

$$\bar{C}_{FF} = 184.05 \text{ in.}$$

Coefficients are based on the airloads on the fuselage forward of FS 528.5.

| Effect | C_{VZ} (shear) | C_{BY} (moment) | C_{VY} (shear) | C_{BZ} (moment) | C_{TX} (torsion) |
|--------------|---------------------|----------------------|---------------------|----------------------|-----------------------|
| $\alpha = 0$ | -.003902 | -.001250 | | | |
| α | .001489 | .000233 | | | |
| P | | | .000056 | .0 | .0 |
| β | | | -.006606 | -.001104 | -.000574 |

C_{VZ} , + Up and normal to the water plane.

C_{BY} , + Nose up and about an axis perpendicular to the plane of symmetry.

C_{VY} , + To the right and normal to the plane of symmetry.

C_{BZ} , + Nose right and about an axis perpendicular to the water plane.

C_{TX} , + Left wing up and about an axis parallel to the longitudinal axis.

TABLE J-V.- AFT FUSELAGE COEFFICIENTS AT
FS 1337.5 FOR 2.20M and $\Lambda_W = 67.5^\circ$

$$S_{AF} = S_{REF} = 1946.0 \text{ ft}^2$$

$$b_{AF}/2 = b_{REF}/2 = 820.08 \text{ in.}$$

$$\bar{C}_{AF} = \bar{C}_{REF} = 184.05 \text{ in.}$$

Coefficients are based on the airloads on the fuselage aft of FS1337.5 and do not include the airloads on the empennage. (Refer to Appendix C for equations which include the airloads on the empennage.)

| Effect | C_{VZ} (shear) | C_{BY} (moment) | C_{VY} (shear) | C_{BZ} (moment) | C_{TY} (torsion) |
|-----------------------|---------------------|----------------------|---------------------|----------------------|-----------------------|
| $\alpha = 0$ | .008028 | .001533 | | | |
| α | .000142 | .000008 | | | |
| $\beta\alpha = 0$ c/o | | | -.000104 | -.000014 | .0 |
| $\beta\alpha$ c/o | | | -.000025 | .0 | .0 |
| $\delta'H$ | | | .000024 | .0 | .0 |
| $\delta'RL$ | | | .000041 | .0 | .0 |
| P | | | .000179 | .000022 | .000016 |
| β | | | -.001422 | -.000144 | -.000124 |

C_{VZ} , + Up and normal to the water plane.

C_{BY} , + Aft end up and about an axis perpendicular to the plane of symmetry.

C_{VY} , + To the right and normal to the plane of symmetry.

C_{BZ} , + Aft end right and about an axis perpendicular to the water plane.

C_{TY} , + Left wing up and about an axis parallel to the longitudinal axis.

TABLE J-VI.- VERTICAL TAIL COEFFICIENTS AT WL 75.0

FOR 2.20M AND $\Lambda_w = 67.5^\circ$

$$S_{VT} = 247.4 \text{ ft}^2$$

$$b_{VT}/2 = 206.76 \text{ in.}$$

$$\bar{c}_{VT} = 188.95 \text{ in.}$$

Coefficients are at the vertical tail root (VTR) and are for use in the equations in Appendix C for the determination of the new airloads coefficients for the aft fuselage point at FS 1337.5.

| Effect | C_{VY} (shear) | C_{BX} (moment) | C_{TZ} (torsion) |
|--------------------|---------------------|----------------------|-----------------------|
| $\beta \alpha = 0$ | .035396 | .008037 | -.004340 |
| $\beta \alpha$ | -.000724 | -.000164 | .000089 |
| $\delta 'H$ | -.001337 | -.000317 | .000310 |
| δSP | -.000118 | -.000030 | .000013 |
| δRU | .003302 | .000990 | -.001193 |
| δRL | .000889 | .000039 | -.000174 |
| P | -.002998 | -.001323 | -.001025 |
| R | .029111 | .006471 | -.004185 |

C_{VY} , + To the right and normal to the plane at symmetry.

C_{BX} , + Tip to the right and about an axis parallel to the plane of symmetry.

C_{TZ} , + Leading edge right and about an axis perpendicular to the water plane.

TABLE J-VII.- LOAD COEFFICIENTS DATA CARD LISTING

NASA ARS CASE 6 M=2.20 SW=67.5 WIND TUNNEL DATA RIGID

NSFG(I) SEQUENCE NUMBER 1XX - WING AT XRS 354.

- 2XX - HORIZONTAL TAIL AT BP 10.75
- 3XX - VERTICAL TAIL AT WL 136.56
- 4XX - VERTICAL TAIL AT WL 75.0
- 5XX - FORWARD FUSELAGE AT FS 528.5
- 6XX - AFT FUSELAGE AT FS 1337.5

CV(I) - COEFFICIENT OF SHEAR EACH EFFECT

CB(I) - COEFFICIENT OF BENDING MOMENT EACH EFFECT

CT(I) - COEFFICIENT OF TORSION EACH EFFECT

| SEQ. NO. | CV | CB | CT | TITLE | |
|----------|-----------|-----------|-----------|---------------------|-------------------------|
| 101 | 0.018800 | 0.005150 | -0.003918 | ALPHA = 0 | M = 2.2 SW = 67.5 |
| 102 | 0.009300 | 0.002617 | -0.000384 | ALPHA | M = 2.2 SW = 67.5 |
| 103 | 0.0 | 0.0 | 0.0 | ALPHA DOT | M = 2.2 SW = 67.5 |
| 104 | -0.000097 | -0.000020 | 0.000016 | DELTA SPOILER | M = 2.2 SW = 67.5 |
| 105 | -0.002083 | -0.000648 | -0.000036 | ROLL VELOCITY P | M = 2.2 SW = 67.5 |
| 106 | 0.025344 | 0.008402 | -0.003291 | PITCH VELOCITY Q | M = 2.2 SW = 67.5 |
| 107 | -0.000743 | -0.000127 | 0.000290 | BETA ALPHA ZERO A/S | M = 2.2 SW = 67.5 |
| 108 | 0.000055 | 0.000011 | 0.0 | BETA ALPHA A/S | M = 2.2 SW = 67.5 |
| 109 | -0.000164 | -0.000116 | -0.000036 | BETA ALPHA ZERO SYM | M = 2.2 SW = 67.5 |
| 110 | -0.000179 | -0.000054 | 0.000058 | BETA ALPHA SYM | M = 2.2 SW = 67.5 |
| 111 | 0.0 | 0.0 | 0.0 | FILLER | M = 2.2 SW = 67.5 |
| 112 | 0.0 | 0.0 | 0.0 | FILLER | M = 2.2 SW = 67.5 |
| 113 | 0.0 | 0.0 | 0.0 | FILLER | M = 2.2 SW = 67.5 |
| 114 | 0.0 | 0.0 | 0.0 | FILLER | M = 2.2 SW = 67.5 |
| 115 | 0.0 | 0.0 | 0.0 | FILLER | M = 2.2 SW = 67.5 |
| 201 | -0.062590 | -0.020695 | 0.022117 | ALPHA = 0 | M = 2.2 SW = 67.5 |
| 202 | 0.018428 | 0.009394 | -0.010369 | ALPHA | M = 2.2 SW = 67.5 |
| 203 | 0.025820 | 0.011969 | -0.012889 | DELTA H | M = 2.2 SW = 67.5 |
| 204 | 0.048821 | 0.024229 | -0.026745 | ALPHA DOT | M = 2.2 SW = 67.5 |
| 205 | 0.0 | 0.0 | 0.0 | BETA | M = 2.2 SW = 67.5 |
| 206 | 0.023039 | 0.010680 | -0.011501 | DELTA H PRIME | M = 2.2 SW = 67.5 |
| 207 | -0.000084 | -0.000039 | 0.000045 | DELTA SPOILER SYM | M = 2.2 SW = 67.5 |
| 208 | 0.000034 | 0.000018 | -0.000020 | DELTA SPOILER A/S | M = 2.2 SW = 67.5 |
| 209 | -0.002071 | -0.001590 | 0.001867 | ROLL VELOCITY P | M = 2.2 SW = 67.5 |
| 210 | 0.254600 | 0.111350 | -0.144600 | PITCH VELOCITY Q | M = 2.2 SW = 67.5 |
| 211 | 0.0 | 0.0 | 0.0 | FILLER | M = 2.2 SW = 67.5 |
| 212 | 0.0 | 0.0 | 0.0 | FILLER | M = 2.2 SW = 67.5 |
| 213 | 0.0 | 0.0 | 0.0 | FILLER | M = 2.2 SW = 67.5 |
| 214 | 0.0 | 0.0 | 0.0 | FILLER | M = 2.2 SW = 67.5 |
| 215 | 0.0 | 0.0 | 0.0 | FILLER | M = 2.2 SW = 67.5 |
| 301 | -0.023527 | -0.003838 | 0.004513 | BETA ALPHA=0 | 136.56M = 2.2 SW = 67.5 |
| 302 | -0.000489 | -0.000078 | 0.000092 | BETA ALPHA | 136.56M = 2.2 SW = 67.5 |
| 303 | -0.001865 | -0.000081 | 0.000386 | DELTA H PRIME | 136.56M = 2.2 SW = 67.5 |
| 304 | -0.000091 | -0.000015 | 0.000015 | DELTA SPOILER | 136.56M = 2.2 SW = 67.5 |
| 305 | 0.003299 | 0.000499 | -0.001192 | DELTA RUD UP | 136.56M = 2.2 SW = 67.5 |
| 306 | 0.0 | 0.0 | 0.0 | DELTA RUD LOW | 136.56M = 2.2 SW = 67.5 |
| 307 | -0.003896 | -0.000768 | 0.000983 | ROLL VELOC P | 136.56M = 2.2 SW = 67.5 |
| 308 | 0.018237 | 0.002966 | -0.004283 | YAW VELOC R | 136.56M = 2.2 SW = 67.5 |
| 309 | 0.0 | 0.0 | 0.0 | FILLER | M = 2.2 SW = 67.5 |
| 310 | 0.0 | 0.0 | 0.0 | FILLER | M = 2.2 SW = 67.5 |
| 311 | 0.0 | 0.0 | 0.0 | FILLER | M = 2.2 SW = 67.5 |
| 312 | 0.0 | 0.0 | 0.0 | FILLER | M = 2.2 SW = 67.5 |
| 313 | 0.0 | 0.0 | 0.0 | FILLER | M = 2.2 SW = 67.5 |
| 314 | 0.0 | 0.0 | 0.0 | FILLER | M = 2.2 SW = 67.5 |
| 315 | 0.0 | 0.0 | 0.0 | FILLER | M = 2.2 SW = 67.5 |
| 401 | 0.035396 | 0.008037 | -0.004340 | BETA ALPHA=0 | WL 75M = 2.2 SW = 67.5 |

TABLE J-VII. Concluded

| | | | | | |
|-----|-----------|-----------|-----------|-----------------------|------------------------|
| 402 | -0.000724 | -0.000164 | 0.000069 | BETA ALPHA | WL 75M = 2.2 SW = 67.5 |
| 403 | -0.001337 | -0.000317 | 0.000310 | DELTA H PRIME | WL 75M = 2.2 SW = 67.5 |
| 404 | -0.000118 | -0.000030 | 0.000013 | DELTA SPOILER | WL 75M = 2.2 SW = 67.5 |
| 405 | 0.003302 | 0.000950 | -0.001193 | DELTA RUD UP | WL 75M = 2.2 SW = 67.5 |
| 406 | 0.000689 | 0.000039 | -0.000174 | DELTA RUD LOW | WL 75M = 2.2 SW = 67.5 |
| 407 | -0.002998 | -0.001323 | 0.001025 | ROLL VELOC P | WL 75M = 2.2 SW = 67.5 |
| 408 | 0.029111 | 0.006471 | -0.004815 | YAW VELOC R | WL 75M = 2.2 SW = 67.5 |
| 409 | 0.0 | 0.0 | 0.0 | FILLER | M = 2.2 SW = 67.5 |
| 410 | 0.0 | 0.0 | 0.0 | FILLER | M = 2.2 SW = 67.5 |
| 411 | 0.0 | 0.0 | 0.0 | FILLER | M = 2.2 SW = 67.5 |
| 412 | 0.0 | 0.0 | 0.0 | FILLER | M = 2.2 SW = 67.5 |
| 413 | 0.0 | 0.0 | 0.0 | FILLER | M = 2.2 SW = 67.5 |
| 414 | 0.0 | 0.0 | 0.0 | FILLER | M = 2.2 SW = 67.5 |
| 415 | 0.0 | 0.0 | 0.0 | FILLER | M = 2.2 SW = 67.5 |
| 501 | -0.003902 | -0.001250 | 0.0 | ALPHA=0 (VERTICAL) | M = 2.2 SW = 67.5 |
| 502 | 0.001489 | 0.000233 | 0.0 | ALPHA (VERTICAL) | M = 2.2 SW = 67.5 |
| 503 | 0.000056 | 0.0 | 0.0 | ROLL VEL P (LATERAL) | M = 2.2 SW = 67.5 |
| 504 | -0.006606 | -0.001104 | -0.000574 | BETA (LATERAL) | M = 2.2 SW = 67.5 |
| 505 | 0.0 | 0.0 | 0.0 | FILLER | M = 2.2 SW = 67.5 |
| 506 | 0.0 | 0.0 | 0.0 | FILLER | M = 2.2 SW = 67.5 |
| 507 | 0.0 | 0.0 | 0.0 | FILLER | M = 2.2 SW = 67.5 |
| 508 | 0.0 | 0.0 | 0.0 | FILLER | M = 2.2 SW = 67.5 |
| 509 | 0.0 | 0.0 | 0.0 | FILLER | M = 2.2 SW = 67.5 |
| 510 | 0.0 | 0.0 | 0.0 | FILLER | M = 2.2 SW = 67.5 |
| 511 | 0.0 | 0.0 | 0.0 | FILLER | M = 2.2 SW = 67.5 |
| 512 | 0.0 | 0.0 | 0.0 | FILLER | M = 2.2 SW = 67.5 |
| 513 | 0.0 | 0.0 | 0.0 | FILLER | M = 2.2 SW = 67.5 |
| 514 | 0.0 | 0.0 | 0.0 | FILLER | M = 2.2 SW = 67.5 |
| 515 | 0.0 | 0.0 | 0.0 | FILLER | M = 2.2 SW = 67.5 |
| 601 | 0.008028 | 0.001533 | 0.0 | ALPHA=0 (VERTICAL) | M = 2.2 SW = 67.5 |
| 602 | 0.000142 | 0.000008 | 0.0 | ALPHA (VERTICAL) | M = 2.2 SW = 67.5 |
| 603 | -0.000104 | -0.000014 | 0.0 | BETA ALPHA=0 C/O LATM | M = 2.2 SW = 67.5 |
| 604 | -0.000025 | 0.0 | 0.0 | BETA ALPHA C/O (LAT) | M = 2.2 SW = 67.5 |
| 605 | 0.000024 | 0.0 | 0.0 | DELTA H PRIME (LAT) | M = 2.2 SW = 67.5 |
| 606 | 0.000041 | 0.0 | 0.0 | DELTA RUD LOW (LAT) | M = 2.2 SW = 67.5 |
| 607 | 0.000179 | 0.000022 | 0.000016 | ROLL VELOCITY P LAT | M = 2.2 SW = 67.5 |
| 608 | -0.001422 | -0.000144 | -0.000124 | BETA (LATERAL) | M = 2.2 SW = 67.5 |
| 609 | 0.0 | 0.0 | 0.0 | FILLER | M = 2.2 SW = 67.5 |
| 610 | 0.0 | 0.0 | 0.0 | FILLER | M = 2.2 SW = 67.5 |
| 611 | 0.0 | 0.0 | 0.0 | FILLER | M = 2.2 SW = 67.5 |
| 612 | 0.0 | 0.0 | 0.0 | FILLER | M = 2.2 SW = 67.5 |
| 613 | 0.0 | 0.0 | 0.0 | FILLER | M = 2.2 SW = 67.5 |
| 614 | 0.0 | 0.0 | 0.0 | FILLER | M = 2.2 SW = 67.5 |
| 615 | 0.0 | 0.0 | 0.0 | FILLER | M = 2.2 SW = 67.5 |

| | | | |
|--|--|--|--|
| 1. Report No. NASA CR-170410 | 2. Government Accession No. | 3. Recipient's Catalog No. | |
| 4. Title and Subtitle AIRLOADS RESEARCH STUDY VOLUME II: AIRLOAD COEFFICIENTS DERIVED FROM WIND TUNNEL DATA | | 5. Report Date January 1984 | 6. Performing Organization Code |
| | | 8. Performing Organization Report No. NA-76-563 | 10. Work Unit No. |
| 7. Author(s) M. D. Bartlett, T. F. Feltz, A. D. Olsen, Jr., D. B. Smith, and P. F. Wildermuth | | 11. Contract or Grant No. NAS4-2769 | 13. Type of Report and Period Covered Contractor Report - Final |
| 9. Performing Organization Name and Address Rockwell International Los Angeles Division Los Angeles, California 90009 | | 14. Sponsoring Agency Code RTOP 505-33-54 | |
| | | 12. Sponsoring Agency Name and Address National Aeronautics and Space Administration Washington D.C. 20546 | |
| 15. Supplementary Notes NASA Technical Monitor: Robert L. Sims, Ames Research Center, Dryden Flight Research Facility, Edwards, CA. 93523. "Volume I: Flight Test Loads Acquisition" is published as NASA CR-170409. | | | |
| 16. Abstract This report describes the development of B-1 aircraft rigid wind tunnel data for use in subsequent tasks of the Airloads Research Study. The basic intent of the overall program is to utilize data acquired during B-1 aircraft tests, analyze these data beyond the scope of Air Force requirements, and prepare research reports that will add to the technology base for future large flexible aircraft. Data from the Rockwell International external structural loads data bank were used to generate coefficients of rigid airload shear, bending moment, and torsion at specific component reference stations for both symmetric and asymmetric loadings. Component stations include the movable wing, horizontal and vertical stabilizers, and forward and aft fuselages. The coefficient data cover a Mach number range from 0.7 to 2.2 for a wing sweep position of 67.5°. | | | |
| 17. Key Words (Suggested by Author(s)) B-1 airplane Wind tunnel airloads | | 18. Distribution Statement Unclassified-Unlimited STAR category 05 | |
| 19. Security Classif. (of this report) Unclassified | 20. Security Classif. (of this page) Unclassified | 21. No. of Pages 107 | 22. Price* A06 |

*For sale by the National Technical Information Service, Springfield, Virginia 22161

End of Document