

NASA CR-168127
Report ME-TSPC-TR-83-02
July 1983



The Effect of Incidence Angle on the Overall Three-Dimensional Aerodynamic Performance of a Classical Annular Airfoil Cascade

Daniel E. Bergsten and Sanford Fleeter

**Thermal Science and Propulsion Center
School of Mechanical Engineering
Purdue University
West Lafayette, Indiana 47907**

{NASA-CR-168127) THE EFFECT OF INCIDENCE
ANGLE ON THE OVERALL THREE-DIMENSIONAL
AERODYNAMIC PERFORMANCE OF A CLASSICAL
ANNULAR AIRFOIL CASCADE (Purdue Univ.)
468 p HC A20/MF A01

N83-34911

Unclas

CSSL 01A G3/02

42170

**Prepared for
National Aeronautics and Space Administration
NASA-Lewis Research Center
Grant NSG-3285**



NASA CR-168127
Report ME-TSPC-TR-83-02

THE EFFECT OF INCIDENCE ANGLE ON THE
OVERALL THREE-DIMENSIONAL AERODYNAMIC PERFORMANCE OF A
CLASSICAL ANNULAR AIRFOIL CASCADE

BY

Daniel E. Bergsten
and
Sanford Fleeter

July 1983

Thermal Sciences and Propulsion Center
School of Mechanical Engineering
Purdue University
West Lafayette, Indiana 47907

Prepared for
NATIONAL AERONAUTICS AND SPACE ADMINISTRATION
NASA-LEWIS RESEARCH CENTER
Grant NSG-3285

1. Report No. NASA CR-168127		2. Government Accession No		3. Recipient's Catalog No	
4. Title and Subtitle The Effect of Incidence Angle on the Overall Three-Dimensional Aerodynamic Performance of a Classical Annular Airfoil Cascade				5. Report Date July, 1983	
				6. Performing Organization Code	
7. Author(s) Daniel E. Bergsten and Sanford Fleeter				8. Performing Organization Report No. ME-TSPC-TR-83-02	
				10. Work Unit No.	
9. Performing Organization Name and Address Thermal Sciences and Propulsion Center School of Mechanical Engineering Purdue University West Lafayette, Indiana 47907				11. Contract or Grant No. NSG-3285	
				13. Type of Report and Period Covered Contractor Report	
12. Sponsoring Agency Name and Address National Aeronautics and Space Administration Washington, DC 20546				14. Sponsoring Agency Code	
15. Supplementary Notes Project Manager, Donald R. Boldman, NASA-Lewis Research Center, Cleveland, Ohio 44135					
16. Abstract <p>To be of quantitative value to the designer and analyst, it is necessary to experimentally verify the flow modeling and the numerics inherent in calculation codes being developed to predict the three-dimensional flow through turbomachine blade rows. This experimental verification requires that predicted flow fields be correlated with three-dimensional data obtained in experiments which model the fundamental phenomena existing in the flow passages of modern turbomachines. The Purdue Annular Cascade Facility has been designed specifically to provide these required three-dimensional data.</p> <p>The overall three-dimensional aerodynamic performance of an instrumented classical airfoil cascade has been determined over a range of incidence angle values. This was accomplished utilizing a fully automated exit flow data acquisition and analysis system. The mean wake data, acquired at two downstream axial locations, are analyzed to determine the effect of incidence angle, the three-dimensionality of the cascade exit flow field, and the similarity of the wake profiles. The hub, mean, and tip chordwise airfoil surface static pressure distributions determined at each incidence angle are correlated with predictions from the MERIDL and TSONIC computer codes.</p> <p style="text-align: center;">ORIGINAL PAGE IS OF POOR QUALITY</p>					
17. Key Words (Suggested by Author(s)) Cascade Flow Turbomachinery Annular Cascade			18. Distribution Statement Unclassified-unlimited STAR Category 02		
19. Security Classif. (of this report) Unclassified		20. Security Classif. (of this page) Unclassified		21. No. of Pages	22. Price*

ACKNOWLEDGMENTS

Support of the research reported herein by the NASA-Lewis Research Center, Cleveland, Ohio, under Grant NSG-3285, with Mr. Don Boldman serving as technical monitor, is gratefully acknowledged.

SUMMARY

Numerical solutions are currently being developed to predict the three-dimensional flow through turbomachine blade rows. To be of quantitative value to the designer and analyst, it is necessary to experimentally verify the flow modeling and the numerics inherent in these calculation codes. This experimental verification requires that the predicted flow fields be correlated with benchmark quality, three-dimensional data obtained in experiments which model the fundamental phenomena existing in the flow passages of modern turbomachines. The Purdue Annular Cascade Facility has been designed specifically to provide these required three-dimensional data.

A fully automated exit flow data acquisition and analysis system has been developed. This computer controlled system includes automated probe positioning; five-hole cone probe data acquisition, analysis, and error analysis; as well as printing and plotting of the analyzed data. Further, a technique to visualize the isobaric exit flow contours has been demonstrated.

The overall three-dimensional aerodynamic performance of an instrumented classical airfoil cascade has been determined over a range of incidence angle values in The Purdue Annular Cascade Facility utilizing this automated exit flow data acquisition and analysis system in conjunction with a previously developed facility and airfoil surface pressure data acquisition and analysis system. The mean wake data, acquired at two downstream axial locations, are analyzed to determine the effect of incidence angle, the three-dimensionality of the cascade exit flow field, and the similarity of the wake profiles. The hub, mean, and tip chordwise airfoil surface static pressure distributions determined at each incidence angle are correlated with predictions from the MERIDL and TSONIC computer codes.

TABLE OF CONTENTS

	Page
SUMMARY.....	iii
LIST OF TABLES.....	viii
LIST OF FIGURES.....	xvix
LIST OF SYMBOLS.....	xxxii
CHAPTER I INTRODUCTION:.....	1
A. General Discussion.....	1
B. Review of Previous Cascade Wake Investigations.....	6
C. Objectives of this Investigation.....	8
CHAPTER II EXPERIMENTAL APPARATUS.....	10
A. The Purdue Annular Cascade Facility.....	10
B. Control Room Instrumentation.....	31
C. Construction/Definition of a Calibration Jet Facility.....	33
CHAPTER III FIVE-HOLE CONE PROBE SELECTION AND CALIBRATION.....	41
A. Probe Selection.....	41
B. Review of Five-Hole Probe Calibration and Application Techniques in the Non-Nullled Mode.....	45
C. Five-Hole Cone Probe Calibration.....	48

CHAPTER IV	DATA ACQUISITION AND REDUCTION.....	61
A.	Preliminary Preparations.....	61
B.	Mean Wake Data Acquisition.....	67
C.	Mean Wake Data Reduction.....	71
D.	Airfoil Surface Data Acquisition and Reduction.....	77
CHAPTER V	DATA PRESENTATION AND ANALYSIS.....	80
A.	Operating Conditions and the Cascade Upstream Inlet Velocity Profile.....	80
B.	Exit Region Data and Analysis.....	83
C.	Airfoil Surface Data and Analysis.....	132
CHAPTER VI	SUMMARY AND CONCLUSIONS.....	153
	LIST OF REFERENCES.....	156
APPENDICES		
APPENDIX A	Probe Alignment Procedure in the Calibration Jet Facility.....	158
APPENDIX B	Calibration Jet Definition Results.....	167
APPENDIX C	Automated Acquisition and Reduction Flowcharts.....	174
APPENDIX D	Error Analysis Techniques.....	178
APPENDIX E	DC-125 Five-Hole Probe Calibration Data in Tabular Form.....	182
APPENDIX F	Least Squares Bivariate Interpolation Scheme.....	190
APPENDIX G	Cascade Inlet Velocity Profile Data.....	197
APPENDIX H	Exit Flow Field Data - Tabular Presentation.....	199

APPENDIX I	Exit Flow Field Data - Graphical Presentation.....	308
APPENDIX J	Isobaric Exit Contour Visualization Technique.....	417
APPENDIX K	NASA Computer Codes.....	421
APPENDIX L	Tabulated Experimental Airfoil Pressure Coefficient Data.....	423

LIST OF TABLES

Table	Page
1. Purdue Annular Cascade Experimental Conditions.....	81
2. Circumferential Measurement Stations.....	84
3. Z_c and Radial Measurement Positions.....	85
Appendix	
Table	
E1. DC-125 Five-Hole Probe Calibration Data, Pitch Angle (DEG) = -30.0.....	183
E2. DC-125 Five-Hole Probe Calibration Data, Pitch Angle (DEG) = -25.0.....	183
E3. DC-125 Five-Hole Probe Calibration Data, Pitch Angle (DEG) = -20.0.....	184
E4. DC-125 Five-Hole Probe Calibration Data, Pitch Angle (DEG) = -15.0.....	184
E5. DC-125 Five-Hole Probe Calibration Data, Pitch Angle (DEG) = -10.0.....	185
E6. DC-125 Five-Hole Probe Calibration Data, Pitch Angle (DEG) = -5.0.....	185
E7. DC-125 Five-Hole Probe Calibration Data, Pitch Angle (DEG) = 0.0.....	186
E8. DC-125 Five-Hole Probe Calibration Data, Pitch Angle (DEG) = +5.0.....	186
E9. DC-125 Five-Hole Probe Calibration Data, Pitch Angle (DEG) = +10.0.....	187

E10.	DC-125 Five-Hole Probe Calibration Data, Pitch Angle (DEG) = +15.0.....	187
E11.	DC-125 Five-Hole Probe Calibration Data, Pitch Angle (DEG) = +20.0.....	188
E12.	DC-125 Five-Hole Probe Calibration Data, Pitch Angle (DEG) = +25.0.....	188
E13.	DC-125 Five-Hole Probe Calibration Data, Pitch Angle (DEG) = +30.0.....	189
G1.	Cascade Inlet Velocity Profile Data.....	198
H1.	Five-Hole Pressure Probe Wake Velocity Data, Incidence Angle (DEG) = 0, $Z_c/C = 0.94$, R = 4.2%.....	200
H2.	Five-Hole Pressure Probe Wake Pressure Data, Incidence Angle (DEG) = 0, $Z_c/C = .94$, R = 4.2%.....	201
H3.	Five-Hole Pressure Probe Wake Velocity Data, Incidence Angle (DEG) = 0, $Z_c/C = 0.94$, R = 8.3%.....	202
H4.	Five-Hole Pressure Probe Wake Pressure Data, Incidence Angle (DEG) = 0, $Z_c/C = 0.94$, R = 8.3%.....	203
H5.	Five-Hole Pressure Probe Wake Velocity Data, Incidence Angle (DEG) = 0, $Z_c/C = 0.94$, R = 12.5%.....	204
H6.	Five-Hole Pressure Probe Wake Pressure Data, Incidence Angle (DEG) = 0, $Z_c/C = 0.94$, R = 12.5%.....	205
H7.	Five-Hole Pressure Probe Wake Velocity Data, Incidence Angle (DEG) = 0, $Z_c/C = 0.94$, R = 16.7%.....	206
H8.	Five-Hole Pressure Probe Wake Pressure Data, Incidence Angle (DEG) = 0, $Z_c/C = 0.94$, R = 16.7%.....	207
H9.	Five-Hole Pressure Probe Wake Velocity Data, Incidence Angle (DEG) = 0, $Z_c/C = 0.94$, R = 25%.....	208
H10.	Five-Hole Pressure Probe Wake Pressure Data, Incidence Angle (DEG) = 0, $Z_c/C = 0.94$, R = 25%.....	209

H11.	Five-Hole Pressure Probe Wake Velocity Data, Incidence Angle (DEG) = 0, $Z_c/C = 0.94$, R = 33.3%.....	210
H12.	Five-Hole Pressure Probe Wake Pressure Data, Incidence Angle (DEG) = 0, $Z_c/C = 0.94$, R = 33.3%.....	211
H13.	Five-Hole Pressure Probe Wake Velocity Data, Incidence Angle (DEG) = 0, $Z_c/C = 0.94$, R = 50%.....	212
H14.	Five-Hole Pressure Probe Wake Pressure Data, Incidence Angle (DEG) = 0, $Z_c/C = 0.94$, R = 50%.....	213
H15.	Five-Hole Pressure Probe Wake Velocity Data, Incidence Angle (DEG) = 0, $Z_c/C = 0.94$, R = 66.7%.....	214
H16.	Five-Hole Pressure Probe Wake Pressure Data, Incidence Angle (DEG) = 0, $Z_c/C = 0.94$, R = 66.7%.....	215
H17.	Five-Hole Pressure Probe Wake Velocity Data, Incidence Angle (DEG) = 0, $Z_c/C = 0.94$, R = 83.3%.....	216
H18.	Five-Hole Pressure Probe Wake Pressure Data, Incidence Angle (DEG) = 0, $Z_c/C = 0.94$, R = 83.3%.....	217
H19.	Five-Hole Pressure Probe Wake Velocity Data, Incidence Angle (DEG) = 0, $Z_c/C = 2.06$, R = 4.2%.....	218
H20.	Five-Hole Pressure Probe Wake Pressure Data, Incidence Angle (DEG) = 0, $Z_c/C = 2.06$, R = 4.2%.....	219
H21.	Five-Hole Pressure Probe Wake Velocity Data, Incidence Angle (DEG) = 0, $Z_c/C = 2.06$, R = 8.3%.....	220
H22.	Five-Hole Pressure Probe Wake Pressure Data, Incidence Angle (DEG) = 0, $Z_c/C = 2.06$, R = 8.3%.....	221
H23.	Five-Hole Pressure Probe Wake Velocity Data, Incidence Angle (DEG) = 0, $Z_c/C = 2.06$, R = 12.5%.....	222

H24.	Five-Hole Pressure Probe Wake Pressure Data, Incidence Angle (DEG) = 0, $Z_c/C = 2.06$, R = 12.5%.....	223
H25.	Five-Hole Pressure Probe Wake Velocity Data, Incidence Angle (DEG) = 0, $Z_c/C = 2.06$, R = 16.7%.....	224
H26.	Five-Hole Pressure Probe Wake Pressure Data, Incidence Angle (DEG) = 0, $Z_c/C = 2.06$, R = 16.7%.....	225
H27.	Five-Hole Pressure Probe Wake Velocity Data, Incidence Angle (DEG) = 0, $Z_c/C = 2.06$, R = 25%.....	226
H28.	Five-Hole Pressure Probe Wake Pressure Data, Incidence Angle (DEG) = 0, $Z_c/C = 2.06$, R = 25%.....	227
H29.	Five-Hole Pressure Probe Wake Velocity Data, Incidence Angle (DEG) = 0, $Z_c/C = 2.06$, R = 33.3%.....	228
H30.	Five-Hole Pressure Probe Wake Pressure Data, Incidence Angle (DEG) = 0, $Z_c/C = 2.06$, R = 33.3%.....	229
H31.	Five-Hole Pressure Probe Wake Velocity Data, Incidence Angle (DEG) = 0, $Z_c/C = 2.06$, R = 50%.....	230
H32.	Five-Hole Pressure Probe Wake Pressure Data, Incidence Angle (DEG) = 0, $Z_c/C = 2.06$, R = 50%.....	231
H33.	Five-Hole Pressure Probe Wake Velocity Data, Incidence Angle (DEG) = 0, $Z_c/C = 2.06$, R = 66.7%.....	232
H34.	Five-Hole Pressure Probe Wake Pressure Data, Incidence Angle (DEG) = 0, $Z_c/C = 2.06$, R = 66.7%.....	233
H35.	Five-Hole Pressure Probe Wake Velocity Data, Incidence Angle (DEG) = 0, $Z_c/C = 2.06$, R = 83.3%.....	234
H36.	Five-Hole Pressure Probe Wake Pressure Data, Incidence Angle (DEG) = 0, $Z_c/C = 2.06$, R = 83.3%.....	235

H37.	Five-Hole Pressure Probe Wake Velocity Data, Incidence Angle (DEG) = 5, $Z_c/C = 0.94$, R = 4.2%.....	236
H38.	Five-Hole Pressure Probe Wake Pressure Data, Incidence Angle (DEG) = 5, $Z_c/C = .94$, R = 4.2%.....	237
H39.	Five-Hole Pressure Probe Wake Velocity Data, Incidence Angle (DEG) = 5, $Z_c/C = 0.94$, R = 8.3%.....	238
H40.	Five-Hole Pressure Probe Wake Pressure Data, Incidence Angle (DEG) = 5, $Z_c/C = 0.94$, R = 8.3%.....	239
H41.	Five-Hole Pressure Probe Wake Velocity Data, Incidence Angle (DEG) = 5, $Z_c/C = 0.94$, R = 12.5%.....	240
H42.	Five-Hole Pressure Probe Wake Pressure Data, Incidence Angle (DEG) = 5, $Z_c/C = 0.94$, R = 12.5%.....	241
H43.	Five-Hole Pressure Probe Wake Velocity Data, Incidence Angle (DEG) = 5, $Z_c/C = 0.94$, R = 16.7%.....	242
H44.	Five-Hole Pressure Probe Wake Pressure Data, Incidence Angle (DEG) = 5, $Z_c/C = 0.94$, R = 16.7%.....	243
H45.	Five-Hole Pressure Probe Wake Velocity Data, Incidence Angle (DEG) = 5, $Z_c/C = 0.94$, R = 25%.....	244
H46.	Five-Hole Pressure Probe Wake Pressure Data, Incidence Angle (DEG) = 5, $Z_c/C = 0.94$, R = 25%.....	245
H47.	Five-Hole Pressure Probe Wake Velocity Data, Incidence Angle (DEG) = 5, $Z_c/C = 0.94$, R = 33.3%.....	246
H48.	Five-Hole Pressure Probe Wake Pressure Data, Incidence Angle (DEG) = 5, $Z_c/C = 0.94$, R = 33.3%.....	247
H49.	Five-Hole Pressure Probe Wake Velocity Data, Incidence Angle (DEG) = 5, $Z_c/C = 0.94$, R = 50%.....	248

H50.	Five-Hole Pressure Probe Wake Pressure Data, Incidence Angle (DEG) = 5, $Z_c/C = 0.94$, R = 50%.....	249
H51.	Five-Hole Pressure Probe Wake Velocity Data, Incidence Angle (DEG) = 5, $Z_c/C = 0.94$, R = 66.7%.....	250
H52.	Five-Hole Pressure Probe Wake Pressure Data, Incidence Angle (DEG) = 5, $Z_c/C = 0.94$, R = 66.7%.....	251
H53.	Five-Hole Pressure Probe Wake Velocity Data, Incidence Angle (DEG) = 5, $Z_c/C = 0.94$, R = 83.3%.....	252
H54.	Five-Hole Pressure Probe Wake Pressure Data, Incidence Angle (DEG) = 5, $Z_c/C = 0.94$, R = 83.3%.....	253
H55.	Five-Hole Pressure Probe Wake Velocity Data, Incidence Angle (DEG) = 5, $Z_c/C = 2.07$, R = 4.2%.....	254
H56.	Five-Hole Pressure Probe Wake Pressure Data, Incidence Angle (DEG) = 5, $Z_c/C = 2.07$, R = 4.2%.....	255
H57.	Five-Hole Pressure Probe Wake Velocity Data, Incidence Angle (DEG) = 5, $Z_c/C = 2.07$, R = 8.3%.....	256
H58.	Five-Hole Pressure Probe Wake Pressure Data, Incidence Angle (DEG) = 5, $Z_c/C = 2.07$, R = 8.3%.....	257
H59.	Five-Hole Pressure Probe Wake Velocity Data, Incidence Angle (DEG) = 5, $Z_c/C = 2.07$, R = 12.5%.....	258
H60.	Five-Hole Pressure Probe Wake Pressure Data, Incidence Angle (DEG) = 5, $Z_c/C = 2.07$, R = 12.5%.....	259
H61.	Five-Hole Pressure Probe Wake Velocity Data, Incidence Angle (DEG) = 5, $Z_c/C = 2.07$, R = 16.7%.....	260
H62.	Five-Hole Pressure Probe Wake Pressure Data, Incidence Angle (DEG) = 5, $Z_c/C = 2.07$, R = 16.7%.....	261

H63.	Five-Hole Pressure Probe Wake Velocity Data, Incidence Angle (DEG) = 5, $Z_c/C = 2.07$, R = 25%.....	262
H64.	Five-Hole Pressure Probe Wake Pressure Data, Incidence Angle (DEG) = 5, $Z_c/C = 2.07$, R = 25%.....	263
H65.	Five-Hole Pressure Probe Wake Velocity Data, Incidence Angle (DEG) = 5, $Z_c/C = 2.07$, R = 33.3%.....	264
H66.	Five-Hole Pressure Probe Wake Pressure Data, Incidence Angle (DEG) = 5, $Z_c/C = 2.07$, R = 33.3%.....	265
H67.	Five-Hole Pressure Probe Wake Velocity Data, Incidence Angle (DEG) = 5, $Z_c/C = 2.07$, R = 50%.....	266
H68.	Five-Hole Pressure Probe Wake Pressure Data, Incidence Angle (DEG) = 5, $Z_c/C = 2.07$, R = 50%.....	267
H69.	Five-Hole Pressure Probe Wake Velocity Data, Incidence Angle (DEG) = 5, $Z_c/C = 2.07$, R = 66.7%.....	268
H70.	Five-Hole Pressure Probe Wake Pressure Data, Incidence Angle (DEG) = 5, $Z_c/C = 2.07$, R = 66.7%.....	269
H71.	Five-Hole Pressure Probe Wake Velocity Data, Incidence Angle (DEG) = 5, $Z_c/C = 2.07$, R = 83.3%.....	270
H72.	Five-Hole Pressure Probe Wake Pressure Data, Incidence Angle (DEG) = 5, $Z_c/C = 2.07$, R = 83.3%.....	271
H73.	Five-Hole Pressure Probe Wake Velocity Data, Incidence Angle (DEG) = 10, $Z_c/C = 0.96$, R = 4.2%.....	272
H74.	Five-Hole Pressure Probe Wake Pressure Data, Incidence Angle (DEG) = 10, $Z_c/C = 0.96$, R = 4.2%.....	273
H75.	Five-Hole Pressure Probe Wake Velocity Data, Incidence Angle (DEG) = 10, $Z_c/C = 0.96$, R = 8.3%.....	274

H76.	Five-Hole Pressure Probe Wake Pressure Data, Incidence Angle (DEG) = 10, $Z_c/C = 0.96$, R = 8.3%.....	275
H77.	Five-Hole Pressure Probe Wake Velocity Data, Incidence Angle (DEG) = 10, $Z_c/C = 0.96$, R = 12.5%.....	276
H78.	Five-Hole Pressure Probe Wake Pressure Data, Incidence Angle (DEG) = 10, $Z_c/C = 0.96$, R = 12.5%.....	277
H79.	Five-Hole Pressure Probe Wake Velocity Data, Incidence Angle (DEG) = 10, $Z_c/C = 0.96$, R = 16.7%.....	278
H80.	Five-Hole Pressure Probe Wake Pressure Data, Incidence Angle (DEG) = 10, $Z_c/C = 0.96$, R = 16.7%.....	279
H81.	Five-Hole Pressure Probe Wake Velocity Data, Incidence Angle (DEG) = 10, $Z_c/C = 0.96$, R = 25%.....	280
H82.	Five-Hole Pressure Probe Wake Pressure Data, Incidence Angle (DEG) = 10, $Z_c/C = 0.96$, R = 25%.....	281
H83.	Five-Hole Pressure Probe Wake Velocity Data, Incidence Angle (DEG) = 10, $Z_c/C = 0.96$, R = 33.3%.....	282
H84.	Five-Hole Pressure Probe Wake Pressure Data, Incidence Angle (DEG) = 10, $Z_c/C = 0.96$, R = 33.3%.....	283
H85.	Five-Hole Pressure Probe Wake Velocity Data, Incidence Angle (DEG) = 10, $Z_c/C = 0.96$, R = 50%.....	284
H86.	Five-Hole Pressure Probe Wake Pressure Data, Incidence Angle (DEG) = 10, $Z_c/C = 0.96$, R = 50%.....	285
H87.	Five-Hole Pressure Probe Wake Velocity Data, Incidence Angle (DEG) = 10, $Z_c/C = 0.96$, R = 66.7%.....	286
H88.	Five-Hole Pressure Probe Wake Pressure Data, Incidence Angle (DEG) = 10, $Z_c/C = 0.96$, R = 66.7%.....	287

H89.	Five-Hole Pressure Probe Wake Velocity Data, Incidence Angle (DEG) = 10, $Z_c/C = 0.96$, R = 83.3%.....	288
H90.	Five-Hole Pressure Probe Wake Pressure Data, Incidence Angle (DEG) = 10, $Z_c/C = 0.96$, R = 83.3%.....	289
H91.	Five-Hole Pressure Probe Wake Velocity Data, Incidence Angle (DEG) = 10, $Z_c/C = 2.10$, R = 4.2%.....	290
H92.	Five-Hole Pressure Probe Wake Pressure Data, Incidence Angle (DEG) = 10, $Z_c/C = 2.10$, R = 4.2%.....	291
H93.	Five-Hole Pressure Probe Wake Velocity Data, Incidence Angle (DEG) = 10, $Z_c/C = 2.10$, R = 8.3%.....	292
H94.	Five-Hole Pressure Probe Wake Pressure Data, Incidence Angle (DEG) = 10, $Z_c/C = 2.10$, R = 8.3%.....	293
H95.	Five-Hole Pressure Probe Wake Velocity Data, Incidence Angle (DEG) = 10, $Z_c/C = 2.10$, R = 12.5%.....	294
H96.	Five-Hole Pressure Probe Wake Pressure Data, Incidence Angle (DEG) = 10, $Z_c/C = 2.10$, R = 12.5%.....	295
H97.	Five-Hole Pressure Probe Wake Velocity Data, Incidence Angle (DEG) = 10, $Z_c/C = 2.10$, R = 16.7%.....	296
H98.	Five-Hole Pressure Probe Wake Pressure Data, Incidence Angle (DEG) = 10, $Z_c/C = 2.10$, R = 16.7%.....	297
H99.	Five-Hole Pressure Probe Wake Velocity Data, Incidence Angle (DEG) = 10, $Z_c/C = 2.10$, R = 25%.....	298
H100.	Five-Hole Pressure Probe Wake Pressure Data, Incidence Angle (DEG) = 10, $Z_c/C = 2.10$, R = 25%.....	299
H101.	Five-Hole Pressure Probe Wake Velocity Data, Incidence Angle (DEG) = 10, $Z_c/C = 2.10$, R = 33.3%.....	300

H102.	Five-Hole Pressure Probe Wake Pressure Data, Incidence Angle (DEG) = 10, $Z_c/C = 2.10$, R = 33.3%.....	301
H103.	Five-Hole Pressure Probe Wake Velocity Data, Incidence Angle (DEG) = 10, $Z_c/C = 2.10$, R = 50%.....	302
H104.	Five-Hole Pressure Probe Wake Pressure Data, Incidence Angle (DEG) = 10, $Z_c/C = 2.10$, R = 50%.....	303
H105.	Five-Hole Pressure Probe Wake Velocity Data, Incidence Angle (DEG) = 10, $Z_c/C = 2.10$, R = 66.7%.....	304
H106.	Five-Hole Pressure Probe Wake Pressure Data, Incidence Angle (DEG) = 10, $Z_c/C = 2.10$, R = 66.7%.....	305
H107.	Five-Hole Pressure Probe Wake Velocity Data, Incidence Angle (DEG) = 10, $Z_c/C = 2.10$, R = 83.3%.....	306
H108.	Five-Hole Pressure Probe Wake Pressure Data, Incidence Angle (DEG) = 10, $Z_c/C = 2.10$, R = 83.3%.....	307
L1.	Airfoil Surface Pressure Coefficient Data, 10% Span, Suction Surface, Incidence Angle (DEG) = 0.0.....	424
L2.	Airfoil Surface Pressure Coefficient Data, 10% Span, Pressure Surface, Incidence Angle (DEG) = 0.0.....	424
L3.	Airfoil Surface Pressure Coefficient Data, 50% Span, Suction Surface, Incidence Angle (DEG) = 0.0.....	425
L4.	Airfoil Surface Pressure Coefficient Data, 50% Span, Pressure Surface, Incidence Angle (DEG) = 0.0.....	425
L5.	Airfoil Surface Pressure Coefficient Data, 90% Span, Suction Surface, Incidence Angle (DEG) = 0.0.....	426
L6.	Airfoil Surface Pressure Coefficient Data, 90% Span, Pressure Surface, Incidence Angle (DEG) = 0.0.....	426

L7.	Airfoil Surface Pressure Coefficient Data, 10% Span, Suction Surface, Incidence Angle (DEG) = 5.0.....	427
L8.	Airfoil Surface Pressure Coefficient Data, 10% Span, Pressure Surface, Incidence Angle (DEG) = 5.0.....	427
L9.	Airfoil Surface Pressure Coefficient Data, 50% Span, Suction Surface, Incidence Angle (DEG) = 5.0.....	428
L10.	Airfoil Surface Pressure Coefficient Data, 50% Span, Pressure Surface, Incidence Angle (DEG) = 5.0.....	428
L11.	Airfoil Surface Pressure Coefficient Data, 90% Span, Suction Surface, Incidence Angle (DEG) = 5.0.....	429
L12.	Airfoil Surface Pressure Coefficient Data, 90% Span, Pressure Surface, Incidence Angle (DEG) = 5.0.....	429
L13.	Airfoil Surface Pressure Coefficient Data, 10% Span, Suction Surface, Incidence Angle (DEG) = 10.0.....	430
L14.	Airfoil Surface Pressure Coefficient Data, 10% Span, Pressure Surface, Incidence Angle (DEG) = 10.0.....	430
L15.	Airfoil Surface Pressure Coefficient Data, 50% Span, Suction Surface, Incidence Angle (DEG) = 10.0.....	431
L16.	Airfoil Surface Pressure Coefficient Data, 50% Span, Pressure Surface, Incidence Angle (DEG) = 10.0.....	431
L17.	Airfoil Surface Pressure Coefficient Data, 90% Span, Suction Surface, Incidence Angle (DEG) = 10.0.....	432
L18.	Airfoil Surface Pressure Coefficient Data, 90% Span, Pressure Surface, Incidence Angle (DEG) = 10.0.....	432

LIST OF FIGURES

Figure		Page
1.	Schematic Representation of the Flow Field in a Turbomachine Blade Row.....	2
2.	The Purdue Annular Cascade Facility.....	4
3.	Schematic of The Purdue Annular Cascade Facility.....	11
4.	Exterior View of Plenum Chamber and Ducting.....	13
5.	Flat Plate Airfoil Dimensions.....	14
6.	Airfoil Surface Static Pressure Tap Spanwise Locations.....	16
7.	Chordwise Distribution of the Airfoil Surface Static Pressure Taps.....	17
8.	Installed Instrumented Airfoils.....	18
9.	Schematic of a Total Pressure Rake.....	19
10.	Probe Traversing Mechanisms.....	21
11.	Traversing Mechanism Mounting on the Annular Cascade.....	22
12.	Typical Scanivalve Multiple-Module Unit.....	25
13.	Cascade Facility Transducer Calibration Pressure System.....	27
14.	Typical Transducer Calibration Curve.....	28
15.	Scanivalve Pressure Measurement System.....	29
16.	Schematic of the Calibration Jet Facility.....	34
17.	The Calibration Jet.....	35

18.	Calibration Jet Air Supply and the Three Leaf Shutter Speed Control Device.....	37
19.	Jet Profile at the Selected Five-Hole Probe Calibration Point.....	40
20.	United Sensor DC-125 Five-Hole Cone Probe.....	43
21.	Five-Hole Probe Coordinate System and Port Designations.....	44
22.	DC-125 Five-Hole Probe Calibration, Flow Angle Bivariate Relationships.....	55
23.	DC-125 Five-Hole Probe Calibration, $C_{p\text{total}}$ Bivariate Relationship, Yaw Angles >0	56
24.	DC-125 Five-Hole Probe Calibration, $C_{p\text{total}}$ Bivariate Relationship, Yaw Angles <0	57
25.	DC-125 Five-Hole Probe Calibration, $C_{p\text{static}}$ Bivariate Relationship, Yaw Angles >0	58
26.	DC-125 Five-Hole Probe Calibration, $C_{p\text{static}}$ Bivariate Relationship, Yaw Angles <0	59
27.	Airfoil Incidence Angle Setting Device.....	62
28.	Yaw Offset Angle Definition Schematic.....	64
29.	Cascade Inlet Velocity Profile.....	82
30.	Circumferential Measurement Geometry.....	84
31.	Z_c and Radial Measurement Geometry.....	85
32.	Typical Exit Velocity Component Data Presentation.....	87
33.	Typical Overall Wake Data Presentation.....	88
34.	Multiple Passage Velocity Component Data, Incidence Angle (DEG) = 0, $Z_c/C = .94$, $R = 8.3\%$, $2T/S = -2$ through $C + 2$	91
35.	Multiple Passage Overall Wake Data, Incidence Angle (DEG) = 0, $Z_c/C = .94$, $R = 8.3\%$, $2T/S = -2$ through $C + 2$	92
36.	Multiple Passage Velocity Component Data, Incidence Angle (DEG) = 0, $Z_c/C = .94$, $R = 8.3\%$, $2T/S = +2$ through $C + 6$	93

37.	Multiple Passage Overall Wake Data, Incidence Angle (DEG) = 0, $Z_c/C = .94$, R = 8.3%, 2T/S = + 2 through $+^c_6$	94
38.	Multiple Passage Velocity Component Data, Incidence Angle (DEG) = 10.0, $Z_c/C = .96$, R = 4.2%, 2T/S = - 2 through $+^c_2$	95
39.	Multiple Passage Overall Wake Data, Incidence Angle (DEG) = 10.0, $Z_c/C = .96$, R = 4.2%, 2T/S = - 2 through $+^c_2$	96
40.	Multiple Passage Velocity Component Data, Incidence Angle (DEG) = 10.0, $Z_c/C = .96$, R = 8.3%, 2T/S = - 2 through $+^c_2$	97
41.	Multiple Passage Overall Wake Data, Incidence Angle (DEG) = 10.0, $Z_c/C = .96$, R = 8.3%, 2T/S = - 2 through $+^c_2$	98
42.	Incidence Angle Crossplots, Front Traversing Slot, R = 4.2%.....	100
43.	Incidence Angle Crossplots, Front Traversing Slot, R = 8.3%.....	101
44.	Incidence Angle Crossplots, Front Traversing Slot, R = 12.5%.....	102
45.	Incidence Angle Crossplots, Front Traversing Slot, R = 16.7%.....	103
46.	Incidence Angle Crossplots, Front Traversing Slot, R = 25%.....	104
47.	Incidence Angle Crossplots, Front Traversing Slot, R = 33.3%.....	105
48.	Incidence Angle Crossplots, Front Traversing Slot, R = 50%.....	106
49.	Incidence Angle Crossplots, Front Traversing Slot, R = 66.7%.....	107
50.	Incidence Angle Crossplots, Front Traversing Slot, R = 83.3%.....	108
51.	Incidence Angle Crossplots, Rear Traversing Slot, R = 4.2%.....	109
52.	Incidence Angle Crossplots, Rear Traversing Slot, R = 8.3%.....	110

53.	Incidence Angle Crossplots, Rear Traversing Slot, R = 12.5%.....	111
54.	Incidence Angle Crossplots, Rear Traversing Slot, R = 16.7%.....	112
55.	Incidence Angle Crossplots, Rear Traversing Slot, R = 25%.....	113
56.	Incidence Angle Crossplots, Rear Traversing Slot, R = 33.3%.....	114
57.	Incidence Angle Crossplots, Rear Traversing Slot, R = 50%.....	115
58.	Incidence Angle Crossplots, Rear Traversing Slot, R = 66.7%.....	116
59.	Incidence Angle Crossplots, Rear Traversing Slot, R = 83.3%.....	117
60.	Three-Dimensionality Crossplots, Incidence Angle (DEG) = 0, $Z_c/C = .94$	119
61.	Three-Dimensionality Crossplots, Incidence Angle (DEG) = 0, $Z_c/C = 2.06$	120
62.	Three-Dimensionality Crossplots, Incidence Angle (DEG) = 5, $Z_c/C = .94$	121
63.	Three-Dimensionality Crossplots, Incidence Angle (DEG) = 5, $Z_c/C = 2.07$	122
64.	Three-Dimensionality Crossplots, Incidence Angle (DEG) = 10, $Z_c/C = .96$	123
65.	Three-Dimensionality Crossplots, Incidence Angle (DEG) = 10, $Z_c/C = 2.10$	124
66.	Wake Profile Similarity, Incidence Angle (DEG) = 0.....	128
67.	Wake Profile Similarity, Incidence Angle (DEG) = 5.....	129
68.	Wake Profile Similarity, Incidence Angle (DEG) = 10.....	130
69.	Chordwise Distribution of the Airfoil Surface Pressure Coefficients, 10% Span, Suction Surface, Incidence Angle (DEG) = 0.....	134

70.	Chordwise Distribution of the Airfoil Surface Pressure Coefficients, 10% Span, Pressure Surface, Incidence Angle (DEG) = 0.....	135
71.	Chordwise Distribution of the Airfoil Surface Pressure Coefficients, 50% Span, Suction Surface, Incidence Angle (DEG) = 0.....	136
72.	Chordwise Distribution of the Airfoil Surface Pressure Coefficients, 50% Span, Pressure Surface, Incidence Angle (DEG) = 0.....	137
73.	Chordwise Distribution of the Airfoil Surface Pressure Coefficients, 90% Span, Suction Surface, Incidence Angle (DEG) = 0.....	138
74.	Chordwise Distribution of the Airfoil Surface Pressure Coefficients, 90% Span, Pressure Surface, Incidence Angle (DEG) = 0.....	139
75.	Chordwise Distribution of the Airfoil Surface Pressure Coefficients, 10% Span, Suction Surface, Incidence Angle (DEG) = 5.....	140
76.	Chordwise Distribution of the Airfoil Surface Pressure Coefficients, 10% Span, Pressure Surface, Incidence Angle (DEG) = 5.....	141
77.	Chordwise Distribution of the Airfoil Surface Pressure Coefficients, 50% Span, Suction Surface, Incidence Angle (DEG) = 5.....	142
78.	Chordwise Distribution of the Airfoil Surface Pressure Coefficients, 50% Span, Pressure Surface, Incidence Angle (DEG) = 5.....	143
79.	Chordwise Distribution of the Airfoil Surface Pressure Coefficients, 90% Span, Suction Surface, Incidence Angle (DEG) = 5.....	144
80.	Chordwise Distribution of the Airfoil Surface Pressure Coefficients, 90% Span, Pressure Surface, Incidence Angle (DEG) = 5.....	145
81.	Chordwise Distribution of the Airfoil Surface Pressure Coefficients, 10% Span, Suction Surface, Incidence Angle (DEG) = 10.....	147
82.	Chordwise Distribution of the Airfoil Surface Pressure Coefficients, 10% Span, Pressure Surface, Incidence Angle (DEG) = 10.....	148

83.	Chordwise Distribution of the Airfoil Surface Pressure Coefficients, 50% Span, Suction Surface, Incidence Angle (DEG) = 10.....	149
84.	Chordwise Distribution of the Airfoil Surface Pressure Coefficients, 50% Span, Pressure Surface, Incidence Angle (DEG) = 10.....	150
85.	Chordwise Distribution of the Airfoil Surface Pressure Coefficients, 90% Span, Suction Surface, Incidence Angle (DEG) = 10.....	151
86.	Chordwise Distribution of the Airfoil Surface Pressure Coefficients, 90% Span, Pressure Surface, Incidence Angle (DEG) = 10.....	152

Appendix
Figure

	Page
A1. Calibration Jet Coordinate System.....	159
A2. Calibration Jet Alignment Procedure Photographs I.....	160
A3. Calibration Jet Alignment Procedure Photographs II.....	164
B1. Calibration Jet Profile, Z/D = .08.....	168
B2. Calibration Jet Profile, Z/D = .22.....	169
B3. Calibration Jet Profile, Z/D = .44.....	170
B4. Calibration Jet Profile, Z/D = .67.....	171
B5. Calibration Jet Profile, Z/D = .89.....	172
B6. Calibration Jet Profile, Z/D = 1.33.....	173
C1. Program "C5HOLE" Flowchart.....	175
C2. Program "AQAUTO" Flowchart.....	176
C3. Program "MATRED" Flowchart.....	177
F1. Least Square Bivariate Local Grid Definition.....	191
I1. Five-Hole Probe Velocity Data, Incidence Angle (DEG) = 0, $Z_c/C = .94$, $R = 4.2\%$	309

12.	Five-Hole Probe Wake Data, Incidence Angle (DEG) = 0, $Z_c/C = .94$, $R = 4.2\%$	310
13.	Five-Hole Probe Velocity Data, Incidence Angle (DEG) = 0, $Z_c/C = .94$, $R = 8.3\%$	311
14.	Five-Hole Probe Wake Data, Incidence Angle (DEG) = 0, $Z_c/C = .94$, $R = 8.3\%$	312
15.	Five-Hole Probe Velocity Data, Incidence Angle (DEG) = 0, $Z_c/C = .94$, $R = 12.5\%$	313
16.	Five-Hole Probe Wake Data, Incidence Angle (DEG) = 0, $Z_c/C = .94$, $R = 12.5\%$	314
17.	Five-Hole Probe Velocity Data, Incidence Angle (DEG) = 0, $Z_c/C = .94$, $R = 16.7\%$	315
18.	Five-Hole Probe Wake Data, Incidence Angle (DEG) = 0, $Z_c/C = .94$, $R = 16.7\%$	316
19.	Five-Hole Probe Velocity Data, Incidence Angle (DEG) = 0, $Z_c/C = .94$, $R = 25\%$	317
110.	Five-Hole Probe Wake Data, Incidence Angle (DEG) = 0, $Z_c/C = .94$, $R = 25\%$	318
111.	Five-Hole Probe Velocity Data, Incidence Angle (DEG) = 0, $Z_c/C = .94$, $R = 33.3\%$	319
112.	Five-Hole Probe Wake Data, Incidence Angle (DEG) = 0, $Z_c/C = .94$, $R = 33.3\%$	320
113.	Five-Hole Probe Velocity Data, Incidence Angle (DEG) = 0, $Z_c/C = .94$, $R = 50\%$	321
114.	Five-Hole Probe Wake Data, Incidence Angle (DEG) = 0, $Z_c/C = .94$, $R = 50\%$	322
115.	Five-Hole Probe Velocity Data, Incidence Angle (DEG) = 0, $Z_c/C = .94$, $R = 66.7\%$	323
116.	Five-Hole Probe Wake Data, Incidence Angle (DEG) = 0, $Z_c/C = .94$, $R = 66.7\%$	324
117.	Five-Hole Probe Velocity Data, Incidence Angle (DEG) = 0, $Z_c/C = .94$, $R = 83.3\%$	325
118.	Five-Hole Probe Wake Data, Incidence Angle (DEG) = 0, $Z_c/C = .94$, $R = 83.3\%$	326
119.	Five-Hole Probe Velocity Data, Incidence Angle (DEG) = 0, $Z_c/C = 2.06$, $R = 4.2\%$	327

I20.	Five-Hole Probe Wake Data, Incidence Angle (DEG) = 0, $Z_c/C = 2.06$, $R = 4.2\%$	328
I21.	Five-Hole Probe Velocity Data, Incidence Angle (DEG) = 0, $Z_c/C = 2.06$, $R = 8.3\%$	329
I22.	Five-Hole Probe Wake Data, Incidence Angle (DEG) = 0, $Z_c/C = 2.06$, $R = 8.3\%$	330
I23.	Five-Hole Probe Velocity Data, Incidence Angle (DEG) = 0, $Z_c/C = 2.06$, $R = 12.5\%$	331
I24.	Five-Hole Probe Wake Data, Incidence Angle (DEG) = 0, $Z_c/C = 2.06$, $R = 12.5\%$	332
I25.	Five-Hole Probe Velocity Data, Incidence Angle (DEG) = 0, $Z_c/C = 2.06$, $R = 16.7\%$	333
I26.	Five-Hole Probe Wake Data, Incidence Angle (DEG) = 0, $Z_c/C = 2.06$, $R = 16.7\%$	334
I27.	Five-Hole Probe Velocity Data, Incidence Angle (DEG) = 0, $Z_c/C = 2.06$, $R = 25\%$	335
I28.	Five-Hole Probe Wake Data, Incidence Angle (DEG) = 0, $Z_c/C = 2.06$, $R = 25\%$	336
I29.	Five-Hole Probe Velocity Data, Incidence Angle (DEG) = 0, $Z_c/C = 2.06$, $R = 33.3\%$	337
I30.	Five-Hole Probe Wake Data, Incidence Angle (DEG) = 0, $Z_c/C = 2.06$, $R = 33.3\%$	338
I31.	Five-Hole Probe Velocity Data, Incidence Angle (DEG) = 0, $Z_c/C = 2.06$, $R = 50\%$	339
I32.	Five-Hole Probe Wake Data, Incidence Angle (DEG) = 0, $Z_c/C = 2.06$, $R = 50\%$	340
I33.	Five-Hole Probe Velocity Data, Incidence Angle (DEG) = 0, $Z_c/C = 2.06$, $R = 66.7\%$	341
I34.	Five-Hole Probe Wake Data, Incidence Angle (DEG) = 0, $Z_c/C = 2.06$, $R = 66.7\%$	342
I35.	Five-Hole Probe Velocity Data, Incidence Angle (DEG) = 0, $Z_c/C = 2.06$, $R = 83.3\%$	343
I36.	Five-Hole Probe Wake Data, Incidence Angle (DEG) = 0, $Z_c/C = 2.06$, $R = 83.3\%$	344
I37.	Five-Hole Probe Velocity Data, Incidence Angle (DEG) = 5, $Z_c/C = .94$, $R = 4.2\%$	345

38.	Five-Hole Probe Wake Data, Incidence Angle (DEG) = 5, $Z_c/C = .94$, $R = 4.2\%$	346
39.	Five-Hole Probe Velocity Data, Incidence Angle (DEG) = 5, $Z_c/C = .94$, $R = 8.3\%$	347
140.	Five-Hole Probe Wake Data, Incidence Angle (DEG) = 5, $Z_c/C = .94$, $R = 8.3\%$	348
141.	Five-Hole Probe Velocity Data, Incidence Angle (DEG) = 5, $Z_c/C = .94$, $R = 12.5\%$	349
142.	Five-Hole Probe Wake Data, Incidence Angle (DEG) = 5, $Z_c/C = .94$, $R = 12.5\%$	350
143.	Five-Hole Probe Velocity Data, Incidence Angle (DEG) = 5, $Z_c/C = .94$, $R = 16.7\%$	351
144.	Five-Hole Probe Wake Data, Incidence Angle (DEG) = 5, $Z_c/C = .94$, $R = 16.7\%$	352
145.	Five-Hole Probe Velocity Data, Incidence Angle (DEG) = 5, $Z_c/C = .94$, $R = 25\%$	353
146.	Five-Hole Probe Wake Data, Incidence Angle (DEG) = 5, $Z_c/C = .94$, $R = 25\%$	354
147.	Five-Hole Probe Velocity Data, Incidence Angle (DEG) = 5, $Z_c/C = .94$, $R = 33.3\%$	355
148.	Five-Hole Probe Wake Data, Incidence Angle (DEG) = 5, $Z_c/C = .94$, $R = 33.3\%$	356
149.	Five-Hole Probe Velocity Data, Incidence Angle (DEG) = 5, $Z_c/C = .94$, $R = 50\%$	357
150.	Five-Hole Probe Wake Data, Incidence Angle (DEG) = 5, $Z_c/C = .94$, $R = 50\%$	358
151.	Five-Hole Probe Velocity Data, Incidence Angle (DEG) = 5, $Z_c/C = .94$, $R = 66.7\%$	359
152.	Five-Hole Probe Wake Data, Incidence Angle (DEG) = 5, $Z_c/C = .94$, $R = 66.7\%$	360
153.	Five-Hole Probe Velocity Data, Incidence Angle (DEG) = 5, $Z_c/C = .94$, $R = 83.3\%$	361
154.	Five-Hole Probe Wake Data, Incidence Angle (DEG) = 5, $Z_c/C = .94$, $R = 83.3\%$	362
155.	Five-Hole Probe Velocity Data, Incidence Angle (DEG) = 5, $Z_c/C = 2.07$, $R = 4.2\%$	363

I56.	Five-Hole Probe Wake Data, Incidence Angle (DEG) = 5, $Z_c/C = 2.07$, $R = 4.2\%$	364
I57.	Five-Hole Probe Velocity Data, Incidence Angle (DEG) = 5, $Z_c/C = 2.07$, $R = 8.3\%$	365
I58.	Five-Hole Probe Wake Data, Incidence Angle (DEG) = 5, $Z_c/C = 2.07$, $R = 8.3\%$	366
I59.	Five-Hole Probe Velocity Data, Incidence Angle (DEG) = 5, $Z_c/C = 2.07$, $R = 12.5\%$	367
I60.	Five-Hole Probe Wake Data, Incidence Angle (DEG) = 5, $Z_c/C = 2.07$, $R = 12.5\%$	368
I61.	Five-Hole Probe Velocity Data, Incidence Angle (DEG) = 5, $Z_c/C = 2.07$, $R = 16.7\%$	369
I62.	Five-Hole Probe Wake Data, Incidence Angle (DEG) = 5, $Z_c/C = 2.07$, $R = 16.7\%$	370
I63.	Five-Hole Probe Velocity Data, Incidence Angle (DEG) = 5, $Z_c/C = 2.07$, $R = 25\%$	371
I64.	Five-Hole Probe Wake Data, Incidence Angle (DEG) = 5, $Z_c/C = 2.07$, $R = 25\%$	372
I65.	Five-Hole Probe Velocity Data, Incidence Angle (DEG) = 5, $Z_c/C = 2.07$, $R = 33.3\%$	373
I66.	Five-Hole Probe Wake Data, Incidence Angle (DEG) = 5, $Z_c/C = 2.07$, $R = 33.3\%$	374
I67.	Five-Hole Probe Velocity Data, Incidence Angle (DEG) = 5, $Z_c/C = 2.07$, $R = 50\%$	375
I68.	Five-Hole Probe Wake Data, Incidence Angle (DEG) = 5, $Z_c/C = 2.07$, $R = 50\%$	376
I69.	Five-Hole Probe Velocity Data, Incidence Angle (DEG) = 5, $Z_c/C = 2.07$, $R = 66.7\%$	377
I70.	Five-Hole Probe Wake Data, Incidence Angle (DEG) = 5, $Z_c/C = 2.07$, $R = 66.7\%$	378
I71.	Five-Hole Probe Velocity Data, Incidence Angle (DEG) = 5, $Z_c/C = 2.07$, $R = 83.3\%$	379
I72.	Five-Hole Probe Wake Data, Incidence Angle (DEG) = 5, $Z_c/C = 2.07$, $R = 83.3\%$	380
I73.	Five-Hole Probe Velocity Data, Incidence Angle (DEG) = 10, $Z_c/C = .96$, $R = 4.2\%$	381

I74.	Five-Hole Probe Wake Data, Incidence Angle (DEG) = 10, $Z_c/C = .96$, $R = 4.2\%$	382
I75.	Five-Hole Probe Velocity Data, Incidence Angle (DEG) = 10, $Z_c/C = .96$, $R = 8.3\%$	383
I76.	Five-Hole Probe Wake Data, Incidence Angle (DEG) = 10, $Z_c/C = .96$, $R = 8.3\%$	384
I77.	Five-Hole Probe Velocity Data, Incidence Angle (DEG) = 10, $Z_c/C = .96$, $R = 12.5\%$	385
I78.	Five-Hole Probe Wake Data, Incidence Angle (DEG) = 10, $Z_c/C = .96$, $R = 12.5\%$	386
I79.	Five-Hole Probe Velocity Data, Incidence Angle (DEG) = 10, $Z_c/C = .96$, $R = 16.7\%$	387
I80.	Five-Hole Probe Wake Data, Incidence Angle (DEG) = 10, $Z_c/C = .96$, $R = 16.7\%$	388
I81.	Five-Hole Probe Velocity Data, Incidence Angle (DEG) = 10, $Z_c/C = .96$, $R = 25\%$	389
I82.	Five-Hole Probe Wake Data, Incidence Angle (DEG) = 10, $Z_c/C = .96$, $R = 25\%$	390
I83.	Five-Hole Probe Velocity Data, Incidence Angle (DEG) = 10, $Z_c/C = .96$, $R = 33.3\%$	391
I84.	Five-Hole Probe Wake Data, Incidence Angle (DEG) = 10, $Z_c/C = .96$, $R = 33.3\%$	392
I85.	Five-Hole Probe Velocity Data, Incidence Angle (DEG) = 10, $Z_c/C = .96$, $R = 50\%$	393
I86.	Five-Hole Probe Wake Data, Incidence Angle (DEG) = 10, $Z_c/C = .96$, $R = 50\%$	394
I87.	Five-Hole Probe Velocity Data, Incidence Angle (DEG) = 10, $Z_c/C = .96$, $R = 66.7\%$	395
I88.	Five-Hole Probe Wake Data, Incidence Angle (DEG) = 10, $Z_c/C = .96$, $R = 66.7\%$	396
I89.	Five-Hole Probe Velocity Data, Incidence Angle (DEG) = 10, $Z_c/C = .96$, $R = 83.3\%$	397
I90.	Five-Hole Probe Wake Data, Incidence Angle (DEG) = 10, $Z_c/C = .96$, $R = 83.3\%$	398
I91.	Five-Hole Probe Velocity Data, Incidence Angle (DEG) = 10, $Z_c/C = 2.10$, $R = 4.2\%$	399

I92.	Five-Hole Probe Wake Data, Incidence Angle (DEG) = 10, $Z_c/C = 2.10$, $R = 4.2\%$	400
I93.	Five-Hole Probe Velocity Data, Incidence Angle (DEG) = 10, $Z_c/C = 2.10$, $R = 8.3\%$	401
I94.	Five-Hole Probe Wake Data, Incidence Angle (DEG) = 10, $Z_c/C = 2.10$, $R = 8.3\%$	402
I95.	Five-Hole Probe Velocity Data, Incidence Angle (DEG) = 10, $Z_c/C = 2.10$, $R = 12.5\%$	403
I96.	Five-Hole Probe Wake Data, Incidence Angle (DEG) = 10, $Z_c/C = 2.10$, $R = 12.5\%$	404
I97.	Five-Hole Probe Velocity Data, Incidence Angle (DEG) = 10, $Z_c/C = 2.10$, $R = 16.7\%$	405
I98.	Five-Hole Probe Wake Data, Incidence Angle (DEG) = 10, $Z_c/C = 2.10$, $R = 16.7\%$	406
I99.	Five-Hole Probe Velocity Data, Incidence Angle (DEG) = 10, $Z_c/C = 2.10$, $R = 25\%$	407
I100.	Five-Hole Probe Wake Data, Incidence Angle (DEG) = 10, $Z_c/C = 2.10$, $R = 25\%$	408
I101.	Five-Hole Probe Velocity Data, Incidence Angle (DEG) = 10, $Z_c/C = 2.10$, $R = 33.3\%$	409
I102.	Five-Hole Probe Wake Data, Incidence Angle (DEG) = 10, $Z_c/C = 2.10$, $R = 33.3\%$	410
I103.	Five-Hole Probe Velocity Data, Incidence Angle (DEG) = 10, $Z_c/C = 2.10$, $R = 50\%$	411
I104.	Five-Hole Probe Wake Data, Incidence Angle (DEG) = 10, $Z_c/C = 2.10$, $R = 50\%$	412
I105.	Five-Hole Probe Velocity Data, Incidence Angle (DEG) = 10, $Z_c/C = 2.10$, $R = 66.7\%$	413
I106.	Five-Hole Probe Wake Data, Incidence Angle (DEG) = 10, $Z_c/C = 2.10$, $R = 66.7\%$	414
I107.	Five-Hole Probe Velocity Data, Incidence Angle (DEG) = 10, $Z_c/C = 2.10$, $R = 83.3\%$	415
I108.	Five-Hole Probe Wake Data, Incidence Angle (DEG) = 10, $Z_c/C = 2.10$, $R = 83.3\%$	416

J1.	Photograph of the Lightbox, the Fiber Optics Probe, and a Sample Result.....	418
J2.	Schematic of the Isobaric Exit Visualization Apparatus in the Annular Cascade Facility.....	419

LIST OF SYMBOLS

C	Chord
C_p	Airfoil Surface Pressure Coefficient
C_{pyaw}	Yaw Angle Nondimensional Coefficient
C_{ppitch}	Pitch Angle Nondimensional Coefficient
C_{ptotal}	Total Pressure Nondimensional Coefficient
$C_{pstatic}$	Static Pressure Nondimensional Coefficient
D	Calibration Jet Exit Diameter
e	Error
F	Function Designator
G	Typical Dependent Variable
k	Specific Heat Ratio for Air
$L_{1/2}$	Wake Half Width
M	Mach Number
P	Pressure
\bar{P}	Normalizing Pressure Parameter
PT1	Upstream Inlet Mass Averaged Total Pressure
PT2	Exit Total Pressure Values
p1	Upstream Inlet Mass Averaged Static Pressure
p2	Exit Static Pressure Values
q	Quantity
R	Radial Coordinate Axis, Radial Position

R_{air}	Gas Constant for Air
S	Airfoil Spacing
T	Tangential Coordinate Axis, Tangential Position
T_s	Static Temperature
T_t	Total Temperature
U	Mean Velocity
U_i	Circumferentially Averaged Rake Velocities
U_{z0}	Mass Averaged Upstream Inlet Velocity
U^*	Normalized Calibration Jet Velocity Values
U_z	Cascade Facility Axial Velocity Component
U_t	Cascade Facility Tangential Velocity Component
U_r	Cascade Facility Radial Velocity Component
V	Scanivalve Mean Voltage Values
\bar{V}	Normalizing Voltage Parameter
W	Velocity Defect
W_{CL}	Centerline Velocity Defect
X	Calibration Jet Coordinate X-Axis
Y	Calibration Jet Coordinate Y-Axis
Y^*	Normalized Calibration Jet Y-Position Values
Z	Axial Coordinate Axis
Z_c	Chordwise Downstream Position

Greek Symbols

α	Probe Pitch Angle
β	Probe Yaw Angle
Γ	Function, $(k-1)/k$
∂	Partial Derivative

η	Normalized Tangential Distance
θ	Probe Yaw Offset Angle
ρ_{z0}	Upstream Static Density

Subscripts

af	Airfoil
fs	Freestream
inc	Incompressible
p	Probe
pz	Probe Axial
pt	Probe Tangential
pr	Probe Radial
s	Static
t	Total
1	Five-Hole Probe Port 1
2	Five-Hole Probe Port 2
3	Five-Hole Probe Port 3
4	Five-Hole Probe Port 4
5	Five-Hole Probe Port 5

CHAPTER I INTRODUCTION

A. General Discussion

Continuing demands to increase efficiency and thrust-to-weight ratio have led to higher operating Mach numbers and lower airfoil aspect ratios in axial flow compressors and turbines. This design trend has resulted in three-dimensional and viscous effects becoming increasingly significant. Hence, to achieve the overall performance potential of such advanced components, the current semi-empirical design systems based on previous experience must be replaced with advanced systems based on first principle, experimentally verified, three-dimensional aerodynamic analyses. The Purdue Annular Cascade Facility has been designed specifically to provide the benchmark data necessary to verify these three-dimensional blade passage mathematical models.

The flow field in an axial flow turbomachine consists of the complex interaction of many flow structures, some of which are identified in Figure 1. Thick boundary layers develop on the inner and outer endwalls as well as on the blade surfaces. Also, secondary flows, tip clearance leakage flows, hub vortices, and tip vortices influence the flow

ORIGINAL PAGE IS
OF POOR QUALITY

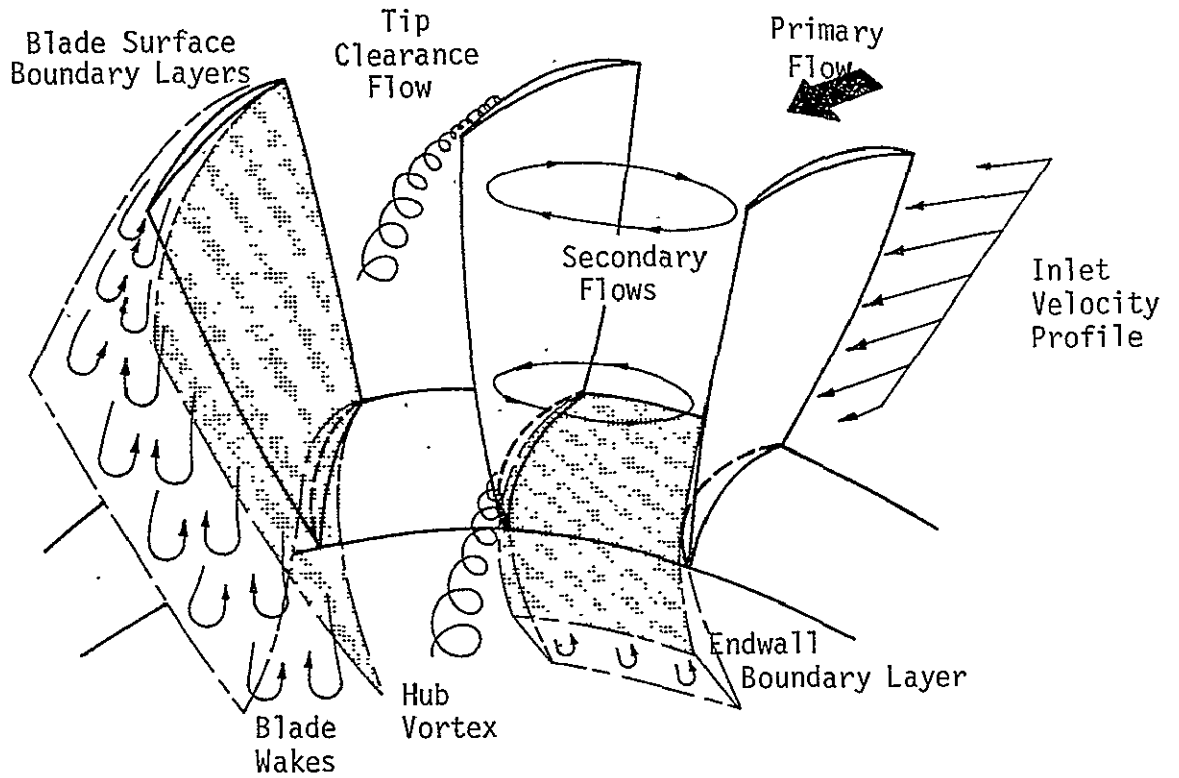

Figure 1. Schematic Representation of the Flow Field in a Turbomachine Blade Row

field. In addition, the inlet velocity profile affects all of these flow structures.

Three-dimensional viscous and inviscid numerical models are currently being developed to model the three-dimensional flow field in a turbomachine blade row. However, because of the extreme complexity of the flow field and the internal geometries, these numerical solutions of necessity involve many computational and numerical assumptions. As a result, to be of quantitative value to the designer and analyst, it is necessary to experimentally verify these predictions. High quality, extensive, three-dimensional data from experiments which model the fundamental phenomenon existing in the flow passages of turbomachines are needed for this verification.

The Purdue Annular Cascade Facility, designed specifically to provide these three-dimensional data, is shown in Figure 2. Both the overall experimental rig and the airfoils are physically large, reflecting the primary design considerations. In particular, the flow passages are large so as to amplify the fundamental flow phenomena as well as to eliminate the need for extreme miniaturization of instrumentation.

This study is directed at the quantification of the overall three-dimensional aerodynamic performance of a classical flat plate airfoil cascade. A fully automated, com-

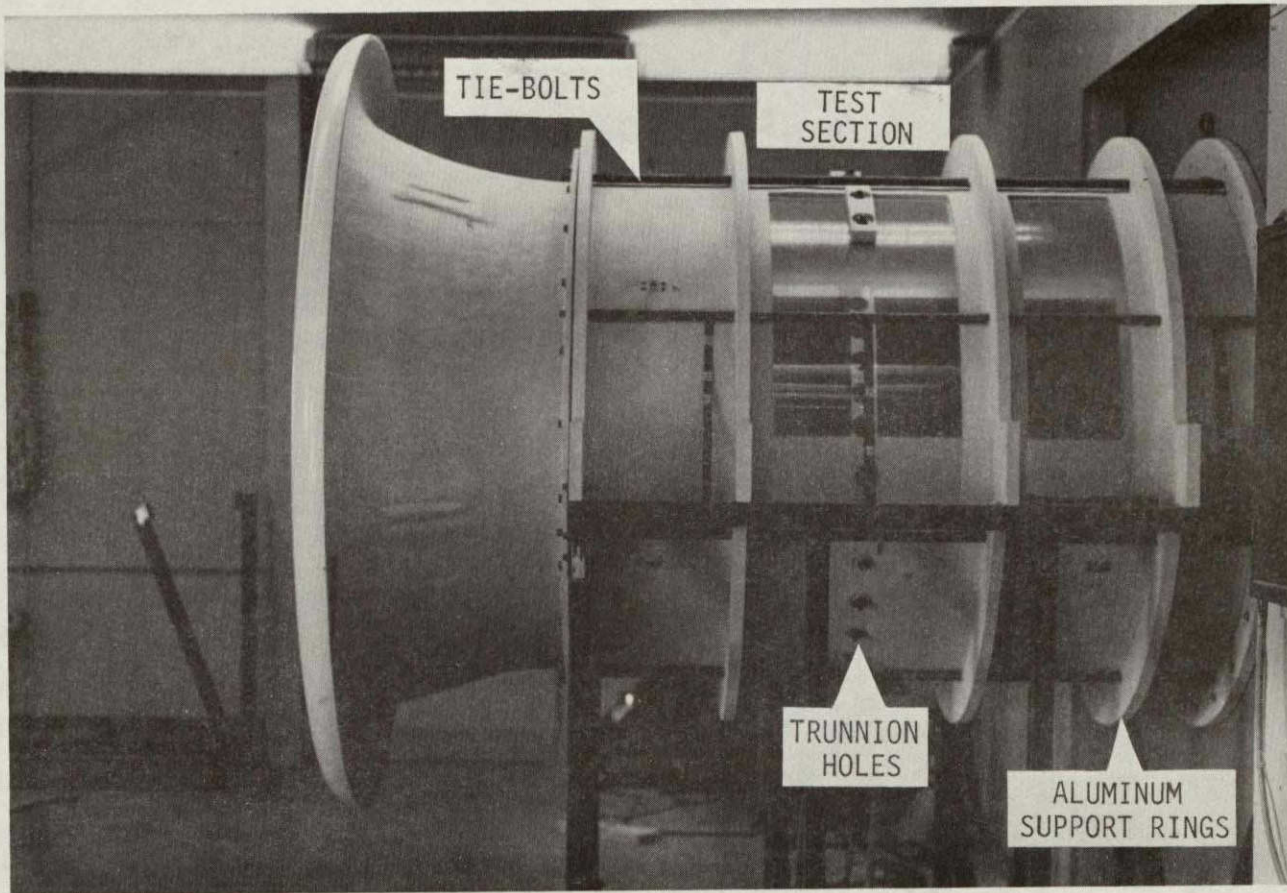

Figure 2. The Purdue Annular Cascade Facility

puter controlled, mean wake data acquisition and reduction system was developed and utilized with a five-hole cone probe. The overall three-dimensional performance of the classical airfoil cascade was determined over a range of incidence angle values using this mean wake acquisition system and a previously developed blade surface pressure data acquisition and analysis system [1].*

* Numbers in the brackets refer to the list of references.

B. Review of Previous Cascade Wake Investigations

A brief review of cascade wake investigations is presented which demonstrates that cascade exit flow fields are dependent on flow field geometry. In particular, the results from two-dimensional cascade studies differ from those of the three-dimensional studies.

The first experimental work on mean wake characteristics was that of Lieblein and Roudebush in 1956 [2]. Their conclusions are based on a limited quantity of data from a two-dimensional cascade, and are very general in nature and application. Further, two-dimensional cascade wake studies were performed by Raj and Lakshminarayana [3]. Their study involved an analytical and experimental investigation into the effects of cascade solidity, incidence angle, and downstream distance on the wake size and shape. Of particular interest are their results showing increased nonsymmetry of the wake with increased incidence angle values and the similarity exhibited by the wake profiles.

A study of the mean three-dimensional velocity characteristics of inlet guide vane and stator blade wakes in an axial flow compressor was performed by Lakshminarayana and Davino [4]. They determined the three-dimensional mean velocity wake decay rate and considered similarity of these wake profiles. The lack of similarity in the hub and tip

regions demonstrated the three-dimensional nature of the downstream flow field.

From the above, it can be concluded that the wakes measured in two-dimensional cascade studies show considerable differences from those measured in the three-dimensional inlet guide vane and stator blade experiments. In particular, the deviation of the similarity results in the hub and tip regions of the inlet guide vane and stator study clearly demonstrates that the experimental verification of advanced three-dimensional analyses requires data obtained in experiments which model the phenomena existing in the flow passages of turbomachines.

C. Objectives of this Investigation

The overall objective of this study is the detailed experimental determination of the three-dimensional aerodynamic performance of a classical airfoil cascade over a range of incidence angle values and the correlation of these unique data with appropriate analyses. This involves the following specific tasks:

- * The automation of an L. C. Smith traversing mechanism to facilitate ease of data acquisition.
- * The design, construction, and checkout of a large (5.715 cm diameter) Calibration Jet Facility for accurate probe calibrations.
- * The automated calibration of a five-hole cone probe in the non-nulled mode.
- * The development of an automated mean wake data acquisition, reduction, and output system.
- * Utilization of the automated mean wake and airfoil surface data acquisition systems to determine the three-dimensional performance of the classical airfoil cascade at incidence angle values of 0° , 5° , and 10° .

- * Analysis of the cascade wake data to quantify: the effect of incidence angle; the three-dimensionality of the flow field; and the similarity or lack thereof for the velocity profiles.

- * Correlation of the airfoil surface data with predictions from the NASA inviscid flow analyses MERIDL and TSONIC.

- * The demonstration of a technique for on-line visualization of downstream pressure contours.

CHAPTER II EXPERIMENTAL APPARATUS

This chapter is divided into three sections: The Purdue Annular Cascade Facility, The Control Room Apparatus, and The Construction/Definition of a Calibration Jet Facility.

A. The Purdue Annular Cascade Facility

Annular Cascade and Air Supply

The Purdue Annular Cascade, pictured in Figure 2 and schematically shown in Figure 3, is comprised of sections fabricated from a honeycomb fiberglass material. The hub sections are held together by inner flanges and are attached to and supported by the outer shroud via five inlet and three exit support struts. The outer shroud consists of a bellmouth together with four other sections joined together with large aluminum support rings and tie-bars. The aluminum support rings rest on a metal stand which supports the entire cascade facility.

ORIGINAL PAGE IS
OF POOR QUALITY

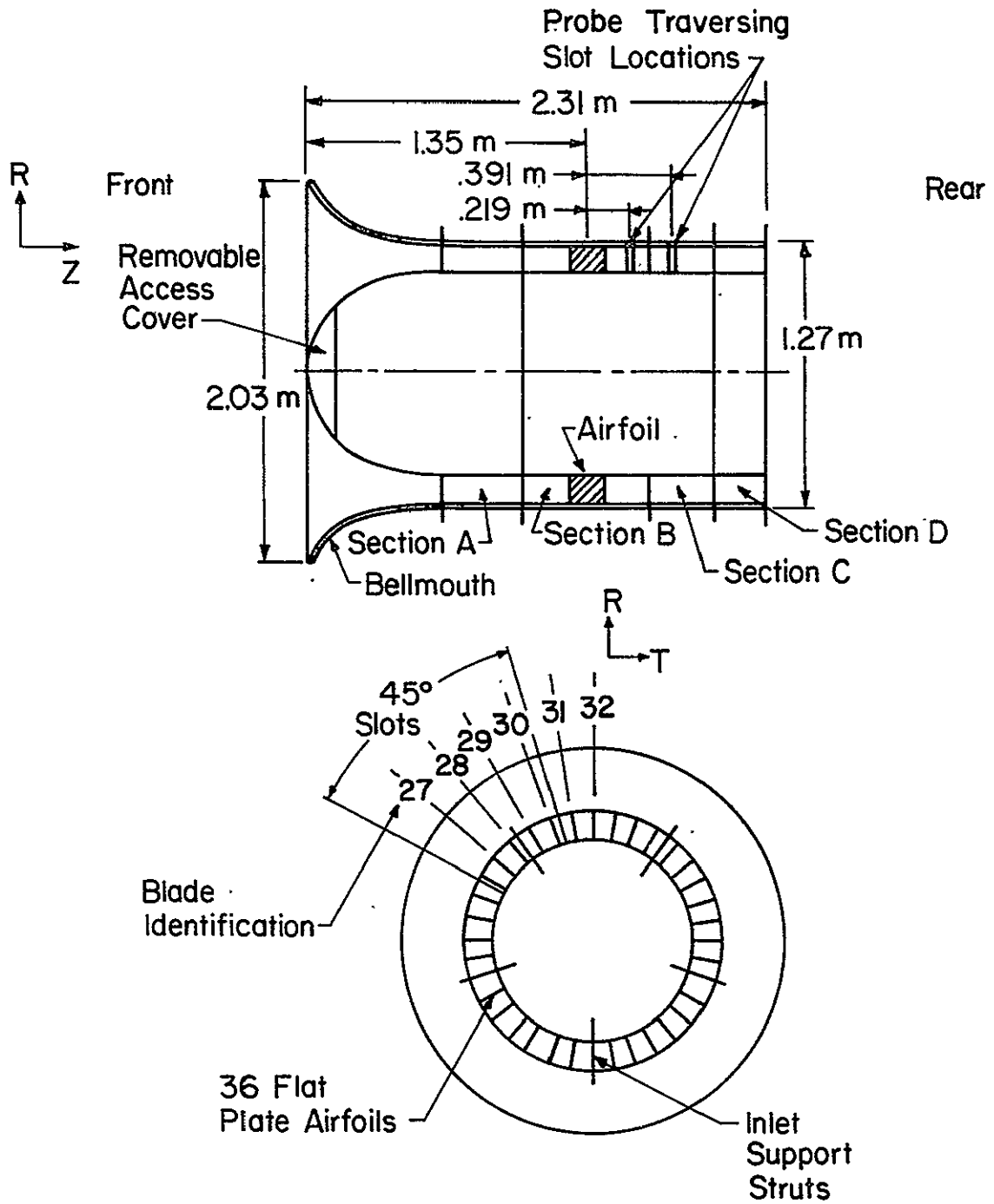

Figure 3. Schematic of The Purdue Annular Cascade Facility

The flow enters the facility through the bellmouth and is accelerated in the annulus formed by the gradually contracting flow region bounded by the hub and bellmouth. At the intersection of the bellmouth and section A, the annulus height of 15.24 cm (6.0 in.) is reached and maintained through the exit region of the facility. Thirty-six airfoil trunnion mounting holes are located in the test section, Section B. Also, two circumferential traversing slots are located downstream of the test section.

Airflow exiting the facility expands into a 24 cubic meter plenum chamber, Figure 4, which provides an even exhaust pressure to the cascade. This steady exhaust pressure is maintained by a large-capacity centrifugal compressor which is capable of exhausting 354 cms (150,000 cfm) of air at a pressure change of 46 cm (18 in.) of water. This compressor is driven through a set of ten v-belts on a jack shaft by a 224 kw (300 Hp) three-phase induction motor. Variable inlet guide vanes upstream of the centrifugal compressor allow for flow rate control. A more detailed description of The Purdue Annular Cascade Facility is presented in Reference [1].

Airfoils

Thirty-six classical flat plate airfoils of aspect ratio unity, schematically shown in Figure 5, were used in

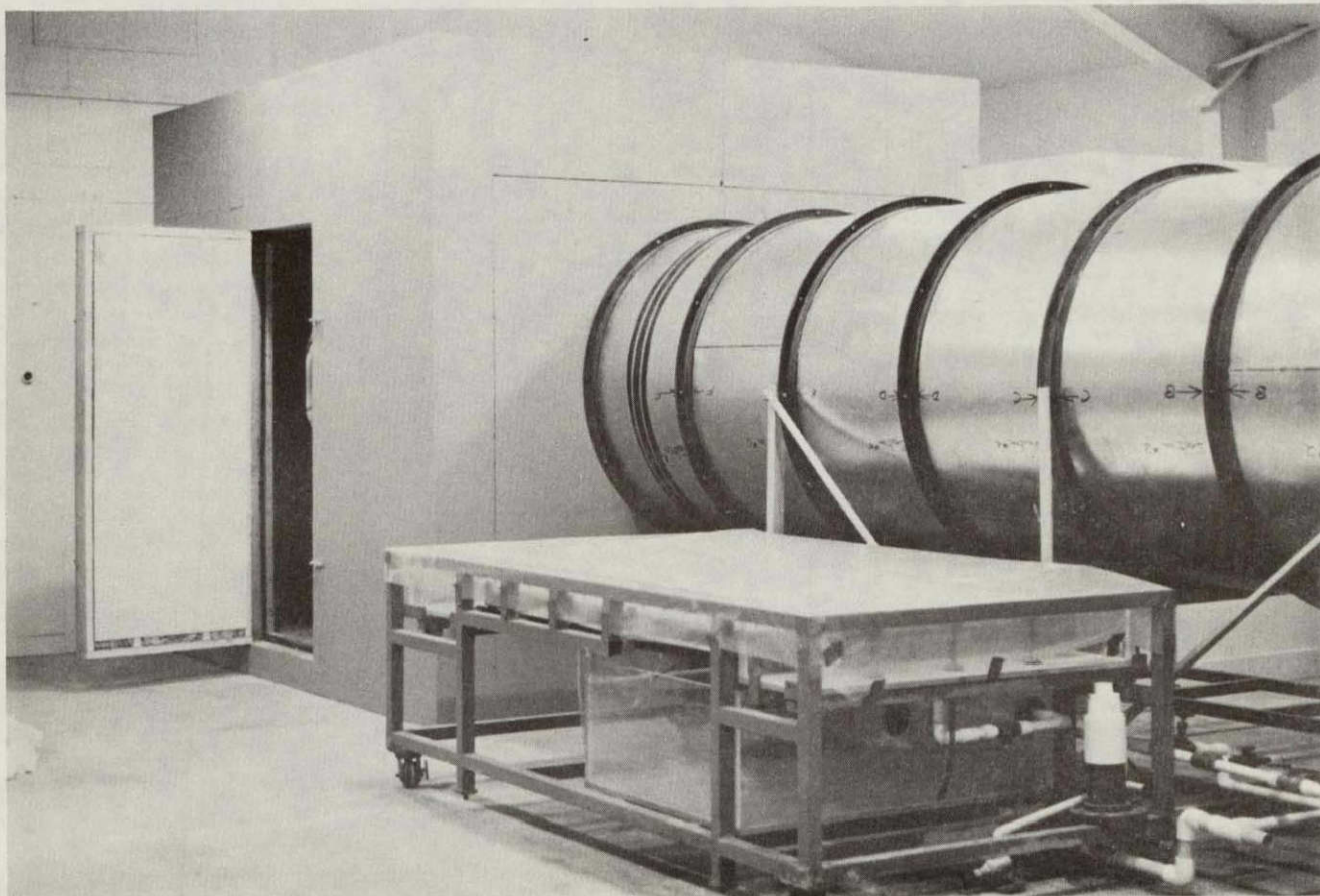

Figure 4. Exterior View of Plenum Chamber and Ducting

ORIGINAL PAGE IS
OF POOR QUALITY

ORIGINAL PAGE IS
OF POOR QUALITY

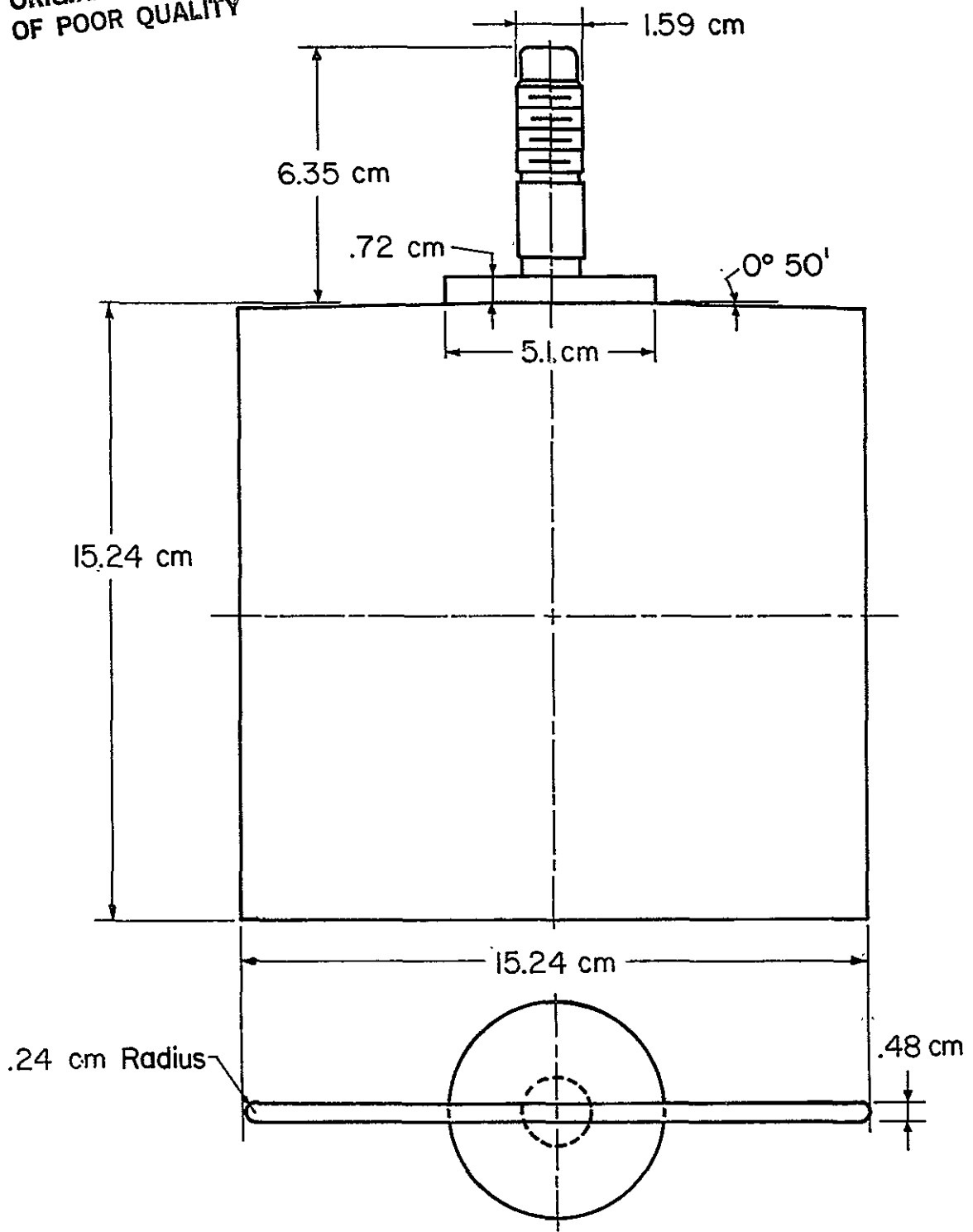

Figure 5. Flat Plate Airfoil Dimensions

this study. Four of the airfoils were instrumented with surface static pressure taps. Two types of instrumented airfoils were used, as depicted in Figure 6: one type with 15 static pressure taps along a chordline at midspan, and the second type with 15 static pressure taps along a chordline at 10% span and 15 static pressure taps along a chordline at 90% span. The chordwise gaussian distribution of each set of 15 surface static pressure taps is presented in Figure 7.

Two airfoils of each type were installed in the facility in front of the circumferential traversing slots such that both the pressure and the suction surfaces of the airfoil were instrumented. As these airfoils were cantilevered from the facility outer shroud, it was necessary to fill in the airfoil-inner shroud gaps. Figure 8 shows a view of the instrumented airfoils installed in the facility with their inner-shroud gaps filled with modeling clay.

Upstream Pressure Rakes

The cascade inlet velocity profile and the mass averaged upstream velocity are determined via three symmetrically distributed pressure rakes, Figure 9, located in section A of the facility. Associated with each rake are two static pressure taps, one on the hub surface and one on the outer shroud surface. Upstream mass averaging is accomplished by averaging the individual rake tap pressure read-

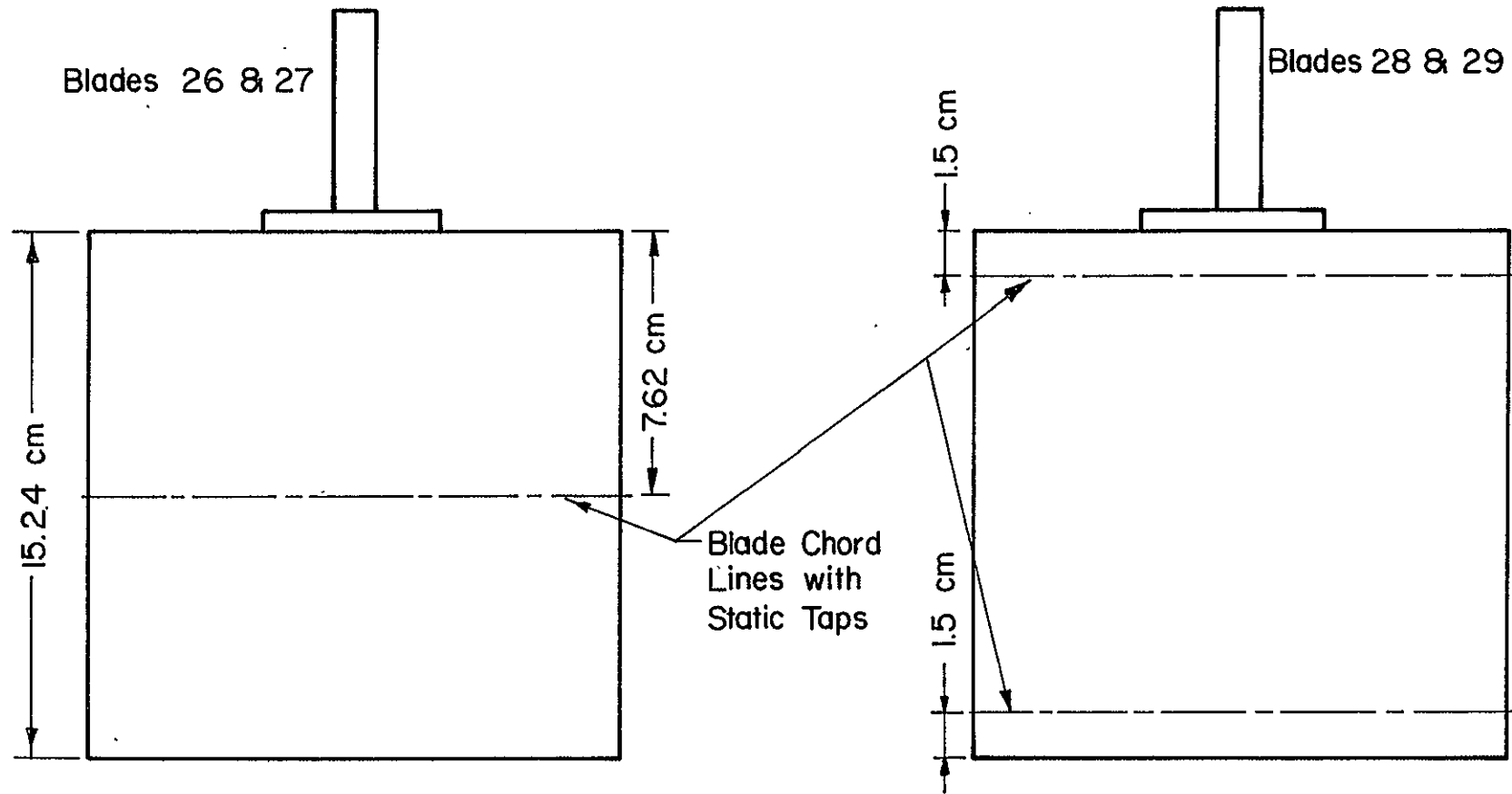

Figure 6. Airfoil Surface Static Pressure Tap Spanwise Locations

Locations of Static Taps Along Blade Chord Line
(Total of 15)

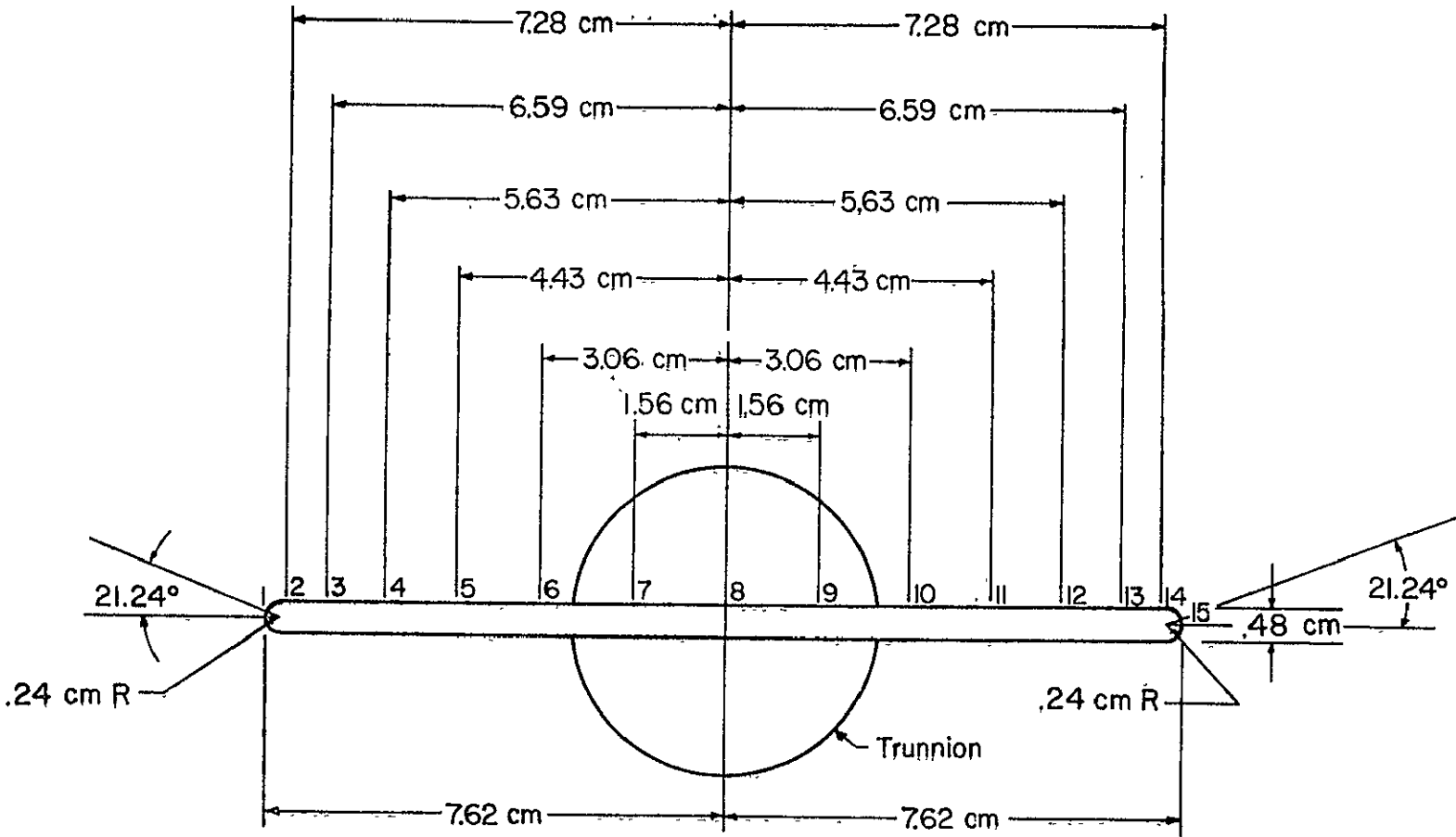

Figure 7. Chordwise Distribution of the Airfoil Surface Static Pressure Taps

ORIGINAL PAGE IS
OF POOR QUALITY

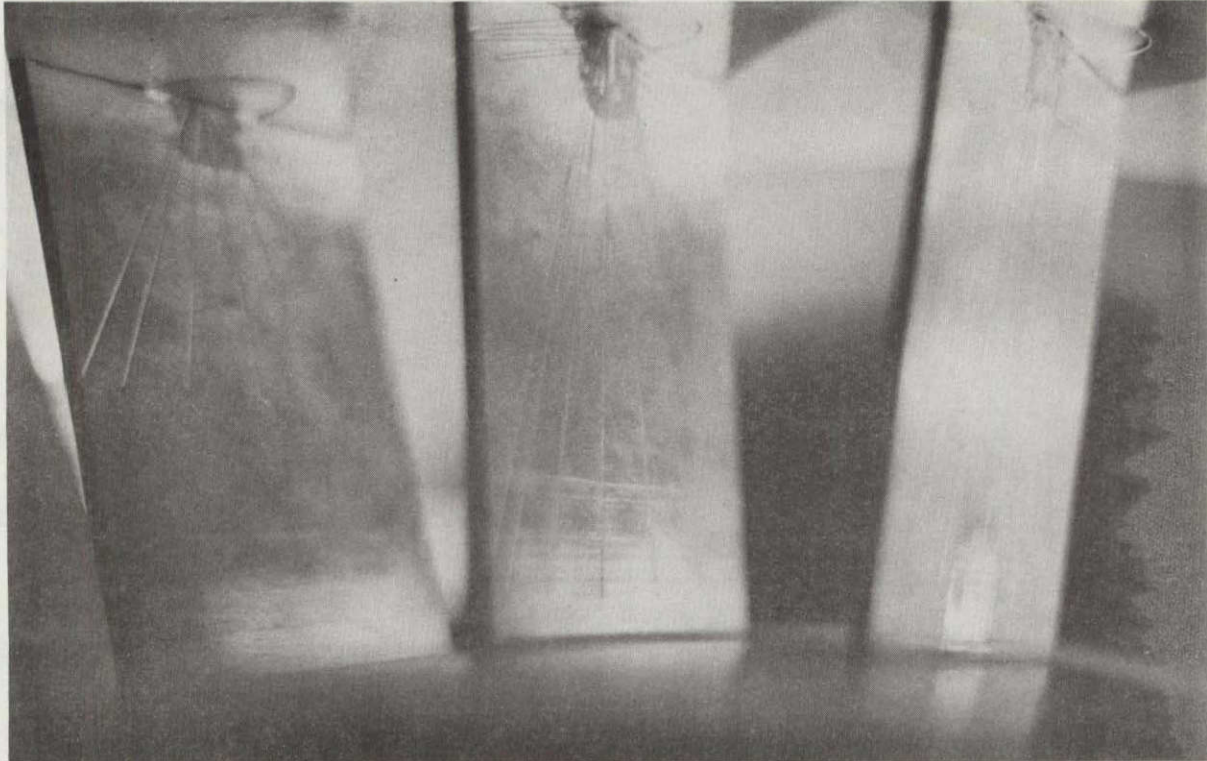

Figure 8. Installed Instrumented Airfoils

PRESSURE RAKE

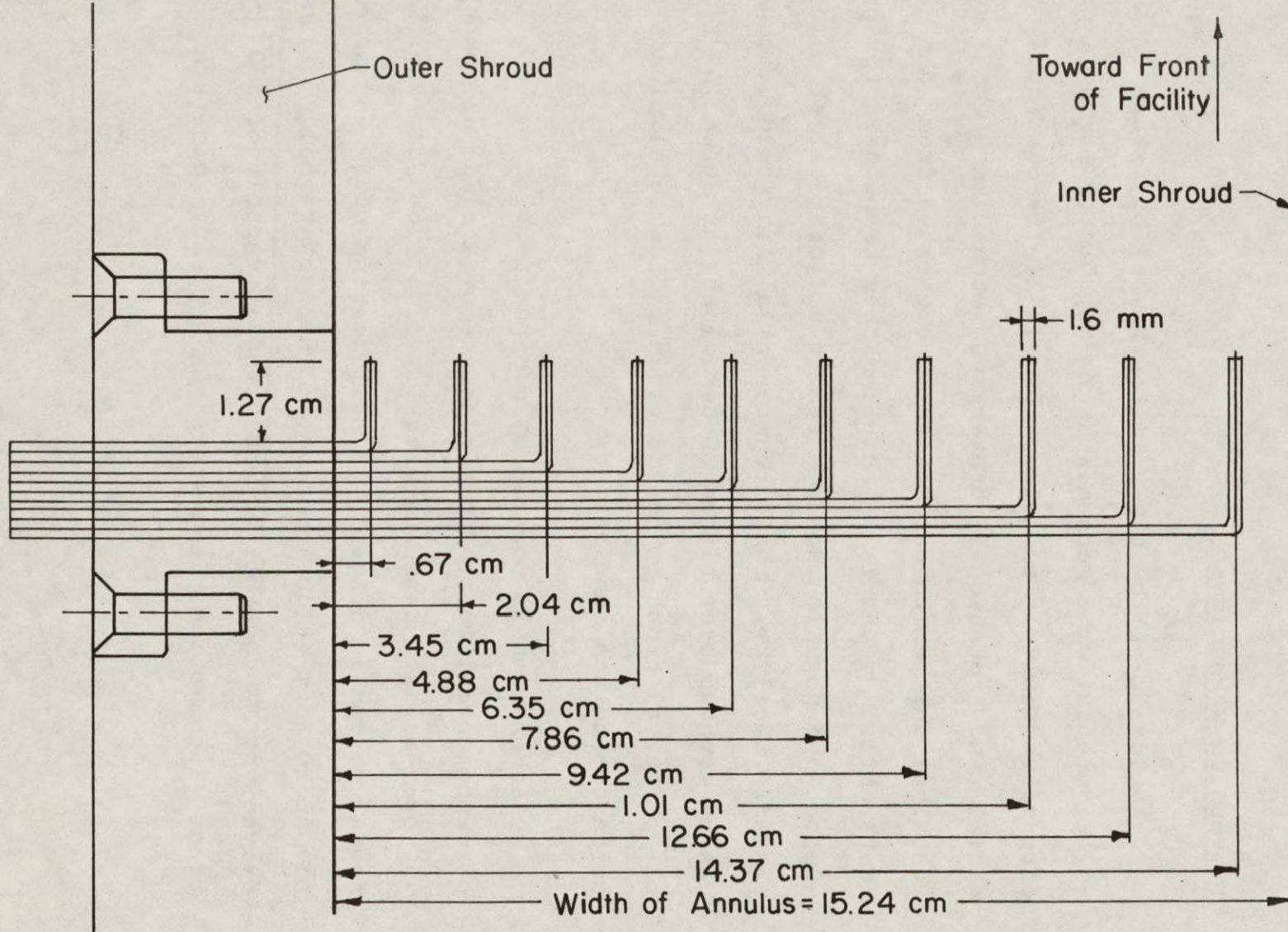

Figure 9. Schematic of a Total Pressure Rake

ORIGINAL PAGE IS
OF POOR QUALITY

ings, as the taps are located at the mid-radius of concentric annuli of equal area.

Traversing Mechanisms

A closeup of the L. C. Smith traversing system is shown in Figure 10. The mechanisms are capable of moving a probe circumferentially, radially, or in self-rotation. The radial and rotational traversing mechanisms form a self-contained unit which can be easily separated from the circumferential mechanism, enabling them to be used for probe support and positioning in a remote calibration jet. In the cascade facility, the circumferential traversing mechanism can be mounted over either of two slots, as shown in Figure 11. The slot not in use is flush filled to eliminate disturbances to the annulus flow.

Each motion is powered by a separate D. C. motor. The circumferential motion unit consists of a slide driven up to 45° over a fixed base by rack and pinion gearing. The radial motion is driven by a ball bearing screw and is capable of 20.3 cm (8 in.) motion. The rotational motion is driven by a gearbox assembly and is capable of 360° rotation. Each motion is geared to a separate ten-turn linear

ORIGINAL PAGE IS
OF POOR QUALITY

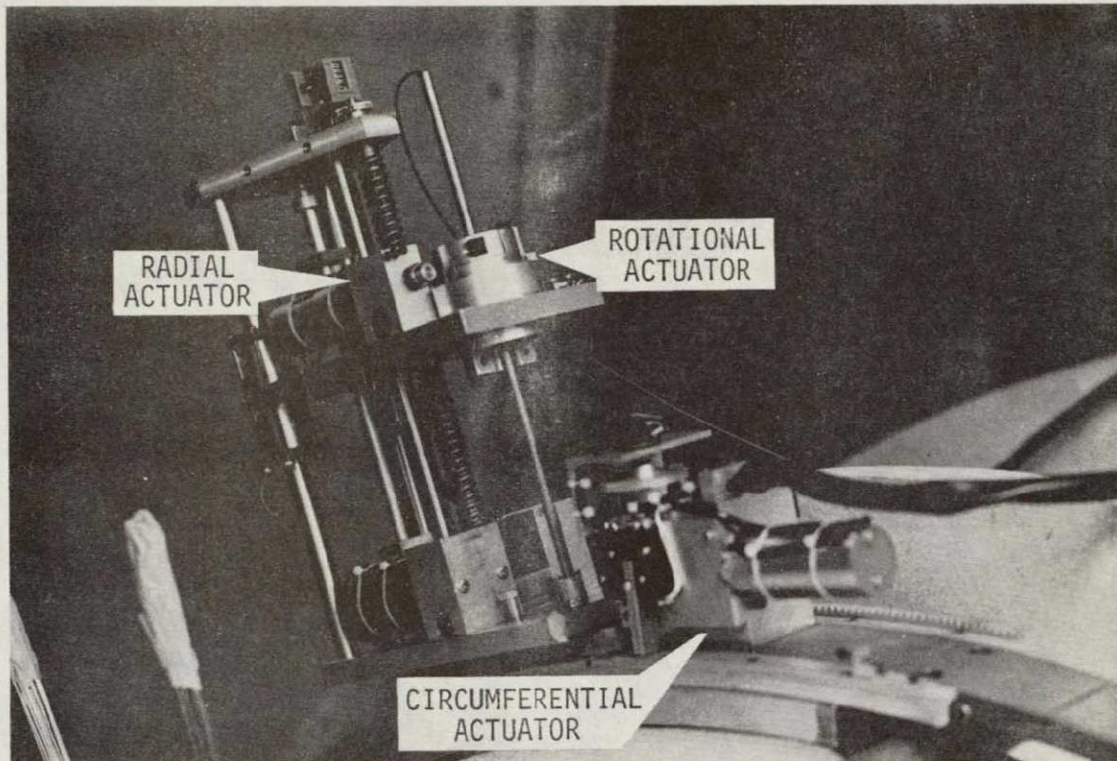

Figure 10. Probe Traversing Mechanisms

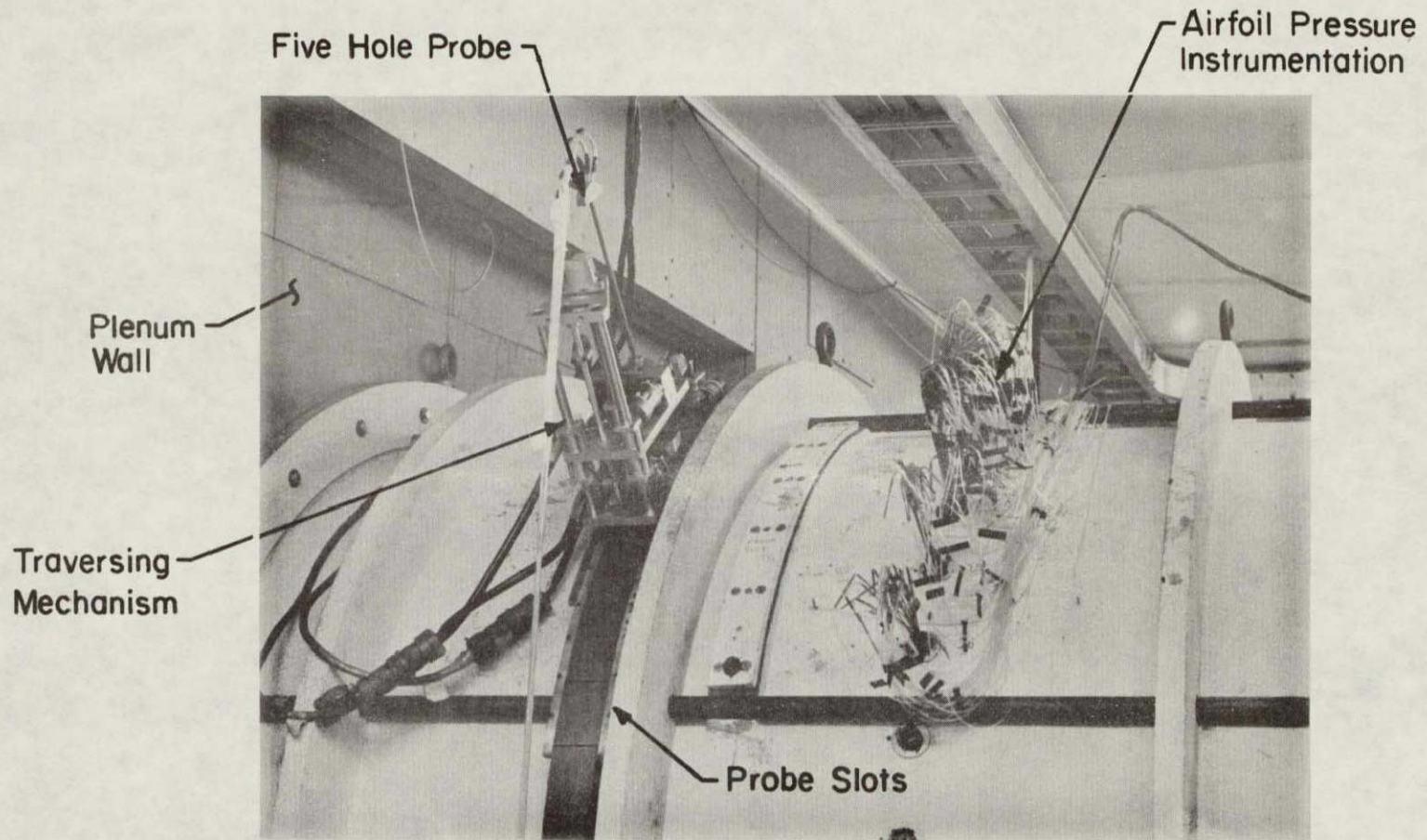

Figure 11. Traversing Mechanism Mounting on the Annular Cascade

ORIGINAL PAGE IS
OF POOR QUALITY

potentiometer and a mechanical counter for position definition.

The movement of the traversing mechanisms is controlled by an L. C. Smith Model D1-3R Indicator. Controls include motion selection, motion speed, and direction of motion. Positioning is displayed on a 3 1/2 digit digital voltmeter which displays the voltage across the selected motion's ten-turn linear potentiometer. This unit is designed to give manual push-button control of probe positioning.

As part of this study, the probe positioning was automated. A separate circuit was designed and fabricated to allow for either automated or manual probe positioning. In the automated mode, the motion selection and the direction of motion are controlled by relays which are, in turn, controlled by computer software. The analog positional voltage signal is transferred to the computer and software decisions are made to move the probe (switching of the proper relays and motoring the probe position) to preset positions. The automated mode includes software confirmation of probe positioning after motion has ceased at each measurement station, and if necessary, the repositioning of the probe.

The accuracy of the three motions is calculated by dividing the amount of travel in any motion for the full ten turns of the potentiometer by one-half the corresponding

smallest increment of voltage (2000). This yields the following accuracy for the positioning of the probe:

Circumferential Motion:	+/-0.023 ^o
Radial Motion:	+/- 0.01 cm
Rotational Motion:	+/-0.18 ^o

Scanivalve Pressure Measurement System

Due to the large number of pressure measurements required, a Scanivalve pressure measurement system was previously developed [1]. The annular cascade Scanivalve system incorporates three modules which rotate in tandem. Figure 12 [5] shows a typical multiple-module unit. Each module consists of a rotating valve-switching device which exposes a single transducer to any of 48 different pressure ports as directed by the solenoid advancer. The solenoid advancer is either push-button manually controlled or computer controlled.

The three transducers are each 6.9 kPa (1 psid) bi-directional differential linear transducers. Two ports of the 48 ports on each module are reserved for calibrating the module's transducer: one for the reference side of the transducer and one for spanning the transducer. The selection of these two pressures is critical. The reference pressure should be both steady and higher (or lower) than any pressure expected to be measured against it in order to

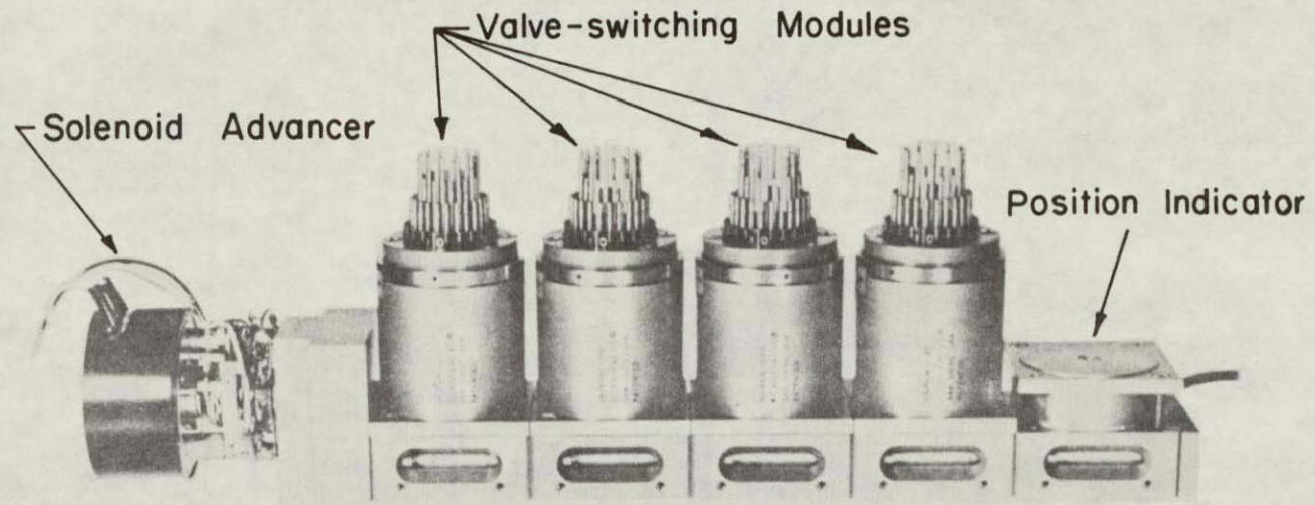

Figure 12. Typical Scanivalve Multiple-Module Unit

ORIGINAL PAGE IS
OF POOR QUALITY

avoid drift and calibration shift problems. The span pressure should be of proper sign and magnitude to flex the transducer diaphragm in the same direction as the measurements to be made. Ambient pressure was chosen for the reference pressure in the annular cascade because it is steady and is the highest possible pressure in the no work cascade. The span pressure was supplied by the vacuum source shown in Figure 13, and was set at approximately 6.9 kPa (1 psi) vacuum, with accurate measurements on a 200 cm u-tube water manometer for each calibration. Figure 14 shows a typical transducer calibration curve for this setup. Specifically, calibration is obtained by selecting the reference port, measuring the offset voltage, and then selecting the span port and measuring the span voltage.

The response time of the Scanivalve transducers has been investigated, showing a settling time of 160 milliseconds to be sufficient. To allow for this settling time, the software incorporated in this study used a 99 millisecond delay command combined with programming steps which confirm the Scanivalve position (totalling over 160 milliseconds) after each solenoid advance. Voltage readings were obtained using statistical sampling techniques to define a mean voltage reading and an estimate of the error in the mean voltage.

Figure 15 shows the complete Scanivalve pressure measurement system package. A 12 x 24 port interface is

ORIGINAL PAGE IS
OF POOR QUALITY

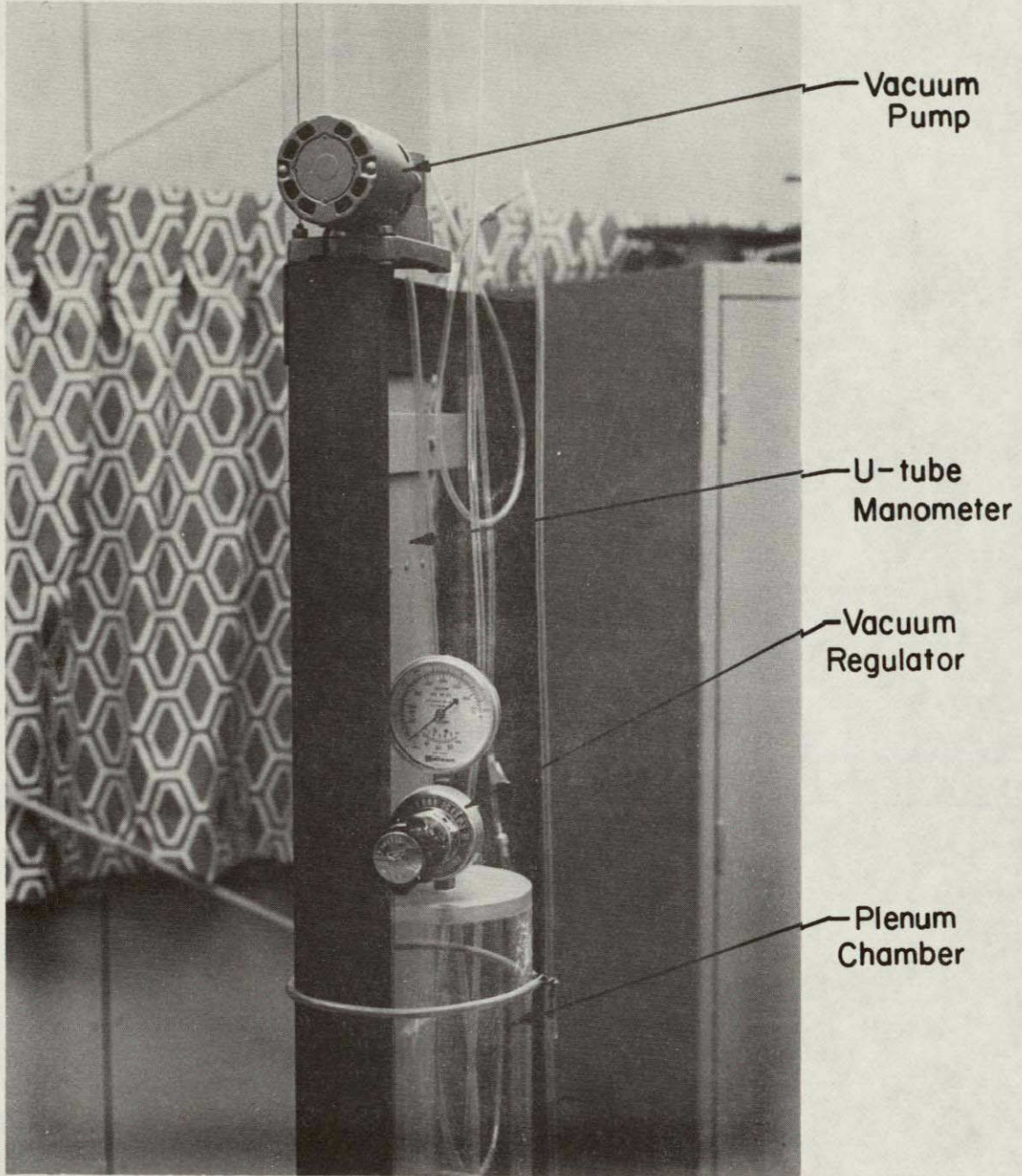

Figure 13. Cascade Facility Transducer Calibration Pressure System

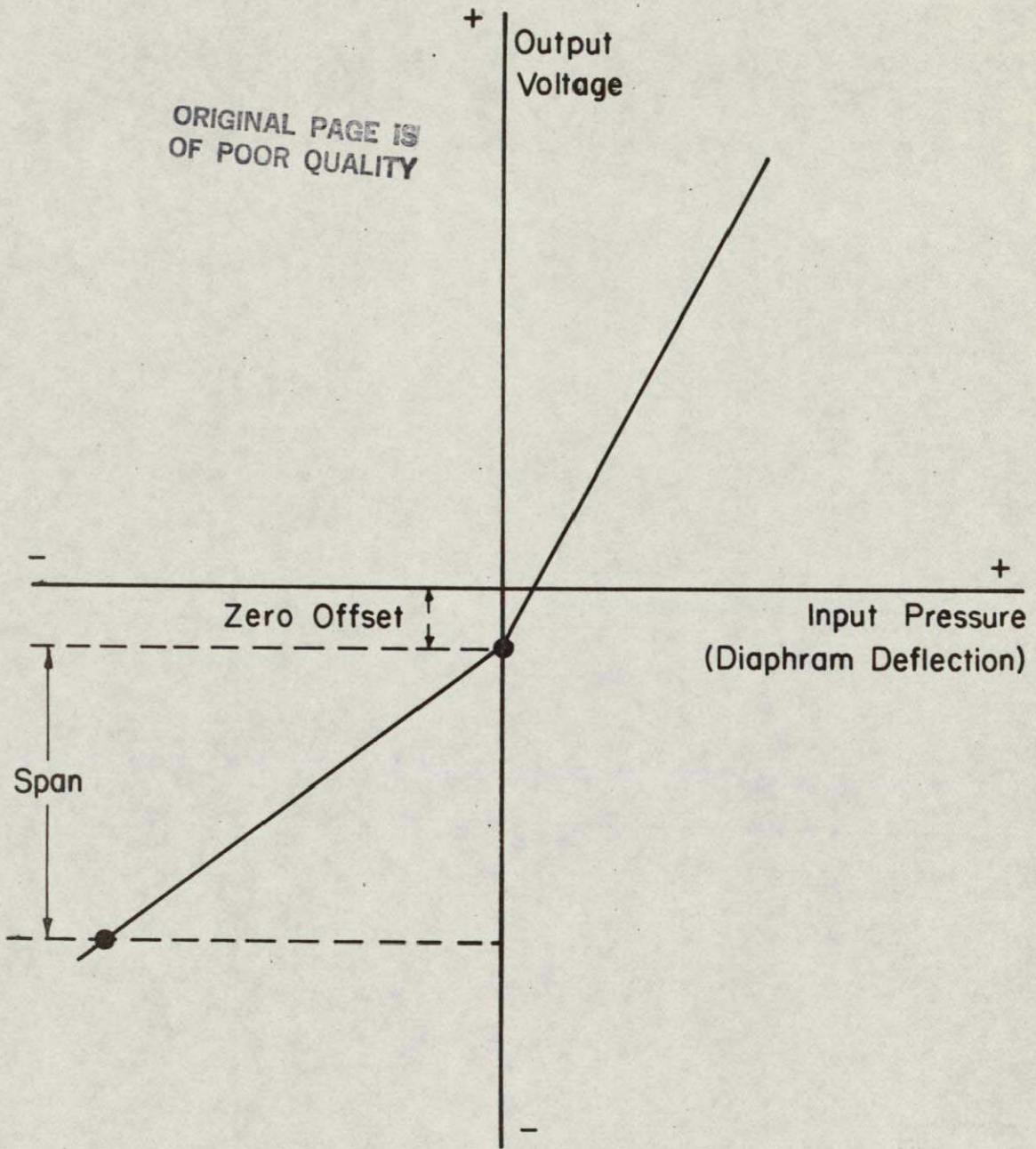

Figure 14. Typical Transducer Calibration Curve



Figure 15. Scanivalve Pressure Measurement System

ORIGINAL PAGE IS
OF POOR QUALITY

provided to facilitate connection of pneumatic tubing in the Scanivalve modules. This interface is arranged in an orderly way to permit identification of the reference port, the span port, and the other 46 ports on each module.

B. Control Room Instrumentation

The automated probe positioning and pressure data acquisition were accomplished utilizing a Hewlett-Packard 3497 data acquisition control unit and a Hewlett-Packard 85 desktop computer. The data acquisition control unit has three types of insert cards which connect external devices to the unit. The first type of card is a 16 channel actuator board for switching peripheral devices such as the probe positioning relays in the modified L. C. Smith indicator unit and the solenoid advancer in the Scanivalve measurement system. The second type of card is a 20 channel analog input board which is connected to an internal voltmeter. It is used for reading external voltages such as the positional voltage from the modified L. C. Smith unit and the pressure voltages from the Scanivalve transducers. The third type of card is a sixteen bit digital input board which is used to read the Scanivalve port position.

The HP-85 desktop computer, programmable in HP-Basic, is connected to the data acquisition unit by a busline. Software commands to open/close actuator channels, read analog voltage channels, send information back to the HP-85 memory, etc., are sent to the 3497 acquisition unit on the busline. These commands have been incorporated in computer programs to completely automate the data acquisition process.

The HP-85 has a tape drive to provide permanent storage of data and programs. Acquisition and reduction of data were accomplished by two separate programs to minimize the acquisition time and to avoid calibration and cascade velocity drifts. Raw data were stored on tape cartridges by the acquisition program and later reduced. To provide full page data printouts in final tabular form and high quality graphic capabilities, an Integral Data Systems 440 Paper Tiger Line Printer and an HP-7470 Plotter were interfaced with the HP-85 desktop computer. With the addition of the line printer and the plotter, all hand transfer of data was eliminated and the automated mean wake acquisition and reduction system development completed.

C. Construction/Definition of a Calibration Jet Facility

A five hole cone probe was used to obtain the mean three-dimensional cascade wake data in this study. The calibration of this probe in the non-nulled mode requires a relatively large calibration jet with a uniform flow core region.

Design

The Calibration Jet Facility is schematically depicted in Figure 16 and shown in Figure 17. A centrifugal blower capable of delivering 0.15 cms (320 cfm) at 43 cm (17 in.) of water is belt driven at constant speed by a 3.73 kW (5 HP) electric motor. The blower feeds the large 50.8 x 50.8 cm (20 x 20 in.) cross-sectioned plenum through a long gradual diffuser section which is equipped with three 100 mesh screen sections for flow straightening and to aid in diffusing the flow. The flow is discharged from the plenum through a nozzle which forms the calibration jet. The nozzle throat (exit) diameter is 5.715 cm (2.25 in.). Thus the area ratio of the plenum cross section to the nozzle cross section is 100 to 1, meeting ASME specifications [6]. Probe support and positioning are supplied by a rotary table with an attached fixture to mount the radial/self-rotational traversing mechanism unit, as seen in Figure 17. A detailed probe to jet alignment procedure is described in Appendix A.

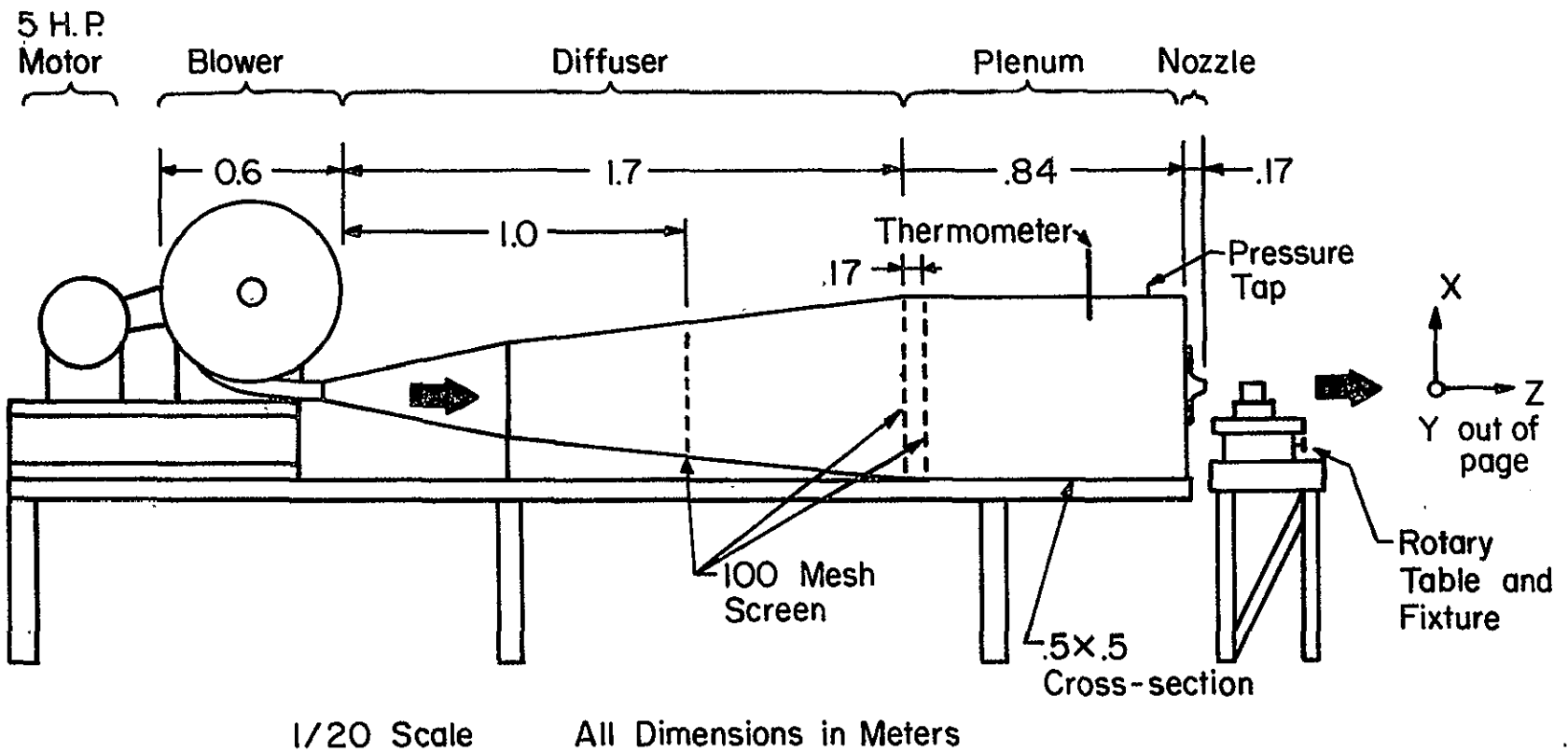

Figure 16. Schematic of the Calibration Jet Facility

ORIGINAL PAGE IS
OF POOR QUALITY

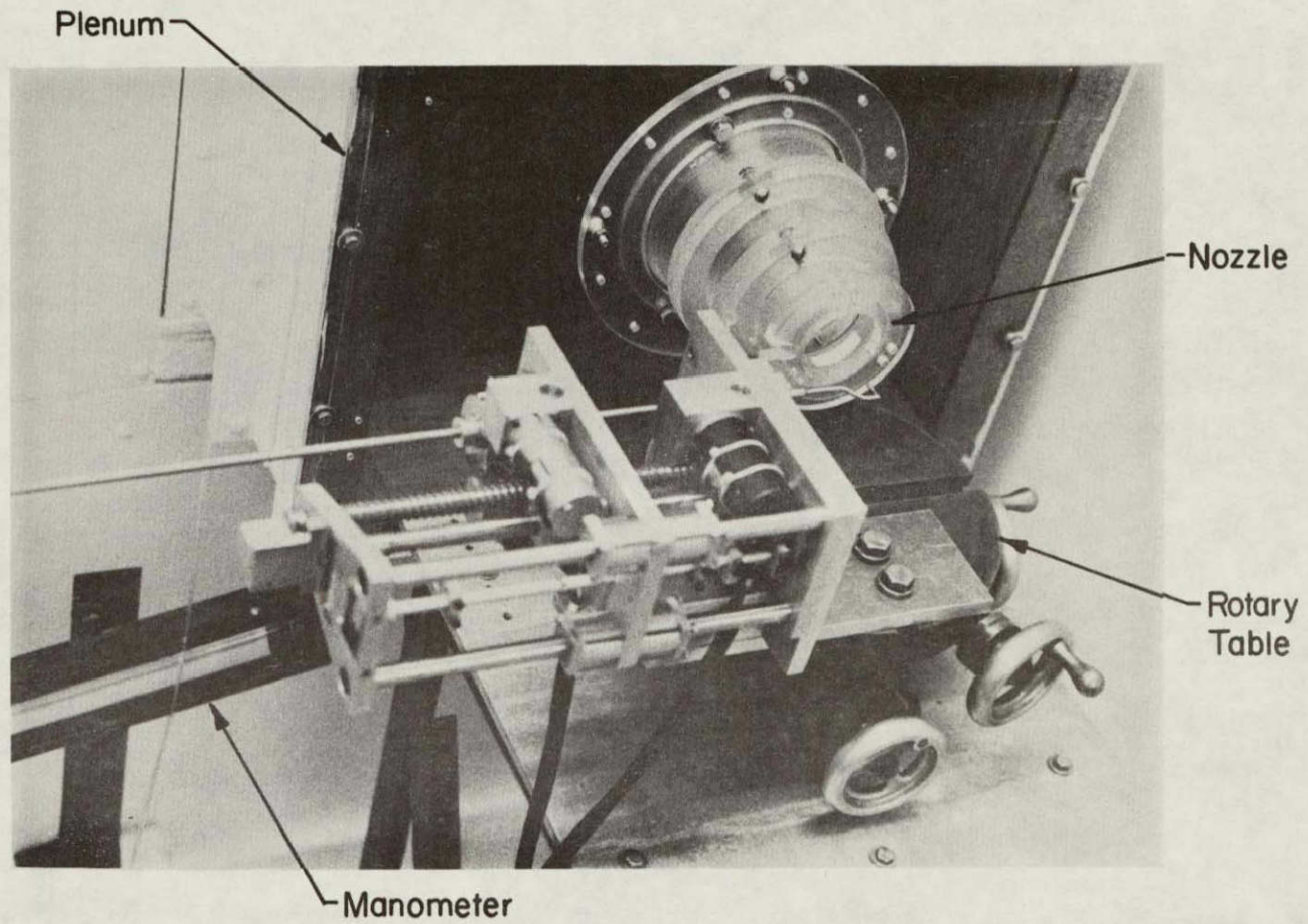

Figure 17. The Calibration Jet

The design of the nozzle shape was considered in detail. Hussian and Ramjee [7] compared the incompressible flow characteristics of a cubic equation contour nozzle, a Batchelor-Shaw nozzle, the ASME β series nozzles and the simple disk nozzle (orifice plate). They found that a uniform mean velocity and low turbulence core region exists with any one of the designs, provided that a sufficient core to probe diameter ratio exists. Based on these results, an ASME β series nozzle was fabricated from a 31 degree plexi-glass cone. The nozzle exit section is 5.715 cm (2.25 in.) in diameter and the entrance was machined to smoothly mate with the inner plenum wall. The jet velocity is controlled by throttling the centrifugal blower inlet by adjusting the three leaf shutters seen in Figure 18.

Check-Out

To quantify the aerodynamic performance of the calibration jet, the jet velocity profile was mapped using a hot-wire anemometer and a pitot probe.

The velocity is calculated assuming isentropic flow. Thus the plenum pressure and temperature, as measured with a Merian Model 40HE35 Inclined Water Manometer and a thermometer in the plenum, correspond to the jet total pressure and total temperature, P_t and T_t , respectively. The static pressure of the jet, P_s , is the ambient pressure as measured

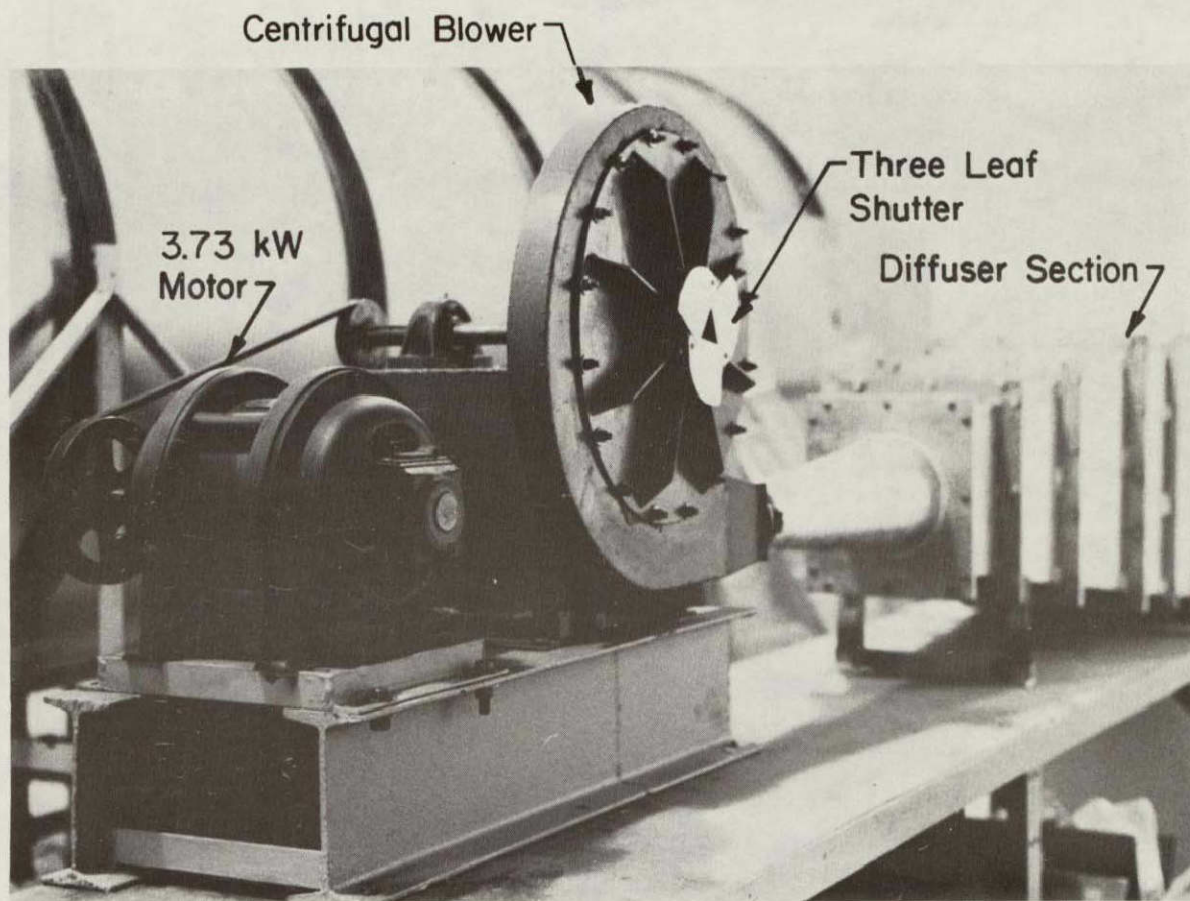

Figure 18. Calibration Jet Air Supply and the Three Leaf Shutter Speed Control Device

on a barometer. The compressible flow equations are then used to calculate the velocity:

ORIGINAL PAGE IS
OF POOR QUALITY

$$T_s = T_t \left[\frac{P_s}{P_t} \right]^{\frac{k-1}{k}} \quad (1)$$

$$M = \left[\frac{2}{k-1} \left[\left[\frac{P_t}{P_s} \right]^{\frac{k-1}{k}} - 1 \right] \right]^{1/2} \quad (2)$$

$$U = \left[k(R_{air})T_s \right]^{1/2} M \quad (3)$$

where k , the specific heat ratio, is 1.4, and R_{air} , the air gas constant, is 287.08 J/kg-K (53.35 ft-lb/lb-R).

The calibration jet mapping was conducted with a jet core velocity of approximately 30.5 m/s (100 ft/s), the nominal velocity anticipated in the annular cascade experiments. A one hour warm-up time for the jet was determined to be more than sufficient for steady conditions to be reached.

Profiles were measured at 6 axial locations downstream of the exit with both a hot-wire and a pitot probe, with

the data analyzed to determine U^* and Y^* values at each Z/D axial location where:

$$U^* = \frac{\text{Probe Measured Velocity}}{\text{Calculated Isentropic Velocity}}$$

$$Y^* = \frac{\text{Distance from the Jet Centerline}}{\text{Nozzle Exit Radius}}$$

and

$$Z/D = \frac{\text{Axial Distance to the Jet Face}}{\text{Nozzle Exit Diameter}}$$

Figure 19 shows the jet velocity profile at the axial location subsequently used for the calibration of the five-hole cone probe. Complete jet velocity profile data are presented in Appendix B. Analysis of these data show that a relatively large core region exists in the jet, with the core diameter decreasing to approximately 3.81 cm (1.5 in.) at $Z/D = 1.33$. Low turbulence intensities, less than 2.0%, were measured throughout the core region. Further, the hot-wire data and pitot probe data exhibit very good agreement. Also, the probe measured core velocities and the calculated isentropic velocities are in excellent agreement, thereby verifying the isentropic nozzle design.

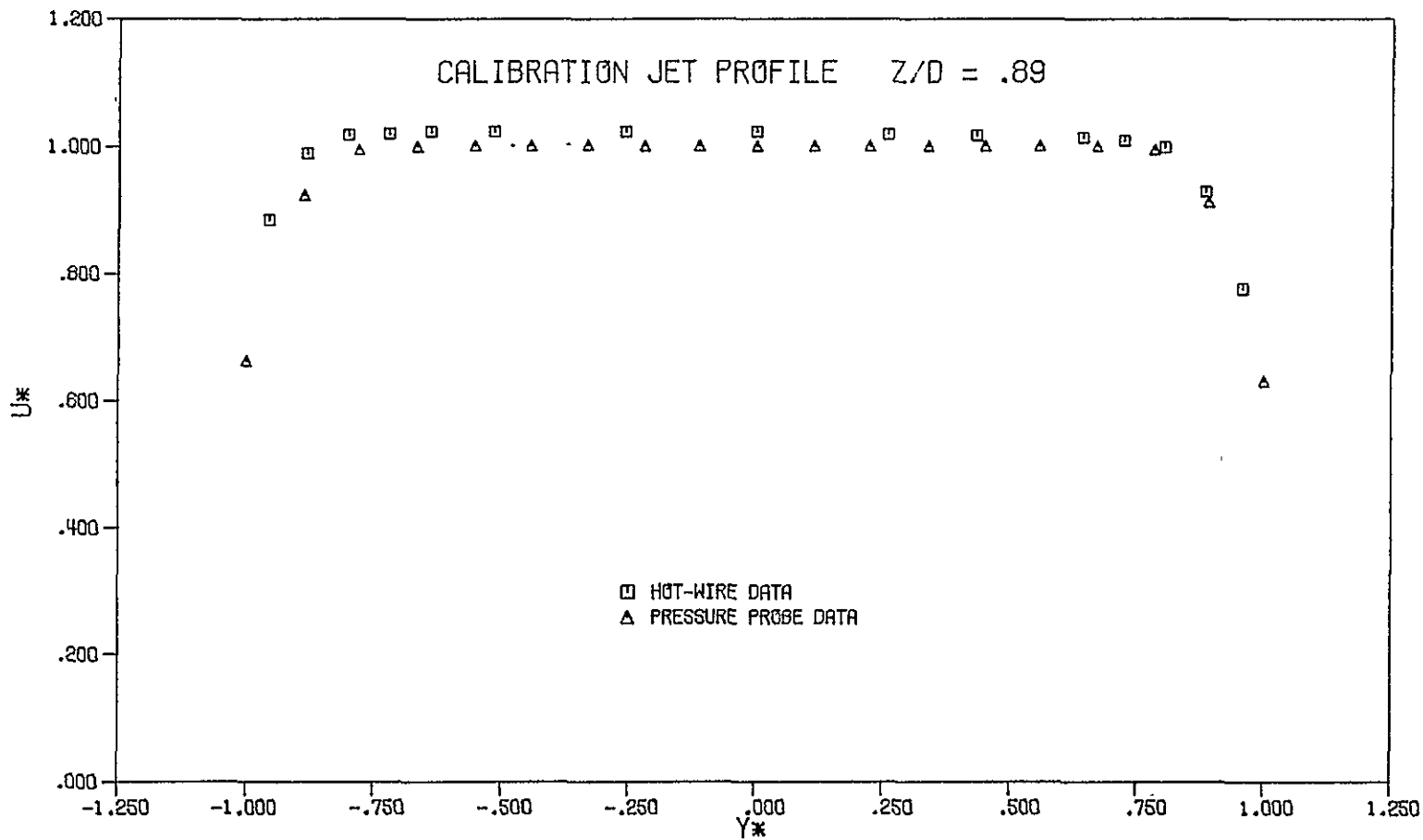

Figure 19. Jet Profile at the Selected Five-Hole Probe Calibration Point

ORIGINAL PAGE IS
OF POOR QUALITY

CHAPTER III FIVE-HOLE CONE PROBE SELECTION AND CALIBRATION

A five-hole cone probe in the non-nulling mode was utilized to measure the three-dimensional classical airfoil cascade exit flow field. This required an extensive calibration of the probe. The non-nulling mode was selected because the time and complexity associated with rotation of the probe for the nulling mode are eliminated.

A. Probe Selection

The five-hole cone probe utilized in this study was selected based on geometric size and shape considerations. Gettelman and Krause [8] determined that the probe tip and the support stem must be separated by at least three stem diameters so as to avoid support interference effects. Further, the sensor head diameter must be sufficiently small as to avoid passage blockage effects and erroneous results in flow regions with steep pressure gradients. Also for calibration purposes, it is desirable for the probe axis of rotation to pass through the tip, resulting in the tip

remaining on the calibration jet centerline for all angular settings.

Based on the above considerations, the United Sensor type DC-125 five-hole cone probe, shown in Figure 20, was selected. This probe has a sensor head diameter of 0.318 cm (0.125 in.). The probe coordinate system and port labeling system, including the definition of the yaw and pitch angles, are shown schematically in Figure 21. The probe coordinate system coincides with that of the annular cascade when the probe and the annular cascade Z-axes coincide.

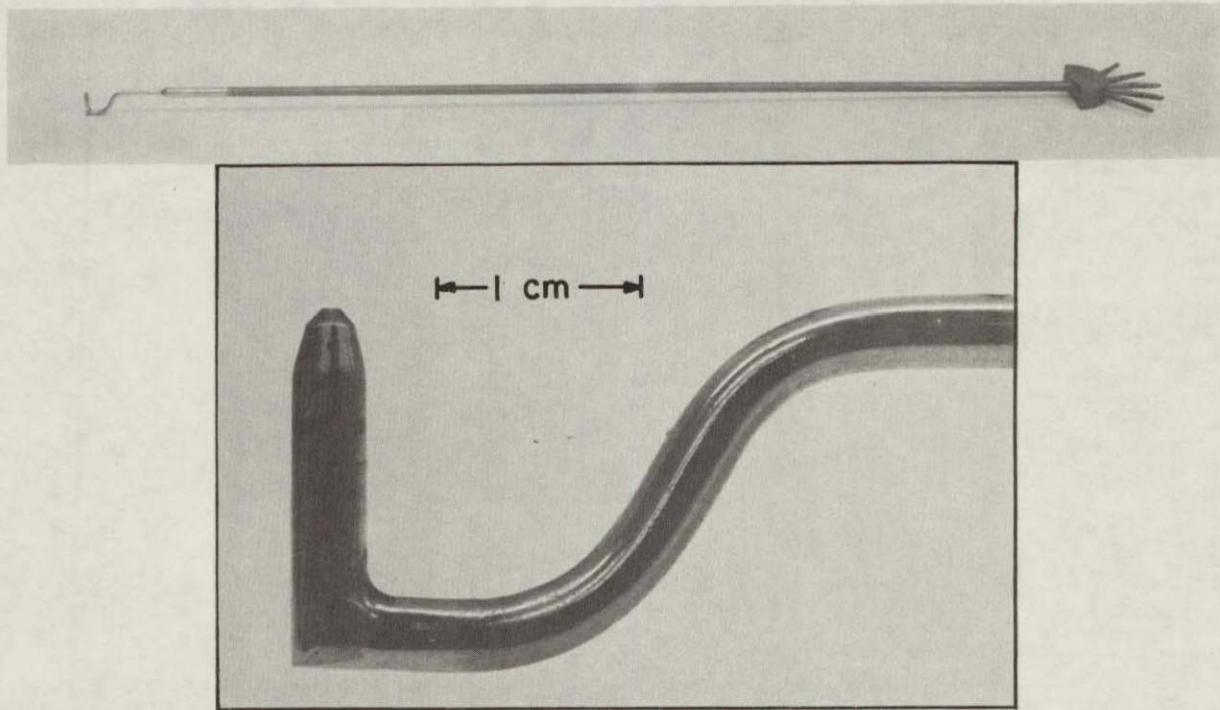

Figure 20. United Sensor DC-125 Five-Hole Cone Probe

ORIGINAL PAGE IS
OF POOR QUALITY

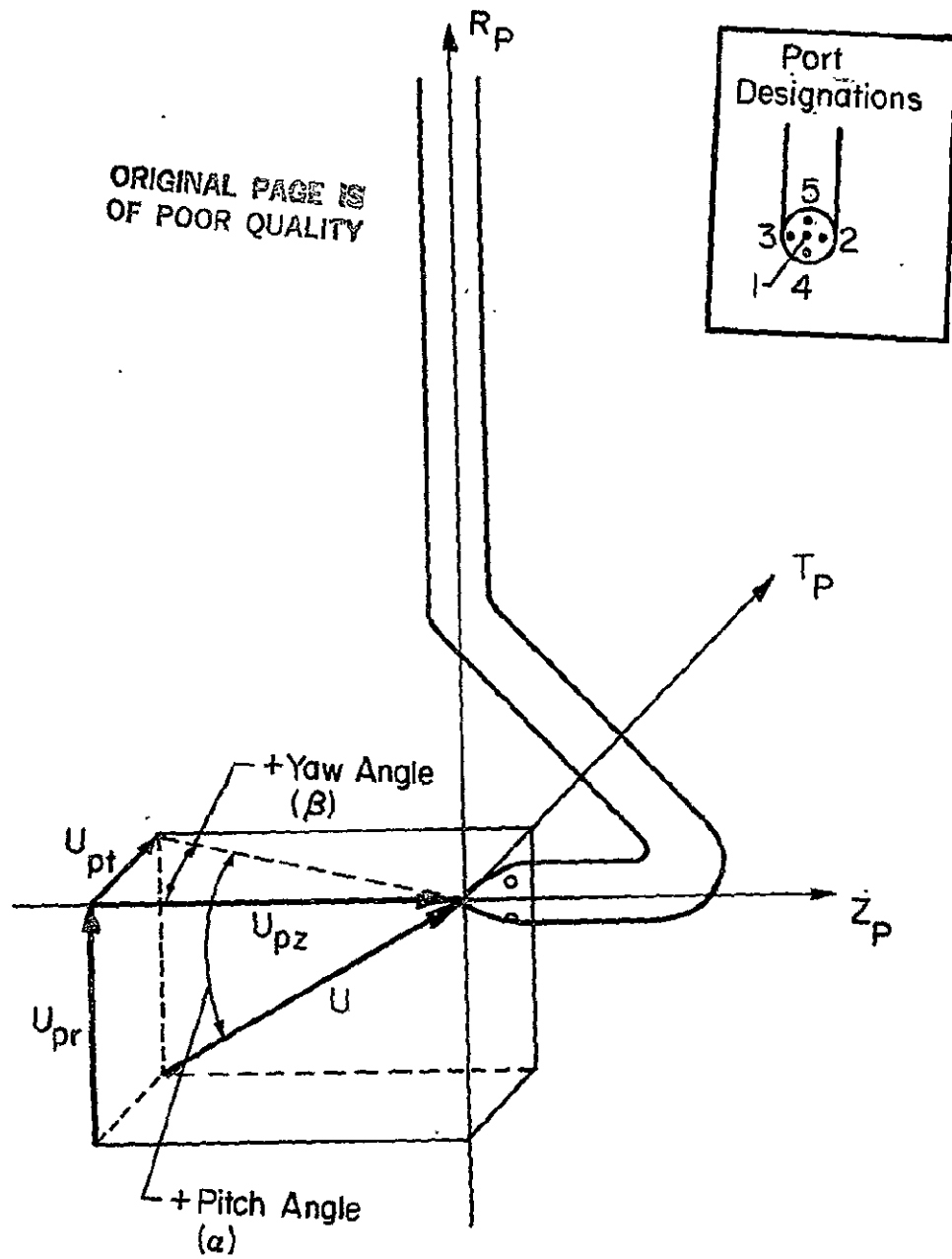

Figure 21. Five-Hole Probe Coordinate System and Port Designations

B. Review of Five-Hole Probe Calibration and Application Techniques in the Non-Nullled Mode

Because of manufacturing tolerances and flow Reynolds number dependence, it is necessary to calibrate individual probes over a range of pitch and yaw angle settings. This calibration consists of measuring the five probe port pressures and the flow total and static pressures over a range of pitch-yaw settings and then determining a set of dimensionless characteristic pressure calibration coefficients.

Dudzinski and Krause [9] calibrated a five-hole probe for use in the non-nulling mode over a range of Reynolds numbers. Their results show that for a limited range Reynolds number application, such as in the Purdue Annular Cascade Facility, one calibration is sufficient. They calibrated for pitch and yaw angles up to $\pm 30^\circ$ in 10° increments, and suggested 5° increments for a more accurate calibration. Treaster and Yocum [10] used the calibration coefficients developed by Dudzinski and Krause to calibrate two types of five-hole probes in an open jet facility, showing support for the calibration coefficients developed by Dudzinski and Krause. Specifically, these nondimensional calibration coefficients, and the ones used in the present

study are presented in Equations 4 through 8.

$$C_{pyaw} = \frac{[P_2 - P_3]}{[P_1 - \bar{P}]} \quad (4)$$

$$C_{ppitch} = \frac{[P_4 - P_5]}{[P_1 - \bar{P}]} \quad (5)$$

$$C_{ptotal} = \frac{[P_1 - P_{total}]}{[P_1 - \bar{P}]} \quad (6)$$

$$C_{pstatic} = \frac{[\bar{P} - P_{static}]}{[P_1 - \bar{P}]} \quad (7)$$

where

$$\bar{P} = [P_2 + P_3 + P_4 + P_5]/4 \quad (8)$$

Bryer and Pankhurst [11] present typical five-hole probe calibrations for flow velocities of 27 m/s (90 ft/s), in the range of velocities expected in the present study. They found that for pitch and yaw angles less than 25°, the accuracy of a five-hole probe used in the non-nulling mode was approximately +/-3%.

The effects of turbulence intensity and wall proximity on five-hole probe measurements were considered by Sitaram, Lakshminarayana, and Ravindranath [12]. Their results are based on measurements with a five-hole probe identical in size to the one used in the present study. They found that for turbulence intensities of up to 10%, the error in velocity due to turbulence was 0.33%. Hinch and Fleeter [13] measured the turbulence intensity in The Purdue Annular Cascade with the classical airfoil cascade installed at a 0° incidence angle. The free stream turbulence intensity was less than 3%, and in the wake region, the turbulence intensity was less than 8% at the rear traversing slot position and less than 12% at the front traversing slot position. Further, the results of Sitaram, Lakshminarayana, and Ravindranath also indicate that when the probe is so close to the wall that the flow accelerates in the region between the probe and the wall, an error in the velocity measurement results. In particular, when the probe is located more than two probe diameters from the wall, the error in the velocity measurement is negligible.

C. Five-Hole Cone Probe Calibration

The DC-125 five-hole cone probe was calibrated in a semi-automated manner. The program, C5HOLE, directs the calibration procedure. A general flow chart of C5HOLE is presented in Appendix C. This section is subdivided into a general overview of the calibration, the probe positioning technique, the pressure measurement method, the calibration coefficient equations, and the calibration results.

Overview

The Calibration Jet Facility provides a well-defined flow field. Initially the probe is aligned on the jet centerline axis using the alignment procedure described in Appendix A. Pitch angles are set by means of a rotary table. At each pitch angle, the yaw angles are set automatically using the self-rotation L. C. Smith traversing mechanism in the automated mode. The probe tip remains on the jet centerline axis for all pitch-yaw settings because the probe tip is both on the rotary table rotation axis and on the probe self-rotation axis. This fixed location of the probe tip in conjunction with the large core region of the calibration jet ensures that the probe sensor head remains in the jet core region. At each pitch-yaw setting, the determination of the nondimensional calibration coefficients

from the five port probe pressures and the known core total and static pressures define the calibration.

The following conditions and flow angles were selected for the specific five-hole probe calibration performed in this study.

- 1) The jet core velocity of approximately 30.5 m/s (100 ft/s) was chosen to match the nominal annular cascade flow velocity.
- 2) The calibration jet axial position of $Z/D = .89$ was chosen because of its large core diameter, 4.6 cm (1.8 in.), and low turbulence intensity.
- 3) To provide sufficient accuracy for the calibration, pitch and yaw angles were each varied independently over $\pm 30^\circ$ in 5° increments.

Probe Positioning Technique

The pitch angles were set by hand when cued by the computer, staying on one side of the positioning screw to ensure accuracy in pitch angle settings. The error in each pitch angle setting is estimated as the smallest division on the rotary table, 1 minute, with a systematic error of not more than 0.1° due to initial misalignment.

The yaw angles are automatically selected by using the L. C. Smith Unit in the automated mode. A home (0° yaw) position in volts is read by the computer at the start of the program. Yaw positions are then calculated in the software using this home position and the volts/degree of yaw rotation. The volts/degree of yaw rotation was measured by using an indicator to measure 180° of probe rotation and reading the associated voltage difference from the display of the L. C. Smith Unit. Errors in the yaw angle positions are $\pm 0.18^{\circ}$ due to the resolution of the traversing mechanism, with a systematic error estimated as not more than 0.1° due to initial misalignment.

Pressure Measurement

Pressure measurements were taken in an automated mode via the Scanivalve system, with 30 samples per voltage reading (statistically equal to an infinite sample) for accuracy. The Scanivalve pneumatic connection arrangement is presented below, with the plenum pressure teed to a Meriam Model 40HE35 Inclined Water Manometer for the calibration of the Scanivalve transducer.

Scanivalve Connections For C5HOLE Code

Module A

<u>Scan Valve Port</u>	<u>Pneumatic Line</u>
1 (Span Port)	Ambient (Jet static) Pressure
2 (Reference Port)	Plenum (Jet total) Pressure
3	Probe Port #1
4	Probe Port #2
5	Probe Port #3
6	Probe Port #4
7	Probe Port #5

A transducer linearity response test was run in the calibration jet by teeing the probe port #1 pneumatic tubing to the inclined manometer and to its Scanivalve port. The probe was rotated about its own axis to obtain the port #1 pressures between the plenum pressure and the ambient pressure. These pressures were read from the manometer. The corresponding Scanivalve port 3 voltages were read using a computer program which displayed the average of 30 voltage samples. A linear regression analysis was performed on

these pressure and voltage data which yielded a correlation coefficient of 0.999994. Thus, the linearity of the Scanivalve transducer response was confirmed.

Calibration Coefficient Equations and Measurement Errors

The objective of the probe calibration was to accurately determine the calibration coefficients. A measure of the accuracy was obtained by using the Maximum Error Technique [14], described in Appendix D. Reading errors are defined as one-half the smallest division and Scanivalve voltage sampling errors are determined via a 99% confidence t-test. The jet velocity is determined from the compressible flow equations using the plenum and ambient conditions (Chapter II, part C).

The calibration coefficients and associated errors are calculated at each pitch-yaw point. The coefficients (Equations 4, 5, 6, and 7) are the ratio of pressure differences, which are equivalent to the ratio of the appropriate Scanivalve voltage differences due to the linear response of the Scanivalve transducers. The calibration coefficients are presented below in terms of probe port, total, and static pressure transducer voltages along with the associated error equations. Each coefficient is expressed in terms of differences of the fundamental transducer voltage measurements with the error, e , in each coefficient due only

to the accuracy of the voltage measurements. These equations are incorporated in the C5HOLE software.

$$C_{pyaw} = \frac{[v_2 - v_3]}{[v_1 - \bar{v}]} \quad (9)$$

$$e_{C_{pyaw}} = \left| \frac{[ev_2 + ev_3]}{[v_1 - \bar{v}]} \right| + \left| \frac{[v_2 - v_3][ev_1 + e\bar{v}]}{[v_1 - \bar{v}]^2} \right| \quad (10)$$

$$C_{ppitch} = \frac{[v_4 - v_5]}{[v_1 - \bar{v}]} \quad (11)$$

$$e_{C_{ppitch}} = \left| \frac{[ev_4 + ev_5]}{[v_1 - \bar{v}]} \right| + \left| \frac{[v_4 - v_5][ev_1 + e\bar{v}]}{[v_1 - \bar{v}]^2} \right| \quad (12)$$

$$C_{ptotal} = \frac{[v_1 - v_{total}]}{[v_1 - \bar{v}]} \quad (13)$$

$$e_{C_{ptotal}} = \left| \frac{[ev_1 + ev_{total}]}{[v_1 - \bar{v}]} \right| + \left| \frac{[v_1 - v_{total}][ev_1 + e\bar{v}]}{[v_1 - \bar{v}]^2} \right| \quad (14)$$

$$C_{pstatic} = \frac{[\bar{v} - v_{static}]}{[v_1 - \bar{v}]} \quad (15)$$

$$e_{c_{pstatic}} = \left| \frac{[e\bar{v} + eV_{static}]}{[v_1 - \bar{v}]} \right| + \left| \frac{[\bar{v} - v_{static}][eV_1 + e\bar{v}]}{[v_1 - \bar{v}]^2} \right| \quad (16)$$

where

$$\bar{v} = [v_2 + v_3 + v_4 + v_5]/4 \quad (17)$$

and

$$e\bar{v} = [eV_2 + eV_3 + eV_4 + eV_5]/4 \quad (18)$$

Calibration Results

The results of the DC-125 Five-Hole Probe calibration are presented in Figures 22 through 26, and in tabular form in Appendix E. The coefficients are permanently stored on a cassette cartridge for automated reduction purposes.

Four bivariate relationships are established with the calibration data. The flow angle bivariate relationships for C_{pyaw} and C_{ppitch} are shown in Figure 22. Figures 23 through 26 present the total pressure coefficient and the static pressure coefficient bivariate relationships with the flow angles. In an unknown flow field, of approximately the same Reynolds number as the jet, the five port pressures are measured and C_{pyaw} and C_{ppitch} values are then calculated.

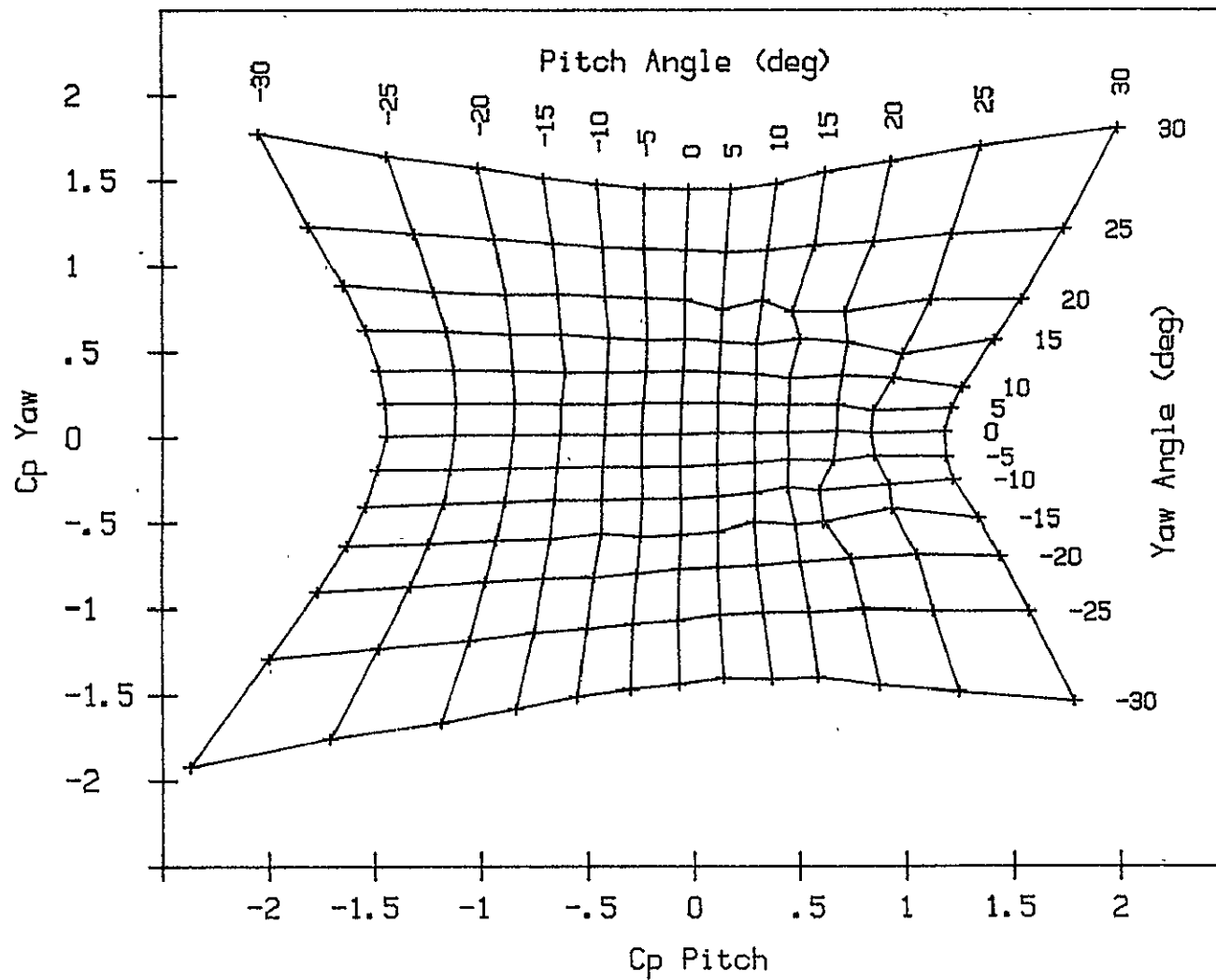

Figure 22. DC-125 Five-Hole Probe Calibration, Flow Angle Bivariate Relationships

ORIGINAL PAGE IS
OF POOR QUALITY

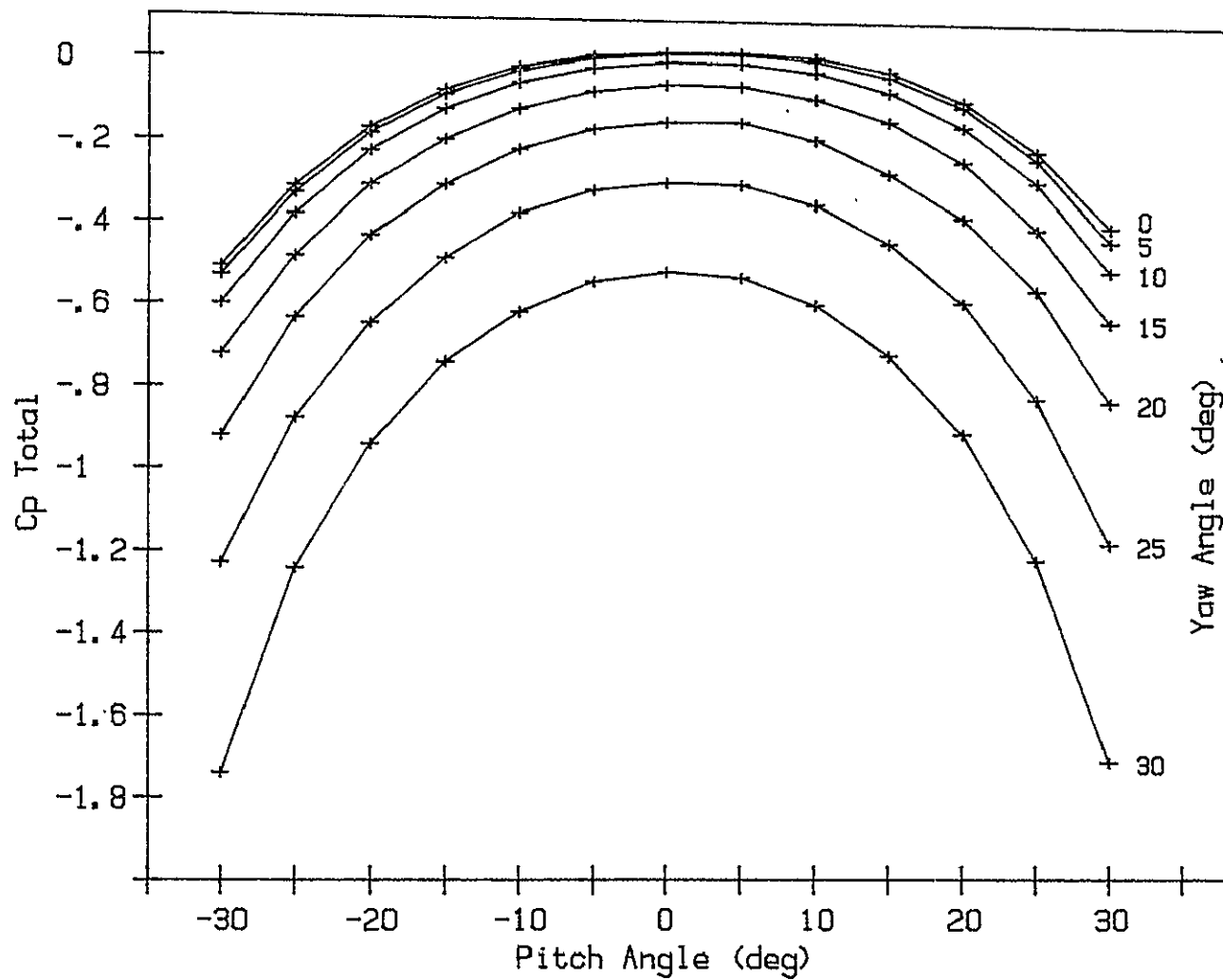

Figure 23. DC-125 Five-Hole Probe Calibration, $C_{p\text{total}}$
 Bivariate Relationship, Yaw Angles > 0

ORIGINAL PAGE IS
 OF POOR QUALITY

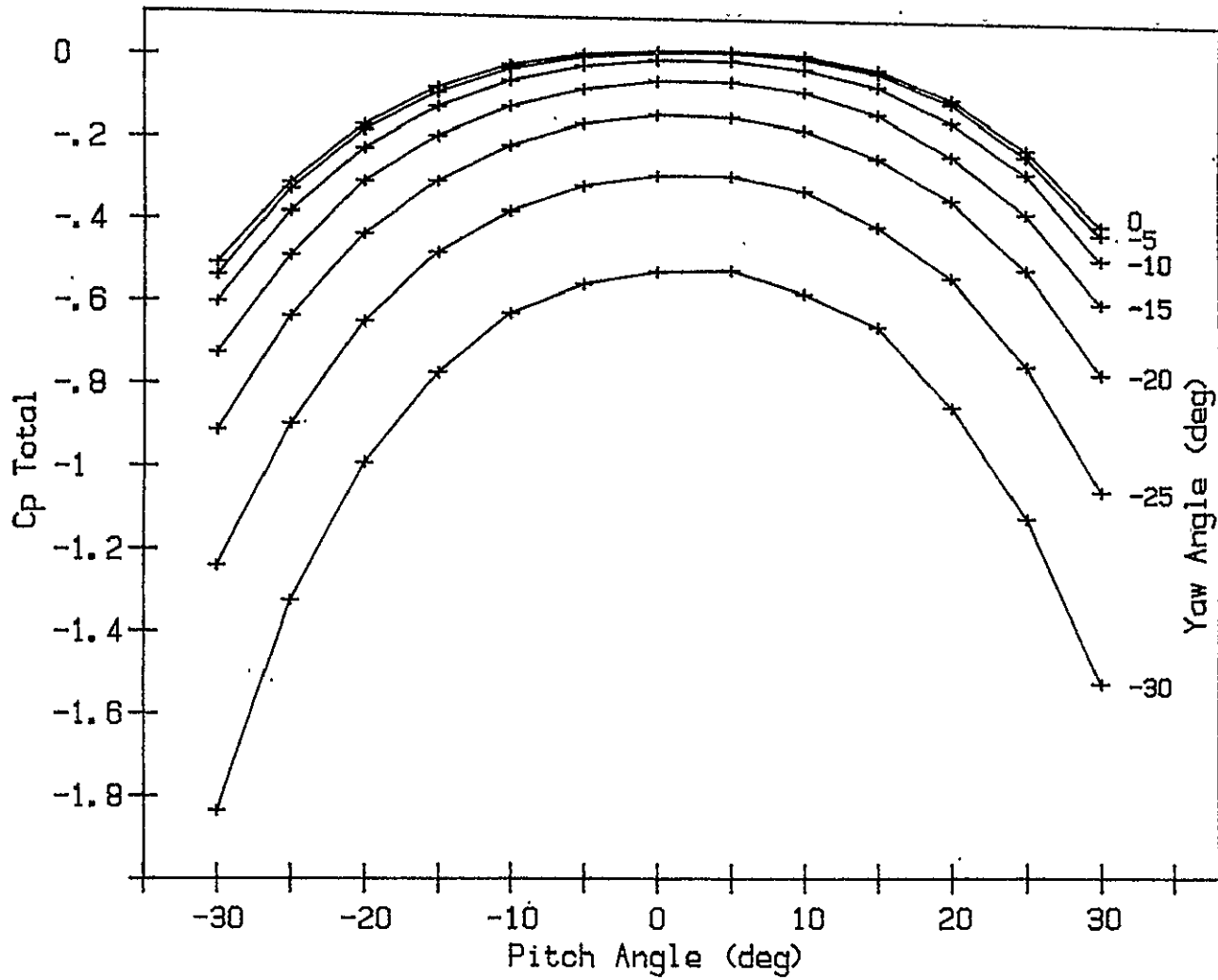

Figure 24. DC-125 Five-Hole Probe Calibration, $C_{p\text{total}}$
 Bivariate Relationship, Yaw Angles < 0

ORIGINAL PAGE IS
 OF POOR QUALITY

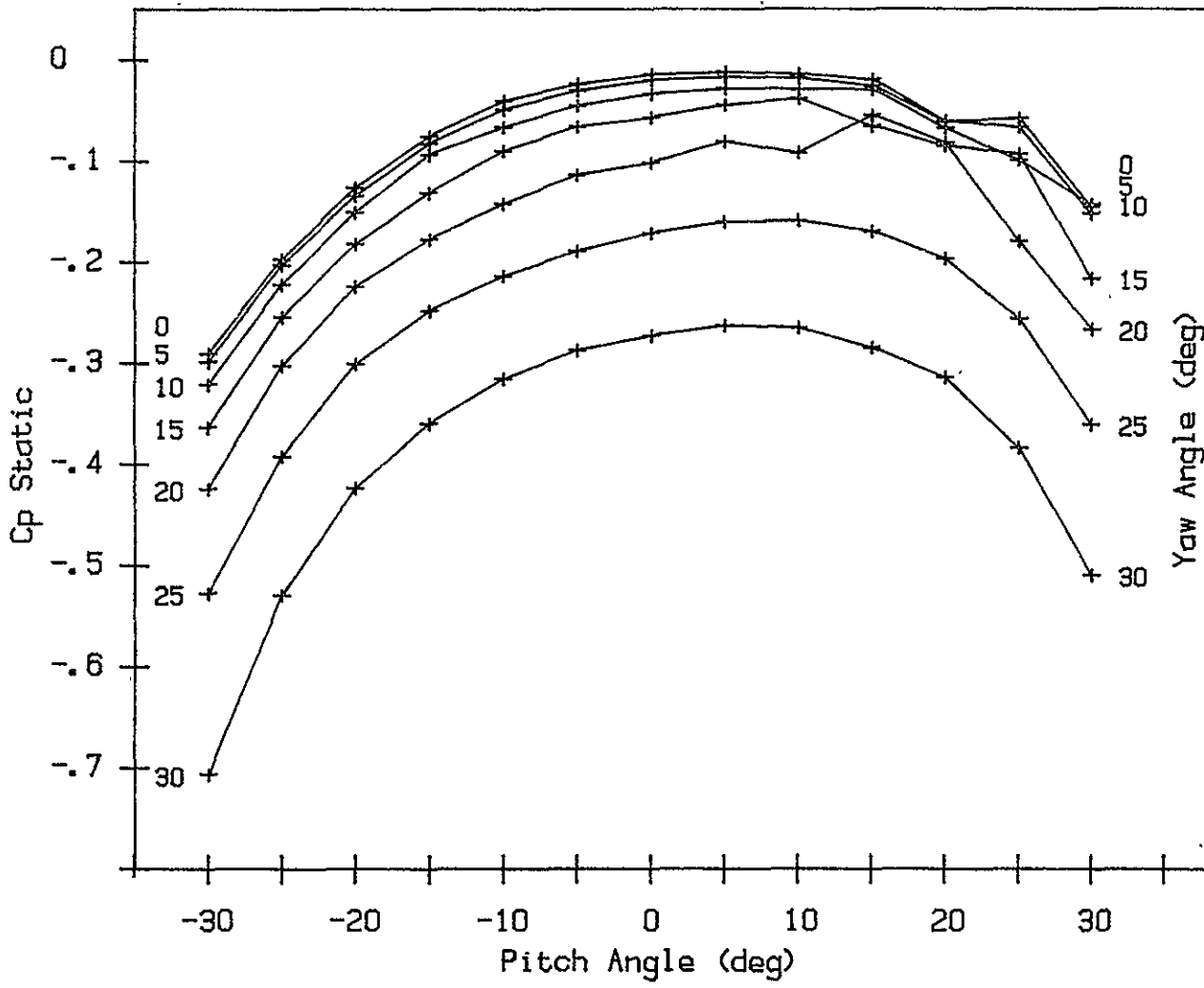

Figure 25. DC-125 Five-Hole Probe Calibration, $C_{pstatic}$
 Bivariate Relationship, Yaw Angles > 0

ORIGINAL PAGE IS
 OF POOR QUALITY

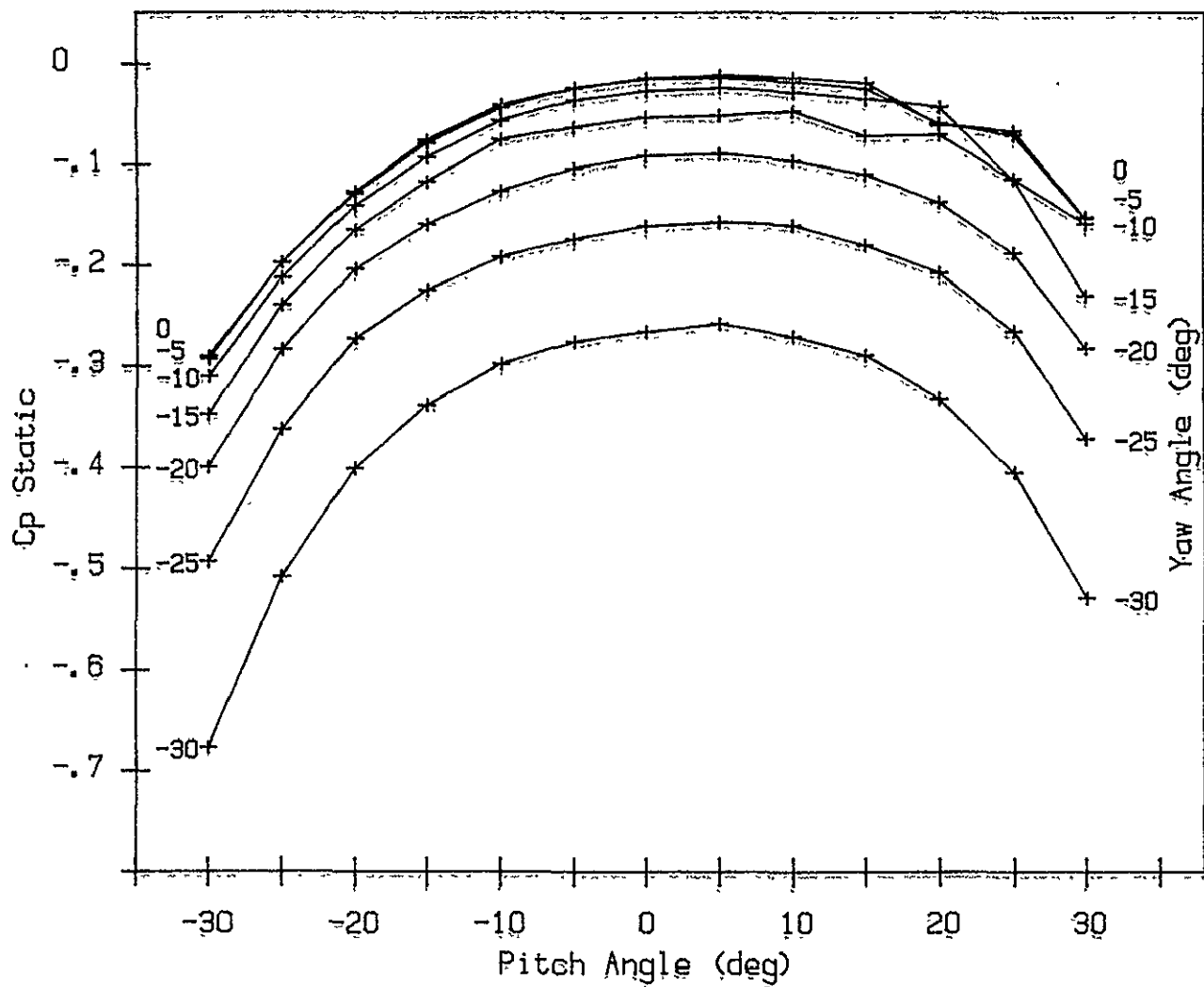

Figure 26. DC-125 Five-Hole Probe Calibration, $C_{p \text{ static}}$
 Bivariate Relationship, Yaw Angles < 0

ORIGINAL PAGE IS
 OF POOR QUALITY

The pitch and yaw angles for the unknown flow field are then determined from the grid of C_{pyaw} and C_{ppitch} , Figure 22, using a numerical interpolation technique. Then, using these pitch and yaw angle values, the C_{ptotal} and $C_{pstatic}$ coefficients for the unknown flow field are interpolated from the appropriate grids, Figures 23-26. Total and static pressures are obtained from the definitions of C_{ptotal} and $C_{pstatic}$ and the measured probe five port pressures.

The lack of smoothness from some of the calibration data at pitch angles greater than 10° is associated with the probe. Previous five-hole probe calibration investigations [10] have noted similar irregularities in the $C_{pstatic}$ calibration curves. The errors in each of the non-zero calibration coefficients were all less than 0.5%. No measurable velocity drift occurred in the calibration jet throughout the calibration process.

CHAPTER IV DATA ACQUISITION AND REDUCTION

The three-dimensional aerodynamic performance of a classical airfoil cascade is to be determined. Quantities to be measured include the inlet flow field, the airfoil surface pressure distribution, and the cascade exit flow field. This chapter presents the methods of the acquisition and the reduction of these data.

A. Preliminary Preparations

Airfoil Alignment and Five-Hole Probe Alignment

The classical flat plate airfoils were aligned in the cascade at the selected incidence angle by removing the facility bellmouth section and using a large T-square type device, Figure 27. Positive incidence angle values correspond to positive tangential velocities in the cascade, as was defined in Figure 3.

Alignment of the five-hole probe in the cascade was accomplished by placing a scale (projecting downstream) on the principal blade. The probe was aligned both circumferentially and in self-rotation, such that the probe Z_p

C-2

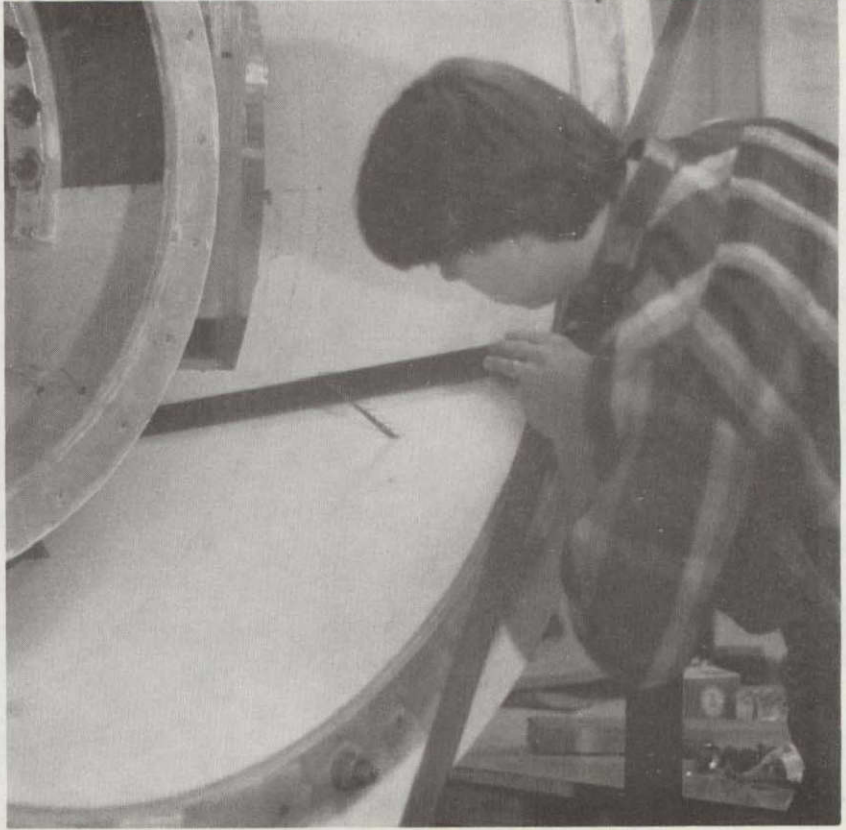
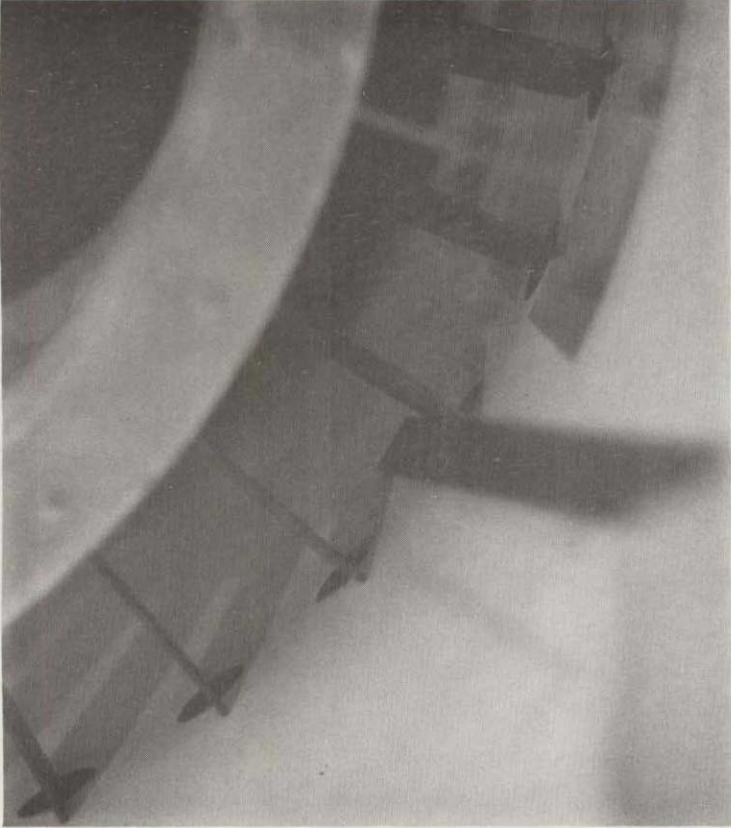

Figure 27. Airfoil Incidence Angle Setting Device

axis coincided with the chordwise direction. This alignment defined a yaw offset angle, θ , between the probe Z_p axis and the cascade Z axis of equal sign and magnitude as the incidence angle, Figure 28. This offset aligns the probe in the principal direction of flow, thereby minimizing the probe yaw and pitch angles to utilize the smoothest regions of the calibration data curves. The probe stem alignment with the cascade circumferential axis was confirmed by moving the probe circumferentially and measuring the uniformity of the spacing between the probe tip and the hub. Confirmation of the probe stem alignment in the Z-T plane was made using a machinist square to check that the probe stem and the annulus were perpendicular. A probe home position was defined and recorded during these alignments, as the chord alignment circumferential traversing mechanism voltage, and the radial traversing mechanism voltage at a measured distance from the hub.

Scanivalve Connection and Traversing Mechanism Checks

The same Scanivalve pneumatic connections were used for both the previously developed Airfoil Surface [1], and the Mean Wake Data Acquisition Systems, with the addition of the

ORIGINAL PAGE IS
OF POOR QUALITY

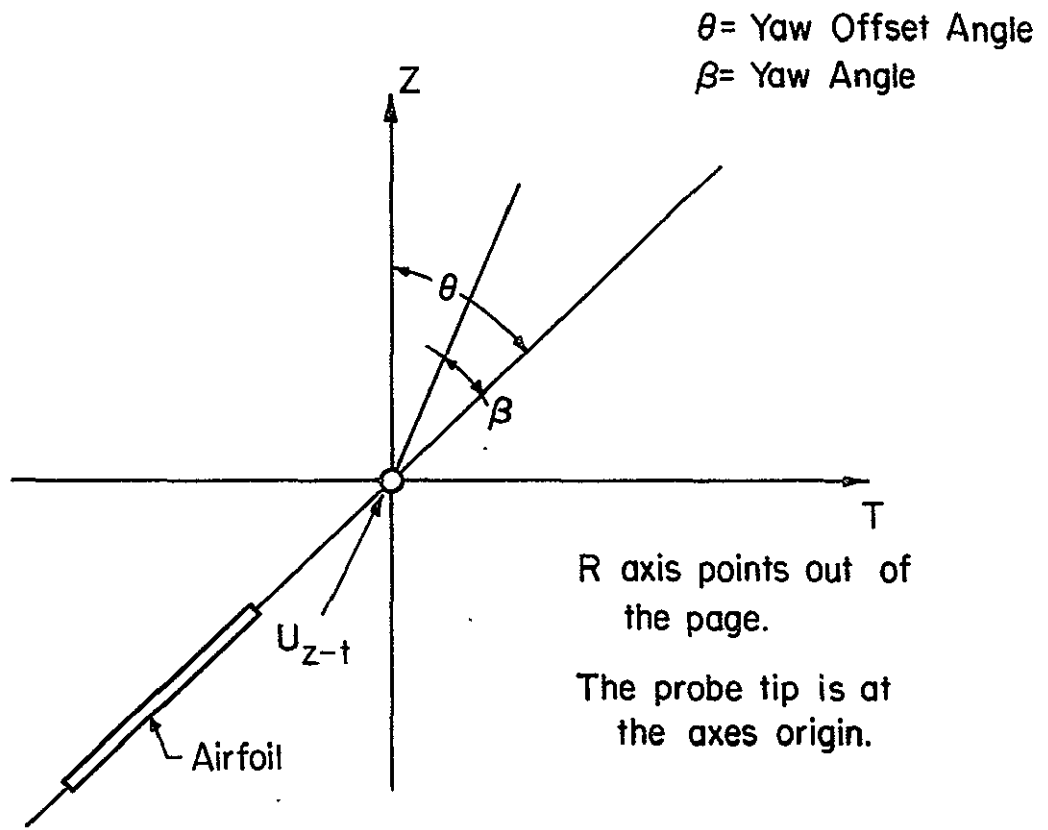

$U_{z-t} = U$ projected into the R-T plane.

Figure 28. Yaw Offset Angle Definition Schematic

following pneumatic connections for the five-hole probe ports.

Scanivalve Module A

<u>Scanivalve Port</u>	<u>Five-Hole Probe Pneumatic Line</u>
39	1
40	2
41	3
42	4
43	5

Verification checks of the volts/unit radial and volts/degree circumferential motions of the traversing mechanism were made using gage blocks and by confirming alignment behind a number of airfoils prior to data acquisition, respectively. No measurable change in these values was found.

Warm-up Time

Prior to data acquisition, the airflow system and the electronics were allowed to warm-up for a minimum of one hour. This warm-up time allowed the facility blower to attain a constant flow rate and the room temperature to reach equilibrium. The Scanivalve signal conditioners required this warm-up time for circuitry stabilization, which, along with the room temperature equilibrium and

frequency of recalibration, minimized calibration drifts to negligible levels.

B. Mean Wake Data Acquisition

Acquisition Principles

An automated mean wake data acquisition system was developed in this study. The acquisition of pressure data and probe positioning are computer controlled, as described in Chapter II. The computer program, AQAUTO, directs the acquisition process, including pauses and instructions for operator inputs and actions. A general flowchart of AQAUTO is presented in Appendix C.

One objective of the system is to minimize the acquisition time, so that negligible transducer calibration and flow rate drift occurs. To facilitate this, data is taken in circumferential sets with the Scanivalve transducer recalibrated at the beginning of each set. The Scanivalve voltage sampling rate of 15 samples/point was determined to sufficiently represent an infinite sample. Each circumferential data set took approximately 20 minutes for 25 measurement stations, a sufficiently short time to avoid calibration drift due to ambient reference pressure or temperature changes. Further, the mass averaged inlet velocity drift was less than 0.15 m/s (0.5 ft/s) between sets, or else the data was retaken.

A second objective of the system was to determine the measurement data band errors. The standard root mean square

technique [14], described in Appendix D, was applied to develop the error relations corresponding to each acquisition equation. Reading errors were assumed to be +/- one-half the smallest division, and Scanivalve voltage reading errors were taken as the statistical 99% confidence t-test values calculated for each sampling. Two values were assumed constant; the specific heat ratio, $k=1.4$, and the gas constant, $R_{air} = 278.08 \text{ J/kg-K}$ (53.35 ft-lb/lb-R).

Measurements and Stored Raw Data

The initialization of AQAUTO results in the computer requesting information, including the probe home position and the radial and circumferential positions selected for data acquisition. An option to use 25 preset circumferential positions is provided, which includes an automated search for the chordline alignment position (the point of minimum probe port #1 pressure) for each circumferential data set.

Ambient conditions are requested at the beginning of each circumferential data set. The Scanivalve module is then calibrated and the upstream mass averaged total and static pressures are determined by averaging the pressure rake data and their associated wall static pressure taps respectively. The cascade is assumed to be adiabatic, and thus the total temperature is equal to the room temperature.

This enables the mass averaged upstream inlet velocity to be calculated from the compressible flow equations, Equations 1, 2 and 3.

For each circumferential measurement station, the five-hole probe Scanivalve voltages are read and C_{pyaw} and C_{ppitch} are calculated from Equations 9, 11, and 17. The voltages are converted to pressures and \bar{P} , Equation 8, is calculated. Upon completion of each circumferential data set the computer requests a storage name and the following quantities are stored on a cassette cartridge.

- 1) Incidence Angle Value
- 2) Probe Yaw Offset Angle
- 3) Downstream Position in the Cascade (Z_c/C)
- 4) % Hub to Tip (radial position)
- 5) Ambient Pressure
- 6) Ambient Temperature
- 7) Mass Averaged Upstream Total Pressure
- 8) Error in Mass Averaged Upstream Total Pressure
- 9) Mass Averaged Upstream Static Pressure
- 10) Error in Mass Averaged Upstream Static Pressure
- 11) Mass Averaged Upstream Inlet Velocity
- 12) Error in Mass Averaged Upstream Inlet Velocity
- 13) The Number of Circumferential Measurement Stations
- 14) The Circumferential Measurement Stations
(2T/S valves)

- 15) Five-Hole Probe Port 1 Gage Pressure at each
Circumferential Measurement Station
- 16) Error in each Five-Hole Probe Port 1 Gage Pressure
at each Circumferential Measurement Station
- 17) The \bar{P} Value at each Circumferential
Measurement Station
- 18) Error in each \bar{P} Value at each Circumferential
Measurement Station
- 19) C_{pyaw} Value at each Circumferential
Measurement Station
- 20) Error in each C_{pyaw} Value at each Circumferential
Measurement Station
- 21) C_{ppitch} Value at each Circumferential
Measurement Station
- 22) Error in each C_{ppitch} Value at each
Circumferential Measurement Station

An option to print the raw data files is provided following the circumferential acquisition and storage at the final radial position.

C. Mean Wake Data Reduction

Reduction Principles

A mean wake reduction program, MATRED, was developed to reduce raw data from up to nine data files in succession. The only operator tasks required, as directed by the MATRED software, are the initial insertion of the five-hole probe calibration data cartridge, followed by the insertion of the raw data cartridge and input of the file names to be reduced. Error analysis, based on the standard root mean square technique [14], is included in all the data reduction calculations. A general flowchart of MATRED is presented in Appendix C.

Method of Reduction

Raw data files are read and analyzed, and the reduced data is then stored. The flow angles and velocity components for each circumferential position are obtained as follows.

The values of the pitch angle, α , and the yaw angle, β , are numerically interpolated from the five-hole probe calibration data. The experimentally determined C_{pyaw} and C_{ppitch} values are applied to the calibration data. The numerical interpolation is accomplished using a least squares bivariate interpolation scheme [15]. A second order

polynomial, with six coefficients, is fitted to a grid composed of the nine calibration points closest to the C_{pyaw} - C_{ppitch} experimental point, as described in Appendix F. A separate polynomial is established for both the pitch-angle bivariate relationship and the yaw angle bivariate relationship, Figure 22, for the interpolation of the pitch and yaw angle values. The values of C_{ptotal} and $C_{pstatic}$ are numerically interpolated in an analogous fashion using the newly established pitch and yaw angles and their bivariate relationships, Figures 23 through 26. The errors in the pitch angle, the yaw angle, C_{ptotal} , and $C_{pstatic}$ are determined by reinterpolating the four possible combinations of the root mean +/- errors added to the experimental C_{pyaw} and C_{ppitch} values, and defining the errors as the greatest deviation from the yaw angle, pitch angle, C_{ptotal} , and $C_{pstatic}$ values.

The total pressure and static pressure at each measurement station are determined per Equations 19 and 20 using the definitions of C_{ptotal} and $C_{pstatic}$ of Equations 6 and 7:

$$P_{total} = P_1 + P_{amb} - C_{ptotal}(P_1 - \bar{P}) \quad (19)$$

$$P_{static} = \bar{P} + P_{amb} - C_{pstatic}(P_1 - \bar{P}) \quad (20)$$

The flow in the cascade is assumed to be adiabatic. Thus the room temperature corresponds to the flow total temperature. Also, the absolute velocity at each measurement station, U , can be calculated using the compressible flow equations, Equations 1, 2 and 3.

The velocity components relative to the cascade coordinate system (the axial velocity, U_z , the tangential velocity, U_t , and the radial velocity, U_r) are calculated from the absolute velocity, U , the pitch angle, α , the yaw angle, β , and the yaw offset angle, θ . Figure 21 defines the probe coordinate system including the definitions of the pitch and yaw angles; Figure 3 shows the facility coordinate system; and Figure 28 presents the geometry of the yaw offset angle and the yaw angle with respect to the facility coordinate system. The radial velocity with respect to the probe, U_{pr} , corresponds to the radial velocity with respect to the cascade facility because the probe radial axis coincides with the facility radial axis. Therefore, the radial velocity component can be vectorally resolved.

$$U_r = U \sin (\alpha) \quad (21)$$

Consideration of the offset yaw angle and yaw angle definitions, and the fact that the Z_p-T_p plane of the probe coincides with the cascade $Z-T$ plane, enables the axial and

tangential velocity components to be vectorally resolved.

$$U_z = U \cos(\alpha) \cos(\theta - \beta) \quad (22)$$

$$U_t = U \cos(\alpha) \sin(\theta - \beta) \quad (23)$$

A reduced data file is stored for each raw data file considered. The following information is stored for subsequent printouts and plotting.

- 1) Incidence Angle Value
- 2) Probe Yaw Offset Angle
- 3) Downstream Position in the Cascade (Z_c/C)
- 4) % Hub to Tip Position (radial position)
- 5) Mass Averaged Upstream Total Pressure
- 6) Error in Mass Averaged Upstream Total Pressure
- 7) Mass Averaged Upstream Static Pressure
- 8) Error in Mass Averaged Upstream Static Pressure
- 9) Mass Averaged Upstream Inlet Velocity
- 10) Error in Mass Averaged Upstream Inlet Velocity
- 11) The number of Circumferential Measurement Stations
- 12) The Circumferential Measurement Stations (2T/S values)
- 13) C_{pyaw} at each Circumferential Measurement Station
- 14) Error in each C_{pyaw} at each Circumferential Measurement Station

- 15) C_{ppitch} at each Circumferential Measurement Station
- 16) Error in each C_{ppitch} at each Circumferential Measurement Station
- 17) The Pitch Angle at each Circumferential Measurement Station
- 18) Error in each Pitch Angle at each Circumferential Measurement Station
- 19) The Yaw Angle at each Circumferential Measurement Station
- 20) Error in each Yaw Angle at each Circumferential Measurement Station
- 21) C_{ptotal} at each Circumferential Measurement Station
- 22) Error in each C_{ptotal} at each Circumferential Measurement Station
- 23) $C_{pstatic}$ at each Circumferential Measurement Station
- 24) Error in each $C_{pstatic}$ at each Circumferential Measurement Station
- 25) Total Pressure at each Circumferential Measurement Station
- 26) Error in each Total Pressure at each Circumferential Measurement Station
- 27) Static Pressure at each Circumferential Measurement Station
- 28) Error in each Static Pressure at each Circumferential Measurement Station
- 29) Absolute Velocity at each Circumferential Measurement Station
- 30) Error in each Absolute Velocity at each Circumferential Measurement Station
- 31) Axial Velocity at each Circumferential Measurement Station
- 32) Error in each Axial Velocity at each Circumferential Measurement Station

- 33) Tangential Velocity at each
Circumferential Measurement Station
- 34) Error in each Tangential Velocity at each
Circumferential Measurement Station
- 35) Radial Velocity at each Circumferential
Measurement Station
- 36) Error in each Radial Velocity at each
Circumferential Measurement Station

D. Airfoil Surface Data Acquisition and Reduction

The Airfoil Surface Data Acquisition and Reduction System was previously developed [1] to provide on-line measurements of the cascade upstream inlet velocity profiles and the airfoil surface pressure distribution. A brief description of this system is presented below.

Acquisition of the pressure data required to define the cascade upstream inlet velocity profiles and the airfoil surface pressure distribution is obtained using the Scanivalve system with the computer as a controller. These data are obtained from the upstream total pressure rakes and facility static pressure taps, and the instrumented airfoils.

The pressure information is reduced using the compressible flow equations yielding individual upstream rake velocities from:

$$U = \left[\frac{2RT_t}{\Gamma} \left[1 - \frac{P_s}{P_t} \right]^\Gamma \right]^{1/2} \quad (24)$$

where.

$$\Gamma = \frac{k-1}{k} \quad (25)$$

and the airfoil pressure coefficients from:

$$C_p = \frac{[P_{tfs} - P_{af}]}{\left[\frac{\rho_{z0} U_{z0}^2}{2} \right]} = \left[\frac{U_{af}}{U_{z0}} \right]_{inc}^2 \quad (26)$$

where the static density is calculated from the isentropic relation:

$$\rho_{z0} = \rho_{tz0} \left[\frac{p_1}{P_{T1}} \right]^{1/k} \quad (27)$$

The experimental values of C_p are calculated from the compressible form of Equation 26. The numerically predicted cascade velocity values were converted to C_p values using the assumption of incompressible flow, appropriate because the cascade Mach number is on the order of 0.1.

Error analysis in the Airfoil Surface Pressure Reduction System assumes negligible reading errors. Upper and lower bounds for the reduced data are set by feeding Scanivalve voltage sampling confidence intervals back through the reduction equations.

A more detailed description of the Airfoil Surface Data Acquisition and Reduction System can be found in Reference [1].

The Airfoil Surface Data and Mean Wake Data Acquisition Systems were run sequentially during each acquisition session to maintain the same cascade conditions.

CHAPTER V DATA PRESENTATION AND ANALYSIS

The overall three-dimensional aerodynamic performance of the classical airfoil cascade, determined in The Purdue Annular Cascade Facility, is presented and discussed in this chapter. In particular, the effect of incidence angle on the detailed three-dimensional airfoil surface and cascade exit region flow field is quantified. The major sections describe the Operating Conditions and the Cascade Upstream Inlet Velocity Profile; the Exit Region Data and Analysis; and the Airfoil Surface Data and Analysis including correlation with appropriate numerical code predictions.

A. Operating Conditions and the Cascade Upstream Inlet Velocity Profile

The physical and nominal flow conditions of the Purdue Annular Cascade are presented in Table 1. Three incidence angle values were investigated.

Table 1. Purdue Annular Cascade Experimental Conditions

Tip Diameter (cm)	127.0
Hub/Tip Radius Ratio	0.76
Airfoil Span (cm)	15.24
Cascade Solidity	1.38
Number of Airfoils	36
Airfoil Shape	Flat Plate
Airfoil Chord (cm)	15.24
Incidence Angles (deg)	0.0, 5.0, 10.0
Axial Velocity (m/s)	30.0
Flow Rate (m ³ /s)	16.1
Chord Reynolds Number	430,000

The inlet velocity profile, measured using the upstream rakes, was essentially flat for all incidence angle values with a thicker boundary layer on the outer shroud wall as compared to the inner hub wall, as shown in Figure 29. The individual rake velocities are circumferentially averaged to form U_i values for each percent hub-to-tip radius, and are then normalized by the mass averaged upstream velocity, U_{20} . These data are tabulated in Appendix G.

ORIGINAL PAGE IS
OF POOR QUALITY

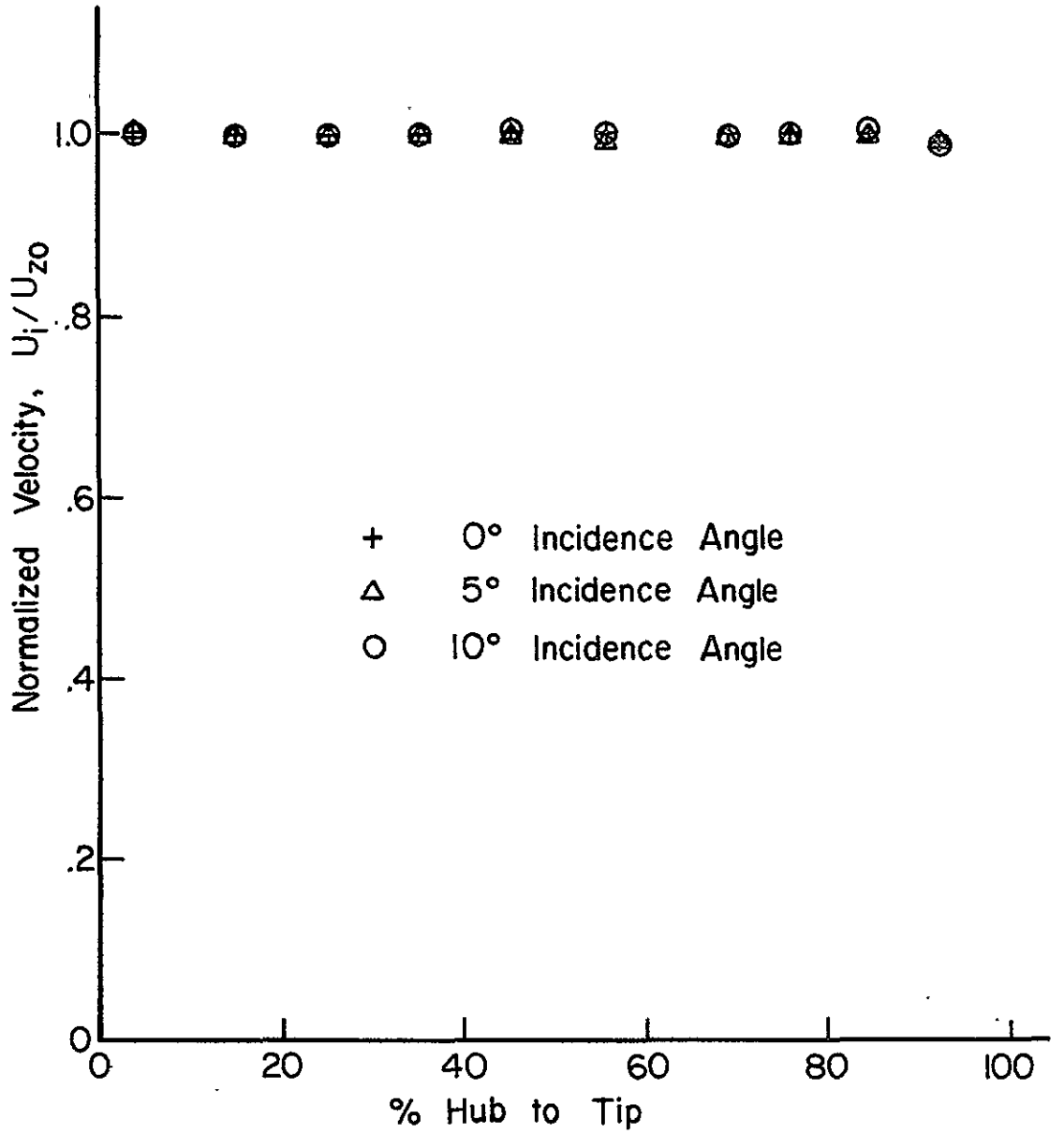

Figure 29. Cascade Inlet Velocity Profile

B. Exit Region Data and Analysis

Cascade Exit Region Measurement Stations

Cascade exit region data were obtained and reduced using the Automated Wake Acquisition System at 0° , 5° , and 10° incidence angle values. Data were taken in circumferential sets of 25 measurement stations at nine radial locations at each of the two exit region traversing slot locations. The 25 circumferential measurement stations were selected so as to accurately define the wake, with 17 stations in the wake region and 8 stations in the freestream regions. Table 2 presents the 25 circumferential measurement stations, with the cascade geometry and nomenclature defined in Figure 30. Table 3 presents the radial and the chordwise downstream measurement positions, with the cascade geometry and nomenclature defined in Figure 31. The radial measurement position nearest to the hub was located two probe diameters from the wall so as to minimize wall proximity effects, as previously discussed. Airfoil #27 was chosen as the principal blade. In addition to the 25 mid-passage to mid-passage circumferential measurement positions, several multi-passage circumferential traverses were conducted to verify the periodicity of the flow.

Table 2. Circumferential Measurement Stations

Station	T (deg)	$\frac{2T}{S}$	Station	T (deg)	$\frac{2T}{S}$
1	-5.0	-1.00	14	0.25	0.05
2	-4.25	-0.85	15	0.5	0.10
3	-3.5	-0.70	16	0.75	0.15
4	-2.75	-0.55	17	1.0	0.20
5	-2.0	-0.40	18	1.25	0.25
6	-1.75	-0.35	19	1.5	0.30
7	-1.5	-0.30	20	1.75	0.35
8	-1.25	-0.25	21	2.0	0.40
9	-1.0	-0.20	22	2.75	0.55
10	-0.75	-0.15	23	3.5	0.70
11	-0.5	-0.10	24	4.25	0.85
12	-0.25	-0.05	25	5.0	1.00
13	0.0	0.00			

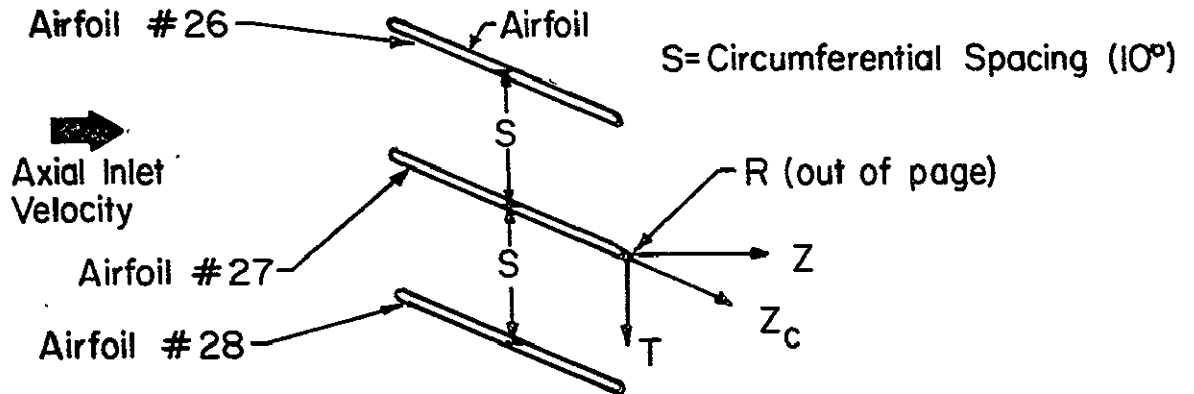

Figure 30. Circumferential Measurement Geometry

Table 3. Z_c and Radial Measurement Positions

Z_c/C Measurement Stations			Radial Stations for Each Z_c Position	
Incidence (deg)	Z_c (cm)	Z_c/C	R (cm)	% Hub-to-Tip
0	14.29	0.94	0.64	4.2
0	31.43	2.06	1.27	8.3
5	14.37	0.94	1.91	12.5
5	31.58	2.07	2.54	16.7
10	14.63	0.96	3.81	25.0
10	32.03	2.10	5.08	33.3
			7.62	50.0
			10.16	66.7
			12.70	83.3

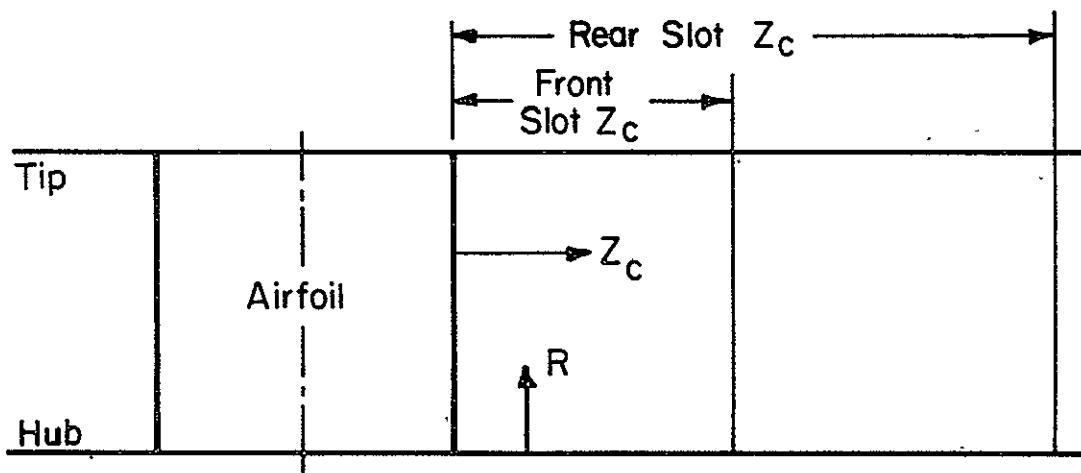

Figure 31. Z_c and Radial Measurement Geometry

Exit Data Presentation and Error Estimates

The exit data obtained at all of the measurement stations is presented in tabular form in Appendix H, and graphically in Appendix I. Each circumferential data set is represented by two tables and two plots. The table designations are the same as the corresponding figure designations. Individual circumferential data sets are identified in their titles by:

- 1) The Incidence Angle Value
- 2) The Nondimensional Downstream Position (Z_c/C)
- 3) The Percent Hub-to-Tip Radial Position (R)

A typical exit velocity component plot is shown in Figure 32 with the corresponding overall wake plot presented in Figure 33. Experimental data points are connected by lines and plotted versus the circumferential measurement stations, $2T/S$, where $2T/S = 0$ corresponds to the principal airfoil circumferential location and $2T/S = +/- 1$ corresponds to the circumferential mid-passage positions, as listed in Table 2. The component exit velocities are defined relative to the Cascade Coordinate System, Figure 3, as the axial velocity, U_z , the tangential velocity, U_t , and the radial velocity U_r . These component exit velocities are obtained from the absolute velocity, the probe pitch angle, the probe yaw angle, and the yaw offset angle as was described in Chapter IV. The pitch and yaw angles with respect to the probe are defined in Figure 21, while Figure 28 defines the yaw offset

ORIGINAL PAGE IS
OF POOR QUALITY

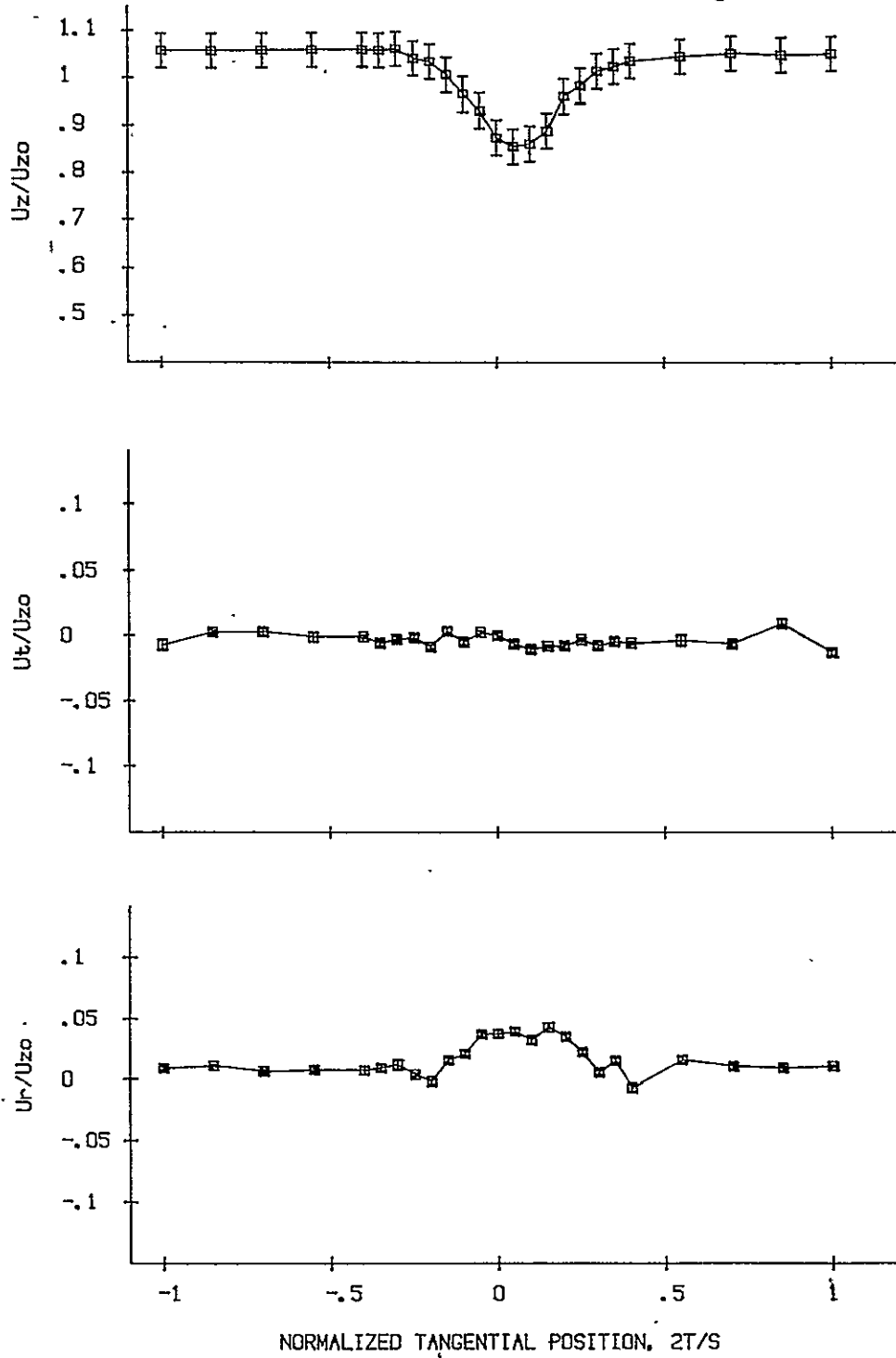

FIVE-HOLE PROBE VELOCITY DATA, INCIDENCE ANGLE (DEG) = 0,
 $Z_c/C = .94$, $R = 16.7\%$

Figure 32. Typical Exit Velocity Component Data Presentation

ORIGINAL PAGE IS
OF POOR QUALITY

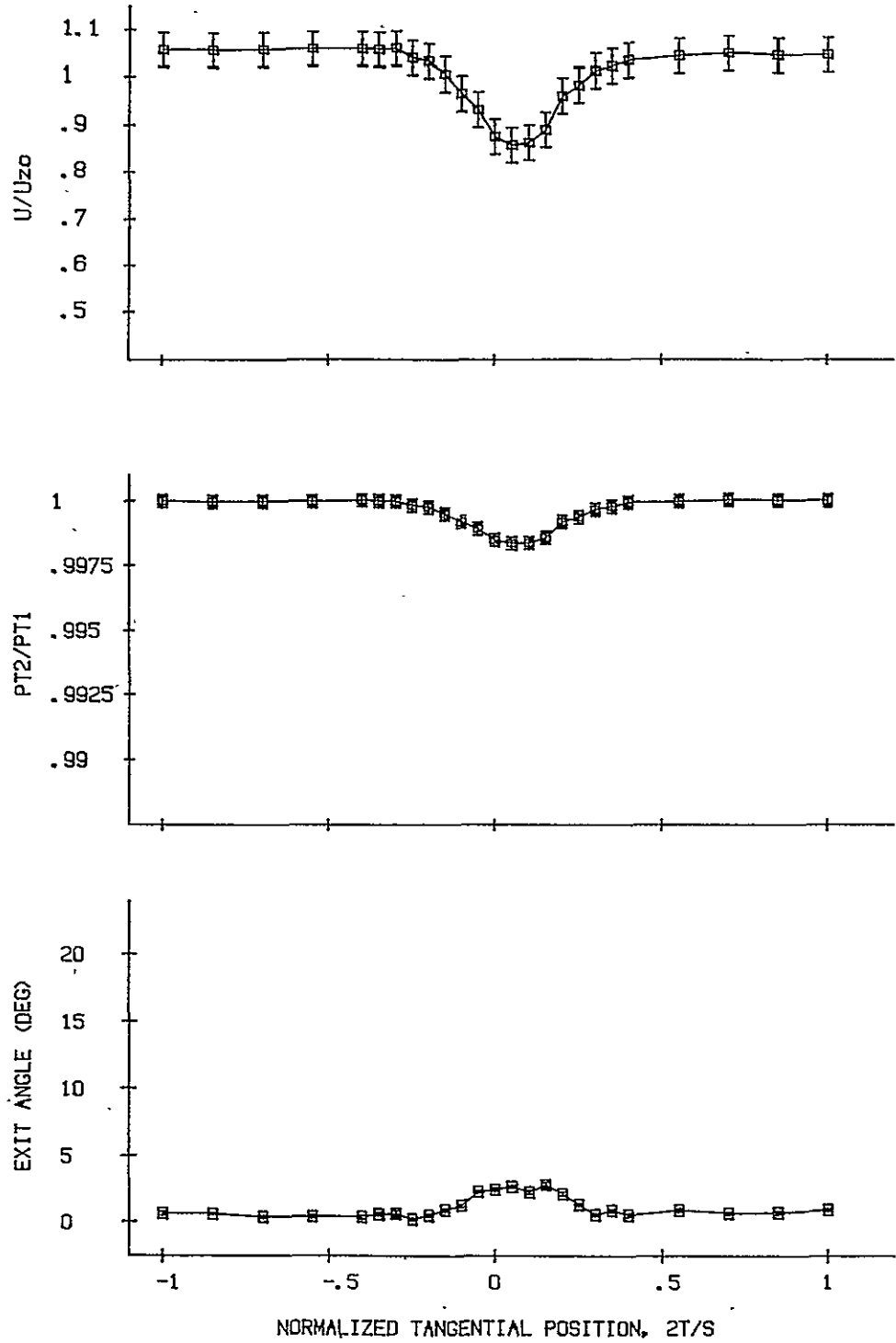

FIVE-HOLE PROBE WAKE DATA, INCIDENCE ANGLE (DEG) = 0,
 $Z_c/C = .94$, $R = 16.7\%$

Figure 33. Typical Overall Wake Data Presentation

angle. Figure 32 shows each of the exit component velocities normalized with respect to the upstream cascade inlet mass averaged velocity, U_{z0} . Figure 33 presents the absolute velocity, U , normalized with respect to U_{z0} ; the total pressure recovery, $PT2/PT1$, defined as the ratio of the exit total pressure to the mass averaged upstream total pressure; and the exit flow angle, defined as the angle between the absolute velocity and the axial direction. Error bands are placed on each data point. In addition to the data contained in the figures, the tabular data contains the mass averaged upstream static pressure, the downstream static pressures, the probe pitch angles, the probe yaw angles, the probe yaw offset angle, and the errors associated with each quantity.

To demonstrate the effects of incidence angle value and the three-dimensionality of the flow field, the exit component velocities are crossplotted, with each of the component velocities normalized with respect to the local freestream velocity, U_{fs} . Thus, each freestream axial velocity ratio is equal to unity.

Errors in the velocities were all less than 3%. Random errors in the pitch and yaw angle measurements are accurate to $\pm 0.2^\circ$, with an estimated systematic error, due to misalignment in the cascade and to the original alignments in the calibration jet for probe calibration, of less than

$\pm 0.5^\circ$. The total pressure and static pressure measurements all had errors less than 0.5%

Multiple Passage Traverses

Multiple passage traverses of the cascade exit region flow field were performed to verify the periodicity of the flow field. Four passages were traversed at 0° incidence angle and two passages were traversed at 10° incidence angle.

Figures 34 through 37 present the four passage circumferential traverse data for the 0° incidence value at a downstream distance of $Z_c/C = 0.94$ and a radial location of $R = 8.3\%$. Airfoils #26, 27, 28, 29, and 30 are circumferentially located at $2T/S = -2, 0, 2, 4,$ and 6 respectively. As seen, at 0° of incidence, the flow is periodic and symmetric about the airfoil circumferential locations. The slight decrease in the axial and absolute velocity near airfoil #28 ($2T/S = 2$, Figures 36 and 37) is a flow disturbance generated by the inlet support strut.

Figures 38 through 41 present two passage circumferential traverse data for an incidence angle of 10° at a downstream distance of $Z_c/C = 0.96$ and radial locations of $R = 4.2\%$ (Figures 38 and 39), and $R = 8.3\%$ (Figures 40 and 41). As seen, the flow is periodic, but it is nonsymmetric about the airfoil circumferential locations. Further, at the

ORIGINAL PAGE IS
OF POOR QUALITY

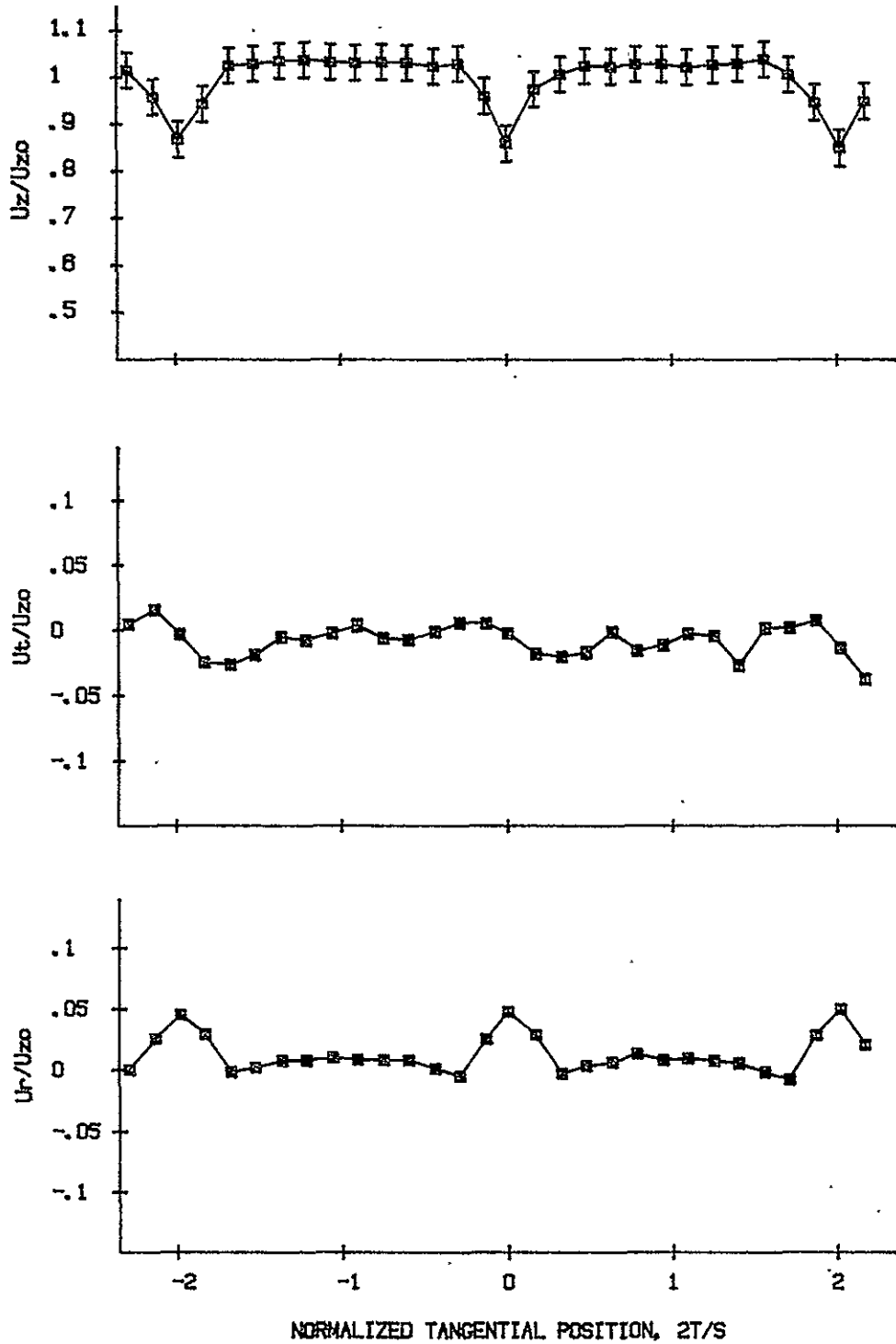

Figure 34. Multiple Passage Velocity Component Data,
Incidence Angle (DEG) = 0, $Z_c/C = .94$,
 $R = 8.3\%$, $2T/S = -2$ through $+2$

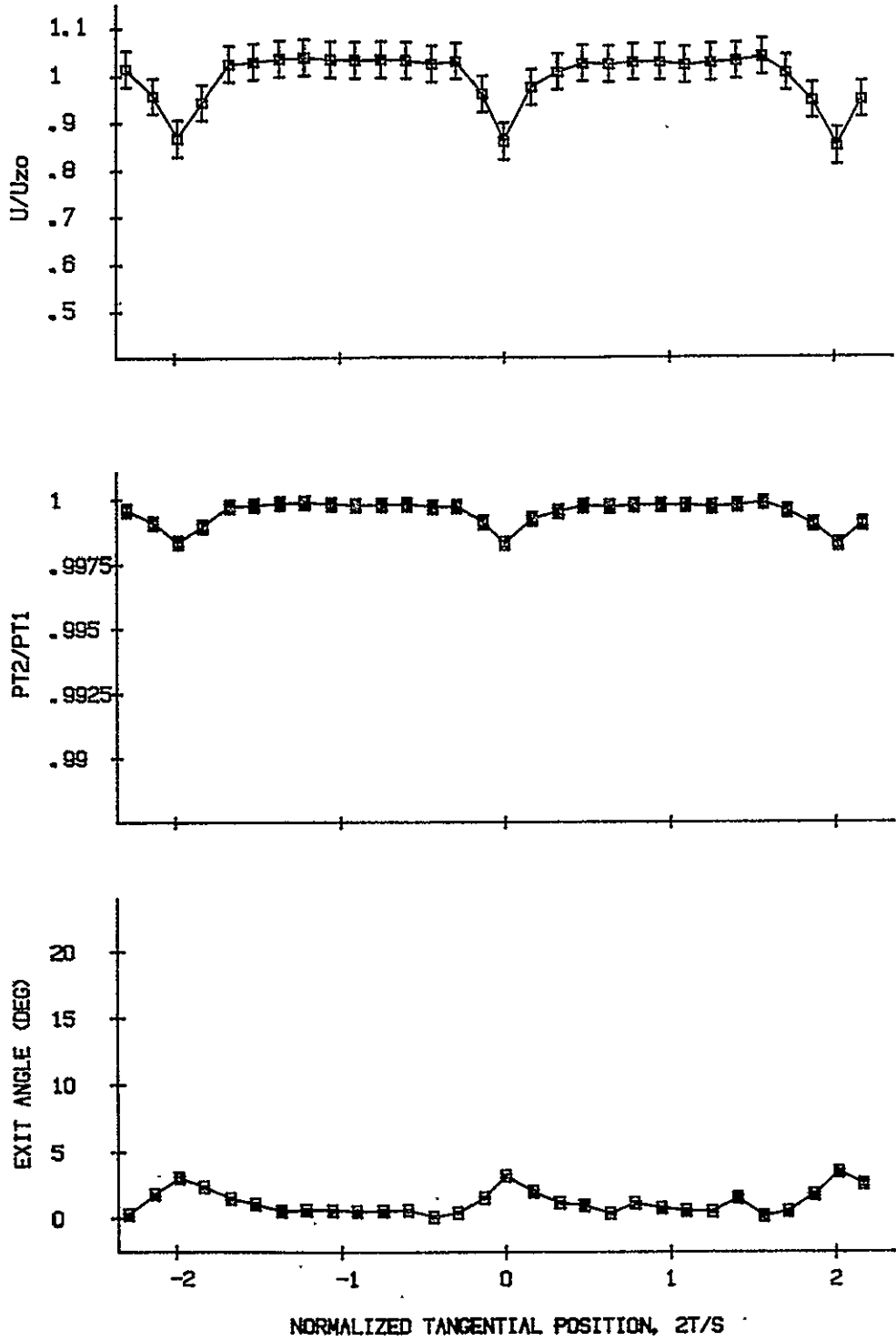

Figure 35. Multiple Passage Overall Wake Data,
Incidence Angle (DEG) = 0, $Z_c/C = .94$,
 $R = 8.3\%$, $2T/S = -2$ through $+2$

ORIGINAL PAGE IS
OF POOR QUALITY

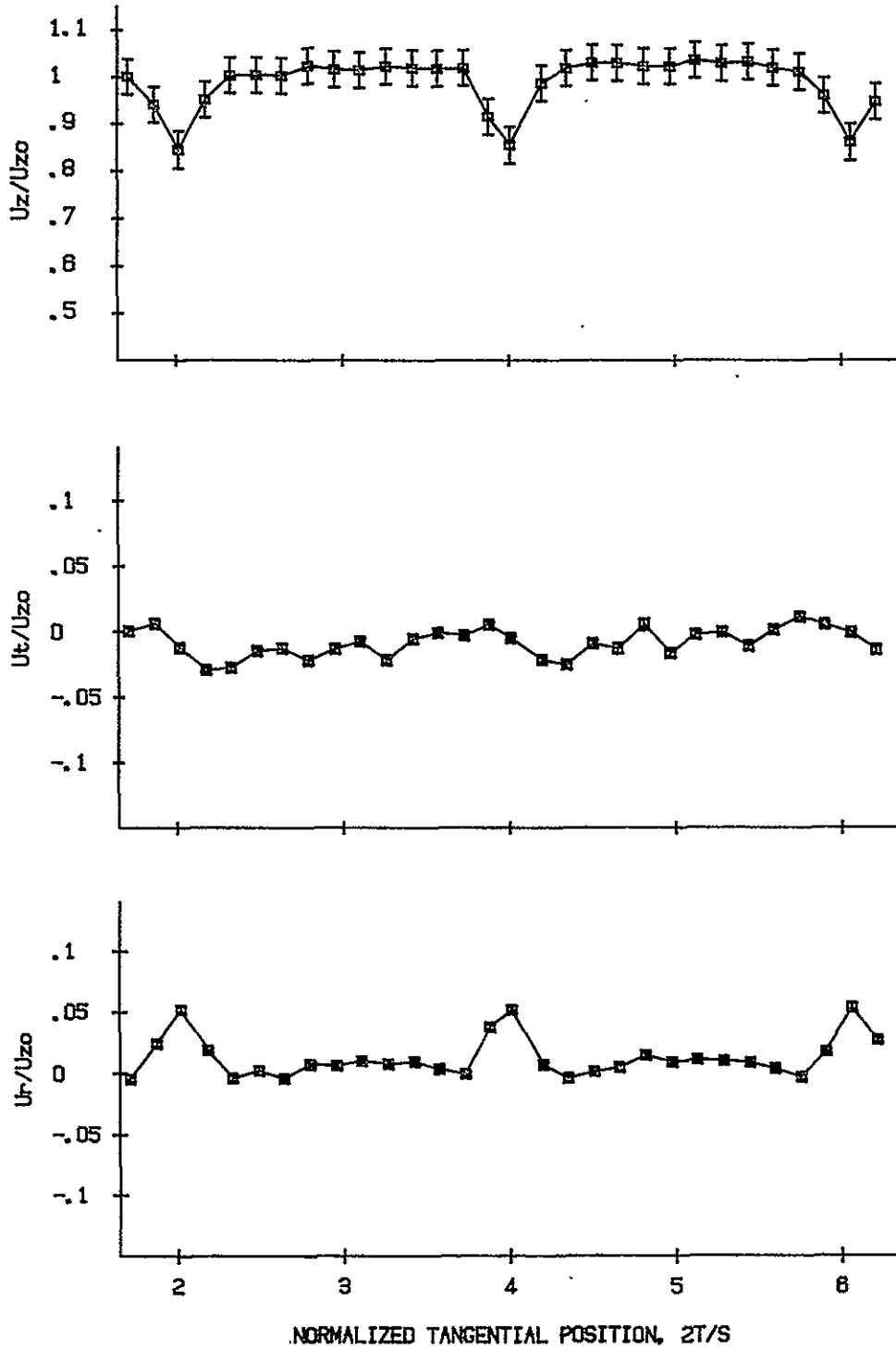

Figure 36. Multiple Passage Velocity Component Data,
Incidence Angle (DEG) = 0, $Z_c/C = .94$,
 $R = 8.3\%$, $2T/S = + 2$ through $+ 6$

ORIGINAL PAGE IS
OF POOR QUALITY

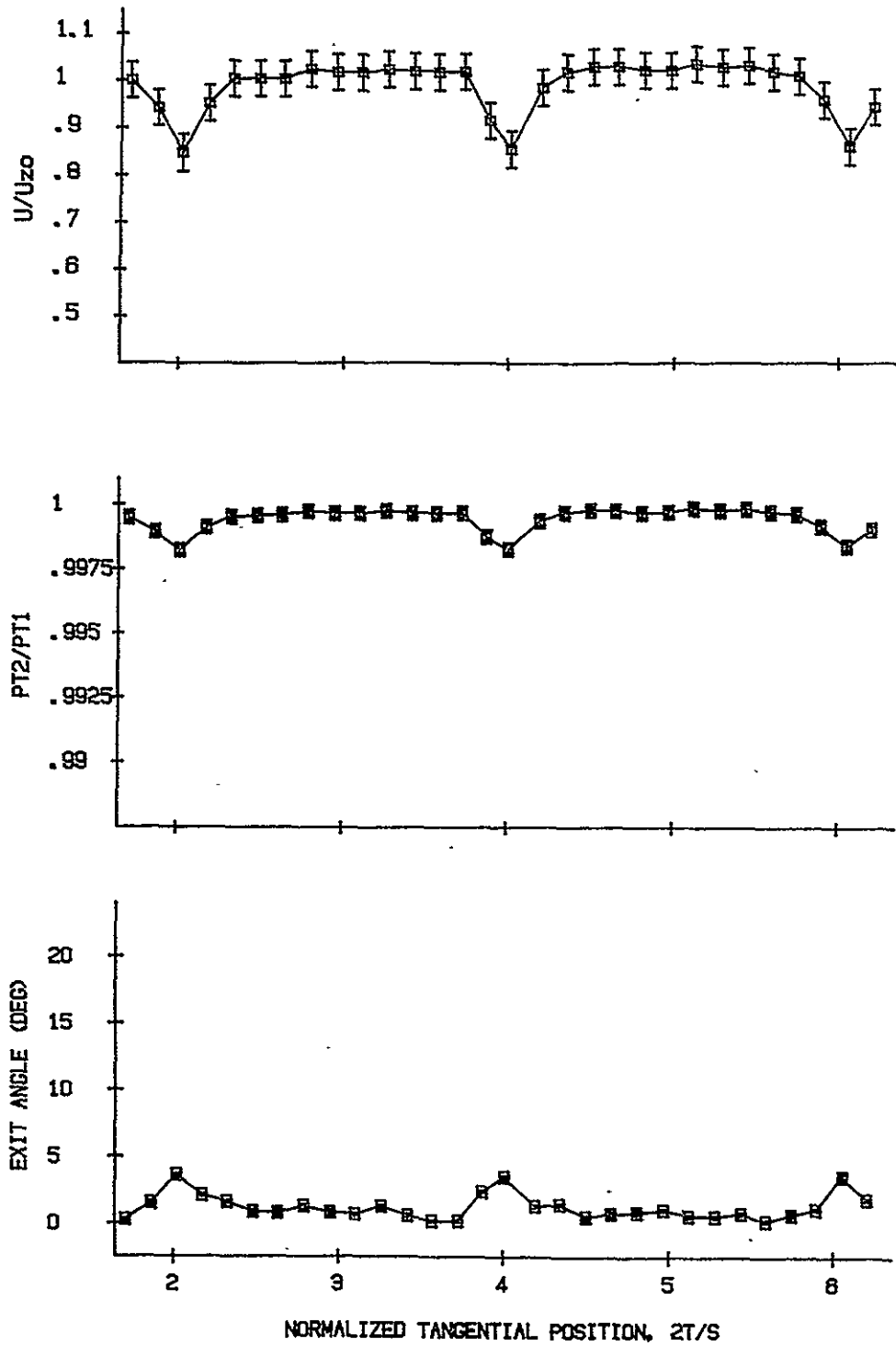

Figure 37. Multiple Passage Overall Wake Data,
Incidence Angle (DEG) = 0, $Z_c/C = .94$,
 $R = 8.3\%$, $2T/S = + 2$ through $+ 6$

ORIGINAL PAGE IS
OF POOR QUALITY

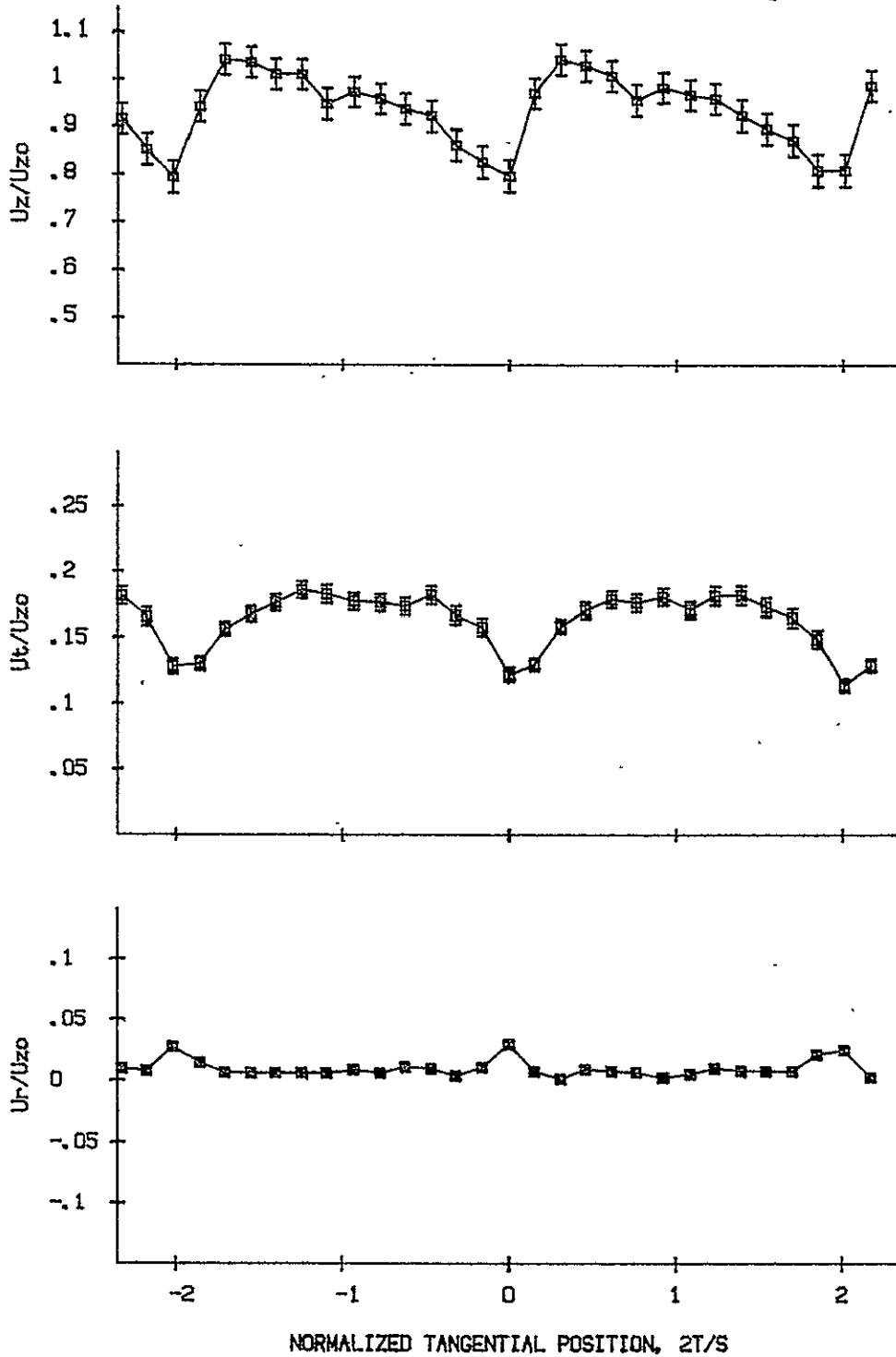

Figure 38. Multiple Passage Velocity Component Data,
Incidence Angle (DEG) = 10.0, $Z_c/C = .96$,
 $R + 4.2\%$, $2T/S = -2$ through $+2$

ORIGINAL PAGE IS
OF POOR QUALITY

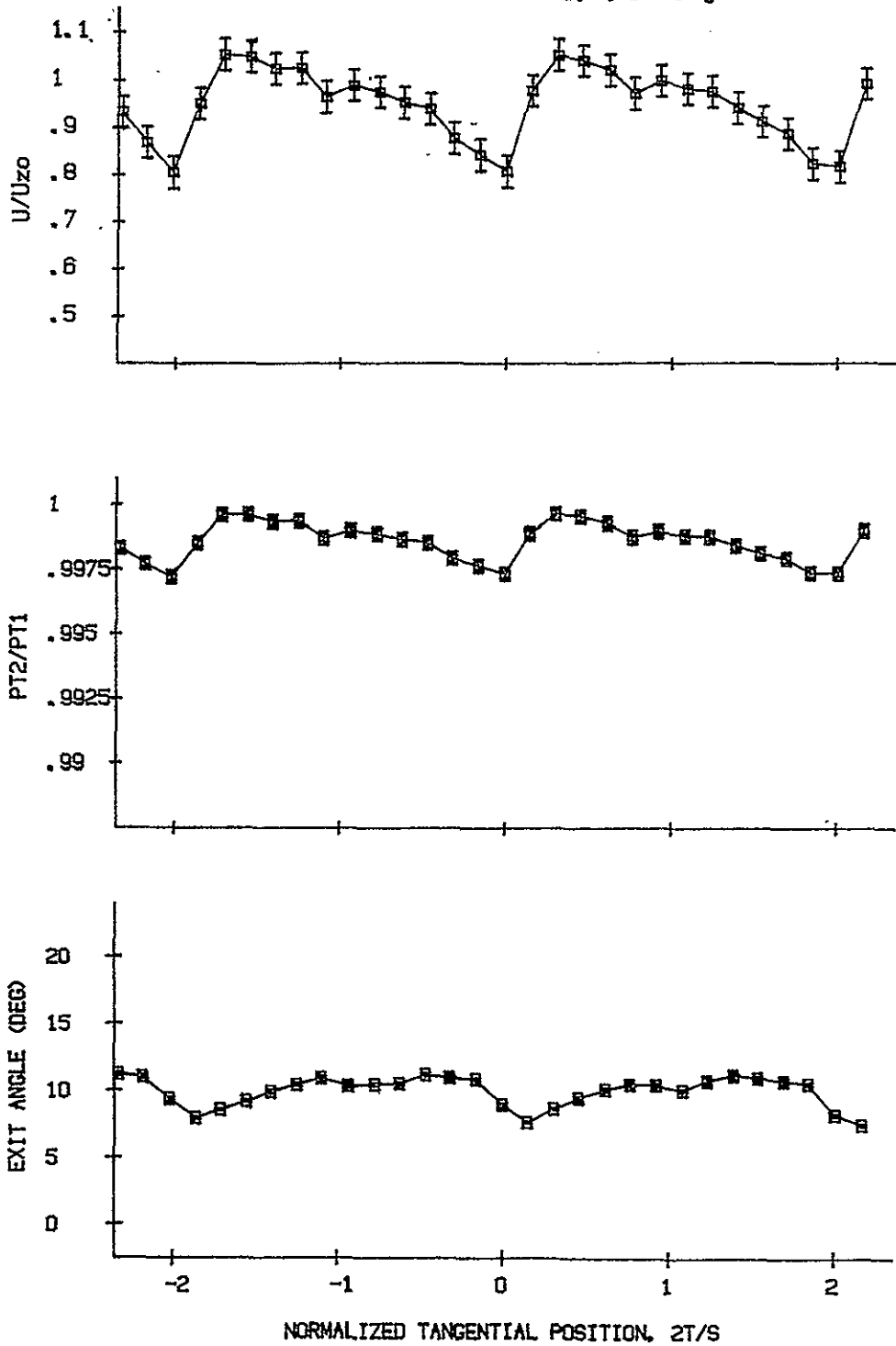

Figure 39. Multiple Passage Overall Wake Data,
Incidence Angle (DEG) = 10.0, $Z_c/C = .96$,
 $R = 4.2\%$, $2T/S = -2$ through $+2$

ORIGINAL PAGE IS
OF POOR QUALITY.

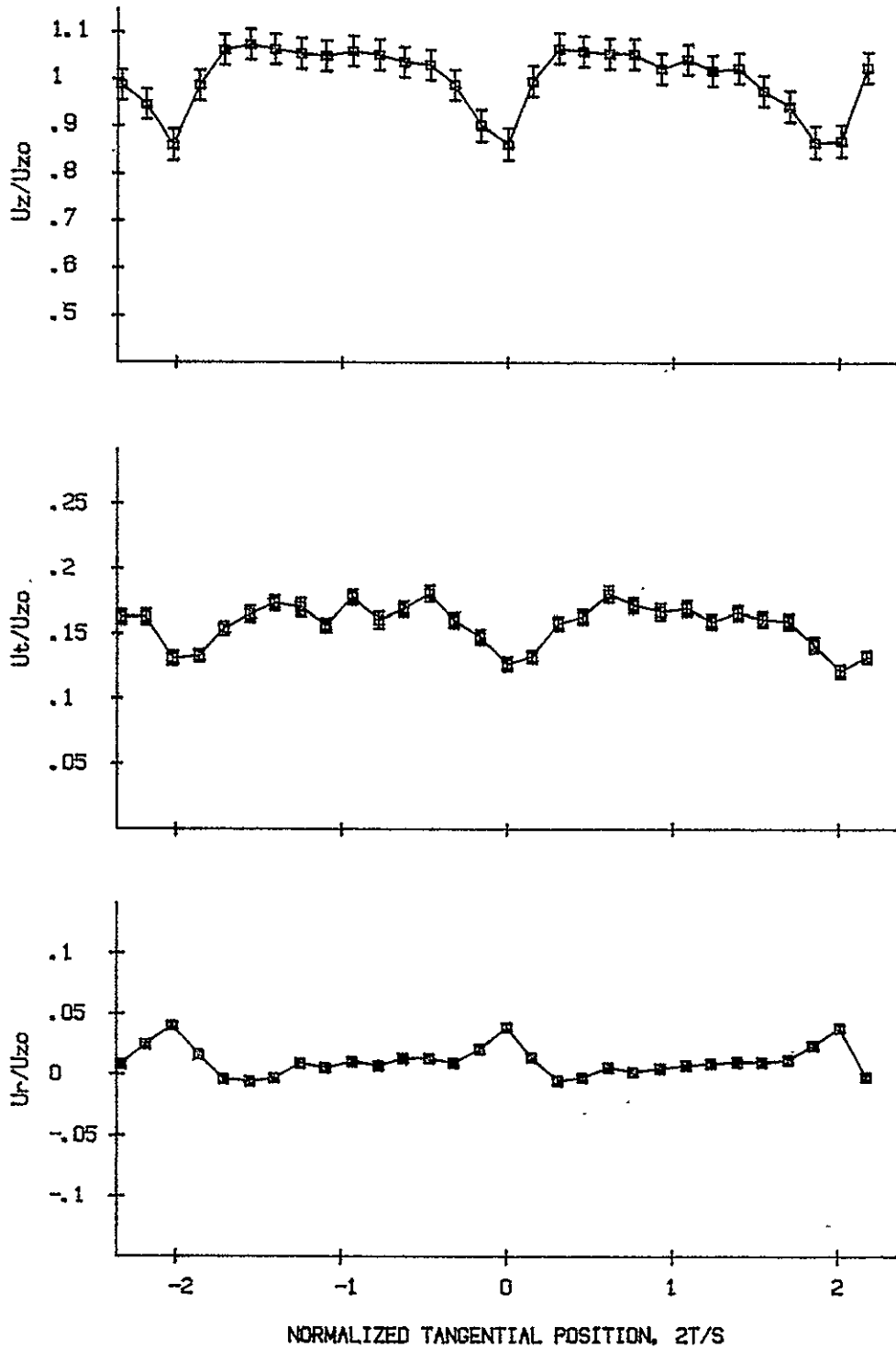

Figure 40. Multiple Passage Velocity Component Data,
Incidence Angle (DEG) = 10.0, $Z_c/C = .96$,
 $R = 8.3\%$, $2T/S = -2$ through $+ 2$

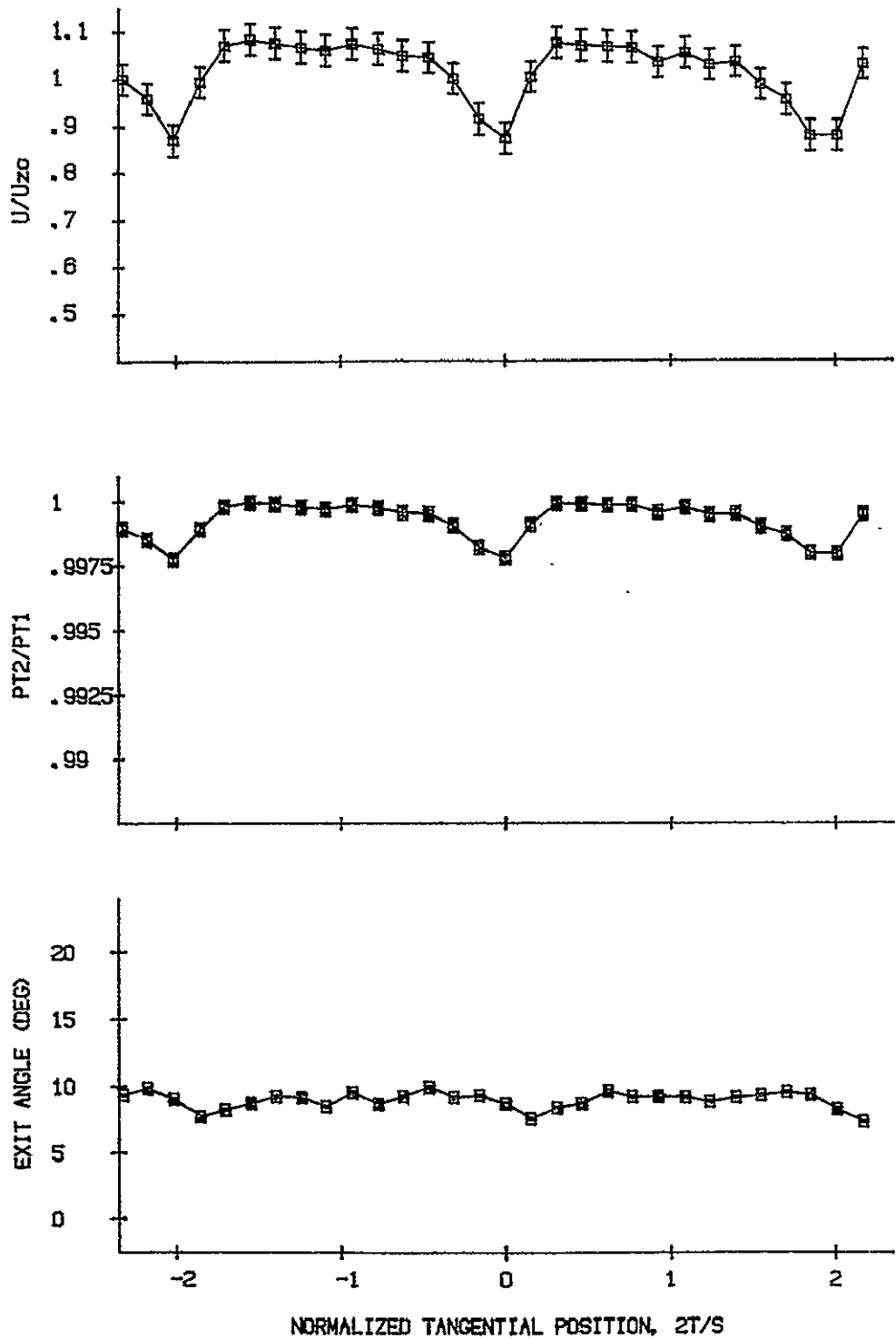

Figure 41. Multiple Passage Overall Wake Data,
Incidence Angle (DEG) = 10.0, $Z_c/C = .96$,
 $R = 8.3\%$, $2T/S = -2$ through $+ 2$

radial location of $R = 8.3\%$ a freestream uniform core region does exist in the blade passages, but no freestream uniform core region is seen in the $R = 4.2\%$ circumferential passage data.

Incidence Angle Effects on the Cascade Exit Flow Field

Crossplots of the exit component velocity data are presented for each circumferential data set at each radial location for the two traversing slot locations to show the effect of incidence angle on the cascade exit flow field, Figures 42 through 59.

As expected, for the classical airfoil cascade at 0° of incidence, the axial velocity component is symmetric about the airfoil circumferential location. As the incidence angle is increased from 0° , the turning of the flow by the airfoil cascade results in the velocity distribution no longer being symmetric about the airfoil circumferential location, with the nonsymmetry increasing with increasing incidence angle value. This nonsymmetry of the airfoil wake region is due to increased boundary layer development on the suction surfaces of the airfoils, and possible separation of the flow at the 10° incidence angle value. This general result of increased nonsymmetry of the airfoil wake region with incidence angle is in agreement with the two-dimensional results of Raj and Lakshminarayana [3].

ORIGINAL PAGE IS
OF POOR QUALITY

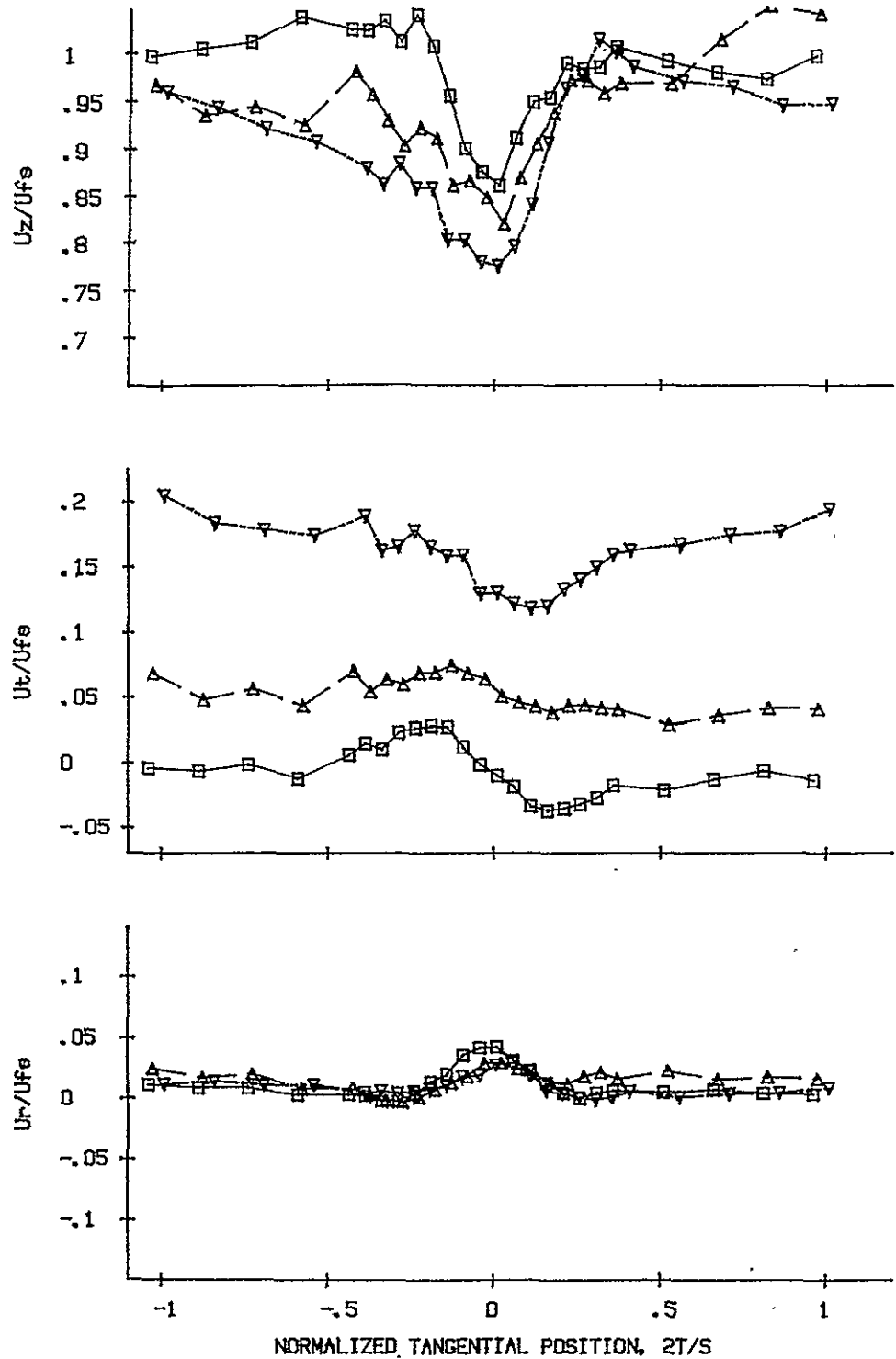

Figure 42. Incidence Angle Crossplots, Front Traversing
Slot, $R = 4.2\%$
 \square INCIDENCE ANGLE = 0 deg, $Z_c/C = .94$, $U_{fs} = 26.9$ m/s.
 \triangle INCIDENCE ANGLE = 5 deg, $Z_c/C = .94$, $U_{fs} = 30.3$ m/s.
 ∇ INCIDENCE ANGLE = 10 deg, $Z_c/C = .96$, $U_{fs} = 30.5$ m/s.

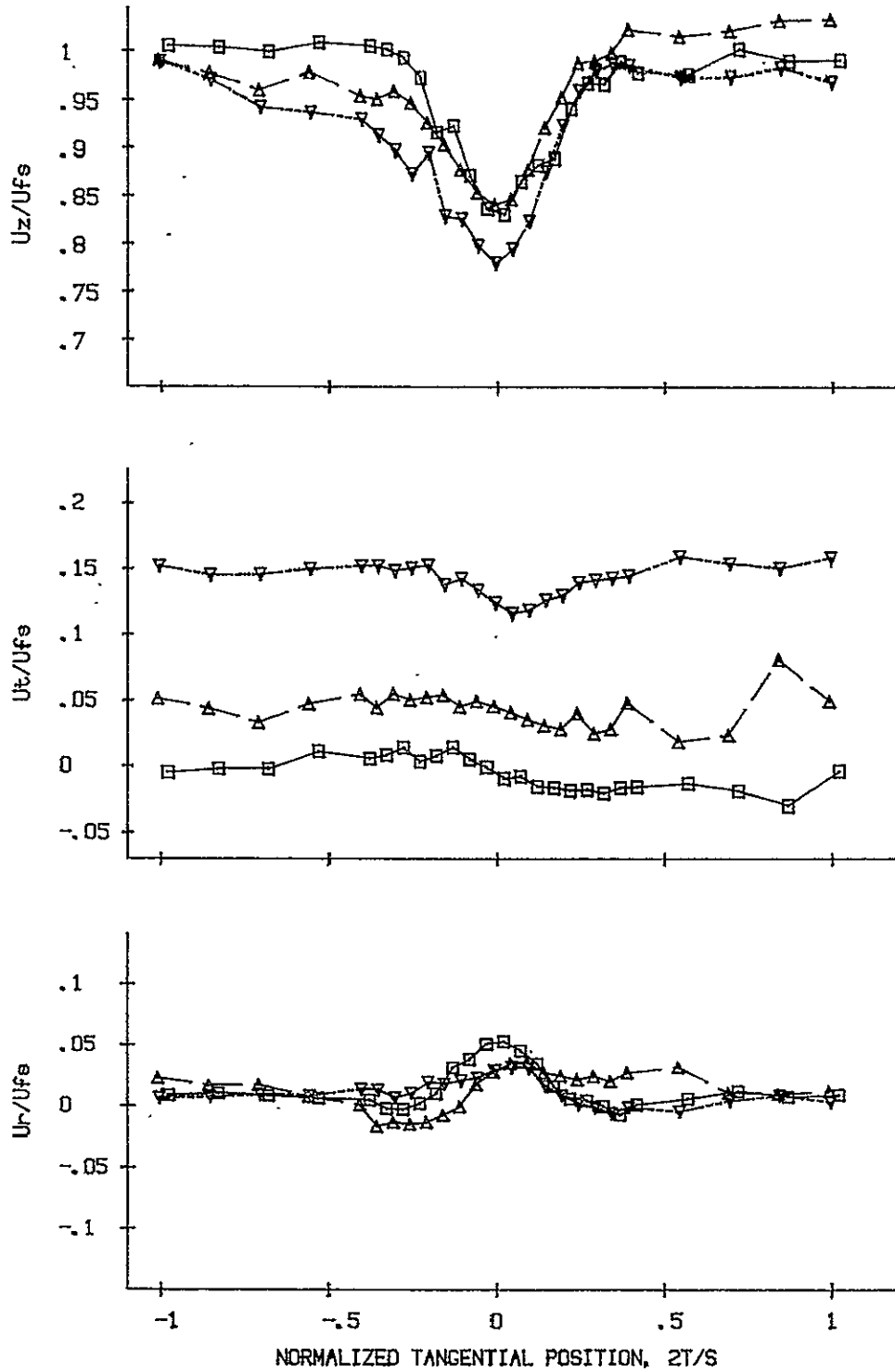

Figure 43. Incidence Angle Crossplots, Front Traversing Slot, $R = 8.3\%$

- INCIDENCE ANGLE = 0 deg, $Z_c/C = .94$, $U_{fs} = 29.5$ m/s.
- △ INCIDENCE ANGLE = 5 deg, $Z_c/C = .94$, $U_{fs} = 31.8$ m/s.
- ▽ INCIDENCE ANGLE = 10 deg, $Z_c/C = .98$, $U_{fs} = 32.2$ m/s.

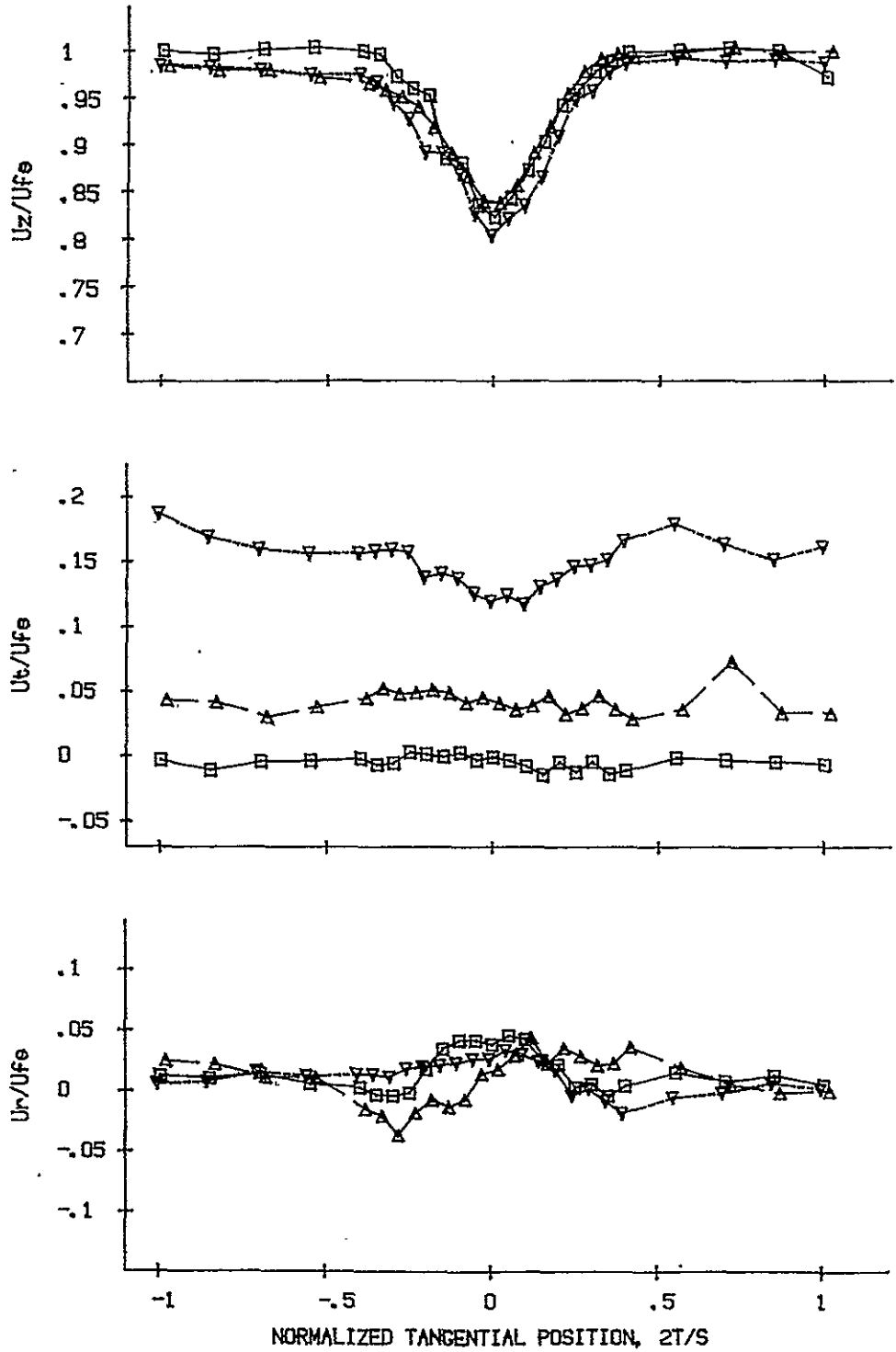

Figure 44. Incidence Angle Crossplots, Front Traversing
Slot, $R = 12.5\%$
□ INCIDENCE ANGLE = 0 deg, $Z_c/C = .94$, $U_{fe} = 29.4$ m/e,
△ INCIDENCE ANGLE = 5 deg, $Z_c/C = .94$, $U_{fe} = 32.7$ m/e,
▽ INCIDENCE ANGLE = 10 deg, $Z_c/C = .98$, $U_{fe} = 32.0$ m/e.

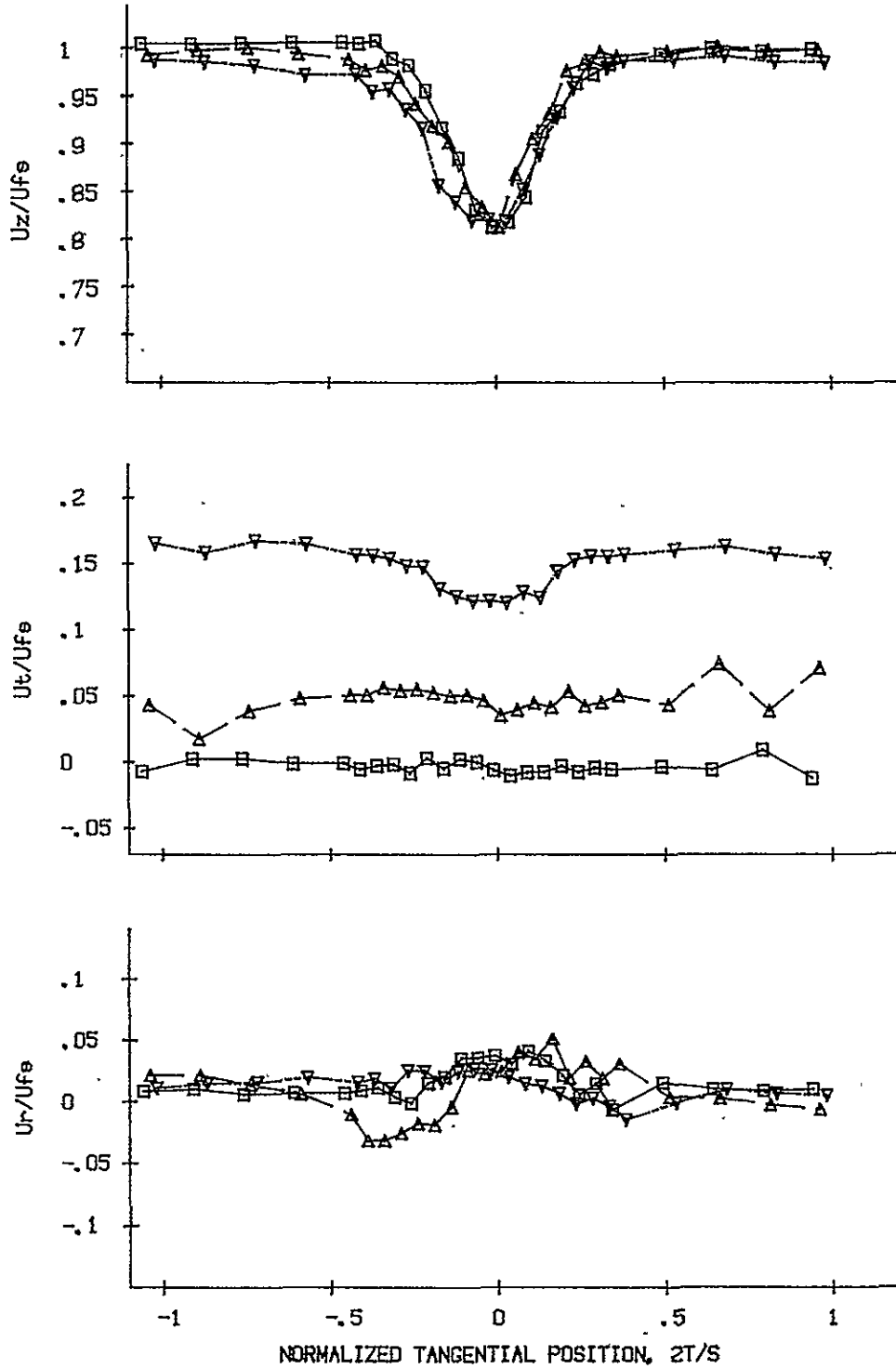

Figure 45. Incidence Angle Crossplots, Front Traversing Slot, $R = 16.7\%$

- INCIDENCE ANGLE = 0 deg, $Z_c/C = .94$, $U_{fe} = 30.0$ m/s.
- △ INCIDENCE ANGLE = 5 deg, $Z_c/C = .94$, $U_{fe} = 32.4$ m/s.
- ▽ INCIDENCE ANGLE = 10 deg, $Z_c/C = .96$, $U_{fe} = 32.2$ m/s.

ORIGINAL PAGE IS
OF POOR QUALITY

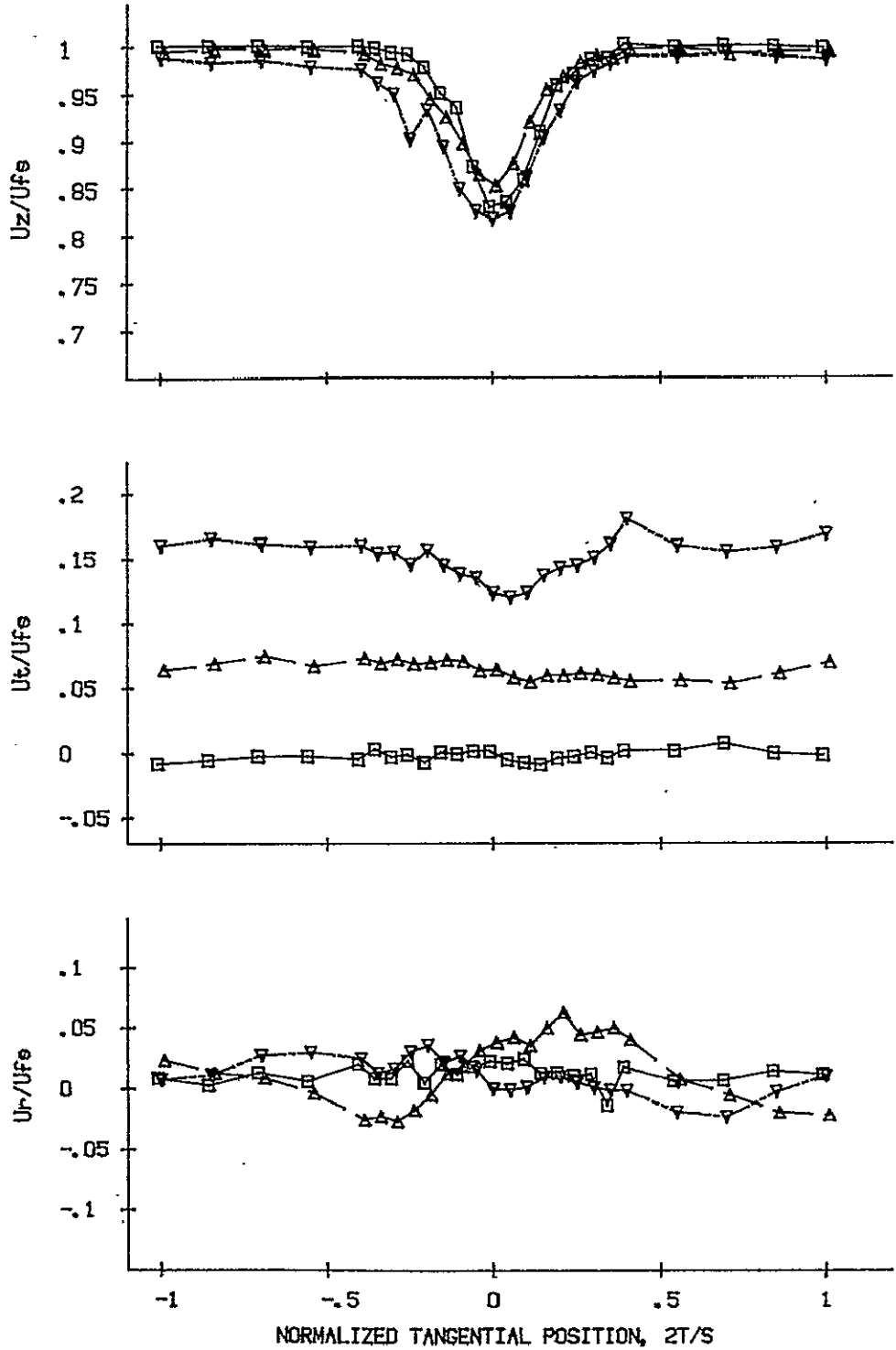

Figure 46. Incidence Angle Crossplots, Front Traversing Slot, $R = 25\%$
 \square INCIDENCE ANGLE = 0 deg, $Z_c/C = .94$, $U_{fe} = 30.0$ m/s.
 \triangle INCIDENCE ANGLE = 5 deg, $Z_c/C = .94$, $U_{fe} = 32.9$ m/s.
 ∇ INCIDENCE ANGLE = 10 deg, $Z_c/C = .96$, $U_{fe} = 32.3$ m/s.

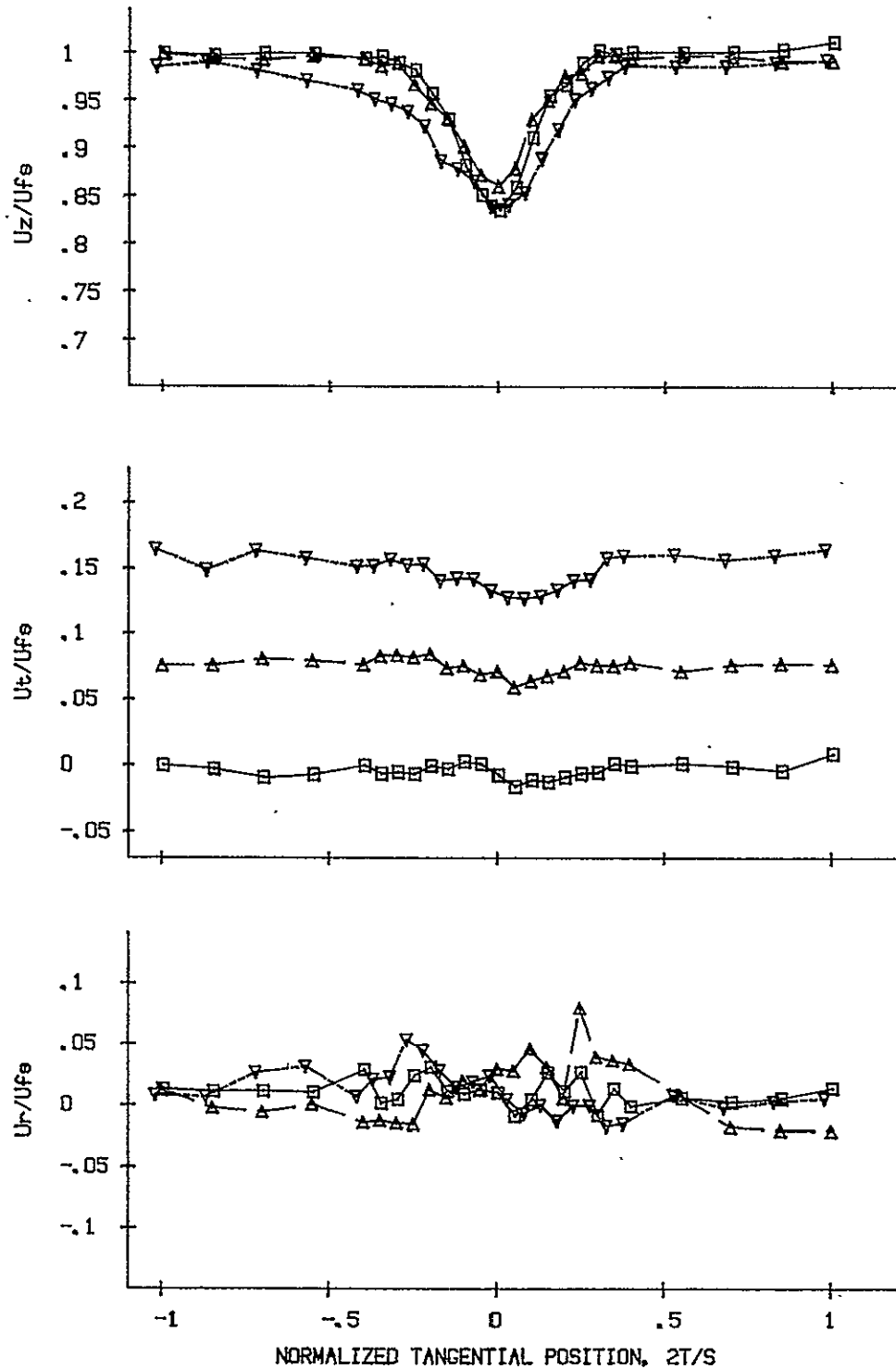

Figure 47. Incidence Angle Crossplots, Front Traversing Slot, $R' = 33.3\%$

- INCIDENCE ANGLE = 0 deg, $Z_c/C = .94$, $U_{fe} = 29.9$ m/s.
- △ INCIDENCE ANGLE = 5 deg, $Z_c/C = .94$, $U_{fe} = 32.8$ m/s.
- ▽ INCIDENCE ANGLE = 10 deg, $Z_c/C = .96$, $U_{fe} = 32.4$ m/s.

ORIGINAL PAGE IS
OF POOR QUALITY

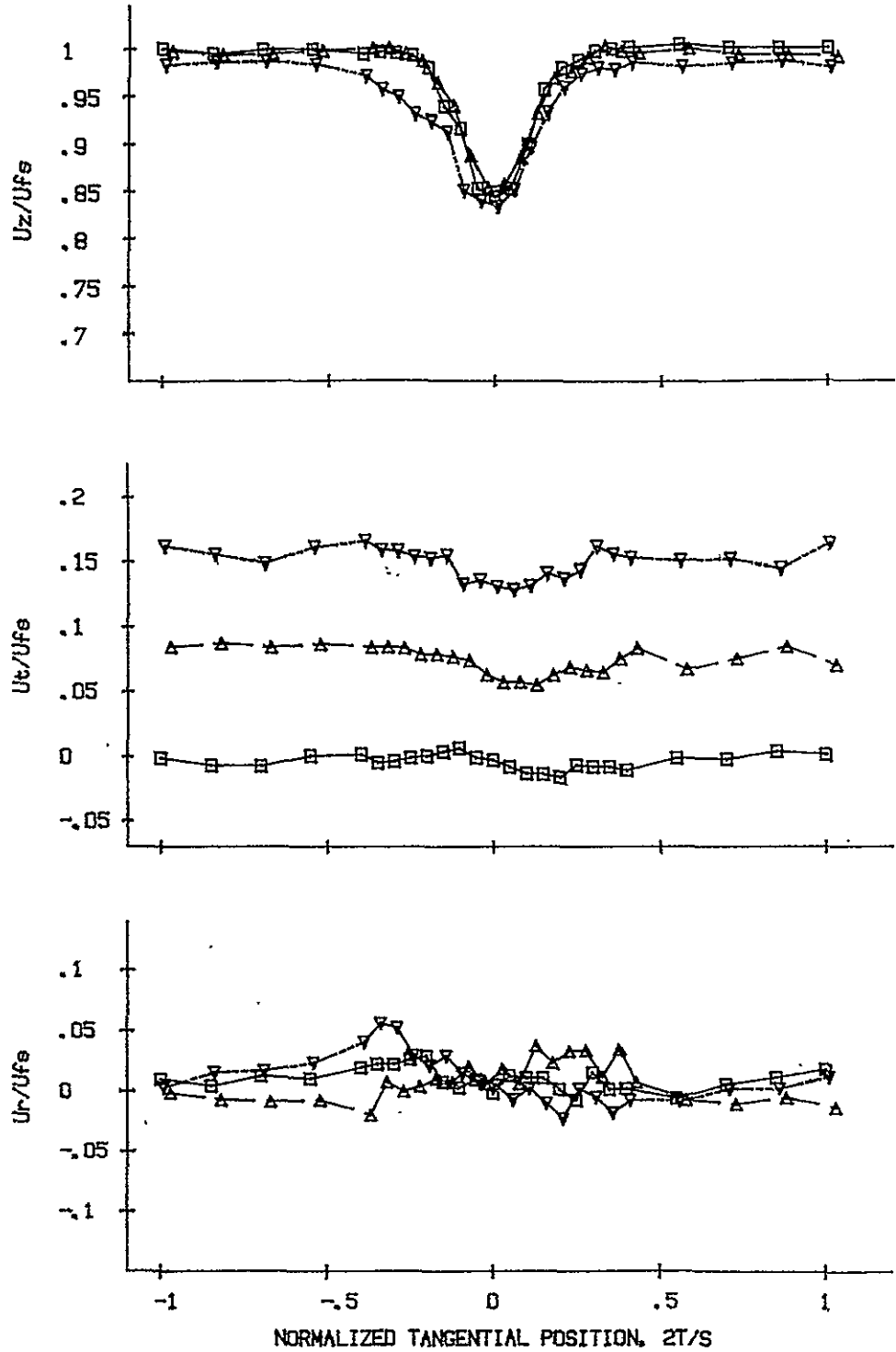

Figure 48. Incidence Angle Crossplots, Front Traversing Slot, $R = 50\%$

- INCIDENCE ANGLE = 0 deg, $Z_c/C = .94$, $U_{fe} = 29.8$ m/e.
- △ INCIDENCE ANGLE = 5 deg, $Z_c/C = .94$, $U_{fe} = 32.6$ m/e.
- ▽ INCIDENCE ANGLE = 10 deg, $Z_c/C = .96$, $U_{fe} = 32.3$ m/e.

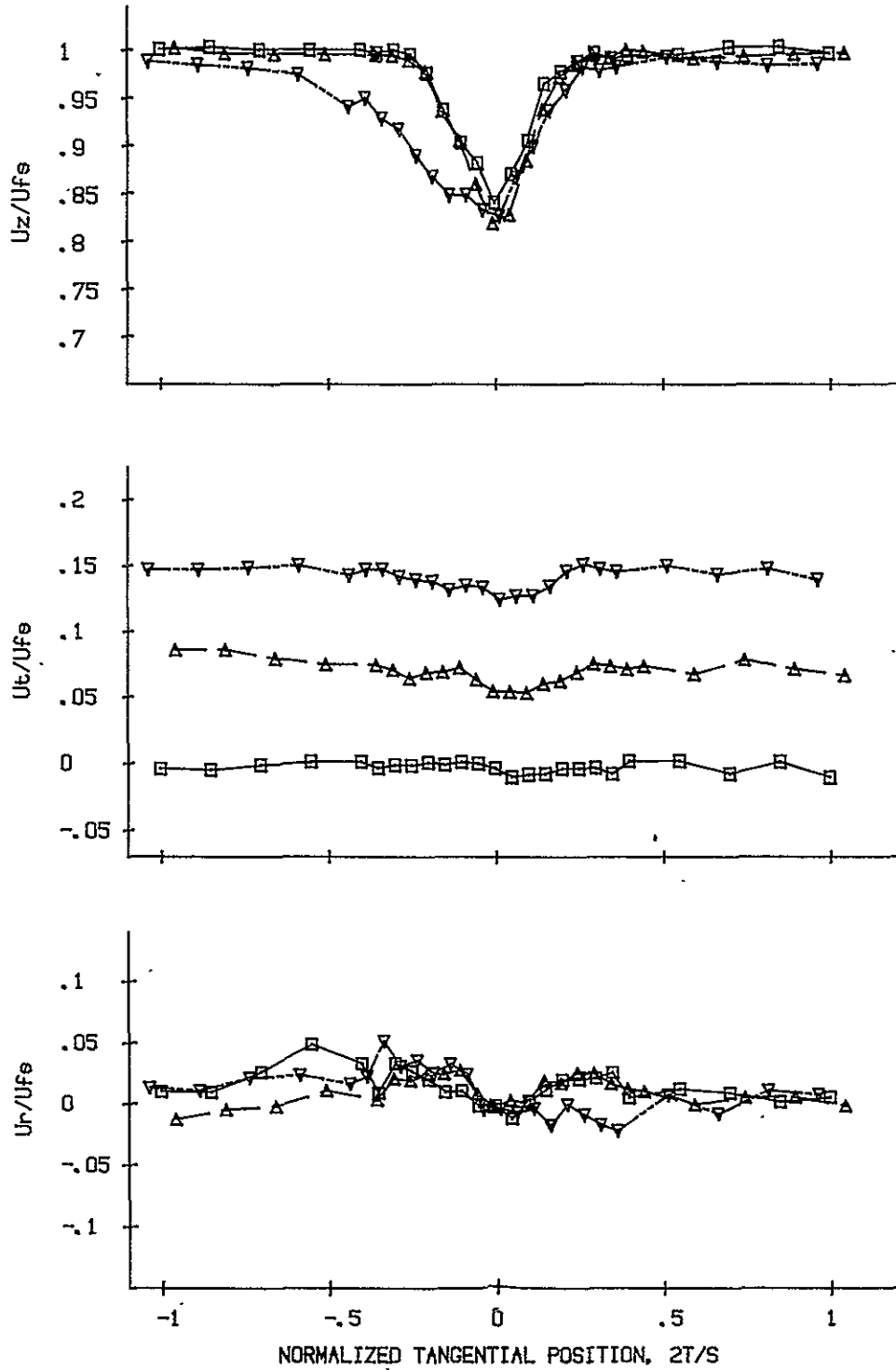

Figure 49. Incidence Angle Crossplots, Front Traversing Slot, R = 66.7%

- INCIDENCE ANGLE = 0 deg, $Z_c/C = .94$, $U_{fe} = 29.7$ m/e.
- △ INCIDENCE ANGLE = 5 deg, $Z_c/C = .94$, $U_{fe} = 32.5$ m/e.
- ▽ INCIDENCE ANGLE = 10 deg, $Z_c/C = .96$, $U_{fe} = 32.1$ m/e.

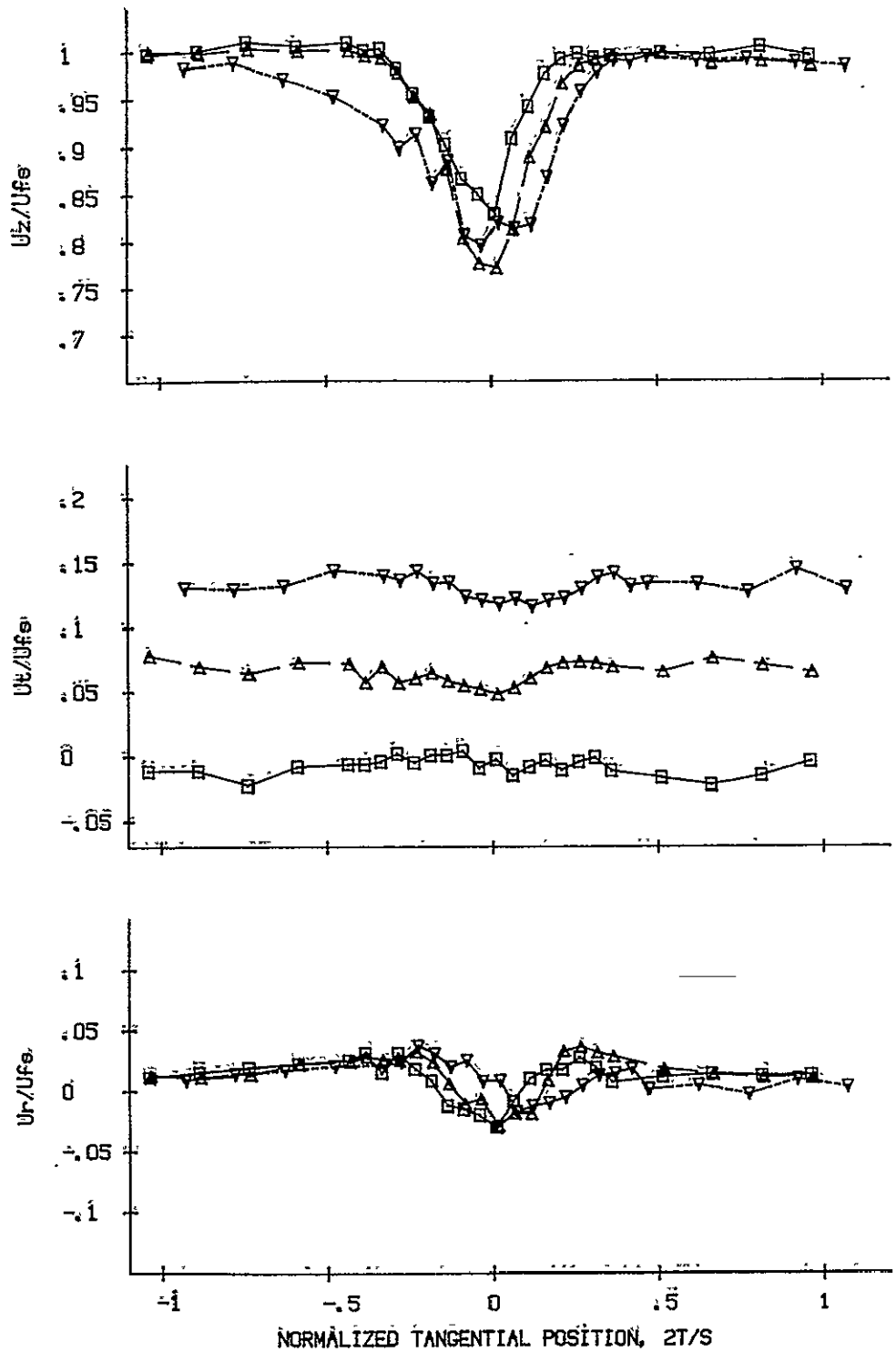

Figure 50. Incidence Angle Crossplots, Front Traversing Slot; $R = 83.3\%$

- INCIDENCE ANGLE = 0 deg, $Z_c/C = .94$, $U_{fe} = 29.3$ m/s.
- △ INCIDENCE ANGLE = 5 deg, $Z_c/C = .94$, $U_{fe} = 32.2$ m/s.
- ▽ INCIDENCE ANGLE = 10 deg, $Z_c/C = .96$, $U_{fe} = 31.7$ m/s.

ORIGINAL PAGE IS
OF POOR QUALITY

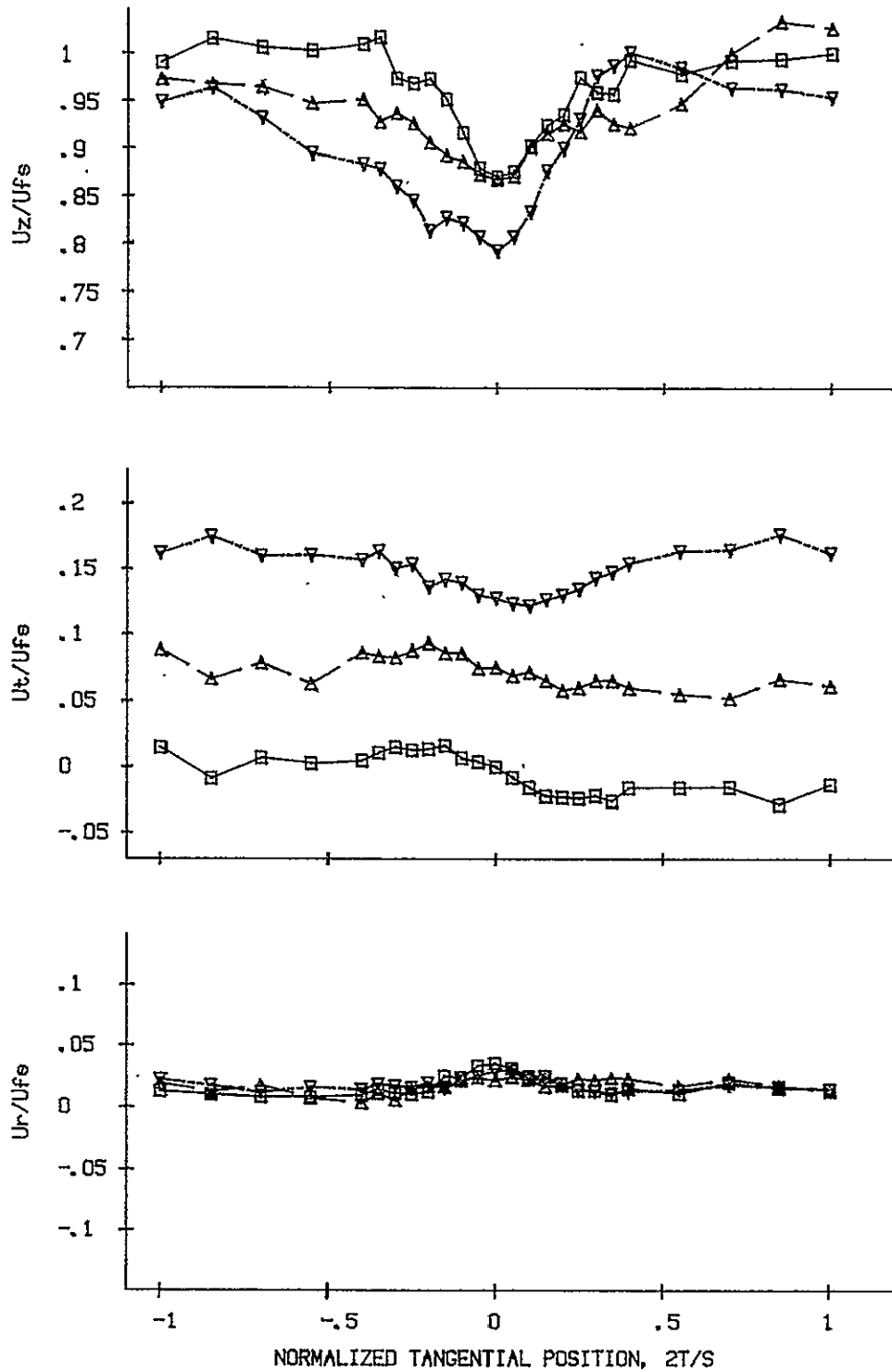

Figure 51. Incidence Angle Crossplots, Rear Traversing Slot, $R = 4.2\%$

- INCIDENCE ANGLE = 0 deg, $Z_c/C = 2.06$, $U_{fs} = 28.0$ m/s.
- △ INCIDENCE ANGLE = 5 deg, $Z_c/C = 2.07$, $U_{fs} = 30.0$ m/s.
- ▽ INCIDENCE ANGLE = 10 deg, $Z_c/C = 2.10$, $U_{fs} = 30.0$ m/s.

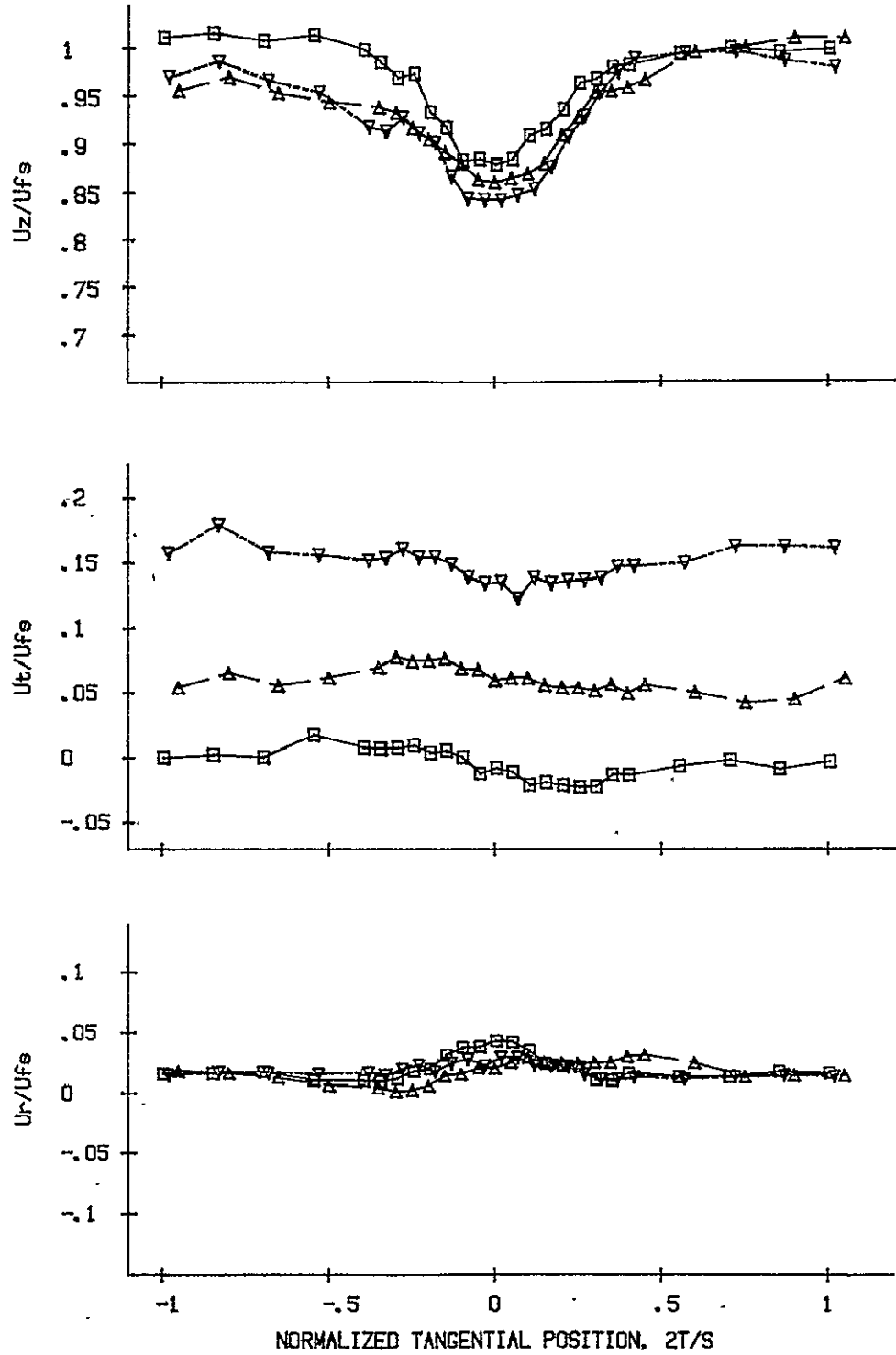

Figure 52. Incidence Angle Crossplots, Rear Traversing Slot, $R = 8.3\%$

- INCIDENCE ANGLE = 0 deg, $Z_c/C = 2.06$, $U_{fe} = 29.2$ m/s.
- △ INCIDENCE ANGLE = 5 deg, $Z_c/C = 2.07$, $U_{fe} = 32.1$ m/s.
- ▽ INCIDENCE ANGLE = 10 deg, $Z_c/C = 2.10$, $U_{fe} = 31.4$ m/s.

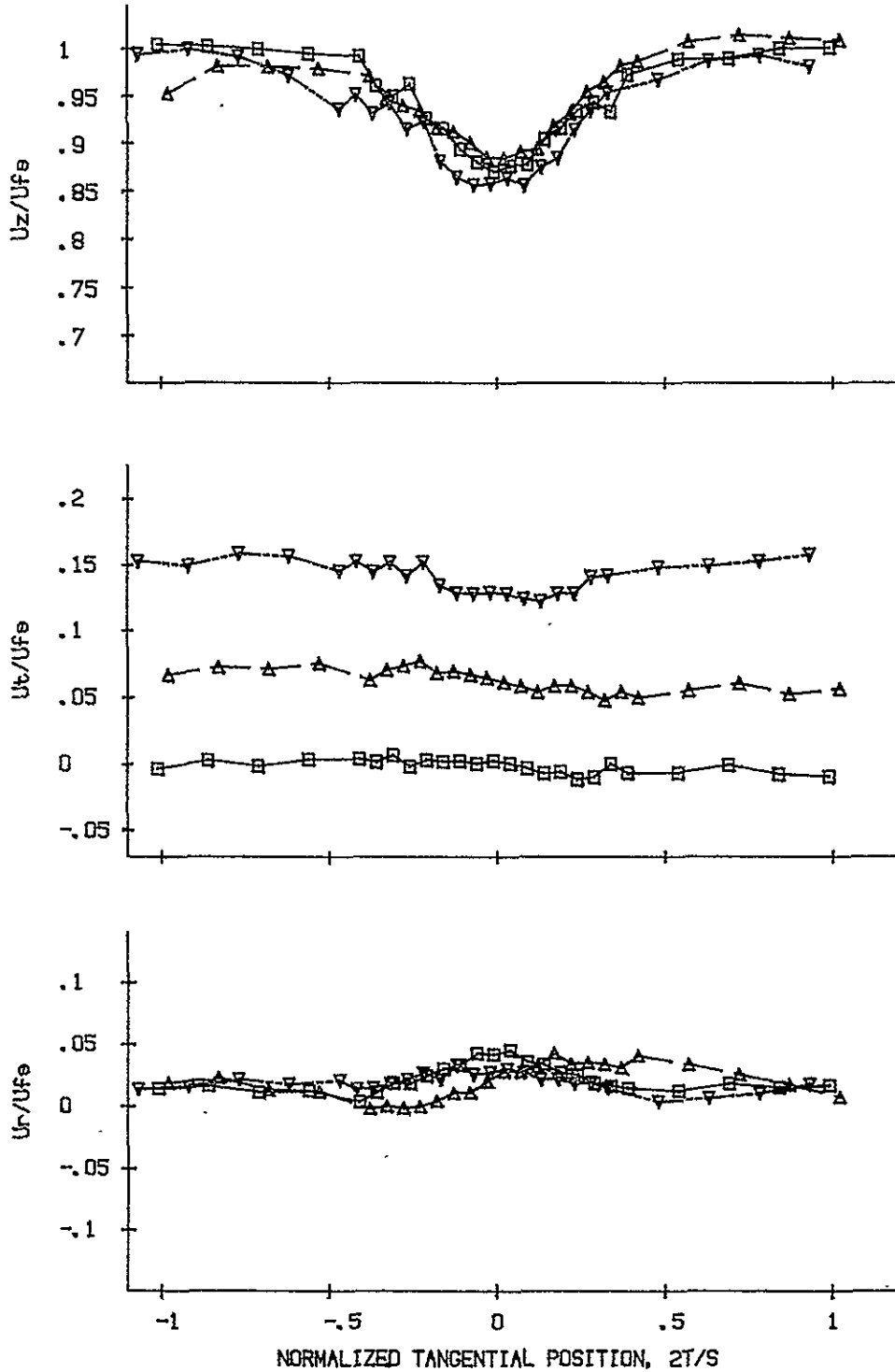

Figure 53. Incidence Angle Crossplots, Rear Traversing
Slot, $R = 12.5\%$

- INCIDENCE ANGLE = 0 deg, $Z_c/C = 2.06$, $U_{fe} = 30.2$ m/s.
- △ INCIDENCE ANGLE = 5 deg, $Z_c/C = 2.07$, $U_{fe} = 32.4$ m/s.
- ▽ INCIDENCE ANGLE = 10 deg, $Z_c/C = 2.10$, $U_{fe} = 31.7$ m/s.

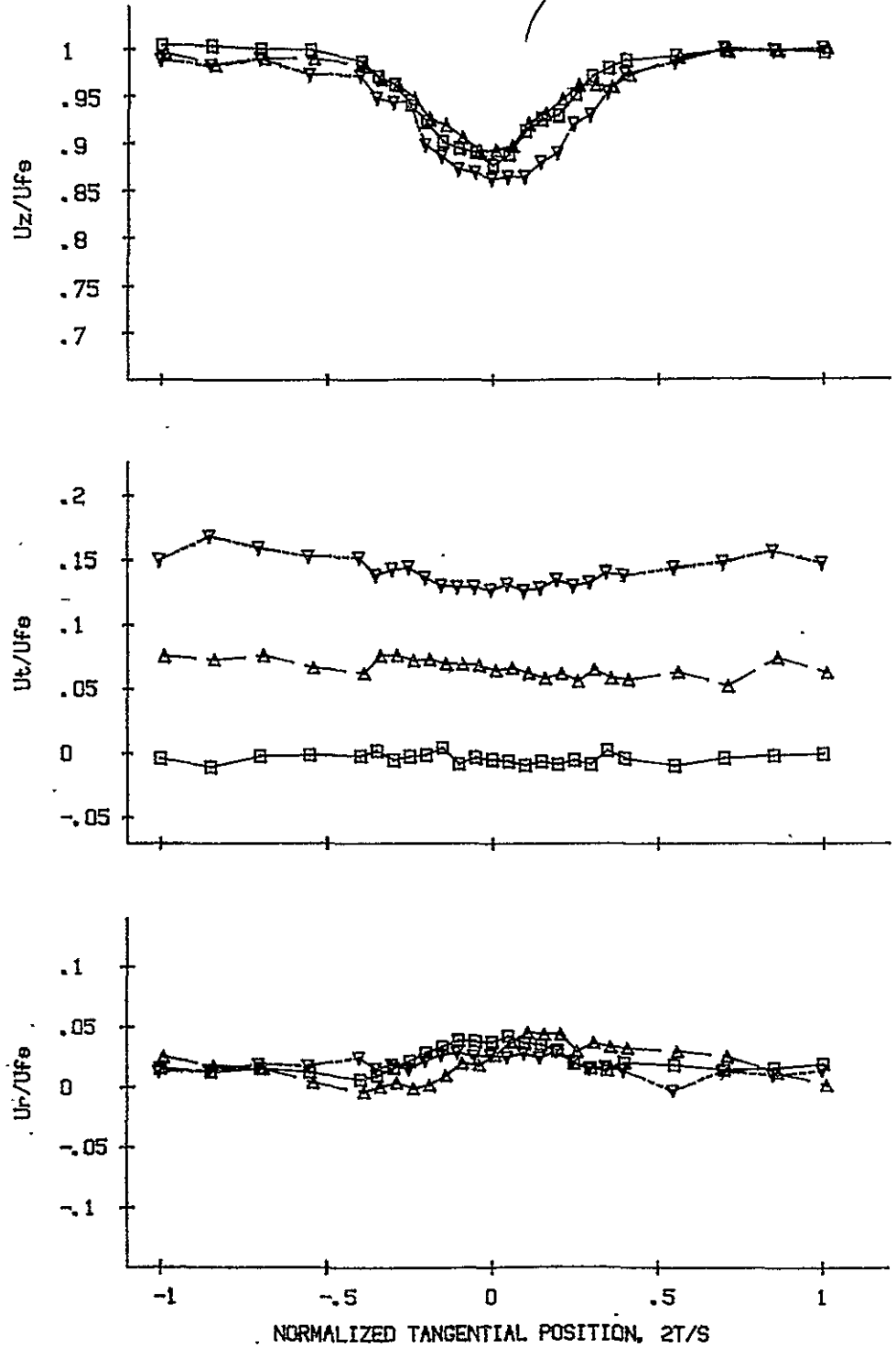

Figure 54. Incidence Angle Crossplots, Rear Traversing Slot, $R = 16.7\%$

- INCIDENCE ANGLE = 0 deg, $Z_c/C = 2.08$, $U_{fs} = 30.0$ m/s.
- △ INCIDENCE ANGLE = 5 deg, $Z_c/C = 2.07$, $U_{fs} = 32.5$ m/s.
- ▽ INCIDENCE ANGLE = 10 deg, $Z_c/C = 2.10$, $U_{fs} = 31.7$ m/s.

ORIGINAL PAGE IS
OF POOR QUALITY

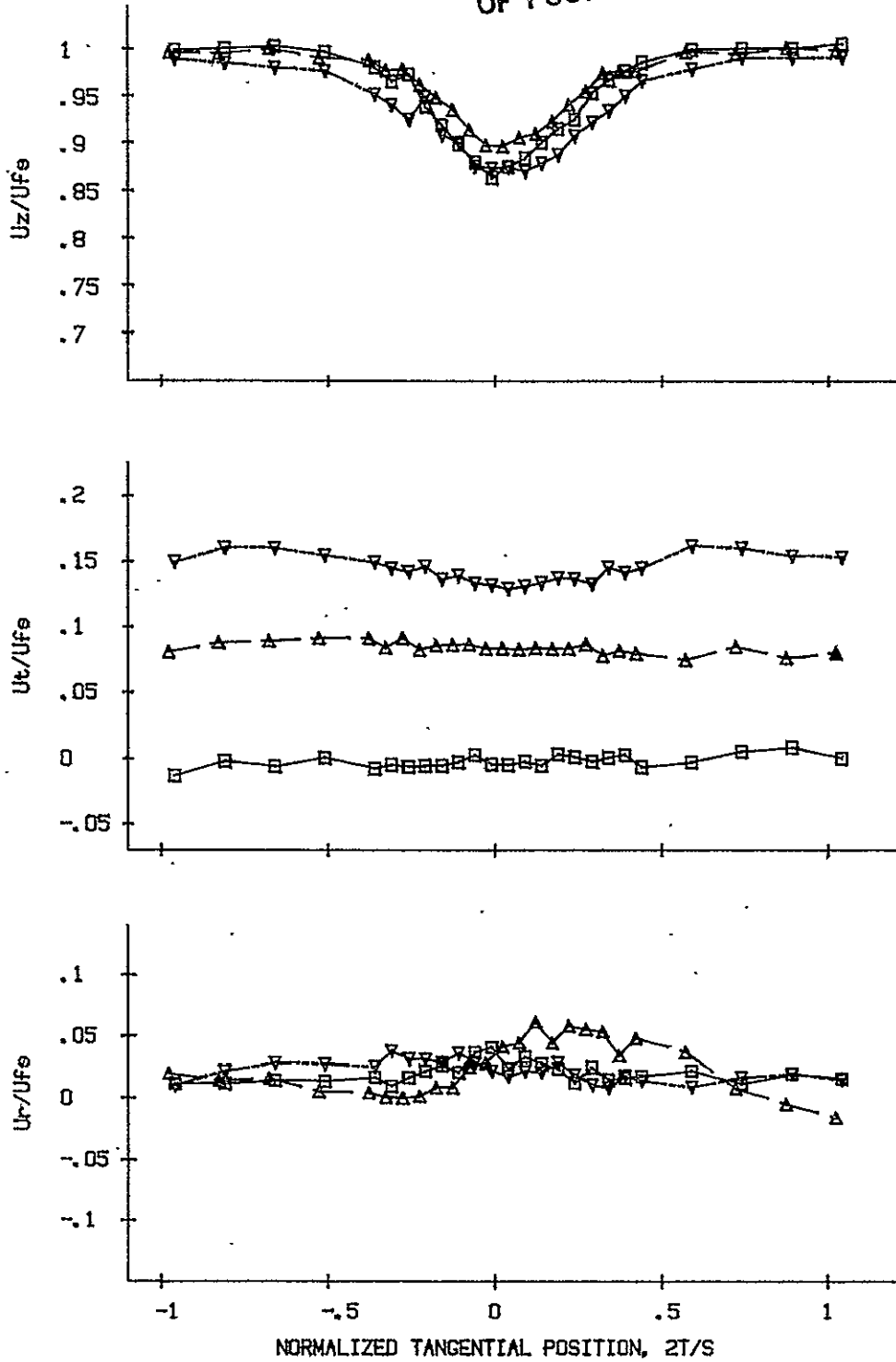

Figure 55. Incidence Angle Crossplots, Rear Traversing Slot, R = 25%

- INCIDENCE ANGLE = 0 deg, $Z_c/C = 2.08$, $U_{fe} = 31.2$ m/s.
- △ INCIDENCE ANGLE = 5 deg, $Z_c/C = 2.07$, $U_{fe} = 32.8$ m/s.
- ▽ INCIDENCE ANGLE = 10 deg, $Z_c/C = 2.10$, $U_{fe} = 32.2$ m/s.

ORIGINAL PAGE IS
OF POOR QUALITY

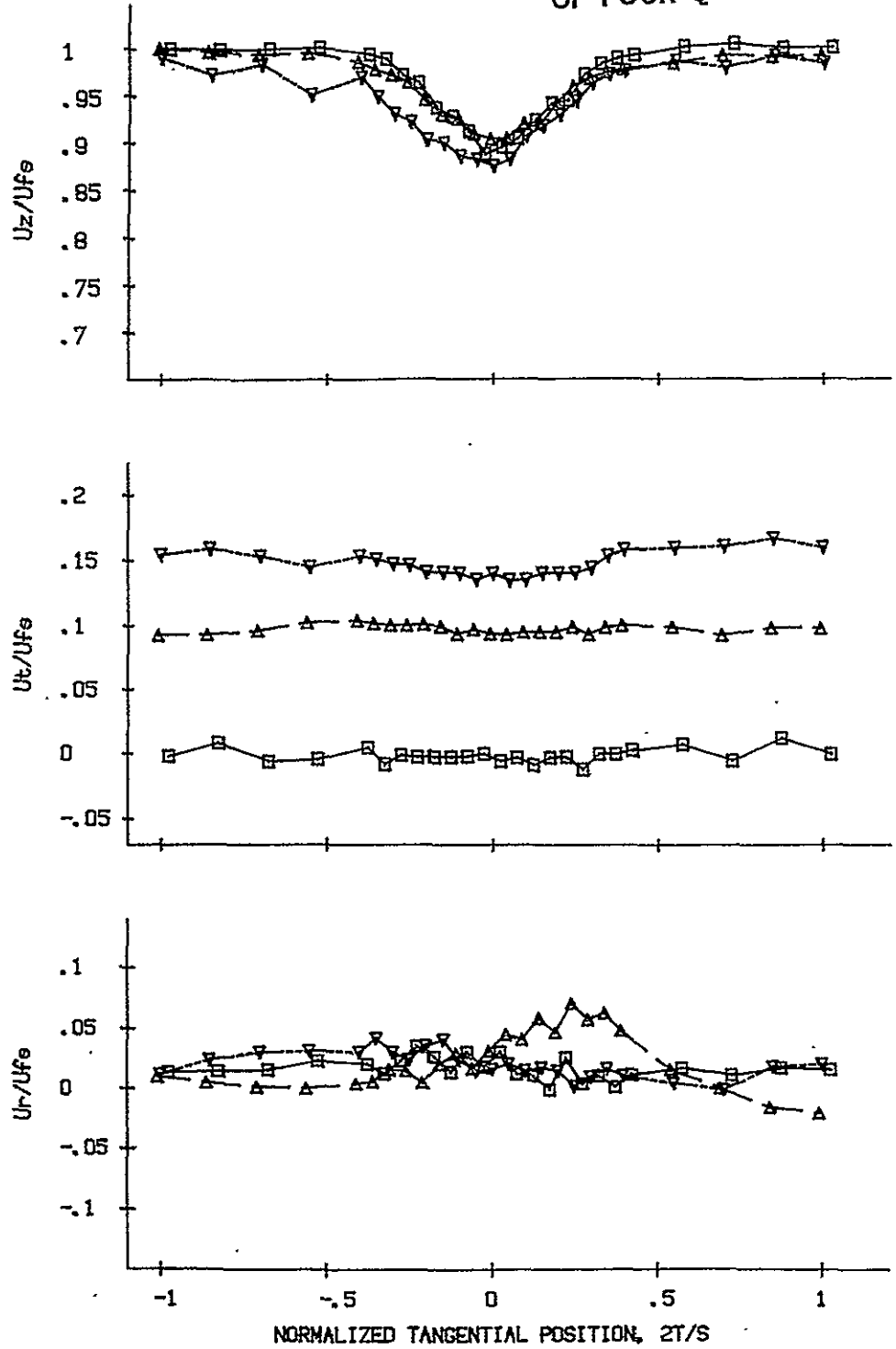

Figure 56. Incidence Angle Crossplots, Rear Traversing Slot, $R = 33.3\%$

- INCIDENCE ANGLE = 0 deg, $Z_c/C = 2.08$, $U_{fe} = 30.9$ m/s.
- △ INCIDENCE ANGLE = 5 deg, $Z_c/C = 2.07$, $U_{fe} = 32.9$ m/s.
- ▽ INCIDENCE ANGLE = 10 deg, $Z_c/C = 2.10$, $U_{fe} = 32.3$ m/s.

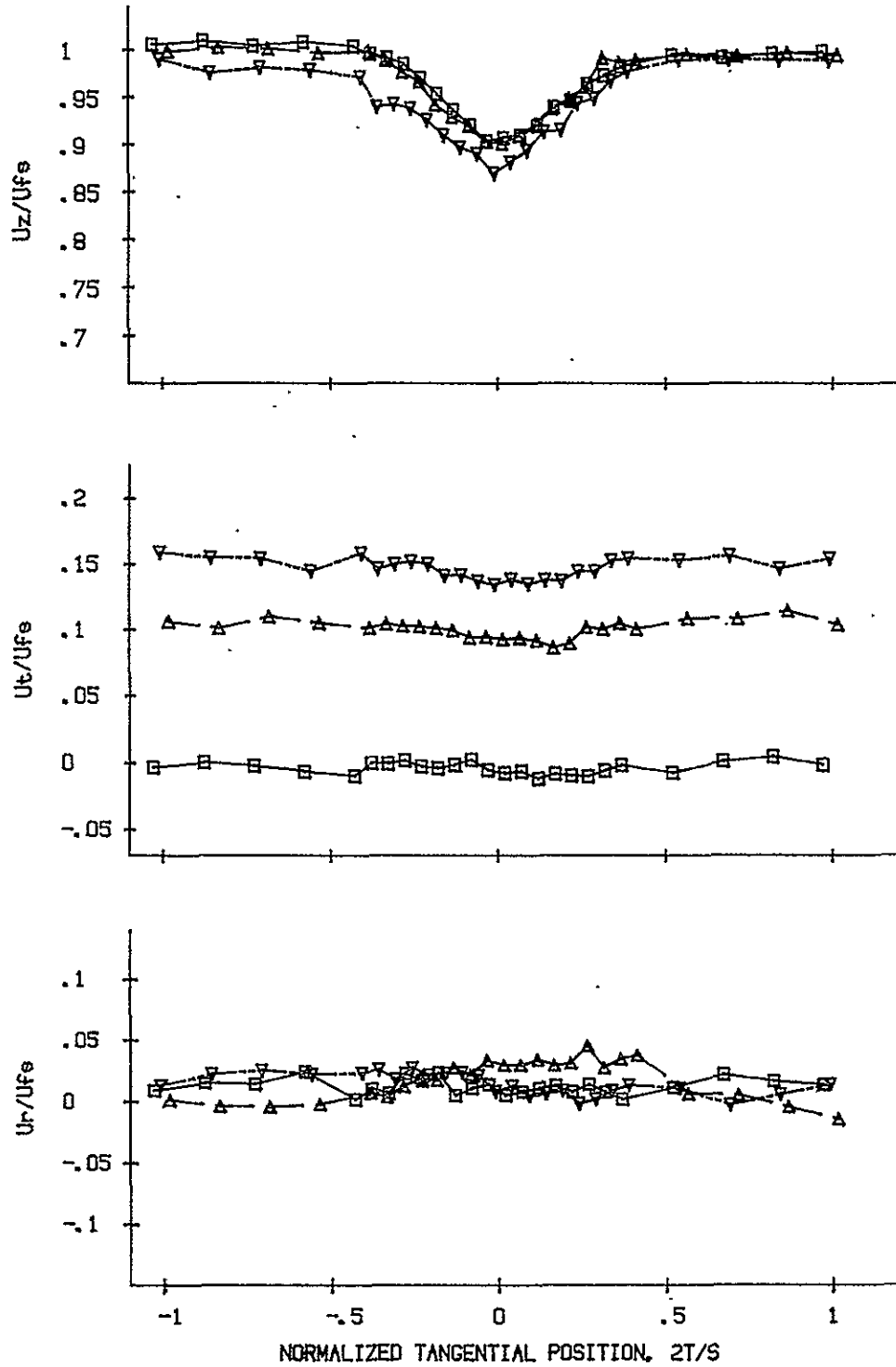

Figure 57. Incidence Angle Crossplots, Rear Traversing Slot, R = 50%

- INCIDENCE ANGLE = 0 deg, $Z_c/C = 2.08$, $U_{fs} = 31.0$ m/s.
- △ INCIDENCE ANGLE = 5 deg, $Z_c/C = 2.07$, $U_{fs} = 32.8$ m/s.
- ▽ INCIDENCE ANGLE = 10 deg, $Z_c/C = 2.10$, $U_{fs} = 32.0$ m/s.

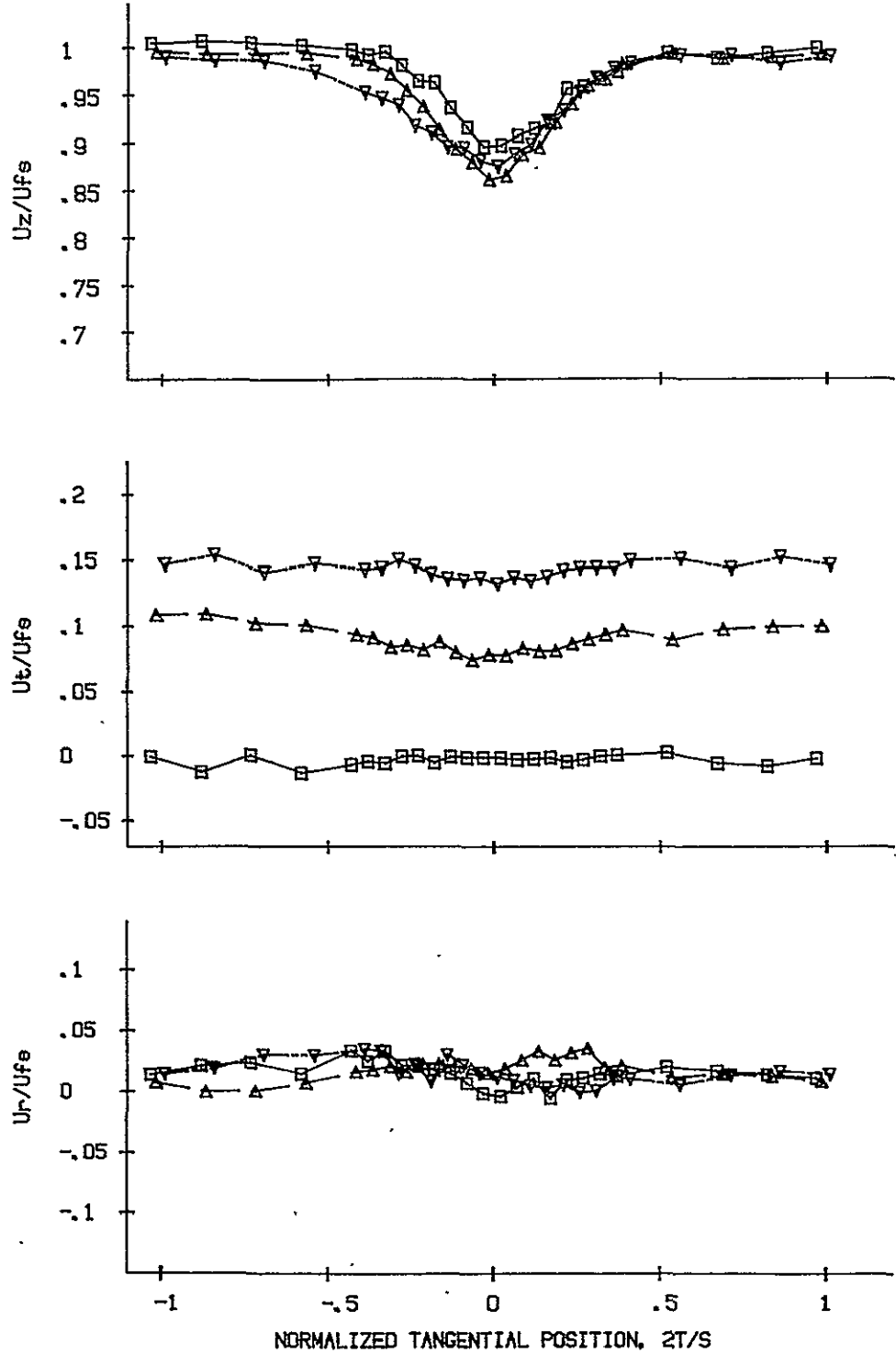

Figure 58. Incidence Angle Crossplots, Rear Traversing Slot, R = 66.7%

- INCIDENCE ANGLE = 0 deg, $Z_c/C = 2.08$, $U_{fe} = 30.9$ m/s.
- △ INCIDENCE ANGLE = 5 deg, $Z_c/C = 2.07$, $U_{fe} = 32.8$ m/s.
- ▽ INCIDENCE ANGLE = 10 deg, $Z_c/C = 2.10$, $U_{fe} = 32.0$ m/s.

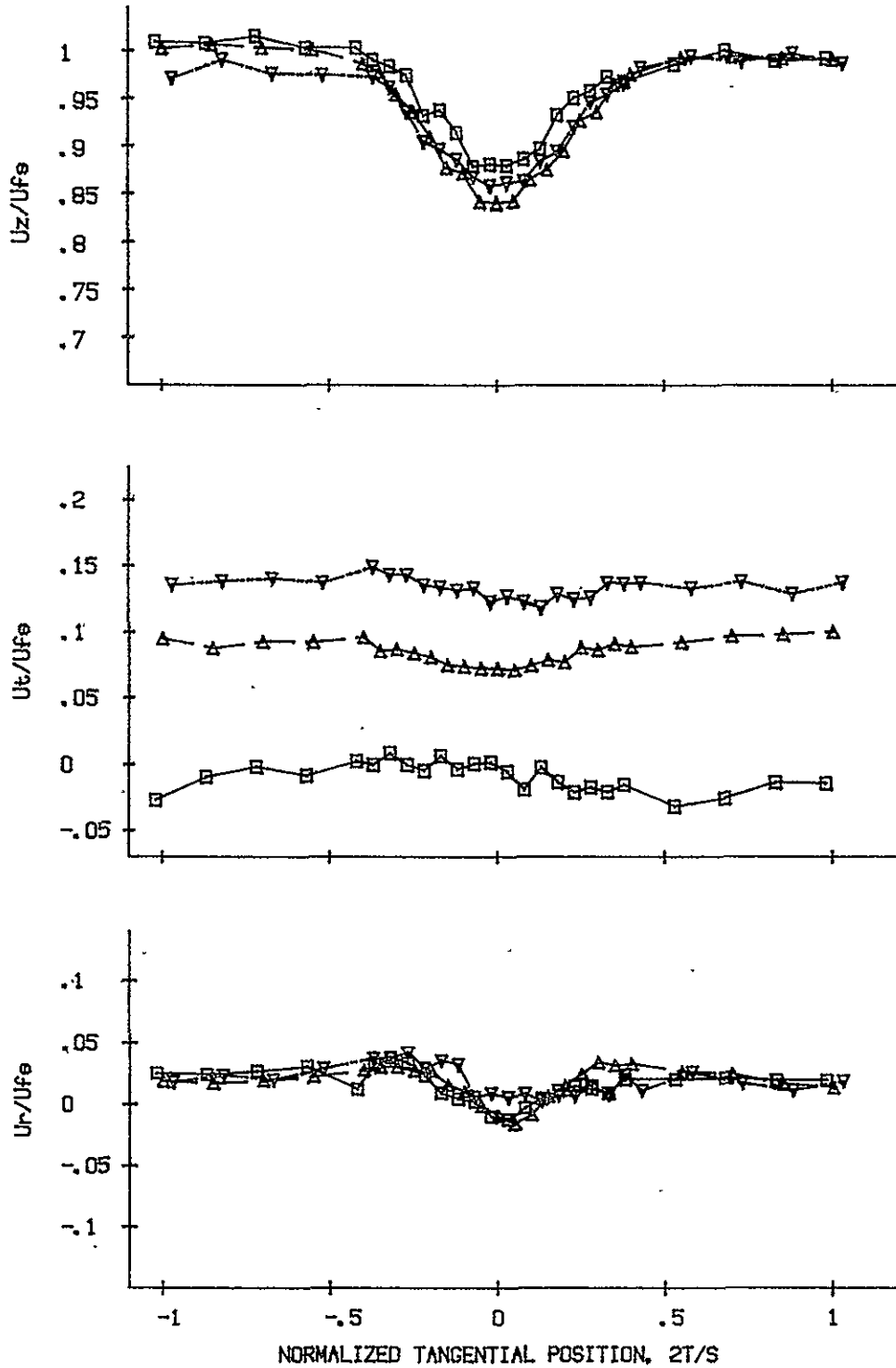

Figure 59. Incidence Angle Crossplots, Rear Traversing Slot, $R = 83.3\%$

- INCIDENCE ANGLE = 0 deg, $Z_c/C = 2.08$, $U_{fe} = 30.8$ m/s.
- △ INCIDENCE ANGLE = 5 deg, $Z_c/C = 2.07$, $U_{fe} = 32.3$ m/s.
- ▽ INCIDENCE ANGLE = 10 deg, $Z_c/C = 2.10$, $U_{fe} = 31.5$ m/s.

Examination of the tangential velocity component data shows the expected result of increased tangential velocity with increased incidence angle value. Consistent centerline tangential wake deficits are not present in the 0° and 5° incidence data. This lack of tangential deficits can be attributed to the negligible levels expected in the far wake downstream measurement stations considered in this study. A slight centerline tangential deficit can be seen for the 10° incidence angle data at the axial slot position of $z_c/C = 0.96$. The radial velocity components show no apparent incidence angle effects, although they appear to exhibit more scatter at the non-zero incidence angle values.

Three-Dimensionality of the Cascade Exit Flow Field

The wake data are correlated at four radial locations for each incidence angle value, Figures 60 through 65, to demonstrate the three-dimensionality of the cascade exit flow region. The local freestream velocity values, U_{fs} , became progressively smaller, due to the boundary layers on the hub and outer shroud walls, as the radial positions approach the annulus walls. In addition to the existence of the three velocity components in the cascade exit flow region, the radial dependence of these velocity components, the decay of the wakes, and the increase in the wake width with downstream position are considered in this section.

ORIGINAL PAGE IS
OF POOR QUALITY

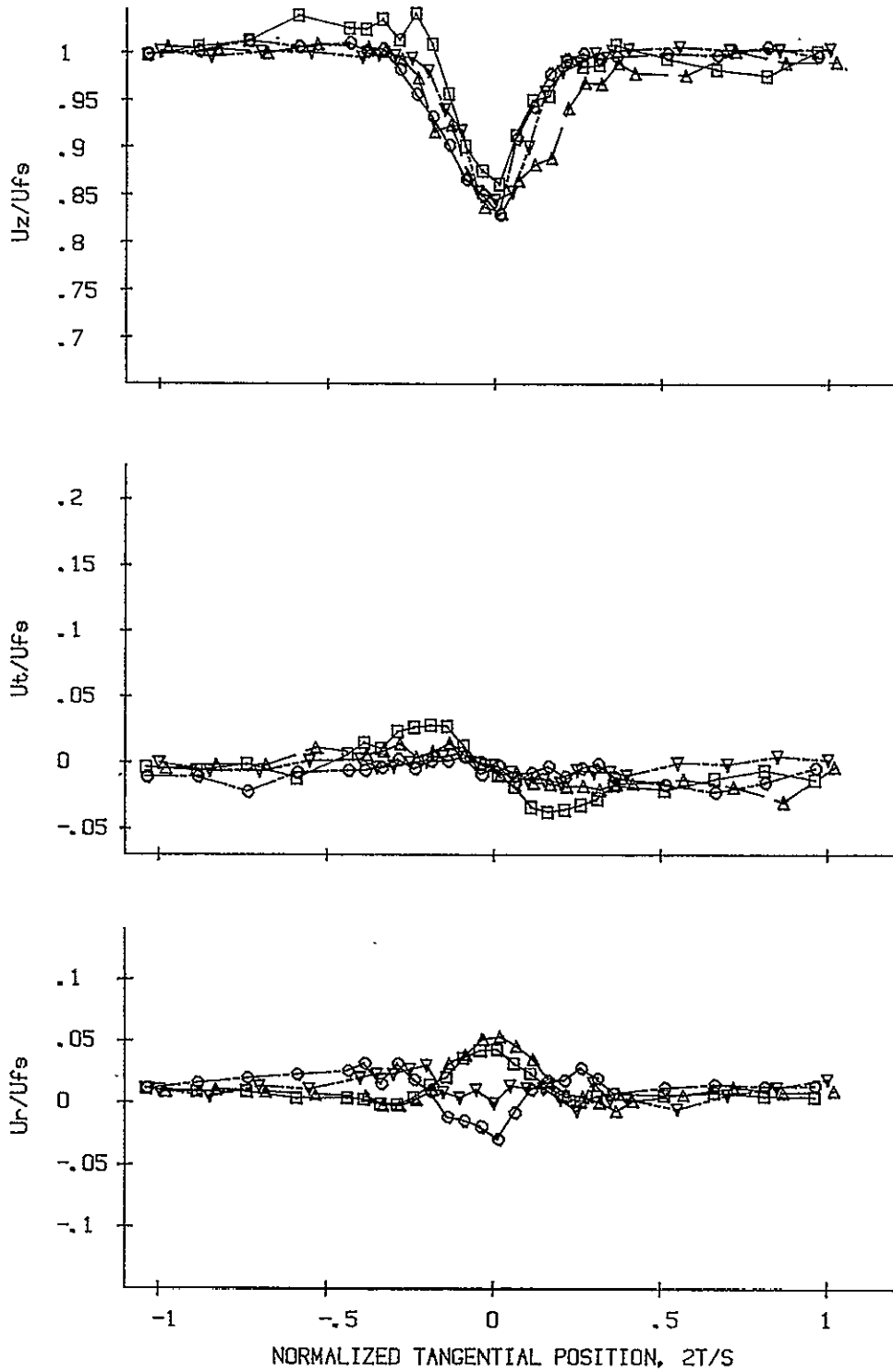

Figure 60. Three-Dimensionality Crossplots, Incidence Angle (DEG) = 0

- R = 4.2%, $Z_c/C = .94$, $U_{fs} = 26.9$ m/s.
- △ R = 8.3%, $Z_c/C = .94$, $U_{fs} = 29.5$ m/s.
- ▽ R = 50%, $Z_c/C = .94$, $U_{fs} = 29.8$ m/s.
- R = 83.3%, $Z_c/C = .94$, $U_{fs} = 29.3$ m/s.

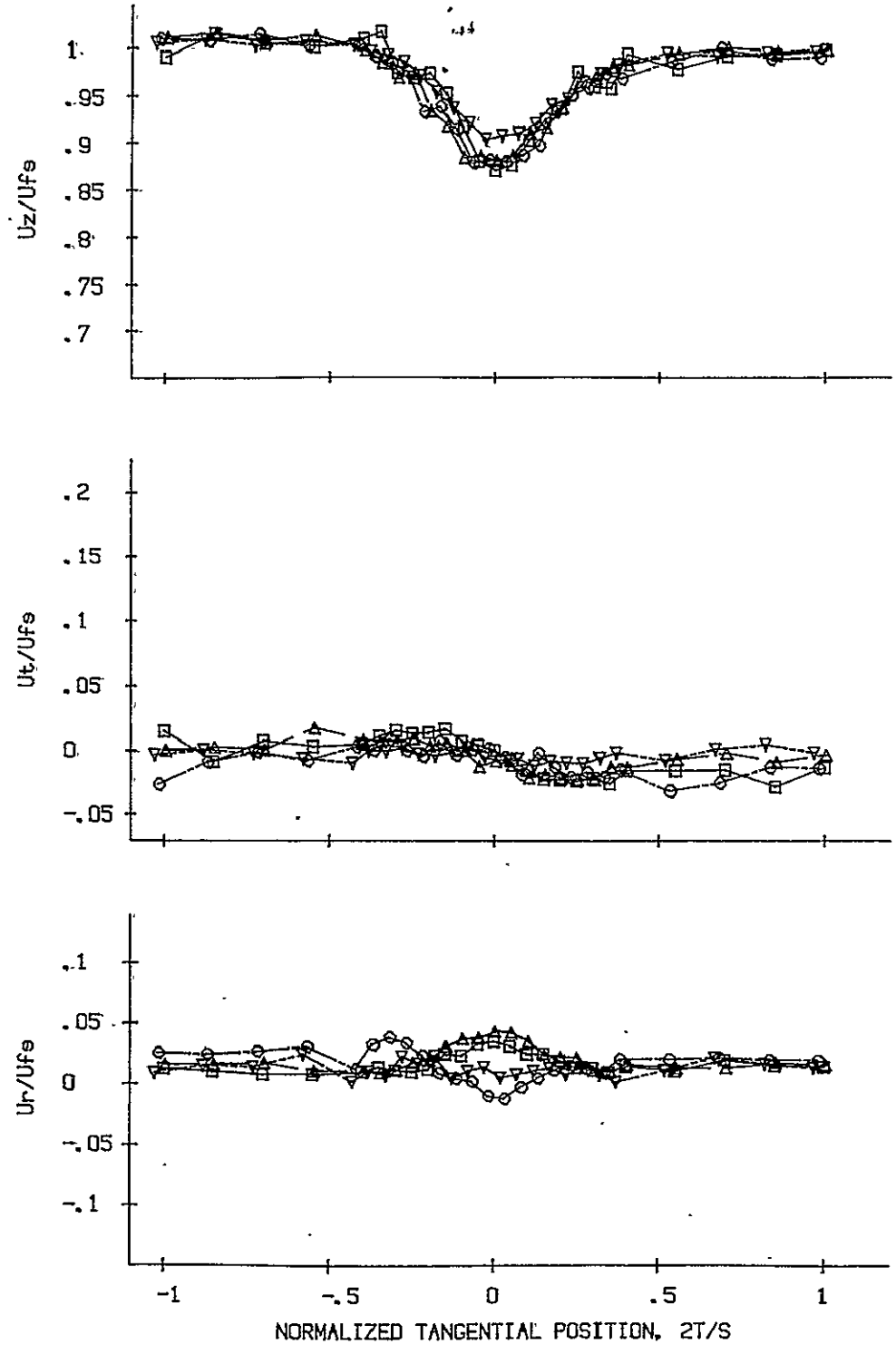

Figure 61. Three-Dimensionality Crossplots, Incidence Angle (DEG) = 0
 \square R = 4.2%, $Z_c/C = 2.06$, $U_{fs} = 28.0$ m/s.
 Δ R = 8.3%, $Z_c/C = 2.06$, $U_{fs} = 29.2$ m/s.
 ∇ R = 50%, $Z_c/C = 2.06$, $U_{fs} = 31.0$ m/s.
 \circ R = 83.3%, $Z_c/C = 2.06$, $U_{fs} = 30.6$ m/s.

ORIGINAL PAGE IS
OF POOR QUALITY

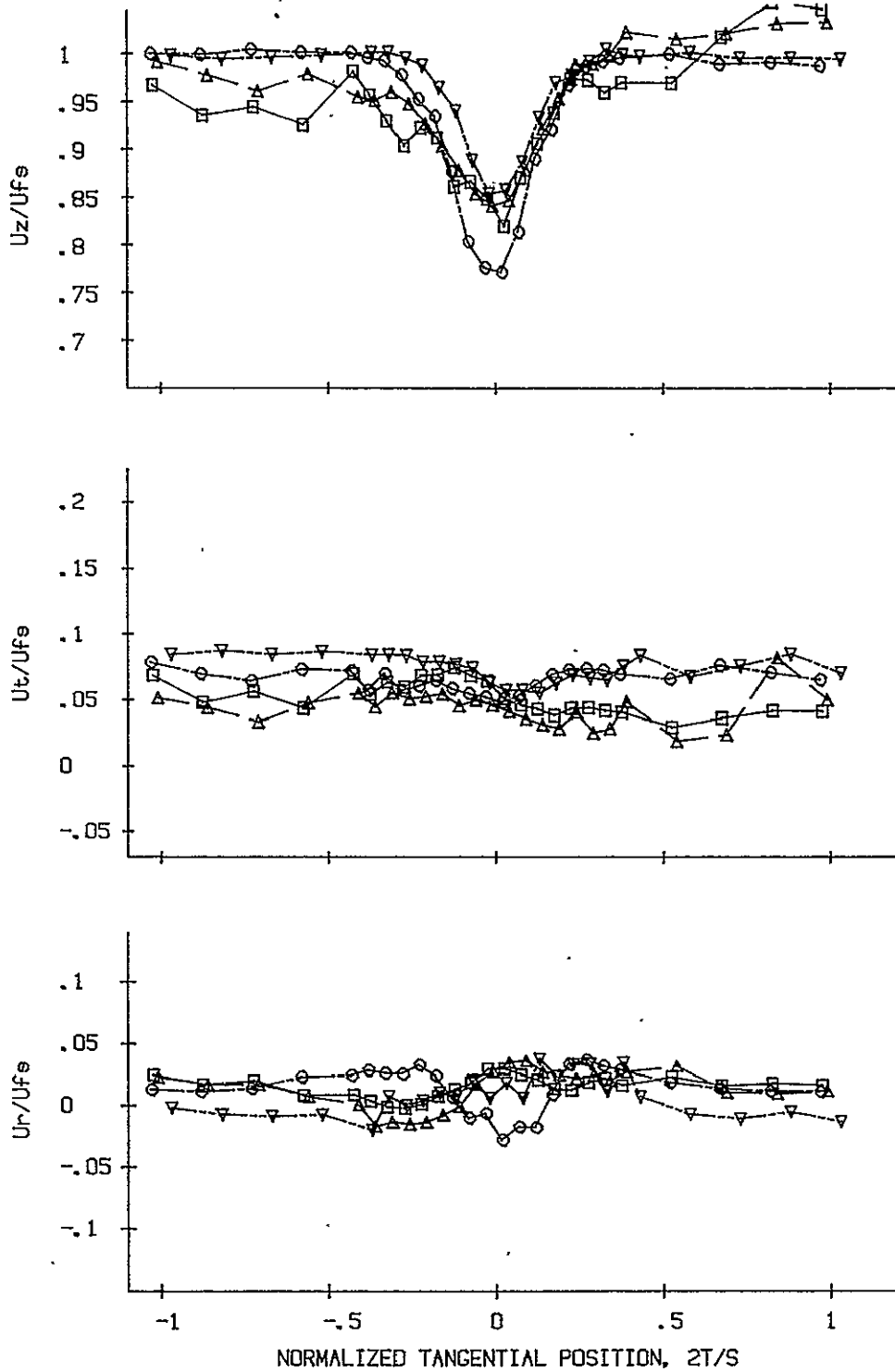

Figure 62. Three-Dimensionality Crossplots, Incidence Angle (DEG) = 5

- R = 4.2%, $Z_c/C = .94$, $U_{fe} = 30.3$ m/s.
- △ R = 8.3%, $Z_c/C = .94$, $U_{fe} = 31.8$ m/s.
- ▽ R = 50%, $Z_c/C = .94$, $U_{fe} = 32.6$ m/s.
- R = 83.3%, $Z_c/C = .94$, $U_{fe} = 32.2$ m/s.

ORIGINAL PAGE IS
OF POOR QUALITY

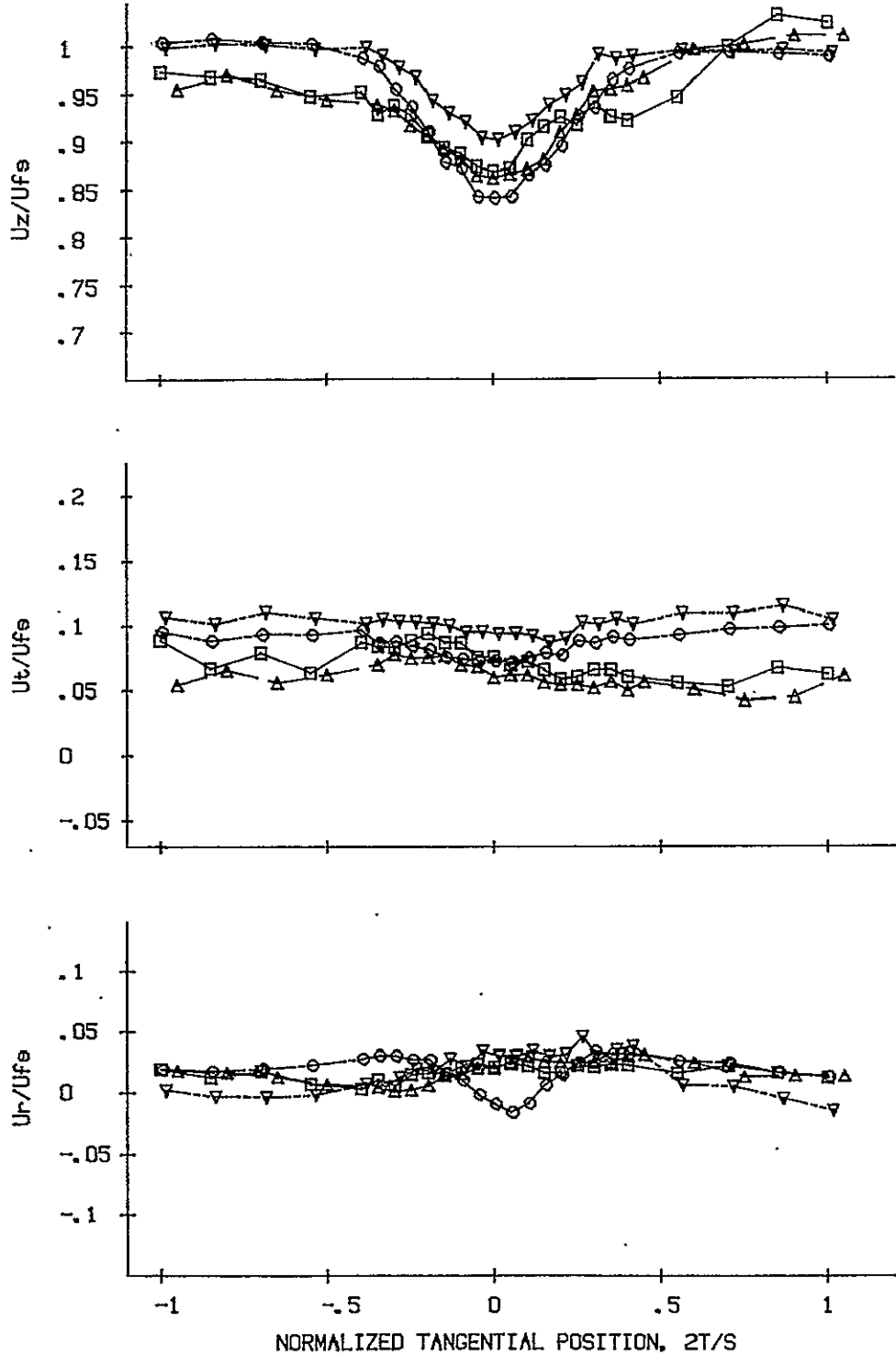

Figure 63. Three Dimensionality Crossplots, Incidence Angle (DEG) = 5

- R = 4.2%, $Z_c/C = 2.07$, $U_{fe} = 30.0$ m/s.
- △ R = 8.3%, $Z_c/C = 2.07$, $U_{fe} = 32.1$ m/s.
- ▽ R = 50%, $Z_c/C = 2.07$, $U_{fe} = 32.6$ m/s.
- R = 83.3%, $Z_c/C = 2.07$, $U_{fe} = 32.3$ m/s.

ORIGINAL PAGE IS
OF POOR QUALITY

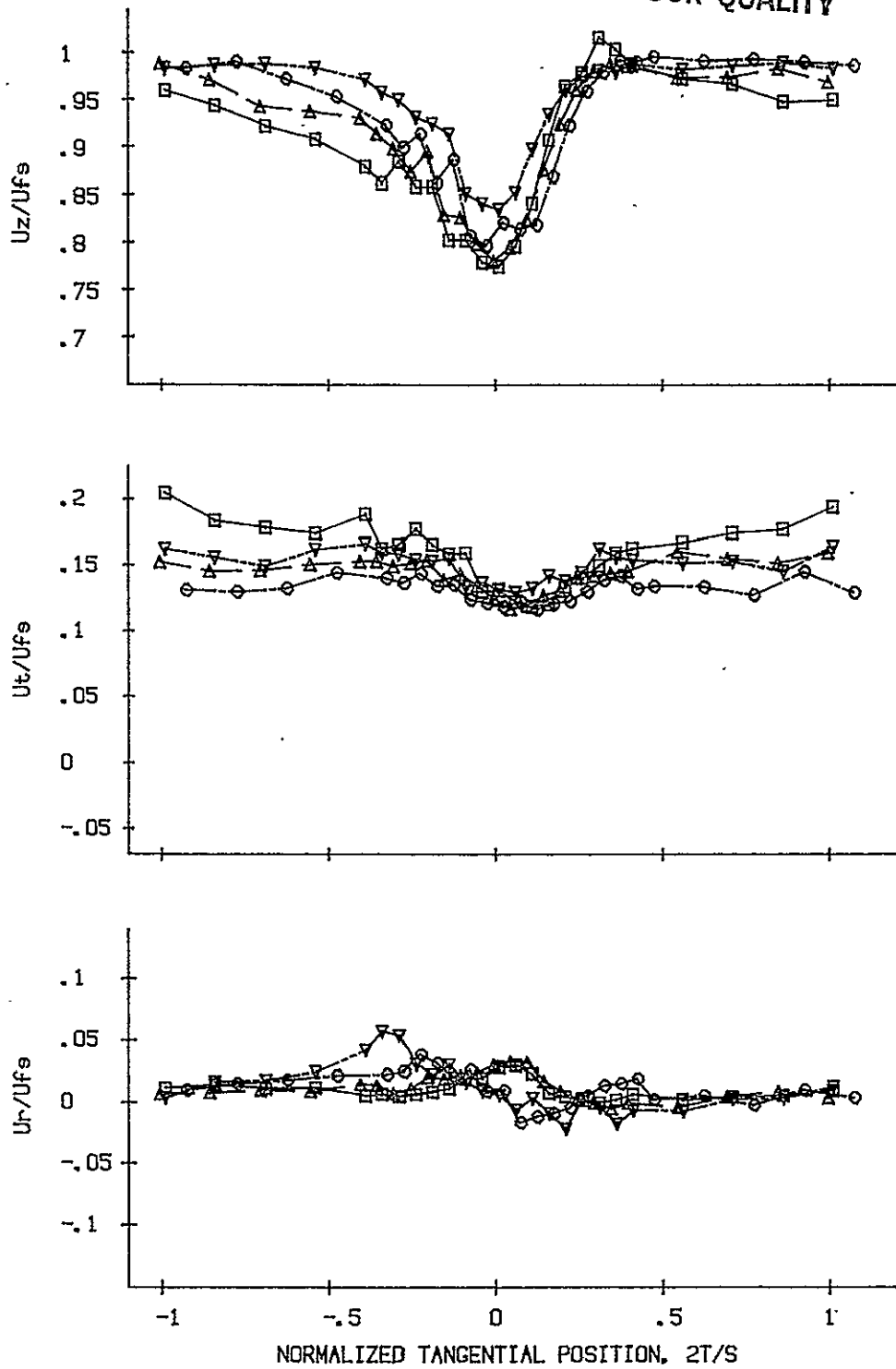

Figure 64. Three-Dimensionality Crossplots, Incidence Angle (DEG) = 10

- R = 4.2%, $Z_c/C = .96$, $U_{fs} = 30.5$ m/s.
- △ R = 8.3%, $Z_c/C = .96$, $U_{fs} = 32.2$ m/s.
- ▽ R = 50%, $Z_c/C = .96$, $U_{fs} = 32.3$ m/s.
- R = 83.3%, $Z_c/C = .96$, $U_{fs} = 31.7$ m/s.

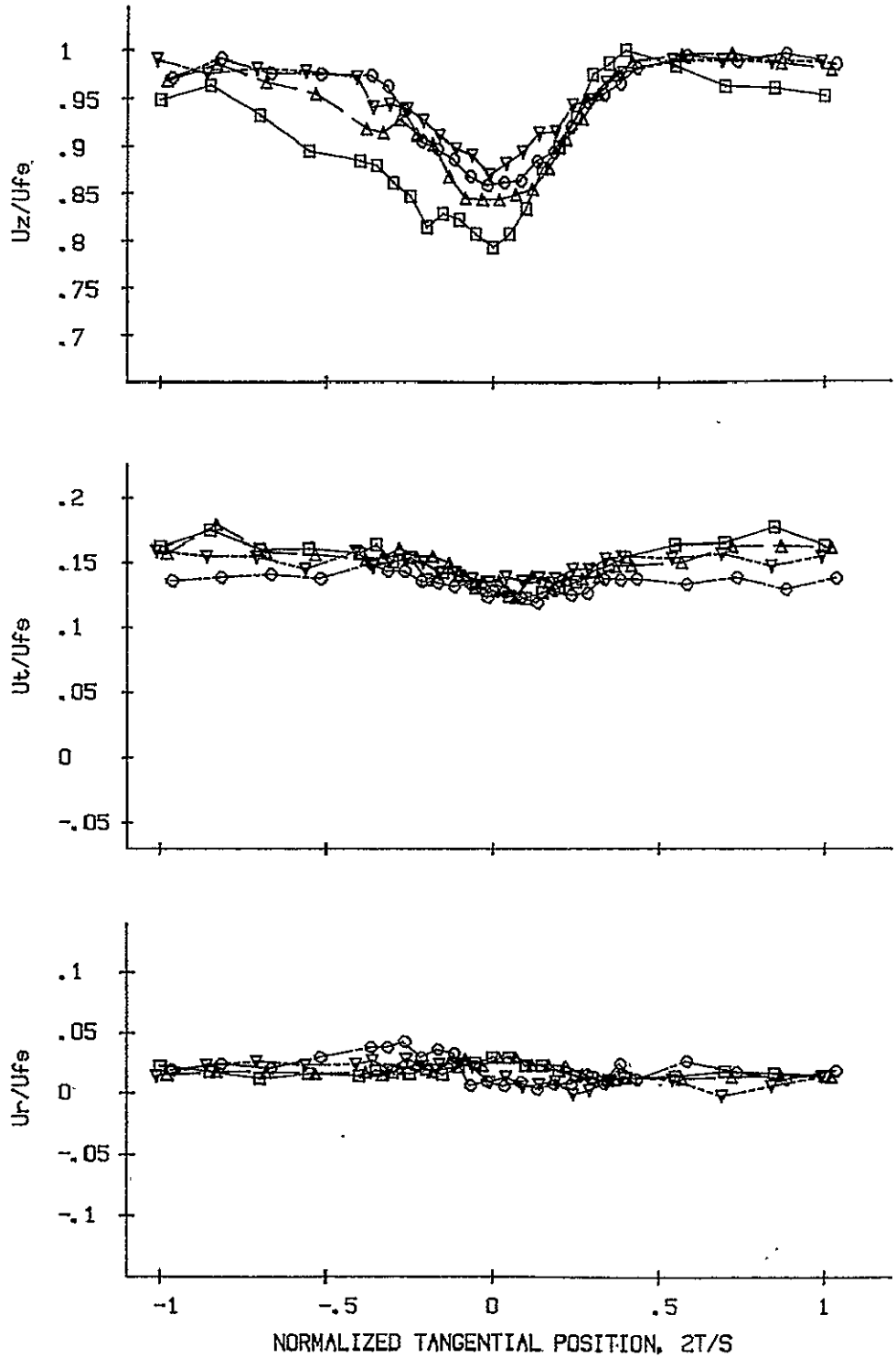

Figure 65. Three-Dimensionality Crossplots, Incidence Angle (DEG) = 10

- $R = 4.2\%$, $Z_c/C = 2.10$, $U_{fs} = 30.0$ m/s.
- △ $R = 8.3\%$, $Z_c/C = 2.10$, $U_{fs} = 31.4$ m/s.
- ▽ $R = 50\%$, $Z_c/C = 2.10$, $U_{fs} = 32.0$ m/s.
- $R = 83.3\%$, $Z_c/C = 2.10$, $U_{fs} = 31.5$ m/s.

The axial velocity component shows interesting radial variations with the incidence angle value. At a 0° incidence angle value, the axial wake profiles are symmetric about the airfoil circumferential location and are essentially identical for all radial positions. At 5° of incidence, the axial wake profiles are nonsymmetric about the airfoil near the hub ($R < 8.3\%$) but symmetric away from the hub region ($R > 8.3\%$). At an incidence angle of 10° , the axial component wake profiles are nonsymmetric about the airfoil for all radial locations, and this nonsymmetry is amplified in the hub and tip regions. Also, separation may occur in the hub region for the 10° incidence angle value, as evidenced by the nonexistence of a local uniform freestream region in the axial component velocity data at $R = 4.2\%$. Further, for each incidence angle value at each radial position, the expected decay of the axial velocity deficit and the increase in the axial wake width with downstream distance can be seen by comparing the corresponding data at the two downstream traversing slot locations.

The radial velocity component data show some interesting trends. Figures 60 through 65 show that the local freestream radial velocities are offset positively from zero. Some offset of the freestream radial velocity component is expected due to growing endwall boundary layers, implying, mass flow away from the cascade facility endwalls. In the hub and tip wake regions, the radial velocities are

clearly directed away from the cascade facility endwalls. This effect is due to the endwall boundary layer interaction with the lower velocity wake flow field. Further, the expected decay of the radial velocity deficit with downstream position for the near hub and tip radial locations can be seen by comparing the corresponding data at the two downstream traversing slot locations for each incidence angle, Figures 60 through 65.

Wake Profile Similarity

Previous investigations have established similarity relationships for mean velocity airfoil wake data. Typically, a Gaussian function, derived from consideration of a two-dimensional isolated flat plate airfoil, is fit to the wake data. In particular, Lakshminarayana and Davino [4] have presented the coefficients for the Gaussian similarity function for inlet guide vane and stator vane wakes as:

$$\frac{W}{W_{c1}} = \exp (-0.693 \eta^2) \quad (28)$$

where: W = Velocity Defect ($U_\eta - U_{fs}$)

W_{c1} = Airfoil Circumferential Location
Velocity Defect

η = Normalized Tangential Distance, $T/L_{1/2}$

$L_{1/2}$ = Wake half width at one-half the depth of W_{c1} ;
with separate values defined for the
pressure and suction sides of the
airfoil.

The correlations of the experimental wake data of the present study with the similarity relation expressed by Equation 28 are shown in Figures 66, 67, and 68 for the 0° , 5° , and 10° incidence angle values, respectively. These figures show excellent correlation between the Gaussian similarity function and the data away from the endwall regions ($12.5\% < R < 75\%$). The poor correlation between the Gaussian similarity function and the data in the hub and tip

ORIGINAL PAGE IS
OF POOR QUALITY

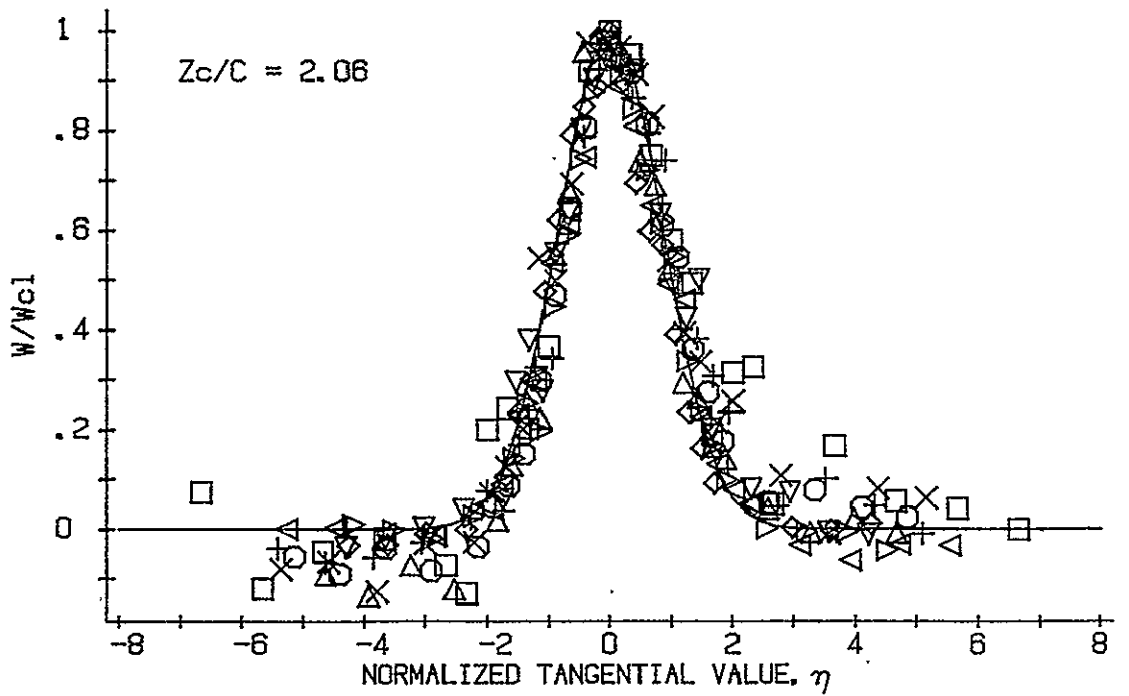
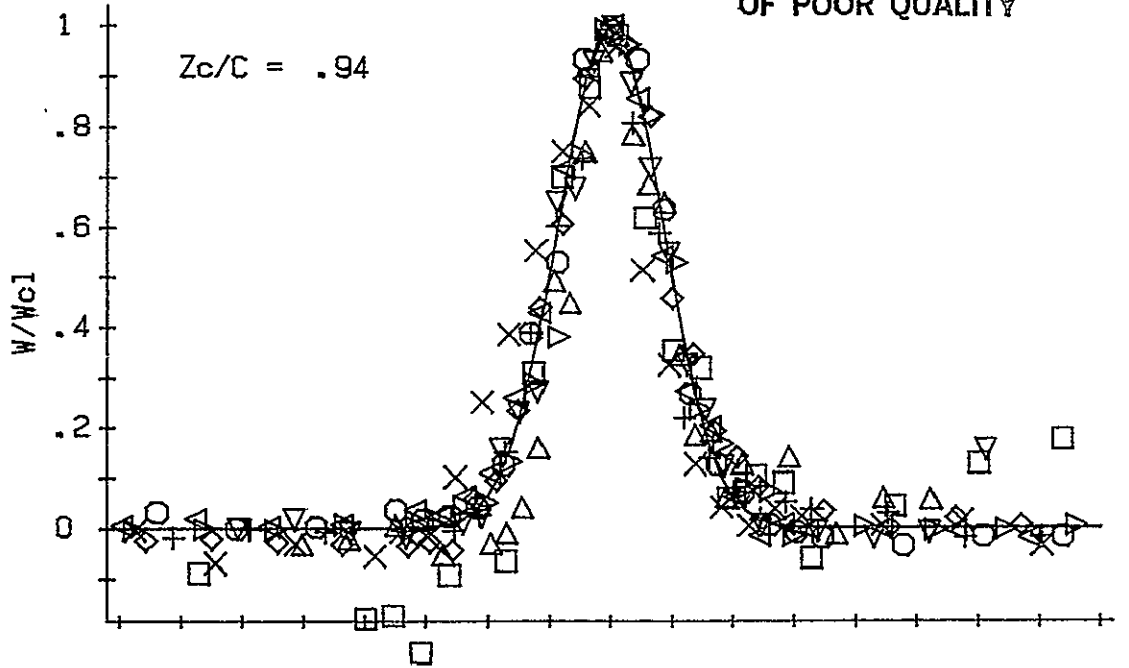

- KEY:
- R = 4.2 %
 - △ R = 8.3 %
 - ▽ R = 12.5 %
 - ◇ R = 16.7 %
 - ∇ R = 25.0 %
 - R = 33.3 %
 - ⊙ R = 50.0 %
 - + R = 66.7 %
 - × R = 83.3 %

— EQUATION 28

Figure 66. Wake Profile Similarity, Incidence Angle (DEG) = 0

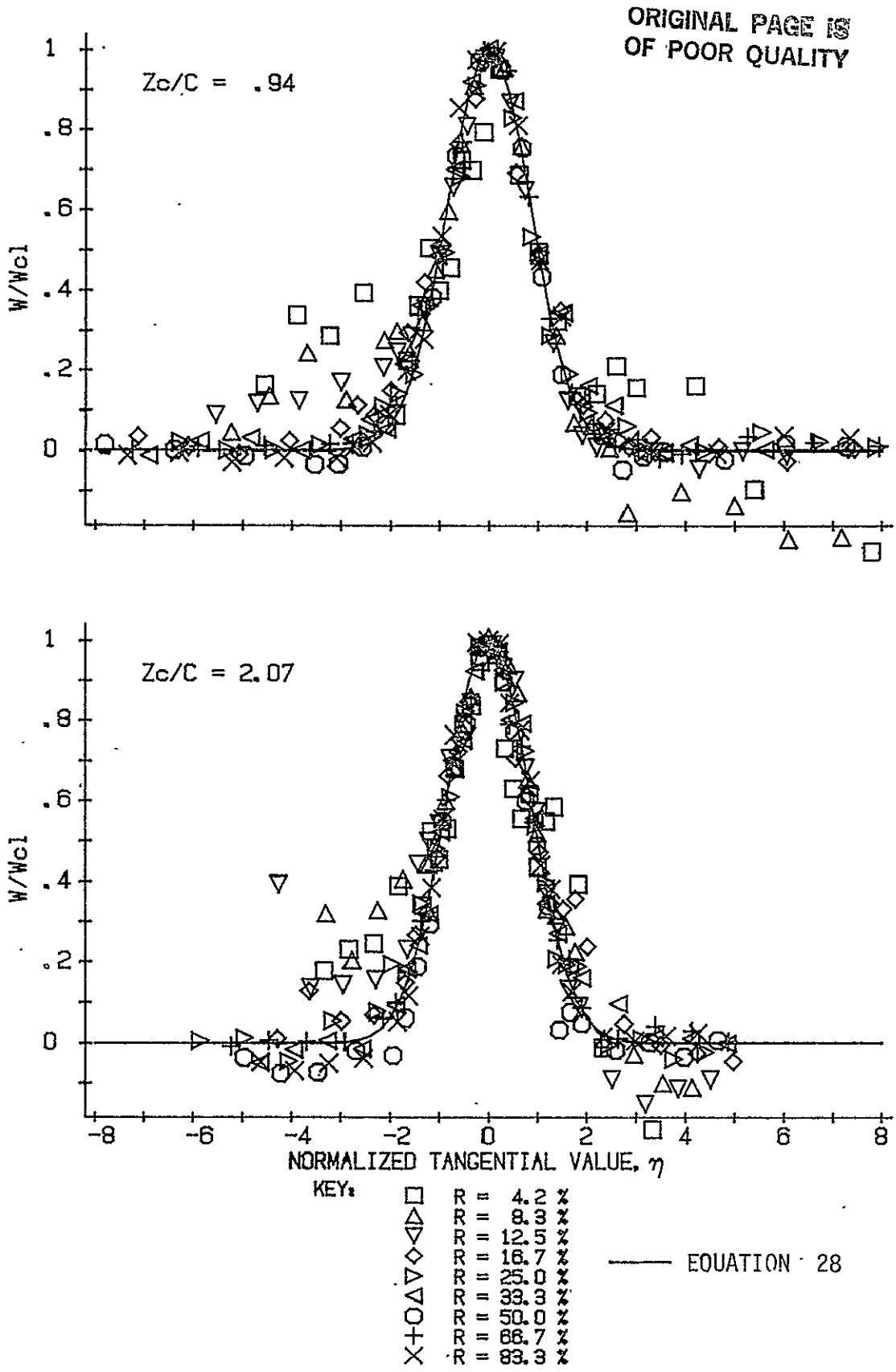
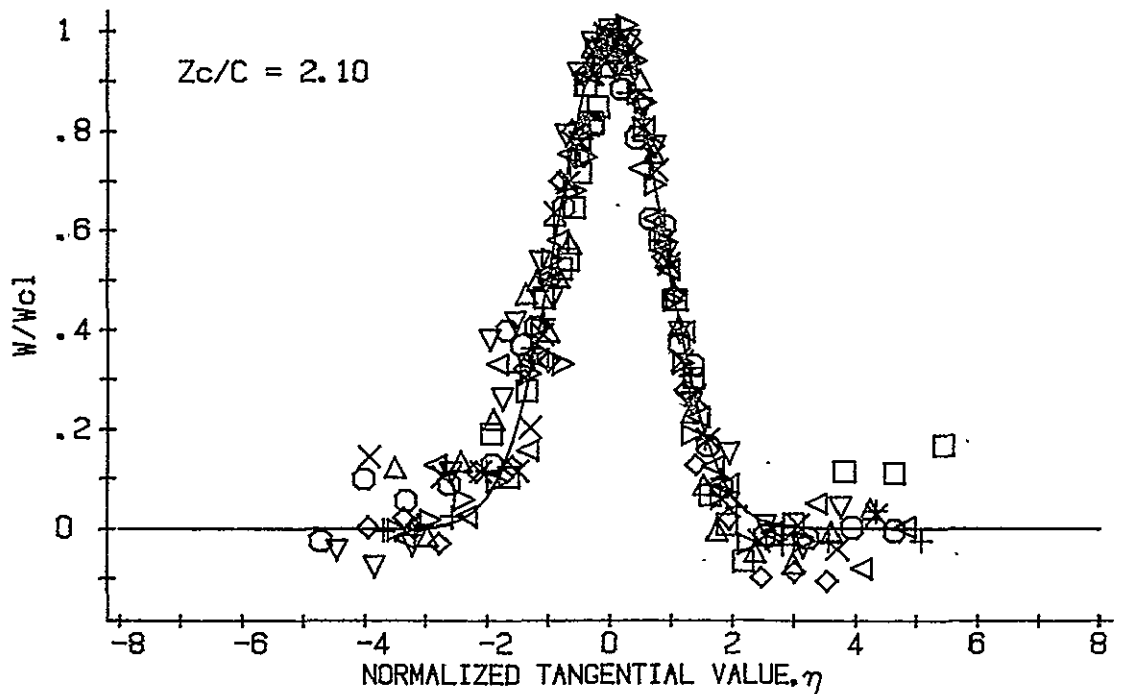
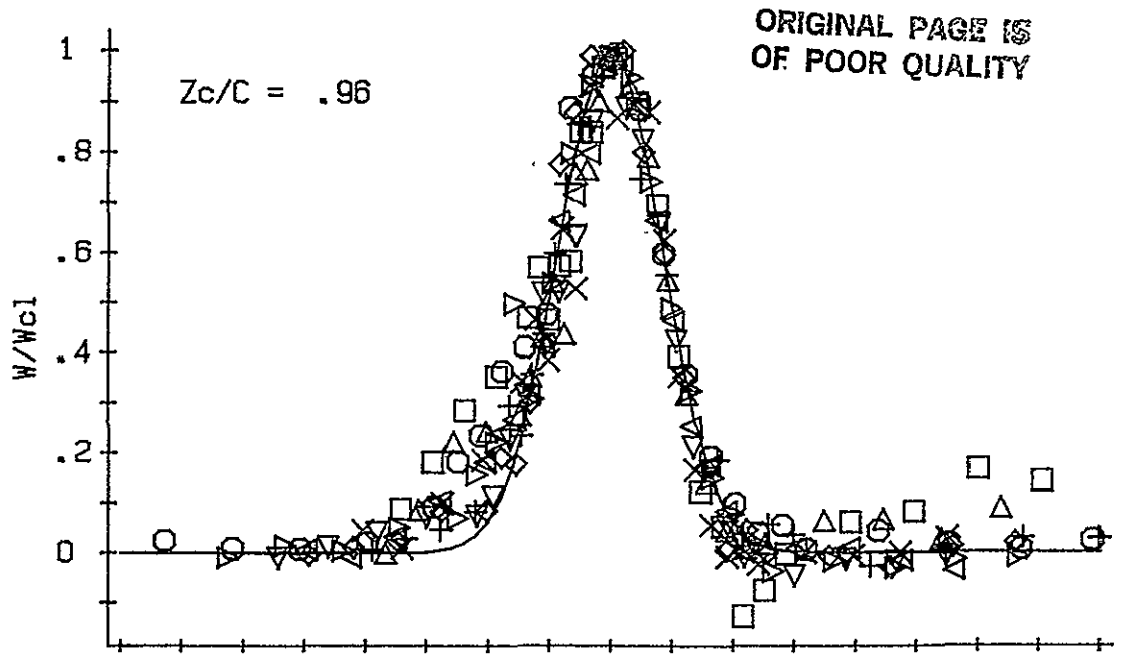

Figure 67. Wake Profile Similarity, Incidence Angle (DEG) = 5



- KEY:
- R = 4.2 %
 - △ R = 8.3 %
 - ▽ R = 12.5 %
 - ◇ R = 16.7 %
 - △ R = 25.0 %
 - R = 33.3 %
 - R = 50.0 %
 - + R = 66.7 %
 - X R = 83.3 %

— EQUATION 28

Figure 68. Wake Profile Similarity, Incidence Angle (DEG) = 10

regions is due to the three-dimensionality of the flow field in these regions and the two-dimensionality of the Gaussian similarity function.

Further, examination of the definition of η shows that as the wake half width increases, the value of η decreases. Hence, examination of Figures 66 through 68, reveals the increasing of the wake width with downstream distance, evidenced by the narrowing of the distribution of the data with increased downstream distance, Z_c/C .

Isobaric Exit Contour Visualization Technique

A technique to visualize the isobaric exit flow contours has been demonstrated in this study. This technique, described in Appendix J, provides an isobaric color photograph of an R-T plane downstream of the airfoil cascade. Three pressure ranges, corresponding to three colors, define the contours. The visualization of the symmetric nature of the wake about the airfoil circumferential location at 0° of incidence, and the nonsymmetric nature of the airfoil wakes at 5° and 10° incidence angles with pronounced nonsymmetry in the endwall regions has been demonstrated.

C. Airfoil Surface Data and Analysis

Data Presentation and Code Inputs

The chordwise distribution of the cascade airfoil surface pressures were measured at the 10, 50, and 90% spanwise locations at incidence angle values of 0° , 5° , and 10° . Confidence intervals which reflect the random scatter of the Scanivalve voltage samples for 20 readings per individual data point at a 99% confidence level have been determined. All of these airfoil surface data are correlated with mathematical predictions.

These mathematical predictions are obtained from the NASA numerical programs, MERIDL [16] and TSONIC [17], as described in Appendix K. These mathematical models consider inviscid, subsonic, flow past an airfoil cascade. The solution of the elliptical differential equations describing the flow field requires that conditions on all boundaries be specified. These boundary inputs include the cascade inlet velocity profile, the cascade geometry, and the local freestream pressure recovery and tangential velocities along a downstream radius.

Data Correlation and Analysis

For a classical airfoil cascade at 0° of incidence, the chordwise distribution of the pressure and the suction surface data should be identical, as demonstrated in Figures 69 through 74. Generally, good correlation exists between the experimental results and the numerical predictions. The experimental data exhibit sharper gradients at the leading edge (0% chord), possibly due to a smoothing effect of the numerical analysis. Also, the experimental data show a slight increase in value along the chord, due to growth of the airfoil surface boundary layer, a phenomenon not considered in the inviscid analytical predictions. Poor correlation in the trailing edge region can be attributed to the airfoil surface boundary layer and the possibility of trailing edge separation. Excellent agreement exists between these 0° incidence angle results and the previous 0° incidence angle flat plate airfoil surface results measured in The Purdue Annular Cascade by Stauter and Fleeter [1].

Distinct differences between the pressure and suction surface data are visible at 5° of incidence, Figures 75 through 80. The correlation between the experimental results and the numerical predictions is generally good with the same discrepancies as noted in the 0° incidence angle in the leading and trailing edge regions. The pressure surface leading edge coefficients are lower than those of the suction surface due to the turning of the flow. Along the

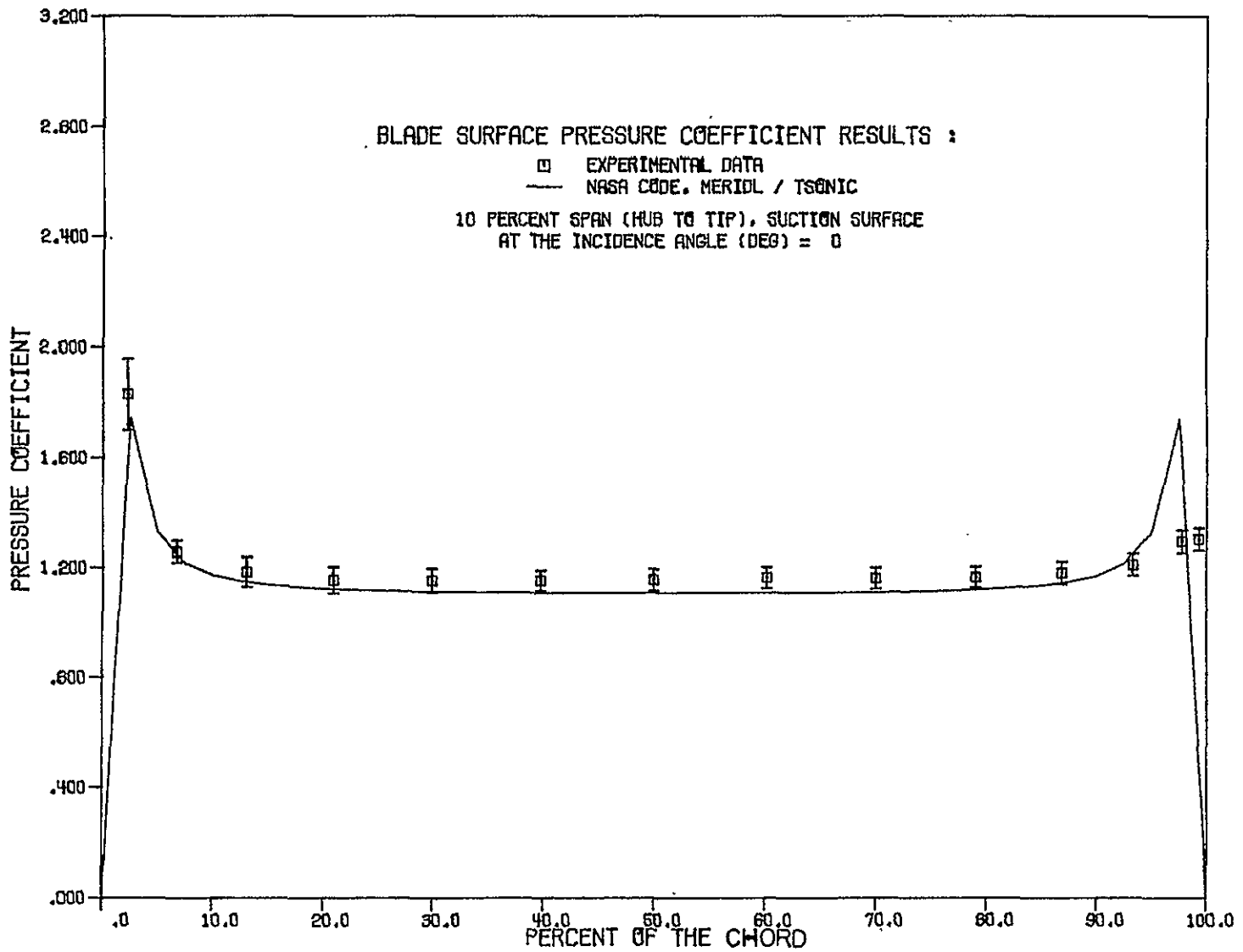

Figure 69. Chordwise Distribution of the Airfoil Surface Pressure Coefficients

ORIGINAL PAGE IS
OF POOR QUALITY

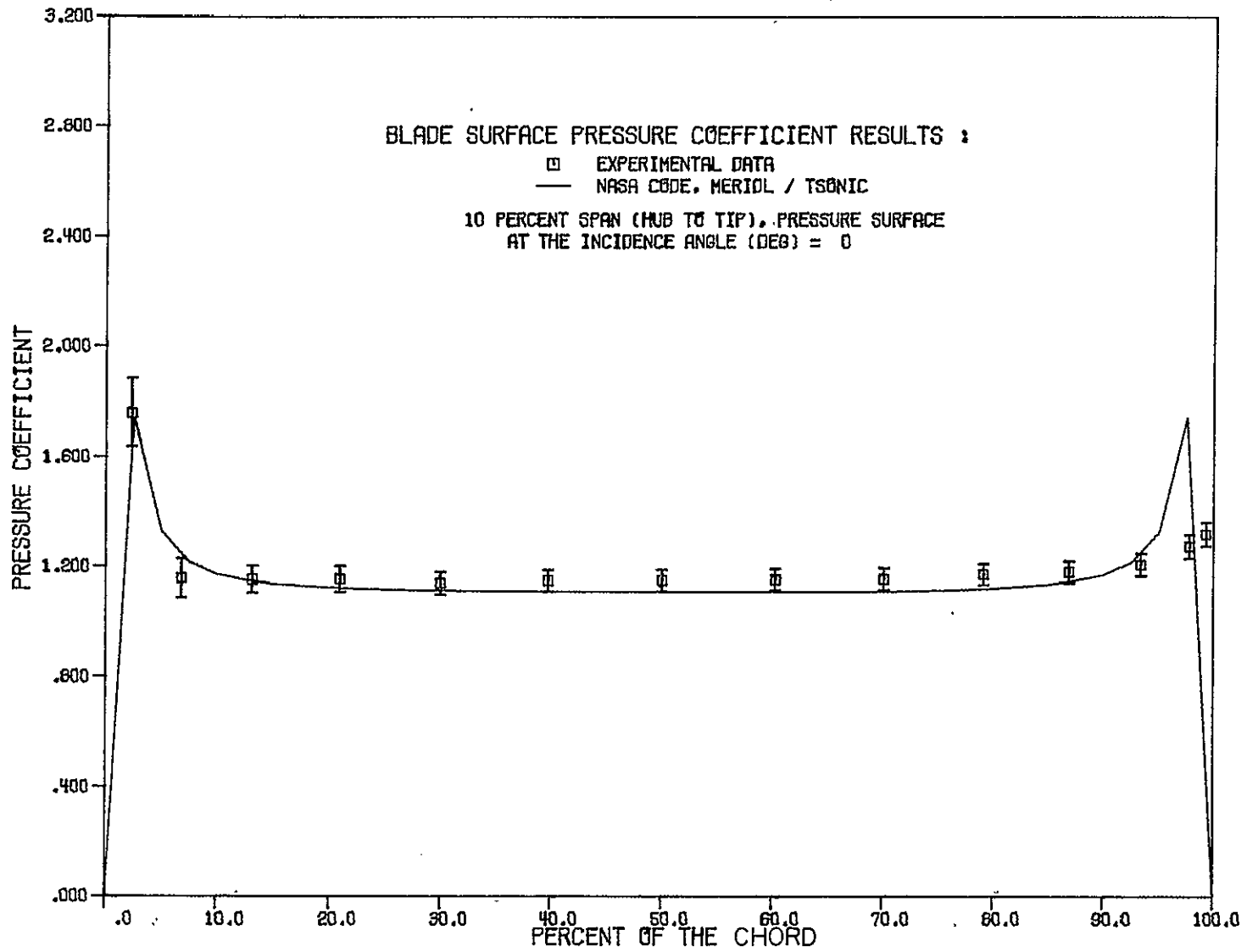

Figure 70. Chordwise Distribution of the Airfoil Surface Pressure Coefficients

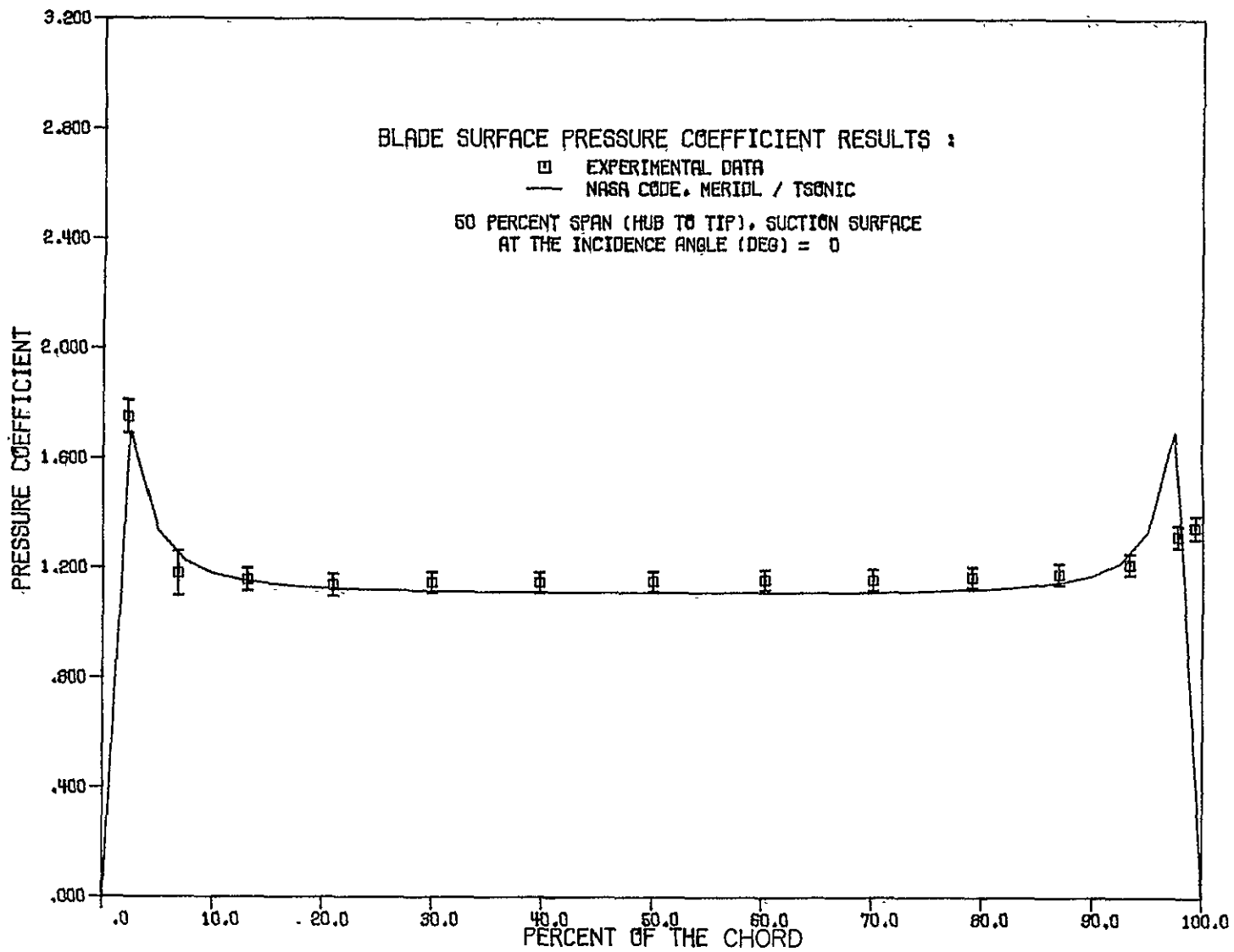

Figure 71. Chordwise Distribution of the Airfoil Surface Pressure Coefficients

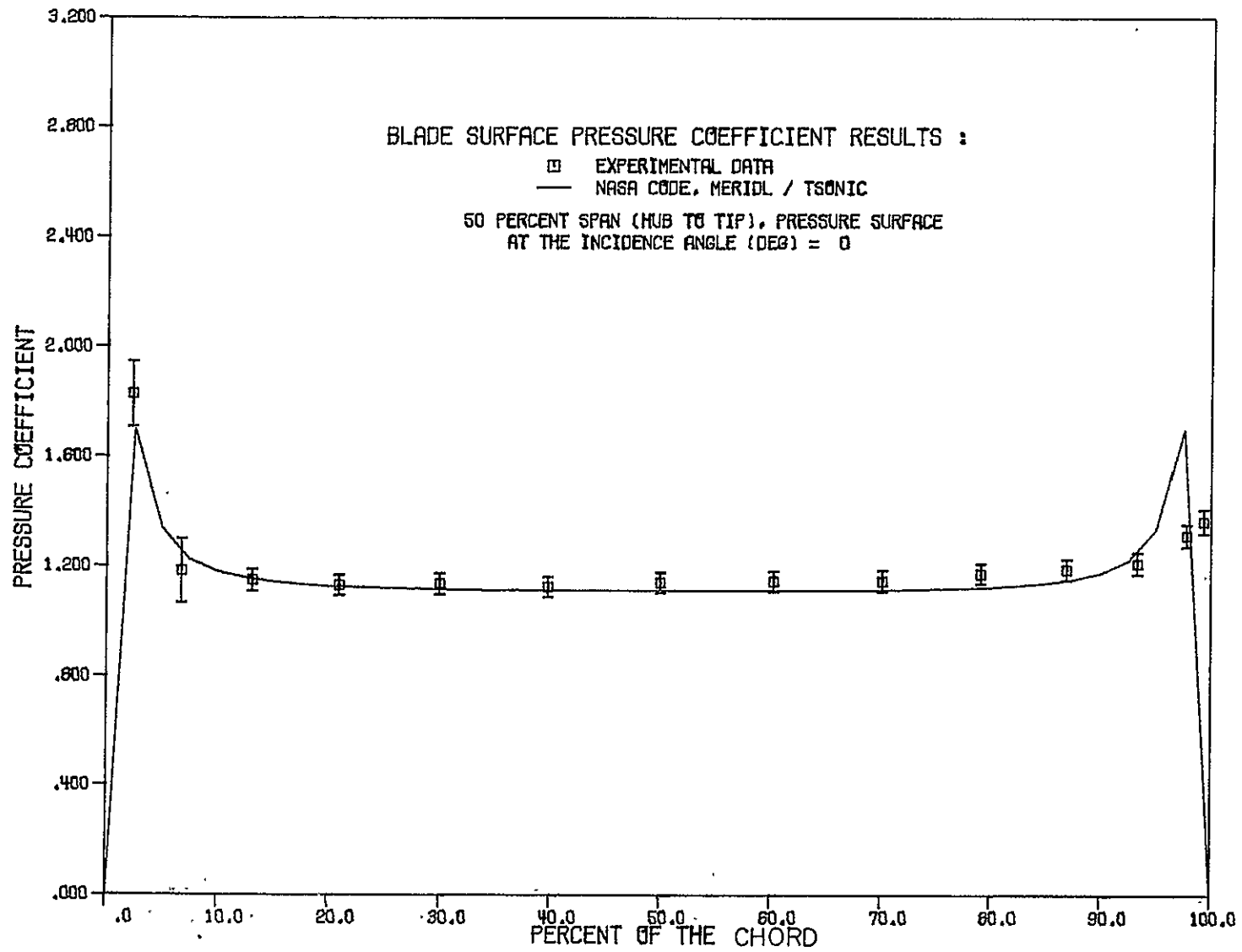

Figure 72. Chordwise Distribution of the Airfoil Surface Pressure Coefficients

ORIGINAL PAGE IS
OF POOR QUALITY

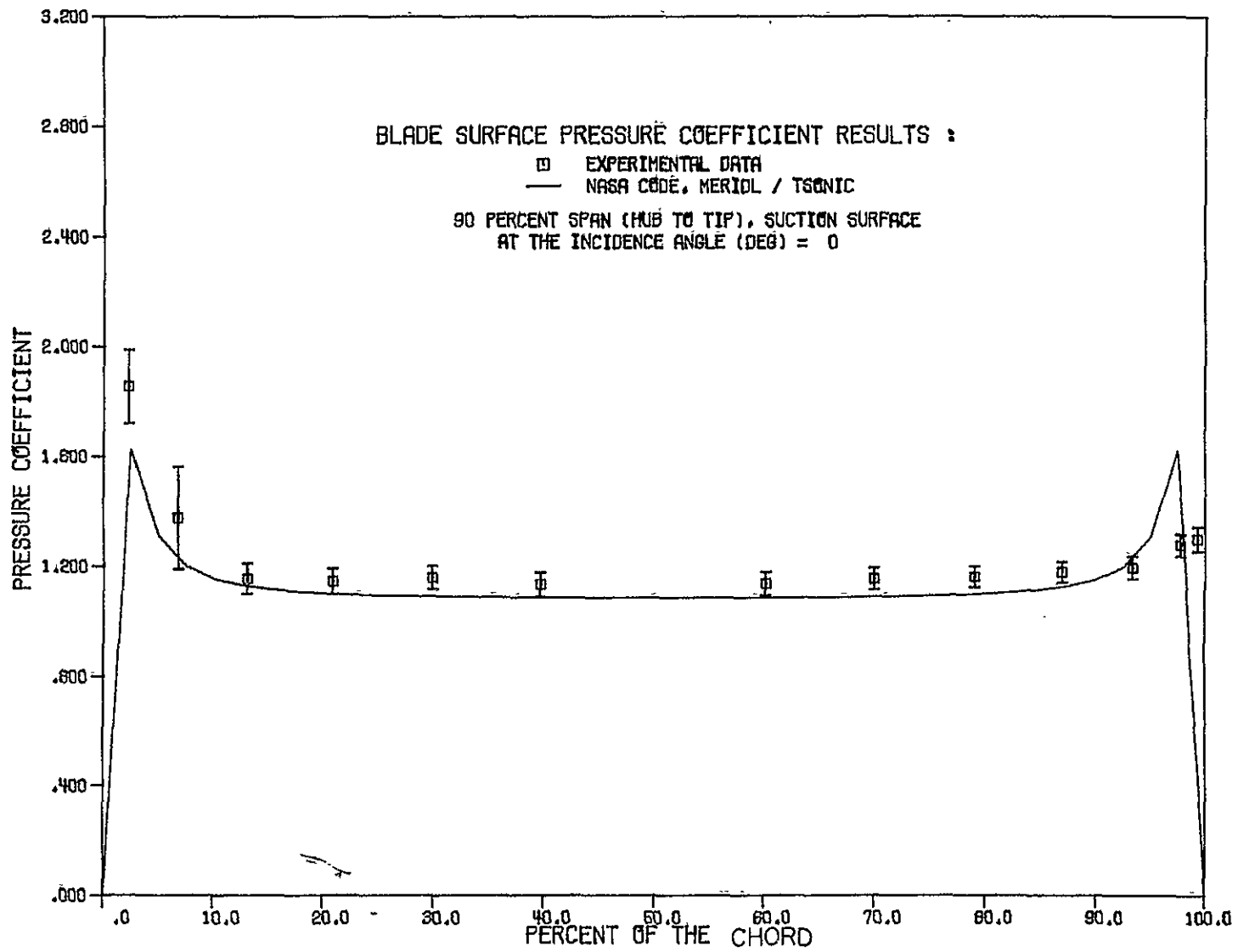

Figure 73. Chordwise Distribution of the Airfoil Surface Pressure Coefficients

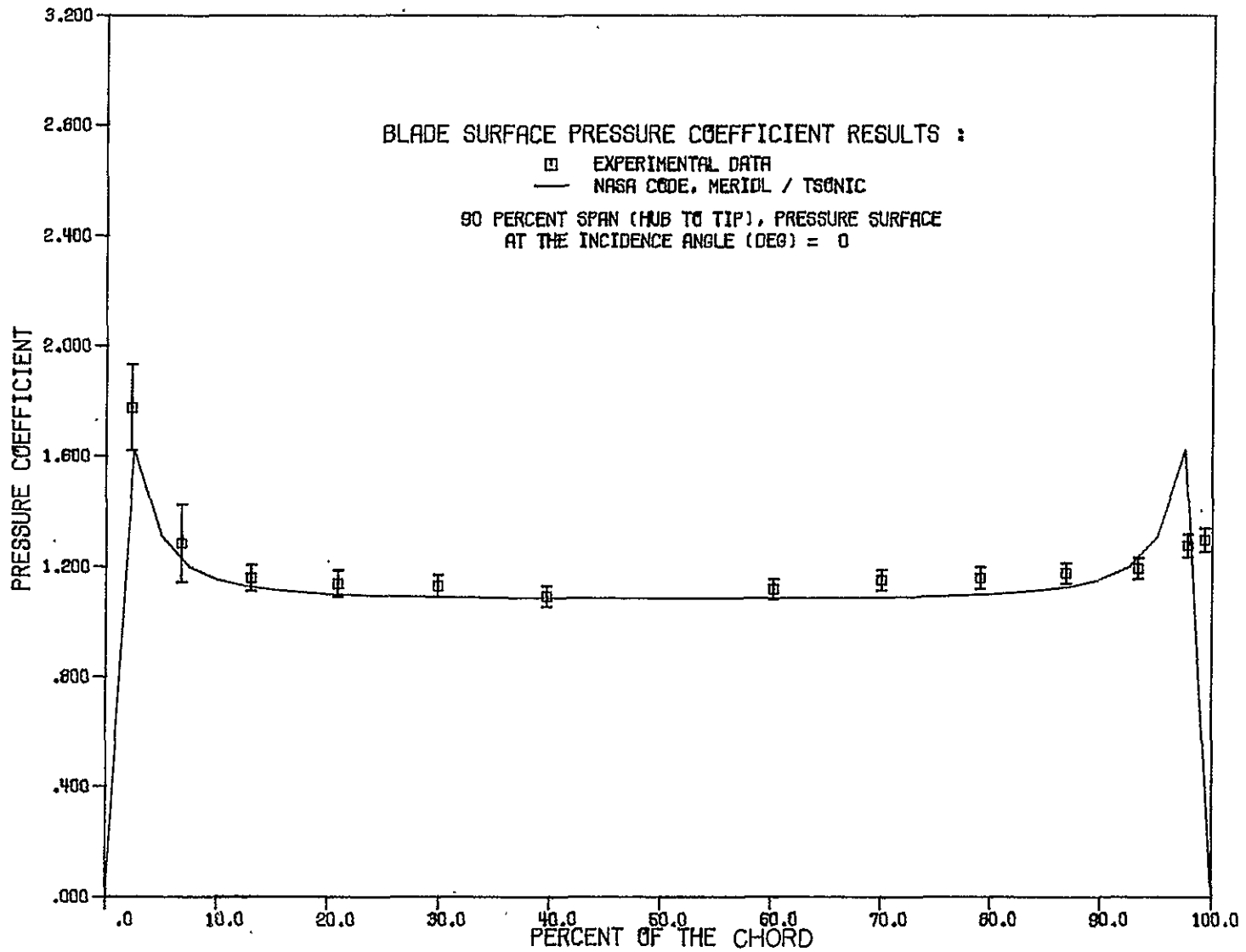

Figure 74. Chordwise Distribution of the Airfoil Surface Pressure Coefficients

ORIGINAL PAGE IS
OF POOR QUALITY

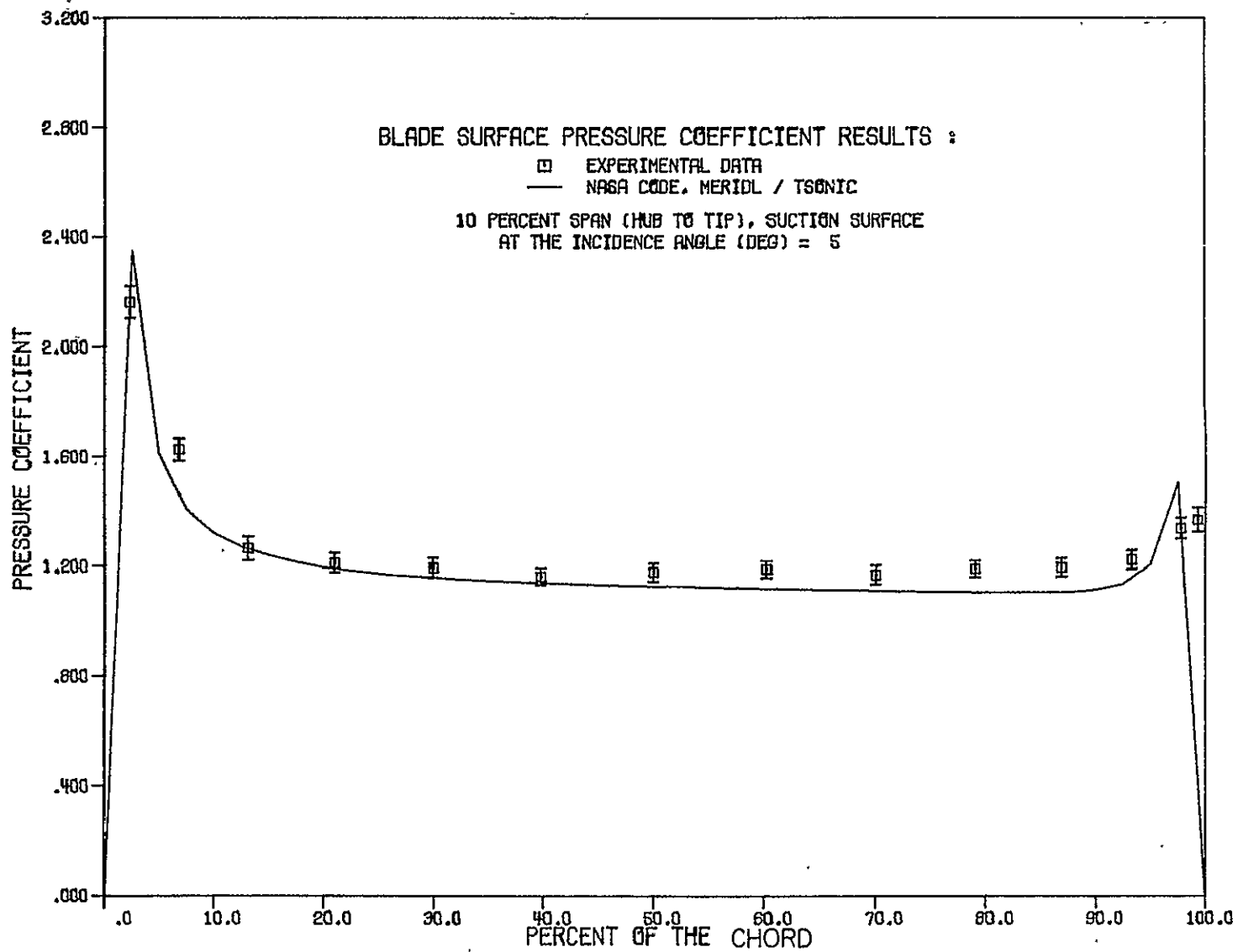

Figure 75. Chordwise Distribution of the Airfoil Surface Pressure Coefficients:

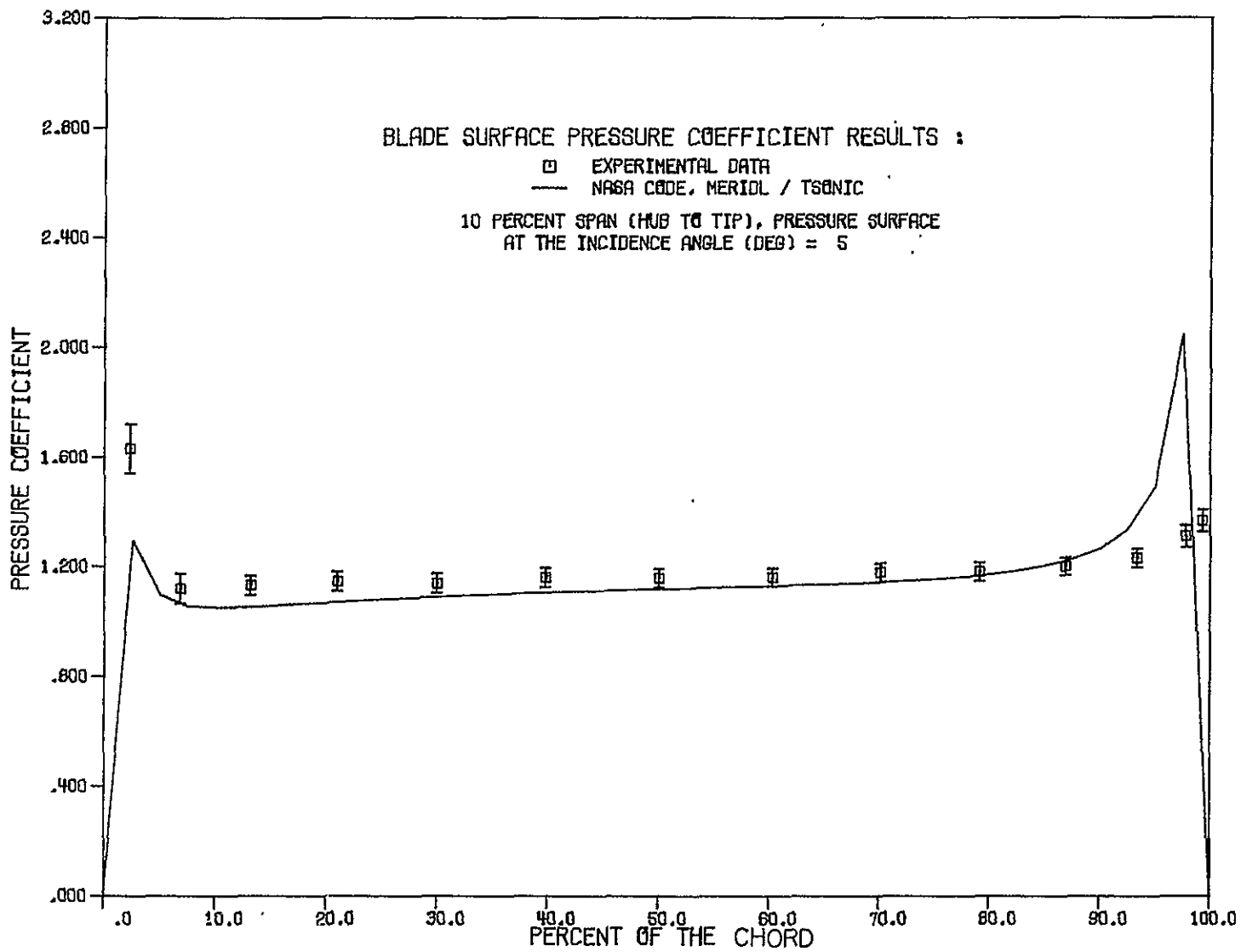

Figure 76. Chordwise Distribution of the Airfoil Surface Pressure Coefficients

ORIGINAL PAGE IS
OF POOR QUALITY

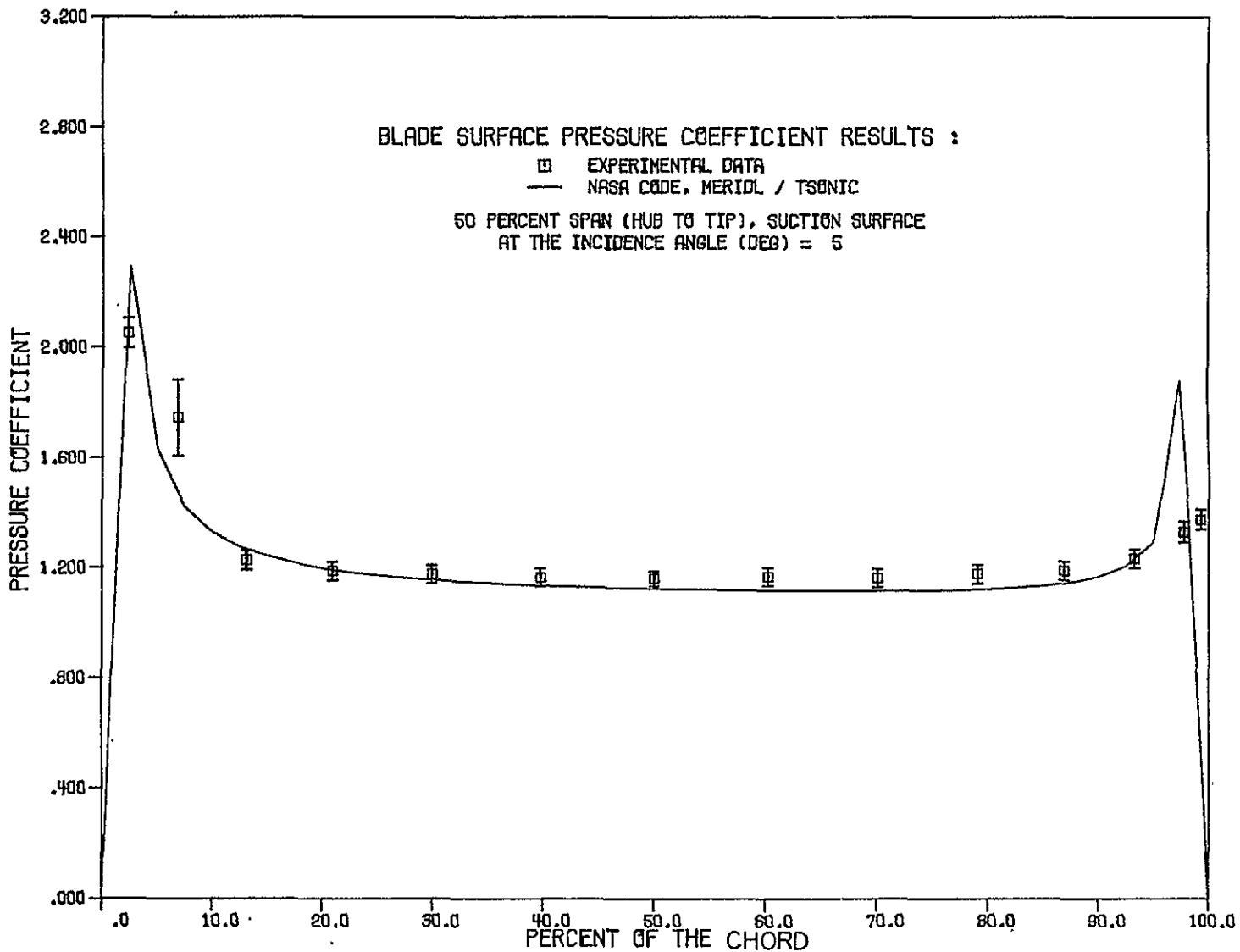

Figure 77. Chordwise Distribution of the Airfoil Surface Pressure Coefficients

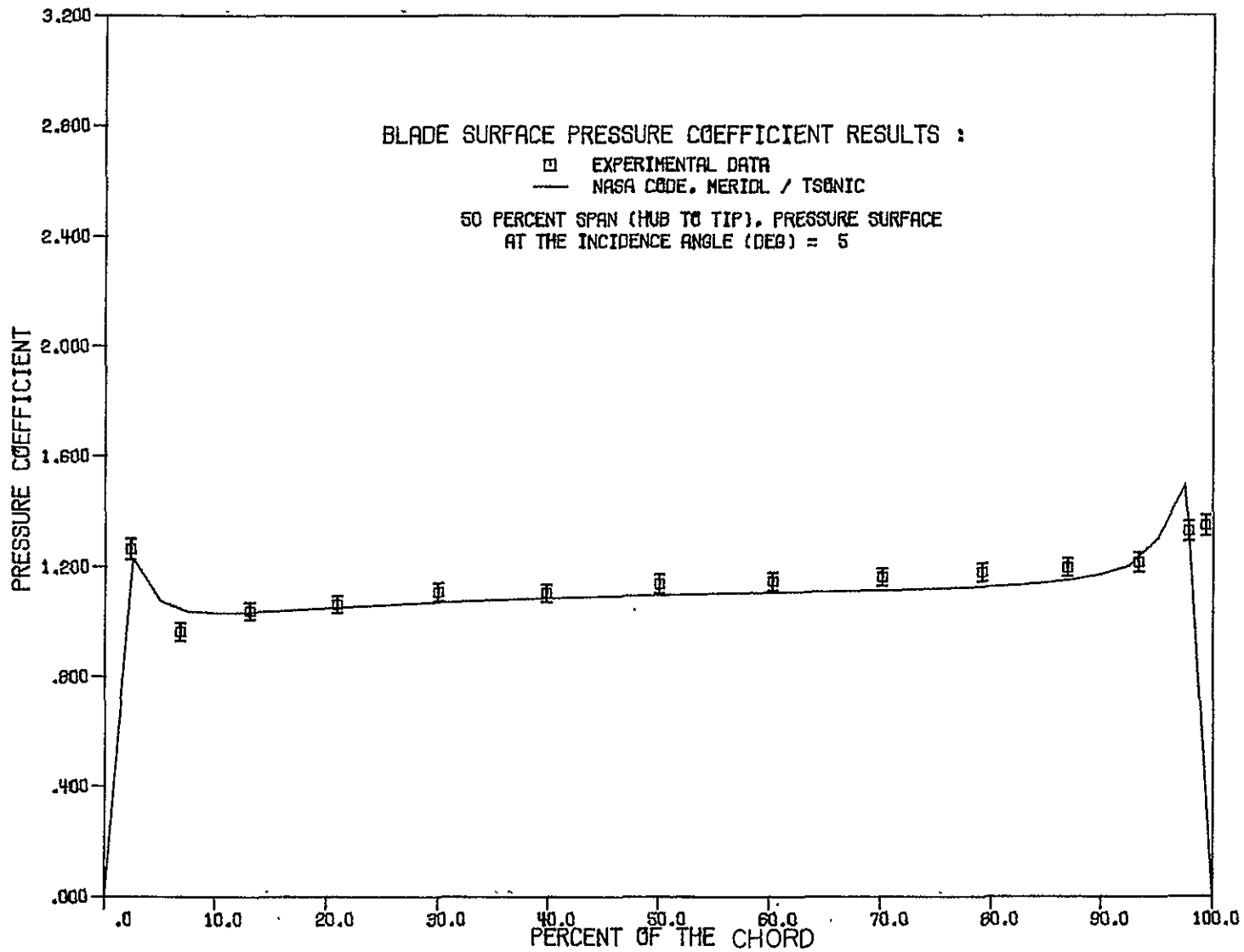

Figure 78. Chordwise Distribution of the Airfoil Surface Pressure Coefficients

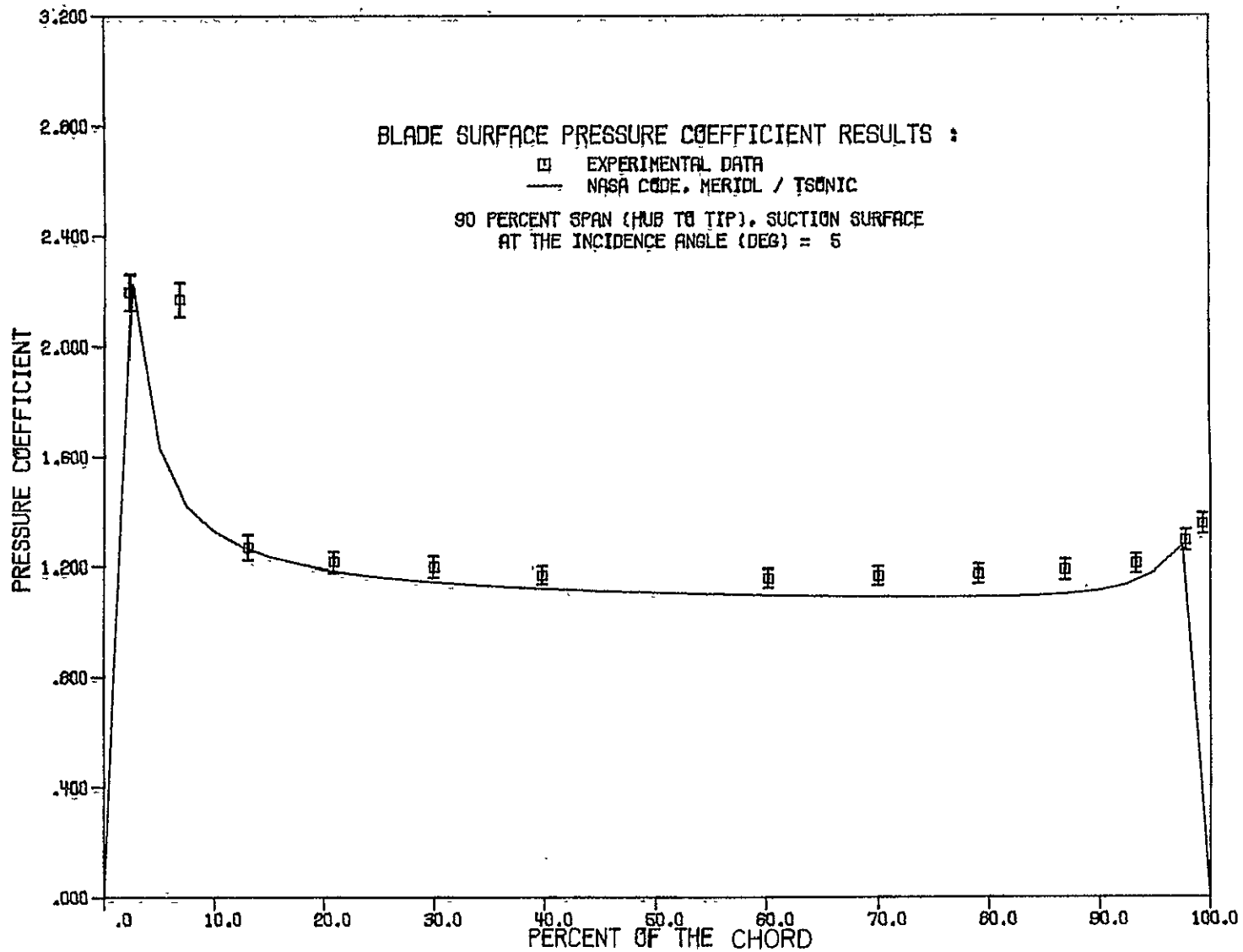

Figure 79. Chordwise Distribution of the Airfoil Surface Pressure Coefficients

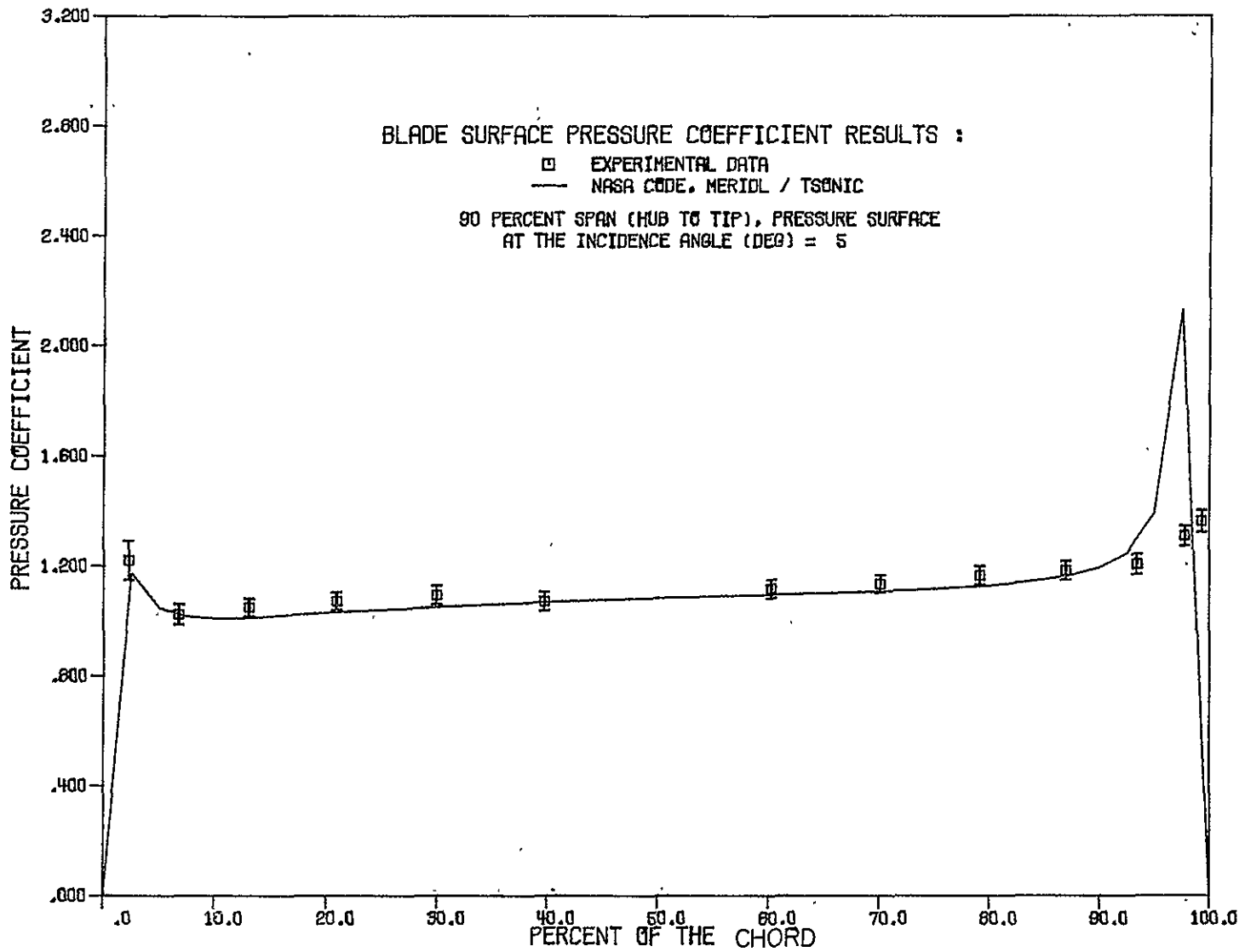

Figure 80. Chordwise Distribution of the Airfoil Surface Pressure Coefficients

chordline, the values of the pressure coefficient increase on the pressure surface and decrease on the suction surface. At 50% of the chord, the suction and the pressure surface experimental pressure coefficients become equal in value and remain so over the remainder of the chord. Thus, the airfoils are loaded for approximately the front 50% of the airfoil at 5° of incidence.

At 10° of incidence, Figures 81 through 86, the correlation between the experimental data and the numerical predictions is fair. The general trends for the pressure and suction surface data show good agreement with the numerical predictions, but the experimental coefficients are consistently higher than the predicted values, particularly on the airfoil suction surface where thick boundary layers exist and leading edge separation may have occurred. As in the 5° incidence angle results, the experimental coefficients at the 10° incidence angle value indicate that the airfoils are loaded for the front 50% of the airfoil. The magnitude of the loading at 10° of incidence, as expected, is greater than that at 5° of incidence.

The experimental pressure coefficient data are presented in tabular form in Appendix L.

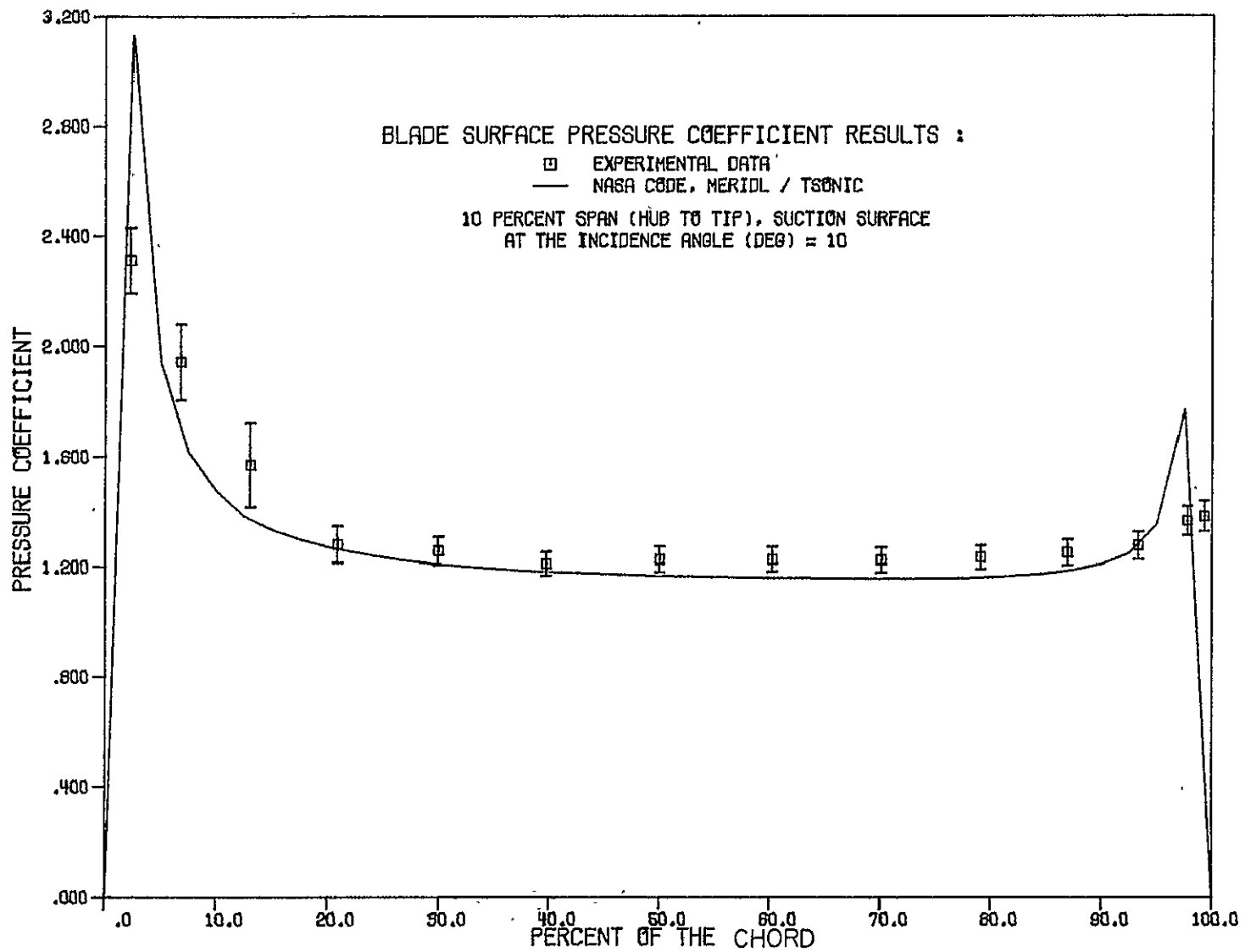

Figure 81. Chordwise Distribution of the Airfoil Surface Pressure Coefficients

ORIGINAL PAGE IS OF POOR QUALITY

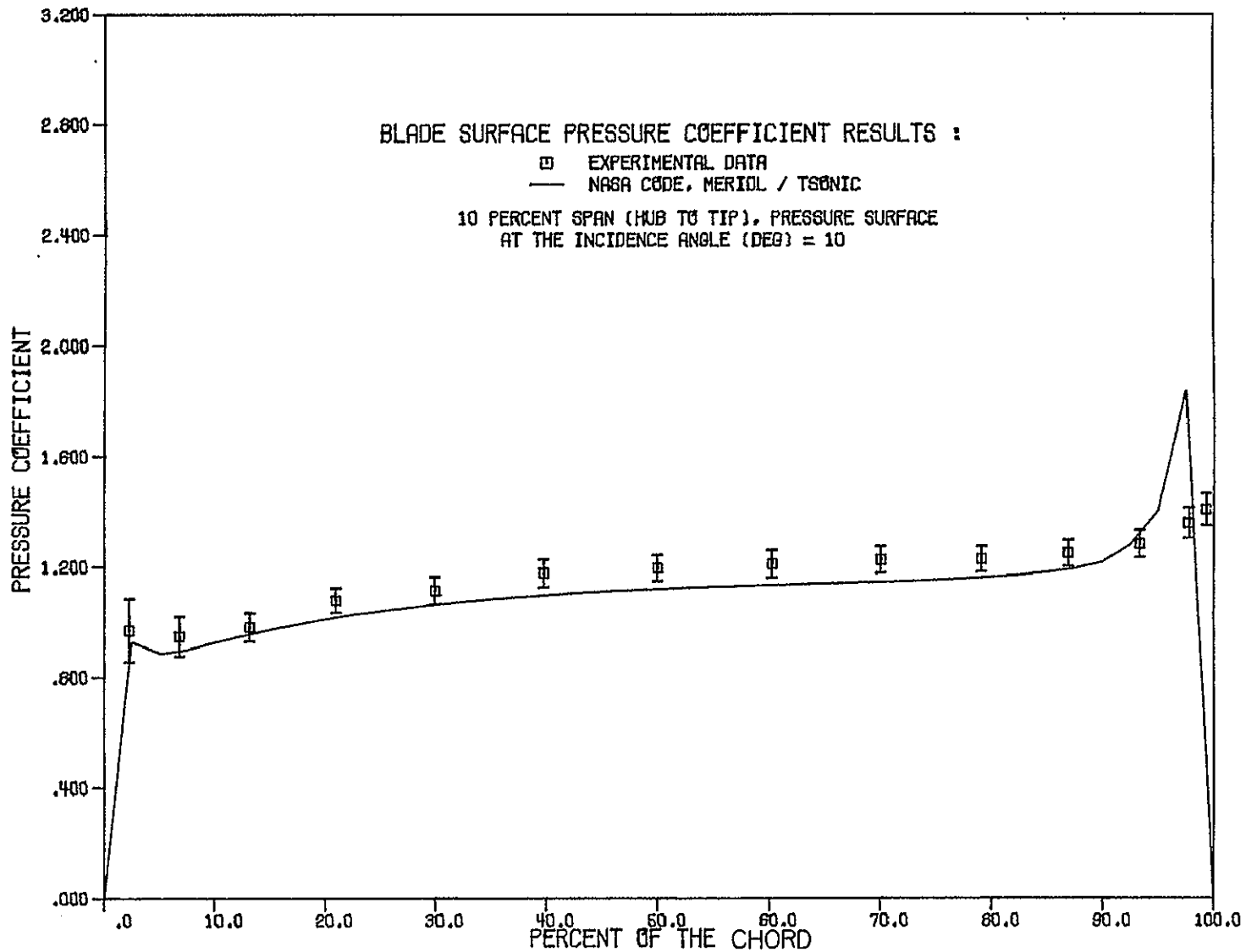

Figure 82. Chordwise Distribution of the Airfoil Surface Pressure Coefficients

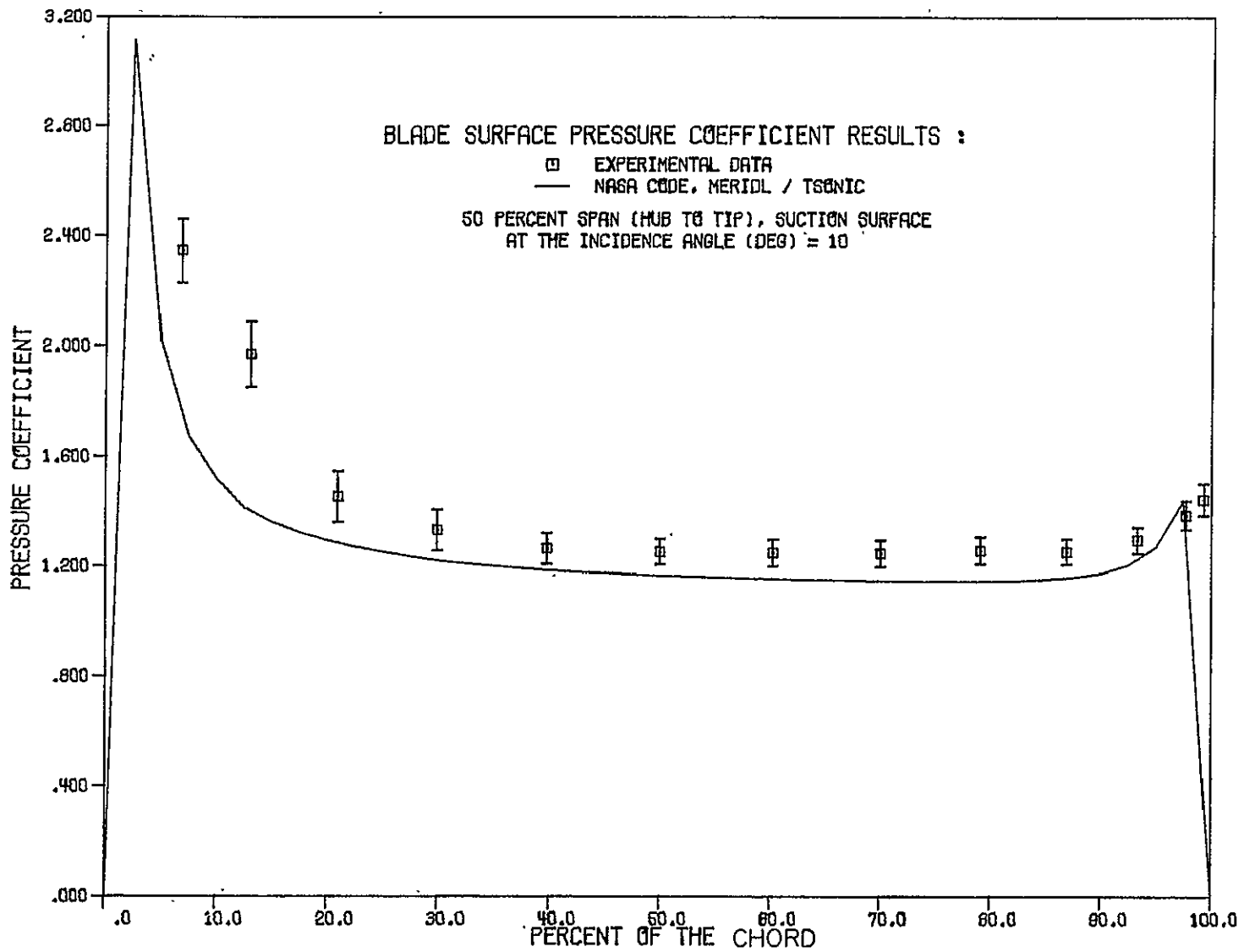

Figure 83. Chordwise Distribution of the Airfoil Surface Pressure Coefficients

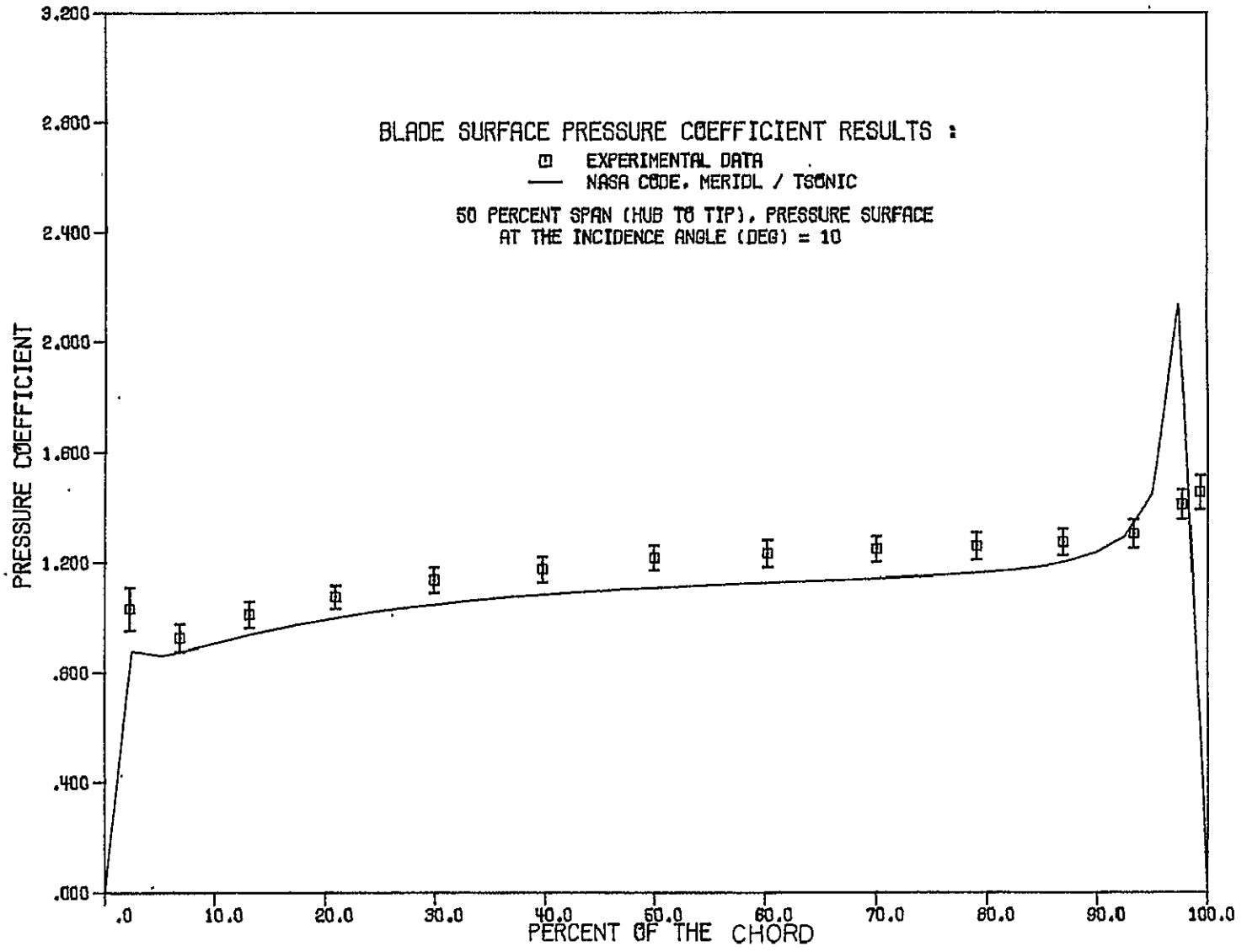

Figure 84. Chordwise Distribution of the Airfoil Surface Pressure Coefficients

ORIGINAL PAGE IS
 OF POOR QUALITY

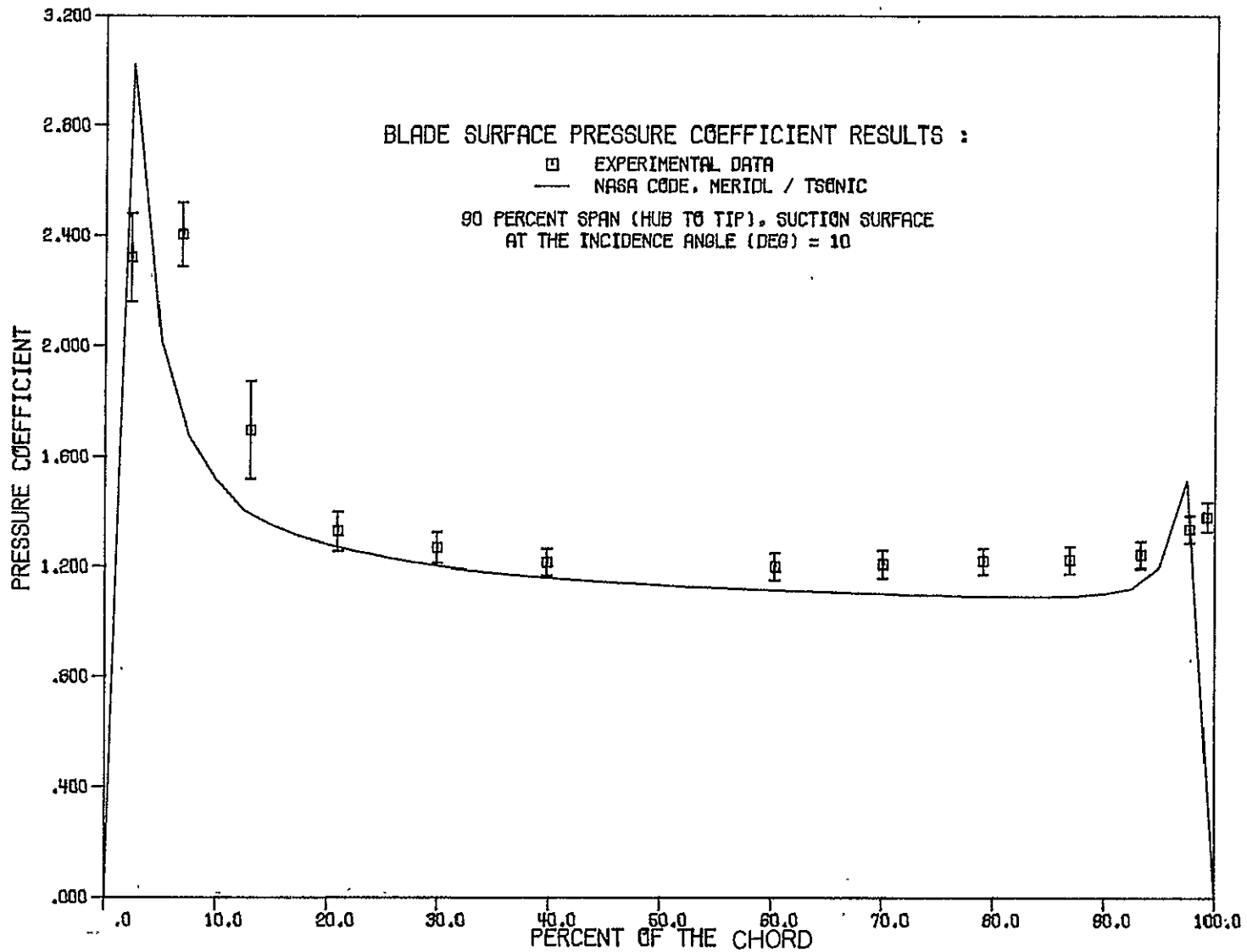
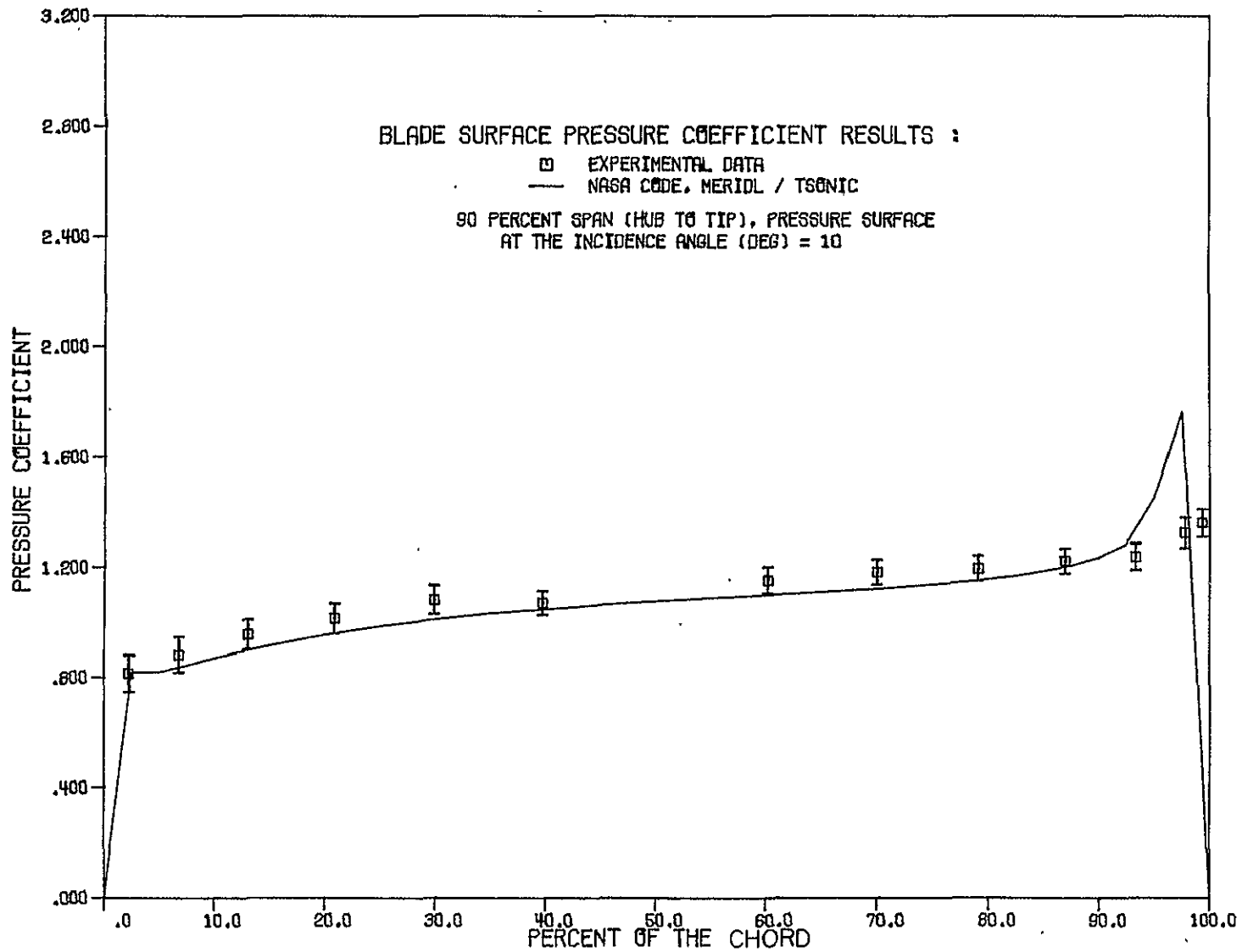

Figure 85. Chordwise Distribution of the Airfoil Surface Pressure Coefficients

ORIGINAL PAGE IS
OF POOR QUALITY



ORIGINAL PAGE IS
OF POOR QUALITY

Figure 86. Chordwise Distribution of the Airfoil Surface Pressure Coefficients

ORIGINAL PAGE IS
OF POOR QUALITY

CHAPTER VI SUMMARY AND CONCLUSIONS

An investigation of the overall three-dimensional aerodynamic performance of a classical airfoil cascade has been performed in The Purdue Annular Cascade Facility. This performance is described in terms of the airfoil surface pressure distribution and the cascade exit region flow field at three incidence angle values for an essentially uniform upstream inlet velocity profile. All data are analyzed and correlated with appropriate theoretical predictions.

A Calibration Jet Facility has been designed, fabricated, and utilized for the calibration of a five-hole cone probe in the non-nulled mode. This facility provides a large uniform jet core with low turbulence intensity.

The aerodynamic performance data were obtained via computer controlled data acquisition and analysis systems. These systems were developed to automate: pressure measurement via Scanivalve transducers; downstream probe positioning; and data reduction. Further, the systems are designed for ease of operator use, minimization of acquisition time, and the inclusion of detailed error analyses.

A summary of the results and the conclusions of this study is presented below.

- * Benchmark quality data have been obtained which quantify the overall three-dimensional aerodynamic performance of a classical airfoil cascade over a range of incidence angle values.
- * The cascade exit region data were obtained at two downstream traversing slot far wake positions. The decay of the wake and the increase in the wake width with increased downstream distance were observed.
- * The axial velocity component of the wake showed an increase in nonsymmetry about the airfoil circumferential location with increasing incidence angle value. Further, this nonsymmetry for nonzero incidence angles was amplified in the highly three-dimensional hub and tip regions. This nonsymmetry was due to increased boundary layer growth on the suction surface and likely airfoil separation at 10° of incidence.
- * Wake profile similarity was demonstrated. The two-dimensional Gaussian similarity was shown to be appropriate in the mid-span region. However, in the hub and tip regions the two-dimensional Gaussian similarity equation does not correlate with the wake data. This breakdown of the two-dimensional similarity equation in

hub and tip regions is due to the increased three-dimensionality of the flow field in these regions.

- * Predictions obtained from the MERIDL and TSONIC numerical codes exhibit good correlation at 0° and 5° of incidence with the experimental airfoil surface data. Deviations between the predictions and the experimental data are a result of smoothing effects in the numerical codes and viscous effects not considered in these inviscid codes.
- * At an incidence angle of 10° , the airfoil surface data were in fair agreement with the corresponding numerical predictions, showing the same general trends between the predicted and experimental values. Increased boundary layer development on the airfoil suction surface and likely airfoil surface flow separation caused the poor correlation between the inviscid predictions and the data.
- * A technique to visualize isobaric exit flow contours has been demonstrated. It has been utilized to visualize the symmetry of the wake at 0° incidence and the nonsymmetry of the wake with increased incidence angle values. Also the amplification of this nonsymmetry in the hub and tip regions was visualized.

LIST OF REFERENCES

LIST OF REFERENCES

1. Stauter, R. C., and Fleeter, S., "The Design and Instrumentation of The Purdue Annular Cascade with Initial Data Acquisition and Analysis", Purdue University, ME-TSPC-TR-82-11, 1982.
2. Lieblein, S., and Roudebush, W. H., "Low-Speed Wake Characteristics of Two-Dimensional Cascade and Insolated Airfoil Sections", NACA TN 3771, 1956.
3. Raj, R., and Lakshminarayana, R., "Characterisitics of the Wake Behind a Cascade of Airfoils", Journal of Fluid Mechanics, Vol. 61, Pt. 4, 1973, pp. 707-730.
4. Lakshminarayana, B., and Davino, R., "Mean Velocity and Decay Characteristics of the Guidevane and Stator Blade Wake of an Axial Flow Compressor", ASME Paper No. 79-GT-9, 1979.
5. Scanivalve "J" Catalog. Scanivalve Corporation, San Diego, California.
6. Bean, H. S., Fluid Meters Their Theory and Application, ASME, New York, 1971, pp. 216-219.
7. Hussain, A. K. M. F., and Ramjee, V., "Effects of the Axisymmetric Contraction Shape on Incompressible Turbulent Flow", ASME Journal of Fluids Engineering, March 1976, pp. 58-69.
8. Gettelman, C. C., and Krause, L. N., "Considerations Entering into the Selection of Probes for Pressure Measurement in Jet Engines", Proceedings of the Instrument Society of America, Vol. 7, 1952, pp. 134-137.
9. Dudzinski T. J., and Krause, L. N., "Flow-Direction Measurement with Fixed-Position Probes", NASA TM X-1904, 1969.

10. Treaster, A. L., and Yocum, A. M., "The Calibration and Application of Five-Hole Probes", Instrument Society of America Transactions, Vol. 18, 1979, pp. 23-34.
11. Bryer, D. W., and Pankhurst, R. C., Pressure-Probe Methods for Determining Wind Speed and Flow Direction, Her Majesty's Stationary Office, London, 1971, pp. 41-74.
12. Sitaram, N., Lakshminarayana, B., and Ravindranath, A., "Conventional Probes for the Relative Flow Measurement in a Turbomachinery Rotor Blade Passage", ASME Journal of Engineering for Power, Vol. 103, 1981, pp. 406-414.
13. Hinch, D. V., and Fleeter, S., "Hot-Wire Anemometry Measurements of Three-Dimensional Mean Velocities in The Purdue Annular Cascade Facility", Purdue University, ME-TSPC-TR-81-10, 1981.
14. Hall, C. W., Errors in Experimentation, Matrix Publishers, Champaign, IL, 1977.
15. Ransom, R. H., Hoffman, J. D., and Thompson, H. D., "A Second-Order Numerical Method of Characteristics for Three-Dimensional Supersonic Flow, Volume I", Least Squares Bivariate Interpolation Scheme Appendix, AFAPL-TR-69-98, Volume I, 1969, pp. 149-152.
16. Katsanis, T., and McNally, W. D., "Revised Fortran Program for Calculating Velocities and Streamlines on the Hub-Shroud Midchannel Stream Surface of an Axial-, Radial-, or Mixed-Flow Turbomachine or Annular Duct", NASA TN D-8430 and TN-D-8431, 1977.
17. Katsanis, T., "Fortran Program for Calculating Transonic Velocities on a Blade-to-Blade Stream Surface of a Turbomachine", NASA TN D-5427, 1969.
18. Crowder, J. P., Hill, E. G., and Pond, C. R., "Selected Wind Tunnel Testing Developments at the Boeing Aerodynamics Laboratory", AIAA-80-0458-CP, 1980.

APPENDICES

APPENDIX A

Probe Alignment Procedure in the Calibration Jet Facility

Accurate three-dimensional calibrations require the accurate alignment of the measuring device with a known coordinate system. The Calibration Jet Facility coordinate system is schematically shown in Figure A1. The probe alignment procedure in the Calibration Jet Facility is outlined below.

1. Check to be sure the jet face is perpendicular to the horizontal by placing a level against the jet face along the X-axis. Shim the plenum support table if required.
2. Mount the rotary table on the top of its stand and hand tighten the mounting bolts.
3. Obtain the alignment pointers (Figure A2a) and place them in the nozzle exit and the rotary table center.
4. Adjust the rotary table stand location and the leveling screws on the bottom of the stand legs

ORIGINAL PAGE IS
OF POOR QUALITY

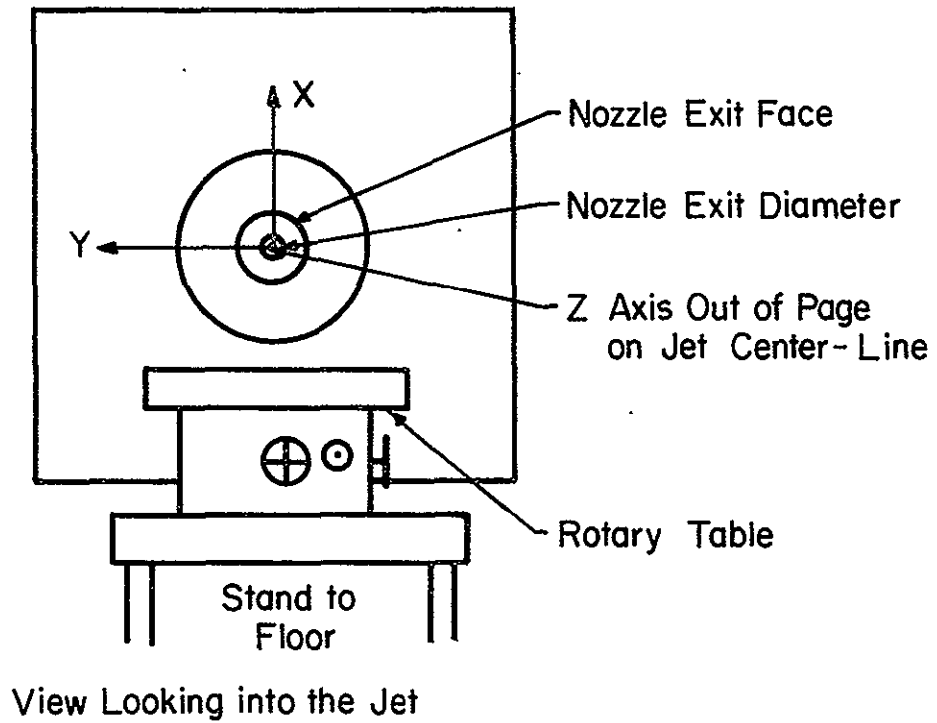

Figure A1. Calibration Jet Coordinate System

e-3

ORIGINAL PAGE IS
OF POOR QUALITY

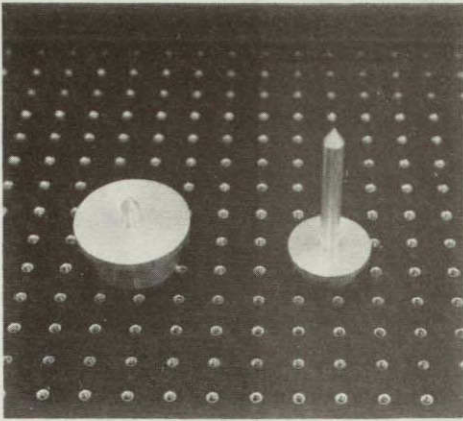

Figure A2a

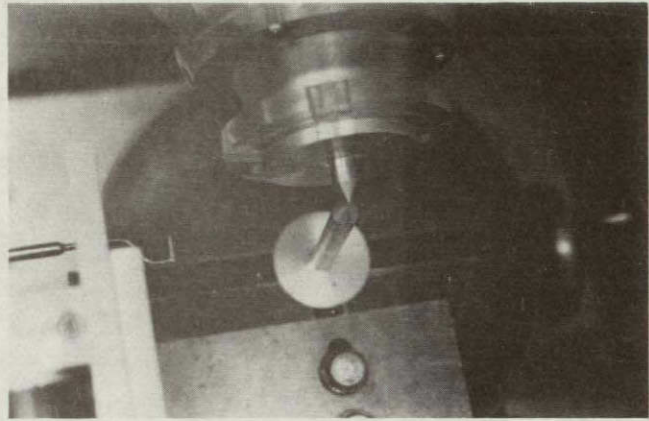

Figure A2b

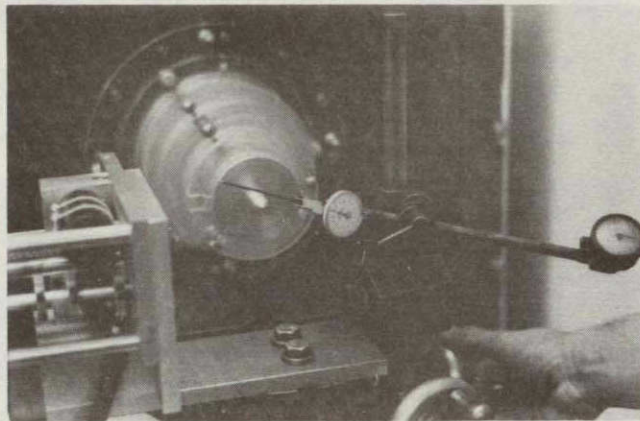

Figure A2c

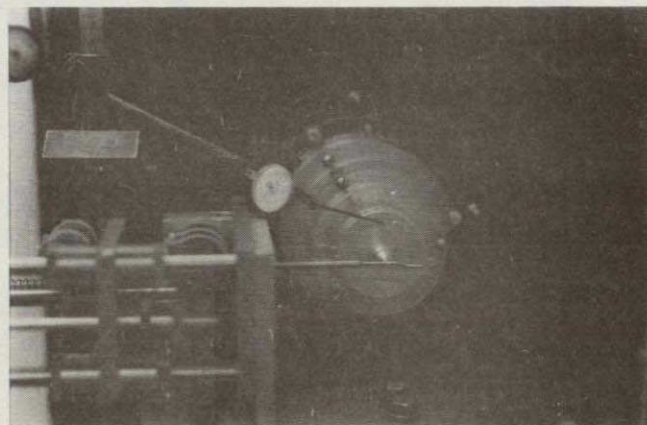

Figure A2d

Figure A2. Calibration Jet Alignment Procedure Photographs I

until the pointers touch (Figure A2b) and the rotary table top is level in the Y-Z plane, as checked by placing a level on the table top in the Y and Z directions. At the completion of this step the rotary table top plane is perpendicular to the jet face plane (double checked with a square) and the rotary table top is at proper height so that with the traversing mechanism mounted in place the probe tip is at the same height as the jet centerline axis.

5. Remove the rotary table pointer and mount the indicator base on the rotary table top. Move the rotary table in the Y-axis direction using the table crank, indicating across the jet pointer face (Figure A2c). Adjust the rotary table position with respect to its stand until the Y-axis of the rotary table is parallel to the jet face within $\pm .0025$ cm ($\pm .001$ in.). Tighten the rotary table mounting bolts and reindicate to check this alignment.
6. Put the rotary table pointer back in place and adjust the Y and Z table cranks until the pointers touch again. At this point the final Y-position of the rotary table is set. Thus, the rotary table can be moved in the Z-direction using the Z-crank (or in the rotary direction using the

rotary crank) and the jet centerline remains on a line parallel to the rotary table top and perpendicular to the rotary table center.

*7. Using the Z-crank move the pointers about 2.54 cm (1 in.) apart. Mount the transversing mechanism radial/self-rotational mechanism unit in its aluminum calibration jet fixture securely. Then mount the fixture assembly hand-tight on the rotary table. Next the probe is securely mounted in the traversing mechanism aligning the probe (fixture assembly) by eye with the rotary table Y-axis, and exactly aligning the center of the sensor head with the rotary table pointer tip. The fixture assembly is then securely tightened to the rotary table.

8. Read and record the Y-position of the probe in volts from the L. C. Smith controlling unit. Then, using the L. C. Smith unit push button controls (with the manual mode selected), move the probe in the positive Y-direction and remove the rotary table pointer.

* NOTE: Extreme care must be taken when a hot-wire probe is being aligned to avoid damaging the fragile wire. It is recommended that a non-operational hot-wire sensor be used in alignment, and subsequently replaced with an operating one after completion of alignment procedures.

9. Place the indicator base on the slide of the traversing mechanism and indicate across the jet pointer face using the L. C. Smith unit (Figure A2d). Adjust the rotary position of the table using the rotary crank (always staying on the same side of the screw for alignment and calibration) until the traversing mechanism's slide motion indicates parallel to the jet face within $\pm .0025$ cm ($\pm .001$ in.).

10. Place the indicator base on the rotary table and touch the indicator to the side of the probe support (Figure A3a). Rotate the probe about its own axis using the L. C. Smith unit, gently flexing the probe, if required, to obtain alignment of the probe and its holder within $\pm .0051$ cm ($\pm .002$ in.). This alignment can further be checked by keeping the same indicator position and using the L. C. Smith unit to move the probe in the Y-direction.

11. The center of the probe sensor head is then moved back to the jet centerline using the L. C. Smith unit and the recorded centerline Y-position from step 8. This procedure is first followed with the rotary table pointer in place, as a final check to be sure that the center of the probe sensor head is on the rotary table rotation axis; and then repeated after

ORIGINAL PAGE IS
OF POOR QUALITY

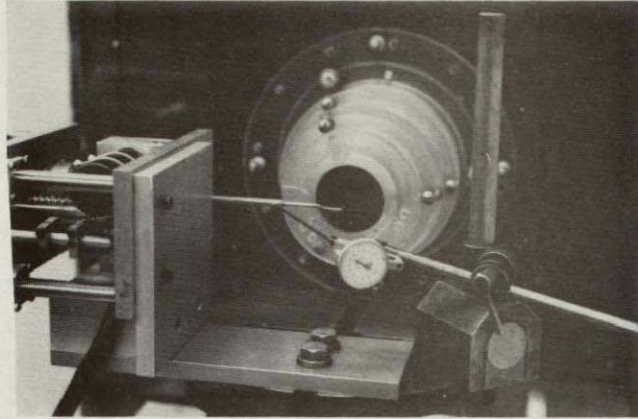

Figure A3a

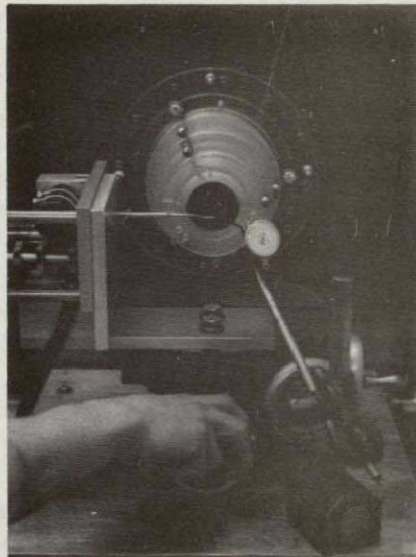

Figure A3b

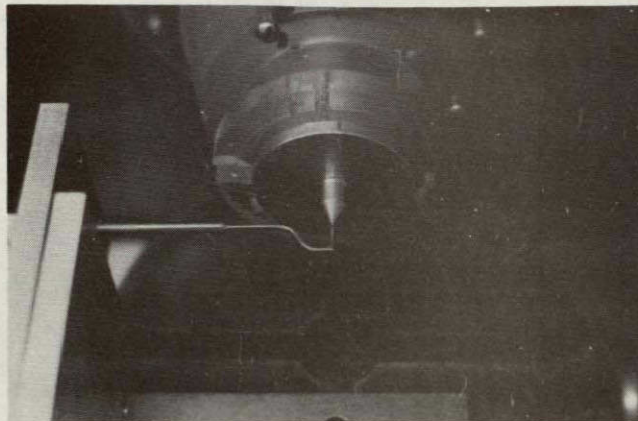

Figure A3c

Figure A3. Calibration Alignment Procedure Photographs II

removal of the pointer for final Y-direction alignment positioning.

12. For the five-hole pressure probe, the final alignment is done by placing the indicator base on the rotary table stand top and indicating along the top of the Z-axis part of the probe tip using the Z-crank of the rotary table (Figure A3b). The probe is rotated (using the L. C. Smith Unit) as needed until no change is visible on the indicator along the tip Z-section of the probe. Experience has shown that this last step is more accurate than turning on the jet and rotating the probe for the highest measured pressure. For the hot-wire probe, this step is accomplished by turning on the jet and rotating the probe for highest output voltage.
13. As a final check, the center of the probe sensor head is moved close to the nozzle pointer using the Z-crank of the rotary table (Figure A3c). This alignment confirms that the center of the probe sensor head is on the jet centerline axis.

Upon completion of these procedures, the center of the probe sensor head is on the jet centerline directly above the rotary table axis of rotation. Thus, rotation of the rotary table is equivalent to rotation of the probe about

the center of its sensor head in the Y-Z plane. Further, the probe support axis and the radial movement of the traversing mechanism are parallel to the Y-axis with the probe support axis in the Y-Z plane.

APPENDIX B

Calibration Jet Definition Results

The calibration jet definition plots at the six axial locations from the jet face, as described in Chapter II, are presented in Figures B1 through B6.

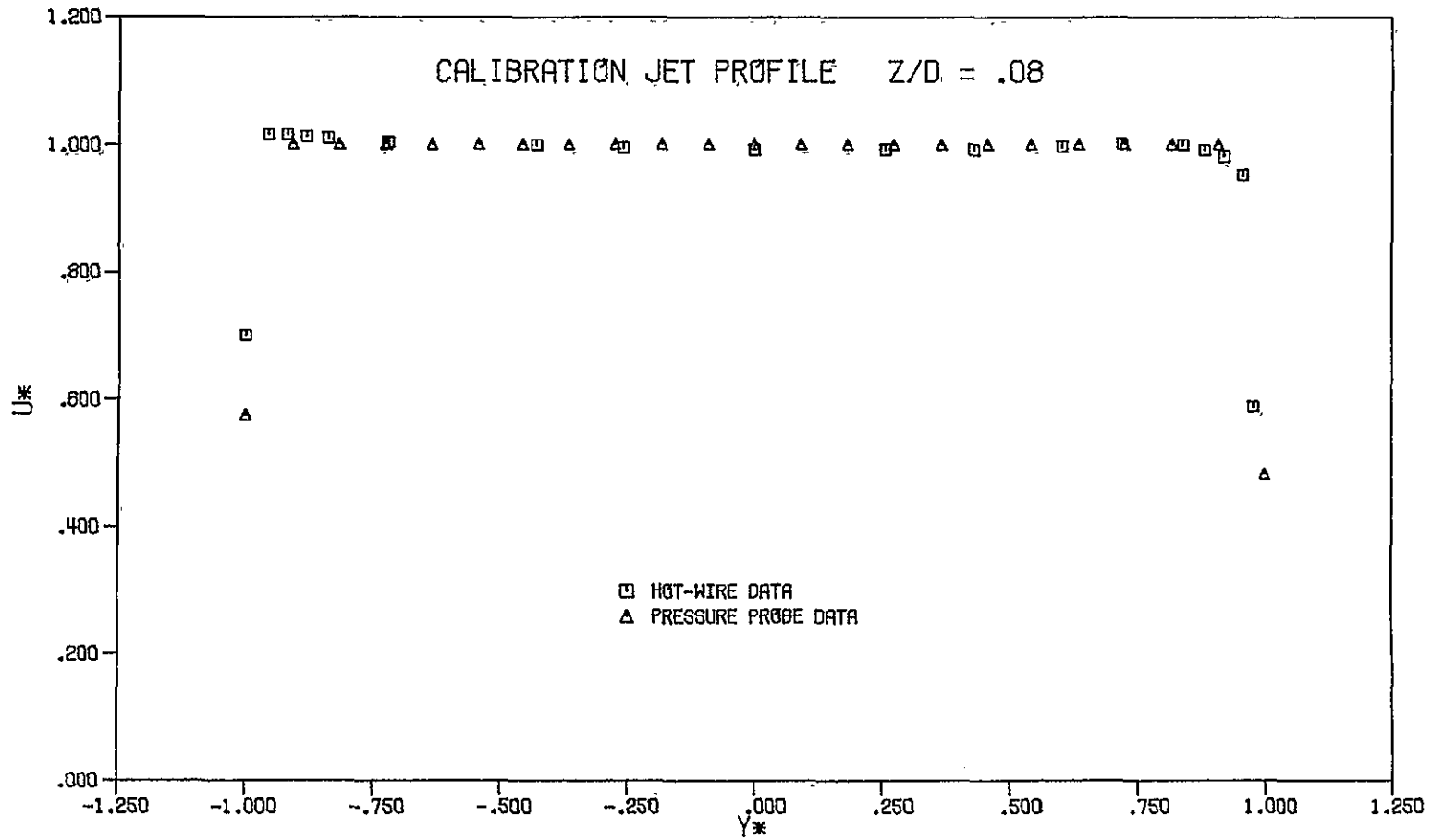
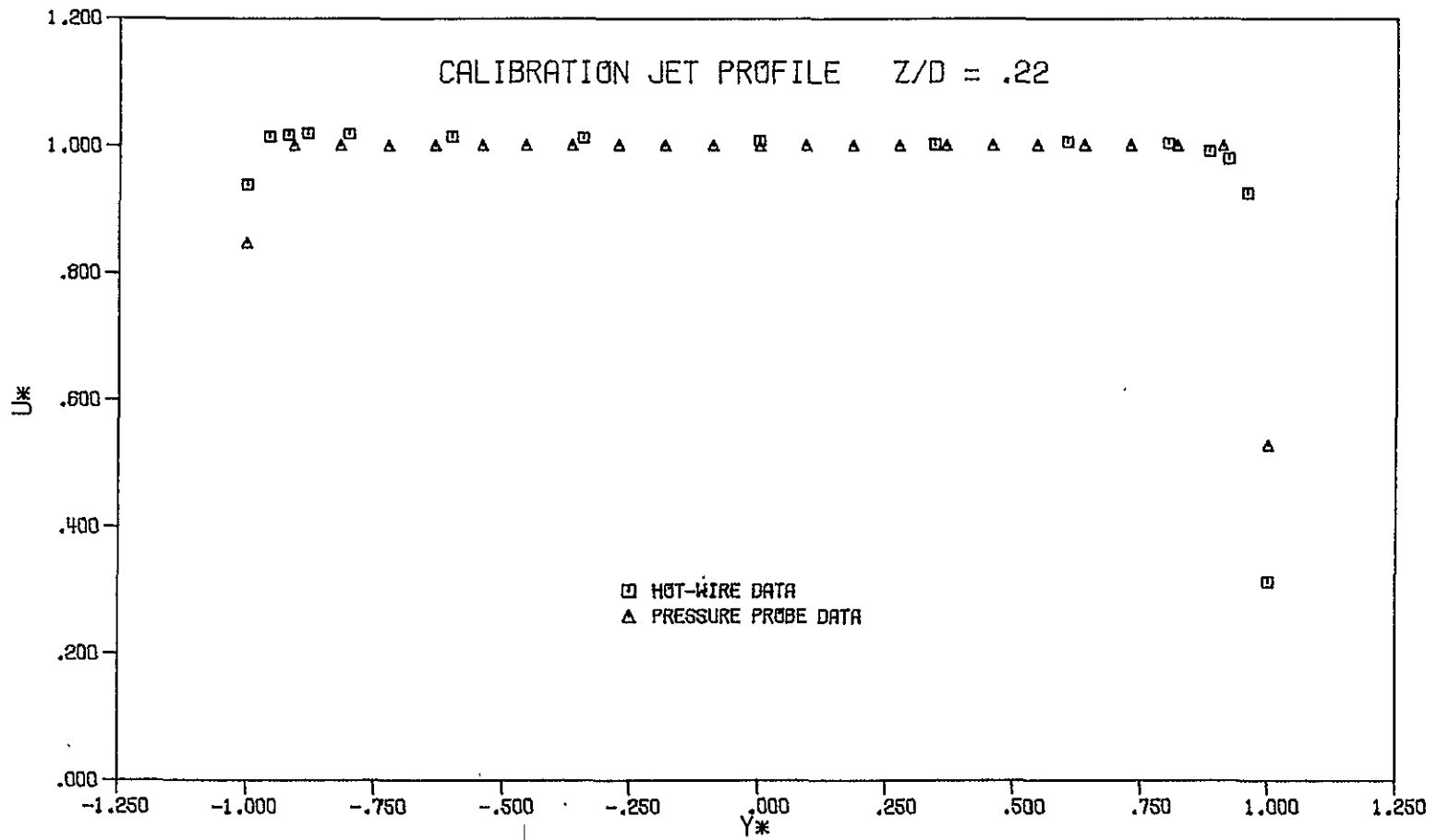

Figure B1. Calibration Jet Profile $Z/D = .08$



ORIGINAL PAGE IS
OF POOR QUALITY

Figure.B2. Calibration Jet Profile, $Z/D = .22$

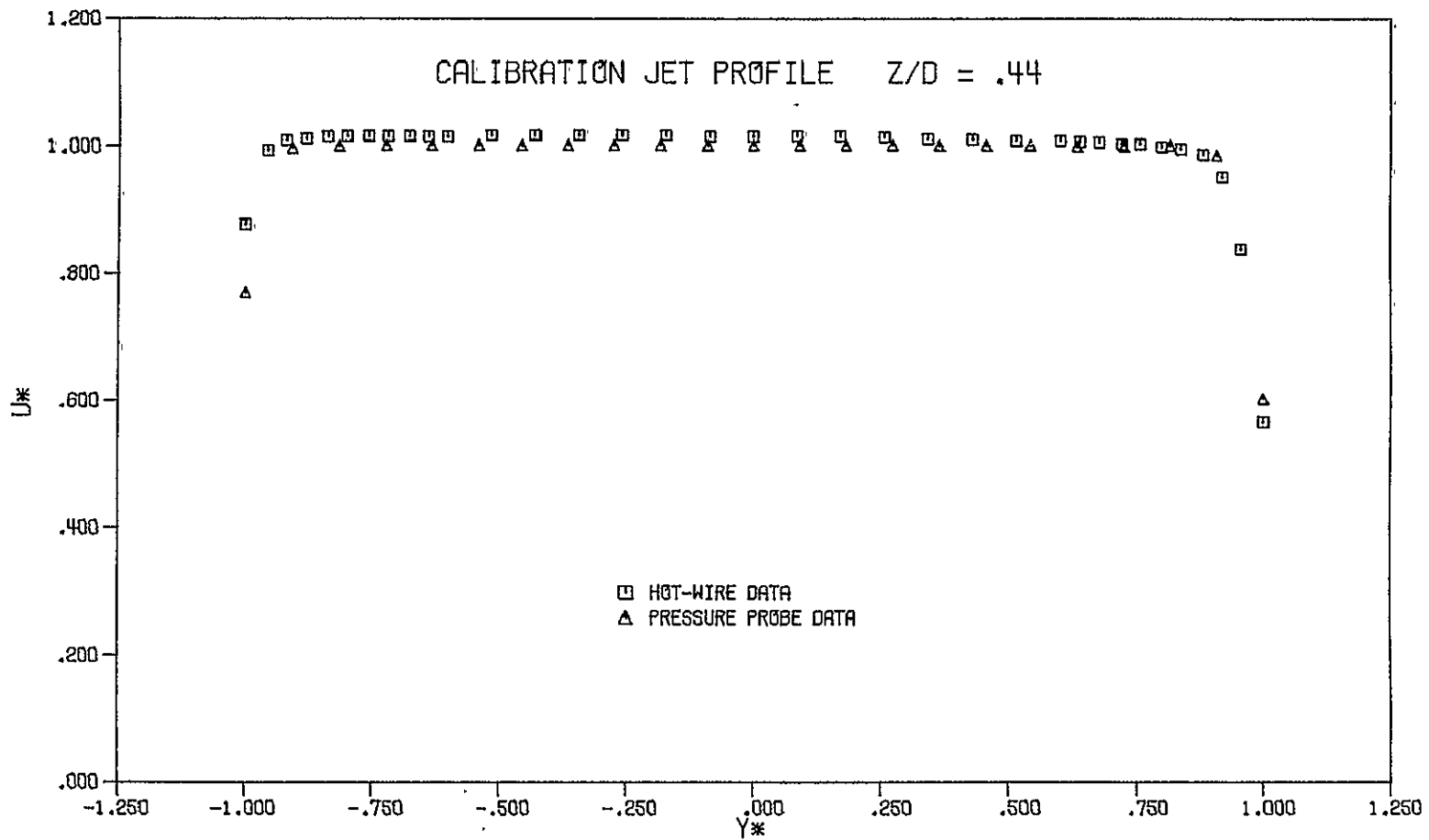
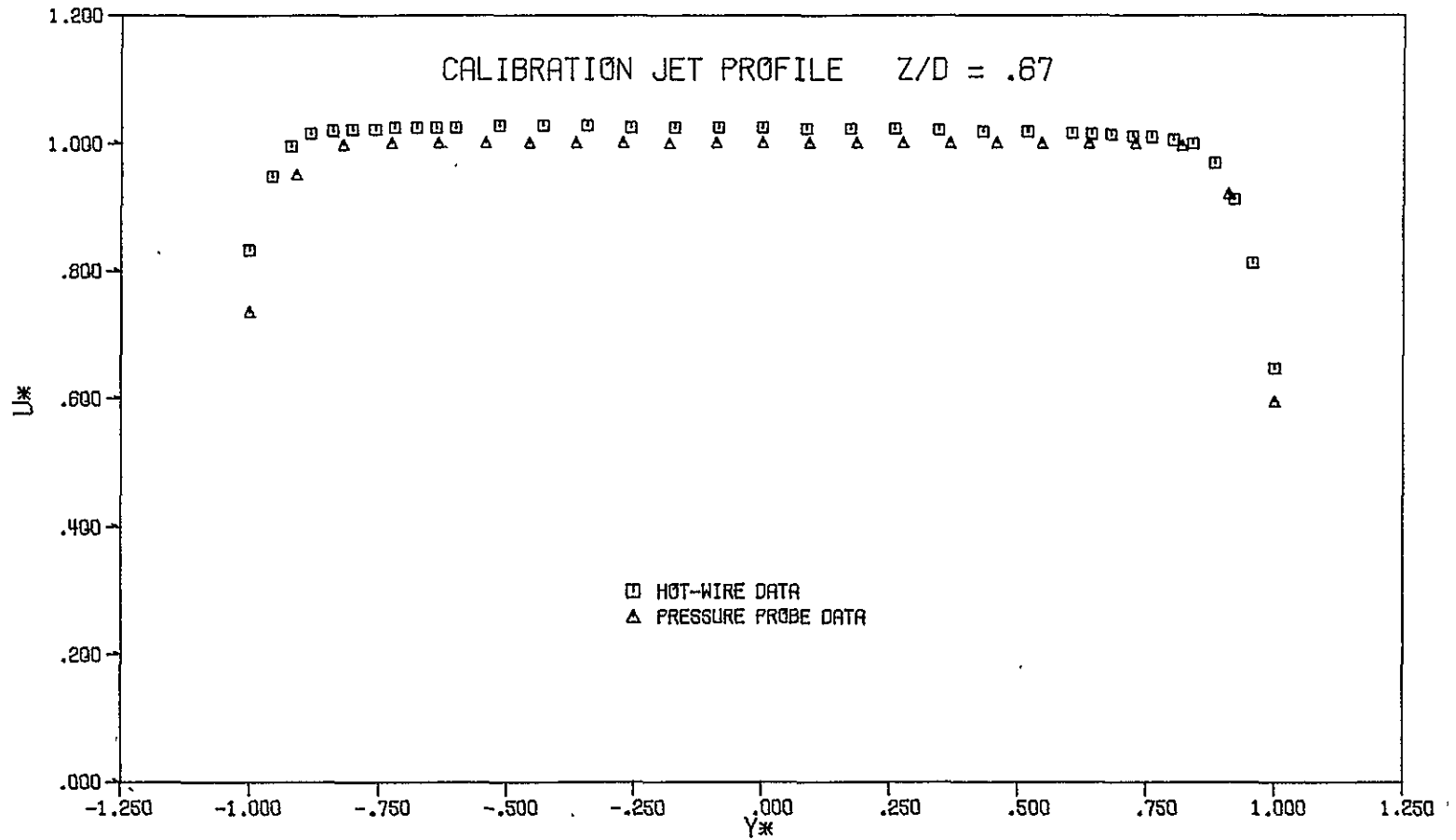
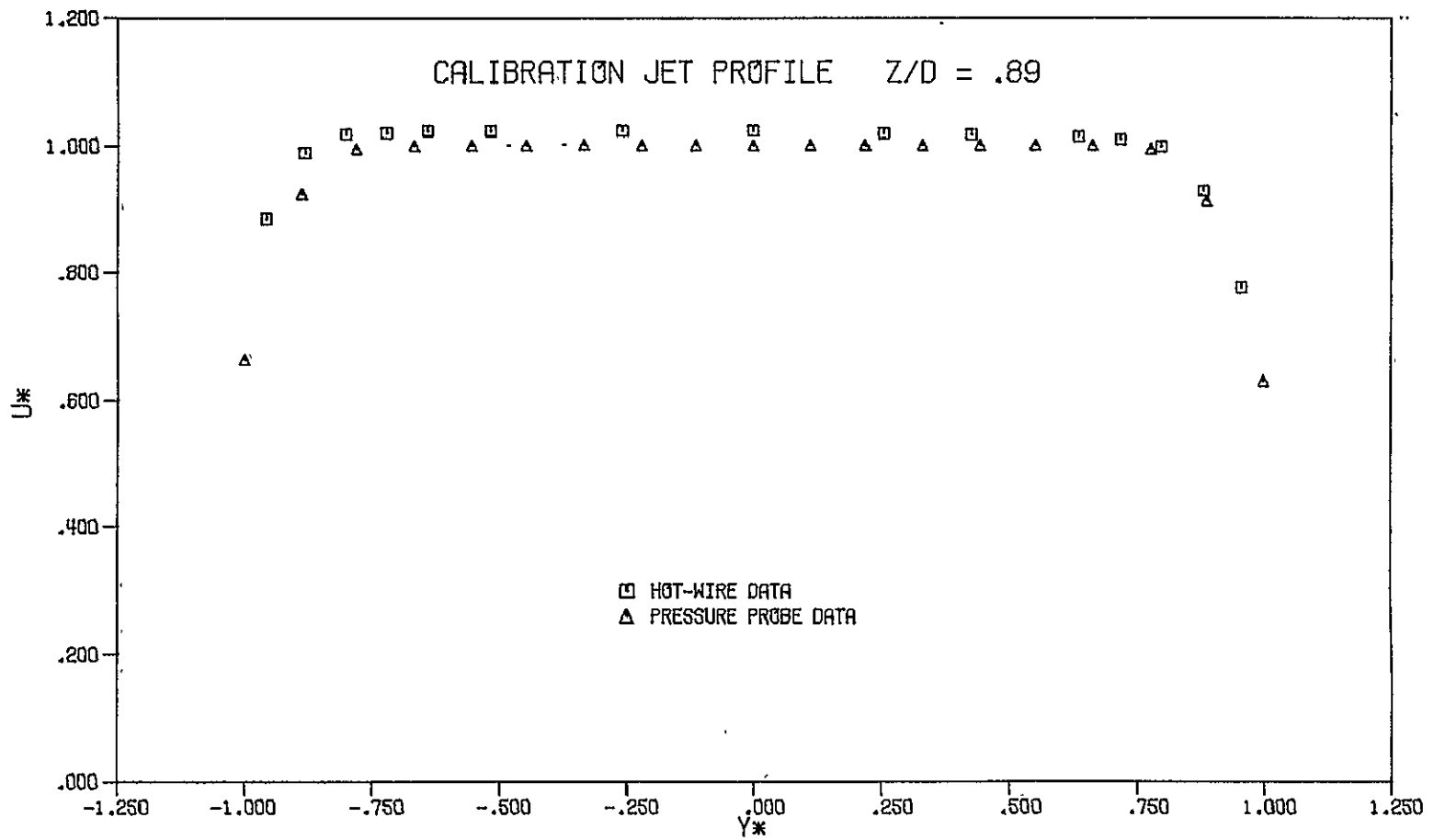

Figure B3. Calibration Jet Profile, $Z/D = .44$



ORIGINAL PAGE IS OF POOR QUALITY

Figure B4. Calibration Jet Profile, $Z/D = .67$



ORIGINAL PAGE IS
 OF POOR QUALITY

Figure B5. Calibration Jet Profile, $Z/D = .89$

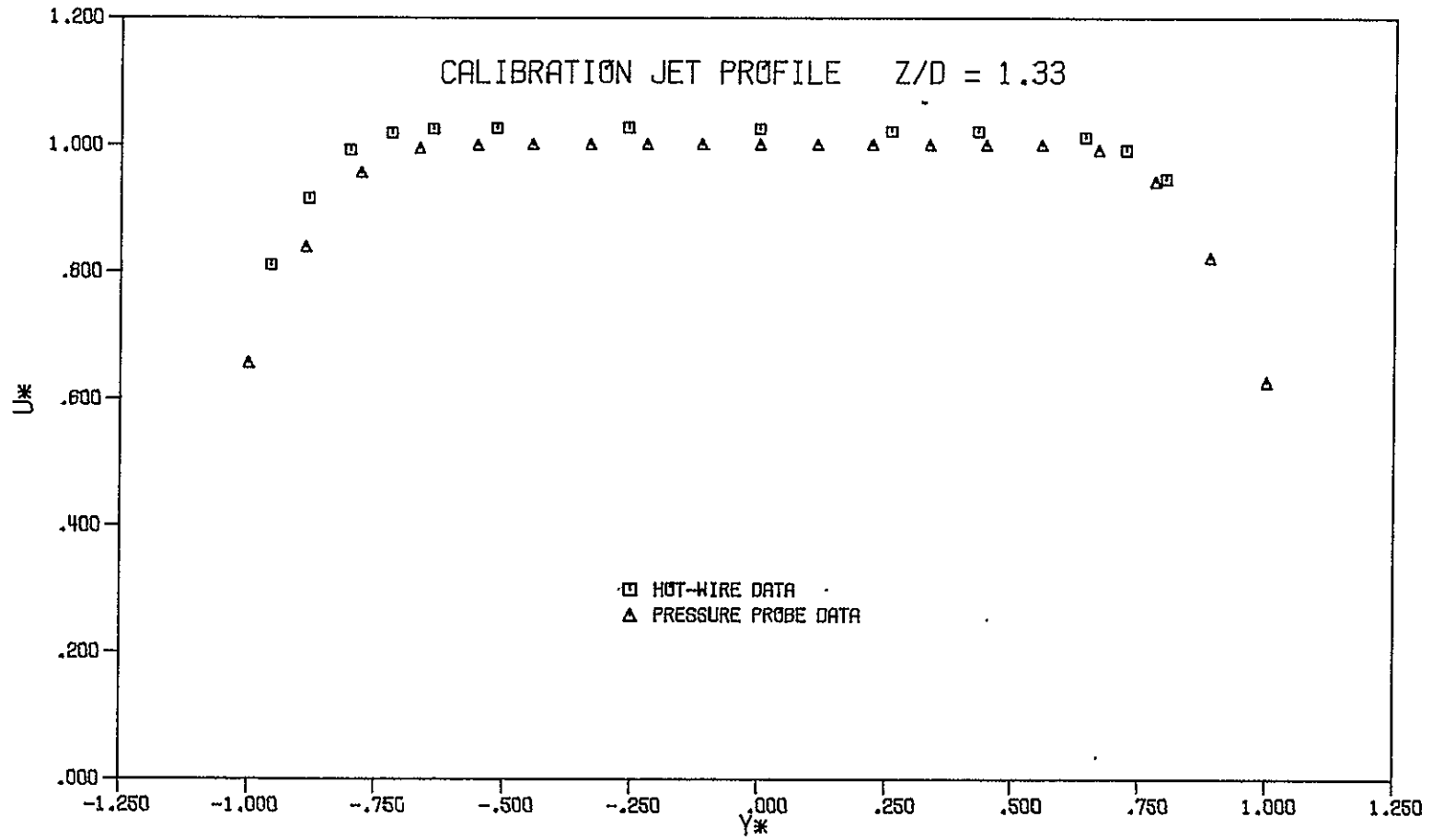

Figure B6. Calibration Jet Profile, $Z/D = 1.33$

APPENDIX C

Automated Data Acquisition and Reduction Flowcharts

<u>Program</u>	<u>Figure</u>
C5HOLE	C1
AQAUTO	C2
MATRED	C3

C5HOLE FLOWCHART

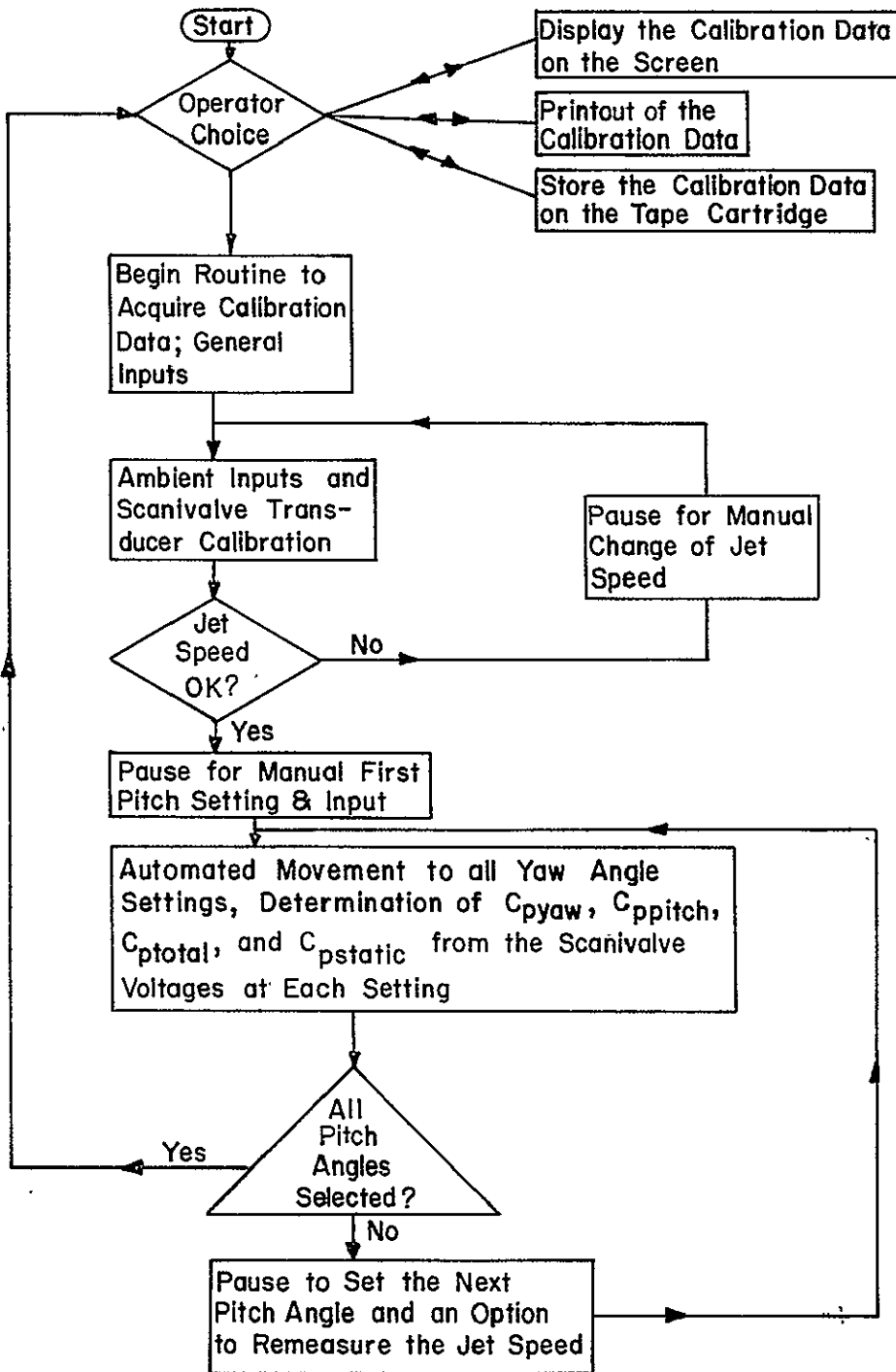

Figure C1. Program "C5HOLE" Flowchart

AQAUTO FLOWCHART

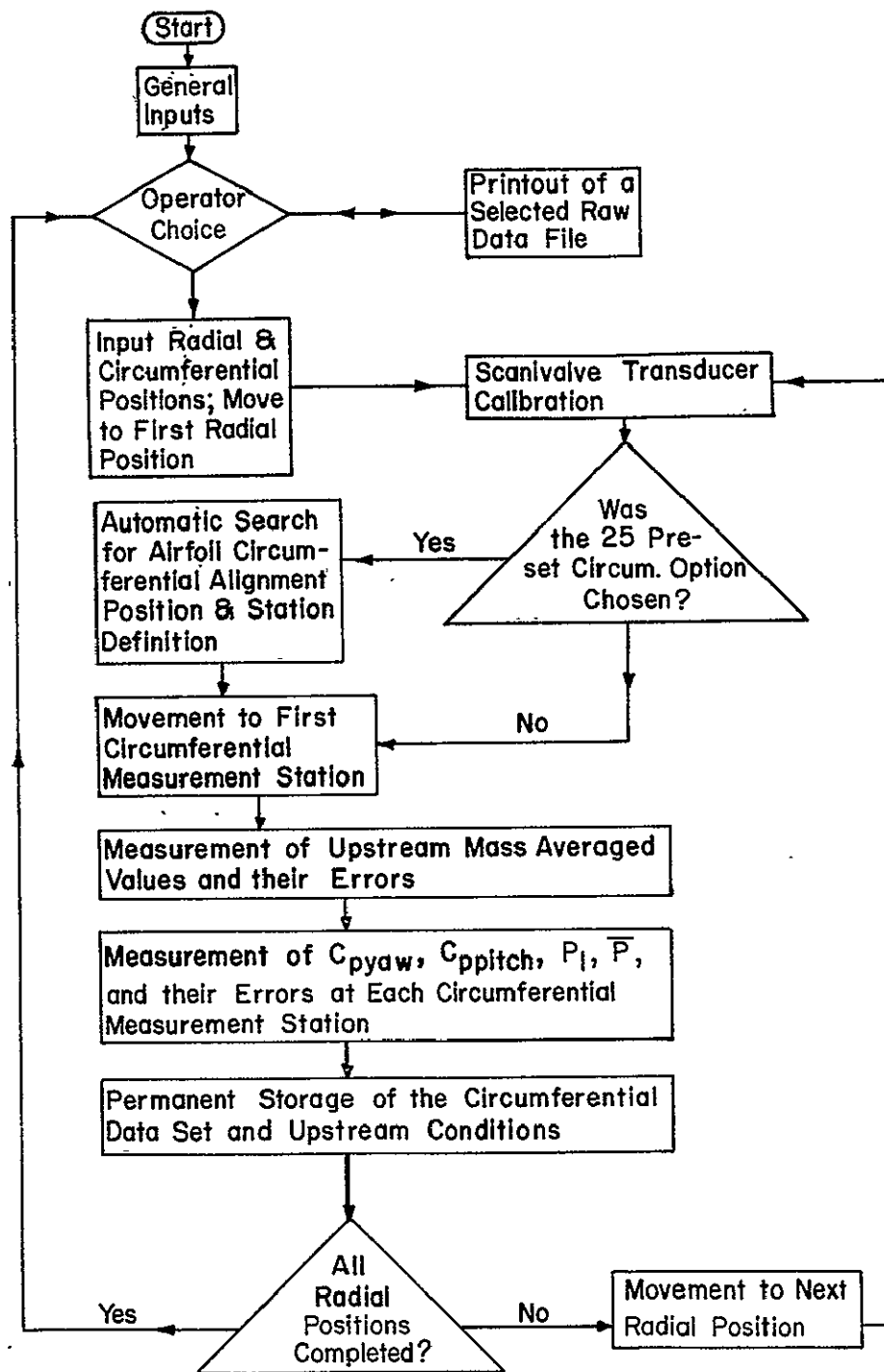

Figure C2. Program "AQAUTO" Flowchart

MATRED FLOWCHART

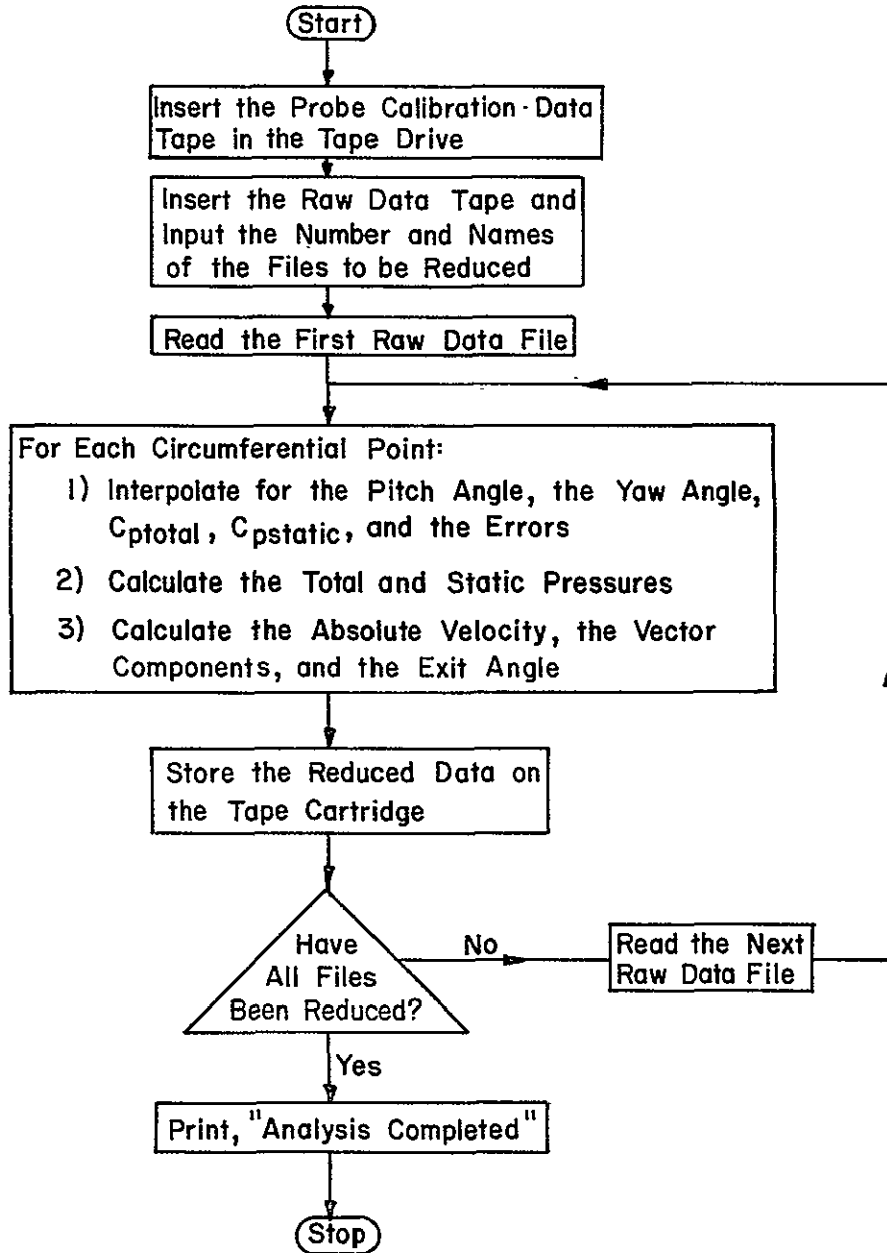

Figure C3. Program "MATRED" Flowchart

APPENDIX D

Error Analysis Techniques

Standard techniques of error analysis [14] were applied to develop error equations for the five-hole probe calibration and the cascade flow and wake acquisition and reduction systems. Reading errors are defined as one-half the smallest division and the Scanivalve voltage sampling errors were determined via a 99% confidence interval t-test. Only two values were assumed constant; the specific heat, $k = 1.4$, and the gas constant, $R_{\text{air}} = 287.08 \text{ J/kg-K}$ (53.35 ft-lb/lb-R).

The derivation of the Maximum Error Estimate Technique and the Standard Root Mean Square Technique are shown below.

For a quantity, q , which is a function of n independent parameters x_i :

$$q = F [x_1, x_2, x_3 \dots x_n] \quad (D1)$$

and

$$dq = \sum_{i=1}^n \left[\frac{\partial F}{\partial x_i} dx_i \right] \tag{D2}$$

The error in q, e_q , is considered to be produced by the errors in $x_1, x_2, x_3 \dots x_n$; $e_1, e_2, e_3 \dots e_n$:

$$e_q = \sum_{i=1}^n \left[\frac{\partial F}{\partial x_i} e_i \right] \tag{D3}$$

The value e_q cannot be evaluated directly because the sign of the error terms is not known. The Maximum Error Estimate Technique assumes the most severe estimate for e_q :

$$e_q = \sum_{i=1}^n \left| \frac{\partial F}{\partial x_i} e_i \right| \tag{D4}$$

The Standard Root Mean Square Error Technique evaluates e_q differently; first Equation D3 is squared,

$$e_q^2 = \sum_{i=1}^n \left[\frac{\partial F}{\partial x_i} \right]^2 e_i^2 + \sum_{i=1, j=1}^n \left[\frac{\partial F}{\partial x_i} \right] \left[\frac{\partial F}{\partial x_j} \right] e_i e_j \tag{D5}$$

where i is not equal to j.

The error components e_i are assumed independent and symmetrical in regard to positive and negative values. Thus:

$$e_q^2 = \sum_{i=1}^n \left[\frac{\partial F}{\partial x_i} \right]^2 e_i^2 \tag{D6}$$

and the Standard Root Mean Error is defined as:

$$e_q = \left[\sum_{i=1}^n \left[\frac{\partial F}{\partial x_i} \right]^2 e_i^2 \right]^{1/2} \tag{D7}$$

The Maximum Error Estimate Technique was applied to develop the error equations used in the five-hole probe calibration program. This technique was chosen because it is the most severe indicator of the accuracy of the calibration process. This most severe indicator was desired because the calibration coefficients, calculated based only on the fundamental Scanivalve voltages (Equations 9 through 17), needed to be determined with extreme confidence and accuracy. This error in the coefficients was determined to be negligible and hence, was neglected in data reduction.

The Standard Root Mean Error Technique was applied to develop the error equations used in the cascade wake acquisition and reduction programs. This technique was

chosen over the Maximum Error Estimate Technique because it is the more common estimate of error.

APPENDIX E

DC-125 Five-Hole Probe Calibration Data in Tablular Form

The DC-125 Five-Hole Probe Calibration Data are presented in Tables E1 through E13. Each table presents the complete set of calibration data at one pitch angle value. Pitch angles from -30° to $+30^{\circ}$ in 5° increments are presented.

Table E1. DC-125 Five-Hole Probe Calibration Data
 Jet Velocity = 30.5 m/s
 Pitch Angle (Deg) = -30.0

Yaw Angle (Deg)	Cpyaw (+/-)	Cppitch (+/-)	Cptotal (+/-)	Cpstatic (+/-)
-30.0	-1.924 .0102	-2.372 .0119	-1.836 .0085	-.677 .0045
-25.0	-1.291 .0080	-1.999 .0097	-1.241 .0065	-.493 .0037
-20.0	-.903 .0054	-1.765 .0056	-.914 .0034	-.399 .0026
-15.0	-.630 .0054	-1.628 .0051	-.728 .0022	-.348 .0025
-10.0	-.403 .0039	-1.537 .0043	-.603 .0020	-.310 .0020
-5.0	-.186 .0024	-1.481 .0045	-.540 .0022	-.293 .0018
0.0	.008 .0019	-1.437 .0050	-.510 .0025	-.290 .0018
5.0	.202 .0018	-1.447 .0044	-.531 .0016	-.299 .0017
10.0	.396 .0023	-1.475 .0035	-.601 .0019	-.321 .0015
15.0	.629 .0039	-1.542 .0053	-.724 .0023	-.363 .0023
20.0	.891 .0034	-1.646 .0052	-.921 .0036	-.424 .0019
25.0	1.231 .0072	-1.809 .0072	-1.230 .0052	-.527 .0032
30.0	1.778 .0099	-2.048 .0105	-1.742 .0088	-.707 .0046

Table E2. DC-125 Five-Hole Probe Calibration Data
 Jet Velocity = 30.5 m/s
 Pitch Angle (Deg) = -25.0

Yaw Angle (Deg)	Cpyaw (+/-)	Cppitch (+/-)	Cptotal (+/-)	Cpstatic (+/-)
-30.0	-1.758 .0068	-1.708 .0071	-1.327 .0050	-.508 .0029
-25.0	-1.232 .0043	-1.479 .0053	-.900 .0026	-.362 .0021
-20.0	-.873 .0025	-1.327 .0029	-.639 .0017	-.283 .0013
-15.0	-.618 .0025	-1.243 .0029	-.492 .0015	-.239 .0012
-10.0	-.385 .0021	-1.170 .0038	-.385 .0011	-.212 .0014
-5.0	-.184 .0014	-1.140 .0024	-.332 .0012	-.197 .0010
0.0	.015 .0016	-1.118 .0028	-.316 .0014	-.197 .0012
5.0	.202 .0016	-1.114 .0026	-.333 .0010	-.203 .0012
10.0	.400 .0023	-1.125 .0032	-.385 .0021	-.222 .0014
15.0	.620 .0023	-1.159 .0037	-.487 .0015	-.254 .0014
20.0	.853 .0047	-1.221 .0037	-.637 .0019	-.303 .0020
25.0	1.190 .0053	-1.308 .0058	-.879 .0041	-.392 .0025
30.0	1.644 .0075	-1.438 .0063	-1.244 .0082	-.529 .0033

ORIGINAL PAGE IS
 OF POOR QUALITY

Table E3. DC-125 Five-Hole Probe Calibration Data
 Jet Velocity = 30.5 m/s
 Pitch Angle (Deg) = -20.0

Yaw Angle (Deg)	Cpyaw (+/-)	Cppitch (+/-)	Cptotal (+/-)	Cpstatic (+/-)
-30.0	-1.667 .0044	-1.187 .0045	-.993 .0029	-.401 .0020
-25.0	-1.186 .0047	-1.054 .0034	-.653 .0017	-.272 .0019
-20.0	-.844 .0022	-.976 .0021	-.441 .0014	-.203 .0010
-15.0	-.599 .0025	-.925 .0030	-.313 .0017	-.164 .0012
-10.0	-.376 .0021	-.887 .0026	-.233 .0008	-.140 .0012
-5.0	-.176 .0017	-.861 .0020	-.188 .0007	-.128 .0010
0.0	.014 .0014	-.844 .0022	-.175 .0009	-.127 .0010
5.0	.201 .0013	-.839 .0020	-.189 .0008	-.135 .0009
10.0	.393 .0015	-.848 .0022	-.232 .0012	-.151 .0011
15.0	.603 .0019	-.861 .0022	-.315 .0015	-.182 .0011
20.0	.837 .0030	-.884 .0032	-.439 .0016	-.224 .0015
25.0	1.158 .0047	-.932 .0050	-.651 .0035	-.301 .0022
30.0	1.577 .0075	-1.008 .0051	-.944 .0052	-.424 .0029

Table E4. DC-125 Five-Hole Probe Calibration Data
 Jet Velocity = 30.5 m/s
 Pitch Angle (Deg) = -15.0

Yaw Angle (Deg)	Cpyaw (+/-)	Cppitch (+/-)	Cptotal (+/-)	Cpstatic (+/-)
-30.0	-1.583 .0053	-.837 .0052	-.778 .0042	-.339 .0022
-25.0	-1.139 .0033	-.750 .0031	-.487 .0017	-.224 .0016
-20.0	-.825 .0026	-.706 .0028	-.313 .0016	-.159 .0013
-15.0	-.589 .0019	-.671 .0016	-.203 .0007	-.116 .0009
-10.0	-.363 .0016	-.649 .0021	-.132 .0007	-.093 .0010
-5.0	-.171 .0013	-.637 .0019	-.097 .0006	-.078 .0008
0.0	.017 .0013	-.621 .0021	-.085 .0006	-.076 .0009
5.0	.197 .0014	-.617 .0011	-.096 .0005	-.083 .0007
10.0	.386 .0015	-.597 .0020	-.132 .0008	-.094 .0010
15.0	.603 .0017	-.620 .0023	-.207 .0008	-.132 .0010
20.0	.839 .0021	-.634 .0018	-.317 .0013	-.178 .0010
25.0	1.132 .0022	-.656 .0029	-.495 .0014	-.249 .0012
30.0	1.516 .0045	-.702 .0024	-.746 .0031	-.360 .0017

ORIGINAL PAGE IS
 OF POOR QUALITY

Table E5. DC-125 Five-Hole Probe Calibration Data
 Jet Velocity = 30.5 m/s
 Pitch Angle (Deg) = -10.0

Yaw Angle (Deg)	Cpyaw (+/-)	Cppitch (+/-)	Cptotal (+/-)	Cpstatic (+/-)
-30.0	-1.510 .0064	-.547 .0047	-.635 .0031	-.298 .0025
-25.0	-1.116 .0030	-.503 .0019	-.387 .0017	-.191 .0012
-20.0	-.818 .0028	-.470 .0025	-.227 .0008	-.126 .0014
-15.0	-.560 .0021	-.432 .0019	-.132 .0006	-.075 .0010
-10.0	-.364 .0019	-.430 .0015	-.070 .0008	-.056 .0009
-5.0	-.167 .0019	-.425 .0019	-.040 .0004	-.043 .0010
0.0	.014 .0008	-.414 .0013	-.031 .0003	-.041 .0007
5.0	.197 .0009	-.409 .0015	-.040 .0004	-.049 .0007
10.0	.386 .0014	-.402 .0013	-.071 .0013	-.067 .0007
15.0	.582 .0025	-.394 .0018	-.133 .0008	-.090 .0012
20.0	.826 .0034	-.413 .0017	-.232 .0008	-.143 .0013
25.0	1.109 .0027	-.424 .0027	-.386 .0015	-.214 .0014
30.0	1.478 .0031	-.449 .0023	-.627 .0017	-.316 .0014

Table E6. DC-125 Five-Hole Probe Calibration Data
 Jet Velocity = 30.5 m/s
 Pitch Angle (Deg) = -5.0

Yaw Angle (Deg)	Cpyaw (+/-)	Cppitch (+/-)	Cptotal (+/-)	Cpstatic (+/-)
-30.0	-1.469 .0034	-.298 .0024	-.566 .0017	-.276 .0014
-25.0	-1.089 .0026	-.286 .0015	-.326 .0014	-.174 .0010
-20.0	-.797 .0025	-.264 .0017	-.175 .0005	-.103 .0011
-15.0	-.577 .0014	-.248 .0016	-.090 .0007	-.063 .0008
-10.0	-.357 .0020	-.238 .0013	-.035 .0003	-.036 .0009
-5.0	-.169 .0016	-.242 .0008	-.012 .0003	-.024 .0007
0.0	.017 .0010	-.240 .0006	-.006 .0003	-.024 .0006
5.0	.205 .0009	-.231 .0011	-.012 .0004	-.030 .0006
10.0	.391 .0010	-.217 .0015	-.036 .0004	-.045 .0008
15.0	.570 .0013	-.213 .0008	-.093 .0004	-.066 .0007
20.0	.816 .0028	-.218 .0015	-.184 .0013	-.114 .0011
25.0	1.101 .0022	-.227 .0022	-.332 .0010	-.189 .0012
30.0	1.452 .0033	-.224 .0022	-.553 .0019	-.287 .0015

ORIGINAL PAGE IS
 OF POOR QUALITY

Table E7. DC-125 Five-Hole Probe Calibration Data
 Jet Velocity = 30.5 m/s
 Pitch Angle (Deg) = 0.0

Yaw Angle (Deg)	Cpyaw (+/-)	Cppitch (+/-)	Cptotal (+/-)	Cpstatic (+/-)
-30.0	-1.441 .0044	-.070 .0019	-.536 .0024	-.266 .0017
-25.0	-1.069 .0032	-.077 .0020	-.302 .0008	-.161 .0014
-20.0	-.770 .0019	-.068 .0013	-.154 .0007	-.091 .0009
-15.0	-.566 .0016	-.060 .0011	-.072 .0007	-.053 .0008
-10.0	-.355 .0017	-.062 .0008	-.021 .0003	-.027 .0008
-5.0	-.166 .0007	-.064 .0008	-.003 .0003	-.015 .0006
0.0	.020 .0009	-.060 .0007	.000 .0003	-.014 .0009
5.0	.206 .0015	-.055 .0008	-.002 .0005	-.020 .0006
10.0	.395 .0015	-.045 .0015	-.023 .0004	-.033 .0008
15.0	.576 .0016	-.037 .0009	-.077 .0005	-.057 .0008
20.0	.807 .0014	-.038 .0014	-.167 .0006	-.102 .0009
25.0	1.093 .0029	-.029 .0017	-.315 .0010	-.172 .0014
30.0	1.448 .0033	-.015 .0010	-.531 .0018	-.273 .0011

Table E8. DC-125 Five-Hole Probe Calibration Data
 Jet Velocity = 30.5 m/s
 Pitch Angle (Deg) = 5.0

Yaw Angle (Deg)	Cpyaw (+/-)	Cppitch (+/-)	Cptotal (+/-)	Cpstatic (+/-)
-30.0	-1.407 .0031	.142 .0011	-.533 .0021	-.258 .0011
-25.0	-1.035 .0026	.123 .0013	-.304 .0012	-.157 .0011
-20.0	-.760 .0039	.114 .0013	-.161 .0008	-.089 .0013
-15.0	-.550 .0016	.113 .0008	-.075 .0010	-.051 .0007
-10.0	-.342 .0019	.113 .0011	-.024 .0005	-.024 .0009
-5.0	-.156 .0020	.113 .0008	-.005 .0002	-.014 .0009
0.0	.028 .0008	.117 .0012	-.001 .0002	-.012 .0007
5.0	.206 .0011	.118 .0008	-.005 .0002	-.017 .0006
10.0	.387 .0008	.126 .0009	-.027 .0003	-.028 .0005
15.0	.560 .0008	.134 .0011	-.082 .0004	-.044 .0006
20.0	.750 .0191	.141 .0018	-.168 .0013	-.080 .0048
25.0	1.082 .0030	.161 .0014	-.320 .0014	-.160 .0011
30.0	1.450 .0033	.186 .0015	-.544 .0017	-.263 .0012

Table E9. DC-125 Five-Hole Probe Calibration Data
 Jet Velocity = 30.5 m/s
 Pitch Angle (Deg) = 10.0

Yaw Angle (Deg)	Cpyaw (+/-)	Cppitch (+/-)	Cptotal (+/-)	Cpstatic (+/-)
-30.0	-1.412 .0040	.369 .0032	-.590 .0020	-.271 .0018
-25.0	-1.023 .0027	.327 .0018	-.342 .0013	-.160 .0011
-20.0	-.749 .0024	.298 .0014	-.193 .0008	-.096 .0010
-15.0	-.496 .0018	.285 .0012	-.101 .0006	-.047 .0008
-10.0	-.322 .0009	.288 .0010	-.047 .0007	-.028 .0006
-5.0	-.142 .0008	.287 .0008	-.020 .0004	-.018 .0005
0.0	.028 .0010	.287 .0012	-.014 .0003	-.014 .0007
5.0	.196 .0009	.297 .0013	-.022 .0003	-.018 .0007
10.0	.376 .0011	.299 .0015	-.050 .0005	-.029 .0008
15.0	.548 .0013	.300 .0010	-.113 .0005	-.038 .0006
20.0	.801 .0024	.330 .0019	-.212 .0009	-.092 .0011
25.0	1.094 .0023	.356 .0025	-.369 .0011	-.159 .0013
30.0	1.481 .0033	.401 .0022	-.612 .0016	-.265 .0014

Table E10. DC-125 Five-Hole Probe Calibration Data
 Jet Velocity = 30.5 m/s
 Pitch Angle (Deg) = 15.0

Yaw Angle (Deg)	Cpyaw (+/-)	Cppitch (+/-)	Cptotal (+/-)	Cpstatic (+/-)
-30.0	-1.401 .0049	.588 .0034	-.671 .0031	-.289 .0019
-25.0	-1.021 .0037	.546 .0041	-.429 .0018	-.180 .0018
-20.0	-.727 .0028	.504 .0019	-.262 .0019	-.109 .0011
-15.0	-.508 .0016	.483 .0013	-.157 .0008	-.071 .0008
-10.0	-.291 .0008	.446 .0009	-.090 .0004	-.035 .0005
-5.0	-.124 .0010	.453 .0012	-.057 .0009	-.025 .0006
0.0	.031 .0013	.449 .0009	-.049 .0004	-.019 .0007
5.0	.194 .0009	.456 .0010	-.062 .0005	-.026 .0006
10.0	.352 .0014	.460 .0011	-.098 .0006	-.029 .0006
15.0	.578 .0012	.509 .0023	-.169 .0007	-.065 .0009
20.0	.738 .0019	.474 .0017	-.296 .0010	-.054 .0009
25.0	1.121 .0033	.582 .0040	-.464 .0015	-.169 .0017
30.0	1.551 .0044	.634 .0034	-.735 .0016	-.284 .0019

Table E11. DC-125 Five-Hole Probe Calibration Data
 Jet Velocity = 30.5 m/s
 Pitch Angle (Deg) = 20.0

Yaw Angle (Deg)	Cpyaw (+/-)	Cppitch (+/-)	Cptotal (+/-)	Cpstatic (+/-)
-30.0	-1.445 .0054	.874 .0041	-.865 .0043	-.332 .0020
-25.0	-1.003 .0031	.799 .0024	-.554 .0014	-.207 .0014
-20.0	-.708 .0020	.741 .0021	-.367 .0010	-.137 .0010
-15.0	-.493 .0022	.618 .0028	-.259 .0009	-.070 .0012
-10.0	-.304 .0093	.597 .0030	-.177 .0011	-.043 .0028
-5.0	-.130 .0008	.663 .0015	-.131 .0004	-.059 .0007
0.0	.039 .0008	.679 .0013	-.122 .0006	-.060 .0006
5.0	.196 .0015	.684 .0024	-.134 .0006	-.061 .0011
10.0	.366 .0023	.703 .0025	-.183 .0009	-.067 .0013
15.0	.559 .0011	.731 .0018	-.268 .0009	-.085 .0007
20.0	.738 .0023	.717 .0018	-.404 .0011	-.082 .0012
25.0	1.144 .0034	.859 .0046	-.609 .0020	-.197 .0018
30.0	1.614 .0066	.942 .0045	-.924 .0042	-.314 .0023

Table E12. DC-125 Five-Hole Probe Calibration Data
 Jet Velocity = 30.5 m/s
 Pitch Angle (Deg) = 25.0

Yaw Angle (Deg)	Cpyaw (+/-)	Cppitch (+/-)	Cptotal (+/-)	Cpstatic (+/-)
-30.0	-1.484 .0091	1.246 .0056	-1.133 .0053	-.405 .0031
-25.0	-1.014 .0053	1.124 .0046	-.768 .0048	-.265 .0020
-20.0	-.684 .0025	1.049 .0028	-.535 .0014	-.188 .0013
-15.0	-.417 .0022	.935 .0028	-.399 .0015	-.114 .0011
-10.0	-.272 .0012	.925 .0020	-.303 .0013	-.114 .0009
-5.0	-.102 .0014	.854 .0096	-.260 .0028	-.071 .0024
0.0	.029 .0012	.840 .0014	-.244 .0007	-.067 .0008
5.0	.160 .0015	.850 .0019	-.264 .0011	-.058 .0009
10.0	.351 .0021	.947 .0114	-.320 .0015	-.099 .0031
15.0	.491 .0026	.992 .0027	-.433 .0013	-.093 .0012
20.0	.807 .0028	1.119 .0044	-.580 .0024	-.160 .0015
25.0	1.188 .0043	1.224 .0036	-.841 .0030	-.256 .0016
30.0	1.703 .0062	1.365 .0059	-1.230 .0055	-.384 .0024

Table E13. DC-125 Five-Hole Probe Calibration Data
 Jet Velocity = 30.5 m/s
 Pitch Angle (Deg) = 30.0

Yaw Angle (Deg)	Cpyaw (+/-)	Cppitch (+/-)	Cptotal (+/-)	Cpstatic (+/-)
-30.0	-1.537 .0068	1.787 .0077	-1.532 .0054	-.529 .0033
-25.0	-1.016 .0053	1.575 .0057	-1.067 .0047	-.372 .0023
-20.0	-.694 .0028	1.439 .0025	-.787 .0012	-.282 .0014
-15.0	-.470 .0030	1.340 .0047	-.617 .0024	-.230 .0017
-10.0	-.242 .0040	1.222 .0050	-.513 .0018	-.159 .0023
-5.0	-.107 .0021	1.188 .0029	-.451 .0013	-.154 .0014
0.0	.036 .0015	1.182 .0031	-.429 .0010	-.152 .0013
5.0	.174 .0022	1.214 .0031	-.464 .0016	-.146 .0014
10.0	.297 .0013	1.266 .0028	-.536 .0017	-.143 .0011
15.0	.571 .0025	1.417 .0047	-.659 .0026	-.216 .0016
20.0	.809 .0037	1.546 .0051	-.850 .0038	-.267 .0019
25.0	1.218 .0050	1.751 .0074	-1.191 .0053	-.361 .0024
30.0	1.808 .0066	2.001 .0080	-1.718 .0052	-.510 .0032

APPENDIX F

Least Squares Bivariate Interpolation Scheme

A least squares bivariate interpolation scheme [15] was incorporated in the mean wake reduction software to automate the interpolation of the five-hole probe calibration bivariate grids. For example, the pitch angle is determined from the measured experimental values of C_{pyaw} and C_{ppitch} via the bivariate relationship. The scheme fits a second order polynomial with six coefficients to a local bivariate grid. A sample local grid is shown in Figure F1. It is composed of a central calibration grid point, the point closest to the experimental point to be interpolated, and its eight surrounding neighbors. Though only six grid points would be required to define the six coefficient polynomial, nine grid points were used (fitted in a least squares manner) to better define the bivariate relationship. The method of determining the second order polynomial is presented as follows:

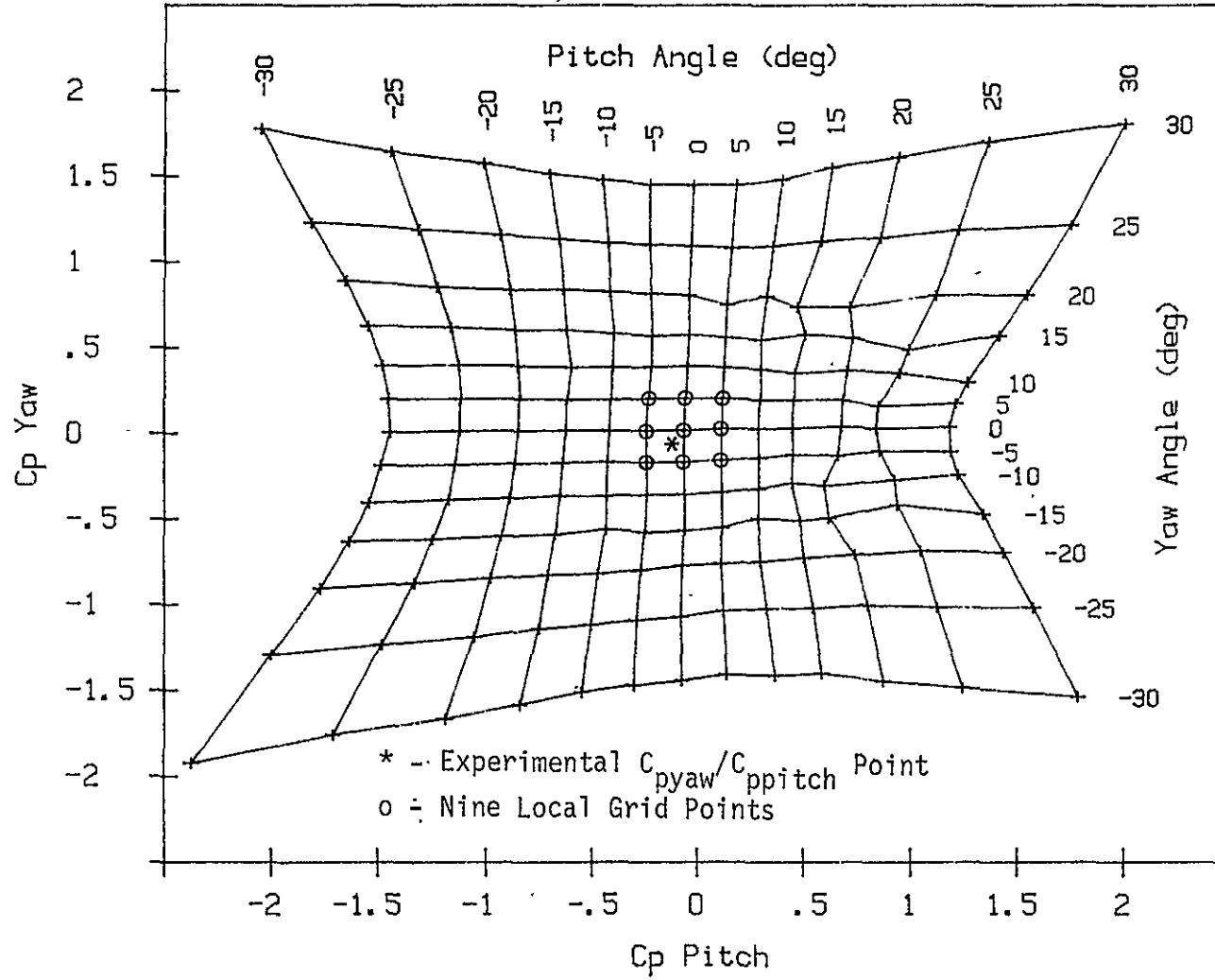

Figure F1. Least Square Bivariate Local Grid Definition

ORIGINAL PAGE IS
OF POOR QUALITY

Suppose a bivariate relationship is defined in a calibration grid as:

$$G = G(y,z) \quad (F1).$$

where G , the dependent variable is to be determined. For example, if G represented the pitch angle, y and z would correspond to the C_{pyaw} and C_{ppitch} values.

A locally fit second order polynomial of the following form is sought.

$$G = A_1 + A_2y + A_3z + A_4yz + A_5y^2 + A_6z^2 \quad (F2)$$

where the six coefficients, A_1 through A_6 , are to be determined by a least squares fit of the nine local grid points associated with the point to be interpolated.

The exact values of the dependent variable, G , at the known local nine grid points are designated by G_i , where the subscript, i , ranges from one to nine to represent the nine local grid points. Applying the interpolating polynomial, Equation F2, to the nine local grid points results in values of the dependent variable designated with a prime, G' .

$$G'_i = A_1 + A_2y_i + A_3z_i + A_4y_iz_i + A_5y_i^2 + A_6z_i^2 \quad (F3)$$

The sum of the squares of the differences between the exact values and the values obtained from the interpolating polynomials at each point is given by

$$\begin{aligned}
 SSQ &= \sum_{i=1}^9 \left[G_i - G_i' \right]^2 && (F4) \\
 &= \sum_{i=1}^9 \left[G_i - A_1 - A_2 y_i - A_3 z_i - A_4 y_i z_i - \right. \\
 & \qquad \qquad \qquad \left. A_5 y_i^2 - A_6 z_i^2 \right]^2
 \end{aligned}$$

Here the repeated indicies do not imply summation. The polynomial coefficients are varied in Equation F4 such that a minimum is obtained for SSQ. The necessary conditions for a minimum are

$$\begin{aligned}
 \frac{\partial(SSQ)}{\partial A_1} &= \frac{\partial(SSQ)}{\partial A_2} = \frac{\partial(SSQ)}{\partial A_3} = \frac{\partial(SSQ)}{\partial A_4} = \frac{\partial(SSQ)}{\partial A_5} = && (F5) \\
 &= \frac{\partial(SSQ)}{\partial A_6} = 0
 \end{aligned}$$

Written out, these six conditions take the form

$$9A_1 + \Sigma Y_i A_2 + \Sigma z_i A_3 + \Sigma Y_i z_i A_4 + \Sigma Y_i^2 A_5 + \quad (F6)$$

$$\Sigma z_i^2 A_6 = \Sigma G_i$$

$$\Sigma Y_i A_1 + \Sigma Y_i^2 A_2 + \Sigma Y_i z_i A_3 + \Sigma Y_i^2 z_i A_4 + \Sigma Y_i^3 A_5 + \quad (F7)$$

$$+ \Sigma Y_i z_i^2 A_6 = \Sigma G_i Y_i$$

$$\Sigma z_i A_1 + \Sigma Y_i z_i A_2 + \Sigma z_i^2 A_3 + \Sigma Y_i z_i^2 A_4 + \Sigma Y_i^2 z_i A_5 + \quad (F8)$$

$$+ \Sigma z_i^3 A_6 = \Sigma G_i z_i$$

$$\Sigma Y_i z_i A_1 + \Sigma Y_i^2 z_i A_2 + \Sigma Y_i z_i^2 A_3 + \Sigma Y_i^2 z_i^2 A_4 + \Sigma Y_i^3 z_i A_5 + \quad (F9)$$

$$+ \Sigma Y_i z_i^3 A_6 = \Sigma G_i Y_i z_i$$

$$\begin{aligned} \Sigma y_i^2 A_1 + \Sigma y_i^3 A_2 + \Sigma y_i^2 z_i A_3 + \Sigma y_i^3 z_i A_2 + \Sigma y_i^2 A_5 + & \quad (F10) \\ + \Sigma y_i^2 z_i^2 A_6 = \Sigma G_i Y_i^2 & \end{aligned}$$

$$\begin{aligned} \Sigma z_i^2 A_1 + \Sigma y_i z_i^2 A_2 + \Sigma z_i^3 A_3 + \Sigma y_i z_i^3 A_2 + \Sigma y_i^2 z_i^2 A_5 + & \quad (F11) \\ + \Sigma z_i^2 A_6 = \Sigma G_i z_i^2 & \end{aligned}$$

where the summations are performed for each of the nine local grid points. Equations F6 through F11 define a system of six simultaneous linear equations for determining the unknowns A1 through A6, which ultimately define the local interpolation polynomial, Equation F2.

In the reduction software, the nine local grid values were determined, the above 6 x 6 matrix was constructed and subsequently solved using a built-in computer matrix rom. The interpolation was accomplished using Equation F2 and the experimental values associated with y and z. In an analogous manner, each of the four bivariate relationships defined by the five-hole probe calibration (Figures 22 through 26) were interpolated from the calibration data,

which were read and stored in temporary computer memory from a cassette data cartridge at the start of the reduction program, as described in Chapter IV.

The accuracy of this interpolation method was checked by feeding calibration data through the interpolation routine, and comparing the exact calibration values with the interpolated values. In the smooth calibration data regions, for pitch angles less than 10° , the exact values showed negligible differences to the interpolated values. In the unsmooth part of the $C_{pstatic}$ calibration data, pitch angles greater than 10° , the agreement was within 5%. Pitch angles in the annular cascade were always less than 10° and hence, the interpolation errors were negligible.

APPENDIX G

Cascade Upstream Inlet Velocity Profile Data

Table G1 presents the cascade upstream inlet velocity profile data.

Table G1. Cascade Inlet Velocity Profile Data

% Hub to Tip	0° Incidence Angle U_i/U_{z0}	5° Incidence Angle U_i/U_{z0}	10° Incidence Angle U_i/U_{z0}
4.2	1.001	1.010	0.997
15.4	1.001	1.001	1.003
25.2	1.001	1.002	1.003
35.7	1.001	1.003	1.003
45.5	1.003	1.001	1.004
56.0	1.002	0.999	1.002
69.2	1.002	1.000	1.002
75.7	1.002	0.997	1.002
84.9	1.001	0.997	1.001
93.4	0.986	0.991	0.984
	U_{z0} (m/s) 28.69	U_{z0} (m/s) 30.52	U_{z0} (m/s) 29.65

APPENDIX H

Exit Flow Field Data - Tabular Presentation

The exit data obtained at all of the measurement stations is presented in tabular form in Appendix H, and graphically in Appendix I. Each circumferential data set, as described in Chapter V, is represented by two tables and two plots. The table designations are the same as the corresponding figure designations. Individual circumferential data sets are identified in their titles by:

- 1) The Incidence Angle Value
- 2) The Nondimensional Downstream Position (Z_c/C)
- 3) The Percent Hub-to-Tip Radial Position (R_c)

The Tables and the Appendix I figures are grouped by incidence angle value and traversing slot position, with increasing radial position in each group.

<u>Table & Figure #</u>	<u>Incidence Angle (DEG)</u>	<u>Z_c/C</u>
1 - 18	0	0.94
19 - 36	0	2.06
37 - 54	5	0.94
55 - 72	5	2.07
73 - 90	10	0.96
91 - 108	10	2.10

Table_H1. FIVE-HOLE PRESSURE PROBE WAKE VELOCITY DATA

INCIDENCE ANGLE (DEG) = 0.0 , Zc/C = .94 , R = 4.2 %

NORMALIZED TANGENTIAL POSITION 2T/S	NORMALIZED TOTAL VELOCITY						NORMALIZED VELOCITY COMPONENTS					
	U/Uzo (+/-)		Pitch Ang Des (+/-)		Yaw Ang Des (+/-)		Uz/Uzo (+/-)		Ut/Uzo (+/-)		Ur/Uzo (+/-)	
-1.000	.937	.0366	.6	.08	.2	.19	.937	.0366	-.004	.0032	.011	.0014
-.850	.946	.0367	.5	.08	.4	.21	.946	.0369	-.006	.0034	.008	.0014
-.700	.952	.0366	.5	.07	.1	.06	.952	.0366	-.001	.0011	.008	.0012
-.550	.977	.0376	.2	.06	.7	.09	.977	.0376	-.012	.0016	.003	.0011
-.400	.964	.0364	.2	.07	-.3	.08	.964	.0364	.006	.0014	.003	.0012
-.350	.963	.0368	.1	.07	-.8	.05	.963	.0368	.014	.0010	.002	.0012
-.300	.973	.0368	-.1	.08	-.5	.07	.973	.0368	.009	.0013	-.002	.0014
-.250	.952	.0366	-.1	.07	-1.3	.09	.952	.0366	.022	.0017	-.002	.0011
-.200	.977	.0366	.2	.11	-1.4	.10	.978	.0366	.025	.0020	.003	.0019
-.150	.949	.0365	.8	.07	-1.6	.08	.948	.0365	.026	.0017	.013	.0013
-.100	.899	.0370	1.2	.08	-1.6	.10	.899	.0370	.025	.0019	.019	.0015
-.050	.848	.0374	2.3	.10	-.8	.09	.847	.0374	.011	.0015	.034	.0021
0.000	.824	.0378	2.7	.11	.1	.10	.823	.0378	-.002	.0015	.039	.0024
.050	.811	.0380	2.8	.09	.7	.16	.809	.0380	-.009	.0024	.040	.0023
.100	.858	.0374	2.0	.11	1.2	.13	.858	.0373	-.018	.0021	.029	.0021
.150	.894	.0369	1.4	.13	2.0	.10	.893	.0368	-.032	.0020	.022	.0023
.200	.898	.0388	.7	.12	2.2	.14	.897	.0387	-.035	.0026	.011	.0019
.250	.932	.0368	.3	.10	2.0	.09	.932	.0368	-.033	.0020	.004	.0016
.300	.926	.0376	-.0	.09	1.9	.11	.926	.0376	-.030	.0021	-.000	.0014
.350	.928	.0366	.3	.10	1.6	.07	.928	.0365	-.026	.0015	.004	.0016
.400	.948	.0372	.4	.08	1.0	.11	.948	.0372	-.017	.0019	.006	.0013
.550	.934	.0371	.3	.06	1.2	.10	.934	.0371	-.020	.0018	.005	.0011
.700	.923	.0367	.4	.06	.8	.17	.923	.0367	-.012	.0028	.007	.0010
.850	.917	.0370	.2	.07	.4	.18	.917	.0370	-.006	.0030	.004	.0011
1.000	.941	.0366	.2	.10	.8	.15	.941	.0366	-.013	.0025	.003	.0016

Upstream Velocity Uzo = 28.6 m/s (+/- .74)
 Probe Yaw Offset Angle = 0.0 Deg

ORIGINAL PAGE IS
OF POOR QUALITY

Table H2. FIVE-HOLE PRESSURE PROBE WAKE PRESSURE DATA
INCIDENCE ANGLE (DEG) = 0.0 , $Z_0/C = .94$, $R = 4.2\%$

NORMALIZED TANGENTIAL POSITION ZT/S	EXIT ANGLE		TOTAL PRESURE PT2		STATIC PRESSURE P2		TOTAL PRESSURE RECOVERY	
	D_{eq} (+/-)		kPa (+/-)		kPa (+/-)		PT2/PT1 (+/-)	
-1.000	.7	.10	99.81	.017	99.40	.017	.9989	.00024
-.850	.6	.14	99.81	.018	99.39	.017	.9989	.00025
-.700	.5	.07	99.82	.017	99.40	.017	.9990	.00024
-.550	.7	.09	99.84	.019	99.39	.017	.9992	.00026
-.400	.4	.08	99.83	.017	99.40	.017	.9991	.00024
-.350	.8	.05	99.83	.018	99.40	.017	.9991	.00025
-.300	.6	.07	99.84	.018	99.39	.017	.9992	.00025
-.250	1.3	.09	99.82	.017	99.39	.017	.9990	.00024
-.200	1.5	.10	99.84	.017	99.39	.017	.9992	.00024
-.150	1.0	.08	99.81	.017	99.39	.017	.9989	.00024
-.100	2.0	.09	99.77	.017	99.39	.017	.9985	.00024
-.050	2.4	.10	99.73	.017	99.39	.017	.9981	.00024
0.000	2.7	.11	99.72	.017	99.40	.017	.9980	.00024
.050	2.9	.10	99.71	.017	99.40	.017	.9979	.00024
.100	2.3	.12	99.75	.017	99.40	.017	.9983	.00024
.150	2.5	.11	99.78	.017	99.40	.017	.9986	.00024
.200	2.4	.14	99.78	.020	99.40	.017	.9986	.00026
.250	2.1	.09	99.81	.017	99.40	.017	.9989	.00024
.300	1.9	.11	99.80	.019	99.40	.017	.9988	.00025
.350	1.6	.07	99.81	.017	99.40	.017	.9989	.00024
.400	1.1	.10	99.82	.018	99.40	.017	.9990	.00025
.550	1.3	.10	99.81	.018	99.40	.017	.9989	.00025
.700	.9	.15	99.80	.017	99.40	.017	.9988	.00024
.850	.5	.16	99.80	.018	99.40	.017	.9988	.00024
1.000	.8	.14	99.81	.017	99.40	.017	.9989	.00024

Upstream Total Pressure PT1 = 99.92 kPa (+/- .017)

Upstream Static Pressure p1 = 99.45 kPa (+/- .017)

Table H3. FIVE HOLE PRESSURE PROBE WAKE VELOCITY DATA
 INCIDENCE ANGLE (DEG) = 0.0 , Zc/C = .74 , R = 0.3 %

NORMALIZED TANGENTIAL POSITION ZT/S	NORMALIZED TOTAL VELOCITY					NORMALIZED VELOCITY COMPONENTS						
	U/Uzo (+/-)		Pitch Ans Deg (+/-)		Yaw Ans Deg (+/-)		Uz/Uzo (+/-)		Ut/Uzo (+/-)		Ur/Uzo (+/-)	
-1.000	1.036	.0364	.5	.07	.3	.16	1.036	.0364	-.005	.0028	.009	.0012
-.850	1.034	.0367	.6	.07	.1	.18	1.034	.0367	-.002	.0033	.011	.0013
-.700	1.030	.0365	.5	.06	.1	.08	1.030	.0365	-.003	.0014	.008	.0011
-.550	1.040	.0364	.3	.07	-.6	.13	1.040	.0364	.011	.0023	.006	.0014
-.400	1.036	.0365	.3	.08	-.3	.07	1.036	.0365	.006	.0014	.005	.0014
-.350	1.032	.0364	-.2	.09	-.5	.08	1.032	.0364	.008	.0015	-.003	.0017
-.300	1.024	.0364	-.2	.08	-.0	.07	1.023	.0364	.014	.0013	-.003	.0014
-.250	1.003	.0364	.1	.08	-.2	.06	1.003	.0364	.003	.0010	.002	.0013
-.200	.944	.0371	.6	.07	-.5	.09	.944	.0371	.008	.0015	.010	.0013
-.150	.952	.0372	1.7	.08	-.9	.10	.952	.0372	.015	.0017	.032	.0019
-.100	.897	.0368	2.5	.07	-.3	.17	.898	.0368	.005	.0026	.039	.0021
-.050	.864	.0371	3.5	.13	.1	.14	.863	.0371	-.001	.0021	.052	.0030
0.000	.858	.0372	3.6	.10	.7	.14	.856	.0371	-.010	.0021	.054	.0028
.050	.893	.0369	3.0	.12	.5	.11	.892	.0368	-.008	.0018	.046	.0026
.100	.910	.0369	2.2	.08	1.0	.11	.910	.0368	-.016	.0018	.035	.0019
.150	.917	.0368	1.0	.16	1.1	.23	.917	.0368	-.017	.0037	.016	.0026
.200	.971	.0367	.3	.12	1.1	.06	.970	.0369	-.019	.0012	.006	.0020
.250	.998	.0365	.2	.08	1.1	.11	.998	.0365	-.017	.0020	.004	.0014
.300	.997	.0365	-.1	.08	1.2	.12	.997	.0365	-.022	.0022	-.001	.0014
.350	1.020	.0364	-.5	.06	1.0	.20	1.020	.0364	-.017	.0037	-.008	.0011
.400	1.008	.0365	.0	.08	.9	.07	1.008	.0365	.017	.0013	.001	.0015
.550	1.006	.0367	.3	.07	.8	.13	1.006	.0367	-.014	.0023	.005	.0012
.700	1.033	.0366	.7	.08	1.1	.31	1.033	.0366	-.020	.0055	.012	.0015
.850	1.020	.0364	.4	.07	1.7	.15	1.020	.0364	-.031	.0028	.007	.0012
1.000	1.021	.0365	.5	.06	.2	.23	1.021	.0365	-.004	.0041	.009	.0012

Upstream Velocity Uzo = 28.6 m/s (+/- .73)
 Probe Yaw Offset Angle = 0.0 Deg

ORIGINAL PAGE IS
OF POOR QUALITY.

Table H4. FIVE-HOLE PRESSURE PROBE WAKE PRESSURE DATA
INCIDENCE ANGLE (DEG) = 0.0 , $Z_c/C = .94$, $R = 8.3\%$

NORMALIZED TANGENTIAL POSITION ZT/S	EXIT ANGLE		TOTAL PRESURE PT2		STATIC PRESSURE P2		TOTAL PRESSURE RECOVERY	
	Deg (+/-)		kPa (+/-)		kPa (+/-)		PT2/PT1 (+/-)	
-1.000	.6	.10	99.90	.017	99.40	.017	.9998	.00024
-.850	.6	.07	99.89	.017	99.39	.017	.9998	.00024
-.700	.5	.06	99.89	.017	99.40	.017	.9997	.00024
-.550	.7	.12	99.90	.017	99.40	.017	.9999	.00024
-.400	.4	.07	99.90	.017	99.39	.017	.9998	.00024
-.350	.5	.08	99.89	.017	99.39	.017	.9997	.00024
-.300	.8	.07	99.88	.017	99.39	.017	.9996	.00024
-.250	.2	.06	99.86	.017	99.39	.017	.9995	.00024
-.200	.8	.08	99.81	.018	99.40	.017	.9989	.00025
-.150	2.1	.09	99.82	.018	99.39	.017	.9990	.00025
-.100	2.5	.09	99.78	.017	99.40	.017	.9986	.00024
-.050	3.5	.13	99.75	.017	99.40	.017	.9983	.00024
0.000	3.7	.10	99.74	.017	99.40	.017	.9983	.00024
.050	3.0	.12	99.77	.017	99.40	.017	.9985	.00024
.100	2.5	.09	99.79	.017	99.40	.017	.9987	.00024
.150	1.5	.20	99.79	.017	99.40	.017	.9987	.00024
.200	1.2	.06	99.84	.018	99.40	.017	.9992	.00025
.250	1.1	.11	99.87	.017	99.40	.017	.9995	.00024
.300	1.2	.12	99.86	.017	99.40	.017	.9995	.00024
.350	1.1	.19	99.89	.017	99.40	.017	.9997	.00024
.400	.9	.07	99.88	.017	99.40	.017	.9996	.00024
.550	.8	.12	99.88	.018	99.40	.017	.9996	.00024
.700	1.3	.27	99.90	.017	99.40	.017	.9998	.00024
.850	1.8	.14	99.89	.017	99.40	.017	.9997	.00024
1.000	.5	.12	99.89	.017	99.40	.017	.9997	.00024

Upstream Total Pressure PT1 = 99.92 kPa (+/- .017)
Upstream Static Pressure P1 = 99.45 kPa (+/- .017)

Table H5. FIVE-HOLE PRESSURE PROBE WAKE VELOCITY DATA
 INCIDENCE ANGLE (DEG) = 0.0 , $Z_0/C = .94$, $R = 12.5\%$

NORMALIZED TANGENTIAL POSITION 2T/S	NORMALIZED TOTAL VELOCITY						NORMALIZED VELOCITY COMPONENTS					
	U/U ₀ (+/-)		Pitch Ang Deg (+/-)		Yaw Ang Deg (+/-)		U _z /U ₀ (+/-)		U _t /U ₀ (+/-)		U _r /U ₀ (+/-)	
-1.000	1.053	.0382	.7	.07	.2	.16	1.053	.0382	-.004	.0030	.013	.0013
-.850	1.050	.0302	.6	.07	.7	.15	1.050	.0382	-.012	.0028	.011	.0014
-.700	1.054	.0382	.8	.09	.3	.11	1.054	.0382	-.005	.0021	.015	.0018
-.550	1.056	.0382	.3	.07	.2	.08	1.056	.0382	-.004	.0015	.006	.0013
-.400	1.051	.0382	.2	.12	.1	.08	1.051	.0382	-.002	.0015	.003	.0022
-.350	1.047	.0382	-.2	.09	.4	.09	1.047	.0382	-.008	.0016	-.004	.0017
-.300	1.024	.0384	-.2	.13	.3	.13	1.024	.0384	-.006	.0023	-.004	.0023
-.250	1.010	.0389	-.1	.16	-.2	.11	1.010	.0389	.003	.0020	-.002	.0028
-.200	1.003	.0383	1.1	.07	-.0	.06	1.002	.0383	.001	.0011	.019	.0015
-.150	.932	.0385	2.2	.10	.1	.13	.931	.0385	-.001	.0020	.036	.0022
-.100	.927	.0389	2.7	.11	-.1	.11	.926	.0388	.002	.0017	.044	.0026
-.050	.881	.0387	2.9	.12	.3	.12	.880	.0387	-.004	.0018	.044	.0026
0.000	.868	.0390	2.7	.13	.1	.15	.867	.0390	-.002	.0022	.040	.0027
.050	.889	.0387	3.1	.08	.3	.09	.887	.0387	-.004	.0014	.048	.0025
.100	.920	.0388	2.8	.13	.6	.10	.919	.0388	-.009	.0016	.045	.0028
.150	.951	.0384	1.6	.12	1.0	.10	.951	.0383	-.016	.0018	.027	.0023
.200	.993	.0383	1.3	.19	.3	.12	.992	.0383	-.005	.0021	.023	.0035
.250	1.009	.0385	.2	.07	.8	.11	1.009	.0385	-.014	.0020	.003	.0012
.300	1.030	.0382	.3	.14	.3	.07	1.030	.0382	-.005	.0013	.006	.0025
.350	1.042	.0382	-.2	.10	.8	.11	1.042	.0382	-.015	.0022	-.004	.0019
.400	1.052	.0382	.3	.08	.7	.14	1.052	.0382	-.012	.0026	.005	.0016
.550	1.054	.0382	.7	.13	.1	.14	1.054	.0382	-.002	.0025	.016	.0024
.700	1.057	.0382	.5	.09	.2	.15	1.056	.0382	-.004	.0028	.008	.0017
.850	1.055	.0382	.7	.08	.3	.15	1.054	.0382	-.005	.0028	.013	.0016
1.000	1.024	.0384	.3	.04	.4	.16	1.024	.0384	-.008	.0029	.005	.0008

Upstream Velocity U₀ = 27.9 m/s (+/- .75)
 Probe Yaw Offset Angle = 0.0 Deg

ORIGINAL PAGE IS
OF POOR QUALITY

Table H6. FIVE-HOLE PRESSURE PROBE WAKE PRESSURE DATA
INCIDENCE ANGLE (DEG) = 0.0 , $Z_c/C = .94$, $R = 12.5\%$

NORMALIZED TANGENTIAL POSITION 2T/S	EXIT ANGLE		TOTAL PRESURE PT2		STATIC PRESURE P2		TOTAL PRESSURE RECOVERY	
	Deg (+/-)		kPa (+/-)		kPa (+/-)		PT2/PT1 (+/-)	
-1.000	.7	.08	100.66	.017	100.17	.017	1.0000	.00024
-.950	.9	.12	100.66	.017	100.17	.017	1.0000	.00024
-.700	.9	.10	100.66	.017	100.17	.017	1.0000	.00024
-.550	.4	.07	100.66	.017	100.16	.017	1.0000	.00024
-.400	.2	.11	100.66	.017	100.16	.017	.9999	.00024
-.350	.5	.09	100.65	.017	100.16	.017	.9999	.00024
-.300	.4	.13	100.64	.018	100.17	.017	.9997	.00024
-.250	.2	.13	100.62	.018	100.17	.017	.9996	.00025
-.200	1.1	.07	100.61	.017	100.16	.017	.9995	.00024
-.150	2.2	.10	100.55	.017	100.16	.017	.9989	.00024
-.100	2.7	.11	100.55	.018	100.16	.017	.9988	.00024
-.050	2.9	.12	100.51	.017	100.17	.017	.9985	.00024
0.000	2.7	.14	100.50	.017	100.17	.017	.9984	.00024
.050	3.1	.08	100.52	.017	100.16	.017	.9985	.00024
.100	2.9	.13	100.54	.018	100.17	.017	.9988	.00024
.150	1.9	.11	100.56	.017	100.16	.017	.9990	.00024
.200	1.4	.19	100.60	.017	100.16	.017	.9994	.00024
.250	.8	.11	100.62	.018	100.16	.017	.9995	.00024
.300	.5	.12	100.64	.017	100.16	.017	.9997	.00024
.350	.9	.11	100.65	.017	100.17	.017	.9999	.00024
.400	.7	.13	100.66	.017	100.17	.017	1.0000	.00024
.550	.9	.13	100.66	.017	100.16	.017	1.0000	.00024
.700	.5	.10	100.66	.017	100.16	.017	1.0000	.00024
.850	.8	.09	100.66	.017	100.17	.017	1.0000	.00024
1.000	.5	.14	100.63	.017	100.16	.017	.9996	.00024

Upstream Total Pressure PT1 = 100.66 kPa (+/- .017)
Upstream Static Pressure P1 = 100.22 kPa (+/- .017)

Table H7. FIVE-HOLE PRESSURE PROBE WAKE VELOCITY DATA

INCIDENCE ANGLE (DEG) = 0.0 , $Z_c/C = .94$, $R = 16.7\%$

NORMALIZED TANGENTIAL POSITION 2T/S	NORMALIZED TOTAL VELOCITY					NORMALIZED VELOCITY COMPONENTS						
	U/U _∞ (+/-)		Pitch Ans Des (+/-)		Yaw Ans Des (+/-)		U _z /U _∞ (+/-)		U _t /U _∞ (+/-)		U _r /U _∞ (+/-)	
-1.000	1.056	.0366	.5	.08	.4	.23	1.056	.0366	-.009	.0043	.009	.0014
-.850	1.055	.0366	.6	.05	-.1	.09	1.055	.0366	.003	.0016	.011	.0010
-.700	1.057	.0366	.3	.08	-.2	.13	1.057	.0366	.003	.0024	.006	.0015
-.550	1.057	.0366	.4	.11	.1	.18	1.057	.0366	-.001	.0034	.007	.0020
-.400	1.058	.0366	.4	.15	.1	.07	1.058	.0366	-.001	.0013	.007	.0028
-.350	1.057	.0366	.5	.14	.3	.11	1.057	.0366	-.006	.0020	.009	.0026
-.300	1.060	.0366	.6	.22	.2	.10	1.060	.0366	-.003	.0019	.012	.0041
-.250	1.040	.0366	.2	.08	.1	.10	1.040	.0366	-.002	.0018	.003	.0014
-.200	1.032	.0366	-.1	.09	.5	.08	1.032	.0366	-.009	.0015	-.002	.0016
-.150	1.005	.0367	.9	.12	-.2	.17	1.005	.0367	.003	.0030	.016	.0021
-.100	.764	.0367	1.2	.11	.3	.11	.764	.0367	-.005	.0018	.021	.0020
-.050	.731	.0372	2.3	.07	-.2	.08	.730	.0371	.002	.0013	.037	.0018
0.000	.874	.0374	2.5	.14	.0	.15	.873	.0373	-.000	.0023	.037	.0026
.050	.855	.0374	2.6	.10	.4	.13	.854	.0373	-.007	.0019	.039	.0023
.100	.861	.0373	2.1	.15	.7	.14	.860	.0373	-.011	.0021	.032	.0026
.150	.888	.0370	2.8	.20	.5	.08	.887	.0370	-.008	.0013	.043	.0035
.200	.761	.0368	2.1	.14	.5	.12	.760	.0368	-.008	.0020	.035	.0027
.250	.793	.0367	1.3	.08	.2	.07	.792	.0366	-.003	.0012	.022	.0016
.300	1.013	.0368	.3	.08	.5	.10	1.013	.0368	-.008	.0017	.005	.0015
.350	1.023	.0368	.8	.11	.3	.12	1.023	.0368	-.005	.0021	.015	.0020
.400	1.035	.0365	-.4	.16	.3	.06	1.035	.0365	-.006	.0012	-.007	.0030
.550	1.044	.0366	.9	.12	.2	.23	1.044	.0366	-.004	.0043	.015	.0023
.700	1.051	.0365	.5	.11	.4	.11	1.051	.0365	-.007	.0020	.010	.0021
.850	1.047	.0365	.5	.11	-.5	.15	1.047	.0365	.009	.0028	.009	.0020
1.000	1.050	.0365	.5	.05	.7	.12	1.050	.0365	-.013	.0022	.010	.0009

Upstream Velocity U_∞ = 28.5 m/s (+/- .73)
 Probe Yaw Offset Angle = 0.0 Des

ORIGINAL PAGE IS
 OF POOR QUALITY

ORIGINAL PAGE IS
OF POOR QUALITY

Table H8. FIVE-HOLE PRESSURE PROBE WAKE PRESSURE DATA
INCIDENCE ANGLE (DEG) = 0.0 , Zc/C = .74 , R = 16.7 X

NORMALIZED TANGENTIAL POSITION ZT/S	EXIT ANGLE		TOTAL PRESSURE PT2		STATIC PRESSURE P2		TOTAL PRESSURE RECOVERY	
	Deg (+/-)		KPa (+/-)		KPa (+/-)		PT2/PT1 (+/-)	
-1.000	.6	.16	99.95	.017	99.43	.017	1.0000	.00024
-.850	.6	.05	99.95	.017	99.43	.017	1.0000	.00024
-.700	.4	.09	99.95	.017	99.43	.017	1.0000	.00024
-.550	.4	.11	99.95	.017	99.43	.017	1.0000	.00024
-.400	.4	.15	99.95	.017	99.43	.017	1.0000	.00024
-.350	.6	.13	99.95	.017	99.43	.017	1.0000	.00024
-.300	.6	.22	99.95	.017	99.42	.017	1.0000	.00024
-.250	.2	.08	99.93	.017	99.43	.017	.9998	.00024
-.200	.5	.08	99.93	.017	99.43	.017	.9997	.00024
-.150	.9	.12	99.90	.017	99.43	.017	.9995	.00024
-.100	1.3	.11	99.87	.017	99.44	.017	.9992	.00024
-.050	2.3	.07	99.84	.018	99.44	.017	.9989	.00025
0.000	2.5	.14	99.80	.017	99.44	.017	.9985	.00024
.050	2.7	.10	99.79	.017	99.44	.017	.9983	.00024
.100	2.3	.15	99.79	.017	99.44	.017	.9983	.00024
.150	2.8	.19	99.81	.017	99.44	.017	.9985	.00024
.200	2.1	.14	99.87	.018	99.44	.017	.9992	.00024
.250	1.3	.08	99.89	.017	99.44	.017	.9993	.00024
.300	.5	.09	99.92	.018	99.44	.017	.9996	.00025
.350	.9	.11	99.93	.018	99.44	.017	.9998	.00024
.400	.5	.13	99.94	.017	99.44	.017	.9999	.00024
.550	.9	.13	99.95	.017	99.44	.017	1.0000	.00024
.700	.7	.11	99.95	.017	99.44	.017	1.0000	.00024
.850	.7	.13	99.95	.017	99.44	.017	1.0000	.00024
1.000	.9	.10	99.95	.017	99.44	.017	1.0000	.00024

Upstream Total Pressure PT1 = 99.95 KPa (+/- .017)

Upstream Static Pressure P1 = 99.49 KPa (+/- .017)

Table H9. FIVE HOLE PRESSURE PROBE WAKE VELOCITY DATA
 INCIDENCE ANGLE (DEG) = 0.0 , Zc/C = .94 , R = 25.0 %

NORMALIZED TANGENTIAL POSITION ZT/S	NORMALIZED TOTAL VELOCITY				NORMALIZED VELOCITY COMPONENTS							
	U/Uzo (+/-)		Pitch Ang Deg (+/-)		Yaw Ang Deg (+/-)		Uz/Uzo (+/-)		Ut/Uzo (+/-)		Ur/Uzo (+/-)	
-1.000	1.055	.0368	.5	.07	.5	.13	1.055	.0368	-.008	.0023	.009	.0013
-.850	1.055	.0368	.1	.07	.3	.08	1.055	.0368	-.006	.0015	.003	.0013
-.700	1.056	.0368	.7	.07	.1	.16	1.056	.0368	-.002	.0029	.014	.0014
-.550	1.053	.0368	.3	.10	.1	.10	1.053	.0368	-.002	.0019	.006	.0019
-.400	1.054	.0368	1.2	.11	.3	.10	1.054	.0368	-.005	.0018	.021	.0021
-.350	1.052	.0368	.5	.19	-.2	.10	1.052	.0368	.003	.0018	.009	.0034
-.300	1.047	.0368	.5	.09	.2	.08	1.047	.0368	-.003	.0015	.009	.0016
-.250	1.046	.0368	1.3	.17	.1	.13	1.046	.0368	-.001	.0024	.024	.0033
-.200	1.031	.0368	.3	.16	.4	.07	1.031	.0368	-.008	.0013	.005	.0030
-.150	1.003	.0374	1.2	.11	-.0	.07	1.003	.0374	.001	.0012	.021	.0021
-.100	.986	.0371	.7	.08	.0	.08	.986	.0371	-.001	.0013	.012	.0014
-.050	.920	.0371	1.2	.12	-.1	.09	.920	.0371	.002	.0014	.019	.0020
0.000	.875	.0374	1.6	.12	-.1	.12	.875	.0374	.001	.0018	.024	.0021
.050	.881	.0377	1.4	.16	.4	.07	.880	.0377	-.006	.0010	.022	.0027
.100	.906	.0371	1.6	.10	.5	.07	.905	.0371	-.008	.0012	.026	.0019
.150	.959	.0374	.8	.21	.6	.08	.959	.0374	-.009	.0014	.013	.0036
.200	1.012	.0368	.8	.11	.2	.07	1.012	.0368	-.004	.0012	.014	.0021
.250	1.025	.0369	.6	.11	.2	.08	1.025	.0369	-.003	.0014	.011	.0020
.300	1.041	.0368	.7	.14	-.0	.06	1.041	.0368	.001	.0012	.012	.0025
.350	1.042	.0368	-.8	.42	.2	.09	1.042	.0368	-.004	.0017	-.014	.0077
.400	1.058	.0369	1.0	.32	-.1	.10	1.058	.0369	.002	.0019	.019	.0060
.550	1.054	.0368	.3	.08	-.1	.09	1.054	.0368	.002	.0017	.006	.0015
.700	1.056	.0368	.4	.09	-.4	.15	1.056	.0368	.008	.0028	.007	.0017
.850	1.055	.0368	.8	.08	.0	.28	1.055	.0368	-.000	.0052	.015	.0016
1.000	1.054	.0368	.6	.06	.1	.10	1.054	.0368	-.002	.0018	.012	.0011

Upstream Velocity Uzo = 28.4 m/s (+/- .74)
 Probe Yaw Offset Angle = 0.0 Deg

- 208 -

 ORIGINAL PAGE IS
 OF POOR QUALITY

ORIGINAL PAGE IS
OF POOR QUALITY

Table H10. FIVE-HOLE PRESSURE PROBE WAKE PRESSURE DATA
INCIDENCE ANGLE (DEG) = 0.0 , $Z_c/C = .94$, $R = 25.0 \%$

NORMALIZED TANGENTIAL POSITION ZT/S	EXIT ANGLE		TOTAL PRESURE PT2		STATIC PRESSURE P2		TOTAL PRESSURE RECOVERY	
	Deg (+/-)		kPa (+/-)		kPa (+/-)		PT2/PT1 (+/-)	
-1.000	.7	.10	99.99	.017	99.47	.017	1.0000	.00024
-.850	.3	.08	99.99	.017	99.47	.017	1.0000	.00024
-.700	.8	.08	99.99	.017	99.47	.017	1.0000	.00024
-.550	.4	.10	99.99	.017	99.47	.017	1.0000	.00024
-.400	1.2	.11	99.99	.017	99.47	.017	1.0000	.00024
-.350	.5	.18	99.99	.017	99.47	.017	1.0000	.00024
-.300	.5	.09	99.98	.017	99.47	.017	.9999	.00024
-.250	1.3	.17	99.98	.017	99.47	.017	.9999	.00024
-.200	.5	.11	99.96	.017	99.47	.017	.9998	.00024
-.150	1.2	.11	99.93	.018	99.47	.017	.9995	.00025
-.100	.7	.08	99.92	.018	99.47	.017	.9993	.00024
-.050	1.2	.12	99.86	.017	99.47	.017	.9987	.00024
0.000	1.6	.12	99.82	.017	99.47	.017	.9984	.00024
.050	1.5	.16	99.83	.018	99.47	.017	.9984	.00024
.100	1.7	.10	99.85	.017	99.47	.017	.9986	.00024
.150	1.0	.18	99.90	.018	99.47	.017	.9991	.00025
.200	.8	.11	99.94	.017	99.47	.017	.9996	.00024
.250	.6	.11	99.95	.017	99.47	.017	.9997	.00024
.300	.7	.14	99.97	.017	99.47	.017	.9999	.00024
.350	.8	.41	99.98	.017	99.48	.017	.9999	.00024
.400	1.0	.32	99.98	.017	99.47	.017	1.0000	.00024
.550	.4	.08	99.98	.017	99.47	.017	1.0000	.00024
.700	.6	.13	99.99	.017	99.47	.017	1.0000	.00024
.850	.8	.08	99.99	.017	99.47	.017	1.0000	.00024
1.000	.7	.06	99.99	.017	99.47	.017	1.0000	.00024

Upstream Total Pressure PT1 = 99.99 kPa (+/- .017)

Upstream Static Pressure P1 = 99.52 kPa (+/- .017)

Table H11. FIVE-HOLE PRESSURE PROBE WAKE VELOCITY DATA
 INCIDENCE ANGLE (DEG) = 0.0 , $Z_c/C = .74$, $R = 33.3\%$

NORMALIZED TANGENTIAL POSITION ZT/S	NORMALIZED TOTAL VELOCITY						NORMALIZED VELOCITY COMPONENTS					
	U/U _∞ (+/-)		Pitch Ang Deg (+/-)		Yaw Ang Deg (+/-)		U _z /U _∞ (+/-)		U _t /U _∞ (+/-)		U _r /U _∞ (+/-)	
-1.000	1.053	.0368	.7	.10	.0	.12	1.053	.0368	-.000	.0021	.014	.0019
-.950	1.051	.0368	.6	.08	.2	.24	1.051	.0368	-.003	.0045	.012	.0015
-.700	1.053	.0368	.6	.08	.5	.13	1.053	.0368	-.010	.0024	.012	.0015
-.550	1.053	.0368	.6	.13	.4	.09	1.052	.0368	-.008	.0017	.011	.0024
-.400	1.048	.0368	1.7	.17	.0	.06	1.047	.0368	-.000	.0010	.030	.0033
-.350	1.050	.0369	.1	.44	.4	.06	1.050	.0369	-.007	.0011	.001	.0081
-.300	1.043	.0368	.3	.10	.3	.08	1.043	.0368	-.006	.0015	.005	.0019
-.250	1.035	.0368	1.4	.15	.4	.08	1.035	.0368	-.007	.0016	.025	.0029
-.200	1.009	.0370	1.8	.18	.0	.08	1.009	.0370	-.001	.0014	.032	.0034
-.150	.980	.0369	.7	.19	.2	.12	.980	.0369	-.003	.0020	.012	.0033
-.100	.930	.0373	.6	.16	-.2	.12	.930	.0373	.003	.0020	.009	.0026
-.050	.897	.0374	.8	.18	-.0	.08	.897	.0374	.001	.0013	.013	.0028
0.000	.881	.0373	.7	.07	.5	.06	.881	.0373	-.008	.0010	.010	.0012
.050	.906	.0372	-.6	.12	1.1	.07	.906	.0372	-.017	.0013	-.010	.0019
.100	.960	.0374	.3	.13	.7	.09	.960	.0374	-.012	.0015	.004	.0021
.150	1.007	.0369	1.6	.16	.8	.07	1.007	.0368	-.014	.0013	.028	.0031
.200	1.019	.0368	.6	.18	.6	.06	1.019	.0368	-.010	.0012	.011	.0033
.250	1.043	.0368	1.5	.20	.4	.06	1.043	.0368	-.007	.0012	.028	.0038
.300	1.057	.0369	-.5	.33	.3	.10	1.056	.0369	-.006	.0018	-.009	.0060
.350	1.052	.0369	.7	.24	-.1	.12	1.052	.0368	.001	.0022	.014	.0045
.400	1.055	.0368	-.1	.13	.0	.05	1.055	.0368	-.001	.0009	-.002	.0023
.550	1.054	.0368	.3	.17	-.1	.10	1.054	.0368	.001	.0019	.006	.0031
.700	1.055	.0368	.1	.06	.1	.07	1.055	.0368	-.002	.0012	.002	.0011
.850	1.057	.0368	.3	.09	.3	.10	1.057	.0368	-.005	.0018	.005	.0016
1.000	1.066	.0369	.8	.11	-.5	.24	1.065	.0369	.007	.0045	.014	.0021

Upstream Velocity U_∞ = 28.4 m/s (+/- .74)
 Probe Yaw Offset Angle = 0.0 Deg

ORIGINAL PAGE IS
OF POOR QUALITY

Table H12. FIVE-HOLE PRESSURE PROBE WAKE PRESSURE DATA
INCIDENCE ANGLE (DEG) = 0.0 , $Z_c/C = .94$, $R = 33.3\%$

NORMALIZED TANGENTIAL POSITION ZT/S	EXIT ANGLE		TOTAL PRESURE PT2		STATIC PRESSURE P2		TOTAL PRESSURE RECOVERY	
	Deg (+/-)		kPa (+/-)		kPa (+/-)		PT2/PT1 (+/-)	
-1.000	.7	.10	99.99	.017	99.47	.017	1.0000	.00024
-.850	.7	.10	99.99	.017	99.48	.017	1.0000	.00024
-.700	.8	.10	99.99	.017	99.47	.017	1.0000	.00024
-.550	.7	.12	99.99	.017	99.47	.017	1.0000	.00024
-.400	1.7	.17	99.99	.017	99.48	.017	1.0000	.00024
-.350	.4	.10	99.99	.017	99.48	.017	1.0000	.00024
-.300	.4	.09	99.98	.017	99.48	.017	.9999	.00024
-.250	1.4	.15	99.97	.017	99.47	.017	.9998	.00024
-.200	1.8	.18	99.94	.017	99.47	.017	.9996	.00024
-.150	.7	.19	99.92	.017	99.47	.017	.9993	.00024
-.100	.6	.15	99.87	.018	99.47	.017	.9988	.00024
-.050	.8	.18	99.84	.017	99.47	.017	.9986	.00024
0.000	.8	.07	99.83	.017	99.47	.017	.9984	.00024
.050	1.3	.09	99.85	.017	99.47	.017	.9986	.00024
.100	.8	.09	99.90	.018	99.47	.017	.9991	.00025
.150	1.8	.15	99.94	.017	99.48	.017	.9996	.00024
.200	.8	.14	99.95	.017	99.47	.017	.9997	.00024
.250	1.6	.20	99.98	.017	99.47	.017	.9999	.00024
.300	.6	.27	99.98	.017	99.47	.017	1.0000	.00024
.350	.7	.24	99.98	.017	99.47	.017	1.0000	.00024
.400	.1	.11	99.99	.017	99.47	.017	1.0000	.00024
.550	.3	.17	99.98	.017	99.47	.017	1.0000	.00024
.700	.1	.06	99.99	.017	99.47	.017	1.0000	.00024
.850	.4	.09	99.98	.017	99.47	.017	1.0000	.00024
1.000	.7	.16	99.99	.017	99.46	.017	1.0000	.00024

Upstream Total Pressure PT1 = 99.99 kPa (+/- .017)
Upstream Static Pressure P1 = 99.52 kPa (+/- .017)

Table H13. FIVE-HOLE PRESSURE PROBE WAKE VELOCITY DATA
 INCIDENCE ANGLE (DEG) = 0.0 , $Z_c/C = .94$, $R = 50.0\%$

NORMALIZED TANGENTIAL POSITION ZT/S	NORMALIZED TOTAL VELOCITY					NORMALIZED VELOCITY COMPONENTS						
	U/U _∞ (+/-)		Pitch Ang Deg (+/-)		Yaw Ang Deg (+/-)		U _z /U _∞ (+/-)		U _t /U _∞ (+/-)		U _r /U _∞ (+/-)	
-1.000	1.055	.0373	.6	.07	.1	.06	1.055	.0373	-.001	.0010	.010	.0013
-.850	1.049	.0373	.2	.11	.4	.11	1.049	.0373	-.008	.0021	.004	.0020
-.700	1.054	.0373	.7	.30	.4	.13	1.054	.0373	-.008	.0024	.013	.0056
-.550	1.054	.0373	.6	.14	-.0	.08	1.054	.0373	.001	.0014	.011	.0026
-.400	1.048	.0373	1.1	.14	-.1	.06	1.048	.0373	.002	.0011	.020	.0027
-.350	1.051	.0373	1.3	.34	.3	.09	1.051	.0373	-.005	.0016	.024	.0062
-.300	1.050	.0373	1.3	.15	.2	.09	1.050	.0373	-.004	.0017	.024	.0029
-.250	1.047	.0373	1.5	.28	.1	.08	1.047	.0373	-.001	.0015	.028	.0053
-.200	1.033	.0373	1.7	.11	-.0	.11	1.033	.0372	.000	.0019	.031	.0023
-.150	.990	.0373	.5	.20	-.2	.08	.990	.0373	.004	.0014	.008	.0035
-.100	.966	.0375	.2	.10	-.4	.05	.966	.0375	.007	.0009	.003	.0017
-.050	.899	.0377	.6	.09	.1	.06	.899	.0377	-.001	.0010	.010	.0015
0.000	.889	.0379	-.1	.16	.2	.09	.889	.0379	-.003	.0014	-.002	.0025
.050	.899	.0377	.9	.13	.6	.14	.899	.0377	-.009	.0022	.013	.0022
.100	.949	.0374	.7	.23	.9	.08	.949	.0374	-.014	.0015	.011	.0038
.150	1.010	.0372	.6	.24	.8	.08	1.010	.0372	-.015	.0015	.011	.0043
.200	1.033	.0374	.1	.14	1.0	.09	1.033	.0374	-.017	.0018	.002	.0026
.250	1.042	.0373	-.4	.35	.4	.06	1.042	.0373	-.007	.0012	-.008	.0063
.300	1.053	.0373	.9	.23	.5	.10	1.053	.0373	-.009	.0019	.016	.0042
.350	1.056	.0373	.1	.10	.5	.09	1.056	.0373	-.008	.0017	.001	.0019
.400	1.058	.0373	.1	.22	.6	.11	1.057	.0373	-.011	.0020	.002	.0041
.550	1.060	.0373	-.4	.10	.1	.17	1.060	.0373	-.001	.0031	-.007	.0018
.700	1.057	.0373	.3	.11	.1	.14	1.057	.0373	-.002	.0025	.005	.0021
.850	1.057	.0373	.6	.09	-.2	.06	1.057	.0373	.004	.0012	.012	.0017
1.000	1.058	.0373	1.0	.17	-.1	.08	1.058	.0373	.001	.0015	.019	.0031

Upstream Velocity U_∞ = 28.2 m/s (+/- .74)
 Probe Yaw Offset Angle = 0.0 Deg

ORIGINAL PAGE IS
OF POOR QUALITY

Table H14. FIVE-HOLE PRESSURE PROBE WAKE PRESSURE DATA.
INCIDENCE ANGLE (DEG) = 0.0 , $Z_c/C = .94$, $R = 50.0\%$

NORMALIZED TANGENTIAL POSITION ZT/S	EXIT ANGLE		TOTAL PRESURE PT2		STATIC PRESSURE P2		TOTAL PRESSURE RECOVERY	
	θ_{ex} (+/-)		kPa (+/-)		kPa (+/-)		PT2/PT1 (+/-)	
-1.000	.6	.07	100.02	.017	99.51	.017	1.0000	.00024
-.850	.5	.11	100.02	.017	99.51	.017	1.0000	.00024
-.700	.8	.27	100.02	.017	99.51	.017	1.0000	.00024
-.550	.6	.14	100.02	.017	99.51	.017	1.0000	.00024
-.400	1.1	.14	100.02	.017	99.52	.017	1.0000	.00024
-.350	1.3	.33	100.02	.017	99.51	.017	1.0000	.00024
-.300	1.3	.15	100.02	.017	99.51	.017	.9999	.00024
-.250	1.5	.28	100.01	.017	99.51	.017	.9999	.00024
-.200	1.7	.11	100.00	.017	99.51	.017	.9998	.00024
-.150	.5	.19	99.96	.017	99.51	.017	.9994	.00024
-.100	.4	.06	99.93	.017	99.51	.017	.9991	.00024
-.050	.6	.09	99.88	.017	99.51	.017	.9986	.00024
0.000	.2	.11	99.87	.017	99.51	.017	.9985	.00024
.050	1.0	.13	99.88	.017	99.51	.017	.9986	.00024
.100	1.1	.15	99.92	.017	99.50	.017	.9990	.00024
.150	1.0	.16	99.97	.017	99.51	.017	.9995	.00024
.200	1.0	.09	100.00	.017	99.51	.017	.9998	.00024
.250	.6	.26	100.01	.017	99.51	.017	.9999	.00024
.300	1.0	.21	100.01	.017	99.51	.017	.9999	.00024
.350	.5	.09	100.02	.017	99.51	.017	1.0000	.00024
.400	.6	.11	100.02	.017	99.51	.017	1.0000	.00024
.550	.4	.10	100.02	.017	99.51	.017	1.0000	.00024
.700	.3	.12	100.02	.017	99.51	.017	1.0000	.00024
.850	.7	.09	100.02	.017	99.51	.017	1.0000	.00024
1.000	1.0	.17	100.02	.017	99.51	.017	1.0000	.00024

Upstream Total Pressure PT1 = 100.02 kPa (+/- .017)
Upstream Static Pressure P1 = 99.56 kPa (+/- .017)

Table H15. FIVE-HOLE PRESSURE PROBE WAKE VELOCITY DATA
 INCIDENCE ANGLE (DEG) = 0.0 , $Z_c/C = .94$, $R = 66.7\%$

NORMALIZED TANGENTIAL POSITION 2T/S	NORMALIZED TOTAL VELOCITY				NORMALIZED VELOCITY COMPONENTS							
	U/U _∞ (+/-)		Pitch Ang Deg (+/-)		Yaw Ang Deg (+/-)		U _z /U _∞ (+/-)		U _t /U _∞ (+/-)		U _r /U _∞ (+/-)	
-1.000	1.054	.0373	.6	.08	.2	.15	1.054	.0373	-.004	.0028	.010	.0014
-.850	1.057	.0373	.5	.08	.3	.33	1.057	.0373	-.005	.0061	.010	.0016
-.700	1.054	.0373	1.5	.12	.1	.10	1.054	.0373	-.002	.0019	.027	.0024
-.550	1.055	.0373	2.8	.23	-.1	.15	1.053	.0372	.001	.0027	.051	.0046
-.400	1.054	.0373	1.9	.11	-.1	.11	1.054	.0372	.001	.0021	.034	.0023
-.350	1.051	.0373	.5	.13	.2	.09	1.051	.0373	-.004	.0016	.009	.0023
-.300	1.054	.0373	1.9	.24	.1	.13	1.054	.0373	-.001	.0024	.035	.0045
-.250	1.049	.0373	1.5	.27	.1	.10	1.049	.0373	-.002	.0018	.028	.0051
-.200	1.028	.0374	1.1	.09	-.0	.05	1.028	.0374	.001	.0009	.020	.0019
-.150	.988	.0373	.6	.21	.1	.06	.988	.0373	-.001	.0011	.010	.0036
-.100	.952	.0373	.6	.11	-.1	.07	.952	.0373	.001	.0011	.011	.0018
-.050	.927	.0376	-.2	.13	.0	.08	.929	.0376	-.000	.0013	-.003	.0020
0.000	.886	.0379	-.1	.08	.3	.10	.886	.0379	-.004	.0016	-.002	.0012
.050	.917	.0376	-.8	.28	.7	.13	.917	.0375	-.011	.0022	-.013	.0045
.100	.954	.0383	.1	.12	.5	.07	.954	.0383	-.009	.0012	.002	.0020
.150	1.017	.0372	.7	.08	.5	.08	1.017	.0372	-.008	.0014	.012	.0016
.200	1.030	.0373	1.1	.18	.2	.07	1.030	.0373	-.004	.0013	.020	.0033
.250	1.042	.0373	1.1	.30	.2	.07	1.041	.0373	-.004	.0013	.021	.0055
.300	1.051	.0373	1.2	.12	.2	.11	1.051	.0373	-.004	.0020	.022	.0023
.350	1.045	.0373	1.5	.21	.5	.19	1.045	.0372	-.009	.0034	.027	.0040
.400	1.047	.0372	.3	.11	-.1	.07	1.047	.0372	.001	.0012	.005	.0020
.550	1.049	.0372	.7	.09	-.1	.10	1.049	.0372	.002	.0018	.012	.0017
.700	1.057	.0373	.5	.18	.5	.15	1.057	.0373	-.009	.0028	.009	.0034
.850	1.057	.0373	.0	.18	-.0	.15	1.057	.0373	.001	.0028	.001	.0033
1.000	1.050	.0373	.3	.09	.6	.09	1.050	.0372	-.012	.0017	.005	.0017

Upstream Velocity U_∞ = 28.2 m/s (+/- .74)
 Probe Yaw Offset Angle = 0.0 Deg

ORIGINAL PAGE IS
OF POOR QUALITY

Table H16. FIVE-HOLE PRESSURE PROBE WAKE PRESSURE DATA
INCIDENCE ANGLE (DEG) = 0.0 , $Z_c/C = .94$, $R = 66.7\%$

NORMALIZED TANGENTIAL POSITION ZT/S	EXIT ANGLE		TOTAL PRESSURE PT2		STATIC PRESSURE P2		TOTAL PRESSURE RECOVERY	
	Deg	(+/-)	KPa	(+/-)	KPa	(+/-)	PT2/PT1	(+/-)
-1.000	.6	.09	100.02	.017	99.51	.017	1.0000	.00024
-.850	.6	.18	100.02	.017	99.51	.017	1.0000	.00024
-.700	1.5	.12	100.02	.017	99.51	.017	1.0000	.00024
-.550	2.8	.23	100.02	.017	99.51	.017	1.0000	.00024
-.400	1.9	.11	100.02	.017	99.51	.017	1.0000	.00024
-.350	.5	.12	100.01	.017	99.51	.017	1.0000	.00024
-.300	1.9	.24	100.01	.017	99.50	.017	.9999	.00024
-.250	1.5	.27	100.01	.017	99.51	.017	.9999	.00024
-.200	1.1	.09	99.99	.017	99.51	.017	.9997	.00024
-.150	.6	.20	99.95	.017	99.51	.017	.9994	.00024
-.100	.7	.11	99.92	.017	99.51	.017	.9990	.00024
-.050	.2	.12	99.90	.017	99.51	.017	.9988	.00024
0.000	.3	.10	99.87	.017	99.51	.017	.9985	.00024
.050	1.1	.23	99.89	.017	99.51	.017	.9988	.00024
.100	.5	.07	99.92	.019	99.51	.017	.9990	.00025
.150	.8	.08	99.99	.017	99.51	.017	.9997	.00024
.200	1.1	.18	100.00	.017	99.51	.017	.9998	.00024
.250	1.2	.29	100.01	.017	99.51	.017	.9999	.00024
.300	1.2	.12	100.02	.017	99.51	.017	1.0000	.00024
.350	1.5	.21	100.02	.017	99.52	.017	1.0000	.00024
.400	.3	.11	100.02	.017	99.52	.017	1.0000	.00024
.550	.7	.09	100.02	.017	99.52	.017	1.0000	.00024
.700	.7	.17	100.02	.017	99.51	.017	1.0000	.00024
.850	.1	.17	100.02	.017	99.51	.017	1.0000	.00024
1.000	.7	.09	100.02	.017	99.51	.017	1.0000	.00024

Upstream Total Pressure PT1 = 100.02 KPa (+/- .017)
Upstream Static Pressure P1 = 99.56 KPa (+/- .017)

Table H17. FIVE HOLE PRESSURE PROBE WAKE VELOCITY DATA
 INCIDENCE ANGLE (DEG) = 0.0, $Z_c/C = .74$, $R = 83.3\%$

NORMALIZED TANGENTIAL POSITION 2T/S	NORMALIZED TOTAL VELOCITY						NORMALIZED VELOCITY COMPONENTS					
	U/U _∞ (+/-)		Pitch Ang Deg (+/-)		Yaw Ang Deg (+/-)		Uz/U _∞ (+/-)		Ut/U _∞ (+/-)		Ur/U _∞ (+/-)	
-1.000	1.037	.0375	.7	.08	.7	.10	1.037	.0375	-.012	.0032	.012	.0016
-.850	1.041	.0375	.9	.09	.7	.10	1.041	.0374	-.012	.0019	.016	.0017
-.700	1.053	.0374	1.1	.10	1.3	.24	1.053	.0374	-.024	.0046	.020	.0020
-.550	1.046	.0379	1.3	.07	.5	.17	1.046	.0379	-.009	.0031	.024	.0016
-.400	1.051	.0374	1.4	.19	.4	.14	1.050	.0374	-.007	.0026	.027	.0036
-.350	1.042	.0376	1.8	.12	.4	.11	1.041	.0376	-.007	.0020	.033	.0025
-.300	1.044	.0374	.9	.11	.3	.05	1.044	.0374	-.005	.0010	.016	.0020
-.250	1.022	.0374	1.8	.18	-.1	.07	1.021	.0374	.002	.0016	.033	.0034
-.200	.994	.0376	1.1	.11	.3	.09	.994	.0376	-.006	.0016	.019	.0020
-.150	.969	.0375	.5	.08	-.0	.11	.969	.0375	.001	.0018	.009	.0014
-.100	.938	.0380	-.8	.08	-.0	.09	.938	.0380	.001	.0014	-.013	.0014
-.050	.902	.0388	-1.0	.13	-.3	.12	.901	.0388	.004	.0019	-.015	.0021
0.000	.885	.0380	-1.3	.11	.6	.09	.884	.0379	-.010	.0014	-.020	.0020
.050	.863	.0381	-2.0	.14	.2	.11	.863	.0381	-.003	.0017	-.031	.0025
.100	.946	.0377	-.5	.09	1.0	.08	.945	.0377	-.016	.0015	-.009	.0014
.150	.981	.0377	.6	.15	.5	.11	.981	.0377	-.009	.0018	.011	.0026
.200	1.017	.0374	1.0	.09	.2	.07	1.017	.0374	-.004	.0013	.018	.0017
.250	1.033	.0373	1.0	.12	.6	.10	1.033	.0373	-.012	.0019	.018	.0023
.300	1.040	.0373	1.6	.11	.3	.09	1.039	.0373	-.005	.0016	.029	.0023
.350	1.034	.0374	1.1	.06	.1	.08	1.033	.0374	-.001	.0015	.020	.0013
.400	1.036	.0374	.4	.11	.7	.13	1.036	.0374	-.012	.0024	.008	.0020
.550	1.040	.0374	.7	.12	1.0	.13	1.040	.0373	-.018	.0025	.012	.0023
.700	1.038	.0374	.8	.17	1.3	.17	1.038	.0374	-.024	.0033	.015	.0030
.850	1.047	.0374	.7	.07	.9	.25	1.047	.0374	-.016	.0046	.013	.0014
1.000	1.037	.0373	.7	.06	.3	.12	1.037	.0373	-.005	.0022	.014	.0011

Upstream Velocity U_∞ = 28.2 m/s (+/- .74)
 Probe Yaw Offset Angle = 0.0 Deg

- 216 -
 ORIGINAL PAGE IS
 OF POOR QUALITY.

ORIGINAL PAGE IS
OF POOR QUALITY

Table H18. FIVE-HOLE PRESSURE PROBE WAKE PRESSURE DATA
INCIDENCE ANGLE (DEG) = 0.0 , Zc/C = .94 , R = 83.3 %

NORMALIZED TANGENTIAL POSITION ZT/S	EXIT ANGLE		TOTAL PRESSURE PT2		STATIC PRESSURE P2		TOTAL PRESSURE RECOVERY	
	Deg	(+/-)	KPa	(+/-)	KPa	(+/-)	PT2/PT1	(+/-)
-1.000	.9	.14	100.04	.017	99.55	.017	.9998	.00024
-.850	1.1	.09	100.04	.017	99.55	.017	.9999	.00024
-.700	1.7	.20	100.05	.017	99.54	.017	1.0000	.00024
-.550	1.4	.09	100.04	.018	99.54	.017	.9999	.00025
-.400	1.5	.19	100.05	.017	99.55	.017	1.0000	.00024
-.350	1.8	.12	100.04	.017	99.54	.017	.9998	.00024
-.300	.9	.10	100.04	.017	99.54	.017	.9999	.00024
-.250	1.8	.18	100.02	.017	99.54	.017	.9996	.00024
-.200	1.1	.11	99.99	.018	99.54	.017	.9994	.00024
-.150	.5	.08	99.97	.017	99.54	.017	.9992	.00024
-.100	.8	.08	99.95	.018	99.55	.017	.9989	.00025
-.050	1.0	.12	99.92	.019	99.55	.017	.9986	.00025
0.000	1.5	.11	99.91	.017	99.55	.017	.9985	.00024
.050	2.0	.14	99.89	.017	99.55	.017	.9984	.00024
.100	1.1	.08	99.96	.018	99.55	.017	.9991	.00024
.150	.8	.13	99.99	.018	99.55	.017	.9994	.00025
.200	1.0	.09	100.02	.017	99.55	.017	.9997	.00024
.250	1.2	.12	100.04	.017	99.55	.017	.9998	.00024
.300	1.6	.11	100.04	.017	99.55	.017	.9999	.00024
.350	1.1	.06	100.04	.017	99.55	.017	.9998	.00024
.400	.8	.13	100.05	.017	99.56	.017	.9999	.00024
.550	1.2	.13	100.04	.017	99.55	.017	.9999	.00024
.700	1.5	.17	100.04	.017	99.55	.017	.9999	.00024
.850	1.1	.20	100.05	.017	99.55	.017	1.0000	.00024
1.000	.8	.07	100.05	.017	99.56	.017	.9999	.00024

Upstream Total Pressure PT1 = 100.05 KPa (+/- .017)
Upstream Static Pressure P1 = 99.60 KPa (+/- .017)

Table H19. FIVE HOLE PRESSURE PROBE WAKE VELOCITY DATA
 INCIDENCE ANGLE (DEG) = 0.0 , Zc/C = 2.06 , R = 4.2 %

NORMALIZED TANGENTIAL POSITION ZT/C	NORMALIZED TOTAL VELOCITY				NORMALIZED VELOCITY COMPONENTS							
	U/Uzo (+/-)		Pitch Ang Deg (+/-)		Yaw Ang Deg (+/-)		Uz/Uzo (+/-)		Uv/Uzo (+/-)		Ur/Uzo (+/-)	
-1.000	.744	.0354	.7	.06	-.9	.11	.744	.0354	.014	.0019	.012	.0011
-.850	.760	.0355	.6	.06	.5	.15	.768	.0354	-.009	.0025	.010	.0010
-.700	.757	.0357	.4	.07	-.4	.17	.759	.0359	.007	.0028	.007	.0016
-.550	.756	.0353	.4	.07	-.1	.09	.756	.0353	.002	.0015	.007	.0013
-.400	.763	.0353	.5	.08	-.3	.07	.762	.0353	.005	.0011	.009	.0014
-.350	.767	.0353	.8	.08	-.6	.16	.767	.0353	.010	.0027	.013	.0014
-.300	.729	.0354	.6	.08	-.7	.07	.729	.0354	.014	.0012	.010	.0013
-.250	.723	.0357	.6	.08	-.8	.07	.723	.0357	.012	.0013	.009	.0014
-.200	.720	.0353	.7	.09	-.0	.13	.728	.0353	.013	.0022	.011	.0015
-.150	.900	.0355	1.5	.09	-1.0	.08	.900	.0355	.016	.0014	.023	.0017
-.100	.874	.0350	1.5	.07	-.4	.07	.874	.0350	.006	.0011	.022	.0014
-.050	.840	.0363	2.2	.11	-.3	.09	.839	.0363	.004	.0013	.032	.0022
0.000	.830	.0364	2.3	.10	-.0	.08	.829	.0363	.000	.0012	.033	.0021
.050	.836	.0363	2.0	.10	.5	.13	.835	.0363	-.008	.0019	.030	.0020
.100	.861	.0361	1.5	.08	1.0	.07	.860	.0361	-.015	.0013	.023	.0016
.150	.882	.0359	1.5	.07	1.4	.07	.881	.0359	-.021	.0014	.023	.0014
.200	.892	.0357	1.1	.10	1.4	.07	.892	.0357	-.022	.0014	.018	.0017
.250	.930	.0357	.8	.07	1.4	.07	.930	.0357	-.023	.0015	.012	.0016
.300	.915	.0358	.8	.07	1.3	.07	.914	.0358	-.021	.0014	.012	.0013
.350	.913	.0364	.6	.09	1.6	.08	.913	.0363	-.025	.0016	.009	.0015
.400	.947	.0354	.8	.07	.7	.12	.947	.0354	-.015	.0020	.014	.0012
.550	.933	.0354	.6	.07	.7	.13	.933	.0354	-.015	.0022	.010	.0015
.700	.947	.0354	1.1	.08	.9	.16	.946	.0354	-.015	.0026	.018	.0015
.850	.940	.0353	.8	.07	1.6	.07	.940	.0353	-.027	.0015	.014	.0013
1.000	.954	.0357	.8	.06	.8	.16	.953	.0357	-.013	.0027	.013	.0011

Upstream Velocity Uzo = 29.3 m/s (+/- .73)
 Probe Yaw Offset Angle = 0.0 Deg

ORIGINAL PAGE IS
OF POOR QUALITY

Table H20. FIVE-HOLE PRESSURE PROBE WAKE PRESSURE DATA
INCIDENCE ANGLE (DEG) = 0.0 , $Z_c/C = 2.06$, $R = 4.2\%$

NORMALIZED TANGENTIAL POSITION ZT/S	EXIT ANGLE		TOTAL PRESSURE PT2		STATIC PRESSURE P2		TOTAL PRESSURE RECOVERY	
	Deg (+/-)		kPa (+/-)		kPa (+/-)		PT2/PT1 (+/-)	
-1.000	1.1	.07	100.24	.017	99.81	.017	.9989	.00024
-.950	.8	.11	100.27	.017	99.82	.017	.9991	.00024
-.900	.6	.13	100.26	.018	99.81	.017	.9990	.00025
-.850	.5	.08	100.26	.017	99.82	.017	.9990	.00024
-.800	.6	.08	100.26	.017	99.81	.017	.9990	.00024
-.750	1.0	.11	100.28	.017	99.82	.017	.9992	.00024
-.700	1.1	.07	100.24	.017	99.82	.017	.9988	.00024
-.650	1.0	.08	100.23	.017	99.82	.017	.9988	.00024
-.600	1.1	.11	100.24	.017	99.82	.017	.9988	.00024
-.550	1.8	.09	100.22	.017	99.82	.017	.9986	.00024
-.500	1.5	.07	100.19	.017	99.82	.017	.9984	.00024
-.450	2.2	.11	100.17	.017	99.83	.017	.9981	.00024
0.000	2.3	.10	100.16	.017	99.83	.017	.9980	.00024
.050	2.1	.11	100.16	.017	99.82	.017	.9980	.00024
.100	1.8	.08	100.18	.017	99.82	.017	.9982	.00024
.150	2.1	.07	100.20	.017	99.82	.017	.9984	.00024
.200	1.8	.08	100.20	.017	99.82	.017	.9985	.00024
.250	1.6	.08	100.24	.018	99.82	.017	.9988	.00024
.300	1.5	.07	100.23	.018	99.82	.017	.9987	.00024
.350	1.7	.08	100.23	.018	99.82	.017	.9987	.00025
.400	1.2	.10	100.24	.017	99.82	.017	.9990	.00024
.550	1.1	.12	100.25	.017	99.83	.017	.9989	.00024
.700	1.4	.12	100.25	.017	99.82	.017	.9989	.00024
.850	1.9	.07	100.25	.017	99.82	.017	.9989	.00024
1.000	1.1	.12	100.25	.018	99.81	.017	.9989	.00025

Upstream Total Pressure PT1 = 100.36 kPa (+/- .017)

Upstream Static Pressure P1 = 99.87 kPa (+/- .017)

Table H21. FIVE-HOLE PRESSURE PROBE WAKE VELOCITY DATA
 INCIDENCE ANGLE (DEG) = 0.0 , Zc/C = 2.06 , R = 8.3 %

NORMALIZED TANGENTIAL POSITION ZT/S	NORMALIZED TOTAL VELOCITY				NORMALIZED VELOCITY COMPONENTS							
	U/Uzo (+/-)		Pitch Ang Deg (+/-)		Yaw Ang Deg (+/-)		Uz/Uzo (+/-)		Ut/Uzo (+/-)		Ur/Uzo (+/-)	
-1.000	1.029	.0368	.9	.06	.0	.11	1.029	.0368	-.000	.0020	.016	.0013
-.850	1.035	.0366	.9	.05	-.1	.20	1.034	.0366	.002	.0035	.016	.0011
-.700	1.027	.0365	1.0	.06	-.0	.16	1.027	.0365	.000	.0029	.018	.0013
-.550	1.033	.0365	.6	.06	-1.0	.20	1.033	.0365	.017	.0036	.011	.0011
-.400	1.016	.0365	.6	.07	-.4	.13	1.016	.0365	.008	.0024	.010	.0013
-.350	1.002	.0367	.5	.06	-.4	.06	1.002	.0367	.007	.0011	.009	.0011
-.300	.906	.0366	.7	.06	-.4	.11	.986	.0366	.007	.0019	.012	.0011
-.250	.991	.0365	1.0	.06	-.5	.12	.991	.0365	.009	.0021	.018	.0012
-.200	.950	.0367	1.2	.08	-.2	.07	.950	.0367	.003	.0011	.020	.0015
-.150	.935	.0368	1.9	.07	-.3	.12	.934	.0368	.005	.0019	.032	.0017
-.100	.900	.0370	2.4	.11	-.0	.08	.900	.0370	.000	.0013	.038	.0023
-.050	.903	.0368	2.5	.14	.8	.12	.902	.0368	-.013	.0019	.039	.0027
0.000	.897	.0370	2.8	.09	.5	.08	.896	.0370	-.008	.0013	.044	.0023
.050	.903	.0369	2.7	.10	.7	.11	.902	.0369	-.011	.0017	.043	.0024
.100	.927	.0367	2.2	.07	1.3	.10	.927	.0366	-.022	.0018	.035	.0018
.150	.933	.0367	1.5	.08	1.2	.11	.933	.0367	-.020	.0020	.024	.0016
.200	.954	.0367	1.3	.08	1.3	.12	.954	.0366	-.022	.0021	.022	.0015
.250	.982	.0365	1.3	.08	1.4	.11	.982	.0365	-.023	.0020	.022	.0016
.300	.986	.0365	.6	.08	1.3	.11	.985	.0365	-.023	.0021	.011	.0015
.350	.998	.0365	.6	.08	.8	.07	.998	.0365	-.013	.0014	.010	.0015
.400	1.001	.0366	.9	.09	.8	.08	1.001	.0366	-.014	.0015	.016	.0017
.550	1.013	.0367	.7	.09	.4	.07	1.013	.0367	-.007	.0012	.013	.0016
.700	1.019	.0365	.7	.05	.1	.09	1.019	.0365	-.002	.0016	.013	.0010
.850	1.016	.0366	1.0	.07	.5	.12	1.015	.0366	-.009	.0022	.017	.0014
1.000	1.019	.0365	.9	.08	.2	.08	1.019	.0365	-.004	.0015	.016	.0015

Upstream Velocity Uzo = 28.7 m/s (+/- .74)
 Probe Yaw Offset Angle = 0.0 Deg

ORIGINAL PAGE IS
 OF POOR QUALITY

ORIGINAL PAGE IS
OF POOR QUALITY

Table H22. FIVE-HOLE PRESSURE PROBE WAKE PRESSURE DATA
INCIDENCE ANGLE (DEG) = 0.0 , $Z_c/C = 2.06$, $R = 0.3 \%$

NORMALIZED TANGENTIAL POSITION ZT/S	EXIT ANGLE		TOTAL PRESSURE PT2		STATIC PRESSURE P2		TOTAL PRESSURE RECOVERY	
	Deg (+/-)		kPa (+/-)		kPa (+/-)		PT2/PT1 (+/-)	
-1.000	.9	.06	99.96	.018	99.46	.017	.9997	.00024
-.850	.9	.06	99.96	.017	99.47	.017	.9998	.00024
-.700	1.0	.06	99.95	.017	99.46	.017	.9997	.00024
-.550	1.1	.17	99.96	.017	99.46	.017	.9998	.00024
-.400	.7	.10	99.95	.017	99.46	.017	.9996	.00024
-.350	.7	.06	99.93	.018	99.46	.017	.9995	.00024
-.300	.8	.08	99.92	.017	99.46	.017	.9993	.00024
-.250	1.2	.07	99.93	.017	99.47	.017	.9994	.00024
-.200	1.2	.08	99.90	.017	99.48	.017	.9991	.00024
-.150	2.0	.08	99.88	.017	99.47	.017	.9990	.00024
-.100	2.4	.11	99.85	.017	99.47	.017	.9987	.00024
-.050	2.6	.13	99.84	.017	99.46	.017	.9986	.00024
0.000	2.8	.09	99.84	.017	99.46	.017	.9985	.00024
.050	2.8	.10	99.84	.017	99.46	.017	.9986	.00024
.100	2.6	.08	99.86	.017	99.46	.017	.9988	.00024
.150	1.9	.09	99.87	.017	99.46	.017	.9988	.00024
.200	1.9	.10	99.88	.017	99.46	.017	.9990	.00024
.250	1.9	.10	99.91	.017	99.46	.017	.9992	.00024
.300	1.5	.11	99.92	.017	99.46	.017	.9993	.00024
.350	1.0	.08	99.93	.017	99.46	.017	.9994	.00024
.400	1.2	.09	99.93	.017	99.47	.017	.9995	.00024
.550	.8	.08	99.95	.017	99.47	.017	.9996	.00024
.700	.7	.05	99.96	.017	99.47	.017	.9997	.00024
.850	1.1	.09	99.96	.017	99.48	.017	.9997	.00024
1.000	.9	.08	99.96	.017	99.47	.017	.9997	.00024

Upstream Total Pressure PT1 = 99.98 kPa (+/- .017)

Upstream Static Pressure P1 = 99.52 kPa (+/- .017)

Table H23. FIVE-HOLE PRESSURE PROBE WAKE VELOCITY DATA
 INCIDENCE ANGLE (DEG) = 0.0 , Zc/C = 2.06 , R = 12.5 %

NORMALIZED TANGENTIAL POSITION ZT/S	NORMALIZED TOTAL VELOCITY					NORMALIZED VELOCITY COMPONENTS						
	U/Uzo (+/-)		Pitch Ang Deg (+/-)		Yaw Ang Deg (+/-)		Uz/Uzo (+/-)		Ut/Uzo (+/-)		Ur/Uzo (+/-)	
-1.000	1.057	.0365	.8	.09	.2	.13	1.057	.0365	-.004	.0023	.015	.0017
-.850	1.055	.0365	.9	.05	-.2	.13	1.054	.0365	.003	.0023	.017	.0011
-.700	1.051	.0365	.6	.06	.1	.08	1.051	.0365	-.002	.0015	.011	.0012
-.550	1.046	.0365	.7	.06	-.2	.07	1.046	.0365	.004	.0014	.013	.0012
-.400	1.044	.0365	.2	.11	-.2	.11	1.044	.0365	.004	.0020	.004	.0020
-.350	1.011	.0367	.6	.07	-.1	.12	1.011	.0367	.002	.0021	.011	.0012
-.300	.997	.0366	1.1	.10	-.4	.09	.997	.0366	.007	.0016	.020	.0019
-.250	1.013	.0369	1.1	.11	.1	.13	1.013	.0369	-.002	.0023	.019	.0020
-.200	.975	.0364	1.5	.06	-.2	.06	.975	.0364	.003	.0011	.026	.0014
-.150	.964	.0367	1.9	.06	-.1	.10	.963	.0366	.002	.0017	.031	.0016
-.100	.941	.0365	2.1	.07	-.1	.15	.940	.0365	.002	.0024	.035	.0020
-.050	.927	.0367	2.8	.11	-.0	.14	.926	.0366	.000	.0022	.045	.0025
0.000	.916	.0367	2.7	.12	-.2	.15	.915	.0366	.003	.0023	.044	.0026
.050	.923	.0369	2.9	.08	-.0	.07	.922	.0369	.000	.0011	.047	.0022
.100	.924	.0367	2.3	.08	.2	.09	.923	.0366	-.004	.0014	.037	.0019
.150	.952	.0368	2.1	.06	.5	.14	.951	.0367	-.007	.0024	.035	.0016
.200	.964	.0375	1.7	.08	.4	.12	.964	.0375	-.006	.0020	.028	.0017
.250	.984	.0365	1.5	.08	.7	.14	.983	.0364	-.013	.0025	.026	.0017
.300	.973	.0364	1.1	.11	.6	.12	.973	.0364	.010	.0022	.019	.0020
.350	.982	.0365	1.0	.11	-.0	.15	.982	.0365	.000	.0026	.017	.0020
.400	1.024	.0365	.8	.09	.4	.12	1.024	.0365	.007	.0022	.015	.0018
.550	1.041	.0365	.7	.07	.4	.11	1.041	.0365	-.007	.0020	.012	.0017
.700	1.042	.0365	1.0	.08	.0	.10	1.041	.0365	-.001	.0017	.019	.0016
.850	1.053	.0365	.8	.06	.5	.21	1.052	.0365	-.008	.0030	.015	.0012
1.000	1.053	.0365	.7	.06	.5	.16	1.053	.0365	-.010	.0030	.017	.0013

Upstream Velocity Uzo = 20.7 m/s (17.74)
 Probe Yaw Offset Angle = 0.0 Deg

ORIGINAL PAGE IS
OF POOR QUALITY

Table H24. FIVE-HOLE PRESSURE PROBE WAKE PRESSURE DATA
INCIDENCE ANGLE (DEG) = 0.0 , Zc/C = 2.06 , R = 12.5 %

NORMALIZED TANGENTIAL POSITION ZT/S	EXIT ANGLE		TOTAL PRESSURE PT2		STATIC PRESSURE P2		TOTAL PRESSURE RECOVERY	
	Deg (1/-)		kPa (1/-)		kPa (1/-)		PT2/PT1 (1/-)	
-1.000	.8	.07	99.78	.017	99.46	.017	.9979	.00024
-.950	.9	.06	99.78	.017	99.46	.017	.9979	.00024
-.700	.6	.06	99.78	.017	99.46	.017	.9979	.00024
-.550	.7	.06	99.77	.017	99.46	.017	.9979	.00024
-.400	.3	.11	99.77	.017	99.46	.017	.9978	.00024
-.350	.7	.07	99.94	.017	99.46	.017	.9975	.00024
-.300	1.2	.10	99.73	.017	99.46	.017	.9974	.00024
-.250	1.1	.11	99.94	.018	99.46	.017	.9975	.00025
-.200	1.5	.06	99.91	.017	99.46	.017	.9972	.00024
-.150	1.9	.06	99.70	.017	99.47	.017	.9972	.00024
-.100	2.1	.07	99.80	.017	99.47	.017	.9970	.00024
-.050	2.8	.11	99.87	.017	99.47	.017	.9989	.00024
0.000	2.7	.12	99.86	.017	99.47	.017	.9988	.00024
.050	2.9	.08	99.87	.017	99.47	.017	.9988	.00024
.100	2.3	.08	99.87	.017	99.47	.017	.9988	.00024
.150	2.2	.06	99.89	.017	99.47	.017	.9971	.00024
.200	1.7	.08	99.91	.019	99.47	.017	.9972	.00025
.250	1.7	.10	99.92	.017	99.47	.017	.9973	.00024
.300	1.2	.11	99.93	.017	99.47	.017	.9974	.00024
.350	1.0	.11	99.92	.017	99.47	.017	.9973	.00024
.400	.9	.10	99.76	.017	99.47	.017	.9977	.00024
.550	.8	.07	99.97	.017	99.47	.017	.9978	.00024
.700	1.0	.08	99.77	.017	99.46	.017	.9978	.00024
.850	.9	.11	99.78	.017	99.46	.017	.9977	.00024
1.000	1.1	.10	99.78	.017	99.46	.017	.9977	.00024

Upstream Total Pressure PT1 = 99.99 kPa (1/- .017)

Upstream Static Pressure P1 = 99.52 kPa (1/- .017)

Table H25. FIVE-HOLE PRESSURE PROBE WAKE VELOCITY DATA
 INCIDENCE ANGLE (DEG) = 0.0 , $Z_c/C = 2.06$, $R = 16.7\%$

NORMALIZED TANGENTIAL POSITION 2T/S	NORMALIZED TOTAL VELOCITY					NORMALIZED VELOCITY COMPONENTS						
	U/U _∞ (+/-)		Pitch Ang Deg (1/-)		Yaw Ang Deg (+/-)		U _z /U _∞ (+/-)		U _t /U _∞ (1/-)		U _r /U _∞ (+/-)	
-1.000	1.057	.0370	.9	.07	.2	.13	1.058	.0370	-.004	.0024	.016	.0014
-.850	1.058	.0370	.7	.05	.6	.12	1.058	.0370	-.011	.0022	.013	.0011
-.700	1.055	.0370	.9	.08	.1	.06	1.055	.0370	-.002	.0011	.016	.0015
-.550	1.054	.0370	.7	.08	.1	.10	1.054	.0370	-.001	.0018	.013	.0015
-.400	1.041	.0370	.3	.08	.1	.09	1.041	.0370	-.002	.0016	.006	.0015
-.350	1.024	.0369	.5	.21	-.1	.08	1.024	.0369	.002	.0015	.010	.0037
-.300	1.016	.0369	1.0	.07	.3	.07	1.015	.0369	-.006	.0012	.017	.0014
-.250	.993	.0373	1.3	.07	.2	.09	.993	.0373	-.003	.0015	.023	.0015
-.200	.974	.0370	1.8	.06	.1	.07	.974	.0369	-.002	.0011	.030	.0015
-.150	.952	.0370	2.1	.06	-.3	.15	.952	.0370	.004	.0025	.035	.0017
-.100	.945	.0370	2.5	.09	.5	.16	.944	.0370	-.009	.0027	.041	.0022
-.050	.940	.0371	2.4	.12	.2	.12	.937	.0371	-.004	.0019	.040	.0025
0.000	.926	.0371	2.4	.12	.3	.14	.925	.0371	-.005	.0022	.039	.0024
.050	.937	.0370	2.7	.08	.4	.07	.938	.0370	-.007	.0012	.045	.0022
.100	.965	.0370	2.3	.06	.6	.11	.964	.0369	.010	.0019	.038	.0018
.150	.977	.0370	2.2	.12	.4	.10	.976	.0370	-.007	.0018	.037	.0025
.200	.981	.0373	1.8	.10	.5	.17	.980	.0372	-.009	.0033	.031	.0020
.250	1.004	.0376	1.2	.16	.3	.09	1.004	.0376	-.005	.0015	.020	.0030
.300	1.024	.0369	.7	.07	.5	.11	1.024	.0369	-.007	.0020	.016	.0017
.350	1.033	.0369	.0	.16	-.1	.12	1.033	.0369	.002	.0022	.014	.0027
.400	1.042	.0370	1.1	.11	.2	.17	1.042	.0370	.004	.0031	.021	.0021
.550	1.048	.0370	1.0	.10	.6	.13	1.048	.0370	-.010	.0023	.019	.0019
.700	1.054	.0370	.8	.07	.2	.14	1.054	.0370	-.004	.0025	.014	.0014
.850	1.055	.0370	.9	.06	.1	.20	1.054	.0370	-.002	.0037	.016	.0013
1.000	1.053	.0370	1.1	.06	.1	.08	1.053	.0370	-.001	.0014	.020	.0013

Upstream Velocity U_∞ = 28.4 m/s (1/- .74)
 Probe Yaw Offset Angle = 0.0 Deg

ORIGINAL PAGE IS
OF POOR QUALITY

Table H26. FIVE-HOLE PRESSURE PROBE WAKE PRESSURE DATA
INCIDENCE ANGLE (DEG) = 0.0 , $Z_c/C = 2.06$, $R = 16.7\%$

NORMALIZED TANGENTIAL POSITION ZT/S	EXIT ANGLE		TOTAL PRESSURE PT2		STATIC PRESSURE P2		TOTAL PRESSURE RECOVERY	
	DEG (+/-)		kPa (+/-)		kPa (+/-)		PT2/PT1 (+/-)	
-1.000	.7	.07	99.98	.017	99.47	.017	1.0000	.00024
-.850	.9	.09	99.98	.017	99.47	.017	1.0000	.00024
-.700	.9	.08	99.99	.017	99.47	.017	1.0000	.00024
-.550	.7	.08	99.98	.017	99.47	.017	.9999	.00024
-.400	.4	.08	99.97	.017	99.47	.017	.9998	.00024
-.350	.6	.21	99.96	.017	99.47	.017	.9997	.00024
-.300	1.0	.07	99.94	.017	99.47	.017	.9996	.00024
-.250	1.3	.07	99.92	.018	99.47	.017	.9994	.00025
-.200	1.8	.06	99.90	.017	99.46	.017	.9992	.00024
-.150	2.1	.06	99.88	.017	99.46	.017	.9990	.00024
-.100	2.5	.09	99.88	.017	99.47	.017	.9989	.00024
-.050	2.5	.12	99.88	.017	99.47	.017	.9989	.00024
0.000	2.5	.12	99.86	.017	99.47	.017	.9988	.00024
.050	2.0	.08	99.87	.017	99.47	.017	.9989	.00024
.100	2.4	.07	99.89	.017	99.46	.017	.9991	.00024
.150	2.2	.12	99.90	.017	99.46	.017	.9992	.00024
.200	1.9	.11	99.91	.018	99.46	.017	.9992	.00024
.250	1.2	.16	99.92	.018	99.46	.017	.9994	.00025
.300	1.0	.10	99.95	.017	99.46	.017	.9996	.00024
.350	.8	.16	99.96	.017	99.47	.017	.9997	.00024
.400	1.2	.11	99.97	.017	99.47	.017	.9998	.00024
.550	1.2	.10	99.98	.017	99.48	.017	1.0000	.00024
.700	.8	.08	99.98	.017	99.47	.017	1.0000	.00024
.850	.9	.07	99.99	.017	99.47	.017	1.0000	.00024
1.000	1.1	.06	99.98	.017	99.47	.017	1.0000	.00024

Upstream Total Pressure PT1 = 99.98 kPa (+/- .017)
Upstream Static Pressure P1 = 99.52 kPa (+/- .017)

Table H27. FIVE-HOLE PRESSURE PROBE WAKE VELOCITY DATA
 INCIDENCE ANGLE (DEG) = 0.0 , $Z_c/C = 2.06$, $R = 25.0\%$

NORMALIZED TANGENTIAL POSITION 2T/S	NORMALIZED TOTAL VELOCITY						NORMALIZED VELOCITY COMPONENTS					
	U/U _∞ (+/-)		Pitch Ang Deg (+/-)		Yaw Ang Deg (+/-)		U _z /U _∞ (+/-)		U _t /U _∞ (+/-)		U _r /U _∞ (+/-)	
-1.000	1.058	.0352	.7	.06	.7	.12	1.058	.0352	-.014	.0023	.012	.0012
-.050	1.060	.0352	.7	.06	.1	.12	1.059	.0352	-.002	.0023	.012	.0012
-.700	1.062	.0352	.8	.08	.3	.08	1.062	.0352	-.006	.0016	.015	.0016
-.550	1.055	.0352	.8	.14	-.0	.09	1.055	.0352	.001	.0017	.014	.0026
-.400	1.038	.0351	1.0	.07	.4	.06	1.038	.0351	-.008	.0011	.018	.0014
-.350	1.022	.0352	.6	.12	.3	.10	1.022	.0352	-.005	.0018	.010	.0021
-.300	1.030	.0351	1.0	.11	.4	.05	1.030	.0351	-.006	.0009	.017	.0020
-.250	.974	.0351	1.3	.08	.3	.07	.974	.0351	-.006	.0013	.023	.0016
-.200	.973	.0351	1.6	.08	.3	.06	.973	.0351	-.006	.0010	.028	.0018
-.150	.951	.0353	1.3	.08	.2	.07	.951	.0353	-.003	.0012	.022	.0015
-.100	.931	.0353	2.4	.12	-.2	.09	.931	.0353	.003	.0015	.039	.0025
-.050	.916	.0354	2.7	.13	.3	.09	.915	.0353	-.005	.0015	.043	.0027
0.000	.927	.0353	1.5	.13	.3	.08	.926	.0353	-.005	.0013	.025	.0024
.050	.936	.0353	2.1	.10	.1	.06	.936	.0353	-.002	.0010	.035	.0021
.100	.954	.0354	1.7	.12	.3	.10	.954	.0354	-.006	.0017	.029	.0023
.150	.970	.0351	1.5	.12	-.2	.17	.969	.0351	.004	.0028	.025	.0022
.200	.980	.0352	.7	.19	-.1	.08	.980	.0352	.001	.0013	.013	.0032
.250	1.010	.0353	1.5	.12	.1	.08	1.010	.0353	-.002	.0014	.026	.0023
.300	1.025	.0352	.9	.21	-.1	.19	1.025	.0352	.001	.0033	.015	.0037
.350	1.035	.0351	.9	.11	-.2	.10	1.035	.0351	.003	.0018	.017	.0020
.400	1.045	.0352	1.0	.14	.4	.14	1.045	.0352	-.007	.0025	.018	.0026
.550	1.059	.0352	1.2	.18	.2	.06	1.059	.0352	-.003	.0011	.023	.0034
.700	1.060	.0352	.6	.11	-.3	.12	1.060	.0352	.006	.0023	.011	.0020
.050	1.060	.0352	1.1	.08	-.5	.08	1.060	.0352	.009	.0015	.020	.0017
1.000	1.065	.0352	.9	.10	-.0	.12	1.065	.0352	.000	.0022	.016	.0019

Upstream Velocity U_∞ = 29.4 m/s (+/- .73)
 Probe Yaw Offset Angle = 0.0 Deg

- 226 -
 ORIGINAL PAGE IS
 OF POOR QUALITY

ORIGINAL PAGE IS
OF POOR QUALITY

Table H28. FIVE-HOLE PRESSURE PROBE WAKE PRESSURE DATA
INCIDENCE ANGLE (DEG) = 0.0 , $Z_c/C = 2.06$, $R = 25.0\%$

NORMALIZED TANGENTIAL POSITION ZT/S	EXIT ANGLE		TOTAL PRESURE PT2		STATIC PRESSURE P2		TOTAL PRESSURE RECOVERY	
	Deq	(+/-)	KPa	(+/-)	KPa	(+/-)	PT2/PT1	(+/-)
-1.000	1.0	.10	100.32	.017	99.78	.017	1.0000	.00024
-.850	.7	.06	100.32	.017	99.78	.017	1.0000	.00024
-.700	.9	.08	100.33	.017	99.78	.017	1.0000	.00024
-.550	.8	.14	100.32	.017	99.78	.017	1.0000	.00024
-.400	1.1	.07	100.30	.017	99.78	.017	.9997	.00024
-.350	.6	.11	100.28	.017	99.78	.017	.9996	.00024
-.300	1.0	.10	100.29	.017	99.77	.017	.9997	.00024
-.250	1.4	.08	100.25	.017	99.78	.017	.9993	.00024
-.200	1.7	.08	100.24	.017	99.78	.017	.9991	.00024
-.150	1.3	.08	100.22	.017	99.78	.017	.9989	.00024
-.100	2.4	.12	100.20	.017	99.79	.017	.9988	.00024
-.050	2.7	.13	100.19	.017	99.79	.017	.9987	.00024
0.000	1.6	.13	100.20	.017	99.79	.017	.9988	.00024
.050	2.1	.10	100.21	.017	99.78	.017	.9989	.00024
.100	1.8	.12	100.23	.017	99.79	.017	.9991	.00024
.150	1.5	.12	100.24	.017	99.79	.017	.9992	.00024
.200	.7	.19	100.25	.017	99.79	.017	.9993	.00024
.250	1.5	.12	100.28	.017	99.79	.017	.9996	.00024
.300	.9	.21	100.30	.017	99.79	.017	.9997	.00024
.350	.9	.11	100.30	.017	99.79	.017	.9998	.00024
.400	1.1	.14	100.31	.017	99.78	.017	.9999	.00024
.550	1.2	.18	100.32	.017	99.78	.017	1.0000	.00024
.700	.7	.11	100.32	.017	99.78	.017	1.0000	.00024
.850	1.2	.08	100.32	.017	99.78	.017	1.0000	.00024
1.000	.9	.10	100.32	.017	99.77	.017	1.0000	.00024

Upstream Total Pressure PT1 = 100.32 KPa (+/- .017)

Upstream Static Pressure P1 = 99.84 KPa (+/- .017)

Table H29. FIVE-HOLE PROBE WAKE VELOCITY DATA
 INCIDENCE ANGLE (DEG) = 0.0 , $Z_c/C = 2.06$, $R = 33.3\%$

NORMALIZED TANGENTIAL POSITION 2T/5	NORMALIZED TOTAL VELOCITY						NORMALIZED VELOCITY COMPONENTS					
	U/U _∞ (+/-)		Pitch Ans Des (+/-)		Yaw Ans Des (+/-)		U _z /U _∞ (+/-)		U _t /U _∞ (+/-)		U _r /U _∞ (+/-)	
1.000	1.058	.0357	.8	.11	.1	.09	1.057	.0357	-.002	.0016	.014	.0021
-.950	1.057	.0357	.8	.07	-.5	.11	1.057	.0357	.008	.0021	.015	.0014
-.700	1.059	.0357	.9	.23	.4	.07	1.059	.0357	-.007	.0013	.016	.0043
-.550	1.059	.0357	1.3	.24	.3	.09	1.059	.0357	-.005	.0016	.024	.0046
-.400	1.052	.0357	1.2	.14	-.3	.16	1.051	.0357	.005	.0030	.021	.0027
-.350	1.047	.0357	.7	.16	.5	.12	1.047	.0357	-.009	.0022	.013	.0029
-.300	1.029	.0356	1.3	.17	.1	.06	1.029	.0356	-.001	.0010	.024	.0031
-.250	1.021	.0357	2.1	.27	.2	.07	1.020	.0357	-.003	.0012	.037	.0050
-.200	.992	.0356	1.6	.10	.2	.06	.992	.0356	-.003	.0010	.028	.0021
-.150	.982	.0356	.8	.16	.2	.08	.982	.0356	-.003	.0014	.014	.0028
-.100	.966	.0357	1.9	.21	.2	.08	.965	.0357	-.003	.0014	.032	.0038
-.050	.940	.0358	1.1	.09	.0	.09	.940	.0358	-.000	.0015	.019	.0017
0.000	.949	.0357	1.9	.14	.4	.08	.948	.0357	-.007	.0013	.032	.0026
.050	.958	.0357	.8	.14	.2	.06	.958	.0357	-.004	.0010	.013	.0024
.100	.978	.0357	.7	.17	.6	.12	.978	.0357	-.010	.0020	.011	.0030
.150	.997	.0357	-.0	.13	.2	.06	.997	.0357	-.004	.0011	.001	.0022
.200	1.001	.0360	1.6	.21	.2	.07	1.001	.0360	-.003	.0012	.027	.0038
.250	1.030	.0356	.2	.10	.7	.11	1.030	.0356	-.013	.0020	.004	.0017
.300	1.042	.0358	.6	.15	.0	.08	1.042	.0357	-.001	.0015	.011	.0028
.350	1.048	.0357	.1	.27	.0	.06	1.048	.0357	-.001	.0010	.001	.0050
.400	1.051	.0357	.7	.11	-.1	.05	1.051	.0357	.002	.0009	.012	.0020
.550	1.062	.0357	1.0	.10	-.4	.06	1.061	.0357	.007	.0011	.018	.0020
.700	1.065	.0357	.6	.10	.3	.12	1.065	.0357	-.006	.0022	.012	.0019
.850	1.061	.0357	1.0	.05	-.7	.17	1.061	.0357	.013	.0031	.018	.0011
1.000	1.062	.0357	.9	.13	.0	.12	1.061	.0357	-.001	.0023	.016	.0025

Upstream Velocity U_∞ = 29.2 m/s (+/- .74)
 Probe Yaw Offset Angle = 0.0 Deg

ORIGINAL PAGE IS
OF POOR QUALITY

Table H30. FIVE-HOLE PRESSURE PROBE WAKE PRESSURE DATA.
INCIDENCE ANGLE (DEG) = 0.0 , $Z_c/C = 2.06$, $R = 33.3\%$

NORMALIZED TANGENTIAL POSITION ZT/S	EXIT ANGLE		TOTAL PRESSURE PT2		STATIC PRESSURE P2		TOTAL PRESSURE RECOVERY	
	Deg (+/-)		kPa (+/-)		kPa (+/-)		PT2/PT1 (+/-)	
-1.000	.8	.11	100.26	.017	99.72	.017	1.0000	.00024
-.850	.9	.08	100.26	.017	99.72	.017	1.0000	.00024
-.700	.9	.22	100.26	.017	99.72	.017	1.0000	.00024
-.550	1.3	.24	100.26	.017	99.72	.017	1.0000	.00024
-.400	1.2	.14	100.25	.017	99.72	.017	.9999	.00024
-.350	.9	.14	100.24	.017	99.72	.017	.9999	.00024
-.300	1.3	.17	100.22	.017	99.72	.017	.9997	.00024
-.250	2.1	.27	100.21	.017	99.72	.017	.9996	.00024
-.200	1.6	.10	100.19	.017	99.72	.017	.9993	.00024
-.150	.9	.16	100.18	.017	99.72	.017	.9992	.00024
-.100	1.9	.21	100.16	.017	99.72	.017	.9990	.00024
-.050	1.1	.09	100.14	.017	99.72	.017	.9989	.00024
0.000	2.0	.13	100.15	.017	99.72	.017	.9990	.00024
.050	.8	.14	100.16	.017	99.72	.017	.9990	.00024
.100	.9	.15	100.18	.017	99.72	.017	.9992	.00024
.150	.2	.07	100.19	.017	99.72	.017	.9994	.00024
.200	1.6	.21	100.20	.018	99.72	.017	.9994	.00024
.250	.8	.11	100.22	.017	99.72	.017	.9997	.00024
.300	.6	.15	100.23	.017	99.71	.017	.9998	.00024
.350	.1	.24	100.24	.017	99.72	.017	.9999	.00024
.400	.7	.10	100.24	.017	99.72	.017	.9999	.00024
.550	1.0	.10	100.26	.017	99.72	.017	1.0000	.00024
.700	.7	.10	100.26	.017	99.72	.017	1.0000	.00024
.850	1.2	.10	100.26	.017	99.72	.017	1.0000	.00024
1.000	.9	.13	100.25	.017	99.72	.017	1.0000	.00024

Upstream Total Pressure PT1 = 100.26 kPa (+/- .017)

Upstream Static Pressure P1 = 99.78 kPa (+/- .017)

Table H31. FIVE-HOLE PRESSURE PROBE WAKE VELOCITY DATA
 INCIDENCE ANGLE (DEG) = 0.0 , $Z_c/C = 2.06$, $R = 50.0\%$

NORMALIZED TANGENTIAL POSITION 2T/S	NORMALIZED TOTAL VELOCITY						NORMALIZED VELOCITY COMPONENTS					
	U/U _∞ (+/-)		Pitch Ang Deg (+/-)		Yaw Ang Deg (+/-)		U _z /U _∞ (+/-)		U _t /U _∞ (+/-)		U _r /U _∞ (+/-)	
-1.000	1.061	.0353	.5	.05	.2	.10	1.061	.0353	-.004	.0019	.010	.0011
-.850	1.064	.0353	.9	.07	-.0	.07	1.064	.0353	.000	.0013	.016	.0014
-.700	1.059	.0353	.8	.07	.1	.09	1.059	.0353	-.003	.0017	.015	.0015
-.550	1.064	.0353	1.4	.09	.4	.09	1.063	.0353	-.007	.0016	.026	.0019
-.400	1.058	.0353	.1	.10	.6	.06	1.058	.0353	-.011	.0012	.002	.0019
-.350	1.050	.0352	.6	.08	.0	.07	1.050	.0352	-.000	.0013	.011	.0015
-.300	1.046	.0353	.4	.13	.0	.06	1.046	.0353	-.001	.0011	.007	.0023
-.250	1.039	.0352	1.3	.16	-.1	.06	1.039	.0352	.002	.0012	.024	.0030
-.200	1.024	.0352	1.0	.14	.2	.06	1.024	.0352	-.003	.0011	.018	.0026
-.150	1.006	.0352	1.4	.12	.3	.07	1.006	.0352	-.005	.0013	.025	.0023
-.100	.988	.0352	.3	.11	.1	.06	.988	.0352	-.002	.0010	.005	.0020
-.050	.971	.0352	.7	.08	-.1	.06	.971	.0352	.002	.0011	.011	.0015
0.000	.953	.0352	.9	.13	.4	.07	.953	.0352	-.006	.0011	.015	.0022
.050	.957	.0353	.3	.17	.5	.10	.957	.0353	-.008	.0017	.005	.0032
.100	.960	.0352	.5	.15	.4	.07	.960	.0352	-.007	.0012	.008	.0025
.150	.970	.0352	.7	.13	.8	.06	.970	.0352	-.013	.0012	.011	.0022
.200	.991	.0352	.8	.13	.5	.09	.991	.0352	-.009	.0016	.014	.0024
.250	.998	.0352	.5	.10	.6	.05	.998	.0352	-.010	.0010	.008	.0018
.300	1.017	.0352	.8	.22	.6	.06	1.017	.0352	-.011	.0012	.015	.0039
.350	1.026	.0352	.4	.21	.4	.06	1.026	.0352	-.006	.0011	.008	.0038
.400	1.036	.0352	.1	.15	.1	.06	1.036	.0352	-.002	.0011	.002	.0028
.550	1.049	.0352	.6	.09	.4	.11	1.049	.0352	-.008	.0021	.012	.0018
.700	1.047	.0352	1.3	.14	-.1	.11	1.046	.0352	.001	.0020	.023	.0027
.850	1.050	.0352	.9	.14	-.2	.06	1.050	.0352	.005	.0012	.017	.0026
1.000	1.052	.0352	.8	.07	.1	.09	1.052	.0352	-.002	.0017	.014	.0013

Upstream Velocity U_∞ = 29.4 m/s (+/- .73)
 Probe Yaw Offset Angle = 0.0 Deg

ORIGINAL PAGE IS
 OF POOR QUALITY

~~ORIGINAL PAGE IS
 OF POOR QUALITY~~

ORIGINAL PAGE IS
OF POOR QUALITY

Table H32. FIVE-HOLE PRESSURE PROBE WAKE PRESSURE DATA
INCIDENCE ANGLE (DEG) = 0.0 , $Z_c/C = 2.06$, $R = 50.0$ %

NORMALIZED TANGENTIAL POSITION ZT/S	EXIT ANGLE		TOTAL PRESURE PT2		STATIC PRESSURE P2		TOTAL PRESSURE RECOVERY	
	Deg (+/-)		kPa (+/-)		kPa (+/-)		PT2/PT1 (+/-)	
-1.000	.6	.06	100.29	.017	99.75	.017	1.0000	.00024
-.850	.9	.07	100.29	.017	99.75	.017	1.0000	.00024
-.700	.8	.07	100.29	.017	99.75	.017	1.0000	.00024
-.550	1.4	.09	100.29	.017	99.75	.017	1.0000	.00024
-.400	.6	.07	100.29	.017	99.75	.017	1.0000	.00024
-.350	.6	.08	100.28	.017	99.75	.017	.9999	.00024
-.300	.4	.13	100.28	.017	99.75	.017	.9999	.00024
-.250	1.3	.16	100.27	.017	99.75	.017	.9998	.00024
-.200	1.0	.14	100.26	.017	99.75	.017	.9997	.00024
-.150	1.4	.12	100.24	.017	99.75	.017	.9995	.00024
-.100	.3	.11	100.23	.017	99.75	.017	.9994	.00024
-.050	.7	.08	100.22	.017	99.76	.017	.9993	.00024
0.000	.9	.12	100.20	.017	99.76	.017	.9991	.00024
.050	.6	.13	100.19	.017	99.75	.017	.9990	.00024
.100	.6	.12	100.20	.017	99.76	.017	.9991	.00024
.150	1.0	.10	100.21	.017	99.75	.017	.9992	.00024
.200	.9	.12	100.23	.017	99.76	.017	.9994	.00024
.250	.8	.08	100.24	.017	99.76	.017	.9995	.00024
.300	1.0	.18	100.26	.017	99.76	.017	.9997	.00024
.350	.6	.17	100.27	.017	99.76	.017	.9998	.00024
.400	.1	.11	100.28	.017	99.76	.017	.9999	.00024
.550	.8	.10	100.29	.017	99.76	.017	1.0000	.00024
.700	1.3	.14	100.29	.017	99.76	.017	1.0000	.00024
.850	1.0	.13	100.29	.017	99.75	.017	1.0000	.00024
1.000	.8	.07	100.29	.017	99.75	.017	1.0000	.00024

Upstream Total Pressure PT1 = 100.29 kPa (+/- .017)

Upstream Static Pressure P1 = 99.81 kPa (+/- .017)

Table H33. FIVE HOLE PRESSURE PROBE WAKE VELOCITY DATA
 INCIDENCE ANGLE (DEG) = 0.0 , Zc/C = 2.06 , R = 66.7 %

NORMALIZED TANGENTIAL POSITION ZT/S	NORMALIZED TOTAL VELOCITY						NORMALIZED VELOCITY COMPONENTS					
	U/Uzo (+/-)		Pitch Ang Des (+/-)		Yaw Ang Des (+/-)		Uz/Uzo (+/-)		Ut/Uzo (+/-)		Ur/Uzo (+/-)	
-1.000	1.051	.0351	.8	.08	.1	.07	1.051	.0351	-.001	.0013	.014	.0015
-.850	1.055	.0351	1.2	.07	.7	.14	1.054	.0351	-.014	.0025	.022	.0016
-.700	1.053	.0351	1.3	.07	-.0	.12	1.053	.0351	.000	.0022	.025	.0016
-.550	1.050	.0351	.8	.09	.8	.18	1.050	.0351	-.014	.0033	.015	.0017
-.400	1.044	.0350	1.7	.07	.4	.06	1.044	.0350	-.008	.0011	.035	.0018
-.350	1.038	.0350	1.4	.21	.3	.07	1.038	.0350	-.005	.0014	.026	.0039
-.300	1.043	.0351	1.9	.18	.4	.19	1.042	.0350	-.007	.0034	.034	.0035
-.250	1.028	.0350	1.2	.20	.0	.05	1.028	.0350	-.001	.0008	.022	.0036
-.200	1.010	.0351	1.2	.21	.0	.00	1.010	.0350	-.000	.0014	.021	.0037
-.150	1.008	.0351	1.0	.13	.3	.09	1.008	.0351	-.004	.0017	.018	.0024
-.100	.980	.0353	.9	.09	.1	.08	.980	.0353	-.001	.0014	.016	.0016
-.050	.958	.0351	.4	.09	.1	.08	.958	.0351	-.002	.0013	.007	.0015
0.000	.937	.0351	-.1	.13	.1	.07	.937	.0351	-.002	.0011	-.002	.0021
.050	.937	.0352	-.3	.21	.1	.06	.937	.0352	-.002	.0010	-.005	.0035
.100	.949	.0351	.2	.15	.2	.08	.949	.0351	-.003	.0013	.004	.0025
.150	.957	.0352	.6	.08	.2	.09	.957	.0352	-.003	.0015	.011	.0014
.200	.963	.0351	-.4	.12	.1	.08	.963	.0351	-.002	.0014	-.006	.0020
.250	1.002	.0350	.6	.10	.3	.06	1.002	.0350	-.005	.0010	.010	.0018
.300	1.004	.0350	.6	.15	.2	.06	1.004	.0350	-.004	.0011	.011	.0026
.350	1.012	.0351	.7	.12	.0	.05	1.012	.0351	-.001	.0010	.015	.0022
.400	1.020	.0350	.7	.13	-.0	.12	1.020	.0350	.000	.0021	.013	.0023
.550	1.042	.0351	1.1	.10	-.1	.09	1.042	.0350	.002	.0016	.021	.0020
.700	1.036	.0351	1.0	.08	.4	.11	1.035	.0351	-.007	.0020	.017	.0015
.850	1.042	.0351	.8	.12	.5	.09	1.042	.0350	-.009	.0016	.014	.0022
1.000	1.040	.0351	.6	.18	.2	.10	1.048	.0351	-.003	.0019	.011	.0033

Upstream Velocity Uzo = 27.5 m/s (+/- .73)
 Probe Yaw Offset Angle = 0.0 Deg

ORIGINAL PAGE IS
OF POOR QUALITY

Table H34. FIVE-HOLE PRESSURE PROBE WAKE PRESSURE DATA
INCIDENCE ANGLE (DEG) = 0.0 , $Z_c/C = 2.06$, $R = 66.7\%$

NORMALIZED TANGENTIAL POSITION ZT/C	EXIT ANGLE		TOTAL PRESURE PT2		STATIC PRESSURE P2		TOTAL PRESSURE RECOVERY	
	Deg (+/-)		kPa (+/-)		kPa (+/-)		PT2/PT1 (+/-)	
-1.000	.8	.08	100.29	.017	99.75	.017	1.0000	.00024
-.850	1.4	.10	100.29	.017	99.75	.017	1.0000	.00024
-.700	1.3	.07	100.29	.017	99.75	.017	1.0000	.00024
-.550	1.1	.14	100.29	.017	99.75	.017	1.0000	.00024
-.400	2.0	.07	100.28	.017	99.75	.017	.9999	.00024
-.350	1.4	.21	100.28	.017	99.76	.017	.9999	.00024
-.300	1.9	.18	100.28	.017	99.75	.017	.9999	.00024
-.250	1.2	.20	100.27	.017	99.75	.017	.9998	.00024
-.200	1.2	.21	100.25	.017	99.75	.017	.9996	.00024
-.150	1.1	.13	100.25	.017	99.75	.017	.9996	.00024
-.100	.9	.09	100.22	.018	99.75	.017	.9993	.00024
-.050	.4	.09	100.20	.017	99.75	.017	.9991	.00024
0.000	.2	.11	100.18	.017	99.75	.017	.9989	.00024
.050	.3	.20	100.18	.017	99.75	.017	.9989	.00024
.100	.3	.12	100.17	.017	99.75	.017	.9990	.00024
.150	.7	.08	100.20	.017	99.75	.017	.9991	.00024
.200	.4	.11	100.21	.017	99.76	.017	.9992	.00024
.250	.6	.09	100.24	.017	99.76	.017	.9995	.00024
.300	.7	.14	100.25	.017	99.76	.017	.9996	.00024
.350	.9	.12	100.26	.017	99.76	.017	.9997	.00024
.400	.7	.13	100.27	.017	99.77	.017	.9998	.00024
.550	1.2	.10	100.29	.017	99.76	.017	1.0000	.00024
.700	1.0	.08	100.28	.017	99.76	.017	.9999	.00024
.850	.7	.11	100.29	.017	99.76	.017	1.0000	.00024
1.000	.6	.17	100.29	.017	99.76	.017	1.0000	.00024

Upstream Total Pressure PT1 = 100.29 kPa (+/- .017)

Upstream Static Pressure P1 = 99.80 kPa (+/- .017)

Table H35. FIVE HOLE PRESSURE PROBE WAKE VELOCITY DATA
INCIDENCE ANGLE (DEG) = 0.0 , Zc/C = 2.06 , R = 03.3 %

NORMALIZED TANGENTIAL POSITION ZT/S	NORMALIZED TOTAL VELOCITY					NORMALIZED VELOCITY COMPONENTS						
	U/Uzo (1/-)		Pitch Ang Deg (1/-)		Yaw Ang Deg (1/-)		Uz/Uzo (1/-)		Ut/Uzo (1/-)		Ur/Uzo (1/-)	
-1.000	1.043	.0349	1.4	.07	1.5	.15	1.043	.0349	-.028	.0028	.026	.0015
-.850	1.041	.0349	1.4	.08	.5	.33	1.041	.0349	-.010	.0060	.025	.0017
-.700	1.049	.0349	1.5	.08	.1	.11	1.049	.0349	-.002	.0020	.028	.0017
-.550	1.037	.0349	1.8	.12	.5	.07	1.036	.0349	-.007	.0013	.032	.0025
-.400	1.036	.0349	.7	.14	-.1	.14	1.036	.0349	.003	.0026	.013	.0026
-.350	1.024	.0349	1.9	.10	.0	.21	1.023	.0349	-.000	.0038	.034	.0022
-.300	1.017	.0349	2.2	.18	-.5	.09	1.016	.0348	.009	.0016	.040	.0034
-.250	1.007	.0351	2.0	.09	.0	.10	1.006	.0350	-.000	.0018	.035	.0019
-.200	.963	.0349	1.4	.15	.3	.08	.963	.0349	-.005	.0014	.024	.0027
-.150	.967	.0353	.6	.10	-.4	.07	.967	.0353	.007	.0012	.009	.0018
-.100	.944	.0352	.3	.14	.2	.12	.944	.0352	-.004	.0020	.005	.0023
-.050	.907	.0354	.1	.10	-.0	.15	.907	.0354	.001	.0024	.002	.0016
0.000	.910	.0351	-.7	.09	-.1	.08	.910	.0351	.002	.0012	-.010	.0014
.050	.908	.0352	-.8	.11	.4	.12	.908	.0352	-.006	.0019	-.013	.0018
.100	.915	.0352	-.2	.12	1.2	.29	.915	.0351	-.020	.0047	-.003	.0020
.150	.926	.0351	.3	.09	.1	.17	.926	.0351	.002	.0027	.005	.0015
.200	.964	.0349	.7	.06	.8	.09	.964	.0349	-.014	.0016	.011	.0011
.250	.982	.0354	.9	.13	1.3	.12	.982	.0353	-.022	.0023	.015	.0024
.300	.990	.0349	.8	.07	1.0	.11	.990	.0349	-.018	.0020	.013	.0017
.350	1.005	.0350	.5	.09	1.2	.12	1.005	.0350	-.022	.0023	.009	.0015
.400	1.000	.0349	1.2	.07	.7	.13	1.000	.0349	-.016	.0023	.021	.0015
.550	1.017	.0355	1.2	.17	1.8	.20	1.018	.0355	-.033	.0037	.021	.0031
.700	1.034	.0349	1.2	.11	1.5	.33	1.033	.0349	.026	.0059	.022	.0021
.850	1.023	.0349	1.1	.07	.8	.14	1.022	.0348	-.014	.0025	.020	.0014
1.000	1.025	.0349	1.1	.08	.8	.23	1.025	.0349	-.015	.0041	.020	.0016

Upstream Velocity Uzo = 29.6 m/s (1/- .73)
Probe Yaw Offset Angle = 0.0 Deg

ORIGINAL PAGE IS
OF POOR QUALITY

Table H30. FIVE-HOLE PRESSURE PROBE WAKE PRESSURE DATA
INCIDENCE ANGLE (DEG) = 0.0 , $Z_c/C = 2.06$, $R = 83.3\%$

NORMALIZED TANGENTIAL POSITION	EXIT ANGLE		TOTAL PRESURE PT2		STATIC PRESSURE P2		TOTAL PRESSURE RECOVERY	
	ZT/S	$\Delta\alpha$ (+/-)	kPa (+/-)		kPa (+/-)		PT2/PT1 (+/-)	
1.000	2.1	.12	100.28	.017	99.75	.017	.9999	.00024
.850	1.5	.14	100.28	.017	99.75	.017	.9999	.00024
-.700	1.5	.08	100.29	.017	99.75	.017	.9999	.00024
-.550	1.8	.12	100.28	.017	99.75	.017	.9999	.00024
-.400	.7	.14	100.28	.017	99.75	.017	.9999	.00024
-.350	1.9	.10	100.27	.017	99.75	.017	.9998	.00024
-.300	2.3	.17	100.26	.017	99.75	.017	.9997	.00024
-.250	2.0	.09	100.25	.017	99.75	.017	.9996	.00024
-.200	1.5	.15	100.21	.017	99.76	.017	.9992	.00024
-.150	.7	.09	100.22	.018	99.76	.017	.9993	.00025
-.100	.4	.13	100.19	.017	99.76	.017	.9990	.00024
-.050	.1	.11	100.16	.017	99.76	.017	.9987	.00024
0.000	.7	.09	100.17	.017	99.76	.017	.9988	.00024
.050	.7	.11	100.16	.017	99.76	.017	.9987	.00024
.100	1.2	.29	100.17	.017	99.76	.017	.9988	.00024
.150	.3	.11	100.18	.017	99.76	.017	.9989	.00024
.200	1.1	.08	100.21	.017	99.76	.017	.9992	.00024
.250	1.5	.13	100.23	.018	99.76	.017	.9994	.00025
.300	1.3	.11	100.24	.017	99.76	.017	.9995	.00024
.350	1.3	.12	100.25	.017	99.76	.017	.9996	.00024
.400	1.5	.10	100.25	.017	99.76	.017	.9996	.00024
.550	2.2	.19	100.27	.018	99.76	.017	.9998	.00025
.700	1.9	.26	100.29	.017	99.77	.017	1.0000	.00024
.850	1.4	.10	100.28	.017	99.77	.017	.9999	.00024
1.000	1.4	.15	100.28	.017	99.77	.017	.9999	.00024

Upstream Total Pressure PT1 = 100.29 kPa (+/- .017)

Upstream Static Pressure P1 = 99.80 kPa (+/- .017)

Table H37. FIVE-HOLE PRESSURE PROBE WAKE VELOCITY DATA
 INCIDENCE ANGLE (DEG) = 5.0 , Zc/C = .94 , R = 4.2 %

NORMALIZED TANGENTIAL POSITION 2T/S	NORMALIZED TOTAL VELOCITY					NORMALIZED VELOCITY COMPONENTS						
	U/Uzo (+/-)		Pitch Ans Deg (+/-)		Yaw Ans Deg (+/-)		Uz/Uzo (+/-)		Ut/Uzo (+/-)		Ur/Uzo (+/-)	
-1.000	.955	.0322	1.5	.17	1.0	.12	.952	.0321	.067	.0030	.024	.0029
-.850	.922	.0324	1.0	.12	2.1	.24	.921	.0324	.047	.0042	.017	.0020
-.700	.932	.0332	1.2	.14	1.6	.22	.930	.0331	.055	.0041	.020	.0024
-.550	.912	.0323	.5	.12	2.3	.27	.911	.0322	.043	.0045	.008	.0019
-.400	.969	.0325	.5	.08	.9	.18	.966	.0324	.069	.0038	.009	.0014
-.350	.944	.0326	.2	.11	1.8	.23	.942	.0325	.053	.0042	.003	.0019
-.300	.918	.0326	-.1	.11	1.1	.18	.916	.0326	.062	.0036	-.001	.0018
-.250	.892	.0324	-.2	.13	1.3	.11	.890	.0323	.058	.0028	-.002	.0020
-.200	.911	.0325	.1	.14	.8	.15	.909	.0324	.067	.0034	.001	.0022
-.150	.901	.0325	.5	.13	.7	.13	.898	.0324	.068	.0032	.007	.0020
-.100	.851	.0329	.9	.11	.1	.18	.848	.0328	.073	.0039	.013	.0018
-.050	.856	.0330	1.2	.12	.5	.10	.853	.0329	.067	.0029	.018	.0019
0.000	.838	.0333	2.0	.13	.7	.10	.836	.0332	.063	.0029	.029	.0022
.050	.809	.0337	2.1	.15	1.5	.14	.807	.0336	.050	.0029	.029	.0024
.100	.858	.0328	1.6	.15	2.0	.10	.857	.0327	.045	.0023	.024	.0024
.150	.893	.0325	1.3	.07	2.3	.10	.892	.0325	.042	.0022	.020	.0013
.200	.925	.0322	.8	.08	2.7	.08	.924	.0321	.037	.0019	.013	.0014
.250	.960	.0322	.7	.08	2.5	.07	.959	.0322	.043	.0019	.012	.0014
.300	.959	.0320	1.1	.10	2.4	.10	.958	.0320	.043	.0022	.018	.0018
.350	.946	.0322	1.3	.10	2.5	.07	.945	.0322	.041	.0018	.021	.0018
.400	.956	.0324	.9	.12	2.6	.10	.955	.0323	.040	.0021	.016	.0020
.550	.955	.0320	1.3	.08	3.3	.08	.954	.0320	.028	.0017	.022	.0015
.700	1.002	.0323	.9	.09	3.0	.10	1.002	.0323	.035	.0021	.015	.0016
.850	1.039	.0320	.9	.09	2.8	.13	1.038	.0320	.041	.0027	.017	.0017
1.000	1.031	.0321	.9	.09	2.8	.10	1.030	.0320	.040	.0022	.016	.0016

Upstream Velocity Uzo = 30.8 m/s (+/- .70)
 Probe Yaw Offset Angle = 5.0 Deg

ORIGINAL PAGE IS
OF POOR QUALITY

Table H38. FIVE-HOLE PRESSURE PROBE WAKE PRESSURE DATA
INCIDENCE ANGLE (DEG) = 5.0 , $Z_c/C = .94$, $R = 4.2\%$

NORMALIZED TANGENTIAL POSITION 2T/S	EXIT ANGLE		TOTAL PRESURE PT2		STATIC PRESSURE P2		TOTAL PRESSURE RECOVERY	
	Deg (+/-)		kPa (+/-)		kPa (+/-)		PT2/PT1 (+/-)	
-1.000	4.3	.13	100.00	.017	99.52	.017	.9988	.00024
-.850	3.1	.23	99.97	.018	99.52	.017	.9985	.00024
-.700	3.6	.21	99.98	.019	99.52	.017	.9986	.00025
-.550	2.7	.26	99.96	.017	99.52	.017	.9984	.00024
-.400	4.1	.18	100.02	.018	99.52	.017	.9990	.00025
-.350	3.2	.23	99.99	.018	99.52	.017	.9987	.00025
-.300	3.9	.18	99.97	.018	99.53	.017	.9985	.00025
-.250	3.8	.11	99.95	.017	99.52	.017	.9982	.00024
-.200	4.2	.15	99.97	.018	99.52	.017	.9984	.00024
-.150	4.3	.13	99.96	.017	99.52	.017	.9983	.00024
-.100	5.0	.18	99.91	.017	99.52	.017	.9979	.00024
-.050	4.6	.10	99.91	.017	99.52	.017	.9979	.00024
0.000	4.7	.11	99.89	.018	99.52	.017	.9977	.00024
.050	4.1	.14	99.87	.018	99.53	.017	.9975	.00024
.100	3.4	.11	99.92	.017	99.52	.017	.9979	.00024
.150	3.0	.09	99.95	.017	99.52	.017	.9983	.00024
.200	2.4	.08	99.98	.017	99.52	.017	.9986	.00024
.250	2.6	.07	100.01	.017	99.52	.017	.9989	.00024
.300	2.8	.10	100.01	.017	99.52	.017	.9989	.00024
.350	2.8	.08	100.00	.017	99.52	.017	.9988	.00024
.400	2.6	.10	100.01	.018	99.52	.017	.9989	.00024
.550	2.2	.08	100.01	.017	99.52	.017	.9989	.00024
.700	2.2	.10	100.06	.018	99.52	.017	.9994	.00025
.850	2.4	.12	100.10	.017	99.52	.017	.9998	.00024
1.000	2.4	.10	100.09	.017	99.52	.017	.9997	.00024

Upstream Total Pressure PT1 = 100.12 kPa (+/- .017)

Upstream Static Pressure P1 = 99.59 kPa (+/- .017)

Table H39. FIVE-HOLE PRESSURE PROBE WAKE VELOCITY DATA
 INCIDENCE ANGLE (DEG) = 5.0 , $Z_c/C = .94$, $R = 8.3\%$

NORMALIZED TANGENTIAL POSITION ZT/S	NORMALIZED TOTAL VELOCITY						NORMALIZED VELOCITY COMPONENTS					
	U/Uzo (+/-)		Pitch Ang Deg (+/-)		Yaw Ang Deg (+/-)		Uz/Uzo (+/-)		Ut/Uzo (+/-)		Ur/Uzo (+/-)	
-1.000	1.025	.0327	1.3	.15	2.0	.12	1.023	.0326	.053	.0028	.024	.0027
-.850	1.010	.0327	1.0	.16	2.4	.18	1.009	.0327	.045	.0035	.017	.0028
-.700	.992	.0334	1.0	.12	3.0	.19	.991	.0334	.034	.0036	.018	.0022
-.550	1.012	.0320	.4	.08	2.2	.16	1.010	.0319	.049	.0032	.007	.0014
-.400	.987	.0323	.0	.14	1.7	.14	.985	.0323	.057	.0031	.000	.0025
-.350	.983	.0320	-1.0	.17	2.3	.14	.982	.0319	.046	.0028	-.018	.0030
-.300	.992	.0322	-.8	.13	1.7	.09	.991	.0321	.057	.0024	-.014	.0023
-.250	.980	.0320	-.9	.15	2.0	.09	.978	.0319	.052	.0023	-.016	.0026
-.200	.958	.0321	-.8	.09	1.8	.09	.957	.0320	.054	.0023	-.014	.0016
-.150	.934	.0321	-.5	.09	1.6	.08	.933	.0321	.056	.0023	-.008	.0015
-.100	.907	.0322	-.1	.11	2.1	.09	.906	.0322	.047	.0021	-.001	.0018
-.050	.883	.0326	1.2	.08	1.7	.08	.881	.0325	.051	.0023	.018	.0013
0.000	.870	.0326	1.9	.10	1.9	.08	.868	.0326	.047	.0022	.029	.0018
.050	.876	.0325	2.3	.14	2.2	.12	.874	.0324	.042	.0024	.036	.0025
.100	.908	.0323	2.3	.09	2.7	.13	.907	.0322	.037	.0024	.037	.0020
.150	.952	.0320	1.7	.09	3.1	.09	.951	.0320	.032	.0018	.028	.0017
.200	.985	.0319	1.5	.11	3.3	.11	.984	.0319	.029	.0021	.025	.0021
.250	1.021	.0320	1.2	.09	2.7	.10	1.020	.0319	.042	.0023	.022	.0017
.300	1.022	.0320	1.4	.09	3.6	.10	1.021	.0320	.025	.0019	.025	.0019
.350	1.031	.0322	1.1	.13	3.4	.14	1.030	.0322	.029	.0027	.021	.0023
.400	1.057	.0321	1.5	.07	2.3	.16	1.056	.0321	.050	.0033	.028	.0016
.550	1.049	.0320	1.8	.11	4.0	.08	1.048	.0320	.019	.0016	.033	.0022
.700	1.054	.0321	.6	.13	3.7	.18	1.054	.0321	.024	.0033	.010	.0025
.850	1.068	.0321	.5	.08	.5	.25	1.065	.0320	.084	.0052	.010	.0015
1.000	1.067	.0321	.6	.09	2.3	.22	1.066	.0320	.051	.0044	.012	.0017

Upstream Velocity Uzo = 30.8 m/s (+/- .70)
 Probe Yaw Offset Angle = 5.0 Deg

ORIGINAL PAGE IS
 OF POOR QUALITY

ORIGINAL PAGE IS
OF POOR QUALITY

Table H40. FIVE-HOLE PRESSURE PROBE WAKE PRESSURE DATA
INCIDENCE ANGLE (DEG) = 5.0 , $Z_c/C = .94$, $R = 8.3\%$

NORMALIZED TANGENTIAL POSITION 2T/S	EXIT ANGLE		TOTAL PRESURE PT2		STATIC PRESSURE P2		TOTAL PRESSURE RECOVERY	
	Deg (+/-)		kPa (+/-)		kPa (+/-)		PT2/PT1 (+/-)	
-1.000	3.2	.13	100.07	.019	99.51	.017	.9995	.00025
-.850	2.7	.18	100.06	.019	99.52	.017	.9994	.00025
-.700	2.2	.18	100.04	.020	99.52	.017	.9992	.00026
-.550	2.8	.16	100.06	.017	99.52	.017	.9994	.00024
-.400	3.3	.14	100.04	.018	99.52	.017	.9992	.00025
-.350	2.9	.14	100.03	.017	99.51	.017	.9991	.00024
-.300	3.4	.09	100.04	.018	99.52	.017	.9992	.00024
-.250	3.2	.10	100.03	.017	99.51	.017	.9990	.00024
-.200	3.3	.09	100.01	.017	99.52	.017	.9989	.00024
-.150	3.5	.08	99.98	.017	99.52	.017	.9986	.00024
-.100	2.9	.09	99.96	.017	99.52	.017	.9983	.00024
-.050	3.5	.08	99.93	.017	99.52	.017	.9981	.00024
0.000	3.6	.09	99.92	.017	99.52	.017	.9980	.00024
.050	3.6	.13	99.93	.017	99.52	.017	.9981	.00024
.100	3.3	.11	99.96	.017	99.52	.017	.9984	.00024
.150	2.5	.09	100.00	.017	99.52	.017	.9988	.00024
.200	2.2	.11	100.03	.017	99.52	.017	.9991	.00024
.250	2.6	.10	100.07	.017	99.51	.017	.9995	.00024
.300	2.0	.09	100.07	.017	99.52	.017	.9995	.00024
.350	2.0	.14	100.08	.017	99.52	.017	.9996	.00024
.400	3.1	.15	100.10	.017	99.51	.017	.9998	.00024
.550	2.1	.10	100.10	.017	99.52	.017	.9998	.00024
.700	1.4	.17	100.12	.017	99.52	.017	.9999	.00024
.850	4.5	.24	100.12	.017	99.51	.017	1.0000	.00024
1.000	2.8	.22	100.12	.017	99.51	.017	1.0000	.00024

Upstream Total Pressure PT1 = 100.12 kPa (+/- .017)

Upstream Static Pressure p1 = 99.59 kPa (+/- .017)

Table H41. FIVE-HOLE PRESSURE PROBE WAKE VELOCITY DATA
 INCIDENCE ANGLE (DEG) = 5.0 , Zc/C = .94 , R = 12.5 %

NORMALIZED TANGENTIAL POSITION 2T/S	NORMALIZED TOTAL VELOCITY					NORMALIZED VELOCITY COMPONENTS						
	U/Uzo (+/-)		Pitch Ang Deg (+/-)		Yaw Ang Deg (+/-)		Uz/Uzo (+/-)		Ut/Uzo (+/-)		Ur/Uzo (+/-)	
-1.000	1.046	.0319	1.4	.11	2.5	.10	1.044	.0319	.045	.0022	.026	.0021
-.850	1.041	.0320	1.3	.10	2.6	.11	1.039	.0320	.044	.0024	.023	.0020
-.700	1.039	.0320	.6	.14	3.3	.10	1.039	.0320	.032	.0021	.012	.0026
-.550	1.031	.0319	.6	.06	2.8	.07	1.030	.0318	.040	.0018	.012	.0012
-.400	1.025	.0318	-.9	.14	2.4	.13	1.024	.0318	.047	.0027	-.016	.0025
-.350	1.018	.0319	-1.3	.14	1.9	.08	1.016	.0318	.055	.0022	-.022	.0026
-.300	1.011	.0319	-2.2	.17	2.1	.11	1.009	.0319	.051	.0026	-.039	.0032
-.250	.999	.0319	-1.1	.11	2.0	.11	.997	.0318	.052	.0025	-.019	.0020
-.200	.975	.0319	-.5	.18	1.9	.13	.974	.0318	.053	.0028	-.008	.0031
-.150	.946	.0319	-.9	.12	1.9	.08	.945	.0319	.051	.0021	-.014	.0020
-.100	.920	.0321	-.5	.16	2.3	.13	.919	.0321	.043	.0025	-.007	.0025
-.050	.892	.0324	1.0	.16	2.0	.08	.891	.0323	.047	.0021	.015	.0025
0.000	.890	.0323	1.2	.15	2.3	.09	.889	.0322	.043	.0021	.019	.0024
.050	.909	.0323	2.0	.16	2.6	.10	.908	.0322	.037	.0020	.031	.0028
.100	.948	.0319	2.8	.11	2.5	.10	.946	.0319	.041	.0021	.047	.0024
.150	.977	.0326	1.4	.10	2.1	.19	.976	.0326	.049	.0037	.024	.0018
.200	1.014	.0318	2.1	.11	3.1	.11	1.013	.0318	.034	.0022	.038	.0022
.250	1.039	.0319	1.7	.14	2.9	.11	1.038	.0318	.039	.0024	.031	.0027
.300	1.054	.0319	1.2	.12	2.3	.20	1.053	.0319	.049	.0039	.023	.0024
.350	1.059	.0319	1.3	.25	3.0	.12	1.058	.0319	.038	.0025	.024	.0047
.400	1.055	.0319	2.1	.14	3.4	.11	1.054	.0319	.030	.0022	.039	.0029
.550	1.061	.0319	1.1	.19	3.0	.11	1.061	.0319	.038	.0024	.021	.0035
.700	1.069	.0320	.3	.17	.9	.09	1.066	.0319	.077	.0029	.006	.0032
.850	1.061	.0319	-.1	.09	3.1	.10	1.061	.0319	.035	.0021	-.002	.0016
1.000	1.063	.0319	-.0	.08	3.1	.14	1.062	.0319	.035	.0028	-.000	.0015

Upstream Velocity Uzo = 30.8 m/s (+/- .69)
 Probe Yaw Offset Angle = 5.0 Deg

ORIGINAL PAGE IS
OF POOR QUALITY

Table H42. FIVE-HOLE PRESSURE PROBE WAKE PRESSURE DATA
INCIDENCE ANGLE (DEG) = 5.0 , Zc/C = .94 , R = 12.5%

NORMALIZED TANGENTIAL POSITION 2T/S	EXIT ANGLE		TOTAL PRESURE PT2		STATIC PRESSURE P2		TOTAL PRESSURE RECOVERY	
	Deg	(+/-)	KPa	(+/-)	KPa	(+/-)	PT2/PT1	(+/-)
-1.000	2.9	.10	100.10	.017	99.51	.017	.9998	.00024
-.850	2.7	.11	100.09	.017	99.51	.017	.9997	.00024
-.700	1.9	.11	100.09	.017	99.52	.017	.9997	.00024
-.550	2.3	.07	100.08	.017	99.52	.017	.9996	.00024
-.400	2.8	.13	100.07	.017	99.51	.017	.9995	.00024
-.350	3.4	.09	100.07	.017	99.52	.017	.9995	.00024
-.300	3.6	.14	100.07	.017	99.52	.017	.9994	.00024
-.250	3.2	.11	100.05	.017	99.52	.017	.9993	.00024
-.200	3.2	.13	100.03	.017	99.52	.017	.9991	.00024
-.150	3.2	.08	99.99	.017	99.52	.017	.9987	.00024
-.100	2.7	.13	99.97	.017	99.51	.017	.9984	.00024
-.050	3.2	.09	99.94	.017	99.52	.017	.9982	.00024
0.000	3.0	.10	99.94	.017	99.52	.017	.9982	.00024
.050	3.1	.13	99.96	.017	99.51	.017	.9984	.00024
.100	3.8	.10	100.00	.017	99.52	.017	.9988	.00024
.150	3.2	.18	100.03	.019	99.52	.017	.9991	.00025
.200	2.9	.11	100.07	.017	99.52	.017	.9995	.00024
.250	2.7	.12	100.09	.017	99.51	.017	.9997	.00024
.300	2.9	.19	100.11	.017	99.51	.017	.9999	.00024
.350	2.4	.17	100.12	.017	99.52	.017	1.0000	.00024
.400	2.6	.13	100.11	.017	99.52	.017	.9999	.00024
.550	2.3	.13	100.12	.017	99.52	.017	1.0000	.00024
.700	4.2	.09	100.12	.017	99.51	.017	1.0000	.00024
.850	1.9	.10	100.12	.017	99.52	.017	1.0000	.00024
1.000	1.9	.14	100.12	.017	99.52	.017	1.0000	.00024

Upstream Total Pressure PT1 = 100.12 kPa (+/- .017)

Upstream Static Pressure p1 = 99.59 kPa (+/- .017)

Table H43. FIVE-HOLE PRESSURE PROBE WAKE VELOCITY DATA
 INCIDENCE ANGLE (DEG) = 5.0 , $Z_c/C = .94$, $R = 16.7\%$

NORMALIZED TANGENTIAL POSITION ZT/S	NORMALIZED TOTAL VELOCITY					NORMALIZED VELOCITY COMPONENTS						
	U/Uzo (+/-)		Pitch Ang Deg (+/-)		Yaw Ang Deg (+/-)		Uz/Uzo (+/-)		Uv/Uzo (+/-)		Ur/Uzo (+/-)	
-1.000	1.057	.0321	1.2	.08	2.5	.17	1.056	.0321	.046	.0035	.023	.0016
-.850	1.062	.0322	1.2	.05	4.0	.08	1.061	.0322	.019	.0016	.023	.0012
-.700	1.065	.0322	.8	.08	2.8	.11	1.065	.0321	.041	.0023	.014	.0016
-.550	1.059	.0321	.4	.13	2.2	.10	1.058	.0321	.051	.0025	.006	.0025
-.400	1.053	.0321	-.6	.11	2.1	.11	1.051	.0321	.054	.0026	-.012	.0021
-.350	1.041	.0321	-1.9	.16	2.0	.09	1.039	.0320	.054	.0024	-.034	.0030
-.300	1.046	.0323	-1.8	.15	1.7	.20	1.044	.0323	.060	.0041	-.034	.0029
-.250	1.034	.0321	-1.5	.12	1.8	.08	1.032	.0321	.058	.0023	-.027	.0024
-.200	1.005	.0320	-1.1	.20	1.6	.11	1.003	.0320	.059	.0027	-.019	.0036
-.150	.980	.0322	-1.2	.21	1.7	.09	.978	.0321	.056	.0024	-.020	.0037
-.100	.962	.0321	-.3	.18	1.8	.09	.960	.0320	.053	.0023	-.005	.0031
-.050	.911	.0324	1.7	.15	1.6	.11	.909	.0323	.054	.0026	.027	.0026
0.000	.888	.0325	1.5	.20	1.8	.13	.887	.0324	.050	.0027	.024	.0033
.050	.866	.0328	1.7	.28	2.5	.00	.865	.0328	.038	.0019	.026	.0044
.100	.925	.0326	2.7	.17	2.4	.15	.923	.0325	.042	.0028	.043	.0032
.150	.965	.0322	2.2	.16	2.2	.11	.963	.0321	.048	.0025	.036	.0030
.200	.994	.0323	3.1	.18	2.5	.11	.991	.0322	.044	.0024	.054	.0036
.250	1.041	.0321	1.1	.11	1.9	.10	1.040	.0320	.057	.0026	.020	.0021
.300	1.049	.0321	1.9	.13	2.5	.12	1.047	.0320	.045	.0025	.035	.0026
.350	1.062	.0322	1.1	.29	2.4	.23	1.060	.0321	.048	.0044	.020	.0054
.400	1.057	.0321	1.8	.14	2.1	.11	1.055	.0320	.054	.0027	.033	.0027
.550	1.062	.0322	.2	.26	2.5	.14	1.061	.0321	.046	.0030	.003	.0047
.700	1.069	.0322	.1	.17	.8	.22	1.066	.0321	.079	.0047	.002	.0031
.850	1.063	.0321	-.2	.14	2.8	.13	1.062	.0321	.041	.0026	-.004	.0026
1.000	1.064	.0321	-.4	.08	.9	.20	1.062	.0321	.076	.0043	-.007	.0014

Upstream Velocity Uzo = 30.5 m/s (+/- .69)
 Probe Yaw Offset Angle = 5.0 Deg

ORIGINAL PAGE IS
OF POOR QUALITY

Table H44. FIVE-HOLE PRESSURE PROBE WAKE PRESSURE DATA
INCIDENCE ANGLE (DEG) = 5.0 , $Z_c/C = .94$, $R = 16.7 \%$

NORMALIZED TANGENTIAL POSITION ZT/S	EXIT ANGLE		TOTAL PRESURE PT2		STATIC PRESSURE P2		TOTAL PRESSURE RECOVERY	
	Deg (+/-)		kPa (+/-)		kPa (+/-)		PT2/PT1 (+/-)	
-1.000	2.8	.16	100.18	.017	99.59	.017	.9999	.00024
-.850	1.6	.07	100.18	.017	99.58	.017	.9999	.00024
-.700	2.3	.10	100.19	.017	99.58	.017	1.0000	.00024
-.550	2.8	.10	100.18	.017	99.58	.017	.9999	.00024
-.400	3.0	.11	100.18	.017	99.59	.017	.9999	.00024
-.350	3.5	.11	100.17	.017	99.59	.017	.9998	.00024
-.300	3.8	.19	100.17	.018	99.58	.017	.9998	.00024
-.250	3.5	.09	100.15	.017	99.58	.017	.9996	.00024
-.200	3.5	.12	100.12	.017	99.59	.017	.9993	.00024
-.150	3.5	.11	100.10	.017	99.59	.017	.9991	.00024
-.100	3.2	.09	100.08	.017	99.59	.017	.9989	.00024
-.050	3.8	.12	100.03	.017	99.59	.017	.9984	.00024
0.000	3.5	.14	100.01	.017	99.59	.017	.9982	.00024
.050	3.0	.17	99.99	.017	99.59	.017	.9980	.00024
.100	3.7	.16	100.04	.018	99.58	.017	.9985	.00024
.150	3.6	.13	100.08	.017	99.58	.017	.9989	.00024
.200	4.0	.16	100.11	.018	99.58	.017	.9992	.00024
.250	3.3	.10	100.16	.017	99.58	.017	.9997	.00024
.300	3.1	.12	100.17	.017	99.59	.017	.9998	.00024
.350	2.8	.24	100.18	.017	99.59	.017	1.0000	.00024
.400	3.4	.12	100.19	.017	99.59	.017	1.0000	.00024
.550	2.5	.15	100.19	.017	99.59	.017	1.0000	.00024
.700	4.2	.22	100.19	.017	99.58	.017	1.0000	.00024
.850	2.2	.13	100.19	.017	99.59	.017	1.0000	.00024
1.000	4.1	.20	100.19	.017	99.59	.017	1.0000	.00024

Upstream Total Pressure PT1 = 100.19 kPa (+/- .017)

Upstream Static Pressure P1 = 99.66 kPa (+/- .017)

Table H45. FIVE-HOLE PRESSURE PROBE WAKE VELOCITY DATA
 INCIDENCE ANGLE (DEG) = 5.0 , $Z_c/C = .94$, $R = 25.0\%$

NORMALIZED TANGENTIAL POSITION 2T/S	NORMALIZED TOTAL VELOCITY				NORMALIZED VELOCITY COMPONENTS							
	U/U _∞ (+/-)		Pitch Ang Deg (+/-)		Yaw Ang Deg (+/-)		U _z /U _∞ (+/-)		U _t /U _∞ (+/-)		U _r /U _∞ (+/-)	
-1.000	1.066	.0320	1.3	.07	1.3	.08	1.063	.0319	.069	.0025	.025	.0014
-.850	1.069	.0320	.7	.10	1.0	.09	1.066	.0319	.074	.0027	.013	.0018
-.700	1.069	.0320	.5	.08	.7	.07	1.066	.0319	.080	.0027	.009	.0016
-.550	1.067	.0320	-.2	.15	1.2	.12	1.064	.0319	.072	.0031	-.004	.0028
-.400	1.063	.0320	-1.5	.30	.8	.13	1.060	.0319	.078	.0033	-.027	.0056
-.350	1.052	.0320	-1.3	.13	1.0	.08	1.049	.0319	.074	.0026	-.024	.0025
-.300	1.047	.0319	-1.6	.17	.8	.07	1.044	.0318	.077	.0027	-.028	.0032
-.250	1.039	.0319	-1.0	.09	1.0	.08	1.037	.0319	.073	.0027	-.018	.0017
-.200	1.012	.0321	-.3	.18	.8	.11	1.010	.0320	.074	.0030	-.005	.0032
-.150	.992	.0319	.8	.11	.6	.10	.989	.0318	.077	.0030	.013	.0020
-.100	.962	.0320	1.2	.30	.5	.15	.959	.0319	.075	.0036	.020	.0050
-.050	.926	.0321	2.1	.31	.8	.18	.923	.0320	.068	.0038	.034	.0051
0.000	.914	.0321	2.6	.17	.7	.13	.911	.0320	.068	.0032	.041	.0030
.050	.939	.0320	2.8	.12	1.2	.16	.936	.0319	.062	.0034	.045	.0025
.100	.985	.0319	2.2	.24	1.6	.17	.983	.0318	.058	.0034	.038	.0043
.150	1.024	.0319	3.0	.25	1.4	.12	1.020	.0318	.064	.0030	.054	.0048
.200	1.039	.0319	3.7	.17	1.5	.15	1.035	.0318	.063	.0034	.067	.0038
.250	1.054	.0320	2.6	.26	1.4	.17	1.051	.0319	.065	.0038	.048	.0049
.300	1.062	.0320	2.7	.24	1.5	.10	1.059	.0319	.064	.0027	.050	.0047
.350	1.060	.0321	2.9	.37	1.7	.26	1.057	.0320	.061	.0052	.054	.0069
.400	1.069	.0320	2.3	.32	1.9	.21	1.067	.0320	.059	.0043	.043	.0062
.550	1.069	.0320	.4	.17	1.8	.15	1.068	.0320	.059	.0033	.008	.0032
.700	1.062	.0320	-.3	.09	1.9	.15	1.061	.0319	.057	.0033	-.006	.0017
.850	1.066	.0320	-1.1	.10	1.5	.13	1.064	.0319	.065	.0031	-.021	.0019
1.000	1.068	.0320	-1.2	.09	1.0	.09	1.065	.0319	.074	.0028	-.023	.0018

Upstream Velocity U_∞ = 30.8 m/s (+/- .69)
 Probe Yaw Offset Angle = 5.0 Deg

ORIGINAL PAGE IS
OF POOR QUALITY

Table H46. FIVE-HOLE PRESSURE PROBE WAKE PRESSURE DATA
INCIDENCE ANGLE (DEG) = 5.0 , $Z_c/C = .94$, $R = 25.0\%$

NORMALIZED TANGENTIAL POSITION 2T/S	EXIT ANGLE		TOTAL PRESURE PT2		STATIC PRESURE P2		TOTAL PRESSURE RECOVERY	
	Deg	(+/-)	kPa	(+/-)	kPa	(+/-)	PT2/PT1	(+/-)
-1.000	3.9	.07	100.12	.017	99.52	.017	1.0000	.00024
-.850	4.0	.09	100.13	.017	99.52	.017	1.0001	.00024
-.700	4.3	.07	100.12	.017	99.51	.017	1.0000	.00024
-.550	3.8	.12	100.13	.017	99.52	.017	1.0001	.00024
-.400	4.4	.15	100.12	.017	99.52	.017	1.0000	.00024
-.350	4.2	.08	100.12	.017	99.53	.017	1.0000	.00024
-.300	4.5	.09	100.11	.017	99.52	.017	.9999	.00024
-.250	4.2	.08	100.09	.017	99.51	.017	.9997	.00024
-.200	4.2	.11	100.06	.017	99.52	.017	.9994	.00024
-.150	4.5	.10	100.04	.017	99.52	.017	.9992	.00024
-.100	4.6	.17	100.02	.017	99.52	.017	.9990	.00024
-.050	4.7	.21	99.98	.017	99.52	.017	.9986	.00024
0.000	5.0	.14	99.96	.017	99.51	.017	.9984	.00024
.050	4.7	.15	99.99	.017	99.52	.017	.9987	.00024
.100	4.0	.19	100.04	.017	99.52	.017	.9992	.00024
.150	4.7	.19	100.07	.017	99.51	.017	.9994	.00024
.200	5.1	.16	100.09	.017	99.52	.017	.9997	.00024
.250	4.4	.21	100.11	.017	99.52	.017	.9999	.00024
.300	4.4	.17	100.11	.017	99.51	.017	.9999	.00024
.350	4.4	.31	100.12	.017	99.52	.017	1.0000	.00024
.400	3.9	.26	100.13	.017	99.52	.017	1.0001	.00024
.550	3.2	.15	100.13	.017	99.52	.017	1.0001	.00024
.700	3.1	.15	100.12	.017	99.51	.017	1.0000	.00024
.850	3.7	.12	100.12	.017	99.52	.017	1.0000	.00024
1.000	4.2	.09	100.12	.017	99.51	.017	1.0000	.00024

Upstream Total Pressure PT1 = 100.12 kPa (+/- .017)

Upstream Static Pressure P1 = 99.59 kPa (+/- .017)

ORIGINAL PAGE IS
OF POOR QUALITY

Table H47. FIVE-HOLE PRESSURE PROBE WAKE VELOCITY DATA
INCIDENCE ANGLE (DEG) = 5.0 , Zc/C = .94 , R = 33.3 %

NORMALIZED TANGENTIAL POSITION 2T/S	NORMALIZED TOTAL VELOCITY					NORMALIZED VELOCITY COMPONENTS						
	U/Uzo (+/-)		Pitch Ang Des (+/-)		Yaw Ang Des (+/-)		Uz/Uzo (+/-)		Ut/Uzo (+/-)		Ur/Uzo (+/-)	
-1.000	1.068	.0319	.7	.13	.7	.11	1.065	.0319	.081	.0032	.013	.0024
-.850	1.063	.0319	-.1	.09	.6	.07	1.060	.0318	.081	.0028	-.003	.0017
-.700	1.062	.0319	-.3	.11	.3	.09	1.058	.0318	.086	.0031	-.006	.0020
-.550	1.066	.0319	.0	.09	.4	.09	1.062	.0318	.085	.0030	.000	.0017
-.400	1.062	.0319	-.8	.18	.6	.08	1.059	.0318	.082	.0029	-.015	.0034
-.350	1.055	.0319	-.7	.18	.2	.05	1.051	.0318	.089	.0029	-.014	.0034
-.300	1.058	.0319	-.9	.12	.2	.10	1.055	.0318	.089	.0032	-.016	.0022
-.250	1.035	.0319	-.9	.16	.1	.08	1.031	.0318	.088	.0031	-.017	.0029
-.200	1.014	.0318	.7	.14	-.1	.10	1.009	.0317	.090	.0033	.013	.0024
-.150	.996	.0319	.3	.30	.5	.09	.992	.0318	.079	.0029	.006	.0051
-.100	.965	.0321	1.3	.24	.2	.13	.961	.0320	.081	.0034	.021	.0041
-.050	.933	.0322	.8	.19	.5	.10	.930	.0321	.073	.0030	.013	.0031
0.000	.921	.0321	1.9	.35	.3	.14	.917	.0320	.076	.0035	.031	.0058
.050	.940	.0322	1.8	.36	1.1	.18	.937	.0321	.063	.0036	.030	.0060
.100	.995	.0318	2.8	.20	1.1	.12	.991	.0317	.068	.0031	.049	.0038
.150	1.016	.0319	1.8	.52	.9	.08	1.013	.0318	.072	.0027	.032	.0092
.200	1.043	.0319	.3	.30	.8	.09	1.040	.0318	.076	.0028	.005	.0054
.250	1.050	.0319	4.6	.30	.4	.07	1.043	.0317	.083	.0028	.085	.0060
.300	1.067	.0320	2.2	.20	.6	.10	1.063	.0318	.081	.0030	.042	.0040
.350	1.067	.0320	2.1	.39	.7	.10	1.063	.0319	.080	.0031	.039	.0073
.400	1.064	.0319	1.9	.15	.5	.11	1.060	.0318	.083	.0033	.035	.0030
.550	1.066	.0319	.4	.10	.9	.08	1.063	.0319	.076	.0027	.008	.0019
.700	1.065	.0319	-1.0	.07	.6	.06	1.062	.0318	.081	.0027	-.019	.0014
.850	1.059	.0319	-1.2	.10	.6	.06	1.056	.0318	.082	.0027	-.022	.0020
1.000	1.060	.0319	-1.2	.08	.6	.08	1.057	.0318	.081	.0028	-.023	.0017

Upstream Velocity Uzo = 30.8 m/s (+/- .69)
Probe Yaw Offset Angle = 5.0 Deg

ORIGINAL PAGE IS
OF POOR QUALITY

ORIGINAL PAGE IS
OF POOR QUALITY

Table H48. FIVE-HOLE PRESSURE PROBE WAKE PRESSURE DATA
INCIDENCE ANGLE (DEG) = 5.0 , $Z_c/C = .94$, $R = 33.3\%$

NORMALIZED TANGENTIAL POSITION 2T/S	EXIT ANGLE		TOTAL PRESURE PT2		STATIC PRESSURE P2		TOTAL PRESSURE RECOVERY	
	Deg (+/-)		kPa (+/-)		kPa (+/-)		PT2/PT1 (+/-)	
-1.000	4.4	.11	100.12	.017	99.51	.017	1.0000	.00024
-.850	4.4	.07	100.12	.017	99.52	.017	1.0000	.00024
-.700	4.7	.09	100.12	.017	99.52	.017	1.0000	.00024
-.550	4.6	.09	100.13	.017	99.52	.017	1.0001	.00024
-.400	4.5	.09	100.12	.017	99.52	.017	1.0000	.00024
-.350	4.9	.06	100.12	.017	99.53	.017	1.0000	.00024
-.300	4.9	.10	100.12	.017	99.52	.017	1.0000	.00024
-.250	4.9	.08	100.10	.017	99.52	.017	.9997	.00024
-.200	5.2	.10	100.07	.017	99.52	.017	.9995	.00024
-.150	4.6	.09	100.05	.017	99.52	.017	.9993	.00024
-.100	5.0	.14	100.02	.017	99.52	.017	.9989	.00024
-.050	4.6	.11	99.98	.017	99.52	.017	.9986	.00024
0.000	5.1	.19	99.97	.017	99.52	.017	.9985	.00024
.050	4.3	.22	99.99	.017	99.51	.017	.9987	.00024
.100	4.8	.15	100.04	.017	99.51	.017	.9992	.00024
.150	4.5	.22	100.07	.017	99.52	.017	.9995	.00024
.200	4.2	.09	100.10	.017	99.52	.017	.9998	.00024
.250	6.5	.22	100.11	.017	99.52	.017	.9999	.00024
.300	4.9	.13	100.12	.017	99.51	.017	1.0000	.00024
.350	4.8	.19	100.12	.017	99.51	.017	1.0000	.00024
.400	4.9	.12	100.12	.017	99.52	.017	1.0000	.00024
.550	4.1	.08	100.12	.017	99.52	.017	1.0000	.00024
.700	4.5	.06	100.12	.017	99.52	.017	1.0000	.00024
.850	4.6	.06	100.12	.017	99.52	.017	1.0000	.00024
1.000	4.6	.08	100.12	.017	99.52	.017	1.0000	.00024

Upstream Total Pressure PT1 = 100.12 kPa (+/- .017)

Upstream Static Pressure p1 = 99.59 kPa (+/- .017)

Table H49. FIVE-HOLE PRESSURE PROBE WAKE VELOCITY DATA
 INCIDENCE ANGLE (DEG) = 5.0 , Zc/C = .94 , R = 50.0 %

NORMALIZED TANGENTIAL POSITION 2T/S	NORMALIZED TOTAL VELOCITY						NORMALIZED VELOCITY COMPONENTS					
	U/Uzo (+/-)		Pitch Ang Des (+/-)		Yaw Ang Des (+/-)		Uz/Uzo (+/-)		Ut/Uzo (+/-)		Ur/Uzo (+/-)	
-1.000	1.062	.0320	-.1	.07	.2	.13	1.058	.0318	.089	.0036	-.002	.0012
-.850	1.059	.0319	-.4	.05	-.0	.06	1.055	.0318	.093	.0030	-.008	.0010
-.700	1.061	.0320	-.5	.11	.2	.06	1.057	.0318	.089	.0029	-.009	.0021
-.550	1.063	.0320	-.4	.11	.0	.09	1.059	.0319	.092	.0032	-.008	.0020
-.400	1.066	.0320	-1.1	.20	.2	.14	1.062	.0319	.089	.0037	-.021	.0037
-.350	1.066	.0320	.4	.10	.2	.11	1.062	.0319	.089	.0034	.008	.0018
-.300	1.060	.0320	-.0	.11	.2	.10	1.056	.0318	.088	.0033	-.000	.0021
-.250	1.051	.0319	.2	.13	.5	.07	1.048	.0318	.083	.0029	.004	.0024
-.200	1.027	.0320	.6	.22	.3	.08	1.023	.0319	.083	.0030	.011	.0040
-.150	1.001	.0319	.5	.20	.3	.08	.998	.0318	.081	.0030	.008	.0034
-.100	.946	.0320	1.3	.12	.3	.10	.942	.0318	.078	.0031	.022	.0021
-.050	.908	.0323	.4	.16	.8	.12	.906	.0322	.066	.0030	.006	.0025
0.000	.912	.0321	1.2	.23	1.2	.11	.909	.0321	.060	.0027	.019	.0037
.050	.943	.0320	.4	.17	1.3	.09	.941	.0320	.060	.0025	.006	.0029
.100	.993	.0319	2.3	.26	1.6	.18	.990	.0318	.058	.0037	.040	.0047
.150	1.031	.0319	1.4	.33	1.3	.12	1.029	.0318	.066	.0029	.025	.0060
.200	1.040	.0319	1.9	.32	1.0	.07	1.037	.0318	.073	.0026	.035	.0059
.250	1.055	.0320	1.9	.35	1.2	.14	1.052	.0319	.070	.0034	.036	.0066
.300	1.068	.0320	.7	.16	1.3	.08	1.066	.0319	.069	.0025	.012	.0030
.350	1.063	.0320	2.0	.14	.7	.10	1.060	.0319	.080	.0030	.036	.0028
.400	1.062	.0320	.4	.26	.2	.14	1.058	.0319	.089	.0037	.007	.0049
.550	1.064	.0320	-.4	.16	1.2	.10	1.062	.0319	.071	.0029	-.008	.0029
.700	1.059	.0320	-.6	.12	.7	.16	1.056	.0319	.080	.0038	-.012	.0022
.850	1.059	.0320	-.3	.08	.1	.14	1.056	.0318	.090	.0037	-.006	.0014
1.000	1.057	.0319	-.8	.09	1.0	.08	1.054	.0319	.074	.0027	-.015	.0018

Upstream Velocity Uzo = 30.7 m/s (+/- .69)
 Probe Yaw Offset Angle = 5.0 Deg

ORIGINAL PAGE IS
OF POOR QUALITY

Table H50. FIVE-HOLE PRESSURE PROBE WAKE PRESSURE DATA
INCIDENCE ANGLE (DEG) = 5.0 , $Z_c/C = .94$, $R = 50.0\%$

NORMALIZED TANGENTIAL POSITION 2T/5	EXIT ANGLE		TOTAL PRESURE PT2		STATIC PRESSURE P2		TOTAL PRESSURE RECOVERY	
	DEG	(+/-)	KPa	(+/-)	KPa	(+/-)	PT2/PT1	(+/-)
-1.000	4.8	.13	100.13	.017	99.52	.017	1.0000	.00024
-.850	5.0	.06	100.12	.017	99.52	.017	1.0000	.00024
-.700	4.9	.07	100.12	.017	99.52	.017	1.0000	.00024
-.550	5.0	.09	100.12	.017	99.52	.017	1.0000	.00024
-.400	4.9	.14	100.12	.017	99.52	.017	1.0000	.00024
-.350	4.8	.11	100.12	.017	99.52	.017	1.0000	.00024
-.300	4.8	.10	100.11	.017	99.51	.017	.9999	.00024
-.250	4.5	.07	100.10	.017	99.51	.017	.9998	.00024
-.200	4.7	.09	100.08	.017	99.52	.017	.9996	.00024
-.150	4.7	.09	100.05	.017	99.51	.017	.9993	.00024
-.100	4.9	.10	99.99	.017	99.51	.017	.9987	.00024
-.050	4.2	.12	99.96	.017	99.52	.017	.9984	.00024
0.000	4.0	.13	99.95	.017	99.51	.017	.9983	.00024
.050	3.7	.09	99.98	.017	99.51	.017	.9986	.00024
.100	4.1	.21	100.04	.017	99.51	.017	.9992	.00024
.150	3.9	.16	100.08	.017	99.51	.017	.9996	.00024
.200	4.5	.15	100.10	.017	99.52	.017	.9998	.00024
.250	4.3	.20	100.12	.017	99.52	.017	1.0000	.00024
.300	3.7	.08	100.12	.017	99.51	.017	1.0000	.00024
.350	4.7	.11	100.12	.017	99.51	.017	1.0000	.00024
.400	4.8	.14	100.12	.017	99.52	.017	1.0000	.00024
.550	3.9	.10	100.13	.017	99.52	.017	1.0001	.00024
.700	4.4	.16	100.12	.017	99.52	.017	1.0000	.00024
.850	4.9	.14	100.12	.017	99.52	.017	1.0000	.00024
1.000	4.1	.08	100.12	.017	99.52	.017	1.0000	.00024

Upstream Total Pressure PT1 = 100.12 KPa (+/- .017)

Upstream Static Pressure p1 = 99.59 KPa (+/- .017)

Table H51. FIVE-HOLE PRESSURE PROBE WAKE VELOCITY DATA
 INCIDENCE ANGLE (DEG) = 5.0 , $Z_c/C = .94$, $R = 66.7\%$

NORMALIZED TANGENTIAL POSITION 2T/S	NORMALIZED TOTAL VELOCITY				NORMALIZED VELOCITY COMPONENTS							
	U/U _∞ (+/-)		Pitch Ang Deg (+/-)		Yaw Ang Deg (+/-)		U _z /U _∞ (+/-)		U _l /U _∞ (+/-)		U _r /U _∞ (+/-)	
-1.000	1.065	.0320	-.7	.07	.1	.10	1.061	.0319	.091	.0033	-.014	.0014
-.850	1.059	.0320	-.3	.11	.1	.07	1.055	.0319	.091	.0030	-.005	.0021
-.700	1.058	.0320	-.1	.08	.4	.07	1.054	.0319	.084	.0029	-.003	.0016
-.550	1.057	.0320	.6	.10	.7	.06	1.054	.0319	.079	.0026	.011	.0018
-.400	1.056	.0320	.2	.09	.7	.10	1.053	.0319	.079	.0030	.003	.0017
-.350	1.056	.0320	1.2	.16	.9	.08	1.053	.0319	.075	.0027	.022	.0031
-.300	1.050	.0320	1.1	.09	1.3	.06	1.048	.0319	.068	.0024	.020	.0018
-.250	1.038	.0319	1.4	.07	1.0	.09	1.035	.0318	.073	.0028	.025	.0014
-.200	.995	.0319	1.5	.19	.8	.11	.992	.0318	.073	.0030	.026	.0033
-.150	.963	.0323	1.7	.11	.4	.09	.959	.0322	.077	.0030	.029	.0021
-.100	.913	.0322	.5	.10	.8	.11	.911	.0321	.067	.0029	.008	.0016
-.050	.870	.0325	-.2	.13	1.2	.12	.868	.0325	.057	.0028	-.003	.0020
0.000	.879	.0325	.2	.15	1.3	.09	.877	.0324	.057	.0025	.003	.0023
.050	.939	.0321	.0	.19	1.6	.11	.937	.0320	.056	.0027	.001	.0031
.100	.996	.0319	1.1	.22	1.3	.09	.994	.0319	.064	.0026	.020	.0039
.150	1.032	.0319	1.0	.15	1.3	.14	1.030	.0318	.066	.0033	.018	.0028
.200	1.047	.0319	1.5	.13	1.0	.09	1.044	.0319	.073	.0027	.027	.0024
.250	1.057	.0320	1.4	.08	.7	.07	1.054	.0319	.080	.0028	.026	.0017
.300	1.054	.0320	.9	.12	.8	.05	1.051	.0319	.078	.0026	.017	.0023
.350	1.063	.0320	.7	.11	.9	.07	1.060	.0319	.075	.0026	.012	.0021
.400	1.061	.0320	.5	.20	.8	.13	1.058	.0319	.078	.0034	.010	.0037
.550	1.053	.0320	-.1	.17	1.1	.10	1.051	.0319	.071	.0028	-.001	.0031
.700	1.056	.0320	.3	.10	.5	.09	1.052	.0319	.083	.0030	.005	.0019
.850	1.057	.0320	.3	.10	.9	.11	1.055	.0319	.075	.0031	.005	.0018
1.000	1.058	.0320	-.1	.07	1.2	.07	1.056	.0319	.070	.0025	-.003	.0012

Upstream Velocity U_∞ = 30.7 m/s (+/- .69)
 Probe Yaw Offset Angle = 5.0 Deg

ORIGINAL PAGE IS
OF POOR QUALITY

Table H52. FIVE-HOLE PRESSURE PROBE WAKE PRESSURE DATA
INCIDENCE ANGLE (DEG) = 5.0 , Zc/C = .94 , R = 66.7 %

NORMALIZED TANGENTIAL POSITION ZT/S	EXIT ANGLE		TOTAL PRESURE PT2		STATIC PRESSURE P2		TOTAL PRESSURE RECOVERY	
	Deg	(+/-)	kPa	(+/-)	kPa	(+/-)	PT2/PT1	(+/-)
-1.000	5.0	.10	100.12	.017	99.52	.017	1.0000	.00024
-.850	4.9	.07	100.12	.017	99.53	.017	1.0000	.00024
-.700	4.6	.07	100.12	.017	99.53	.017	1.0000	.00024
-.550	4.3	.06	100.12	.017	99.52	.017	1.0000	.00024
-.400	4.3	.10	100.12	.017	99.53	.017	1.0000	.00024
-.350	4.2	.09	100.11	.017	99.52	.017	.9999	.00024
-.300	3.9	.07	100.11	.017	99.52	.017	.9999	.00024
-.250	4.3	.09	100.09	.017	99.52	.017	.9997	.00024
-.200	4.5	.12	100.05	.017	99.52	.017	.9992	.00024
-.150	4.9	.10	100.01	.018	99.52	.017	.9989	.00025
-.100	4.2	.11	99.97	.017	99.52	.017	.9984	.00024
-.050	3.8	.12	99.93	.017	99.53	.017	.9981	.00024
0.000	3.7	.09	99.93	.017	99.52	.017	.9981	.00024
.050	3.4	.11	99.98	.017	99.51	.017	.9986	.00024
.100	3.8	.11	100.05	.017	99.52	.017	.9993	.00024
.150	3.8	.14	100.09	.017	99.52	.017	.9997	.00024
.200	4.3	.09	100.11	.017	99.52	.017	.9999	.00024
.250	4.5	.07	100.12	.017	99.52	.017	1.0000	.00024
.300	4.3	.06	100.11	.017	99.52	.017	.9999	.00024
.350	4.1	.07	100.12	.017	99.52	.017	1.0000	.00024
.400	4.2	.14	100.12	.017	99.52	.017	1.0000	.00024
.550	3.9	.10	100.12	.017	99.53	.017	1.0000	.00024
.700	4.5	.09	100.12	.017	99.53	.017	1.0000	.00024
.850	4.1	.11	100.12	.017	99.52	.017	1.0000	.00024
1.000	3.8	.07	100.12	.017	99.52	.017	1.0000	.00024

Upstream Total Pressure PT1 = 100.12 kPa (+/- .017)

Upstream Static Pressure P1 = 99.59 kPa (+/- .017)

Table H53. FIVE-HOLE PRESSURE PROBE WAKE VELOCITY DATA
 INCIDENCE ANGLE (DEG) = 5.0 , Zc/C = .94 , R = 83.3 %

NORMALIZED TANGENTIAL POSITION 2T/S	NORMALIZED TOTAL VELOCITY						NORMALIZED VELOCITY COMPONENTS					
	U/Uzo (+/-)		Pitch Ang Des (+/-)		Yaw Ang Des (+/-)		Uz/Uzo (+/-)		Ut/Uzo (+/-)		Ur/Uzo (+/-)	
-1.000	1.053	.0319	.8	.09	.5	.09	1.050	.0318	.082	.0030	.014	.0016
-.850	1.052	.0319	.7	.10	1.0	.13	1.049	.0318	.073	.0032	.012	.0020
-.700	1.057	.0319	.8	.07	1.3	.11	1.055	.0319	.067	.0029	.014	.0014
-.550	1.055	.0319	1.3	.07	.8	.13	1.051	.0318	.077	.0034	.024	.0015
-.400	1.055	.0319	1.4	.09	.9	.14	1.052	.0318	.075	.0035	.026	.0019
-.350	1.048	.0319	1.6	.10	1.7	.10	1.046	.0318	.060	.0026	.030	.0021
-.300	1.046	.0319	1.5	.08	1.0	.09	1.043	.0318	.073	.0028	.027	.0017
-.250	1.029	.0319	1.5	.16	1.7	.07	1.027	.0319	.060	.0023	.027	.0030
-.200	1.003	.0319	2.0	.10	1.4	.08	1.001	.0318	.063	.0024	.034	.0021
-.150	.984	.0319	1.5	.09	1.0	.10	.981	.0318	.068	.0028	.025	.0017
-.100	.923	.0322	.4	.11	1.2	.10	.920	.0322	.061	.0026	.007	.0018
-.050	.846	.0332	-.7	.17	1.1	.16	.844	.0331	.057	.0033	-.011	.0025
0.000	.818	.0331	-.5	.18	1.2	.10	.816	.0331	.054	.0027	-.007	.0025
.050	.813	.0334	-2.1	.23	1.5	.13	.810	.0333	.050	.0028	-.030	.0035
.100	.857	.0329	-1.2	.18	1.3	.18	.855	.0328	.055	.0034	-.018	.0027
.150	.937	.0320	-1.2	.09	1.1	.10	.935	.0320	.063	.0027	-.019	.0016
.200	.970	.0321	.5	.13	.7	.08	.967	.0320	.072	.0028	.009	.0022
.250	1.020	.0319	1.9	.11	.7	.09	1.016	.0318	.076	.0029	.035	.0022
.300	1.039	.0319	2.1	.10	.8	.07	1.036	.0318	.077	.0027	.039	.0022
.350	1.045	.0319	1.8	.08	.8	.08	1.042	.0318	.076	.0027	.033	.0017
.400	1.049	.0319	1.6	.10	1.0	.07	1.046	.0318	.073	.0026	.030	.0021
.550	1.052	.0319	1.0	.13	1.3	.12	1.050	.0318	.069	.0031	.019	.0024
.700	1.042	.0319	.8	.09	.6	.08	1.039	.0318	.080	.0029	.014	.0017
.850	1.043	.0319	.6	.08	.9	.14	1.040	.0318	.074	.0034	.012	.0015
1.000	1.039	.0319	.6	.07	1.3	.09	1.037	.0318	.068	.0027	.011	.0014

Upstream Velocity Uzo = 30.7 m/s (+/- .69)
 Probe Yaw Offset Angle = 5.0 Deg

ORIGINAL PAGE IS
OF POOR QUALITY

Table H54. FIVE-HOLE PRESSURE PROBE WAKE PRESSURE DATA
INCIDENCE ANGLE (DEG) = 5.0 , $Z_c/C = .94$, $R = 83.3\%$

NORMALIZED TANGENTIAL POSITION 2T/S	EXIT ANGLE		TOTAL PRESURE PT2		STATIC PRESSURE P2		TOTAL PRESSURE RECOVERY	
	Deg (+/-)		kPa (+/-)		kPa (+/-)		PT2/PT1 (+/-)	
-1.000	4.6	.09	100.15	.017	99.56	.017	1.0000	.00024
-.850	4.0	.13	100.15	.017	99.56	.017	1.0000	.00024
-.700	3.7	.11	100.16	.017	99.56	.017	1.0001	.00024
-.550	4.4	.13	100.15	.017	99.56	.017	1.0000	.00024
-.400	4.3	.14	100.15	.017	99.56	.017	1.0000	.00024
-.350	3.7	.10	100.15	.017	99.56	.017	1.0000	.00024
-.300	4.3	.09	100.15	.017	99.56	.017	.9999	.00024
-.250	3.6	.09	100.13	.017	99.56	.017	.9997	.00024
-.200	4.1	.08	100.09	.017	99.56	.017	.9994	.00024
-.150	4.2	.10	100.07	.017	99.55	.017	.9992	.00024
-.100	3.8	.10	100.01	.017	99.56	.017	.9986	.00024
-.050	4.0	.16	99.94	.018	99.56	.017	.9979	.00024
0.000	3.8	.11	99.92	.017	99.57	.017	.9977	.00024
.050	4.1	.16	99.91	.017	99.56	.017	.9976	.00024
.100	3.9	.18	99.96	.017	99.56	.017	.9980	.00024
.150	4.1	.10	100.03	.017	99.56	.017	.9987	.00024
.200	4.3	.08	100.07	.018	99.56	.017	.9991	.00024
.250	4.7	.10	100.12	.017	99.56	.017	.9996	.00024
.300	4.8	.08	100.13	.017	99.56	.017	.9998	.00024
.350	4.5	.08	100.14	.017	99.56	.017	.9999	.00024
.400	4.3	.08	100.15	.017	99.56	.017	.9999	.00024
.550	3.9	.12	100.15	.017	99.56	.017	.9999	.00024
.700	4.5	.08	100.15	.017	99.57	.017	.9999	.00024
.850	4.1	.14	100.14	.017	99.56	.017	.9999	.00024
1.000	3.8	.09	100.15	.017	99.57	.017	.9999	.00024

Upstream Total Pressure PT1 = 100.16 kPa (+/- .017)

Upstream Static Pressure p1 = 99.62 kPa (+/- .017)

Table H55. FIVE-HOLE PRESSURE PROBE WAKE VELOCITY DATA
 INCIDENCE ANGLE (DEG) = 5.0 , Zc/C = 2.07 , R = 4.2 %

NORMALIZED TANGENTIAL POSITION 2T/5	NORMALIZED TOTAL VELOCITY					NORMALIZED VELOCITY COMPONENTS						
	U/Uzo (+/-)		Pitch Ang Deg (+/-)		Yaw Ang Deg (+/-)		Uz/Uzo (+/-)		Ut/Uzo (+/-)		Ur/Uzo (+/-)	
-1.000	.952	.0314	1.1	.08	-.2	.09	.948	.0313	.086	.0032	.019	.0015
-.850	.945	.0316	.7	.12	1.1	.29	.943	.0316	.065	.0053	.012	.0020
-.700	.944	.0321	1.0	.16	.3	.13	.940	.0319	.077	.0034	.017	.0027
-.550	.925	.0317	.4	.13	1.2	.26	.923	.0317	.061	.0047	.007	.0021
-.400	.932	.0316	.2	.08	-.2	.13	.928	.0315	.085	.0036	.003	.0013
-.350	.908	.0317	.7	.11	-.2	.12	.904	.0315	.082	.0034	.011	.0018
-.300	.917	.0317	.3	.13	-.1	.11	.913	.0316	.081	.0033	.005	.0020
-.250	.907	.0319	.9	.09	-.4	.11	.903	.0317	.086	.0035	.015	.0016
-.200	.888	.0319	1.0	.10	-.9	.09	.883	.0317	.091	.0036	.016	.0017
-.150	.874	.0320	1.0	.11	-.5	.10	.870	.0319	.084	.0035	.016	.0017
-.100	.868	.0322	1.4	.18	-.6	.11	.864	.0320	.084	.0035	.021	.0029
-.050	.854	.0323	1.5	.10	.1	.13	.851	.0322	.073	.0033	.023	.0018
0.000	.849	.0322	1.4	.14	.0	.11	.846	.0321	.074	.0032	.021	.0022
.050	.852	.0321	1.6	.11	.5	.11	.849	.0320	.068	.0030	.023	.0019
.100	.882	.0319	1.4	.12	.4	.11	.879	.0318	.070	.0030	.022	.0019
.150	.895	.0318	1.0	.12	.9	.08	.892	.0318	.064	.0026	.016	.0019
.200	.904	.0321	1.1	.14	1.4	.11	.902	.0320	.057	.0027	.017	.0022
.250	.896	.0327	1.4	.11	1.3	.09	.894	.0326	.059	.0025	.022	.0019
.300	.919	.0317	1.3	.09	1.0	.13	.917	.0316	.064	.0031	.021	.0016
.350	.905	.0318	1.4	.12	1.0	.19	.902	.0317	.064	.0037	.023	.0020
.400	.900	.0323	1.4	.14	1.3	.11	.898	.0322	.058	.0027	.022	.0023
.550	.925	.0316	1.0	.14	1.7	.15	.923	.0315	.054	.0030	.016	.0023
.700	.976	.0314	1.3	.08	2.0	.08	.974	.0314	.051	.0021	.022	.0015
.850	1.009	.0315	.9	.06	1.3	.14	1.007	.0314	.065	.0031	.016	.0012
1.000	1.002	.0313	.7	.11	1.6	.13	1.000	.0313	.060	.0029	.012	.0019

Upstream Velocity Uzo = 30.7 m/s (+/- .68)
 Probe Yaw Offset Angle = 5.0 Deg

ORIGINAL PAGE IS
OF POOR QUALITY

Table H56. FIVE-HOLE PRESSURE PROBE WAKE PRESSURE DATA
INCIDENCE ANGLE (DEG) = 5.0 , $Z_c/C = 2.07$, $R = 4.2\%$

NORMALIZED TANGENTIAL POSITION 2T/S	EXIT ANGLE		TOTAL PRESURE PT2		STATIC PRESSURE P2		TOTAL PRESSURE RECOVERY	
	Deg (+/-)		kPa (+/-)		kPa (+/-)		PT2/PT1 (+/-)	
-1.000	5.3	.09	99.69	.017	99.19	.017	.9987	.00024
-.850	4.0	.29	99.68	.017	99.19	.017	.9986	.00024
-.700	4.8	.13	99.67	.018	99.19	.017	.9986	.00025
-.550	3.8	.26	99.65	.017	99.19	.017	.9984	.00024
-.400	5.2	.13	99.66	.017	99.19	.017	.9985	.00024
-.350	5.2	.12	99.64	.017	99.19	.017	.9982	.00024
-.300	5.1	.11	99.65	.017	99.19	.017	.9983	.00024
-.250	5.5	.11	99.64	.017	99.20	.017	.9983	.00024
-.200	6.0	.09	99.63	.017	99.20	.017	.9981	.00024
-.150	5.6	.10	99.62	.017	99.20	.017	.9980	.00024
-.100	5.7	.11	99.61	.017	99.20	.017	.9980	.00024
-.050	5.1	.12	99.60	.017	99.20	.017	.9978	.00024
0.000	5.2	.11	99.60	.017	99.21	.017	.9978	.00024
.050	4.8	.11	99.60	.017	99.21	.017	.9979	.00024
.100	4.8	.11	99.63	.017	99.21	.017	.9981	.00024
.150	4.2	.08	99.64	.017	99.21	.017	.9983	.00024
.200	3.8	.12	99.66	.018	99.21	.017	.9984	.00025
.250	4.0	.09	99.65	.019	99.21	.017	.9984	.00025
.300	4.2	.13	99.68	.017	99.22	.017	.9986	.00024
.350	4.3	.18	99.66	.017	99.21	.017	.9984	.00024
.400	4.0	.11	99.66	.018	99.22	.017	.9984	.00025
.550	3.5	.15	99.68	.017	99.21	.017	.9986	.00024
.700	3.2	.08	99.73	.017	99.21	.017	.9991	.00024
.850	3.8	.13	99.76	.017	99.20	.017	.9994	.00024
1.000	3.5	.13	99.75	.017	99.21	.017	.9994	.00024

Upstream Total Pressure PT1 = 99.82 kPa (+/- .017)

Upstream Static Pressure P1 = 99.27 kPa (+/- .017)

Table H57. FIVE-HOLE PRESSURE PROBE WAKE VELOCITY DATA
 INCIDENCE ANGLE (DEG) = 5.0 , $Z_c/C = 2.07$, $R = 8.3\%$

NORMALIZED TANGENTIAL POSITION ZT/S	NORMALIZED TOTAL VELOCITY					NORMALIZED VELOCITY COMPONENTS						
	U/Uzo (+/-)		Pitch Ang Des (+/-)		Yaw Ang Des (+/-)		Uz/Uzo (+/-)		Uv/Uzo (+/-)		Ur/Uzo (+/-)	
-1.000	1.001	.0318	1.1	.14	1.8	.14	.999	.0317	.056	.0030	.019	.0025
-.850	1.018	.0317	1.0	.09	1.1	.13	1.015	.0316	.068	.0032	.017	.0017
-.700	1.000	.0317	.8	.08	1.7	.19	.998	.0316	.058	.0037	.013	.0015
-.550	.989	.0319	.4	.09	1.3	.14	.987	.0318	.065	.0032	.007	.0016
-.400	.984	.0316	.3	.10	.8	.09	.981	.0315	.073	.0028	.004	.0018
-.350	.979	.0315	.1	.08	.2	.11	.975	.0314	.081	.0032	.001	.0013
-.300	.962	.0315	.1	.10	.4	.12	.959	.0314	.078	.0032	.002	.0016
-.250	.950	.0316	.4	.08	.3	.14	.947	.0315	.078	.0035	.006	.0014
-.200	.937	.0317	.9	.09	.1	.09	.933	.0315	.080	.0030	.015	.0016
-.150	.925	.0317	1.0	.12	.5	.10	.922	.0316	.072	.0029	.016	.0020
-.100	.907	.0318	1.3	.11	.5	.09	.904	.0317	.071	.0029	.021	.0019
-.050	.904	.0319	1.3	.11	1.1	.14	.902	.0318	.062	.0031	.021	.0019
0.000	.908	.0318	1.7	.10	.9	.09	.906	.0317	.064	.0026	.026	.0018
.050	.914	.0318	1.9	.12	1.0	.13	.911	.0317	.064	.0030	.030	.0022
.100	.924	.0318	1.6	.08	1.4	.08	.922	.0317	.058	.0024	.026	.0016
.150	.954	.0316	1.5	.08	1.6	.08	.952	.0315	.056	.0023	.026	.0015
.200	.973	.0317	1.5	.07	1.7	.10	.971	.0316	.056	.0025	.025	.0015
.250	1.000	.0315	1.5	.06	1.9	.07	.998	.0315	.054	.0021	.026	.0013
.300	1.002	.0316	1.5	.07	1.6	.09	1.000	.0315	.059	.0024	.026	.0015
.350	1.006	.0316	1.8	.10	2.1	.10	1.004	.0316	.052	.0024	.031	.0020
.400	1.015	.0317	1.8	.09	1.7	.07	1.013	.0316	.058	.0023	.033	.0019
.550	1.045	.0317	1.4	.12	2.1	.10	1.043	.0316	.052	.0024	.025	.0024
.700	1.050	.0317	.7	.09	2.6	.07	1.049	.0316	.044	.0018	.013	.0016
.850	1.061	.0316	.8	.09	2.5	.11	1.059	.0316	.046	.0025	.015	.0017
1.000	1.062	.0317	.8	.10	1.6	.15	1.060	.0316	.064	.0033	.014	.0018

Upstream Velocity Uzo = 30.7 m/s (+/- .68)
 Probe Yaw Offset Angle = 5.0 Des

C-4

ORIGINAL PAGE IS
OF POOR QUALITY

Table H58. FIVE-HOLE PRESSURE PROBE WAKE PRESSURE DATA
INCIDENCE ANGLE (DEG) = 5.0 , $Z_c/C = 2.07$, $R = 8.3\%$

NORMALIZED TANGENTIAL POSITION 2T/S	EXIT ANGLE		TOTAL PRESURE PT2		STATIC PRESSURE P2		TOTAL PRESSURE RECOVERY	
	Deg (+/-)		kPa (+/-)		kPa (+/-)		PT2/PT1 (+/-)	
-1.000	3.4	.14	99.75	.018	99.21	.017	.9993	.00024
-.850	4.0	.13	99.76	.017	99.20	.017	.9994	.00024
-.700	3.4	.18	99.74	.017	99.20	.017	.9993	.00024
-.550	3.8	.14	99.73	.018	99.20	.017	.9991	.00025
-.400	4.3	.09	99.72	.017	99.20	.017	.9991	.00024
-.350	4.8	.11	99.72	.017	99.20	.017	.9990	.00024
-.300	4.6	.12	99.70	.017	99.20	.017	.9988	.00024
-.250	4.8	.14	99.68	.017	99.20	.017	.9987	.00024
-.200	5.0	.09	99.67	.017	99.20	.017	.9986	.00024
-.150	4.6	.10	99.66	.017	99.20	.017	.9984	.00024
-.100	4.7	.09	99.65	.017	99.21	.017	.9983	.00024
-.050	4.2	.14	99.65	.017	99.21	.017	.9983	.00024
0.000	4.4	.09	99.66	.017	99.21	.017	.9984	.00024
.050	4.5	.12	99.66	.017	99.21	.017	.9984	.00024
.100	4.0	.08	99.67	.017	99.21	.017	.9986	.00024
.150	3.7	.08	99.70	.017	99.21	.017	.9989	.00024
.200	3.6	.10	99.72	.017	99.20	.017	.9990	.00024
.250	3.4	.07	99.74	.017	99.20	.017	.9993	.00024
.300	3.7	.09	99.74	.017	99.20	.017	.9993	.00024
.350	3.4	.10	99.75	.017	99.20	.017	.9993	.00024
.400	3.8	.08	99.75	.017	99.19	.017	.9994	.00024
.550	3.2	.10	99.79	.017	99.20	.017	.9997	.00024
.700	2.5	.07	99.79	.017	99.20	.017	.9998	.00024
.850	2.6	.11	99.81	.017	99.20	.017	.9999	.00024
1.000	3.5	.15	99.82	.017	99.21	.017	1.0000	.00024

Upstream Total Pressure PT1 = 99.82 kPa (+/- .017)

Upstream Static Pressure p1 = 99.27 kPa (+/- .017)

Table H59. FIVE-HOLE PRESSURE PROBE WAKE VELOCITY DATA
 INCIDENCE ANGLE (DEG) = 5.0 , $Z_c/C = 2.07$, $R = 12.5\%$

NORMALIZED TANGENTIAL POSITION 2T/S	NORMALIZED TOTAL VELOCITY					NORMALIZED VELOCITY COMPONENTS						
	U/U _∞ (+/-)		Pitch Ang Des (+/-)		Yaw Ang Des (+/-)		U _z /U _∞ (+/-)		U _t /U _∞ (+/-)		U _r /U _∞ (+/-)	
-1.000	1.013	.0317	1.1	.10	1.0	.13	1.010	.0316	.071	.0032	.020	.0019
-.850	1.044	.0317	1.3	.07	.8	.07	1.041	.0316	.077	.0027	.024	.0015
-.700	1.043	.0318	.7	.13	.8	.10	1.040	.0317	.076	.0030	.014	.0024
-.550	1.041	.0319	.7	.09	.6	.08	1.038	.0318	.080	.0029	.012	.0016
-.400	1.032	.0317	-.1	.11	1.3	.16	1.030	.0316	.067	.0035	-.002	.0020
-.350	1.006	.0317	-.0	.09	.7	.09	1.004	.0316	.075	.0028	-.000	.0015
-.300	1.000	.0317	-.1	.09	.5	.10	.997	.0316	.078	.0030	-.002	.0015
-.250	.994	.0317	-.0	.11	.3	.07	.991	.0316	.082	.0029	-.001	.0019
-.200	.974	.0317	.2	.10	.7	.10	.972	.0316	.073	.0029	.004	.0016
-.150	.971	.0317	.7	.09	.6	.11	.968	.0316	.074	.0031	.011	.0015
-.100	.958	.0317	.7	.12	.7	.08	.955	.0317	.071	.0027	.011	.0021
-.050	.941	.0318	1.3	.11	.8	.11	.938	.0317	.069	.0029	.021	.0020
0.000	.940	.0318	1.8	.09	1.0	.09	.937	.0317	.065	.0027	.030	.0018
.050	.947	.0318	1.8	.09	1.2	.10	.945	.0317	.062	.0026	.030	.0018
.100	.951	.0319	2.0	.13	1.6	.09	.949	.0318	.057	.0025	.034	.0024
.150	.977	.0317	2.6	.10	1.3	.09	.974	.0316	.062	.0026	.045	.0023
.200	.991	.0319	2.1	.12	1.4	.13	.988	.0318	.062	.0031	.036	.0024
.250	1.015	.0318	2.1	.12	1.8	.12	1.013	.0317	.057	.0027	.037	.0024
.300	1.025	.0317	2.0	.08	2.2	.09	1.023	.0317	.051	.0022	.036	.0018
.350	1.044	.0317	1.8	.07	1.8	.09	1.042	.0317	.058	.0024	.033	.0017
.400	1.049	.0318	2.4	.11	2.1	.12	1.047	.0317	.053	.0028	.043	.0024
.550	1.071	.0318	1.9	.10	1.9	.12	1.069	.0318	.058	.0028	.035	.0022
.700	1.078	.0318	1.4	.08	1.6	.12	1.076	.0318	.064	.0029	.027	.0017
.850	1.074	.0318	.9	.12	2.0	.10	1.072	.0318	.056	.0025	.018	.0023
1.000	1.071	.0318	.4	.09	1.8	.18	1.069	.0318	.060	.0038	.007	.0018

Upstream Velocity U_∞ = 30.6 m/s (+/- .69)
 Probe Yaw Offset Angle = 5.0 Deg

ORIGINAL PAGE IS
 OF POOR QUALITY

ORIGINAL PAGE IS
OF POOR QUALITY

Table H60. FIVE-HOLE PRESSURE PROBE WAKE PRESSURE DATA
INCIDENCE ANGLE (DEG) = 5.0 , $Z_c/C = 2.07$, $R = 12.5\%$

NORMALIZED TANGENTIAL POSITION ZT/S	EXIT ANGLE		TOTAL PRESSURE PT2		STATIC PRESSURE P2		TOTAL PRESSURE RECOVERY	
	Deg	(+/-)	kPa	(+/-)	kPa	(+/-)	PT2/PT1	(+/-)
-1.000	4.2	.13	99.76	.017	99.21	.017	.9994	.00024
-.950	4.4	.07	99.78	.017	99.20	.017	.9997	.00024
-.700	4.2	.10	99.78	.017	99.19	.017	.9996	.00024
-.550	4.5	.08	99.78	.017	99.20	.017	.9997	.00024
-.400	3.7	.16	99.76	.017	99.19	.017	.9995	.00024
-.350	4.3	.09	99.75	.017	99.20	.017	.9993	.00024
-.300	4.5	.10	99.74	.017	99.20	.017	.9992	.00024
-.250	4.7	.07	99.73	.017	99.20	.017	.9991	.00024
-.200	4.3	.10	99.70	.017	99.19	.017	.9989	.00024
-.150	4.4	.11	99.70	.017	99.20	.017	.9989	.00024
-.100	4.3	.08	99.68	.017	99.19	.017	.9987	.00024
-.050	4.4	.11	99.67	.017	99.19	.017	.9985	.00024
0.000	4.4	.09	99.67	.017	99.19	.017	.9985	.00024
.050	4.2	.10	99.68	.017	99.19	.017	.9986	.00024
.100	4.0	.10	99.68	.017	99.20	.017	.9987	.00024
.150	4.5	.10	99.71	.017	99.19	.017	.9989	.00024
.200	4.1	.13	99.72	.017	99.19	.017	.9990	.00024
.250	3.8	.12	99.75	.017	99.19	.017	.9993	.00024
.300	3.5	.08	99.76	.017	99.19	.017	.9994	.00024
.350	3.6	.09	99.78	.017	99.19	.017	.9996	.00024
.400	3.7	.12	99.78	.017	99.19	.017	.9997	.00024
.550	3.7	.12	99.81	.017	99.19	.017	.9999	.00024
.700	3.7	.11	99.82	.017	99.19	.017	1.0000	.00024
.850	3.1	.10	99.81	.017	99.19	.017	1.0000	.00024
1.000	3.2	.18	99.82	.017	99.20	.017	1.0000	.00024

Upstream Total Pressure PT1 = 99.82 kPa (+/- .017)

Upstream Static Pressure P1 = 99.28 kPa (+/- .017)

Table H61. FIVE-HOLE PRESSURE PROBE WAKE VELOCITY DATA
 INCIDENCE ANGLE (DEG) = 5.0 , Zc/C = 2.07 , R = 16.7 %

NORMALIZED TANGENTIAL POSITION ZT/S	NORMALIZED TOTAL VELOCITY					NORMALIZED VELOCITY COMPONENTS						
	U/Uzo (+/-)		Pitch Ang Deg (+/-)		Yaw Ang Deg (+/-)		Uz/Uzo (+/-)		Ut/Uzo (+/-)		Ur/Uzo (+/-)	
-1.000	1.054	.0315	1.4	.10	.7	.12	1.051	.0314	.080	.0033	.027	.0019
-.850	1.041	.0313	1.0	.11	.8	.11	1.038	.0312	.077	.0030	.018	.0020
-.700	1.049	.0313	.9	.09	.6	.08	1.046	.0312	.080	.0028	.016	.0017
-.550	1.048	.0313	.2	.11	1.2	.13	1.045	.0313	.070	.0032	.004	.0021
-.400	1.039	.0314	-.2	.20	1.4	.11	1.037	.0313	.065	.0029	-.004	.0036
-.350	1.025	.0312	.0	.10	.5	.09	1.022	.0312	.080	.0029	.000	.0018
-.300	1.019	.0312	.2	.09	.5	.07	1.016	.0311	.080	.0028	.004	.0015
-.250	1.004	.0312	-.1	.10	.7	.09	1.001	.0311	.076	.0028	-.001	.0018
-.200	.981	.0312	.1	.10	.5	.13	.978	.0312	.077	.0033	.002	.0017
-.150	.974	.0312	.6	.11	.7	.09	.972	.0311	.073	.0028	.010	.0018
-.100	.960	.0313	1.3	.12	.6	.08	.957	.0312	.073	.0027	.021	.0021
-.050	.945	.0313	1.2	.13	.6	.10	.942	.0312	.072	.0029	.019	.0022
0.000	.946	.0314	1.7	.21	.9	.10	.943	.0313	.068	.0028	.028	.0036
.050	.952	.0313	2.4	.12	.8	.13	.948	.0312	.070	.0031	.040	.0024
.100	.976	.0312	2.8	.15	1.1	.12	.973	.0311	.066	.0029	.048	.0030
.150	.987	.0313	2.7	.12	1.4	.10	.984	.0313	.061	.0026	.046	.0026
.200	1.002	.0313	2.6	.10	1.3	.11	.999	.0312	.065	.0028	.046	.0023
.250	1.017	.0313	1.7	.14	1.7	.08	1.015	.0313	.059	.0023	.031	.0027
.300	1.018	.0313	2.2	.22	1.1	.21	1.015	.0312	.069	.0042	.039	.0041
.350	1.015	.0314	2.0	.14	1.5	.10	1.013	.0313	.061	.0026	.035	.0028
.400	1.029	.0320	1.9	.13	1.6	.16	1.026	.0319	.060	.0034	.034	.0026
.550	1.050	.0313	1.7	.10	1.4	.13	1.047	.0313	.066	.0031	.031	.0020
.700	1.056	.0313	1.4	.10	2.0	.11	1.054	.0313	.055	.0026	.026	.0021
.850	1.058	.0313	.7	.11	.8	.27	1.055	.0312	.078	.0055	.012	.0021
1.000	1.060	.0313	.1	.09	1.5	.15	1.058	.0313	.065	.0034	.001	.0017

Upstream Velocity Uzo = 30.8 m/s (+/- .68)
 Probe Yaw Offset Angle = 5.0 Deg

ORIGINAL PAGE IS
OF POOR QUALITY

Table H62. FIVE-HOLE PRESSURE PROBE WAKE PRESSURE DATA
INCIDENCE ANGLE (DEG) = 5.0 , $Z_c/C = 2.07$, $R = 16.7\%$

NORMALIZED TANGENTIAL POSITION 2T/S	EXIT ANGLE		TOTAL PRESURE PT2		STATIC PRESSURE P2		TOTAL PRESSURE RECOVERY	
	Deg (+/-)		kPa (+/-)		kPa (+/-)		PT2/PT1 (+/-)	
-1.000	4.6	.12	99.80	.017	99.19	.017	.9998	.00024
-.850	4.4	.11	99.79	.017	99.20	.017	.9997	.00024
-.700	4.5	.08	99.79	.017	99.19	.017	.9998	.00024
-.550	3.8	.13	99.79	.017	99.19	.017	.9998	.00024
-.400	3.6	.11	99.78	.017	99.19	.017	.9997	.00024
-.350	4.5	.09	99.77	.017	99.19	.017	.9995	.00024
-.300	4.5	.07	99.75	.017	99.19	.017	.9994	.00024
-.250	4.3	.09	99.74	.017	99.19	.017	.9992	.00024
-.200	4.5	.13	99.72	.017	99.19	.017	.9990	.00024
-.150	4.3	.09	99.71	.017	99.19	.017	.9989	.00024
-.100	4.6	.08	99.70	.017	99.19	.017	.9988	.00024
-.050	4.5	.10	99.68	.017	99.19	.017	.9987	.00024
0.000	4.5	.12	99.69	.017	99.20	.017	.9987	.00024
.050	4.9	.13	99.70	.017	99.20	.017	.9988	.00024
.100	4.8	.13	99.72	.017	99.20	.017	.9990	.00024
.150	4.5	.11	99.73	.017	99.20	.017	.9991	.00024
.200	4.6	.11	99.75	.017	99.20	.017	.9994	.00024
.250	3.7	.10	99.77	.017	99.20	.017	.9995	.00024
.300	4.4	.21	99.77	.017	99.21	.017	.9996	.00024
.350	4.0	.11	99.76	.017	99.20	.017	.9995	.00024
.400	3.8	.15	99.79	.019	99.21	.017	.9997	.00025
.550	4.0	.13	99.81	.017	99.21	.017	1.0000	.00024
.700	3.3	.11	99.82	.017	99.21	.017	1.0001	.00024
.850	4.3	.27	99.82	.017	99.21	.017	1.0000	.00024
1.000	3.5	.15	99.82	.017	99.20	.017	1.0000	.00024

Upstream Total Pressure PT1 = 99.81 kPa (+/- .017)

Upstream Static Pressure P1 = 99.27 kPa (+/- .017)

Table H63. FIVE-HOLE PROBE WAKE VELOCITY DATA
 INCIDENCE ANGLE (DEG) = 5.0 , $Z_c/C = 2.07$, $R = 25.0\%$

NORMALIZED TANGENTIAL POSITION 2T/S	NORMALIZED TOTAL VELOCITY					NORMALIZED VELOCITY COMPONENTS						
	U/U _∞ (+/-)		Pitch Ang Deg (+/-)		Yaw Ang Deg (+/-)		U _z /U _∞ (+/-)		U _t /U _∞ (+/-)		U _r /U _∞ (+/-)	
-1.000	1.063	.0313	1.1	.10	.4	.07	1.060	.0312	.086	.0029	.021	.0019
-.850	1.062	.0313	.8	.06	-.1	.06	1.058	.0311	.094	.0030	.015	.0013
-.700	1.067	.0313	.9	.06	-.1	.06	1.064	.0312	.095	.0030	.017	.0012
-.550	1.058	.0313	.3	.08	-.3	.09	1.054	.0311	.097	.0033	.005	.0015
-.400	1.056	.0312	.2	.07	-.3	.10	1.051	.0311	.097	.0034	.004	.0013
-.350	1.043	.0312	.0	.11	.1	.08	1.039	.0311	.089	.0031	.000	.0020
-.300	1.045	.0312	-.9	.10	-.3	.07	1.041	.0311	.097	.0032	-.000	.0018
-.250	1.027	.0312	.1	.19	.1	.09	1.023	.0311	.088	.0031	.001	.0035
-.200	1.013	.0312	.5	.16	-.2	.09	1.009	.0311	.091	.0032	.009	.0028
-.150	.999	.0312	.5	.18	-.3	.09	.995	.0310	.092	.0032	.009	.0032
-.100	.977	.0312	1.6	.20	-.4	.09	.972	.0311	.092	.0034	.027	.0035
-.050	.959	.0312	1.8	.23	-.3	.09	.954	.0311	.089	.0032	.030	.0039
0.000	.958	.0312	2.6	.15	-.3	.13	.953	.0311	.089	.0036	.044	.0029
.050	.969	.0312	2.8	.14	-.2	.08	.964	.0310	.088	.0031	.047	.0028
.100	.974	.0313	3.8	.15	-.3	.09	.968	.0311	.089	.0032	.065	.0033
.150	.987	.0314	2.7	.16	-.2	.10	.982	.0313	.089	.0033	.047	.0031
.200	1.007	.0313	3.5	.08	-.1	.10	1.001	.0311	.089	.0032	.062	.0024
.250	1.022	.0313	3.3	.15	-.2	.13	1.016	.0311	.092	.0036	.059	.0032
.300	1.042	.0312	3.1	.11	.4	.10	1.037	.0311	.083	.0031	.057	.0026
.350	1.043	.0314	2.0	.29	.2	.11	1.039	.0312	.087	.0033	.036	.0054
.400	1.044	.0312	2.8	.16	.3	.15	1.039	.0311	.085	.0037	.051	.0033
.550	1.064	.0313	2.1	.11	.7	.12	1.061	.0312	.079	.0032	.039	.0024
.700	1.063	.0313	.4	.09	.1	.18	1.059	.0312	.090	.0042	.008	.0017
.850	1.068	.0313	-.3	.10	.6	.12	1.065	.0312	.081	.0033	-.006	.0018
1.000	1.066	.0313	-.9	.08	.4	.12	1.063	.0312	.085	.0034	-.018	.0016

Upstream Velocity U_∞ = 30.9 m/s (+/- .58)
 Probe Yaw Offset Angle = 5.0 Deg

ORIGINAL PAGE IS
OF POOR QUALITY

Table H64. FIVE-HOLE PRESSURE PROBE WAKE PRESSURE DATA
INCIDENCE ANGLE (DEG) = 5.0 , $Z_c/C = 2.07$, $R = 25.0\%$

NORMALIZED TANGENTIAL POSITION 2T/S	EXIT ANGLE		TOTAL PRESSURE PT2		STATIC PRESSURE P2		TOTAL PRESSURE RECOVERY	
	Deg	(+/-)	kPa	(+/-)	kPa	(+/-)	PT2/PT1	(+/-)
-1.000	4.8	.08	99.81	.017	99.19	.017	1.0000	.00024
-.850	5.1	.06	99.81	.017	99.19	.017	1.0000	.00024
-.700	5.2	.06	99.82	.017	99.19	.017	1.0000	.00024
-.550	5.3	.09	99.81	.017	99.20	.017	1.0000	.00024
-.400	5.3	.10	99.81	.017	99.20	.017	.9999	.00024
-.350	4.9	.08	99.80	.017	99.20	.017	.9998	.00024
-.300	5.3	.07	99.80	.017	99.20	.017	.9998	.00024
-.250	4.9	.09	99.78	.017	99.20	.017	.9996	.00024
-.200	5.2	.09	99.77	.017	99.21	.017	.9995	.00024
-.150	5.3	.09	99.75	.017	99.20	.017	.9993	.00024
-.100	5.6	.11	99.72	.017	99.20	.017	.9991	.00024
-.050	5.6	.11	99.71	.017	99.20	.017	.9989	.00024
0.000	6.0	.13	99.71	.017	99.21	.017	.9989	.00024
.050	5.9	.09	99.72	.017	99.20	.017	.9990	.00024
.100	6.5	.11	99.72	.017	99.20	.017	.9991	.00024
.150	5.8	.12	99.73	.018	99.20	.017	.9992	.00024
.200	6.2	.09	99.76	.017	99.20	.017	.9994	.00024
.250	6.1	.13	99.78	.017	99.21	.017	.9996	.00024
.300	5.5	.11	99.79	.017	99.20	.017	.9998	.00024
.350	5.2	.15	99.79	.017	99.20	.017	.9998	.00024
.400	5.4	.15	99.79	.017	99.20	.017	.9998	.00024
.550	4.8	.12	99.82	.017	99.20	.017	1.0000	.00024
.700	4.9	.18	99.81	.017	99.20	.017	1.0000	.00024
.850	4.4	.12	99.81	.017	99.19	.017	1.0000	.00024
1.000	4.7	.12	99.81	.017	99.19	.017	1.0000	.00024

Upstream Total Pressure PT1 = 99.81 kPa (+/- .017)

Upstream Static Pressure P1 = 99.27 kPa (+/- .017)

Table H65. FIVE-HOLE PRESSURE PROBE WAKE VELOCITY DATA
 INCIDENCE ANGLE (DEG) = 5.0 , $Z_c/C = 2.07$, $R = 33.3\%$

NORMALIZED TANGENTIAL POSITION 2T/S	NORMALIZED TOTAL VELOCITY				NORMALIZED VELOCITY COMPONENTS							
	U/U _∞ (+/-)		Pitch Ang Deg (+/-)		Yaw Ang Deg (+/-)		U _z /U _∞ (+/-)		U _t /U _∞ (+/-)		U _r /U _∞ (+/-)	
-1.000	1.072	.0314	.5	.08	-.3	.09	1.067	.0312	.099	.0034	.011	.0015
-.850	1.069	.0313	.3	.11	-.4	.07	1.064	.0312	.100	.0032	.005	.0020
-.700	1.066	.0313	.1	.09	-.5	.06	1.061	.0312	.103	.0032	.001	.0017
-.550	1.068	.0313	-.0	.07	-.9	.08	1.063	.0312	.109	.0035	-.000	.0013
-.400	1.058	.0313	.2	.08	-1.0	.09	1.052	.0312	.111	.0037	.004	.0015
-.350	1.049	.0313	.3	.11	-.9	.06	1.044	.0311	.108	.0034	.006	.0020
-.300	1.044	.0313	.9	.10	-.9	.07	1.038	.0311	.107	.0035	.017	.0019
-.250	1.036	.0313	.9	.09	-.9	.09	1.030	.0311	.107	.0036	.016	.0017
-.200	1.016	.0314	.3	.12	-1.1	.09	1.011	.0313	.108	.0037	.005	.0021
-.150	.999	.0313	1.2	.23	-1.1	.09	.993	.0311	.106	.0037	.022	.0041
-.100	.994	.0313	1.8	.25	-.7	.08	.989	.0311	.099	.0034	.031	.0044
-.050	.977	.0313	1.0	.33	-1.1	.09	.972	.0312	.103	.0037	.018	.0057
0.000	.971	.0313	2.0	.22	-.9	.07	.966	.0311	.100	.0034	.033	.0038
.050	.972	.0312	2.8	.13	-.8	.08	.966	.0310	.099	.0034	.048	.0027
.100	.989	.0313	2.5	.33	-.9	.12	.983	.0311	.101	.0038	.044	.0058
.150	.990	.0312	3.6	.19	-.9	.07	.983	.0310	.101	.0034	.063	.0038
.200	1.013	.0312	2.8	.23	-.7	.11	1.007	.0311	.101	.0036	.050	.0043
.250	1.034	.0313	4.2	.20	-.9	.07	1.025	.0310	.106	.0034	.076	.0042
.300	1.041	.0313	3.4	.12	-.5	.09	1.034	.0311	.099	.0034	.061	.0029
.350	1.049	.0313	3.7	.12	-.8	.07	1.041	.0311	.105	.0034	.067	.0029
.400	1.052	.0313	2.8	.16	-.8	.07	1.045	.0311	.107	.0034	.052	.0033
.550	1.058	.0313	.9	.12	-.7	.09	1.052	.0312	.105	.0035	.017	.0022
.700	1.066	.0313	-.0	.09	-.3	.08	1.061	.0312	.098	.0032	-.000	.0016
.850	1.066	.0313	-.9	.09	-.6	.06	1.061	.0312	.105	.0033	-.017	.0018
1.000	1.067	.0314	-1.2	.09	-.6	.09	1.062	.0312	.104	.0035	-.022	.0018

Upstream Velocity U_∞ = 30.8 m/s (+/- .68)
 Probe Yaw Offset Angle = 5.0 Deg

ORIGINAL PAGE IS
OF POOR QUALITY

Table H66. FIVE-HOLE PRESSURE PROBE WAKE PRESSURE DATA
INCIDENCE ANGLE (DEG) = 5.0 ; $Z_c/C = 2.07$; $R = 33.3\%$

NORMALIZED TANGENTIAL POSITION ZT/S	EXIT ANGLE		TOTAL PRESURE PT2		STATIC PRESSURE P2		TOTAL PRESSURE RECOVERY	
	Deg (+/-)		kPa (+/-)		kPa (+/-)		PT2/PT1 (+/-)	
-1.000	5.3	.09	99.82	.017	99.19	.017	1.0000	.00024
-.850	5.4	.07	99.81	.017	99.19	.017	1.0000	.00024
-.700	5.5	.06	99.82	.017	99.20	.017	1.0000	.00024
-.550	5.9	.08	99.82	.017	99.20	.017	1.0000	.00024
-.400	6.0	.09	99.81	.017	99.20	.017	1.0000	.00024
-.350	5.9	.06	99.80	.017	99.20	.017	.9999	.00024
-.300	6.0	.08	99.79	.017	99.19	.017	.9998	.00024
-.250	6.0	.09	99.78	.017	99.19	.017	.9996	.00024
-.200	6.1	.09	99.76	.017	99.20	.017	.9995	.00024
-.150	6.2	.10	99.74	.017	99.20	.017	.9993	.00024
-.100	6.0	.11	99.74	.017	99.20	.017	.9992	.00024
-.050	6.1	.11	99.72	.017	99.20	.017	.9991	.00024
0.000	6.2	.09	99.72	.017	99.20	.017	.9990	.00024
.050	6.5	.09	99.72	.017	99.21	.017	.9991	.00024
.100	6.4	.17	99.74	.017	99.21	.017	.9993	.00024
.150	6.9	.12	99.74	.017	99.21	.017	.9993	.00024
.200	6.4	.14	99.76	.017	99.20	.017	.9995	.00024
.250	7.2	.13	99.78	.017	99.20	.017	.9996	.00024
.300	6.4	.10	99.79	.017	99.20	.017	.9998	.00024
.350	6.8	.09	99.80	.017	99.20	.017	.9999	.00024
.400	6.5	.09	99.80	.017	99.20	.017	.9999	.00024
.550	5.8	.09	99.81	.017	99.20	.017	1.0000	.00024
.700	5.3	.08	99.82	.017	99.20	.017	1.0000	.00024
.850	5.7	.06	99.82	.017	99.20	.017	1.0000	.00024
1.000	5.7	.09	99.82	.017	99.20	.017	1.0001	.00024

Upstream Total Pressure PT1 = 99.81 kPa (+/- .017)

Upstream Static Pressure P1 = 99.27 kPa (+/- .017)

Table H67: FIVE-HOLE PRESSURE PROBE WAKE VELOCITY DATA
 INCIDENCE ANGLE (DEG) = 5.0 , Zc/C = 2.07 , R = 50.0 %

NORMALIZED TANGENTIAL POSITION 2T/S	NORMALIZED TOTAL VELOCITY				NORMALIZED VELOCITY COMPONENTS							
	U/U _∞ (+/-)		Pitch Ang Deg (+/-)		Yaw Ang Deg (+/-)		Uz/U _∞ (+/-)		U _t /U _∞ (+/-)		U _r /U _∞ (+/-)	
-1.000	1.065	.0314	.1	.09	-1.1	.11	1.059	.0313	.113	.0039	.001	.0018
-.850	1.069	.0315	-.2	.07	-.8	.12	1.064	.0313	.107	.0039	-.004	.0013
-.700	1.069	.0314	-.2	.10	-1.3	.07	1.062	.0313	.117	.0037	-.005	.0019
-.550	1.064	.0315	-.1	.09	-1.0	.10	1.058	.0313	.112	.0038	-.002	.0017
-.400	1.065	.0314	.4	.10	-.8	.13	1.059	.0313	.107	.0039	.007	.0019
-.350	1.055	.0314	.2	.10	-1.0	.06	1.049	.0312	.111	.0035	.004	.0019
-.300	1.043	.0314	.7	.13	-1.0	.12	1.037	.0312	.109	.0039	.013	.0023
-.250	1.032	.0314	1.1	.11	-1.0	.07	1.026	.0312	.108	.0035	.020	.0021
-.200	1.006	.0313	1.0	.08	-1.1	.09	1.000	.0311	.107	.0037	.018	.0015
-.150	.993	.0314	1.7	.15	-1.1	.12	.986	.0312	.106	.0039	.030	.0027
-.100	.982	.0313	1.3	.11	-.8	.10	.976	.0312	.100	.0036	.023	.0020
-.050	.965	.0314	2.1	.14	-1.0	.07	.959	.0312	.100	.0035	.036	.0026
0.000	.963	.0314	1.9	.10	-.9	.08	.957	.0312	.098	.0035	.032	.0020
.050	.971	.0313	1.9	.23	-.9	.08	.965	.0312	.099	.0035	.032	.0040
.100	.984	.0313	2.1	.12	-.7	.10	.978	.0312	.097	.0035	.036	.0024
.150	1.001	.0313	1.8	.27	-.3	.09	.996	.0312	.092	.0032	.031	.0047
.200	1.012	.0313	1.9	.20	-.4	.09	1.007	.0312	.095	.0033	.033	.0037
.250	1.027	.0313	2.7	.13	-1.1	.15	1.021	.0311	.108	.0042	.048	.0027
.300	1.058	.0315	1.6	.20	-.8	.13	1.053	.0313	.106	.0040	.029	.0039
.350	1.054	.0314	2.0	.23	-1.1	.09	1.047	.0312	.111	.0037	.037	.0043
.400	1.057	.0314	2.2	.09	-.8	.11	1.051	.0313	.106	.0037	.040	.0021
.550	1.063	.0314	.3	.17	-1.2	.15	1.057	.0313	.115	.0043	.006	.0032
.700	1.061	.0314	.3	.09	-1.2	.12	1.055	.0312	.115	.0041	.005	.0017
.850	1.065	.0314	-.3	.07	-1.5	.07	1.058	.0312	.121	.0038	-.005	.0017
1.000	1.061	.0314	-.8	.07	-.7	.16	1.055	.0312	.110	.0044	-.016	.0013

Upstream Velocity U_∞ = 30.7 m/s (+/- .68)
 Probe Yaw Offset Angle = 5.0 Deg

ORIGINAL PAGE IS
OF POOR QUALITY

Table H68. FIVE-HOLE PRESSURE PROBE WAKE PRESSURE DATA
INCIDENCE ANGLE (DEG) = 5.0 , $Z_c/C = 2.07$, $R = 50.0\%$

NORMALIZED TANGENTIAL POSITION ZT/S	EXIT ANGLE		TOTAL PRESURE PT2		STATIC PRESSURE P2		TOTAL PRESSURE RECOVERY	
	Deg (+/-)		kPa (+/-)		kPa (+/-)		PT2/PT1 (+/-)	
1.000	6.1	.11	99.81	.017	99.20	.017	1.0000	.00024
.850	5.8	.12	99.82	.017	99.19	.017	1.0000	.00024
.700	6.3	.07	99.82	.017	99.20	.017	1.0001	.00024
.550	6.0	.10	99.82	.017	99.20	.017	1.0000	.00024
.400	5.8	.13	99.81	.017	99.20	.017	1.0000	.00024
.350	6.0	.06	99.80	.017	99.20	.017	.9999	.00024
.300	6.1	.12	99.79	.017	99.20	.017	.9997	.00024
.250	6.1	.07	99.77	.017	99.19	.017	.9996	.00024
.200	6.2	.09	99.74	.017	99.19	.017	.9993	.00024
.150	6.3	.12	99.73	.017	99.19	.017	.9991	.00024
.100	6.0	.10	99.72	.017	99.20	.017	.9991	.00024
.050	6.3	.08	99.70	.017	99.20	.017	.9989	.00024
0.000	6.2	.09	99.70	.017	99.20	.017	.9989	.00024
.050	6.2	.11	99.71	.017	99.20	.017	.9990	.00024
.100	6.1	.10	99.72	.017	99.19	.017	.9991	.00024
.150	5.6	.12	99.74	.017	99.20	.017	.9993	.00024
.200	5.7	.10	99.75	.017	99.19	.017	.9994	.00024
.250	6.6	.14	99.77	.017	99.20	.017	.9996	.00024
.300	6.0	.14	99.80	.017	99.20	.017	.9999	.00024
.350	6.4	.11	99.81	.017	99.20	.017	.9999	.00024
.400	6.2	.10	99.80	.017	99.19	.017	.9999	.00024
.550	6.2	.15	99.81	.017	99.20	.017	1.0000	.00024
.700	6.2	.12	99.82	.017	99.20	.017	1.0000	.00024
.850	6.5	.07	99.81	.017	99.20	.017	1.0000	.00024
1.000	6.0	.16	99.82	.017	99.20	.017	1.0000	.00024

Upstream Total Pressure PT1 = 99.81 kPa (+/- .017)

Upstream Static Pressure P1 = 99.27 kPa (+/- .017)

Table H69. FIVE-HOLE PRESSURE PROBE WAKE VELOCITY DATA
 INCIDENCE ANGLE (DEG) = 5.0 , Zc/C = 2.07 , R = 66.7 %

NORMALIZED TANGENTIAL POSITION ZT/S	NORMALIZED TOTAL VELOCITY					NORMALIZED VELOCITY COMPONENTS						
	U/Uzo (+/-)		Pitch Ang Deg (+/-)		Yaw Ang Deg (+/-)		Uz/Uzo (+/-)		Ut/Uzo (+/-)		Ur/Uzo (+/-)	
-1.000	1.082	.0311	.4	.13	-1.2	.08	1.056	.0309	.115	.0037	.008	.0024
-.850	1.060	.0311	-.0	.09	-1.3	.08	1.053	.0309	.116	.0037	-.000	.0017
-.700	1.060	.0311	.0	.09	-.9	.10	1.055	.0309	.108	.0037	.000	.0016
-.550	1.060	.0311	.4	.10	-.8	.12	1.055	.0309	.107	.0038	.007	.0019
-.400	1.052	.0311	.9	.09	-.4	.09	1.047	.0309	.098	.0033	.017	.0017
-.350	1.046	.0311	1.0	.09	-.3	.07	1.042	.0309	.096	.0031	.019	.0017
-.300	1.036	.0310	1.2	.10	.1	.07	1.032	.0309	.088	.0029	.022	.0020
-.250	1.017	.0310	1.0	.14	-.1	.07	1.013	.0309	.090	.0030	.017	.0025
-.200	.999	.0310	1.4	.11	.1	.07	.995	.0309	.086	.0030	.024	.0020
-.150	.973	.0310	1.4	.08	-.5	.09	.969	.0309	.093	.0033	.024	.0015
-.100	.951	.0311	1.3	.10	-.1	.08	.947	.0309	.084	.0031	.022	.0018
-.050	.936	.0311	1.2	.12	.2	.11	.933	.0310	.078	.0032	.020	.0020
0.000	.917	.0312	1.0	.17	-.2	.10	.913	.0311	.082	.0032	.016	.0028
.050	.922	.0312	1.2	.13	-.1	.08	.918	.0311	.082	.0031	.020	.0022
.100	.946	.0311	1.7	.09	-.3	.12	.941	.0310	.088	.0035	.027	.0017
.150	.954	.0311	2.1	.10	-.1	.14	.949	.0309	.085	.0036	.035	.0020
.200	.981	.0310	1.6	.15	-.0	.10	.977	.0309	.086	.0032	.027	.0027
.250	1.002	.0310	1.9	.10	-.2	.08	.997	.0308	.091	.0031	.034	.0020
.300	1.024	.0311	2.1	.10	-.3	.06	1.019	.0309	.095	.0031	.038	.0021
.350	1.031	.0310	1.1	.11	-.5	.07	1.026	.0309	.099	.0032	.020	.0021
.400	1.048	.0311	1.2	.15	-.6	.07	1.043	.0309	.102	.0033	.022	.0029
.550	1.059	.0311	.7	.16	-.1	.08	1.055	.0310	.094	.0031	.012	.0031
.700	1.055	.0311	.8	.10	-.6	.07	1.050	.0309	.103	.0033	.015	.0019
.850	1.056	.0311	.7	.09	-.7	.09	1.051	.0309	.105	.0035	.013	.0016
1.000	1.060	.0311	.5	.09	-.7	.14	1.055	.0309	.105	.0040	.008	.0017

Upstream Velocity Uzo = 30.9 m/s (+/- .68)
 Probe Yaw Offset Angle = 5.0 Deg

- 268 -
 ORIGINAL PAGE IS
 OF POOR QUALITY

ORIGINAL PAGE IS
OF POOR QUALITY

Table H70. FIVE-HOLE PRESSURE PROBE WAKE PRESSURE DATA
INCIDENCE ANGLE (DEG) = 5.0 , Zc/C = 2.07 , R = 66.7 %

NORMALIZED TANGENTIAL POSITION ZT/S	EXIT ANGLE	TOTAL PRESURE PT2	STATIC PRESSURE P2	TOTAL PRESSURE RECOVERY
	Dea (+/-)	kPa (+/-)	kPa (+/-)	PT2/PT1 (+/-)
-1.000	6.2 .08	99.82 .017	99.20 .017	1.0000 .00024
-.850	6.3 .08	99.81 .017	99.20 .017	1.0000 .00024
-.700	5.9 .10	99.82 .017	99.20 .017	1.0000 .00024
-.550	5.8 .12	99.82 .017	99.20 .017	1.0000 .00024
-.400	5.5 .09	99.81 .017	99.20 .017	.9999 .00024
-.350	5.4 .07	99.80 .017	99.20 .017	.9999 .00024
-.300	5.0 .07	99.79 .017	99.20 .017	.9998 .00024
-.250	5.2 .07	99.77 .017	99.20 .017	.9996 .00024
-.200	5.1 .08	99.75 .017	99.20 .017	.9993 .00024
-.150	5.7 .09	99.72 .017	99.20 .017	.9991 .00024
-.100	5.2 .08	99.70 .017	99.20 .017	.9989 .00024
-.050	4.9 .11	99.68 .017	99.20 .017	.9987 .00024
0.000	5.2 .10	99.66 .017	99.20 .017	.9985 .00024
.050	5.2 .09	99.67 .017	99.20 .017	.9985 .00024
.100	5.6 .12	99.69 .017	99.20 .017	.9988 .00024
.150	5.5 .13	99.70 .017	99.20 .017	.9989 .00024
.200	5.3 .10	99.73 .017	99.20 .017	.9991 .00024
.250	5.6 .08	99.75 .017	99.20 .017	.9994 .00024
.300	5.7 .06	99.77 .017	99.20 .017	.9996 .00024
.350	5.6 .08	99.78 .017	99.20 .017	.9997 .00024
.400	5.7 .08	99.80 .017	99.20 .017	.9999 .00024
.550	5.2 .08	99.81 .017	99.20 .017	1.0000 .00024
.700	5.7 .07	99.81 .017	99.20 .017	1.0000 .00024
.850	5.7 .09	99.81 .017	99.20 .017	1.0000 .00024
1.000	5.7 .14	99.82 .017	99.20 .017	1.0000 .00024

Upstream Total Pressure PT1 = 99.81 kPa (+/- .017)

Upstream Static Pressure P1 = 99.26 kPa (+/- .017)

Table H71. FIVE-HOLE PRESSURE PROBE WAKE VELOCITY DATA
 INCIDENCE ANGLE (DEG) = 5.0 , Zc/C = 2.07 , R = 83.3 %

NORMALIZED TANGENTIAL POSITION 2T/5	NORMALIZED TOTAL VELOCITY						NORMALIZED VELOCITY COMPONENTS					
	U/Uzo (+/-)		Pitch Ang Deg (+/-)		Yaw Ang Deg (+/-)		Uz/Uzo (+/-)		Ut/Uzo (+/-)		Ur/Uzo (+/-)	
-1.000	1.057	.0313	1.1	.09	-.4	.11	1.052	.0311	.100	.0036	.020	.0017
-.850	1.061	.0313	1.0	.08	.0	.17	1.057	.0312	.092	.0042	.018	.0015
-.700	1.058	.0313	1.1	.06	-.3	.10	1.053	.0311	.097	.0034	.020	.0013
-.550	1.056	.0313	1.3	.07	-.3	.09	1.051	.0311	.097	.0033	.024	.0015
-.400	1.041	.0312	1.6	.06	-.6	.14	1.035	.0311	.101	.0039	.029	.0014
-.350	1.030	.0312	1.8	.10	-.0	.10	1.026	.0311	.090	.0032	.032	.0020
-.300	1.006	.0313	1.8	.09	-.2	.08	1.002	.0311	.091	.0032	.032	.0018
-.250	.986	.0312	1.7	.06	-.1	.10	.982	.0311	.088	.0032	.029	.0014
-.200	.958	.0313	1.7	.12	-.1	.10	.954	.0312	.085	.0032	.029	.0023
-.150	.924	.0314	1.0	.13	.1	.10	.920	.0313	.079	.0031	.017	.0022
-.100	.918	.0315	.7	.12	.2	.09	.914	.0314	.077	.0030	.011	.0020
-.050	.886	.0317	-.1	.10	.1	.10	.883	.0315	.076	.0031	-.001	.0016
0.000	.885	.0316	-.6	.10	.1	.09	.882	.0315	.076	.0031	-.010	.0016
.050	.887	.0316	-1.1	.12	.2	.10	.883	.0315	.075	.0031	-.017	.0020
.100	.911	.0315	-.6	.08	.1	.08	.908	.0313	.078	.0030	-.009	.0013
.150	.922	.0314	.4	.11	-.1	.11	.918	.0313	.083	.0033	.007	.0018
.200	.943	.0313	1.0	.16	.1	.08	.939	.0312	.081	.0030	.016	.0027
.250	.977	.0312	1.5	.13	-.4	.11	.973	.0311	.092	.0035	.026	.0024
.300	.987	.0312	2.1	.08	-.3	.08	.982	.0310	.090	.0032	.036	.0017
.350	1.018	.0312	1.9	.10	-.4	.12	1.013	.0311	.096	.0036	.033	.0020
.400	1.029	.0312	1.9	.09	-.2	.12	1.024	.0311	.093	.0036	.035	.0019
.550	1.047	.0313	1.5	.11	-.3	.10	1.042	.0311	.097	.0034	.028	.0022
.700	1.049	.0313	1.4	.07	-.6	.08	1.043	.0311	.102	.0034	.026	.0015
.850	1.047	.0312	.9	.07	-.6	.08	1.041	.0311	.103	.0034	.017	.0014
1.000	1.045	.0312	.8	.09	-.8	.10	1.040	.0311	.105	.0037	.014	.0017

Upstream Velocity Uzo = 30.8 m/s (+/- .68)
 Probe Yaw Offset Angle = 5.0 Deg

ORIGINAL PAGE IS
OF POOR QUALITY

Table H72. FIVE-HOLE PRESSURE PROBE WAKE PRESSURE DATA
INCIDENCE ANGLE (DEG) = 5.0 , $Z_c/C = 2.07$, $R = 83.3\%$

NORMALIZED TANGENTIAL POSITION	EXIT ANGLE	TOTAL PRESSURE PT2	STATIC PRESSURE P2	TOTAL PRESSURE RECOVERY
2T/S	DeS (+/-)	KPa (+/-)	KPa (+/-)	PT2/PT1 (+/-)
-1.000	5.5 .11	99.81 .017	99.21 .017	1.0000 .00024
-.850	5.1 .17	99.82 .017	99.21 .017	1.0001 .00024
-.700	5.4 .10	99.82 .017	99.21 .017	1.0001 .00024
-.550	5.4 .09	99.81 .017	99.20 .017	1.0000 .00024
-.400	5.3 .13	99.80 .017	99.21 .017	.9999 .00024
-.350	5.3 .10	99.79 .017	99.21 .017	.9998 .00024
-.300	5.5 .03	99.75 .017	99.20 .017	.9994 .00024
-.250	5.4 .09	99.73 .017	99.20 .017	.9992 .00024
-.200	5.4 .10	99.71 .017	99.20 .017	.9989 .00024
-.150	5.0 .10	99.67 .017	99.20 .017	.9986 .00024
-.100	4.9 .09	99.67 .017	99.21 .017	.9985 .00024
-.050	4.9 .10	99.64 .017	99.21 .017	.9983 .00024
0.000	5.0 .09	99.63 .017	99.21 .017	.9982 .00024
.050	4.9 .10	99.64 .017	99.21 .017	.9983 .00024
.100	5.0 .08	99.66 .017	99.21 .017	.9985 .00024
.150	5.2 .11	99.67 .017	99.21 .017	.9986 .00024
.200	5.0 .09	99.70 .017	99.21 .017	.9988 .00024
.250	5.6 .11	99.73 .017	99.20 .017	.9991 .00024
.300	5.7 .08	99.74 .017	99.21 .017	.9993 .00024
.350	5.7 .12	99.78 .017	99.21 .017	.9996 .00024
.400	5.5 .12	99.79 .017	99.21 .017	.9997 .00024
.550	5.5 .10	99.81 .017	99.21 .017	1.0000 .00024
.700	5.7 .08	99.81 .017	99.21 .017	.9999 .00024
.850	5.7 .08	99.80 .017	99.20 .017	.9999 .00024
1.000	5.8 .10	99.80 .017	99.21 .017	.9999 .00024

Upstream Total Pressure PT1 = 99.81 kPa (+/- .017)

Upstream Static Pressure P1 = 99.27 kPa (+/- .017)

Table H73. FIVE-HOLE PRESSURE PROBE WAKE VELOCITY DATA
 INCIDENCE ANGLE (DEG) = 10.0 , $Z_c/C = .76$, $R = 4.2\%$

NORMALIZED TANGENTIAL POSITION 2T/5	NORMALIZED TOTAL VELOCITY						NORMALIZED VELOCITY COMPONENTS					
	U/U _∞ (+/-)		Pitch Ang Deg (+/-)		Yaw Ang Deg (+/-)		U _z /U _∞ (+/-)		U _t /U _∞ (+/-)		U _r /U _∞ (+/-)	
-1.000	1.011	.0333	.7	.08	-2.0	.20	.989	.0325	.211	.0077	.012	.0015
-.950	.990	.0335	.8	.10	-1.0	.11	.972	.0329	.189	.0066	.014	.0017
-.900	.967	.0333	.7	.12	-.7	.08	.949	.0327	.184	.0065	.011	.0021
-.850	.952	.0335	.7	.12	-.8	.10	.935	.0329	.179	.0065	.012	.0020
-.800	.926	.0360	.3	.14	-2.1	.27	.906	.0352	.194	.0087	.005	.0023
-.750	.903	.0345	.4	.10	-.7	.16	.888	.0339	.167	.0068	.006	.0015
-.700	.927	.0342	.3	.10	-.6	.16	.911	.0336	.170	.0067	.004	.0016
-.650	.903	.0340	.4	.08	-1.7	.16	.884	.0333	.182	.0073	.006	.0013
-.600	.900	.0336	.5	.09	-.7	.13	.884	.0330	.170	.0066	.008	.0015
-.550	.843	.0344	.7	.11	-1.1	.10	.827	.0338	.163	.0068	.011	.0016
-.500	.843	.0350	1.3	.10	-1.2	.17	.827	.0344	.164	.0073	.017	.0017
-.450	.814	.0345	1.4	.14	.6	.12	.803	.0340	.134	.0057	.020	.0021
0.000	.810	.0345	2.0	.14	.4	.10	.798	.0340	.135	.0057	.027	.0023
.050	.830	.0343	2.1	.13	1.3	.13	.820	.0339	.125	.0055	.030	.0022
.100	.875	.0347	1.5	.11	2.0	.12	.867	.0343	.122	.0051	.023	.0019
.150	.743	.0335	.4	.10	2.5	.09	.735	.0332	.124	.0046	.007	.0017
.200	1.003	.0330	.2	.08	2.1	.08	.994	.0327	.137	.0047	.004	.0014
.250	1.017	.0335	.0	.08	1.8	.06	1.008	.0332	.145	.0047	.001	.0014
.300	1.058	.0331	.1	.11	1.6	.06	1.047	.0328	.154	.0047	.001	.0021
.350	1.047	.0331	.1	.07	1.8	.06	1.034	.0327	.164	.0053	.001	.0013
.400	1.031	.0330	.3	.08	.7	.07	1.017	.0326	.167	.0055	.006	.0015
.550	1.016	.0339	.1	.08	.3	.14	1.002	.0334	.172	.0062	.001	.0013
.700	1.012	.0342	.2	.09	-.2	.10	.996	.0337	.179	.0063	.004	.0017
.850	.993	.0336	.3	.12	-.6	.13	.976	.0330	.182	.0065	.005	.0021
1.000	.979	.0332	.5	.06	-1.5	.18	.978	.0325	.199	.0073	.009	.0011

Upstream Velocity U_∞ = 29.6 m/s (17.80)
 Probe Yaw Offset Angle = 10.0 Deg

ORIGINAL PAGE IS
OF POOR QUALITY

Table H74. FIVE-HOLE PRESSURE PROBE WAKE PRESSURE DATA
INCIDENCE ANGLE (DEG) = 10.0 , $Z_c/C = .96$, $R = 4.2\%$

NORMALIZED TANGENTIAL POSITION ZT/S	EXIT ANGLE		TOTAL PRESSURE PT2		STATIC PRESSURE P2		TOTAL PRESSURE RECOVERY	
	θ_{up}	θ_{down}	kPa	(+/-)	kPa	(+/-)	PT2/PT1	(+/-)
-1.000	12.0	.20	100.00	.018	99.48	.017	.9992	.00024
-.850	11.0	.11	99.98	.018	99.47	.017	.9989	.00025
-.700	11.0	.08	99.96	.018	99.48	.017	.9987	.00024
-.550	10.7	.10	99.94	.018	99.47	.017	.9985	.00025
-.400	12.1	.27	99.92	.022	99.48	.017	.9983	.00027
-.350	10.7	.16	99.90	.019	99.47	.017	.9981	.00025
-.300	10.6	.16	99.92	.019	99.47	.017	.9983	.00025
-.250	11.7	.16	99.90	.018	99.48	.017	.9981	.00025
-.200	10.9	.13	99.89	.017	99.48	.017	.9981	.00024
-.150	11.2	.10	99.84	.018	99.48	.017	.9976	.00024
-.100	11.3	.19	99.85	.019	99.48	.017	.9976	.00025
-.050	7.5	.12	99.82	.017	99.48	.017	.9973	.00024
0.000	7.8	.10	99.82	.017	99.48	.017	.9973	.00024
.050	8.7	.13	99.84	.017	99.48	.017	.9975	.00024
.100	8.1	.12	99.88	.019	99.47	.017	.9977	.00025
.150	7.5	.09	99.94	.018	99.48	.017	.9985	.00025
.200	7.7	.08	100.00	.017	99.48	.017	.9991	.00024
.250	8.2	.06	100.01	.018	99.47	.017	.9992	.00025
.300	8.4	.06	100.06	.017	99.48	.017	.9997	.00024
.350	7.8	.06	100.04	.017	99.48	.017	.9995	.00024
.400	7.3	.07	100.02	.017	99.47	.017	.9993	.00024
.550	7.7	.14	100.01	.019	99.48	.017	.9992	.00025
.700	10.2	.10	100.00	.019	99.47	.017	.9992	.00024
.850	10.6	.13	99.98	.018	99.48	.017	.9990	.00025
1.000	11.5	.18	99.99	.017	99.48	.017	.9990	.00024

Upstream Total Pressure PT1 = 100.07 kPa (+/- .017)

Upstream Static Pressure P1 = 99.57 kPa (+/- .017)

Table H75. FIVE HOLE PRESSURE PROBE WAKE VELOCITY DATA
 INCIDENCE ANGLE (DEG) = 10.0 , Zc/C = .76 , R = 0.3 %

NORMALIZED TANGENTIAL POSITION ZT/S	NORMALIZED TOTAL VELOCITY					NORMALIZED VELOCITY COMPONENTS						
	U/Uzo (+/-)		Pitch Ans Des (+/-)		Yaw Ans Des (+/-)		Uz/Uzo (+/-)		Ut/Uzo (+/-)		Ur/Uzo (+/-)	
-1.000	1.000	.0337	.4	.07	1.2	.24	1.076	.0333	.166	.0067	.007	.0014
-.950	1.069	.0340	.4	.05	1.5	.14	1.057	.0336	.150	.0056	.008	.0010
-.900	1.030	.0344	.6	.10	1.2	.11	1.026	.0340	.157	.0056	.010	.0017
-.850	1.033	.0357	.5	.07	.9	.11	1.020	.0353	.163	.0060	.009	.0013
-.800	1.025	.0336	.8	.08	.7	.00	1.012	.0331	.166	.0056	.015	.0015
-.750	1.008	.0377	.0	.11	.5	.13	.994	.0371	.166	.0066	.014	.0020
-.700	.990	.0334	.4	.08	.6	.11	.977	.0329	.162	.0050	.007	.0013
-.650	.964	.0341	.7	.08	.2	.09	.950	.0336	.164	.0060	.011	.0014
-.600	.988	.0333	1.2	.07	.3	.10	.974	.0328	.167	.0057	.021	.0014
-.550	.915	.0343	1.2	.12	.5	.10	.902	.0339	.150	.0057	.020	.0021
-.500	.913	.0337	1.4	.12	.2	.09	.899	.0332	.155	.0057	.023	.0020
-.450	.881	.0337	1.6	.21	.5	.22	.869	.0333	.146	.0065	.025	.0034
0.000	.860	.0339	2.1	.12	.9	.08	.849	.0334	.135	.0055	.032	.0022
.050	.875	.0337	2.3	.15	1.7	.19	.865	.0333	.126	.0057	.035	.0027
.100	.907	.0335	2.1	.16	1.8	.15	.897	.0331	.129	.0053	.034	.0028
.150	.963	.0333	1.0	.11	1.8	.15	.953	.0330	.138	.0053	.018	.0020
.200	1.015	.0332	.5	.10	2.0	.10	1.005	.0329	.142	.0049	.009	.0019
.250	1.056	.0332	.1	.07	1.7	.08	1.045	.0329	.152	.0050	.002	.0012
.300	1.078	.0333	-.1	.09	1.8	.08	1.067	.0330	.154	.0050	-.002	.0017
.350	1.086	.0335	-.4	.09	1.7	.14	1.075	.0331	.156	.0055	-.007	.0017
.400	1.084	.0334	-.1	.08	1.6	.09	1.073	.0330	.158	.0051	-.002	.0015
.550	1.073	.0333	-.3	.08	.7	.23	1.059	.0329	.174	.0069	-.006	.0016
.700	1.073	.0333	.2	.09	1.0	.08	1.060	.0329	.168	.0054	.004	.0018
.850	1.082	.0334	.5	.09	1.3	.19	1.069	.0330	.164	.0062	.009	.0017
1.000	1.068	.0334	.2	.09	.7	.17	1.054	.0329	.173	.0063	.003	.0016

Upstream Velocity Uzo = 29.6 m/s (1/- .67)
 Probe Yaw Offset Angle = 10.0 Des

- 27A -
 ORIGINAL PAGE IS
 OF POOR QUALITY

ORIGINAL PAGE IS
OF POOR QUALITY

Table H76. FIVE-HOLE PRESSURE PROBE WAKE PRESSURE DATA
INCIDENCE ANGLE (DEG) = 10.0 , $Z_c/C = .96$, $R = 8.3\%$.

NORMALIZED TANGENTIAL POSITION ZT/S	EXIT ANGLE		TOTAL PRESSURE PT2		STATIC PRESSURE P2		TOTAL PRESSURE RECOVERY	
	DEG	(+/-)	KPa	(+/-)	KPa	(+/-)	PT2/PT1	(+/-)
-1.000	8.8	.24	100.07	.018	99.46	.017	.9999	.00025
-.850	8.5	.14	100.05	.019	99.47	.017	.9997	.00025
-.700	8.8	.11	100.02	.020	99.46	.017	.9993	.00026
-.550	9.1	.11	100.02	.022	99.47	.017	.9993	.00028
-.400	9.3	.08	100.01	.018	99.47	.017	.9993	.00025
-.350	9.5	.13	99.99	.025	99.47	.017	.9990	.00030
-.300	9.4	.11	99.98	.017	99.47	.017	.9989	.00024
-.250	9.8	.09	99.95	.019	99.47	.017	.9986	.00025
-.200	9.8	.10	99.97	.017	99.47	.017	.9989	.00024
-.150	9.5	.10	99.91	.019	99.48	.017	.9982	.00025
-.100	9.9	.09	99.91	.018	99.48	.017	.9982	.00024
-.050	9.6	.22	99.88	.017	99.49	.017	.9980	.00024
0.000	9.3	.09	99.86	.017	99.48	.017	.9978	.00024
.050	8.6	.19	99.88	.017	99.48	.017	.9979	.00024
.100	8.5	.15	99.91	.017	99.48	.017	.9982	.00024
.150	8.3	.15	99.96	.017	99.48	.017	.9987	.00024
.200	8.0	.10	100.01	.017	99.48	.017	.9992	.00024
.250	8.3	.08	100.05	.017	99.47	.017	.9996	.00024
.300	8.2	.08	100.07	.017	99.47	.017	.9998	.00024
.350	8.3	.14	100.08	.017	99.47	.017	.9999	.00024
.400	8.4	.09	100.08	.017	99.47	.017	.9999	.00024
.550	9.3	.23	100.07	.017	99.48	.017	.9998	.00024
.700	9.0	.08	100.06	.017	99.47	.017	.9998	.00024
.850	8.7	.19	100.07	.017	99.47	.017	.9999	.00024
1.000	7.3	.17	100.06	.017	99.47	.017	.9997	.00024

Upstream Total Pressure PT1 = 100.09 kPa (+/- .017)

Upstream Static Pressure P1 = 99.57 kPa (+/- .017)

Table H77. FIVE-HOLE PRESSURE PROBE WAKE VELOCITY DATA
 INCIDENCE ANGLE (DEG) = 10.0 , Zc/C = .76 , R = 12.5 %

NORMALIZED TANGENTIAL POSITION ZT/S	NORMALIZED TOTAL VELOCITY				NORMALIZED VELOCITY COMPONENTS							
	U/U _∞ (+/-)		Pitch Ang Deg (+/-)		Yaw Ang Deg (+/-)		Uz/U _∞ (+/-)		Uv/U _∞ (+/-)		Uw/U _∞ (+/-)	
-1.000	1.081	.0332	.3	.08	-.8	.24	1.022	.0326	.202	.0076	.006	.0015
-.850	1.077	.0332	.4	.08	.2	.17	1.061	.0327	.183	.0064	.008	.0016
-.700	1.071	.0333	.7	.07	.8	.11	1.057	.0328	.172	.0057	.017	.0015
-.550	1.064	.0332	.7	.09	.9	.11	1.051	.0328	.168	.0056	.013	.0018
-.400	1.064	.0333	.8	.11	.9	.08	1.051	.0328	.168	.0054	.015	.0022
-.350	1.057	.0335	.8	.12	.7	.10	1.043	.0330	.170	.0057	.014	.0023
-.300	1.033	.0333	.7	.18	.5	.13	1.019	.0328	.171	.0060	.012	.0032
-.250	1.015	.0335	1.1	.10	.4	.16	1.001	.0330	.167	.0062	.020	.0018
-.200	.973	.0335	1.3	.07	1.3	.13	.962	.0331	.148	.0055	.022	.0017
-.150	.973	.0336	1.4	.10	1.1	.12	.961	.0332	.151	.0056	.023	.0018
-.100	.947	.0339	1.5	.09	1.1	.09	.938	.0334	.147	.0055	.025	.0018
-.050	.902	.0334	1.8	.11	1.4	.07	.892	.0330	.135	.0051	.028	.0020
0.000	.877	.0336	1.9	.14	1.6	.18	.867	.0332	.127	.0056	.028	.0024
.050	.897	.0334	2.3	.13	1.4	.20	.886	.0330	.133	.0058	.037	.0024
.100	.910	.0333	2.1	.15	2.0	.14	.901	.0330	.126	.0051	.033	.0026
.150	.944	.0332	1.6	.10	1.5	.21	.933	.0328	.140	.0060	.026	.0018
.200	.993	.0330	1.1	.15	1.5	.14	.981	.0327	.147	.0054	.020	.0026
.250	1.036	.0331	-.2	.10	1.3	.10	1.024	.0327	.157	.0053	.004	.0018
.300	1.045	.0334	.1	.09	1.3	.14	1.033	.0331	.158	.0057	.002	.0016
.350	1.068	.0332	-.5	.11	1.2	.21	1.055	.0328	.163	.0063	-.009	.0021
.400	1.081	.0332	-1.0	.18	.5	.14	1.066	.0328	.179	.0061	-.020	.0034
.550	1.088	.0332	-.3	.07	-.2	.10	1.071	.0327	.193	.0062	-.005	.0014
.700	1.082	.0332	-.1	.09	.7	.11	1.067	.0328	.176	.0058	-.002	.0016
.850	1.083	.0332	.4	.14	1.4	.28	1.070	.0329	.163	.0072	.007	.0027
1.000	1.081	.0332	.1	.07	.8	.15	1.067	.0328	.173	.0060	.002	.0012

Upstream Velocity U_∞ = 29.6 m/s (17.8 ft/s)
 Probe Yaw Offset Angle = 10.0 Deg

ORIGINAL PAGE IS
OF POOR QUALITY

Table H78. FIVE-HOLE PRESSURE PROBE WAKE PRESSURE DATA
INCIDENCE ANGLE (DEG) = 10.0 , $Z_c/C = .96$, $R = 12.5\%$

NORMALIZED TANGENTIAL POSITION ZT/S	EXIT ANGLE		TOTAL PRESSURE PT2		STATIC PRESSURE P2		TOTAL PRESSURE RECOVERY	
	Deg	(+/-)	kPa	(+/-)	kPa	(+/-)	PT2/PT1	(+/-)
-1.000	10.0	.24	100.08	.017	99.48	.017	.9997	.00024
-.850	9.0	.17	100.08	.017	99.48	.017	.9997	.00024
-.700	7.3	.11	100.07	.017	99.48	.017	.9998	.00024
-.550	7.1	.11	100.06	.017	99.48	.017	.9998	.00024
-.400	7.1	.08	100.06	.017	99.48	.017	.9997	.00024
-.350	7.3	.10	100.05	.018	99.48	.017	.9997	.00025
-.300	7.6	.13	100.03	.018	99.48	.017	.9994	.00024
-.250	7.7	.16	100.00	.018	99.47	.017	.9992	.00025
-.200	8.0	.13	99.96	.018	99.48	.017	.9988	.00025
-.150	7.0	.12	99.96	.018	99.47	.017	.9987	.00025
-.100	7.1	.09	99.94	.018	99.47	.017	.9985	.00025
-.050	8.0	.07	99.89	.017	99.47	.017	.9981	.00024
0.000	8.6	.17	99.87	.017	99.48	.017	.9978	.00024
.050	8.7	.19	99.89	.017	99.47	.017	.9980	.00024
.100	8.2	.14	99.90	.017	99.47	.017	.9981	.00024
.150	8.7	.20	99.93	.017	99.47	.017	.9984	.00024
.200	8.6	.14	99.98	.017	99.47	.017	.9989	.00024
.250	8.7	.10	100.02	.017	99.47	.017	.9994	.00024
.300	8.7	.14	100.04	.018	99.47	.017	.9995	.00025
.350	8.8	.21	100.06	.017	99.47	.017	.9997	.00024
.400	7.6	.14	100.07	.017	99.47	.017	.9999	.00024
.550	10.2	.10	100.09	.017	99.47	.017	1.0000	.00024
.700	7.3	.11	100.08	.017	99.48	.017	1.0000	.00024
.850	8.7	.28	100.08	.017	99.47	.017	.9999	.00024
1.000	9.2	.15	100.08	.017	99.47	.017	.9999	.00024

Upstream Total Pressure PT1 = 100.09 kPa (+/- .017)
Upstream Static Pressure p1 = 99.57 kPa (+/- .017)

Table H79. FIVE HOLE PRESSURE PROBE WAKE VELOCITY DATA
 INCIDENCE ANGLE (DEG) = 10.0 , $Z_c/C = .96$, $R = 16.7\%$

NORMALIZED TANGENTIAL POSITION ZT/S	NORMALIZED TOTAL VELOCITY						NORMALIZED VELOCITY COMPONENTS					
	U/U _∞ (1/-)		Pitch Ang Deg (1/-)		Yaw Ang Deg (1/-)		U _x /U _∞ (1/-)		U _y /U _∞ (1/-)		U _r /U _∞ (1/-)	
-1.000	1.095	.0331	.6	.14	.5	.22	1.070	.0327	.179	.0069	.012	.0027
-.950	1.092	.0331	.8	.08	.9	.13	1.068	.0327	.172	.0058	.016	.0016
-.700	1.077	.0331	.9	.03	.3	.07	1.064	.0326	.182	.0057	.017	.0016
-.550	1.068	.0334	1.1	.08	.4	.11	1.053	.0330	.179	.0060	.021	.0016
-.400	1.068	.0331	.9	.15	.0	.07	1.054	.0327	.170	.0054	.017	.0020
-.350	1.048	.0331	1.1	.00	.7	.09	1.034	.0327	.170	.0056	.020	.0016
-.300	1.051	.0331	.6	.10	.9	.12	1.038	.0326	.167	.0057	.012	.0033
-.250	1.020	.0333	1.5	.12	1.0	.10	1.015	.0329	.161	.0055	.027	.0023
-.200	1.007	.0345	1.5	.08	.8	.08	.994	.0341	.160	.0057	.027	.0017
-.150	.939	.0331	1.0	.11	1.3	.08	.928	.0327	.142	.0052	.017	.0019
-.100	.920	.0332	1.6	.14	1.5	.09	.909	.0328	.136	.0051	.026	.0024
-.050	.897	.0334	1.9	.17	1.5	.09	.889	.0330	.132	.0051	.027	.0027
0.000	.897	.0333	1.8	.17	1.5	.10	.889	.0329	.132	.0051	.028	.0028
.050	.897	.0333	1.4	.08	1.6	.12	.887	.0329	.131	.0052	.022	.0015
.100	.934	.0331	.9	.16	1.4	.08	.924	.0327	.140	.0051	.015	.0026
.150	.973	.0330	.8	.07	2.0	.09	.963	.0326	.135	.0048	.013	.0013
.200	1.010	.0327	.4	.11	1.2	.00	1.006	.0325	.156	.0052	.007	.0017
.250	1.052	.0331	.1	.08	.9	.00	1.039	.0327	.166	.0054	.003	.0015
.300	1.093	.0331	.1	.19	1.0	.15	1.070	.0327	.169	.0057	.003	.0035
.350	1.075	.0331	-.3	.11	1.0	.12	1.062	.0327	.169	.0057	.005	.0022
.400	1.004	.0331	-.9	.19	1.0	.10	1.070	.0327	.170	.0056	.016	.0036
.550	1.095	.0331	-.1	.08	.8	.11	1.071	.0327	.174	.0057	.002	.0015
.700	1.089	.0331	.5	.16	.7	.13	1.075	.0327	.177	.0057	.010	.0030
.850	1.082	.0331	.3	.08	.9	.12	1.068	.0327	.170	.0057	.007	.0016
1.000	1.080	.0331	.2	.10	1.1	.09	1.067	.0327	.167	.0054	.005	.0018

Upstream Velocity U_∞ = 27.8 m/s (1/- .07)
 Probe Yaw Offset Angle = 10.0 Deg

- 278 - ORIGINAL PAGE IS OF POOR QUALITY

ORIGINAL PAGE IS
OF POOR QUALITY

Table H80. FIVE-HOLE PRESSURE PROBE WAKE PRESSURE DATA
INCIDENCE ANGLE (DEG) = 10.0 ; $Z_0/C = .96$; $R = 16.7\%$

NORMALIZED TANGENTIAL POSITION ZT/C	EXIT ANGLE		TOTAL PRESSURE PT2		STATIC PRESSURE P2		TOTAL PRESSURE RECOVERY	
	Deg	(+/-)	KPa	(+/-)	KPa	(+/-)	PT2/PT1	(+/-)
-1.000	9.5	.22	100.00	.017	99.47	.017	1.0000	.00024
-.850	9.2	.13	100.08	.017	99.48	.017	.9997	.00024
-.700	9.7	.07	100.08	.017	99.48	.017	.9997	.00024
-.550	9.7	.11	100.07	.018	99.48	.017	.9990	.00025
-.400	9.2	.07	100.07	.017	99.47	.017	.9998	.00024
-.350	9.4	.09	100.05	.017	99.48	.017	.9996	.00024
-.300	9.2	.12	100.05	.017	99.48	.017	.9996	.00024
-.250	9.1	.10	100.02	.018	99.48	.017	.9994	.00025
-.200	9.3	.08	100.00	.020	99.47	.017	.9991	.00026
-.150	8.8	.08	99.93	.017	99.48	.017	.9985	.00024
-.100	8.7	.09	99.92	.017	99.48	.017	.9983	.00024
-.050	8.7	.10	99.90	.017	99.48	.017	.9981	.00024
0.000	8.7	.10	99.89	.017	99.47	.017	.9981	.00024
.050	8.5	.12	99.89	.017	99.48	.017	.9981	.00024
.100	8.6	.08	99.93	.017	99.48	.017	.9984	.00024
.150	8.0	.09	99.96	.017	99.47	.017	.9987	.00024
.200	8.8	.08	100.01	.017	99.47	.017	.9992	.00024
.250	9.1	.08	100.04	.017	99.47	.017	.9996	.00024
.300	9.0	.15	100.07	.017	99.46	.017	.9998	.00024
.350	9.0	.12	100.07	.017	99.47	.017	.9998	.00024
.400	9.1	.10	100.08	.017	99.48	.017	1.0000	.00024
.550	9.2	.11	100.09	.017	99.48	.017	1.0000	.00024
.700	9.4	.13	100.09	.017	99.47	.017	1.0000	.00024
.850	9.1	.12	100.08	.017	99.48	.017	.9999	.00024
1.000	8.9	.09	100.08	.017	99.48	.017	.9999	.00024

Upstream Total Pressure PT1 = 100.09 KPa (+/- .017)

Upstream Static Pressure P1 = 99.57 KPa (+/- .017)

Table H81. FIVE-HOLE PRESSURE PROBE WAKE VELOCITY DATA
 INCIDENCE ANGLE (DEG) = 10.0 , $Z_c/C = .96$, $R = 25.0\%$

NORMALIZED TANGENTIAL POSITION 2T/S	NORMALIZED TOTAL VELOCITY				NORMALIZED VELOCITY COMPONENTS							
	U/Uzo (+/-)		Pitch Ans Deg (+/-)		Yaw Ans Deg (+/-)		Uz/Uzo (+/-)		Ut/Uzo (+/-)		Ur/Uzo (+/-)	
-1.000	1.087	.0331	.4	.07	.8	.20	1.073	.0327	.174	.0065	.008	.0014
-.850	1.083	.0332	.7	.10	.4	.20	1.067	.0328	.180	.0066	.012	.0018
-.700	1.084	.0331	1.6	.10	.7	.15	1.070	.0326	.175	.0061	.030	.0022
-.550	1.076	.0331	1.7	.07	.8	.06	1.061	.0326	.173	.0054	.033	.0017
-.400	1.072	.0331	1.4	.25	.7	.10	1.058	.0326	.173	.0056	.027	.0048
-.350	1.056	.0331	.7	.16	.9	.09	1.042	.0326	.167	.0055	.014	.0029
-.300	1.043	.0331	1.0	.25	.7	.07	1.030	.0326	.168	.0055	.018	.0046
-.250	.991	.0357	1.9	.29	.9	.15	.978	.0352	.157	.0062	.033	.0052
-.200	1.027	.0338	2.2	.17	.5	.07	1.012	.0333	.170	.0057	.039	.0033
-.150	.983	.0331	1.4	.23	.8	.09	.970	.0326	.157	.0055	.024	.0041
-.100	.933	.0331	1.8	.11	.8	.09	.921	.0327	.149	.0055	.030	.0021
-.050	.907	.0343	1.1	.12	.7	.11	.895	.0338	.146	.0058	.017	.0020
0.000	.896	.0333	-.0	.15	1.4	.11	.886	.0329	.133	.0052	-.000	.0023
.050	.904	.0332	-.1	.12	1.8	.10	.895	.0329	.130	.0050	-.001	.0019
.100	.944	.0330	.1	.14	1.9	.08	.934	.0327	.134	.0048	.001	.0023
.150	.992	.0329	.6	.20	1.4	.07	.981	.0325	.148	.0050	.010	.0034
.200	1.023	.0331	.6	.18	1.3	.08	1.012	.0327	.155	.0052	.011	.0033
.250	1.057	.0330	.3	.12	1.5	.08	1.045	.0326	.157	.0051	.006	.0023
.300	1.071	.0330	.0	.10	1.2	.15	1.058	.0326	.163	.0057	.001	.0017
.350	1.081	.0331	-.1	.19	.7	.10	1.067	.0326	.175	.0057	-.002	.0036
.400	1.092	.0332	-.1	.10	-.3	.39	1.075	.0327	.195	.0094	-.002	.0020
.550	1.088	.0331	-1.1	.13	.9	.18	1.074	.0327	.173	.0062	-.021	.0026
.700	1.091	.0331	-1.3	.21	1.1	.10	1.078	.0327	.168	.0055	-.025	.0041
.850	1.088	.0331	-.2	.20	.9	.08	1.074	.0327	.172	.0054	-.003	.0037
1.000	1.087	.0331	.6	.07	.3	.21	1.071	.0326	.183	.0068	.011	.0013

Upstream Velocity Uzo = 29.7 m/s (+/- .6%)
 Probe Yaw Offset Angle = 10.0 Deg

ORIGINAL PAGE IS
OF POOR QUALITY

Table H82. FIVE-HOLE PRESSURE PROBE WAKE PRESSURE DATA
INCIDENCE ANGLE (DEG) = 10.0 , Zc/C = .96 , R = 25.0 %

NORMALIZED TANGENTIAL POSITION ZT/S	EXIT ANGLE		TOTAL PRESURE PT2		STATIC PRESSURE P2		TOTAL PRESSURE RECOVERY	
	Deg	(+/-)	KPa	(+/-)	KPa	(+/-)	PT2/PT1	(+/-)
-1.000	9.2	.20	100.08	.017	99.47	.017	1.0000	.00024
-.850	9.6	.20	100.08	.017	99.47	.017	.9999	.00024
-.700	9.4	.15	100.08	.017	99.47	.017	1.0000	.00024
-.550	9.4	.06	100.07	.017	99.47	.017	.9998	.00024
-.400	9.4	.10	100.07	.017	99.47	.017	.9998	.00024
-.350	9.1	.09	100.05	.017	99.47	.017	.9996	.00024
-.300	9.3	.07	100.04	.017	99.48	.017	.9996	.00024
-.250	9.3	.16	99.99	.022	99.48	.017	.9990	.00028
-.200	9.8	.07	100.02	.019	99.48	.017	.9993	.00025
-.150	9.3	.09	99.98	.017	99.48	.017	.9990	.00024
-.100	9.4	.09	99.93	.017	99.48	.017	.9984	.00024
-.050	9.3	.11	99.91	.019	99.48	.017	.9982	.00025
0.000	8.6	.11	99.90	.017	99.48	.017	.9981	.00024
.050	8.2	.10	99.91	.017	99.48	.017	.9982	.00024
.100	8.1	.08	99.94	.017	99.48	.017	.9986	.00024
.150	8.6	.07	99.99	.017	99.48	.017	.9990	.00024
.200	8.7	.08	100.02	.017	99.48	.017	.9993	.00024
.250	8.5	.08	100.06	.017	99.48	.017	.9997	.00024
.300	8.8	.15	100.07	.017	99.48	.017	.9998	.00024
.350	9.3	.10	100.08	.017	99.47	.017	.9999	.00024
.400	10.3	.39	100.08	.017	99.46	.017	1.0000	.00024
.550	9.2	.18	100.09	.017	99.47	.017	1.0000	.00024
.700	9.0	.11	100.09	.017	99.47	.017	1.0000	.00024
.850	9.1	.08	100.09	.017	99.47	.017	1.0000	.00024
1.000	9.7	.21	100.09	.017	99.47	.017	1.0000	.00024

Upstream Total Pressure PT1 = 100.09 kPa (+/- .017)
Upstream Static Pressure p1 = 99.57 kPa (+/- .017)

Table H83. FIVE-HOLE PROBE WAKE VELOCITY DATA
 INCIDENCE ANGLE (DEG) = 10.0 , $Z_c/C = .96$, $R = 33.3\%$

NORMALIZED TANGENTIAL POSITION 2T/S	NORMALIZED TOTAL VELOCITY						NORMALIZED VELOCITY COMPONENTS					
	U/U _∞ (+/-)		Pitch Ang		Yaw Ang		U _z /U _∞ (+/-)		U _t /U _∞ (+/-)		U _r /U _∞ (+/-)	
			Des (+/-)		Des (+/-)							
-1.000	1.087	.0330	.5	.07	.5	.09	1.072	.0326	.179	.0057	.009	.0014
-.850	1.070	.0330	.4	.08	1.5	.16	1.078	.0327	.162	.0058	.007	.0016
-.700	1.083	.0331	1.5	.20	.5	.16	1.068	.0326	.178	.0062	.029	.0038
-.550	1.071	.0331	1.8	.12	.8	.10	1.056	.0326	.172	.0056	.034	.0025
-.400	1.058	.0330	.4	.28	1.0	.08	1.045	.0326	.165	.0053	.007	.0052
-.350	1.049	.0330	1.2	.15	.9	.08	1.035	.0325	.166	.0054	.023	.0028
-.300	1.044	.0329	1.4	.16	.6	.15	1.030	.0325	.171	.0060	.025	.0031
-.250	1.036	.0335	3.2	.29	.8	.11	1.021	.0330	.166	.0057	.058	.0055
-.200	1.019	.0332	2.7	.10	.5	.09	1.004	.0328	.167	.0057	.049	.0024
-.150	.978	.0337	1.8	.21	1.0	.10	.965	.0332	.153	.0055	.030	.0038
-.100	.967	.0335	.9	.12	.8	.11	.956	.0331	.155	.0057	.016	.0021
-.050	.955	.0335	1.2	.14	.7	.10	.942	.0330	.155	.0057	.021	.0024
0.000	.925	.0334	1.6	.16	1.0	.08	.914	.0330	.145	.0054	.026	.0027
.050	.926	.0331	.3	.11	1.4	.10	.915	.0327	.139	.0052	.005	.0018
.100	.939	.0330	-.5	.18	1.5	.09	.929	.0326	.138	.0050	-.008	.0030
.150	.977	.0328	-.0	.15	1.7	.11	.967	.0325	.140	.0050	-.000	.0026
.200	1.011	.0328	-.8	.09	1.7	.08	1.000	.0325	.146	.0049	-.015	.0017
.250	1.046	.0330	-.0	.15	1.6	.11	1.035	.0326	.154	.0052	-.001	.0027
.300	1.059	.0329	-.0	.17	1.6	.13	1.048	.0326	.154	.0053	-.001	.0032
.350	1.074	.0330	-1.0	.30	.8	.27	1.060	.0326	.172	.0073	-.019	.0056
.400	1.088	.0331	-.9	.27	.8	.13	1.074	.0326	.174	.0058	-.017	.0052
.550	1.087	.0330	.4	.23	.7	.09	1.073	.0326	.175	.0056	.008	.0044
.700	1.087	.0330	-.1	.09	1.0	.09	1.073	.0326	.171	.0054	-.003	.0018
.850	1.071	.0330	.1	.08	.8	.11	1.077	.0326	.174	.0056	.002	.0016
1.000	1.074	.0331	.3	.06	.6	.12	1.079	.0326	.179	.0057	.006	.0012

Upstream Velocity U_∞ = 29.7 m/s (1/ .69)
 Probe Yaw Offset Angle = 10.0 Deg

ORIGINAL PAGE IS
OF POOR QUALITY

Table H84. FIVE-HOLE PRESSURE PROBE WAKE PRESSURE DATA
INCIDENCE ANGLE (DEG) = 10.0 , $Z_0/C = .96$, $R = 33.3 \%$

NORMALIZED TANGENTIAL POSITION ZT/S	EXIT ANGLE		TOTAL PRESURE PT2		STATIC PRESSURE P2		TOTAL PRESSURE RECOVERY	
	DEG	(+/-)	KPa	(+/-)	KPa	(+/-)	PT2/PT1	(+/-)
1.000	7.5	.09	100.09	.017	99.47	.017	1.0000	.00024
.950	8.6	.16	100.09	.017	99.47	.017	1.0000	.00024
.700	7.6	.16	100.08	.017	99.47	.017	.9999	.00024
.550	7.4	.10	100.07	.017	99.48	.017	.9999	.00024
.400	7.0	.08	100.06	.017	99.48	.017	.9997	.00024
.350	7.2	.08	100.06	.017	99.49	.017	.9997	.00024
.300	7.5	.15	100.04	.017	99.48	.017	.9996	.00024
.250	7.8	.14	100.04	.018	99.48	.017	.9995	.00025
.200	7.8	.09	100.02	.018	99.48	.017	.9993	.00025
.150	7.2	.11	99.98	.019	99.48	.017	.9989	.00025
.100	7.3	.11	99.97	.018	99.48	.017	.9988	.00025
.050	7.4	.10	99.95	.018	99.48	.017	.9987	.00025
0.000	7.2	.09	99.93	.018	99.48	.017	.9984	.00025
.050	8.6	.10	99.92	.017	99.48	.017	.9984	.00024
.100	8.5	.09	99.93	.017	99.48	.017	.9985	.00024
.150	8.3	.11	99.98	.017	99.48	.017	.9989	.00024
.200	8.3	.08	100.01	.017	99.48	.017	.9993	.00024
.250	8.4	.11	100.05	.017	99.48	.017	.9996	.00024
.300	8.4	.13	100.07	.017	99.48	.017	.9998	.00024
.350	7.3	.27	100.08	.017	99.48	.017	.9999	.00024
.400	7.2	.13	100.09	.017	99.47	.017	1.0000	.00024
.550	7.3	.09	100.09	.017	99.47	.017	1.0000	.00024
.700	7.0	.09	100.09	.017	99.47	.017	1.0000	.00024
.850	7.2	.11	100.09	.017	99.47	.017	1.0000	.00024
1.000	7.4	.12	100.09	.017	99.47	.017	1.0000	.00024

Upstream Total Pressure PT1 = 100.09 kPa (+/- .017)
Upstream Static Pressure P1 = 99.57 kPa (+/- .017)

Table H85. FIVE-HOLE PRESSURE PROBE WAKE VELOCITY DATA
 INCIDENCE ANGLE (DEG) = 10.0 , Zc/C = .96 , R = 50.0 %

NORMALIZED TANGENTIAL POSITION 2T/S	NORMALIZED TOTAL VELOCITY						NORMALIZED VELOCITY COMPONENTS					
	U/Uzo (+/-)		Pitch Ang Des (+/-)		Yaw Ang Des (+/-)		Uz/Uzo (+/-)		Ut/Uzo (+/-)		Ur/Uzo (+/-)	
-1.000	1.084	.0332	.2	.12	.7	.12	1.070	.0328	.176	.0058	.003	.0022
-.850	1.087	.0332	.9	.11	1.1	.07	1.074	.0328	.169	.0053	.017	.0022
-.700	1.087	.0333	1.0	.15	1.4	.16	1.075	.0329	.162	.0057	.018	.0029
-.550	1.085	.0333	1.3	.36	.7	.09	1.070	.0328	.175	.0056	.025	.0068
-.400	1.073	.0333	2.4	.13	.3	.09	1.057	.0328	.180	.0059	.044	.0028
-.350	1.058	.0332	3.3	.21	.6	.13	1.042	.0327	.172	.0059	.061	.0044
-.300	1.049	.0332	3.1	.29	.6	.09	1.033	.0327	.172	.0057	.057	.0056
-.250	1.027	.0332	1.8	.25	.7	.08	1.013	.0327	.167	.0056	.032	.0046
-.200	1.019	.0332	1.3	.40	.7	.13	1.005	.0328	.165	.0059	.023	.0071
-.150	1.008	.0333	1.8	.16	.4	.13	.993	.0328	.168	.0060	.032	.0029
-.100	.937	.0334	1.0	.30	1.1	.11	.926	.0330	.145	.0055	.016	.0050
-.050	.926	.0332	.5	.10	.8	.09	.914	.0328	.148	.0055	.009	.0017
0.000	.919	.0334	.3	.13	1.1	.08	.908	.0330	.142	.0053	.005	.0021
.050	.938	.0332	-.5	.16	1.4	.12	.927	.0328	.140	.0053	-.008	.0026
.100	.987	.0334	.1	.16	1.7	.11	.976	.0330	.143	.0052	.003	.0027
.150	1.028	.0331	-.6	.37	1.4	.15	1.016	.0328	.154	.0056	-.011	.0066
.200	1.056	.0332	-1.3	.17	1.9	.08	1.045	.0328	.149	.0049	-.025	.0031
.250	1.072	.0332	.1	.22	1.6	.10	1.060	.0329	.156	.0052	.002	.0042
.300	1.082	.0333	-.3	.27	.7	.30	1.067	.0328	.176	.0070	-.006	.0051
.350	1.079	.0332	-1.1	.29	1.0	.13	1.066	.0328	.169	.0057	-.020	.0055
.400	1.087	.0333	-.5	.24	1.2	.11	1.075	.0329	.166	.0055	-.007	.0047
.550	1.081	.0332	-.5	.13	1.3	.10	1.069	.0328	.164	.0054	-.009	.0024
.700	1.086	.0332	.1	.21	1.2	.12	1.073	.0329	.165	.0055	.002	.0039
.850	1.087	.0332	.1	.12	1.7	.07	1.076	.0329	.157	.0050	.002	.0022
1.000	1.084	.0332	.7	.10	.6	.08	1.070	.0328	.170	.0056	.013	.0020

Upstream Velocity Uzo = 29.7 m/s (+/- .07)
 Probe Yaw Offset Angle = 10.0 Deg

ORIGINAL PAGE IS
OF POOR QUALITY

Table H86. FIVE-HOLE PRESSURE PROBE WAKE PRESSURE DATA
INCIDENCE ANGLE (DEG) = 10.0 , Zc/C = .96 , R = 50.0 %

NORMALIZED TANGENTIAL POSITION ZT/S	EXIT ANGLE		TOTAL PRESURE PT2		STATIC PRESSURE P2		TOTAL PRESSURE RECOVERY	
	Des	(+/-)	kPa	(+/-)	kPa	(+/-)	PT2/PT1	(+/-)
-1.000	9.3	.12	100.08	.017	99.48	.017	1.0000	.00024
-.850	9.0	.07	100.09	.017	99.48	.017	1.0000	.00024
-.700	8.6	.16	100.08	.017	99.47	.017	1.0000	.00024
-.550	9.4	.10	100.08	.017	99.48	.017	1.0000	.00024
-.400	10.0	.10	100.07	.017	99.47	.017	.9998	.00024
-.350	10.0	.14	100.05	.017	99.47	.017	.9996	.00024
-.300	9.9	.12	100.04	.017	99.47	.017	.9995	.00024
-.250	9.5	.09	100.02	.017	99.48	.017	.9993	.00024
-.200	9.4	.14	100.00	.017	99.46	.017	.9991	.00024
-.150	9.8	.13	99.99	.017	99.47	.017	.9991	.00024
-.100	8.9	.12	99.93	.017	99.47	.017	.9984	.00024
-.050	9.2	.09	99.92	.017	99.48	.017	.9983	.00024
0.000	8.9	.08	99.91	.017	99.48	.017	.9982	.00024
.050	8.6	.12	99.93	.017	99.48	.017	.9984	.00024
.100	8.4	.11	99.98	.018	99.48	.017	.9989	.00024
.150	8.6	.15	100.02	.017	99.47	.017	.9993	.00024
.200	8.2	.08	100.05	.017	99.47	.017	.9996	.00024
.250	8.4	.10	100.06	.017	99.47	.017	.9998	.00024
.300	9.4	.30	100.08	.017	99.47	.017	.9999	.00024
.350	9.1	.13	100.08	.017	99.48	.017	1.0000	.00024
.400	8.8	.11	100.09	.017	99.48	.017	1.0000	.00024
.550	8.7	.10	100.07	.017	99.49	.017	1.0000	.00024
.700	8.8	.12	100.09	.017	99.48	.017	1.0000	.00024
.850	8.3	.07	100.09	.017	99.48	.017	1.0000	.00024
1.000	9.5	.08	100.08	.017	99.48	.017	1.0000	.00024

Upstream Total Pressure PT1 = 100.09 kPa (+/- .017)

Upstream Static Pressure P1 = 99.57 kPa (+/- .017)

Table H87. FIVE-HOLE PRESSURE PROBE WAKE VELOCITY DATA
 INCIDENCE ANGLE (DEG) = 10.0 , $Z_0/C = .96$, $R = 66.7\%$

NORMALIZED TANGENTIAL POSITION 2T/S	NORMALIZED TOTAL VELOCITY						NORMALIZED VELOCITY COMPONENTS					
	U/U _∞ (+/-)		Pitch Ans Des (+/-)		Yaw Ans Des (+/-)		U _z /U _∞ (+/-)		U _t /U _∞ (+/-)		U _r /U _∞ (+/-)	
-1.000	1.082	.0332	.8	.08	1.5	.16	1.071	.0327	.157	.0050	.014	.0016
-.850	1.079	.0331	.6	.13	1.5	.10	1.067	.0328	.159	.0053	.012	.0025
-.700	1.075	.0332	1.2	.09	1.4	.10	1.063	.0328	.161	.0053	.023	.0017
-.550	1.069	.0331	1.4	.15	1.2	.14	1.056	.0327	.163	.0057	.025	.0028
-.400	1.031	.0343	1.0	.18	1.4	.10	1.020	.0339	.155	.0054	.017	.0032
-.350	1.042	.0332	1.3	.57	1.2	.11	1.030	.0328	.160	.0054	.024	.0108
-.300	1.020	.0350	3.1	.15	1.0	.09	1.006	.0345	.160	.0057	.056	.0033
-.250	1.006	.0332	1.7	.17	1.2	.10	.994	.0328	.154	.0053	.033	.0034
-.200	.977	.0335	2.2	.18	1.1	.08	.965	.0330	.151	.0053	.038	.0034
-.150	.952	.0331	1.6	.20	1.0	.13	.940	.0327	.150	.0056	.027	.0034
-.100	.931	.0333	2.1	.20	1.2	.14	.919	.0329	.143	.0056	.035	.0035
-.050	.932	.0334	1.6	.13	.9	.06	.920	.0330	.147	.0053	.026	.0023
0.000	.914	.0334	-.4	.22	.7	.13	.903	.0329	.145	.0057	-.006	.0035
.050	.906	.0333	-.3	.25	1.4	.11	.896	.0329	.135	.0052	-.005	.0037
.100	.950	.0331	-.5	.14	1.7	.14	.940	.0327	.138	.0053	-.008	.0024
.150	.985	.0330	-.3	.21	1.7	.08	.975	.0327	.138	.0048	-.005	.0036
.200	1.026	.0330	-1.1	.09	1.8	.10	1.015	.0324	.146	.0050	-.020	.0018
.250	1.051	.0332	-.1	.31	1.3	.10	1.037	.0328	.158	.0053	-.001	.0057
.300	1.077	.0331	-.5	.27	1.3	.09	1.064	.0328	.164	.0053	-.010	.0051
.350	1.073	.0331	-1.0	.24	1.4	.11	1.061	.0327	.160	.0053	-.019	.0045
.400	1.077	.0331	-1.3	.11	1.6	.13	1.065	.0328	.158	.0054	-.024	.0023
.550	1.088	.0332	.4	.14	1.4	.07	1.076	.0328	.163	.0051	.007	.0027
.700	1.082	.0331	-.5	.21	1.7	.15	1.070	.0328	.155	.0055	-.010	.0040
.850	1.078	.0331	.6	.23	1.5	.20	1.066	.0328	.160	.0061	.011	.0043
1.000	1.079	.0331	.4	.09	2.0	.09	1.068	.0328	.151	.0049	.008	.0016

Upstream Velocity U_∞ = 29.7 m/s (+/- .6%)
 Probe Yaw Offset Angle = 10.0 Deg

ORIGINAL PAGE IS
 OF POOR QUALITY

ORIGINAL PAGE IS
OF POOR QUALITY

Table H88. FIVE-HOLE PRESSURE PROBE WAKE PRESSURE DATA
INCIDENCE ANGLE (DEG) = 10.0 , $Z_c/C = .96$, $R = 66.7$ %

NORMALIZED TANGENTIAL POSITION ZT/S	EXIT ANGLE		TOTAL PRESSURE PT2		STATIC PRESSURE P2		TOTAL PRESSURE RECOVERY	
	Deg (+/-)		KPa (+/-)		KPa (+/-)		PT2/PT1 (+/-)	
-1.000	8.5	.16	100.09	.017	99.48	.017	1.0000	.00024
-.850	8.5	.10	100.08	.017	99.48	.017	.9999	.00024
-.700	8.7	.10	100.08	.017	99.48	.017	.9999	.00024
-.550	8.9	.14	100.07	.017	99.48	.017	.9998	.00024
-.400	8.7	.10	100.03	.020	99.48	.017	.9994	.00026
-.350	8.9	.14	100.04	.017	99.48	.017	.9995	.00024
-.300	9.6	.10	100.02	.021	99.48	.017	.9993	.00027
-.250	9.0	.10	100.01	.017	99.49	.017	.9992	.00024
-.200	9.2	.09	99.97	.018	99.48	.017	.9989	.00025
-.150	9.2	.13	99.95	.017	99.48	.017	.9986	.00024
-.100	9.1	.15	99.93	.017	99.49	.017	.9985	.00024
-.050	9.2	.06	99.93	.018	99.49	.017	.9985	.00024
0.000	9.1	.13	99.92	.017	99.48	.017	.9983	.00024
.050	8.6	.11	99.91	.017	99.49	.017	.9982	.00024
.100	8.4	.14	99.95	.017	99.48	.017	.9986	.00024
.150	8.1	.08	99.99	.017	99.49	.017	.9990	.00024
.200	8.3	.10	100.02	.017	99.48	.017	.9994	.00024
.250	8.7	.10	100.05	.017	99.48	.017	.9997	.00024
.300	8.8	.09	100.08	.017	99.48	.017	.9999	.00024
.350	8.6	.11	100.08	.017	99.49	.017	1.0000	.00024
.400	8.5	.13	100.09	.017	99.49	.017	1.0000	.00024
.550	8.6	.07	100.07	.017	99.48	.017	1.0000	.00024
.700	8.3	.15	100.09	.017	99.48	.017	1.0000	.00024
.850	8.6	.20	100.08	.017	99.48	.017	1.0000	.00024
1.000	8.0	.09	100.08	.017	99.48	.017	1.0000	.00024

Upstream Total Pressure PT1 = 100.09 KPa (+/- .017)

Upstream Static Pressure P1 = 99.57 KPa (+/- .017)

Table H89. FIVE-HOLE PRESSURE PROBE WAKE VELOCITY DATA
 INCIDENCE ANGLE (DEG) = 10.0 , $Z_c/C = .76$, $R = 83.3\%$

NORMALIZED TANGENTIAL POSITION ZT/S	NORMALIZED TOTAL VELOCITY					NORMALIZED VELOCITY COMPONENTS						
	U/U _∞ (1/-)		Pitch Ang Deg (1/-)		Yaw Ang Deg (1/-)		Uz/U _∞ (1/-)		Ut/U _∞ (1/-)		Uv/U _∞ (1/-)	
-1.000	1.054	.0334	.5	.06	2.4	.16	1.045	.0331	.139	.0053	.010	.0012
-.950	1.062	.0328	.8	.11	2.6	.14	1.053	.0325	.137	.0050	.015	.0021
-.700	1.043	.0329	1.0	.13	2.3	.07	1.033	.0326	.140	.0046	.017	.0025
-.550	1.025	.0336	1.2	.13	1.4	.15	1.013	.0332	.153	.0056	.022	.0024
-.400	.992	.0336	1.3	.21	1.4	.14	.981	.0333	.148	.0056	.023	.0038
-.350	.966	.0331	1.5	.28	1.4	.08	.955	.0327	.145	.0051	.026	.0047
-.300	.983	.0337	2.3	.17	1.1	.12	.971	.0332	.152	.0056	.040	.0033
-.250	.928	.0337	2.0	.24	1.2	.10	.916	.0332	.142	.0054	.033	.0041
-.200	.953	.0330	1.3	.15	1.4	.13	.942	.0326	.143	.0054	.021	.0025
-.150	.868	.0337	1.8	.26	1.3	.18	.858	.0333	.131	.0057	.027	.0041
-.100	.856	.0336	.6	.17	1.4	.09	.847	.0332	.128	.0052	.009	.0025
-.050	.881	.0346	.6	.16	1.8	.10	.872	.0342	.125	.0051	.009	.0025
0.000	.875	.0334	-1.2	.13	1.5	.14	.865	.0330	.130	.0054	.018	.0022
.050	.879	.0332	-.9	.13	1.9	.10	.870	.0329	.123	.0049	-.013	.0020
.100	.932	.0328	-.6	.13	2.1	.08	.924	.0325	.128	.0047	-.010	.0022
.150	.990	.0327	-.3	.10	2.5	.11	.981	.0324	.130	.0047	-.005	.0017
.200	1.029	.0326	.3	.08	2.3	.14	1.020	.0323	.138	.0050	.005	.0015
.250	1.052	.0327	.8	.16	2.0	.08	1.042	.0324	.147	.0048	.014	.0029
.300	1.066	.0328	.8	.16	1.9	.19	1.055	.0325	.150	.0050	.016	.0031
.350	1.062	.0328	1.1	.11	2.4	.20	1.053	.0325	.140	.0057	.020	.0021
.400	1.069	.0328	.1	.10	2.4	.17	1.059	.0325	.142	.0054	.002	.0019
.550	1.064	.0327	.3	.08	2.4	.11	1.054	.0325	.142	.0048	.005	.0016
.700	1.065	.0328	-.2	.11	2.7	.19	1.056	.0325	.135	.0054	-.003	.0020
.850	1.064	.0328	.5	.11	1.7	.28	1.053	.0325	.154	.0070	.010	.0021
1.000	1.058	.0328	.2	.09	2.6	.17	1.049	.0325	.137	.0052	.003	.0016

Upstream Velocity U_∞ = 29.0 m/s (1/- .69)
 Probe Yaw Offset Angle = 10.0 Deg

ORIGINAL PAGE IS
OF POOR QUALITY

Table H90. FIVE-HOLE PRESSURE PROBE WAKE PRESSURE DATA
INCIDENCE ANGLE (DEG) = 10.0 , $Z_c/C = .96$, $R = 83.3\%$

NORMALIZED TANGENTIAL POSITION ZT/S	EXIT ANGLE		TOTAL PRESURE PT2		STATIC PRESSURE P2		TOTAL PRESSURE RECOVERY	
	Deg (+/-)		kPa (+/-)		kPa (+/-)		PT2/PT1 (+/-)	
-1.000	7.6	.16	100.06	.018	99.48	.017	.9998	.00025
-.850	7.5	.14	100.08	.017	99.49	.017	.9999	.00024
-.700	7.8	.07	100.06	.018	99.49	.017	.9997	.00024
-.550	8.7	.14	100.04	.019	99.49	.017	.9995	.00026
-.400	8.7	.15	100.00	.019	99.49	.017	.9992	.00025
-.350	8.7	.09	99.97	.018	99.49	.017	.9989	.00025
-.300	7.2	.12	99.99	.019	99.49	.017	.9991	.00025
-.250	9.0	.11	99.74	.018	99.49	.017	.9985	.00025
-.200	8.7	.13	99.76	.018	99.49	.017	.9988	.00024
-.150	8.9	.18	99.89	.018	99.49	.017	.9980	.00025
-.100	8.6	.09	99.87	.017	99.49	.017	.9979	.00024
-.050	8.2	.10	99.89	.019	99.49	.017	.9981	.00026
0.000	8.6	.14	99.89	.017	99.49	.017	.9981	.00024
.050	8.1	.10	99.89	.017	99.49	.017	.9981	.00024
.100	7.9	.08	99.95	.017	99.49	.017	.9986	.00024
.150	7.5	.11	100.00	.017	99.49	.017	.9991	.00024
.200	7.7	.14	100.04	.017	99.49	.017	.9995	.00024
.250	8.1	.08	100.07	.017	99.49	.017	.9998	.00024
.300	8.2	.19	100.07	.017	99.48	.017	.9999	.00024
.350	7.7	.20	100.08	.017	99.49	.017	.9999	.00024
.400	7.6	.17	100.08	.017	99.49	.017	1.0000	.00024
.550	7.7	.11	100.08	.017	99.49	.017	.9999	.00024
.700	7.3	.19	100.08	.017	99.48	.017	.9999	.00024
.850	8.3	.28	100.08	.017	99.48	.017	.9999	.00024
1.000	7.4	.17	100.07	.017	99.49	.017	.9999	.00024

Upstream Total Pressure PT1 = 100.09 kPa (+/- .017)

Upstream Static Pressure P1 = 99.56 kPa (+/- .017)

Table H91. FIVE HOLE PRESSURE PROBE WAKE VELOCITY DATA
 INCIDENCE ANGLE (DEG) = 10.0 , Zc/C = 2.10 , R = 4.2 %

NORMALIZED TANGENTIAL POSITION ZT/C	NORMALIZED TOTAL VELOCITY						NORMALIZED VELOCITY COMPONENTS					
	U/Uzo (+/-)		Pitch Ang Deg (+/-)		Yaw Ang Deg (+/-)		Uz/Uzo (+/-)		Ut/Uzo (+/-)		Uv/Uzo (+/-)	
-1.000	.978	.0330	1.3	.00	.3	.07	.964	.0333	.165	.0059	.023	.0013
-.850	.976	.0340	1.0	.13	-.3	.17	.977	.0334	.170	.0067	.018	.0024
-.700	.961	.0342	.7	.07	.2	.16	.947	.0337	.163	.0064	.012	.0016
-.550	.924	.0397	1.0	.10	-.2	.12	.907	.0398	.163	.0073	.016	.0018
-.400	.912	.0344	.9	.12	-.1	.12	.890	.0339	.160	.0063	.014	.0020
-.350	.908	.0342	1.2	.12	-.6	.14	.893	.0336	.167	.0066	.019	.0021
-.300	.887	.0348	1.1	.13	.1	.14	.874	.0343	.153	.0064	.017	.0021
-.250	.873	.0345	1.0	.15	-.3	.13	.857	.0340	.156	.0065	.016	.0024
-.200	.839	.0349	1.3	.10	.5	.16	.827	.0344	.139	.0062	.020	.0017
-.150	.854	.0346	1.0	.11	.2	.17	.841	.0341	.145	.0064	.015	.0018
-.100	.847	.0349	1.5	.12	.3	.12	.835	.0344	.142	.0061	.022	.0020
-.050	.831	.0352	1.7	.11	.0	.16	.820	.0347	.132	.0061	.025	.0019
0.000	.816	.0352	2.1	.12	.0	.18	.805	.0347	.130	.0062	.030	.0021
.050	.830	.0347	2.0	.10	1.3	.12	.820	.0345	.126	.0056	.029	.0019
.100	.856	.0346	1.5	.13	1.7	.11	.847	.0342	.124	.0053	.023	.0022
.150	.901	.0341	1.4	.07	1.8	.10	.871	.0338	.129	.0051	.022	.0017
.200	.924	.0342	1.1	.10	1.8	.08	.915	.0339	.132	.0051	.018	.0018
.250	.956	.0341	.8	.08	1.7	.12	.946	.0338	.137	.0053	.014	.0014
.300	1.003	.0337	.7	.06	1.6	.10	.992	.0335	.146	.0052	.013	.0012
.350	1.015	.0340	.6	.08	1.5	.13	1.003	.0337	.150	.0055	.011	.0015
.400	1.029	.0337	.7	.11	1.2	.07	1.017	.0335	.157	.0054	.012	.0020
.550	1.015	.0341	.8	.11	.6	.11	1.001	.0336	.166	.0057	.014	.0019
.700	.994	.0340	1.0	.11	.3	.11	.979	.0335	.168	.0060	.018	.0021
.850	.994	.0341	.9	.07	-.4	.12	.978	.0336	.180	.0065	.016	.0016
1.000	.983	.0338	.8	.12	.4	.13	.967	.0334	.165	.0061	.014	.0022

Upstream Velocities Uzo = 29.6 m/s (1/- .71)
 Probe Yaw Offset Angle = 10.0 Deg

ORIGINAL PAGE IS
OF POOR QUALITY

Table H92. FIVE HOLE PRESSURE PROBE WAKE PRESSURE DATA
INCIDENCE ANGLE (DEG) = 10.0 , $Z_0/C = 2.10$, $R = 4.2 \%$

NORMALIZED TANGENTIAL POSITION ZT/S	EXIT ANGLE		TOTAL PRESURE PT2		STATIC PRESSURE P2		TOTAL PRESSURE RECOVERY	
	Deg (+/-)		kPa (+/-)		kPa (+/-)		PT2/PT1 (+/-)	
-1.000	9.0	.09	99.46	.017	98.98	.017	.9988	.00024
-.850	10.4	.16	99.48	.017	98.98	.017	.9990	.00024
-.700	9.8	.16	99.44	.018	98.98	.017	.9986	.00025
-.550	10.2	.12	99.41	.026	98.98	.017	.9983	.00031
-.400	10.1	.12	99.40	.018	98.98	.017	.9982	.00025
-.350	10.6	.14	99.40	.017	98.98	.017	.9982	.00024
-.300	10.0	.14	99.38	.018	98.99	.017	.9980	.00025
-.250	10.4	.13	99.37	.017	98.99	.017	.9979	.00024
-.200	9.6	.16	99.34	.017	98.99	.017	.9976	.00024
-.150	9.8	.17	99.35	.017	98.98	.017	.9977	.00024
-.100	9.8	.12	99.35	.017	98.99	.017	.9977	.00024
-.050	9.3	.16	99.34	.017	98.99	.017	.9976	.00024
0.000	9.4	.18	99.32	.017	98.99	.017	.9974	.00024
.050	8.9	.12	99.33	.017	98.98	.017	.9975	.00024
.100	8.5	.11	99.36	.017	98.99	.017	.9978	.00024
.150	8.4	.10	99.39	.017	98.98	.017	.9981	.00024
.200	8.3	.08	99.41	.017	98.98	.017	.9983	.00024
.250	8.3	.12	99.45	.018	98.98	.017	.9987	.00024
.300	8.4	.10	99.49	.017	98.98	.017	.9991	.00024
.350	8.5	.13	99.50	.018	98.98	.017	.9992	.00025
.400	8.8	.09	99.52	.017	98.98	.017	.9994	.00024
.550	9.5	.11	99.50	.018	98.98	.017	.9992	.00025
.700	9.8	.11	99.47	.017	98.99	.017	.9991	.00024
.850	10.4	.12	99.48	.018	98.98	.017	.9990	.00025
1.000	9.7	.13	99.47	.017	98.98	.017	.9989	.00024

Upstream Total Pressure PT1 = 99.58 kPa (+/- .017)

Upstream Static Pressure P1 = 99.07 kPa (+/- .017)

Table H93. FIVE HOLE PRESSURE PROBE WAKE VELOCITY DATA
 INCIDENCE ANGLE (DEG) = 10.0 , Zc/C = 2.10 , R = 0.3 %

NORMALIZED TANGENTIAL POSITION 2T/S	NORMALIZED TOTAL VELOCITY				NORMALIZED VELOCITY COMPONENTS							
	U/Uzo (+/-)		Pitch Ang Deg (+/-)		Yaw Ang Deg (+/-)		Uz/Uzo (+/-)		Ut/Uzo (+/-)		Ur/Uzo (+/-)	
-1.000	1.041	.0339	.7	.05	.8	.19	1.028	.0335	.167	.0064	.016	.0011
-.850	1.063	.0341	1.0	.08	-.3	.15	1.045	.0335	.190	.0067	.018	.0016
-.700	1.039	.0340	1.0	.08	.7	.09	1.025	.0336	.168	.0057	.018	.0015
-.550	1.026	.0349	.9	.10	.7	.15	1.012	.0345	.166	.0062	.017	.0019
-.400	.986	.0340	1.0	.12	.6	.08	.973	.0343	.161	.0059	.018	.0021
-.350	.982	.0347	.9	.10	.4	.09	.968	.0343	.163	.0060	.015	.0018
-.300	.998	.0330	1.2	.07	.2	.14	.983	.0333	.171	.0063	.021	.0015
-.250	.981	.0338	1.4	.10	.4	.13	.967	.0333	.164	.0060	.024	.0018
-.200	.970	.0343	1.1	.07	.3	.09	.956	.0338	.164	.0060	.018	.0014
-.150	.933	.0340	1.6	.11	.2	.12	.920	.0335	.158	.0061	.026	.0020
-.100	.908	.0341	1.9	.10	.6	.09	.895	.0336	.148	.0057	.029	.0019
-.050	.906	.0342	1.5	.11	.9	.12	.894	.0338	.143	.0057	.024	.0019
0.000	.906	.0345	2.0	.09	.7	.09	.894	.0340	.144	.0056	.031	.0019
.050	.910	.0341	2.0	.12	1.8	.09	.900	.0337	.130	.0051	.031	.0023
.100	.918	.0340	1.5	.13	.8	.10	.906	.0336	.147	.0057	.024	.0023
.150	.941	.0337	1.5	.14	1.3	.11	.930	.0335	.143	.0054	.024	.0024
.200	.974	.0337	1.3	.14	1.5	.13	.963	.0335	.145	.0055	.023	.0025
.250	.996	.0330	.9	.09	1.6	.11	.985	.0334	.145	.0053	.016	.0017
.300	1.024	.0339	.6	.07	1.7	.11	1.013	.0336	.147	.0053	.011	.0013
.350	1.047	.0337	.6	.10	1.4	.09	1.035	.0335	.156	.0053	.011	.0018
.400	1.061	.0340	.7	.12	1.5	.07	1.049	.0337	.157	.0052	.013	.0023
.550	1.068	.0341	.6	.08	1.4	.15	1.056	.0337	.159	.0058	.012	.0015
.700	1.071	.0340	.7	.10	.8	.14	1.057	.0335	.172	.0060	.013	.0019
.850	1.062	.0341	.8	.08	.7	.10	1.048	.0337	.172	.0058	.015	.0016
1.000	1.055	.0339	.7	.10	.7	.12	1.041	.0334	.171	.0059	.014	.0019

Upstream Velocity Uzo = 29.6 m/s (+/- .71)
 Probe Yaw Offset Angle = 10.0 Deg

ORIGINAL PAGE IS
OF POOR QUALITY

Table H94. FIVE-HOLE PRESSURE PROBE WAKE PRESSURE DATA
INCIDENCE ANGLE (DEG) = 10.0 , Zc/C = 2.10 , R = 8.3 %

NORMALIZED TANGENTIAL POSITION ZT/C	EXIT ANGLE		TOTAL PRESURE PT2		STATIC PRESSURE P2		TOTAL PRESSURE RECOVERY	
	DEG	(+/-)	KPa	(+/-)	KPa	(+/-)	PT2/PT1	(+/-)
-1.000	9.3	.19	99.19	.017	98.64	.017	.9995	.00024
.850	10.4	.15	99.21	.017	98.64	.017	.9997	.00025
-.700	9.3	.09	99.19	.017	98.64	.017	.9995	.00024
-.550	9.3	.15	99.17	.019	98.64	.017	.9993	.00026
.400	9.5	.08	99.13	.019	98.64	.017	.9989	.00026
-.350	9.6	.09	99.13	.019	98.64	.017	.9989	.00026
-.300	9.7	.14	99.14	.017	98.64	.017	.9990	.00024
-.250	9.7	.13	99.12	.017	98.64	.017	.9988	.00024
-.200	9.8	.09	99.11	.018	98.64	.017	.9987	.00025
-.150	9.9	.12	99.08	.017	98.64	.017	.9984	.00024
-.100	9.5	.09	99.06	.017	98.64	.017	.9982	.00024
.050	9.2	.12	99.05	.017	98.64	.017	.9981	.00024
0.000	9.3	.09	99.05	.018	98.64	.017	.9981	.00025
.050	8.5	.07	99.06	.017	98.64	.017	.9982	.00024
.100	9.4	.10	99.07	.017	98.64	.017	.9983	.00024
.150	8.8	.11	99.09	.017	98.64	.017	.9985	.00024
.200	8.7	.13	99.12	.017	98.64	.017	.9988	.00024
.250	8.4	.11	99.14	.017	98.64	.017	.9990	.00024
.300	8.3	.11	99.17	.017	98.64	.017	.9993	.00024
.350	8.6	.07	99.19	.017	98.64	.017	.9995	.00024
.400	8.5	.07	99.21	.017	98.64	.017	.9997	.00024
.550	8.6	.15	99.22	.017	98.64	.017	.9998	.00024
.700	9.3	.14	99.22	.017	98.64	.017	.9998	.00024
.850	9.3	.10	99.21	.018	98.64	.017	.9997	.00025
1.000	9.3	.12	99.20	.017	98.64	.017	.9996	.00024

Upstream Total Pressure PT1 = 99.24 KPa (+/- .017)

Upstream Static Pressure P1 = 98.73 KPa (+/- .017)

Table H95. FIVE HOLE PRESSURE PROBE WAKE VELOCITY DATA
 INCIDENCE ANGLE (DEG) = 10.0 , Zc/C = 2.10 , R = 12.5 %

NORMALIZED TANGENTIAL POSITION 2T/S	NORMALIZED TOTAL VELOCITY					NORMALIZED VELOCITY COMPONENTS						
	U/Uzo (+/-)		Pitch Ang Des (+/-)		Yaw Ang Des (+/-)		Uz/Uzo (+/-)		Ut/Uzo (+/-)		Ur/Uzo (+/-)	
-1.000	1.079	.0341	.8	.06	1.3	.13	1.066	.0338	.164	.0057	.015	.0012
-.850	1.084	.0342	.9	.09	1.5	.07	1.072	.0338	.160	.0052	.017	.0017
-.700	1.078	.0342	1.2	.08	.9	.24	1.064	.0338	.170	.0070	.023	.0016
-.550	1.056	.0344	1.0	.08	.8	.08	1.043	.0339	.168	.0057	.019	.0016
-.400	1.017	.0353	1.2	.13	1.2	.07	1.005	.0349	.156	.0057	.022	.0025
-.350	1.034	.0341	.0	.09	.9	.09	1.021	.0337	.164	.0057	.015	.0016
-.300	1.012	.0351	.9	.12	1.2	.08	1.000	.0346	.156	.0056	.015	.0022
-.250	1.025	.0349	1.1	.13	.8	.14	1.011	.0344	.163	.0061	.019	.0024
-.200	.994	.0340	1.3	.11	1.2	.13	.982	.0336	.152	.0057	.023	.0020
-.150	1.005	.0343	1.6	.09	.6	.11	.991	.0338	.164	.0059	.029	.0019
-.100	.956	.0343	1.4	.11	1.3	.13	.945	.0339	.145	.0056	.023	.0020
-.050	.938	.0343	2.2	.13	1.5	.12	.927	.0339	.138	.0054	.035	.0025
0.000	.929	.0342	1.7	.10	1.5	.11	.918	.0338	.138	.0054	.027	.0019
.050	.931	.0341	1.8	.11	1.4	.10	.920	.0337	.139	.0053	.029	.0021
.100	.937	.0341	2.0	.10	1.6	.12	.927	.0338	.138	.0054	.032	.0020
.150	.928	.0342	1.8	.12	1.7	.10	.918	.0338	.134	.0052	.029	.0022
.200	.949	.0340	1.4	.11	2.0	.14	.939	.0337	.131	.0052	.023	.0019
.250	.960	.0340	1.4	.07	1.7	.11	.949	.0336	.138	.0052	.023	.0015
.300	.991	.0340	1.1	.11	2.0	.11	.981	.0337	.138	.0051	.019	.0020
.350	1.015	.0343	1.1	.08	1.4	.07	1.003	.0339	.151	.0053	.020	.0015
.400	1.036	.0340	.8	.07	1.5	.11	1.024	.0336	.152	.0053	.015	.0014
.550	1.051	.0344	.2	.08	1.3	.16	1.038	.0340	.159	.0059	.004	.0015
.700	1.072	.0341	.4	.08	1.4	.10	1.060	.0337	.160	.0054	.007	.0015
.850	1.078	.0341	.6	.10	1.2	.16	1.066	.0337	.164	.0060	.011	.0019
1.000	1.067	.0341	1.0	.15	.9	.14	1.053	.0337	.169	.0060	.018	.0028

Upstream Velocity Uzo = 29.6 m/s (+/- .71)
 Probe Yaw Offset Angle = 10.0 Deg

ORIGINAL PAGE IS
OF POOR QUALITY

Table H96. FIVE HOLE PRESSURE PROBE WAKE PRESSURE DATA
INCIDENCE ANGLE (DEG) = 10.0 , $Z_c/C = 2.10$, $R = 12.5\%$

NORMALIZED TANGENTIAL POSITION ZT/C	EXIT ANGLE		TOTAL PRESSURE PT2		STATIC PRESSURE P2		TOTAL PRESSURE RECOVERY	
	Deg (+/-)		KPa (+/-)		KPa (+/-)		PT2/PT1 (+/-)	
-1.000	8.8	.12	99.23	.017	98.65	.017	.9999	.00024
-.850	8.6	.07	99.23	.017	98.64	.017	.9999	.00024
-.700	7.2	.24	99.22	.017	98.64	.017	.9999	.00024
-.550	7.2	.08	99.20	.018	98.64	.017	.9996	.00025
-.400	8.9	.07	99.16	.020	98.65	.017	.9993	.00026
-.350	7.2	.09	99.18	.017	98.64	.017	.9994	.00024
-.300	8.7	.08	99.16	.019	98.65	.017	.9992	.00026
-.250	7.2	.14	99.17	.019	98.65	.017	.9993	.00026
-.200	8.9	.13	99.14	.017	98.64	.017	.9990	.00024
-.150	7.5	.11	99.15	.018	98.65	.017	.9991	.00025
-.100	8.8	.13	99.11	.018	98.65	.017	.9987	.00025
-.050	8.7	.12	99.09	.017	98.65	.017	.9985	.00025
0.000	8.7	.11	99.08	.017	98.64	.017	.9984	.00024
.050	8.8	.10	99.08	.017	98.65	.017	.9984	.00024
.100	8.7	.12	99.08	.017	98.64	.017	.9984	.00024
.150	8.5	.10	99.08	.017	98.65	.017	.9984	.00024
.200	8.1	.13	99.10	.017	98.65	.017	.9986	.00024
.250	8.4	.11	99.11	.017	98.65	.017	.9987	.00024
.300	8.1	.11	99.14	.017	98.65	.017	.9990	.00024
.350	8.7	.09	99.16	.018	98.64	.017	.9992	.00025
.400	8.5	.10	99.18	.017	98.65	.017	.9994	.00024
.550	8.7	.16	99.20	.018	98.65	.017	.9996	.00025
.700	8.6	.10	99.23	.017	98.65	.017	.9999	.00024
.850	8.8	.16	99.23	.017	98.65	.017	.9999	.00024
1.000	7.2	.14	99.22	.017	98.64	.017	.9998	.00024

Upstream Total Pressure PT1 = 99.24 KPa (+/- .017)

Upstream Static Pressure P1 = 98.74 KPa (+/- .017)

Table H97. FIVE HOLE PRESSURE PROBE WAKE VELOCITY DATA
 INCIDENCE ANGLE (DEG) = 10.0 , $Z_0/C = 2.10$, $R = 16.7\%$

NORMALIZED TANGENTIAL POSITION 2T/3	NORMALIZED TOTAL VELOCITY				NORMALIZED VELOCITY COMPONENTS							
	U/U ₀ (+/-)	Pitch Ang Deg (+/-)	Yaw Ang Deg (+/-)		U _z /U ₀ (+/-)		U _t /U ₀ (+/-)		U _r /U ₀ (+/-)			
-1.000	1.075	.0344	.7	.09	1.4	.10	1.063	.0340	.161	.0055	.014	.0018
-.950	1.072	.0344	.8	.07	.3	.12	1.057	.0339	.181	.0062	.015	.0014
-.700	1.079	.0344	1.1	.09	.9	.18	1.065	.0340	.172	.0064	.020	.0017
-.550	1.059	.0347	1.0	.07	1.1	.09	1.046	.0343	.164	.0056	.019	.0014
-.400	1.058	.0348	1.4	.12	1.1	.12	1.045	.0344	.163	.0058	.026	.0024
-.350	1.031	.0342	.9	.13	1.7	.12	1.020	.0339	.149	.0054	.016	.0024
-.300	1.027	.0344	1.1	.17	1.4	.09	1.015	.0340	.154	.0054	.020	.0031
-.250	1.029	.0349	.9	.17	1.3	.09	1.017	.0345	.155	.0055	.016	.0030
-.200	.979	.0350	1.4	.11	1.4	.13	.967	.0345	.147	.0057	.024	.0021
-.150	.965	.0344	1.7	.14	1.6	.09	.954	.0341	.140	.0052	.029	.0025
-.100	.949	.0342	1.9	.11	1.6	.12	.938	.0338	.139	.0054	.031	.0021
-.050	.946	.0342	1.7	.14	1.5	.07	.935	.0338	.139	.0052	.028	.0026
0.000	.938	.0343	1.7	.18	1.6	.12	.927	.0339	.137	.0054	.028	.0031
.050	.941	.0342	1.6	.15	1.3	.09	.930	.0338	.142	.0053	.027	.0026
.100	.940	.0343	1.8	.14	1.7	.12	.930	.0339	.136	.0054	.030	.0025
.150	.957	.0342	1.6	.12	1.7	.07	.947	.0338	.139	.0052	.026	.0021
.200	.967	.0342	1.7	.11	1.3	.11	.957	.0338	.146	.0055	.032	.0021
.250	1.000	.0341	1.3	.11	1.9	.10	.990	.0338	.140	.0051	.022	.0020
.300	1.010	.0342	.9	.14	1.9	.12	1.000	.0337	.143	.0053	.015	.0024
.350	1.037	.0342	1.0	.08	1.6	.14	1.026	.0338	.151	.0056	.017	.0016
.400	1.058	.0342	.8	.07	1.9	.21	1.047	.0339	.149	.0062	.014	.0016
.550	1.072	.0343	-.2	.10	1.7	.14	1.061	.0340	.155	.0056	-.004	.0019
.700	1.089	.0344	.7	.07	1.6	.14	1.077	.0340	.159	.0057	.014	.0015
.850	1.087	.0344	.5	.07	1.1	.16	1.074	.0340	.168	.0061	.010	.0017
1.000	1.090	.0344	.8	.08	1.7	.10	1.078	.0340	.150	.0053	.014	.0016

Upstream Velocity U₀ = 27.5 m/s (+/- .71)
 Probe Yaw Offset Angle = 10.0 Deg

ORIGINAL PAGE IS
OF POOR QUALITY

Table H98. FIVE-HOLE PRESSURE PROBE WAKE PRESSURE DATA
INCIDENCE ANGLE (DEG) = 10.0 , $Z_c/C = 2.10$, $R = 16.7\%$

NORMALIZED TANGENTIAL POSITION ZT/S	EXIT ANGLE		TOTAL PRESURE PT2		STATIC PRESSURE P2		TOTAL PRESSURE RECOVERY	
	Deg	(+/-)	kPa	(+/-)	kPa	(+/-)	PT2/PT1	(+/-)
-1.000	8.7	.10	99.22	.017	98.65	.017	.9998	.00024
-.850	9.8	.12	99.21	.017	98.64	.017	.9998	.00024
-.700	9.2	.18	99.22	.017	98.64	.017	.9998	.00024
-.550	9.0	.09	99.21	.018	98.65	.017	.9997	.00025
-.400	9.0	.12	99.20	.018	98.64	.017	.9996	.00025
-.350	8.4	.12	99.17	.017	98.64	.017	.9993	.00024
-.300	8.7	.09	99.17	.018	98.64	.017	.9993	.00025
-.250	8.7	.09	99.18	.018	98.65	.017	.9994	.00025
-.200	8.7	.13	99.12	.019	98.65	.017	.9988	.00025
-.150	8.5	.09	99.11	.018	98.64	.017	.9987	.00025
-.100	8.6	.12	99.10	.017	98.65	.017	.9986	.00024
-.050	8.6	.07	99.09	.017	98.65	.017	.9985	.00024
0.000	8.6	.12	99.08	.017	98.64	.017	.9984	.00024
.050	8.0	.09	99.09	.017	98.64	.017	.9985	.00024
.100	8.5	.12	99.09	.017	98.65	.017	.9985	.00024
.150	8.5	.09	99.10	.017	98.65	.017	.9986	.00024
.200	8.7	.11	99.11	.017	98.64	.017	.9987	.00024
.250	8.2	.10	99.14	.017	98.64	.017	.9990	.00024
.300	8.2	.12	99.15	.017	98.64	.017	.9991	.00024
.350	8.5	.14	99.18	.017	98.64	.017	.9994	.00024
.400	8.1	.21	99.20	.017	98.64	.017	.9996	.00024
.550	8.3	.14	99.22	.017	98.65	.017	.9998	.00024
.700	8.4	.14	99.23	.017	98.64	.017	1.0000	.00024
.850	8.9	.16	99.23	.017	98.64	.017	.9999	.00024
1.000	8.4	.10	99.23	.017	98.64	.017	.9999	.00024

Upstream Total Pressure PT1 = 99.24 kPa (+/- .017)

Upstream Static Pressure P1 = 98.74 kPa (+/- .017)

Table H99. FIVE HOLE PRESSURE PROBE WAKE VELOCITY DATA
 INCIDENCE ANGLE (DEG) = 10.0 , Zc/C = 2.10 , R = 25.0 %

NORMALIZED TANGENTIAL POSITION 2T/S	NORMALIZED TOTAL VELOCITY						NORMALIZED VELOCITY COMPONENTS					
	U/Uzo (+/-)		Pitch Ans Des (+/-)		Yaw Ans Des (+/-)		Uz/Uzo (+/-)		Ut/Uzo (+/-)		Ur/Uzo (+/-)	
-1.000	1.088	.0340	.6	.11	1.4	.08	1.076	.0337	.162	.0053	.011	.0021
-.850	1.085	.0341	1.2	.09	.7	.11	1.071	.0336	.175	.0059	.024	.0019
-.700	1.080	.0341	1.6	.13	.7	.13	1.065	.0336	.174	.0060	.031	.0027
-.550	1.075	.0343	1.6	.09	1.0	.11	1.062	.0338	.168	.0057	.030	.0020
-.400	1.047	.0340	1.5	.16	1.1	.07	1.034	.0336	.162	.0054	.027	.0031
-.350	1.035	.0340	2.3	.12	1.2	.08	1.022	.0344	.158	.0055	.041	.0026
-.300	1.010	.0340	1.7	.09	1.3	.09	1.005	.0336	.155	.0054	.034	.0020
-.250	1.045	.0339	1.9	.11	1.2	.10	1.032	.0335	.159	.0055	.034	.0023
-.200	1.000	.0343	1.8	.16	1.5	.09	.988	.0339	.148	.0053	.031	.0029
-.150	.991	.0344	2.3	.11	1.2	.08	.970	.0340	.152	.0055	.039	.0023
-.100	.963	.0339	1.8	.14	1.3	.08	.952	.0335	.145	.0053	.031	.0026
-.050	.960	.0339	1.4	.18	1.4	.09	.949	.0335	.144	.0053	.024	.0031
0.000	.961	.0339	1.1	.12	1.6	.08	.950	.0335	.141	.0051	.019	.0021
.050	.957	.0339	1.4	.06	1.4	.10	.946	.0335	.143	.0053	.023	.0013
.100	.966	.0338	1.3	.11	1.3	.10	.955	.0334	.146	.0054	.022	.0019
.150	.977	.0338	1.8	.12	1.2	.11	.965	.0334	.150	.0055	.031	.0023
.200	.998	.0339	1.2	.21	1.4	.09	.987	.0335	.149	.0053	.020	.0037
.250	1.013	.0338	.6	.12	1.8	.10	1.002	.0335	.144	.0051	.011	.0021
.300	1.028	.0338	.5	.10	1.1	.26	1.016	.0334	.158	.0069	.009	.0018
.350	1.045	.0339	1.0	.17	1.5	.07	1.033	.0335	.154	.0052	.019	.0031
.400	1.063	.0340	.8	.15	1.5	.12	1.051	.0336	.158	.0055	.015	.0028
.550	1.079	.0340	.5	.13	.6	.11	1.064	.0336	.176	.0059	.009	.0024
.700	1.091	.0341	.9	.15	.8	.12	1.077	.0336	.174	.0059	.018	.0029
.850	1.090	.0341	1.1	.10	1.2	.11	1.077	.0336	.168	.0056	.021	.0020
1.000	1.091	.0341	.8	.09	1.2	.07	1.078	.0337	.167	.0054	.015	.0017

Upstream Velocity Uzo = 29.6 m/s (+/- .71)
 Probe Yaw Offset Angle = 10.0 Deg

ORIGINAL PAGE IS
OF POOR QUALITY

Table H100. FIVE-HOLE PRESSURE PROBE WAKE PRESSURE DATA
INCIDENCE ANGLE (DEG) = 10.0 , $Z_c/C = 2.10$, $R = 25.0\%$

NORMALIZED TANGENTIAL POSITION ZT/C	EXIT ANGLE		TOTAL PRESSURE PT2		STATIC PRESSURE P2		TOTAL PRESSURE RECOVERY	
	Deg (+/-)		kPa (+/-)		kPa (+/-)		PT2/PT1 (+/-)	
-1.000	8.6	.08	99.31	.017	98.71	.017	1.0000	.00024
-.850	9.3	.11	99.30	.017	98.71	.017	.9999	.00024
-.700	9.4	.13	99.29	.017	98.71	.017	.9999	.00024
-.550	9.1	.11	99.29	.018	98.71	.017	.9998	.00025
-.400	9.0	.07	99.26	.017	98.71	.017	.9995	.00024
-.350	9.0	.08	99.25	.019	98.71	.017	.9994	.00026
-.300	9.0	.09	99.23	.017	98.71	.017	.9992	.00024
-.250	9.0	.10	99.25	.017	98.70	.017	.9994	.00024
-.200	8.7	.09	99.21	.018	98.71	.017	.9990	.00025
-.150	9.1	.08	99.20	.018	98.70	.017	.9989	.00025
-.100	8.9	.08	99.17	.017	98.71	.017	.9987	.00024
-.050	8.7	.09	99.17	.017	98.71	.017	.9986	.00024
0.000	8.5	.08	99.17	.017	98.70	.017	.9986	.00024
.050	8.7	.10	99.17	.017	98.71	.017	.9986	.00024
.100	8.8	.10	99.18	.017	98.71	.017	.9987	.00024
.150	9.0	.11	99.19	.017	98.71	.017	.9986	.00024
.200	8.7	.10	99.21	.017	98.70	.017	.9990	.00024
.250	8.2	.10	99.22	.017	98.71	.017	.9992	.00024
.300	8.9	.26	99.24	.017	98.71	.017	.9993	.00024
.350	8.5	.08	99.25	.017	98.70	.017	.9995	.00024
.400	8.6	.12	99.27	.017	98.70	.017	.9997	.00024
.550	9.4	.11	99.29	.017	98.70	.017	.9998	.00024
.700	9.2	.12	99.31	.017	98.71	.017	1.0000	.00024
.850	8.9	.11	99.31	.017	98.71	.017	1.0000	.00024
1.000	8.8	.07	99.30	.017	98.70	.017	1.0000	.00024

Upstream Total Pressure PT1 = 99.31 kPa (+/- .017)
Upstream Static Pressure P1 = 98.80 kPa (+/- .017)

Table H101. FIVE HOLE PRESSURE PROBE WAKE VELOCITY DATA
 INCIDENCE ANGLE (DEG) = 10.0 , Zc/C = 2.10 , R = 33.3 %

NORMALIZED TANGENTIAL POSITION ZT/S	NORMALIZED TOTAL VELOCITY						NORMALIZED VELOCITY COMPONENTS					
	U/Uzo (+/-)		Pitch Ang Deg (+/-)		Yaw Ang Deg (+/-)		Uz/Uzo (+/-)		Ut/Uzo (+/-)		Ur/Uzo (+/-)	
-1.000	1.090	.0339	.7	.10	1.1	.11	1.077	.0335	.168	.0057	.013	.0019
-.850	1.072	.0339	1.4	.12	.7	.17	1.058	.0335	.173	.0063	.026	.0024
-.700	1.084	.0339	1.7	.12	1.1	.07	1.071	.0335	.167	.0054	.033	.0024
-.550	1.047	.0343	1.7	.10	1.3	.00	1.035	.0339	.158	.0054	.034	.0021
-.400	1.068	.0339	1.8	.27	1.0	.07	1.055	.0335	.167	.0056	.033	.0051
-.350	1.046	.0338	2.5	.18	1.0	.14	1.032	.0333	.164	.0059	.046	.0036
-.300	1.026	.0337	1.0	.15	1.0	.07	1.013	.0333	.160	.0055	.033	.0030
-.250	1.017	.0337	1.5	.17	1.0	.00	1.004	.0333	.159	.0054	.026	.0035
-.200	.995	.0339	2.2	.14	1.2	.00	.983	.0335	.153	.0054	.039	.0028
-.150	.992	.0337	2.6	.23	1.1	.14	.977	.0333	.153	.0057	.044	.0042
-.100	.976	.0337	1.5	.26	1.0	.07	.964	.0333	.152	.0055	.026	.0045
-.050	.971	.0337	.9	.09	1.3	.07	.960	.0333	.147	.0052	.016	.0017
0.000	.965	.0337	1.0	.12	.9	.13	.953	.0332	.152	.0057	.018	.0022
.050	.972	.0337	1.3	.15	1.4	.07	.961	.0333	.146	.0052	.022	.0027
.100	.979	.0336	.7	.08	1.6	.00	.980	.0333	.147	.0051	.016	.0015
.150	1.011	.0337	1.1	.16	1.3	.07	1.000	.0333	.152	.0052	.019	.0029
.200	1.024	.0337	.7	.11	1.5	.08	1.012	.0333	.152	.0052	.016	.0021
.250	1.039	.0337	.1	.20	1.6	.10	1.028	.0333	.152	.0052	.002	.0036
.300	1.060	.0337	.6	.12	1.5	.00	1.048	.0334	.156	.0052	.011	.0022
.350	1.072	.0338	1.0	.16	1.1	.16	1.059	.0334	.167	.0060	.018	.0031
.400	1.077	.0338	.6	.13	.8	.13	1.063	.0334	.172	.0059	.012	.0025
.550	1.089	.0339	.2	.07	.8	.11	1.075	.0334	.173	.0057	.005	.0017
.700	1.081	.0339	-.1	.12	.7	.07	1.067	.0334	.175	.0056	-.001	.0023
.850	1.097	.0339	1.0	.12	.5	.10	1.082	.0334	.181	.0057	.020	.0023
1.000	1.087	.0338	1.1	.00	.8	.10	1.073	.0334	.173	.0057	.022	.0017

Upstream Velocity Uzo = 29.7 m/s (+/- .71)
 Probe Yaw Offset Angle = 10.0 Deg

ORIGINAL PAGE IS
OF POOR QUALITY

Table H102. FIVE-HOLE PRESSURE PROBE WAKE PRESSURE DATA
INCIDENCE ANGLE (DEG) = 10.0 , $Z_c/C = 2.10$, $R = 33.3\%$

NORMALIZED TANGENTIAL POSITION Z/C	EXIT ANGLE		TOTAL PRESSURE PT2		STATIC PRESSURE P2		TOTAL PRESSURE RECOVERY	
	Deg (+/-)		kPa (+/-)		kPa (+/-)		PT2/PT1 (+/-)	
-1.000	8.9	.11	99.27	.017	98.67	.017	1.0000	.00024
-.850	9.4	.17	99.26	.017	98.67	.017	.9998	.00024
-.700	9.0	.07	99.26	.017	98.67	.017	.9999	.00024
-.550	8.9	.08	99.23	.018	98.67	.017	.9996	.00025
-.400	9.2	.10	99.25	.017	98.67	.017	.9997	.00024
-.350	9.4	.15	99.22	.017	98.67	.017	.9995	.00024
-.300	9.2	.10	99.21	.017	98.67	.017	.9993	.00024
-.250	9.1	.08	99.20	.017	98.67	.017	.9992	.00024
-.200	9.1	.08	99.17	.018	98.67	.017	.9990	.00025
-.150	9.2	.15	99.17	.017	98.67	.017	.9990	.00024
-.100	9.1	.10	99.16	.017	98.67	.017	.9988	.00024
-.050	8.7	.07	99.15	.017	98.67	.017	.9988	.00024
0.000	9.1	.13	99.15	.017	98.68	.017	.9987	.00024
.050	8.7	.08	99.15	.017	98.67	.017	.9988	.00024
.100	8.5	.08	99.18	.017	98.67	.017	.9990	.00024
.150	8.7	.08	99.19	.017	98.67	.017	.9991	.00024
.200	8.6	.08	99.20	.017	98.67	.017	.9993	.00024
.250	8.4	.10	99.22	.017	98.68	.017	.9995	.00024
.300	8.5	.08	99.24	.017	98.67	.017	.9997	.00024
.350	9.0	.16	99.25	.017	98.67	.017	.9998	.00024
.400	9.2	.13	99.25	.017	98.67	.017	.9998	.00024
.550	9.2	.11	99.27	.017	98.67	.017	1.0000	.00024
.700	9.3	.07	99.27	.017	98.67	.017	.9999	.00024
.850	9.6	.10	99.27	.017	98.67	.017	1.0000	.00024
1.000	9.2	.10	99.27	.017	98.67	.017	1.0000	.00024

Upstream Total Pressure PT1 = 99.27 kPa (+/- .017)
Upstream Static Pressure P1 = 98.77 kPa (+/- .017)

Table H103. FIVE HOLE PRESSURE PROBE WAKE VELOCITY DATA
 INCIDENCE ANGLE (DEG) = 10.0 , Zc/C = 2.10 , R = 50.0 %

NORMALIZED TANGENTIAL POSITION ZT/C	NORMALIZED TOTAL VELOCITY						NORMALIZED VELOCITY COMPONENTS					
	U/Uzo (+/-)		Pitch Ang Deg (+/-)		Yaw Ang Deg (+/-)		Uz/Uzo (+/-)		Uv/Uzo (+/-)		Ur/Uzo (+/-)	
-1.000	1.093	.0345	.0	.10	.9	.15	1.079	.0341	.173	.0061	.015	.0020
-.850	1.077	.0344	1.3	.11	1.0	.11	1.063	.0340	.169	.0058	.025	.0023
-.700	1.083	.0345	1.5	.12	1.1	.11	1.067	.0341	.168	.0057	.028	.0024
-.550	1.070	.0345	1.3	.15	1.6	.08	1.067	.0341	.158	.0053	.024	.0029
-.400	1.073	.0345	1.4	.15	.7	.10	1.059	.0340	.173	.0059	.025	.0030
-.350	1.037	.0346	1.6	.32	1.1	.09	1.024	.0342	.160	.0055	.029	.0058
-.300	1.041	.0345	1.1	.32	1.0	.12	1.028	.0341	.164	.0058	.020	.0058
-.250	1.036	.0347	1.7	.22	.0	.14	1.023	.0342	.166	.0061	.030	.0041
-.200	1.023	.0345	1.3	.39	.8	.15	1.007	.0341	.164	.0061	.024	.0070
-.150	1.004	.0343	1.4	.15	1.2	.13	.992	.0339	.154	.0057	.025	.0028
-.100	.990	.0347	1.5	.21	1.0	.21	.978	.0342	.154	.0065	.026	.0037
-.050	.982	.0344	1.4	.14	1.3	.13	.970	.0340	.149	.0057	.025	.0025
0.000	.959	.0344	.5	.17	1.2	.14	.940	.0339	.146	.0058	.009	.0029
.050	.973	.0344	.8	.07	1.1	.12	.961	.0340	.151	.0057	.014	.0013
.100	.986	.0343	.3	.13	1.4	.10	.974	.0339	.147	.0054	.005	.0023
.150	1.007	.0343	.4	.18	1.4	.12	.996	.0339	.150	.0055	.007	.0032
.200	1.009	.0343	.5	.12	1.5	.08	.990	.0339	.150	.0053	.010	.0022
.250	1.041	.0344	-.1	.15	1.3	.09	1.029	.0340	.157	.0055	-.002	.0027
.300	1.046	.0343	.1	.12	1.4	.09	1.035	.0340	.157	.0054	.002	.0023
.350	1.060	.0344	.5	.17	1.0	.14	1.055	.0340	.166	.0059	.009	.0031
.400	1.077	.0345	.0	.17	1.0	.13	1.066	.0340	.168	.0059	.014	.0033
.550	1.092	.0345	.6	.16	1.2	.06	1.079	.0341	.167	.0054	.011	.0031
.700	1.093	.0345	-.2	.16	1.0	.23	1.079	.0341	.170	.0069	-.003	.0031
.850	1.090	.0345	.3	.07	1.6	.10	1.070	.0341	.159	.0054	.006	.0013
1.000	1.091	.0345	.0	.10	1.2	.09	1.070	.0341	.168	.0056	.015	.0019

Upstream Velocity Uzo = 29.4 m/s (+/- .71)
 Probe Yaw Offset Angle = 10.0 Deg

ORIGINAL PAGE IS
OF POOR QUALITY

Table H104. FIVE-HOLE PRESSURE PROBE WAKE PRESSURE DATA
INCIDENCE ANGLE (DEG) = 10.0 , $Z_c/C = 2.10$, $R = 50.0$ %

NORMALIZED TANGENTIAL POSITION ZT/S	EXIT ANGLE		TOTAL PRESSURE PT2		STATIC PRESSURE P2		TOTAL PRESSURE RECOVERY	
	DEG (+/-)		KPa (+/-)		KPa (+/-)		PT2/PT1 (+/-)	
-1.000	7.1	.15	99.57	.017	98.98	.017	1.0000	.00024
-.850	7.1	.11	99.57	.017	98.99	.017	.9999	.00024
-.700	7.1	.11	99.58	.017	99.00	.017	1.0000	.00024
-.550	6.5	.09	99.57	.017	98.99	.017	.9999	.00024
-.400	7.4	.11	99.56	.017	98.98	.017	.9998	.00024
-.350	7.0	.10	99.53	.018	98.99	.017	.9995	.00024
-.300	7.1	.13	99.53	.017	98.99	.017	.9995	.00024
-.250	7.4	.14	99.52	.018	98.99	.017	.9994	.00025
-.200	7.3	.16	99.50	.017	98.98	.017	.9992	.00024
-.150	8.7	.13	99.49	.017	98.99	.017	.9991	.00024
-.100	7.1	.21	99.47	.018	98.99	.017	.9990	.00025
-.050	8.8	.13	99.47	.017	98.99	.017	.9989	.00024
0.000	8.8	.14	99.45	.017	99.00	.017	.9988	.00024
.050	7.0	.12	99.47	.017	99.00	.017	.9989	.00024
.100	8.6	.10	99.48	.017	99.00	.017	.9990	.00024
.150	8.6	.12	99.49	.017	98.99	.017	.9992	.00024
.200	8.5	.08	99.50	.017	98.99	.017	.9992	.00024
.250	8.7	.09	99.53	.017	98.99	.017	.9995	.00024
.300	8.6	.09	99.53	.017	98.99	.017	.9995	.00024
.350	7.0	.14	99.55	.017	98.99	.017	.9998	.00024
.400	7.0	.13	99.57	.017	98.99	.017	.9999	.00024
.550	8.8	.06	99.58	.017	98.99	.017	1.0000	.00024
.700	7.0	.23	99.57	.017	98.98	.017	.9999	.00024
.850	8.4	.10	99.58	.017	98.99	.017	1.0000	.00024
1.000	8.7	.07	99.58	.017	98.98	.017	1.0000	.00024

Upstream Total Pressure PT1 = 99.58 KPa (+/- .017)
Upstream Static Pressure P1 = 99.08 KPa (+/- .017)

Table H105. FIVE HOLE PRESSURE PROBE WAKE VELOCITY DATA
 INCIDENCE ANGLE (DEG) = 10.0 , Zc/C = 2.10 , R = 66.7 %

NORMALIZED TANGENTIAL POSITION ZT/S	NORMALIZED TOTAL VELOCITY				NORMALIZED VELOCITY COMPONENTS							
	U/Uzo (+/-)		Pitch Ang Deg (+/-)		Yaw Ang Deg (+/-)		Uz/Uzo (+/-)		Ut/Uzo (+/-)		Uv/Uzo (+/-)	
-1.000	1.077	.0339	.0	.00	1.5	.11	1.065	.0336	.158	.0054	.015	.0016
-.850	1.078	.0339	1.1	.09	1.1	.14	1.063	.0335	.166	.0059	.020	.0017
-.700	1.074	.0339	1.7	.11	1.9	.10	1.062	.0336	.152	.0051	.032	.0024
-.550	1.062	.0340	1.7	.23	1.4	.09	1.050	.0336	.159	.0053	.032	.0044
-.400	1.037	.0341	2.1	.10	1.5	.09	1.025	.0337	.153	.0053	.037	.0035
-.350	1.032	.0330	2.0	.19	1.4	.13	1.019	.0334	.155	.0056	.036	.0037
-.300	1.024	.0338	.7	.15	.7	.07	1.011	.0334	.162	.0056	.016	.0027
-.250	1.000	.0339	1.4	.19	1.0	.12	.988	.0335	.156	.0057	.024	.0035
-.200	.991	.0343	.5	.23	1.3	.07	.900	.0339	.150	.0053	.009	.0040
-.150	.975	.0339	1.9	.37	1.4	.11	.964	.0335	.146	.0054	.032	.0064
-.100	.974	.0338	1.4	.28	1.4	.11	.963	.0335	.145	.0053	.023	.0048
-.050	.960	.0339	1.0	.08	1.2	.09	.948	.0335	.147	.0054	.016	.0015
0.000	.953	.0338	.8	.19	1.4	.08	.942	.0334	.142	.0052	.013	.0032
.050	.967	.0330	.6	.10	1.2	.09	.956	.0334	.148	.0054	.010	.0018
.100	.970	.0330	.3	.10	1.5	.09	.967	.0334	.145	.0052	.005	.0017
.150	1.004	.0330	.2	.12	1.5	.14	.993	.0334	.140	.0056	.003	.0021
.200	1.017	.0330	.3	.13	1.4	.12	1.005	.0334	.153	.0055	.006	.0023
.250	1.030	.0330	-.1	.25	1.4	.06	1.027	.0334	.155	.0051	-.001	.0046
.300	1.054	.0339	.0	.13	1.6	.08	1.043	.0335	.155	.0052	.000	.0025
.350	1.064	.0339	.6	.13	1.7	.07	1.053	.0335	.154	.0051	.011	.0024
.400	1.071	.0339	.6	.23	1.4	.11	1.059	.0335	.161	.0055	.011	.0043
.550	1.081	.0340	.3	.19	1.4	.10	1.068	.0336	.162	.0054	.006	.0036
.700	1.080	.0339	.0	.13	1.8	.13	1.069	.0336	.155	.0055	.014	.0024
.850	1.072	.0339	.7	.12	1.2	.14	1.060	.0335	.164	.0058	.010	.0022
1.000	1.000	.0339	.0	.07	1.6	.00	1.068	.0336	.157	.0052	.015	.0014

Upstream Velocity Uzo = 29.7 m/s (+/- .71)
 Probe Yaw Offset Angle = 10.0 Deg

ORIGINAL PAGE IS
OF POOR QUALITY

Table H106. FIVE HOLE PRESSURE PROB WAKE PRESSURE DATA
INCIDENCE ANGLE (DEG) = 10.0 , $Z_c/C = 2.10$, $R = 66.7\%$

NORMALIZED TANGENTIAL POSITION ZT/C	EXIT ANGLE		TOTAL PRESSURE PT2		STATIC PRESSURE P2		TOTAL PRESSURE RECOVERY	
	DEG (+/-)		KPa (+/-)		KPa (+/-)		PT2/PT1 (+/-)	
-1.000	8.5	.11	99.27	.017	98.69	.017	1.0000	.00024
-.850	8.9	.14	99.27	.017	98.68	.017	1.0000	.00024
-.700	8.3	.10	99.26	.017	98.68	.017	.9997	.00024
-.550	8.8	.10	99.25	.017	98.68	.017	.9977	.00024
-.400	8.7	.10	99.23	.018	98.68	.017	.9975	.00025
-.350	8.9	.13	99.22	.017	98.67	.017	.9975	.00024
-.300	9.1	.10	99.21	.017	98.68	.017	.9974	.00024
-.250	9.1	.12	99.18	.017	98.68	.017	.9991	.00024
-.200	8.7	.07	99.18	.018	98.67	.017	.9991	.00025
-.150	8.8	.13	99.16	.017	98.68	.017	.9989	.00024
-.100	8.7	.11	99.16	.017	98.68	.017	.9987	.00024
-.050	8.9	.09	99.15	.017	98.69	.017	.9988	.00024
0.000	8.6	.09	99.14	.017	98.69	.017	.9987	.00024
.050	8.8	.09	99.16	.017	98.68	.017	.9988	.00024
.100	8.5	.09	99.17	.017	98.68	.017	.9989	.00024
.150	8.5	.14	99.19	.017	98.69	.017	.9992	.00024
.200	8.7	.12	99.20	.017	98.68	.017	.9993	.00024
.250	8.6	.06	99.23	.017	98.68	.017	.9975	.00024
.300	8.4	.08	99.25	.017	98.67	.017	.9997	.00024
.350	8.4	.07	99.26	.017	98.67	.017	.9998	.00024
.400	8.7	.11	99.26	.017	98.68	.017	.9999	.00024
.550	8.6	.10	99.27	.017	98.68	.017	1.0000	.00024
.700	8.3	.13	99.27	.017	98.69	.017	1.0000	.00024
.850	8.8	.14	99.27	.017	98.69	.017	1.0000	.00024
1.000	8.4	.08	99.27	.017	98.69	.017	1.0000	.00024

Upstream Total Pressure PT1 = 99.27 KPa (+/- .017)

Upstream Static Pressure P1 = 98.77 KPa (+/- .017)

Table H107. FIVE HOLE PRESSURE PROBE WAKE VELOCITY DATA
 INCIDENCE ANGLE (DEG) = 10.0 , Zc/C = 2.10 , R = 93.3 %

NORMALIZED TANGENTIAL POSITION ZT/C	NORMALIZED TOTAL VELOCITY					NORMALIZED VELOCITY COMPONENTS						
	U/Uzo (+/-)		Pitch Ang Deg (+/-)		Yaw Ang Deg (+/-)		Uz/Uzo (+/-)		Uv/Uzo (+/-)		Ur/Uzo (+/-)	
-1.000	1.038	.0350	1.1	.21	2.1	.07	1.028	.0347	.143	.0051	.019	.0038
-.850	1.059	.0338	1.4	.13	2.1	.14	1.049	.0334	.146	.0053	.025	.0025
-.700	1.044	.0337	1.2	.08	1.8	.13	1.033	.0334	.147	.0054	.021	.0016
-.550	1.042	.0341	1.7	.19	2.0	.15	1.032	.0338	.145	.0055	.031	.0036
-.400	1.042	.0336	2.2	.09	1.3	.10	1.030	.0332	.158	.0054	.040	.0021
-.350	1.030	.0338	2.2	.14	1.5	.12	1.018	.0334	.151	.0054	.040	.0028
-.300	1.003	.0340	2.6	.13	1.3	.10	.991	.0336	.151	.0054	.045	.0027
-.250	.968	.0356	1.8	.15	1.5	.11	.957	.0352	.143	.0056	.031	.0027
-.200	.960	.0350	2.3	.18	1.5	.23	.948	.0346	.141	.0064	.038	.0033
-.150	.948	.0339	2.1	.22	1.6	.11	.937	.0335	.139	.0053	.034	.0038
-.100	.929	.0338	.4	.22	1.3	.09	.918	.0334	.141	.0053	.006	.0035
-.050	.917	.0341	.6	.10	1.9	.09	.908	.0338	.130	.0050	.010	.0017
0.000	.921	.0338	.4	.13	1.6	.13	.911	.0335	.134	.0054	.006	.0021
.050	.923	.0338	.6	.14	1.9	.08	.913	.0334	.130	.0049	.009	.0022
.100	.944	.0337	.2	.12	2.4	.11	.936	.0334	.125	.0048	.003	.0020
.150	.956	.0336	.4	.11	1.8	.09	.946	.0333	.136	.0050	.007	.0019
.200	.983	.0336	.4	.08	2.3	.07	.974	.0333	.132	.0048	.007	.0014
.250	1.011	.0336	.7	.13	2.4	.10	1.002	.0333	.133	.0048	.016	.0023
.300	1.021	.0337	.4	.12	1.8	.09	1.010	.0334	.145	.0051	.008	.0021
.350	1.033	.0339	1.4	.13	2.0	.12	1.022	.0336	.144	.0052	.025	.0024
.400	1.050	.0336	.6	.10	2.1	.16	1.040	.0333	.145	.0054	.012	.0018
.550	1.062	.0337	1.5	.17	2.4	.12	1.052	.0334	.140	.0050	.028	.0032
.700	1.058	.0337	1.0	.06	2.1	.13	1.048	.0334	.146	.0052	.018	.0013
.850	1.064	.0337	.6	.10	2.7	.16	1.056	.0334	.136	.0052	.012	.0018
1.000	1.055	.0338	1.1	.11	2.1	.27	1.045	.0335	.145	.0067	.020	.0020

Upstream Velocity Uzo = 29.8 m/s (+/- .71)
 Probe Yaw Offset Angle = 10.0 Deg

ORIGINAL PAGE IS
OF POOR QUALITY

Table H108. FIVE HOLE PRESSURE PROBE WAKE PRESSURE DATA
INCIDENCE ANGLE (DEG) = 10.0 , $Z_c/C = 2.10$, $R = 83.3\%$

NORMALIZED TANGENTIAL POSITION ZT/C	EXIT ANGLE		TOTAL PRESURE PT2		STATIC PRESSURE P2		TOTAL PRESSURE RECOVERY	
	Deg (+/-)		kPa (+/-)		kPa (+/-)		PT2/PT1 (+/-)	
-1.000	8.0	.10	99.23	.020	98.69	.017	.9996	.00026
-.850	8.1	.14	99.26	.017	98.69	.017	.9999	.00024
-.700	8.3	.13	99.24	.017	98.69	.017	.9997	.00024
-.550	8.2	.15	99.24	.018	98.69	.017	.9996	.00025
-.400	7.0	.10	99.24	.017	98.68	.017	.9996	.00024
-.350	8.7	.12	99.22	.017	98.69	.017	.9995	.00024
-.300	9.0	.10	99.19	.018	98.68	.017	.9992	.00025
-.250	8.7	.11	99.16	.021	98.69	.017	.9989	.00027
-.200	8.8	.23	99.16	.020	98.69	.017	.9988	.00026
-.150	8.7	.12	99.14	.017	98.69	.017	.9987	.00024
-.100	8.7	.09	99.13	.017	98.69	.017	.9986	.00024
-.050	8.1	.09	99.11	.018	98.69	.017	.9984	.00025
0.000	8.4	.13	99.12	.017	98.69	.017	.9985	.00024
.050	8.1	.08	99.12	.017	98.69	.017	.9985	.00024
.100	7.6	.11	99.14	.017	98.69	.017	.9987	.00024
.150	8.2	.07	99.15	.017	98.69	.017	.9988	.00024
.200	7.7	.07	99.18	.017	98.69	.017	.9991	.00024
.250	7.6	.10	99.21	.017	98.69	.017	.9994	.00024
.300	8.2	.09	99.22	.017	98.69	.017	.9994	.00024
.350	8.2	.12	99.23	.018	98.69	.017	.9996	.00025
.400	8.0	.15	99.25	.017	98.69	.017	.9997	.00024
.550	7.7	.12	99.27	.017	98.69	.017	.9999	.00024
.700	8.0	.13	99.25	.017	98.69	.017	.9998	.00024
.850	7.4	.16	99.26	.017	98.69	.017	.9999	.00024
1.000	8.0	.26	99.25	.017	98.69	.017	.9998	.00024

Upstream Total Pressure PT1 = 99.27 kPa (+/- .017)
Upstream Static Pressure P1 = 98.77 kPa (+/- .017)

APPENDIX I

Exit Flow Field Data - Graphical Presentation

The exit data at all of the measurement stations is presented in graphical form in this Appendix. The figures are presented in groups as described in the introduction to Appendix H.

ORIGINAL PAGE IS
OF POOR QUALITY

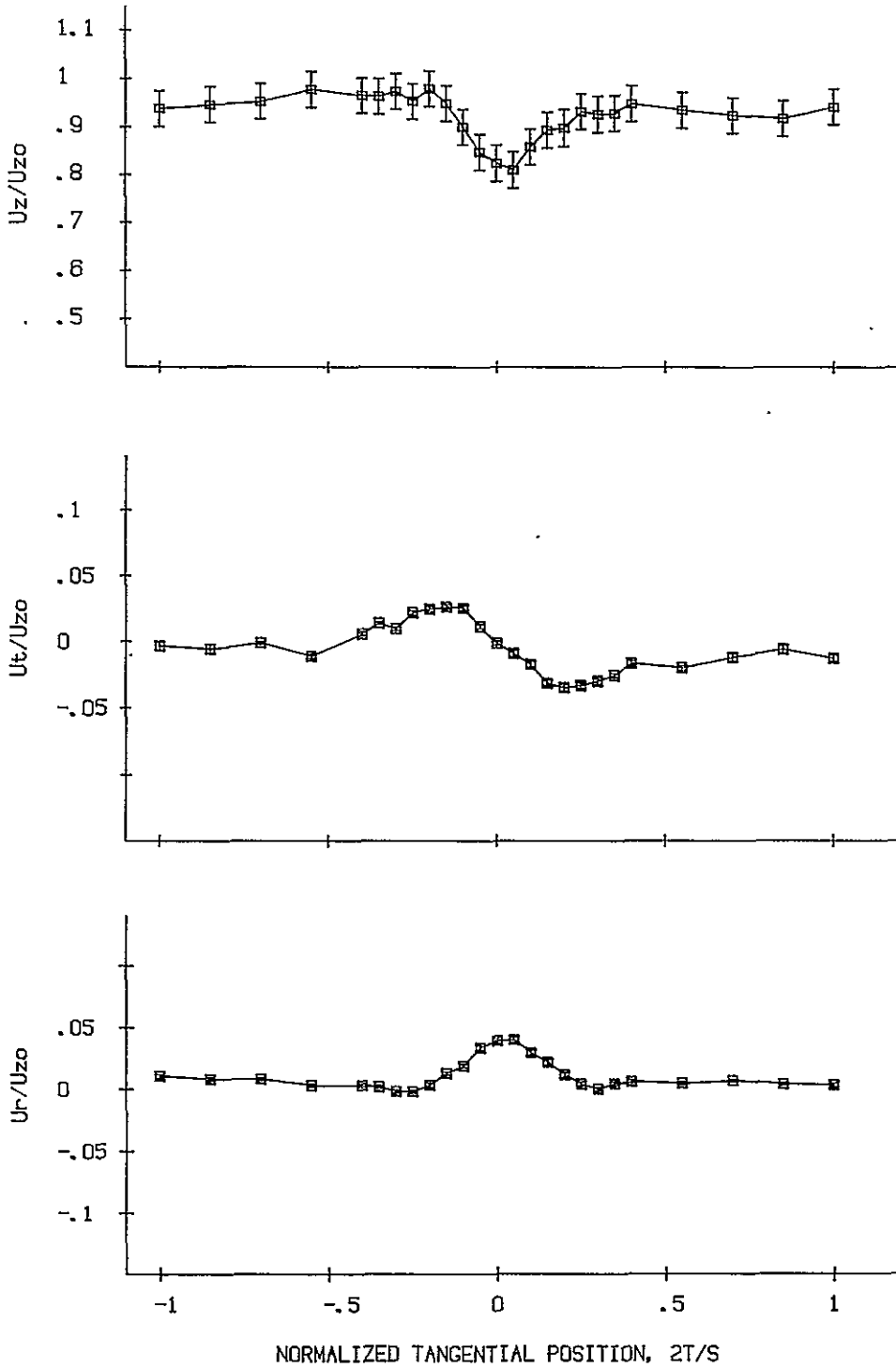

Figure II. FIVE-HOLE PROBE VELOCITY DATA, INCIDENCE ANGLE (DEG) = 0,
 $Z_c/C = .94$, $R = 4.2\%$

ORIGINAL PAGE IS
OF POOR QUALITY

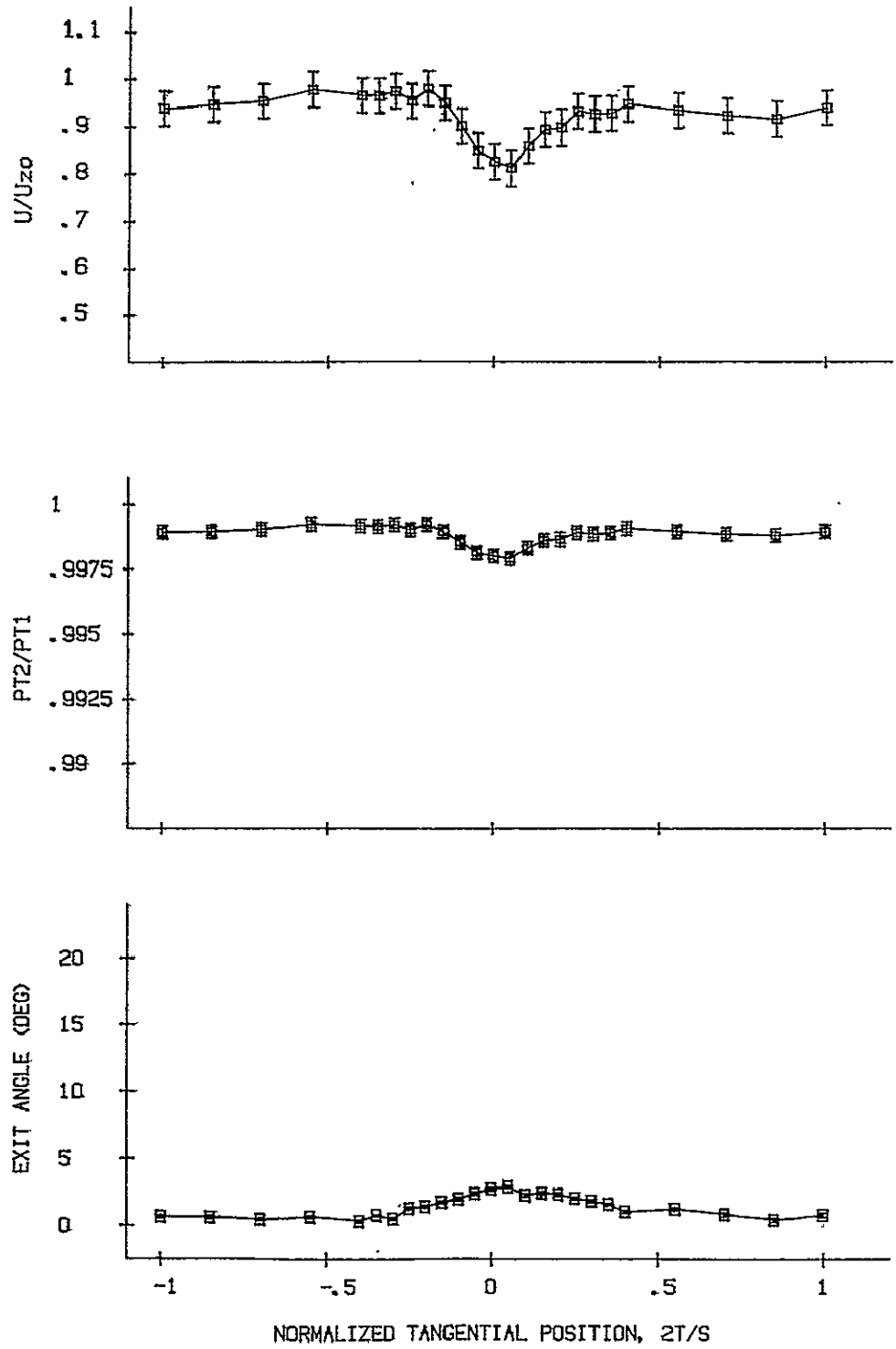

Figure I2. FIVE-HOLE PROBE WAKE DATA, INCIDENCE ANGLE (DEG) = 0,
 $Z_c/C = .94$, $R = 4.2\%$

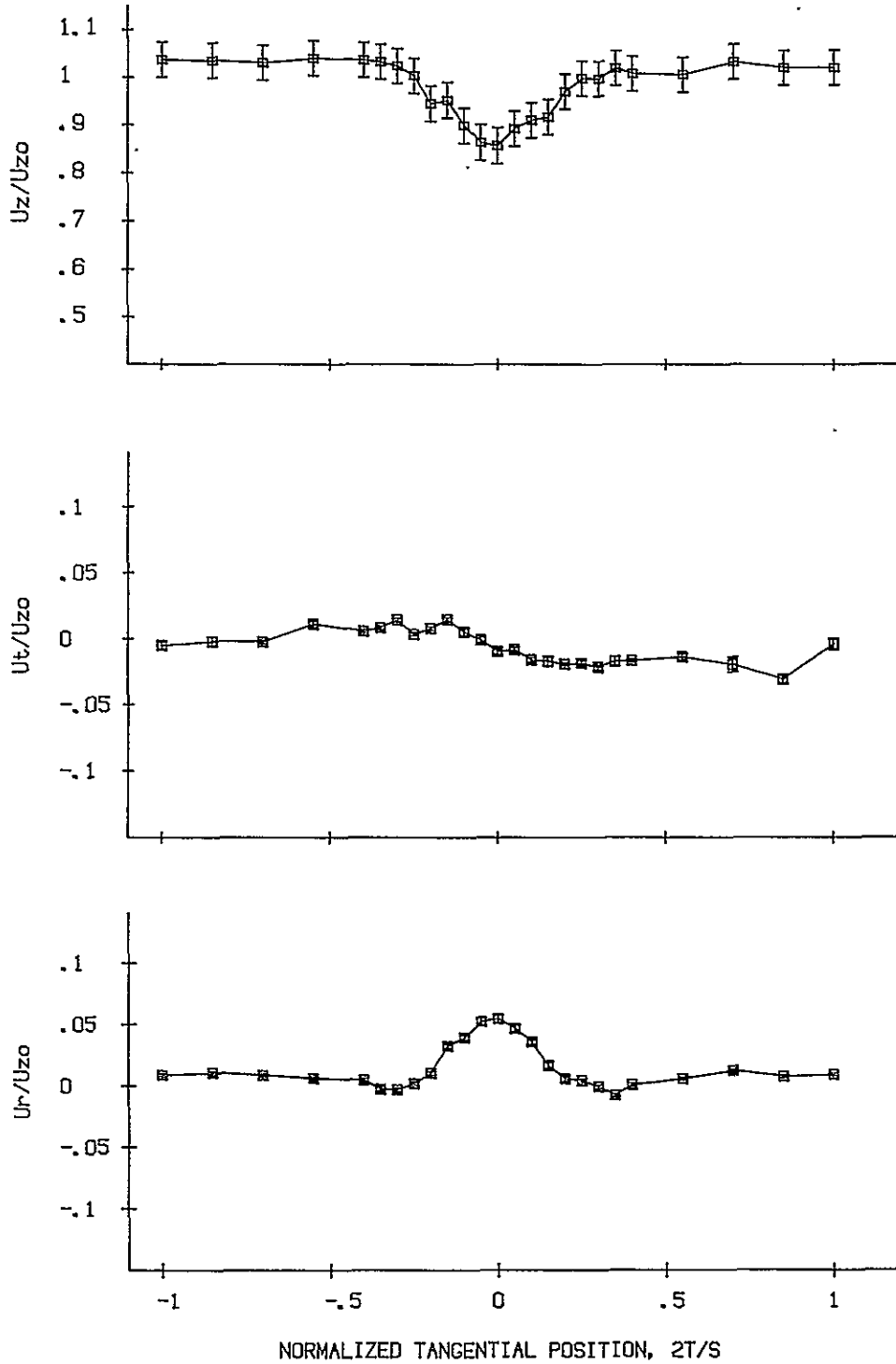

Figure I3. FIVE-HOLE PROBE VELOCITY DATA, INCIDENCE ANGLE (DEG) = 0,
 $Z_c/C = .94$, $R = 8.3\%$

ORIGINAL PAGE IS
OF POOR QUALITY

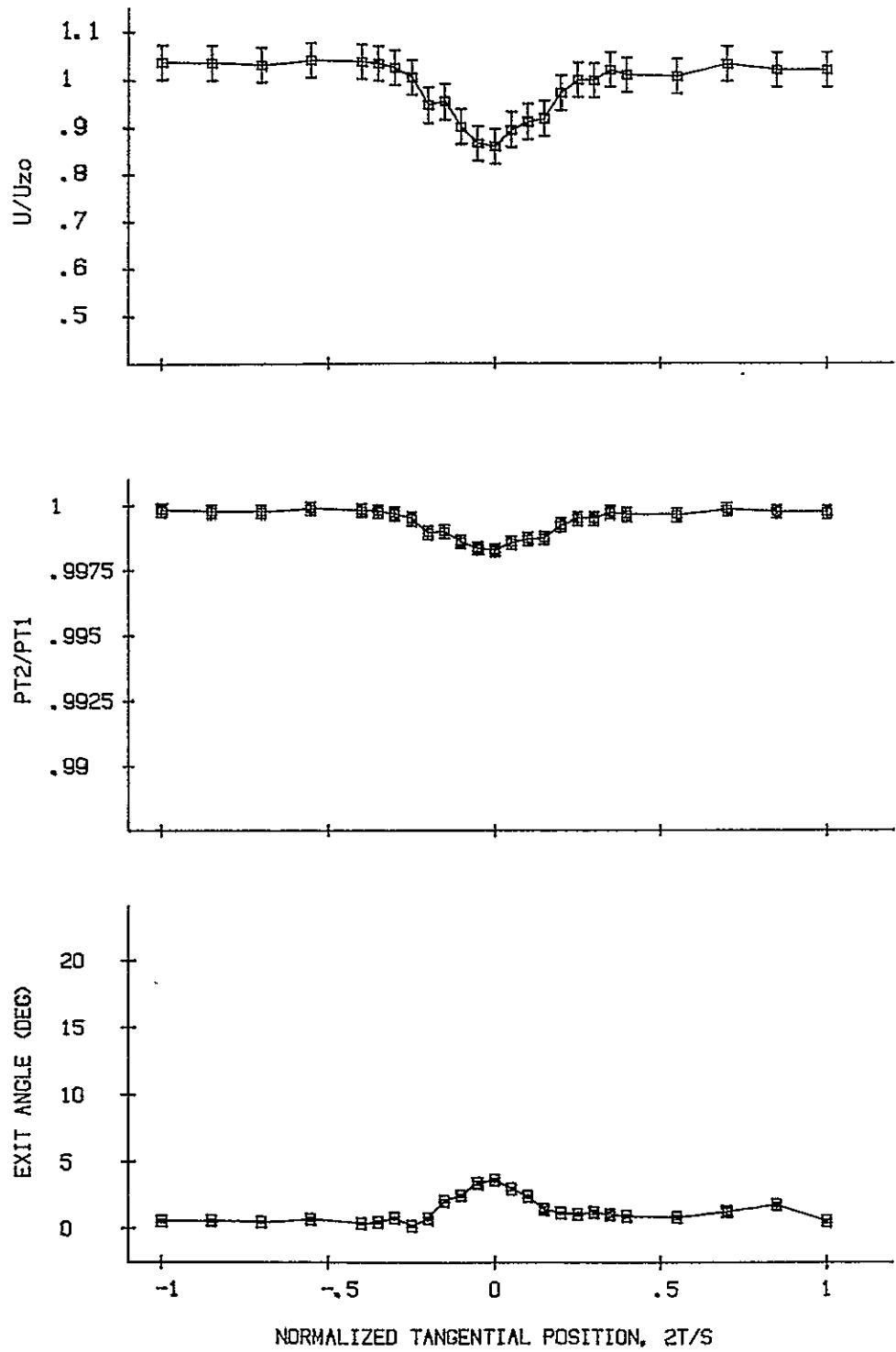

Figure I4. FIVE-HOLE PROBE WAKE DATA, INCIDENCE ANGLE (DEG) = 0,
 $Z_c/C = .94$, $R = 8.3\%$

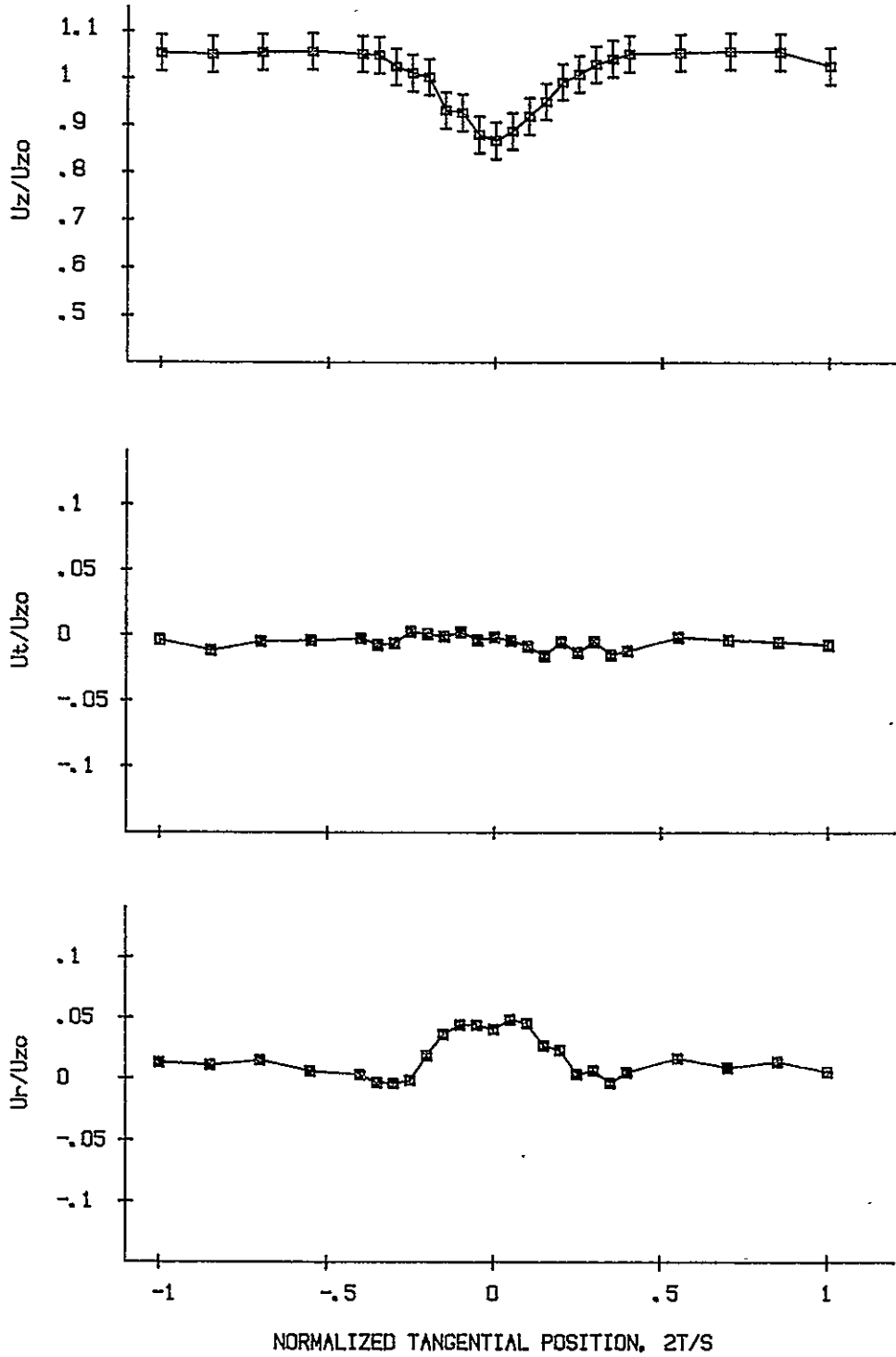

Figure I5. FIVE-HOLE PROBE VELOCITY DATA, INCIDENCE ANGLE (DEG) = 0,
 $Z_0/C = .94$, $R = 12.5\%$

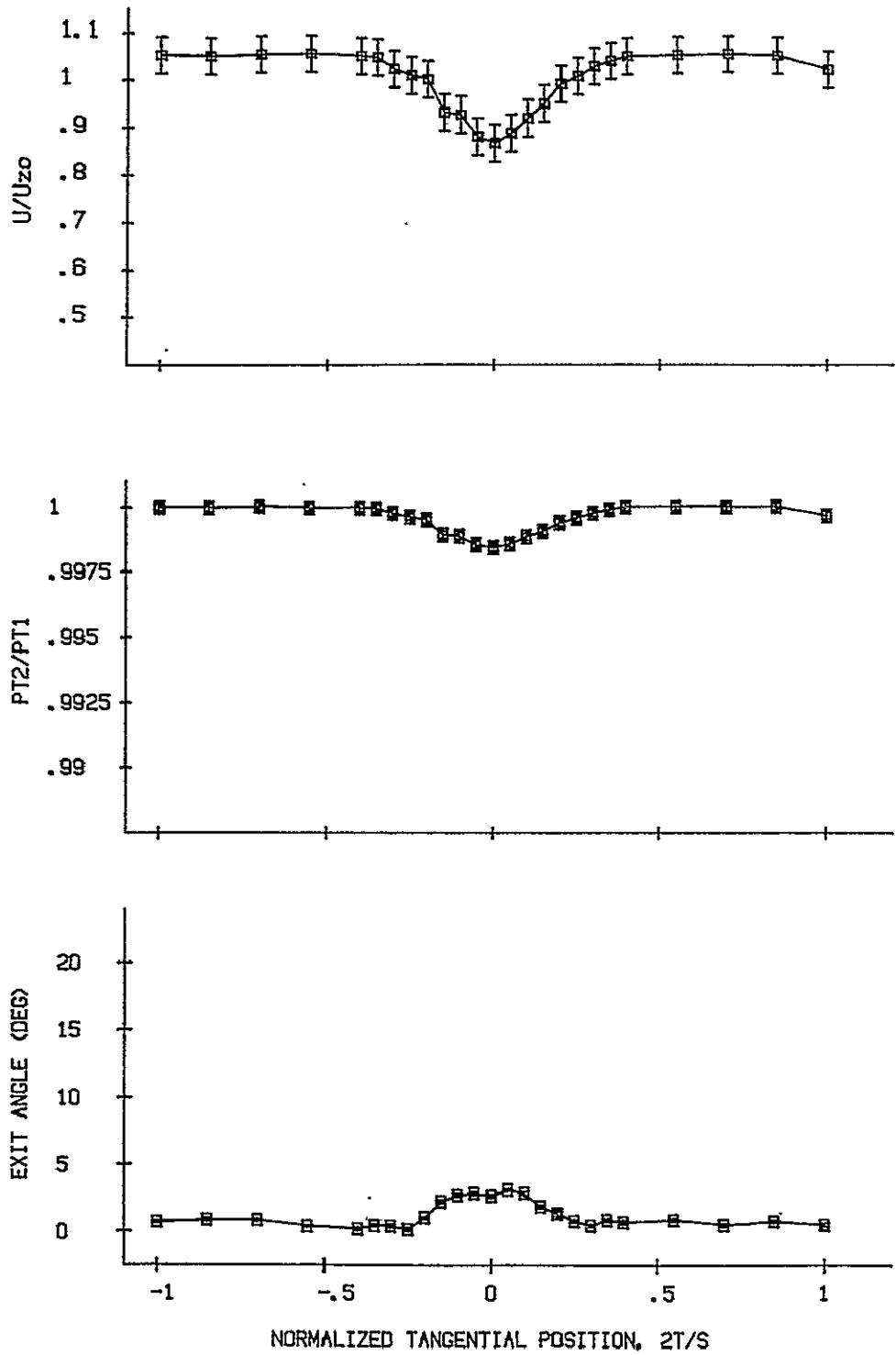

Figure I6. FIVE-HOLE PROBE WAKE DATA, INCIDENCE ANGLE (DEG) = 0,
 $Z_c/C = .94$, $R = 12.5\%$

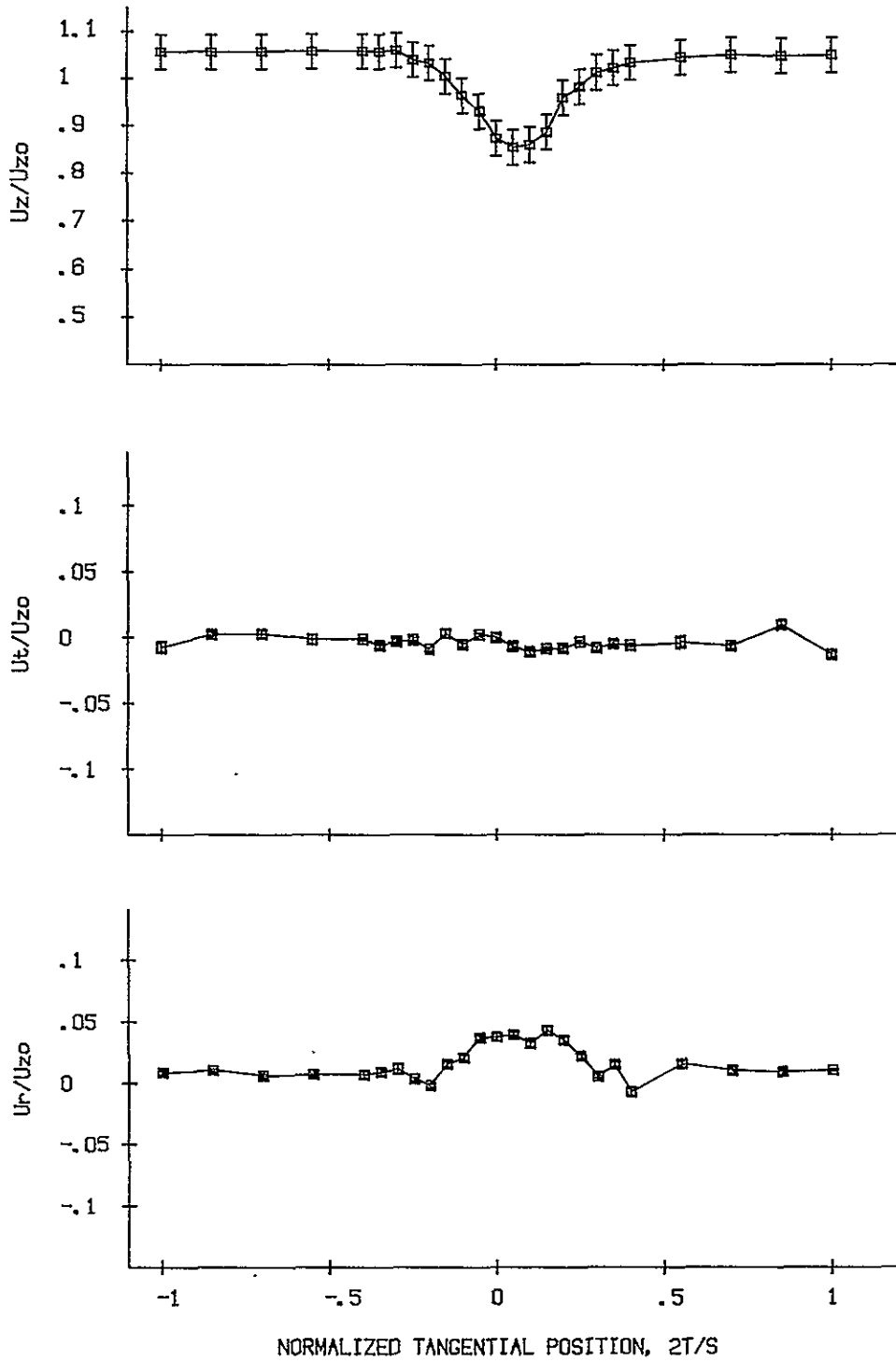

Figure I7. FIVE-HOLE PROBE VELOCITY DATA, INCIDENCE ANGLE (DEG) = 0,
 $Z_c/C = .94$, $R = 16.7\%$

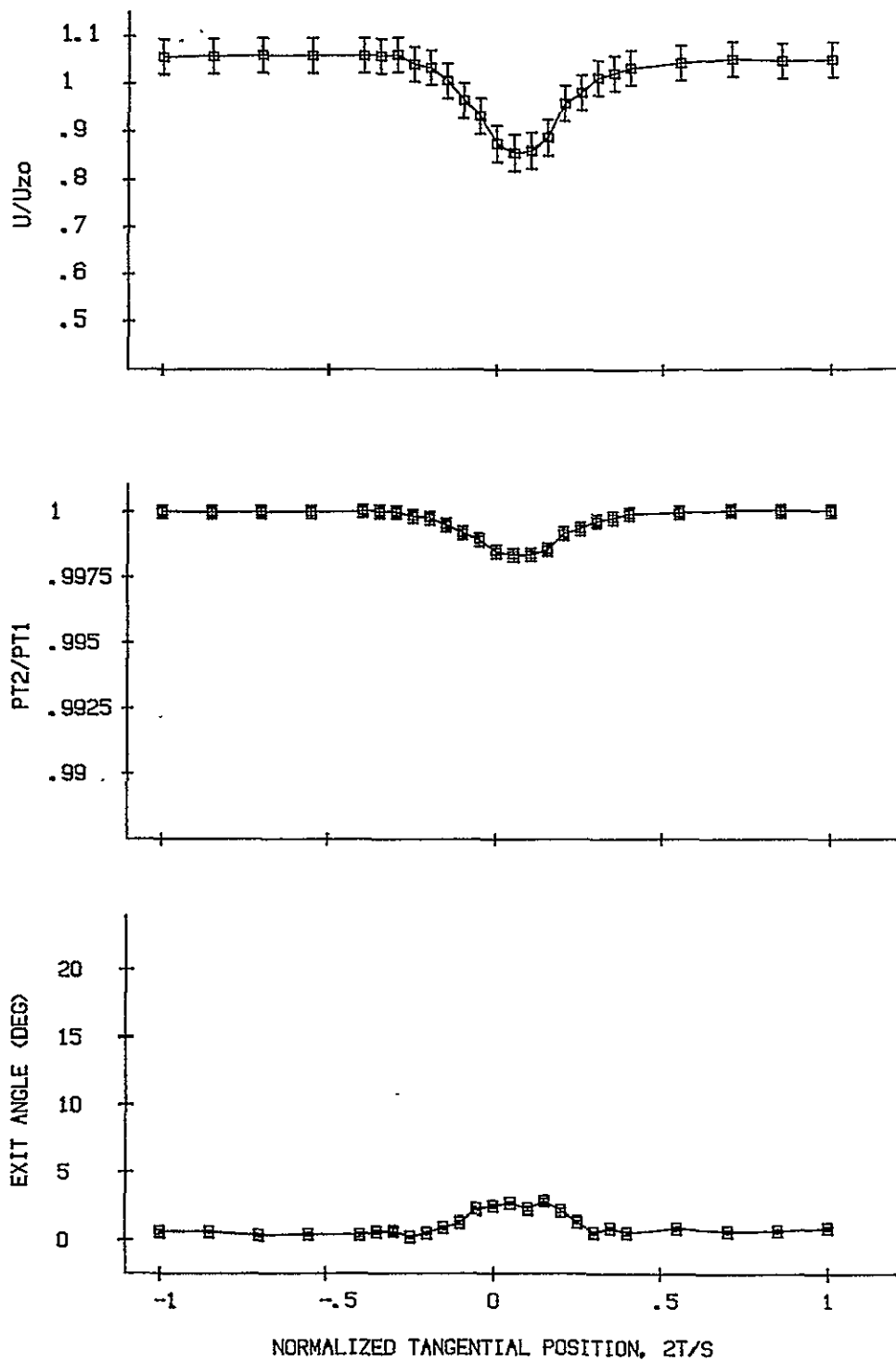

Figure I8. FIVE-HOLE PROBE WAKE DATA, INCIDENCE ANGLE (DEG) = 0,
 $Z_c/C = .94$, $R = 16.7\%$

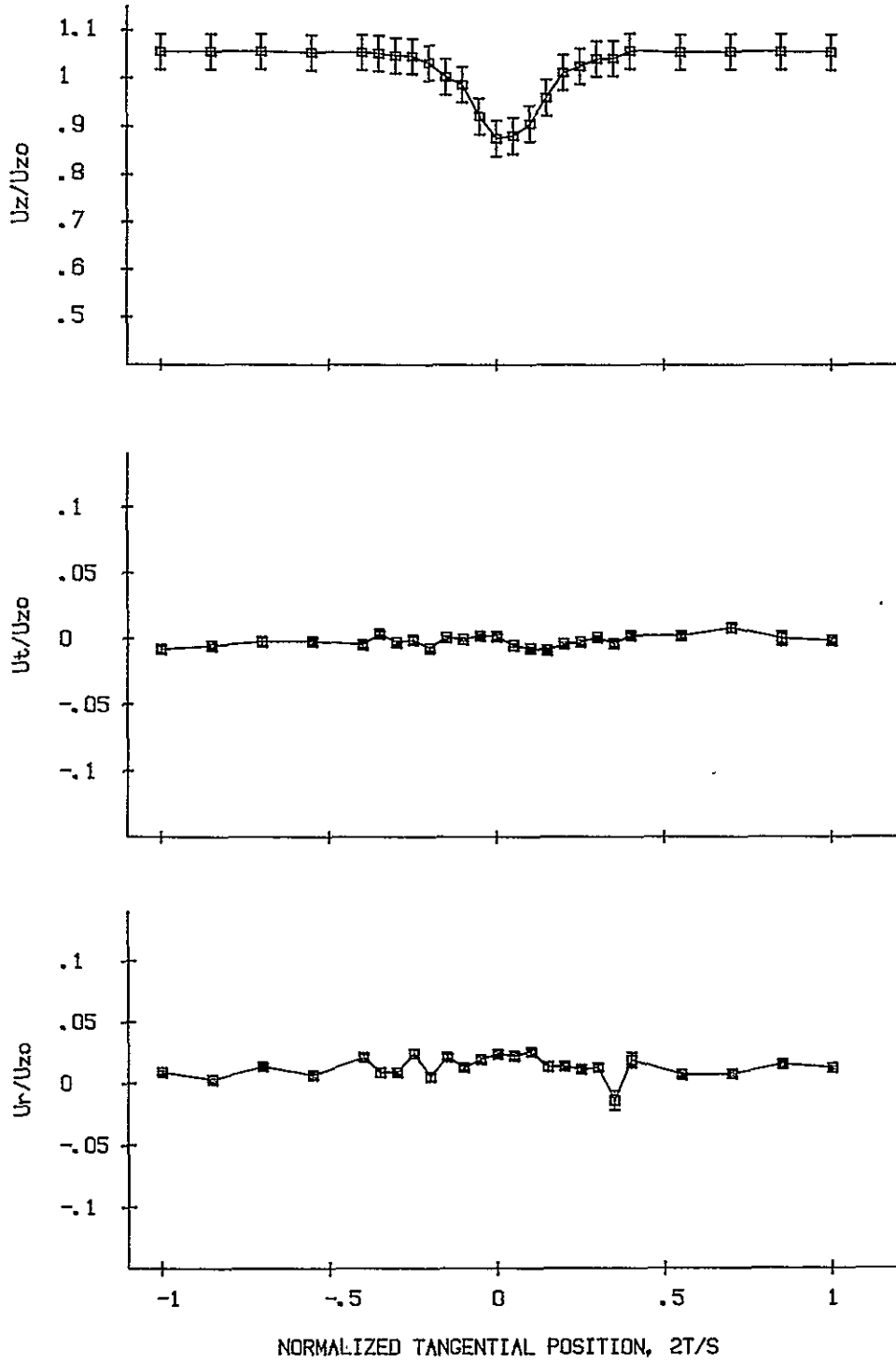

Figure I9. FIVE-HOLE PROBE VELOCITY DATA, INCIDENCE ANGLE (DEG) = 0,
 $Z_c/C = .94$, $R = 25\%$

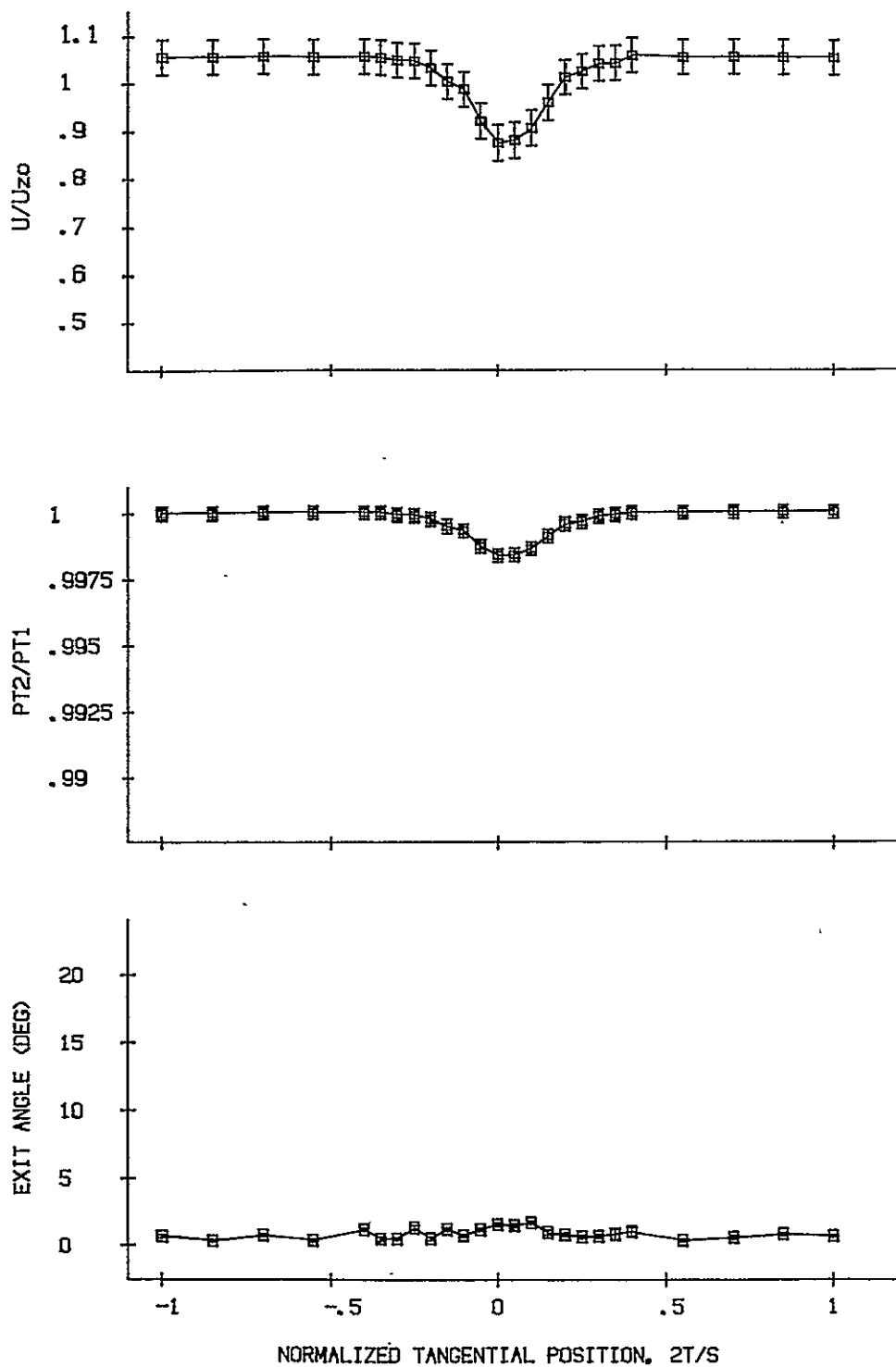

Figure I10. FIVE-HOLE PROBE WAKE DATA, INCIDENCE ANGLE (DEG) = 0,
 $Z_c/C = .94$, $R = 25\%$

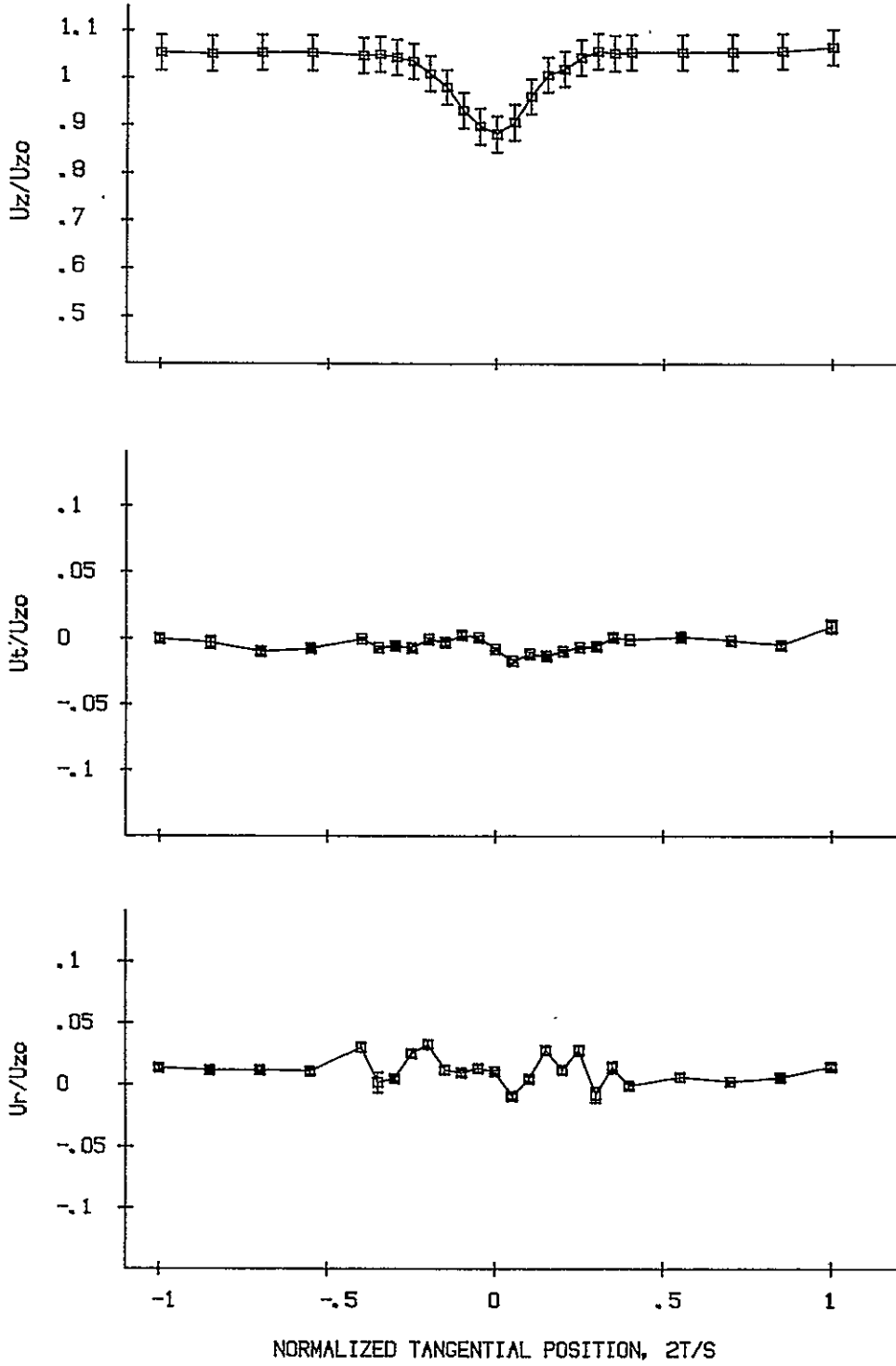

Figure III. FIVE-HOLE PROBE VELOCITY DATA, INCIDENCE ANGLE (DEG) = 0,
 $Z_c/C = .94$, $R = 33.3\%$

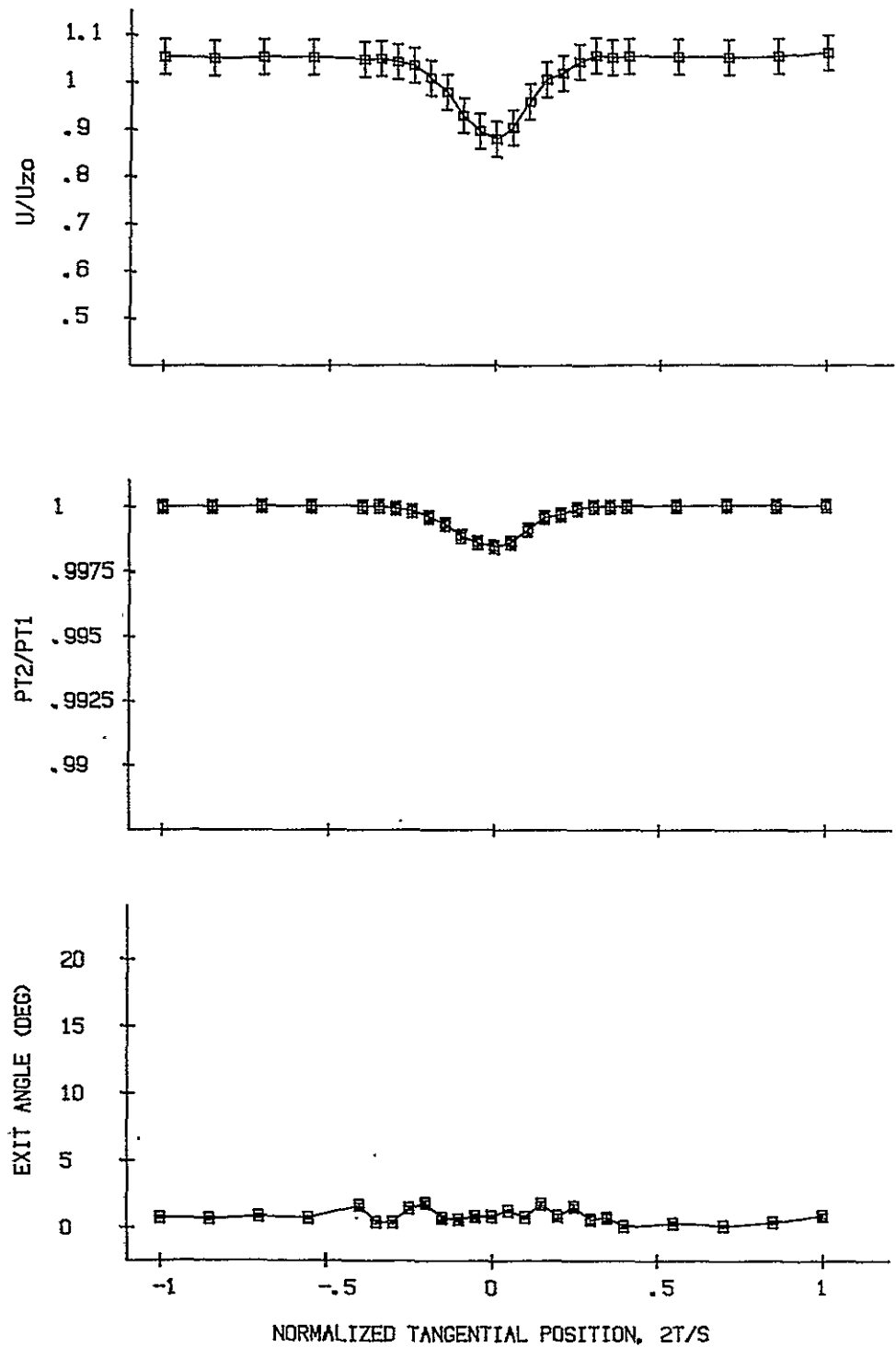

Figure I12. FIVE-HOLE PROBE WAKE DATA, INCIDENCE ANGLE (DEG) = 0,
 $Z_c/C = .94$, $R = 33.3\%$

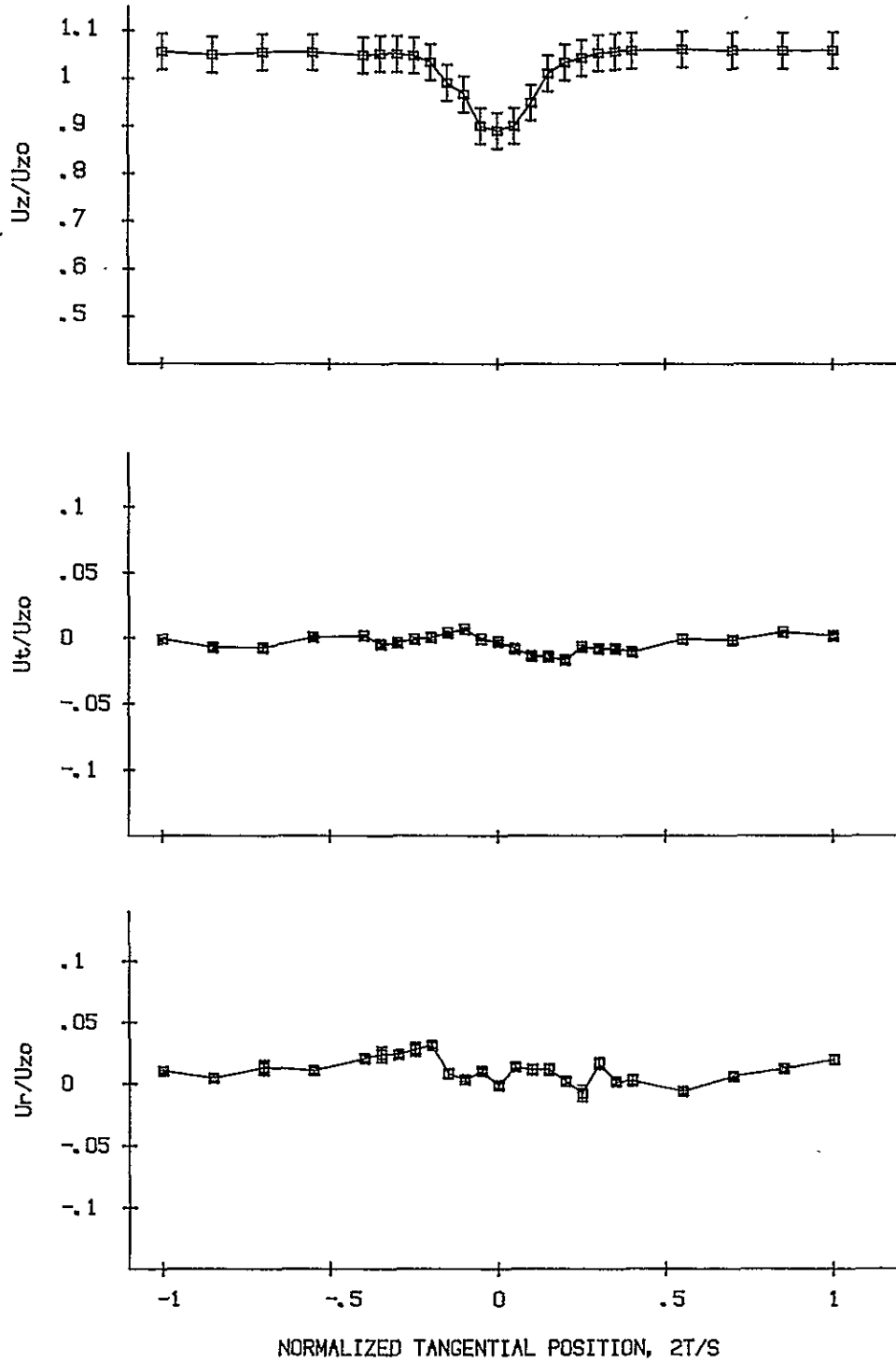

Figure I13. FIVE-HOLE PROBE VELOCITY DATA, INCIDENCE ANGLE (DEG) = 0,
 $Z_c/C = .94$, $R = 50\%$

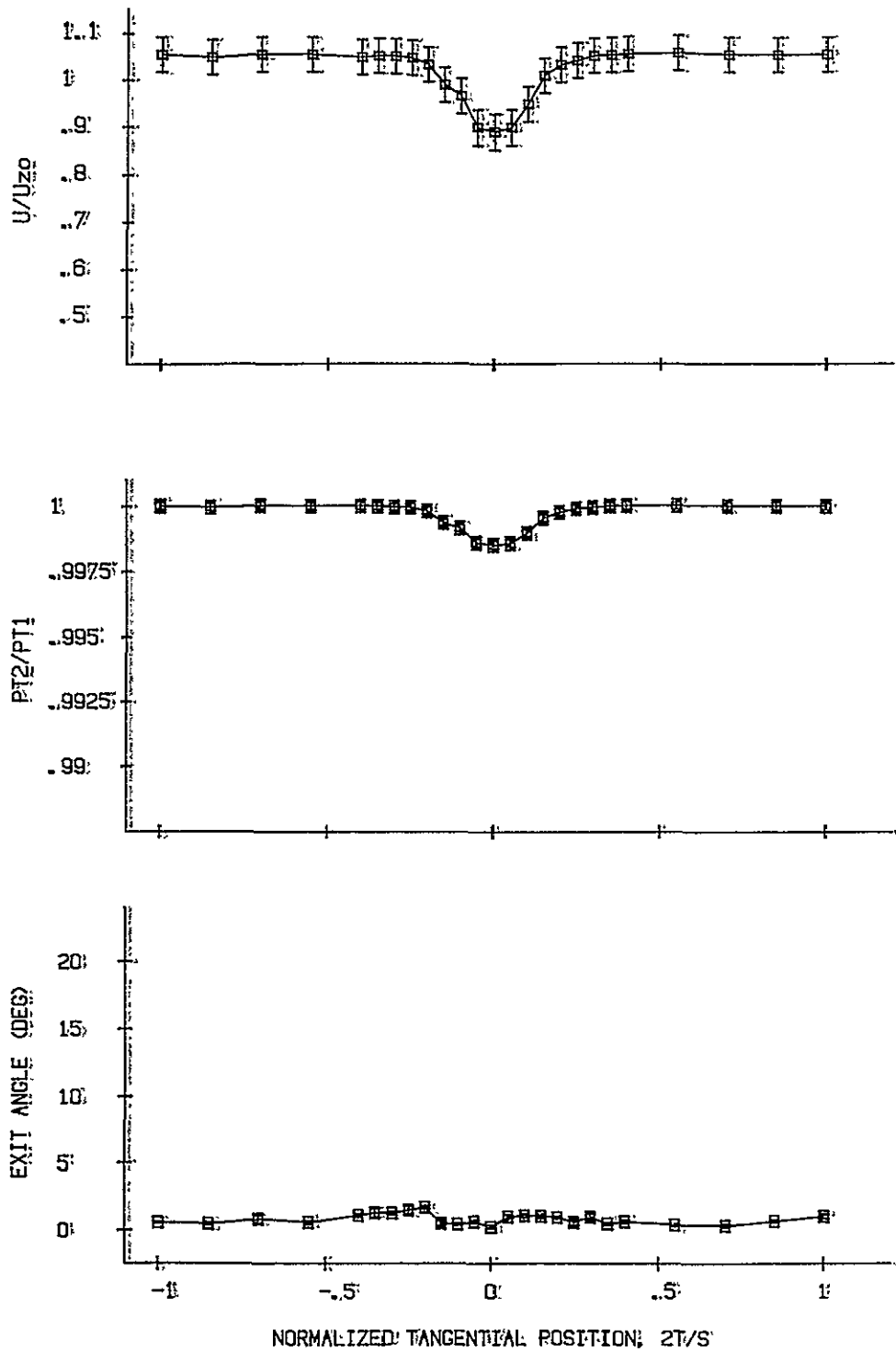

Figure B14. FIVE-HOLE PROBE WAKE DATA, INCIDENCE ANGLE (DEG) = 0,
 $Z_c/C = .94$, $R = 50\%$

ORIGINAL PAGE IS
OF POOR QUALITY

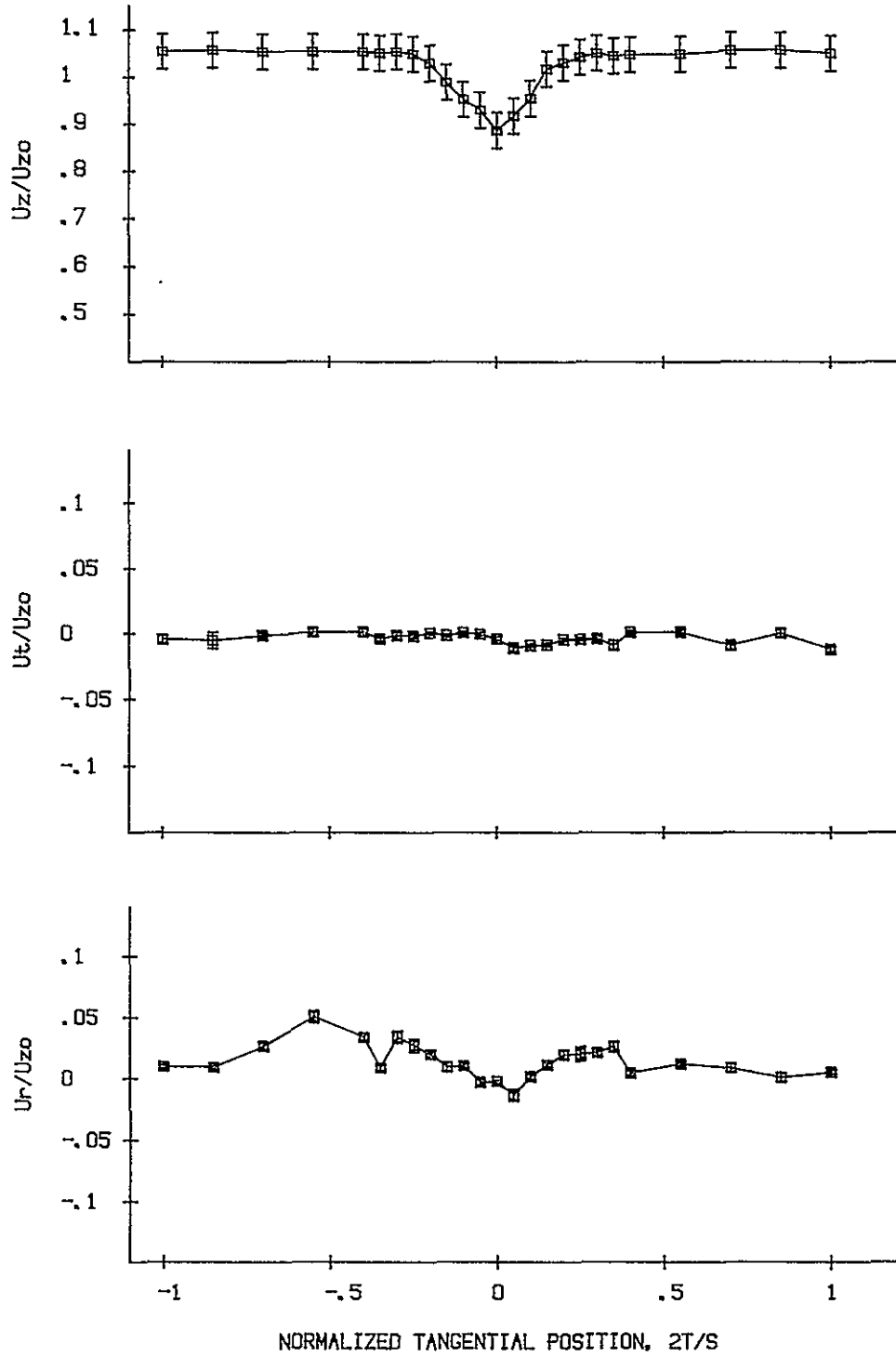

Figure I15. FIVE-HOLE PROBE VELOCITY DATA, INCIDENCE ANGLE (DEG) = 0,
 $Z_c/C = .94$, $R = 66.7\%$

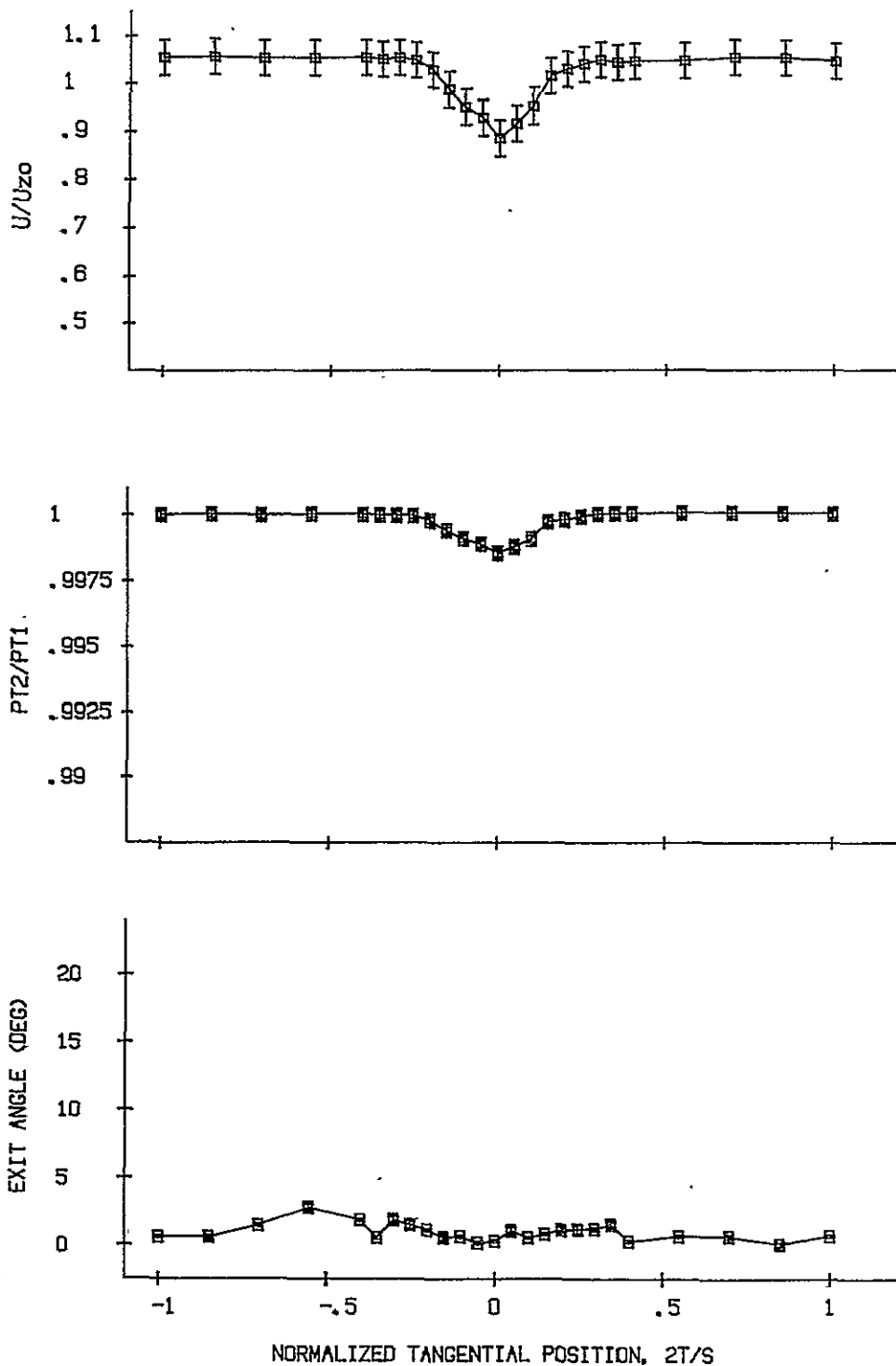

Figure II6. FIVE-HOLE PROBE WAKE DATA, INCIDENCE ANGLE (DEG) = 0,
 $Z_c/C = .94$, $R = 66.7\%$

ORIGINAL PAGE IS
OF POOR QUALITY

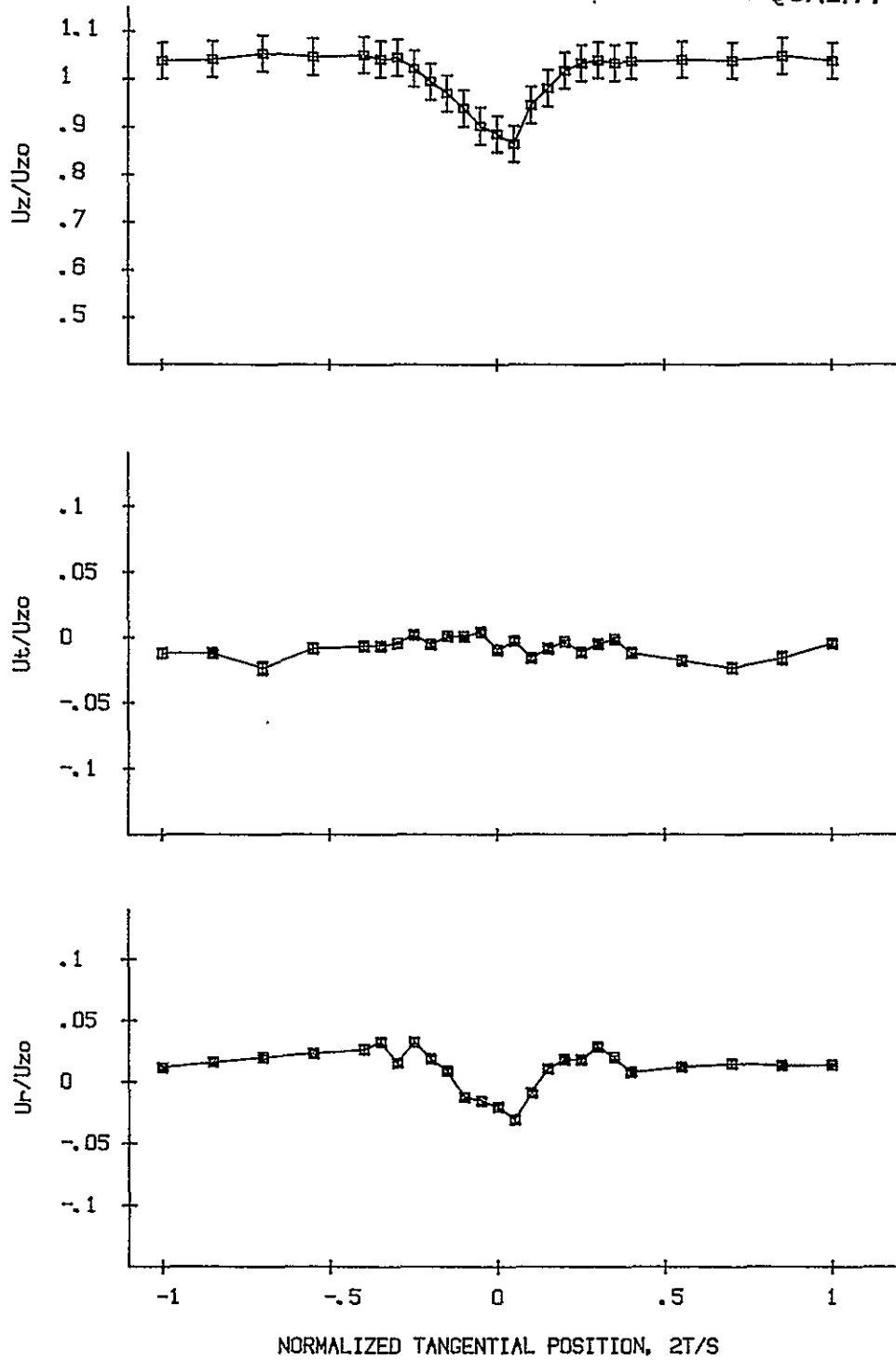

Figure I17: FIVE-HOLE PROBE VELOCITY DATA, INCIDENCE ANGLE (DEG) = 0,
 $Z_c/C = .94$, $R = 83.3\%$

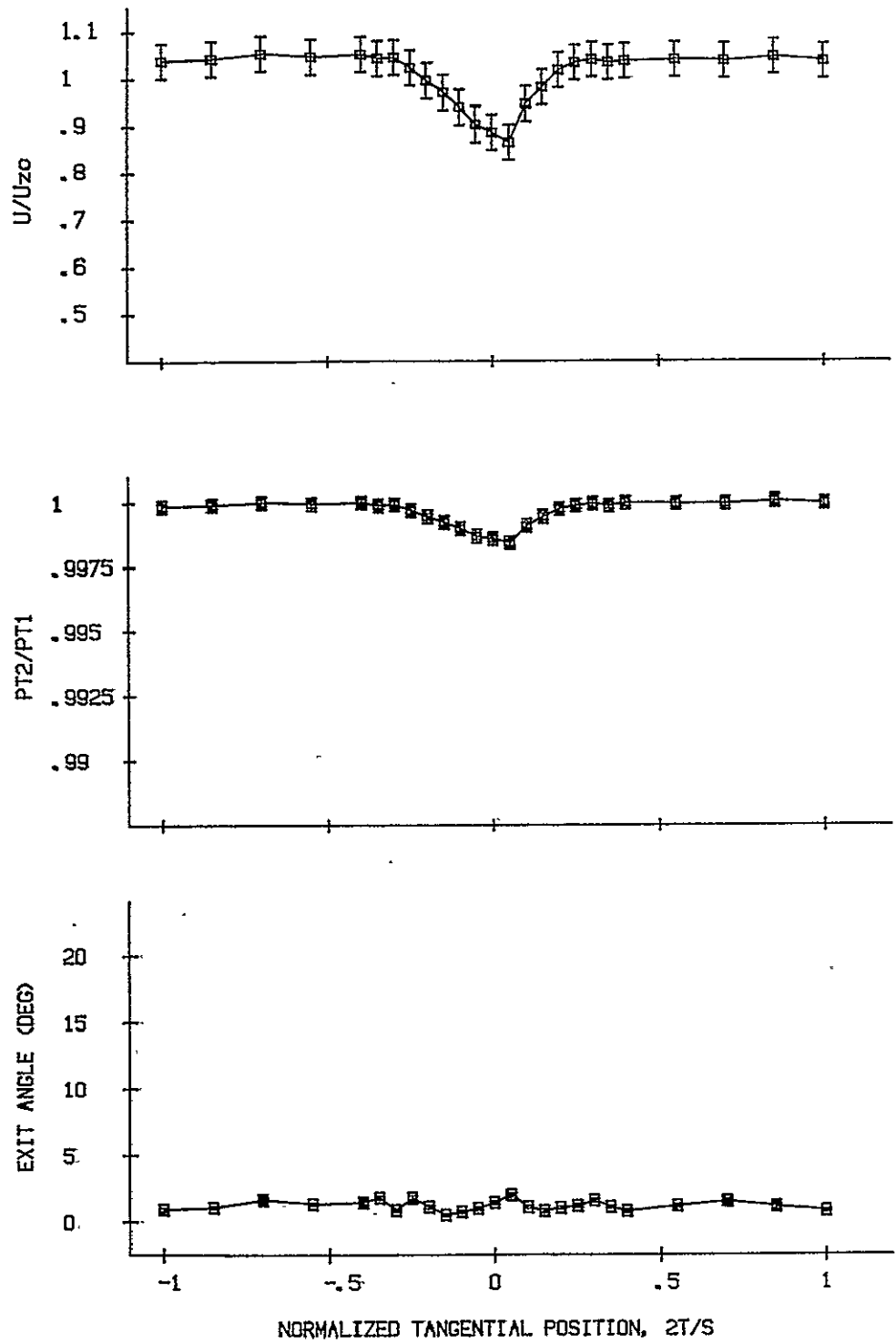

Figure I18.

FIVE-HOLE PROBE WAKE DATA, INCIDENCE ANGLE (DEG) = 0,
 $Z_c/C = .94$, $R = 83.3\%$

ORIGINAL PAGE IS
OF POOR QUALITY

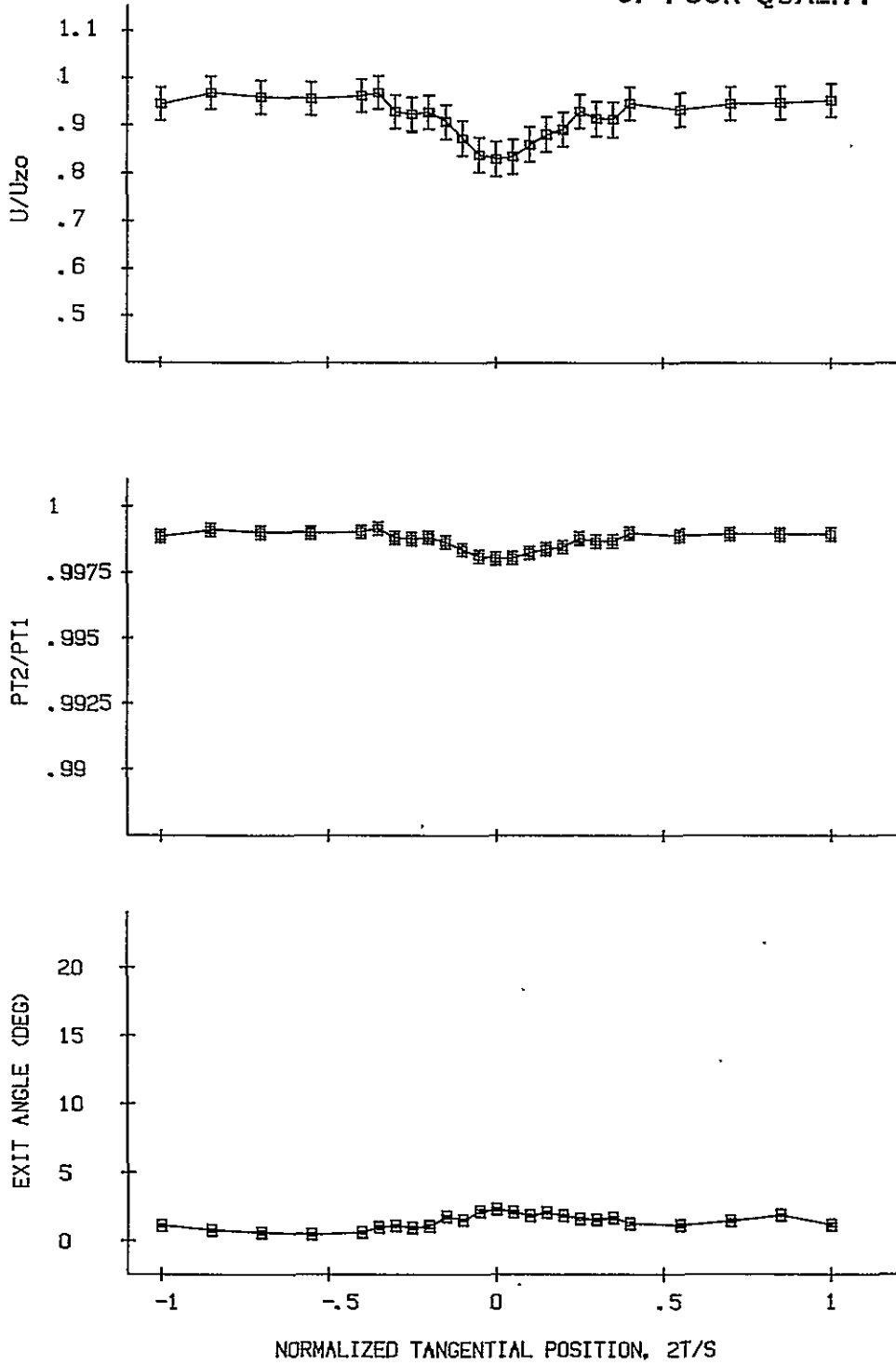

Figure I19. FIVE-HOLE PROBE WAKE DATA, INCIDENCE ANGLE (DEG) = 0,
 $Z_c/C = 2.06$, $R = 4.2\%$

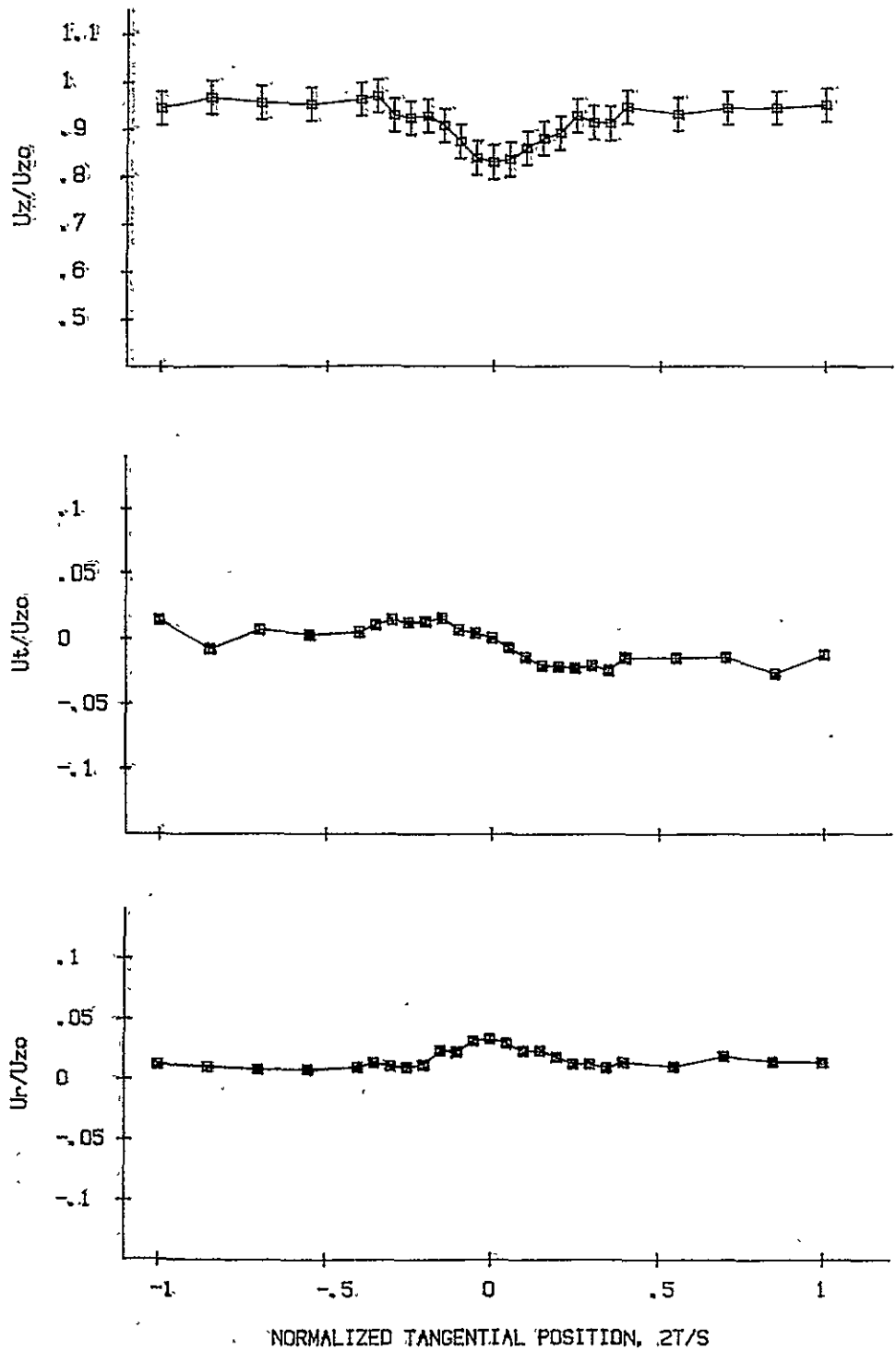

Figure I20. FIVE-HOLE PROBE VELOCITY DATA, INCIDENCE ANGLE (DEG) = 0,
 $Z_c/C = 2.06$, $R = 4.2\%$.

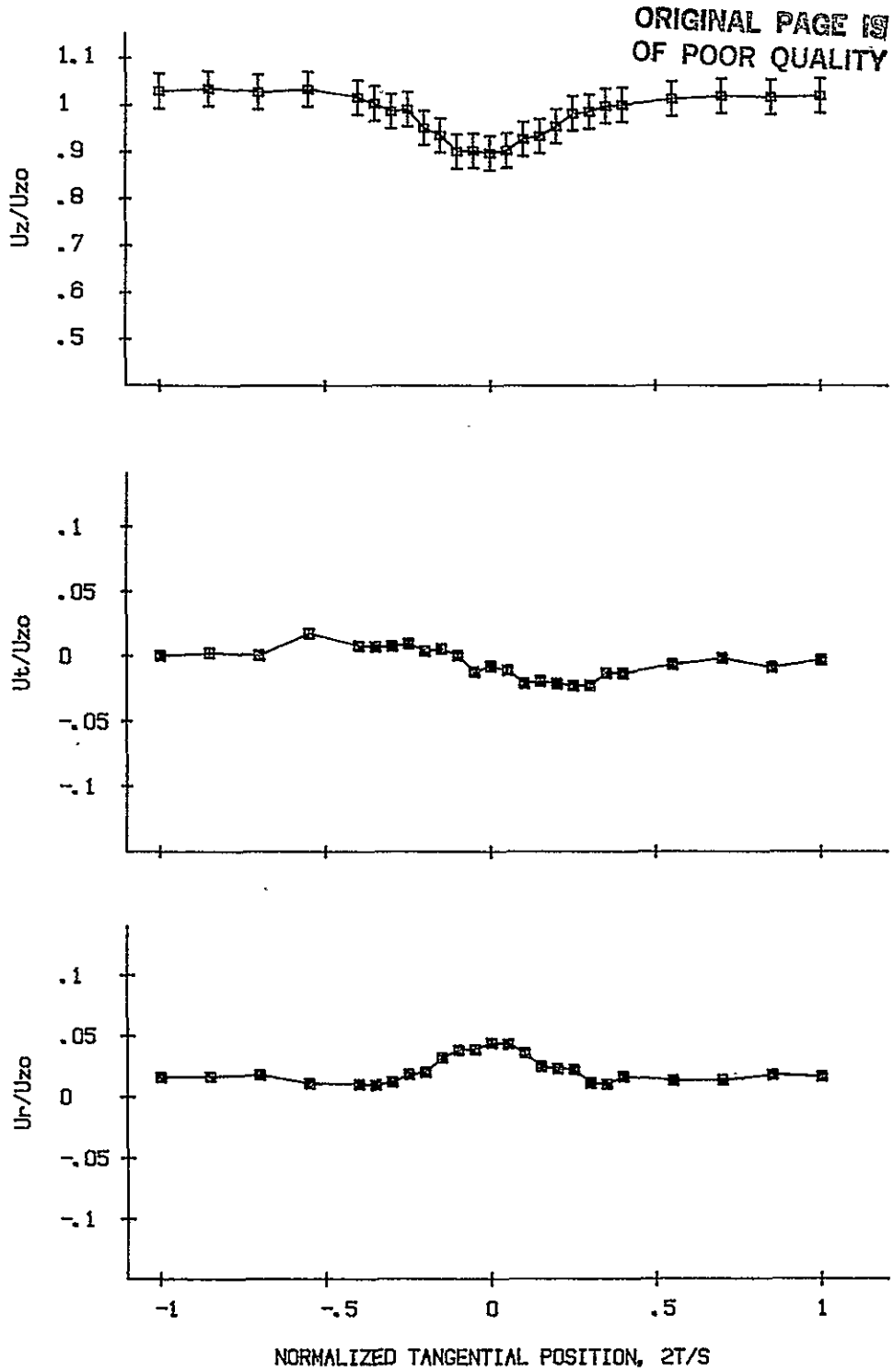

Figure I21. FIVE-HOLE PROBE VELOCITY DATA, INCIDENCE ANGLE (DEG) = 0,
 $Z_c/C = 2.06$, $R = 8.3\%$

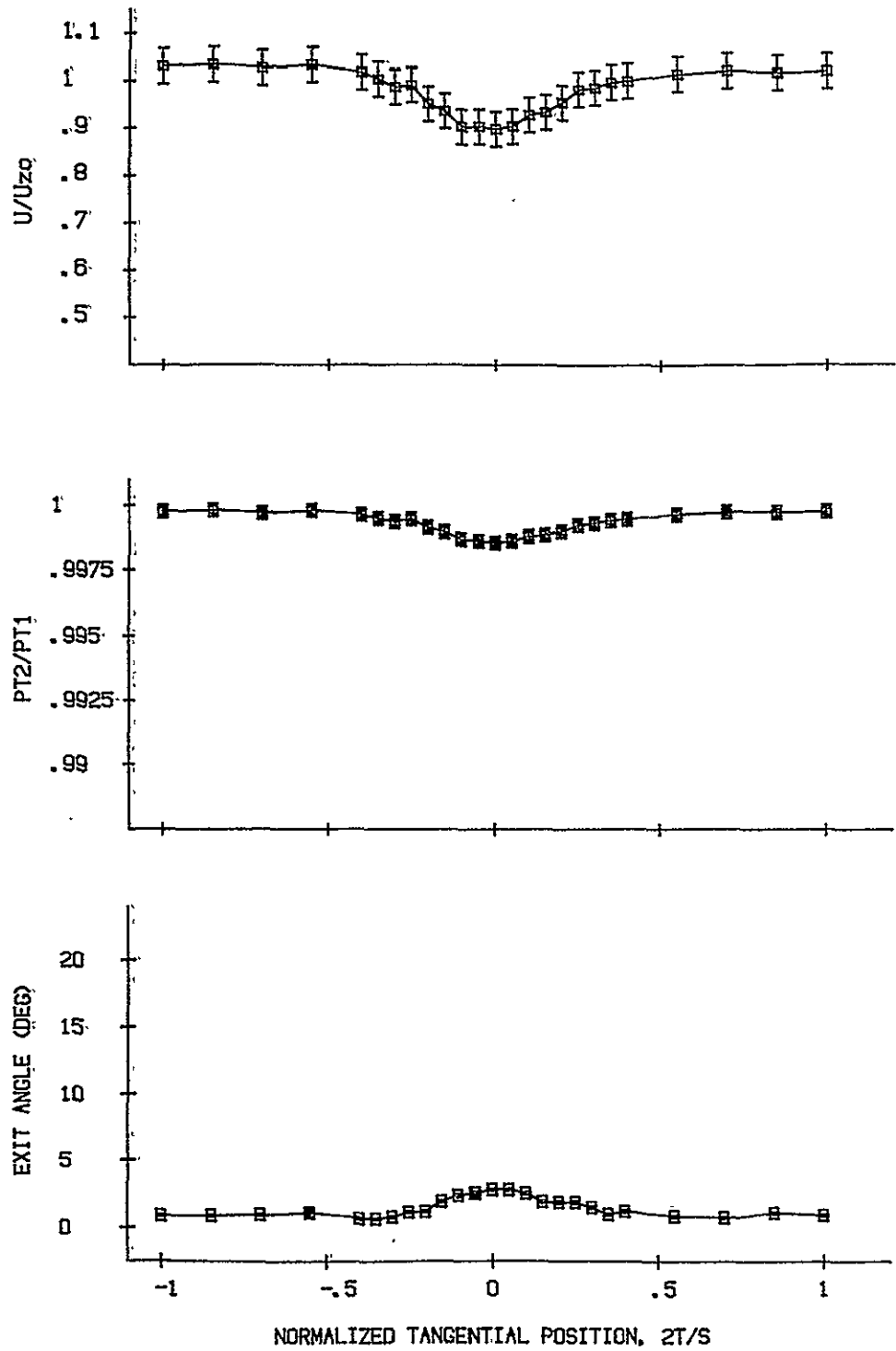

Figure I22.

FIVE-HOLE PROBE WAKE DATA, INCIDENCE ANGLE (DEG) = 0,
 $Z_c/C = 2.06$, $R = 8.3\%$

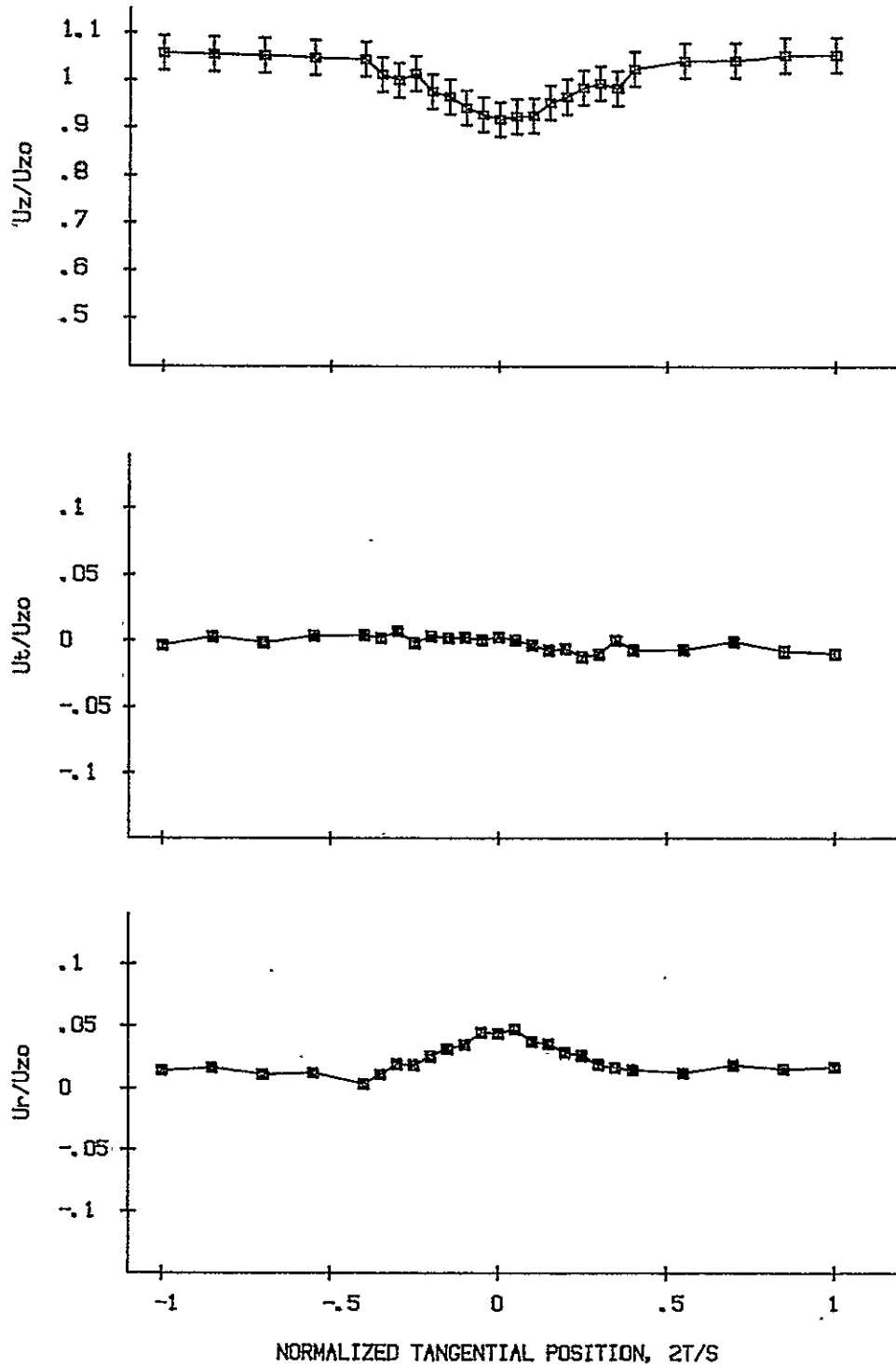

Figure I23. FIVE-HOLE PROBE VELOCITY DATA, INCIDENCE ANGLE (DEG) = 0,
 $Z_c/C = 2.06$, $R = 12.5\%$

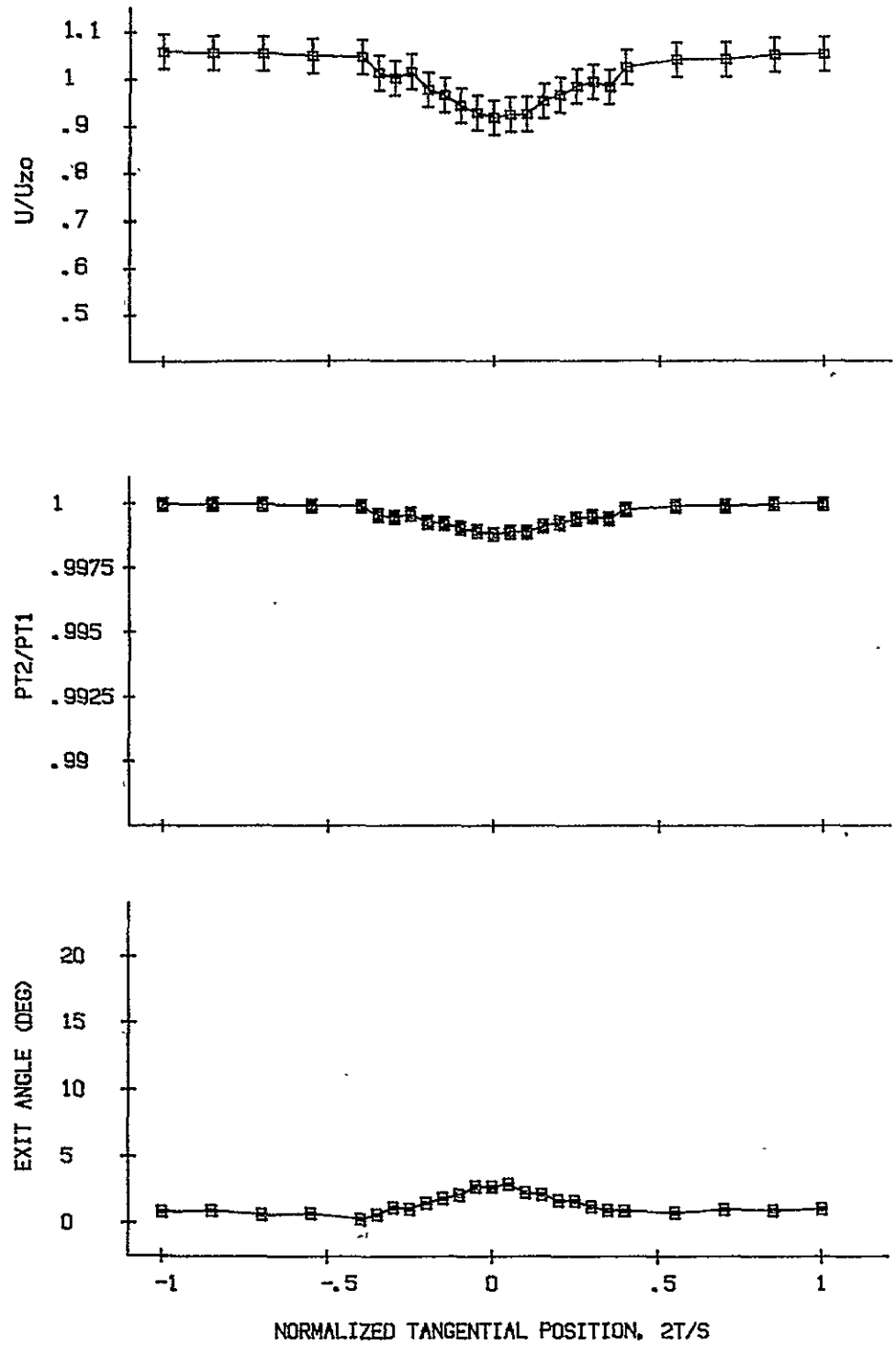

Figure I24. FIVE-HOLE PROBE WAKE DATA, INCIDENCE ANGLE (DEG) = 0,
 $Z_c/C = 2.06$, $R = 12.5\%$

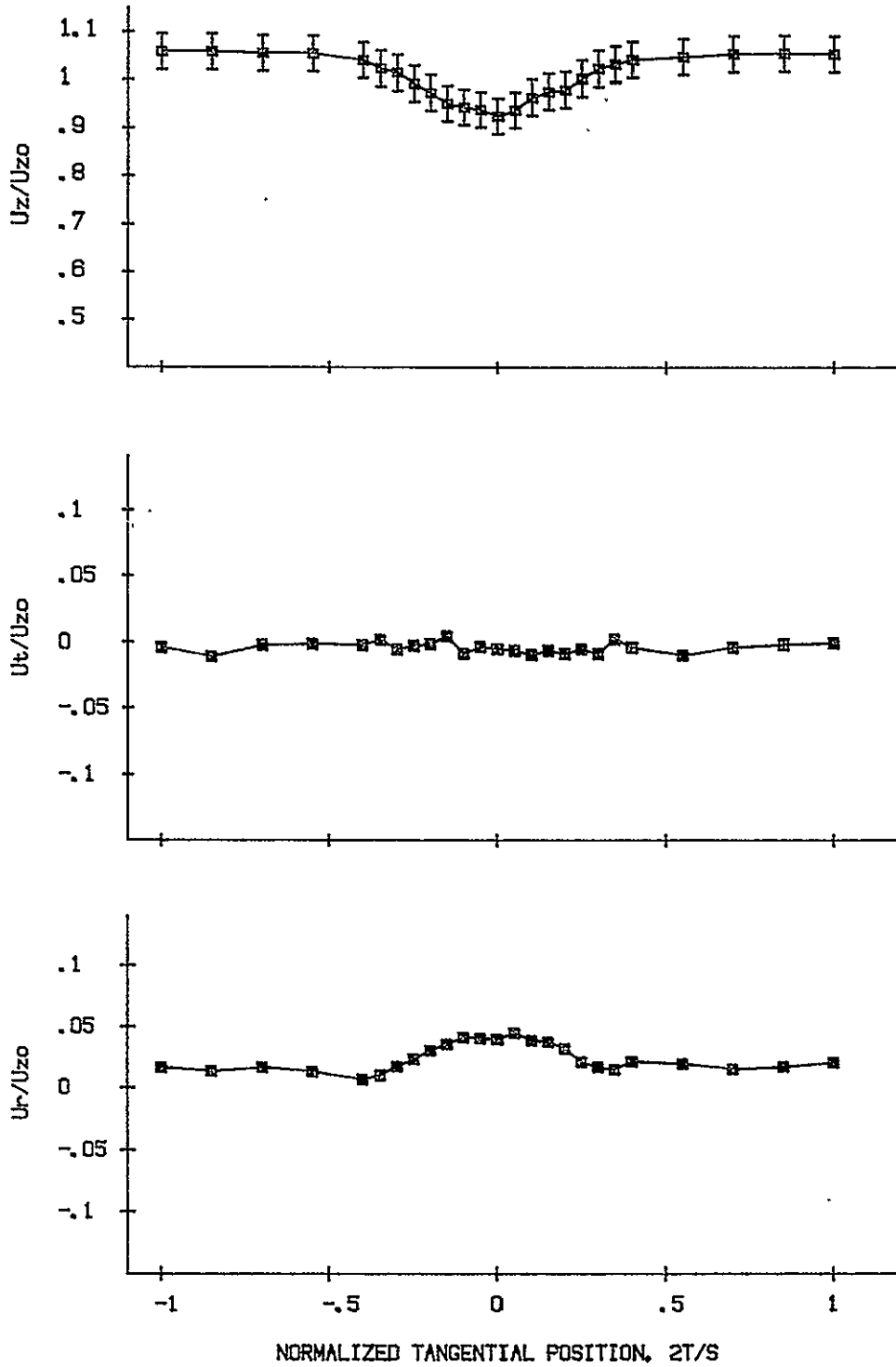

Figure I25. FIVE-HOLE PROBE VELOCITY DATA, INCIDENCE ANGLE (DEG) = 0,
 $Z_c/C = 2.06$, $R = 16.7\%$

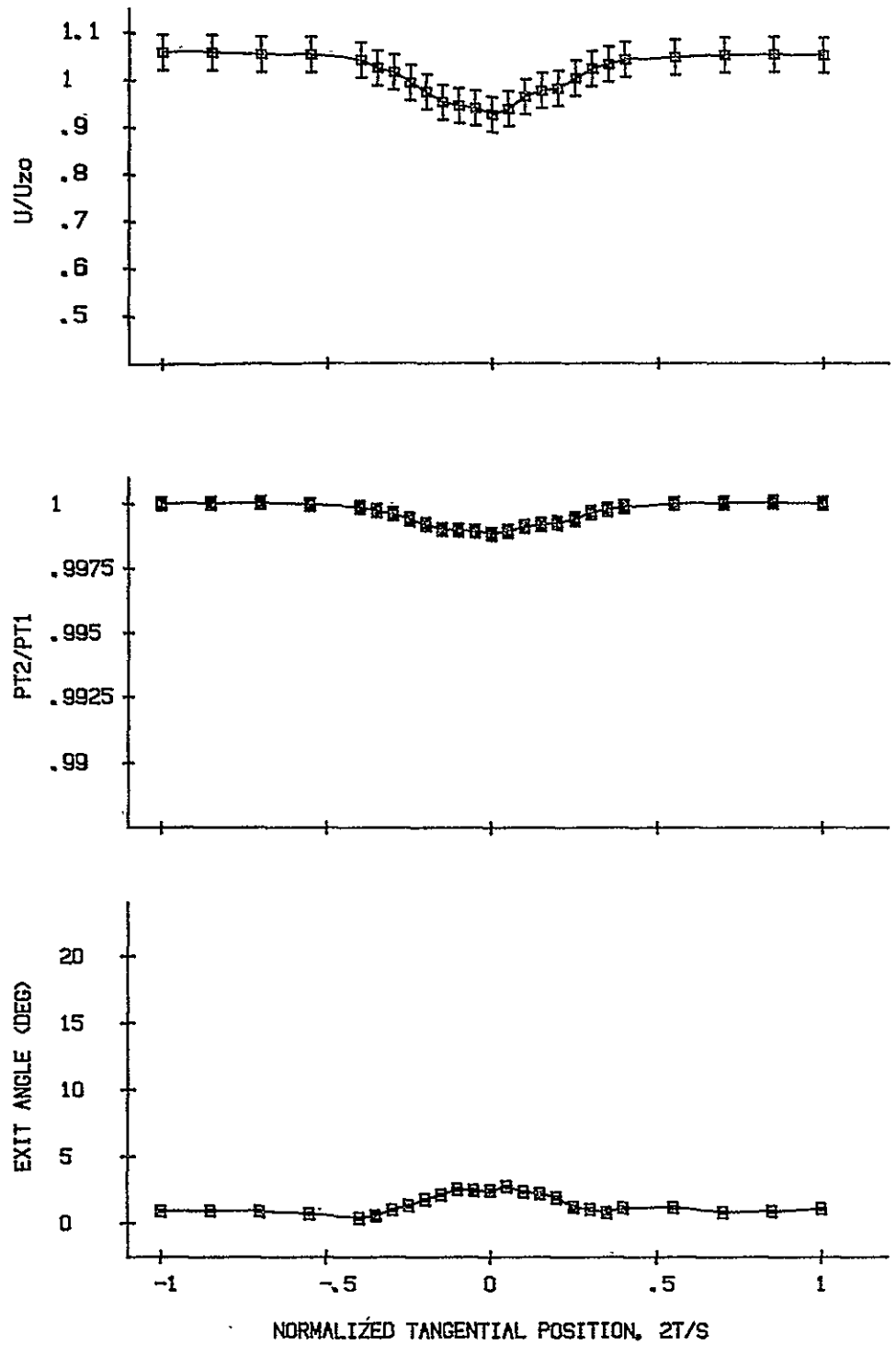

Figure I26. FIVE-HOLE PROBE WAKE DATA, INCIDENCE ANGLE (DEG) = 0, $Z_c/C = 2.06$, $R = 16.7\%$

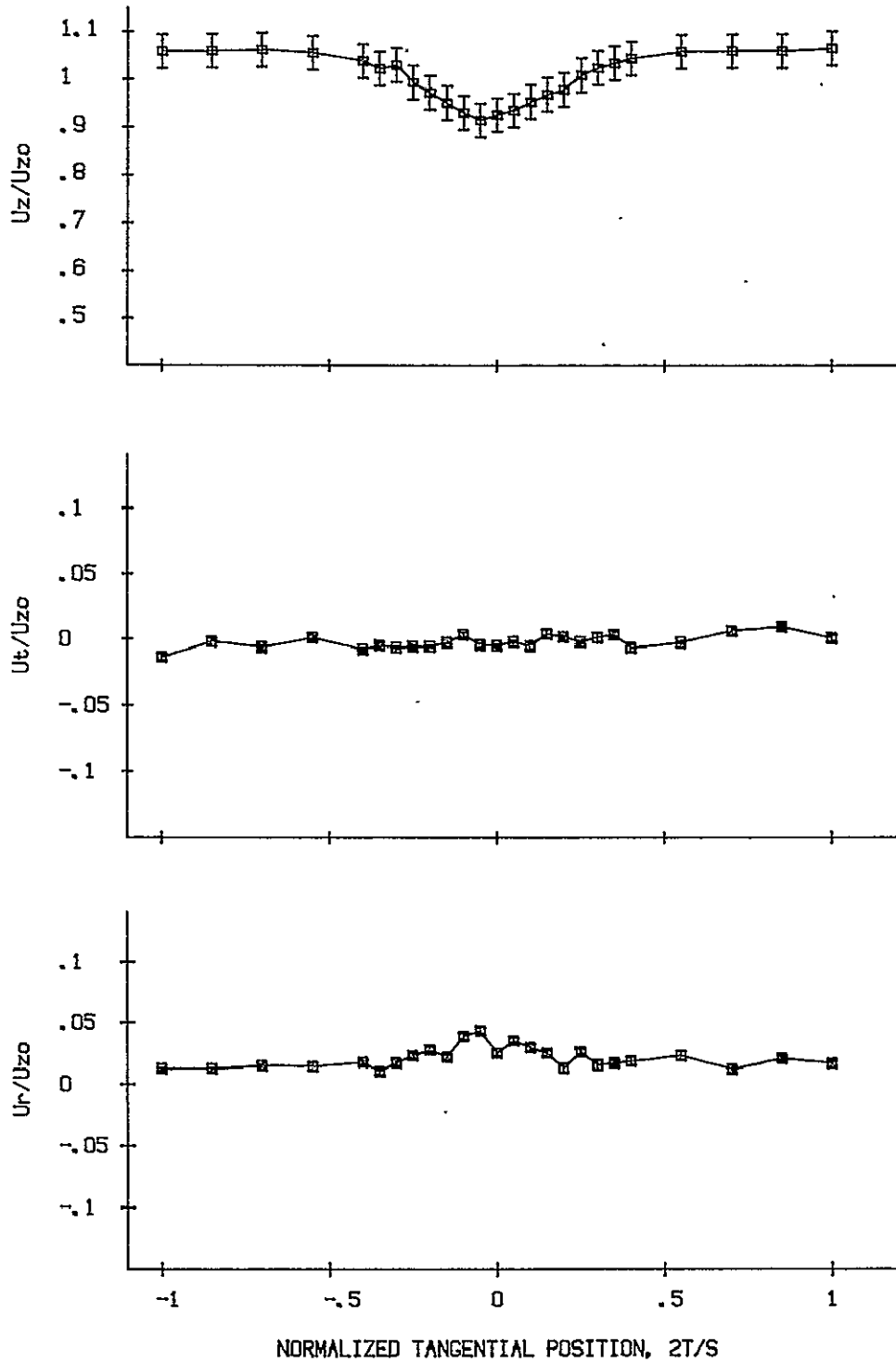

Figure I27. FIVE-HOLE PROBE VELOCITY DATA, INCIDENCE ANGLE (DEG) = 0,
 $Z_c/C = 2.06$, $R = 25\%$

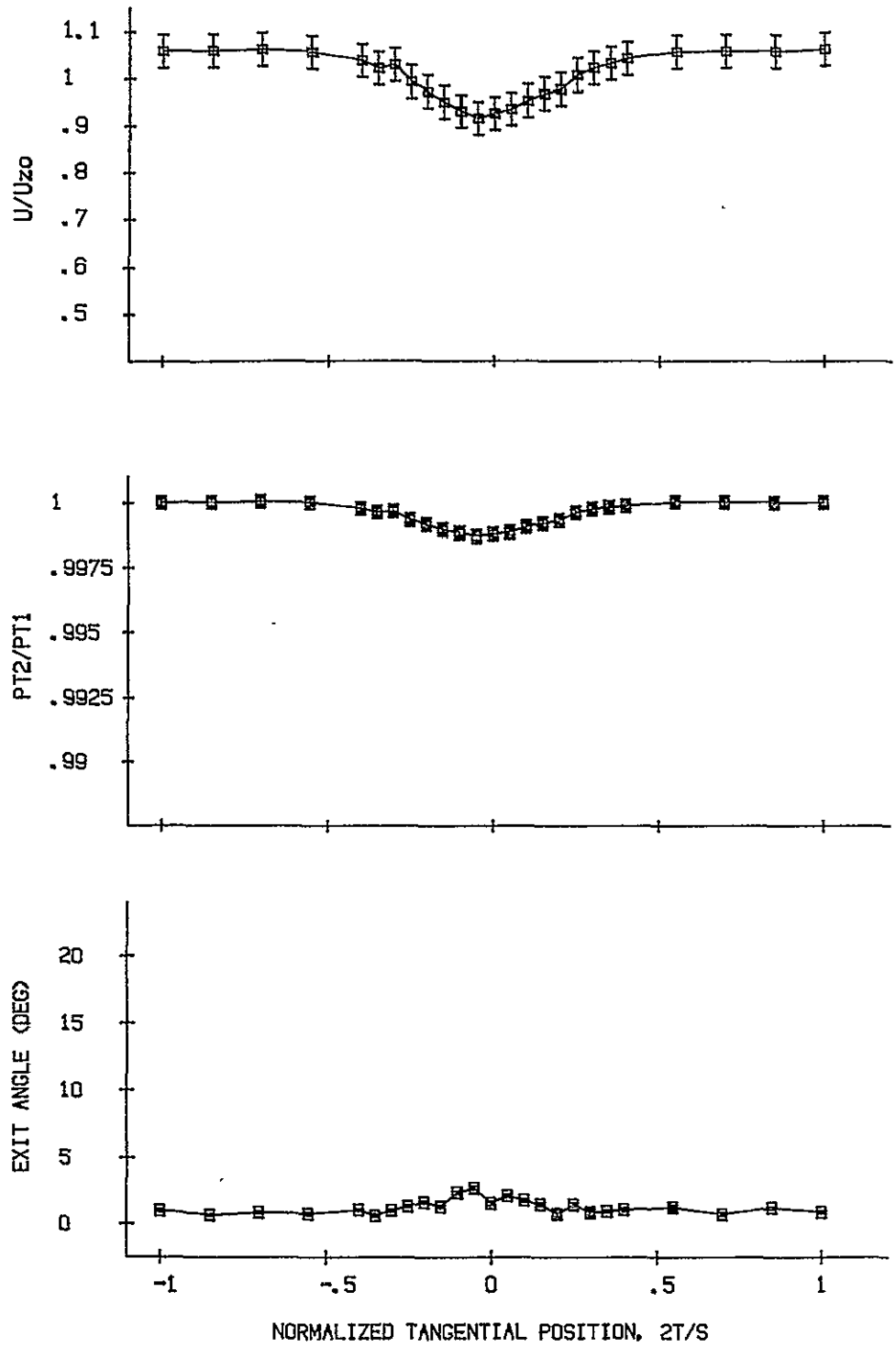

Figure I28.

FIVE-HOLE PROBE WAKE DATA, INCIDENCE ANGLE (DEG) = 0,
 $Z_c/C = 2.06$, $R = 25\%$

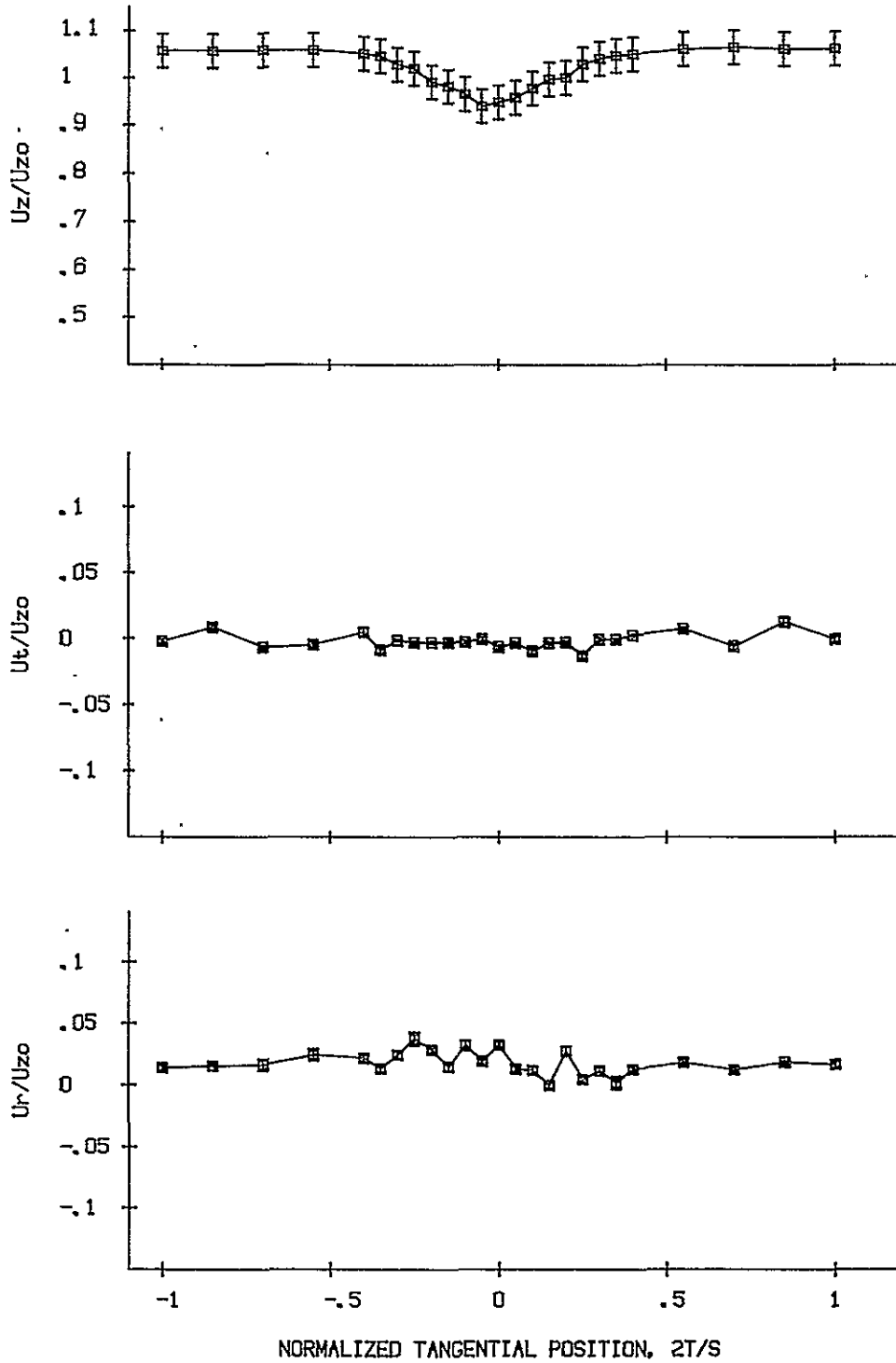

Figure I29. FIVE-HOLE PROBE VELOCITY DATA, INCIDENCE ANGLE (DEG) = 0,
 $Z_c/C = 2.06$, $R = 33.3\%$

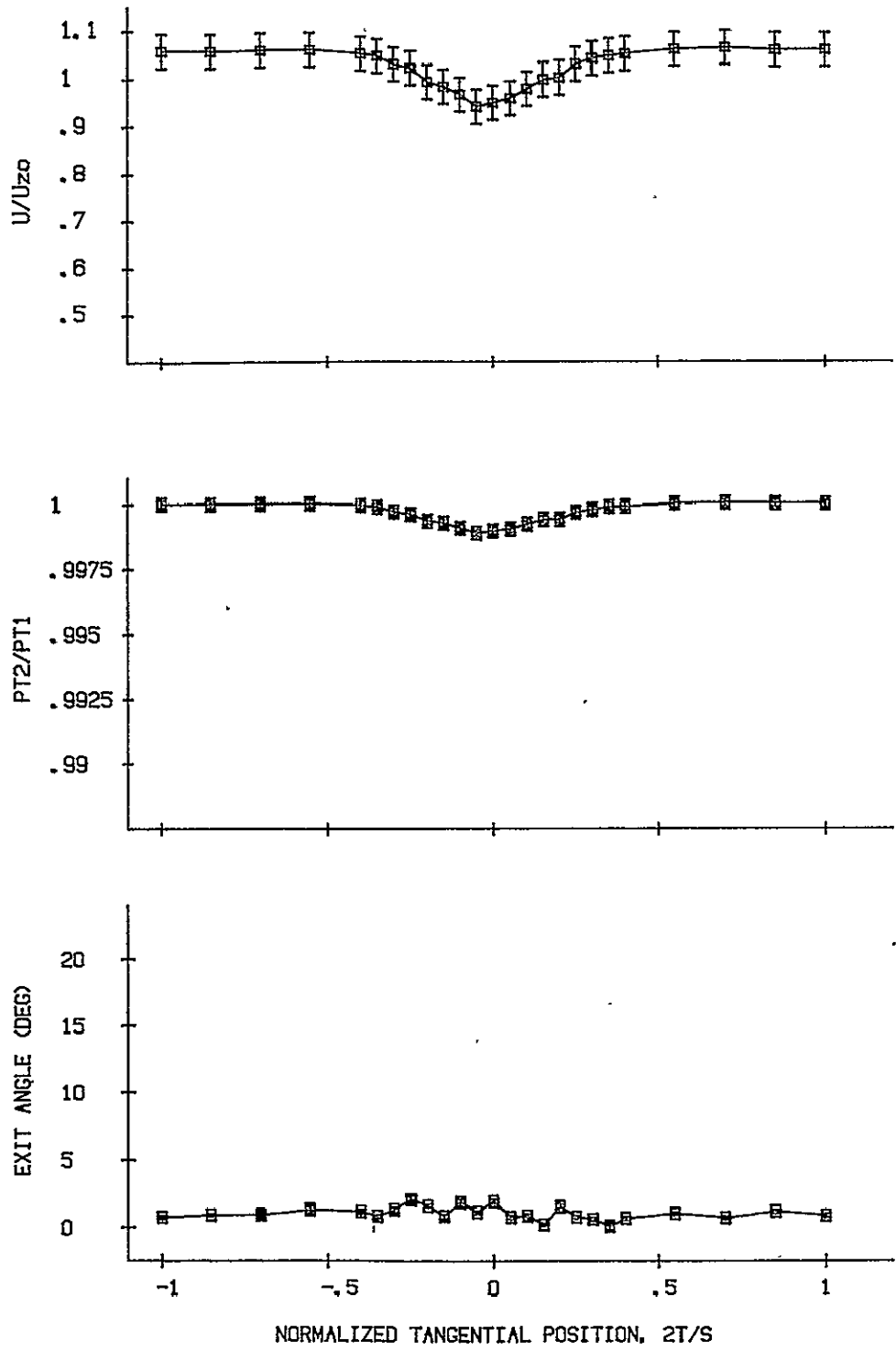

Figure I30: FIVE-HOLE PROBE WAKE DATA, INCIDENCE ANGLE (DEG) = 0,
 $Z_0/C = 2.06$, $R = 33.3\%$

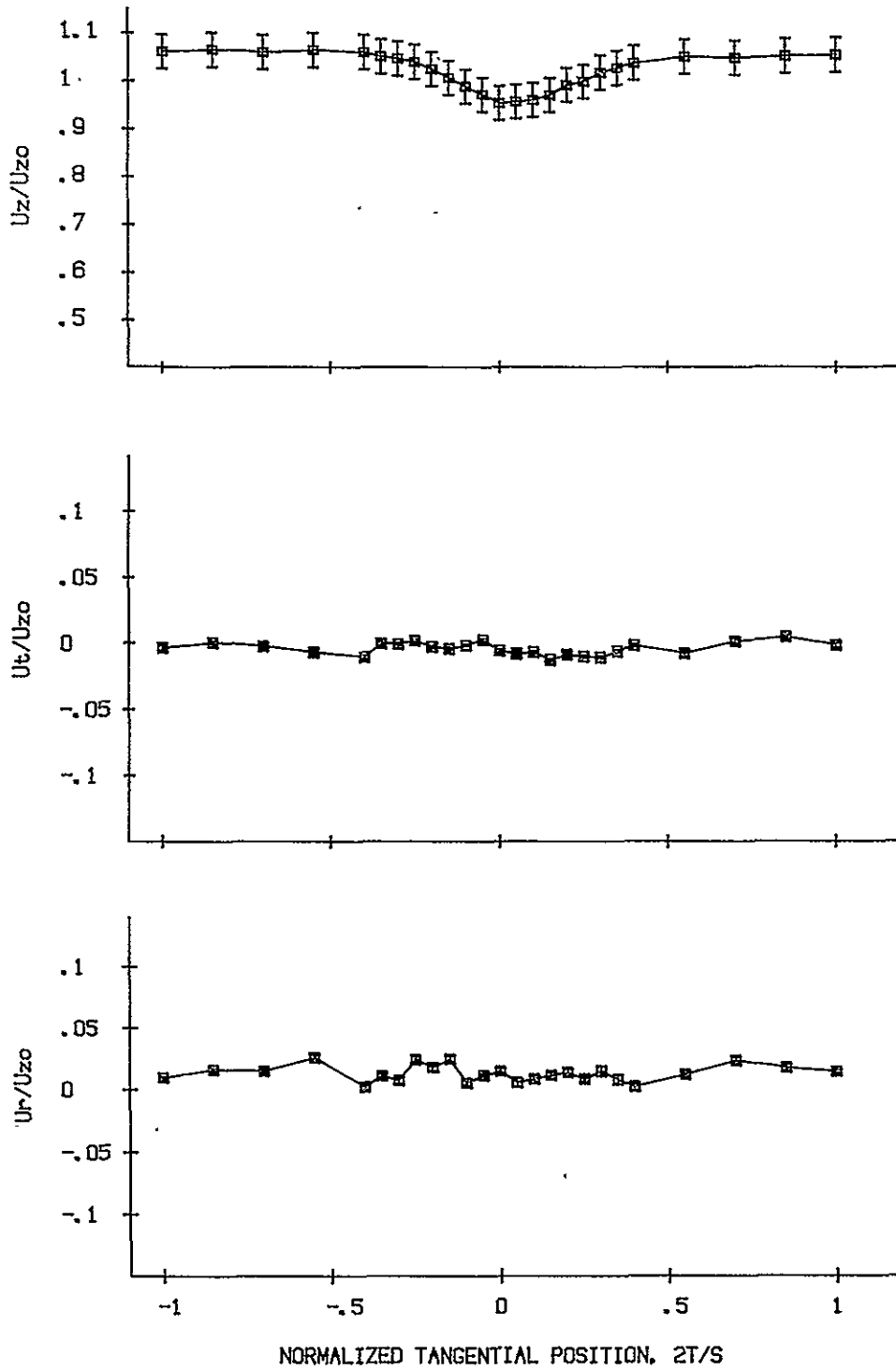

Figure I31. FIVE-HOLE PROBE VELOCITY DATA, INCIDENCE ANGLE (DEG) = 0,
 $Z_c/C = 2.06$, $R = 50\%$

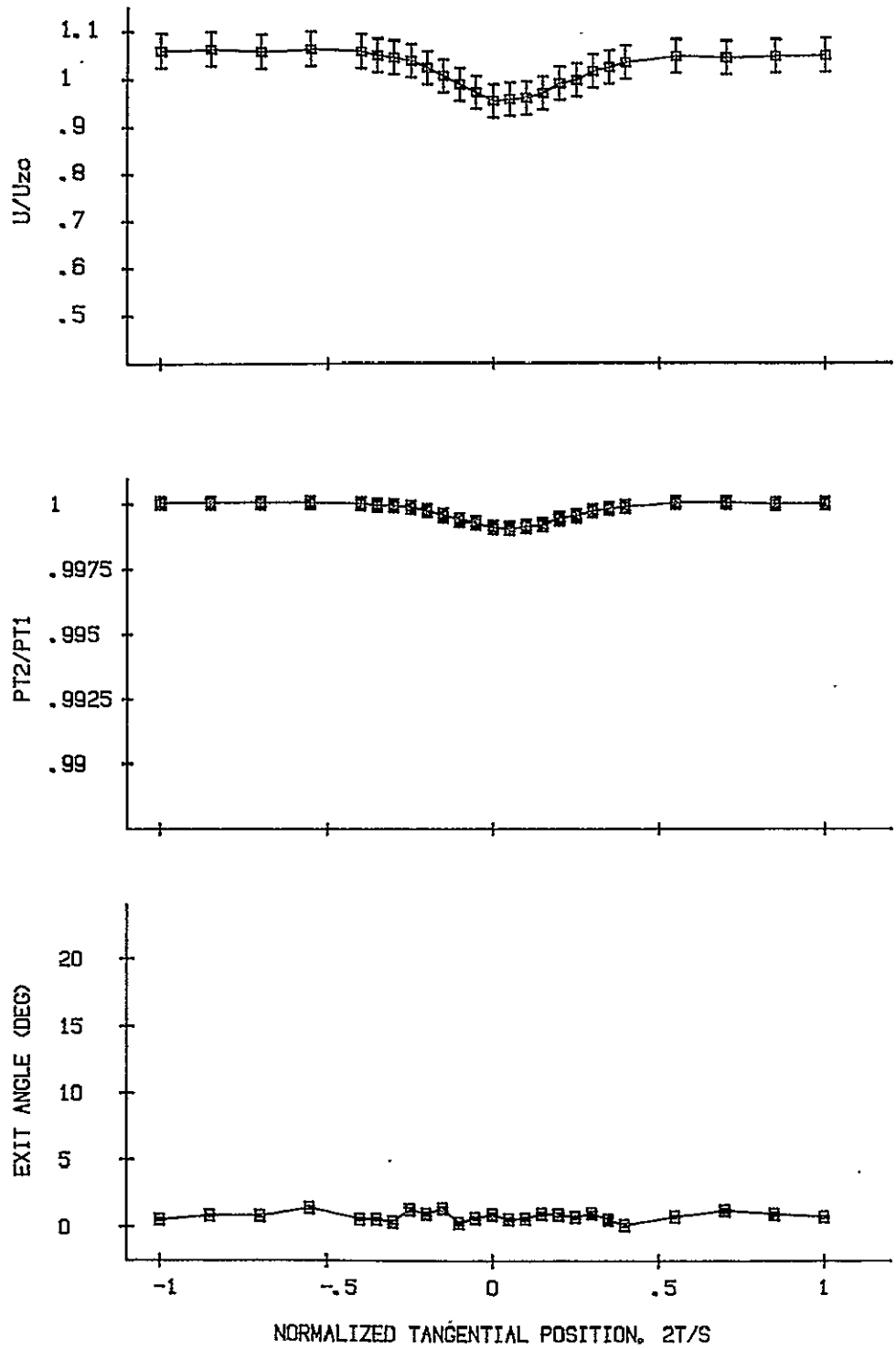

Figure I32. FIVE-HOLE PROBE WAKE DATA, INCIDENCE ANGLE (DEG) = 0,
 $Z_c/C = 2.06$, $R = 50\%$

ORIGINAL PAGE IS
OF POOR QUALITY

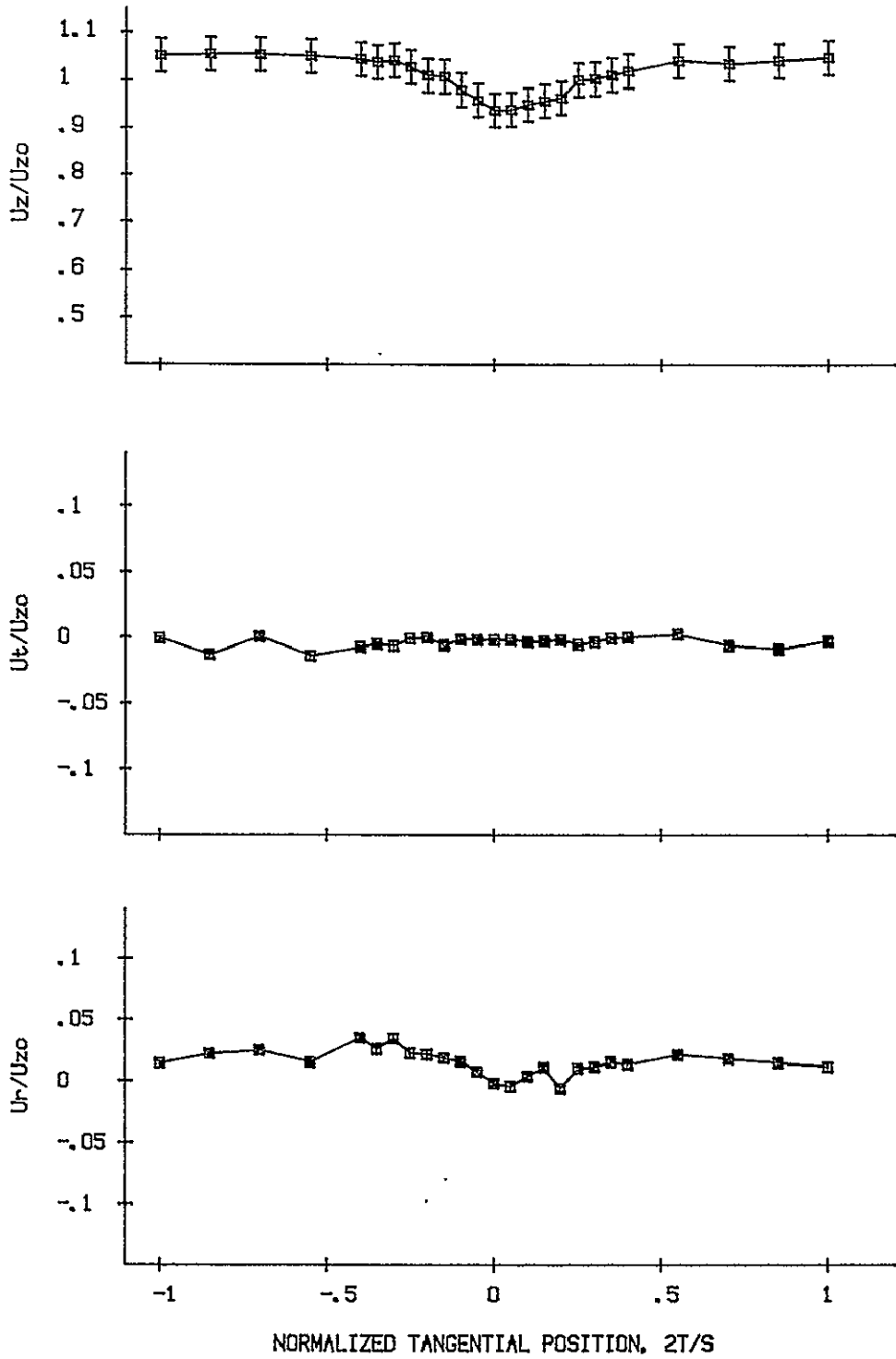

Figure I33. FIVE-HOLE PROBE VELOCITY DATA, INCIDENCE ANGLE (DEG) = 0,
 $Z_c/C = 2.06$, $R = 66.7\%$

ORIGINAL PAGE IS
OF POOR QUALITY

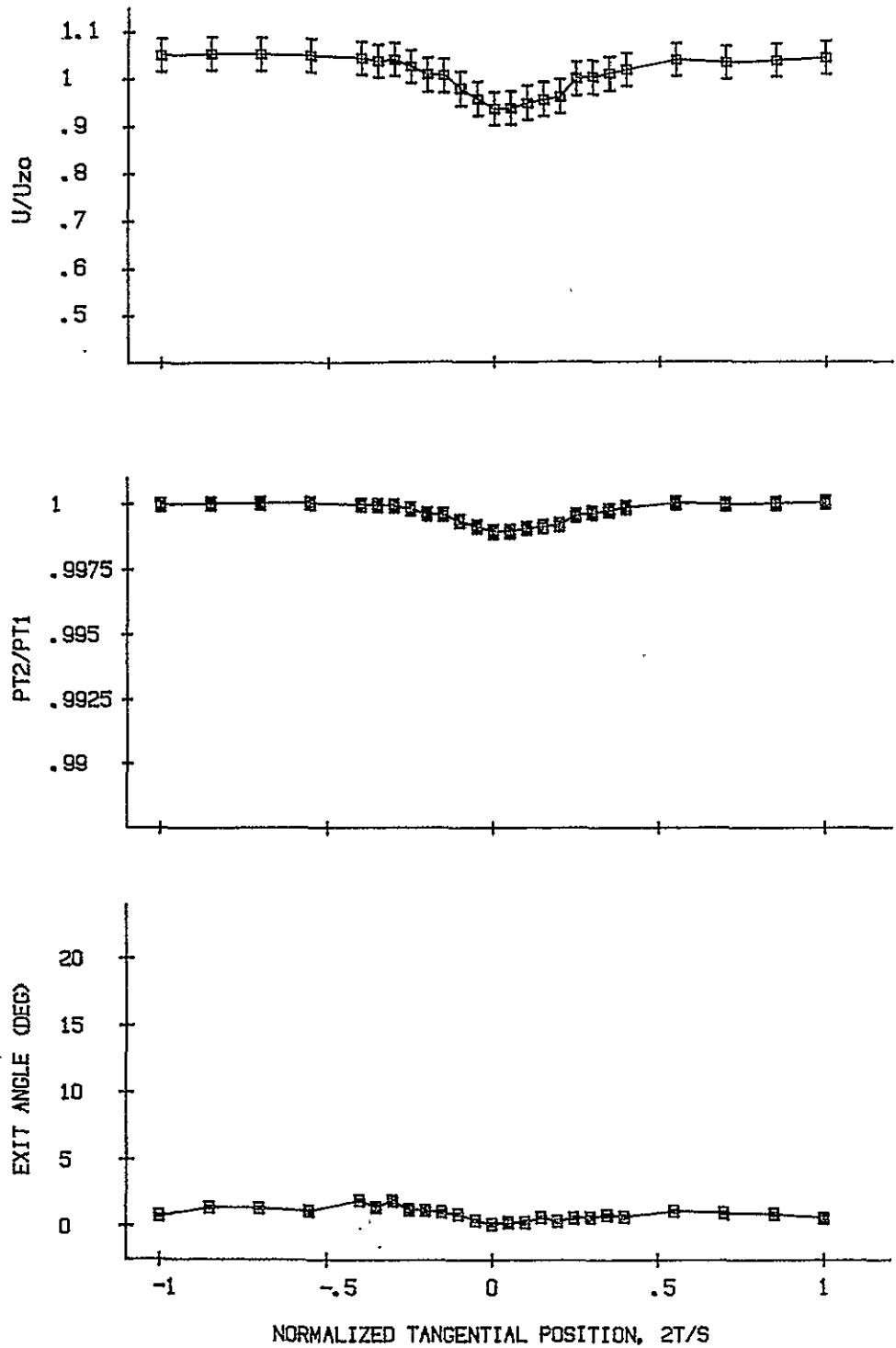

Figure I34. FIVE-HOLE PROBE WAKE DATA, INCIDENCE ANGLE (DEG) = 0,
 $Z_c/C = 2.08$, $R = 86.7\%$

ORIGINAL PAGE IS
OF POOR QUALITY

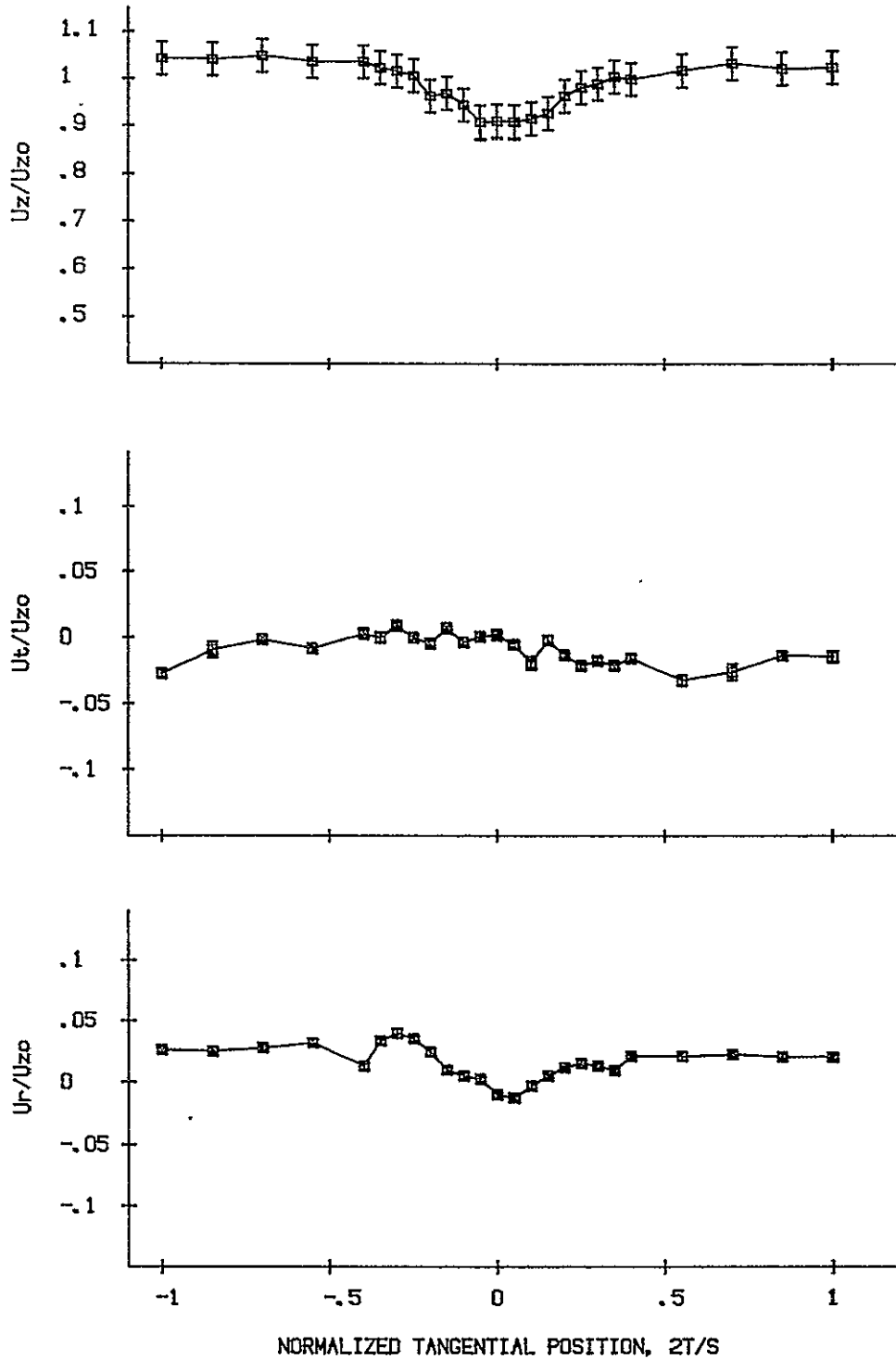

Figure I35. FIVE-HOLE PROBE VELOCITY DATA, INCIDENCE ANGLE (DEG) = 0,
 $Z_c/C = 2.06$, $R = 83.3\%$

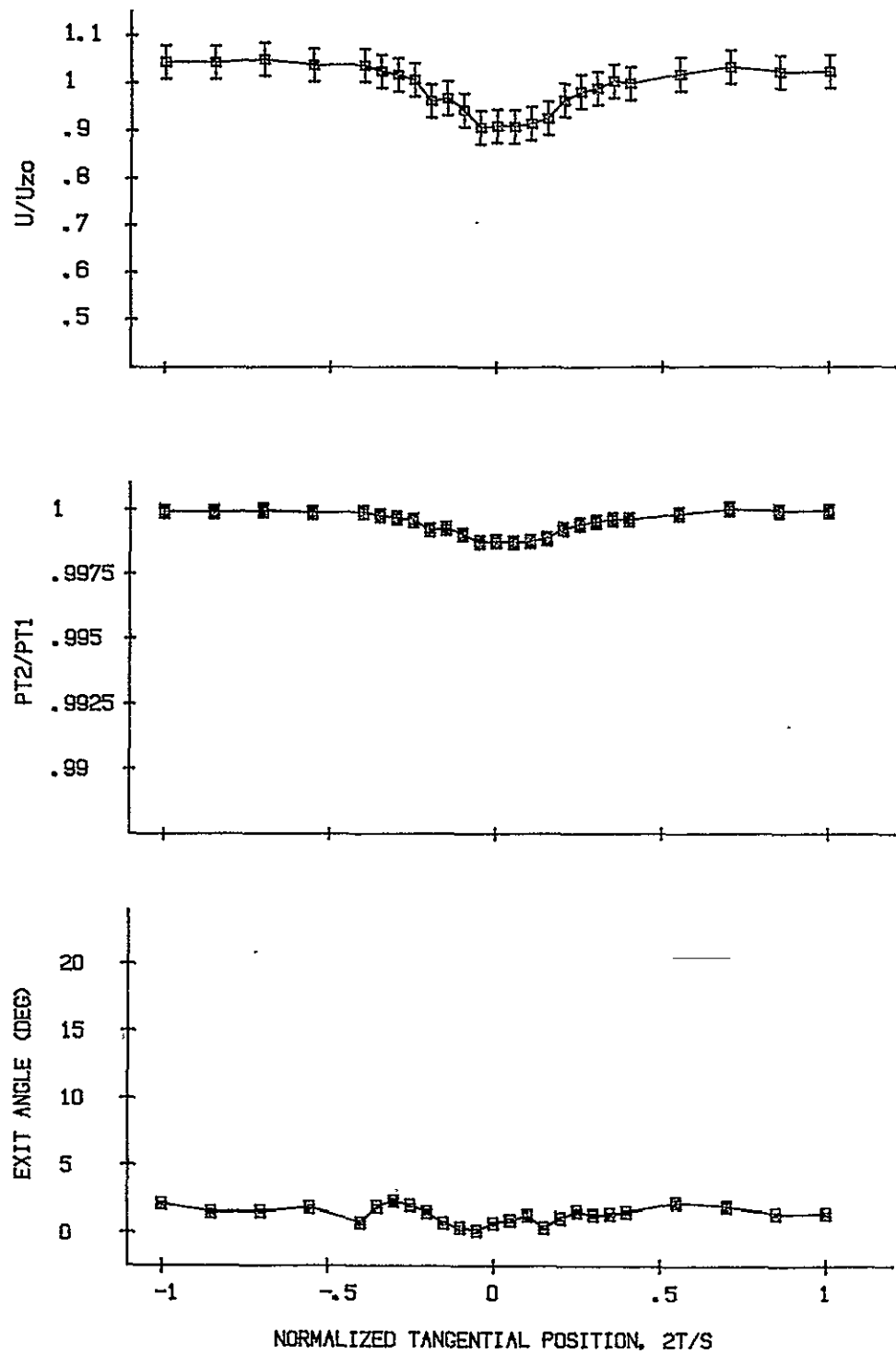

Figure I36. FIVE-HOLE PROBE WAKE DATA, INCIDENCE ANGLE (DEG) = 0,
 $Z_c/C = 2.06$, $R = 83.3\%$

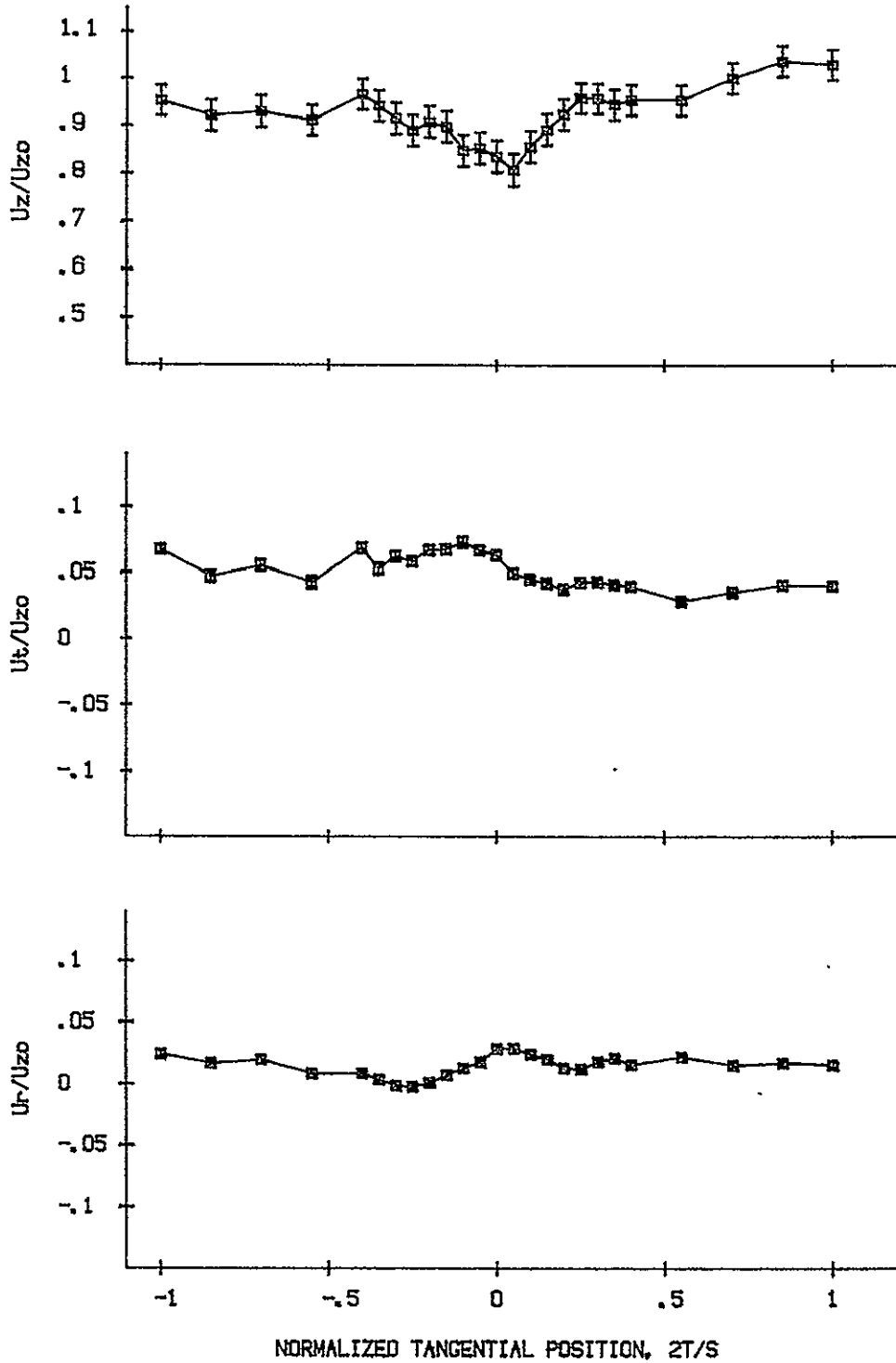

Figure I37. FIVE-HOLE PROBE VELOCITY DATA, INCIDENCE ANGLE (DEG) = 5,
 $Z_c/C = .94$, $R = 4.2\%$

ORIGINAL PAGE IS
OF POOR QUALITY

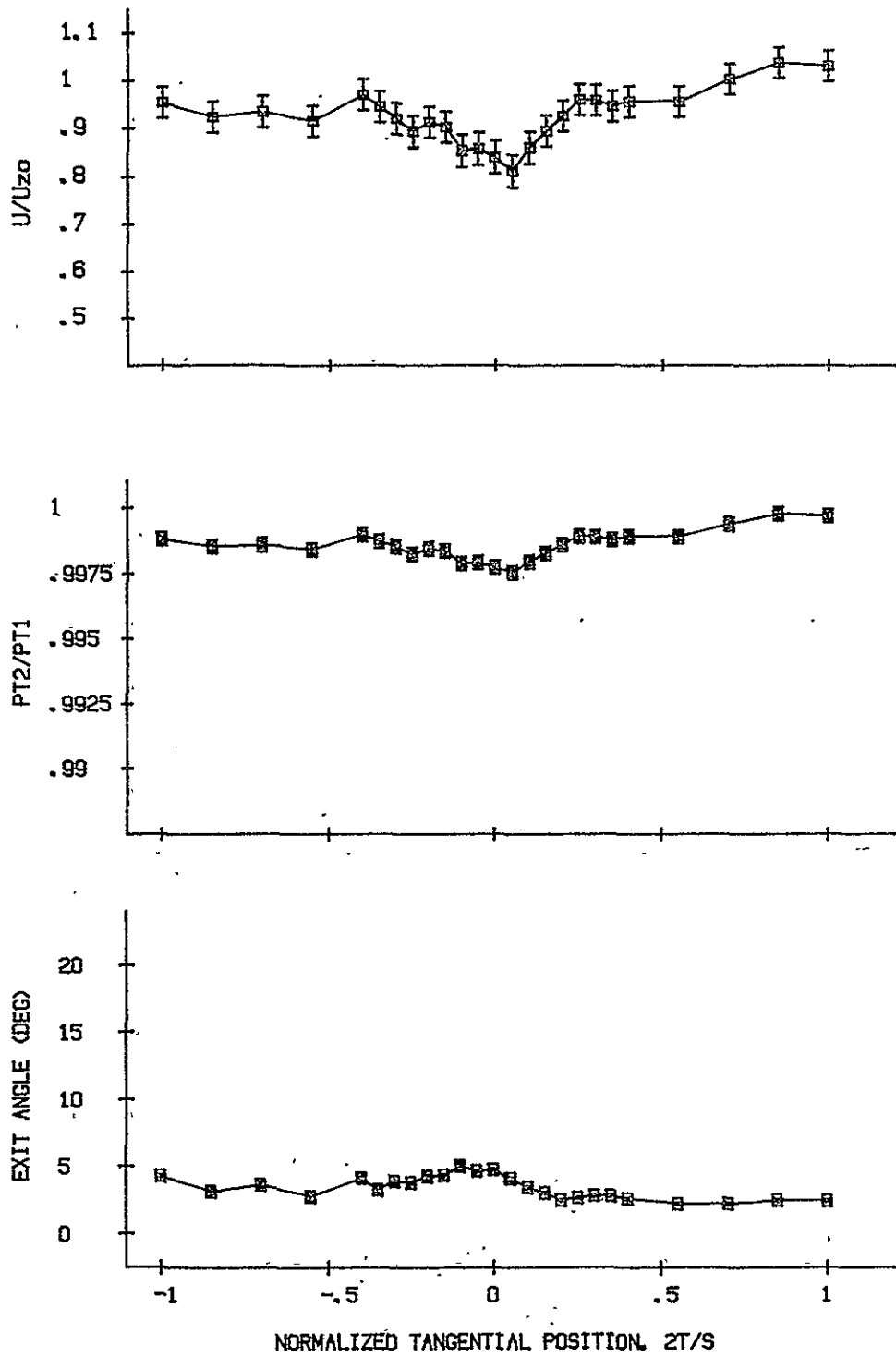

Figure I38. FIVE-HOLE PROBE WAKE DATA, INCIDENCE ANGLE (DEG) = 5,
 $Z_c/C = .94$, $R = 4.2\%$

ORIGINAL PAGE IS
OF POOR QUALITY

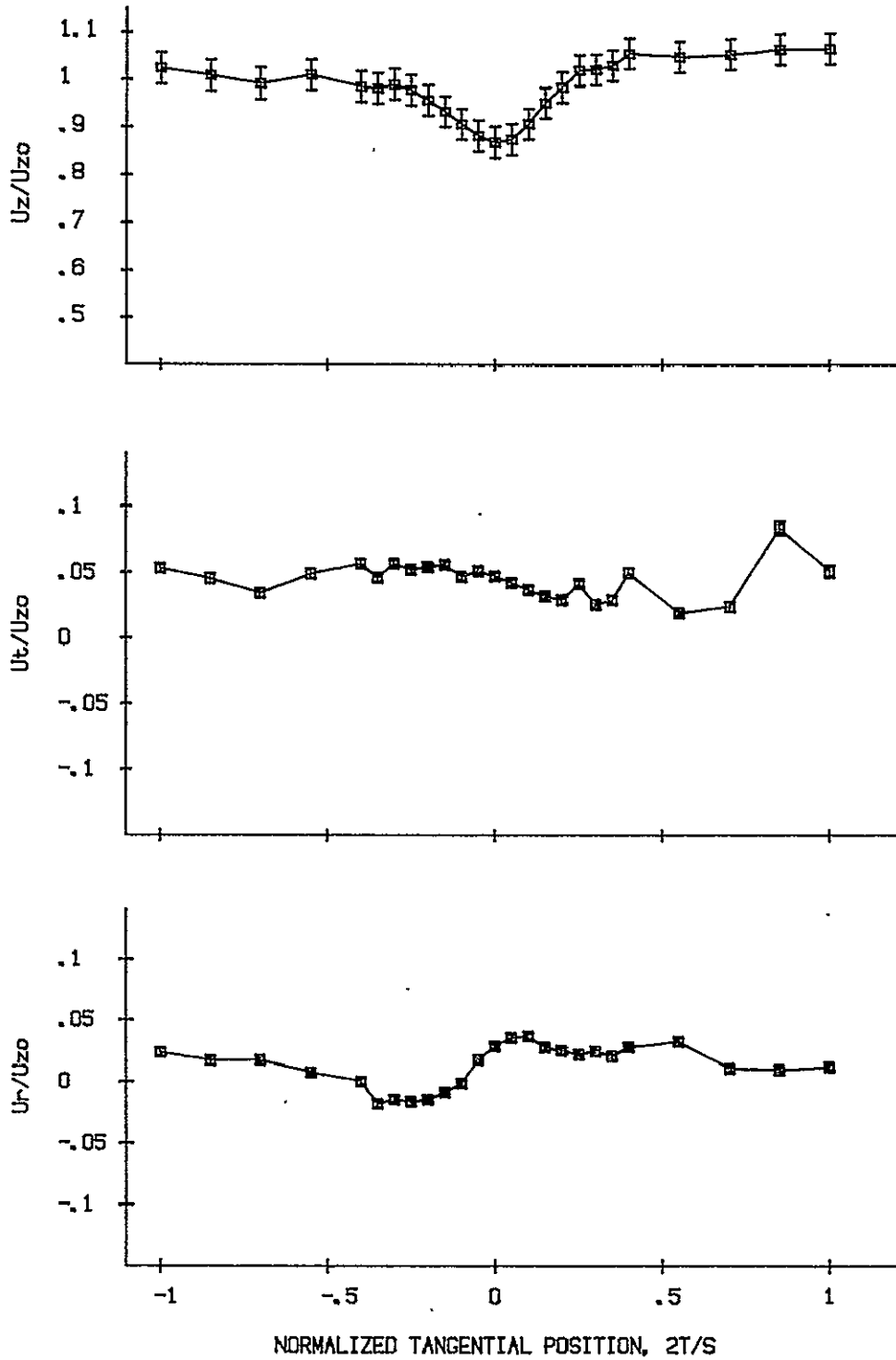

Figure I39. FIVE-HOLE PROBE VELOCITY DATA, INCIDENCE ANGLE (DEG) = 5,
 $Z_c/C = .94$, $R = 8.3\%$

ORIGINAL PAGE IS
OF POOR QUALITY

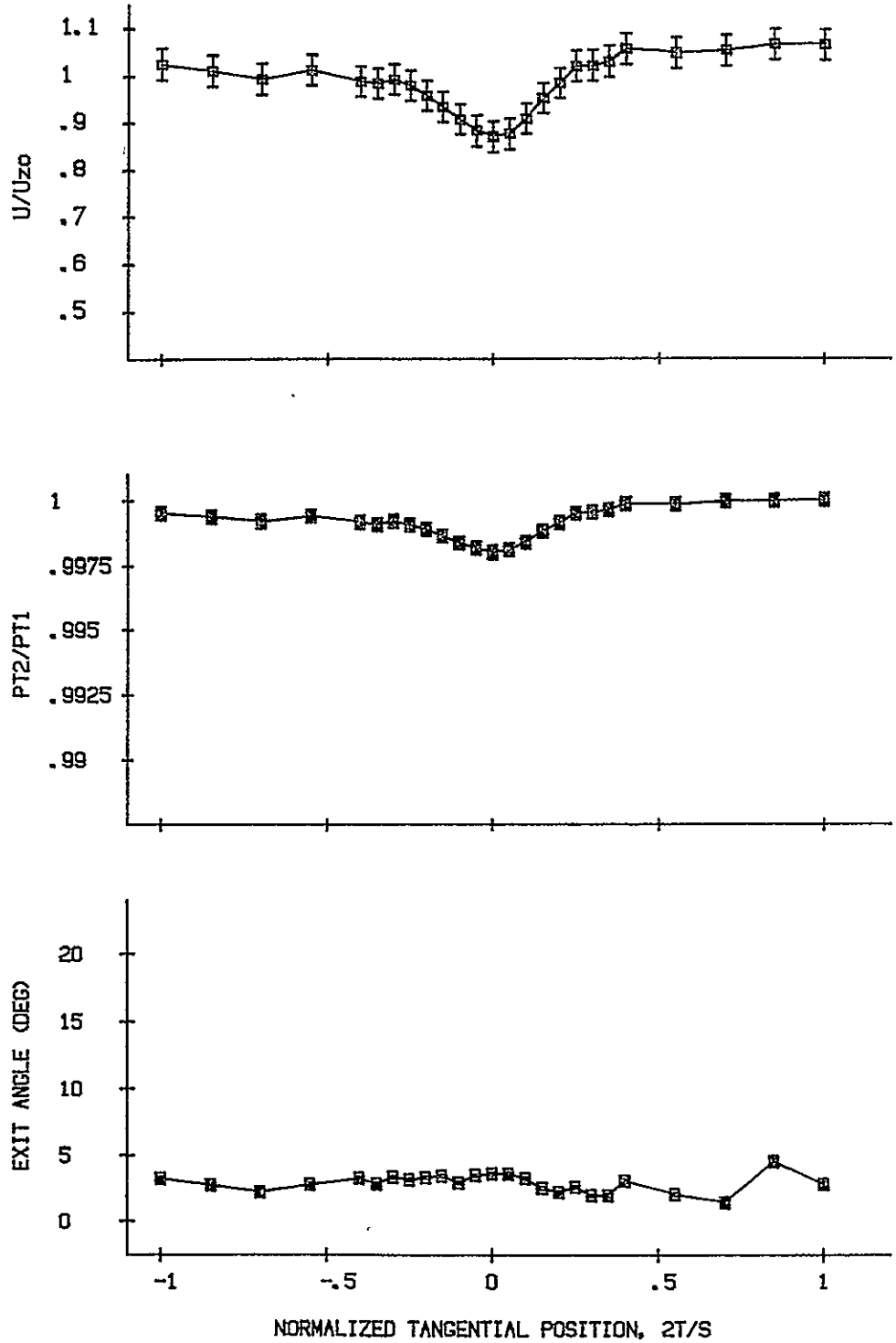

Figure I40.

FIVE-HOLE PROBE WAKE DATA, INCIDENCE ANGLE (DEG) = 5,
 $Z_0/C = .94$, $R = 8.3\%$

ORIGINAL PAGE IS
OF POOR QUALITY

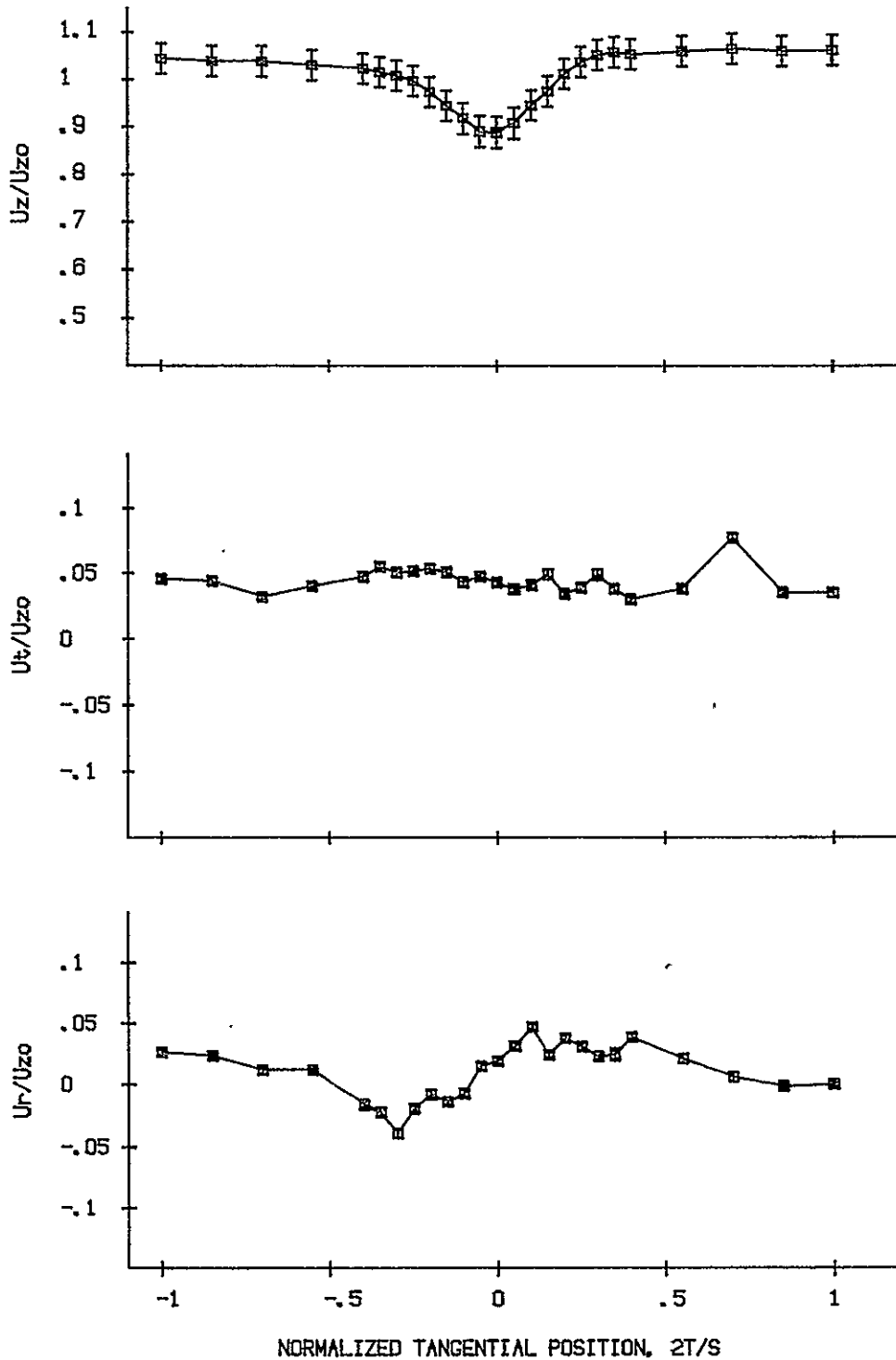

Figure I41. FIVE-HOLE PROBE VELOCITY DATA, INCIDENCE ANGLE (DEG) = 5,
 $Z_c/C = .94$, $R = 12.5\%$

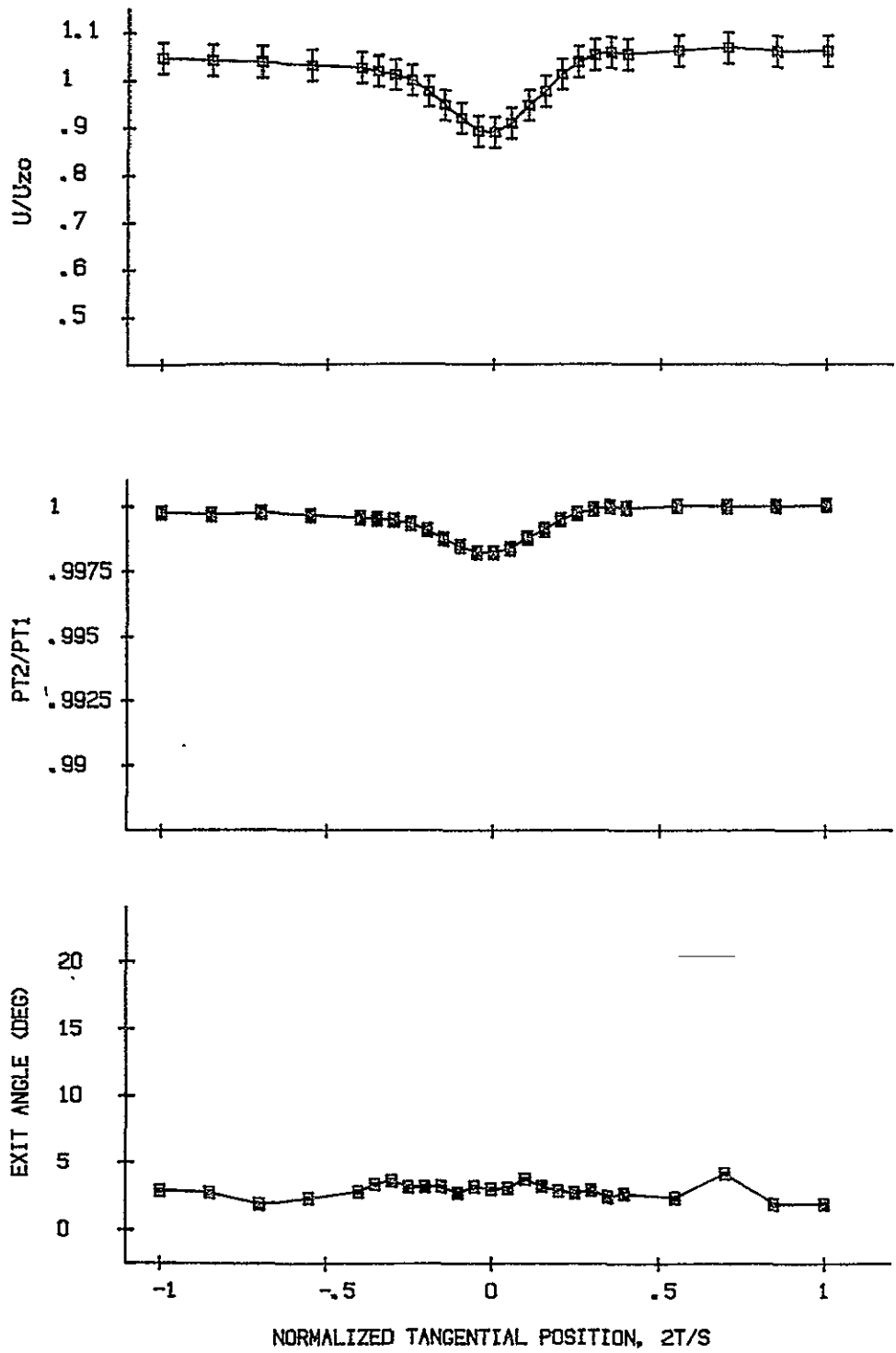

Figure I42.

FIVE-HOLE PROBE WAKE DATA, INCIDENCE ANGLE (DEG) = 5,
 $Z_c/C = .94$, $R = 12.5\%$

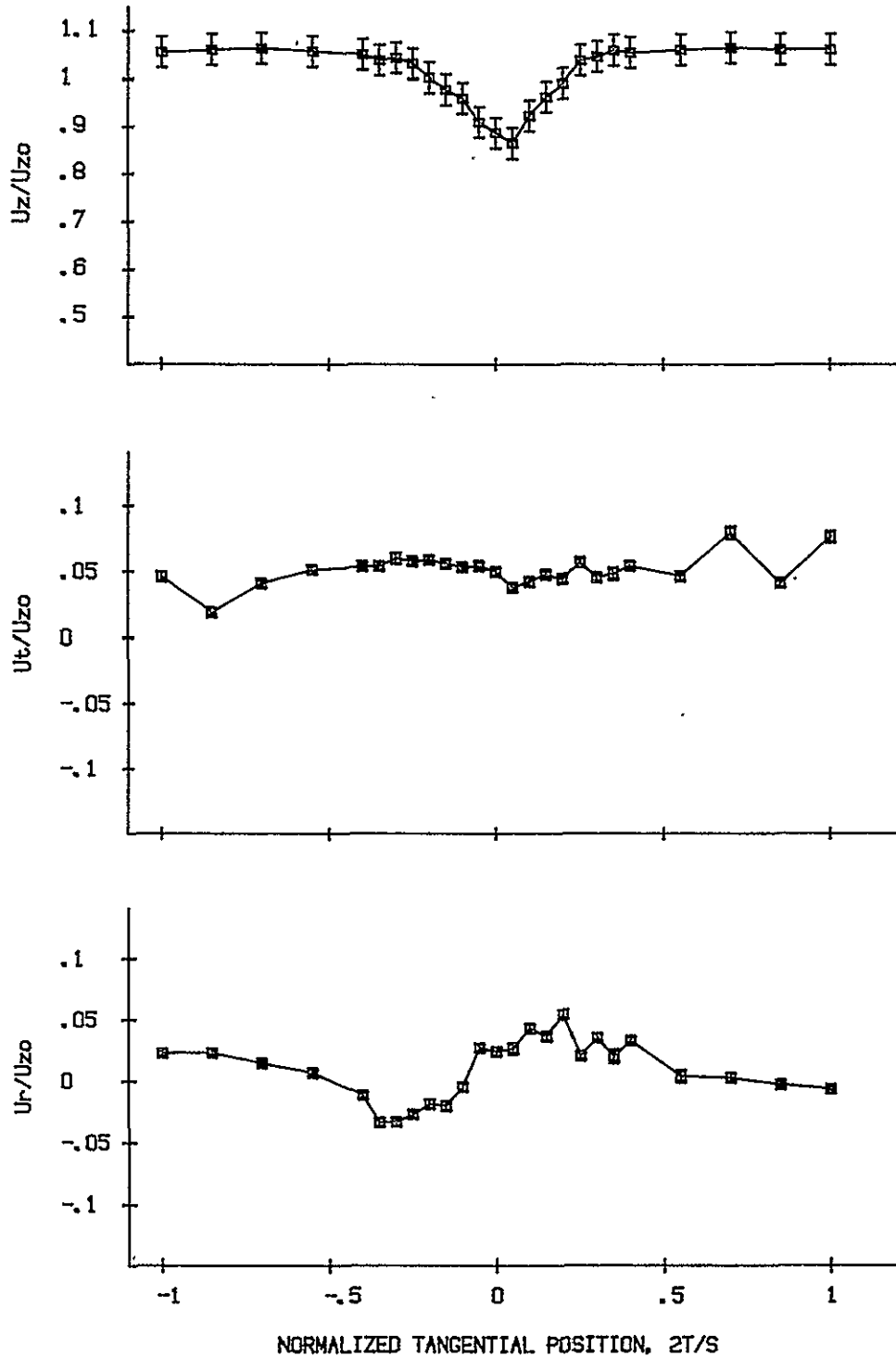

Figure I43. FIVE-HOLE PROBE VELOCITY DATA, INCIDENCE ANGLE (DEG) = 5,
 $Z_c/C = .94$, $R = 16.7\%$

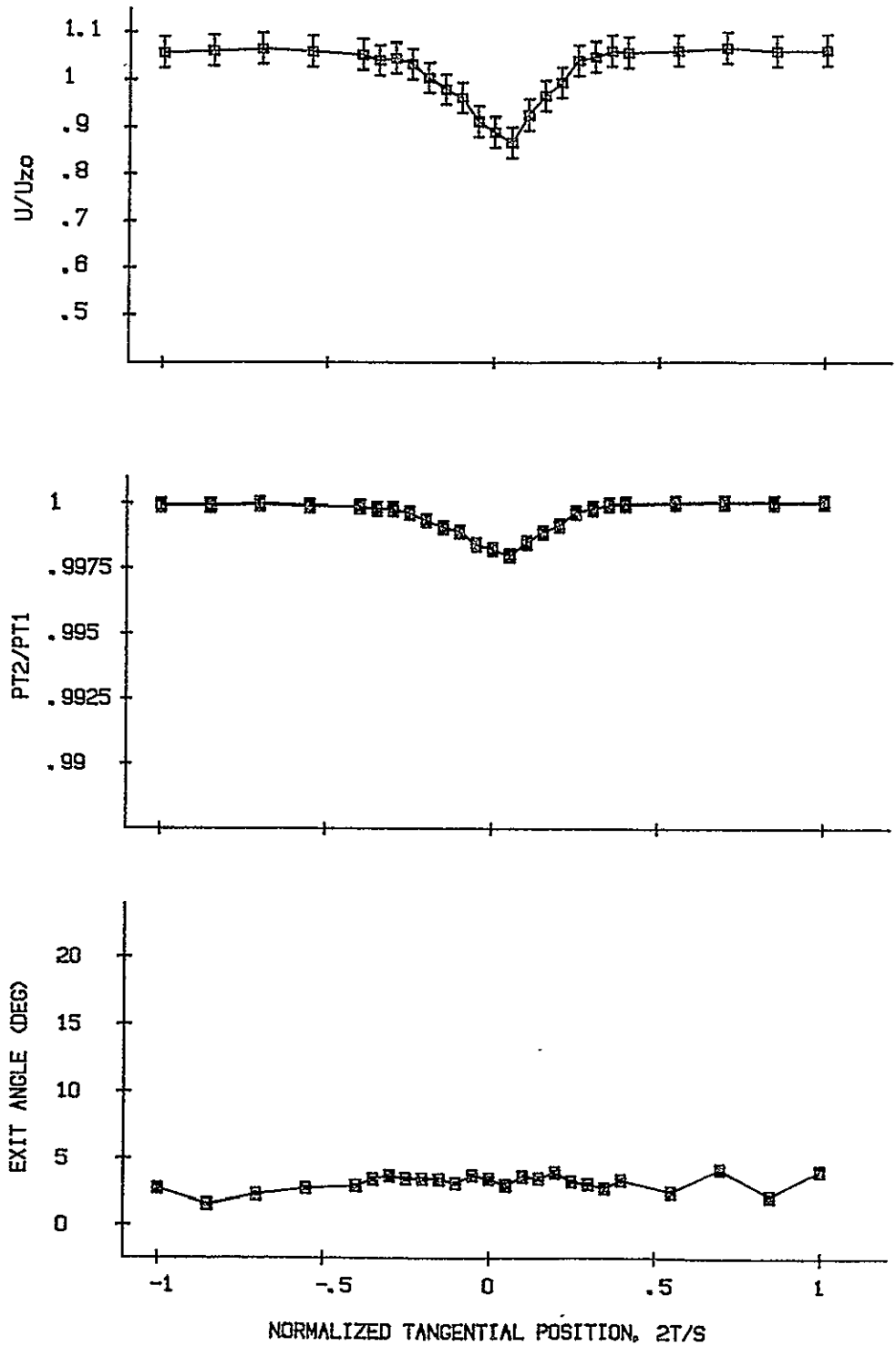

Figure I44. FIVE-HOLE PROBE WAKE DATA, INCIDENCE ANGLE (DEG) = 5, $Z_c/C = .94$, $R = 18.7\%$

ORIGINAL PAGE IS
OF POOR QUALITY

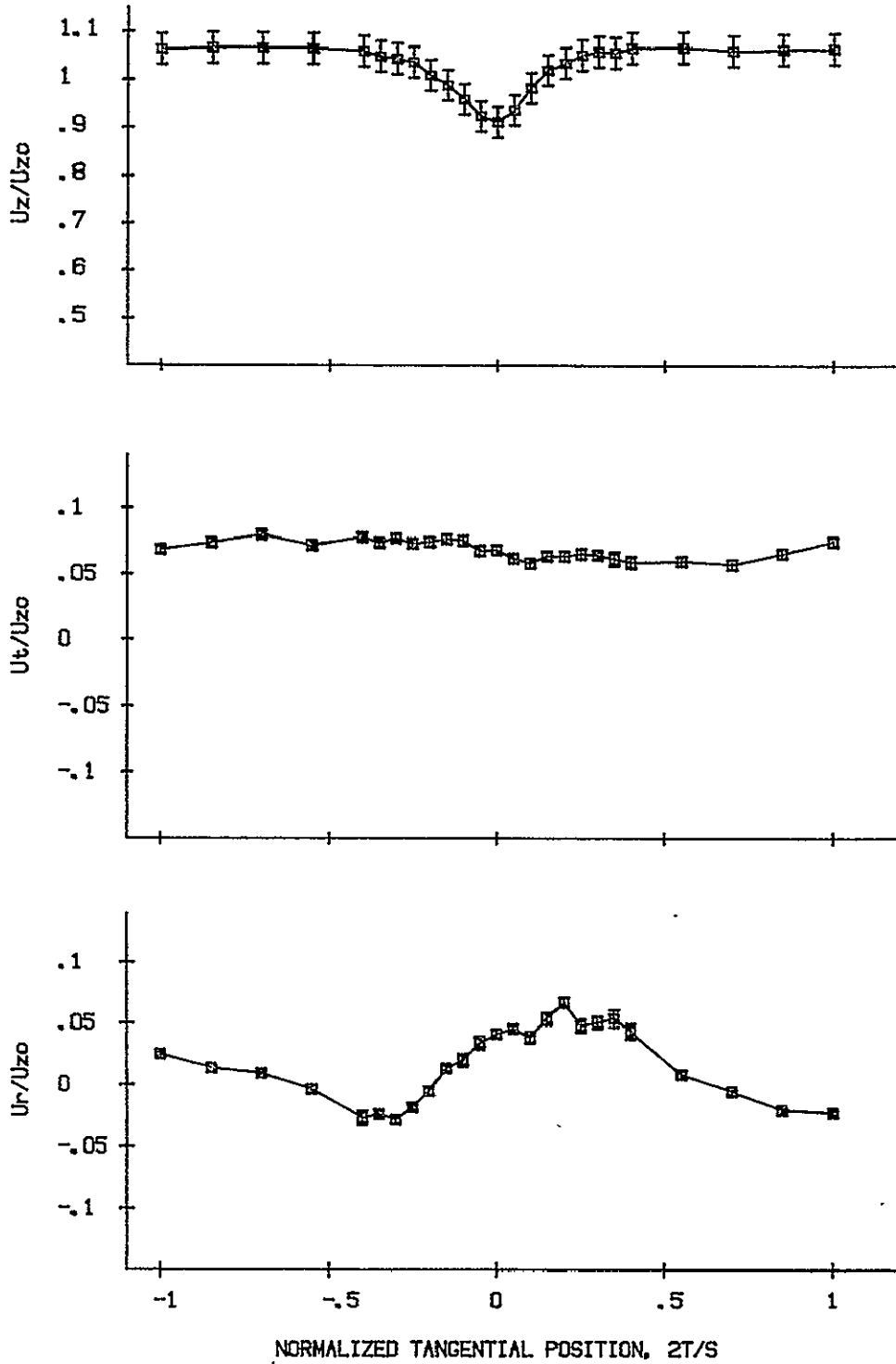

Figure I45. FIVE-HOLE PROBE VELOCITY DATA, INCIDENCE ANGLE (DEG) = 5,
 $Z_c/C = .94$, $R = 25\%$

C-5

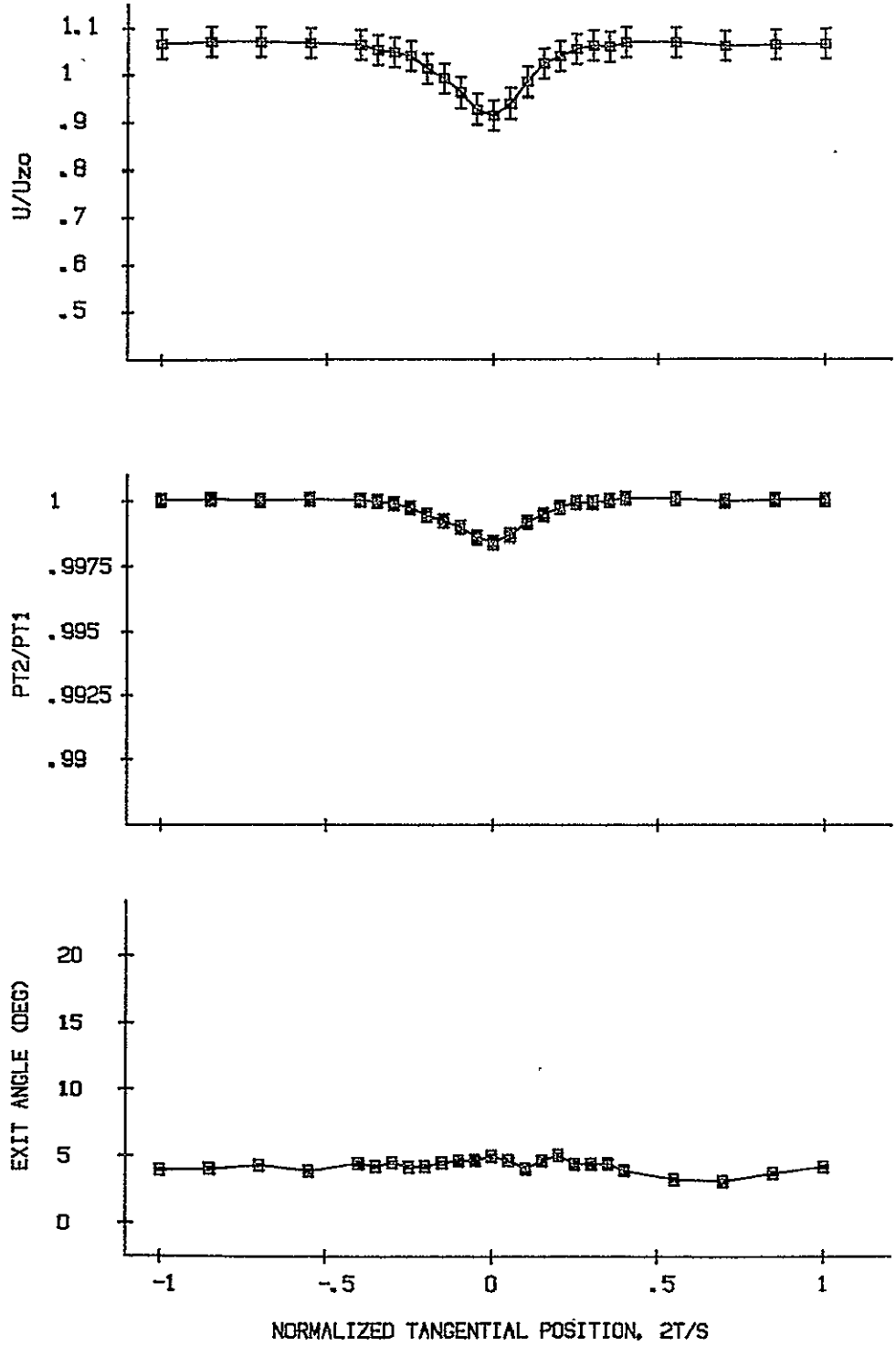

Figure I46. FIVE-HOLE PROBE WAKE DATA, INCIDENCE ANGLE (DEG) = 5,
 $Z_c/C = .94$, $R = 25\%$

ORIGINAL PAGE IS
OF POOR QUALITY

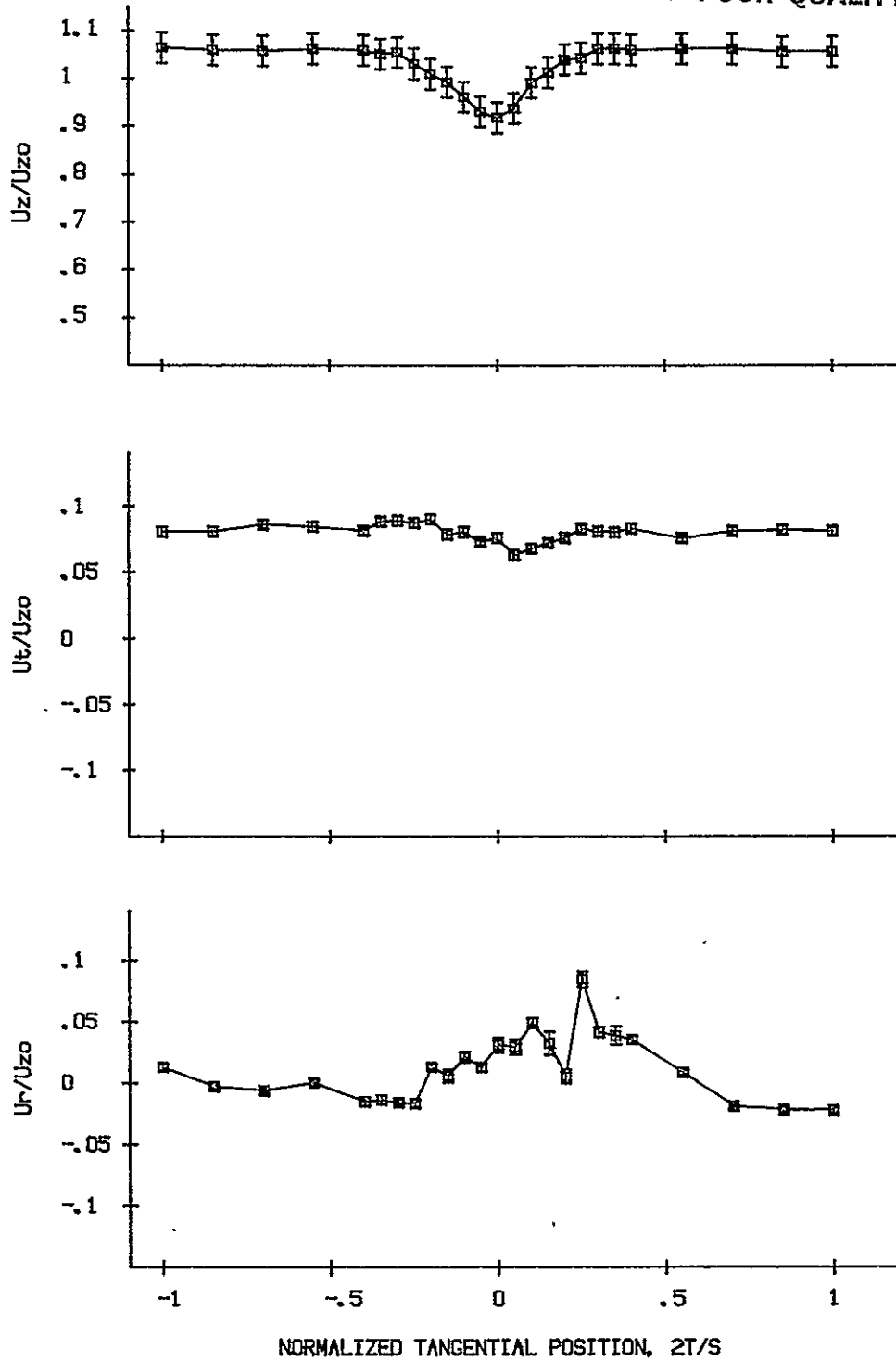

Figure I47. FIVE-HOLE PROBE VELOCITY DATA, INCIDENCE ANGLE (DEG) = 5,
 $Z_c/C = .94$, $R = 33.3\%$

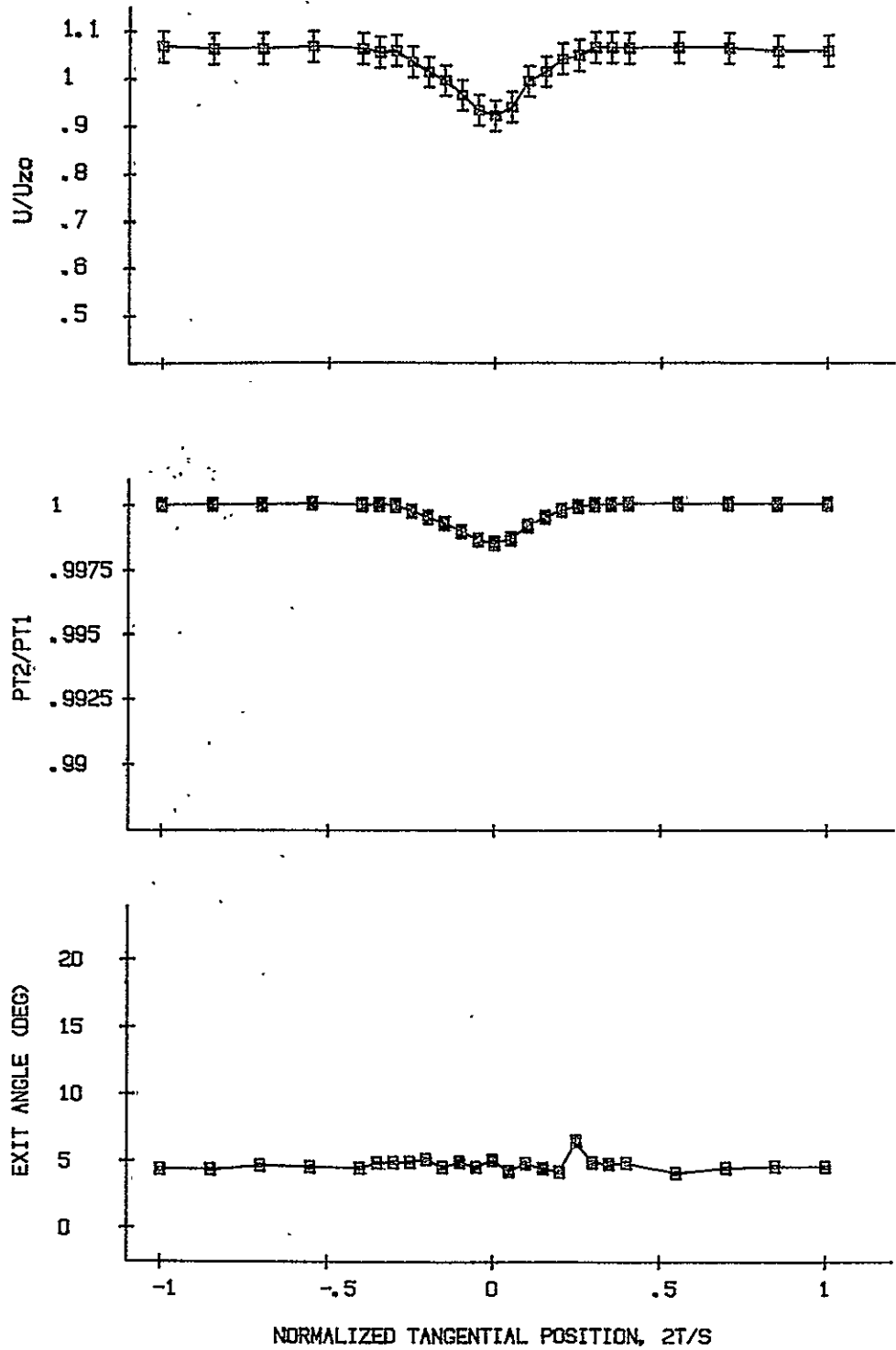

Figure I48. FIVE-HOLE PROBE WAKE DATA, INCIDENCE ANGLE (DEG) = 5,
 $Z_c/C = .94$, $R = 93.3\%$

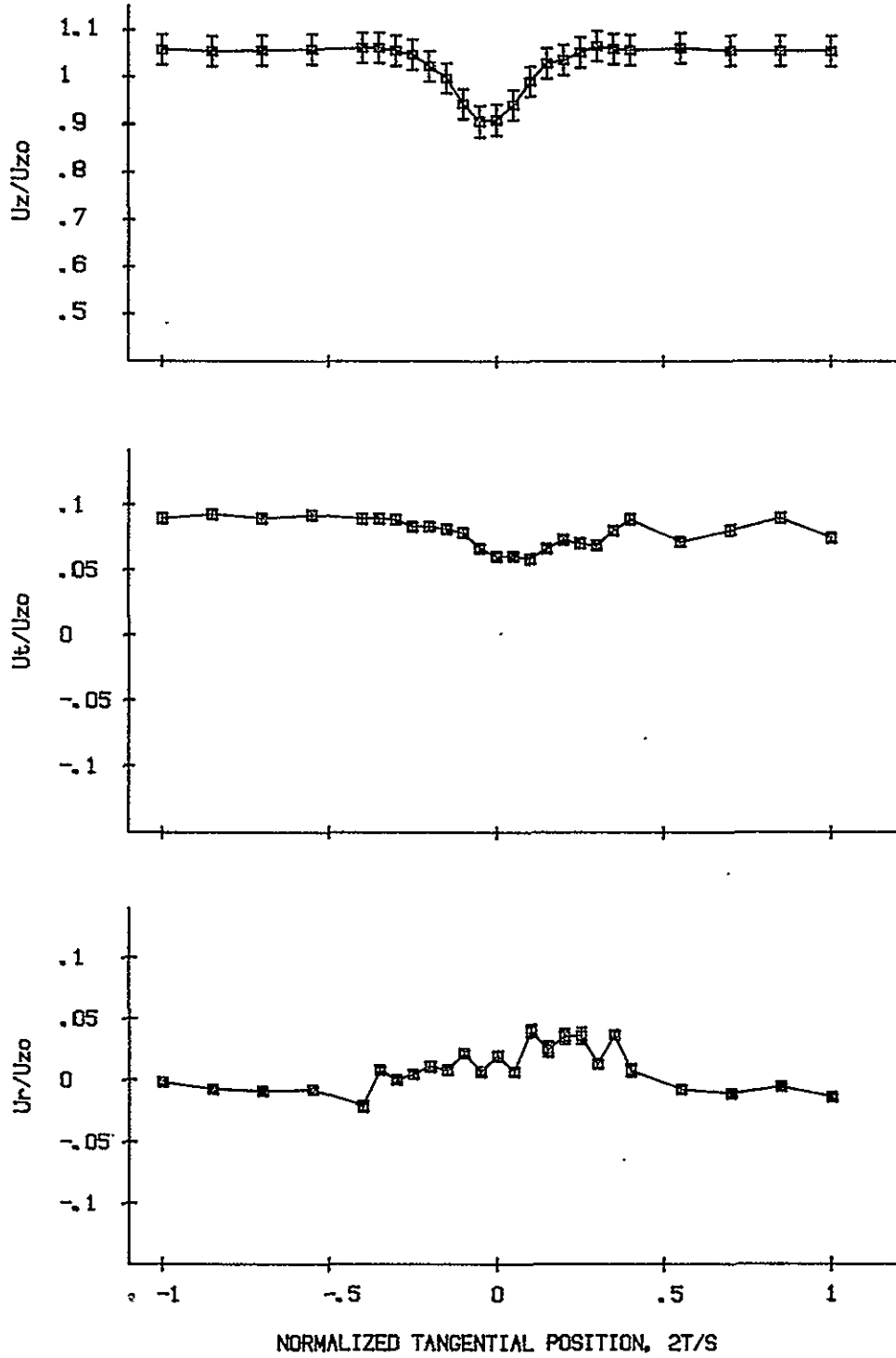

Figure I49. FIVE-HOLE PROBE VELOCITY DATA, INCIDENCE ANGLE (DEG) = 5,
 $Z_c/C = .94$, $R = 50\%$

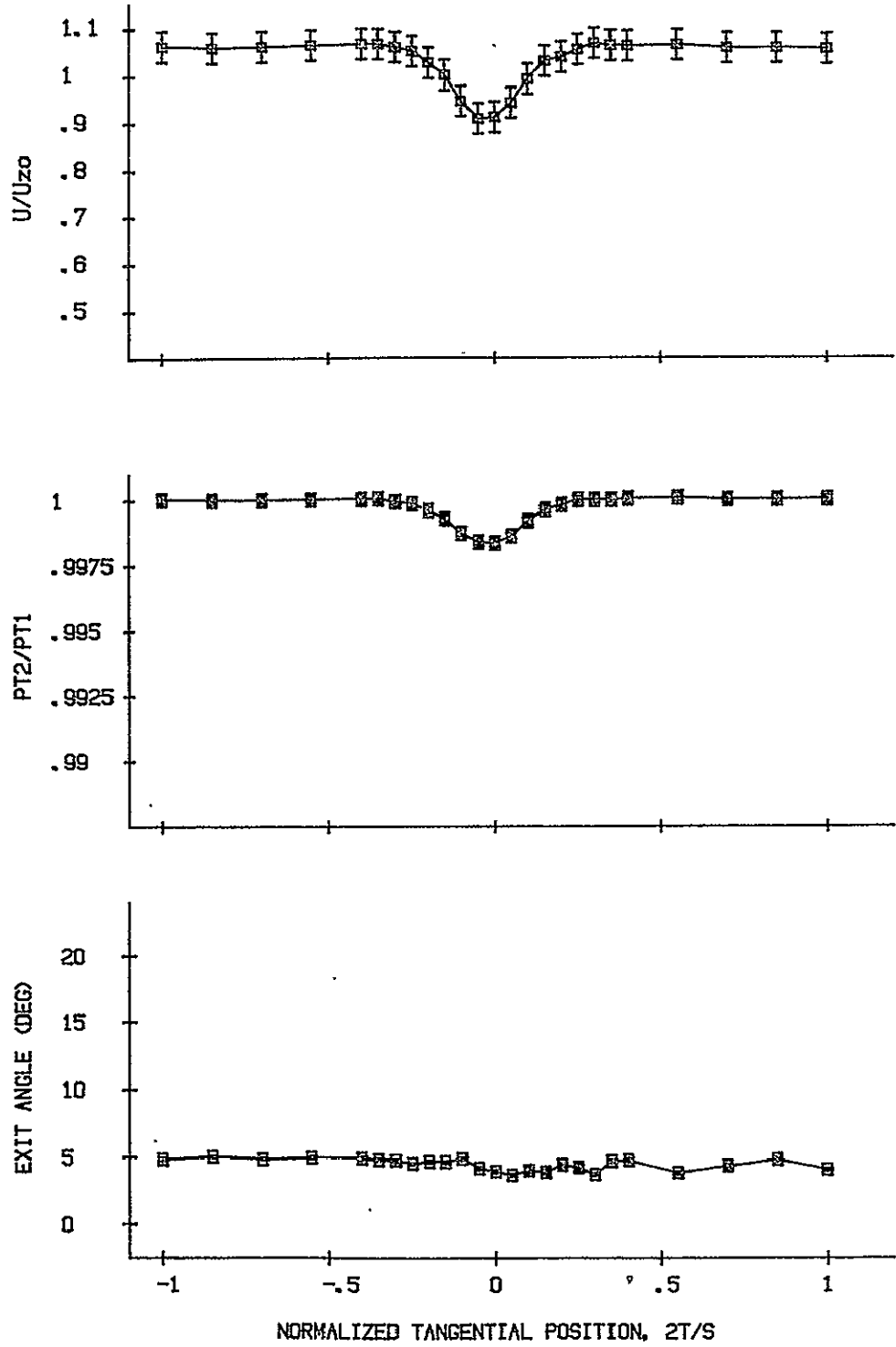

Figure I50.

FIVE-HOLE PROBE WAKE DATA, INCIDENCE ANGLE (DEG) = 5,
 $Z_0/C = .94$, $R = 50\%$

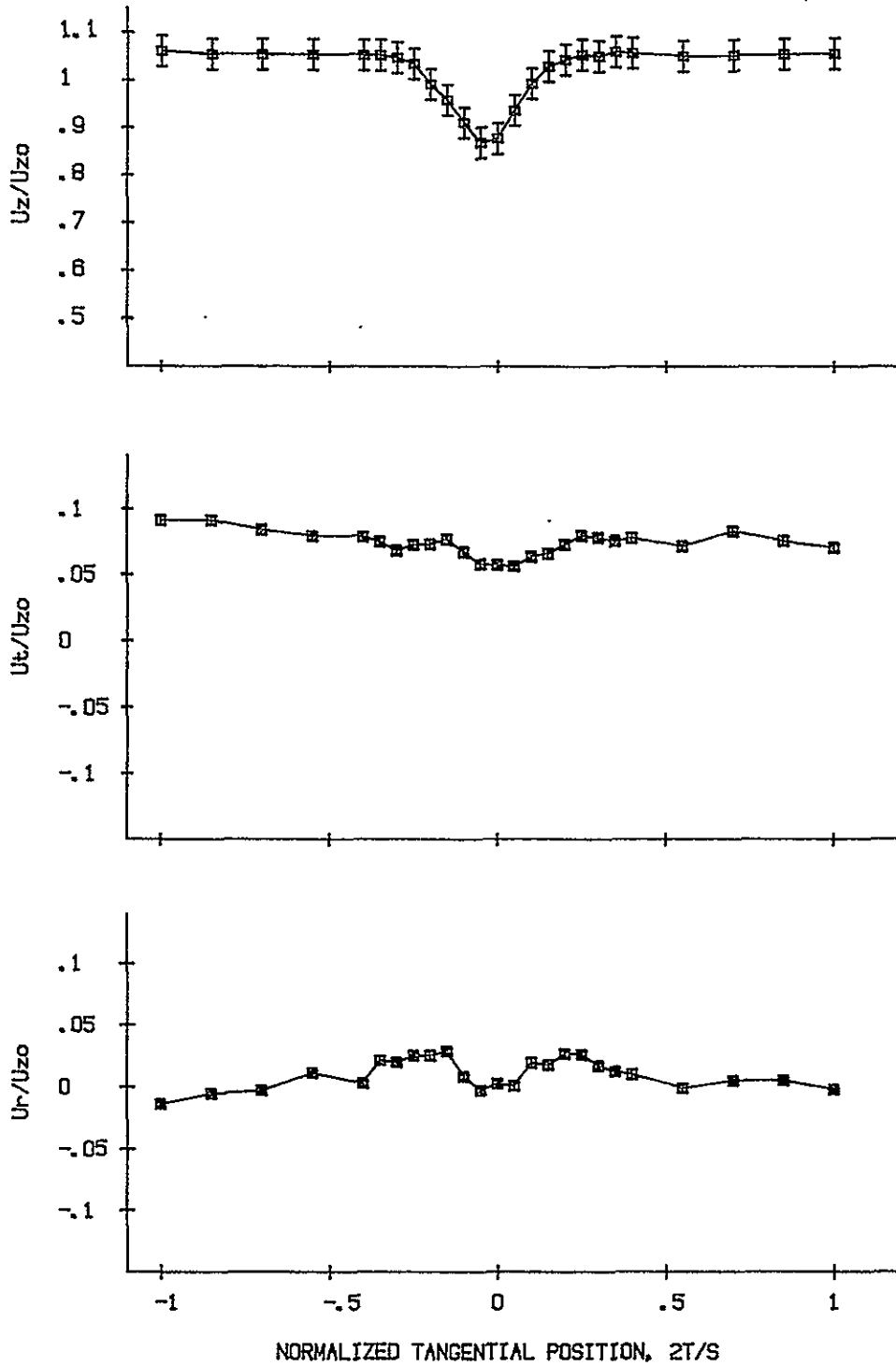

Figure I51. FIVE-HOLE PROBE VELOCITY DATA, INCIDENCE ANGLE (DEG) = 5,
 $Z_c/C = .94$, $R = 86.7\%$

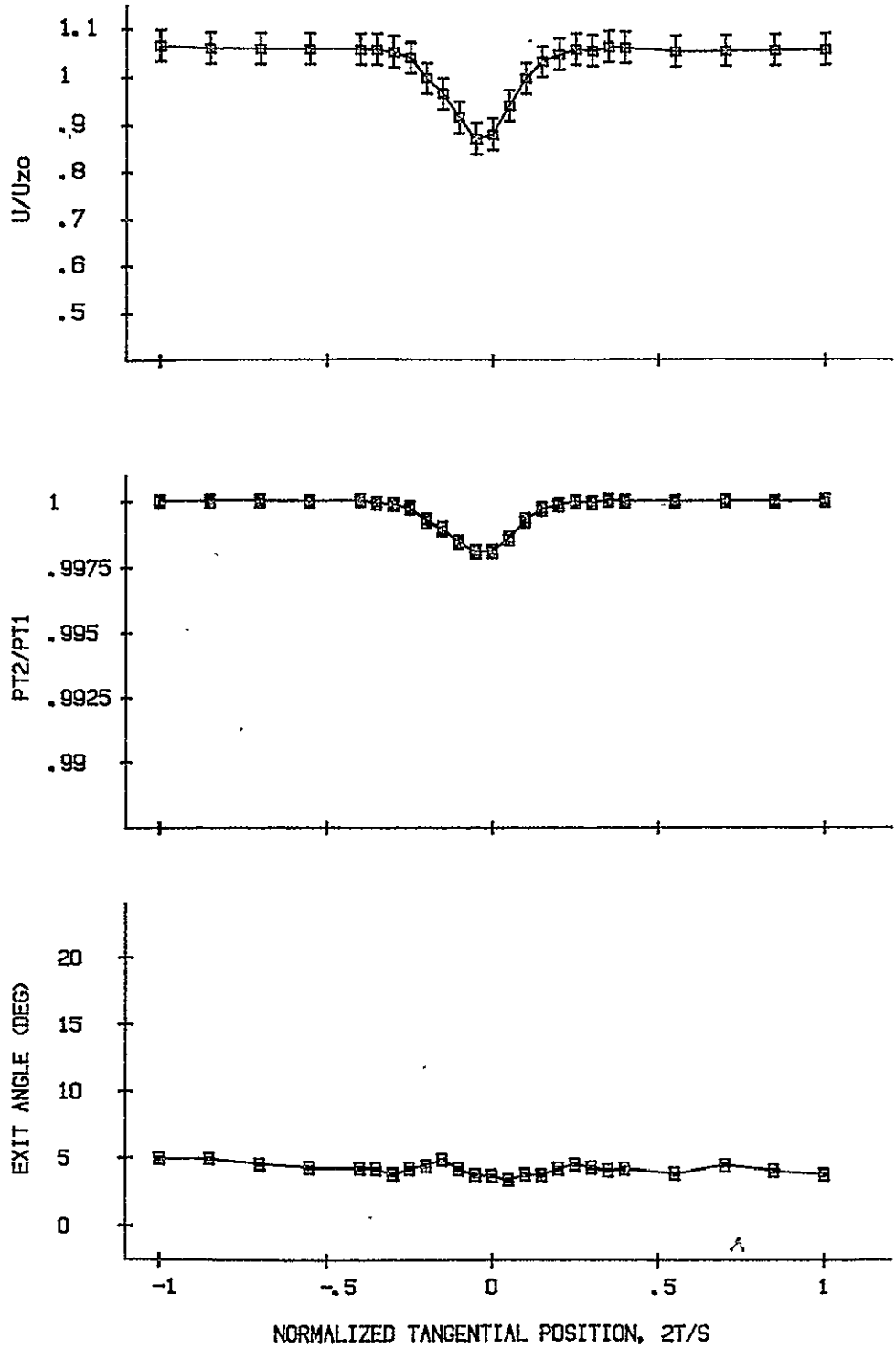

Figure I52.

FIVE-HOLE PROBE WAKE DATA, INCIDENCE ANGLE (DEG) = 5,
 $Z_c/C = .94$, $R = 68.7\%$

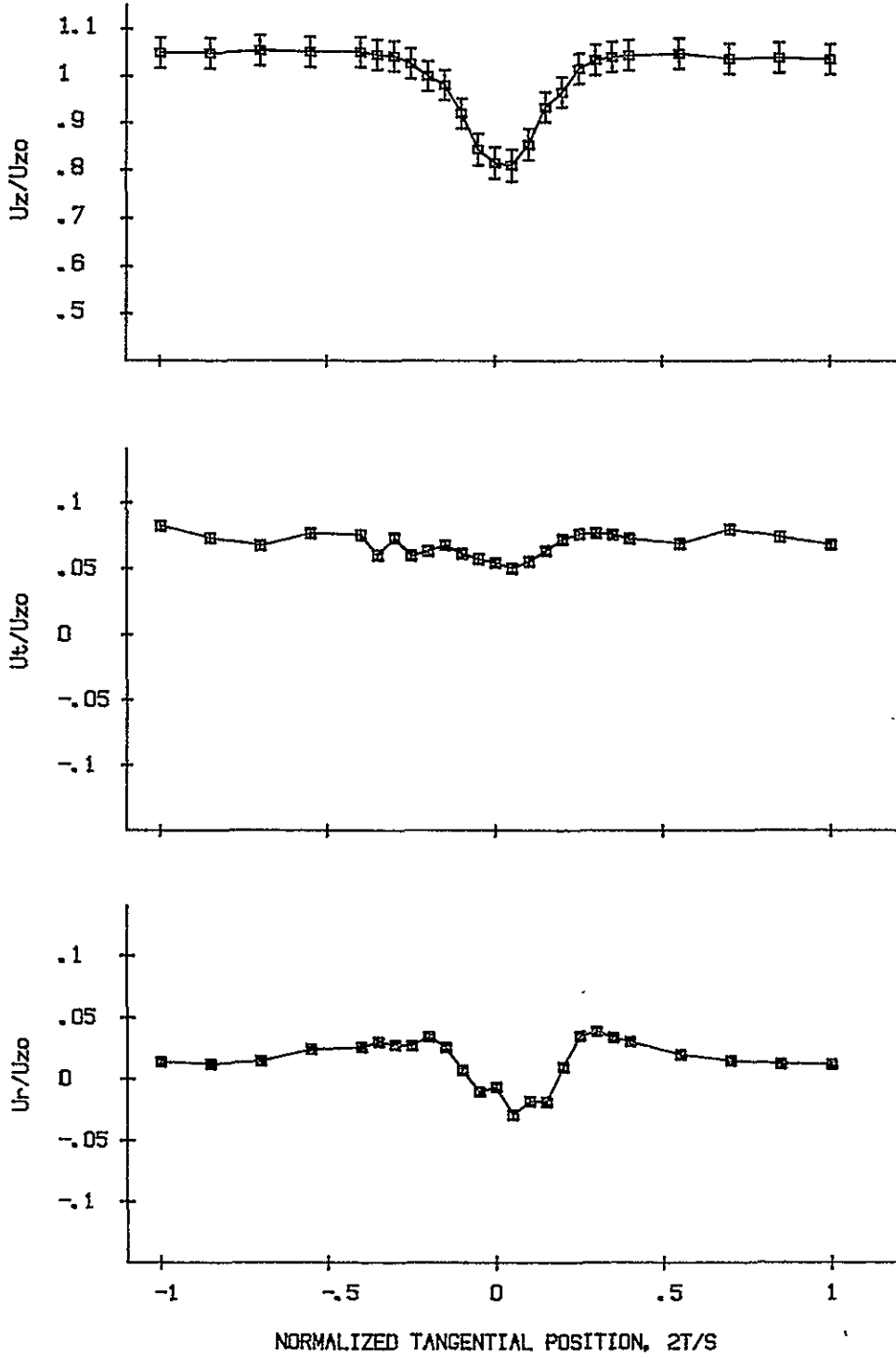

Figure I53. FIVE-HOLE PROBE VELOCITY DATA, INCIDENCE ANGLE (DEG) = 5,
 $Z_c/C = .94$, $R = 83.3\%$

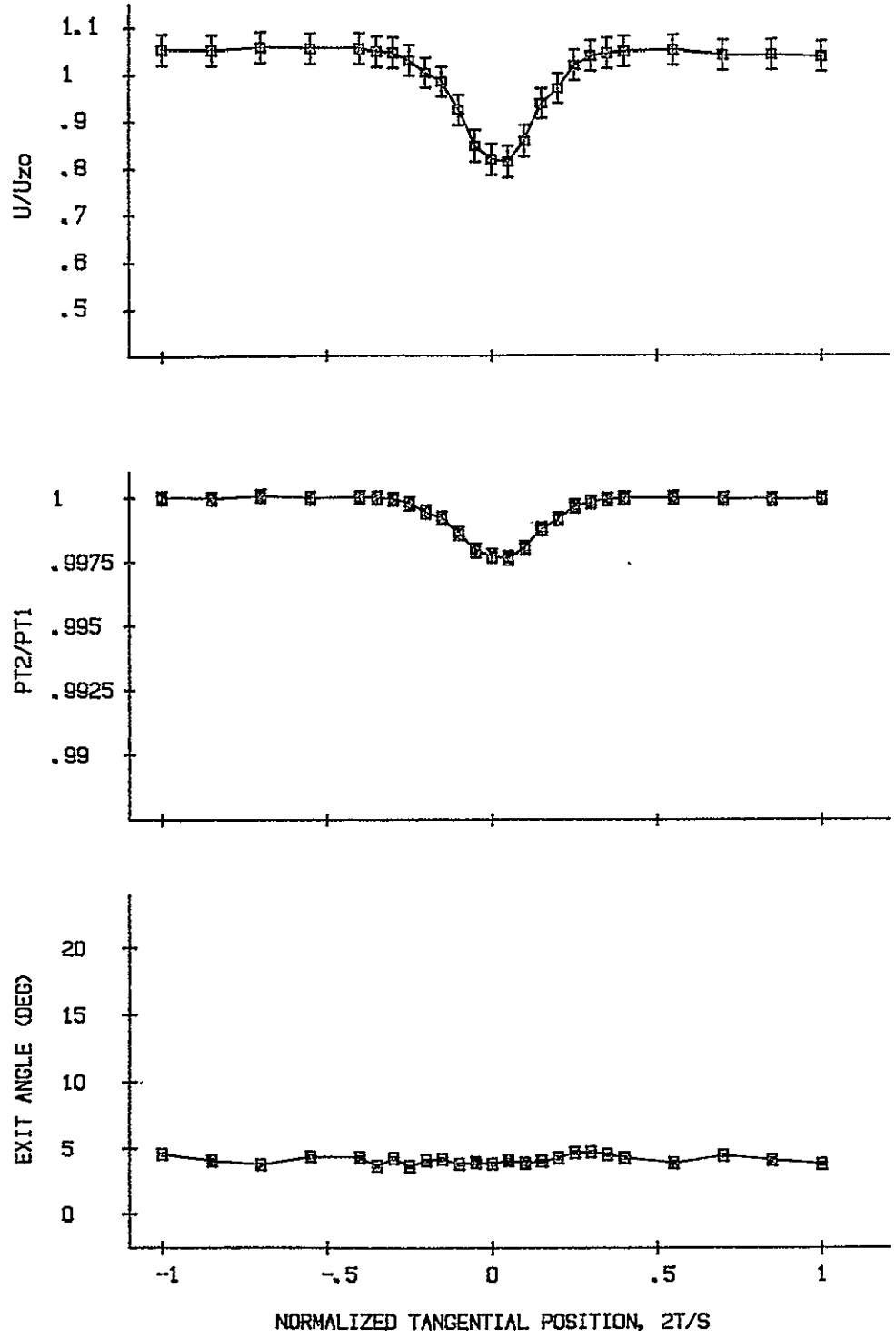

Figure I54.

FIVE-HOLE PROBE WAKE DATA, INCIDENCE ANGLE (DEG) = 5,
 $Z_c/C = .94$, $R = 83.3\%$

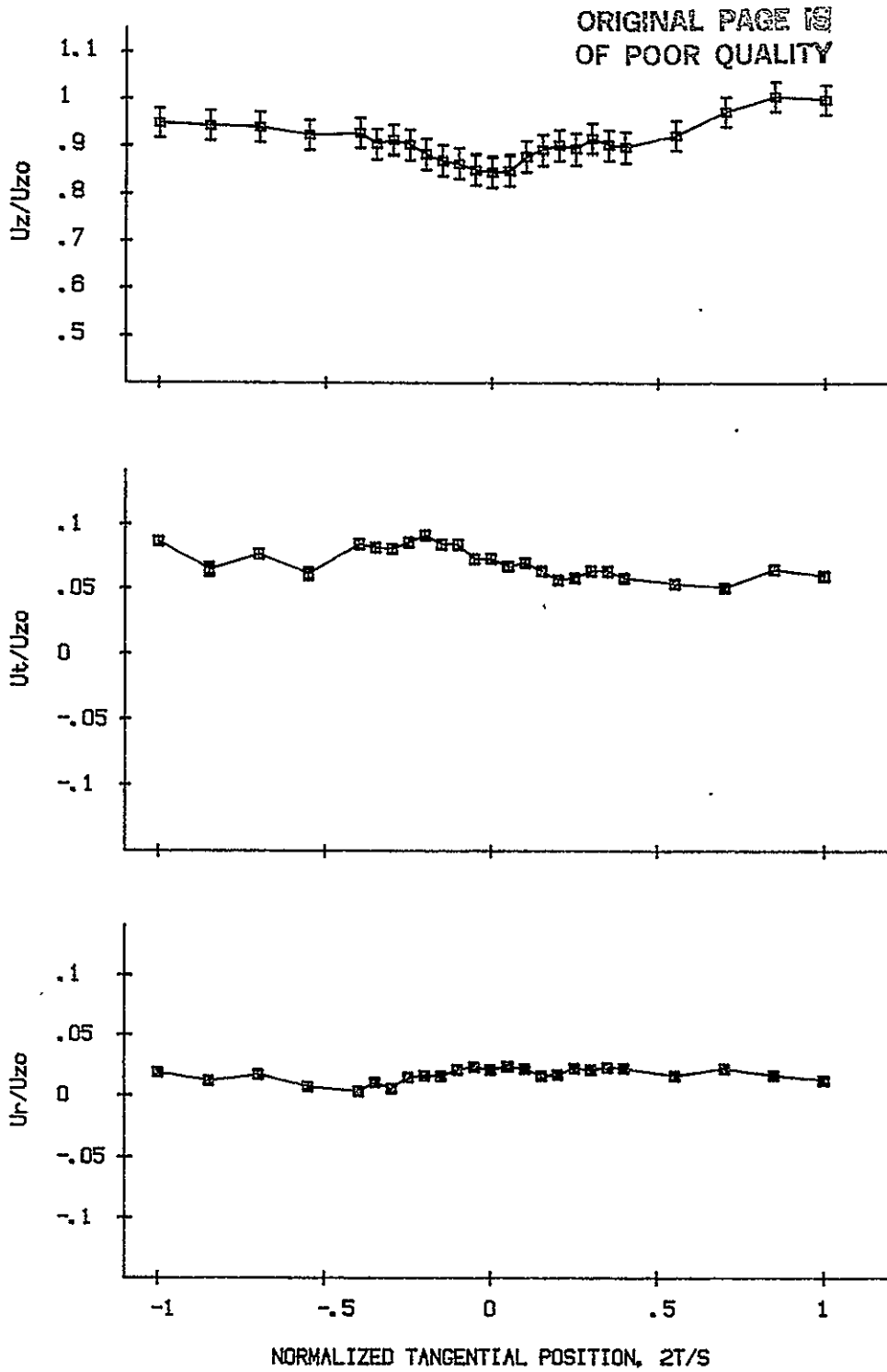

Figure I55. FIVE-HOLE PROBE VELOCITY DATA, INCIDENCE ANGLE (DEG) = 5,
 $Z_c/C = 2.07$, $R = 4.2\%$

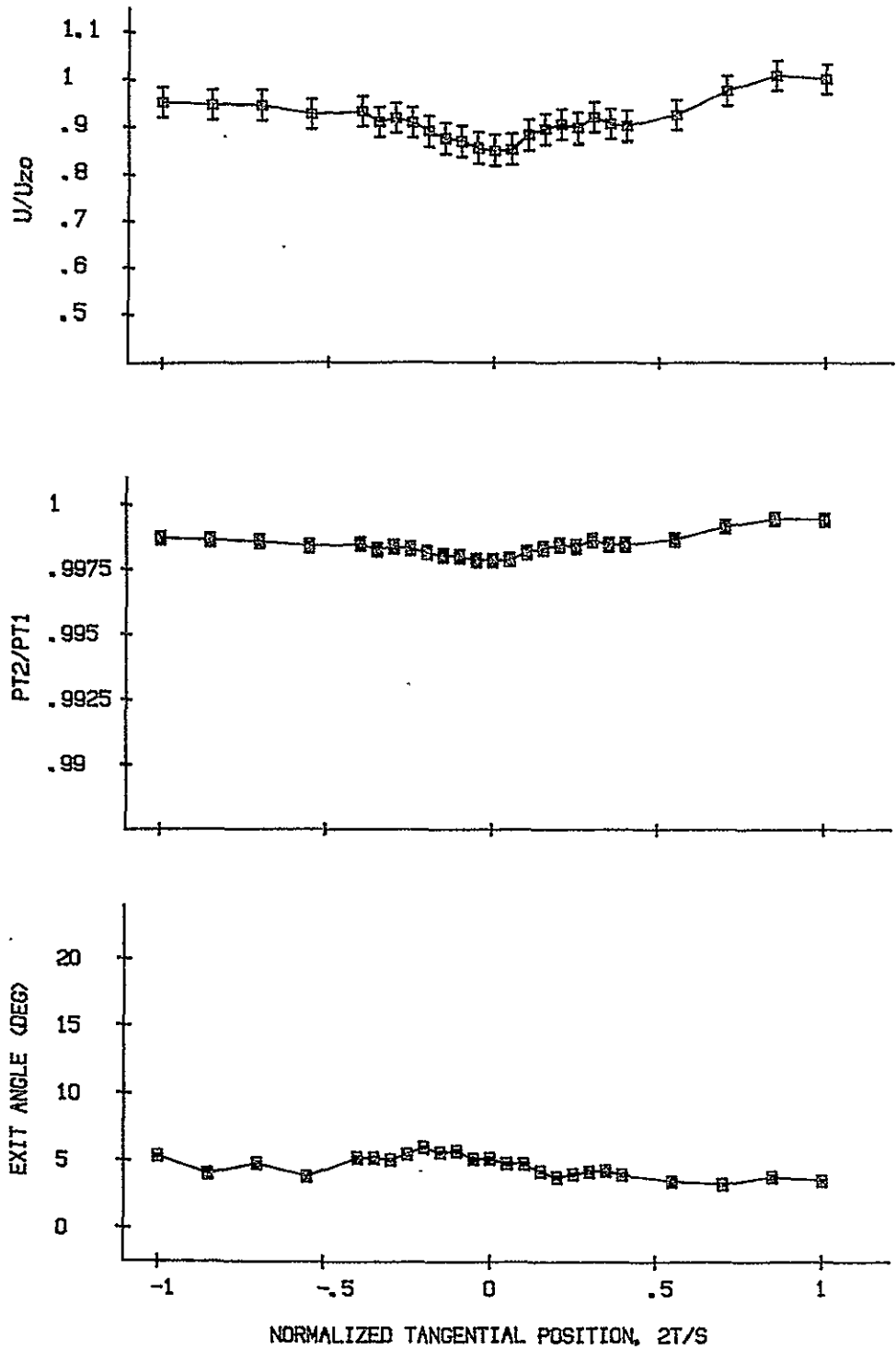

Figure I56. FIVE-HOLE PROBE WAKE DATA, INCIDENCE ANGLE (DEG) = 5,
 $Z_c/C = 2.07$, $R = 4.2\%$

ORIGINAL PAGE IS
OF POOR QUALITY

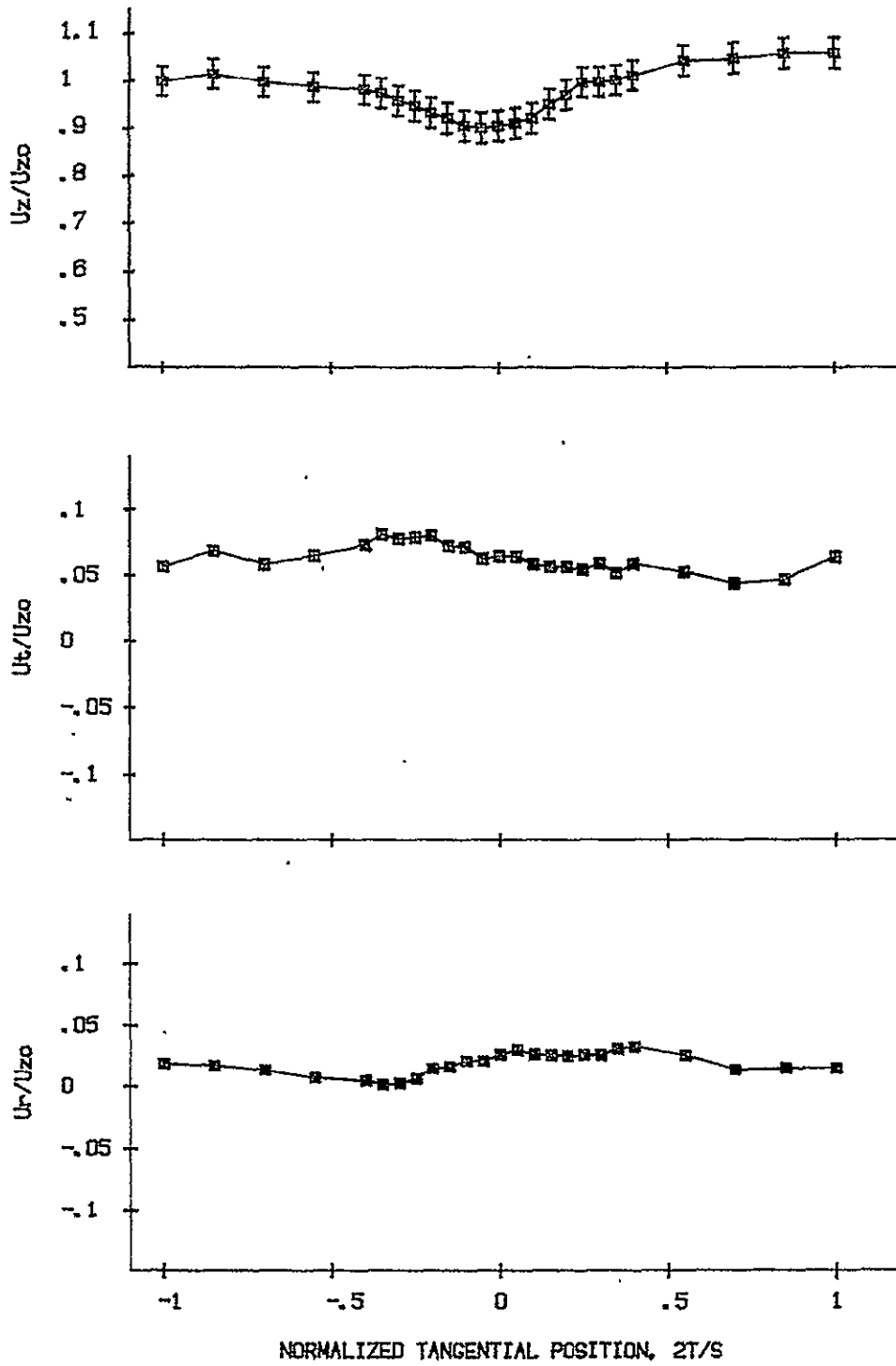

Figure I57. FIVE-HOLE PROBE VELOCITY DATA, INCIDENCE ANGLE (DEG) = 5,
 $Z_0/C = 2.07$, $R = 8.3\%$

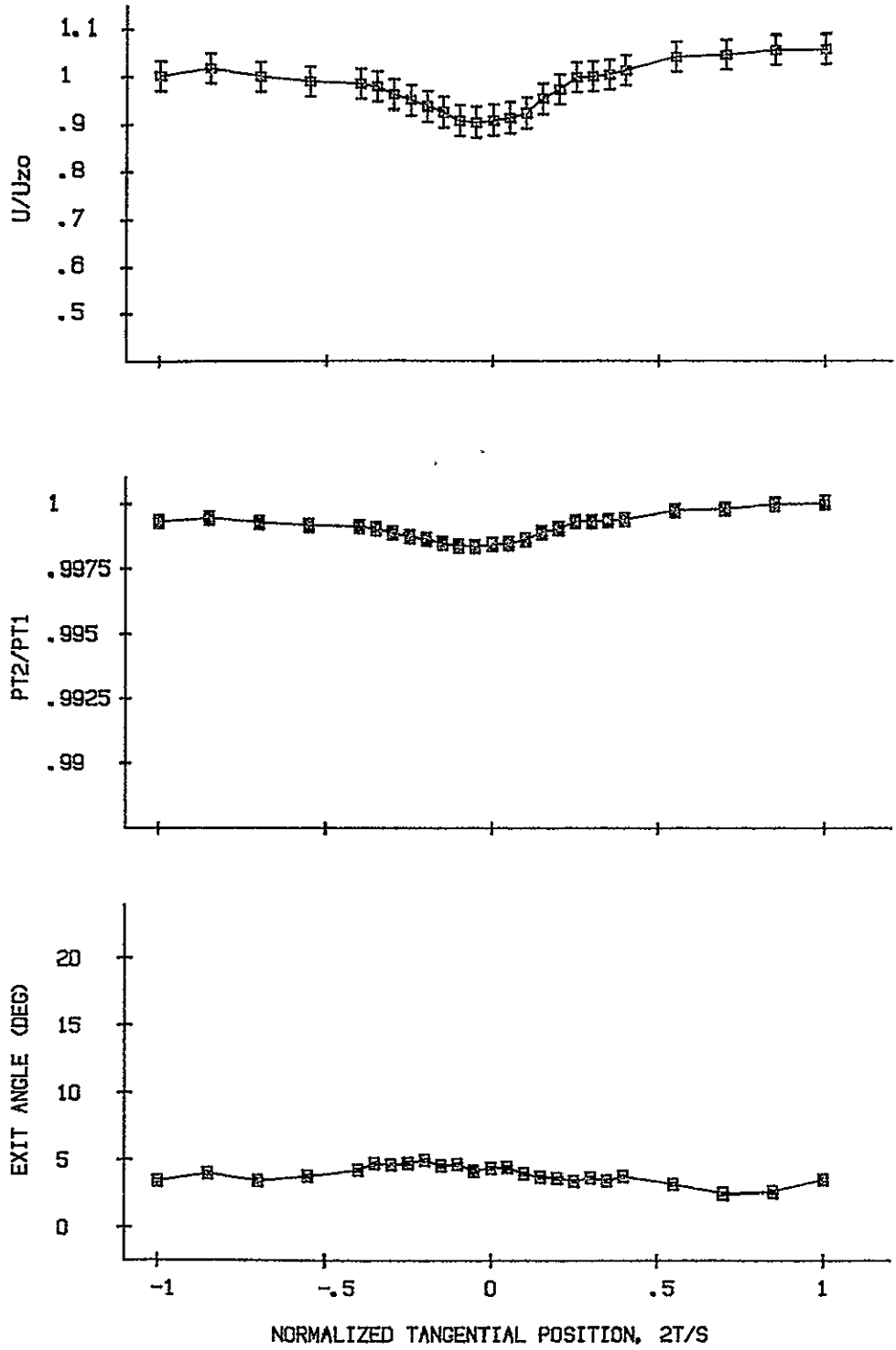

Figure I58. FIVE-HOLE PROBE WAKE DATA, INCIDENCE ANGLE (DEG) = 5,
 $Z_c/C = 2.07$, $R = 8.3\%$

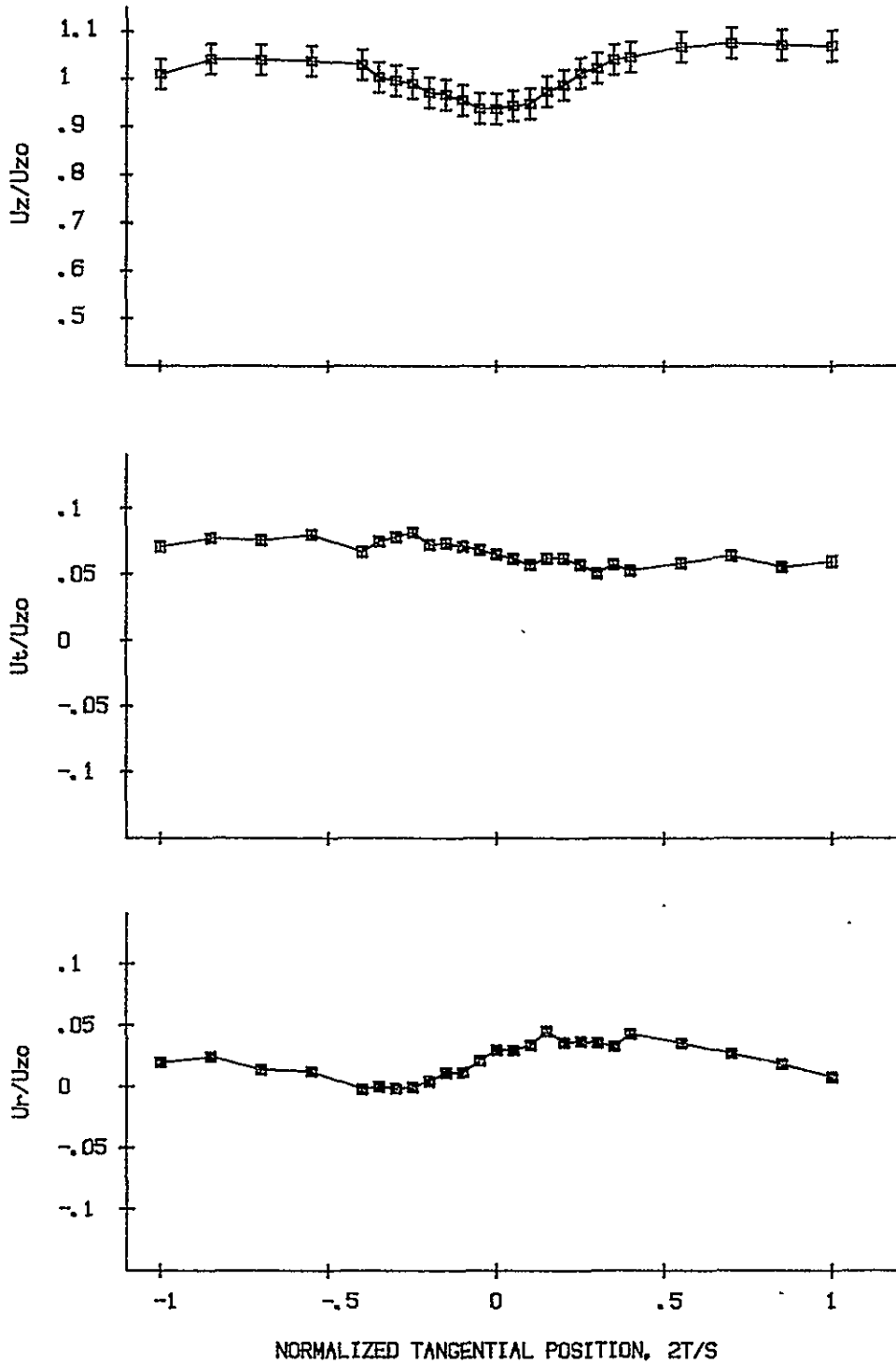

Figure I59. FIVE-HOLE PROBE VELOCITY DATA, INCIDENCE ANGLE (DEG) = 5,
 $Z_c/C = 2.07$, $R = 12.5\%$

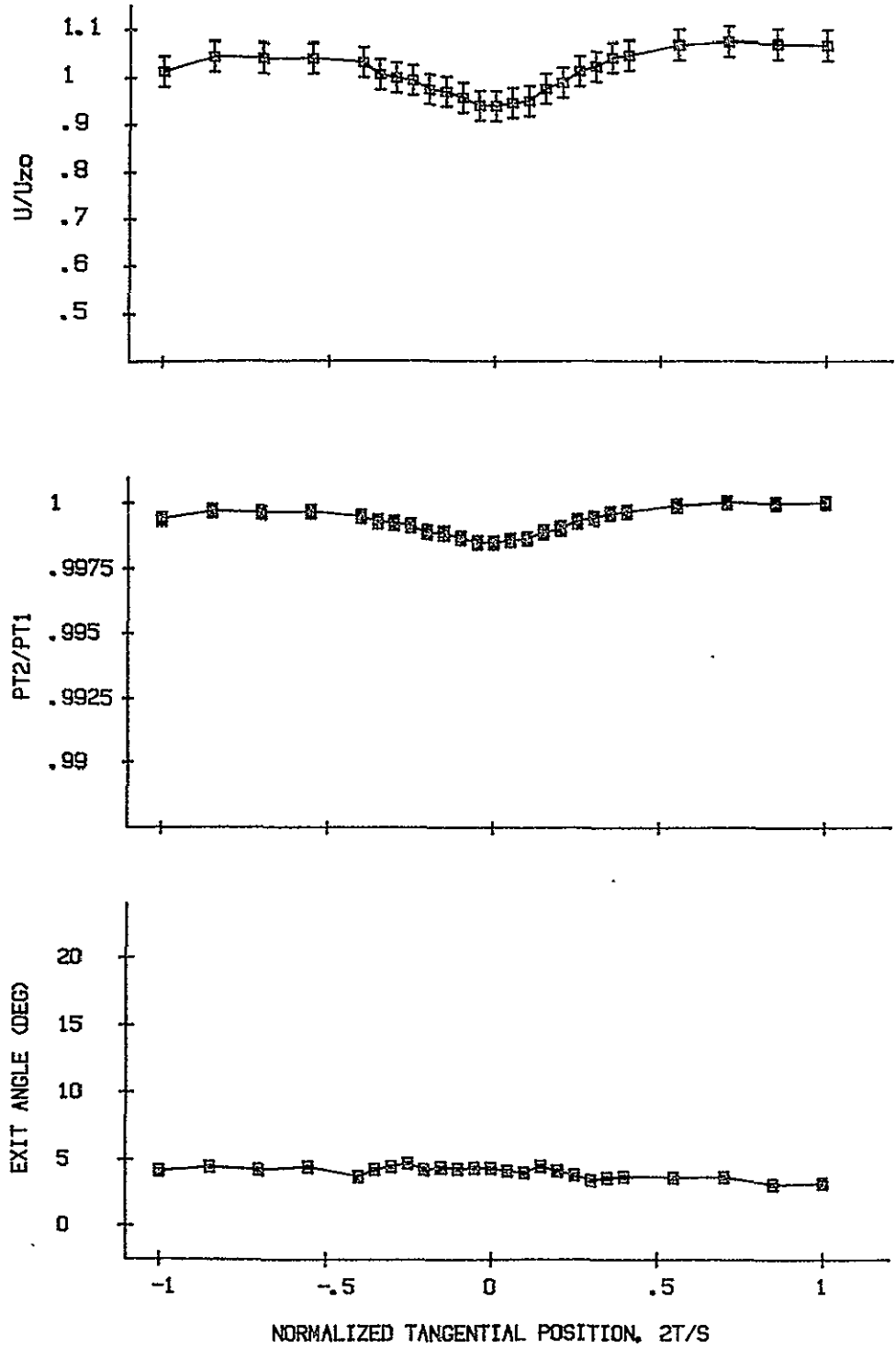

Figure I60. FIVE-HOLE PROBE WAKE DATA, INCIDENCE ANGLE (DEG) = 5,
 $Z_c/C = 2.07$, $R = 12.5\%$

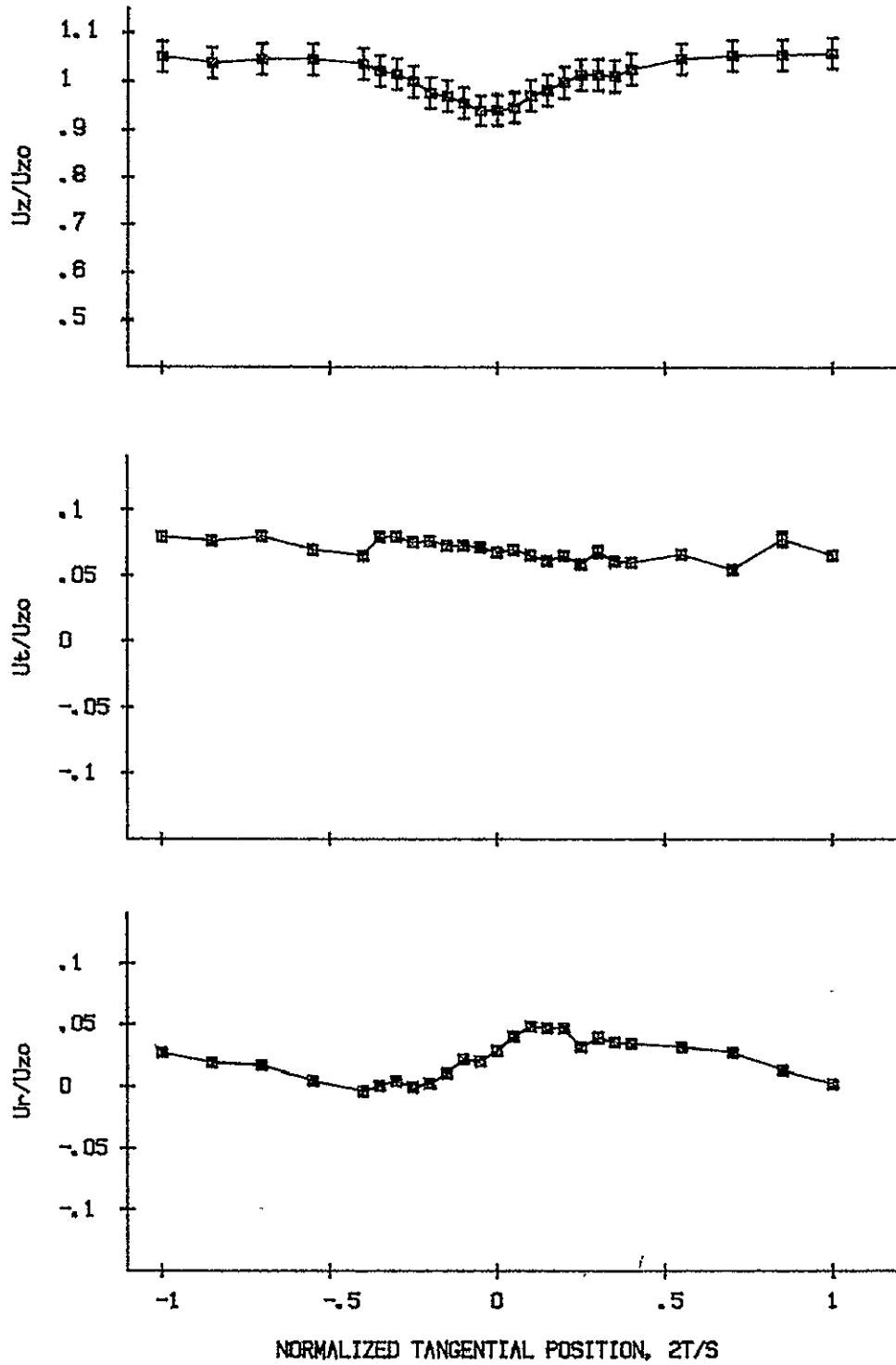

Figure I61. FIVE-HOLE PROBE VELOCITY DATA, INCIDENCE ANGLE (DEG) = 5,
 $Z_c/C = 2.07$, $R = 16.7\%$

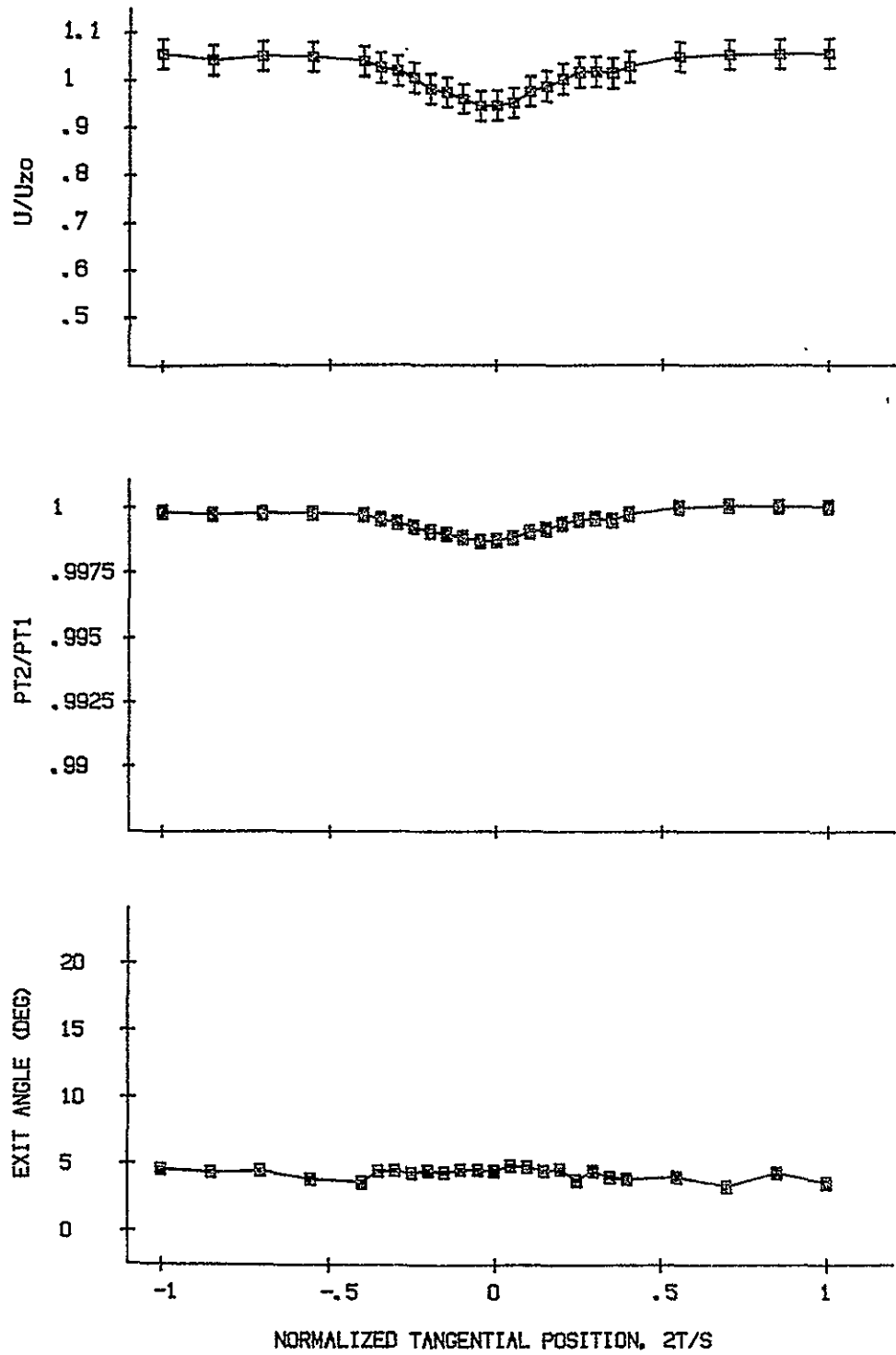

Figure I62.

FIVE-HOLE PROBE WAKE DATA, INCIDENCE ANGLE (DEG) = 5,
 $Z_c/C = 2.07$, $R = 16.7\%$

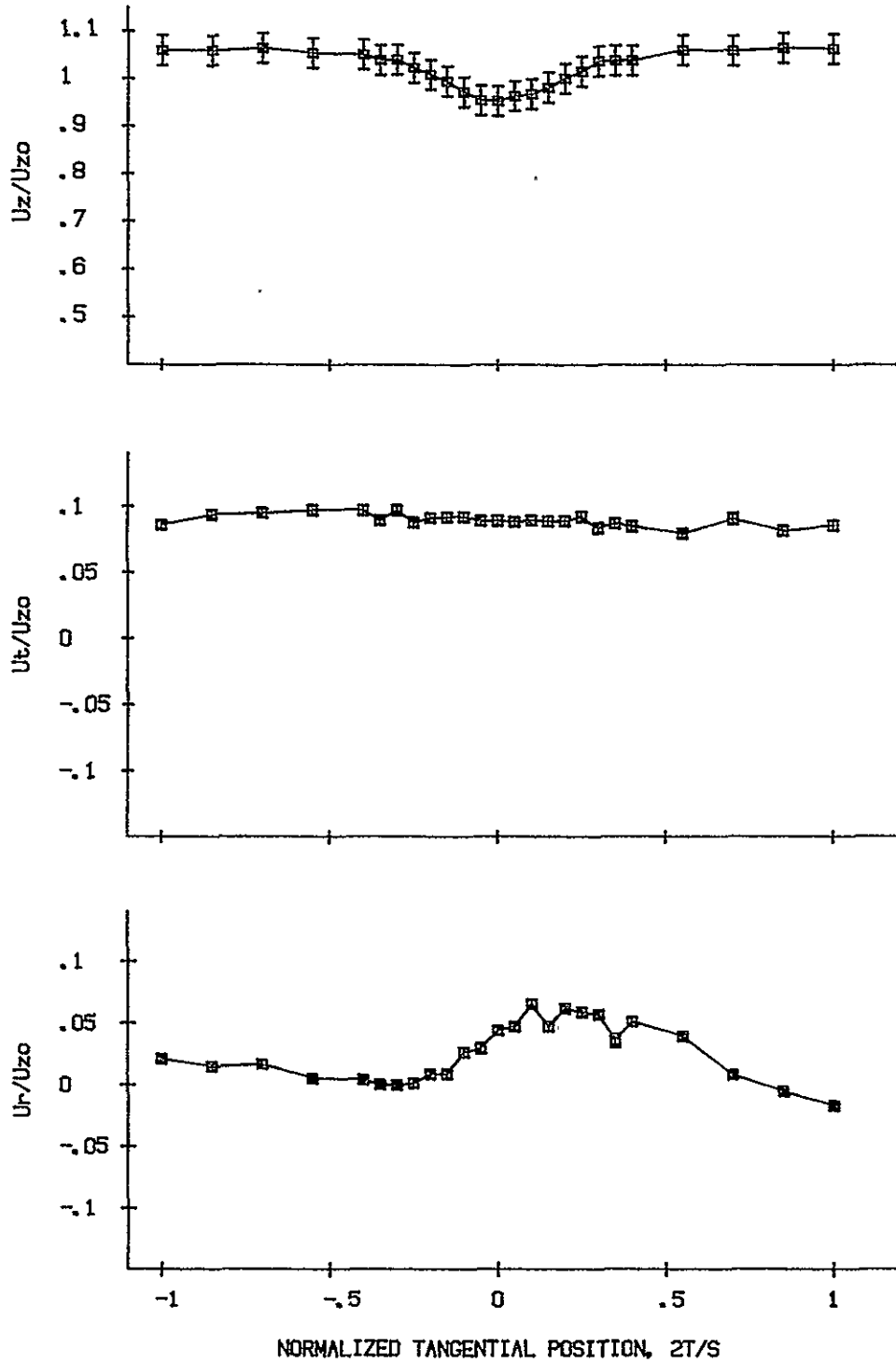

Figure I63. FIVE-HOLE PROBE VELOCITY DATA, INCIDENCE ANGLE (DEG) = 5,
 $Z_c/C = 2.07$, $R = 25\%$

ORIGINAL PAGE IS
OF POOR QUALITY

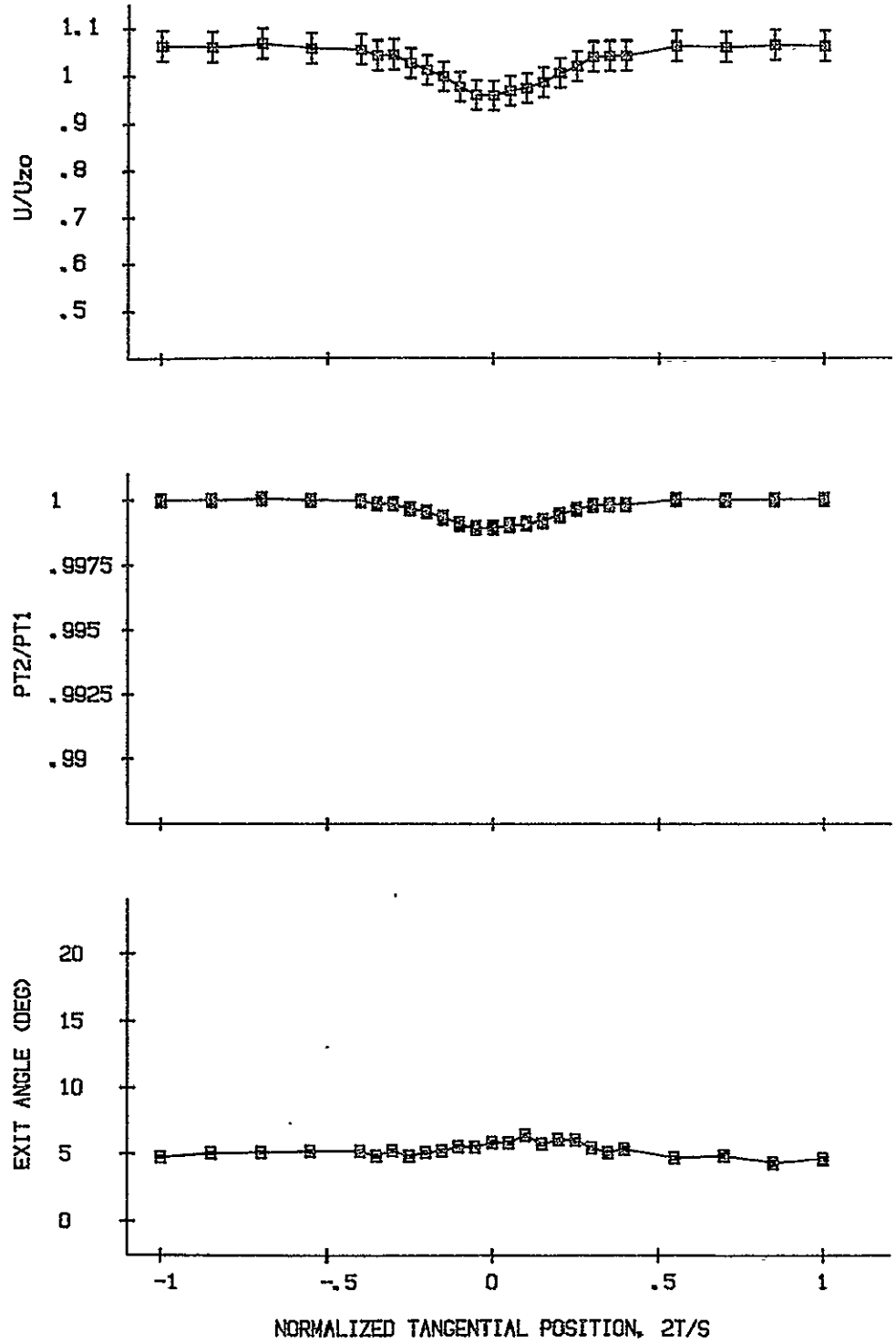

Figure I64. FIVE-HOLE PROBE WAKE DATA, INCIDENCE ANGLE (DEG) = 5,
 $Z_c/C = 2.07$, $R = 25\%$

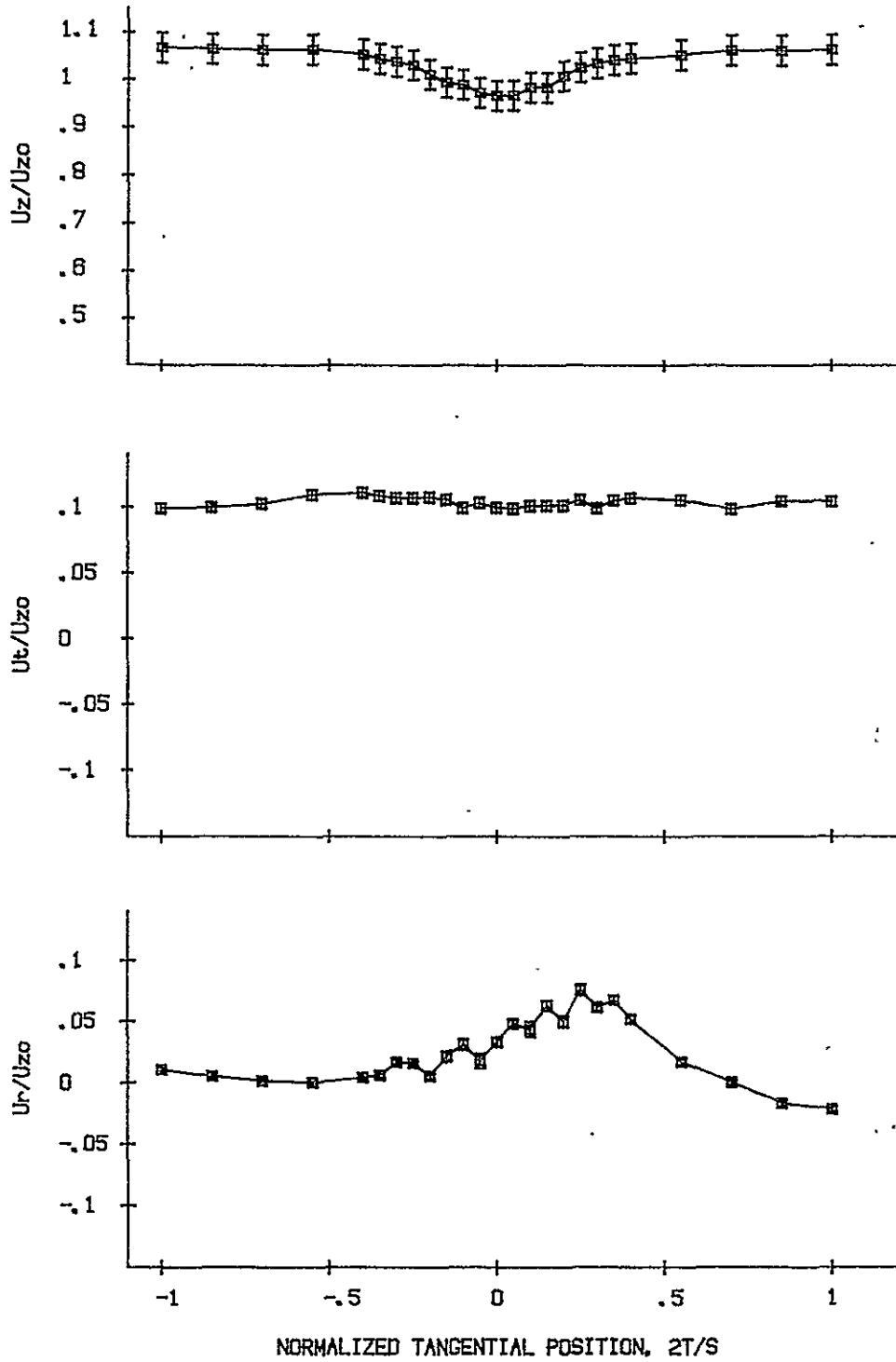

Figure I65. FIVE-HOLE PROBE VELOCITY DATA, INCIDENCE ANGLE (DEG) = 5,
 $Z_c/C = 2.07$, $R = 33.3\%$

ORIGINAL PAGE IS
OF POOR QUALITY

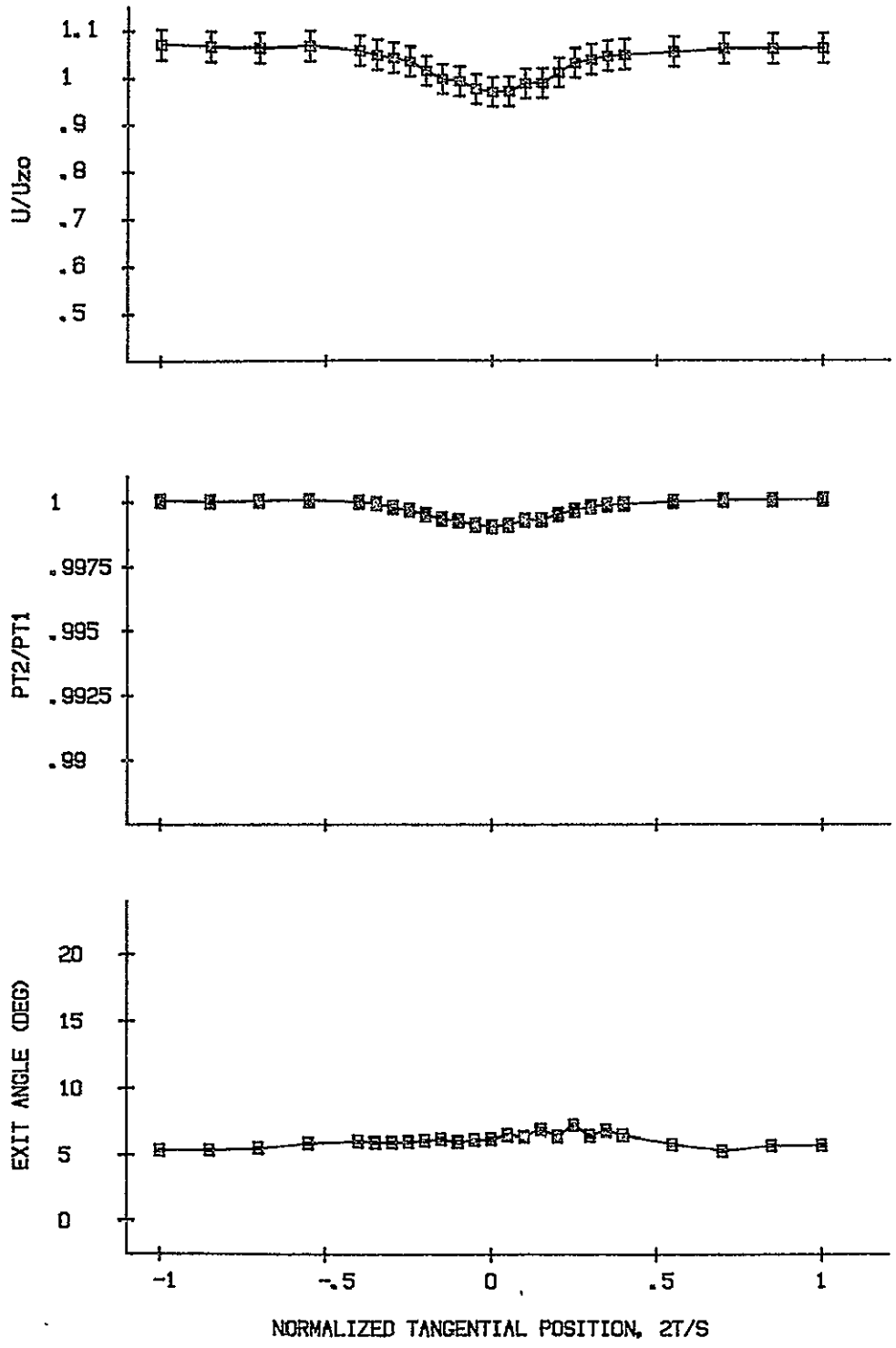

Figure I66. FIVE-HOLE PROBE WAKE DATA, INCIDENCE ANGLE (DEG) = 5,
 $Z_c/C = 2.07$, $R = 33.3\%$

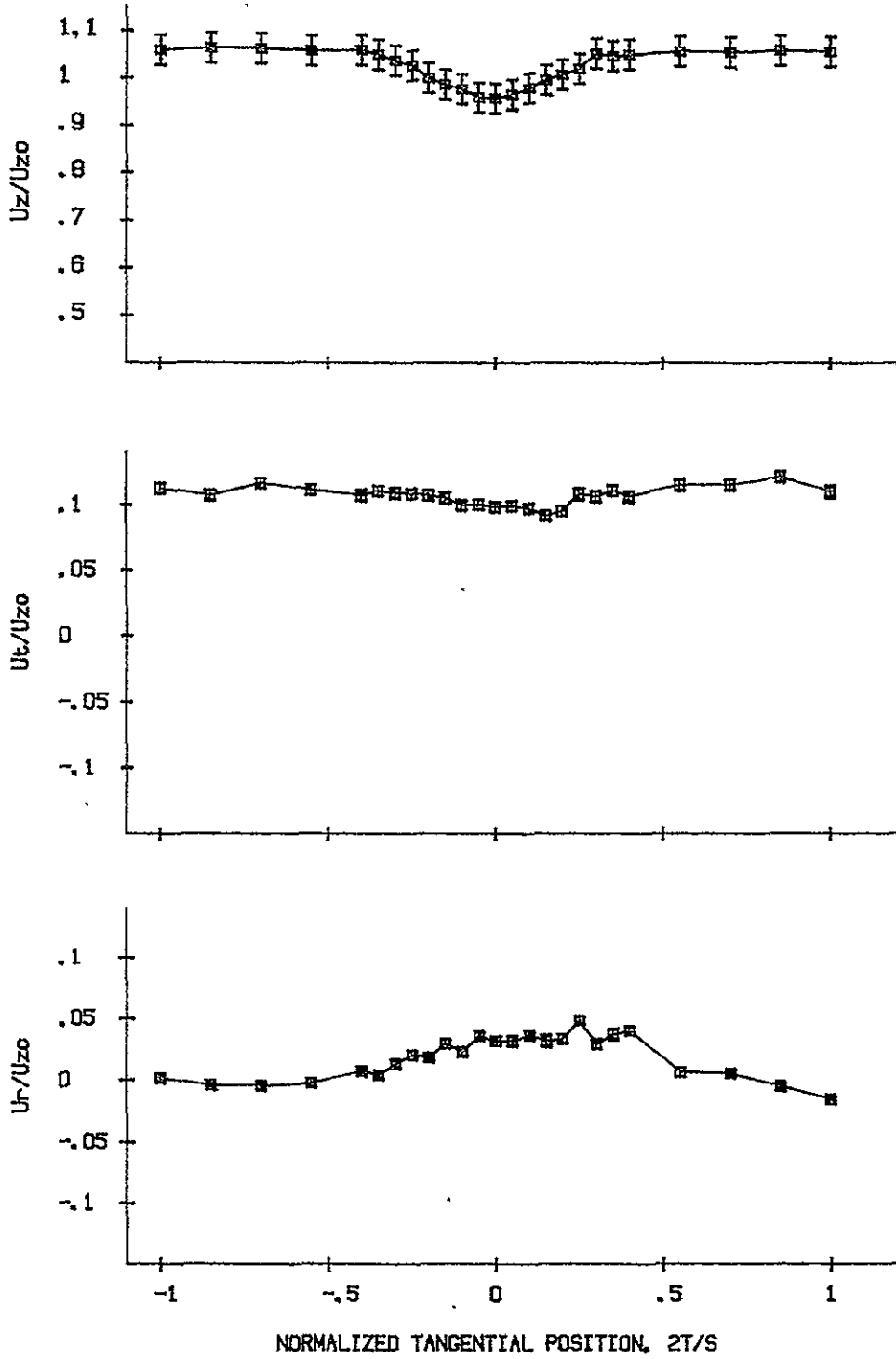

Figure I67. FIVE-HOLE PROBE VELOCITY DATA, INCIDENCE ANGLE (DEG) = 5,
 $Z_c/C = 2.07$, $R = 50\%$

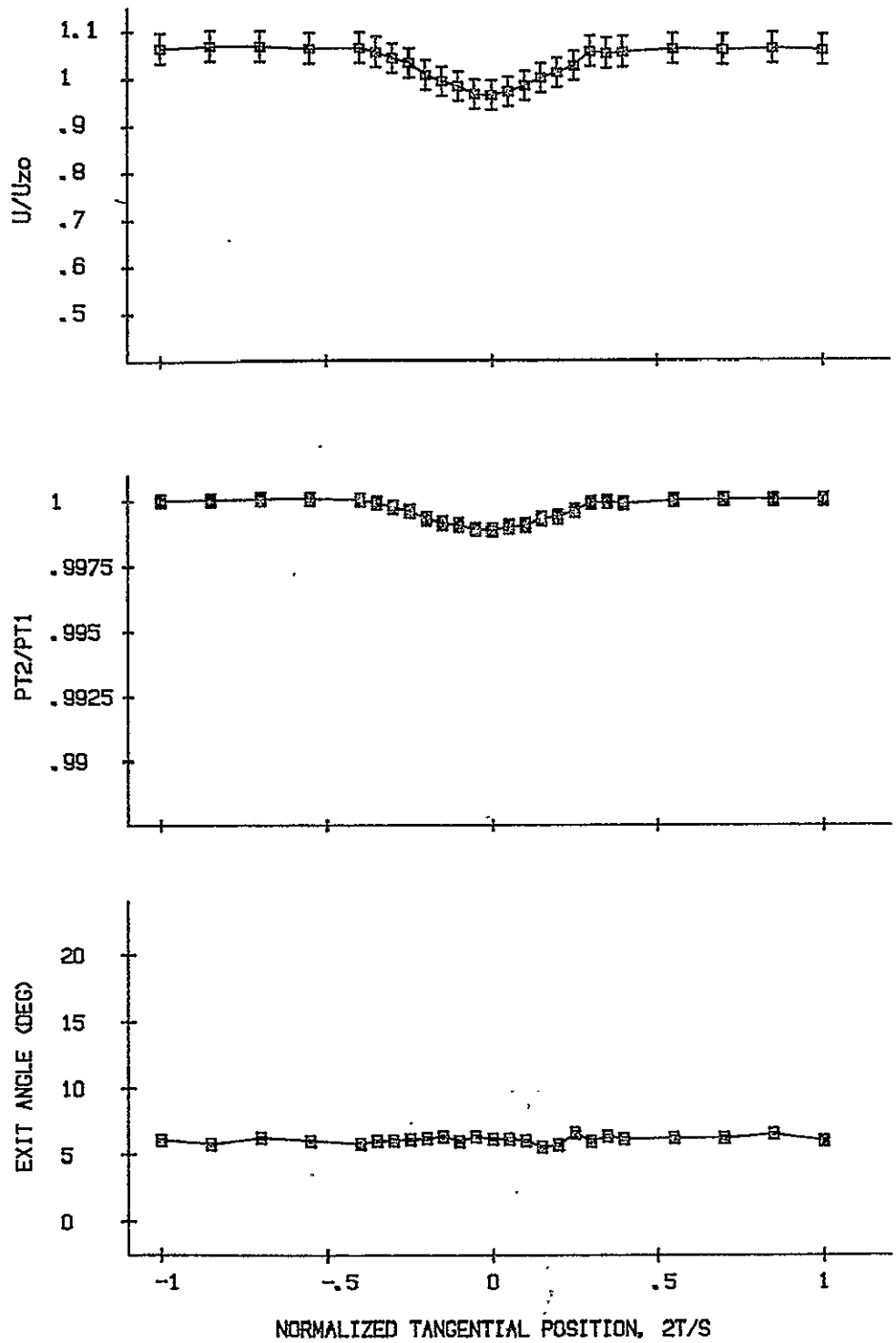

Figure I68.

FIVE-HOLE PROBE WAKE DATA, INCIDENCE ANGLE (DEG) = 5.
 $Z_c/C = 2.07$, $R = 50\%$

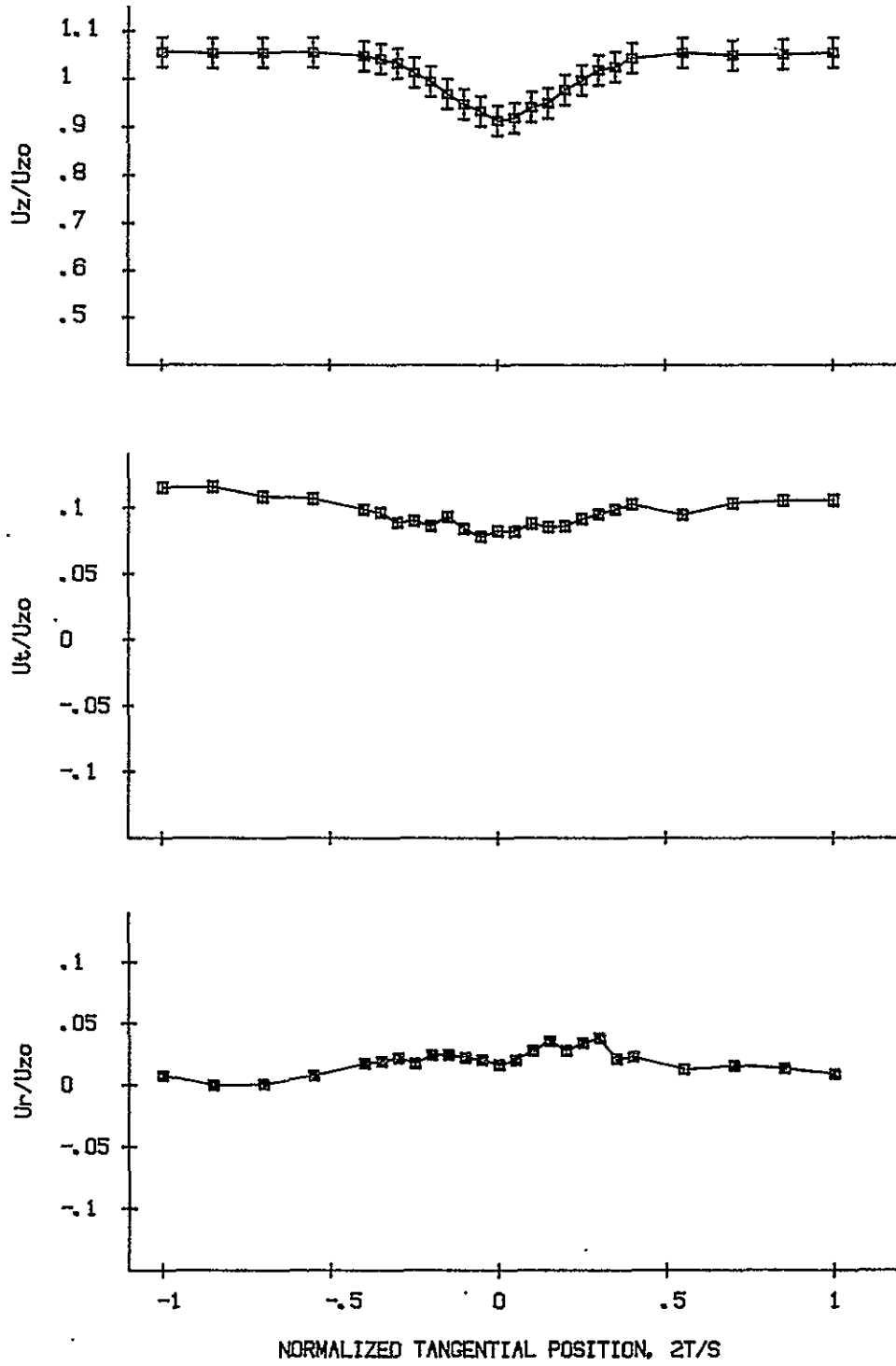

Figure I69. FIVE-HOLE PROBE VELOCITY DATA, INCIDENCE ANGLE (DEG) = 5,
 $Z_c/C = 2.07$, $R = 86.7\%$

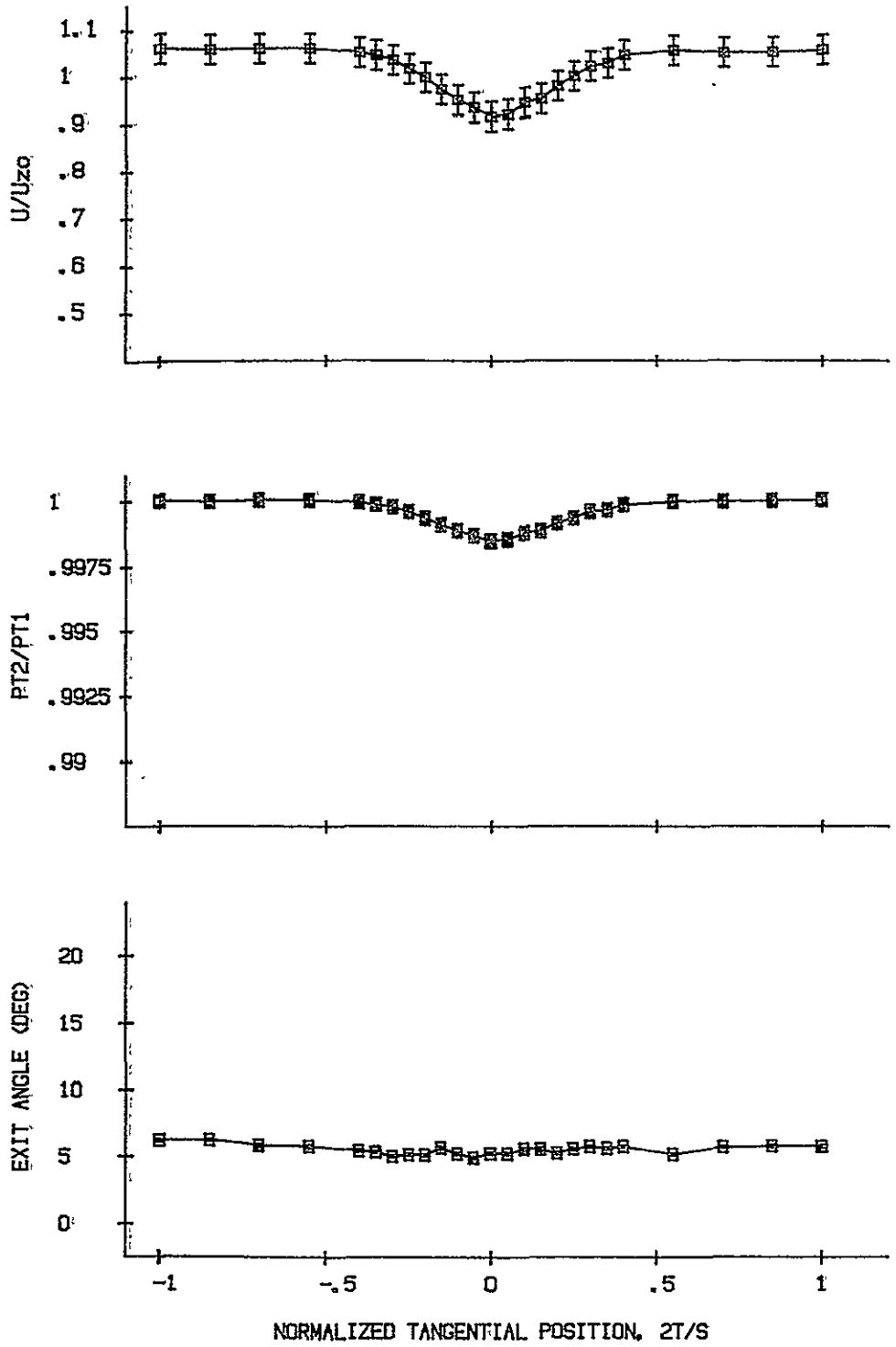

Figure I70. FIVE-HOLE PROBE WAKE DATA, INCIDENCE ANGLE (DEG) = 5,
 $Z_c/C = 2.07$, $R = 86.7\%$

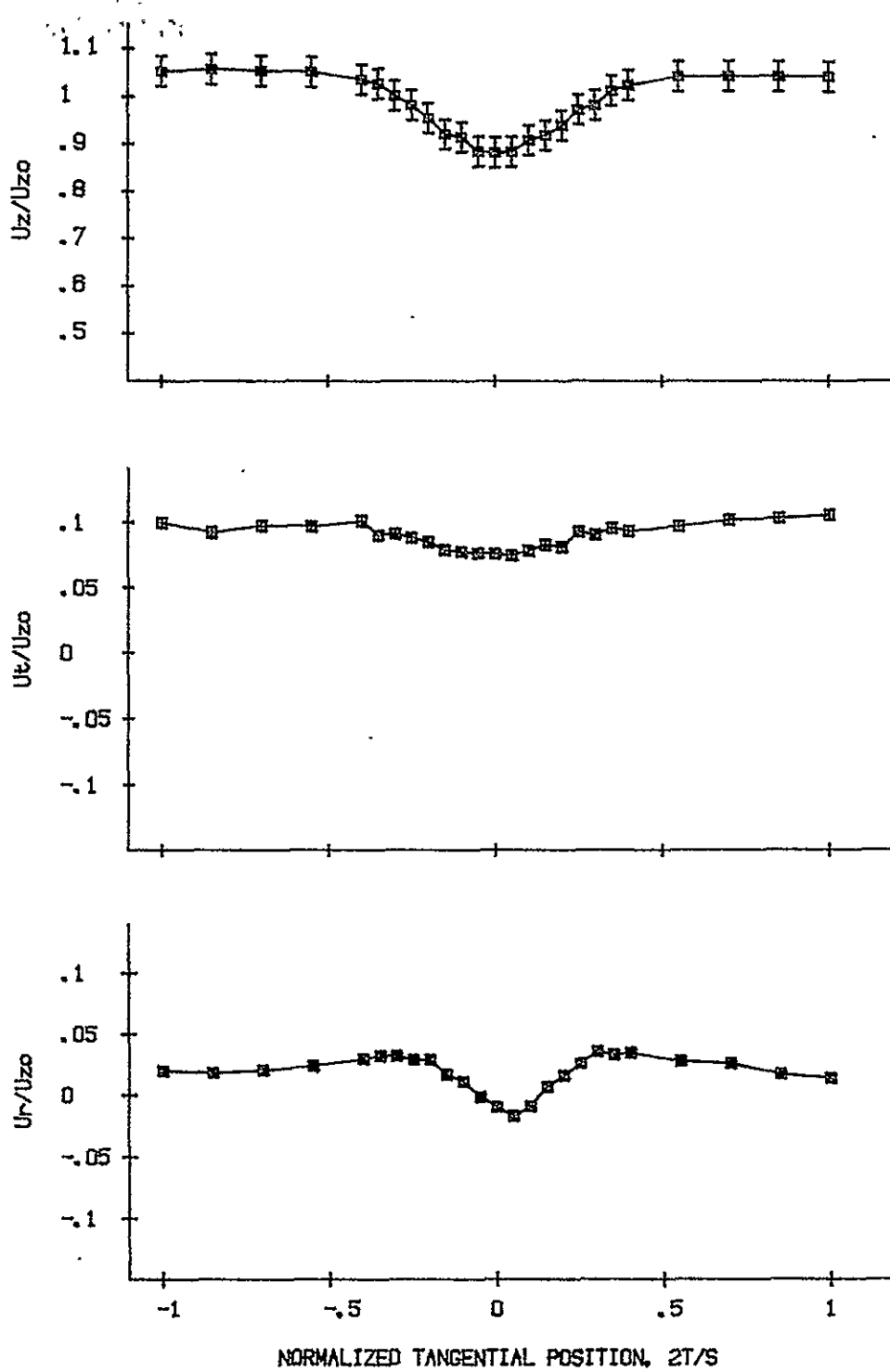

Figure I71. FIVE-HOLE PROBE VELOCITY DATA, INCIDENCE ANGLE (DEG) = 5,
 $Z_c/C = 2.07$, $R = 83.3\%$

ORIGINAL PAGE IS
OF POOR QUALITY

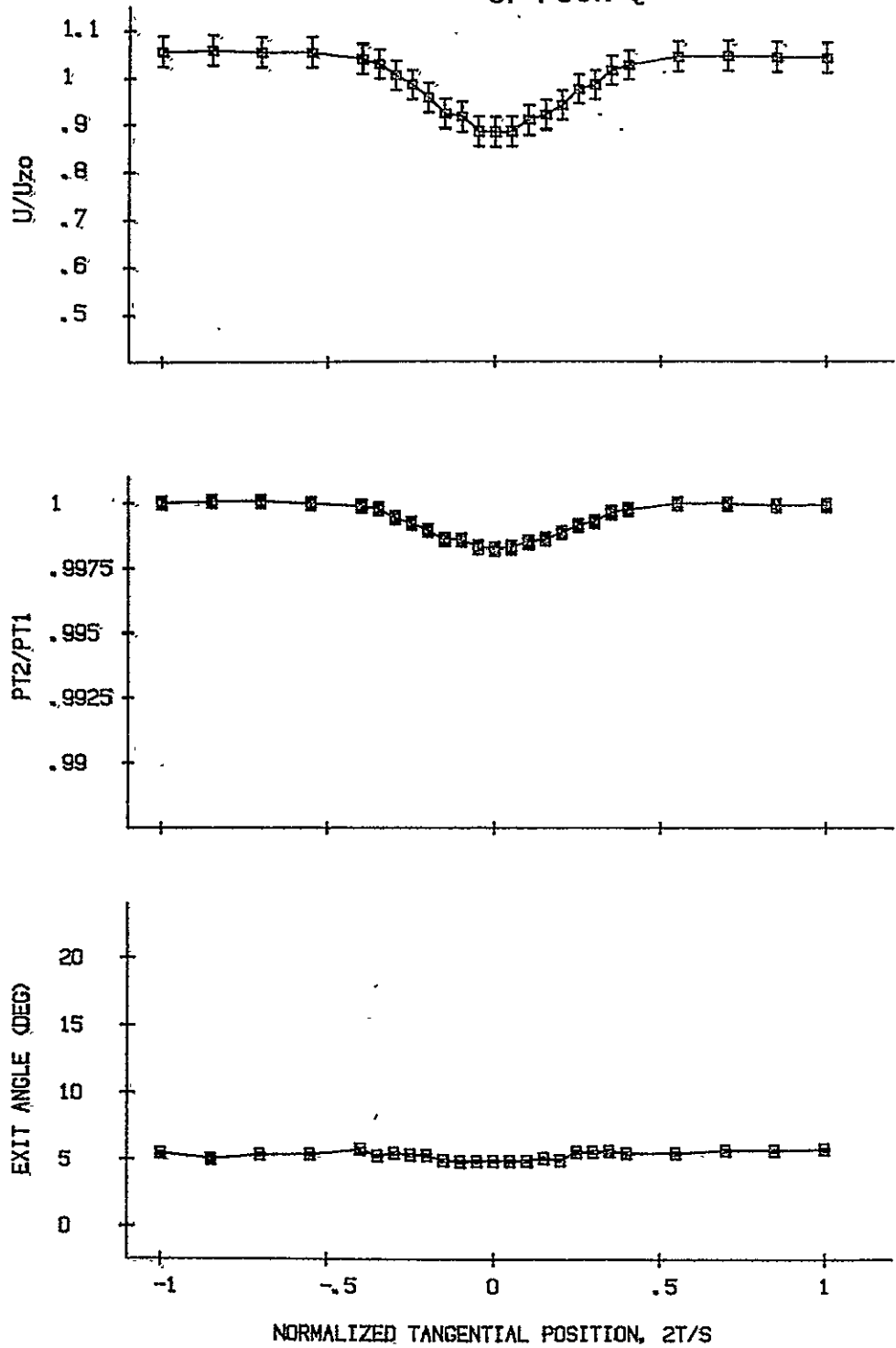

Figure I72.

FIVE-HOLE PROBE WAKE DATA, INCIDENCE ANGLE (DEG) = 5,
 $Z_0/C = 2.07$, $R = 83.3\%$

ORIGINAL PAGE IS
OF POOR QUALITY

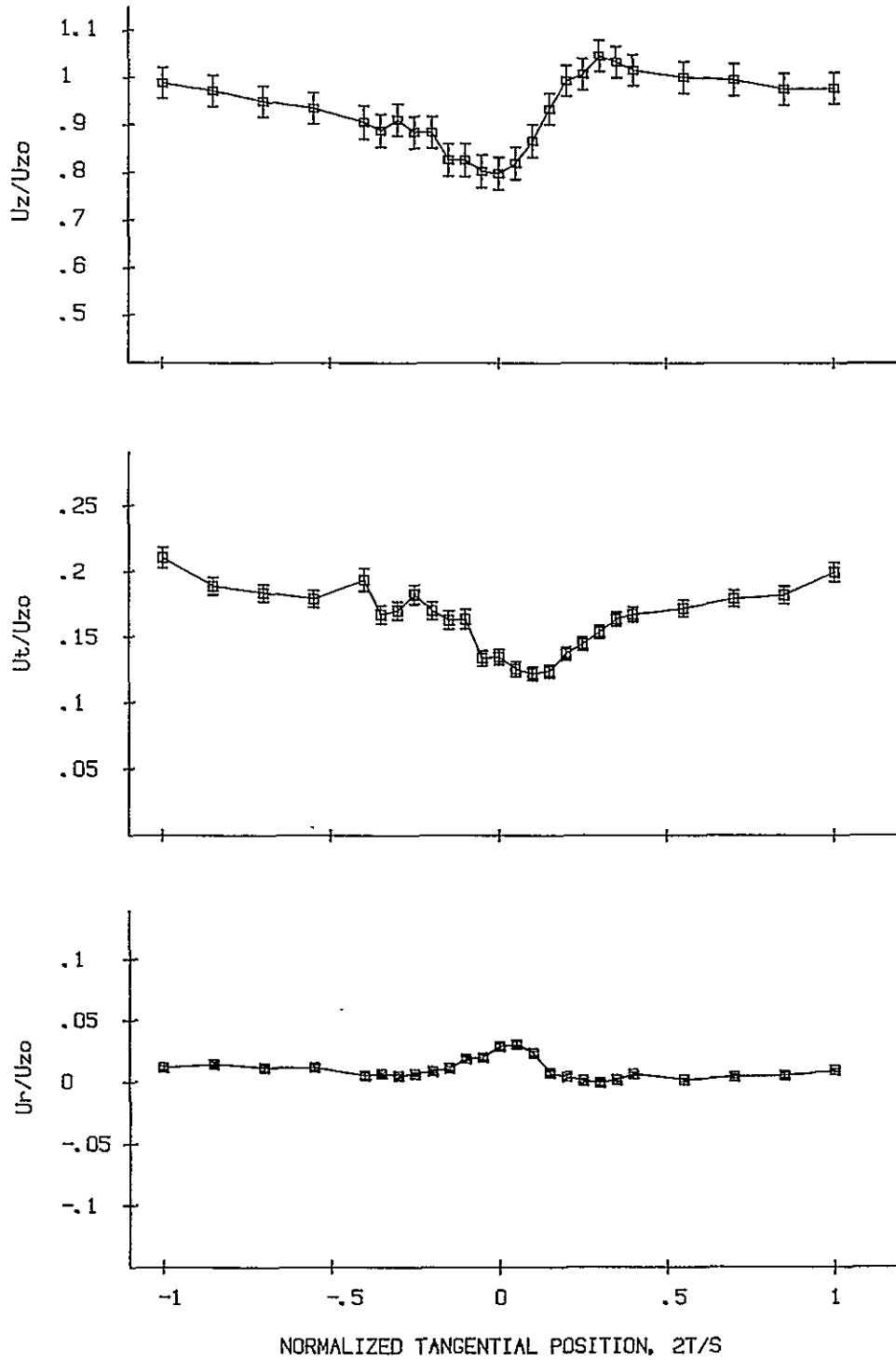

Figure I73. FIVE-HOLE PROBE VELOCITY DATA, INCIDENCE ANGLE (DEG) = 10,
 $Z_c/C = .96$, $R = 4.2\%$

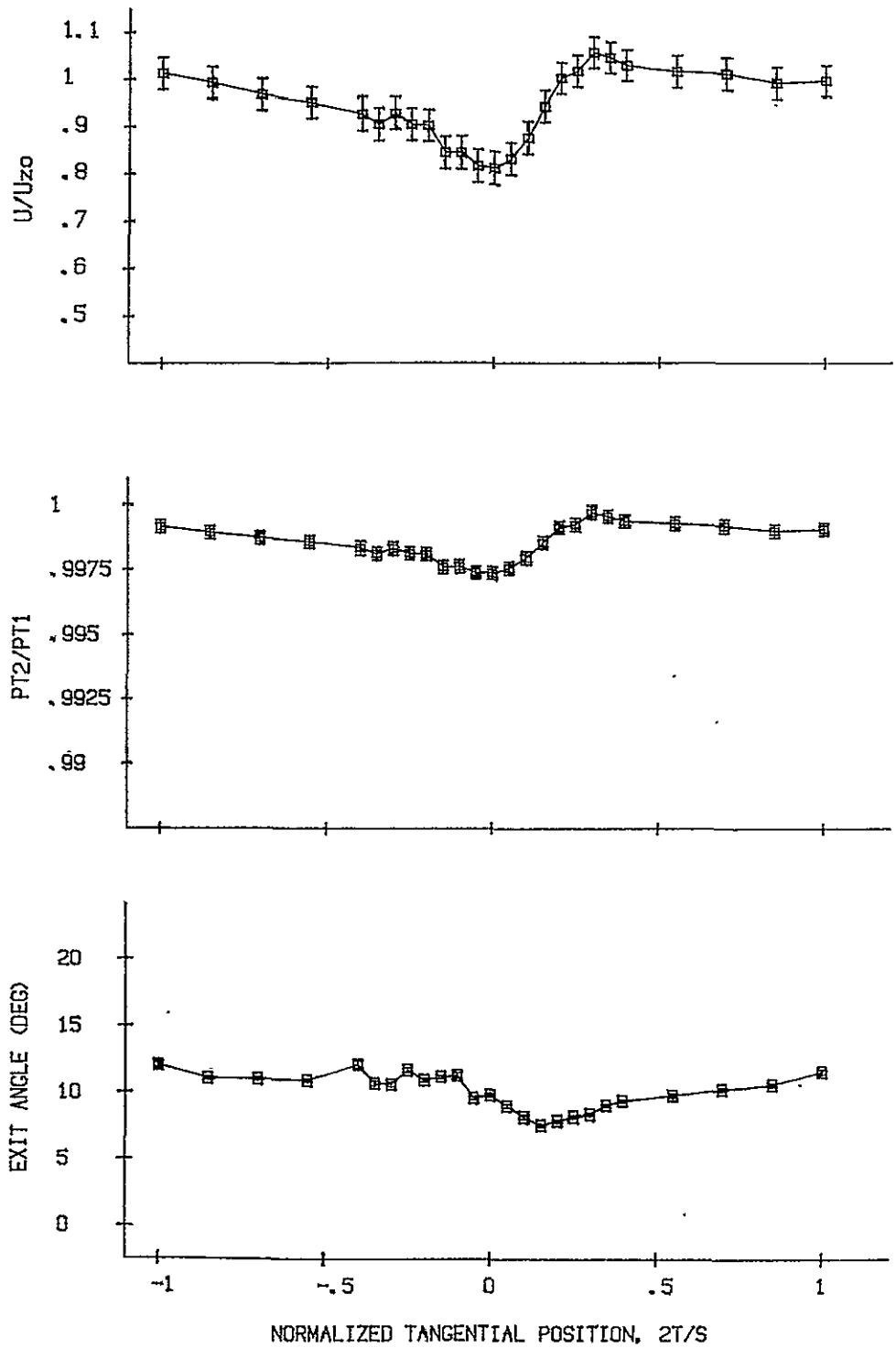

Figure I74.

FIVE-HOLE PROBE WAKE DATA, INCIDENCE ANGLE (DEG) = 10,
 $Z_0/C = .96$, $R = 4.2\%$

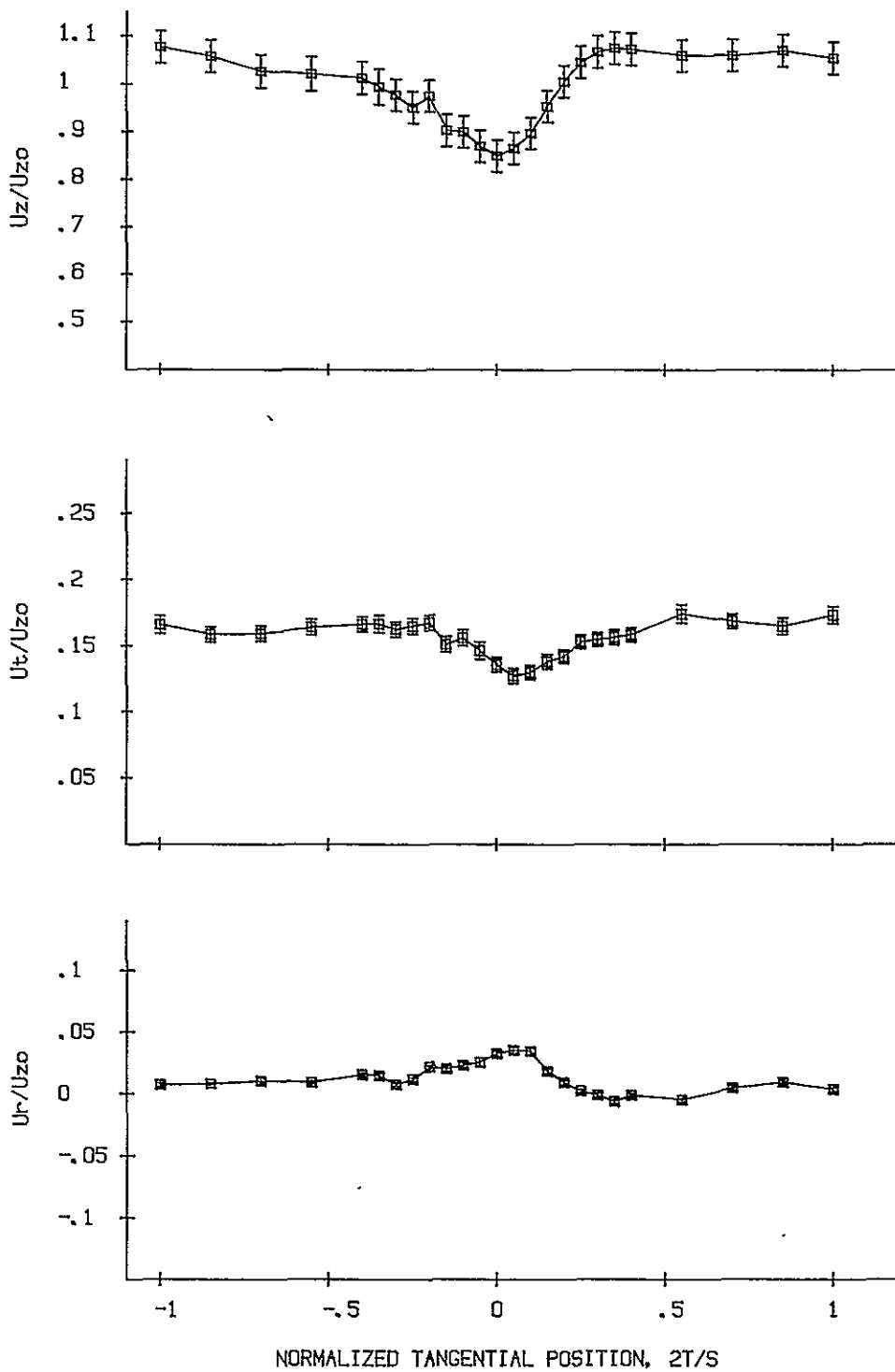

Figure 175. FIVE-HOLE PROBE VELOCITY DATA, INCIDENCE ANGLE (DEG) = 10,
 $Z_c/C = .96$, $R = 8.3\%$

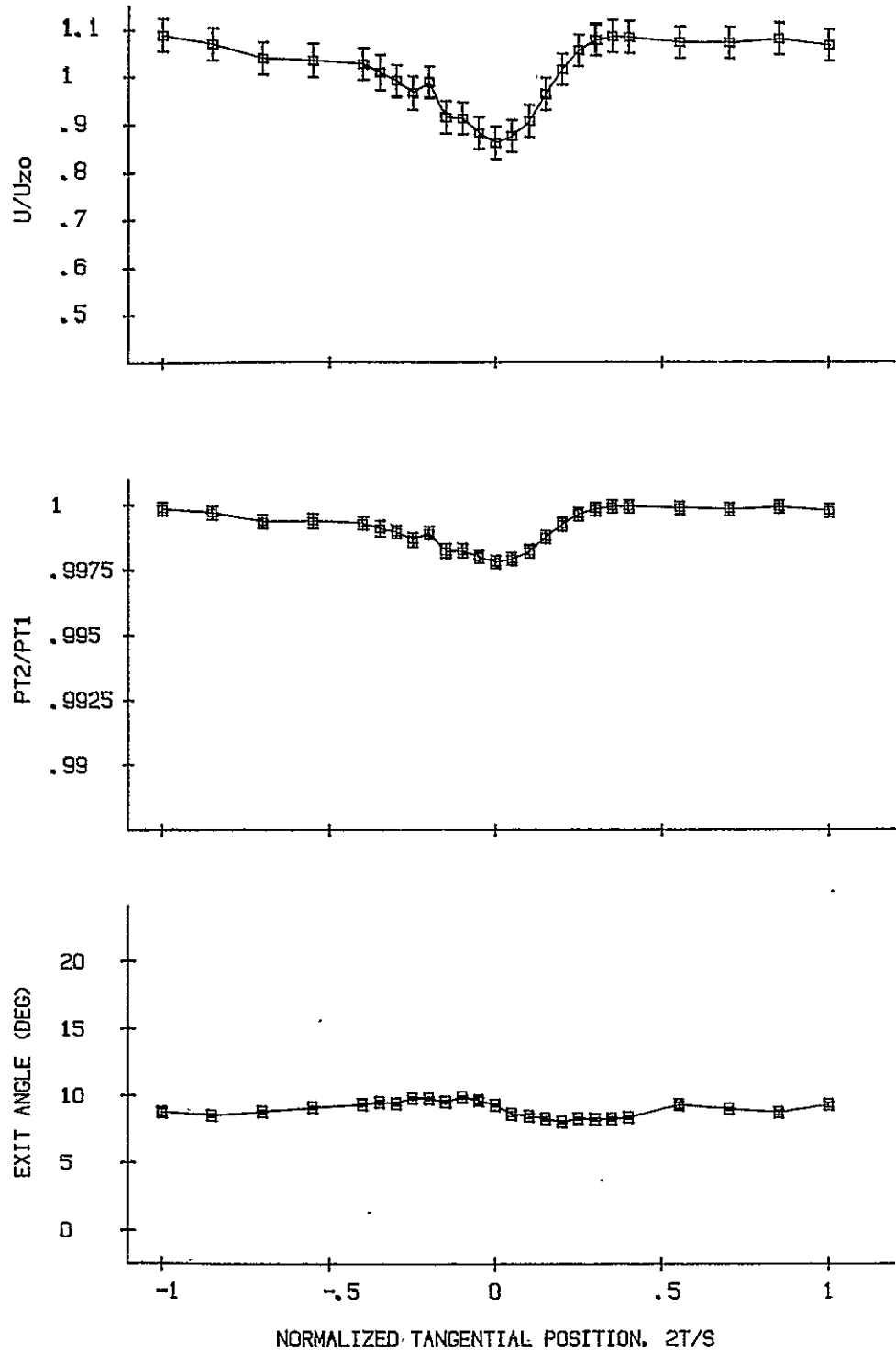

Figure I76. FIVE-HOLE PROBE WAKE DATA, INCIDENCE ANGLE (DEG) = 10,
 $Z_c/C = .96$, $R = 8.3\%$

ORIGINAL PAGE IS
OF POOR QUALITY

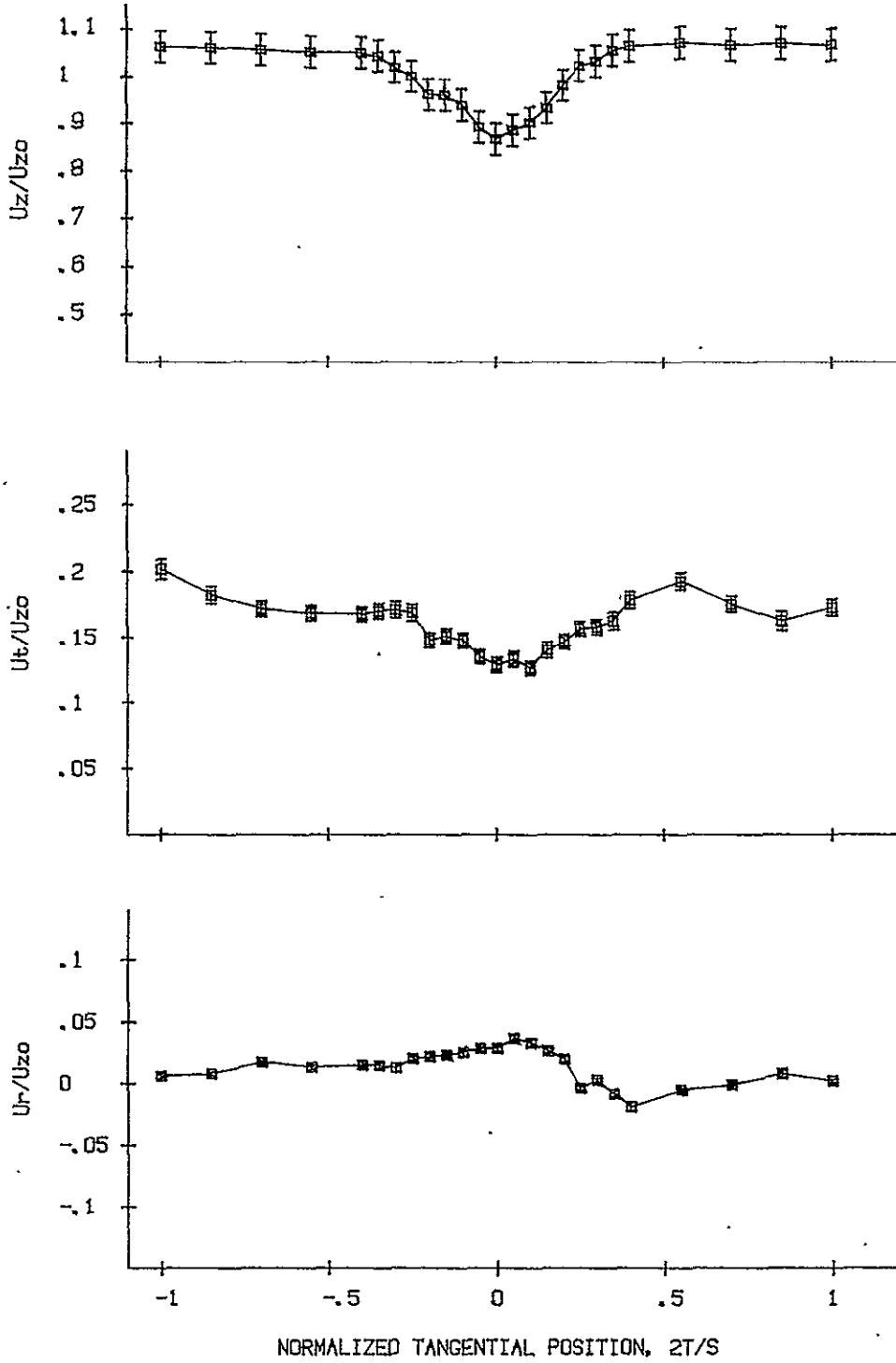

Figure I77. FIVE-HOLE PROBE VELOCITY DATA, INCIDENCE ANGLE (DEG) = 10,
 $Z_c/C = .96$, $R = 12.5\%$

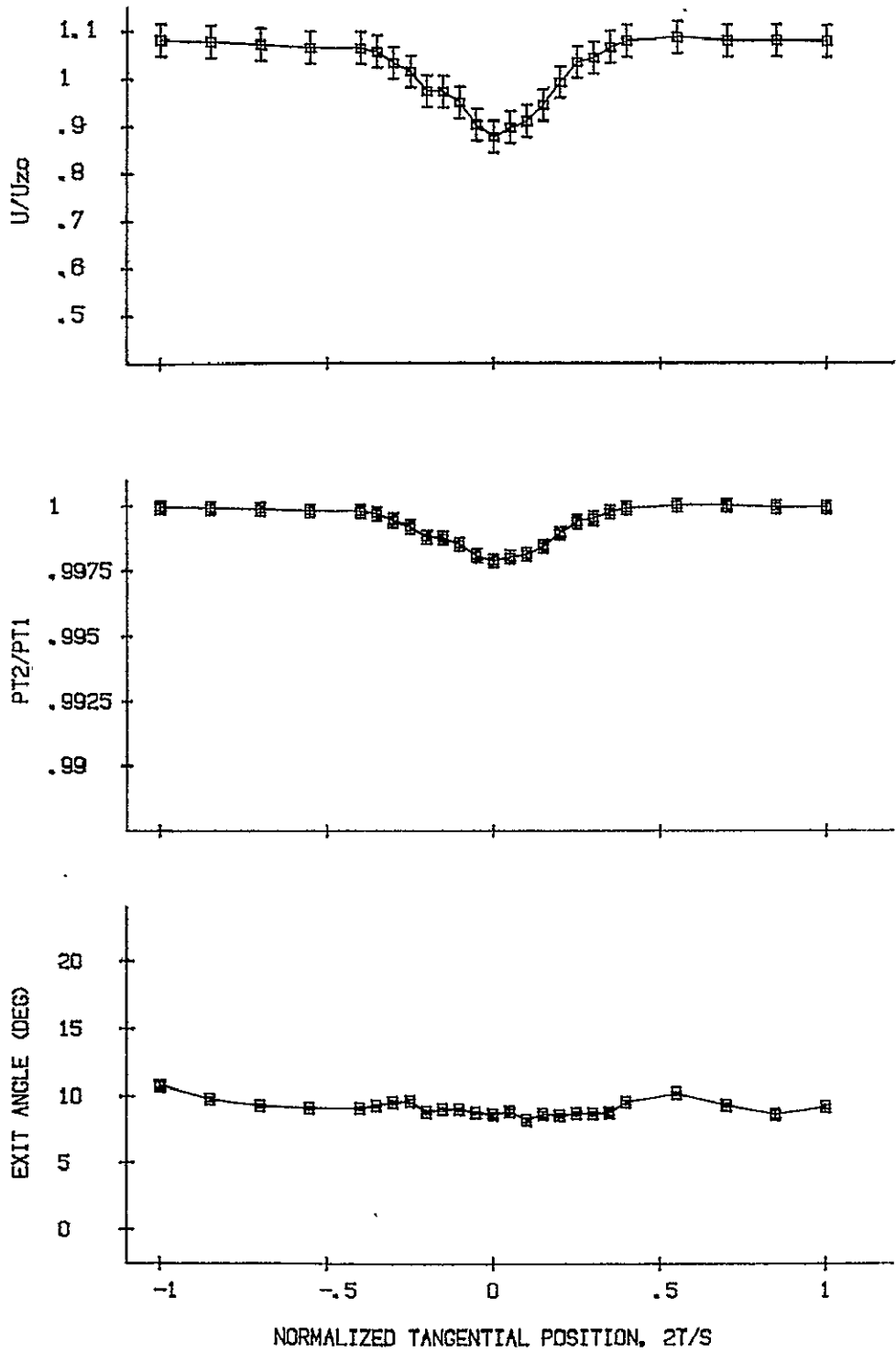

Figure I78. FIVE-HOLE PROBE WAKE DATA, INCIDENCE ANGLE (DEG) = 10,
 $Z_c/C = .96$, $R = 12.5\%$

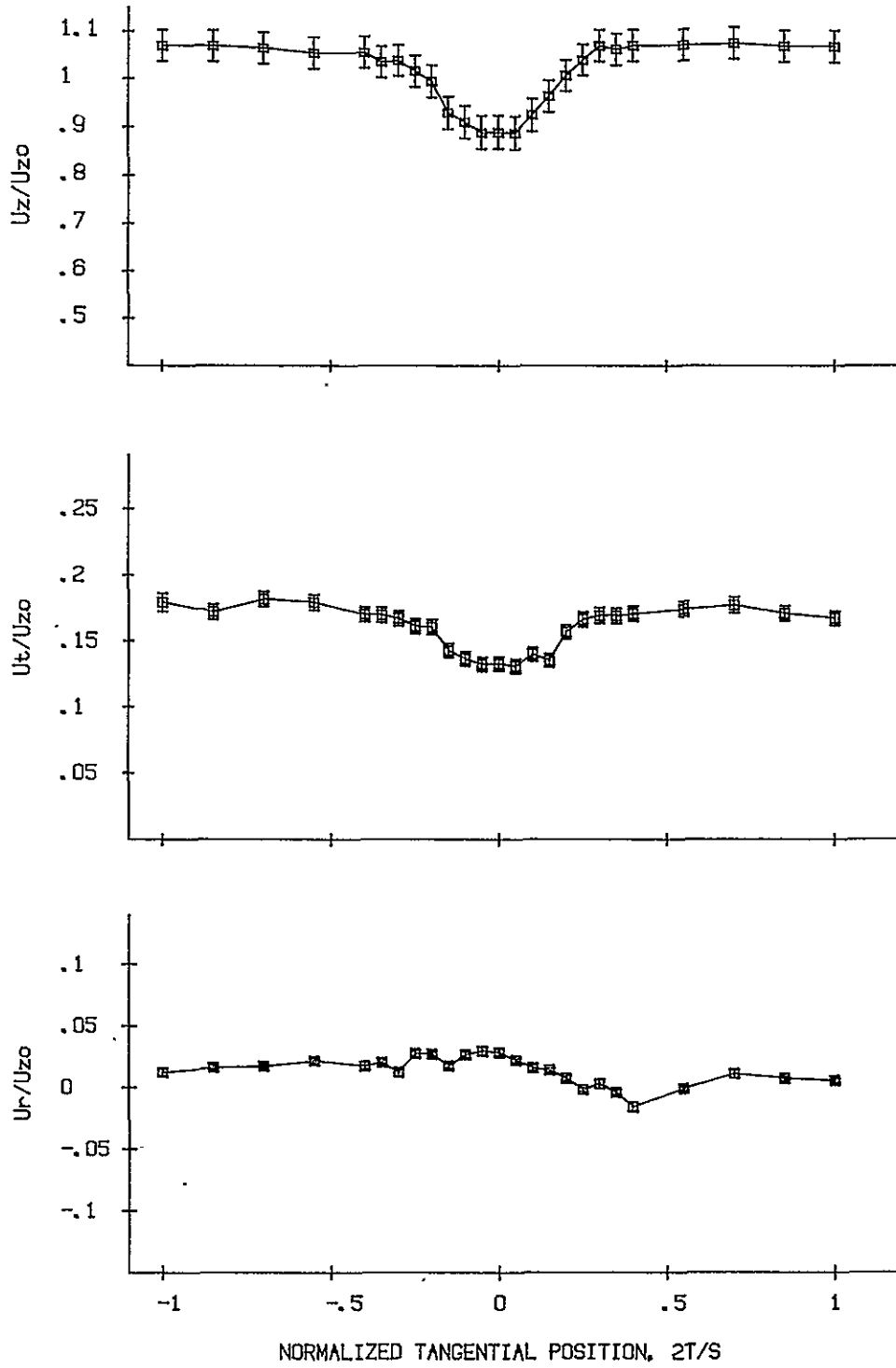

Figure I79. FIVE-HOLE PROBE VELOCITY DATA, INCIDENCE ANGLE (DEG) = 10,
 $Z_c/C = .96$, $R = 16.7\%$

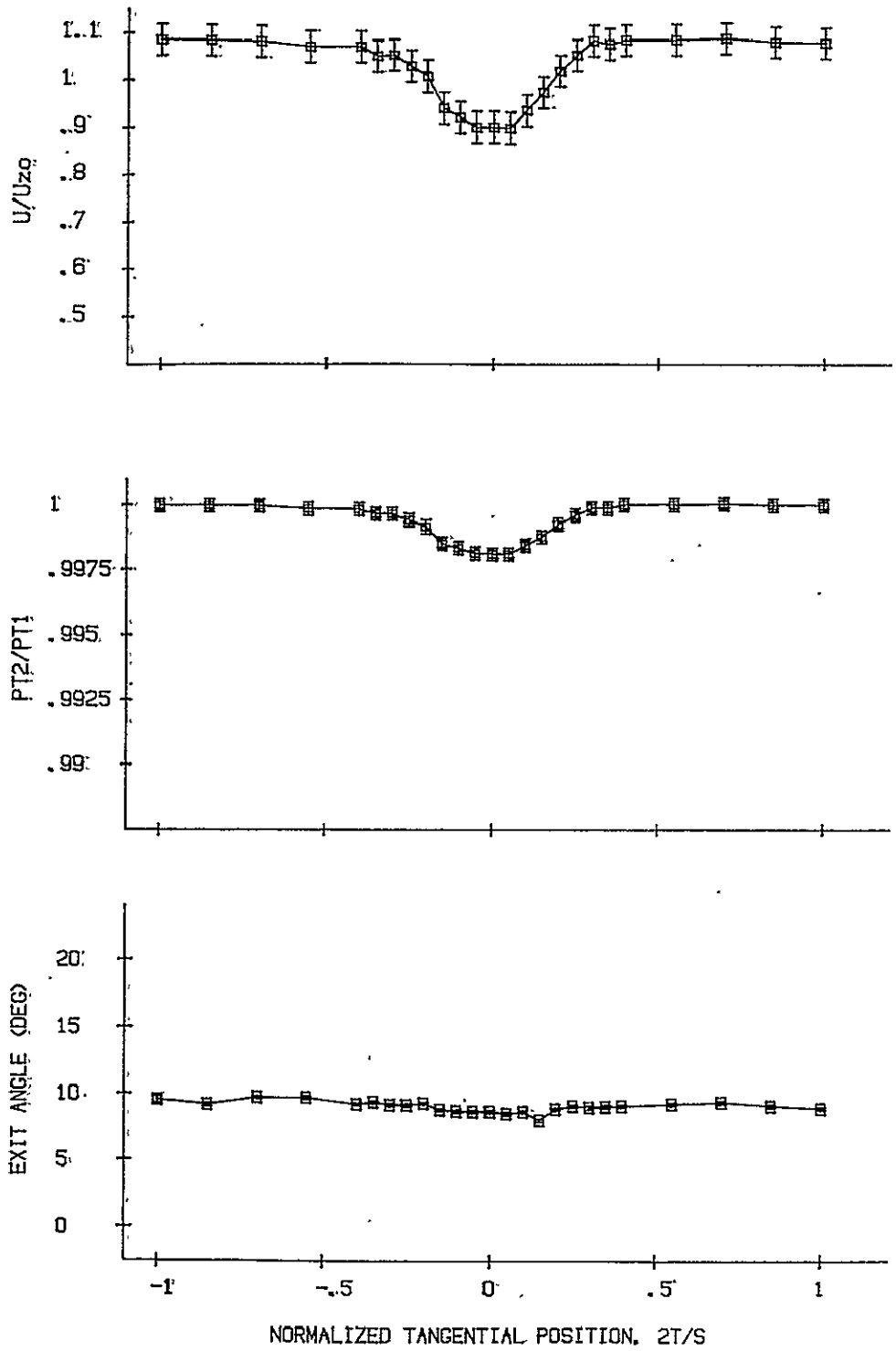

Figure I80. FIVE-HOLE PROBE WAKE DATA, INCIDENCE ANGLE (DEG) = 10,
 $Zc/C = .96$, $R = 16.7\%$

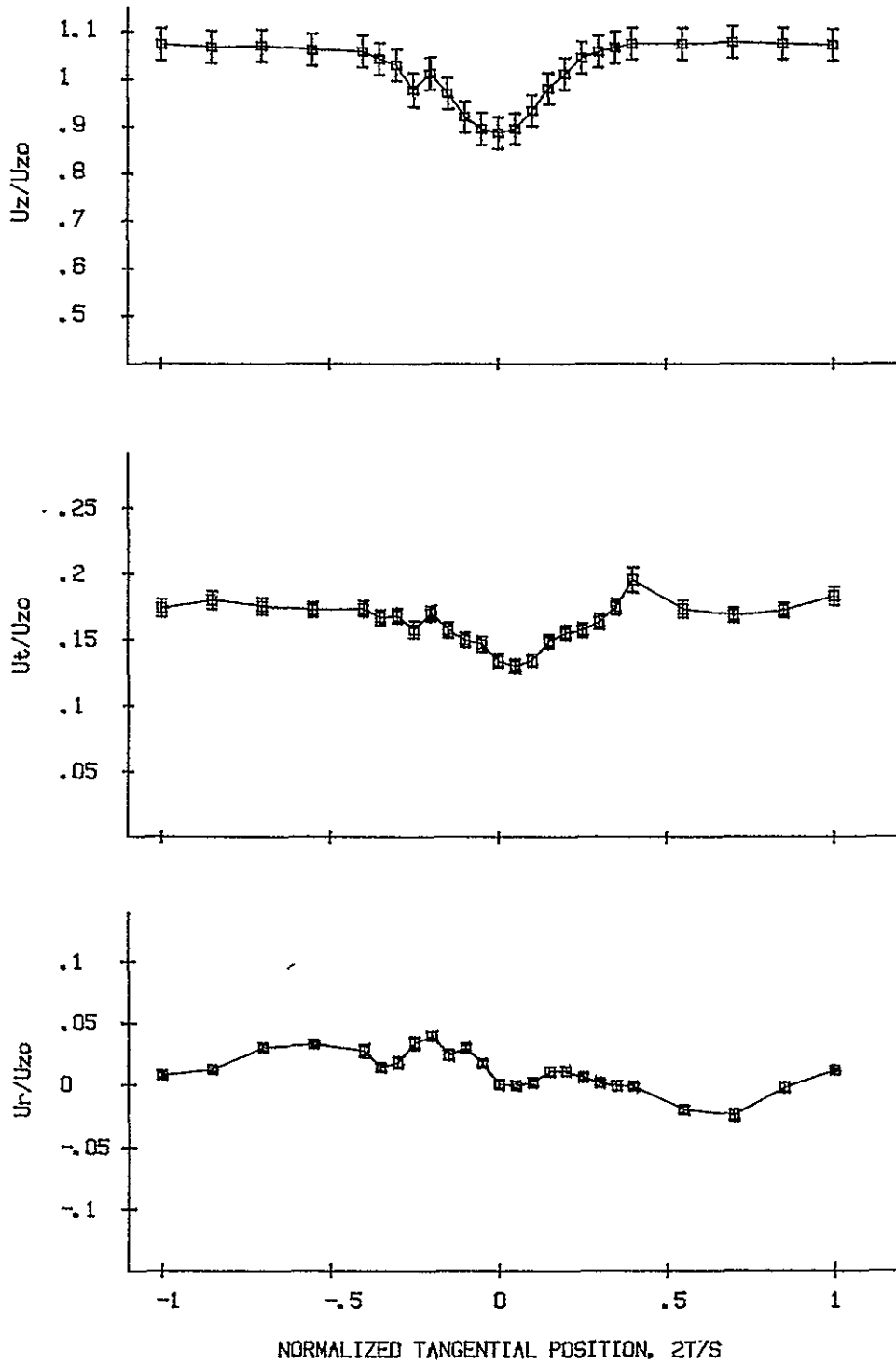

Figure I81. FIVE-HOLE PROBE VELOCITY DATA, INCIDENCE ANGLE (DEG) = 10,
 $Z_c/C = .96$, $R = 25\%$

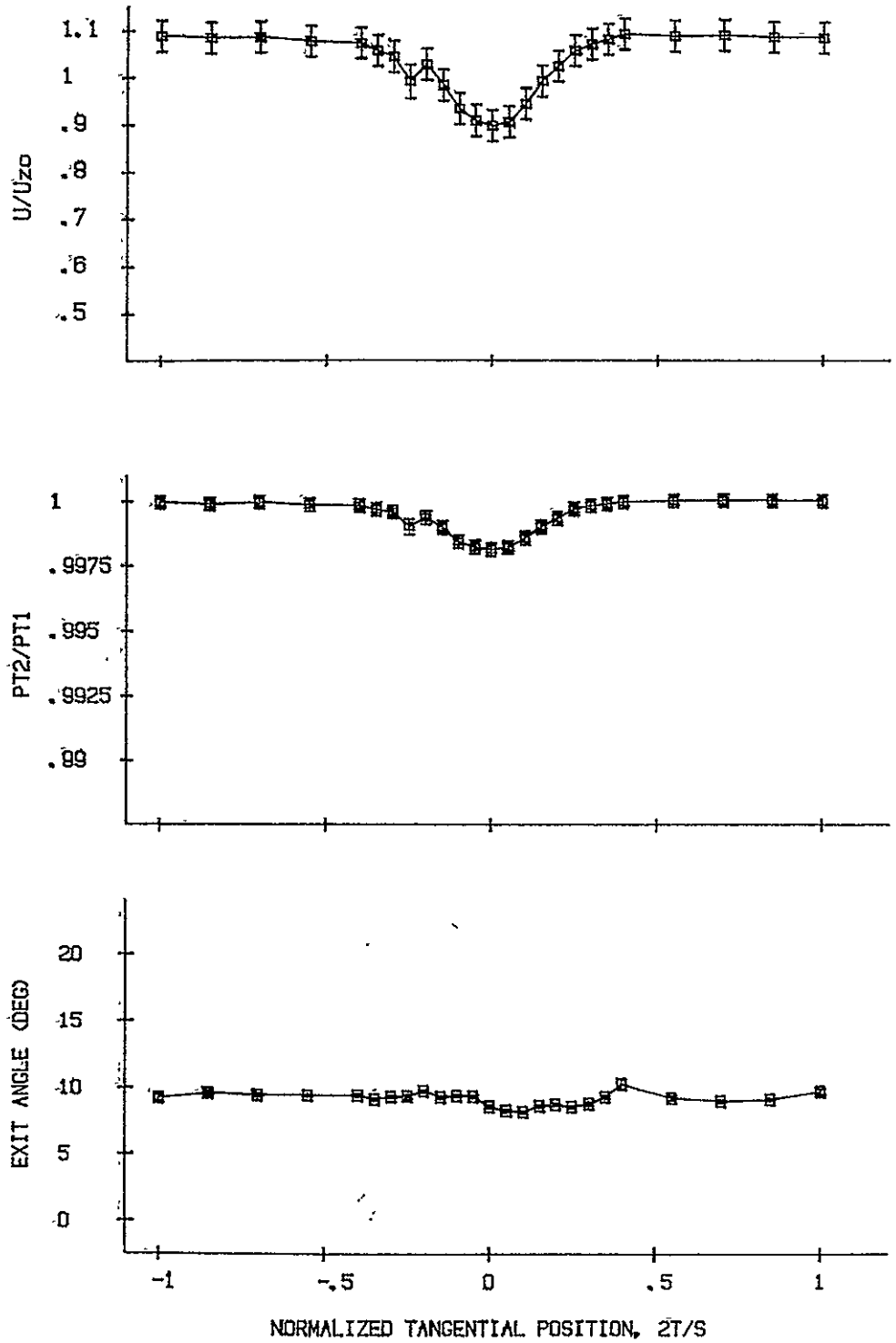

Figure I82. FIVE-HOLE PROBE WAKE DATA, INCIDENCE ANGLE (DEG) = 10,
 $Z_c/C = .96$, $R = 25\%$

ORIGINAL PAGE IS
OF POOR QUALITY

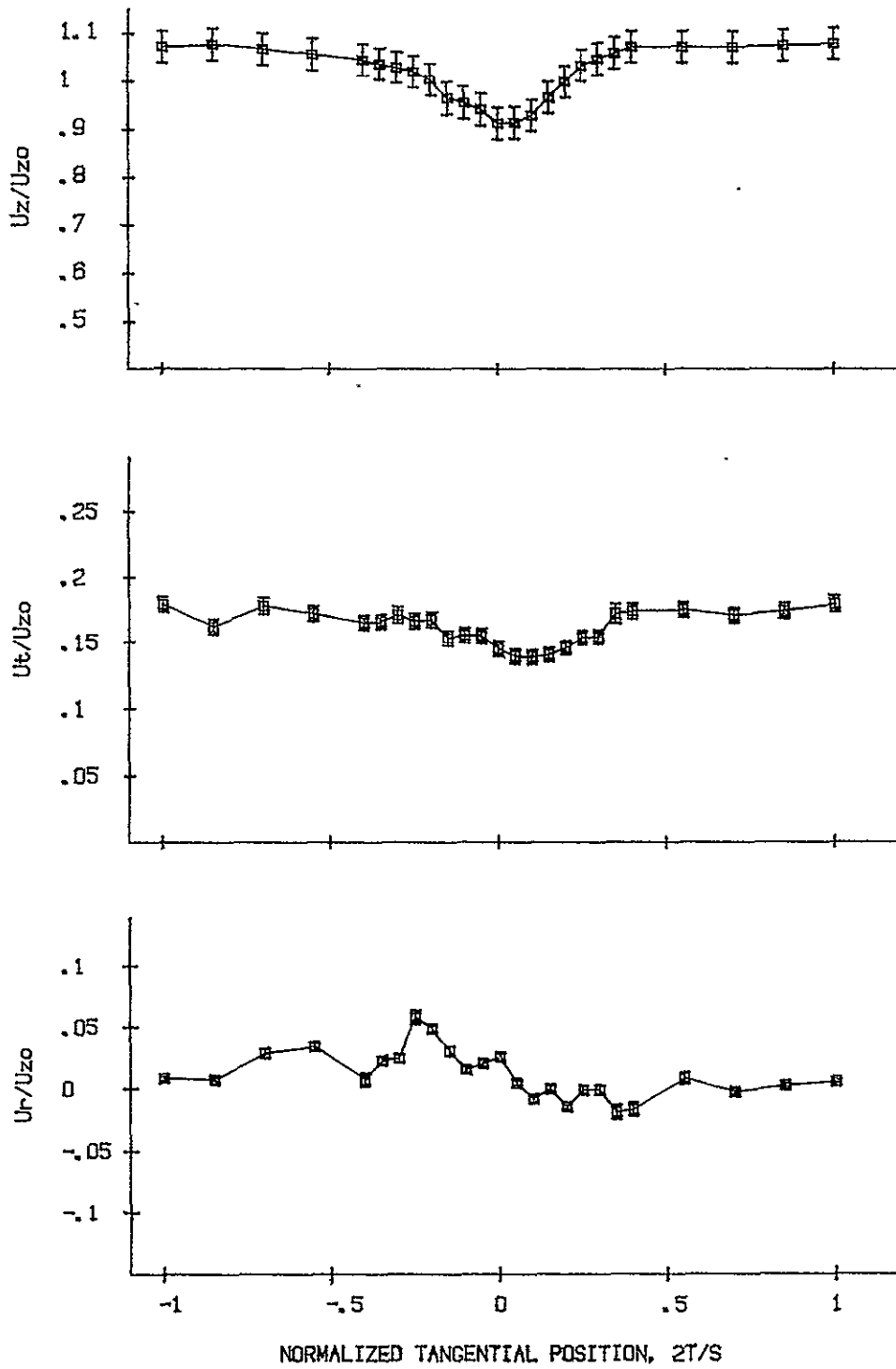

Figure I83. FIVE-HOLE PROBE VELOCITY DATA, INCIDENCE ANGLE (DEG) = 10,
 $Z_c/C = .96$, $R = 93.3\%$

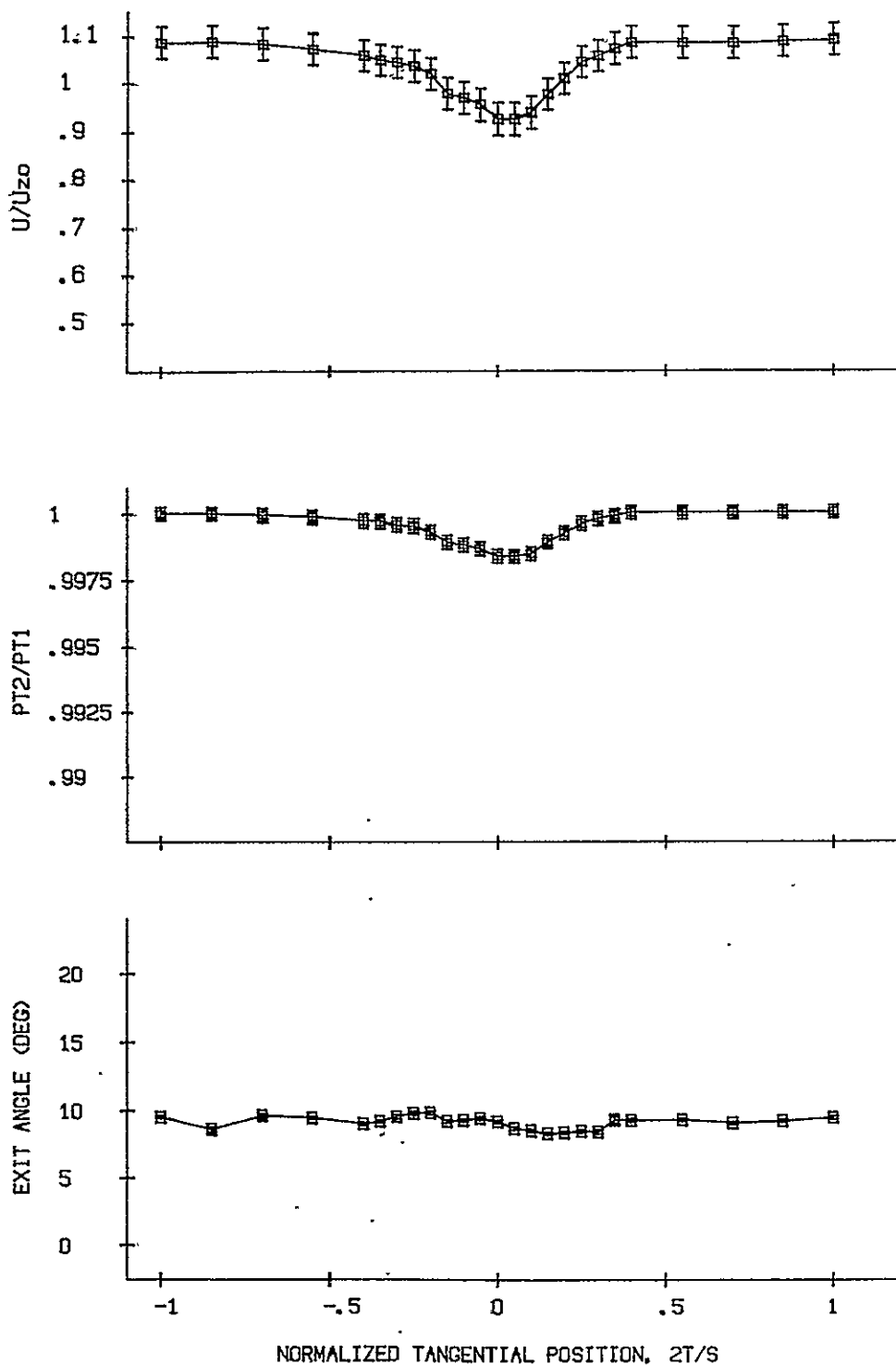

Figure I84. FIVE-HOLE PROBE WAKE DATA, INCIDENCE ANGLE (DEG) = 10,
 $Z_c/C = .96$, $R = 33.3\%$

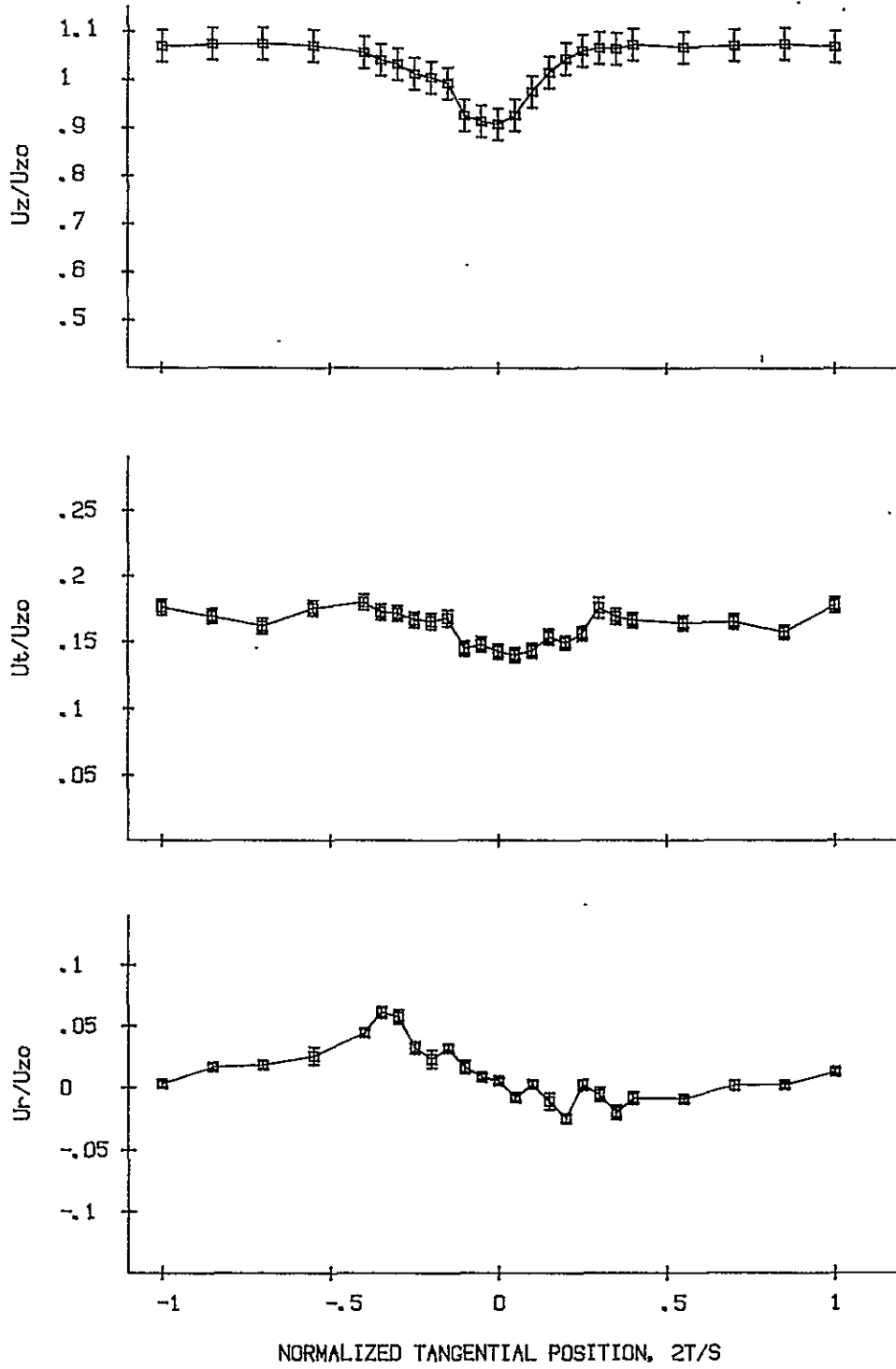

Figure I85. FIVE-HOLE PROBE VELOCITY DATA, INCIDENCE ANGLE (DEG) = 10,
 $Z_0/C = .96$, $R = 50\%$

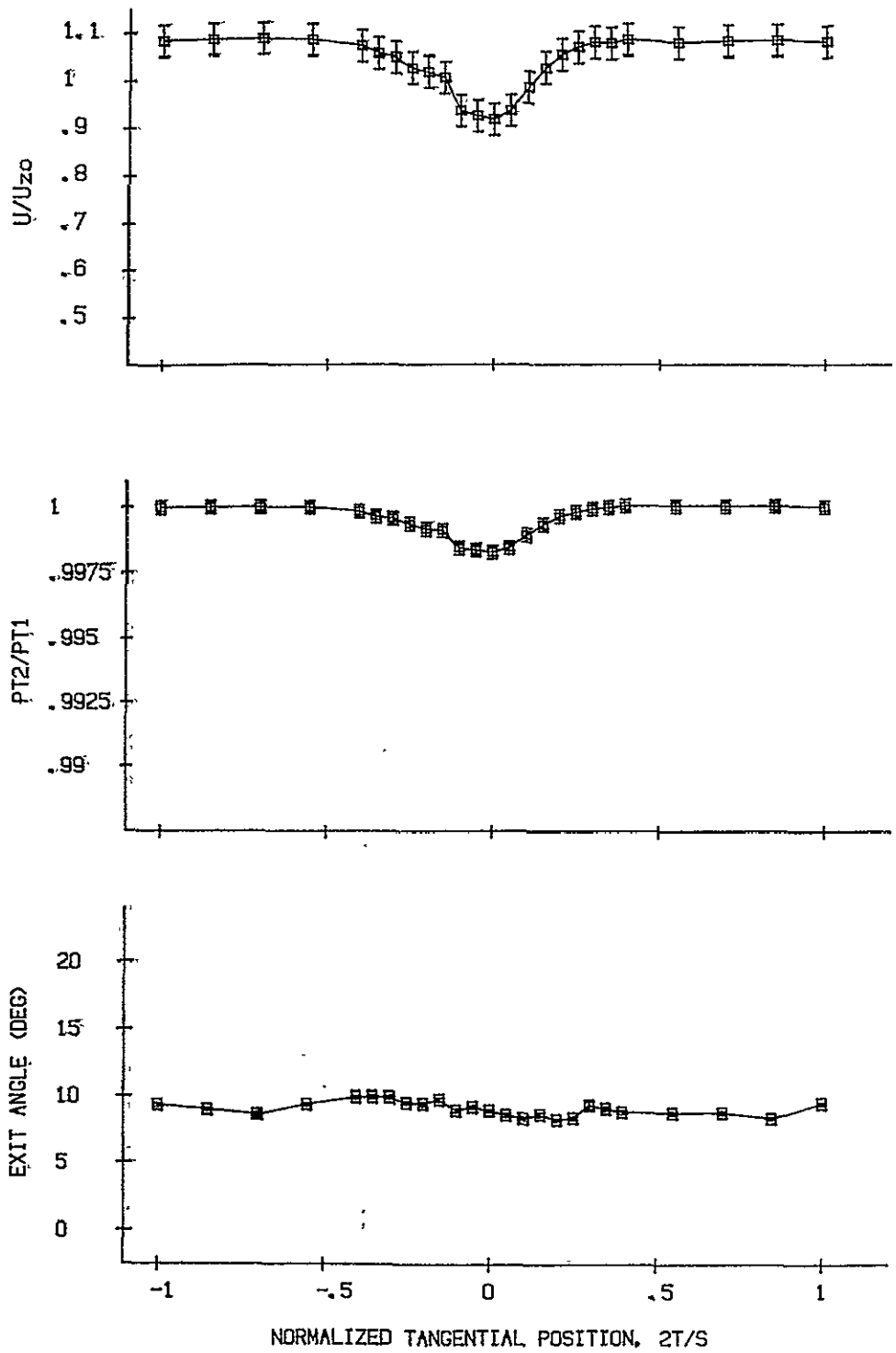

Figure I86. FIVE-HOLE PROBE WAKE DATA, INCIDENCE ANGLE (DEG) = 10,
 $Z_c/C = .96$, $R = 50\%$.

ORIGINAL PAGE IS
OF POOR QUALITY.

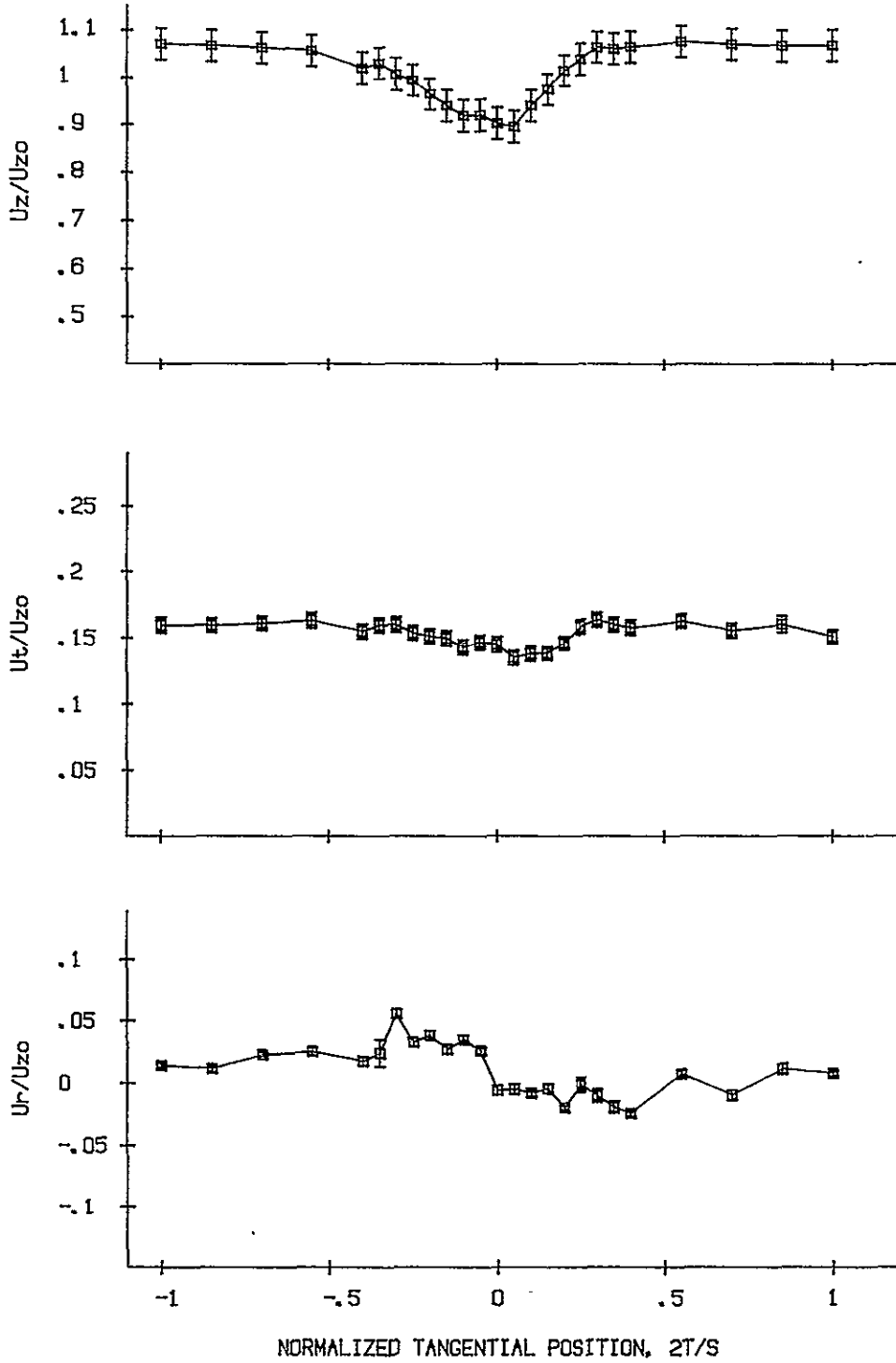

Figure I87. FIVE-HOLE PROBE VELOCITY DATA, INCIDENCE ANGLE (DEG) = 10,
 $Z_c/C = .96$, $R = 66.7\%$

ORIGINAL PAGE IS
OF POOR QUALITY

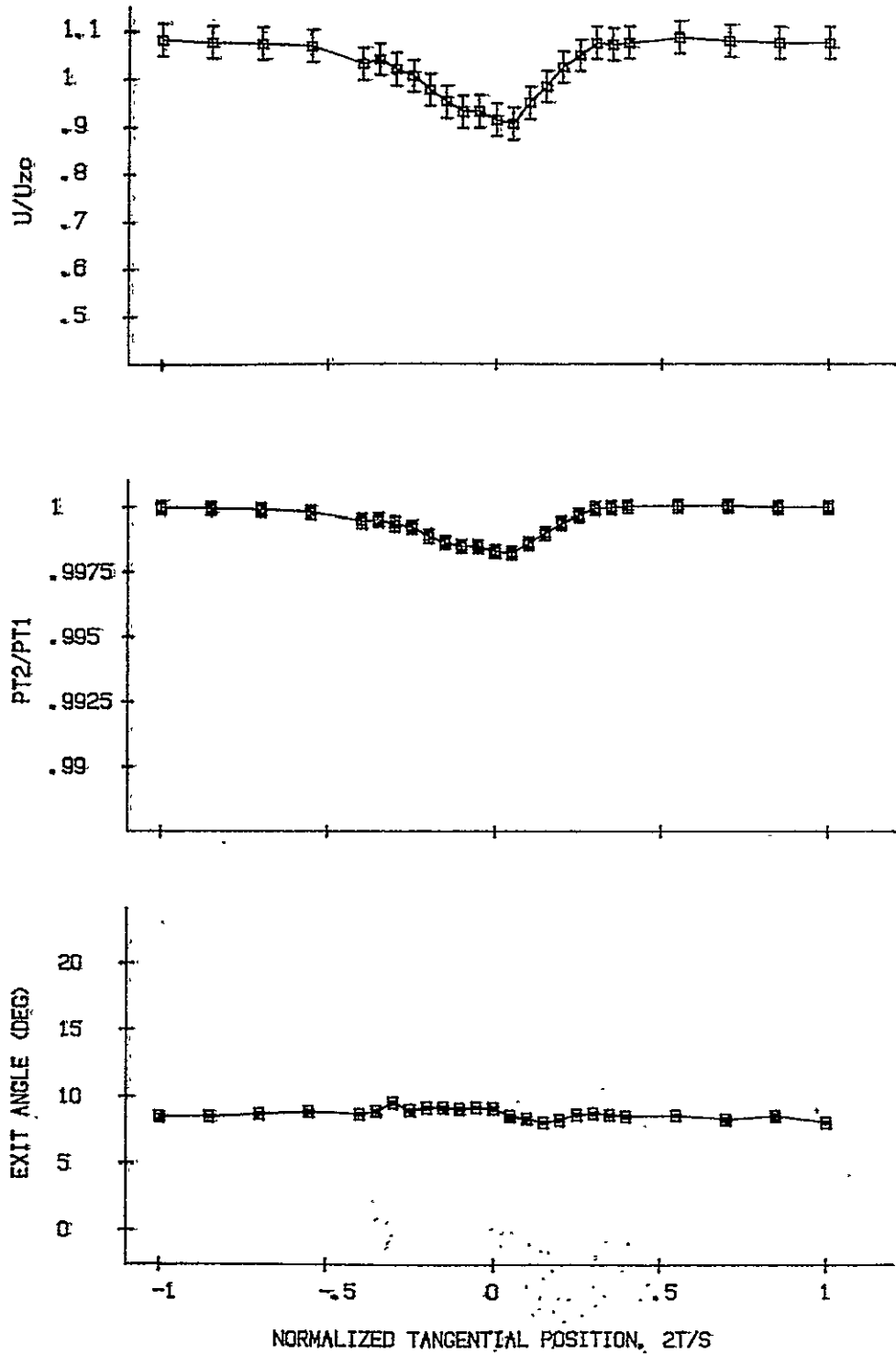

Figure I88. FIVE-HOLE PROBE WAKE DATA, INCIDENCE ANGLE (DEG) = 10,
 $Zc/C = .96$, $R = 66.7\%$

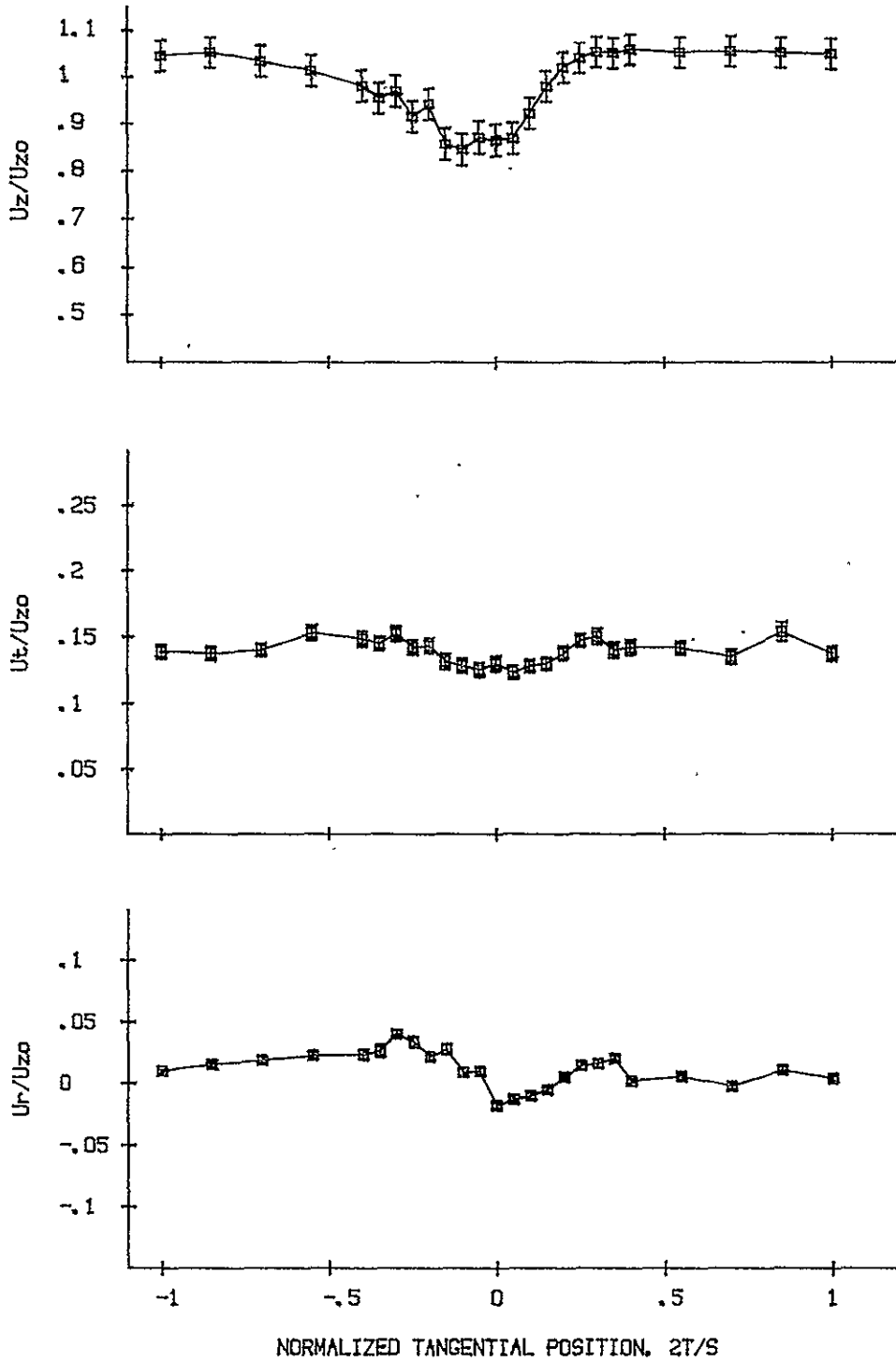

Figure I89. FIVE-HOLE PROBE VELOCITY DATA, INCIDENCE ANGLE (DEG) = 10,
 $Z_c/C = .96$, $\bar{R} = 83.3\%$

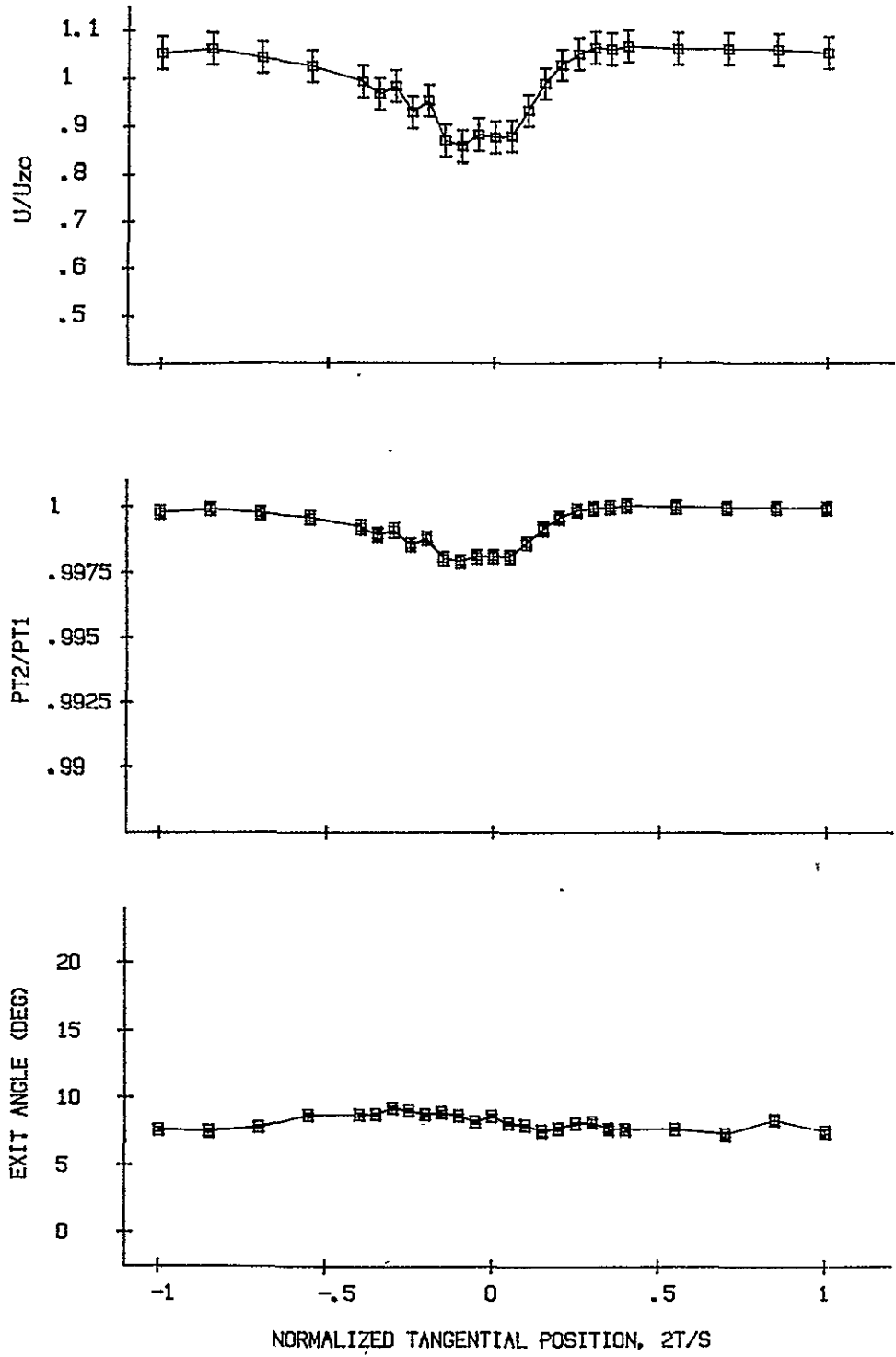

Figure I90.

FIVE-HOLE PROBE WAKE DATA, INCIDENCE ANGLE (DEG) = 10,
 $Z_0/C = .96$, $R = 83.3\%$

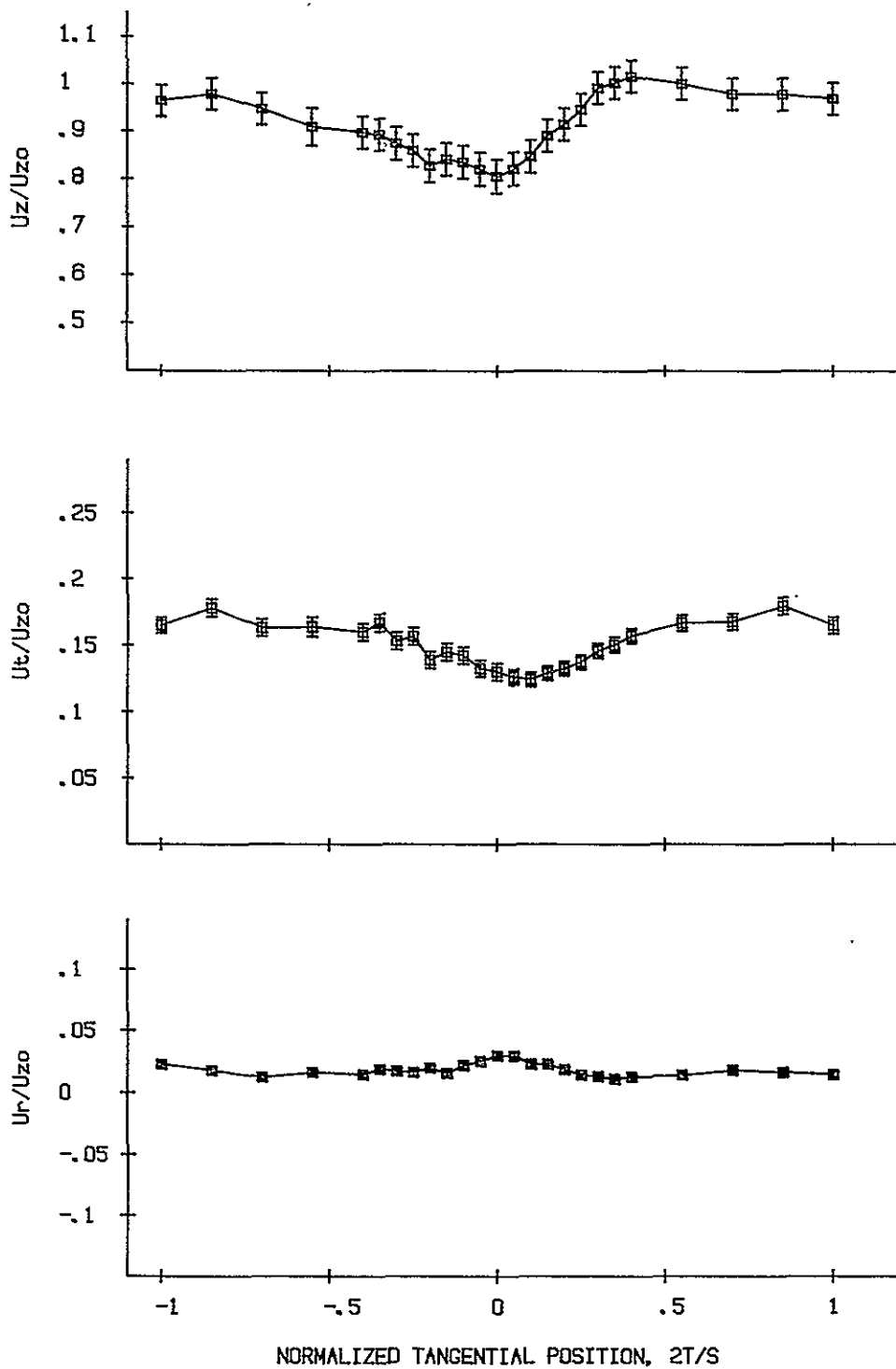

Figure I91. FIVE-HOLE PROBE VELOCITY DATA, INCIDENCE ANGLE (DEG) = 10,
 $Z_c/C = 2.10$, $R = 4.2\%$

ORIGINAL PAGE IS
OF POOR QUALITY

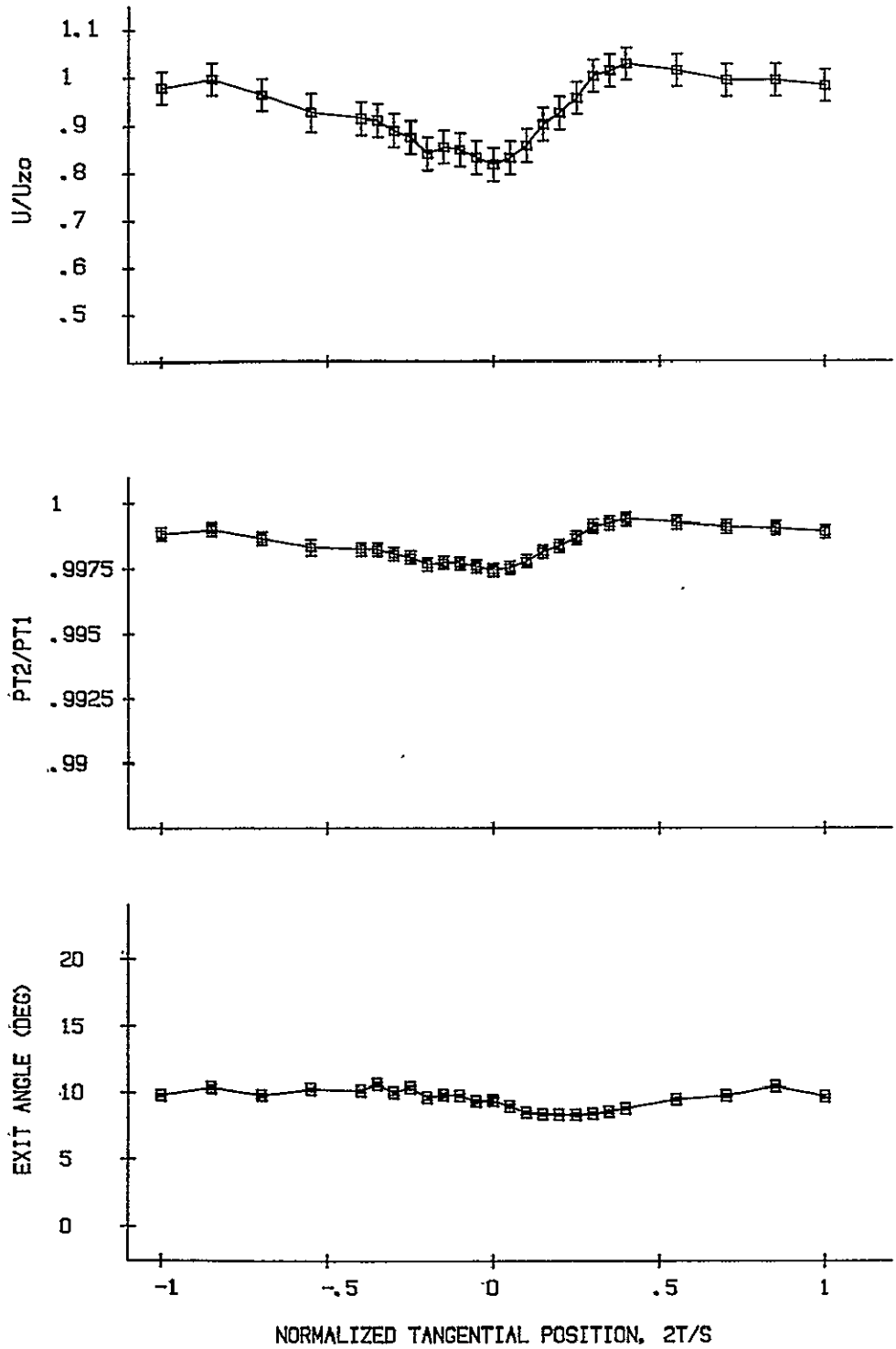

Figure I92. FIVE-HOLE PROBE WAKE DATA, INCIDENCE ANGLE (DEG) = 10,
 $Z_c/C = 2.10$, $R = 4.2\%$

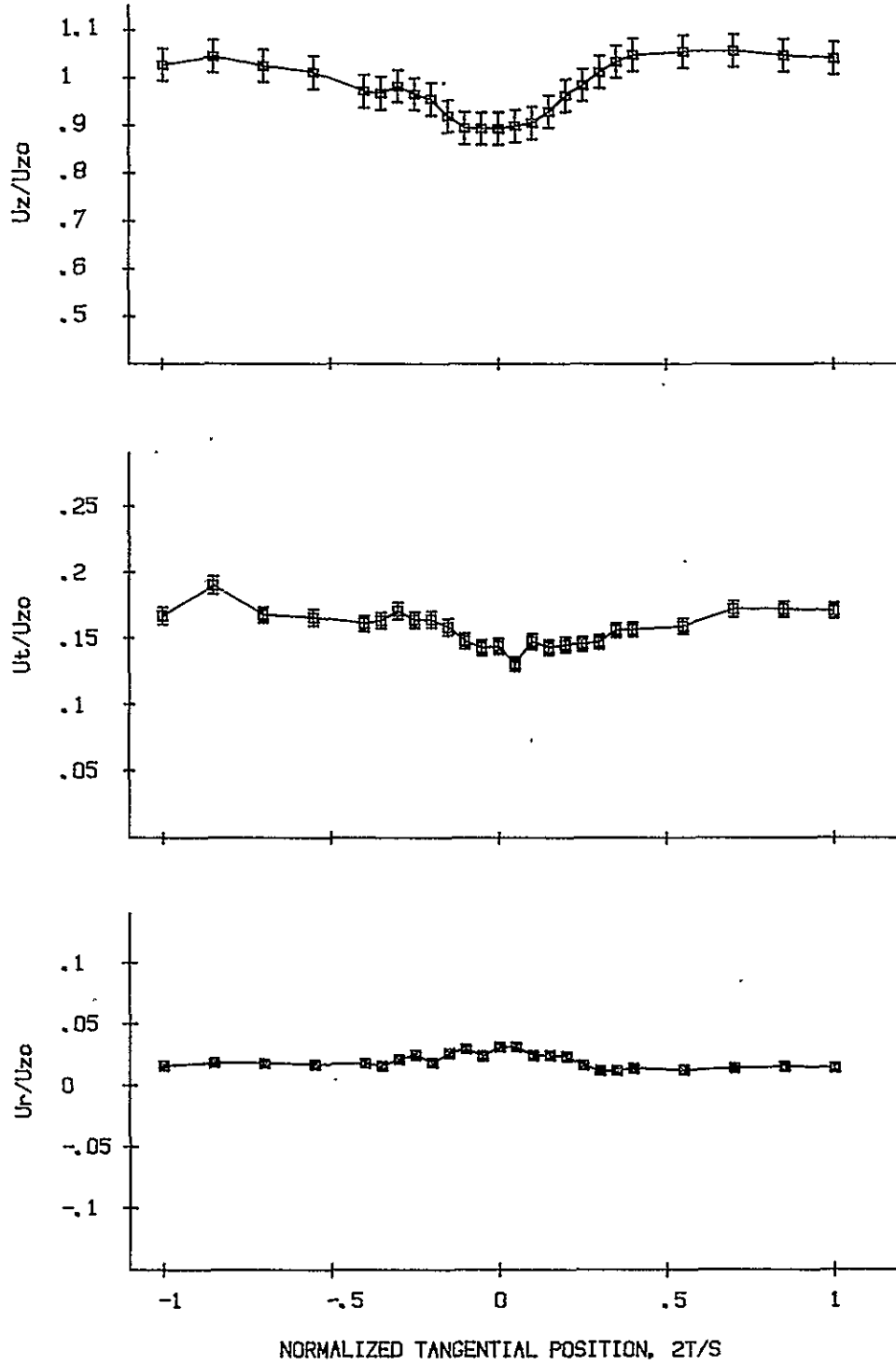

Figure I93. FIVE-HOLE PROBE VELOCITY DATA, INCIDENCE ANGLE (DEG) = 10,
 $Z_c/C = 2.10$, $R = 8.3\%$

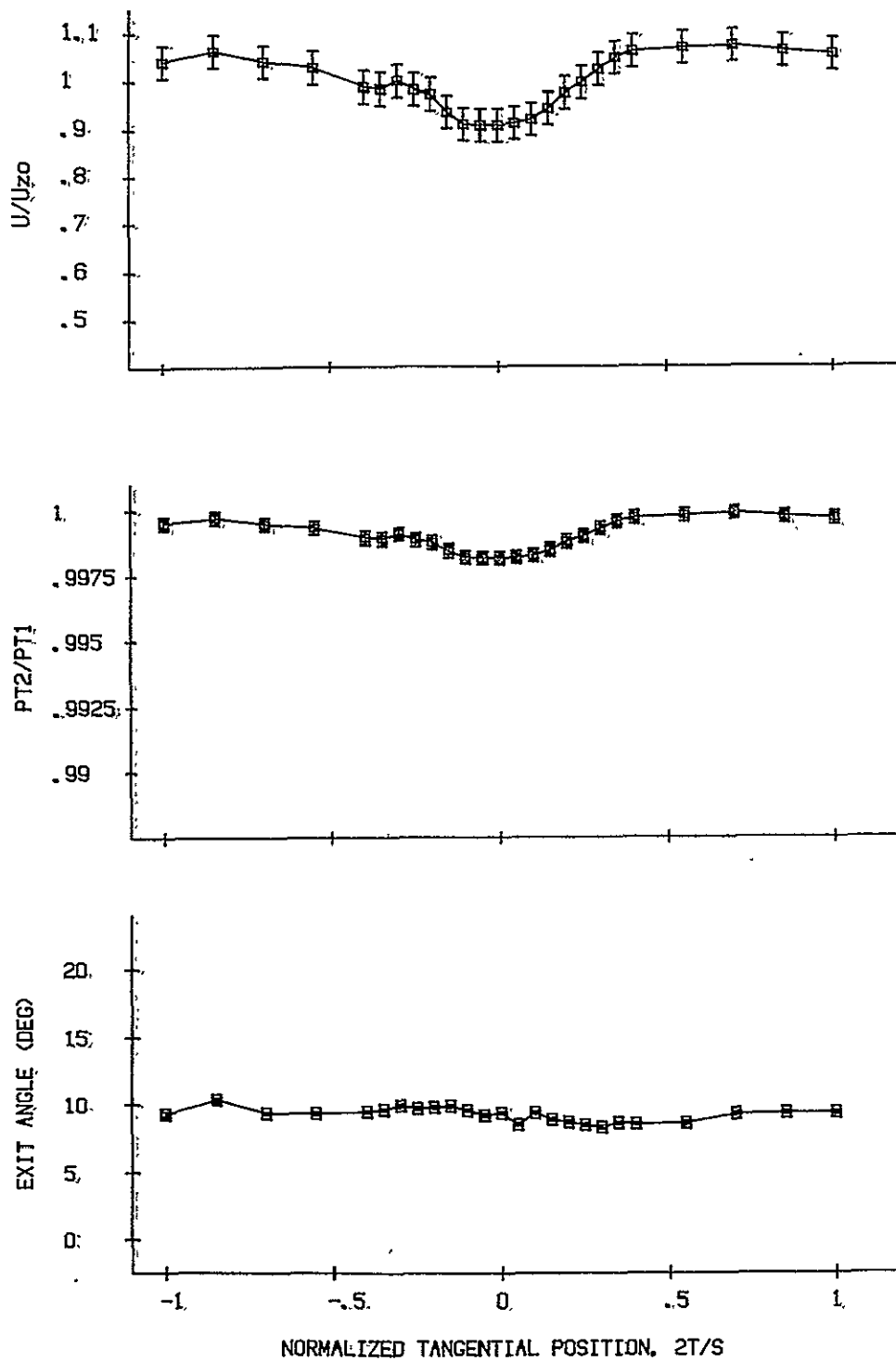

Figure 194. FIVE-HOLE PROBE WAKE DATA, INCIDENCE ANGLE (DEG) = 10,
 $Z_c/C = 2.10$, $R = 8.3\%$

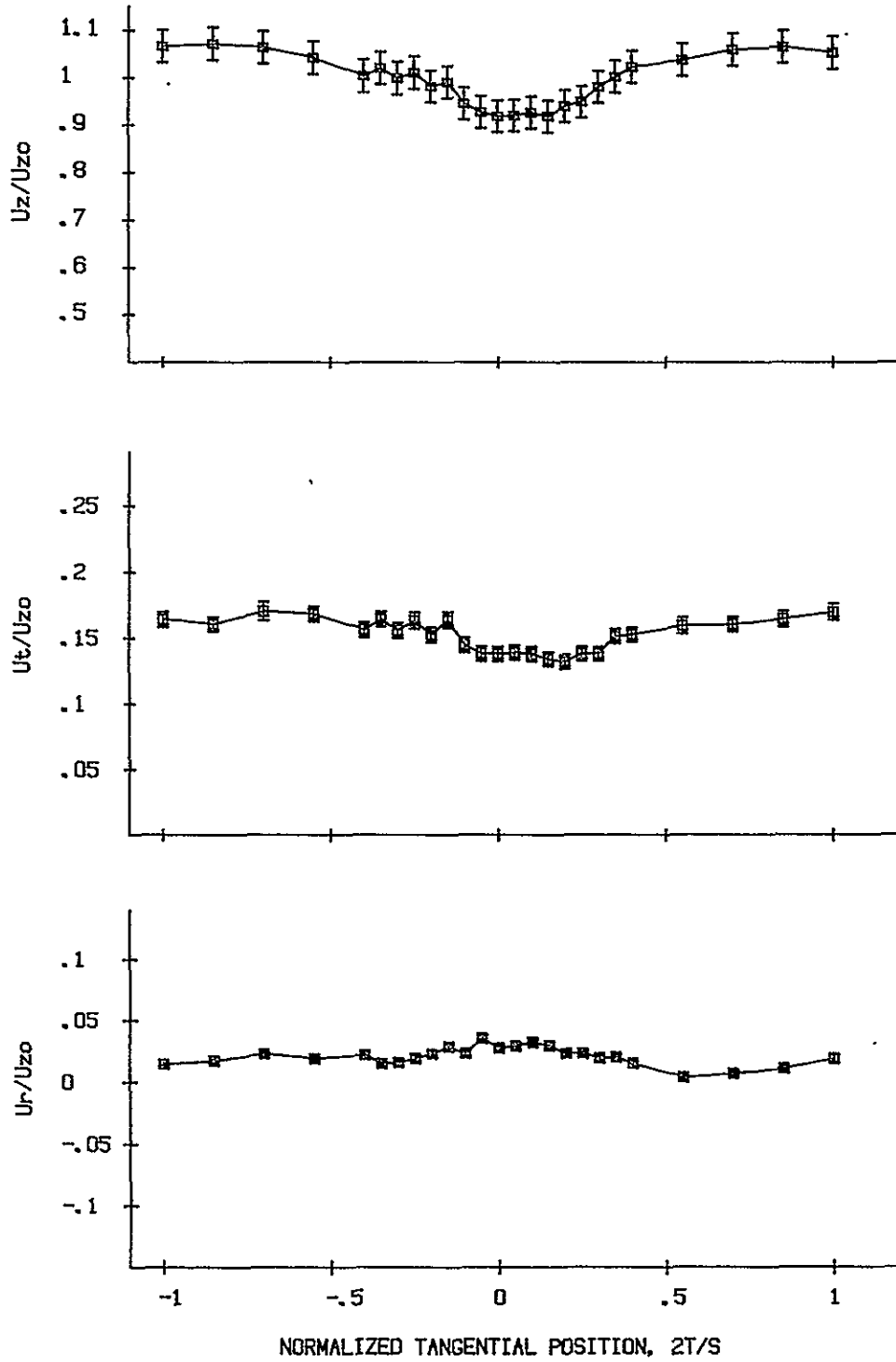

Figure I95. FIVE-HOLE PROBE VELOCITY DATA, INCIDENCE ANGLE (DEG) = 10,
 $Z_c/C = 2.10$, $R = 12.5\%$

ORIGINAL PAGE IS
OF POOR QUALITY

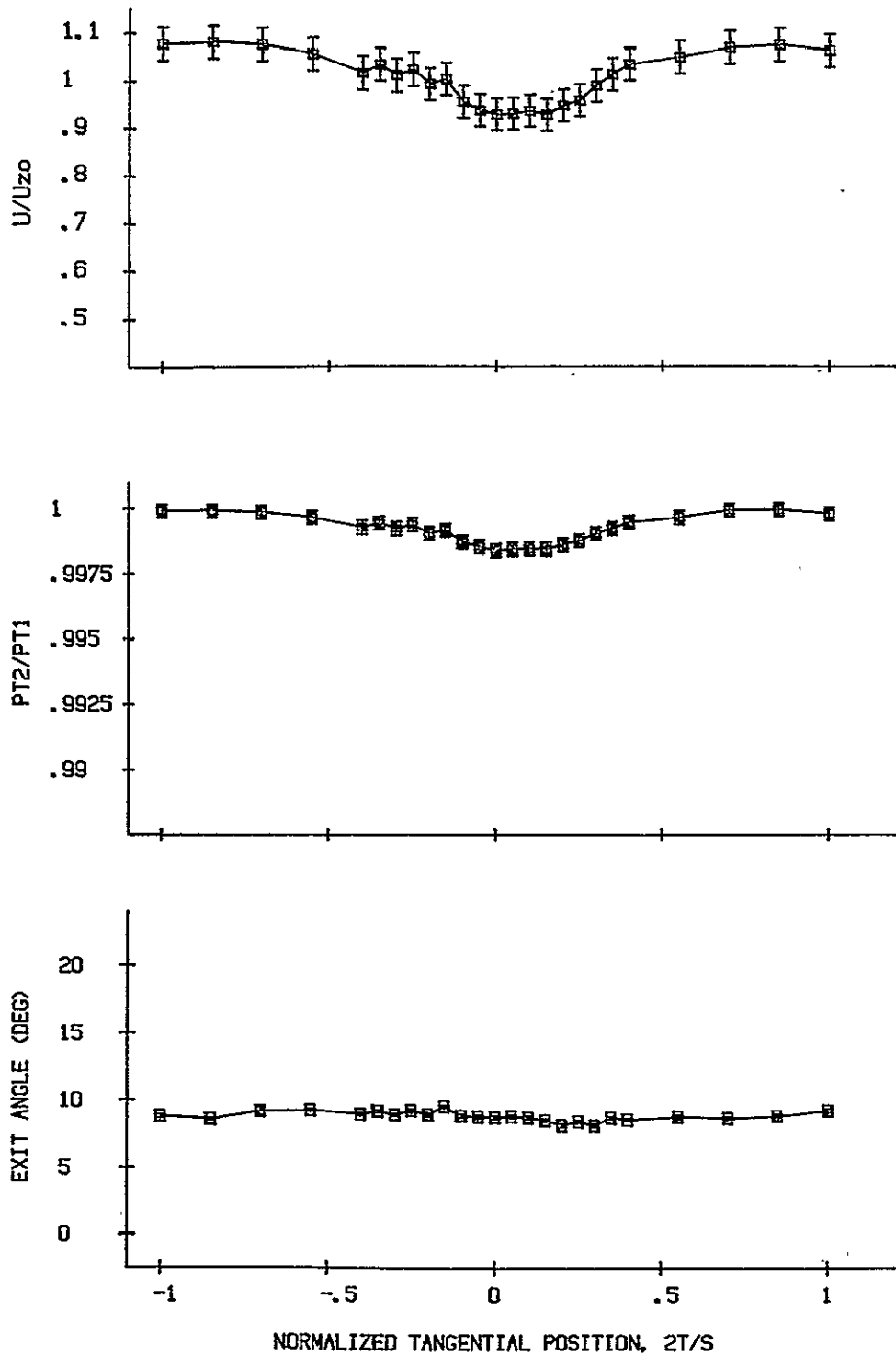

Figure I96. FIVE-HOLE PROBE WAKE DATA, INCIDENCE ANGLE (DEG) = 10,
 $Z_c/C = 2.10$, $R = 12.5\%$

ORIGINAL PAGE IS
OF POOR QUALITY

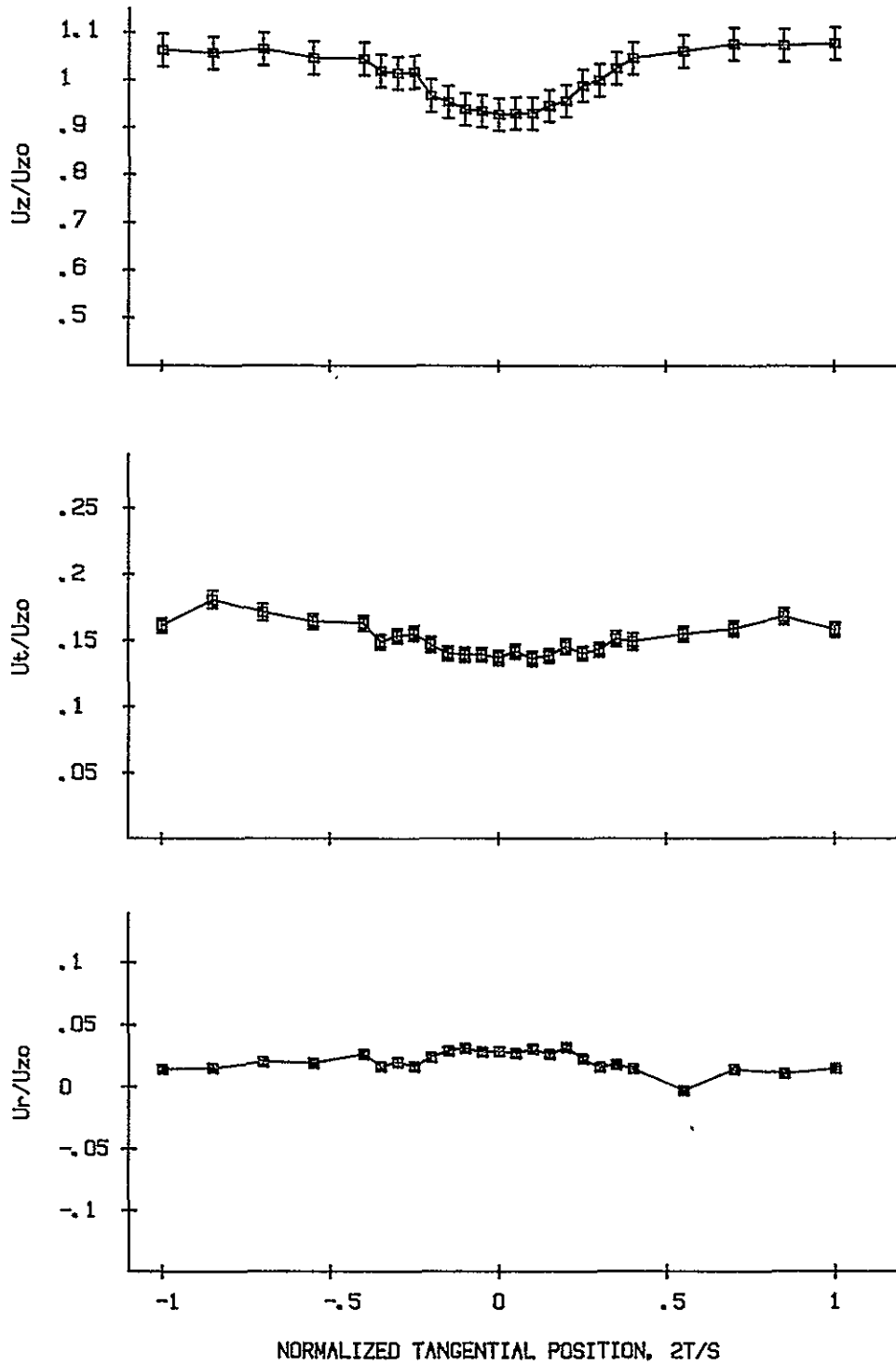

Figure I97. FIVE-HOLE PROBE VELOCITY DATA, INCIDENCE ANGLE (DEG) = 10,
 $Z_c/C = 2.10$, $R = 16.7\%$

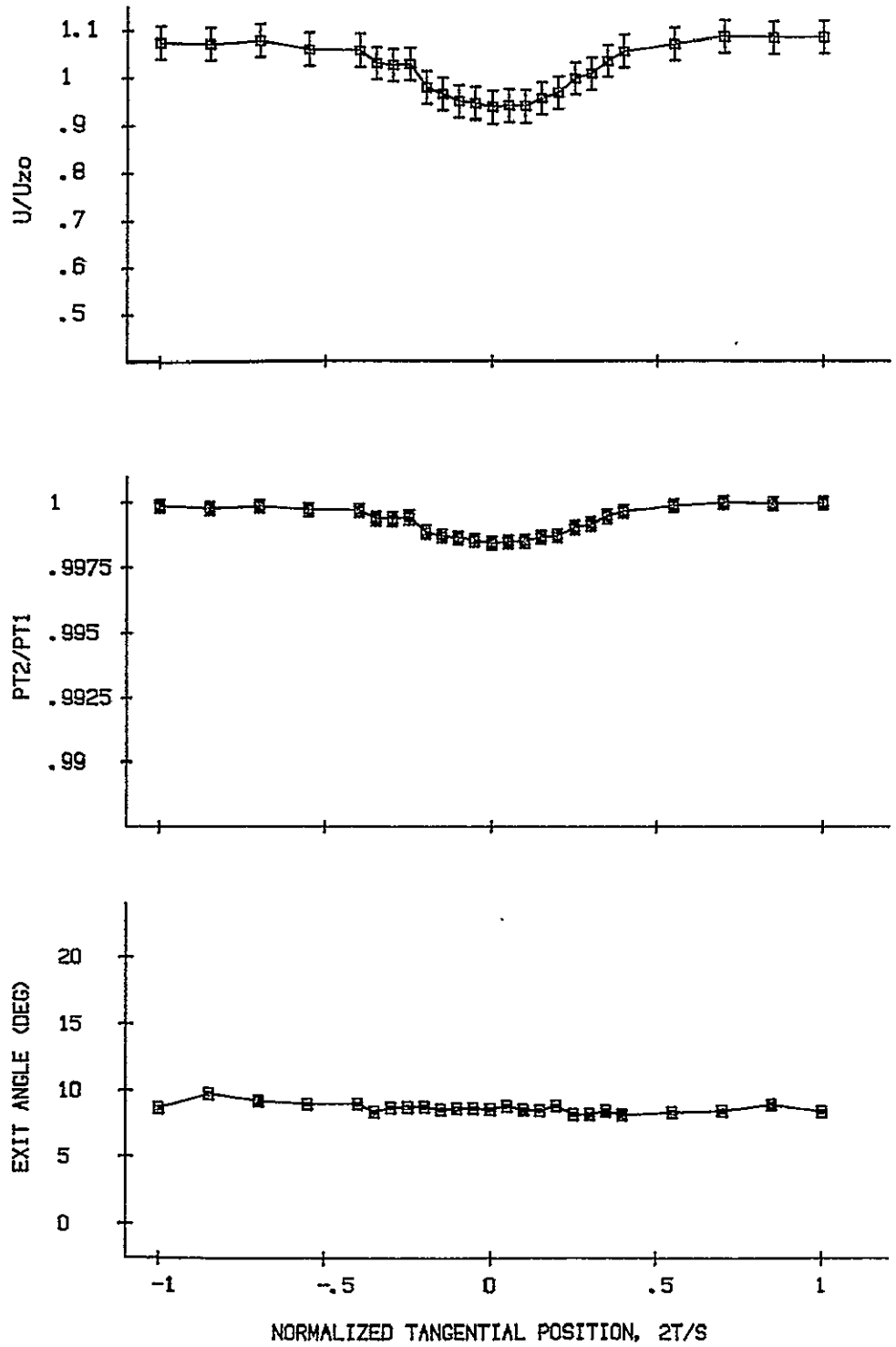

Figure I98. FIVE-HOLE PROBE WAKE DATA, INCIDENCE ANGLE (DEG) = 10,
 $Z_c/C = 2.10$, $R = 16.7\%$

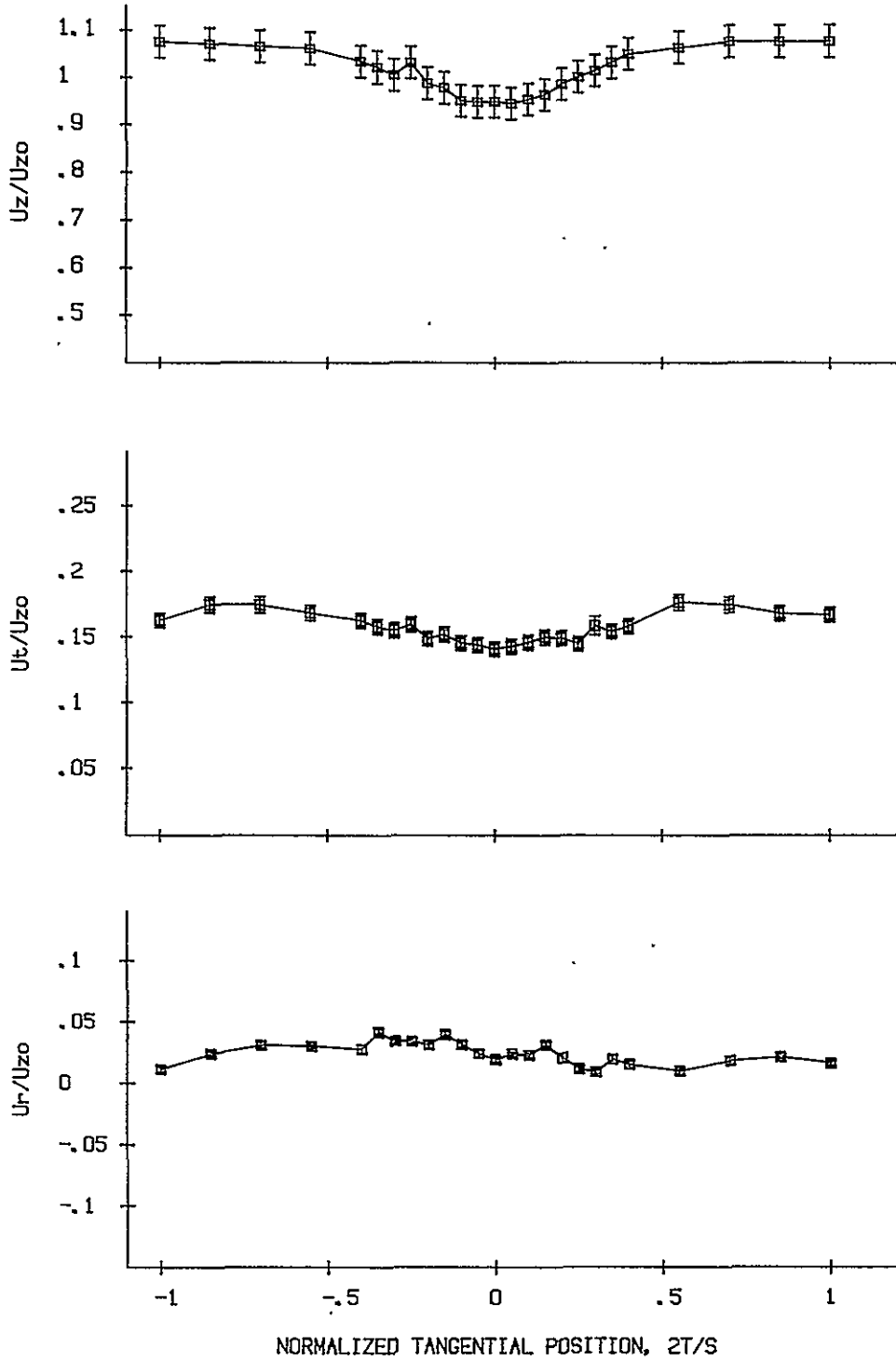

Figure I99. FIVE-HOLE PROBE VELOCITY DATA, INCIDENCE ANGLE (DEG) = 10.
 $Z_c/C = 2.10$, $R = 25.0\%$

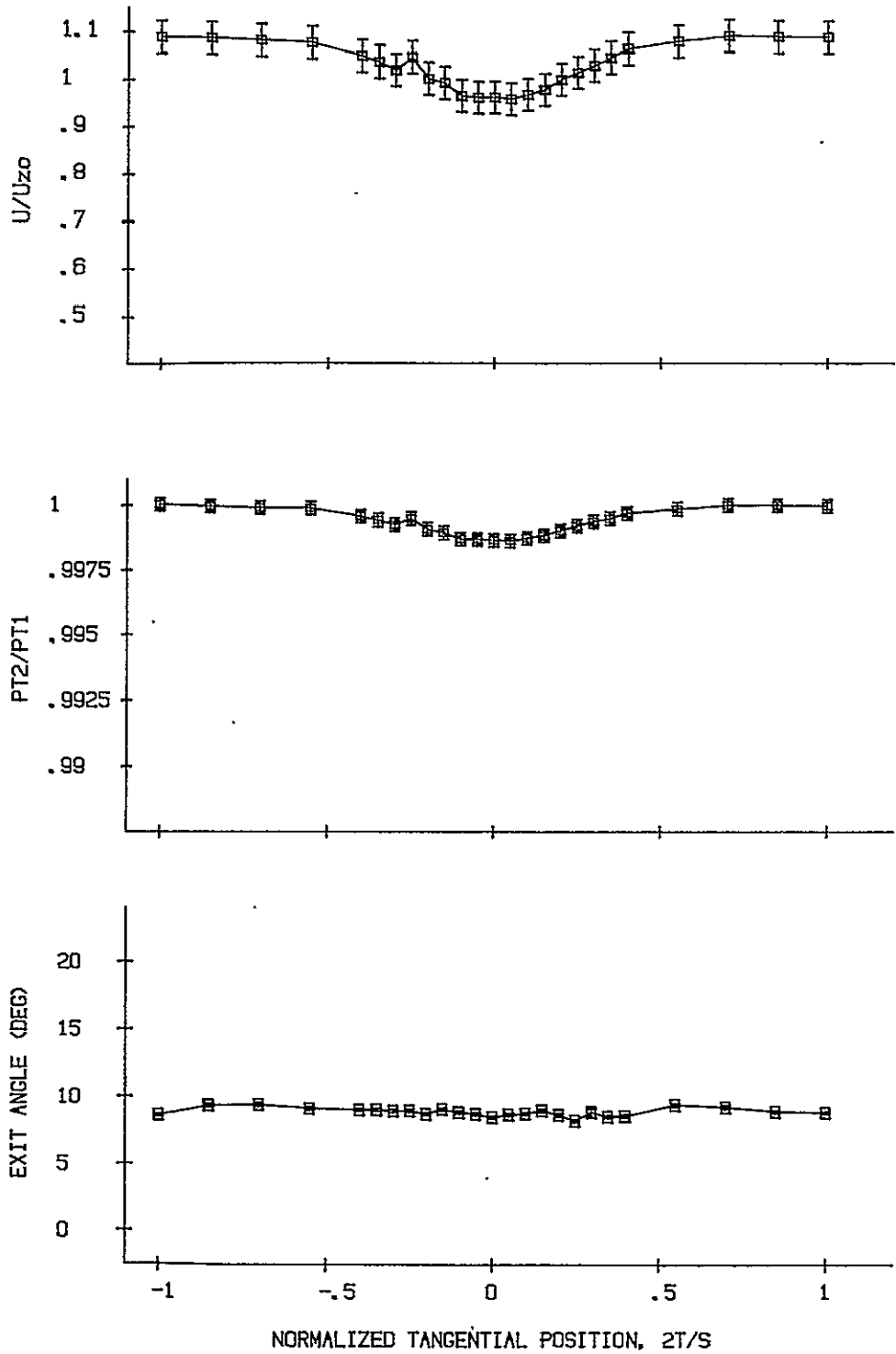

Figure I100. FIVE-HOLE PROBE WAKE DATA, INCIDENCE ANGLE (DEG) = 10,
 $Z_c/C = 2.10$, $R = 25.0\%$

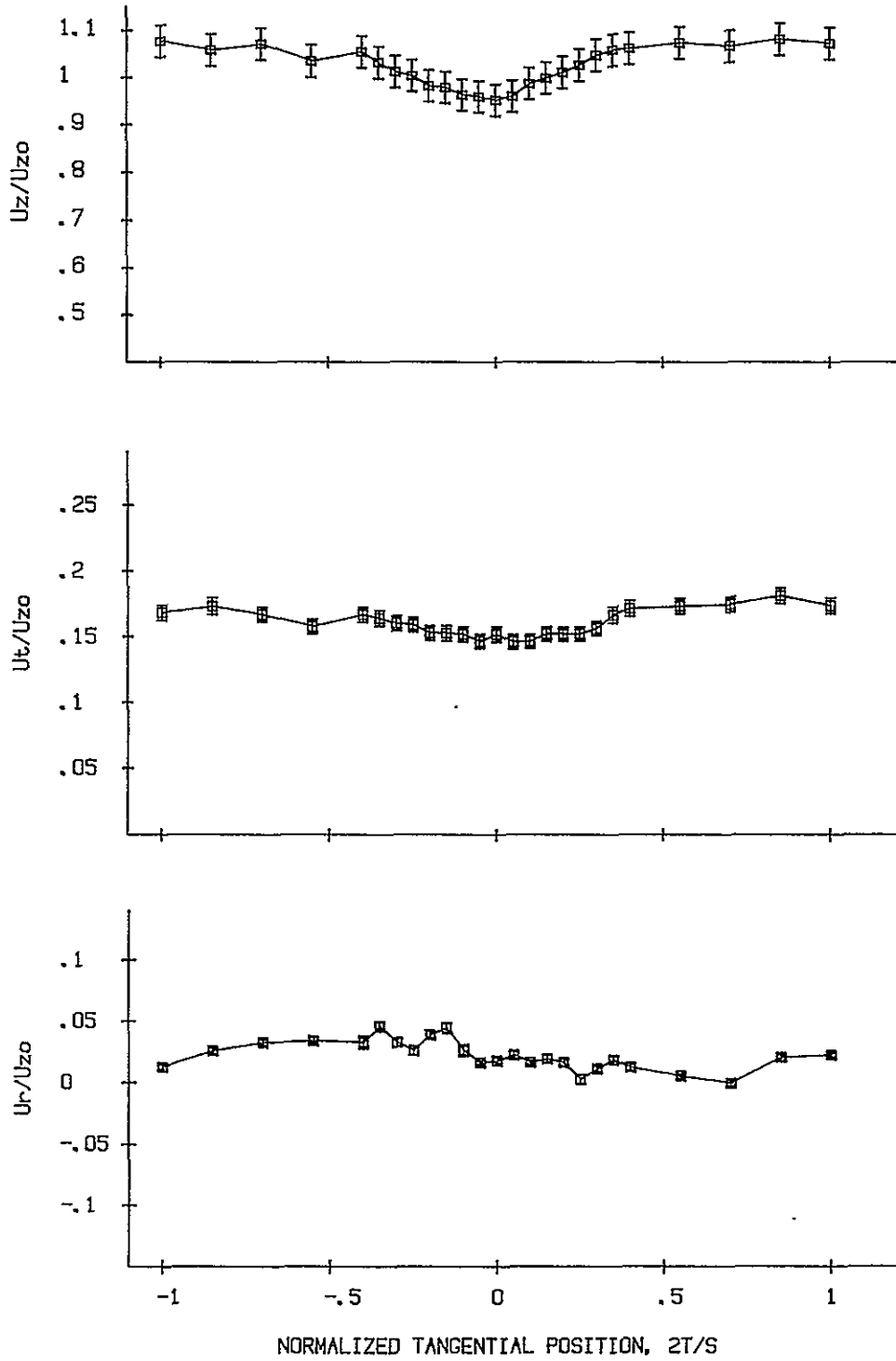

Figure II01. FIVE-HOLE PROBE VELOCITY DATA, INCIDENCE ANGLE (DEG) = 10,
 $Z_c/C = 2.1$, $R = 33.3\%$

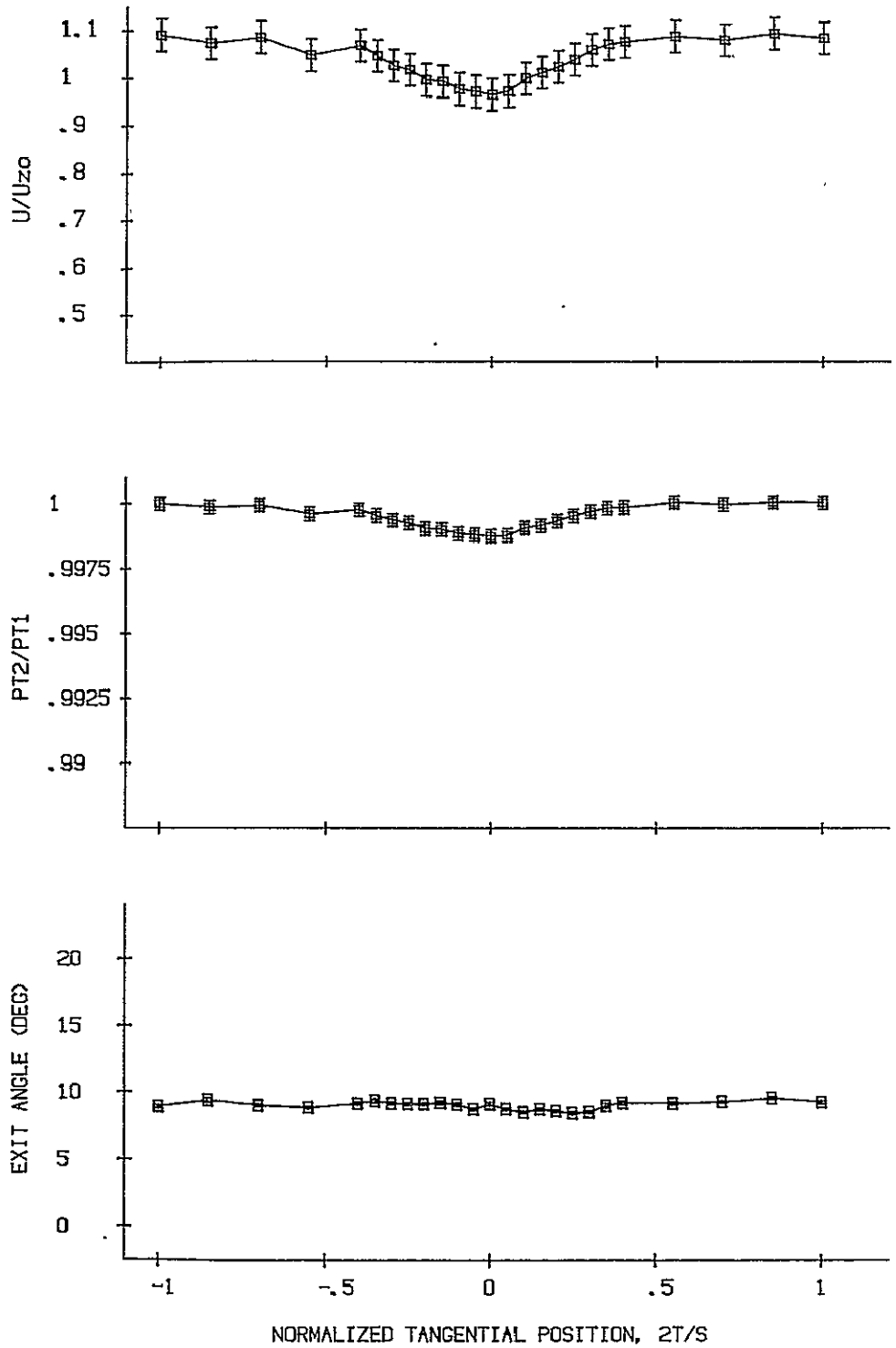

Figure I102. FIVE-HOLE PROBE WAKE DATA, INCIDENCE ANGLE (DEG) = 10,
 $Z_c/C = 2.10$, $R = 33.3\%$

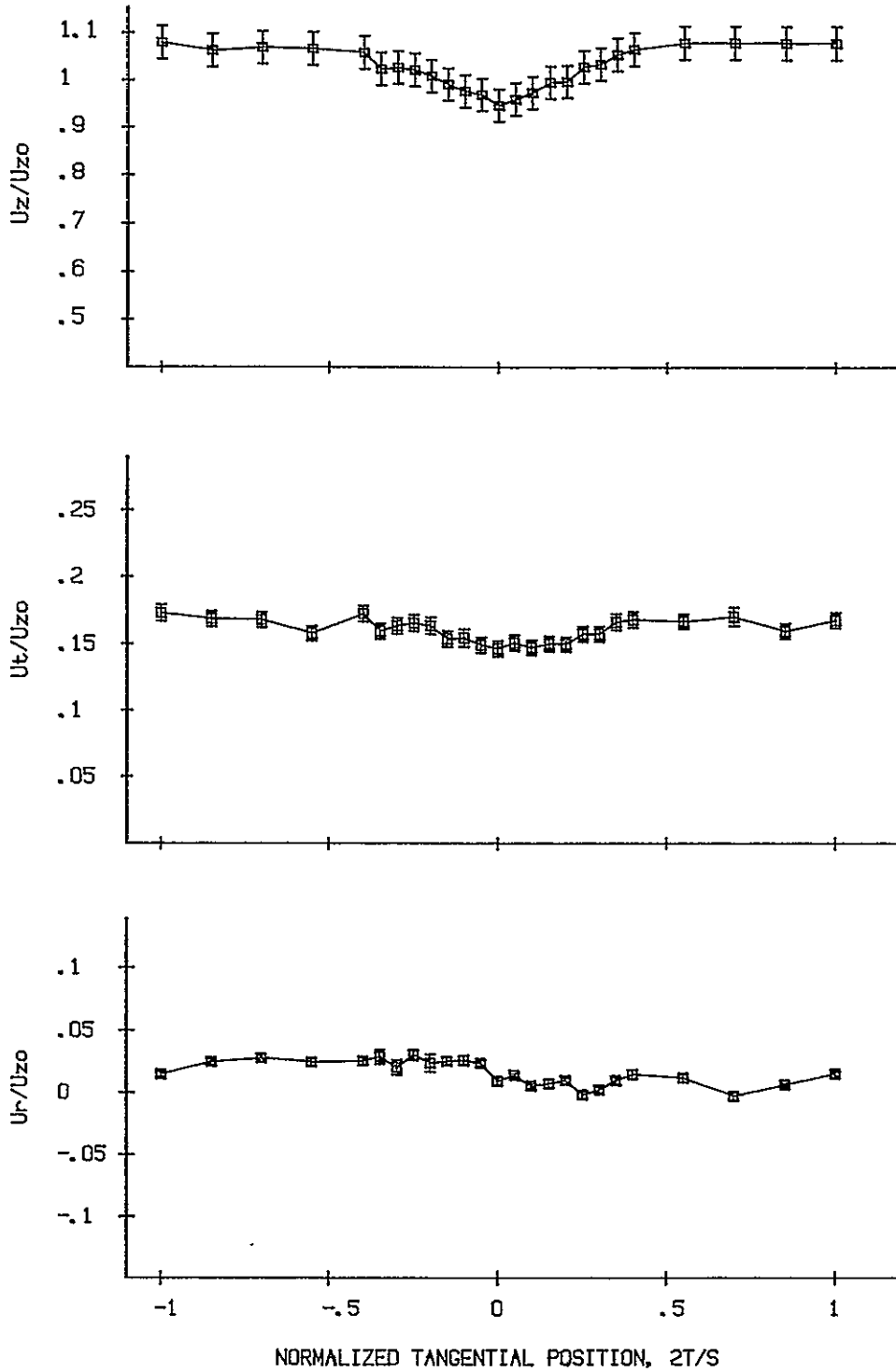

Figure I103. FIVE-HOLE PROBE VELOCITY DATA, INCIDENCE ANGLE (DEG) = 10,
 $Z_c/C = 2.10$, $R = 50.0\%$

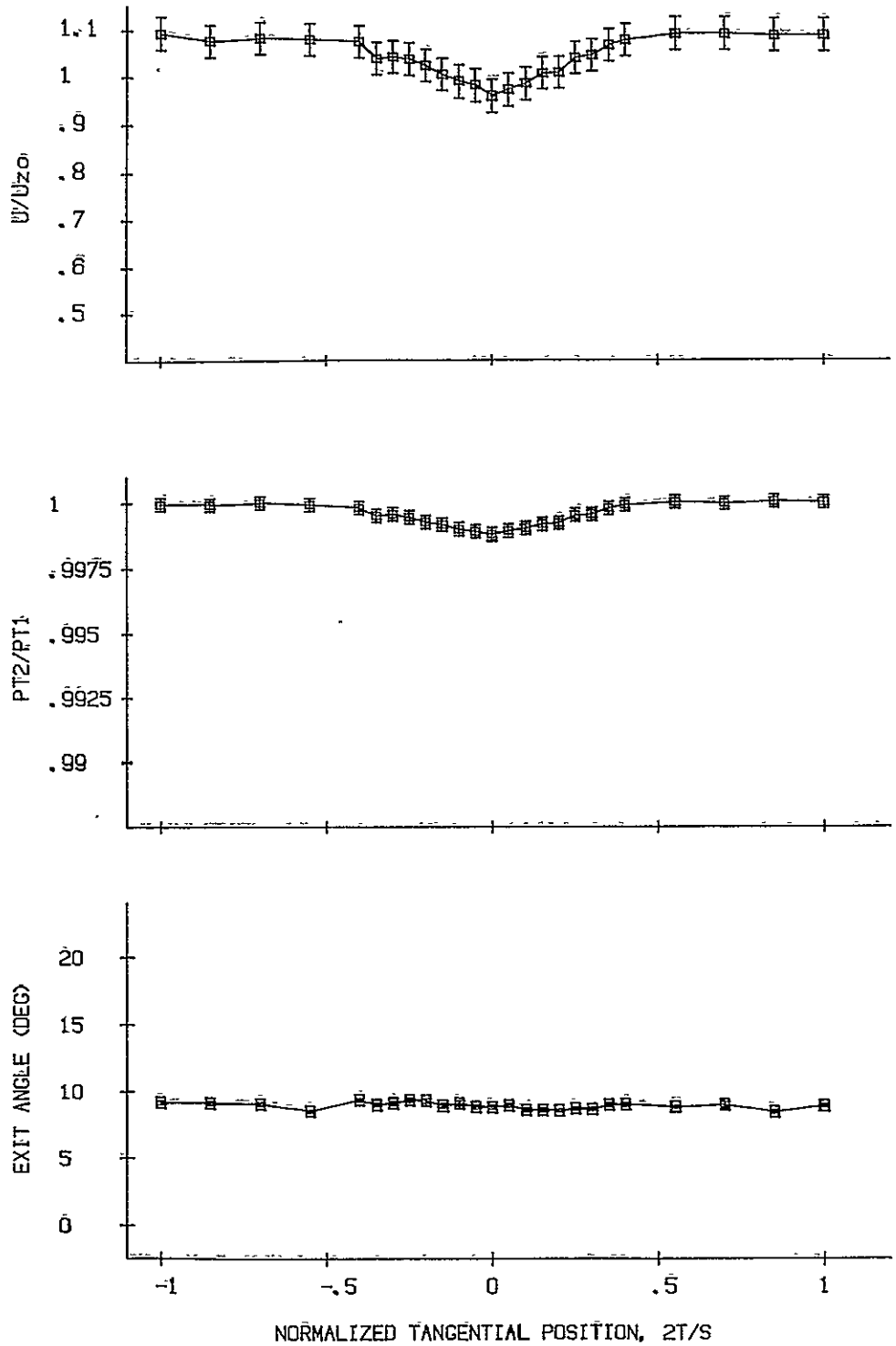

Figure I104. FIVE-HOLE PROBE WAKE DATA, INCIDENCE ANGLE (DEG) = 10,
 $Z_c/C = 2.10$, $R = 50.0\%$

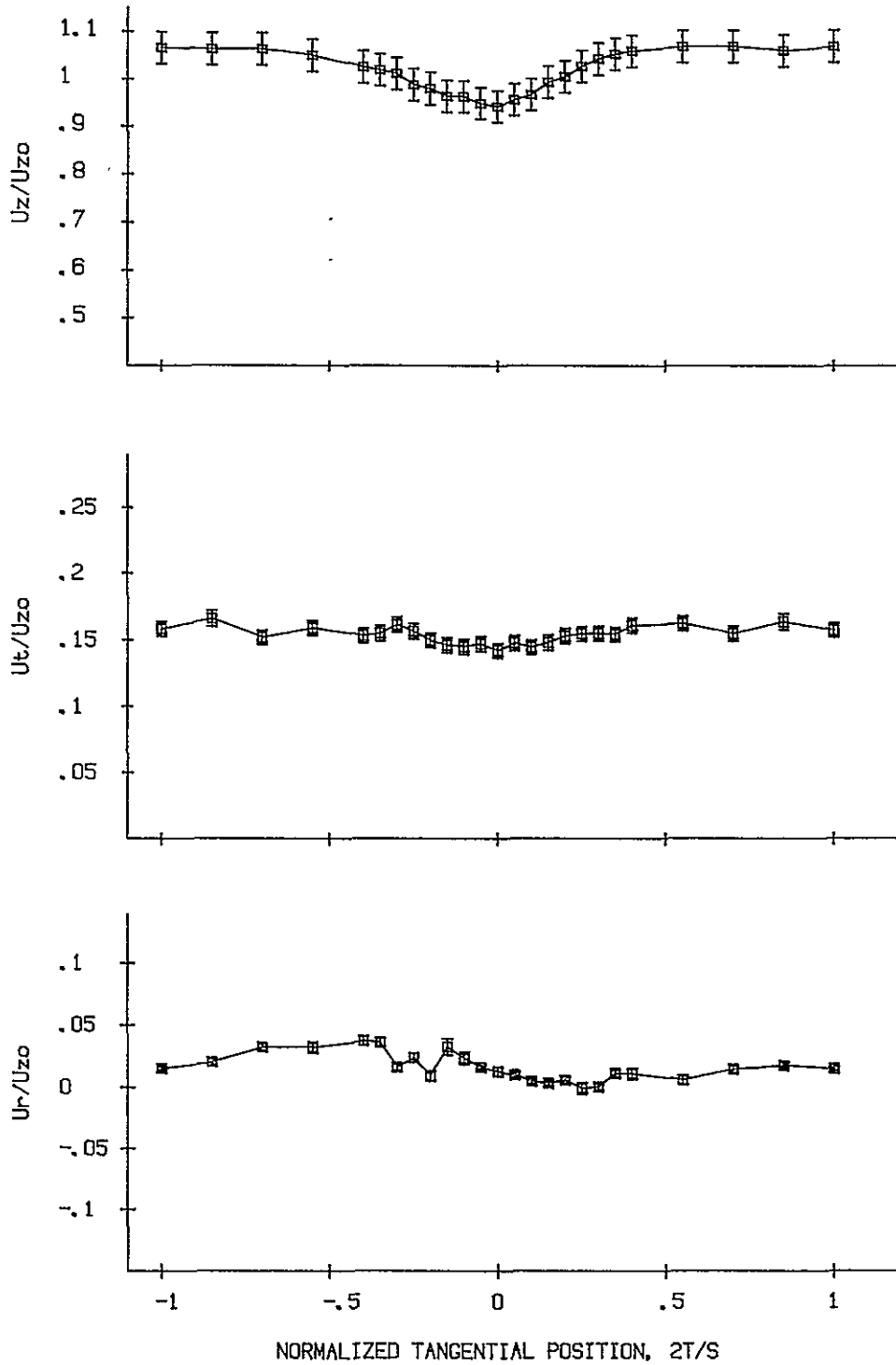

Figure I105. FIVE-HOLE PROBE VELOCITY DATA, INCIDENCE ANGLE (DEG) = 10,
 $Z_c/C = 2.10$, $R = 66.7\%$

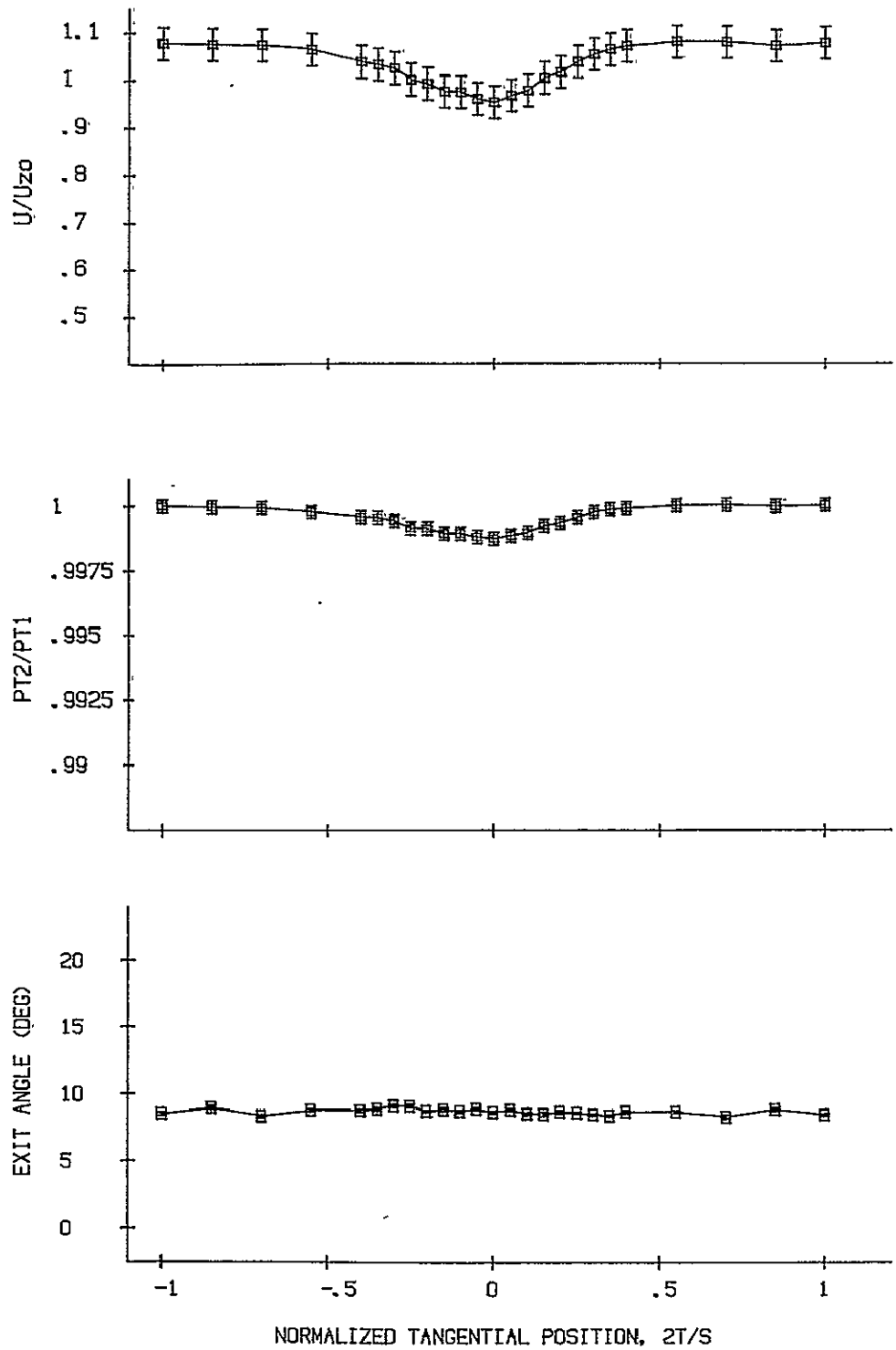

Figure I106. FIVE-HOLE PROBE WAKE DATA, INCIDENCE ANGLE (DEG) = 10,
.Zc/C = 2.10, R = 66.7%

ORIGINAL PAGE IS
OF POOR QUALITY

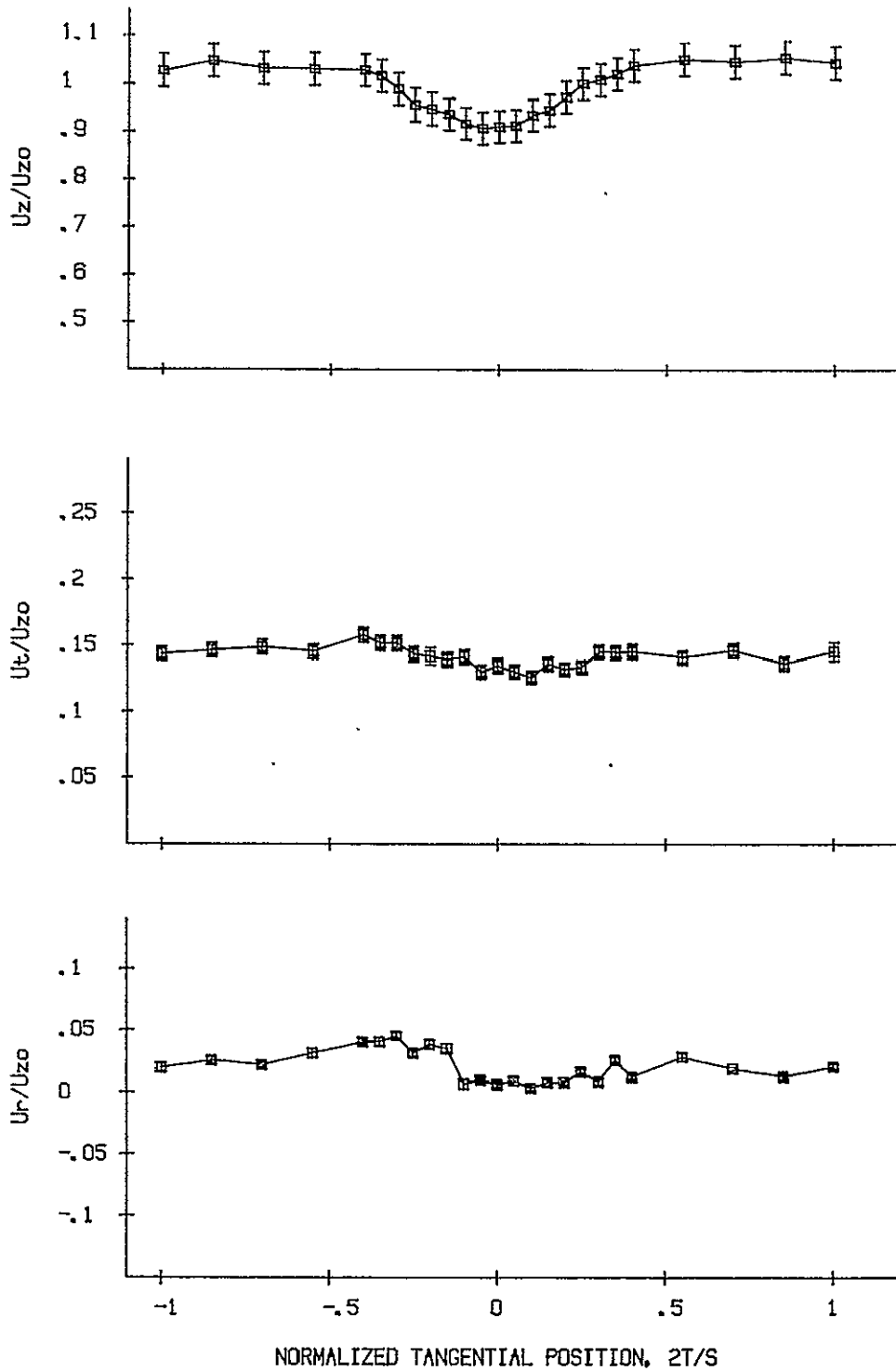

Figure I107. FIVE-HOLE PROBE VELOCITY DATA, INCIDENCE ANGLE (DEG) = 10,
 $Z_c/C = 2.10$, $R = 83.3\%$

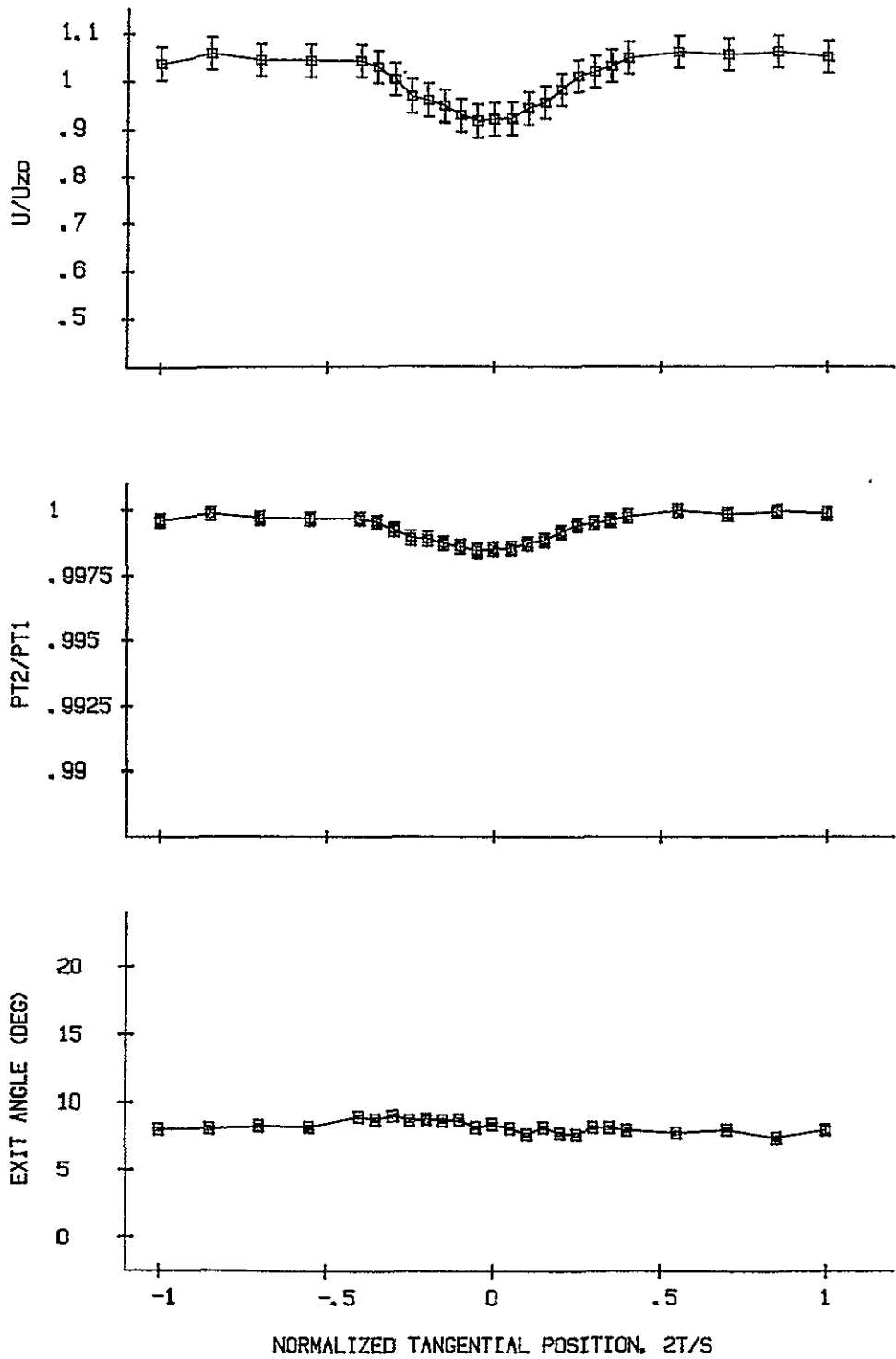

Figure I108. FIVE-HOLE PROBE WAKE DATA, INCIDENCE ANGLE (DEG) = 10,
 $Z_0/C = 2.10$, $R = 83.3\%$

APPENDIX J

Isobaric Exit Contour Visualization Technique

The concept of producing on-line photographic isobaric contour maps of a flow field has been developed at the Boeing Company [18]. A sensor, such as a total pressure probe, is traversed in a plane perpendicular to the flow axis. The pressure is read via electronic transducers, and a light source, attached to the downstream side of the sensor, is flashed in a color corresponding to a preset pressure level. A downstream camera viewing the flow field is used to record the color isobaric contours. This concept was adapted for obtaining isobaric contour maps of the wake regions in the R-T plane in The Purdue Annular Cascade Facility.

The apparatus developed for use is shown in Figure J1, with its installation in the annular cascade facility schematically shown in Figure J2. The program, PPHOT2, directs the automated flow visualization process. The probe pressure is automatically read via a Scanivalve transducer with the traversing of the probe in the facility R-T plane accomplished via the automated L. C. Smith Traversing System. Probe alignment is in the chordwise direction to align

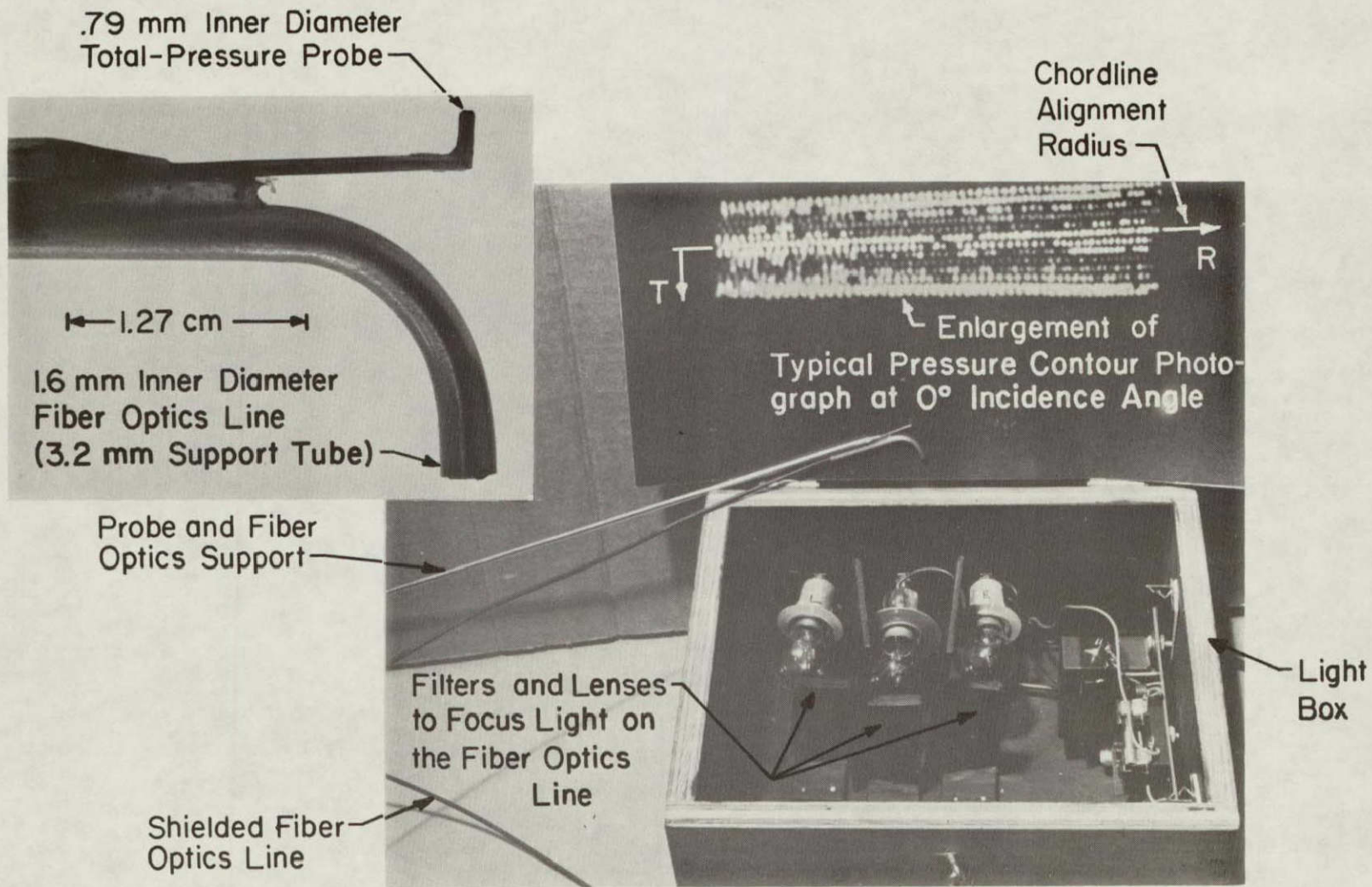

Figure J1. Photograph of the Lightbox, the Fiber Optics Probe, and a Sample Result

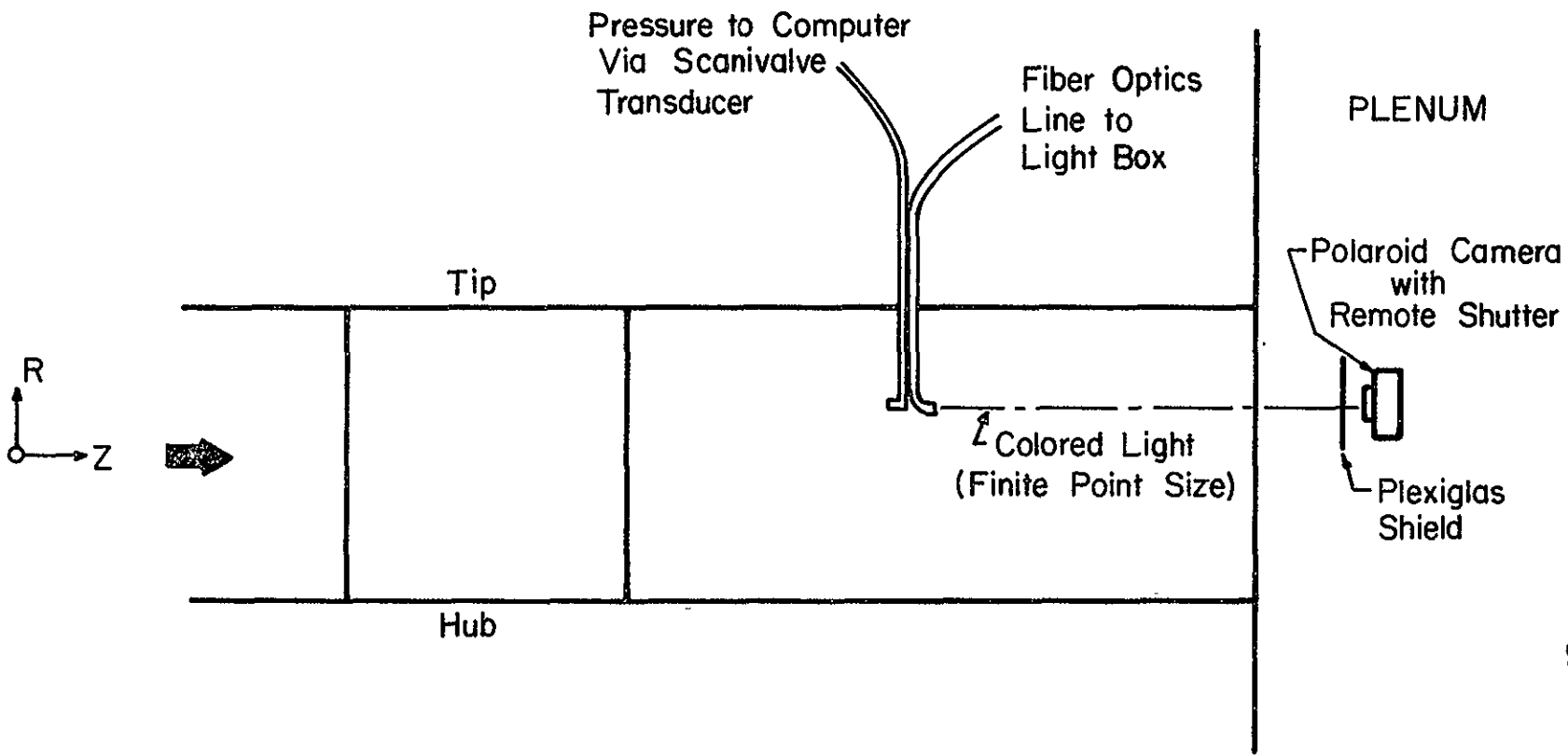

Figure J2. Schematic of the Isobaric Exit Visualization Apparatus in the Annular Cascade Facility

the total pressure probe in the principal flow direction. A light box was fabricated to provide automated flashing of any one of three high intensity light sources. Each light source is filtered to color the source, and focused on the end of a shielded fiber optics cable, which is mounted through the light box wall. Red, green, and yellow filters are used with each source to designate three pressure ranges. The other end of the shielded fiber optics cable is attached to the downstream side of the probe tip, directing a colinear flash of light downstream into the facility plenum. A Polaroid camera with remote shutter control is located in the plenum. As the probe traverses the R-T plane, the proper light is selected and flashed through the fiber optics line, and dots of colored light are recorded on a print created by the Polaroid camera (open shutter time exposure). Upon completion of the traverse, the shutter is closed and the polaroid camera provides an on-line isobaric photographic contour map, with the pressure ranges defined by different colors.

The preset pressure levels were determined prior to each experiment session by traversing the probe circumferentially at a mid-span location and surveying the resulting pressure data. A black and white copy of a colored contour photograph which shows the symmetric nature of the wake about the airfoil circumferential location at 0° incidence is presented in Figure 31.

APPENDIX K [1]

NASA Computer Codes

Two NASA-developed computer codes were used to predict the chordwise distribution of the airfoil surface pressure coefficient. The two programs, MERIDL [16] and TSONIC [17] are based on inviscid analyses and are intended for computing turbomachine flow field.

The governing flow equations are the continuity equation, the momentum equation (the inviscid form of the Navier-Stokes equations), and the thermodynamic equations. For steady subsonic flows, these equations form a system of elliptic partial differential equations. Solving an elliptic system requires that the flow conditions be completely specified on all boundaries of the solution region. Both programs generate two-dimensional grids upon which the governing equations are solved as finite difference equations using successive-over-relaxation.

The MERIDL program generates its grid along the hub-to-tip mean stream-sheet in the center of the airfoil passage. This stream-sheet is assumed to have the same shape

as the airfoil camber line with flow-matching corrections at the leading and trailing edges. One of the primary purposes of the MERIDL program is to compute the radial shift of the streamlines in the solution region (airfoil passage). Part of MERIDL's output is the input, in its required format, for the TSONIC program. It was to be expected for the facility geometry (constant radius annulus walls and flat-plate airfoils) that there would be very little radial shift of the streamlines. MERIDL was primarily used for completeness and to generate the extensive input required for TSONIC.

The TSONIC program generates its numerical grid and solves the governing equations along an airfoil-to-airfoil stream-sheet. The program assumes that this stream-sheet is a surface of revolution. Any arbitrary stream-sheet from hub to tip can be specified provided that MERIDL had been instructed to generate the appropriate input to TSONIC. Part of the output from TSONIC is the airfoil surface velocities. These can easily be converted to the corresponding pressure coefficients by dividing them by the mass-averaged velocity through the facility and squaring the results.

APPENDIX L

Tabulated Experimental Pressure
Coefficient Data

The experimental pressure coefficient data are presented here. Tables L1 through L18 are grouped by incidence angle with 10, 50, and 90% span data presented for both the suction and pressure surfaces.

<u>Table</u>	<u>Incidence Angle (DEG)</u>
L1 - L6	0
L7 - L12	5
L13 - L18	10

Table L1. Airfoil Surface Pressure Coefficient Data
10 Percent Span, Suction Surface,
Incidence Angle (deg) = 0.0

Mass-Averaged Inlet Velocity = 28.69 m/s		
Percent Chord	Cp Coefficient	+/- Cp Confidence
2.25	1.828	0.1268
6.78	1.256	0.0382
13.08	1.183	0.0520
20.90	1.155	0.0473
29.92	1.154	0.0422
39.75	1.155	0.0354
50.00	1.158	0.0391
60.25	1.165	0.0375
70.08	1.163	0.0375
79.10	1.167	0.0362
86.92	1.184	0.0388
93.32	1.211	0.0376
97.75	1.295	0.0416
99.30	1.304	0.0408

Table L2. Airfoil Surface Pressure Coefficient Data
10 Percent Span, Pressure Surface,
Incidence Angle (deg) = 0.0

Mass-Averaged Inlet Velocity = 28.69 m/s		
Percent Chord	Cp Coefficient	+/- Cp Confidence
2.25	1.760	0.1216
6.78	1.159	0.0692
13.08	1.154	0.0475
20.90	1.156	0.0454
29.92	1.140	0.0392
39.75	1.150	0.0375
50.00	1.151	0.0377
60.25	1.154	0.0370
70.08	1.157	0.0377
79.10	1.172	0.0369
86.92	1.182	0.0380
93.32	1.208	0.0393
97.75	1.274	0.0430
99.30	1.318	0.0425

Table L3. Airfoil Surface Pressure Coefficient Data
 50 Percent Span, Suction Surface,
 Incidence Angle (deg) = 0.0

Mass-Averaged Inlet Velocity = 28.69 m/s		
Percent Chord	Cp Coefficient	+/- Cp Confidence
2.25	1.751	0.0591
6.78	1.180	0.0801
13.08	1.158	0.0411
20.90	1.138	0.0392
29.92	1.148	0.0376
39.75	1.148	0.0371
50.00	1.153	0.0350
60.25	1.159	0.0366
70.08	1.159	0.0378
79.10	1.169	0.0373
86.92	1.181	0.0385
93.32	1.217	0.0380
97.75	1.318	0.0403
99.30	1.352	0.0419

Table L4. Airfoil Surface Pressure Coefficient Data
 50 Percent Span, Pressure Surface,
 Incidence Angle (deg) = 0.0

Mass-Averaged Inlet Velocity = 28.69 m/s		
Percent Chord	Cp Coefficient	+/- Cp Confidence
2.25	1.826	0.1173
6.78	1.183	0.1156
13.08	1.149	0.0396
20.90	1.131	0.0359
29.92	1.136	0.0373
39.75	1.124	0.0360
50.00	1.141	0.0359
60.25	1.145	0.0370
70.08	1.147	0.0378
79.10	1.175	0.0358
86.92	1.190	0.0376
93.32	1.213	0.0392
97.75	1.315	0.0401
99.30	1.366	0.0448

Table L5. Airfoil Surface Pressure Coefficient Data
 90 Percent Span, Suction Surface,
 Incidence Angle (deg) = 0.0

Mass-Averaged Inlet Velocity = 28.69 m/s		
Percent Chord	Cp Coefficient	+/- Cp Confidence
2.25	1.854	0.1328
6.78	1.376	0.1852
13.08	1.156	0.0543
20.90	1.147	0.0451
29.92	1.159	0.0412
39.75	1.134	0.0434
50.00	-----	-----
60.25	1.137	0.0417
70.08	1.155	0.0379
79.10	1.162	0.0372
86.92	1.179	0.0365
93.32	1.196	0.0400
97.75	1.276	0.0394
99.30	1.300	0.0439

Table L6. Airfoil Surface Pressure Coefficient Data
 90 Percent Span, Pressure Surface,
 Incidence Angle (deg) = 0.0

Mass-Averaged Inlet Velocity = 28.69 m/s		
Percent Chord	Cp Coefficient	+/- Cp Confidence
2.25	1.776	0.1554
6.78	1.286	0.1399
13.08	1.160	0.0461
20.90	1.140	0.0464
29.92	1.131	0.0391
39.75	1.094	0.0365
50.00	-----	-----
60.25	1.118	0.0349
70.08	1.152	0.0364
79.10	1.159	0.0381
86.92	1.177	0.0365
93.32	1.194	0.0369
97.75	1.276	0.0409
99.30	1.298	0.0417

Table L7. Airfoil Surface Pressure Coefficient Data
 10 Percent Span, Suction Surface,
 Incidence Angle (deg) = 5.0

Mass-Averaged Inlet Velocity = 30.52 m/s		
Percent Chord	Cp Coefficient	+/- Cp Confidence
2.25	2.163	0.0579
6.78	1.626	0.0404
13.08	1.265	0.0427
20.90	1.213	0.0344
29.92	1.195	0.0355
39.75	1.162	0.0297
50.00	1.178	0.0325
60.25	1.188	0.0296
70.08	1.168	0.0337
79.10	1.190	0.0297
86.92	1.196	0.0325
93.32	1.224	0.0335
97.75	1.339	0.0377
99.30	1.371	0.0444

Table L8. Airfoil Surface Pressure Coefficient Data
 10 Percent Span, Pressure Surface,
 Incidence Angle (deg) = 5.0

Mass-Averaged Inlet Velocity = 30.52 m/s		
Percent Chord	Cp Coefficient	+/- Cp Confidence
2.25	1.632	0.0890
6.78	1.119	0.0529
13.08	1.132	0.0337
20.90	1.145	0.0341
29.92	1.140	0.0342
39.75	1.160	0.0338
50.00	1.158	0.0330
60.25	1.160	0.0314
70.08	1.178	0.0335
79.10	1.180	0.0330
86.92	1.200	0.0310
93.32	1.231	0.0330
97.75	1.310	0.0393
99.30	1.366	0.0393

Table L9. Airfoil Surface Pressure Coefficient Data
50 Percent Span, Suction Surface,
Incidence Angle (deg) = 5.0

Mass-Averaged Inlet Velocity = 30.52 m/s		
Percent Chord	Cp Coefficient	+/- Cp Confidence
2.25	2.053	0.0546
6.78	1.745	0.1362
13.08	1.228	0.0353
20.90	1.189	0.0331
29.92	1.178	0.0319
39.75	1.167	0.0321
50.00	1.162	0.0262
60.25	1.169	0.0323
70.08	1.164	0.0327
79.10	1.179	0.0334
86.92	1.190	0.0331
93.32	1.234	0.0332
97.75	1.331	0.0361
99.30	1.375	0.0362

Table L10. Airfoil Surface Pressure Coefficient Data
50 Percent Span, Pressure Surface,
Incidence Angle (deg) = 5.0

Mass-Averaged Inlet Velocity = 30.52 m/s		
Percent Chord	Cp Coefficient	+/- Cp Confidence
2.25	1.264	0.0364
6.78	0.963	0.0318
13.08	1.039	0.0306
20.90	1.063	0.0304
29.92	1.108	0.0323
39.75	1.105	0.0302
50.00	1.139	0.0337
60.25	1.147	0.0321
70.08	1.163	0.0306
79.10	1.179	0.0316
86.92	1.197	0.0311
93.32	1.216	0.0337
97.75	1.329	0.0356
99.30	1.348	0.0375

Table L11. Airfoil Surface Pressure Coefficient Data
 90 Percent Span, Suction Surface,
 Incidence Angle (deg) = 5.0

Mass-Averaged Inlet Velocity = 30.52 m/s		
Percent Chord	Cp Coefficient	+/- Cp Confidence
2.25	2.197	0.0642
6.78	2.171	0.0605
13.08	1.271	0.0450
20.90	1.217	0.0369
29.92	1.200	0.0379
39.75	1.170	0.0312
50.00	-----	-----
60.25	1.158	0.0333
70.08	1.167	0.0323
79.10	1.173	0.0338
86.92	1.188	0.0354
93.32	1.210	0.0331
97.75	1.294	0.0374
99.30	1.355	0.0383

Table L12. Airfoil Surface Pressure Coefficient Data
 90 Percent Span, Pressure Surface,
 Incidence Angle (deg) = 5.0

Mass-Averaged Inlet Velocity = 30.52 m/s		
Percent Chord	Cp Coefficient	+/- Cp Confidence
2.25	1.220	0.0699
6.78	1.024	0.0365
13.08	1.050	0.0326
20.90	1.073	0.0310
29.92	1.095	0.0339
39.75	1.072	0.0333
50.00	-----	-----
60.25	1.116	0.0319
70.08	1.135	0.0306
79.10	1.165	0.0329
86.92	1.182	0.0337
93.32	1.205	0.0355
97.75	1.309	0.0354
99.30	1.362	0.0392

Table L13. Airfoil Surface Pressure Coefficient Data
10 Percent Span, Suction Surface,
Incidence Angle (deg) = 10.0

Mass-Averaged Inlet Velocity = 29.65 m/s		
Percent Chord	Cp Coefficient	+/- Cp Confidence
2.25	2.311	0.1180
6.78	1.942	0.1373
13.08	1.570	0.1527
20.90	1.281	0.0657
29.92	1.257	0.0505
39.75	1.210	0.0419
50.00	1.227	0.0461
60.25	1.227	0.0436
70.08	1.225	0.0449
79.10	1.234	0.0418
86.92	1.252	0.0466
93.32	1.277	0.0485
97.75	1.367	0.0519
99.30	1.382	0.0551

Table L14. Airfoil Surface Pressure Coefficient Data
10 Percent Span, Pressure Surface,
Incidence Angle (deg) = 10.0

Mass-Averaged Inlet Velocity = 29.65 m/s		
Percent Chord	Cp Coefficient	+/- Cp Confidence
2.25	0.970	0.1146
6.78	0.948	0.0716
13.08	0.982	0.0502
20.90	1.079	0.0446
29.92	1.116	0.0481
39.75	1.178	0.0489
50.00	1.196	0.0458
60.25	1.211	0.0492
70.08	1.226	0.0468
79.10	1.228	0.0446
86.92	1.249	0.0463
93.32	1.283	0.0484
97.75	1.359	0.0549
99.30	1.408	0.0568

Table L15. Airfoil Surface Pressure Coefficient Data
 50 Percent Span, Suction Surface,
 Incidence Angle (deg) = 10.0

Mass-Averaged Inlet Velocity = 29.65 m/s		
Percent Chord	Cp Coefficient	+/- Cp Confidence
2.25	-.----	-.-----
6.78	2.344	0.1148
13.08	1.968	0.1188
20.90	1.453	0.0921
29.92	1.332	0.0729
39.75	1.265	0.0550
50.00	1.253	0.0455
60.25	1.250	0.0472
70.08	1.247	0.0473
79.10	1.258	0.0477
86.92	1.254	0.0448
93.32	1.296	0.0454
97.75	1.387	0.0521
99.30	1.444	0.0572

Table L16. Airfoil Surface Pressure Coefficient Data
 50 Percent Span, Pressure Surface,
 Incidence Angle (deg) = 10.0

Mass-Averaged Inlet Velocity = 29.65 m/s		
Percent Chord	Cp Coefficient	+/- Cp Confidence
2.25	1.032	0.0789
6.78	0.926	0.0497
13.08	1.012	0.0479
20.90	1.076	0.0414
29.92	1.137	0.0445
39.75	1.176	0.0450
50.00	1.218	0.0446
60.25	1.233	0.0490
70.08	1.248	0.0457
79.10	1.260	0.0494
86.92	1.274	0.0479
93.32	1.305	0.0520
97.75	1.412	0.0513
99.30	1.457	0.0614

Table L17. Airfoil Surface Pressure Coefficient Data
90 Percent Span, Suction Surface,
Incidence Angle (deg) = 10.0

Mass-Averaged Inlet Velocity = 29.65 m/s		
Percent Chord	Cp Coefficient	+/- Cp Confidence
2.25	2.320	0.1588
6.78	2.404	0.1160
13.08	1.696	0.1749
20.90	1.328	0.0710
29.92	1.269	0.0550
39.75	1.216	0.0467
50.00	-----	-----
60.25	1.202	0.0475
70.08	1.210	0.0483
79.10	1.221	0.0450
86.92	1.226	0.0476
93.32	1.245	0.0471
97.75	1.338	0.0494
99.30	1.382	0.0530

Table L18. Airfoil Surface Pressure Coefficient Data
90 Percent Span, Pressure Surface,
Incidence Angle (deg) = 10.0

Mass-Averaged Inlet Velocity = 29.65 m/s		
Percent Chord	Cp Coefficient	+/- Cp Confidence
2.25	0.813	0.0659
6.78	0.882	0.0641
13.08	0.957	0.0536
20.90	1.016	0.0545
29.92	1.084	0.0522
39.75	1.072	0.0429
50.00	-----	-----
60.25	1.155	0.0470
70.08	1.184	0.0440
79.10	1.197	0.0444
86.92	1.224	0.0438
93.32	1.239	0.0467
97.75	1.326	0.0543
99.30	1.362	0.0498

DISTRIBUTION LIST

THE EFFECT OF INCIDENCE ANGLE ON THE OVERALL THREE-DIMENSIONAL AERODYNAMIC
PERFORMANCE OF A CLASSICAL ANNULAR AIRFOIL CASCADE - NSG 3285

	<u>Mail Stop</u>	<u>No. of Copies</u>
1. NASA-Lewis Research Center 21000 Brookpark Road Cleveland, OH 44135		
Attn: J. J. Adamczyk	M.S. 60-5	1
C. L. Ball	M.S. 60-5	1
D. R. Boldman	M.S. 60-5	6
L. D. Nichols	M.S. 60-2	1
L. A. Povinelli	M.S. 77-2	1
L. Reid	M.S. 77-5	1
D. M. Sandercock	M.S. 60-5	1
R. J. Simoneau	M.S. 77-2	1
P. M. Sockol	M.S. 77-5	1
A. J. Strazisar	M.S. 77-5	1
J. R. Wood	M.S. 77-5	1
Grants and Facilities Section	M.S. 501-11	1
Report Control Office	M.S. 60-1	1
Library	M.S. 60-3	2
2. NASA Scientific and Technical Information Facility 6571 Elkridge Landing Road Linthicum Heights, MD 21090 Attn: Accessioning Department		5
3. NASA Headquarters Washington, D.C. 20546 Attn: Mr. Cecil Rosen	RTP-6	1
4. Headquarters Wright-Patterson AFB, OH 45433 Attn: E. E. Bailey	AFWAL/NASA-PO	1
5. Pratt & Whitney Aircraft 400 Main Street East Hartford, CT 06108 Attn: Library (Comm. Prod. Div.) Library (UTRC)		1 1
6. Pratt & Whitney Aircraft Government Products Division P. O. Box 2691 West Palm Beach, FL 33402 Attn: Library (Govt. Prod. Div.)		1
7. General Electric Company Aircraft Engine Group Cincinnati, OH 45215 Attn: Technical Information Center	N-32	1

	<u>Mail Stop</u>	<u>No. of Copies</u>
8. General Electric Company 1000 Western Avenue Lynn, MA 01910 Attn: Library (Aircraft Engine Group) 24001		1
9. Detroit Diesel Allison Division General Motors Corporation P. O. Box 894 Indianapolis, IN 46206 Attn: R. L. Jay	W-16 S-6	1 1
10. Iowa State University of Science and Technology Ames, IA 50010 Attn: Dept. of Mech. Engrg. Prof. G. K. Serovy Prof. T. H. Okiishi		1 1
11. AiResearch Mfg. Co. 2525 West 190th Street Torrance, CA 90509 Attn: Library		1
12. University of Notre Dame Notre Dame, IN 46556 Attn: Engineering Library		1
13. Williams International 2280 West Maple Road P. O. Box 200 Walled Lake, MI 48088 Attn: Mr. Raymond A. Horn, Jr.		1
14. Massachusetts Institute of Technology Gas Turbine and Plasma Dynamics Lab Cambridge, MA 02139 Attn: Dr. Eugene Covert		1
15. Naval Postgraduate School Department of Aeronautics Monterey, CA 93940 Attn: Dr. Max E. Platzner		1