

(NASA-CR-165475) TESTING OF SOLAR CELL
COVERS AND ENCAPSULANTS CONDUCTED IN A
SIMULATED SPACE ENVIRONMENT Final Report
(Boeing Co., Seattle, Wash.) 267 p
HC A12/MF A01

N82-12571

Unclass

CSCL 10A G3/44 08523

NASA CR-165475
D180-26590-1



**TESTING OF SOLAR CELL COVERS AND ENCAPSULANTS CONDUCTED
IN A SIMULATED SPACE ENVIRONMENT**

Prepared by D.A. Russell
The Boeing Company

prepared for
National Aeronautics and Space Administration

NASA Lewis Research Center
Contract NAS3-22222



**NASA CR-165475
D180-26590-1**



**TESTING OF SOLAR CELL COVERS AND ENCAPSULANTS CONDUCTED
IN A SIMULATED SPACE ENVIRONMENT**

**Prepared by D.A. Russell
The Boeing Company**

**prepared for
National Aeronautics and Space Administration**

**NASA Lewis Research Center
Contract NAS3-72222**

1. Report No. CR 165475		2. Government Accession No.		3. Recipient's Catalog No.	
4. Title and Subtitle TESTING OF SOLAR CELL COVERS AND ENCAPSULANTS CONDUCTED IN A SIMULATED SPACE ENVIRONMENT				5. Report Date November 1981	
				6. Performing Organization Code	
7. Author(s) D. A. Russell				8. Performing Organization Report No. D180-26590-1	
9. Performing Organization Name and Address Boeing Aerospace Company P.O. Box 3999 Seattle, Washington 98124				10. Work Unit No.	
				11. Contract or Grant No. NAS 3-22222	
12. Sponsoring Agency Name and Address National Aeronautics and Space Administration Washington, D.C. 20546				13. Type of Report and Period Covered Contractor Report	
				14. Sponsoring Agency Code	
15. Supplementary Notes Project Manager, Jacob D. Broder, Solar and Electro-Chemistry Division, NASA-Lewis Research Center, Cleveland, Ohio					
16. Abstract This document reports the work performed at the Boeing Radiation Effects Laboratory for NASA-Lewis Research Center during the period from February 1980 to June 1981 on the evaluation of solar cell covers and encapsulants in simulated space environments. The materials included in the evaluation were 0211 micro-sheet, FEP-A used as a cover and as an adhesive, DC 93-500 adhesive, PFA "hard coat" used as a cover, GE 615/UV-24 used as a cover, GR 650 used as a cover and electrostatically bonded 7070 glass. The test environments were 1 MeV electron irradiation interspersed with thermal cycling, 0.5 MeV proton irradiation interspersed with thermal cycling and UV exposure interspersed with thermal cycling. Summary data is given describing the response of the test materials both visually and electrically to the three different environments.					
17. Key Words (Suggested by Author(s)) Electron Photon Solar Cell Cover Solar Cell Encapsulant Thermal Cycling Ultraviolet			18. Distribution Statement Unclassified - unlimited		
19. Security Classif. (of this report) Unclassified		20. Security Classif. (of this page) Unclassified		21. No. of Pages 270	22. Price*

* For sale by the National Technical Information Service, Springfield, Virginia 22161

FOREWORD

This report was prepared by the Boeing Aerospace Company under NASA contract NAS3-22222. The principal investigator on this program was Mr. D. A. Russell. Mr. W. E. Horne was responsible for the original program instigation at Boeing and gave valuable guidance and consultation during the effort. Other significant contributors at Boeing were Mr. A. C. Day who provided valuable expertise and assistance in computerizing the I-V measurements and data analysis, Mr. C. P. Baze who provided assistance in the mechanical design and operation of the test systems and Mrs. S. L. Holfeltz who provided expertise in compiling and organizing the data and editing the report. A special thanks to Miss A. D. Yeremian for her assistance in data analysis programming.

The author would like to thank the contract technical monitor, Mr. Jacob D. Broder of NASA-Lewis Research Center for his guidance and technical support throughout this program.

TABLE OF CONTENTS

	<u>Page</u>
FOREWORD	2
1.0 INTRODUCTION	13
2.0 ENCAPSULANTS AND COVERS EVALUATED	15
2.1 PRELIMINARY THERMAL CYCLING TESTS	15
3.0 EXPERIMENTAL TEST FACILITIES	18
3.1 SIMULATION OF ELECTRON AND PROTON ENVIRONMENTS	18
3.2 THERMAL CYCLING SYSTEM	20
3.3 VACUUM TEST CHAMBERS	23
3.3.1 Particle Beam Vacuum Test Chamber	23
3.3.2 UV Exposure Vacuum Test Chamber	24
3.4 SOLAR SIMULATORS	27
4.0 TEST INSTRUMENTATION	30
4.1 ELECTRON AND PROTON DOSIMETRY	30
4.1.1 Tolerances	30
4.2 UV DOSIMETRY	32
4.3 I-V MEASUREMENTS	33
4.3.1 1 AMO Calibration - In Situ	33
4.3.2 1 AMO Calibration - Ex Situ	33
4.4 DATA ACQUISITION SYSTEM	34
4.5 DATA REDUCTION SYSTEM	35
4.6 TEMPERATURE CONTROL	37
5.0 TEST PLAN AND PROCEDURE	38
5.1 EFFECTS OF ELECTRON IRRADIATION INTERSPERSED BY THERMAL CYCLING	43
5.2 EFFECTS OF LOW ENERGY PROTON IRRADIATION INTERSPERSED BY THERMAL CYCLING	47
5.3 EFFECTS OF UV EXPOSURE INTERSPERSED WITH THERMAL CYCLING	52

TABLE OF CONTENTS (Continued)

	<u>Page</u>
6.0 ANALYSIS OF RESULTS	56
6.1 DATA FORMAT	57
6.2 CONTROL CELLS	65
6.3 MONITOR CELLS	77
6.4 A SERIES CELLS	80
6.4.1 Electron Irradiation	80
6.4.2 Proton Irradiation	87
6.4.3 UV Exposure	93
6.5 C SERIES CELLS	99
6.5.1 Electron Irradiation	99
6.5.2 Proton Irradiation	106
6.5.3 UV Exposure	113
6.6 D SERIES CELLS	119
6.6.1 Electron Irradiation	119
6.6.2 Proton Irradiation	125
6.6.3 UV Exposure	132
6.7 E SERIES CELLS	138
6.7.1 Electron Irradiation	138
6.7.2 Proton Irradiation	144
6.7.3 UV Exposure	151
6.8 P SERIES CELLS	157
6.8.1 Electron Irradiation	157
6.8.2 Proton Irradiation	163
6.8.3 UV Exposure	170
6.9 GE CELLS	176
6.9.1 Electron Irradiation	176
6.9.2 Proton Irradiation	184
6.9.3 UV Exposure	192

TABLE OF CONTENTS (Continued)

	<u>Page</u>
6.10 DOUBLE NUMBER CELLS	201
6.10.1 Electron Irradiation	201
6.10.2 Proton Irradiation	207
6.10.3 UV Exposure	213
6.11 ELECTROSTATICALLY BONDED CELLS (ESB)	219
6.11.1 Electron Irradiation	219
6.11.2 Proton Irradiation	227
6.11.3 UV Exposure	233
6.12 2-mil 7070 GLASS	241
6.12.1 Electron Irradiation	241
6.12.2 Proton Irradiation	241
6.13 NASA-LEWIS MODULE #1	242
6.14 JPL MODULE #2	249
7.0 SUMMARY OF RESULTS	256
7.1 INTRODUCTION	256
7.2 CONCLUSIONS	257
7.2.1 A Series	257
7.2.2 C Series	259
7.2.3 D Series	259
7.2.4 E Series	260
7.2.5 P Series	260
7.2.6 GE Cells	261
7.2.7 Double Number Cells	261
7.2.8 Electrostatically Bonded Cells (ESB)	262
7.2.9 B Series	263
7.2.10 Module 1 (made by NASA-Lewis)	263
7.2.11 Module 2 (made for JPL)	264
7.3 CONCLUDING REMARKS	264

LIST OF FIGURES

<u>Figure</u>		<u>Page</u>
1	Dynamitron Beam Handling System	18
2	Side View of Vacuum Test Chamber	19
3	Top View of Vacuum Test Chamber	20
4	Sample Plate in Thermal Cycling Position	21
5	Thermal Cycling System	22
6	Typical Thermal Cycle Temperature Profile	22
7	Vacuum Test Chamber and Solar Simulator	23
8	Test Chamber in Sample Irradiation Position	25
9	Monitor Cell Plate in Position for Measurements	25
10	Side View UV Exposure Vacuum Test Chamber	26
11	UV Exposure Vacuum Test Chamber	26
12	End View of UV Exposure Vacuum Chamber	27
13	X-25L Solar Simulator Spectrum	28
14	X-25L Uniformity of In Situ Light Field	28
15	UV Exposure X-25L Solar Simulator Spectrum	29
16	Electron Beam Profile	31
17	Proton Beam Profile	31
18	Transmission Curve for Corning 051 Filter	32
19	Block Diagram of Data Acquisition System	35
20	Block Diagram of Data Reduction System	36
21	Sample Plate Layout - 1st Set Electron Irradiation	44
22	Pre-Irradiation Electron Set #1	44
23	Sample Plate Layout - 2nd Set Electron Irradiation	45
24	Pre-Irradiation Electrons Set #2	45
25	Sample Plate Layout - 1st Set Proton Irradiation	48
26	Pre-Irradiation Protons Set #1	48
27	Sample Plate Layout - 2nd Set Proton Irradiation	49
28	Pre-Irradiated Proton Set #2	49
29	Sample Plate Layout - 3rd Set Proton Irradiation	50
30	Top Half of Sample Plate Pre-Irradiation Proton Set #3	50
31	Sample Plate Layout - UV Exposure Set #1	53
32	Pre-Exposure UV Set #1	53
33	Sample Plate Layout - UV Exposure Set #2	54
34	Pre-Exposure UV Set #2	54
35	Example of Computer-Plotted I-V Curves	59
36	Example of Summary Plot	61
37	Control Cells Electron Irradiation In Situ Summary Plot	66
38	Control Cells Electron Irradiation In Situ Summary Plot	66
39	Control Cell Proton Irradiation In Situ Summary Plot	69
40	Control Cell Proton Irradiation In Situ Summary Plot	69

LIST OF FIGURES (Continued)

<u>Figure</u>		<u>Page</u>
41	Control Cell Proton Irradiation In Situ Summary Plot	70
42	Control Cell Proton Irradiation In Situ Summary Plot	70
43	Control Cells UV Irradiation In Situ Summary Plot	73
44	Control Cells UV Irradiation In Situ Summary Plot	73
45	Control Cells UV Irradiation In Situ Summary Plot	74
46	Control Cells UV Irradiation In Situ Summary Plot	74
47	Monitor Cells Electron Irradiation In Situ Summary Plot	78
48	Monitor Cells Proton Irradiation In Situ Summary Plot	78
49	Monitor Cells UV Irradiation In Situ Summary Plot	79
50	A Series Electron Irradiation In Situ Summary Plot	81
51	A Series Electron Irradiation In Situ Summary Plot	81
52	A Series Electron Irradiation In Situ Summary Plot	82
53	A Series Electron Irradiation In Situ Summary Plot	82
54	0211 Micro Sheet Transmittance Versus 1 MeV Electron Fluence	83
55	A Series Electron Irradiation Ex Situ I-V Curves	86
56	A Series Proton Irradiation In Situ Summary Plots	88
57	A Series Proton Irradiation In Situ Summary Plots	88
58	A Series Proton Irradiation In Situ Summary Plots	89
59	A Series Proton Irradiation In Situ Summary Plots	89
60	A Series Proton Irradiation Ex Situ I-V Curves	92
61	A Series UV Irradiation In Situ Summary Plots	94
62	A Series UV Irradiation In Situ Summary Plots	94
63	A Series UV Irradiation In Situ Summary Plots	95
64	A Series UV Irradiation In Situ Summary Plots	95
65	A Series UV Irradiation Ex Situ I-V Curves	98
66	C Series Electron Irradiation In Situ Summary Plots	100
67	C Series Electron Irradiation In Situ Summary Plots	100
68	C Series Electron Irradiation In Situ Summary Plots	101
69	C Series Electron Irradiation In Situ Summary Plots	101
70	C Series Electron Irradiation Ex Situ I-V Curves	104
71	Sample C 1 (401) Showing FEP-A Cracks, Post Electron Irradiation	105
72	C Series Proton Irradiation In Situ Summary Plots	107
73	C Series Proton Irradiation In Situ Summary Plots	107
74	C Series Proton Irradiation In Situ Summary Plots	108
75	C Series Proton Irradiation In Situ Summary Plots	108
76	C Series Proton Irradiation In Situ I-V Curves	111
77	C Series UV Irradiation In Situ Summary Plots	114
78	C Series UV Irradiation In Situ Summary Plots	114
79	C Series UV Irradiation In Situ Summary Plots	115
80	C Series UV Irradiation In Situ Summary Plots	115
81	C Series UV Irradiation Ex Situ I-V Curves	118
82	D Series Electron Irradiation In Situ Summary Plots	120
83	D Series Electron Irradiation In Situ Summary Plots	120
84	D Series Electron Irradiation In Situ Summary Plots	121
85	D Series Electron Irradiation In Situ Summary Plots	121

LIST OF FIGURES (Continued)

<u>Figure</u>		<u>Page</u>
86	D Series Electron Irradiation Ex Situ I-V Curves	124
87	D Series Proton Irradiation In Situ Summary Plots	126
88	D Series Proton Irradiation In Situ Summary Plots	126
89	D Series Proton Irradiation In Situ Summary Plots	127
90	D Series Proton Irradiation In Situ Summary Plots	127
91	Sample D28 (507) Showing Cracks, Post-Proton Irradiation Ex Situ	130
92	D Series Proton Irradiation Ex Situ I-V Curves	131
93	D Series UV Irradiation In Situ Summary Plots	133
94	D Series UV Irradiation In Situ Summary Plots	133
95	D Series UV Irradiation In Situ Summary Plots	134
96	D Series UV Irradiation In Situ Summary Plots	134
97	D Series UV Irradiation Ex Situ I-V Curves	137
98	E Series Electron Irradiation In Situ Summary Plots	139
99	E Series Electron Irradiation In Situ Summary Plots	139
100	E Series Electron Irradiation In Situ Summary Plots	140
101	E Series Electron Irradiation In Situ Summary Plots	140
102	E Series Electron Irradiation Ex Situ I-V Curves	143
103	E Series Proton Irradiation In Situ Summary Plots	145
104	E Series Proton Irradiation In Situ Summary Plots	145
105	E Series Proton Irradiation In Situ Summary Plots	146
106	E Series Proton Irradiation In Situ Summary Plots	146
107	Photograph of Sample E 32 (607) After Proton Irradiation	149
108	E Series Proton Irradiation Ex Situ I-V Curves	150
109	E Series UV Irradiation In Situ Summary Plots	152
110	E Series UV Irradiation In Situ Summary Plots	152
111	E Series UV Irradiation In Situ Summary Plots	153
112	E Series UV Irradiation In Situ Summary Plots	153
113	E Series UV Irradiation Ex Situ I-V Curves	156
114	P Series Electron Irradiation In Situ Summary Plots	158
115	P Series Electron Irradiation In Situ Summary Plots	158
116	P Series Electron Irradiation In Situ Summary Plots	159
117	P Series Electron Irradiation In Situ Summary Plots	159
118	P Series Electron Irradiation Ex Situ I-V Curves	162
119	P Series Proton Irradiation In Situ Summary Plots	164
120	P Series Proton Irradiation In Situ Summary Plots	164
121	P Series Proton Irradiation In Situ Summary Plots	165
122	P Series Proton Irradiation In Situ Summary Plots	165
123	P Series Proton Irradiation In Situ I-V Curves	168
124	P Series UV Irradiation In Situ Summary Plots	171
125	P Series UV Irradiation In Situ Summary Plots	171
126	P Series UV Irradiation In Situ Summary Plots	172
127	P Series UV Irradiation In Situ Summary Plots	172
128	P Series UV Irradiation Ex Situ I-V Curves	175

LIST OF FIGURES (Continued)

<u>Figure</u>		<u>Page</u>
129	Photograph of GE 4 (802) Sample Showing Cracked Cells and PFA Covers	177
130	GE Cells Electron Irradiation In Situ Summary Plots	178
131	GE Cells Electron Irradiation In Situ Summary Plots	178
132	GE Cells Electron Irradiation In Situ Summary Plots	179
133	GE Cells Electron Irradiation In Situ Summary Plots	179
134	GE Cells Electron Irradiation In Situ I-V Curves	182
135	Blistering and Peeling of Cell GE12 (806), Post Proton Irradiation Ex Situ	185
136	GE Cells Proton Irradiation In Situ Summary Plots	186
137	GE Cells Proton Irradiation In Situ Summary Plots	186
138	GE Cells Proton Irradiation In Situ Summary Plots	187
139	GE Cells Proton Irradiation In Situ Summary Plots	187
140	GE Cells Proton Irradiation In Situ I-V Curves	190
141	Sample GE26 (812), Showing Hairline Cracks in PFA, Post Exposure UV	193
142	GE Cells UV Irradiation In Situ Summary Plots	194
143	GE Cells UV Irradiation In Situ Summary Plots	194
144	GE Cells UV Irradiation In Situ Summary Plots	195
145	GE Cells UV Irradiation In Situ Summary Plots	195
146	GE Cells UV Irradiation In Situ I-V Curves	198
147	DN Series Electron Irradiation In Situ Summary Plots	202
148	DN Series Electron Irradiation In Situ Summary Plots	202
149	DN Series Electron Irradiation In Situ Summary Plots	203
150	DN Series Electron Irradiation In Situ Summary Plots	203
151	DN Series Electron Irradiation Ex Situ I-V Curves	206
152	DN Series Proton Irradiation In Situ Summary Plots	208
153	DN Series Proton Irradiation In Situ Summary Plots	208
154	DN Series Proton Irradiation In Situ Summary Plots	209
155	DN Series Proton Irradiation In Situ Summary Plots	209
156	DN Series Proton Irradiation Ex Situ I-V Curves	212
157	DN Cells UV Irradiation In Situ Summary Plots	214
158	DN Cells UV Irradiation In Situ Summary Plots	214
159	DN Cells UV Irradiation In Situ Summary Plots	215
160	DN Cells UV Irradiation In Situ Summary Plots	215
161	DN Series UV Irradiation Ex Situ I-V Curves	218
162	ESB Cells Electron Irradiation In Situ Summary Plots	220
163	ESB Cells Electron Irradiation In Situ Summary Plots	220
164	ESB Cells Electron Irradiation In Situ Summary Plots	221
165	ESB Cells Electron Irradiation In Situ Summary Plots	221
166	ESB Cells Electron Irradiation In Situ I-V Curves	226
167	ESB Cells Proton Irradiation In Situ Summary Plots	228
168	ESB Cells Proton Irradiation In Situ Summary Plots	228
169	ESB Cells Proton Irradiation In Situ Summary Plots	229
170	ESB Cells Proton Irradiation In Situ Summary Plots	229
171	ESB Cells Proton Irradiation Ex Situ I-V Curves	232

LIST OF FIGURES (Continued)

<u>Figure</u>		<u>Page</u>
172	ESB Cells UV Irradiation In Situ Summary Plots	234
173	ESB Cells UV Irradiation In Situ Summary Plots	234
174	ESB Cells UV Irradiation In Situ Summary Plots	235
175	ESB Cells UV Irradiation In Situ Summary Plots	235
176	ESB Cells UV Irradiation In Situ I-V Curves	238
177	Photograph Showing Hazy Region of NASA-Lewis Module (1101), Post UV Exposure Ex Situ	243
178	Module Number 1 UV Irradiation In Situ Summary Plots	244
179	Module Number 1 UV Irradiation In Situ Summary Plots	244
180	Module Number 1 UV Irradiation In Situ Summary Plots	245
181	Module Number 1 UV Irradiation In Situ Summary Plots	245
182	Module Number 1 UV Irradiation Ex Situ I-V Curves	248
183	Module Number 2 UV Irradiation In Situ Summary Plots	250
184	Module Number 2 UV Irradiation In Situ Summary Plots	250
185	Module Number 2 UV Irradiation In Situ Summary Plots	251
186	Module Number 2 UV Irradiation In Situ Summary Plots	251
187	JPL Module (1102) at Completion of Exposure, Post Exposure UV	254
188	Module Number 2 UV Irradiation Ex Situ I-V Curves	255

LIST OF TABLES

<u>Table</u>		<u>Page</u>
1	Program Cell-Cover-Adhesive Combinations	16
2	Cell Designations and Environments	39
3	Electron Irradiation Test Parameters	43
4	Program Flow Diagram of Electron Irradiation Interspersed with Thermal Cycling - Task I	46
5	Proton Irradiation Test Parameters	47
6	Program Flow Diagram of Low Energy Proton Irradiation Interspersed with Thermal Cycling - Task II	51
7	UV Irradiation Test Parameters	52
8	Program Flow Diagram of UV Irradiation Interspersed with Thermal Cycling - Task III	55
9	Tabulated Test Parameters and Their Normalized Values	60
10	Average Normalized Cell Parameters	61
11	Summary of Electron Irradiation - Visual Inspection	62
12	Summary of Proton Irradiation - Visual Inspection	63
13	Summary of UV Exposure - Visual Inspection	64
14	Tabulated Control Cell Data - Electron Irradiation	67
15	Tabulated Control Cell Data - Proton Irradiation	71
16	Tabulated Control Cell Data - UV irradiation	75
17	Tabulated A Series Data - Electron Irradiation	84
18	Tabulated A Series Data - Proton Irradiation	90
19	Tabulated A Series Data - UV Irradiation	96
20	Tabulated C Series Data - Electron Irradiation	102
21	Tabulated C Series Data - Proton Irradiation	109
22	Tabulated C Series Data - UV Irradiation	116
23	Tabulated D Series Data - Electron Irradiation	122
24	Tabulated D Series Data - Proton Irradiation	128
25	Tabulated D Series Data - UV Irradiation	135
26	Summary of HESP Cell Data	138
27	Tabulated E Series Data - Electron Irradiation	141
28	Tabulated E Series Data - Proton Irradiation	147
29	Tabulated E Series Data - UV Irradiation	154
30	Tabulated P Series Data - Electron Irradiation	160
31	Tabulated P Series Data - Proton Irradiation	166
32	Tabulated P Series Data - UV Irradiation	173
33	Tabulated GE Series Data - Electron Irradiation	180
34	Tabulated GE Series Data - Proton Irradiation	188
35	Tabulated GE Series Data - UV Irradiation	196
36	Tabulated DN Series Data - Electron Irradiation	204
37	Tabulated DN Series Data - Proton Irradiation	210
38	Tabulated DN Series Data - UV Irradiation	216
39	Tabulated ESB Series Data - Electron Irradiation	222

LIST OF TABLES (Continued)

<u>Table</u>		<u>Page</u>
40	Tabulated ESB Series Data - Proton Irradiation	230
41	Tabulated ESB Series Data - UV Irradiation	236
42	Tabulated Module Data - UV Irradiation	246
43	Tabulated Module Data - UV Irradiation	252
44	Summary of Results	258

1.0 INTRODUCTION

Current and projected trends in space solar power systems require larger and more efficient photovoltaic arrays. Thus, the increased emphasis on the power/weight ratio of solar cell arrays and on improving the economy of manufacture of these structures has required new efforts to discover materials suitable for use as solar cell covers. As these new materials are being developed, it is necessary to conduct evaluation testing of these new materials and/or methods, to determine their feasibility for various space missions. During this program, laboratory tests that provide a basis for meaningful evaluation, have been conducted under conditions which closely approximate the environmental conditions of space. The materials tested include several new candidates for space solar array encapsulants. These materials are 1) 0211 Ceria-doped microsheet, 2) FEP-A coatings, 3) DC 93-500 adhesive, 4) PFA "hard coated", 5) GE 615/UV-24 and 6) electrostatically bonded 7070 glass.

There were fifteen each of nine types of individual test specimens (2 cm x 2 cm) and two 3 x 3 cell modules provided by NASA-Lewis Research Center for this program. The test was divided into three separate environmental factors: 1 MeV electrons interspersed with thermal cycling, 0.5 MeV protons interspersed with thermal cycling and ultraviolet exposure interspersed with thermal cycling. There were five samples of each type in each environment with the two modules being exposed only in the ultraviolet test. The total fluence exposure was done in increments and each incremental fluence or exposure was followed by a set of fifteen thermal cycles in vacuum. There were four incremental fluence levels of electrons that reached a total fluence of 1×10^{16} e/cm². There were two incremental fluence levels of protons that reached a total fluence of 3.3×10^{15} p/cm². The UV exposure was divided into three increments with a total exposure of 8,760 ESH. The thermal cycling range was $-175^{\circ}\text{C} \pm 10^{\circ}\text{C}$ to $+55^{\circ}\text{C} \pm 5^{\circ}\text{C}$.

Measurements of the I-V characteristics of each specimen were made in situ prior to, between and following each irradiation and set of 15 thermal cycles. Specially prepared silicon cells were used as

control cells to be exposed to the same conditions as the covered cells. Bare silicon cells, protected from the radiation environment, were used as monitor cells for adjustment of the light intensity during the in situ I-V measurements.

The program is discussed in detail in the following sections. Section 2.0 discusses the types of materials tested and describes a preliminary thermal cycling test. Section 3.0 describes the experimental test facilities and Section 4.0 describes the test instrumentation. Section 5.0 gives a detailed explanation of the test plan and test procedures. Section 6.0 contains the analysis of results arranged by sample type including summary plots of the four test parameters (I_{sc} , V_{oc} , P_{max} and Fill factor) versus particle fluence or UV exposure. Section 7.0 summarizes the results.

2.0 ENCAPSULANTS AND COVERS EVALUATED

The program included nine types of encapsulants or cover materials applied to solar cells in various ways. The solar cells served two functions. They served as a test vehicle to measure the changes in the light transmission properties of the materials and they were also part of the total physical system made up of encapsulant or cover materials, adhesive, and cell. In this way, both the material properties and their application technique were evaluated for their performance in the space environment.

Table 1 describes the types of cell-cover-adhesive combinations included in this program. The A Series, Double Number and electrostatically bonded (ESB) cells all have glass covers. The B Series, C Series, and GE cells are plastic covered type. The D Series and E Series have only a thick layer of adhesive as the cover. The P Series have 0.5 mil of GR 650 Glass Resin^(R) as the cover.

2.1 PRELIMINARY THERMAL CYCLING TESTS

A preliminary thermal cycling test was conducted on spare A Series, B Series, C Series, Double Number and P Series samples provided by NASA-Lewis. The purpose of the test was to determine the amount of bending or flexing of the cell-cover combination and then to determine the best method to mount the cells to the sample plate. The test fixture was a temperature controlled copper block with a thermocouple for monitoring the temperature mounted on it. The cells were then mounted to the copper block. The cell temperature was lowered to LN₂ temperature and then warmed to ~55°C. The cell was observed throughout the cycle.

The A Series test samples, which were glass-covered, did not curl or break when held down on each side as might be expected. The samples were held down by two small beryllium-copper clips attached to the block with 0-80 screws. The beryllium-copper clips were used throughout the test because they allowed the sample to flex.

The B Series samples are encapsulated in FEP-A and Kapton with GE 6574 as an adhesive (Table 1). It was found that at about -50°C

TABLE 1. PROGRAM CELL-COVER-ADHESIVE COMBINATIONS

SERIES	CELL	COVER	BACK	ADHESIVE	REMARKS
A	OCLI 8-mil 10 Ω -cm BSF/R	4 mil 0211 ceria doped	None	93-500 ~0.5 mils	
C	OCLI 2-mil 10 Ω -cm Ta ₂ O ₅ BSF	2 mil FEP-A	1 mil Kapton	93-500 front and back ~2 mil ea.	
D	OCLI 8-mil 10 Ω -cm BSF/R	~1.5 mil 93-500	None	None	Weld "footprint" may be present on some cells
P	Solarex 2 mil 2 Ω -cm Ta ₂ O ₅	~0.5 mil GR 650	None	None	
GE Cells	Solarex 2 mil	2 mil PFA "Hard-coated"	1 mil Kapton	93-500 front and back	
Double Number	Spectrolab 2-mil Space Qualified Texturized BSF	~2 mil 0211	2 mil FEP-20C 1½ mil fiber- glass 2 mil FEP-20C 1 mil Kapton	2 mil FEP-A	Portions of 16-1 & 16-2 exposed, 15-16 may be broken
E	Spectrolab 10-mil 10 Ω -cm Series 4500 K 4½	2 mil GE 615/UV-24	None	None	
ESB*	ASEC 2 mil, 50 Ω /sq	2 mil 7070	None	None	
Control Monitor	Spectrolab 8-10 mil 10 Ω -cm				
B	2 mil	2 mil FEP-A	1 mil Kapton	GE 6574 front and back, ~1 mil each	Not included in test program due to poor response to preliminary thermal cycling test.

*Electrostatically bonded

D180-26590-1
16

the cover and the cell started to curl then at about -100°C the cell would flatten again. A closer visual inspection of the cell at room temperature showed that the FEP-A had debonded from the cell and blistered up in places. After five thermal cycles all the covers on several test samples of this type were completely debonded. Apparently the GE 6574 adhesive was not able to hold the cell-cover combination together at low temperatures. With this result and the approval of the Contract Monitor the B Series samples were removed from the test plan.

The C Series samples have the same encapsulant materials as the B Series except DC 93-500 was used as the adhesive. These samples curled slightly but after five cycles there was no apparent blistering or debonding of the FEP-A.

The Double Number samples were cycled with no curling or other damage. The P Series samples did not curl or break during cycling. Small pieces of Kapton were placed under the beryllium-copper clips to protect the surface and give the sample greater flexibility by allowing lateral slipping under the clips.

Therefore, through these preliminary thermal cycling tests it was found that the beryllium-copper clips with Kapton pads work well for such tests. It was also found that all the test samples except the B Series encapsulated samples were suitable for carrying forward into the more complete evaluation testing program.

3.0 EXPERIMENTAL TEST FACILITIES

The general objective of the program was to determine the in-vacuum effects of space radiation (electrons, protons and ultraviolet) and thermal cycling on a variety of solar cells and cover combinations under environmental conditions which will be described in this section.

3.1 SIMULATION OF ELECTRON AND PROTON ENVIRONMENTS

The Boeing Dynamitron accelerator was used for both the 1.0 MeV electron and 0.5 MeV proton irradiations. The particle beams were energy analyzed by a 90-degree bending magnet and directed into a vacuum test chamber where they impinged on a high-purity aluminum foil. (See Figure 1.)

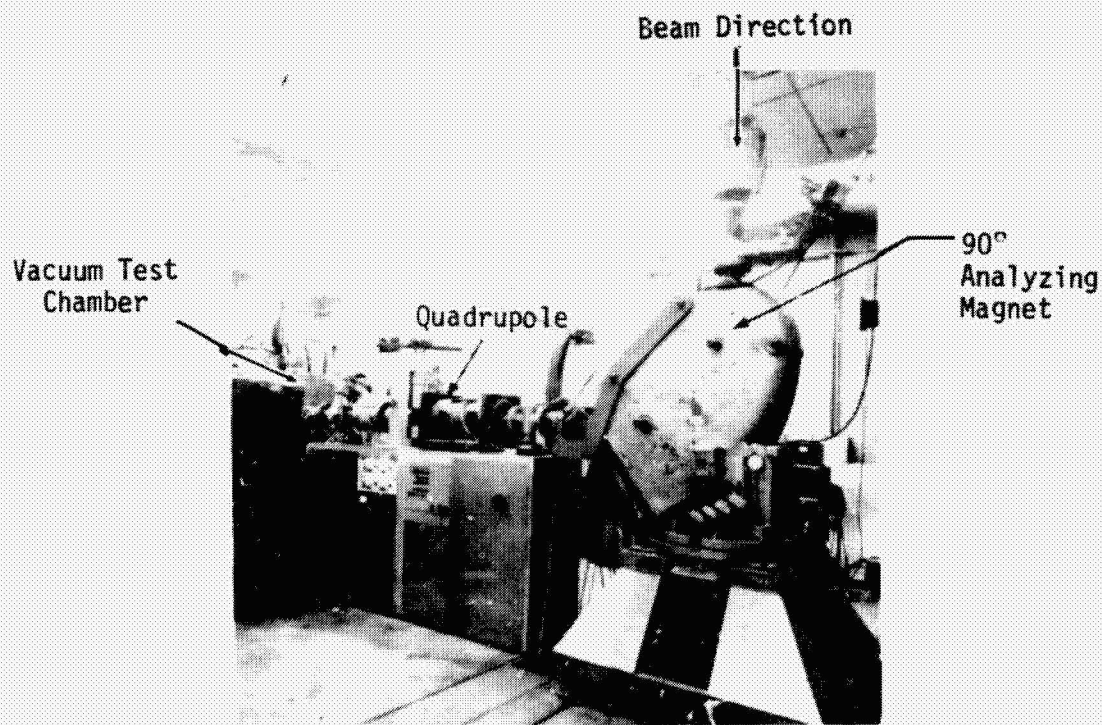

FIGURE 1. DYNAMITRON BEAM HANDLING SYSTEM

The thickness of the scattering foil was selected to give the desired profile for the scattered particle field at the sample plane. The incident particle beam was adjusted in energy so that, after losing energy in traversing the scattering foil, the particles emerged with the desired energy on the sample plane. The scattered particle field was mapped using a remotely controlled Faraday cup which was rotated in front of the sample and in a plane normal to the sample plate with the axis of rotation at the scattering foil. The relative incident flux profile on the sample plane was then determined from this angular beam distribution and the absolute intensities at the sample location were measured by a second Faraday cup fixed at the sample plane. Current collecting tabs were located around the periphery of the sample array and were monitored during the test to ensure that the beam had not shifted from its original axis.

The main features of the vacuum test chamber are shown in Figures 2 and 3. They show the placement of the foil holder, rotating Faraday cup, current collecting tabs and test samples. The vacuum test chamber was a diffusion pumped system with a liquid nitrogen cold trap.

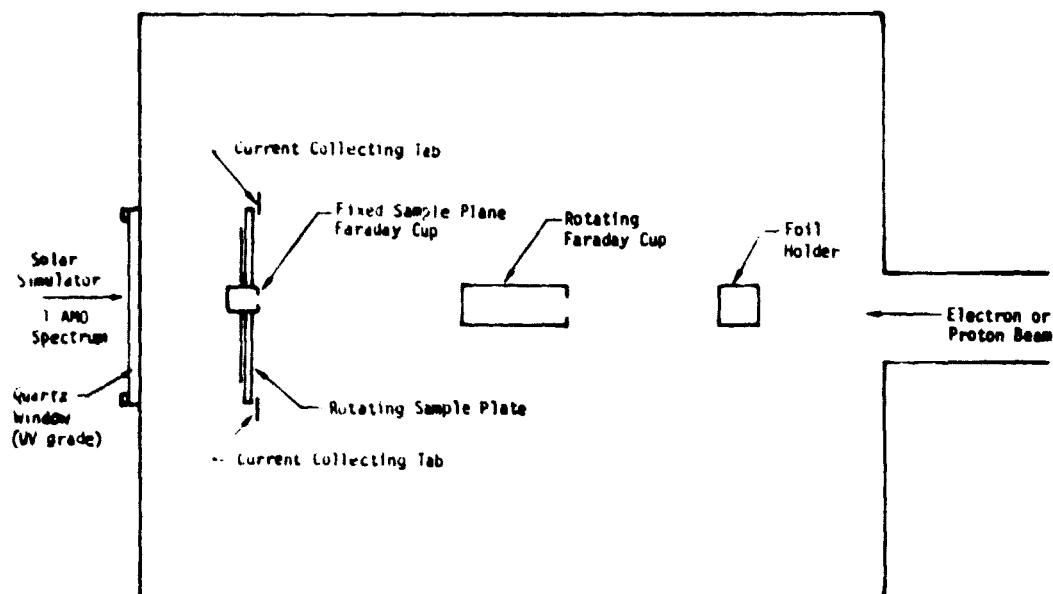

FIGURE 2. SIDE VIEW OF VACUUM TEST CHAMBER

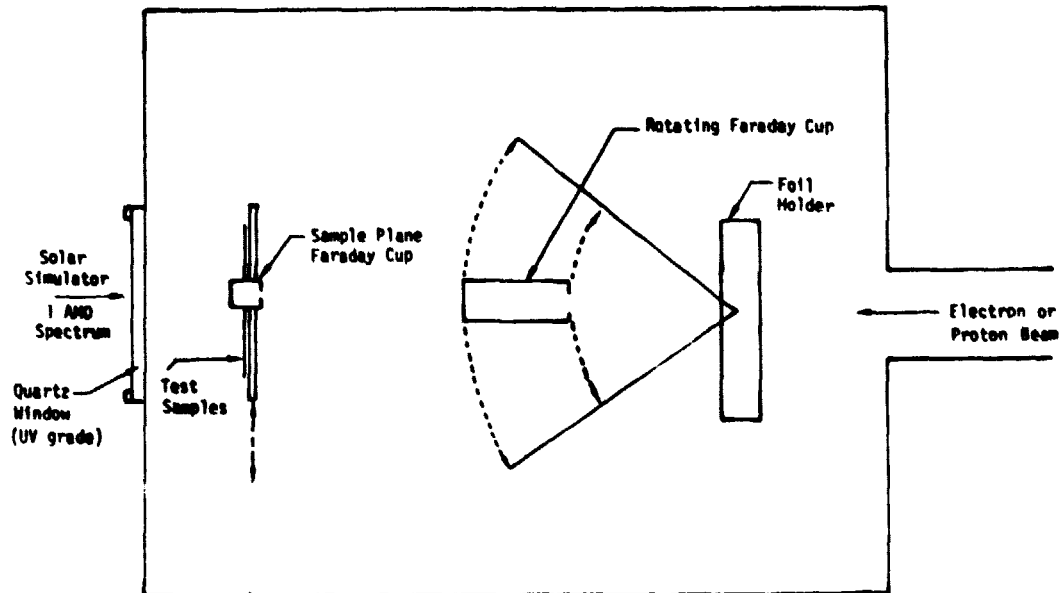

FIGURE 3. TOP VIEW OF VACUUM TEST CHAMBER

The electron irradiations were divided into four fluence levels of 5×10^{14} , 1×10^{15} , 5×10^{15} and 1×10^{16} e/cm². The 1 MeV electron flux ranged from 5×10^{10} e/cm²-sec to 2×10^{11} e/cm²-sec.

The proton irradiations were divided into two fluence levels of 3×10^{14} and 3.3×10^{15} p/cm². The 0.5 MeV proton flux was 1×10^{11} p/cm²-sec.

3.2 THERMAL CYCLING SYSTEM

The thermal cycling system was made up of two parts, 1) the sample plate holder and 2) the thermal cycling cover plate. The sample plate holder was a 9 x 9 inch copper plate. The plate had an internal heater and a 3/8-inch temperature control fluid line passing through it. The thermal cycling cover plate was also a 9 x 9 inch copper plate that was blackened using the nickel black process in order to improve radiative heat transfer between it and the samples during cycling. The cover plate also had internal heaters and fluid lines. The cover plate was used only during thermal cycling when it was brought in to cover the samples

in a "sandwich"-like fashion. This was necessary because the samples had such a variety of thermal conduction properties.

The uses of the cover plate provided a very realistic thermal cycling environment because the samples could see nothing but the correct thermal environment both front and back. Figure 4 shows the two plates in the thermal cycling position.

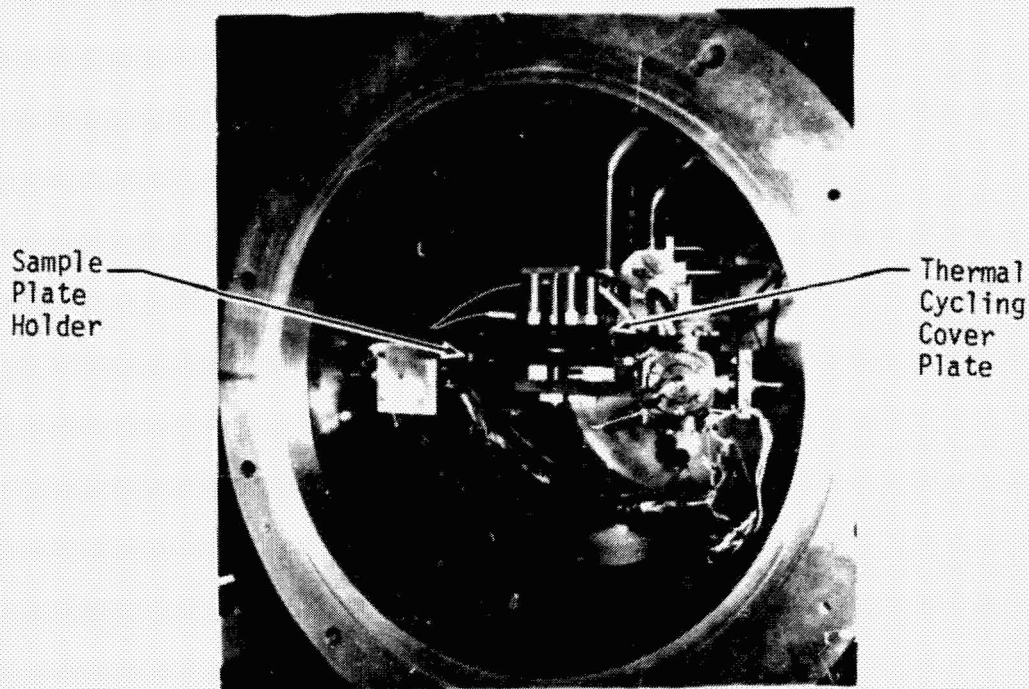

FIGURE 4. SAMPLE PLATE IN THERMAL CYCLING POSITION

The samples were cycled from $+55^{\circ}\text{C} \pm 5^{\circ}\text{C}$ to $-175^{\circ}\text{C} \pm 10^{\circ}\text{C}$. The heating was accomplished by warming the plates with a combination of the internal plate heaters and by passing hot nitrogen gas through the plates. The cooling was accomplished by passing liquid nitrogen through the plates. Figure 5 is a diagram of the thermal cycling systems. A five minute temperature soak was observed at both extremes of each cycle. The temperatures were monitored by one or two thermocouples mounted on each type of cell on the plate and by thermocouples mounted on the sample

plate, sample holder and cover plate. Figure 6 is a typical thermal cycle temperature profile.

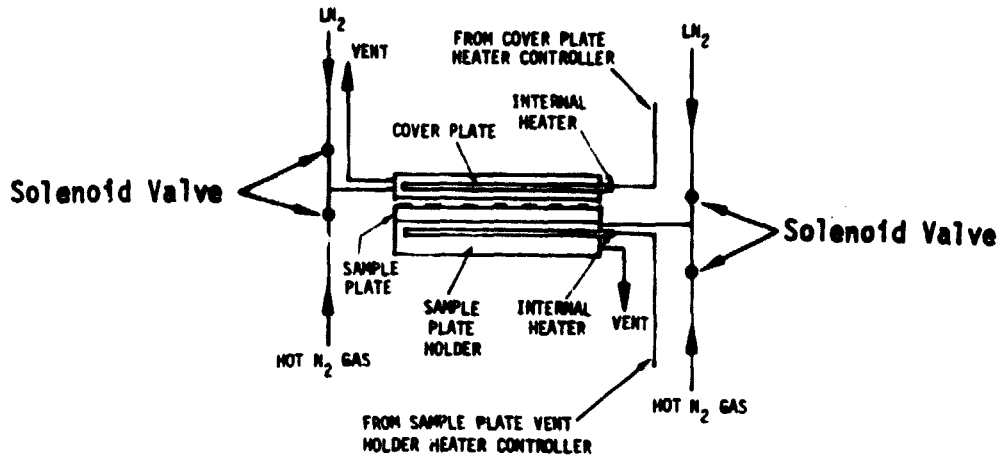

FIGURE 5. THERMAL CYCLING SYSTEM.

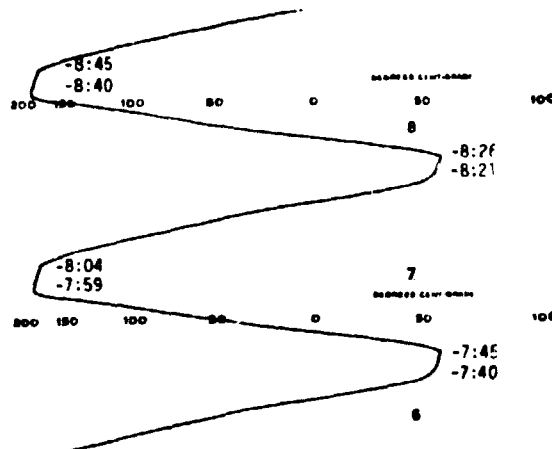

FIGURE 6. TYPICAL THERMAL CYCLE TEMPERATURE PROFILE.

ORIGINAL PAGE IS
OF POOR QUALITY

3.3 VACUUM TEST CHAMBERS

There are two vacuum test chambers used for the entire program, one for the electron and proton irradiation and one for the UV exposure.

3.3.1 Particle Beam Vacuum Test Chamber

The test chamber used for the particle beam irradiations has been partially explained in the particle beam environment section. Additional features of the chamber peculiar to this program will be explained in this section. Figure 2 shows the position of the quartz window used for the in situ I-V measurements and the in situ visual inspections. Figure 7 is a photograph showing the external layout of the vacuum test chamber and positioning of the solar simulator. Due to limited space it was necessary to deflect the solar simulator beam with a first surface aluminized mirror.

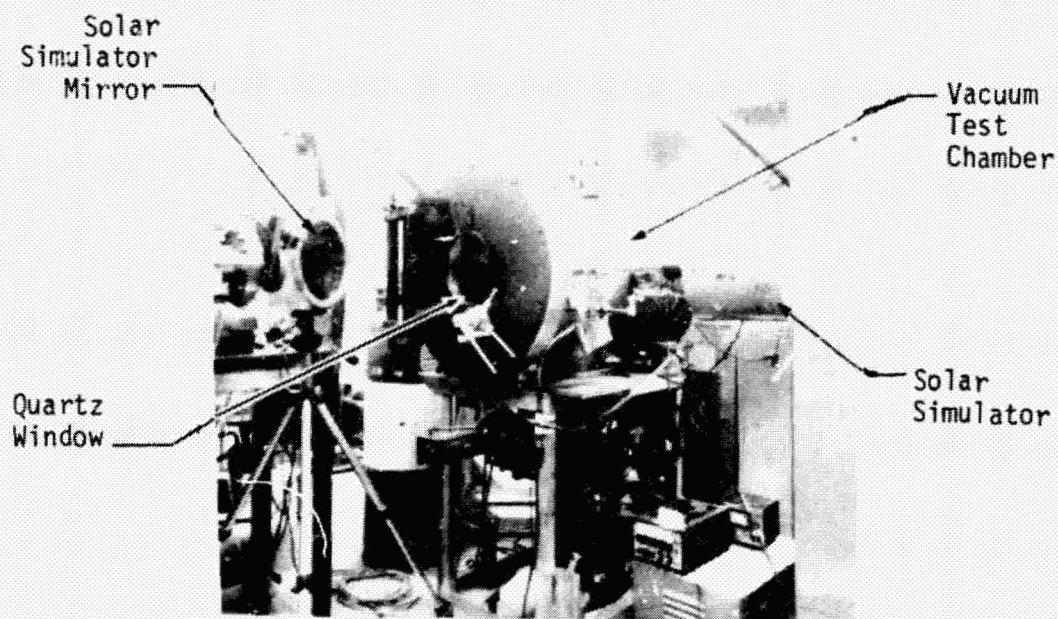

FIGURE 7. VACUUM TEST CHAMBER AND SOLAR SIMULATOR

Figure 8 shows the inside of the test chamber. The sample plate holder is shown in the irradiation position (the particle beam would be coming out of the page). This plate was mounted on a moveable rotating shaft with internal temperature control tubing. This allowed the plate to be translated horizontally and rotated 270° around its horizontal axis. In the center of the sample plate is the Faraday cup used to adjust beam intensity during dosimetry. For I-V measurements, the sample plate holder was rotated 180° from the position shown so that it faced the solar simulator. Also visible in Figure 8 is the monitor cell plate shown in the protected position. This plate was mounted on a moveable rotating shaft with internal temperature control tubing. This allowed the plate to be translated horizontally into the chamber and rotated to remove the protective cover (see Figure 9). The thermal cycling cover plate is shown out of the way as was the case during the particle irradiations. It is mounted on a shaft with internal fluid lines which translates vertically in and out of the chamber. The test chamber used a 6-inch diffusion pumped system with a liquid nitrogen cold trap. Typical vacuum pressures were in the 10^{-6} torr range.

3.3.2 UV Exposure Vacuum Test Chamber

The UV Exposure vacuum test chamber was set up as a separate facility. Figure 10 is a diagram of the side view of the test chamber. This chamber used the same sample plate holder and thermal cycling cover plate used in the particle beam test chamber. The UV chamber is equipped with a water window in order to reduce the heating of the samples due to the solar simulator beam used as the UV source. Figure 11 is a photograph of the test chamber. Figure 12 illustrates the positions of the sample plate and thermal cycling cover plates in both the exposure and thermal cycling positions as seen from the end of the chamber (UV beam into the page).

ORIGINAL PAGE IS
OF POOR QUALITY.

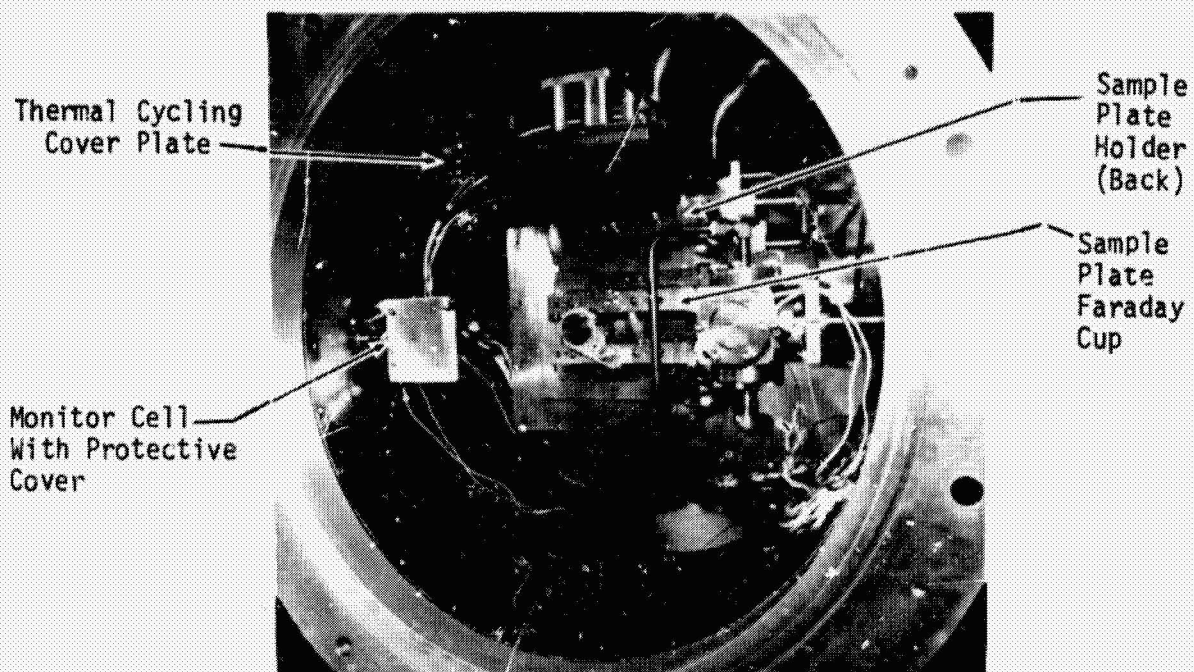

FIGURE 8. TEST CHAMBER IN SAMPLE IRRADIATION POSITION

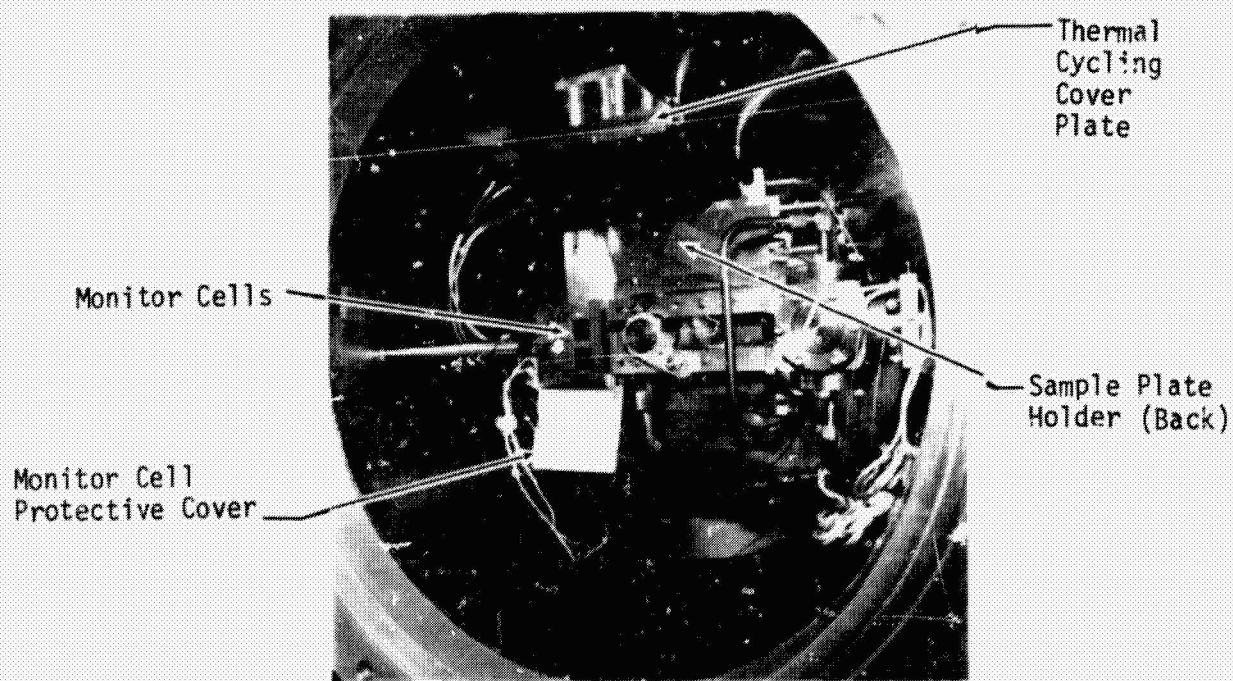

FIGURE 9. MONITOR CELL PLATE IN POSITION FOR MEASUREMENTS

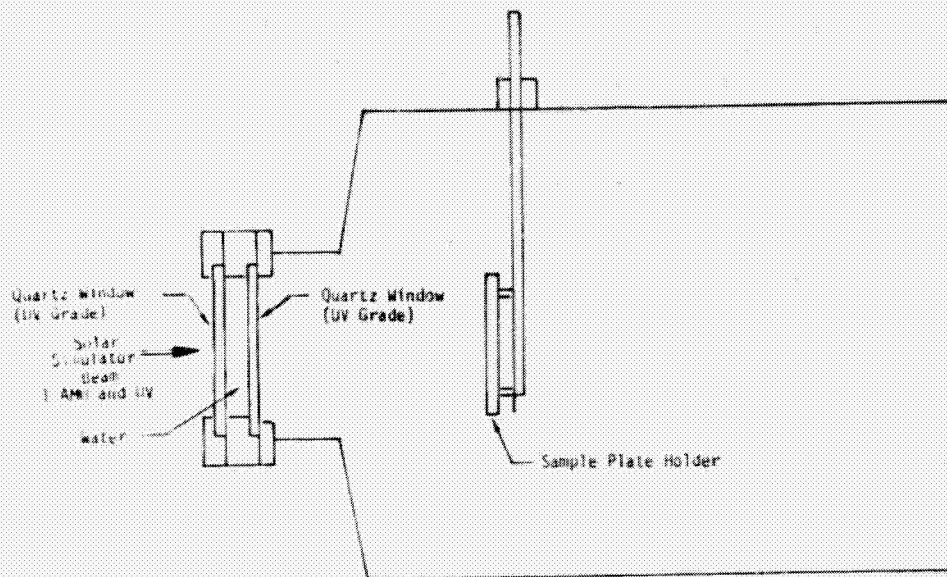

FIGURE 10. SIDE VIEW UV EXPOSURE VACUUM TEST CHAMBER

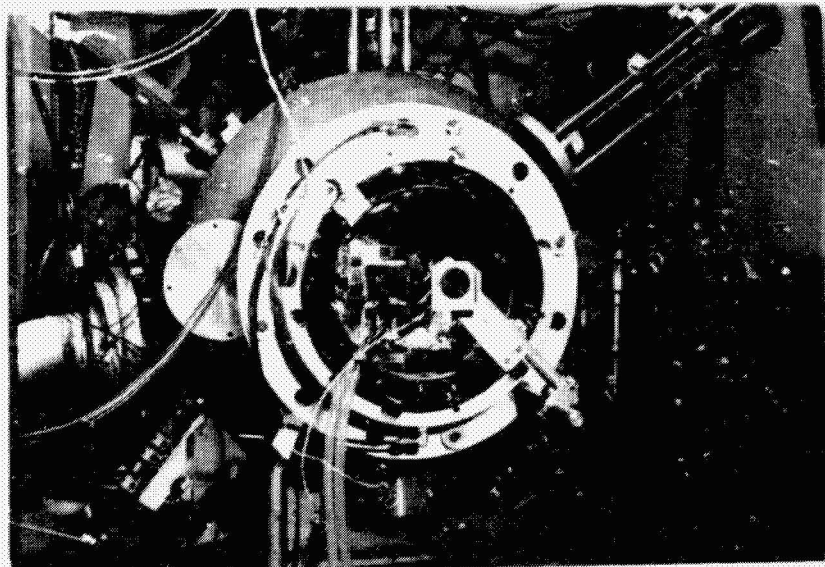

FIGURE 11. UV EXPOSURE VACUUM TEST CHAMBER

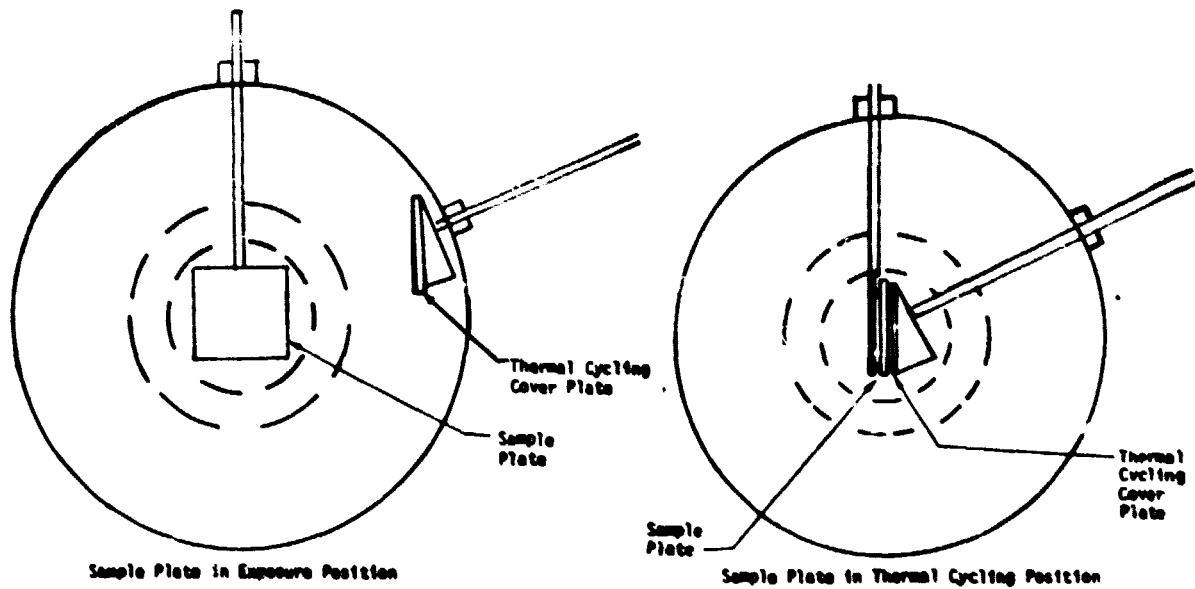

FIGURE 12. END VIEW OF UV EXPOSURE VACUUM CHAMBER

This chamber used a 1500 L/s turbomolecular pump for the vacuum. The same thermal cycling equipment and methods were used for the UV testing as in the particle beam tests. The sample temperature during irradiation was controlled by pulsing the flow of liquid nitrogen to the sample plate. The pulse length was controlled by a temperature recorder. The plate temperature was controlled to within $\pm 2^\circ\text{C}$ with this system.

3.4 SOLAR SIMULATORS

Two solar simulators were used to accomplish this program. Both simulators were Spectrolab X-25L simulator. One simulator was used only for I-V measurements. It was set up for AMO at a 72-inch focal distance. Figure 13 is a plot of the spectrum of the X-25L equipped with close match filters. Figure 14 is a plot of the intensity uniformity of the X-25L at 72 inches. Uniformity is typically ± 2 percent.

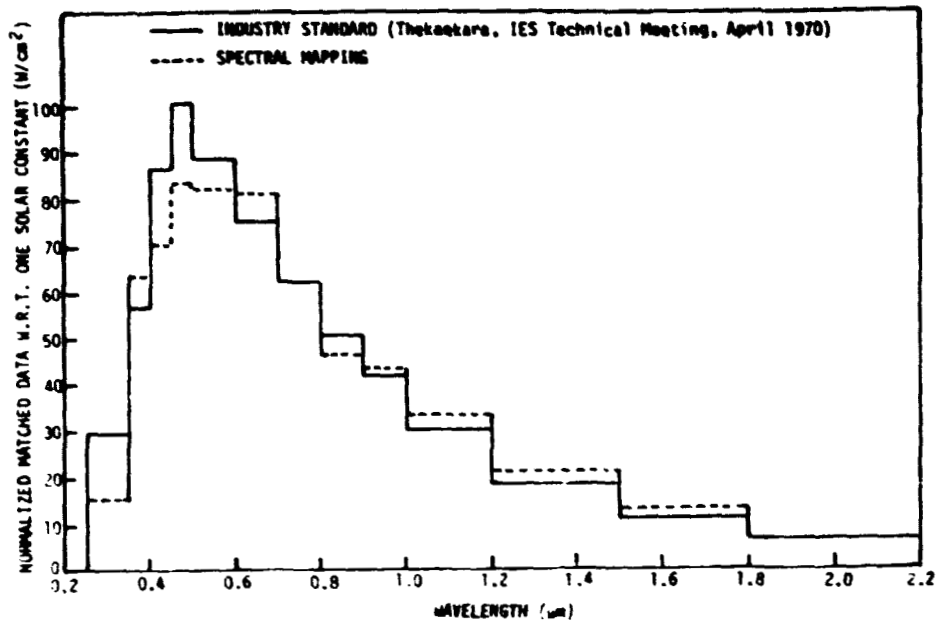

FIGURE 13. X-25L SOLAR SIMULATOR SPECTRUM

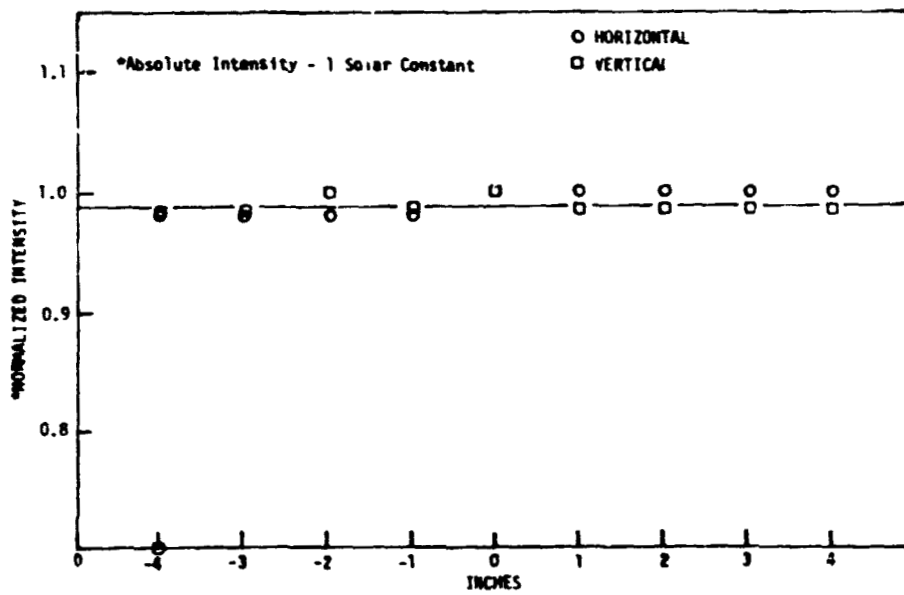

FIGURE 14. X-25L UNIFORMITY OF IN SITU LIGHT FIELD

The second X-25L solar simulator was used as the UV source for the UV exposure tests. This simulator was identical to the AMO simulator except there was no spectral filter. Figure 15 is the spectrum of the simulator used for the UV test showing the water window cut-off wavelength.

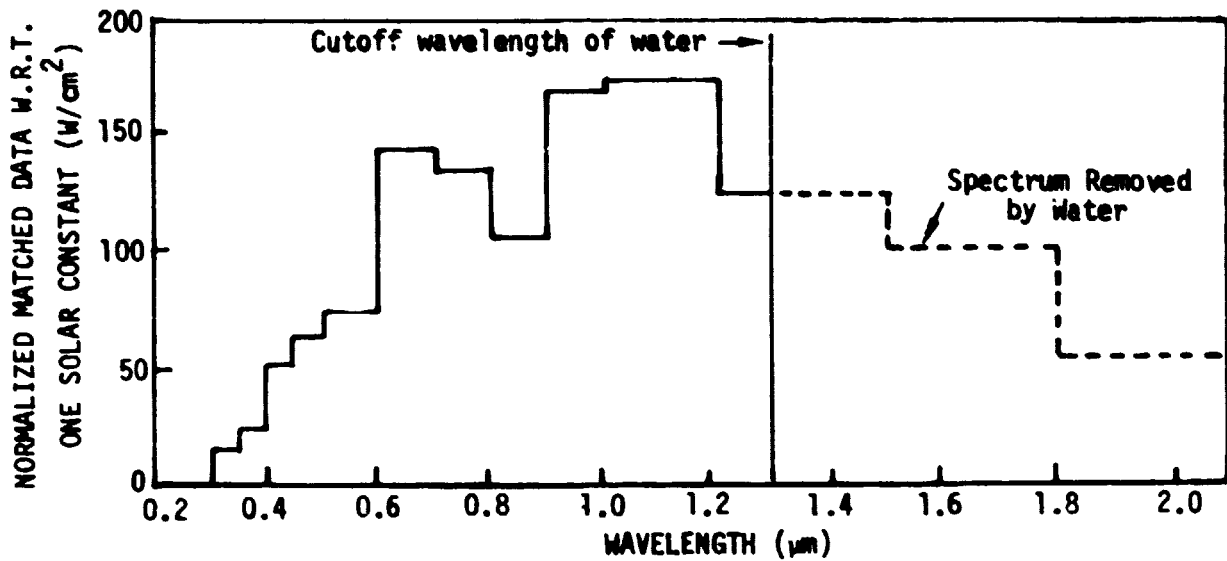

FIGURE 15. UV EXPOSURE X-25L SOLAR SIMULATOR SPECTRUM

4.0 TEST INSTRUMENTATION

This section will cover the particle beam dosimetry, the UV dosimetry, the I-V measurements and data reduction programs and the temperature measurements.

4.1 ELECTRON AND PROTON DOSIMETRY

The particle beam was scattered by an aluminum foil scattering system. The particle beam dosimetry was done with the sample rotated 180° from the direction of the beam. The required current from the accelerator was set using the reading in the sample plane Faraday cup (see Figure 3). The current reading in the sample plane Faraday cup (I) was calculated from a predetermined flux (F) at the sample plane using the following equation:

$$I = FeA$$

where e = The charge of a proton or electron in coulombs

A = The area of the sample plane Faraday cup opening

A beam profile map was made before each irradiation using the rotating Faraday cup once an accelerator current was set. A profile point was taken every 0.9° so that a total of 25 points make up a plot of beam uniformity over the sample area. Figures 16 and 17 are plots of relative fluence uniformity across the samples as they were positioned in the chamber.

Having achieved a given flux at the sample plane, a current integrator was used which automatically stopped the beam when the required fluence was reached.

4.1.1 Tolerances

The tolerance of the Faraday cups was $\pm 15\%$ and the tolerance of the Keithley 610 electrometer was $\pm 3\%$, therefore, the probable error in the flux was $[(0.15)^2 + (0.03)^2]^{1/2}$ or $\pm 15.3\%$. The tolerance of the

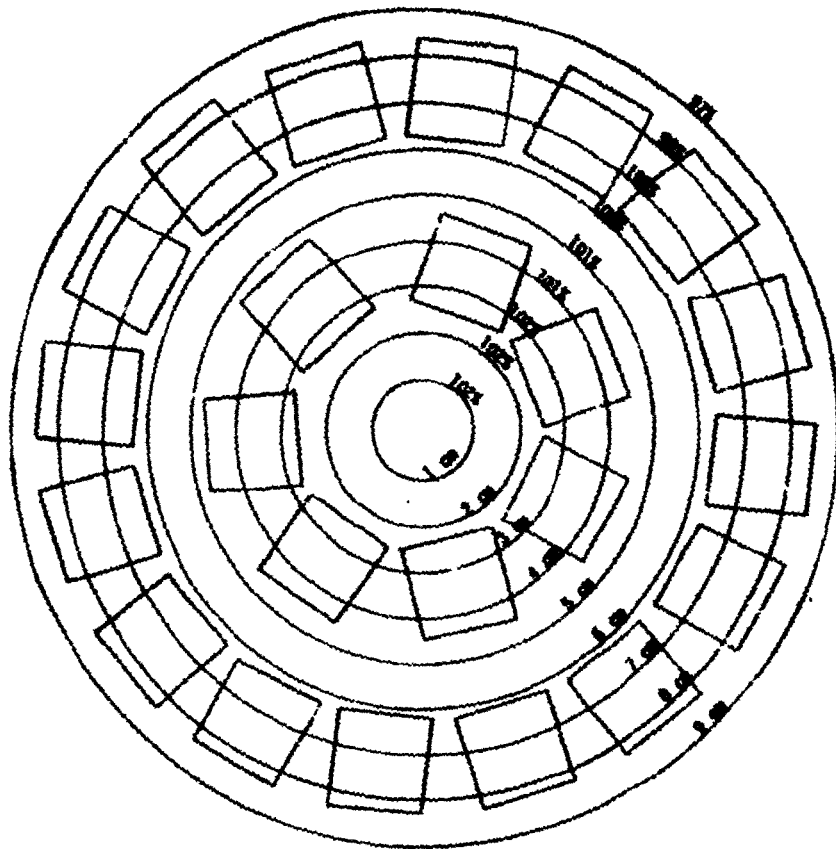

Figure 16 .
Electron Beam Profile

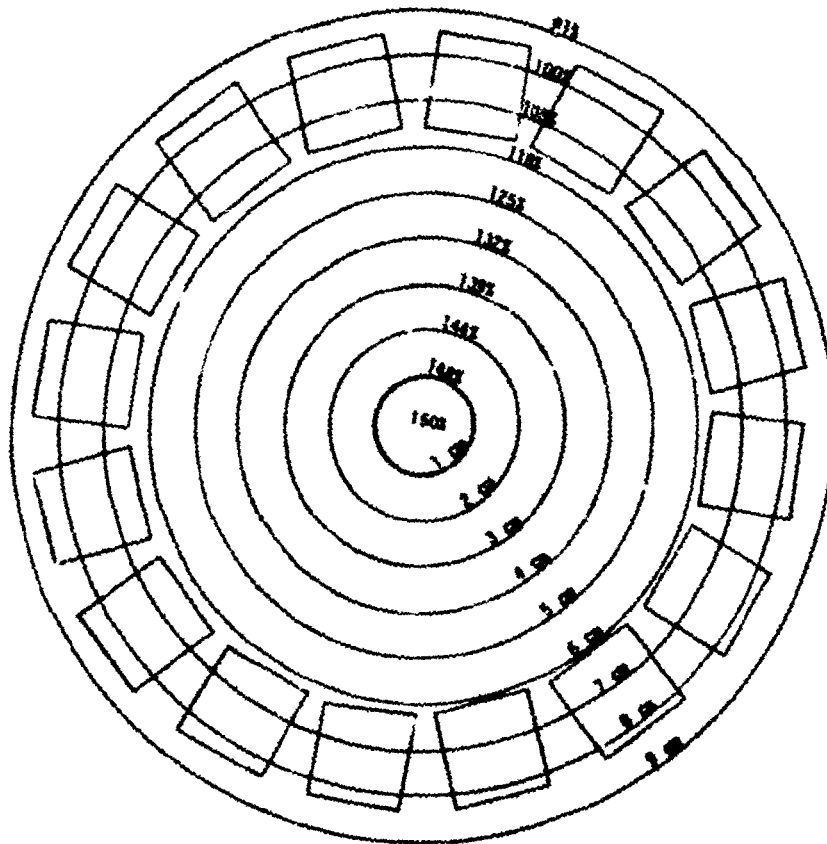

Figure 17 .
Proton Beam Profile

current integrator was $\pm 2\%$. Therefore the probable error in the fluence was $[(0.15)^2 + (0.03)^2 + (0.02)^2]^{1/2}$ or $\pm 15.4\%$.

4.2 UV DOSIMETRY

For purposes of this program one AMO UV-energy-equivalent solar constant was defined to be a UV intensity with total energy below $0.4 \mu\text{m}$ in AMO sunlight. The UV intensity was measured with a Hy-Therm Pyrheliometer manufactured by Hy-Cal Engineering. It was a water-cooled radiation flux sensor with a spectral response from 0.2 to 4.5 microns. A Corning filter No. 051 with a transmission cut-off of $0.4 \mu\text{m}$ was used to determine the UV content of the beam. Figure 18 is the transmission curve of the Corning 051 filter.

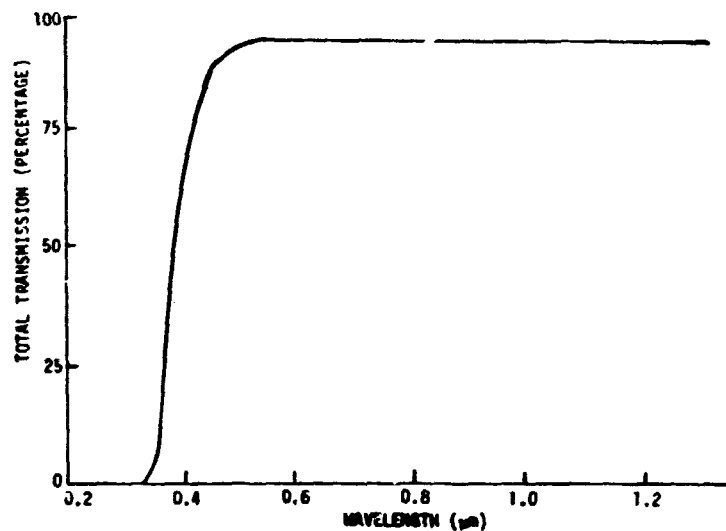

FIGURE 18. TRANSMISSION CURVE FOR CORNING 051 FILTER

The UV content was determined from pyrheliometer readings with and without the UV-absorbing filter over the detector. The following formula describes the calculation:

$$\text{UV sun rate} = \frac{T - 1.18 F}{(4.76) (0.091)} = 2.31 (T - 1.18 F)$$

where T = total radiation reading without UV-absorbing filter
F = Reading with UV-absorbing filter
1.18 is a factor related to reflection losses of each surface
of the filter and transmission losses of the filter.
4.76 is the pyrhelimeter sensitivity in millivolts per
incident sun (135.3 mw/cm^2)
0.091 is the decimal ultraviolet content of the 1 AMO spectrum.

The UV content was set by mounting the pyrhelimeter on the sample plane and passing the X-25L beam through the water window. Five sets of filtered and unfiltered readings were then taken and the UV content calculated from the averaged readings. The pyrhelimeter was then moved to a special mount which provided repeatable positioning outside the chamber. Another five sets of filtered and unfiltered readings were taken. From the UV content measured outside a calibration factor was computed which then allowed the UV content to be measured and adjusted from outside the vacuum chamber. The uncertainty in the pyrhelimeter was $\pm 3\%$ of a solar constant.

4.3 I-V MEASUREMENTS

4.3.1 AMO Calibration - In Situ

The 1 AMO calibration was made using the secondary standard provided by NASA-Lewis. The standard was mounted at the sample plane and the X-25L solar simulator beam passed through the quartz window onto the standard. Without adjusting the simulator the two monitor cells and a cell mounted outside the chamber were cross calibrated to the standard. This allowed the standard to be removed during the test. This procedure was followed each time a sample plate was mounted in either chamber. Each time a I-V measurement set was made the monitor cells mounted inside the chamber were used to set the solar simulator intensity. The monitor cells were mounted on a rotating translating shaft such that the cells could be protected from the radiation environment.

4.3.2 AMO Calibration - Ex Situ

The ex situ calibration was made using the NASA-Lewis secondary standard mounted on an array with eight other solar cells used to monitor the intensity and spectrum of the X-25L simulator. The array was made up of two each of four types of cells with different spectral responses ranging from conventional N/P 2 Ω cm to blue-shifted cells and BSF cells having enhanced red response. Thus, by imposing the requirement that all of these cells reproduce their calibration value for short circuit current, any significant shift in spectral output of the X-25L could be detected.

4.4 DATA ACQUISITION SYSTEM

A block diagram of the data acquisition system is shown in Figure 19. A four terminal measurement system was used. The cells were mounted on the sample plates with two leads connected to the top contact bar and a common back contact. The top contact leads were kept separate until they reached a stepping switch array located just outside the vacuum chamber. In the switch array each cell could be selected one at a time to be connected to the electronic load bank. Therefore a cell at the time of measurement had two top contacts (I,V) and two bottom contacts (I,V) connected to the load bank thus removing any circuit resistance problems.

A mini-computer was used to drive the electronic load bank from short-circuit current to open-circuit voltage. The computer also collected the I-V data which was stored on magnetic tape and printed out on the line printer. The computer took twenty I-V pairs to make up a curve. More data points were taken around the knee of the curve where the detail is more important than at either side of the knee. The accuracy of the acquisition system was ± 2 mV for voltage and ± 0.1 mA for current.

The ex situ measurements for the electron and proton cells differ only in that they were made using the calibration array and not mounted in the chamber. On the temperature controlled calibration array the back contact was made through pressure exerted by the vacuum hold-down system. Contact was made to the top surface contact bar by two silver-

plated spring contacts. Special leads were attached to cell types that had no back contact due to encapsulation.

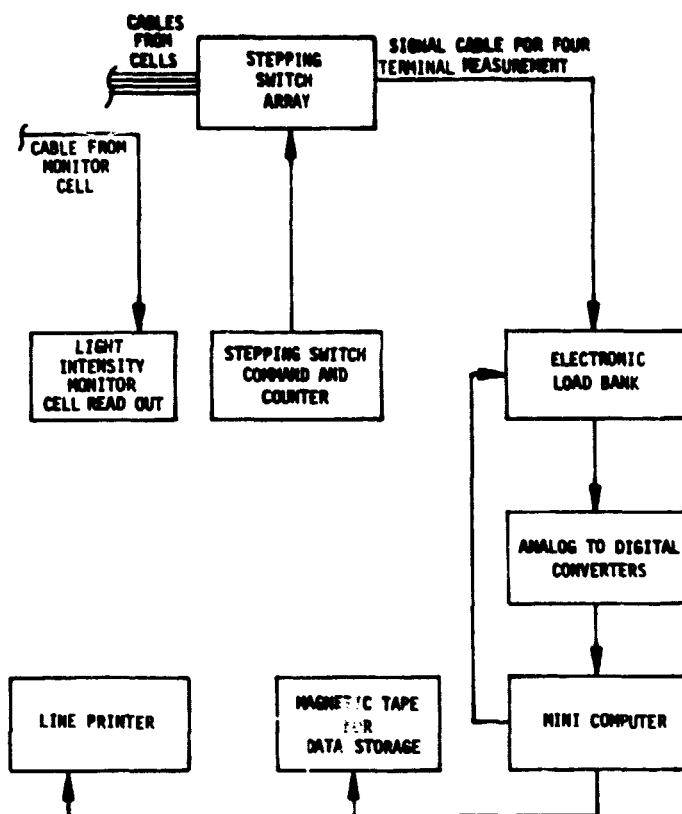

FIGURE 19. BLOCK DIAGRAM OF DATA ACQUISITION SYSTEM

4.5 DATA REDUCTION SYSTEM

The outputs of the data reduction system are computer-fitted I-V curves, summary plots of cell parameters and data tables of absolute and normalized cell parameters. Figure 20 is a block diagram of the data reduction system.

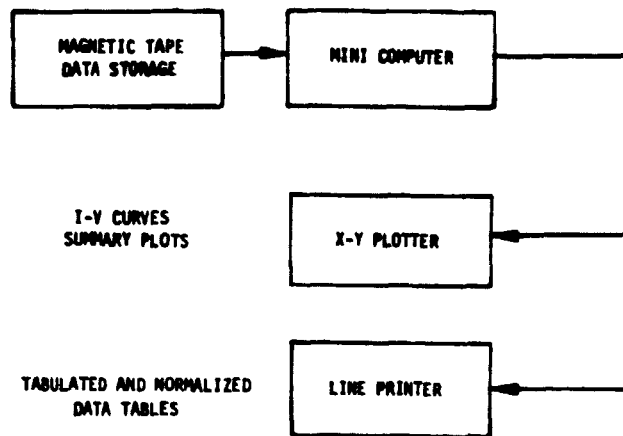

FIGURE 20. BLOCK DIAGRAM OF DATA REDUCTION SYSTEM

A curve fitting routine was used which first makes a least-squares fit to several data points near the short circuit current from which it finds accurate values for the short-circuit current and the shunt resistance. The effects of shunt resistance are then subtracted out from each data point and an exponential fit is made to find the three other unknown parameters, including the series resistance. The maximum power is found by applying Newton's method using the solar cell equation including all five parameters.

$$I = I_{sc} - I_0 \exp \left[\frac{qV}{nkT} (V + IR_s) \right] - \frac{V}{R_{SH}}$$

where

- I = cell's output current
- I_{sc} = cell's short-circuit current
- I_0 = diode saturation current
- R_s = cell's series resistance
- R_{SH} = shunt resistance
- n = cell junction quality factor
- q = electronic charge
- V = cell's terminal voltage
- k = Boltzmann's constant
- T = absolute temperature

4.6 TEMPERATURE CONTROL

A Neslab RTE-8 refrigerated circulating bath was used for temperature control of the sample plate during the electron and proton irradiations.

There were one or two thermocouples on each sample type in each test. However, it was necessary to use the sample plate thermocouples as the standard to set the I-V measurement temperature of $25^{\circ}\text{C} \pm 1^{\circ}\text{C}$ because of the varying amount of thermal contact each sample type had with the sample plate. The flexing and curling due to thermal cycling of some types of samples caused the differences. It was impossible to change the sample plate temperature for each sample so it was decided to standardize on the sample plate temperature which was repeatable.

5.0 TEST PLAN AND PROCEDURE

The program was divided into three testing tasks. The titles of the tasks were:

- Task I - Effects of electron irradiation interspersed by thermal cycling
- Task II - Effects of low energy proton irradiation interspersed by thermal cycling
- Task III - Effects of ultraviolet irradiation followed by thermal cycling.

There were eight types of samples included in all three tasks. There were also two modules of nine cells (3 x 3) included in the UV exposures. There were five samples of each type for each task. There were also ten control cells and ten monitor cells that were used at different times throughout the test. Each sample from NASA-Lewis was labeled; however, it was necessary to assign a three or four digit number to each test sample due to computer program restraints. Table 2 is a listing of samples in the tests with their NASA-Lewis number, their Boeing numbers and the type of environment in which each sample was tested.

Photographs were taken of one representative sample of each group before the beginning of each test and each sample was photographed after the completion of testing. These photographs were taken in the vacuum chamber under vacuum. In addition, each sample was photographed outside the chamber under improved photographic conditions.

There was one control cell in each electron and proton test. A 6-mil removeable quartz cover was placed over each control cell. In the UV exposure test there were two control cells in each test. These cells were bare and without any AR coating. There were also two bare monitor cells in each test for the AMO intensity adjustment. These cells were mounted on a moveable, rotating shaft with a thick aluminum cover shield attached so that the cells would be protected during the irradiations.

TABLE 2. CELL DESIGNATIONS AND ENVIRONMENTS

<u>CELL TYPE</u>	<u>NASA CELL NUMBER</u>	<u>BOEING CELL NUMBER</u>	<u>TYPE OF ENVIRONMENT</u>
Control Cells	UK-1	101	UV
	UK-2	102	UV
	UK-4	103	UV
	UK-3	104	UV
	K-51	105	Electrons
	K-52	106	Electrons
	K-53	107	---
	K-54	108	Protons
	K-55	109	Protons
	K-56	110	Protons
Monitor Cells	M-57	201	Electrons & Protons
	M-58	202	Electrons & Protons
	M-59	203	UV
	M-61	204	UV
	M-62	205	Not Used
	M-63	206	Not Used
	M-64	207	Not Used
	M-65	208	Not Used
	M-66	209	Not Used
M-67	210	Not Used	
A Series	A19	301	Electrons
	A27	302	Electrons
	A34	303	Electrons
	A60	304	Electrons
	A61	305	Electrons
	A62	306	Protons
	A63	307	Protons
	A64	308	Protons
	A65	309	Protons
	A68	310	Protons
	A69	311	UV
	A70	312	UV
	A71	313	UV
	A73	314	UV
	A75	315	UV
C Series	C1	401	Electrons
	C2	402	Electrons
	C3	403	Electrons
	C4	404	Electrons
	C5	405	Electrons
	C6	406	Protons
	C7	407	Protons
	C8	408	Protons
	C9	409	Protons
	C10	410	Protons
	C11	411	UV
	C12	412	UV
	C13	413	UV
	C14	414	UV
	C15	415	UV

TABLE 2. CELL DESIGNATIONS AND ENVIRONMENTS (Continued)

<u>CELL TYPE</u>	<u>NASA CELL NUMBER</u>	<u>BOEING CELL NUMBER</u>	<u>TYPE OF ENVIRONMENT</u>
D Series	D18	501	Electrons
	D20	502	Electrons
	D22	503	Electrons
	D23	504	Electrons
	D25	505	Electrons
	D26	506	Protons
	D28	507	Protons
	D30	508	Protons
	D50	509	Protons
	D51	510	Protons
	D52	511	UV
	D53	512	UV
	D54	513	UV
	D55	514	UV
	D56	515	UV
E Series	E4	601	Electrons
	E14	602	Electrons
	E27	603	Electrons
	E28	604	Electrons
	E29	605	Electrons
	E31	606	Protons
	E32	607	Protons
	E33	608	Protons
	E34	609	Protons
	E36	610	Protons
	E37	611	UV
	E39	612	UV
	E42	613	UV
	E45	614	UV
	E46	615	UV
P Series	P1	701	Electrons
	P2	702	Electrons
	P3	703	Electrons
	P4	704	Electrons
	P5	705	Electrons
	P7	707	Protons
	P11	708	Protons
	P13	709	Protons
	P14	710	Protons
	P15	711	Protons
	P6	706	UV
	P22	712	UV
	P23	713	UV
	P24	714	UV
	P28	715	UV

TABLE 2. CELL DESIGNATIONS AND ENVIRONMENTS (Continued)

<u>CELL TYPE</u>	<u>NASA CELL NUMBER</u>	<u>BOEING CELL NUMBER</u>	<u>TYPE OF ENVIRONMENT</u>	
GE	3	801	Electrons	
	4	802	Electrons	
	6	803	Electrons	
	10	804	Electrons	
	13	806	Electrons	
	12	805	Protons	
	20	808	Protons	
	23	809	Protons	
	24	810	Protons	
	19	807	Protons	
	25	811	UV	
	26	812	UV	
	29	813	UV	
	30	814	UV	
	31	815	UV	
	DN Series (Double Numbers)	14-16	901	Electrons
15-3		902	Electrons	
15-4		903	Electrons	
15-6		904	Electrons	
15-9		905	Electrons	
15-12		906	Protons	
15-16		907	Protons	
15-19		908	Protons	
15-20		909	Protons	
16-1		910	Protons	
16-2		911	UV	
16-4		912	UV	
16-5		913	UV	
16-7		914	UV	
16-11	915	UV		
ESB	C-4	1001	Electrons	
	C-5	1002	Electrons	
	C-10	1003	Electrons	
	C-11	1004	Electrons	
	C-13	1005	Electrons	
	C-65	1006	Protons	
	C-70	1007	Protons	
	C-71	1008	Protons	
	C-72	1009	Protons	
	C-73	1010	Protons	
	2-1	1011	UV	
	2-5	1012	UV	
	2-31	1013	UV	
	3-104	1014	UV	
	3-130	1015	UV	
	NASA-Lewis Module		1101	UV
	JPL Module		1102	UV

A visual inspection was made of all the samples following each increment of irradiation or a set of 15 thermal cycles. All visual inspections were made through the quartz window except the post-test ex situ inspections.

I-V measurements were made both ex situ and in situ. The ex situ measurements were made before the start of irradiation and after the completion of all irradiation and thermal cycling. All ex situ measurements were made in the ex situ measurement facility except the UV exposure measurements. They were made in the test chamber just before and just after the total exposure and in situ measurements. The chamber was filled with nitrogen for this test. This procedure was used to allow for post-test I-V measurements without the fear that the damage would anneal out. The in situ measurements differ from the ex situ measurements only in that the solar simulator is beamed through a GE124 optical-grade fused silica window and the intensity is monitored by two monitor cells located in the vacuum test chamber but protected from the irradiation. The same Spectrolab X-25L solar simulator with an AMO close-match filter was used for both the ex situ and in situ measurements. The I-V measurements were made at a nominal 25°C.

Beryllium-copper clips were used to mount the samples to the sample plate. They were used because of their ability to flex with the cell. Heat sink compound was used under each sample to improve the thermal contact between sample and the temperature controlled sample plate.

5.1 EFFECTS OF ELECTRON IRRADIATION INTERSPERSED BY THERMAL CYCLING

The 1 MeV electron irradiations with thermal cycling were the first tests performed. Table 3 lists the electron fluences the samples received, the number of thermal cycles the samples received and the level number of each measurement. It was necessary to assign each measurement a level number in order to computerize the data, therefore use Table 3 to translate the level numbers to test conditions for the electron tests. Also included in Table 3 is the flux used to achieve each incremental fluence.

TABLE 3. ELECTRON IRRADIATION TEST PARAMETERS

LEVEL NUMBER	TOTAL NUMBER THERMAL CYCLES	TOTAL FLUENCE (e/cm ²)	INCREMENTAL FLUENCE (e/cm ²)	FLUX (e/cm ² -sec)
0	0	0	0	0
1	0	5 x 10 ¹⁴	5 x 10 ¹⁴	5 x 10 ¹⁰
2	0	1 x 10 ¹⁵	5 x 10 ¹⁴	5 x 10 ¹⁴
3	15	1 x 10 ¹⁵	---	---
4	15	5 x 10 ¹⁵	4 x 10 ¹⁵	2 x 10 ¹¹
5	30	5 x 10 ¹⁵	---	---
6	30	1 x 10 ¹⁶	5 x 10 ¹⁵	2 x 10 ¹¹
7	45	1 x 10 ¹⁶	---	---

The samples were divided into two groups for the electron test. The first group included the A Series, C Series, D Series and Double Number samples (see Figures 21 and 22). Also included in the first tests were five samples of 2-mil thick 7070 glass. The second group included the P Series, E Series, GE cells and ESB cells. (See Figures 23 and 24.)

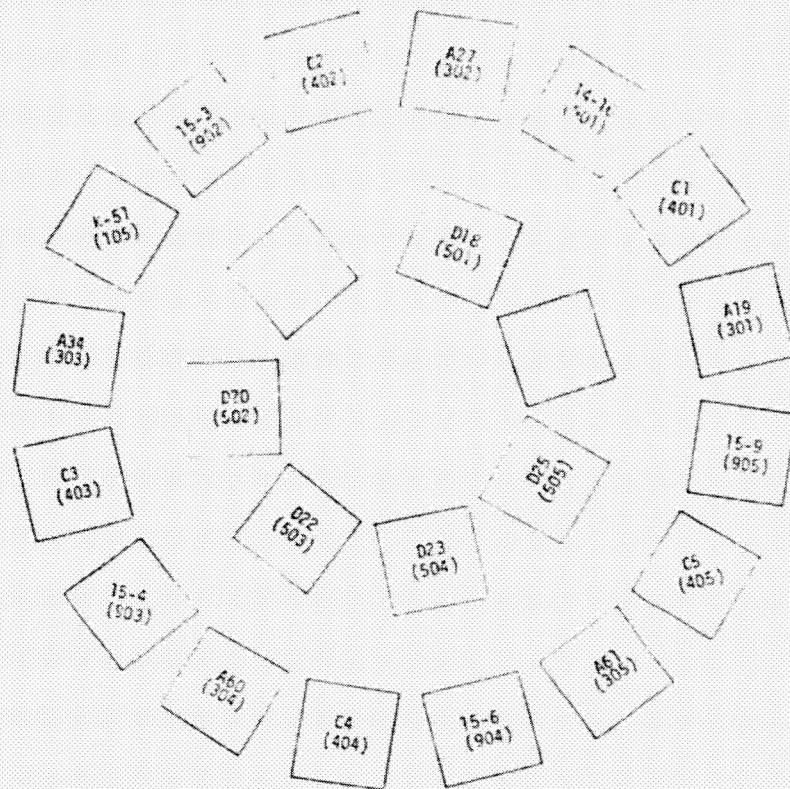

FIGURE 21. SAMPLE PLATE LAYOUT - 1ST SET ELECTRON IRRADIATIONS

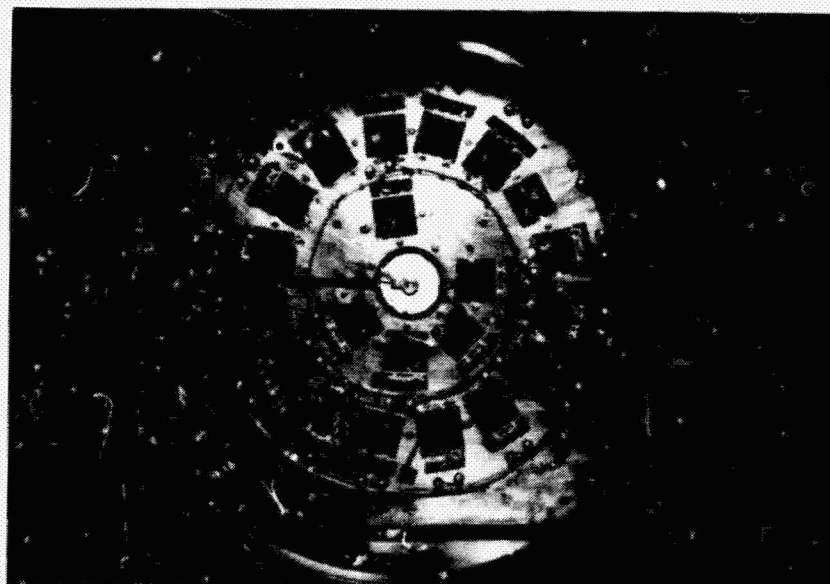

FIGURE 22. PRE-IRRADIATION ELECTRON SET #1

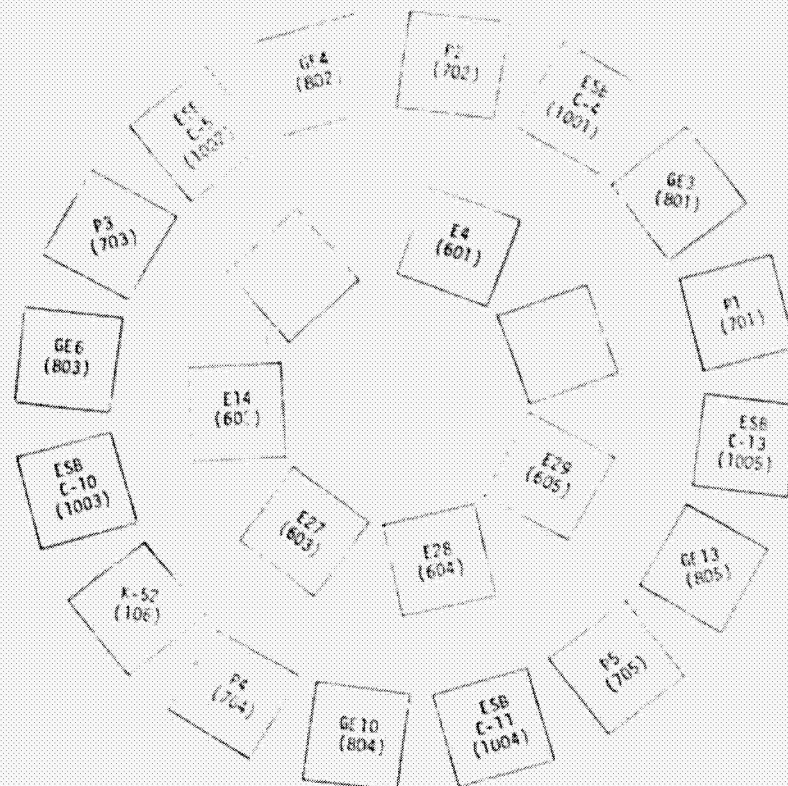

FIGURE 23. SAMPLE PLATE LAYOUT - 2nd SET ELECTRON IRRADIATIONS

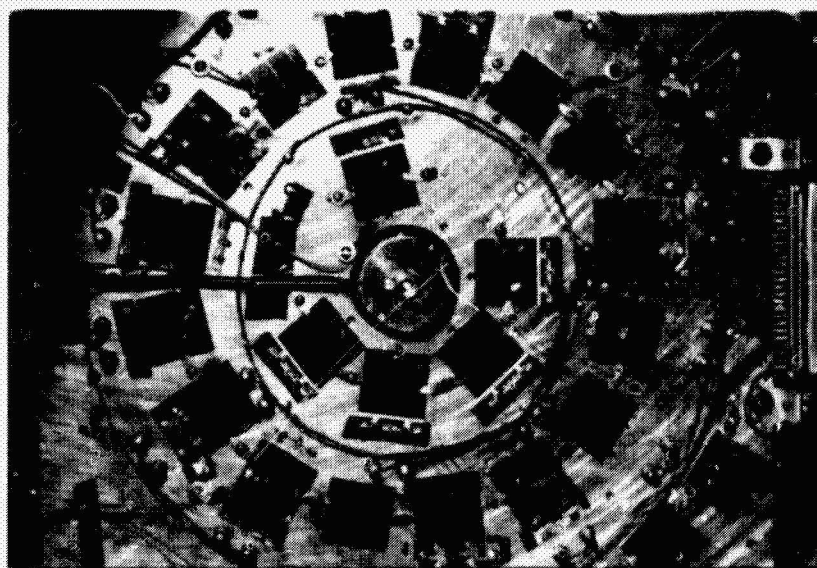
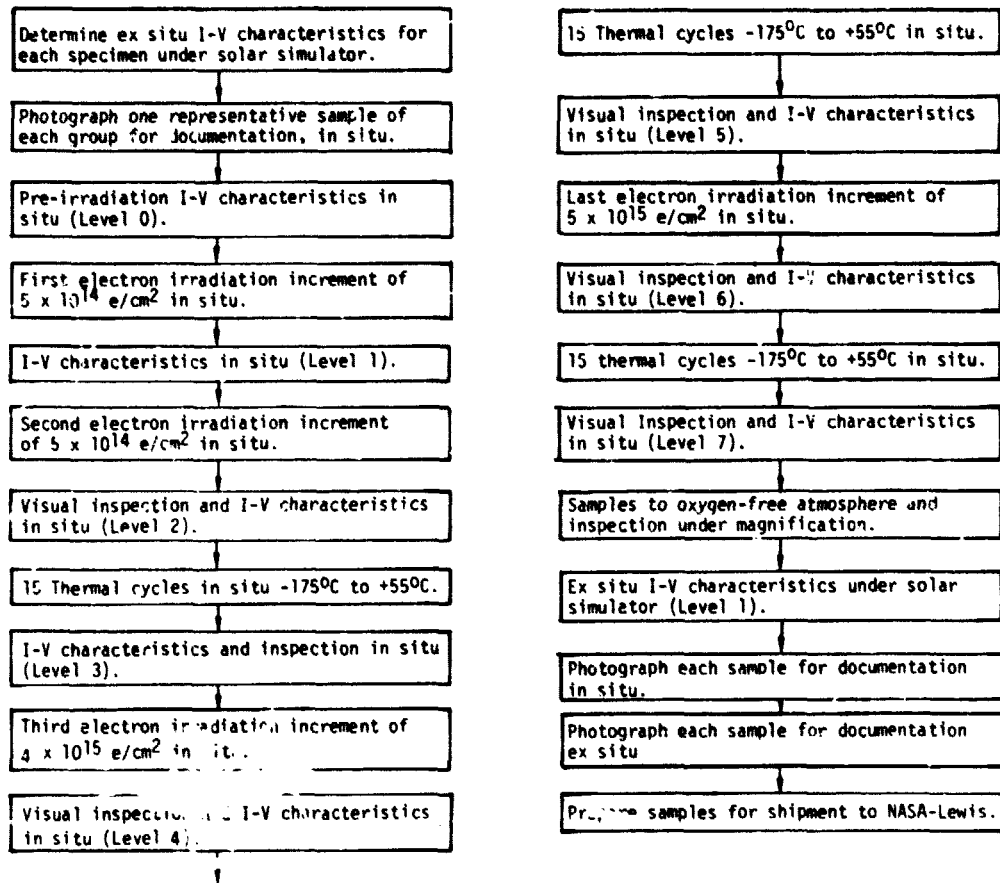

FIGURE 24. PRE-IRRADIATION ELECTRONS SET #2

Table 4 is a flow diagram of the electron test with the measurement level numbers included.

TABLE 4. PROGRAM FLOW DIAGRAM OF ELECTRON IRRADIATION INTERSPERSED WITH THERMAL CYCLING - TASK I



5.2 EFFECTS OF LOW ENERGY PROTON IRRADIATION INTERSPERSED BY THERMAL CYCLING

The 0.5 MeV proton irradiations with thermal cycling were performed after all electron tests were completed. Table 5 lists the proton fluences the samples received, the number of thermal cycles the sample received and the level number of each measurement. Also included is the flux used to achieve each incremental fluence.

TABLE 5. PROTON IRRADIATION TEST PARAMETERS

LEVEL NUMBER	TOTAL NUMBER THERMAL CYCLES	TOTAL FLUENCE (p/cm ²)	INCREMENTAL FLUENCE (p/cm ²)	FLUX (p/cm ² -sec)
0	0	0	0	0
1	0	3 x 10 ¹⁴	3 x 10 ¹⁴	1 x 10 ¹¹
2	15	3 x 10 ¹⁴	---	---
3	15	3.3 x 10 ¹⁵	3 x 10 ¹⁵	1 x 10 ¹¹
4	30	3.3 x 10 ¹⁵	---	---

The samples were divided into three groups for the proton test. The first group included A Series, C Series, and GE cells (see Figures 25 and 26). The second group included D Series, DN Series and 7070 glass (see Figures 27 and 28). The third group included E Series, P Series and ESB cells (see Figures 29 and 30).

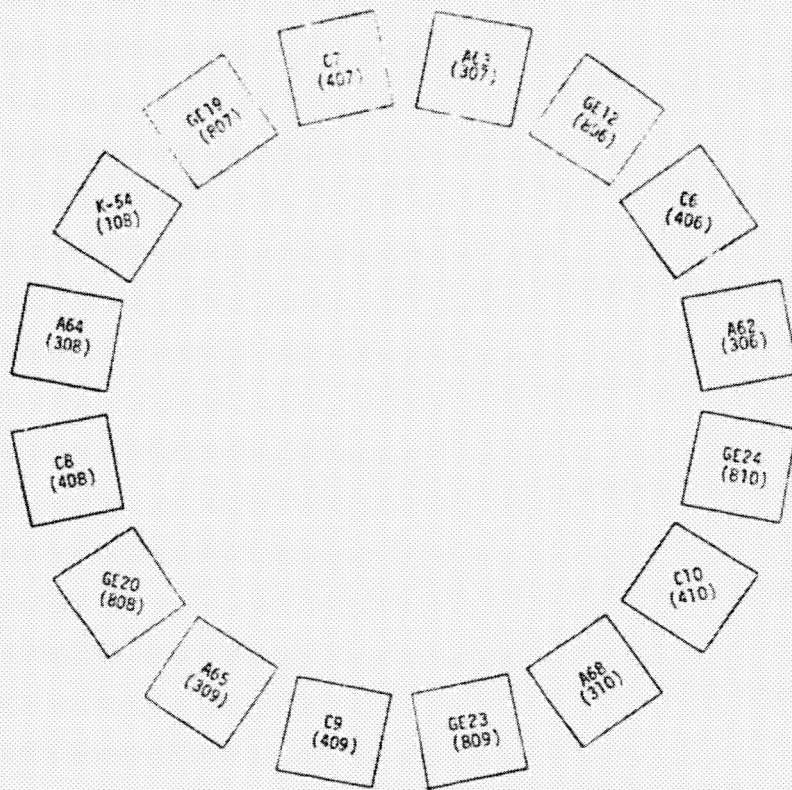
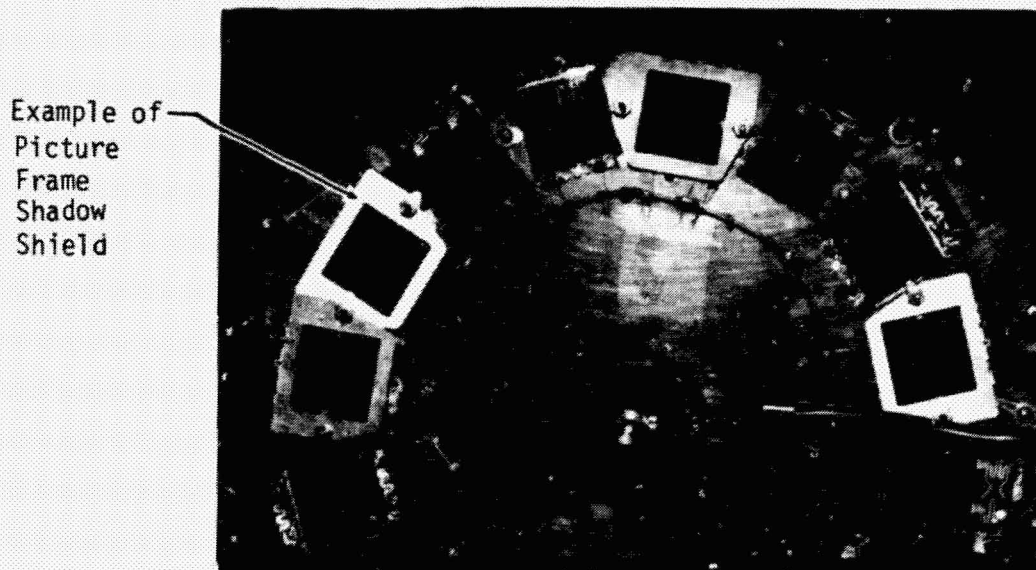

FIGURE 25. SAMPLE PLATE LAYOUT - 1ST SET PROTON IRRADIATION



Example of
Picture
Frame
Shadow
Shield

FIGURE 26. PRE-IRRADIATION PROTONS SET #1

ORIGINAL PAGE IS
OF POOR QUALITY.

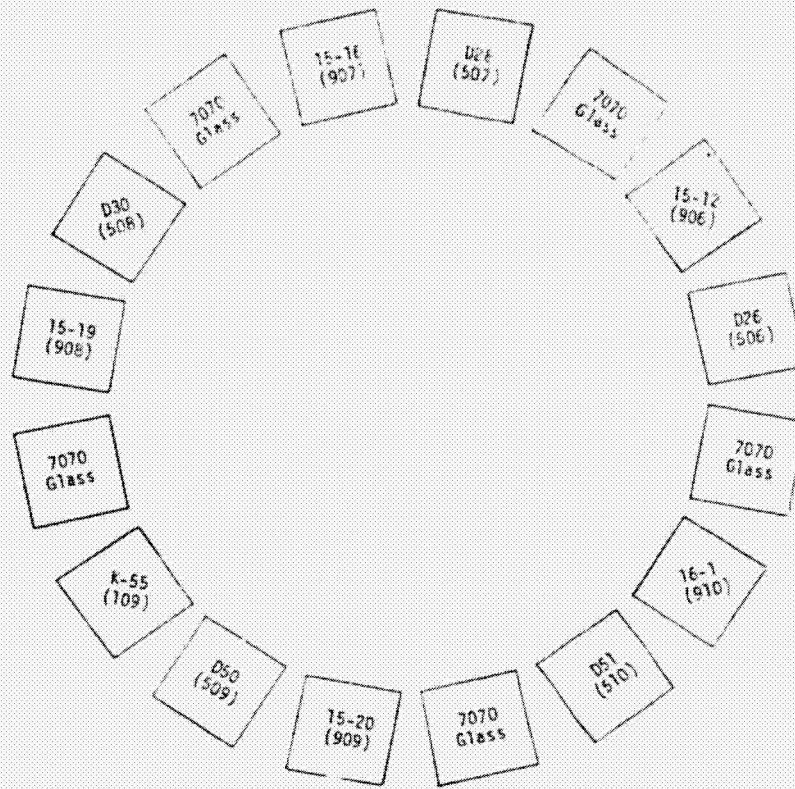

FIGURE 27. SAMPLE PLATE LAYOUT - 2nd SET PROTON IRRADIATION

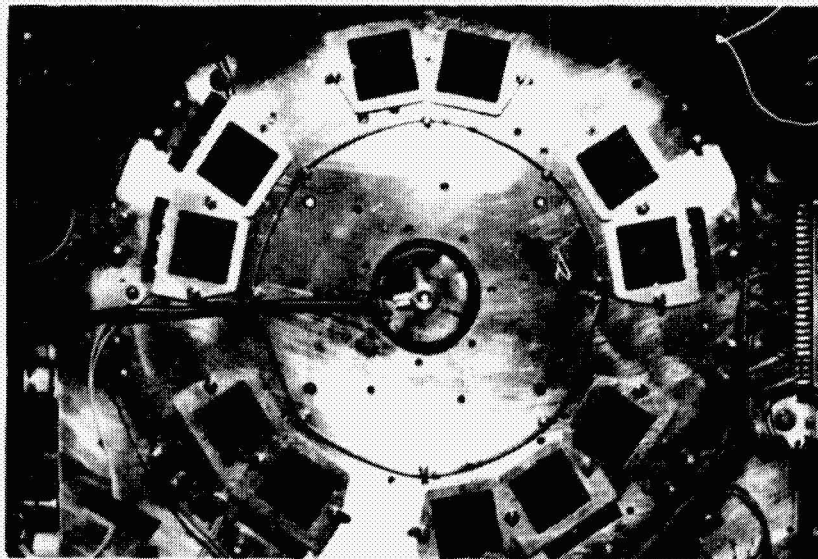

FIGURE 28. PRE-IRRADIATED PROTON SET #2

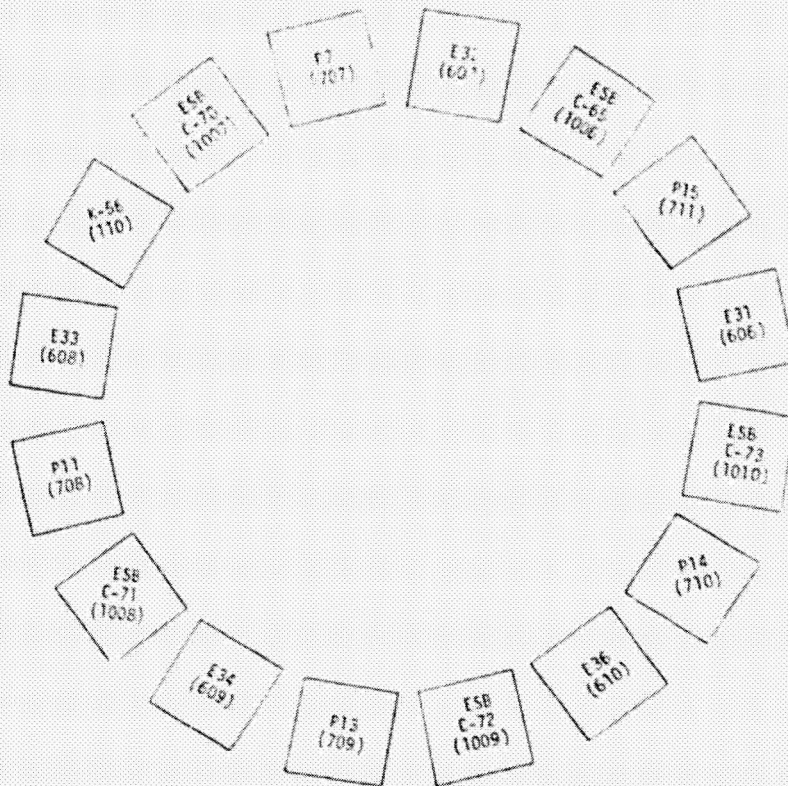

FIGURE 29. SAMPLE PLATE LAYOUT - 3rd SET PROTON IRRADIATION

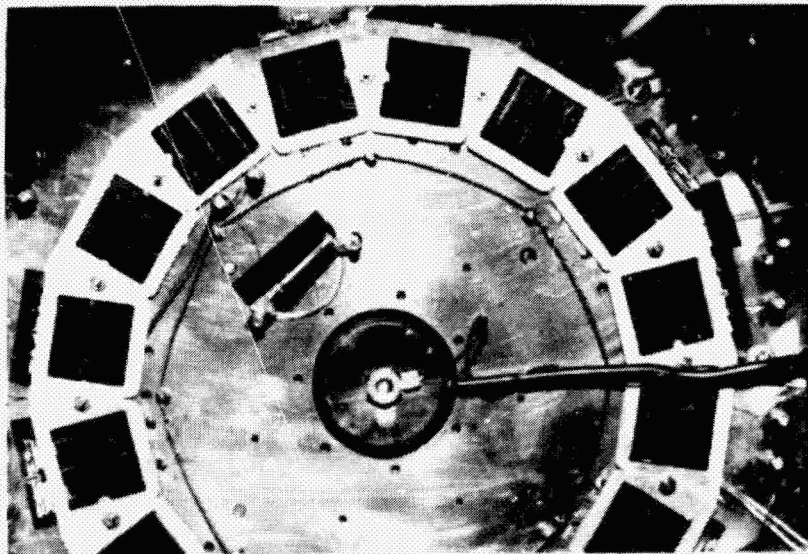
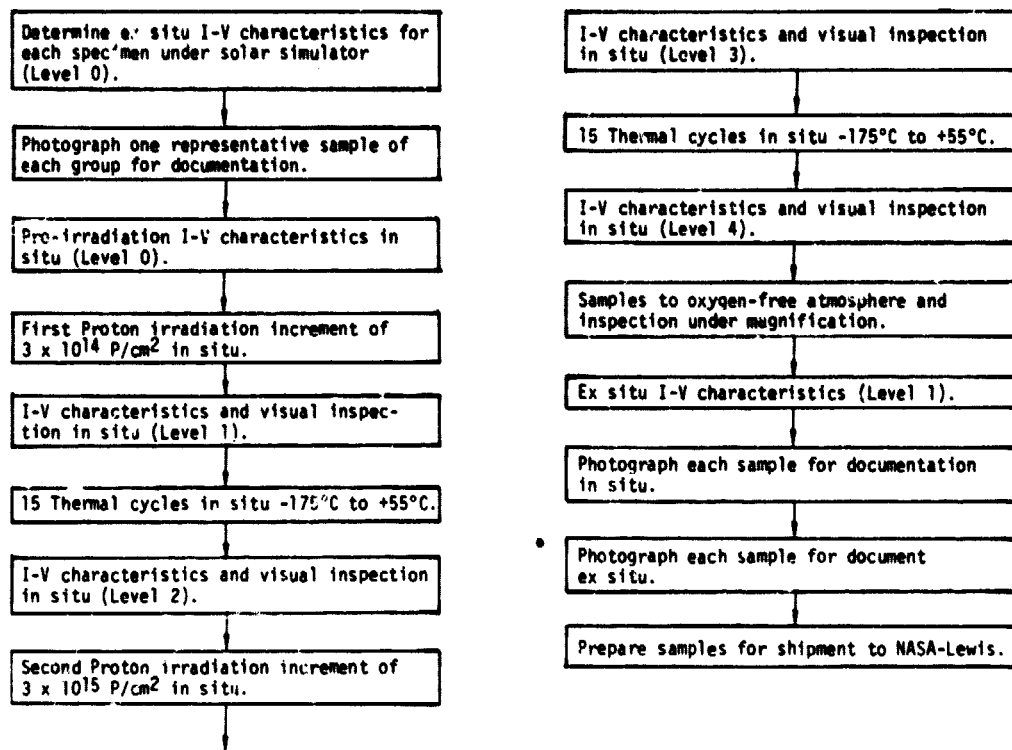

FIGURE 30. TOP HALF OF SAMPLE PLATE PRE-IRRADIATION PROTON SET #3

Table 6 is a flow diagram of the proton irradiation, showing the order of the testing and including the measurement level numbers.

TABLE 6. PROGRAM FLOW DIAGRAM OF LOW ENERGY PROTON IRRADIATION INTERSPERSED WITH THERMAL CYCLING - TASK II



A special picture frame type of shadow shield was placed over those types of cells that may have exposed edges (see Figures 26, 28 and 30). This was done to prevent any proton damage to the samples caused by exposed edges. This would prevent complicating the analysis of the data. The samples that had shadow shields were A Series, D Series, DN Series, E Series, P Series, ESB cells and control cells.

5.3 EFFECTS OF UV EXPOSURE INTERSPERSED WITH THERMAL CYCLING

The UV exposures with thermal cycling were performed after both the electron and proton tests were completed. Table 7 lists the UV exposure the sample received, the number of thermal cycles the sample received and the level number of each measurement. Also included is the range of the exposure rate used to achieve each incremental exposure.

TABLE 7. UV IRRADIATION TEST PARAMETERS

LEVEL NUMBER	TOTAL NUMBER THERMAL CYCLES	TOTAL EXPOSURES (ESH)*	INCREMENTAL EXPOSURE (ESH)*	EXPOSURE RATE (ESH/hr)
0	0	0	0	0
1	0	1000	1000	4-5
2	15	1000	---	---
3	15	4000	3000	4-6
4	30	4000	---	---
5	30	8760	4760	4-6
6	45	8760	---	---

*ESH = equivalent sun hours

The samples were divided into two groups for this test. The first group included A Series, C Series, D Series, P Series, and the 3 x 3 module made by NASA-Lewis (see Figures 31 and 32). The second group included E Series, DN Series, GE cells, ESB cells and the JPL 3 x 3 module (see Figures 33 and 34).

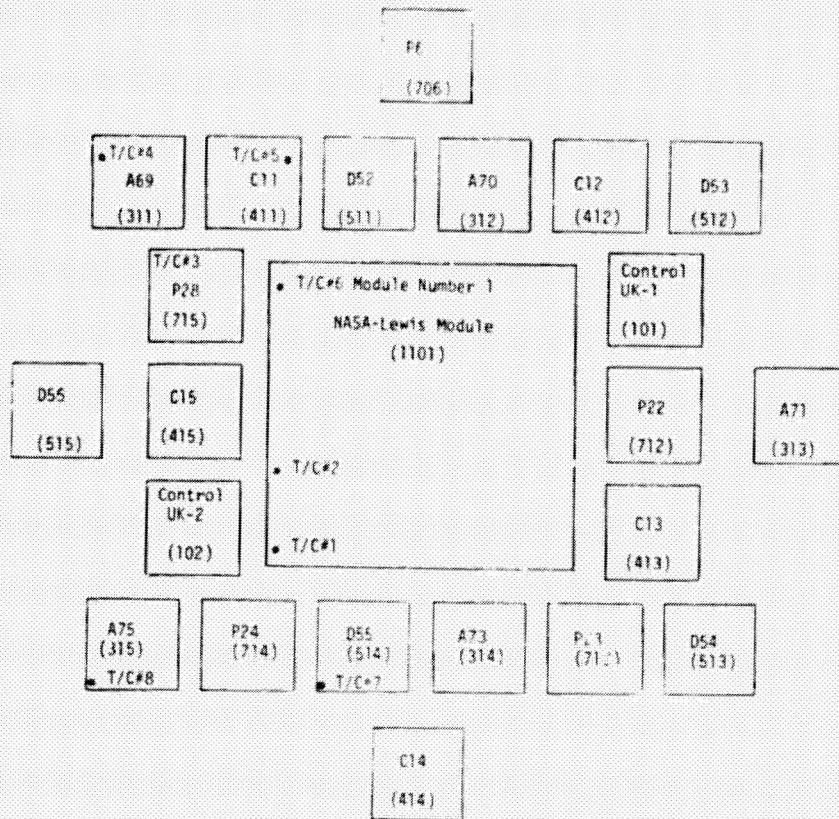

FIGURE 31. SAMPLE PLATE LAYOUT - UV EXPOSURE SET #1

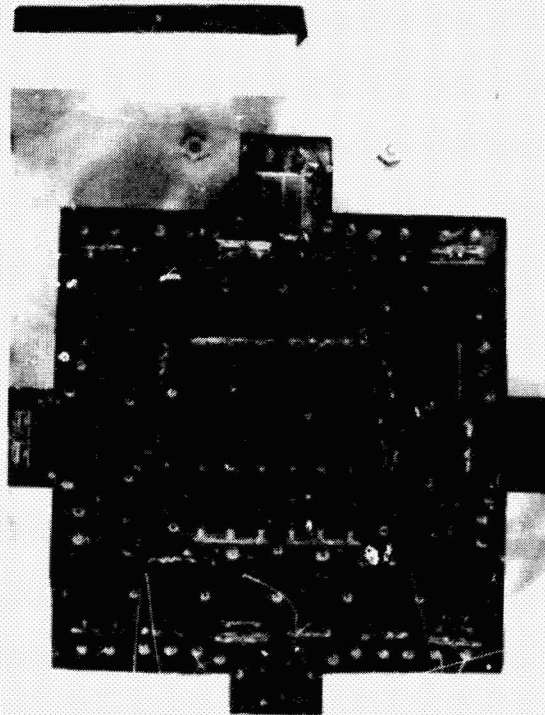

FIGURE 32. PRE-EXPOSURE UV SET #1

ORIGINAL PAGE IS
OF POOR QUALITY

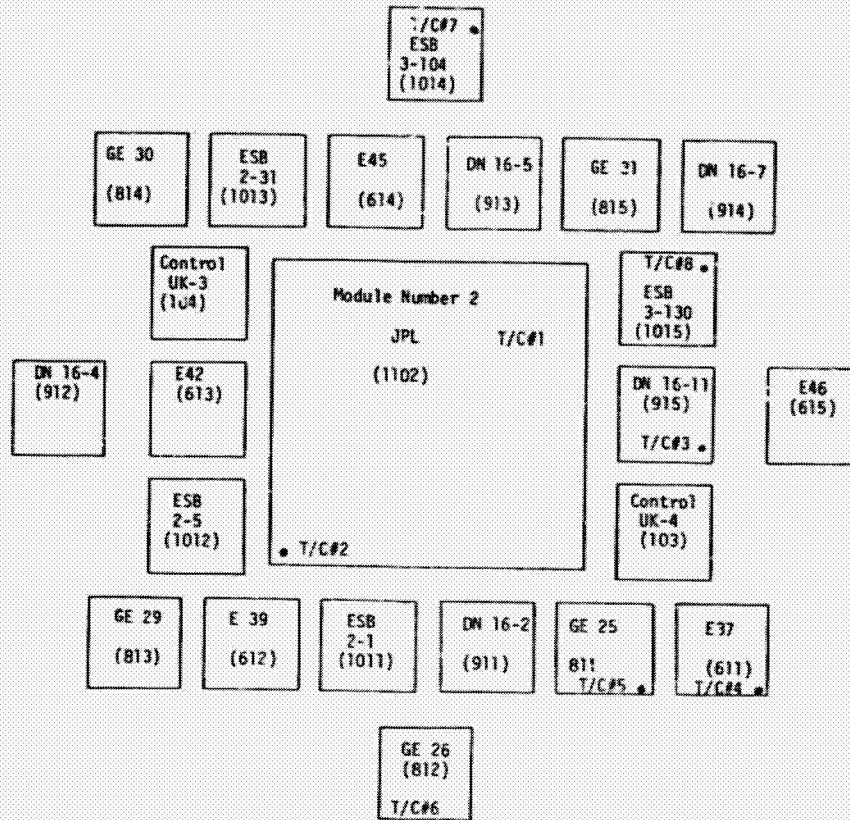

FIGURE 33. SAMPLE PLATE LAYOUT - UV EXPOSURE SET #2

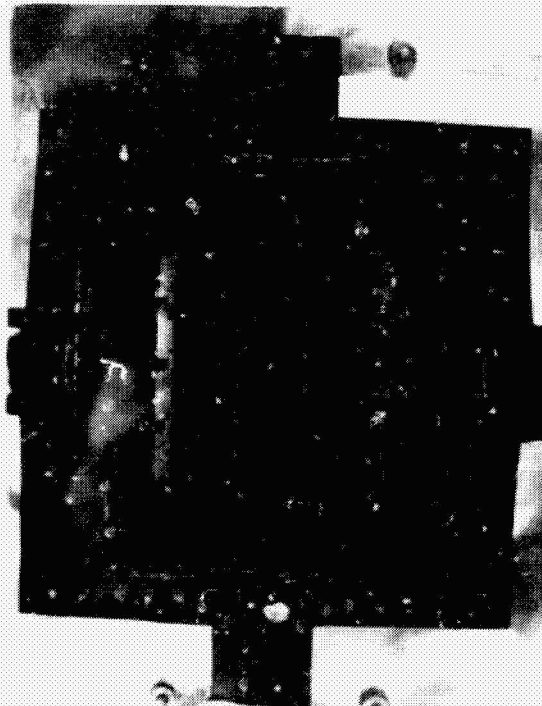
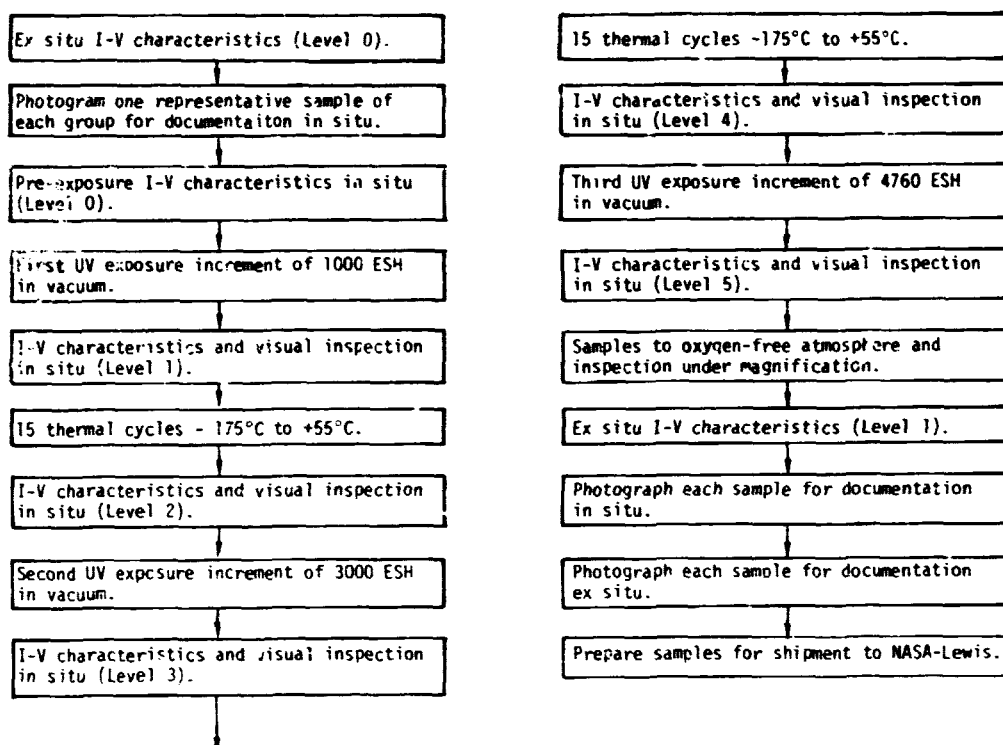

FIGURE 34. PRÉ-EXPOSURE UV SET #2

Table 8 is a flow diagram of the UV exposure test showing the order of testing and including the measurement level numbers.

TABLE 8. PROGRAM FLOW DIAGRAM OF UV IRRADIATION INTERSPERSED WITH THERMAL CYCLING - TASK III



During the first UV exposure test the test chamber developed a vacuum leak when a ceramic electrical Feed-through cracked suddenly during the first set of thermal cycles. The failure caused an instant up to air condition in the chamber and an electrical short of the sample plate heater leads. The feed-through was replaced and the chamber pumped out again. It was observed from this point on that some of the samples had hazy regions on them including the control cells. When the samples were removed at the end of the test it was found, for example, that much of the haziness could be wiped off of the NASA-Lewis module. Also the bare control cells had signs of defraction patterns. These are indications of contamination. The contamination was probably pump oil from extra pump downs and other unknown compounds created when the feed-through cracked and shorted out. The contamination appeared to be uneven in coverage over the entire sample plate so that the contamination portion of the transmission lost could not be factored out.

It must be remembered that the contamination was only present during the first UV exposure test which included A Series, C Series, D Series, P Series, and the 3 x 3 module made by NASA-Lewis. The second UV exposure test, which included E Series, DN Series, GE cells, ESB cells and the JPL 3 x 3 module, was contamination free.

6.0 ANALYSIS OF RESULTS

The testing program included eight types of encapsulants or cover materials applied to solar cells in various ways and two 3 cell x 3 cell modules. The solar cells not only served as a test vehicle to measure the changes in the light transmission properties of the materials, they were also a part of the total physical system made up of the encapsulant or cover material, the adhesive and the cell to evaluate the physical properties of the materials in space environments.

The results of the program are in two parts, the visual inspections of the cells and the electrical measurements of the cells. The visual inspections describe the outside physical properties of the samples. The electrical measurements indicate the electrical properties of the cell and integrates the visual damage into the values of I_{sc} , V_{oc} , P_{max} and F.F. In the case of the electrical measurements the cell changes must be separated from the cover changes in order to assess the cover materials' transmission loss. Therefore, the possible causes of solar cell output changes will be discussed.

The 1.0 MeV electrons penetrated through the covers and the cells causing displacement damage in the silicon cells and ionization and/or displacement damage in the cover materials. The 0.5 MeV protons did not penetrate through the cover materials but caused heavy ionization and displacement damage in the covers, primarily near the front surface. The UV radiation was absorbed by some cover materials and transmitted into the cell by others. Generally, for unirradiated cells, UV radiation is not damaging; however, for irradiated cells UV light may enhance vacancy migration and interaction with impurities in the cell to alter cell characteristics. Therefore, unirradiated cells were used in the UV tests so that significant changes are not expected. Thermal cycling may cause changes in the cell output also. Generally for the temperature range of -170°C to $+55^{\circ}\text{C}$ the major effects of thermal cycling will be mechanical but these mechanical changes may be manifested electrically by contact resistance changes in the cell or transmission loss due to delamination at interfaces.

In order to separate the effects of encapsulant degradation and cell degradation it is first helpful to consider the nature of the effects of degradation in the various regions of the cell cover system on electrical output of the cell. Cover degradation would normally result only in a loss of light transmission into the cell and would result simply in a lateral shift of the I-V curve to a lower short circuit current, I_{SC} , value. The fill factor, i.e., series or shunt resistance, would not be expected to change due to darkening of the cover material. Normally incident 1.0 MeV electron damage will cause changes in both the I_{SC} and open circuit voltage, V_{OC} , values of the cell due to uniform minority carrier lifetime degradation throughout the cell. Usually, the fill factor is not significantly affected. For proton damage, the damage, if any, will be in localized regions of the cell, i.e., exposed regions at the periphery of the cover and the effects on overall cell output will be primarily a shunting effect on the remainder of the cell. Thus the fill factor would be seriously degraded in the form of a "softened" knee on the I-V curve. For thermal cycling one would normally expect changes in series resistance due to contact stresses or loss of I_{SC} due to transmission losses at delaminated interfaces; thus, in the former case the fill factor would be changed in the form of increased loss of output voltage with increasing output current.

6.1 DATA FORMAT

The data is of two basic types, visual and electrical (I-V measurements). The visual data were recorded at the same time the I-V measurements were made. The visual data are in the form of written observations and photographs. The photographs were taken only at the beginning and at the end of testing (post-test). There are both in situ and ex situ end of test photographs. All the photographs are part of the Data Report. Selected photographs are used in this report to illustrate the damage to the samples where necessary.

The I-V measurements are in the form of I-V curves which describe the sample performance over an I-V range from short-circuit current to

open-circuit voltage. Due to the large number of I-V measurements involved, a mini-computer was used to collect, store and reduce the measurements. The Data Report contains the computer-plotted I-V curves (see Figure 35 for an example). Each I-V curve also has plotted with it the P-V curve and a listing of short-circuit current (i_{sc}), open-circuit voltage (V_{oc}), maximum power (P_{max}) and fill factor (F.F.). Each page contains more than one curve to aid in analysis and to reduce the number of pages. The level numbers refer to the fluence and number of thermal cycles received. There are I-V curves for both the ex situ and in situ measurements. Tables 3, 5 and 7 should be used to translate the level number to test conditions for electrons, protons and UV, respectively.

The I-V measurement data were reduced in several ways. Tables were created of the four cell parameters (i_{sc} , V_{oc} , P_{max} , F.F.) and their normalized values for each level of each test (see Table 9 for an example). Summary tables were created which then listed the average normalized value of the four cell parameters for each level (see Table 10 for an example). The average normalized value of the four cell parameters was plotted versus the fluence for electrons and protons and the exposure for UV. The range of the normalized values is also shown on these plots. Figure 36 is an example of the plots. The level number is written beside each point. The X refers to measurements made after an irradiation and O refers to measurements made after thermal cycles. The range of the normalized data is also plotted. The bars with horizontal lines $\overline{\text{X}}$ refer to the range of measurements made after an irradiation and bars with wavy lines $\overline{\text{O}}$ refer to the range of measurements made after thermal cycles. The \diamond indicates the ex situ post-test value. The ex-situ data for the test samples in the electron and proton tests were taken in the ex situ measurement facility. For post-test measurements the samples were removed from the irradiation sample plate and measured one by one in the ex situ measurement facility. Some samples were difficult to remove from the irradiation plate without coming apart or further damaging. Therefore, the ex situ post-test data sometimes varies from the in situ data. Under these circumstances it is felt that the in situ data is of greater value in this study.

The results are grouped by sample type. The three environments are discussed for a sample type before moving to another sample type. The visual observations are summarized in Tables 11, 12 and 13 for the electron, proton and UV test, respectively. Included with each sample type and environment are the summary plots of normalized test parameters versus fluence and summary tables of normalized and averaged normalized test parameters.

S/N : 302	LEVEL : 0	1
TEMP: 25 C	ISC(MA) : 152.0	107.7
AREA: 4 CM^2	VOC(MV) : 598.8	484.4
INT. : 1*AM0	PMAX(MW): 70.0	37.5
	F.F. : 0.772	0.750

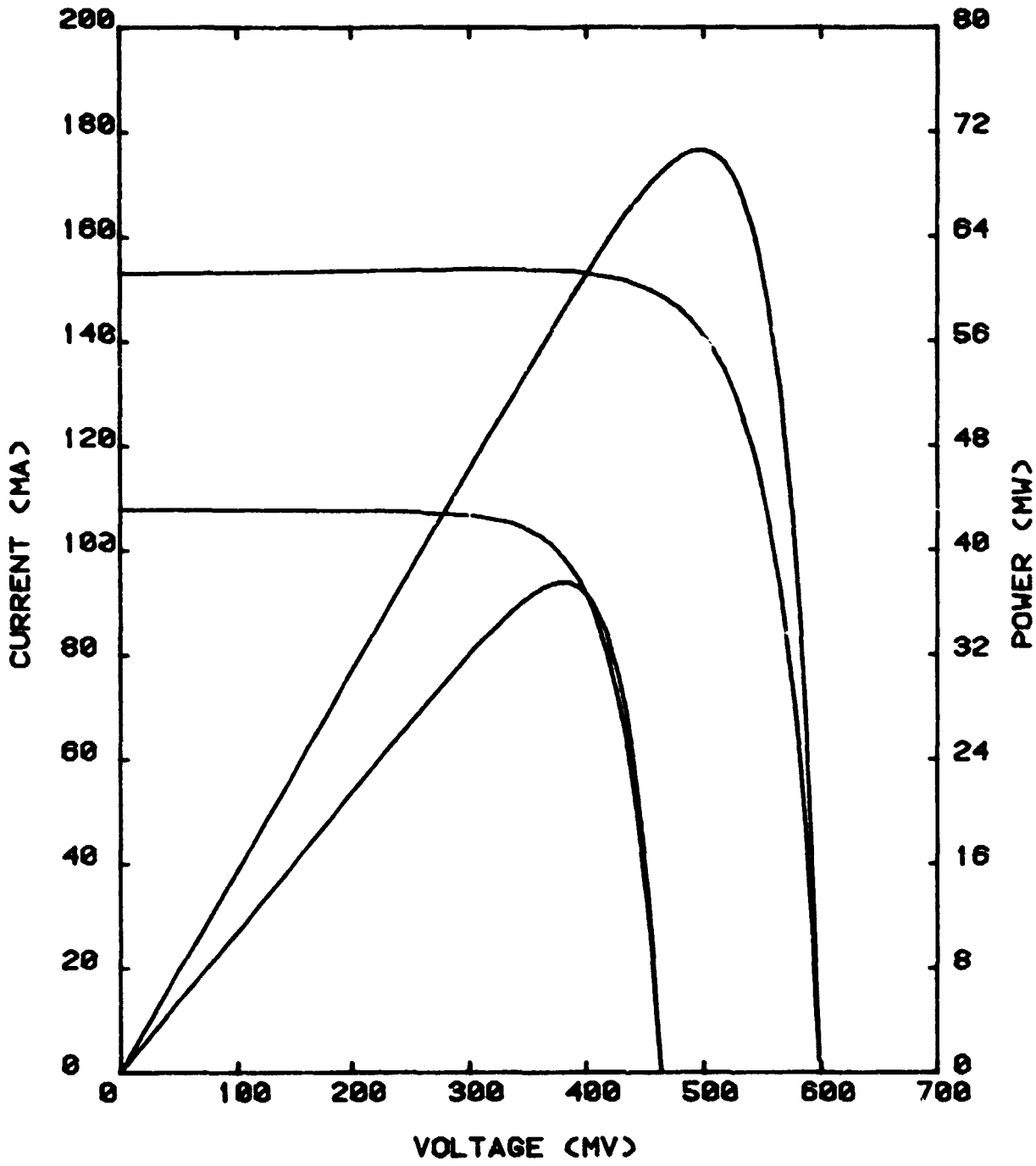

A SERIES ELECTRON IRRADIATION EX-SITU

FIGURE 35. EXAMPLE OF COMPUTER-PLOTTED I-V CURVES

TABLE 9. TABULATED TEST PARAMETERS AND THEIR NORMALIZED VALUES

A SERIES ELECTRON IRRADIATION IN-SITU
TEMP. (C): 25 AREA: 4 INTENSITY 1*AM0

Serial Number	Level Number	Isc (mA)	Isc/ Isco	Voc (mV)	Voc/ Voc0	Pmx (mW)	Pmx/ Pm00	F. F. I. Fac.	F. F. I. F. F. o
301	0	129.5	1.000	591.6	1.000	59.30	1.000	0.774	1.000
302	0	128.9	1.000	601.3	1.000	59.78	1.000	0.771	1.000
303	0	128.0	1.000	606.2	1.000	59.92	1.000	0.772	1.000
304	0	128.6	1.000	610.5	1.000	59.68	1.000	0.760	1.000
305	0	129.9	1.000	604.7	1.000	59.48	1.000	0.757	1.000
301	1	111.2	0.859	521.5	0.882	44.40	0.749	0.765	0.989
302	1	110.4	0.856	520.3	0.865	44.19	0.739	0.769	0.998
303	1	110.6	0.864	520.9	0.859	44.19	0.738	0.767	0.994
304	1	111.1	0.864	520.9	0.853	44.13	0.739	0.763	1.003
305	1	111.5	0.858	521.5	0.862	44.11	0.742	0.759	1.002
301	2	107.1	0.827	510.2	0.862	41.63	0.702	0.762	0.985
302	2	105.7	0.820	508.7	0.846	41.14	0.695	0.766	0.993
303	2	106.6	0.833	509.7	0.841	41.04	0.698	0.770	0.998
304	2	106.4	0.828	510.2	0.836	41.05	0.688	0.756	0.994
305	2	107.6	0.828	510.3	0.844	41.34	0.695	0.753	0.994
301	3	102.9	0.794	512.3	0.866	40.15	0.677	0.762	0.984
302	3	106.3	0.824	509.9	0.848	41.75	0.698	0.770	0.999
303	3	107.1	0.836	511.2	0.843	41.91	0.700	0.766	0.992
304	3	106.8	0.830	512.3	0.839	41.24	0.691	0.754	0.992
305	3	107.8	0.830	512.3	0.847	42.05	0.707	0.762	1.006
301	4	90.4	0.698	483.9	0.818	33.11	0.558	0.757	0.978
302	4	93.5	0.725	483.3	0.804	34.29	0.574	0.759	0.984
303	4	93.1	0.727	483.2	0.797	34.01	0.568	0.756	0.979
304	4	95.6	0.744	484.8	0.794	34.69	0.581	0.748	0.984
305	4	95.2	0.733	484.2	0.801	34.33	0.577	0.744	0.983
301	5	90.7	0.701	482.8	0.816	33.22	0.560	0.758	0.980
302	5	93.7	0.727	483.1	0.803	34.66	0.580	0.766	0.993
303	5	94.0	0.734	482.6	0.796	34.58	0.577	0.762	0.988
304	5	95.4	0.742	484.3	0.793	35.15	0.589	0.761	1.001
305	5	95.3	0.734	482.2	0.797	34.43	0.579	0.749	0.989
301	6	84.1	0.649	466.5	0.788	29.47	0.497	0.751	0.971
302	6	87.1	0.676	466.7	0.776	30.73	0.514	0.756	0.980
303	6	87.7	0.685	466.5	0.770	30.74	0.513	0.752	0.974
304	6	89.4	0.696	470.4	0.771	31.61	0.520	0.752	0.988
305	6	89.9	0.692	466.6	0.772	31.36	0.527	0.747	0.987
301	7	84.5	0.652	464.2	0.785	29.67	0.500	0.756	0.977
302	7	87.4	0.678	464.2	0.772	30.34	0.508	0.748	0.970
303	7	87.9	0.687	464.6	0.766	31.01	0.518	0.759	0.983
304	7	90.4	0.707	465.1	0.762	31.56	0.529	0.751	0.987
305	7	90.0	0.693	465.1	0.769	31.54	0.530	0.754	0.995

TABLE 10. AVERAGE NORMALIZED CELL PARAMETERS

A SERIES ELECTRON IRRADIATION IN-SITU
 TEMP. (C): 25 AREA: 4 INTENSITY 1*AM0

Level Number	AVERAGE Isc/Isc0	AVERAGE Voc/Voc0	AVERAGE Pmx/Pmx0	AVERAGE F. F. /F. F. 0
0	1.000	1.000	1.000	1.000
1	0.860	0.864	0.742	0.998
2	0.827	0.846	0.694	0.993
3	0.823	0.849	0.695	0.996
4	0.725	0.803	0.572	0.983
5	0.727	0.801	0.576	0.989
6	0.687	0.772	0.521	0.982
7	0.683	0.771	0.518	0.984

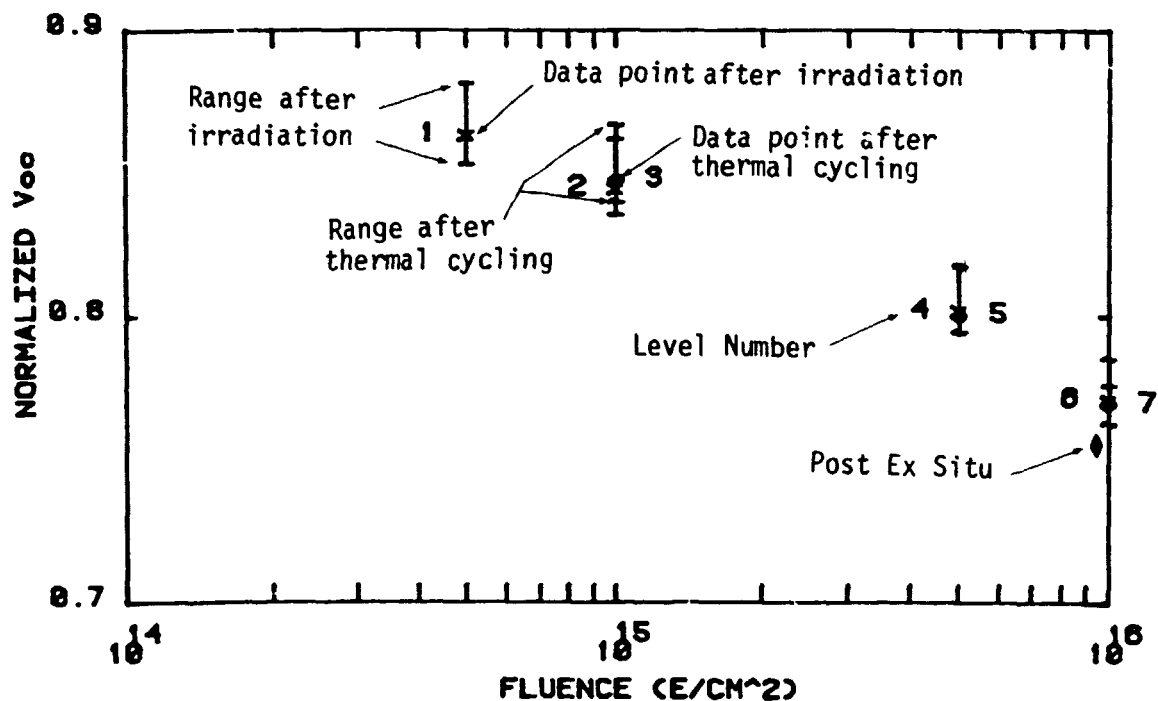

FIGURE 36. EXAMPLE OF SUMMARY PLOT

D180-26590-1
62

TABLE 11. SUMMARY OF ELECTRON IRRADIATION - VISUAL INSPECTION

LEVEL	TOTAL FLUENCE ($\frac{e}{cm^2}$)	TOTAL THERMAL CYCLES	SERIES						ESB	GE CELL	7070 GLASS
			A	C	D	E	DN	P			
0	0	0	--	--	--	--	--	--	1 cell has cracked corner	bubbles in encapsulant	
1	5×10^{14}	0	NC	NC	NC	NC	NC	NC	NC	NC	NC
2	1×10^{15}	0	NC	1 cracked 4 NC	NC	NC	NC	NC	NC	NC	NC
3	1×10^{15}	15	1 cracked cover 4 NC	NC	NC	NC	1 cracked cover 4 NC	1 cracked cover 4 NC	NC	3 cracked covers 2 NC	NC
4	5×10^{15}	15	2 cracked covers 3 NC	NC	NC	NC	NC	1 cracked cell / NC	NC	NC	NC
5	5×10^{15}	30	NC	all covers blistered and cracked	NC	NC	NC	4 cells cracked	NC	4 cracked covers 1 NC	NC
6	1×10^{16}	30	NC	NC	NC	NC	3 cracked covers 2 NC	NC	NC	NC	NC
7	1×10^{16}	45	NC	more blistering and cracking	NC	NC	NC	NC	NC	NC	NC
Ex situ visual	1×10^{16}	45	2 cracked covers 2 covers debonded 1 NC	covers blistered and cracked	NC		5 cracked covers some curling	4 cells cracked 1 ok	4 cells cracked 1 ok	cells and covers cracked and brittle	NC

NC - no change

D180-26590-1
 63

TABLE 12. SUMMARY OF PROTON IRRADIATION - VISUAL INSPECTION

LEVEL	TOTAL FLUENCE ($\frac{P}{cm^2}$)	TOTAL THERMAL CYCLES	SERIES						ESB	GE CELL	7070 GLASS
			A	C	D	E	DN	P			
0	0	0	--	2 cells with air bubble	--	--	--	--	--	--	--
1	3×10^{14}	0	NC	NC	3 cracks in 93-500	NC	NC	NC	NC	2 blistered 2 curled	NC
2	3×10^{14}	15	NC	no bubble covers hazy	93-500 cracked all cells	many cracks in cover	NC	3 cracked cells 2 NC	1 cracked cover & cell 4 NC	more blistering, curling	curled
3	3.3×10^{15}	15	NC	NC	yellowish appearance	yellowish appearance	NC	NC	NC	badly blistered	curled
4	3.3×10^{15}	30	3 covers cracked	all covers hazy	yellowish appearance, cracked cover	yellowish appearance, cracked cover	NC	4 cracked cells 1 NC	3 cells curling	badly blistered & peeled	NC
Ex situ visual	3.3×10^{15}	30	3 covers cracked 2 ok	FEP-A is hazy 1 cell cracked	yellowish appearance, cracked cover	yellowish appearance, cracked cover	NC	all cells cracked	1 cracked cover & cell, some curling	badly blistered & peeled	curled badly

NC - no change

D180-26590-1
64

TABLE 13. SUMMARY OF UV EXPOSURE - VISUAL INSPECTION

LEVEL	TOTAL UV EXPOSURE (ESH)	TOTAL THERMAL CYCLES	SERIES						ESB	GE CELL	MODULES
			A	C	D	E	DN	P			
0	0	0	--	--	--	--	--	1 partial	--	--	--
1	1000	0	NC	NC	NC	NC	NC	NC	NC	NC	#1 - NC #2 - NC
2	1000	15	NC	NC	NC	NC	NC	4 cracked cells 1 NC	NC	NC	#1 hazy near center #2 NC
3	4000	15	hazy appearance	little wrinkling	NC	yellowish appearance	NC	hazy appearance	NC	4 hairline cracks 1 NC	#1 NC #2 NC
4	4000	30	NC	NC	NC	NC	NC	NC	NC	NC	#1 NC #2 NC
5	8760	30	NC	4 cells hazy	NC	NC	NC	very hazy	NC	NC	#1 NC #2 NC
6	8760	45	NC	NC	NC	NC	NC	NC	NC	NC	#1 NC #2 NC
Ex situ visual	8760	45	little hazy	little curling	NC	yellowish appearance	NC	4 cracked cells 1 NC	NC	hairline cracks & curling	#1 1/3 of area hazy #2 NC

NC - no change

6.2 CONTROL CELLS

The control cells used in this program were Spectrolab 8-10 mil 10 Ω -cm cells. They were supplied with 6-mil removeable quartz covers. The control cells were used to check the amount of damage received with what was expected from past experience. Figures 37 and 38 are plots of normalized I_{SC} and V_{OC} versus fluence for the electron test. Also plotted on the same plots are the solar cell radiation handbook (JPL Publication 77-56) values for 1 MeV electrons on a 8-mil 10 Ω -cm conventional cell. The handbook data agrees well with the test data and verifies that the electron irradiation fluences did not produce any anomalous results. Tables 14A and 14B list the normalized parameters and the average normalized parameters.

In the proton test, the control cells were again covered with the 6-mil quartz cover. The tabulated data Tables 15A and 15B and summary plots Figures 39, 40, 41 and 42 show, as expected, there was no damage to the cell due to the thick cover stopping the protons.

There were two uncovered, uncoated control cells in each of the two UV exposure runs. The purpose of the cells were to check for contamination. The two cells in the first UV exposure (101, 102) showed signs of contamination when they were removed from the chamber. The contamination appeared to have acted as a poor AR coating causing an increase in I_{SC} . (See Section 5.3 for further details.) The cells in the second UV exposure showed no sign of contamination.

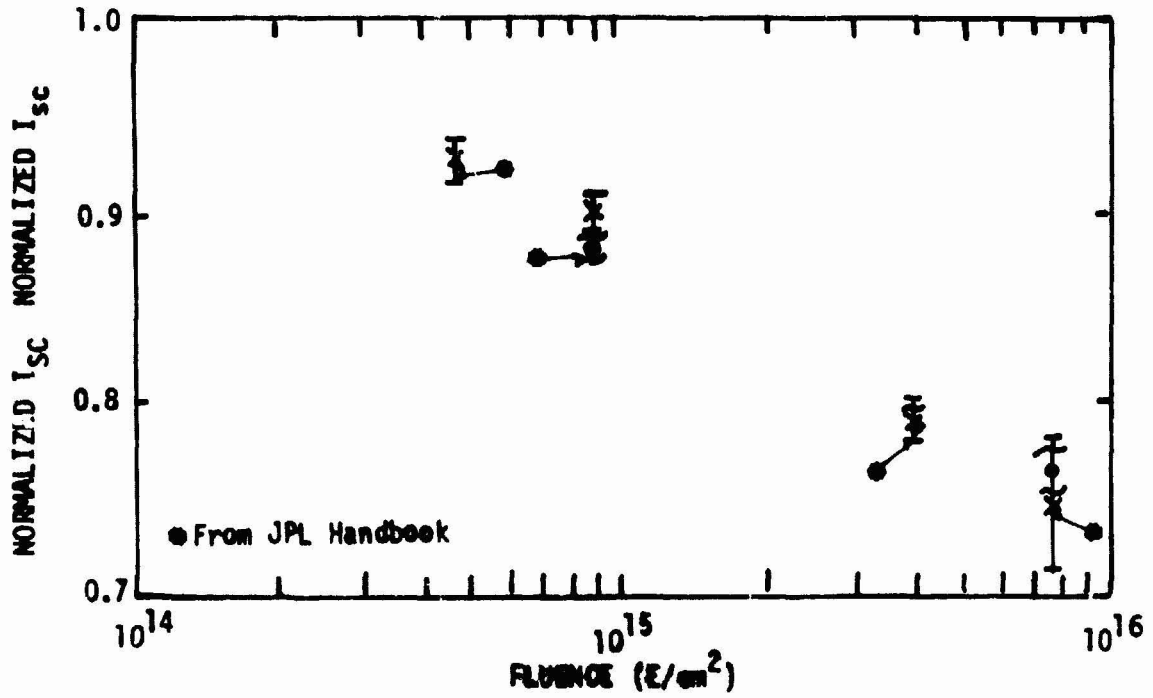

FIGURE 37. CONTROL CELLS ELECTRON IRRADIATION IN-SITU

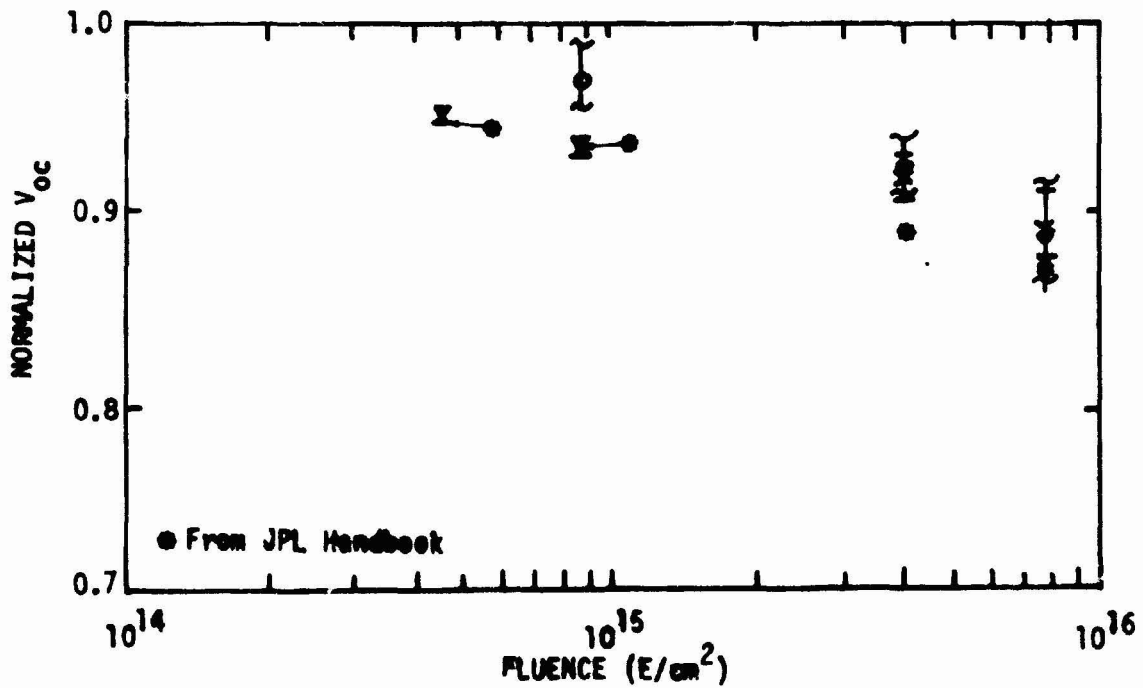

FIGURE 38. CONTROL CELLS ELECTRON IRRADIATION IN-SITU

TABLE 14A. TABULATED CONTROL CELLS DATA - ELECTRON IRRADIATION

CONTROL CELLS EX-SITU				
TEMP. (C): 25 AREA: 4 INTENSITY AM0				
Level Number	AVERAGE Isc/Isc0	AVERAGE Voc/Voc0	AVERAGE Pmx/Pmx0	AVERAGE F. F. /F. F. 0
0	1.000	1.000	1.000	1.000
1	0.776	0.852	0.635	0.961

CONTROL CELLS EX-SITU									
TEMP. (C): 25 AREA: 4 INTENSITY AM0									
Serial Number	Level Number	Isc (mA)	Isc/Isc0	Voc (mV)	Voc/Voc0	Pmx (mW)	Pmx/Pmx0	Fill Fac.	F. F. /F. F. 0
105	0	149.1	1.000	550.5	1.000	64.18	1.000	0.782	1.000
106	0	152.0	1.000	546.9	1.000	64.06	1.000	0.771	1.000
105	1	114.6	0.769	468.0	0.850	40.36	0.629	0.752	0.962
106	1	119.0	0.783	466.4	0.853	41.11	0.642	0.741	0.961

ORIGINAL PAGE IS
OF POOR QUALITY.

TABLE 14B. TABULATED CONTROL CELLS DATA - ELECTRON IRRADIATION

CONTROL CELLS ELECTRON IRRADIATION IN-SITU
TEMP. (C): 25 AREA: 4 INTENSITY 1*AM0

Serial Number	Level Number	Isc (mA)	Isc/Isc0	Voc (mV)	Voc/Voc0	Pmx (mW)	Pmx/Pmx0	F. F. / F. F. 0	F. F. / F. F. 0
105	0	116.6	1.000	533.6	1.000	48.36	1.000	0.777	1.000
106	0	120.9	1.000	500.0	1.000	45.39	1.000	0.751	1.000
105	1	107.1	0.919	506.1	0.949	41.71	0.863	0.770	0.990
106	1	113.7	0.941	474.4	0.949	40.05	0.887	0.746	0.994
105	2	104.2	0.894	495.0	0.928	39.81	0.833	0.771	0.993
106	2	110.5	0.904	464.7	0.929	38.09	0.849	0.742	0.998
105	3	103.0	0.883	508.2	0.952	40.50	0.817	0.774	0.995
106	3	107.5	0.889	492.9	0.986	40.47	0.891	0.763	1.017
105	4	91.2	0.782	480.5	0.908	33.47	0.692	0.763	0.982
106	4	97.2	0.804	463.9	0.928	33.89	0.747	0.752	1.001
105	5	91.5	0.785	481.1	0.902	34.04	0.704	0.737	0.995
106	5	96.2	0.796	468.6	0.937	34.13	0.752	0.757	1.000
105	6	83.1	0.712	464.4	0.870	29.67	0.613	0.709	0.990
106	6	94.9	0.785	452.9	0.906	30.07	0.706	0.746	0.991
105	7	88.1	0.756	459.9	0.860	30.46	0.630	0.733	0.969
106	7	93.6	0.776	455.3	0.911	31.00	0.702	0.747	0.995

CONTROL CELLS ELECTRON IRRADIATION IN-SITU
TEMP. (C): 25 AREA: 4 INTENSITY 1*AM0

Level Number	AVERAGE Isc/Isc0	AVERAGE Voc/Voc0	AVERAGE Pmx/Pmx0	AVERAGE F. F. / F. F. 0
0	1.000	1.000	1.000	1.000
1	0.930	0.949	0.875	0.992
2	0.904	0.929	0.831	0.991
3	0.886	0.969	0.864	1.006
4	0.793	0.914	0.710	0.992
5	0.791	0.920	0.728	1.002
6	0.749	0.898	0.660	0.992
7	0.766	0.886	0.666	0.982

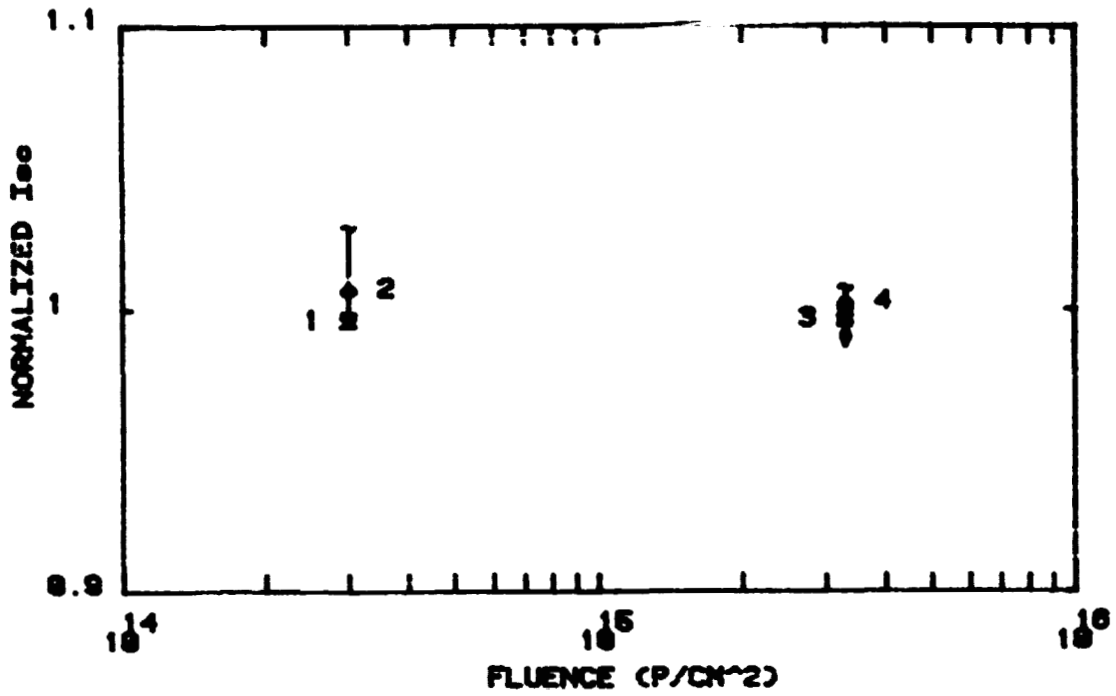

FIGURE 39. CONTROL CELL PROTON IRRADIATION IN-SITU

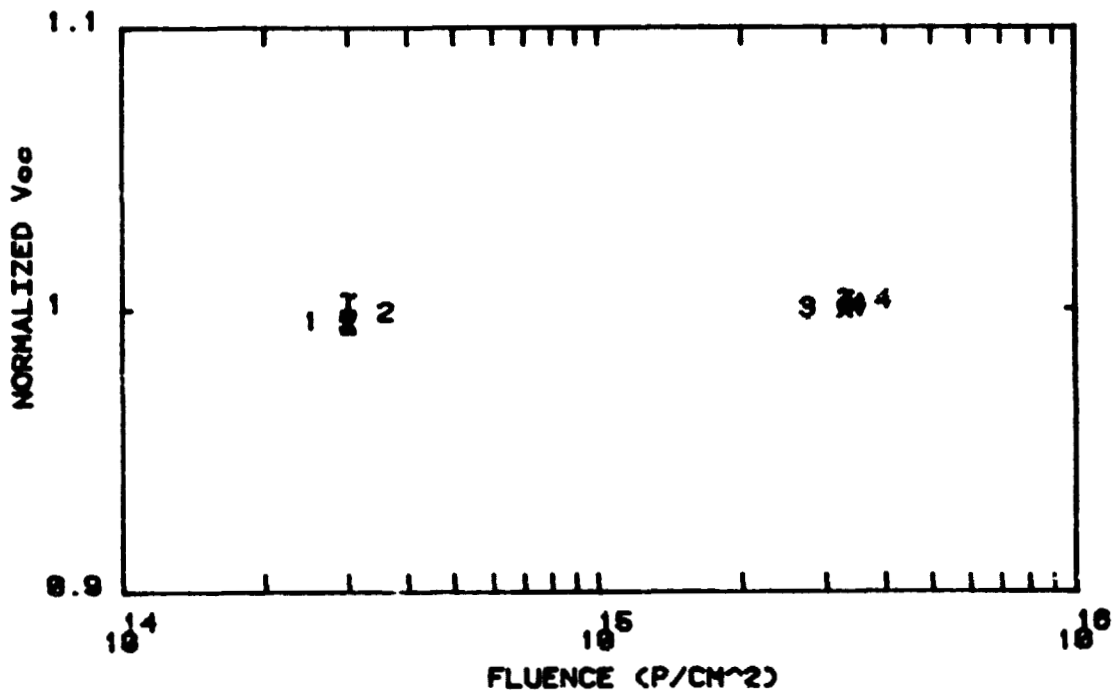

FIGURE 40. CONTROL CELL PROTON IRRADIATION IN-SITU

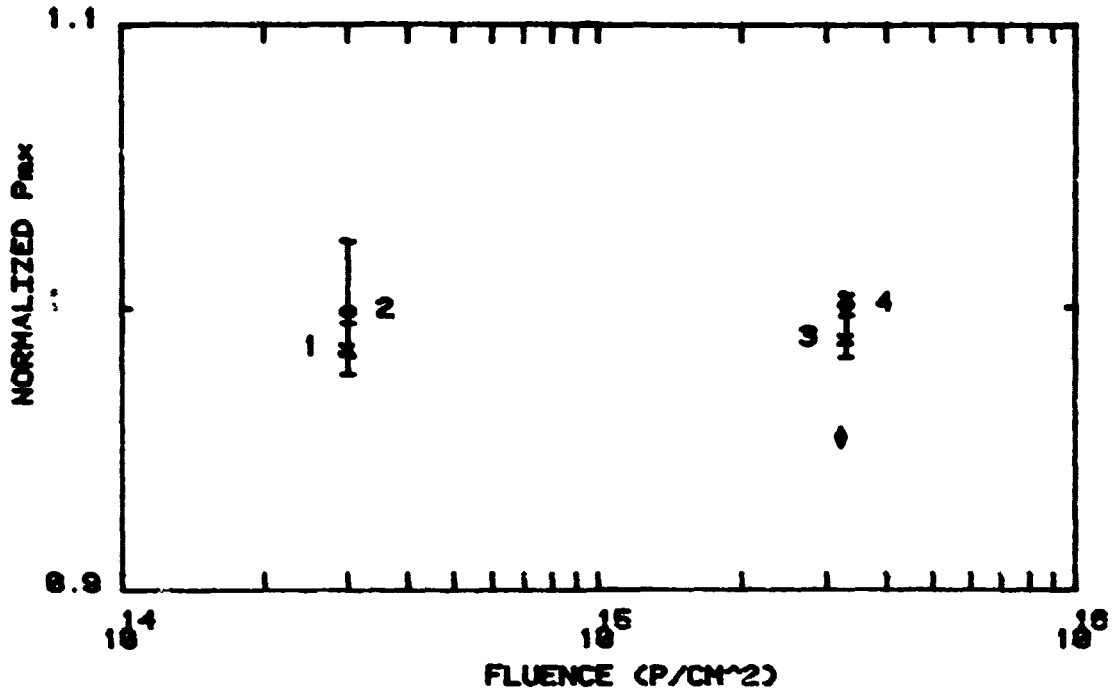

FIGURE 41. CONTROL CELL PROTON IRRADIATION IN-SITU

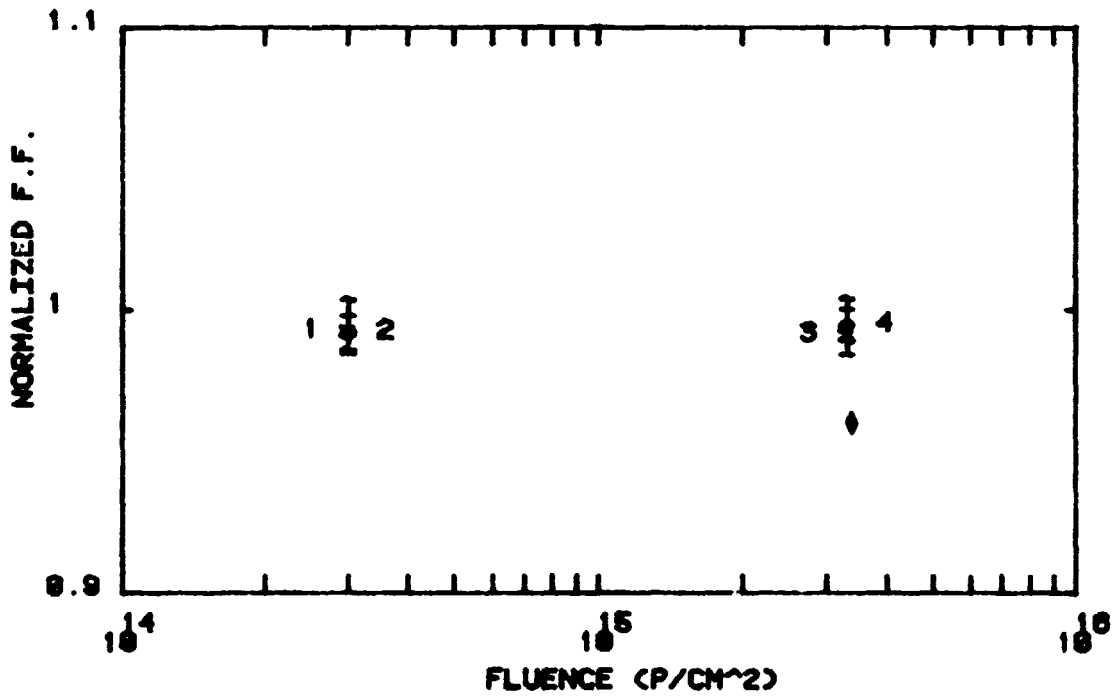

FIGURE 42. CONTROL CELL PROTON IRRADIATION IN-SITU

TABLE 15A. TABULATED CONTROL CELLS DATA - PROTON IRRADIATION

CONTROL CELLS EX-SITU PROTON IRRADIATION
 TEMP. (C): 25 AREA: 4. INTENSITY AM0

Level Number	AVERAGE I _c /I _{sc0}	AVERAGE Voc/Voc0	AVERAGE P _{mx} /P _{mx0}	AVERAGE F. F. /F. F. 0
0	1.000	1.000	1.000	1.000
1	0.992	1.000	0.954	0.962

CONTROL CELL PROTON IRRADIATION IN-SITU
 TEMP. (C): 25 AREA: 4. INTENSITY 1*AM0

Level Number	AVERAGE I _{sc} /I _{sc0}	AVERAGE Voc/Voc0	AVERAGE P _{mx} /P _{mx0}	AVERAGE F. F. /F. F. 0
0	1.000	1.000	1.000	1.000
1	0.997	0.996	0.987	0.994
2	1.000	0.999	1.000	0.993
3	0.997	1.000	0.990	0.992
4	1.003	1.003	1.002	0.996

TABLE 15B. TABULATED CONTROL CELLS DATA - PROTON IRRADIATION

		CONTROL CELL		PROTON IRRADIATION		IN-SITU			
		TEMP. (C): 25		AREA: 4		INTENSITY 1*AM0			
Serial Number	Level Number	Isc (mA)	Isc/ Isco	Voc (mV)	Voc/ Voco	Pmx (mW)	Pmx/ Pmxo	Fill Fac.	F. F. / F. F. o
108	0	109.8	1.000	556.4	1.000	48.23	1.000	0.790	1.000
109	0	105.6	1.000	556.9	1.000	44.66	1.000	0.759	1.000
110	0	111.0	1.000	554.5	1.000	48.52	1.000	0.788	1.000
108	1	109.5	0.997	556.2	1.000	47.99	0.995	0.788	0.998
109	1	105.5	0.999	552.4	0.992	44.17	0.989	0.758	0.998
110	1	110.4	0.994	553.1	0.998	47.37	0.976	0.776	0.985
108	2	109.7	1.000	558.9	1.004	47.98	0.995	0.782	0.991
109*	2	108.6	1.028	552.4	0.992	45.68	1.023	0.762	1.003
110	2	110.6	0.996	555.3	1.001	47.67	0.982	0.776	0.985
108	3	109.3	0.996	557.1	1.001	48.12	0.998	0.790	1.001
109*	3	69.6	0.659	541.4	0.972	24.00	0.537	0.637	0.838
110	3	110.9	0.999	554.4	1.000	47.67	0.983	0.776	0.984
108	4	110.6	1.007	559.2	1.005	48.26	1.001	0.780	0.988
109*	4	70.0	0.663	541.0	0.972	23.99	0.537	0.634	0.834
110	4	110.9	0.999	555.3	1.001	48.70	1.004	0.791	1.003

*NOT INCLUDED IN AVERAGE

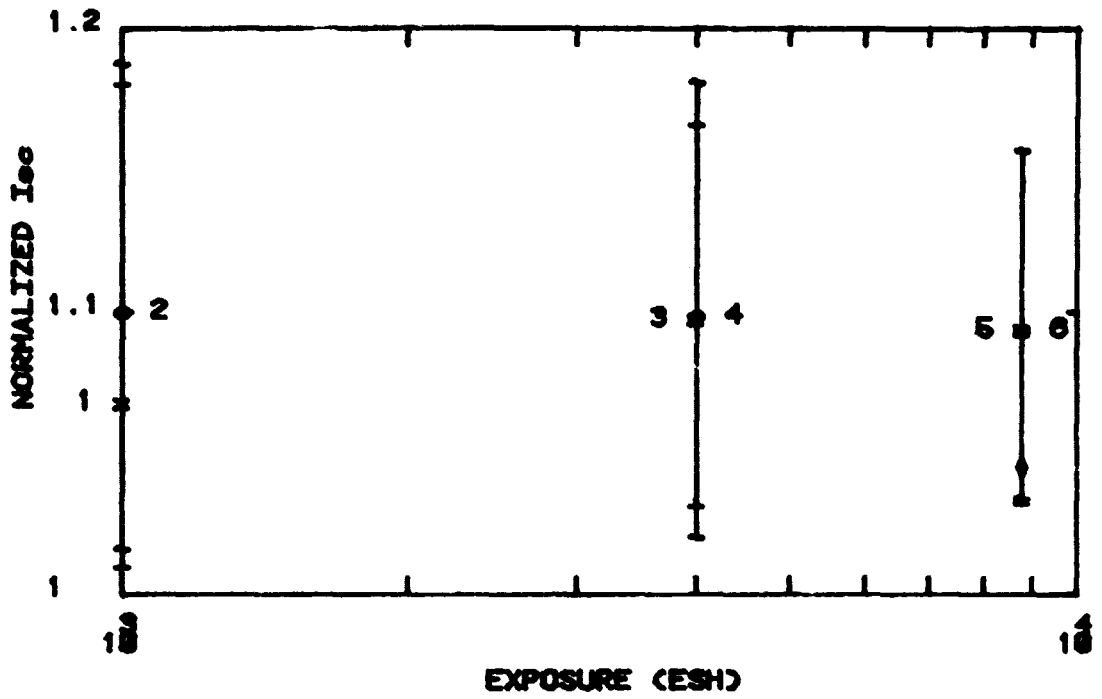

FIGURE 43. CONTROL CELLS UV IRRADIATION IN SITU

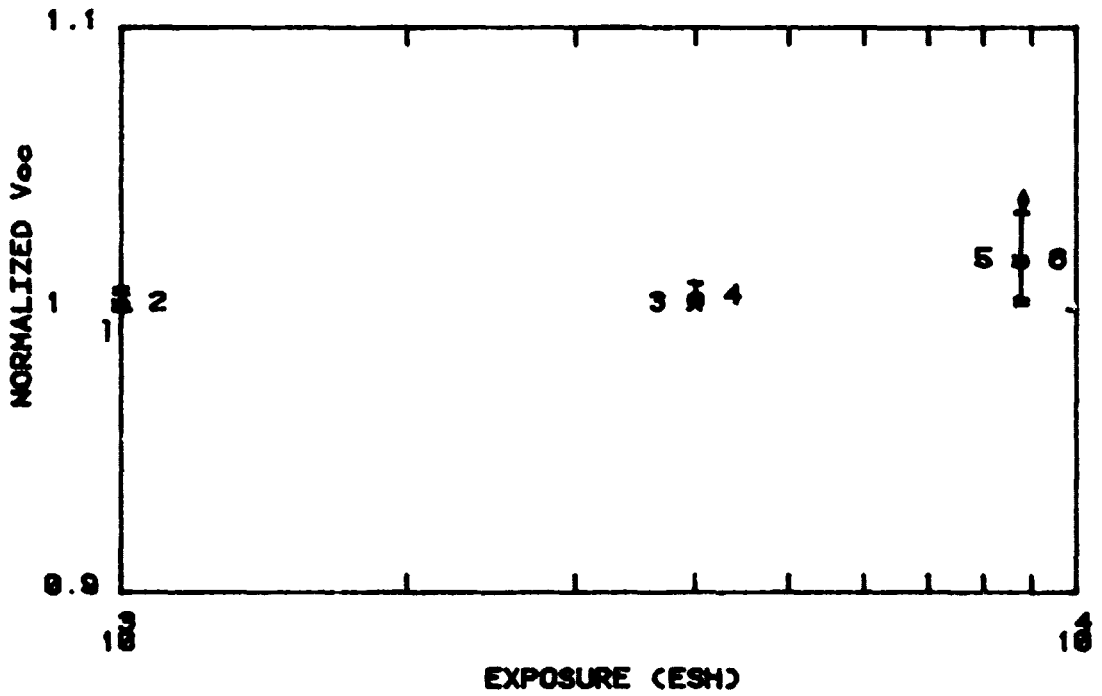

FIGURE 44. CONTROL CELLS UV IRRADIATION IN SITU

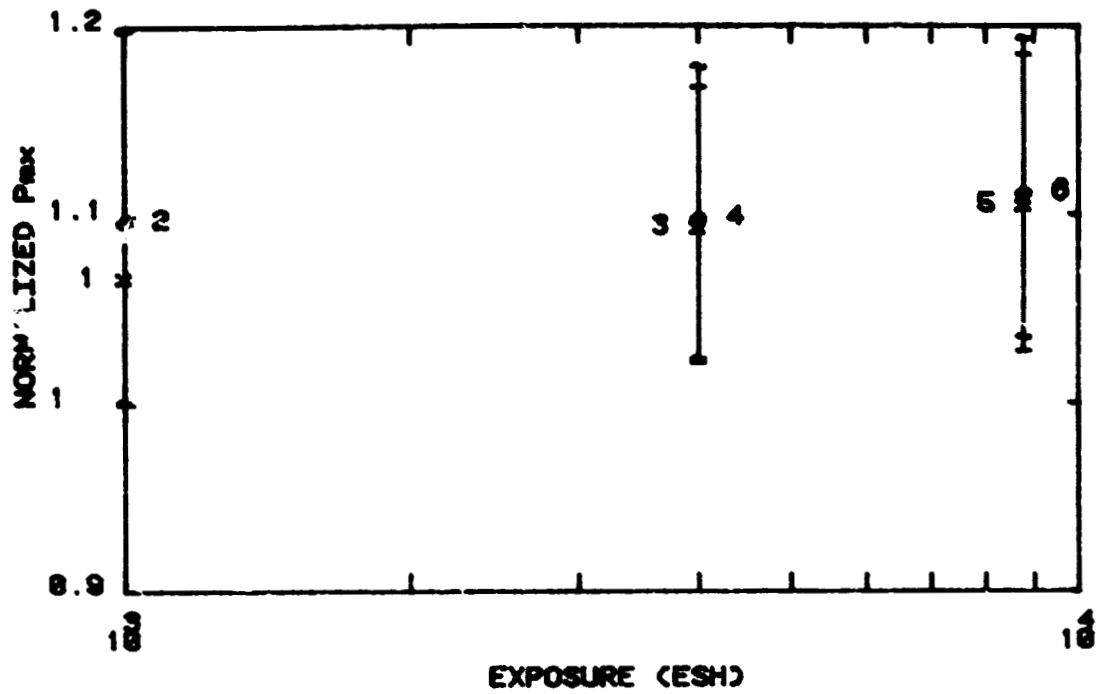

FIGURE 45. CONTROL CELLS UV IRRADIATION IN SITU

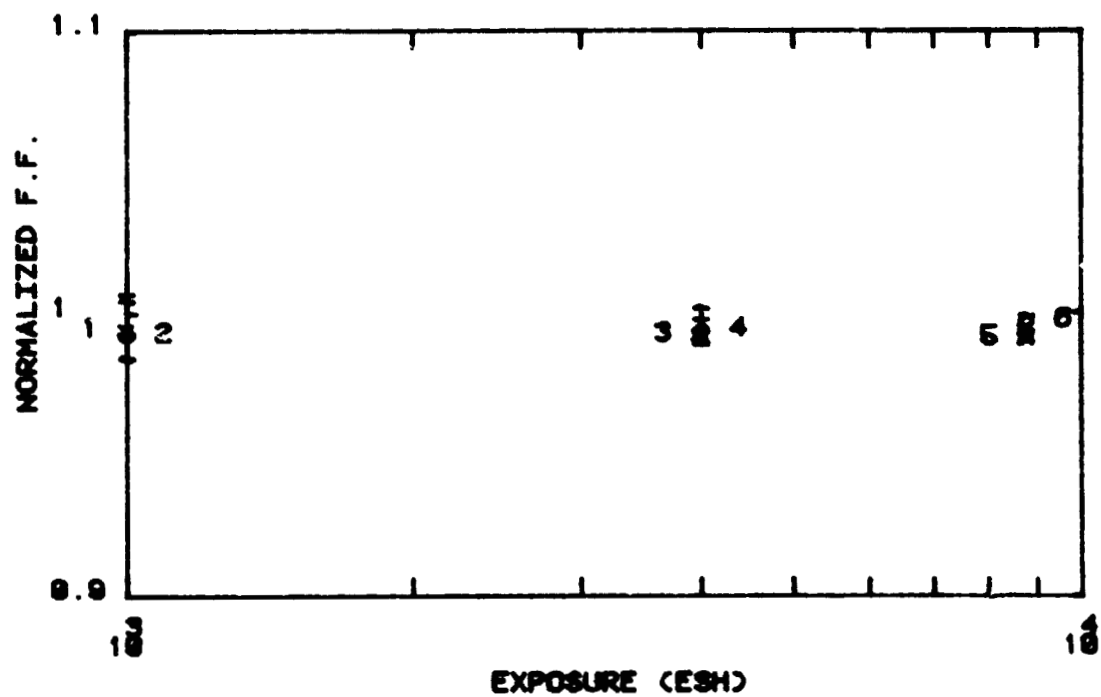

FIGURE 46. CONTROL CELLS UV IRRADIATION IN SITU

TABLE 16A. TABULATED CONTROL CELLS DATA - UV IRRADIATION

CONTROL CELLS UV IRRADIATION EX-SITU
TEMP. (C): 25 AREA: 4 INTENSITY 1*AM0

Level Number	AVERAGE Isc/Isc0	AVERAGE Voc/Voc0	AVERAGE Pmx/Pmx0	AVERAGE F. F. /F. F. 0
0	1.000	1.000	1.000	1.000
1	1.042	1.043	0.981	0.887

CONTROL CELLS UV IRRADIATION IN SITU
TEMP. (C): 25 AREA: 4 INTENSITY 1*AM0

Level Number	AVERAGE Isc/Isc0	AVERAGE Voc/Voc0	AVERAGE Pmx/Pmx0	AVERAGE F. F. /F. F. 0
0	1.000	1.000	1.000	1.000
1	1.069	1.003	1.068	0.996
2	1.101	1.003	1.098	0.994
3	1.099	1.003	1.095	0.993
4	1.100	1.005	1.100	0.995
5	1.095	1.018	1.106	0.992
6	1.095	1.018	1.113	0.998

CONTROL CELLS UV IRRADIATION EX-SITU
TEMP. (C): 25 AREA: 4 INTENSITY 1*AM0

Serial Number	Level Number	Isc (mA)	Isc/Isc0	Voc (mV)	Voc/Voc0	Pmx (mW)	Pmx/Pmx0	Fill Fac.	F. F. /F. F. 0
101	0	95.5	1.000	546.6	1.000	39.39	1.000	0.754	1.000
102	0	95.2	1.000	545.4	1.000	37.33	1.000	0.719	1.000
103	0	95.8	1.000	559.5	1.000	40.43	1.000	0.754	1.000
104	0	0.0	0.000	0.0	0.000	0.00	0.000	0.000	0.000
101	1	87.4	0.915	567.8	1.039	28.86	0.733	0.582	0.771
102	1	111.2	1.168	571.7	1.048	45.86	1.229	0.722	1.004
103*	1	41.4	0.432	560.2	1.001	14.26	0.353	0.615	0.815
104	1	97.4	0.000	557.5	0.000	40.75	0.000	0.751	0.000

*NOT INCLUDED IN AVERAGE

TABLE 168. TABULATED CONTROL CELLS DATA - UV IRRADIATION

CONTROL CELLS UV IRRADIATION IN SITU
 TEMP. (C): 25 AREA: 4 INTENSITY 1*AM0

Serial Number	Level Number	Isc (mA)	Isc/ Isco	Voc (mV)	Voc/ Voc0	Pmx (mW)	Pmx/ Pmx0	Fill Fac.	F. F. / F. F. 0
101	0	94.8	1.000	553.4	1.000	39.70	1.000	0.757	1.000
102	0	94.9	1.000	551.8	1.000	37.81	1.000	0.722	1.000
103	0	95.1	1.000	560.0	1.000	40.01	1.000	0.751	1.000
104	0	92.6	1.000	557.6	1.000	39.10	1.000	0.757	1.000
101	1	101.3	1.068	554.4	1.002	42.18	1.063	0.751	0.991
102	1	112.0	1.180	556.3	1.008	45.31	1.198	0.727	1.007
103	1	96.0	1.010	560.6	1.001	40.27	1.007	0.748	0.996
104	1	94.2	1.016	557.4	1.000	39.10	1.000	0.745	0.984
101	2	101.4	1.069	548.6	0.991	36.06	0.908	0.649	0.857
102	2	112.6	1.187	554.7	1.005	45.28	1.197	0.725	1.004
103*	2	62.5	0.657	562.4	1.004	26.74	0.668	0.761	1.012
104	2	94.1	1.015	558.0	1.001	39.07	0.999	0.744	0.983
101	3	121.6	1.282	555.0	1.003	42.19	1.063	0.625	0.827
102	3	110.7	1.166	553.9	1.004	44.16	1.168	0.721	0.998
103*	3	38.0	0.400	560.2	1.000	13.03	0.326	0.612	0.815
104	3	95.5	1.031	558.8	1.002	39.96	1.022	0.748	0.989
101	4	122.8	1.295	555.0	1.003	38.79	0.977	0.569	0.752
102	4	112.0	1.180	556.6	1.009	44.51	1.177	0.714	0.989
103*	4	37.6	0.395	561.5	1.003	13.06	0.326	0.619	0.824
104	4	94.4	1.019	558.8	1.002	39.98	1.023	0.758	1.001
101	5	108.5	1.144	566.0	1.023	33.47	0.843	0.545	0.720
102	5	109.8	1.157	571.0	1.035	44.82	1.185	0.715	0.990
103*	5	37.9	0.399	561.2	1.002	13.26	0.332	0.623	0.829
104	5	95.6	1.032	558.5	1.002	40.18	1.028	0.752	0.994
101	6	86.8	0.915	566.1	1.023	28.75	0.724	0.585	0.774
102	6	109.7	1.156	570.1	1.033	45.08	1.192	0.721	0.998
103*	6	41.1	0.432	561.1	1.002	14.06	0.352	0.610	0.812
104	6	95.7	1.033	559.2	1.003	40.43	1.034	0.755	0.998

*NOT INCLUDED IN AVERAGE

6.3 MONITOR CELLS

The monitor cells were used to adjust the AMO intensity inside the test chambers. Two cells were mounted on a moveable shaft so that they could be moved out of the radiation beam. They were used before each measurement to set the X-25L AMO intensity. Figures 47, 48 and 49 are plots of the I_{sc} versus fluence for the electron, proton and UV tests. They show that the repeatability of the intensity was very good.

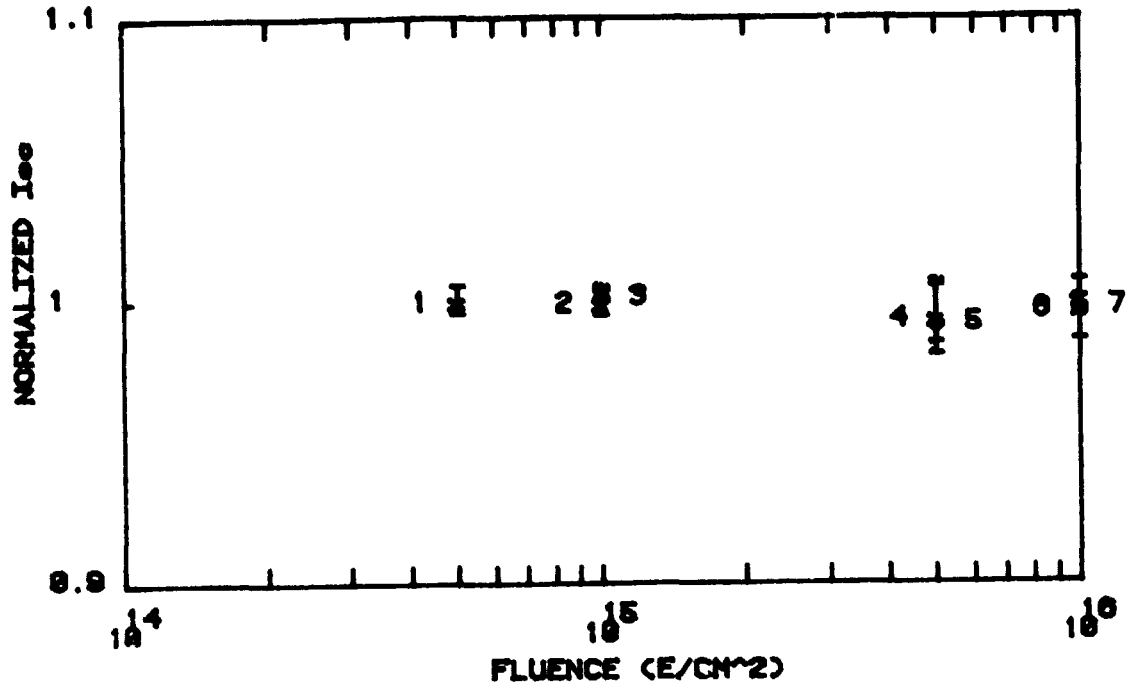

FIGURE 47. MONITOR CELLS ELECTRON IRRADIATION IN-SITU

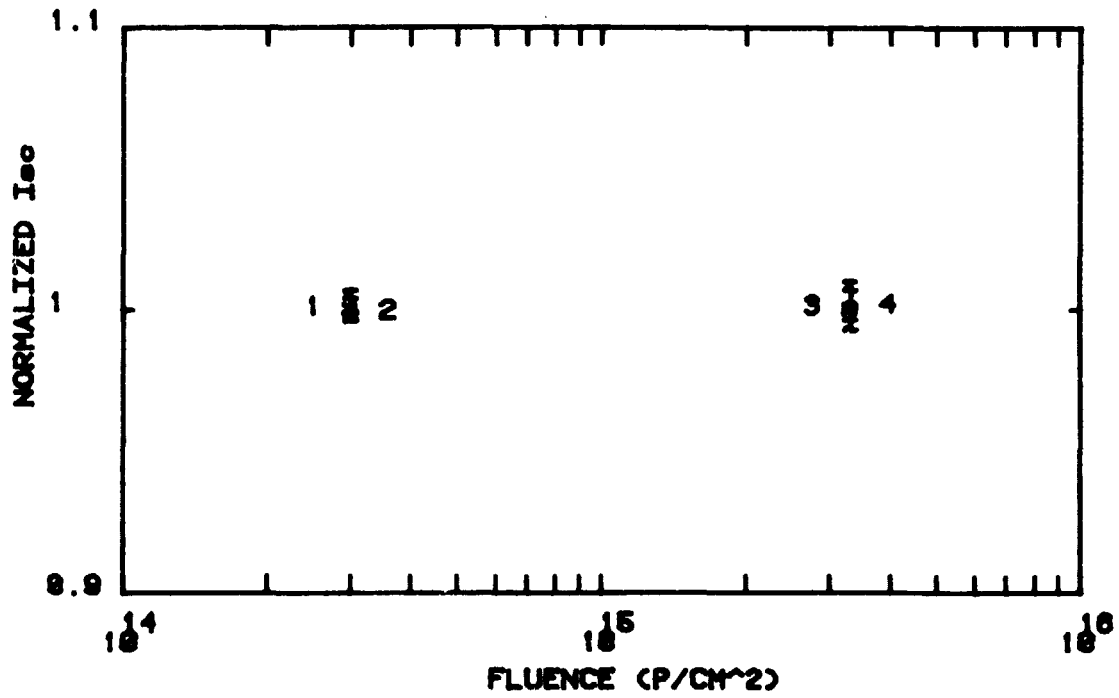

FIGURE 48. MONITOR CELLS PROTON IRRADIATION IN-SITU

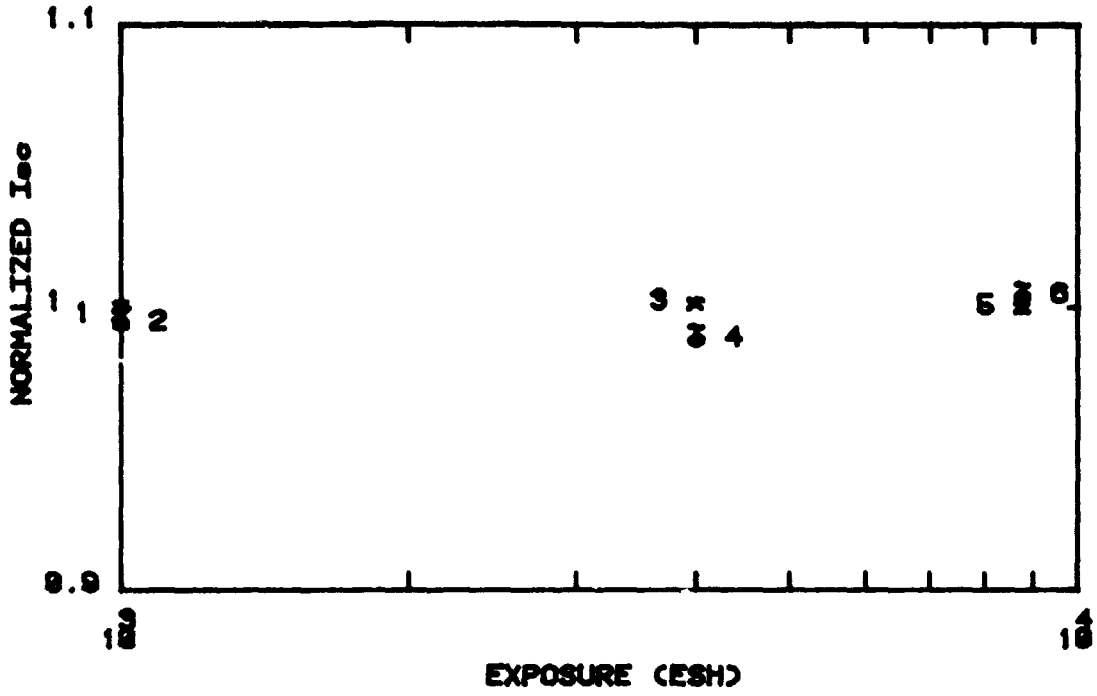

FIGURE 49. MONITOR CELLS UV IRRADIATION IN-SITU

6.4 A SERIES CELLS

(OCLI 8-mil 10 Ω -cm BSF/R cell, 4-mil 0211 ceria doped cover, 0.5 mil 93-500 adhesive.)

6.4.1 Electron Irradiation

The electrical parameters are plotted in Figures 50, 51, 52 and 53. For comparison, the JPL Handbook values are also plotted for an 8-mil 10 Ω -cm BSF cell without cover. Figure 50 shows, relative to the bare cell, that the encapsulated cell had 3-4% greater loss in I_{sc} at 5×10^{14} and 1×10^{15} and 5% to 6% greater loss in I_{sc} at 5×10^{15} and 1×10^{16} e/cm². The V_{oc} data agrees with the handbook data for bare cells. The additional loss in I_{sc} can be explained by the darkening of the 0211 micro sheet. Figure 54 shows the I_{sc}/I_{sc0} versus fluence for 0211 microsheet and shows the loss at 1×10^{15} e/cm² is 4% and the loss at 1×10^{16} e/cm² is 5%. Thus, the method of additive cover and cell degradation is demonstrated in this sample whose response has been well established. Tables 17A and 17B contain the tabulated data. Figure 55 is a typical pre- and post-ex situ I-V curve. The temperature during the irradiation ranged from 52°C to 56°C. Visually there was some cracking of the covers during thermal cycling and an indication that two covers were starting to debond by the end of the test.

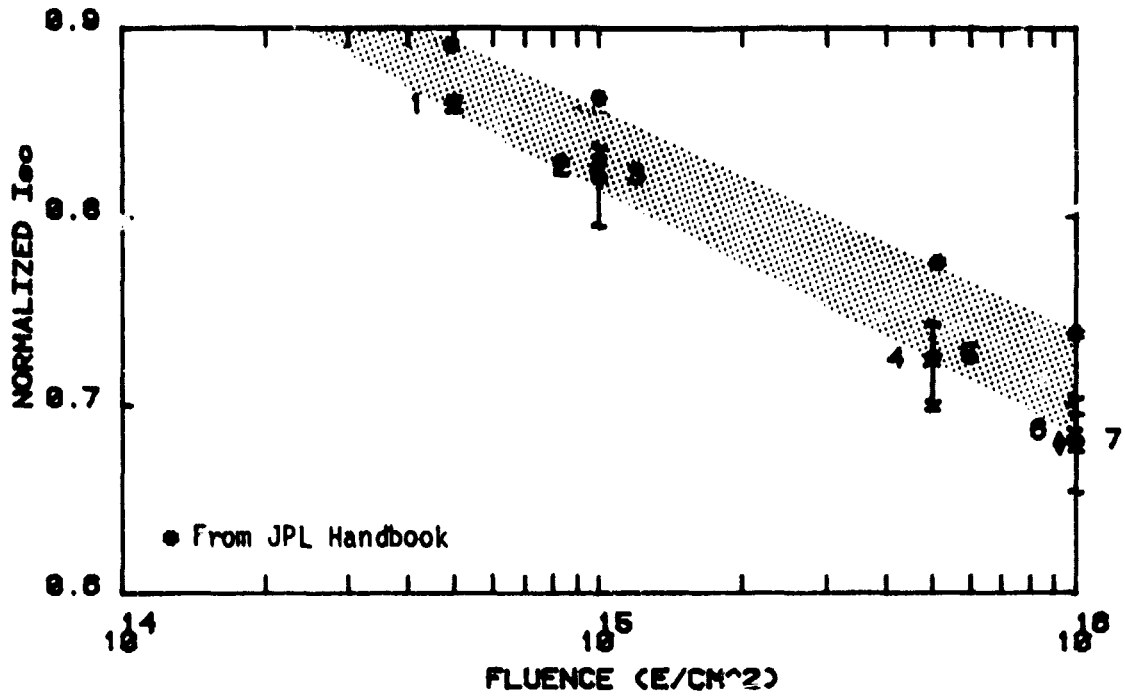

FIGURE 50. A SERIES ELECTRON IRRADIATION IN-SITU

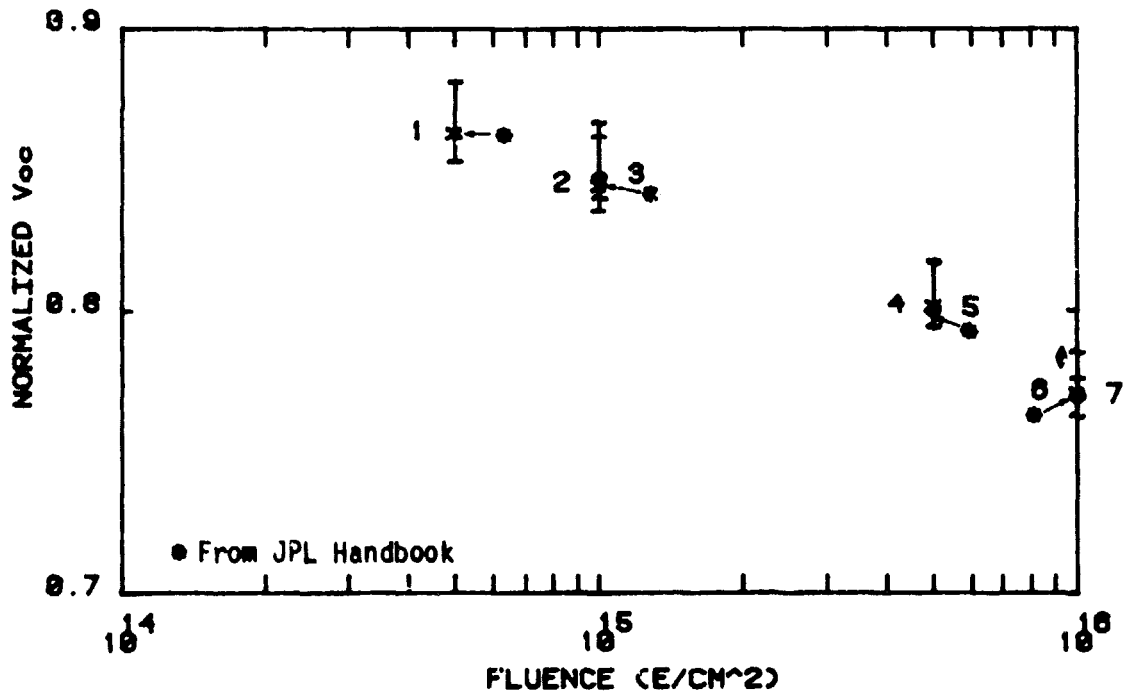

FIGURE 51. A SERIES ELECTRON IRRADIATION IN-SITU

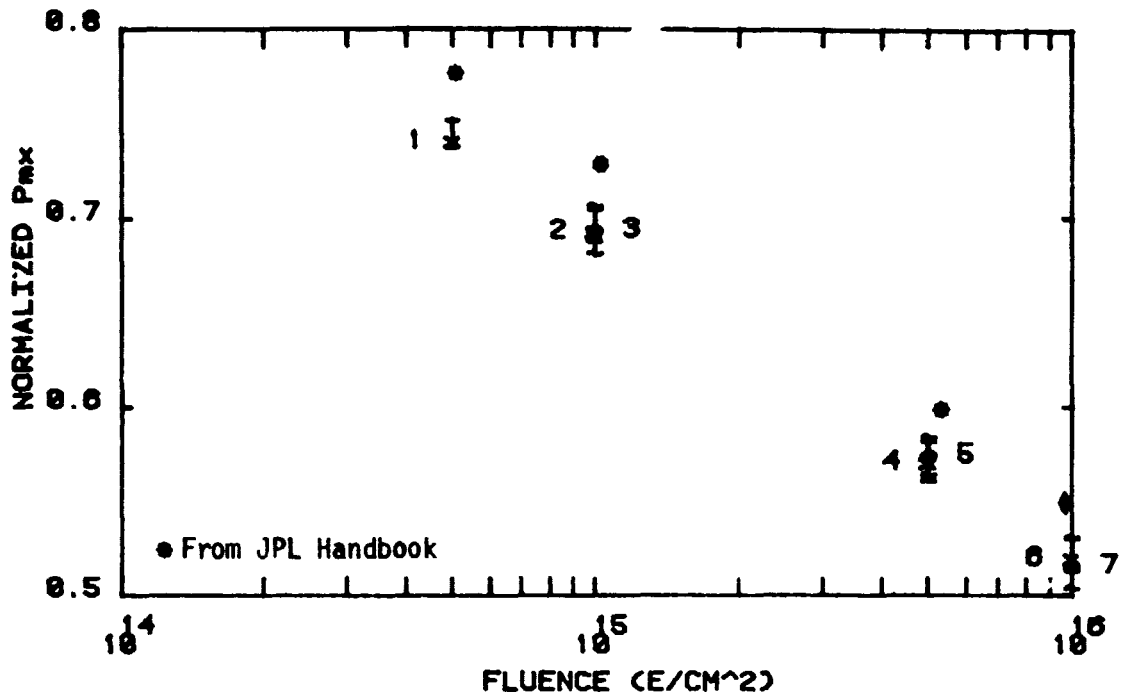

FIGURE 52. A SERIES ELECTRON IRRADIATION IN-SITU

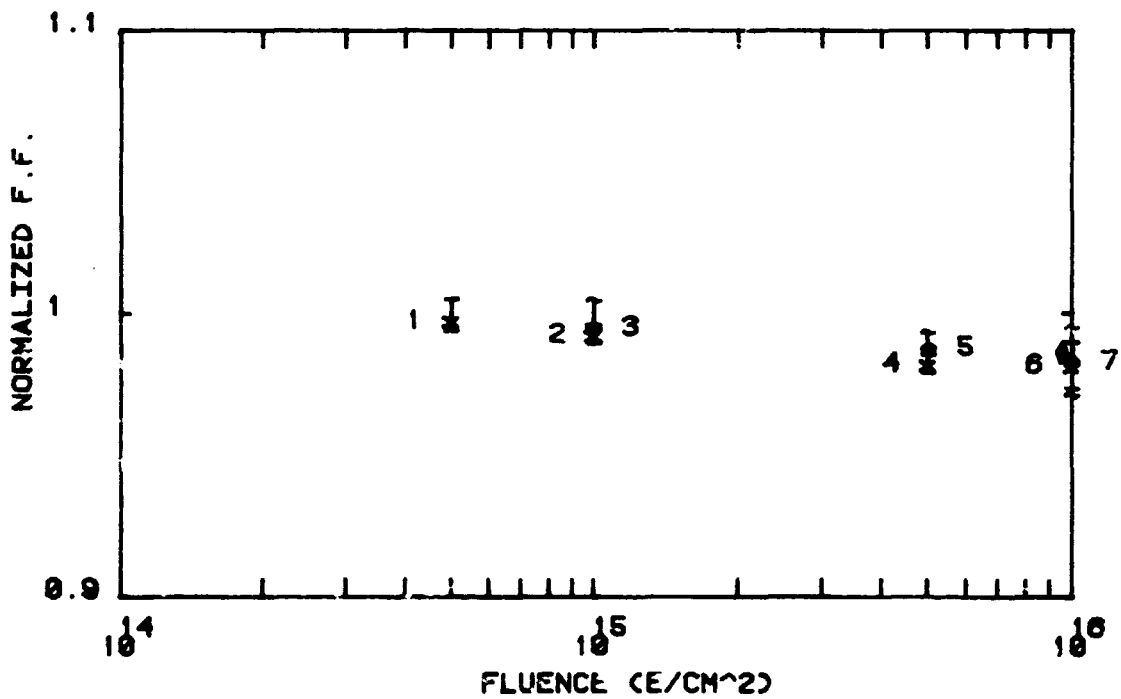

FIGURE 53. A SERIES ELECTRON IRRADIATION IN-SITU

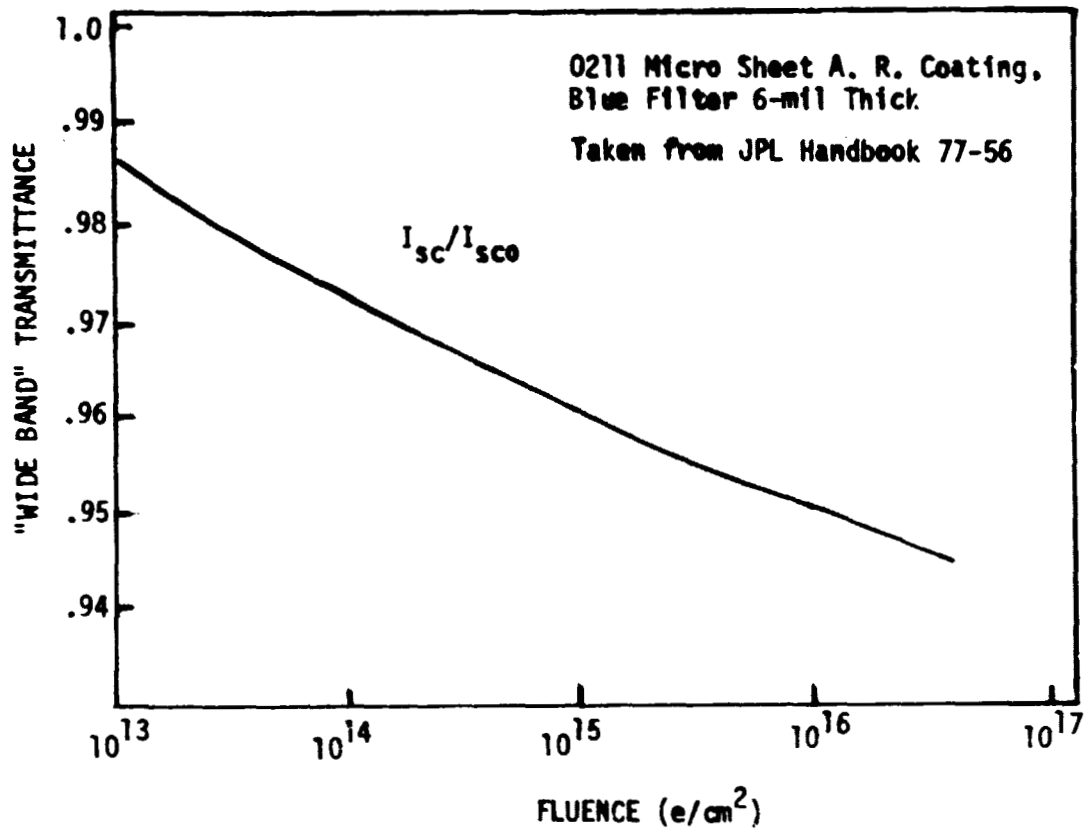

Figure 54. O211 Micro Sheet Transmittance Versus 1 MeV Electron Fluence

TABLE 17A. TABULATED A SERIES DATA - ELECTRON IRRADIATION

A SERIES ELECTRON IRRADIATION EX-SITU
 TEMP. (C): 25 AREA: 4. INTENSITY 1*AM0

Level Number	AVERAGE Isc/Isc0	AVERAGE Voc/Voc0	AVERAGE Pmx/Pmx0	AVERAGE F. F. /F. F. 0
0	1.000	1.000	1.000	1.000
1	0.702	0.778	0.530	0.969

A SERIES ELECTRON IRRADIATION IN-SITU
 TEMP. (C): 25 AREA: 4. INTENSITY 1*AM0

Level Number	AVERAGE Isc/Isc0	AVERAGE Voc/Voc0	AVERAGE Pmx/Pmx0	AVERAGE F. F. /F. F. 0
0	1.000	1.000	1.000	1.000
1	0.860	0.864	0.742	0.998
2	0.827	0.846	0.694	0.993
3	0.823	0.849	0.695	0.996
4	0.725	0.803	0.572	0.983
5	0.727	0.801	0.576	0.989
6	0.687	0.772	0.521	0.982
7	0.683	0.771	0.518	0.984

A SERIES ELECTRON IRRADIATION EX-SITU
 TEMP. (C): 25 AREA: 4 INTENSITY 1*AM0

Serial Number	Level Number	Isc (mA)	Isc/Isc0	Voc (mV)	Voc/Voc0	Pmx (mW)	Pmx/Pmx0	Fill Fac.	F. F. /F. F. 0
301	0	153.6	1.000	586.2	1.000	70.01	1.000	0.778	1.000
302	0	152.9	1.000	598.8	1.000	70.63	1.000	0.772	1.000
303	0	154.3	1.000	603.3	1.000	71.81	1.000	0.772	1.000
304	0	154.9	1.000	605.3	1.000	71.93	1.000	0.767	1.000
305	0	154.6	1.000	599.4	1.000	70.38	1.000	0.759	1.000
301	1	110.1	0.717	466.0	0.795	37.87	0.541	0.738	0.950
302	1	107.7	0.705	464.4	0.776	37.54	0.531	0.750	0.972
303	1	106.2	0.688	466.0	0.772	37.26	0.519	0.753	0.976
304	1	108.8	0.702	466.4	0.771	37.65	0.523	0.742	0.967
305	1	107.9	0.698	465.9	0.777	37.51	0.533	0.746	0.983

TABLE 17B. TABULATED A SERIES DATA - ELECTRON IRRADIATION

A SERIES ELECTRON IRRADIATION IN-SITU
 TEMP. (C): 25 AREA: 4 INTENSITY 1*AM0

Serial Number	Level Number	Isc (mA)	Isc/ Isco	Voc (mV)	Voc/ Voc0	Pmx (mW)	Pmx/ Pmx0	Fill Fac.	F. F. / F. F. 0
301	0	129.5	1.000	591.6	1.000	59.30	1.000	0.774	1.000
302	0	128.9	1.000	601.3	1.000	59.76	1.000	0.771	1.000
303	0	128.0	1.000	606.2	1.000	59.92	1.000	0.772	1.000
304	0	128.6	1.000	610.5	1.000	59.68	1.000	0.760	1.000
305	0	129.9	1.000	604.7	1.000	59.48	1.000	0.757	1.000
301	1	111.2	0.859	521.5	0.882	44.40	0.749	0.765	0.989
302	1	110.4	0.856	520.3	0.865	44.18	0.739	0.769	0.998
303	1	110.6	0.864	520.9	0.859	44.19	0.738	0.767	0.994
304	1	111.1	0.864	520.9	0.853	44.13	0.739	0.763	1.003
305	1	111.5	0.858	521.5	0.862	44.11	0.742	0.759	1.002
301	2	107.1	0.827	510.2	0.862	41.63	0.702	0.762	0.985
302	2	105.7	0.820	508.7	0.846	41.14	0.688	0.766	0.993
303	2	106.6	0.833	509.7	0.841	41.04	0.698	0.770	0.998
304	2	106.4	0.828	510.2	0.836	41.05	0.688	0.756	0.994
305	2	107.6	0.828	510.3	0.844	41.34	0.695	0.753	0.994
301	3	102.9	0.794	512.3	0.866	40.15	0.677	0.762	0.984
302	3	106.3	0.824	509.9	0.848	41.75	0.698	0.770	0.999
303	3	107.1	0.836	511.2	0.843	41.91	0.700	0.766	0.992
304	3	106.8	0.830	512.3	0.877	41.24	0.691	0.754	0.992
305	3	107.8	0.830	512.3	0.847	42.05	0.707	0.762	1.006
301	4	90.4	0.698	483.9	0.818	33.11	0.558	0.757	0.978
302	4	93.5	0.725	483.3	0.804	34.29	0.574	0.759	0.984
303	4	93.1	0.727	483.2	0.797	34.01	0.568	0.756	0.979
304	4	95.6	0.744	484.8	0.794	34.69	0.581	0.746	0.984
305	4	95.2	0.733	484.2	0.801	34.33	0.577	0.744	0.983
301	5	90.7	0.701	482.8	0.816	33.22	0.560	0.758	0.980
302	5	93.7	0.727	483.1	0.803	34.66	0.580	0.766	0.993
303	5	94.0	0.734	482.6	0.796	34.56	0.577	0.762	0.988
304	5	95.4	0.742	484.3	0.793	35.15	0.589	0.761	1.001
305	5	95.3	0.734	482.2	0.797	34.43	0.579	0.749	0.989
301	6	84.1	0.649	466.5	0.788	29.47	0.497	0.751	0.971
302	6	87.1	0.676	466.7	0.776	30.73	0.514	0.756	0.980
303	6	87.7	0.685	466.5	0.770	30.74	0.513	0.752	0.974
304	6	89.4	0.690	470.4	0.771	31.61	0.530	0.752	0.986
305	6	89.9	0.692	466.6	0.772	31.36	0.527	0.747	0.987
301	7	84.5	0.652	464.2	0.785	29.67	0.500	0.756	0.977
302	7	87.4	0.678	464.2	0.772	30.34	0.508	0.748	0.970
303	7	87.9	0.687	464.6	0.766	31.01	0.516	0.759	0.983
304	7	90.4	0.703	465.1	0.762	31.56	0.529	0.751	0.987
305	7	90.0	0.690	465.1	0.769	31.54	0.530	0.754	0.995

S/N : 304	LEVEL : 0	1
TEMP: 25 C	ISC(MA) : 154.9	108.8
AREA: 4 CM^2	VOC(MV) : 605.3	466.4
INT. : 1*AM0	PMAX(MW) : 71.9	37.6
	F.F. : 0.767	0.742

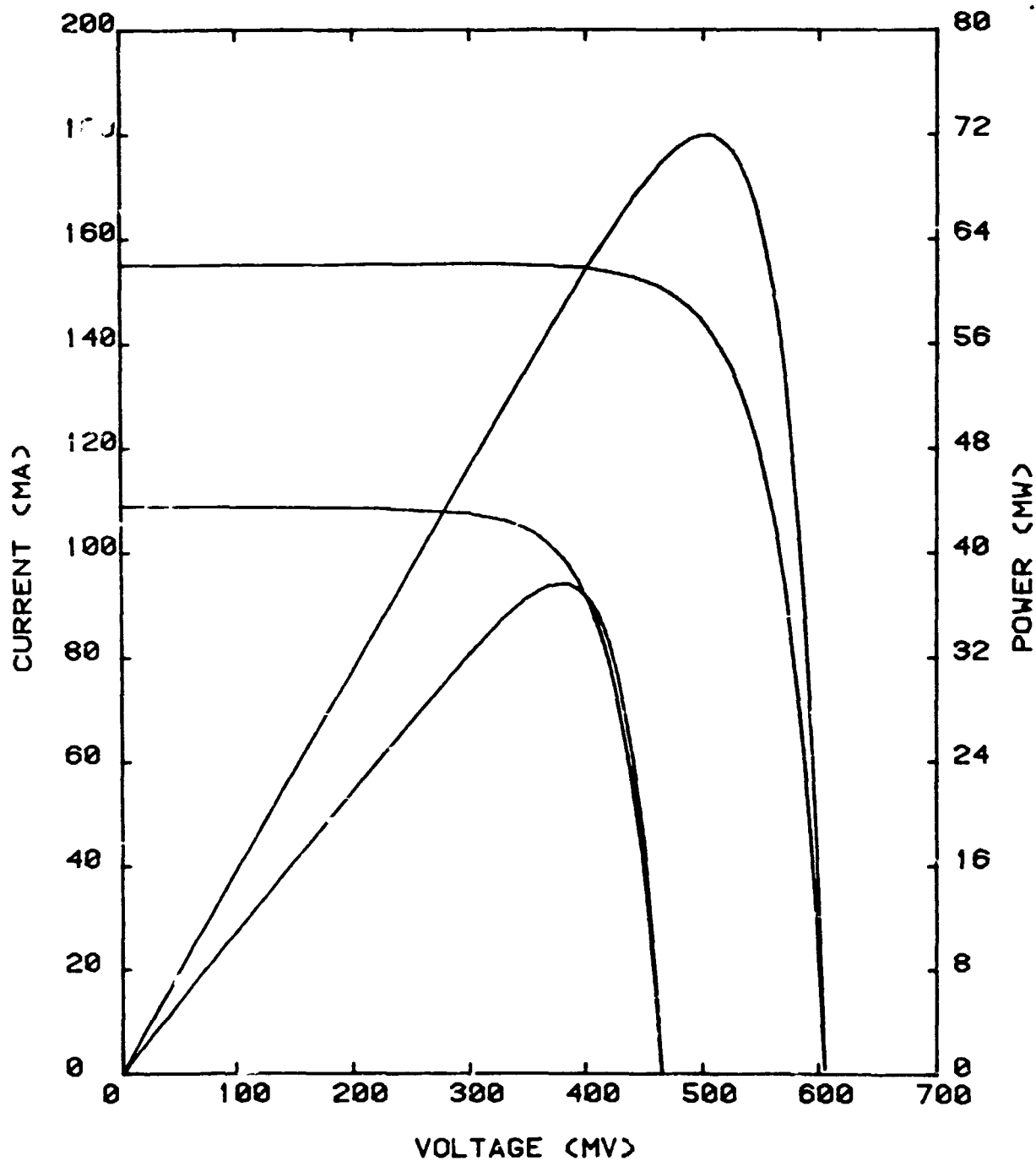

FIGURE 55.

A SERIES ELECTRON IRRADIATION EX-SITU

D180-26590-1

6.4.2 Proton Irradiation

Due to the thick cover (4-mil) the samples did not degrade in the proton-thermal cycling environments (see Figures 56, 57, 58 and 59). Several covers cracked in the last set of thermal cycles probably due to mounting stress. Tables 18A and 18B contain the tabulated data and Figure 60 shows a typical pre- and post-test I-V curve. The temperature during the irradiation ranged from 50°C to 57°C.

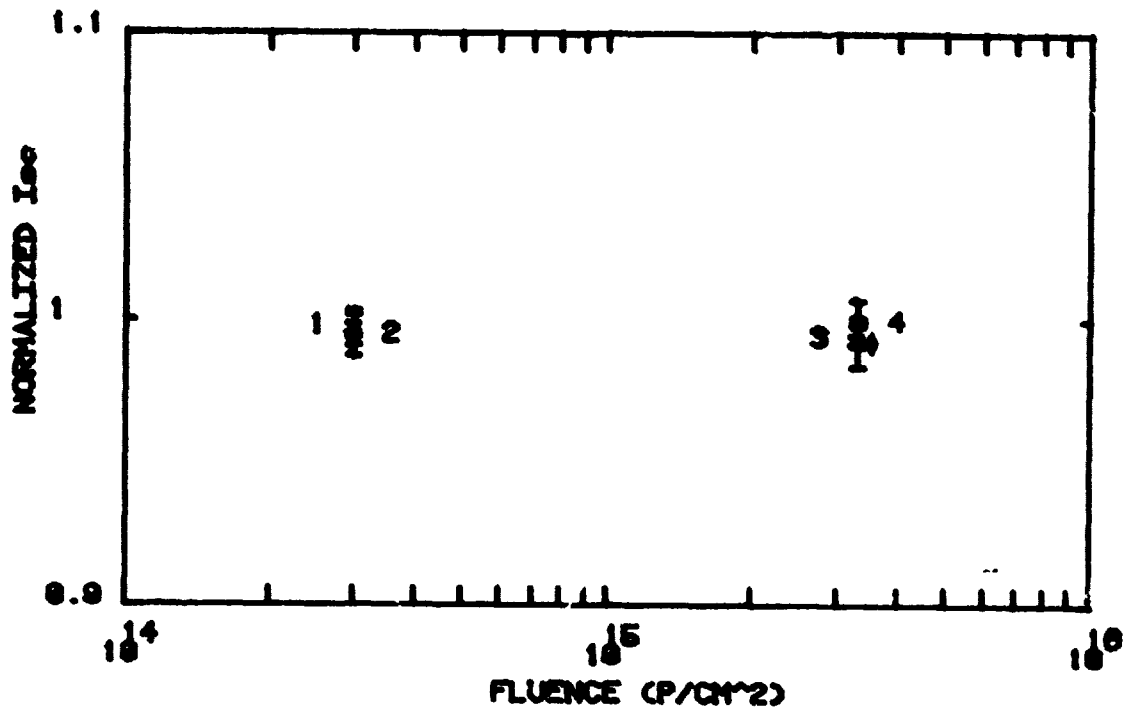

FIGURE 56. A SERIES PROTON IRRADIATION IN-SITU

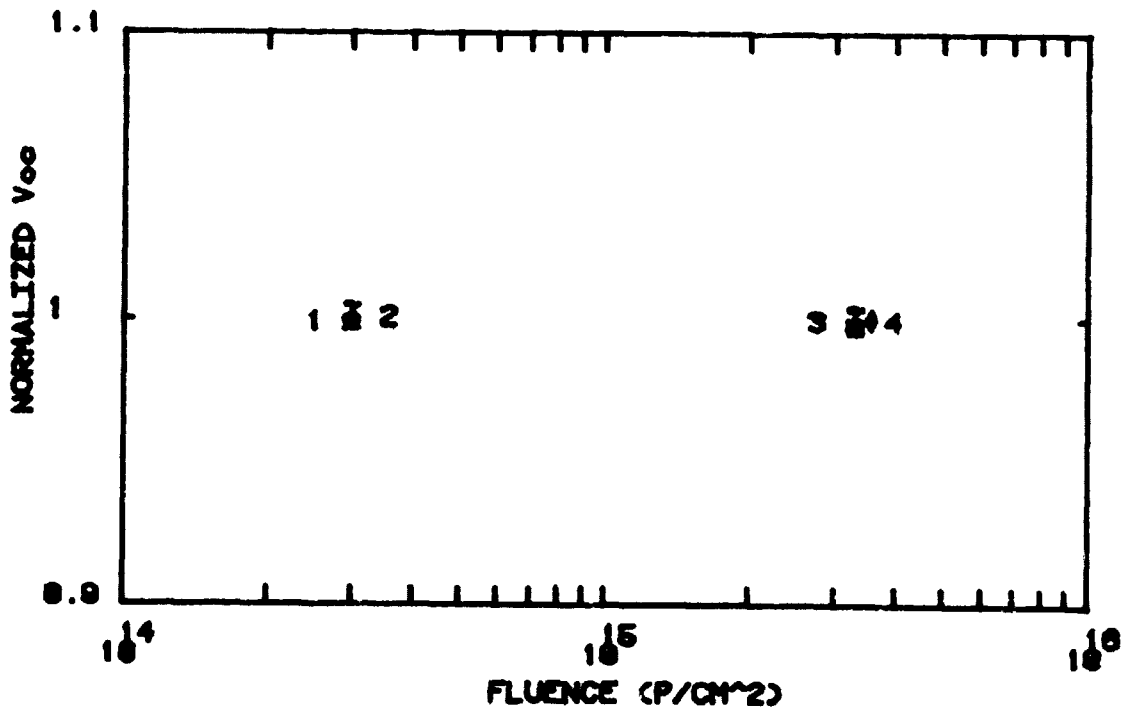

FIGURE 57. A SERIES PROTON IRRADIATION IN-SITU

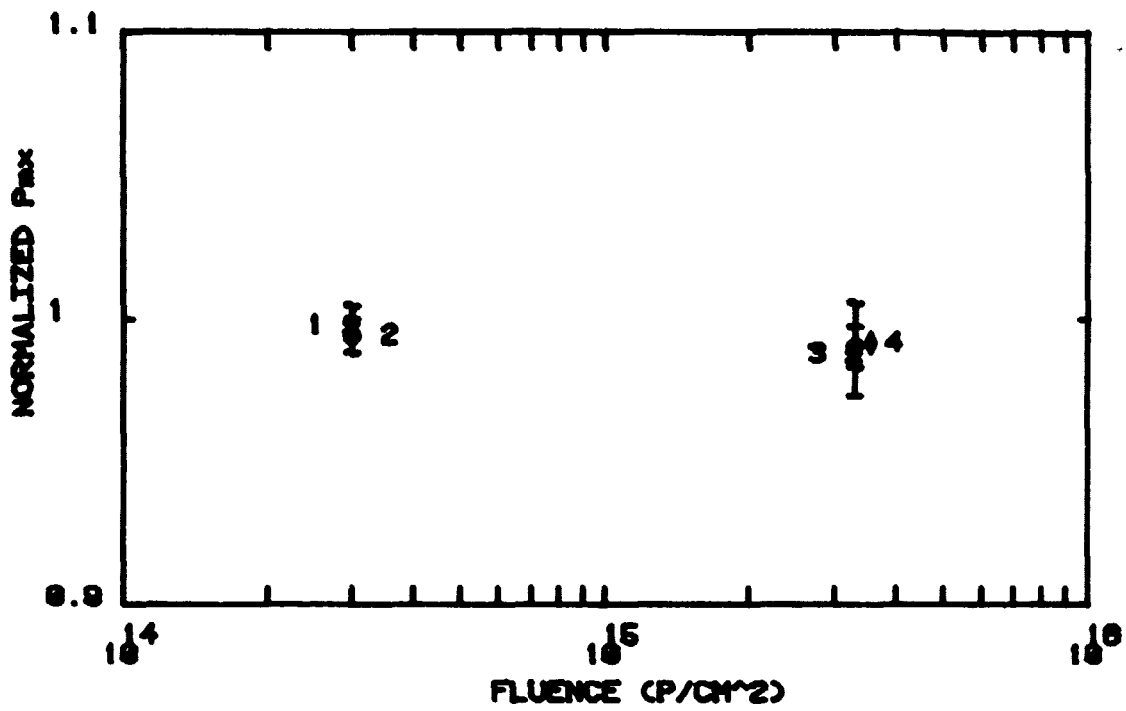

FIGURE 58. A SERIES PROTON IRRADIATION IN-SITU

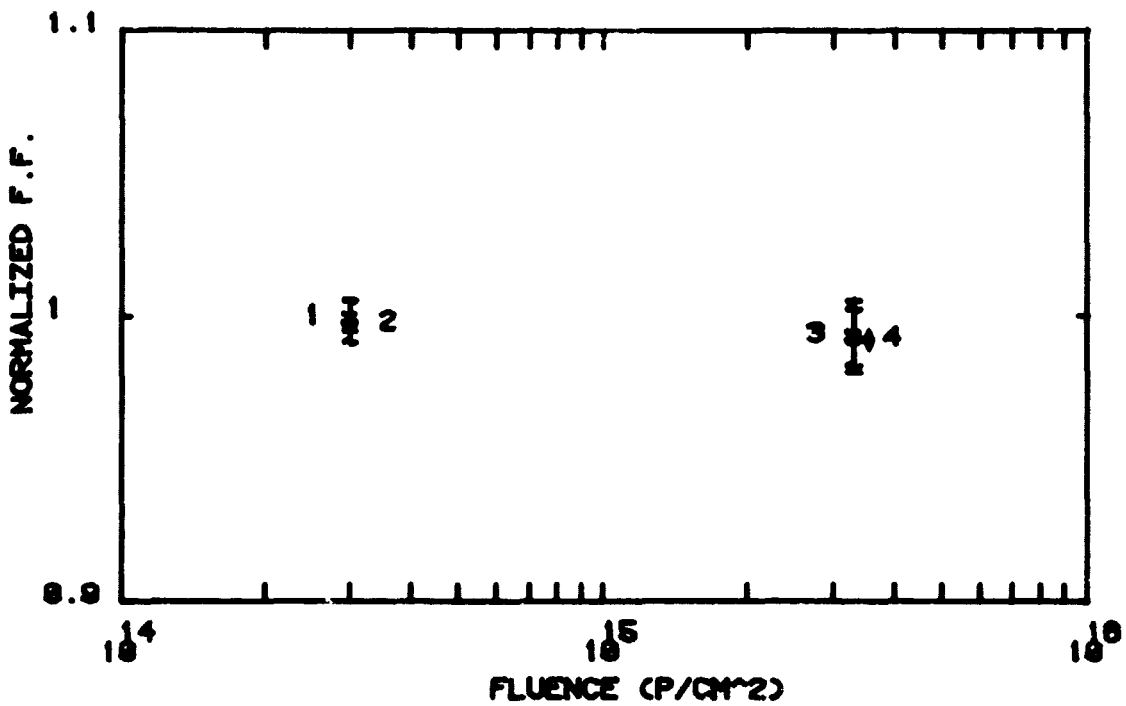

FIGURE 59. A SERIES PROTON IRRADIATION IN-SITU

TABLE 18A. TABULATED A SERIES DATA - PROTON IRRADIATION

A SERIES PROTON IRRADIATION EX-SITU
 TEMP. (C): 25 AREA: 4. INTENSITY 1*AM0

Level Number	AVERAGE Isc/Isc0	AVERAGE Voc/Voc0	AVERAGE Pmx/Pmx0	AVERAGE F. F. /F. F. 0
0	1.000	1.000	1.000	1.000
1	0.996	0.998	0.982	0.987

A SERIES PROTON IRRADIATION IN-SITU
 TEMP. (C): 25 AREA: 4. INTENSITY 1*AM0

Level Number	AVERAGE Isc/Isc0	AVERAGE Voc/Voc0	AVERAGE Pmx/Pmx0	AVERAGE F. F. /F. F. 0
0	1.000	1.000	1.000	1.000
1	0.998	0.999	0.998	1.001
2	0.995	1.001	0.995	0.999
3	0.994	1.000	0.988	0.994
4	1.000	0.999	0.992	0.993

A SERIES PROTON IRRADIATION EX-SITU
 TEMP. (C): 25 AREA: 4 INTENSITY 1*AM0

Serial Number	Level Number	Isc (mA)	Isc/Isc0	Voc (mV)	Voc/Voc0	Pmx (mW)	Pmx/Pmx0	Fill Fac.	F. F. /F. F. 0
306	0	153.5	1.000	589.8	1.000	68.86	1.000	0.761	1.000
307	0	153.9	1.000	605.9	1.000	66.82	1.000	0.717	1.000
308	0	152.1	1.000	583.2	1.000	68.14	1.000	0.768	1.000
309	0	153.0	1.000	589.9	1.000	68.69	1.000	0.761	1.000
310	0	143.0	1.000	563.7	1.000	59.39	1.000	0.737	1.000
306	1	153.8	1.002	589.1	0.999	67.82	0.985	0.748	0.984
307	1	154.0	1.001	602.9	0.995	65.35	0.978	0.704	0.982
308	1	150.7	0.991	585.7	1.004	66.74	0.980	0.756	0.984
309	1	151.6	0.991	586.9	0.995	66.12	0.963	0.743	0.976
310*	1	99.3	0.694	550.8	0.977	32.80	0.552	0.600	0.814

*NOT INCLUDED IN AVERAGE

TABLE 100. TABULATED A SERIES DATA - PROTON IRRADIATION

A SERIES PROTON IRRADIATION IN-SITU
 TEMP. (C): 25 AREA: 4 INTENSITY 1*AM0

Serial Number	Level Number	Isc (mA)	Isc/ Isco	Voc (mV)	Voc/ Voco	Pmx (mW)	Pmx/ Pmxo	Fill Fac.	F. F. / F. F. o
306	0	121.3	1.000	597.8	1.000	55.66	1.000	0.768	1.000
307	0	122.6	1.000	608.1	1.000	52.69	1.000	0.707	1.000
308	0	119.5	1.000	592.0	1.000	53.76	1.000	0.760	1.000
309	0	120.8	1.000	597.7	1.000	55.21	1.000	0.765	1.000
310	0	111.8	1.000	571.3	1.000	48.02	1.000	0.752	1.000
306	1	121.3	1.000	598.0	1.000	55.62	0.999	0.767	0.999
307	1	122.4	0.999	608.6	1.001	52.60	0.998	0.706	0.998
308	1	118.4	0.991	590.6	0.998	53.46	0.994	0.765	1.006
309	1	121.2	1.003	598.0	1.001	55.15	0.999	0.761	0.995
310	1	111.7	0.998	569.5	0.997	48.04	1.000	0.755	1.005
306	2	121.3	1.000	599.1	1.002	55.88	1.004	0.769	1.002
307	2	122.7	1.001	610.6	1.004	52.44	0.995	0.700	0.990
308	2	117.9	0.987	592.2	1.000	53.22	0.990	0.762	1.003
309	2	120.3	0.996	596.5	0.998	54.51	0.987	0.759	0.993
310	2	111.1	0.994	570.8	0.999	47.90	0.997	0.755	1.005
306	3	121.4	1.001	598.4	1.001	55.54	0.998	0.764	0.996
307	3	122.7	1.001	610.5	1.004	52.56	0.997	0.702	0.992
308	3	117.5	0.984	591.4	0.999	52.67	0.980	0.758	0.997
309	3	120.4	0.996	595.5	0.996	53.74	0.973	0.750	0.981
310	3	110.7	0.990	569.9	0.998	47.69	0.993	0.756	1.006
306	4	121.8	1.004	598.4	1.001	55.93	1.005	0.767	0.999
307	4	123.3	1.006	610.1	1.003	52.22	0.991	0.694	0.982
308	4	118.3	0.990	591.4	0.999	53.27	0.991	0.761	1.002
309	4	120.7	0.999	594.4	0.995	54.24	0.982	0.756	0.989
310*	4	112.3	1.004	562.4	0.984	36.28	0.755	0.574	0.764

*NOT INCLUDED IN AVERAGE

S/N : 306	LEVEL : 0	1
TEMP: 25 C	ISCC(MA) : 153.5	153.8
AREA: 4 CM ²	VOC(MV) : 589.8	589.1
INT. : 1=AM0	PMAX(MW) : 68.9	67.8
	F.F. : 0.781	0.748

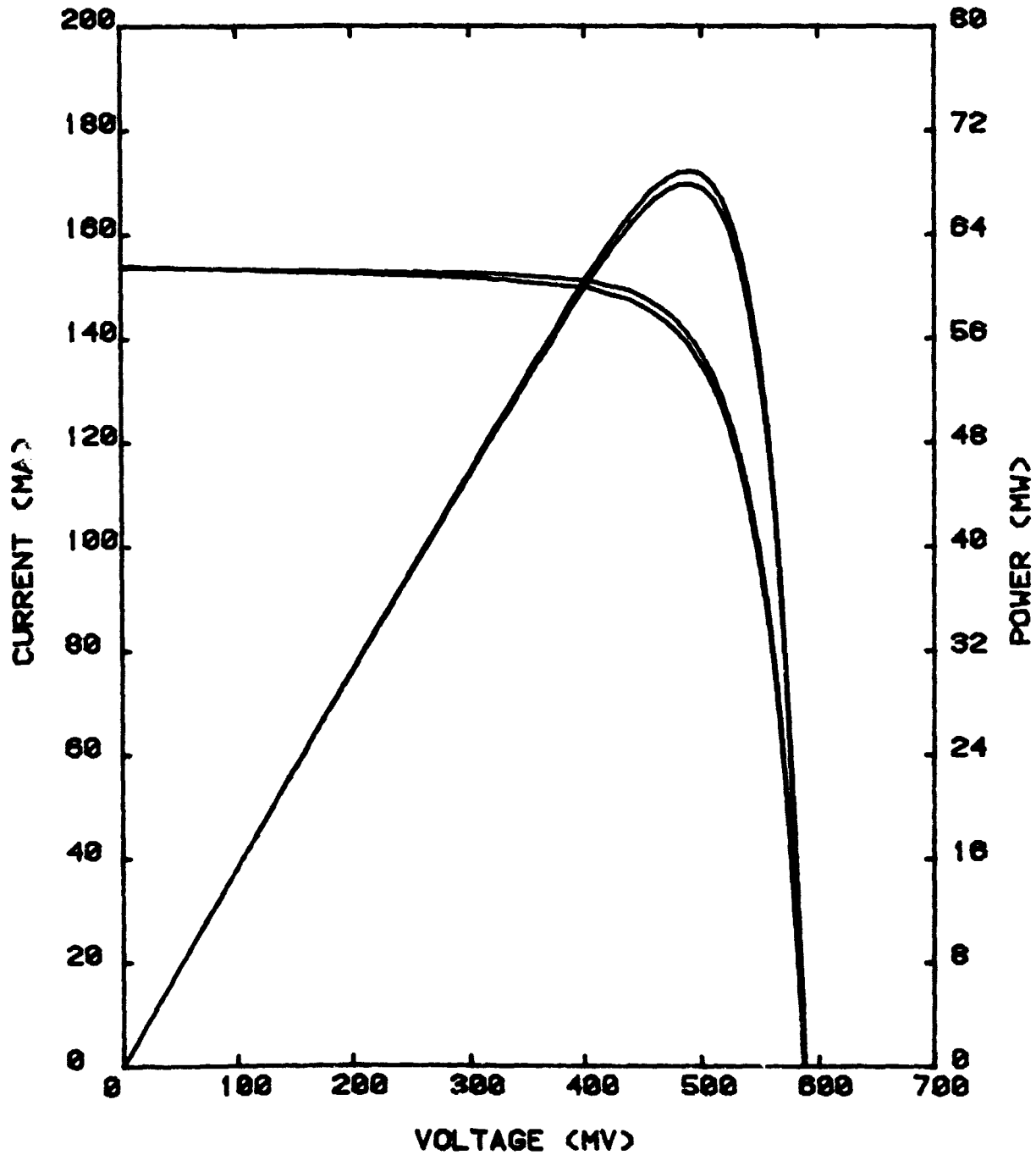

FIGURE 60.

A SERIES PROTON IRRADIATION EX-SITU

6.4.3 UV Exposure

There was a 7% decrease in I_{sc} at the completion of the exposure; however, there was no change in V_{oc} therefore the change in I_{sc} appears to be due to a transmission loss. The samples appeared hazy during the exposure and as mentioned in Section 6.2, there were signs of contamination on the cells. The cause of the 7% loss was therefore one or more of the following: (1) contamination during the UV exposure, (2) darkening of the 0211 microsheet or (3) darkening of the DC 93-500 adhesive. Figures 61, 62, 63 and 64 are plots of the average normalized test parameters. The tabulated data are in Tables 19A and 19B. Figure 65 is a typical pre- and post-test I-V curve. The temperature during exposure ranged from 45°C to 48°C.

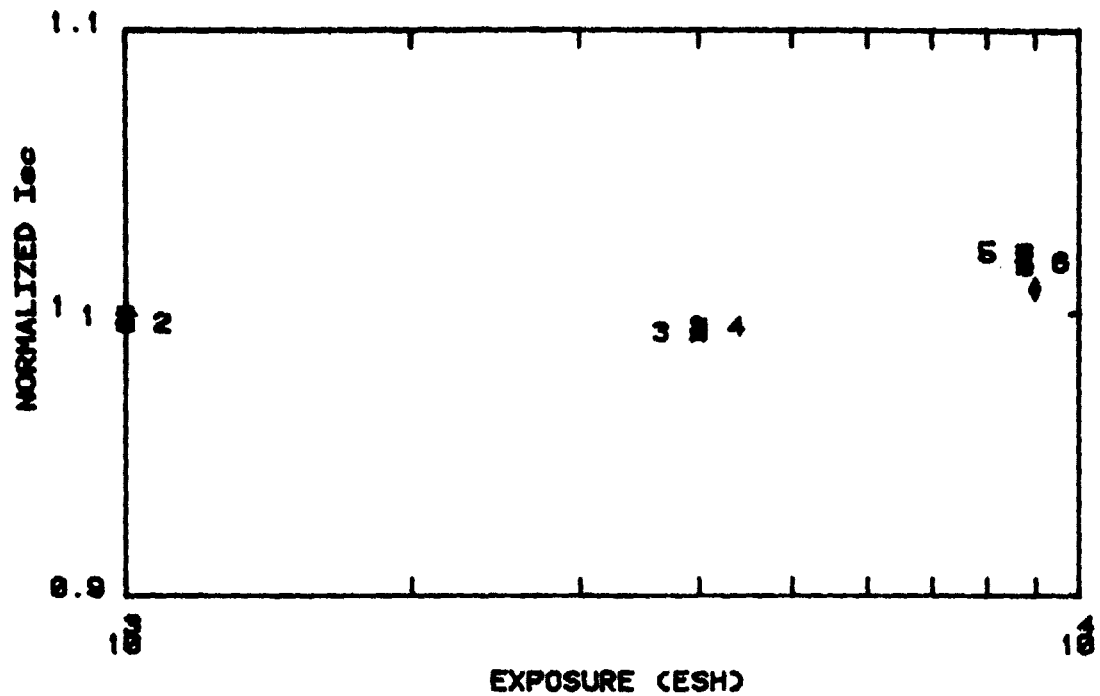

FIGURE 61. A SERIES UV IRRADIATION IN SITU

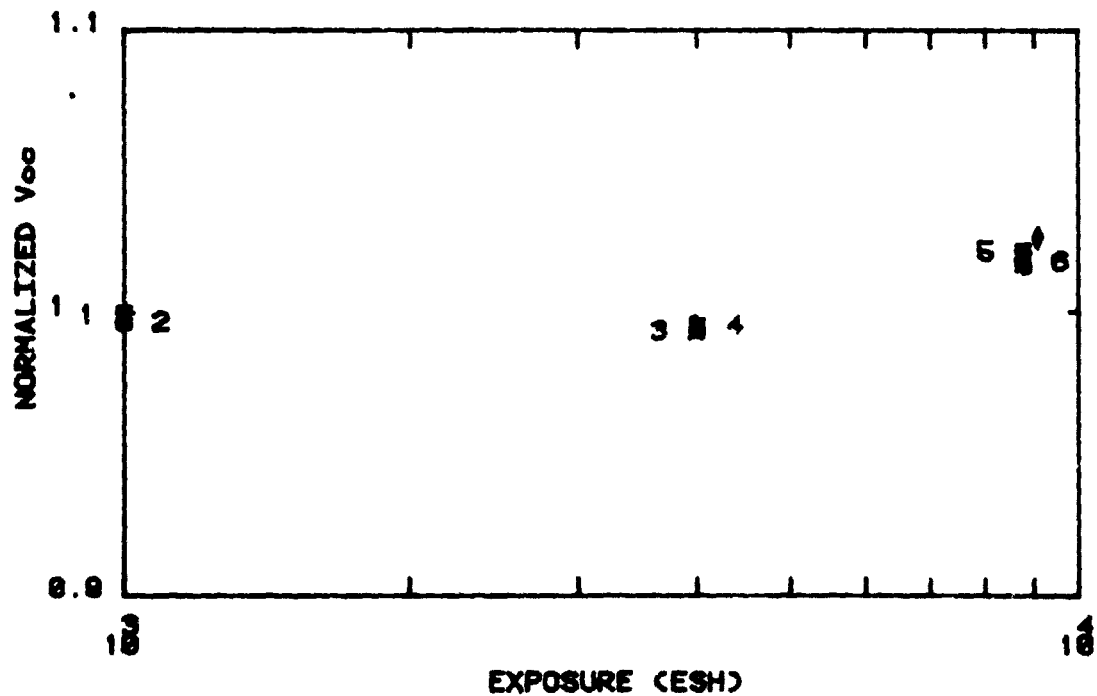

FIGURE 62. A SERIES UV IRRADIATION IN SITU

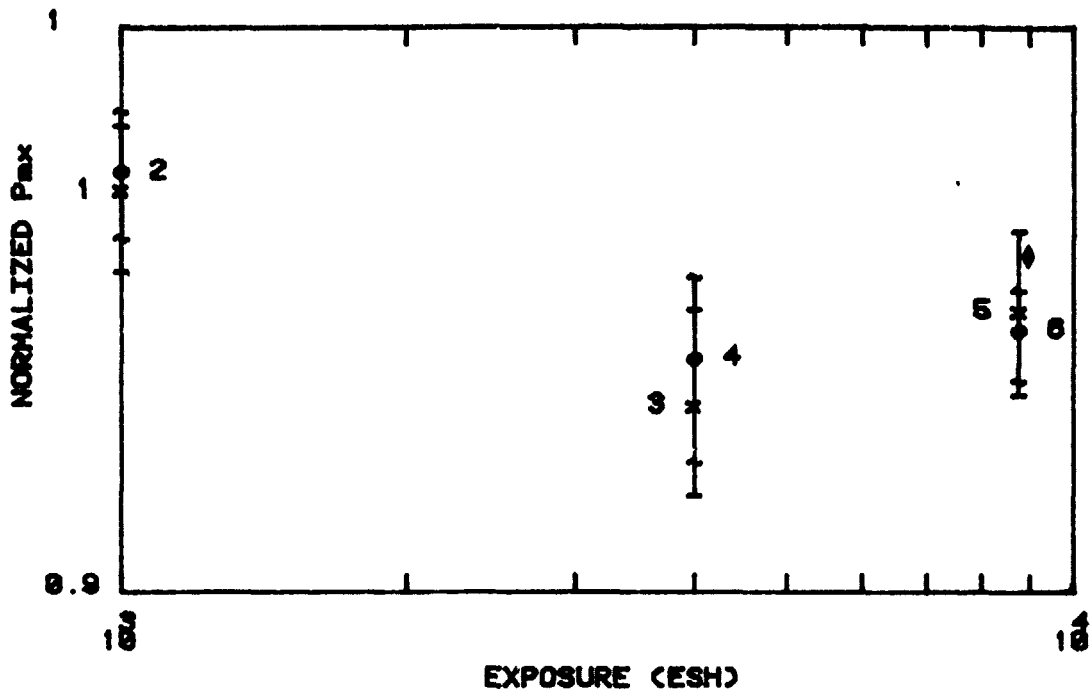

FIGURE 63. A SERIES UV IRRADIATION IN SITU

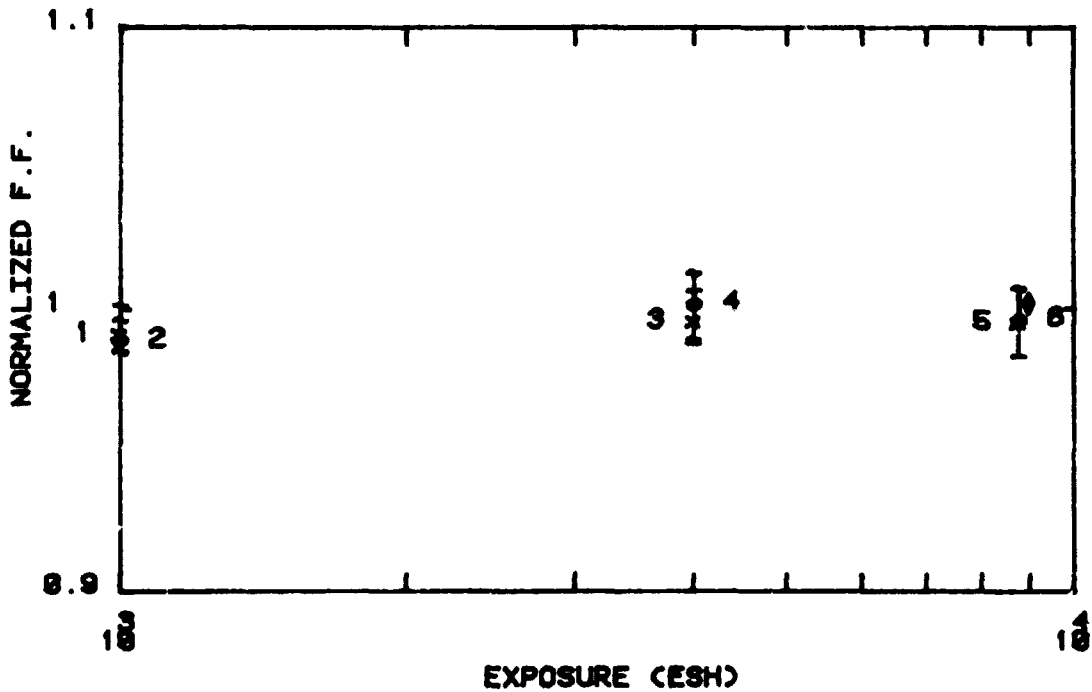

FIGURE 64. A SERIES UV IRRADIATION IN SITU

TABLE 19A. TABULATED A SERIES DATA - UV IRRADIATION

A SERIES UV IRRADIATION EX-SITU
 TEMP. (C): 25 AREA: 4. INTENSITY 1*AM0

Level Number	AVERAGE Isc/Isc0	AVERAGE Voc/Voc0	AVERAGE Pmx/Pmx0	AVERAGE F. F. /F. F. 0
0	1.000	1.000	1.000	1.000
1	0.927	1.032	0.961	1.005

A SERIES UV IRRADIATION IN SITU
 TEMP. (C): 25 AREA: 4. INTENSITY 1*AM0

Level Number	AVERAGE Isc/Isc0	AVERAGE Voc/Voc0	AVERAGE Pmx/Pmx0	AVERAGE F. F. /F. F. 0
0	1.000	1.000	1.000	1.000
1	0.980	1.000	0.972	0.992
2	0.988	0.997	0.975	0.990
3	0.943	0.994	0.934	0.997
4	0.943	0.996	0.942	1.003
5	0.934	1.022	0.950	0.996
6	0.933	1.018	0.947	0.997

A SERIES UV IRRADIATION EX-SITU
 TEMP. (C): 25 AREA: 4 INTENSITY 1*AM0

Serial Number	Level Number	Isc (mA)	Isc/Isc0	Voc (mV)	Voc/Voc0	Pmx (mW)	Pmx/Pmx0	Fill Fac.	F. F. /F. F. 0
311	0	152.2	1.000	580.7	1.000	66.84	1.000	0.756	1.000
312	0	150.9	1.000	572.9	1.000	64.91	1.000	0.751	1.000
313	0	152.6	1.000	580.6	1.000	65.31	1.000	0.737	1.000
314	0	148.0	1.000	577.8	1.000	64.42	1.000	0.753	1.000
315	0	155.7	1.000	580.2	1.000	67.10	1.000	0.743	1.000
311	1	141.9	0.933	599.1	1.032	64.97	0.972	0.764	1.010
312	1	138.6	0.919	594.7	1.038	61.66	0.950	0.748	0.996
313	1	142.4	0.933	596.5	1.027	62.75	0.961	0.738	1.002
314	1	136.2	0.920	596.6	1.032	61.71	0.958	0.760	1.008
315	1	144.4	0.928	599.1	1.032	64.83	0.966	0.749	1.009

C-2

TABLE 198. TABULATED A SERIES DATA - UV IRRADIATION

A SERIES UV IRRADIATION IN SITU
 TEMP. (C): 25 AREA: 4 INTENSITY 1*AM0

Serial Number	Level Number	Isc (mA)	Isc/Isc0	Voc (mV)	Voc/Voc0	Pmx (mW)	Pmx/Pmx0	Fill Fac.	F. F. / F. F. 0
311	0	150.4	1.000	586.9	1.000	67.23	1.000	0.762	1.000
312	0	149.0	1.000	581.3	1.000	64.73	1.000	0.747	1.000
313	0	150.7	1.000	585.9	1.000	65.16	1.000	0.738	1.000
314	0	145.9	1.000	582.4	1.000	64.80	1.000	0.763	1.000
315	0	154.1	1.000	585.6	1.000	67.43	1.000	0.747	1.000
311	1	147.5	0.981	585.8	0.998	65.01	0.967	0.752	0.988
312	1	144.3	0.969	582.6	1.002	62.96	0.973	0.749	1.002
313	1	149.7	0.993	584.7	0.998	64.02	0.983	0.731	0.991
314	1	141.8	0.972	581.9	0.999	62.00	0.957	0.752	0.985
315	1	151.5	0.983	585.8	1.000	66.00	0.979	0.744	0.995
311	2	148.9	0.990	584.5	0.996	65.24	0.970	0.749	0.984
312	2	145.7	0.978	580.1	0.998	62.28	0.962	0.737	0.986
313	2	149.6	0.993	582.4	0.994	63.97	0.982	0.734	0.995
314	2	143.7	0.985	582.0	0.999	63.23	0.976	0.756	0.991
315	2	153.0	0.993	583.9	0.997	66.39	0.985	0.743	0.995
311	3	141.7	0.942	582.7	0.993	62.71	0.933	0.760	0.997
312	3	139.8	0.979	578.0	0.994	59.92	0.926	0.741	0.992
313	3	144.4	0.958	581.1	0.992	61.91	0.950	0.738	1.000
314	3	135.9	0.931	580.4	0.997	59.43	0.917	0.754	0.988
315	3	145.3	0.943	580.9	0.992	63.51	0.942	0.752	1.007
311	4	141.8	0.943	584.3	0.996	63.67	0.947	0.768	1.009
312	4	140.1	0.940	579.6	0.997	60.76	0.939	0.748	1.001
313	4	144.6	0.959	581.1	0.992	62.25	0.955	0.741	1.004
314	4	136.5	0.936	580.7	0.997	59.78	0.923	0.754	0.989
315	4	144.7	0.939	583.3	0.996	63.83	0.947	0.756	1.012
311	5	141.3	0.940	599.9	1.022	63.97	0.952	0.755	0.991
312	5	138.1	0.927	595.3	1.024	61.26	0.946	0.745	0.997
313	5	141.9	0.941	595.6	1.017	62.81	0.964	0.743	1.008
314	5	135.6	0.930	595.6	1.023	60.59	0.935	0.750	0.983
315	5	143.6	0.932	599.2	1.023	64.36	0.954	0.748	1.001
311	6	141.6	0.941	597.5	1.018	64.07	0.953	0.758	0.994
312	6	138.6	0.931	593.0	1.020	61.13	0.944	0.744	0.995
313	6	142.2	0.943	594.2	1.014	61.97	0.951	0.734	0.995
314	6	134.6	0.923	593.7	1.020	60.72	0.937	0.760	0.996
315	6	142.6	0.925	597.0	1.020	64.02	0.949	0.752	1.006

S/N : 313	LEVEL : 0	1
TEMP: 25 C	ISC(MA) : 152.0	142.4
AREA: 4 CM ²	VOC(MV) : 588.0	586.5
INT. : 1*AM0	PMAX(MW) : 65.9	62.8
	F.F. : 0.797	0.798

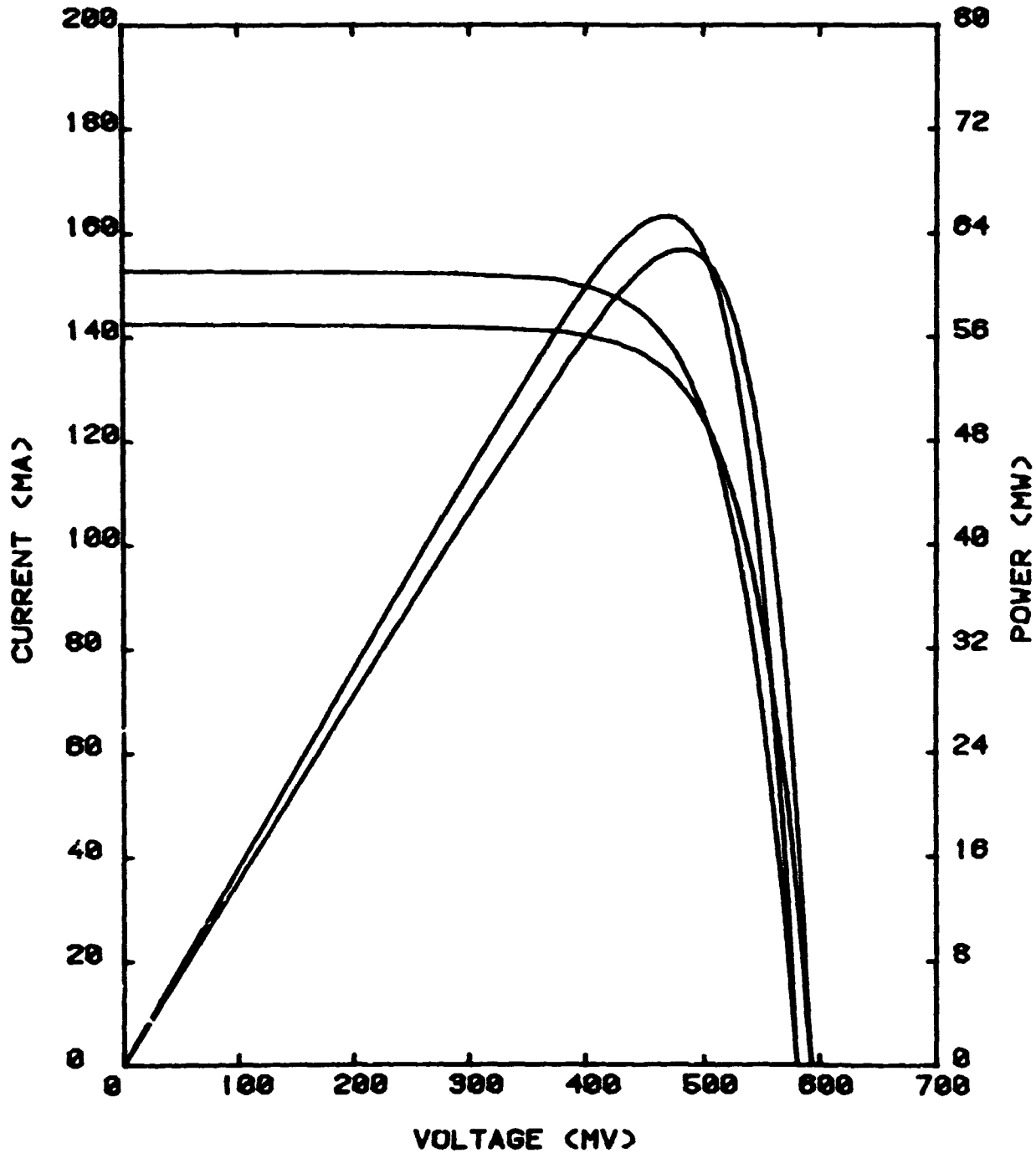

FIGURE 65
A SERIES UV IRRADIATION EX-SITU

6.5 C SERIES CELLS

(OCLI 2-mil, 10 Ω -cm BSF cell with Ta₂O₅, 2-mil FEP-A cover, 1-mil Kapton back and 2-mil of 93-500 adhesive on front and back.)

6.5.1 Electron Irradiation

The first visible damage was observed after a fluence of 5×10^{15} e/cm² and 30 thermal cycles. At this point the FEP-A covers started coming loose from the cell. The cracking became worse after the third set of thermal cycles were completed. The electrons caused the FEP-A to harden and the flexing during the thermal cycles caused the cracking and blistering.

The summary plots (Figures 66, 67, 68, and 69) include the JPL Handbook values for a 2 Ω -cm BSF cell. However, the physical damage to the samples preclude any meaningful interpretation of the electrical data. The tabulated data are in Tables 20A and 20B and Figure 70 is a typical I-V curve. Figure 71 is a photograph of a sample showing the FEP-A cracks. The sample temperature ranged from 54°C to 56°C during the irradiations.

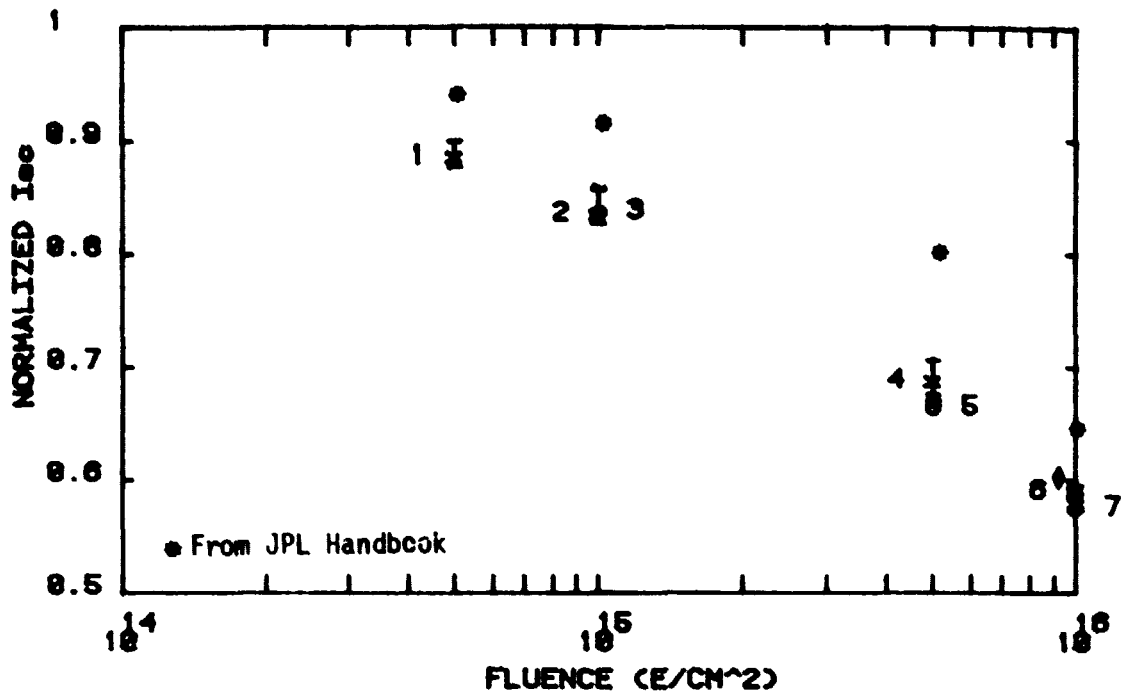

FIGURE 66. C SERIES ELECTRON IRRADIATION IN-SITU

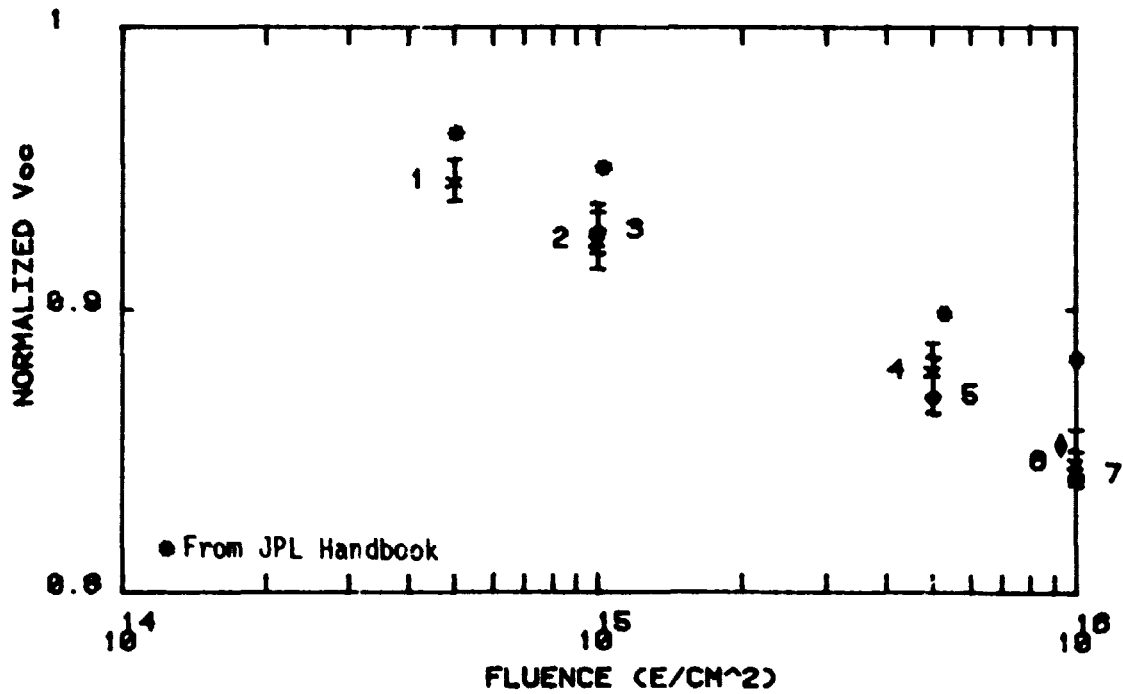

FIGURE 67. C SERIES ELECTRON IRRADIATION IN-SITU

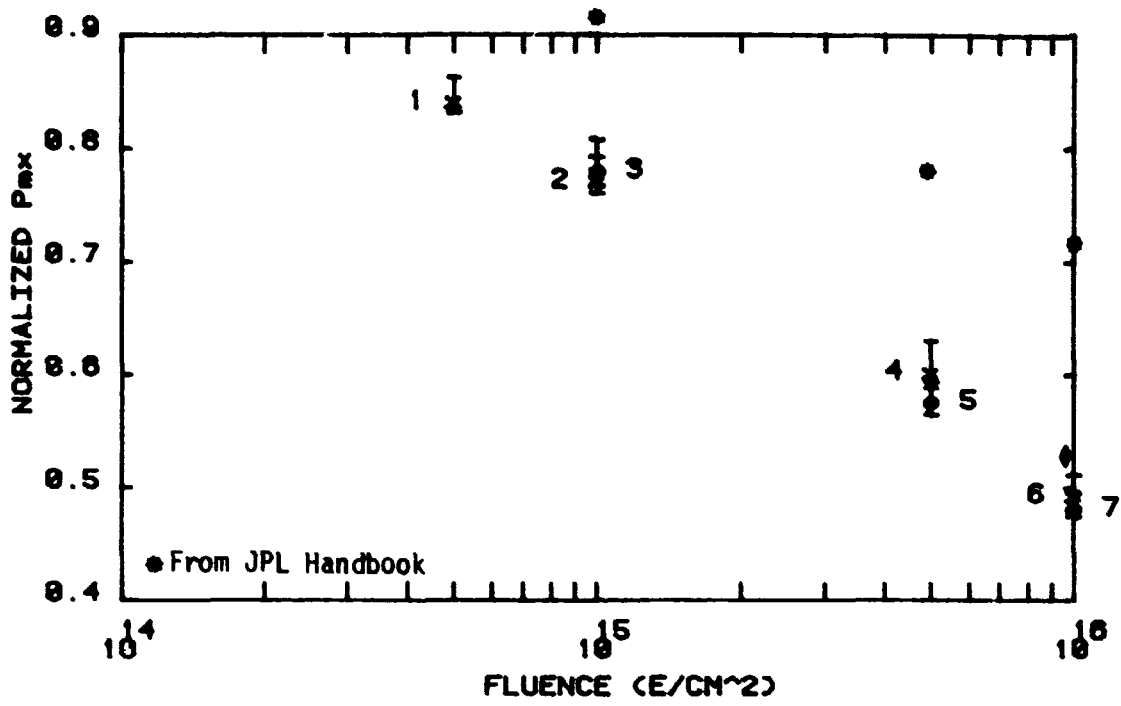

FIGURE 68. C SERIES ELECTRON IRRADIATION IN-SITU

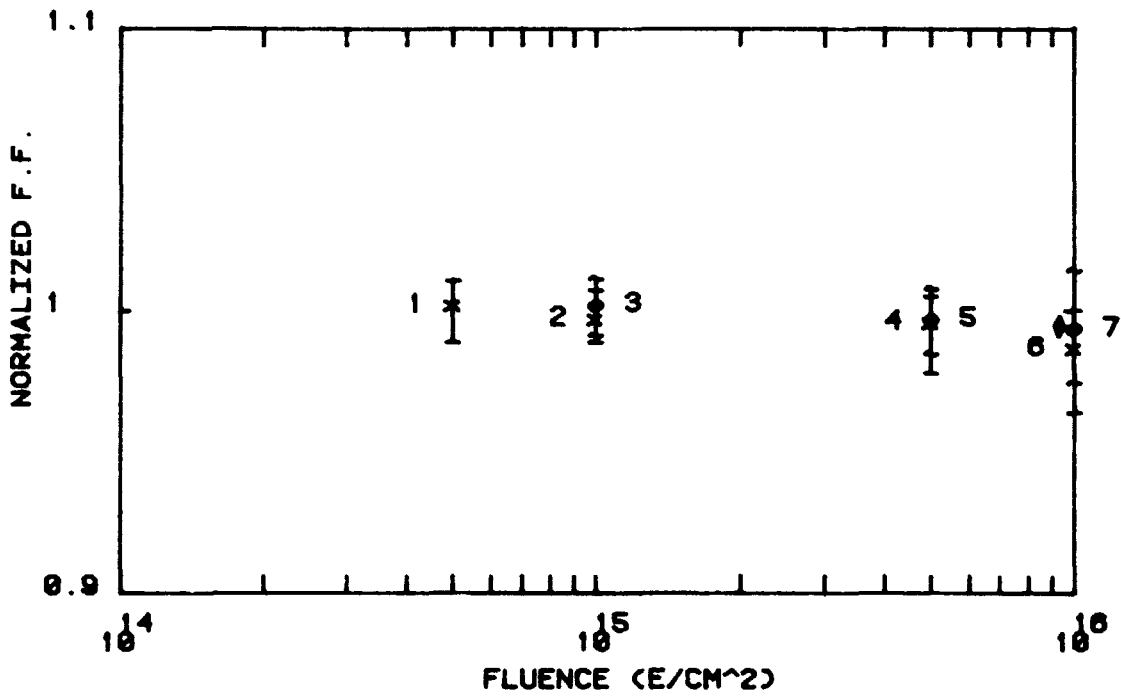

FIGURE 69. C SERIES ELECTRON IRRADIATION IN-SITU

TABLE 20A. TABULATED C SERIES DATA - ELECTRON IRRADIATION

C SERIES ELECTRON IRRADIATION EX-SITU
 TEMP. (C): 25 AREA: 4. INTENSITY 1*AM0

Level Number	AVERAGE Isc/Isc0	AVERAGE Voc/Voc0	AVERAGE Pmx/Pmx0	AVERAGE F. F. /F. F. 0
0	1.000	1.000	1.000	1.000
1	0.602	0.852	0.512	0.998

C SERIES ELECTRON IRRADIATION IN-SITU
 TEMP. (C): 25 AREA: 4. INTENSITY 1*AM0

Level Number	AVERAGE Isc/Isc0	AVERAGE Voc/Voc0	AVERAGE Pmx/Pmx0	AVERAGE F. F. /F. F. 0
0	1.000	1.000	1.000	1.000
1	0.889	0.946	0.843	1.003
2	0.837	0.925	0.773	0.998
3	0.840	0.929	0.783	1.003
4	0.691	0.879	0.605	0.997
5	0.667	0.870	0.579	0.998
6	0.592	0.847	0.496	0.988
7	0.578	0.842	0.484	0.995

C SERIES ELECTRON IRRADIATION EX-SITU
 TEMP. (C): 25 AREA: 4 INTENSITY 1*AM0

Serial Number	Level Number	Isc (mA)	Isc/Isc0	Voc (mV)	Voc/Voc0	Pmx (mW)	Pmx/Pmx0	Fill Fac.	F. F. /F. F. 0
401	0	144.0	1.000	561.6	1.000	59.31	1.000	0.734	1.000
402	0	147.1	1.000	560.2	1.000	61.77	1.000	0.750	1.000
403	0	151.9	1.000	574.5	1.000	64.24	1.000	0.736	1.000
404	0	148.0	1.000	567.0	1.000	64.17	1.000	0.765	1.000
405	0	145.5	1.000	557.7	1.000	56.85	1.000	0.701	1.000
401	1	0.0	0.000	0.0	0.000	0.00	0.000	0.000	0.000
402	1	0.0	0.000	0.0	0.000	0.00	0.000	0.000	0.000
403	1	90.6	0.596	484.4	0.843	32.40	0.504	0.738	1.003
404	1	88.8	0.600	486.0	0.857	32.26	0.503	0.748	0.978
405	1	88.6	0.609	477.8	0.857	30.01	0.528	0.709	1.012

TABLE 20B. TABULATED C SERIES DATA - ELECTRON IRRADIATION

C SERIES ELECTRON IRRADIATION IN-SITU
 TEMP. (C): 25 AREA: 4 INTENSITY 1*AM0

Serial Number	Level Number	Isc (mA)	Isc/Isc0	Voc (mV)	Voc/Voc0	Pmx (mW)	Pmx/Pmx0	Fill Fac.	F. F. / F. F. 0
401	0	41.9	1.000	484.0	1.000	13.63	1.000	0.672	1.000
402	0	125.3	1.000	555.9	1.000	52.38	1.000	0.752	1.000
403	0	128.4	1.000	564.0	1.000	53.54	1.000	0.739	1.000
404	0	125.4	1.000	567.6	1.000	55.00	1.000	0.773	1.000
405	0	125.6	1.000	559.5	1.000	49.90	1.000	0.710	1.000
401*	1	39.5	0.941	407.1	0.841	10.31	0.757	0.642	0.955
402	1	112.8	0.900	530.0	0.953	45.22	0.863	0.757	1.006
403	1	113.6	0.885	529.4	0.939	44.74	0.836	0.744	1.006
404	1	111.9	0.892	535.0	0.943	45.78	0.832	0.765	0.990
405	1	110.2	0.877	532.2	0.951	42.19	0.845	0.719	1.013
401*	2	38.2	0.912	402.9	0.832	9.92	0.728	0.644	0.959
402	2	107.3	0.857	519.6	0.935	41.54	0.793	0.745	0.990
403	2	106.2	0.827	515.8	0.915	40.82	0.762	0.745	1.007
404	2	104.5	0.834	523.0	0.923	41.83	0.761	0.764	0.989
405	2	104.4	0.831	520.2	0.930	38.87	0.779	0.716	1.008
401*	3	38.4	0.917	393.1	0.812	9.71	0.712	0.642	0.956
402	3	107.2	0.856	520.7	0.937	42.20	0.806	0.756	1.005
403	3	107.0	0.833	518.3	0.919	41.29	0.771	0.745	1.007
404	3	104.7	0.835	525.5	0.926	42.09	0.765	0.765	0.990
405	3	105.0	0.836	522.1	0.933	39.43	0.790	0.719	1.013
401*	4	35.2	0.839	398.9	0.824	9.06	0.665	0.646	0.961
402	4	88.6	0.707	493.7	0.888	33.08	0.631	0.756	1.005
403	4	88.5	0.690	490.3	0.869	32.21	0.602	0.742	1.004
404	4	86.4	0.689	496.5	0.875	32.42	0.589	0.756	0.978
405	4	85.0	0.677	494.5	0.884	30.01	0.601	0.714	1.006
401*	5	0.0	0.000	0.0	0.000	0.00	0.000	0.000	0.000
402*	5	24.1	0.192	441.4	0.794	6.03	0.115	0.566	0.753
403	5	85.8	0.668	488.3	0.866	31.11	0.581	0.743	1.004
404	5	83.4	0.665	489.5	0.862	31.02	0.564	0.760	0.984
405	5	83.9	0.668	493.5	0.882	29.66	0.594	0.717	1.009
401*	6	0.0	0.000	0.0	0.000	0.00	0.000	0.000	0.000
402*	6	21.2	0.169	420.5	0.756	5.44	0.104	0.610	0.811
403	6	75.7	0.589	473.5	0.840	26.46	0.494	0.739	0.999
404	6	74.1	0.591	478.5	0.843	26.43	0.480	0.745	0.964
405	6	75.0	0.597	480.0	0.858	25.61	0.513	0.712	1.003
401*	7	0.0	0.000	0.0	0.000	0.00	0.000	0.000	0.000
402*	7	11.7	0.093	412.8	0.742	2.46	0.047	0.510	0.678
403	7	74.5	0.580	473.9	0.840	26.01	0.486	0.737	0.997
404	7	72.6	0.580	475.1	0.837	26.01	0.473	0.752	0.974
405	7	72.0	0.573	475.2	0.849	24.69	0.495	0.721	1.016

*NOT INCLUDED IN AVERAGE

S/N : 403	LEVEL : 0	1
TEMP: 25 C	ISCC(MA) : 151.9	90.6
AREA: 4 CM^2	VOC(MV) : 574.5	484.4
INT. : 1*AM0	PMAX(MW) : 64.2	32.4
	F.F. : 0.736	0.738

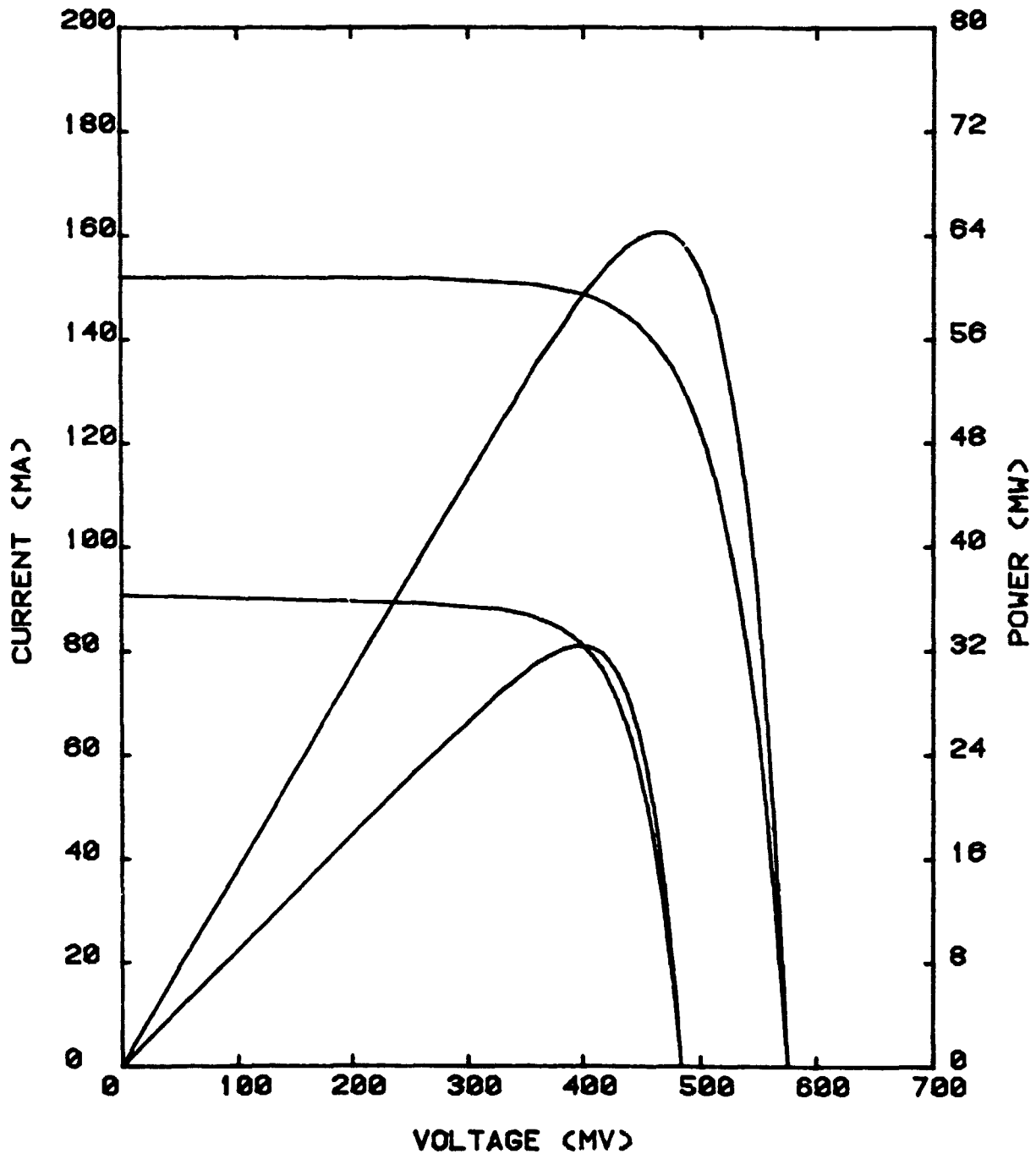

FIGURE 70

C SERIES ELECTRON IRRADIATION EX-SITU

D180-26590-1

ORIGINAL PAGE IS
OF POOR QUALITY.

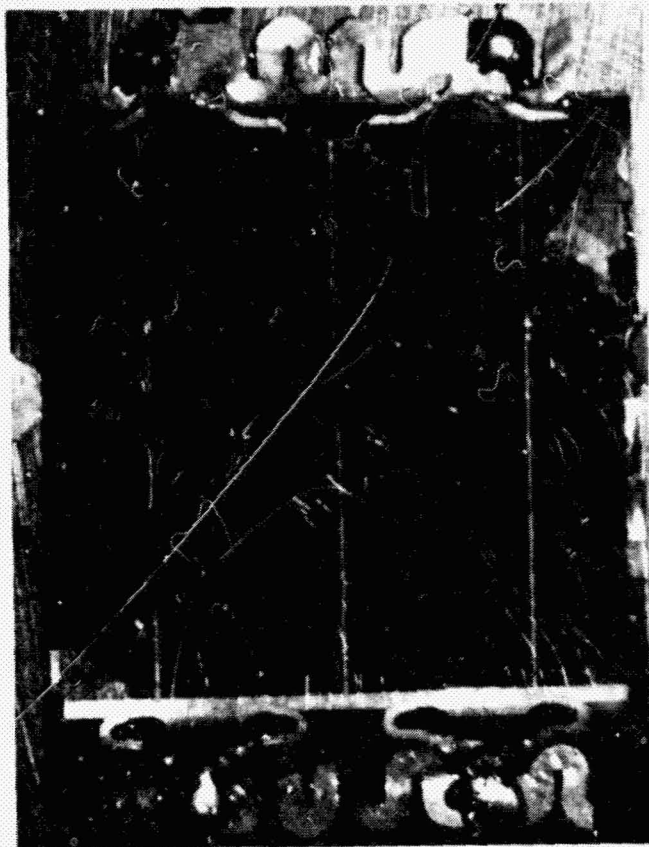

FIGURE 71. SAMPLE C 1 (401) SHOWING FEP-A
CRACKS, POST-ELECTRON IRRADIATION

6.5.2 Proton Irradiation

The only visible damage observed was after 3×10^{14} p/cm² and fifteen thermal cycles where the samples had a hazy appearance. After 3.3×10^{15} p/cm² and 30 thermal cycles the FEP-A was hazier and this was reflected in a decrease in I_{sc} of 4.5 percent. The V_{oc} was not affected. Therefore the loss in I_{sc} was caused by transmission loss of the FEP-A covers. Figures 72, 73, 74 and 75 are the summary plots and Tables 21A and 21B contain the tabulated data. Figures 76A and 76B are a typical full set of in situ I-V curves. The sample temperature ranged from 50°C to 54°C during the irradiations.

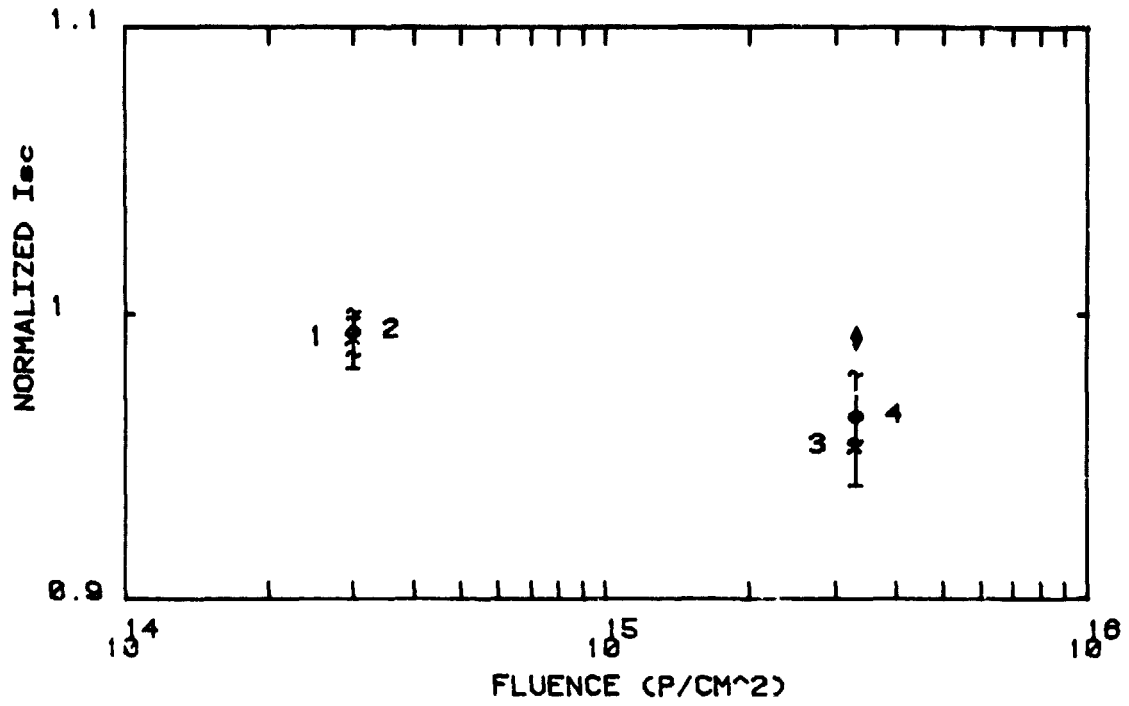

FIGURE 72. C SERIES PROTON IRRADIATION IN-SITU

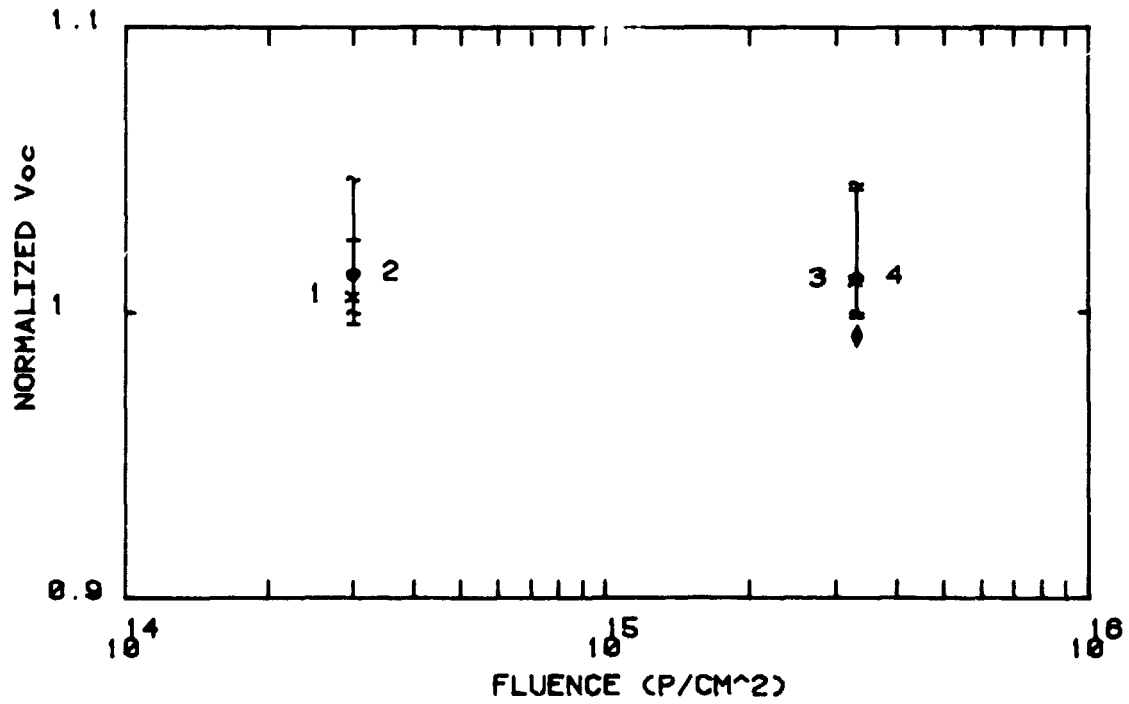

FIGURE 73. C SERIES PROTON IRRADIATION IN-SITU

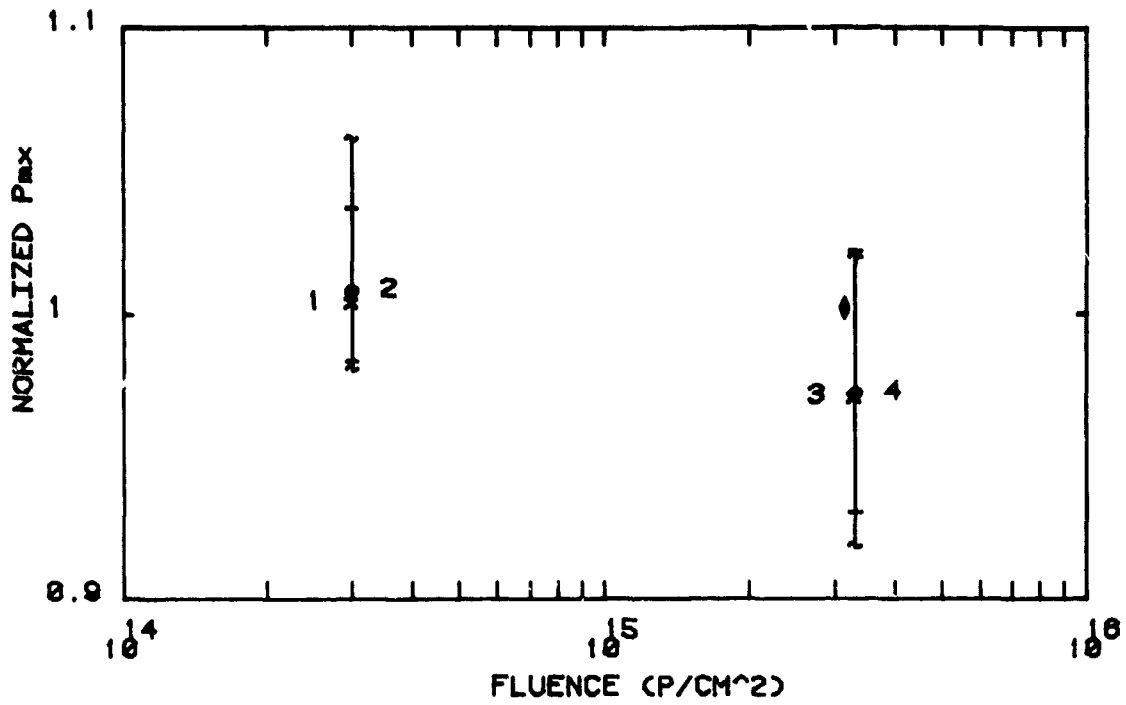

FIGURE 74. C SERIES PROTON IRRADIATION IN-SITU

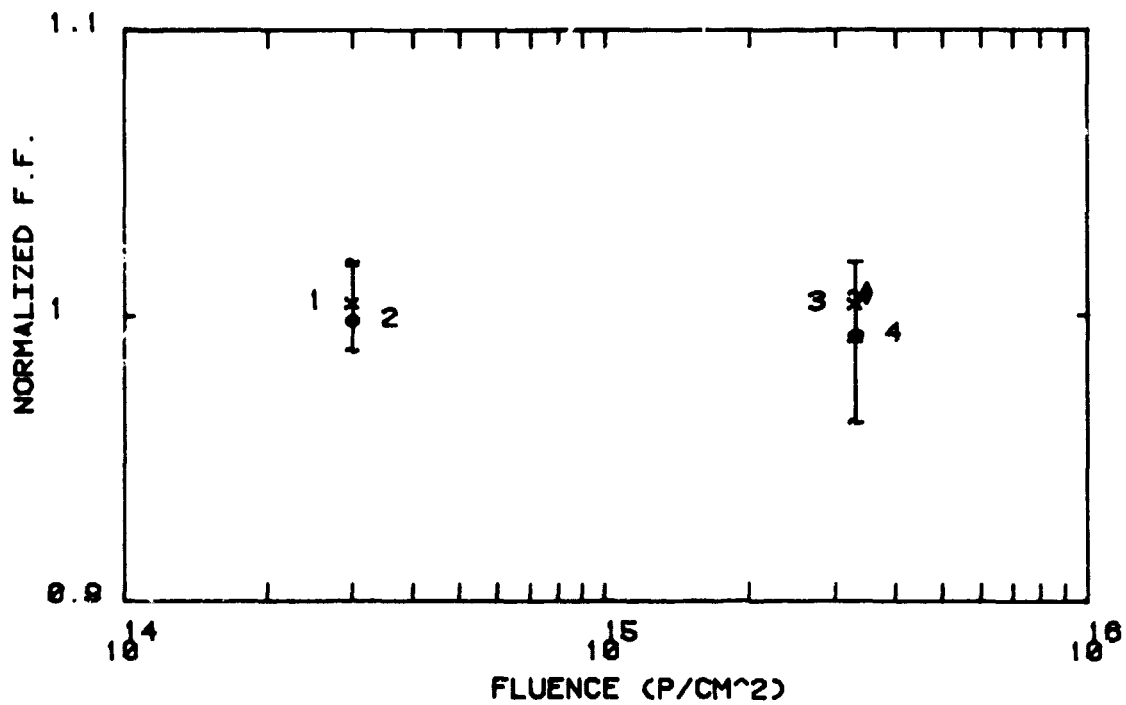

FIGURE 75. C SERIES PROTON IRRADIATION IN-SITU

TABLE 21A. TABULATED C SERIES DATA - PROTON IRRADIATION

C SERIES PROTON IRRADIATION EX-SITU
 TEMP. (C): 25 AREA: 4. INTENSITY 1*AM0

Level Number	AVERAGE Isc/Isc0	AVERAGE Voc/Voc0	AVERAGE Pmx/Pmx0	AVERAGE F. F. /F. F. 0
0	1.000	1.000	1.000	1.000
1	0.999	0.997	1.015	1.018

C SERIES PROTON IRRADIATION IN-SITU
 TEMP. (C): 25 AREA: 4. INTENSITY 1*AM0

Level Number	AVERAGE Isc/Isc0	AVERAGE Voc/Voc0	AVERAGE Pmx/Pmx0	AVERAGE F. F. /F. F. 0
0	1.000	1.000	1.000	1.000
1	0.993	1.007	1.005	1.006
2	0.995	1.015	1.009	1.000
3	0.955	1.012	0.972	1.005
4	0.966	1.013	0.974	0.994

C SERIES PROTON IRRADIATION EX-SITU
 TEMP. (C): 25 AREA: 4 INTENSITY 1*AM0

Serial Number	Level Number	Isc (mA)	Isc/Isc0	Voc (mV)	Voc/Voc0	Pmx (mW)	Pmx/Pmx0	Full Fac.	F. F. /F. F. 0
406	0	151.7	1.000	574.8	1.000	65.72	1.000	0.754	1.000
407	0	147.9	1.000	562.5	1.000	61.23	1.000	0.736	1.000
408	0	146.2	1.000	556.3	1.000	56.70	1.000	0.697	1.000
409	0	145.3	1.000	560.6	1.000	59.46	1.000	0.720	1.000
410	0	147.7	1.000	561.8	1.000	59.94	1.000	0.722	1.000
406	1	148.7	0.980	570.6	0.993	63.97	0.973	0.754	1.000
407*	1	56.7	0.384	556.5	0.989	23.39	0.382	0.741	1.006
408	1	146.8	1.004	552.7	0.994	58.43	1.030	0.720	1.033
409	1	146.5	1.008	558.6	0.996	60.98	1.026	0.745	1.021
410	1	148.3	1.004	564.6	1.005	61.66	1.029	0.736	1.019

*NOT INCLUDED IN AVERAGE

TABLE 21B. TABULATED C SERIES DATA - PROTON IRRADIATION

C SERIES PROTON IRRADIATION IN-SITU
 TEMP. (C): 25 AREA: 4 INTENSITY 1*AM0

Serial Number	Level Number	Isc (mA)	Isc/ Isco	Voc (mV)	Voc/ Voco	Pmx (mW)	Pmx/ Pmxo	Fill Fac.	F. F. / F. F. o
406	0	128.4	1.000	585.1	1.000	57.86	1.000	0.770	1.000
407	0	125.4	1.000	530.5	1.000	46.76	1.000	0.703	1.000
408	0	124.1	1.000	569.6	1.000	51.62	1.000	0.730	1.000
409	0	124.3	1.000	573.3	1.000	53.61	1.000	0.752	1.000
410	0	128.5	1.000	543.4	1.000	50.91	1.000	0.729	1.000
406	1	128.3	0.999	586.0	1.002	57.82	0.999	0.769	0.999
407*	1	121.6	0.970	514.5	0.970	32.68	0.699	0.522	0.743
408	1	121.7	0.981	567.5	0.996	50.78	0.984	0.735	1.007
409	1	123.9	0.997	575.6	1.004	53.61	1.000	0.752	0.999
410	1	127.6	0.993	557.4	1.026	52.82	1.037	0.742	1.018
406	2	128.4	1.000	588.3	1.005	57.43	0.993	0.760	0.987
407*	2	50.1	0.399	526.1	0.992	19.46	0.416	0.739	1.051
408	2	122.2	0.985	569.2	0.999	50.60	0.980	0.728	0.996
409	2	124.2	0.999	578.3	1.009	53.85	1.004	0.750	0.997
410	2	127.9	0.996	568.5	1.046	54.03	1.061	0.742	1.018
406	3	122.4	0.953	586.1	1.002	55.51	0.959	0.774	1.005
407*	3	48.2	0.384	493.9	0.931	17.23	0.369	0.724	1.030
408	3	116.7	0.940	568.7	0.998	48.03	0.931	0.724	0.991
409	3	120.0	0.965	576.9	1.006	52.34	0.976	0.756	1.005
410	3	123.5	0.961	567.1	1.044	52.04	1.022	0.743	1.019
406	4	123.2	0.960	587.5	1.004	56.14	0.970	0.775	1.007
407*	4	48.8	0.390	494.4	0.932	16.13	0.345	0.668	0.951
408	4	118.5	0.955	569.2	0.999	47.38	0.918	0.703	0.962
409	4	121.6	0.979	576.6	1.006	52.89	0.987	0.754	1.003
410	4	124.6	0.970	567.6	1.045	51.89	1.019	0.734	1.006

*NOT INCLUDED IN AVERAGE

S/N : 408	LEVEL : 0	1	2
TEMP: 25 C	ISC(MA) : 124.1	121.7	122.2
AREA: 4 CM ²	VOC(MV) : 509.6	507.5	509.2
INT. : 1*AM0	PMAX(MW) : 51.6	50.6	50.6
	F.F. : 0.730	0.735	0.728

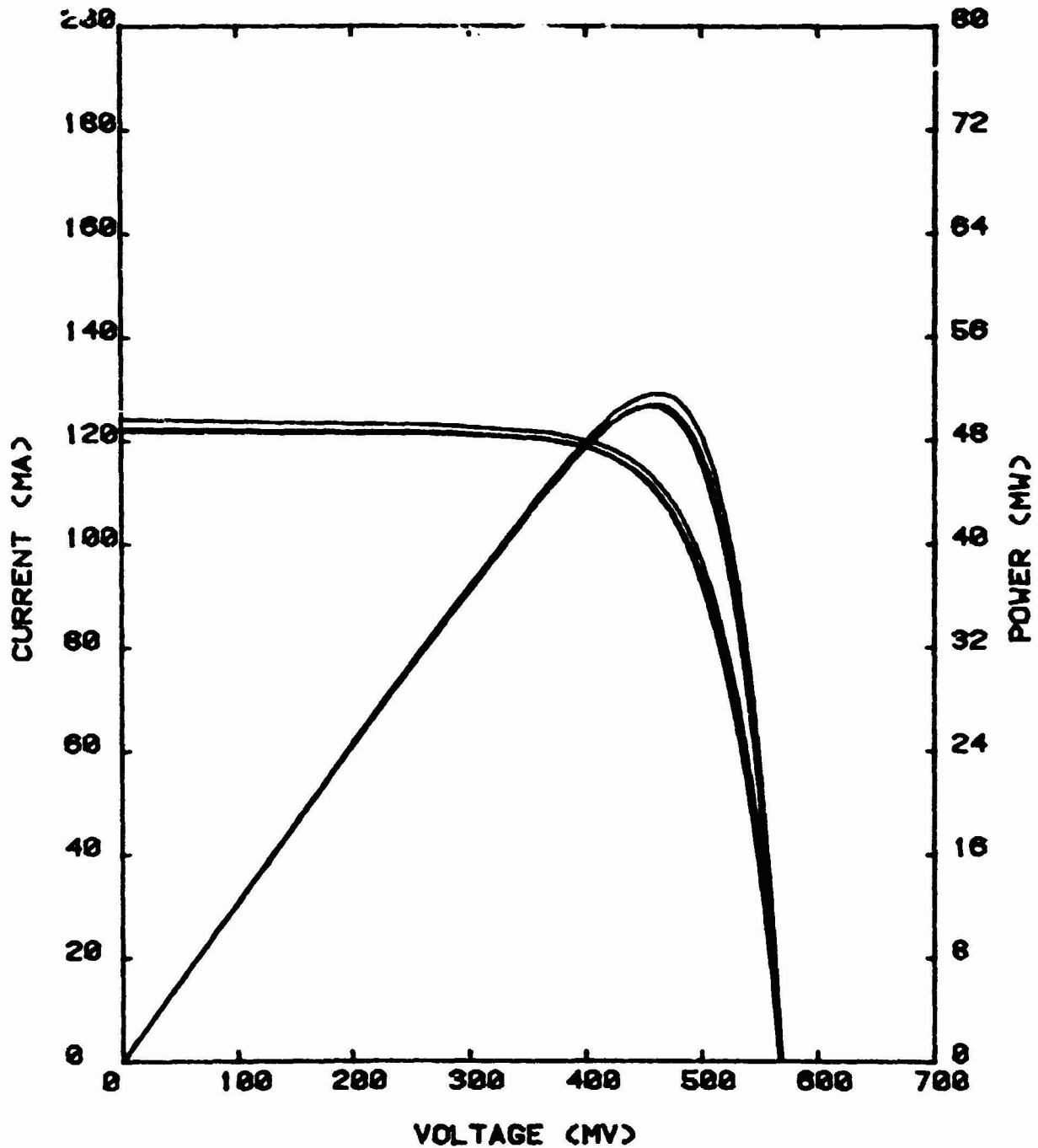

FIGURE 76A.
C SERIES PROTON IRRADIATION IN-SITU
D180-26590-1
111

S/N : 408	LEVEL : 3	4
TEMP: 25 C	ISC(MA) : 116.7	118.5
AREA: 4 CM^2	VOC(MV) : 568.7	569.2
INT. : 1*AM0	PMAX(MW): 48.0	47.4
	F.F. : 0.724	0.703

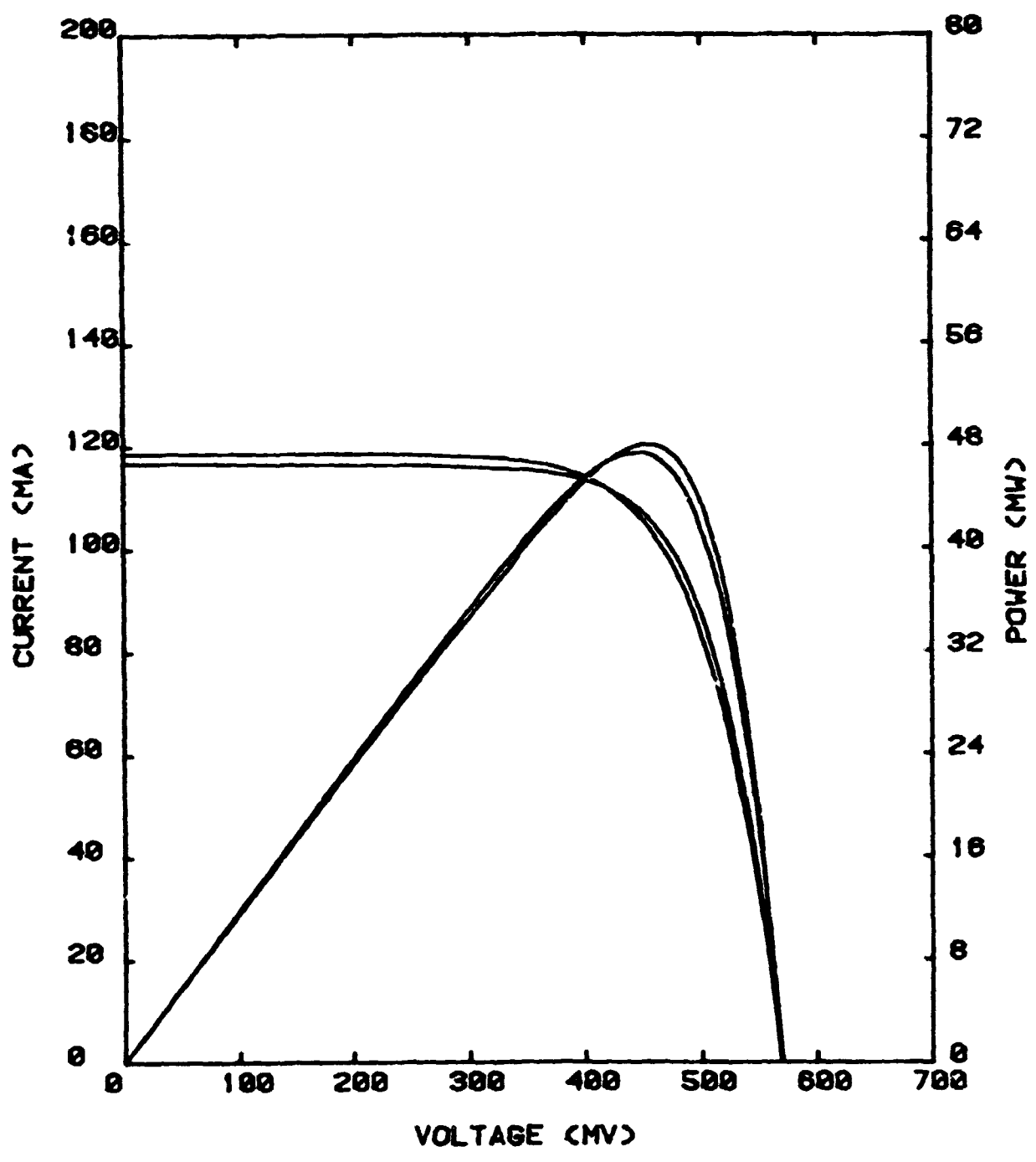

FIGURE 76B.
 C SERIES PROTON IRRADIATION IN-SITU
 DT80-26590-1
 112

6.5.3 UV Exposure

I_{sc} degraded by 13% at the completion of the exposure. The visual inspections showed the sample looked hazy. The loss in I_{sc} is due to a transmission loss caused by one or more of the following: (1) contamination during the UV exposure (see Section 6.2), (2) darkening of the FEP-A or (3) darkening of the DC 93-500. Figures 77, 78, 79, and 80 are the summary plots of the test parameters and Tables 22A and 22B contain the tabulated data. Figure 81 is a typical pre- and post-test I-V curve. The thermocouple attached to the cell failed after the first set of thermal cycles; however, before that time the sample read 34°C.

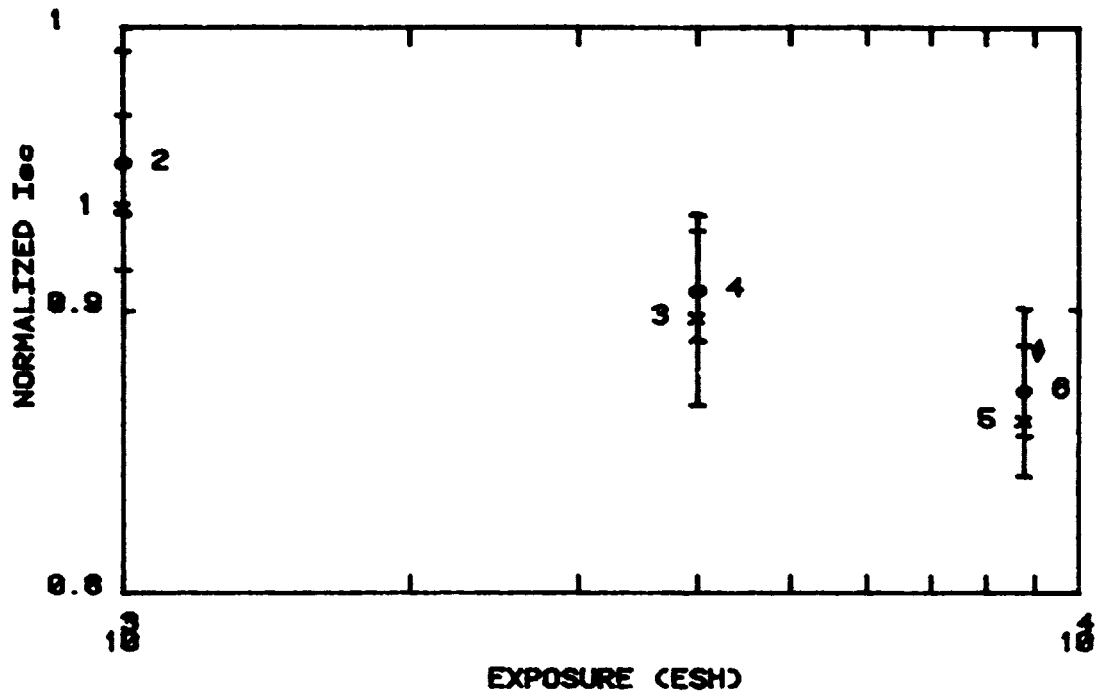

FIGURE 77. C SERIES UV IRRADIATION IN SITU

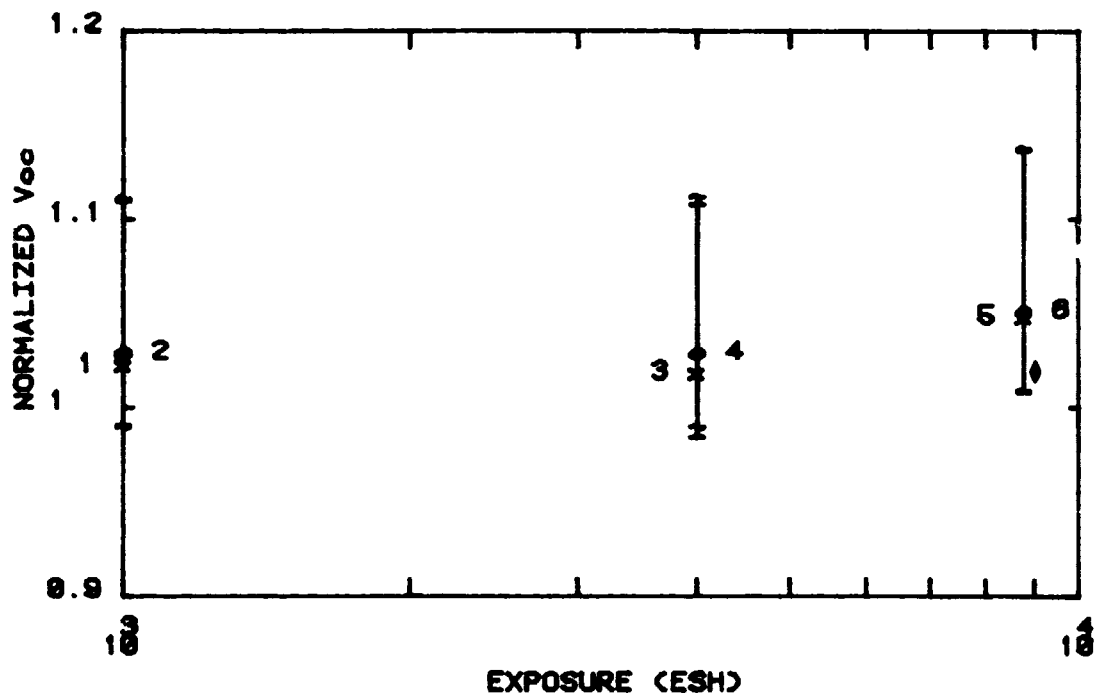

FIGURE 78. C SERIES UV IRRADIATION IN SITU

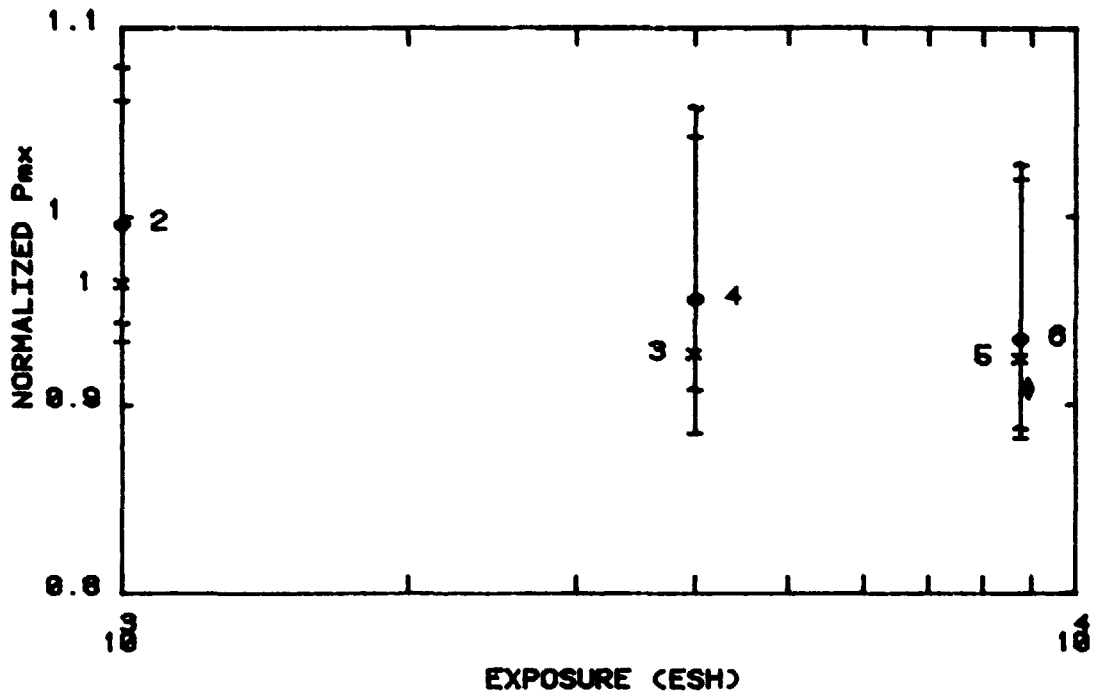

FIGURE 79. C SERIES UV IRRADIATION IN SITU

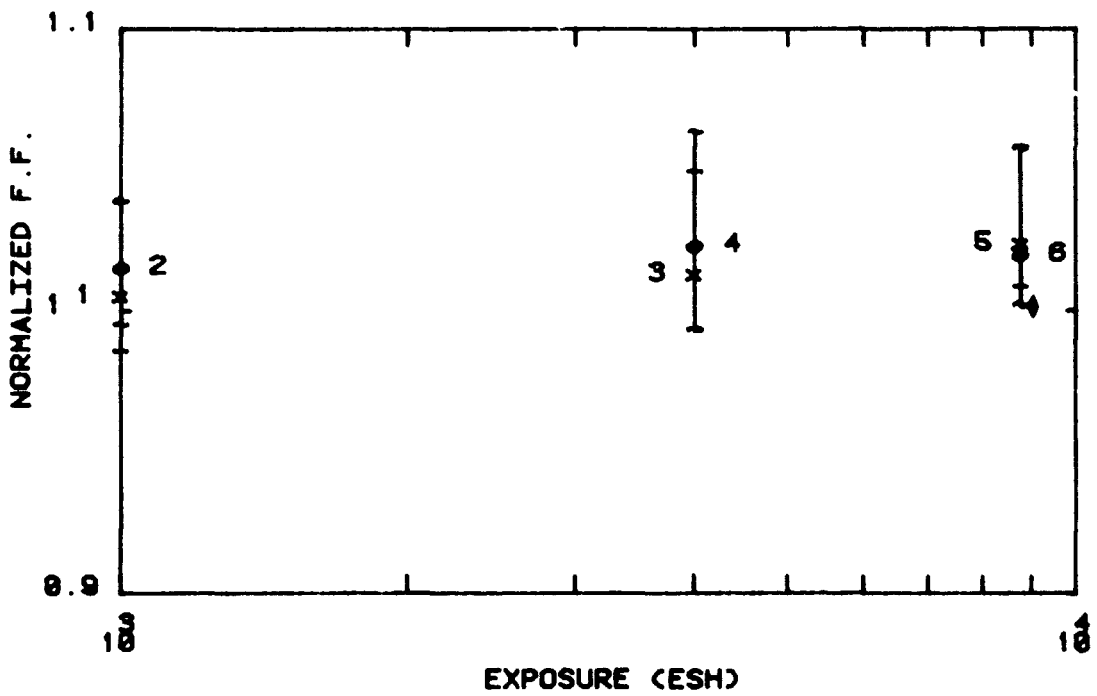

FIGURE 80. C SERIES UV IRRADIATION IN SITU

TABLE 22A. TABULATED C SERIES DATA - UV IRRADIATION

C SERIES UV IRRADIATION EX-SITU
 TEMP. (C): 25 AREA: 4. INTENSITY 1*AM0

Level Number	AVERAGE Isc/Isc0	AVERAGE Voc/Voc0	AVERAGE Pmx/Pmx0	AVERAGE F. F. /F. F. 0
0	1.000	1.000	1.000	1.000
1	0.887	1.024	0.915	1.007

C SERIES UV IRRADIATION IN SITU
 TEMP. (C): 25 AREA: 4. INTENSITY 1*AM0

Level Number	AVERAGE Isc/Isc0	AVERAGE Voc/Voc0	AVERAGE Pmx/Pmx0	AVERAGE F. F. /F. F. 0
0	1.000	1.000	1.000	1.000
1	0.938	1.024	0.966	1.006
2	0.953	1.031	0.998	1.016
3	0.899	1.020	0.930	1.014
4	0.908	1.030	0.959	1.024
5	0.860	1.049	0.927	1.025
6	0.873	1.052	0.937	1.021

C SERIES UV IRRADIATION EX-SITU
 TEMP. (C): 25 AREA: 4 INTENSITY 1*AM0

Serial Number	Level Number	Isc (mA)	Isc/Isc0	Voc (mV)	Voc/Voc0	Pmx (mW)	Pmx/Pmx0	Fill Fac.	F. F. /F. F. 0
411	0	153.4	1.000	575.8	1.000	67.58	1.000	0.765	1.000
412	0	152.3	1.000	574.7	1.000	66.60	1.000	0.761	1.000
413	0	154.1	1.000	575.8	1.000	63.49	1.000	0.715	1.000
414	0	152.0	1.000	572.3	1.000	65.60	1.000	0.754	1.000
415	0	150.4	1.000	575.9	1.000	65.22	1.000	0.753	1.000
411	1	133.5	0.871	590.6	1.025	61.63	0.912	0.781	1.021
412	1	136.2	0.894	590.6	1.028	60.27	0.905	0.749	0.985
413	1	136.4	0.885	585.9	1.017	58.04	0.914	0.727	1.016
414	1	136.4	0.897	588.2	1.028	60.44	0.921	0.753	0.999
415	1	134.0	0.890	587.0	1.019	60.08	0.921	0.764	1.015

TABLE 220. TABULATED C SERIES DATA - UV IRRADIATION

C SERIES UV IRRADIATION IN SITU
 TEMP. (C): 25 AREA: 4 INTENSITY 1*AM0

Serial Number	Level Number	Isc (mA)	Isc/Isc0	Voc (mV)	Voc/Voc0	Pmx (mW)	Pmx/Pmx0	Fill Fac.	F. F. / F. F. 0
411	0	151.6	1.000	575.9	1.000	66.25	1.000	0.759	1.000
412	0	154.3	1.000	523.7	1.000	58.01	1.000	0.718	1.000
413	0	151.7	1.000	572.7	1.000	62.34	1.000	0.717	1.000
414	0	150.3	1.000	563.7	1.000	62.93	1.000	0.743	1.000
415	0	153.6	1.000	506.8	1.000	55.59	1.000	0.714	1.000
411	1	142.4	0.939	570.8	0.991	62.33	0.941	0.767	1.011
412	1	141.1	0.915	538.9	1.029	54.74	0.944	0.720	1.003
413	1	143.4	0.945	569.8	0.995	58.22	0.934	0.712	0.993
414	1	145.6	0.969	561.1	0.995	59.85	0.951	0.732	0.986
415	1	141.4	0.921	562.6	1.110	59.03	1.062	0.742	1.039
411	2	143.7	0.947	571.7	0.993	63.40	0.957	0.772	1.018
412	2	144.0	0.933	556.3	1.062	59.50	1.026	0.743	1.034
413	2	145.5	0.959	566.0	0.988	58.75	0.942	0.713	0.994
414	2	148.9	0.991	563.6	1.000	62.18	0.988	0.741	0.997
415	2	143.7	0.936	562.4	1.110	59.93	1.078	0.742	1.038
411	3	135.0	0.890	571.0	0.991	58.65	0.885	0.761	1.003
412	3	133.7	0.867	533.6	1.019	52.63	0.907	0.738	1.028
413	3	138.4	0.912	563.7	0.984	55.62	0.892	0.713	0.994
414	3	139.5	0.929	561.2	0.996	57.90	0.920	0.739	0.995
415	3	137.6	0.896	561.7	1.108	57.97	1.043	0.750	1.050
411	4	136.4	0.900	571.1	0.992	60.16	0.908	0.772	1.018
412	4	137.1	0.889	557.6	1.065	56.53	0.974	0.740	1.030
413	4	140.3	0.925	566.2	0.989	56.55	0.907	0.712	0.993
414	4	140.2	0.933	561.8	0.996	59.55	0.946	0.756	1.018
415	4	137.5	0.895	563.0	1.111	58.75	1.057	0.759	1.063
411	5	129.8	0.856	586.0	1.017	58.47	0.883	0.769	1.013
412	5	129.8	0.841	556.3	1.062	53.32	0.919	0.738	1.028
413	5	133.0	0.876	577.2	1.008	55.52	0.891	0.723	1.008
414	5	133.4	0.888	576.0	1.022	57.92	0.920	0.754	1.015
415	5	130.3	0.848	576.1	1.137	56.73	1.021	0.756	1.059
411	6	131.3	0.866	583.1	1.012	58.72	0.886	0.767	1.011
412	6	132.8	0.861	568.8	1.086	55.49	0.957	0.735	1.023
413	6	134.0	0.883	577.0	1.007	55.53	0.891	0.718	1.001
414	6	135.2	0.900	574.4	1.019	58.28	0.926	0.756	1.010
415	6	131.3	0.855	575.9	1.136	57.06	1.026	0.755	1.057

S/N : 411	LEVEL : 0	1
TEMP: 25 C	ISC(MA) : 153.4	133.5
AREA: 4 CM^2	VOC(MV) : 575.8	590.6
INT. : 1*AM0	PMAX(MW) : 67.6	61.6
	F.F. : 0.785	0.781

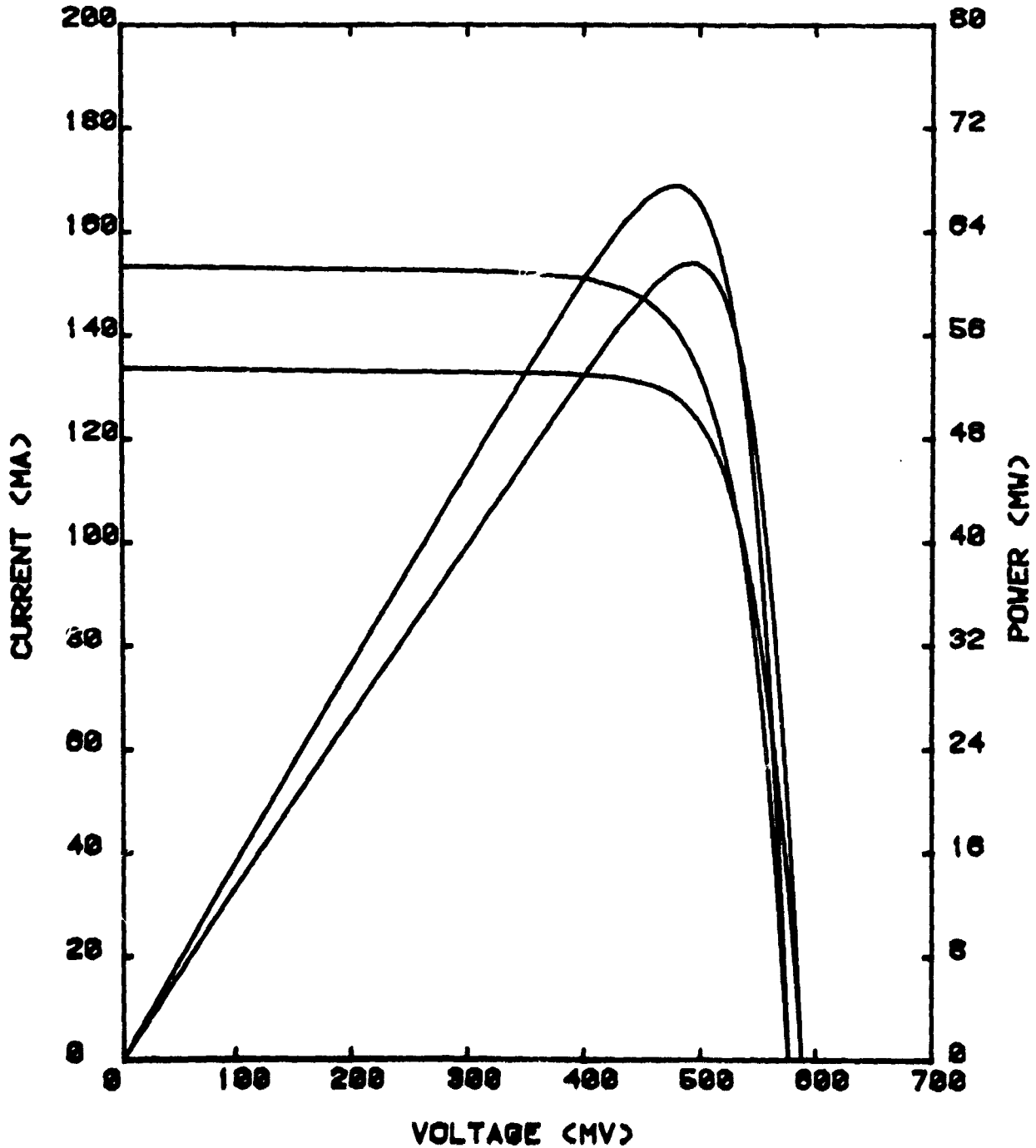

FIGURE 81.
C SERIES UV IRRADIATION EX-SITU

D180-26590-1

6.6 D SERIES CELLS

(OCLI 8-mil 10 Ω -cm BSF/R cell, 21.5 mil 93-500 cover, no backing, no adhesive.)

6.6.1 Electron Irradiation

There was no visible damage observed throughout the irradiation. On summary plots (Figures 82, 83, 84 and 85) are also plotted the JPL Handbook data for an 8-mil 10 Ω -cm BSF cell for comparison. The normalized I_{SC} curve shows that there is an additional 3-4% loss compared to the bare cell data. This additional 3-4% loss is attributed to darkening in the 93-500 cover material. The normalized voltage data compares well indicating no unusual electron effects in the cell itself. Tables 23A and 23B contain the tabulated data and Figure 86 shows a typical pre- and post-test I-V curves. The sample temperature during the irradiations ranged from 50°C to 54°C.

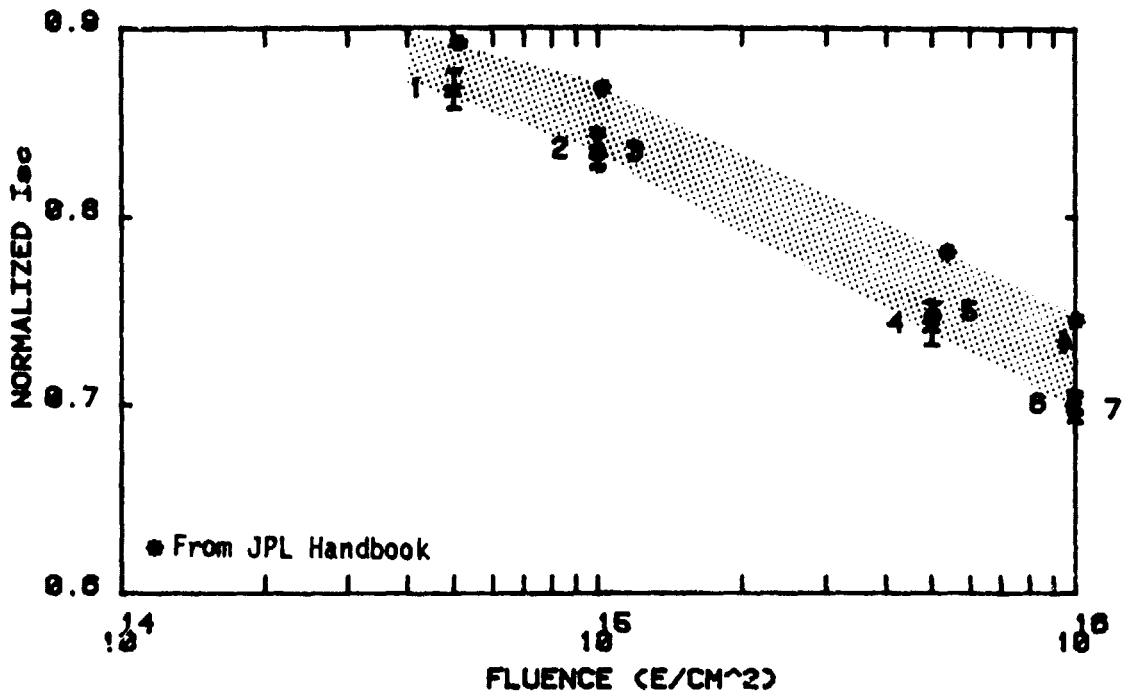

FIGURE 82. D SERIES ELECTRON IRRADIATION IN-SITU

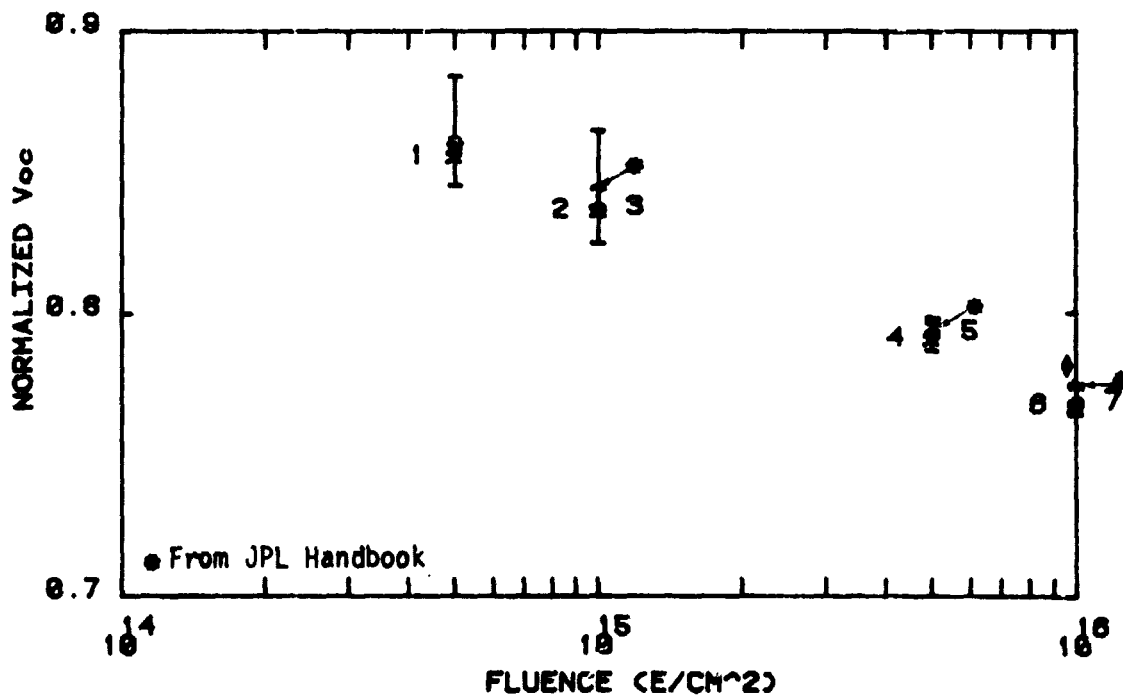

FIGURE 83. D SERIES ELECTRON IRRADIATION IN-SITU

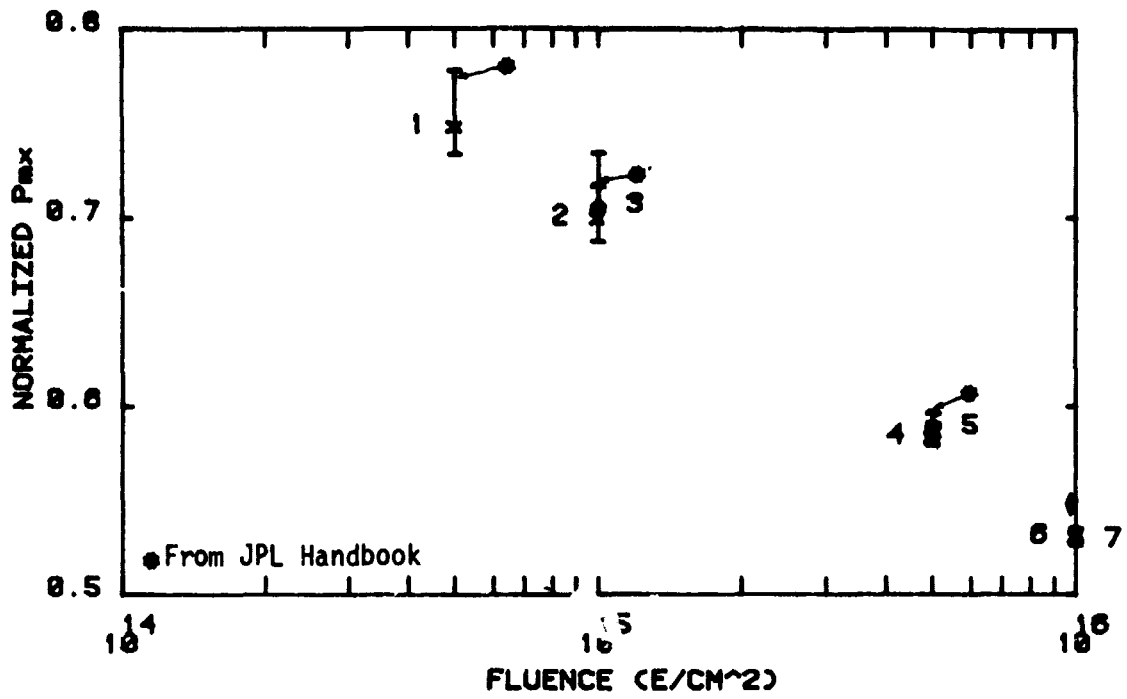

FIGURE 84. D SERIES ELECTRON IRRADIATION IN-SITU

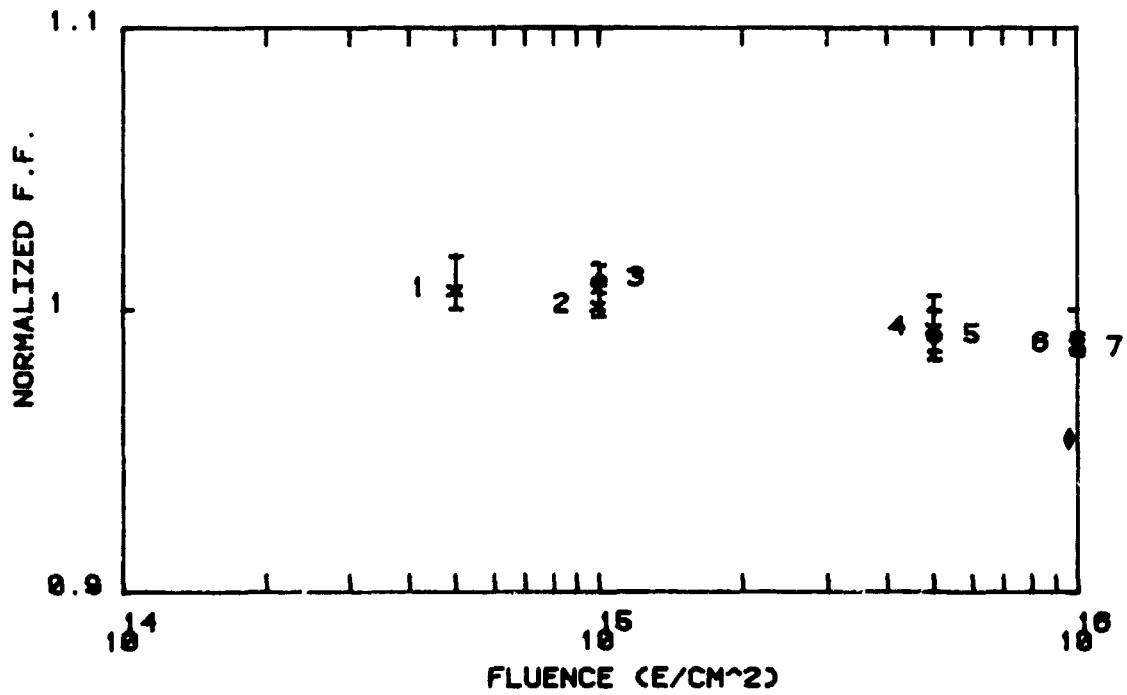

FIGURE 85. D SERIES ELECTRON IRRADIATION IN-SITU

TABLE 23A. TABULATED D SERIES DATA - ELECTRON IRRADIATION

D SERIES ELECTRON IRRADIATION EX-SITU
 TEMP. (C): 25 AREA: 4. INTENSITY 1*AM0

Level Number	AVERAGE Isc/Isc0	AVERAGE Voc/Voc0	AVERAGE Pmx/Pmx0	AVERAGE F. F. /F. F. 0
0	1.000	1.000	1.000	1.000
1	0.724	0.776	0.541	0.964

D SERIES ELECTRON IRRADIATION IN-SITU
 TEMP. (C): 25 AREA: 4. INTENSITY 1*AM0

Level Number	AVERAGE Isc/Isc0	AVERAGE Voc/Voc0	AVERAGE Pmx/Pmx0	AVERAGE F. F. /F. F. 0
0	1.000	1.000	1.000	1.000
1	0.868	0.857	0.750	1.008
2	0.836	0.837	0.702	1.002
3	0.835	0.838	0.708	1.012
4	0.744	0.792	0.586	0.994
5	0.750	0.794	0.591	0.992
6	0.701	0.768	0.532	0.989
7	0.698	0.770	0.531	0.987

D SERIES ELECTRON IRRADIATION EX-SITU
 TEMP. (C): 25 AREA: 4 INTENSITY 1*AM0

Cell Number	Level Number	Isc (mA)	Isc/Isc0	Voc (mV)	Voc/Voc0	Pmx (mW)	Pmx/Pmx0	Fill Fac.	F. F. /F. F. 0
501	0	150.7	1.000	601.1	1.000	69.36	1.000	0.755	1.000
502	0	154.7	1.000	605.3	1.000	72.07	1.000	0.770	1.000
503	0	149.7	1.000	581.8	1.000	67.41	1.000	0.774	1.000
504	0	152.7	1.000	608.3	1.000	71.03	1.000	0.765	1.000
505	0	153.3	1.000	608.4	1.000	72.51	1.000	0.778	1.000
501	1	108.7	0.721	465.3	0.774	37.48	0.540	0.741	0.968
502	1	111.2	0.718	466.5	0.771	38.73	0.537	0.747	0.971
503	1	109.2	0.730	465.9	0.801	37.63	0.558	0.739	0.955
504	1	111.0	0.727	466.0	0.766	38.08	0.536	0.736	0.963
505	1	111.1	0.725	466.5	0.767	38.80	0.535	0.749	0.963

D SERIES ELECTRON IRRADIATION IN-SITU
 TEMP. (C): 25 AREA: 4 INTENSITY 1*AM0

Serial Number	Level Number	Isc (mA)	Isc/Isc0	Voc (mV)	Voc/Voc0	Pmx (mW)	Pmx/Pmx0	Fill Fac.	F. F. / F. F. 0
501	0	128.5	1.000	595.9	1.000	57.94	1.000	0.757	1.000
502	0	131.3	1.000	596.1	1.000	59.00	1.000	0.754	1.000
503	0	129.0	1.000	572.7	1.000	56.04	1.000	0.758	1.000
504	0	132.7	1.000	595.9	1.000	59.33	1.000	0.750	1.000
505	0	132.6	1.000	598.0	1.000	60.60	1.000	0.764	1.000
501	1	110.1	0.857	510.1	0.856	42.53	0.734	0.757	1.000
502	1	114.8	0.875	507.0	0.850	44.73	0.758	0.769	1.019
503	1	113.3	0.878	506.5	0.884	43.62	0.778	0.760	1.002
504	1	115.5	0.870	504.2	0.846	44.05	0.742	0.756	1.008
505	1	114.3	0.862	505.6	0.845	44.65	0.737	0.772	1.011
501	2	106.2	0.827	498.7	0.837	40.20	0.694	0.759	1.003
502	2	110.0	0.838	495.5	0.831	41.48	0.703	0.761	1.009
503	2	109.2	0.846	495.6	0.865	41.18	0.735	0.761	1.003
504	2	110.8	0.835	493.0	0.827	40.88	0.689	0.748	0.997
505	2	110.6	0.834	493.3	0.825	41.69	0.688	0.764	1.000
501	3	105.9	0.824	502.7	0.844	40.82	0.704	0.767	1.013
502	3	110.5	0.842	500.8	0.840	42.24	0.716	0.764	1.013
503	3	0.0	0.000	0.0	0.000	0.00	0.000	0.000	0.000
504	3	111.0	0.836	496.9	0.834	42.00	0.708	0.762	1.015
505	3	110.9	0.837	499.8	0.836	42.59	0.703	0.768	1.005
501	4	94.1	0.733	474.9	0.797	33.60	0.580	0.752	0.993
502	4	98.3	0.749	473.4	0.777	34.85	0.591	0.749	0.993
503	4	0.0	0.000	0.0	0.000	0.00	0.000	0.000	0.000
504	4	99.3	0.749	468.9	0.787	35.13	0.592	0.754	1.005
505	4	99.0	0.746	471.5	0.788	35.14	0.580	0.753	0.985
501	5	95.8	0.745	475.2	0.797	33.80	0.583	0.743	0.982
502	5	98.4	0.750	474.2	0.795	35.15	0.596	0.753	0.999
503	5	0.0	0.000	0.0	0.000	0.00	0.000	0.000	0.000
504	5	100.0	0.754	471.2	0.791	35.32	0.595	0.749	0.999
505	5	99.8	0.753	473.9	0.793	35.70	0.589	0.755	0.986
501	6	88.9	0.692	461.2	0.774	30.76	0.531	0.751	0.992
502	6	92.7	0.707	458.3	0.769	31.63	0.536	0.744	0.987
503	6	0.0	0.000	0.0	0.000	0.00	0.000	0.000	0.000
504	6	93.9	0.708	455.3	0.764	31.75	0.535	0.742	0.989
505	6	92.7	0.699	457.8	0.765	31.98	0.528	0.754	0.986
501	7	88.7	0.690	461.3	0.774	30.45	0.526	0.744	0.983
502	7	91.8	0.700	459.4	0.771	31.45	0.533	0.746	0.989
503	7	0.0	0.000	0.0	0.000	0.00	0.000	0.000	0.000
504	7	93.5	0.704	456.7	0.766	31.66	0.534	0.742	0.989
505	7	92.7	0.699	459.1	0.768	32.12	0.530	0.755	0.988

S/N : 501	LEVEL : 0	1
TEMP: 25 C	ISC(MA) : 150.7	108.7
AREA: 4 CM^2	VOC(MV) : 601.1	465.3
INT. : 1*AM0	PMAX(MW) : 69.4	37.5
	F.F. : 0.765	0.741

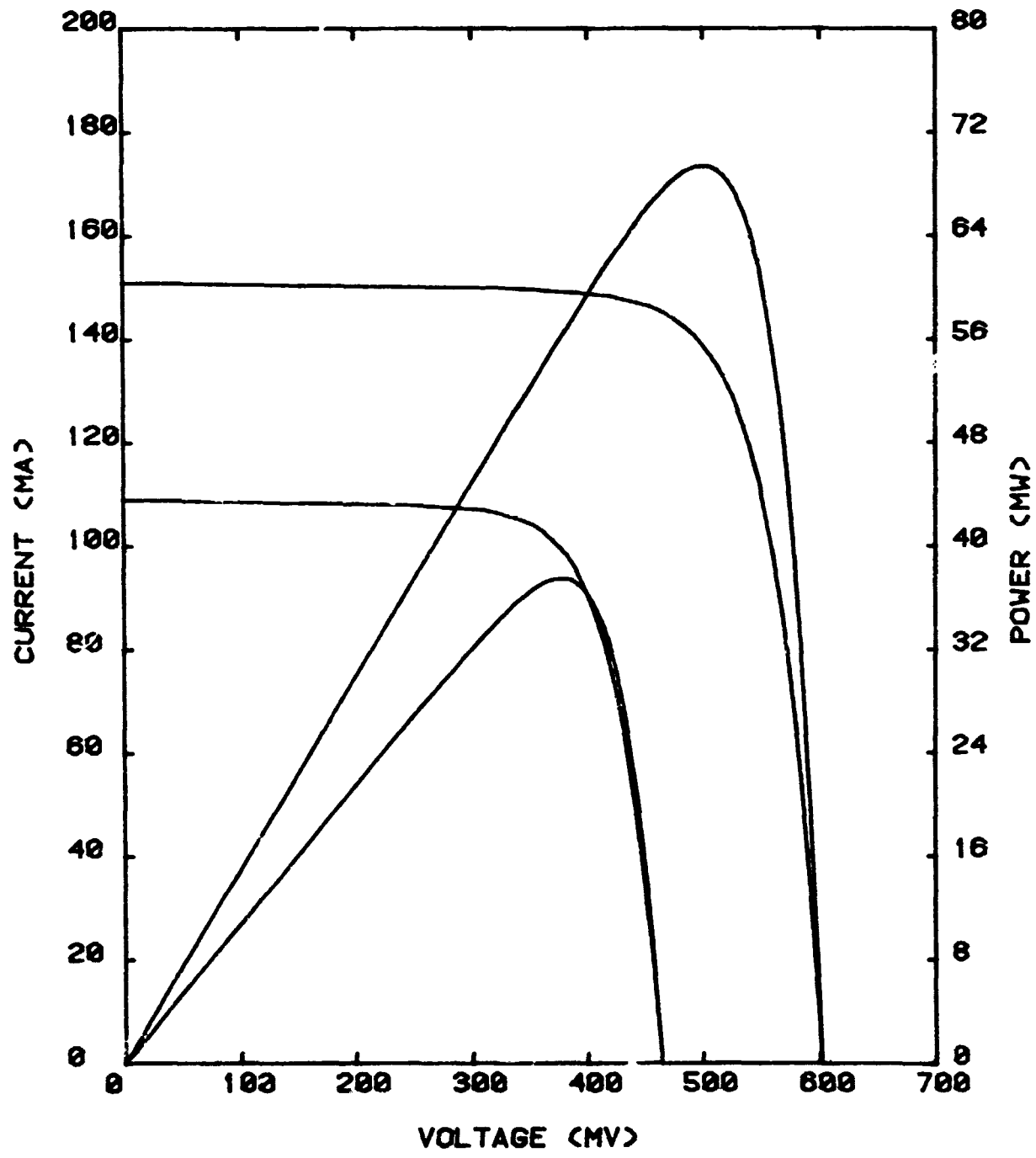

FIGURE 86
D SERIES ELECTRON IRRADIATION EX-SITU

6.6.2 Proton Irradiation

Cracks started to show in the 93-500 used as a cover after 3×10^{14} p/cm² without any thermal cycling. The rest of the proton fluence and thermal cycling caused further cracking until the 93-500 was full of small cracks. It appears that the 93-500 hardened in the proton beam then cracked due to the stress of thermal cycling. The summary plots (Figures 87, 88, 89 and 90) show the affects of protons getting through the 93-500 where there were cracks. This result makes the 93-500 a poor choice as a cover. Figure 91 is a photograph of a D Series samples showing the cracks. The tabulated data is contained in Tables 24A and 24B and Figure 92 is a pre- and post-test I-V curve. A temperature range of 53°C to 56°C was recorded for the samples during the irradiations.

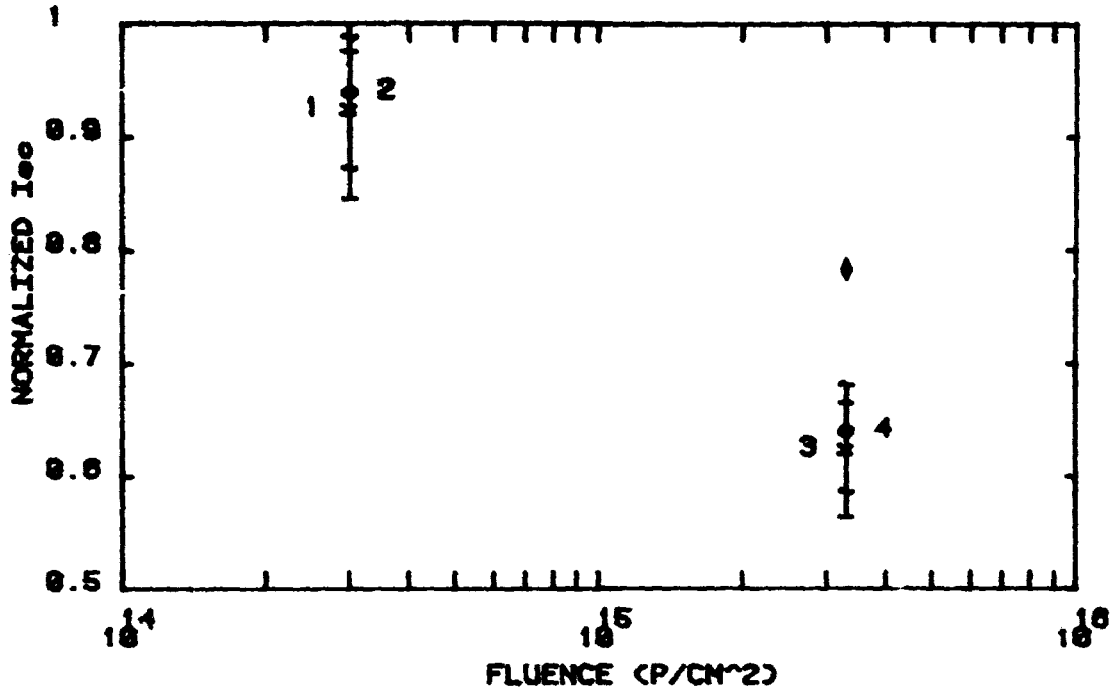

FIGURE 87. D SERIES PROTON IRRADIATION IN-SITU

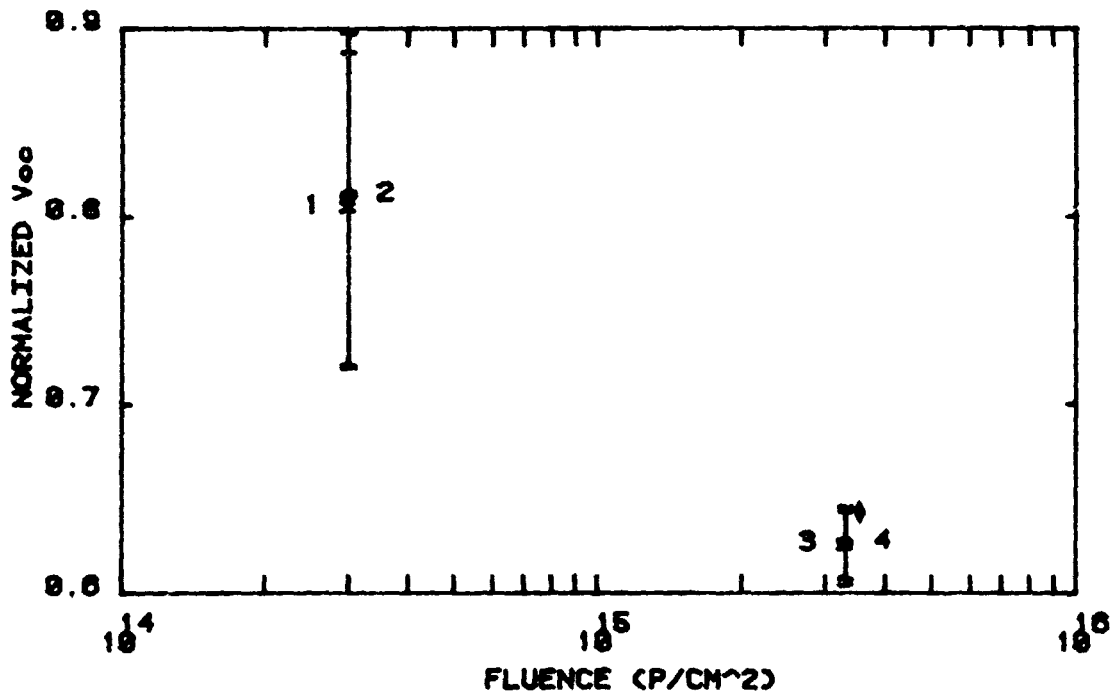

FIGURE 88. D SERIES PROTON IRRADIATION IN-SITU

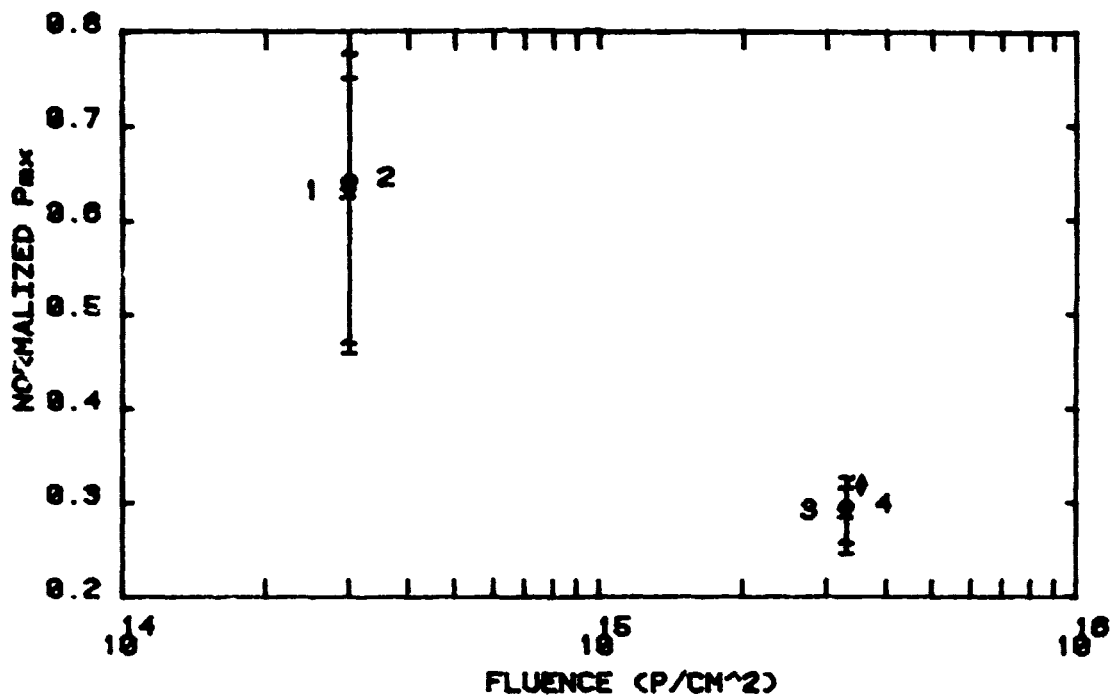

FIGURE 89. D SERIES PROTON IRRADIATION IN-SITU

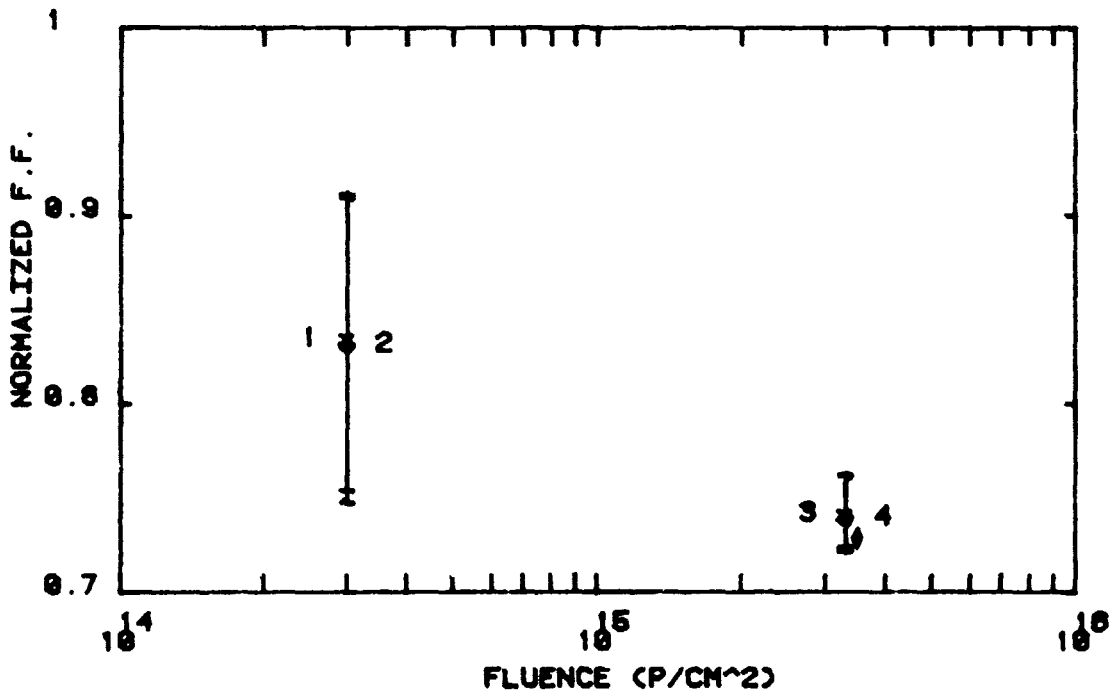

FIGURE 90. D SERIES PROTON IRRADIATION IN-SITU

TABLE 24A. TABULATED D SERIES DATA - PROTON IRRADIATION

D SERIES PROTON IRRADIATION EX-SITU
 TEMP. (C): 25 AREA: 4 INTENSITY 1*AM0

Level Number	AVERAGE Isc/Isc0	AVERAGE Voc/Voc0	AVERAGE Pmx/Pmx0	AVERAGE F. F. /F. F. 0
0	1.000	1.000	1.000	1.000
1	0.777	0.645	0.366	0.729

D SERIES PROTON IRRADIATION IN-SITU
 TEMP. (C): 25 AREA: 4 INTENSITY 1*AM0

Level Number	AVERAGE Isc/Isc0	AVERAGE Voc/Voc0	AVERAGE Pmx/Pmx0	AVERAGE F. F. /F. F. 0
0	1.000	1.000	1.000	1.000
1	0.928	0.807	0.633	0.836
2	0.943	0.813	0.647	0.833
3	0.627	0.627	0.293	0.742
4	0.644	0.628	0.301	0.741

D SERIES PROTON IRRADIATION EX-SITU
 TEMP. (C): 25 AREA: 4 INTENSITY 1*AM0

Serial Number	Level Number	Isc (mA)	Isc/Isc0	Voc (mV)	Voc/Voc0	Pmx (mW)	Pmx/Pmx0	F. F. /F. F. 0	F. F. /F. F. 0
506	0	151.9	1.000	603.8	1.000	70.22	1.000	0.765	1.000
507	0	152.9	1.000	600.9	1.000	70.60	1.000	0.768	1.000
508	0	0.0	0.000	0.0	0.000	0.00	0.000	0.000	0.000
509	0	154.6	1.000	599.7	1.000	69.14	1.000	0.746	1.000
510	0	153.0	1.000	588.2	1.000	69.00	1.000	0.767	1.000
506	1	127.3	0.838	405.7	0.672	28.88	0.411	0.559	0.731
507	1	111.5	0.729	374.4	0.623	22.54	0.319	0.540	0.703
508	1	76.8	0.000	350.8	0.000	13.06	0.000	0.485	0.000
509*	1	94.4	0.610	359.2	0.599	17.86	0.258	0.527	0.707
510	1	117.0	0.765	376.4	0.640	25.41	0.368	0.577	0.752

*NOT INCLUDED IN AVERAGE

TABLE 24B. TABULATED D SERIES DATA - PROTON IRRADIATION

D SERIES PROTON IRRADIATION IN-SITU
 TEMP. (C): 25 AREA: 4 INTENSITY 1*AM0

Serial Number	Level Number	Isc (mA)	Isc/Isc0	Voc (mV)	Voc/Voc0	Pmx (mW)	Pmx/Pmx0	Fill Fac.	F. F. / F. F. 0
506	0	122.7	1.000	601.3	1.000	56.73	1.000	0.769	1.000
507	0	117.9	1.000	608.4	1.000	55.52	1.000	0.774	1.000
508	0	120.9	1.000	606.2	1.000	56.87	1.000	0.776	1.000
509	0	121.9	1.000	606.5	1.000	54.99	1.000	0.744	1.000
510	0	122.2	1.000	594.8	1.000	56.12	1.000	0.772	1.000
506	1	118.9	0.969	533.9	0.888	41.67	0.734	0.656	0.853
507	1	112.6	0.955	524.8	0.863	41.72	0.751	0.706	0.912
508	1	102.3	0.846	436.2	0.720	26.11	0.459	0.585	0.754
509	1	108.6	0.890	442.6	0.730	28.52	0.519	0.594	0.798
510	1	119.4	0.977	496.0	0.834	39.39	0.702	0.665	0.862
506	2	120.1	0.979	539.2	0.897	42.74	0.753	0.660	0.858
507	2	114.8	0.974	532.8	0.876	43.00	0.774	0.703	0.908
508	2	105.3	0.871	436.2	0.720	26.60	0.468	0.579	0.746
509	2	110.3	0.904	444.3	0.733	28.95	0.527	0.591	0.795
510	2	120.6	0.987	501.3	0.843	39.93	0.711	0.661	0.856
506	3	81.9	0.668	387.0	0.644	18.05	0.318	0.570	0.740
507	3	66.6	0.564	367.6	0.604	13.70	0.247	0.560	0.724
508*	3	45.1	0.373	346.8	0.572	7.91	0.139	0.506	0.652
509*	3	60.6	0.497	357.9	0.590	11.54	0.210	0.532	0.716
510	3	79.5	0.650	377.5	0.635	17.67	0.315	0.589	0.763
506	4	83.5	0.681	387.3	0.644	18.44	0.325	0.570	0.741
507	4	69.0	0.585	368.9	0.606	14.20	0.256	0.557	0.720
508*	4	47.3	0.391	346.6	0.572	8.21	0.144	0.501	0.645
509*	4	62.2	0.510	356.6	0.588	11.97	0.218	0.540	0.726
510	4	81.4	0.666	377.5	0.635	18.04	0.321	0.587	0.760

*NOT INCLUDED IN AVERAGE

ORIGINAL PAGE IS
OF POOR QUALITY



FIGURE 91. SAMPLE D28 (507) SHOWING CRACKS,
POST-PROTON IRRADIATION EX SITU

S/N : 507	LEVEL : 0	1
TEMP: 25 C	ISC(MA) : 152.0	111.5
AREA: 4 CM^2	VOC(MV) : 600.9	374.4
INT. : 1*AM0	PMAX(MW) : 70.8	22.5
	F.F. : 0.768	0.540

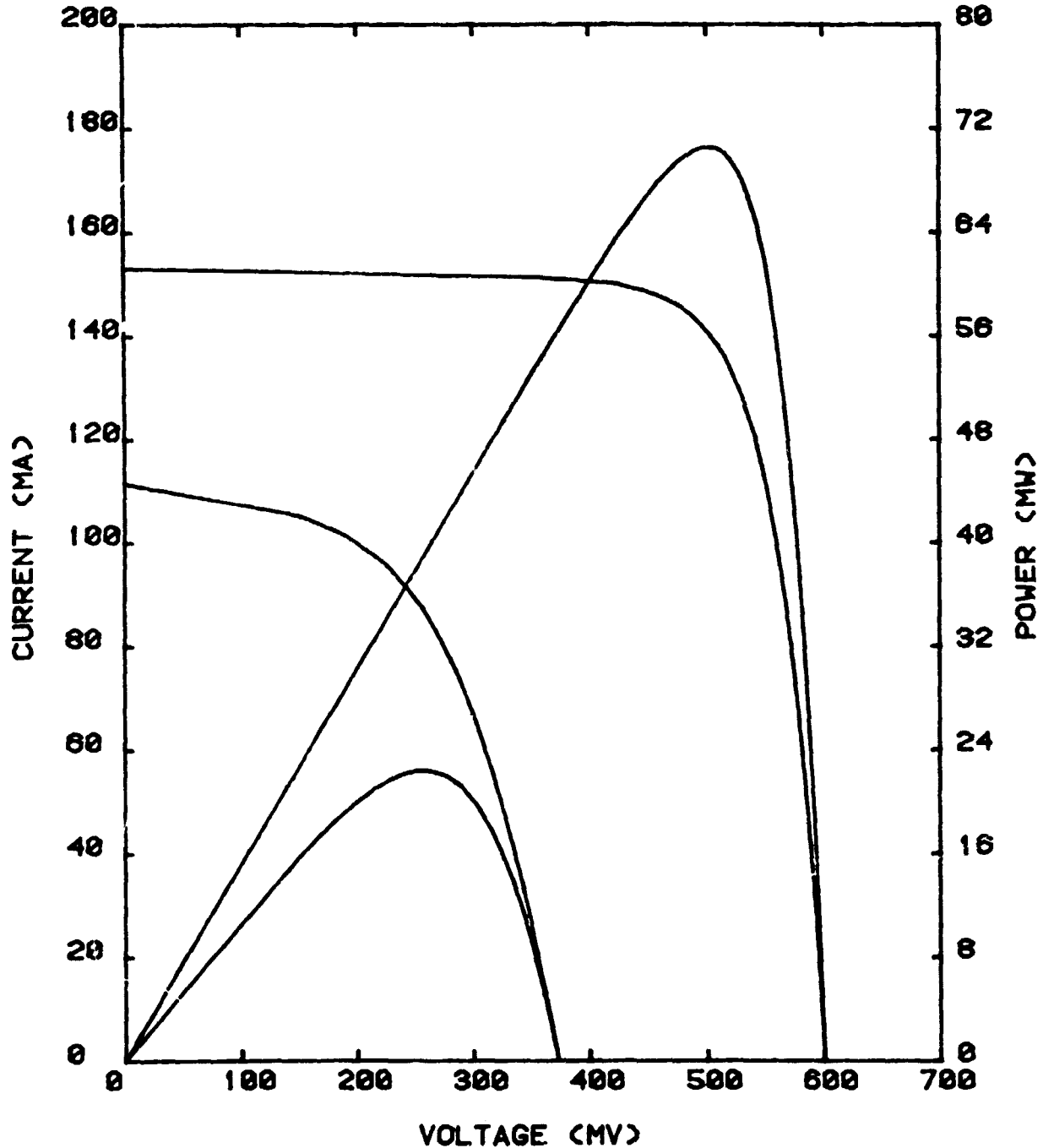

FIGURE 92
D SERIES PROTON IRRADIATION EX-SITU

6.6.3 UV Exposure

The I_{sc} degraded by 7% to 14% from 1000 ESH to 8760 ESH. The loss was caused by either one or a combination of the darkening of the DC 93-500 or contamination during the UV exposure. Figures 93, 94, 95 and 96 are the summary plots and Tables 25A and 25B are the tabulated data. Figure 97 shows a typical pre- and post-test I-V curve. The sample temperature thermocouple failed during the first part of the exposure.

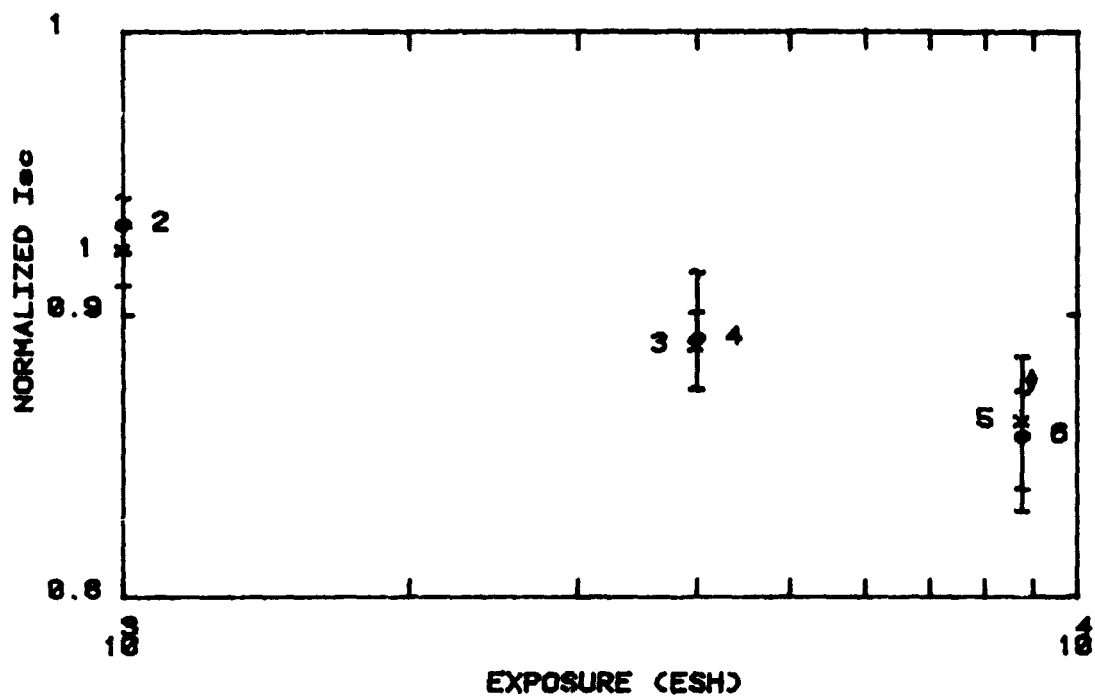

FIGURE 93. D SERIES UV IRRADIATION IN SITU

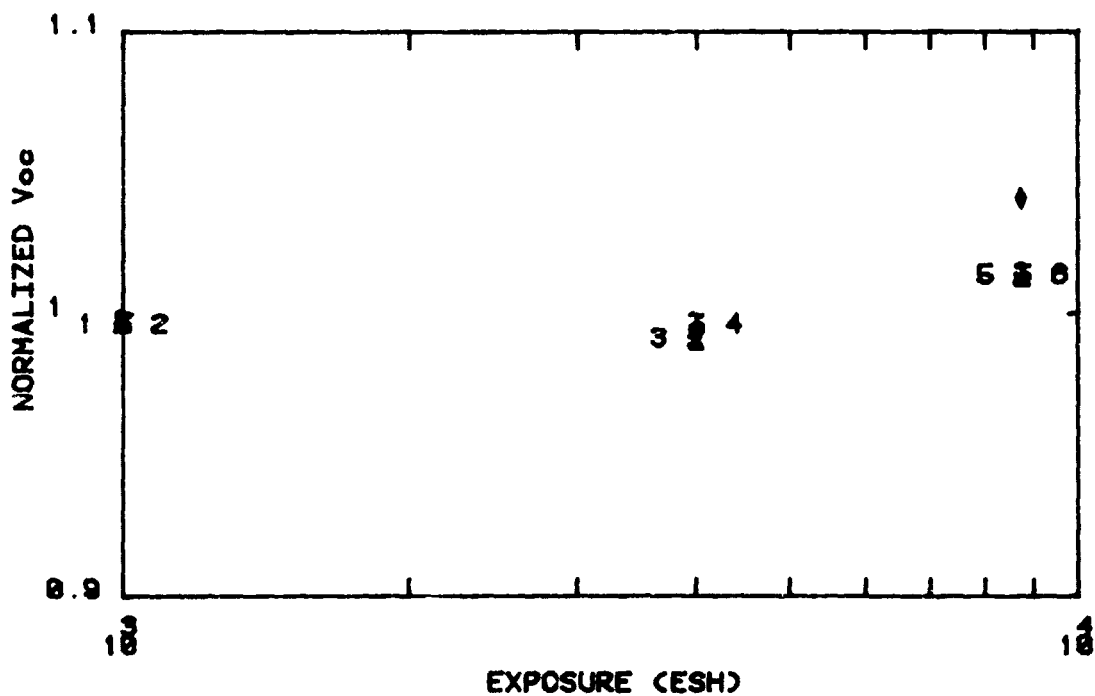

FIGURE 94. D SERIES UV IRRADIATION IN SITU

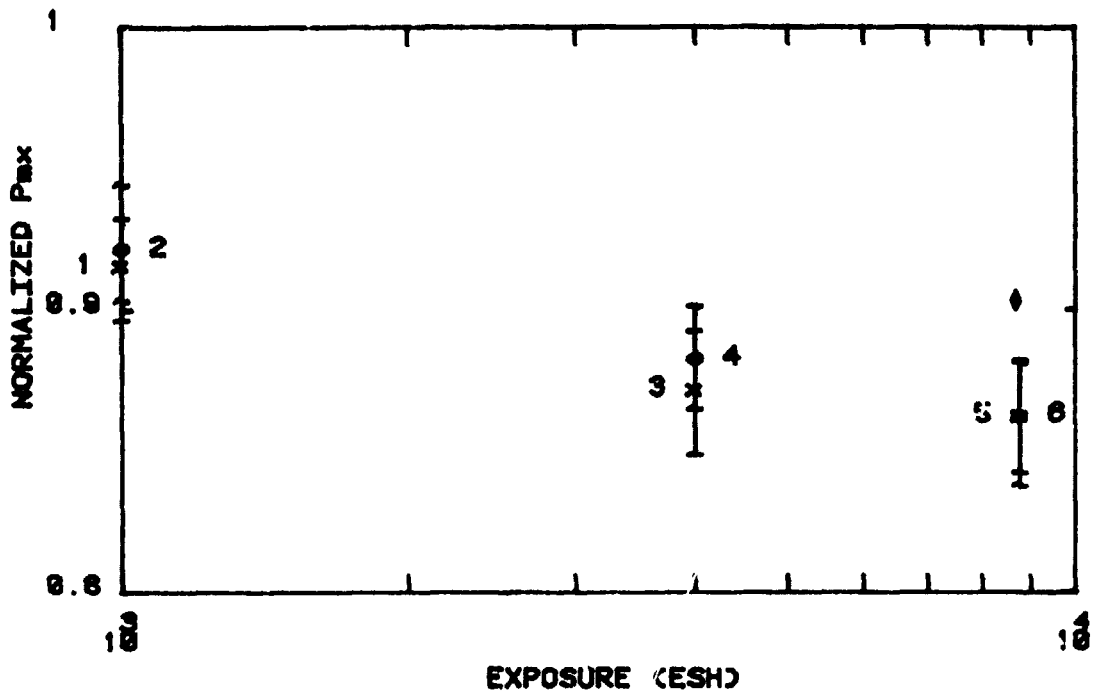

FIGURE 95. D SERIES UV IRRADIATION IN SITU

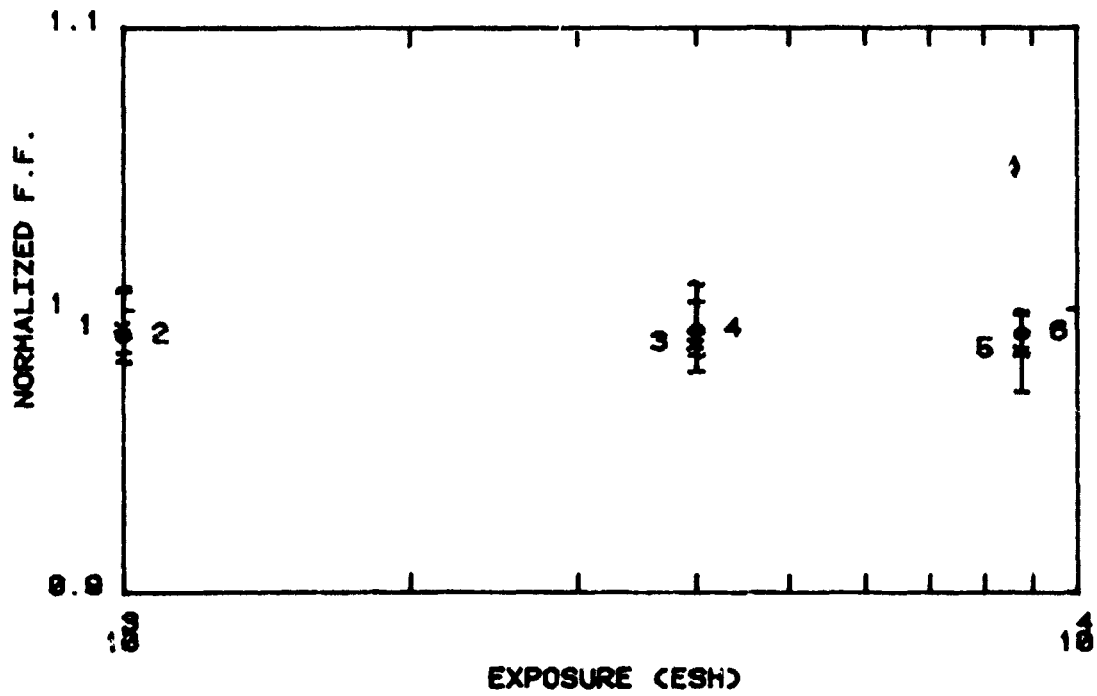

FIGURE 96. D SERIES UV IRRADIATION IN SITU

TABLE 25A. TABULATED D SERIES DATA - UV IRRADIATION

D SERIES UV IRRADIATION EX-SITU
 TEMP. (C): 25 AREA: 4. INTENSITY 1*AM0

Level Number	AVERAGE Isc/Isc0	AVERAGE Voc/Voc0	AVERAGE Pmx/Pmx0	AVERAGE F. F. /F. F. 0
0	1.000	1.000	1.000	1.000
1	0.881	1.023	0.907	1.006

D SERIES UV IRRADIATION IN SITU
 TEMP. (C): 25 AREA: 4. INTENSITY 1*AM0

Level Number	AVERAGE Isc/Isc0	AVERAGE Voc/Voc0	AVERAGE Pmx/Pmx0	AVERAGE F. F. /F. F. 0
0	1.000	1.000	1.000	1.000
1	0.924	0.997	0.917	0.995
2	0.932	0.997	0.923	0.992
3	0.890	0.992	0.873	0.989
4	0.893	0.996	0.884	0.994
5	0.864	1.014	0.864	0.986
6	0.858	1.014	0.864	0.993

D SERIES UV IRRADIATION EX-SITU
 TEMP. (C): 25 AREA: 4 INTENSITY 1*AM0

Serial Number	Level Number	Isc (mA)	Isc/Isc0	Voc (mV)	Voc/Voc0	Pmx (mW)	Pmx/Pmx0	Fill Fac.	F. F. /F. F. 0
511	0	152.9	1.000	611.8	1.000	70.64	1.000	0.755	1.000
512	0	153.4	1.000	610.0	1.000	69.67	1.000	0.745	1.000
513	0	151.5	1.000	610.1	1.000	68.87	1.000	0.745	1.000
514	0	151.8	1.000	609.1	1.000	69.11	1.000	0.747	1.000
515	0	155.4	1.000	611.5	1.000	70.92	1.000	0.746	1.000
511	1	131.4	0.860	626.1	1.023	62.02	0.878	0.754	0.998
512	1	136.8	0.892	622.3	1.020	64.03	0.919	0.752	1.010
513	1	134.4	0.887	624.2	1.023	63.08	0.910	0.752	1.009
514	1	131.6	0.867	623.4	1.023	61.20	0.835	0.746	0.998
515	1	139.7	0.899	628.3	1.027	66.46	0.937	0.757	1.015

TABLE 250. TABULATED D SERIES DATA - UV IRRADIATION

D SERIES UV IRRADIATION IN SITU
 TEMP. (C): 25 AREA: 4 INTENSITY 1*AM0

Serial Number	Level Number	Isc (mA)	Isc/Isco	Voc (mV)	Voc/Voco	Pmx (mW)	Pmx/Pmxo	F(1) Fac.	F. F. / F. F. o
511	0	150.7	1.000	613.5	1.000	70.28	1.000	0.760	1.000
512	0	151.1	1.000	613.2	1.000	69.74	1.000	0.752	1.000
513	0	148.8	1.000	613.7	1.000	67.77	1.000	0.742	1.000
514	0	150.1	1.000	610.3	1.000	68.82	1.000	0.751	1.000
515	0	154.5	1.000	618.7	1.000	71.04	1.000	0.743	1.000
511	1	137.3	0.911	611.6	0.997	63.00	0.896	0.751	0.988
512	1	140.2	0.926	611.0	0.996	63.50	0.911	0.741	0.985
513	1	138.6	0.932	611.5	0.996	62.84	0.927	0.741	0.999
514	1	138.3	0.921	609.9	0.999	63.15	0.918	0.749	0.997
515	1	143.7	0.930	615.2	0.994	66.27	0.933	0.749	1.000
511	2	138.9	0.922	612.4	0.998	63.43	0.903	0.746	0.981
512	2	142.1	0.940	610.0	0.995	64.28	0.922	0.741	0.985
513	2	140.0	0.941	612.0	0.997	63.95	0.944	0.746	1.006
514	2	139.2	0.927	610.0	0.999	62.69	0.911	0.738	0.983
515	2	144.7	0.937	614.8	0.994	66.52	0.926	0.748	1.006
511	3	132.1	0.876	609.7	0.994	60.25	0.857	0.748	0.985
512	3	136.2	0.901	607.1	0.990	61.24	0.878	0.741	0.984
513	3	133.7	0.899	610.0	0.994	60.22	0.889	0.738	0.995
514	3	131.2	0.874	605.9	0.993	58.42	0.849	0.735	0.978
515	3	139.1	0.901	611.3	0.988	63.43	0.893	0.746	1.003
511	4	133.0	0.882	612.0	0.998	61.34	0.873	0.754	0.992
512	4	135.7	0.898	609.6	0.994	61.92	0.880	0.748	0.995
513	4	133.4	0.897	611.3	0.996	61.04	0.901	0.749	1.000
514	4	131.0	0.873	609.5	0.999	59.48	0.864	0.745	0.991
515	4	141.3	0.914	616.1	0.996	63.59	0.895	0.731	0.983
511	5	127.1	0.843	623.8	1.017	59.67	0.849	0.753	0.991
512	5	133.2	0.881	620.8	1.012	60.41	0.866	0.731	0.971
513	5	130.6	0.878	622.3	1.014	59.46	0.877	0.732	0.986
514	5	124.7	0.831	619.8	1.016	57.98	0.842	0.750	0.999
515	5	136.8	0.885	624.9	1.010	62.70	0.883	0.734	0.987
511	6	126.3	0.838	623.4	1.016	58.84	0.837	0.748	0.984
512	6	131.7	0.871	620.2	1.011	60.82	0.872	0.745	0.990
513	6	129.7	0.872	622.3	1.014	59.69	0.881	0.739	0.996
514	6	126.0	0.840	619.7	1.015	58.38	0.848	0.748	0.995
515	6	134.6	0.871	626.1	1.012	62.54	0.880	0.742	0.987

S/N : 512	LEVEL : 0	1
TEMP: 25 C	ISC(MA) : 153.4	136.8
AREA: 4 CM ²	VOC(MV) : 610.0	622.3
INT. : 1*AM0	PMAX(MW): 69.7	64.0
	F.F. : 0.745	0.752

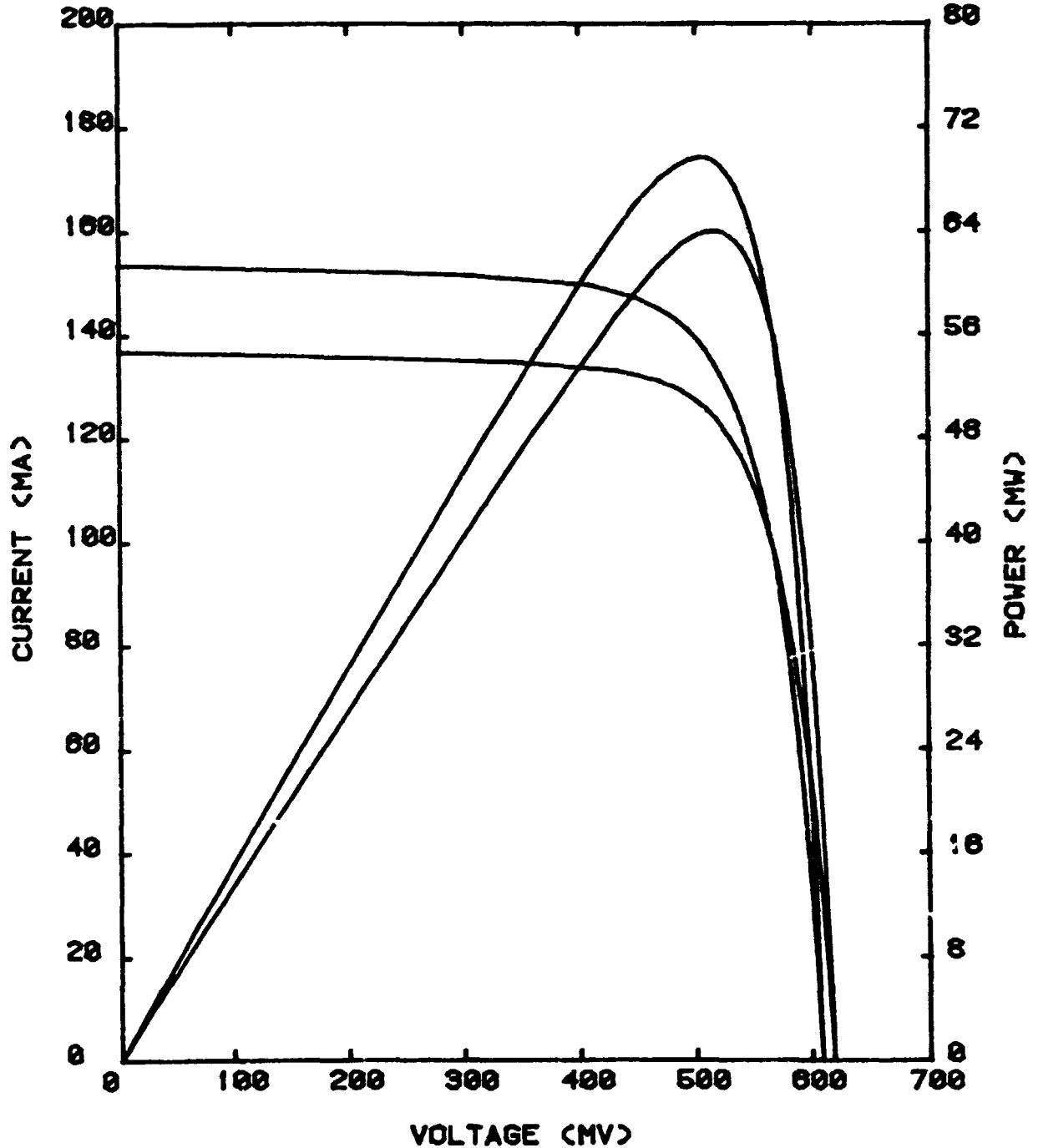

FIGURE 97.
D SERIES UV IRRADIATION EX-SITU

D180-26590-1

6.7 E SERIES CELLS

(Spectrolab 10-mil 10 Ω -cm series 4500 (K 4 1/2) cell, 2-mils of GE 615/UV-24 as a cover, no backing and no adhesive.)

6.7.1 Electron Irradiation

Figures 98, 99, 100 and 101 show the test parameter versus fluence and plotted with it are data from Spectrolab for similar HESP cells (Type 2 and 8) (see Table 26). The HESP cells differ in thickness but the values used bracket the E-Series cell. The agreement indicates that there was no significant darkening of the GE 615/UV24. Tables 27A and 27B contain the tabulated data and Figure 102 is a typical pre- and post-test I-V curve. The sample temperature during the irradiations were between 55°C and 57°C.

TABLE 26. SUMMARY OF HESP CELL DATA*

	$1 \times 10^{15} \text{ e/cm}^2$			$1 \times 10^{16} \text{ e/cm}^2$		
	$\frac{I_{sc}}{I_{sco}}$	$\frac{V_{oc}}{V_{oco}}$	$\frac{P_{mx}}{P_{mxo}}$	$\frac{I_{sc}}{I_{sco}}$	$\frac{V_{oc}}{V_{oco}}$	$\frac{P_{mx}}{P_{mxo}}$
HESP HYBRID TYPE 2 12 mil 10 Ω -cm	0.86	0.92	0.77	0.74	0.84	0.58
TYPE 8 8 mil 10 Ω -cm	0.87	0.93	0.80	0.75	0.85	0.61

*Taken from High Efficiency Solar Panel Report No. AFAPL-TR-722-36 by Spectrolab, Inc.

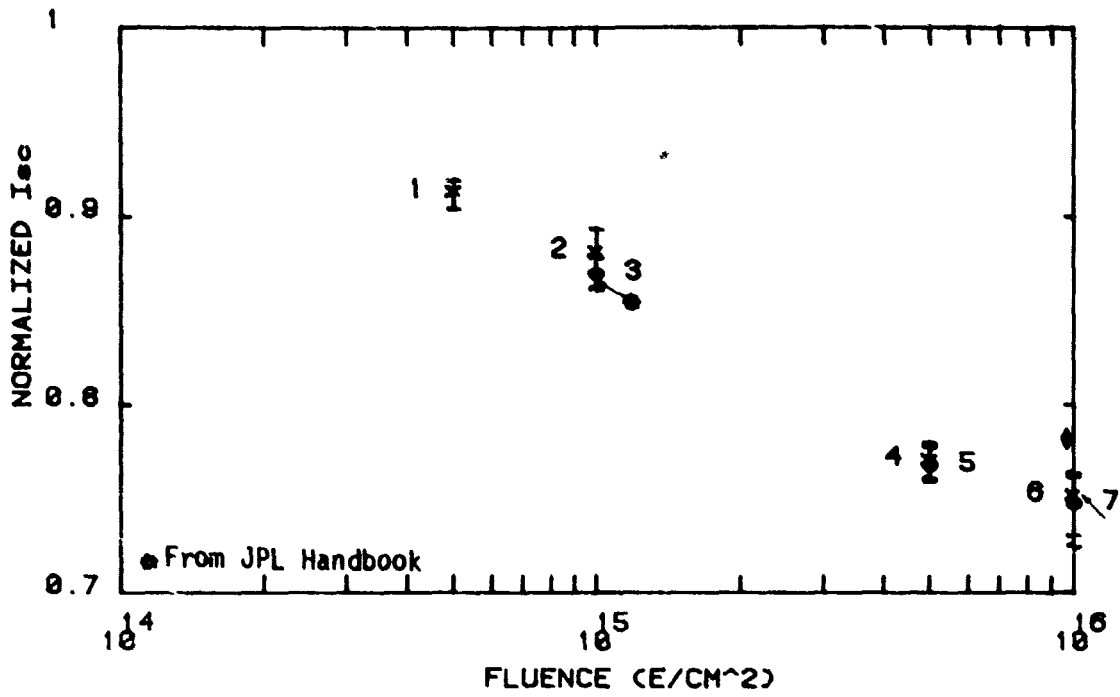

FIGURE 98. E SERIES ELECTRON IRRADIATION IN-SITU

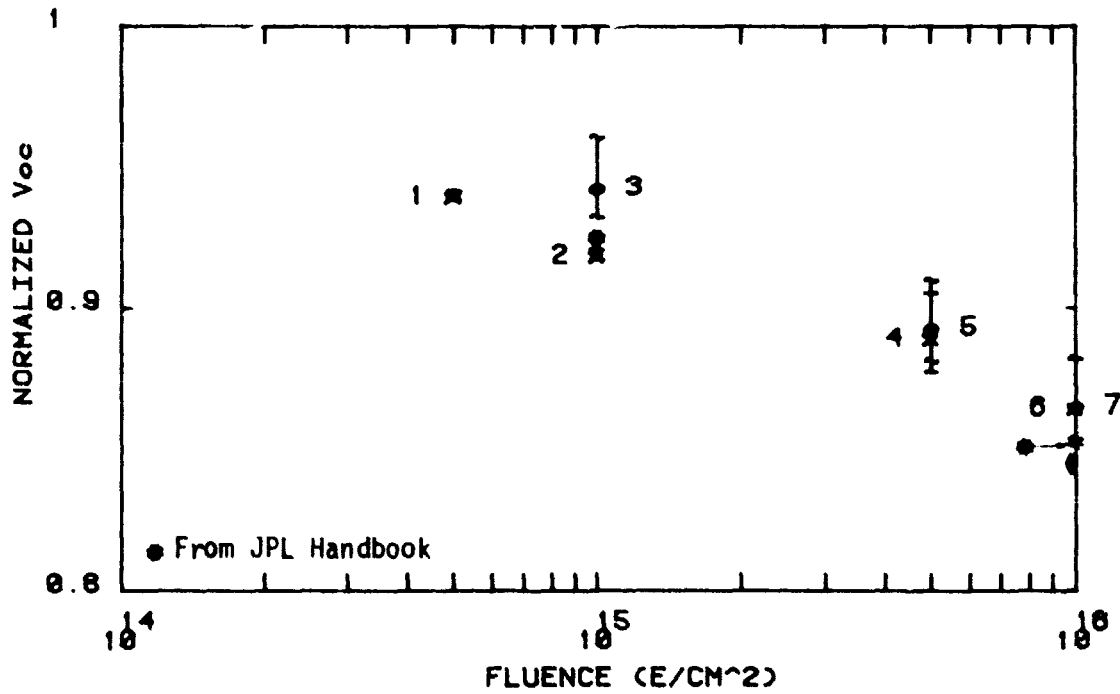

FIGURE 99. F SERIES ELECTRON IRRADIATION IN-SITU

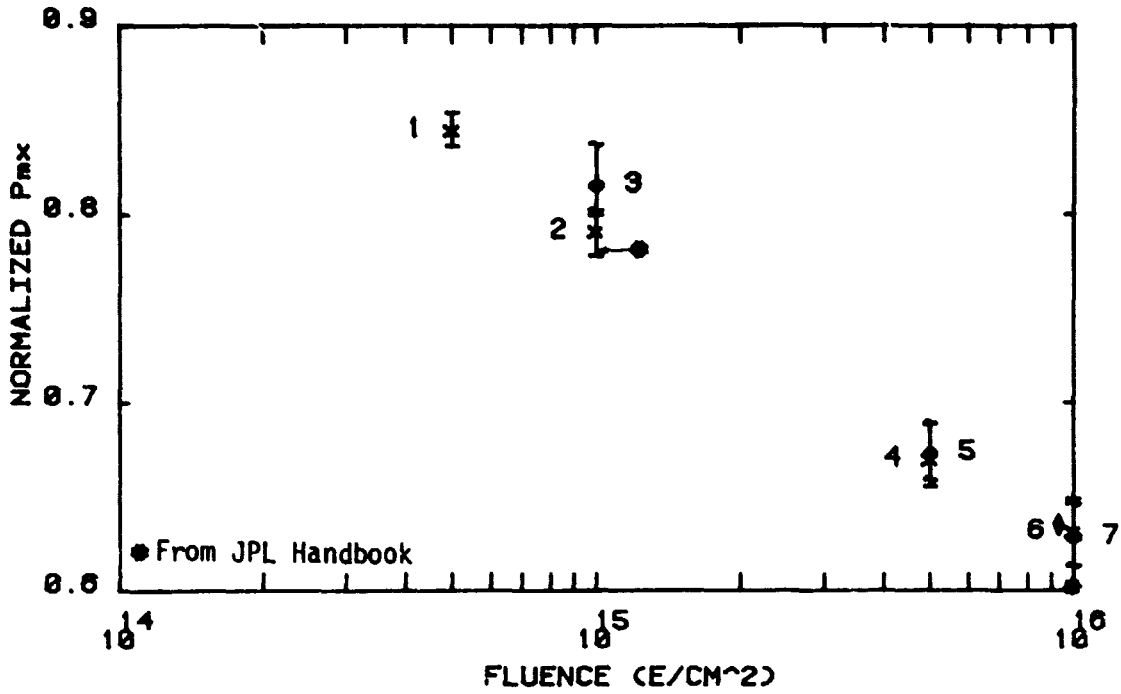

FIGURE 100. E SERIES ELECTRON IRRADIATION IN-SITU

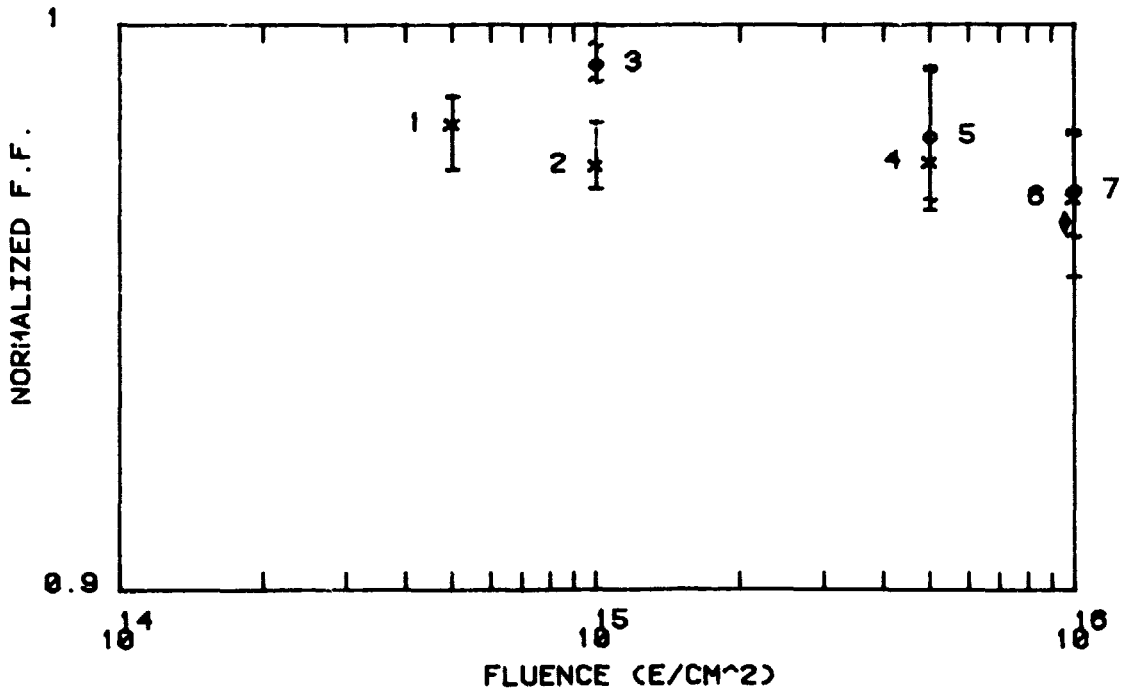

FIGURE 101. E SERIES ELECTRON IRRADIATION IN-SITU

TABLE 27A. TABULATED E SERIES DATA - ELECTRON IRRADIATION

E SERIES ELECTRON IRRADIATION EXSITU
 TEMP. (C): 25 AREA: 4. INTENSITY 1*AM0

Level Number	AVERAGE Isc/Isc0	AVERAGE Voc/Voc0	AVERAGE Pmx/Pmx0	AVERAGE F. F. /F. F. 0
0	1.000	1.000	1.000	1.000
1	0.785	0.840	0.634	0.962

E SERIES ELECTRON IRRADIATION IN-SITU
 TEMP. (C): 25 AREA: 4. INTENSITY 1*AM0

Level Number	AVERAGE Isc/Isc0	AVERAGE Voc/Voc0	AVERAGE Pmx/Pmx0	AVERAGE F. F. /F. F. 0
0	1.000	1.000	1.000	1.000
1	0.916	0.940	0.846	0.983
2	0.884	0.919	0.793	0.976
3	0.872	0.944	0.817	0.994
4	0.773	0.890	0.672	0.976
5	0.770	0.894	0.675	0.981
6	0.754	0.865	0.633	0.970
7	0.749	0.866	0.630	0.971

E SERIES ELECTRON IRRADIATION EXSITU
 TEMP. (C): 25 AREA: 4 INTENSITY 1*AM0

Serial Number	Level Number	Isc (mA)	Isc/Isc0	Voc (mV)	Voc/Voc0	Pmx (mW)	Pmx/Pmx0	Full Fac.	F. F. /F. F. 0
601	0	145.3	1.000	554.4	1.000	60.78	1.000	0.754	1.000
602	0	149.8	1.000	550.5	1.000	63.98	1.000	0.776	1.000
603	0	146.5	1.000	549.1	1.000	61.13	1.000	0.760	1.000
604	0	144.9	1.000	549.5	1.000	62.59	1.000	0.786	1.000
605	0	145.9	1.000	549.9	1.000	63.15	1.000	0.787	1.000
601	1	111.8	0.769	467.7	0.843	39.35	0.647	0.753	0.990
602	1	118.8	0.793	461.1	0.838	40.39	0.631	0.738	0.951
603	1	115.9	0.791	461.3	0.840	39.26	0.642	0.734	0.966
604	1	113.5	0.783	459.8	0.837	39.30	0.628	0.733	0.950
605	1	115.0	0.788	461.9	0.840	39.26	0.622	0.739	0.929

TABLE 27B. TABULATED E SERIES DATA - ELECTRON IRRADIATION

E SERIES ELECTRON IRRADIATION IN-SITU
 TEMP. (C): 25 AREA: 4 INTENSITY 1*AM0

Serial Number	Level Number	Isc (mA)	Isc/ Isco	Voc (mV)	Voc/ Voco	Pmx (mW)	Pmx/ Pmxo	Fill Fac.	F. F. / F. F. o
601	0	123.5	1.000	545.9	1.000	52.35	1.000	0.776	1.000
602	0	130.1	1.000	526.4	1.000	53.01	1.000	0.774	1.000
603	0	126.4	1.000	531.7	1.000	50.62	1.000	0.753	1.000
604	0	126.5	1.000	541.2	1.000	53.72	1.000	0.765	1.000
605	0	128.8	1.000	535.5	1.000	53.85	1.000	0.781	1.000
601	1	111.7	0.904	512.5	0.939	43.77	0.836	0.765	0.985
602	1	119.5	0.918	495.3	0.941	45.10	0.851	0.762	0.984
603	1	116.3	0.920	500.0	0.940	43.24	0.854	0.744	0.987
604	1	116.2	0.919	509.8	0.942	45.30	0.843	0.765	0.975
605	1	118.1	0.917	502.6	0.939	45.59	0.847	0.768	0.983
601	2	107.5	0.870	502.9	0.921	40.73	0.778	0.734	0.971
602	2	116.3	0.894	484.8	0.921	42.44	0.801	0.753	0.972
603	2	112.3	0.888	488.4	0.918	40.46	0.799	0.738	0.960
604	2	111.2	0.879	497.2	0.919	42.64	0.794	0.771	0.983
605	2	114.3	0.887	491.4	0.918	42.62	0.791	0.759	0.972
601	3	106.3	0.860	511.9	0.938	41.93	0.801	0.771	0.993
602	3	113.7	0.874	505.4	0.960	44.31	0.836	0.771	0.996
603	3	110.9	0.877	501.6	0.943	41.65	0.823	0.749	0.995
604	3	110.5	0.874	504.4	0.932	43.50	0.810	0.780	0.994
605	3	112.4	0.873	506.1	0.945	43.97	0.817	0.773	0.990
601	4	93.8	0.760	483.3	0.885	34.33	0.656	0.757	0.975
602	4	100.3	0.771	476.6	0.905	36.09	0.681	0.755	0.975
603	4	98.7	0.781	473.1	0.890	34.89	0.689	0.747	0.993
604	4	98.5	0.779	475.0	0.878	35.67	0.664	0.762	0.971
605	4	99.8	0.775	477.4	0.891	35.99	0.668	0.755	0.967
601	5	93.9	0.760	485.1	0.889	34.45	0.658	0.757	0.975
602	5	99.5	0.765	478.5	0.909	36.49	0.688	0.766	0.990
603	5	98.1	0.776	474.9	0.893	34.79	0.687	0.747	0.992
604	5	98.2	0.777	476.5	0.880	35.57	0.662	0.760	0.968
605	5	99.5	0.772	480.6	0.897	36.53	0.678	0.764	0.979
601	6	90.3	0.731	470.4	0.862	32.10	0.613	0.756	0.974
602	6	99.2	0.763	464.3	0.882	34.42	0.649	0.747	0.965
603	6	96.4	0.762	459.4	0.864	32.71	0.646	0.739	0.981
604	6	96.0	0.759	461.0	0.852	33.18	0.618	0.750	0.955
605	6	97.4	0.756	464.3	0.867	34.35	0.638	0.759	0.973
601	7	89.4	0.724	471.1	0.863	32.04	0.612	0.761	0.960
602	7	95.2	0.755	464.0	0.882	34.20	0.645	0.750	0.969
603	7	96.4	0.763	460.7	0.867	32.60	0.644	0.734	0.975
604	7	95.5	0.755	461.6	0.853	33.51	0.624	0.761	0.969
605	7	96.7	0.751	464.1	0.867	33.72	0.626	0.751	0.962

S/N : 601	LEVEL : 0	1
TEMP: 25 C	ISC(MA) : 145.3	111.8
AREA: 4 CM ²	VOC(MV) : 554.4	467.7
INT. : 1*AM0	PMAX(MW): 60.8	39.3
	F.F. : 0.754	0.753

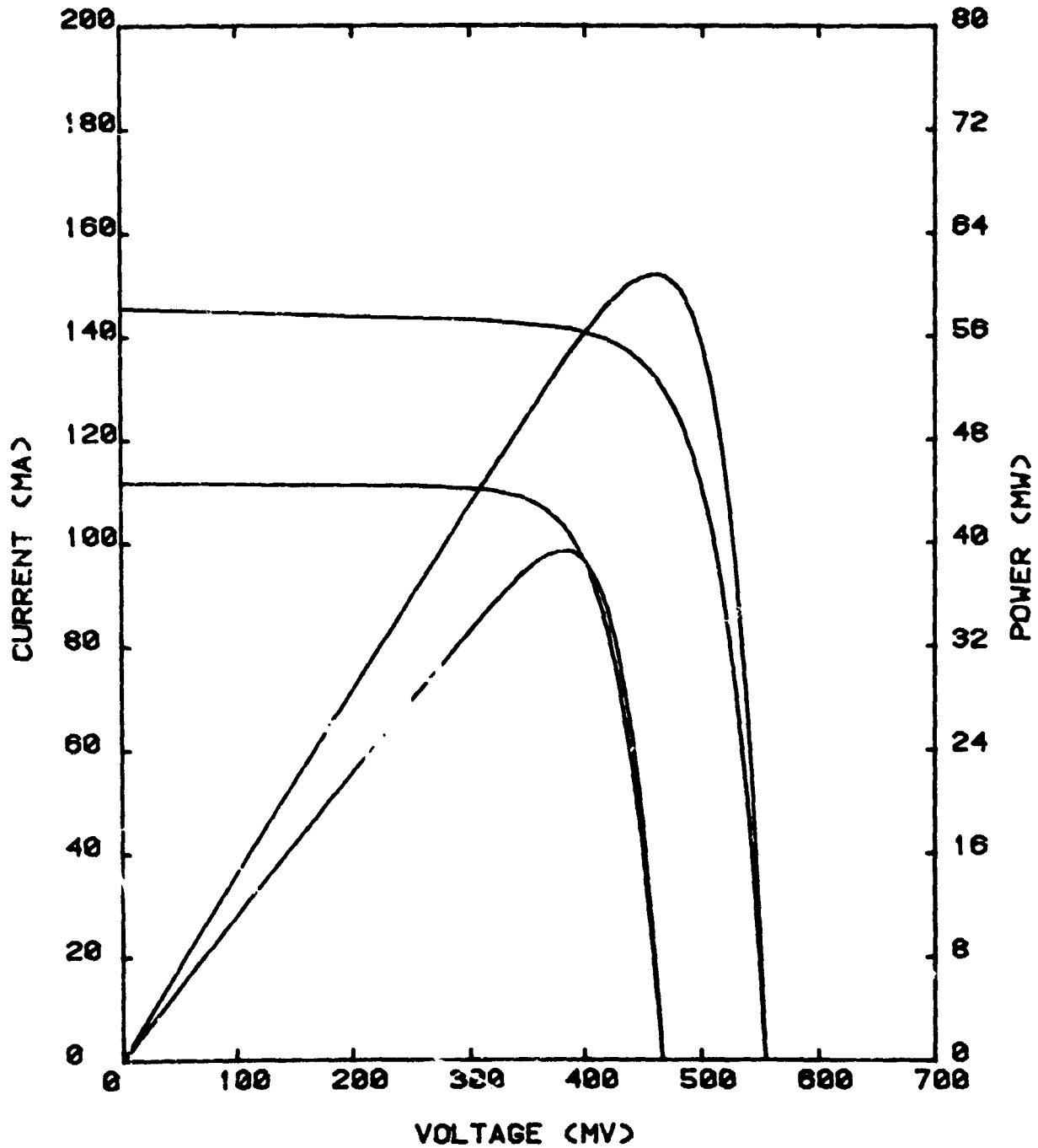

FIGURE 102.

E SERIES ELECTRON IRRADIATION EXSITU

D180-26590-1

6.7.2 Proton Irradiation

Cracks started to show in the GE cover material after the first set of thermal cycles. The rest of the proton fluence and thermal cycling caused further cracking until the GE 615/UV-24 was full of many cracks similar to the D Series cells. It is clear from the summary plots (Figures 103, 104, 105 and 106) that the cracks in the cover material allowed protons to reach the cells and degrade them. Figure 107 is a photograph of a sample after the proton irradiation. The tabulated data are listed in Tables 28A and 28B and a pre- and post-test I-V curve is shown in Figure 108. During the irradiations the sample temperature varied from 55°C to 56°C.

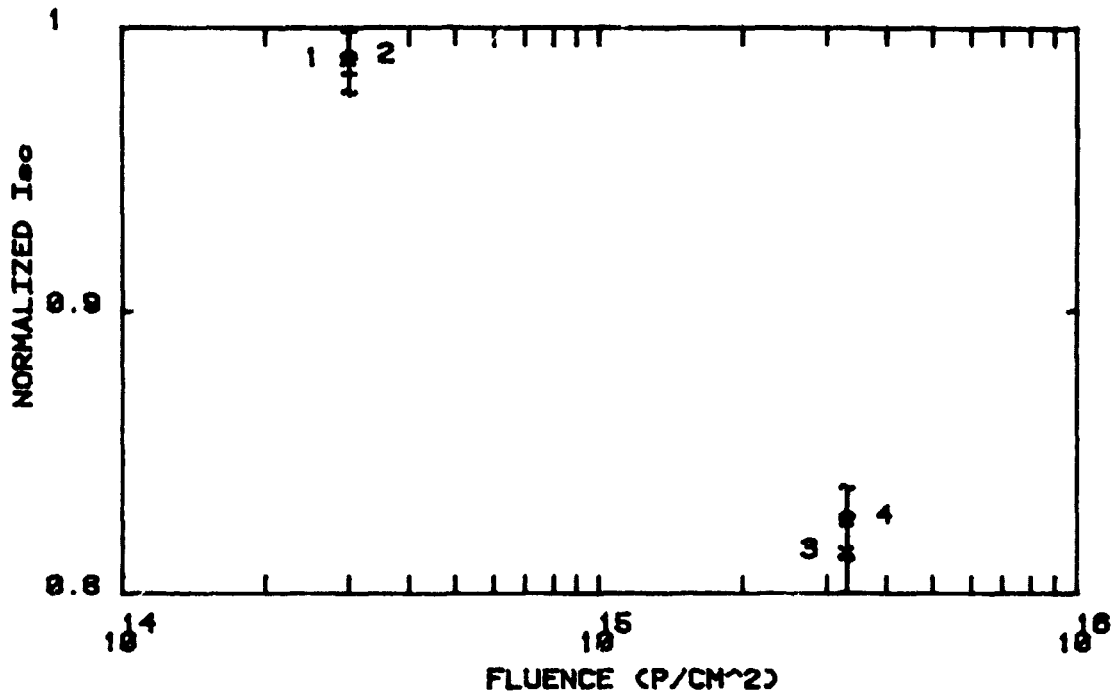

FIGURE 103. E SERIES PROTON IRRADIATION IN-SITU

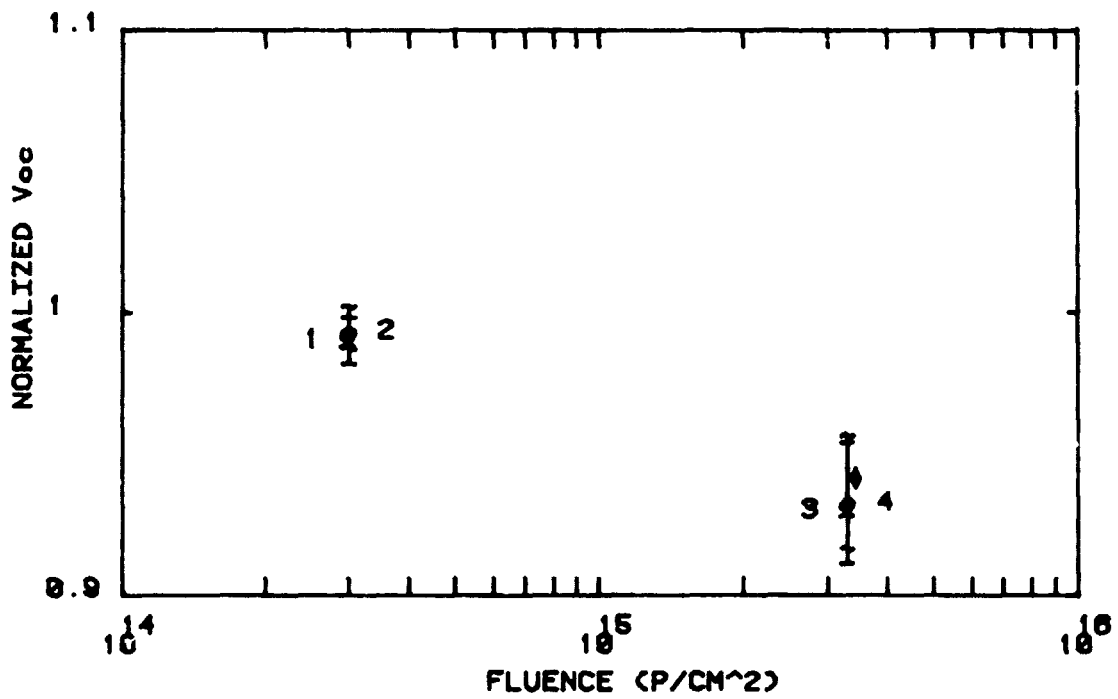

FIGURE 104. E SERIES PROTON IRRADIATION IN-SITU

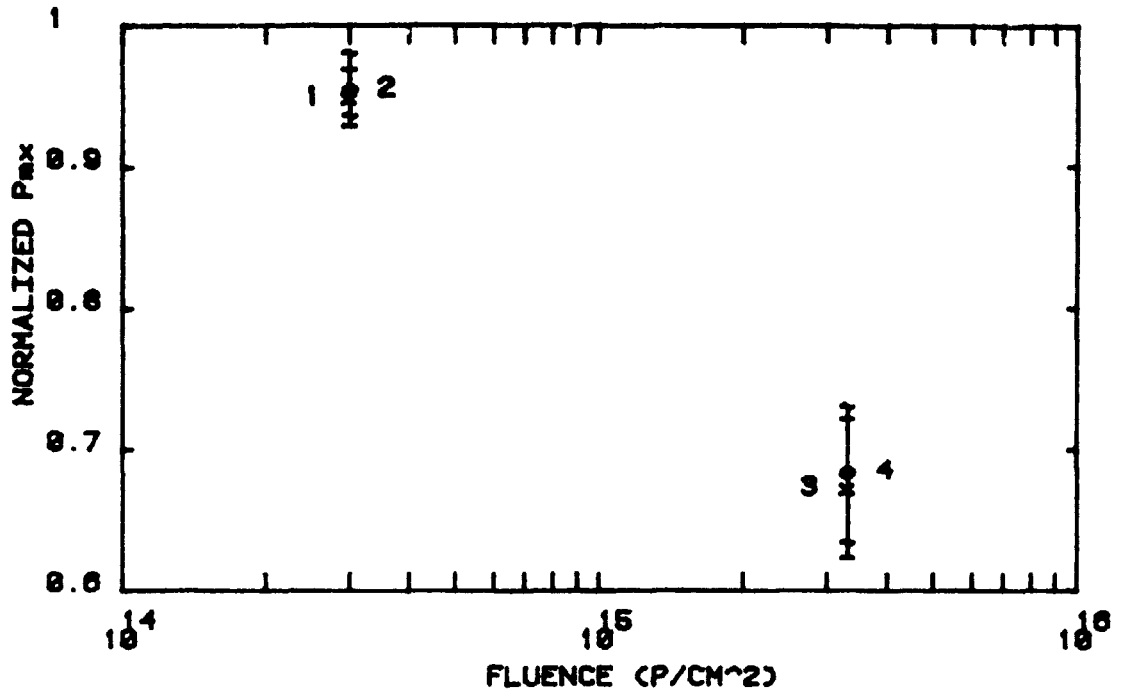

FIGURE 105. E SERIES PROTON IRRADIATION IN-SITU

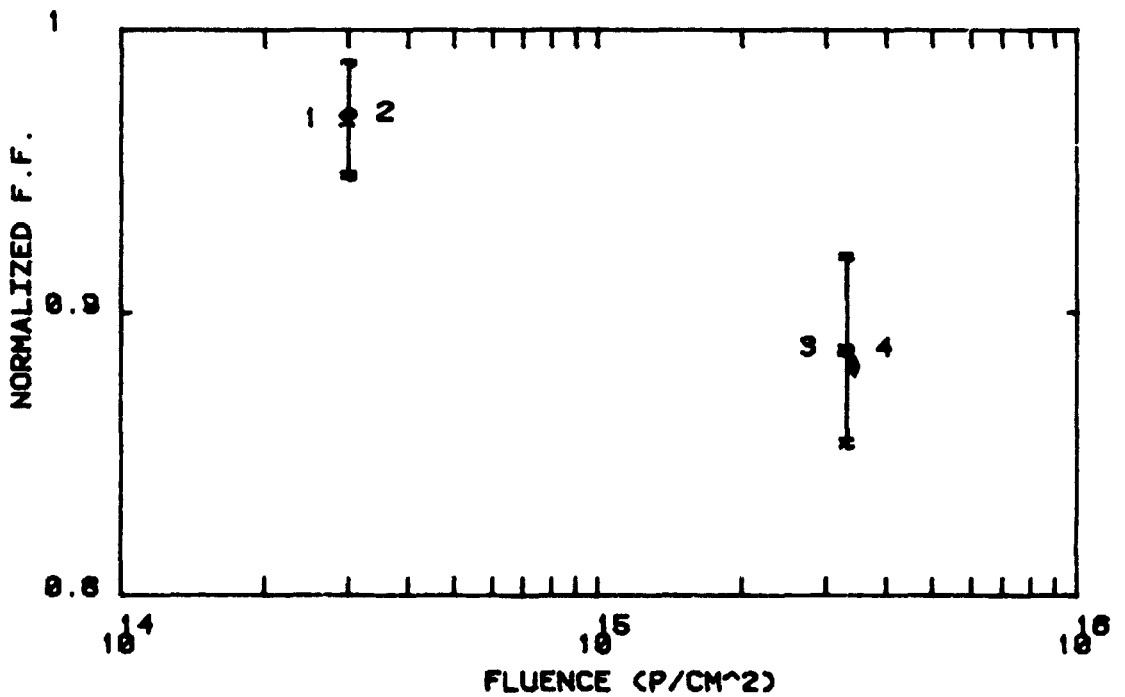

FIGURE 106. E SERIES PROTON IRRADIATION IN-SITU

TABLE 20A. TABULATED E SERIES DATA - PROTON IRRADIATION

E SERIES PROTON IRRADIATION EX-SITU
 TEMP. (C): 25 AREA: 4. INTENSITY 1*AM0

Level Number	AVERAGE Isc/Isc0	AVERAGE Voc/Voc0	AVERAGE Pmx/Pmx0	AVERAGE F. F. /F. F. 0
0	1.000	1.000	1.000	1.000
1	0.956	0.942	0.796	0.883

E SERIES PROTON IRRADIATION IN-SITU
 TEMP. (C): 25 AREA: 4. INTENSITY 1*AM0

Level Number	AVERAGE Isc/Isc0	AVERAGE Voc/Voc0	AVERAGE Pmx/Pmx0	AVERAGE F. F. /F. F. 0
0	1.000	1.000	1.000	1.000
1	0.990	0.991	0.950	0.969
2	0.991	0.994	0.957	0.971
3	0.816	0.931	0.675	0.888
4	0.828	0.933	0.687	0.888

E SERIES PROTON IRRADIATION EX-SITU
 TEMP. (C): 25 AREA: 4 INTENSITY 1*AM0

Serial Number	Level Number	Isc (mA)	Isc/Isc0	Voc (mV)	Voc/Voc0	Pmx (mW)	Pmx/Pmx0	Fill Fac.	F. F. /F. F. 0
606	0	146.2	1.000	549.5	1.000	61.93	1.000	0.771	1.000
607	0	146.4	1.000	550.5	1.000	62.00	1.000	0.769	1.000
607	0	146.4	1.000	550.5	1.000	62.00	1.000	0.769	1.000
608	0	145.2	1.000	551.9	1.000	62.74	1.000	0.783	1.000
609	0	147.6	1.000	552.0	1.000	63.42	1.000	0.778	1.000
606	1	141.8	0.970	529.4	0.963	52.55	0.849	0.700	0.908
607	1	139.1	0.950	515.0	0.935	48.15	0.777	0.672	0.874
607	1	139.1	0.950	515.0	0.935	48.15	0.777	0.672	0.874
608	1	137.4	0.946	511.1	0.926	47.00	0.749	0.669	0.855
609	1	140.9	0.954	526.3	0.953	51.96	0.819	0.701	0.901

TABLE 28B. TABULATED E SERIES DATA - PROTON IRRADIATION

E SERIES PROTON IRRADIATION IN-SITU									
TEMP. (C): 25 AREA: 4 INTENSITY 1*AM0									
Serial Number	Level Number	Isc (mA)	Isc/ Isco	Voc (mV)	Voc/ Voco	Pmx (mW)	Pmx/ Pmxo	Fill Fac.	F. F. / F. F. o
606	0	115.0	1.000	553.3	1.000	49.00	1.000	0.770	1.000
607	0	114.7	1.000	553.5	1.000	48.76	1.000	0.768	1.000
608	0	114.8	1.000	557.4	1.000	50.41	1.000	0.788	1.000
609	0	115.5	1.000	553.4	1.000	50.42	1.000	0.789	1.000
610	0	116.7	1.000	557.1	1.000	48.97	1.000	0.753	1.000
606	1	113.2	0.984	551.4	0.997	47.53	0.970	0.762	0.989
607	1	113.1	0.986	545.7	0.986	46.01	0.944	0.745	0.971
608	1	114.7	0.999	552.4	0.991	47.42	0.941	0.749	0.950
609	1	113.7	0.984	552.6	0.990	48.81	0.968	0.777	0.983
610	1	116.3	0.996	547.0	0.982	45.48	0.929	0.715	0.949
606	2	112.3	0.976	552.9	0.999	47.20	0.963	0.760	0.987
607	2	114.0	0.993	548.4	0.991	46.72	0.958	0.748	0.974
608	2	114.2	0.995	553.1	0.992	47.12	0.935	0.746	0.947
609	2	114.7	0.993	554.2	1.001	49.34	0.979	0.776	0.984
610	2	116.6	0.999	549.5	0.986	46.51	0.950	0.726	0.964
606	3	94.7	0.823	528.0	0.954	35.43	0.723	0.709	0.921
607	3	94.5	0.824	510.8	0.923	32.44	0.665	0.672	0.875
608	3	91.9	0.800	507.9	0.911	31.48	0.624	0.675	0.856
609	3	93.4	0.809	522.5	0.944	34.41	0.682	0.705	0.894
610	3	96.2	0.824	512.7	0.920	33.29	0.680	0.675	0.896
606	4	95.7	0.832	528.6	0.955	35.75	0.730	0.707	0.918
607	4	95.8	0.835	512.5	0.926	33.11	0.679	0.674	0.878
608	4	93.1	0.811	510.3	0.915	31.89	0.633	0.671	0.852
609	4	95.5	0.827	523.8	0.947	35.22	0.699	0.704	0.893
610	4	97.7	0.837	513.9	0.922	33.94	0.693	0.676	0.898

ORIGINAL PAGE IS
OF POOR QUALITY



FIGURE 107. PHOTOGRAPH OF SAMPLE E32 (607)
AFTER PROTON IRRADIATION

S/N : 607	LEVEL : 0	1
TEMP: 25 C	ISCC(MA) : 146.4	139.1
AREA: 4 CM^2	VOC(MV) : 550.5	515.0
INT. : 1*AM0	PMAX(MW) : 62.0	48.1
	F.F. : 0.709	0.672

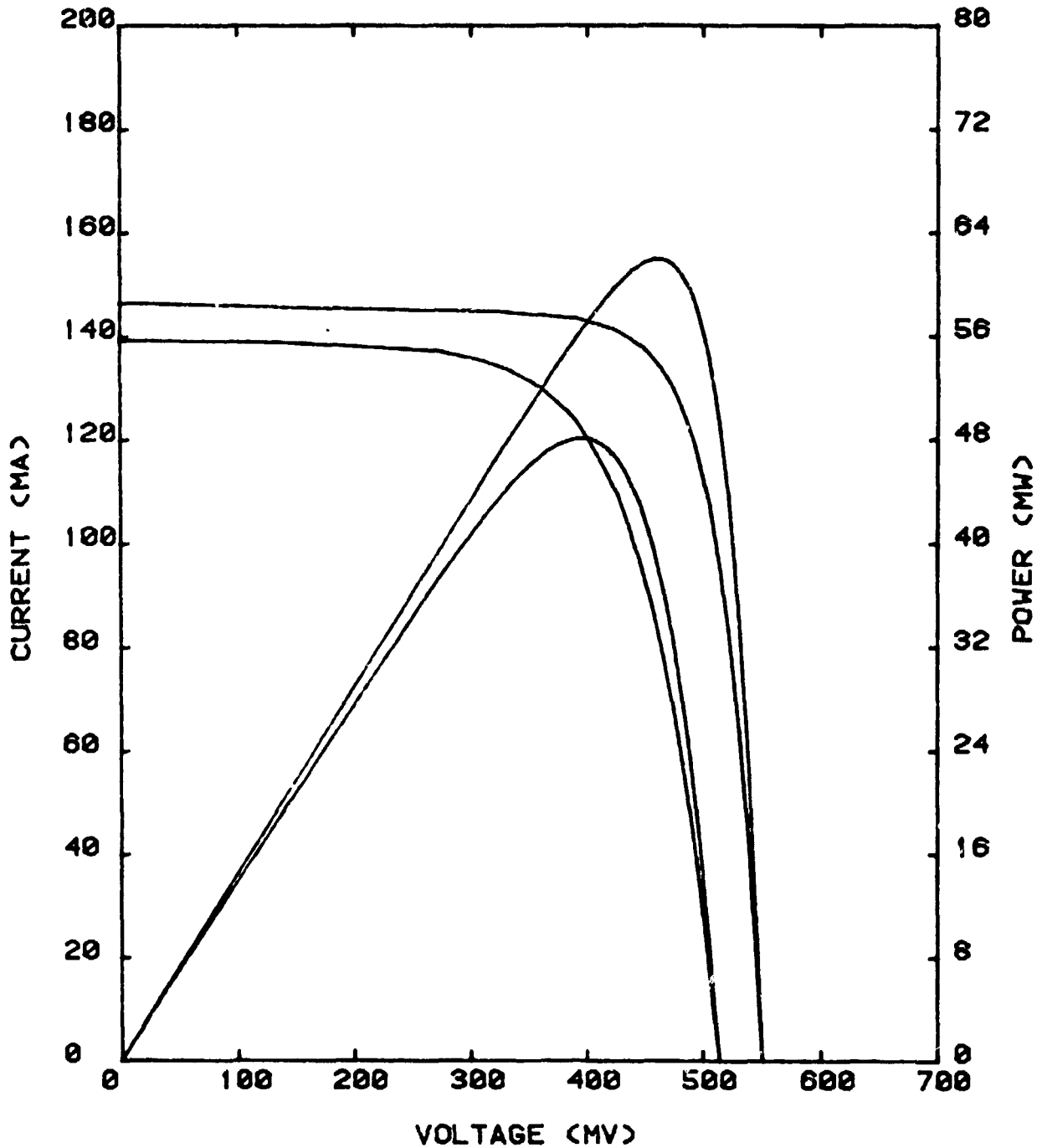

FIGURE 108.
 E SERIES PROTON IRRADIATION EX-SITU
 D180-26590-1
 150

6.7.3 UV Exposure

The samples appeared to develop a yellowish appearance as the exposure progressed. I_{SC} dropped after the first 1000 ESH (by 11%) and continued to drop throughout the test for a total loss of 25% in I_{SC} (see Figure 109). V_{OC} did not change during the test (see Figure 110), therefore the loss in I_{SC} can be attributed to transmission loss in the GE615/UV-24. Figures 111 and 112 complete the summary plots of the test parameters. Tables 29A and 29B list the tabulated data and Figure 113 shows a pre- and post-test I-V curve. The sample temperature ranged from 35°C to 42° during the exposure.

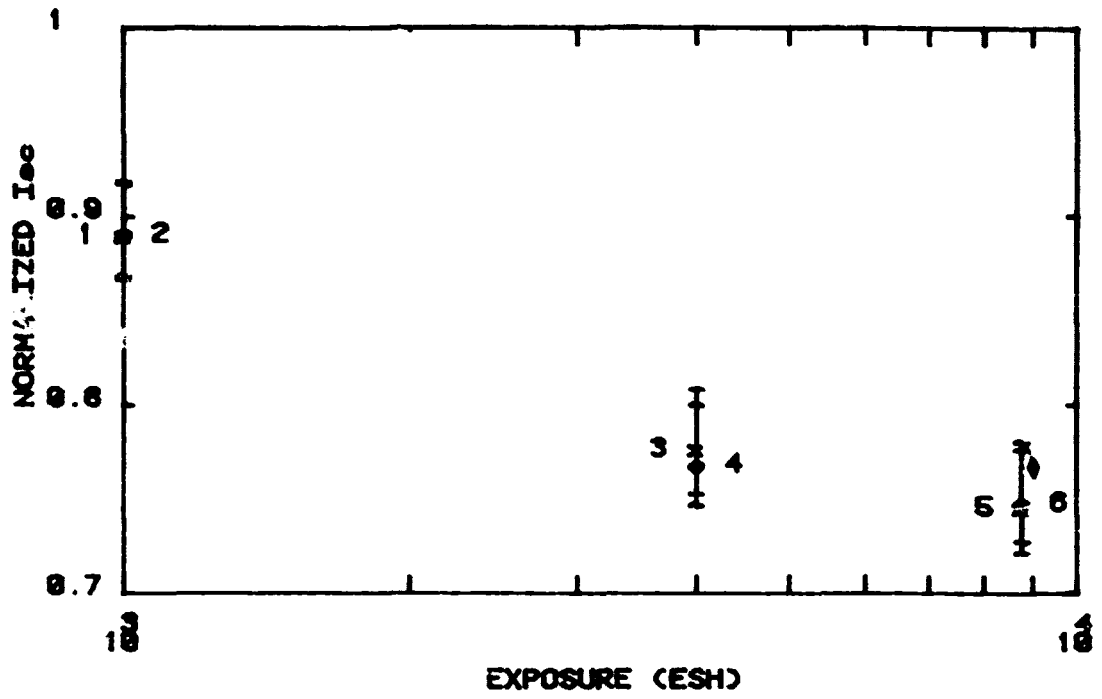

FIGURE 109. E SERIES UV IRRADIATION IN SITU

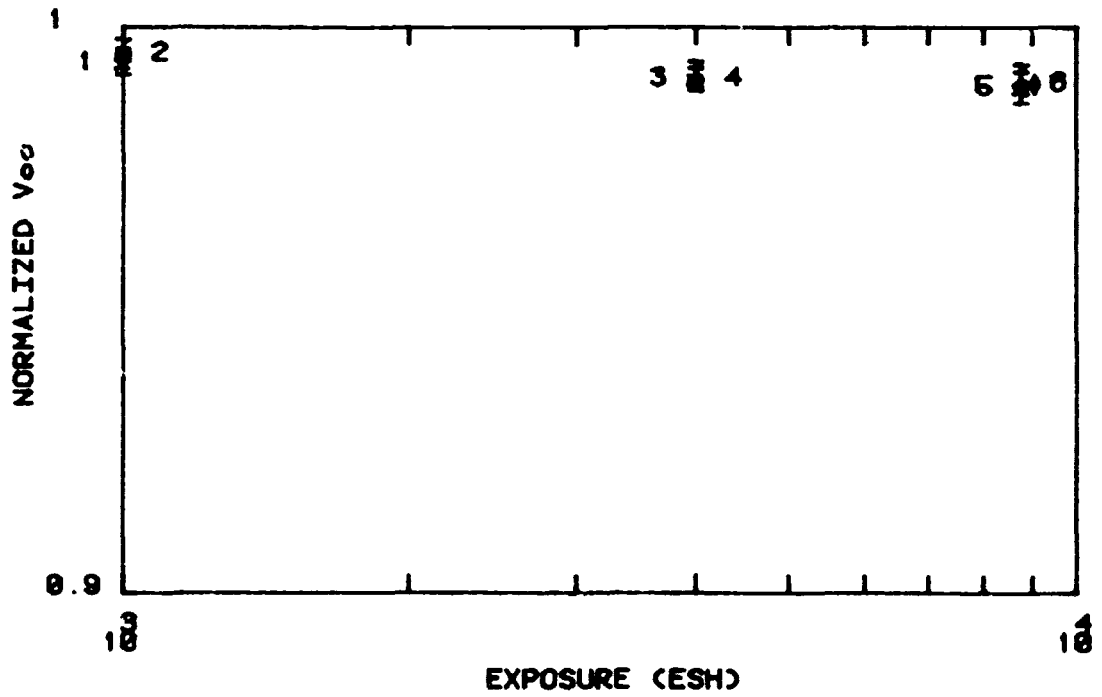

FIGURE 110. E SERIES UV IRRADIATION IN SITU

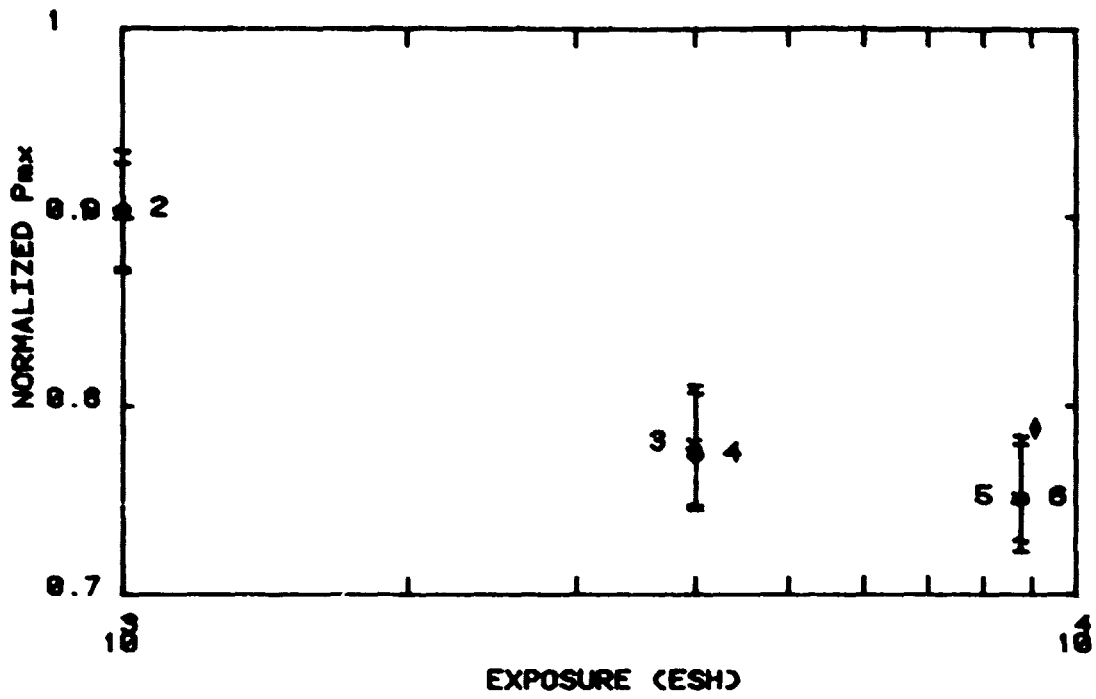

FIGURE 111. E SERIES UV IRRADIATION IN SITU

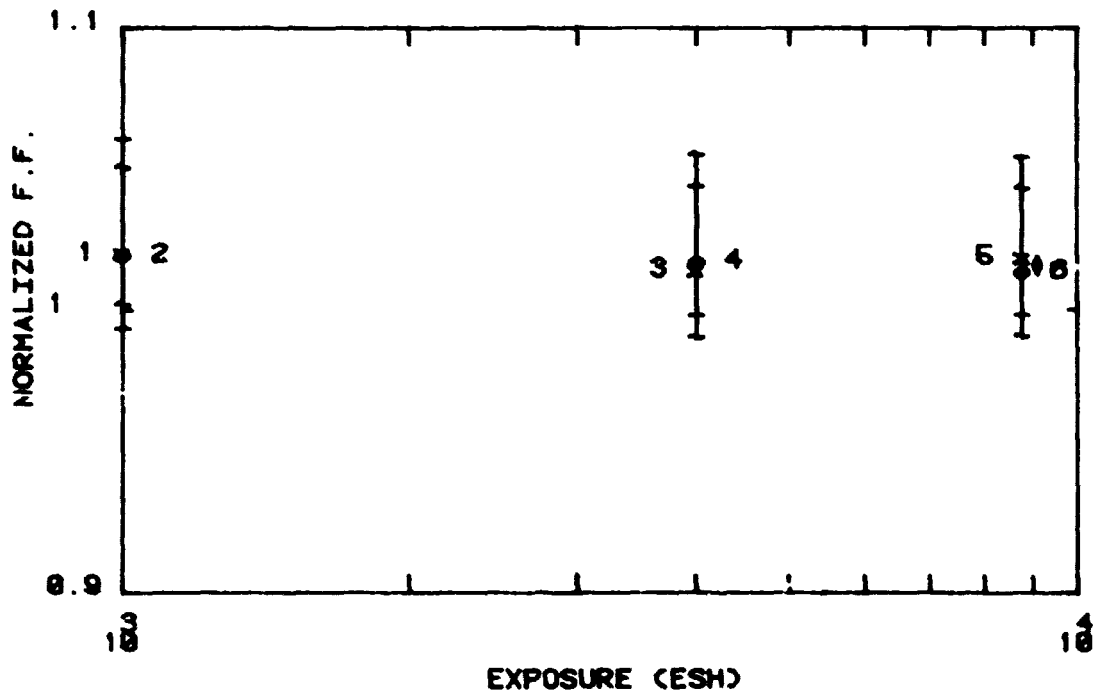

FIGURE 112. E SERIES UV IRRADIATION IN SITU

TABLE 29A TABULATED E SERIES DATA - UV IRRADIATION

E SERIES UV IRRADIATION EX-SITU
 TEMP. (C): 25 AREA: 4 INTENSITY 1*AM0

Level Number	AVERAGE Isc/Isc0	AVERAGE Voc/Voc0	AVERAGE Pmx/Pmx0	AVERAGE F. F. /F. F. 0
0	1.000	1.000	1.000	1.000
1	0.771	0.991	0.775	1.015

E SERIES UV IRRADIATION IN SITU
 TEMP. (C): 25 AREA: 4 INTENSITY 1*AM0

Level Number	AVERAGE Isc/Isc0	AVERAGE Voc/Voc0	AVERAGE Pmx/Pmx0	AVERAGE F. F. /F. F. 0
0	1.000	1.000	1.000	1.000
1	0.891	0.994	0.904	1.021
2	0.892	0.996	0.906	1.020
3	0.777	0.991	0.782	1.015
4	0.769	0.991	0.776	1.018
5	0.746	0.990	0.752	1.019
6	0.749	0.990	0.752	1.014

E SERIES UV IRRADIATION EX-SITU
 TEMP. (C): 25 AREA: 4 INTENSITY 1*AM0

Serial Number	Level Number	Isc (mA)	Isc/Isc0	Voc (mV)	Voc/Voc0	Pmx (mW)	Pmx/Pmx0	Full Fac.	F. F. /F. F. 0
611	0	141.1	1.000	598.2	1.000	112.39	1.000	1.331	1.000
612	0	144.0	1.000	566.8	1.000	64.33	1.000	0.788	1.000
613	0	143.3	1.000	569.2	1.000	61.58	1.000	0.755	1.000
614	0	144.6	1.000	568.7	1.000	64.67	1.000	0.787	1.000
615	0	145.3	1.000	569.5	1.000	64.42	1.000	0.778	1.000
611*	1	111.2	0.788	564.6	0.944	49.61	0.441	0.790	0.593
612	1	112.1	0.778	562.4	0.992	49.34	0.767	0.782	0.993
613	1	109.3	0.763	562.7	0.989	48.51	0.788	0.789	1.044
614	1	108.2	0.749	562.4	0.989	47.97	0.742	0.786	1.002
615	1	115.2	0.792	565.3	0.992	51.72	0.803	0.794	1.021

*NOT INCLUDED IN AVERAGE

TABLE 29B. TABULATED E SERIES DATA - UV IRRADIATION

E SERIES UV IRRADIATION IN SITU
TEMP. (C): 25 AREA: 4 INTENSITY 1*AM0

Serial Number	Level Number	Isc (mA)	Isc/Isco	Voc (mV)	Voc/Voco	Pmx (mW)	Pmx/Pmxo	Fill Fac.	F. F. / F. F. o
611*	0	139.9	1.000	599.1	1.000	22.71	1.000	0.271	1.000
612	0	142.3	1.000	568.5	1.000	64.46	1.000	0.797	1.000
613	0	141.7	1.000	571.0	1.000	60.48	1.000	0.747	1.000
614	0	143.0	1.000	569.9	1.000	63.56	1.000	0.780	1.000
615	0	142.9	1.000	570.2	1.000	64.13	1.000	0.787	1.000
611*	1	126.7	0.905	575.9	0.961	42.51	1.872	0.583	2.151
612	1	127.9	0.899	565.6	0.995	57.29	0.889	0.792	0.994
613	1	124.6	0.880	566.2	0.992	55.96	0.925	0.793	1.061
614	1	124.0	0.867	565.9	0.993	55.50	0.873	0.791	1.014
615	1	131.3	0.919	568.1	0.996	59.61	0.929	0.799	1.015
611*	2	126.9	0.907	567.7	0.948	56.73	2.499	0.787	2.906
612	2	128.2	0.901	566.5	0.996	57.92	0.899	0.798	1.001
613	2	125.2	0.883	567.3	0.994	55.72	0.921	0.785	1.050
614	2	124.0	0.867	567.2	0.995	55.31	0.870	0.786	1.008
615	2	130.9	0.916	568.7	0.997	59.90	0.934	0.805	1.022
611*	3	110.9	0.793	566.2	0.915	49.47	2.179	0.788	2.908
612	3	110.9	0.780	563.7	0.992	50.20	0.779	0.803	1.007
613	3	108.8	0.768	564.7	0.989	47.96	0.793	0.781	1.044
614	3	107.6	0.753	565.3	0.992	47.36	0.745	0.779	0.998
615	3	115.6	0.809	566.2	0.993	52.05	0.812	0.795	1.011
611*	4	109.4	0.782	566.2	0.945	49.46	2.178	0.798	2.947
612	4	110.5	0.777	564.8	0.993	49.22	0.764	0.789	0.990
613	4	107.1	0.756	565.0	0.989	47.70	0.789	0.788	1.055
614	4	106.6	0.745	563.7	0.989	47.42	0.746	0.789	1.012
615	4	114.1	0.799	566.2	0.993	51.70	0.806	0.800	1.016
611*	5	106.6	0.762	565.2	0.943	48.13	2.120	0.799	2.949
612	5	107.0	0.752	563.5	0.991	47.96	0.744	0.795	0.998
613	5	104.2	0.735	563.3	0.987	46.26	0.765	0.788	1.055
614	5	103.2	0.721	563.6	0.989	45.93	0.723	0.790	1.013
615	5	111.0	0.777	565.8	0.992	50.04	0.780	0.797	1.012
611*	6	106.7	0.763	565.0	0.943	48.07	2.117	0.797	2.943
612	6	107.4	0.755	563.8	0.992	47.77	0.741	0.789	0.990
613	6	104.3	0.736	564.1	0.988	45.85	0.758	0.779	1.042
614	6	103.8	0.726	563.7	0.989	46.22	0.727	0.790	1.013
615	6	111.3	0.779	566.2	0.993	50.21	0.783	0.796	1.012

*NOT INCLUDED IN AVERAGE

S/N : 814	LEVEL : 0	1
TEMP: 25 C	ISC(MA) : 144.0	106.2
AREA: 4 CM ²	VOC(MV) : 568.7	502.4
INT. : 1*AM0	PMAX(MW) : 64.7	48.0
	F.F. : 0.787	0.788

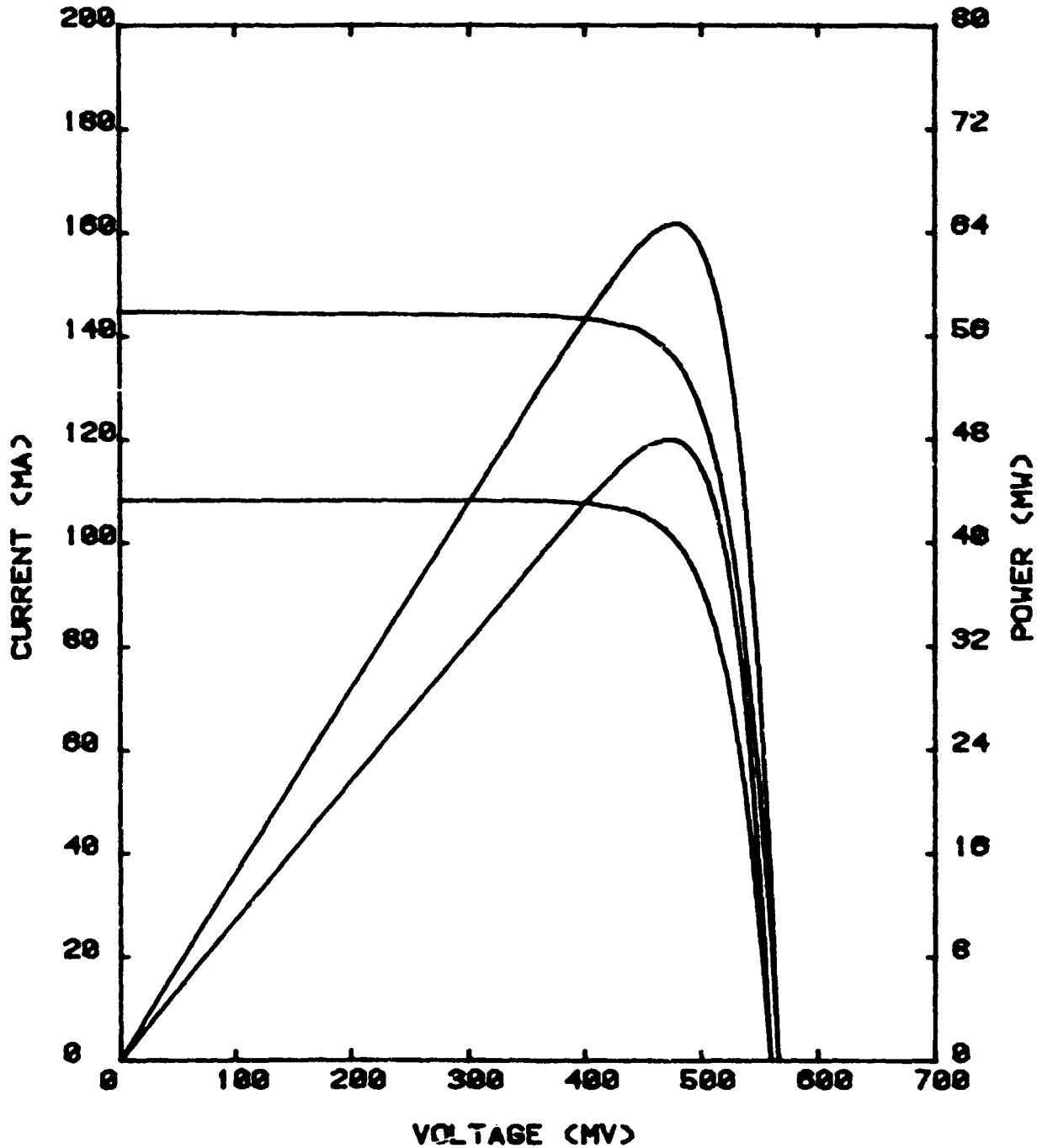

FIGURE 113
E SERIES UV IRRADIATION EX-SITU
D180-26590-1
156

6.8 P SERIES CELLS

(Solarex 2-mil 2 Ω -cm with Ta₂O₅ cell, 0.5 mil of GR 650 as a cover, no backing, no adhesive.)

6.8.1 Electron Irradiation

The P Series cells were very delicate cells and did not survive thermal cycling well. At the end of the electron test there was only one cell that had not cracked. Due to these mechanical failures no transmission or electrical performance conclusions are made. Summary plots (Figures 114, 115, 116 and 117) and tabulated data (Tables 30A and 30B) are included for completeness only. Figure 118 is an I-V curve. The sample temperature ranged from 53°C to 56°C.

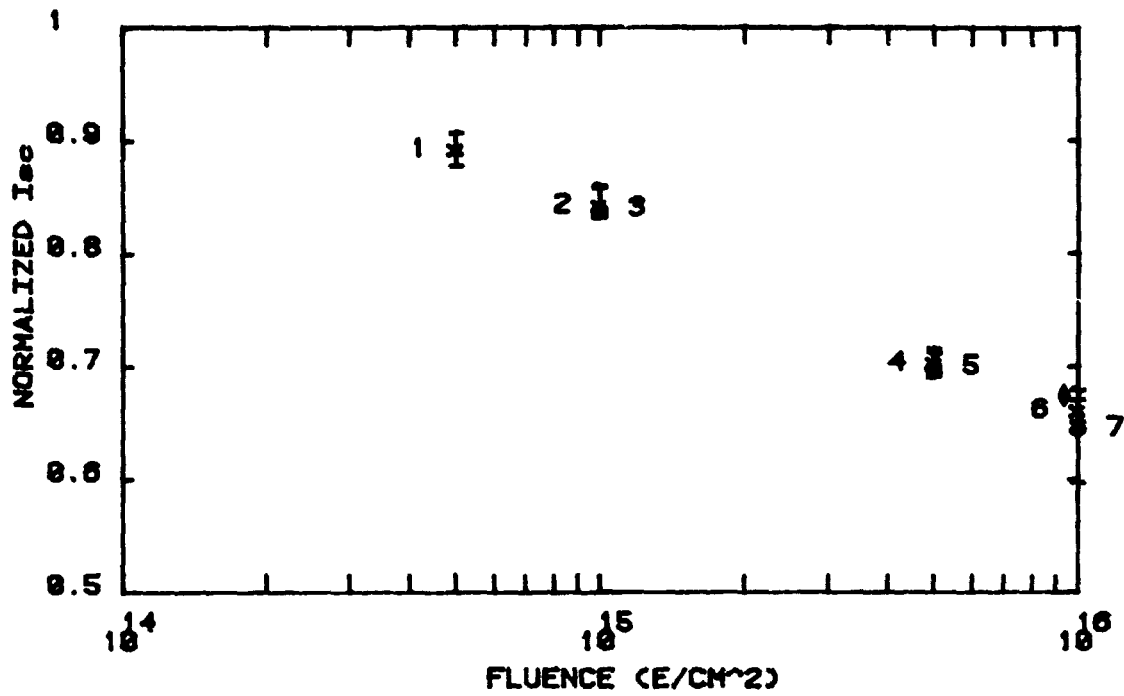

FIGURE 114. P SERIES ELECTRON IRRADIATION IN-SITU

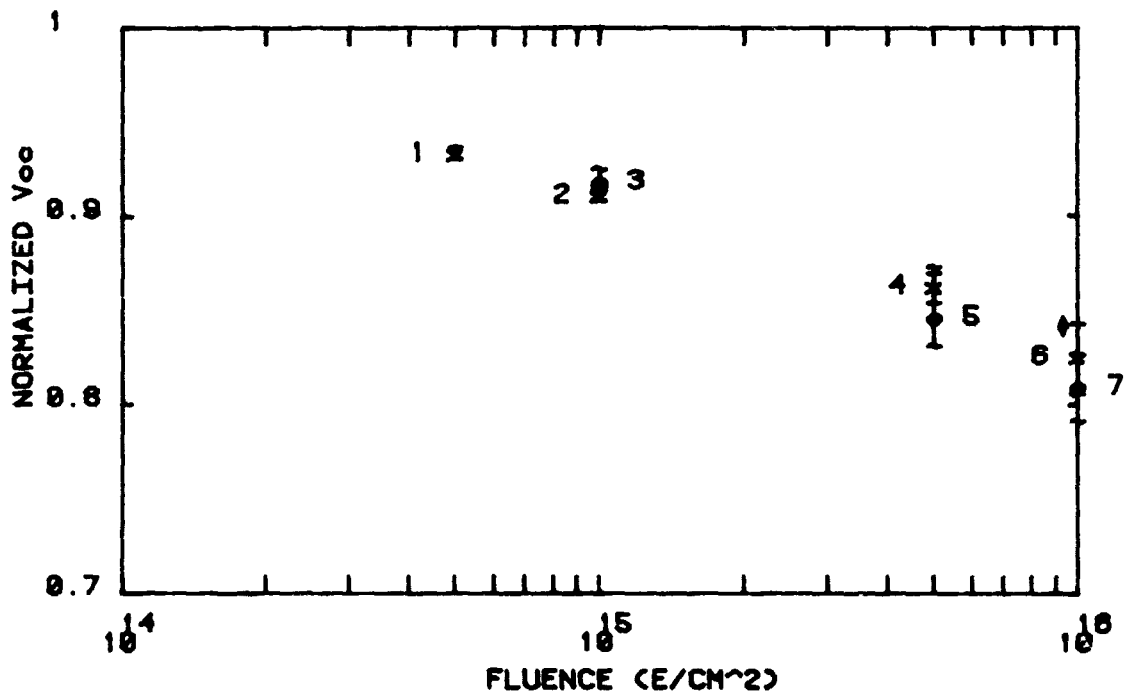

FIGURE 115. P SERIES ELECTRON IRRADIATION IN-SITU

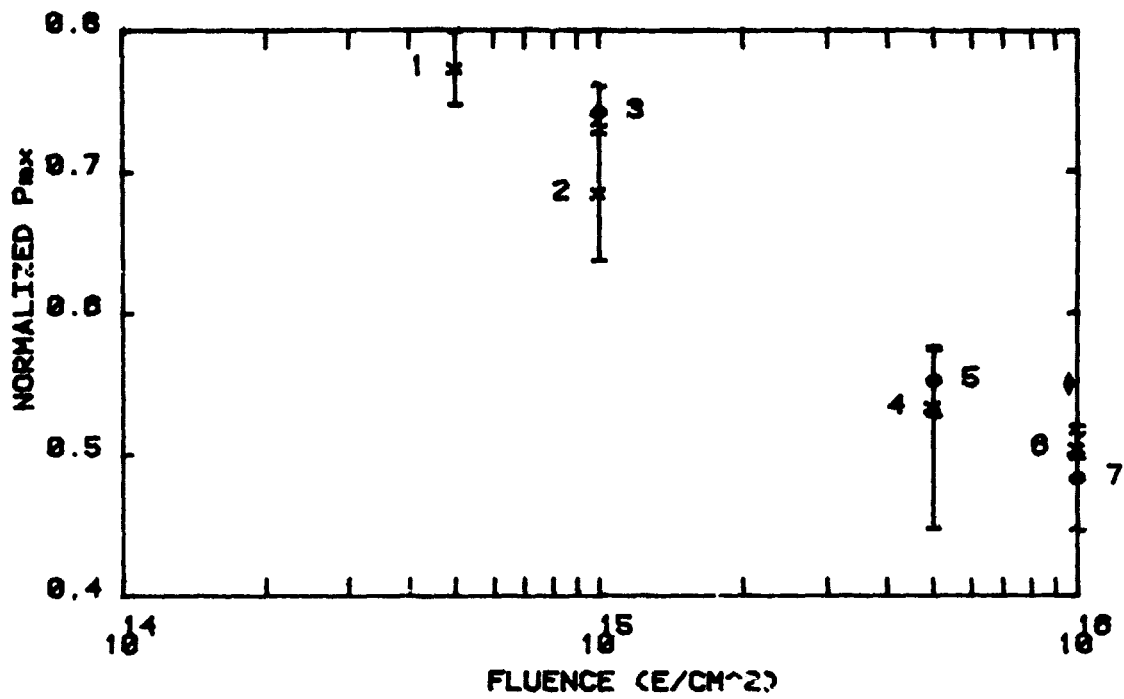

FIGURE 116. P SERIES ELECTRON IRRADIATION IN-SITU

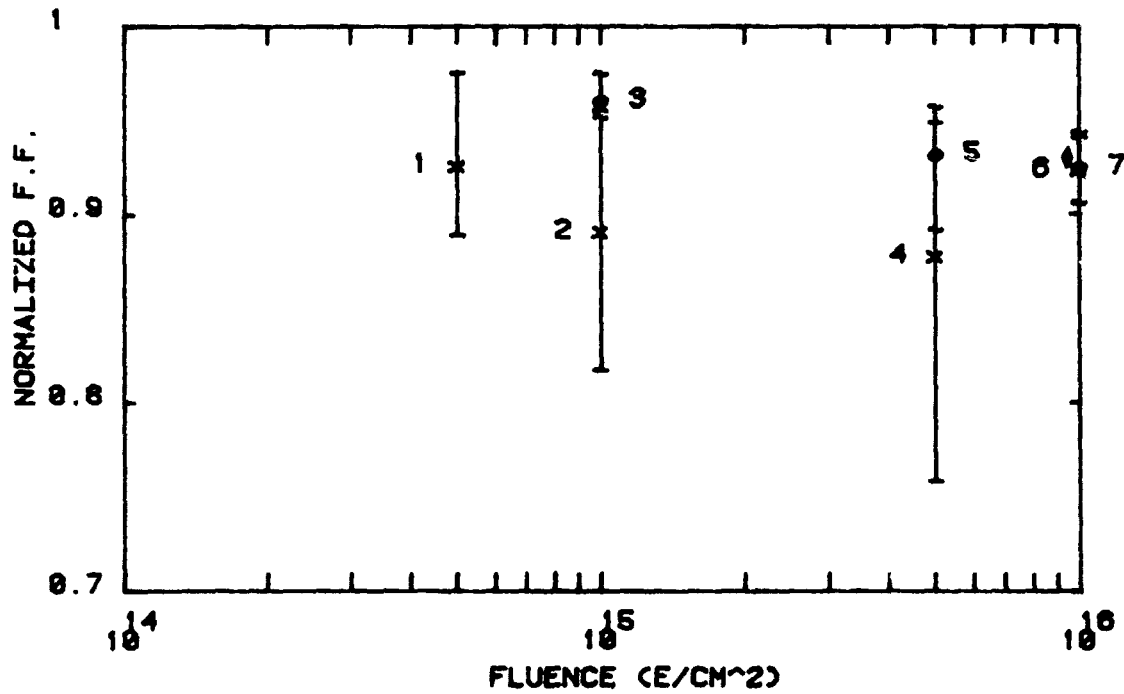

FIGURE 117. P SERIES ELECTRON IRRADIATION IN-SITU

TABLE 30A. TABULATED P SERIES DATA - ELECTRON IRRADIATION

P SERIES ELECTRON IRRADIATION EX-SITU
 TEMP. (C): 25 AREA: 4. INTENSITY 1*AM0

Level Number	AVERAGE Isc/Isc0	AVERAGE Voc/Voc0	AVERAGE Pmx/Pmx0	AVERAGE F. F. /F. F. 0
0	1.000	1.000	1.000	1.000
1	0.674	0.842	0.527	0.930

P SERIES ELECTRON IRRADIATION IN-SITU
 TEMP. (C): 25 AREA: 4. INTENSITY 1*AM0

Level Number	AVERAGE Isc/Isc0	AVERAGE Voc/Voc0	AVERAGE Pmx/Pmx0	AVERAGE F. F. /F. F. 0
0	1.000	1.000	1.000	1.000
1	0.895	0.935	0.776	0.928
2	0.845	0.912	0.687	0.892
3	0.842	0.919	0.744	0.962
4	0.785	0.864	0.536	0.879
5	0.782	0.847	0.555	0.933
6	0.663	0.826	0.507	0.925
7	0.647	0.811	0.486	0.927

P SERIES ELECTRON IRRADIATION EX-SITU
 TEMP. (C): 25 AREA: 4 INTENSITY 1*AM0

Serial Number	Level Number	Isc (mA)	Isc/Isc0	Voc (mV)	Voc/Voc0	Pmx (mW)	Pmx/Pmx0	Full Fac.	F. F. / F. F. 0
701	0	149.0	1.000	574.6	1.000	66.60	1.000	0.778	1.000
702	0	144.1	1.000	562.8	1.000	62.14	1.000	0.766	1.000
703	0	0.0	0.000	0.0	0.000	0.00	0.000	0.000	0.000
704	0	142.7	1.000	562.7	1.000	61.49	1.000	0.766	1.000
705	0	148.1	1.000	576.3	1.000	66.62	1.000	0.780	1.000
701	1	99.9	0.670	480.0	0.835	36.22	0.544	0.756	0.971
702	1	97.7	0.678	477.5	0.848	31.74	0.511	0.680	0.888
703	1	0.0	0.000	0.0	0.000	0.00	0.000	0.000	0.000
704	1	0.0	0.000	0.0	0.000	0.00	0.000	0.000	0.000
705	1	0.0	0.000	0.0	0.000	0.00	0.000	0.000	0.000

TABLE 30B. TABULATED P SERIES DATA - ELECTRON IRRADIATION

P SERIES ELECTRON IRRADIATION IN-SITU
 TEMP. (C): 25 AREA: 4 INTENSITY 1*AM0

Serial Number	Level Number	Isc (mA)	Isc/Isc0	Voc (mV)	Voc/Voc0	Pmx (mW)	Pmx/Pmx0	Fill Fac.	F. F. / F. F. 0
701	0	126.3	1.000	582.7	1.000	56.57	1.000	0.769	1.000
702	0	123.0	1.000	572.2	1.000	53.87	1.000	0.766	1.000
703	0	81.5	1.000	573.9	1.000	36.90	1.000	0.789	1.000
704	0	121.1	1.000	576.7	1.000	52.55	1.000	0.752	1.000
705	0	126.6	1.000	582.7	1.000	57.09	1.000	0.774	1.000
701	1	112.6	0.892	542.4	0.931	44.65	0.789	0.731	0.951
702	1	110.2	0.896	536.3	0.937	41.85	0.777	0.708	0.925
703	1	74.0	0.908	537.9	0.937	28.20	0.764	0.708	0.898
704	1	109.0	0.900	539.2	0.935	39.30	0.748	0.669	0.889
705	1	111.2	0.878	543.4	0.933	45.64	0.799	0.755	0.976
701	2	105.1	0.832	531.2	0.912	40.38	0.714	0.723	0.941
702	2	103.5	0.841	523.1	0.914	36.27	0.673	0.670	0.875
703	2	69.9	0.858	524.6	0.914	25.24	0.684	0.688	0.872
704	2	104.0	0.859	523.8	0.908	33.50	0.638	0.615	0.817
705	2	105.8	0.835	531.2	0.912	41.56	0.728	0.740	0.956
701	3	105.1	0.832	533.1	0.915	41.74	0.738	0.745	0.969
702	3	102.3	0.832	527.3	0.922	39.41	0.732	0.731	0.954
703	3	69.9	0.858	528.8	0.921	27.73	0.751	0.750	0.950
704	3	103.4	0.854	532.8	0.924	39.91	0.759	0.725	0.963
705	3	105.4	0.833	533.3	0.915	42.37	0.742	0.754	0.974
701	4	88.3	0.699	503.0	0.863	32.03	0.566	0.721	0.938
702	4	85.1	0.692	488.6	0.854	24.14	0.448	0.581	0.759
703	4	58.4	0.716	499.3	0.870	20.88	0.566	0.717	0.909
704	4	86.9	0.717	499.5	0.866	27.41	0.522	0.632	0.840
705	4	85.0	0.703	504.0	0.865	32.96	0.577	0.735	0.949
701	5	86.4	0.700	498.9	0.856	32.42	0.573	0.735	0.956
702	5	87.4	0.711	475.5	0.831	28.34	0.526	0.682	0.891
703	5	56.5	0.693	500.1	0.871	21.04	0.578	0.744	0.944
704*	5	47.3	0.391	495.1	0.859	13.69	0.261	0.584	0.776
705	5	85.3	0.705	483.6	0.830	31.53	0.552	0.730	0.944
701	6	84.2	0.667	483.5	0.830	29.47	0.521	0.724	0.941
702*	6	82.9	0.674	452.6	0.791	21.58	0.401	0.575	0.751
703	6	53.1	0.651	484.1	0.844	18.36	0.498	0.715	0.906
704*	6	44.6	0.368	480.7	0.834	12.04	0.229	0.562	0.747
705	6	85.0	0.671	469.5	0.806	28.65	0.502	0.718	0.928
701	7	84.3	0.667	476.0	0.817	29.06	0.514	0.725	0.942
702*	7	84.1	0.684	444.5	0.777	23.46	0.436	0.628	0.820
703	7	48.6	0.596	473.6	0.825	16.42	0.445	0.714	0.905
704*	7	27.9	0.230	476.7	0.827	8.60	0.164	0.647	0.860
705	7	85.8	0.678	460.3	0.790	28.50	0.499	0.721	0.932

*NOT INCLUDED IN AVERAGE

S/N : 701	LEVEL : 0	1
TEMP: 25 C	ISCC(MA) : 149.0	99.9
AREA: 4 CM^2	VOC(MV) : 574.6	480.0
INT. : 1*AM0	PMAX(MW) : 66.6	36.2
	F.F. : 0.778	0.758

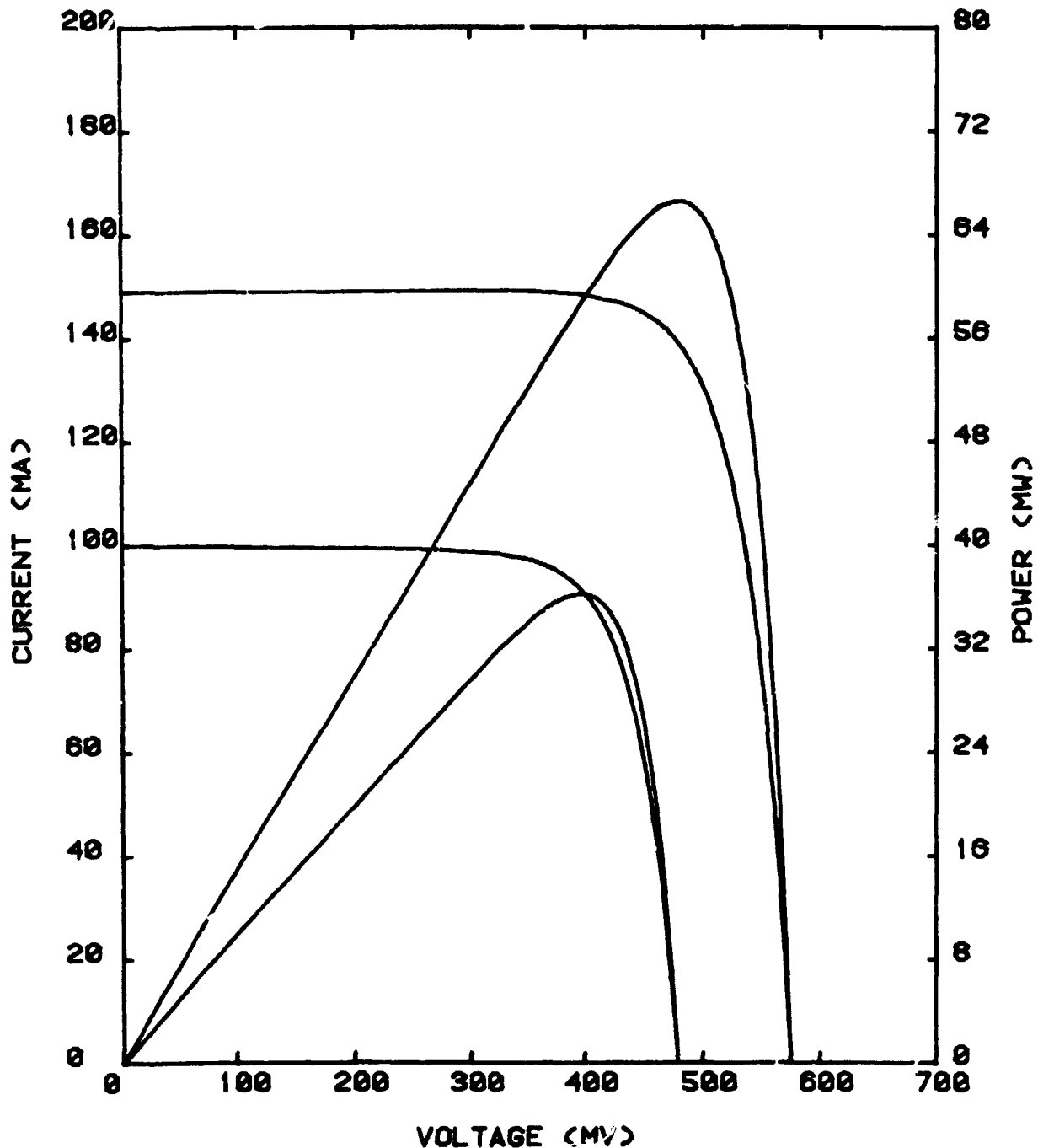

FIGURE 118

P SERIES ELECTRON IRRADIATION EX-SITU

0180-26590-1

6.8.2 Proton Irradiation

The summary plots Figures 119, 120, 121 and 122 show that the cells degraded 90% in I_{sc} with a fluence of 3×10^{14} P/cm². It is apparent that the GR 650 either has many holes in it or it is just not thick enough to stop the protons; therefore, no conclusions can be made about its transparency. As in the electron test the cells also cracked with repeated thermal cycling. Tables 31A and 31B contain the tabulated data and Figures 123A and 123B show an in situ I-V curve. The sample temperature during the irradiations ranged from 53°C to 55°C.

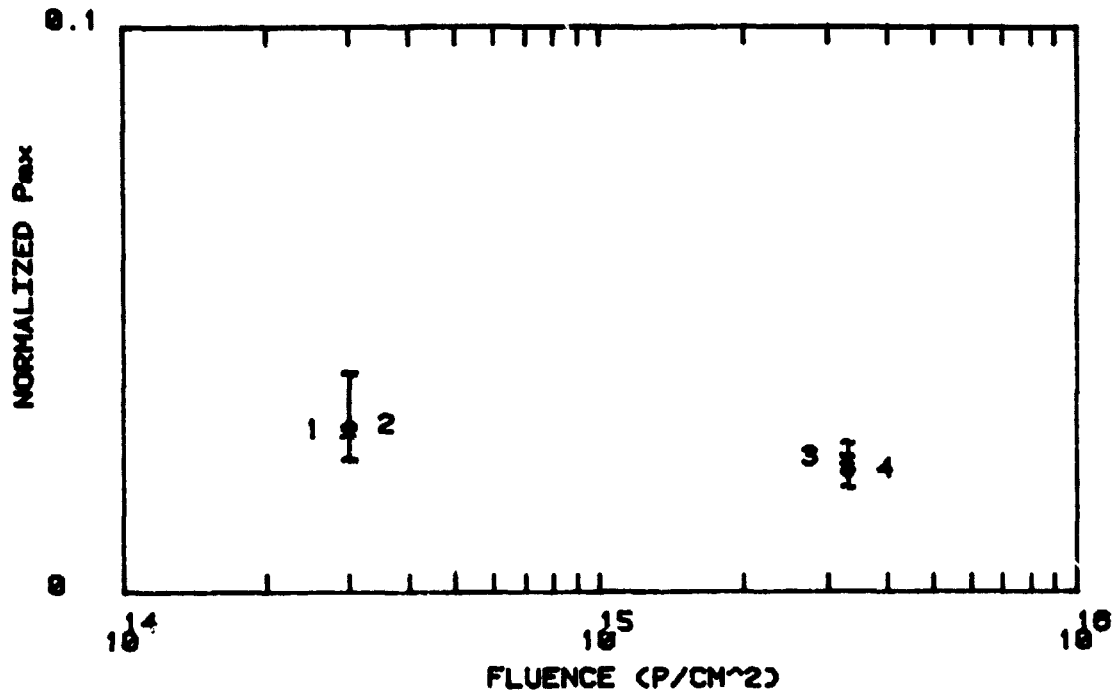

FIGURE 119. P SERIES PROTON IRRADIATION IN-SITU

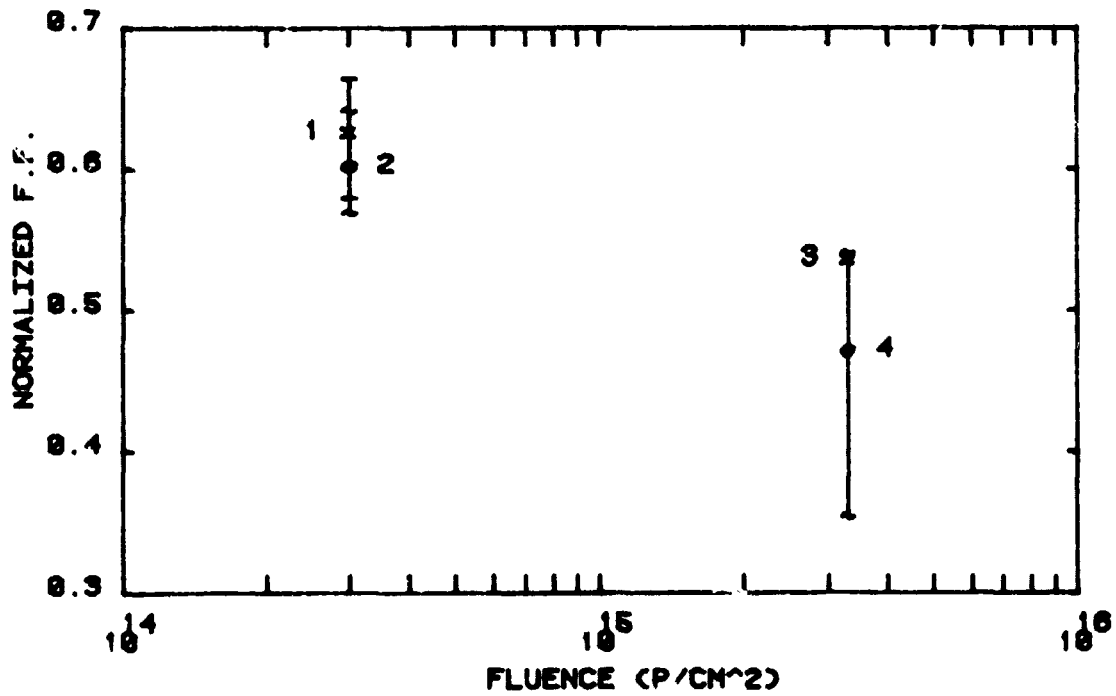

FIGURE 120. P SERIES PROTON IRRADIATION IN-SITU

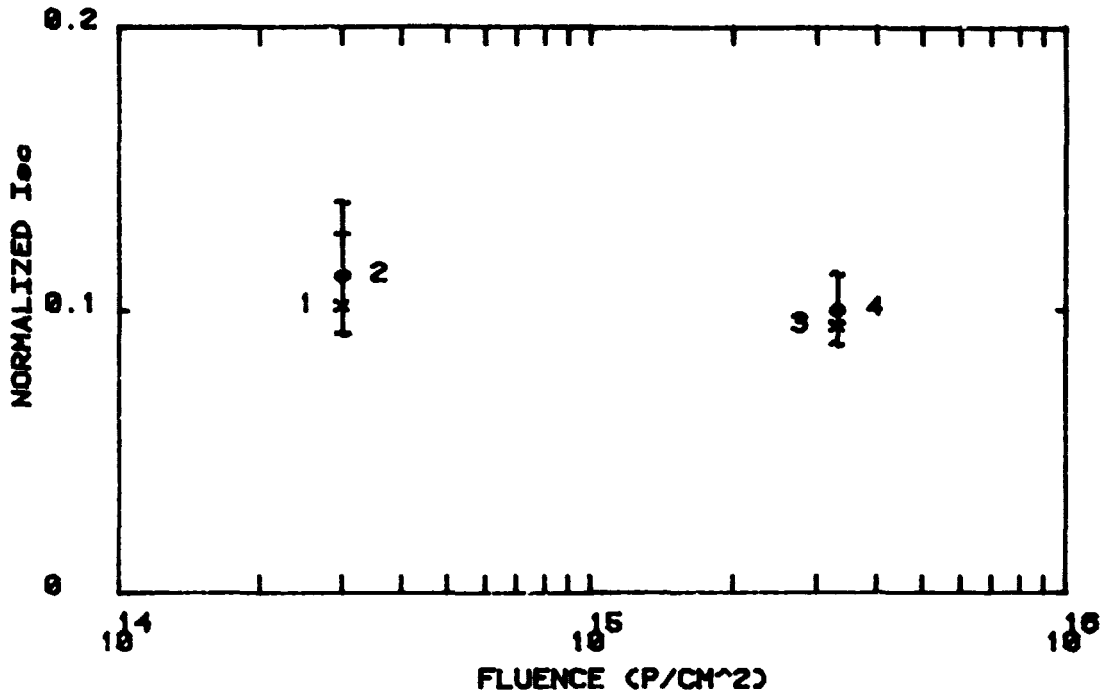

FIGURE 121. P SERIES PROTON IRRADIATION IN-SITU

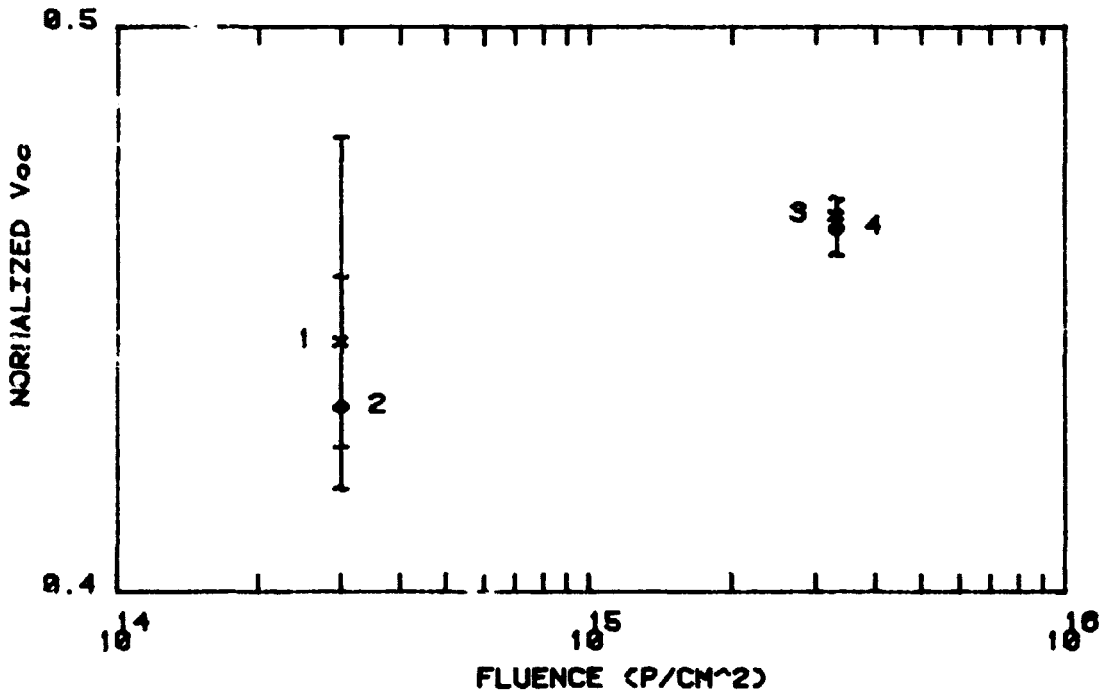

FIGURE 122. P SERIES PROTON IRRADIATION IN-SITU

TABLE 31A. TABULATED P SERIES DATA - PROTON IRRADIATION

P SERIES PROTON IRRADIATION EX-SITU
 TEMP. (C): 25 AREA: 4 INTENSITY 1*AM0

Level Number	AVERAGE Isc/Isc0	AVERAGE Voc/Voc0	AVERAGE Pmx/Pmx0	AVERAGE F. F. /F. F. 0
0	1.000	1.000	1.000	1.000
1	0.000	0.000	0.000	0.000

All cells broken.

P SERIES PROTON IRRADIATION IN-SITU
 TEMP. (C): 25 AREA: 4 INTENSITY 1*AM0

Level Number	AVERAGE Isc/Isc0	AVERAGE Voc/Voc0	AVERAGE Pmx/Pmx0	AVERAGE F. F. /F. F. 0
0	1.000	1.000	1.000	1.000
1	0.103	0.445	0.029	0.629
2	0.114	0.433	0.030	0.605
3	0.096	0.467	0.024	0.538
4	0.102	0.465	0.022	0.474

P SERIES PROTON IRRADIATION EX-SITU
 TEMP. (C): 25 AREA: 4 INTENSITY 1*AM0

Serial Number	Level Number	Isc (mA)	Isc/Isc0	Voc (mV)	Voc/Voc0	Pmx (mW)	Pmx/Pmx0	Fill Fac.	F. F. /F. F. 0
706	0	0.0	0.000	0.0	0.000	0.00	0.000	0.000	0.000
707	0	133.6	1.000	554.6	1.000	57.77	1.000	0.780	1.000
708	0	149.1	1.000	573.7	1.000	65.04	1.000	0.760	1.000
709	0	0.0	0.000	0.0	0.000	0.00	0.000	0.000	0.000
710	0	146.7	1.000	568.9	1.000	64.09	1.000	0.768	1.000
706	1	0.0	0.000	0.0	0.000	0.00	0.000	0.000	0.000
707	1	0.0	0.000	0.0	0.000	0.00	0.000	0.000	0.000
708	1	0.0	0.000	0.0	0.000	0.00	0.000	0.000	0.000
709	1	0.0	0.000	0.0	0.000	0.00	0.000	0.000	0.000
710	1	0.0	0.000	0.0	0.000	0.00	0.000	0.000	0.000

TABLE 318. TABULATED P SERIES DATA - PROTON IRRADIATION

P SERIES PROTON IRRADIATION IN-SITU
 TEMP. (C): 25 AREA: 4 INTENSITY 1*AM0

Serial Number	Level Number	Isc (mA)	Isc/Isc0	Voc (mV)	Voc/Voc0	Pmx (mW)	Pmx/Pmx0	Fill Fac.	F. F. / F. F. 0
707	0	99.7	1.000	558.8	1.000	44.19	1.000	0.793	1.000
708	0	104.4	1.000	578.3	1.000	47.03	1.000	0.779	1.000
709	0	101.3	1.000	555.6	1.000	42.79	1.000	0.760	1.000
710	0	109.7	1.000	571.5	1.000	48.58	1.000	0.775	1.000
711	0	105.8	1.000	569.8	1.000	45.67	1.000	0.758	1.000
707	1	9.3	0.094	237.8	0.426	1.07	0.024	0.482	0.608
708	1	9.9	0.095	248.4	0.430	1.11	0.024	0.452	0.580
709	1	9.3	0.092	236.9	0.426	1.10	0.026	0.496	0.653
710	1	14.0	0.128	274.6	0.481	1.90	0.039	0.493	0.637
711	1	11.2	0.106	263.3	0.462	1.49	0.033	0.504	0.665
707	2	10.8	0.108	235.9	0.422	1.17	0.027	0.461	0.581
708	2	12.4	0.119	246.4	0.426	1.35	0.029	0.442	0.568
709	2	9.2	0.091	232.2	0.418	0.99	0.023	0.462	0.608
710	2	15.1	0.138	254.2	0.445	1.86	0.038	0.485	0.626
711	2	11.9	0.113	259.4	0.455	1.50	0.033	0.485	0.640
707	3	7.7	0.077	242.8	0.435	1.63	0.037	0.877	1.106
708	3	11.4	0.109	270.6	0.438	1.74	0.037	0.566	0.726
709	3	0.0	0.000	0.0	0.000	0.00	0.000	0.000	0.000
710	3	10.5	0.096	267.0	0.467	1.17	0.024	0.417	0.538
711	3	8.6	0.081	268.4	0.471	0.96	0.021	0.418	0.552
707	4	0.0	0.000	0.0	0.000	0.00	0.000	0.000	0.000
708	4	11.7	0.112	265.5	0.459	0.85	0.018	0.274	0.352
709	4	0.0	0.000	0.0	0.000	0.00	0.000	0.000	0.000
710	4	11.5	0.105	268.1	0.469	1.27	0.026	0.410	0.530
711	4	9.2	0.087	265.7	0.466	1.00	0.022	0.408	0.539

S/N : 707	LEVEL : 0	1	2
TEMP: 25 C	ISCC(MA) : 99.7	9.3	10.8
AREA: 4 CM ²	VOC(MV) : 558.8	237.8	235.9
INT. : 1*AM0	PMAX(MW) : 44.2	1.1	1.2
	F.F. : 0.793	0.482	0.491

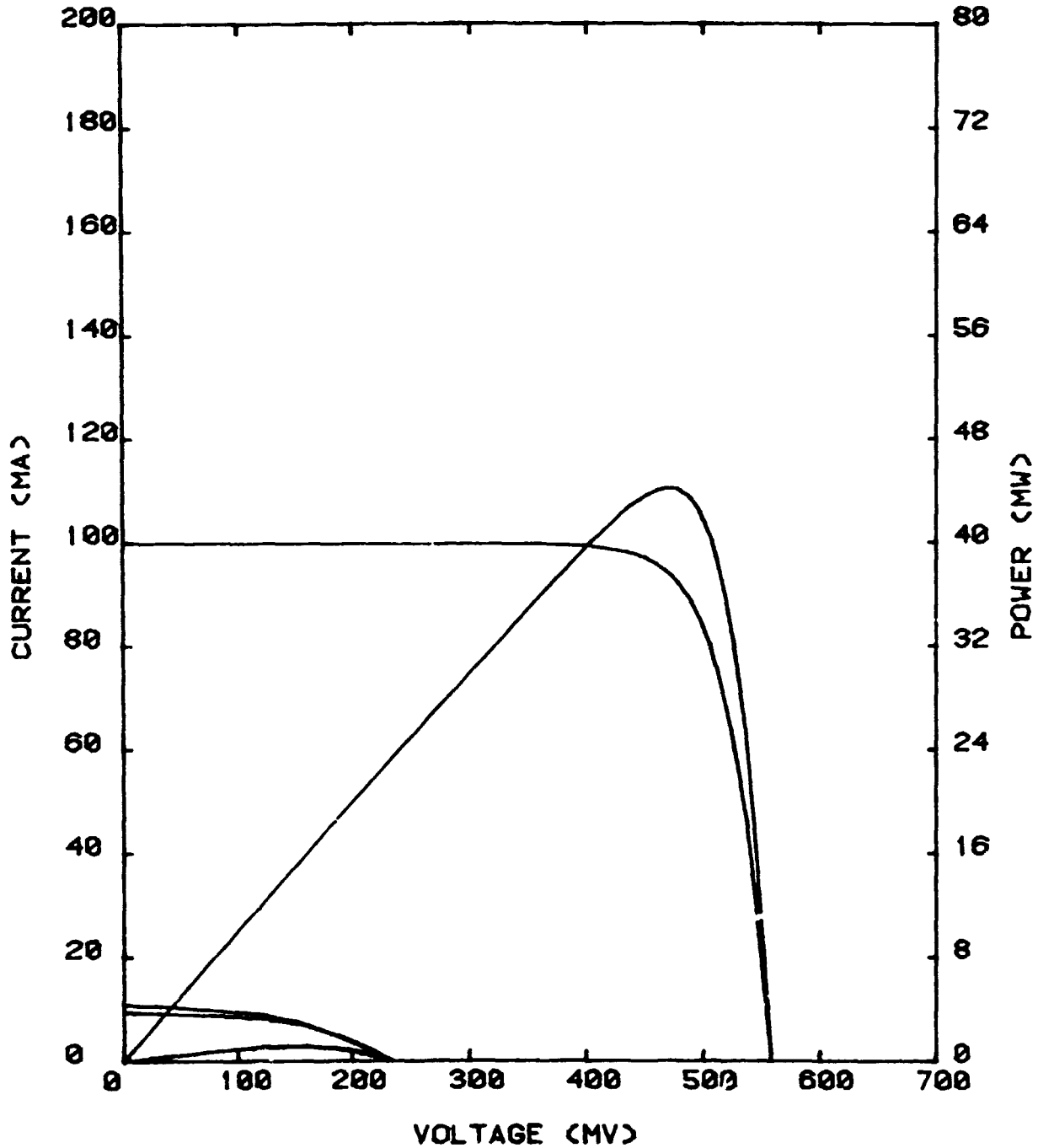

FIGURE 123A
P SERIES PROTON IRRADIATION IN-SITU
D180-26590-1
168

S/N : 707	LEVEL : 3
TEMP: 25 C	ISC(MA) : 11.4
AREA: 4 CM ²	VOC(MV) : 242.8
INT. : 1*AM0	PMAX(MW) : 4.7
	F.F. : 1.708

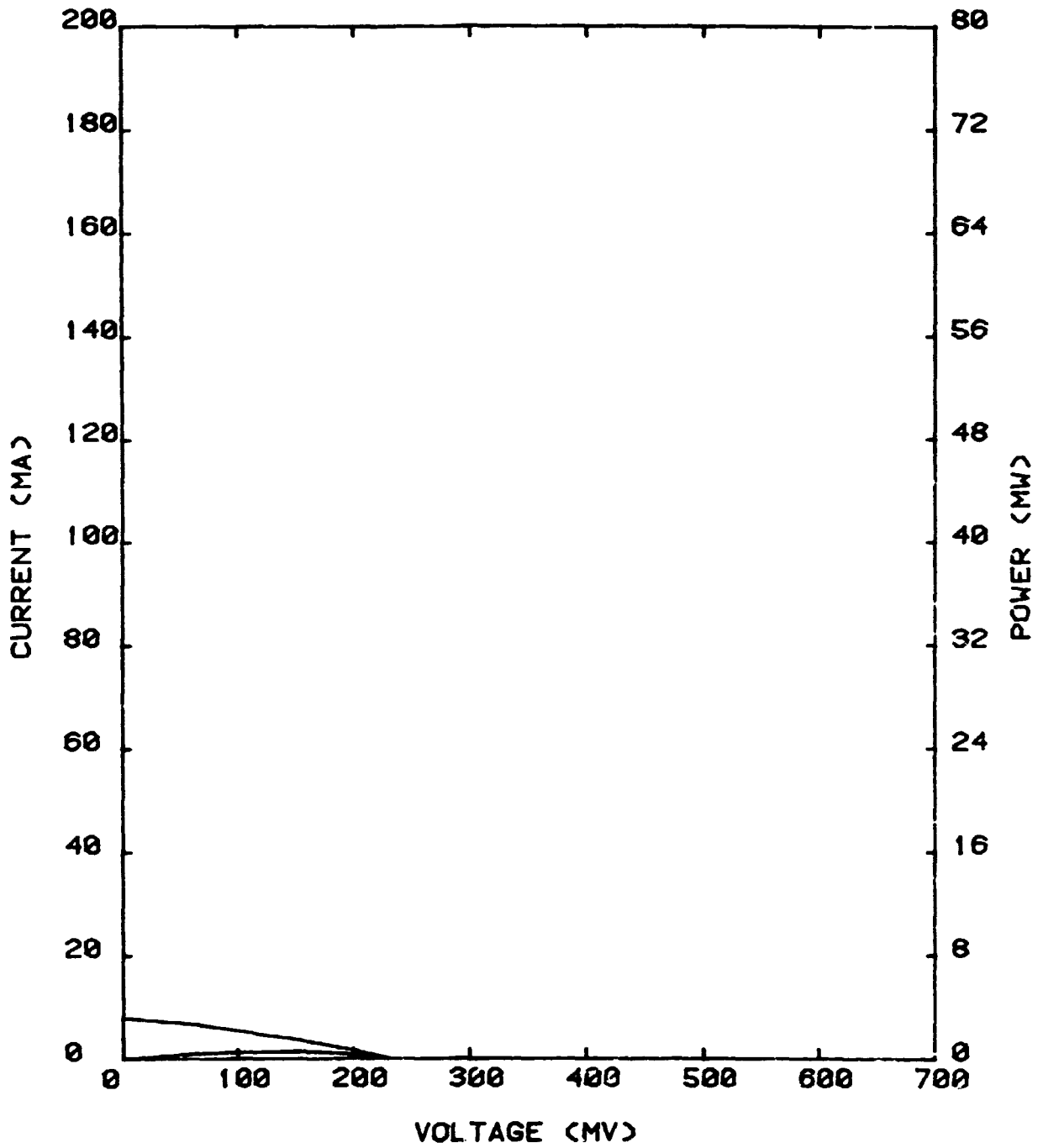

FIGURE 1238
P SERIES PROTON IRRADIATION IN-SITU
D180-26590-1
169

6.8.3 UV Exposure

There appeared to be a haze developing on the samples as the exposure progressed. The summary plots, Figures 124, 125, 126 and 127 show that I_{sc} has degraded 9% by the end of the exposure. There was little change in V_{oc} therefore the I_{sc} loss can be attributed to a transmission change caused by one or both the darkening of the GR 650 or contamination during the UV exposure. The tabulated data is listed in Tables 32A and 32B and a pre- and post-test I-V curve is shown in Figure 128. The sample which had the thermocouple attached cracked causing the temperature data to be faulty.

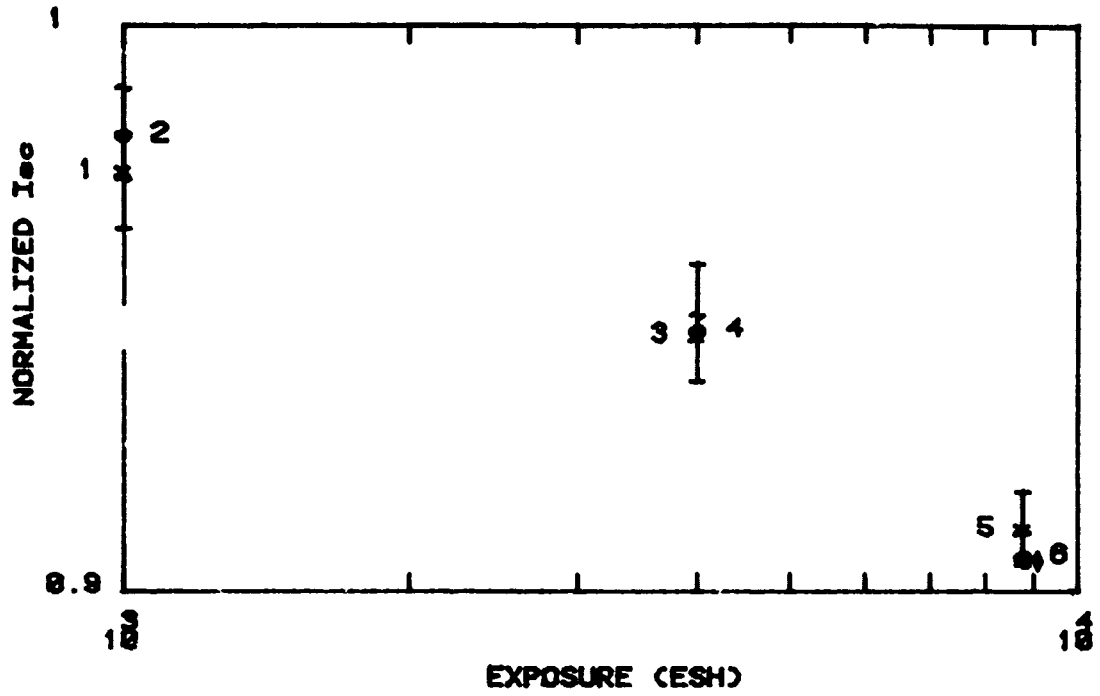

FIGURE 124. P SERIES UV IRRADIATION IN SITU

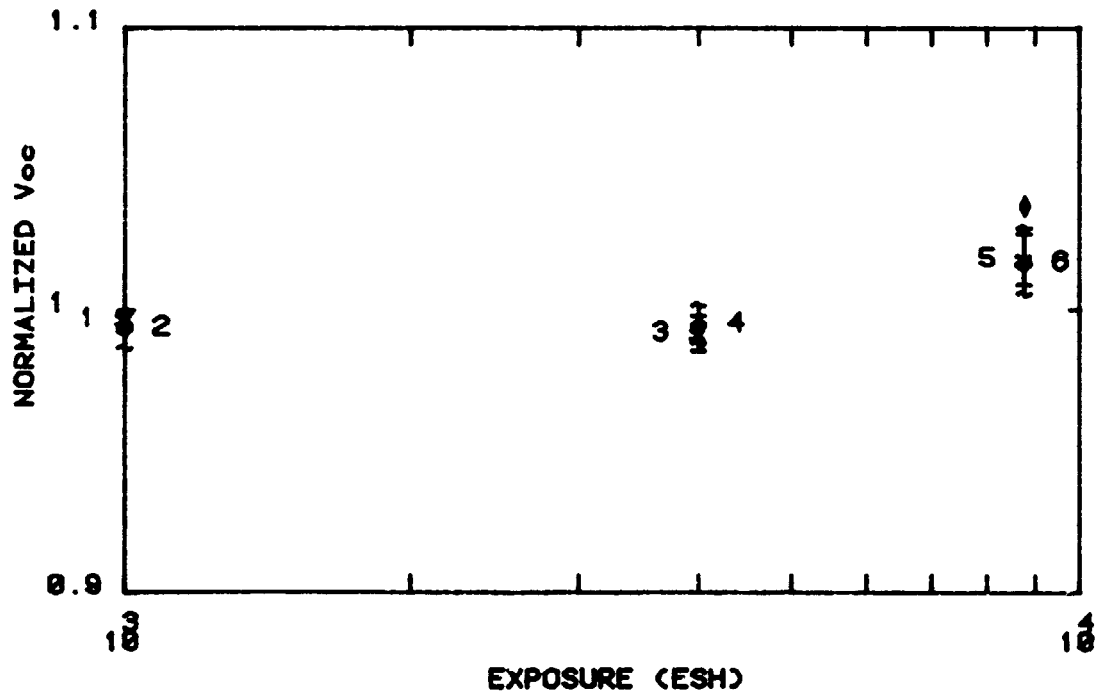

FIGURE 125. P SERIES UV IRRADIATION IN SITU

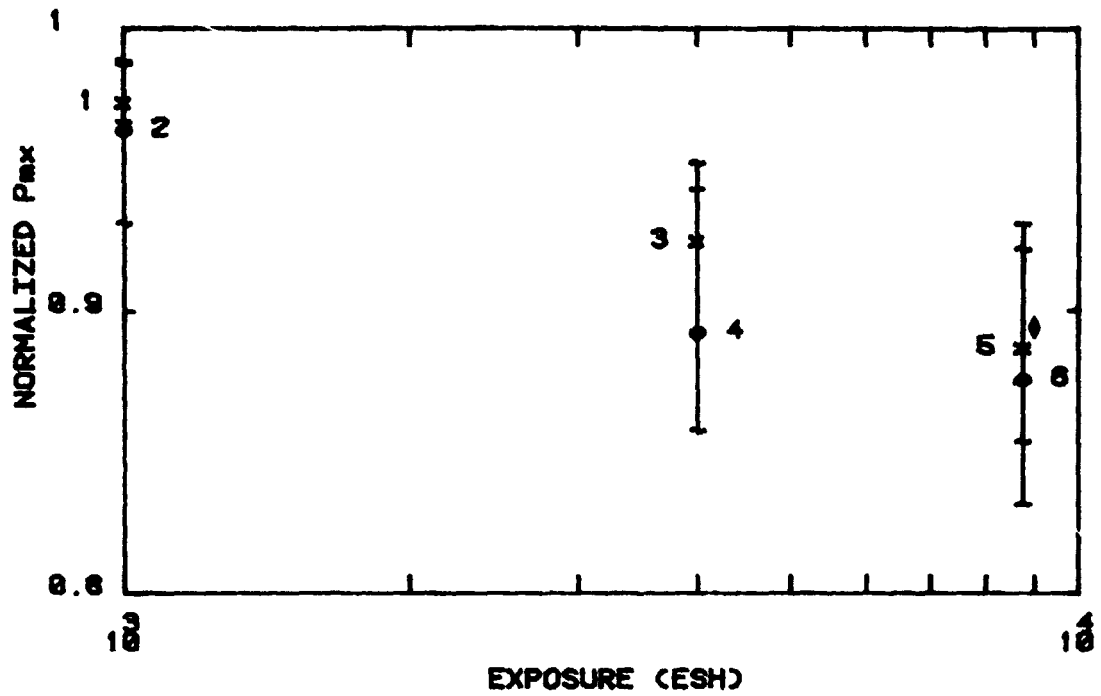

FIGURE 126. P SERIES UV IRRADIATION IN SITU

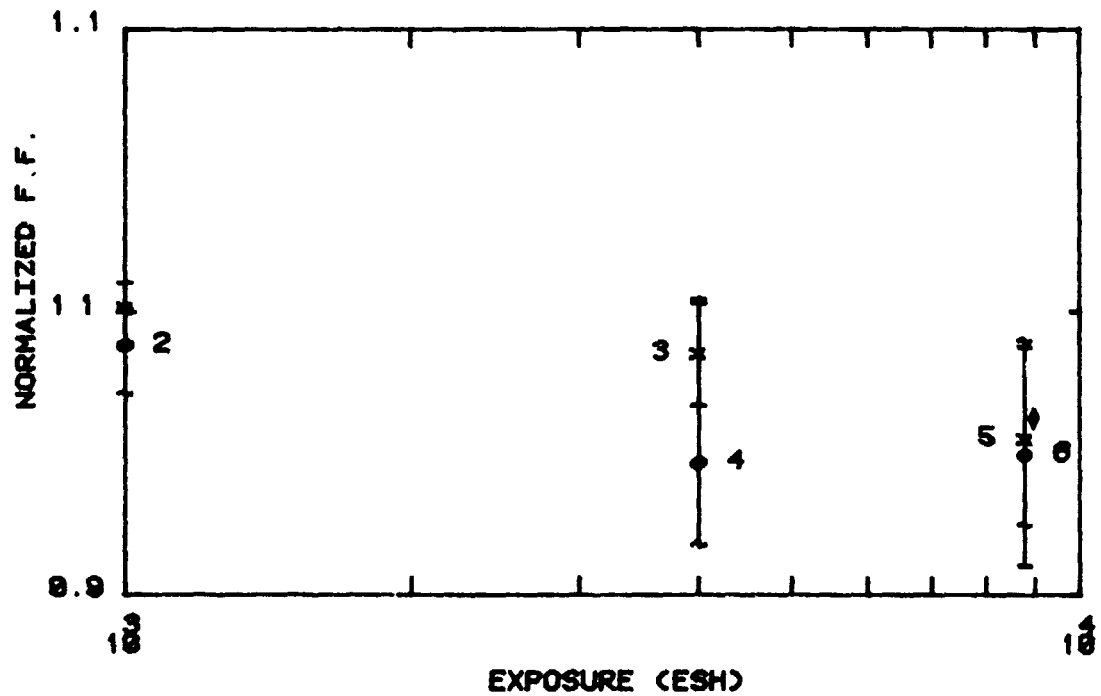

FIGURE 127. P SERIES UV IRRADIATION IN SITU

TABLE 32A. TABULATED P SERIES DATA - UV IRRADIATION

P SERIES UV IRRADIATION EX-SITU
 TEMP. (C): 25 AREA: 4. INTENSITY 1*AM0

Level Number	AVERAGE Isc/Isc0	AVERAGE Voc/Voc0	AVERAGE Pmx/Pmx0	AVERAGE F. F. /F. F. 0
0	1.000	1.000	1.000	1.000
1	0.902	1.030	0.889	0.956

P SERIES UV IRRADIATION IN SITU
 TEMP. (C): 25 AREA: 4. INTENSITY 1*AM0

Level Number	AVERAGE Isc/Isc0	AVERAGE Voc/Voc0	AVERAGE Pmx/Pmx0	AVERAGE F. F. /F. F. 0
0	1.000	1.000	1.000	1.000
1	0.975	0.998	0.975	1.003
2	0.981	0.994	0.965	0.989
3	0.946	0.992	0.926	0.986
4	0.947	0.996	0.894	0.948
5	0.911	1.019	0.888	0.950
6	0.907	1.017	0.877	0.950

P SERIES UV IRRADIATION EX-SITU
 TEMP. (C): 25 AREA: 4 INTENSITY 1*AM0

Serial Number	Level Number	Isc (mA)	Isc/Isc0	Voc (mV)	Voc/Voc0	Pmx (mW)	Pmx/Pmx0	F. F. /Fac.	F. F. /F. F. 0
706	0	46.0	1.000	574.6	1.000	20.77	1.000	0.786	1.000
712	0	146.2	1.000	572.9	1.000	65.03	1.000	0.776	1.000
713	0	145.9	1.000	572.9	1.000	65.47	1.000	0.783	1.000
714	0	146.9	1.000	572.4	1.000	64.84	1.000	0.771	1.000
715	0	143.1	1.000	572.4	1.000	62.91	1.000	0.768	1.000
706	1	42.6	0.926	599.4	1.043	19.77	0.952	0.775	0.985
712	1	127.3	0.871	579.7	1.012	54.64	0.840	0.740	0.953
713	1	135.5	0.929	595.2	1.039	61.61	0.941	0.764	0.975
714*	1	136.7	0.930	589.4	1.030	50.39	0.777	0.626	0.811
715*	1	126.3	0.883	587.4	1.026	51.78	0.823	0.698	0.909

*NOT INCLUDED IN AVERAGE

TABLE 32B. TABULATED P SERIES DATA - UV IRRADIATION

P SERIES UV IRRADIATION IN SITU
 TEMP. (C): 25 AREA: 4 INTENSITY 1*AM0

Serial Number	Level Number	Isc (mA)	Isc/ Isco	Voc (mV)	Voc/ Voco	Pmx (mW)	Pmx/ Pmxo	Fill Fac.	F. F. / F. F. o
706	0	46.0	1.000	581.3	1.000	20.90	1.000	0.782	1.000
712	0	137.3	1.000	570.7	1.000	61.57	1.000	0.786	1.000
713	0	144.0	1.000	577.0	1.000	63.71	1.000	0.767	1.000
714	0	145.3	1.000	578.8	1.000	63.90	1.000	0.760	1.000
715	0	141.3	1.000	577.8	1.000	62.88	1.000	0.770	1.000
706	1	45.0	0.979	580.7	0.999	20.22	0.967	0.774	0.989
712	1	132.4	0.964	567.9	0.995	59.71	0.970	0.794	1.011
713	1	141.3	0.981	576.2	0.999	62.95	0.988	0.773	1.008
714*	1	143.0	0.984	576.1	0.995	61.66	0.965	0.748	0.985
715*	1	127.0	0.898	575.6	0.956	53.97	0.858	0.738	0.959
706	2	45.4	0.989	580.5	0.999	20.64	0.988	0.783	1.000
712	2	133.5	0.973	562.6	0.986	57.28	0.930	0.763	0.970
713	2	141.5	0.983	576.2	0.999	62.32	0.978	0.764	0.997
714*	2	142.3	0.980	570.4	0.985	57.53	0.900	0.709	0.932
715*	2	129.9	0.919	555.1	0.961	49.18	0.782	0.682	0.886
706	3	44.0	0.958	580.2	0.998	19.72	0.944	0.772	0.987
712	3	128.7	0.937	562.4	0.986	54.99	0.893	0.760	0.967
713	3	135.7	0.942	573.3	0.994	59.94	0.941	0.771	1.005
714*	3	137.1	0.944	566.3	0.978	54.85	0.858	0.706	0.929
715*	3	125.0	0.885	554.7	0.960	47.57	0.757	0.686	0.891
706	4	43.6	0.949	581.8	1.001	19.89	0.952	0.784	1.003
712	4	130.0	0.947	563.5	0.987	52.76	0.857	0.720	0.917
713	4	136.1	0.945	576.5	0.999	55.57	0.872	0.708	0.924
714*	4	136.6	0.940	570.1	0.985	49.68	0.777	0.638	0.839
715*	4	125.3	0.887	555.1	0.961	48.15	0.766	0.692	0.899
706	5	42.2	0.918	597.2	1.027	19.46	0.931	0.773	0.988
712	5	124.3	0.905	575.8	1.009	51.19	0.831	0.715	0.910
713	5	131.2	0.911	588.5	1.020	57.43	0.901	0.744	0.970
714*	5	131.0	0.902	583.0	1.007	48.42	0.758	0.634	0.834
715*	5	119.6	0.846	569.2	0.985	47.43	0.754	0.697	0.905
706	6	41.6	0.906	597.7	1.028	19.25	0.921	0.774	0.989
712	6	124.1	0.904	573.4	1.005	52.51	0.853	0.738	0.939
713	6	131.0	0.910	588.1	1.019	54.59	0.857	0.708	0.924
714*	6	133.4	0.919	581.7	1.005	47.38	0.741	0.610	0.807
715*	6	120.8	0.855	570.9	0.988	47.52	0.756	0.689	0.895

*NOT INCLUDED IN AVERAGE

S/N : 712	LEVEL : 0	1
TEMP: 25 C	ISC(MA) : 140.2	127.3
AREA: 4 CM^2	VOC(MV) : 572.9	579.7
INT. : 1nA0	PMAX(MW): 65.0	54.6
	F.F. : 0.778	0.740

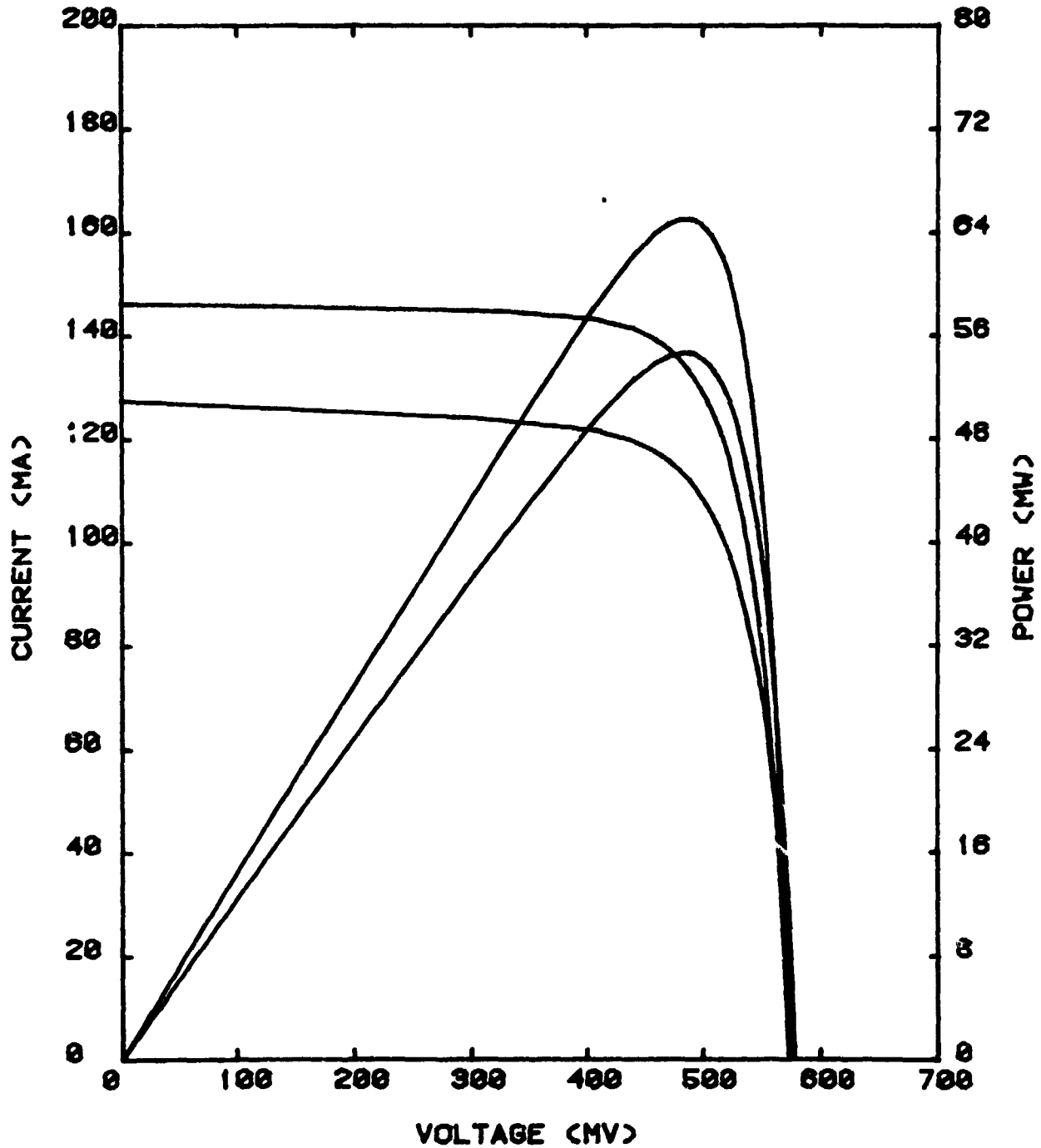

FIGURE 128
P SERIES UV IRRADIATION EX-SITU
D180-26590-1
175

6.9 GE CELLS

(Solarex 2-mil cells, 2-mil PFA "Hard-coated" cover, 1-mil Kapton back, 93-500 adhesive front and back.)

6.9.1 Electron Irradiation

The GE samples all had bubbles trapped in the encapsulant before mounting in the test chamber and the edges of the samples would not lay flat on the sample plate. However, the cells exhibited no visible damage until they had received a total fluence of 1×10^{15} e/cm² and 15 thermal cycles. At this point three cells had cracks in the PFA cover material. After a total fluence of 5×10^{15} e/cm² and 45 thermal cycles all the cells and PFA covers were badly cracked (see Figure 129). The PFA and Kapton had become very brittle. There is little significance in the electrical data because of the physical response of the cell. The summary plots (Figures 130, 131, 132 and 133) and tabulated data (Tables 33A and 33B) are included for completeness. Figure 134A and 134B are in situ I-V curves. The sample plate temperature ranged from 54°C to 58°C during the irradiations.

ORIGINAL PAGE IS
OF POOR QUALITY.

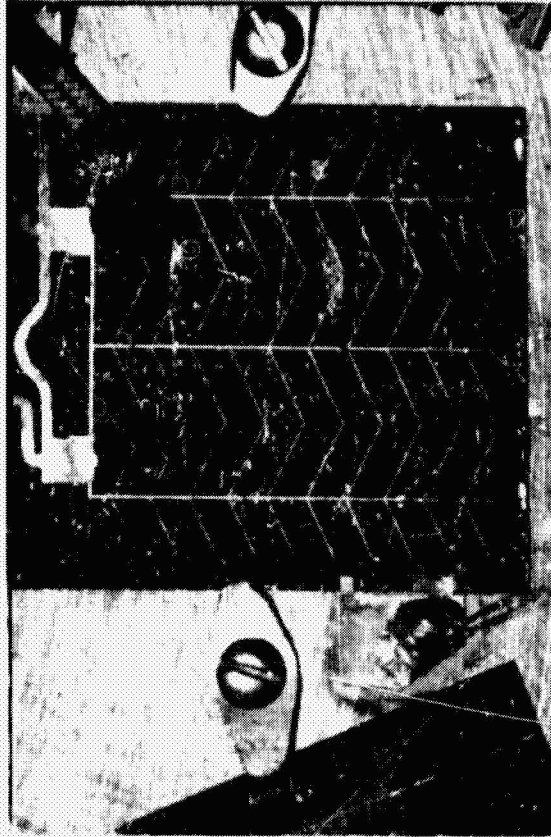

FIGURE 129. PHOTOGRAPH OF GE 4 (803) SAMPLE
SHOWING CRACKED CELLS AND PFA COVERS

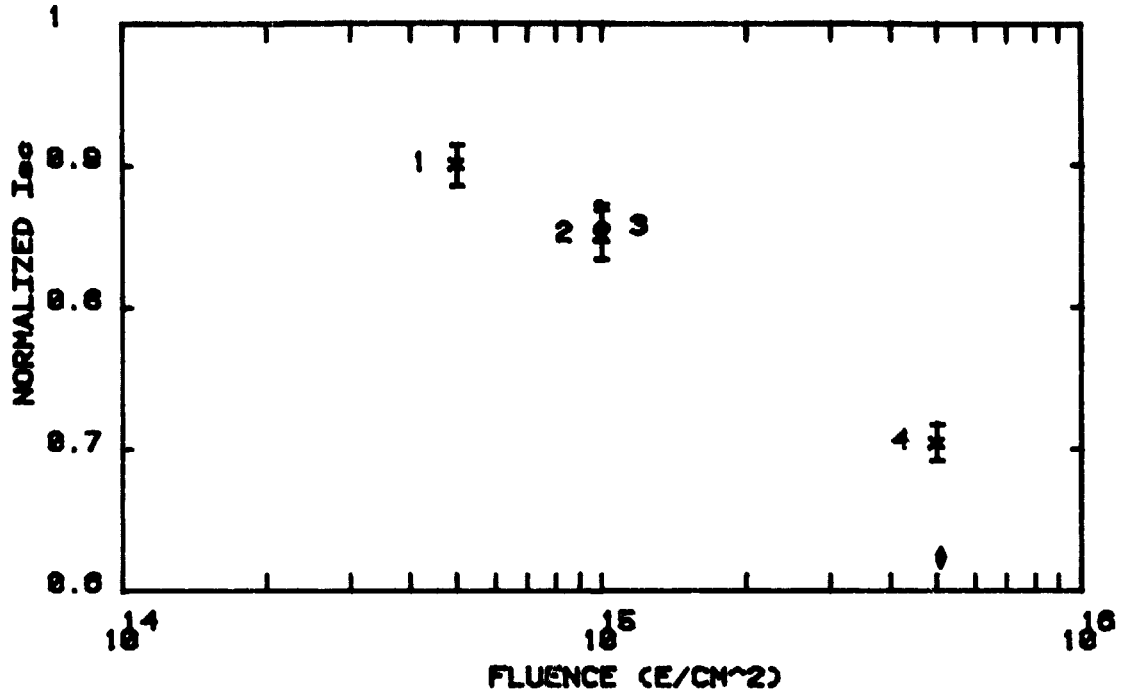

FIGURE 130. GE CELLS ELECTRON IRRADIATION IN-SITU

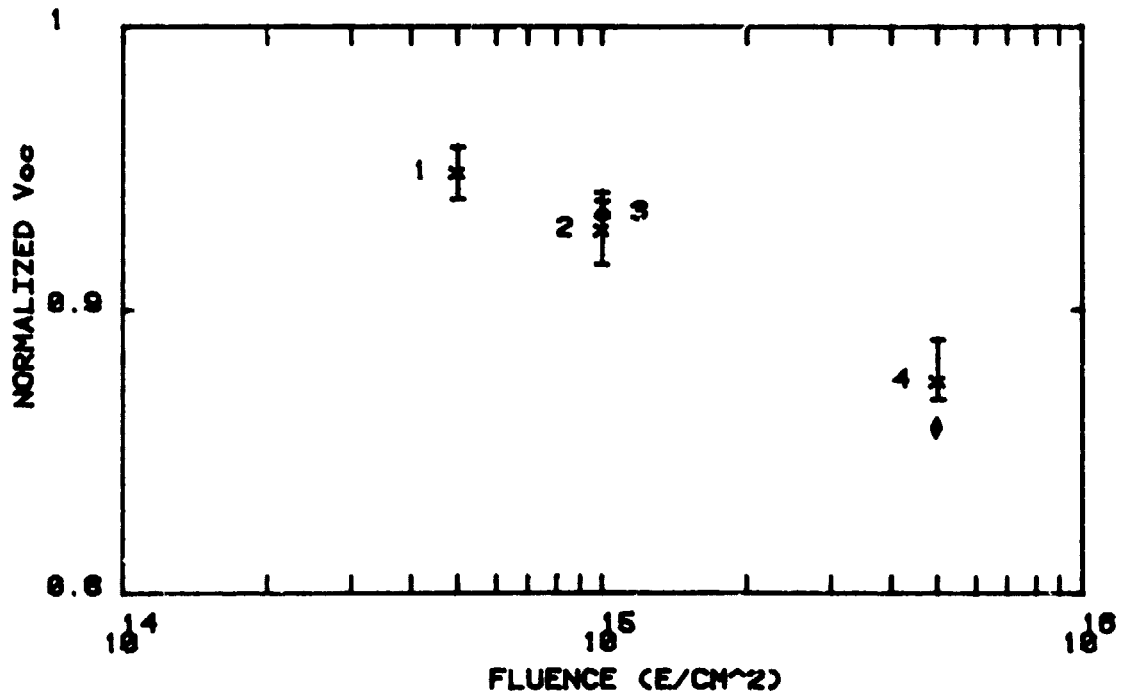

FIGURE 131. GE CELLS ELECTRON IRRADIATION IN-SITU

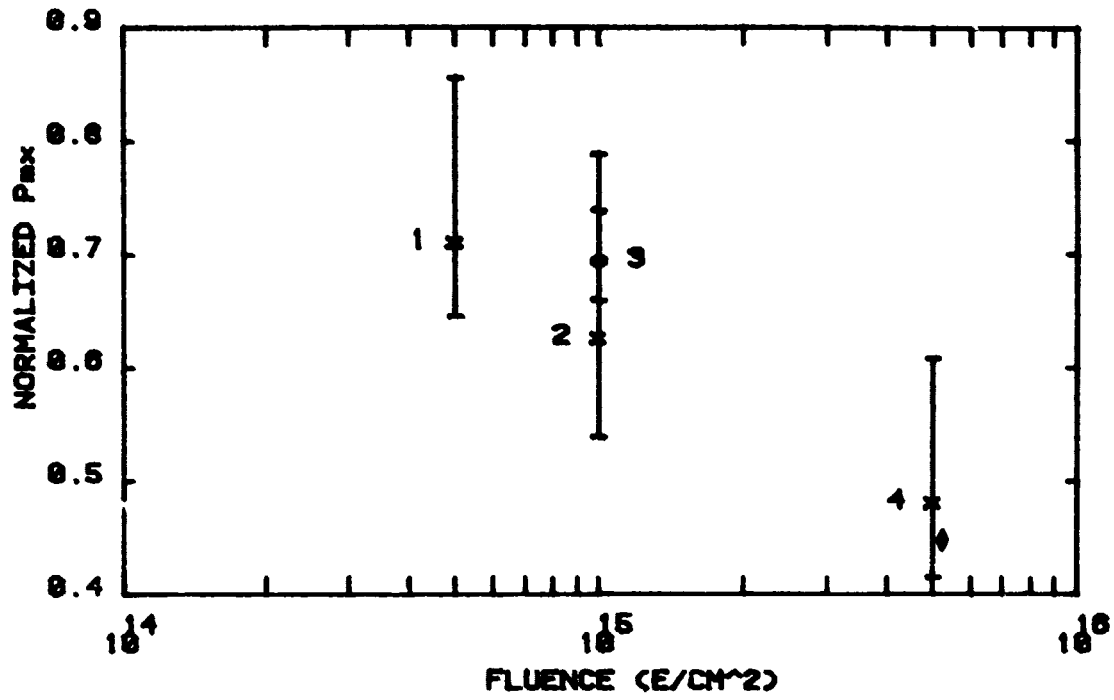

FIGURE 132. GE CELLS ELECTRON IRRADIATION IN-SITU

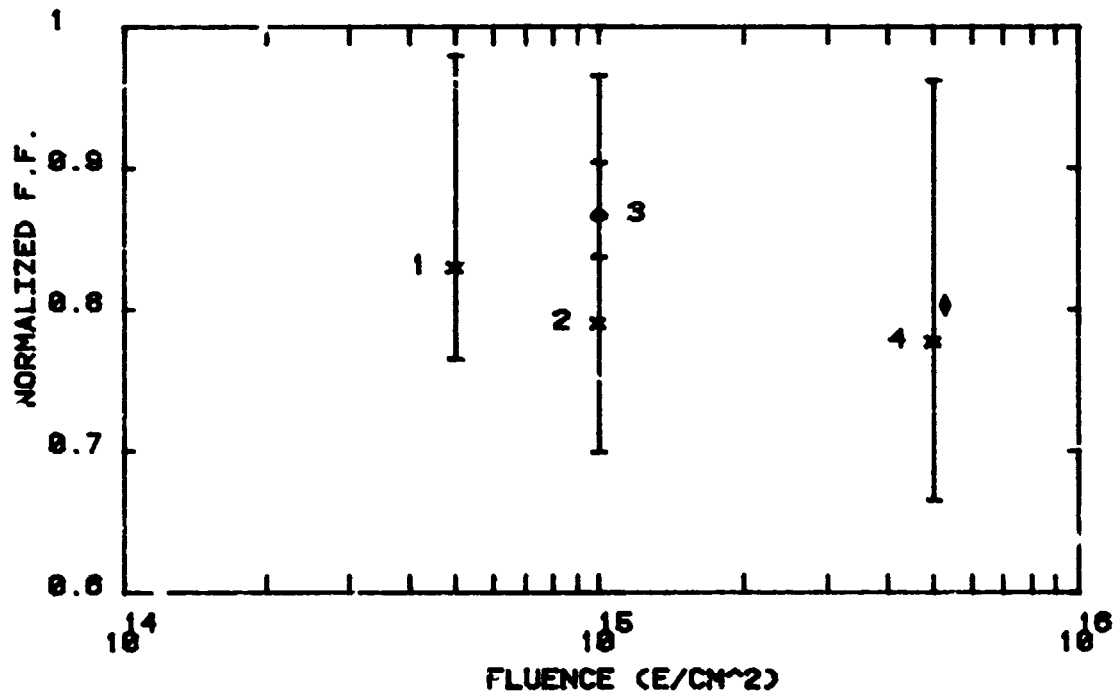

FIGURE 133. GE CELLS ELECTRON IRRADIATION IN-SITU

TABLE 33A. TABULATED GE CELL DATA - ELECTRON IRRADIATION

GE CELLS ELECTRON IRRADIATION EX-SITU
 TEMP. (C): 25 AREA: 4. INTENSITY 1*AM0

Level Number	AVERAGE Isc/Isc0	AVERAGE Voc/Voc0	AVERAGE Pmx/Pmx0	AVERAGE F. F. /F. F. 0
0	1.000	1.000	1.000	1.000
1	0.607	0.856	0.420	0.809

GE CELLS ELECTRON IRRADIATION IN-SITU
 TEMP. (C): 25 AREA: 4. INTENSITY 1*AM0

Level Number	AVERAGE Isc/Isc0	AVERAGE Voc/Voc0	AVERAGE Pmx/Pmx0	AVERAGE F. F. /F. F. 0
0	1.000	1.000	1.000	1.000
1	0.903	0.950	0.714	0.832
2	0.854	0.929	0.630	0.792
3	0.859	0.935	0.698	0.869
4	0.707	0.876	0.484	0.779

GE CELLS ELECTRON IRRADIATION EX-SITU
 TEMP. (C): 25 AREA: 4 INTENSITY 1*AM0

Serial Number	Level Number	Isc (mA)	Isc/Isc0	Voc (mV)	Voc/Voc0	Pmx (mW)	Pmx/Pmx0	F. F. Fac.	F. F. /F. F. 0
801	0	129.9	1.000	549.9	1.000	52.64	1.000	0.737	1.000
802	0	131.8	1.000	552.3	1.000	54.35	1.000	0.747	1.000
803	0	129.4	1.000	554.4	1.000	55.12	1.000	0.768	1.000
804	0	131.7	1.000	550.7	1.000	52.00	1.000	0.717	1.000
806	0	135.2	1.000	559.2	1.000	57.63	1.000	0.762	1.000
801	1	78.4	0.604	467.7	0.851	22.58	0.429	0.615	0.835
802	1	84.2	0.639	478.4	0.866	23.32	0.429	0.579	0.775
803	1	0.0	0.000	0.0	0.000	0.00	0.000	0.000	0.000
804	1	76.2	0.577	469.6	0.853	20.88	0.402	0.585	0.816
806	1		0.000	0.0	0.000	0.00	0.000	0.000	0.000

TABLE 33B. TABULATED GE CELL DATA - ELECTRON IRRADIATION

GE CELLS ELECTRON IRRADIATION IN-SITU									
TEMP. (C): 25 AREA: 4 INTENSITY 1*AM0									
Serial Number	Level Number	Isc (mA)	Isc/ Isc0	Voc (mV)	Voc/ Voc0	Pmx (mW)	Pmx/ Pmx0	Fill Fac.	F. F. / F. F. 0
801	0	112.0	1.000	562.2	1.000	45.72	1.000	0.726	1.000
802	0	113.2	1.000	562.0	1.000	48.62	1.000	0.764	1.000
803	0	111.7	1.000	567.2	1.000	49.96	1.000	0.789	1.000
804	0	113.2	1.000	558.9	1.000	42.34	1.000	0.669	1.000
805	0	0.0	0.000	0.0	0.000	0.00	0.000	0.000	0.000
801	1	102.5	0.915	532.7	0.947	32.01	0.700	0.586	0.808
802	1	101.8	0.900	527.8	0.939	31.34	0.645	0.583	0.703
803	1	101.9	0.912	543.4	0.958	42.80	0.857	0.773	0.980
804	1	100.3	0.886	533.3	0.954	27.70	0.654	0.518	0.774
805	1	105.5	0.000	526.4	0.000	27.07	0.000	0.488	0.000
801	2	97.4	0.870	520.1	0.925	26.66	0.583	0.526	0.725
802	2	93.3	0.842	515.0	0.916	26.17	0.538	0.533	0.697
803	2	96.9	0.868	534.4	0.942	39.46	0.790	0.752	0.966
804	2	94.4	0.834	521.6	0.933	25.69	0.607	0.522	0.779
805	2	101.4	0.000	516.8	0.000	24.48	0.000	0.467	0.000
801	3	97.6	0.872	527.2	0.938	33.73	0.738	0.655	0.903
802	3	95.7	0.846	523.8	0.932	31.94	0.657	0.637	0.834
803	3	0.0	0.000	0.0	0.000	0.00	0.000	0.000	0.000
804	3	0.0	0.000	0.0	0.000	0.00	0.000	0.000	0.000
805	3	100.2	0.000	527.2	0.000	32.00	0.000	0.606	0.000
801	4	80.5	0.719	488.6	0.869	18.99	0.415	0.483	0.665
802	4	78.3	0.692	488.2	0.869	20.72	0.426	0.542	0.709
803	4	0.0	0.000	0.0	0.000	0.00	0.000	0.000	0.000
804	4	80.5	0.712	497.4	0.890	25.80	0.609	0.644	0.962
805	4	0.0	0.000	0.0	0.000	0.00	0.000	0.000	0.000
801	5	0.0	0.000	0.0	0.000	0.00	0.000	0.000	0.000
802	5	0.0	0.000	0.0	0.000	0.00	0.000	0.000	0.000
803	5	0.0	0.000	0.0	0.000	0.00	0.000	0.000	0.000
804	5	0.0	0.000	0.0	0.000	0.00	0.000	0.000	0.000
805	5	0.0	0.000	0.0	0.000	0.00	0.000	0.000	0.000
801	6	0.0	0.000	0.0	0.000	0.00	0.000	0.000	0.000
802	6	0.0	0.000	0.0	0.000	0.00	0.000	0.000	0.000
803	6	0.0	0.000	0.0	0.000	0.00	0.000	0.000	0.000
804	6	0.0	0.000	0.0	0.000	0.00	0.000	0.000	0.000
805	6	0.0	0.000	0.0	0.000	0.00	0.000	0.000	0.000
801	7	0.0	0.000	0.0	0.000	0.00	0.000	0.000	0.000
802	7	0.0	0.000	0.0	0.000	0.00	0.000	0.000	0.000
803	7	0.0	0.000	0.0	0.000	0.00	0.000	0.000	0.000
804	7	0.0	0.000	0.0	0.000	0.00	0.000	0.000	0.000
805	7	0.0	0.000	0.0	0.000	0.00	0.000	0.000	0.000

S/N : 001	LEVEL : 0	1	2
TEMP: 25 C	ISC(MA) : 112.0	102.5	97.4
AREA: 4 CM^2	VOC(MV) : 502.2	532.7	520.1
INT. : 1*AM0	PMAX(MW) : 45.7	32.0	26.7
	F.F. : 0.726	0.586	0.526

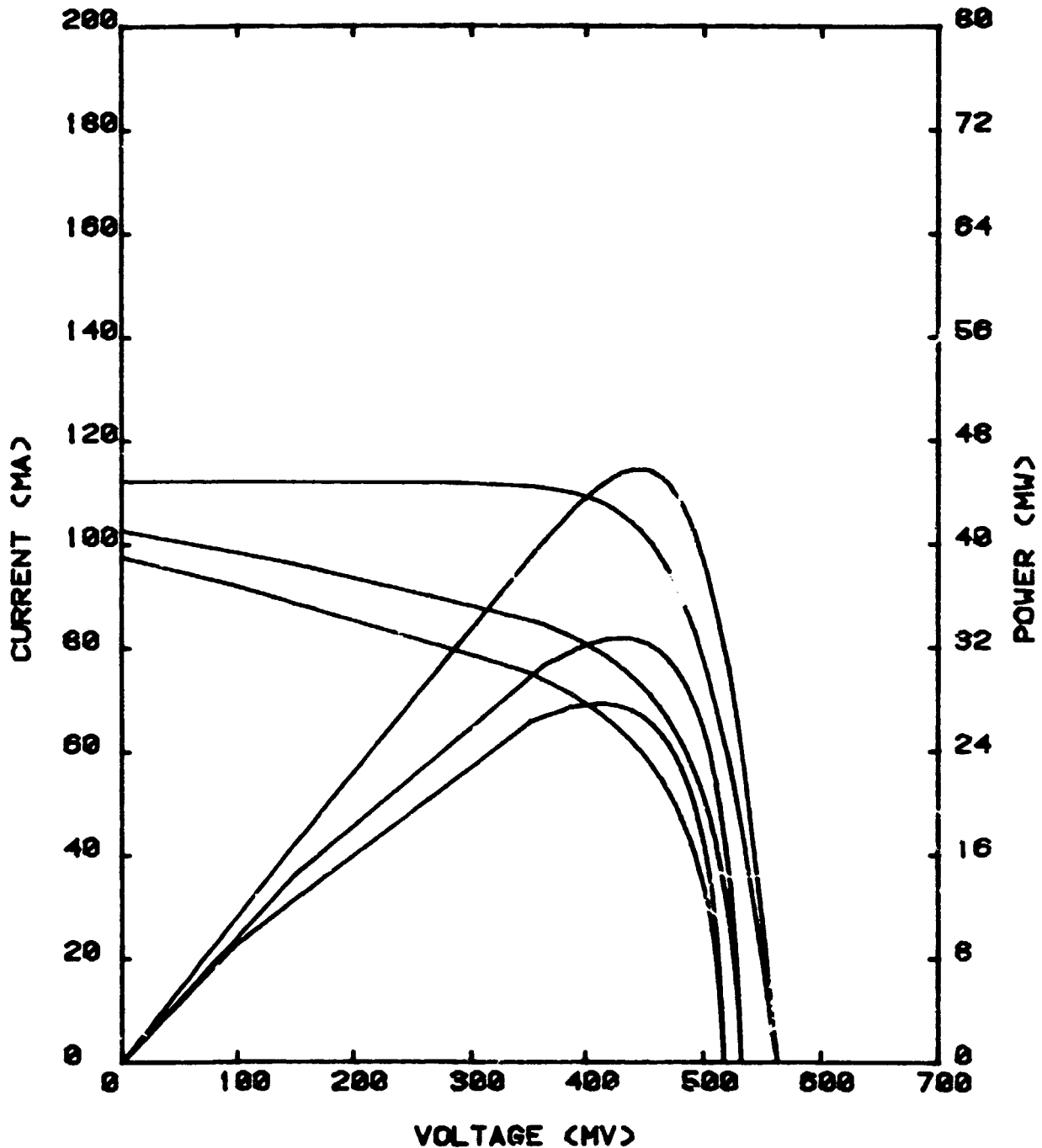

FIGURE 134A
 GE CELLS ELECTRON IRRADIATION IN-SITU
 D180-26590-1
 182

S/N : 801	LEVEL : 3	4	5	6	7
TEMP: 25 C	ISC(MA) : 97.8	80.5	NO OUTPUT		
AREA: 4 CM ²	VOC(MV) : 527.2	488.6			
INT. : 1*AM0	PMAX(MW) : 33.7	19.0			
	F.F. : 0.855	0.483			

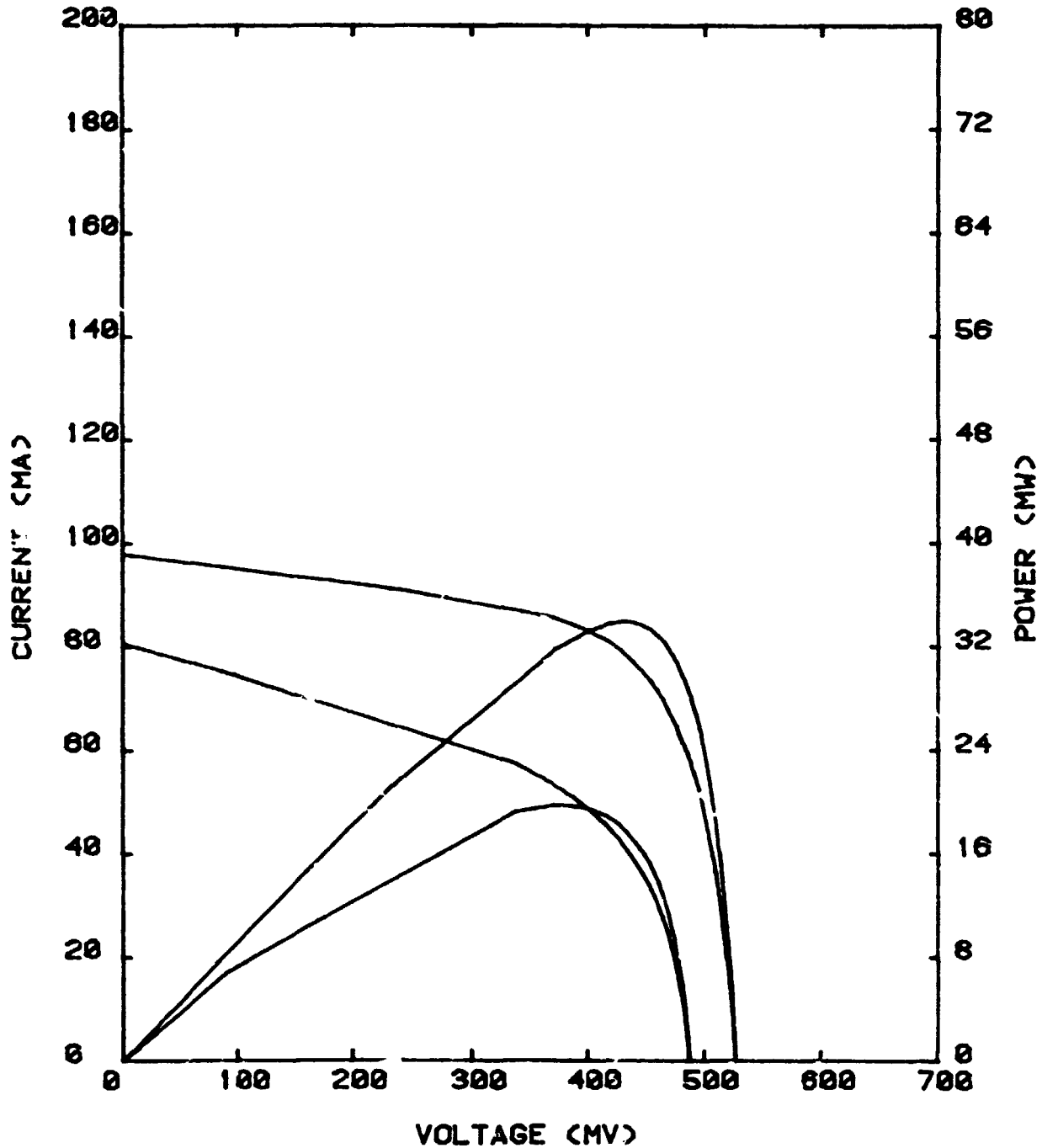

FIGURE 134B
 GE CELLS ELECTRON IRRADIATION IN-SITU
 D180-26590-1
 183

6.9.2 Proton Irradiation

The GE cells showed visible damage after the first proton fluence of 3×10^{14} p/cm² and no thermal cycles. Four of the five cells had started to curl up from the contact bar end indicating a shrinking of the PFA cover material. One cell's cover had started to blister. After the first 15 thermal cycles the only additional damage was more curling. After a total fluence of 3.3×10^{15} p/cm² and 15 thermal cycles the PFA covers were blistered and peeling off on all five cells. The last 15 thermal cycles only made the blistering and peeling worse. Figure 135 is a photograph showing the blistering and peeling after the completed proton test. The summary plots, Figures 136, 137, 138 and 139 and tabulated data (Tables 34A and 34B) indicate that once the PFA curled up protons were able to penetrate and degrade the cell electrically. As in the case of the electron damage the mechanical damage was so severe that no meaningful electrical performance conclusions can be made. Figures 140A and 140B are in situ I-V curves for a cell showing how the cell degraded. The sample temperature during the irradiation ranged from 57°C to 58°C.

ORIGINAL PAGE IS
OF POOR QUALITY



FIGURE 135. BLISTERING AND PEELING OF CELL GE12 (806),
POST-PROTON IRRADIATION EX SITU

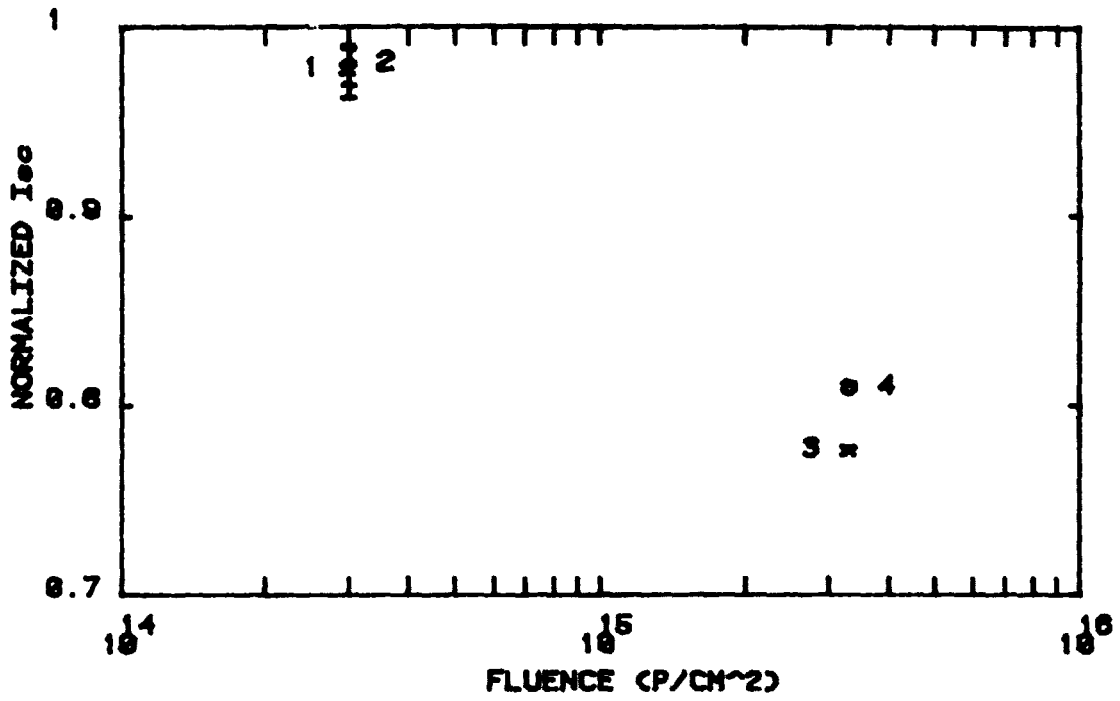

FIGURE 136. GE CELLS PROTON IRRADIATION IN-SITU

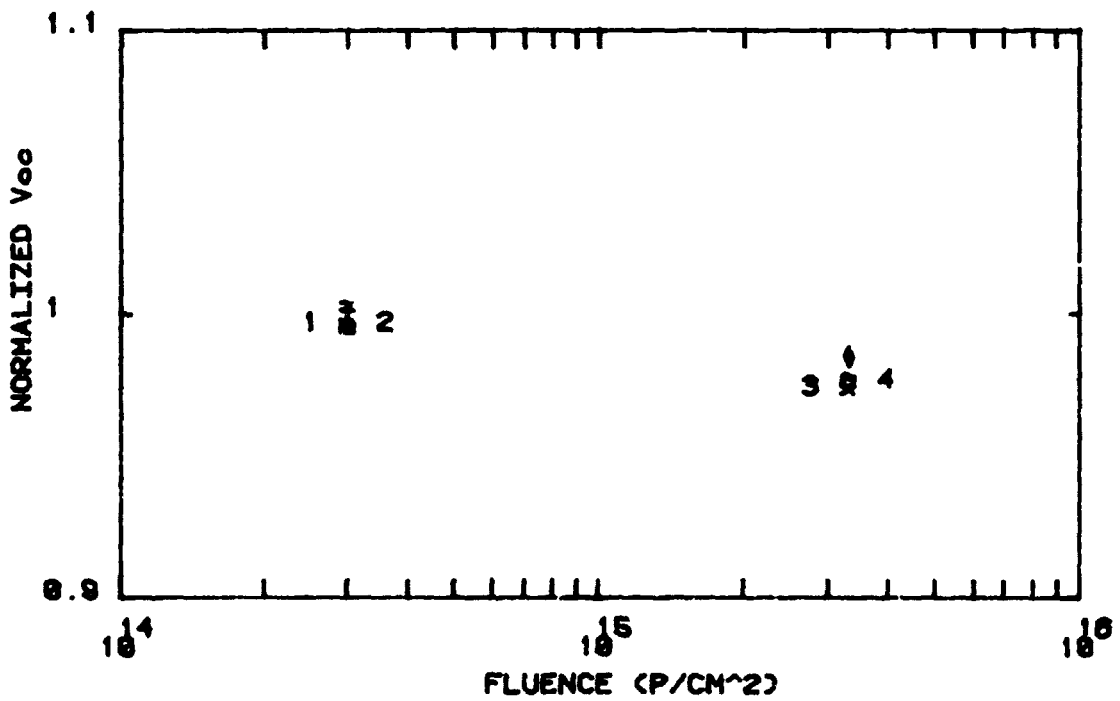

FIGURE 137. GE CELLS PROTON IRRADIATION IN-SITU

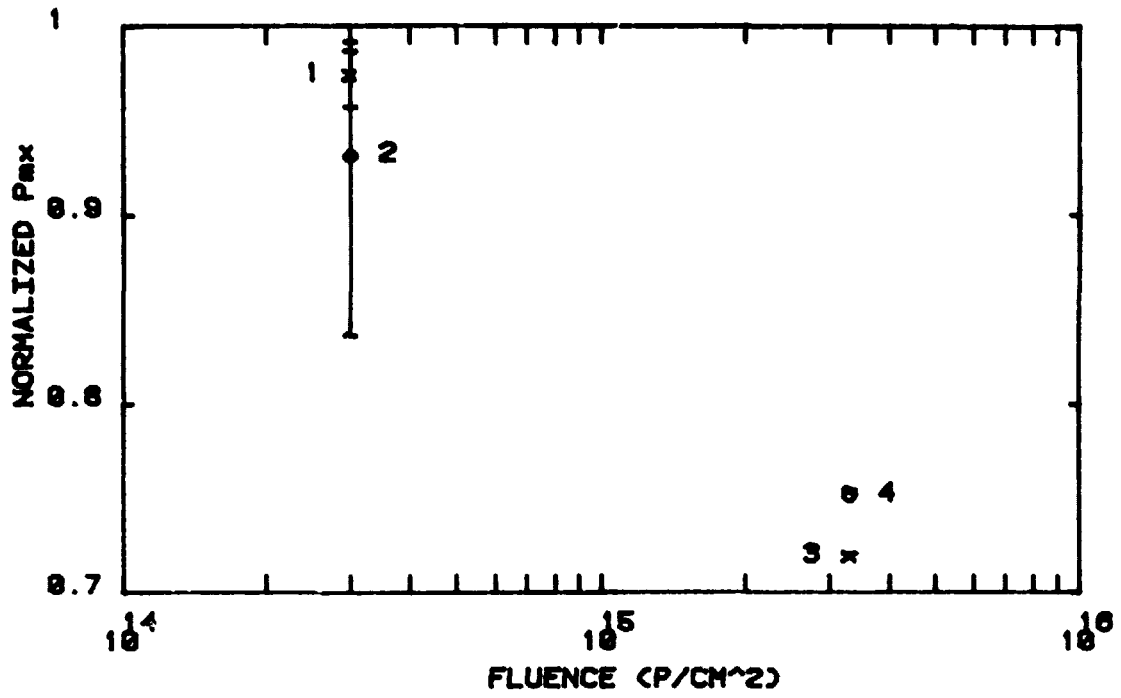

FIGURE 136. GE CELLS PROTON IRRADIATION IN-SITU

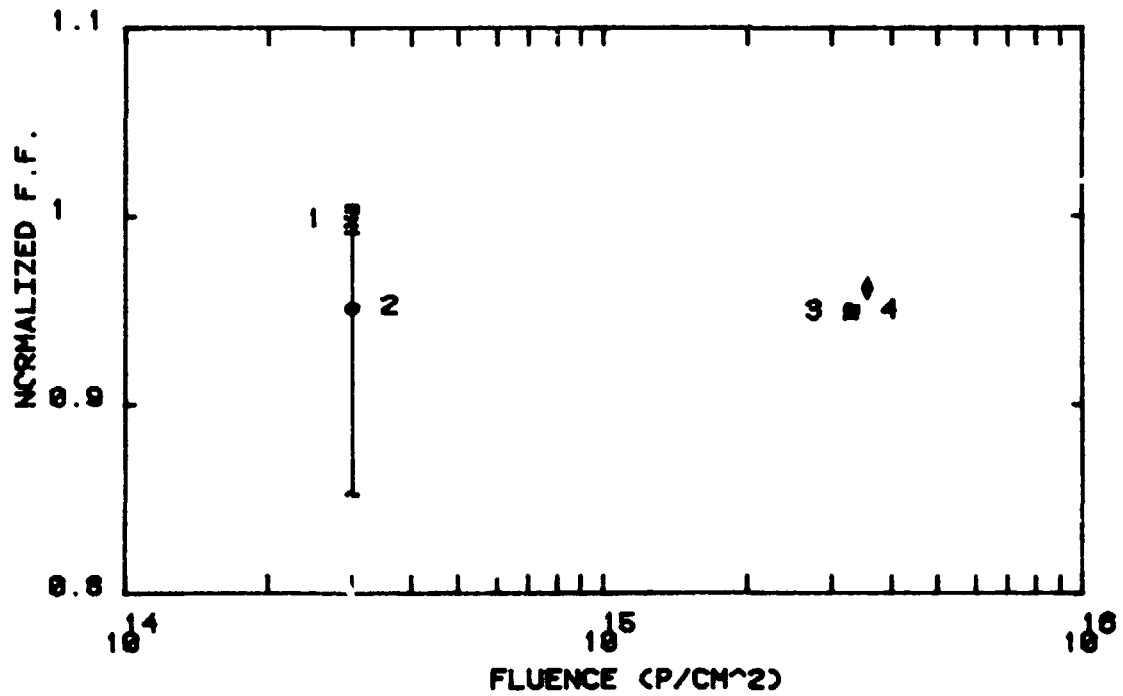

FIGURE 139. GE CELLS PROTON IRRADIATION IN-SITU

TABLE 34A. TABULATED GE CELL DATA - PROTON IRRADIATION

GE CELLS PROTON IRRADIATION EX-SITU
TEMP. (C): 25 AREA. 4. INTENSITY 1*AM0

Level Number	AVERAGE Isc/Isc0	AVERAGE Voc/Voc0	AVERAGE Pmx/Pmx0	AVERAGE F. F. /F. F. 0
0	1.000	1.000	1.000	1.000
1	0.928	0.982	0.876	0.960

GE CELLS PROTON IRRADIATION IN-SITU
TEMP. (C): 25 AREA. 4. INTENSITY 1*AM0

Level Number	AVERAGE Isc/Isc0	AVERAGE Voc/Voc0	AVERAGE Pmx/Pmx0	AVERAGE F. F. /F. F. 0
0	1.000	1.000	1.000	1.000
1	0.979	0.997	0.976	0.999
2	0.982	0.997	0.933	0.953
3	0.778	0.975	0.721	0.950
4	0.811	0.977	0.754	0.951

GE CELLS PROTON IRRADIATION EX-SITU
TEMP. (C): 25 AREA: 4 INTENSITY 1*AM0

Serial Number	Level Number	Isc (mA)	Isc/Isc0	Voc (mV)	Voc/Voc0	Pmx (mW)	Pmx/Pmx0	Full Fac	F. F. /F. F. 0
805	0	135.6	1.000	559.1	1.000	58.03	1.000	0.765	1.000
807	0	0.0	0.000	0.0	0.000	0.00	0.000	0.000	0.000
806	0	147.2	1.000	567.0	1.000	63.76	1.000	0.764	1.000
803	0	127.9	1.000	542.3	1.000	51.97	1.000	0.749	1.000
810	0	130.0	1.000	549.4	1.000	54.68	1.000	0.766	1.000
805	1	0.0	0.000	0.0	0.000	0.00	0.000	0.000	0.000
807	1	0.0	0.000	0.0	0.000	0.00	0.000	0.000	0.000
808	1	139.1	0.945	564.5	0.996	58.02	0.910	0.729	0.968
809*	1	111.2	0.869	472.3	0.871	32.22	0.620	0.614	0.819
810	1	118.5	0.912	531.6	0.968	46.00	0.841	0.730	0.953

*NOT INCLUDED IN AVERAGE

TABLE 348. TABULATED GE CELL DATA - PROTON IRRADIATION

GE CELLS PROTON IRRADIATION IN-SITU									
TEMP. (C): 25 AREA: 4 INTENSITY 1*AM0									
Serial Number	Level Number	Isc (mA)	Isc/ Isco	Voc (mV)	Voc/ Voco	Pmx (mW)	Pmx/ Pmxo	Fill Fac.	F. F. / F. F. o
806	0	115.1	1.000	565.9	1.000	50.19	1.000	0.771	1.000
807	0	0.0	0.000	0.0	0.000	0.00	0.000	0.000	0.000
808	0	124.5	1.000	577.1	1.000	55.37	1.000	0.771	1.000
809	0	107.7	1.000	554.1	1.000	46.65	1.000	0.781	1.000
810	0	109.5	1.000	556.9	1.000	47.42	1.000	0.778	1.000
806	1	113.3	0.985	566.8	1.001	49.80	0.992	0.775	1.006
807	1	109.0	0.000	561.4	0.000	47.66	0.000	0.779	0.000
808	1	119.9	0.963	573.3	0.993	53.00	0.957	0.771	1.001
809	1	105.4	0.979	551.8	0.996	45.05	0.966	0.775	0.991
810	1	108.5	0.991	556.0	0.998	46.84	0.988	0.776	0.998
806	2	113.5	0.986	567.6	1.003	49.46	0.985	0.768	0.996
807	2	109.1	0.000	565.2	0.000	47.90	0.000	0.777	0.000
808	2	120.6	0.968	574.5	0.996	51.40	0.928	0.742	0.963
809	2	106.2	0.986	551.4	0.995	38.97	0.835	0.665	0.851
810	2	108.1	0.988	554.2	0.995	46.68	0.984	0.779	1.002
806	3	0.0	0.000	0.0	0.000	0.00	0.000	0.000	0.000
807	3	84.4	0.000	533.6	0.000	30.94	0.000	0.687	0.000
808	3	0.0	0.000	0.0	0.000	0.00	0.000	0.000	0.000
809*	3	83.5	0.776	480.7	0.868	23.20	0.497	0.578	0.739
810	3	85.2	0.778	542.8	0.975	34.18	0.721	0.739	0.950
806	4	0.0	0.000	0.0	0.000	0.00	0.000	0.000	0.000
807	4	85.8	0.000	533.6	0.000	28.78	0.000	0.629	0.000
808	4	0.0	0.000	0.0	0.000	0.00	0.000	0.000	0.000
809	4	0.0	0.000	0.0	0.000	0.00	0.000	0.000	0.000
810	4	88.8	0.811	544.2	0.977	35.74	0.754	0.739	0.951

*NOT INCLUDED IN AVERAGE

S/N : 800	LEVEL : 0	1	2
TEMP: 25 C	ISC(MA) : 107.7	105.4	100.2
AREA: 4 CM ²	VOC(MV) : 554.1	551.8	551.4
INT.: 1*AM0	PMAX(MW): 48.0	45.1	39.0
	F.F. : 0.761	0.775	0.685

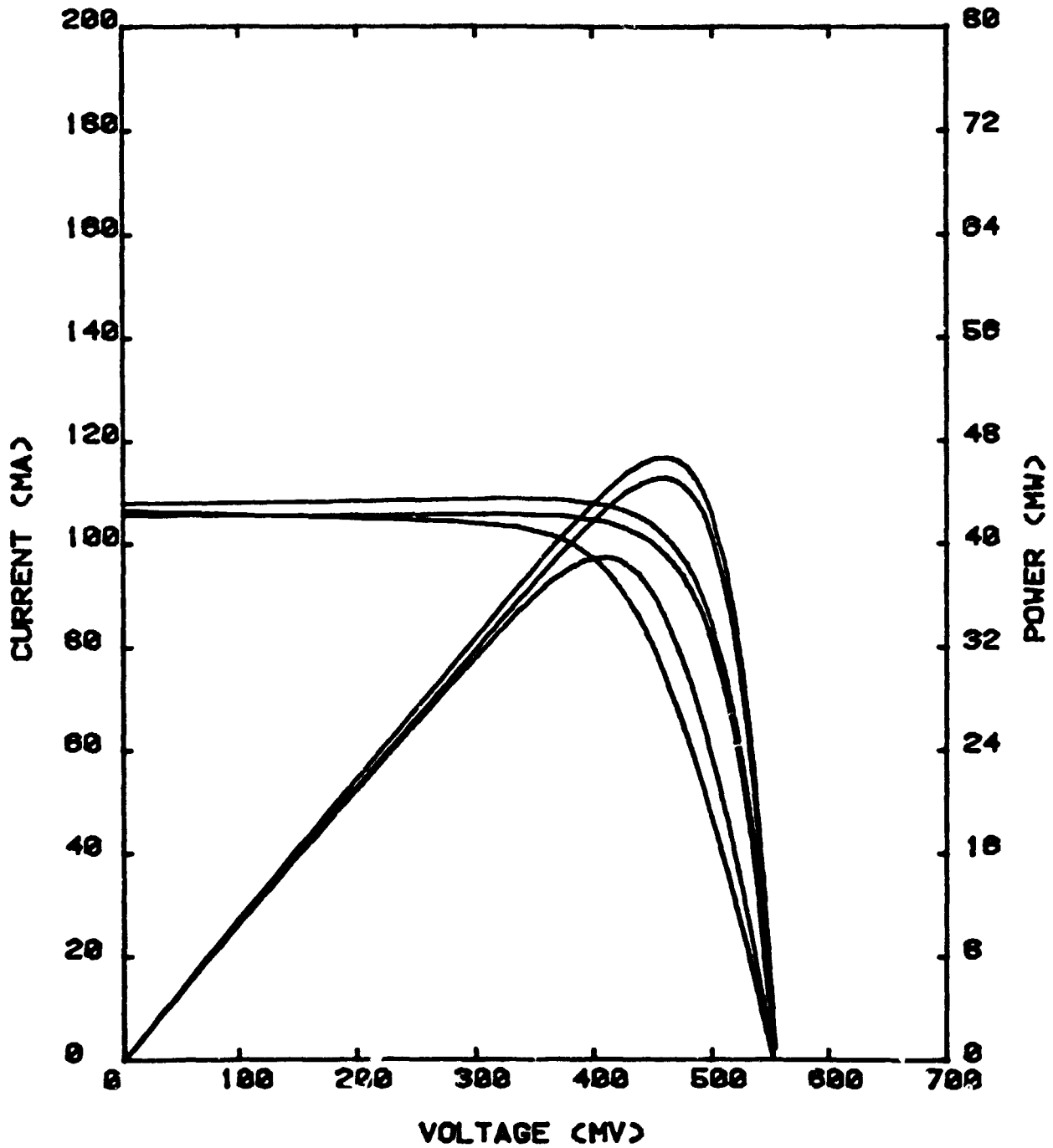

FIGURE 140A
 GE CELLS PROTON IRRADIATION IN-SITU

S/N : 809	LEVEL : 3	4
TEMP: 25 C	ISC(MA) : 83.5	NO OUTPUT
AREA: 4 CM ²	VOC(MV) : 480.7	
INT.: 1nA/M0	PMAX(MW) : 23.2	
	F.F. : 0.578	

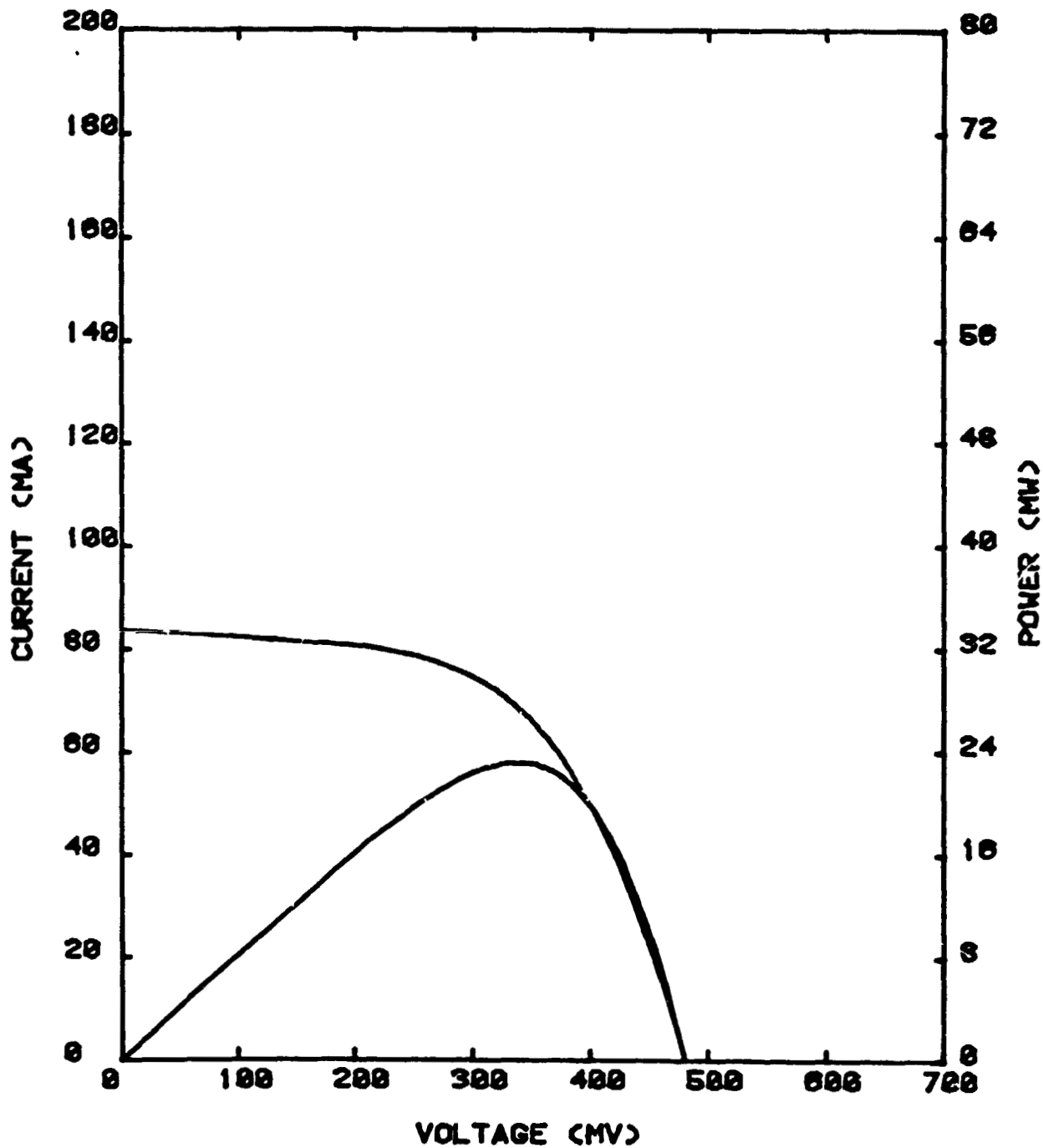

FIGURE 140B
 GE CELLS PROTON IRRADIATION IN-SITU
 D180-26590-1
 191

6.9.3 UV Exposure

There were small hairline cracks in the PFA after 4000 ESH and by the end of the test all the samples had them (see Figure 141). The summary plots (Figures 142, 143, 144 and 145) show that there was a 13 percent drop in I_{sc} over the entire test with no change in V_{oc} . This was apparently due to the cracks scattering the solar spectrum and darkening of the DC 93-500. The tabulated data are contained in Tables 35A and 35B and an in situ I-V curve is shown in Figures 146A, 146B and 146C. The sample temperature ranged from 53°C to 59°C during the UV exposure.

ORIGINAL PAGE IS
OF POOR QUALITY



FIGURE 141. SAMPLE GE26 (812), SHOWING
HAIRLINE CRACKS IN PFA, POST-EXPOSURE UV

C-3

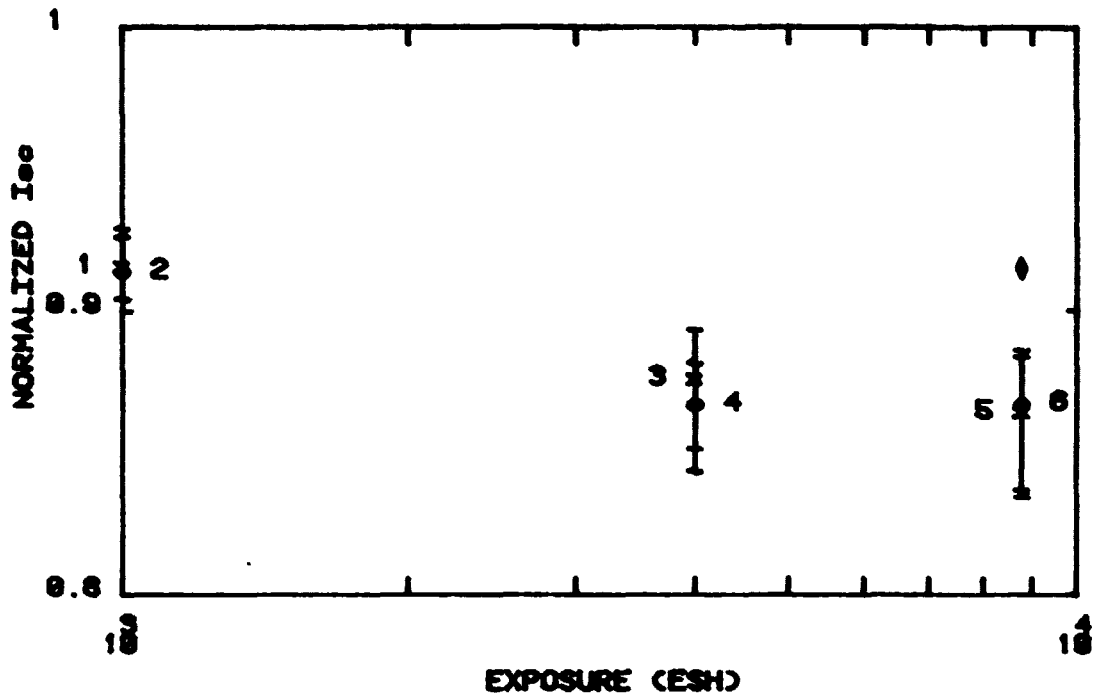

FIGURE 142. GE CELLS UV IRRADIATION IN SITU

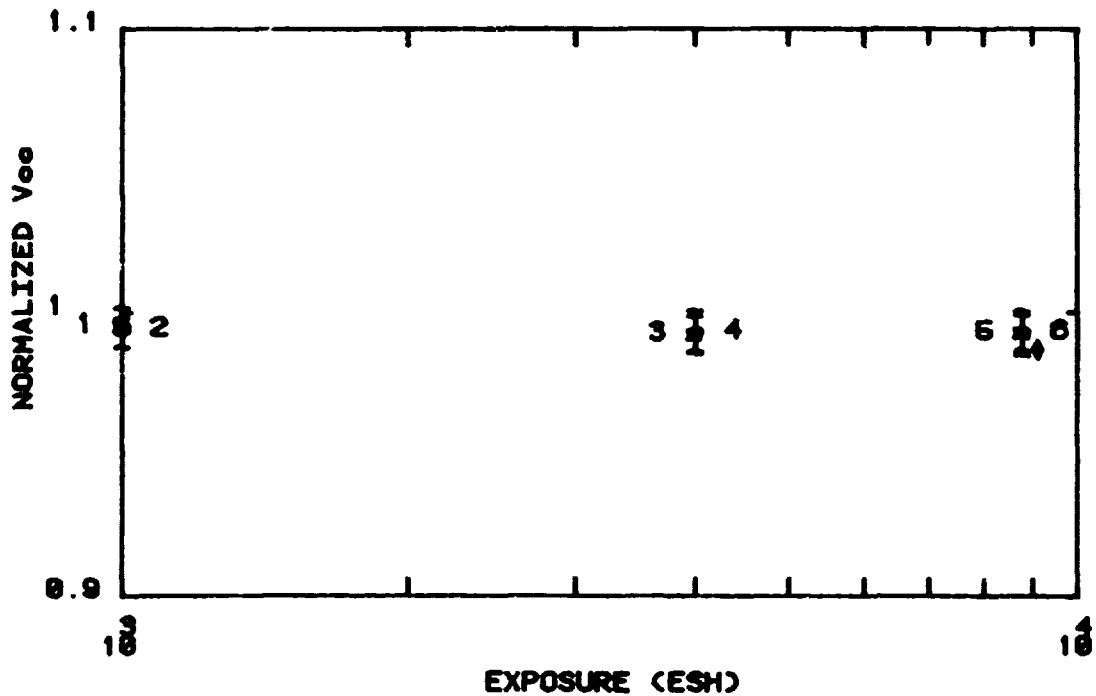

FIGURE 143. GE CELLS UV IRRADIATION IN SITU

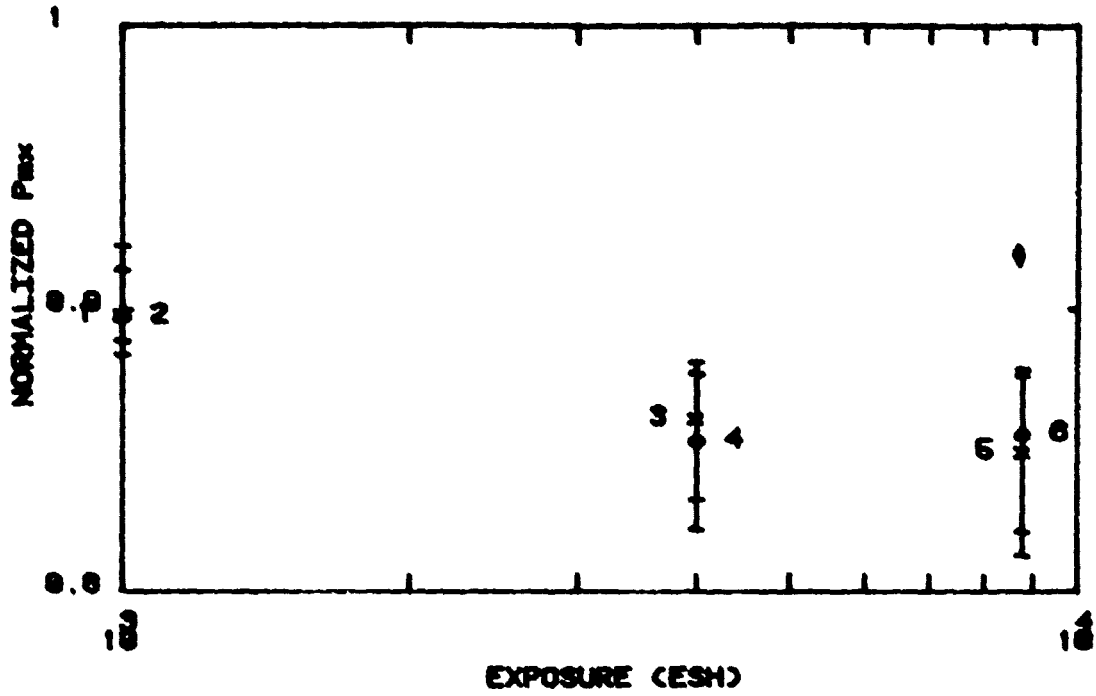

FIGURE 144. GE CELLS UV IRRADIATION IN SITU

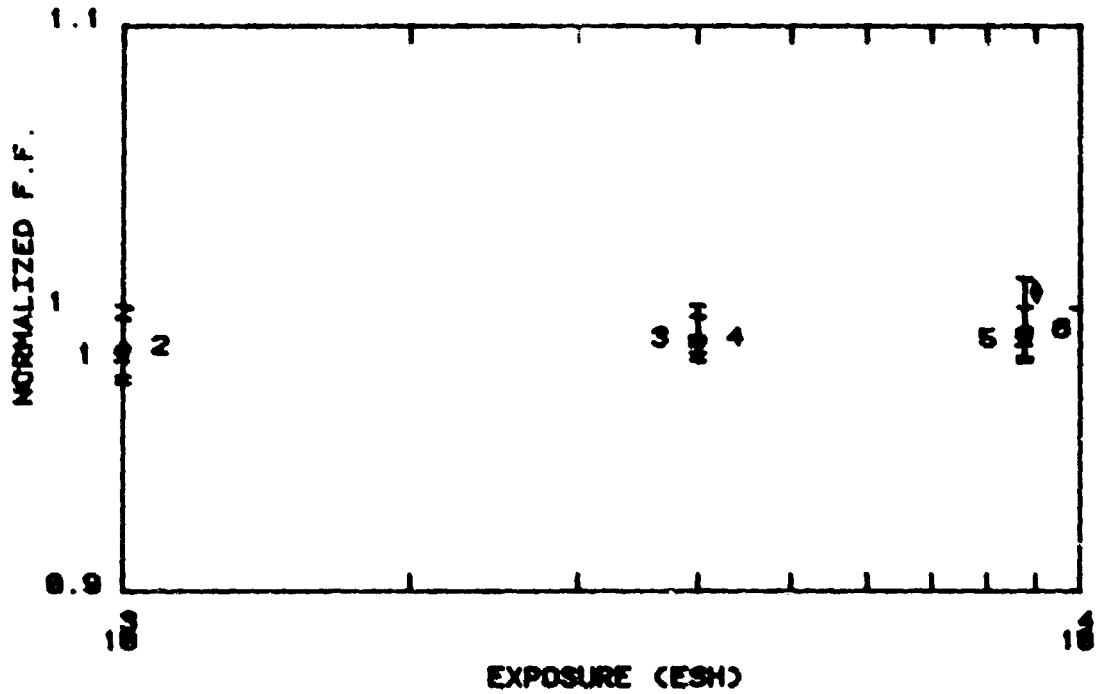

FIGURE 145. GE CELLS UV IRRADIATION IN SITU

TABLE 35A. TABULATED GE CELL DATA - UV IRRADIATION

GE CELLS UV IRRADIATION EX-SITU
 TEMP. (C): 25 AREA: 4 INTENSITY 1*AM0

Level Number	AVERAGE Isc/Isc0	AVERAGE Voc/Voc0	AVERAGE Pmx/Pmx0	AVERAGE F. F. /F. F. 0
0	1.000	1.000	1.000	1.000
1	0.927	0.996	0.927	1.003

GE CELLS UV IRRADIATION IN SITU
 TEMP. (C): 25 AREA: 4 INTENSITY 1*AM0

Level Number	AVERAGE Isc/Isc0	AVERAGE Voc/Voc0	AVERAGE Pmx/Pmx0	AVERAGE F. F. /F. F. 0
0	1.000	1.000	1.000	1.000
1	0.917	0.996	0.899	0.984
2	0.915	0.995	0.899	0.987
3	0.877	0.993	0.863	0.990
4	0.868	0.994	0.855	0.990
5	0.866	0.994	0.851	0.989
6	0.869	0.994	0.857	0.993

GE CELLS UV IRRADIATION EX-SITU
 TEMP. (C): 25 AREA: 4 INTENSITY 1*AM0

Serial Number	Level Number	Isc (mA)	Isc/Isc0	Voc (mV)	Voc/Voc0	Pmx (mW)	Pmx/Pmx0	Full Fac.	F. F. /F. F. 0
811	0	128.5	1.000	566.2	1.000	55.82	1.000	0.767	1.000
812	0	131.3	1.000	573.3	1.000	57.76	1.000	0.767	1.000
813	0	127.6	1.000	562.4	1.000	56.40	1.000	0.786	1.000
814	0	143.8	1.000	592.5	1.000	65.78	1.000	0.772	1.000
815	0	0.0	0.000	0.0	0.000	0.00	0.000	0.000	0.000
811	1	116.1	0.903	563.9	0.996	50.77	0.909	0.776	1.011
812	1	122.7	0.935	568.7	0.992	53.40	0.925	0.765	0.997
813	1	118.1	0.926	562.1	0.999	52.36	0.928	0.789	1.003
814	1	135.9	0.945	591.1	0.998	62.09	0.944	0.773	1.001
815	1	120.7	0.000	572.4	0.000	50.07	0.000	0.725	0.000

TABLE 35B. TABULATED GE CELL DATA - UV IRRADIATION

GE CELLS UV IRRADIATION IN SITU									
TEMP. (C): 25 AREA: 4 INTENSITY 1*AM0									
Serial Number	Level Number	Isc (mA)	Isc/ Isco	Voc (mV)	Voc/ Voco	Pmx (mW)	Pmx/ Pmxo	Fill Fac.	F. F. / F. F. o
811	0	128.3	1.000	565.2	1.000	56.38	1.000	0.778	1.030
812	0	129.8	1.000	572.4	1.000	57.40	1.000	0.772	1.000
813	0	126.9	1.000	558.9	1.000	55.50	1.000	0.782	1.000
814	0	142.8	1.000	588.4	1.000	65.09	1.000	0.774	1.000
815	0	0.0	0.000	0.0	0.000	0.00	0.000	0.000	0.000
811	1	116.1	0.905	562.6	0.995	49.85	0.884	0.764	0.982
812	1	120.3	0.926	570.4	0.996	51.73	0.901	0.754	0.976
813	1	116.0	0.914	556.5	0.996	49.27	0.888	0.763	0.975
814	1	131.9	0.923	587.3	0.998	59.93	0.921	0.774	0.999
815	1	0.0	0.000	0.0	0.000	0.00	0.000	0.000	0.000
811	2	115.9	0.903	563.0	0.996	50.07	0.888	0.767	0.987
812	2	120.5	0.928	565.0	0.987	51.19	0.892	0.752	0.973
813	2	115.4	0.909	556.7	0.996	50.04	0.901	0.779	0.996
814	2	131.4	0.920	588.8	1.001	59.44	0.913	0.768	0.992
815	2	119.5	0.000	562.4	0.000	47.25	0.000	0.703	0.000
811	3	109.3	0.852	560.5	0.992	46.95	0.833	0.767	0.986
812	3	114.8	0.884	564.6	0.986	49.28	0.858	0.760	0.985
813	3	111.7	0.880	556.5	0.996	48.71	0.878	0.784	1.001
814	3	127.7	0.894	587.8	0.999	57.39	0.882	0.765	0.988
815	3	0.0	0.000	0.0	0.000	0.00	0.000	0.000	0.000
811	4	108.1	0.843	561.8	0.994	46.32	0.822	0.763	0.981
812	4	114.1	0.879	563.8	0.985	49.10	0.855	0.763	0.988
813	4	110.5	0.871	557.6	0.998	48.04	0.866	0.780	0.996
814	4	125.9	0.881	588.2	1.000	57.07	0.877	0.771	0.995
815	4	112.1	0.000	561.8	0.000	44.42	0.000	0.705	0.000
811	5	107.1	0.835	561.2	0.993	45.83	0.813	0.763	0.981
812	5	113.4	0.874	563.7	0.985	48.58	0.846	0.760	0.984
813	5	110.4	0.870	557.7	0.998	48.21	0.868	0.783	1.000
814	5	126.3	0.884	587.9	0.999	57.09	0.877	0.769	0.993
815	5	111.1	0.000	563.5	0.000	41.86	0.000	0.669	0.000
811	6	107.2	0.836	561.4	0.993	46.29	0.821	0.769	0.989
812	6	114.7	0.883	564.1	0.986	49.05	0.855	0.758	0.982
813	6	110.4	0.870	557.5	0.998	48.60	0.876	0.790	1.009
814	6	126.5	0.885	588.1	1.000	57.17	0.878	0.769	0.992
815	6	111.5	0.000	561.7	0.000	44.35	0.000	0.708	0.000

S/N : 811	LEVEL : 0	1	2
TEMP: 25 C	ISC(MA) : 128.3	118.1	115.9
AREA: 4 CM ²	VOC(MV) : 585.2	582.6	583.0
INT. : 1*AM0	PMAX(MW) : 58.4	49.9	50.1
	F.F. : 0.778	0.764	0.767

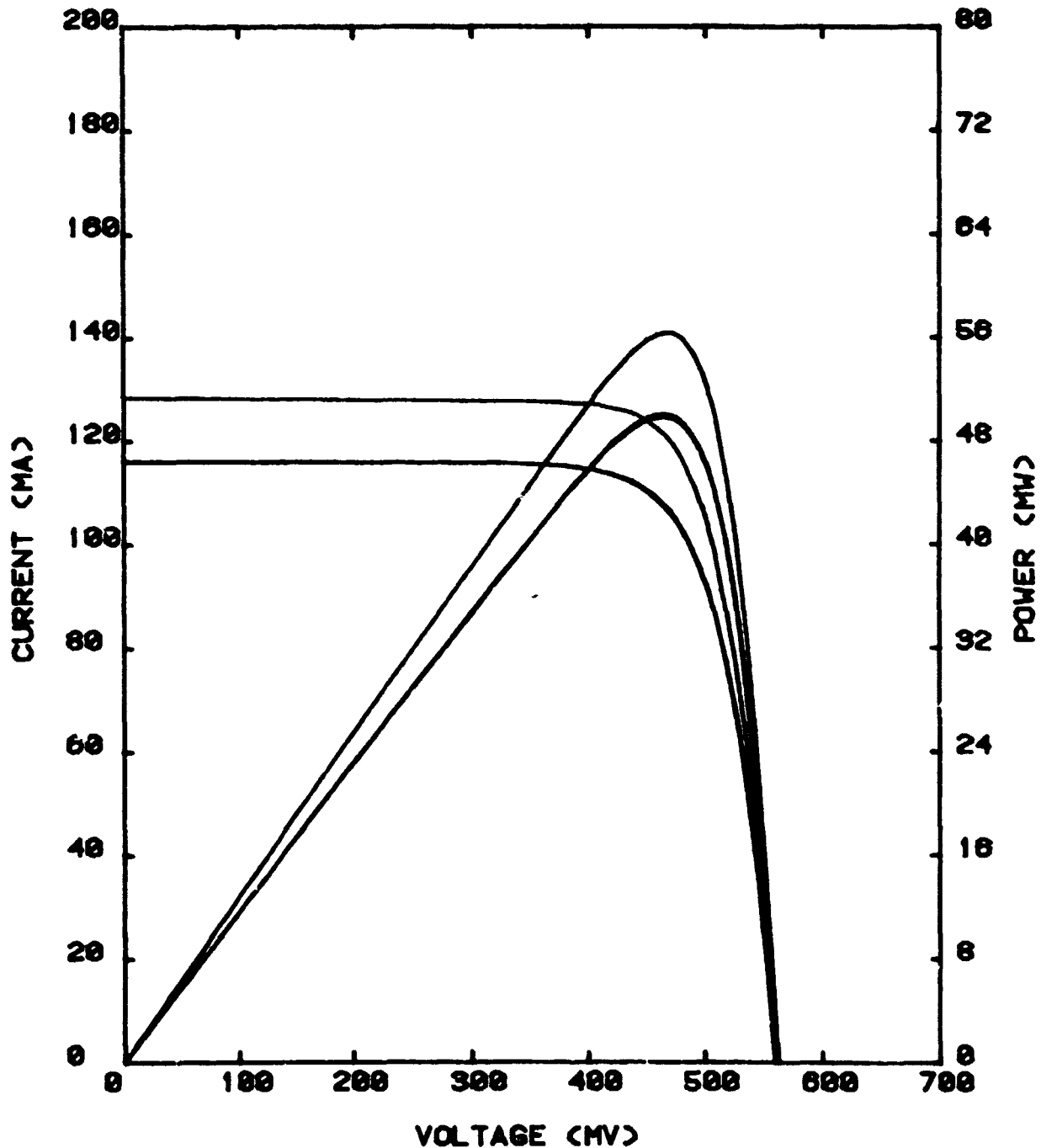

FIGURE 146A
 GE CELLS UV IRRADIATION IN SITU
 D180-26590-1
 198

S/N : 811	LEVEL : 3	4
TEMP: 25 C	ISC(MA) : 109.3	108.1
AREA: 4 CM^2	VOC(MV) : 500.5	501.8
INT.: 1*AM0	PMAX(MW) : 47.0	46.3
	F.F. : 0.767	0.763

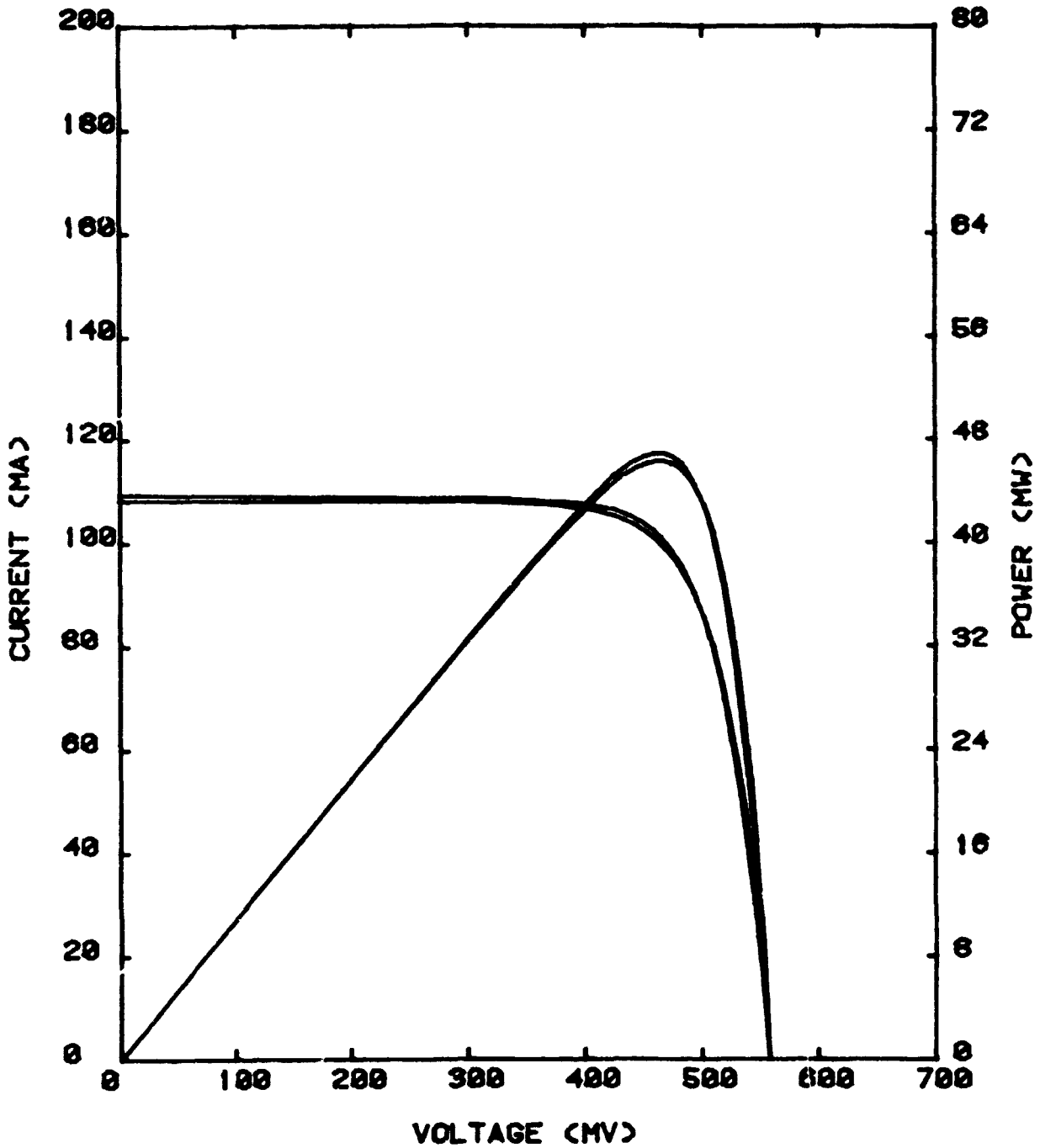

FIGURE 146B
 GE CELLS UV IRRADIATION IN SITU

S/N : 811	LEVEL : 5	0
TEMP: 25 C	ISC(MA) : 107.1	107.2
AREA: 4 CM^2	VOC(MV) : 561.2	561.4
INT. : 1uAM0	PMAX(MW) : 45.8	46.3
	F.F. : 0.763	0.769

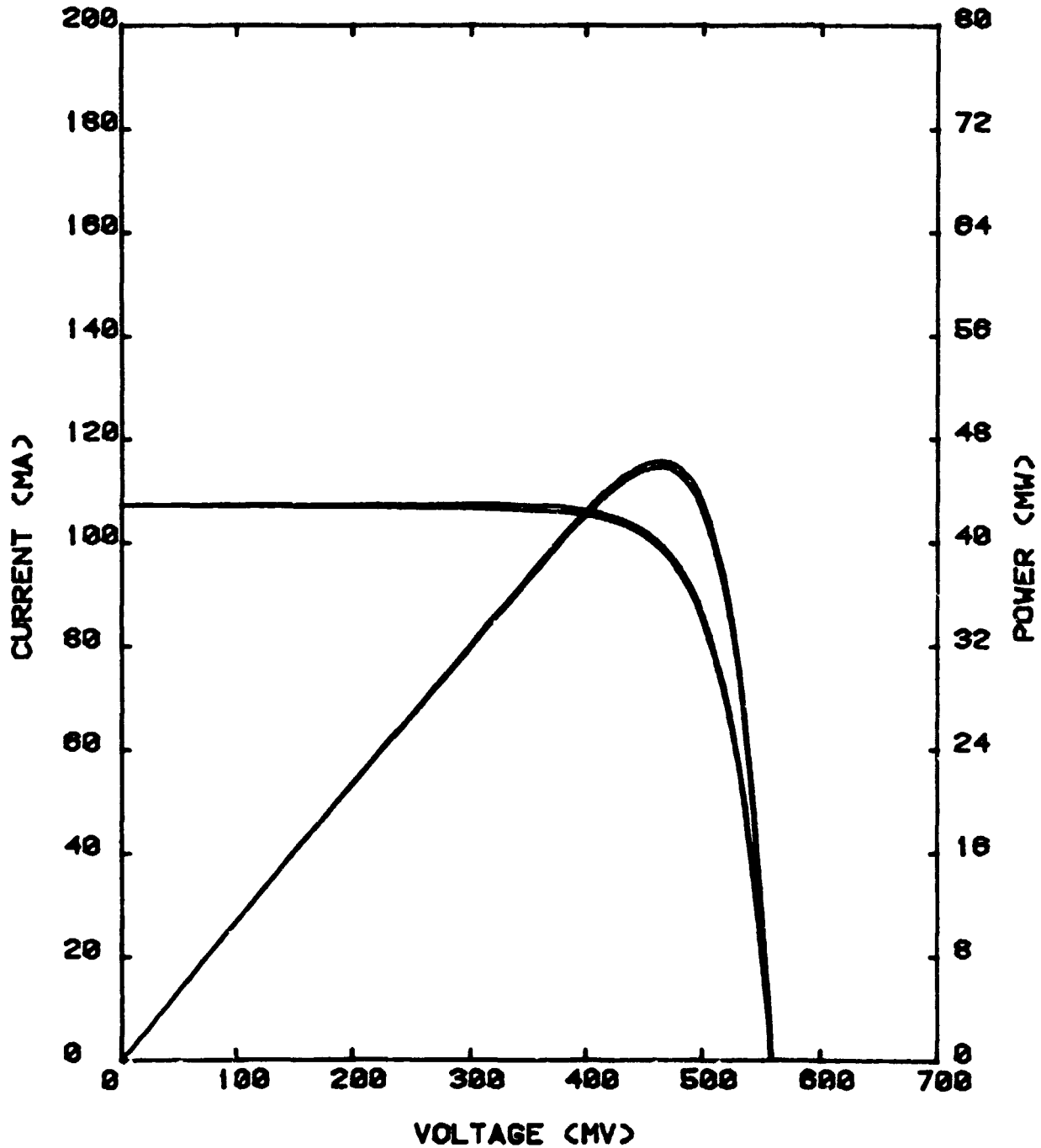

FIGURE 146C
 GE CELLS UV IRRADIATION IN SITU

6.10 DOUBLE NUMBER CELLS

(Spectrolab 2-mil space-qualified texturized BSF cells; 2-mil 0211 as cover; 2-mil FEP-A adhesive; 2-mil FEP-20C, 1 1/2 mil fiberglass, 2-mil FEP-20C and 1-mil Kapton backing.)

6.10.1 Electron Irradiation

There was a slight haze when viewed at an angle between the covers and the cells after the first set of thermal cycles. The next visible damage occurred after a total fluence of 1×10^{16} e/cm² in which a total of three cells had cracked covers. After the final set of thermal cycles the cell-cover interface looked hazy when viewed at an angle and the covers were coming loose. When the samples were removed from the sample plate the backing separated from the cell. There is insufficient information about this cell type to permit conclusive separation of cover/cell response. Figures 147, 148, 149 and 150 are summary plots of the test parameters. The last data point (7) on the summary plots taken right after the last set of thermal cycles shows that the samples were in poor condition. The V_{oc} dropped indicating that the samples were losing contact with the thermal control plate and heating up. During the ex situ measurements the samples were made to have better thermal contact and therefore a more realistic V_{oc} was obtained as the summary plot indicates (Figure 148). Tables 36A and 36B list the tabulated data and Figure 151 shows pre- and post-test I-V curves. The sample temperature ranged from 54°C to 57°C during the electron irradiation.

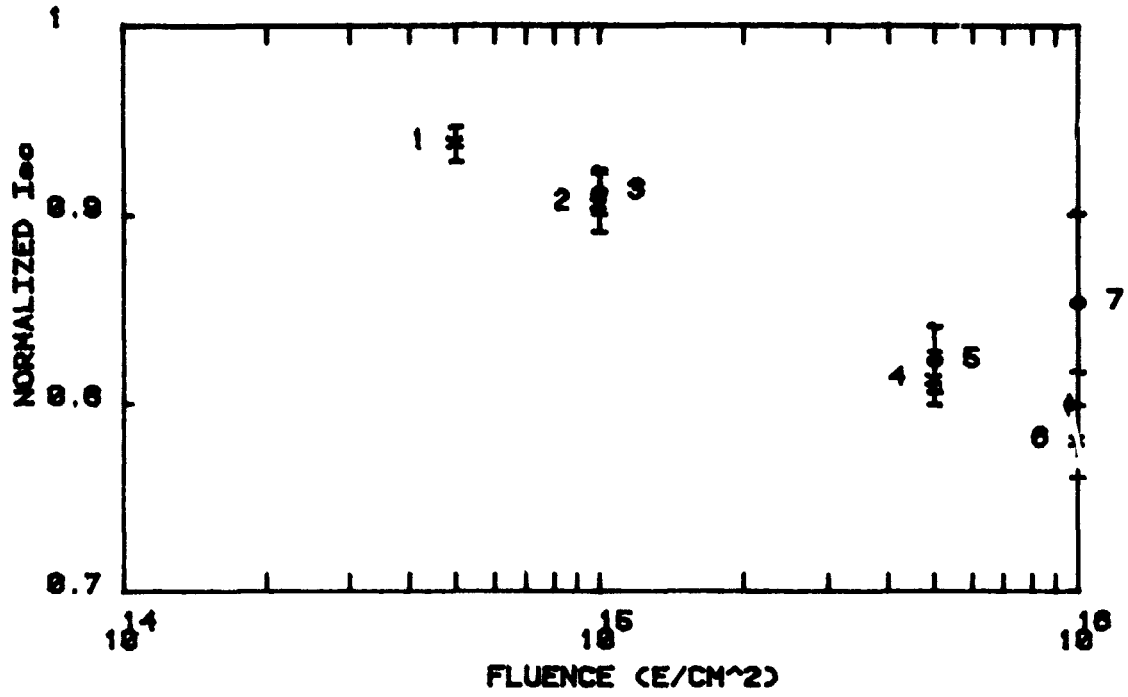

FIGURE 147. DN SERIES ELECTRON IRRADIATION IN-SITU

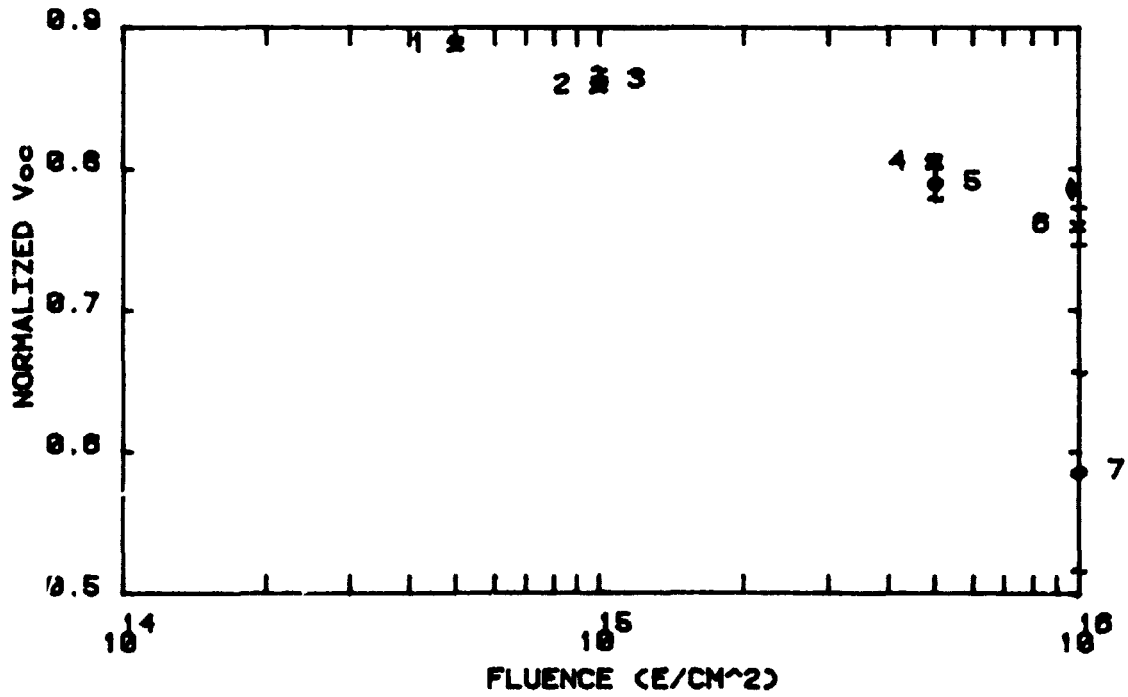

FIGURE 148. DN SERIES ELECTRON IRRADIATION IN-SITU

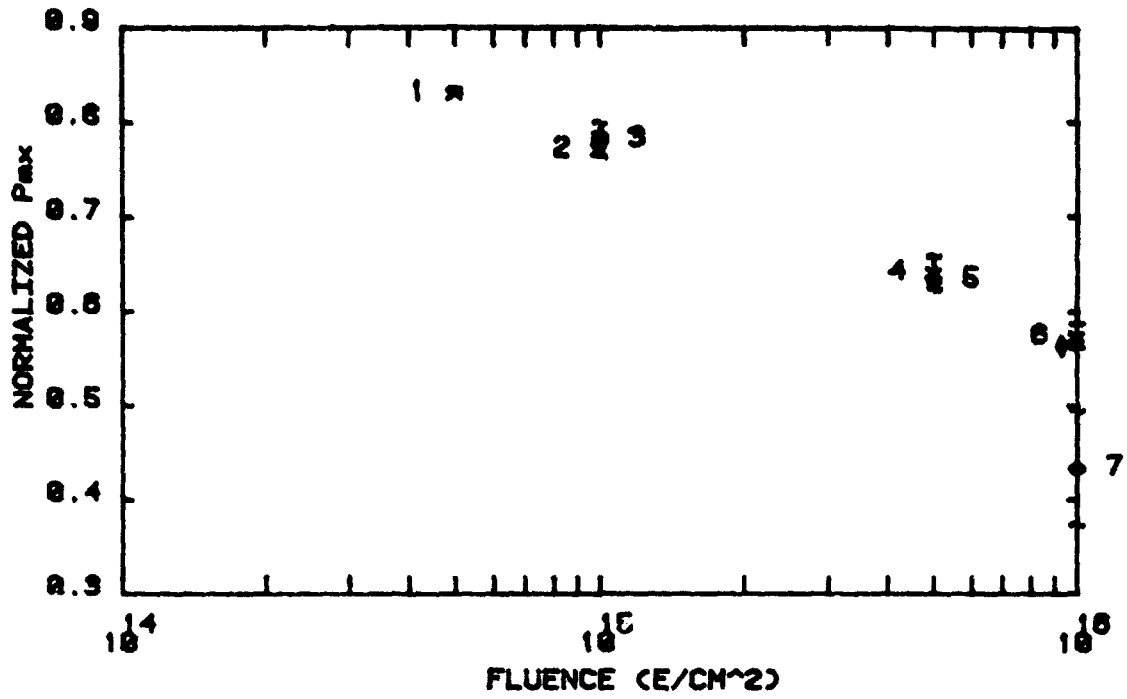

FIGURE 149. DN SERIES ELECTRON IRRADIATION IN-SITU

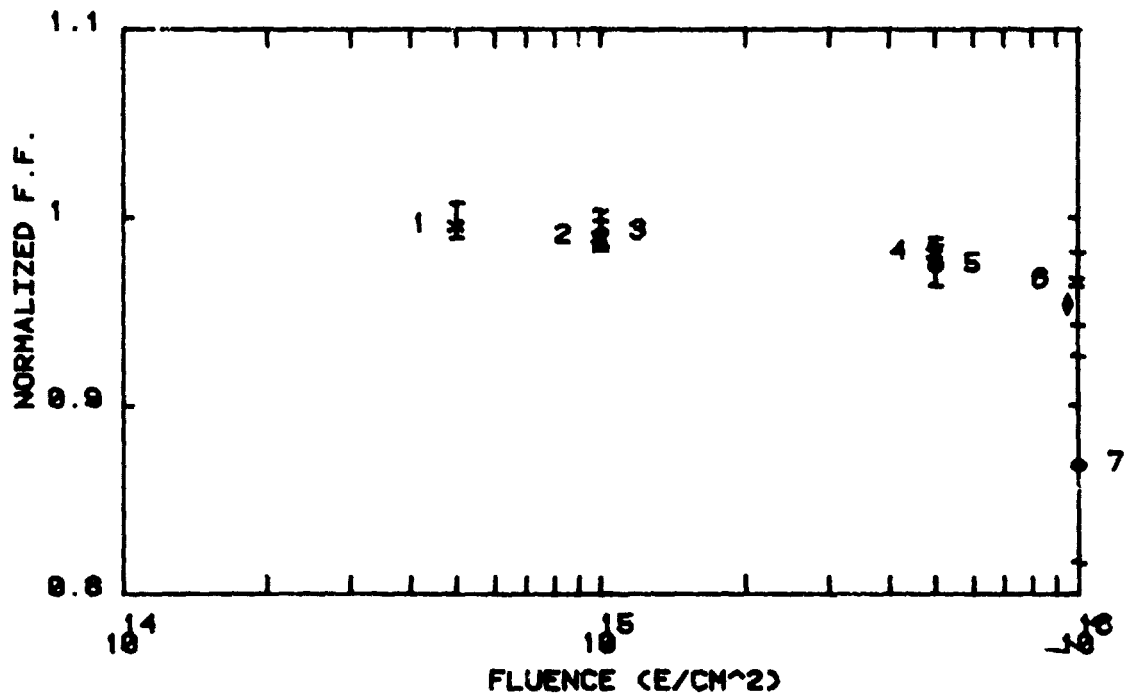

FIGURE 150. DN SERIES ELECTRON IRRADIATION IN-SITU

TABLE 36A. TABULATED DN SERIES DATA - ELECTRON IRRADIATION

DN SERIES ELECTRON IRRADIATION EX-SITU
 TEMP. (C): 25 AREA: 4. INTENSITY 1*AM0

Level Number	AVERAGE Isc/Isc0	AVERAGE Voc/Voc0	AVERAGE Pmx/Pmx0	AVERAGE F. F. /F. F. 0
0	1.000	1.000	1.000	1.000
1	0.806	0.700	0.597	0.951

DN SERIES ELECTRON IRRADIATION IN-SITU
 TEMP. (C): 25 AREA: 4. INTENSITY 1*AM0

Level Number	AVERAGE Isc/Isc0	AVERAGE Voc/Voc0	AVERAGE Pmx/Pmx0	AVERAGE F. F. /F. F. 0
0	1.000	1.000	1.000	1.000
1	0.940	0.890	0.834	0.997
2	0.908	0.861	0.774	0.991
3	0.914	0.865	0.785	0.994
4	0.814	0.806	0.645	0.982
5	0.825	0.792	0.637	0.976
6	0.782	0.762	0.577	0.968
7	0.855	0.588	0.438	0.870

DN SERIES ELECTRON IRRADIATION EX-SITU
 TEMP. (C): 25 AREA: 4 INTENSITY 1*AM0

Serial Number	Level Number	Isc (mA)	Isc/Isc0	Voc (mV)	Voc/Voc0	Pmx (mW)	Pmx/Pmx0	F. I. I. Fac.	F. F. /F. F. 0
901	0	161.8	1.000	580.7	1.000	69.18	1.000	0.736	1.000
902	0	158.3	1.000	585.6	1.000	69.43	1.000	0.749	1.000
903	0	162.2	1.000	587.3	1.000	72.48	1.000	0.761	1.000
904	0	166.0	1.000	588.5	1.000	75.34	1.000	0.771	1.000
905	0	162.4	1.000	586.4	1.000	69.68	1.000	0.732	1.000
901	1	134.5	0.831	452.9	0.780	40.07	0.579	0.658	0.894
902	1	126.8	0.801	457.8	0.782	42.95	0.619	0.740	0.988
903	1	126.5	0.780	459.7	0.783	43.06	0.594	0.740	0.973
904	1	134.1	0.808	455.2	0.774	42.76	0.568	0.701	0.908
905	1	131.4	0.809	457.1	0.780	43.59	0.626	0.726	0.992

DN SERIES ELECTRON IRRADIATION IN-SITU
 TEMP. (C): 25 AREA: 4 INTENSITY 1*AM0

Serial Number	Level Number	Isc (mA)	Isc/ Isco	Voc (mV)	Voc/ Voco	Pmx (mW)	Pmx/ Pmxo	Fill Fac.	F. F. / F. F. o
901	0	140.0	1.000	582.7	1.000	60.73	1.000	0.744	1.000
902	0	133.8	1.000	588.8	1.000	59.84	1.000	0.759	1.000
903	0	136.4	1.000	576.1	1.000	60.42	1.000	0.769	1.000
904	0	139.6	1.000	588.0	1.000	63.97	1.000	0.779	1.000
905	0	139.4	1.000	587.1	1.000	60.08	1.000	0.734	1.000
901	1	132.6	0.947	519.8	0.892	50.83	0.837	0.738	0.991
902	1	124.2	0.928	523.3	0.889	49.77	0.832	0.766	1.008
903	1	128.4	0.941	514.5	0.893	50.55	0.837	0.765	0.995
904	1	131.6	0.942	524.0	0.891	53.14	0.831	0.771	0.989
905	1	131.3	0.942	519.5	0.885	50.21	0.836	0.736	1.003
901	2	129.2	0.922	502.8	0.863	47.87	0.788	0.737	0.990
902	2	119.2	0.891	506.2	0.860	45.76	0.765	0.758	0.999
903	2	124.4	0.912	498.6	0.865	46.87	0.776	0.756	0.983
904	2	127.0	0.909	505.4	0.859	49.27	0.770	0.768	0.985
905	2	126.0	0.904	502.6	0.856	46.44	0.773	0.733	0.999
901	3	129.2	0.923	504.1	0.865	48.35	0.796	0.742	0.997
902	3	120.4	0.899	510.2	0.866	46.74	0.781	0.761	1.002
903	3	125.1	0.917	500.6	0.869	47.36	0.784	0.756	0.984
904	3	128.0	0.917	507.7	0.863	49.92	0.780	0.768	0.986
905	3	127.2	0.912	504.1	0.859	47.00	0.782	0.733	0.999
901	4	115.9	0.828	471.0	0.808	40.09	0.660	0.734	0.986
902	4	107.1	0.800	476.7	0.810	38.35	0.641	0.751	0.989
903	4	112.5	0.824	464.1	0.806	39.18	0.648	0.750	0.976
904	4	114.6	0.821	472.1	0.803	41.10	0.642	0.760	0.975
905	4	111.5	0.799	471.0	0.802	37.95	0.632	0.723	0.985
901	5	117.6	0.840	463.3	0.795	39.90	0.657	0.733	0.984
902	5	107.7	0.805	471.2	0.800	37.81	0.632	0.745	0.981
903	5	113.8	0.834	460.4	0.799	39.09	0.647	0.746	0.971
904	5	116.2	0.832	456.7	0.777	39.78	0.622	0.750	0.962
905	5	113.3	0.812	463.3	0.789	37.79	0.629	0.720	0.981
901	6	111.0	0.793	444.8	0.763	35.67	0.587	0.723	0.971
902	6	101.9	0.761	455.3	0.773	34.46	0.576	0.743	0.979
903	6	108.3	0.794	443.0	0.769	35.56	0.589	0.741	0.964
904	6	111.6	0.799	438.8	0.746	35.98	0.563	0.735	0.943
905	6	106.6	0.764	444.9	0.758	34.17	0.569	0.721	0.982
901	7	123.3	0.880	301.1	0.517	22.58	0.372	0.608	0.817
902	7	109.2	0.816	385.5	0.655	29.53	0.493	0.702	0.924
903	7	122.7	0.900	296.4	0.514	22.80	0.377	0.627	0.815
904	7	119.6	0.857	363.5	0.618	29.47	0.461	0.678	0.870
905	7	115.0	0.825	373.3	0.636	29.16	0.485	0.679	0.925

S/N : 904	LEVEL : 0	1
TEMP: 25 C	ISC(MA) : 166.0	134.1
AREA: 4 CM^2	VOC(MV) : 588.5	455.2
INT. : 1*AM0	PMAX(MW) : 75.3	42.8
	F.F. : 0.771	0.701

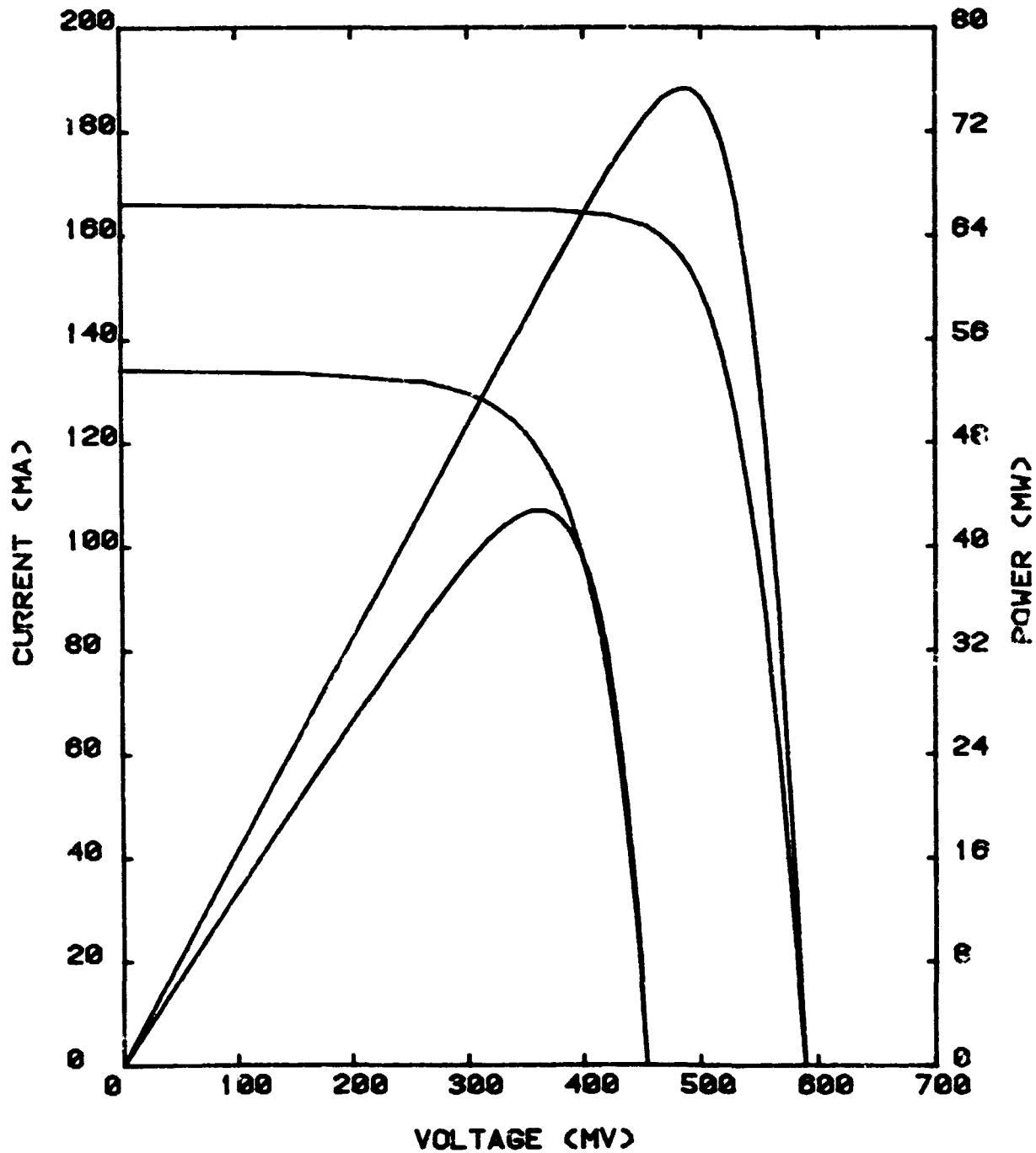

FIGURE 151
 DN SERIES ELECTRON IRRADIATION EX-SITU
 0180-26590-1
 206

6.10.2 Proton Irradiation

There was no visible damage throughout the test. The summary plots, Figures 152, 153, 154 and 155 show no damage also. The 2-mils of O211 stopped the protons as expected and without the radiation hardening the FEP-A adhesive the thermal cycling did not affect the samples. The tabulated data are in Tables 37A and 37B and pre- and post-test I-V curves in Figure 156. Sample temperatures ranged from 43°C to 54°C.

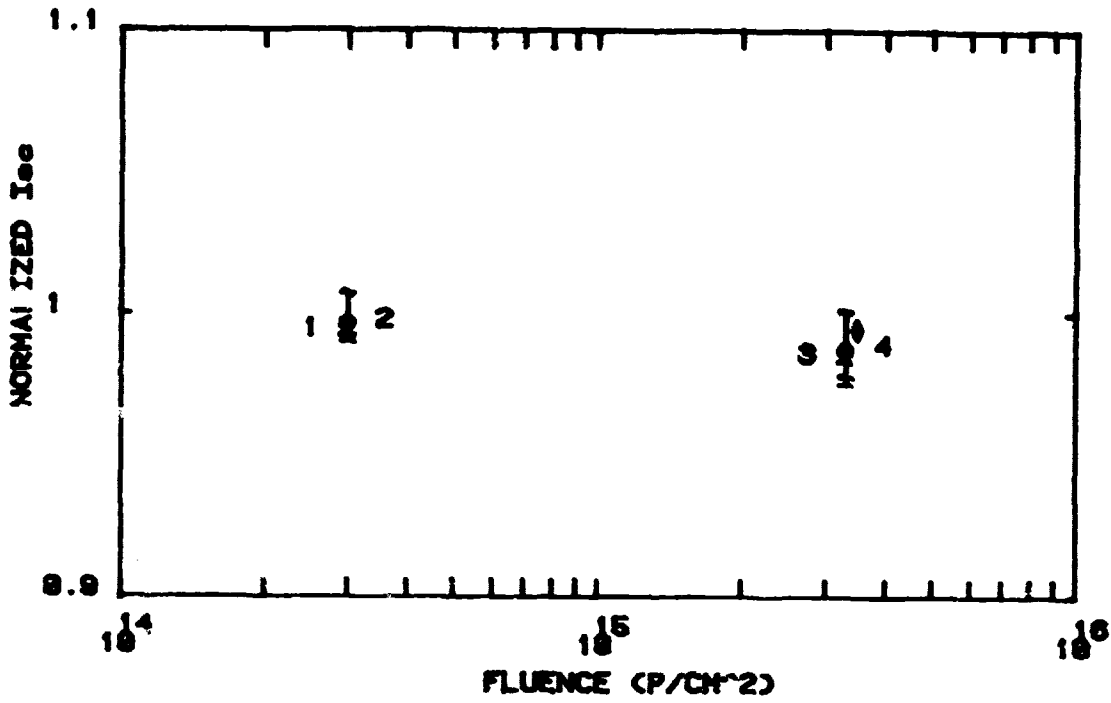

FIGURE 152. DN SERIES PROTON IRRADIATION IN-SITU

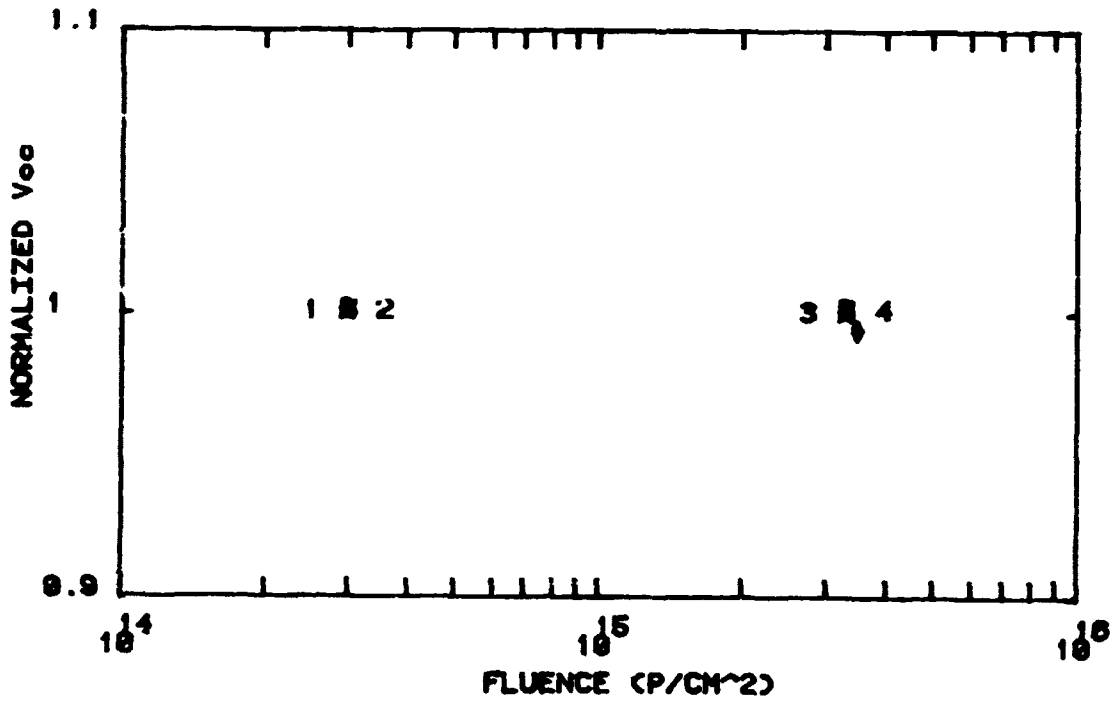

FIGURE 153. DN SERIES PROTON IRRADIATION IN-SITU

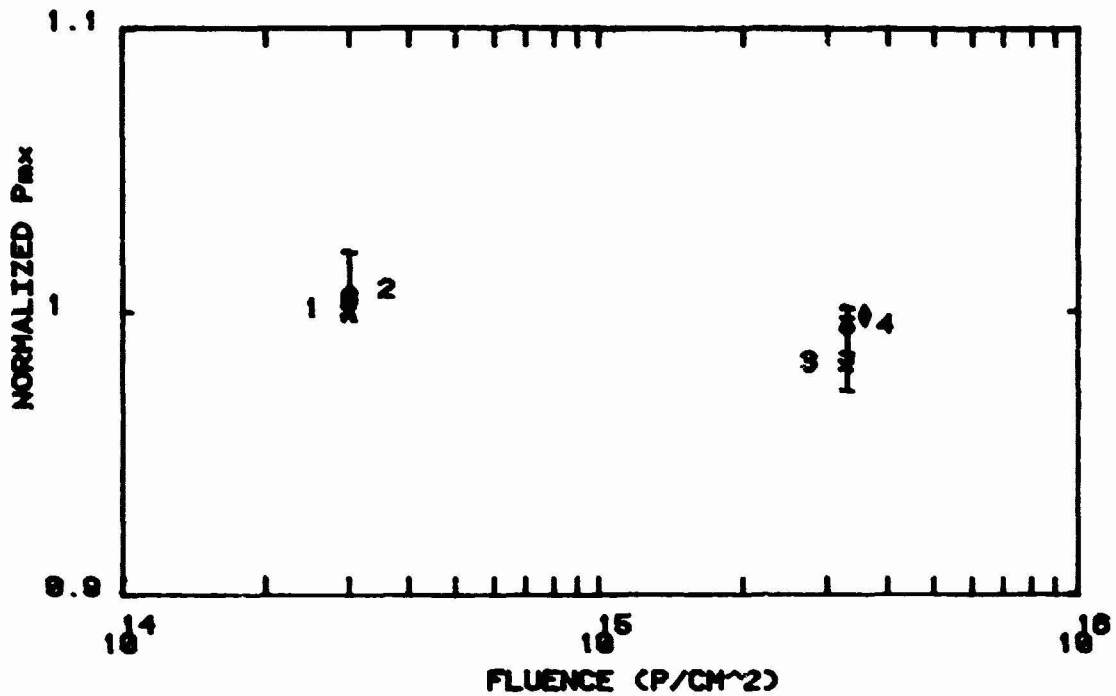

FIGURE 154. DN SERIES PROTON IRRADIATION IN-SITU

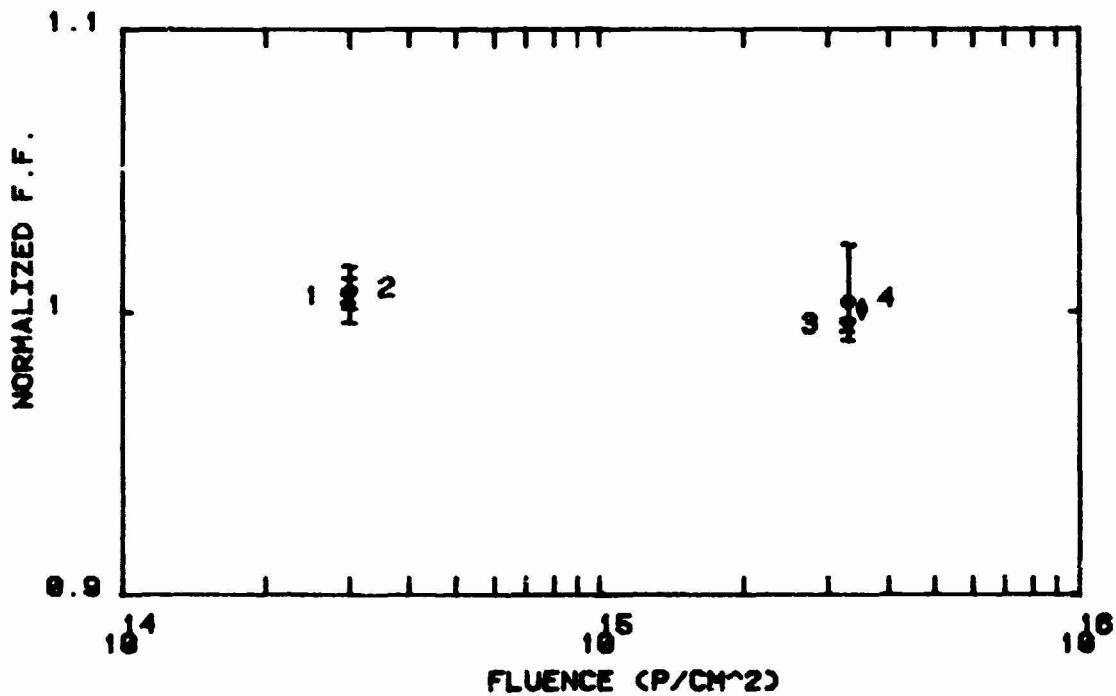

FIGURE 155. DN SERIES PROTON IRRADIATION IN-SITU

TABLE 37A. TABULATED DN SERIES DATA - PROTON IRRADIATION

DN SERIES PROTON IRRADIATION EX-SITU
 TEMP. (C): 25 AREA: 4 INTENSITY 1*AM0

Level Number	AVERAGE Isc/Isc0	AVERAGE Voc/Voc0	AVERAGE Pmx/Pmx0	AVERAGE F. F. /F. F. 0
0	1.000	1.000	1.000	1.000
1	0.999	0.998	1.000	1.003

DN SERIES PROTON IRRADIATION IN-SITU
 TEMP. (C): 25 AREA: 4 INTENSITY 1*AM0

Level Number	AVERAGE Isc/Isc0	AVERAGE Voc/Voc0	AVERAGE Pmx/Pmx0	AVERAGE F. F. /F. F. 0
0	1.000	1.000	1.000	1.000
1	0.995	1.001	1.002	1.006
2	0.998	1.001	1.008	1.009
3	0.986	1.001	0.983	0.996
4	0.990	1.002	0.996	1.005

DN SERIES PROTON IRRADIATION EX-SITU
 TEMP (C): 25 AREA: 4 INTENSITY 1*AM0

Serial Number	Level Number	Isc (mA)	Isc/Isc0	Voc (mV)	Voc/Voc0	Pmx (mW)	Pmx/Pmx0	F. F. /F. F. 0	F. F. /F. F. 0
906	0	160.3	1.000	586.1	1.000	70.59	1.000	0.751	1.000
907	0	162.1	1.000	581.6	1.000	67.61	1.000	0.717	1.000
908	0	162.6	1.000	587.3	1.000	68.97	1.000	0.722	1.000
909	0	160.1	1.000	586.3	1.000	70.19	1.000	0.748	1.000
910	0	161.6	1.000	581.3	1.000	70.41	1.000	0.750	1.000
906	1	0.0	0.000	0.0	0.000	0.00	0.000	0.000	0.000
907	1	161.0	0.993	581.4	1.000	67.38	0.997	0.720	1.004
908	1	162.3	0.998	586.2	0.998	68.82	0.998	0.723	1.002
909	1	161.9	1.011	585.9	0.999	71.39	1.017	0.753	1.007
910	1	160.6	0.994	577.3	0.993	69.63	0.989	0.751	1.002

TABLE 37B. TABULATED DN SERIES DATA - PROTON IRRADIATION

Serial Number	Level Number	DN SERIES PROTON IRRADIATION IN-SITU							
		Temp. (C)	Area	Intensity	1*AM0				
		Isc (mA)	Isc/Isc0	Voc (mV)	Voc/Voc0	Pmx (mW)	Pmx/Pmx0	Fill Fac.	F.F./F.F.0
906	0	121.7	1.000	595.9	1.000	55.61	1.000	0.767	1.000
907	0	123.9	1.000	590.3	1.000	53.27	1.000	0.729	1.000
908	0	124.0	1.000	596.2	1.000	53.96	1.000	0.730	1.000
909	0	122.0	1.000	594.5	1.000	55.53	1.000	0.766	1.000
910	0	122.7	1.000	586.5	1.000	54.65	1.000	0.759	1.000
906	1	121.0	0.994	596.2	1.001	55.74	1.002	0.773	1.008
907	1	123.1	0.994	590.4	1.000	53.33	1.001	0.734	1.007
908	1	123.7	0.998	596.5	1.001	54.22	1.005	0.735	1.006
909	1	120.8	0.990	594.5	1.000	55.65	1.002	0.775	1.012
910	1	122.5	0.998	588.5	1.003	54.50	0.997	0.756	0.996
906	2	120.7	0.992	596.2	1.001	55.81	1.004	0.776	1.011
907	2	123.0	0.993	591.1	1.001	53.79	1.010	0.740	1.015
908	2	124.8	1.006	596.6	1.001	55.07	1.020	0.740	1.013
909	2	122.1	1.001	594.4	1.000	55.76	1.004	0.769	1.004
910	2	122.6	0.999	588.5	1.003	54.80	1.003	0.760	1.001
906	3	118.7	0.976	595.8	1.000	54.07	0.972	0.764	0.997
907	3	121.5	0.981	590.9	1.001	52.17	0.979	0.727	0.998
908	3	124.2	1.002	595.7	0.999	53.89	0.999	0.728	0.998
909	3	120.0	0.984	594.2	0.999	54.43	0.980	0.764	0.997
910	3	121.5	0.990	588.4	1.000	53.73	0.983	0.752	0.990
906	4	119.9	0.986	596.1	1.000	54.75	0.985	0.766	0.999
907	4	121.1	0.978	591.0	1.001	53.32	1.001	0.745	1.023
908	4	124.0	1.000	597.5	1.002	53.86	0.998	0.727	0.996
909	4	121.2	0.994	594.7	1.000	55.23	0.995	0.766	1.001
910	4	121.6	0.991	588.7	1.004	54.69	1.001	0.764	1.006

S/N : 907	LEVEL : 0	1
TEMP: 25 C	ISC(MA) : 162.1	161.0
AREA: 4 CM ²	VOC(MV) : 581.6	581.4
INT. : 1*AM0	PMAX(MW): 67.6	67.4
	F.F. : 0.717	0.720

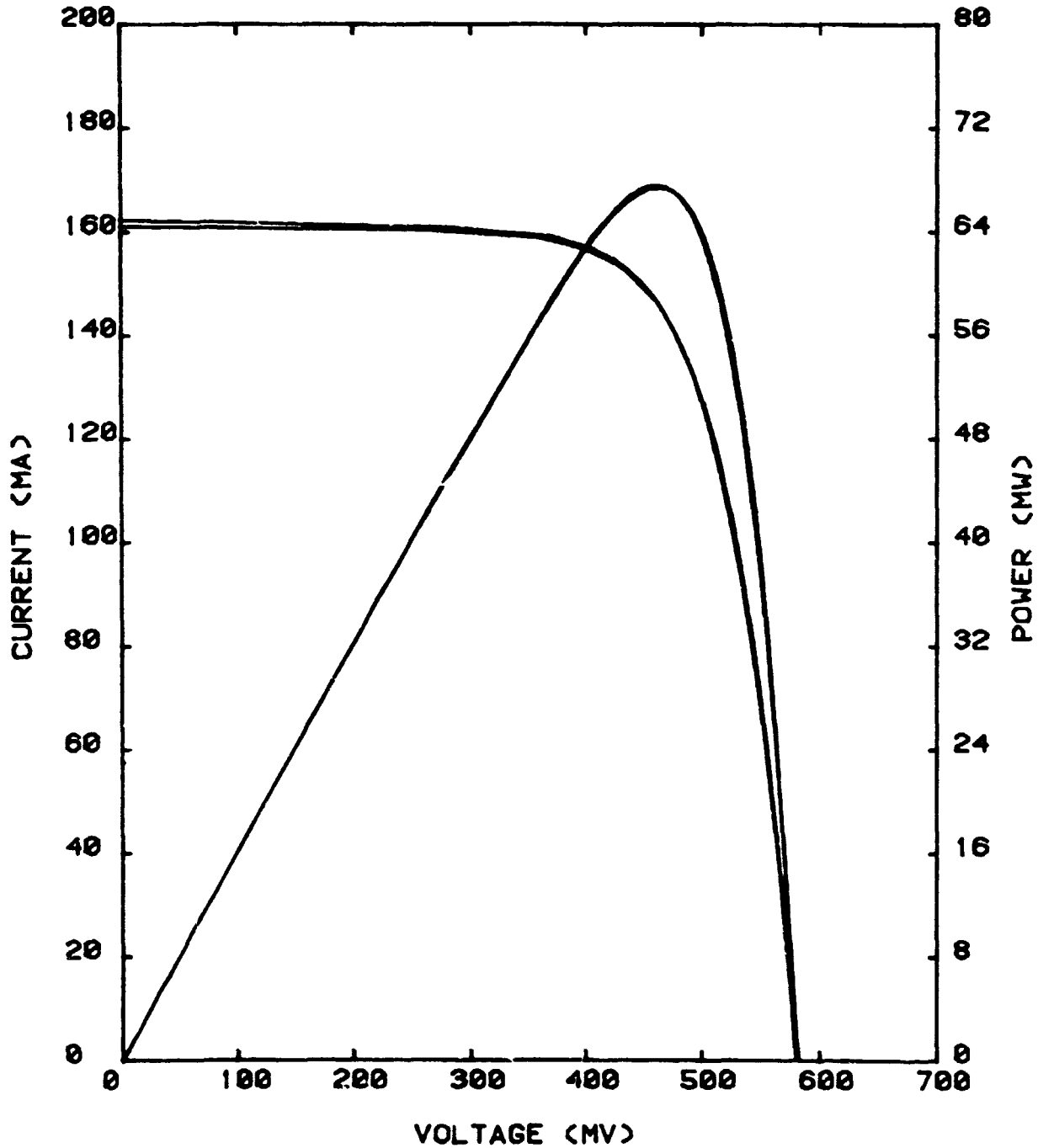

FIGURE 156
 DN SERIES PROTON IRRADIATION EX-SITU
 0180-26590-1
 212

6.10.3 UV Exposure

There was no visible damage throughout the test. The summary plots Figures 157, 158, 159 and 160 also indicate there was no damage. Tables 38A and 38B contain the tabulated data and Figure 161 shows examples of pre- and post-test I-V curves. The sample temperature during the exposure ranged from 55°C to 60°C.

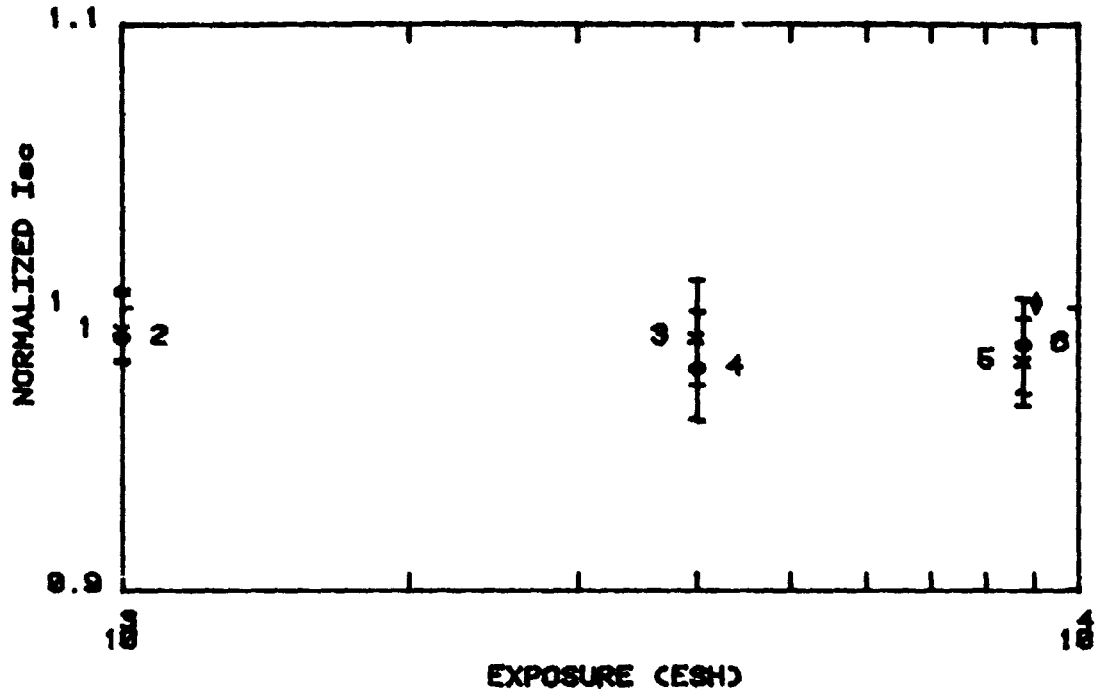

FIGURE 157. DN CELLS UV IRRADIATION IN SITU

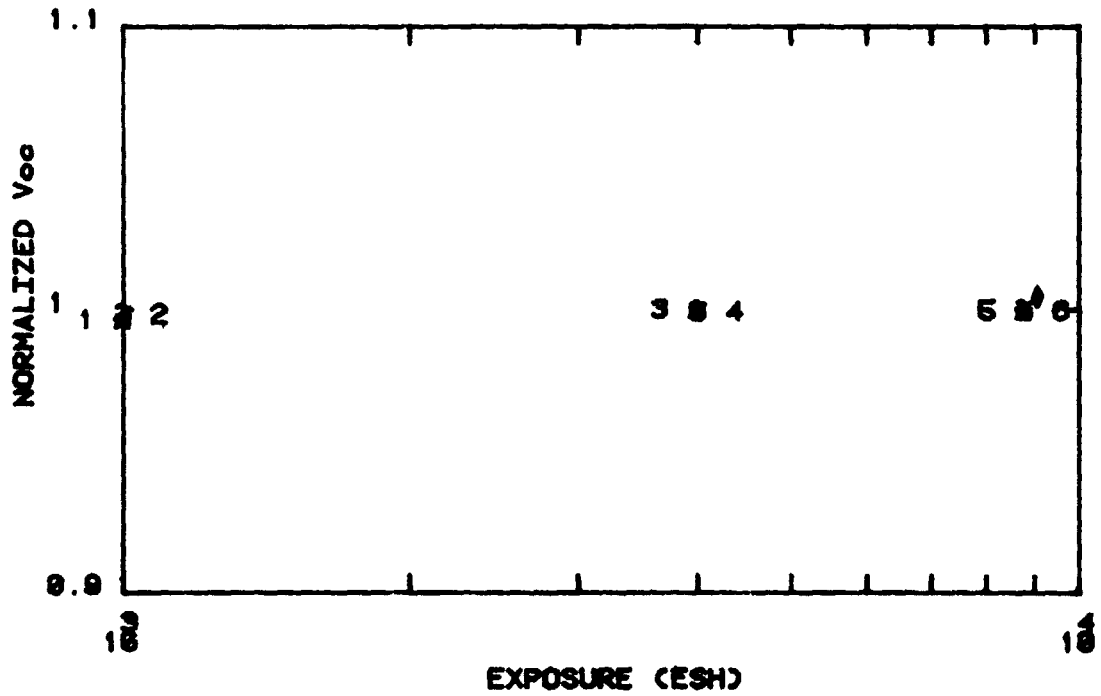

FIGURE 158. DN CELLS UV IRRADIATION IN SITU

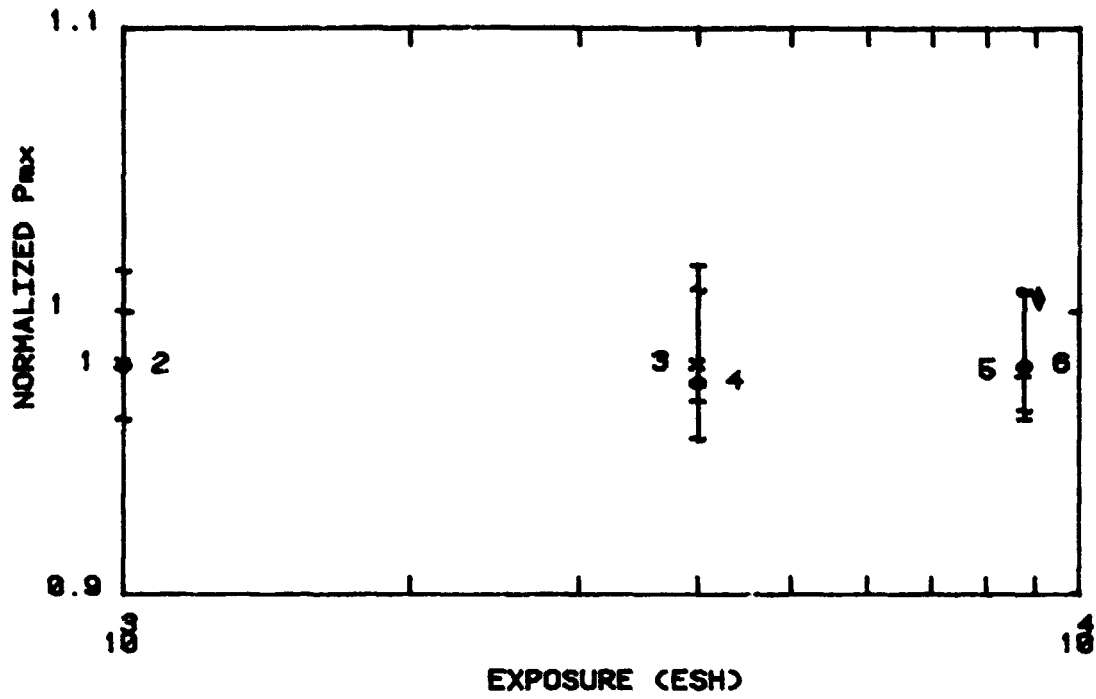

FIGURE 159. DN CELLS UV IRRADIATION IN SITU

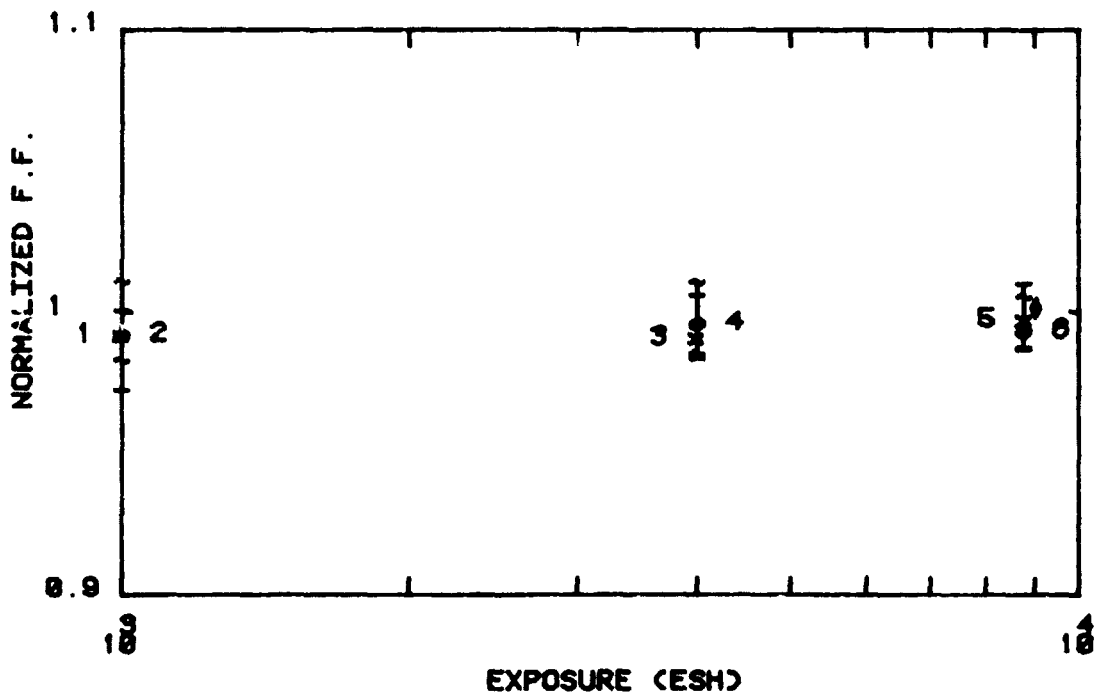

FIGURE 160. DN CELLS UV IRRADIATION IN SITU

TABLE 38A. TABULATED DN SERIES DATA - UV IRRADIATION

DN SERIES UV IRRADIATION EX-SITU
 TEMP. (C): 25 AREA: 4. INTENSITY 1*AM0

Level Number	AVERAGE Isc/Isc0	AVERAGE Voc/Voc0	AVERAGE Pmx/Pmx0	AVERAGE F. F. /F. F. 0
0	1.000	1.000	1.000	1.000
1	1.004	1.003	1.008	1.001

DN CELLS UV IRRADIATION IN SITU
 TEMP. (C): 25 AREA: 4. INTENSITY 1*AM0

Level Number	AVERAGE Isc/Isc0	AVERAGE Voc/Voc0	AVERAGE Pmx/Pmx0	AVERAGE F. F. /F. F. 0
0	1.000	1.000	1.000	1.000
1	0.993	0.997	0.983	0.993
2	0.991	0.998	0.982	0.993
3	0.991	1.000	0.983	0.992
4	0.980	0.999	0.976	0.997
5	0.982	1.000	0.980	0.998
6	0.988	1.000	0.982	0.994

DN1 SERIES UV IRRADIATION EX-SITU
 TEMP. (C): 25 AREA: 4 INTENSITY 1*AM0

Serial Number	Level Number	Isc (mA)	Isc/Isc0	Voc (mV)	Voc/Voc0	Pmx (mW)	Pmx/Pmx0	Fill Fac.	F. F. /F. F. 0
911	0	162.2	1.000	600.4	1.000	74.69	1.000	0.767	1.000
912	0	161.8	1.000	606.2	1.000	73.91	1.000	0.754	1.000
913	0	162.9	1.000	607.5	1.000	73.46	1.000	0.742	1.000
914	0	163.2	1.000	607.8	1.000	73.54	1.000	0.741	1.000
915	0	163.4	1.000	608.4	1.000	75.93	1.000	0.764	1.000
911	1	159.5	0.984	600.9	1.001	73.44	0.983	0.766	0.999
912	1	164.0	1.014	608.8	1.004	75.23	1.018	0.753	1.000
913	1	162.3	0.997	609.4	1.003	73.91	1.006	0.747	1.006
914	1	166.2	1.019	610.1	1.004	74.93	1.019	0.739	0.997
915	1	164.9	1.009	609.7	1.002	77.13	1.016	0.767	1.004

TABLE 308. TABULATED DN SERIES DATA - UV IRRADIATION

DN CELLS UV IRRADIATION IN SITU									
TEMP. (C): 25 AREA: 4 INTENSITY 1*AM0									
Serial Number	Level Number	Isc (mA)	Isc/ Isco	Voc (mV)	Voc/ Voco	Pmx (mW)	Pmx/ Pmxo	Fill Fac.	F. F. / F. F. o
911	0	161.5	1.000	597.9	1.000	74.36	1.000	0.770	1.000
912	0	161.3	1.000	606.3	1.000	74.03	1.000	0.757	1.000
913	0	161.5	1.000	607.9	1.000	73.19	1.000	0.746	1.000
914	0	163.4	1.000	609.1	1.000	72.68	1.000	0.730	1.000
915	0	163.9	1.000	609.1	1.000	77.38	1.000	0.775	1.000
911	1	158.6	0.982	596.5	0.998	72.30	0.972	0.764	0.992
912	1	161.3	1.000	605.2	0.998	73.63	0.995	0.754	0.997
913	1	159.1	0.986	605.2	0.995	71.87	0.982	0.746	1.001
914	1	164.3	1.005	607.5	0.997	72.72	1.001	0.729	0.998
915	1	163.1	0.995	606.0	0.995	74.46	0.962	0.754	0.972
911	2	158.3	0.980	598.1	1.000	72.05	0.969	0.761	0.989
912	2	161.0	0.998	606.4	1.000	73.48	0.993	0.752	0.994
913	2	159.3	0.986	606.5	0.998	71.29	0.974	0.738	0.990
914	2	164.4	1.006	607.7	0.998	73.67	1.014	0.738	1.010
915	2	161.0	0.982	607.0	0.996	74.37	0.961	0.761	0.982
911	3	157.1	0.973	598.4	1.001	72.03	0.969	0.766	0.995
912	3	161.3	1.000	607.5	1.002	73.27	0.990	0.748	0.988
913	3	159.4	0.987	607.2	0.999	71.00	0.970	0.734	0.984
914	3	165.1	1.010	609.2	1.000	73.89	1.017	0.735	1.006
915	3	161.2	0.984	609.0	1.000	74.98	0.969	0.764	0.985
911	4	155.0	0.960	598.1	1.000	70.96	0.954	0.765	0.994
912	4	159.8	0.990	607.0	1.001	73.08	0.987	0.753	0.995
913	4	156.5	0.969	606.6	0.998	70.88	0.968	0.747	1.001
914	4	163.1	0.998	608.8	0.999	73.20	1.007	0.737	1.010
915	4	161.1	0.983	607.5	0.997	74.67	0.965	0.763	0.984
911	5	155.9	0.966	597.9	1.000	71.41	0.960	0.766	0.995
912	5	160.5	0.995	606.6	1.000	73.40	0.991	0.754	0.996
913	5	157.7	0.977	607.3	0.999	71.21	0.973	0.744	0.997
914	5	162.8	0.997	609.2	1.000	73.17	1.007	0.738	1.010
915	5	160.4	0.979	608.4	0.999	74.61	0.964	0.764	0.987
911	6	156.5	0.969	598.8	1.001	71.70	0.964	0.765	0.994
912	6	161.7	1.002	606.6	1.001	73.91	0.998	0.754	0.996
913	6	158.4	0.981	607.2	0.999	71.04	0.971	0.738	0.990
914	6	163.0	1.002	609.2	1.000	73.18	1.007	0.733	1.004
915	6	161.8	0.987	607.6	0.997	75.13	0.971	0.764	0.986

S/N : 913	LEVEL : 0	1
TEMP: 25 C	ISCC(MA) : 102.9	102.3
AREA: 4 CM ²	VOC(MV) : 607.5	609.4
INT. : 1*AM0	PMAX(MW) : 73.5	73.9
	F.F. : 0.742	0.747

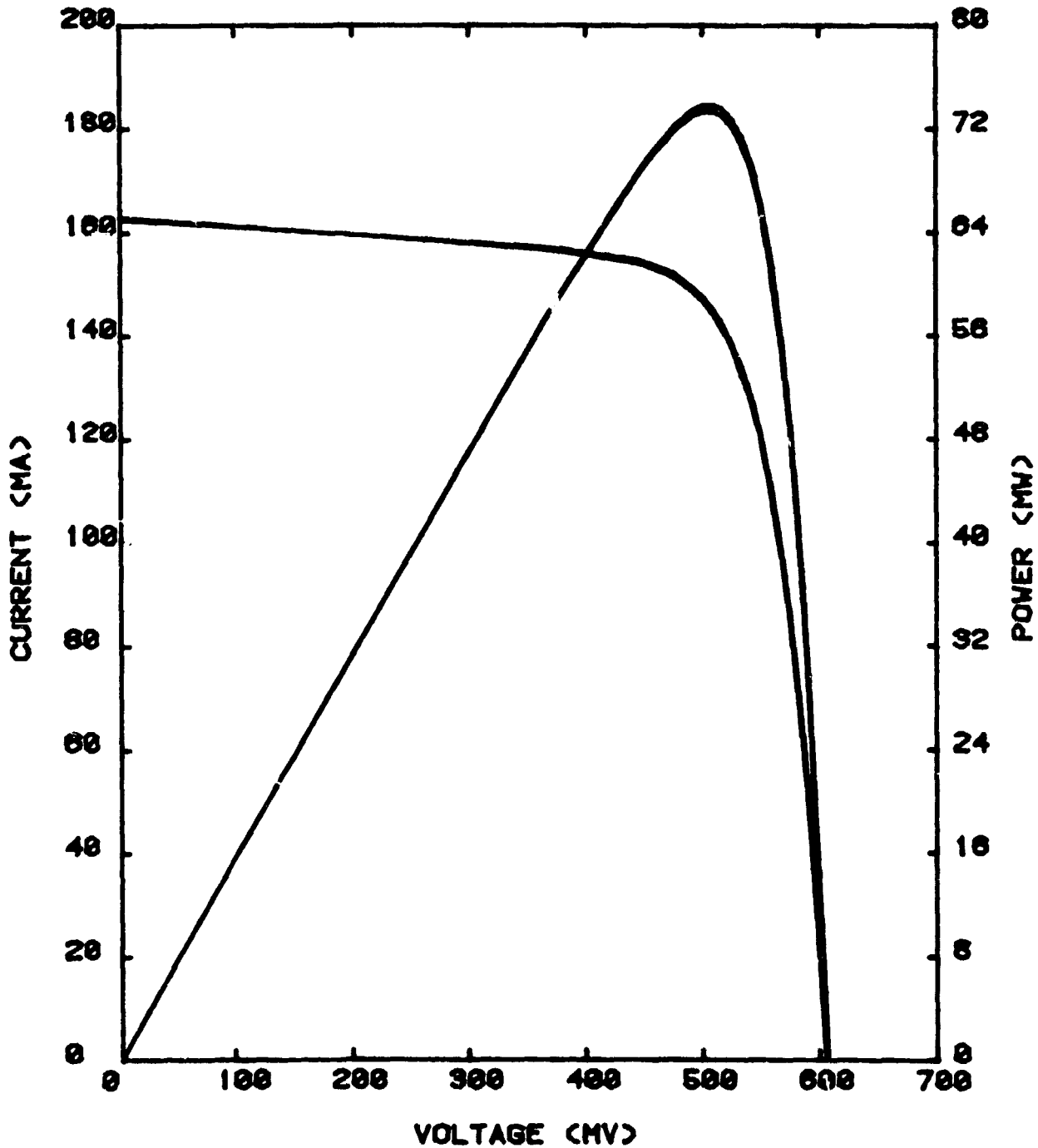

FIGURE 161
 DN SERIES UV IRRADIATION EX-SITU
 D180-26590-1
 218

6.11 ELECTROSTATICALLY BONDED CELLS (ESB)

(ASEC 2 mil, BSF/R, 50 Ω /sq., 0.2 μ junction depth; 2-4 mil 7070 glass electrostatically bonded as a cover.)

6.11.1 Electron Irradiation

The ESB cells showed no visible damage until they had received a total fluence of 1×10^{15} e/cm² and 15 thermal cycles. At this point four of the five cells had cracks in the cover or portions of the cover were missing or coming loose. After a total fluence of 1×10^{16} e/cm² and 45 thermal cycles the damage became worse with the covers coming loose on two cells. One cell displayed no visible damage throughout the test. It should be mentioned that the cells used in this test were some of the first cells made during the parameter optimization phase of the electrostatic bonding program (NAS3-22216) and did not have the quality bond that was later achieved as demonstrated in the UV tests. There was little information found about the electron degradation of bare ASEC 2-mil cells of this type therefore transmission losses can not be evaluated. Figures 162, 163, 164 and 165 are the summary plots and Tables 39A and 39B are the tabulated data. Figures 166A, B and C are an example of in situ I-V curves. The sample temperature ranged from 52°C to 56°C during the irradiations. There was no post ex situ data taken on these samples because the cells all cracked during the test or during removal from the sample plate.

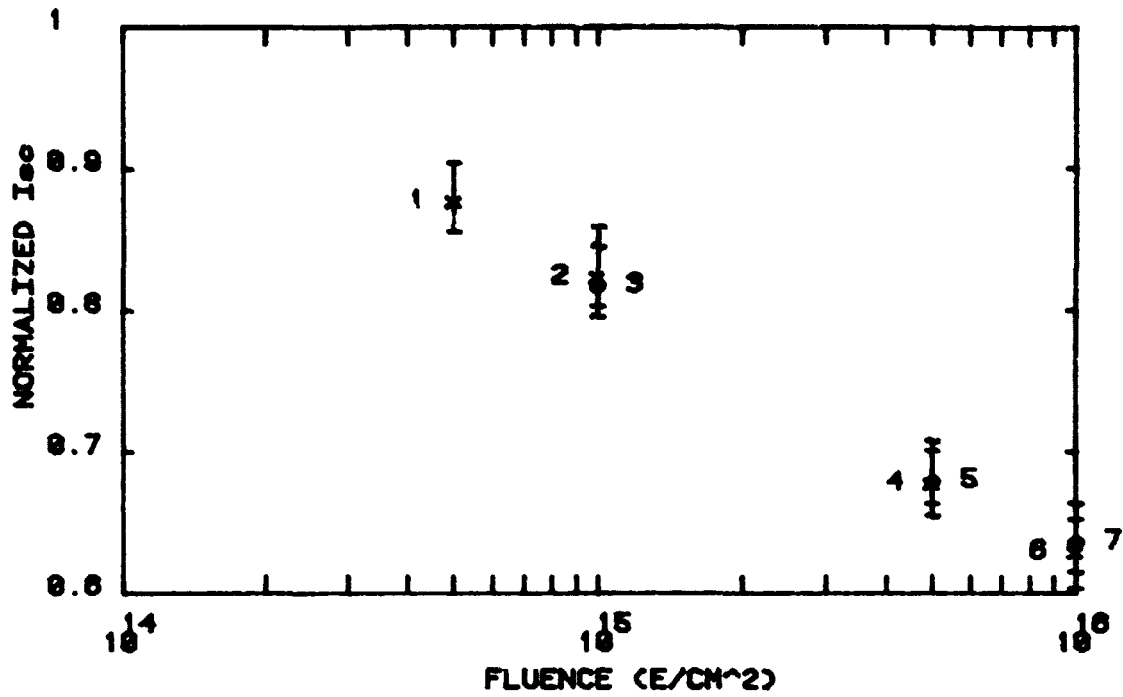

FIGURE 162. ESB CELLS ELECTRON IRRADIATION IN-SITU

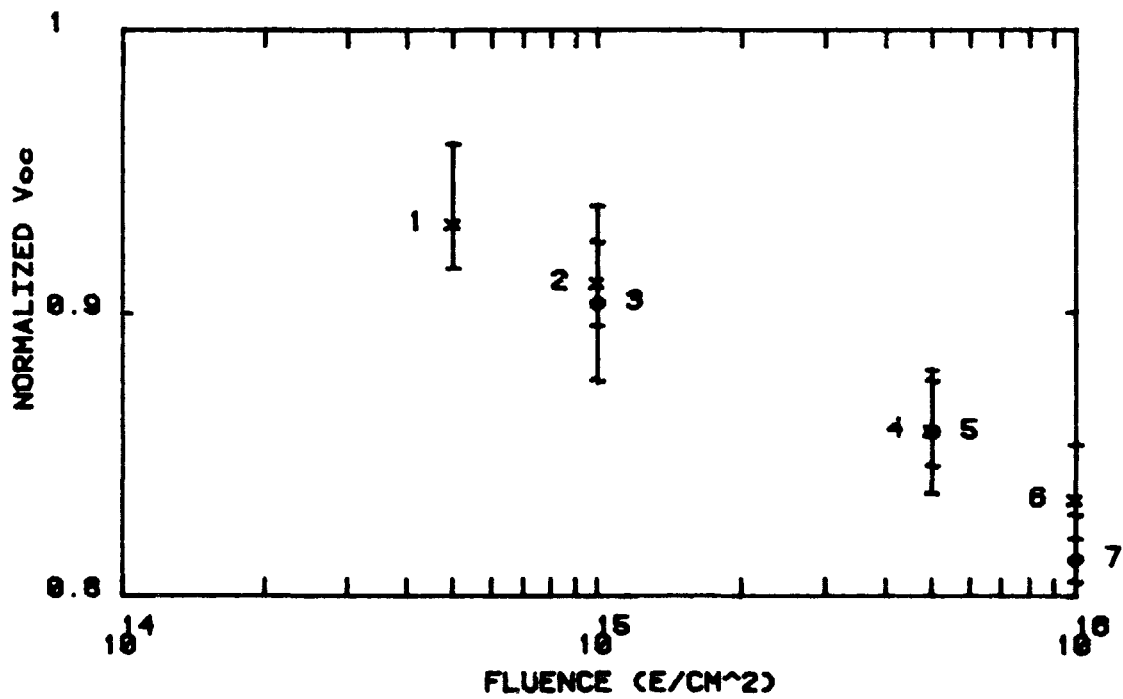

FIGURE 163. ESB CELLS ELECTRON IRRADIATION IN-SITU

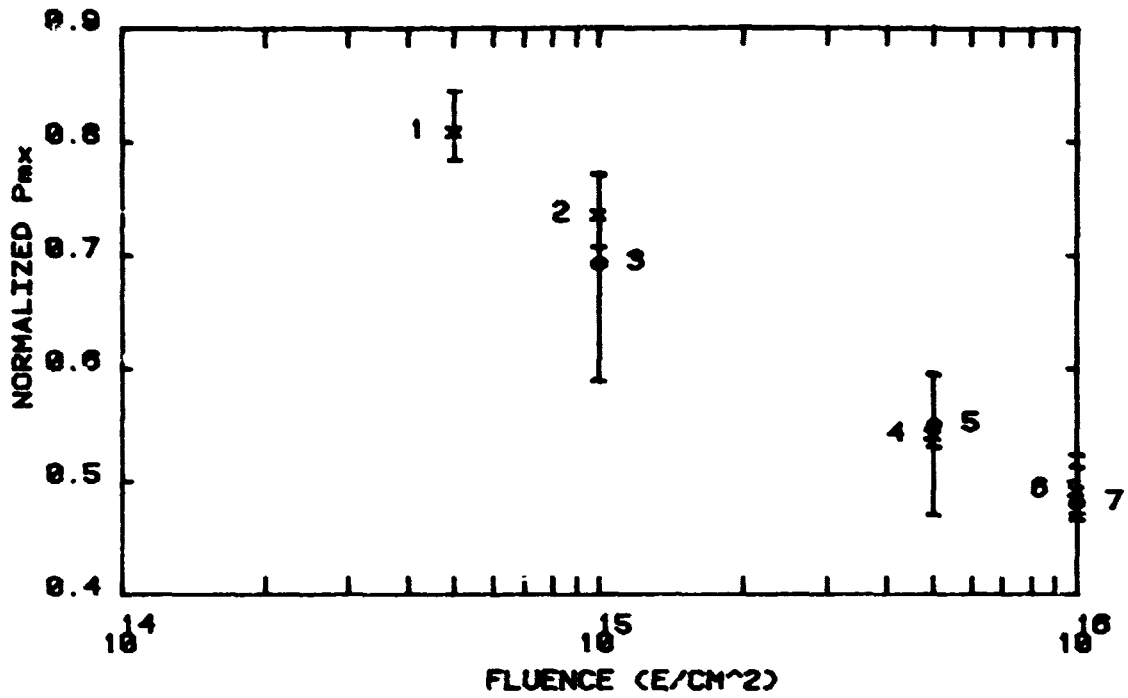

FIGURE 164. ESB CELLS ELECTRON IRRADIATION IN-SITU

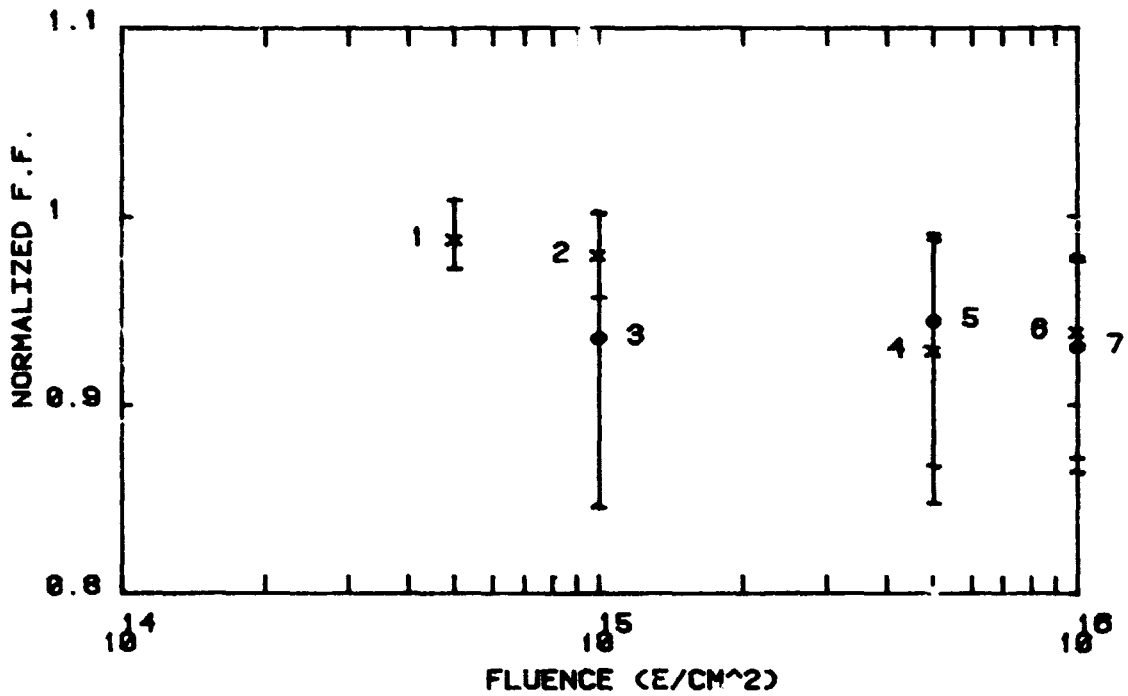

FIGURE 165. ESB CELLS ELECTRON IRRADIATION IN-SITU

TABLE 39A. TABULATED ESB CELL DATA - ELECTRON IRRADIATION

ESB CELLS ELECTRON IRRADIATION IN-SITU
 TEMP (C). 25 AREA: 4. INTENSITY 1*AM0

Level Number	AVERAGE Isc/Isc0	AVERAGE Voc/Voc0	AVERAGE Pm/Pm0	AVERAGE F. F. /F. F. 0
0	1.000	1.000	1.000	1.000
1	0.879	0.933	0.811	0.989
2	0.826	0.912	0.729	0.981
3	0.820	0.905	0.696	0.937
4	0.680	0.859	0.544	0.920
5	0.682	0.859	0.555	0.946
6	0.621	0.825	0.495	0.940
7	0.629	0.814	0.484	0.923

TABLE 39B. TABULATED ESB CELL DATA - ELECTRON IRRADIATION

ESB CELLS ELECTRON IRRADIATION IN-SITU
 TEMP. (C): 25 AREA: 4 INTENSITY 1*AM0

Serial Number	Level Number	Isc (mA)	Isc/Isc0	Voc (mV)	Voc/Voc0	Pmx (mW)	Pmx/Pmx0	Fill Fac.	F. F. / F. F. 0
1001	0	99.4	1.000	562.1	1.000	44.82	1.000	0.802	1.000
1002	0	115.3	1.000	592.4	1.000	53.62	1.000	0.781	1.000
1003	0	107.1	1.000	595.9	1.000	48.78	1.000	0.764	1.000
1004	0	114.7	1.000	577.9	1.000	51.70	1.000	0.780	1.000
1005	0	113.1	1.000	577.8	1.000	50.30	1.000	0.769	1.000
1001	1	90.0	0.905	539.9	0.960	37.89	0.845	0.780	0.972
1002	1	99.2	0.857	543.5	0.917	42.02	0.784	0.779	0.997
1003	1	91.8	0.857	545.7	0.916	38.65	0.792	0.771	1.009
1004	1	101.5	0.884	537.4	0.930	41.55	0.804	0.762	0.977
1005	1	101.0	0.893	543.4	0.940	41.84	0.832	0.762	0.991
1001	2	85.5	0.860	527.5	0.938	34.62	0.772	0.768	0.957
1002	2	93.1	0.804	530.7	0.896	37.93	0.707	0.768	0.982
1003	2	86.2	0.805	533.6	0.896	35.23	0.722	0.766	1.002
1004	2	94.3	0.822	523.8	0.907	37.48	0.725	0.759	0.973
1005	2	94.9	0.838	532.9	0.922	38.55	0.766	0.763	0.991
1001	3	83.9	0.844	519.6	0.924	30.34	0.677	0.696	0.867
1002	3	93.2	0.805	534.7	0.903	38.43	0.717	0.771	0.987
1003	3	87.1	0.813	534.7	0.897	35.63	0.730	0.765	1.001
1004	3	91.1	0.795	505.7	0.875	30.36	0.587	0.659	0.844
1005	3	95.4	0.843	533.7	0.924	38.65	0.768	0.759	0.986
1001	4	69.8	0.702	494.6	0.880	24.11	0.538	0.699	0.871
1002	4	77.3	0.668	505.8	0.854	29.45	0.549	0.753	0.963
1003	4	71.8	0.670	507.7	0.852	27.61	0.566	0.757	0.991
1004	4	76.1	0.664	483.2	0.836	24.32	0.470	0.661	0.848
1005	4	78.8	0.697	505.8	0.875	29.98	0.596	0.752	0.977
1001	5	70.2	0.707	491.9	0.875	24.01	0.536	0.695	0.866
1002	5	75.7	0.653	500.6	0.845	28.35	0.529	0.748	0.958
1003	5	71.4	0.667	504.2	0.846	27.14	0.556	0.753	0.986
1004*	5	76.1	0.664	457.0	0.791	22.36	0.432	0.643	0.824
1005	5	75.2	0.700	502.2	0.869	29.83	0.593	0.750	0.975
1001	6	64.9	0.653	479.9	0.854	21.78	0.486	0.699	0.872
1002	6	69.9	0.603	486.0	0.820	25.30	0.472	0.745	0.953
1003	6	66.2	0.618	491.4	0.825	24.28	0.498	0.746	0.977
1004*	6	70.7	0.616	442.0	0.765	19.67	0.380	0.629	0.807
1005	6	73.6	0.651	485.9	0.841	26.41	0.525	0.738	0.959
1001	7	65.6	0.660	465.2	0.828	21.12	0.471	0.692	0.863
1002	7	71.0	0.613	476.3	0.804	24.92	0.465	0.736	0.942
1003	7	66.3	0.619	482.3	0.809	23.89	0.490	0.747	0.977
1004*	7	47.3	0.412	428.5	0.742	13.10	0.253	0.646	0.829
1005	7	74.9	0.662	471.1	0.815	25.72	0.511	0.729	0.947

*NOT INCLUDED IN AVERAGE

S/N : 1001	LEVEL : 0	1	2
TEMP: 25 C	ISC(MA) : 99.4	90.0	85.5
AREA: 4 CM ²	VOC(MV) : 562.1	539.9	527.5
INT. : 1*AM0	PMAX(MW): 44.8	37.9	34.6
	F.F. : 0.802	0.780	0.768

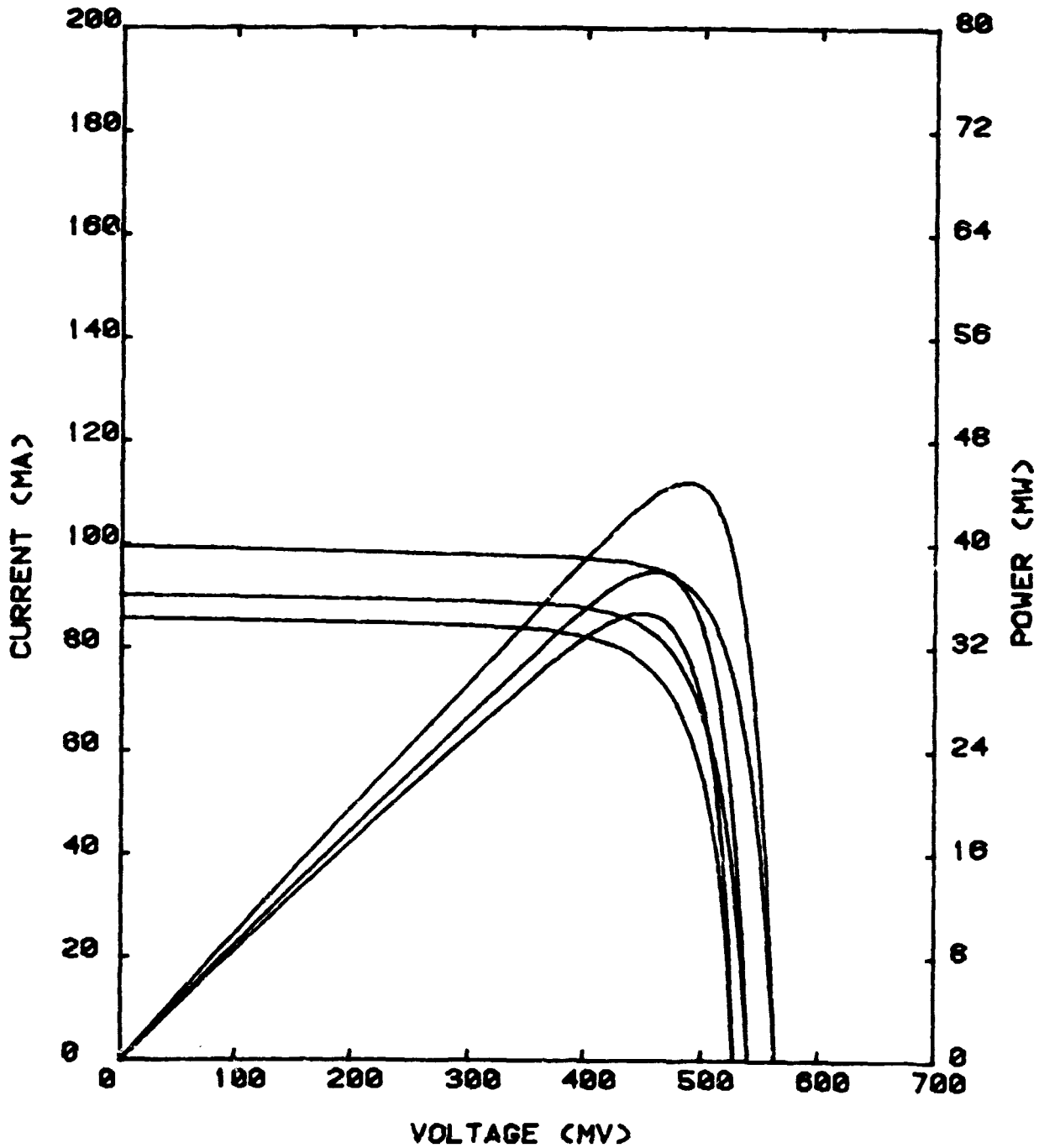

FIGURE 166A
 ESB CELLS ELECTRON IRRADIATION IN-SITU
 O100-26590-1
 224

S/N : 1001	LEVEL : 3	4	5
TEMP: 25 C	ISC(MA) : 83.9	69.8	70.2
AREA: 4 CM^2	VOC(MV) : 519.6	494.6	481.8
INT. : 1*AM0	PMAX(MW): 30.3	24.1	24.0
	F.F. : 0.696	0.699	0.695

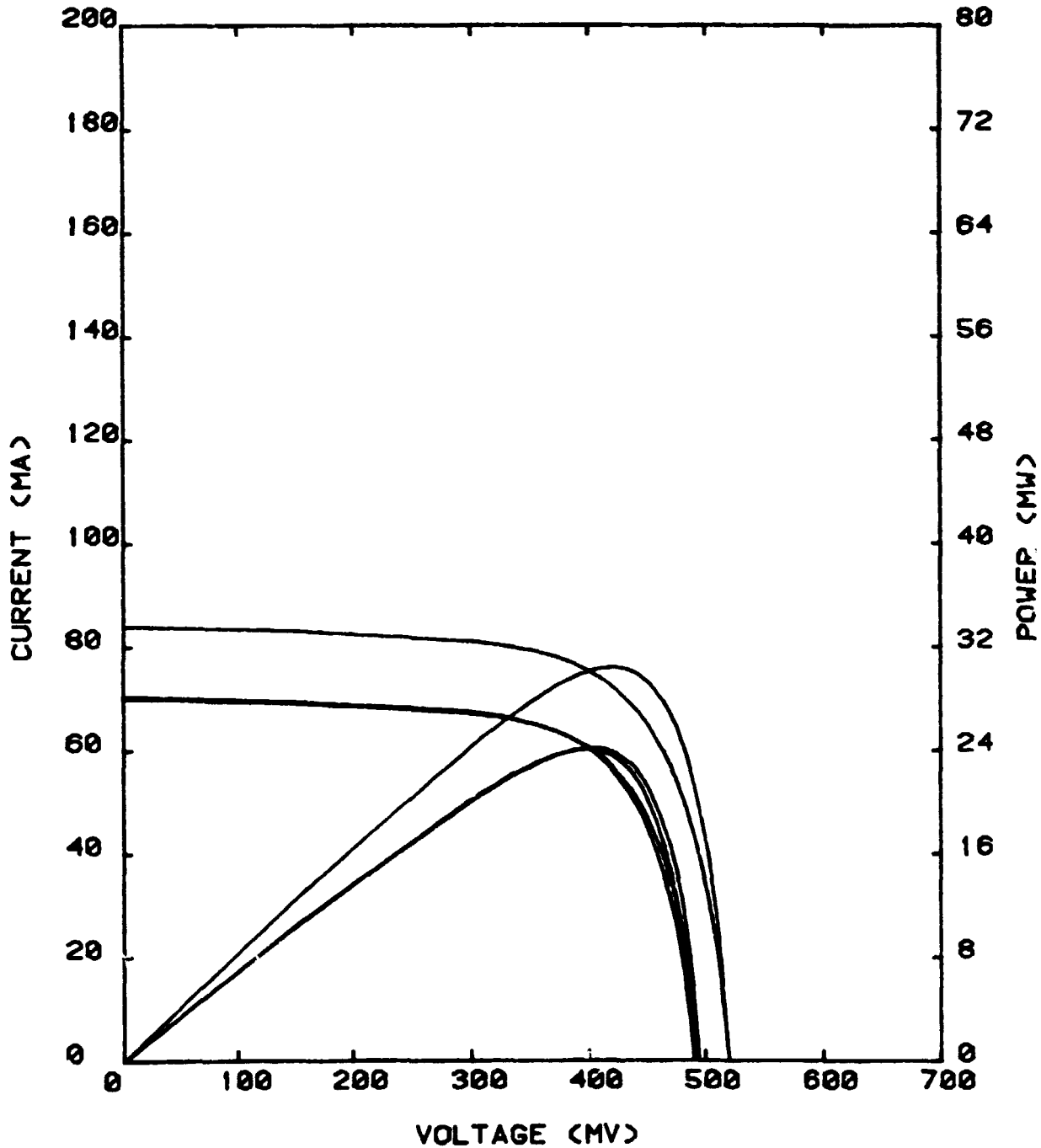

FIGURE 166B
 ESB CELLS ELECTRON IRRADIATION IN-SITU
 D180-26590-1
 225

S/N : 1001	LEVEL : 6	7
TEMP: 25 C	ISCC(MA) : 64.9	65.0
AREA: 4 CM ²	VOC(MV) : 479.9	485.2
INT. : 1*AM0	PMAX(MW) : 21.8	21.1
	F.F. : 0.699	0.692

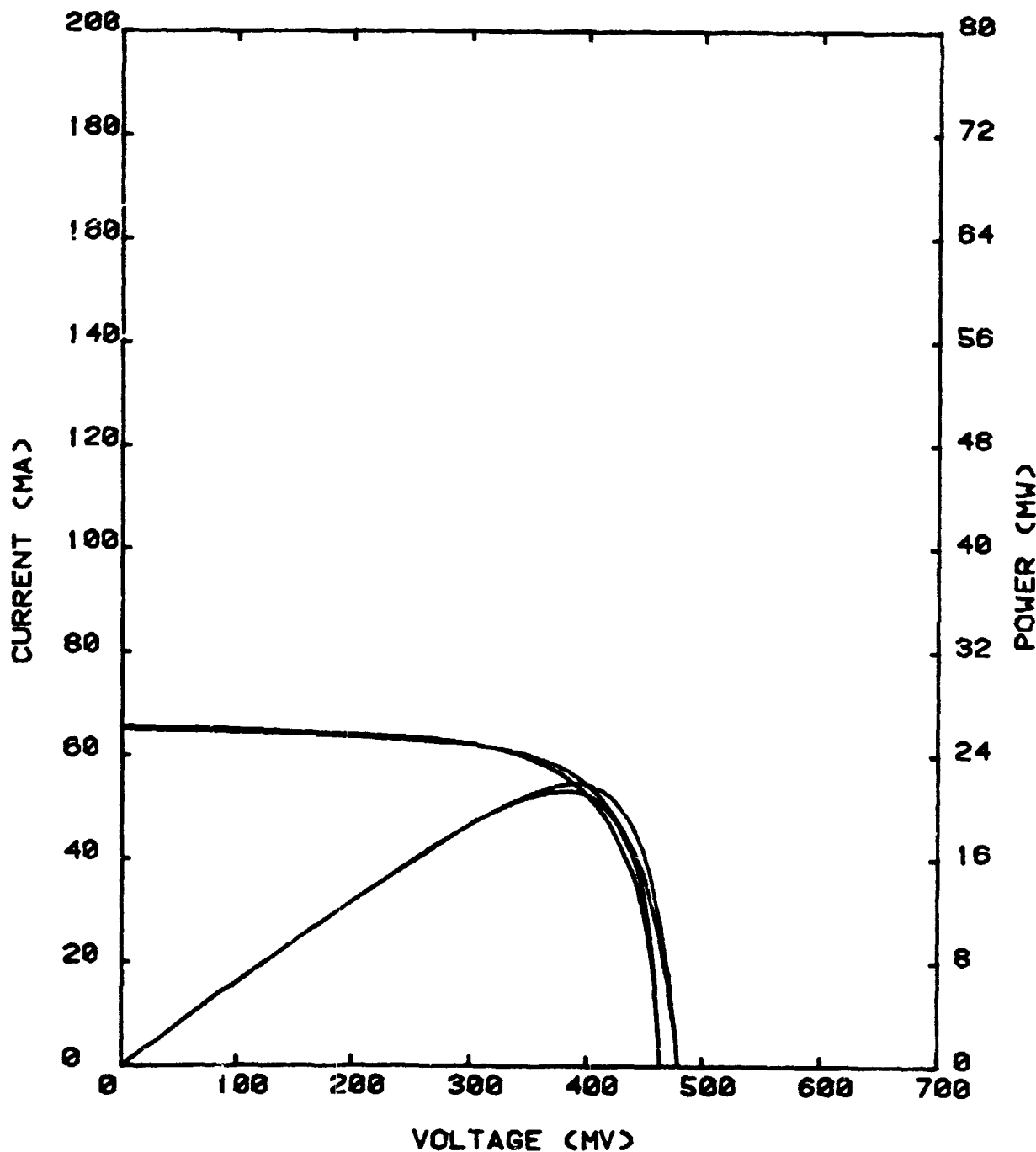

FIGURE 166C
 ESB CELLS ELECTRON IRRADIATION IN-SITU
 0180-26590-1
 226

6.11.2 Proton Irradiation

No visible damage was observed until after the first set of thermal cycles. At this point two of the five cells had cracked and had a reduced output or no output at all. There were no further changes in the cells' appearance until the testing was completed. At this point, two cells showed no change from the beginning except some curling on the ends, two cells were cracked and curled and had no output and one cell was curled and had several lengthwise cracks in the glass.

The summary plots (Figures 167, 168, 169 and 170) show that for the cells that had an output there was no damage due to the protons. Tables 40A and 40B contain the tabulated data and Figure 171 shows an example of pre- and post-test I-V curves. During the irradiation the sample temperature varied from 52°C to 53°C.

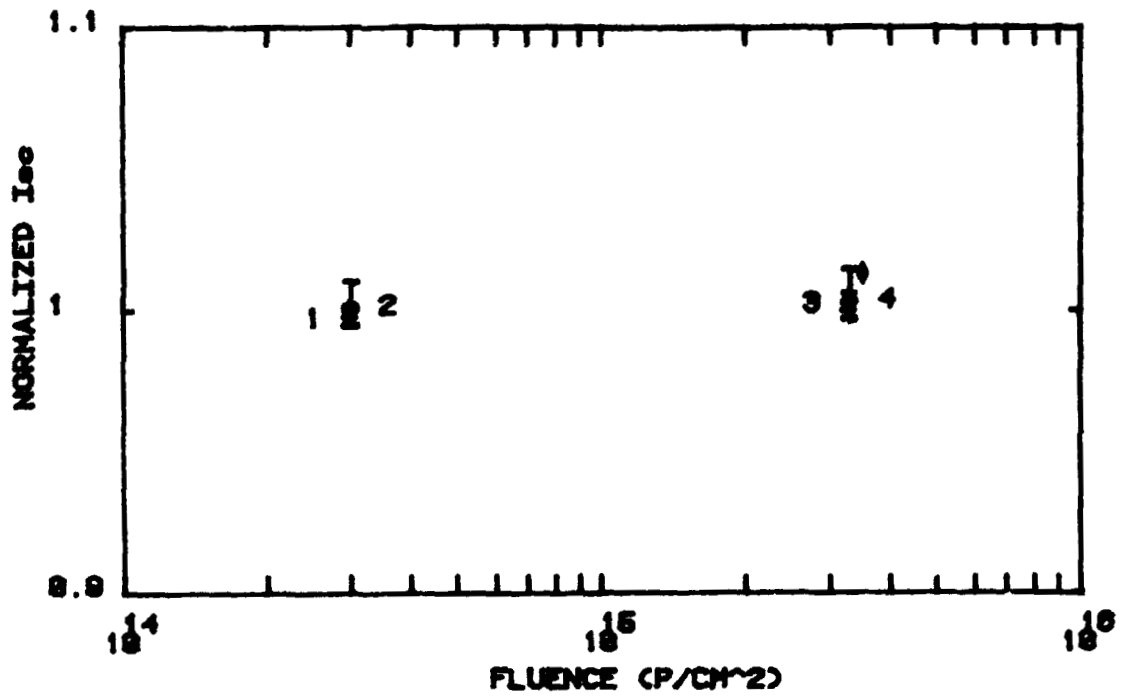

FIGURE 167. ESB CELLS PROTON IRRADIATION IN-SITU

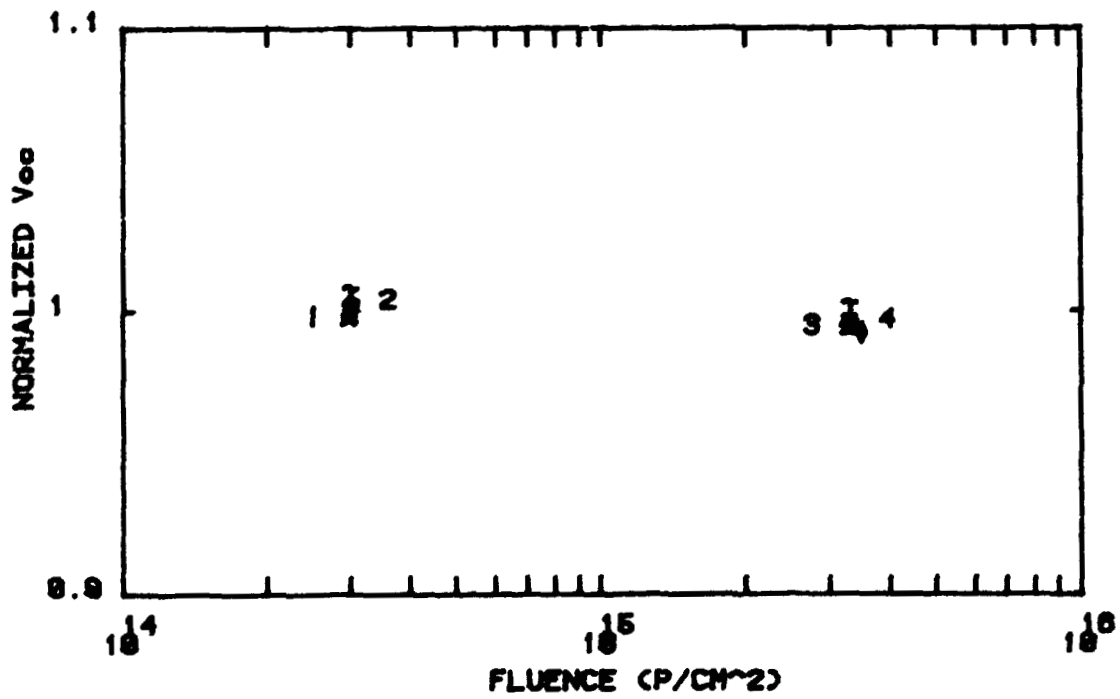

FIGURE 168. ESB CELLS PROTON IRRADIATION IN-SITU

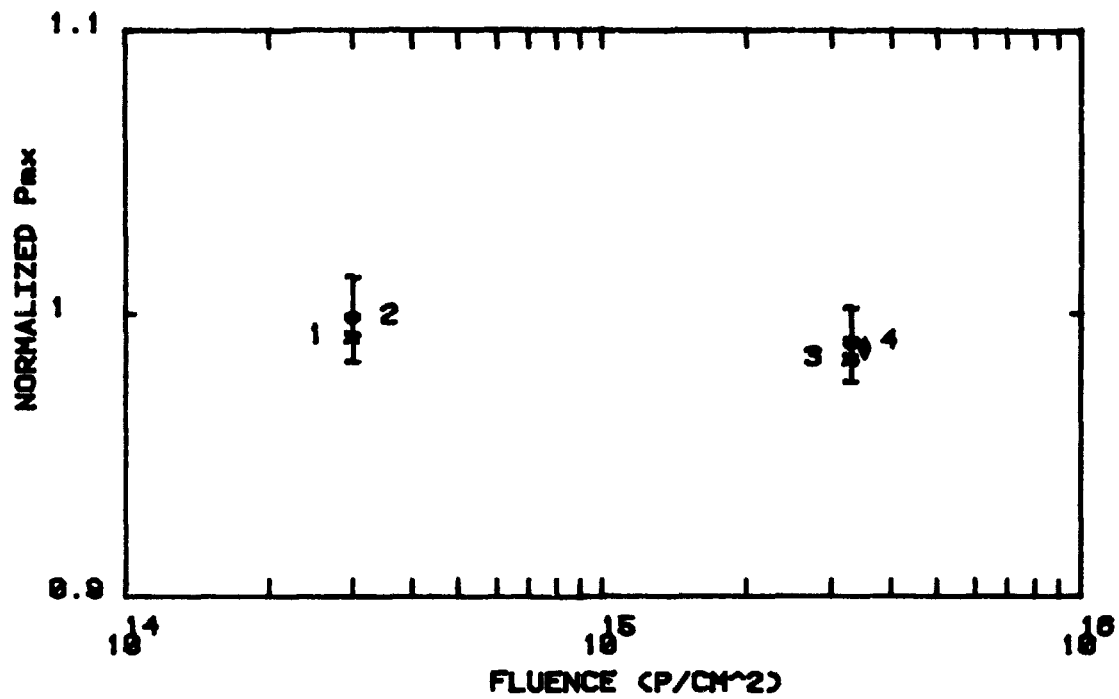

FIGURE 169. ESB CELLS PROTON IRRADIATION IN-SITU

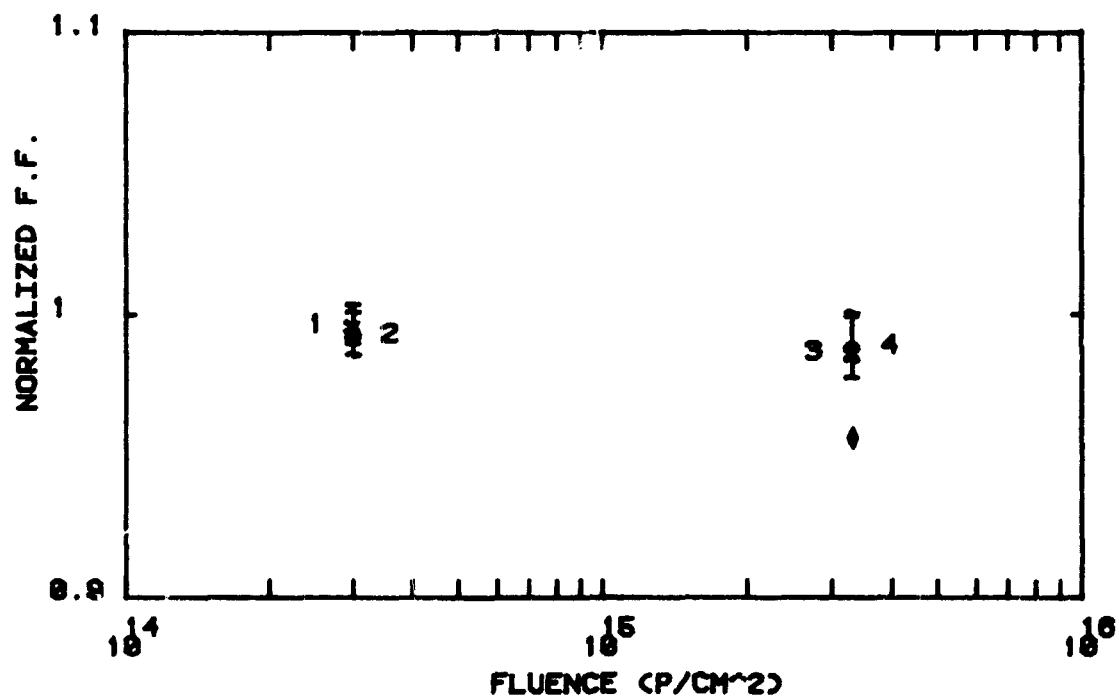

FIGURE 170. ESB CELLS PROTON IRRADIATION IN-SITU

TABLE 40A. TABULATED ESB CELL DATA - PROTON IRRADIATION

ESB CELLS PROTON IRRADIATION EX-SITU
TEMP. (C): 25 AREA: 4. INTENSITY 1*AM0

Level Number	AVERAGE Isc/Isco	AVERAGE Voc/Voco	AVERAGE Pmx/Pmxo	AVERAGE F. F. /F. F. o
0	1.000	1.000	1.000	1.000
1	1.009	0.994	0.955	0.952

ESB CELLS PROTON IRRADIATION IN-SITU
TEMP. (C): 25 AREA: 4. INTENSITY 1*AM0

Level Number	AVERAGE Isc/Isco	AVERAGE Voc/Voco	AVERAGE Pmx/Pmxo	AVERAGE F. F. /F. F. o
0	1.000	1.000	1.000	1.000
1	0.998	0.998	0.993	0.997
2	1.002	1.004	1.000	0.994
3	1.003	0.995	0.985	0.987
4	1.005	0.997	0.991	0.990

ESB CELLS PROTON IRRADIATION EX-SITU
TEMP. (C): 25 AREA: 4 INTENSITY 1*AM0

Serial Number	Level Number	Isc (mA)	Isc/Isco	Voc (mV)	Voc/Voco	Pmx (mW)	Pmx/Pmxo	Fill Fac.	F. F. /F. F. o
1006	0	87.9	1.000	552.1	1.000	26.98	1.000	0.556	1.000
1007	0	101.6	1.000	586.8	1.000	45.69	1.000	0.766	1.000
1008	0	96.7	1.000	592.4	1.000	42.68	1.000	0.745	1.000
1009	0	103.1	1.000	600.2	1.000	48.32	1.000	0.780	1.000
1010	0	97.6	1.000	577.8	1.000	38.27	1.000	0.678	1.000
1006	1	88.7	1.010	552.4	1.001	27.35	1.014	0.558	1.003
1007	1	102.9	1.013	581.9	0.992	45.67	1.000	0.763	0.995
1008	1	97.4	1.008	586.2	0.989	34.44	0.807	0.603	0.809
1009*	1	54.5	0.529	592.1	0.987	21.99	0.455	0.681	0.872
1010	1	96.3	1.007	573.9	0.993	38.21	0.998	0.677	0.999

*NOT INCLUDED IN AVERAGE

TABLE 408. TABULATED ESB CELL DATA - PROTON IRRADIATION

ESB CELLS PROTON IRRADIATION IN-SITU
TEMP. (C): 25 AREA: 4 INTENSITY 1*AM0

Serial Number	Level Number	Isc (mA)	Isc/Isc0	Voc (mV)	Voc/Voc0	Pmx (mW)	Pmx/Pmx0	Fill Fac.	F. F. / F. F. 0
1006	0	86.5	1.000	547.1	1.000	26.56	1.000	0.561	1.000
1007	0	101.4	1.000	581.1	1.000	45.68	1.000	0.776	1.000
1008	0	96.0	1.000	588.2	1.000	42.06	1.000	0.745	1.000
1009	0	103.2	1.000	592.5	1.000	47.67	1.000	0.779	1.000
1010	0	98.2	1.000	573.3	1.000	38.06	1.000	0.676	1.000
1006	1	86.3	0.997	546.7	0.999	26.56	1.000	0.563	1.004
1007	1	101.3	0.999	581.3	1.000	45.41	0.994	0.771	0.994
1008	1	96.1	1.001	586.8	0.998	41.78	0.993	0.741	0.995
1009	1	102.9	0.997	590.4	0.996	46.86	0.983	0.772	0.990
1010	1	97.7	0.995	572.7	0.999	37.88	0.995	0.677	1.002
1006	2	87.4	1.010	551.1	1.007	26.89	1.012	0.558	0.995
1007	2	101.7	1.003	583.3	1.004	45.31	0.992	0.764	0.985
1008	2	0.0	0.000	0.0	0.000	0.00	0.000	0.000	0.000
1009*	2	72.1	0.696	538.3	0.993	32.52	0.682	0.767	0.984
1010	2	97.7	0.994	574.2	1.001	37.91	0.996	0.676	1.000
1006	3	87.0	1.005	546.1	0.998	26.24	0.988	0.552	0.985
1007	3	102.0	1.006	576.4	0.992	44.59	0.976	0.758	0.978
1008	3	0.0	0.000	0.0	0.000	0.00	0.000	0.000	0.000
1009*	3	72.3	0.701	581.0	0.981	31.41	0.659	0.748	0.959
1010	3	98.0	0.998	569.9	0.994	37.74	0.991	0.676	1.000
1006	4	87.8	1.014	548.2	1.002	26.60	1.002	0.553	0.986
1007	4	101.8	1.004	578.5	0.996	44.89	0.983	0.762	0.983
1008	4	0.0	0.000	0.0	0.000	0.00	0.000	0.000	0.000
1009	4	0.0	0.000	0.0	0.000	0.00	0.000	0.000	0.000
1010	4	97.8	0.996	569.7	0.994	37.66	0.990	0.676	1.000

*NOT INCLUDED IN AVERAGE

S/N : 1007	LEVEL : 0	1
TEMP: 25 C	ISC(MA) : 101.0	102.0
AREA: 4 CM^2	VOC(MV) : 580.8	581.8
INT. : 1*AM0	PMAX(MW) : 45.7	45.7
	F.F. : 0.766	0.763

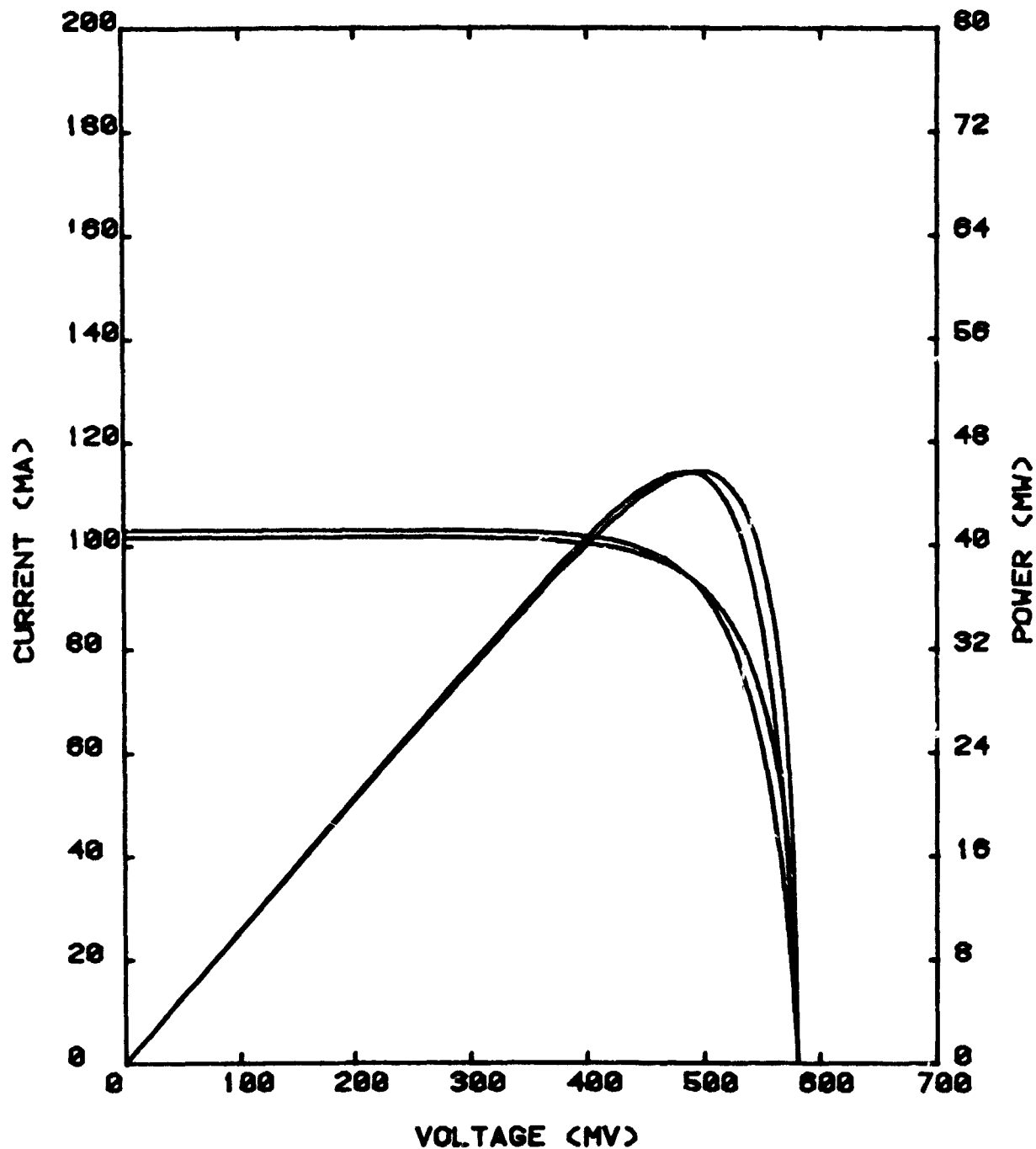

FIGURE 171

ESB CELLS PROTON IRRADIATION EX-SITU

D180-26590-1

6.11.3 UV Exposure

The ESB cells used in the UV test did not degrade electrically or visually. These cells were some of the last ones made under the electrostatic bonding program (NAS3-22216) and withstood thermal cycling very well. The summary plots are shown in Figures 172, 173, 174 and 175 and the tabulated data are listed in Tables 4A and 4B. Figures 176A, B and C are in situ I-V curves. The sample temperature varied from 37°C to 45°C during the exposure.

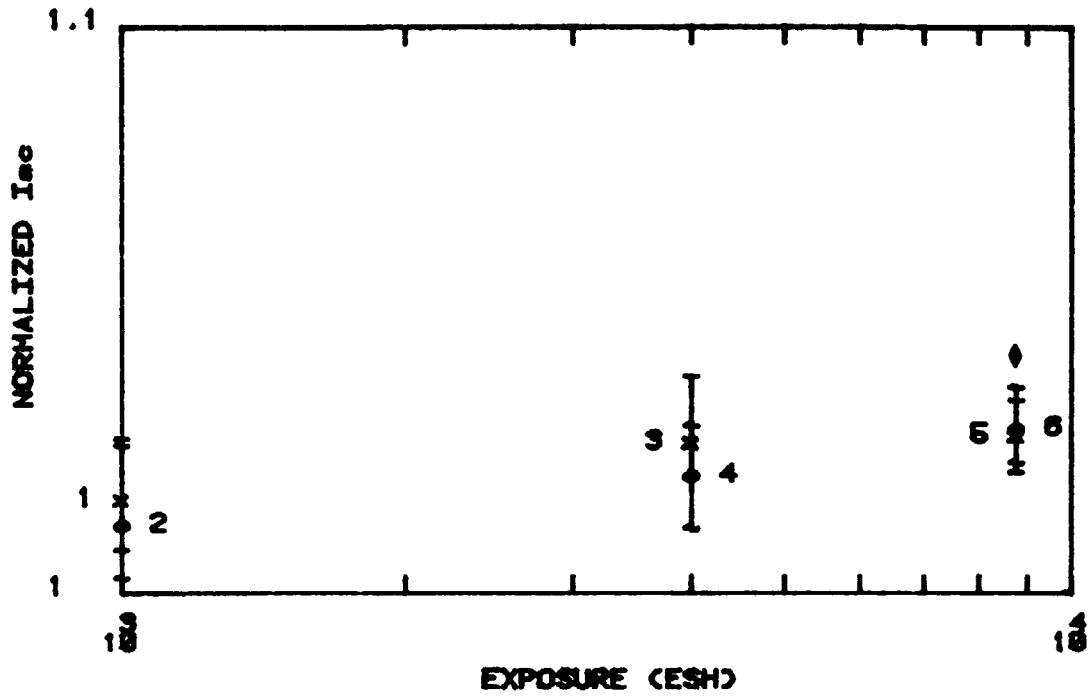

FIGURE 172. ESB CELLS UV IRRADIATION IN SITU

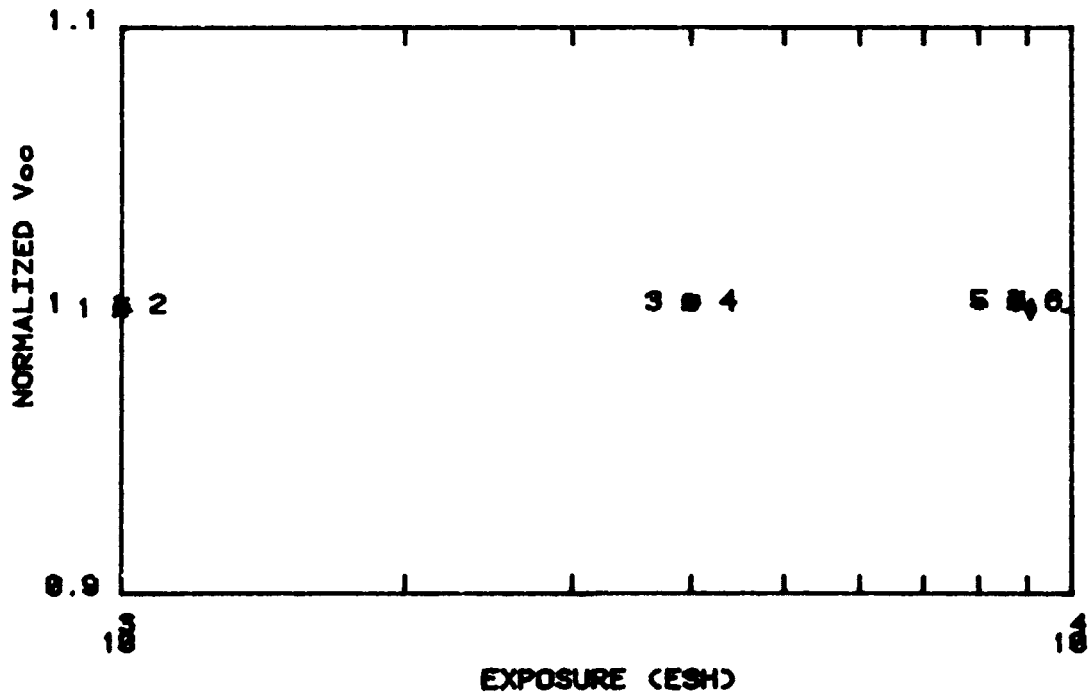

FIGURE 173. ESB CELLS UV IRRADIATION IN SITU

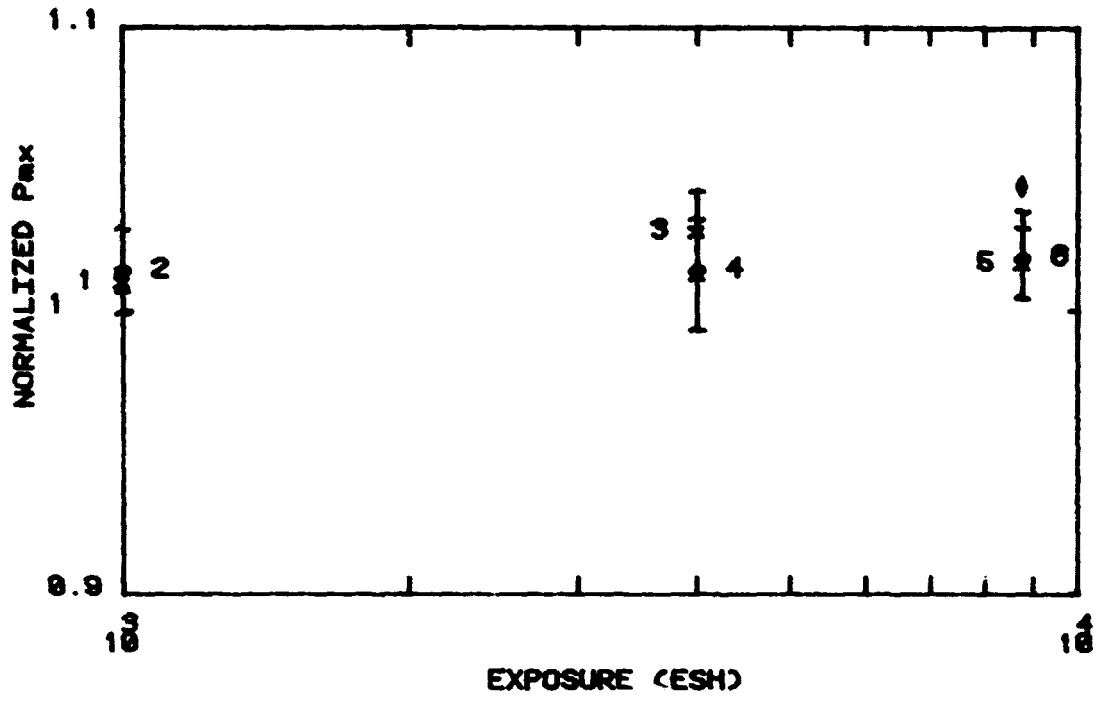

FIGURE 174. ESB CELLS UV IRRADIATION IN SITU

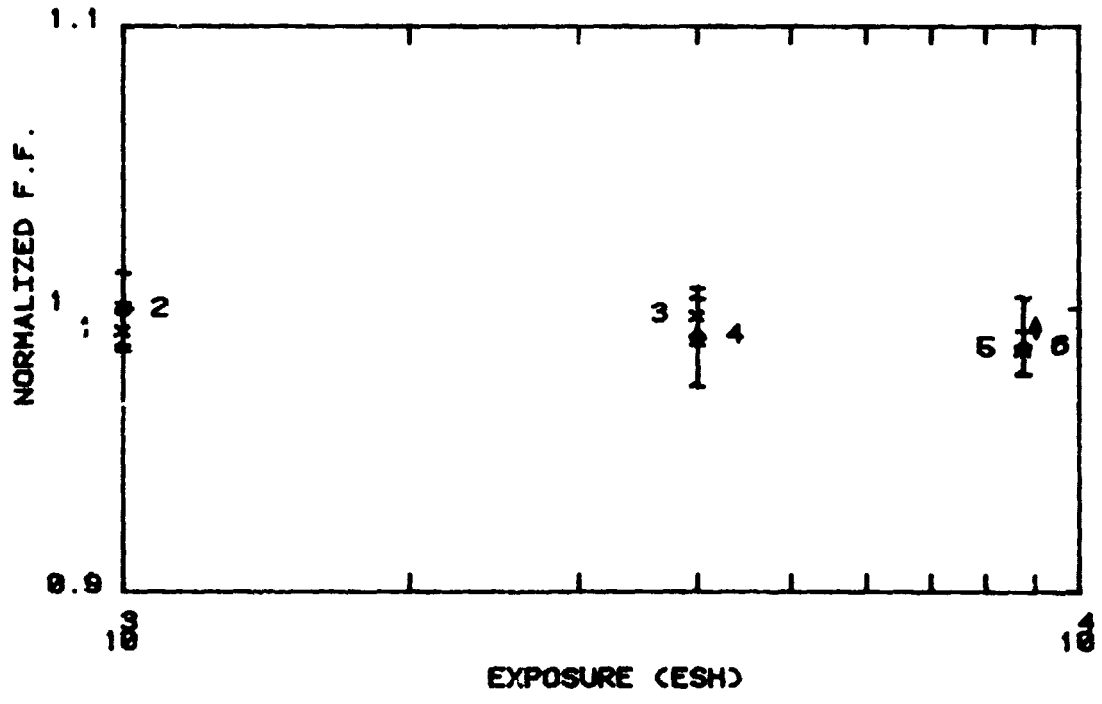

FIGURE 175. ESB CELLS UV IRRADIATION IN SITU

TABLE 41A. TABULATED ESB CELL DATA - UV IRRADIATION

ESB CELLS UV IRRADIATION EX-SITU
TEMP. (C): 25 AREA: 4 INTENSITY 1*AM0

Level Number	AVERAGE Isc/Isc0	AVERAGE Voc/Voc0	AVERAGE Pmx/Pmx0	AVERAGE F. F. /F. F. 0
0	1.000	1.000	1.000	1.000
1	1.050	1.005	1.046	0.992

ESB CELLS UV IRRADIATION IN SITU
TEMP. (C): 25 AREA: 4 INTENSITY 1*AM0

Level Number	AVERAGE Isc/Isc0	AVERAGE Voc/Voc0	AVERAGE Pmx/Pmx0	AVERAGE F. F. /F. F. 0
0	1.000	1.000	1.000	1.000
1	1.017	1.001	1.011	0.995
2	1.012	1.002	1.015	1.001
3	1.027	1.003	1.029	0.997
4	1.021	1.003	1.016	0.991
5	1.028	1.004	1.018	0.986
6	1.030	1.003	1.020	0.987

ESB CELLS UV IRRADIATION EX-SITU
TEMP. (C): 25 AREA: 4 INTENSITY 1*AM0

Serial Number	Level Number	Isc (mA)	Isc/Isc0	Voc (mV)	Voc/Voc0	Pmx (mW)	Pmx/Pmx0	Fv11 Fac.	F. F. /F. F. 0
1011	0	123.5	1.000	585.2	1.000	53.13	1.000	0.735	1.000
1012	0	124.0	1.000	599.1	1.000	56.63	1.000	0.762	1.000
1013	0	127.1	1.000	599.4	1.000	58.24	1.000	0.764	1.000
1014	0	136.1	1.000	607.8	1.000	61.35	1.000	0.742	1.000
1015	0	0.0	0.000	0.0	0.000	0.00	0.000	0.000	0.000
1011	1	129.5	1.048	589.2	1.007	56.82	1.069	0.745	1.013
1012	1	130.3	1.050	601.6	1.004	57.67	1.018	0.736	0.965
1013	1	134.9	1.061	600.4	1.002	60.52	1.039	0.747	0.978
1014	1	141.4	1.039	611.2	1.006	64.79	1.056	0.750	1.010
1015	1	138.6	0.000	607.5	0.000	60.58	0.000	0.720	0.000

TABLE 41B. TABULATED ESB CELL DATA - UV IRRADIATION

ESB CELLS UV IRRADIATION IN SITU									
TEMP. (C): 25 AREA: 4 INTENSITY 1*AM0									
Serial Number	Level Number	Isc (mA)	Isc/Isc0	Voc (mV)	Voc/Voc0	Pmx (mW)	Pmx/Pmx0	Full Fac.	F. F. / F. F. 0
1011	0	123.5	1.000	586.5	1.000	54.06	1.000	0.746	1.000
1012	0	123.4	1.000	600.7	1.000	56.15	1.000	0.757	1.000
1013	0	126.7	1.000	599.2	1.000	58.39	1.000	0.769	1.000
1014	0	134.1	1.000	609.4	1.000	62.08	1.000	0.760	1.000
1015	0	0.0	0.000	0.0	0.000	0.00	0.000	0.000	0.000
1011	1	124.8	1.010	587.0	1.001	54.43	1.007	0.743	0.996
1012	1	124.4	1.008	600.7	1.000	56.70	1.010	0.759	1.002
1013	1	129.6	1.023	600.5	1.002	59.28	1.015	0.762	0.990
1014	1	137.8	1.028	610.1	1.001	62.93	1.014	0.749	0.985
1015	1	134.5	0.000	605.2	0.000	56.93	0.000	0.699	0.000
1011	2	124.7	1.009	588.2	1.003	53.97	0.998	0.726	0.986
1012	2	123.7	1.002	601.5	1.001	56.81	1.012	0.764	1.008
1013	2	128.2	1.012	601.3	1.003	60.03	1.028	0.779	1.012
1014	2	137.5	1.026	610.2	1.001	63.53	1.023	0.757	0.996
1015	2	134.1	0.000	605.5	0.000	57.46	0.000	0.708	0.000
1011	3	126.1	1.021	588.8	1.004	54.69	1.012	0.737	0.987
1012	3	126.2	1.022	602.7	1.003	58.03	1.033	0.760	1.006
1013	3	0.0	0.000	0.0	0.000	0.00	0.000	0.000	0.000
1014	3	139.3	1.039	611.2	1.003	64.72	1.043	0.760	1.001
1015	3	134.5	0.000	606.5	0.000	57.86	0.000	0.709	0.000
1011	4	124.9	1.011	588.9	1.004	55.04	1.018	0.748	1.003
1012	4	125.7	1.019	602.4	1.003	55.75	0.993	0.736	0.972
1013	4	130.4	1.029	601.5	1.004	60.24	1.032	0.768	0.998
1014	4	137.6	1.036	611.3	1.003	63.36	1.021	0.753	0.991
1015	4	132.9	0.000	606.7	0.000	57.45	0.000	0.712	0.000
1011	5	126.2	1.021	589.2	1.005	54.96	1.017	0.739	0.991
1012	5	126.6	1.026	602.5	1.003	56.44	1.005	0.740	0.977
1013	5	130.7	1.032	601.0	1.003	59.59	1.021	0.759	0.986
1014	5	138.7	1.034	611.5	1.004	63.93	1.030	0.754	0.992
1015	5	133.4	0.000	606.9	0.000	57.72	0.000	0.713	0.000
1011	6	126.7	1.026	589.7	1.005	55.94	1.035	0.748	1.003
1012	6	126.2	1.023	602.7	1.003	56.39	1.004	0.741	0.979
1013	6	130.9	1.034	600.3	1.002	59.03	1.011	0.751	0.976
1014	6	138.9	1.036	611.5	1.003	63.98	1.031	0.753	0.991
1015	6	134.0	0.000	606.7	0.000	57.55	0.000	0.708	0.000

S/N : 1011	LEVEL : 0	1	2
TEMP: 25 C	ISCC(MA) : 123.5	124.0	124.7
AREA: 4 CM ²	VOC(MV) : 588.5	587.0	588.2
INT. : 1*AM0	PMAX(MW) : 54.1	54.4	54.0
	F.F. : 0.740	0.749	0.790

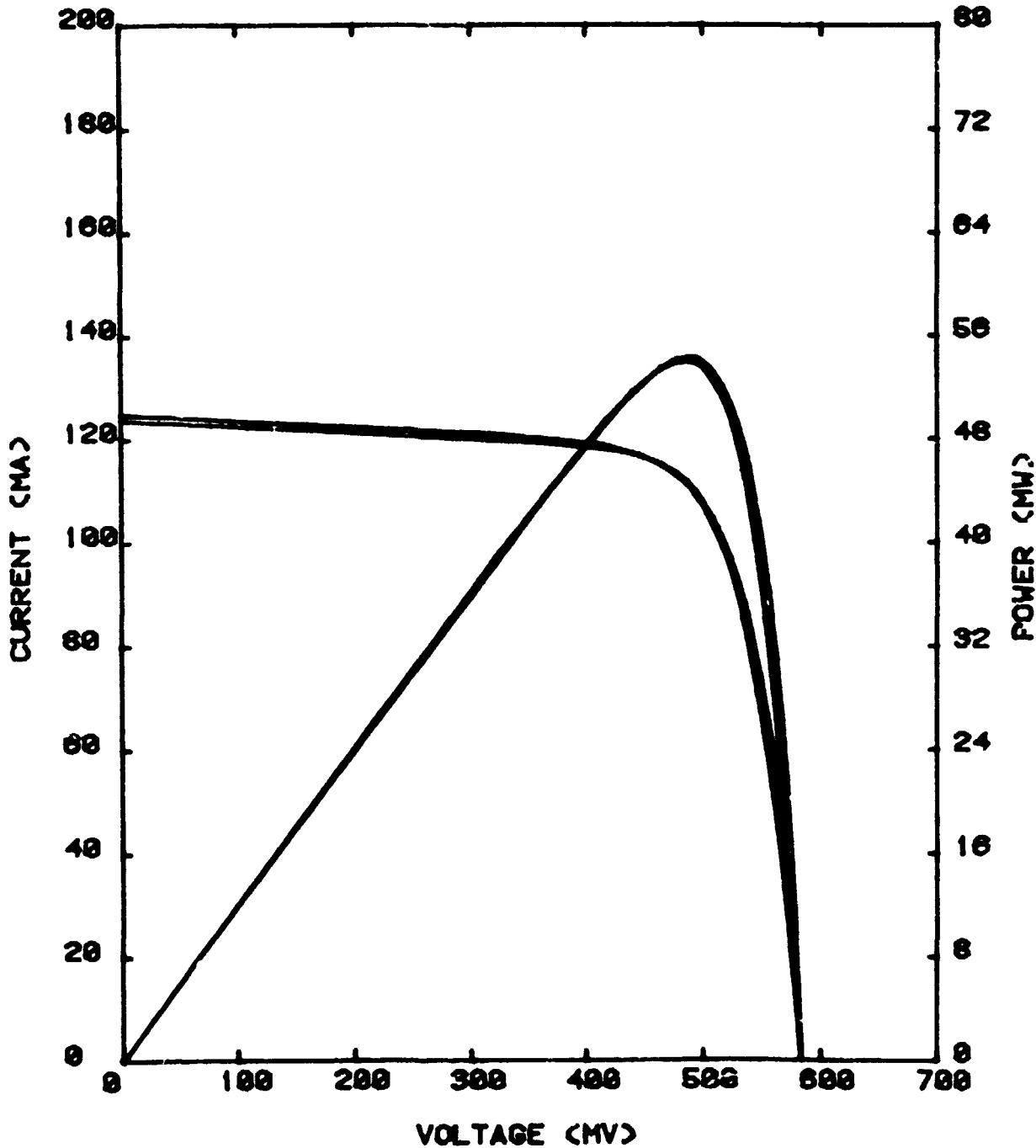

FIGURE 176A

ESB CELLS UV IRRADIATION IN SITU

D180-26590-1

S/N : 1011	LEVEL : 3	4
TEMP: 25 C	ISC(MA) : 120.1	124.0
AREA: 4 CM ²	VOC(MV) : 588.8	588.9
INT. : 1*AM0	PMAX(MW) : 54.7	55.0
	F.F. : 0.737	0.748

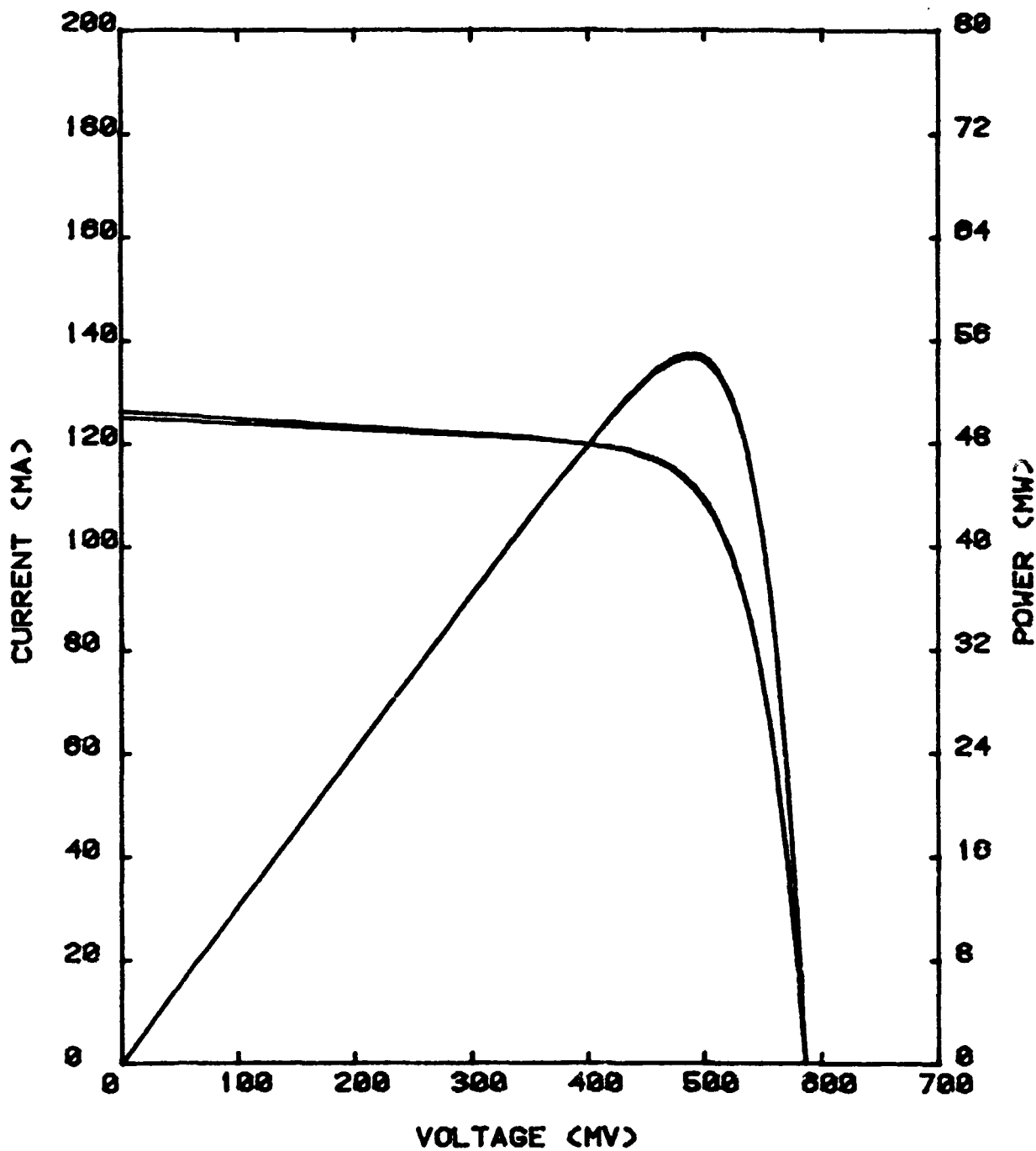

FIGURE 176B
ESB CELLS UV IRRADIATION IN SITU

S/N : 1011	LEVEL : 5	0
TEMP: 25 C	ISC(MA) : 120.2	120.7
AREA: 4 CM^2	VOC(MV) : 589.2	589.7
INT. : 1*AM0	PMAX(MW) : 55.0	55.9
	F.F. : 0.739	0.748

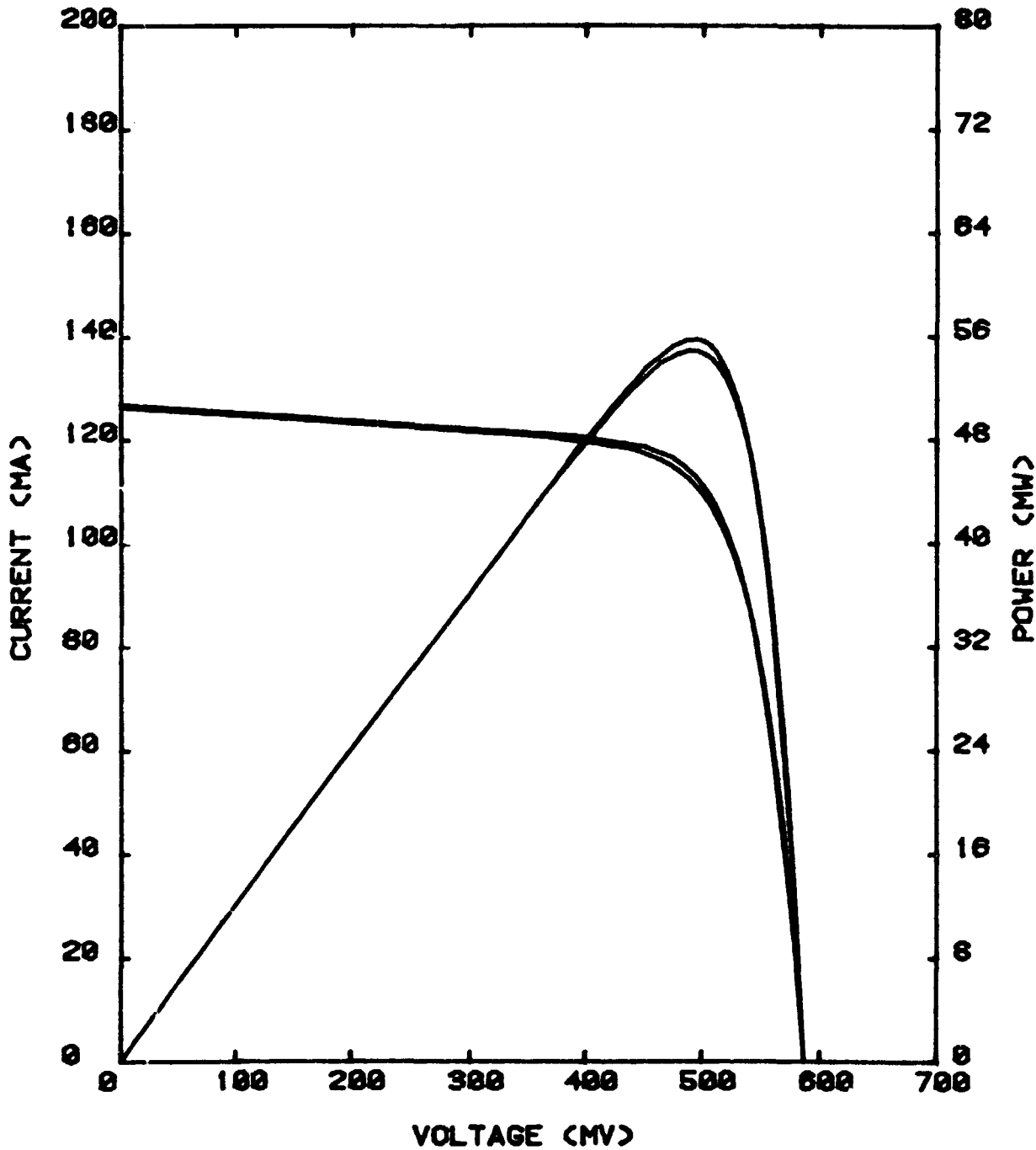

FIGURE 176C
ESB CELLS UV IRRADIATION IN SITU
 D180-26590-1
 240

6.12 2-mil 7070 GLASS

Samples of 2-mil 7070 glass 2 cm x 2 cm in size were also included in the electron and proton irradiations.

6.12.1 Electron Irradiation

There was no visible damage to the glass throughout the electron irradiation.

6.12.2 Proton Irradiation

The glass started to curl on the ends which were not held down after the first set of thermal cycles and 3×10^{14} p/cm² fluence. The curling continued throughout the test. The glass curled up as much as 5-mm off the surface of the plate at the ends. It is thought that the protons may be compacting the glass at the surface therefore changing its density which creates shear stress when glass is tempered. These surface stresses on only one surface result in the curling observed.

6.13 NASA-LEWIS MODULE #1

(2 mil cell; 7070 cover; 1 mil FEP-C adhesive; 1/2 mil FEP-C, 1 1/2 mil fiberglass, 1/2 mil FEP-C, 0.3 mil Kapton back; 0.5 mil silver interconnects)

This module was exposed to the UV and thermal cycling environment only. The module developed a hazy region after 1000 ESH and 15 thermal cycles. At the end of the test the hazy region covered 1/3 of the module area. It was found that the hazy region could be wiped off after the module was removed from the chamber indicating that the hazy region was contamination of some type (see Section 5.3). Figure 177 is a photograph showing the hazy region. Figures 178, 179, 180, 181 are the summary plots. Tables 42A and 42B list the tabulated data and Figure 182 is the pre- and post-test I-V curves. The sample temperature during the exposure ranged from 42°C to 58°C.

ORIGINAL PAGE IS
OF POOR QUALITY.

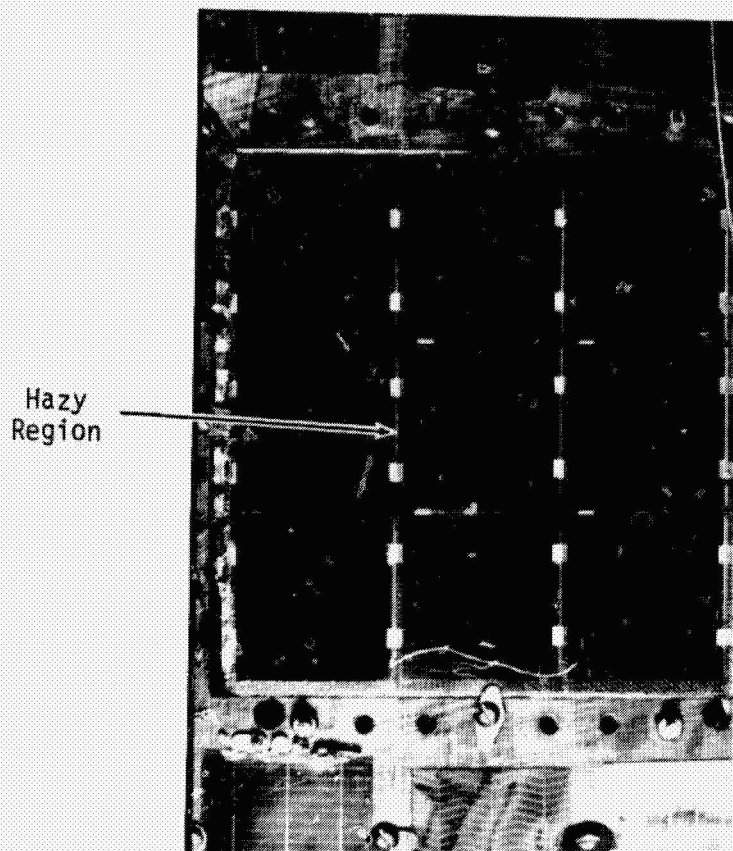

FIGURE 177. PHOTOGRAPH SHOWING HAZY REGION OF NASA-
LEWIS MODULE (1101), POST-UV EXPOSURE EX SITU

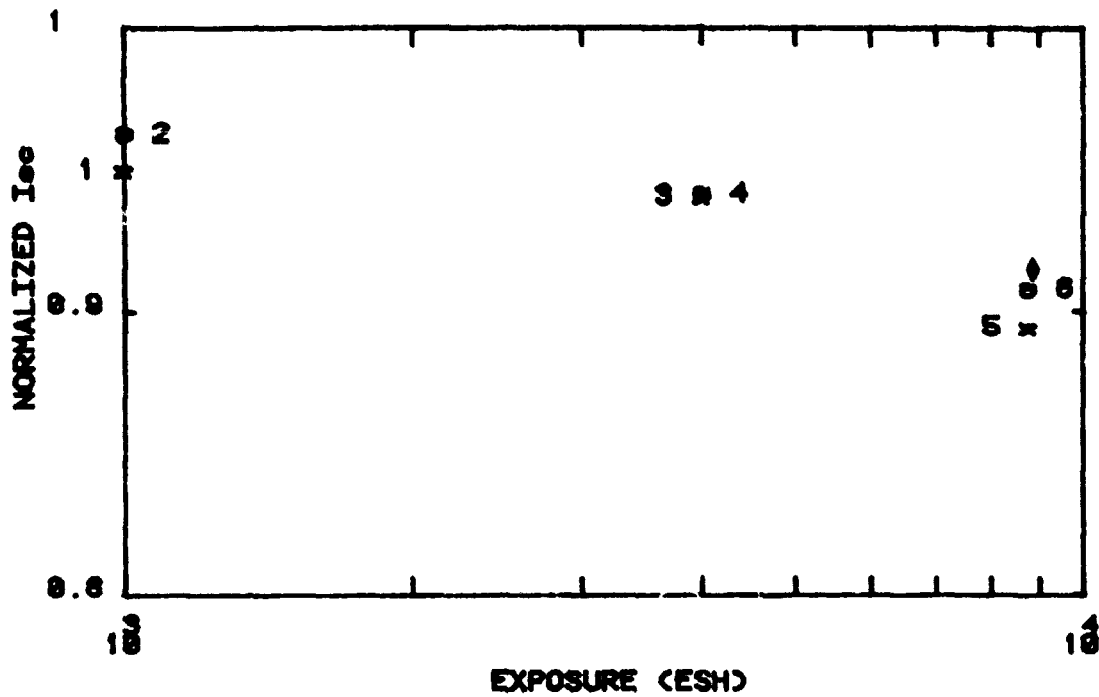

FIGURE 178. MODULE NUMBER 1 UV IRRADIATION IN SITU

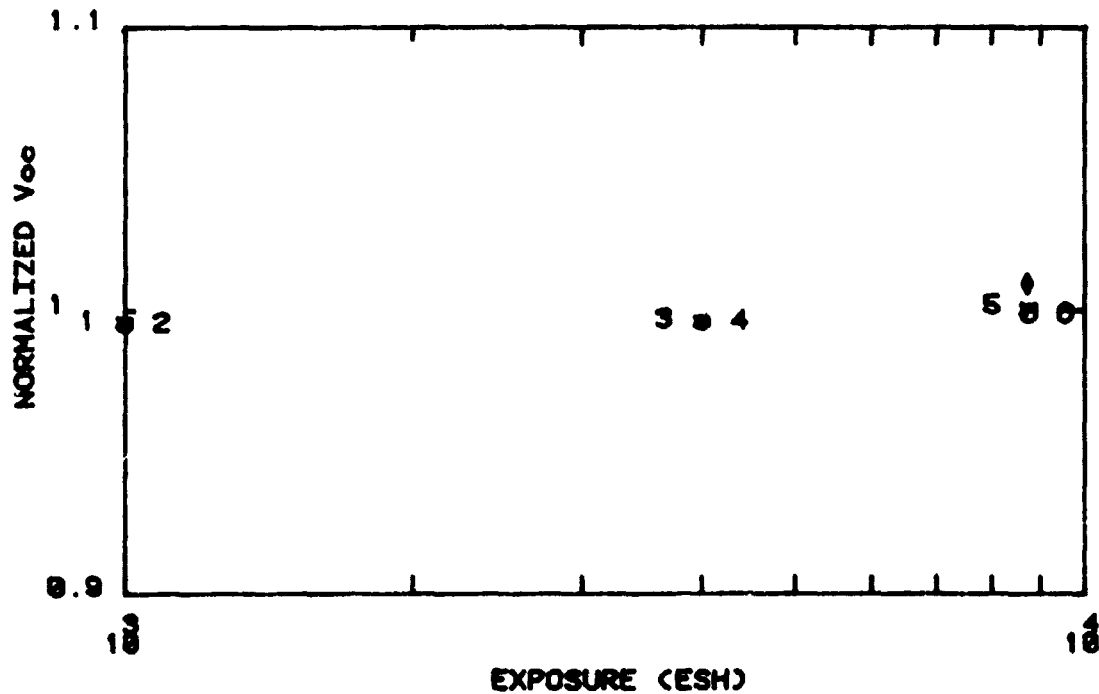

FIGURE 179. MODULE NUMBER 1 UV IRRADIATION IN SITU

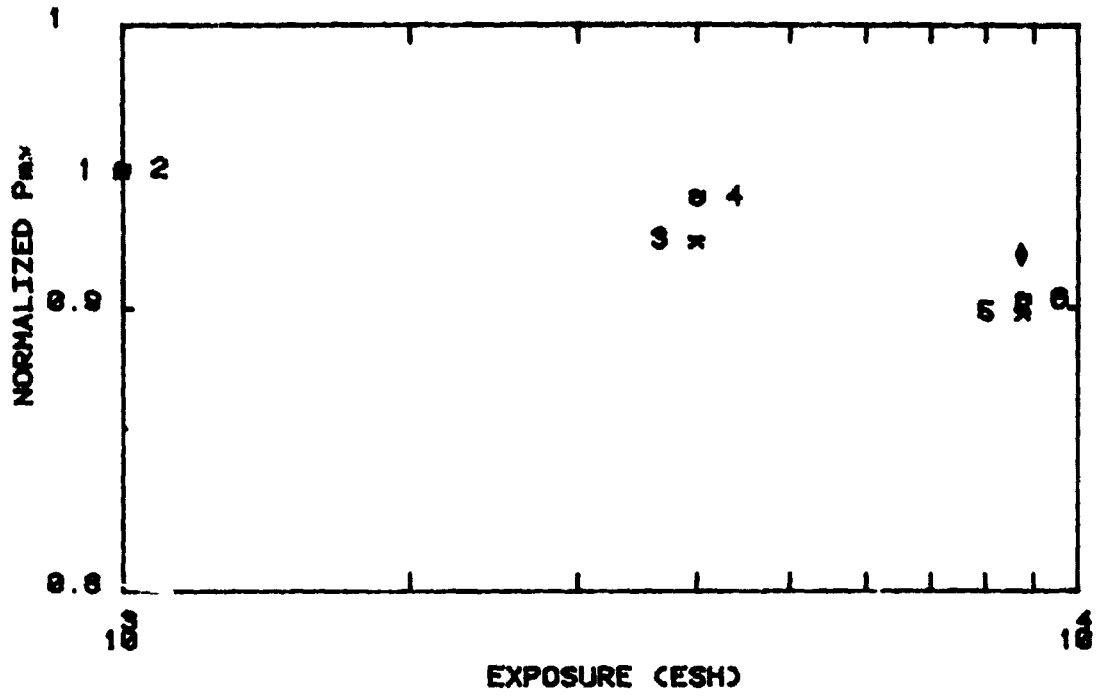

FIGURE 180. MODULE NUMBER 1 UV IRRADIATION IN SITU

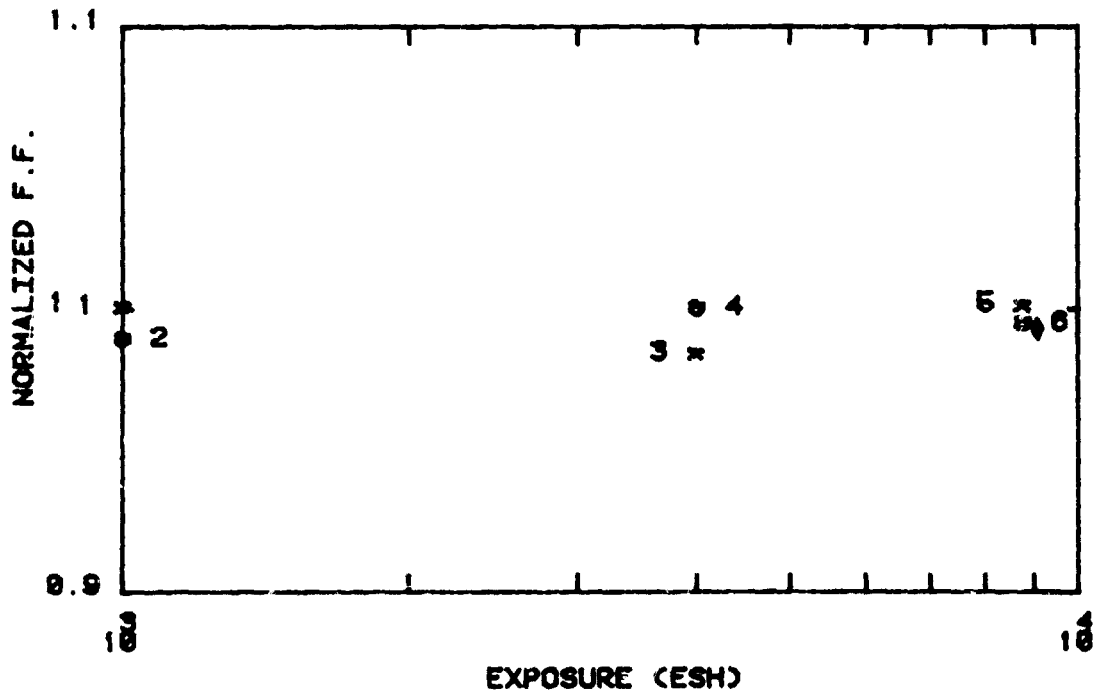

FIGURE 181. MODULE NUMBER 1 UV IRRADIATION IN SITU

TABLE 42A. TABULATED MODULE 1 DATA - UV IRRADIATION

MODULE NUMBER 1 UV IRRADIATION EX-SITU
 TEMP. (C): 25 AREA: 36 INTENSITY 1*AM0

Serial Number	Level Number	Isc (mA)	Isc/Isco	Voc (mV)	Voc/Voco	Pmx (mW)	Pmx/Pmxo	Fvll Fac.	F.F. / F.F. o
1101	0	511.6	1.000	1786.1	1.000	724.27	1.000	0.793	1.000
1101	1	469.5	0.918	1803.8	1.010	660.40	0.912	0.780	0.984

MODULE NUMBER 1 UV IRRADIATION IN SITU
 TEMP. (C): 25 AREA: 36 INTENSITY 1*AM0

Level Number	AVERAGE Isc/Isco	AVERAGE Voc/Voco	AVERAGE Pmx/Pmxo	AVERAGE F.F. / F.F. o
0	1.000	1.000	1.000	1.000
1	0.951	0.997	0.949	1.002
2	0.963	0.996	0.950	0.990
3	0.941	0.997	0.925	0.985
4	0.942	0.997	0.940	1.001
5	0.895	1.002	0.899	1.002
6	0.909	0.999	0.904	0.996

TABLE 42B. TABULATED MODULE 1 DATA - UV IRRADIATION

MODULE NUMBER 1 UV IRRADIATION IN SITU
 TEMP. (C): 25 AREA: 36 INTENSITY 1*AM0

Serial Number	Level Number	Isc (rA)	Isc/ Isco	Voc (mV)	Voc/ Voco	Pmx (mW)	Pmx/ Pmxo	Full Fac.	F. F. / F. F. o
1101	0	506.9	1.000	1752.5	1.000	693.49	1.000	0.781	1.000
1101	1	481.8	0.951	1747.4	0.997	658.47	0.949	0.782	1.002
1101	2	488.3	0.963	1745.5	0.996	658.78	0.950	0.772	0.990
1101	3	477.1	0.941	1747.7	0.997	641.35	0.925	0.769	0.985
1101	4	477.5	0.942	1746.6	0.997	651.76	0.940	0.781	1.001
1101	5	453.9	0.895	1755.8	1.002	623.58	0.899	0.782	1.002
1101	6	460.6	0.909	1750.9	0.999	626.79	0.904	0.777	0.996

S/N : 1101	LEVEL : 0	1
TEMP: 25 C	ISCC(MA) : 511.6	489.5
AREA: 36 CM^2	VOC(MV) : 1786.1	1803.8
INT. : 1*AM0	PMAX(MW) : 724.3	680.4
	F.F. : 0.793	0.780

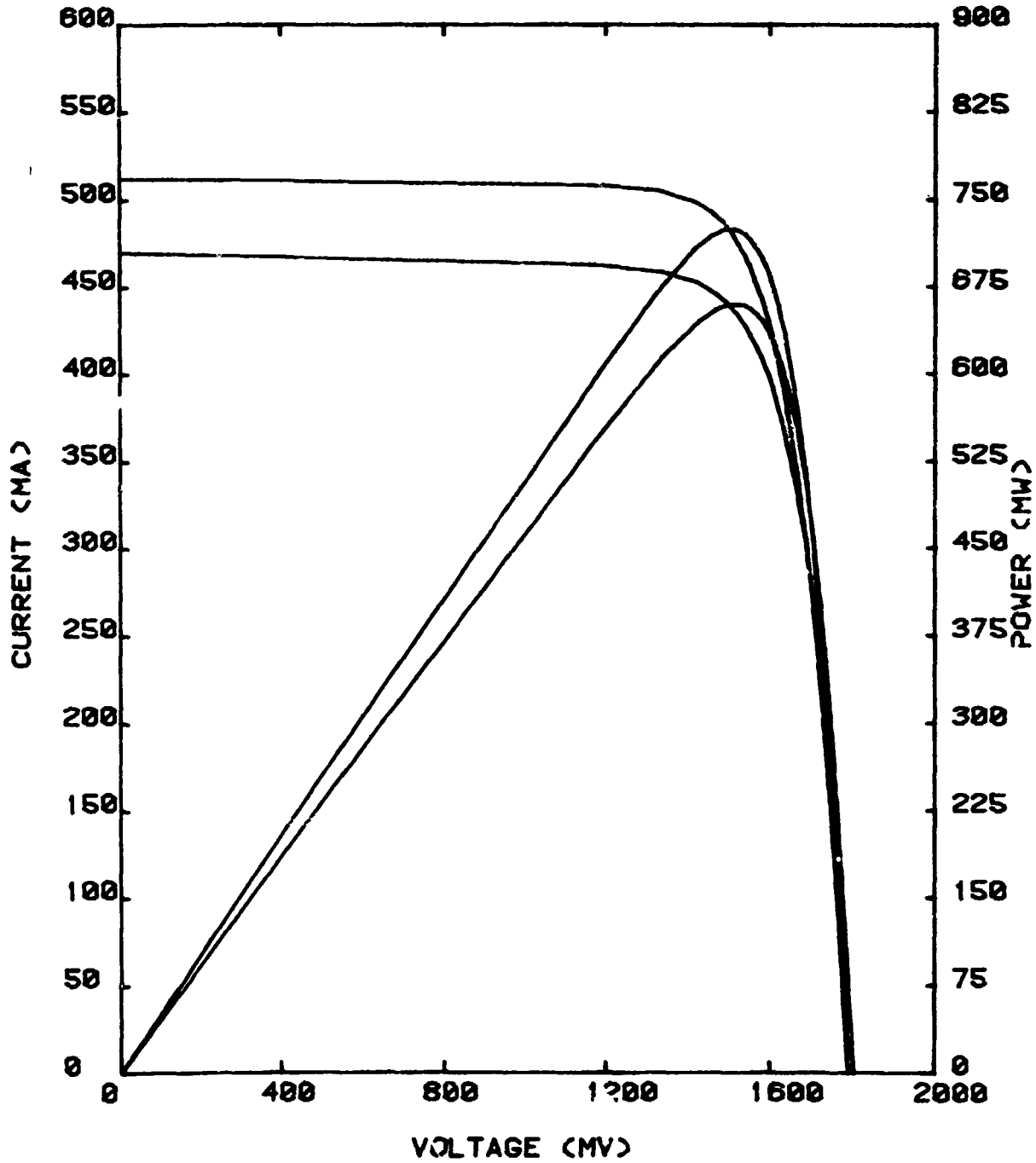

FIGURE 182
MODULE NUMBER 1 UV IRRADIATION EX-SITU
0180-26590-1
248

6.14 MODULE #2 (made for JPL by TRW)

(2 mil Solarex cell with Ta₂O₅, 3 mil O21i cover with DC 93-500 adhesive)

There was no change observed throughout the exposure. The summary plots (Figures 183, 184, 185 and 186) indicate there was no degradation. Tables 43A and 43B are the tabulated data and Figure 187 is a photograph of the module at the completion of the exposure. Figure 188 is the pre- and post-test I-V curve. The module temperature during exposure ranged from 46°C to 54°C.

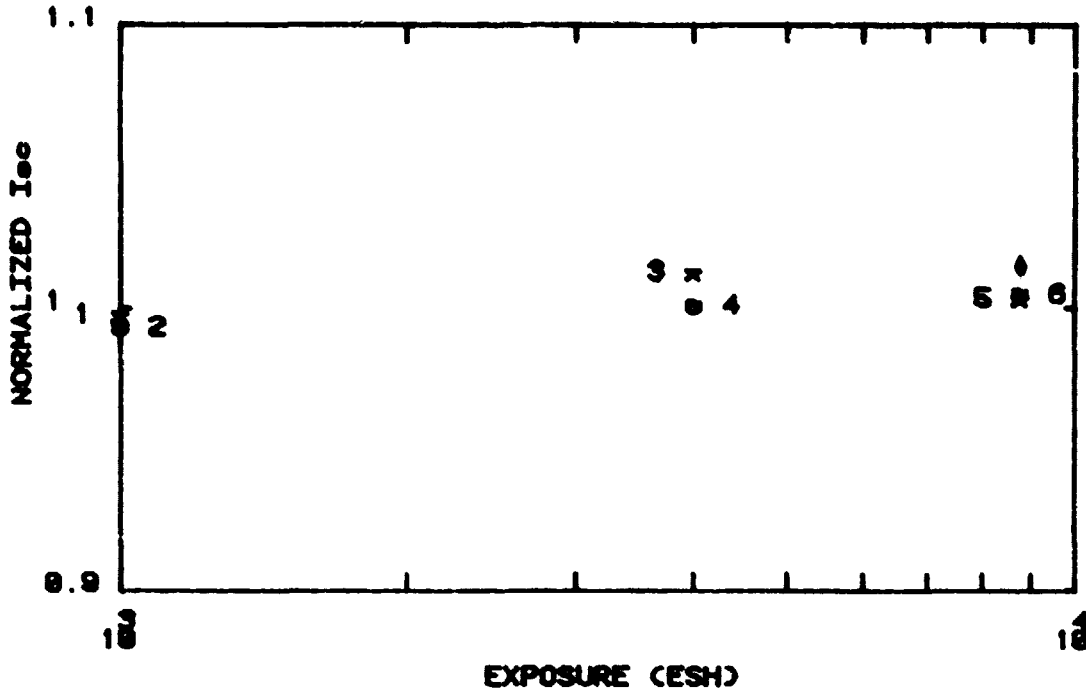

FIGURE 183. MODULE NUMBER 2 UV IRRADIATION IN SITU

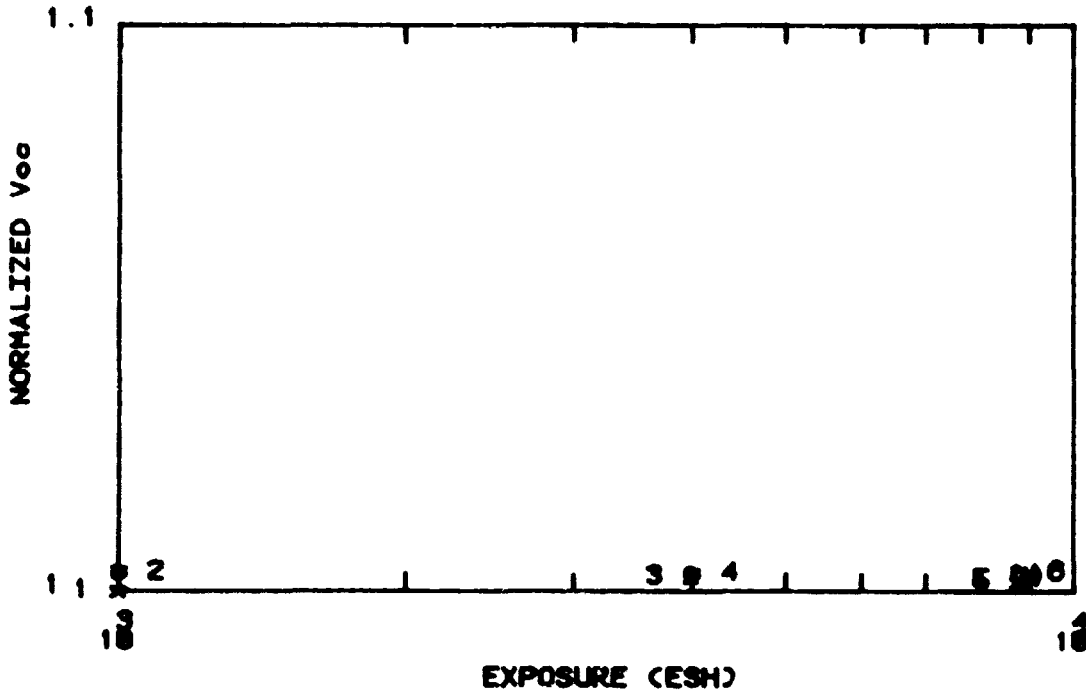

FIGURE 184. MODULE NUMBER 2 UV IRRADIATION IN SITU

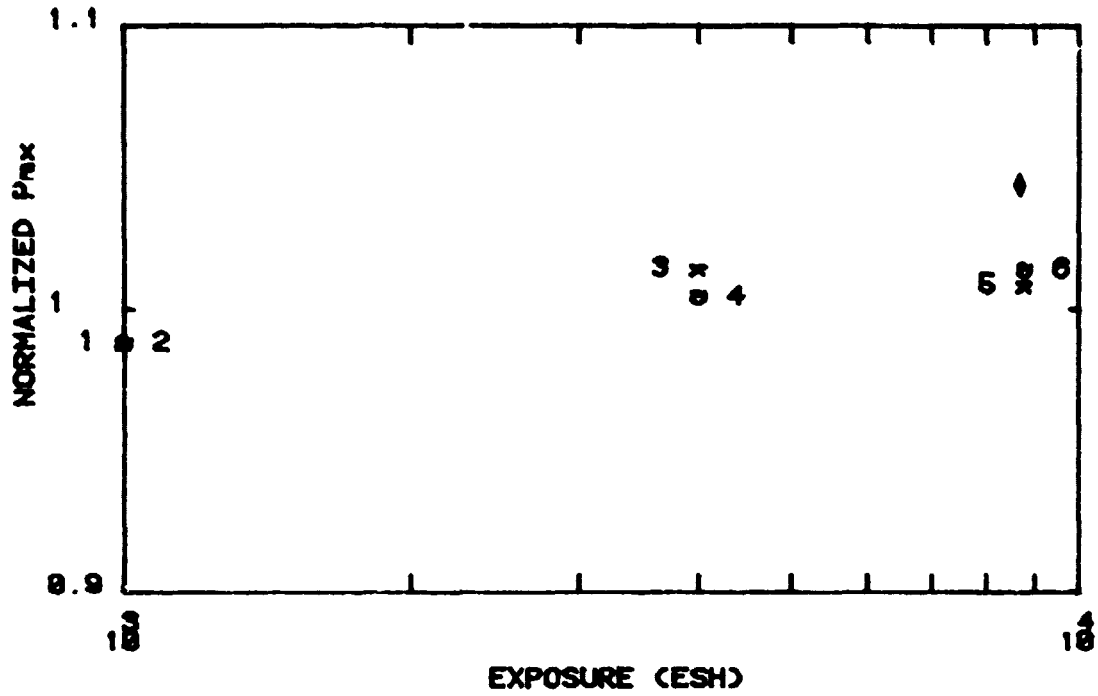

FIGURE 185. MODULE NUMBER 2 UV IRRADIATION IN SITU

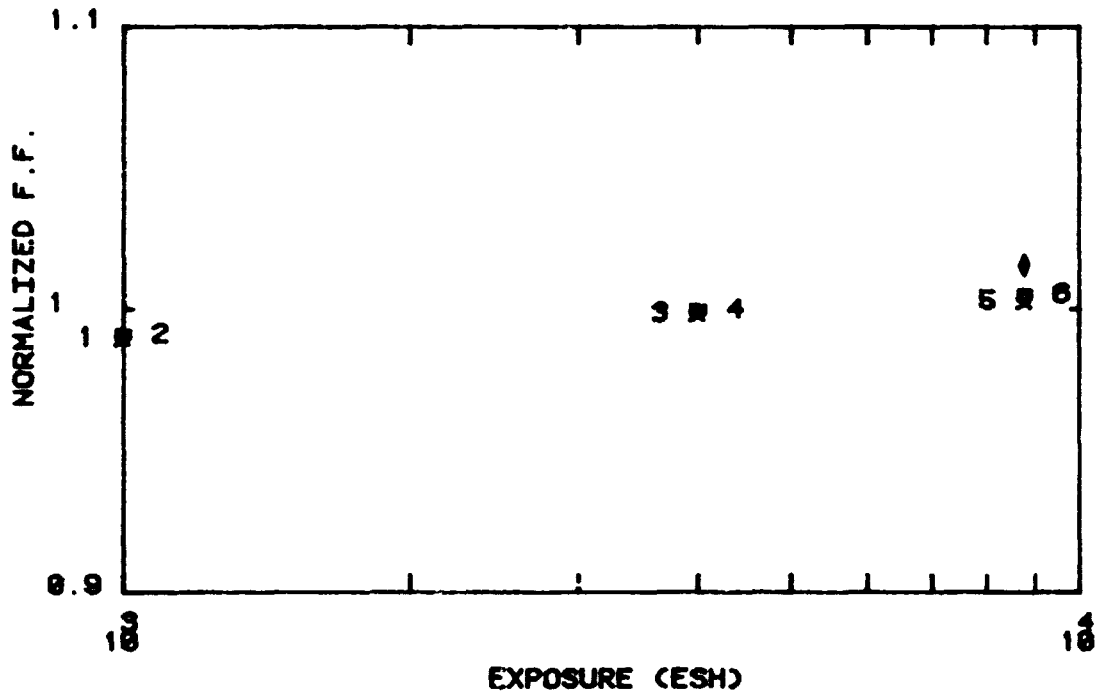

FIGURE 186. MODULE NUMBER 2 UV IRRADIATION IN SITU

TABLE 43A. TABULATED MODULE 2 DATA - UV IRRADIATION

MODULE NUMBER 2 UV IRRADIATION EX-SITU
 TEMP. (C): 25 AREA: 36 INTENSITY 1*AM0

Serial Number	Level Number	Isc (mA)	Isc/Isc0	Voc (mV)	Voc/Voc0	Pmx (mW)	Pmx/Pmx0	Fill Fac	F.F./F.F.0
1102	0	179.3	1.000	1657.3	1.000	477.95	1.000	0.760	1.000
1102	1	391.7	1.033	1662.5	1.003	499.29	1.045	0.767	1.008

MODULE NUMBER 2 UV IRRADIATION IN SITU
 TEMP. (C) 25 AREA 36 INTENSITY 1*AM0

Level Number	AVERAGE Isc/Isc0	AVERAGE Voc/Voc0	AVERAGE Pmx/Pmx0	AVERAGE F.F./F.F.0
0	1.000	1.000	1.000	1.000
1	0.998	1.001	0.989	0.990
2	0.994	1.004	0.989	0.992
3	1.013	1.003	1.015	0.999
4	1.002	1.003	1.005	1.000
5	1.004	1.002	1.009	1.003
6	1.005	1.004	1.015	1.006

TABLE 43B. TABULATED MODULE 2 DATA - UV IRRADIATION

MODULE NUMBER 2 UV IRRADIATION IN SITU
 TEMP. (C): 25 AREA: 36 INTENSITY 1*AM0

Serial Number	Level Number	Isc (mA)	Isc/ Isco	Voc (mV)	Voc/ Voco	Pmx (mW)	Pmx/ Pmxo	Full Fac.	F. F. / F. F. o
1102	0	377.3	1.000	1651.2	1.000	469.87	1.000	0.754	1.000
1102	1	376.5	0.998	1652.1	1.001	464.76	0.989	0.747	0.990
1102	2	374.8	0.994	1657.3	1.004	464.63	0.989	0.748	0.992
1102	3	382.3	1.013	1656.1	1.003	477.05	1.015	0.753	0.999
1102	4	377.9	1.002	1657.0	1.003	472.39	1.005	0.755	1.000
1102	5	378.7	1.004	1654.9	1.002	474.29	1.009	0.757	1.003
1102	6	379.3	1.005	1657.3	1.004	476.81	1.015	0.759	1.006

ORIGINAL PAGE IS
OF POOR QUALITY

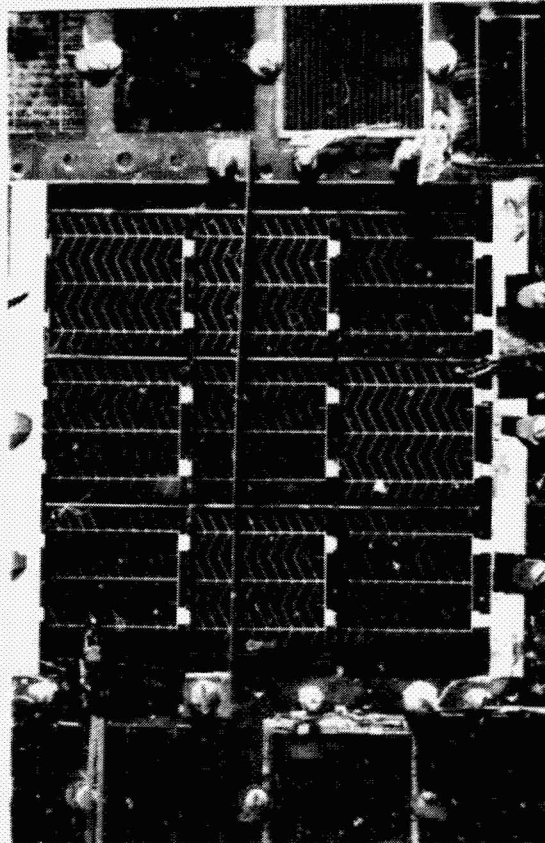

FIGURE 187. JPL MODULE (1102) AT COMPLETION OF EXPOSURE,
POST-EXPOSURE UV

S/N : 1102	LEVEL : 0	1
TEMP: 25 C	ISC(MA) : 378.3	391.7
AREA: 36 CM^2	VOC(MV) : 1657.3	1662.5
INT. : 1*AM0	PMAX(MW): 478.0	499.3
	F.F. : 0.760	0.767

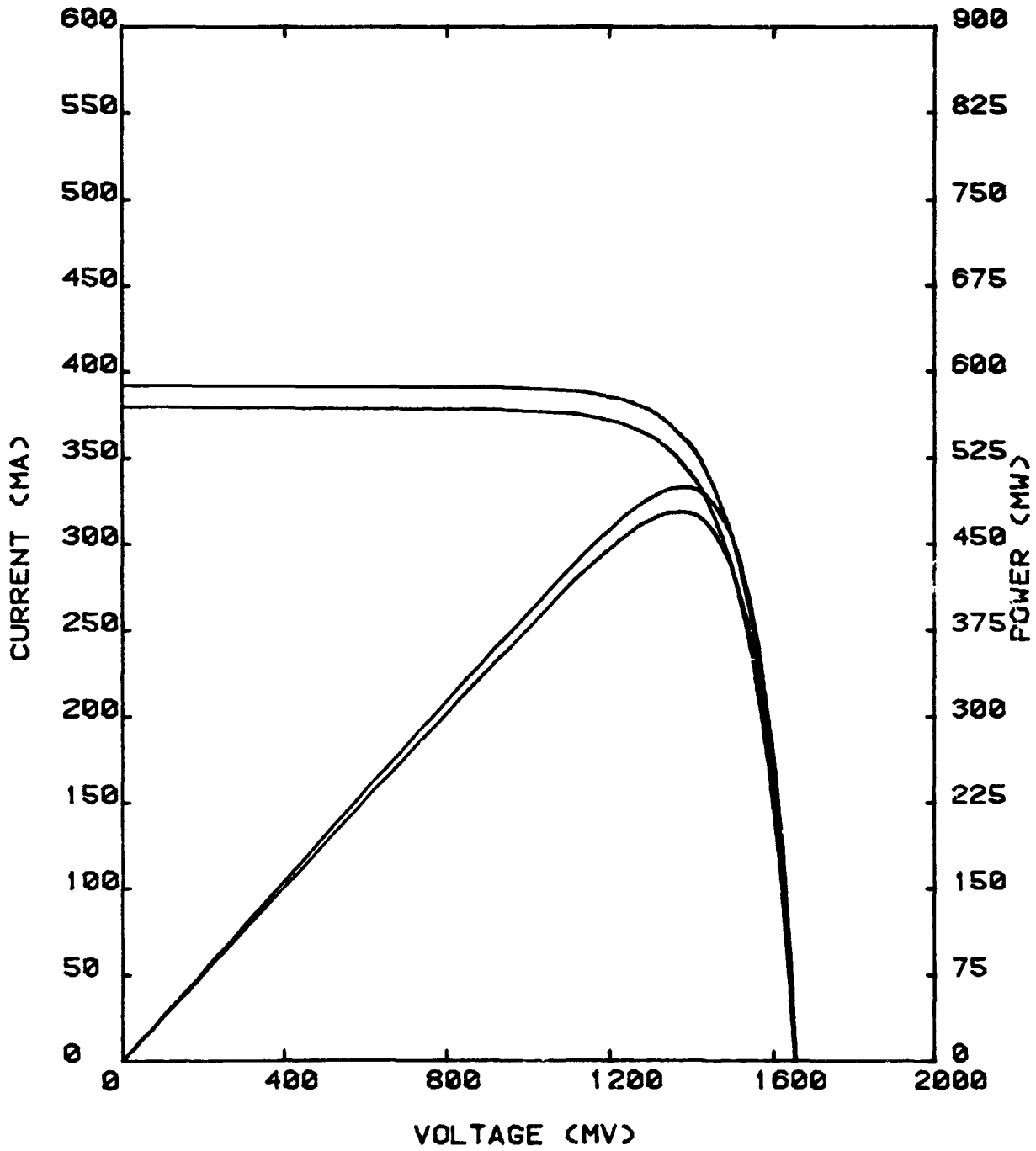

FIGURE 188.
 MODULE NUMBER 2 UV IRRADIATION EX-SITU
 0180-26590-1
 255

7.0 SUMMARY OF RESULTS

7.1 INTRODUCTION

Current and projected trends in space solar power systems require larger and more efficient photovoltaic arrays. Thus, the increased emphasis on the power/weight ratio of solar cell arrays and on improving the economy of manufacture of these structures has required new efforts to discover materials suitable for use as solar cell covers. As these new materials are being developed, it is necessary to conduct evaluation testing of these new materials and/or methods, to determine their feasibility for various space missions. During this program, laboratory tests that provide a basis for meaningful evaluation have been conducted under conditions which closely approximate the environmental conditions of space. The materials tested include several new candidates for space solar array encapsulants. These materials are 1) 0211 Ceria-doped micro-sheet, 2) FEP-A coatings, 3) DC 93-500 adhesive, 4) PFA "hard coated," 5) GE 615/UV-24 and 6) electrostatically bonded 7070 glass.

There were fifteen each of nine types of individual test specimens (2 cm x 2 cm) and two 3 x 3 cell modules provided by NASA-Lewis Research Center for this program. The test was divided into three separate environmental factors: 1 MeV electrons interspersed with thermal cycling, 0.5 MeV protons interspersed with thermal cycling and ultraviolet exposure interspersed with thermal cycling. There were five samples of each type in each environment with the two modules being exposed only in the ultraviolet test. The total fluence exposure was done in increments and each incremental fluence or exposure was followed by a set of fifteen thermal cycles in vacuum. There were four incremental fluence levels of electrons that reached a total fluence of $1 \times 10^{16} \text{ e/cm}^2$. There were two incremental fluence levels of protons that reached a total fluence of $3.3 \times 10^{15} \text{ p/cm}^2$. The UV exposure was divided into three increments with a total exposure of 8,760 ESH. The thermal cycling range was $-175^\circ\text{C} \pm 10^\circ\text{C}$ to $+55^\circ\text{C} \pm 5^\circ\text{C}$.

Measurements of the I-V characteristics of each specimen were made in situ prior to, between and following each irradiation and set

of 15 thermal cycles. Specially prepared silicon cells were used as control cells to be exposed to the same conditions as the covered cells. Bare silicon cells, protected from the radiation environment, were used as monitor cells for adjustment of the light intensity during the in situ I-V measurements.

7.2 CONCLUSIONS

It should be mentioned that while some types of samples were in poor condition at the end of the electron or proton environment tests, the total fluence reached in each test was extreme and may not represent fluences reached in any particular mission. For this reason, it is important to also analyze the test results of intermediate fluences. To relate this work to an actual mission one must know the exact orbit parameters and use the proper radiation model to predict the radiation environment the solar cells are to encounter. The fluence levels expressed in this report are the fluences impinging on the surface of the samples.

The results will be summarized by sample type with all three environments discussed before continuing to the next sample type. Where it was possible damage thresholds and limits of reliable use are discussed. Table 44 is a summary of the test results at the maximum fluence or exposure the samples received.

7.2.1 A Series

(OCLI 8-mil 10 Ω -cm BSF/R cell, 4-mil 0211 ceria-doped cover, 0.5 mil 93-500 adhesive)

These samples responded as one would predict. At an electron fluence of 5×10^{14} , I_{SC} lost 14% (11% from cell and 3% from cover) with the loss increasing to 32% (27% from cell and 5% from cover) at 1×10^{16} e/cm². Therefore, the electron irradiation caused a 3-5% transmission loss in the 0211 microsheet cover. In the proton environment the 0211 microsheet was thick enough to stop the protons and protect the cell from proton damage. There was no transmission loss in the 0211. In the UV test there was a transmission loss of 2% to 7% from 1000 ESH to

TABLE 4.4. SUMMARY OF RESULTS

CELL-COVER-ADHESIVE COMBINATION	SIMULATION ENVIRONMENT		
	1.0 MeV ELECTRONS WITH THERMAL CYCLING	0.5 MeV PROTONS WITH THERMAL CYCLING	UV EXPOSURE WITH THERMAL CYCLING
A SERIES - Sec. 6.4 Cell - OCLI 8-mil 10 Ω -cm, BSF/R Cover - 4 mil O211 Ceria doped Adhesive - 0.5 mil DC 93-500	5% transmission loss in O211	O211 stopped protons thus no damage to sample	7% transmission loss due to possible contamination, O211 microsheet darkening or DC 93-500 darkening
C SERIES - Sec. 6.5 Cell - OCLI 2-mil, 10 Ω -cm, Ta ₂ O ₅ BSF Cover - 2 mil FEP-A Back - 1 mil Kapton Adhesive - 2 mil DC 93-500 front & back	FEP-A hardened, cracked and blistered	4.5% transmission loss in FEP-A	13% transmission loss due to possible contamination, FEP-A darkening or DC 93-500 darkening
D SERIES - Sec. 6.6 Cell - OCLI 8-mil, 10 Ω -cm, BSF/R Cover - 1.5 mil DC 93-500	3-4% transmission loss in DC 93-500	DC 93-500 hardened with protons and cracked badly	14% transmission loss due to DC 93-500 darkening or possible contamination
E SERIES - Sec. 6.7 Cell - Spectrolab 10 mil, 10 Ω -cm, Series 4500 Cover - 2-mil GE 615/UV-24	No transmission loss in GE 615/UV-24	GE 615/UV-24 hardened with protons and cracked badly	25% transmission loss in GE 615/UV-24
P SERIES - Sec. 6.8 Cell - Solarex 2-mil, 2 Ω -cm Ta ₂ O ₅ Cover - 0.5 mil GR 650	Failed mechanically due to thermal cycling	GR 650 allowed protons to severely degrade cells	9% transmission loss due to possible contamination or darkening of the GR 650
GE CELL - Sec. 6.9 Cell - Solarex 2-mil Cover - 2-mil PFA "Hard-coated" Back - 1 mil Kapton Adhesive - DC 93-500 front & back	PFA became brittle with electron and cracked badly making samples useless	PFA covers blistered and peeled off making samples useless	Cracks or darkening in PFA and darkening of DC 93-500 caused 13% transmission loss
DOUBLE NUMBER CELLS - Sec. 6.10 Cell - Spectrolab 2-mil, Texturized BSF Cover - 2 mil O211 Back - 2 mil FEP-20C, 1.5 mil fiberglass 2 mil FEP-20C, 1 mil Kapton Adhesive - 2 mil FEP-A	FEP-A adhesive hardened and the covers came off in thermal cycling	Cover stopped protons thus no damage to samples	No damage
ESB CELLS - Sec. 6.11 Cell - ASEC, 2-mil, 50 Ω /sq. Cover - 2 mil 7070	Insufficient data to evaluate	Cover stopped protons thus no damage to cells	No damage
B SERIES - Sec. 2.1 Cell - 2 mil Cover - 2 mil FEP-A Back - 1 mil Kapton Adhesive - GE 6574 front & back	These samples did not pass a preliminary thermal cycling test. The cover debonded from cell after a few thermal cycles. They were not included further in the evaluations.		
Module 1 (made by NASA-Lewis) - Sec. 6.12 Cell - 2 mil Cover - 7070 glass Adhesive - 1 mil FEP-C Back - 0.5 mil FEP-20C, 1 1/2 mil fiberglass 0.5 mil FEP-20C, 0.3 mil Kapton	---	---	10% transmission loss before cleaning - 2.7% after. Possibly due to FEP-C adhesive
Module 2 (made for JPL) - Sec. 6.13	---	---	

D180-26590-1
258

8760 ESH. The cause of the loss was one or more of the following: (1) contamination during the UV exposure, (2) darkening of the 0211 microsheet or (3) darkening of the DC 93-500 adhesive. It is not possible to separate the causes because of the presence of some contamination during this UV exposure as explained in Section 5.3. However, it is felt that some portion of the 7% loss is caused by the DC 93-500 adhesive and 0211 microsheet.

7.2.2 C Series

(OCLI 2-mil, 10 Ω -cm BSF cell with Ta₂O₅, 2 mils FEP-A cover, 1 mil Kapton back and 2 mils of DC 93-500 adhesive on front and back.)

In the electron test the sample survived to a fluence between 1×10^{15} e/cm² and 5×10^{15} e/cm². By 5×10^{15} e/cm² the FEP-A was becoming hard and then the thermal cycling caused blistering. The protons caused the FEP-A to start becoming hazy at 3×10^{14} p/cm² and by 3.3×10^{15} p/cm² there was a 4.5 percent transmission loss. In the UV test there was a 6% to 13% transmission loss from 1000 ESH to 8760 ESH. The loss was caused by one or more of the following: (1) contamination during the UV exposure (see Section 5.3), (2) darkening of the FEP-A or (3) darkening of the DC 93-500. The reaction, if any, between the FEP-A and the contamination is unknown but the contamination was not felt to be responsible for the entire transmission loss.

7.2.3 D Series

(OCLI 8-mil 10 Ω -cm BSF/R cell, 1.5 mil 93-500 cover)

In the electron test there was a 13% to 30% loss in I_{sc} from 5×10^{14} e/cm² to 1×10^{16} e/cm². When the bare cell electron damage was subtracted it was found there was a 3 to 4 percent transmission loss in the DC 93-500. In the proton test cracks were apparent in the DC 93-500 at the intermediate fluence of 3×10^{14} p/cm². The DC 93-500 hardened during the proton irradiations and then cracked badly during thermal cycling. In the UV exposure there was a 7% to 14% loss from 1000 ESH to 8760 ESH. The loss was caused by either one or a combination of the

darkening of the DC 93-500 or contamination during the UV exposure.

7.2.4 E Series

(Spectrolab 10-mil 10 Ω -cm, series 4500 (K 4 1/2) cell, 2 mils of GE 615/UV-24 as a cover.)

During the electron test there was no degradation of the GE 615/UV-24 throughout the total fluence of 1×10^{16} e/cm². In the proton test cracks appeared in the cover material after the intermediate fluence of 3×10^{14} p/cm² and 15 thermal cycles. The protons caused the GE 615/UV-24 to become brittle and then crack during thermal cycling. Therefore, the threshold for embrittlement is below 3×10^{14} p/cm². In the UV test it was found that I_{sc} degraded from 11% at 1000 ESH to 25% at 8760 ESH. The samples had a yellowish appearance at 4000 ESH indicating that the degradation was due to transmission loss in the cover material. The high transmission loss under UV exposure and the proton embrittlement would indicate that using GE 615/UV-24 as a cover alone is not advisable.

7.2.5 P Series

(Solarex 2-mil 2 Ω -cm with Ta₂O₅ cell, 0.5 mil of GR 650 as a cover.)

During the electron test the delicate samples cracked and broke due to thermal cycling induced mechanical stresses. There were no performance conclusions made. During the proton test the samples again cracked; however, there was enough data to show that I_{sc} degraded 90 percent at the intermediate fluence of 3×10^{14} p/cm². It appears that the GR 650 either had many holes in it or it was just not thick enough to stop the protons. During the UV test it was found that I_{sc} degraded from 2% at 1000 ESH to 9% at 8760 ESH. The cause for the loss is either one or a combination of darkening of the GR 650 or contamination during the UV exposure. The loss is not large indicating that either or both causes are not great.

Improvement in the method of applying the GR 650 and determining the proper thickness for the mission and proper mounting techniques on the panels could make this type of sample a candidate for use. Additional testing would be required to verify that the improvements were successful.

7.2.6 GE Cells

(Solarex 2-mil cell, 2-mil PFA "Hard-coated" cover, 1 mil Kapton back, DC 93-500 adhesive front and back.)

In the electron test the electrons caused the PFA to become brittle and then crack during thermal cycling. At a fluence of 1×10^{15} e/cm² the PFA had already become brittle and cracked during the thermal cycles that followed. Further electron irradiation and thermal cycling made the cracking worse. In the proton test the cover started to curl and blister at or before the 3×10^{14} p/cm² fluence. Further, irradiation caused worse blistering and peeling. During the UV exposure small hair-line cracks began to show up after 4000 ESH and became worse by the end of the 8760 ESH exposure. There was a 13 percent drop in I_{sc} over the entire test caused by one or more of the following: (1) cracks in the PFA scattering the solar spectrum, (2) darkening of the PFA cover or (3) darkening of the DC 93-500. The amounts of transmission loss could not be separated.

7.2.7 Double Number Cells

(Spectrolab 2 mil space-qualified texturized BSF cells, 2-mil 0211 cover; 2 mil FEP-A adhesive; 2 mil FEP-20C, 1 1/2 mil fiberglass, 2 mil FEP-20C and 1 mil Kapton backing.)

In the electron test the first indication of hardening of the FEP-A adhesive occurred at 1×10^{15} e/cm². The thermal cycling caused the cover to loosen due to the flexing of the cell-cover system. As the FEP-A hardened and was thermal cycled it became hazy. When the samples were removed from the sample plate the backing separated from the cell. In the proton test the 0211 cover stopped the protons as expected

and therefore there was no damage to the cells. The UV exposure did not affect these samples. It was not possible to determine if the 0211 cover had a UV filter therefore the lack of transmission loss cannot be attributed to the FEP-A adhesive withstanding the UV exposure. In fact, in light of the ATS-6 results* where an early 2% loss in I_{SC} due to UV effects was observed in cells with FEP used as a cover adhesive without a UV rejecting filter, it would appear that there was a UV rejecting filter on the double number cells.

7.2.8 Electrostatically Bonded Cells (ESB)

(ASEC 2 mil, BSF/R, 50 Ω /sq., 0.2 μ junction depth; 2-4 mil 7070 glass electrostatically bonded as a cover.)

In the electron test the first visible damage was observed after a fluence of 1×10^{15} e/cm² and 15 thermal cycles when there were cracks in the covers or the covers had come off. This continued through the total fluence of 1×10^{16} e/cm² and 45 thermal cycles. There was however, one cell that did not crack throughout the entire test. It should be mentioned that the cells used in this test were some of the first cells made during the parameter optimization phase of the electrostatic bonding program (NAS3-22216) and did not have the quality bond that was later achieved as demonstrated in the UV test.

In the proton test the thermal cycling appeared to cause the cracking of one cover and cell. The proton irradiation also caused the samples to curl on the ends. It is thought that the protons may be compacting the glass at the surface therefore changing its density

*L. J. Goldhammer and Luther W. Slifer, Jr., "Summary Results of the ATS-6 Solar Cell Flight Experiment," Proceedings of the Fourteenth IEEE Photovoltaic Specialists Conference, Jan. 1980.

which creates shear stress when the glass is heated. These surface stresses on only one surface resulted in the observed curling. The 7070 glass cover was thick enough to stop the protons so that there was no electrical degradation.

In the UV exposure there was no electrical or visual degradation. The samples withstood thermal cycling very well.

7.2.9 B Series

(2-mil cell, 2-mil FEP-A cover, 1-mil Kapton back, GE 6574 front and back as adhesive.)

These samples were not included in the test program. It was found in a preliminary thermal cycling test that the covers debonded from the cell after a few thermal cycles. The GE 6574 apparently was not able to hold the cover and cell together at low temperatures.

7.2.10 Module 1 (made by NASA-Lewis)

(2-mil cell; 7070 cover; 1-mil FEP-C adhesive; 1/2 mil FEP-C, 1 1/2 mil Fiberglass, 1/2 mil FEP-C, 0.3 mil Kapton back; 0.5 mil silver interconnect.)

This module was involved in the UV exposure only. There was about 1/3 of the module that appeared hazy at the completion of the test. It was found that the hazy region could be wiped off after the module was removed from the chamber. This indicates that the hazy region was contamination from the vacuum chamber. There was a 10% loss in I_{SC} before removing the contamination and a 2.7% loss after removing the contamination. The 2.7% loss is minimal and may be from incomplete removal of contaminants or early UV effects on the FEP-C adhesive as described in the ATS-6 solar cell flight experiment*.

*L. J. Goldharmer and Luther W. Slifer, Jr., "Summary Results of the ATS-6 Solar Cell Flight Experiment," Proceedings of the Fourteenth IEEE Photovoltaic Specialists Conference, Jan. 1980.

7.2.11 Module 2 (made for JPL by TRW)

(2-mil Solarex cell with Ta₂O₅, 3-mil O211 cover with DC 93-500 adhesive.)

This module was only tested in the UV exposure test. The module showed no degradation whatever. The results indicate that up to 8760 ESH there is no significant darkening of the O211 cover or the DC 93-500 adhesive.

7.3 RECOMMENDATIONS

Some general comments and recommendations can be made from the test results of this program.

The electrostatically bonded (ESB) cells showed great promise. They survived well in the proton and UV tests and would have survived the electron test if they had not been the first cells produced during the parameter optimization task of the ESB contract (NAS3-22216). Additional testing is recommended in all three environments using improved mounting and thermal cycling techniques for thin solar cells and the latest ESB technology cells.

FEP-A used as a cover or as an adhesive showed signs of embrittlement at electron fluences of 1×10^{15} e/cm². For proton environments between 3×10^{14} p/cm² and 3.3×10^{15} p/cm² the FEP-A covers became hazy and caused transmission loss of 4-5%. The UV results were difficult to separate for the FEP-A covers; however, the FEP-A adhesive showed no damage. The results indicate the FEP-A covers or adhesives are only useful if used in environments which have 1 MeV electron fluences less than 1×10^{15} e/cm² and 0.5 MeV proton fluences less than 5×10^{14} p/cm². These restrictions limit the use of the FEP-A to shorter missions than other materials.

PFA "hard coat" used as a cover is not recommended due to embrittlement and blistering in the electron and proton environments.

DC 93-500 and GE 615/UV-24 are not recommended for use as covers only due to the hardening and cracking caused by protons and thermal cycling.

The use of GR 650 as a cover material showed promise in the electron and UV environments. However, the protons were able to penetrate

the material. Improvements in applying the GR 650 could increase the proton hardness to acceptable levels. Additional proton environment testing would be required to prove hardness.

It is clear that some of the materials included in this program show promise. Further improvements in application of the materials to the solar cell and then evaluation testing in simulated environments is required.