

N O T I C E

THIS DOCUMENT HAS BEEN REPRODUCED FROM
MICROFICHE. ALTHOUGH IT IS RECOGNIZED THAT
CERTAIN PORTIONS ARE ILLEGIBLE, IT IS BEING RELEASED
IN THE INTEREST OF MAKING AVAILABLE AS MUCH
INFORMATION AS POSSIBLE

9950-355

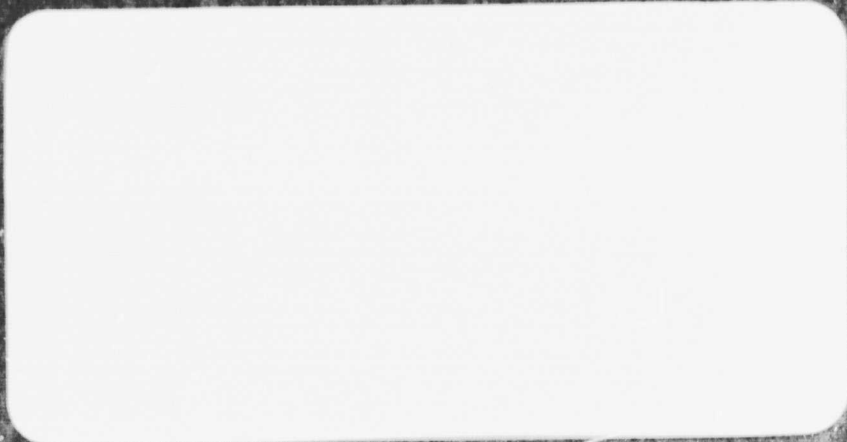

(NASA-CR-163037) DESIGN TRADEOFF STUDIES
AND SENSITIVITY ANALYSIS, APPENDICES B1 - B4
(South Coast Technology, Inc.) 190 p
HC A09/MF A01

N80-27225

CSSL 13F

Unclas

G3/85

27872



**SOUTH COAST
TECHNOLOGY, INC.**
Santa Barbara, California

A P P E N D I C E S B 1 - B 4

DESIGN TRADEOFF STUDIES

AND

SENSITIVITY ANALYSIS

PREPARED FOR:

JET PROPULSION LABORATORIES

CONTRACT NUMBER 955189

PREPARED BY:

SOUTH COAST TECHNOLOGY, INC.

MAY 25, 1979

TABLE OF CONTENTS

A P P E N D I C E S

B1. COMPUTER PROGRAM DOCUMENTATION
FOR "HYBRID". B-1

B2. MATERIAL SUBSTITUTION STUDY
ADVANCED HYBRID VEHICLE B-41

B3. MARKET POTENTIAL FOR HYBRID
VEHICLES. B-82

B4. BATTERY COMPARTMENT WEIGHT
DISTRIBUTION AND VEHICLE
HANDLING DYNAMICS B-180

A P P E N D I X B I

DOCUMENTATION FOR "HYBRID"

COMPUTER PROGRAM

B1.1 PROGRAM DESCRIPTION

HYBRID computes the fuel and energy consumption of a hybrid vehicle with a bi-modal control strategy over specified component driving cycles. Fuel and energy consumption are computed separately for the two modes of operation. The program also computes yearly average fuel and energy consumption using a composite driving cycle which varies as a function of daily travel.

The distribution of daily travel is specified as input data, as well as the weights which the component driving cycles are given in each of the composite cycles

EQUATIONS FOR 'HYBRID' COMPUTER PROGRAM

1. REQUIRED TRACTIVE EFFORT

1.1 ACCELERATION

$$F_{AC} = \left(M_T + \frac{I_{DL}}{R_T^2} \right) a_V \quad (N)$$

1.2 ROLLING RESISTANCE

$$F_R = M_T g (C_1 + C_2 V) \quad (N)$$

1.3 AERODYNAMIC DRAG

$$F_A = C_D A \cdot \frac{1}{2} \rho V^2 \quad (N)$$

1.4 NET TRACTIVE EFFORT

$$F_{NET} = F_A + F_R + F_{AC}$$

2. FINAL DRIVE ASSEMBLY

$$2.1 \quad T_{DO} = F_{NET} R_T$$

$$2.2 \quad T_{TO} = \left\{ \begin{array}{l} T_{DO} / (\mu_D r_D), \quad F_{NET} \geq 0 \\ T_{DO} \mu_D / r_D, \quad F_{NET} < 0 \end{array} \right\} \quad (N-M)$$

$$2.3 \quad \omega_{DO} = (60 / 2\pi) V / R_T \quad (RPM)$$

$$2.4 \quad \omega_{TO} = \omega_{DO} r_D$$

3. TRANSMISSION

$$3.1 \quad P_{50} = \left\{ \begin{array}{l} \frac{2\pi}{60,000} T_{TO} \omega_{TO} / \mu_T, F_{NET} \geq 0 \\ \frac{2\pi}{60,000} T_{TD} \omega_{TO} \mu, F_{NET} < 0 \end{array} \right\} \quad (\text{KW})$$

4. HEAT ENGINE/MOTOR/BRAKES (OUTPUT)

A. FOR $F_{NET} \geq 0$, $V > 0$, OR $Q_V > 0$

$$4.1 \quad P_{BRK} = 0 \quad (\text{MODE 1 AND MODE 2})$$

$$4.2 \quad P_{GO} = 0 \quad (\text{MODE 1 AND MODE 2})$$

A1. ON MODE 1:

$$4.3 \quad P_{EO} = \left\{ \begin{array}{l} 0, P_{50} \leq P_{EOMIN} \\ P_{EOMIN}, P_{EOMIN} < P_{50} \leq P_{MMAX} + P_{EOMIN} \\ P_{50} - P_{MMAX}, P_{MMAX} + P_{EOMIN} < P_{50} \end{array} \right\}$$

$$4.4 \quad P_{MO} = \left\{ \begin{array}{l} P_{50}, P_{50} \leq P_{EOMIN} \\ P_{50} - P_{EOMIN}, P_{EOMIN} < P_{50} \leq P_{MMAX} + P_{EOMIN} \\ P_{MMAX}, P_{MMAX} + P_{EOMIN} < P_{50} \end{array} \right\}$$

A2. ON MODE 2:

$$4.5 \quad P_{EO} = \begin{cases} P_{SO}, & P_{SO} \leq P_{HEMAX} \\ P_{HEMAX}, & P_{SO} > P_{HEMAX} \end{cases}$$

$$4.6 \quad P_{MO} = \begin{cases} 0, & P_{SO} \leq P_{HEMAX} \\ P_{SO} - P_{HEMAX}, & P_{SO} > P_{HEMAX} \end{cases}$$

B. FOR $V = a_v = 0$ (CAR AT REST, MODE 1 AND MODE 2)

$$4.7 \quad P_{EO} = P_{MO} = P_{GO} = P_{BRK} = 0$$

C. $F_{NET} < 0$ (DECELERATION, MODE 1 AND MODE 2)

$$4.8 \quad P_{MO} = P_{EO} = 0$$

$$4.9 \quad P_{GO} = \begin{cases} P_{SO}, & P_{SO} \geq P_{MMIN} \\ P_{MMIN}, & P_{SO} < P_{MMIN} \end{cases}$$

$$4.10 \quad P_{BRK} = \begin{cases} 0, & P_{SO} \geq P_{MMIN} \\ P_{SO} - P_{MMIN}, & P_{SO} < P_{MMIN} \end{cases} \quad *$$

* This representation is a bit fictitious in that it models the brakes as being at the transmission input. However, this is of no significance as far as the propulsion system computations are concerned.

5. HEAT ENGINE INPUT (FUEL, MODES 1 AND 2)

$$5.1 \quad F_c = \begin{cases} 0, & P_{EO} = 0 \\ P_{EO} \cdot \text{BSFC} = P_{EO} \cdot f(P_{EO}), & P_{EO} \neq 0 \end{cases} \text{ (gm/hr)}$$

6. BATTERY OUTPUT (ELECTRICAL, MODES 1 AND 2)

$$6.1 \quad P_B = \begin{cases} P_{NLD} + P_{mo}/\mu_m + P_{GO} \cdot \mu_G \mu_{RG} & \text{(MODE 1)} \\ P_{NLD} + P_{mo}/\mu_m + P_{GO} \cdot \mu_G \mu_{RG2} & \text{(MODE 2)} \end{cases}$$

**
 μ_{RG} and μ_{RG2} represent average battery regeneration efficiencies on Modes 1 and 2, respectively. μ_{RG2} is assumed to be higher than μ_{RG} because of the lower average state of charge on Mode 2.

7. ENERGY AND FUEL OVER THE INTERVAL (0, T) (MODE 1 AND MODE 2)

7.1 ROLLING RESISTANCE

$$E_R = 10^{-3} \int_0^T P_R dt = 10^{-6} \int_0^T F_R V dt \quad (\text{mJ})$$

7.2 AERODYNAMIC

$$E_A = 10^{-3} \int_0^T P_A dt = 10^{-6} \int_0^T F_A V dt \quad (\text{mJ})$$

7.3 FINAL DRIVE

$$E_D = 10^{-3} \int_0^T |P_T - P_D| dt = 10^{-6} \cdot \frac{2\pi}{60} \int_0^T |T_{T0} \omega_{T0} - T_{D0} \omega_{D0}| dt \quad (\text{mJ})$$

7.4 TRANSMISSION

$$E_T = \int_0^T |P_{S0} - P_T| dt = 10^{-3} \int_0^T |P_{S0} - \frac{2\pi}{60,000} T_{T0} \omega_{T0}| dt \quad (\text{mJ})$$

7.5 BRAKES

$$E_{BRK} = 10^{-3} \int_0^T |P_{BRK}| dt \quad (\text{mJ})$$

7.6 ENGINE OUTPUT

$$E_{EO} = 10^{-3} \int_0^T P_{EO} dt \quad (\text{mJ})$$

7.7 MOTOR/GENERATOR OUTPUT

$$E_{MO} = 10^{-3} \int_0^T P_{MO} dt \quad (\text{mJ})$$

$$E_{GO} = 10^{-3} \int_0^T P_{GO} dt \quad (\text{mJ})$$

7.8 BATTERY OUTPUT

$$E_B = 10^{-3} \int_0^T P_E dt \quad (\text{mJ})$$

7.9 FUEL

$$F_{CT} = \frac{1}{3600} \int_0^T F_C dt \quad (\text{g})$$

HYBRID

B-8

PARAMETERS		UNITS	DESCRIPTION	ORIGINAL PAGE IS OF POOR QUALITY
EQUATION	TRC.CAN			
	APWR	—	PHEZ, 20% matrix size	
	PHEZR0	KW	Heat engine power, nominal	
	FCDL	g/hr	Fuel consumption at idle (unsealed)	
	FUELSG		Fuel specific gravity	
	PHLE(20)	KW	Heat engine power (unsealed)	
BSFC	BSFC(20)		Brake specific fuel consumption	
μ_T	EMIT	—	Transmission efficiency	
	NDISCH	—	(DDISCH, CYCLES) matrix size	
	CHSEFF	—	Battery charging efficiency	
	DDISCH(20)		Battery discharge depth	
	CYCLES(20)	—	Number of cycles at battery discharge depth	
r_D	DRATIO	—	Differential ratio	
μ_D	EMUD	—	Differential efficiency	
R_T	RTIRE	m	Tire radius	
C_s	CTIRE1	—	Rolling resistance coefficient	
C_a	CTIRE2	—	Rolling resistance coefficient	
	NCYCLE	—	Number of driving cycles	
	NTL(3)	—	(TIME, SPEED) matrix size	
	NTRT(3)	—	Output, printout - for driving cycles	
	HUNIT:	—	MILES/HR to KM/HR conversion flag	
	DTC(3)	SEC	Time interval for driving cycles	
	TFC(3)	SEC	Final time for driving cycles	
	TTIME(3,200)	—	Time on driving cycles	
	SPEED(3,200)	KM/HR	Speed on driving cycles	
	NCONF	—	(DSUP, DNG, GAMMA, matrix size)	
	DSTAV	—	Average usage	
	DSUP(30)	KML	MAX. distance on driving cycle	} Trans Distribution
	DNG(30)	—	Fraction of total distance	
	GAMMA(30)	—	Driving cycle volume	
	NCASE	—	Number of cases	
P_{eomir}	PEOMIR	KW	Heat engine minimum power	
	LEFF		Battery discharge efficiency	
P_{emax}	PEEMAX	KW	Heat engine power, maximum	
P_{mmax}	PEMMAX	KW	Motor power, maximum	
P_{eomzn}	PEOMZN	KW	Motor power, minimum	
μ_r	EMR	—	Motor efficiency	
μ_g	EMIG	—	Generator efficiency (of motor)	
P_{NLD}	PEINLD	KW	Motor no-load input	
	WB	KG	Battery weight	
	EGMAX		Battery energy density	

ORIGINAL PAGE IS
OF POOR QUALITY

PARAMETERS		UNITS	DESCRIPTION
SYMBOL	DESCRIPTION		
μ_{gs}	EMURE	—	Average gear efficiency (of motor)
μ_{gs2}	EMURE2	—	Maximum gear efficiency (of motor)
m_r	VMASS	KG	Vehicle mass
I_{ol}	DLI		Driveline inertia
C_{DA}	CDA		Drag coefficient * Area

HYBRID

B-10

VARIABLES		UNITS	DESCRIPTION
SUBROUTINE	PROGRAM		
	A(3)	m/sec ²	Accelerations
	BLIFE :	Km	Battery life (expected)
	DBAR(30)	Km	Interpolated values of driving cycle distances
	DDAV	Km	Avg. distance on driving cycle
	DELT	SEC	Time interval size
	DIST(3)	M	Distance on each cycle
	DLOW	Km	Minimum distance on driving cycle
	DT	SEC	Time increment
P _B P _E	EB	MJ	Mode 1 battery power output
	EB2	MJ	Mode 2 battery power output
	ECAV	MJ/KM	Yearly average energy consumption
	ECBAR(30)	MJ/KM	Mode 1 composite cycles energy consumption
	ECBAR2(30)	MJ/KM	Mode 2 composite cycles energy consumption
	ECHE(3)	MJ/KM	Heat engine energy consumption, each cycle
	ECMAV(30)	MJ/KM	Mode averaged composite cycles energy consumption
	ECMNS(3)	MJ/KM	Mode 1 cycle energy consumption
	ECMNS2(3)	MJ/KM	Mode 2 cycle energy consumption
	ECSYS(3)	MJ/KM	System energy consumption each cycle
	EHEAV	MJ/KM	Yr. avg. heat engine energy consumption
	EHEBAR(30)	MJ/KM	Heat engine energy consumption, composite
	EK(30)	—	Runga-Kutta integration variables
	ESYSAV	MJ/KM	Yr. avg. system energy consumption
	ESYBR(30)	MJ/KM	System energy consumption, composite
	FNAV	g/km	Yearly average fuel consumption
	FBAR(30)	g/km	Mode 1 composite cycles fuel consumption
	FBAR2(30)	g/km	Mode 2 composite cycles fuel consumption
	FCIDLE	g/hr	Fuel consumption at idle (scaled)
	FCMAV(30)	g/km	Mode averaged composite cycles fuel consumption
	FCMNS(3)	g/km	Mode 1, cycle fuel consumption
	FCMNS2(3)	g/km	Mode 2, cycle fuel consumption
	FNAV	Km/g	Yr. avg. fuel economy
	HEFT	—	Heat engine energy fraction
	INT1	—	Function subroutine, 1 dimensional interpolation
	INT2	—	Function subroutine, 2 dimensional interpolation
	K	—	Incremented print flag
	NPRINT	—	Print flag for specified cycle
	NTIME	—	Number of time points for specified cycle
P _{BRK}	PBRK	KW	Mode 1 braking power output
	PBRK2	KW	Mode 2 braking power output

ORIGINAL PAGE IS
OF POOR QUALITY

VARIABLES		UNITS	DESCRIPTION
EQUATION	PROGRAM		
	P10	KW	Mode 1 engine power output
	P200	KW	Mode 2 engine power output
	PG0	KW	Mode 1 generator power output
	P300	KW	Mode 2 generator power output
	PHE(20)	KW	Heat engine power (scaled)
	PM0	KW	Mode 1 motor power output
	PM02	KW	Mode 2 motor power output
	PS0	KW	System power output
	RANGE(30)	KM	Range for new battery discharge limit
	RETRAC(30)	—	Fraction of total driving cycle
	SCALE	—	Heat engine scale factor
	SPEED(300)	KM/HK	Speeds for specified driving cycle
	T	SEC	Time (incremented for integration)
	TI	SEC	Final time for specified cycle
	TIME(300)	SEC	Times for specified driving cycle
	TIMEP	SEC	Time holder
V	Y(6)	m/sec	Velocities
M _T	YMASS2		Vehicle inertial mass
	VTMP	m/sec	Velocity hold
	VTMPL	m/sec	Velocity hold
	WPAV	KW/KM	Yr. avg. wall plug output
E _A	Y(1)	MJ	Aerodynamic energy loss
E _R	Y(2)	MJ	Rolling resistance energy loss
E _D	Y(3)	MJ	Differential energy loss
E _T	Y(4)	MJ	Transmission energy loss
	Y(5)	MJ	System output energy
E _{MO}	Y(6)	MJ	Motor output energy, Mode 1
	Y(7)	MJ	Motor output energy, Mode 2
E _{EO}	Y(8)	MJ	Engine output energy, Mode 1
	Y(9)	MJ	Engine output energy, Mode 2
E _{GO}	Y(10)	MJ	Generator output energy, Mode 1
	Y(11)	m/sec	Velocity
	Y(12)	KM	Distance
	Y(13)	MJ	Generator output energy, Mode 2
E _{BR1}	Y(14)	MJ	Brake output energy, Mode 1
	Y(15)	MJ	Brake output energy, Mode 2
F _{CT}	Y(16)	g.	Fuel output energy, Mode 1
	Y(17)	g.	Fuel output energy, Mode 2
E _B	Y(18)	MJ	Battery output energy, Mode 1
	Y(19)	MJ	Battery output energy, Mode 2

HYBRID

B-12

VARIABLE		UNITS	DESCRIPTION
EQUATION	PROGRAM		
	YDOT(J)	—	RUNGA-KUTTA integration variables
	YTMF(J)	—	RUNGA-KUTTA integration variables

SUBROUTINE VEHIC

VARIABLES		UNITS	DESCRIPTION
EQUATION	PROGRAM		
F_A	FA	N	Force of aerodynamic drag
F_{AC}	FAC	N	Force of acceleration
F_c	FC	g/hr	Mode 1 fuel consumption
	FC2	g/hr	Mode 2 fuel consumption
F_R	FR	N	Force of rolling resistance
F_{NET}	FNET	N	Net force on wheels
	PA	KW	Aerodynamic power
P_{BRK}	PBRK	KW	Mode 1 braking power output
	PBRK2	KW	Mode 2 braking power output
	PD	KW	Drive train power
P_{EO}	PEO	KW	Mode 1 engine power output
	PEO2	KW	Mode 2 engine power output
P_{GO}	PGO	KW	Mode 1 generator power output
	PGO2	KW	Mode 2 generator power output
P_{MO}	PMD	KW	Mode 1 motor power output
	PMD2	KW	Mode 2 motor power output
	PR	KW	Rolling resistance power
P_{SO}	PSO	KW	System power output
	PT	KW	Transmission power
ω_{DO}	RPMDO	RPM	Drive train output
ω_{TO}	RPMTO	RPM	Transmission output
T_{DO}	TDO	NT.M	Drive train output torque
T_{TO}	TTD	NT.M	Transmission output torque
	VMPS	m/sec	Velocity (meters/sec)
	YDOT(2)	—	Variables of integration

FORTRAN CODING FORM

GRC
GENERAL RESEARCH CORPORATION

PROGRAM
HYBRID

PAGE
2 OF **2**

ROUTINE
MAIN PROGRAM

STATE- MENT NO.	FORTRAN STATEMENT		SERIAL NUMBER
	0= ZERO 0= ALPHA 0	1= ONE 1= ALPHA 1	
1	TRAVEL DISTRIBUTION	DATA	
2	DISCOMP	DISCOMP	
3	DISUP(1)	GAMMA(1,1)	
4	DISUP(1)	GAMMA(1,1)	
5	DISUP(1)	GAMMA(1,1)	
6	DISUP(1)	GAMMA(1,1)	
7	DISUP(1)	GAMMA(1,1)	
8	DISUP(1)	GAMMA(1,1)	
9	DISUP(1)	GAMMA(1,1)	
10	DISUP(1)	GAMMA(1,1)	
11	DISUP(1)	GAMMA(1,1)	
12	DISUP(1)	GAMMA(1,1)	
13	DISUP(1)	GAMMA(1,1)	
14	DISUP(1)	GAMMA(1,1)	
15	DISUP(1)	GAMMA(1,1)	
16	DISUP(1)	GAMMA(1,1)	
17	DISUP(1)	GAMMA(1,1)	
18	DISUP(1)	GAMMA(1,1)	
19	DISUP(1)	GAMMA(1,1)	
20	DISUP(1)	GAMMA(1,1)	
21	DISUP(1)	GAMMA(1,1)	
22	DISUP(1)	GAMMA(1,1)	
23	DISUP(1)	GAMMA(1,1)	
24	DISUP(1)	GAMMA(1,1)	
25	DISUP(1)	GAMMA(1,1)	
26	DISUP(1)	GAMMA(1,1)	
27	DISUP(1)	GAMMA(1,1)	
28	DISUP(1)	GAMMA(1,1)	
29	DISUP(1)	GAMMA(1,1)	
30	DISUP(1)	GAMMA(1,1)	
31	DISUP(1)	GAMMA(1,1)	
32	DISUP(1)	GAMMA(1,1)	
33	DISUP(1)	GAMMA(1,1)	
34	DISUP(1)	GAMMA(1,1)	
35	DISUP(1)	GAMMA(1,1)	
36	DISUP(1)	GAMMA(1,1)	
37	DISUP(1)	GAMMA(1,1)	
38	DISUP(1)	GAMMA(1,1)	
39	DISUP(1)	GAMMA(1,1)	
40	DISUP(1)	GAMMA(1,1)	
41	DISUP(1)	GAMMA(1,1)	
42	DISUP(1)	GAMMA(1,1)	
43	DISUP(1)	GAMMA(1,1)	
44	DISUP(1)	GAMMA(1,1)	
45	DISUP(1)	GAMMA(1,1)	
46	DISUP(1)	GAMMA(1,1)	
47	DISUP(1)	GAMMA(1,1)	
48	DISUP(1)	GAMMA(1,1)	
49	DISUP(1)	GAMMA(1,1)	
50	DISUP(1)	GAMMA(1,1)	
51	DISUP(1)	GAMMA(1,1)	
52	DISUP(1)	GAMMA(1,1)	
53	DISUP(1)	GAMMA(1,1)	
54	DISUP(1)	GAMMA(1,1)	
55	DISUP(1)	GAMMA(1,1)	
56	DISUP(1)	GAMMA(1,1)	
57	DISUP(1)	GAMMA(1,1)	
58	DISUP(1)	GAMMA(1,1)	
59	DISUP(1)	GAMMA(1,1)	
60	DISUP(1)	GAMMA(1,1)	
61	DISUP(1)	GAMMA(1,1)	
62	DISUP(1)	GAMMA(1,1)	
63	DISUP(1)	GAMMA(1,1)	
64	DISUP(1)	GAMMA(1,1)	
65	DISUP(1)	GAMMA(1,1)	
66	DISUP(1)	GAMMA(1,1)	
67	DISUP(1)	GAMMA(1,1)	
68	DISUP(1)	GAMMA(1,1)	
69	DISUP(1)	GAMMA(1,1)	
70	DISUP(1)	GAMMA(1,1)	
71	DISUP(1)	GAMMA(1,1)	
72	DISUP(1)	GAMMA(1,1)	
73	DISUP(1)	GAMMA(1,1)	
74	DISUP(1)	GAMMA(1,1)	
75	DISUP(1)	GAMMA(1,1)	
76	DISUP(1)	GAMMA(1,1)	
77	DISUP(1)	GAMMA(1,1)	
78	DISUP(1)	GAMMA(1,1)	
79	DISUP(1)	GAMMA(1,1)	
80	DISUP(1)	GAMMA(1,1)	
81	DISUP(1)	GAMMA(1,1)	
82	DISUP(1)	GAMMA(1,1)	
83	DISUP(1)	GAMMA(1,1)	
84	DISUP(1)	GAMMA(1,1)	
85	DISUP(1)	GAMMA(1,1)	
86	DISUP(1)	GAMMA(1,1)	
87	DISUP(1)	GAMMA(1,1)	
88	DISUP(1)	GAMMA(1,1)	
89	DISUP(1)	GAMMA(1,1)	
90	DISUP(1)	GAMMA(1,1)	
91	DISUP(1)	GAMMA(1,1)	
92	DISUP(1)	GAMMA(1,1)	
93	DISUP(1)	GAMMA(1,1)	
94	DISUP(1)	GAMMA(1,1)	
95	DISUP(1)	GAMMA(1,1)	
96	DISUP(1)	GAMMA(1,1)	
97	DISUP(1)	GAMMA(1,1)	
98	DISUP(1)	GAMMA(1,1)	
99	DISUP(1)	GAMMA(1,1)	
100	DISUP(1)	GAMMA(1,1)	

Hybrid Flowchart

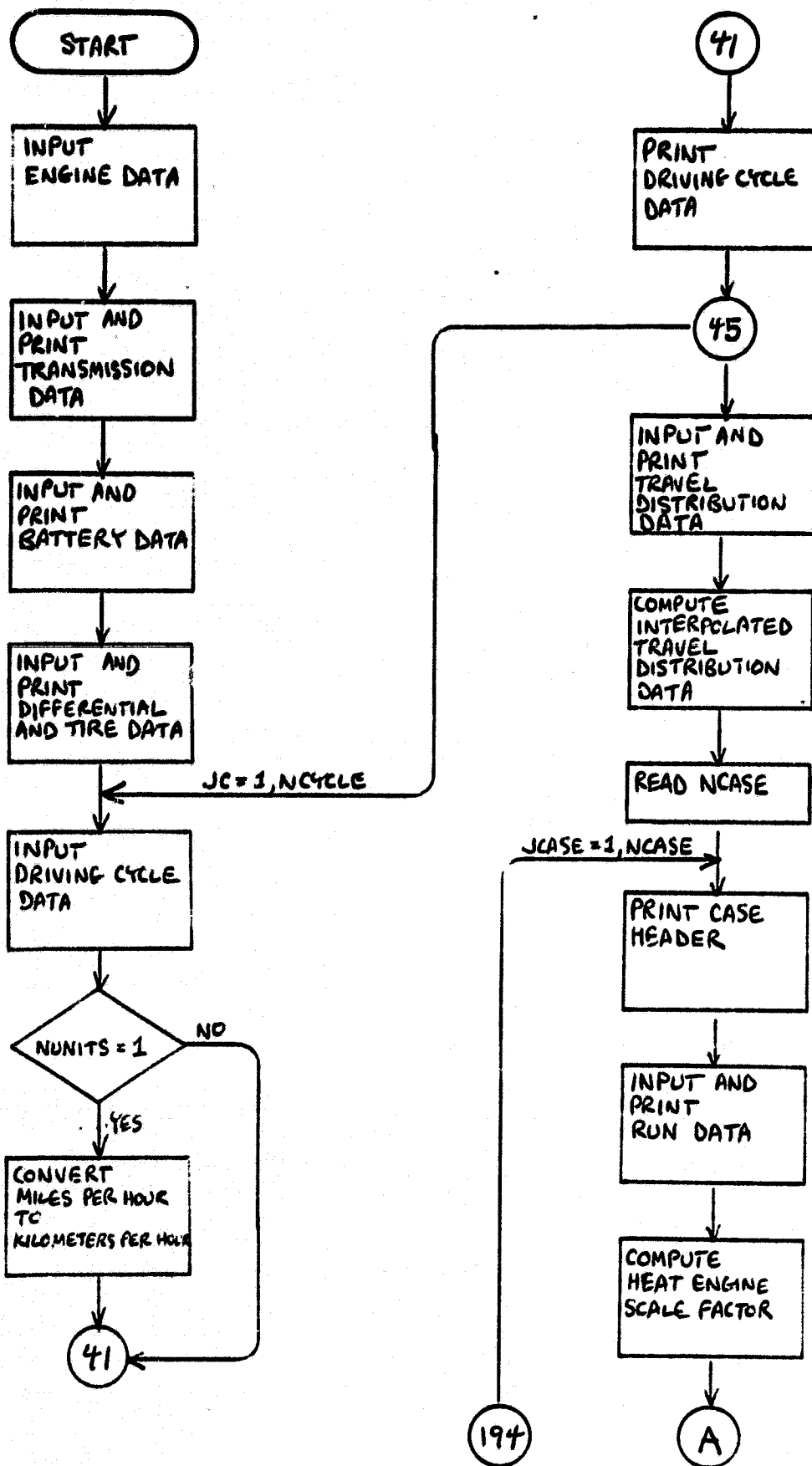

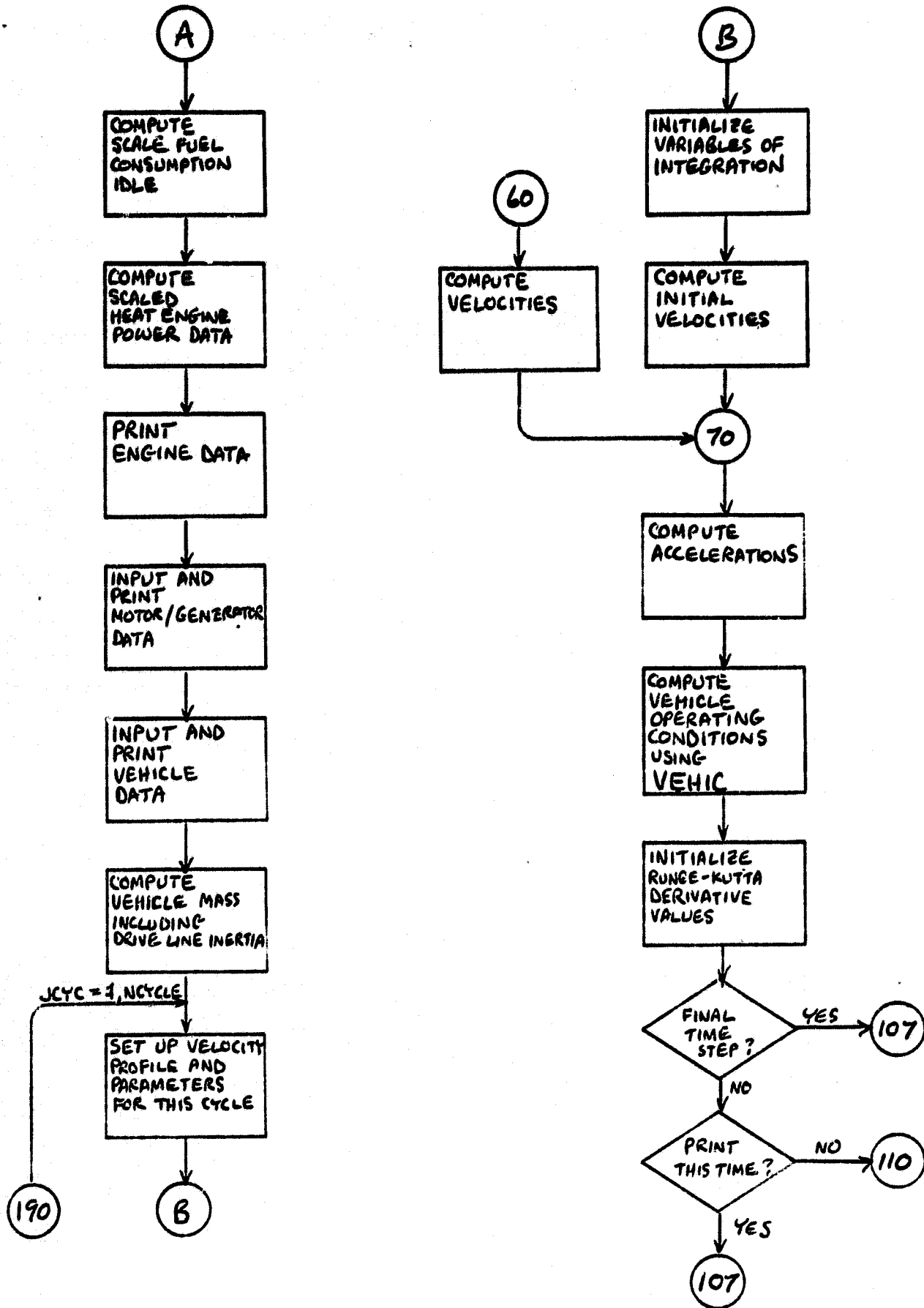

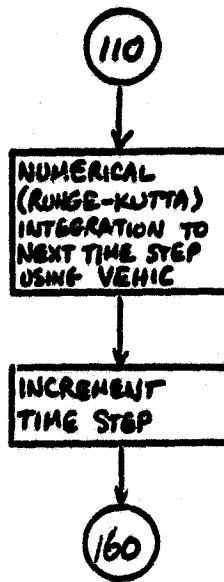
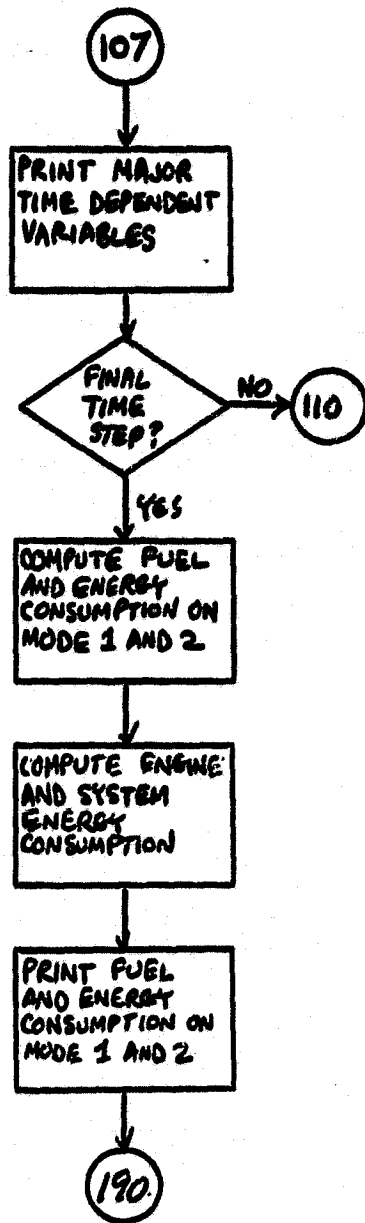

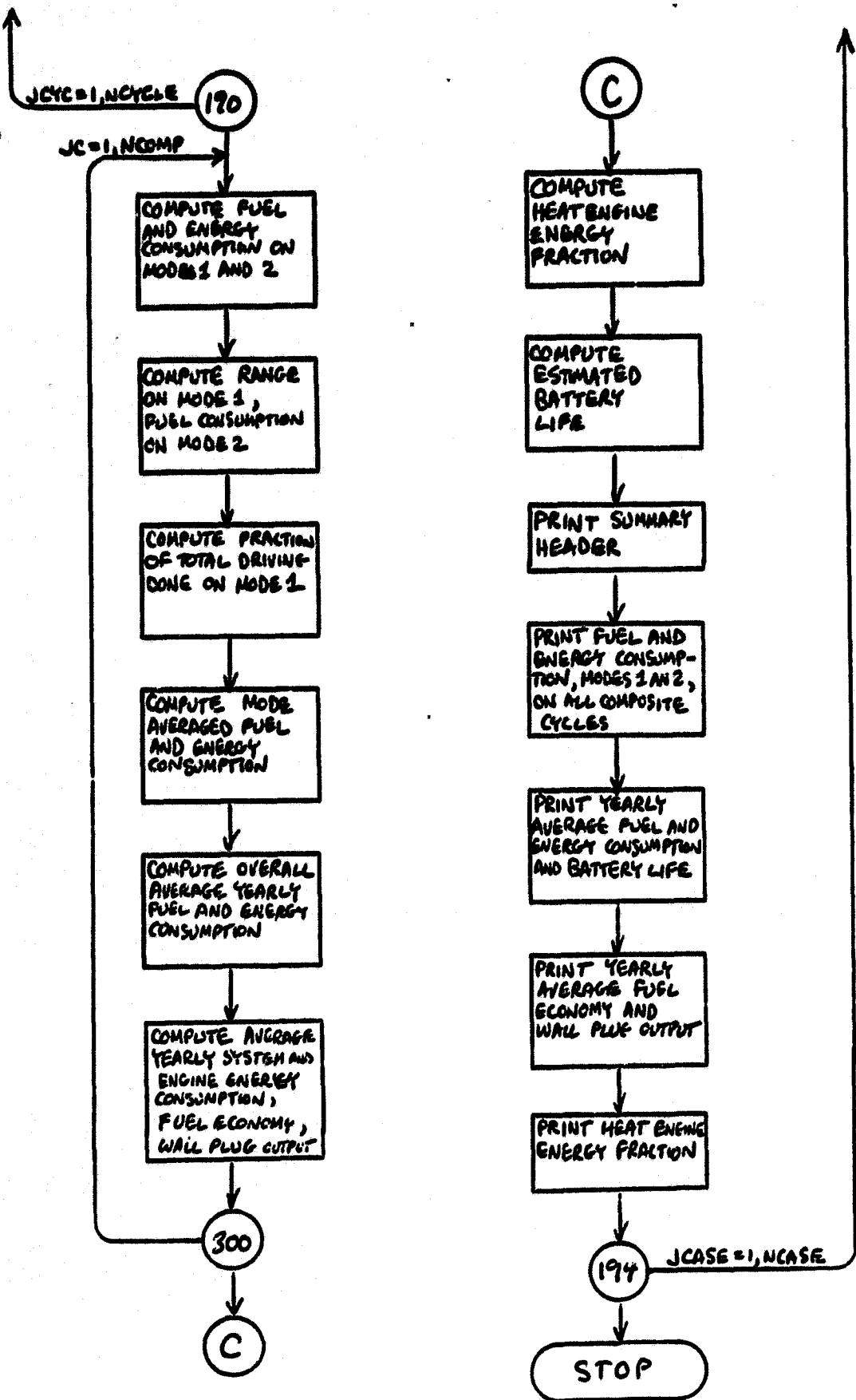

VEHIC Subroutine Flowchart

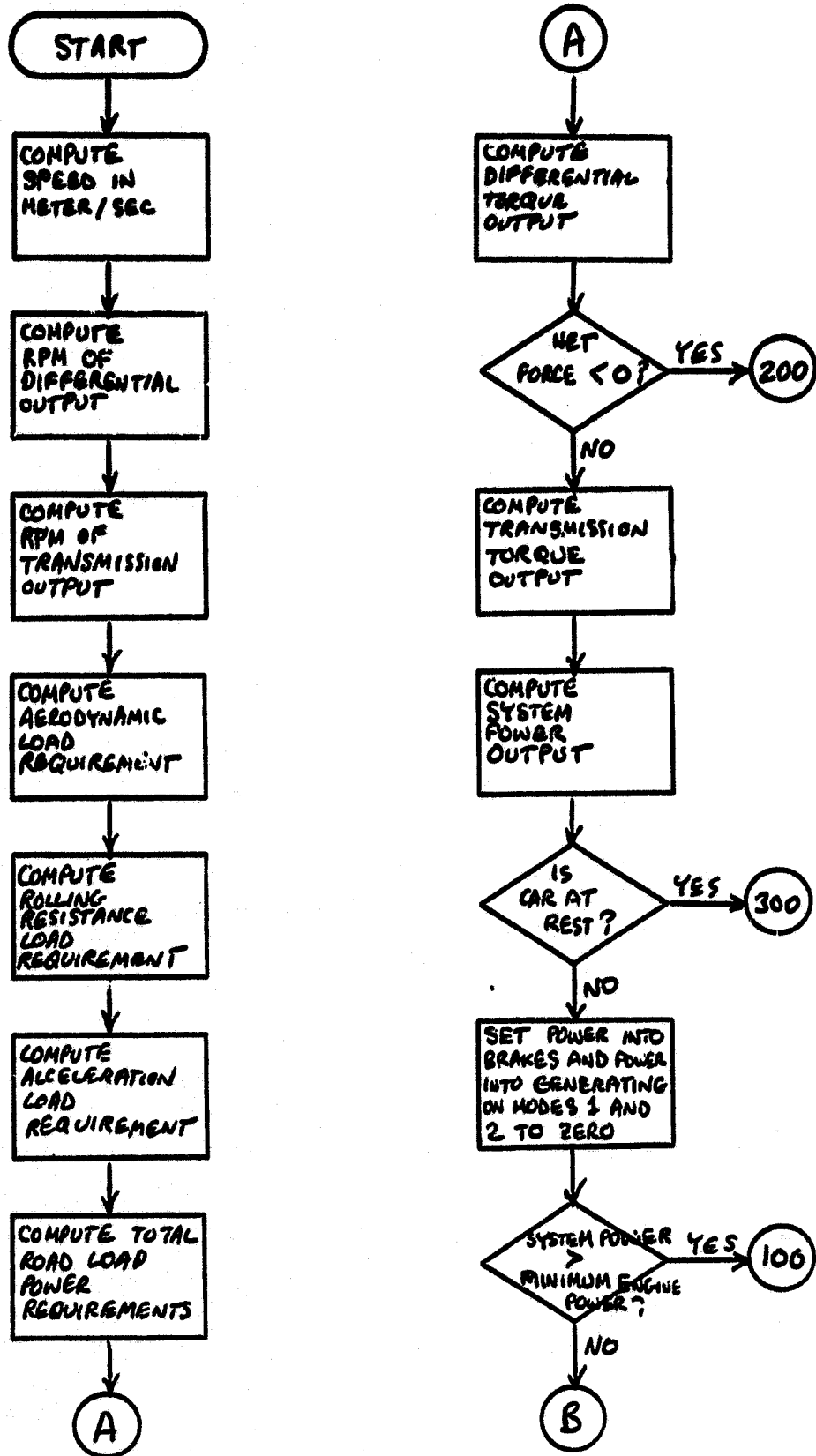

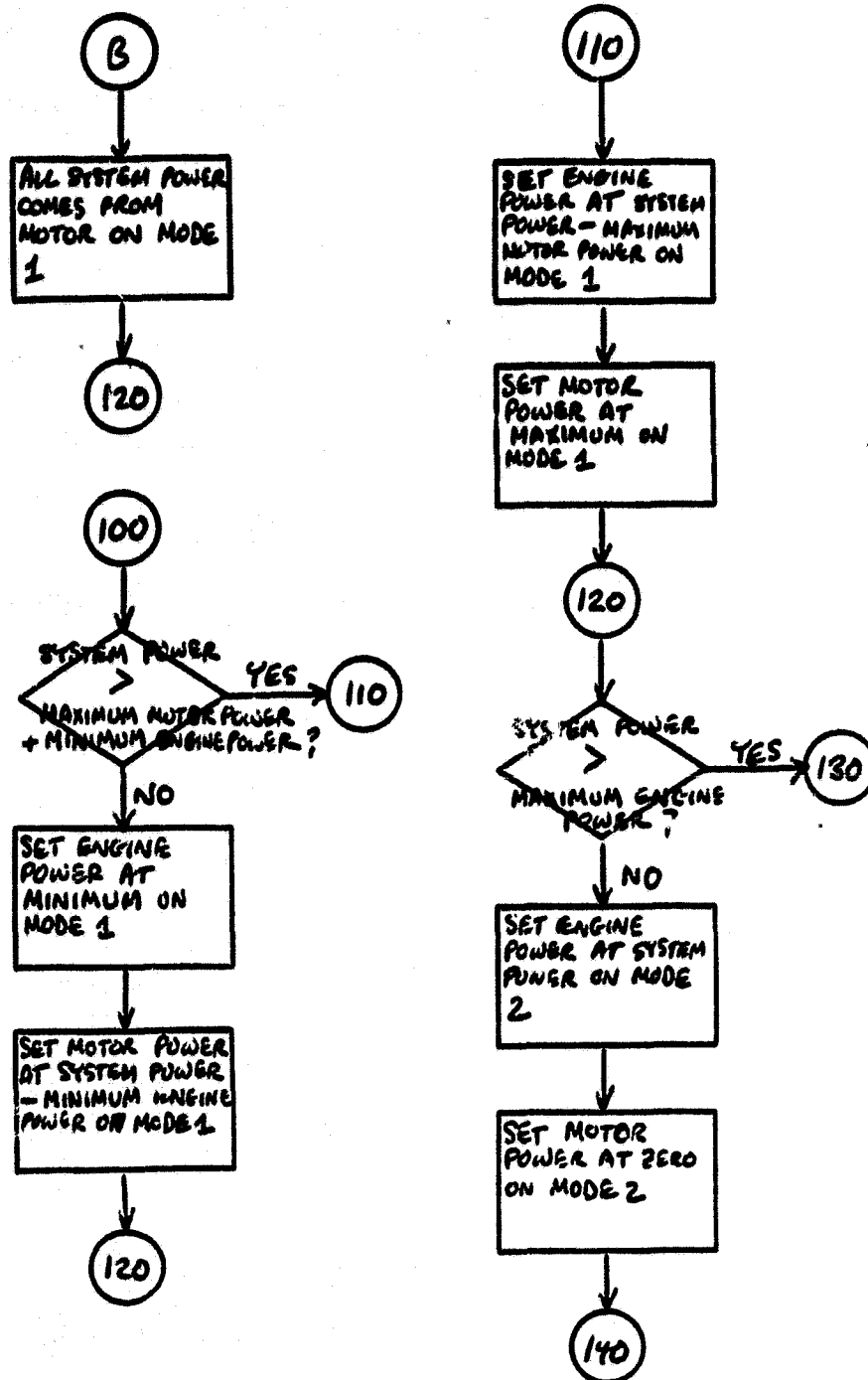

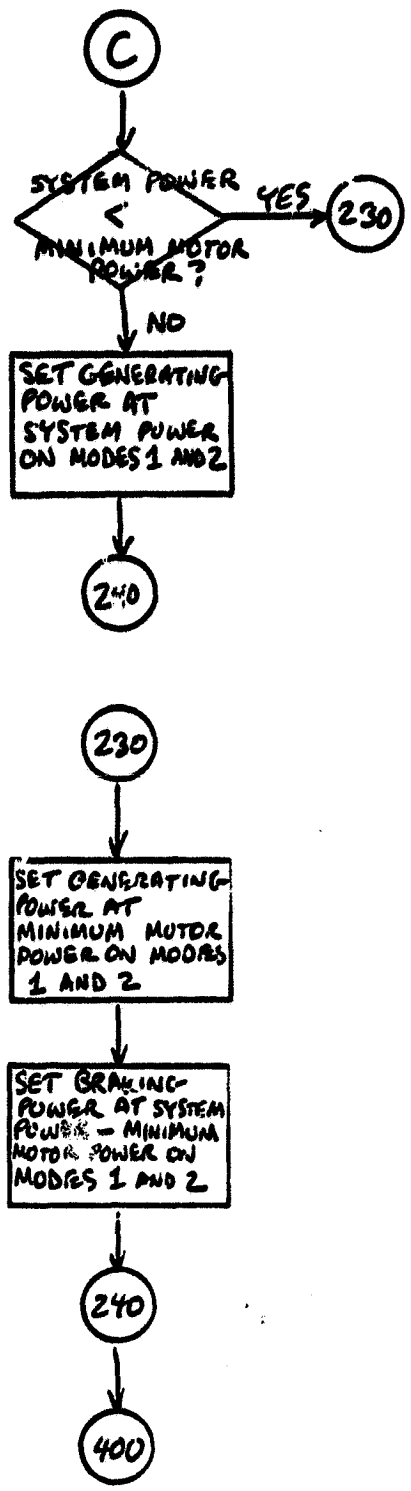
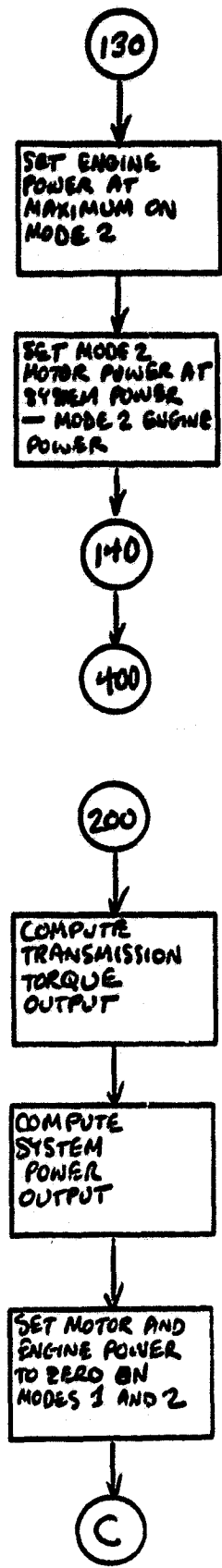

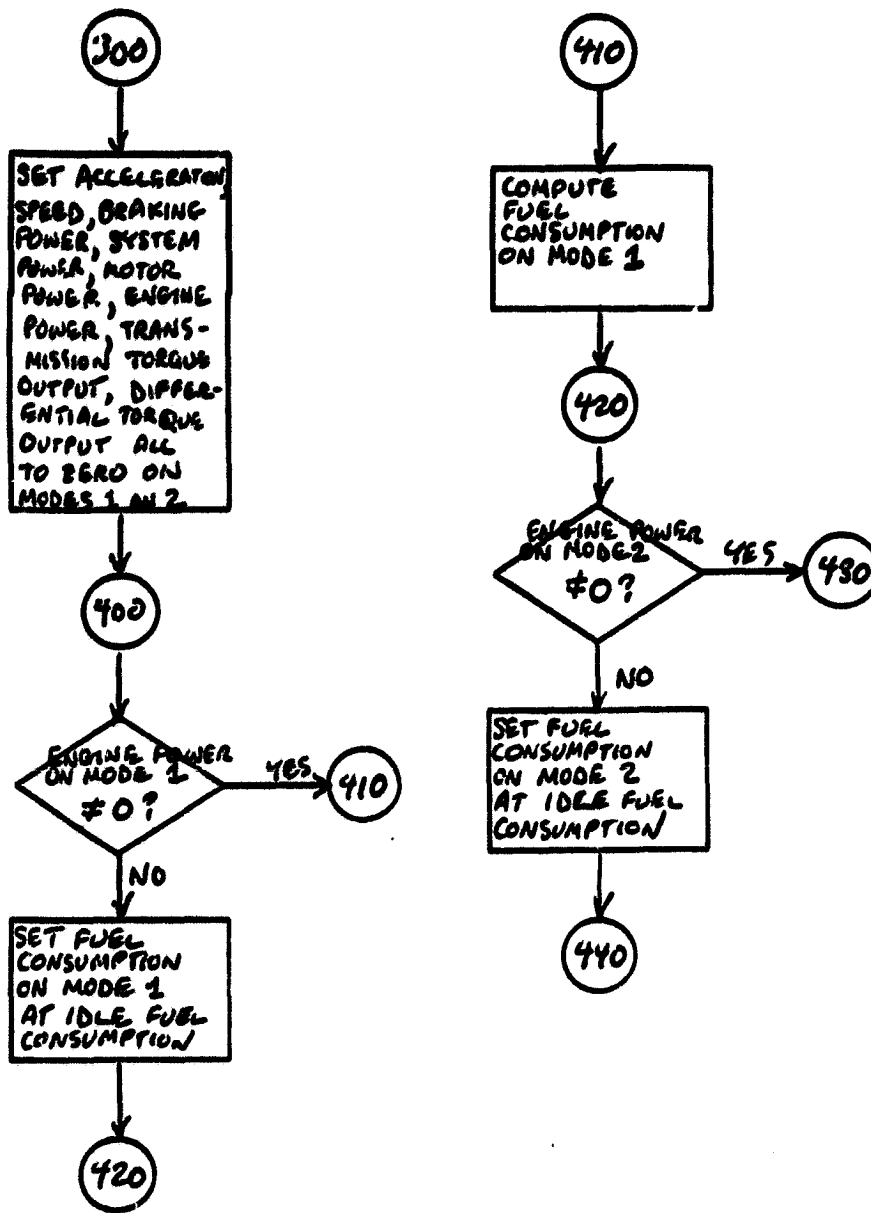

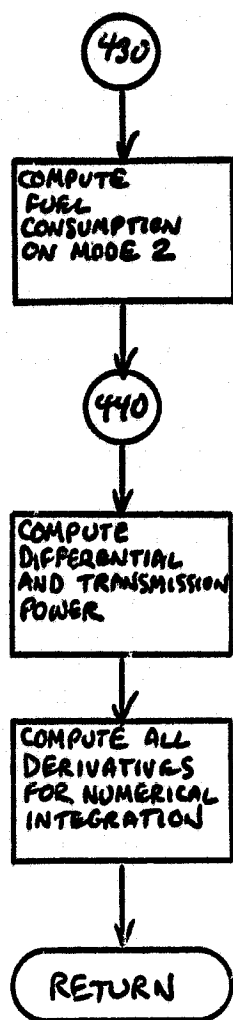

SUBROUTINE INT1

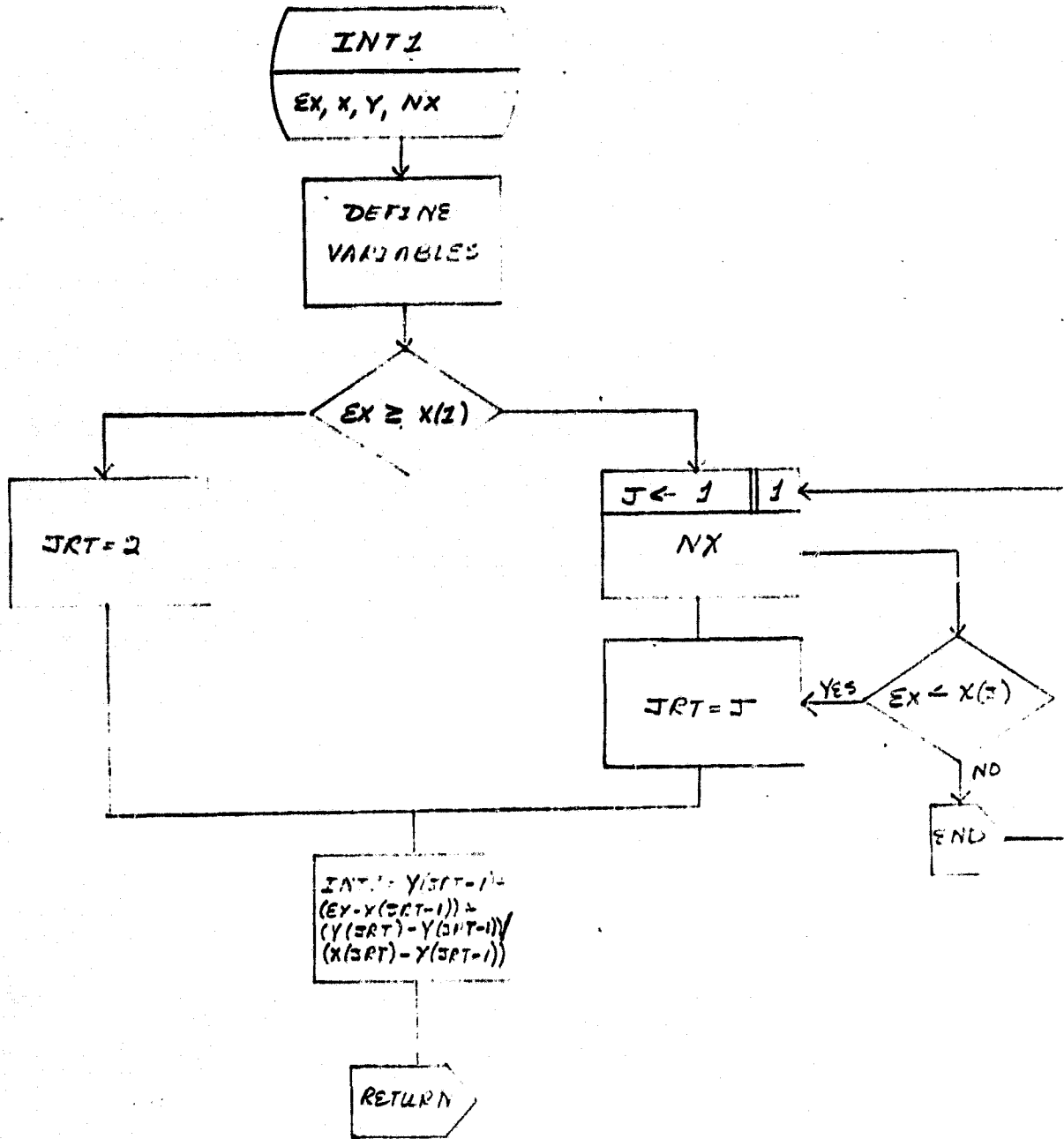

ORIGINAL PAGE IS
OF POOR QUALITY

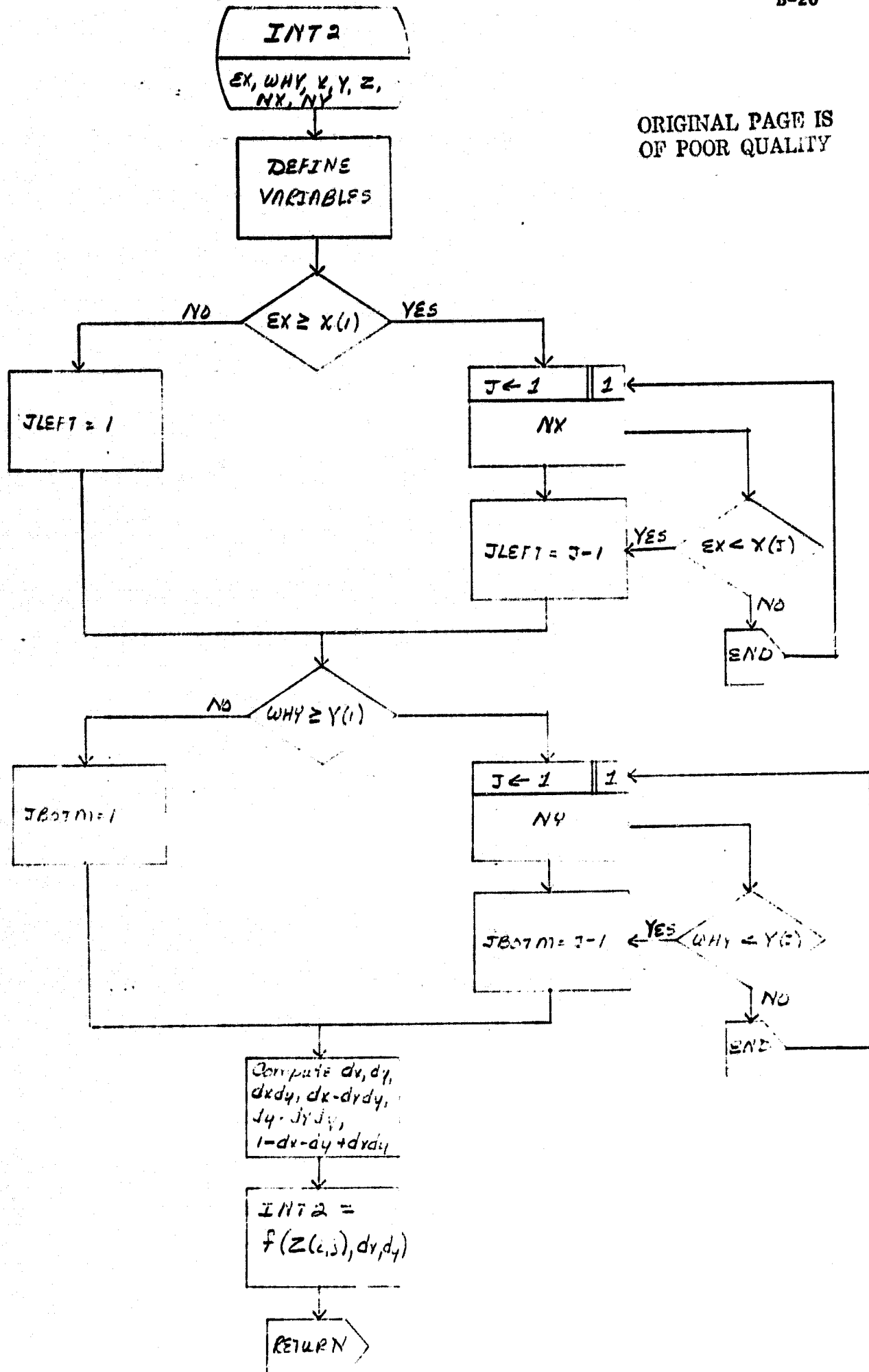

PROGRAM HYBRID

ORIGINAL PAGE IS
OF POOR QUALITYC
C
C
C
C

HYBRID MODELS OPERATION OF A HYBRID VEHICLE OVER SPECIFIED DRIVE CYCLES.

000003

DATA IN COMMON -
 COMMON RTIRE, DRATIO, CDA, CTIRE1, CTIRE2, VMASS, DLI, EMUD, EMUT, NPWR,
 1PHE(20), BSFC(20), PHEZRO, PHEMAX, PMMAX, PMMIN, EMUM, EMUG, EMURG, EMU
 2EBMAX, HB, NTC(3), TIMC(3,200), SPEDC(3,200), PEOMIN, DBMAX, NCYCLE,
 3TIME(200), SPEED(200), NPRTC(3), DTC(3), TFC(3)
 4, FCIDLE, PINNLD

C
C

000003

VARIABLES IN COMMON -
 COMMON FA, FR, FAC, FNET, TDO, TTO, RPMDO, RPMT0, VMASS2, SKALE, PSO, PEO,
 1PEO2, PMO, PMO2, PGO, PGO2, PBRK, PBRK2, FC, PD, PT

C

000003

REAL YDOT(20), Y(20), INT1, INT2, V(6), A(3), YTMP(20)

000003

REAL EK(80)

000003

REAL DIST(3), FCONS(3), FC CNS2(3), ECONS(3), ECONS2(3)

000003

REAL DDISCH(20), CYCLES(20), DSUP(30), DNC(30), GAMMA(30,3), FCBAR(
 1FCBAR2(30), ECBAR(30), ECBAR2(30), RANGE(30), FCMAV(30), ECMAV(30),
 2RFRAC(30), DBAR(30), PHEZ(20)

000003

REAL ECHE(3), ECSYS(3), EHEBAR(30), ESYSBR(30)

C

INPUT ENGINE DATA

C

000003

READ 600, NPWR, PHEZRO, FCDL, FUELSG

000017

READ 610, (PHEZ:J), BSFC(J), J=1, NPWR)

C

C

INPUT TRANSMISSION DATA

C

000034

READ 610, EMUT

000042

PRINT 843

000046

PRINT 845, EMUT

C

C

INPUT BATTERY DATA

C

000054

READ 600, NDDSCH, CHGEFF

000064

READ 610, (DDISCH(J), CYCLES(J), J=1, NDDSCH)

000101

PRINT 850

000105

PRINT 980

000111

PRINT 910, (DDISCH(J), CYCLES(J), J=1, NDDSCH)

C

C

INPUT DIFFERENTIAL AND TIRE DATA

C

000126

READ 610, DRATIO, EMUD, RTIRE, CTIRE1, CTIRE2

000144

PRINT 875

000150

PRINT 880

000154

PRINT 885, DRATIO, EMUD, RTIRE, CTIRE1, CTIRE2

C

C

INPUT DRIVING CYCLE DATA

C

000172

READ 620, NCYCLE

000200

PRINT 915

000204

DO 45 JC=1, NCYCLE

000206

READ 625, NTC(JC), NPRTC(JC), NUNITS, DTC(JC), TFC(JC)

```

000223      NT=NTC(JC)
000225      READ 610,(TIMC(JC,J),SPECC(JC,J),J=1,NT)
000245      IF(NUNITS.NE.1)GO TO 41

C
C      CONVERT MPH TO KILOMETERS PER HOUR
C
000247      30 DO 40 J=1,NT
000251          SPECC(JC,J)=SPECC(JC,J)*1.6093
000254          40 CONTINUE
000256          41 PRINT 920
000262          PRINT 910,(TIMC(JC,J),SPECC(JC,J),J=1,NT)
000302          45 CONTINUE
000305          READ 600,NCOMP,DSTAV
000314          PRINT 990,DSTAV
000322          PRINT 995
000326          DO 320 JC=1,NCOMP
000330          READ 610,DSUP(JC),DNC(JC),(GAMMA(JC,J),J=1,NCYCLE)
000347          PRINT 815,DSUP(JC),DNC(JC),(GAMMA(JC,J),J=1,NCYCLE)
000367          320 CONTINUE
000372          DBAR(1)=DSUP(1)/2.
000374          DO 46 J=2,NCOMP
000375          DBAR(J)=(DSUP(J)+DSUP(J-1))/2.
000401          46 CONTINUE
C
C      INPUT RUN DATA
C
000403      READ 600,NCASE
000410      DO 194 JCASE=1,NCASE
000412      PRINT 925,JCASE
000417      READ 610,PEOMIN,OBMAX,PHEMAX
000431      PRINT 930,PECMIN,OBMAX
000441      SKALE=PHEMAX/PHEZRO
000443      FCIDLE=FCOL*SKALE
000445      PRINT 800,FCIDLE
000452      DO 5 J=1,NPWR
000454      PHE(J)=PHEZ(J)*SKALE
000457      5 CONTINUE
000461      PRINT 805
000464      PRINT 820,(PHE(J),BSFC(J),J=1,NPWR)

C
C      INPUT MOTOR/GENERATOR DATA
C
000501      READ 610,PMMAX,PMIN,EMUM,EMUG,PINNLD
000517      PRINT 811
000523      PRINT 812
000527      PRINT 815,PMMAX,PMIN,EMUM,EMUG,PINNLD
000545      READ 610,WB,EBMAX,EMURG,EMURG2
000561      PRINT 855
000565      PRINT 910,WB,EBMAX,EMURG,EMURG2

C
C      INFUT VEHICLE DATA
C
000601      READ 610,VMASS,DLI,CDA
000613      PRINT 890,VMASS,DLI,CDA
000625      VMASS2=VMASS+DLI/RTIRE**2
000631      DO 190 JCYC=1,NCYCLE

```

```

000632      PRINT 700
000635      NTIME=NTC(JCYC)
000637      NPRNT=NPRTC(JCYC)
000641      DELT=DTC(JCYC)
000642      TF=TFC(JCYC)
000644      DO 47 J=1,NTIME
000645      TIME(J)=TMC(JCYC,J)
000651      SPEED(J)=SPEDC(JCYC,J)
000654      47 CONTINUE

      C
      C
      C      INITIALIZE VARIABLES OF INTEGRATION
000656      DO 50 J=1,20
000657      Y(J)=0.0
000660      50 CONTINUE
000662      T=0.0
000663      K=NPRNT

      C
      C
      C      COMPUTE VELOCITY AND ACCELERATION
000664      V(1)=0.0
000665      V(3)=SPEED(1)
000666      V(4)=INT1(DELT/2.,TIME,SPEED,NTIME)
000674      V(5)=INT1(DELT,TIME,SPEED,NTIME)
000700      V(6)=INT1(3.*DELT/2.,TIME,SPEED,NTIME)
000706      V(2)=V(3)+V(3)-V(4)
000710      GO TO 70
000711      60 V(1)=V(3)
000713      V(3)=Y(11)
000714      V(2)=(V(1)+V(3))/2.
000717      V(4)=V(6)
000720      V(5)=INT1(T+DFLT,TIME,SPEED,NTIME)
000726      V(6)=INT1(T+3.*DELT/2.,TIME,SPEED,NTIME)
000736      70 A(1)=(V(4)-V(2))/(3.6*DELT)
000742      A(1)=AMIN1(A(1),9.8)
000745      A(2)=(V(5)-V(3))/(3.6*DELT)
000751      A(2)=AMIN1(A(2),9.8)

      C
      C
      C      COMPUTE VEHICLE OPERATING CONDITIONS AT MAJOR TIME POINT
000754      CALL VEHIC(V(3),A(1),T,YDOT)
000757      105 DO 106 JV=1,19
000761      EK(JV)=YDOT(JV)
000763      106 CONTINUE

      C
      C
      C      TIME TO PRINT RESULTS -
000765      IF(T.EQ.TF)GO TO 107
000767      K=K+1
000770      IF(K.LT.NPRNT)GO TO 110
000772      K=0
000773      107 EB=Y(18)
000775      EB2=Y(19)
000776      PRINT 710,T,Y(11),PSO,(Y(J),J=1,5),PMO,PEO,PGO,PBRK,Y(6),Y(8),
1) ,Y(14),Y(16),EB,PMO2,PEO2,PGO2,PBRK2,Y(7),Y(9),Y(13),Y(15),Y(

```

2E92

```

001066 IF(T.LT.TF)GO TO 110
001071 DIST(JCYC)=Y(12)
001073 FCONS(JCYC)=Y(16)/Y(12)
001075 ECONS(JCYC)=EB/(3.6*Y(12))
001077 FCONS2(JCYC)=Y(17)/Y(12)
001101 ECONS2(JCYC)=EB2/(3.6*Y(12))
001104 ECHE(JCYC)=Y(8)/Y(12)
001106 ECSYS(JCYC)=(Y(6)+Y(8))/Y(12)
001110 PRINT 940,Y(12),FCONS(JCYC),FCONS2(JCYC),ECONS(JCYC),ECONS2(JCY
001126 IF(T.GE.TF)GO TO 190

```

C
C
C

INTEGRATE TO NEXT TIME STEP

```

001131 110 TTMP=T
001133 DO 170 JV=1,3
001134 JA=MAX0(2,JV)
001137 IF(JV.EQ.2)GO TO 121
001140 TTMP=TTMP+DELT/2.
001143 121 DT=TTMP-T
001145 IF(JV.NE.3)GO TO 122
001147 A(3)=(V(6)-(VTMP+VTMPL)/2.)/(3.6*DELT)
001156 A(3)=AMIN1(A(3),9.8)
001161 122 VTMPL=VTMP
001163 VTMP=Y(11)+EK(11+(JV-1)*19)*DT
001172 130 CALL VEHIC(VTMP,A(JA),TTMP,YDOT)
001177 160 DO 170 JK=1,19
001201 EK(JK+19*JV)=YDOT(JK)
001206 170 CONTINUE
001212 DO 180 JK=1,19
001213 Y(JK)=Y(JK)+DELT*(EK(JK)+2.*(EK(JK+19)+EK(JK+38))+EK(JK+57))/6.
001224 180 CONTINUE
001226 T=T+DELT
001227 GO TO 60
001230 190 CONTINUE
001233 FCAV=0.0
001234 ECAV=0.0
001235 EHEAV=0.0
001236 ESYSAV=0.0
001237 DO 300 JC=1,NCOMP

```

C
C
C
CCOMPUTE FUEL AND ENERGY CONSUMPTION ON COMPOSITE DRIVING CYCLES
FOR MODES1 AND 2.

```

001240 FCBAR(JC)=0.0
001241 FCBAR2(JC)=0.0
001242 ECBAR(JC)=0.0
001243 ECBAR2(JC)=0.0
001244 EHEBAR(JC)=0.0
001245 ESYBAR(JC)=0.0
001246 DO 260 KC=1,NCYCLE
001250 FCBAR(JC)=FCBAR(JC)+GAMMA(JC,KC)*FCONS(KC)
001256 FCBAR2(JC)=FCBAR2(JC)+GAMMA(JC,KC)*FCONS2(KC)
001263 ECBAR(JC)=ECBAR(JC)+GAMMA(JC,KC)*ECONS(KC)
001270 ECBAR2(JC)=ECBAR2(JC)+GAMMA(JC,KC)*ECONS2(KC)

```

GOLETA FORTRAN 1.3 * SEMI-AUTO RFL * (01-10-73)

```

001276      EHEBAR(JC)=EHEBAR(JC)+GAMMA(JC,KC)*ECHE(KC)
001303      ESYSBR(JC)=ESYSBR(JC)+GAMMA(JC,KC)*ECSYS(KC)
001311      260 CONTINUE
C
C      COMPUTE RANGE ON MODE 1 AND CORRECT FUEL CONSUMPTION FOR NON-ZI
C      BATTERY ENERGY USAGE ON MODE 2, FOR COMPOSITE DRIVING CYCLE.
C
001313      RANGE(JC)=EBMAX*WB*DBMAX/(1000.*ECBAR(JC))
001320      FCBAR2(JC)=(FCBAR2(JC)*ECBAR(JC)-FCBAR(JC)*ECBAR2(JC))/(ECBAR(
1ECBAR2(JC))
C
C      COMPUTE FRACTION OF TOTAL DRIVING DONE ON MODE 1 FOR EACH
C      COMPOSITE CYCLE.
C
001327      IF(JC.NE.1)GO TO 265
001331      DLOW=0.
001332      GO TO 266
001332      265 DLOW=DSUP(JC-1)
001334      266 IF(RANGE(JC).GT.DLOW)GO TO 270
001341      RFRAC(JC)=RANGE(JC)/DBAR(JC)
001343      GO TO 280
001344      270 IF(RANGE(JC).GT.DSUP(JC))GO TO 275
001351      RFRAC(JC)=(RANGE(JC)/DBAR(JC))*(1.-(RANGE(JC)-DLOW)**2/(2.*
1RANGE(JC)*(DSUP(JC)-DLOW)))
      GO TO 280
001365      275 RFRAC(JC)=1.
001367      280 CONTINUE
C
C      COMPUTE MODE-AVERAGED FUEL AND ENERGY CONSUMPTION FOR COMPOSITE
C      DRIVING CYCLE.
C
001367      FCM AV(JC)=RFRAC(JC)*FCBAR(JC)+(1.-RFRAC(JC))*FCBAR2(JC)
001375      ECM AV(JC)=RFRAC(JC)*ECBAR(JC)+(1.-RFRAC(JC))*ECBAR2(JC)
C
C      COMPUTE OVERALL FUEL AND ENERGY CONSUMPTION.
C
001402      FCAV=FCAV+DNC(JC)*FCMAV(JC)
001406      ECAV=ECAV+DNC(JC)*ECMAV(JC)
001411      EHEAV=EHEAV+DNC(JC)*EHEBAR(JC)
001415      ESYS AV=EESYS AV+DNC(JC)*ESYSBR(JC)
001420      FEAV=1000.*FUELSG*.89/FCAV
001424      WPAV=ECAV/CHGEFF
001426      300 CONTINUE
C
001430      HEEF=EHEAV/ESYS AV
C      ESTIMATE BATTERY LIFE.
C
001432      ODAV=ECAV*DISTAV*1000./(EBMAX*WB)
001437      BLIFE=DISTAV*INT1(ODAV,DISCH,CYCLES,NDSCH)
001444      PRINT 950
001447      PRINT 960,(FCBAR(J),FCBAR2(J),ECBAR(J),RANGE(J),FCMAV(J),ECMAV
1J=1,NCOMP)
001474      PRINT 970,FCAV,ECAV,BLIFE
001506      PRINT 975,FEAV,WPAV
001516      PRINT 1010,HEEF

```

```

001524      194 CONTINUE
001527      200 STOP

      C
      C      FORMAT STATEMENTS
001531      600 FORMAT(I10,6F10.4)
001531      610 FORMAT(7F10.4)
001531      620 FORMAT(7I10)
001531      625 FORMAT(3I10,2F10.4)
001531      700 FORMAT(1H0,4X,4HTIME,8X,5HSPEED,5X,9HSYS. PWR.,5X,5HAERO.,7X,
      15HTIRES,7X,5HDIFF.,6X,6HTRANS.,4X,10HSYSTEM OUT/7X,9HMOT. PWR.,
      23X,9HENG. PWR.,3X,9HGEN. PWR.,3X,9HBRK. PWR.,3X,9HMOTOR OUT,2X,
      310HENGINE OUT,3X,7HGEN. IN,6X,6HBRAKES,7X,4HFUEL,6X,9HBATT. OUT)
001531      710 FORMAT(1H ,8E12.4/6X,10E12.4/6X,10E12.4)
001531      800 FORMAT(1H0,11HENGINE DATA/1X,16HIDLE FUEL RATE =,E12.4)
001531      805 FORMAT(1H0,6X,5HPOWER,11X,4HBSFC)
001531      810 FORMAT(1H ,4E16.6)
001531      811 FORMAT(1H0,20HMOTOR/GENERATOR DATA)
001531      812 FORMAT(1H0,3X,10HMAX. POWER,6X,10HMIN. POWER,6X,10HMOTOR EFF.,E
      19HGEN. EFF.,5X,13HNO LOAD INPUT)
001531      815 FORMAT(1H ,5E16.6)
001531      820 FORMAT(1H ,2E16.6)
001531      840 FORMAT(1H0,12HGEARBOX DATA)
001531      845 FORMAT(1H0,5X,12HEFFICIENCY =,E16.6)
001531      850 FORMAT(1H0,12HBATTERY DATA)
001531      855 FORMAT(1H0,6X,4HMASS,7X,14HENERGY DENSITY,2X,15HAV. REGEN. EFF.
      11X,15HMAX REGEN. EFF.)
001531      875 FORMAT(1H0,18HAXLE AND TIRE DATA )
001531      880 FORMAT(1H0,3X,11HDIFF. RATIO,5X,10HEFFICIENCY,4X 14HROLLING RA
      1,5X,25HROLL. RESIST. COEFFICIENTS)
001531      885 FORMAT(1H ,5E16.6)
001531      890 FORMAT(1H0,14HVEHICLE MASS =,E16.6,5X,19HDRIVELINE INERTIA =,E1
      1,5X,19H(DRAG COEF.)*AREA =,E16.6)
001531      910 FORMAT(1H ,2E16.6)
001531      915 FORMAT(1H0,14HDRIVING CYCLES)
001531      920 FORMAT(1H0,6X,4HTIME,12X,5HSPEED)
001531      925 FORMAT(1H1,27HCONTROL PARAMETERS FOR CASE,I2)
001531      930 FORMAT(1H0,5X,25HHEAT ENG. SHUTOFF POWER =,E11.4,22H BATT. DIS
      1 LIMIT =,E11.4)
001531      950 FORMAT(1H0,47HFUEL AND ENERGY CONSUMPTION ON COMPOSITE CYCLES/3
      113HFUEL - MODE 1,3X,13HFUEL - MODE 2,2X,15HENERGY - MODE 1,1X,
      214HRANGE - MODE 1,4X,10HFUEL - AV.,5X,12HENERGY - AV.)
001531      960 FORMAT(1H ,6E16.6)
001531      970 FORMAT(1H0,29HYEARLY AV. FUEL CONSUMPTION =,E16.6/1X,34HYEARLY
      1 BATTERY ENERGY OUTPUT =,E16.6/1X,23HEXPECTED BATTERY LIFE =,E1
      2)
001531      975 FORMAT(1H0,25HYEARLY AV. FUEL ECONOMY =,E16.6/1X,
      129HYEARLY AV. WALL PLUG OUTPUT =,E16.6)
001531      940 FORMAT(1H0,16HCYCLE DISTANCE =,E12.4/1X,28HFUEL CONSUMPTION ON
      1E 1 =,E12.4/21X,8HMODE 2 =,E12.4/1X,36HBATT. ENERGY CONSUMPTIOI
      2 MODE 1 =,E12.4/29X,8HMODE 2 =,E12.4)
001531      980 FORMAT(1H0,1X,15HDEPTH OF DISCH.,6X,10HCYCLE LIFE)
001531      990 FORMAT(1H0,24HTRAVEL DISTRIBUTION DATA/1X,11HAV. USAGE =,E12.4)
001531      995 FORMAT(1H0,3X,10HMAX. DIST.,4X,15HFRACT. OF TOTAL,14X,21HDRIVII
      1 YCLE WEIGHTS)
001531     1010 FORMAT(1H0,29HHEAT ENGINE ENERGY FRACTION =,E16.6)

```

G7LETA FORTRAN 1.3 * SEMI-AUTO RFL * (01-13-73)

SUBROUTINE VEHIC (V,A,T,YDOT)

VEHIC COMPUTES POWER REQUIREMENTS AND LOSSES FROM REAR WHEELS
THROUGH ENGINE

DATA IN COMMON -

000007

COMMON RTIRE,DRATIO,CDA,CTIRE1,CTIRE2,VMASS,DLI,EMUD,EMUT,NPWR,
1PHE(20),BSFC(20),PHEZRO,PHEMAX,PMAX,PMIN,EMUM,EMUG,EMURG,EMUR
2ERMAX,WB,NTC(3),TIMC(3,200),SPEDC(3,200),PEOMIN,DBMAX,NCYCLE,
3TIME(200),SPEED(200),NPRTC(3),DTC(3),TFC(3)
4,FCIDLE,PINNLO

VARIABLES IN COMMON -

000007

COMMON FA,FR,FAC,FNET,TDO,TTO,RPMDO,RPMT0,VMASS2,SKALE,PSO,PEO,
1PEO2,PMO,PMO2,PGO,PGO2,PBRK,PBRK2,FC,PD,PT

000007

REAL YDOT(20),INT1,INT2

COMPUTE SPEEDS AND LOAD-INDEPENDENT LOSSES THROUGH DRIVE TRAIN

000007

VMPS=V/3.6

000011

RPMDO=9.5492967*VMPS/RTIRE

000013

RPMT0=RPMDO*DRATIO

COMPUTE ROAD LOAD POWER REQUIREMENTS
AERODYNAMIC -

000015

FA=0.6125*CDA*VMPS**2

000017

PA=FA*VMPS/1000.

000021

YDOT(1)=PA/1000.

ROLLING RESISTANCE -

000022

FR=9.807*VMASS*(CTIRE1+CTIRE2*V)

000027

PR=FR*VMPS/1000.

000031

YDOT(2)=PR/1000.

ACCELERATION -

000033

FAC=VMASS2*A

000034

FNET=FA+FR+FAC+FG

000040

TDO=FNET*RTIRE

000042

IF(FNET.LT.0.0)GO TO 200

NON-NEG. NET DRIVING FORCE TO THE WHEELS IS NEEDED
DIFFERENTIAL -

000043

TTO=TDO/(EMUD*DRATIO)

TRANSMISSION -

000046

PSO=TTO*RPMT0*0.0001047197/EMUT

IS CAR AT REST AND IDLING -

```

C
100051 IF (ABS(VMPS).LT.0.2.AND.ABS(A).LT.0.1)GO TO 300
C
000063 PBRK=0.0
000064 PGO=0.0
000065 PRRK2=0.0
000066 PGO2=0.0
000067 IF (PSO.GT.PEOMIN)GO TO 100
000072 PEO=0.0
000072 PMC=PSO
000073 GO TO 120
000074 100 IF (PSO.GT.(PMMAX+PEOMIN))GO TO 110
000101 PEO=PEOMIN
000101 PMO=PSO-PEOMIN
000103 GO TO 120
000103 110 PEO=PSO-PMMAX
000105 PMO=PMMAX
000106 120 IF (PSO.GT.PHEMAX)GO TO 130
000112 PEO2=PSO
000112 PMO2=0.0
000113 GO TO 140
000114 130 PEO2=PHEMAX
000116 PMO2=PSO-PEO2
000120 140 GO TO 400
C
C NET DRIVING FORCE AT WHEELS IS NEGATIVE
C
J00121 200 TTO=TDO*EMUD/ORATIO
000124 PSO=TTO*RPMTC*0.0001047197*EMUT
000127 PMO=0.0
000130 PEO=0.0
000131 PMO2=0.0
000132 PEO2=0.0
000133 IF (PSO.LT.PMMIN)GO TO 230
000135 PGO=PSO
000136 PGO2=PSO
000137 GO TO 240
000137 230 PGO=PMMIN
000141 PBRK=PSO-PMMIN
000142 PGO2=PMMIN
000143 PBRK2=PBRK
000145 240 GO TO 400
C
C CAR IS AT REST AND IDLING
C
000146 300 A=0.0
000147 VMPS=0.0
000150 PRRK=0.0
000151 PBRK2=0.0
000152 PSO=0.0
000153 PMO=0.0
000154 PMO2=0.0
000155 PEO=0.0
000156 PEO2=0.0
000157 TTO=0.0

```

```

--000160      TDO=0.0
)
C
C      COMPUTE ENGINE FUEL RATE AND DERIVATIVES OF VARIABLES
C
000161      400 IF (PEO.NE.0.0)GO TO 410
000162      FC=FCIOLE
000164      GO TO 420
000164      410 FC=INT1(PEO,PHE,BSFC,NPWR)*PEO
000171      420 IF (PEO2.NE.0.0)GO TO 430
000175      FC2=FCIOLE
000176      GO TO 440
000177      430 FC2=INT1(PEO2,PHE,BSFC,NPWR)*PEO2
000204      440 PD=TDO*RPMD0*0.0001047197
000207      PT=TT0*RPMT0*0.0001047197
000211      YDOT(3)=ABS (PT-PD)/1000.
000217      YDOT(4)=ABS (PSO-PT)/1000.
000222      YDOT(5)=PSO/1000.
000223      YDOT(6)=PM0/1000.
000225      YDOT(7)=PM02/1000.
000226      YDOT(8)=PEO/1000.
000230      YDOT(9)=PEO2/1000.
000231      YDOT(10)=PG0/1000.
000233      YDOT(11)=A*3.6
000235      YDOT(12)=VMPS/1000.
000237      YDOT(13)=PG02/1000.
000240      YDOT(14)=PBRK/1000.
000242      YDOT(15)=PBRK2/1000.
000243      YDOT(16)=FC/3600.
000245      YDOT(17)=FC2/3600.
000247      YDOT(18)=(PINNLD+PM0/EMUM+PG0*EMUG*EMURG)/1000.
000256      YDOT(19)=(PINNLD+PM02/EMUM+PG02*EMUG*EMURG2)/1000.
000265      RETURN
000266      END

```

GOLETA FORTRAN 1.3 * SEMI-AUTO RFL * (01-10-73)

```
REAL FUNCTION INT1(EX,X,Y,NX)
000007 REAL X(200),Y(200)
000007 IF(EX.GE.X(1))GO TO 5
000011 JRT=2
000012 GO TO 20
000013 5 DO 10 J=1,NX
000015 IF(EX.LT.X(J))GO TO 15
000020 10 CONTINUE
000022 15 JRT=J
000024 20 INT1=Y(JRT-1)+(EX-X(JRT-1))*(Y(JRT)-Y(JRT-1))/(X(JRT)-X(JRT-1))
000040 RETURN
000041 END
```

GOLETA FORTRAN 1.3 * SEMI-AUTO RFL * (01-10-73)

REAL FUNCTION INT2(EX,WHY,X,Y,Z,NX,NY)

C
C
C
CINT2 INTERPOLATES IN TWO VARIABLES INTERPOLATION SURFACE IS A
RULED SURFACE.

```

000012     REAL X(20),Y(20),Z(20,20)
000012     IF(EX.GE.X(1))GO TO 5
000014     JLEFT=1
000015     GO TO 20
000016     5 DO 10 J=1,NX
000020     IF(EX.LT.X(J))GO TO 15
000023     10 CONTINUE
000025     15 JLEFT=J-1
000027     20 IF(WHY.GE.Y(1))GO TO 25
000032     JBOTH=1
000033     GO TO 40
000033     25 DO 30 J=1,NY
000035     IF(WHY.LT.Y(J))GO TO 35
000040     30 CONTINUE
000043     35 JBOTH=J-1
000045     40 RX=(EX-X(JLEFT))/(X(JLEFT+1)-X(JLEFT))
000052     RY=(WHY-Y(JBOTH))/(Y(JBOTH+1)-Y(JBOTH))
000056     RXRY=RX*RY
000060     W1=1.-RX-RY+RXRY
000063     W2=RY-RXRY
000065     W3=RXRY
000066     W4=RX-RXRY
000067     INT2=W1*Z(JLEFT,JBOTH)+W2*Z(JLEFT,JBOTH+1)+W3*Z(JLEFT+1,JBOTH+
1+W4*Z(JLEFT+1,JBOTH)
000110     RETURN
000110     END

```

GEARBOX DATA

EFFICIENCY = 9.200000E-01

BATTERY DATA

DEPTH OF DISCH. CYCLE LIFE

0. 9.000000E+03

2.000000E-01 6.800000E+03

4.000000E-01 3.300000E+03

5.000000E-01 2.700000E+03

6.000000E-01 2.250000E+03

7.000000E-01 1.800000E+03

8.000000E-01 1.500000E+03

9.000000E-01 1.200000E+03

1.000000E+01 1.000000E+03

AXLE AND TIRE DATA

DIFF. RATIO EFFICIENCY ROLLING RADIUS ROLL. RESIST. COEFFICIENT

3.090000E+00 9.600000E-01 3.160000E-01 1.000000E-02

DRIVING CYCLES

TIME	SPEED
0.	0.
1.000000E+01	9.000000E+00
3.900000E+03	1.600000E+01
9.000000E+00	2.400000E+01
1.900000E+01	3.200000E+01
3.800000E+01	3.200000E+01
6.200000E+01	2.950000E+01
4.700000E+01	0.
7.200000E+01	0.

TIME	SPEED
0.	0.
2.000000E+01	0.
2.600000E+01	2.735110E+01
3.100000E+01	3.637010E+01
3.700000E+01	3.219600E+01
3.900000E+01	2.465671E+01
4.300000E+01	2.542694E+01
4.600000E+01	3.653111E+01
5.000000E+01	3.653111E+01
5.600000E+01	2.413950E+01
5.960000E+01	3.942795E+01
6.070000E+01	4.335971E+01
6.720000E+01	4.909365E+01
1.006000E+02	6.908165E+01
1.123000E+02	5.398039E+01
1.150000E+02	5.133667E+01
1.246000E+02	0.
1.610000E+02	0.
1.590000E+02	3.620975E+01
1.710000E+02	4.266464E+01
1.740000E+02	3.974971E+01
1.910000E+02	4.023250E+01
1.915000E+02	4.825575E+01
1.940000E+02	3.713717E+01
1.940000E+02	3.988888E+01

ORIGINAL PAGE IS
OF POOR QUALITY

MAX. DIST.	AV. USAGE = 5.570E+01	TRAVEL DISTRIBUTION DATA	FRACT. OF TOTAL	DRIVING CYCLE WEIGHTS	0.
5.920000E+02	7.805570E+01	7.000000E+01	2.040000E-01	7.960000E-01	0.
5.900000E+02	7.805570E+01	6.607400E-02	0.160000E-01	9.194000E-01	0.
6.030000E+02	7.644175E+01	5.602400E-02	0.820000E-02	9.417100E-01	0.
6.090000E+02	7.966035E+01	7.592300E-02	5.820000E-02	7.973300E-01	1.573300E-01
6.130000E+02	7.402780E+01	7.905700E-02	4.533300E-02	6.523600E-01	1.105500E-01
6.163000E+02	7.402780E+01	7.690900E-02	3.709100E-02	5.520000E-01	4.166200E-01
6.230000E+02	8.460025E+01	3.130500E-02	3.130500E-02	6.784000E-01	4.944000E-01
6.330000E+02	9.947700E+01	2.723000E-02	2.723000E-02	5.221200E-01	5.530000E-01
6.370000E+02	9.529290E+01	2.400000E-02	2.400000E-02	3.776000E-01	6.006400E-01
6.400000E+02	7.402780E+01	1.954500E-02	1.954500E-02	3.261000E-01	6.552700E-01
6.437000E+02	7.402780E+01	2.147400E-02	2.147400E-02	2.392000E-01	7.003100E-01
6.546000E+02	8.401011E+01	1.569200E-02	1.569200E-02	2.392000E-01	7.672000E-01
6.585000E+02	9.207430E+01	1.954500E-02	1.954500E-02	2.110600E-01	7.769400E-01
6.610000E+02	8.207430E+01	1.073700E-02	1.073700E-02	1.984000E-01	9.004200E-01
6.670000E+02	8.413137E+01	9.714000E-03	9.714000E-03	1.709600E-01	9.194300E-01
6.710000E+02	8.416539E+01	8.670000E-03	8.670000E-03	1.560000E-01	9.351300E-01
6.750000E+02	9.401011E+01	7.556000E-03	7.556000E-03	1.432000E-01	9.403200E-01
6.827000E+02	7.956035E+01	7.033600E-03	7.033600E-03	1.237200E-01	9.593600E-01
6.870000E+02	9.260359E+01	6.541000E-03	6.541000E-03	1.157400E-01	9.692400E-01
7.070000E+02	9.237302E+01	5.192000E-03	5.192000E-03	1.097300E-01	9.776400E-01
7.170000E+02	9.527056E+01				9.850900E-01
7.195000E+02	9.527056E+01				
7.290000E+02	8.931615E+01				
7.300000E+02	8.133050E+01				
7.430000E+02	7.354581E+01				
7.450000E+02	6.839525E+01				
7.500000E+02	4.146139E+01				
7.600000E+02	6.827300E+01				
7.625000E+02	0.				
9.000000E+02	0.				

TRAVEL DISTRIBUTION DATA
AV. USAGE = 5.570E+01

MAX. DIST.	FRACT. OF TOTAL
7.000000E+01	4.607400E-02
1.000000E+01	5.602400E-02
6.000000E+01	7.592300E-02
5.000000E+01	7.905700E-02
6.000000E+01	7.690900E-02
7.000000E+01	5.026500E-02
9.000000E+01	6.722000E-02
0.000000E+01	5.790630E-02
1.000000E+02	5.960900E-02
1.200000E+02	9.261600E-02
1.400000E+02	6.525600E-02
1.500000E+02	5.371300E-02
1.900000E+02	4.571500E-02
2.000000E+02	3.065600E-02
2.200000E+02	2.259900E-02
2.400000E+02	2.061700E-02
2.600000E+02	1.364600E-02
2.800000E+02	1.452100E-02
1.000000E+02	1.039000E-02
1.200000E+02	1.111500E-02
1.400000E+02	4.141300E-02

CONTROL PARAMETERS FOR CASE 1

HEAT ENG. SHUTOFF POWER = 1.0000E+01 BATT. DISCH. LIMIT = 8.0000E-01

ENGINE DATA
IDLE FUEL RATE = 0.

POWER	BSFC
9.753304E-01	1.765000E+03
1.750661E+00	9.130000E+02
2.632673E+00	6.090000E+02
3.571322E+00	4.900000E+02
5.251982E+00	3.830000E+02
7.009325E+00	3.350000E+02
1.051065E+01	2.830000E+02
1.401865E+01	2.650000E+02
1.751997E+01	2.890000E+02
2.636642E+01	3.270000E+02
3.390402E+01	3.470000E+02
4.237000E+01	3.530000E+02

MOTOR/GENERATOR DATA

MAX. POWER	MIN. POWER	MOTOR EFF.	GEN. EFF.	NO LOAD INPUT
2.824000E+01	-2.824000E+01	8.700000E-01	8.700000E-01	1.500000E+00

MASS	ENRGY DENSITY	AV. REGEN. EFF.	MAX REGEN. EFF.
2.420000E+12	5.000000E+11	6.000000E-01	9.500000E-01

VEHICLE MASS = 2.376000E+03 DRIVELINE INERTIA = 6.620000E+00 (DRAG COEF.) AREA = 8.720000E-01

TIME	MOT. PWR.	ENG. PWR.	SYS. PWR.	AERO.	TIRES	DIFF.	TRANS.	SYSTEM OUT	FUEL	BATT. OUT
3.	0.	0.	0.	0.	0.	0.	0.	0.	0.	0.
2.0000E+00	1.0792E+01	5.3435E+00	1.1417E-05	7.6118E-04	4.3264E-04	3.4052E-04	1.1756E-02	0.	0.	0.
5.9435E+00	0.	0.	0.	0.	1.1756E-02	0.	0.	0.	0.	0.
4.0000E+00	1.6118E+01	7.1234E+00	7.0131E-05	2.2874E-03	9.9187E-04	2.1562E-03	2.6953E-02	0.	1.1764E+00	1.6513E-02
7.1234E+00	0.	0.	0.	0.	2.6953E-02	0.	0.	0.	0.	3.0000E-03
0.	7.1234E+00	0.	0.	0.	0.	2.6953E-02	0.	0.	2.5542E+00	3.6900E-02
5.0000E+00	1.9054E+01	6.4360E+00	1.9603E-04	4.2775E-03	1.4353E-03	3.1202E-03	3.9002E-02	0.	0.	6.0000E-03
6.4360E+00	0.	0.	0.	0.	3.9002E-02	0.	0.	0.	0.	5.3030E-02
3.	6.4960E+00	0.	0.	0.	0.	3.9002E-02	0.	0.	3.7637E+00	9.0000E-03
9.0000E+00	2.1264E+01	7.5160E+00	1.3453E-04	6.5950E-03	1.9507E-03	4.2407E-03	5.3009E-02	0.	0.	7.2930E-02
7.5160E+00	0.	0.	0.	0.	5.3009E-02	0.	0.	0.	0.	5.0729E+00
0.	7.5160E+00	0.	0.	0.	0.	5.3009E-02	0.	0.	0.	1.2000E-02
1.0000E+01	2.4514E+01	5.5756E+00	6.9740E-04	9.2349E-03	2.6407E-03	5.3920E-03	6.7410E-02	0.	0.	9.2403E-02
5.5756E+00	0.	0.	0.	0.	6.7410E-02	0.	0.	0.	0.	6.4050E+00
0.	5.5756E+00	0.	0.	0.	0.	6.7410E-02	0.	0.	0.	1.5000E-02
1.2000E+01	2.6167E+01	5.7947E+00	1.0601E-03	1.2094E-02	2.9037E-03	6.3125E-03	7.8906E-02	0.	0.	1.0070E-01
5.9947E+00	0.	0.	0.	0.	7.8906E-02	0.	0.	0.	0.	1.0000E-02
0.	5.9947E+00	0.	0.	0.	0.	7.8906E-02	0.	0.	0.	7.5076E+00
1.4000E+01	2.7937E+01	6.1971E+00	1.5112E-03	1.5149E-02	3.1593E-03	7.3024E-03	9.1245E-02	0.	0.	1.2593E-01
6.1971E+00	0.	0.	0.	0.	9.1245E-02	0.	0.	0.	0.	2.1000E-02
0.	6.1971E+00	0.	0.	0.	0.	9.1245E-02	0.	0.	0.	1.2593E-01
1.6000E+01	2.9577E+01	6.9166E+00	2.0510E-03	1.9398E-02	3.4455E-03	8.3590E-03	1.0450E-01	0.	0.	2.1000E-02
6.9166E+00	0.	0.	0.	0.	1.0450E-01	0.	0.	0.	0.	1.4411E-01
0.	6.9166E+00	0.	0.	0.	0.	1.0450E-01	0.	0.	0.	2.6000E-02
1.8000E+01	3.1167E+01	7.2427E+00	2.6905E-03	2.1416E-02	4.3629E-03	9.6945E-03	1.1056E-01	0.	0.	0.

ORIGINAL PAGE IS
OF POOR QUALITY

APPENDIX B2

MATERIAL SUBSTITUTION STUDY
ADVANCED HYBRID VEHICLE

DATE: 26 March 1979

FOR:

South Coast Technology
5790 Thornwood
Goleta, CA 93017

BY:

Lonney S. Pauls
Technical Consultant
5569 Crestone Ct.
Ventura, CA 93003

TABLE OF CONTENT

CONTENT	PAGE
1.0 Introduction	1
2.0 Objective	1
3.0 Analytical Approach	1
4.0 Basic Assumptions	1
5.0 Theoretical Development	2
5.1 Panel Members	4
5.1.1 Resistance to "Oil-Canning"	4
5.1.2 Resistance to Denting	5
5.1.3 Resistance to Elastic Buckling	6
5.1.4 Resistance to Vibration	7
5.2 Thin-Wall Beam Members	9
5.2.1 Bending Stiffness	10
5.2.2 Torsional Stiffness (Closed Sections)	10
5.2.3 Torsional Stiffness (Open Section)	12
5.2.4 Resistance to Yielding	12
5.2.5 Resistance to Buckling	14
5.2.6 Resistance to Vibration	16
5.2.7 Resistance to Impact (Energy Absorption)	18
5.3 Solid Section Members	20
5.3.1 Out-of-plane Bending	20
5.3.2 In-Plane Bending	21
5.4 Weight Reduction Estimates	22

TABLE OF CONTENT Cont'd

CONTENT	PAGE
6.0 Ford LTD Weight Saving Calculations	23
6.1 Weight Saving Potential - Frame Assembly	23
6.1.1 Zone #1	24
6.1.2 Zone #2	27
6.1.3 Zone #3	28
6.2 Weight Saving Potential - Hood Assembly	28
6.2.1 Inner Panel	29
6.2.2 Outer Panel	29
6.3 Weight Saving Potential - Deck Lid Assembly	31
6.4 Weight Saving Potential - Front Fender (outer only)	31
6.5 Weight Saving Potential - Bumper Assembly	31
6.6 Weight Saving Potential - Door Assembly	32
6.6.1 Outer Panel	32
6.6.2 Inner Panel	32
6.6.3 Door Frame	33
6.6.4 Inner Door Beam	34
6.7 Hardware Components	34
6.8 Wheels	35
List of References	

J.S. [Signature] 26 MAR '79

ORIGINAL PAGE IS
OF POOR QUALITY

1.0 INTRODUCTION

THIS STUDY IS CONCERNED WITH THE HYBRID VEHICLE WEIGHT REDUCTION PROGRAM BEING UNDERTAKEN BY SOUTH COAST TECHNOLOGY. THE HYBRID VEHICLE, WHICH IS BEING DEVELOPED AT SCT, WILL CONSIST OF A MODIFIED 1979 FORD LTD. THE PURPOSE OF THIS STUDY IS TO INVESTIGATE THE WEIGHT REDUCTION POSSIBILITIES OF THE LTD THRU MATERIAL SUBSTITUTIONS.

2.0 OBJECTIVE

THE OBJECTIVE OF THIS STUDY IS TO DETERMINE THE WEIGHT REDUCTION POTENTIAL OF VARIOUS MATERIAL SUBSTITUTES TAKING INTO ACCOUNT THEIR STRUCTURAL REQUIREMENTS.

3.0 ANALYTICAL APPROACH

THE WEIGHT REDUCTION POSSIBILITIES OF MATERIAL SUBSTITUTES ARE STUDIED IN THIS REPORT BY "REPLACING" THE ORIGINAL MATERIAL OF THE BASELINE 1979 FORD LTD WITH AN "EQUIVALENT" STRUCTURE (OF THE SUBSTITUTE MATERIAL) HAVING THE SAME MAJOR DIMENSIONS, GEOMETRICAL DESIGN CHARACTERISTICS, AND FUNCTION AS THAT OF THE ORIGINAL MATERIAL. IT IS NOTED THAT ALTHOUGH FURTHER WEIGHT REDUCTION POSSIBILITIES MAY EXIST THRU THE OPTIMIZATION OF THE GEOMETRY, GEOMETRICAL DESIGN CHARACTERISTICS AND FUNCTION OF THE SUBSTITUTE STRUCTURE, THESE ARE CONSIDERED TO BE BEYOND THE SCOPE OF THIS STUDY.

4.0 BASIC ASSUMPTIONS

ONE BASIC ASSUMPTION IN THIS STUDY IS THAT THE SUBSTITUTE MATERIALS PROVIDE AT LEAST THE SAME STRUCTURAL PERFORMANCE AS THE ORIGINAL MATERIALS. ANOTHER ASSUMPTION IS THAT THE SECTION GEOMETRY OF THE SUBSTITUTE STRUCTURE IS INVARIANT EXCEPT FOR THE MATERIAL THICKNESS. OTHER ASSUMPTIONS WILL BE IDENTIFIED LATER IN THIS REPORT.

J.S. [Signature] 26 MAY '79
ORIGINAL PAGE IS
OF POOR QUALITY

5.0 THEORETICAL DEVELOPMENT

IN GENERAL, THE STRUCTURAL DESIGN REQUIREMENTS OF A PASSENGER VEHICLE MAY BE GROUPED IN THE FOLLOWING THREE CATEGORIES (1):

1. STATIC DESIGN LOADS
2. DYNAMIC DESIGN LOADS
3. CRASHWORTHINESS

IN THE FIRST CATEGORY (STATIC DESIGN LOADS) ARE INCLUDED (A) VEHICLE BEAMING, (B) VEHICLE TORSION, (C) REAR-END BEAMING, (D) JACKING, (E) HOISTING AND TOWING, (F) DASHBOARD, DOOR, ROOF, CENTER-PILLAR AND DECK-LID LOADS ETC.

THE SECOND CATEGORY (DYNAMIC DESIGN LOADS) IS ASSOCIATED WITH LOADING FROM (A) TERRAIN, (B) BRAKING (C) MANEUVERING AND (D) VIBRATION.

THE THIRD CATEGORY (CRASHWORTHINESS) IS DERIVED FROM THE REQUIREMENTS OF THE CURRENT APPLICABLE FMVSS SPECIFICATIONS. INCLUDED HEREIN ARE,

- 30 MPH FRONTAL BARRIER IMPACT
- ROLLOVER
- SIDE DOOR PENETRATION
- BUMPER IMPACT
- ROOF CRUSH
- FUEL SYSTEM INTEGRITY

AS INDICATED EARLIER, THE OBJECTIVE OF THIS STUDY IS TO EVALUATE THE WEIGHT REDUCTION POTENTIAL THROUGH THE USE OF VARIOUS SUBSTITUTE MATERIALS. A REQUIREMENT OF THIS SUBSTITUTION IS THAT THE NEW MATERIALS PROVIDE AT LEAST THE SAME LEVEL OF STRUCTURAL PERFORMANCE, IN RESISTING THE LOADS IDENTIFIED ABOVE, AS THE

(1) INDICATES REFERENCES AT THE END OF THIS REPORT. MOST OF THE THEORETICAL DEVELOPMENT PRESENTED HEREIN WAS OBTAINED FROM REFERENCES 1.

J.S. [Signature] 26 MAR '79

S.C. THEORETICAL DEVELOPMENT CONT'DORIGINAL PAGE IS
OF POOR QUALITY

ORIGINAL MATERIALS.

FROM THE STANDPOINT OF STRUCTURAL PERFORMANCE, THE STRUCTURAL DESIGN REQUIREMENTS OF A PASSENGER VEHICLE ARE RELATED TO THE FOLLOWING (1):

1. STIFFNESS
2. STRENGTH
3. VIBRATION
4. IMPACT

IN THIS REPORT, THE STIFFNESS DESIGN REQUIREMENT IS DEFINED AS THE MAXIMUM ALLOWABLE DEFLECTION FOR A SPECIFIED LOAD. THE STRENGTH DESIGN REQUIREMENT IS DEFINED AS THE MAXIMUM ALLOWABLE STRESS FOR A SPECIFIED LOAD. THE VIBRATION DESIGN REQUIREMENT IS DEFINED AS THE DESIRED FREQUENCY AND MODE RESPONSE. THE IMPACT DESIGN REQUIREMENTS ARE RELATED TO ENERGY ABSORPTION AND IMPACT ATTENUATION.

IN GENERAL, THE STRUCTURAL SYSTEM OF A PASSENGER VEHICLE CAN BE THOUGHT OF AS AN ASSEMBLAGE OF THE FOLLOWING STRUCTURAL ELEMENTS (1):

1. PANEL MEMBERS
2. THIN-WALL BEAM MEMBERS
3. SOLID SECTION MEMBERS

TO ILLUSTRATE, PANEL MEMBERS INCLUDE THE HOOD, ROOF AND DOOR PANELS. THIN-WALLED - BEAM ELEMENTS INCLUDE THE CHASSIS FRAME, PILLARS AND RUCKER PANELS. SOLID SECTION MEMBERS INCLUDE VARIOUS REINFORCEMENT BRACKETS, HINGES AND HOOD-LATCH SUPPORTS. THE FOLLOWING SECTIONS DISCUSS INDIVIDUALLY EACH OF THESE ELEMENT TYPES AND DERIVE THEIR GOVERNING EQUATIONS FOR MATERIAL SUBSTITUTION.

James S. [Signature] 26 MAR '74

5.0 THEORETICAL DEVELOPMENT CONT'D

5.1 PANEL MEMBERS

PANEL MEMBERS ARE USED IN THE HOOD, ROOF, TRUNK, FLOOR AND SIDE-WALL ASSEMBLIES OF PASSENGER VEHICLES. THE STRUCTURAL REQUIREMENTS OF THESE PANELS INCLUDE:

- RESISTANCE TO "OIL-CANNING"
- RESISTANCE TO DENTING
- RESISTANCE TO ELASTIC BUCKLING
- RESISTANCE TO VIBRATION

5.1.1 RESISTANCE TO "OIL-CANNING" (1, 2, 3)

"OIL-CANNING" RESISTANCE IS DEFINED AS THE CONCENTRATED LOAD, APPLIED NORMAL TO THE PANEL SURFACE, REQUIRED TO PRODUCE UNIT DEFLECTION IN THE DIRECTION OF LOAD (1). "OIL-CANNING" RESISTANCE CAN BE EXPRESSED (APPROXIMATELY) AS

$$RESIST_{OIL-CAN} = \frac{COEF_{GEOM}}{E \cdot t^m} \dots \dots (1)$$

WHERE,

COEF_{GEOM} = GEOMETRICAL COEFFICIENT; A FUNCTION OF PANEL SIZE AND EDGE FINITY.

E = YOUNG'S MODULUS

m = A CONSTANT DEPENDING ON PANEL CURVATURE

t = PANEL THICKNESS

LET THE SUBSCRIPT O, N DENOTE THE ORIGINAL AND NEW (SUBSTITUTE MATERIAL). THEN,

$$\frac{RESIST_{OIL-CAN_N}}{RESIST_{OIL-CAN_O}} = \frac{(COEF_{GEOM_N} E_N t_N^m)}{(COEF_{GEOM_O} E_O t_O^m)} \dots \dots (2)$$

James S. ... 26 MAR '75

5.0 THEORETICAL DEVELOPMENT ... (CONT'D)

SINCE THE GEOMETRY AND EDGE FINISH OF THE ORIGINAL AND NEW PANEL ARE TO BE IDENTICAL (BY ASSUMPTION) THEN,

$$COEF_{GEOM,0} = COEF_{GEOM,N} \dots (3)$$

THEREFORE,

$$\frac{RESIST_{OIL-CAN,N}}{RESIST_{OIL-CAN,0}} = \left(\frac{E_N}{E_0}\right) \cdot \left(\frac{t_N}{t_0}\right)^m \dots (4)$$

FOR AUTOMOTIVE APPLICATIONS $m \approx 2$ (M CAN VARY FROM 1, FOR A HIGHLY CURVED PANEL, TO 3, FOR A FLAT PANEL). FOR EQUAL RESISTANCE TO "OIL-CANNING" BY THE ORIGINAL AND SUBSTITUTE MATERIAL, WE HAVE:

$$\frac{t_N}{t_0} = \sqrt{\frac{E_0}{E_N}} \dots (5)$$

PANEL OIL-CAN RESIST.

5.1.2 RESISTANCE TO DENTING (1,2,3)

THE RELATIVE DENT RESISTANCE $RESIST_{DENT,N} / RESIST_{DENT,0}$ IS DEFINED AS THE ENERGY REQUIRED TO PRODUCE A DENT OF A SPECIFIED DEPTH (2,3). THE PANEL DENT RESISTANCE DEPENDS ON THE MATERIAL YIELD STRENGTH, ITS STRAIN RATE SENSITIVITY, THE PANEL THICKNESS AND STIFFNESS (1). THIS (1),

$$RESIST_{DENT} \sim \frac{[S_{YD}(\dot{\epsilon}) t]^2}{STIFF_{PANEL}} \dots (6)$$

WHERE,

$S_{YD}(\dot{\epsilon})$ = MATERIAL YIELD STRENGTH AT THE STRAIN-RATE OF INDENTATION.

Ans 5/1 26 MAR '79

S.0 THEORETICAL DEVELOPMENT (CONT'D)

t = PANEL THICKNESS

$$STIFF_{PANEL} = RESIST_{OIL-CAN} \dots\dots (7)$$

ORIGINAL PAGE IS
OF POOR QUALITY

THEREFORE,

$$\frac{RESIST_{DENT_N}}{RESIST_{DENT_0}} = \left[\frac{SYLD(\dot{\epsilon})_N}{SYLD(\dot{\epsilon})_0} \right]^2 \left(\frac{t_N}{t_0} \right)^4 \frac{STIFF_0}{STIFF_N} \dots\dots (8)$$

USING (7) IN (8) WE HAVE,

$$\frac{RESIST_{DENT_N}}{RESIST_{DENT_0}} = \left[\frac{SYLD(\dot{\epsilon})_N}{SYLD(\dot{\epsilon})_0} \right]^2 \left(\frac{t_N}{t_0} \right)^2 \frac{E_0}{E_N} \dots\dots (9)$$

FOR EQUAL DENT RESISTANCE,

$$\frac{t_N}{t_0} = \left[\frac{SYLD(\dot{\epsilon})_0}{SYLD(\dot{\epsilon})_N} \right] \left(\frac{E_N}{E_0} \right)^{1/2} \dots\dots (10)$$

PANEL DENT RESISTANCE

S.1.3 RESISTANCE TO ELASTIC BUCKLING (E)

THE BUCKLING STRENGTH OF A CURVED PANEL IS GIVEN BY BRUNN (5), AS

$$RESIST_{BUCKLING} = K_C \cdot G_{DOM} \cdot \frac{E}{1-\nu^2} t^3 \dots\dots (11)$$

WHERE,

K_C = PANEL BUCKLING COEFFICIENT; DEPENDS ON TYPE OF LOADING.

G_{DOM} = PANEL GEOMETRY CONSTANT; DEPENDS ON PANEL SHAPE AND LOADING CONDITIONS.

John S. ... 31 MAR '79

5.0 THEORETICAL DEVELOPMENT CONT'D

THUS, SINCE THE PANEL GEOMETRY IS INVARIANT WITH THE MATERIAL SUBSTITUTION WE HAVE:

$$\frac{\text{RESIST}_{\text{BUCKLING}_N}}{\text{RESIST}_{\text{BUCKLING}_0}} = \left(\frac{E_N}{E_0} \right) \left(\frac{1 - \nu_0^2}{1 - \nu_N^2} \right) \left(\frac{t_N}{t_0} \right)^3 \dots \dots (12)$$

FOR EQUAL BUCKLING RESISTANCE,

$$\frac{t_N}{t_0} = \left[\frac{1 - \nu_N^2}{1 - \nu_0^2} \cdot \frac{E_0}{E_N} \right]^{1/3} \dots \dots (13)$$

PANEL BUCKLING RESISTANCE

ORIGINAL PAGE IS
OF POOR QUALITY

5.1.4 RESISTANCE TO VIBRATION

IN THIS STUDY, IT IS ASSUMED THAT THE RESISTANCE OF THE PANEL TO VIBRATION IS PROPORTIONAL TO THE FUNDAMENTAL FREQUENCY OF OSCILLATION OF THE PANEL (THE MODE OF VIBRATION IS ASSUMED TO BE INVARIANT WITH THE MATERIAL SUBSTITUTION). I.E.,

$$\text{RESIST}_{\text{VIB}} \sim \omega_{\text{FUNDAMENTAL}} \dots \dots (14)$$

NOW,

$$\omega_{\text{FUNDAMENTAL}} = C \sqrt{\frac{K}{M}} \dots \dots (15)$$

WHERE,

$$K = \text{PANEL STIFFNESS (= RESIST}_{\text{OIL-CAN}})$$

$$M = \rho t^2 \dots \dots (16)$$

$$\rho = \text{MATERIAL DENSITY}$$

$$t = \text{MATERIAL THICKNESS}$$

DATE: 19 MAR '79

Jay S. P. Smith

S.O. THEORETICAL DEVELOPMENT CONT'D

ξ = CONSTANT DEPENDING ON PANEL GEOMETRY AND VIBRATION MODE SHAPE.

USING (1), AND (6) IN (15)

$$\omega_{\text{FUNDAMENTAL}} = C \sqrt{\frac{\text{CONF}_{\text{GEOM}} \cdot E \cdot t^m}{\rho L \xi}} \dots\dots (17)$$

FOR PRACTICAL AUTOMOTIVE DESIGNS $m \approx 2$. THEREFORE,

$$\frac{\omega_{\text{FUNDAMENTAL}_N}}{\omega_{\text{FUNDAMENTAL}_0}} = \sqrt{\frac{E_N \cdot \rho_0 \cdot t_N}{E_0 \cdot \rho_N \cdot t_0}} = \frac{\text{RESIST}_{\text{VIB}_N}}{\text{RESIST}_{\text{VIB}_0}} \dots\dots (18)$$

FOR EQUAL RESISTANCE TO VIBRATION,

$$\frac{t_N}{t_0} = \frac{E_0 \cdot \rho_N}{E_N \cdot \rho_0} \dots\dots (19)$$

PANEL RESISTANCE TO VIB.

ORIGINAL PAGE IS OF POOR QUALITY

5.0 THEORETICAL DEVELOPMENT (CONT'D)5.2 THIN - WALL BEAM MEMBERSORIGINAL PAGE IS
OF POOR QUALITY

THIN - WALL BEAM MEMBERS ARE USED FOR THE CHASSIS FRAMES, SIDE-WALL PILLARS, ROCKER PANELS AND OTHER PARTS OF THE STRUCTURE. THE STRUCTURAL REQUIREMENTS OF THESE MEMBERS INCLUDE:

- BENDING STIFFNESS
- TORSIONAL STIFFNESS (CLOSED SECTIONS)
- TORSIONAL STIFFNESS (OPEN SECTIONS)
- RESISTANCE TO YIELDING
- RESISTANCE TO BUCKLING
- RESISTANCE TO VIBRATION
- ENERGY ABSORPTION (IMPACT PROTECTION)

5.2.1 BENDING STIFFNESS (1)

IT IS ASSUMED THAT THE SHAPE OF THE CROSS-SECTION OF THE BEAM ELEMENT CAN BE APPROXIMATED BY m STRAIGHT LINE SEGMENTS. THE LENGTH AND THICKNESS OF THE j th SEGMENT IS DENOTED AS L_j AND t_j . NOW, SINCE THE "NEW" AND "ORIGINAL" BEAMS ARE TO HAVE THE SAME LENGTH AND END FIXITY, THE BEAM STIFFNESS WILL BE PROPORTIONAL TO THE MODULUS OF ELASTICITY OF THE MATERIAL AND THE AREA MOMENT OF INERTIA OF THE BEAM CROSS-SECTION (THE SHAPE OF THE CROSS-SECTION IS ASSUMED TO BE CONSTANT OVER THE BEAM LENGTH). I.E.,

$$\text{STIFF}_{\text{BEND}} \sim EI \quad \dots \dots (20)$$

IF WE MAKE THE ASSUMPTION THAT THE CROSS-SECTIONAL SHAPE REMAINS INVARIANT WITH THE MATERIAL SUBSTITUTION (I.E. THE CENTROID WILL REMAIN CONSTANT) THEN THE AREA MOMENT OF INERTIA CAN BE APPROXIMATED AS FOLLOWS:

$$I \approx \sum_{j=1}^m L_j t_j (a_j t_j^3 + c_j) \quad \dots \dots (21)$$

John S. [Signature] 20 MAR '79

5.0 THEORETICAL DEVELOPMENT CONT'D

WHERE,

L = SECTION ELEMENT LENGTH

t = MATERIAL THICKNESS

Q = SECTION SHAPING FACTOR

C = " " " "

ORIGINAL PAGE IS
OF POOR QUALITY

NOW LET $t_i = K_i t_{REF}$ (22)

USING (22) & (21) IN (20) AND NOTING THAT $Q_j t_j^2$ IS USUALLY $\ll C_j$:

$$STIFF_{BUND} \sim E t_{REF} \sum_{j=1}^m K_j L_j C_j \quad \dots (23)$$

OR

$$\frac{STIFF_{BUND_N}}{STIFF_{BUND_0}} = \left(\frac{E_N}{E_0} \right) \cdot \left(\frac{t_{REF_N}}{t_{REF_0}} \right) \quad \dots (24)$$

FOR EQUAL STIFFNESS,

$$\boxed{\frac{t_N}{t_0} = \frac{t_{REF_N}}{t_{REF_0}} = \left(\frac{E_0}{E_N} \right) \quad \dots (25)}$$

BUNDLING STIFFNESS

5.2.2 TORSIONAL STIFFNESS (CLOSED SECTIONS) - REF 1

THE TORSIONAL STIFFNESS OF A THIN-WALL CLOSED SECTION DUTM IS EXPRESSED AS

$$STIFF_{TORYON} = C_{b9} G K_t \quad \dots (26)$$

WHERE,

G = SHEAR MODULUS

K_t = TORSIONAL RIGIDITY

C_{b9} = BEAM TORSIONAL COEFFICIENT DEPENDING ON DUTM EFFECTIVE LENGTH AND BOUNDARY CONDITIONS.

5.0 THEORETICAL DEVELOPMENT CONT'D

NOW THE TORSIONAL RIGIDITY OF THE SECTION (K_t) IS,

$$K_t = \frac{t A_R^2}{\sum_{i=1}^m \left(\frac{S_i}{K_i} \right)} \dots \dots \dots (27)$$

WHERE,

- t = MATERIAL THICKNESS
- A_R = ENCLOSED MEAN AREA OF THE MEAN CROSS-SECTION
- S_i = LENGTH OF i^{th} ELEMENT MAKING UP THE CROSS-SECTION
- K_i = THICKNESS DISTRIBUTION FACTOR (CROSS-SECTION)

USING (27) IN (26),

$$STIFF_{TORSION} = \frac{C_b G t A_R^2}{\sum_{i=1}^m \left(\frac{S_i}{K_i} \right)} \dots \dots \dots (28)$$

OR

$$\frac{STIFF_{TORSION_N}}{STIFF_{TORSION_0}} = \frac{G_N}{G_0} \cdot \frac{t_N}{t_0} \sim \frac{E_N}{E_0} \cdot \frac{t_N}{t_0} \dots \dots (29)$$

FOR EQUAL STIFFNESS,

$$\frac{t_N}{t_0} = \frac{E_0}{E_N} \dots \dots \dots (30)$$

CLOSED SECTION TORSIONAL STIFFNESS

John S. P. 26 MAR '79

5.0 THEORETICAL DEVELOPMENT CONT'D5.2.3 TORSIONAL STIFFNESS (OPEN SECTION) - REF 1

FOR OPEN SECTIONS (THIN-WALLED) THE TORSIONAL STIFFNESS CONSISTS OF TWO PARTS, ONE PART DUE TO TORSIONAL RIGIDITY AND THE OTHER PART DUE TO WARPING RIGIDITY. THE STIFFNESS IS EXPRESSED AS FOLLOWS:

$$STIFF_{TORSION} = C_{03} \left[\frac{Gt^3}{3} \sum_{i=1}^m S_i K_L^3 + \frac{Et}{3} \sum_{i=1}^m C_i S_i K_L \right] \dots (31)$$

IN GENERAL THE WARPING RIGIDITY \gg TORSIONAL RIGIDITY. THEREFORE,

$$STIFF_{TORSION} \cong C_{03} \frac{Et}{3} \sum_{i=1}^m C_i S_i K_i \dots (32)$$

THUS,

$$\frac{STIFF_{TORSION_N}}{STIFF_{TORSION_0}} \cong \frac{E_N}{E_0} \cdot \frac{t_N}{t_0} \dots (33)$$

FOR EQUAL STIFFNESS,

$$\frac{t_N}{t_0} = \frac{E_0}{E_N} \dots (34)$$

5.2.4 RESISTANCE TO YIELDING

IT IS ASSUMED THAT BENDING IS THE PRINCIPAL MODE OF LOADING FOR THE BEAMA. THUS THE STRESS ACTING ON THE SECTION IS,

$$STRESS = \frac{M \cdot c}{I} \dots (35)$$

26 MAR '79

S.O. THEORETICAL DEVELOPMENT CONT'D

WHERE,

M = APPLIED SECTION MOMENT (INVARIANT WITH MATERIAL SUBSTITUTION).

C = FIBRE DISTANCE FROM CENTROID

I = AREA MOMENT OF INERTIA

THE CROSS-SECTION IS ASSUMED TO BE COMPRISED OF M STRAIGHT LINE SEGMENTS. HENCE, THE AREA MOMENT OF INERTIA MAY BE EXPRESSED AS,

$$I = \sum_{j=1}^M L_j t_j (a_j t_j^2 + C_j) \dots \dots (36)$$

WHERE,

L_j = LENGTH OF j^{th} ELEMENT

t_j = THICKNESS OF j^{th} "

a_j = SECTION SHAPE FACTOR

C_j = "

FROM (35),

$$M = \frac{\text{STRESS} \cdot I}{C} = \frac{\text{STRESS}}{C} \cdot \sum_{j=1}^M L_j t_j (a_j t_j^2 + C_j) \dots \dots (37)$$

NOW, NOTING THAT C_j IS USUALLY $\gg a_j t_j^2$ AND LETTING $t_j = k_j t_0$:

$$\frac{M_N}{M_0} = \left(\frac{\text{STRESS}_{YLD_N}}{\text{STRESS}_{YLD_0}} \right) \cdot \frac{t_N}{t_0} \dots \dots (38)$$

FOR EQUAL STRENGTH (OF SECTION)

$$\frac{t_N}{t_0} = \frac{\text{STRESS}_{YLD_0}}{\text{STRESS}_{YLD_N}} \dots \dots (39)$$

BUILDING STRENGTH

John S. [Signature] 26 MAR '79

5.0 THEORETICAL DEVELOPMENT CONT'D

5.2.5 RESISTANCE TO BUCKLING

THE BUCKLING MODES OF INTEREST HERE INCLUDE THE FOLLOWING:

- PRIMARY COLUMN BUCKLING
- LOCAL FLANGE BUCKLING
- CRIPPLING

PRIMARY COLUMN BUCKLING: THE PRIMARY COLUMN BUCKLING LOAD CAN BE EXPRESSED BY THE FOLLOWING,

$$RESIST_{BUCK} = C_{geom} E I \quad \dots \quad (40)$$

WHERE,

C_{geom} = geom. & end fixity factor

E = Modulus of Elasticity

I = Area Moment of Inertia

ASSUMING THAT THE SECTION IS MADE UP OF m STRAIGHT LINE SEGMENTS,

$$I = \sum_{j=1}^m L_j t_j (a_j t_j^2 + c_j) \quad \dots \quad (41)$$

USUALLY $c_j \gg a_j t_j^2$. ALSO, LETTING $t_j = t k_j$ WE HAVE:

$$I \approx t \sum_{j=1}^m L_j k_j c_j \quad \dots \quad (42)$$

USING (42) IN (40) WE HAVE

$$RESIST_{BUCK} = C_{geom} E t \sum_{j=1}^m L_j k_j c_j$$

OR

$$\frac{RESIST_{BUCK_N}}{RESIST_{BUCK_0}} = \frac{E_N}{E_0} \cdot \frac{t_N}{t_0} \quad \dots \quad (43)$$

James S. [Signature] 26 MAR '79

S.O THEORETICAL DEVELOPMENT CONT'D

FOR EQUAL RESISTANCE TO BUCKLING,

$$\frac{t_N}{t_0} = \frac{E_0}{E_N} \dots \dots (44)$$

COLUMN BUCKLING

LOCAL FLANGE BUCKLING: THE LOCAL FLANGE BUCKLING RESISTANCE CAN BE EXPRESSED AS,

$$RESIST_{BUCK} = C_{geo} \frac{E}{1-\nu^2} t^3 \dots \dots (45)$$

WHERE,

C_{geo} = COEFF. DEPENDING ON GEOMETRY, END FIXITY AND LOADING.

E = MODULUS OF ELASTICITY

ν = POISSON'S RATIO

t = MATERIAL THICKNESS

FOR MATERIAL SUBSTITUTION WE HAVE,

$$\frac{RESIST_{BUCK_N}}{RESIST_{BUCK_0}} = \left(\frac{E_N}{E_0} \right) \left(\frac{1-\nu_0^2}{1-\nu_N^2} \right) \left(\frac{t_N}{t_0} \right)^3 \dots \dots (46)$$

FOR EQUAL RESISTANCE TO BUCKLING,

$$\frac{t_N}{t_0} = \left[\frac{E_0}{E_N} \cdot \frac{1-\nu_N^2}{1-\nu_0^2} \right]^{1/3} \dots \dots (47)$$

FLANGE BUCKLING

John S. [Signature] 21 MAR '79

S.O. THEORETICAL DEVELOPMENT CONT'D

CRIPPLING OF SECTION: THE CRIPPLING STRENGTH OF A THIN-WALL MEMBER MAY BE EXPRESSED AS, (NEEDHAM METHOD):

$$RESIST_{CRIP} = C_{bg} \cdot C_s \cdot (S_{YID} E)^{0.5} t^{1.75} \dots (48)$$

WHERE,

C_{bg} = GEOMETRY FACTOR

C_s = SECTION SHAPE FACTOR DEPENDING ON DEGREE OF EDGE SUPPORT.

S_{YID} = YIELD STRENGTH OF MATERIAL

E = MODULUS OF ELASTICITY

t = MATERIAL THICKNESS

FOR MATERIAL SUBSTITUTION,

$$\frac{RESIST_{CRIPN}}{RESIST_{CRIP0}} = \left(\frac{S_{YIDN}}{S_{YID0}} \cdot \frac{E_N}{E_0} \right)^{1/2} \left(\frac{t_N}{t_0} \right)^{1.75} \dots (49)$$

FOR EQUAL STRENGTH,

$$\frac{t_N}{t_0} = \left(\frac{S_{YID0}}{S_{YIDN}} \cdot \frac{E_0}{E_N} \right)^{1/3.5} \dots (50)$$

CRIPPLING

5.2.6 RESISTANCE TO VIBRATION

VIBRATION OF BEAM ELEMENTS CAN TAKE ON TWO FORMS:

1. VIBRATION OF BEAM ELEMENT MASS
2. VIBRATION OF A SEPARATE MASS SUPPORTED BY A BEAM ELEMENT.

John S. Pasili 26 Mar '75

5.0 THEORETICAL DEVELOPMENT CONT'D

VIBRATION OF BEAM ELEMENT MASS: THE VIBRATION OF THE BEAM ELEMENT MASS CAN BE MONITORED IN TERMS OF ITS FREQUENCY RESPONSE. THE FREQUENCY RESPONSE OF A THIN-WALLED BEAM MEMBER (HAVING NEGLIGIBLE DAMPING) IS,

$$\omega = C \left(\frac{K}{M} \right)^{1/2} \dots \dots (51)$$

NOW,

$$K \sim EI$$

$$M \sim \rho L$$

$$\therefore \omega = C \left(\frac{E}{\rho} \right)^{1/2} \dots \dots (52)$$

THUS, IN THIS CASE, THE FREQUENCY RESPONSE IS INDEPENDENT OF THE THICKNESS.

$$\frac{\omega_N}{\omega_0} = \sqrt{\frac{E_N}{E_0} \cdot \frac{\rho_0}{\rho_N}} \dots \dots (53)$$

VIBRATION OF BEAM SUPPORTED MASS: IN THIS CASE THE SUSPENDED MASS IS INDEPENDENT OF MATERIAL THICKNESS. IT IS ASSUMED THAT THE SUSPENDED MASS IS INVARIANT WITH THE MATERIAL SUBSTITUTION. THE FREQUENCY RESPONSE FOR THIS CASE IS,

$$\omega = C \left(\frac{K}{M} \right)^{1/2} \dots \dots (54)$$

NOW,

$$K \sim EI \dots \dots (55)$$

$$M = \text{CONST}$$

$$\therefore \omega = C \left(\frac{EI}{M} \right)^{1/2} \dots \dots (56)$$

John D. ... 26 MAR '79

5.0 THEORETICAL DEVELOPMENT ... CONT'D

NOW,

$$\frac{\omega_N}{\omega_0} = \left[\frac{E_N}{E_0} \cdot \frac{I_N}{I_0} \right]^{1/2} \dots (57)$$

FOR EQUAL FREQUENCY RESPONSE,

$$\frac{I_N}{I_0} = \frac{E_0}{E_N} \dots (58)$$

BEAM SUPPORTED MASS

5.2.7 RESISTANCE TO IMPACT (ENERGY ABSORPTION) - REF 5

IN DETERMINING THE RESISTANCE TO IMPACT FOR THIN-SECTION BEAM ELEMENTS IT WILL BE ASSUMED THAT THE SECTION GEOMETRY IS THAT SHOWN IN FIGURE 1. FROM REF. 5 THE AVERAGE CRUSH STRENGTH OF THE SECTION IS GIVEN BY,

$$P_{MS}^* \approx \frac{t^2 \sigma_{YLD}(\dot{\epsilon})}{h - K_2(t)} \left\{ (a + b + 4t) \left(\frac{\pi}{2} + K_1 \right) + 2h + 0.570 \frac{h^2}{r} \right\} \dots (59)$$

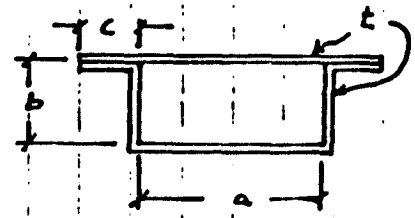

FIGURE 1

WHERE,

$$\left. \begin{aligned} h &= b/2 \\ r &= t \\ K_2(t) &= 5t \\ K_1 &= 2.96 \end{aligned} \right\} \dots (60)$$

* THIS EQUATION WAS DERIVED FOR STEEL. IT IS ASSUMED THAT IT APPLIES TO OTHER MATERIALS AS WELL.

James S. [Signature] 24 MAR '79

S.O THEORETICAL DEVELOPMENT (CONT'D)

USING (60) IN (59)

$$P_{MS} = \frac{L^2 S_{YLD}(\dot{\epsilon})}{\frac{L}{2} - st} \left\{ (a+b+4c) \left(\frac{L}{2} + 2.9L \right) + b + .1435 \frac{b^2}{L} \right\} \dots (61)$$

FOR PRACTICAL FRAME DESIGNS,

$$(a+b+4c) \left(\frac{L}{2} + 2.9L \right) + b \gg .1435 \frac{b^2}{L} \dots (62)$$

$$P_{MS} \approx \frac{L^2 S_{YLD}(\dot{\epsilon})}{\frac{L}{2} - st} \rho_{geom} \dots (63)$$

NOW, THE RESISTANCE TO IMPACT IS PROPORTIONAL TO THE ENERGY ABSORPTION CAPABILITY OF THE BEAM ELEMENT. I.E.,

$$RESIST_{IMPACT} \sim EN \dots (64)$$

BUT,

$$EN = P_{MS} \cdot \Delta CRUSH \dots (65)$$

FOR A GIVEN AMOUNT OF CRUSH,

$$\frac{EN_N}{EN_0} = \frac{P_{MS_N}}{P_{MS_0}} = \frac{L_N^2 S_{YLD}(\dot{\epsilon})_N}{\left(\frac{L}{2} - st_N \right)} \cdot \frac{\left(\frac{L}{2} - st_0 \right)}{L_0^2 S_{YLD}(\dot{\epsilon})_0}$$

$$\frac{EN_N}{EN_0} = \left(\frac{L_N}{L_0} \right)^2 \cdot \left(\frac{S_{YLD}(\dot{\epsilon})_N}{S_{YLD}(\dot{\epsilon})_0} \right) \cdot \frac{\left(\frac{L}{2} - st_0 \right)}{\left(\frac{L}{2} - st_N \right)} \dots (66)$$

FOR $\frac{L}{2} \gg L_0; \gg L_N$ AND FOR EQUAL ENERGY ABSORPTION,

$$\frac{L_N}{L_0} \approx \sqrt{\frac{S_{YLD}(\dot{\epsilon})_0}{S_{YLD}(\dot{\epsilon})_N}} \dots (67)$$

ENERGY ABSORPTION

John S. P.

5.0 THEORETICAL DEVELOPMENT . . . CONT'D

5.3 SOLID SECTION MEMBERS

SOLID SECTION MEMBERS INCLUDE SUCH ITEMS AS REINFORCEMENT BRACKETS, HINGES, HOOD-LATCH SUPPORTS E.T.C. IN THIS REPORT, BENDING IS CONSIDERED TO BE THE PREDOMINANT LOADING. BOTH OUT-OF-PLANE AND IN-PLANE BENDING OF THE MEMBERS ARE CONSIDERED. THE SOLID SECTION MEMBERS CONSIDERED IN THIS REPORT ARE ASSUMED TO BE PLATE ELEMENTS HAVING A THICKNESS (t).

5.3.1 OUT-OF-PLANE BENDING

OUT-OF-PLANE BENDING, AS USED IN THIS REPORT, IMPLIES THAT THE MOMENT VECTOR (USING THE RIGHT HAND RULE) IS NORMAL TO THE SURFACE OF THE PLATE AS SHOWN IN FIGURE 2. FOR THIS CASE,

$$S_b = \frac{M a^2}{I} \dots (68)$$

HERE,

$$I = \frac{1}{12} E a^3 \dots (69)$$

USING (66) IN (65) WE HAVE:

$$S_b = \frac{6 M}{E a^2} \dots (70)$$

OR,

$$M = \frac{S_b E a^2}{6} \dots (71)$$

FOR EQUAL MOMENTS (NEW AND ORIGINAL MATERIAL),

$$\frac{E_N}{E_O} = \frac{S_{bYLO}}{S_{bYN}} \dots (72)$$

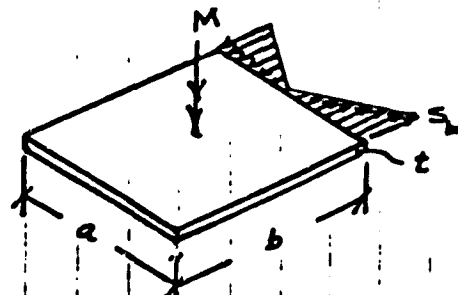

James S. Paul 26 MAR '79

5.0 THEORETICAL DEVELOPMENT CONT'D

5.3.2 IN-PLANE BENDING

IN-PLANE BENDING, AS USED IN THIS REPORT, IMPLIES THAT THE APPLIED MOMENT VECTOR (USING THE RIGHT HAND RULE) IS IN THE PLANE OF THE PLATE MEMBER, AS SHOWN IN FIGURE 3. FOR THIS CASE,

$$S_b = \frac{M t/2}{I} \dots\dots (73)$$

WHERE,

$$I = \frac{1}{12} a t^3 \dots\dots (74)$$

USING (71) IN (70) WE HAVE,

$$S_b = \frac{6M}{a t^2} \dots\dots (75)$$

OR,

$$M = \frac{S_b a t^2}{6} \dots\dots (76)$$

FOR EQUAL MOMENTS (NEW AND ORIGINAL MATERIAL) AND USING YIELD STRESS AS THE STRESS LEVEL,

$$\frac{E_N}{E_o} = \sqrt{\frac{S_{YLD_o}}{S_{YLD_N}}} \dots\dots (77)$$

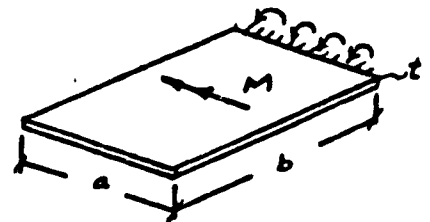

FIGURE 3

John S. [Signature] 26 MAR '79

5.0 THEORETICAL DEVELOPMENT CONT'D

5.4 WEIGHT ESTIMATES

IN THE FOREGOING DISCUSSIONS IT WAS ASSUMED THAT THE SHAPE OF THE MEMBER IN QUESTION REMAINED INVARIANT DURING MATERIAL SUBSTITUTION (EXCEPT FOR THE MATERIAL THICKNESS). THUS, THE WEIGHT OF THE NEW MATERIAL CAN BE RELATED TO THE WEIGHT OF THE ORIGINAL MATERIAL AS FOLLOWS:

$$\frac{W_N}{W_0} = \frac{t_N}{t_0} \cdot \frac{\rho_N}{\rho_0} \dots\dots (78)$$

THE PERCENTAGE CHANGE IN WEIGHT IS,

$$\Delta W = \frac{100(W_N - W_0)}{W_0} = 100 \left(\frac{W_N}{W_0} - 1 \right) \dots\dots (79)$$

OR,

$$\Delta W = 100 \left[\frac{t_N}{t_0} \cdot \frac{\rho_N}{\rho_0} - 1 \right] \dots\dots (80)$$

ORIGINAL PAGE IS
OF BEST QUALITY

John S. [Signature] 26 MAR '79

6.0 FORD LTD WEIGHT SAVING CALCULATIONS

SECTION 5.0 PROVIDES THE ANALYTICAL TOOLS FOR ESTIMATING THE WEIGHT SAVING POTENTIAL OF VARIOUS CANDIDATE SUBSTITUTE MATERIALS. THIS SECTION UTILIZES THESE ANALYTICAL TOOLS IN ESTIMATING THE WEIGHT SAVING POSSIBILITIES, THRU MATERIAL SUBSTITUTION, FOR VARIOUS MAJOR STRUCTURAL SUBSYSTEMS COMPRISING THE 1979 FORD LTD. IN A SEPARATE EFFORT AT SOUTH COAST TECHNOLOGY, THE FOLLOWING MAJOR STRUCTURAL SUBSYSTEMS WERE IDENTIFIED AS PRIORITY ITEMS FOR WEIGHT REDUCTION THRU MATERIAL SUBSTITUTION (THE LIST IS PROVIDED IN DESCENDING ORDER OF PRIORITY):

1. FRAME ASSEMBLY
2. HOOD ASSEMBLY
3. DECK LID ASSEMBLY
4. FRONT FENDER (OUTER ONLY)
5. BUMPER ASSEMBLY
6. DOOR ASSEMBLY
7. HARDWARE
8. WHEELS

6.1 WEIGHT SAVING POTENTIAL - FRAME ASSEMBLY

THE FRAME ASSEMBLY OF THE FORD LTD IS ILLUSTRATED IN FIGURE 4. THE FIGURE IDENTIFIES THREE ZONES ON THE FRAME THAT WILL BE EVALUATED HEREIN. ZONES #1 AND #3 HAVE AS THEIR PREDOMINANT LOADING,

- 5 MPH BARRIER IMPACT PROTECTION PER FMVSS 215.
- CRASH PROTECTION PER FMVSS 208.
- JACKING/MOISTING/TOWING

ZONE #2 LOADING IS CONCERNED PRIMARILY WITH THE BEARING OF THE SUSPENDED WEIGHT OF THE VEHICLE TO THE FORE AND AFT AXLES AND THE STIFFNESS REQUIREMENTS FOR RIDING AND HANDLING.

ORIGINAL PAGE IS
OF POOR QUALITY

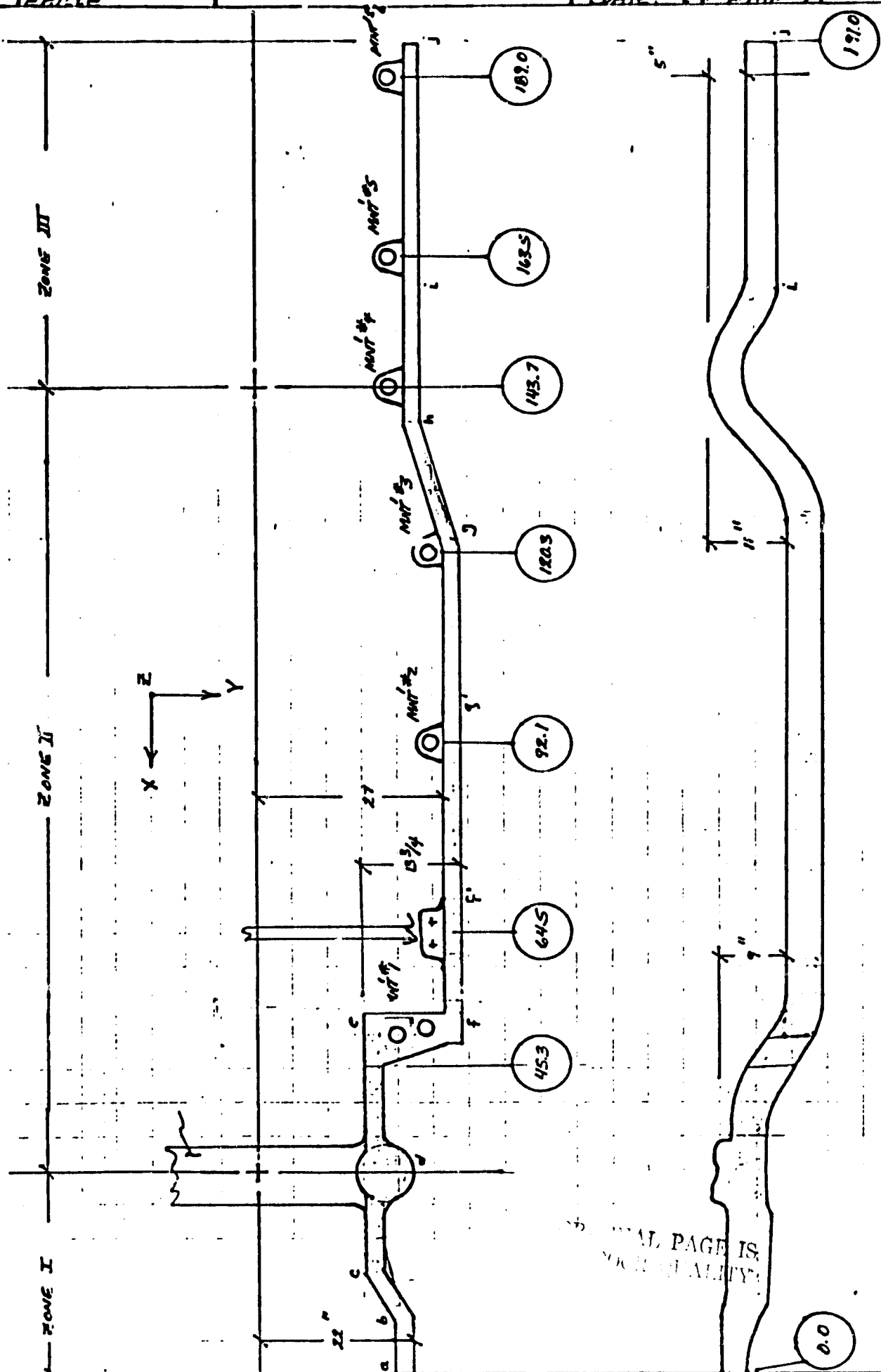

FIGURE 4

James S. Lee

6.0 FORD LTD WEIGHT SAVING CALCULATIONS

6.1.1 ZONE 1 (FIGURE 4)

AS SHOWN IN FIGURE 4, THIS ZONE MAKES UP THE FORWARD END OF THE FRAME ASSEMBLY AND INCLUDES THE LATERAL BRACING WHICH SERVES AS A SUPPORT FOR THE ENGINE AND A TORSIONAL RESTRAINT FOR THE LONGITUDINAL FRAMES. THE LONGITUDINAL FRAME MEMBERS IN ZONE 1 ARE FABRICATED FROM HSLA grade 950X HAVING THE FOLLOWING MECHANICAL PROPERTIES:

- $S_{EU} = 65,000 \text{ psi (min)}$
- $S_{EYM} = 50,000 \text{ psi (min)}$
- $E = 30 \times 10^6 \text{ psi}$
- $\nu \approx .25$

THE LATERAL BRACING IS ASSUMED TO BE FABRICATED FROM AN SAE 1006 STEEL ALLOY (OR EQUIVALENT) WITH THE FOLLOWING MECHANICAL PROPERTIES (7):

- $S_{EU} = 40,000 \text{ psi (min)}$
- $S_{YLD} = 25,000 \text{ psi (min)}$
- $E = 30 \times 10^6$
- $\nu \approx .25$

THE ABOVE MATERIALS ARE FOR STATIC CONDITIONS. FOR DYNAMIC CONDITIONS, THE STRAIN RATE EFFECTS MUST BE CONSIDERED. REFERENCE 7 PROVIDES TEST DATA FROM THE CRUSH OF 4 INCH DIAMETER TUBES MADE FROM HSLA STEEL AND ALUMINUM. THE FOLLOWING STRAIN RATE FACTORS WERE DERIVED FROM THAT DATA.

$$\left. \begin{aligned} \sigma_{STEEL} &= 1 + .02 V \\ \sigma_{AL} &= 1 + .0071 V \end{aligned} \right\} \dots (B1)$$

WHERE,

$V = \text{IMPACT SPEED (MPH)}$

Jenny S. Paul 26 MAR '75

60 FORD LTD WEIGHT SAVING CALCULATIONS CONT'D

IN ZONE #1, OF THE FRAME, THE FOLLOWING MATERIAL PERFORMANCES ARE CONSIDERED TO BE CRUCIAL TO THIS DESIGN:

1. YIELDING OF SECTION
2. BUCKLING OF SECTION ELEMENTS
 - FLANGE
 - CRIPPLING
3. IMPACT RESISTANCE

TABLE I SUMMARIZES THE CALCULATIONS FOR THIN-WALL BEAM ELEMENTS FOR A VARIETY OF ORIGINAL AND SUBSTITUTE MATERIALS AND FOR VARIOUS MATERIAL PERFORMANCE CATEGORIES, INCLUDING:

- STIFFNESS - COLUMNS 11 & 12
- YIELDING - " 13 & 14
- BUCKLING
 - COLUMN " 15 & 16
 - FLANGE " 17 & 18
 - CRIPPLING " 19 & 20
- VIBRATION -
 - ELEMENT MASS " 21 & 22
 - MASS SUPPORTED BY ELEMENT " 23 & 24
- IMPACT RESISTANCE " 25 & 26

THIS PAGE IS QUALITY

CONSIDERING FIRST THE LONGITUDINAL FRAME MEMBER IN ZONE #1, WHICH IS ORIGINALLY A HSLA-950X STEEL, TABLE I SHOWS THE FOLLOWING MATERIAL PERFORMANCES FOR THE THREE PERFORMANCE CATEGORIES OF INTEREST HERE.

SUBSTITUTE MATERIAL	YIELDING		BUCKLING				IMPACT	
	E_n/E_o	$\Delta W\%$	FLANGE		CRIPPLING		E_n/E_o	$\Delta W\%$
ALUMINUM ALLOY	E_n/E_o	$\Delta W\%$	E_n/E_o	$\Delta W\%$	E_n/E_o	$\Delta W\%$	E_n/E_o	$\Delta W\%$
5182	1.72	-39.1	1.41	-50.2	1.60	-43.5	1.52	-46.9
2014-T4	1.35	-52.2	1.41	-50.2	1.47	-47.3	1.34	-52.6
6061-T6	1.25	-55.8	1.41	-50.2	1.46	-42.9	1.29	-54.6

J. S. [Signature] 26 MAR '79

6.0 FORD LTD WEIGHT SAVING CALCULATIONS CONT'D

THE RESULTS SHOW THAT FOR AL-5182, YIELDING LIMITS THE POTENTIAL WEIGHT SAVING TO 39.1%. FOR THE OTHER TWO ALUMINUM ALLOYS, HAVING A SOMEWHAT HIGHER YIELD STRENGTH, THE CRIPPLING STRENGTH BECOMES THE LIMITING FACTOR FOR WEIGHT SAVINGS. FOR AL 2014-T4, THE WEIGHT SAVINGS IS LIMITED TO 47.3% AND FOR AL-6061-T6 IS LIMITED TO 48.5%.

NOTE, THAT IN THE ABOVE DISCUSSION IT WAS ASSUMED THAT THE STIFFNESS AND VIBRATION FACTORS ARE OF SECONDARY IMPORTANCE IN ZONE 2 OF THE FRAME. HERICE, WITH THE ALUMINUM MATERIAL SUBSTITUTION, IT CAN BE EXPECTED THAT THE FRONT END STRUCTURE WILL BE MORE FLEXIBLE (E.G. UNDER JOLTING LOADS) THAN THE ORIGINAL CONFIGURATION.

THE LATERAL BEARING, ALSO LOCATED IN ZONE I, HAS BASICALLY THE SAME MATERIAL PERFORMANCE REQUIREMENTS AS THE LONGITUDINAL FRAME MATERIAL (EXCEPT FOR IMPACT RESISTANCE - I.E. ENERGY ABSORPTION). TABLE I (ROWS 5, 6 & 7) SHOWS THE THICKNESS REQUIREMENTS AND POTENTIAL WEIGHT SAVINGS, OF THE LATERAL MEMBER, FOR VARIOUS MATERIAL SUBSTITUTES AND MATERIAL PERFORMANCE CATEGORIES. THE FOLLOWING SUMMARIZE THE APPROPRIATE RESULTS FOR THE LATERAL MEMBER:

SUBSTITUTE MATERIAL	YIELDING		BUCKLING			
			FLANGE		CRIPPLING	
ALUMINUM ALLOY	E_n/E_0	ΔW %	E_n/E_0	ΔW %	E_n/E_0	ΔW %
5182	.86	-70.0	1.41	-50.2	1.31	-50.2
2014-T4	.68	-76.0	1.41	-50.2	1.22	-56.8
6061-T6	.63	-77.9	1.41	-50.2	1.20	-57.7

THE RESULTS SHOW THAT FLANGE BUCKLING IS CRITICAL, LIMITING THE POTENTIAL WEIGHT SAVINGS TO ~ 50% FOR ALL MATERIAL CANDIDATES. HERE, AN INCREASE IN MATERIAL YIELD STRENGTH IS OF NO VALUE IN REDUCING THE WEIGHT OF THE

James S. [Signature]

6.0 FORD LTD WEIGHT SAVING CALCULATIONS CONT'D

PART.

6.1.2 ZONE #2 (FIGURE 4)

ZONE #2 MAKES UP THE MIDSpan OF THE FRAMES BETWEEN THE FRONT AND REAR AXLES. THE LONGITUDINAL FRAME MEMBERS IN THIS ZONE ARE BELIEVED TO BE FABRICATED FROM A SAE 1020 STEEL ALLOY (OR EQUIVALENT) HAVING THE FOLLOWING MECHANICAL PROPERTIES:

- $S_{YLD} = 36,000 \text{ PSI}$
- $E = 30 \times 10^6 \text{ PSI}$
- $\nu = .25$

TABLE I (ROWS 8, 9, 10) SHOWS THE MATERIAL THICKNESS REQUIREMENTS AND POTENTIAL WEIGHT SAVINGS FOR A MATERIAL SUBSTITUTION IN ZONE 2 OF THE FRAME. THE MATERIAL PERFORMANCE REQUIREMENTS HERE INCLUDE:

- STIFFNESS
- YIELDING
- BUCKLING
 - FLANGE
 - CRIPPLING
- VIBRATION (SUPPORTS MAIN)

COMPARING COLUMNS 11-24 IN ROWS 8, 9, 10 WE FIND THAT BOTH THE STIFFNESS (COLUMNS 11, 12) AND THE VIBRATION (COLUMNS 23 & 24) REQUIREMENTS OF THE FRAME MATERIAL IN ZONE #2 DOMINATES. THE RESULTS SHOW THAT THERE WILL BE AN INCREASE IN THE WEIGHT OF THE FRAME (67%) WHEN A SUBSTITUTION WITH ALUMINUM IS MADE. THE RESULTS IMPLY THAT WEIGHT SAVINGS CAN BE OBTAIN HERE ONLY AT THE EXPENSE OF THE VEHICLE BEARING STIFFNESS, AND VIBRATION CHARACTERISTICS.

ORIGINAL PAGE IS
OF POOR QUALITY

DATE: 22 MAR '79

John S. [Signature] 26 MAR '79

6.0 FORD LTD WEIGHT SAVING CALCULATIONS CONT'D

6.1.3 ZONE #3 (FIGURE 4)

ZONE #3 OF THE FRAME MAKES UP THE REAR OVERLAPPING OF THE FRAME (REARWARD OF THE REAR AXLE). THE MATERIAL PERFORMANCE REQUIREMENTS FOR THIS ZONE ARE BASICALLY THE SAME AS THAT FOR ZONE #1. I. E. THE FOLLOWING,

- YIELDING RESISTANCE
- BUCKLING RESISTANCE
 - FLANGE
 - CRIPPLING
- IMPACT RESISTANCE

THE ORIGINAL MATERIAL FOR THE FRAME IN ZONE #3 IS THE SAME AS THAT FOR ZONE #2 (SEE PAGE 19). TABLE I, ROWS 8, 9 AND 10 SUMMARIZE THE CALCULATIONS APPROPRIATE FOR ZONE #3. COMPARING COLUMN 19 (TABLE I) WITH OTHER APPROPRIATE COLUMNS IN TABLE I SHOWS THAT FLANGE BUCKLING LIMITS THE POTENTIAL WEIGHT REDUCTION IN THIS ZONE TO APPROXIMATELY 50%. IT IS NOTED THAT THIS EDGE OF THE FRAME STRUCTURE WILL BE MORE FLEXIBLE THAN THE ORIGINAL SINCE IT WAS ASSUMED THAT STIFFNESS AND VIBRATION WERE NON-CRITICAL TO THE DESIGN HERE.

6.2 WEIGHT SAVING POTENTIAL - HOOD ASSEMBLY

THE HOOD ASSEMBLY CONSISTS OF AN INNER AND OUTER PANEL. THE INNER PANEL IS FORMED WITH STIFFENING RIBS TO SUPPORT THE OUTER PANEL. THUS, THE INNER PANEL CAN BE THOUGHT OF AS AN ASSEMBLY OF THIN-WALL BEAM TYPE ELEMENTS. THE OUTER PANEL IS PROVIDED PRIMARILY FOR "COSMETICS" AND CONSISTS PRIMARILY OF A CONTOURED SHEET.

James S. Paul 26 Mar '79

6.0 FORD LTD WEIGHT SAVING CALCULATIONS CONT'D

6.2.1 INNER PANEL

THE INNER PANEL WILL FUNCTION PRIMARILY AS AN ASSEMBLY OF THIN-WALL BEAM TYPE ELEMENTS; HENCE, TABLE I IS APPLICABLE HERE. THE CRITICAL MATERIAL REQUIREMENTS FOR THIS PANEL INCLUDE:

- STIFFNESS
- VIBRATION
- YIELD STRENGTH
- BUCKLING RESISTANCE
 - FLANGE
 - CRIPPLING
- IMPACT RESISTANCE (ENERGY ABSORPTION)

ASSUMING THAT THE ORIGINAL MATERIAL IS AN SAE 1020 STEEL ALLOY (OR EQUIVALENT) THEN ROWS 8-11 OF TABLE I SUMMARIZE THE CALCULATIONS APPROPRIATE HERE. COMPARING COLUMNS 11-26 (TABLE I) REVEALS THAT STIFFNESS AND VIBRATION DOMINATES THE DESIGN AND NEITHER ALUMINUM OR PLASTIC OFFER A WEIGHT ADVANTAGE OVER THE ORIGINAL STEEL MATERIAL.

IF THE STIFFNESS AND VIBRATION CHARACTERISTICS ARE NOT CONSIDERED IMPORTANT, THEN THE CONTROLLING FACTORS WILL BE:

1. ALUMINUM SUBSTITUTION - FLANGE BUCKLING, $\Delta W_{max} = -50.2\%$
2. PLASTIC SUBSTITUTION - YIELDING, $\Delta W_{max} = -10.3\%$

6.2.2 OUTER PANEL

THIS PAGE IS
QUALITY

THE OUTER HOOD PANEL IS PRIMARILY A COSMETIC SURFACE. TABLE II IS APPLICABLE HERE. IT IS ASSUMED THAT THE ORIGINAL MATERIAL IS SAE 1010 (COLD ROLLED), OR EQUIVALENT. ROWS 1-4 IN TABLE II SUMMARIZE THE CALCULATIONS FOR FOUR (4) SUBSTITUTE MATERIALS AND VARIOUS CRITICAL REQUIREMENTS (I.E., COLUMNS 11-18). THE TABLE SHOWS THAT THE "OIL-CANNING" RESISTANCE IS CRITICAL FOR ALL OF THE SUBSTITUTE MATERIALS CONSIDERED (COMPARE

J.S. Paul 26 MAR '79

TABLE II: SUMMARY OF CALCULATIONS FOR PANEL ELEMENTS

1	2	3	4	5	6	7	8	9	10	11	12	13	14	15	16	17	18	MATERIAL PERFORMANCE - t_w/t_o ; ΔW			
																		ORIGINAL MATERIAL		SUBSTITUTE MATERIAL	
ALLOY	S_{y0} 110	P 44	E 30	ν .30	ALLOY	S_{y0} 110	P 44	E 30	ν .30	t_w/t_o	ΔW %	t_w/t_o	ΔW %	t_w/t_o	ΔW %	t_w/t_o	ΔW %				
1010 C.R. STEEL	44	.280	30	.30	2056-74	44	.1	10	.32	1.79 (5)	-38.8 (80)	.81 (80)	-71.5 (80)	1.42 (13)	-49.8 (80)	1.06 (17)	-62.5 (80)	1			
"	44	.280	30	.30	6182	27	.1	10	.32	1.73 (5)	-38.8 (80)	1.25 (10)	-55.7 (80)	1.42 (13)	-49.8 (80)	1.06 (17)	-62.5 (80)	2			
"	44	.280	30	.30	P19C (ALUM)	9.5	.067	1.85	.35	4.03 (5)	-4.6 (80)	1.84 (10)	-56.9 (80)	3.40 (13)	-41.4 (80)	3.84 (19)	-9.1 (80)	3			
"	44	.280	30	.30	DYNEX (ALUM)	8.4	.044	.9	.35	5.77 (5)	-10.2 (80)	1.45 (10)	-77.4 (80)	3.15 (13)	-51.0 (80)	5.18 (17)	-17.4 (80)	4			

NOTE: () INDICATES THE EQUATIONS USED IN THE CALCULATIONS

1. STATIC YIELD STRESS; DYNAMIC YIELD STRESS $\approx 1.6 S_{y0 static}$ (E 50 MPa)
2. " " ; DYNAMIC YIELD STRESS (ALUMINUM) $\approx 1.2 S_{y0 static}$ (E 50 MPa) ;
DYNAMIC YIELD STRESS (PLASTIC) $\approx 1.0 S_{y0 static}$
3. POISSON'S RATIO
4. PARAPLEX P19C, SHEET MOLDED COMPOUND BY BOMBA & HAYS CO., HAS 50% GLASS REINFORCEMENT.
5. DYNEX 280, HAS 20% GLASS REINFORCEMENT; BY ARCO/POLYMER INC.
6. YIELD STRENGTHS UNAVAILABLE; HENCE, $S_{y0} \approx .7 S_{ULT}$ ASSUMED.

James S. [Signature] 26 MAR '79

6.0 FORD LTD WEIGHT SAVING CALCULATIONS CONT'D

COLUMN 11 WITH COLUMNS 13, 15 & 17). FOR ALUMINUM, THE WEIGHT REDUCTION POTENTIAL APPEARS TO BE LIMITED TO 39%. FOR PLASTIC, THE POTENTIAL FOR WEIGHT REDUCTION IS LIMITED TO APPROXIMATELY 10%.

6.3 WEIGHT SAVING POTENTIAL - DECK LID ASSEMBLY

THE RESULTS DISCUSSED IN SECTION 6.2 ARE APPLICABLE HERE.

6.4 WEIGHT SAVING POTENTIAL - FRONT FENDER (OUTER ONLY)

THE FRONT FENDER ASSEMBLY (OUTER) CAN BE THOUGHT OF AS A PANEL TYPE ELEMENT; HENCE, TABLE II IS APPLICABLE HERE. THE FRONT FENDER ASSEMBLY IS PRIMARILY FOR "COSMETICS". THE FOLLOWING MATERIAL REQUIREMENTS ARE CONSIDERED TO BE CRITICAL TO THE DESIGN:

- DENT RESISTANCE (COLUMNS 13 & 14, TABLE II)
- ELASTIC BUCKLING (COLUMNS 15 & 16, TABLE II)

THE TABLE SHOWS THAT ELASTIC BUCKLING DOMINATES FOR ALL SUBSTITUTE MATERIALS CONSIDERED. THIS DESIGN REQUIREMENT LIMITS THE POTENTIAL WEIGHT SAVING TO 50% FOR ALUMINUM AND 51% FOR PLASTIC.

6.5 WEIGHT SAVING POTENTIAL - BUMPER ASSEMBLY

THE BUMPER SYSTEM CONSISTS PRIMARILY OF THIN-WALL BEAM TYPE ELEMENTS; HENCE, TABLE I IS APPLICABLE HERE. THE CRITICAL MATERIAL REQUIREMENTS FOR THIS ASSEMBLY ARE,

- YIELDING (COLUMNS 13 & 14)
- CRIPPLING (COLUMNS 19 & 20)

IF IT IS ASSUMED THAT THE ORIGINAL MATERIAL IS SAE 1020 STEEL ALLOY (OR EQUIVALENT) THEN ROWS B-11 OF TABLE I ARE APPLICABLE HERE. THE RESULTS IN THE

John S. Jones 26 MAR '79

6.0 FORD LTD WEIGHT SAVING CALCULATIONS CONT'D

TABLE SHOW THAT FOR ALUMINUM SUBSTITUTES THE POTENTIAL WEIGHT SAVINGS ARE LIMITED TO APPROXIMATELY 53% BY CRIPPLING. FOR PLASTIC, YIELDING SEEMS TO BE CRITICAL, LIMITING THE POTENTIAL WEIGHT SAVINGS TO APPROXIMATELY 10%.

6.6 WEIGHT SAVING POTENTIAL - DOOR ASSEMBLY

THE DOOR ASSEMBLY IS COMPRISED OF AN OUTER PANEL, AN INNER PANEL, A DOOR FRAME (ONTO WHICH THE HINGES AND THE LATCHES ARE ATTACHED) AND AN INNER DOOR BEAM.

6.6.1 OUTER PANEL

THE OUTER PANEL OF THE DOOR ASSEMBLY IS PRIMARILY A "COSMETIC" SURFACE, AND CAN BE CONSIDERED A PANEL TYPE ELEMENT (HENCE, TABLE II IS APPLICABLE HERE). THE CRITICAL MATERIAL REQUIREMENTS FOR THIS PANEL ARE:

- OIL-CANNING RESISTANCE
- DENT RESISTANCE

TABLE II (COLUMNS 11 & 13) SHOWS THAT OIL-CANNING RESISTANCE IS CRITICAL FOR ALL THE SUBSTITUTE MATERIALS CONSIDERED. THIS REQUIREMENT LIMITS THE POTENTIAL WEIGHT SAVINGS TO 39% FOR AN ALUMINUM SUBSTITUTE AND TO 10% FOR A PLASTIC SUBSTITUTE.

6.6.2 INNER PANEL

ORIGINAL PAGE IS
OF POOR QUALITY

THE INNER PANEL OF THE DOOR ASSEMBLY WILL HAVE THE SAME MATERIAL SUBSTITUTION LIMITATIONS AS THE OUTER PANEL SINCE THE CRITICAL MATERIAL REQUIREMENT HERE IS ALSO OIL-CANNING RESISTANCE. HENCE, THE POTENTIAL WEIGHT SAVINGS FOR THE INNER PANEL

James S. Van 36 Mo. '79

6.0 FORD LTD WEIGHT SAVING CALCULATIONS CONT'D

WILL BE LIMITED TO APPROXIMATELY 59% FOR ALUMINUM AND 10% FOR PLASTIC MATERIAL SUBSTITUTES.

6.6.3 DOOR FRAME

THE DOOR FRAME CAN BE THOUGHT OF AS A SOLID BEAM ELEMENT WHICH MUST RESIST IN-PLANE BENDING FROM THE HINGE AND LATCH LOADS. THUS, EQUATION 77, P 21 IS APPLICABLE HERE. ASSUMING THAT THE DOOR FRAME IS AN SAE 1020 STEEL HAVING THE FOLLOWING MECHANICAL PROPERTIES,

- $S_{yld} = 36 \text{ KSI}$
- $E = 30 \times 10^6 \text{ PSI}$
- $\nu = .25$
- $\rho = .283$

THEN THE FOLLOWING POTENTIAL WEIGHT SAVINGS WILL BE POSSIBLE:

ALLOY	S_{yld} $\times 10^3 \text{ PSI}$	IN-PLANE BENDING	
		$L_n/t - \text{Eq. 77}$	$\Delta W(\%) - \text{Eq. 80}$
2086-T4	42	.925	- 67.3
5182	27	1.15	- 59.2
P19C [*] (PLASTIC)	9.5	1.94	- 53.9
DYLAEK ^h - 240 PLASTIC	8.4	2.04	- 67.8

* SEE TABLE II

ALL PAGE IS
QUALITY

6.0 FORD LTD WEIGHT SAVING CALCULATIONS ... CONT'D

6.6.4 INNER DOOR BEAM

THE INNER DOOR BEAM IS A THIN-WALL BEAM TYPE ELEMENT. HENCE, TABLE I IS APPLICABLE HERE. ASSUMING THAT THE ORIGINAL MATERIAL IS SAE 1020 STEEL (OR EQUIVALENT) THEN ROWS 8-11, OF TABLE I, SUMMARIZES THE POTENTIAL WEIGHT SAVING CALCULATIONS. FOR THIS MEMBER, CRIPPLING WILL BE THE CRITICAL MATERIAL PERFORMANCE REQUIREMENT; HENCE COLUMNS 19 & 20 APPLY. TABLE I SHOWS THAT FOR AN ALUMINUM SUBSTITUTE, THE POTENTIAL WEIGHT SAVING IS LIMITED TO APPROXIMATELY 53%. THE WEIGHT SAVING POTENTIAL FOR PLASTIC IS LIMITED TO APPROXIMATELY 23%. ALTHOUGH NOT SHOWN IN THE TABLE, THE POTENTIAL WEIGHT SAVING FOR HSLA STEEL 9801 ALLOY ($S_{y10} = 80 \text{ KSI}$) IS (SEE EQUATIONS 50 & 80):

$$\frac{E_N}{E_0} = \left[\frac{36}{80} \cdot \frac{30}{30} \right]^{1/3.5} = .796$$

$$\Delta W = -20.4\%$$

6.7 HARDWARE COMPONENTS

HARDWARE COMPONENTS INCLUDE SUCH ITEMS AS HINGES, LATCHES, BRACES, ETC. USUALLY THESE COMPONENTS CONSIST OF SOLID, BENDING TYPE ELEMENTS HENCE, EQUATIONS 72 AND 77 APPLY. IF WE ASSUME THAT THE BASELINE MATERIAL IS SAE 1020 ($S_{y10} = 36 \text{ KSI}$) THEN THE FOLLOWING MATERIAL SUBSTITUTE REQUIREMENTS EXIST:

MATERIAL SUBSTITUTE	SYLD	OUT-OF-PLANE BEND.		IN-PLANE BENDING	
		E_N/E_0	$\Delta W - \%$	E_N/E_0	$\Delta W - \%$
HSLA 9801	80	.45	-55	.67	-33
2014-T4	37	.973	-66	.986	-65
6061-T6	40	.9	-68.2	.949	-66.5
5182	29	1.24	-56.1	1.11	-60.6

James S. Paul 2. mar '79

6.0 FORD LTD WEIGHT SAVING CALCULATIONS

6.8 WHEELS

THE WHEELS CAN BE THOUGHT OF AS A SOLID BENDING ELEMENT (ASSUMING THAT THE SIDE SKID LOADING OF THE WHEEL IS MOST CRITICAL) WITH IN-PLANE BENDING; HENCE, EQUATION 77 APPLIES HERE. ASSUMING THAT THE ORIGINAL MATERIAL IS SAE 1020 ($S_{y0} = 36$ KSI), OR EQUIVALENT, THEN THE FOLLOWING WEIGHT REDUCTION POSSIBILITIES EXIST THROUGH MATERIAL SUBSTITUTION:

MATERIAL SUBSTITUTE	S_{y0} KSI	t_N/t_0	$\Delta W - \%$
HSLA 750K	50	.849	-15.1
S1B2	29	1.11	-60.6
2014-T4	37	.984	-65.1
6061-T6	40	.949	-66.6

LIST OF REFERENCES

1. David C. Chang and J. W. Justusson. "Structural Requirements in Material Substitution for Car-Weight Reduction". SAE 760023.
2. J.A. DiCell and R.A. George. "Design Criteria for Dent Resistance of Auto Body Panels". SAE 740081.
3. T. E. Johnson, Jr., and W. O. Schaffnit. "Dent Resistance of Cold Rolled Low-Carbon Steel Sheet." SAE 730528.
4. E. F. Bruhn. "Analysis and Design of Flight Vehicle Structures". Tri-State Offset Company, Cincinnati, Ohio, 1965.
5. Y. Ohkubo, T. Akamatsu, and K. Shirasawa. "Mean Crushing Strength of Closed-Hat Section Members". SAE 740040.
6. Sheet Committees. "Cost-Effective Weight Reduction with Sheet Steel". American Iron and Steel Institute, Washington D.C., Report SG 631R-1177-10M-RP.
7. Committee of Sheet Steel Producers. "The Materials Decision". American Iron and Steel Institute, Washington D.C., Report SG 834-279-5M-DJ.

IMAGE IS
QUALITY



APPENDIX B3

THE MARKET POTENTIAL
FOR HYBRID VEHICLES

by

Colin J. Loxley
Priscilla Luce
Kathleen Rodenrys

March 1979

A Report Prepared by

Wharton EFA, Inc.
3624 Science Center
Philadelphia, PA 19104

for

South Coast Technology, Inc.
Santa Barbara, CA

THE IS
BY



TABLE OF CONTENTS

- . Executive Summary
- . Review of Forecast Results
- . A Guide to Concepts and Measures Used in the Wharton EFA Motor Vehicle Model
- . Methodology
- . Hybrid Study Control Forecast
- . Hybrid Scenarios Forecast Tables
- . Hybrid Study Control Forecast Tables



THE MARKET POTENTIAL FOR HYBRID VEHICLES

EXECUTIVE SUMMARY

This study used the Wharton EFA Motor Vehicle Model to analyze the market potential for "hybrid" vehicles: cars possessing both gasoline engines and electric motors. Sales volume was predicted under a range of alternative scenarios to examine the forecasts' sensitivity to particular assumptions.

The basic proposition underlying this study is that the hybrid technology can be proven to be both technically and economically feasible for mass production and sale, together with the provision of the required recharging facilities, in time to be offered for sale in 1985. The second basic premise is that the traditional U.S. auto market segments will continue to be valid as distinct marketing "targets" for different car models designed to meet different tastes, perceptions, and budgets.

The results of this study suggest that under certain conditions there is a significant market for a range of hybrid automobile models, and that the potential savings in petroleum fuel usage in the long run are substantial.

Key findings are:

1. The added cost of hybrids is very important: a price differential in the 25% to 40% range yields a market share of 25%, with volume of between 3 and 4 million units annually; a 45%-80% price differential produces only a 5% share, with volume less than 1 million units.
2. Maximum hybrid sales would occur if manufacturers had to replace all mid-size and larger vehicles with hybrids due to stringent CAFE and emissions requirements after 1985; this could yield a 45% market share, with sales of 5-7 million, although total domestic sales would be lower.
3. The real price of gasoline is critical: each 1% change produces almost a 1% change in hybrid sales; for real electricity prices, the effect is almost exactly half as important.



4. The most effective way to maximize hybrid sales is with models in each market segment: even though large cars benefit the most, the size of the mid-size/intermediate segment established in the U.S. market makes this a significant potential source of hybrid sales.
5. The long-term petroleum fuel savings are very substantial and very sensitive to the hybrid's sales volume as well as to gasoline prices: our baseline hybrid forecast suggests annual fuel savings of over 11 billion gallons by 1995, a 14% reduction.

WHARTON EPA MOTOR VEHICLE DEMAND MODEL
HYBRIDS NEW REGISTRATIONS
REGULATION SCENARIOS

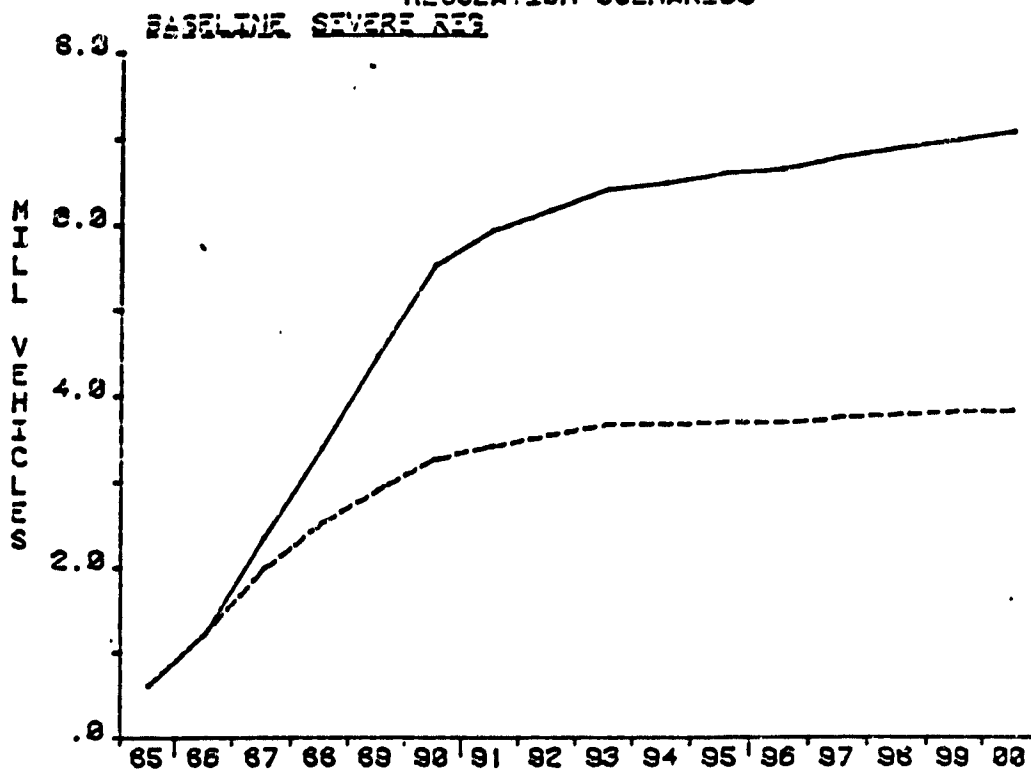

WHARTON EPA MOTOR VEHICLE DEMAND MODEL
HYBRIDS NEW REGISTRATIONS
HYBRID PRICE SCENARIOS

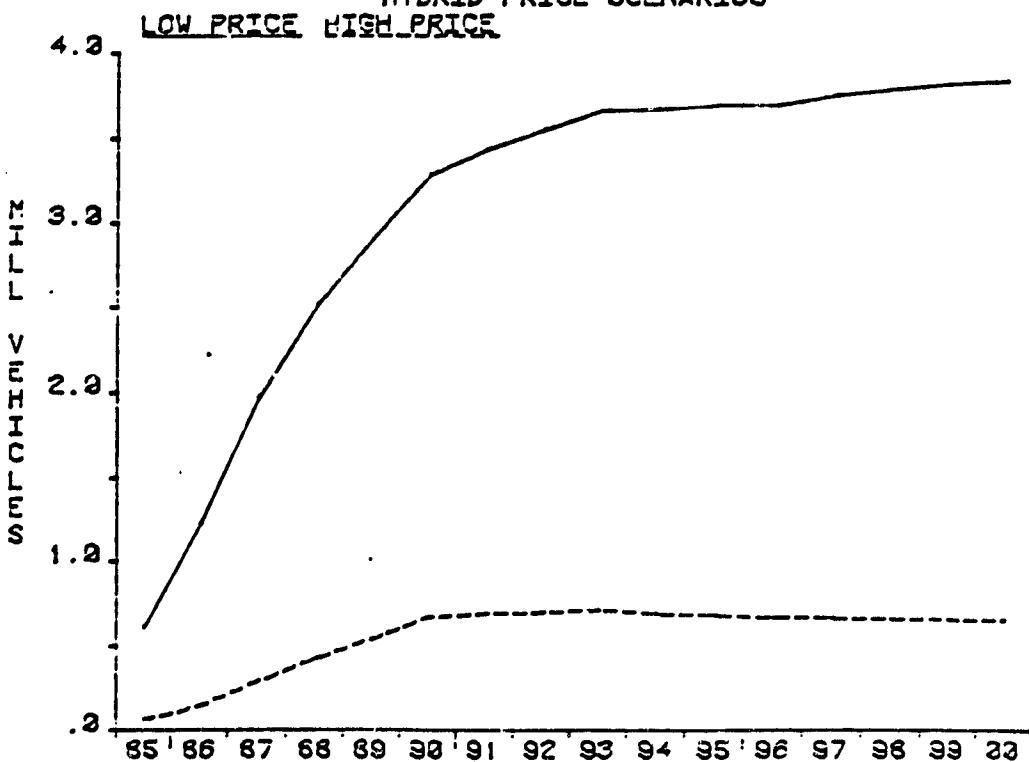

198521

TIME

222221

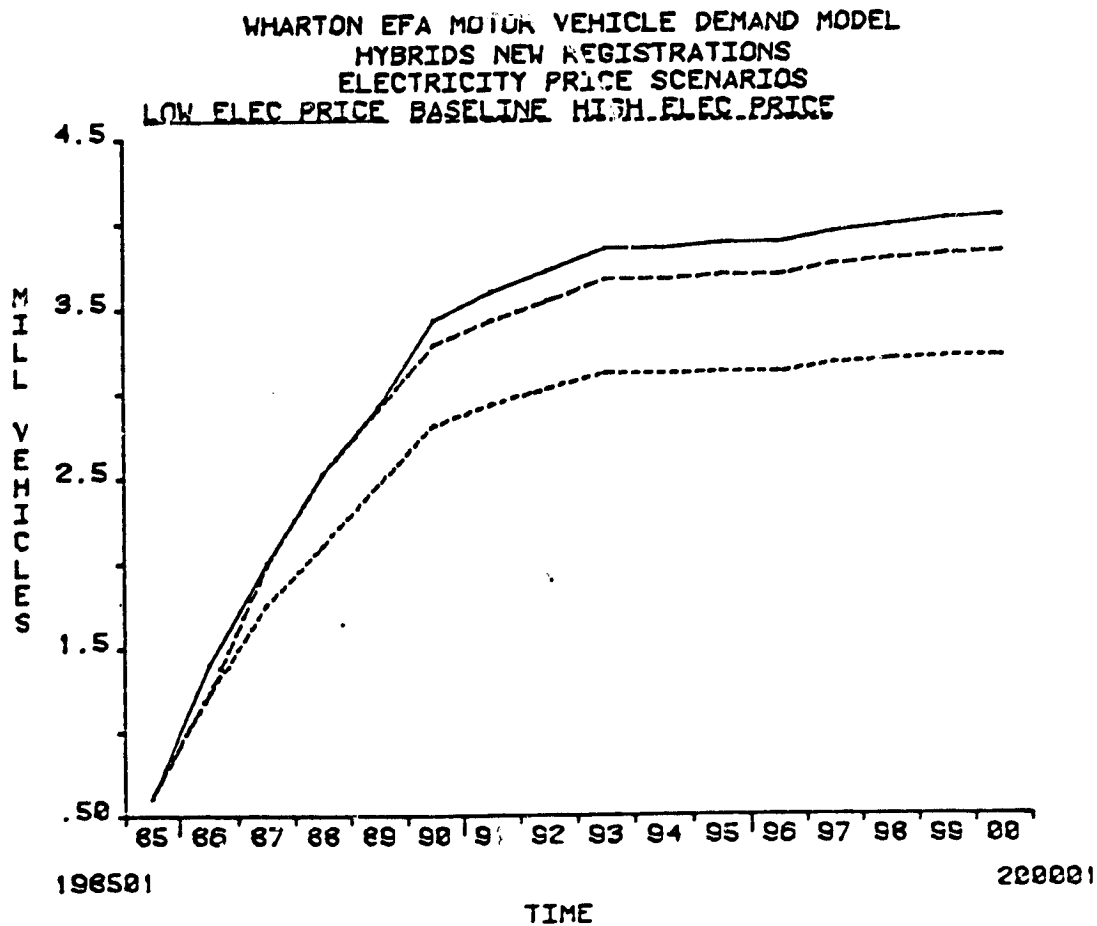
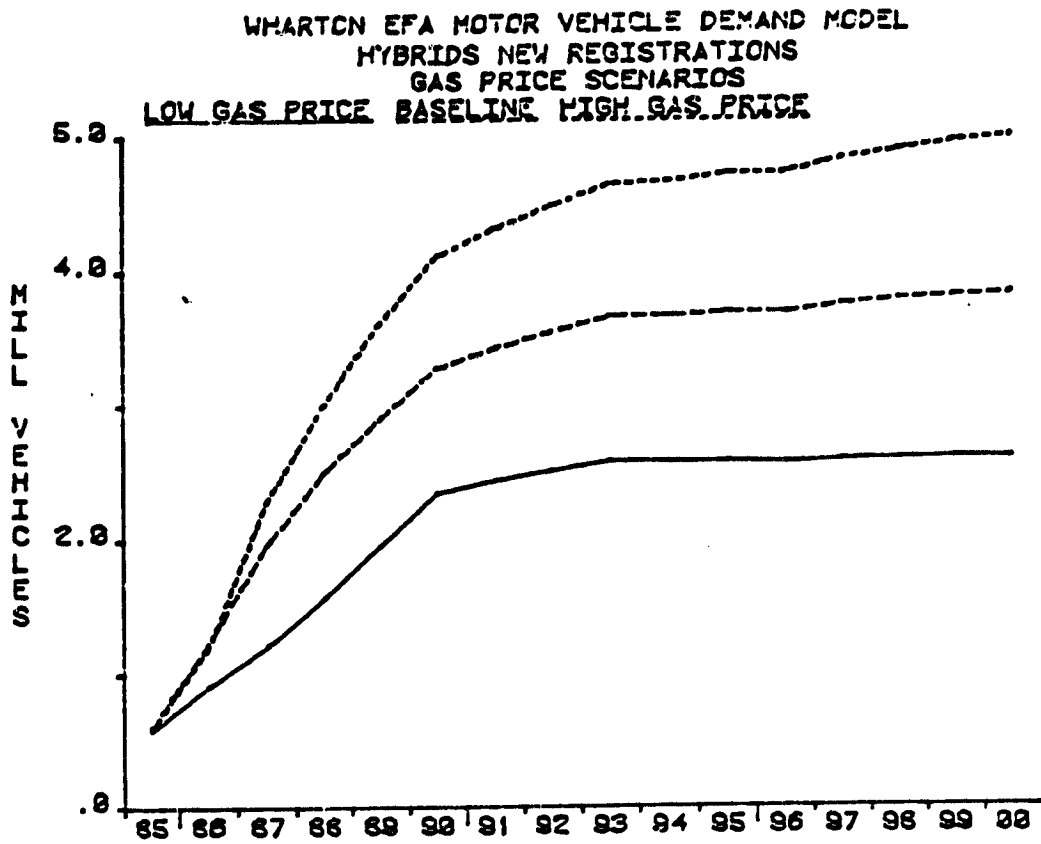



REVIEW OF FORECAST RESULTS

The first major issue is one of price. The additional cost for the electric motor and its components is obviously subject to a wide band around a particular estimate. The two "typical" vehicles specified as possible electrification candidates were the 1978 Ford Fairmont, a mid-size by 1985 standards, and the 1978 Ford LTD, a fullsize/luxury car currently slightly larger than the projected 1985 luxury cars.

The low estimates of increased price were specified as \$2,000 and \$1,750, respectively. The larger car is estimated to be cheaper in absolute terms as its suspension, etc., are already adequate for the increased weight. The high price estimates are specified as twice these values, \$4,000 and \$3,500, respectively. In order to maintain these estimates in constant dollars over the forecast period, we expressed the price changes in percentage terms, as follows:

	<u>"Midsize"</u> (1978 Fairmont)	<u>"Fullsize"</u> (Wharton Estimate)	<u>"Luxury"</u> (1978 Ford LTD)
Base Purchase			
Price with Options	\$ 4,641	\$	\$ 7,297
Average Tax	226		355
Freight Charges	268		292
Total Price	<u>\$ 5,135</u>	<u>\$</u>	<u>\$ 7,944</u>
For Hybrid Parts			
Low Price	\$ 2,000	\$	\$ 1,750
% Increase	<u>39%^{1/}</u>	<u>33%</u>	<u>22%</u>
High Price	\$ 4,000	\$	\$
% Increase	<u>78%</u>	<u>67%</u>	<u>44%</u>

^{1/} Since the Fairmont is at the lower end of our average compact /mid-size price range, and the LTD is priced intermediate between our average fullsized and luxury cars, these percentages may be slightly on the high side. On the other hand, it is likely that the additional hybrid cost would be varied according to the car's price.



Of course, given traditional marketing strategies, it is not implausible that the more expensive cars would be used to subsidize the cheaper, implying more nearly equal increases, or that non-hybrids might initially be used to subsidize some of the hybrids' costs.

The Scenarios

Severe Regulation

This presupposes increased pressure to raise CAFE's by a significant amount, probably implemented with formal legislation. At the same time, further downsizing after 1985 would be very problematic and of limited applicability. In addition, emissions standards by that time can be expected to pose severe constraints on technical changes to internal combustion engines. Hence, the hybrid technology becomes the major option, and it is assumed that domestic manufacturers change all their mid-size, fullsize, and luxury models to hybrids, at the low price differential--to encourage sales.

Low Price Hedonic Shares

This scenario is a "free market" prediction of the hybrid shares by segment, using an hedonic share estimation procedure to predict the hybrid share of the "desired" (long-run) mid-size, full-size, and luxury shares (see Methodology). This recognizes the importance of non-price attributes in the demand for hybrids. The low price increases are assumed to apply.

High Price Hedonic

This scenario is the same as the previous, but with the high price increases applied.

Since hybrid sales were so poor under the High Price assumptions, the remaining scenarios utilize the "Low Price Hedonic" results as their "baseline" or starting point.

High/Low Gasoline Prices

Gasoline prices per gallon are varied by +30% to -30% compared to the Low Price Hedonic assumptions.



High/Low Electricity Prices

Electricity prices per KWH are varied by +30% to -10% compared to the Low Price Hedonic assumption.

The Results

The following charts and tables summarize the forecast results under the different scenario conditions. A complete discussion of the underlying macroeconomic and demographic forecasts, and the results for the rest of the market, along with the output tables for the hybrid forecasts, are presented later in the report.

For each forecast, we have phased-in hybrid sales progressively over a five year period, 1985-1990. Hybrid mass production cannot start until 1985 at the earliest, and it would be unreasonable to immediately start with large-scale production. Rather, like the diesels, the process can be expected to extend over a four to five year period.

Not surprisingly, the Severe Regulation scenario produces the greatest demand for hybrid vehicles, in total and within each class. Total hybrid new registrations rise to 5.5 million by 1990 and grow to over 7 million by 2000, with over 45% of all sales being hybrids. This "forced" conversion is not without its side effects: as a result of switching all mid-size, fullsize, and luxury to hybrid models, a significant increase in small car sales occurs, both domestic and foreign, as buyers switch to cheaper cars. Since some of these are imports, total domestic sales of all types decrease--from 10.3 million in 1990 "before hybrids" to 9.8 million, a 5% drop.

In contrast, the Low Price Hedonic scenario (also labeled "Baseline" in the accompanying graphs) results in hybrid sales of from 3 to 4 million, approximately 25% of the total market. Hence, we see that the potential demand for hybrids at the lower price increase is quite good, despite their cost disadvantage. In fact, however, in the low price case, the fuel savings do provide a substantial offset: compared to their conventional counterparts, the mid-size hybrids capitalized cost per mile is 10% to 11% higher, the fullsize 9% to 10% higher, and the luxury only 6% to 7% higher.

These differences increase massively in the "high price" case, however, almost obliterating hybrid sales, and leaving them at only slightly over 0.5 million units annually. This is not surprising since the price differentials are so great, and the hybrid capitalized



TABLE 1

HYBRID VEHICLES NEW REGISTRATIONS
(millions)

Scenario	1985	1990	1995	2000
Severe Regulation	0.6	5.5	6.6	7.1
Low Price Hedonic	0.6	3.3	3.7	3.8
High Price Hedonic	0.1	0.6	0.7	0.6
Low Price Hedonic with (and % change):				
Low Gas Prices (-30%) % change	0.6 --	2.4 -28%	2.6 -30%	2.6 -32%
High Gas Prices (+30%) % change	0.6 --	4.1 +25%	4.7 +28%	5.0 +30%
Low Electricity Prices (-10%) % change	0.6 --	3.4 +4%	3.9 +5%	4.0 +5%
High Electricity Prices (+30%) % change	0.6 --	2.8 -14%	3.1 -15%	3.2 -16%

TABLE 2

HYBRID VEHICLES IN OPERATION
(millions)

Scenario	1985	1990	1995	2000
Severe Regulation	0.6	17.2	44.5	61.0
Low Price Hedonic	0.6	12.2	27.1	34.4
High Price Hedonic	0.1	2.1	5.0	6.2
Low Price Hedonic with:				
Low Gas Prices	0.6	8.4	18.9	27.9
High Gas Prices	0.6	14.5	33.7	44.0
Low Electricity Prices	0.6	12.6	28.2	36.1
High Electricity Prices	0.6	10.7	23.2	29.1



costs per mile are 27%, 24%, and 18% higher, for the mid-size, full-size, and luxury classes, respectively. Hence, the cost differential triples, and sales fall 80%. Given the availability of close substitutes within each class as well as between classes, this high response elasticity is not too surprising.

Using the Low Price Hedonic forecast, we now examine the sensitivity of hybrid sales to fuel costs: both gasoline and electricity. The importance of the gas price is dramatically illustrated. If we assume a more rapid rate of price increases over the 1985-1990 period such that by 1990, the gas price is 30% higher, hybrid new registrations are almost 30% higher. As noted later on, the base case gasoline price assumptions are already very high. A 30% higher level would thus represent almost crisis proportions (not only for transportation but for the economy in general). Of special interest here is that total new car registrations decline due to high gas prices--for instance, domestic new registrations fall to 9.9 million in 1990, so that hybrids increase their share of total new registrations (to one-third), slightly more than their volume increase. They would account for 40% of domestic sales in this scenario.

The Low Gas Price scenario has essentially symmetrical results in the opposite direction. Total sales increase, the hybrid share drops, and again the elasticity of response is around unity: a 1% change in hybrids for each 1% change in the real price of gasoline.

Changes in electricity prices are naturally less significant than gasoline, but still have substantial effects: each 1% change in real electricity prices yields a 0.5% change in hybrid sales, lower prices yielding higher sales.

The mid-size/intermediate segment of the market is too important to ignore as Table 4 shows. Despite the fact that the larger cars benefit more from "hybridization" and are relatively more cost effective, the total price and the capitalized cost per mile of mid-size hybrids are both lower than the fullsize/luxury hybrid models, and the size of the total mid-size market--one-third of domestic sales--makes this too important to ignore. In general, mid-size hybrids take a smaller share of the mid-size market than the large hybrids do of theirs, but mid-size hybrids account for between 41% and 49% of all hybrids in 1990 depending on the scenario. The higher the purchase cost differential, the lower the mid-size share of hybrids, while higher gasoline and electricity prices boost the mid-size share.

TABLE 3
HYBRID SHARES OF NEW REGISTRATIONS
(%)

Scenario	1985	1990	1995	2000
<u>Severe Regulation</u>	5.2	45.5	45.9	45.0
<u>Low Price Hedonic</u>	5.2	26.3	25.6	24.2
<u>High Price Hedonic</u>	0.5	5.2	4.6	4.0
<u>Low Price Hedonic with:</u>				
<u>Low Gas Prices</u>	4.9	18.7	17.6	16.3
<u>High Gas Prices</u>	5.1	33.4	33.0	32.0
<u>Low Electricity Prices</u>	5.2	27.6	26.8	25.6
<u>High Electricity Prices</u>	5.2	22.5	21.6	20.3

TABLE 4
MID-SIZE SHARE OF HYBRID SALES
(%)

Scenario	1985	1990	1995	2000
<u>Severe Regulation</u>	48.7	48.4	50.6	52.1
<u>Low Price Hedonic</u>	48.7	47.8	49.0	50.5
<u>High Price Hedonic</u>	49.2	40.7	40.9	42.2
<u>Low Price Hedonic with:</u>				
<u>Low Gas Prices</u>	51.6	47.3	48.2	49.7
<u>High Gas Prices</u>	49.9	48.9	50.1	51.6
<u>Low Electricity Prices</u>	48.7	47.5	48.9	50.5
<u>High Electricity Prices</u>	48.7	48.5	49.4	50.9



TABLE 5
GASOLINE CONSUMPTION
(billion gallons)

Scenario	1985	1990	1995	2000
Control - No Hybrids	79.5	76.2	82.6	93.7
Severe Regulation	79.5	69.3	62.6	64.4
Low Price Hedonic	79.5	71.3	70.8	77.7
High Price Hedonic	79.6	75.3	80.4	90.8
<u>Low Price Hedonic with:</u>				
Low Gas Prices	90.2	82.7	84.4	93.8
High Gas Prices	72.4	64.1	61.8	66.6
Low Electricity Prices	79.5	71.2	70.4	77.0
High Electricity Prices	79.5	71.8	72.4	80.0

TABLE 6
HYBRID ELECTRICITY CONSUMPTION
(billion KWH)

Scenario	1985	1990	1995	2000
Severe Regulation	1.71	82.78	255.22	391.07
Low Price Hedonic	1.71	60.73	156.81	222.38
High Price Hedonic	0.18	10.0	28.94	40.53
<u>Low Price Hedonic with:</u>				
Low Gas Prices	1.78	45.41	120.22	170.03
High Gas Prices	1.52	66.07	180.25	262.81
Low Electricity Prices	1.72	63.02	164.75	235.22
High Electricity Prices	1.66	51.74	131.0	183.76



Finally, we examine the implications for fuel use of hybrid sales. The petroleum fuel savings are a joint function of hybrid sales and gasoline prices. As shown in Table 5, the Severe Regulation scenario saves 20 billion gallons per year by 1995 (24%). The baseline Low Price Hedonic also saves substantial amounts--over 11 billion gallons: However, 30% lower gasoline prices would then increase conventional vehicle sales of less efficient vehicles, encourage more driving, and would be sufficient to completely offset the savings from hybrid vehicles. Interestingly, 30% higher gasoline prices, with low-priced hybrids, would yield the same results as enforced regulation of sales in the Severe Regulation scenario. Electricity prices have a slight effect, a 30% increase raising gasoline consumption by 2.3%—an elasticity of under 0.1%.

ORIGINAL PAGE IS
OF POOR QUALITY



A GUIDE TO CONCEPTS AND MEASURES USED IN
THE WHARTON EFA MOTOP VEHICLE MODEL

"CARS IN OPERATION, YEAR-END"

(See Tables 1.00, 4.00 - 5.20, MID-YEAR estimates in Tables 6.00 - 7.10)

Derived from R. L. Polk's estimates, adjusted to exclude compact passenger vans (Sportvan, Clubwagon, VW Bus, etc.). Lower than total registrations, which double-counts cars registered in more than one state and includes cars registered but scrapped. Vintage estimates are based on a twenty year life and vintage-specific survival probabilities, which vary over time with a given distribution. Vehicles by class and by domestic or foreign origin are derived from applying the same survival probabilities to the sales of each class.

"RETAIL SALES", and "NEW REGISTRATIONS"

(Tables 1.00 - 3.20)

Both exclude compact vans, and adjust for missing data. New registrations are cars put into use, therefore, are slightly lower than reported sales, and lag them by 1-2 months. New registrations detail is better and provides the data for the distributions by class and domestic versus foreign.

"SCRAPPAGE"

(Tables 1.00, 8.00, 801)

Historically, estimated by identity, given stock and new registrations data. Total scrappage is forecast behaviorally, allocated by vintage with the "normal" survival probabilities, and allocated by class based upon class shares in the stock.

"VEHICLE MILES"

(Tables 1.00, 9.00, 9.01)

Taken from Highway Statistics, these are for cars only, excluding motorcycles. Urban and rural travel are predicted separately due to their very different trends.



"MPG ESTIMATES"

"TOTAL FLEET MPG (WEFA)", "NEW CAR FLEET MPG (EPA)", "DOMESTIC", "FOREIGN", "MPG (WEFA)", "MPG (EPA)", (Tables 1.00, 14.00 - 15.10)

WEFA estimates are actual "on-road" performance, based on a massive database of individual car road tests by CONSUMER REPORTS. City and highway estimates and forecasts are based on vehicle curb weight, engine displacement, cylinders, transmission type, and technological changes. New car fleet estimates are sales-weighted class estimates. The total fleet estimate is a vintage stock-weighted estimate of past mpg's allowing for lower miles driven by older cars. It is consistent with the "Highway Statistics" average. The EPA estimates are also based on individual car drive-cycle results, city and highway being predicted by the same auto characteristics as the WEFA estimates. The class averages are 55-45 weighted, and sales-weighted to yield new car fleet estimates.

SIZE CLASSES

Five sizes are distinguished:

Subcompact - up to 100" wheelbase (historically); 1975 average curb weight = 2803 lbs. domestic, 2392 lbs. import; 1985 projections 2500, 2094; perceived as "tight" 4 passenger, primarily for 1-2 passenger travel, increasingly so by 1985.

Compact - 100" to 111" (historically); 1975 average curb weight = 3429 lbs. domestic, 2882 lbs. import, 1985 projections 2700, 2698; "roomy" 4 passenger, becoming "tight" 4 passenger.

Mid-Size (Domestic only) - 111" to 118" (historically); 1975 = 4170 lbs., 1985 = 3000; roomy 4-5 passenger, becoming 4 to "tight" 5; sportier/power-up compact and "stripped"/low power fullsize substitutes, very few V8's (15%).

Fullsize (Domestic only) - over 118" (historically); 1975 = 4656 lbs., 1985 = 3200; 6 passenger cars, becoming 5 to "tight" 6 by 1985, few V8's (20%), much lower power.

Luxury - classified by price; domestics are fullsize dimensions (except Corvette), foreign vary widely in size. Curb weights: 1975 domestic = 5022 lbs., foreign = 3595, 1985 domestic = 3500, foreign = 2808. Domestics are higher quality, more luxurious, fullsize, more power, more options and V8's. Foreign correspond to more luxurious compact-size cars.



METHODOLOGY

Our primary approach to this study was to modify the existing Wharton EFA Motor Vehicle Model to allow for the inclusion of hybrid vehicles and to utilize pre-existing empirical work relevant to the market penetration of a new technology.

The Motor Vehicle Model predicts the desired composition of the vehicle fleet, divided into eight classes: foreign subcompact, domestic subcompact, foreign compact, domestic compact, mid-size, fullsize, foreign luxury, and domestic luxury. The desired share equations are based upon 1972 cross-sectional state data, with each class share a function of income variables, family size variables, population age distribution, and, the class cost per mile relative to competing (substitute) classes.^{1/}

The procedure followed here is to first predict or assume the "desired" hybrid shares of each market segment, for mid-size, fullsize, and luxury domestics. Given the hybrid shares, the model then proceeds normally, consistently predicting desired shares for all mid-size, fullsize, etc. These then enter the predictions for desired stock, and the new registrations shares. Together with the predictions of total new registrations and scrappage, these yield hybrid new registrations and stocks by class.

In performing this analysis, we computed capitalized cost per mile measures for the hybrids corresponding to our methodology for regular cars. We assumed that repair, insurance, and other non-fuel operating costs would be proportionately similar to non-hybrids. Fuel costs were computed under the admittedly simplifying assumptions of all highway use being with the gasoline engine, at the same miles per gallon as non-hybrids, while 60% of urban driving was performed

^{1/} The Wharton EFA Motor Vehicle Model is fully documented in George R. Schink and Colin J. Loxley, An Analysis of the Automobile Market: Modeling the Long-Run Determinants of the Demand for Automobiles, February 1977, and in Colin J. Loxley, Tim Osiecki, Kate Rodenrys, and Sheela Thanawala, Revisions to the Wharton EFA Automobile Demand Model. The Wharton EFA Motor Vehicle Demand Model (Mark 1), draft, June 1978, both reports prepared by Wharton EFA for the Department of Transportation, Transportation Systems Center, Cambridge MA.



using the electric motor, at 1.6 miles per KWH for mid-size, and 1.3 miles per KWH for fullsize and luxury.^{1/} Overall, these assumptions probably slightly favor the hybrids.

The analysis assumes that hybrid sales and scrappage adjust at the same speed with respect to the gap between desired and actual stocks as the non-hybrids of the corresponding class. It is also assumed that the survival probabilities by vintage are equal. On this basis, the vehicles in operation computation is modified to include hybrids, and the new domestic EPA mpg and total fleet average mpg identities are calculated with the hybrids included.

The final modification was to the urban vehicle miles equation. Miles per vehicle are a function of the "real" fuel cost per mile, real disposable income per capita, and the ratio of urban licensed drivers to total vehicle stock. The fuel cost term was modified to reflect the combined gas and electricity costs, yielding a specific hybrid urban mileage forecast.

HEDONIC SHARES

The shares of hybrids in the desired stock by class are estimated using the hedonic choice model outlined in "The Impact of Electric Passenger Automobiles on Utility System Loads, 1985-2000", by E. Patrick Marfisi, Charles U. Upton, and Carson E. Agnew, a report by MATHTECH, Inc. for EPRI, November 1977.

In this analysis, shares by size class are estimated relative to subcompacts as a function of vehicle attributes (capitalized cost per mile, automatic transmission fraction and passenger capacity) and variables shifting the attribute coefficients (SMSA population as a percent of total roadway per land area, and geographical dummies). The hybrid share can be estimated by using the hedonic choice equation and assuming a set of attributes for hybrids. The fraction of hybrids with automatic transmission is set at one (a desirable attribute); and the seating capacities are assumed to be slightly larger (by 0.5 on average) than regular cars in the same class, reflecting a perception of hybrids as "larger".

^{1/} Assumptions supplied by South Coast Technology, Inc.



The equation used is:

$$\begin{aligned} \ln (\text{SHR}_1 - \ln (\text{SHRST}) = & (\text{US}_1 \text{FAUTO} - \text{USSTFAUTO}) * (4.417 \\ & - .0052 \text{NPMET} + .325 \text{RW/LA} - 2.2150 \text{DUMW}) + (\text{CPM}_1 \text{CAP} \\ & - \text{CPMSTCAP}) * (-138.4 + .463 \text{NPMET} - 5.09 \text{RW/LA} \\ & + 21.72 \text{DUMW} - 0.5 \text{DUMS}) + (\text{NP}_1^2 - \text{NPST}^2) \\ & * (.19 - .00041 \text{NPMET} + .002601 \text{RW/LA} - .002959 \text{DUMW} \\ & + .002345 \text{DUMS}) + \text{DUML} + (1.357 + .008593 \text{NPMET} + .234 \text{RW/LA} \\ & - .296 \text{DUMW} + .43 \text{DUMS}) \end{aligned}$$

where:

- SHR_1 = Share of size class 1, 1 = subcompact, compact, mid-size, mid-size hybrid, fullsize, fullsize hybrid, luxury, and luxury hybrid
- SHRST = Share of subcompacts
- $\text{US}_1 \text{FAUTO}$ = Fraction of size class 1 with automatic transmission
- USSTFAUTO = Fraction of subcompacts with automatic transmission
- NPMET = SMSA population as percent of total
- RW/LA = Roadway per land area
- DUMW = Dummy for western states
- DUMS = Dummy for southern states
- $\text{CPM}_1 \text{CAP}$ = Capitalized cost per mile, size class 1
- CPMSTCAP = Capitalized cost per mile, subcompacts
- NP_1 = Passenger capacity, size class 1
- NPST = Passenger capacity, subcompacts
- DUML = dummy for luxury cars, = 1 for luxury cars, 0 otherwise



What this procedure does is to enter some qualitative vehicle characteristics which induce purchases despite a possibly adverse relative cost, and which provides a tentative means of analyzing the appeal of a completely new design. Clearly the qualitative aspects are still very limited. Nonetheless, the predictions which result appear very reasonable. The unquantifiable component is the impact of uncertainty about future petroleum fuel supplies, although the present and near future should provide some useful insight from diesel sales developments.



HYBRID STUDY CONTROL FORECAST

ASSUMPTIONS

The Control Forecast, before the inclusion of hybrids, uses as its input assumptions for economic and demographic variables the February 1979 Wharton Annual Model Year 2000 Forecast. This predicts slow real growth and high inflation for 1979-80, with the probability of an actual recession and the strength of the recovery dependent upon the severity of fiscal and monetary restraint applied to control inflation, and what domestic and international energy policies are implemented.

In the absence of any severe shocks, the long-term trend for annual real GNP growth is projected at 3%, with real per capita disposable income averaging just below 2% annual growth, during the 1980's, and 2.6% for the decade 1990-2000. Inflation is projected to decline at a moderate pace, with growth in the consumer price index averaging over 6.5% for 1980-85, falling to 5% for 1985-90, and remaining at around 4.5% for the rest of the century.

Sectors of the economy experiencing strong growth are predicted to include investment expenditures and both exports and imports. Both consumer durables and services are expected to show above average growth. Mining, durables manufacturing, and utilities are the leading industrial sectors.

For fiscal policy, it is assumed that real government expenditures will show slower growth than past trends, and decline as a share of real GNP. As a consequence, the federal deficit is steadily diminished, moving into balance in the late 1980's. The key energy assumptions include a gradual progress towards decontrol of domestic oil prices, being completed in the later 1980's. The long-term OPEC policy is assumed to be to raise prices at about the U.S. inflation rate.



The demographic assumptions used are taken from the Bureau of the Census, Current Population Report P-20, July 1978. These utilize the Series II fertility assumption, implying population growth in the 0.9% range. The size of families continues to fall, with family formation and the number of single individuals outpacing general population growth. The aging population yields a declining proportion in the lower age brackets, and contributes to the rapid slowing down of growth in licensed drivers.

The gasoline price projection uses the rate of growth of real gas prices specified for the median case. The average 1978 price for regular gas is 65.3 cents/gallon (compared to the 72.0 specified in the sensitivity assumptions, Table B-1). Our 1990 "real" price deflated by the CPI is, therefore, $110.0 \times 65.3/72.0 = 99.8¢/\text{gallon}$. The rates of growth in gasoline prices are extremely high, and definitely in the upper range of the possible trend. The Wharton Annual Model forecasts the gasoline price consistently based on assumed OPEC prices and the domestic energy situation. Assuming an average imports price/bbl of \$19.20 by 1980 (up 30% over 1978) with a 6.5% annual rate of increase thereafter, and with full domestic decontrol by 1986, the 1985 Annual Model gas price reaches \$1.26 (vs. \$1.38).

All of the specific assumptions utilized in the forecast are shown in the "MARCH CONTROL FOR HYBRIDS" output, Tables 17.00-23.10, and 32.10. Except for the specific variables changed in the various hybrid vehicles scenarios, these remain unchanged for all the hybrid forecasts.

Forecast Results

The following Summary Table presents the long-term trends for most of the key variables. Despite the current short-term weakness, the long-term outlook is for a moderately good growth path. A decline in real income and high inflation cause a decline in sales in 1979-80, but the sales rebound during the early 1980's averages 2.7% per year. Sales growth slows during the late 1980's, but averages over 2% during the 1990's. This robust long-term trend is supported by good turnover of the stock, with both the sales and scrappage rates registering levels close to their historical averages.

ORIGINAL PAGE IS
OF POOR QUALITY

WHARTON EFA, INC.



HYBRID STUDY CONTROL FORECAST SUMMARY TABLE

	1970	1975	1978	1980	1985	1990	1995	2000
RETAIL SALES, TOTAL (million)	8.4	8.7	11.3	11.0	12.6	13.3	15.2	16.7
average annual growth rate	0.5	0.5	9.2	-1.3	2.8	1.1	2.7	1.9
COMPACT VANS (million)	0.115	0.124	0.175	0.185	0.260	0.290	0.350	0.410
average annual growth rate	1.5	1.5	12.2	2.8	7.0	2.2	3.8	3.2
NEW CAR SALES (million)	8.3	8.6	11.1	10.8	12.3	13.0	14.9	16.3
average annual growth rate	0.5	0.5	9.2	-1.4	2.7	1.1	2.7	1.8
HUNDRETS SHARE (%)	14.2	18.2	17.8	17.0	16.4	18.9	20.1	20.7
AVERAGE NEW CAR PRICE (\$)	3,833	5,427	6,830	7,896	11,083	14,462	18,749	24,091
average annual growth rate	7.2	7.2	8.0	7.5	6.9	5.5	5.3	5.1
COST PER MILE (¢)	13.9	20.3	25.2	29.3	41.6	57.0	75.2	98.6
average annual growth rate	7.9	7.9	7.5	7.8	7.3	6.5	5.7	5.6
CONSUMER PRICE INDEX (1967-100)	116.3	161.2	195.3	227.2	311.6	396.8	497.7	618.4
average annual growth rate	6.7	6.7	6.6	7.9	6.5	5.0	4.6	4.4
DISP. FAMILY INCOME (1972\$)	9,810	9,420	9,830	9,720	10,000	10,490	11,360	12,300
average annual growth rate	0.8	0.8	1.4	-0.6	0.6	1.0	1.6	1.6
SALES RATE	0.105	0.088	0.110	0.105	0.110	0.107	0.114	0.115
SCRAPAGE RATE	0.077	0.062	0.107	0.085	0.092	0.094	0.098	0.097
CARS IN OPERATION YEAR END (million)	81.4	95.6	99.4	102.9	112.1	120.5	129.5	130.7
average annual growth rate	3.3	3.3	1.3	1.7	1.7	1.5	1.5	1.7
TOTAL POPULATION (million)	204.9	213.5	218.5	222.2	231.0	243.6	252.9	260.3
average annual growth rate	0.8	0.8	0.8	0.8	1.0	0.9	0.8	0.6
LICENSED DRIVERS (million)	111.5	129.8	141.2	147.2	159.5	169.7	178.2	188.2
average annual growth rate	3.1	3.1	2.8	2.1	1.6	1.2	1.0	1.1
VEHICLE MILES (million)	891	1,028	1,186	1,265	1,347	1,499	1,694	1,916
average annual growth rate	2.9	2.9	4.9	2.5	1.6	2.2	2.5	2.5
AVERAGE TOTAL FLEET MILE average annual growth rate	13.6	13.5	13.8	14.2	16.9	19.7	20.5	20.5
average annual growth rate	-0.1	-0.1	0.7	1.4	3.5	3.0	0.9	0.0
FUEL CONSUMPTION (billion)	65.7	76.0	86.2	87.6	79.6	76.2	82.6	93.7
average annual growth rate	3.0	3.0	4.3	0.8	-1.9	-0.9	1.6	2.6
PER OIL PRICE BICIMAR (¢)	35.7	57.2	65.3	80.7	138.2	202.8	254.3	316.0
				11.7	11.6	8.0	4.6	4.4



The composition of sales is not expected to shift dramatically in the short-term as each segment goes through a downsizing program through 1985. The downsizing, together with technological improvement to engines and transmissions, is assumed to yield compliance with the CAFE standards, provided significantly stricter emissions and safety requirements are not imposed. Small domestic car base prices do increase less rapidly than the larger models' in order to maintain their market share versus imports. The imports share drops in 1979 due to discontinued "captives" and VW of America production. We project increasing domestic production of former imports through 1985.

In the long-run, we project increases in the small car shares, at the expense of fullsize. The fullsize declines from an 18.4% share of the total in 1979 to 11.5% by 2000, while subcompacts grow from 25.1% to 28.1%. The foreign share increases reaching a plateau of 20% in the mid-1990's, largely due to less rapid increases in imports prices. The composition of the stock of vehicles changes accordingly, and more dramatically. From 1978 to 2000, the subcompact share of total stock grows from 20.7% to 27.4%, compacts grow from 19.5% to 22.9% mid-size go from 24% to 25.8%, fullsize declines from 26.5% to 13%, and luxury rises from 9.3% to 15.4%. The overall foreign share climbs from 14.5% to 20%.

The average new car purchase cost is projected to rise rapidly, at 7% per year through 1985, and averaging over 5% through the end of the century. With the rapid rates of increase of other operating costs, particularly insurance and gasoline, the total capitalized cost per mile rises even more rapidly, despite the offset of rapidly improving new car fuel economy up to 1985. These high inflation rates are, of course, general throughout the economy and hence the "real" cost per mile (relative to the CPI) increases by slightly under 1% annually during the forecast period.

The number of cars in operation reaches 141 million by 2000, a 1.6% annual average growth rate. Market saturation increases slightly, the ratio of cars to licensed drivers rising from 0.7 in 1978 to 0.75 by 2000. With the very rapid fuel price increases combined with only moderate income growth, vehicle miles per car shows no growth through the mid-1980's, and averages only 0.6% per annum for 1985-90. Thereafter, "real" gasoline prices are assumed to remain constant, and stronger real income growth yields an average annual growth rate of 0.9%. The growth of vehicle stock and miles per vehicle thus combine to yield vehicle miles traveled (VMT) growth well below historical trends, at only 1.6% per year for the early 1980's, and slightly under 2.5% thereafter. Urban travel continues to grow substantially more rapidly than rural/highway, reaching 67% by 2000.



The low vehicle miles growth, together with the better than 3% per year average improvement in fleet average fuel efficiency during the decade 1980-1990, leads to declining fuel consumption. From the peak of 87.6 billion gallons in 1980, consumption falls to a low of 76.2 in 1990, a 13% decline. Consumption rises significantly during the late 1990's with the onset of renewed VMT growth, zero mpg improvement, and constant real gas prices; nonetheless, it is 1998 before the 1980 peak is exceeded.

THE WHARTON EFA MOTOR VEHICLE DEMAND MODEL
MARCH CONTROL WITH LOW PRICE HYBRIDS IN 1985

LINE	ITEM	1.10 HYBRID CARS									
		1985	1986	1987	1988	1989	1990	1991	1992	1993	
1	UNDESIRED SHARE OF HYBRIDS IN MID-SIZE	10.00	20.00	40.00	60.00	80.00	100.00	100.00	100.00	100.00	100.00
2	FULL SIZE	10.00	20.00	40.00	60.00	80.00	100.00	100.00	100.00	100.00	100.00
3	LUXURY	10.00	20.00	40.00	60.00	80.00	100.00	100.00	100.00	100.00	100.00
4											
5	NEW REGISTRATIONS OF HYBRIDS	0.608	1.224	2.338	3.383	4.466	5.519	5.921	6.154	6.404	
6	MID-SIZE	5.2	10.2	19.8	28.8	37.3	45.5	45.6	45.7	45.9	
7	FULL SIZE	0.296	0.593	1.128	1.636	2.162	2.673	2.902	3.002	3.108	
8	LUXURY	2.5	4.9	9.5	13.9	18.1	22.0	22.3	22.6	22.9	
9		0.207	0.411	0.758	1.098	1.327	1.578	1.667	1.715	1.760	
10		1.8	3.4	6.4	8.9	11.1	13.0	12.8	12.7	12.7	
11		0.104	0.220	0.452	0.699	0.977	1.268	1.352	1.397	1.440	
12		0.9	1.8	3.6	5.9	8.2	10.4	10.4	10.4	10.4	
13											
14	YEAR END STOCK OF HYBRIDS	0.607	1.825	4.195	7.006	11.864	17.221	22.860	28.540	34.187	
15	MID-SIZE	0.296	0.486	2.005	3.621	5.741	8.335	11.101	13.913	16.734	
16	FULL SIZE	0.207	0.616	1.368	2.403	3.701	5.227	6.806	8.373	9.908	
17	LUXURY	0.104	0.323	0.771	1.462	2.422	3.658	4.958	6.258	7.588	
18											
19	HYBRID PURCHASE PRICE										
20	MID-SIZE	15805.	16309.	17286.	18199.	19165.	20184.	21263.	22400.	23582.	
21	FULL SIZE	16098.	17038.	18013.	19005.	20007.	21064.	22181.	23361.	24585.	
22	LUXURY	22106.	23366.	24672.	26003.	27348.	28769.	30260.	31851.	33492.	
23											
24	HYBRID CAPITALIZED COST PER MILE \$/MILE										
25	MID-SIZE	0.477	0.508	0.540	0.573	0.608	0.644	0.680	0.719	0.760	
26	FULL SIZE	0.503	0.535	0.569	0.604	0.641	0.678	0.716	0.757	0.800	
27	LUXURY	0.613	0.651	0.691	0.732	0.776	0.820	0.865	0.914	0.968	
28											
29	HYBRID VEHICLE MILES(ELECTRIC) BILL MILES	2.839	9.789	24.098	47.078	78.420	118.352	168.783	213.670	268.801	
30											
31	ELECTRICITY CONSUMED	1.705	6.848	16.851	32.929	54.051	82.779	115.203	149.370	188.810	
32											
33	TOTAL DOMESTIC NEW CAR MPG (EPA)	28.14	28.62	29.64	30.71	31.80	32.98	32.96	32.97	32.98	
34											
35	OVERALL FLEET MPG (WEFA)	16.94	17.73	18.58	19.60	20.78	22.07	23.50	24.79	26.01	
36											
37	AUTO MOTOR FUEL CONSUMPTION	79.502	77.818	76.234	74.155	71.770	69.262	67.078	65.357	64.048	

A PRODUCT OF WHARTON EFA, INC.

ORIGINAL PAGE IS
OF POOR QUALITY

THE WHARTON EFA MOTOR VEHICLE DEMAND MODEL
MARCH CONTROL WITH LOW PRICE HYBRIDS IN 1985

TABLE 1.10 HYBRID CAPS

LINE	ITEM	1994	1995	1996	1997	1998	1999	2000
1	UNDESIRABLE SHARE OF HYBRIDS IN MID-SIZE	100.00	100.00	100.00	100.00	100.00	100.00	100.00
2	FULL SIZE	100.00	100.00	100.00	100.00	100.00	100.00	100.00
3	LUXURY	100.00	100.00	100.00	100.00	100.00	100.00	100.00
4								
5	NEW REGISTRATIONS OF HYBRIDS	6.470	6.584	6.627	6.777	6.873	6.974	7.064
6	MILL VEH	45.9	45.9	45.7	45.4	45.3	45.1	45.0
7	XSHARE	3.250	3.334	3.386	3.491	3.558	3.624	3.683
8	MID-SIZE	23.1	23.2	23.3	23.4	23.4	23.5	23.5
9	FULL SIZE	1.751	1.745	1.708	1.700	1.690	1.680	1.668
10		12.4	12.2	11.8	11.4	11.1	10.9	10.6
11	LUXURY	1.469	1.506	1.532	1.586	1.626	1.670	1.713
12		10.4	10.5	10.6	10.6	10.7	10.8	10.9
13								
14	YEAR END STOCK OF HYBRIDS	39.540	44.528	48.964	52.841	56.117	58.818	60.981
15	MID-SIZE	19.444	21.997	24.316	26.391	28.187	29.711	30.976
16	FULL SIZE	11.320	12.579	13.631	14.474	15.115	15.569	15.853
17	LUXURY	8.784	9.952	11.017	11.977	12.815	13.537	14.151
18								
19	HYBRID PURCHASE PRICE							
20	MID-SIZE	24063.	26173.	27543.	28940.	30426.	31954.	33595.
21	FULL SIZE	25411.	27265.	28678.	30122.	31658.	33232.	34925.
22	LUXURY	35270.	37084.	38979.	40915.	42975.	45085.	47360.
23								
24	HYBRID CAPITALIZED COST PER MILE							
25	MID-SIZE	0.803	0.849	0.898	0.946	0.998	1.052	1.110
26	FULL SIZE	0.845	0.893	0.944	0.994	1.048	1.105	1.166
27	LUXURY	1.018	1.074	1.134	1.194	1.257	1.324	1.396
28								
29	HYBRID VEHICLE MILES(ELECTRIC) BILL MILES	315.771	365.577	412.024	454.964	494.568	530.283	561.707
30								
31	ELECTRICITY CONSUMED	220.555	255.223	287.503	317.289	344.706	369.381	391.069
32								
33	TOTAL DOMESTIC NEW CAR MPG (EPA)	32.98	32.98	32.98	32.98	32.97	32.97	32.95
34								
35	OVERALL FLEET MPG (WEFA)	27.11	28.11	28.97	29.69	30.23	30.62	30.88
36								
37	AUTO MOTOR FUEL CONSUMPTION	63.159	62.564	62.190	62.136	62.557	63.353	64.418

A PRODUCT OF WHARTON EFA, INC.

THE WHARTON EFA MO. VEHICLE DEMAND MODEL
LOW PRICE HYBRIDS - MEDDIONIC SHARES

TABLE 1.10 HYBRID CARS

LINE	ITEM	1985	1986	1987	1988	1989	1990	1991	1992	1993
1	DESIRED SHARE OF HYBRIDS IN MID-SIZE	10.00	20.00	30.00	40.00	45.00	52.30	52.20	52.10	51.70
2	FULL SIZE	10.00	20.00	40.00	50.00	60.00	67.10	67.10	66.90	66.70
3	LUXURY	10.00	20.00	30.00	40.00	45.00	49.80	49.90	49.90	49.70
4										
5	WHEN REGISTRATIONS OF HYBRIDS	0.608	1.224	1.973	2.513	2.899	3.278	3.424	3.583	3.661
6	MILL VEH	5.2	10.2	16.4	20.9	23.6	26.3	26.3	26.2	26.1
7	XSHARE	0.296	0.593	0.888	1.168	1.348	1.566	1.686	1.789	1.770
8	MID-SIZE	2.5	4.9	7.4	9.7	11.0	12.6	12.6	12.6	12.6
9	XSHARE	0.207	0.411	0.737	0.871	0.994	1.079	1.116	1.148	1.181
10	FULL SIZE	1.8	3.4	6.1	7.2	8.1	8.7	8.6	8.5	8.4
11	XSHARE	0.104	0.220	0.348	0.474	0.557	0.633	0.663	0.686	0.710
12	LUXURY	0.9	1.8	2.9	3.9	4.5	5.1	5.1	5.1	5.1
13										
14	YEAR END STOCK OF HYBRIDS	0.607	1.825	3.780	6.255	9.078	12.219	15.417	18.589	21.678
15	MID-SIZE	0.296	0.886	1.766	2.916	4.228	5.730	7.269	8.804	10.302
16	FULL SIZE	0.207	0.616	1.307	2.204	3.171	4.203	5.280	6.259	7.242
17	LUXURY	0.104	0.323	0.668	1.134	1.678	2.287	2.908	3.526	4.130
18										
19	HYBRID PURCHASE PRICE	15005.	16309.	17286.	18199.	19165.	20188.	21263.	22400.	23582.
20	MID-SIZE	16098.	17038.	18013.	19005.	20007.	21068.	22181.	23361.	24585.
21	FULL SIZE	22106.	23366.	24672.	26003.	27348.	28769.	30260.	31851.	33492.
22	LUXURY									
23										
24	HYBRID CAPITALIZED COST PER MILE \$/MILE	0.477	0.508	0.540	0.573	0.608	0.644	0.680	0.719	0.760
25	MID-SIZE	0.503	0.535	0.569	0.604	0.641	0.678	0.716	0.757	0.800
26	FULL SIZE	0.613	0.651	0.691	0.732	0.776	0.820	0.865	0.914	0.968
27	LUXURY									
28										
29	HYBRID VEHICLE MILES(ELECTRIC) BILL MILES	2.439	9.789	22.614	40.585	62.060	86.530	113.427	141.193	169.567
30	BILL KWH	1.705	6.844	15.853	28.488	43.567	60.726	79.556	98.988	118.831
31	ELECTRICITY CONSUMED	28.14	28.62	29.30	29.81	30.14	30.48	30.88	30.87	30.44
32	TOTAL DOMESTIC NEW CAR MPG (EPA)	16.94	17.73	18.56	19.48	20.42	21.32	22.21	22.95	23.57
33	UNIVERSAL FLEET MPG (MEFA)	79.502	77.818	76.290	74.500	72.786	71.264	70.324	69.806	69.741
34	AUTO MOTOR FUEL CONSUMPTION									

ORIGINAL PAGE IS
OF POOR QUALITY

A PRODUCT OF WHARTON EFA, INC.

ORIGINAL PAGE IS
OF POOR QUALITY

WHARTON EFA MOTOR VEHICLE DEMAND MODEL
LOW PRICE HYBRIDS - MEDUMIC SHARES

TABLE 1.10 HYBRID CARS

LINE	ITEM	1998	1995	1996	1997	1998	1999	2000
1	UNDESIRED SHARE OF HYBRIDS IN MID-SIZE	51.30	50.90	50.60	50.50	50.20	49.90	49.40
2	FULL SIZE	66.30	65.90	65.70	65.70	65.50	65.20	64.70
3	LUXURY	49.40	49.00	48.90	48.90	48.80	48.60	48.20
4								
5	NEW REGISTRATIONS OF HYBRIDS	3.663	3.691	3.685	3.789	3.781	3.812	3.827
6	MILL VEH	25.8	25.6	25.3	25.0	24.8	24.5	24.2
7	XSHARE	1.783	1.808	1.821	1.867	1.892	1.917	1.934
8	MID-SIZE	12.6	12.5	12.5	12.5	12.4	12.3	12.3
9	FULL SIZE	1.163	1.153	1.124	1.115	1.104	1.092	1.076
10	LUXURY	8.2	8.0	7.7	7.4	7.2	7.0	6.8
11		0.717	0.730	0.741	0.767	0.785	0.803	0.817
12		5.1	5.1	5.1	5.1	5.1	5.2	5.2
13								
14	YEAR END STOCK OF HYBRIDS	24.515	27.045	29.192	30.979	32.422	33.560	34.410
15	MID-SIZE	11.697	12.958	14.053	14.993	15.777	16.422	16.938
16	FULL SIZE	8.122	8.878	9.478	9.928	10.246	10.450	10.553
17	LUXURY	4.695	5.209	5.662	6.058	6.398	6.688	6.931
18								
19	HYBRID PURCHASE PRICE							
20	MID-SIZE	24863.	26173.	27543.	28980.	30426.	31954.	33595.
21	FULL SIZE	25911.	27265.	28670.	30122.	31658.	33232.	34925.
22	LUXURY	35270.	37084.	38979.	40915.	42975.	45085.	47360.
23								
24	HYBRID CAPITALIZED COST PER MILE							
25	MID-SIZE	0.804	0.809	0.898	0.946	0.998	1.052	1.110
26	FULL SIZE	0.845	0.893	0.944	0.995	1.048	1.105	1.166
27	LUXURY	1.018	1.074	1.134	1.198	1.258	1.325	1.396
28								
29	HYBRID VEHICLE MILS(ELECTRIC) BILL MILES	197.578	223.936	247.559	268.604	287.461	304.085	318.393
30								
31	ELECTRICITY CONSUMED	138.410	156.813	173.281	187.918	201.002	212.509	222.384
32								
33	TOTAL DOMESTIC NEW CAR MPG (EPA)	30.41	30.39	30.37	30.37	30.35	30.33	30.29
34								
35	OVERALL FLEET MPG (WEFA)	24.06	24.06	24.75	24.98	25.10	25.17	25.19
36								
37	AUTO MOTOR FUEL CONSUMPTION	70.141	70.800	71.603	72.645	74.080	75.798	77.689

A PRODUCT OF WHARTON EFA, INC.

ORIGINAL PAGE IS
OF POOR QUALITY

THE WHARTON EFA MODEL VEHICLE DEMAND MODEL
HIGH PRICE HYBRIDS - HYBRID CARS

LINE	ITEM	TABLE 1.10 HYBRID CARS											
		1985	1986	1987	1988	1989	1990	1991	1992	1993			
1	UNDESIRABLE SHARE OF HYBRIDS IN MID-SIZE												
2	FULL SIZE	1.00	2.00	4.00	6.00	7.00	8.30	8.20	8.10	7.90			
3	LUXURY	1.00	3.00	6.00	9.00	12.00	16.70	16.60	16.30	16.00			
4		1.00	2.00	4.00	6.00	8.00	9.30	9.30	9.20	9.00			
5	NEW REGISTRATIONS OF HYBRIDS	0.063	0.149	0.290	0.428	0.538	0.672	0.680	0.700	0.710			
6	MID-SIZE	0.5	1.2	2.4	3.5	4.3	5.3	5.3	5.2	5.0			
7	FULL SIZE	0.031	0.063	0.126	0.198	0.223	0.260	0.275	0.281	0.285			
8	LUXURY	0.3	0.5	1.0	1.5	1.8	2.1	2.1	2.1	2.0			
9		0.021	0.064	0.123	0.172	0.202	0.221	0.229	0.229	0.302			
10		0.2	0.5	1.0	1.4	1.8	2.3	2.3	2.2	2.1			
11		0.011	0.022	0.045	0.068	0.098	0.112	0.117	0.121	0.123			
12		0.1	0.2	0.4	0.6	0.8	0.9	0.9	0.9	0.9			
13													
14	YEAR END STOCK OF HYBRIDS	0.063	0.211	0.593	0.926	1.458	2.106	2.759	3.400	4.017			
15	MID-SIZE	0.031	0.093	0.219	0.408	0.623	0.881	1.181	1.397	1.643			
16	FULL SIZE	0.021	0.065	0.207	0.378	0.574	0.878	1.160	1.435	1.690			
17	LUXURY	0.011	0.032	0.077	0.145	0.224	0.348	0.457	0.568	0.676			
18													
19	HYBRID PURCHASE PRICE												
20	MID-SIZE	15805.	16309.	17246.	18199.	19165.	20184.	21263.	22400.	23582.			
21	FULL SIZE	16098.	17038.	18013.	19005.	20007.	21064.	22181.	23361.	24585.			
22	LUXURY	22106.	23366.	24672.	26003.	27380.	28769.	30268.	31851.	33492.			
23													
24	HYBRID CAPITALIZED COST PER MILE \$/MILE												
25	MID-SIZE	0.477	0.508	0.540	0.573	0.608	0.644	0.680	0.719	0.760			
26	FULL SIZE	0.503	0.535	0.569	0.604	0.641	0.678	0.716	0.757	0.800			
27	LUXURY	0.613	0.651	0.691	0.732	0.776	0.820	0.865	0.914	0.964			
28													
29	HYBRID VEHICLE MILES(ELECTRIC) BILL MILFS	0.253	1.101	2.877	5.770	9.612	14.422	19.903	25.490	31.134			
30													
31	ELECTRICITY CONSUMED	0.176	0.775	2.032	4.076	6.796	10.215	14.116	18.093	22.109			
32													
33	TOTAL DOMESTIC NEW CAR MPG (EPA)	27.69	27.74	27.86	27.98	28.08	28.21	28.19	28.18	28.15			
34													
35	UNVEHALL FLEET MPG (WEFA)	16.93	17.58	18.21	18.83	19.42	19.93	20.38	20.72	20.98			
36													
37	UNITED MOTOR FUEL CONSUMPTION	79.578	78.327	77.461	76.608	75.887	75.379	75.577	76.113	77.233			

A PRODUCT OF WHARTON EFA, INC.

ORIGINAL PAGE IS OF POOR QUALITY

THE WHARTON EFA MOTOR VEHICLE DEMAND MODEL
HIGH PRICE HYBRIDS - HYBRID SHARES

LINE	ITEM	1994	1995	1996	1997	1998	1999	2000
1	UNDESIRED SHARE OF HYBRIDS IN MID-SIZE	7.60	7.40	7.20	7.10	7.00	6.80	6.60
2	FULL SIZE	15.60	15.20	14.90	14.70	14.50	14.20	13.80
3	LUXURY	8.80	8.60	8.50	8.40	8.30	8.20	8.00
4								
5	NEW REGISTRATIONS OF HYBRIDS	0.691	0.681	0.666	0.667	0.665	0.657	0.646
6	MILL VEH XSHARE	4.9	4.7	4.5	4.4	4.3	4.2	4.1
7	MID-SIZE	0.278	0.276	0.271	0.275	0.276	0.271	0.270
8	FULL SIZE	1.9	1.9	1.9	1.9	1.8	1.8	1.7
9	LUXURY	0.291	0.282	0.270	0.265	0.260	0.253	0.245
10		2.0	1.9	1.8	1.8	1.7	1.6	1.5
11		0.123	0.123	0.124	0.127	0.129	0.131	0.131
12		0.9	0.8	0.8	0.8	0.8	0.8	0.8
13								
14	YEAR END STOCK OF HYBRIDS	4.572	5.059	5.461	5.783	6.026	6.189	6.277
15	MID-SIZE	1.863	2.057	2.219	2.351	2.453	2.524	2.567
16	FULL SIZE	1.932	2.133	2.293	2.414	2.496	2.542	2.552
17	LUXURY	0.777	0.868	0.949	1.019	1.076	1.123	1.158
18								
19	HYBRID PURCHASE PRICE	24863.	26173.	27543.	28940.	30426.	31954.	33595.
20	MID-SIZE	25911.	27265.	28678.	30122.	31658.	33232.	34925.
21	FULL SIZE	35270.	37084.	38979.	40915.	42975.	45095.	47360.
22	LUXURY							
23								
24	HYBRID CAPITALIZED COST PER MILE	0.804	0.849	0.898	0.946	0.998	1.052	1.111
25	MID-SIZE	0.845	0.893	0.940	0.995	1.048	1.105	1.166
26	FULL SIZE	1.018	1.074	1.134	1.194	1.258	1.325	1.396
27	LUXURY							
28								
29	HYBRID VEHICLE MILES(ELECTRIC) BILL MILES	36.616	41.684	46.146	50.014	53.344	56.079	58.162
30								
31	ELECTRICITY CONSUMED	26.011	29.617	32.791	35.541	37.984	39.883	41.314
32								
33	TOTAL DOMESTIC NEW CAR MPG (EPA)	24.13	28.12	28.12	28.12	28.12	28.11	28.10
34								
35	OVERALL FLEET MPG (WEFA)	21.06	21.15	21.20	21.24	21.23	21.20	21.17
36								
37	HYBRID MOTOR FUEL CONSUMPTION	78.738	80.409	82.083	83.890	86.026	88.380	90.883

A PRODUCT OF WHARTON EFA, INC.

THE WHARTON EFA MOTOR VEHICLE DEMAND MODEL
LOW PRICE HYBRIDS - LOW FLEC PRICE - MIDNIC SHARES

LINE	ITEM	1.10 HYBRID CAPS									
		1985	1986	1987	1988	1989	1990	1991	1992	1993	
1	DEFINED SHARE OF HYBRIDS IN MID-SIZE	10.00	20.00	30.00	40.00	45.00	54.70	50.70	58.50	59.20	
2	FULL SIZE	10.00	30.00	40.00	50.00	60.00	69.60	69.60	69.50	69.30	
3	LUXURY	10.00	20.00	30.00	40.00	45.00	52.00	52.00	52.00	52.70	
4	NEW REGISTRATIONS OF HYBRIDS	0.600	1.401	1.990	2.520	2.915	3.420	3.593	3.716	3.802	
5	MID-SIZE	5.2	11.8	16.5	21.0	23.7	27.6	27.6	27.5	27.8	
6	FULL SIZE	0.296	0.507	0.896	1.170	1.350	1.624	1.721	1.786	1.853	
7	LUXURY	2.5	5.0	7.0	9.7	11.0	13.1	13.2	13.2	13.2	
8	NEW REGISTRATIONS OF HYBRIDS	0.200	0.500	0.753	0.883	1.010	1.124	1.171	1.200	1.227	
9	MID-SIZE	1.8	4.9	6.2	7.3	8.2	9.1	9.0	8.9	8.8	
10	FULL SIZE	0.100	0.220	0.349	0.472	0.555	0.666	0.701	0.726	0.752	
11	LUXURY	0.9	1.9	2.9	3.9	4.5	5.4	5.4	5.4	5.4	
12	NEW REGISTRATIONS OF HYBRIDS	0.607	2.001	3.981	6.868	9.300	12.578	15.937	19.269	22.512	
13	MID-SIZE	0.296	0.690	1.777	2.929	4.242	5.808	7.818	9.028	10.606	
14	FULL SIZE	0.207	0.785	1.531	2.308	3.379	4.858	5.539	6.608	7.425	
15	LUXURY	0.100	0.327	0.673	1.137	1.679	2.329	2.980	3.637	4.282	
16	HYBRID PURCHASE PRICE	15005.	16309.	17246.	18199.	19165.	20108.	21263.	22000.	23582.	
17	MID-SIZE	16008.	17038.	18013.	19005.	20007.	21068.	22181.	23361.	24585.	
18	FULL SIZE	22106.	23366.	24672.	26003.	27308.	28769.	30260.	31851.	33492.	
19	LUXURY	0.475	0.505	0.537	0.570	0.605	0.640	0.677	0.715	0.756	
20	NEW REGISTRATIONS OF HYBRIDS	0.500	0.532	0.566	0.600	0.636	0.673	0.712	0.752	0.795	
21	MID-SIZE	0.610	0.648	0.688	0.728	0.772	0.815	0.861	0.909	0.959	
22	FULL SIZE	2.063	10.509	24.337	42.598	60.343	89.640	118.020	147.400	177.000	
23	LUXURY	1.722	7.451	17.155	29.997	45.273	63.016	82.895	103.857	128.467	
24	NEW REGISTRATIONS OF HYBRIDS	20.10	20.60	29.30	29.81	30.10	30.62	30.62	30.61	30.59	
25	MID-SIZE	16.90	17.73	18.60	19.50	20.00	21.36	22.20	23.06	23.71	
26	FULL SIZE	79.503	77.797	76.176	74.477	72.735	71.191	70.157	69.570	69.003	
27	LUXURY										

A PRODUCT OF WHARTON EFA, INC.

THE WHARTON EFA MODEL VEHICLE DEMAND MODEL
LOW PRICE HYBRIDS - LOW VEC PRICE - MEDIC SHARES

LINE	UNIT	1.10 HYBRID CARS							1999	2000
		1994	1995	1996	1997	1998	1999	2000		
1	UNDESIGNED SHARE OF HYBRIDS IN MID-SIZE									
2	FULL SIZE	53.70	53.30	53.10	53.00	52.00	52.50	52.00	52.00	
3	LUXURY	69.00	68.60	68.40	68.30	68.20	68.00	68.00	67.60	
4		52.40	52.10	52.00	52.00	51.90	51.70	51.70	51.30	
5	NEW REGISTRATIONS OF HYBRIDS	3.044	3.075	3.073	3.041	3.079	3.014	3.031	3.031	
6	MID-SIZE	27.1	26.8	26.5	26.3	26.1	25.0	25.6	25.6	
7	LUXURY	1.865	1.893	1.910	1.960	1.990	2.017	2.035	2.035	
8		13.2	13.1	13.1	13.1	13.0	13.0	12.9	12.9	
9	FULL SIZE	1.219	1.206	1.175	1.166	1.155	1.144	1.129	1.129	
10	LUXURY	0.6	0.4	0.1	7.0	7.6	7.4	7.2	7.2	
11		0.760	0.776	0.788	0.815	0.835	0.854	0.869	0.869	
12		5.4	5.4	5.4	5.4	5.5	5.5	5.5	5.5	
13										
14	YEAR END STOCK OF HYBRIDS	25.508	28.176	30.453	32.362	33.922	35.166	36.112	36.112	
15	MID-SIZE	12.077	13.414	14.588	15.597	16.451	17.158	17.723	17.723	
16	FULL SIZE	8.539	9.319	9.933	10.395	10.728	10.939	11.049	11.049	
17	LUXURY	4.887	5.442	5.935	6.371	6.747	7.070	7.340	7.340	
18										
19	HYBRID PURCHASE PRICE									
20	MID-SIZE	28863.	26173.	27543.	28940.	30426.	31954.	33505.	35095.	
21	FULL SIZE	25911.	27265.	28678.	30122.	31658.	33232.	34825.	36425.	
22	LUXURY	35270.	37084.	38979.	40915.	42975.	45085.	47360.	49760.	
23										
24	HYBRID CAPITALIZED COST PER MILE									
25	MID-SIZE	0.799	0.844	0.893	0.941	0.992	1.047	1.108	1.174	
26	FULL SIZE	0.840	0.887	0.938	0.989	1.042	1.098	1.159	1.226	
27	LUXURY	1.013	1.068	1.128	1.188	1.251	1.318	1.390	1.468	
28										
29	HYBRID VEHICLE MILES(ELECTRIC) RILL MILES	207.128	235.114	260.268	282.766	303.063	321.088	336.676	350.000	
30										
31	ELECTRICITY CONSUMED	185.217	164.754	182.276	197.916	211.992	224.442	235.219	244.000	
32										
33	TOTAL DOMESTIC NEW CAR MPG (EPA)	30.56	30.53	30.52	30.51	30.50	30.48	30.46	30.44	
34										
35	OVERALL FLEET MPG (WVFA)	24.23	24.66	24.97	25.22	25.36	25.45	25.48	25.48	
36										
37	AUTO MOTOR FUEL CONSUMPTION	69.749	70.365	71.113	72.096	73.072	75.135	76.978	78.978	

A PRODUCT OF WHARTON EFA, INC.

THE WHARTON EFA MOTOR VEHICLE DEMAND MODEL
LOW PRICE HYBRIDS - HIGH ELEC PRICE - HYBRIDIC SHARES

LINE	ITEM	1-10 HYBRID CARS									
		1995	1996	1997	1998	1999	2000	2001	2002	2003	2004
1	DESIRED SHARE OF HYBRIDS IN MID-SIZE	10.00	20.00	30.00	35.00	40.00	45.00	45.00	45.00	45.00	45.00
2	FULL SIZE	10.00	20.00	30.00	40.00	50.00	50.00	50.00	50.00	50.00	50.00
3	LUXURY	10.00	20.00	25.00	30.00	35.00	41.10	41.10	41.10	41.10	41.10
5	NEW REGISTRATIONS OF HYBRIDS	0.606	1.210	1.750	2.093	2.456	2.895	2.927	3.021	3.116	
6	MID-SIZE	5.2	10.1	14.5	17.3	20.0	22.5	22.5	22.3	22.2	
8	FULL SIZE	0.295	0.590	0.877	1.027	1.190	1.360	1.474	1.474	1.523	
9	LUXURY	2.5	4.9	7.2	8.5	9.7	10.9	10.9	10.9	10.9	
10	YEAR END STOCK OF HYBRIDS	0.206	0.400	0.582	0.707	0.826	0.921	0.950	0.981	1.011	
11	MID-SIZE	1.0	3.0	4.8	5.0	6.7	7.4	7.3	7.3	7.2	
12	FULL SIZE	0.104	0.220	0.291	0.359	0.436	0.524	0.507	0.505	0.503	
13	LUXURY	0.9	1.0	2.4	3.0	3.5	4.2	4.2	4.2	4.2	
14	YEAR END STOCK OF HYBRIDS	0.605	1.017	3.550	5.607	7.992	10.672	13.393	16.000	18.600	
15	MID-SIZE	0.295	0.802	1.751	2.760	3.920	5.210	6.504	7.854	9.124	
16	FULL SIZE	0.206	0.612	1.100	1.482	2.004	3.562	4.007	5.317	6.155	
17	LUXURY	0.104	0.323	0.612	0.964	1.300	1.891	2.402	2.909	3.400	
19	HYBRID PURCHASE PRICE	15005.	16309.	17246.	18199.	19165.	20184.	21263.	22400.	23582.	
20	MID-SIZE	16098.	17038.	18013.	19005.	20007.	21060.	22181.	23361.	24585.	
21	FULL SIZE	22106.	23366.	24672.	26003.	27300.	28769.	30260.	31851.	33492.	
25	HYBRID CAPITALIZED COST PER MILE	0.405	0.516	0.549	0.502	0.610	0.654	0.692	0.731	0.773	
26	MID-SIZE	0.512	0.545	0.580	0.615	0.653	0.691	0.730	0.772	0.815	
27	FULL SIZE	0.622	0.661	0.702	0.740	0.780	0.833	0.879	0.920	0.960	
29	HYBRID VEHICLE MILES(ELECTRIC) RILL MILES	2.370	9.507	21.132	36.164	53.750	74.062	96.062	119.500	142.950	
31	ELECTRICITY CONSUMED	1.656	6.647	14.760	25.249	37.530	51.741	67.402	83.509	99.896	
33	TOTAL DOMESTIC NEW CAR MFG (EPA)	28.14	28.63	29.06	29.41	29.73	30.06	30.06	30.06	30.01	
35	OVERALL FLEET MPG (WEFA)	16.94	17.73	18.56	19.41	20.27	21.10	21.90	22.56	23.09	
37	AUTO MOTOR FUEL CONSUMPTION	79.498	77.802	76.293	74.710	73.168	71.618	71.063	70.707	70.467	

A PRODUCT OF WHARTON EFA, INC.

ORIGINAL PAGE IS
OF POOR QUALITY

THE WHARTON EFA MODEL VEHICLE DEMAND MODEL
LOW PRICE HYBRIDS - HIGH FUEL PRICE - MEDIANIC SHARES

LINE	ITEM	1974	1975	1976	1977	1978	1979	1999	2009
1	UNDESIRABLE SHARE OF HYBRIDS IN MID-SIZE	43.80	43.30	43.00	42.90	42.60	42.60	42.20	41.601
2	FULL SIZE	57.70	57.20	56.90	56.80	56.50	56.50	56.10	55.601
3	LUXURY	80.30	79.90	79.70	79.70	79.50	79.50	79.20	78.701
5	NEW REGISTRATIONS OF HYBRIDS	3.110	3.125	3.115	3.166	3.188	3.188	3.204	3.2051
6	MID-SIZE	21.9	21.6	21.3	21.1	20.9	20.9	20.6	20.31
7	FULL SIZE	1.528	1.544	1.552	1.589	1.609	1.628	1.628	1.6321
8	LUXURY	10.8	10.7	10.6	10.6	10.5	10.5	10.5	10.31
9	HYBRID	0.996	0.986	0.961	0.954	0.948	0.948	0.932	0.9171
10	FULL SIZE	7.0	6.8	6.6	6.8	6.2	6.2	6.0	5.81
11	LUXURY	0.586	0.595	0.602	0.622	0.635	0.635	0.648	0.6561
12	HYBRID	4.1	4.1	4.1	4.2	4.2	4.2	4.2	4.21
14	HYBRID PURCHASE PRICE	21.058	23.157	24.921	26.382	27.557	28.871	29.1801	29.1801
15	MID-SIZE	10.298	11.336	12.226	12.901	13.604	14.107	14.4981	14.4981
16	FULL SIZE	6.907	7.552	8.065	8.455	8.735	8.916	9.0071	9.0071
17	LUXURY	3.857	4.269	4.638	4.987	5.218	5.448	5.6551	5.6551
20	HYBRID CAPITALIZED COST PER MILE	20863.	26173.	27593.	28980.	30826.	31954.	33595.	34925.1
21	MID-SIZE	25911.	27265.	28670.	30122.	31650.	33232.	34925.1	36760.1
22	FULL SIZE	35270.	37084.	38979.	40915.	42975.	45085.	47360.1	49760.1
23	LUXURY	0.817	0.863	0.912	0.962	1.018	1.069	1.128	1.191
24	HYBRID	0.841	0.910	0.962	1.013	1.068	1.126	1.188	1.251
25	MID-SIZE	1.038	1.091	1.152	1.213	1.277	1.345	1.418	1.491
26	FULL SIZE	165.983	187.896	206.638	223.606	238.774	252.088	263.413	272.413
27	LUXURY	115.991	130.998	144.386	156.158	166.690	175.928	183.761	190.761
29	HYBRID VEHICLE MILES(ELECTRIC) HILL MILES	29.90	29.90	29.93	29.92	29.91	29.88	29.88	29.881
30	MID-SIZE	23.89	23.81	24.08	24.21	24.29	24.33	24.33	24.331
31	FULL SIZE	71.488	72.386	73.329	74.525	76.097	77.983	79.958	82.058
32	LUXURY	115.991	130.998	144.386	156.158	166.690	175.928	183.761	190.761
33	HYBRID VEHICLE MILES(ELECTRIC) HILL MILES	29.90	29.90	29.93	29.92	29.91	29.88	29.88	29.881
34	MID-SIZE	23.89	23.81	24.08	24.21	24.29	24.33	24.33	24.331
35	FULL SIZE	71.488	72.386	73.329	74.525	76.097	77.983	79.958	82.058
36	LUXURY	115.991	130.998	144.386	156.158	166.690	175.928	183.761	190.761

A PRODUCT OF WHARTON EFA, INC.

ORIGINAL PAGE IS OF POOR QUALITY

THE WHARTON EFA MOTOR VEHICLE DEMAND MODEL
LOW PRICE HYBRIDS - LOW PRICE GAS - MEDDIONIC SHARES

LINE	ITEM	TABLE 1-10 HYBRID CARS									
		1985	1986	1987	1988	1989	1990	1991	1992	1993	
1	INDUSTRIAL SHARE OF HYBRIDS IN MID-SIZE	10.00	15.00	20.00	25.00	30.00	36.10	45.90	55.50	65.10	
2	FULL SIZE	10.00	15.00	20.00	30.00	40.00	50.00	60.00	70.00	80.00	
3	LUXURY	5.00	10.00	15.00	20.00	25.00	31.10	31.00	30.70	30.40	
4											
5	NEW REGISTRATIONS OF HYBRIDS	0.501	0.913	1.221	1.576	1.952	2.351	2.809	2.510	2.506	
6	MID-SIZE	0.300	0.458	0.610	0.755	0.921	1.111	1.168	1.198	1.230	
7	FULL SIZE	0.227	0.341	0.436	0.583	0.719	0.839	0.867	0.888	0.912	
8	LUXURY	0.054	0.113	0.175	0.239	0.312	0.401	0.410	0.420	0.401	
9		0.4	0.9	1.4	1.9	2.5	3.2	3.2	3.1	3.1	
10	1 YEAR END STOCK OF HYBRIDS	0.580	1.487	2.694	4.241	6.130	8.390	10.677	12.926	15.100	
11	MID-SIZE	0.299	0.755	1.358	2.099	2.992	4.058	5.138	6.205	7.230	
12	FULL SIZE	0.227	0.566	0.997	1.568	2.266	3.069	3.876	4.666	5.428	
13	LUXURY	0.054	0.166	0.339	0.578	0.879	1.267	1.663	2.055	2.437	
14	HYBRID PURCHASE PRICE	15805.	16309.	17246.	18199.	19145.	20188.	21243.	22800.	23582.	
15	MID-SIZE	16098.	17030.	18013.	19005.	20007.	21068.	22181.	23361.	24585.	
16	FULL SIZE	22106.	23366.	24672.	26003.	27388.	28769.	30260.	31851.	33492.	
17	LUXURY										
18	HYBRID CAPITALIZED COST PER MILE \$/MILE	0.471	0.501	0.533	0.566	0.600	0.635	0.672	0.710	0.751	
19	MID-SIZE	0.496	0.528	0.562	0.596	0.632	0.669	0.707	0.748	0.790	
20	FULL SIZE	0.606	0.644	0.683	0.728	0.766	0.810	0.855	0.903	0.954	
21	LUXURY										
22	HYBRID VEHICLE MILES (ELECTRIC) MILL MILES	2.566	9.162	18.568	30.873	46.219	64.938	86.882	107.786	129.825	
23	ELECTRICITY CONSUMED	1.783	6.374	12.930	21.529	32.283	45.816	60.231	75.881	92.880	
24	TOTAL DOMESTIC NEW CAR MPG (EPA)	28.03	28.27	28.52	28.88	29.21	29.58	29.97	30.38	30.81	
25	OVERALL FLEET MPG (WEFA)	17.03	17.79	18.54	19.29	20.08	20.88	21.58	22.16	22.62	
26	INTERNAL MOTOR FUEL CONSUMPTION	90.261	86.865	87.053	85.593	84.078	82.705	81.883	81.939	82.317	

A PRODUCT OF WHARTON EFA, INC.

ORIGINAL PAGE IS OF POOR QUALITY

THE WHARTON EPA MILEAGE VEHICLE DEMAND MODEL
LOW PRICE HYBRIDS - LOW PRICE GAS - MEDIAN SHARES

LINE	ITEM	TABLE 1.10 HYBRID CARS						
		1994	1995	1996	1997	1998	1999	2000
1	DESIRED SHARE OF HYBRIDS IN MID-SIZE							
2	FULL SIZE	34.60	34.10	33.70	33.50	33.10	32.80	32.201
3	LUXURY	44.50	47.98	47.60	47.30	46.70	46.50	45.901
4		30.00	29.60	29.40	29.20	29.00	28.70	28.301
5	NEW REGISTRATIONS OF HYBRIDS	2,573	2,576	2,559	2,549	2,597	2,606	2,5971
6	MID-SIZE	17.9	17.6	17.3	17.1	16.8	16.6	16.31
7	FULL SIZE	1.230	1.242	1.243	1.244	1.274	1.290	1.2921
8	LUXURY	0.6	0.5	0.4	0.4	0.3	0.2	0.11
9	NEW REGISTRATIONS OF HYBRIDS	0.894	0.888	0.866	0.850	0.848	0.837	0.8211
10	MID-SIZE	6.3	6.1	5.9	5.7	5.5	5.3	5.11
11	FULL SIZE	0.441	0.446	0.450	0.462	0.471	0.479	0.4841
12	LUXURY	3.1	3.1	3.0	3.0	3.0	3.0	3.01
13								
14	YEAR END STOCK OF HYBRIDS	17,090	16,861	20,354	21,594	22,506	23,346	23,8771
15	MID-SIZE	4,190	9,036	9,762	10,379	10,805	11,291	11,5941
16	FULL SIZE	6,114	6,705	7,143	7,554	7,825	8,001	8,0891
17	LUXURY	2,794	3,120	3,409	3,662	3,876	4,053	4,1931
18								
19	HYBRID PURCHASE PRICE							
20	MID-SIZE	24463.	26173.	27543.	28940.	30426.	31954.	33505.1
21	FULL SIZE	25911.	27265.	28670.	30122.	31650.	33232.	34925.1
22	LUXURY	35270.	37084.	38979.	40915.	42975.	45065.	47340.1
23								
24	HYBRID CAPITALIZED COST PER MILE							
25	MID-SIZE	0.794	0.839	0.887	0.936	0.987	1.041	1.0991
26	FULL SIZE	0.835	0.882	0.933	0.983	1.037	1.094	1.1541
27	LUXURY	1.007	1.063	1.123	1.182	1.245	1.312	1.3811
28								
29	HYBRID VEHICLE MILES(ELECTRIC) BILL MILES	151,468	171,709	189,790	205,800	220,232	232,713	243,1341
30								
31	ELECTRICITY CONSUMED	106,047	120,220	132,871	144,113	154,122	162,805	170,8341
32								
33	TOTAL DOMESTIC NEW CAR MPG (EPA)	29.44	29.45	29.43	29.42	29.40	29.38	29.341
34								
35	OVERALL FLEET MPG (WEFA)	22.96	23.23	23.41	23.55	23.62	23.64	23.631
36								
37	AUTO MOTOR FUEL CONSUMPTION	83,214	84,391	85,671	87,173	89,101	91,338	93,7541

A PRODUCT OF WHARTON FFA, INC.

THE WHARTON EFA MID-LEVEL VEHICLE DEMAND MODEL
 LOW PRICE HYBRIDS - HIGH PRICE GAS - MEDICINE SHARES

TABLE 1.10 HYBRID CARS

LINE	ITEM	1995	1996	1997	1998	1999	2000	2001	2002	2003
1	UNDESIRED SHARE OF HYBRIDS IN MID-SIZE	10.00	20.00	40.00	50.00	60.00	67.00	67.00	67.00	67.00
2	FULL SIZE	10.00	20.00	40.00	60.00	70.00	80.00	80.50	80.50	80.50
3	LUXURY	10.00	20.00	40.00	50.00	60.00	68.00	68.00	68.00	68.00
5	NEW REGISTRATIONS OF HYBRIDS	0.585	1.188	2.297	3.008	3.610	4.110	4.319	4.478	4.646
6	MID-SIZE	5.1	10.0	19.4	25.4	29.8	33.4	33.5	33.4	33.5
7	FULL SIZE	0.292	0.590	1.137	1.438	1.755	2.000	2.121	2.200	2.297
8	LUXURY	2.5	5.0	9.7	12.2	14.5	16.3	16.8	16.5	16.6
9	WILL VEHICLE SHARE	0.189	0.378	0.710	0.993	1.123	1.249	1.296	1.330	1.370
10	FULL SIZE	1.6	3.2	6.1	8.3	9.3	10.2	10.0	10.0	9.9
11	LUXURY	0.104	0.219	0.450	0.587	0.732	0.852	0.902	0.936	0.975
12	WILL VEHICLE SHARE	0.9	1.0	3.8	5.0	6.0	6.9	7.0	7.0	7.0
14	VEHICLE END STOCK OF HYBRIDS	0.584	1.766	4.085	7.013	10.542	14.507	18.549	22.629	26.615
15	MID-SIZE	0.292	0.879	2.007	3.426	5.141	7.076	9.073	11.076	13.051
16	FULL SIZE	0.188	0.565	1.269	2.239	3.336	4.538	5.750	6.957	8.125
17	LUXURY	0.104	0.322	0.769	1.340	2.065	2.800	3.741	4.595	5.000
19	HYBRID PURCHASE PRICE	15805.	16309.	17246.	18199.	19165.	20104.	21263.	22409.	23582.
20	MID-SIZE	16098.	17038.	18013.	19005.	20007.	21064.	22181.	23361.	24545.
21	FULL SIZE	22106.	23366.	24672.	26003.	27348.	28769.	30268.	31851.	33492.
22	LUXURY	0.483	0.515	0.548	0.581	0.616	0.652	0.689	0.729	0.770
24	HYBRID CAPITALIZED COST PER MILE	0.509	0.542	0.577	0.612	0.649	0.687	0.726	0.767	0.810
25	MID-SIZE	0.620	0.659	0.700	0.741	0.785	0.830	0.876	0.924	0.975
26	FULL SIZE	2.182	0.790	21.790	41.562	66.031	94.533	126.066	158.030	192.500
27	LUXURY	1.521	6.130	15.201	29.025	46.146	66.066	88.095	110.976	134.516
29	HYBRID VEHICLE MILE(ELECTRIC) BILL MILES	28.19	28.65	29.66	30.34	30.87	31.34	31.35	31.36	31.35
30	ELECTRICITY CONSUMED	16.49	17.68	18.53	19.53	20.57	21.61	22.66	23.58	24.39
31	TOTAL DOMESTIC NEW CAR MPG (EPA)	72.302	70.830	69.006	67.599	65.760	64.063	62.862	62.031	61.600
32	HYBRID MOTOR FUEL CONSUMPTION									

A PRODUCT OF WHARTON EFA, INC.

ORIGINAL PAGE IS
 POOR QUALITY

THE WHARTON EFA MOTOR VEHICLE DEMAND MODEL
LOW PRICE HYBRIDS - HIGH PRICE GAS - ECONOMIC SHARES

LINE	I T E M	TABLE 1.10 HYBRID CARS						
		1994	1995	1996	1997	1998	1999	2000
1	UNFINISHED SHARE OF HYBRIDS IN MID-SIZE	67.50	67.20	67.20	67.20	67.00	67.00	66.601
2	FULL SIZE	80.30	80.10	80.10	80.10	80.10	80.00	79.791
3	LUXURY	68.70	68.40	68.50	68.80	68.80	68.70	68.501
4	NEW REGISTRATIONS OF HYBRIDS	4.665	4.716	4.732	4.830	4.887	4.951	4.998
5	MID-SIZE	33.3	33.0	32.8	32.5	32.3	32.2	32.0
6	FULL SIZE	2.322	2.363	2.391	2.459	2.498	2.508	2.575
7	LUXURY	16.6	16.5	16.6	16.6	16.5	16.5	16.5
8	YEAR END STOCK OF HYBRIDS	1.355	1.343	1.311	1.300	1.290	1.280	1.267
9	MID-SIZE	9.7	9.8	9.1	8.8	8.5	8.3	8.1
10	FULL SIZE	0.989	1.011	1.030	1.071	1.099	1.127	1.153
11	LUXURY	7.0	7.1	7.1	7.2	7.3	7.3	7.6
12	YEAR END STOCK OF HYBRIDS	30.320	33.607	36.597	39.064	41.091	42.730	44.211
13	MID-SIZE	18.905	16.603	18.101	19.401	20.497	21.416	22.164
14	FULL SIZE	9.183	10.104	10.850	11.423	11.830	12.115	12.271
15	LUXURY	6.240	6.901	7.646	8.240	8.756	9.203	9.585
16	HYBRID PURCHASE PRICE	24863.	26173.	27543.	28940.	30426.	31954.	33595.
17	MID-SIZE	25911.	27265.	28678.	30122.	31650.	33232.	34925.
18	FULL SIZE	35270.	37088.	38979.	40915.	42975.	45065.	47368.
19	LUXURY	0.813	0.859	0.908	0.957	1.009	1.068	1.122
20	CAPITALIZED COST PER MILE	0.856	0.903	0.955	1.006	1.060	1.117	1.178
21	MID-SIZE	1.029	1.086	1.145	1.206	1.270	1.337	1.409
22	FULL SIZE	226.162	258.188	287.240	313.530	337.345	358.580	377.172
23	LUXURY	157.957	180.249	200.498	218.763	235.277	249.978	262.805
24	VEHICLE MILES(ELECTRIC) WILL MILES	31.32	31.30	31.29	31.29	31.20	31.27	31.24
25	VEHICLE MILES(ELECTRIC) WILL MILES	25.06	25.63	26.07	26.43	26.65	26.80	26.89
26	VEHICLE MILES(ELECTRIC) WILL MILES	61.588	61.822	62.213	62.848	63.865	65.160	66.630
27	VEHICLE MILES(ELECTRIC) WILL MILES	157.957	180.249	200.498	218.763	235.277	249.978	262.805
28	VEHICLE MILES(ELECTRIC) WILL MILES	31.32	31.30	31.29	31.29	31.20	31.27	31.24
29	VEHICLE MILES(ELECTRIC) WILL MILES	25.06	25.63	26.07	26.43	26.65	26.80	26.89
30	VEHICLE MILES(ELECTRIC) WILL MILES	61.588	61.822	62.213	62.848	63.865	65.160	66.630
31	VEHICLE MILES(ELECTRIC) WILL MILES	157.957	180.249	200.498	218.763	235.277	249.978	262.805
32	VEHICLE MILES(ELECTRIC) WILL MILES	31.32	31.30	31.29	31.29	31.20	31.27	31.24
33	VEHICLE MILES(ELECTRIC) WILL MILES	25.06	25.63	26.07	26.43	26.65	26.80	26.89
34	VEHICLE MILES(ELECTRIC) WILL MILES	61.588	61.822	62.213	62.848	63.865	65.160	66.630
35	VEHICLE MILES(ELECTRIC) WILL MILES	157.957	180.249	200.498	218.763	235.277	249.978	262.805
36	VEHICLE MILES(ELECTRIC) WILL MILES	31.32	31.30	31.29	31.29	31.20	31.27	31.24
37	VEHICLE MILES(ELECTRIC) WILL MILES	25.06	25.63	26.07	26.43	26.65	26.80	26.89
38	VEHICLE MILES(ELECTRIC) WILL MILES	61.588	61.822	62.213	62.848	63.865	65.160	66.630

A PRODUCT OF WHARTON EFA, INC.



INDEX OF TABLES

<u>TABLE NUMBER</u>	<u>FIRST PAGE</u>	<u>LAST PAGE</u>	<u>TABLE TITLE</u>
1.00	1	2	Selected Market Indicators
2.00	3	3	New Registrations (mill. autos)
2.10	3	3	Total Domestic New Registrations (mill. autos)
2.20	3	3	Foreign New Registrations (mill. autos)
3.00	5	6	Growth Rates, New Registrations
3.10	5	6	Growth Rates, Domestic New Registrations
3.20	5	6	Growth Rates, Foreign New Registrations
4.00	7	8	Passenger Cars in Operations: Year-End (mill. autos)
4.10	7	8	Domestic Cars in Operation: Year-End (mill. autos)
4.20	7	8	Foreign Cars in Operations: Year-End (mill. autos)
5.00	9	10	Growth Rates, Cars in Operation: Year-End
5.10	9	10	Growth Rates, Domestic Cars in Operation: Year-End
5.20	9	10	Growth Rates, Foreign Cars in Operations: Year-End
6.00	11	12	Cars in Operations by Age: Mid-Year (mill. autos)
6.10	11	12	Cars in Operation: Shares by Age (percent)
7.00	13	14	Growth Rates, Cars in Operation: Mid-Year
7.10	13	14	Growth Rates, Cars in Operation: Shares by Age
8.00	15	16	Scrappage (mill. autos)
8.10	15	16	Growth Rates, Scrappage
9.00	17	18	Miscellaneous Market Variables
9.10	17	18	Growth Rates, Miscellaneous Market Variables
10.00	19	20	Domestic Auto Prices (dollars)
11.00	21	22	Growth Rates, Domestic Auto Prices
12.00	23	24	Foreign Auto Prices (dollars)
12.10	23	24	Growth Rates, Foreign Auto Prices
13.00	25	26	Capitalized Costs per Mile (dollars per mile)
13.10	25	26	Growth Rates, Capitalized Costs per Mile
14.00	27	28	Miles per Gallon (WEFA)
14.10	27	28	New Auto Miles per Gallon (EPA)
15.00	29	30	Growth Rates, Miles per Gallon (WEFA)
15.10	29	30	Growth Rates, New Auto Miles per Gallon (EPA)
16.00	31	32	Used Car Market
16.10	31	32	Growth Rates, Used Car Market
17.00	33	34	Demographic Variables
17.10	33	34	Growth Rates, Demographic Variables
18.00	35	36	Economic Variables
19.00	37	38	Growth Rates, Economic Variables
20.00	39	40	Auto Characteristics
21.00	41	42	Growth Rates, Auto Characteristics
22.00	43	44	Fuel Consumption Efficiency Factors
23.00	45	46	Miscellaneous Assumptions
23.10	45	46	Growth Rates, Miscellaneous Assumptions
32.00	47	52	Constant Adjustments
32.10	53	58	Exogenous Assumptions

THE WHARTON EPA MOTOR VEHICLE DEMAND MODEL
MARCH CONTROL FOR HYDRIDS

TABLE 1.00 SELECTED MARKET INDICATORS

LINE	ITEM	1979	1980	1981	1982	1983	1984	1985	1986	1987	1988	1989
1	CARS IN OPERATION	100,877	102,857	104,471	106,272	108,258	110,212	112,130	113,984	115,777	117,522	119,072
2	%GROWTH	1.4	2.0	1.6	1.7	1.9	1.8	1.7	1.6	1.6	1.5	1.3
3												
4	NEW CAR RETAIL SALES	11,052	10,789	11,049	11,621	11,798	11,847	12,345	12,615	12,712	12,672	12,828
5	%GROWTH	-1.5	-2.4	2.4	5.2	1.5	0.4	4.2	2.2	0.8	-0.7	1.6
6												
7	TOTAL NEW CAR REGISTRATIONS	10,802	10,503	10,798	11,362	11,537	11,585	12,076	12,337	12,429	12,336	12,538
8	%GROWTH	-1.6	-2.4	2.4	5.2	1.5	0.4	4.2	2.2	0.7	-0.7	1.6
9												
10	DOMESTIC	8,989	8,756	8,958	9,462	9,633	9,670	10,100	10,263	10,273	10,126	10,229
11	%GROWTH	-0.4	-2.6	2.3	5.6	1.8	0.4	4.8	1.6	0.1	-1.4	1.0
12	FOREIGN	1,813	1,787	1,839	1,900	1,904	1,915	1,975	2,079	2,156	2,210	2,305
13	%GROWTH	-7.3	-1.4	2.9	3.3	0.2	0.6	3.2	5.0	3.9	2.5	4.3
14												
15	% FOREIGN	16.79	16.95	17.03	16.72	16.50	16.53	16.36	16.42	17.35	17.92	18.39
16	%GROWTH	-5.8	1.0	0.5	-1.8	-1.3	0.2	-1.0	2.8	3.2	3.3	2.7
17	% SMALL CARS (SIIR + COMP)	46.68	46.79	46.92	46.65	46.89	46.63	46.66	46.90	47.41	48.10	48.64
18	%GROWTH	-1.7	0.2	0.3	-0.6	-0.3	0.3	0.1	0.5	1.1	1.5	1.1
19												
20	TOTAL AUTOS SCRAPPED	9,415	8,563	9,184	9,562	9,555	9,627	10,158	10,523	10,506	10,592	10,948
21	%GROWTH	-11.1	-9.1	7.3	4.1	-0.1	0.8	5.5	3.6	0.7	-0.0	3.7
22												
23	VEHICLE MILES TRAVELLED	1208,28	1244,92	1255,22	1270,15	1288,96	1315,56	1346,89	1376,37	1409,97	1440,59	1470,12
24	%GROWTH	1.9	3.0	0.8	1.2	1.5	2.1	2.4	2.2	2.4	2.2	2.0
25												
26	TOTAL FLEET MPG (WEFA EST.)	13,93	14,22	14,59	15,07	15,63	16,25	16,92	17,56	18,16	18,72	19,28
27	%GROWTH	1.3	2.0	2.6	3.3	3.7	4.0	4.2	3.8	3.4	3.1	2.8
28												
29	AUTO MOTOR FUEL CONSUMPTION	86,72	87,97	86,05	84,30	82,49	80,96	79,59	78,39	77,63	76,95	76,42
30	%GROWTH	0.6	1.0	-1.7	-2.0	-2.1	-1.9	-1.7	-1.5	-1.0	-0.9	-0.7
31	AUTO MOTOR FUEL EXPENDITURES	29,15	30,18	29,79	29,35	28,89	28,51	28,19	27,92	27,81	27,72	27,68
32	%GROWTH	2.9	3.4	-1.2	-1.5	-1.6	-1.3	-1.1	-0.9	-0.8	-0.5	-0.1
33												
34	NEW CAR FLEET MPG (EPA EST.)	20,38	21,06	22,03	24,68	26,60	27,67	28,09	28,09	28,11	28,15	28,17
35	%GROWTH	5.7	5.3	6.4	8.1	7.8	8.0	1.5	0.0	0.1	0.1	0.1
36												
37	DOMESTIC	19,97	20,66	22,05	24,00	26,07	27,12	27,55	27,53	27,53	27,55	27,56
38	%GROWTH	6.5	8.6	6.7	8.8	8.6	8.0	1.6	-0.1	0.0	0.1	0.0
39	FOREIGN	25,68	26,51	27,63	28,78	29,67	30,87	31,20	31,22	31,25	31,26	31,28
40	%GROWTH	2.2	3.2	4.2	4.2	3.1	4.0	1.1	0.1	0.1	0.0	0.1
41												
42	AVERAGE NEW CAR PURCHASE COST	7369.	7896.	8512.	9108.	9742.	10395.	11043.	11698.	12362.	13080.	13726.
43	%GROWTH	7.9	7.1	7.8	7.0	7.0	6.7	6.2	5.9	5.7	5.5	5.3
44	NEW CAR EXPENDITURES	33,77	32,40	33,13	35,69	37,14	38,14	40,37	41,78	42,50	42,63	43,79
45	%GROWTH	-6.1	-4.0	2.2	7.7	4.1	2.7	5.8	3.5	1.7	3.3	2.7
46												
47	Avg Cap. Cost per Mile	27,35	29,27	31,69	34,05	36,37	38,91	41,59	44,50	47,48	50,55	53,71
48	%GROWTH	8.6	7.0	8.3	7.5	6.8	7.0	6.9	7.0	6.7	6.5	6.3
49												
50	Avg Used Car Wholesale Price	3436.	3730.	4050.	4371.	4709.	5050.	5398.	5758.	6134.	6516.	6896.
51	%GROWTH	10.7	8.7	8.5	7.9	7.7	7.3	6.8	6.7	6.5	6.2	5.8
52	TOTAL USED CAR PURCHASES	15,663	16,401	17,248	17,233	16,971	17,463	18,156	18,072	18,339	18,818	19,370
53	%GROWTH	7.1	6.2	3.9	-0.3	-1.5	2.9	4.0	-0.5	1.5	2.6	2.9

THE WHARTON EPA MODEL VEHICLE DEMAND MODEL
MARCH CONTROL FOR HYBRIDS

TABLE 1.00 SELECTED MARKET INDICATORS

LINE	TIME	1990	1991	1992	1993	1994	1995	1996	1997	1998	1999	2000
1	CARS IN OPERATION	120,535	122,237	123,893	125,548	127,084	129,063	131,897	133,625	135,915	138,323	140,709
2	XGROWTH	1.2	1.0	1.4	1.3	1.5	1.6	1.6	1.6	1.7	1.7	1.7
3												
4	NEW CAR RETAIL SALES	12,949	13,415	13,920	14,480	14,600	14,074	15,031	15,886	15,727	16,003	16,255
5	XGROWTH	1.3	3.3	3.8	3.7	1.1	1.9	1.1	2.9	1.8	1.8	1.6
6												
7	TOTAL NEW CAR REGISTRATIONS	12,688	13,103	13,595	14,104	14,258	14,525	14,676	15,079	15,354	15,623	15,870
8	XGROWTH	1.2	3.3	3.8	3.7	1.1	1.9	1.0	2.7	1.8	1.8	1.6
9												
10	DOMESTIC	10,291	10,585	10,941	11,324	11,016	11,607	11,704	11,977	12,178	12,349	12,585
11	XGROWTH	0.6	2.9	3.4	3.5	0.8	1.7	0.8	2.3	1.7	1.7	1.6
12	FOREIGN	2,397	2,519	2,654	2,779	2,882	2,918	2,972	3,102	3,176	3,234	3,285
13	XGROWTH	4.0	5.1	5.4	4.7	2.3	2.7	1.9	8.2	2.8	1.8	1.6
14												
15	X FOREIGN	16.89	19.22	19.52	19.71	19.93	20.09	20.25	20.57	20.68	20.70	20.70
16	XGROWTH	2.7	7.7	1.6	0.9	1.1	0.8	0.8	1.6	0.5	0.1	-0.0
17	X SMALL CARS (SIR + COMP)	49.19	49.41	49.57	49.65	49.91	50.14	50.49	50.85	51.04	51.18	51.29
18	XGROWTH	1.1	0.4	0.3	0.2	0.5	0.5	0.7	0.7	0.4	0.3	0.2
19												
20	TOTAL AUTOS SCRAPPED	11,225	11,402	11,939	12,448	12,322	12,546	12,642	12,952	13,063	13,216	13,483
21	XGROWTH	2.2	1.6	4.7	4.3	-1.0	1.8	0.8	2.8	0.9	1.2	2.0
22												
23	VEHICLE MILES TRAVELLED	1498,50	1535,56	1572,44	1610,76	1651,46	1693,52	1732,91	1774,01	1818,51	1866,87	1915,76
24	XGROWTH	1.9	2.5	2.4	2.4	2.5	2.5	2.3	2.4	2.5	2.6	2.6
25												
26	TOTAL FLEET MPG (WEFA EST.)	19.66	20.02	20.27	20.41	20.47	20.51	20.53	20.53	20.51	20.48	20.45
27	XGROWTH	2.2	1.8	1.3	0.7	0.3	0.2	0.1	0.0	-0.1	-0.1	-0.2
28												
29	AUTO MOTOR FUEL CONSUMPTION	76.21	76.72	77.59	78.91	80.67	82.57	84.43	86.39	88.66	91.13	93.68
30	XGROWTH	-0.3	0.7	1.1	1.7	2.2	2.3	2.3	2.3	2.6	2.8	2.8
31	AUTO MOTOR FUEL EXPENDITURES	27.76	27.94	28.26	28.74	29.38	30.07	30.75	31.46	32.29	33.19	34.12
32	XGROWTH	0.3	0.7	1.1	1.7	2.2	2.3	2.3	2.1	2.6	2.8	2.8
33												
34	NEW CAR FLEET MPG (EPA EST.)	28.20	28.21	28.22	28.22	28.24	28.25	28.27	28.29	28.30	28.30	28.31
35	XGROWTH	0.1	0.0	0.0	0.0	0.0	0.0	0.1	0.1	0.0	0.0	0.0
36												
37	DOMESTIC	27.57	27.57	27.57	27.56	27.55	27.56	27.57	27.58	27.59	27.59	27.59
38	XGROWTH	0.1	-0.0	-0.0	-0.0	-0.0	0.0	0.0	0.0	0.0	0.0	-0.0
39	FOREIGN	31.28	31.29	31.29	31.32	31.35	31.38	31.39	31.39	31.40	31.41	31.44
40	XGROWTH	-0.0	0.0	0.0	0.1	0.1	0.1	0.1	-0.0	0.0	0.0	0.1
41												
42	AVERAGE NEW CAR PURCHASE COST	18462.	15200.	16070.	16918.	17818.	18749.	19718.	20737.	21811.	22922.	24091.
43	XGROWTH	5.4	5.8	5.4	5.3	5.3	5.2	5.2	5.2	5.2	5.1	5.1
44	NEW CAR EXPENDITURES	48.85	47.08	49.68	52.42	53.79	55.64	57.28	59.79	61.47	64.00	66.10
45	XGROWTH	2.4	5.0	5.5	5.5	2.6	3.4	2.9	8.4	3.3	3.4	3.3
46												
47	AVG CAP. COST PER MILE	56.97	60.29	63.77	67.41	71.24	75.24	79.59	83.96	88.57	93.47	98.62
48	XGROWTH	6.1	5.8	5.8	5.7	5.7	5.6	5.8	5.5	5.5	5.5	5.5
49												
50	AVG USED CAR WHOLESALE PRICE	7301.	7738.	8220.	8741.	9295.	9860.	10445.	11080.	11682.	12347.	13051.
51	XGROWTH	5.9	6.0	6.2	6.3	6.3	6.1	5.9	5.7	5.8	5.7	5.7
52	TOTAL USED CAR PURCHASES	19,424	19,673	19,754	19,857	20,059	20,489	21,047	21,809	21,649	22,072	22,510
53	XGROWTH	0.3	1.3	0.4	0.5	1.0	3.1	1.7	2.1	0.9	1.8	2.0

THE WHARTON EFA MOTOR VEHICLE DEMAND MODEL
MARCH CONTROL FOR HYBRIDS

LINE	I T E M	TABLE 2.00 NEW REGISTRATIONS (MILL AUTOS)										
		1979	1980	1981	1982	1983	1984	1985	1986	1987	1988	1989
1	TOTAL NEW REGISTRATIONS	10,802	10,943	10,798	11,362	11,537	11,585	12,076	12,337	12,829	12,336	12,534
21												
31	SUBCOMPACT	2,712	2,651	2,717	2,818	2,839	2,854	2,976	3,067	3,136	3,166	3,261
41		25.11	25.15	25.16	24.80	24.60	24.64	24.65	24.86	25.23	25.66	26.02
51	COMPACT	2,330	2,281	2,350	2,482	2,525	2,588	2,658	2,719	2,756	2,760	2,836
61		21.57	21.64	21.76	21.88	21.89	21.99	22.02	22.08	22.10	22.48	22.63
71	MID-SIZE	2,742	2,692	2,746	2,914	2,972	2,975	3,105	3,168	3,190	3,169	3,228
81		25.38	25.54	25.43	25.64	25.76	25.68	25.71	25.65	25.67	25.69	25.72
91	FULL SIZE	1,986	1,919	1,957	2,071	2,114	2,109	2,158	2,163	2,095	1,969	1,912
101		18.39	18.20	18.12	18.23	18.32	18.21	17.87	17.54	16.85	15.96	15.25
111	LUXURY	1,032	0,999	1,028	1,077	1,067	1,099	1,177	1,228	1,252	1,268	1,302
121		9.95	9.48	9.52	9.88	9.82	9.88	9.75	9.92	10.07	10.25	10.38

MARCH CONTROL FOR HYBRIDS

LINE	I T E M	TABLE 2.10 TOTAL DOMESTIC NEW REGISTRATIONS (MILL AUTOS)										
		1979	1980	1981	1982	1983	1984	1985	1986	1987	1988	1989
1	TOTAL DOMESTIC NEW REGISTRATIONS	8,989	8,756	8,958	9,462	9,633	9,670	10,100	10,263	10,273	10,126	10,229
21												
31	SUBCOMPACTS	1,085	1,084	1,060	1,103	1,119	1,122	1,198	1,187	1,172	1,189	1,151
41		12.07	11.92	11.83	11.66	11.62	11.60	11.82	11.56	11.41	11.35	11.26
51	COMPACT	2,237	2,193	2,266	2,402	2,489	2,476	2,590	2,653	2,698	2,709	2,780
61		24.88	25.04	25.29	25.38	25.42	25.60	25.64	25.85	26.23	26.75	27.18
71	MID-SIZE	2,742	2,692	2,746	2,914	2,972	2,975	3,105	3,168	3,190	3,169	3,228
81		30.50	30.75	30.65	30.79	30.86	30.76	30.74	30.88	31.05	31.30	31.52
91	FULL SIZE	1,986	1,919	1,957	2,071	2,114	2,109	2,158	2,163	2,095	1,969	1,912
101		22.10	21.92	21.85	21.89	21.94	21.81	21.37	21.08	20.39	19.85	18.69
111	LUXURY	0,939	0,908	0,930	0,972	0,979	0,989	1,053	1,095	1,122	1,129	1,162
121		10.45	10.37	10.38	10.27	10.16	10.23	10.83	10.67	10.92	11.15	11.36

MARCH CONTROL FOR HYBRIDS

LINE	I T E M	TABLE 2.20 FOREIGN NEW REGISTRATIONS (MILL AUTOS)										
		1979	1980	1981	1982	1983	1984	1985	1986	1987	1988	1989
1	TOTAL FOREIGN NEW REGISTRATIONS	1,813	1,787	1,839	1,900	1,900	1,915	1,975	2,075	2,196	2,210	2,305
21												
31	SUBCOMPACT	1,628	1,607	1,657	1,718	1,719	1,733	1,783	1,881	1,968	2,017	2,110
41		89.76	89.90	90.09	90.20	90.32	90.50	90.25	90.64	91.08	91.25	91.52
51	COMPACT	0,093	0,089	0,084	0,080	0,076	0,072	0,069	0,065	0,062	0,059	0,056
61		5.15	4.97	4.59	4.22	4.00	3.78	3.88	3.15	2.88	2.67	2.83
71	LUXURY	0,092	0,091	0,098	0,105	0,108	0,110	0,124	0,129	0,110	0,110	0,140
81		5.09	5.09	5.32	5.54	5.68	5.72	6.27	6.22	6.08	6.08	6.05
101	FOREIGN MARKET SHARES: % OF TOTAL	16.79	16.95	17.03	16.72	16.50	16.53	16.36	16.82	17.19	17.92	18.39
111	% OF SUBCOMPACT	60.01	60.62	60.99	60.80	60.37	60.71	59.90	61.11	62.63	63.71	68.69
121	% OF COMPACT	4.01	3.89	3.59	3.23	3.01	2.84	2.58	2.80	2.25	2.13	1.97
131	% OF LUXURY	8.95	9.11	9.52	9.78	9.95	9.97	10.53	10.58	10.88	10.88	10.72

THE WHARTON EFA MODEL VEHICLE DEMAND MODEL
MARCH CONTROL FOR HYBRIDS

LINE	ITEM	TABLE 2,00 NEW REGISTRATIONS (MILL AUTOS)										
		1990	1991	1992	1993	1994	1995	1996	1997	1998	1999	2000
11	TOTAL NEW REGISTRATIONS	12,688	13,103	13,595	14,104	14,250	14,525	14,676	15,079	15,354	15,623	15,070
21	SURCOMPACT	3,356	3,495	3,657	3,806	3,873	3,970	4,043	4,204	4,307	4,393	4,861
41	COMPACT	26,425	26,68	26,90	26,99	27,17	27,33	27,55	27,91	28,05	28,12	28,11
51	MID-SIZE	2,885	2,979	3,042	3,106	3,242	3,313	3,367	3,450	3,529	3,603	3,679
61	FULL SIZE	22,774	22,73	22,67	22,66	22,74	22,81	22,94	22,94	22,99	23,06	23,14
71	LUXURY	3,257	3,365	3,488	3,625	3,748	3,748	3,747	3,804	3,962	4,037	4,114
81		25,67	25,64	25,66	25,70	25,74	25,78	25,81	25,78	25,80	25,84	25,92
91		1,853	1,871	1,910	1,956	1,924	1,913	1,866	1,849	1,838	1,824	1,821
101		14,60	14,28	14,05	13,47	13,52	13,17	12,71	12,26	11,97	11,70	11,87
111		1,337	1,393	1,458	1,520	1,545	1,585	1,612	1,675	1,718	1,761	1,795
121		10,54	10,63	10,72	10,74	10,84	10,91	10,99	11,11	11,19	11,27	11,31

MARCH CONTROL FOR HYBRIDS

LINE	ITEM	TABLE 2,10 TOTAL DOMESTIC NEW REGISTRATIONS (MILL AUTOS)										
		1990	1991	1992	1993	1994	1995	1996	1997	1998	1999	2000
11	TOTAL DOMESTIC NEW REGISTRATIONS	10,291	10,585	10,941	11,324	11,416	11,607	11,704	11,977	12,170	12,340	12,545
21	SURCOMPACTS	1,163	1,186	1,221	1,244	1,242	1,260	1,275	1,319	1,345	1,373	1,381
41	COMPACT	11,30	11,21	11,16	10,94	10,80	10,85	10,89	11,01	11,04	11,06	10,90
51	MID-SIZE	2,832	2,928	3,034	3,150	3,199	3,271	3,324	3,422	3,484	3,549	3,647
61	FULL SIZE	27,52	27,67	27,73	27,82	28,02	28,18	28,44	28,57	28,69	28,81	28,94
71	LUXURY	3,257	3,365	3,488	3,625	3,670	3,748	3,747	3,804	3,962	4,037	4,114
81		31,65	31,79	31,88	32,01	32,15	32,26	32,36	32,46	32,53	32,59	32,69
91		1,853	1,871	1,910	1,956	1,920	1,913	1,866	1,849	1,838	1,824	1,821
101		14,01	13,68	13,46	12,88	12,88	12,88	12,88	12,88	12,88	12,88	12,88
111		1,186	1,234	1,288	1,349	1,376	1,419	1,448	1,489	1,539	1,581	1,622
121		11,53	11,66	11,77	11,91	12,07	12,22	12,37	12,52	12,64	12,76	12,89

MARCH CONTROL FOR HYBRIDS

LINE	ITEM	TABLE 2,20 FOREIGN NEW REGISTRATIONS (MILL AUTOS)										
		1990	1991	1992	1993	1994	1995	1996	1997	1998	1999	2000
11	TOTAL FOREIGN NEW REGISTRATIONS	2,397	2,519	2,654	2,779	2,882	2,918	2,972	3,102	3,176	3,234	3,285
21	SURCOMPACT	2,190	2,309	2,436	2,562	2,632	2,711	2,769	2,849	2,962	3,021	3,079
41	COMPACT	91,50	91,70	91,79	92,20	92,60	92,90	93,15	93,13	93,26	93,41	93,75
51	MID-SIZE	0,053	0,051	0,048	0,046	0,043	0,041	0,039	0,037	0,035	0,034	0,032
61	FULL SIZE	2,22	2,01	1,81	1,64	1,52	1,41	1,31	1,20	1,11	1,04	0,97
71	LUXURY	0,151	0,159	0,170	0,171	0,167	0,166	0,165	0,176	0,179	0,180	0,174
81		6,28	6,30	6,40	6,16	5,84	5,69	5,54	5,67	5,62	5,55	5,28
91		14,89	14,22	13,52	12,71	12,93	13,09	13,25	13,57	13,68	13,70	13,70
101	FOREIGN MARKET SHARES: % OF TOTAL	65,36	66,07	66,61	67,12	67,94	68,27	68,47	68,66	68,77	68,74	69,03
111	% OF SURCOMPACT	1,84	1,70	1,56	1,43	1,34	1,24	1,16	1,07	1,00	0,93	0,87
121	% OF COMPACT	11,26	11,39	11,65	11,27	10,81	10,47	10,21	10,50	10,40	10,20	9,67
131	% OF LUXURY											

THE WHARTON EFA MOTOR VEHICLE DEMAND MODEL
MARCH CONTROL FOR HYBRIDS

TABLE 3.00 GROWTH RATES, NEW REGISTRATIONS

LINE	ITEM	1979	1980	1981	1982	1983	1984	1985	1986	1987	1988	1989
1	TOTAL NEW REGISTRATIONS	-1.6	-2.8	2.4	5.2	1.5	0.4	4.2	2.2	0.7	-0.7	1.6
2	SUBCOMPACT	-6.7	-2.2	2.5	3.7	0.7	0.6	4.3	3.1	2.2	1.0	3.0
3	COMPACT	1.1	-2.1	3.0	5.6	1.7	0.9	4.3	2.3	1.4	0.4	2.5
4	MID-SIZE	-1.7	-1.8	2.0	6.1	2.0	0.1	4.4	1.9	0.8	-0.6	1.7
5	FULL SIZE	3.5	-3.4	2.0	5.8	2.0	-0.2	2.3	0.2	-3.2	-6.0	-2.9
6	LUXURY	-2.5	-3.2	2.9	4.8	0.9	1.1	7.1	4.0	2.3	0.9	3.0

MARCH CONTROL FOR HYBRIDS

TABLE 3.10 GROWTH RATES, DOMESTIC NEW REGISTRATIONS

LINE	ITEM	1979	1980	1981	1982	1983	1984	1985	1986	1987	1988	1989
1	TOTAL DOMESTIC NEW REGISTRATIONS	-0.4	-2.6	2.3	5.6	1.8	0.4	4.4	1.6	0.1	-1.4	1.0
2	SUBCOMPACTS	-7.1	-3.6	1.5	4.1	1.4	0.2	6.4	-0.6	-1.2	-2.0	0.2
3	COMPACT	1.4	-2.0	3.3	6.0	2.0	1.1	4.6	2.5	1.5	0.5	2.6
4	MID-SIZE	-1.7	-1.6	2.0	6.1	2.0	0.1	4.8	1.9	0.8	-0.6	1.7
5	FULL SIZE	3.5	-3.4	2.0	5.8	2.0	-0.2	2.3	0.2	-3.2	-6.0	-2.9
6	LUXURY	-0.0	-3.3	2.4	4.5	0.7	1.0	6.5	3.9	2.5	0.7	2.9

MARCH CONTROL FOR HYBRIDS

TABLE 3.20 GROWTH RATES, FOREIGN NEW REGISTRATIONS

LINE	ITEM	1979	1980	1981	1982	1983	1984	1985	1986	1987	1988	1989
1	TOTAL FOREIGN NEW REGISTRATIONS	-7.3	-1.4	2.9	3.3	0.2	0.6	3.2	5.0	3.9	2.5	4.3
2	SUBCOMPACT	-6.4	-1.2	3.1	3.5	0.3	0.4	2.9	5.5	4.4	2.7	4.6
3	COMPACT	-5.0	-5.0	-5.0	-5.0	-5.0	-5.0	-5.0	-5.0	-5.0	-5.0	-5.0
4	LUXURY	-22.4	-1.4	7.6	7.6	2.7	1.3	13.1	4.1	1.0	3.3	3.7

ORIGINAL PAGE IS
OF POOR QUALITY

THE WHARTON EFA MOTOR VEHICLE DEMAND MODEL
MARCH CONTROL FOR HYBRIDS

TABLE 3.00 GROWTH RATES, NEW REGISTRATIONS

LINE	ITEM	1990	1991	1992	1993	1998	1995	1996	1997	1998	1999	2000
1	TOTAL NEW REGISTRATIONS	1.2	3.3	3.0	3.7	1.1	1.9	1.0	2.7	1.8	1.8	1.6
21	SUBCOMPACT	2.9	4.1	4.6	4.1	1.8	2.5	1.8	4.1	2.3	2.0	1.5
31	COMPACT	1.7	3.3	3.5	3.7	1.4	2.2	1.7	2.7	2.0	2.1	2.1
41	MID-SIZE	1.0	3.3	3.7	3.9	1.2	2.0	1.1	2.7	1.9	1.9	1.9
51	FULL SIZE	-3.1	1.0	2.1	2.4	-1.5	-0.8	-2.5	-0.9	-0.6	-0.5	-0.6
61	LUXURY	2.7	4.2	4.7	4.3	1.6	2.6	1.7	3.9	2.6	2.5	2.0

MARCH CONTROL FOR HYBRIDS

TABLE 3.10 GROWTH RATES, DOMESTIC NEW REGISTRATIONS

LINE	ITEM	1990	1991	1992	1993	1998	1995	1996	1997	1998	1999	2000
1	TOTAL DOMESTIC NEW REGISTRATIONS	0.6	2.9	3.4	3.5	0.8	1.7	0.8	2.3	1.7	1.7	1.6
21	SUBCOMPACTS	1.0	2.0	3.0	1.9	-0.2	1.4	1.2	3.5	2.0	2.1	0.6
31	COMPACT	1.9	3.4	3.6	3.8	1.5	2.3	1.7	2.8	2.1	2.2	2.2
41	MID-SIZE	1.0	3.3	3.7	3.9	1.2	2.0	1.1	2.7	1.9	1.9	1.9
51	FULL SIZE	-3.1	1.0	2.1	2.4	-1.5	-0.8	-2.5	-0.9	-0.6	-0.5	-0.6
61	LUXURY	2.1	4.0	4.4	4.7	2.1	3.0	2.0	3.6	2.7	2.7	2.6

MARCH CONTROL FOR HYBRIDS

TABLE 3.20 GROWTH RATES, FOREIGN NEW REGISTRATIONS

LINE	ITEM	1990	1991	1992	1993	1998	1995	1996	1997	1998	1999	2000
1	TOTAL FOREIGN NEW REGISTRATIONS	4.0	5.1	5.4	4.7	2.3	2.7	1.9	4.8	2.8	1.0	1.6
21	SUBCOMPACT	4.0	5.3	5.5	5.2	2.7	3.0	2.1	4.4	2.5	2.0	1.9
31	COMPACT	-5.0	-5.0	-5.0	-5.0	-5.0	-5.0	-5.0	-5.0	-5.0	-5.0	-5.0
41	LUXURY	7.9	5.3	7.1	0.9	-2.5	-0.6	-0.6	6.9	1.5	0.6	-3.8

THE WHARTON EFA MOTOR VEHICLE DEMAND MODEL
MARCH CONTROL FOR HYBRIDS

LINE	I T E M	4.00 PASSENGER CARS IN OPERATION: YEAR-END (MILL AUTOS)										
		1979	1980	1981	1982	1983	1984	1985	1986	1987	1988	1989
1	TOTAL CARS IN OPERATION YEAR-END	100,877	102,857	108,071	106,272	108,250	110,212	112,130	113,000	115,777	117,522	119,072
21	SURCOMPACT	22,078	23,370	24,464	25,026	26,274	26,909	27,630	28,200	28,770	29,333	29,879
31	COMPACT	21,000	22,72	23,82	23,93	24,27	24,50	24,68	24,75	24,85	24,96	25,09
41	MID-SIZE	20,086	20,826	21,084	22,168	22,800	23,408	24,076	24,608	25,137	25,658	26,189
51	FULL SIZE	19,91	20,25	20,56	20,86	21,11	21,31	21,47	21,60	21,71	21,83	21,96
61	LUXURY	24,821	25,724	25,750	26,866	27,198	27,871	28,502	29,058	29,576	30,065	30,588
71		28,21	24,83	24,66	24,90	25,12	25,29	25,42	25,50	25,55	25,58	25,61
81		28,804	23,806	22,836	22,088	21,608	21,330	21,181	21,120	21,099	21,027	20,868
91		24,59	23,18	21,86	20,78	19,96	19,35	18,89	18,54	18,22	17,89	17,52
101		9,892	9,730	9,929	10,127	10,326	10,523	10,781	10,961	11,105	11,238	11,382
111		9,81	9,86	9,50	9,53	9,58	9,55	9,58	9,62	9,67	9,73	9,81
121												

MARCH CONTROL FOR HYBRIDS

LINE	I T E M	4.10 DOMESTIC CARS IN OPERATION: YEAR-END (MILL AUTOS)										
		1979	1980	1981	1982	1983	1984	1985	1986	1987	1988	1989
1	TOTAL CARS IN OPERATION	85,614	86,865	87,849	89,077	90,537	92,031	93,555	94,972	96,380	97,672	98,751
21	SURCOMPACTS	8,680	9,299	9,797	10,206	10,583	10,803	11,035	11,200	11,335	11,441	11,512
31	COMPACTS	10,114	10,71	11,15	11,46	11,64	11,78	11,80	11,79	11,76	11,71	11,66
41	MID-SIZE	19,095	19,817	20,871	21,166	21,864	22,530	23,158	23,726	24,295	24,854	25,385
51	FULL SIZE	22,30	22,61	23,30	23,76	24,15	24,48	24,75	24,98	25,21	25,45	25,71
61	LUXURY	24,821	25,724	25,750	26,866	27,198	27,871	28,502	29,058	29,576	30,065	30,588
71		28,21	24,83	24,66	24,90	25,12	25,29	25,42	25,50	25,55	25,58	25,61
81		28,804	23,806	22,836	22,088	21,608	21,330	21,181	21,120	21,099	21,027	20,868
91		24,59	23,18	21,86	20,78	19,96	19,35	18,89	18,54	18,22	17,89	17,52
101		9,892	9,730	9,929	10,127	10,326	10,523	10,781	10,961	11,105	11,238	11,382
111		9,81	9,86	9,50	9,53	9,58	9,55	9,58	9,62	9,67	9,73	9,81
121												

MARCH CONTROL FOR HYBRIDS

LINE	I T E M	4.20 FOREIGN CARS IN OPERATION: YEAR-END (MILL AUTOS)										
		1979	1980	1981	1982	1983	1984	1985	1986	1987	1988	1989
1	TOTAL CARS IN OPERATION	15,263	15,992	16,623	17,195	17,717	18,181	18,575	18,972	19,397	19,850	20,321
21	SURCOMPACTS	13,398	14,071	14,667	15,219	15,731	16,196	16,595	17,000	17,435	17,892	18,367
31	COMPACTS	17,75	17,99	18,28	18,51	18,79	19,08	19,38	19,61	19,89	20,18	20,38
41	MID-SIZE	0,991	1,010	1,013	1,003	0,988	0,958	0,922	0,882	0,842	0,808	0,765
51	FULL SIZE	6,889	6,31	6,09	5,83	5,56	5,27	4,96	4,65	4,34	4,05	3,76
61	LUXURY	0,878	0,912	0,982	0,973	1,001	1,027	1,058	1,089	1,120	1,158	1,190
71		5,75	5,70	5,67	5,66	5,65	5,65	5,70	5,78	5,77	5,81	5,86
81		15,13	15,55	15,91	16,18	16,37	16,50	16,57	16,65	16,75	16,89	17,07
91		60,68	60,21	59,95	59,86	59,87	59,99	60,06	60,20	60,60	61,00	61,47
101		0,93	0,85	0,71	0,52	0,31	0,08	3,83	3,58	3,35	3,13	2,92
111		9,25	9,37	9,89	9,60	9,70	9,76	9,85	9,98	10,00	10,00	10,19
121												

THE WHARTON EFA MOTOR VEHICLE DEMAND MODEL
MARCH CONTROL FOR HYBRIDS

LINE	ITEM	TABLE 4.00 PASSENGER CARS IN OPERATION: YEAR-END (MILL AUTOS)										
		1990	1991	1992	1993	1994	1995	1996	1997	1998	1999	2000
1	TOTAL CARS IN OPERATION YEAR-END	120,535	122,237	123,093	125,588	127,000	129,063	131,007	133,625	135,915	138,323	140,700
21												
31	SURCOMPACT	30,009	31,103	31,776	32,068	33,289	34,058	34,888	35,770	36,707	37,000	38,551
41	COMPACT	25,26	25,48	25,86	26,08	26,30	26,53	26,76	27,01	27,27	27,52	27,80
51		26,619	27,127	27,618	28,090	28,628	29,163	29,723	30,203	30,807	31,527	32,162
61		22,00	22,19	22,29	22,37	22,45	22,53	22,60	22,67	22,73	22,79	22,86
71	MID-SIZE	30,899	31,356	31,797	32,237	32,700	33,272	33,813	34,372	34,977	35,620	36,269
81		25,63	25,85	25,67	25,60	25,69	25,70	25,71	25,72	25,73	25,75	25,70
91	FULL SIZE	20,620	20,815	20,165	19,901	19,671	19,438	19,193	18,935	18,710	18,515	18,334
101		17,11	16,70	16,28	15,85	15,43	15,01	14,60	14,17	13,77	13,39	13,03
111	LUXURY	11,939	12,236	12,580	12,892	13,191	13,537	13,868	14,287	14,628	15,013	15,393
121		9,91	10,01	10,12	10,24	10,35	10,46	10,56	10,66	10,76	10,85	10,98

MARCH CONTROL FOR HYBRIDS

LINE	ITEM	TABLE 4.10 DOMESTIC CARS IN OPERATION: YEAR-END (MILL AUTOS)										
		1990	1991	1992	1993	1994	1995	1996	1997	1998	1999	2000
1	TOTAL CARS IN OPERATION	99,608	100,801	101,816	102,799	103,992	105,214	106,485	107,811	109,295	110,910	112,509
21												
31	SURCOMPACTS	11,973	11,640	11,689	11,719	11,766	11,818	11,887	11,946	12,117	12,272	12,028
41	COMPACTS	11,61	11,53	11,68	11,80	11,31	11,23	11,16	11,12	11,09	11,06	11,04
51		25,898	26,939	26,965	27,080	28,048	28,620	29,211	29,809	30,480	31,096	31,753
61		25,97	26,23	26,48	26,73	26,97	27,20	27,43	27,65	27,85	28,08	28,21
71	MID-SIZE	30,899	31,356	31,797	32,237	32,789	33,272	33,813	34,372	34,977	35,620	36,269
81		30,99	31,11	31,23	31,36	31,49	31,62	31,75	31,88	32,00	32,12	32,22
91	FULL SIZE	20,620	20,815	20,165	19,901	19,671	19,438	19,193	18,935	18,710	18,515	18,334
101		20,69	20,25	19,81	19,36	18,92	18,47	18,02	17,56	17,12	16,69	16,29
111	LUXURY	10,708	10,950	11,200	11,462	11,750	12,066	12,382	12,708	13,050	13,400	13,760
121		19,74	19,86	11,00	11,15	11,31	11,47	11,63	11,79	11,94	12,09	12,23

MARCH CONTROL FOR HYBRIDS

LINE	ITEM	TABLE 4.20 FOREIGN CARS IN OPERATION: YEAR-END (MILL AUTOS)										
		1990	1991	1992	1993	1994	1995	1996	1997	1998	1999	2000
1	TOTAL FOREIGN CARS IN OPERATION	20,837	21,036	22,076	22,799	23,492	24,249	25,012	25,818	26,621	27,412	28,160
21												
31	SURCOMPACTS	18,877	19,563	20,087	20,789	21,483	22,236	22,998	23,792	24,590	25,376	26,127
41	COMPACTS	90,59	90,80	90,99	91,21	91,43	91,70	91,95	92,17	92,37	92,57	92,78
51		0,726	0,688	0,689	0,610	0,575	0,582	0,512	0,483	0,457	0,432	0,408
61		3,88	3,21	2,98	2,68	2,45	2,24	2,05	1,87	1,72	1,58	1,45
71	LUXURY	1,235	1,285	1,340	1,390	1,433	1,471	1,502	1,539	1,574	1,605	1,629
81		5,93	6,00	6,07	6,11	6,10	6,06	6,01	5,96	5,91	5,85	5,77
101	FOREIGN SHARES: % OF TOTAL	17,29	17,58	17,82	18,12	18,43	18,73	19,02	19,32	19,59	19,82	20,01
111	% OF SUBCOMPACT	61,99	62,58	63,21	63,91	64,61	65,30	65,93	66,50	66,99	67,40	67,77
121	% OF COMPACT	2,73	2,58	2,35	2,17	2,01	1,86	1,72	1,60	1,48	1,37	1,27
131	% OF LUXURY	10,38	10,50	10,69	10,81	10,87	10,86	10,82	10,80	10,76	10,69	10,55

ORIGINAL PAGE IS
OF POOR QUALITY

TABLE 5.00 GROWTH RATES, CARS IN OPERATION, YEAR-END

LINE	ITEM	1979	1980	1981	1982	1983	1984	1985	1986	1987	1988	1989	1990
1	TOTAL CARS IN OPERATION YEAR-END	1.4	2.0	1.6	1.7	1.9	1.8	1.7	1.6	1.6	1.5	1.5	1.31
21	SUBCOMPACT	6.8	5.9	4.7	3.9	3.3	2.0	2.3	2.1	2.0	2.0	1.9	1.91
41	COMPACT	3.5	3.7	3.2	3.2	3.1	2.0	2.5	2.2	2.2	2.1	1.9	1.91
61	MID-SIZE	2.2	2.9	2.5	2.7	2.0	2.5	2.3	1.9	1.0	1.7	1.7	1.01
81	FULL SIZE	-5.5	-4.0	-4.1	-3.3	-2.2	-1.3	-0.7	-0.3	-0.1	-0.1	-0.1	-0.01
101	LUXURY	2.2	2.5	2.0	2.0	2.0	1.9	2.1	2.1	2.1	2.2	2.2	2.11

MARCH CONTROL FOR HYBRIDS

TABLE 5.10 GROWTH RATES, DOMESTIC CARS IN OPERATION, YEAR-END

LINE	ITEM	1979	1980	1981	1982	1983	1984	1985	1986	1987	1988	1989	1990
1	DOMESTIC CARS IN OPERATION	0.8	1.5	1.1	1.4	1.6	1.6	1.7	1.5	1.5	1.3	1.3	1.1
21	SUBCOMPACTS	9.0	7.1	5.3	4.2	3.3	2.5	2.1	1.5	1.2	0.9	0.9	0.6
41	COMPACTS	3.6	3.8	3.3	3.4	3.3	3.0	2.8	2.5	2.8	2.3	2.3	2.1
61	MID-SIZE	2.2	2.9	2.5	2.7	2.0	2.5	2.3	1.9	1.0	1.7	1.7	1.0
81	FULL SIZE	-5.5	-4.0	-4.1	-3.3	-2.2	-1.3	-0.7	-0.3	-0.1	-0.1	-0.1	-0.0
101	LUXURY	2.1	2.8	1.9	1.9	1.9	1.6	2.0	2.0	2.1	2.1	2.1	2.0

MARCH CONTROL FOR HYBRIDS

TABLE 5.20 GROWTH RATES, FOREIGN CARS IN OPERATION, YEAR-END

LINE	ITEM	1979	1980	1981	1982	1983	1984	1985	1986	1987	1988	1989	1990
1	FOREIGN CARS IN OPERATION	5.1	4.0	3.9	3.8	3.0	2.6	2.2	2.1	2.2	2.3	2.0	2.0
21	SUBCOMPACTS	5.4	5.1	4.2	3.8	3.4	3.0	2.5	2.4	2.6	2.6	2.6	2.7
41	COMPACTS	2.5	1.9	0.3	-1.0	-1.0	-2.7	-3.6	-4.6	-6.5	-4.5	-4.9	-4.9
61	LUXURY	4.1	3.8	3.4	3.2	2.9	2.5	3.1	3.0	2.8	3.1	3.1	3.1

ORIGINAL PAGE IS
OF POOR QUALITY

TABLE 5.00 GROWTH RATES, CARS IN OPERATION, YEAR-END

LINE	ITEM	1990	1991	1992	1993	1994	1995	1996	1997	1998	1999	2000
11	TOTAL CARS IN OPERATION YEAR-END	1.2	1.4	1.6	1.3	1.5	1.6	1.6	1.6	1.7	1.8	1.7
21	SUBCOMPACT	1.0	2.1	2.2	2.2	2.4	2.4	2.4	2.4	2.6	2.6	2.6
41	COMPACT	1.8	1.9	1.8	1.7	1.9	1.9	1.9	1.9	2.0	2.0	2.0
61	MID-SIZE	1.3	1.5	1.4	1.4	1.6	1.6	1.6	1.7	1.8	1.8	1.8
81	FULL SIZE	-1.1	-1.0	-1.2	-1.3	-1.2	-1.2	-1.3	-1.3	-1.2	-1.0	-1.0
101	LUXURY	2.2	2.5	2.5	2.5	2.6	2.6	2.6	2.6	2.6	2.7	2.5

MARCH CONTROL FOR HYBRIDS

TABLE 5.10 GROWTH RATES, DOMESTIC CARS IN OPERATION, YEAR-END

LINE	ITEM	1990	1991	1992	1993	1994	1995	1996	1997	1998	1999	2000
11	TOTAL CARS IN OPERATION	1.0	1.1	1.0	1.0	1.2	1.2	1.2	1.2	1.0	1.5	1.5
21	SUBCOMPACTS	0.5	0.6	0.4	0.3	0.4	0.4	0.6	0.8	1.1	1.3	1.2
41	COMPACTS	2.0	2.1	2.0	1.9	2.1	2.0	2.1	2.0	2.1	2.2	2.1
61	MID-SIZE	1.3	1.5	1.4	1.4	1.6	1.6	1.6	1.7	1.8	1.8	1.8
81	FULL SIZE	-1.1	-1.0	-1.2	-1.3	-1.2	-1.2	-1.3	-1.3	-1.2	-1.0	-1.0
101	LUXURY	2.0	2.3	2.3	2.3	2.6	2.6	2.6	2.6	2.7	2.7	2.7

MARCH CONTROL FOR HYBRIDS

TABLE 5.20 GROWTH RATES, FOREIGN CARS IN OPERATION, YEAR-END

LINE	ITEM	1990	1991	1992	1993	1994	1995	1996	1997	1998	1999	2000
11	TOTAL CARS IN OPERATION	2.5	2.9	3.0	3.0	3.3	3.2	3.1	3.2	3.1	3.0	2.7
21	SUBCOMPACTS	2.6	3.1	3.2	3.3	3.5	3.5	3.4	3.5	3.4	3.2	3.0
41	COMPACTS	-5.1	-5.2	-5.6	-6.0	-5.7	-5.7	-5.6	-5.6	-5.5	-5.4	-5.4
61	MID-SIZE	3.0	3.1	3.3	3.7	3.1	2.6	2.2	2.4	2.3	2.0	1.2
81	FULL SIZE	3.0	3.1	3.1	3.1	3.1	2.6	2.2	2.4	2.3	2.0	1.2
101	LUXURY	3.0	3.1	3.1	3.1	3.1	2.6	2.2	2.4	2.3	2.0	1.2

ORIGINAL PAGE IS
OF POOR QUALITY

THE WHARTON EFA MOTOR VEHICLE DEMAND MODEL
MARCH CONTROL FOR HYBRIDS

TABLE 6.00 CARS IN OPERATION BY AGE MID YEAR (MILL AUTOS)

LINE	ITEM	1979	1980	1981	1982	1983	1984	1985	1986	1987	1988	1989
21	1 CARS IN OPERATION ALL VINTAGES	100,148	101,815	103,605	105,317	107,196	109,157	111,088	112,948	114,775	116,573	118,212
31	LESS THAN 1 YEAR OLD	5,391	5,262	5,309	5,671	5,758	5,782	6,027	6,157	6,203	6,156	6,255
41	AGE 1 YEAR OLD	10,924	10,753	10,895	10,748	11,310	11,488	11,531	12,017	12,277	12,369	12,276
51	AGE 2 YEARS OLD	10,594	10,838	10,669	10,812	10,663	11,221	11,391	11,810	11,916	12,175	12,265
61	AGE 3 YEARS OLD	9,430	10,455	10,698	10,528	10,278	10,523	11,070	11,233	11,275	11,751	12,005
71	AGE 4 YEARS OLD	7,832	9,246	10,247	10,480	10,314	10,067	10,305	10,833	10,991	11,033	11,098
81	AGE 5 YEARS OLD	8,003	7,595	8,972	9,936	10,162	10,003	9,756	9,977	10,085	10,681	10,679
91	AGE 6 YEARS OLD	9,990	7,688	7,262	8,568	9,404	9,709	9,586	9,296	9,502	9,990	10,135
101	AGE 7 YEARS OLD	8,578	9,307	7,133	6,763	7,981	8,644	9,586	8,859	8,621	8,018	9,266
111	AGE 8 YEARS OLD	7,250	7,766	8,952	6,860	6,125	7,235	7,999	8,130	7,978	7,747	7,980
121	AGE 9 YEARS OLD	5,383	6,321	6,789	7,360	5,627	5,382	6,287	6,916	7,027	6,898	7,008
131	AGE 10 YEARS OLD	8,098	4,107	5,175	5,528	5,991	4,589	4,333	5,868	5,554	5,655	5,539
141	AGE 11 YEARS OLD	3,637	3,718	3,342	3,945	4,209	4,579	3,485	3,258	3,786	4,165	4,236
151	AGE 12 YEARS OLD	2,374	2,666	2,769	2,884	2,905	3,111	3,362	2,526	2,387	2,738	3,010
161	AGE 13 YEARS OLD	1,691	1,720	1,966	2,020	1,795	2,125	2,261	2,818	1,801	1,670	1,957
171	AGE 14 YEARS OLD	1,868	1,370	1,268	1,835	1,872	1,313	1,544	1,621	1,718	1,208	1,199
181	AGE 15 YEARS OLD	0,938	1,068	1,011	0,926	1,045	1,077	0,954	1,107	1,156	1,228	0,920
191	AGE 16 YEARS OLD	0,627	0,680	0,785	0,737	0,674	0,765	0,783	0,688	0,789	0,826	0,870
201	AGE 17 YEARS OLD	0,405	0,458	0,502	0,572	0,537	0,493	0,556	0,561	0,608	0,588	0,590
211	AGE 18 YEARS OLD	0,282	0,298	0,335	0,366	0,417	0,393	0,359	0,398	0,400	0,348	0,403
221	AGE 19 YEARS OLD	0,193	0,175	0,217	0,284	0,267	0,305	0,286	0,257	0,288	0,286	0,288
231	AGE 20 YEARS OLD	0,125	0,140	0,129	0,158	0,176	0,195	0,222	0,205	0,183	0,203	0,208

MARCH CONTROL FOR HYBRIDS

TABLE 6.10 CARS IN OPERATION: SHARES BY AGE (PERCENT)

LINE	ITEM	1979	1980	1981	1982	1983	1984	1985	1986	1987	1988	1989
31	LESS THAN 1 YEAR OLD	5.38	5.17	5.20	5.38	5.37	5.30	5.42	5.45	5.40	5.20	5.29
41	AGE 1 YEAR OLD	10.91	10.56	10.13	10.21	10.55	10.52	10.38	10.68	10.70	10.61	10.38
51	AGE 2 YEARS OLD	10.58	10.68	10.30	9.89	9.95	10.28	10.25	10.12	10.38	10.88	10.38
61	AGE 3 YEARS OLD	7.82	10.27	10.33	10.00	9.58	9.68	9.97	9.95	9.82	10.00	10.16
71	AGE 4 YEARS OLD	7.99	9.08	9.89	9.95	9.62	9.22	9.29	9.59	9.58	9.86	9.73
81	AGE 5 YEARS OLD	9.98	7.46	8.66	9.83	9.88	9.16	8.78	8.81	9.18	9.13	9.03
91	AGE 6 YEARS OLD	8.57	7.51	7.01	8.18	8.05	8.89	8.59	8.23	8.28	8.57	8.97
101	AGE 7 YEARS OLD	7.25	7.63	8.08	6.82	7.85	8.10	8.13	7.88	7.51	7.56	7.88
111	AGE 8 YEARS OLD	5.33	6.21	6.55	6.13	5.71	6.63	7.20	7.21	6.95	6.54	6.72
121	AGE 9 YEARS OLD	4.89	4.27	4.99	6.99	5.25	4.89	5.66	6.12	6.12	6.54	5.67
131	AGE 10 YEARS OLD	3.63	3.65	3.23	5.25	5.59	4.20	3.98	4.88	4.88	4.85	4.69
141	AGE 11 YEARS OLD	2.37	2.62	2.67	3.75	3.93	4.19	3.14	2.80	3.30	3.57	3.58
151	AGE 12 YEARS OLD	1.89	1.69	1.90	2.71	2.71	2.85	3.03	2.28	2.08	2.35	2.55
161	AGE 13 YEARS OLD	1.87	1.35	1.22	1.36	1.37	1.20	1.39	1.83	1.57	1.88	1.66
171	AGE 14 YEARS OLD	0.98	1.08	0.98	0.88	0.98	0.99	0.86	0.98	1.01	1.05	0.78
181	AGE 15 YEARS OLD	0.63	0.67	0.76	0.70	0.63	0.70	0.66	0.61	0.69	0.71	0.78
191	AGE 16 YEARS OLD	0.40	0.45	0.38	0.58	0.50	0.45	0.50	0.50	0.42	0.48	0.50
201	AGE 17 YEARS OLD	0.28	0.29	0.32	0.35	0.39	0.36	0.32	0.15	0.35	0.38	0.38
211	AGE 18 YEARS OLD	0.19	0.17	0.21	0.23	0.25	0.28	0.26	0.23	0.25	0.25	0.21
221	AGE 19 YEARS OLD	0.12	0.18	0.12	0.15	0.17	0.18	0.20	0.18	0.16	0.17	0.17

ORIGINAL PAGE IS
OF POOR QUALITY

THE WARTON EFA MOTU-4 VEHICLE DEMAND MODEL
MARCH CONTROL FOR HYBRIDS

TABLE 6.00 CARS IN OPERATION BY AGE1 MID YEAR (MILL AUTOS)

LINE	1990	1991	1992	1993	1998	1995	1996	1997	1998	1999	2000
11 CARS IN OPERATION: ALL VINTAGES	119,719	121,312	122,981	124,635	126,430	128,012	130,425	132,500	134,707	137,054	139,000
21 LESS THAN 1 YEAR OLD	6,332	6,539	6,748	7,037	7,114	7,247	7,323	7,521	7,669	7,799	7,917
31 AGE1 1 YEAR OLD	12,472	12,625	13,036	13,523	14,028	14,181	14,446	14,596	14,906	15,240	15,535
41 AGE1 2 YEARS OLD	12,171	12,165	12,513	12,917	13,390	13,694	14,004	14,309	14,456	14,852	15,120
51 AGE1 3 YEARS OLD	12,091	11,997	12,383	12,322	12,710	13,191	13,641	13,927	14,082	14,225	14,413
61 AGE1 4 YEARS OLD	11,742	11,423	11,725	11,897	12,030	12,415	12,874	13,389	13,480	13,735	13,871
71 AGE1 5 YEARS OLD	11,123	11,355	11,424	11,315	11,477	11,603	11,971	12,400	12,461	12,993	13,224
81 AGE1 6 YEARS OLD	10,163	10,580	10,787	10,432	10,723	10,873	10,984	11,329	11,737	12,162	12,242
91 AGE1 7 YEARS OLD	9,384	9,407	9,773	9,935	9,969	9,864	9,945	10,090	10,395	10,765	11,149
101 AGE1 8 YEARS OLD	8,324	8,424	8,423	8,714	8,846	8,871	8,764	8,872	8,986	9,211	9,532
111 AGE1 9 YEARS OLD	6,880	7,162	7,221	7,173	7,400	7,513	7,523	7,871	7,897	7,554	7,740
121 AGE1 10 YEARS OLD	5,369	5,460	5,605	5,678	5,624	5,800	5,849	5,859	5,764	5,017	5,050
131 AGE1 11 YEARS OLD	4,127	3,985	4,024	4,136	4,107	4,064	4,177	4,210	4,185	4,111	4,134
141 AGE1 12 YEARS OLD	3,041	2,950	2,826	2,811	2,860	2,847	2,804	2,870	2,878	2,856	2,794
151 AGE1 13 YEARS OLD	2,136	2,140	2,067	1,950	1,924	1,962	1,934	1,991	1,935	1,937	1,910
161 AGE1 14 YEARS OLD	1,380	1,509	1,505	1,426	1,334	1,316	1,336	1,314	1,241	1,302	1,297
171 AGE1 15 YEARS OLD	0,851	0,991	1,057	1,039	0,976	0,913	0,896	0,905	0,896	0,862	0,873
181 AGE1 16 YEARS OLD	0,653	0,601	0,687	0,729	0,711	0,660	0,621	0,607	0,610	0,596	0,570
191 AGE1 17 YEARS OLD	0,419	0,461	0,421	0,474	0,499	0,486	0,454	0,471	0,489	0,411	0,400
201 AGE1 18 YEARS OLD	0,296	0,440	0,323	0,291	0,324	0,341	0,331	0,300	0,244	0,275	0,276
211 AGE1 19 YEARS OLD	0,177	0,202	0,207	0,213	0,153	0,136	0,151	0,194	0,200	0,191	0,145
221 AGE1 20 YEARS OLD	0,177	0,202	0,207	0,213	0,153	0,136	0,151	0,194	0,200	0,191	0,145

MARCH CONTROL FOR HYBRIDS

TABLE 6.10 CARS IN OPERATION: SHARES BY AGE (PERCENT)

LINE	1990	1991	1992	1993	1998	1995	1996	1997	1998	1999	2000
11 LESS THAN 1 YEAR OLD	5.29	5.39	5.52	5.63	5.63	5.64	5.61	5.60	5.69	5.69	5.69
21 AGE1 1 YEAR OLD	10.42	10.41	10.60	10.85	11.10	11.04	11.00	11.02	11.13	11.14	11.14
31 AGE1 2 YEARS OLD	10.17	10.19	10.17	10.36	10.60	10.82	10.77	10.80	10.73	10.84	10.84
41 AGE1 3 YEARS OLD	10.10	9.89	9.91	9.89	10.06	10.27	10.49	10.49	10.45	10.30	10.40
51 AGE1 4 YEARS OLD	9.81	9.79	9.53	9.55	9.52	9.67	9.47	10.07	10.01	10.02	9.95
61 AGE1 5 YEARS OLD	9.29	9.36	9.29	9.08	9.08	9.04	9.10	9.36	9.55	9.40	9.40
71 AGE1 6 YEARS OLD	8.69	8.72	8.77	8.69	8.44	8.47	8.42	8.55	8.71	8.47	8.41
81 AGE1 7 YEARS OLD	7.84	7.75	7.95	7.97	7.80	7.64	7.66	7.62	7.72	7.85	7.99
91 AGE1 8 YEARS OLD	6.96	6.95	6.85	6.90	7.00	6.91	6.72	6.70	6.64	6.72	6.83
101 AGE1 9 YEARS OLD	5.71	5.90	5.87	5.76	5.86	5.89	5.77	5.60	5.57	5.51	5.57
111 AGE1 10 YEARS OLD	4.44	4.50	4.62	4.56	4.45	4.52	4.50	4.42	4.28	4.24	4.19
121 AGE1 11 YEARS OLD	3.85	3.28	3.27	3.32	3.25	3.17	3.20	3.18	3.11	3.00	2.97
131 AGE1 12 YEARS OLD	2.54	2.43	2.30	2.26	2.27	2.22	2.15	2.17	2.14	2.08	2.07
141 AGE1 13 YEARS OLD	1.78	1.77	1.68	1.56	1.52	1.53	1.49	1.43	1.44	1.41	1.37
151 AGE1 14 YEARS OLD	1.16	1.24	1.22	1.14	1.06	1.02	1.02	0.99	0.95	0.95	0.93
161 AGE1 15 YEARS OLD	0.71	0.81	0.86	0.83	0.77	0.71	0.69	0.64	0.66	0.63	0.63
171 AGE1 16 YEARS OLD	0.55	0.50	0.56	0.59	0.56	0.52	0.48	0.46	0.45	0.43	0.41
181 AGE1 17 YEARS OLD	0.52	0.34	0.34	0.34	0.34	0.38	0.35	0.32	0.30	0.30	0.29
191 AGE1 18 YEARS OLD	0.35	0.36	0.26	0.23	0.26	0.27	0.25	0.23	0.21	0.20	0.20
201 AGE1 19 YEARS OLD	0.24	0.24	0.25	0.19	0.16	0.17	0.16	0.17	0.15	0.14	0.13
211 AGE1 20 YEARS OLD	0.15	0.17	0.17	0.17	0.12	0.11	0.12	0.12	0.11	0.10	0.09

THE WHARTON EPA MTC VEHICLE DEMAND MODEL
MARCH CONTROL FOR HYBRIDS

TABLE 7.00 GROWTH RATES, CARS IN OPERATIONS MID-YEAR

LINE	ITEM	1979	1980	1981	1982	1983	1984	1985	1986	1987	1988	1989
1	CARS IN OPERATIONS ALL VINTAGES	0.9	1.7	1.0	1.7	1.0	1.0	1.0	1.7	1.0	1.0	1.0
21	LESS THAN 1 YEAR OLD	-1.6	-2.0	2.0	3.2	1.5	0.6	0.2	2.2	0.7	-0.7	1.0
31	AGE 1 YEAR OLD	2.2	-1.6	-2.0	2.0	5.2	1.5	0.0	0.2	2.2	0.7	-0.7
41	AGE 2 YEARS OLD	10.6	2.3	-1.5	-2.0	2.0	5.2	1.3	0.0	0.2	2.2	0.7
51	AGE 3 YEARS OLD	17.0	10.0	2.3	-1.6	-2.0	2.0	2.0	1.5	0.4	0.2	2.2
61	AGE 4 YEARS OLD	-5.0	19.1	10.0	2.3	-1.6	-2.0	2.0	5.1	1.5	0.4	0.2
71	AGE 5 YEARS OLD	-23.9	-2.1	10.1	10.7	2.3	-1.6	-2.5	2.3	5.1	1.5	0.0
81	AGE 6 YEARS OLD	7.6	-23.5	-5.0	10.0	10.0	2.3	-1.7	-2.6	2.2	5.1	1.0
91	AGE 7 YEARS OLD	5.0	0.5	-23.0	-5.2	10.0	10.0	2.1	-1.9	-2.7	2.3	5.1
101	AGE 8 YEARS OLD	16.0	7.0	0.0	-23.6	10.1	10.3	10.3	1.0	-2.0	-2.0	2.2
111	AGE 9 YEARS OLD	-13.0	10.3	7.0	0.0	-23.6	-5.1	17.7	10.0	1.6	-1.9	2.2
121	AGE 10 YEARS OLD	-1.3	-11.2	19.1	6.0	0.0	-23.0	17.0	16.0	0.7	1.0	-2.0
131	AGE 11 YEARS OLD	7.9	2.2	-10.1	10.0	6.7	0.0	-5.6	16.0	10.3	1.0	-2.0
141	AGE 12 YEARS OLD	-12.0	12.3	3.9	-11.0	17.9	7.1	0.1	-6.0	-7.1	10.0	1.7
151	AGE 13 YEARS OLD	-10.5	-9.0	14.3	2.7	-11.1	10.0	0.0	-20.0	-25.3	10.0	9.0
161	AGE 14 YEARS OLD	0.7	-6.7	-7.0	13.1	2.6	-10.0	6.0	0.0	0.0	-0.0	16.0
171	AGE 15 YEARS OLD	4.0	13.0	-5.0	-0.0	13.0	3.0	-11.0	0.0	0.0	-25.1	-0.0
181	AGE 16 YEARS OLD	7.5	0.5	15.0	-6.0	-0.5	13.0	2.3	-12.0	15.0	0.7	-0.3
191	AGE 17 YEARS OLD	16.5	12.1	10.0	18.1	-6.1	-0.2	12.0	0.0	-13.0	15.7	0.0
201	AGE 18 YEARS OLD	-12.0	21.3	14.1	9.2	14.0	-5.0	-0.0	11.1	0.0	-12.0	15.0
211	AGE 19 YEARS OLD	7.3	-9.1	23.7	12.9	9.1	16.0	-0.0	-10.0	10.5	0.7	-12.0
221	AGE 20 YEARS OLD	27.5	11.9	-7.5	22.0	12.7	9.5	13.7	-7.7	-10.5	10.0	0.0

MARCH CONTROL FOR HYBRIDS

TABLE 7.10 GROWTH RATES, CARS IN OPERATIONS SHARED BY AGE

LINE	ITEM	1979	1980	1981	1982	1983	1984	1985	1986	1987	1988	1989
11	LESS THAN 1 YEAR OLD	-2.5	-0.0	0.6	3.5	-0.2	-1.0	2.0	0.5	-0.0	-2.3	0.2
21	AGE 1 YEAR OLD	1.3	-3.2	-0.1	0.7	3.0	-0.3	-1.3	2.5	0.5	-0.0	-2.1
31	AGE 2 YEARS OLD	9.6	0.6	-3.3	-0.0	0.6	3.3	-0.2	-1.3	2.5	0.6	-0.7
41	AGE 3 YEARS OLD	16.7	9.0	0.6	-3.2	-0.1	0.6	3.0	-0.2	-1.2	2.6	0.7
51	AGE 4 YEARS OLD	-6.3	16.1	6.0	0.6	-3.3	-0.1	0.6	3.0	-1.2	-1.2	2.0
61	AGE 5 YEARS OLD	-24.6	-6.7	16.1	0.9	0.5	-3.3	-5.2	0.6	3.0	-0.1	-1.0
71	AGE 6 YEARS OLD	6.7	-20.7	-6.6	16.1	0.0	0.5	-3.2	-0.2	0.6	3.5	0.0
81	AGE 7 YEARS OLD	0.0	6.7	-20.7	-6.7	15.9	0.0	0.0	-3.5	-0.2	0.7	3.0
91	AGE 8 YEARS OLD	15.0	5.2	7.0	-20.0	-6.0	16.0	0.0	0.1	-3.6	-0.1	0.0
101	AGE 9 YEARS OLD	-10.2	16.0	5.5	0.7	-20.0	-6.0	15.0	0.2	-0.0	-3.0	-0.0
111	AGE 10 YEARS OLD	-2.1	-12.6	17.0	5.0	6.5	-20.0	-7.2	0.0	0.0	0.2	-3.0
121	AGE 11 YEARS OLD	6.0	0.5	-11.7	16.1	0.0	6.0	6.2	-0.1	10.5	0.3	0.3
131	AGE 12 YEARS OLD	-13.6	10.5	2.1	-12.5	15.0	5.2	6.2	-26.1	-0.6	10.0	0.0
141	AGE 13 YEARS OLD	-11.3	-10.5	12.3	1.1	-12.7	16.2	0.5	0.0	-26.5	-0.3	15.0
151	AGE 14 YEARS OLD	7.7	-0.2	-9.0	11.3	0.0	-12.0	15.0	3.2	0.5	-20.2	-0.2
161	AGE 15 YEARS OLD	3.0	11.5	-6.6	-0.9	11.0	1.2	-12.0	10.1	2.7	0.7	-0.2
171	AGE 16 YEARS OLD	6.5	6.7	13.0	-7.5	-10.1	11.0	0.6	-10.0	13.5	3.1	0.0
181	AGE 17 YEARS OLD	15.5	10.2	0.5	12.3	-7.0	-9.0	10.7	-0.7	-10.0	13.0	3.2
191	AGE 18 YEARS OLD	-13.7	19.5	12.1	7.0	12.0	-7.5	-10.0	0.3	-1.2	-10.2	10.0
201	AGE 19 YEARS OLD	6.3	-10.0	21.6	11.0	7.2	12.0	-0.0	-11.5	0.0	-0.0	-10.0
211	AGE 20 YEARS OLD	26.3	10.1	-9.1	20.0	10.7	7.5	11.7	-0.2	-11.0	0.1	-0.0

ORIGINAL PAGE IS
OF SUPER QUALITY

THE WHARTON EFA MOTO VEHICLE DEMAND MODEL
MARCH CONTROL FOR HYBRIDS

AGE 18

TABLE 7.00 GROWTH RATES, CARS IN OPERATIONS: MID-YEAR

LINE	I T E M	AGE										
		1990	1991	1992	1993	1994	1995	1996	1997	1998	1999	2000
1	CARS IN OPERATIONS: ALL VINTAGES	1.3	1.3	1.4	1.3	1.4	1.6	1.6	1.6	1.7	1.7	1.0
21	LESS THAN 1 YEAR OLD	1.2	3.3	3.7	3.7	1.1	1.9	1.0	2.7	1.8	1.8	1.6
31	AGE 1 YEAR OLD	1.6	1.2	3.3	3.7	3.7	1.1	1.9	1.0	2.7	1.8	1.6
41	AGE 2 YEARS OLD	-0.8	1.6	1.2	3.2	3.7	3.7	1.1	1.9	1.0	2.7	1.6
51	AGE 3 YEARS OLD	0.7	-0.8	1.6	1.1	3.2	3.7	1.1	1.9	1.0	2.7	1.0
61	AGE 4 YEARS OLD	2.1	0.7	-0.8	1.5	1.1	3.2	3.7	1.1	1.0	1.0	1.0
71	AGE 5 YEARS OLD	0.2	2.1	0.6	-1.0	1.4	1.1	3.2	3.7	3.6	1.0	1.0
81	AGE 6 YEARS OLD	0.3	0.1	2.0	0.4	-1.0	1.0	1.1	3.1	3.6	3.6	1.0
91	AGE 7 YEARS OLD	1.3	0.2	3.9	1.7	0.3	-1.1	1.3	1.0	3.0	3.6	3.6
101	AGE 8 YEARS OLD	4.9	1.2	-0.1	3.5	1.5	0.3	-1.2	1.2	0.8	3.0	3.5
111	AGE 9 YEARS OLD	2.0	4.7	0.8	-0.7	3.3	1.8	0.1	-1.4	1.0	0.8	2.6
121	AGE 10 YEARS OLD	-3.1	1.7	4.1	-0.1	-1.0	3.1	1.2	-0.2	1.6	0.9	0.6
131	AGE 11 YEARS OLD	-2.6	-3.0	1.0	2.8	-0.7	-1.0	2.8	0.8	-0.6	-1.8	0.7
141	AGE 12 YEARS OLD	1.0	0.6	-4.2	-0.5	2.0	-0.7	-1.5	2.3	0.3	-0.8	-2.0
151	AGE 13 YEARS OLD	9.2	0.6	-3.8	-5.7	-1.3	2.0	-1.2	-1.7	0.1	0.1	-1.0
161	AGE 14 YEARS OLD	15.8	8.7	-0.2	-5.3	-6.4	-1.4	1.5	-1.6	-2.5	1.6	-0.2
171	AGE 15 YEARS OLD	-7.5	15.2	7.8	-1.8	-6.0	-6.5	-1.8	1.1	-2.2	-2.6	1.3
181	AGE 16 YEARS OLD	-25.6	-7.9	14.3	6.1	-2.6	-6.1	-6.9	-2.3	0.5	-2.8	-2.9
191	AGE 17 YEARS OLD	5.5	-26.0	-8.7	12.6	5.3	-2.6	-6.5	-7.3	-2.8	0.3	-2.6
201	AGE 18 YEARS OLD	3.9	5.0	-26.6	-10.1	11.6	5.2	-3.1	-6.9	-7.8	-3.0	0.0
211	AGE 19 YEARS OLD	14.8	3.4	4.2	-27.7	-10.8	11.6	4.7	-3.5	-7.8	-8.0	-3.3
231	AGE 20 YEARS OLD	-13.5	14.3	2.6	2.6	-28.3	-10.8	11.1	4.3	-8.0	-7.6	-8.3

MARCH CONTROL FOR HYBRIDS

TABLE 7.10 GROWTH RATES, CARS IN OPERATIONS: SHARES BY AGE

LINE	I T E M	AGE										
		1990	1991	1992	1993	1994	1995	1996	1997	1998	1999	2000
11	LESS THAN 1 YEAR OLD	-0.0	1.9	2.3	2.4	-0.3	0.3	-0.5	1.1	0.1	0.0	-0.2
21	AGE 1 YEAR OLD	0.3	-0.1	1.9	2.4	2.3	-0.5	0.3	-0.5	1.1	0.1	-0.0
31	AGE 2 YEARS OLD	-2.0	0.3	-0.2	1.9	2.3	2.1	-0.5	0.3	-0.6	1.0	0.1
41	AGE 3 YEARS OLD	-0.6	-2.1	0.2	-0.2	1.7	2.1	2.1	-0.5	0.2	-0.7	1.0
51	AGE 4 YEARS OLD	0.6	-0.6	-2.2	0.1	-0.3	1.6	2.1	2.1	-0.6	0.1	-0.7
61	AGE 5 YEARS OLD	-2.8	0.7	-0.8	-2.3	-0.0	-0.5	1.6	2.0	2.0	-0.7	0.1
71	AGE 6 YEARS OLD	-1.0	2.7	0.6	-0.9	-2.4	-0.2	-0.5	1.5	1.9	1.8	-0.0
81	AGE 7 YEARS OLD	0.0	-1.1	2.5	0.3	-1.1	-2.6	-0.2	-0.6	1.3	1.8	1.8
91	AGE 8 YEARS OLD	3.6	-0.1	-1.4	-2.1	0.1	-1.3	-2.7	-0.8	-0.8	1.2	1.7
101	AGE 9 YEARS OLD	0.7	3.3	-0.5	-2.0	1.8	-0.1	-1.8	-2.9	-0.6	-1.0	1.1
111	AGE 10 YEARS OLD	-4.3	0.4	2.7	-1.4	-2.8	1.6	-0.8	-1.7	-3.2	-0.8	-1.2
121	AGE 11 YEARS OLD	-3.8	-8.7	-0.4	1.4	-2.1	-2.6	1.2	-0.8	-2.2	-3.5	-1.1
131	AGE 12 YEARS OLD	-0.2	-8.3	-5.5	-1.8	0.6	-2.3	-3.0	0.7	-1.8	-2.5	-3.7
141	AGE 13 YEARS OLD	7.8	-0.7	-5.1	-6.9	-2.7	0.8	-2.8	-3.8	0.1	-1.6	-2.7
151	AGE 14 YEARS OLD	14.3	7.2	-1.6	-6.5	-7.8	-2.9	-0.1	-3.2	-8.1	-0.1	-1.9
161	AGE 15 YEARS OLD	-8.7	13.7	6.3	-3.1	-7.4	-7.9	-3.8	-0.5	-3.8	-8.3	-0.8
171	AGE 16 YEARS OLD	-26.6	-9.1	12.8	4.7	-8.0	-7.5	-8.8	-3.8	-1.1	-8.0	-8.6
181	AGE 17 YEARS OLD	4.2	-24.9	-9.9	11.1	3.8	-4.1	-8.0	-8.8	-8.8	-1.8	-8.3
191	AGE 18 YEARS OLD	2.6	3.6	-27.6	-11.3	10.1	3.6	-4.6	-8.8	-9.3	-8.6	-1.7
201	AGE 19 YEARS OLD	13.4	2.1	2.8	-28.6	-12.1	9.9	3.1	-5.0	-9.0	-9.6	-8.9
211	AGE 20 YEARS OLD	-14.6	12.8	1.2	1.2	-29.3	-12.2	9.3	2.7	-5.6	-9.2	-9.8

THE WHARTON EFA MOTOR VEHICLE DEMAND MODEL
MARCH CONTROL FOR HYBRIDS

TABLE 8.00 SCRAPPAGE (MILL AUTOS)

LINE	ITEM	1979	1980	1981	1982	1983	1984	1985	1986	1987	1988	1989
11	TOTAL SCRAPPAGE DOMESTIC AND FOREIGN	9,415	9,563	9,149	9,562	9,555	9,627	10,138	10,523	10,596	10,592	10,988
21	SURCOMPACT DOMESTIC	0,371	0,428	0,562	0,690	0,783	0,861	0,962	1,072	1,037	1,082	1,000
41	SURCOMPACT FOREIGN	0,988	0,931	1,060	1,162	1,208	1,267	1,348	1,475	1,529	1,560	1,635
51	SURCOMPACT TOTAL	1,315	1,355	1,623	1,856	1,991	2,129	2,310	2,547	2,567	2,602	2,716
71	COMPACT DOMESTIC	1,578	1,471	1,611	1,707	1,751	1,809	1,966	2,081	2,129	2,150	2,209
81	COMPACT FOREIGN	0,070	0,070	0,081	0,090	0,095	0,099	0,105	0,105	0,102	0,097	0,095
91	COMPACT TOTAL	1,647	1,541	1,693	1,797	1,846	1,908	2,071	2,186	2,227	2,247	2,304
101	MID-SIZE	2,212	1,989	2,112	2,206	2,280	2,302	2,475	2,612	2,668	2,680	2,791
121	FULL SIZE	3,818	2,918	2,927	2,823	2,590	2,387	2,307	2,225	2,115	2,042	2,075
141	LUXURY DOMESTIC	0,766	0,703	0,762	0,804	0,800	0,817	0,866	0,906	0,919	0,921	0,958
161	LUXURY FOREIGN	0,058	0,058	0,067	0,075	0,079	0,084	0,092	0,098	0,100	0,100	0,108
171	LUXURY TOTAL	0,823	0,761	0,829	0,879	0,880	0,902	0,958	1,003	1,019	1,021	1,057

MARCH CONTROL FOR HYBRIDS

TABLE 8.10 GROWTH RATES, SCRAPPAGE

LINE	ITEM	1979	1980	1981	1982	1983	1984	1985	1986	1987	1988	1989
11	TOTAL SCRAPPAGE DOMESTIC AND FOREIGN	-11.1	-9.1	7.3	4.1	-0.1	0.8	5.5	3.6	0.7	-0.0	3.7
21	SURCOMPACT DOMESTIC	9.0	14.3	32.6	23.4	12.8	10.0	11.6	6.3	1.5	0.5	3.7
41	SURCOMPACT FOREIGN	-2.0	-1.4	13.9	9.6	3.9	8.9	9.2	6.5	3.7	2.0	4.8
51	SURCOMPACT TOTAL	1.0	3.1	19.8	14.4	7.3	6.9	10.2	6.4	2.0	1.4	4.8
71	COMPACT DOMESTIC	-8.3	-6.7	9.5	5.9	2.6	3.3	6.7	5.8	2.1	1.2	4.6
81	COMPACT FOREIGN	-1.0	0.4	16.0	11.3	4.8	4.3	6.2	0.7	-3.8	-4.7	-1.7
91	COMPACT TOTAL	-6.1	-6.4	9.8	6.2	2.7	3.8	6.6	3.6	1.9	0.9	4.3
101	MID-SIZE	-13.0	-10.1	6.2	4.5	1.6	2.7	7.5	5.5	2.2	0.8	4.2
121	FULL SIZE	-15.6	-10.6	0.3	-3.6	-8.3	-7.8	-3.4	-3.6	-8.9	-3.5	1.7
141	LUXURY DOMESTIC	-9.5	-8.2	8.5	5.5	0.5	1.1	6.0	4.5	1.5	0.2	3.6
161	LUXURY FOREIGN	-0.3	0.0	16.3	11.9	5.8	6.0	9.8	5.6	2.1	0.5	3.3
171	LUXURY TOTAL	-9.9	-7.6	9.1	6.0	1.0	1.5	6.8	4.6	1.5	0.2	3.6

A PRODUCT OF WHARTON EFA, INC.

ORIGINAL PAGE IS
OF POOR QUALITY

THE WHARTON EFA MOTIC VEHICLE DEMAND MODEL
MARCH CONTROL FOR HYBRIDS

TABLE 6.00 SCRAPPAGE (MILL AUTOS)

LINE	ITEM	1990	1991	1992	1993	1994	1995	1996	1997	1998	1999	2000
11	TOTAL SCRAPPAGE DOMESTIC AND FOREIGN	11,225	11,002	11,939	12,888	12,322	12,546	12,682	12,952	13,063	13,216	13,883
21	SUBCOMPACT DOMESTIC	1,102	1,119	1,172	1,218	1,194	1,208	1,206	1,219	1,215	1,210	1,229
31	SUBCOMPACT FOREIGN	1,683	1,723	1,812	1,900	1,898	1,957	2,007	2,075	2,163	2,236	2,328
51	SUBCOMPACT TOTAL	2,786	2,842	2,984	3,114	3,092	3,166	3,213	3,314	3,378	3,453	3,557
61	COMPACT DOMESTIC	2,323	2,393	2,509	2,635	2,630	2,700	2,738	2,828	2,863	2,918	2,989
81	COMPACT FOREIGN	0,092	0,088	0,087	0,088	0,078	0,078	0,069	0,066	0,062	0,058	0,055
91	COMPACT TOTAL	2,415	2,471	2,595	2,720	2,708	2,778	2,807	2,889	2,925	2,973	3,045
101	MIN-SIZE	2,856	2,907	3,047	3,185	3,150	3,221	3,246	3,329	3,357	3,395	3,465
121	FULL SIZE	2,088	2,085	2,159	2,220	2,158	2,146	2,111	2,107	2,063	2,023	2,001
141	LUXURY DOMESTIC	0,978	0,988	1,039	1,087	1,082	1,110	1,132	1,173	1,197	1,223	1,261
151	LUXURY FOREIGN	0,106	0,108	0,115	0,122	0,123	0,129	0,133	0,139	0,148	0,149	0,158
171	LUXURY TOTAL	1,080	1,096	1,153	1,209	1,205	1,239	1,265	1,312	1,341	1,372	1,415

MARCH CONTROL FOR HYBRIDS

TABLE 6.10 GROWTH RATES, SCRAPPAGE

LINE	ITEM	1990	1991	1992	1993	1994	1995	1996	1997	1998	1999	2000
11	TOTAL SCRAPPAGE DOMESTIC AND FOREIGN	2.2	1.6	4.7	4.3	-1.0	1.8	0.8	2.8	0.9	1.2	2.0
21	SUBCOMPACT DOMESTIC	2.0	1.5	4.7	3.6	-1.6	1.2	-0.2	1.1	-0.4	0.2	1.0
31	SUBCOMPACT FOREIGN	2.9	2.3	5.2	4.8	-0.1	3.1	2.6	4.8	3.3	3.3	4.1
51	SUBCOMPACT TOTAL	2.6	2.0	5.0	4.3	-0.7	2.4	1.5	3.2	1.9	2.2	3.0
61	COMPACT DOMESTIC	3.3	2.6	5.3	5.0	-0.2	2.6	1.8	3.1	1.8	1.8	2.6
81	COMPACT FOREIGN	-3.0	-0.0	-1.9	-2.6	-7.5	-5.2	-6.2	-5.3	-5.9	-5.9	-5.2
91	COMPACT TOTAL	3.0	2.3	5.0	4.8	-0.4	2.0	1.2	2.9	1.2	1.6	2.8
101	MIN-SIZE	2.3	1.8	4.8	4.5	-0.9	2.0	0.8	2.6	0.8	1.1	2.1
121	FULL SIZE	0.6	-0.2	3.6	2.8	-2.8	-0.6	-1.6	-0.2	-2.1	-1.9	-1.1
141	LUXURY DOMESTIC	2.2	1.4	5.1	4.6	-0.4	2.6	2.0	3.6	2.1	2.2	3.1
151	LUXURY FOREIGN	2.1	2.5	6.0	6.1	1.1	4.5	3.3	4.8	3.2	3.8	3.7
171	LUXURY TOTAL	2.2	1.5	5.2	4.8	-0.3	2.8	2.1	3.7	2.2	2.3	3.2

A PRODUCT OF WHARTON EFA, INC.

TABLE 9.00 MISCELLANEOUS MARKET VARIABLES

ITEM	1979	1980	1981	1982	1983	1984	1985	1986	1987	1988	1989
11 LONG-RUN EQUILIBRIUM ('DESTREED') VALUES											
21 DESIRED STOCK	101.306	103.668	105.598	107.860	110.297	112.536	114.812	117.078	119.276	121.211	122.977
31 DESIRED STOCK PER DRIVER	0.702	0.704	0.704	0.707	0.712	0.716	0.720	0.728	0.727	0.730	0.732
41											
SIDESTREED SHARE BY SIZE-CLASS (PERCENT)											
61 TOTAL DOMESTIC	86.42	86.19	86.02	86.14	86.23	86.16	86.26	85.91	85.52	85.10	84.73
71 SUBCOMPACT	10.86	11.08	11.26	11.36	11.45	11.49	11.63	11.47	11.33	11.21	11.09
81 COMPACT	19.24	19.41	19.65	19.89	20.07	20.26	20.39	20.87	20.61	20.83	21.02
91 MID-SIZE	24.48	24.68	24.77	25.04	25.25	25.31	25.41	25.41	25.83	25.88	26.45
101 FULL SIZE	23.19	22.37	21.68	21.20	20.83	20.45	20.06	19.70	19.20	18.59	18.08
111 LUXURY	8.67	8.64	8.66	8.65	8.62	8.66	8.77	8.86	8.96	9.08	9.13
121											
131 TOTAL FOREIGN	13.58	13.81	13.98	13.86	13.77	13.84	13.74	14.09	14.88	14.90	15.27
141 SUBCOMPACT	12.02	12.26	12.44	12.36	12.30	12.39	12.29	12.66	13.08	13.49	13.87
151 COMPACT AND LUXURY	1.55	1.55	1.54	1.50	1.47	1.45	1.46	1.43	1.80	1.41	1.40
161											
171 AVG AGE OF AUTO STOCK	5.612	5.625	5.656	5.657	5.681	5.635	5.619	5.586	5.559	5.552	5.550
181											
191 YEAR-END STOCK PER FAMILY	1.239	1.240	1.236	1.234	1.235	1.236	1.238	1.239	1.240	1.241	1.240
201 VEHICLE MILES PER AUTO: TOTAL	12.06	12.22	12.11	12.05	12.02	12.04	12.12	12.14	12.28	12.35	12.43
211 URBAN	6.936	7.065	7.029	7.034	7.064	7.188	7.258	7.353	7.862	7.558	7.650
221 RURAL	5.124	5.156	5.080	5.020	4.953	4.896	4.862	4.825	4.413	4.792	4.777
231 NEW REGIS. TO BEGINNING STOCK	0.109	0.109	0.105	0.109	0.109	0.107	0.110	0.110	0.109	0.107	0.107
241 SCRAPAGE TO BEGINNING STOCK	0.095	0.085	0.089	0.092	0.090	0.089	0.092	0.098	0.093	0.091	0.091

MARCH CONTROL FOR HYBRIDS

TABLE 9.10 GROWTH RATES, MISCELLANEOUS MARKET VARIABLES

ITEM	1979	1980	1981	1982	1983	1984	1985	1986	1987	1988	1989
11 LONG-RUN EQUILIBRIUM ('DESTREED') VALUES											
21 DESIRED STOCK	2.1	2.3	1.9	2.1	2.3	2.0	2.0	2.0	1.9	1.8	1.5
31 DESIRED STOCK PER DRIVER	-0.1	0.3	-0.0	0.4	0.7	0.5	0.6	0.5	0.4	0.4	0.8
41											
SIDESTREED SHARE BY SIZE-CLASS (PERCENT)											
61 TOTAL DOMESTIC	0.7	-0.3	-0.2	0.1	0.1	-0.1	0.1	-0.4	-0.5	-0.5	-0.8
71 SUBCOMPACT	1.4	2.1	1.6	0.9	0.8	0.3	1.3	-1.4	-1.3	-1.0	-1.1
81 COMPACT	3.1	0.9	1.2	1.2	0.9	0.9	0.6	0.4	0.7	1.0	0.9
91 MID-SIZE	0.5	0.8	0.4	1.1	0.8	0.2	0.4	0.0	0.1	0.0	0.1
101 FULL SIZE	-1.6	-3.6	-3.1	-2.2	-1.8	-1.8	-1.9	-1.8	-2.5	-3.2	-2.9
111 LUXURY	1.3	-0.3	0.2	-0.1	-0.3	0.4	1.3	1.0	1.0	0.9	1.0
121											
131 TOTAL FOREIGN	-4.2	1.8	1.2	-0.9	-0.6	0.5	-0.7	2.5	2.0	2.9	2.5
141 SUBCOMPACT	-2.9	2.0	1.8	-0.7	-0.4	0.7	-0.8	3.0	3.3	3.2	2.8
151 COMPACT AND LUXURY	-12.6	-0.3	-0.6	-2.5	-1.9	-1.8	0.7	-1.6	-2.1	0.4	-0.9
161											
171 AVG AGE OF AUTO STOCK	-0.9	0.2	0.6	0.0	-0.3	-0.1	-0.3	-0.6	-0.5	-0.1	-0.0
181											
191 YEAR-END STOCK PER FAMILY	-0.6	0.1	-0.3	-0.1	0.1	0.1	0.1	0.1	0.1	0.1	-0.1
201 VEHICLE MILES PER AUTO: TOTAL	1.0	1.3	-0.9	-0.4	-0.3	0.2	0.6	0.5	0.6	0.6	0.6
211 URBAN	0.8	1.0	-0.5	0.1	0.4	1.2	1.5	1.8	1.5	1.3	1.2
221 RURAL	1.2	0.6	-1.5	-1.2	-1.3	-1.2	-0.7	-0.8	-0.2	-0.4	-0.3
231 NEW REGIS. TO BEGINNING STOCK	-1.7	0.8	3.6	3.6	-0.2	-1.8	2.8	0.8	-0.9	-2.3	0.1
241 SCRAPAGE TO BEGINNING STOCK	-10.3	3.2	3.2	2.5	-1.8	-1.1	3.6	1.8	-0.9	-1.6	2.2

ORIGINAL PAGE IS
OF POOR QUALITY

THE WHARTON EPA MOTOR VEHICLE DEMAND MODEL
MARCH CONTROL FOR HYBRIDS

LINE	ITEM	1990	1991	1992	1993	1994	1995	1996	1997	1998	1999	2000
TABLE 9.00 MISCELLANEOUS MARKET VARIABLES												
1	LONG-RUN EQUILIBRIUM ('DESIRED') VALUES											
21	DESIRED STOCK	124,689	126,598	128,671	130,859	132,991	135,148	137,217	139,688	142,096	144,501	146,970
31	DESIRED STOCK PER DRIVER	0.735	0.739	0.744	0.749	0.754	0.759	0.762	0.767	0.772	0.776	0.781
41	DESIRED SHARE BY SIZE-CLASS (PERCENT)											
61	TOTAL DOMESTIC	64.33	64.03	63.73	63.50	63.24	63.04	62.84	62.52	62.34	62.27	62.21
71	SURCOMPACT	11.04	10.93	10.84	10.69	10.57	10.49	10.45	10.48	10.42	10.41	10.35
81	COMPACT	21.15	21.22	21.33	21.33	21.45	21.55	21.70	21.75	21.88	21.98	22.07
91	MID-SIZE	25.44	25.46	25.47	25.52	25.55	25.59	25.62	25.62	25.65	25.69	25.76
101	FULL SIZE	17.51	17.14	16.82	16.52	16.13	15.75	15.31	14.87	14.52	14.19	13.89
111	LUXURY	9.20	9.27	9.35	9.45	9.55	9.66	9.76	9.88	9.98	10.04	10.14
121	TOTAL FOREIGN	15.67	15.97	16.27	16.50	16.76	16.96	17.16	17.47	17.68	17.73	17.79
131	SURCOMPACT	14.25	14.56	14.83	15.13	15.43	15.68	15.91	16.21	16.39	16.50	16.62
141	COMPACT	1.42	1.41	1.42	1.37	1.32	1.29	1.25	1.27	1.25	1.22	1.17
151	MID-SIZE											
161	FULL SIZE											
171	LUXURY											
181	AVG AGE OF AUTO STOCK	5.543	5.533	5.504	5.453	5.400	5.363	5.331	5.301	5.271	5.249	5.235
191	YEAR-END STOCK PER FAMILY	1.230	1.239	1.239	1.239	1.241	1.244	1.246	1.250	1.254	1.259	1.264
201	VEHICLE MILES PER AUTO: TOTAL	12.51	12.65	12.78	12.91	13.05	13.18	13.28	13.38	13.49	13.61	13.73
211	URBAN	7.742	7.878	8.015	8.160	8.307	8.452	8.575	8.703	8.845	8.996	9.150
221	RURAL	4.766	4.772	4.762	4.755	4.746	4.730	4.706	4.680	4.669	4.616	4.502
231	NEW REGIS. TO BEGINNING STOCK	0.107	0.109	0.111	0.114	0.114	0.114	0.113	0.115	0.115	0.115	0.115
241	SCRAPAGE TO BEGINNING STOCK	0.094	0.095	0.098	0.100	0.098	0.098	0.098	0.098	0.098	0.097	0.097

MARCH CONTROL FOR HYBRIDS

LINE	ITEM	1990	1991	1992	1993	1994	1995	1996	1997	1998	1999	2000
TABLE 9.10 GROWTH RATES, MISCELLANEOUS MARKET VARIABLES												
LONG-RUN EQUILIBRIUM ('DESIRED') VALUES												
21	DESIRED STOCK	1.4	1.5	1.6	1.7	1.6	1.6	1.5	1.8	1.8	1.7	1.7
31	DESIRED STOCK PER DRIVER	0.4	0.5	0.7	0.8	0.6	0.6	0.5	0.7	0.6	0.6	0.6
41	DESIRED SHARE BY SIZE-CLASS (PERCENT)											
61	TOTAL DOMESTIC	-0.5	-0.4	-0.4	-0.3	-0.3	-0.2	-0.2	-0.8	-0.2	-0.1	-0.1
71	SURCOMPACT	-0.5	-1.0	-0.8	-1.0	-1.2	-0.7	-0.4	-0.0	-0.2	-0.1	-0.7
81	COMPACT	0.6	0.3	0.2	0.3	0.5	0.5	0.7	0.2	0.8	0.5	0.6
91	MID-SIZE	-0.1	0.1	0.0	0.2	0.1	0.2	0.1	0.0	0.1	0.2	0.2
101	FULL SIZE	-2.9	-2.1	-1.9	-1.8	-2.3	-2.4	-2.8	-2.9	-2.8	-2.3	-2.1
111	LUXURY	0.6	0.8	0.8	1.0	1.1	1.1	1.0	0.9	1.0	1.0	1.0
121	TOTAL FOREIGN	2.6	1.9	1.9	1.4	1.5	1.2	1.2	1.8	0.9	0.5	0.4
131	SURCOMPACT	2.7	2.2	2.0	1.9	2.0	1.6	1.5	1.9	1.1	0.7	0.7
141	COMPACT	2.0	-0.7	0.2	-3.2	-3.4	-2.9	-2.5	-1.4	-1.4	-2.0	-6.5
151	MID-SIZE											
161	FULL SIZE											
171	LUXURY											
181	AVG AGE OF AUTO STOCK	-0.1	-0.2	-0.5	-0.9	-1.0	-0.7	-0.6	-0.6	-0.6	-0.4	-0.3
191	YEAR-END STOCK PER FAMILY	-0.1	0.1	0.0	-0.0	0.2	0.2	0.2	0.3	0.8	0.4	0.4
201	VEHICLE MILES PER AUTO: TOTAL	0.6	1.1	1.0	1.1	1.1	1.0	0.8	0.8	0.8	0.9	0.9
211	URBAN	1.2	1.4	1.7	1.8	1.8	1.7	1.5	1.5	1.6	1.7	1.7
221	RURAL	-0.2	0.1	-0.2	-0.2	-0.2	-0.3	-0.5	-0.6	-0.7	-0.7	-0.7
231	NEW REGIS. TO BEGINNING STOCK	2.0	2.0	2.3	2.4	2.4	2.3	2.4	2.2	2.2	2.0	2.0
241	SCRAPAGE TO BEGINNING STOCK	0.3	0.3	0.3	0.3	0.3	0.3	0.3	0.3	0.3	0.3	0.3

THE WHARTON EFA MOTOR VEHICLE DEMAND MODEL
MARCH CONTROL FOR HYBRIDS

LINE	ITEM	1979	1980	1981	1982	1983	1984	1985	1986	1987	1988	1989
TABLE 10.00 DOMESTIC AUTO PRICES (DOLLARS)												
TOTAL AUTO PRICES												
21	SURCOMPACT	5126.	5486.	5897.	6303.	6751.	7213.	7694.	8194.	8714.	9234.	9761.
31	COMPACT	6313.	6759.	7275.	7757.	8277.	8816.	9370.	9980.	10532.	11141.	11759.
41	MID-SIZE	7409.	7989.	8573.	9165.	9799.	10454.	11087.	11737.	12412.	13094.	13782.
51	FULL SIZE	7903.	8508.	9218.	9899.	10625.	11376.	12060.	12764.	13498.	14237.	14984.
61	LUXURY	11789.	12473.	13936.	14938.	16007.	17112.	18115.	19144.	20214.	21304.	22411.
STATE AND LOCAL TAXES:												
91	SURCOMPACT	234.	258.	285.	314.	345.	374.	414.	452.	492.	533.	577.
101	COMPACT	248.	316.	351.	385.	422.	462.	504.	548.	595.	645.	694.
111	MID-SIZE	340.	375.	416.	454.	504.	552.	601.	652.	707.	764.	825.
121	FULL SIZE	363.	402.	449.	496.	548.	603.	656.	712.	771.	833.	899.
131	LUXURY	558.	617.	684.	759.	836.	918.	997.	1081.	1170.	1263.	1362.
TRANSPORTATION CHARGES:												
151	SURCOMPACT	225.	251.	268.	285.	309.	336.	360.	389.	427.	467.	507.
171	COMPACT	294.	333.	354.	370.	391.	416.	437.	461.	492.	525.	556.
181	MID-SIZE	299.	335.	354.	370.	391.	416.	437.	461.	492.	525.	556.
191	FULL SIZE	314.	339.	354.	370.	391.	416.	437.	461.	492.	525.	556.
201	LUXURY	314.	339.	354.	370.	391.	416.	437.	461.	492.	525.	556.
LEASE PRICES FIXED WTD AVERAGE TOTAL												
221	SURCOMPACT	5711.	6107.	6603.	7062.	7554.	8063.	8548.	9046.	9560.	10084.	10611.
231	COMPACT	4119.	4377.	4702.	5000.	5320.	5651.	5994.	6347.	6709.	7074.	7444.
241	MID-SIZE	4771.	5076.	5466.	5819.	6199.	6594.	6994.	7415.	7844.	8281.	8722.
251	FULL SIZE	5536.	5905.	6367.	6794.	7252.	7725.	8177.	8641.	9119.	9607.	10099.
261	LUXURY	5854.	6294.	6835.	7344.	7866.	8445.	8980.	9484.	9975.	10510.	11049.
271		9544.	10237.	11094.	11894.	12752.	13633.	14421.	15231.	16056.	16917.	17775.
MAX OPTIONS PRICES FIXED WTD AVERAGE												
291	SURCOMPACT	1624.	1730.	1846.	1959.	2074.	2190.	2302.	2411.	2525.	2637.	2744.
301	COMPACT	1498.	1594.	1702.	1806.	1912.	2019.	2122.	2224.	2324.	2431.	2533.
311	MID-SIZE	1574.	1676.	1789.	1894.	2009.	2122.	2230.	2334.	2446.	2555.	2663.
321	FULL SIZE	1652.	1759.	1877.	1992.	2109.	2227.	2340.	2454.	2567.	2681.	2794.
331	LUXURY	1647.	1744.	1872.	1986.	2103.	2220.	2334.	2446.	2560.	2673.	2786.
341		1679.	1744.	1909.	2026.	2144.	2264.	2380.	2495.	2610.	2724.	2841.
VALUE OF OPTIONS INSTALLED:												
361	SURCOMPACT	544.	600.	642.	705.	774.	844.	926.	1010.	1090.	1160.	1229.
381	COMPACT	961.	1034.	1105.	1183.	1264.	1345.	1431.	1516.	1601.	1690.	1743.
391	MID-SIZE	1234.	1334.	1436.	1543.	1652.	1761.	1873.	1983.	2093.	2202.	2313.
401	FULL SIZE	1372.	1473.	1579.	1684.	1800.	1913.	2027.	2141.	2256.	2369.	2483.
411	LUXURY	1573.	1681.	1796.	1911.	2028.	2145.	2260.	2375.	2489.	2604.	2716.

A PRODUCT OF WHARTON EFA, INC.

THE WHARTON EFA MOTOR VEHICLE DEMAND MODEL
MARCH CONTROL FOR HYBRIDS

LINE	ITEM	1990	1991	1992	1993	1994	1995	1996	1997	1998	1999	2000
TABLE 10.00 DOMESTIC AUTO PRICES (DOLLARS)												
11	TOTAL AUTO PRICES	10316.	10916.	11555.	12221.	12921.	13638.	14388.	15165.	15996.	16855.	17777.
21	SUBCOMPACT	12413.	13108.	13842.	14607.	15419.	16291.	17186.	18097.	19069.	20078.	21151.
31	COMPACT	18526.	19302.	16121.	16972.	17898.	18837.	19822.	20827.	21897.	22997.	24178.
41	MID-SIZE	15779.	16616.	17500.	18410.	19410.	20425.	21488.	22565.	23715.	24898.	26163.
51	FULL SIZE	23576.	24804.	26101.	27445.	28903.	30389.	31942.	33529.	35217.	36985.	38810.
61	LUXURY	624.	676.	732.	792.	858.	928.	1002.	1082.	1168.	1260.	1359.
71	LUXURY	755.	818.	885.	957.	1036.	1120.	1210.	1308.	1407.	1517.	1634.
81	COMPACT	890.	961.	1038.	1119.	1209.	1308.	1405.	1512.	1628.	1750.	1888.
91	MID-SIZE	970.	1047.	1130.	1219.	1316.	1419.	1528.	1644.	1769.	1901.	2046.
101	FULL SIZE	1068.	1584.	1708.	1840.	1986.	2139.	2308.	2477.	2665.	2863.	3080.
111	LUXURY	509.	598.	652.	709.	758.	811.	869.	929.	997.	1071.	1151.
121	SUBCOMPACT	589.	626.	666.	709.	758.	811.	869.	929.	997.	1071.	1151.
131	COMPACT	589.	626.	666.	709.	758.	811.	869.	929.	997.	1071.	1151.
141	MID-SIZE	589.	626.	666.	709.	758.	811.	869.	929.	997.	1071.	1151.
151	FULL SIZE	589.	626.	666.	709.	758.	811.	869.	929.	997.	1071.	1151.
161	LUXURY	589.	626.	666.	709.	758.	811.	869.	929.	997.	1071.	1151.
171	TRANSPORTATION CHARGES	11170.	11758.	12378.	13019.	13715.	14420.	15159.	15903.	16698.	17506.	18380.
181	SUBCOMPACT	7840.	8251.	8685.	9132.	9617.	10108.	10619.	11138.	11688.	12287.	12950.
191	COMPACT	9189.	9680.	10198.	10734.	11315.	11905.	12519.	13188.	13809.	14485.	15216.
201	MID-SIZE	10619.	11167.	11745.	12343.	12991.	13688.	14433.	15031.	15772.	16524.	17381.
211	FULL SIZE	11620.	12220.	12855.	13510.	14221.	14982.	15693.	16459.	17272.	18098.	18993.
221	LUXURY	18683.	19638.	20648.	21690.	22821.	23968.	25163.	26381.	27678.	28980.	30412.
231	MAX PRICE	2862.	2978.	3096.	3217.	3342.	3468.	3596.	3728.	3856.	3988.	4125.
241	FIXED MID AVERAGE	2638.	2745.	2859.	2966.	3081.	3197.	3315.	3433.	3555.	3677.	3803.
251	SUBCOMPACT	2772.	2885.	3000.	3117.	3238.	3360.	3488.	3608.	3736.	3868.	3997.
261	COMPACT	2910.	3028.	3149.	3271.	3398.	3527.	3657.	3787.	4055.	4055.	4195.
271	MID-SIZE	2901.	3019.	3139.	3262.	3388.	3516.	3646.	3776.	3909.	4043.	4183.
281	FULL SIZE	2958.	3078.	3201.	3326.	3455.	3586.	3718.	3850.	3986.	4123.	4265.
291	LUXURY	1300.	1391.	1486.	1587.	1687.	1791.	1898.	2017.	2143.	2278.	2416.
301	TRANSPORTATION CHARGES	1880.	1985.	2093.	2208.	2329.	2456.	2589.	2719.	2836.	3002.	3189.
311	SUBCOMPACT	2428.	2508.	2672.	2801.	2936.	3078.	3215.	3356.	3501.	3650.	3803.
321	COMPACT	2600.	2722.	2849.	2979.	3115.	3253.	3393.	3531.	3677.	3828.	3978.
331	MID-SIZE	2835.	2956.	3080.	3206.	3338.	3471.	3607.	3742.	3881.	4022.	4168.
341	FULL SIZE											
351	LUXURY											

A PRODUCT OF WHARTON EFA, INC.

ORIGINAL PAGE IS OF POOR QUALITY

THE WHARTON EFA MOTOR VEHICLE DEMAND MODEL
MARCH CONTROL FOR HYBRIDS

TABLE 11.00 GROWTH RATES, DOMESTIC AUTO PRICES

LINE	ITEM	1979	1980	1981	1982	1983	1984	1985	1986	1987	1988	1989
11	TOTAL AUTO PRICES											
21	SURCOMPACT	7.5	7.0	7.5	6.9	7.1	6.8	6.7	6.5	6.3	6.0	5.7
31	COMPACT	6.0	7.1	7.6	6.6	6.7	6.5	6.3	6.1	6.0	5.8	5.5
41	MID-SIZE	7.8	7.3	7.8	6.9	6.9	6.7	6.1	5.9	5.7	5.5	5.3
51	FULL SIZE	8.1	7.6	8.3	7.4	7.3	7.1	6.0	5.8	5.7	5.5	5.3
61	LUXURY	7.9	7.0	8.3	7.2	7.2	6.9	5.9	5.7	5.6	5.4	5.2
71												
81	STATE AND LOCAL TAXES											
91	SURCOMPACT	10.6	10.0	10.7	9.9	10.0	9.7	9.4	9.2	8.8	8.6	8.2
101	COMPACT	11.1	10.0	10.8	9.8	9.7	9.4	9.1	8.8	8.6	8.3	8.2
111	MID-SIZE	10.9	10.3	11.1	10.0	9.9	9.6	8.8	8.6	8.8	8.1	7.9
121	FULL SIZE	11.5	10.9	11.7	10.5	10.4	10.0	8.8	8.6	8.3	8.1	7.9
131	LUXURY	11.2	10.6	11.5	10.3	10.1	9.8	8.6	8.4	8.2	8.0	7.8
141												
151	TRANSPORTATION CHARGES											
161	SURCOMPACT	11.0	11.4	6.8	6.5	8.2	8.8	7.2	8.0	9.7	9.8	8.6
171	COMPACT	12.6	13.2	6.6	4.5	5.7	6.2	5.1	5.6	6.8	6.6	6.0
181	MID-SIZE	11.6	12.0	5.7	4.5	5.7	6.2	5.1	5.6	6.8	6.6	6.0
191	FULL SIZE	7.5	7.8	4.7	4.5	5.7	6.2	5.1	5.6	6.8	6.6	6.0
201	LUXURY	7.5	7.8	4.7	4.5	5.7	6.2	5.1	5.6	6.8	6.6	6.0
211												
221	RASF PRICE: FIXED MTD AVERAGE TOTAL	7.8	6.9	8.1	7.0	7.0	6.7	6.0	5.8	5.7	5.5	5.2
231	SURCOMPACT	6.8	6.3	7.4	6.3	6.8	6.2	6.1	5.9	5.7	5.5	5.2
241	COMPACT	7.4	6.4	7.7	6.5	6.5	6.4	6.1	5.9	5.8	5.6	5.3
251	MID-SIZE	7.1	6.7	7.8	6.7	6.7	6.5	5.8	5.7	5.5	5.3	5.1
261	FULL SIZE	8.0	7.5	8.6	7.4	7.4	7.1	5.9	5.7	5.6	5.4	5.1
271	LUXURY	7.8	7.3	8.4	7.2	7.2	6.9	5.9	5.6	5.5	5.3	5.1
281												
291	MAX OPTIONS PRICE: FIXED MTD AVERAGE	7.0	6.5	6.7	6.1	5.9	5.6	9.1	8.0	8.6	8.4	8.2
301	SURCOMPACT	7.0	6.5	6.7	6.1	5.9	5.6	5.1	4.8	4.6	4.4	4.2
311	COMPACT	7.0	6.5	6.7	6.1	5.9	5.6	5.1	4.8	4.6	4.4	4.2
321	MID-SIZE	7.0	6.5	6.7	6.1	5.9	5.6	5.1	4.8	4.6	4.4	4.2
331	FULL SIZE	7.0	6.5	6.7	6.1	5.9	5.6	5.1	4.8	4.6	4.4	4.2
341	LUXURY	7.0	6.5	6.7	6.1	5.9	5.6	5.1	4.8	4.6	4.4	4.2
351												
361	VALUE OF OPTIONS INSTALLED:											
371	SURCOMPACT	9.8	9.6	6.9	9.9	10.3	9.0	9.2	9.1	7.9	6.8	6.0
381	COMPACT	8.5	7.6	6.8	7.1	6.8	6.4	6.8	5.9	5.6	5.6	5.5
391	MID-SIZE	9.1	8.1	7.6	7.4	7.1	6.6	6.3	5.9	5.6	5.2	5.0
401	FULL SIZE	8.2	7.4	7.2	6.9	6.6	6.3	6.0	5.6	5.8	5.0	4.8
411	LUXURY	7.5	6.8	6.9	6.8	6.1	5.8	5.4	5.1	4.8	4.6	4.4

ORIGINAL PAGE 18
OF POOR QUALITY

A PRODUCT OF WHARTON EFA, INC.

THE WHARFON EFA MOTOR VEHICLE DEMAND MODEL
MARCH CONTROL FOR HYBRIDS

TABLE 11.00 GROWTH RATES, DOMESTIC AUTO PRICES

LINE	1990	1991	1992	1993	1994	1995	1996	1997	1998	1999	2000
ITEM											
TOTAL AUTO PRICES											
21	5.7	5.8	5.9	5.8	5.7	5.6	5.5	5.4	5.5	5.4	5.5
31	5.6	5.6	5.6	5.5	5.7	5.5	5.5	5.3	5.4	5.3	5.4
41	5.3	5.3	5.4	5.3	5.4	5.3	5.2	5.1	5.1	5.3	5.0
51	5.3	5.3	5.3	5.2	5.0	5.2	5.2	5.0	5.1	5.0	5.1
61	5.2	5.2	5.2	5.1	5.3	5.1	5.1	5.0	5.0	4.9	5.0
71											
STATE AND LOCAL TAXES											
91	0.2	0.3	0.3	0.2	0.3	0.1	0.0	7.9	0.0	7.0	7.9
101	0.2	0.2	0.2	0.1	0.3	0.1	0.0	7.0	7.9	7.0	7.9
111	0.0	0.0	0.0	7.9	0.0	7.0	7.0	7.6	7.7	7.5	7.6
121	7.9	7.9	7.9	7.8	0.0	7.0	7.7	7.6	7.6	7.5	7.6
131	7.0	7.0	7.9	7.0	7.0	7.7	7.7	7.5	7.6	7.4	7.0
141											
TRANSPORTATION CHARGES											
161	0.2	0.0	0.0	0.0	7.0	7.0	7.1	6.9	7.3	7.0	7.0
171	5.0	6.0	6.3	6.5	7.0	7.0	7.1	6.9	7.3	7.0	7.0
181	5.0	6.0	6.3	6.5	7.0	7.0	7.1	6.9	7.3	7.0	7.0
191	5.0	6.0	6.3	6.5	7.0	7.0	7.1	6.9	7.3	7.0	7.0
201	5.0	6.0	6.3	6.5	7.0	7.0	7.1	6.9	7.3	7.0	7.0
211											
PRICE FIXED WTD AVERAGE TOTAL											
231	5.3	5.3	5.3	5.2	5.3	5.1	5.1	0.9	5.0	0.0	5.0
241	5.3	5.2	5.3	5.2	5.3	5.1	5.0	0.9	0.9	0.0	0.9
251	5.4	5.3	5.4	5.3	5.3	5.2	5.2	5.0	5.1	0.9	5.0
261	5.2	5.2	5.2	5.1	5.3	5.1	5.0	0.9	0.9	0.0	0.9
271	9.1	5.1	5.1	5.0	5.2	5.0	5.0	0.9	0.9	0.0	0.9
281											
PRICE FIXED WTD AVERAGE											
301	0.1	0.1	0.0	3.9	3.9	3.0	3.7	3.6	3.5	3.0	3.0
311	0.1	0.1	0.0	3.0	3.9	3.0	3.7	3.6	3.5	3.0	3.0
321	0.1	0.1	0.0	3.9	3.9	3.0	3.7	3.6	3.5	3.0	3.0
331	0.1	0.1	0.0	3.9	3.9	3.0	3.7	3.6	3.5	3.0	3.0
341	0.1	0.1	0.0	3.9	3.9	3.0	3.7	3.6	3.5	3.0	3.0
351											
VALUE OF OPTIONS INSTALLED											
371	6.1	6.7	6.9	6.0	6.3	6.2	6.0	6.2	6.2	6.3	6.1
381	5.5	5.6	5.5	5.0	5.5	5.0	5.0	5.1	5.0	5.1	0.9
391	5.0	5.0	4.9	0.0	0.0	0.7	0.6	0.0	0.3	0.3	0.2
401	0.7	0.7	0.6	0.6	0.6	0.0	0.3	0.1	0.1	0.0	0.9
411	0.3	0.3	0.2	0.1	0.1	0.0	0.0	0.0	0.1	0.0	0.0

A PRODUCT OF WHARFON EFA, INC.

TABLE 12.00 FOREIGN AUTO PRICES (DOLLARS)

LINE	ITEM	1979	1980	1981	1982	1983	1984	1985	1986	1987	1988	1989
11TOTAL AUTO PRICES												
21	SURCOMPACT	6000.	6345.	6793.	7224.	7684.	8143.	8579.	9039.	9509.	9984.	10479.
31	COMPACT	10101.	10744.	11458.	12183.	12941.	13699.	14414.	15154.	15914.	16718.	17508.
41	LUXURY	21033.	22723.	24604.	26603.	28799.	30942.	32965.	35090.	37290.	39627.	42080.
61STATE AND LOCAL TAXES												
71	SURCOMPACT	276.	302.	331.	361.	395.	429.	464.	500.	539.	570.	621.
81	COMPACT	869.	918.	964.	1017.	1073.	1132.	1190.	1252.	1317.	1386.	1461.
91	LUXURY	992.	1103.	1234.	1372.	1522.	1691.	1837.	2006.	2184.	2374.	2589.
11TRANSPORTATION CHARGES												
121	SURCOMPACT	227.	252.	270.	287.	311.	338.	362.	392.	424.	470.	510.
131	COMPACT	289.	313.	329.	344.	364.	387.	407.	430.	460.	491.	521.
141	LUXURY	290.	313.	329.	344.	364.	387.	407.	430.	460.	491.	521.
161BASE PRICES												
171	SURCOMPACT	4950.	5230.	5551.	5871.	6202.	6528.	6820.	7137.	7451.	7779.	8114.
181	COMPACT	8382.	8843.	9461.	10039.	10680.	11235.	11786.	12336.	12937.	13587.	14179.
191	LUXURY	18179.	19626.	21325.	23056.	24885.	26730.	28661.	30280.	32156.	34155.	36252.

MARCH CONTROL FOR HYBRIDS

TABLE 12.10 GROWTH RATES, FOREIGN AUTO PRICES

LINE	ITEM	1979	1980	1981	1982	1983	1984	1985	1986	1987	1988	1989
11TOTAL AUTO PRICES												
21	SURCOMPACT	7.7	6.4	6.4	6.3	6.4	6.0	5.8	5.8	5.2	5.0	6.9
31	COMPACT	7.9	6.4	6.6	6.3	6.2	5.9	5.2	5.1	5.0	5.0	5.0
41	LUXURY	10.0	8.0	8.6	8.1	7.9	7.4	6.5	6.4	6.3	6.3	6.2
61STATE AND LOCAL TAXES												
71	SURCOMPACT	10.9	9.4	9.5	9.4	9.2	8.7	8.0	7.9	7.6	7.4	7.4
81	COMPACT	11.1	9.5	9.8	9.4	9.2	8.7	7.9	7.8	7.5	7.6	7.6
91	LUXURY	13.4	11.3	11.8	11.2	10.9	10.4	9.3	9.2	8.9	8.9	8.9
11TRANSPORTATION CHARGES												
121	SURCOMPACT	11.0	11.4	6.0	6.5	6.2	6.0	7.2	8.0	9.7	9.8	8.6
131	COMPACT	12.4	8.8	8.8	4.6	5.8	6.3	5.2	5.7	6.9	6.7	6.2
141	LUXURY	7.6	8.1	8.0	4.6	5.0	6.3	5.2	5.7	6.9	6.7	6.2
161BASE PRICES												
171	SURCOMPACT	7.1	5.7	6.1	5.8	5.6	5.3	4.6	4.5	4.8	4.9	4.9
181	COMPACT	7.5	6.0	6.5	6.1	6.0	5.6	4.9	4.8	4.7	4.7	4.7
191	LUXURY	10.0	8.0	8.7	8.1	7.9	7.8	6.5	6.8	6.2	6.2	6.1

ORIGINAL PAGE IS
OF POOR QUALITY

THE WHARTON EFA MARCH VEHICLE DEMAND MODEL
MARCH CONTROL FOR HYBRIDS

TABLE 12.00 FOREIGN AUTO PRICES (DOLLARS)

LINE	ITEM	1990	1991	1992	1993	1994	1995	1996	1997	1998	1999	2000
TOTAL AUTO PRICES:												
21	SURCOMPACT	10996.	11544.	12124.	12734.	13375.	14007.	14752.	15449.	16260.	17033.	17954.
31	COMPACT	18817.	19350.	20332.	21368.	22465.	23621.	24839.	26094.	27420.	28820.	30291.
41	LUXURY	44693.	47507.	50504.	53699.	57110.	60744.	64619.	68674.	72990.	77605.	82516.
51												
STATE AND LOCAL TAXES:												
61	SURCOMPACT	667.	718.	772.	831.	893.	961.	1033.	1110.	1190.	1283.	1380.
71	COMPACT	1141.	1229.	1323.	1425.	1535.	1653.	1781.	1916.	2062.	2219.	2389.
81	LUXURY	2020.	3073.	3389.	3650.	3970.	4334.	4730.	5152.	5612.	6113.	6640.
91												
TRANSPORTATION CHARGES:												
101	SURCOMPACT	552.	547.	625.	666.	713.	764.	819.	876.	941.	1011.	1087.
111	COMPACT	552.	547.	625.	666.	713.	764.	819.	876.	941.	1011.	1087.
121	LUXURY	552.	547.	625.	666.	713.	764.	819.	876.	941.	1011.	1087.
131												
BASE PRICES:												
141	SURCOMPACT	8473.	8889.	9281.	9651.	10081.	10531.	11002.	11486.	11991.	12520.	13073.
151	COMPACT	18844.	15549.	16290.	17069.	17880.	18740.	19651.	20583.	21561.	22584.	23666.
161	LUXURY	30887.	40890.	43450.	46176.	49079.	52171.	55664.	59695.	62545.	64959.	70601.

MARCH CONTROL FOR HYBRIDS

TABLE 12.10 GROWTH RATES, FOREIGN AUTO PRICES

LINE	ITEM	1990	1991	1992	1993	1994	1995	1996	1997	1998	1999	2000
TOTAL AUTO PRICES:												
21	SURCOMPACT	4.9	5.0	5.0	5.0	5.0	5.0	5.0	5.0	5.0	5.1	5.1
31	COMPACT	5.0	5.1	5.1	5.1	5.1	5.1	5.2	5.1	5.1	5.1	5.1
41	LUXURY	6.2	6.3	6.3	6.3	6.4	6.4	6.4	6.3	6.3	6.3	6.3
51												
STATE AND LOCAL TAXES:												
61	SURCOMPACT	7.4	7.6	7.6	7.6	7.5	7.5	7.5	7.5	7.5	7.5	7.5
71	COMPACT	7.6	7.7	7.7	7.7	7.7	7.7	7.7	7.6	7.6	7.6	7.6
81	LUXURY	8.9	9.0	9.0	9.0	9.0	9.0	9.0	8.9	8.9	8.9	8.9
91												
TRANSPORTATION CHARGES:												
101	SURCOMPACT	8.2	6.5	6.4	6.6	7.1	7.0	7.2	7.0	7.0	7.5	7.5
111	COMPACT	5.9	6.5	6.4	6.6	7.1	7.0	7.2	7.0	7.0	7.5	7.5
121	LUXURY	5.9	6.5	6.4	6.6	7.1	7.0	7.2	7.0	7.0	7.5	7.5
131												
BASE PRICES:												
141	SURCOMPACT	4.4	4.4	4.4	4.4	4.5	4.5	4.5	4.4	4.4	4.4	4.4
151	COMPACT	4.7	4.8	4.8	4.8	4.8	4.8	4.8	4.7	4.7	4.7	4.7
161	LUXURY	6.2	6.2	6.3	6.3	6.3	6.3	6.3	6.2	6.2	6.2	6.2

A PRODUCT OF WHARTON EFA, INC.

THE WHARTON EFA MO VEHICLE DEMAND MODEL
MARCH CONTROL FOR HYBRIDS

TABLE 13.00 CAPITALIZED COSTS PER MILE (DOLLARS PER MILE)

LINE	ITEM	1979	1980	1981	1982	1983	1984	1985	1986	1987	1988	1989	
11	AVG MINIMAL CAP. COST PER MILE	0.273	0.293	0.317	0.341	0.364	0.389	0.416	0.445	0.475	0.506	0.537	
12	AVG REAL CAP. COST PER MILE	0.162	0.161	0.163	0.164	0.164	0.166	0.167	0.170	0.172	0.175	0.178	
13	SICAPITALIZED COST PER MILE BY SIZE:												
14	SURCOMPACTS	0.222	0.230	0.254	0.279	0.300	0.321	0.343	0.364	0.383	0.409	0.445	
15	COMPACTS	0.251	0.269	0.292	0.313	0.334	0.357	0.382	0.410	0.434	0.467	0.497	
16	MID-SIZE	0.270	0.294	0.322	0.346	0.368	0.394	0.422	0.451	0.482	0.513	0.546	
17	FULL SIZE	0.293	0.316	0.342	0.364	0.393	0.421	0.449	0.481	0.513	0.547	0.581	
18	LUXURY	0.343	0.411	0.447	0.482	0.515	0.552	0.589	0.629	0.669	0.713	0.757	
19	2ICAP. COST PER MILE BY FOR/DOM:												
20	TOTAL DOMESTIC	0.277	0.297	0.321	0.345	0.368	0.394	0.422	0.452	0.483	0.514	0.547	
21	SURCOMPACT	0.216	0.232	0.252	0.272	0.291	0.312	0.334	0.359	0.380	0.410	0.437	
22	COMPACT	0.249	0.267	0.289	0.311	0.332	0.355	0.380	0.408	0.436	0.465	0.495	
23	LUXURY	0.371	0.394	0.432	0.464	0.496	0.531	0.565	0.601	0.643	0.683	0.725	
24	TOTAL FOREIGN												
25	SURCOMPACT	0.244	0.262	0.284	0.308	0.331	0.355	0.381	0.406	0.432	0.459	0.484	
26	COMPACT	0.226	0.242	0.263	0.284	0.303	0.327	0.349	0.373	0.398	0.423	0.450	
27	LUXURY	0.304	0.325	0.352	0.380	0.407	0.436	0.462	0.492	0.523	0.556	0.589	
28	TOTAL												
29	LUXURY	0.502	0.542	0.591	0.641	0.690	0.741	0.791	0.845	0.900	0.949	1.022	

MARCH CONTROL FOR HYBRIDS

TABLE 13.10 GROWTH RATES, CAPITALIZED COSTS PER MILE

LINE	ITEM	1979	1980	1981	1982	1983	1984	1985	1986	1987	1988	1989	
11	AVG MINIMAL CAP. COST PER MILE	8.6	7.0	6.3	7.5	6.8	7.0	6.9	7.0	6.7	6.5	6.3	
12	AVG REAL CAP. COST PER MILE	0.3	-0.4	1.0	0.5	0.2	0.4	1.0	1.5	1.5	1.6	1.5	
13	SICAPITALIZED COST PER MILE BY SIZE:												
14	SURCOMPACTS	9.3	7.4	6.5	8.0	7.3	7.2	6.9	7.1	6.9	6.6	6.4	
15	COMPACTS	8.0	7.3	6.3	7.3	6.6	7.0	7.0	7.1	6.9	6.6	6.4	
16	MID-SIZE	8.7	6.9	6.3	7.2	6.6	7.0	6.9	7.1	6.8	6.5	6.3	
17	FULL SIZE	8.5	7.2	6.4	7.5	6.7	7.1	6.8	7.0	6.4	6.5	6.3	
18	LUXURY	7.9	7.4	6.6	7.4	7.0	7.0	6.8	6.8	6.5	6.4	6.2	
19	2ICAP. COST PER MILE BY FOR/DOM:												
20	TOTAL DOMESTIC	8.7	7.1	6.4	7.4	6.7	7.0	6.9	7.2	6.4	6.5	6.3	
21	SURCOMPACT	9.1	7.4	6.5	7.9	7.2	7.2	7.0	7.0	7.1	6.6	6.5	
22	COMPACT	8.0	7.3	6.4	7.4	6.8	7.0	7.1	7.2	6.9	6.7	6.5	
23	LUXURY	8.4	7.2	6.4	7.5	6.9	6.9	6.5	6.7	6.5	6.3	6.1	
24	TOTAL FOREIGN												
25	SURCOMPACT	8.4	7.3	6.6	8.3	7.5	7.1	7.4	6.7	6.3	6.4	6.1	
26	COMPACT	9.4	7.3	6.4	8.1	7.4	7.1	6.4	6.9	6.4	6.2	6.1	
27	LUXURY	9.4	7.1	6.3	7.9	7.1	6.4	6.5	6.5	6.3	6.1	6.1	
28	TOTAL												
29	LUXURY	10.6	7.9	6.1	8.6	7.6	7.4	6.4	6.8	6.6	6.6	6.5	

THE WHARTON EFA MOT... VEHICLE DEMAND MODEL
MARCH CONTROL FOR HYBRIDS

TABLE 13.00 CAPITALIZED COSTS PER MILE (DOLLARS PER MILE)

LINE	ITEM	1990	1991	1992	1993	1994	1995	1996	1997	1998	1999	2000
11	AVG NOMINAL CAP. COST PER MILE	0.570	0.603	0.630	0.674	0.712	0.752	0.796	0.840	0.886	0.935	0.986
21	AVG REAL CAP. COST PER MILE	0.100	0.102	0.104	0.106	0.108	0.109	0.102	0.104	0.106	0.108	0.200
12	CAP. COST PER MILE BY FOR/DOM											
13	TOTAL DOMESTIC	0.580	0.614	0.650	0.694	0.729	0.769	0.814	0.858	0.901	0.950	1.009
14	SURCOMPACT	0.865	0.493	0.523	0.554	0.587	0.621	0.659	0.696	0.736	0.770	0.822
15	COMPACT	0.526	0.557	0.590	0.625	0.661	0.700	0.741	0.783	0.827	0.870	0.923
16	LUXURY	0.768	0.811	0.857	0.905	0.955	1.008	1.065	1.121	1.181	1.245	1.312
17	TOTAL FOREIGN	0.518	0.588	0.580	0.612	0.648	0.679	0.718	0.759	0.801	0.805	0.809
18	SURCOMPACT	0.877	0.504	0.533	0.563	0.595	0.629	0.665	0.702	0.741	0.783	0.826
19	COMPACT	0.624	0.659	0.696	0.735	0.775	0.818	0.865	0.912	0.962	1.015	1.070
20	LUXURY	1.096	1.158	1.225	1.302	1.381	1.466	1.560	1.650	1.753	1.860	1.970

MARCH CONTROL FOR HYBRIDS

TABLE 13.10 GROWTH RATES, CAPITALIZED COSTS PER MILE

LINE	ITEM	1990	1991	1992	1993	1994	1995	1996	1997	1998	1999	2000
11	AVG NOMINAL CAP. COST PER MILE	6.1	5.0	5.8	5.7	5.7	5.6	5.8	5.5	5.5	5.5	5.5
21	AVG REAL CAP. COST PER MILE	1.5	1.0	1.1	1.1	1.0	1.0	1.1	1.1	1.1	1.0	1.1
12	CAP. COST PER MILE BY FOR/DOM											
13	TOTAL DOMESTIC	6.1	5.9	5.9	5.8	5.7	5.7	5.9	5.6	5.6	5.6	5.6
14	SURCOMPACTS	6.2	5.9	5.9	5.8	5.7	5.7	5.9	5.6	5.6	5.6	5.6
15	COMPACTS	6.2	5.9	5.9	5.8	5.7	5.7	5.9	5.6	5.6	5.6	5.6
16	MID-SIZE	6.1	5.8	5.8	5.7	5.7	5.6	5.8	5.5	5.5	5.5	5.5
17	FULL SIZE	6.1	5.8	5.8	5.7	5.7	5.6	5.8	5.5	5.5	5.5	5.5
18	LUXURY	6.2	5.8	5.8	5.5	5.6	5.4	5.6	5.6	5.6	5.6	5.2
19	TOTAL FOREIGN	6.1	5.9	5.8	5.8	5.8	5.7	5.8	5.5	5.5	5.5	5.6
20	SURCOMPACT	6.3	6.1	6.0	6.0	5.9	5.8	6.0	5.7	5.7	5.7	5.7
21	COMPACT	6.3	6.0	5.9	5.8	5.8	5.8	5.9	5.6	5.6	5.6	5.6
22	LUXURY	5.9	5.7	5.6	5.6	5.6	5.5	5.7	5.3	5.3	5.4	5.4
17	TOTAL FOREIGN	6.3	5.8	5.9	5.8	5.3	5.8	5.5	5.7	5.5	5.6	5.2
18	SURCOMPACT	6.0	5.8	5.7	5.7	5.6	5.6	5.8	5.5	5.5	5.6	5.6
19	COMPACT	5.9	5.6	5.6	5.6	5.5	5.5	5.7	5.8	5.8	5.5	5.3
20	LUXURY	6.3	6.2	6.2	6.2	6.1	6.1	6.8	6.8	6.8	6.1	6.1

ORIGINAL PAGE IS
OF POOR QUALITY

THE WHARTON EPA MOTOR VEHICLE DEMAND MODEL
MARCH CONTROL FOR HYBRIDS

TABLE 14.00 MILES PER GALLON (MEFA)

LINE	ITEM	1979	1980	1981	1982	1983	1984	1985	1986	1987	1988	1989
11	OVERALL FLEET MILES PER GALLON	13.93	14.22	14.59	15.07	15.43	16.25	16.92	17.54	18.14	18.72	19.24
21	31MP AUTO MILES PER GALLON	18.52	15.18	16.12	17.26	18.43	19.21	19.89	19.45	19.43	19.42	19.41
31	TOTAL DOMESTIC AND FOREIGN	19.63	20.45	21.27	22.11	23.01	23.78	24.16	24.10	24.05	24.00	23.96
41	SURCOMPACT	15.32	15.05	16.00	18.01	19.21	20.02	20.30	20.25	20.21	20.17	20.13
51	COMPACT	13.10	13.96	14.91	16.23	17.54	18.31	18.53	18.48	18.48	18.40	18.37
61	MID-SIZE	12.80	13.02	13.96	15.09	16.31	17.09	17.30	17.13	17.29	17.25	17.22
71	FULL SIZE	11.67	12.37	13.24	14.16	15.03	15.70	15.90	15.98	15.90	15.87	15.84
81	LUXURY	13.73	14.38	15.34	16.54	17.76	18.56	18.86	18.88	18.76	18.73	18.70
91	TOTAL DOMESTIC	16.46	19.15	20.20	21.34	22.63	23.62	24.30	24.24	24.19	24.14	24.10
101	SURCOMPACT	15.23	15.77	16.74	17.98	19.20	20.02	20.31	20.25	20.21	20.17	20.13
111	COMPACT	11.50	12.07	12.94	13.88	14.76	15.43	15.71	15.67	15.63	15.60	15.57
121	LUXURY	20.37	20.89	21.50	22.11	22.72	23.33	23.49	23.45	23.43	23.39	23.37
131	TOTAL FOREIGN	20.87	21.40	22.02	22.65	23.27	23.88	24.07	24.02	23.97	23.92	23.88
141	SURCOMPACT	17.78	18.16	18.63	19.10	19.56	20.01	20.10	20.05	20.00	19.96	19.93
151	COMPACT	15.96	16.41	16.94	17.48	18.03	18.55	18.75	18.70	18.66	18.62	18.58
161	LUXURY											

MARCH CONTROL FOR HYBRIDS

TABLE 14.10 NEW AUTO MILES PER GALLON (EPA)

LINE	ITEM	1979	1980	1981	1982	1983	1984	1985	1986	1987	1988	1989
11	OVERALL FLEET MILES PER GALLON	20.38	21.46	22.03	24.68	26.60	27.67	28.09	28.09	28.11	28.15	28.17
21	31MP AUTO MILES PER GALLON	25.63	26.67	28.04	29.56	30.98	32.26	32.85	32.82	32.79	32.76	32.74
31	TOTAL DOMESTIC AND FOREIGN	21.19	22.22	23.62	25.61	27.72	28.87	29.32	29.32	29.33	29.33	29.34
41	SURCOMPACT	19.04	20.20	21.47	23.44	25.66	26.88	27.06	27.04	27.06	27.06	27.06
51	COMPACT	16.03	17.06	18.42	22.27	24.27	25.21	25.54	25.54	25.54	25.54	25.54
61	MID-SIZE	17.17	18.09	19.48	21.13	22.65	23.51	23.82	23.82	23.81	23.82	23.82
71	FULL SIZE	19.57	20.66	22.05	24.00	26.07	27.12	27.55	27.53	27.53	27.55	27.56
81	LUXURY	24.68	25.97	27.64	29.71	31.97	33.37	34.32	34.32	34.32	34.32	34.32
91	TOTAL DOMESTIC	21.15	22.20	23.62	25.64	27.80	28.96	29.40	29.40	29.40	29.40	29.40
101	SURCOMPACT	16.91	17.84	19.25	20.94	22.52	23.37	23.65	23.65	23.65	23.65	23.65
111	COMPACT	25.68	26.51	27.63	29.78	29.67	30.47	31.20	31.22	31.25	31.26	31.28
121	MID-SIZE	26.31	27.15	28.30	29.46	30.37	31.58	31.94	31.94	31.94	31.94	31.94
131	FULL SIZE	22.21	22.84	23.73	24.62	25.29	26.21	26.41	26.41	26.41	26.41	26.41
141	LUXURY	20.33	21.04	22.05	23.06	23.87	24.91	25.24	25.24	25.24	25.24	25.24
151	TOTAL FOREIGN											
161	SURCOMPACT											
171	COMPACT											
181	MID-SIZE											
191	FULL SIZE											
201	LUXURY											

A PRODUCT OF WHARTON EPA, INC.

THE WHARTON EPA MODEL VEHICLE DEMAND MODEL
MARCH CONTROL FOR HYBRIDS

TABLE 14.00 MILES PER GALLON (WEFA)

LINE	ITEM	1990	1991	1992	1993	1994	1995	1996	1997	1998	1999	2000
1	OVERALL FLEET MILES PER GALLON	19.65	20.02	20.27	20.41	20.47	20.51	20.53	20.53	20.51	20.48	20.45
2	NEW AUTO MILES PER GALLON:											
3	TOTAL DOMESTIC AND FOREIGN	19.41	19.38	19.35	19.31	19.27	19.23	19.21	19.18	19.18	19.09	19.04
4	SUBCOMPACT	23.92	23.67	23.42	23.77	23.72	23.66	23.61	23.56	23.51	23.45	23.39
5	COMPACT	20.10	20.06	20.01	19.97	19.92	19.87	19.83	19.78	19.73	19.68	19.63
6	MID-SIZE	18.33	18.30	18.25	18.21	18.17	18.12	18.08	18.04	17.99	17.94	17.89
7	FULL SIZE	17.19	17.15	17.11	17.07	17.03	16.99	16.95	16.91	16.86	16.81	16.77
8	LUXURY	15.83	15.80	15.77	15.72	15.67	15.62	15.57	15.58	15.49	15.44	15.39
9	TOTAL DOMESTIC	18.68	18.60	18.59	18.54	18.49	18.45	18.41	18.38	18.33	18.27	18.23
10	SUBCOMPACT	24.06	23.82	23.96	23.91	23.86	23.81	23.75	23.70	23.64	23.58	23.52
11	COMPACT	20.10	20.06	20.02	19.97	19.92	19.88	19.83	19.79	19.74	19.68	19.63
12	LUXURY	15.54	15.51	15.47	15.43	15.39	15.35	15.31	15.27	15.23	15.19	15.14
13	TOTAL FOREIGN	23.32	23.29	23.24	23.22	23.19	23.16	23.12	23.07	23.02	22.97	22.93
14	SUBCOMPACT	23.84	23.80	23.75	23.70	23.65	23.60	23.55	23.50	23.44	23.39	23.33
15	COMPACT	19.89	19.85	19.81	19.76	19.72	19.67	19.62	19.58	19.53	19.48	19.42
16	LUXURY	18.53	18.51	18.47	18.43	18.38	18.34	18.29	18.25	18.20	18.15	18.10

MARCH CONTROL FOR HYBRIDS

TABLE 14.10 NEW AUTO MILES PER GALLON (EPA)

LINE	ITEM	1990	1991	1992	1993	1994	1995	1996	1997	1998	1999	2000
1	OVERALL FLEET MILES PER GALLON	28.20	28.21	28.22	28.22	28.24	28.25	28.27	28.24	28.30	28.30	28.31
2	NEW AUTO MILES PER GALLON:											
3	TOTAL DOMESTIC AND FOREIGN	32.72	32.71	32.70	32.68	32.66	32.66	32.65	32.65	32.65	32.65	32.64
4	SUBCOMPACT	29.34	29.35	29.35	29.36	29.36	29.36	29.37	29.37	29.37	29.37	29.38
5	COMPACT	27.06	27.06	27.06	27.06	27.06	27.06	27.06	27.06	27.06	27.06	27.06
6	MID-SIZE	25.54	25.54	25.54	25.54	25.54	25.54	25.54	25.54	25.54	25.54	25.54
7	FULL SIZE	23.83	23.83	23.83	23.83	23.82	23.81	23.81	23.82	23.81	23.81	23.80
8	LUXURY	27.57	27.57	27.57	27.56	27.55	27.56	27.57	27.57	27.59	27.59	27.59
9	TOTAL DOMESTIC	34.32	34.32	34.32	34.32	34.32	34.32	34.32	34.32	34.32	34.32	34.32
10	SUBCOMPACT	29.40	29.40	29.40	29.40	29.40	29.40	29.40	29.40	29.40	29.40	29.40
11	COMPACT	23.65	23.65	23.65	23.65	23.65	23.65	23.65	23.65	23.65	23.65	23.65
12	LUXURY	31.28	31.29	31.29	31.32	31.35	31.38	31.39	31.39	31.40	31.41	31.40
13	TOTAL FOREIGN	31.94	31.94	31.94	31.94	31.94	31.94	31.94	31.94	31.94	31.94	31.94
14	SUBCOMPACT	26.41	26.41	26.41	26.41	26.41	26.41	26.41	26.41	26.41	26.41	26.41
15	COMPACT	25.28	25.28	25.28	25.28	25.28	25.28	25.28	25.28	25.28	25.28	25.28
16	LUXURY	29.28	29.28	29.28	29.28	29.28	29.28	29.28	29.28	29.28	29.28	29.28

A PRODUCT OF WHARTON EPA, INC.

THE WHARTON EFA MODEL VEHICLE DEMAND MODEL
MARCH CONTROL FOR HYBRIDS

TABLE 15.00 GROWTH RATES, MILES PER GALLON (MFFA)

LINE	ITEM	1979	1980	1981	1982	1983	1984	1985	1986	1987	1988	1989
1	OVERALL FLEET MILES PER GALLON	1.31	2.04	2.61	3.29	3.71	3.99	4.15	1.76	3.43	3.07	2.77
21	31RPN AUTO MILES PER GALLON	5.5	4.5	6.2	7.1	6.7	4.2	1.5	-0.2	-0.1	-0.1	-0.1
31	TOTAL DOMESTIC AND FOREIGN	2.2	3.1	4.0	4.0	4.1	3.3	1.6	-0.3	-0.2	-0.2	-0.2
41	SURCOMPACT	9.2	3.5	6.0	7.2	6.7	4.2	1.8	-0.3	-0.2	-0.2	-0.2
51	COMPACT	5.4	5.0	6.8	8.9	8.1	4.8	1.2	-0.3	-0.2	-0.2	-0.2
61	MID-SIZE	7.2	5.0	7.2	8.1	8.1	4.8	1.7	-0.3	-0.2	-0.2	-0.2
71	FULL SIZE	6.5	4.2	7.0	7.0	6.2	4.8	1.6	-0.3	-0.3	-0.2	-0.2
81	LUXURY	6.5	4.7	6.7	7.8	7.4	4.5	1.6	-0.3	-0.2	-0.2	-0.2
91	TOTAL DOMESTIC	9.6	3.5	6.1	7.4	6.8	4.3	1.8	-0.3	-0.2	-0.2	-0.2
101	SURCOMPACT	7.6	4.2	7.2	7.3	6.4	4.5	1.8	-0.3	-0.2	-0.2	-0.2
111	COMPACT	1.7	2.5	2.9	2.9	2.8	2.7	0.7	-0.2	-0.1	-0.2	-0.1
121	LUXURY	1.3	2.2	2.6	2.5	2.7	2.6	0.8	-0.2	-0.2	-0.2	-0.2
131	TOTAL FOREIGN	2.1	2.8	3.2	3.2	3.1	2.9	1.0	-0.3	-0.2	-0.2	-0.2
141	SURCOMPACT								-0.3	-0.2	-0.2	-0.2
151	COMPACT								-0.3	-0.2	-0.2	-0.2
161	LUXURY								-0.3	-0.2	-0.2	-0.2

MARCH CONTROL FOR HYBRIDS

TABLE 15.10 GROWTH RATE, NEW AUTO MILES PER GALLON (FPA)

LINE	ITEM	1979	1980	1981	1982	1983	1984	1985	1986	1987	1988	1989
1	OVERALL FLEET MILES PER GALLON	5.7	3.3	6.4	8.1	7.8	4.0	1.5	0.0	0.1	0.1	0.1
21	31RPN AUTO MILES PER GALLON	2.5	4.1	5.1	5.4	4.0	4.1	1.8	-0.1	-0.1	-0.1	-0.1
31	TOTAL DOMESTIC AND FOREIGN	8.7	4.9	6.3	8.4	8.2	4.2	1.5	0.0	0.0	0.0	0.0
41	SURCOMPACT	5.3	6.1	6.3	9.4	9.3	4.0	1.8	0.0	0.0	0.0	0.0
51	COMPACT	7.6	5.7	7.2	9.1	9.0	3.9	1.3	0.0	0.0	0.0	0.0
61	MID-SIZE	7.1	5.4	7.7	8.4	7.2	3.8	1.3	0.0	-0.0	0.0	0.0
71	FULL SIZE	6.5	5.6	6.7	8.8	8.6	4.0	1.6	-0.1	0.0	0.1	0.0
81	LUXURY	3.3	5.2	6.4	7.5	7.6	4.4	2.8	0.0	0.0	0.0	0.0
91	TOTAL DOMESTIC	9.0	9.0	6.4	8.6	8.4	4.2	1.5	0.0	0.0	0.0	0.0
101	SURCOMPACT	8.0	5.5	7.9	8.8	7.5	1.8	1.2	0.0	0.0	0.0	0.0
111	COMPACT	2.2	3.2	4.2	4.2	3.1	4.0	1.1	0.1	0.1	0.0	0.1
121	LUXURY	1.9	3.2	4.2	4.1	3.1	4.0	1.1	0.0	0.0	0.0	0.0
131	TOTAL FOREIGN	1.8	2.8	3.9	3.8	2.7	3.6	0.8	0.0	0.0	0.0	0.0
141	SURCOMPACT	2.5	3.5	4.6	4.6	3.5	4.3	1.5	0.0	0.0	0.0	0.0
151	COMPACT								0.0	0.0	0.0	0.0
161	LUXURY								0.0	0.0	0.0	0.0

A PRODUCT OF WHARTON EFA, INC.

ORIGINAL PAGE IS
OF POOR QUALITY

THE WHARTON EPA MODEL VEHICLE DEMAND MODEL
MARCH CONTROL FOR HYBRIDS

TABLE 15.00 GROWTH RATES, MILES PER GALLON (MEFA)

LINE	ITEM	1990	1991	1992	1993	1994	1995	1996	1997	1998	1999	2000
1	OVERALL FLEET MILES PER GALLON	2.20	1.80	1.26	0.72	0.29	0.19	0.07	0.08	-0.12	-0.14	-0.15
2	TOTAL MILES PER GALLON	-0.0	-0.1	-0.2	-0.2	-0.2	-0.2	-0.1	-0.1	-0.2	-0.2	-0.3
3	TOTAL DOMESTIC AND FOREIGN	-0.2	-0.2	-0.2	-0.2	-0.2	-0.2	-0.2	-0.2	-0.2	-0.3	-0.3
4	SURCOMPACT	-0.2	-0.2	-0.2	-0.2	-0.2	-0.2	-0.2	-0.2	-0.2	-0.3	-0.3
5	COMPACT	-0.2	-0.2	-0.2	-0.2	-0.2	-0.2	-0.2	-0.2	-0.2	-0.3	-0.3
6	MID-SIZE	-0.2	-0.2	-0.2	-0.2	-0.2	-0.2	-0.2	-0.2	-0.2	-0.3	-0.3
7	FULL SIZE	-0.2	-0.2	-0.2	-0.2	-0.2	-0.2	-0.2	-0.2	-0.2	-0.3	-0.3
8	LUXURY	-0.1	-0.2	-0.2	-0.3	-0.3	-0.3	-0.3	-0.2	-0.3	-0.3	-0.3
9	TOTAL DOMESTIC	-0.1	-0.2	-0.2	-0.3	-0.2	-0.2	-0.2	-0.2	-0.2	-0.3	-0.3
10	SURCOMPACT	-0.2	-0.2	-0.2	-0.2	-0.2	-0.2	-0.2	-0.2	-0.2	-0.3	-0.3
11	COMPACT	-0.2	-0.2	-0.2	-0.2	-0.2	-0.2	-0.2	-0.2	-0.2	-0.3	-0.3
12	LUXURY	-0.2	-0.2	-0.2	-0.2	-0.3	-0.3	-0.2	-0.3	-0.3	-0.3	-0.3
13	TOTAL FOREIGN	-0.2	-0.1	-0.2	-0.1	-0.1	-0.1	-0.1	-0.2	-0.2	-0.2	-0.2
14	SURCOMPACT	-0.2	-0.2	-0.2	-0.2	-0.2	-0.2	-0.2	-0.2	-0.2	-0.3	-0.2
15	COMPACT	-0.2	-0.2	-0.2	-0.2	-0.2	-0.2	-0.2	-0.2	-0.2	-0.3	-0.3
16	LUXURY	-0.2	-0.2	-0.2	-0.2	-0.2	-0.2	-0.2	-0.2	-0.2	-0.3	-0.3

MARCH CONTROL FOR HYBRIDS

TABLE 15.10 GROWTH RATES, NEW AUTO MILES PER GALLON (EPA)

LINE	ITEM	1990	1991	1992	1993	1994	1995	1996	1997	1998	1999	2000
1	TOTAL DOMESTIC AND FOREIGN	0.1	0.0	0.0	0.0	0.0	0.0	0.1	0.1	0.0	0.0	0.0
2	SURCOMPACT	-0.0	-0.1	-0.0	-0.1	-0.0	-0.0	-0.0	-0.0	-0.0	0.0	-0.0
3	COMPACT	0.0	0.0	0.0	0.0	0.0	0.0	0.0	0.0	0.0	0.0	0.0
4	MID-SIZE	0.0	0.0	0.0	0.0	0.0	0.0	0.0	0.0	0.0	0.0	0.0
5	FULL SIZE	0.0	0.0	0.0	0.0	0.0	0.0	0.0	0.0	0.0	0.0	0.0
6	LUXURY	0.0	0.0	0.0	-0.0	-0.0	-0.0	-0.0	0.0	0.0	-0.0	-0.0
7	TOTAL DOMESTIC	0.1	-0.0	-0.0	-0.0	-0.0	0.0	0.0	0.0	0.0	0.0	-0.0
8	SURCOMPACT	0.0	0.0	0.0	0.0	0.0	0.0	0.0	0.0	0.0	0.0	0.0
9	COMPACT	0.0	0.0	0.0	0.0	0.0	0.0	0.0	0.0	0.0	0.0	0.0
10	LUXURY	0.0	0.0	0.0	0.0	0.0	0.0	0.0	0.0	0.0	0.0	0.0
11	TOTAL FOREIGN	-0.0	0.0	0.0	0.1	0.1	0.1	0.1	-0.0	0.0	0.0	0.1
12	SURCOMPACT	0.0	0.0	0.0	0.0	0.0	0.0	0.0	0.0	0.0	0.0	0.0
13	COMPACT	0.0	0.0	0.0	0.0	0.0	0.0	0.0	0.0	0.0	0.0	0.0
14	LUXURY	0.0	0.0	0.0	0.0	0.0	0.0	0.0	0.0	0.0	0.0	0.0
15	TOTAL FOREIGN	-0.0	0.0	0.0	0.1	0.1	0.1	0.1	-0.0	0.0	0.0	0.1
16	SURCOMPACT	0.0	0.0	0.0	0.0	0.0	0.0	0.0	0.0	0.0	0.0	0.0
17	COMPACT	0.0	0.0	0.0	0.0	0.0	0.0	0.0	0.0	0.0	0.0	0.0
18	LUXURY	0.0	0.0	0.0	0.0	0.0	0.0	0.0	0.0	0.0	0.0	0.0

ORIGINAL PAGE IS
OF POOR QUALITY

THE WHARTON EFA MODEL VEHICLE DEMAND MODEL
MARCH CONTROL FOR HYBRIDS

TABLE 16.00 USED CAR MARKET

LINE	TYPE	1974	1980	1981	1982	1983	1984	1985	1986	1987	1988	1989
1	AVERAGE WHOLESALE PRICE	3036.	3730.	4050.	4371.	4709.	5054.	5398.	5758.	6138.	6516.	6896.
2	PRICE OF 1 YR OLD CAR/NEW CAR (X)											
3	SURCOMPACT	79.41	80.39	80.50	79.98	79.75	80.00	79.98	79.80	79.89	80.18	80.27
4	COMPACT	70.23	70.70	70.98	70.18	69.88	70.08	69.98	69.63	69.73	70.09	70.18
5	MID-SIZE	64.14	64.93	64.92	64.67	64.80	64.50	64.66	64.85	64.58	64.85	64.98
6	FULL-SIZE	58.66	61.76	61.66	60.72	59.78	60.78	61.55	60.87	61.19	62.81	63.00
7	LUXURY	69.57	70.80	70.65	70.05	69.50	70.15	70.38	70.07	70.32	70.90	71.29
10	TOTAL USED CARS PURCHASED... MILL AUTOS	15,663	16,641	17,288	17,233	16,971	17,863	18,156	18,072	18,339	18,818	19,370

TABLE 16.10 GROWTH RATES, USED CAR MARKET

LINE	TYPE	1979	1980	1981	1982	1983	1984	1985	1986	1987	1988	1989
1	AVERAGE WHOLESALE PRICE	10.78	8.66	8.46	7.98	7.72	7.38	6.81	6.66	6.53	6.23	5.88
2	PRICE OF 1 YR OLD CAR/NEW CAR (X)											
3	SURCOMPACT	0.37	1.20	0.18	-0.65	-0.28	0.31	-0.03	-0.22	0.11	0.36	0.11
4	COMPACT	1.23	0.67	0.39	-1.18	-0.43	0.35	-0.20	-0.45	0.15	0.32	0.07
5	MID-SIZE	1.80	1.24	-0.02	-0.39	-0.42	0.28	0.13	-0.13	0.18	0.47	0.21
6	FULL-SIZE	5.81	5.28	-0.16	-1.53	-1.58	1.67	1.27	-1.11	0.53	1.99	0.95
7	LUXURY	5.45	1.76	-0.20	-0.85	-0.79	0.93	0.78	-0.38	0.35	0.83	0.58
10	TOTAL USED CARS PURCHASED... MILL AUTOS	7.07	6.24	3.89	-0.32	-1.52	2.90	1.97	-0.46	1.87	2.82	2.91

A PRODUCT OF WHARTON EFA, INC.

THE WHARTON EFA MODEL VEHICLE DEMAND MODEL
MARCH CONTROL FOR HYBRIDS

TABLE 16.00 USED CAR MARKET

LINE	ITEM	1990	1991	1992	1993	1994	1995	1996	1997	1998	1999	2000
1	AVERAGE WHOLESALE PRICE DOLLARS	7301.	7736.	8220.	8741.	9295.	9860.	10485.	11080.	11682.	12387.	13051.
3	PRICE OF 1 YR OLD CAR/NEW CAR (X)											
4	SUBCOMPACT	80.21	80.01	79.73	79.88	79.85	79.55	79.62	79.57	79.87	79.86	79.88
5	COMPACT	70.01	69.77	69.39	69.06	69.13	69.22	69.31	69.18	69.08	69.06	69.15
6	MID-SIZE	68.89	68.78	68.86	68.23	68.20	68.32	68.38	68.38	68.27	68.29	68.32
7	FULL SIZE	62.71	62.09	61.05	60.12	59.97	60.51	60.76	60.69	60.35	60.87	60.50
8	LUXURY	70.93	70.69	70.00	69.65	69.61	69.87	69.99	69.70	69.66	69.75	69.98
9												
10	TOTAL USED CARS PURCHASED.. MILL AUTOS	19,028	19,673	19,758	19,857	20,059	20,689	21,087	21,895	21,880	22,072	22,510

TABLE 16.10 GROWTH RATES, USED CAR MARKET

LINE	ITEM	1990	1991	1992	1993	1994	1995	1996	1997	1998	1999	2000
1	AVERAGE WHOLESALE PRICE DOLLARS	5.87	5.99	6.22	6.34	6.34	6.08	5.93	5.78	5.81	5.69	5.71
3	PRICE OF 1 YR OLD CAR/NEW CAR (X)											
4	SUBCOMPACT	-0.08	-0.25	-0.34	-0.37	0.01	0.13	0.08	-0.03	-0.15	-0.01	0.02
5	COMPACT	-0.18	-0.35	-0.58	-0.49	0.11	0.12	0.13	-0.25	-0.09	-0.02	0.11
6	MID-SIZE	-0.15	-0.23	-0.43	-0.36	-0.04	0.19	0.09	-0.06	-0.12	0.08	0.08
7	FULL SIZE	-0.07	-0.09	-1.67	-1.53	-0.28	0.89	0.81	-0.10	-0.57	0.20	0.05
8	LUXURY	-0.50	-0.38	-0.98	-0.50	-0.05	0.37	0.17	-0.81	-0.06	0.18	0.27
9												
10	TOTAL USED CARS PURCHASED.. MILL AUTOS	0.28	1.28	0.41	0.52	1.02	3.18	1.71	2.13	0.86	1.81	1.99

A PRODUCT OF WHARTON EFA, INC.

ORIGINAL PAGE IS
OF POOR QUALITY

THE WHARTON FFA MOTOR VEHICLE DEMAND MODEL
MARCH CONTROL FOR HYBRIDS

TABLE 17.00 DEMOGRAPHIC VARIABLES

LINE	ITEM	1979	1980	1981	1982	1983	1984	1985	1986	1987	1988	1989
111	NUMBER OF FAMILIES	59,268	60,260	61,275	62,312	63,316	64,287	65,201	66,099	66,970	67,817	68,668
211	NUMBER OF UNREL. INDIVIDUALS	22,122	22,682	23,244	23,782	24,323	24,861	25,404	25,901	26,191	26,876	27,172
31	PERCENT OF FAMILIES WITH 3 OR 4 PERS.	30.98	31.18	31.32	31.47	31.61	31.65	31.79	31.79	31.83	31.87	31.91
51	PERCENT OF FAMILIES WITH 5+ PERSONS	13.01	12.28	11.68	11.12	10.56	10.21	9.65	9.37	9.02	8.67	8.32
61	PERSONS 20 TO 29 PER FAMILY	0.478	0.477	0.475	0.471	0.466	0.459	0.450	0.439	0.424	0.411	0.398
71	NUMBER OF LICENSED DRIVERS	144,311	147,200	149,950	152,444	154,888	157,177	159,455	161,766	164,111	166,166	167,977
91	PERCENT OF POPULATION											
111	IN METROPOLITAN AREAS	73.27	73.27	73.27	73.27	73.27	73.27	73.27	73.27	73.27	73.27	73.27
121	IN NEW ENGLAND REGION	5.66	5.64	5.63	5.62	5.60	5.59	5.57	5.56	5.55	5.53	5.52
131	IN SOUTH ATLANTIC REGION	15.68	15.60	15.60	15.56	15.52	15.48	15.44	15.40	15.36	15.32	15.28
141	IN EAST NORTH CENTRAL REGION	19.28	19.34	19.41	19.47	19.53	19.59	19.66	19.72	19.78	19.84	19.91
151	IN WEST SOUTH CENTRAL REGION	6.08	6.01	5.94	5.87	5.81	5.74	5.67	5.61	5.54	5.48	5.41
161	IN MOUNTAIN REGION	4.88	4.94	5.00	5.10	5.20	5.30	5.50	5.61	5.72	5.83	5.95
171	IN PACIFIC REGION	13.70	13.81	13.91	14.01	14.12	14.23	14.33	14.44	14.55	14.66	14.77
181	IN WEST NORTH CENTRAL REGION	7.71	7.67	7.64	7.61	7.58	7.55	7.52	7.49	7.46	7.43	7.40
191	IN WEST SOUTH CENTRAL REGION	10.08	10.14	10.20	10.26	10.32	10.39	10.45	10.51	10.57	10.64	10.70
211	GROWTH RATES											
221	PASSENGERS / EMPLOYMENT	0.97	0.97	0.97	0.97	0.97	0.97	0.97	0.97	0.97	0.97	0.97
231	PASS / PUBLIC TRANSIT M.T.W.	0.99	0.99	0.99	0.99	0.99	0.99	0.99	0.99	0.99	0.99	0.99
241	OTHER M.T.W. / EMPLOYMENT	0.98	0.98	0.98	0.98	0.98	0.98	0.98	0.98	0.98	0.98	0.98

MARCH CONTROL FOR HYBRIDS

TABLE 17.10 GROWTH RATES, DEMOGRAPHIC VARIABLES

LINE	ITEM	1979	1980	1981	1982	1983	1984	1985	1986	1987	1988	1989
111	NUMBER OF FAMILIES	1.7	1.7	1.7	1.7	1.6	1.5	1.4	1.4	1.3	1.3	1.3
211	NUMBER OF UNREL. INDIVIDUALS	2.6	2.5	2.5	2.3	2.3	2.2	2.2	2.0	1.9	1.8	1.8
31	PERCENT OF FAMILIES WITH 3 OR 4 PERS.	0.0	0.0	0.0	0.5	0.4	0.1	0.4	0.0	0.1	0.1	0.1
51	PERCENT OF FAMILIES WITH 5+ PERSONS	-0.1	-5.9	-4.6	-4.8	-5.0	-3.3	-5.5	-2.9	-3.7	-3.9	-4.0
61	PERSONS 20 TO 29 PER FAMILY	-0.2	-0.2	-0.4	-0.4	-1.1	-1.4	-1.9	-2.5	-3.0	-3.6	-4.0
71	NUMBER OF LICENSED DRIVERS	2.20	2.00	1.87	1.69	1.58	1.48	1.45	1.45	1.45	1.24	1.10
91	PERCENT OF POPULATION											
111	IN METROPOLITAN AREAS	0.0	0.0	0.0	0.0	0.0	0.0	0.0	0.0	0.0	0.0	0.0
121	IN NEW ENGLAND REGION	-0.3	-0.2	-0.2	-0.3	-0.3	-0.2	-0.3	-0.3	-0.3	-0.3	-0.2
131	IN SOUTH ATLANTIC REGION	-0.3	-0.3	-0.3	-0.3	-0.3	-0.3	-0.3	-0.3	-0.3	-0.3	-0.3
141	IN EAST NORTH CENTRAL REGION	0.3	0.3	0.3	0.3	0.3	0.3	0.3	0.3	0.3	0.3	0.3
151	IN WEST SOUTH CENTRAL REGION	-1.2	-1.2	-1.2	-1.2	-1.2	-1.2	-1.2	-1.2	-1.2	-1.2	-1.2
161	IN MOUNTAIN REGION	2.0	2.0	2.0	2.0	2.0	2.0	2.0	2.0	2.0	2.0	2.0
171	IN PACIFIC REGION	0.7	0.7	0.7	0.7	0.7	0.7	0.7	0.7	0.7	0.7	0.7
181	IN WEST NORTH CENTRAL REGION	-0.4	-0.4	-0.4	-0.4	-0.4	-0.4	-0.4	-0.4	-0.4	-0.4	-0.4
191	IN WEST SOUTH CENTRAL REGION	0.6	0.6	0.6	0.6	0.6	0.6	0.6	0.6	0.6	0.6	0.6

ORIGINAL PAGE IS
OF POOR QUALITY

THE WHARTON EFA MOTOC VEHICLE DEMAND MODEL
MARCH CONTROL FOR HYBRIDS

TABLE 17.00 DEMOGRAPHIC VARIABLES

LINE	ITEM	1990	1991	1992	1993	1994	1995	1996	1997	1998	1999	2000
1	NUMBER OF FAMILIES	69,083	70,310	71,147	71,993	72,050	71,717	74,598	75,082	76,380	77,289	78,209
2	NUMBER OF UNREL. INDIVIDUALS	27,870	28,355	28,888	29,350	29,061	30,381	30,909	31,687	31,998	32,551	33,117
31	PERCENT OF FAMILIES WITH 3 OR 4 PERS.	31.98	32.02	32.08	32.14	32.21	32.29	32.37	32.46	32.56	32.66	32.77
61	SUPPORT OF FAMILIES WITH 5+ PERSONS	7.97	7.73	7.50	7.30	7.11	6.94	6.78	6.50	6.38	6.30	6.26
7	PERSONS 20 TO 29 PER FAMILY	0.383	0.373	0.364	0.351	0.337	0.327	0.318	0.310	0.305	0.300	0.293
8	NUMBER OF LICENSED DRIVERS	169,688	171,422	173,055	174,666	176,339	178,161	180,033	182,022	184,066	186,133	188,199
10	PERCENT OF POPULATION											
111	IN METROPOLITAN AREAS	73.27	73.27	73.27	73.27	73.27	73.27	73.27	73.27	73.27	73.27	73.27
121	IN NEW ENGLAND REGION	5.50	5.89	5.48	5.06	5.45	5.88	5.82	5.81	5.39	5.38	5.37
131	IN SOUTH ATLANTIC REGION	15.24	15.20	15.16	15.12	15.08	15.04	15.00	14.96	14.92	14.89	14.85
141	IN EAST NORTH CENTRAL REGION	19.97	20.03	20.10	20.16	20.23	20.29	20.36	20.42	20.49	20.55	20.62
151	IN EAST SOUTH CENTRAL REGION	9.35	9.29	9.23	9.17	9.11	9.05	8.99	8.93	8.87	8.82	8.76
161	IN MOUNTAIN REGION	6.07	6.19	6.31	6.44	6.57	6.70	6.88	6.97	7.11	7.25	7.40
171	IN PACIFIC REGION	14.08	14.99	15.10	15.21	15.33	15.44	15.56	15.68	15.79	15.91	16.03
181	IN WEST NORTH CENTRAL REGION	7.37	7.38	7.31	7.28	7.25	7.22	7.19	7.16	7.13	7.10	7.07
191	IN WEST SOUTH CENTRAL REGION	10.76	10.83	10.89	10.96	11.03	11.09	11.16	11.23	11.29	11.36	11.43
21	GROWTH RATES											
221	PASSENGERS / EMPLOYMENT	0.97	0.97	0.97	0.97	0.97	0.97	0.97	0.97	0.97	0.97	0.97
231	PASS / PUBLIC TRANSIT M.T.W.	0.99	0.99	0.99	0.99	0.99	0.99	0.99	0.99	0.99	0.99	0.99
241	OTHER M.T.W. / EMPLOYMENT	0.98	0.98	0.98	0.98	0.98	0.98	0.98	0.98	0.98	0.98	0.98

MARCH CONTROL FOR HYBRIDS

TABLE 17.10 GROWTH RATES, DEMOGRAPHIC VARIABLES

LINE	ITEM	1990	1991	1992	1993	1994	1995	1996	1997	1998	1999	2000
1	NUMBER OF FAMILIES	1.2	1.2	1.2	1.2	1.2	1.2	1.2	1.2	1.2	1.2	1.2
2	NUMBER OF UNREL. INDIVIDUALS	1.6	1.7	1.7	1.7	1.7	1.7	1.7	1.7	1.7	1.7	1.7
31	PERCENT OF FAMILIES WITH 3 OR 4 PERS.	0.1	0.3	0.2	0.2	0.2	0.2	0.2	0.3	0.3	0.3	0.3
61	SUPPORT OF FAMILIES WITH 5+ PERSONS	-0.2	-1.0	-3.0	-2.7	-2.6	-2.8	-2.3	-8.1	-1.8	-1.3	-0.6
7	PERSONS 20 TO 29 PER FAMILY	-2.8	-2.7	-2.3	-3.7	-3.0	-3.1	-2.8	-2.3	-1.8	-1.5	-2.8
8	NUMBER OF LICENSED DRIVERS	1.02	1.02	0.95	0.98	0.99	1.00	1.05	1.10	1.12	1.12	1.11
10	PERCENT OF POPULATION											
111	IN METROPOLITAN AREAS	0.0	0.0	0.0	0.0	0.0	0.0	0.0	0.0	0.0	0.0	0.0
121	IN NEW ENGLAND REGION	-0.3	-0.3	-0.3	-0.2	-0.3	-0.3	-0.3	-0.3	-0.2	-0.3	-0.2
131	IN SOUTH ATLANTIC REGION	-0.3	-0.3	-0.3	-0.3	-0.3	-0.3	-0.3	-0.3	-0.3	-0.3	-0.3
141	IN EAST NORTH CENTRAL REGION	0.3	0.3	0.3	0.3	0.3	0.3	0.3	0.3	0.3	0.3	0.3
151	IN EAST SOUTH CENTRAL REGION	-1.2	-1.2	-1.2	-1.2	-1.2	-1.2	-1.2	-1.2	-1.2	-1.2	-1.2
161	IN MOUNTAIN REGION	2.0	2.0	2.0	2.0	2.0	2.0	2.0	2.0	2.0	2.0	2.0
171	IN PACIFIC REGION	0.7	0.7	0.7	0.7	0.7	0.7	0.7	0.7	0.7	0.7	0.7
181	IN WEST NORTH CENTRAL REGION	-0.8	-0.8	-0.8	-0.8	-0.8	-0.8	-0.8	-0.8	-0.8	-0.8	-0.8
191	IN WEST SOUTH CENTRAL REGION	0.6	0.6	0.6	0.6	0.6	0.6	0.6	0.6	0.6	0.6	0.6

THE WHARTON EFA MODEL VEHICLE DEMAND MODEL
MARCH CONTROL FOR HYBRIDS

LINE	ITEM	1979	1980	1981	1982	1983	1984	1985	1986	1987	1988	1989
16	GENERAL											
21	PERSONAL INCOME	1841.01	2052.70	2263.40	2490.46	2723.59	2963.39	3230.52	3506.19	3789.11	4076.06	4391.82
31	PERSONAL INCOME TAXES	279.53	302.97	343.37	385.13	427.59	471.83	518.21	567.18	617.99	673.25	736.89
41	TRANSFER PAYMENTS	250.51	288.25	317.46	349.79	388.98	422.09	460.49	500.39	543.09	588.38	635.91
51	REAL DISP. INCOME/FAMILY	9.81	9.72	9.76	9.82	9.85	9.88	10.00	10.17	10.22	10.29	10.40
71	FAMILIES WITH INCOME OVER \$15,000											
81	TH 1970 \$	25.09	25.20	25.63	25.78	25.78	25.91	26.29	26.77	27.41	28.20	29.06
91	PERCENT											
101	EMPLOYMENT											
111	UNEMPLOYMENT RATE	96.38	97.73	99.67	101.42	102.98	104.33	105.89	107.51	109.10	110.88	111.96
121	PERCENT	6.19	6.78	6.38	6.08	5.99	5.91	5.69	5.83	5.28	5.20	4.99
131	CONSUMER INSTALL. CREDIT RATE,											
141	NEW AUTOS	12.40	12.33	12.41	12.52	12.12	11.98	11.76	11.62	11.88	11.88	11.52
151	PERCENT											
161	CONSUMER PRICE INDICES (1967=100)											
171	TOTAL	211.4	227.2	243.5	260.2	277.3	294.4	311.6	328.8	345.2	361.8	378.9
181	AUTO REPAIRS	267.7	291.3	317.0	348.6	373.1	402.2	431.6	461.0	490.7	520.7	551.3
191	AUTO INSURANCE PREMIUMS	263.5	291.2	325.6	361.5	400.3	440.6	481.3	523.8	570.1	617.4	666.8
201	TIRES	158.7	168.0	173.8	184.3	195.3	207.0	219.5	232.6	246.6	261.4	277.1
211	MOTOR OIL	192.7	206.6	222.1	237.8	253.9	269.9	285.8	301.5	317.3	332.9	348.2
221	PARKING FEES	261.6	288.0	309.0	336.8	366.3	397.1	428.1	460.0	492.0	526.8	561.6
231	PERCENT											
241	OTHER COSTS AND PRICES											
251	NEW AUTO UNIT PRICE	4.70	4.73	4.81	4.98	5.08	5.21	5.30	5.38	5.45	5.53	5.61
261	NEW AUTOS PRICE INDEX	100.2	158.0	167.3	174.6	181.8	189.2	197.6	206.2	215.2	223.9	232.5
271	NEW AUTOS INPUT PRICE INDEX	158.3	168.7	181.2	193.3	205.9	218.9	231.5	244.2	257.2	270.5	283.0
281	IMPORTED GOODS PRICE INDEX	213.1	227.6	244.3	261.1	278.6	296.0	312.1	328.9	345.9	363.9	382.6
291	TRANSPORTATION PRICE INDEX	158.4	163.2	168.2	174.2	181.3	188.3	196.2	204.1	213.9	224.0	233.6
301	PERCENT											
311	AVG RETAIL PRICE OF GASOLINE	74.20	80.70	92.20	103.70	115.20	126.70	138.20	151.10	164.00	176.90	189.80
321	EXCLUDING TAXES	61.00	67.70	79.02	90.38	101.67	112.98	124.28	136.98	149.69	162.19	175.09
331	FEDERAL TAX	4.00	4.00	4.00	4.00	4.00	4.00	4.00	4.00	4.00	4.00	4.00
341	STATE AND LOCAL TAX	8.80	9.00	9.18	9.36	9.53	9.72	9.92	10.12	10.31	10.51	10.71
351	PERCENT											
361	STEEL SCRAP PRICE	85.22	89.89	93.96	98.66	103.59	108.77	114.21	119.92	125.91	132.21	138.82

A PRODUCT OF WHARTON EFA, INC.

ORIGINAL PAGE IS OF POOR QUALITY

THE WHARTON EFA MOTOR VEHICLE DEMAND MODEL
MARCH CONTROL FOR HYBRIDS

LINE	UNIT	1990	1991	1992	1993	1994	1995	1996	1997	1998	1999	2000
TAR.F 18.00 ECONOMIC VARIABLES												
11	GENERAL											
21	PERSONAL INCOME	4726.33	5100.50	5513.20	5961.08	6431.28	6939.60	7482.02	8078.19	8712.26	9398.88	10132.54
31	PERSONAL INCOME TAXES	804.83	875.39	955.03	1041.53	1131.39	1228.22	1338.31	1452.48	1578.08	1716.05	1869.88
41	TRANSFER PAYMENTS	687.70	745.68	806.10	870.88	943.36	1020.87	1105.87	1195.05	1292.13	1398.33	1511.61
51												
61	REAL DISP. INCOME/FAMILY	10.49	10.63	10.81	11.01	11.17	11.38	11.50	11.72	11.91	12.10	12.30
71	FAMILIES WITH INCOME (OVER \$15,000)											
81	IN 1970 \$	29.88	30.71	31.66	32.88	34.28	35.76	37.37	38.98	40.55	42.25	44.01
91	PERCENTI											
101	EMPLOYMENT											
111	UNEMPLOYMENT RATE	113.00	114.72	116.27	117.90	119.28	120.81	122.35	124.00	125.65	127.35	129.08
121		0.81	0.82	0.59	0.30	0.33	0.22	0.22	0.21	0.22	0.23	0.19
131	CONSUMER INSTALL. CREDIT RATE, PERCENTI											
141	NEW AUTOS	11.48	11.37	11.33	11.14	11.25	11.18	11.23	11.12	11.02	10.96	10.95
151												
161	CONSUMER PRICE INDICES (1967=100)											
171	TOTAL	396.8	415.6	434.8	458.5	475.7	497.7	520.6	543.2	566.9	592.3	618.8
181	AUTO REPAIRS	583.8	617.7	653.5	690.4	729.9	771.7	815.8	868.8	927.2	997.0	1069.3
191	AUTO INSURANCE PREMIUMS	720.5	779.8	841.5	907.6	981.2	1060.1	1143.6	1229.8	1328.1	1427.5	1535.1
201	TYPES	293.7	311.3	330.0	349.8	370.8	393.0	416.6	441.6	468.1	496.2	526.8
211	MOTOR OIL	365.6	383.3	401.8	419.9	439.8	460.3	481.9	503.1	525.3	549.0	573.8
221	PARKING FEES	598.0	636.7	677.8	720.8	766.6	815.9	867.8	921.6	977.9	1038.2	1101.9
231												
241	OTHER COSTS AND PRICES											
251	NEW AUTO UNIT PRICE	5.69	5.78	5.87	5.97	6.06	6.15	6.24	6.36	6.46	6.56	6.67
261	NEW AUTOS PRICE INDEX	241.5	259.7	260.2	269.7	280.0	290.5	300.1	311.0	322.1	333.3	344.8
271	NEW AUTO INPUT PRICE INDEX	297.6	312.2	327.4	343.2	360.1	377.3	395.2	413.8	432.8	451.9	472.7
281	IMPROVED GOODS PRICE INDEX	402.3	423.2	445.2	468.8	492.8	518.5	545.6	573.5	603.0	633.9	664.5
291	TRANSPORTATION PRICE INDEX	243.2	254.1	265.5	277.6	291.2	305.8	320.7	336.3	353.8	371.7	391.0
301												
311	AVG RETAIL PRICE OF GASOLINE	202.80	213.10	223.40	233.70	244.00	254.30	266.60	278.90	291.20	303.60	316.00
321	EXCLUDING TAXES	187.89	197.98	208.07	218.16	228.28	238.31	250.19	262.85	274.52	286.68	298.83
331	FEDERAL TAX	8.00	8.00	8.00	8.00	8.00	8.00	8.00	8.00	8.00	8.00	8.00
341	STATE AND LOCAL TAX	10.91	11.12	11.33	11.54	11.76	11.99	12.21	12.45	12.68	12.92	13.17
351												
361	STEEL SCRAP PRICE	105.76	153.05	160.70	168.74	177.17	186.03	195.33	205.10	215.15	226.12	237.83

A PRODUCT OF WHARTON EFA, INC.

ORIGINAL PAGE IS
OF POOR QUALITY

THE WHARTON EFA MOTOR VEHICLE DEMAND MODEL
MARCH CONTROL FOR HYBRIDS

TABLE 19.00 GROWTH RATES, ECONOMIC VARIABLES

LINE	ITEM	1970	1980	1981	1982	1983	1984	1985	1986	1987	1988	1989
1	PERSONAL INCOME TAXES	10.3	9.1	10.3	10.0	9.3	8.8	9.0	8.5	8.1	7.6	7.7
2	PERSONAL INCOME TAXES	9.5	8.8	13.3	12.2	11.0	10.3	9.8	9.8	9.0	8.9	9.0
3	TRANSFER PAYMENTS	17.3	13.3	10.1	10.2	10.1	9.6	9.1	8.7	8.5	8.3	8.1
4	MEAL DISP. INCOME/FAMILY	-0.2	-0.9	0.4	0.6	0.3	0.3	1.2	1.2	1.5	0.7	1.0
5	FAMILIES WITH INCOME OVER \$15,000	1.5	0.6	1.5	0.4	0.0	0.7	1.4	1.9	2.4	2.9	3.1
6	EMPLOYMENT	2.3	1.0	2.0	1.8	1.5	1.4	1.9	1.5	1.5	1.3	1.3
7	UNEMPLOYMENT RATE	2.3	9.6	-6.0	-4.6	-1.6	-1.2	-3.0	-6.0	-2.9	-1.4	-0.2
8	CONSUMER INSTALL. CREDIT RATE,	4.1	-0.0	0.6	0.9	-3.2	-1.5	-1.9	-1.2	-1.2	-0.3	0.6
9	NEW AUTOS	8.2	7.5	7.2	6.9	6.6	6.2	5.8	5.8	5.1	4.8	4.7
10	TOTAL	9.2	8.8	8.6	8.7	8.3	7.8	7.3	6.8	6.4	6.1	5.9
11	AUTO REPAIRS	10.6	10.5	11.0	11.0	10.7	10.1	9.2	8.0	8.0	8.3	8.0
12	AUTO INSURANCE PREMIUMS	6.0	6.0	6.0	6.0	6.0	6.0	6.0	6.0	6.0	6.0	6.0
13	TIRES	7.7	7.2	7.5	7.1	6.8	6.3	5.9	5.5	5.2	4.9	4.8
14	MOTOR OIL	9.0	8.6	8.8	9.0	8.8	8.4	7.9	7.8	7.1	6.9	6.6
15	PARKING FEES	0.0	0.5	1.0	2.6	2.0	2.6	1.8	1.6	1.3	1.0	1.0
16	OTHER COSTS AND PRICES	7.0	6.6	5.9	4.4	4.1	4.1	4.0	4.3	4.0	4.0	3.8
17	NEW AUTO UNIT PRICE	7.1	6.6	7.8	6.7	6.5	6.3	5.8	5.5	5.3	5.1	4.9
18	NEW AUTO PRICE INDEX	8.6	8.8	7.8	6.9	6.7	6.2	5.8	5.8	5.2	5.2	5.1
19	DOM. AUTO INPUT PRICE INDEX	5.5	5.7	3.8	3.2	4.1	4.8	3.6	4.0	4.8	4.7	4.3
20	IMPORTED GOODS PRICE INDEX	11.6	8.8	14.3	12.5	11.1	10.0	9.1	9.3	8.5	7.9	7.3
21	TRANSPORTATION PRICE INDEX	16.5	10.3	16.7	14.3	12.5	11.1	10.0	10.2	9.3	8.5	7.8
22	AVG RETAIL PRICE OF GASOLINE	0.0	0.0	0.0	0.0	0.0	0.0	0.0	0.0	0.0	0.0	0.0
23	EXCISING TAXES	2.3	2.3	2.0	1.9	1.9	1.9	2.1	2.0	1.9	1.9	1.9
24	FEDERAL TAX	5.0	5.0	5.0	5.0	5.0	5.0	5.0	5.0	5.0	5.0	5.0
25	STATE AND LOCAL TAX	5.0	5.0	5.0	5.0	5.0	5.0	5.0	5.0	5.0	5.0	5.0
26	STEEL SCRAP PRICE	5.0	5.0	5.0	5.0	5.0	5.0	5.0	5.0	5.0	5.0	5.0

A PRODUCT OF WHARTON EFA, INC.

ORIGINAL PAGE IS
OF POOR QUALITY

THE WHARTON EFA AND VEHICLE DEMAND MODEL
MARCH CONTROL FOR HYBRIDS

TABLE 10.00 GROWTH RATES, ECONOMIC VARIABLES

LINE	ITEM	1990	1991	1992	1993	1994	1995	1996	1997	1998	1999	2000
1	GENERAL											
21	PERSONAL INCOME	7.6	7.9	8.1	8.1	7.9	7.9	7.8	8.0	7.0	7.9	7.8
31	PERSONAL INCOME TAXES	9.2	8.0	9.1	9.1	8.6	8.6	8.6	8.9	8.7	8.7	8.6
41	TRANSFER PAYMENTS	8.1	8.8	8.1	8.0	8.2	8.3	8.3	8.1	8.1	8.2	8.1
51	FFAL DISP. INCOME/FAMILY	0.9	1.8	1.7	1.8	1.8	1.8	1.8	1.8	1.7	1.6	1.6
71	FAMILIES WITH INCOME OVER \$15,000											
81	IN 1970 \$	2.8	2.8	3.1	3.7	4.2	4.4	4.5	4.2	4.1	4.2	4.2
91	PERCENT											
101	EMPLOYMENT	1.3	1.2	1.3	1.8	1.1	1.3	1.3	1.3	1.3	1.3	1.0
111	UNEMPLOYMENT RATE	-1.5	0.2	-0.8	-6.8	0.7	-2.6	-0.6	-0.2	0.4	0.1	-1.0
121												
131	CONSUMER INSTALL. CREDIT RATE,											
141	NEW AUTOS	-0.6	-0.6	-0.8	0.1	-0.0	-0.7	0.5	-1.0	-1.0	-0.5	-0.1
151	PERCENT											
161	CONSUMER PRICE INDICES (1967=100)											
171	TOTAL	4.7	4.7	4.6	4.5	4.7	4.6	4.6	4.3	4.8	4.5	4.8
181	AUTO REPAIRS	5.8	5.9	5.8	5.6	5.7	5.7	5.7	5.5	5.8	5.5	5.5
191	AUTO INSURANCE PREMIUMS	8.1	8.2	7.0	7.9	8.1	8.0	7.9	7.5	7.7	7.0	7.5
201	TYPES	6.0	6.0	6.0	6.0	6.0	6.0	6.0	6.0	6.0	6.0	6.0
211	MOTOR OIL	4.8	4.8	4.7	4.6	4.7	4.7	4.7	4.8	4.9	4.5	4.8
221	PARKING FEES	6.5	6.5	6.5	6.3	6.4	6.4	6.4	6.2	6.1	6.2	6.1
231												
241	OTHER COSTS AND PRICES											
251	NEW AUTO UNIT PRICE	1.5	1.6	1.6	1.6	1.5	1.5	1.9	1.5	1.6	1.6	1.6
261	NEW AUTOS PRICE INDEX	3.9	3.8	3.8	3.6	3.8	3.7	3.3	3.6	3.6	3.5	3.5
271	IMP. AUTO INPUT PRICE INDEX	4.9	4.9	4.9	4.8	4.9	4.8	4.7	4.6	4.6	4.5	4.6
281	IMPORTED GOODS PRICE INDEX	5.1	5.2	5.2	5.2	5.2	5.2	5.2	5.1	5.1	5.1	5.1
291	TRANSPORTATION PRICE INDEX	4.1	4.5	4.5	4.6	4.9	4.9	5.0	4.9	5.1	5.2	5.2
301												
311	AVG RETAIL PRICE OF GASOLINE	6.8	5.1	4.8	4.6	4.8	4.2	4.8	4.6	4.8	4.3	4.1
321	FIXING TAXES	7.3	5.8	5.1	4.8	4.6	4.4	5.1	4.8	4.6	4.8	4.2
331	FEDERAL TAX	0.0	0.0	0.0	0.0	0.0	0.0	0.0	0.0	0.0	0.0	0.0
341	STATE AND LOCAL TAX	1.9	1.9	1.9	1.9	1.9	1.9	1.9	1.9	1.9	1.9	1.9
351												
361	STEEL SCRAP PRICE	5.0	5.0	5.0	5.0	5.0	5.0	5.0	5.0	5.0	5.0	5.0

A PRODUCT OF WHARTON EFA, INC.

ORIGINAL PAGE IS
OF POOR QUALITY

THE WHARTON EFA MOT. VEHICLE DEMAND MODEL
MARCH CONTRACT FOR HYBRIDS

TABLE 20.00 AUTO CHARACTERISTICS

LINE	ITEM	1979	1980	1981	1982	1983	1984	1985	1986	1987	1988	1989
11	CURR WEIGHT (POUNDS)											
21	DOMESTIC SURCOMPACT	2600.	2550.	2500.	2400.	2300.	2330.	2300.	2300.	2300.	2300.	2300.
31	FOREIGN SURCOMPACT	2293.	2258.	2228.	2191.	2158.	2126.	2094.	2094.	2094.	2094.	2094.
41	DOMESTIC COMPACT	2865.	3050.	3000.	2900.	2800.	2750.	2700.	2700.	2700.	2700.	2700.
51	FOREIGN COMPACT	3550.	3450.	3400.	3250.	2752.	2725.	2698.	2698.	2698.	2698.	2698.
61	MID-SIZE	3800.	3740.	3600.	3850.	3300.	3050.	3000.	3000.	3000.	3000.	3000.
71	FULL SIZE	4100.	4000.	3950.	3700.	3600.	3250.	3200.	3200.	3200.	3200.	3200.
81	DOMESTIC LUXURY	3169.	3106.	3044.	2983.	2923.	2865.	2808.	2808.	2808.	2808.	2808.
91	FOREIGN LUXURY											
101	ENGINE DISPLACEMENT (CUBIC INCHES)											
111	DOMESTIC SURCOMPACT	103.0	135.0	130.0	125.0	115.0	110.0	105.0	105.0	105.0	105.0	105.0
121	FOREIGN SURCOMPACT	93.9	92.1	90.2	88.4	86.6	84.9	83.2	83.2	83.2	83.2	83.2
131	DOMESTIC COMPACT	217.0	207.0	198.0	183.0	167.0	150.0	150.0	150.0	150.0	150.0	150.0
141	FOREIGN COMPACT	114.5	112.8	111.1	109.4	107.0	106.2	104.6	104.6	104.6	104.6	104.6
151	MID-SIZE	263.0	249.0	238.0	219.0	198.0	189.0	180.0	180.0	180.0	180.0	180.0
161	FULL SIZE	287.0	278.0	259.0	242.0	228.0	216.0	210.0	210.0	210.0	210.0	210.0
171	DOMESTIC LUXURY	351.0	336.0	318.0	298.0	283.0	272.0	265.0	265.0	265.0	265.0	265.0
181	FOREIGN LUXURY	171.0	168.4	165.9	161.4	160.9	158.5	156.1	156.1	156.1	156.1	156.1
211	PERCENT WITH AUTOMATIC TRANSMISSION											
221	DOMESTIC SURCOMPACT	60.00	57.50	55.00	52.50	47.50	42.50	40.00	40.00	40.00	40.00	40.00
231	FOREIGN SURCOMPACT	35.00	25.00	25.00	25.00	25.00	25.00	25.00	25.00	25.00	25.00	25.00
241	DOMESTIC COMPACT	67.50	65.00	60.00	75.00	70.00	67.50	67.50	67.50	67.50	67.50	67.50
251	FOREIGN COMPACT	55.00	45.00	45.00	45.00	45.00	45.00	45.00	45.00	45.00	45.00	45.00
261	MID-SIZE	90.00	85.00	80.00	77.50	75.00	72.50	72.50	72.50	72.50	72.50	72.50
271	FULL SIZE	98.00	97.00	95.00	92.50	90.00	87.50	85.00	85.00	85.00	85.00	85.00
281	DOMESTIC LUXURY	97.00	96.00	95.00	94.00	92.00	90.00	88.00	88.00	88.00	88.00	88.00
291	FOREIGN LUXURY	60.00	50.00	49.00	47.00	45.00	45.00	45.00	45.00	45.00	45.00	45.00
311	PERCENT WITH 6 CYLINDERS											
321	DOMESTIC SURCOMPACT	75.00	77.50	80.00	82.50	85.00	87.50	90.00	90.00	90.00	90.00	90.00
331	FOREIGN SURCOMPACT	95.00	95.00	95.00	95.00	95.00	95.00	95.00	95.00	95.00	95.00	95.00
341	DOMESTIC COMPACT	15.00	20.00	30.00	40.00	45.00	50.00	55.00	55.00	55.00	55.00	55.00
351	FOREIGN COMPACT	85.00	85.00	85.00	85.00	85.00	85.00	85.00	85.00	85.00	85.00	85.00
361	MID-SIZE	0.0	2.50	5.00	7.50	10.00	15.00	15.00	15.00	15.00	15.00	15.00
371	FULL SIZE	0.0	2.50	5.00	7.50	10.00	12.50	15.00	15.00	15.00	15.00	15.00
381	DOMESTIC LUXURY	0.10	0.50	1.00	2.00	5.00	10.00	15.00	15.00	15.00	15.00	15.00
391	FOREIGN LUXURY	60.00	60.00	60.00	60.00	60.00	60.00	60.00	60.00	60.00	60.00	60.00
411	PERCENT WITH 6 CYLINDERS											
421	DOMESTIC SURCOMPACT	25.00	22.50	20.00	17.50	15.00	12.50	10.00	10.00	10.00	10.00	10.00
431	FOREIGN SURCOMPACT	5.00	5.00	5.00	5.00	5.00	5.00	5.00	5.00	5.00	5.00	5.00
441	DOMESTIC COMPACT	60.00	55.00	50.00	45.00	40.00	35.00	30.00	30.00	30.00	30.00	30.00
451	FOREIGN COMPACT	15.00	15.00	15.00	15.00	15.00	15.00	15.00	15.00	15.00	15.00	15.00
461	MID-SIZE	20.00	35.00	50.00	65.00	70.00	70.00	70.00	70.00	70.00	70.00	70.00
471	FULL SIZE	10.00	20.00	30.00	40.00	50.00	60.00	65.00	65.00	65.00	65.00	65.00
481	DOMESTIC LUXURY	5.00	10.00	15.00	20.00	25.00	30.00	35.00	35.00	35.00	35.00	35.00
491	FOREIGN LUXURY	40.00	40.00	40.00	40.00	40.00	40.00	40.00	40.00	40.00	40.00	40.00

THE WHARTON EFA MOT VEHICLE DEMAND MODEL
MARCH CONTINUED FOR HYBRIDS

TABLE 20.00 AUTO CHARACTERISTICS

LINE	ITEM	1990	1991	1992	1993	1994	1995	1996	1997	1998	1999	2000
11	VEHICLE WEIGHT (POUNDS)											
21	DOMESTIC SUBCOMPACT	2300.	2300.	2300.	2300.	2300.	2300.	2300.	2300.	2300.	2300.	2300.
31	FOREIGN SUBCOMPACT	2098.	2098.	2098.	2098.	2098.	2098.	2098.	2098.	2098.	2098.	2098.
41	DOMESTIC COMPACT	2700.	2700.	2700.	2700.	2700.	2700.	2700.	2700.	2700.	2700.	2700.
51	FOREIGN COMPACT	2698.	2698.	2698.	2698.	2698.	2698.	2698.	2698.	2698.	2698.	2698.
61	MID-SIZE	3000.	3000.	3000.	3000.	3000.	3000.	3000.	3000.	3000.	3000.	3000.
71	FULL SIZE	3200.	3200.	3200.	3200.	3200.	3200.	3200.	3200.	3200.	3200.	3200.
81	DOMESTIC LUXURY	3500.	3500.	3500.	3500.	3500.	3500.	3500.	3500.	3500.	3500.	3500.
91	FOREIGN LUXURY	2800.	2800.	2800.	2800.	2800.	2800.	2800.	2800.	2800.	2800.	2800.
11	ENGINE DISPLACEMENT (CUBIC INCHES)											
121	DOMESTIC SUBCOMPACT	105.0	105.0	105.0	105.0	105.0	105.0	105.0	105.0	105.0	105.0	105.0
131	FOREIGN SUBCOMPACT	83.2	83.2	83.2	83.2	83.2	83.2	83.2	83.2	83.2	83.2	83.2
141	DOMESTIC COMPACT	150.0	150.0	150.0	150.0	150.0	150.0	150.0	150.0	150.0	150.0	150.0
151	FOREIGN COMPACT	104.6	104.6	104.6	104.6	104.6	104.6	104.6	104.6	104.6	104.6	104.6
161	MID-SIZE	180.0	180.0	180.0	180.0	180.0	180.0	180.0	180.0	180.0	180.0	180.0
171	FULL SIZE	210.0	210.0	210.0	210.0	210.0	210.0	210.0	210.0	210.0	210.0	210.0
181	DOMESTIC LUXURY	265.0	265.0	265.0	265.0	265.0	265.0	265.0	265.0	265.0	265.0	265.0
191	FOREIGN LUXURY	156.1	156.1	156.1	156.1	156.1	156.1	156.1	156.1	156.1	156.1	156.1
21	PERCENT WITH AUTOMATIC TRANSMISSION											
221	DOMESTIC SUBCOMPACT	80.00	80.00	80.00	80.00	80.00	80.00	80.00	80.00	80.00	80.00	80.00
231	FOREIGN SUBCOMPACT	25.00	25.00	25.00	25.00	25.00	25.00	25.00	25.00	25.00	25.00	25.00
241	DOMESTIC COMPACT	67.50	67.50	67.50	67.50	67.50	67.50	67.50	67.50	67.50	67.50	67.50
251	FOREIGN COMPACT	45.00	45.00	45.00	45.00	45.00	45.00	45.00	45.00	45.00	45.00	45.00
261	MID-SIZE	72.50	72.50	72.50	72.50	72.50	72.50	72.50	72.50	72.50	72.50	72.50
271	FULL SIZE	85.00	85.00	85.00	85.00	85.00	85.00	85.00	85.00	85.00	85.00	85.00
281	DOMESTIC LUXURY	88.00	88.00	88.00	88.00	88.00	88.00	88.00	88.00	88.00	88.00	88.00
291	FOREIGN LUXURY	45.00	45.00	45.00	45.00	45.00	45.00	45.00	45.00	45.00	45.00	45.00
31	PERCENT WITH 6 CYLINDERS											
321	DOMESTIC SUBCOMPACT	90.00	90.00	90.00	90.00	90.00	90.00	90.00	90.00	90.00	90.00	90.00
331	FOREIGN SUBCOMPACT	95.00	95.00	95.00	95.00	95.00	95.00	95.00	95.00	95.00	95.00	95.00
341	DOMESTIC COMPACT	55.00	55.00	55.00	55.00	55.00	55.00	55.00	55.00	55.00	55.00	55.00
351	FOREIGN COMPACT	45.00	45.00	45.00	45.00	45.00	45.00	45.00	45.00	45.00	45.00	45.00
361	MID-SIZE	15.00	15.00	15.00	15.00	15.00	15.00	15.00	15.00	15.00	15.00	15.00
371	FULL SIZE	15.00	15.00	15.00	15.00	15.00	15.00	15.00	15.00	15.00	15.00	15.00
381	DOMESTIC LUXURY	15.00	15.00	15.00	15.00	15.00	15.00	15.00	15.00	15.00	15.00	15.00
391	FOREIGN LUXURY	60.00	60.00	60.00	60.00	60.00	60.00	60.00	60.00	60.00	60.00	60.00
41	PERCENT WITH 6 CYLINDERS											
421	DOMESTIC SUBCOMPACT	10.00	10.00	10.00	10.00	10.00	10.00	10.00	10.00	10.00	10.00	10.00
431	FOREIGN SUBCOMPACT	5.00	5.00	5.00	5.00	5.00	5.00	5.00	5.00	5.00	5.00	5.00
441	DOMESTIC COMPACT	30.00	30.00	30.00	30.00	30.00	30.00	30.00	30.00	30.00	30.00	30.00
451	FOREIGN COMPACT	15.00	15.00	15.00	15.00	15.00	15.00	15.00	15.00	15.00	15.00	15.00
461	MID-SIZE	70.00	70.00	70.00	70.00	70.00	70.00	70.00	70.00	70.00	70.00	70.00
471	FULL SIZE	65.00	65.00	65.00	65.00	65.00	65.00	65.00	65.00	65.00	65.00	65.00
481	DOMESTIC LUXURY	35.00	35.00	35.00	35.00	35.00	35.00	35.00	35.00	35.00	35.00	35.00
491	FOREIGN LUXURY	80.00	80.00	80.00	80.00	80.00	80.00	80.00	80.00	80.00	80.00	80.00

ORIGINAL PAGE IS
OF POOR QUALITY

THE WHARTON EFA MOTOR VEHICLE DEMAND MODEL
MARCH CONTROL FOR HYBRIDS

TABLE 21.00 GROWTH RATES, AUTO CHARACTERISTICS

LINE	ITEM	1979	1980	1981	1982	1983	1984	1985	1986	1987	1988	1989	1990
11	WIGHT (POUNDS)												
21	DOMESTIC SUBCOMPACT	-1.9	-1.9	-2.0	-2.4	-2.5	-2.1	-1.3	0.0	0.0	0.0	0.0	0.0
31	FOREIGN SUBCOMPACT	-1.5	-1.5	-1.5	-1.5	-1.5	-1.5	-1.5	0.0	0.0	0.0	0.0	0.0
41	DOMESTIC COMPACT	-6.8	-1.6	-1.6	-3.3	-3.4	-1.0	-1.8	0.0	0.0	0.0	0.0	0.0
51	FOREIGN COMPACT	-1.0	-1.0	-1.0	-1.0	-1.0	-1.0	-1.0	0.0	0.0	0.0	0.0	0.0
61	MID-SIZE	-4.3	-2.8	-1.4	-4.4	-4.6	-1.6	-1.6	0.0	0.0	0.0	0.0	0.0
71	FULL SIZE	-7.3	-2.6	-2.7	-4.2	-4.3	-1.5	-1.5	0.0	0.0	0.0	0.0	0.0
81	DOMESTIC LUXURY	-7.9	-2.4	-3.6	-3.9	-2.7	-1.8	-1.4	0.0	0.0	0.0	0.0	0.0
91	FOREIGN LUXURY	-2.0	-2.0	-2.0	-2.0	-2.0	-2.0	-2.0	0.0	0.0	0.0	0.0	0.0
101	ENGINE DISPLACEMENT (CUBIC INCHES)												
121	DOMESTIC SUBCOMPACT	-5.9	-5.6	-3.7	-3.8	-8.8	-4.3	-4.5	0.0	0.0	0.0	0.0	0.0
131	FOREIGN SUBCOMPACT	-2.0	-2.0	-2.0	-2.0	-2.0	-2.0	-2.0	0.0	0.0	0.0	0.0	0.0
141	DOMESTIC COMPACT	-12.5	-4.6	-4.3	-7.6	-8.2	-6.0	-5.1	0.0	0.0	0.0	0.0	0.0
151	FOREIGN COMPACT	-1.5	-1.5	-1.5	-1.5	-1.5	-1.5	-1.5	0.0	0.0	0.0	0.0	0.0
161	MID-SIZE	-6.7	-5.7	-4.0	-8.4	-9.2	-4.5	-4.0	0.0	0.0	0.0	0.0	0.0
171	FULL SIZE	-9.2	-4.5	-5.3	-6.6	-7.8	-3.6	-2.8	0.0	0.0	0.0	0.0	0.0
181	DOMESTIC LUXURY	-9.3	-4.3	-5.4	-6.3	-5.0	-3.9	-2.4	0.0	0.0	0.0	0.0	0.0
191	FOREIGN LUXURY	-1.5	-1.5	-1.5	-1.5	-1.5	-1.5	-1.5	0.0	0.0	0.0	0.0	0.0
201	PERCENT WITH AUTOMATIC TRANSMISSION												
221	DOMESTIC SUBCOMPACT	-4.00	-4.17	-4.35	-4.55	-9.32	-10.53	-5.88	0.0	0.0	0.0	0.0	0.0
231	FOREIGN SUBCOMPACT	-12.50	-28.57	0.0	0.0	0.0	0.0	0.0	0.0	0.0	0.0	0.0	0.0
241	DOMESTIC COMPACT	-2.78	-2.86	-5.88	-6.25	-6.67	-3.57	0.0	0.0	0.0	0.0	0.0	0.0
251	FOREIGN COMPACT	-15.38	-14.18	0.0	0.0	0.0	0.0	0.0	0.0	0.0	0.0	0.0	0.0
261	MID-SIZE	-5.26	-5.56	-5.88	-3.13	-3.23	-3.33	0.0	0.0	0.0	0.0	0.0	0.0
271	FULL SIZE	-1.01	-1.02	-2.06	-2.63	-2.70	-2.74	-2.86	0.0	0.0	0.0	0.0	0.0
281	DOMESTIC LUXURY	-1.02	-1.03	-1.04	-1.05	-2.13	-2.17	-2.22	0.0	0.0	0.0	0.0	0.0
291	FOREIGN LUXURY	-14.29	-16.67	-2.00	-4.08	-4.26	0.0	0.0	0.0	0.0	0.0	0.0	0.0
301	PERCENT WITH 4 CYLINDERS												
321	DOMESTIC SUBCOMPACT	3.85	3.33	3.23	3.13	3.03	2.98	2.84	0.0	0.0	0.0	0.0	0.0
331	FOREIGN SUBCOMPACT	0.0	0.0	0.0	0.0	0.0	0.0	0.0	0.0	0.0	0.0	0.0	0.0
341	DOMESTIC COMPACT	20.00	33.33	50.00	33.33	12.50	11.11	10.00	0.0	0.0	0.0	0.0	0.0
351	FOREIGN COMPACT	-5.56	0.0	0.0	0.0	0.0	0.0	0.0	0.0	0.0	0.0	0.0	0.0
361	MID-SIZE			100.00	50.00	33.33	50.00	0.0	0.0	0.0	0.0	0.0	0.0
371	FULL SIZE			100.00	50.00	33.33	25.00	20.00	0.0	0.0	0.0	0.0	0.0
381	DOMESTIC LUXURY		80.00	100.00	100.00	150.00	100.00	50.00	0.0	0.0	0.0	0.0	0.0
391	FOREIGN LUXURY	9.09	0.0	0.0	0.0	0.0	0.0	0.0	0.0	0.0	0.0	0.0	0.0
401	PERCENT WITH 6 CYLINDERS												
421	DOMESTIC SUBCOMPACT	-1.96	-10.00	-11.11	-12.50	-14.29	-16.67	-20.00	0.0	0.0	0.0	0.0	0.0
431	FOREIGN SUBCOMPACT	0.0	0.0	0.0	0.0	0.0	0.0	0.0	0.0	0.0	0.0	0.0	0.0
441	DOMESTIC COMPACT	20.00	-8.33	-9.09	-10.00	-11.11	-12.50	-18.29	0.0	0.0	0.0	0.0	0.0
451	FOREIGN COMPACT	50.00	0.0	0.0	0.0	0.0	0.0	0.0	0.0	0.0	0.0	0.0	0.0
461	MID-SIZE	73.91	75.00	42.86	30.00	7.69	0.0	0.0	0.0	0.0	0.0	0.0	0.0
471	FULL SIZE	100.00	100.00	50.00	33.33	25.00	20.00	8.33	0.0	0.0	0.0	0.0	0.0
481	DOMESTIC LUXURY		100.00	50.00	33.33	25.00	20.00	16.67	0.0	0.0	0.0	0.0	0.0
491	FOREIGN LUXURY	-11.11	0.0	0.0	0.0	0.0	0.0	0.0	0.0	0.0	0.0	0.0	0.0

ORIGINAL PAGE IS
OF POOR QUALITY

THE WHARTON EFA MODEL VEHICLE DEMAND MODEL
MARCH CONTROL FOR HYBRIDS

TABLE 21.00 GROWTH RATES, AUTO CHARACTERISTICS

LINE	1990	1991	1992	1993	1994	1995	1996	1997	1998	1999	2000
11 CURR WEIGHT (POUNDS)											
21 DOMESTIC SUBCOMPACT	0.0	0.0	0.0	0.0	0.0	0.0	0.0	0.0	0.0	0.0	0.0
31 FOREIGN SUBCOMPACT	0.0	0.0	0.0	0.0	0.0	0.0	0.0	0.0	0.0	0.0	0.0
41 DOMESTIC COMPACT	0.0	0.0	0.0	0.0	0.0	0.0	0.0	0.0	0.0	0.0	0.0
51 FOREIGN COMPACT	0.0	0.0	0.0	0.0	0.0	0.0	0.0	0.0	0.0	0.0	0.0
61 MID-SIZE	0.0	0.0	0.0	0.0	0.0	0.0	0.0	0.0	0.0	0.0	0.0
71 FULL SIZE	0.0	0.0	0.0	0.0	0.0	0.0	0.0	0.0	0.0	0.0	0.0
81 DOMESTIC LUXURY	0.0	0.0	0.0	0.0	0.0	0.0	0.0	0.0	0.0	0.0	0.0
91 FOREIGN LUXURY	0.0	0.0	0.0	0.0	0.0	0.0	0.0	0.0	0.0	0.0	0.0
101											
111 ENGINE DISPLACEMENT (CURIC INCHES)											
121 DOMESTIC SUBCOMPACT	0.0	0.0	0.0	0.0	0.0	0.0	0.0	0.0	0.0	0.0	0.0
131 FOREIGN SUBCOMPACT	0.0	0.0	0.0	0.0	0.0	0.0	0.0	0.0	0.0	0.0	0.0
141 DOMESTIC COMPACT	0.0	0.0	0.0	0.0	0.0	0.0	0.0	0.0	0.0	0.0	0.0
151 FOREIGN COMPACT	0.0	0.0	0.0	0.0	0.0	0.0	0.0	0.0	0.0	0.0	0.0
161 MID-SIZE	0.0	0.0	0.0	0.0	0.0	0.0	0.0	0.0	0.0	0.0	0.0
171 FULL SIZE	0.0	0.0	0.0	0.0	0.0	0.0	0.0	0.0	0.0	0.0	0.0
181 DOMESTIC LUXURY	0.0	0.0	0.0	0.0	0.0	0.0	0.0	0.0	0.0	0.0	0.0
191 FOREIGN LUXURY	0.0	0.0	0.0	0.0	0.0	0.0	0.0	0.0	0.0	0.0	0.0
201											
211 PERCENT WITH AUTOMATIC TRANSMISSION											
221 DOMESTIC SUBCOMPACT	0.0	0.0	0.0	0.0	0.0	0.0	0.0	0.0	0.0	0.0	0.0
231 FOREIGN SUBCOMPACT	0.0	0.0	0.0	0.0	0.0	0.0	0.0	0.0	0.0	0.0	0.0
241 DOMESTIC COMPACT	0.0	0.0	0.0	0.0	0.0	0.0	0.0	0.0	0.0	0.0	0.0
251 FOREIGN COMPACT	0.0	0.0	0.0	0.0	0.0	0.0	0.0	0.0	0.0	0.0	0.0
261 MID-SIZE	0.0	0.0	0.0	0.0	0.0	0.0	0.0	0.0	0.0	0.0	0.0
271 FULL SIZE	0.0	0.0	0.0	0.0	0.0	0.0	0.0	0.0	0.0	0.0	0.0
281 DOMESTIC LUXURY	0.0	0.0	0.0	0.0	0.0	0.0	0.0	0.0	0.0	0.0	0.0
291 FOREIGN LUXURY	0.0	0.0	0.0	0.0	0.0	0.0	0.0	0.0	0.0	0.0	0.0
301											
311 PERCENT WITH 4 CYLINDERS											
321 DOMESTIC SUBCOMPACT	0.0	0.0	0.0	0.0	0.0	0.0	0.0	0.0	0.0	0.0	0.0
331 FOREIGN SUBCOMPACT	0.0	0.0	0.0	0.0	0.0	0.0	0.0	0.0	0.0	0.0	0.0
341 DOMESTIC COMPACT	0.0	0.0	0.0	0.0	0.0	0.0	0.0	0.0	0.0	0.0	0.0
351 FOREIGN COMPACT	0.0	0.0	0.0	0.0	0.0	0.0	0.0	0.0	0.0	0.0	0.0
361 MID-SIZE	0.0	0.0	0.0	0.0	0.0	0.0	0.0	0.0	0.0	0.0	0.0
371 FULL SIZE	0.0	0.0	0.0	0.0	0.0	0.0	0.0	0.0	0.0	0.0	0.0
381 DOMESTIC LUXURY	0.0	0.0	0.0	0.0	0.0	0.0	0.0	0.0	0.0	0.0	0.0
391 FOREIGN LUXURY	0.0	0.0	0.0	0.0	0.0	0.0	0.0	0.0	0.0	0.0	0.0
401											
411 PERCENT WITH 6 CYLINDERS											
421 DOMESTIC SUBCOMPACT	0.0	0.0	0.0	0.0	0.0	0.0	0.0	0.0	0.0	0.0	0.0
431 FOREIGN SUBCOMPACT	0.0	0.0	0.0	0.0	0.0	0.0	0.0	0.0	0.0	0.0	0.0
441 DOMESTIC COMPACT	0.0	0.0	0.0	0.0	0.0	0.0	0.0	0.0	0.0	0.0	0.0
451 FOREIGN COMPACT	0.0	0.0	0.0	0.0	0.0	0.0	0.0	0.0	0.0	0.0	0.0
461 MID-SIZE	0.0	0.0	0.0	0.0	0.0	0.0	0.0	0.0	0.0	0.0	0.0
471 FULL SIZE	0.0	0.0	0.0	0.0	0.0	0.0	0.0	0.0	0.0	0.0	0.0
481 DOMESTIC LUXURY	0.0	0.0	0.0	0.0	0.0	0.0	0.0	0.0	0.0	0.0	0.0
491 FOREIGN LUXURY	0.0	0.0	0.0	0.0	0.0	0.0	0.0	0.0	0.0	0.0	0.0

ORIGINAL PAGE IS
OF POOR QUALITY

THE WHARTON EFA MOTOR VEHICLE DEMAND MODEL
 TABLE 22.00 FUEL CONSUMPTION EFFICIENCY FACTORS

LINE	ITEM	1979	1980	1981	1982	1983	1984	1985	1986	1987	1988	1989
11	CITY EFFICIENCY FACTOR: ALL CLASSES	0.0	0.0	0.0	0.0	0.0	0.0	0.0	0.0	0.0	0.0	0.0
21	DOMESTIC SURCOMPACT	2.00	4.00	6.00	12.00	16.00	19.00	21.00	21.00	21.00	21.00	21.00
31	FOREIGN SURCOMPACT	1.00	2.00	4.00	6.00	8.00	10.00	10.00	10.00	10.00	10.00	10.00
41	DOMESTIC COMPACT	2.00	4.00	6.00	12.00	16.00	19.00	19.00	19.00	19.00	19.00	19.00
51	FOREIGN COMPACT	1.00	2.00	4.00	6.00	8.00	10.00	10.00	10.00	10.00	10.00	10.00
61	MID-SIZE	2.00	4.00	6.00	12.00	16.00	19.00	19.00	19.00	19.00	19.00	19.00
71	FULL SIZE	2.00	4.00	6.00	12.00	16.00	19.00	19.00	19.00	19.00	19.00	19.00
81	DOMESTIC LUXURY	2.00	4.00	6.00	12.00	16.00	19.00	19.00	19.00	19.00	19.00	19.00
91	FOREIGN LUXURY	1.00	2.00	4.00	6.00	8.00	10.00	10.00	10.00	10.00	10.00	10.00
101	ALL CLASSES	0.0	0.0	0.0	0.0	0.0	0.0	0.0	0.0	0.0	0.0	0.0
111	HIGHWAY EFFICIENCY FACTOR: ALL CLASSES	0.0	0.0	0.0	0.0	0.0	0.0	0.0	0.0	0.0	0.0	0.0
121	DOMESTIC SURCOMPACT	2.00	4.00	6.00	12.00	16.00	19.00	21.00	21.00	21.00	21.00	21.00
131	FOREIGN SURCOMPACT	1.00	2.00	4.00	6.00	8.00	10.00	10.00	10.00	10.00	10.00	10.00
141	DOMESTIC COMPACT	2.00	4.00	6.00	12.00	16.00	19.00	19.00	19.00	19.00	19.00	19.00
151	FOREIGN COMPACT	1.00	2.00	4.00	6.00	8.00	10.00	10.00	10.00	10.00	10.00	10.00
161	MID-SIZE	2.00	4.00	6.00	12.00	16.00	19.00	19.00	19.00	19.00	19.00	19.00
171	FULL SIZE	2.00	4.00	6.00	12.00	16.00	19.00	19.00	19.00	19.00	19.00	19.00
181	DOMESTIC LUXURY	2.00	4.00	6.00	12.00	16.00	19.00	19.00	19.00	19.00	19.00	19.00
191	FOREIGN LUXURY	1.00	2.00	4.00	6.00	8.00	10.00	10.00	10.00	10.00	10.00	10.00

A PRODUCT OF WHARTON EFA, INC.

ORIGINAL PAGE IS
 OF POOR QUALITY

THE WHARTON EFA MOTOR VEHICLE DEMAND MODEL
TABLE 22.00 FUEL CONSUMPTION EFFICIENCY FACTORS

LINE	ITEM	1990	1991	1992	1993	1994	1995	1996	1997	1998	1999	2000
21	CITY EFFICIENCY FACTOR: ALL CLASSES	0.0	0.0	0.0	0.0	0.0	0.0	0.0	0.0	0.0	0.0	0.0
31	DOMESTIC SUBCOMPACT	21.00	21.00	21.00	21.00	21.00	21.00	21.00	21.00	21.00	21.00	21.00
41	FOREIGN SUBCOMPACT	10.00	10.00	10.00	10.00	10.00	10.00	10.00	10.00	10.00	10.00	10.00
51	DOMESTIC COMPACT	19.00	19.00	19.00	19.00	19.00	19.00	19.00	19.00	19.00	19.00	19.00
61	FOREIGN COMPACT	10.00	10.00	10.00	10.00	10.00	10.00	10.00	10.00	10.00	10.00	10.00
71	MID-SIZE	19.00	19.00	19.00	19.00	19.00	19.00	19.00	19.00	19.00	19.00	19.00
81	FULL SIZE	19.00	19.00	19.00	19.00	19.00	19.00	19.00	19.00	19.00	19.00	19.00
91	DOMESTIC LUXURY	19.00	19.00	19.00	19.00	19.00	19.00	19.00	19.00	19.00	19.00	19.00
101	FOREIGN LUXURY	10.00	10.00	10.00	10.00	10.00	10.00	10.00	10.00	10.00	10.00	10.00
111	HIGHWAY EFFICIENCY FACTOR: ALL CLASSES	0.0	0.0	0.0	0.0	0.0	0.0	0.0	0.0	0.0	0.0	0.0
121	DOMESTIC SUBCOMPACT	21.00	21.00	21.00	21.00	21.00	21.00	21.00	21.00	21.00	21.00	21.00
131	FOREIGN SUBCOMPACT	10.00	10.00	10.00	10.00	10.00	10.00	10.00	10.00	10.00	10.00	10.00
141	DOMESTIC COMPACT	19.00	19.00	19.00	19.00	19.00	19.00	19.00	19.00	19.00	19.00	19.00
151	FOREIGN COMPACT	10.00	10.00	10.00	10.00	10.00	10.00	10.00	10.00	10.00	10.00	10.00
161	MID-SIZE	19.00	19.00	19.00	19.00	19.00	19.00	19.00	19.00	19.00	19.00	19.00
171	FULL SIZE	19.00	19.00	19.00	19.00	19.00	19.00	19.00	19.00	19.00	19.00	19.00
181	DOMESTIC LUXURY	19.00	19.00	19.00	19.00	19.00	19.00	19.00	19.00	19.00	19.00	19.00
191	FOREIGN LUXURY	10.00	10.00	10.00	10.00	10.00	10.00	10.00	10.00	10.00	10.00	10.00

A PRODUCT OF WHARTON EFA, INC.

THE WHARTON EPA MOTOR VEHICLE DEMAND MODEL
MARCH CONTROL FOR HYBRIDS

TABLE 23.00 MISCELLANEOUS ASSUMPTIONS

LINE	ITEM	1979	1980	1981	1982	1983	1984	1985	1986	1987	1988	1989
110	INDUSTRY CLASS BASE PRICE/AVG (RATIO)											
21	SURCOMPACT	0.729	0.728	0.727	0.726	0.725	0.724	0.723	0.722	0.721	0.720	0.719
31	COMPACT	0.833	0.833	0.833	0.833	0.833	0.833	0.833	0.833	0.833	0.833	0.833
41	MID-SIZE	0.929	0.929	0.929	0.929	0.929	0.929	0.929	0.929	0.929	0.929	0.929
51	FULL SIZE	1.019	1.019	1.019	1.019	1.019	1.019	1.019	1.019	1.019	1.019	1.019
61	LUXURY	1.621	1.621	1.621	1.621	1.621	1.621	1.621	1.621	1.621	1.621	1.621
71												
810M	CLASS MAX OPT PRICE/AVG (RATIO)											
91	SURCOMPACT	0.922	0.922	0.922	0.922	0.922	0.922	0.922	0.922	0.922	0.922	0.922
101	COMPACT	0.969	0.969	0.969	0.969	0.969	0.969	0.969	0.969	0.969	0.969	0.969
111	MID-SIZE	1.017	1.017	1.017	1.017	1.017	1.017	1.017	1.017	1.017	1.017	1.017
121	FULL SIZE	1.014	1.014	1.014	1.014	1.014	1.014	1.014	1.014	1.014	1.014	1.014
131	LUXURY	1.034	1.034	1.034	1.034	1.034	1.034	1.034	1.034	1.034	1.034	1.034
141												
15	CITY DRIVING, URBAN MILES / TOTAL	0.575	0.576	0.580	0.584	0.588	0.594	0.599	0.604	0.608	0.612	0.616
161												
171	EXPONENTIAL DECAY RATE, USED CAR PRICES											
181	SURCOMPACT	0.192	0.192	0.192	0.192	0.192	0.192	0.192	0.192	0.192	0.192	0.192
191	COMPACT	0.163	0.163	0.163	0.163	0.163	0.163	0.163	0.163	0.163	0.163	0.163
201	MID-SIZE	0.189	0.189	0.189	0.189	0.189	0.189	0.189	0.189	0.189	0.189	0.189
211	FULL SIZE	0.265	0.265	0.265	0.265	0.265	0.265	0.265	0.265	0.265	0.265	0.265
221	LUXURY	0.229	0.229	0.229	0.229	0.229	0.229	0.229	0.229	0.229	0.229	0.229

MARCH CONTROL FOR HYBRIDS

TABLE 23.10 GROWTH RATES, MISCELLANEOUS ASSUMPTIONS

LINE	ITEM	1979	1980	1981	1982	1983	1984	1985	1986	1987	1988	1989
110	INDUSTRY CLASS BASE PRICE/AVG (RATIO)											
21	SURCOMPACT	0.0	-0.1	-0.1	-0.1	-0.1	-0.1	-0.1	-0.1	-0.1	-0.1	-0.1
31	COMPACT	0.0	0.0	0.0	0.0	0.0	0.0	0.0	0.0	0.0	0.0	0.0
41	MID-SIZE	0.0	0.0	0.0	0.0	0.0	0.0	0.0	0.0	0.0	0.0	0.0
51	FULL SIZE	0.0	0.0	0.0	0.0	0.0	0.0	0.0	0.0	0.0	0.0	0.0
61	LUXURY	0.0	0.0	0.0	0.0	0.0	0.0	0.0	0.0	0.0	0.0	0.0
71												
810M	CLASS MAX OPT PRICE/AVG (RATIO)											
91	SURCOMPACT	0.0	0.0	0.0	0.0	0.0	0.0	0.0	0.0	0.0	0.0	0.0
101	COMPACT	0.0	0.0	0.0	0.0	0.0	0.0	0.0	0.0	0.0	0.0	0.0
111	MID-SIZE	0.0	0.0	0.0	0.0	0.0	0.0	0.0	0.0	0.0	0.0	0.0
121	FULL-SIZE	0.0	0.0	0.0	0.0	0.0	0.0	0.0	0.0	0.0	0.0	0.0
131	LUXURY	0.0	0.0	0.0	0.0	0.0	0.0	0.0	0.0	0.0	0.0	0.0
141												
15	CITY DRIVING, URBAN MILES / TOTAL	-0.2	0.5	0.4	0.5	0.7	1.0	0.9	0.8	0.7	0.7	0.6
161												
171	EXPONENTIAL DECAY RATE, USED CAR PRICES											
181	SURCOMPACT	0.0	0.0	0.0	0.0	0.0	0.0	0.0	0.0	0.0	0.0	0.0
191	COMPACT	0.0	0.0	0.0	0.0	0.0	0.0	0.0	0.0	0.0	0.0	0.0
201	MID-SIZE	0.0	0.0	0.0	0.0	0.0	0.0	0.0	0.0	0.0	0.0	0.0
211	FULL SIZE	0.0	0.0	0.0	0.0	0.0	0.0	0.0	0.0	0.0	0.0	0.0

ORIGINAL PAGE IS
OF POOR QUALITY

TABLE 23.00 MISCELLANEOUS ASSUMPTIONS

LINE	ITEM	1990	1991	1992	1993	1994	1995	1996	1997	1998	1999	2000
110	DOMESTIC CLASS RATE PRICE/AVG (RATIO)											
21	SURCOMPACT	0.710	0.717	0.716	0.715	0.714	0.713	0.712	0.711	0.710	0.709	0.708
31	COMPACT	0.833	0.833	0.833	0.833	0.833	0.833	0.833	0.833	0.833	0.833	0.833
41	MID-SIZE	0.929	0.929	0.929	0.929	0.929	0.929	0.929	0.929	0.929	0.929	0.929
51	FULL SIZE	1.019	1.019	1.019	1.019	1.019	1.019	1.019	1.019	1.019	1.019	1.019
61	LUXURY	1.621	1.621	1.621	1.621	1.621	1.621	1.621	1.621	1.621	1.621	1.621
71												
810M	CLASS MAX (OPT PRICE/AVG (RATIO))											
91	SURCOMPACT	0.922	0.922	0.922	0.922	0.922	0.922	0.922	0.922	0.922	0.922	0.922
101	COMPACT	0.969	0.969	0.969	0.969	0.969	0.969	0.969	0.969	0.969	0.969	0.969
111	MID-SIZE	1.017	1.017	1.017	1.017	1.017	1.017	1.017	1.017	1.017	1.017	1.017
121	FULL SIZE	1.014	1.014	1.014	1.014	1.014	1.014	1.014	1.014	1.014	1.014	1.014
131	LUXURY	1.034	1.034	1.034	1.034	1.034	1.034	1.034	1.034	1.034	1.034	1.034
141												
151	CITY DRIVING, URBAN MILES / TOTAL	0.619	0.623	0.627	0.632	0.636	0.641	0.646	0.650	0.655	0.661	0.666
161												
171	EXPONENTIAL DECAY RATE, USED CAR PRICES											
181	SURCOMPACT	0.192	0.192	0.192	0.192	0.192	0.192	0.192	0.192	0.192	0.192	0.192
191	COMPACT	0.163	0.163	0.163	0.163	0.163	0.163	0.163	0.163	0.163	0.163	0.163
201	MID-SIZE	0.189	0.189	0.189	0.189	0.189	0.189	0.189	0.189	0.189	0.189	0.189
211	FULL SIZE	0.265	0.265	0.265	0.265	0.265	0.265	0.265	0.265	0.265	0.265	0.265
221	LUXURY	0.229	0.229	0.229	0.229	0.229	0.229	0.229	0.229	0.229	0.229	0.229

MARCH CONTROL FOR HYBRIDS

TABLE 23.10 GROWTH RATES, MISCELLANEOUS ASSUMPTIONS

LINE	ITEM	1990	1991	1992	1993	1994	1995	1996	1997	1998	1999	2000
110	DOMESTIC CLASS RATE PRICE/AVG (RATIO)											
21	SURCOMPACT	-0.1	-0.1	-0.1	-0.1	-0.1	-0.1	-0.1	-0.1	-0.1	-0.1	-0.1
31	COMPACT	0.0	0.0	0.0	0.0	0.0	0.0	0.0	0.0	0.0	0.0	0.0
41	MID-SIZE	0.0	0.0	0.0	0.0	0.0	0.0	0.0	0.0	0.0	0.0	0.0
51	FULL SIZE	0.0	0.0	0.0	0.0	0.0	0.0	0.0	0.0	0.0	0.0	0.0
61	LUXURY	0.0	0.0	0.0	0.0	0.0	0.0	0.0	0.0	0.0	0.0	0.0
71												
810M	CLASS MAX (OPT PRICE/AVG (RATIO))											
91	SURCOMPACT	0.0	0.0	0.0	0.0	0.0	0.0	0.0	0.0	0.0	0.0	0.0
101	COMPACT	0.0	0.0	0.0	0.0	0.0	0.0	0.0	0.0	0.0	0.0	0.0
111	MID-SIZE	0.0	0.0	0.0	0.0	0.0	0.0	0.0	0.0	0.0	0.0	0.0
121	FULL-SIZE	0.0	0.0	0.0	0.0	0.0	0.0	0.0	0.0	0.0	0.0	0.0
131	LUXURY	0.0	0.0	0.0	0.0	0.0	0.0	0.0	0.0	0.0	0.0	0.0
141												
151	CITY DRIVING, URBAN MILES / TOTAL	0.6	0.6	0.7	0.7	0.7	0.7	0.7	0.7	0.7	0.7	0.7
161												
171	EXPONENTIAL DECAY RATE, USED CAR PRICES											
181	SURCOMPACT	0.0	0.0	0.0	0.0	0.0	0.0	0.0	0.0	0.0	0.0	0.0
191	COMPACT	0.0	0.0	0.0	0.0	0.0	0.0	0.0	0.0	0.0	0.0	0.0
201	MID-SIZE	0.0	0.0	0.0	0.0	0.0	0.0	0.0	0.0	0.0	0.0	0.0
211	FULL SIZE	0.0	0.0	0.0	0.0	0.0	0.0	0.0	0.0	0.0	0.0	0.0
221	LUXURY	0.0	0.0	0.0	0.0	0.0	0.0	0.0	0.0	0.0	0.0	0.0

ORIGINAL PAGE IS
OF POOR QUALITY

THE WHARTON EPA INT. VEHICLE DEMAND MODEL
MARCH CONTROL FOR HYBRIDS

TABLE 20.00 CONSTANT ADJUSTMENTS

LINE	VAR LABEL	1979	1980	1981	1982	1983	1984	1985	1986	1987	1988	1989
1	AVAGF0-20	0.0	0.0	0.0	0.0	0.0	0.0	0.0	0.0	0.0	0.0	0.0
2	EPACF0HGH	0.0	0.0	0.0	0.0	0.0	0.0	0.0	0.0	0.0	0.0	0.0
3	EPACF0HGH	0.0	0.0	0.0	0.0	0.0	0.0	0.0	0.0	0.0	0.0	0.0
4	EPACF0HGH	-0.90	-0.90	-0.90	-0.90	-0.90	-0.90	-0.90	-0.90	-0.90	-0.90	-0.90
5	EPACF0HGH	-1.40	-1.40	-1.40	-1.40	-1.40	-1.40	-1.40	-1.40	-1.40	-1.40	-1.40
6	EPACF0HGH	0.01	0.01	0.01	0.01	0.01	0.01	0.01	0.01	0.01	0.01	0.01
7	EPACF0HGH	0.02	0.02	0.02	0.02	0.02	0.02	0.02	0.02	0.02	0.02	0.02
8	EPACF0HGH	0.0	0.0	0.0	0.0	0.0	0.0	0.0	0.0	0.0	0.0	0.0
9	EPACF0HGH	0.0	0.0	0.0	0.0	0.0	0.0	0.0	0.0	0.0	0.0	0.0
10	EPACF0HGH	-0.75	-0.75	-0.75	-0.75	-0.75	-0.75	-0.75	-0.75	-0.75	-0.75	-0.75
11	EPACF0HGH	-1.00	-1.00	-1.00	-1.00	-1.00	-1.00	-1.00	-1.00	-1.00	-1.00	-1.00
12	EPACF0HGH	0.0	0.0	0.0	0.0	0.0	0.0	0.0	0.0	0.0	0.0	0.0
13	EPACF0HGH	0.0	0.0	0.0	0.0	0.0	0.0	0.0	0.0	0.0	0.0	0.0
14	EPACF0HGH	0.0	0.0	0.0	0.0	0.0	0.0	0.0	0.0	0.0	0.0	0.0
15	EPACF0HGH	0.0	0.0	0.0	0.0	0.0	0.0	0.0	0.0	0.0	0.0	0.0
16	EPACF0HGH	-1.00	-1.00	-1.00	-1.00	-1.00	-1.00	-1.00	-1.00	-1.00	-1.00	-1.00
17	EPACF0HGH	-1.60	-1.60	-1.60	-1.60	-1.60	-1.60	-1.60	-1.60	-1.60	-1.60	-1.60
18	EPACF0HGH	0.20	0.20	0.20	0.20	0.20	0.20	0.20	0.20	0.20	0.20	0.20
19	GASVIAHGH	0.0	0.0	0.0	0.0	0.0	0.0	0.0	0.0	0.0	0.0	0.0
20	KFID0AV/LD	-0.006	-0.006	-0.006	-0.006	-0.006	-0.006	-0.006	-0.006	-0.006	-0.006	-0.006
21	UMVIAHGH	-1.060	-1.060	-1.060	-1.060	-1.060	-1.060	-1.060	-1.060	-1.060	-1.060	-1.060
22	UPVIAHGH+LFYEND	0.0	0.0	0.0	0.0	0.0	0.0	0.0	0.0	0.0	0.0	0.0
23	PCM112-1701	0.0	0.0	0.0	0.0	0.0	0.0	0.0	0.0	0.0	0.0	0.0
24	PCM121-1001	0.0	0.0	0.0	0.0	0.0	0.0	0.0	0.0	0.0	0.0	0.0
25	PCM122-1001	0.0	0.0	0.0	0.0	0.0	0.0	0.0	0.0	0.0	0.0	0.0
26	PCM122-17A3	0.0	0.0	0.0	0.0	0.0	0.0	0.0	0.0	0.0	0.0	0.0
27	POLFNADV	6.030	9.260	10.670	10.710	10.900	10.270	11.360	12.700	14.500	16.000	17.500
28	PERISA	0.0	0.0	0.0	0.0	0.0	0.0	0.0	0.0	0.0	0.0	0.0
29	PIMPITA	0.0	0.0	0.0	0.0	0.0	0.0	0.0	0.0	0.0	0.0	0.0
30	PIMPACT	0.0	0.0	0.0	0.0	0.0	0.0	0.0	0.0	0.0	0.0	0.0
31	PIMPACT	0.0	0.0	0.0	0.0	0.0	0.0	0.0	0.0	0.0	0.0	0.0
32	PIMPACT	0.0	0.0	0.0	0.0	0.0	0.0	0.0	0.0	0.0	0.0	0.0
33	PIMPACT	0.0	0.0	0.0	0.0	0.0	0.0	0.0	0.0	0.0	0.0	0.0
34	PIMPACT	0.0	0.0	0.0	0.0	0.0	0.0	0.0	0.0	0.0	0.0	0.0
35	PIMPACT	0.090	0.090	0.090	0.090	0.090	0.090	0.090	0.090	0.090	0.090	0.090
36	PIMPACT	0.0	0.0	0.0	0.0	0.0	0.0	0.0	0.0	0.0	0.0	0.0
37	PIMPACT	0.0	0.0	0.0	0.0	0.0	0.0	0.0	0.0	0.0	0.0	0.0
38	SANDRAV	0.0	0.0	0.0	0.0	0.0	0.0	0.0	0.0	0.0	0.0	0.0
39	SANDRAV-V	0.070	0.070	0.070	0.070	0.070	0.070	0.070	0.070	0.070	0.070	0.070
40	SANDRAV-V	0.0	0.0	0.0	0.0	0.0	0.0	0.0	0.0	0.0	0.0	0.0
41	SCVIA	1.420	1.420	1.420	1.420	1.420	1.420	1.420	1.420	1.420	1.420	1.420
42	SCVIA+LF	0.0	0.0	0.0	0.0	0.0	0.0	0.0	0.0	0.0	0.0	0.0
43	SCVIAHGH	0.0	0.0	0.0	0.0	0.0	0.0	0.0	0.0	0.0	0.0	0.0
44	SCVIAHGH	0.0	0.0	0.0	0.0	0.0	0.0	0.0	0.0	0.0	0.0	0.0
45	SCVIAHGH	0.0	0.0	0.0	0.0	0.0	0.0	0.0	0.0	0.0	0.0	0.0
46	SCVIAHGH	0.0	0.0	0.0	0.0	0.0	0.0	0.0	0.0	0.0	0.0	0.0
47	SCVIAHGH	0.0	0.0	0.0	0.0	0.0	0.0	0.0	0.0	0.0	0.0	0.0
48	SCVIAHGH	0.0	0.0	0.0	0.0	0.0	0.0	0.0	0.0	0.0	0.0	0.0
49	SCVIAHGH	0.0	0.0	0.0	0.0	0.0	0.0	0.0	0.0	0.0	0.0	0.0
50	SCVIAHGH	0.0	0.0	0.0	0.0	0.0	0.0	0.0	0.0	0.0	0.0	0.0

ORIGINAL PAGE IS
OF POOR QUALITY

THE WHARTON EFA 100 VEHICLE DEMAND MODEL
MARCH CONTROL FOR MYRRIDS

TABLE 24.00 CONSTANT ADJUSTMENTS

LINE	VAR LABEL	1979	1980	1981	1982	1983	1984	1985	1986	1987	1988	1989
1	SCVIAASQ	0.0	0.0	0.0	0.0	0.0	0.0	0.0	0.0	0.0	0.0	0.0
2	SCVIAASF	0.0	0.0	0.0	0.0	0.0	0.0	0.0	0.0	0.0	0.0	0.0
3	SCVIAAST	0.0	0.0	0.0	0.0	0.0	0.0	0.0	0.0	0.0	0.0	0.0
4	SCVIAIATD	0.0	0.0	0.0	0.0	0.0	0.0	0.0	0.0	0.0	0.0	0.0
5	SCVIAIATE	0.0	0.0	0.0	0.0	0.0	0.0	0.0	0.0	0.0	0.0	0.0
6	SURCALFTNR	0.002	0.002	0.002	0.002	0.002	0.002	0.002	0.002	0.002	0.002	0.002
7	SURCALFA	0.020	0.020	0.020	0.020	0.020	0.020	0.020	0.020	0.020	0.020	0.020
8	SURCALFTR	0.0037	0.0037	0.0037	0.0037	0.0037	0.0037	0.0037	0.0037	0.0037	0.0037	0.0037
9	SURCEFA	-0.000	-0.001	-0.001	-0.002	-0.003	-0.003	-0.004	-0.004	-0.005	-0.005	-0.005
10	SURCEFAA	-0.050	-0.050	-0.050	-0.050	-0.050	-0.050	-0.050	-0.050	-0.050	-0.050	-0.050
11	SURCEFAH	-0.0260	-0.0260	-0.0260	-0.0260	-0.0260	-0.0260	-0.0260	-0.0260	-0.0260	-0.0260	-0.0260
12	SURCALFAA	0.0	0.0	0.0	0.0	0.0	0.0	0.0	0.0	0.0	0.0	0.0
13	SURCALFAH	-0.001	-0.001	-0.001	-0.001	-0.001	-0.001	-0.001	-0.001	-0.001	-0.001	-0.001
14	SURCALFAA	0.006	0.006	0.006	0.006	0.006	0.006	0.006	0.006	0.006	0.006	0.006
15	SURCALFAA	0.050	0.050	0.050	0.050	0.050	0.050	0.050	0.050	0.050	0.050	0.050
16	SURCALFTR	0.0006	0.0006	0.0006	0.0006	0.0006	0.0006	0.0006	0.0006	0.0006	0.0006	0.0006
17	SURCALFAA	0.016	0.017	0.017	0.018	0.019	0.019	0.019	0.019	0.019	0.019	0.019
18	SURCALFTR	0.0071	0.0071	0.0071	0.0071	0.0071	0.0071	0.0071	0.0071	0.0071	0.0071	0.0071
19	SURCALFAA	-0.008	-0.008	-0.008	-0.009	-0.010	-0.010	-0.010	-0.010	-0.010	-0.010	-0.010
20	SURCALFTR	0.0253	0.0253	0.0253	0.0253	0.0253	0.0253	0.0253	0.0253	0.0253	0.0253	0.0253
21	USCALMPC	0.0	0.0	0.0	0.0	0.0	0.0	0.0	0.0	0.0	0.0	0.0
22	USCALMPC	0.0	0.0	0.0	0.0	0.0	0.0	0.0	0.0	0.0	0.0	0.0
23	USCALMPC	0.0	0.0	0.0	0.0	0.0	0.0	0.0	0.0	0.0	0.0	0.0
24	USCALMPC	0.0	0.0	0.0	0.0	0.0	0.0	0.0	0.0	0.0	0.0	0.0
25	USCALMPC	13.	-12.	-37.	-67.	-97.	-127.	-127.	-127.	-127.	-127.	-127.
26	USCALMPC	57.	51.	45.	39.	33.	27.	21.	15.	9.	9.	9.
27	USCALMPC	-7.	-7.	-7.	-7.	-7.	-7.	-7.	-7.	-7.	-7.	-7.
28	USCALMPC	0.0	0.0	0.0	0.0	0.0	0.0	0.0	0.0	0.0	0.0	0.0
29	USCALMPC	686.	686.	686.	686.	686.	686.	686.	686.	686.	686.	686.
30	USCALMPC	0.0	0.0	0.0	0.0	0.0	0.0	0.0	0.0	0.0	0.0	0.0
31	USCALMPC	0.0	0.0	0.0	0.0	0.0	0.0	0.0	0.0	0.0	0.0	0.0
32	USCALMPC	0.0	0.0	0.0	0.0	0.0	0.0	0.0	0.0	0.0	0.0	0.0
33	USCALMPC	0.0	0.0	0.0	0.0	0.0	0.0	0.0	0.0	0.0	0.0	0.0
34	USCALMPC	14.	69.	100.	100.	100.	224.	220.	224.	224.	224.	224.
35	USCALMPC	15.	15.	15.	15.	15.	15.	15.	15.	15.	15.	15.
36	USCALMPC	10.	10.	10.	10.	10.	10.	10.	10.	10.	10.	10.
37	USCALMPC	0.0	0.0	0.0	0.0	0.0	0.0	0.0	0.0	0.0	0.0	0.0
38	USCALMPC	0.0	0.0	0.0	0.0	0.0	0.0	0.0	0.0	0.0	0.0	0.0
39	USCALMPC	0.0	0.0	0.0	0.0	0.0	0.0	0.0	0.0	0.0	0.0	0.0
40	USCALMPC	205.	335.	300.	005.	500.	555.	555.	555.	555.	555.	555.
41	USCALMPC	13.	13.	13.	13.	13.	13.	13.	13.	13.	13.	13.
42	USCALMPC	17.	17.	17.	17.	17.	17.	17.	17.	17.	17.	17.
43	USCALMPC	0.0	0.0	0.0	0.0	0.0	0.0	0.0	0.0	0.0	0.0	0.0
44	USCALMPC	0.0	0.0	0.0	0.0	0.0	0.0	0.0	0.0	0.0	0.0	0.0
45	USCALMPC	0.0	0.0	0.0	0.0	0.0	0.0	0.0	0.0	0.0	0.0	0.0
46	USCALMPC	0.0	0.0	0.0	0.0	0.0	0.0	0.0	0.0	0.0	0.0	0.0
47	USCALMPC	0.0	0.0	0.0	0.0	0.0	0.0	0.0	0.0	0.0	0.0	0.0
48	USCALMPC	0.0	0.0	0.0	0.0	0.0	0.0	0.0	0.0	0.0	0.0	0.0
49	USCALMPC	0.0	0.0	0.0	0.0	0.0	0.0	0.0	0.0	0.0	0.0	0.0
50	USCALMPC	230.	230.	230.	230.	230.	230.	230.	230.	230.	230.	230.

ORIGINAL PAGE IS
OF POOR QUALITY

THE WHARTON EFA MODEL VEHICLE DEMAND MODEL
MARCH CONTROL FOR HYBRIDS

TABLE 26.00 CONSTANT ADJUSTMENTS

VAR LABEL	1970	1971	1972	1983	1984	1985	1986	1987	1988	1989
1 USSDPHPT-2	-35.	-35.	-35.	-35.	-35.	-35.	-35.	-35.	-35.	-35.
2 USSDPHPT-1	-3.	-3.	-3.	-3.	-3.	-3.	-3.	-3.	-3.	-3.
3 USSDPHPT	0.0	0.0	0.0	0.0	0.0	0.0	0.0	0.0	0.0	0.0
4 USSDPHPT-1	0.0	0.0	0.0	0.0	0.0	0.0	0.0	0.0	0.0	0.0
5 USSDPHPT-2	0.0	0.0	0.0	0.0	0.0	0.0	0.0	0.0	0.0	0.0
6 USSDPHPT-3	-45.	-100.	-130.	-160.	-190.	-190.	-190.	-190.	-190.	-190.
7 USSDPHPT-4	10.	6.	2.	-2.	-6.	-10.	-10.	-10.	-10.	-10.
8 USSDPHPT-5	0.0	0.0	0.0	0.0	0.0	0.0	0.0	0.0	0.0	0.0
9 USSDPHPT-6	0.0	0.0	0.0	0.0	0.0	0.0	0.0	0.0	0.0	0.0
10 USSDPHPT-7	242.	242.	242.	242.	242.	242.	242.	242.	242.	242.
11 USSDPHPT-8	0.0	0.0	0.0	0.0	0.0	0.0	0.0	0.0	0.0	0.0
12 USSDPHPT-9	103.	173.	208.	243.	278.	313.	348.	383.	418.	453.
13 USSDPHPT-10	103.	103.	103.	103.	103.	103.	103.	103.	103.	103.
14 VMT/EK	0.0	0.0	0.0	0.0	0.0	0.0	0.0	0.0	0.0	0.0
15 VMT/K	0.0	0.0	0.0	0.0	0.0	0.0	0.0	0.0	0.0	0.0
16 VMT/VK-1	0.0	0.0	0.0	0.0	0.0	0.0	0.0	0.0	0.0	0.0
17 VMT/VK-2	0.070	0.070	0.060	0.050	0.040	0.030	0.020	0.020	0.020	0.020
18 VMT/VK-3	0.090	0.070	0.040	0.0	0.0	0.0	0.0	0.0	0.0	0.0
19 VMT/VK-4	0.090	0.070	0.040	0.0	0.0	0.0	0.0	0.0	0.0	0.0

A PRODUCT OF WHARTON EFA, INC.

THE WHARTON FFA MOTOR VEHICLE DEMAND MODEL
MARCH CONTROL FOR HYBRIDS

TABLE 20.00 CONSTANT ADJUSTMENTS

LINE	VAR LABEL	1990	1991	1992	1993	1994	1995	1996	1997	1998	1999	2000
1	AVAGE0-20	0.0	0.0	0.0	0.0	0.0	0.0	0.0	0.0	0.0	0.0	0.0
2	EPAPN0G0	0.0	0.0	0.0	0.0	0.0	0.0	0.0	0.0	0.0	0.0	0.0
3	EPAPN0G1	0.0	0.0	0.0	0.0	0.0	0.0	0.0	0.0	0.0	0.0	0.0
4	EPAPN0G2	-0.90	-0.90	-0.90	-0.90	-0.90	-0.90	-0.90	-0.90	-0.90	-0.90	-0.90
5	EPAPN0G3	-1.40	-1.40	-1.40	-1.40	-1.40	-1.40	-1.40	-1.40	-1.40	-1.40	-1.40
6	EPAPN0G4	0.01	0.01	0.01	0.01	0.01	0.01	0.01	0.01	0.01	0.01	0.01
7	EPAPN0G5	0.02	0.02	0.02	0.02	0.02	0.02	0.02	0.02	0.02	0.02	0.02
8	EPAPN0G6	0.0	0.0	0.0	0.0	0.0	0.0	0.0	0.0	0.0	0.0	0.0
9	EPAPN0G7	0.0	0.0	0.0	0.0	0.0	0.0	0.0	0.0	0.0	0.0	0.0
10	EPAPN0G8	-0.75	-0.75	-0.75	-0.75	-0.75	-0.75	-0.75	-0.75	-0.75	-0.75	-0.75
11	EPAPN0G9	-1.00	-1.00	-1.00	-1.00	-1.00	-1.00	-1.00	-1.00	-1.00	-1.00	-1.00
12	EPAPN0G0	0.0	0.0	0.0	0.0	0.0	0.0	0.0	0.0	0.0	0.0	0.0
13	EPAPN0G1	0.0	0.0	0.0	0.0	0.0	0.0	0.0	0.0	0.0	0.0	0.0
14	EPAPN0G2	0.0	0.0	0.0	0.0	0.0	0.0	0.0	0.0	0.0	0.0	0.0
15	EPAPN0G3	0.0	0.0	0.0	0.0	0.0	0.0	0.0	0.0	0.0	0.0	0.0
16	EPAPN0G4	-1.00	-1.00	-1.00	-1.00	-1.00	-1.00	-1.00	-1.00	-1.00	-1.00	-1.00
17	EPAPN0G5	-1.60	-1.60	-1.60	-1.60	-1.60	-1.60	-1.60	-1.60	-1.60	-1.60	-1.60
18	EPAPN0G6	0.20	0.20	0.20	0.20	0.20	0.20	0.20	0.20	0.20	0.20	0.20
19	GAS010ADJ	0.0	0.0	0.0	0.0	0.0	0.0	0.0	0.0	0.0	0.0	0.0
20	KF010ADJ	-0.006	-0.006	-0.006	-0.006	-0.006	-0.006	-0.006	-0.006	-0.006	-0.006	-0.006
21	IM010ADJ	-1.060	-1.060	-1.060	-1.060	-1.060	-1.060	-1.060	-1.060	-1.060	-1.060	-1.060
22	UP010ADJ	0.0	0.0	0.0	0.0	0.0	0.0	0.0	0.0	0.0	0.0	0.0
23	PC0112-1701	0.0	0.0	0.0	0.0	0.0	0.0	0.0	0.0	0.0	0.0	0.0
24	PC0121-1001	0.0	0.0	0.0	0.0	0.0	0.0	0.0	0.0	0.0	0.0	0.0
25	PC0122-1001	0.0	0.0	0.0	0.0	0.0	0.0	0.0	0.0	0.0	0.0	0.0
26	PC0122-1703	0.0	0.0	0.0	0.0	0.0	0.0	0.0	0.0	0.0	0.0	0.0
27	PC0122-1703	12.000	20.500	22.000	23.500	25.500	27.500	28.500	30.500	32.500	34.500	36.500
28	PC0122-1703	0.0	0.0	0.0	0.0	0.0	0.0	0.0	0.0	0.0	0.0	0.0
29	PC0122-1703	0.0	0.0	0.0	0.0	0.0	0.0	0.0	0.0	0.0	0.0	0.0
30	PC0122-1703	0.0	0.0	0.0	0.0	0.0	0.0	0.0	0.0	0.0	0.0	0.0
31	PC0122-1703	0.0	0.0	0.0	0.0	0.0	0.0	0.0	0.0	0.0	0.0	0.0
32	PC0122-1703	0.0	0.0	0.0	0.0	0.0	0.0	0.0	0.0	0.0	0.0	0.0
33	PC0122-1703	0.0	0.0	0.0	0.0	0.0	0.0	0.0	0.0	0.0	0.0	0.0
34	PC0122-1703	0.0	0.0	0.0	0.0	0.0	0.0	0.0	0.0	0.0	0.0	0.0
35	PC0122-1703	0.004	0.004	0.004	0.004	0.004	0.004	0.004	0.004	0.004	0.004	0.004
36	PC0122-1703	0.0	0.0	0.0	0.0	0.0	0.0	0.0	0.0	0.0	0.0	0.0
37	PC0122-1703	90.000	90.000	90.000	90.000	90.000	90.000	90.000	90.000	90.000	90.000	90.000
38	PC0122-1703	0.0	0.0	0.0	0.0	0.0	0.0	0.0	0.0	0.0	0.0	0.0
39	PC0122-1703	0.070	0.070	0.070	0.070	0.070	0.070	0.070	0.070	0.070	0.070	0.070
40	PC0122-1703	0.0	0.0	0.0	0.0	0.0	0.0	0.0	0.0	0.0	0.0	0.0
41	PC0122-1703	1.420	1.420	1.420	1.420	1.420	1.420	1.420	1.420	1.420	1.420	1.420
42	PC0122-1703	0.0	0.0	0.0	0.0	0.0	0.0	0.0	0.0	0.0	0.0	0.0
43	PC0122-1703	0.0	0.0	0.0	0.0	0.0	0.0	0.0	0.0	0.0	0.0	0.0
44	PC0122-1703	0.0	0.0	0.0	0.0	0.0	0.0	0.0	0.0	0.0	0.0	0.0
45	PC0122-1703	0.0	0.0	0.0	0.0	0.0	0.0	0.0	0.0	0.0	0.0	0.0
46	PC0122-1703	0.0	0.0	0.0	0.0	0.0	0.0	0.0	0.0	0.0	0.0	0.0
47	PC0122-1703	0.0	0.0	0.0	0.0	0.0	0.0	0.0	0.0	0.0	0.0	0.0
48	PC0122-1703	0.0	0.0	0.0	0.0	0.0	0.0	0.0	0.0	0.0	0.0	0.0
49	PC0122-1703	0.0	0.0	0.0	0.0	0.0	0.0	0.0	0.0	0.0	0.0	0.0
50	PC0122-1703	0.0	0.0	0.0	0.0	0.0	0.0	0.0	0.0	0.0	0.0	0.0

THE WHARTON EFA MODEL VEHICLE DEMAND MODEL
MARCH CONTROL FOR HYBRIDS

TABLE 24.00 CONSTANT ADJUSTMENTS

LINE	VAR LABEL	1990	1991	1992	1993	1994	1995	1996	1997	1998	1999	2000
1	SCNVAASD	0.0	0.0	0.0	0.0	0.0	0.0	0.0	0.0	0.0	0.0	0.0
2	SCNVAASF	0.0	0.0	0.0	0.0	0.0	0.0	0.0	0.0	0.0	0.0	0.0
3	SCNVAASL	0.0	0.0	0.0	0.0	0.0	0.0	0.0	0.0	0.0	0.0	0.0
4	SCNVAATD	0.0	0.0	0.0	0.0	0.0	0.0	0.0	0.0	0.0	0.0	0.0
5	SCNVAATF	0.0	0.0	0.0	0.0	0.0	0.0	0.0	0.0	0.0	0.0	0.0
6	SCNVAATM	0.002	0.002	0.002	0.002	0.002	0.002	0.002	0.002	0.002	0.002	0.002
7	SCNVAASA	0.020	0.020	0.020	0.020	0.020	0.020	0.020	0.020	0.020	0.020	0.020
8	SCNVAATP	0.0037	0.0037	0.0037	0.0037	0.0037	0.0037	0.0037	0.0037	0.0037	0.0037	0.0037
9	SCNVAASA	-0.005	-0.005	-0.005	-0.005	-0.005	-0.005	-0.005	-0.005	-0.005	-0.005	-0.005
10	SCNVAASA	-0.050	-0.050	-0.050	-0.050	-0.050	-0.050	-0.050	-0.050	-0.050	-0.050	-0.050
11	SCNVAATN	-0.0260	-0.0260	-0.0260	-0.0260	-0.0260	-0.0260	-0.0260	-0.0260	-0.0260	-0.0260	-0.0260
12	SCNVAASA	0.0	0.0	0.0	0.0	0.0	0.0	0.0	0.0	0.0	0.0	0.0
13	SCNVAATN	-0.001	-0.001	-0.001	-0.001	-0.001	-0.001	-0.001	-0.001	-0.001	-0.001	-0.001
14	SCNVAASA	0.006	0.006	0.006	0.006	0.006	0.006	0.006	0.006	0.006	0.006	0.006
15	SCNVAASA	0.050	0.050	0.050	0.050	0.050	0.050	0.050	0.050	0.050	0.050	0.050
16	SCNVAATN	0.006	0.006	0.006	0.006	0.006	0.006	0.006	0.006	0.006	0.006	0.006
17	SCNVAASA	0.019	0.019	0.019	0.019	0.019	0.019	0.019	0.019	0.019	0.019	0.019
18	SCNVAATN	0.0071	0.0071	0.0071	0.0071	0.0071	0.0071	0.0071	0.0071	0.0071	0.0071	0.0071
19	SCNVAASA	-0.015	-0.015	-0.015	-0.015	-0.015	-0.015	-0.015	-0.015	-0.015	-0.015	-0.015
20	SCNVAATN	0.0253	0.0253	0.0253	0.0253	0.0253	0.0253	0.0253	0.0253	0.0253	0.0253	0.0253
21	USCNPVGC	0.0	0.0	0.0	0.0	0.0	0.0	0.0	0.0	0.0	0.0	0.0
22	USCNPVGC	0.0	0.0	0.0	0.0	0.0	0.0	0.0	0.0	0.0	0.0	0.0
23	USCNPVGC	0.0	0.0	0.0	0.0	0.0	0.0	0.0	0.0	0.0	0.0	0.0
24	USCNPVGC-2	-127.	-127.	-127.	-127.	-127.	-127.	-127.	-127.	-127.	-127.	-127.
25	USCNPVGC-2	9.	9.	9.	9.	9.	9.	9.	9.	9.	9.	9.
26	USCNPVGC	-7.	-7.	-7.	-7.	-7.	-7.	-7.	-7.	-7.	-7.	-7.
27	USCNPVGC	0.0	0.0	0.0	0.0	0.0	0.0	0.0	0.0	0.0	0.0	0.0
28	USCNPVGC	0.0	0.0	0.0	0.0	0.0	0.0	0.0	0.0	0.0	0.0	0.0
29	USCNPVGC-2	686.	686.	686.	686.	686.	686.	686.	686.	686.	686.	686.
30	USCNPVGC	0.0	0.0	0.0	0.0	0.0	0.0	0.0	0.0	0.0	0.0	0.0
31	USCNPVGC	0.0	0.0	0.0	0.0	0.0	0.0	0.0	0.0	0.0	0.0	0.0
32	USCNPVGC	0.0	0.0	0.0	0.0	0.0	0.0	0.0	0.0	0.0	0.0	0.0
33	USCNPVGC	0.0	0.0	0.0	0.0	0.0	0.0	0.0	0.0	0.0	0.0	0.0
34	USCNPVGC-2	224.	224.	224.	224.	224.	224.	224.	224.	224.	224.	224.
35	USCNPVGC-2	15.	15.	15.	15.	15.	15.	15.	15.	15.	15.	15.
36	USCNPVGC	14.	14.	14.	14.	14.	14.	14.	14.	14.	14.	14.
37	USCNPVGC	0.0	0.0	0.0	0.0	0.0	0.0	0.0	0.0	0.0	0.0	0.0
38	USCNPVGC	0.0	0.0	0.0	0.0	0.0	0.0	0.0	0.0	0.0	0.0	0.0
39	USCNPVGC	0.0	0.0	0.0	0.0	0.0	0.0	0.0	0.0	0.0	0.0	0.0
40	USCNPVGC-2	555.	555.	555.	555.	555.	555.	555.	555.	555.	555.	555.
41	USCNPVGC-2	13.	13.	13.	13.	13.	13.	13.	13.	13.	13.	13.
42	USCNPVGC	17.	17.	17.	17.	17.	17.	17.	17.	17.	17.	17.
43	USCNPVGC	0.0	0.0	0.0	0.0	0.0	0.0	0.0	0.0	0.0	0.0	0.0
44	USCNPVGC	0.0	0.0	0.0	0.0	0.0	0.0	0.0	0.0	0.0	0.0	0.0
45	USCNPVGC-2	902.	902.	902.	902.	902.	902.	902.	902.	902.	902.	902.
46	USCNPVGC	7.	7.	7.	7.	7.	7.	7.	7.	7.	7.	7.
47	USCNPVGC	0.0	0.0	0.0	0.0	0.0	0.0	0.0	0.0	0.0	0.0	0.0
48	USCNPVGC	0.0	0.0	0.0	0.0	0.0	0.0	0.0	0.0	0.0	0.0	0.0
49	USCNPVGC	0.0	0.0	0.0	0.0	0.0	0.0	0.0	0.0	0.0	0.0	0.0
50	USCNPVGC-2	230.	230.	230.	230.	230.	230.	230.	230.	230.	230.	230.

GENERAL COMMENTS
POOR QUALITY

THE WHARTON EFA MIP VEHICLE DEMAND MONIFL
MARCH CONTROL FOR HYBRIDS

TABLE 24.00 CONSTANT ADJUSTMENTS

LINE	VAR LABEL	1991	1992	1993	1994	1995	1996	1997	1998	1999	2000
1	USSMPPUPT-2	-35.	-35.	-35.	-35.	-35.	-35.	-35.	-35.	-35.	-35.
2	USSMPPUPTN	-3.	-3.	-3.	-3.	-3.	-3.	-3.	-3.	-3.	-3.
3	USSDMPGC	0.0	0.0	0.0	0.0	0.0	0.0	0.0	0.0	0.0	0.0
4	USSMPPGM	0.0	0.0	0.0	0.0	0.0	0.0	0.0	0.0	0.0	0.0
5	USSMPPPTM	0.0	0.0	0.0	0.0	0.0	0.0	0.0	0.0	0.0	0.0
6	USSMPPMASE-2	-190.	-190.	-190.	-190.	-190.	-190.	-190.	-190.	-190.	-190.
7	USSMPPUPT-2	-10.	-10.	-10.	-10.	-10.	-10.	-10.	-10.	-10.	-10.
8	USSMPPUPTN	0.	0.	0.	0.	0.	0.	0.	0.	0.	0.
9	USSFMPC	0.0	0.0	0.0	0.0	0.0	0.0	0.0	0.0	0.0	0.0
10	USSFMPCG	0.0	0.0	0.0	0.0	0.0	0.0	0.0	0.0	0.0	0.0
11	USSFMPCASE-2	282.	282.	282.	282.	282.	282.	282.	282.	282.	282.
12	USSFMPCN	0.	0.	0.	0.	0.	0.	0.	0.	0.	0.
13	USMPPUPTMFW	523.	558.	593.	628.	663.	698.	733.	768.	803.	838.
14	USMPPUPTMASEFW	103.	103.	103.	103.	103.	103.	103.	103.	103.	103.
15	VMT/FM	0.0	0.0	0.0	0.0	0.0	0.0	0.0	0.0	0.0	0.0
16	VMT/K	0.0	0.0	0.0	0.0	0.0	0.0	0.0	0.0	0.0	0.0
17	VMTMVA-MC	0.0	0.0	0.0	0.0	0.0	0.0	0.0	0.0	0.0	0.0
18	VMTMVA/K	0.020	0.020	0.020	0.020	0.020	0.020	0.020	0.020	0.020	0.020
19	VMTMVA/K	0.0	0.0	0.0	0.0	0.0	0.0	0.0	0.0	0.0	0.0

A PRODUCT OF WHARTON EFA, INC.

THE WHARTON FFA MOTR VEHICLE DEMAND MTRFL
MARCH CONTR FOR HYBRID

TABLE 28.10 EXOGENOUS ASSUMPTIONS

LINE	I T F M	1979	1980	1981	1982	1983	1984	1985	1986	1987	1988	1989	1990
1	DIMANTONS	0.0	0.0	0.0	0.0	0.0	0.0	0.0	0.0	0.0	0.0	0.0	0.0
2	EFFC	0.	0.	0.	0.	0.	0.	0.	0.	0.	0.	0.	0.
3	EFFC	0.	0.	0.	0.	0.	0.	0.	0.	0.	0.	0.	0.
4	EFFCND	2.	0.	0.	12.	16.	19.	19.	19.	19.	19.	19.	19.
5	EFFCND	3.	0.	0.	17.	23.	26.	26.	26.	26.	26.	26.	26.
6	EFFCFC	1.	0.	0.	6.	0.	10.	10.	10.	10.	10.	10.	10.
7	EFFCFC	2.	0.	0.	9.	11.	14.	14.	14.	14.	14.	14.	14.
8	EFFCFO	2.	0.	0.	12.	16.	19.	19.	19.	19.	19.	19.	19.
9	EFFCFO	3.	0.	0.	17.	23.	26.	26.	26.	26.	26.	26.	26.
10	EFFCLO	2.	0.	0.	12.	16.	19.	19.	19.	19.	19.	19.	19.
11	EFFCLD	3.	0.	0.	17.	23.	26.	26.	26.	26.	26.	26.	26.
12	EFFFLF	1.	0.	0.	6.	0.	10.	10.	10.	10.	10.	10.	10.
13	EFFCLE	2.	0.	0.	9.	11.	14.	14.	14.	14.	14.	14.	14.
14	EFFCND	2.	0.	0.	12.	16.	19.	19.	19.	19.	19.	19.	19.
15	EFFCND	3.	0.	0.	17.	23.	26.	26.	26.	26.	26.	26.	26.
16	EFFCND	2.	0.	0.	12.	16.	19.	19.	19.	19.	19.	19.	19.
17	EFFCSD	3.	0.	0.	17.	23.	26.	26.	26.	26.	26.	26.	26.
18	EFFCSF	1.	0.	0.	6.	0.	10.	10.	10.	10.	10.	10.	10.
19	EFFCSF	2.	0.	0.	9.	11.	14.	14.	14.	14.	14.	14.	14.
20	EFFH	0.	0.	0.	0.	0.	0.	0.	0.	0.	0.	0.	0.
21	EFFH	0.	0.	0.	0.	0.	0.	0.	0.	0.	0.	0.	0.
22	EFFHND	2.	0.	0.	12.	16.	19.	19.	19.	19.	19.	19.	19.
23	EFFHND	3.	0.	0.	17.	23.	26.	26.	26.	26.	26.	26.	26.
24	EFFHFC	1.	0.	0.	6.	0.	10.	10.	10.	10.	10.	10.	10.
25	EFFHFC	2.	0.	0.	9.	11.	14.	14.	14.	14.	14.	14.	14.
26	EFFHFD	2.	0.	0.	12.	16.	19.	19.	19.	19.	19.	19.	19.
27	EFFHFD	3.	0.	0.	17.	23.	26.	26.	26.	26.	26.	26.	26.
28	EFFHLD	2.	0.	0.	12.	16.	19.	19.	19.	19.	19.	19.	19.
29	EFFHLD	3.	0.	0.	17.	23.	26.	26.	26.	26.	26.	26.	26.
30	EFFHLF	1.	0.	0.	6.	0.	10.	10.	10.	10.	10.	10.	10.
31	EFFHLF	2.	0.	0.	9.	11.	14.	14.	14.	14.	14.	14.	14.
32	EFFHND	2.	0.	0.	12.	16.	19.	19.	19.	19.	19.	19.	19.
33	EFFHND	3.	0.	0.	17.	23.	26.	26.	26.	26.	26.	26.	26.
34	EFFHSD	2.	0.	0.	12.	16.	19.	19.	19.	19.	19.	19.	19.
35	EFFHSD	3.	0.	0.	17.	23.	26.	26.	26.	26.	26.	26.	26.
36	EFFHSE	1.	0.	0.	6.	0.	10.	10.	10.	10.	10.	10.	10.
37	EFFHSE	2.	0.	0.	9.	11.	14.	14.	14.	14.	14.	14.	14.
38	FFMPC	5.00	5.00	5.00	5.00	5.00	5.00	5.00	5.00	5.00	5.00	5.00	5.00
39	GUTM/HFR	0.983	0.983	0.983	0.983	0.983	0.983	0.983	0.983	0.983	0.983	0.983	0.983
40	GAPIT/HFR	0.978	0.978	0.978	0.978	0.978	0.978	0.978	0.978	0.978	0.978	0.978	0.978
41	GAPIT/PTA	0.994	0.994	0.994	0.994	0.994	0.994	0.994	0.994	0.994	0.994	0.994	0.994
42	HCFM3+R/FM	0.309	0.312	0.313	0.315	0.316	0.317	0.318	0.318	0.318	0.318	0.318	0.318
43	HCFM5+R/FM	0.130	0.122	0.117	0.111	0.106	0.102	0.096	0.098	0.098	0.098	0.098	0.098
44	HDMFT	73.270	73.270	73.270	73.270	73.270	73.270	73.270	73.270	73.270	73.270	73.270	73.270
45	HDMFC/N	0.193	0.193	0.194	0.195	0.195	0.196	0.197	0.197	0.197	0.197	0.197	0.197
46	HDMFC/N	0.061	0.060	0.059	0.059	0.058	0.057	0.057	0.056	0.055	0.055	0.054	0.054
47	HDMFC/N	0.089	0.050	0.051	0.052	0.053	0.054	0.055	0.056	0.057	0.057	0.058	0.058
48	HDMFC/N	0.057	0.056	0.056	0.056	0.056	0.056	0.056	0.056	0.056	0.056	0.056	0.056
49	HDMFC/R	0.137	0.138	0.139	0.140	0.141	0.142	0.143	0.143	0.143	0.143	0.143	0.143
50	HDMFC/R	0.157	0.156	0.156	0.156	0.155	0.155	0.154	0.154	0.154	0.153	0.153	0.153

A PRODUCT OF WHARTON FFA, INC.

THE WHARTON LFA MITE VEHICLE DEMAND MODEL
MARCH CONTROL FOR HYBRIDS

TABLE 24.10 EXGENIUS ASSUMPTIONS

LINE	ITEM	1970	1980	1981	1982	1983	1984	1985	1986	1987	1988	1989
1	URMNC/R	0.077	0.077	0.076	0.076	0.074	0.076	0.075	0.075	0.075	0.074	0.070
2	URMNC/R	0.101	0.101	0.102	0.103	0.103	0.104	0.108	0.105	0.106	0.106	0.107
3	URMNC/R	34.80	34.54	40.13	40.55	40.81	40.91	40.74	40.39	39.76	38.09	37.45
4	URMNC/R	0.003	0.000	0.000	0.000	0.076	0.072	0.069	0.065	0.062	0.059	0.056
5	URMNC/R	150.7	164.0	173.0	184.3	195.3	207.0	219.5	232.6	246.6	261.0	277.1
6	URMNC/R	05.22	07.49	03.06	08.66	103.59	108.77	114.21	119.92	125.91	132.21	138.82
7	URMNC/R	0.163	0.163	0.163	0.163	0.163	0.163	0.163	0.163	0.163	0.163	0.163
8	URMNC/R	0.265	0.265	0.265	0.265	0.265	0.265	0.265	0.265	0.265	0.265	0.265
9	URMNC/R	0.229	0.229	0.229	0.229	0.229	0.229	0.229	0.229	0.229	0.229	0.229
10	URMNC/R	0.189	0.189	0.189	0.189	0.189	0.189	0.189	0.189	0.189	0.189	0.189
11	URMNC/R	0.192	0.192	0.192	0.192	0.192	0.192	0.192	0.192	0.192	0.192	0.192
12	URMNC/R	42.663	42.663	42.663	42.663	42.663	42.663	42.663	42.663	42.663	42.663	42.663
13	URMNC/R	0.0	0.0	0.0	0.0	0.0	0.0	0.0	0.0	0.0	0.0	0.0
14	URMNC/R	0.0	0.0	0.0	0.0	0.0	0.0	0.0	0.0	0.0	0.0	0.0
15	URMNC/R	0.0	0.0	0.0	0.0	0.0	0.0	0.0	0.0	0.0	0.0	0.0
16	URMNC/R	0.0	0.0	0.0	0.0	0.0	0.0	0.0	0.0	0.0	0.0	0.0
17	URMNC/R	0.0	0.0	0.0	0.0	0.0	0.0	0.0	0.0	0.0	0.0	0.0
18	URMNC/R	0.0	0.0	0.0	0.0	0.0	0.0	0.0	0.0	0.0	0.0	0.0
19	URMNC/R	0.0	0.0	0.0	0.0	0.0	0.0	0.0	0.0	0.0	0.0	0.0
20	URMNC/R	0.0	0.0	0.0	0.0	0.0	0.0	0.0	0.0	0.0	0.0	0.0
21	URMNC/R	0.0	0.0	0.0	0.0	0.0	0.0	0.0	0.0	0.0	0.0	0.0
22	URMNC/R	0.0	0.0	0.0	0.0	0.0	0.0	0.0	0.0	0.0	0.0	0.0
23	URMNC/R	5.02	5.18	5.34	5.50	5.66	5.82	5.98	6.14	6.30	6.47	6.64
24	URMNC/R	3100.	3050.	3000.	2900.	2800.	2750.	2700.	2700.	2700.	2700.	2700.
25	URMNC/R	217.0	207.0	198.0	183.0	168.0	158.0	150.0	150.0	150.0	150.0	150.0
26	URMNC/R	0.875	0.850	0.800	0.750	0.700	0.675	0.675	0.675	0.675	0.675	0.675
27	URMNC/R	0.0	0.0	0.0	0.0	0.0	0.0	0.0	0.0	0.0	0.0	0.0
28	URMNC/R	0.150	0.200	0.300	0.400	0.450	0.500	0.550	0.550	0.550	0.550	0.550
29	URMNC/R	0.600	0.550	0.500	0.450	0.400	0.350	0.300	0.300	0.300	0.300	0.300
30	URMNC/R	0.969	0.969	0.969	0.969	0.969	0.969	0.969	0.969	0.969	0.969	0.969
31	URMNC/R	0.833	0.833	0.833	0.833	0.833	0.833	0.833	0.833	0.833	0.833	0.833
32	URMNC/R	2845.	2837.	2800.	2780.	2752.	2725.	2698.	2698.	2698.	2698.	2698.
33	URMNC/R	112.5	112.8	111.1	109.4	107.8	106.2	104.6	104.6	104.6	104.6	104.6
34	URMNC/R	0.450	0.450	0.450	0.450	0.450	0.450	0.450	0.450	0.450	0.450	0.450
35	URMNC/R	0.0	0.0	0.0	0.0	0.0	0.0	0.0	0.0	0.0	0.0	0.0
36	URMNC/R	0.450	0.450	0.450	0.450	0.450	0.450	0.450	0.450	0.450	0.450	0.450
37	URMNC/R	0.150	0.150	0.150	0.150	0.150	0.150	0.150	0.150	0.150	0.150	0.150
38	URMNC/R	3800.	3700.	3600.	3450.	3300.	3250.	3200.	3200.	3200.	3200.	3200.
39	URMNC/R	287.0	278.0	259.0	242.0	224.8	216.0	210.0	210.0	210.0	210.0	210.0
40	URMNC/R	0.980	0.970	0.950	0.925	0.900	0.875	0.850	0.850	0.850	0.850	0.850
41	URMNC/R	0.0	0.0	0.0	0.0	0.0	0.0	0.0	0.0	0.0	0.0	0.0
42	URMNC/R	0.0	0.025	0.050	0.075	0.100	0.125	0.150	0.150	0.150	0.150	0.150
43	URMNC/R	0.100	0.200	0.300	0.400	0.500	0.600	0.650	0.650	0.650	0.650	0.650
44	URMNC/R	1.010	1.010	1.010	1.010	1.010	1.010	1.010	1.010	1.010	1.010	1.010
45	URMNC/R	1.010	1.010	1.010	1.010	1.010	1.010	1.010	1.010	1.010	1.010	1.010
46	URMNC/R	8100.	8000.	3850.	3700.	3600.	3550.	3500.	3500.	3500.	3500.	3500.
47	URMNC/R	351.0	336.0	318.0	298.0	283.0	272.0	265.0	265.0	265.0	265.0	265.0
48	URMNC/R	0.970	0.960	0.950	0.940	0.920	0.900	0.880	0.880	0.880	0.880	0.880
49	URMNC/R	0.0	0.0	0.0	0.0	0.0	0.0	0.0	0.0	0.0	0.0	0.0

FINAL PAGE IS
IDENTICAL

A PRODUCT OF WHARTON LFA, INC.

THE 1970 FFA FUTURE PRICE DEMAND MODEL
MARCH CONTINUED FOR HYBRIDS

TABLE 24.10 EXGENOUS ASSUMPTIONS

LINE	ITEM	1970	1980	1991	1992	1993	1994	1995	1996	1997	1998	1999
1	USLNFACYL	0.001	0.005	0.010	0.020	0.050	0.100	0.150	0.150	0.150	0.150	0.150
2	USLNFACYL	0.050	0.100	0.150	0.200	0.250	0.300	0.350	0.350	0.350	0.350	0.350
3	USLNFACYL	1.030	1.030	1.030	1.030	1.030	1.030	1.030	1.030	1.030	1.030	1.030
4	USLNFACYL	1.621	1.621	1.621	1.621	1.621	1.621	1.621	1.621	1.621	1.621	1.621
5	USLNFACYL	3100.	3100.	3000.	2900.	2800.	2700.	2600.	2500.	2400.	2300.	2200.
6	USLNFACYL	171.0	160.0	145.0	130.0	115.0	100.0	85.0	70.0	55.0	40.0	25.0
7	USLNFACYL	0.600	0.500	0.400	0.300	0.200	0.100	0.050	0.025	0.010	0.005	0.002
8	USLNFACYL	0.000	0.000	0.000	0.000	0.000	0.000	0.000	0.000	0.000	0.000	0.000
9	USLNFACYL	0.600	0.600	0.600	0.600	0.600	0.600	0.600	0.600	0.600	0.600	0.600
10	USLNFACYL	0.000	0.000	0.000	0.000	0.000	0.000	0.000	0.000	0.000	0.000	0.000
11	USLNFACYL	3550.	3450.	3400.	3200.	3000.	2800.	2600.	2400.	2200.	2000.	1800.
12	USLNFACYL	263.0	200.0	230.0	210.0	190.0	170.0	150.0	130.0	110.0	90.0	70.0
13	USLNFACYL	0.000	0.000	0.000	0.000	0.000	0.000	0.000	0.000	0.000	0.000	0.000
14	USLNFACYL	0.000	0.000	0.000	0.000	0.000	0.000	0.000	0.000	0.000	0.000	0.000
15	USLNFACYL	0.000	0.025	0.050	0.075	0.100	0.150	0.200	0.250	0.300	0.350	0.400
16	USLNFACYL	0.200	0.350	0.500	0.650	0.700	0.700	0.700	0.700	0.700	0.700	0.700
17	USLNFACYL	1.017	1.017	1.017	1.017	1.017	1.017	1.017	1.017	1.017	1.017	1.017
18	USLNFACYL	0.920	0.920	0.920	0.920	0.920	0.920	0.920	0.920	0.920	0.920	0.920
19	USLNFACYL	2600.	2550.	2500.	2400.	2300.	2200.	2100.	2000.	1900.	1800.	1700.
20	USLNFACYL	103.0	135.0	130.0	125.0	115.0	110.0	105.0	105.0	105.0	105.0	105.0
21	USLNFACYL	0.600	0.575	0.550	0.525	0.475	0.425	0.400	0.400	0.400	0.400	0.400
22	USLNFACYL	0.000	0.000	0.000	0.000	0.000	0.000	0.000	0.000	0.000	0.000	0.000
23	USLNFACYL	0.750	0.775	0.800	0.825	0.850	0.875	0.900	0.900	0.900	0.900	0.900
24	USLNFACYL	0.250	0.225	0.200	0.175	0.150	0.125	0.100	0.100	0.100	0.100	0.100
25	USLNFACYL	0.922	0.922	0.922	0.922	0.922	0.922	0.922	0.922	0.922	0.922	0.922
26	USLNFACYL	0.720	0.720	0.720	0.720	0.720	0.720	0.720	0.720	0.720	0.720	0.720
27	USLNFACYL	2200.	2250.	2220.	2190.	2150.	2120.	2090.	2090.	2090.	2090.	2090.
28	USLNFACYL	0.350	0.250	0.250	0.250	0.250	0.250	0.250	0.250	0.250	0.250	0.250
29	USLNFACYL	0.000	0.000	0.000	0.000	0.000	0.000	0.000	0.000	0.000	0.000	0.000
30	USLNFACYL	0.950	0.950	0.950	0.950	0.950	0.950	0.950	0.950	0.950	0.950	0.950
31	USLNFACYL	0.050	0.050	0.050	0.050	0.050	0.050	0.050	0.050	0.050	0.050	0.050
32	USLNFACYL	0.050	0.050	0.050	0.050	0.050	0.050	0.050	0.050	0.050	0.050	0.050

A PRODUCT OF WHARTON FFA, INC.

THE WHARTON EFA MUTI VEHICLE DEMAND MODEL
MARCH CONTROL FOR HYBRIDS

TABLE 20.10 EXOGENOUS ASSUMPTIONS

LINE	I T F M	1990	1991	1992	1993	1994	1995	1996	1997	1998	1999	2000
1	0.0	0.0	0.0	0.0	0.0	0.0	0.0	0.0	0.0	0.0	0.0	0.0
2	0.0	0.0	0.0	0.0	0.0	0.0	0.0	0.0	0.0	0.0	0.0	0.0
3	0.0	0.0	0.0	0.0	0.0	0.0	0.0	0.0	0.0	0.0	0.0	0.0
4	19.	19.	19.	19.	19.	19.	19.	19.	19.	19.	19.	19.
5	26.	26.	26.	26.	26.	26.	26.	26.	26.	26.	26.	26.
6	10.	10.	10.	10.	10.	10.	10.	10.	10.	10.	10.	10.
7	14.	14.	14.	14.	14.	14.	14.	14.	14.	14.	14.	14.
8	19.	19.	19.	19.	19.	19.	19.	19.	19.	19.	19.	19.
9	26.	26.	26.	26.	26.	26.	26.	26.	26.	26.	26.	26.
10	19.	19.	19.	19.	19.	19.	19.	19.	19.	19.	19.	19.
11	26.	26.	26.	26.	26.	26.	26.	26.	26.	26.	26.	26.
12	10.	10.	10.	10.	10.	10.	10.	10.	10.	10.	10.	10.
13	14.	14.	14.	14.	14.	14.	14.	14.	14.	14.	14.	14.
14	19.	19.	19.	19.	19.	19.	19.	19.	19.	19.	19.	19.
15	26.	26.	26.	26.	26.	26.	26.	26.	26.	26.	26.	26.
16	21.	21.	21.	21.	21.	21.	21.	21.	21.	21.	21.	21.
17	28.	28.	28.	28.	28.	28.	28.	28.	28.	28.	28.	28.
18	10.	10.	10.	10.	10.	10.	10.	10.	10.	10.	10.	10.
19	14.	14.	14.	14.	14.	14.	14.	14.	14.	14.	14.	14.
20	0.0	0.0	0.0	0.0	0.0	0.0	0.0	0.0	0.0	0.0	0.0	0.0
21	0.0	0.0	0.0	0.0	0.0	0.0	0.0	0.0	0.0	0.0	0.0	0.0
22	19.	19.	19.	19.	19.	19.	19.	19.	19.	19.	19.	19.
23	26.	26.	26.	26.	26.	26.	26.	26.	26.	26.	26.	26.
24	10.	10.	10.	10.	10.	10.	10.	10.	10.	10.	10.	10.
25	14.	14.	14.	14.	14.	14.	14.	14.	14.	14.	14.	14.
26	19.	19.	19.	19.	19.	19.	19.	19.	19.	19.	19.	19.
27	26.	26.	26.	26.	26.	26.	26.	26.	26.	26.	26.	26.
28	19.	19.	19.	19.	19.	19.	19.	19.	19.	19.	19.	19.
29	26.	26.	26.	26.	26.	26.	26.	26.	26.	26.	26.	26.
30	10.	10.	10.	10.	10.	10.	10.	10.	10.	10.	10.	10.
31	14.	14.	14.	14.	14.	14.	14.	14.	14.	14.	14.	14.
32	19.	19.	19.	19.	19.	19.	19.	19.	19.	19.	19.	19.
33	26.	26.	26.	26.	26.	26.	26.	26.	26.	26.	26.	26.
34	21.	21.	21.	21.	21.	21.	21.	21.	21.	21.	21.	21.
35	28.	28.	28.	28.	28.	28.	28.	28.	28.	28.	28.	28.
36	10.	10.	10.	10.	10.	10.	10.	10.	10.	10.	10.	10.
37	14.	14.	14.	14.	14.	14.	14.	14.	14.	14.	14.	14.
38	5.00	5.00	5.00	5.00	5.00	5.00	5.00	5.00	5.00	5.00	5.00	5.00
39	0.943	0.943	0.943	0.943	0.943	0.943	0.943	0.943	0.943	0.943	0.943	0.943
40	0.974	0.974	0.974	0.974	0.974	0.974	0.974	0.974	0.974	0.974	0.974	0.974
41	0.994	0.994	0.994	0.994	0.994	0.994	0.994	0.994	0.994	0.994	0.994	0.994
42	0.319	0.320	0.321	0.322	0.323	0.324	0.325	0.326	0.327	0.328	0.329	0.330
43	0.080	0.077	0.075	0.073	0.071	0.069	0.068	0.067	0.066	0.065	0.064	0.063
44	73.270	73.270	73.270	73.270	73.270	73.270	73.270	73.270	73.270	73.270	73.270	73.270
45	0.200	0.200	0.201	0.202	0.202	0.203	0.204	0.205	0.206	0.207	0.208	0.209
46	0.054	0.053	0.052	0.052	0.051	0.050	0.050	0.049	0.048	0.048	0.047	0.046
47	0.061	0.062	0.063	0.064	0.065	0.066	0.067	0.068	0.069	0.070	0.071	0.072
48	0.055	0.055	0.055	0.055	0.054	0.054	0.054	0.054	0.054	0.054	0.054	0.054
49	0.140	0.150	0.151	0.152	0.153	0.154	0.155	0.156	0.157	0.158	0.159	0.160
50	0.152	0.152	0.152	0.151	0.151	0.150	0.150	0.150	0.150	0.149	0.149	0.149

A PRODUCT OF WHARTON EFA, INC.

THE WHARTON FFA MOTOR VEHICLE FORWARD MILEAGE
MARCH CONTROL FOR HYBRIDS

TABLE 24.10 EXIGEMINUS ASSUMPTIONS

LINE	I T E M	1991	1992	1993	1994	1995	1996	1997	1998	1999	2000
1	USCENR	0.074	0.073	0.07	0.072	0.072	0.072	0.072	0.071	0.071	0.0711
2	USCENR	0.104	0.109	0.110	0.111	0.112	0.112	0.112	0.113	0.113	0.114
3	USCENR	37.29	36.40	35.53	34.64	33.76	32.88	32.00	31.13	30.25	29.37
4	USCENR	0.053	0.051	0.049	0.047	0.045	0.043	0.041	0.039	0.037	0.035
5	USCENR	293.7	311.3	330.0	348.7	367.4	386.1	404.8	423.5	442.2	460.9
6	USCENR	145.76	153.05	160.34	167.63	174.92	182.21	189.50	196.79	204.08	211.37
7	USCENR	0.163	0.163	0.163	0.163	0.163	0.163	0.163	0.163	0.163	0.163
8	USCENR	0.265	0.265	0.265	0.265	0.265	0.265	0.265	0.265	0.265	0.265
9	USCENR	0.229	0.229	0.229	0.229	0.229	0.229	0.229	0.229	0.229	0.229
10	USCENR	0.149	0.149	0.149	0.149	0.149	0.149	0.149	0.149	0.149	0.149
11	USCENR	0.192	0.192	0.192	0.192	0.192	0.192	0.192	0.192	0.192	0.192
12	USCENR	42.663	42.663	42.663	42.663	42.663	42.663	42.663	42.663	42.663	42.663
13	USCENR	0.0	0.0	0.0	0.0	0.0	0.0	0.0	0.0	0.0	0.0
14	USCENR	0.0	0.0	0.0	0.0	0.0	0.0	0.0	0.0	0.0	0.0
15	USCENR	0.0	0.0	0.0	0.0	0.0	0.0	0.0	0.0	0.0	0.0
16	USCENR	0.0	0.0	0.0	0.0	0.0	0.0	0.0	0.0	0.0	0.0
17	USCENR	0.0	0.0	0.0	0.0	0.0	0.0	0.0	0.0	0.0	0.0
18	USCENR	0.0	0.0	0.0	0.0	0.0	0.0	0.0	0.0	0.0	0.0
19	USCENR	0.0	0.0	0.0	0.0	0.0	0.0	0.0	0.0	0.0	0.0
20	USCENR	0.0	0.0	0.0	0.0	0.0	0.0	0.0	0.0	0.0	0.0
21	USCENR	0.0	0.0	0.0	0.0	0.0	0.0	0.0	0.0	0.0	0.0
22	USCENR	0.0	0.0	0.0	0.0	0.0	0.0	0.0	0.0	0.0	0.0
23	USCENR	6.82	7.01	7.20	7.39	7.58	7.77	7.96	8.15	8.34	8.53
24	USCENR	2700.	2700.	2700.	2700.	2700.	2700.	2700.	2700.	2700.	2700.
25	USCENR	150.0	150.0	150.0	150.0	150.0	150.0	150.0	150.0	150.0	150.0
26	USCENR	0.675	0.675	0.675	0.675	0.675	0.675	0.675	0.675	0.675	0.675
27	USCENR	0.0	0.0	0.0	0.0	0.0	0.0	0.0	0.0	0.0	0.0
28	USCENR	0.550	0.550	0.550	0.550	0.550	0.550	0.550	0.550	0.550	0.550
29	USCENR	0.300	0.300	0.300	0.300	0.300	0.300	0.300	0.300	0.300	0.300
30	USCENR	0.969	0.969	0.969	0.969	0.969	0.969	0.969	0.969	0.969	0.969
31	USCENR	0.833	0.833	0.833	0.833	0.833	0.833	0.833	0.833	0.833	0.833
32	USCENR	2698.	2698.	2698.	2698.	2698.	2698.	2698.	2698.	2698.	2698.
33	USCENR	104.6	104.6	104.6	104.6	104.6	104.6	104.6	104.6	104.6	104.6
34	USCENR	0.450	0.450	0.450	0.450	0.450	0.450	0.450	0.450	0.450	0.450
35	USCENR	0.0	0.0	0.0	0.0	0.0	0.0	0.0	0.0	0.0	0.0
36	USCENR	0.450	0.450	0.450	0.450	0.450	0.450	0.450	0.450	0.450	0.450
37	USCENR	0.150	0.150	0.150	0.150	0.150	0.150	0.150	0.150	0.150	0.150
38	USCENR	3200.	3200.	3200.	3200.	3200.	3200.	3200.	3200.	3200.	3200.
39	USCENR	210.0	210.0	210.0	210.0	210.0	210.0	210.0	210.0	210.0	210.0
40	USCENR	0.450	0.450	0.450	0.450	0.450	0.450	0.450	0.450	0.450	0.450
41	USCENR	0.0	0.0	0.0	0.0	0.0	0.0	0.0	0.0	0.0	0.0
42	USCENR	0.150	0.150	0.150	0.150	0.150	0.150	0.150	0.150	0.150	0.150
43	USCENR	0.650	0.650	0.650	0.650	0.650	0.650	0.650	0.650	0.650	0.650
44	USCENR	1.014	1.014	1.014	1.014	1.014	1.014	1.014	1.014	1.014	1.014
45	USCENR	1.019	1.019	1.019	1.019	1.019	1.019	1.019	1.019	1.019	1.019
46	USCENR	3500.	3500.	3500.	3500.	3500.	3500.	3500.	3500.	3500.	3500.
47	USCENR	265.0	265.0	265.0	265.0	265.0	265.0	265.0	265.0	265.0	265.0
48	USCENR	0.450	0.450	0.450	0.450	0.450	0.450	0.450	0.450	0.450	0.450
49	USCENR	0.0	0.0	0.0	0.0	0.0	0.0	0.0	0.0	0.0	0.0

ORIGINAL PAGE IS
OF POOR QUALITY

THE WHARTON EPA MDT VEHICLE DEMAND MODEL
MARCH CONTROL FOR HYBRIDS

TABLE 24.10 EXGENEHA ASSUMPTIONS

LINE	TYPE	1990	1991	1992	1993	1994	1995	1996	1997	1998	1999	2000
1	USLDFACV1	0.150	0.150	0.150	0.150	0.150	0.150	0.150	0.150	0.150	0.150	0.150
2	USLDFACV2	0.350	0.350	0.350	0.350	0.350	0.350	0.350	0.350	0.350	0.350	0.350
3	USLDFACV3	1.034	1.034	1.034	1.034	1.034	1.034	1.034	1.034	1.034	1.034	1.034
4	USLDFACV4	1.621	1.621	1.621	1.621	1.621	1.621	1.621	1.621	1.621	1.621	1.621
5	USLDFACV5	2808.	2808.	2808.	2808.	2808.	2808.	2808.	2808.	2808.	2808.	2808.
6	USLDFACV6	156.1	156.1	156.1	156.1	156.1	156.1	156.1	156.1	156.1	156.1	156.1
7	USLDFACV7	0.450	0.450	0.450	0.450	0.450	0.450	0.450	0.450	0.450	0.450	0.450
8	USLDFACV8	0.0	0.0	0.0	0.0	0.0	0.0	0.0	0.0	0.0	0.0	0.0
9	USLDFACV9	0.600	0.600	0.600	0.600	0.600	0.600	0.600	0.600	0.600	0.600	0.600
10	USLDFACV10	0.800	0.800	0.800	0.800	0.800	0.800	0.800	0.800	0.800	0.800	0.800
11	USLDFACV11	3000.	3000.	3000.	3000.	3000.	3000.	3000.	3000.	3000.	3000.	3000.
12	USLDFACV12	180.0	180.0	180.0	180.0	180.0	180.0	180.0	180.0	180.0	180.0	180.0
13	USLDFACV13	0.725	0.725	0.725	0.725	0.725	0.725	0.725	0.725	0.725	0.725	0.725
14	USLDFACV14	0.0	0.0	0.0	0.0	0.0	0.0	0.0	0.0	0.0	0.0	0.0
15	USLDFACV15	0.150	0.150	0.150	0.150	0.150	0.150	0.150	0.150	0.150	0.150	0.150
16	USLDFACV16	0.700	0.700	0.700	0.700	0.700	0.700	0.700	0.700	0.700	0.700	0.700
17	USLDFACV17	1.017	1.017	1.017	1.017	1.017	1.017	1.017	1.017	1.017	1.017	1.017
18	USLDFACV18	0.929	0.929	0.929	0.929	0.929	0.929	0.929	0.929	0.929	0.929	0.929
19	USLDFACV19	2300.	2300.	2300.	2300.	2300.	2300.	2300.	2300.	2300.	2300.	2300.
20	USLDFACV20	105.0	105.0	105.0	105.0	105.0	105.0	105.0	105.0	105.0	105.0	105.0
21	USLDFACV21	0.400	0.400	0.400	0.400	0.400	0.400	0.400	0.400	0.400	0.400	0.400
22	USLDFACV22	0.0	0.0	0.0	0.0	0.0	0.0	0.0	0.0	0.0	0.0	0.0
23	USLDFACV23	0.900	0.900	0.900	0.900	0.900	0.900	0.900	0.900	0.900	0.900	0.900
24	USLDFACV24	0.100	0.100	0.100	0.100	0.100	0.100	0.100	0.100	0.100	0.100	0.100
25	USLDFACV25	0.922	0.922	0.922	0.922	0.922	0.922	0.922	0.922	0.922	0.922	0.922
26	USLDFACV26	0.714	0.714	0.716	0.715	0.713	0.712	0.711	0.710	0.709	0.708	0.708
27	USLDFACV27	2094.	2094.	2094.	2094.	2094.	2094.	2094.	2094.	2094.	2094.	2094.
28	USLDFACV28	43.2	43.2	43.2	43.2	43.2	43.2	43.2	43.2	43.2	43.2	43.2
29	USLDFACV29	0.250	0.250	0.250	0.250	0.250	0.250	0.250	0.250	0.250	0.250	0.250
30	USLDFACV30	0.0	0.0	0.0	0.0	0.0	0.0	0.0	0.0	0.0	0.0	0.0
31	USLDFACV31	0.950	0.950	0.950	0.950	0.950	0.950	0.950	0.950	0.950	0.950	0.950
32	USLDFACV32	0.050	0.050	0.050	0.050	0.050	0.050	0.050	0.050	0.050	0.050	0.050

A PRODUCT OF WHARTON EPA, INC.

ORIGINAL PAGE IS
OF POOR QUALITY

APPENDIX B4

BATTERY COMPARTMENT WEIGHT DISTRIBUTION
AND VEHICLE HANDLING ANALYSIS

ORIGINAL PAGE IS
OF POOR QUALITY

Battery configuration summary for LTD :

Configuration	x_{cm} (m)	weight distribution		yaw moment I_{zz}	z_{cm} (m)
		front %	rear %		
Baseline	1.280	.559	.441	4837.	.286
(A)	1.628	.439	.561	6134.	.260
(B)	1.631	.438	.562	6157.	.252
(C)	1.577	.456	.544	5797.	.319
(D)	1.576	.457	.543	5777.	.286
(E)	1.500	.483	.517	5380.	.293
(F)	1.559	.462	.538	5689.	.319
(G)	1.493	.485	.515	5405.	.251
(H)	1.491	.486	.514	5352.	.279
(I)	1.494	.485	.515	5374.	.281
(J)	1.636	.436	.564	6278.	.273
(K)	1.647	.432	.568	6374.	.281
(L)	1.632	.437	.563	6164.	.257
(M)	1.580	.455	.545	5819.	.304

wheelbase $\cdot l = 2.90$

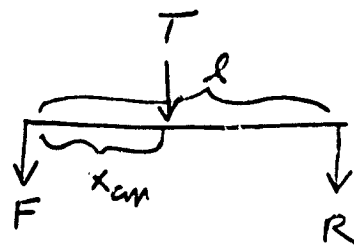

$$\begin{aligned}
 T &= F + R \\
 R &= T \frac{x_{cm}}{l}
 \end{aligned}
 \left. \vphantom{\begin{aligned} T &= F + R \\ R &= T \frac{x_{cm}}{l} \end{aligned}} \right\}
 \begin{aligned}
 \frac{R}{T} &= \frac{x_{cm}}{l} \\
 \frac{F}{T} &= 1 - \frac{R}{T}
 \end{aligned}$$

LTD Battery configurations :

28 kg / battery
~~27.67 kg / battery~~

Wheelbase : 2.90 m , 10 ³/₈ in ,

Gerstenberger drawing scale : $\frac{2.90}{10.375} = .280$ m/in

m (x, y, z) (a, b, c)

(A)

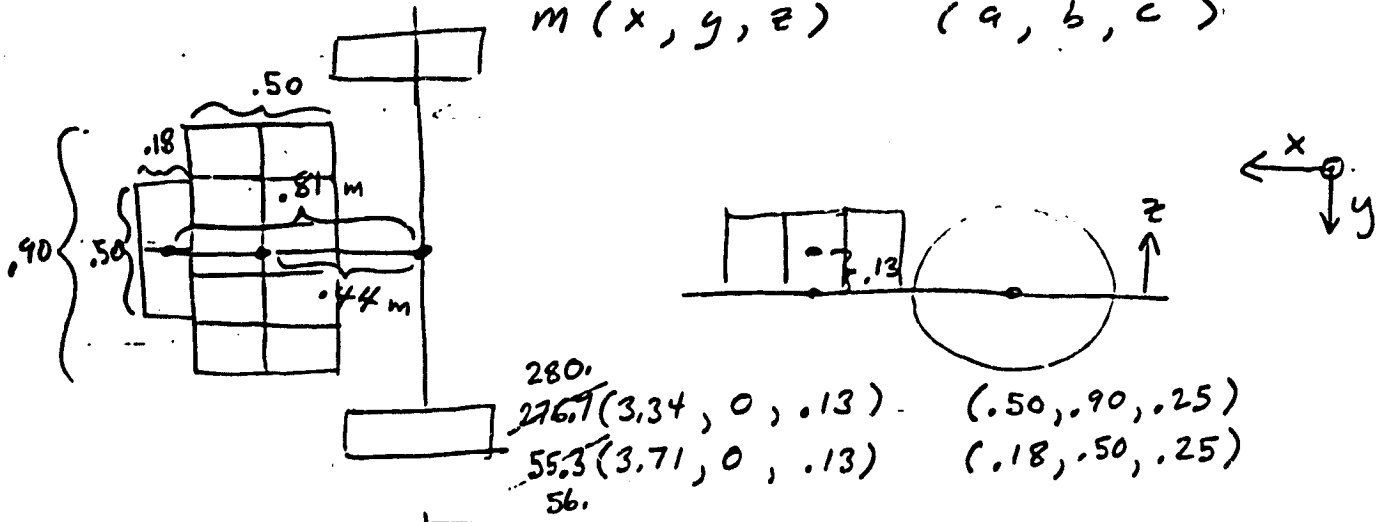

(B)

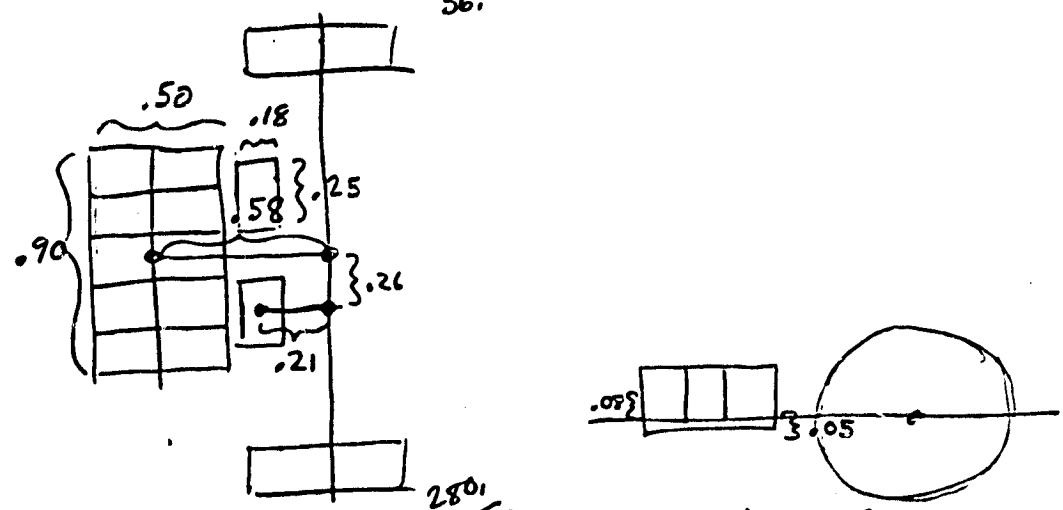

(C)

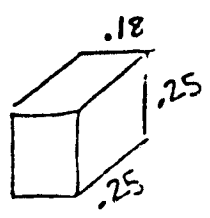
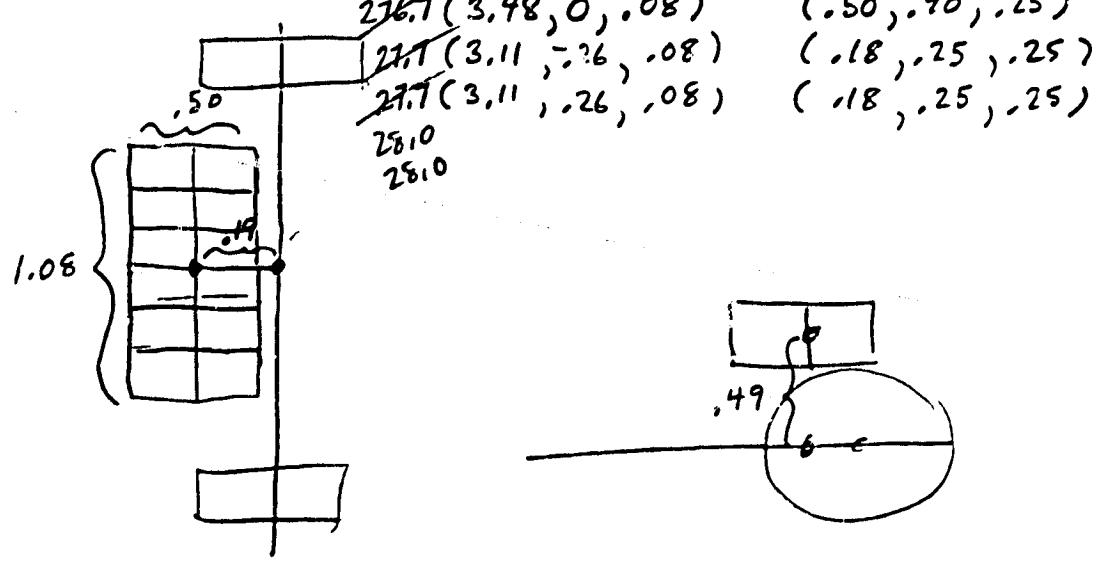

LTD Battery configurations (cont'd) :

m (a, b, c) (x, y, z)

(D)

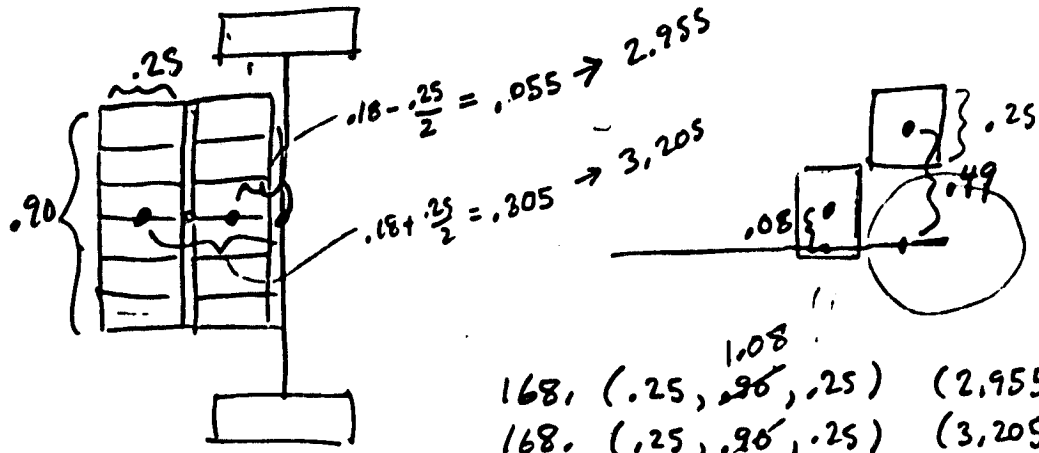

168. (.25, ^{1.08}.90, .25) (2.955, 0, .49)
 168. (.25, .90, .25) (3.205, 0, .08)
 1.08

LTD Battery Configurations (cont'd) .280 m/i

$m(a, b, c)(x, y, z)$

(E)

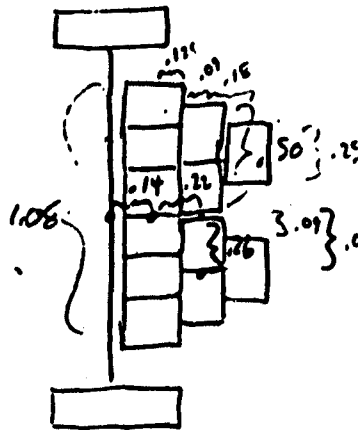

$2.90 - .14 =$
 $2.90 - (.14 + .72) = 2.90 - .86 = 2.54$
 $2.54 - .18 = 2.36$

$3.07 \cdot \frac{.25}{2} = .22$

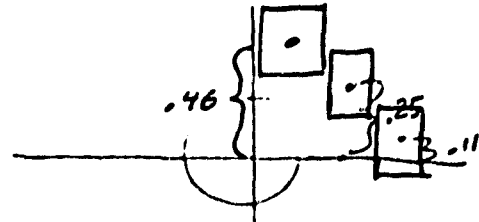

- $168. (.25, 1.08, .25)(2.76, 0, .46)$
- $56. (.18, .50, .25)(2.54, .26, .25)$
- $56. (.18, .50, .25)(2.54, -.26, .25)$
- $28. (.18, .25, .25)(2.36, .22, .11)$
- $28. (.18, .25, .25)(2.36, -.22, .11)$

(F)

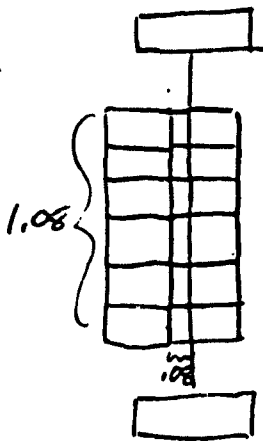

$2.90 + .08 = 2.98$

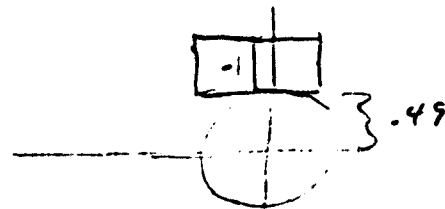

- $336. (.50, 1.08, .25)(2.98, 0, .49)$

(G)

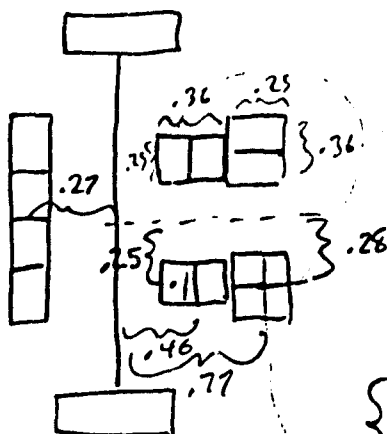

$2.9 + .27 = 3.17$

$2.9 + .46 = 2.44$

$2.9 - .77 = 2.13$

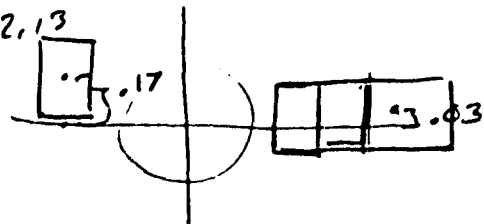

- $112. (.18, 1.0, .25)(3.17, 0, .17)$
- $56. (.36, .25, .25)(2.44, +.25, .03)$
- $56. (.36, .25, .25)(2.44, -.25, .03)$
- $56. (.25, .36, .25)(2.13, +.28, .03)$
- $56. (.25, .36, .25)(2.13, -.28, .03)$

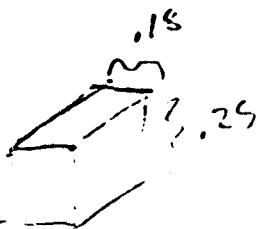

$m(a, b, c) (x, y, z)$

(H)

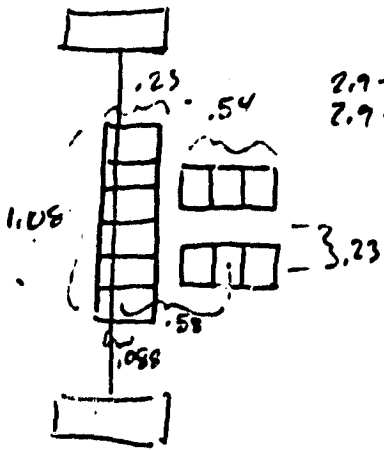

$2.9 - .088 = 2.81$
 $2.9 - .58 = 2.32$

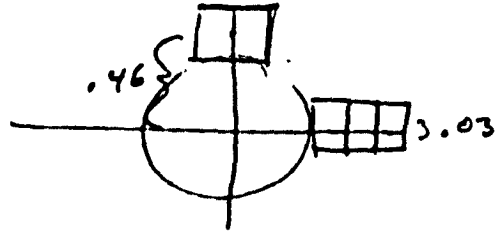

- $168, (.25, 1.08, .25) (2.81, 0, .46)$
- $84, (.54, .25, .25) (2.32, +.23, .03)$
- $84, (.54, .25, .25) (2.32, -.23, .03)$

(I)

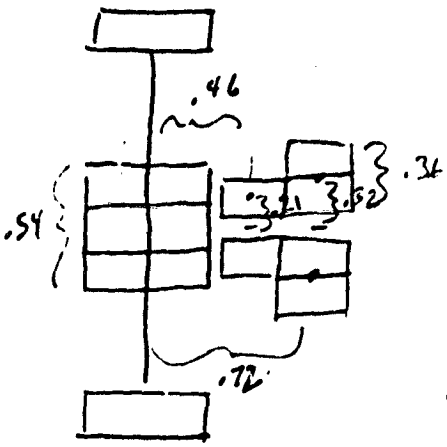

$2.9 - .46 = 2.44$
 $2.9 - .72 = 2.18$

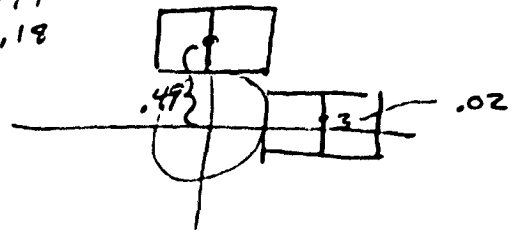

- $168, (.50, .54, .25) (2.90, 0, .49)$
- $28, (.25, .18, .25) (2.44, +.21, .02)$
- $28, (.25, .18, .25) (2.44, -.21, .02)$
- $56, (.25, .36, .25) (2.18, +.32, .02)$
- $56, (.25, .36, .25) (2.18, -.32, .02)$

(J)

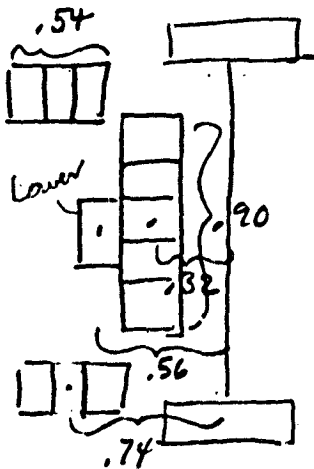

$2.9 + .32 = 3.22$
 $2.9 + .56 = 3.46$
 $2.9 + .74 = 3.64$

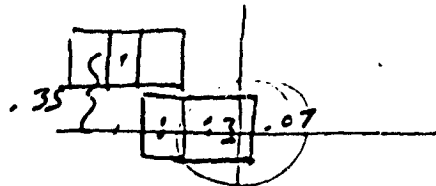

- $84, (.54, .25, .25) (3.64, .73, .35)$
- $84, (.54, .25, .25) (3.64, -.73, .35)$
- $28, (.18, .25, .25) (3.46, 0, .07)$
- $140, (.25, .90, .25) (3.22, 0, .07)$

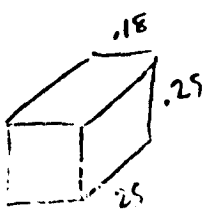

m (a , b , c) (x , y , z)

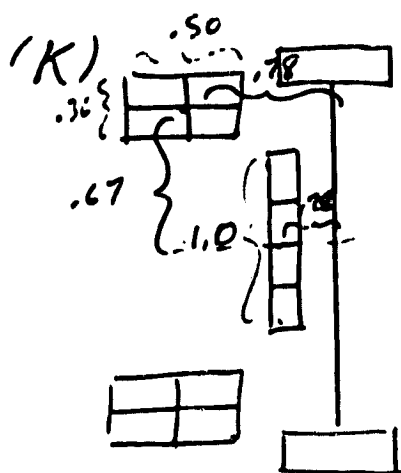

$$2.9 + .78 = 3.68$$

$$2.9 + .28 = 3.18$$

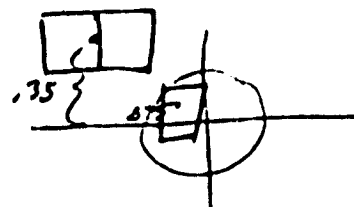

$$112, (.50, .36, .25) (3.68, .67, .35)$$

$$112, (.50, .36, .25) (3.68, .67, .35)$$

$$112, (.18, 1.0, .25) (3.18, 0, .07)$$

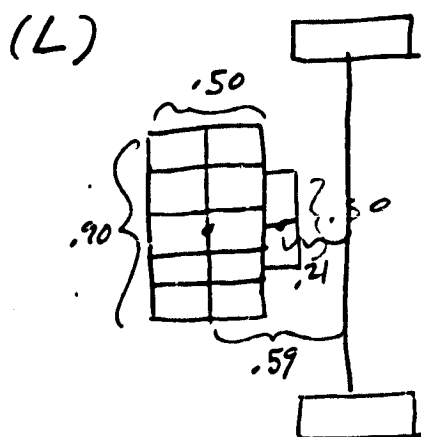

$$2.9 + .21 = 3.11$$

$$2.9 + .59 = 3.49$$

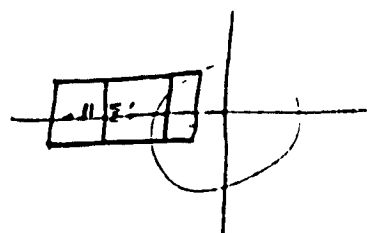

$$280, (.50, .90, .25) (3.49, 0, .11)$$

$$56, (.18, .50, .25) (3.11, 0, .11)$$

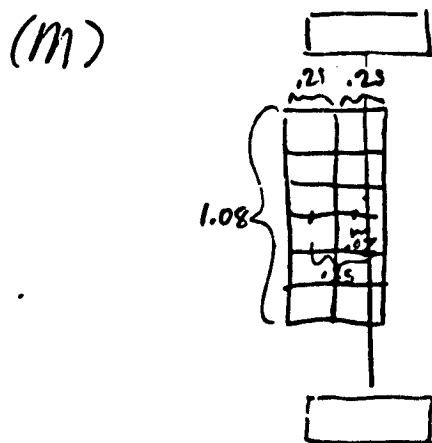

$$2.9 + .07 = 2.97$$

$$2.9 + .35 = 3.25$$

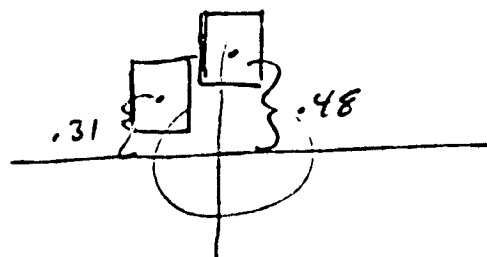

$$168, (.25, 1.08, .25) (3.25, 0, .31)$$

$$168, (.25, 1.08, .25) (2.97, 0, .48)$$