

(NASA-CR-159714) CORE COMPRESSOR EXIT STAGE
STUDY 1: AERODYNAMIC AND MECHANICAL
DESIGN (Pratt and Whitney Aircraft Group)
178 p HC A07/MF A01 CSCL 21E

N80-19113

g3/07 Unclass 47566



CORE COMPRESSOR EXIT STAGE STUDY

I. AERODYNAMIC AND MECHANICAL DESIGN

by

E. A. Burdsall, E. Canal Jr. and K. A. Lyons

September 1979

UNITED TECHNOLOGIES CORPORATION
Pratt & Whitney Aircraft Group
Commercial Products Division

Prepared for

NATIONAL AERONAUTICS AND SPACE ADMINISTRATION
NASA-Lewis Research Center
Contract NAS3-20578

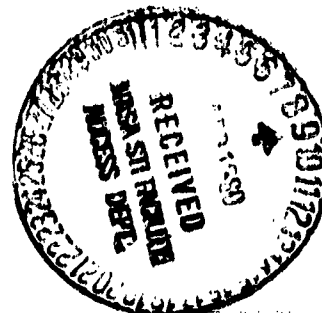

FOREWORD

The compressor designs described herein were prepared under NASA Contract NAS3-20578 by Pratt & Whitney Aircraft Group, Commercial Products Division, United Technologies Corporation, Hartford, Connecticut under the direction of Mr. N. T. Monsarrat, Program Manager. The NASA Project Manager was Mr. R. S. Ruggeri, NASA-Lewis Research Center, Fluid System Components Division, Fan and Compressor Branch. The work was performed during the period 20 October 1976 through 30 June 1979. The authors wish to acknowledge the participation and significant contributions in the fulfillment of this contract by the United Technologies Research Center test facilities operations group under the direction of Mr. C. I. Crockett.

PRECEDING PAGE BLANK NOT FILMED

TABLE OF CONTENTS

Title	Page
SUMMARY	1
INTRODUCTION	1
AERODYNAMIC DESIGN	2
MECHANICAL DESIGN	7
REFERENCES	12
APPENDICES	
A Symbols and Definitions	41
B Flow Field Calculation Procedures	45
C Airfoil Aerodynamic Summary 3S1/3S2 Compressor	47
D Airfoil Geometry on Conical Surfaces 3S1/3S2 Compressor	65
E Airfoil Manufacturing Coordinates for Sections Normal to Stacking Line 3S1/3S2 Compressor	91
DISTRIBUTION LIST	125

LIST OF TABLES

Table	Title	Page
I	Aerodynamic Design Parameters	3
II	Maximum Airfoil Stress	10
III	Summary of Rotating Hardware Stresses	11

CORE COMPRESSOR EXIT STAGE STUDY
I. AERODYNAMIC AND MECHANICAL DESIGN

by

E. A. Burdsall, E. Canal, Jr. and K. A. Lyons
Pratt & Whitney Aircraft Group

SUMMARY

The Core Compressor Exit Stage Study (Contract NAS3-20578) is being conducted to demonstrate improved blading for the rear stages of highly loaded advanced compressors for advanced aircraft engines. The basic technology, developed at Pratt & Whitney Aircraft, has been shown to reduce endwall losses, at least for moderate or more conventional hub-tip ratios. The objective is to reduce endwall losses through the use of low aspect ratio blading. The intent is to demonstrate this objective by means of design and subsequent testing of two advanced three-stage compressors of similar design but having significantly different aspect ratios. This report describes the aerodynamic and mechanical designs of these two compressors.

The 3S1 compressor is a test model of the last three stages of an eight-stage compressor identified during an earlier NASA contract as an optimum configuration for commercial service in the 1980's. The 3S2 compressor is basically the same as the 3S1 configuration, but has a fifty percent higher aspect ratio: the aspect ratio of the 3S1 configuration is 0.81; the aspect ratio of the 3S2 is 1.22. Both configurations have a mean wheel speed of 167 m/sec (547 ft/sec), a flow capacity of 4.30 kgm/sec (9.47 lbm/sec), and a tip diameter of 60.96 cm (24.0 in.). Circular arc mean camber line airfoils with 65 series thickness distribution were chosen for both compressors.

This report presents calculated design performance and design parameters such as incidence angles, diffusion factor, and static pressure loading factor. Aerodynamic design parameters, airfoil geometry on conical surfaces, and blade and vane manufacturing coordinates are presented in tabulated form in the appendices.

INTRODUCTION

Engine cycle studies conducted to determine technology requirements for advanced aircraft engines of the 1980's indicate that core compressors for these engines will have to operate at high pressure ratios and with increased overall efficiency compared with present designs. When considering the many factors involved in the design of these advanced compressors (weight, cost, number of parts, etc.), this implies the need for higher blade tip speeds and greater pressure-rise capability per stage. The design of the rear stages for these compressors presents a particularly difficult problem compared with current conventional designs because (1) the hub/tip ratios will be considerably higher (exceeding 0.9) than current practice and (2) the

blade aspect ratio will be low. The combination of these two factors makes secondary flow considerations extremely important and must be properly accounted for in the design process in order to achieve reduced endwall losses and increased efficiencies in rear stages of these compressors. Conventional compressor design practice may not be adequate to account for the strong secondary flow effects.

Techniques have been developed by Pratt & Whitney Aircraft for designing compressors with reduced endwall losses for lower hub-tip ratios. These techniques involve optimization of aspect ratio and camber changes in the blade end regions in order to reduce endwall loss as well as maximizing average spanwise blade loading. However, little experience is currently available to substantiate the technique at high hub-tip ratios.

The objective of the present core compressor exit stage study is to demonstrate improved blading design for the rear stages of high loaded advanced compressors through the design and subsequent testing of two three-stage compressor configurations in a realistic environment. One configuration (designated 3S1) is basically a test model of the last three stages (stages 6, 7, and 8) of the compressor identified in a previous NASA Contract Study (NAS3-19445), "Advanced Multistage Axial Flow Compressor (AMAC) Design Study," as an optimum compressor for commercial engines of the 1980's (ref. 1). Configuration 3S1 is designed for a pressure ratio of 1.357 and has an average blade aspect ratio of 0.81. Configuration 3S2 is very similar in design to configuration 3S1 (PR = 1.324), but has an aspect ratio of 1.22. Both compressors were designed for a corrected flow of 4.30 kg/sec (9.47 lbm/sec), a corrected mean wheel speed of 167 m/sec (547 ft/sec) and a diameter of 60.96 cm (24.0 in.).

This report presents the detailed aerodynamic and mechanical design for both the 3S1 and 3S2 compressors together with a description of the methods and procedures used.

AERODYNAMIC DESIGN

DESIGN PARAMETERS AND PROCEDURE

A schematic drawing of the 3S1/3S2 compressor is presented in Figure 1. The average blade aspect ratio of the 3S1 configuration is 0.81; the overall pressure ratio at design speed is 1.357; and the average diffusion factor (D-factor) is 0.529. The aspect ratio of the 3S2 configuration is 1.22; the overall pressure ratio at design speed is 1.324; and the average D-factor is 0.491. The higher pressure ratio of the 3S1 compressor is in recognition of the increased capability believed to exist at lower aspect ratios. The design mean wheel speed of both configurations is 167 m/sec (547 ft/sec); flow capacity is 4.30 kg/sec (9.47 lbm/sec); and the tip diameter is a constant 60.96 cm (24.0 in.). These design parameters were influenced by the capabilities of the existing test facility. The principal aerodynamic design parameters of the AMAC, 3S1, and 3S2 compressors (3-stage) are listed in Table I.

TABLE I
AERODYNAMIC DESIGN PARAMETERS

	AMAC STAGES 6, 7, & 8	Compressor 3S1	Compressor 3S2
Inlet Corrected Flow; kg/sec (lbm/sec)	3.90 (8.63)	4.30 (9.47)	4.30 (9.47)
Corrected Mean Wheel Speed, 50% Span; m/sec (ft/sec)	265 (869)	167 (547)	167 (547)
Overall Pressure Ratio	2.09	1.357	1.324
Overall Adiabatic Efficiency %	-	88.3	88.7
Aspect Ratio, Avg.	0.81	0.81	1.22
Solidity, Avg.	1.09	1.10	1.10
Inlet Hub-Tip Ratio	0.88	0.915	0.915
Exit Hub-Tip Ratio	0.92	0.915	0.915
Work Coefficient -E-, Avg.	0.71	0.702	0.644
Flow Coefficient - V_z/U , Avg. (50% Span)	0.46	0.440	0.444
D Factor, Avg.*	0.536	0.529	0.491
$\Delta P/(P_o - P)$, Avg.	0.489	0.497	0.467
Tip Clearance, Avg.; cm (in.)	0.025 (0.010)	0.033 (0.013)	0.033 (0.013)
Reaction		0.517	0.517
Aspect Ratio			
Inlet Guide Vane	-	1.03	1.55
Rotor-1	-	0.96	1.44
Stator-1	-	0.89	1.34
Rotor-2	-	0.83	1.25
Stator-2	-	0.77	1.16
Rotor-3	-	0.72	1.08
Stator-3	-	0.69	1.03

*D Factor Avg. = Mass Avg. D Factor From Streamline Analysis Computer Program For Each Blade Row Divided By The Number Of Blade Rows

The aerodynamic design was performed in three steps. First the analytical design system was adjusted to ensure performance agreement with data from tests of three-stage compressors similar to the 3S1 configuration. Next a preliminary effort based on a meanline approach provided an approximate flowpath and average values of aerodynamic parameters. Finally, a detailed fullspan design which utilized a streamline-calculation procedure established the blading geometry and finalized the flowpath dimensions.

BLOCKAGE, LOSS AND TURNING EVALUATION

Data from three previously tested compressors (referred to as TR-1, TR-2, and TR-3) with similar work and flow coefficients and loading levels were used to adjust general cascade loss and turning criteria and blockage factors. The effort utilized the Pratt & Whitney Aircraft streamline-analysis computer program and cascade correlation system, which was included as an integral part of the computer program. The streamline analysis program defined velocity vectors and flow conditions by means of an axisymmetric compressible-flow solution of the continuity, energy, and radial equilibrium equations with curvature, enthalpy, and entropy gradient terms included in the equilibrium equation (see Appendix B).

The data from the three tested compressors included (1) spanwise total temperatures at the compressor inlet, at each stator leading edge, and at the compressor exit, (2) spanwise total pressure at the same locations, and (3) outer diameter static pressure measurements at each blade row leading edge, at each blade row trailing edge, and at the midgap between each blade row. The streamline analysis program determined the rotor turning and loss that matched the test data and then compared these results with those predicted with the cascade system based on the airfoil geometry. The differences between the results indicated by the test data and those predicted by the cascade system were split equally between the rotors and stators and applied as an adjustment to the cascade system for each blade row. The adjustments required were the same for all three tested compressors.

Blockage adjustments were established in a similar manner. Velocity and static pressure profiles that matched static pressures measured at the outer diameter were computed, and a blockage factor for each blade row was calculated from these profiles. All three compressors had similar blockage distributions. The blockage distribution shown in Figure 2 was adopted for the design of 3S1 and 3S2 and is typical of the distributions determined from tests of TR-1, TR-2, and TR-3.

The validity of the adjustments to the cascade system and the blockage distribution was checked by using the adjustments to recalculate the performance of the three tested compressors and then comparing the calculated performance with test data. Two sets of checks were made for each of the three tested compressors. The first check compared

test and predicted total temperature and pressure profiles at the design point. As shown in Figures 3, 4, and 5, the test and predicted profiles matched well. The second check compared the shapes of the 100 percent design speedlines. Good agreement was obtained as shown in Figure 6. The slightly steeper predicted speedline shapes noted are probably a result of small blockage variations over the speedline, which were not accounted for because they would not significantly affect the design.

PRELIMINARY DESIGN

The primary purpose of the meanline design was to establish a preliminary flowpath and stage pressure ratio distribution consistent with a selected 15 percent surge margin. Average stage values of flow coefficient, reaction, and diffusion factor and the midspan values of solidity and aspect ratio of the 3S1-configuration were set similar to the AMAC compressor. Because the capabilities of the test facility limit design speed, flow rate, and the flowpath outer diameter; wheel speed, Mach numbers, and pressure ratios are lower than those determined for the AMAC study program. However, parameters such as loading, flow coefficient, and work coefficient were maintained (see Table I).

A preliminary flowpath and a set of meanline air triangles were calculated from the above information and the blockages established as previously described. The resulting flowpath was slightly divergent, but was reset to a constant inner diameter and outer diameter configuration, which necessitated minor changes in air angles and less than one percent change in the flow coefficients. The overall pressure ratio was determined using Pratt & Whitney Aircraft's design rules of loading capability versus average aspect ratio to yield the design average D-factor and for the selected 15 percent surge margin. Stage pressure ratio distribution was determined by maintaining the same stage-by-stage D-factor distribution established for the AMAC compressor at the 3S1 design overall pressure ratio.

DETAILED DESIGN

Compressor 3S1 Design

Utilizing the average aerodynamic parameter determined by the meanline analysis, a fullspan blade-row-by-blade-row design was performed by means of a streamline analysis computer program that incorporates the cascade correlation system. When used in the design mode, the cascade correlation system determines the airfoil metal angles and aerodynamic losses. Airfoil series, solidity, thickness-to-chord ratio, inlet and exit air angles, Mach number, and axial velocity density ratio are required inputs. Circular-arc mean-camber-line airfoils with a 65 series thickness distribution were chosen because of their excellent low-speed characteristics and to be consistent with the AMAC design.

The spanwise solidity was determined by combining the mean solidity and chord utilized in the meanline design with a constant chord design. Because of structural considerations, spanwise thickness-to-chord ratio was modeled after the previously tested compressors (TR-1, TR-2, and TR-3). Inlet and exit air angles, Mach numbers, and axial velocity density ratios were calculated by the streamline analysis program (flow, speed, pressure ratios, reactions, and blockages determined beforehand and the losses predicted by the cascade system were required inputs). Design incidence angle for all blade rows was set for minimum loss. The solidity, thickness-to-chord ratio, and blade metal angles for the 3S1 compressor airfoils are shown in Figures 7 through 12 and the values for the 3S2 design (described in the following section) are also shown for comparison.

The selection of the airfoil leading and trailing edge angles are affected by the flow conditions in the endwall region as well as in the freestream (core flow). The cascade system in the freestream mode sets the incidence angle relative to minimum loss and the estimated deviation angle. Leading edge and trailing edge overcambers were applied at both endwalls to align the blading to the anticipated endwall flow and to ensure an acceptable discharge velocity profile. The blading, established previously for design conditions, was reanalyzed in an offdesign analysis to estimate incidence angles at the predicted surge point. As a result, a slight overcamber (increased incidence angle) was added at the root leading edge of the second and third stage blading in order to prevent premature surge. Final values of incidence and deviation angles are presented as functions of percent span in Figures 13 through 18.

The predicted efficiency shown in Table I was produced by a meanline efficiency prediction program based on analytical model correlations of compressor data and is in basic agreement with the overall test efficiency of the majority of Pratt & Whitney Aircraft compressor experience. Two-dimensional cascade, endwall, and tip clearance loss effects are included. The efficiencies shown in the streamline design summary (Appendix C) result from a design procedure derived only for airfoil geometry selection. The resultant average and spanwise shape of efficiency are not predictions and do not, therefore, agree with the meanline program results.

Manufacturing limitations for cast aluminum airfoils indicated that the minimum permissible radius for the blade and vane leading and trailing edges was 0.23 mm (0.009 in.). The constant inner and outer diameter flowpath established during the meanline design was retained in the final design. The axial spacing between blade rows in terms of axial spacing-to-chord ratio was modeled after conventional compressor rear stages.

The airfoil aerodynamic summary for the blades and vanes for the three 3S1 compressor stages is presented in Appendix C, pages 50 to 56;

airfoil geometry on conical surfaces is presented in Appendix D, pages 67 to 73 ; and manufacturing coordinates for sections normal to the stacking line are presented in Appendix E, pages 82 to 102.

Compressor 3S2 Design

The 3S2 compressor has a 50 percent higher aspect ratio than the 3S1 compressor, but the designs are essentially the same. A comparison of 3S1 and 3S2 compressor design parameters is presented in Table I.

The blockages and the adjustments to the cascade system used for 3S1 compressor were also applied to the 3S2 compressor. The only difference in the meanline design was that the 3S2 design loading level was reduced, but the stage distribution was maintained to make it consistent with the Pratt & Whitney Aircraft aspect-ratio aerodynamic-loading correlation. The 3S2 airfoil designs were established by means of the same procedure used for 3S1.

The blade-row-by-blade-row spanwise distributions of loss, deviation, incidence, loadings, thickness ratio, solidity, and metal angles from the streamline design for the two configurations are compared in Figures 7 through 24. Leading and trailing edge radii were maintained at a constant 0.23 mm (0.009 in.). The flowpath O.D. and I.D. were not changed, but the axial spacing between all the blade rows was scaled by the chord change between 3S1 and 3S2 so that each blade row would be affected by equivalent values of unmixed wake blockage. The airfoil aerodynamic summary, the airfoil geometry, and the manufacturing coordinates for the 3S2 compressor are presented respectively in Appendix C pages 57 to 63; Appendix D pages 74 to 80; and Appendix E pages 102 to 123.

MECHANICAL DESIGN

MECHANICAL DESIGN PROCEDURE

The basic mechanical design of 3S1 and 3S2 compressors has been used successfully in many previous test programs. The design consists of an assembly of interlocking aluminum rings forming the compressor case and a set of aluminum wheels keyed to a central shaft forming the compressor hub. Simplified techniques were employed in the mechanical design of such special parts as flowpath cases, disks, and blade retainers. Steady-state stress analyses were performed for all blading and for all rotating parts to ensure structural integrity. A schematic of the compressor assemblies is shown in Figure 1.

OUTER CASING DESIGN

Case components include inlet guide vane and stator carrier rings, rotor tip shroud rings, spacer rings, and front and rear end flanges. Axial widths of individual rings are different for the 3S1 and 3S2

designs because of the chord lengths of the particular airfoils. End flanges are heavy steel members positioned at the front and rear of the case. Long tie bolts compress the interlocking case rings between the end flanges to form a structurally rigid compressor case assembly.

ROTATING DRUM DESIGN

An existing compressor hub is utilized, consisting of a rotor assembly supported by bearings at the front and rear of the compressor. The rotor assembly consists of a stack of aluminum rotor blade carrier and spacer wheels keyed to a central shaft that is threaded at both ends. The parts are secured in place on the shaft by steel end-plates, spacer sleeves, and a large nut.

The steel front and rear bearing assemblies are supported through the case end flanges by four steel bolts. Precision grease-packed bearings are utilized. The bearings and the bearing support assembly have been utilized in other three-stage compressor programs. Thrust loads on the bearings are compensated for by means of a vented chamber surrounding the rear bearing. Leakage between the bearing compartments and the flowpath is controlled by a series of knife edge seals on the rotating members and opposing soft abradable seals on nonrotating surfaces.

AIRFOILS

All blading is cast to the specifications of the aerodynamic design. The blade specifications are presented in tabulations of profile geometries at incremental radial stations from hub to tip for all blading stations and of corresponding stagger angles, stacking points, and section properties. Thirteen radial stations were selected to define the blade shape for each blade row.

Casting was selected as the most cost effective means for obtaining duplicate blading in relatively small lots. The blade cast material is A356-T6, an aluminum alloy used successfully for cast blading in similar compressor designs since 1968.

Blading attachment is accomplished by means of a bolt, as shown in Figure 25, which secures an integral stud on the blade or vane into a corresponding recessed hole in the blade or vane carrier. This method of blading installation, which is mechanically simple and provides the option to restagger any or all blade rows, has been used successfully in previous programs. A photograph of typical cast aluminum blading, including mounting pads, for a three-stage compressor is shown in Figure 26. Typical rotor and cantilevered stator assemblies are shown respectively in Figures 27 and 28. All airfoils were designed to permit trimming to the specified tip clearances after assembly.

3S1 AND 3S2 AIRFOIL STRESS ANALYSES

Static stresses for the IGV, R1, R2, R3, S1, S2, and S3 blading were calculated to verify that the blade designs were adequate for stresses at design loadings. The stress analyses included a bending analysis and an air load analysis. The bending analysis assumed that the air load passes through the shear center, thus applying no torque to the airfoil. Rotor and stator airfoil loads and moments, caused by pressure and flow, were calculated in the axial, tangential, and meridional directions.

The maximum airfoil stresses, which occur at the rotor hub and at the stator outer diameter, are presented in Table II. For purposes of comparison, Table II also contains stress levels calculated for the first-stage rotor of a Pratt & Whitney Aircraft low aspect ratio compressor that operated successfully for 40 hours and which utilized similar A356-T6 cast aluminum blades.

Displacements, strains, and stresses in compressor rotating hardware were calculated to verify that these components are adequate for operation at design speed. Maximum stresses are summarized in Table III. The rotating components were analyzed as bodies of revolution subjected to axisymmetric inertia loading caused by the component itself and by the blades and blade attachment fittings at 6200 rpm (110 percent design speed). Displacements, strains, and stresses in both the tangential and radial directions were obtained by a finite element analysis. All disks were mass balanced, resulting in rim designs which equalize radial growth relative to their planes of rotation. The elimination of this possible hub distortion permits compressor operation with minimum blade tip clearances. Table III also gives the calculated stress levels of a typical rotor wheel and spacer in the same compressor used for the comparison in Table II.

TABLE II
MAXIMUM AIRFOIL STRESS

		<u>Max. Stress Due to Centrifugal Load</u>		<u>Max. Stress Due to Bending</u>	
		<u>N/cm²</u>	<u>lbf/in.²</u>	<u>N/cm²</u>	<u>lbf/in.²</u>
Compressor 3S1	IGV	0	0	445	646
	R1	683	990	399	578
	S1	0	0	601	871
	R2	806	1169	334	484
	S2	0	0	427	620
	R3	687	996	238	345
	S3	0	0	367	532
Compressor 3S2	IGV	0	0	393	570
	R1	654	949	820	1189
	S1	0	0	566	821
	R2	738	1071	592	858
	S2	0	0	520	754
	R3	825	1197	468	679
	S3	0	0	364	528
Ref. TR-3 Compressor	R1	1338	1941	268	389
	S1	0	0	411	596

Yield Stress for A356-T6 Aluminum = 13,800 N/cm² (20,000 lbf/in.²)

Factor of Safety (Min.)* = 8.64 (3S1, R2)

Factor of Safety (Min.)* = 6.68 (3S2, R1)

Factor of Safety (Min.)* = 6.13 (Ref. Comp. TR-3, R1)

$$\text{*Factor of Safety} = \frac{\text{Yield Stress}}{\text{_____}}$$

(max. stress due to centrifugal load + max. stress due to bending) x (stress concentration factor, 1.4)

TABLE III
SUMMARY OF ROTATING HARDWARE STRESSES

		<u>Max. Stress Due to Centrifugal Load</u>	
		<u>N/cm²</u>	<u>lbf/in.²</u>
Compressor 3S1	Inlet Seal Wheel	11,210	16,260
	Rotor 1 Wheel	11,290	16,380
	Rotor 2 Wheel	11,220	16,280
	Rotor 3 Wheel	10,710	15,530
	Rotor-Spacer Wheel		
	Stator 1	7,070	10,260
	Stator 2	10,890	15,800
	Stator 3	9,100	13,200
	Exit Seal Wheel	8,140	11,860
Compressor 3S2	Inlet Seal Wheel	11,210	16,260
	Rotor 1 Wheel	10,370	15,040
	Rotor 2 Wheel	8,340	12,100
	Rotor 3 Wheel	8,760	12,700
	Rotor-Spacer Wheel		
	Stator 2	3,180	11,860
	Stator 3	9,310	13,500
	Exit Seal Wheel	8,180	11,860
	Ref. No. TR-3 Compressor	Rotor 1 Wheel	11,850

Yield Stress for 6060-T6 Aluminum Alloy = 27,600 N/cm² (40,000 lbf/in.²)

Factor of Safety (Min.)* = 2.44 (3S1, R-1)

Factor of Safety (Min.)* = 2.46 (3S2, Inlet Seal)

Factor of Safety (Min.)* = 2.33 (Ref. Compressor TR-3, R-1)

*Factor of Safety = $\frac{\text{Yield Stress}}{\text{Max. Stress due to Centrifugal Load}}$

REFERENCE

1. Marman, H. V. and Marchant, R. D.: "Preliminary Compressor Design Study for Advanced Multistage Axial Flow Compressor, Final Report," NASA CR-135091, PWA-5318, 1976.

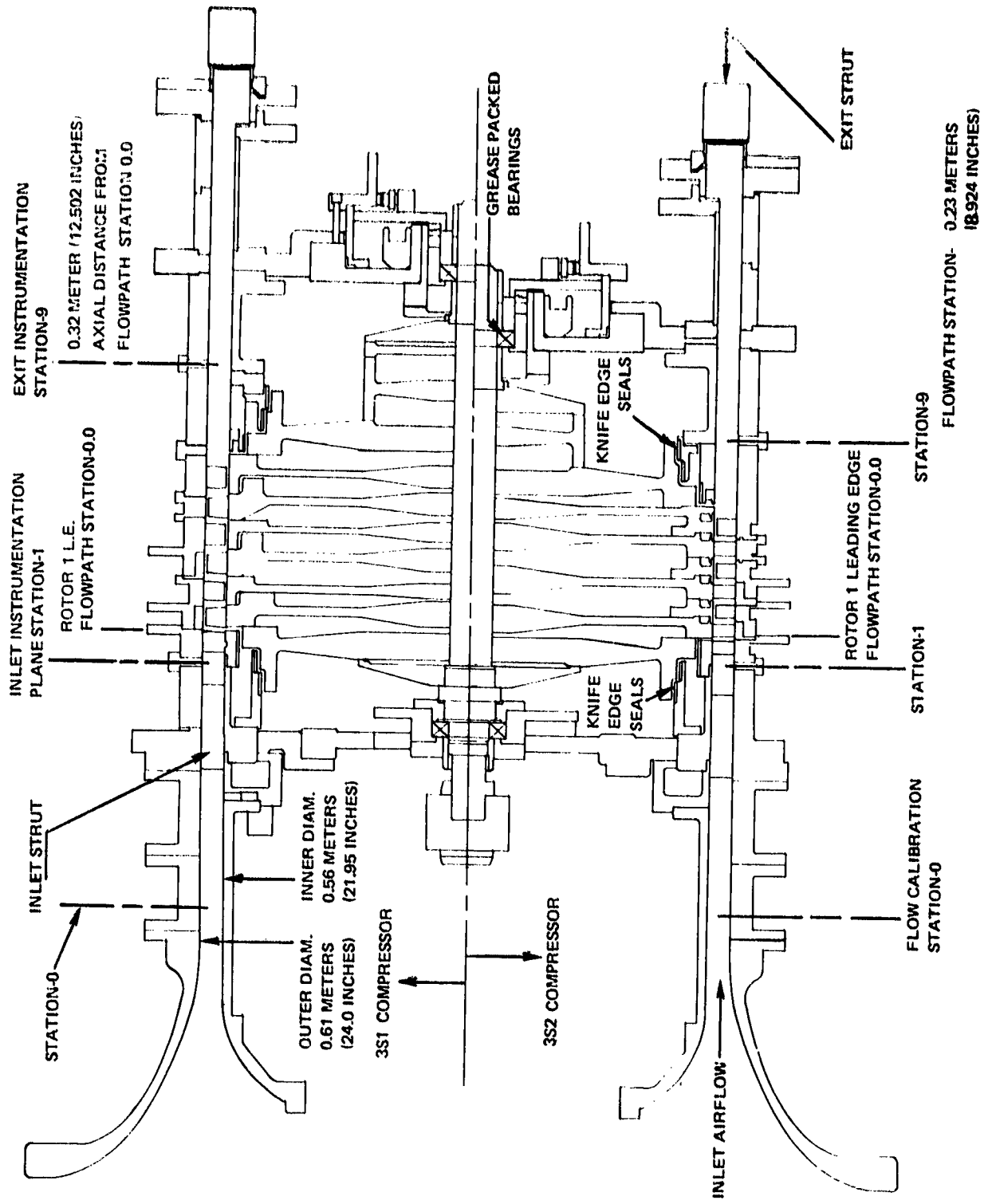

Figure 1 Schematic of 3S1 and 3S2 Compressor Assemblies

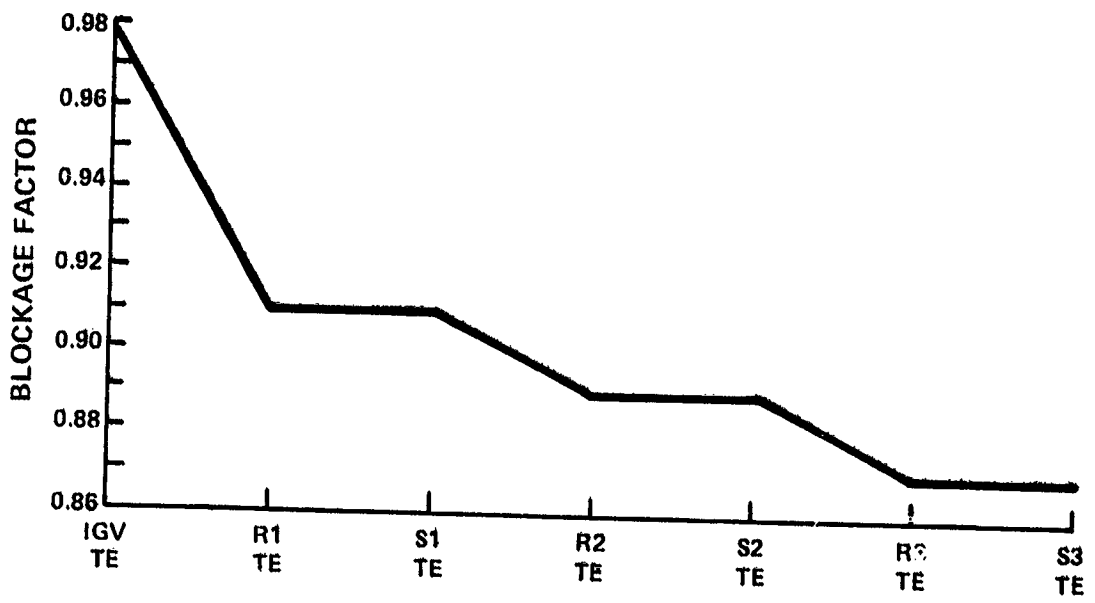

Figure 2 Blockage Distribution for 3S1 and 3S2 Compressor Configurations

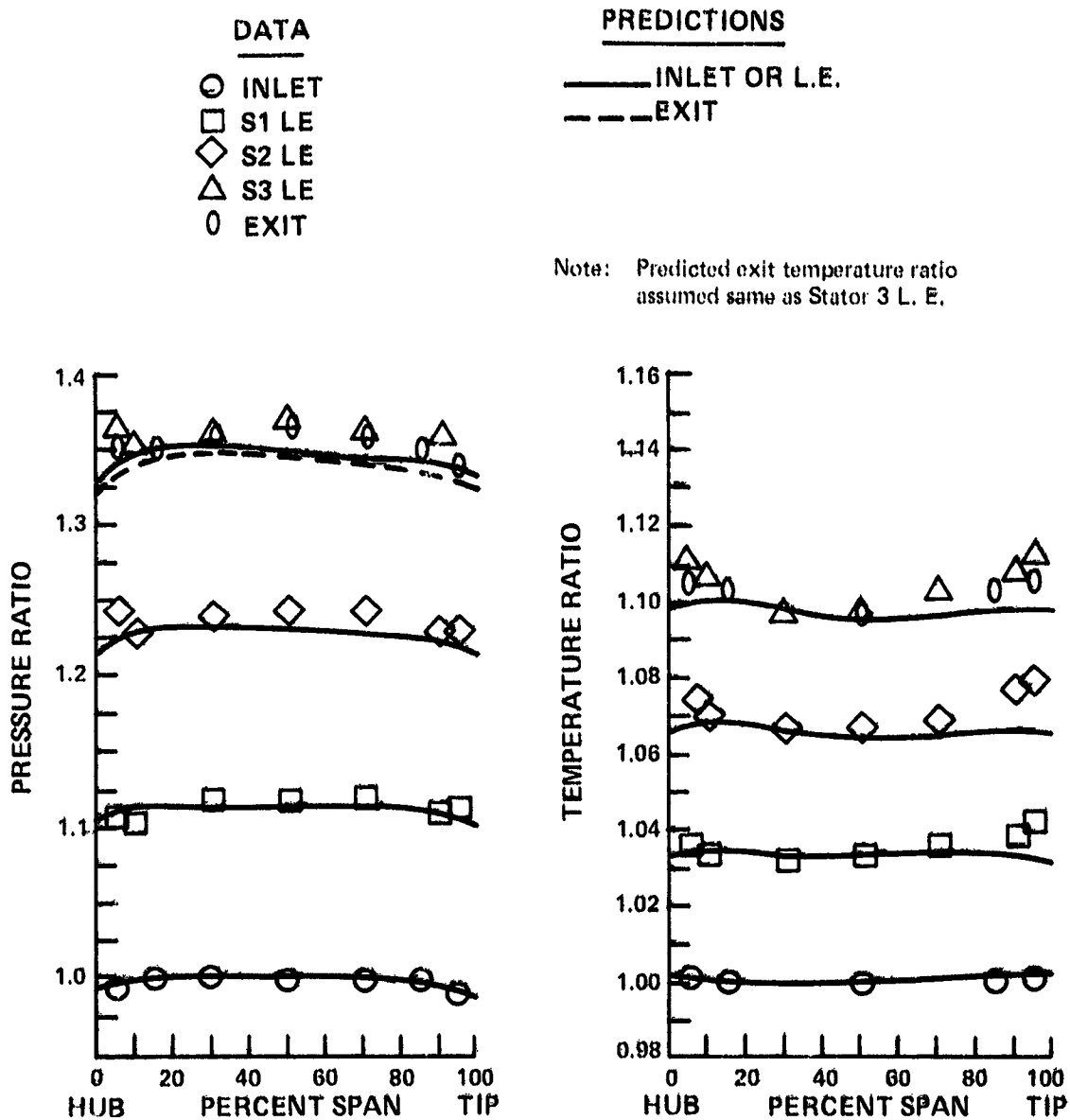

Figure 3 Comparison of Predicted and Measured Pressure and Temperature Profiles at Design Point and Peak Efficiency for Previously Tested Compressor Reference No. TR-1

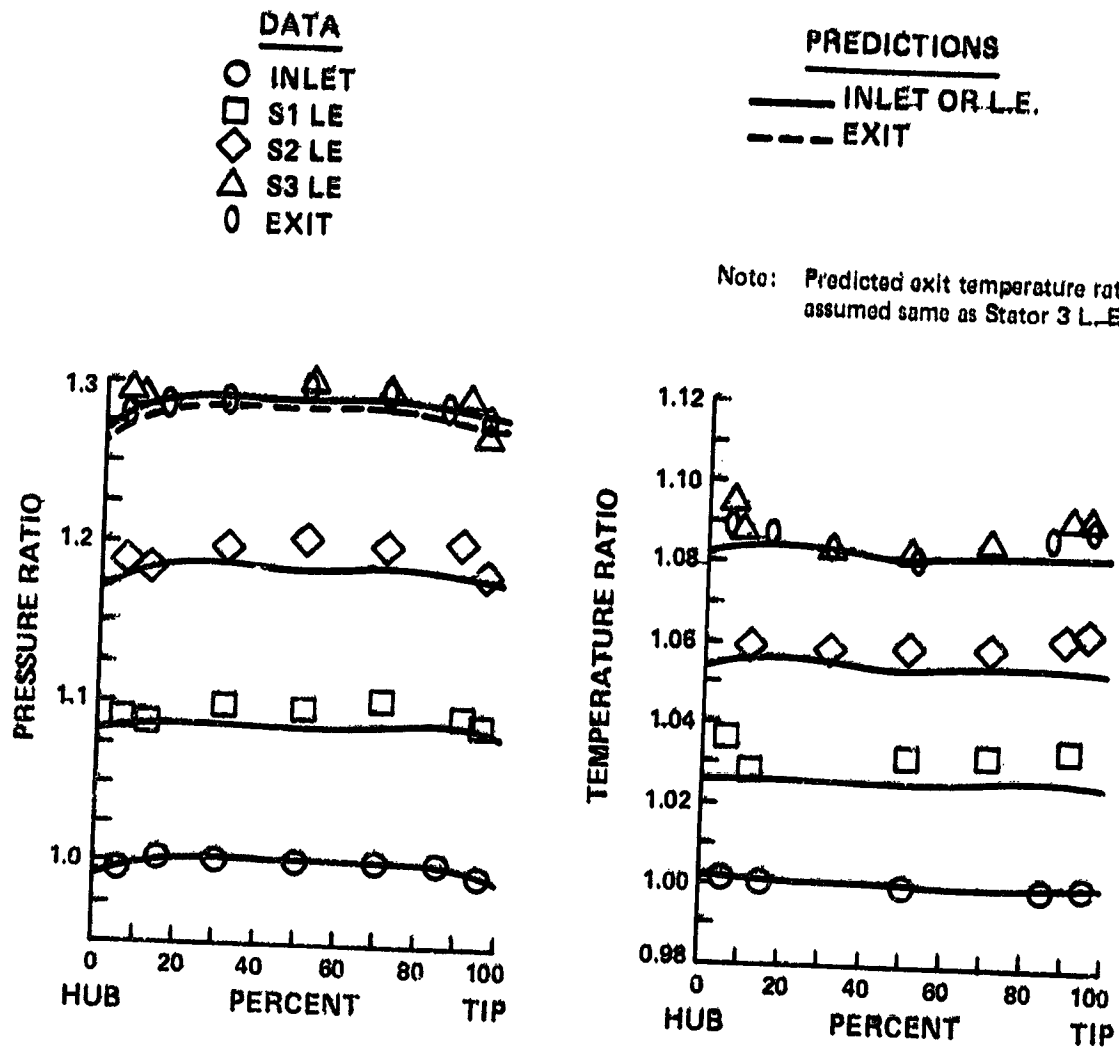

Figure 4 Comparison of Predicted and Measured Pressure and Temperature Profiles at Design Point and Peak Efficiency for Previously tested Compressor Reference No. TR-2

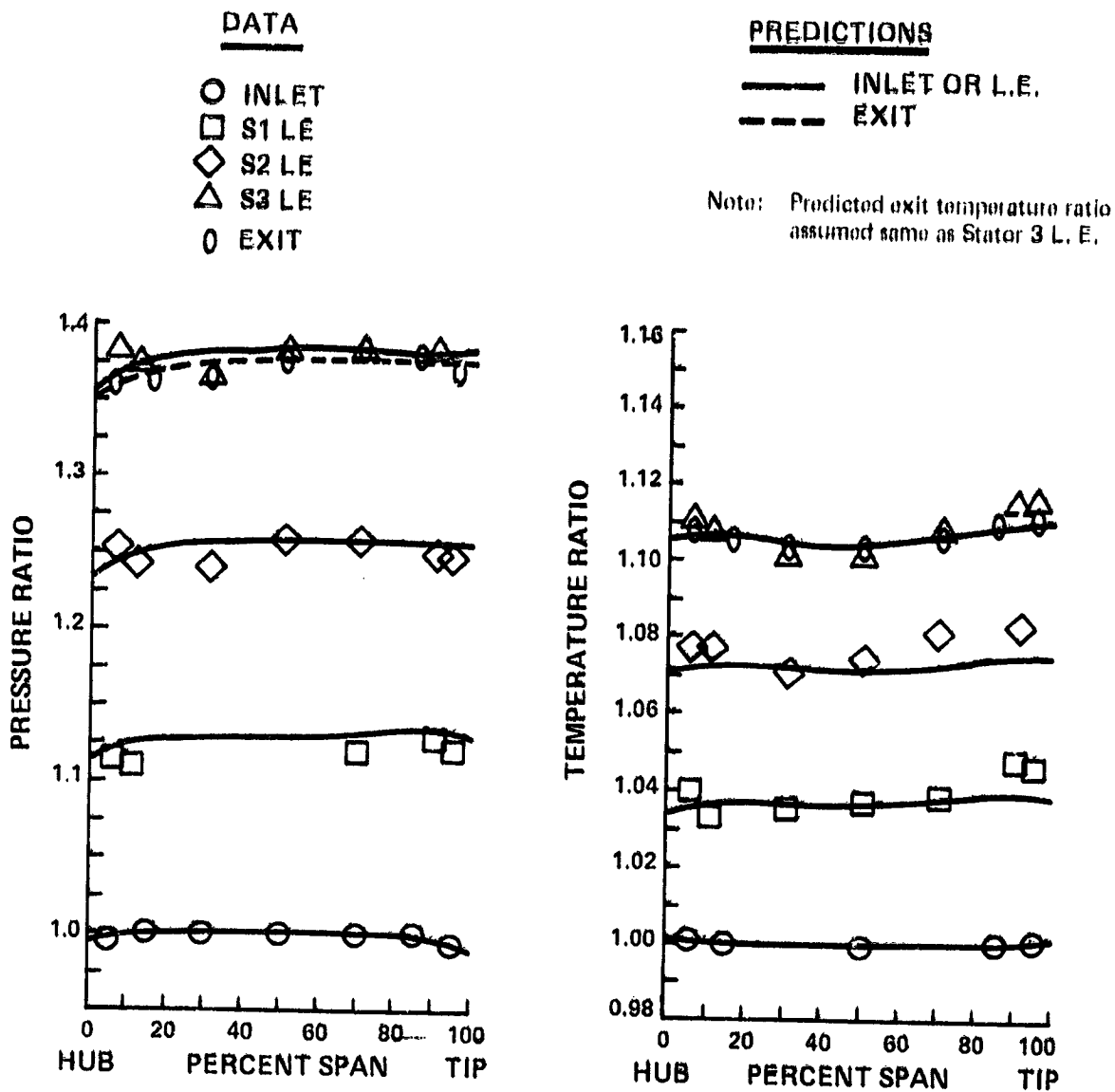

Figure 5 Comparison of Predicted and Measured Pressure and Temperature Profiles at Design Point and Peak Efficiency for Previously Tested Compressor Reference No. TR-3

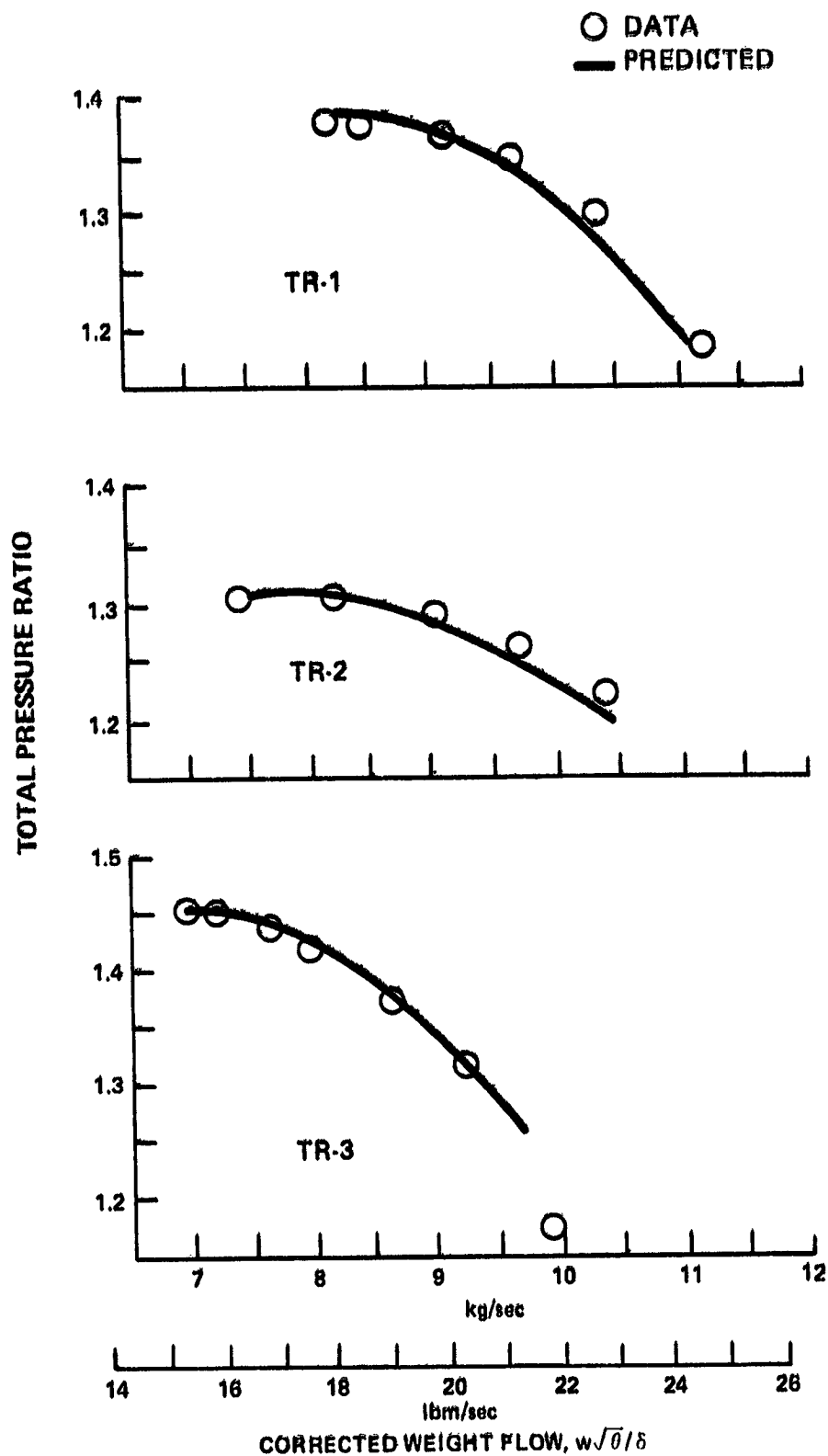

Figure 6

Comparison of Predicted and Measured Speedline Shapes for Three Compressor Configurations at 100 Percent Design Speed

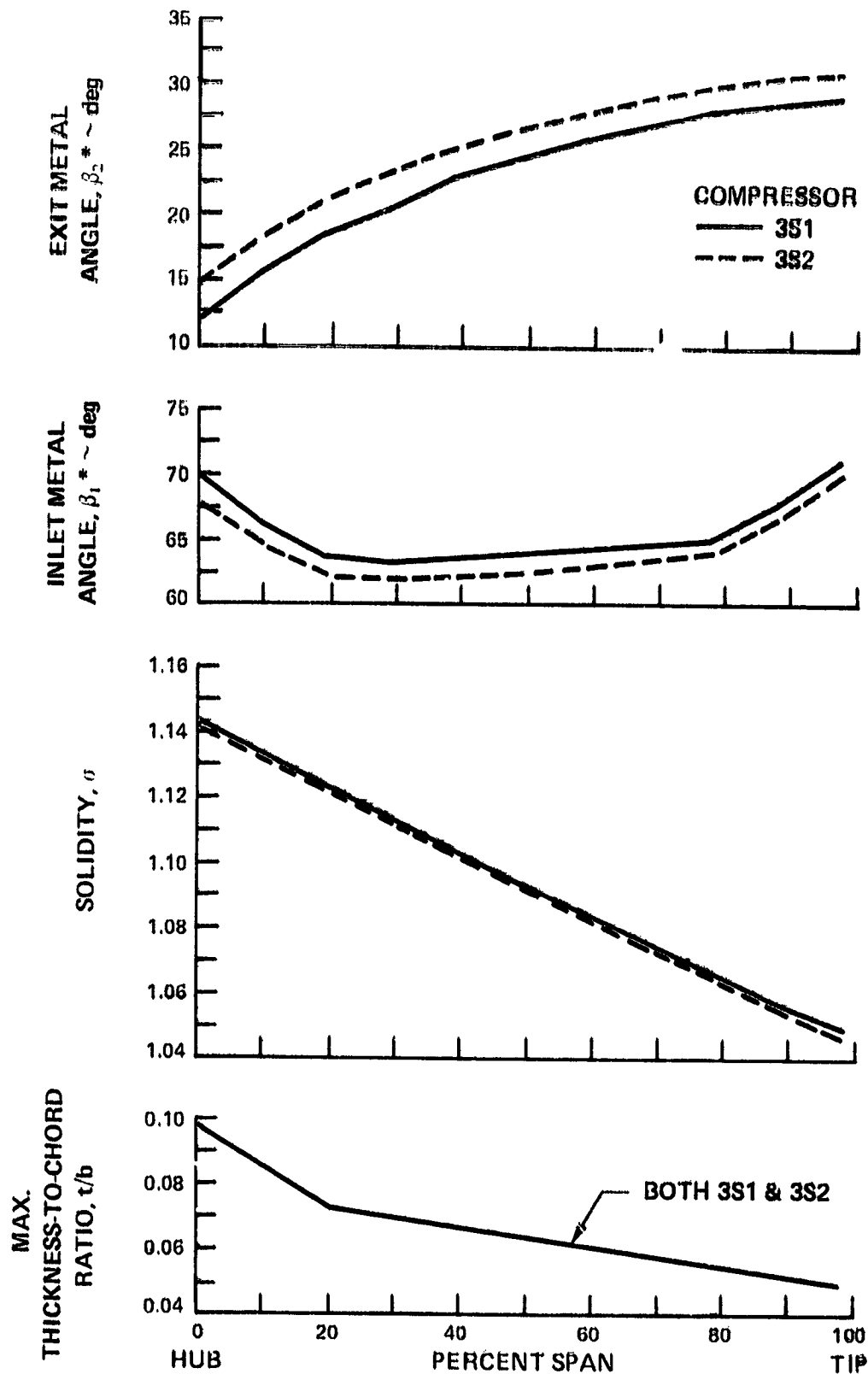

Figure 7

Compressor 3S1 and 3S2 Inlet and Exit Metal Angles, Solidity, and Thickness-to-Chord Ratio as a Function of Percent Span - Rotor 1

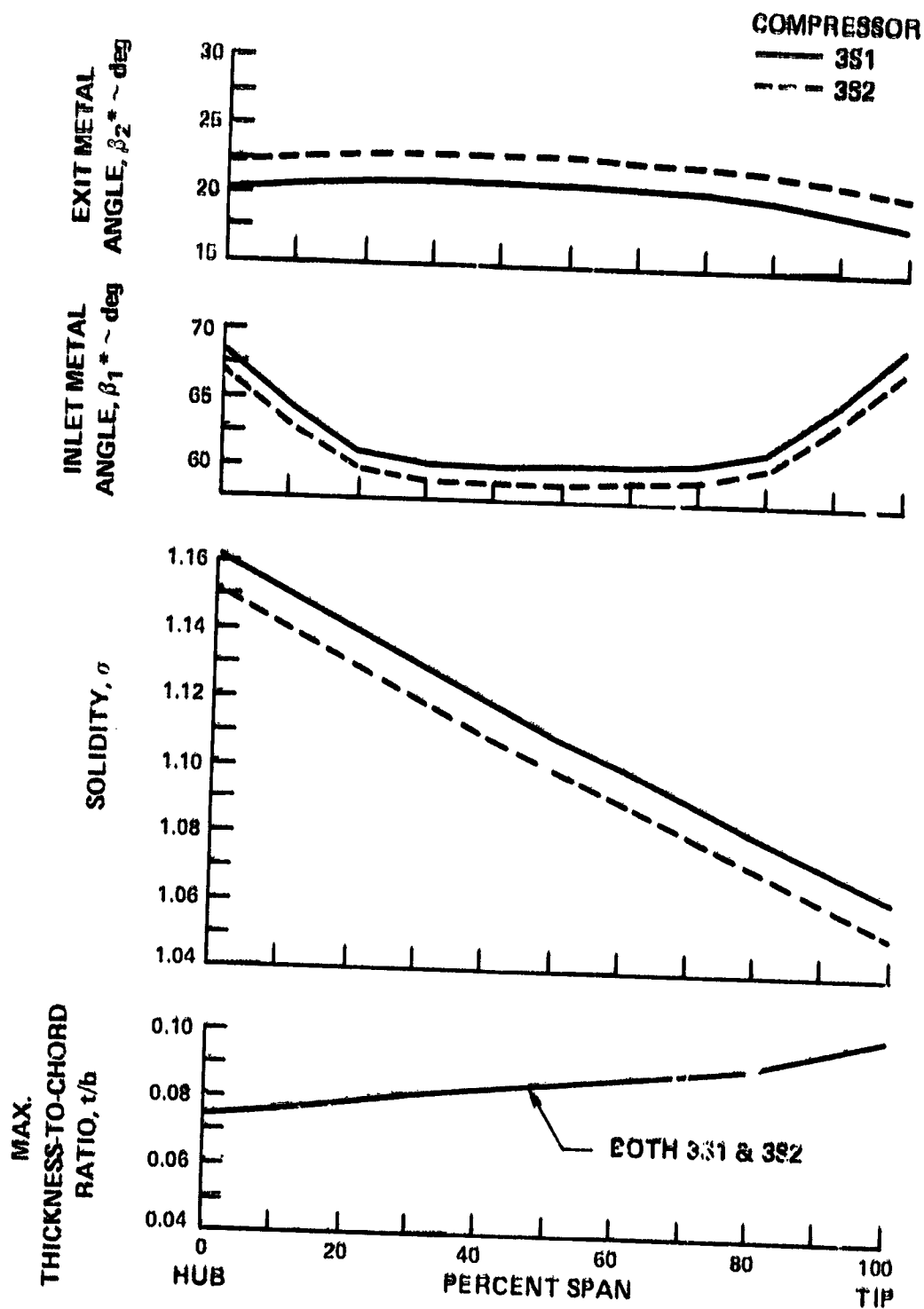

Figure 8

Compressor 3S1 and 3S2 Inlet and Exit Metal Angles, Solidity, and Thickness-to-Chord Ratio as a Function of Percent Span - Stator 1

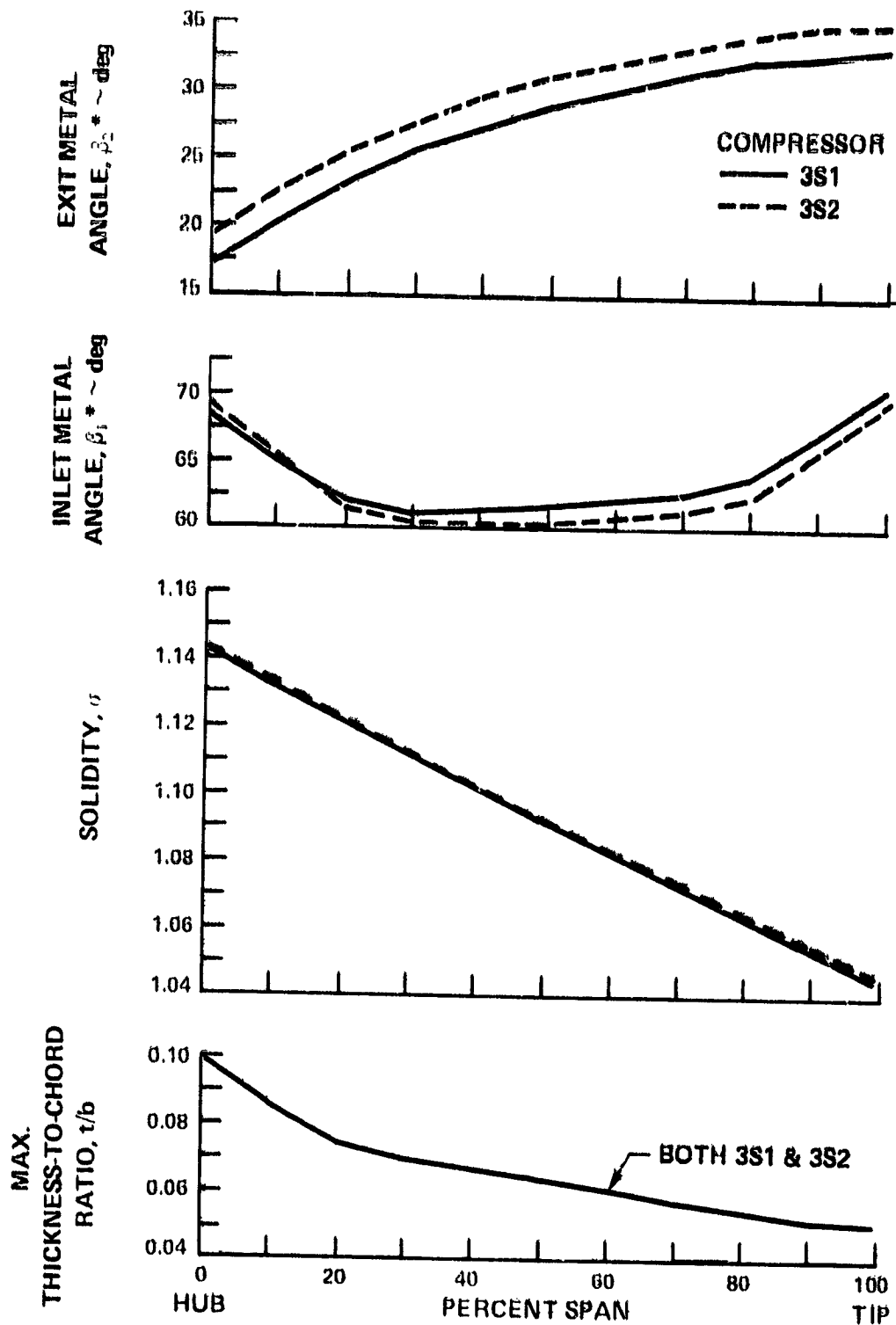

Figure 9 Compressor 3S1 and 3S2 Inlet and Exit Metal Angles, Solidity, and Thickness-to-Chord Ratio as a Function of Percent Span - Rotor 2

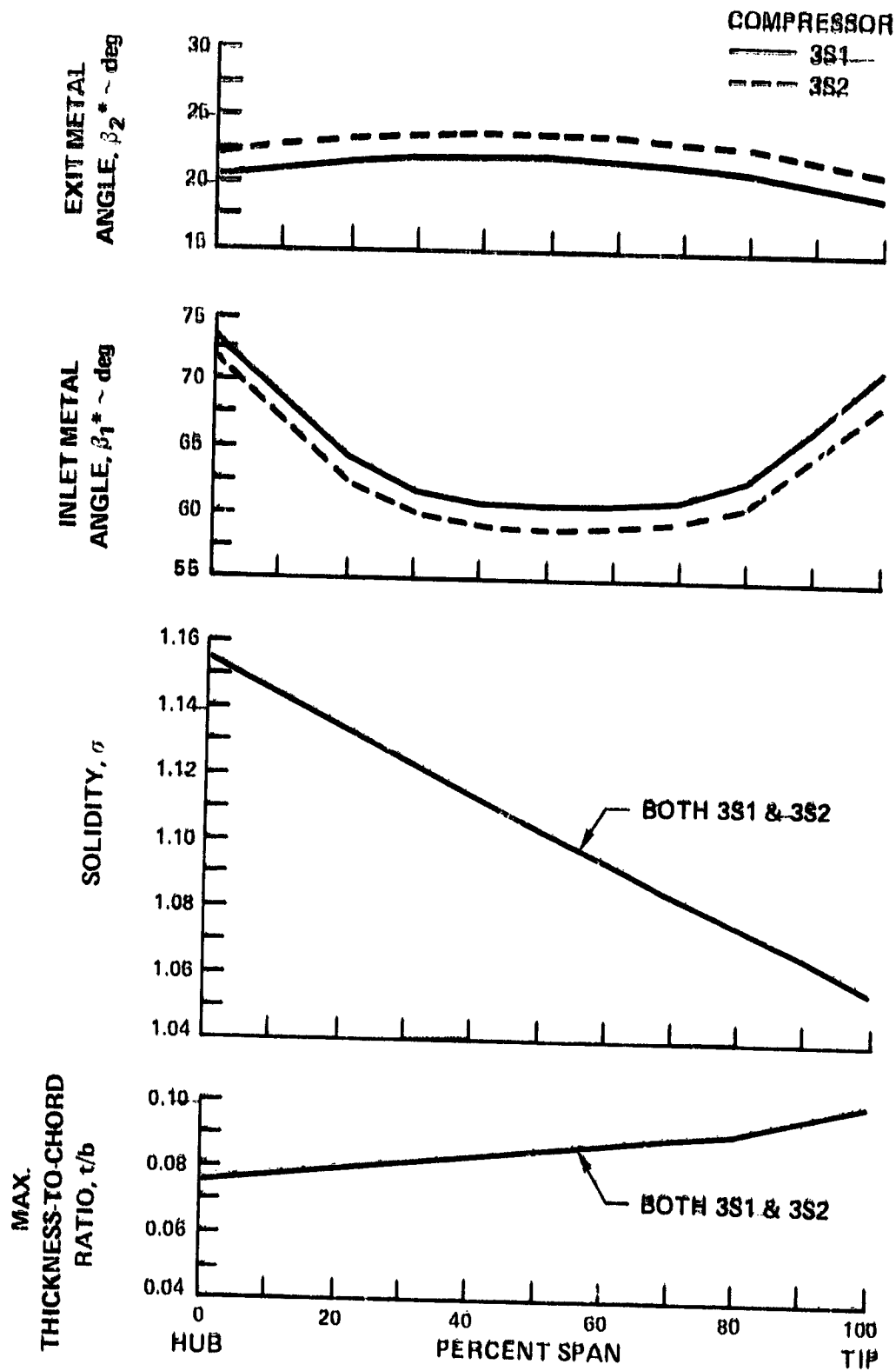

Figure 10

Compressor 3S1 and 3S2 Inlet and Exit Metal Angles, Solidity, and Thickness-to-Chord Ratio as a Function of Percent Span - Stator 2

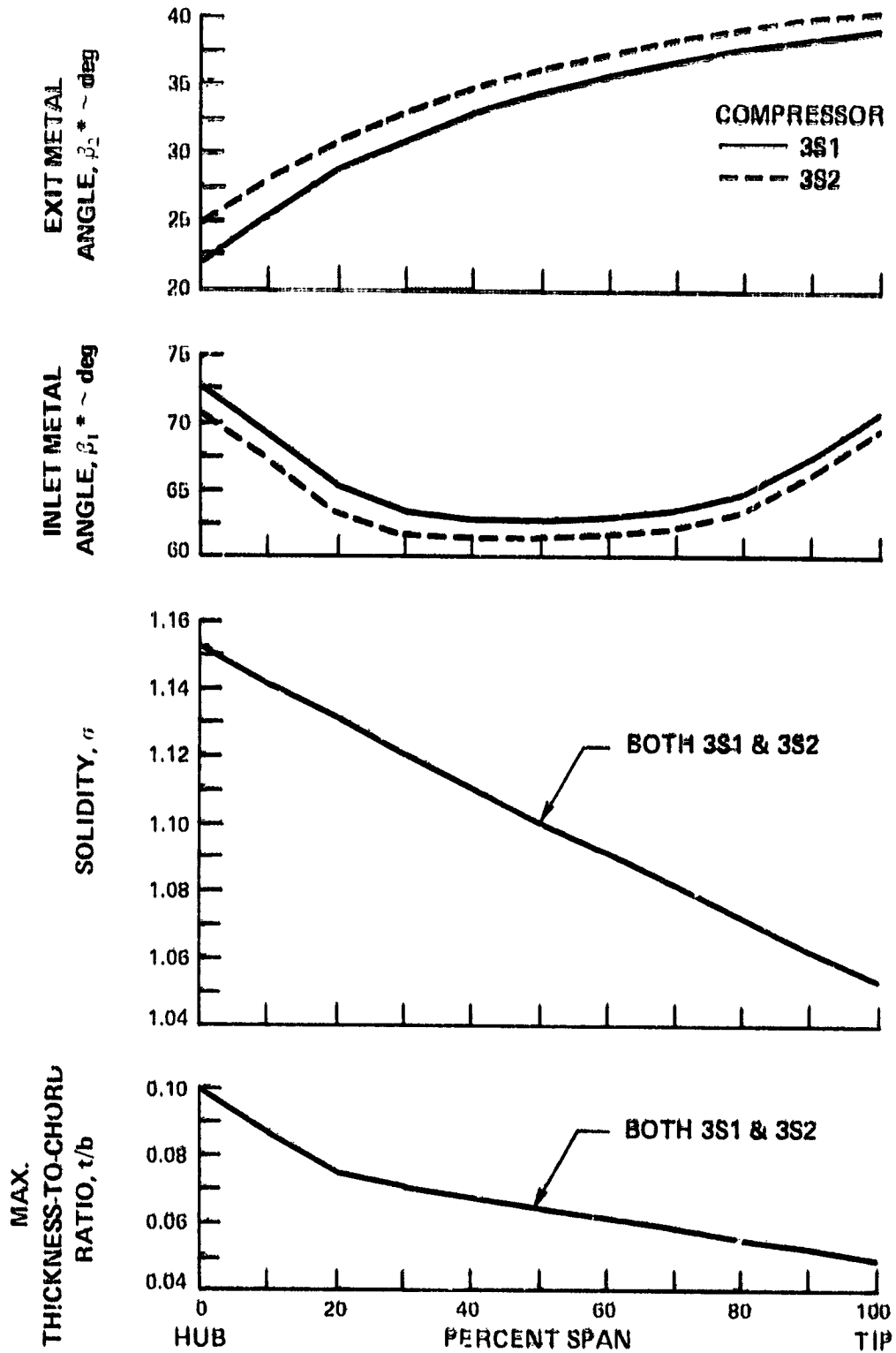

Figure 11

Compressor 3S1 and 3S2 Inlet and Exit Metal Angles, Solidity, and Thickness-to-Chord Ratio as a Function of Percent Span - Rotor 3

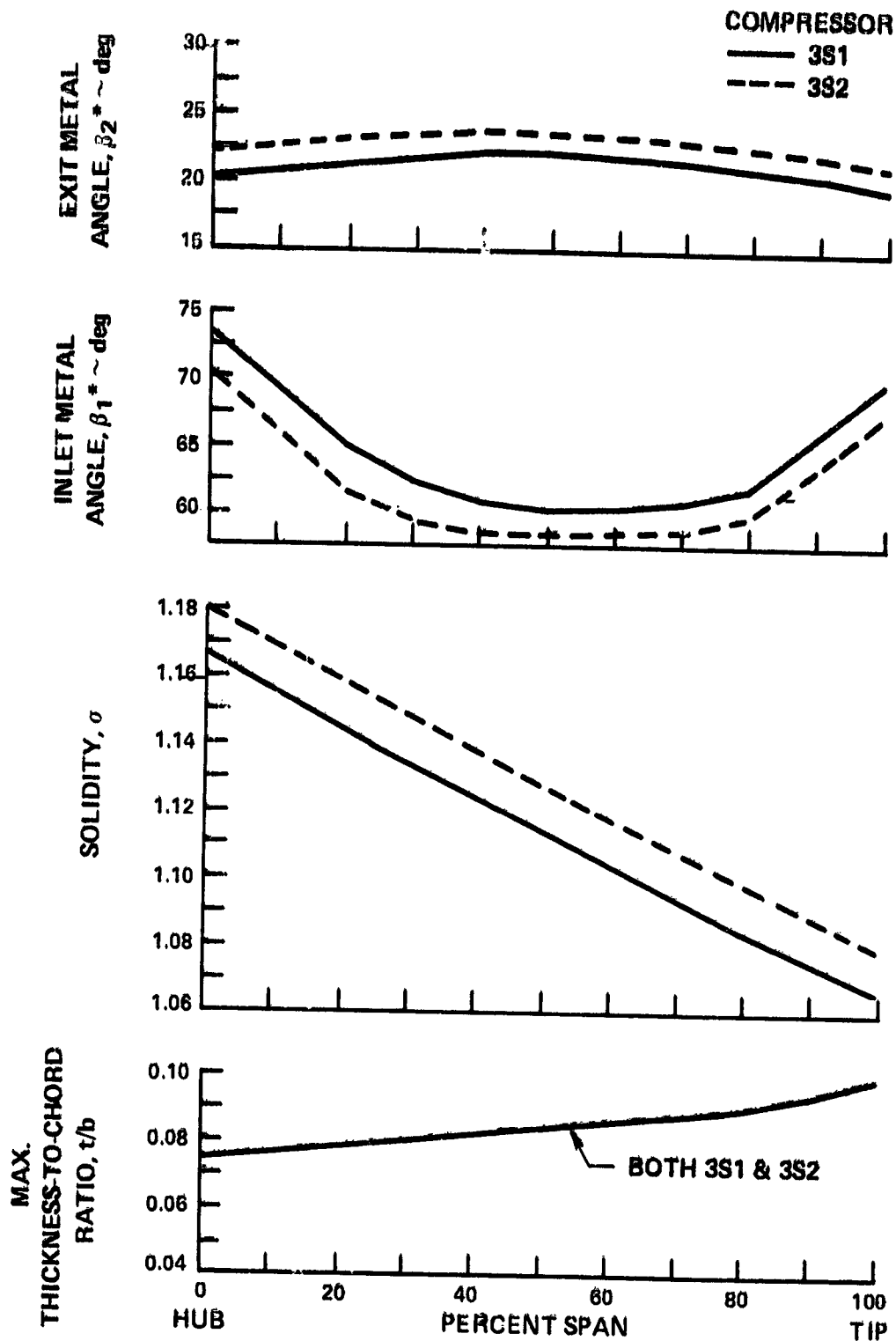

Figure 12 Compressor 3S1 and 3S2 Inlet and Exit Metal Angles, Solidity, and Thickness-to-Chord Ratio as a Function of Percent Span - Stator 3

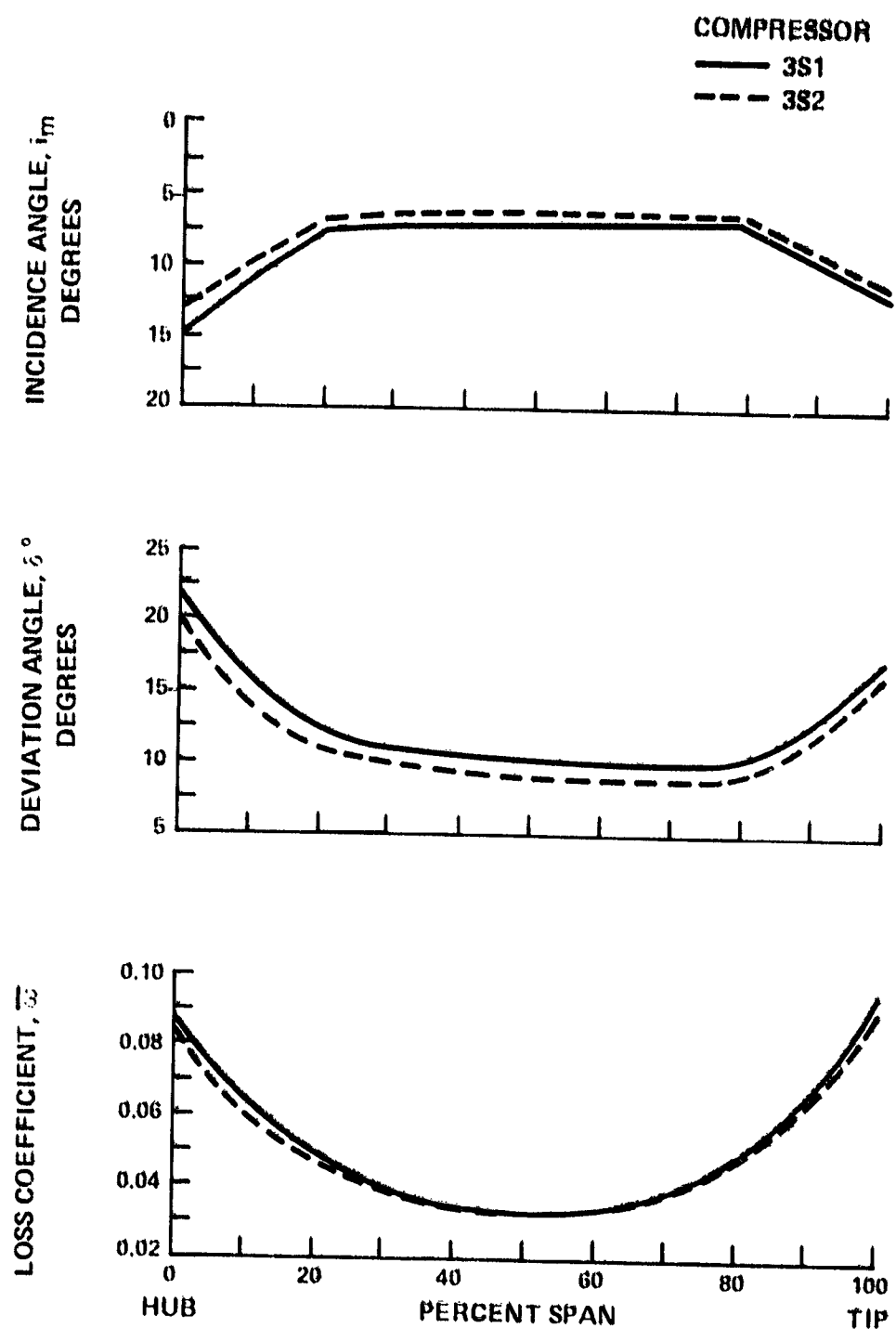

Figure 13 Compressor 3S1 and 3S2 Incidence Angle, Deviation Angle, and Loss as a Function of Percent Span - Rotor 1

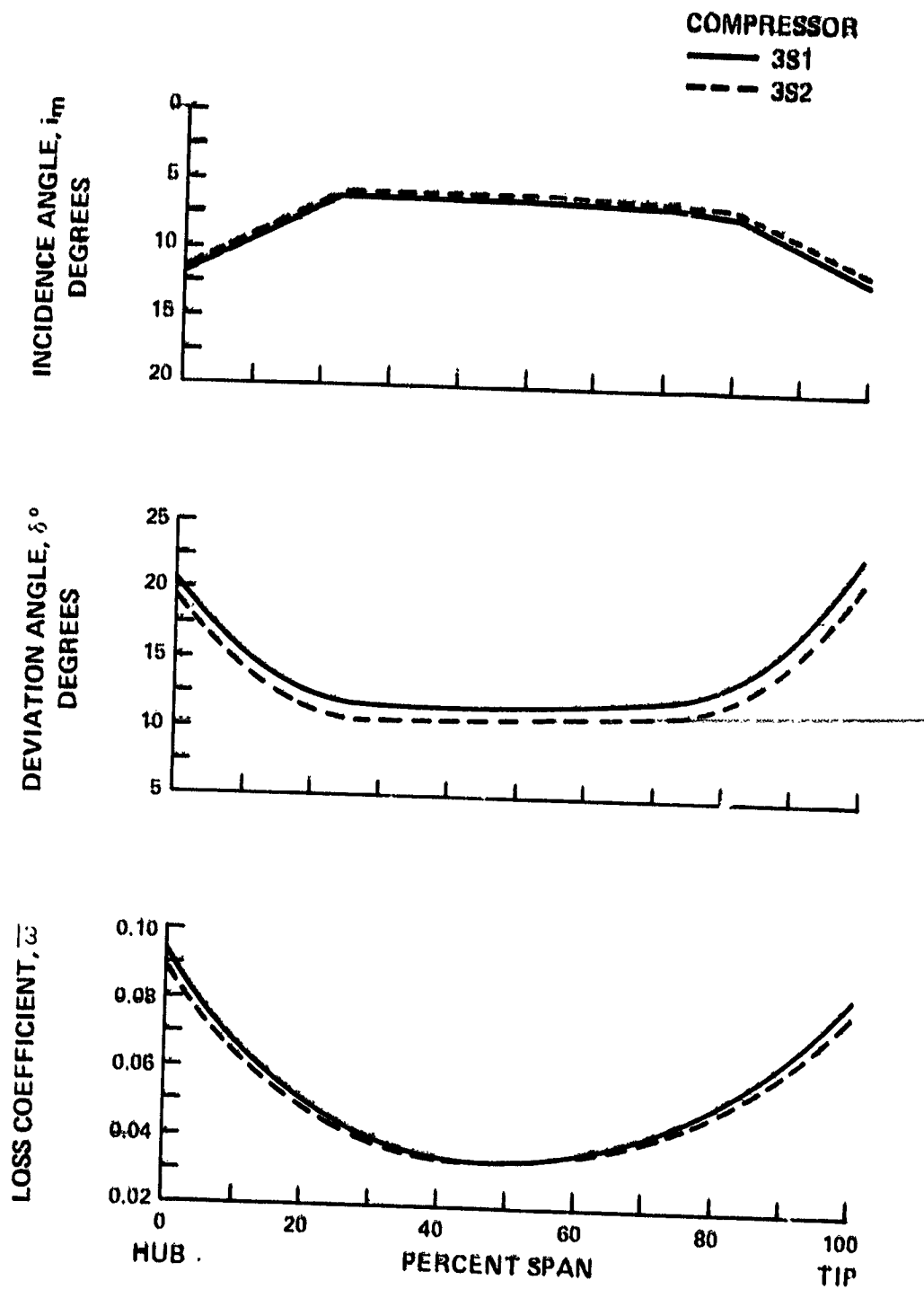

Figure 14 Compressor 3S1 and 3S2 Incidence Angle, Deviation Angle, and Loss as a Function of Percent Span - Stator 1

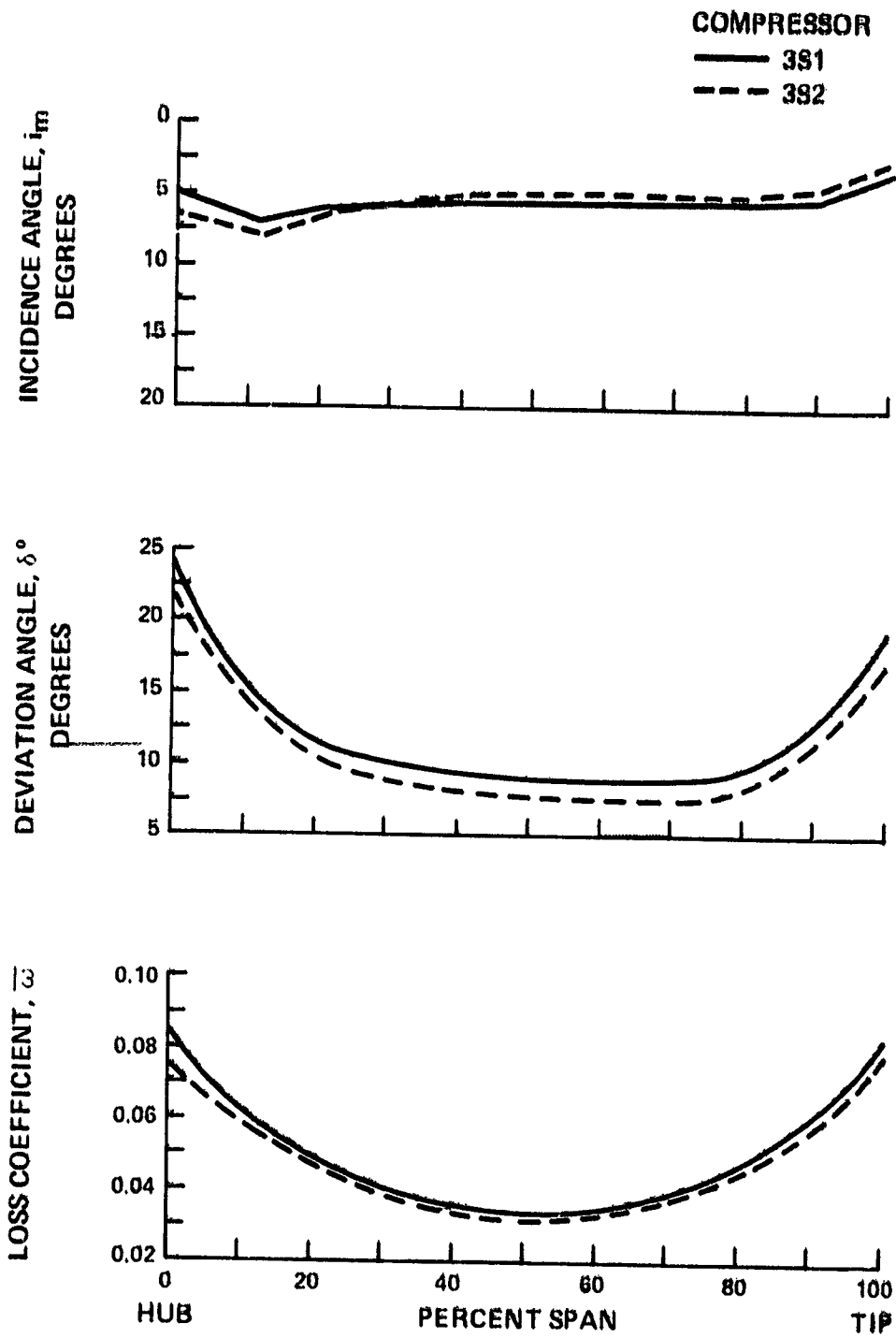

Figure 15 Compressor 3S1 and 3S2 Incidence Angle, Deviation Angle, and Loss as a Function of Percent Span - Rotor 2

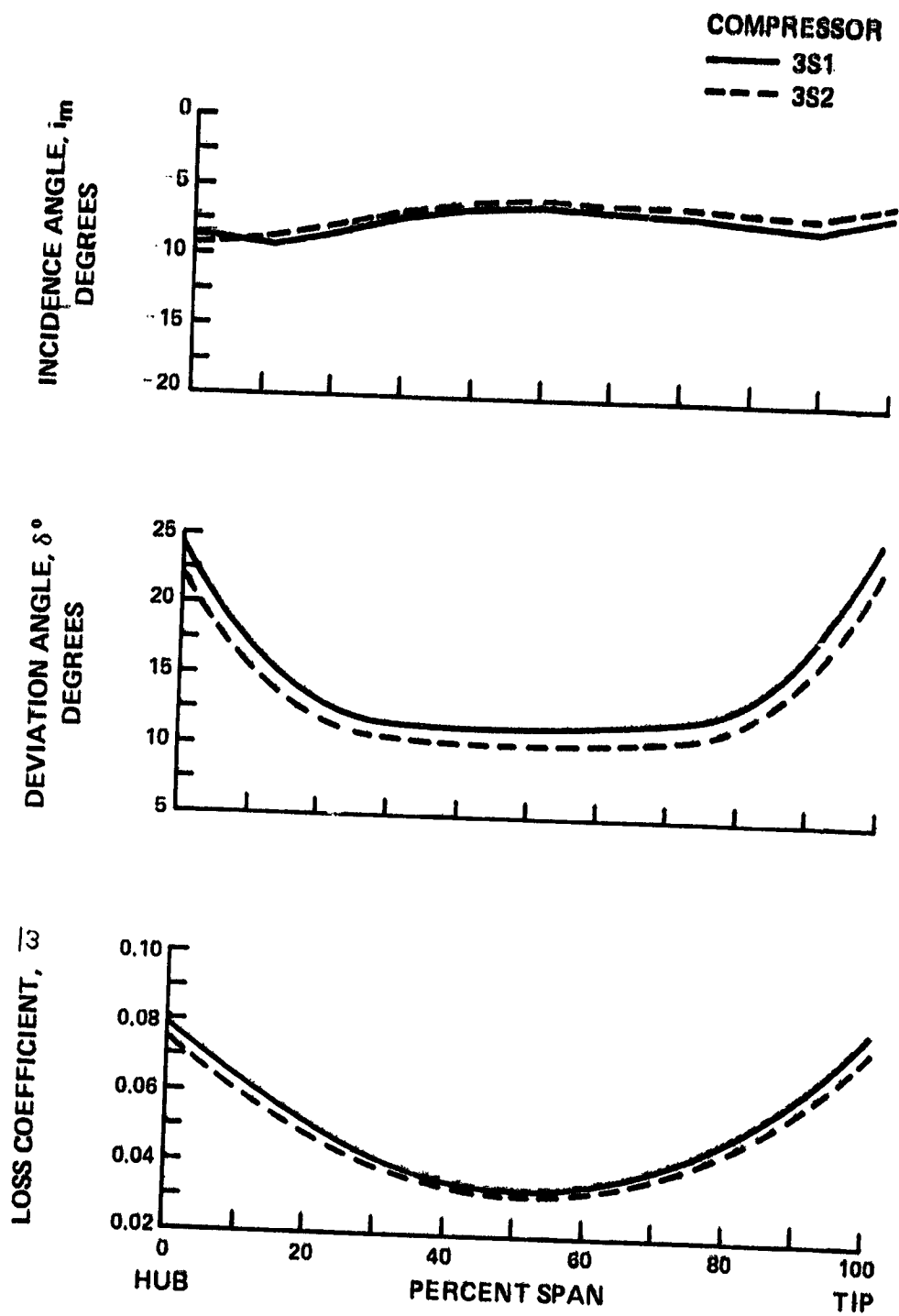

Figure 16 Compressor 3S1 and 3S2 Incidence Angle, Deviation Angle, and Loss as a Function of Percent Span - Stator 2

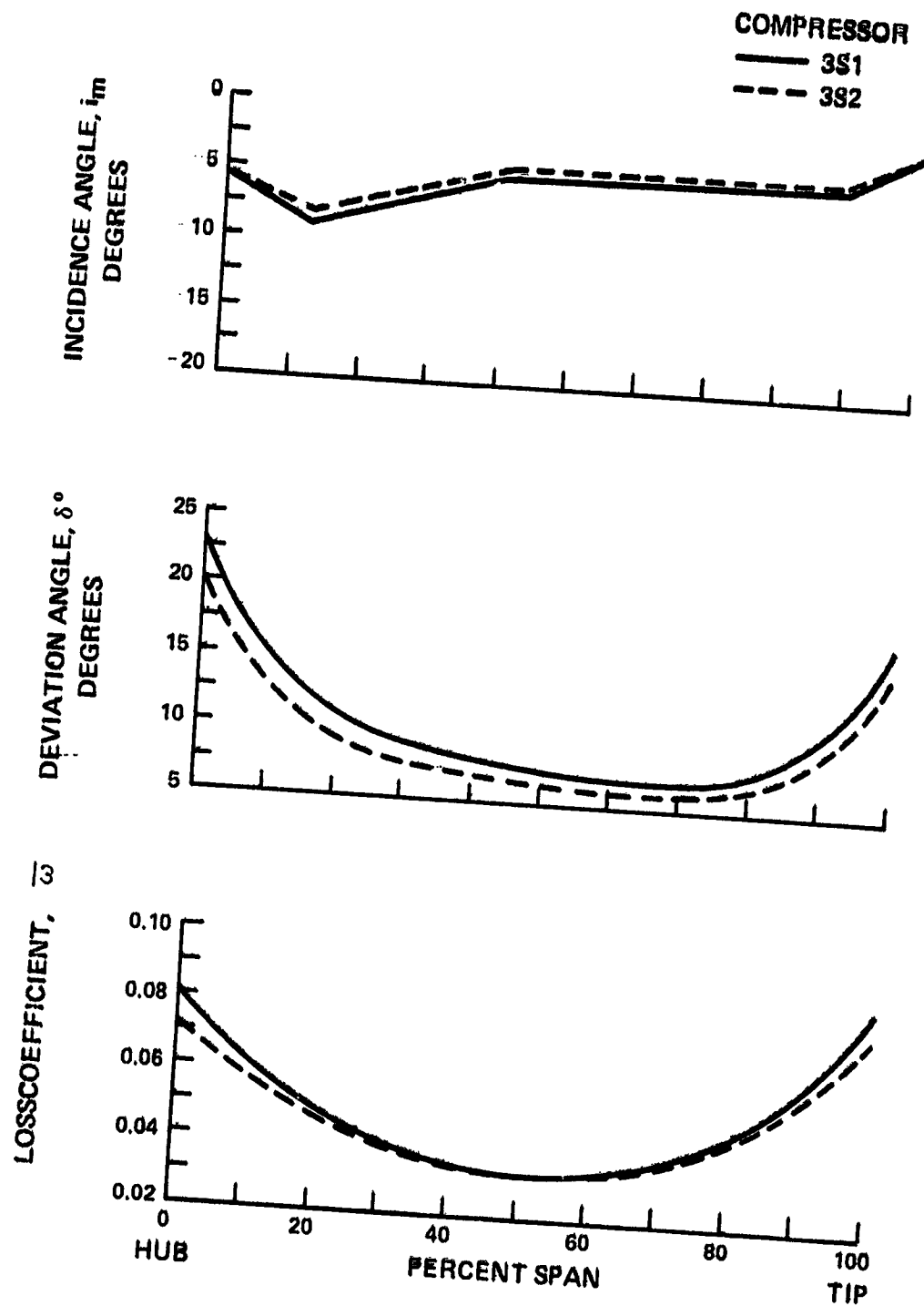

Figure 17 Compressor 3S1 and 3S2 Incidence Angle, Deviation Angle, and Loss as a Function of Percent Span - Rotor 3

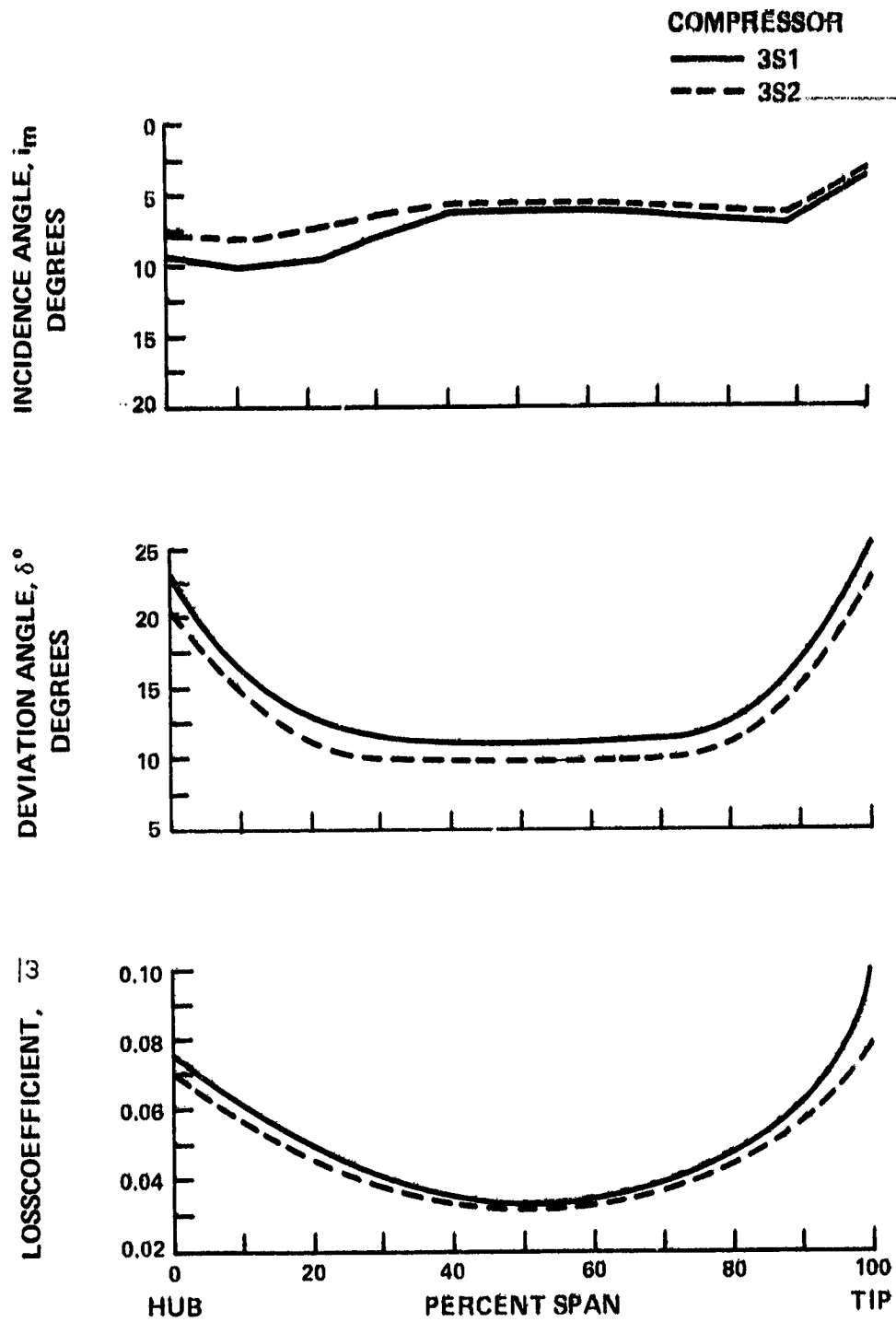

Figure 18 Compressor 3S1 and 3S2 Incidence Angle, Deviation Angle, and Loss as a Function of Percent Span - Stator 3

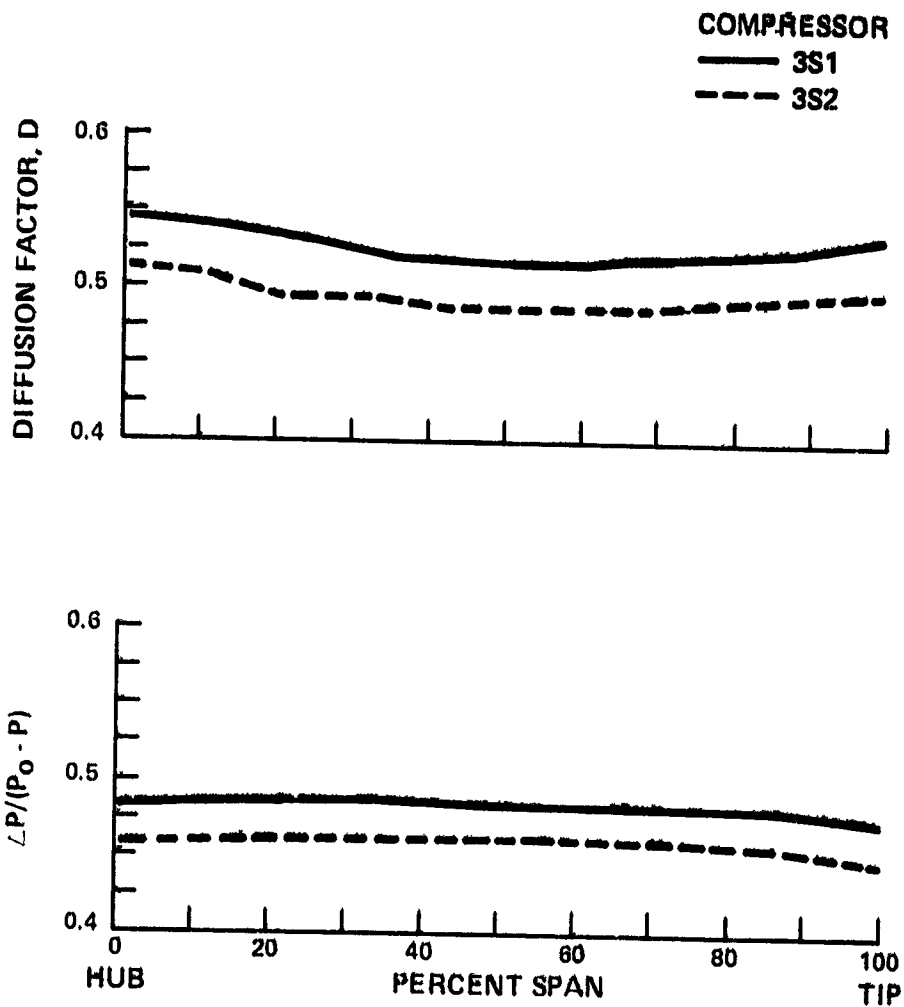

Figure 19 Spanwise Distribution of Diffusion Factor and $\Delta P / (P_0 - P)$ for Rotor 1 - Compressors 3S1 and 3S2

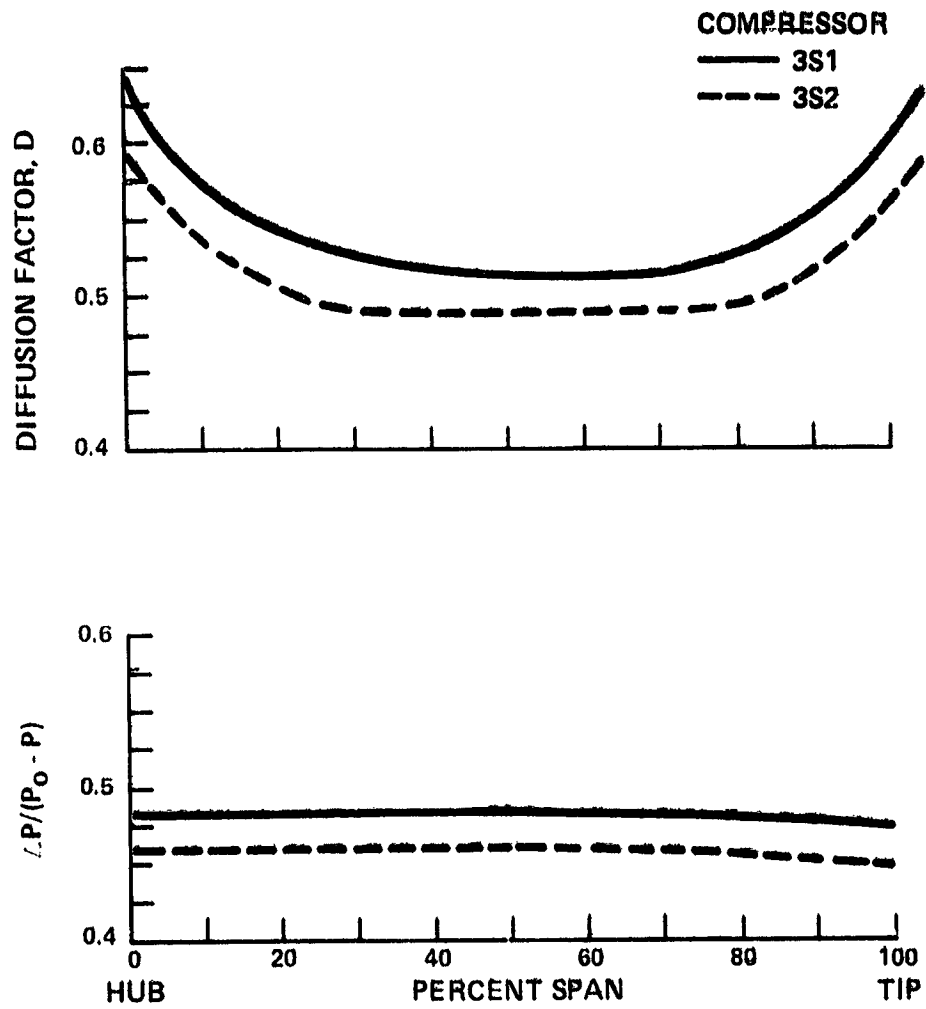

Figure 20 Spanwise Distribution of Diffusion Factor and $\Delta P / (P_0 - P)$ for Stator 1 - Compressors 3S1 and 3S2

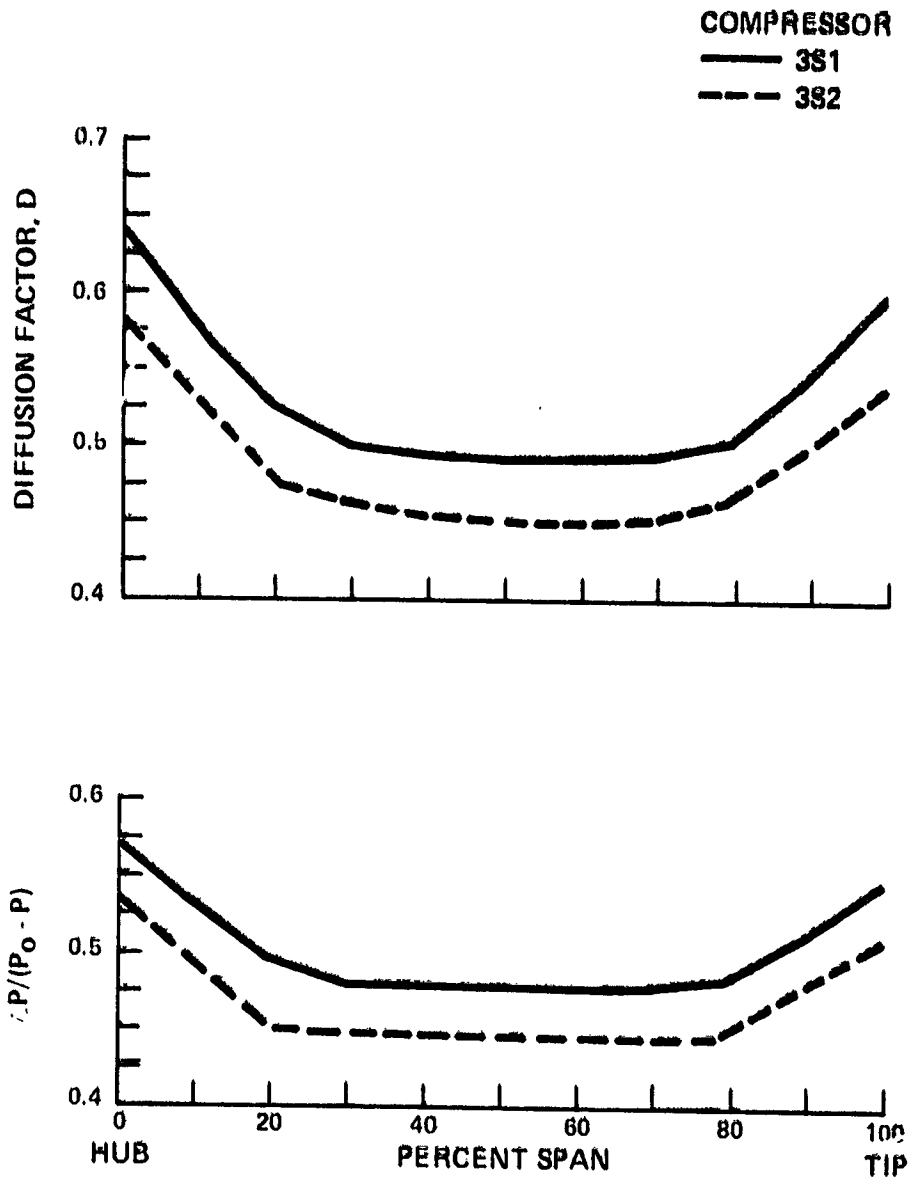

Figure 21 Spanwise Distribution of Diffusion Factor and $\Delta P / (P_0 - P)$ for Rotor 2 - Compressors 3S1 and 3S2

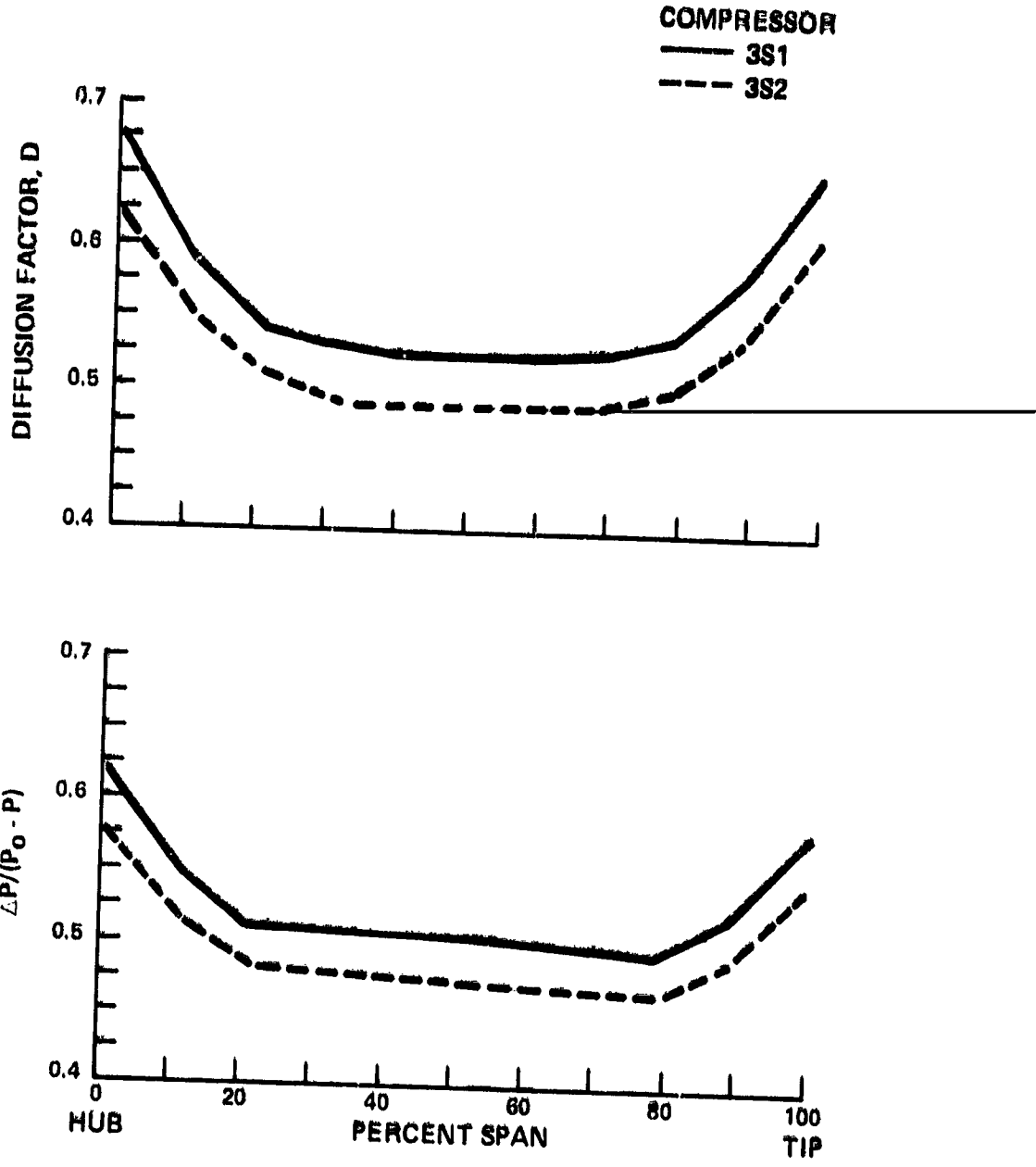

Figure 22 Spanwise Distribution of Diffusion Factor and $\Delta P / (P_0 - P)$ for Stator 2 - Compressors 3S1 and 3S2

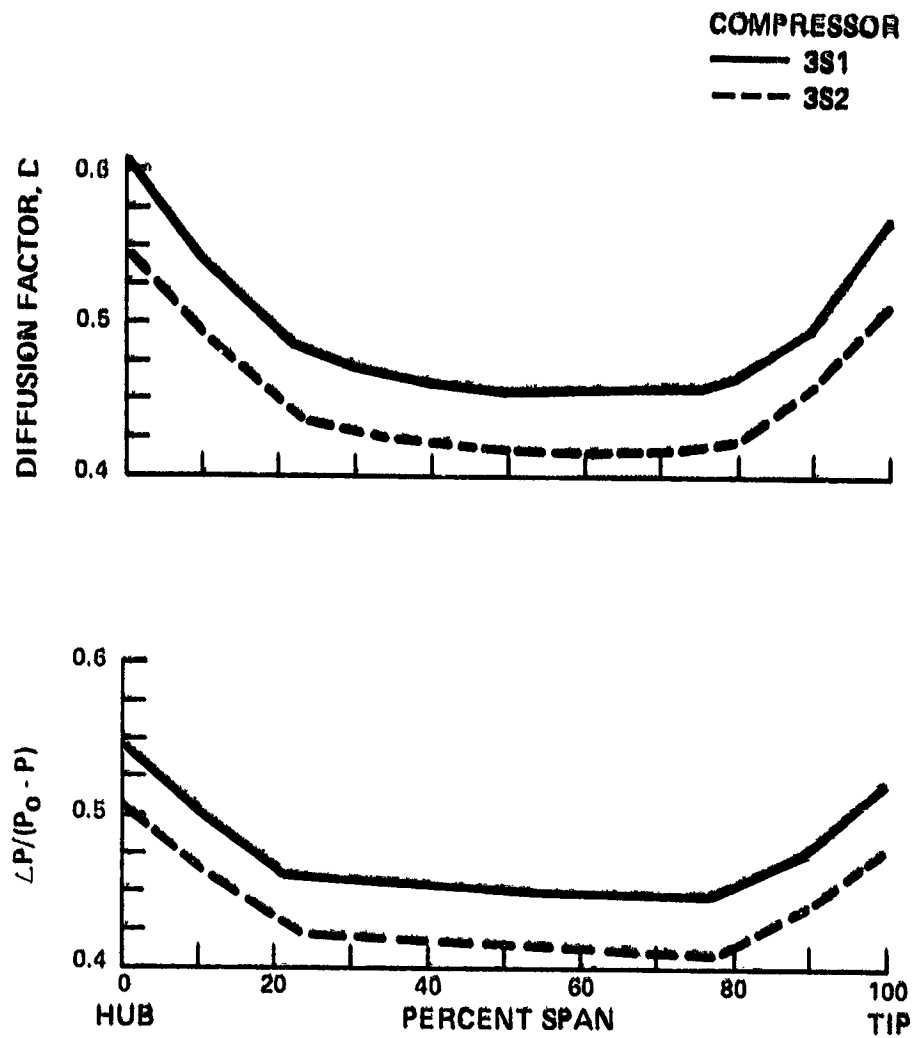

Figure 23 Spanwise Distribution of Diffusion Factor and $\Delta P / (P_0 - P)$ for Rotor 3 - Compressors 3S1 and 3S2

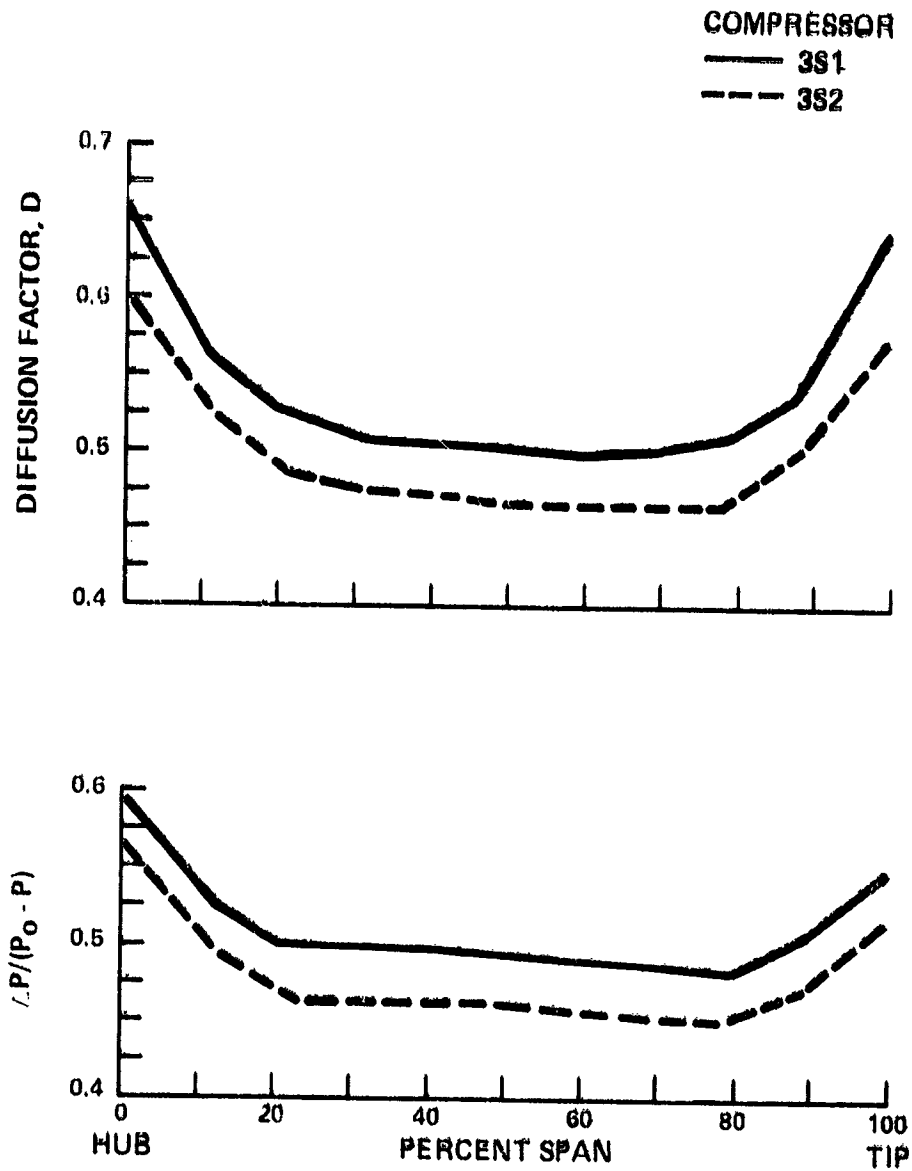

Figure 24 Spanwise Distribution of Diffusion Factor and $\Delta P / (P_0 - P)$ for Stator 3 - Compressors 3S1 and 3S2

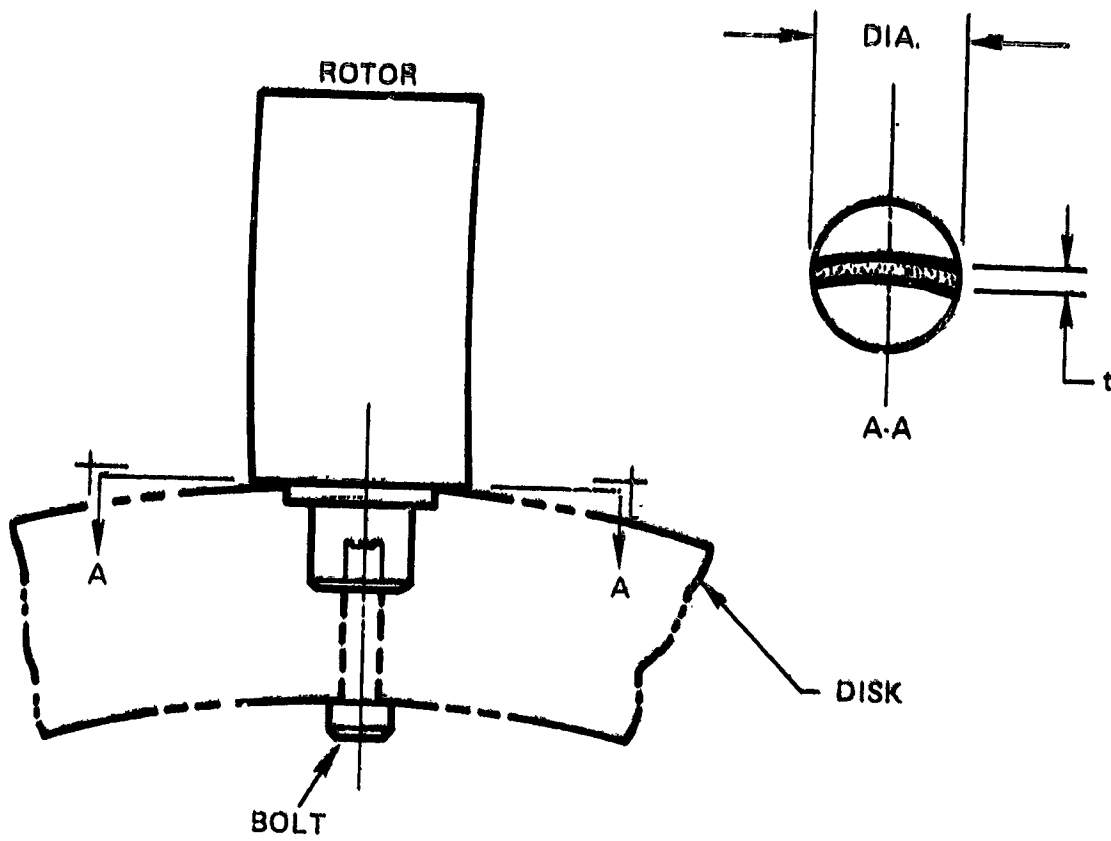

Figure 25 Schematic of Rotor Blade Attachment to Cylindrical Stub

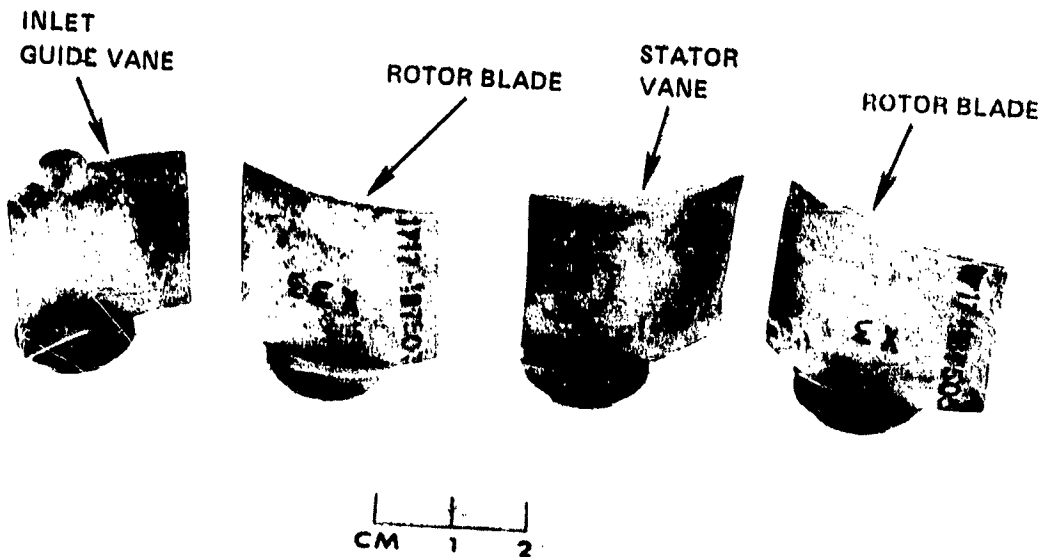

Figure 26 Photograph of Typical Cast Aluminum Blades

ORIGINAL PAGE IS
OF POOR QUALITY

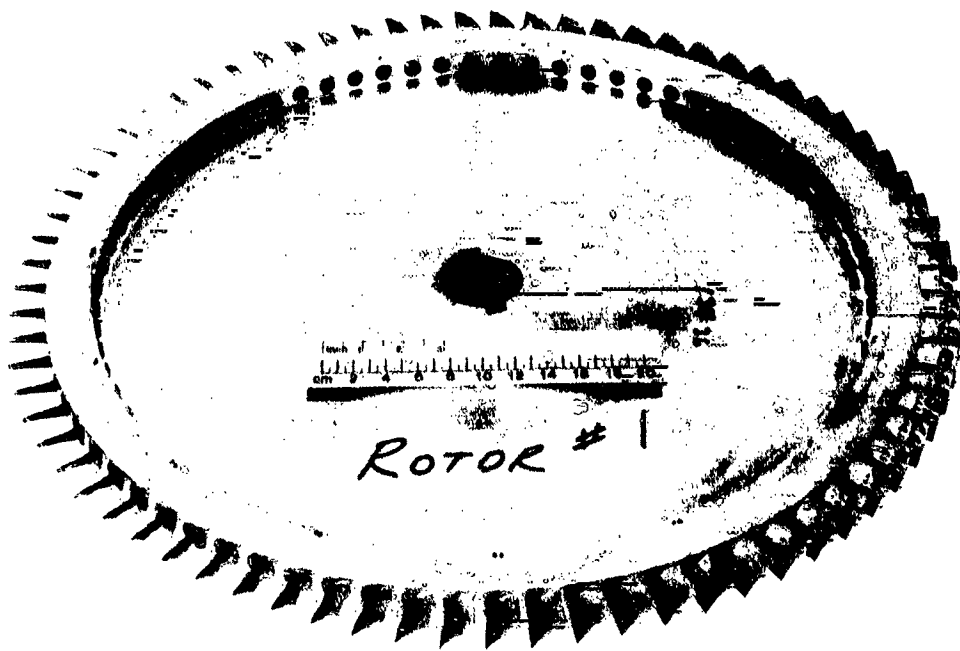

Figure 27 Photograph of Typical Rotor Assembly

ORIGINAL PAGE IS
OF POOR QUALITY

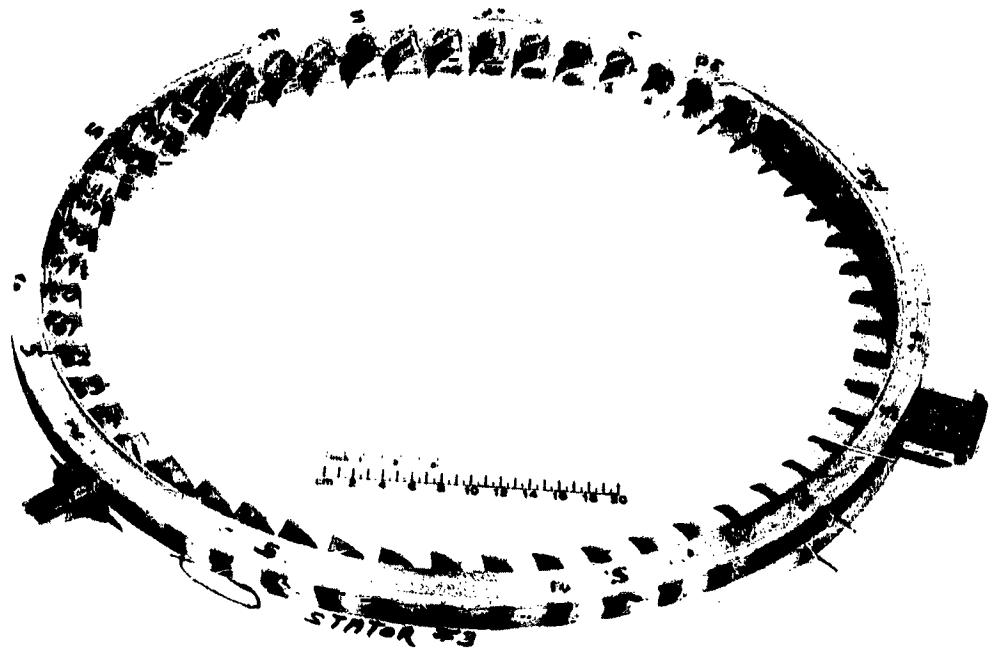

Figure 28 Photograph of Typical Stator Assembly

APPENDIX A
SYMBOLS AND DEFINITIONS

- A - Area
- b - Chord
- D - Diffusion factor
for rotor:

$$= 1 - \frac{V'_2}{V'_1} + \frac{r_2 V_{\theta 2} - r_1 V_{\theta 1}}{(r_1 + r_2) \sigma V'_1}$$
 for stator:

$$= 1 - \frac{V_2}{V_1} + \frac{r_1 V_{\theta 1} - r_2 V_{\theta 2}}{(r_1 + r_2) \sigma V_1}$$
- D - Diameter
- E - Work coefficient

$$= \frac{U_2 V_{\theta 2} - U_1 V_{\theta 1}}{\frac{1}{2} U_1^2}$$
- H - Stagnation enthalpy
- i_m - Incidence angle between inlet air direction and line tangent to blade mean camber line at leading edge, degrees
- I.D. - Inside diameter
- IGV - Inlet guide vane
- K - Local blockage factor
- LE - Leading edge
- LER - Leading edge radius
- M - Mach number
- N - Rotor speed, rpm
- O - Minimum distance between two adjacent airfoil sections

APPENDIX A (Cont'd.)

- P - Static pressure (absolute)
- P_0 - Total or stagnation pressure (absolute)
- R_C - Streamline radius of curvature
- R - Radius
- s - Blade spacing
- T - Temperature
- t - Blade maximum thickness
- TE - Trailing edge
- TER - Trailing edge radius
- U - Rotor tangential speed
- V - Air velocity
- W - Weight flow
- Y_p - Airfoil coordinate of pressure surface normal to chord line
- Y_s - Airfoil coordinate of suction surface normal to chord line
- YCSL - Vertical distance to airfoil stacking line from chord line
- y - Length along calculation station

APPENDIX A (Cont'd.)

- z_c - Airfoil coordinate parallel to chord line
- z_{CSL} - Horizontal distance to airfoil stacking line from leading edge along chord line
- β - Absolute air angle = $\text{COT}^{-1} (V_m/V_\theta)$
- β' - Relative air angle = $\text{COT}^{-1} \frac{(V_m)}{(V'_\theta)}$
- β^* - Metal angle: angle between tangent to mean camber line and meridional direction
- γ - Specific Heat Ratio or Blade chord angle: angle between chord and axial direction
- δ^o - Deviation angle - exit air angle minus metal angle at trailing edge
- δ - Total Pressure/Standard Day Total Pressure
- ϵ - Angle between tangent to streamline projectd on meridional plane and axial direction
- θ - Total Temperature/Standard Day Total Temperature
- η - Efficiency
- σ - Solidity = $\frac{b}{s}$
- $\bar{\omega}$ - Loss coefficient for rotor:

$$= \frac{P'_{01} \left(\frac{T'_{02}}{T'_{01}} \right)^{\frac{\gamma}{\gamma-1}} - P'_{02}}{\frac{1}{2} \rho_1 V_1^2}$$

for stator:

$$= \frac{P_{01} - P_{02}}{\frac{1}{2} \rho_1 V_1^2}$$

- ρ - Density

APPENDIX A (Cont'd.)

Subscripts

- avg - Average
- ad - Adiabatic
- CORR - Corrected to standard day
- in - Inlet
- LE - Leading edge
- m - Meridional (velocity), mean camber line (angle)
- p - Profile (loss); polytropic (efficiency)
- TE - Trailing edge
- z - Axial component
- θ - Tangential Component
- 0 - Total Condition
- 1 - Station into rotor or stator along leading edge
- 2 - Station out of rotor or stator along trailing edge
- 3 - Station out of stage

Superscripts

- ' - Relative to rotor
- * - Designates blade metal angle

APPENDIX B

FLOW FIELD CALCULATION PROCEDURES

The aerodynamic flow field calculation used in this design assumes axisymmetric flow and uses solutions of continuity, energy, and radial equilibrium equations. These equations account for streamline curvature and radial gradients of enthalpy and entropy but neglect viscous terms. Calculations were performed on stations oriented at an angle γ with respect to the axial direction.

$$\frac{1}{2} \frac{\partial V_m^2}{\partial m} \cos(\lambda - \epsilon) - \frac{V_m^2}{R_C} \sin(\lambda - \epsilon) \frac{V^2}{r} + \frac{1}{\rho} \frac{\partial P}{\partial r} = 0$$

$$R_C = \frac{\partial \epsilon}{\partial m} = \text{streamline radius of curvature}$$

Enthalpy rise across a rotor for a streamline, ψ , is given by the Euler relationship:

$$H_{\text{Rotor}} = (U_2 V_{\theta 2}) - (U_1 V_{\theta 1})$$

Weight flow is calculated by the continuity equation:

$$W = 2\pi \int_{y_{hub}}^{y_{tip}} \bar{K} V_m \frac{\sin(\lambda - \epsilon)}{\sin \lambda} y dy$$

where \bar{K} is the local blockage factor and y is the length along the calculation station from the centerline to the point of interest.

APPENDIX C
AIRFOIL AERODYNAMIC SUMMARY
3S1/3S2 COMPRESSOR

PRECEDING PAGE BLANK NOT FILMED

TRANSLATION OF COMPUTER SYMBOLS TO ENGINEERING SYMBOLS (ROTOR)

SL	V-1	V-2	VM-1	VM-2	V0-1	V0-2	U-1	U-2	V'-1	V'-2	V0'-1	V0'-2	RHOWM-1	RHOWM-2	EPSI-1	EPSI-2	PO/PO
	M/SEC	M/SEC	M/SEC	M/SEC	M/SEC	M/SEC	M/SEC	M/SEC	M/SEC	M/SEC	M/SEC	M/SEC	KG/M2 SEC	KG/M2 SEC	RADIAN	RADIAN	INLET
	V _{LE}	V _{TE}	V _{MLE}	V _{MTE}	V _{0LE}	V _{0TE}	U _{LE}	U _{TE}	V' _{LE}	V' _{TE}	V _{0LE}	V _{0TE}	ρ _{V_{MLE}}	ρ _{V_{MTE}}	ε _{LE}	ε _{TE}	P _{OTE}
																	P _{oin}

SL	B-1	B-2	B'-1	B'-2	M-1	M-2	M'-1	M'-2	INC	DEV	TURN	D	LOSS-P	PO2/	PO2/	PO2/	PO2/
	DEGREE	DEGREE	DEGREE	DEGREE	M/SEC	M/SEC	M/SEC	M/SEC	DEGREE	DEGREE	DEGREE	DEGREE	TOTAL	TOTAL	TOTAL	TOTAL	TOTAL
	β _{LE}	β _{TE}	β' _{LE}	β' _{TE}	M _{LE}	M _{TE}	M' _{LE}	M' _{TE}	i _m	δ	Δβ	D	ω	ω cos ϕ	ρ _{OLE}	ρ _{OLE}	ρ _{OLE}
													2σ	P _{OTE}	P _{OTE}	P _{OTE}	P _{OTE}
																	LE→TE
																	LE→TE

SL	V-1	V-2	VM-1	VM-2	V0-1	V0-2	U-1	U-2	V'-1	V'-2	V0'-1	V0'-2	RHOWM-1	RHOWM-2	EPSI-1	EPSI-2	PCT
	FT/SEC	FT/SEC	FT/SEC	FT/SEC	FT/SEC	FT/SEC	FT/SEC	FT/SEC	FT/SEC	FT/SEC	FT/SEC	FT/SEC	LBW/FT2SEC	LBW/FT2SEC	DEGREE	DEGREE	SPAN
	V _{LE}	V _{TE}	V _{MLE}	V _{MTE}	V _{0LE}	V _{0TE}	U _{LE}	U _{TE}	V' _{LE}	V' _{TE}	V _{0LE}	V _{0TE}	ρ _{V_{MLE}}	ρ _{V_{MTE}}	ε _{LE}	ε _{TE}	TE

$$\left(\frac{M \sqrt{\theta}}{\delta A LE} \right) \left(\frac{M \sqrt{\theta}}{\delta A LE} \right)$$

$$\frac{T_{OTE}}{T_{OLE}} \frac{P_{OTE}}{P_{OLE}} \frac{\eta_{ad}}{\eta_{ad}}$$

$$\frac{T_{OTE}}{T_{Oin}} \frac{P_{OTE}}{P_{Oin}} \frac{\eta_{ad}}{\eta_{ad}}$$

$$\frac{T_{OTE}}{T_{OLE}} \frac{P_{OTE}}{P_{OLE}} \frac{\eta_{ad}}{\eta_{ad}}$$

TRANSLATION OF COMPUTER SYMBOLS TO ENGINEERING SYMBOLS (STATOR OR IGV)

SL	V-1 M/SEC	V-2 M/SEC	VM-1 M/SEC	VM-2 M/SEC	Vθ-1 M/SEC	Vθ-2 M/SEC	RHOWM-1 KG/MZ SEC	RHOWM-2 KG/MZ SEC	PO/PO INLET	TO/TO INLET	XEFF-A TOT-INLET	XEFF-P TOT-INLET	EPSI-1 RADIAN	EPSI-2 RADIAN
	V _{LE}	V _{TE}	V _{mLE}	V _{mTE}	V _{θLE}	V _{θTE}	ρ _{VmLE}	ρ _{VmTE}	$\frac{P_{OTE}}{P_{oin}}$	$\frac{T_{OTE}}{T_{oin}}$	$\frac{\eta_{ad}}{\eta_{in \rightarrow TE}}$	$\frac{\eta_p}{\eta_{in \rightarrow TE}}$	ε _{LE}	ε _{TE}

SL	B-1 DEGREE	B-2 DEGREE	M-1 M/SEC	M-2 M/SEC	INC DEGREE	DEV DEGREE	TURN DEGREE	D-FAC	OMEGA-B TOTAL	LOSS-P TOTAL	P02/ P01	PO/PO STAGE	TO/TO STAGE	XEFF-A TOT-STG	XEFF-P TOT-STG
	β _{LE}	β _{TE}	M _{LE}	M _{TE}	θ _m	δ ^o	Δβ	D	Ω	$\frac{\omega \cos \beta_{TE}}{2\sigma}$	$\frac{P_{OTE}}{P_{oLE}}$	$\frac{P_{o3}}{P_{o1}}$	$\frac{T_{o3}}{T_{o1}}$	$\frac{\eta_{ad1 \rightarrow 3}}{\eta_{p1 \rightarrow 3}}$	$\frac{\eta_{ad1 \rightarrow 3}}{\eta_{p1 \rightarrow 3}}$

SL	V-1 FT/SEC	V-2 FT/SEC	VM-1 FT/SEC	VM-2 FT/SEC	Vθ-1 FT/SEC	Vθ-2 FT/SEC	RHOWM-1 LBM/FT2SEC	RHOWM-2 LBM/FT2SEC	PCT SPAN	TE SPAN	TO/TO INLET	XEFF-A TOT-INLET	XEFF-P TOT-INLET	EPSI-1 DEGREE	EPSI-2 DEGREE
	V _{LE}	V _{TE}	V _{mLE}	V _{mTE}	V _{θLE}	V _{θTE}	ρ _{VmLE}	ρ _{VmTE}	% Span	% Span	$\frac{T_{OTE}}{T_{oin}}$	$\frac{\eta_{ad}}{\eta_{in \rightarrow TE}}$	$\frac{\eta_p}{\eta_{in \rightarrow TE}}$	ε _{LE}	ε _{TE}

MCORR INLET RPM	MCORR INLET LBM/SEC	MCORR INLET M ³ /θ ¹	TO/TO INLET	PO/PO INLET	EFF-AD INLET	EFF-P INLET	TO/TO STAGE	P02/P01 STAGE	P0/P0 STAGE	EFF-AD STAGE	EFF-P STAGE
$\frac{\sqrt{\theta_1}}{\theta_1}$	$\frac{\sqrt{\theta_1}}{\theta_1}$	$\frac{\delta_1}{\theta_1}$	$\frac{T_{OTE}}{T_{oin}}$	$\frac{P_{OTE}}{P_{oin}}$	$\frac{\eta_{ad}}{\eta_{in \rightarrow TE}}$	$\frac{\eta_p}{\eta_{in \rightarrow TE}}$	$\frac{T_{o3}}{T_{o1}}$	$\frac{P_{OTE}}{P_{oLE}}$	$\frac{P_{o3}}{P_{o1}}$	$\frac{\eta_{ad1 \rightarrow 3}}{\eta_{p1 \rightarrow 3}}$	$\frac{\eta_{p1 \rightarrow 3}}{\eta_{p1 \rightarrow 3}}$

AERODYNAMIC SUMMARY
COMPRESSOR 351 - 15V

SL	V-1	V-2	VM-1	VM-2	VB-1	VB-2	RHOWM-1	RHOWM-2	PO/PO	TOT-TO	EFF-A	EFF-P	EPSI-I	EPSI-2
1	75.4	91.1	75.4	78.6	0.0	46.0	90.07	97.71	0.9985	1.0000				
2	75.3	90.9	75.3	78.4	0.0	45.9	90.05	97.54	0.9985	1.0000				
3	75.3	90.7	75.3	78.3	0.0	45.8	90.02	97.40	0.9985	1.0000	N/A	N/A		
4	75.3	90.6	75.3	78.2	0.0	45.8	89.99	97.26	0.9985	1.0000				
5	75.3	90.4	75.3	78.0	0.0	45.7	89.97	97.09	0.9985	1.0000				
6	75.3	90.2	75.3	77.8	0.0	45.6	89.96	91.84	0.9985	1.0000				
7	75.3	90.0	75.3	77.6	0.0	45.5	89.96	91.67	0.9985	1.0000				
8	75.3	89.7	75.3	77.4	0.0	45.3	89.98	91.42	0.9985	1.0000				
9	75.3	89.4	75.3	77.2	0.0	45.2	90.01	91.15	0.9985	1.0000				
10	75.3	89.1	75.3	76.9	0.0	45.0	90.05	90.87	0.9985	1.0000				
11	75.4	88.9	75.4	76.7	0.0	44.9	90.07	90.64	0.9985	1.0000				
SL	B-1	B-2	M-1	M-2	INCS	INCM	DEV	TURN	O-FAC	OMEGA-B	LOSS-P	POZ/	POZ/	POZ/
1	0.0	30.4	0.2225	0.2695	8-10	-5.39	-30.4	-0.1318	0.0266	0.0166	0.9985	0.9985	0.9985	0.9985
2	0.0	30.4	0.2225	0.2690	8.20	-5.45	-30.4	-0.1297	0.0264	0.0166	0.9985	0.9985	0.9985	0.9985
3	0.0	30.4	0.2224	0.2685	8.30	-5.51	-30.4	-0.1284	0.0264	0.0170	0.9985	0.9985	0.9985	0.9985
4	0.0	30.4	0.2223	0.2681	8.40	-5.57	-30.4	-0.1268	0.0264	0.0171	0.9985	0.9985	0.9985	0.9985
5	0.0	30.4	0.2223	0.2675	8.50	-5.63	-30.4	-0.1259	0.0264	0.0173	0.9985	0.9985	0.9985	0.9985
6	0.0	30.4	0.2222	0.2669	8.60	-5.69	-30.4	-0.1225	0.0266	0.0174	0.9985	0.9985	0.9985	0.9985
7	0.0	30.4	0.2222	0.2662	8.70	-5.74	-30.4	-0.1195	0.0264	0.0176	0.9985	0.9985	0.9985	0.9985
8	0.0	30.4	0.2223	0.2654	8.80	-5.80	-30.4	-0.1159	0.0264	0.0177	0.9985	0.9985	0.9985	0.9985
9	0.0	30.4	0.2224	0.2646	8.90	-5.86	-30.4	-0.1120	0.0264	0.0179	0.9985	0.9985	0.9985	0.9985
10	0.0	30.4	0.2222	0.2637	9.00	-5.92	-30.4	-0.1078	0.0264	0.0181	0.9985	0.9985	0.9985	0.9985
11	0.0	30.4	0.2225	0.2629	9.10	-5.98	-30.4	-0.1045	0.0264	0.0182	0.9985	0.9985	0.9985	0.9985
SL	V-1	V-2	VM-1	VM-2	VB-1	VB-2	RHOWM-1	RHOWM-2	PCT TE	TOT-TO	EFF-A	EFF-P	EPSI-1	EPSI-2
1	247.3	298.8	247.3	257.8	0.0	151.0	18.45	18.99	0.0000	1.0000				
2	247.2	298.2	247.2	257.3	0.0	150.7	18.44	18.99	0.1000	1.0000				
3	247.1	297.7	247.1	256.9	0.0	150.4	18.44	18.93	0.2000	1.0000				
4	247.0	297.2	247.0	256.5	0.0	150.2	18.43	18.89	0.3000	1.0000				
5	247.0	296.6	247.0	256.0	0.0	149.9	18.43	18.86	0.4000	1.0000				
6	246.9	295.9	246.9	255.4	0.0	149.5	18.42	18.87	0.5000	1.0000				
7	246.9	295.2	246.9	254.7	0.0	149.1	18.42	18.77	0.6000	1.0000				
8	247.0	294.3	247.0	254.0	0.0	148.7	18.43	18.72	0.7000	1.0000				
9	247.1	293.4	247.1	253.2	0.0	148.2	18.43	18.67	0.8000	1.0000				
10	247.2	292.4	247.2	252.3	0.0	147.7	18.44	18.61	0.9000	1.0000				
11	247.3	291.6	247.3	251.6	0.0	147.3	18.45	18.56	1.0000	1.0000				
	W CORR	W CORR	W CORR	W CORR	TO/TO	PO/PO	EFF-A0	EFF-P	PCT TE	TOT-TO	EFF-A	EFF-P	EFF-A	EFF-P
	INLET	INLET	INLET	INLET	INLET	INLET	INLET	INLET	INLET	INLET	INLET	INLET	INLET	INLET
	RPM	RPM	RPM	RPM	RPM	RPM	RPM	RPM	RPM	RPM	RPM	RPM	RPM	RPM
	5455.00	5455.00	5455.00	5455.00	1.0000	0.9985	N/A	N/A	N/A	0.0000	0.9985	0.9985	N/A	N/A

N/A = NOT APPLICABLE TO IGV

AERODYNAMIC SURFACE
COMPRESSOR 351-Rotor 1

SL	V-1 M/SEC	V-2 M/SEC	VM-1 M/SEC	VM-2 M/SEC	V0-1 M/SEC	V0-2 M/SEC	U-1 M/SEC	U-2 M/SEC	V'-1 M/SEC	V'-2 M/SEC	V0'-1 M/SEC	V0'-2 M/SEC	W0'-1 M/SEC	W0'-2 M/SEC	RDW0'-1 KG/M2 SEC	RDW0'-2 KG/M2 SEC	EP01-1 RESI23	EP01-2 RESI23
1	91.2	131.3	78.7	73.7	46.0	103.7	159.2	159.2	137.9	89.4	-113.2	-50.6	95.83	90.16	0.0000	0.0000		
2	91.0	136.5	78.5	78.3	45.9	111.8	160.7	160.7	139.1	92.3	-114.8	-43.9	92.65	96.11	0.0019	0.0033		
3	90.8	139.8	78.4	80.8	45.8	112.9	162.2	162.2	140.3	94.6	-116.4	-49.3	92.43	99.23	0.0015	0.0002		
4	90.6	137.9	78.2	81.0	45.8	111.6	163.7	163.7	141.5	96.3	-117.9	-52.1	92.30	99.66	0.0034	-0.0004		
5	90.4	136.8	78.0	80.8	45.7	110.4	165.2	165.2	142.7	97.6	-119.5	-54.8	92.11	99.56	-0.0009	-2.0010		
6	90.2	135.9	77.8	80.5	45.6	109.5	166.7	166.7	144.0	98.7	-121.1	-57.2	91.86	99.28	-0.0020	-0.0020		
7	89.9	135.3	77.6	80.1	45.5	109.1	168.2	168.2	145.2	99.5	-122.7	-59.8	91.64	99.86	-0.0031	-0.0025		
8	89.7	134.8	77.4	79.5	45.3	108.9	169.6	169.6	146.4	100.0	-124.3	-60.1	91.37	99.69	-0.0047	-0.0035		
9	89.4	133.8	77.1	78.3	45.2	108.6	171.1	171.1	147.7	100.2	-126.0	-62.6	91.08	99.80	-0.0041	-0.0035		
10	89.1	129.3	76.8	73.9	45.0	106.1	172.6	172.6	148.9	99.4	-127.6	-66.5	90.80	91.34	-0.0000	-0.0027		
11	88.8	122.7	76.6	66.6	44.9	103.1	174.1	174.1	150.2	97.3	-129.2	-71.0	90.57	82.33	0.0000	0.0000		

ST	8-1 DEGREE	8-2 DEGREE	8'-1 DEGREE	8'-2 DEGREE	W-1 M/SEC	W-2 M/SEC	M-1 M/SEC	M-2 M/SEC	D-1 DEGREE	D-2 DEGREE	T-1 M/SEC	T-2 M/SEC	U-1 M/SEC	U-2 M/SEC	V'-1 M/SEC	V'-2 M/SEC	W0'-1 M/SEC	W0'-2 M/SEC
1	70.3	55.8	34.44	0.2628	0.3530	0.4001	0.2421	-15.10	72.35	21.76	0.5197	0.0395	0.0395	0.0395	1.1151	91.76	91.76	91.76
2	30.3	55.0	55.63	31.92	0.2682	0.4152	0.2707	-10.73	16.18	23.64	0.5467	0.0666	0.0666	0.0666	0.0649	1.1257	91.64	91.64
3	30.3	51.4	56.04	31.42	0.2682	0.4069	0.4152	-7.56	12.52	24.67	0.5376	0.0501	0.0501	0.0501	0.0610	1.1311	95.58	95.58
4	30.3	51.0	56.45	32.77	0.2682	0.4042	0.4133	-7.00	11.45	23.69	0.5261	0.0503	0.0503	0.0503	0.0610	1.1311	95.58	95.58
5	30.3	51.8	56.86	34.15	0.2676	0.4010	0.4224	-6.76	10.28	22.71	0.5210	0.0356	0.0356	0.0356	0.0610	1.1311	95.58	95.58
6	30.4	53.7	57.27	35.37	0.2669	0.3934	0.4260	-6.59	10.47	21.27	0.5164	0.0332	0.0332	0.0332	0.0610	1.1310	95.19	95.19
7	30.4	53.7	57.69	36.42	0.2681	0.3965	0.4293	-6.46	10.10	20.71	0.5163	0.0332	0.0332	0.0332	0.0610	1.1310	95.19	95.19
8	30.4	53.9	58.11	37.40	0.2673	0.3949	0.4333	-6.46	10.45	19.89	0.5231	0.0494	0.0494	0.0494	0.0610	1.1311	95.17	95.17
9	30.4	54.2	58.53	38.64	0.2644	0.3920	0.4370	-6.59	10.45	19.89	0.5231	0.0494	0.0494	0.0494	0.0610	1.1311	95.17	95.17
10	30.4	55.1	58.96	41.99	0.2635	0.3785	0.4407	-8.91	13.14	16.96	0.5264	0.0669	0.0669	0.0669	0.0610	1.1310	93.17	93.17
11	30.4	57.2	59.33	46.84	0.2628	0.3590	0.4444	-11.93	17.61	12.48	0.5370	0.0774	0.0774	0.0774	0.0610	1.1311	89.52	89.52

SL	V-1 FT/SEC	V-2 FT/SEC	VM-1 FT/SEC	VM-2 FT/SEC	V0-1 FT/SEC	V0-2 FT/SEC	U-1 FT/SEC	U-2 FT/SEC	V'-1 FT/SEC	V'-2 FT/SEC	W0'-1 FT/SEC	W0'-2 FT/SEC	RDW0'-1 LB/FT2 SEC	RDW0'-2 LB/FT2 SEC	EP01-1 RESI-EE	EP01-2 RESI-EE
1	293.1	430.9	253.2	241.9	151.0	356.6	522.5	522.5	452.4	293.3	-371.5	-165.9	19.01	13.51	0.0000	0.0000
2	292.4	447.9	257.6	256.9	150.7	366.9	527.3	527.3	456.4	307.9	-376.7	-163.5	19.94	19.63	0.109	0.118
3	287.9	452.3	257.1	265.0	150.4	370.3	532.2	532.2	460.3	310.9	-381.8	-161.9	18.92	27.33	0.097	0.093
4	287.3	459.3	256.6	265.7	150.2	366.1	537.1	537.1	464.3	315.9	-386.9	-171.0	18.86	29.41	0.021	-0.024
5	286.6	448.8	256.0	265.0	149.9	362.1	542.0	542.0	468.3	320.4	-392.1	-179.9	18.86	29.34	-0.049	-0.068
6	285.9	446.0	255.4	264.1	149.5	359.3	546.8	546.8	472.3	323.9	-397.3	-187.5	18.82	29.21	-0.116	-0.115
7	285.1	444.0	254.6	262.8	149.1	357.8	551.7	551.7	476.4	326.6	-402.6	-191.9	18.77	29.25	-0.177	-0.159
8	284.2	442.3	253.8	260.7	148.7	357.2	556.6	556.6	480.4	328.2	-407.9	-199.4	18.71	29.10	-0.231	-0.193
9	283.2	439.1	253.0	256.7	148.2	356.2	561.5	561.5	484.5	328.7	-413.3	-205.2	18.65	29.00	-0.267	-0.203
10	282.7	424.2	252.1	242.5	147.7	348.1	566.4	566.4	488.7	326.3	-418.6	-219.3	18.60	29.00	-0.331	-0.187
11	281.4	402.7	251.4	218.4	147.3	338.3	571.2	571.2	492.9	319.3	-423.9	-232.9	18.55	16.64	0.000	0.000

AERODYNAMIC SUMMARY
COMPRESSOR 351-Stator 1

SL	V-1 M/SEC	V-2 M/SEC	WM-1 M/SEC	WM-2 M/SEC	VM-1 M/SEC	VM-2 M/SEC	VO-1 M/SEC	VO-2 M/SEC	RHOWM-1 KG/M2 SEC	RHOWM-2 KG/M2 SEC	PO/PO INLET	TO/TO INLET	KEFF-A TOT-INLET	KEFF-P TOT-INLET	EPSI-1 RADIUS	EPSI-2 RADIUS
1	131.3	74.2	73.6	56.1	108.7	48.6	90.20	71.58	1.1034	1.0345	82.67	82.92	0.0000	0.0000	0.0000	0.0000
2	136.4	85.1	78.2	68.5	111.8	50.6	95.99	87.59	1.1153	1.0355	86.88	87.08	0.0040	0.0041	0.0040	0.0041
3	138.8	91.6	80.7	76.3	112.9	50.6	99.23	97.69	1.1230	1.0375	89.91	90.03	0.0045	0.0047	0.0045	0.0047
4	137.9	92.5	81.0	77.7	111.6	50.2	99.66	99.61	1.1246	1.0373	91.58	91.72	0.0038	0.0038	0.0038	0.0038
5	136.8	92.3	80.8	77.6	110.4	50.0	99.60	99.50	1.1243	1.0370	92.52	92.64	0.0030	0.0030	0.0030	0.0030
6	135.9	92.0	80.5	77.4	109.5	49.9	99.33	99.20	1.1243	1.0359	92.84	92.95	0.0021	0.0016	0.0021	0.0016
7	135.3	91.8	80.1	77.2	109.1	49.7	98.90	98.98	1.1249	1.0370	92.54	92.65	0.0012	0.0004	0.0012	0.0004
8	134.9	91.3	79.5	76.8	108.9	49.5	98.18	98.48	1.1245	1.0373	91.62	91.75	0.0001	0.0009	0.0001	0.0009
9	133.8	89.6	78.2	74.9	108.6	49.2	96.66	96.00	1.1228	1.0375	89.94	90.09	-0.0010	-0.0012	-0.0010	-0.0012
10	129.3	82.3	73.8	66.3	106.1	48.6	91.25	84.96	1.1148	1.0354	85.73	86.59	-0.0015	-0.0014	-0.0015	-0.0014
11	122.7	71.9	66.5	54.2	103.1	47.3	82.10	69.32	1.1045	1.0351	82.33	82.55	0.0000	0.0000	0.0000	0.0000

SL	B-1 DEGREE	B-2 DEGREE	M-1	M-2	INCH DEGREE	DEGREE	DEV DEGREE	TURM DEGREE	D-FAC	OMEGA-B TOTAL	LOSS-P TOTAL	P02/ P01	PO/PO STAGE	TO/TO STAGE	KEFF-A TOT-INLET	KEFF-P TOT-INLET	EPSI-1 DESIRE	EPSI-2 DESIRE
1	55.9	40.9	0.3848	0.2153	-17.21	20.67	14.99	0.6317	0.0934	0.0303	0.9809	1.1050	1.0345	83.95	84.19	0.0000	0.0000	
2	55.0	36.4	0.4000	0.2473	-9.01	15.74	18.61	0.5684	0.0682	0.0238	0.9929	1.1169	1.0355	88.12	88.29	0.0000	0.0000	
3	54.4	33.5	0.4069	0.2660	-6.47	12.56	20.83	0.5353	0.0509	0.0186	0.9945	1.1247	1.0375	91.12	91.25	0.0000	0.0000	
4	54.0	32.8	0.4042	0.2689	-6.18	11.74	21.70	0.5261	0.0410	0.0152	0.9956	1.1263	1.0373	92.30	92.30	0.0000	0.0000	
5	53.8	32.8	0.4011	0.2683	-6.19	11.67	21.00	0.5223	0.0354	0.0133	0.9963	1.1265	1.0370	93.73	93.82	0.0000	0.0000	
6	53.7	32.8	0.3985	0.2675	-6.27	11.73	20.86	0.5205	0.0334	0.0126	0.9965	1.1265	1.0359	94.85	94.84	0.0000	0.0000	
7	53.7	32.8	0.3966	0.2667	-6.41	11.92	20.91	0.5208	0.0350	0.0134	0.9964	1.1265	1.0370	93.74	93.55	0.0000	0.0000	
8	53.9	32.8	0.3950	0.2654	-6.63	12.27	21.09	0.5243	0.0400	0.0156	0.9959	1.1263	1.0373	92.79	92.93	0.0000	0.0000	
9	54.2	33.3	0.3920	0.2603	-7.07	13.32	20.91	0.5341	0.0499	0.0193	0.9950	1.1245	1.0375	91.12	91.15	0.0000	0.0000	
10	55.2	36.3	0.3784	0.2388	-9.64	16.99	18.91	0.5693	0.0651	0.0245	0.9939	1.1165	1.0354	83.01	83.20	0.0000	0.0000	
11	57.2	41.1	0.3589	0.2086	-11.94	22.78	16.10	0.6278	0.0828	0.0293	0.9929	1.1062	1.0350	83.59	83.81	0.0000	0.0000	

SL	V-1 FT/SEC	V-2 FT/SEC	WM-1 FT/SEC	WM-2 FT/SEC	VM-1 FT/SEC	VM-2 FT/SEC	VO-1 FT/SEC	VO-2 FT/SEC	RHOWM-1 LBW/FT2SEC	RHOWM-2 LBW/FT2SEC	PCT IE SPAN	TO/TO INLET	KEFF-A TOT-INLET	KEFF-P TOT-INLET	EPSI-1 DESIRE	EPSI-2 DESIRE
1	430.6	243.4	241.5	184.0	356.6	159.4	18.47	14.65	0.0000	1.0345	82.67	82.92	0.0000	0.0000	0.0000	0.0000
2	447.7	279.4	256.5	224.8	366.9	165.9	19.66	17.94	0.1000	1.0355	86.88	87.08	0.0040	0.0041	0.0040	0.0041
3	455.3	300.4	264.8	250.4	370.3	166.0	20.32	20.01	0.2000	1.0375	89.91	90.03	0.0045	0.0047	0.0045	0.0047
4	452.3	303.6	265.7	255.1	366.1	164.6	20.41	20.40	0.3000	1.0373	91.58	91.72	0.0038	0.0038	0.0038	0.0038
5	448.9	302.8	265.2	254.6	362.1	164.0	20.40	20.38	0.4000	1.0370	92.52	92.64	0.0030	0.0030	0.0030	0.0030
6	446.0	301.9	264.3	253.8	359.3	163.6	20.34	20.32	0.5000	1.0359	92.84	92.95	0.0021	0.0016	0.0021	0.0016
7	444.0	301.1	262.9	253.2	357.8	163.0	20.26	20.27	0.6000	1.0370	92.54	92.65	0.0012	0.0004	0.0012	0.0004
8	442.3	299.7	260.8	252.0	357.2	162.3	20.11	20.17	0.7000	1.0373	91.62	91.75	0.0001	0.0009	0.0001	0.0009
9	439.1	294.1	256.7	248.7	356.2	161.5	19.80	19.66	0.8000	1.0375	89.94	90.09	-0.0010	-0.0012	-0.0010	-0.0012
10	424.1	269.9	242.3	217.6	348.1	159.6	18.69	17.40	0.9000	1.0364	85.78	86.59	-0.0015	-0.0014	-0.0015	-0.0014
11	402.5	235.9	218.1	177.8	338.3	155.1	16.82	14.20	1.0000	1.0351	82.33	82.55	0.0000	0.0000	0.0000	0.0000

SL	V-1 FT/SEC	V-2 FT/SEC	WM-1 FT/SEC	WM-2 FT/SEC	VM-1 FT/SEC	VM-2 FT/SEC	VO-1 FT/SEC	VO-2 FT/SEC	RHOWM-1 LBW/FT2SEC	RHOWM-2 LBW/FT2SEC	PCT IE SPAN	TO/TO STAGE	KEFF-A STAGE	KEFF-P STAGE	EPSI-1 STAGE	EPSI-2 STAGE	
1	5455.00	5455.00	9.47	4.29	1.0369	1.1209	90.00	90.15	1.0369	0.9950	1.1225	91.19	91.34				

AERODYNAMIC SUMMARY
COMPRESSOR 3C1-Rotor 2

SL	V-1	V-2	VM-1	VM-2	V0-1	V0-2	U-1	U-2	V'-1	V'-2	V0'-1	V0'-2	RHOVM-1	RHOVM-2	EPSSI-1	EPSSI-2	TOY/TO
	M/SEC	M/SEC	M/SEC	M/SEC	M/SEC	M/SEC	M/SEC	M/SEC	M/SEC	M/SEC	M/SEC	M/SEC	KG/M2 SEC	KG/M2 SEC	DEGREE	DEGREE	PERCENT
1	74.1	124.2	56.0	54.5	48.6	111.6	159.2	159.2	124.0	72.4	-110.7	-47.7	71.49	72.13	-0.0060	-0.0060	1.2240
2	65.1	130.2	68.5	66.4	50.6	112.0	160.7	160.7	129.7	82.3	-110.2	-48.7	87.52	87.99	-0.0014	-0.0002	1.2419
3	65.1	133.4	75.3	74.7	50.6	110.6	162.2	162.2	135.2	90.8	-111.6	-51.6	97.64	99.19	-0.0015	-0.0002	1.2591
4	92.5	133.1	77.7	76.6	50.2	108.8	163.7	163.7	137.6	94.3	-113.5	-54.9	101.99	101.99	-0.0013	-0.0004	1.2503
5	92.0	132.0	77.6	76.6	50.0	107.5	165.2	165.2	138.9	95.9	-115.2	-57.7	99.47	102.11	-0.0010	-0.0007	1.2528
6	91.3	131.2	77.3	76.3	49.9	106.7	166.7	166.7	141.4	97.0	-116.8	-59.9	99.19	101.74	-0.0010	-0.0010	1.2597
7	91.3	130.6	77.2	75.9	49.7	106.3	168.2	168.2	141.4	97.9	-118.5	-61.9	98.98	101.34	-0.0008	-0.0013	1.2500
8	91.3	130.1	76.8	75.2	49.5	106.2	169.6	169.6	147.6	98.4	-121.2	-63.5	98.48	101.52	-0.0005	-0.0013	1.2503
9	89.6	129.0	74.9	72.7	49.2	106.5	171.1	171.1	143.1	97.3	-121.9	-64.6	96.00	97.09	0.0009	-0.0013	1.2495
10	82.3	124.7	66.3	64.0	46.6	107.0	172.6	172.6	140.6	91.6	-124.9	-65.6	84.96	75.35	0.0003	-0.0005	1.2341
11	71.9	118.5	54.2	51.2	47.3	106.9	174.1	174.1	137.9	84.5	-126.9	-67.2	69.32	63.23	-0.0000	0.0000	1.2356

SL	B-1	B-2	B'-1	B'-2	M-1	M-2	M'-1	M'-2	IMCM	DEV	TURN	0	FAC	OMEGA-B	LOSS-P	POE/	TEFF-A	TEFF-P
	DEGREE	DEGREE	DEGREE	DEGREE	DEGREE	DEGREE	DEGREE	DEGREE	DEGREE	DEGREE	DEGREE	DEGREE	DEGREE	TOTAL	TOTAL	FOI	DEGREE	DEGREE
1	40.9	63.9	63.16	41.14	0.2151	0.3575	0.3600	0.2085	-5.18	24.12	22.02	0.6330	0.0348	0.0279	1.1151	93.55	93.55	
2	36.4	59.4	58.15	36.27	0.2471	0.3750	0.3767	0.2371	-6.90	15.95	21.87	0.5747	0.0626	0.0223	1.1135	94.77	94.85	
3	33.6	56.0	55.65	34.67	0.2659	0.3844	0.3927	0.2616	-6.37	11.55	20.98	0.5262	0.0784	0.0177	1.1126	95.55	95.62	
4	32.8	54.8	55.61	35.62	0.2683	0.3835	0.3998	0.2717	-5.86	10.20	19.99	0.5063	0.0797	0.0145	1.1118	95.17	95.23	
5	32.8	54.5	56.04	36.96	0.2682	0.3805	0.4037	0.2764	-5.66	9.26	19.03	0.4974	0.0346	0.0125	1.1112	96.57	96.63	
6	32.8	54.4	56.49	38.16	0.2675	0.3781	0.4072	0.2796	-5.54	9.26	18.34	0.4933	0.0329	0.0118	1.1110	96.68	96.73	
7	32.8	54.5	56.92	39.17	0.2667	0.3764	0.4109	0.2822	-5.48	9.03	17.75	0.4921	0.0344	0.0123	1.1112	96.49	96.54	
8	32.8	54.7	57.43	40.16	0.2654	0.3747	0.4144	0.2835	-5.50	8.96	17.26	0.4950	0.0393	0.0140	1.1118	95.95	96.02	
9	33.3	55.7	58.43	41.62	0.2603	0.3712	0.4156	0.2801	-5.72	9.55	16.81	0.5077	0.0477	0.0167	1.1130	95.16	95.24	
10	36.3	59.1	61.85	45.72	0.2388	0.3585	0.4032	0.2636	-5.43	12.93	16.13	0.5445	0.0604	0.0200	1.1153	94.25	94.33	
11	41.1	64.4	66.87	52.69	0.2086	0.3404	0.4001	0.2429	-3.74	19.43	14.17	0.5936	0.0821	0.0238	1.1169	52.65	52.77	

SL	V-1	V-2	VM-1	VM-2	V0-1	V0-2	U-1	U-2	V'-1	V'-2	V0'-1	V0'-2	RHOVM-1	RHOVM-2	EPSSI-1	EPSSI-2	PCT FE
	FT/SEC	FT/SEC	FT/SEC	FT/SEC	FT/SEC	FT/SEC	FT/SEC	FT/SEC	FT/SEC	FT/SEC	FT/SEC	FT/SEC	LBW/FT2SEC	LBW/FT2SEC	DEGREE	DEGREE	PERCENT
1	243.2	407.5	183.7	179.0	159.4	366.1	522.5	522.5	406.9	237.7	-363.1	-156.4	14.64	14.77	-0.0000	-0.0000	0.0000
2	279.2	427.2	224.6	217.8	165.9	367.5	527.3	527.3	425.6	270.1	-361.5	-159.8	17.92	18.02	-0.0079	-0.010	0.1990
3	300.3	437.7	250.2	245.0	166.0	362.8	532.2	532.2	443.5	297.9	-366.2	-169.4	20.06	20.31	-0.0085	-0.010	0.2000
4	303.5	436.6	255.0	251.4	164.6	357.0	537.1	537.1	451.4	309.3	-372.5	-180.1	20.39	20.89	-0.0072	-0.020	0.3000
5	302.8	433.2	254.6	251.4	164.0	352.8	542.0	542.0	455.7	314.7	-378.0	-189.2	20.37	20.91	-0.0063	-0.039	0.4000
6	301.9	430.5	253.8	250.3	163.6	350.2	546.8	546.8	459.6	318.3	-383.3	-196.6	20.32	20.84	-0.0056	-0.058	0.5000
7	301.1	428.6	253.2	249.1	163.0	348.7	551.7	551.7	463.9	321.3	-388.7	-203.0	20.27	20.75	-0.0045	-0.073	0.6000
8	299.7	426.9	252.0	246.8	162.3	348.3	556.6	556.6	468.0	323.0	-394.4	-208.3	20.17	20.57	-0.0026	-0.073	0.7000
9	294.1	423.2	245.7	238.6	161.5	349.4	561.5	561.5	469.4	319.2	-399.9	-212.0	19.66	19.88	0.0003	-0.073	0.8000
10	269.9	409.0	217.7	209.9	159.6	351.1	566.4	566.4	461.3	300.7	-406.8	-215.3	17.40	17.48	0.0020	-0.048	0.9000
11	235.9	388.8	177.8	168.1	155.1	350.6	571.2	571.2	452.5	277.4	-416.2	-220.6	14.20	13.98	-0.0000	0.000	1.0000

AERODYNAMIC SUMMARY
COMPRESSOR 351-Stator 3

SL	V-1 M/SEC	V-2 M/SEC	VM-1 M/SEC	VM-2 M/SEC	VB-1 M/SEC	VB-2 M/SEC	RHVM-1 KG/M ² SEC	RHVM-2 KG/M ² SEC	PO/PO INLET	TO/TO INLET	%EFF-A TOT-INLET	%EFF-P TOT-INLET	EPSI-1 RADIANS	EPSI-2 RADIANS
1	118.0	66.5	51.7	47.9	106.1	46.0	73.19	70.16	1.3390	1.1015	85.71	86.29	0.0000	0.0000
2	123.6	77.4	63.2	61.1	106.3	47.4	69.78	89.69	1.3512	1.1021	88.02	88.52	0.0020	0.0019
3	126.2	83.4	71.1	68.8	104.2	47.1	101.30	101.09	1.3586	1.1017	90.05	90.47	0.0025	0.0025
4	125.5	84.7	73.0	70.4	102.3	47.0	104.19	103.70	1.3606	1.1003	91.70	92.06	0.0023	0.0023
5	124.6	84.6	72.9	70.5	101.1	46.9	104.26	103.82	1.3609	1.0933	92.74	93.06	0.0032	0.0033
6	123.8	84.5	72.7	70.4	100.2	46.8	104.07	103.79	1.3610	1.0990	93.03	93.33	0.0035	0.0036
7	123.2	84.3	72.4	70.3	99.7	46.6	103.66	103.64	1.3611	1.0993	92.80	93.10	0.0037	0.0038
8	122.8	84.1	71.9	70.2	99.6	46.3	102.90	103.42	1.3611	1.1002	91.90	92.25	0.0036	0.0038
9	121.8	82.9	69.6	68.9	100.0	46.1	99.55	101.37	1.3598	1.1016	90.38	90.79	0.0031	0.0032
10	118.1	77.1	60.7	61.4	101.3	46.6	86.76	90.17	1.3532	1.1025	88.15	88.65	0.0013	0.0020
11	113.2	66.6	46.5	47.3	103.2	46.9	66.29	69.24	1.3421	1.1038	84.52	85.16	-0.0090	-0.0000

SL	B-1 DEGREE	B-2 DEGREE	M-1	M-2	INCH DEGREE	TURN DEGREE	OMEGA-8 TOTAL	LOSS-P TOTAL	PO2/ F01	PO/P0 STAGE	TO/TO STAGE	%EFF-A TOT-STG	%EFF-P TOT-STG	EPSI-1 DEGREE	EPSI-2 DEGREE
1	64.1	43.8	0.3342	0.1868	-9.29	23.53	0.6551	0.0753	0.9944	1.0965	1.0302	89.19	89.34	83.34	83.34
2	59.3	37.8	0.3504	0.2176	-9.83	16.97	0.5802	0.0637	0.9948	1.0949	1.0294	89.15	89.30	89.30	89.30
3	55.7	34.4	0.3578	0.2343	-9.35	13.13	0.5368	0.0530	0.9955	1.0931	1.0285	90.33	90.46	90.46	90.46
4	54.5	33.7	0.3565	0.2386	-7.74	11.76	0.5204	0.0423	0.9964	1.0926	1.0279	91.93	92.04	92.04	92.04
5	54.2	33.6	0.3537	0.2386	-6.22	11.30	0.5141	0.0356	0.9970	1.0926	1.0275	93.04	93.13	93.13	93.13
6	54.0	33.6	0.3514	0.2382	-6.11	11.28	0.5114	0.0337	0.9972	1.0926	1.0274	93.36	93.45	93.45	93.45
7	54.0	33.5	0.3497	0.2377	-6.24	11.43	0.5090	0.0320	0.9972	1.0925	1.0275	93.08	93.17	93.17	93.17
8	54.2	33.4	0.3483	0.2370	-6.39	11.68	0.5132	0.0392	0.9968	1.0926	1.0278	92.27	92.37	92.37	92.37
9	55.2	33.8	0.3451	0.2334	-6.71	12.56	0.5235	0.0469	0.9963	1.0930	1.0283	90.97	91.09	91.09	91.09
10	59.1	37.2	0.3342	0.2168	-6.54	16.63	0.5629	0.0617	0.9954	1.0943	1.0292	89.29	89.44	89.44	89.44
11	65.7	44.8	0.3198	0.1870	-3.92	25.06	0.6443	0.1030	0.9930	1.0949	1.0307	85.35	85.55	85.55	85.55

SL	V-1 FT/SEC	V-2 FT/SEC	VM-1 FT/SEC	VM-2 FT/SEC	VB-1 FT/SEC	VB-2 FT/SEC	RHVM-1 LBM/FT ² SEC	RHVM-2 LBM/FT ² SEC	PCT TE SPAN	TO/TO INLET	%EFF-A TOT-INLET	%EFF-P TOT-INLET	EPSI-1 DEGREE	EPSI-2 DEGREE		
1	387.3	218.1	169.5	157.3	348.2	151.1	14.99	14.37	0.0000	1.1015	85.71	86.29	0.0000	0.0000		
2	405.6	253.8	207.3	200.6	348.7	155.4	18.39	18.37	0.1000	1.1021	88.02	88.52	0.115	0.110		
3	414.0	273.6	233.3	225.7	342.0	154.6	20.75	20.70	0.2000	1.1017	90.05	90.47	0.144	0.142		
4	412.2	277.8	239.4	231.1	335.6	154.1	21.34	21.24	0.3000	1.1003	91.70	92.06	0.162	0.164		
5	408.9	277.7	239.2	231.2	331.6	153.9	21.35	21.27	0.4000	1.0993	92.74	93.06	0.183	0.189		
6	405.2	277.2	238.6	230.9	328.8	153.4	21.32	21.26	0.5000	1.0990	93.08	93.38	0.200	0.208		
7	404.4	276.6	237.5	230.6	327.2	152.8	21.23	21.23	0.6000	1.0993	92.80	93.10	0.210	0.219		
8	403.0	275.9	235.8	230.2	326.8	152.0	21.08	21.18	0.7000	1.1002	91.90	92.25	0.204	0.216		
9	399.6	271.9	228.3	226.0	328.0	151.3	20.39	20.76	0.8000	1.1016	90.38	90.79	0.175	0.186		
10	387.5	252.9	199.2	201.4	332.3	152.9	17.77	18.47	0.9000	1.1025	88.15	88.65	0.168	0.172		
11	371.3	218.6	152.5	155.2	338.5	153.9	13.58	14.18	1.0000	1.1038	84.52	85.16	-0.0000	-0.0000		
	NCORR INLET RPM	5455.00	NCORR INLET RPM	5455.00	TO/TO INLET	1.1008	TO/TO INLET	1.3574	PO/PO EFF-P %	90.56	PO/PO EFF-P %	90.97	PO/PO EFF-P %	91.11	PO/PO EFF-P %	91.23

AERODYNAMIC SUMMARY
COMPRESSOR 352 - ISV

CL	V-1	V-2	VM-1	VM-2	V9-1	V9-2	PHOV-1	PHOV-2	P0/P0	T0/T0	%EFF-A	%EFF-P	EPSI-1	EPSI-2					
1	75.4	75.4	75.4	75.4	0.0	48.3	90.07	92.77	0.9985	1.0000									
2	75.3	75.3	75.3	75.3	0.0	48.2	90.05	92.59	0.9985	1.0000									
3	75.3	75.3	75.3	75.3	0.0	48.1	90.02	92.44	0.9985	1.0000									
4	75.3	75.3	75.3	75.3	0.0	48.1	89.99	92.28	0.9985	1.0000									
5	75.3	75.3	75.3	75.3	0.0	47.9	89.97	92.09	0.9985	1.0000									
6	75.3	75.3	75.3	75.3	0.0	47.8	89.96	91.89	0.9985	1.0000									
7	75.3	75.3	75.3	75.3	0.0	47.7	89.96	91.65	0.9985	1.0000									
8	75.3	75.3	75.3	75.3	0.0	47.6	89.97	91.40	0.9985	1.0000									
9	75.3	75.3	75.3	75.3	0.0	47.4	90.01	91.12	0.9985	1.0000									
10	75.3	75.3	75.3	75.3	0.0	47.2	90.04	90.83	0.9985	1.0000									
11	75.4	75.4	75.4	75.4	0.0	47.1	90.07	90.59	0.9985	1.0000									
CL	B-1	B-2	M-1	M-2	IMCS	INCM	DEV	TURN	D-FAC	WEGA-B	LOSS-P	P02/P01	TOT-INLET	%EFF-P	P02/P01	TOT-INLET	%EFF-P	EPSI-1	EPSI-2
1	0.0	31.6	0.2225	0.2734	DEGREE	DEGREE	DEGREE	DEGREE	TOTAL	TOTAL	TOTAL	P01	TOT-INLET	%EFF-P	P01	TOT-INLET	%EFF-P	DEGREE	DEGREE
2	0.0	31.6	0.2225	0.2729		8.05	-6.94	-31.6	-0.1452	0.0444	0.0164	0.9985			0.9985			-0.000	-0.000
3	0.0	31.6	0.2224	0.2728		9.16	-6.89	-31.6	-0.1429	0.0444	0.0166	0.9985			0.9985			-0.000	-0.000
4	0.0	31.6	0.2223	0.2718		8.27	-4.94	-31.6	-0.1414	0.0444	0.0167	0.9985			0.9985			-0.000	-0.000
5	0.0	31.6	0.2223	0.2712	N/A	8.39	-4.99	-31.6	-0.1397	0.0445	0.0169	0.9985			0.9985			-0.000	-0.000
6	0.0	31.6	0.2223	0.2706		8.49	-5.04	-31.6	-0.1375	0.0444	0.0171	0.9985			0.9985			-0.000	-0.000
7	0.0	31.6	0.2222	0.2698		8.60	-5.09	-31.6	-0.1349	0.0444	0.0172	0.9985			0.9985			-0.000	-0.000
8	0.0	31.6	0.2222	0.2690		8.71	-5.13	-31.6	-0.1318	0.0444	0.0174	0.9985			0.9985			-0.000	-0.000
9	0.0	31.6	0.2223	0.2681		8.82	-5.18	-31.6	-0.1281	0.0444	0.0175	0.9985			0.9985			-0.000	-0.000
10	0.0	31.6	0.2224	0.2672		8.93	-5.23	-31.6	-0.1249	0.0444	0.0177	0.9985			0.9985			-0.000	-0.000
11	0.0	31.6	0.2225	0.2664		9.04	-5.28	-31.6	-0.1197	0.0445	0.0178	0.9985			0.9985			-0.000	-0.000
SL	V-1	V-2	VM-1	VM-2	V9-1	V9-2	PHOV-1	PHOV-2	PCT TE	TO/TO	%EFF-A	%EFF-P	EPSI-1	EPSI-2					
1	247.3	303.1	247.3	259.3	FT/SEC	FT/SEC	FT/SEC	FT/SEC	SPAN	INLET	TOT-INLET	TOT-INLET	DEGREE	DEGREE					
2	247.2	302.4	247.2	257.7	0.0	158.6	18.45	19.00	0.0000	1.0000									
3	247.1	301.9	247.1	257.3	0.0	158.2	18.44	18.96	0.1000	1.0000									
4	247.0	301.3	247.0	256.8	0.0	158.0	18.44	18.93	0.2000	1.0000									
5	247.0	300.7	247.0	256.2	0.0	157.7	18.43	18.90	0.3000	1.0000									
6	246.9	299.9	246.9	255.6	0.0	157.3	18.43	18.86	0.4000	1.0000									
7	246.9	299.1	246.9	254.9	0.0	156.9	18.42	18.82	0.5000	1.0000									
8	247.0	298.2	247.0	254.1	0.0	156.5	18.42	18.77	0.6000	1.0000									
9	247.1	297.2	247.1	253.3	0.0	156.0	18.43	18.72	0.7000	1.0000									
10	247.2	296.2	247.2	252.4	0.0	155.5	18.43	18.66	0.8000	1.0000									
11	247.3	295.4	247.3	251.7	0.0	155.0	18.44	18.60	0.9000	1.0000									
					TO/TO	P0/P0	EFF-AD	EFF-P											
					INLET	INLET	INLET	INLET											
					1.0000	0.9985	N/A	N/A											
					5455.00	9.47	4.29												
					N/A = NOT APPLICABLE TO IGV														

AERODYNAMIC SUMMARY
COMPRESSOR 3S2-Rotor 1

SL	V-1 M/SEC	V-2 M/SEC	VM-1 M/SEC	VM-2 M/SEC	V0-1 M/SEC	V0-2 M/SEC	U-1 M/SEC	U-2 M/SEC	V'-1 M/SEC	V'-2 M/SEC	W0'-1 M/SEC	W0'-2 M/SEC	RHOVM-1 KG/M2 SEC	RHOVM-2 KG/M2 SEC	RHOVM-2 KG/M2 SEC	EPSI-1 RADIANT	EPSI-2 RADIANT	EPSI-2 PO/PO
1	92.5	129.1	78.8	74.0	48.3	105.8	159.2	159.2	136.1	91.2	-110.9	-53.4	92.90	90.30	90.30	0.0000	0.0000	1.1033
2	92.3	134.5	78.6	78.7	48.2	109.1	160.7	160.7	137.3	94.1	-112.5	-51.6	92.69	96.19	96.19	0.0019	0.0004	1.1140
3	92.1	136.9	78.5	81.1	48.1	110.3	162.2	162.2	138.5	96.3	-114.1	-51.9	92.51	99.33	99.33	0.0015	0.0002	1.1197
4	91.9	136.2	78.3	81.3	48.1	109.2	163.7	163.7	139.7	97.9	-115.6	-54.5	92.32	99.67	99.67	0.0004	-0.0004	1.1197
5	91.7	135.1	78.1	81.1	47.9	108.1	165.2	165.2	140.9	99.2	-117.2	-57.1	92.11	99.53	99.53	-0.0008	-0.0012	1.1192
6	91.4	134.3	77.9	80.8	47.8	107.3	166.7	166.7	142.1	100.3	-118.8	-59.4	91.88	99.23	99.23	-0.0019	-0.0020	1.1190
7	91.1	133.7	77.7	80.4	47.7	106.9	168.2	168.2	143.3	101.1	-120.5	-61.3	91.62	98.81	98.81	-0.0030	-0.0027	1.1193
8	90.9	133.2	77.4	79.8	47.6	106.7	169.6	169.6	144.6	101.7	-122.1	-63.0	91.35	98.16	98.16	-0.0039	-0.0033	1.1196
9	90.5	132.3	77.1	78.7	47.4	106.3	171.1	171.1	145.8	101.9	-123.7	-64.8	91.05	96.79	96.79	-0.0046	-0.0035	1.1191
10	90.2	127.5	76.9	74.3	47.2	103.6	172.6	172.6	147.1	101.4	-125.4	-69.0	90.76	91.42	91.42	-0.0041	-0.0027	1.1121
11	90.0	120.5	76.7	66.8	47.1	100.4	174.1	174.1	148.3	99.5	-127.0	-73.7	90.51	82.12	82.12	0.0000	0.0000	1.1019

SL	B-1 DEGREE	B-2 DEGREE	B'-1 DEGREE	B'-2 DEGREE	M-1	M-2	M'-1	M'-2	INCM DEGREE	DEV DEGREE	TURH DEGREE	D FAC	OMEGA-B TOTAL	LOSS-P TOTAL	POZ/ POI	KEFF-A TOTAL	KEFF-P TOTAL
1	31.5	55.0	54.60	35.81	0.2737	0.3789	0.4028	0.2677	-13.42	20.57	18.78	0.5141	0.0864	0.0306	1.1050	91.55	91.58
2	31.5	54.2	55.04	33.26	0.2731	0.3948	0.4063	0.2762	-9.56	14.74	21.78	0.5097	0.0642	0.0237	1.1157	93.94	94.04
3	31.5	53.7	55.47	32.60	0.2725	0.4019	0.4098	0.2827	-6.70	11.17	22.87	0.5040	0.0483	0.0181	1.1214	95.50	95.58
4	31.5	53.2	55.90	33.82	0.2719	0.3996	0.4134	0.2873	-6.30	10.21	22.08	0.4956	0.0397	0.0148	1.1214	96.24	96.29
5	31.5	53.1	56.33	35.14	0.2713	0.3966	0.4170	0.2911	-6.12	9.71	21.19	0.4891	0.0348	0.0129	1.1209	96.61	96.67
6	31.6	53.0	56.76	36.31	0.2706	0.3941	0.4206	0.2943	-6.00	9.34	20.44	0.4855	0.0331	0.0122	1.1207	96.72	96.77
7	31.6	53.0	57.19	37.31	0.2698	0.3923	0.4242	0.2966	-5.96	9.12	19.87	0.4850	0.0347	0.0127	1.1210	96.51	96.58
8	31.6	53.2	57.62	38.27	0.2689	0.3907	0.4278	0.2982	-5.95	9.00	19.35	0.4870	0.0395	0.0144	1.1213	96.01	96.06
9	31.6	53.5	58.06	39.48	0.2679	0.3878	0.4315	0.2989	-6.06	9.34	18.58	0.4907	0.0477	0.0173	1.1208	95.10	95.18
10	31.6	54.4	58.49	42.87	0.2670	0.3737	0.4352	0.2971	-8.40	12.03	15.61	0.4922	0.0646	0.0224	1.1138	93.03	93.14
11	31.6	56.4	58.89	47.84	0.2662	0.3530	0.4390	0.2913	-11.38	16.48	11.05	0.5008	0.0945	0.0303	1.1036	89.16	89.32

SL	V-1 FT/SEC	V-2 FT/SEC	VM-1 FT/SEC	VM-2 FT/SEC	V0-1 FT/SEC	V0-2 FT/SEC	U-1 FT/SEC	U-2 FT/SEC	V'-1 FT/SEC	V'-2 FT/SEC	W0'-1 FT/SEC	W0'-2 FT/SEC	RHOVM-1 LBM/FT2SEC	RHOVM-2 LBM/FT2SEC	RHOVM-2 LBM/FT2SEC	EPSI-1 DEGREE	EPSI-2 DEGREE	EPSI-2 PCI TE
1	303.4	423.7	258.6	242.7	158.6	347.3	522.5	522.5	446.4	299.3	-363.9	-175.2	19.03	18.49	18.49	0.000	0.000	0.0000
2	302.7	441.4	258.0	258.2	158.2	358.0	527.3	527.3	450.3	308.8	-369.1	-169.4	18.98	19.70	19.70	0.110	0.022	0.1000
3	302.1	449.3	257.5	266.2	158.0	361.9	532.2	532.2	454.3	316.0	-374.3	-170.3	18.95	20.34	20.34	0.088	0.012	0.2000
4	301.4	446.7	256.9	266.8	157.7	358.3	537.1	537.1	458.2	321.2	-379.4	-178.8	18.91	20.41	20.41	0.023	-0.023	0.3000
5	300.7	443.4	256.3	266.2	157.3	354.6	542.0	542.0	462.2	325.5	-384.6	-187.4	18.87	20.38	20.38	-0.045	-0.067	0.4000
6	299.9	440.7	255.6	265.2	156.9	352.0	546.8	546.8	466.2	329.1	-389.9	-194.9	18.82	20.32	20.32	-0.110	-0.112	0.5000
7	299.0	438.8	254.8	263.9	156.5	350.6	551.7	551.7	470.2	331.8	-395.2	-201.1	18.77	20.24	20.24	-0.170	-0.155	0.6000
8	298.1	437.1	254.0	261.9	156.0	350.0	556.6	556.6	474.3	333.6	-400.6	-206.6	18.71	20.10	20.10	-0.224	-0.189	0.7000
9	297.1	434.0	253.1	258.2	155.5	348.8	561.5	561.5	478.4	334.5	-406.0	-212.7	18.65	19.82	19.82	-0.263	-0.201	0.8000
10	296.0	418.4	252.2	243.8	155.0	340.0	566.4	566.4	482.5	332.7	-411.4	-226.4	18.59	18.72	18.72	-0.233	-0.157	0.9000
11	295.2	395.5	251.5	219.1	154.5	329.3	571.2	571.2	486.7	326.4	-416.7	-241.9	18.54	16.82	16.82	0.000	0.000	1.0000

SOFT	WCI/AI LBM/SEC	WCI/AI KG/SEC	TO/TO PO/PO	TO/TO EFF-AD	TO/TO INLET	TO/TO INLET	TO/TO EFF-P	ROTOR X	ROTOR X	ROTOR X
18.46	90.08	90.08	1.0342	1.1166	93.79	93.89	1.0342	1.1183	95.10	95.17

ACRODYNAMIC SUMMARY
COMPRESSOR 352-Station 1

SL	V-1 M/SEC	V-2 M/SEC	VM-1 M/SEC	VM-2 M/SEC	V0-1 M/SEC	V0-2 M/SEC	RHOWM-1 KG/M2 SEC	RHOWM-2 KG/M2 SEC	PO/PO INLET	TO/TO INLET	KEFF-A TOT-INLET	KEFF-P TOT-INLET	EPST-1 RADIANS	EPST-2 RADIANS			
1	129.1	76.3	73.9	56.9	105.8	50.9	90.21	72.07	1.0940	1.0317	82.16	82.37	0.0000	0.0000			
2	134.5	87.0	78.6	69.2	109.1	52.8	96.12	77.84	1.1058	1.0337	86.63	86.82	0.0033	0.0041			
3	137.0	93.2	81.2	76.9	110.3	52.7	99.35	77.69	1.1135	1.0348	89.71	89.87	0.0043	0.0047			
4	136.2	94.2	81.4	78.3	109.2	52.4	99.73	79.56	1.1151	1.0346	91.36	91.49	0.0035	0.0037			
5	135.2	94.0	81.2	78.1	108.1	52.2	99.62	79.44	1.1153	1.0344	92.24	92.36	0.0023	0.0026			
6	134.4	93.7	80.9	77.9	107.3	52.0	99.34	79.18	1.1152	1.0343	92.55	92.67	0.0020	0.0018			
7	133.8	93.5	80.5	77.8	106.9	51.9	98.93	79.00	1.1154	1.0344	92.28	92.38	0.0011	0.0003			
8	133.3	93.0	79.9	77.4	106.7	51.6	98.25	78.53	1.1152	1.0347	91.36	91.48	-0.0070	-0.0010			
9	132.3	91.4	78.7	75.5	106.3	51.4	96.84	76.14	1.1135	1.0348	89.73	89.88	-0.0011	-0.0023			
10	127.5	84.0	74.3	66.9	103.6	50.7	91.39	85.12	1.1053	1.0336	86.51	86.70	-0.0015	-0.0025			
11	120.5	73.4	66.7	54.6	100.4	49.2	82.06	69.59	1.0947	1.0321	81.76	82.00	0.0050	0.0060			
SL	B-1 DEGREE	B-2 DEGREE	M-1 M-2	INCM DEGREE	FT/SEC	FT/SEC	TURN DEGREE	O-FAC TOTAL	OMEGA-B TOTAL	LOSS-P TOTAL	P02/ P01	PO/PO STAGE	TO/TO STAGE	KEFF-A TOT-STG	KEFF-P TOT-STG	EPST-1 DEGREE	EPST-2 DEGREE
1	55.1	41.8	0.3789	0.2219	-11.51	19.36	13.25	0.5936	0.0901	0.0291	0.9915	1.0317	1.0317	83.53	83.75		
2	54.2	37.3	0.3947	0.2534	-9.44	14.50	16.90	0.5340	0.0653	0.0227	0.9934	1.1075	1.0337	87.96	89.13		
3	53.7	34.5	0.4019	0.2713	-5.97	11.40	18.20	0.5035	0.0490	0.0178	0.9949	1.1152	1.0348	90.99	91.23		
4	53.3	33.8	0.3997	0.2742	-5.73	10.63	19.51	0.4947	0.0397	0.0147	0.9959	1.1163	1.0346	92.63	92.75		
5	53.1	33.7	0.3967	0.2735	-5.76	10.57	19.33	0.4911	0.0345	0.0129	0.9964	1.1169	1.0344	93.53	93.65		
6	53.0	33.7	0.3942	0.2727	-5.83	10.65	19.24	0.4896	0.0327	0.0124	0.9967	1.1170	1.0343	93.26	93.34		
7	53.0	33.7	0.3925	0.2720	-5.97	10.83	19.30	0.4899	0.0342	0.0130	0.9965	1.1171	1.0344	93.55	93.65		
8	53.2	33.7	0.3909	0.2707	-6.14	11.15	19.46	0.4928	0.0392	0.0151	0.9962	1.1169	1.0347	92.65	92.74		
9	53.5	34.2	0.3878	0.2653	-6.51	12.13	19.25	0.5016	0.0480	0.0185	0.9953	1.1151	1.0348	91.01	91.14		
10	54.4	37.1	0.3736	0.2442	-8.96	15.71	17.22	0.5350	0.0623	0.0233	0.9943	1.1070	1.0336	87.86	88.01		
11	56.4	42.0	0.3529	0.2134	-11.07	21.34	18.37	0.5922	0.0794	0.0280	0.9934	1.0964	1.0321	83.17	83.37		
SL	V-1 FT/SEC	V-2 FT/SEC	VM-1 FT/SEC	VM-2 FT/SEC	V0-1 FT/SEC	V0-2 FT/SEC	RHOWM-1 LBW/FT2SEC	RHOWM-2 LBW/FT2SEC	PCI TE SPAN	TO/TO INLET	KEFF-A TOT-INLET	KEFF-P TOT-INLET	EPST-1 DEGREE	EPST-2 DEGREE			
1	423.6	250.4	242.5	186.6	347.3	167.0	13.48	14.76	0.0000	1.0317	82.16	82.37	0.000	0.000			
2	441.2	285.5	258.0	227.1	358.0	173.1	19.69	17.99	0.1000	1.0337	86.63	86.82	0.218	0.233			
3	449.3	305.9	266.3	252.2	361.9	173.1	20.35	20.01	0.2000	1.0348	89.71	89.87	0.246	0.263			
4	446.9	309.0	267.0	256.8	358.3	171.9	20.43	20.39	0.3000	1.0346	91.36	91.49	0.209	0.215			
5	443.6	308.3	266.5	256.4	354.6	171.3	20.37	20.37	0.4000	1.0344	92.24	92.36	0.163	0.151			
6	440.9	307.4	265.5	255.6	352.0	170.7	20.35	20.31	0.5000	1.0343	92.55	92.67	0.115	0.087			
7	439.0	306.7	264.2	255.1	350.6	170.2	20.26	20.28	0.6000	1.0344	92.28	92.38	0.061	0.019			
8	437.3	305.2	262.2	253.9	350.0	169.4	20.12	20.18	0.7000	1.0347	91.36	91.48	-0.000	-0.059			
9	434.0	299.8	258.3	247.9	348.8	168.6	19.83	19.69	0.8000	1.0343	89.73	89.88	-0.063	-0.134			
10	419.3	275.5	243.7	219.6	340.0	166.3	18.72	17.43	0.9000	1.0336	86.51	86.70	-0.086	-0.143			
11	395.4	240.9	218.9	179.0	329.3	161.3	16.81	14.19	1.0000	1.0321	81.76	82.00	0.000	0.000			
	NCORR INLET	NCORR INLET	NCORR INLET	NCORR INLET	TO/TO INLET	TO/TO INLET	EFF-AD INLET	EFF-AD INLET	PO/PO STAGE	PO2/ P01	PO/PO STAGE	TO/TO STAGE	EFF-AD STAGE	EFF-AD STAGE	PO/PO STAGE	TO/TO STAGE	EFF-AD STAGE
	5455.00	5455.00	9.47	4.79	1.0342	1.1114	89.75	89.88	0.9953	1.1130	91.03	91.16					

AERODYNAMIC SUMMARY
COMPRESSOR 3S2-Rotor 2

SL	V-1 M/SEC	V-2 M/SEC	VM-1 M/SEC	VM-2 M/SEC	V0-1 M/SEC	V0-2 M/SEC	U-1 M/SEC	U-2 M/SEC	V'-1 M/SEC	V'-2 M/SEC	W0-1 M/SEC	W0-2 M/SEC	RHOW-1 KG/M2 SEC	RHOW-2 KG/M2 SEC	RHOW-1 RADIANS	RHOW-2 RADIANS	EPSI-1 DEGREE	EPSI-2 DEGREE	PD/PO INLET
1	75.3	122.6	56.8	56.8	50.9	50.9	159.2	159.2	122.3	76.0	-108.3	-50.6	72.02	74.36	-0.0000	-0.0000	0.0000	0.0000	1.2099
2	87.0	128.3	69.2	67.7	52.8	52.8	160.7	160.7	128.2	85.1	-108.0	-51.7	87.79	88.78	-0.0015	-0.0015	0.0003	0.0003	1.2205
3	93.2	131.4	76.8	75.5	52.7	52.7	162.2	162.2	133.7	93.3	-109.5	-54.7	97.66	99.28	-0.0016	-0.0016	0.0003	0.0003	1.2275
4	94.2	131.1	78.3	77.4	52.4	52.4	163.7	163.7	136.1	96.6	-111.3	-57.8	99.54	101.87	-0.0012	-0.0012	0.0004	0.0004	1.2285
5	94.0	130.2	78.1	77.4	52.2	52.2	165.2	165.2	137.4	98.2	-113.0	-60.4	99.43	102.00	-0.0010	-0.0010	0.0006	0.0006	1.2282
6	93.7	129.4	77.9	77.1	52.0	52.0	166.7	166.7	138.6	99.4	-114.7	-62.7	99.19	101.73	-0.0008	-0.0008	0.0008	0.0008	1.2281
7	93.5	128.9	77.8	76.7	51.9	51.9	168.2	168.2	139.9	100.3	-115.3	-64.6	99.02	101.32	-0.0005	-0.0005	0.0010	0.0010	1.2283
8	93.0	128.4	77.4	76.1	51.6	51.6	169.6	169.6	141.2	101.9	-118.0	-66.3	98.56	100.52	-0.0004	-0.0004	0.0010	0.0010	1.2286
9	91.4	127.3	75.6	73.9	51.4	51.4	171.1	171.1	141.6	100.0	-119.7	-67.4	96.18	97.93	0.0004	0.0004	0.0009	0.0009	1.2280
10	84.0	123.0	67.0	65.4	50.7	50.7	172.6	172.6	139.1	94.7	-121.9	-68.4	85.16	86.33	0.0007	0.0007	0.0005	0.0005	1.2217
11	73.5	116.4	54.6	52.8	49.2	49.2	174.1	174.1	136.4	88.0	-125.0	-70.4	69.35	69.65	-0.0000	-0.0000	0.0000	0.0000	1.2117

SL	B-1 DEGREE	B-2 DEGREE	B'-1 DEGREE	B'-2 DEGREE	M-1	M-2	M'-1	M'-2	INCM DEGREE	DEV DEGREE	TURN DEGREE	D FAC	OMEGA-B TOTAL	LOSS-P TOTAL	POZ/ PO1	XEFF-A TOTAL	XEFF-P TOTAL
1	41.9	62.4	67.33	41.66	0.2218	0.3538	0.3557	0.2194	-7.01	22.34	20.66	0.5848	0.0755	0.0246	1.1050	93.94	94.03
2	37.3	58.2	57.36	37.36	0.2530	0.3705	0.3730	0.2458	-8.09	14.65	19.99	0.5301	0.0610	0.0214	1.1037	94.55	94.63
3	34.5	54.9	54.93	35.91	0.2712	0.3794	0.3892	0.2693	-6.94	10.37	19.02	0.4853	0.0480	0.0173	1.1024	95.27	95.35
4	33.8	53.8	54.89	36.77	0.2741	0.3788	0.3960	0.2790	-5.85	8.98	18.12	0.4668	0.0392	0.0141	1.1017	95.96	96.02
5	33.7	53.5	55.33	38.00	0.2735	0.3761	0.3999	0.2836	-5.12	8.32	17.33	0.4586	0.0340	0.0121	1.1012	96.39	96.45
6	33.7	53.4	55.80	39.12	0.2727	0.3739	0.4035	0.2870	-4.95	7.97	16.68	0.4533	0.0324	0.0115	1.1011	96.49	96.54
7	33.7	53.5	56.23	40.10	0.2721	0.3721	0.4072	0.2897	-4.90	7.74	16.13	0.4533	0.0324	0.0115	1.1012	96.30	96.35
8	33.7	53.6	56.74	41.04	0.2708	0.3706	0.4108	0.2913	-4.90	7.67	15.70	0.4558	0.0381	0.0134	1.1018	95.78	95.86
9	34.2	54.5	57.74	42.39	0.2659	0.3673	0.4119	0.2885	-5.12	8.18	15.35	0.4671	0.0459	0.0159	1.1030	95.02	95.09
10	37.1	57.9	61.22	46.29	0.2442	0.3547	0.4045	0.2729	-4.79	11.37	14.93	0.5014	0.0577	0.0189	1.1055	94.14	94.22
11	42.0	63.0	66.40	53.11	0.2135	0.3352	0.3962	0.2534	-2.99	17.70	13.28	0.5457	0.0776	0.0223	1.1089	92.58	92.70

SL	V-1 FT/SEC	V-2 FT/SEC	VM-1 FT/SEC	VM-2 FT/SEC	V0-1 FT/SEC	V0-2 FT/SEC	U-1 FT/SEC	U-2 FT/SEC	V'-1 FT/SEC	V'-2 FT/SEC	W0-1 FT/SEC	W0-2 FT/SEC	RHOW-1 LBM/FT2SEC	RHOW-2 LBM/FT2SEC	EPSI-1 DEGREE	EPSI-2 DEGREE	PCT SPAN
1	250.3	402.4	186.4	186.4	167.0	167.0	522.5	522.5	401.4	249.5	-355.5	-165.9	14.75	15.23	-0.0000	-0.0000	0.0000
2	285.4	421.1	226.9	222.0	173.1	173.1	527.3	527.3	420.7	279.3	-354.3	-169.5	17.98	18.18	-0.0086	-0.0086	0.1000
3	305.8	431.1	252.1	247.8	173.1	173.1	532.2	532.2	438.8	306.0	-359.1	-179.5	20.00	20.33	-0.0590	-0.0590	0.2000
4	309.0	430.3	256.8	253.9	171.9	171.9	537.1	537.1	446.4	316.9	-365.2	-189.7	20.39	20.86	-0.071	-0.071	0.3000
5	308.3	427.2	256.4	253.9	171.3	171.3	542.0	542.0	450.7	322.1	-370.7	-198.3	20.32	20.89	-0.0555	-0.0555	0.4000
6	307.4	424.7	255.6	253.0	170.7	170.7	546.8	546.8	454.8	326.0	-376.2	-205.7	20.32	20.84	-0.044	-0.044	0.5000
7	306.7	422.8	255.2	251.8	170.2	170.2	551.7	551.7	459.0	329.2	-381.6	-212.0	20.28	20.75	-0.028	-0.028	0.6000
8	305.3	421.2	254.0	249.7	169.4	169.4	556.6	556.6	463.1	331.1	-387.2	-217.4	20.19	20.59	-0.005	-0.005	0.7000
9	299.9	417.8	248.0	242.3	168.6	168.6	561.5	561.5	464.6	328.1	-392.8	-221.2	19.70	19.98	0.026	0.026	0.8000
10	275.6	403.6	219.7	214.6	166.3	166.3	566.4	566.4	456.4	310.6	-400.0	-224.5	17.44	17.68	0.038	0.038	0.9000
11	241.1	381.9	179.2	173.3	161.3	161.3	571.2	571.2	447.4	288.8	-410.0	-231.0	14.20	14.27	-0.000	-0.000	1.0000

TO2/TO1	PO2/PO1	EFF-AD	EFF-P	ROTOR	ROTOR
1.0297	1.1026	95.35	95.42	%	%

AFRUDYNAMICAL SUMMARY
COMPRESSIONOR 312-Station 2

SL	V-1 M/SEC	V-2 M/SEC	VM-1 M/SEC	VM-2 M/SEC	VO-1 M/SEC	VO-2 M/SEC	RHOVM-1 KG/M ³ SEC	RHOVM-2 KG/M ³ SEC	RHOVM-2 KG/M ³ SEC	PO/PO INLET	TO/TO INLET	KEFF-A TOT-INLET	SETT-P TOT-INLET	EP-1-1 RADIUS	EP-1-2 RADIUS		
1	122.7	71.3	56.9	51.1	108.7	49.8	74.43	69.27	1.2013	1.0635	84.81	85.21	0.0000	0.0000			
2	128.4	82.0	67.7	64.0	109.1	51.3	88.81	86.92	1.2132	1.0649	87.54	87.88	0.0012	0.0000			
3	131.4	83.8	75.5	72.4	107.5	51.4	99.30	98.49	1.2215	1.0655	89.90	90.19	0.0015	0.0042			
4	131.1	90.4	77.4	74.5	105.9	51.7	101.83	101.47	1.2233	1.0669	91.55	91.78	0.0016	0.0047			
5	130.2	90.4	77.4	74.6	104.7	51.1	101.98	101.69	1.2242	1.0644	92.51	92.73	0.0017	0.0040			
6	129.4	90.3	77.1	74.5	104.0	50.9	101.74	101.60	1.2244	1.0642	92.84	93.05	0.0019	0.0037			
7	128.9	90.1	76.8	74.4	103.5	50.7	101.35	101.45	1.2245	1.0644	92.77	92.77	0.0017	0.0032			
8	123.4	89.7	76.1	74.2	103.4	50.5	100.56	101.06	1.2244	1.0650	91.67	91.91	0.0015	0.0025			
9	127.4	89.4	73.9	72.6	103.7	50.4	97.61	98.85	1.2230	1.0657	90.15	90.43	0.0011	0.0016			
10	124.1	82.0	65.5	64.5	104.2	50.6	96.45	87.77	1.2158	1.0655	87.77	88.10	0.0005	0.0005			
11	116.4	71.6	52.9	51.1	103.7	50.2	69.78	69.37	1.2050	1.0649	84.77	84.78	-0.0000	-0.0000			
SL	B-1 DEGREE	B-2 DEGREE	M-1	M-2	INCH DEGREE	DEV DEGREE	TURB DEGREE	D-FAC TOTAL	OHGCA-P TOTAL	LOSS-P TOTAL	PO2/ PO1	TO/TO STAGE	KEFF-A TOT-STG	EP-1-1 DEGREE	EP-1-2 DEGREE		
1	62.4	44.3	0.3539	0.2077	-9.38	21.99	13.13	0.6765	0.0754	0.0234	0.9937	1.0303	87.96	89.17			
2	53.7	33.7	0.3705	0.2350	-8.91	15.69	19.46	0.5566	0.0627	0.0214	0.9944	1.0303	89.04	89.19			
3	54.9	35.4	0.3794	0.2545	-7.75	11.85	19.56	0.5122	0.0503	0.0180	0.9953	1.0297	90.57	90.70			
4	53.8	34.5	0.3783	0.2592	-6.53	10.64	19.36	0.4963	0.0404	0.0148	0.9962	1.0293	92.10	92.20			
5	53.6	34.4	0.3761	0.2593	-5.65	10.33	19.17	0.4907	0.0348	0.0129	0.9968	1.0290	93.16	93.19			
6	53.4	34.3	0.3739	0.2635	-5.62	10.36	19.10	0.4833	0.0379	0.0123	0.9970	1.0289	93.41	93.50			
7	53.4	34.3	0.3727	0.2633	-5.75	10.52	19.15	0.4832	0.0382	0.0129	0.9969	1.0290	93.14	93.23			
8	53.6	34.3	0.3706	0.2572	-5.96	10.81	19.37	0.4910	0.0337	0.0147	0.9965	1.0293	92.29	92.41			
9	54.5	34.8	0.3574	0.2532	-6.39	11.74	19.75	0.5010	0.0465	0.0178	0.9959	1.0299	90.95	91.03			
10	57.8	38.1	0.3548	0.2347	-6.75	15.71	19.77	0.5384	0.0585	0.0216	0.9951	1.0309	89.49	89.64			
11	63.0	44.5	0.3353	0.2048	-5.79	23.04	18.50	0.6026	0.0746	0.0252	0.9944	1.0318	87.41	87.59			
SL	V-1 FT/SEC	V-2 FT/SEC	VM-1 FT/SEC	VM-2 FT/SEC	VO-1 FT/SEC	VO-2 FT/SEC	RHOVM-1 LBM/FT ³ SEC	RHOVM-2 LBM/FT ³ SEC	PCT TE SPAN	TO/TO INLET	KEFF-A TOT-INLET	SETT-P TOT-INLET	EP-1-1 DEGREE	EP-1-2 DEGREE			
1	402.4	233.9	186.6	167.6	356.6	163.7	15.24	14.18	0.0070	1.0635	84.81	85.21	0.0000	0.0000			
2	421.1	269.2	222.1	210.1	357.8	168.3	18.19	17.80	0.1000	1.0649	87.54	87.88	0.0015	0.0000			
3	431.1	291.4	247.8	237.6	352.8	168.6	20.34	20.17	0.2000	1.0655	89.90	90.19	0.0016	0.0040			
4	430.3	296.6	253.9	244.5	347.4	167.9	20.87	20.78	0.3000	1.0649	91.55	91.78	0.0017	0.0042			
5	427.2	296.7	253.8	244.8	343.6	167.5	20.89	20.83	0.4000	1.0644	92.51	92.73	0.0019	0.0039			
6	424.7	296.2	251.0	244.5	341.1	167.1	20.84	20.81	0.5000	1.0642	92.84	93.05	0.0020	0.0042			
7	422.9	295.5	251.9	244.2	339.7	166.5	20.76	20.78	0.6000	1.0644	92.56	92.77	0.0019	0.0035			
8	421.3	294.4	249.8	243.3	339.2	165.7	20.60	20.70	0.7000	1.0650	91.67	91.91	0.0015	0.0029			
9	417.9	289.5	242.5	238.7	340.3	165.3	19.99	20.24	0.8000	1.0657	90.15	90.43	0.0011	0.0029			
10	403.8	269.0	214.9	211.8	341.9	165.9	17.71	17.98	0.9000	1.0655	87.77	88.10	0.0010	0.0029			
11	337.0	234.9	173.7	167.7	340.3	164.6	14.29	14.21	1.0000	1.0649	84.77	84.78	-0.0000	-0.0000			
											PO/PO STAGE	EFF-AD STAGE	EFF-P STAGE	EFF-P STAGE	EFF-P STAGE		
											1.0297	0.9959	1.0931	91.27	91.39		
											5455.00	9.47	4.29	1.0649	1.2204	90.31	90.58

AERODYNAMIC SUMMARY
COMPRESSOR 352-Stage 3

STAGE	V-1 M/SEC	V-2 M/SEC	VM-1 M/SEC	VM-2 M/SEC	V0-1 M/SEC	V0-2 M/SEC	RHWM-1 KG/M2 SEC	RHWM-2 KG/M2 SEC	PO/PO INLET	TO/TO INLET	WFF-A TOT-INLET	WFF-P TOT-INLET	EP51-1 DEGREE	EP51-2 DEGREE			
1	116.4	69.5	54.1	50.5	103.1	47.7	75.45	72.54	1.3067	1.0928	85.65	85.13	9.0600	0.0000			
2	121.8	79.5	65.0	62.9	107.9	49.5	99.94	90.62	1.3192	1.0935	87.83	83.30	9.9013	0.0017			
3	124.3	85.2	72.5	70.3	101.0	49.1	101.70	101.62	1.3253	1.0933	89.89	89.78	9.8023	0.0023			
4	127.0	95.4	74.3	71.8	99.3	49.0	104.28	103.76	1.3271	1.0921	91.46	91.50	9.6036	0.0025			
5	129.5	95.2	74.2	71.8	98.1	47.9	104.35	103.85	1.3275	1.0912	92.43	92.73	9.4029	0.0029			
6	132.3	95.1	73.9	71.7	97.4	47.8	104.07	103.71	1.3275	1.0910	92.75	93.04	9.2034	0.0034			
7	131.7	95.9	73.6	71.5	97.0	47.6	103.62	103.52	1.3276	1.0912	92.47	92.77	9.0034	0.0035			
8	131.3	95.7	73.1	71.4	96.8	47.3	102.94	103.29	1.3275	1.0921	91.61	91.95	8.8033	0.0035			
9	129.5	84.8	71.1	70.5	97.2	47.2	100.11	101.77	1.3275	1.0914	90.15	90.54	8.6029	0.0031			
10	116.7	79.4	62.7	63.4	99.4	47.8	86.20	91.41	1.3205	1.0940	86.01	86.47	8.4013	0.0013			
11	111.1	70.0	49.1	50.2	99.7	48.9	68.91	72.13	1.3104	1.0947	84.62	85.40	-0.0000	-0.0000			
Σ	B-1 DEGREE	B-2 DEGREE	M-1 DEGREE	M-2 DEGREE	INCOR DEGREE	DEV DEGREE	TURN DEGREE	Ω TOTAL	Ω TOTAL	LOSS-P TOTAL	PO2/ PO1	PO/PO STAGE	TO/TO STAGE	WFF-A TOT-STG	WFF-P TOT-STG	EP51-1 DEGREE	EP51-2 DEGREE
1	62.3	43.4	0.3308	0.1961	-7.77	21.15	18.91	0.6044	0.0714	0.0000	0.9949	1.0276	1.0276	86.74	83.39		
2	57.7	37.6	0.3463	0.2245	-7.94	14.93	20.09	0.5330	0.0534	0.0000	0.9953	1.0269	1.0269	89.11	89.24		
3	54.3	34.4	0.3532	0.2409	-7.27	11.29	19.90	0.4979	0.0493	0.0000	0.9960	1.0261	1.0261	90.37	90.23		
4	52.9	33.8	0.3529	0.2443	-6.34	10.24	19.45	0.4835	0.0445	0.0000	0.9967	1.0255	1.0255	91.73	91.63		
5	52.9	33.7	0.3504	0.2462	-5.49	9.97	19.21	0.4782	0.0369	0.0000	0.9972	1.0252	1.0252	92.56	92.75		
6	52.8	33.7	0.3493	0.2438	-5.49	10.00	19.10	0.4755	0.0332	0.0000	0.9973	1.0252	1.0252	92.56	92.75		
7	52.3	33.7	0.3465	0.2432	-5.60	10.14	19.16	0.4753	0.0344	0.0000	0.9973	1.0252	1.0252	92.56	92.75		
8	52.9	33.5	0.3452	0.2424	-5.75	10.37	19.39	0.4773	0.0383	0.0000	0.9970	1.0252	1.0252	92.56	92.75		
9	53.8	33.8	0.3426	0.2399	-5.97	11.10	19.93	0.4851	0.0452	0.0000	0.9965	1.0259	1.0259	90.52	90.74		
10	57.5	37.0	0.3316	0.2242	-5.83	14.90	20.47	0.5195	0.0570	0.0000	0.9983	1.0268	1.0268	89.13	89.31		
11	63.8	44.2	0.3153	0.1975	-3.44	22.85	19.53	0.5818	0.0797	0.0000	0.9947	1.0280	1.0280	85.53	85.79		
Σ	V-1 FT/SEC	V-2 FT/SEC	VM-1 FT/SEC	VM-2 FT/SEC	V0-1 FT/SEC	V0-2 FT/SEC	RHWM-1 LBM/FT2SEC	RHWM-2 LBM/FT2SEC	PCI IE SPAN	TO/TO INLET	WFF-A TOT-INLET	WFF-P TOT-INLET	EP51-1 DEGREE	EP51-2 DEGREE			
1	331.9	227.9	177.5	165.6	338.2	156.6	15.45	14.86	0.0003	1.0923	85.65	86.12	0.000	0.000			
2	339.5	260.7	213.4	206.5	337.7	159.2	18.62	18.56	0.1009	1.0935	87.83	83.30	0.103	0.103			
3	347.9	279.5	238.1	230.7	331.2	157.9	20.83	20.77	0.2009	1.0933	89.89	89.78	0.130	0.130			
4	346.7	283.4	243.6	235.6	325.7	157.4	21.36	21.25	0.3009	1.0921	91.46	91.60	0.148	0.150			
5	343.7	283.1	243.4	235.6	322.0	157.1	21.37	21.27	0.4000	1.0912	92.43	92.73	0.163	0.174			
6	341.2	282.6	242.6	235.1	319.6	156.8	21.31	21.24	0.5000	1.0910	92.75	93.04	0.185	0.195			
7	339.4	282.0	241.4	234.7	318.2	156.3	21.22	21.20	0.6009	1.0912	92.47	92.77	0.155	0.165			
8	338.0	281.1	239.9	234.3	317.6	155.3	21.08	21.15	0.7000	1.0921	91.61	91.95	0.150	0.207			
9	335.3	278.3	233.4	231.2	319.0	155.0	20.50	20.84	0.8000	1.0934	90.15	90.54	0.163	0.180			
10	333.0	260.5	205.9	208.0	322.9	156.8	18.06	18.72	0.9000	1.0940	88.01	88.47	0.101	0.111			
11	364.7	229.7	161.1	164.6	327.2	160.3	14.11	14.77	1.0000	1.0947	84.82	85.40	-0.000	-0.000			
Σ	WOPR INLET RPM	WOPR INLET RPM	WOPR INLET LBM/SEC	WOPR INLET LBM/SEC	TO/TO INLET	PO/PO INLET	EFF-AD INLET	EFF-P INLET	PO/PO STAGE	PO/PO STAGE	EFF-AD STAGE	EFF-P STAGE	WOPR INLET	WOPR INLET			
1	5455.00	5455.00	9.47	4.29	1.0925	1.3242	90.34	90.71	0.9964	1.0950	90.91	91.03					

APPENDIX D

AIRFOIL GEOMETRY ON CONICAL SURFACES
3S1/3S2 COMPRESSOR

PRECEDING PAGE BLANK NOT FILMED

TRANSLATION OF COMPUTER SYMBOLS TO ENGINEERING SYMBOLS (ROTOR)

DIA LE (CM) DLE	DIA TE (CM) DTE	BETA 1* (RADIAN) β_{LE}	BETA 2* (RADIAN) β_{TE}	CHORD (CM) b	DIA LE (INCHES) DLE	DIA TE (INCHES) DTE	BETA 1* (DEGREE) β_{LE}	BETA 2* (DEGREE) β_{TE}	CHORD (INCHES) b
-----------------------	-----------------------	-------------------------------------	-------------------------------------	--------------------	---------------------------	---------------------------	-------------------------------------	-------------------------------------	------------------------

O/TAU o/s	TAU/B s/b	T/B t/b	LER (CM) LER	TER (CM) TER	O/TAU o/s	TAU/B s/b	T/B t/b	LER (INCHES) LER	TER (INCHES) TER
--------------	--------------	------------	--------------------	--------------------	--------------	--------------	------------	------------------------	------------------------

TRANSLATION OF COMPUTER SYMBOLS TO ENGINEERING SYMBOLS (STATOR OR IGW)

DIA LE (CM) DLE	DIA TE (CM) DTE	BETA 1* (RADIAN) β_{LE}	BETA 2* (RADIAN) β_{TE}	CHORD (CM) b	DIA LE (INCHES) DLE	DIA TE (INCHES) DTE	BETA 1* (DEGREE) β_{LE}	BETA 2* (DEGREE) β_{TE}	CHORD (INCHES) b
-----------------------	-----------------------	-------------------------------------	-------------------------------------	--------------------	---------------------------	---------------------------	-------------------------------------	-------------------------------------	------------------------

O/TAU o/s	TAU/B s/b	T/B t/b	LER (CM) LER	TER (CM) TER	O/TAU o/s	TAU/B s/b	T/B t/b	LER (INCHES) LER	TER (INCHES) TER
--------------	--------------	------------	--------------------	--------------------	--------------	--------------	------------	------------------------	------------------------

AIRFOIL GEOMETRY
Compressor 3SI-IGV

SI UNITS				ENGLISH UNITS					
DIA LE (CM)	DIA TE (CM)	BETA 1* (RADIAN)	BETA 2* (RADIAN)	CHORD (CM)	DIA LE (INCHES)	DIA TE (INCHES)	BETA 1* (DEGREES)	BETA 2* (DEGREES)	CHORD (INCHES)
55.7530	55.7530	-0.1414	0.6238	2.5200	21.950	21.950	-8.100	35.740	0.992
56.2966	56.2940	-0.1432	0.6248	2.5200	22.164	22.163	-8.204	35.801	0.992
56.8325	56.8300	-0.1450	0.6259	2.5200	22.375	22.374	-8.307	35.862	0.992
57.3659	57.3608	-0.1468	0.6270	2.5200	22.585	22.583	-8.409	35.922	0.992
57.8917	57.8866	-0.1485	0.6280	2.5200	22.792	22.790	-8.510	35.982	0.992
58.4149	58.4098	-0.1503	0.6290	2.5200	22.998	22.996	-8.611	36.041	0.992
58.9331	58.928	-0.1520	0.6301	2.5200	23.202	23.200	-8.710	36.100	0.992
59.4462	59.4411	-0.1537	0.6311	2.5200	23.404	23.402	-8.809	36.158	0.992
59.9542	59.9516	-0.1555	0.6321	2.5200	23.604	23.603	-8.907	36.216	0.992
60.4596	60.4571	-0.1571	0.6331	2.5200	23.803	23.802	-9.004	36.273	0.992
60.9600	60.9600	-0.1588	0.6341	2.5200	24.000	24.000	-9.100	36.330	0.992
O/TAU	TAU/B	T/B	LER (CM)	TER (CM)	O/TAU	TAU/B	T/B	LER (INCHES)	TER (INCHES)
0.8689	0.8773	0.0750	0.0228	0.0228	0.8689	0.8778	0.0750	0.009	0.009
0.8857	0.8857	0.0771	0.0228	0.0228	0.8778	0.8857	0.0771	0.009	0.009
0.8940	0.8940	0.0791	0.0228	0.0228	0.8857	0.8940	0.0791	0.009	0.009
0.9022	0.9022	0.0812	0.0228	0.0228	0.8940	0.9022	0.0812	0.009	0.009
0.9104	0.9104	0.0832	0.0228	0.0228	0.9022	0.9104	0.0832	0.009	0.009
0.9184	0.9184	0.0852	0.0228	0.0228	0.9104	0.9184	0.0852	0.009	0.009
0.9264	0.9264	0.0872	0.0228	0.0228	0.9184	0.9264	0.0872	0.009	0.009
0.9344	0.9344	0.0892	0.0228	0.0228	0.9264	0.9344	0.0892	0.009	0.009
0.9423	0.9423	0.0913	0.0228	0.0228	0.9344	0.9423	0.0913	0.009	0.009
0.9501	0.9501	0.0957	0.0228	0.0228	0.9423	0.9501	0.0957	0.010	0.009
		0.1000	0.0279	0.0228			0.1000	0.011	0.009

AIRFOIL GEOMETRY
Compressor 3SI-Rotor 1

SI UNITS				ENGLISH UNITS					
DIA LE (CM)	DIA TE (CM)	BETA 1* (RADIAN)	BETA 2* (RADIAN)	CHORD (CM)	DIA LE (INCHES)	DIA TE (INCHES)	BETA 1* (DEGREES)	BETA 2* (DEGREES)	CHORD (INCHES)
55.7530	55.7530	1.2280	0.2111	2.7134	21.9500	21.9500	70.3571	12.0837	1.0683
56.2900	56.3126	1.1561	0.2810	2.7134	22.1614	22.1703	66.2356	16.0911	1.0683
56.8229	56.8414	1.1072	0.3349	2.7134	22.3712	22.3785	63.4360	19.1788	1.0683
57.3517	57.3575	1.1075	0.3756	2.7134	22.5794	22.5817	63.4547	21.5093	1.0683
57.8767	57.8686	1.1106	0.4084	2.7134	22.7861	22.7829	63.6310	23.3918	1.0683
58.3982	58.3763	1.1150	0.4358	2.7134	22.9914	22.9828	63.8840	24.9523	1.0683
58.9166	58.8815	1.1204	0.4576	2.7134	23.1955	23.1817	64.1909	26.2035	1.0683
59.4317	59.3850	1.1274	0.4763	2.7134	23.3983	23.3799	64.5946	27.2782	1.0683
59.9440	59.8891	1.1370	0.4914	2.7134	23.6000	23.5784	65.1426	28.1453	1.0683
60.4533	60.4055	1.1857	0.5032	2.7134	23.8005	23.7817	67.9356	28.8227	1.0683
60.9600	60.9600	1.2437	0.5105	2.7134	24.0000	24.0000	71.2557	29.2379	1.0683

O/TAU	TAU/B	T/B	LER (CM)	TER (CM)	O/TAU	TAU/B	T/B	LER (INCHES)	TER (INCHES)
0.5490	0.8723	0.1000	0.0228	0.0228	0.5490	0.8723	0.1000	0.009	0.009
0.5805	0.8809	0.0863	0.0228	0.0228	0.5805	0.8809	0.0863	0.009	0.009
0.6029	0.8892	0.0738	0.0228	0.0228	0.6029	0.8892	0.0738	0.009	0.009
0.5998	0.8973	0.0708	0.0228	0.0228	0.5998	0.8973	0.0708	0.009	0.009
0.5964	0.9054	0.0678	0.0228	0.0228	0.5964	0.9054	0.0678	0.009	0.009
0.5930	0.9135	0.0648	0.0228	0.0228	0.5930	0.9135	0.0648	0.009	0.009
0.5900	0.9215	0.0619	0.0228	0.0228	0.5900	0.9215	0.0619	0.009	0.009
0.5866	0.9294	0.0589	0.0228	0.0228	0.5866	0.9294	0.0589	0.009	0.009
0.5826	0.9374	0.0560	0.0228	0.0228	0.5826	0.9374	0.0560	0.009	0.009
0.5617	0.9454	0.0531	0.0228	0.0228	0.5617	0.9454	0.0531	0.009	0.009
0.5375	0.9537	0.0500	0.0228	0.0228	0.5375	0.9537	0.0500	0.009	0.009

AIRFOIL GEOMETRY
Compressor 3SI-Stator 1

SI UNITS ENGLISH UNITS

DIA LE (CM)	DIA TE (CM)	BETA 1* (RADIAN)	BETA 2* (RADIAN)	CHORD (CM)	DIA LE (INCHES)	DIA TE (INCHES)	BETA 1* (DEGREES)	BETA 2* (DEGREES)	CHORD (INCHES)
55.7530	55.7530	1.1887	0.3533	2.9108	21.9500	21.9500	68.1077	20.2332	1.1460
56.3131	56.3751	1.1126	0.3626	2.9108	22.1705	22.1949	63.7427	20.7670	1.1460
56.8424	56.9031	1.0581	0.3674	2.9108	22.3789	22.4028	60.6222	21.0397	1.1460
57.3583	57.4022	1.0503	0.3685	2.9108	22.5820	22.5993	60.1744	21.1030	1.1460
57.8691	57.8970	1.0464	0.3687	2.9108	22.7831	22.7941	59.9510	21.1120	1.1460
58.3763	58.3885	1.0461	0.3680	2.9108	22.9828	22.9876	59.9345	21.0749	1.1460
58.8810	58.8770	1.0490	0.3643	2.9108	23.1815	23.1799	60.1028	20.8621	1.1460
59.3844	59.3631	1.0557	0.3586	2.9108	23.3797	23.3713	60.4838	20.5362	1.1460
59.8984	59.8500	1.0664	0.3508	2.9108	23.5781	23.5630	61.0958	20.0892	1.1460
60.4050	60.3629	1.1262	0.3388	2.9108	23.7815	23.7649	64.5237	19.4010	1.1460
60.9600	60.9600	1.2066	0.3199	2.9108	24.0000	24.0000	69.1321	18.3200	1.1460
O/TAU	TAU/B	T/B	LER (CM)	TER (CM)	O/TAU	TAU/B	T/B	LER (INCHES)	TER (INCHES)
0.5556	0.8596	0.0750	0.0228	0.0228	0.5556	0.8596	0.0750	0.009	0.009
0.5893	0.8687	0.0773	0.0228	0.0228	0.5893	0.8687	0.0773	0.009	0.009
0.6132	0.8769	0.0793	0.0228	0.0228	0.6132	0.8769	0.0793	0.009	0.009
0.6169	0.8847	0.0813	0.0228	0.0228	0.6169	0.8847	0.0813	0.009	0.009
0.6191	0.8924	0.0832	0.0228	0.0228	0.6191	0.8924	0.0832	0.009	0.009
0.6198	0.9002	0.0851	0.0228	0.0228	0.6198	0.9002	0.0851	0.009	0.009
0.6197	0.9078	0.0870	0.0228	0.0228	0.6197	0.9078	0.0870	0.009	0.009
0.6183	0.9154	0.0889	0.0228	0.0228	0.6183	0.9154	0.0889	0.009	0.009
0.6155	0.9231	0.0909	0.0228	0.0228	0.6155	0.9231	0.0909	0.009	0.009
0.5918	0.9310	0.0950	0.0228	0.0228	0.5918	0.9310	0.0950	0.009	0.009
0.5607	0.9399	0.1000	0.0228	0.0228	0.5607	0.9399	0.1000	0.009	0.009

AIRFOIL GEOMETRY Compressor 3SI-Rotor 2				ENGLISH UNITS				
SI UNITS		ENGLISH UNITS		ENGLISH UNITS		ENGLISH UNITS		
DIA LE (CM)	DIA TE (CM)	BETA 1* (RADIAN)	BETA 2* (RADIAN)	DIA LE (INCHES)	DIA TE (INCHES)	BETA 1* (DEGREES)	BETA 2* (DEGREES)	
55.7530	55.7530	1.1929	0.2973	21.9500	21.9500	68.3466	17.0200	
56.3756	56.3819	1.1241	0.3668	22.1951	22.1976	64.4013	21.0082	
56.9036	56.9110	1.0718	0.4141	22.4030	22.4059	61.4053	23.7157	
57.4030	57.4073	1.0731	0.4505	22.5996	22.6013	61.4830	25.8046	
57.8978	57.8975	1.0775	0.4809	22.7944	22.7943	61.7351	27.5444	
58.3893	58.3845	1.0830	0.5059	22.9879	22.9860	62.0469	28.9750	
58.8777	58.8691	1.0892	0.5259	23.1802	23.1768	62.4034	30.1260	
59.3636	59.3527	1.0972	0.5433	23.3715	23.3672	62.8647	31.1211	
59.8503	59.8386	1.1127	0.5577	23.5631	23.5585	63.7502	31.9465	
60.3631	60.3524	1.1657	0.5714	23.7650	23.7608	66.7855	32.7304	
60.9600	60.9600	1.2324	0.5807	24.0000	24.0000	70.6116	33.2664	
				O/TAU	TAU/B	T/B	LER (INCHES)	TER (INCHES)
0.5518	0.8742	0.1000	0.0228	0.5518	0.8742	0.1000	0.009	0.009
0.5829	0.8840	0.0845	0.0228	0.5829	0.8840	0.0845	0.009	0.009
0.6065	0.8923	0.0734	0.0228	0.6065	0.8923	0.0734	0.009	0.009
0.6030	0.9001	0.0705	0.0228	0.6030	0.9001	0.0705	0.009	0.009
0.5988	0.9078	0.0676	0.0228	0.5988	0.9078	0.0676	0.009	0.009
0.5949	0.9155	0.0648	0.0228	0.5949	0.9155	0.0648	0.009	0.009
0.5913	0.9231	0.0620	0.0228	0.5913	0.9231	0.0620	0.009	0.009
0.5872	0.9307	0.0592	0.0228	0.5872	0.9307	0.0592	0.009	0.009
0.5802	0.9383	0.0564	0.0228	0.5802	0.9383	0.0564	0.009	0.009
0.5566	0.9464	0.0535	0.0228	0.5566	0.9464	0.0535	0.009	0.009
0.5278	0.9558	0.0500	0.0228	0.5278	0.9558	0.0500	0.009	0.009

AIRFOIL GEOMETRY
Compressor 3SI-Stator 2

SI UNITS

ENGLISH UNITS

SI UNITS		ENGLISH UNITS					
DIA LE (CM)	BETA 1* (RADIAN)	BETA 2* (RADIAN)	CHORD (CM)	DIA LE (INCHES)	BETA 1* (DEGREES)	BETA 2* (DEGREES)	CHORD (INCHES)
55.7530	1.2763	0.3601	3.3756	21.9500	73.1264	20.6205	1.3290
56.3822	1.1828	0.3735	3.3756	22.1977	67.7695	21.3880	1.3290
56.9112	1.1092	0.3807	3.3756	22.4060	63.5475	21.8044	1.3290
57.4076	1.0762	0.3873	3.3756	22.6014	61.6592	22.1828	1.3290
57.8978	1.0584	0.3915	3.3756	22.7944	60.6408	22.4205	1.3290
58.3852	1.0592	0.3877	3.3756	22.9863	60.6853	22.2029	1.3290
58.8701	1.0618	0.3838	3.3756	23.1772	60.8313	21.9804	1.3290
59.3535	1.0682	0.3777	3.3756	23.3675	61.2025	21.5308	1.3290
59.8394	1.0864	0.3700	3.3756	23.5588	62.2432	21.1904	1.3290
60.3530	1.1538	0.3575	3.3756	23.7610	66.1087	20.4747	1.3290
60.9600	1.2421	0.3377	3.3756	24.0000	71.1643	19.3360	1.3290

SI UNITS		ENGLISH UNITS							
O/TAU	TAU/B	T/B	LER (CM)	O/TAU	TAU/B	T/B	LER (INCHES)	TER (CM)	TER (INCHES)
0.5157	0.8648	0.0750	0.0228	0.5157	0.8648	0.0750	0.009	0.0228	0.009
0.5574	0.8747	0.0775	0.0228	0.5574	0.8747	0.0775	0.009	0.0228	0.009
0.5899	0.8830	0.0795	0.0228	0.5899	0.8830	0.0795	0.009	0.0228	0.009
0.6039	0.8906	0.0814	0.0228	0.6039	0.8906	0.0814	0.009	0.0228	0.009
0.6115	0.8983	0.0833	0.0228	0.6115	0.8983	0.0833	0.009	0.0228	0.009
0.6123	0.9058	0.0852	0.0228	0.6123	0.9058	0.0852	0.009	0.0228	0.009
0.6124	0.9133	0.0870	0.0228	0.6124	0.9133	0.0870	0.009	0.0228	0.009
0.6112	0.9208	0.0889	0.0228	0.6112	0.9208	0.0889	0.009	0.0228	0.009
0.5053	0.9283	0.0908	0.0228	0.5053	0.9283	0.0908	0.009	0.0228	0.009
0.5786	0.9362	0.0948	0.0228	0.5786	0.9362	0.0948	0.009	0.0228	0.009
0.5444	0.9456	0.1000	0.0228	0.5444	0.9456	0.1000	0.009	0.0228	0.009

AIRFOIL GEOMETRY
Compressor 351-Rotor 3

SI UNITS

ENGLISH UNITS

DIA LE (CM)	DIA TE (CM)	BETA 1* (RADIAN)	BETA 2* (RADIAN)	CHORD (CM)	DIA LE (INCHES)	DIA TE (INCHES)	BETA 1* (DEGREE)	BETA 2* (DEGREE)	CHORD (INCHES)
55.7530	55.7530	1.2686	0.3898	3.6055	21.9500	21.9500	72.6870	22.3246	1.4195
56.4032	56.3814	1.1934	0.4612	3.6055	22.2060	22.1974	68.3749	26.4133	1.4195
56.9326	56.9085	1.1262	0.5108	3.6055	22.4144	22.4049	64.5265	29.2576	1.4195
57.5292	57.4043	1.1038	0.5523	3.6055	22.6099	22.6001	63.2394	31.6349	1.4195
57.9206	57.8947	1.0896	0.5864	3.6055	22.8034	22.7932	62.4246	33.5888	1.4195
58.4086	58.3817	1.0946	0.6094	3.6055	22.9955	22.9849	62.7121	34.9087	1.4195
58.8927	58.8660	1.0995	0.6291	3.6055	23.1861	23.1756	62.9937	36.0372	1.4195
59.3738	59.3484	1.1063	0.6450	3.6055	23.3755	23.3655	63.3834	36.9474	1.4195
59.8546	59.8317	1.1171	0.6600	3.6055	23.5648	23.5558	64.0040	37.8079	1.4195
60.3590	60.3420	1.1671	0.6748	3.6055	23.7634	23.7567	66.8672	38.6544	1.4195
60.9600	60.9600	1.2304	0.6866	3.6055	24.0000	24.0000	70.4970	39.3319	1.4195

O/TAU	TAU/B	T/B	LER (CM)	TER (CM)	O/TAU	TAU/B	T/B	LER (INCHES)	TER (INCHES)
0.5006	0.8675	0.1000	0.0228	0.0228	0.5006	0.8675	0.1000	0.009	0.009
0.5340	0.8774	0.0842	0.0228	0.0228	0.5340	0.8774	0.0842	0.009	0.009
0.5635	0.8857	0.0733	0.0228	0.0228	0.5635	0.8857	0.0733	0.009	0.009
0.5691	0.8934	0.0704	0.0228	0.0228	0.5691	0.8934	0.0704	0.009	0.009
0.5719	0.9010	0.0676	0.0228	0.0228	0.5719	0.9010	0.0676	0.009	0.009
0.5679	0.9086	0.0648	0.0228	0.0228	0.5679	0.9086	0.0648	0.009	0.009
0.5643	0.9161	0.0620	0.0228	0.0228	0.5643	0.9161	0.0620	0.009	0.009
0.5605	0.9236	0.0592	0.0228	0.0228	0.5605	0.9236	0.0592	0.009	0.009
0.5549	0.9311	0.0564	0.0228	0.0228	0.5549	0.9311	0.0564	0.009	0.009
0.5311	0.9390	0.0535	0.0228	0.0228	0.5311	0.9390	0.0535	0.009	0.009
0.5021	0.9485	0.0500	0.0228	0.0228	0.5021	0.9485	0.0500	0.009	0.009

AIRFOIL GEOMETRY
Compressor 3SI-Stator 3

SI UNITS

ENGLISH UNITS

SI UNITS		ENGLISH UNITS					
DIA LE (CM)	BETA 1* (RADIAN)	BETA 2* (RADIAN)	CHORD (CM)	DIA LE (INCHES)	BETA 1* (DEGREE)	BETA 2* (DEGREE)	CHORD (INCHES)
55.7530	1.2800	0.3545	3.7843	21.9500	73.3379	20.3034	1.4899
56.3809	1.1908	0.3650	3.7843	22.1972	68.2249	20.9002	1.4899
56.9077	1.1202	0.3739	3.7843	22.4045	64.1782	21.4099	1.4899
57.4032	1.0788	0.3857	3.7843	22.5997	61.8072	22.0909	1.4899
57.8937	1.0511	0.3912	3.7843	22.7928	60.2182	22.4033	1.4899
58.3809	1.0497	0.3897	3.7843	22.9846	60.1425	22.3165	1.4899
58.8653	1.0517	0.3858	3.7843	23.1753	60.2560	22.0971	1.4899
59.3479	1.0559	0.3802	3.7843	23.3653	60.4969	21.7727	1.4899
59.8315	1.0692	0.3721	3.7843	23.5557	61.2553	21.3114	1.4899
60.3418	1.1316	0.3614	3.7843	23.7566	64.8347	20.6989	1.4899
60.9600	1.2159	0.3440	3.7843	24.0000	69.6624	19.6977	1.4899

SI UNITS		ENGLISH UNITS					
O/TAU	TAU/B	T/B	LER (CM)	O/TAU	TAU/B	T/B	LER (INCHES)
0.5127	0.8571	0.0750	0.0228	0.5127	0.8571	0.0750	0.009
0.5532	0.8668	0.0774	0.0228	0.5532	0.8668	0.0774	0.009
0.5843	0.8749	0.0795	0.0228	0.5843	0.8749	0.0795	0.009
0.6012	0.8826	0.0814	0.0228	0.6012	0.8826	0.0814	0.009
0.6130	0.8902	0.0833	0.0228	0.6130	0.8902	0.0833	0.009
0.6143	0.8977	0.0851	0.0228	0.6143	0.8977	0.0851	0.009
0.6146	0.9051	0.0870	0.0228	0.6146	0.9051	0.0870	0.009
0.6142	0.9125	0.0889	0.0228	0.6142	0.9125	0.0889	0.009
0.6104	0.9200	0.0908	0.0228	0.6104	0.9200	0.0908	0.009
0.5853	0.9277	0.0947	0.0228	0.5853	0.9277	0.0947	0.009
0.5521	0.9371	0.1000	0.0228	0.5521	0.9371	0.1000	0.009

AIRFOIL GEOMETRY
COMPRESSOR 3S2 - IGV

SI UNITS				ENGLISH UNITS					
DIA LE (CM)	DIA TE (CM)	BETA 1* (RADIAN)	BETA 2* (RADIAN)	CHORD (CM)	DIA LE (INCHES)	DIA TE (INCHES)	BETA 1* (DEGREES)	BETA 2* (DEGREES)	CHORD (INCHES)
55.7530	55.7530	-0.1405	0.6351	1.6797	21.950	21.950	-8.050	36.390	0.6613
56.2966	56.2889	-0.1425	0.6360	1.6797	22.164	22.161	-8.164	36.441	0.6613
56.8325	56.8223	-0.1444	0.6369	1.6797	22.375	22.371	-8.275	36.490	0.6613
57.3659	57.3532	-0.1464	0.6378	1.6797	22.585	22.580	-8.389	36.541	0.6613
57.8917	57.8764	-0.1484	0.6386	1.6797	22.792	22.786	-8.500	36.591	0.6613
58.4149	58.3997	-0.1503	0.6395	1.6797	22.998	22.992	-8.611	36.640	0.6613
58.9331	58.9178	-0.1522	0.6403	1.6797	23.202	23.196	-8.720	36.689	0.6613
59.4462	59.4335	-0.1541	0.6412	1.6797	23.404	23.399	-8.829	36.737	0.6613
59.9542	59.9640	-0.1560	0.6420	1.6797	23.604	23.600	-8.936	36.785	0.6613
60.4596	60.4545	-0.1578	0.6429	1.6797	23.803	23.801	-9.044	36.833	0.6613
60.9600	60.9600	-0.1597	0.6437	1.6797	24.000	24.000	-9.150	36.880	0.6613
O/TAU	TAU/B	T/B	LER (CM)	TER (CM)	O/TAU	TAU/B	T/B	LER (INCHES)	TER (INCHES)
0.8689	0.8689	0.0750	0.0228	0.0228	0.8689	0.8689	0.0750	0.009	0.009
0.8773	0.8773	0.0771	0.0228	0.0228	0.8773	0.8773	0.0771	0.009	0.009
0.8857	0.8857	0.0791	0.0228	0.0228	0.8857	0.8857	0.0791	0.009	0.009
0.8940	0.8940	0.0812	0.0228	0.0228	0.8940	0.8940	0.0812	0.009	0.009
0.9022	0.9022	0.0832	0.0228	0.0228	0.9022	0.9022	0.0832	0.009	0.009
0.9104	0.9104	0.0852	0.0228	0.0228	0.9104	0.9104	0.0852	0.009	0.009
0.9184	0.9184	0.0872	0.0228	0.0228	0.9184	0.9184	0.0872	0.009	0.009
0.9264	0.9264	0.0892	0.0228	0.0228	0.9264	0.9264	0.0892	0.009	0.009
0.9344	0.9344	0.0913	0.0228	0.0228	0.9344	0.9344	0.0913	0.009	0.009
0.9423	0.9423	0.0957	0.0228	0.0228	0.9423	0.9423	0.0957	0.009	0.009
0.9501	0.9501	0.1000	0.0228	0.0228	0.9501	0.9501	0.1000	0.009	0.009

AIRFOIL GEOMETRY
COMPRESSOR 3S2 - ROTOR 1

SI UNITS				ENGLISH UNITS					
DIA LE (CM)	DIA TE (CM)	BETA 1* (RADIAN)	BETA 2* (RADIAN)	CHORD (CM)	DIA LE (INCHES)	DIA TE (INCHES)	BETA 1* (DEGREES)	BETA 2* (DEGREES)	CHORD (INCHES)
55.7530	55.7530	1.1872	0.2663	1.8069	21.9500	21.9500	68.0189	15.2473	0.7114
56.2897	56.3126	1.1275	0.3279	1.8069	22.1613	22.1703	64.6001	18.7747	0.7114
56.8221	56.8412	1.0829	0.3787	1.8069	22.3709	22.3784	62.0437	21.5901	0.7114
57.3509	57.3570	1.0858	0.4153	1.8069	22.5791	22.5815	62.2084	23.7853	0.7114
57.8759	57.8686	1.0903	0.4461	1.8069	22.7858	22.7829	62.4655	25.5475	0.7114
58.3974	58.3766	1.0958	0.4719	1.8069	22.9911	22.9829	62.7839	27.0312	0.7114
58.9158	58.8818	1.1026	0.4925	1.8069	23.1952	23.1818	63.1738	28.2071	0.7114
59.4312	59.3855	1.1101	0.5106	1.8069	23.3981	23.3801	63.6012	29.2438	0.7114
59.9435	59.8894	1.1195	0.5256	1.8069	23.5998	23.5785	64.1424	30.1063	0.7114
60.4530	60.4055	1.1687	0.5378	1.8069	23.8004	23.7817	66.9623	30.8069	0.7114
60.9600	60.9600	1.2264	0.5474	1.8069	24.0000	24.0000	70.2640	31.3570	0.7114
O/TAU	TAU/B	T/B	LER (CM)	TER (CM)	O/TAU	TAU/B	T/B	LER (INCHES)	TER (INCHES)
0.5589	0.8734	0.1000	0.0228	0.0228	0.5589	0.8734	0.1000	0.009	0.009
0.5860	0.8820	0.0863	0.0228	0.0228	0.5860	0.8820	0.0863	0.009	0.009
0.6068	0.8903	0.0738	0.0228	0.0228	0.6068	0.8903	0.0738	0.009	0.009
0.6030	0.8984	0.0708	0.0228	0.0228	0.6030	0.8984	0.0708	0.009	0.009
0.5991	0.9055	0.0678	0.0228	0.0228	0.5991	0.9055	0.0678	0.009	0.009
0.5953	0.9146	0.0648	0.0228	0.0228	0.5953	0.9146	0.0648	0.009	0.009
0.5917	0.9226	0.0619	0.0228	0.0228	0.5917	0.9226	0.0619	0.009	0.009
0.5880	0.9305	0.0589	0.0228	0.0228	0.5880	0.9305	0.0589	0.009	0.009
0.5839	0.9385	0.0560	0.0228	0.0228	0.5839	0.9385	0.0560	0.009	0.009
0.5625	0.9465	0.0531	0.0228	0.0228	0.5625	0.9465	0.0531	0.009	0.009
0.5377	0.9548	0.0500	0.0228	0.0228	0.5377	0.9548	0.0500	0.009	0.009

AIRFOIL GEOMETRY
COMPRESSOR 352 - STATOR 1

SI UNITS					ENGLISH UNITS				
DIA LE (CM)	DIA TE (CM)	BETA 1* (RADIAN)	BETA 2* (RADIAN)	CHORD (CM)	DIA LE (INCHES)	DIA TE (INCHES)	BETA 1* (DEGREES)	BETA 2* (DEGREES)	CHORD (INCHES)
55.7530	55.7530	1.1621	0.3923	1.9413	21.9500	21.9500	66.5825	22.4671	0.7643
56.3133	56.3730	1.0884	0.3995	1.9413	22.1706	22.1941	62.3595	22.8810	0.7643
56.8422	56.9011	1.0361	0.4033	1.9413	22.3788	22.4020	59.3603	23.1002	0.7643
57.3578	57.4010	1.0300	0.4049	1.9413	22.5818	22.5988	59.0100	23.1878	0.7643
57.8688	57.8963	1.0267	0.4047	1.9413	22.7830	22.7938	58.8247	23.1771	0.7643
58.3766	58.3885	1.0265	0.4029	1.9413	22.9829	22.9876	58.8098	23.0759	0.7643
58.8815	58.8775	1.0293	0.3995	1.9413	23.1817	23.1801	58.9689	22.8785	0.7643
59.3850	59.3639	1.0348	0.3943	1.9413	23.3799	23.3716	59.2848	22.5831	0.7643
59.8886	59.8508	1.0439	0.3873	1.9413	23.5782	23.5633	59.8054	22.1831	0.7643
60.4048	60.3631	1.1006	0.3761	1.9413	23.7814	23.7650	63.0583	21.5407	0.7643
60.9600	60.9600	1.1772	0.3611	1.9413	24.0000	24.0000	67.4484	20.6765	0.7643
O/TAU	TAU/B	T/B	LER (CM)	TER (CM)	O/TAU	TAU/B	T/B	LER (INCHES)	TER (INCHES)
0.5632	0.8675	0.0750	0.0228	0.0228	0.5632	0.8675	0.0750	0.009	0.009
0.5959	0.8767	0.0773	0.0228	0.0228	0.5959	0.8767	0.0773	0.009	0.009
0.6188	0.8849	0.0793	0.0228	0.0228	0.6188	0.8849	0.0793	0.009	0.009
0.6217	0.8928	0.0813	0.0228	0.0228	0.6217	0.8928	0.0813	0.009	0.009
0.6236	0.9006	0.0832	0.0228	0.0228	0.6236	0.9006	0.0832	0.009	0.009
0.6244	0.9084	0.0851	0.0228	0.0228	0.6244	0.9084	0.0851	0.009	0.009
0.6243	0.9161	0.0870	0.0228	0.0228	0.6243	0.9161	0.0870	0.009	0.009
0.6233	0.9238	0.0889	0.0228	0.0228	0.6233	0.9238	0.0889	0.009	0.009
0.6210	0.9315	0.0909	0.0228	0.0228	0.6210	0.9315	0.0909	0.009	0.009
0.5986	0.9395	0.0950	0.0228	0.0228	0.5986	0.9395	0.0950	0.009	0.009
0.5685	0.9485	0.1000	0.0228	0.0228	0.5685	0.9485	0.1000	0.009	0.009

AIRFOIL GEOMETRY
COMPRESSOR 3S2 - ROTOR 2

SI UNITS				ENGLISH UNITS					
DIA LE (CM)	DIA TE (CM)	BETA 1* (RADIAN)	BETA 2* (RADIAN)	CHORD (CM)	DIA LE (INCHES)	DIA TE (INCHES)	BETA 1* (DEGREES)	BETA 2* (DEGREES)	CHORD (INCHES)
55.7530	55.7530	1.2102	0.3374	2.0878	21.9500	21.9500	69.3408	19.3206	0.8220
56.3733	56.3738	1.1293	0.4079	2.0878	22.1942	22.1944	64.7045	23.3614	0.8220
56.9016	56.9044	1.0673	0.4558	2.0878	22.4022	22.4033	61.1476	26.1083	0.8220
57.4017	57.4033	1.0586	0.4914	2.0878	22.5991	22.5997	60.6490	28.1460	0.8220
57.8970	57.8963	1.0547	0.5218	2.0878	22.7941	22.7938	60.4246	29.8903	0.8220
58.3893	58.3857	1.0608	0.5451	2.0878	22.9879	22.9865	60.7780	31.2235	0.8220
58.8782	58.8727	1.0669	0.5649	2.0878	23.1804	23.1782	61.1285	32.3558	0.8220
59.3646	59.3583	1.0749	0.5815	2.0878	23.3719	23.3694	61.5820	33.3107	0.8220
59.8513	59.8452	1.0901	0.5955	2.0878	23.5635	23.5611	62.4579	34.1095	0.8220
60.3634	60.3583	1.1436	0.6082	2.0878	23.7651	23.7631	65.5230	34.8399	0.8220
60.9600	60.9600	1.2110	0.6182	2.0878	24.0000	24.0000	69.3866	35.4129	0.8220

O/TAU	TAU/B	T/B	LER (CM)	TER (CM)	O/TAU	TAU/B	T/B	LER (INCHES)	TER (INCHES)
0.5377	0.8739	0.1000	0.0228	0.0228	0.5377	0.8739	0.1000	0.009	0.009
0.5736	0.8836	0.0846	0.0228	0.0228	0.5736	0.8836	0.0846	0.009	0.009
0.6013	0.8919	0.0734	0.0228	0.0228	0.6013	0.8919	0.0734	0.009	0.009
0.6022	0.8997	0.0705	0.0228	0.0228	0.6022	0.8997	0.0705	0.009	0.009
0.6014	0.9075	0.0677	0.0228	0.0228	0.6014	0.9075	0.0677	0.009	0.009
0.5973	0.9152	0.0648	0.0228	0.0228	0.5973	0.9152	0.0648	0.009	0.009
0.5936	0.9228	0.0620	0.0228	0.0228	0.5936	0.9228	0.0620	0.009	0.009
0.5895	0.9305	0.0592	0.0228	0.0228	0.5895	0.9305	0.0592	0.009	0.009
0.5825	0.9381	0.0564	0.0228	0.0228	0.5825	0.9381	0.0564	0.009	0.009
0.5585	0.9461	0.0534	0.0228	0.0228	0.5585	0.9461	0.0534	0.009	0.009
0.5290	0.9555	0.0500	0.0228	0.0228	0.5290	0.9555	0.0500	0.009	0.009

AIRFOIL GEOMETRY
COMPRESSOR 3S2 - STATOR 2

SI UNITS				ENGLISH UNITS					
DIA LE (CM)	DIA TE (CM)	BETA 1* (RADIAN)	BETA 2* (RADIAN)	CHORD (CM)	DIA LE (INCHES)	DIA TE (INCHES)	BETA 1* (DEGREE)	BETA 2* (DEGREE)	CHORD (INCHES)
55.7530	55.7530	1.2525	0.3905	2.2501	21.9500	21.9500	71.7642	22.3647	0.8859
56.3738	56.3921	1.1550	0.4044	2.2501	22.1944	22.2016	66.1769	23.1628	0.8859
56.9044	56.9232	1.0776	0.4122	2.2501	22.4033	22.4107	61.7377	23.6090	0.8859
57.4035	57.4231	1.0486	0.4173	2.2501	22.5998	22.6075	60.0794	23.9609	0.8859
57.8968	57.9171	1.0311	0.4204	2.2501	22.7940	22.8020	59.0743	24.0788	0.8859
58.3862	58.4073	1.0308	0.4185	2.2501	22.9867	22.9950	59.0598	23.9690	0.8859
58.8734	58.8942	1.0331	0.4150	2.2501	23.1785	23.1867	59.1903	23.7651	0.8859
59.3588	59.3779	1.0388	0.4097	2.2501	23.3696	23.3771	59.5153	23.4618	0.8859
59.8460	59.8607	1.0543	0.4033	2.2501	23.5614	23.5672	60.4063	23.0992	0.8859
60.3588	60.3654	1.1162	0.3929	2.2501	23.7633	23.7659	63.9494	22.4997	0.8859
60.9600	60.9600	1.2000	0.3741	2.2501	24.0000	24.0000	68.7528	21.4222	0.8859
O/TAU	TAU/B	T/B	LER (CM)	TER (CM)	O/TAU	TAU/B	T/B	LER (INCHES)	TER (INCHES)
0.5214	0.8649	0.0750	0.0228	0.0228	0.5214	0.8649	0.0750	0.009	0.009
0.5646	0.8747	0.0774	0.0228	0.0228	0.5646	0.8747	0.0774	0.009	0.009
0.5986	0.8829	0.0795	0.0228	0.0228	0.5986	0.8829	0.0795	0.009	0.009
0.6110	0.8907	0.0814	0.0228	0.0228	0.6110	0.8907	0.0814	0.009	0.009
0.6186	0.8983	0.0833	0.0228	0.0228	0.6186	0.8983	0.0833	0.009	0.009
0.6195	0.9059	0.0852	0.0228	0.0228	0.6195	0.9059	0.0852	0.009	0.009
0.6196	0.9135	0.0870	0.0228	0.0228	0.6196	0.9135	0.0870	0.009	0.009
0.6185	0.9210	0.0889	0.0228	0.0228	0.6185	0.9210	0.0889	0.009	0.009
0.6135	0.9285	0.0909	0.0228	0.0228	0.6135	0.9285	0.0909	0.009	0.009
0.5887	0.9364	0.0948	0.0228	0.0228	0.5887	0.9364	0.0948	0.009	0.009
0.5561	0.9457	0.1000	0.0228	0.0228	0.5561	0.9457	0.1000	0.009	0.009

AIRFOIL GEOMETRY
COMPRESSOR 3S2 - ROTOR 3

SI UNITS				ENGLISH UNITS					
DIA LE (CM)	DIA TE (CM)	BETA 1* (RADIAN)	BETA 2* (RADIAN)	CHORD (CM)	DIA LE (INCHES)	DIA TE (INCHES)	BETA 1* (DEGREES)	BETA 2* (DEGREES)	CHORD (INCHES)
55.7530	55.7530	1.2328	0.4413	2.4038	21.9500	21.9500	70.6307	25.2778	0.9464
56.3916	56.3735	1.1568	0.5075	2.4038	22.2014	22.1943	66.2785	29.0710	0.9454
56.9224	56.9019	1.0933	0.5537	2.4038	22.4104	22.4023	62.6386	31.7181	0.9454
57.4220	57.4002	1.0776	0.5887	2.4038	22.6071	22.5985	61.7406	33.7207	0.9454
57.9163	57.8935	1.0677	0.6187	2.4038	22.8017	22.7927	61.1694	35.4412	0.9454
58.4065	58.3834	1.0725	0.6402	2.4038	22.9947	22.9856	61.4449	36.5739	0.9454
58.8932	58.8709	1.0781	0.6587	2.4038	23.1863	23.1775	61.7673	37.7357	0.9454
59.3771	59.3565	1.0848	0.6746	2.4038	23.3768	23.3687	62.1499	38.6469	0.9464
59.8602	59.8424	1.0947	0.6875	2.4038	23.5670	23.5600	62.7180	39.3823	0.9464
60.3651	60.3527	1.1443	0.7017	2.4038	23.7658	23.7609	65.5644	40.1975	0.9464
60.9600	60.9600	1.2080	0.7137	2.4038	24.0000	24.0000	69.2107	40.8852	0.9464
O/TAU	TAU/B	T/B	LER (CM)	TER (CM)	O/TAU	TAU/B	T/B	LER (INCHES)	TER (INCHES)
0.5077	0.8674	0.1000	0.0228	0.0228	0.5077	0.8674	0.1000	0.009	0.009
0.5419	0.8772	0.0844	0.0228	0.0228	0.5419	0.8772	0.0844	0.009	0.009
0.5703	0.8854	0.0733	0.0228	0.0228	0.5703	0.8854	0.0733	0.009	0.009
0.5738	0.8932	0.0705	0.0228	0.0228	0.5738	0.8932	0.0705	0.009	0.009
0.5754	0.9009	0.0676	0.0228	0.0228	0.5754	0.9009	0.0676	0.009	0.009
0.5716	0.9085	0.0648	0.0228	0.0228	0.5716	0.9085	0.0648	0.009	0.009
0.5678	0.9161	0.0620	0.0228	0.0228	0.5678	0.9161	0.0620	0.009	0.009
0.5639	0.9236	0.0592	0.0228	0.0228	0.5639	0.9236	0.0592	0.009	0.009
0.5590	0.9312	0.0564	0.0228	0.0228	0.5590	0.9312	0.0564	0.009	0.009
0.5353	0.9391	0.0535	0.0228	0.0228	0.5353	0.9391	0.0535	0.009	0.009
0.5058	0.9484	0.0500	0.0228	0.0228	0.5058	0.9484	0.0500	0.009	0.009

AIRFOIL GEOMETRY
COMPRESSOR 3S2 - STATOR 3

SI UNITS				ENGLISH UNITS					
DIA LE (CM)	DIA TE (CM)	BETA 1* (RADIAN)	BETA 2* (RADIAN)	CHORD (CM)	DIA LE (INCHES)	DIA TE (INCHES)	BETA 1* (DEGREES)	BETA 2* (DEGREES)	CHORD (INCHES)
55.7530	55.7530	1.2231	0.3883	2.5229	21.9500	21.9500	70.0765	22.2403	0.9933
56.3733	56.3945	1.1311	0.3980	2.5229	22.1942	22.1986	64.9078	22.7938	0.9933
56.9013	56.9141	1.0602	0.4051	2.5229	22.4021	22.4071	60.7425	23.1987	0.9933
57.3997	57.4162	1.0349	0.4120	2.5229	22.5983	22.6048	59.2905	23.5957	0.9933
57.8927	57.9133	1.0173	0.4147	2.5229	22.7924	22.8005	58.2347	23.7503	0.9933
58.3827	58.4068	1.0175	0.4138	2.5229	22.9853	22.9948	59.2936	23.7017	0.9933
58.8704	58.8968	1.0195	0.4103	2.5229	23.1773	23.1877	58.4099	23.5002	0.9933
59.3560	59.3837	1.0235	0.4048	2.5229	23.3685	23.3794	58.6355	23.1860	0.9933
59.8419	59.8683	1.0346	0.3979	2.5229	23.5598	23.5702	59.2750	22.7892	0.9933
60.3524	60.3712	1.0938	0.3878	2.5229	23.7608	23.7682	62.6650	22.2112	0.9933
60.9600	60.9600	1.1732	0.3736	2.5229	24.0000	24.0000	67.2.83	21.3932	0.9933
O/TAU	TAU/B	T/B	LER (CM)	TER (CM)	O/TAU	TAU/B	T/B	LER (INCHES)	TER (INCHES)
0.5303	0.8467	0.0750	0.0228	0.0228	0.5303	0.8467	0.0750	0.009	0.009
0.5720	0.8562	0.0774	0.0228	0.0228	0.5720	0.8562	0.0774	0.009	0.009
0.6034	0.8642	0.0794	0.0228	0.0228	0.6034	0.8642	0.0794	0.009	0.009
0.6140	0.8718	0.0814	0.0228	0.0228	0.6140	0.8718	0.0814	0.009	0.009
0.6216	0.8793	0.0833	0.0228	0.0228	0.6216	0.8793	0.0833	0.009	0.009
0.6220	0.8868	0.0852	0.0228	0.0228	0.6220	0.8868	0.0852	0.009	0.009
0.6221	0.8942	0.0870	0.0228	0.0228	0.6221	0.8942	0.0870	0.009	0.009
0.6217	0.9016	0.0889	0.0228	0.0228	0.6217	0.9016	0.0889	0.009	0.009
0.6185	0.9089	0.0909	0.0228	0.0228	0.6185	0.9089	0.0909	0.009	0.009
0.5944	0.9166	0.0948	0.0228	0.0228	0.5944	0.9166	0.0948	0.009	0.009
0.5622	0.9257	0.1000	0.0228	0.0228	0.5622	0.9257	0.1000	0.009	0.009

APPENDIX E

AIRFOIL MANUFACTURING COORDINATES FOR
SECTIONS NORMAL TO STACKING LINE
CONFIGURATION 3S1/3S2

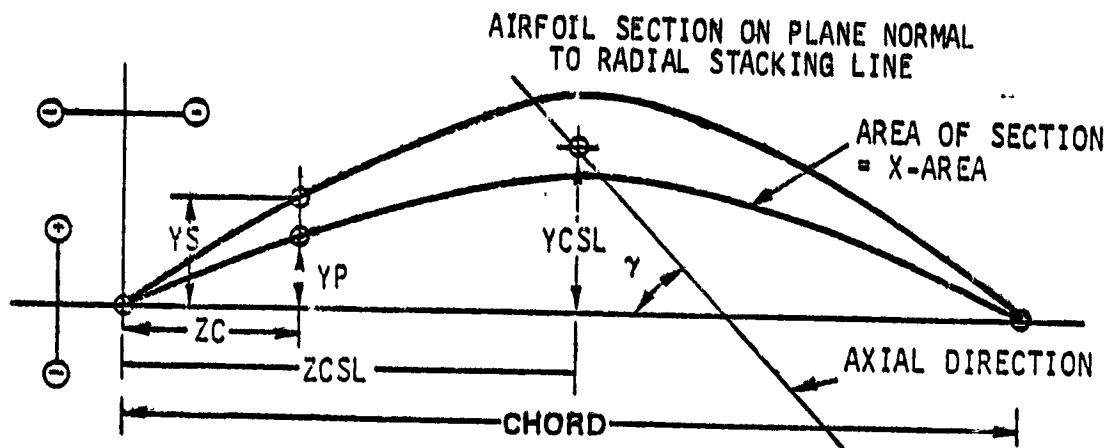

AIRFOIL COORDINATE DEFINITIONS FOR MANUFACTURING SECTIONS

MANUFACTURING COORDINATES
COMPRESSOR 3S1 - INLET GUIDE VANE

20 PERCENT SPAN

METERS			INCHES		
ZC	YP	YS	ZC	YP	YS
-0.0000	-0.0001	-0.0001	-0.0009	-0.0039	-0.0039
0.0000	-0.0002	0.0000	0.0007	-0.0093	0.0013
0.0001	-0.0003	0.0001	0.0024	-0.0121	0.0030
0.0001	-0.0004	0.0001	0.0041	-0.0147	0.0041
0.0004	-0.0007	0.0002	0.0150	-0.0263	0.0061
0.0007	-0.0009	0.0001	0.0259	-0.0346	0.0056
0.0009	-0.0011	0.0001	0.0369	-0.0423	0.0037
0.0012	-0.0013	0.0000	0.0478	-0.0495	0.0016
0.0015	-0.0014	-0.0000	0.0587	-0.0560	-0.0008
0.0028	-0.0021	-0.0003	0.1087	-0.0807	-0.0132
0.0040	-0.0025	-0.0006	0.1586	-0.0998	-0.0255
0.0053	-0.0029	-0.0009	0.2085	-0.1144	-0.0366
0.0066	-0.0032	-0.0012	0.2585	-0.1249	-0.0459
0.0078	-0.0033	-0.0013	0.3084	-0.1317	-0.0529
0.0091	-0.0034	-0.0015	0.3584	-0.1348	-0.0572
0.0104	-0.0034	-0.0015	0.4084	-0.1350	-0.0594
0.0116	-0.0034	-0.0015	0.4583	-0.1327	-0.0597
0.0129	-0.0033	-0.0015	0.5083	-0.1286	-0.0589
0.0142	-0.0031	-0.0015	0.5582	-0.1230	-0.0572
0.0154	-0.0029	-0.0014	0.6082	-0.1158	-0.0543
0.0167	-0.0027	-0.0013	0.6581	-0.1069	-0.0503
0.0180	-0.0025	-0.0011	0.7081	-0.0965	-0.0451
0.0193	-0.0021	-0.0010	0.7580	-0.0846	-0.0386
0.0205	-0.0018	-0.0008	0.8080	-0.0711	-0.0310
0.0218	-0.0014	-0.0006	0.8579	-0.0561	-0.0220
0.0231	-0.0010	-0.0003	0.9079	-0.0397	-0.0117
0.0239	-0.0007	-0.0001	0.9401	-0.0285	-0.0043
0.0242	-0.0006	-0.0000	0.9510	-0.0245	-0.0017
0.0244	-0.0005	0.0000	0.9620	-0.0205	0.0010
0.0247	-0.0004	0.0001	0.9729	-0.0164	0.0038
0.0251	-0.0003	0.0001	0.9875	-0.0108	0.0053
0.0251	-0.0002	0.0001	0.9891	-0.0098	0.0042
0.0252	-0.0002	0.0001	0.9908	-0.0080	0.0024
0.0252	-0.0001	-0.0001	0.9924	-0.0028	-0.0028

RADIUS (METERS) = 0.2840
 CHORD (METERS) = 0.0252
 ZCSL (METERS) = 0.0111
 YCSL (METERS) = -0.0018
 RLE (METERS) = 0.000229
 RTE (METERS) = 0.000229
 X-AREA (SQ. METERS) = 0.000037
 GAMMA-CHORD (DEG.) = 17.78

RADIUS (INCHES) = 11.1800
 CHORD (INCHES) = 0.9920
 ZCSL (INCHES) = 0.4374
 YCSL (INCHES) = -0.0723
 RLE (INCHES) = 0.0090
 RTE (INCHES) = 0.0090
 X-AREA (SQ. IN.) = 0.0578
 GAMMA-CHORD (RAD.) = 0.3104

MANUFACTURING COORDINATES
COMPRESSOR 3S1 - INLET GUIDE VANE

50 PERCENT SPAN

METERS			INCHES		
ZC	YP	YS	ZC	YP	YS
-0.0000	-0.0001	-0.0001	-0.0009	-0.0040	-0.0040
0.0000	-0.0002	0.0000	0.0007	-0.0094	0.0012
0.0001	-0.0003	0.0001	0.0024	-0.0125	0.0030
0.0001	-0.0004	0.0001	0.0041	-0.0152	0.0041
0.0004	-0.0007	0.0002	0.0150	-0.0274	0.0063
0.0007	-0.0009	0.0002	0.0259	-0.0362	0.0060
0.0009	-0.0011	0.0001	0.0368	-0.0443	0.0045
0.0012	-0.0013	0.0001	0.0478	-0.0516	0.0026
0.0015	-0.0015	0.0000	0.0587	-0.0584	0.0004
0.0028	-0.0021	-0.0003	0.1086	-0.0839	-0.0115
0.0040	-0.0026	-0.0006	0.1586	-0.1034	-0.0236
0.0053	-0.0030	-0.0009	0.2085	-0.1183	-0.0347
0.0066	-0.0033	-0.0011	0.2585	-0.1289	-0.0439
0.0078	-0.0034	-0.0013	0.3084	-0.1358	-0.0510
0.0091	-0.0035	-0.0014	0.3584	-0.1389	-0.0555
0.0104	-0.0035	-0.0015	0.4083	-0.1390	-0.0577
0.0116	-0.0035	-0.0015	0.4583	-0.1366	-0.0582
0.0129	-0.0034	-0.0015	0.5082	-0.1323	-0.0575
0.0142	-0.0032	-0.0014	0.5582	-0.1265	-0.0559
0.0154	-0.0030	-0.0014	0.6082	-0.1190	-0.0532
0.0167	-0.0028	-0.0013	0.6581	-0.1098	-0.0494
0.0180	-0.0025	-0.0011	0.7081	-0.0991	-0.0443
0.0193	-0.0022	-0.0010	0.7580	-0.0867	-0.0380
0.0205	-0.0019	-0.0008	0.8080	-0.0728	-0.0305
0.0218	-0.0015	-0.0006	0.8579	-0.0574	-0.0218
0.0231	-0.0010	-0.0003	0.9079	-0.0406	-0.0116
0.0239	-0.0007	-0.0001	0.9401	-0.0289	-0.0043
0.0242	-0.0006	-0.0000	0.9511	-0.0249	-0.0017
0.0244	-0.0005	0.0000	0.9620	-0.0208	0.0010
0.0247	-0.0004	0.0001	0.9729	-0.0166	0.0038
0.0251	-0.0003	0.0001	0.9875	-0.0109	0.0052
0.0251	-0.0002	0.0001	0.9891	-0.0098	0.0042
0.0252	-0.0002	0.0001	0.9908	-0.0080	0.0024
0.0252	-0.0001	-0.0001	0.9924	-0.0028	-0.0028

RADIUS (METERS) = 0.2916
 CHORD (METERS) = 0.0252
 ZCSL (METERS) = 0.0111
 YCSL (METERS) = -0.0019
 RLE (METERS) = 0.000229
 RTE (METERS) = 0.000229
 X-AREA (SQ. METERS) = 0.000040
 GAMMA-CHORD (DEG.) = 17.76

RADIUS (INCHES) = 11.4800
 CHORD (INCHES) = 0.9920
 ZCSL (INCHES) = 0.4357
 YCSL (INCHES) = -0.0735
 RLE (INCHES) = 0.0090
 RTE (INCHES) = 0.0090
 X-AREA (SQ. IN.) = 0.0617
 GAMMA-CHORD (RAD.) = 0.3099

MANUFACTURING COORDINATES
 COMPRESSOR 3S1 - INLET GUIDE VANE

80 PERCENT SPAN

METERS			INCHES		
ZC	YP	YS	ZC	YP	YS
-0.0000	-0.0001	-0.0001	-0.0009	-0.0040	-0.0040
0.0000	-0.0002	0.0000	0.0007	-0.0096	0.0012
0.0001	-0.0003	0.0001	0.0024	-0.0129	0.0030
0.0001	-0.0004	0.0001	0.0040	-0.0158	0.0040
0.0004	-0.0007	0.0002	0.0150	-0.0286	0.0064
0.0007	-0.0010	0.0002	0.0259	-0.0379	0.0065
0.0009	-0.0012	0.0001	0.0368	-0.0462	0.0053
0.0012	-0.0014	0.0001	0.0477	-0.0539	0.0036
0.0015	-0.0015	0.0000	0.0587	-0.0608	0.0015
0.0026	-0.0022	-0.0002	0.1086	-0.0871	-0.0098
0.0040	-0.0027	-0.0006	0.1586	-0.1071	-0.0217
0.0053	-0.0031	-0.0008	0.2085	-0.1222	-0.0327
0.0066	-0.0034	-0.0011	0.2585	-0.1330	-0.0419
0.0078	-0.0036	-0.0012	0.3084	-0.1399	-0.0491
0.0091	-0.0036	-0.0014	0.3584	-0.1430	-0.0537
0.0104	-0.0036	-0.0014	0.4083	-0.1431	-0.0560
0.0116	-0.0036	-0.0014	0.4583	-0.1405	-0.0567
0.0129	-0.0035	-0.0014	0.5082	-0.1360	-0.0561
0.0142	-0.0033	-0.0014	0.5582	-0.1299	-0.0547
0.0154	-0.0031	-0.0013	0.6082	-0.1222	-0.0521
0.0167	-0.0029	-0.0012	0.6581	-0.1127	-0.0485
0.0180	-0.0026	-0.0011	0.7081	-0.1016	-0.0436
0.0193	-0.0023	-0.0010	0.7580	-0.0889	-0.0375
0.0205	-0.0019	-0.0008	0.8080	-0.0746	-0.0301
0.0218	-0.0015	-0.0005	0.8579	-0.0587	-0.0215
0.0231	-0.0011	-0.0003	0.9079	-0.0414	-0.0115
0.0239	-0.0007	-0.0001	0.9401	-0.0295	-0.0042
0.0242	-0.0006	-0.0000	0.9511	-0.0253	-0.0016
0.0244	-0.0005	0.0000	0.9620	-0.0210	0.0010
0.0247	-0.0004	0.0001	0.9729	-0.0168	0.0038
0.0251	-0.0003	0.0001	0.9875	-0.0109	0.0052
0.0251	-0.0002	0.0001	0.9891	-0.0098	0.0041
0.0252	-0.0002	0.0001	0.9908	-0.0080	0.0024
0.0252	-0.0001	-0.0001	0.9925	-0.0028	-0.0028

RADIUS (METERS) = 0.2995
 CHORD (METERS) = 0.0252
 ZCSL (METERS) = 0.0110
 YCSL (METERS) = -0.0019
 RLE (METERS) = 0.00229
 RTE (METERS) = 0.00229
 X-AREA (SQ. METERS) = 0.00042
 GAMMA-CHORD (DEG.) = 17.73

RADIUS (INCHES) = 11.7900
 CHORD (INCHES) = 0.9920
 ZCSL (INCHES) = 0.4343
 YCSL (INCHES) = -0.0746
 RLE (INCHES) = 0.0090
 RTE (INCHES) = 0.0090
 X-AREA (SQ. IN.) = 0.0656
 GAMMA-CHORD (RAD.) = 0.3094

MANUFACTURING COORDINATES
COMPRESSOR 3S1 - ROTOR 1

20 PERCENT SPAN

METERS			INCHES		
ZC	YP	YS	ZC	YP	YS
-0.0000	-0.0001	-0.0001	-0.0007	-0.0034	-0.0034
0.0000	0.0001	-0.0002	0.0011	0.0020	-0.0088
0.0001	0.0001	-0.0003	0.0029	0.0038	-0.0106
0.0001	0.0001	-0.0003	0.0047	0.0048	-0.0122
0.0004	0.0001	-0.0005	0.0164	0.0051	-0.0208
0.0007	0.0001	-0.0007	0.0282	0.0033	-0.0279
0.0010	0.0000	-0.0009	0.0400	0.0010	-0.0345
0.0013	-0.0000	-0.0010	0.0517	-0.0015	-0.0408
0.0016	-0.0001	-0.0012	0.0635	-0.0039	-0.0467
0.0030	-0.0004	-0.0018	0.1173	-0.0156	-0.0705
0.0043	-0.0007	-0.0023	0.1711	-0.0267	-0.0901
0.0057	-0.0009	-0.0027	0.2249	-0.0367	-0.1064
0.0071	-0.0011	-0.0030	0.2787	-0.0452	-0.1198
0.0084	-0.0013	-0.0033	0.3324	-0.0524	-0.1301
0.0098	-0.0015	-0.0035	0.3862	-0.0582	-0.1377
0.0112	-0.0016	-0.0036	0.4400	-0.0625	-0.1425
0.0125	-0.0017	-0.0037	0.4938	-0.0655	-0.1447
0.0139	-0.0017	-0.0037	0.5476	-0.0672	-0.1440
0.0153	-0.0017	-0.0036	0.6014	-0.0675	-0.1408
0.0166	-0.0017	-0.0034	0.6552	-0.0663	-0.1349
0.0180	-0.0016	-0.0032	0.7090	-0.0635	-0.1264
0.0194	-0.0015	-0.0029	0.7627	-0.0589	-0.1155
0.0207	-0.0013	-0.0026	0.8165	-0.0522	-0.1023
0.0221	-0.0011	-0.0022	0.8703	-0.0435	-0.0868
0.0235	-0.0008	-0.0018	0.9241	-0.0325	-0.0689
0.0248	-0.0005	-0.0012	0.9779	-0.0192	-0.0487
0.0257	-0.0002	-0.0009	1.0126	-0.0092	-0.0344
0.0260	-0.0001	-0.0007	1.0244	-0.0056	-0.0293
0.0263	-0.0000	-0.0006	1.0362	-0.0018	-0.0241
0.0266	0.0001	-0.0005	1.0479	0.0020	-0.0188
0.0270	0.0001	-0.0003	1.0636	0.0048	-0.0116
0.0271	0.0001	-0.0003	1.0654	0.0038	-0.0106
0.0271	0.0001	-0.0002	1.0672	0.0020	-0.0088
0.0272	-0.0001	-0.0001	1.0690	-0.0034	-0.0034

RADIUS (METERS) = 0.2840
 CHORD (METERS) = 0.0271
 ZCSL (METERS) = 0.0126
 YCSL (METERS) = 0.0020
 RLE (METERS) = 0.00229
 RTE (METERS) = 0.00229
 X-AREA (SQ. METERS) = 0.00040
 GAMMA-CHORD (DEG.) = 41.32

RADIUS (INCHES) = 11.1800
 CHORD (INCHES) = 1.0683
 ZCSL (INCHES) = 0.4952
 YCSL (INCHES) = 0.0797
 RLE (INCHES) = 0.0090
 RTE (INCHES) = 0.0090
 X-AREA (SQ. IN.) = 0.0624
 GAMMA-CHORD (RAD.) = 0.7212

MANUFACTURING COORDINATES
COMPRESSOR 3S1 - ROTOR 1

50 PERCENT SPAN

METERS			INCHES		
ZC	YP	YS	ZC	YP	YS
-0.0000	-0.0001	-0.0001	-0.0005	-0.0030	-0.0030
0.0000	0.0001	-0.0002	0.0013	0.0024	-0.0083
0.0001	0.0001	-0.0003	0.0031	0.0042	-0.0102
0.0001	0.0001	-0.0003	0.0048	0.0052	-0.0114
0.0004	0.0001	-0.0005	0.0166	0.0053	-0.0185
0.0007	0.0001	-0.0006	0.0284	0.0037	-0.0246
0.0010	0.0000	-0.0008	0.0401	0.0017	-0.0302
0.0013	-0.0000	-0.0009	0.0519	-0.0005	-0.0355
0.0016	-0.0001	-0.0010	0.0637	-0.0027	-0.0405
0.0030	-0.0003	-0.0015	0.1174	-0.0129	-0.0610
0.0043	-0.0006	-0.0020	0.1712	-0.0227	-0.0779
0.0057	-0.0008	-0.0023	0.2250	-0.0315	-0.0921
0.0071	-0.0010	-0.0026	0.2787	-0.0388	-0.1037
0.0084	-0.0011	-0.0029	0.3325	-0.0452	-0.1127
0.0098	-0.0013	-0.0030	0.3863	-0.0502	-0.1193
0.0112	-0.0014	-0.0031	0.4401	-0.0540	-0.1236
0.0125	-0.0014	-0.0032	0.4938	-0.0566	-0.1255
0.0139	-0.0015	-0.0032	0.5476	-0.0580	-0.1251
0.0153	-0.0015	-0.0031	0.6014	-0.0581	-0.1223
0.0166	-0.0014	-0.0030	0.6551	-0.0570	-0.1173
0.0180	-0.0014	-0.0028	0.7089	-0.0545	-0.1099
0.0194	-0.0013	-0.0026	0.7627	-0.0503	-0.1005
0.0207	-0.0011	-0.0023	0.8164	-0.0444	-0.0891
0.0221	-0.0009	-0.0019	0.8702	-0.0367	-0.0757
0.0235	-0.0007	-0.0015	0.9240	-0.0271	-0.0603
0.0248	-0.0004	-0.0011	0.9778	-0.0155	-0.0429
0.0257	-0.0002	-0.0008	1.0315	-0.0068	-0.0306
0.0260	-0.0001	-0.0007	1.0243	-0.0037	-0.0263
0.0263	-0.0000	-0.0006	1.0360	-0.0004	-0.0219
0.0266	0.0001	-0.0004	1.0478	0.0029	-0.0174
0.0270	0.0001	-0.0003	1.0634	0.0052	-0.0112
0.0271	0.0001	-0.0003	1.0652	0.0042	-0.0102
0.0271	0.0001	-0.0002	1.0670	0.0024	-0.0084
0.0271	-0.0001	-0.0001	1.0688	-0.0030	-0.0030
RADIUS (METERS) = 0.2916			RADIUS (INCHES) = 11.4800		
CHORD (METERS) = 0.0271			CHORD (INCHES) = 1.0683		
ZCSL (METERS) = 0.0127			ZCSL (INCHES) = 0.4985		
YCSL (METERS) = 0.0017			YCSL (INCHES) = 0.0686		
RLE (METERS) = 0.00229			RLE (INCHES) = 0.0090		
RIE (METERS) = 0.00229			RIE (INCHES) = 0.0090		
X-AREA (SQ. METERS) = 0.00035			X-AREA (SQ. IN.) = 0.0550		
GAMMA-CHORD (DEG.) = 44.37			GAMMA-CHORD (RAD.) = 0.7743		

MANUFACTURING COORDINATES
COMPRESSOR 3S1 - ROTOR 1

80 PERCENT SPAN

METERS			INCHES		
ZC	YP	YS	ZC	YP	YS
-0.0000	-0.0001	-0.0001	-0.0004	-0.0028	-0.0028
0.0000	0.0001	-0.0002	0.0013	0.0026	-0.0082
0.0001	0.0001	-0.0003	0.0031	0.0043	-0.0100
0.0001	0.0001	-0.0003	0.0049	0.0054	-0.0111
0.0004	0.0001	-0.0004	0.0166	0.0051	-0.0171
0.0007	0.0001	-0.0006	0.0284	0.0032	-0.0226
0.0010	0.0000	-0.0007	0.0402	0.0012	-0.0277
0.0013	-0.0000	-0.0008	0.0519	-0.0011	-0.0325
0.0016	-0.0001	-0.0009	0.0637	-0.0034	-0.0371
0.0030	-0.0003	-0.0014	0.1175	-0.0137	-0.0558
0.0043	-0.0006	-0.0018	0.1712	-0.0234	-0.0714
0.0057	-0.0008	-0.0021	0.2250	-0.0320	-0.0845
0.0071	-0.0010	-0.0024	0.2788	-0.0393	-0.0953
0.0084	-0.0012	-0.0026	0.3325	-0.0454	-0.1037
0.0098	-0.0013	-0.0028	0.3863	-0.0503	-0.1098
0.0112	-0.0014	-0.0029	0.4401	-0.0540	-0.1139
0.0125	-0.0014	-0.0029	0.4938	-0.0563	-0.1158
0.0139	-0.0015	-0.0029	0.5476	-0.0575	-0.1155
0.0153	-0.0015	-0.0029	0.6014	-0.0574	-0.1131
0.0166	-0.0014	-0.0028	0.6551	-0.0560	-0.1085
0.0180	-0.0014	-0.0026	0.7089	-0.0533	-0.1019
0.0194	-0.0012	-0.0024	0.7627	-0.0490	-0.0933
0.0207	-0.0011	-0.0021	0.8164	-0.0430	-0.0829
0.0221	-0.0009	-0.0018	0.8702	-0.0354	-0.0706
0.0235	-0.0007	-0.0014	0.9240	-0.0260	-0.0564
0.0248	-0.0004	-0.0010	0.9777	-0.0146	-0.0403
0.0257	-0.0002	-0.0007	1.0124	-0.0063	-0.0290
0.0260	-0.0001	-0.0006	1.0242	-0.0032	-0.0250
0.0263	-0.0000	-0.0005	1.0359	-0.0001	-0.0209
0.0266	0.0001	-0.0004	1.0477	0.0031	-0.0168
0.0270	0.0001	-0.0003	1.0634	0.0054	-0.0111
0.0271	0.0001	-0.0003	1.0652	0.0044	-0.0100
0.0271	0.0001	-0.0002	1.0669	0.0026	-0.0082
0.0271	-0.0001	-0.0001	1.0688	-0.0028	-0.0028

RADIUS (METERS) = 0.2995
 CHORD (METERS) = 0.0271
 ZCSL (METERS) = 0.0128
 YCSL (METERS) = 0.0016
 RLE (METERS) = 0.00229
 RTE (METERS) = 0.00229
 X-AREA (SQ. METERS) = 0.00031
 GAMMA-CHORD (LEG.) = 46.70

RADIUS (INCHES) = 11.7900
 CHORD (INCHES) = 1.0683
 ZCSL (INCHES) = 0.5021
 YCSL (INCHES) = 0.0643
 RLE (INCHES) = 0.0090
 RTE (INCHES) = 0.0090
 X-AREA (SQ. IN.) = 0.0483
 GAMMA-CHORD (RAL.) = 0.8150

MANUFACTURING COORDINATES
COMPRESSOR 3S1 - STATOR 1

20 PERCENT SPAN

METERS			INCHES		
ZC	YP	YS	ZC	YP	YS
-0.0000	0.0001	0.0001	-0.0000	0.0030	0.0030
0.0000	-0.0001	0.0002	0.0014	-0.0025	0.0086
0.0001	-0.0001	0.0003	0.0033	-0.0043	0.0105
0.0001	-0.0001	0.0003	0.0052	-0.0054	0.0123
0.0005	-0.0002	0.0005	0.0178	-0.0063	0.0215
0.0008	-0.0001	0.0007	0.0304	-0.0052	0.0287
0.0011	-0.0001	0.0009	0.0431	-0.0033	0.0353
0.0014	-0.0000	0.0011	0.0557	-0.0015	0.0417
0.0017	0.0000	0.0012	0.0683	0.0005	0.0477
0.0032	0.0003	0.0018	0.1260	0.0103	0.0715
0.0047	0.0005	0.0023	0.1837	0.0199	0.0910
0.0061	0.0007	0.0027	0.2413	0.0287	0.1072
0.0076	0.0009	0.0031	0.2990	0.0362	0.1205
0.0091	0.0011	0.0033	0.3567	0.0428	0.1307
0.0105	0.0012	0.0035	0.4144	0.0481	0.1381
0.0120	0.0013	0.0036	0.4721	0.0522	0.1428
0.0135	0.0014	0.0037	0.5297	0.0551	0.1448
0.0149	0.0014	0.0037	0.5874	0.0570	0.1439
0.0164	0.0015	0.0036	0.6451	0.0576	0.1405
0.0179	0.0014	0.0034	0.7028	0.0570	0.1344
0.0193	0.0014	0.0032	0.7605	0.0551	0.1256
0.0208	0.0013	0.0029	0.8181	0.0514	0.1144
0.0222	0.0012	0.0026	0.8758	0.0457	0.1011
0.0237	0.0010	0.0022	0.9335	0.0381	0.0855
0.0252	0.0007	0.0017	0.9912	0.0285	0.0677
0.0266	0.0004	0.0012	1.0489	0.0166	0.0477
0.0276	0.0002	0.0009	1.0861	0.0076	0.0337
0.0279	0.0001	0.0007	1.0967	0.0044	0.0287
0.0282	0.0000	0.0006	1.1114	0.0010	0.0236
0.0285	-0.0001	0.0005	1.1240	-0.0025	0.0185
0.0290	-0.0001	0.0003	1.1408	-0.0054	0.0114
0.0290	-0.0001	0.0003	1.1427	-0.0043	0.0104
0.0291	-0.0001	0.0002	1.1446	-0.0025	0.0086
0.0291	0.0001	0.0001	1.1465	0.0030	0.0030

RADIUS (METERS) = 0.2840	RADIUS (INCHES) = 11.1800
CHCRE (METERS) = 0.0291	CHORE (INCHES) = 1.1460
ZCSL (METERS) = 0.0134	ZCSL (INCHES) = 0.5285
YCSL (METERS) = 0.0019	YCSL (INCHES) = 0.0762
RLE (METERS) = 0.00229	RLE (INCHES) = 0.0090
RTE (METERS) = 0.00229	RTE (INCHES) = 0.0090
X-AREA (SQ. METERS) = 0.00048	X-AREA (SQ. IN.) = 0.0748
GAMMA-CHORD (DEG.) = 40.90	GAMMA-CHORD (RAD.) = 0.7139

MANUFACTURING COORDINATES
COMPRESSOR 3S1 - STATOR 1

50 PERCENT SPAN

METERS			INCHES		
ZC	YP	YS	ZC	YP	YS
-0.0000	0.0001	0.0001	-0.0005	0.0030	0.0030
0.0000	-0.0001	0.0002	0.0014	-0.0026	0.0085
0.0001	-0.0001	0.0003	0.0033	-0.0044	0.0106
0.0001	-0.0001	0.0003	0.0052	-0.0054	0.0124
0.0005	-0.0002	0.0006	0.0179	-0.0068	0.0221
0.0008	-0.0002	0.0007	0.0305	-0.0061	0.0293
0.0011	-0.0001	0.0009	0.0431	-0.0046	0.0361
0.0014	-0.0001	0.0011	0.0557	-0.0030	0.0426
0.0017	-0.0000	0.0012	0.0683	-0.0013	0.0487
0.0032	0.0002	0.0018	0.1260	0.0075	0.0727
0.0047	0.0004	0.0023	0.1837	0.0162	0.0924
0.0061	0.0006	0.0028	0.2413	0.0243	0.1086
0.0076	0.0008	0.0031	0.2990	0.0314	0.1218
0.0091	0.0010	0.0034	0.3567	0.0375	0.1320
0.0105	0.0011	0.0035	0.4144	0.0425	0.1394
0.0120	0.0012	0.0037	0.4721	0.0465	0.1440
0.0135	0.0013	0.0037	0.5297	0.0494	0.1459
0.0149	0.0013	0.0037	0.5874	0.0515	0.1449
0.0164	0.0013	0.0036	0.6451	0.0524	0.1413
0.0179	0.0013	0.0034	0.7028	0.0521	0.1349
0.0193	0.0013	0.0032	0.7605	0.0506	0.1259
0.0208	0.0012	0.0029	0.8181	0.0475	0.1146
0.0222	0.0011	0.0026	0.8758	0.0424	0.1011
0.0237	0.0009	0.0022	0.9335	0.0355	0.0854
0.0252	0.0007	0.0017	0.9912	0.0265	0.0676
0.0266	0.0004	0.0012	1.0488	0.0153	0.0476
0.0276	0.0002	0.0009	1.0861	0.0069	0.0335
0.0279	0.0001	0.0007	1.0987	0.0038	0.0286
0.0282	0.0000	0.0006	1.1113	0.0006	0.0235
0.0285	-0.0001	0.0005	1.1239	-0.0027	0.0184
0.0290	-0.0001	0.0003	1.1408	-0.0054	0.0114
0.0290	-0.0001	0.0003	1.1427	-0.0044	0.0103
0.0291	-0.0001	0.0002	1.1446	-0.0026	0.0085
0.0291	0.0001	0.0001	1.1465	0.0030	0.0030

RADIUS (METERS) = 0.2916
 CHORD (METERS) = 0.0291
 ZCSL (METERS) = 0.0134
 YCSL (METERS) = 0.0019
 RLE (METERS) = 0.000229
 RTE (METERS) = 0.000229
 X-AREA (SQ. METERS) = 0.000052
 GAMMA-CHORD (DEG.) = 40.54

RADIUS (INCHES) = 11.4800
 CHOR (INCHES) = 1.1460
 ZCSL (INCHES) = 0.5270
 YCSL (INCHES) = 0.0747
 RLE (INCHES) = 0.0090
 RTE (INCHES) = 0.0090
 X-AREA (SQ. IN.) = 0.0799
 GAMMA-CHORD (RAD.) = 0.7076

MANUFACTURING COORDINATES
COMPRESSOR 3S1 - STATOR 1

80 PERCENT SPAN

METERS			INCHES		
ZC	YP	YS	ZC	YP	YS
-0.0000	0.0001	0.0001	-0.0006	0.0031	0.0031
0.0000	-0.0001	0.0002	0.0013	-0.0024	0.0087
0.0001	-0.0001	0.0003	0.0033	-0.0042	0.0111
0.0001	-0.0001	0.0003	0.0052	-0.0052	0.0132
0.0005	-0.0002	0.0006	0.0178	-0.0071	0.0238
0.0008	-0.0002	0.0008	0.0304	-0.0065	0.0315
0.0011	-0.0001	0.0010	0.0430	-0.0049	0.0387
0.0014	-0.0001	0.0012	0.0556	-0.0033	0.0457
0.0017	-0.0000	0.0013	0.0683	-0.0015	0.0523
0.0032	0.0002	0.0020	0.1259	0.0076	0.0778
0.0047	0.0004	0.0025	0.1836	0.0168	0.0988
0.0061	0.0006	0.0029	0.2413	0.0253	0.1160
0.0076	0.0008	0.0033	0.2990	0.0327	0.1300
0.0091	0.0010	0.0036	0.3567	0.0392	0.1407
0.0105	0.0011	0.0038	0.4144	0.0444	0.1486
0.0120	0.0012	0.0039	0.4721	0.0487	0.1534
0.0135	0.0013	0.0039	0.5297	0.0518	0.1553
0.0149	0.0014	0.0039	0.5874	0.0541	0.1542
0.0164	0.0014	0.0038	0.6451	0.0551	0.1503
0.0179	0.0014	0.0036	0.7028	0.0549	0.1435
0.0193	0.0014	0.0034	0.7605	0.0535	0.1339
0.0208	0.0013	0.0031	0.8182	0.0503	0.1218
0.0222	0.0011	0.0027	0.8758	0.0451	0.1074
0.0237	0.0010	0.0023	0.9335	0.0378	0.0907
0.0252	0.0007	0.0018	0.9912	0.0284	0.0716
0.0266	0.0004	0.0013	1.0489	0.0166	0.0503
0.0276	0.0002	0.0009	1.0862	0.0078	0.0353
0.0279	0.0001	0.0008	1.0988	0.0045	0.0300
0.0282	0.0000	0.0006	1.1114	0.0011	0.0246
0.0285	-0.0001	0.0005	1.1240	-0.0023	0.0191
0.0290	-0.0001	0.0003	1.1408	-0.0052	0.0116
0.0290	-0.0001	0.0003	1.1427	-0.0042	0.0105
0.0291	-0.0001	0.0002	1.1446	-0.0024	0.0087
0.0291	0.0001	0.0001	1.1466	0.0031	0.0031

RADIUS (METERS) = 0.2995
 CHCRD (METERS) = 0.0291
 ZCSL (METERS) = 0.0133
 YCSL (METERS) = 0.0020
 RLE (METERS) = 0.000229
 RTE (METERS) = 0.000229
 X-AREA (SQ. METERS) = 0.000055
 GAMMA-CHORD (DEG.) = 40.62

RADIUS (INCHES) = 11.7900
 CHORD (INCHES) = 1.1460
 ZCSL (INCHES) = 0.5250
 YCSL (INCHES) = 0.0794
 RLE (INCHES) = 0.0090
 RTE (INCHES) = 0.0090
 X-AREA (SQ. IN.) = 0.0854
 GAMMA-CHORD (RAD.) = 0.7089

MANUFACTURING COORDINATES
COMPRESSOR 3S1 - ROTOR 2

20 PERCENT SPAN

METERS			INCHES		
ZC	YP	YS	ZC	YP	YS
-0.0000	-0.0001	-0.0001	-0.0000	-0.0030	-0.0030
0.0000	0.0001	-0.0002	0.0015	0.0028	-0.0087
0.0001	0.0001	-0.0003	0.0030	0.0046	-0.0110
0.0001	0.0001	-0.0003	0.0057	0.0056	-0.0130
0.0005	0.0002	-0.0006	0.0192	0.0067	-0.0223
0.0008	0.0001	-0.0008	0.0328	0.0054	-0.0299
0.0012	0.0001	-0.0009	0.0464	0.0035	-0.0368
0.0015	0.0000	-0.0011	0.0599	0.0015	-0.0433
0.0019	-0.0000	-0.0013	0.0735	-0.0007	-0.0495
0.0034	-0.0003	-0.0019	0.1355	-0.0111	-0.0743
0.0050	-0.0005	-0.0024	0.1976	-0.0213	-0.0946
0.0066	-0.0008	-0.0028	0.2596	-0.0306	-0.1115
0.0082	-0.0010	-0.0032	0.3216	-0.0385	-0.1253
0.0097	-0.0012	-0.0035	0.3837	-0.0454	-0.1360
0.0113	-0.0013	-0.0037	0.4457	-0.0509	-0.1438
0.0129	-0.0014	-0.0038	0.5077	-0.0553	-0.1487
0.0145	-0.0015	-0.0038	0.5697	-0.0584	-0.1507
0.0160	-0.0015	-0.0038	0.6318	-0.0603	-0.1499
0.0176	-0.0015	-0.0037	0.6938	-0.0609	-0.1463
0.0192	-0.0015	-0.0036	0.7558	-0.0602	-0.1399
0.0208	-0.0015	-0.0033	0.8178	-0.0581	-0.1307
0.0223	-0.0014	-0.0030	0.8799	-0.0542	-0.1191
0.0239	-0.0012	-0.0027	0.9419	-0.0483	-0.1051
0.0255	-0.0010	-0.0023	1.0039	-0.0404	-0.0889
0.0271	-0.0008	-0.0018	1.0660	-0.0302	-0.0703
0.0287	-0.0005	-0.0013	1.1280	-0.0178	-0.0494
0.0297	-0.0002	-0.0009	1.1680	-0.0084	-0.0347
0.0300	-0.0001	-0.0008	1.1816	-0.0050	-0.0296
0.0304	-0.0000	-0.0006	1.1952	-0.0015	-0.0243
0.0307	0.0001	-0.0005	1.2087	0.0022	-0.0189
0.0312	0.0001	-0.0003	1.2268	0.0056	-0.0115
0.0312	0.0001	-0.0003	1.2289	0.0046	-0.0105
0.0313	0.0001	-0.0002	1.2309	0.0028	-0.0087
0.0313	-0.0001	-0.0001	1.2330	-0.0030	-0.0030

RADIUS (METERS) = 0.2840
 CHCRE (METERS) = 0.0313
 ZCSL (METERS) = 0.0144
 YCSL (METERS) = 0.0020
 RLE (METERS) = 0.00229
 RTE (METERS) = 0.00229
 X-AREA (SQ. METERS) = 0.00053
 GAMMA-CHORD (DEG.) = 42.76

RADIUS (INCHES) = 11.1800
 CHORD (INCHES) = 1.2325
 ZCSL (INCHES) = 0.5673
 YCSL (INCHES) = 0.0797
 RLE (INCHES) = 0.0090
 RTE (INCHES) = 0.0090
 X-AREA (SQ. IN.) = 0.0828
 GAMMA-CHORD (RAD.) = 0.7463

MANUFACTURING COORDINATES
COMPRESSOR 3S1 - ROTOR 2

50 PERCENT SPAN

METERS			INCHES		
ZC	YP	YS	ZC	YP	YS
-0.0000	-0.0001	-0.0001	-0.0004	-0.0025	-0.0025
0.0000	0.0001	-0.0002	0.0017	0.0032	-0.0083
0.0001	0.0001	-0.0003	0.0037	0.0050	-0.0102
0.0001	0.0002	-0.0003	0.0058	0.0060	-0.0119
0.0005	0.0002	-0.0005	0.0194	0.0069	-0.0197
0.0008	0.0001	-0.0007	0.0329	0.0056	-0.0260
0.0012	0.0001	-0.0008	0.0465	0.0040	-0.0317
0.0015	0.0001	-0.0009	0.0601	0.0022	-0.0372
0.0019	0.0000	-0.0011	0.0736	0.0003	-0.0424
0.0034	-0.0002	-0.0016	0.1356	-0.0086	-0.0633
0.0050	-0.0004	-0.0020	0.1977	-0.0175	-0.0805
0.0066	-0.0006	-0.0024	0.2597	-0.0254	-0.0949
0.0082	-0.0008	-0.0027	0.3217	-0.0322	-0.1068
0.0097	-0.0010	-0.0029	0.3837	-0.0382	-0.1159
0.0113	-0.0011	-0.0031	0.4457	-0.0429	-0.1226
0.0129	-0.0012	-0.0032	0.5078	-0.0466	-0.1268
0.0145	-0.0013	-0.0033	0.5698	-0.0492	-0.1286
0.0160	-0.0013	-0.0033	0.6318	-0.0507	-0.1280
0.0176	-0.0013	-0.0032	0.6938	-0.0512	-0.1250
0.0192	-0.0013	-0.0030	0.7558	-0.0505	-0.1195
0.0208	-0.0012	-0.0028	0.8179	-0.0486	-0.1118
0.0223	-0.0011	-0.0026	0.8799	-0.0452	-0.1019
0.0239	-0.0010	-0.0023	0.9419	-0.0400	-0.0901
0.0255	-0.0008	-0.0019	1.0039	-0.0331	-0.0763
0.0271	-0.0006	-0.0015	1.0659	-0.0245	-0.0606
0.0286	-0.0004	-0.0011	1.1279	-0.0139	-0.0429
0.0297	-0.0001	-0.0008	1.1680	-0.0059	-0.0306
0.0300	-0.0001	-0.0007	1.1816	-0.0030	-0.0262
0.0304	0.0000	-0.0006	1.1951	0.0000	-0.0218
0.0307	0.0001	-0.0004	1.2087	0.0031	-0.0173
0.0312	0.0002	-0.0003	1.2268	0.0060	-0.0111
0.0312	0.0001	-0.0003	1.2288	0.0050	-0.0101
0.0313	0.0001	-0.0002	1.2309	0.0032	-0.0083
0.0313	-0.0001	-0.0001	1.2330	-0.0025	-0.0025

RADIUS (METERS) = 0.2916
 CHORD (METERS) = 0.0313
 ZCSL (METERS) = 0.0145
 YCSL (METERS) = 0.0017
 RLE (METERS) = 0.000229
 RTE (METERS) = 0.000229
 X-AREA (SQ. METERS) = 0.000046
 GAMMA-CHORD (DEG.) = 45.42

RADIUS (INCHES) = 11.4800
 CHORD (INCHES) = 1.2326
 ZCSL (INCHES) = 0.5710
 YCSL (INCHES) = 0.0673
 RLE (INCHES) = 0.0090
 RTE (INCHES) = 0.0090
 X-AREA (SQ. IN.) = 0.0720
 GAMMA-CHORD (RAD.) = 0.7927

MANUFACTURING COORDINATES
COMPRESSOR 3S1 - ROTOR 2

80 PERCENT SPAN

METERS			INCHES		
ZC	YP	YS	ZC	YP	YS
-0.0000	-0.0001	-0.0001	-0.0000	-0.0025	-0.0025
0.0000	0.0001	-0.0002	0.0017	0.0033	-0.0082
0.0001	0.0001	-0.0003	0.0038	0.0051	-0.0100
0.0001	0.0002	-0.0003	0.0058	0.0061	-0.0113
0.0005	0.0002	-0.0005	0.0194	0.0063	-0.0184
0.0008	0.0001	-0.0006	0.0330	0.0048	-0.0240
0.0012	0.0001	-0.0007	0.0465	0.0029	-0.0293
0.0015	0.0000	-0.0009	0.0601	0.0010	-0.0343
0.0019	-0.0000	-0.0010	0.0737	-0.0011	-0.0390
0.0034	-0.0003	-0.0015	0.1357	-0.0105	-0.0584
0.0050	-0.0005	-0.0019	0.1977	-0.0196	-0.0744
0.0066	-0.0007	-0.0022	0.2597	-0.0277	-0.0878
0.0082	-0.0009	-0.0025	0.3217	-0.0346	-0.0990
0.0097	-0.0010	-0.0027	0.3837	-0.0405	-0.1076
0.0113	-0.0011	-0.0029	0.4457	-0.0453	-0.1139
0.0129	-0.0012	-0.0030	0.5078	-0.0489	-0.1179
0.0145	-0.0013	-0.0030	0.5698	-0.0513	-0.1198
0.0160	-0.0013	-0.0030	0.6318	-0.0525	-0.1194
0.0176	-0.0013	-0.0030	0.6938	-0.0527	-0.1167
0.0192	-0.0013	-0.0028	0.7558	-0.0517	-0.1118
0.0208	-0.0013	-0.0027	0.8178	-0.0495	-0.1047
0.0223	-0.0012	-0.0024	0.8799	-0.0457	-0.0956
0.0239	-0.0011	-0.0022	0.9419	-0.0402	-0.0848
0.0255	-0.0008	-0.0016	1.0039	-0.0331	-0.0720
0.0271	-0.0006	-0.0015	1.0659	-0.0243	-0.0573
0.0286	-0.0003	-0.0010	1.1279	-0.0137	-0.0408
0.0297	-0.0001	-0.0007	1.1680	-0.0057	-0.0292
0.0300	-0.0001	-0.0006	1.1815	-0.0028	-0.0252
0.0304	0.0000	-0.0005	1.1951	0.0002	-0.0210
0.0307	0.0001	-0.0004	1.2087	0.0032	-0.0168
0.0312	0.0002	-0.0003	1.2268	0.0061	-0.0110
0.0312	0.0001	-0.0003	1.2288	0.0051	-0.0100
0.0313	0.0001	-0.0002	1.2309	0.0033	-0.0082
0.0313	-0.0001	-0.0001	1.2329	-0.0025	-0.0025

RADIUS (METERS) = 0.2995
 CHORD (METERS) = 0.0313
 ZCSL (METERS) = 0.0146
 YCSL (METERS) = 0.0016
 RLE (METERS) = 0.000229
 RTE (METERS) = 0.000229
 X-AREA (SQ. METERS) = 0.000041
 GAMMA-CHORD (DEG.) = 48.24

RADIUS (INCHES) = 11.7900
 CHORD (INCHES) = 1.2326
 ZCSL (INCHES) = 0.5747
 YCSL (INCHES) = 0.0643
 RLE (INCHES) = 0.0090
 RTE (INCHES) = 0.0090
 X-AREA (SQ. IN.) = 0.0631
 GAMMA-CHORD (RAD.) = 0.8419

MANUFACTURING COORDINATES
COMPRESSOR 3S1 - STATOR 2

20 PERCENT SPAN

METERS			INCHES		
ZC	YP	YS	ZC	YP	YS
-0.0000	0.0001	0.0001	-0.0006	0.0033	0.0033
0.0000	-0.0001	0.0002	0.0016	-0.0027	0.0092
0.0001	-0.0001	0.0003	0.0038	-0.0045	0.0120
0.0002	-0.0001	0.0004	0.0061	-0.0054	0.0144
0.0005	-0.0002	0.0006	0.0207	-0.0065	0.0253
0.0009	-0.0001	0.0009	0.0353	-0.0048	0.0342
0.0013	-0.0001	0.0011	0.0499	-0.0025	0.0424
0.0016	0.0000	0.0013	0.0646	0.0001	0.0500
0.0020	0.0001	0.0015	0.0792	0.0027	0.0573
0.0037	0.0004	0.0022	0.1461	0.0154	0.0864
0.0054	0.0007	0.0028	0.2130	0.0278	0.1103
0.0071	0.0010	0.0033	0.2799	0.0389	0.1301
0.0088	0.0012	0.0037	0.3468	0.0485	0.1463
0.0105	0.0014	0.0040	0.4137	0.0567	0.1588
0.0122	0.0016	0.0043	0.4805	0.0634	0.1679
0.0139	0.0017	0.0044	0.5474	0.0685	0.1736
0.0156	0.0018	0.0045	0.6143	0.0722	0.1760
0.0173	0.0019	0.0044	0.6812	0.0744	0.1751
0.0190	0.0019	0.0043	0.7481	0.0751	0.1709
0.0207	0.0019	0.0042	0.8150	0.0742	0.1634
0.0224	0.0018	0.0039	0.8819	0.0717	0.1527
0.0241	0.0017	0.0035	0.9488	0.0669	0.1391
0.0258	0.0015	0.0031	1.0157	0.0598	0.1227
0.0275	0.0013	0.0026	1.0826	0.0502	0.1036
0.0292	0.0010	0.0021	1.1495	0.0380	0.0817
0.0309	0.0006	0.0014	1.2163	0.0231	0.0570
0.0320	0.0003	0.0010	1.2595	0.0118	0.0396
0.0324	0.0002	0.0009	1.2742	0.0077	0.0335
0.0327	0.0001	0.0007	1.2888	0.0035	0.0272
0.0331	-0.0000	0.0005	1.3034	-0.0009	0.0208
0.0336	-0.0001	0.0003	1.3229	-0.0054	0.0121
0.0337	-0.0001	0.0003	1.3252	-0.0045	0.0110
0.0337	-0.0001	0.0002	1.3274	-0.0027	0.0092
0.0338	0.0001	0.0001	1.3296	0.0033	0.0033

RADIUS (METERS) = 0.2840
 CHORD (METERS) = 0.0338
 ZCSL (METERS) = 0.0155
 YCSL (METERS) = 0.0024
 RLE (METERS) = 0.00229
 RTE (METERS) = 0.00229
 X-AREA (SQ. METERS) = 0.00064
 GAMMA-CHORD (DEG.) = 43.04

RADIUS (INCHES) = 11.1800
 CHORD (INCHES) = 1.3290
 ZCSL (INCHES) = 0.6089
 YCSL (INCHES) = 0.0950
 RLE (INCHES) = 0.0090
 RTE (INCHES) = 0.0090
 X-AREA (SQ. IN.) = 0.0998
 GAMMA-CHORD (RAD.) = 0.7513

MANUFACTURING COORDINATES
COMPRESSOR 3S1 - STATOR 2

50 PERCENT SPAN

METERS			INCHES		
ZC	YP	YS	ZC	YP	YS
-0.0000	0.0001	0.0001	-0.0005	0.0030	0.0030
0.0000	-0.0001	0.0002	0.0017	-0.0030	0.0089
0.0001	-0.0001	0.0003	0.0039	-0.0048	0.0118
0.0002	-0.0001	0.0004	0.0061	-0.0058	0.0143
0.0005	-0.0002	0.0006	0.0208	-0.0078	0.0250
0.0009	-0.0002	0.0009	0.0354	-0.0069	0.0337
0.0013	-0.0001	0.0011	0.0500	-0.0053	0.0415
0.0016	-0.0001	0.0012	0.0647	-0.0035	0.0489
0.0020	-0.0000	0.0014	0.0793	-0.0015	0.0558
0.0037	0.0002	0.0021	0.1462	0.0083	0.0836
0.0054	0.0005	0.0027	0.2131	0.0162	0.1063
0.0071	0.0007	0.0032	0.2799	0.0274	0.1250
0.0088	0.0009	0.0036	0.3468	0.0354	0.1402
0.0105	0.0011	0.0039	0.4137	0.0424	0.1519
0.0122	0.0012	0.0041	0.4806	0.0481	0.1604
0.0139	0.0013	0.0042	0.5475	0.0527	0.1657
0.0156	0.0014	0.0043	0.6143	0.0561	0.1678
0.0173	0.0015	0.0042	0.6812	0.0584	0.1666
0.0190	0.0015	0.0041	0.7481	0.0595	0.1624
0.0207	0.0015	0.0039	0.8150	0.0594	0.1549
0.0224	0.0015	0.0037	0.8819	0.0579	0.1445
0.0241	0.0014	0.0033	0.9487	0.0545	0.1313
0.0258	0.0012	0.0029	1.0156	0.0489	0.1156
0.0275	0.0010	0.0025	1.0825	0.0411	0.0974
0.0292	0.0008	0.0019	1.1494	0.0311	0.0767
0.0309	0.0005	0.0014	1.2163	0.0185	0.0535
0.0320	0.0002	0.0009	1.2594	0.0090	0.0373
0.0324	0.0001	0.0008	1.2741	0.0055	0.0316
0.0327	0.0000	0.0007	1.2887	0.0019	0.0258
0.0331	-0.0000	0.0005	1.3033	-0.0018	0.0198
0.0336	-0.0001	0.0003	1.3228	-0.0058	0.0117
0.0337	-0.0001	0.0003	1.3251	-0.0048	0.0107
0.0337	-0.0001	0.0002	1.3273	-0.0030	0.0089
0.0338	0.0001	0.0001	1.3295	0.0030	0.0030

RADIUS (METERS) = 0.2916
 CHORD (METERS) = 0.0338
 ZCSL (METERS) = 0.0154
 YCSL (METERS) = 0.0022
 RLE (METERS) = 0.000229
 RTE (METERS) = 0.000229
 X-AREA (SQ. METERS) = 0.000007
 GAMMA-CHORD (DEG.) = 41.45

RADIUS (INCHES) = 11.4800
 CHORD (INCHES) = 1.3290
 ZCSL (INCHES) = 0.6075
 YCSL (INCHES) = 0.0859
 RLE (INCHES) = 0.0090
 RTE (INCHES) = 0.0090
 X-AREA (SQ. IN.) = 0.0106
 GAMMA-CHORD (RAD.) = 0.7234

MANUFACTURING COORDINATES
 COMPRESSOR 3S1 - STATOR 2

80 PERCENT SPAN

METERS			INCHES		
ZC	YP	YS	ZC	YP	YS
-0.0000	0.0001	0.0001	-0.0006	0.0032	0.0032
0.0000	-0.0001	0.0002	0.0016	-0.0027	0.0093
0.0001	-0.0001	0.0003	0.0038	-0.0046	0.0125
0.0002	-0.0001	0.0004	0.0061	-0.0055	0.0153
0.0005	-0.0002	0.0007	0.0207	-0.0077	0.0270
0.0009	-0.0002	0.0009	0.0353	-0.0068	0.0364
0.0013	-0.0001	0.0011	0.0500	-0.0051	0.0450
0.0016	-0.0001	0.0013	0.0646	-0.0032	0.0530
0.0020	-0.0000	0.0015	0.0792	-0.0010	0.0606
0.0037	0.0002	0.0023	0.1461	0.0096	0.0907
0.0054	0.0005	0.0029	0.2130	0.0204	0.1152
0.0071	0.0008	0.0034	0.2799	0.0303	0.1355
0.0088	0.0010	0.0039	0.3468	0.0390	0.1519
0.0105	0.0012	0.0042	0.4136	0.0466	0.1645
0.0122	0.0013	0.0044	0.4805	0.0527	0.1737
0.0139	0.0015	0.0046	0.5474	0.0577	0.1793
0.0156	0.0016	0.0046	0.6143	0.0615	0.1815
0.0173	0.0016	0.0046	0.6812	0.0641	0.1802
0.0190	0.0017	0.0045	0.7480	0.0653	0.1756
0.0207	0.0017	0.0043	0.8149	0.0652	0.1676
0.0224	0.0016	0.0040	0.8818	0.0636	0.1562
0.0241	0.0015	0.0037	0.9487	0.0600	0.1419
0.0258	0.0014	0.0032	1.0156	0.0539	0.1250
0.0275	0.0012	0.0027	1.0825	0.0455	0.1053
0.0292	0.0009	0.0021	1.1493	0.0346	0.0828
0.0309	0.0005	0.0015	1.2162	0.0209	0.0576
0.0320	0.0003	0.0010	1.2594	0.0105	0.0399
0.0324	0.0002	0.0009	1.2740	0.0067	0.0337
0.0327	0.0001	0.0007	1.2887	0.0028	0.0274
0.0331	-0.0000	0.0005	1.3033	-0.0012	0.0209
0.0336	-0.0001	0.0003	1.3228	-0.0055	0.0120
0.0337	-0.0001	0.0003	1.3250	-0.0046	0.0109
0.0337	-0.0001	0.0002	1.3272	-0.0028	0.0091
0.0338	0.0001	0.0001	1.3295	0.0032	0.0032

RADIUS (METERS) = 0.2995
 CHORD (METERS) = 0.0338
 ZCSL (METERS) = 0.0154
 YCSL (METERS) = 0.0024
 RLE (METERS) = 0.000229
 RTE (METERS) = 0.000229
 X-AREA (SQ. METERS) = 0.000007
 GAMMA-CHORD (DEG.) = 41.95

RADIUS (INCHES) = 11.7900
 CHORD (INCHES) = 1.3289
 ZCSL (INCHES) = 0.6058
 YCSL (INCHES) = 0.0935
 RLE (INCHES) = 0.0090
 RTE (INCHES) = 0.0090
 X-AREA (SQ. IN.) = 0.0114
 GAMMA-CHORD (RAD.) = 0.7322

2

MANUFACTURING COORDINATES
COMPRESSOR 3S1 - ROTOR 3

20 PERCENT SPAN

METERS			INCHES		
ZC	YP	YS	ZC	YP	YS
-0.0000	-0.0001	-0.0001	-0.0004	-0.0028	-0.0028
0.0000	0.0001	-0.0002	0.0019	0.0033	-0.0089
0.0001	0.0001	-0.0003	0.0043	0.0051	-0.0117
0.0002	0.0002	-0.0004	0.0067	0.0060	-0.0141
0.0006	0.0002	-0.0006	0.0223	0.0076	-0.0247
0.0010	0.0002	-0.0008	0.0379	0.0064	-0.0332
0.0014	0.0001	-0.0010	0.0535	0.0046	-0.0409
0.0018	0.0001	-0.0012	0.0691	0.0025	-0.0482
0.0022	0.0000	-0.0014	0.0848	0.0003	-0.0550
0.0040	-0.0003	-0.0021	0.1562	-0.0105	-0.0827
0.0058	-0.0005	-0.0027	0.2276	-0.0212	-0.1053
0.0076	-0.0008	-0.0032	0.2990	-0.0310	-0.1241
0.0094	-0.0010	-0.0035	0.3705	-0.0394	-0.1394
0.0112	-0.0012	-0.0038	0.4419	-0.0468	-0.1512
0.0130	-0.0013	-0.0041	0.5133	-0.0527	-0.1599
0.0149	-0.0015	-0.0042	0.5847	-0.0575	-0.1653
0.0167	-0.0015	-0.0043	0.6562	-0.0609	-0.1675
0.0185	-0.0016	-0.0042	0.7276	-0.0631	-0.1665
0.0203	-0.0016	-0.0041	0.7990	-0.0640	-0.1623
0.0221	-0.0016	-0.0039	0.8705	-0.0635	-0.1550
0.0239	-0.0016	-0.0037	0.9419	-0.0616	-0.1446
0.0257	-0.0015	-0.0033	1.0133	-0.0577	-0.1315
0.0276	-0.0013	-0.0029	1.0847	-0.0516	-0.1159
0.0294	-0.0011	-0.0025	1.1562	-0.0433	-0.0977
0.0312	-0.0008	-0.0020	1.2276	-0.0327	-0.0769
0.0330	-0.0005	-0.0014	1.2990	-0.0196	-0.0537
0.0342	-0.0002	-0.0010	1.3451	-0.0096	-0.0374
0.0346	-0.0002	-0.0008	1.3608	-0.0060	-0.0317
0.0350	-0.0001	-0.0007	1.3764	-0.0023	-0.0258
0.0354	0.0000	-0.0005	1.3920	0.0016	-0.0199
0.0359	0.0002	-0.0003	1.4128	0.0060	-0.0118
0.0359	0.0001	-0.0003	1.4152	0.0051	-0.0107
0.0360	0.0001	-0.0002	1.4176	0.0033	-0.0089
0.0361	-0.0001	-0.0001	1.4199	-0.0028	-0.0028

RADIUS (METERS) = 0.2840
 CHCRD (METERS) = 0.0361
 ZCSL (METERS) = 0.0165
 YCSL (METERS) = 0.0022
 RLE (METERS) = 0.000229
 RTE (METERS) = 0.000229
 X-AREA (SQ. METERS) = 0.000007
 GAMMA-CHORD (DEG.) = 47.05

RADIUS (INCHES) = 11.1800
 CHORD (INCHES) = 1.4195
 ZCSL (INCHES) = 0.6500
 YCSL (INCHES) = 0.0874
 RLE (INCHES) = 0.0090
 RTE (INCHES) = 0.0090
 X-AREA (SQ. IN.) = 0.0109
 GAMMA-CHORD (RAD.) = 0.8212

MANUFACTURING COORDINATES
COMPRESSOR 3S1 - ROTOR 3

50 PERCENT SPAN

METERS			INCHES		
ZC	YP	YS	ZC	YP	YS
-0.0000	-0.0001	-0.0001	-0.0003	-0.0021	-0.0021
0.0001	0.0001	-0.0002	0.0021	0.0039	-0.0082
0.0001	0.0001	-0.0003	0.0045	0.0058	-0.0104
0.0002	0.0002	-0.0003	0.0068	0.0067	-0.0124
0.0006	0.0002	-0.0005	0.0225	0.0084	-0.0207
0.0010	0.0002	-0.0007	0.0381	0.0077	-0.0273
0.0014	0.0002	-0.0008	0.0537	0.0066	-0.0333
0.0018	0.0001	-0.0010	0.0693	0.0052	-0.0388
0.0022	0.0001	-0.0011	0.0849	0.0037	-0.0441
0.0040	-0.0001	-0.0017	0.1564	-0.0036	-0.0656
0.0058	-0.0003	-0.0021	0.2278	-0.0112	-0.0831
0.0076	-0.0005	-0.0025	0.2992	-0.0182	-0.0976
0.0094	-0.0006	-0.0028	0.3706	-0.0242	-0.1096
0.0112	-0.0008	-0.0030	0.4420	-0.0295	-0.1188
0.0130	-0.0009	-0.0032	0.5134	-0.0339	-0.1255
0.0149	-0.0010	-0.0033	0.5848	-0.0374	-0.1297
0.0167	-0.0010	-0.0033	0.6562	-0.0400	-0.1314
0.0185	-0.0011	-0.0033	0.7276	-0.0417	-0.1306
0.0203	-0.0011	-0.0032	0.7990	-0.0426	-0.1273
0.0221	-0.0011	-0.0031	0.8704	-0.0425	-0.1214
0.0239	-0.0010	-0.0029	0.9418	-0.0413	-0.1132
0.0257	-0.0010	-0.0026	1.0132	-0.0387	-0.1029
0.0275	-0.0009	-0.0023	1.0846	-0.0345	-0.0907
0.0294	-0.0007	-0.0019	1.1560	-0.0287	-0.0766
0.0312	-0.0005	-0.0015	1.2274	-0.0212	-0.0606
0.0330	-0.0003	-0.0011	1.2989	-0.0118	-0.0426
0.0342	-0.0001	-0.0008	1.3450	-0.0046	-0.0304
0.0346	-0.0001	-0.0007	1.3606	-0.0020	-0.0260
0.0350	0.0000	-0.0005	1.3762	0.0007	-0.0216
0.0354	0.0001	-0.0004	1.3918	0.0035	-0.0171
0.0359	0.0002	-0.0003	1.4126	0.0067	-0.0110
0.0359	0.0001	-0.0003	1.4150	0.0058	-0.0101
0.0360	0.0001	-0.0002	1.4174	0.0040	-0.0082
0.0361	-0.0001	-0.0001	1.4198	-0.0021	-0.0021

RADIUS (METERS) = 0.2916
 CHORD (METERS) = 0.0361
 ZCSL (METERS) = 0.0166
 YCSL (METERS) = 0.0017
 RLE (METERS) = 0.000229
 RTE (METERS) = 0.000229
 X-AREA (SQ. METERS) = 0.000061
 GAMMA-CHORD (DEG.) = 48.74

RADIUS (INCHES) = 11.4800
 CHORD (INCHES) = 1.4195
 ZCSL (INCHES) = 0.6540
 YCSL (INCHES) = 0.0652
 RLE (INCHES) = 0.0090
 RTE (INCHES) = 0.0090
 X-AREA (SQ. IN.) = 0.0941
 GAMMA-CHORD (RAD.) = 0.8506

MANUFACTURING COORDINATES
COMPRESSOR 3S1 - ROTOR 3

80 PERCENT SPAN

METERS			INCHES		
ZC	YP	YS	ZC	YP	YS
-0.0000	-0.0001	-0.0001	-0.0002	-0.0021	-0.0021
0.0001	0.0001	-0.0002	0.0021	0.0040	-0.0081
0.0001	0.0001	-0.0003	0.0045	0.0059	-0.0101
0.0002	0.0002	-0.0003	0.0069	0.0067	-0.0118
0.0006	0.0002	-0.0005	0.0225	0.0077	-0.0192
0.0010	0.0002	-0.0006	0.0381	0.0067	-0.0251
0.0014	0.0001	-0.0008	0.0537	0.0053	-0.0305
0.0018	0.0001	-0.0009	0.0693	0.0037	-0.0356
0.0022	0.0001	-0.0010	0.0850	0.0020	-0.0404
0.0040	-0.0001	-0.0015	0.1564	-0.0059	-0.0602
0.0058	-0.0004	-0.0019	0.2278	-0.0139	-0.0763
0.0076	-0.0005	-0.0023	0.2992	-0.0211	-0.0898
0.0094	-0.0007	-0.0026	0.3706	-0.0272	-0.1010
0.0112	-0.0008	-0.0028	0.4420	-0.0326	-0.1096
0.0130	-0.0009	-0.0029	0.5134	-0.0370	-0.1159
0.0149	-0.0010	-0.0030	0.5848	-0.0404	-0.1199
0.0167	-0.0011	-0.0031	0.6562	-0.0428	-0.1216
0.0185	-0.0011	-0.0031	0.7276	-0.0442	-0.1211
0.0203	-0.0011	-0.0030	0.7990	-0.0447	-0.1181
0.0221	-0.0011	-0.0029	0.8704	-0.0443	-0.1129
0.0239	-0.0011	-0.0027	0.9418	-0.0426	-0.1054
0.0257	-0.0010	-0.0024	1.0132	-0.0396	-0.0961
0.0275	-0.0009	-0.0022	1.0846	-0.0351	-0.0849
0.0294	-0.0007	-0.0018	1.1560	-0.0289	-0.0719
0.0312	-0.0005	-0.0014	1.2274	-0.0212	-0.0570
0.0330	-0.0003	-0.0010	1.2988	-0.0117	-0.0405
0.0342	-0.0001	-0.0007	1.3449	-0.0045	-0.0290
0.0346	-0.0000	-0.0006	1.3606	-0.0019	-0.0249
0.0350	0.0000	-0.0005	1.3762	0.0008	-0.0208
0.0354	0.0001	-0.0004	1.3918	0.0036	-0.0166
0.0359	0.0002	-0.0003	1.4126	0.0067	-0.0109
0.0359	0.0001	-0.0003	1.4150	0.0059	-0.0100
0.0360	0.0001	-0.0002	1.4173	0.0041	-0.0082
0.0361	-0.0001	-0.0001	1.4197	-0.0021	-0.0021

RADIUS (METERS) = 0.2995
 CHCRD (METERS) = 0.0361
 ZCSL (METERS) = 0.0167
 YCSL (METERS) = 0.0016
 RLE (METERS) = 0.000229
 RTE (METERS) = 0.000229
 X-AREA (SQ. METERS) = 0.000053
 GAMMA-CHORD (DEG.) = 51.24

RADIUS (INCHES) = 11.7900
 CHORD (INCHES) = 1.4195
 ZCSL (INCHES) = 0.6578
 YCSL (INCHES) = 0.0621
 RLE (INCHES) = 0.0090
 RTE (INCHES) = 0.0090
 X-AREA (SQ. IN.) = 0.0823
 GAMMA-CHORD (RAD.) = 0.8943

MANUFACTURING COORDINATES
 COMPRESSOR 3S1 - STATOR 3

20 PERCENT SPAN

METERS			INCHES		
ZC	YP	YS	ZC	YP	YS
-0.0000	0.0001	0.0001	-0.0006	0.0033	0.0033
0.0000	-0.0001	0.0002	0.0018	-0.0029	0.0097
0.0001	-0.0001	0.0003	0.0043	-0.0047	0.0130
0.0002	-0.0001	0.0004	0.0068	-0.0056	0.0158
0.0006	-0.0002	0.0007	0.0232	-0.0067	0.0283
0.0010	-0.0001	0.0010	0.0396	-0.0046	0.0385
0.0014	-0.0000	0.0012	0.0560	-0.0019	0.0478
0.0018	0.0000	0.0014	0.0724	0.0010	0.0565
0.0023	0.0001	0.0016	0.0888	0.0041	0.0648
0.0042	0.0005	0.0025	0.1638	0.0188	0.0982
0.0061	0.0008	0.0032	0.2388	0.0331	0.1255
0.0080	0.0012	0.0038	0.3138	0.0460	0.1481
0.0099	0.0014	0.0042	0.3888	0.0570	0.1666
0.0118	0.0017	0.0046	0.4638	0.0665	0.1809
0.0137	0.0019	0.0049	0.5387	0.0741	0.1913
0.0156	0.0020	0.0050	0.6137	0.0800	0.1978
0.0175	0.0021	0.0051	0.6887	0.0842	0.2006
0.0194	0.0022	0.0051	0.7637	0.0867	0.1996
0.0213	0.0022	0.0049	0.8387	0.0875	0.1948
0.0232	0.0022	0.0047	0.9137	0.0865	0.1862
0.0251	0.0021	0.0044	0.9887	0.0836	0.1739
0.0270	0.0020	0.0040	1.0636	0.0782	0.1583
0.0289	0.0018	0.0035	1.1386	0.0699	0.1396
0.0308	0.0015	0.0030	1.2136	0.0589	0.1177
0.0327	0.0011	0.0023	1.2886	0.0450	0.0925
0.0346	0.0007	0.0016	1.3636	0.0278	0.0642
0.0359	0.0004	0.0011	1.4120	0.0149	0.0442
0.0363	0.0003	0.0009	1.4284	0.0102	0.0371
0.0367	0.0001	0.0008	1.4448	0.0053	0.0299
0.0371	0.0000	0.0006	1.4612	0.0003	0.0226
0.0377	-0.0001	0.0003	1.4831	-0.0056	0.0125
0.0377	-0.0001	0.0003	1.4855	-0.0047	0.0114
0.0378	-0.0001	0.0002	1.4880	-0.0029	0.0095
0.0379	0.0001	0.0001	1.4905	0.0033	0.0033

RADIUS (METERS) = 0.2840
 CHORD (METERS) = 0.0378
 ZCSL (METERS) = 0.0173
 YCSL (METERS) = 0.0028
 RLE (METERS) = 0.000229
 RTE (METERS) = 0.000229
 X-AREA (SQ. METERS) = 0.000080
 GAMMA-CHORD (DEG.) = 43.18

RADIUS (INCHES) = 11.1800
 CHORD (INCHES) = 1.4899
 ZCSL (INCHES) = 0.6799
 YCSL (INCHES) = 0.1093
 RLE (INCHES) = 0.0090
 RTE (INCHES) = 0.0090
 X-AREA (SQ. IN.) = 0.1246
 GAMMA-CHORD (RAD.) = 0.7536

MANUFACTURING COORDINATES
COMPRESSOR 3S1 - STATOR 3

50 PERCENT SPAN

METERS			INCHES		
ZC	YP	YS	ZC	YP	YS
-0.0000	0.0001	0.0001	-0.0005	0.0029	0.0029
0.0001	-0.0001	0.0002	0.0020	-0.0033	0.0093
0.0001	-0.0001	0.0003	0.0045	-0.0052	0.0126
0.0002	-0.0002	0.0004	0.0070	-0.0061	0.0154
0.0006	-0.0002	0.0007	0.0234	-0.0085	0.0275
0.0010	-0.0002	0.0009	0.0398	-0.0076	0.0371
0.0014	-0.0002	0.0012	0.0562	-0.0060	0.0458
0.0018	-0.0001	0.0014	0.0726	-0.0041	0.0540
0.0023	-0.0001	0.0016	0.0890	-0.0020	0.0617
0.0042	0.0002	0.0023	0.1639	0.0085	0.0925
0.0061	0.0005	0.0030	0.2389	0.0192	0.1176
0.0080	0.0007	0.0035	0.3139	0.0292	0.1384
0.0099	0.0010	0.0039	0.3888	0.0379	0.1553
0.0118	0.0012	0.0043	0.4638	0.0455	0.1682
0.0137	0.0013	0.0045	0.5388	0.0517	0.1777
0.0156	0.0014	0.0047	0.6137	0.0567	0.1835
0.0175	0.0015	0.0047	0.6887	0.0606	0.1857
0.0194	0.0016	0.0047	0.7637	0.0632	0.1844
0.0213	0.0016	0.0046	0.8387	0.0645	0.1796
0.0232	0.0016	0.0043	0.9136	0.0645	0.1712
0.0251	0.0016	0.0041	0.9886	0.0631	0.1595
0.0270	0.0015	0.0037	1.0636	0.0595	0.1448
0.0289	0.0014	0.0032	1.1385	0.0536	0.1273
0.0308	0.0012	0.0027	1.2135	0.0453	0.1071
0.0327	0.0009	0.0021	1.2885	0.0344	0.0840
0.0346	0.0005	0.0015	1.3634	0.0209	0.0583
0.0359	0.0003	0.0010	1.4118	0.0105	0.0404
0.0363	0.0002	0.0009	1.4283	0.0068	0.0340
0.0367	0.0001	0.0007	1.4446	0.0029	0.0276
0.0371	-0.0000	0.0005	1.4611	-0.0012	0.0210
0.0377	-0.0002	0.0003	1.4829	-0.0060	0.0120
0.0377	-0.0001	0.0003	1.4854	-0.0052	0.0109
0.0378	-0.0001	0.0002	1.4879	-0.0033	0.0091
0.0379	0.0001	0.0001	1.4904	0.0029	0.0029

RADIUS (METERS) = 0.2916
 CHCRD (METERS) = 0.0378
 ZCSL (METERS) = 0.0172
 YCSL (METERS) = 0.0024
 RLE (METERS) = 0.00229
 RTE (METERS) = 0.000229
 X-AREA (SQ. METERS) = 0.000086
 GAMMA-CHORD (DEG.) = 41.21

RADIUS (INCHES) = 11.4800
 CHORD (INCHES) = 1.4899
 ZCSL (INCHES) = 0.6787
 YCSL (INCHES) = 0.0948
 RLE (INCHES) = 0.0090
 RTE (INCHES) = 0.0090
 X-AREA (SQ. IN.) = 0.1327
 GAMMA-CHORD (RAD.) = 0.7192

MANUFACTURING COORDINATES
COMPRESSOR 3S1 - STATOR 3

80 PERCENT SPAN

METERS			INCHES		
ZC	YP	YS	ZC	YP	YS
-0.0000	0.0001	0.0001	-0.0005	0.0031	0.0031
0.0000	-0.0001	0.0002	0.0019	-0.0031	0.0097
0.0001	-0.0001	0.0003	0.0044	-0.0050	0.0133
0.0002	-0.0002	0.0004	0.0069	-0.0059	0.0164
0.0006	-0.0002	0.0007	0.0233	-0.0085	0.0294
0.0010	-0.0002	0.0010	0.0397	-0.0076	0.0399
0.0014	-0.0002	0.0013	0.0561	-0.0049	0.0494
0.0018	-0.0001	0.0015	0.0725	-0.0039	0.0582
0.0023	-0.0000	0.0017	0.0889	-0.0017	0.0666
0.0042	0.0002	0.0025	0.1639	0.0096	0.0998
0.0061	0.0005	0.0032	0.2389	0.0210	0.1269
0.0080	0.0008	0.0038	0.3139	0.0316	0.1492
0.0099	0.0010	0.0042	0.3888	0.0409	0.1672
0.0118	0.0012	0.0046	0.4638	0.0490	0.1811
0.0137	0.0014	0.0049	0.5388	0.0557	0.1912
0.0156	0.0016	0.0050	0.6138	0.0611	0.1974
0.0175	0.0017	0.0051	0.6888	0.0653	0.1997
0.0194	0.0017	0.0050	0.7637	0.0681	0.1982
0.0213	0.0018	0.0049	0.8387	0.0696	0.1931
0.0232	0.0018	0.0047	0.9137	0.0698	0.1841
0.0251	0.0017	0.0044	0.9887	0.0683	0.1715
0.0270	0.0016	0.0040	1.0637	0.0645	0.1556
0.0289	0.0015	0.0035	1.1386	0.0582	0.1368
0.0308	0.0013	0.0029	1.2136	0.0493	0.1150
0.0327	0.0010	0.0023	1.2886	0.0377	0.0902
0.0346	0.0006	0.0016	1.3636	0.0231	0.0624
0.0359	0.0003	0.0011	1.4120	0.0120	0.0430
0.0363	0.0002	0.0009	1.4284	0.0079	0.0361
0.0367	0.0001	0.0007	1.4448	0.0037	0.0292
0.0371	-0.0000	0.0006	1.4612	-0.0006	0.0220
0.0377	-0.0001	0.0003	1.4831	-0.0058	0.0123
0.0377	-0.0001	0.0003	1.4855	-0.0050	0.0112
0.0378	-0.0001	0.0002	1.4880	-0.0031	0.0093
0.0379	0.0001	0.0001	1.4906	0.0031	0.0031

RADIUS (METERS) = 0.2995
 CHORD (METERS) = 0.0378
 ZCSL (METERS) = 0.0172
 YCSL (METERS) = 0.0026
 RLE (METERS) = 0.00229
 RTE (METERS) = 0.00229
 X-AREA (SQ. METERS) = 0.00092
 GAMMA-CHORD (DEG.) = 41.53

RADIUS (INCHES) = 11.7900
 CHORD (INCHES) = 1.4900
 ZCSL (INCHES) = 0.6769
 YCSL (INCHES) = 0.1022
 RLE (INCHES) = 0.0090
 RTE (INCHES) = 0.0090
 X-AREA (SQ. IN.) = 0.1422
 GAMMA-CHORD (RAD.) = 0.7248

MANUFACTURING COORDINATES
COMPRESSOR 3S2 - INLET GUIDE VANE

20 PERCENT SPAN

METERS			INCHES		
ZC	YP	YS	ZC	YP	YS
-0.0000	-0.0001	-0.0001	-0.0007	-0.0035	-0.0035
0.0000	-0.0002	0.0000	0.0004	-0.0078	0.0008
0.0000	-0.0002	0.0001	0.0015	-0.0094	0.0024
0.0001	-0.0003	0.0001	0.0026	-0.0105	0.0035
0.0003	-0.0004	0.0001	0.0099	-0.0151	0.0054
0.0004	-0.0005	0.0001	0.0172	-0.0193	0.0041
0.0006	-0.0006	0.0001	0.0245	-0.0234	0.0026
0.0008	-0.0007	0.0000	0.0318	-0.0272	0.0011
0.0010	-0.0008	-0.0000	0.0391	-0.0308	-0.0005
0.0018	-0.0012	-0.0002	0.0724	-0.0454	-0.0078
0.0027	-0.0015	-0.0004	0.1057	-0.0574	-0.0148
0.0035	-0.0017	-0.0005	0.1390	-0.0674	-0.0211
0.0044	-0.0019	-0.0007	0.1724	-0.0756	-0.0264
0.0052	-0.0021	-0.0008	0.2057	-0.0820	-0.0309
0.0061	-0.0022	-0.0009	0.2390	-0.0866	-0.0345
0.0069	-0.0023	-0.0009	0.2723	-0.0896	-0.0373
0.0078	-0.0023	-0.0010	0.3057	-0.0910	-0.0391
0.0086	-0.0023	-0.0010	0.3390	-0.0906	-0.0401
0.0095	-0.0023	-0.0010	0.3723	-0.0887	-0.0402
0.0103	-0.0022	-0.0010	0.4056	-0.0852	-0.0393
0.0111	-0.0020	-0.0009	0.4390	-0.0802	-0.0374
0.0120	-0.0019	-0.0009	0.4723	-0.0736	-0.0343
0.0128	-0.0017	-0.0008	0.5056	-0.0656	-0.0300
0.0137	-0.0014	-0.0006	0.5389	-0.0563	-0.0243
0.0145	-0.0012	-0.0004	0.5723	-0.0454	-0.0173
0.0154	-0.0008	-0.0002	0.6056	-0.0332	-0.0087
0.0159	-0.0006	-0.0001	0.6271	-0.0245	-0.0024
0.0161	-0.0005	-0.0000	0.6344	-0.0215	-0.0001
0.0163	-0.0005	0.0001	0.6417	-0.0183	0.0022
0.0165	-0.0004	0.0001	0.6490	-0.0151	0.0047
0.0167	-0.0003	0.0001	0.6587	-0.0105	0.0035
0.0168	-0.0002	0.0001	0.6598	-0.0094	0.0024
0.0168	-0.0002	0.0000	0.6609	-0.0078	0.0008
0.0168	-0.0001	-0.0001	0.6620	-0.0035	-0.0035

RADIUS (METERS) = 0.2840
 CHCRL (METERS) = 0.0168
 ZCSL (METERS) = 0.0076
 YCSL (METERS) = -0.0012
 RLE (METERS) = 0.000229
 RTE (METERS) = 0.000229
 X-AREA (SQ. METERS) = 0.000017
 GAMMA-CHORD (DEG.) = 18.16

RADIUS (INCHES) = 11.1800
 CHORD (INCHES) = 0.6613
 ZCSL (INCHES) = 0.2994
 YCSL (INCHES) = -0.0481
 RLE (INCHES) = 0.0090
 RTE (INCHES) = 0.0090
 X-AREA (SQ. IN.) = 0.0265
 GAMMA-CHORD (RAD.) = 0.3169

MANUFACTURING COORDINATES
COMPRESSOR 3S2 - INLET GUIDE VANE

50 PERCENT SPAN

METERS			INCHES		
ZC	YP	YS	ZC	YP	YS
-0.0000	-0.0001	-0.0001	-0.0007	-0.0035	-0.0035
0.0000	-0.0002	0.0000	0.0004	-0.0078	0.0008
0.0000	-0.0002	0.0001	0.0015	-0.0094	0.0024
0.0001	-0.0003	0.0001	0.0026	-0.0105	0.0035
0.0003	-0.0004	0.0001	0.0099	-0.0154	0.0054
0.0004	-0.0005	0.0001	0.0172	-0.0199	0.0042
0.0006	-0.0006	0.0001	0.0245	-0.0241	0.0029
0.0008	-0.0007	0.0000	0.0318	-0.0281	0.0015
0.0010	-0.0008	-0.0000	0.0391	-0.0318	-0.0000
0.0018	-0.0012	-0.0002	0.0724	-0.0469	-0.0071
0.0027	-0.0015	-0.0004	0.1057	-0.0594	-0.0139
0.0035	-0.0018	-0.0005	0.1390	-0.0696	-0.0200
0.0044	-0.0020	-0.0006	0.1723	-0.0780	-0.0252
0.0052	-0.0021	-0.0008	0.2057	-0.0845	-0.0297
0.0061	-0.0023	-0.0008	0.2390	-0.0893	-0.0332
0.0069	-0.0023	-0.0009	0.2723	-0.0923	-0.0360
0.0078	-0.0024	-0.0010	0.3057	-0.0936	-0.0379
0.0086	-0.0024	-0.0010	0.3390	-0.0932	-0.0390
0.0095	-0.0023	-0.0010	0.3723	-0.0912	-0.0391
0.0103	-0.0022	-0.0010	0.4056	-0.0875	-0.0384
0.0111	-0.0021	-0.0009	0.4390	-0.0822	-0.0367
0.0120	-0.0019	-0.0009	0.4723	-0.0754	-0.0338
0.0128	-0.0017	-0.0008	0.5056	-0.0672	-0.0295
0.0137	-0.0015	-0.0006	0.5389	-0.0575	-0.0240
0.0145	-0.0012	-0.0004	0.5723	-0.0464	-0.0171
0.0154	-0.0009	-0.0002	0.6056	-0.0338	-0.0087
0.0159	-0.0006	-0.0001	0.6271	-0.0249	-0.0024
0.0161	-0.0006	-0.0000	0.6344	-0.0216	-0.0001
0.0163	-0.0005	0.0001	0.6417	-0.0186	0.0022
0.0165	-0.0004	0.0001	0.6490	-0.0153	0.0046
0.0167	-0.0003	0.0001	0.6587	-0.0105	0.0035
0.0168	-0.0002	0.0001	0.6598	-0.0094	0.0024
0.0168	-0.0002	0.0000	0.6609	-0.0078	0.0008
0.0168	-0.0001	-0.0001	0.6620	-0.0035	-0.0035

RADIUS (METERS) = 0.2916
 CHORD (METERS) = 0.0168
 ZCSL (METERS) = 0.0076
 YCSL (METERS) = -0.0012
 RLE (METERS) = 0.00229
 RTE (METERS) = 0.00229
 X-AREA (SQ. METERS) = 0.00018
 GAMMA-CHORD (DEG.) = 18.10

RADIUS (INCHES) = 11.4800
 CHORD (INCHES) = 0.6613
 ZCSL (INCHES) = 0.2979
 YCSL (INCHES) = -0.0489
 RLE (INCHES) = 0.0090
 RTE (INCHES) = 0.0090
 X-AREA (SQ. IN.) = 0.0282
 GAMMA-CHORD (RAD.) = 0.3159

MANUFACTURING COORDINATES
COMPRESSOR 3S2 - INLET GUIDE VANE

80 PERCENT SPAN

METERS			INCHES		
ZC	YP	YS	ZC	YP	YS
-0.0000	-0.0001	-0.0001	-0.0007	-0.0035	-0.0035
0.0000	-0.0002	0.0000	0.0004	-0.0079	0.0008
0.0000	-0.0002	0.0001	0.0015	-0.0094	0.0024
0.0001	-0.0003	0.0001	0.0026	-0.0105	0.0034
0.0003	-0.0004	0.0001	0.0099	-0.0155	0.0053
0.0004	-0.0005	0.0001	0.0172	-0.0202	0.0042
0.0006	-0.0006	0.0001	0.0245	-0.0246	0.0030
0.0008	-0.0007	0.0000	0.0316	-0.0288	0.0016
0.0010	-0.0008	0.0000	0.0390	-0.0327	0.0003
0.0018	-0.0012	-0.0002	0.0724	-0.0484	-0.0064
0.0027	-0.0016	-0.0003	0.1057	-0.0612	-0.0130
0.0035	-0.0018	-0.0005	0.1390	-0.0718	-0.0189
0.0044	-0.0020	-0.0006	0.1723	-0.0804	-0.0240
0.0052	-0.0022	-0.0007	0.2057	-0.0871	-0.0284
0.0061	-0.0023	-0.0008	0.2390	-0.0919	-0.0319
0.0069	-0.0024	-0.0009	0.2723	-0.0950	-0.0347
0.0078	-0.0024	-0.0009	0.3056	-0.0963	-0.0366
0.0086	-0.0024	-0.0010	0.3390	-0.0958	-0.0378
0.0095	-0.0024	-0.0010	0.3723	-0.0936	-0.0381
0.0103	-0.0023	-0.0010	0.4056	-0.0898	-0.0375
0.0111	-0.0021	-0.0009	0.4390	-0.0843	-0.0359
0.0120	-0.0020	-0.0008	0.4723	-0.0772	-0.0332
0.0128	-0.0017	-0.0007	0.5056	-0.0688	-0.0291
0.0137	-0.0015	-0.0006	0.5389	-0.0588	-0.0237
0.0145	-0.0012	-0.0004	0.5723	-0.0473	-0.0169
0.0154	-0.0009	-0.0002	0.6056	-0.0344	-0.0086
0.0159	-0.0006	-0.0001	0.6271	-0.0253	-0.0024
0.0161	-0.0006	-0.0000	0.6344	-0.0221	-0.0001
0.0163	-0.0005	0.0001	0.6417	-0.0188	0.0022
0.0165	-0.0004	0.0001	0.6490	-0.0154	0.0046
0.0167	-0.0003	0.0001	0.6587	-0.0105	0.0034
0.0168	-0.0002	0.0001	0.6598	-0.0094	0.0024
0.0168	-0.0002	0.0000	0.6609	-0.0079	0.0008
0.0168	-0.0001	-0.0001	0.6620	-0.0035	-0.0035

RADIUS (METERS) = 0.2995
 CHORD (METERS) = 0.0168
 ZCSL (METERS) = 0.0075
 YCSL (METERS) = -0.0013
 RLE (METERS) = 0.00229
 RTE (METERS) = 0.00229
 X-AREA (SQ. METERS) = 0.00019
 GAMMA-CHORD (DEG.) = 18.04

RADIUS (INCHES) = 11.7900
 CHORD (INCHES) = 0.6613
 ZCSL (INCHES) = 0.2965
 YCSL (INCHES) = -0.0497
 RLE (INCHES) = 0.0090
 RTE (INCHES) = 0.0090
 X-AREA (SQ. IN.) = 0.0299
 GAMMA-CHORD (RAD.) = 0.3149

MANUFACTURING COORDINATES
COMPRESSOR 3S2 - ROTOR 1

20 PERCENT SPAN

METERS			INCHES		
ZC	YP	YS	ZC	YP	YS
-0.0000	-0.0001	-0.0001	-0.0005	-0.0031	-0.0031
0.0000	0.0000	-0.0002	0.0006	0.0014	-0.0076
0.0000	0.0001	-0.0002	0.0018	0.0030	-0.0092
0.0001	0.0001	-0.0003	0.0030	0.0041	-0.0103
0.0003	0.0001	-0.0004	0.0109	0.0056	-0.0150
0.0005	0.0001	-0.0005	0.0187	0.0044	-0.0193
0.0007	0.0001	-0.0006	0.0265	0.0031	-0.0233
0.0009	0.0000	-0.0007	0.0344	0.0016	-0.0270
0.0011	0.0000	-0.0008	0.0422	0.0001	-0.0305
0.0020	-0.0002	-0.0011	0.0780	-0.0069	-0.0449
0.0029	-0.0003	-0.0014	0.1138	-0.0137	-0.0568
0.0038	-0.0005	-0.0017	0.1497	-0.0197	-0.0667
0.0047	-0.0006	-0.0019	0.1855	-0.0249	-0.0748
0.0056	-0.0007	-0.0021	0.2213	-0.0293	-0.0811
0.0065	-0.0008	-0.0022	0.2571	-0.0328	-0.0857
0.0074	-0.0009	-0.0023	0.2930	-0.0355	-0.0887
0.0084	-0.0009	-0.0023	0.3288	-0.0373	-0.0900
0.0093	-0.0010	-0.0023	0.3646	-0.0383	-0.0897
0.0102	-0.0010	-0.0022	0.4004	-0.0384	-0.0878
0.0111	-0.0010	-0.0021	0.4362	-0.0375	-0.0843
0.0120	-0.0009	-0.0020	0.4721	-0.0358	-0.0792
0.0129	-0.0008	-0.0018	0.5079	-0.0328	-0.0727
0.0138	-0.0007	-0.0016	0.5437	-0.0286	-0.0648
0.0147	-0.0006	-0.0014	0.5796	-0.0232	-0.0555
0.0156	-0.0004	-0.0011	0.6154	-0.0164	-0.0448
0.0165	-0.0002	-0.0008	0.6512	-0.0082	-0.0327
0.0171	-0.0001	-0.0006	0.6743	-0.0021	-0.0241
0.0173	0.0000	-0.0005	0.6822	0.0001	-0.0211
0.0175	0.0001	-0.0005	0.6900	0.0024	-0.0180
0.0177	0.0001	-0.0004	0.6978	0.0048	-0.0149
0.0180	0.0001	-0.0003	0.7083	0.0041	-0.0103
0.0180	0.0001	-0.0002	0.7095	0.0030	-0.0092
0.0181	0.0000	-0.0002	0.7107	0.0014	-0.0076
0.0181	-0.0001	-0.0001	0.7118	-0.0031	-0.0031

RADIUS (METERS) = 0.2840
 CHCRD (METERS) = 0.0181
 ZCSL (METERS) = 0.0085
 YCSL (METERS) = 0.0012
 RLE (METERS) = 0.00229
 RTE (METERS) = 0.00229
 X-AREA (SQ. METERS) = 0.00019
 GAMMA-CHORD (DEG.) = 41.87

RADIUS (INCHES) = 11.1800
 CHORD (INCHES) = 0.7113
 ZCSL (INCHES) = 0.3360
 YCSL (INCHES) = 0.0474
 RLE (INCHES) = 0.0090
 RTE (INCHES) = 0.0090
 X-AREA (SQ. IN.) = 0.0289
 GAMMA-CHORD (RAD.) = 0.7307

MANUFACTURING COORDINATES
COMPRESSOR 3S2 - ROTOR 1

50 PERCENT SPAN

METERS			INCHES		
ZC	YP	YS	ZC	YP	YS
-0.0000	-0.0001	-0.0001	-0.0004	-0.0027	-0.0027
0.0000	0.0000	-0.0002	0.0008	0.0017	-0.0072
0.0000	0.0001	-0.0002	0.0019	0.0034	-0.0088
0.0001	0.0001	-0.0003	0.0031	0.0045	-0.0099
0.0003	0.0002	-0.0004	0.0110	0.0060	-0.0139
0.0005	0.0001	-0.0004	0.0128	0.0049	-0.0175
0.0007	0.0001	-0.0005	0.0266	0.0036	-0.0209
0.0009	0.0001	-0.0006	0.0345	0.0022	-0.0240
0.0011	0.0000	-0.0007	0.0423	0.0008	-0.0270
0.0020	-0.0001	-0.0010	0.0781	-0.0055	-0.0394
0.0029	-0.0003	-0.0013	0.1139	-0.0116	-0.0496
0.0038	-0.0004	-0.0015	0.1498	-0.0170	-0.0581
0.0047	-0.0005	-0.0017	0.1856	-0.0216	-0.0652
0.0056	-0.0006	-0.0018	0.2214	-0.0255	-0.0707
0.0065	-0.0007	-0.0019	0.2572	-0.0287	-0.0747
0.0074	-0.0008	-0.0020	0.2930	-0.0310	-0.0773
0.0084	-0.0008	-0.0020	0.3288	-0.0325	-0.0785
0.0093	-0.0008	-0.0020	0.3647	-0.0334	-0.0783
0.0102	-0.0008	-0.0019	0.4005	-0.0333	-0.0767
0.0111	-0.0008	-0.0019	0.4363	-0.0325	-0.0737
0.0120	-0.0008	-0.0018	0.4721	-0.0308	-0.0693
0.0129	-0.0007	-0.0016	0.5079	-0.0281	-0.0637
0.0138	-0.0006	-0.0014	0.5437	-0.0243	-0.0569
0.0147	-0.0005	-0.0012	0.5796	-0.0195	-0.0489
0.0156	-0.0003	-0.0010	0.6154	-0.0134	-0.0397
0.0165	-0.0002	-0.0007	0.6512	-0.0062	-0.0293
0.0171	-0.0000	-0.0006	0.6743	-0.0008	-0.0220
0.0173	0.0000	-0.0005	0.6821	0.0012	-0.0194
0.0175	0.0001	-0.0004	0.6900	0.0032	-0.0167
0.0177	0.0001	-0.0004	0.6978	0.0052	-0.0140
0.0180	0.0001	-0.0003	0.7083	0.0045	-0.0099
0.0180	0.0001	-0.0002	0.7095	0.0034	-0.0088
0.0181	0.0000	-0.0002	0.7106	0.0018	-0.0072
0.0181	-0.0001	-0.0001	0.7118	-0.0027	-0.0027

RADIUS (METERS) = 0.2916
 CHORD (METERS) = 0.0181
 ZCSL (METERS) = 0.0086
 YCSL (METERS) = 0.0010
 RLE (METERS) = 0.00229
 RTE (METERS) = 0.00229
 X-AREA (SQ. METERS) = 0.00017
 GAMMA-CHORD (DEG.) = 44.83

RADIUS (INCHES) = 11.4800
 CHORD (INCHES) = 0.7114
 ZCSL (INCHES) = 0.3383
 YCSL (INCHES) = 0.0410
 RLE (INCHES) = 0.0090
 RTE (INCHES) = 0.0090
 X-AREA (SQ. IN.) = 0.0257
 GAMMA-CHORD (RAD.) = 0.7824

MANUFACTURING COORDINATES
COMPRESSOR 3S2 - ROTOR 1

80 PERCENT SPAN

METERS			INCHES		
ZC	YP	YS	ZC	YP	YS
-0.0000	-0.0001	-0.0001	-0.0004	-0.0026	-0.0026
0.0000	0.0000	-0.0002	0.0008	0.0019	-0.0071
0.0001	0.0001	-0.0002	0.0020	0.0035	-0.0087
0.0001	0.0001	-0.0002	0.0032	0.0046	-0.0098
0.0003	0.0002	-0.0003	0.0110	0.0061	-0.0135
0.0005	0.0001	-0.0004	0.0188	0.0049	-0.0167
0.0007	0.0001	-0.0005	0.0267	0.0035	-0.0197
0.0009	0.0001	-0.0006	0.0345	0.0020	-0.0226
0.0011	0.0000	-0.0006	0.0424	0.0005	-0.0253
0.0020	-0.0002	-0.0009	0.0782	-0.0061	-0.0364
0.0029	-0.0003	-0.0012	0.1140	-0.0123	-0.0458
0.0038	-0.0005	-0.0014	0.1498	-0.0178	-0.0536
0.0047	-0.0006	-0.0015	0.1856	-0.0224	-0.0602
0.0056	-0.0007	-0.0017	0.2214	-0.0263	-0.0652
0.0065	-0.0007	-0.0018	0.2572	-0.0293	-0.0690
0.0074	-0.0008	-0.0018	0.2930	-0.0316	-0.0715
0.0084	-0.0008	-0.0018	0.3288	-0.0330	-0.0727
0.0093	-0.0009	-0.0018	0.3647	-0.0337	-0.0731
0.0102	-0.0009	-0.0018	0.4005	-0.0335	-0.0712
0.0111	-0.0008	-0.0017	0.4363	-0.0325	-0.0695
0.0120	-0.0008	-0.0016	0.4721	-0.0307	-0.0646
0.0129	-0.0007	-0.0015	0.5079	-0.0278	-0.0595
0.0138	-0.0006	-0.0014	0.5437	-0.0239	-0.0533
0.0147	-0.0005	-0.0012	0.5795	-0.0190	-0.0460
0.0156	-0.0003	-0.0010	0.6153	-0.0130	-0.0375
0.0165	-0.0001	-0.0007	0.6511	-0.0058	-0.0278
0.0171	-0.0000	-0.0005	0.6743	-0.0005	-0.0210
0.0173	0.0000	-0.0005	0.6821	0.0014	-0.0186
0.0175	0.0001	-0.0004	0.6899	0.0034	-0.0162
0.0177	0.0001	-0.0003	0.6978	0.0054	-0.0137
0.0180	0.0001	-0.0002	0.7082	0.0046	-0.0098
0.0180	0.0001	-0.0002	0.7094	0.0035	-0.0087
0.0180	0.0000	-0.0002	0.7106	0.0019	-0.0071
0.0181	-0.0001	-0.0001	0.7118	-0.0026	-0.0026

RADIUS (METERS) = 0.2995
 CHORD (METERS) = 0.0181
 ZCSL (METERS) = 0.0086
 YCSL (METERS) = 0.0010
 RLE (METERS) = 0.00229
 RTE (METERS) = 0.00229
 X-AREA (SQ. METERS) = 0.00015
 GAMMA-CHORD (DEG.) = 47.15

RADIUS (INCHES) = 11.7900
 CHORD (INCHES) = 0.7114
 ZCSL (INCHES) = 0.3405
 YCSL (INCHES) = 0.0385
 RLE (INCHES) = 0.0090
 RTE (INCHES) = 0.0090
 X-AREA (SQ. IN.) = 0.0228
 GAMMA-CHORD (RAD.) = 0.8229

MANUFACTURING COORDINATES
COMPRESSOR 3S2 - STATOR 1

20 PERCENT SPAN

METERS			INCHES		
ZC	YP	YS	ZC	YP	YS
-0.0000	0.0001	0.0001	-0.0004	0.0028	0.0028
0.0000	-0.0000	0.0002	0.0008	-0.0018	0.0074
0.0001	-0.0001	0.0002	0.0021	-0.0035	0.0091
0.0001	-0.0001	0.0003	0.0034	-0.0046	0.0102
0.0003	-0.0002	0.0004	0.0118	-0.0061	0.0153
0.0005	-0.0001	0.0005	0.0202	-0.0054	0.0198
0.0007	-0.0001	0.0006	0.0286	-0.0045	0.0239
0.0009	0.0001	0.0007	0.0371	-0.0033	0.0277
0.0012	-0.0001	0.0008	0.0455	-0.0021	0.0313
0.0021	0.0001	0.0012	0.0839	0.0038	0.0459
0.0031	0.0002	0.0015	0.1224	0.0096	0.0579
0.0041	0.0004	0.0017	0.1609	0.0149	0.0678
0.0051	0.0005	0.0019	0.1994	0.0195	0.0759
0.0060	0.0006	0.0021	0.2379	0.0235	0.0822
0.0070	0.0007	0.0022	0.2763	0.0267	0.0868
0.0080	0.0007	0.0023	0.3148	0.0292	0.0897
0.0090	0.0008	0.0023	0.3533	0.0310	0.0909
0.0100	0.0008	0.0023	0.3918	0.0322	0.0904
0.0109	0.0008	0.0022	0.4302	0.0325	0.0883
0.0119	0.0008	0.0021	0.4687	0.0320	0.0846
0.0129	0.0008	0.0020	0.5072	0.0307	0.0793
0.0139	0.0007	0.0018	0.5457	0.0284	0.0726
0.0148	0.0006	0.0016	0.5842	0.0249	0.0645
0.0158	0.0005	0.0014	0.6226	0.0201	0.0551
0.0168	0.0004	0.0011	0.6611	0.0142	0.0443
0.0178	0.0002	0.0008	0.6996	0.0068	0.0323
0.0184	0.0000	0.0006	0.7244	0.0013	0.0238
0.0186	-0.0000	0.0005	0.7329	-0.0007	0.0208
0.0188	-0.0001	0.0005	0.7413	-0.0028	0.0178
0.0190	-0.0001	0.0004	0.7497	-0.0049	0.0147
0.0193	-0.0001	0.0003	0.7609	-0.0046	0.0102
0.0194	-0.0001	0.0002	0.7622	-0.0035	0.0091
0.0194	-0.0000	0.0002	0.7635	-0.0018	0.0074
0.0194	0.0001	0.0001	0.7647	0.0028	0.0028

RADIUS (METERS) = 0.2840
 CHORD (METERS) = 0.0194
 ZCSL (METERS) = 0.0091
 YCSL (METERS) = 0.0012
 RLE (METERS) = 0.00229
 RTE (METERS) = 0.00229
 X-AREA (SQ. METERS) = 0.00022
 GAMMA-CHORD (DEG.) = 41.30

RADIUS (INCHES) = 11.1800
 CHORD (INCHES) = 0.7643
 ZCSL (INCHES) = 0.3587
 YCSL (INCHES) = 0.0458
 RLE (INCHES) = 0.0090
 RTE (INCHES) = 0.0090
 X-AREA (SQ. IN.) = 0.0346
 GAMMA-CHORD (RAD.) = 0.7208

MANUFACTURING COORDINATES
COMPRESSOR 3S2 - STATOR 1

50 PERCENT SPAN

METERS			INCHES		
ZC	YP	YS	ZC	YP	YS
-0.0000	0.0001	0.0001	-0.0004	0.0027	0.0027
0.0000	-0.0000	0.0002	0.0008	-0.0019	0.0074
0.0001	-0.0001	0.0002	0.0021	-0.0036	0.0090
0.0001	-0.0001	0.0003	0.0034	-0.0046	0.0101
0.0003	-0.0002	0.0004	0.0118	-0.0063	0.0156
0.0005	-0.0002	0.0005	0.0202	-0.0059	0.0202
0.0007	-0.0001	0.0006	0.0287	-0.0051	0.0243
0.0009	-0.0001	0.0007	0.0371	-0.0042	0.0282
0.0012	-0.0001	0.0008	0.0455	-0.0031	0.0319
0.0021	0.0001	0.0012	0.0840	0.0021	0.0467
0.0031	0.0002	0.0015	0.1224	0.0073	0.0589
0.0041	0.0003	0.0017	0.1609	0.0122	0.0689
0.0051	0.0004	0.0020	0.1994	0.0165	0.0770
0.0060	0.0005	0.0021	0.2379	0.0202	0.0833
0.0070	0.0006	0.0022	0.2763	0.0233	0.0879
0.0080	0.0007	0.0023	0.3148	0.0257	0.0907
0.0090	0.0007	0.0023	0.3533	0.0275	0.0919
0.0100	0.0007	0.0023	0.3918	0.0287	0.0913
0.0109	0.0007	0.0023	0.4302	0.0292	0.0891
0.0119	0.0007	0.0022	0.4687	0.0290	0.0853
0.0129	0.0007	0.0020	0.5072	0.0280	0.0798
0.0139	0.0007	0.0019	0.5457	0.0260	0.0729
0.0148	0.0006	0.0016	0.5842	0.0229	0.0647
0.0158	0.0005	0.0014	0.6226	0.0185	0.0552
0.0168	0.0003	0.0011	0.6611	0.0130	0.0444
0.0178	0.0002	0.0008	0.6996	0.0061	0.0322
0.0184	0.0000	0.0006	0.7244	0.0008	0.0238
0.0186	-0.0000	0.0005	0.7328	-0.0011	0.0208
0.0188	-0.0001	0.0005	0.7413	-0.0030	0.0177
0.0190	-0.0001	0.0004	0.7497	-0.0050	0.0146
0.0193	-0.0001	0.0003	0.7609	-0.0046	0.0101
0.0194	-0.0001	0.0002	0.7622	-0.0036	0.0090
0.0194	-0.0000	0.0002	0.7635	-0.0019	0.0074
0.0194	0.0001	0.0001	0.7647	0.0027	0.0027

RADIUS (METERS) = 0.2916
 CHORD (METERS) = 0.0194
 ZCSL (METERS) = 0.0091
 YCSL (METERS) = 0.0011
 RLE (METERS) = 0.00229
 RTE (METERS) = 0.00229
 X-AREA (SQ. METERS) = 0.00024
 GAMMA-CHORD (DEG.) = 40.95

RADIUS (INCHES) = 11.4800
 CHORD (INCHES) = 0.7643
 ZCSL (INCHES) = 0.3575
 YCSL (INCHES) = 0.0450
 RLE (INCHES) = 0.0090
 RTE (INCHES) = 0.0090
 X-AREA (SQ. IN.) = 0.0368
 GAMMA-CHORD (RAD.) = 0.7146

MANUFACTURING COORDINATES
COMPRESSOR 3S2 - STATOR 1

80 PERCENT SPAN

METERS			INCHES		
ZC	YP	YS	ZC	YP	YS
-0.0000	0.0001	0.0001	-0.0005	0.0029	0.0029
0.0000	-0.0000	0.0002	0.0008	-0.0017	0.0075
0.0001	-0.0001	0.0002	0.0021	-0.0034	0.0092
0.0001	-0.0001	0.0003	0.0033	-0.0045	0.0103
0.0003	-0.0002	0.0004	0.0118	-0.0063	0.0165
0.0005	-0.0002	0.0005	0.0202	-0.0060	0.0214
0.0007	-0.0001	0.0007	0.0286	-0.0052	0.0258
0.0009	-0.0001	0.0008	0.0370	-0.0042	0.0301
0.0012	-0.0001	0.0009	0.0454	-0.0032	0.0341
0.0021	0.0001	0.0013	0.0839	0.0022	0.0499
0.0031	0.0002	0.0016	0.1224	0.0076	0.0629
0.0041	0.0003	0.0019	0.1609	0.0128	0.0736
0.0051	0.0004	0.0021	0.1994	0.0172	0.0822
0.0060	0.0005	0.0023	0.2378	0.0211	0.0889
0.0070	0.0006	0.0024	0.2763	0.0243	0.0938
0.0080	0.0007	0.0025	0.3148	0.0269	0.0968
0.0090	0.0007	0.0025	0.3533	0.0289	0.0980
0.0100	0.0008	0.0025	0.3918	0.0302	0.0973
0.0109	0.0008	0.0024	0.4302	0.0308	0.0949
0.0119	0.0008	0.0023	0.4687	0.0307	0.0908
0.0129	0.0008	0.0022	0.5072	0.0297	0.0849
0.0139	0.0007	0.0020	0.5457	0.0277	0.0775
0.0148	0.0006	0.0017	0.5842	0.0245	0.0687
0.0158	0.0005	0.0015	0.6227	0.0199	0.0585
0.0168	0.0004	0.0012	0.6611	0.0141	0.0469
0.0178	0.0002	0.0009	0.6996	0.0069	0.0340
0.0184	0.0000	0.0006	0.7245	0.0014	0.0249
0.0186	-0.0000	0.0005	0.7329	-0.0006	0.0217
0.0188	-0.0001	0.0005	0.7413	-0.0027	0.0184
0.0190	-0.0001	0.0004	0.7497	-0.0048	0.0150
0.0193	-0.0001	0.0003	0.7610	-0.0045	0.0103
0.0194	-0.0001	0.0002	0.7622	-0.0034	0.0092
0.0194	-0.0000	0.0002	0.7635	-0.0017	0.0075
0.0194	0.0001	0.0001	0.7648	0.0029	0.0029

RADIUS (METERS) = 0.2995
 CHCRD (METERS) = 0.0194
 ZCSL (METERS) = 0.0090
 YCSL (METERS) = 0.0012
 RLE (METERS) = 0.00229
 RTE (METERS) = 0.00229
 X-AREA (SQ. METERS) = 0.00025
 GAMMA-CHORD (DEG.) = 41.06

RADIUS (INCHES) = 11.7900
 CHORD (INCHES) = 0.7643
 ZCSL (INCHES) = 0.3561
 YCSL (INCHES) = 0.0480
 RLE (INCHES) = 0.0090
 RTE (INCHES) = 0.0090
 X-AREA (SQ. IN.) = 0.0392
 GAMMA-CHORD (RAD.) = 0.7167

MANUFACTURING COORDINATES
COMPRESSOR 3S2 - ROTOR 2

20 PERCENT SPAN

METERS			INCHES		
ZC	YP	YS	ZC	YP	YS
-0.0000	-0.0001	-0.0001	-0.0004	-0.0028	-0.0028
0.0000	0.0001	-0.0002	0.0009	0.0020	-0.0075
0.0001	0.0001	-0.0002	0.0023	0.0037	-0.0092
0.0001	0.0001	-0.0003	0.0037	0.0048	-0.0103
0.0003	0.0002	-0.0004	0.0127	0.0061	-0.0159
0.0006	0.0001	-0.0005	0.0218	0.0054	-0.0205
0.0008	0.0001	-0.0006	0.0308	0.0043	-0.0248
0.0010	0.0001	-0.0007	0.0399	0.0030	-0.0288
0.0012	0.0000	-0.0008	0.0489	0.0017	-0.0326
0.0023	-0.0001	-0.0012	0.0903	-0.0047	-0.0480
0.0033	-0.0003	-0.0015	0.1317	-0.0110	-0.0607
0.0044	-0.0004	-0.0018	0.1731	-0.0168	-0.0712
0.0054	-0.0006	-0.0020	0.2145	-0.0217	-0.0798
0.0065	-0.0007	-0.0022	0.2558	-0.0259	-0.0864
0.0075	-0.0007	-0.0023	0.2972	-0.0294	-0.0913
0.0086	-0.0008	-0.0024	0.3386	-0.0321	-0.0944
0.0097	-0.0009	-0.0024	0.3800	-0.0340	-0.0957
0.0107	-0.0009	-0.0024	0.4213	-0.0351	-0.0952
0.0118	-0.0009	-0.0024	0.4627	-0.0355	-0.0930
0.0128	-0.0009	-0.0023	0.5041	-0.0349	-0.0891
0.0139	-0.0009	-0.0021	0.5455	-0.0335	-0.0835
0.0149	-0.0008	-0.0019	0.5869	-0.0310	-0.0764
0.0160	-0.0007	-0.0017	0.6282	-0.0272	-0.0678
0.0170	-0.0006	-0.0015	0.6696	-0.0221	-0.0579
0.0181	-0.0004	-0.0012	0.7110	-0.0157	-0.0465
0.0191	-0.0002	-0.0009	0.7524	-0.0078	-0.0337
0.0198	-0.0000	-0.0006	0.7791	-0.0019	-0.0247
0.0200	0.0000	-0.0005	0.7881	0.0002	-0.0215
0.0202	0.0001	-0.0005	0.7972	0.0024	-0.0183
0.0205	0.0001	-0.0004	0.8062	0.0047	-0.0150
0.0208	0.0001	-0.0003	0.8183	0.0048	-0.0103
0.0208	0.0001	-0.0002	0.8197	0.0037	-0.0092
0.0209	0.0001	-0.0002	0.8211	0.0020	-0.0075
0.0209	-0.0001	-0.0001	0.8224	-0.0028	-0.0028

RADIUS (METERS) = 0.2840
 CHORD (METERS) = 0.0209
 ZCSL (METERS) = 0.0098
 YCSL (METERS) = 0.0012
 RLE (METERS) = 0.00229
 RTE (METERS) = 0.00229
 X-AREA (SQ. METERS) = 0.00025
 GAMMA-CHORD (DEG.) = 43.62

RADIUS (INCHES) = 11.1800
 CHORD (INCHES) = 0.8220
 ZCSL (INCHES) = 0.3852
 YCSL (INCHES) = 0.0487
 RLE (INCHES) = 0.0090
 RTE (INCHES) = 0.0090
 X-AREA (SQ. IN.) = 0.0382
 GAMMA-CHORD (RAD.) = 0.7614

MANUFACTURING COORDINATES
COMPRESSOR 3S2 - ROTOR 2

50 PERCENT SPAN

METERS			INCHES		
ZC	YP	YS	ZC	YP	YS
-0.0000	-0.0001	-0.0001	-0.0003	-0.0023	-0.0023
0.0000	0.0001	-0.0002	0.0011	0.0025	-0.0070
0.0001	0.0001	-0.0002	0.0025	0.0042	-0.0087
0.0001	0.0001	-0.0002	0.0038	0.0053	-0.0098
0.0003	0.0002	-0.0004	0.0129	0.0066	-0.0143
0.0006	0.0002	-0.0005	0.0219	0.0060	-0.0180
0.0008	0.0001	-0.0005	0.0310	0.0050	-0.0215
0.0010	0.0001	-0.0006	0.0400	0.0040	-0.0247
0.0012	0.0001	-0.0007	0.0491	0.0029	-0.0278
0.0023	-0.0001	-0.0010	0.0904	-0.0024	-0.0403
0.0033	-0.0002	-0.0013	0.1318	-0.0076	-0.0506
0.0044	-0.0003	-0.0015	0.1732	-0.0123	-0.0592
0.0054	-0.0004	-0.0017	0.2145	-0.0163	-0.0663
0.0065	-0.0005	-0.0018	0.2559	-0.0198	-0.0718
0.0076	-0.0006	-0.0019	0.2972	-0.0227	-0.0758
0.0086	-0.0006	-0.0020	0.3386	-0.0249	-0.0783
0.0097	-0.0007	-0.0020	0.3800	-0.0264	-0.0795
0.0107	-0.0007	-0.0020	0.4213	-0.0273	-0.0791
0.0118	-0.0007	-0.0020	0.4627	-0.0275	-0.0773
0.0128	-0.0007	-0.0019	0.5041	-0.0271	-0.0741
0.0139	-0.0007	-0.0018	0.5454	-0.0259	-0.0695
0.0149	-0.0006	-0.0016	0.5868	-0.0237	-0.0637
0.0160	-0.0005	-0.0014	0.6282	-0.0206	-0.0567
0.0170	-0.0004	-0.0012	0.6695	-0.0164	-0.0486
0.0181	-0.0003	-0.0010	0.7109	-0.0112	-0.0393
0.0191	-0.0001	-0.0007	0.7523	-0.0048	-0.0289
0.0198	0.0000	-0.0005	0.7790	0.0000	-0.0217
0.0200	0.0000	-0.0005	0.7880	0.0018	-0.0191
0.0202	0.0001	-0.0004	0.7971	0.0036	-0.0165
0.0205	0.0001	-0.0004	0.8061	0.0054	-0.0138
0.0208	0.0001	-0.0002	0.8182	0.0053	-0.0098
0.0208	0.0001	-0.0002	0.8195	0.0042	-0.0087
0.0209	0.0001	-0.0002	0.8209	0.0025	-0.0071
0.0209	-0.0001	-0.0001	0.8223	-0.0023	-0.0023

RADIUS (METERS) = 0.2916
 CHORD (METERS) = 0.0209
 ZCSL (METERS) = 0.0099
 YCSL (METERS) = 0.0010
 RLE (METERS) = 0.00229
 RTE (METERS) = 0.00229
 X-AREA (SQ. METERS) = 0.00022
 GAMMA-CHORD (DEG.) = 45.91

RADIUS (INCHES) = 11.4800
 CHORD (INCHES) = 0.8220
 ZCSL (INCHES) = 0.3879
 YCSL (INCHES) = 0.0394
 RLE (INCHES) = 0.0090
 RTE (INCHES) = 0.0090
 X-AREA (SQ. IN.) = 0.0334
 GAMMA-CHORD (RAD.) = 0.8013

MANUFACTURING COORDINATES
COMPRESSOR 3S2 - ROTOR 2

80 PERCENT SPAN

METERS			INCHES		
ZC	YP	YS	ZC	YP	YS
-0.0000	-0.0001	-0.0001	-0.0003	-0.0022	-0.0022
0.0000	0.0001	-0.0002	0.0011	0.0026	-0.0070
0.0001	0.0001	-0.0002	0.0025	0.0043	-0.0087
0.0001	0.0001	-0.0002	0.0038	0.0054	-0.0098
0.0003	0.0002	-0.0003	0.0129	0.0065	-0.0137
0.0006	0.0001	-0.0004	0.0219	0.0056	-0.0171
0.0008	0.0001	-0.0005	0.0310	0.0045	-0.0202
0.0010	0.0001	-0.0006	0.0400	0.0033	-0.0231
0.0012	0.0001	-0.0007	0.0491	0.0020	-0.0259
0.0023	-0.0001	-0.0009	0.0904	-0.0037	-0.0374
0.0033	-0.0002	-0.0012	0.1318	-0.0092	-0.0469
0.0044	-0.0004	-0.0014	0.1732	-0.0141	-0.0549
0.0054	-0.0005	-0.0016	0.2145	-0.0182	-0.0615
0.0065	-0.0006	-0.0017	0.2559	-0.0218	-0.0666
0.0076	-0.0006	-0.0018	0.2972	-0.0247	-0.0704
0.0086	-0.0007	-0.0019	0.3386	-0.0268	-0.0729
0.0097	-0.0007	-0.0019	0.3800	-0.0282	-0.0740
0.0107	-0.0007	-0.0019	0.4213	-0.0290	-0.0738
0.0118	-0.0007	-0.0018	0.4627	-0.0290	-0.0722
0.0128	-0.0007	-0.0018	0.5041	-0.0283	-0.0694
0.0139	-0.0007	-0.0017	0.5454	-0.0269	-0.0652
0.0149	-0.0006	-0.0015	0.5868	-0.0245	-0.0599
0.0160	-0.0005	-0.0014	0.6281	-0.0211	-0.0536
0.0170	-0.0004	-0.0012	0.6695	-0.0167	-0.0460
0.0181	-0.0003	-0.0009	0.7109	-0.0113	-0.0374
0.0191	-0.0001	-0.0007	0.7522	-0.0048	-0.0277
0.0198	0.0000	-0.0005	0.7789	0.0001	-0.0209
0.0200	0.0000	-0.0005	0.7880	0.0018	-0.0185
0.0202	0.0001	-0.0004	0.7970	0.0036	-0.0160
0.0205	0.0001	-0.0003	0.8061	0.0055	-0.0136
0.0208	0.0001	-0.0002	0.8182	0.0054	-0.0098
0.0208	0.0001	-0.0002	0.8195	0.0043	-0.0087
0.0209	0.0001	-0.0002	0.8209	0.0026	-0.0070
0.0209	-0.0001	-0.0001	0.8223	-0.0022	-0.0022

RADIUS (METERS) = 0.2995
 CHORD (METERS) = 0.0209
 ZCSL (METERS) = 0.0099
 YCSL (METERS) = 0.0010
 RLE (METERS) = 0.00229
 RTE (METERS) = 0.00229
 X-AREA (SQ. METERS) = 0.00019
 GAMMA-CHORD (DEG.) = 48.48

RADIUS (INCHES) = 11.7900
 CHORD (INCHES) = 0.8220
 ZCSL (INCHES) = 0.3907
 YCSL (INCHES) = 0.0376
 RLE (INCHES) = 0.0090
 RTE (INCHES) = 0.0090
 X-AREA (SQ. IN.) = 0.0296
 GAMMA-CHORD (RAD.) = 0.8462

MANUFACTURING COORDINATES
COMPRESSOR 3S2 - STATOR 2

20 PERCENT SPAN

METERS			INCHES		
ZC	YP	YS	ZC	YP	YS
-0.0000	0.0001	0.0001	-0.0005	0.0030	0.0030
0.0000	-0.0001	0.0002	0.0010	-0.0020	0.0079
0.0001	-0.0001	0.0002	0.0025	-0.0037	0.0096
0.0001	-0.0001	0.0003	0.0039	-0.0048	0.0107
0.0003	-0.0001	0.0004	0.0132	-0.0056	0.0169
0.0006	-0.0001	0.0006	0.0234	-0.0047	0.0226
0.0008	-0.0001	0.0007	0.0332	-0.0035	0.0276
0.0011	-0.0001	0.0008	0.0430	-0.0020	0.0323
0.0013	-0.0000	0.0009	0.0527	-0.0004	0.0367
0.0025	0.0002	0.0014	0.0973	0.0070	0.0548
0.0036	0.0004	0.0018	0.1419	0.0143	0.0696
0.0047	0.0005	0.0021	0.1865	0.0209	0.0818
0.0059	0.0007	0.0023	0.2311	0.0266	0.0918
0.0070	0.0008	0.0025	0.2757	0.0316	0.0996
0.0081	0.0009	0.0027	0.3203	0.0356	0.1052
0.0093	0.0010	0.0028	0.3649	0.0387	0.1088
0.0104	0.0010	0.0028	0.4095	0.0409	0.1103
0.0115	0.0011	0.0028	0.4541	0.0423	0.1097
0.0127	0.0011	0.0027	0.4987	0.0427	0.1071
0.0138	0.0011	0.0026	0.5433	0.0421	0.1026
0.0149	0.0010	0.0024	0.5879	0.0405	0.0961
0.0161	0.0010	0.0022	0.6325	0.0376	0.0878
0.0172	0.0008	0.0020	0.6771	0.0331	0.0778
0.0183	0.0007	0.0017	0.7217	0.0272	0.0662
0.0195	0.0005	0.0013	0.7663	0.0198	0.0529
0.0206	0.0003	0.0010	0.8109	0.0106	0.0380
0.0213	0.0001	0.0007	0.8397	0.0037	0.0274
0.0216	0.0000	0.0006	0.8494	0.0012	0.0237
0.0218	-0.0000	0.0005	0.8592	-0.0013	0.0200
0.0221	-0.0001	0.0004	0.8690	-0.0040	0.0161
0.0224	-0.0001	0.0003	0.8820	-0.0048	0.0107
0.0224	-0.0001	0.0002	0.8834	-0.0037	0.0096
0.0225	-0.0001	0.0002	0.8849	-0.0020	0.0079
0.0225	0.0001	0.0001	0.8864	0.0030	0.0030

RADIUS (METERS)	=	0.2840	RADIUS (INCHES)	=	11.1800
CHCRD (METERS)	=	0.0225	CHORD (INCHES)	=	0.8859
ZCSL (METERS)	=	0.0105	ZCSL (INCHES)	=	0.4135
YCSL (METERS)	=	0.0015	YCSL (INCHES)	=	0.0572
RLE (METERS)	=	0.00229	RLE (INCHES)	=	0.0090
RTE (METERS)	=	0.00229	RTE (INCHES)	=	0.0090
X-AREA (SQ. METERS)	=	0.00029	X-AREA (SQ. IN.)	=	0.0457
GAMMA-CHORD (DEG.)	=	42.99	GAMMA-CHORD (RAD.)	=	0.7504

MANUFACTURING COORDINATES
COMPRESSOR 3S2 - STATOR 2

50 PERCENT SPAN

METERS			INCHES		
ZC	YP	YS	ZC	YP	YS
-0.0000	0.0001	0.0001	-0.0004	0.0027	0.0027
0.0000	-0.0001	0.0002	0.0011	-0.0023	0.0076
0.0001	-0.0001	0.0002	0.0026	-0.0040	0.0094
0.0001	-0.0001	0.0003	0.0040	-0.0051	0.0105
0.0004	-0.0002	0.0004	0.0138	-0.0064	0.0168
0.0006	-0.0002	0.0006	0.0235	-0.0060	0.0222
0.0008	-0.0001	0.0007	0.0333	-0.0053	0.0271
0.0011	-0.0001	0.0008	0.0430	-0.0043	0.0316
0.0013	-0.0001	0.0009	0.0528	-0.0032	0.0359
0.0025	0.0001	0.0013	0.0974	0.0024	0.0531
0.0036	0.0002	0.0017	0.1420	0.0081	0.0671
0.0047	0.0003	0.0020	0.1866	0.0135	0.0786
0.0059	0.0005	0.0022	0.2311	0.0182	0.0881
0.0070	0.0006	0.0024	0.2757	0.0223	0.0953
0.0081	0.0007	0.0026	0.3203	0.0257	0.1006
0.0093	0.0007	0.0026	0.3649	0.0285	0.1038
0.0104	0.0008	0.0027	0.4095	0.0305	0.1051
0.0115	0.0008	0.0027	0.4541	0.0320	0.1044
0.0127	0.0008	0.0026	0.4987	0.0327	0.1018
0.0138	0.0008	0.0025	0.5433	0.0326	0.0972
0.0149	0.0008	0.0023	0.5879	0.0316	0.0909
0.0161	0.0008	0.0021	0.6324	0.0296	0.0828
0.0172	0.0007	0.0019	0.6770	0.0262	0.0733
0.0183	0.0005	0.0016	0.7216	0.0215	0.0623
0.0195	0.0004	0.0013	0.7662	0.0154	0.0497
0.0206	0.0002	0.0009	0.8108	0.0078	0.0358
0.0213	0.0001	0.0007	0.8396	0.0020	0.0260
0.0216	-0.0000	0.0006	0.8494	-0.0001	0.0225
0.0218	-0.0001	0.0005	0.8591	-0.0023	0.0190
0.0221	-0.0001	0.0004	0.8689	-0.0046	0.0155
0.0224	-0.0001	0.0003	0.8819	-0.0051	0.0104
0.0224	-0.0001	0.0002	0.8834	-0.0040	0.0094
0.0225	-0.0001	0.0002	0.8848	-0.0023	0.0076
0.0225	0.0001	0.0001	0.8863	0.0027	0.0027

RADIUS (METERS) = 0.2916
 CHORD (METERS) = 0.0225
 ZCSL (METERS) = 0.0105
 YCSL (METERS) = 0.0013
 HLE (METERS) = 0.000229
 RTE (METERS) = 0.000229
 X-AREA (SQ. METERS) = 0.000031
 GAMMA-CHORD (DEG.) = 41.49

RADIUS (INCHES) = 11.4800
 CHORD (INCHES) = 0.8859
 ZCSL (INCHES) = 0.4121
 YCSL (INCHES) = 0.0515
 HLE (INCHES) = 0.0090
 RTE (INCHES) = 0.0090
 X-AREA (SQ. IN.) = 0.0486
 GAMMA-CHORD (RAD.) = 0.7241

MANUFACTURING COORDINATES
COMPRESSOR 3S2 - STATOR 2

80 PERCENT SPAN

METERS			INCHES		
ZC	YP	YS	ZC	YP	YS
-0.0000	0.0001	0.0001	-0.0005	0.0029	0.0029
0.0000	-0.0001	0.0002	0.0010	-0.0021	0.0078
0.0001	-0.0001	0.0002	0.0025	-0.0038	0.0096
0.0001	-0.0001	0.0003	0.0040	-0.0049	0.0111
0.0003	-0.0002	0.0005	0.0137	-0.0068	0.0186
0.0006	-0.0002	0.0006	0.0235	-0.0065	0.0241
0.0008	-0.0001	0.0007	0.0332	-0.0055	0.0294
0.0011	-0.0001	0.0009	0.0430	-0.0045	0.0344
0.0013	-0.0001	0.0010	0.0527	-0.0034	0.0391
0.0025	0.0001	0.0015	0.0973	0.0027	0.0575
0.0036	0.0002	0.0018	0.1419	0.0089	0.0726
0.0047	0.0004	0.0022	0.1865	0.0147	0.0850
0.0059	0.0005	0.0024	0.2311	0.0198	0.0951
0.0070	0.0006	0.0026	0.2757	0.0243	0.1029
0.0081	0.0007	0.0028	0.3203	0.0279	0.1085
0.0093	0.0008	0.0028	0.3649	0.0309	0.1120
0.0104	0.0008	0.0029	0.4095	0.0332	0.1133
0.0115	0.0009	0.0029	0.4541	0.0348	0.1125
0.0127	0.0009	0.0028	0.4987	0.0356	0.1096
0.0138	0.0009	0.0027	0.5433	0.0355	0.1047
0.0149	0.0009	0.0025	0.5879	0.0346	0.0978
0.0161	0.0008	0.0023	0.6325	0.0324	0.0891
0.0172	0.0007	0.0020	0.6771	0.0288	0.0788
0.0183	0.0006	0.0017	0.7217	0.0238	0.0669
0.0195	0.0004	0.0014	0.7663	0.0172	0.0533
0.0206	0.0002	0.0010	0.8109	0.0090	0.0381
0.0213	0.0001	0.0007	0.8397	0.0028	0.0275
0.0216	0.0000	0.0006	0.8494	0.0005	0.0237
0.0218	-0.0000	0.0005	0.8592	-0.0018	0.0199
0.0221	-0.0001	0.0004	0.8689	-0.0042	0.0160
0.0224	-0.0001	0.0003	0.8819	-0.0049	0.0106
0.0224	-0.0001	0.0002	0.8834	-0.0038	0.0096
0.0225	-0.0001	0.0002	0.8849	-0.0021	0.0078
0.0225	0.0001	0.0001	0.8864	0.0029	0.0029

RADIUS (METERS) = 0.2995
 CHCRD (METERS) = 0.0225
 ZCSL (METERS) = 0.0104
 YCSL (METERS) = 0.0014
 RLE (METERS) = 0.00229
 RTE (METERS) = 0.00229
 X-AREA (SQ. METERS) = 0.00034
 GAMMA-CHORD (DEG.) = 41.93

RADIUS (INCHES) = 11.7900
 CHORD (INCHES) = 0.8859
 ZCSL (INCHES) = 0.4100
 YCSL (INCHES) = 0.0557
 RLE (INCHES) = 0.0090
 RTE (INCHES) = 0.0090
 X-AREA (SQ. IN.) = 0.0520
 GAMMA-CHORD (RAD.) = 0.7318

MANUFACTURING COORDINATES
COMPRESSOR 352 - ROTOR 3

20 PERCENT SPAN

METERS			INCHES		
ZC	YP	YS	ZC	YP	YS
-0.0000	-0.0001	-0.0001	-0.0000	-0.0025	-0.0025
0.0000	0.0001	-0.0002	0.0012	0.0026	-0.0076
0.0001	0.0001	-0.0002	0.0028	0.0044	.0093
0.0001	0.0001	-0.0003	0.0044	0.0055	-0.0104
0.0004	0.0002	-0.0004	0.0148	0.0065	-0.0164
0.0006	0.0002	-0.0005	0.0252	0.0061	-0.0216
0.0009	0.0001	-0.0007	0.0356	0.0052	-0.0262
0.0012	0.0001	-0.0008	0.0461	0.0042	-0.0306
0.0014	0.0001	-0.0009	0.0565	0.0030	-0.0347
0.0026	-0.0001	-0.0013	0.1041	-0.0027	-0.0512
0.0039	-0.0002	-0.0016	0.1517	-0.0085	-0.0648
0.0051	-0.0004	-0.0019	0.1994	-0.0139	-0.0760
0.0063	-0.0005	-0.0022	0.2470	-0.0186	-0.0852
0.0075	-0.0006	-0.0023	0.2946	-0.0227	-0.0922
0.0087	-0.0007	-0.0025	0.3422	-0.0261	-0.0974
0.0099	-0.0007	-0.0026	0.3899	-0.0288	-0.1006
0.0111	-0.0008	-0.0026	0.4375	-0.0306	-0.1019
0.0123	-0.0008	-0.0026	0.4851	-0.0321	-0.1012
0.0135	-0.0008	-0.0025	0.5327	-0.0327	-0.0988
0.0147	-0.0008	-0.0024	0.5804	-0.0325	-0.0944
0.0160	-0.0008	-0.0022	0.6280	-0.0314	-0.0883
0.0172	-0.0007	-0.0020	0.6756	-0.0293	-0.0805
0.0184	-0.0007	-0.0018	0.7232	-0.0259	-0.0713
0.0196	-0.0005	-0.0015	0.7709	-0.0211	-0.0606
0.0208	-0.0004	-0.0012	0.8185	-0.0151	-0.0484
0.0220	-0.0002	-0.0009	0.8661	-0.0075	-0.0349
0.0228	-0.0000	-0.0006	0.8969	-0.0018	-0.0254
0.0230	0.0000	-0.0006	0.9073	0.0003	-0.0221
0.0233	0.0001	-0.0005	0.9177	0.0024	-0.0187
0.0236	0.0001	-0.0004	0.9281	0.0046	-0.0152
0.0239	0.0001	-0.0003	0.9420	0.0055	-0.0104
0.0240	0.0001	-0.0002	0.9436	0.0044	-0.0093
0.0240	0.0001	-0.0002	0.9452	0.0026	-0.0076
0.0240	-0.0001	-0.0001	0.9467	-0.0025	-0.0025

RADIUS (METERS) = 0.2840
 CHORD (METERS) = 0.0240
 ZCSL (METERS) = 0.0112
 YCSL (METERS) = 0.0013
 RLE (METERS) = 0.00229
 RTE (METERS) = 0.00229
 X-AREA (SQ. METERS) = 0.00032
 GAMMA-CHORD (DEG.) = 47.28

RADIUS (INCHES) = 11.1800
 CHORD (INCHES) = 0.9464
 ZCSL (INCHES) = 0.4413
 YCSL (INCHES) = 0.0502
 RLE (INCHES) = 0.0090
 RTE (INCHES) = 0.0090
 X-AREA (SQ. IN.) = 0.0497
 GAMMA-CHORD (RAD.) = 0.8252

MANUFACTURING COORDINATES
COMPRESSOR 352 - ROTOR 3

50 PERCENT SPAN

METERS			INCHES		
ZC	YP	YS	ZC	YP	YS
-0.0000	-0.0000	-0.0000	-0.0002	-0.0019	-0.0019
0.0000	0.0001	-0.0002	0.0014	0.0032	-0.0070
0.0001	0.0001	-0.0002	0.0030	0.0049	-0.0088
0.0001	0.0002	-0.0002	0.0045	0.0060	-0.0098
0.0004	0.0002	-0.0004	0.0149	0.0069	-0.0142
0.0006	0.0002	-0.0005	0.0254	0.0066	-0.0183
0.0009	0.0002	-0.0006	0.0358	0.0061	-0.0220
0.0012	0.0001	-0.0006	0.0462	0.0054	-0.0253
0.0014	0.0001	-0.0007	0.0566	0.0045	-0.0285
0.0026	0.0000	-0.0011	0.1042	0.0005	-0.0416
0.0039	-0.0001	-0.0013	0.1518	-0.0038	-0.0522
0.0051	-0.0002	-0.0016	0.1994	-0.0078	-0.0611
0.0063	-0.0003	-0.0017	0.2470	-0.0113	-0.0684
0.0075	-0.0004	-0.0019	0.2947	-0.0144	-0.0740
0.0087	-0.0004	-0.0020	0.3423	-0.0169	-0.0780
0.0099	-0.0005	-0.0020	0.3899	-0.0190	-0.0806
0.0111	-0.0005	-0.0021	0.4375	-0.0205	-0.0816
0.0123	-0.0005	-0.0021	0.4851	-0.0216	-0.0811
0.0135	-0.0006	-0.0020	0.5327	-0.0221	-0.0791
0.0147	-0.0006	-0.0019	0.5803	-0.0220	-0.0756
0.0159	-0.0005	-0.0018	0.6279	-0.0212	-0.0707
0.0172	-0.0005	-0.0016	0.6755	-0.0197	-0.0646
0.0184	-0.0004	-0.0015	0.7232	-0.0171	-0.0574
0.0196	-0.0003	-0.0012	0.7708	-0.0136	-0.0490
0.0208	-0.0002	-0.0010	0.8184	-0.0091	-0.0395
0.0220	-0.0001	-0.0007	0.8660	-0.0035	-0.0289
0.0228	0.0000	-0.0005	0.8967	0.0008	-0.0216
0.0230	0.0001	-0.0005	0.9071	0.0023	-0.0190
0.0233	0.0001	-0.0004	0.9176	0.0039	-0.0164
0.0236	0.0001	-0.0003	0.9280	0.0056	-0.0137
0.0239	0.0002	-0.0002	0.9419	0.0060	-0.0098
0.0240	0.0001	-0.0002	0.9434	0.0049	-0.0088
0.0240	0.0001	-0.0002	0.9450	0.0032	-0.0070
0.0240	-0.0000	-0.0000	0.9466	-0.0019	-0.0019

RADIUS (METERS) = 0.2916
 CHORD (METERS) = 0.0240
 ZCSL (METERS) = 0.0113
 YCSL (METERS) = 0.0010
 RLE (METERS) = 0.00229
 RTE (METERS) = 0.00229
 X-AREA (SQ. METERS) = 0.00028
 GAMMA-CHORD (DEG.) = 49.00

RADIUS (INCHES) = 11.4800
 CHORD (INCHES) = 0.9464
 ZCSL (INCHES) = 0.4447
 YCSL (INCHES) = 0.0383
 RLE (INCHES) = 0.0090
 RTE (INCHES) = 0.0090
 X-AREA (SQ. IN.) = 0.0433
 GAMMA-CHORD (RAD.) = 0.8552

MANUFACTURING COORDINATES
COMPRESSOR 352 - ROTOR 3

80 PERCENT SPAN

METERS			INCHES		
ZC	YP	YS	ZC	YP	YS
-0.0000	-0.0000	-0.0000	-0.0002	-0.0018	-0.0018
0.0000	0.0001	-0.0002	0.0014	0.0033	-0.0069
0.0001	0.0001	-0.0002	0.0030	0.0050	-0.0087
0.0001	0.0002	-0.0002	0.0045	0.0061	-0.0097
0.0004	0.0002	-0.0004	0.0150	0.0072	-0.0140
0.0006	0.0002	-0.0004	0.0254	0.0067	-0.0175
0.0009	0.0001	-0.0005	0.0358	0.0059	-0.0206
0.0012	0.0001	-0.0006	0.0462	0.0050	-0.0237
0.0014	0.0001	-0.0007	0.0566	0.0041	-0.0265
0.0026	-0.0000	-0.0010	0.1042	-0.0004	-0.0382
0.0039	-0.0001	-0.0012	0.1518	-0.0050	-0.0477
0.0051	-0.0002	-0.0014	0.1995	-0.0092	-0.0557
0.0063	-0.0003	-0.0016	0.2471	-0.0128	-0.0623
0.0075	-0.0004	-0.0017	0.2947	-0.0159	-0.0674
0.0087	-0.0005	-0.0018	0.3423	-0.0185	-0.0711
0.0099	-0.0005	-0.0019	0.3899	-0.0205	-0.0735
0.0111	-0.0006	-0.0019	0.4375	-0.0218	-0.0745
0.0123	-0.0006	-0.0019	0.4851	-0.0227	-0.0742
0.0135	-0.0006	-0.0018	0.5327	-0.0230	-0.0724
0.0147	-0.0006	-0.0018	0.5803	-0.0226	-0.0694
0.0159	-0.0006	-0.0017	0.6279	-0.0217	-0.0651
0.0172	-0.0005	-0.0015	0.6755	-0.0199	-0.0596
0.0184	-0.0004	-0.0013	0.7231	-0.0171	-0.0531
0.0196	-0.0003	-0.0012	0.7707	-0.0135	-0.0455
0.0208	-0.0002	-0.0009	0.8184	-0.0089	-0.0369
0.0220	-0.0001	-0.0007	0.8660	-0.0033	-0.0272
0.0228	0.0000	-0.0005	0.8967	0.0010	-0.0206
0.0230	0.0001	-0.0005	0.9071	0.0025	-0.0182
0.0233	0.0001	-0.0004	0.9176	0.0041	-0.0158
0.0236	0.0001	-0.0003	0.9280	0.0057	-0.0134
0.0239	0.0002	-0.0002	0.9419	0.0061	-0.0097
0.0240	0.0001	-0.0002	0.9434	0.0050	-0.0087
0.0240	0.0001	-0.0002	0.9450	0.0033	-0.0069
0.0240	-0.0000	-0.0000	0.9466	-0.0018	-0.0018

RADIUS (METERS) = 0.2995
 CHORD (METERS) = 0.0240
 ZCSL (METERS) = 0.0113
 YCSL (METERS) = 0.0009
 RLE (METERS) = 0.00229
 RTE (METERS) = 0.00229
 X-AREA (SQ. METERS) = 0.00025
 GAMMA-CHORD (DEG.) = 51.25

RADIUS (INCHES) = 11.7900
 CHORD (INCHES) = 0.9464
 ZCSL (INCHES) = 0.4468
 YCSL (INCHES) = 0.0358
 RLE (INCHES) = 0.0090
 RTE (INCHES) = 0.0090
 X-AREA (SQ. IN.) = 0.0383
 GAMMA-CHORD (RAD.) = 0.8945

MANUFACTURING COORDINATES
COMPRESSOR 3S2 - STATOR 3

20 PERCENT SPAN

METERS			INCHES		
ZC	YP	YS	ZC	YP	YS
-0.0000	0.0001	0.0001	-0.0005	0.0029	0.0029
0.0000	-0.0001	0.0002	0.0012	-0.0023	0.0081
0.0001	-0.0001	0.0003	0.0028	-0.0041	0.0099
0.0001	-0.0001	0.0003	0.0045	-0.0051	0.0112
0.0004	-0.0002	0.0005	0.0154	-0.0061	0.0187
0.0007	-0.0001	0.0006	0.0263	-0.0052	0.0248
0.0009	-0.0001	0.0008	0.0373	-0.0038	0.0303
0.0012	-0.0001	0.0009	0.0482	-0.0022	0.0356
0.0015	-0.0000	0.0010	0.0592	-0.0006	0.0406
0.0028	0.0002	0.0015	0.1091	0.0074	0.0606
0.0040	0.0004	0.0020	0.1592	0.0153	0.0770
0.0053	0.0006	0.0023	0.2091	0.0225	0.0906
0.0066	0.0007	0.0026	0.2591	0.0287	0.1017
0.0079	0.0009	0.0028	0.3091	0.0341	0.1103
0.0091	0.0010	0.0030	0.3591	0.0385	0.1166
0.0104	0.0011	0.0031	0.4091	0.0419	0.1205
0.0117	0.0011	0.0031	0.4591	0.0444	0.1221
0.0129	0.0012	0.0031	0.5091	0.0459	0.1214
0.0142	0.0012	0.0030	0.5591	0.0465	0.1185
0.0155	0.0012	0.0029	0.6091	0.0460	0.1134
0.0167	0.0011	0.0027	0.6591	0.0443	0.1060
0.0180	0.0010	0.0025	0.7091	0.0413	0.0967
0.0193	0.0009	0.0022	0.7591	0.0366	0.0856
0.0205	0.0008	0.0018	0.8091	0.0303	0.0726
0.0218	0.0006	0.0015	0.8590	0.0222	0.0578
0.0231	0.0003	0.0010	0.9090	0.0123	0.0411
0.0239	0.0001	0.0007	0.9413	0.0049	0.0295
0.0242	0.0001	0.0006	0.9523	0.0022	0.0254
0.0245	-0.0000	0.0005	0.9632	-0.0006	0.0211
0.0247	-0.0001	0.0004	0.9741	-0.0035	0.0168
0.0251	-0.0001	0.0003	0.9887	-0.0051	0.0110
0.0252	-0.0001	0.0003	0.9904	-0.0041	0.0099
0.0252	-0.0001	0.0002	0.9920	-0.0023	0.0081
0.0252	0.0001	0.0001	0.9937	0.0029	0.0029

RADIUS (METERS) = 0.2840
 CHORD (METERS) = 0.0252
 ZCSL (METERS) = 0.0117
 YCSL (METERS) = 0.0016
 RLE (METERS) = 0.000229
 RTE (METERS) = 0.000229
 X-AREA (SQ. METERS) = 0.000037
 GAMMA-CHORD (DEG.) = 42.26

RADIUS (INCHES) = 11.1800
 CHORD (INCHES) = 0.9932
 ZCSL (INCHES) = 0.4610
 YCSL (INCHES) = 0.0632
 RLE (INCHES) = 0.0090
 RTE (INCHES) = 0.0090
 X-AREA (SQ. IN.) = 0.0568
 GAMMA-CHORD (RAD.) = 0.7376

MANUFACTURING COORDINATES
 COMPRESSOR 3S2 - STATOR 3

50 PERCENT SPAN

METERS			INCHES		
ZC	YP	YS	ZC	YP	YS
-0.0000	0.0001	0.0001	-0.0004	0.0026	0.0026
0.0000	-0.0001	0.0002	0.0013	-0.0026	0.0079
0.0001	-0.0001	0.0002	0.0029	-0.0043	0.0096
0.0001	-0.0001	0.0003	0.0046	-0.0054	0.0110
0.0004	-0.0002	0.0005	0.0155	-0.0069	0.0186
0.0007	-0.0002	0.0006	0.0264	-0.0066	0.0245
0.0009	-0.0001	0.0008	0.0374	-0.0057	0.0299
0.0012	-0.0001	0.0009	0.0483	-0.0047	0.0350
0.0015	-0.0001	0.0010	0.0593	-0.0036	0.0398
0.0028	0.0001	0.0015	0.1092	0.0024	0.0590
0.0040	0.0002	0.0019	0.1592	0.0087	0.0746
0.0053	0.0004	0.0022	0.2092	0.0145	0.0875
0.0066	0.0005	0.0025	0.2592	0.0197	0.0980
0.0079	0.0006	0.0027	0.3092	0.0242	0.1060
0.0091	0.0007	0.0028	0.3592	0.0279	0.1119
0.0104	0.0008	0.0029	0.4092	0.0310	0.1155
0.0117	0.0008	0.0030	0.4592	0.0333	0.1169
0.0129	0.0009	0.0029	0.5092	0.0349	0.1160
0.0142	0.0009	0.0029	0.5591	0.0358	0.1130
0.0155	0.0009	0.0027	0.6091	0.0358	0.1079
0.0167	0.0009	0.0026	0.6591	0.0349	0.1007
0.0180	0.0008	0.0023	0.7091	0.0327	0.0917
0.0193	0.0007	0.0021	0.7591	0.0292	0.0810
0.0206	0.0006	0.0017	0.8091	0.0241	0.0686
0.0218	0.0004	0.0014	0.8591	0.0175	0.0545
0.0231	0.0002	0.0010	0.9091	0.0093	0.0389
0.0239	0.0001	0.0007	0.9413	0.0030	0.0280
0.0242	-0.0000	0.0006	0.9523	0.0007	0.0241
0.0245	-0.0000	0.0005	0.9632	-0.0017	0.0202
0.0247	-0.0001	0.0004	0.9742	-0.0041	0.0162
0.0251	-0.0001	0.0003	0.9887	-0.0054	0.0107
0.0252	-0.0001	0.0002	0.9904	-0.0043	0.0096
0.0252	-0.0001	0.0002	0.9920	-0.0026	0.0079
0.0252	0.0001	0.0001	0.9937	0.0026	0.0026

RADIUS (METERS) = 0.2916
 CHCRD (METERS) = 0.0252
 ZCSL (METERS) = 0.0117
 YCSL (METERS) = 0.0015
 RLE (METERS) = 0.00229
 RTE (METERS) = 0.00229
 X-AREA (SQ. METERS) = 0.00039
 GAMMA-CHORD (DEG.) = 41.01

RADIUS (INCHES) = 11.4800
 CHORD (INCHES) = 0.9933
 ZCSL (INCHES) = 0.4596
 YCSL (INCHES) = 0.0572
 RLE (INCHES) = 0.0090
 RTE (INCHES) = 0.0090
 X-AREA (SQ. IN.) = 0.0605
 GAMMA-CHORD (RAD.) = 0.7157

MANUFACTURING COORDINATES
 COMPRESSOR 3S2 - STATOR 3

80 PERCENT SPAN

METERS			INCHES		
ZC	YP	YS	ZC	YP	YS
-0.0000	0.0001	0.0001	-0.0005	0.0028	0.0028
0.0000	-0.0001	0.0002	0.0012	-0.0024	0.0080
0.0001	-0.0001	0.0003	0.0029	-0.0041	0.0100
0.0001	-0.0001	0.0003	0.0045	-0.0052	0.0117
0.0004	-0.0002	0.0005	0.0155	-0.0073	0.0202
0.0007	-0.0002	0.0007	0.0264	-0.0071	0.0264
0.0009	-0.0002	0.0008	0.0373	-0.0061	0.0322
0.0012	-0.0001	0.0010	0.0483	-0.0050	0.0378
0.0015	-0.0001	0.0011	0.0592	-0.0038	0.0430
0.0028	0.0001	0.0016	0.1092	0.0026	0.0635
0.0040	0.0002	0.0020	0.1592	0.0092	0.0802
0.0053	0.0004	0.0024	0.2092	0.0154	0.0940
0.0066	0.0005	0.0027	0.2592	0.0209	0.1052
0.0079	0.0007	0.0029	0.3092	0.0257	0.1137
0.0091	0.0008	0.0030	0.3592	0.0297	0.1200
0.0104	0.0008	0.0031	0.4092	0.0329	0.1238
0.0117	0.0009	0.0032	0.4592	0.0354	0.1253
0.0129	0.0009	0.0032	0.5092	0.0373	0.1243
0.0142	0.0010	0.0031	0.5591	0.0382	0.1211
0.0155	0.0010	0.0029	0.6091	0.0384	0.1156
0.0167	0.0010	0.0027	0.6591	0.0375	0.1078
0.0180	0.0009	0.0025	0.7091	0.0353	0.0981
0.0193	0.0008	0.0022	0.7591	0.0315	0.0865
0.0206	0.0007	0.0019	0.8091	0.0262	0.0732
0.0218	0.0005	0.0015	0.8591	0.0192	0.0581
0.0231	0.0003	0.0010	0.9091	0.0105	0.0413
0.0239	0.0001	0.0007	0.9414	0.0038	0.0295
0.0242	0.0000	0.0006	0.9523	0.0013	0.0253
0.0245	-0.0000	0.0005	0.9633	-0.0012	0.0211
0.0247	-0.0001	0.0004	0.9742	-0.0038	0.0168
0.0251	-0.0001	0.0003	0.9888	-0.0052	0.0109
0.0252	-0.0001	0.0002	0.9904	-0.0041	0.0098
0.0252	-0.0001	0.0002	0.9921	-0.0024	0.0080
0.0252	0.0001	0.0001	0.9938	0.0028	0.0028

RADIUS (METERS) = 0.2995
 CHCRC (METERS) = 0.0252
 ZCSL (METERS) = 0.0116
 YCSL (METERS) = 0.0016
 RLE (METERS) = 0.000229
 RTE (METERS) = 0.000229
 X-AREA (SQ. METERS) = 0.000042
 GAMMA-CHORD (DEG.) = 41.20

RADIUS (INCHES) = 11.7900
 CHORD (INCHES) = 0.9933
 ZCSL (INCHES) = 0.4576
 YCSL (INCHES) = 0.0614
 RLE (INCHES) = 0.0090
 RTE (INCHES) = 0.0090
 X-AREA (SQ. IN.) = 0.0647
 GAMMA-CHORD (RAD.) = 0.7191