

## **General Disclaimer**

### **One or more of the Following Statements may affect this Document**

- This document has been reproduced from the best copy furnished by the organizational source. It is being released in the interest of making available as much information as possible.
- This document may contain data, which exceeds the sheet parameters. It was furnished in this condition by the organizational source and is the best copy available.
- This document may contain tone-on-tone or color graphs, charts and/or pictures, which have been reproduced in black and white.
- This document is paginated as submitted by the original source.
- Portions of this document are not fully legible due to the historical nature of some of the material. However, it is the best reproduction available from the original submission.

# NASA Contractor Report 145280

(NASA-CR-145280) LOW-SPEED AERODYNAMIC  
CHARACTERISTICS FROM WIND-TUNNEL TESTS OF A  
LARGE-SCALE ADVANCED ARROW-WING  
SUPERSONIC-CRUISE TRANSPORT CONCEPT (Vought  
Corp., Hampton, Va.) 102 p HC A06/MF A01

N78-21053

Unclas

G3/02 12448

## LOW-SPEED AERODYNAMIC CHARACTERISTICS FROM WIND-TUNNEL TESTS OF A LARGE-SCALE ADVANCED ARROW-WING SUPERSONIC-CRUISE TRANSPORT CONCEPT

Paul M. Smith

VOUGHT CORPORATION

HAMPTON TECHNICAL CENTER

Hampton, VA 23666

CONTRACT NAS1-13500

April 1978

**NASA**

National Aeronautics and  
Space Administration

**Langley Research Center**  
Hampton, Virginia 23665



## SUMMARY

Tests have been conducted in the Langley full-scale wind tunnel to extend the existing low-speed aerodynamic data base of advanced supersonic-cruise arrow-wing configurations. Principle configuration variables included wing leading-edge flap deflection, wing trailing-edge flap deflection, horizontal tail effectiveness, and fuselage-forebody strakes. A limited investigation was also conducted to determine the low-speed aerodynamic effects due to slotted trailing-edge flaps.

Results of this investigation demonstrated that deflecting the wing leading-edge flaps downward to suppress the wing-apex vortices provided improved static longitudinal stability; however, it also resulted in significantly reduced static directional stability. The use of selected fuselage forebody strakes was found to be effective in increasing the level of positive static directional stability throughout the tested angle of attack range, with a slight attendant decrement in static longitudinal stability at high angles of attack. Drooping the fuselage nose, which is required for low-speed pilot vision, significantly improved the lateral-directional trim characteristics.

## INTRODUCTION

The National Aeronautics and Space Administration is currently investigating the low-speed aerodynamic characteristics of advanced supersonic-cruise transport concepts incorporating low-aspect-ratio highly swept arrow wings. Although wind tunnel tests of such configurations have indicated high levels of aerodynamic efficiency at transonic and supersonic speeds (see references 1 and 2), recent low-speed wind tunnel investigations (see references 3 and 4) have indicated several deficiencies in the areas of low-speed performance, stability, and control. Ground-based and in-flight simulator studies have determined that low levels of roll control capability, coupled with relatively high positive dihedral effect, are detrimental to airplane low-speed handling characteristics (see reference 5).

The model used in the investigation of reference 4 was primarily intended

for free-flight and forced-oscillation testing and, thus, was of extremely light construction. Because of its low strength, the investigation of reference 4 was restricted to low dynamic pressure and to low Reynolds number.

The present investigation was undertaken with a larger-scale model to confirm and extend the results of reference 4 at significantly greater Reynolds number. The current study examines the low-speed performance, trim, static stability, and longitudinal control characteristics. Data presented herein allows an assessment of: (1) the effect of revised leading-edge devices on longitudinal stability; (2) trailing-edge flap effectiveness; (3) the effect of the various model components, including fuselage-forebody strakes, on lateral-directional stability; and (4) horizontal-tail effectiveness.

### SYMBOLS

The longitudinal data is referred to the stability system of axes, and the lateral-directional data is referred to the body system of axes as illustrated in figure 1. The moment reference center for the data is located at 59.16 percent of the wing-reference mean aerodynamic chord.

The dimensional quantities herein are given in both the International Systems of Units (SI) and the U.S. Customary Units.

b	wing span, m (ft)
BS	body station
$C_D$	drag coefficient, $\frac{\text{Drag}}{qS}$
$C_L$	lift coefficient, $\frac{\text{Lift}}{qS}$
$C_l$	rolling-moment coefficient, $\frac{\text{Rolling-moment}}{qSb}$
$C_m$	pitching-moment coefficient, $\frac{\text{Pitching-moment}}{qSc}$
$C_n$	yawing-moment coefficient, $\frac{\text{Yawing-moment}}{qSb}$
$C_Y$	side-force coefficient, $\frac{\text{Side-force}}{qS}$
2	

ORIGINAL PAGE IS  
OF POOR QUALITY

$\bar{c}$	reference mean aerodynamic chord
$c_f$	trailing-edge flap chord, m (ft)
$i_t$	horizontal-tail incidence, positive when leading-edge is up, deg
$q$	free-stream dynamic pressure, Pa (lbf/ft <sup>2</sup> )
$q_{corr}$	corrected dynamic pressure, Pa (lbf/ft <sup>2</sup> )
$S$	reference wing area, m <sup>2</sup> (ft <sup>2</sup> )
$X, Y, Z$	body-axis coordinates
$\alpha$	angle of attack, deg
$\beta$	angle of sideslip, deg
$\delta_e$	elevator deflection, positive when trailing-edge is down, deg
$\delta_f$	trailing-edge flap deflection, positive when trailing-edge is down, deg
$\Delta\alpha$	wind-tunnel upwash flow angularity, deg
$\Delta\beta$	wind-tunnel sidewash flow angularity, deg
$\epsilon$	downwash angle at the horizontal tail, deg

#### Model Component Designations

$H_1, H_2$	horizontal tails (see figure 2(e))
K45	Krueger flap (see figure 2(c))
$L_1, L_2$	wing leading-edge apex flaps (see figures 2(a) and 2(b))
$L_6$	leading-edge flap on outboard wing panels (see figure 2(c))
$S_1, S_2$	fuselage forebody strakes (see figure 2(f))
$t_1, t_3, t_5, t_6$	wing trailing-edge flap segments (see figure 2(a))
$V_{1,2}$	vertical wing fins
$V_3$	vertical tail

$V_4$	ventral fin
WB	wing-body combination
N	flow-through engine nacelles

Basic configuration refers to:  $WB, N, V_{1,2}, L_{1,2,6} = 0^\circ$

#### MODEL

The model dimensions are listed in table I, and drawings of the model are given in figure 2. A photograph of the model mounted in the Langley full-scale tunnel is presented in figure 3.

Previous tests with this model have been reported in reference 3. For the present tests, the leading and trailing-edge flaps were modified and the horizontal tail configurations include deflection of the elevators.

The wing consisted of an arrow planform, with a 0.68 percent-chord leading-edge radius, an inboard leading-edge sweep angle of  $74^\circ$ , a midspan sweep angle of  $70.84^\circ$ , and an outboard sweep angle of  $60^\circ$ . The modified inboard wing-leading-edge flaps could be deflected from  $0^\circ$  to  $30^\circ$ . The outboard wing-leading-edge flaps could be positioned at  $0^\circ$  and  $45^\circ$ . The trailing-edge flaps  $t_1$  and  $t_3$  (see figure 2(a)) could be deflected from  $0^\circ$  to  $40^\circ$ ,  $t_5$  from  $5^\circ$  to  $40^\circ$ , and  $t_6$  was fixed at  $5^\circ$ . The horizontal tail could be deflected from  $-20^\circ$  to  $20^\circ$  with elevator deflections of from  $-20^\circ$  to  $20^\circ$ .

The fuselage forebody was constructed with a fixed downward deflection to simulate the drooped nose necessary to meet low-speed vision requirements.

#### TEST AND CORRECTIONS

The tests were conducted over a range of angles of attack from about  $-10^\circ$  to  $25^\circ$  for sideslip angles of  $0^\circ$  and  $\pm 5^\circ$  (in certain cases,  $\pm 10^\circ$ ). The majority of tests were conducted at a Reynolds number (based on the reference mean aerodynamic chord) of approximately  $5.88 \times 10^6$  with some performance tests conducted over a range of Reynolds number of from  $3.05$  to  $9.01 \times 10^6$ .

(Calculated leading-edge suction levels, as a function of lift coefficient, were

determined to be the same at Reynolds numbers  $\geq 5.88 \times 10^6$ ). A limited number of smoke-flow visualization tests were conducted to aid in the interpretation of the results.

The test data has been corrected for air-flow angularity ( $\Delta\alpha = 0.6^\circ$  and  $\Delta\beta = 0^\circ$ ), horizontal buoyancy ( $\Delta C_D = .0010$ ), tunnel blockage ( $q_{corr}/q = 1.04$ ). Strut-tare data was inferred from the tests of reference 6. No tunnel wall corrections were applied as the lifting-line theory of reference 7 indicates them to be negligible. (There is a lack of appropriate lifting-surface theory for this tunnel configuration). No adjustments were made to the measured drag coefficients to account for the internal skin-friction drag of the flow-through nacelles.

## PRESENTATION OF RESULTS

A run schedule, Appendix A, and a tabular listing, Appendix B, are included in this report. The results and discussion are presented according to the following table:

	Page	Figures
<b>Longitudinal Aerodynamic Characteristics</b>		
Effect of wing leading-edge devices. . . . .	6	4,5
Effect of trailing-edge flap deflection. . . . .	7	6,7
Horizontal tail effectiveness. . . . .	7	8,9,10
Effect of fuselage-forebody strakes. . . . .	8	11,12
<b>Lateral-Directional Characteristics</b>		
Effect of wing leading-edge devices. . . . .	9	13
Model component build-up . . . . .	9	14,15,16
Effect of fuselage-forebody strakes. . . . .	10	17
Effect of deflected fuselage forebody (nose-droop) . .	10	18

## RESULTS AND DISCUSSION

### Longitudinal Aerodynamic Characteristics

Effect of wing leading-edge devices. - The effect of deflecting the leading-edge devices on the longitudinal aerodynamic characteristics of the basic configuration, plus ventral fin and vertical tail, is shown in figure 4. The data show that at low angles of attack ( $\alpha < 6^\circ$ ), the tested leading-edge devices had a light effect on trim and no effect on stability. However, at angles of attack greater than  $6^\circ$ , the leading-edge devices had a favorable effect on the resulting longitudinal aerodynamic characteristics. These results are consistent with those previously obtained in reference 4. In this configuration, lift and pitching moment indicate the presence of significant vortex lift, and its associated pitch-up, above approximately  $6^\circ$  angle of attack. This flow character was confirmed by a limited number of smoke visualization tests. Previous smoke-flow studies indicated that deflection of the wing-apex flap alone was effective in reducing the intensity of the apex vortices. The data of figure 4, with both wing-apex and outboard leading-edge flaps deflected, indicate that suppression of the vortex lift improved the pitching moment behavior as well as slightly improving the lift-drag characteristics. However, note that there is still gradual pitch-up present above approximately  $10^\circ$  angle of attack. Figure 5, which is replotted from the data of reference 4 (converted to coefficients based on reference dimensions), shows that the outboard wing leading-edge flap provided a small favorable contribution to longitudinal stability ( $\partial C_m / \partial C_L$ ) at high angles of attack because of an improvement of the flow over the outboard wing panels. The present data, together with those of reference 4, indicate more pitch-up than was obtained previously with a modified SCAT 15-F configuration (reference 8). Since the wing twist distribution of the current models are different from that of the SCAT 15-F model (reference 8), one must assume that the flow on the outboard wing panels is separating during the present study as well as in the tests of reference 4. Thus, it may be necessary to modify the outboard wing panel twist distribution to avoid separation.



Effect of trailing-edge flap deflection. - The segmented trailing-edge flap system is sketched in figure 2(a). The angular deflection of each flap segment is measured normal to its individual hinge line. Trailing-edge flap deflections are designated by a series of three angles; for example, a trailing-edge flap setting of  $\delta_f = 40^\circ/40^\circ/5^\circ$  indicates that the inboard trailing-edge flap segments  $t_1$  are deflected  $40^\circ$ , the mid-span segments  $t_3$  are deflected  $40^\circ$ , and the outer flap segments  $t_5$  are deflected  $5^\circ$ . For all tests, the deflection of segments  $t_6$  was fixed at  $5^\circ$ .

Figure 6 presents the longitudinal aerodynamic characteristics of the basic configuration, plus ventral fin and vertical tail, with leading-edge devices deflected for various trailing-edge flap deflections. Note that the only configuration difference between these two sets of data is the deflection of flap segments  $t_5$  (figure 2(a)). Comparison of the data shows slightly more negative pitching moment due to the increased deflection of flap segments  $t_5$ . Both sets of data indicate that, for angles of attack less than approximately  $10^\circ$ , deflection of the plain trailing-edge flaps from  $0^\circ$  to  $30^\circ$  resulted in an essentially linear increase in lift with increasing flap deflection. At higher angles of attack and flap deflection, the effectiveness of the trailing-edge flap system is significantly reduced probably because of separated flow over the flaps.

A limited investigation using a slotted flap (figure 2(d)) was conducted in an effort to improve the trailing-edge flap effectiveness for the case of  $\delta_f = 40^\circ/40^\circ/5^\circ$ . These data are compared to those for the plain flap in figure 7, the comparison indicates much improved lift characteristics. It can be inferred, therefore, that slotted flaps can provide improved lift characteristics for all trailing-edge deflections at high angles of attack.

Horizontal tail effectiveness. - Figure 8 presents the longitudinal aerodynamic data with the horizontal tail  $H_1$  on and off for various trailing-edge flap configurations. In all cases, the horizontal tail provided a small stabilizing contribution at low angle of attack. At higher angles of attack, the stabilizing tail contribution was greater.

The measured longitudinal-control capability using tail incidence was

shown to be fairly constant over the tested angle of attack range, and this capability was essentially the same for each trailing-edge flap configuration. The longitudinal control capability was further improved by deflecting the elevators. This increase is shown in figure 9, which presents such data for the configuration with  $\delta_f = 0^\circ/0^\circ/5^\circ$ , and similar data for the configuration with  $\delta_f = 40^\circ/40^\circ/40^\circ$ .

To investigate the effect of a change in horizontal tail size and planform on the resulting longitudinal aerodynamic characteristics, the horizontal tail  $H_2$  was tested. The horizontal tail planform is presented in figure 2(e). For a trailing-edge flap deflection of  $\delta_f = 40^\circ/40^\circ/40^\circ$ , figures 8(d) and 10 present the results for the two different horizontal tail configurations. Estimation of the horizontal tail-lift-curve slopes by the method of reference 9 indicates that horizontal tail  $H_2$  has a lift-curve slope approximately 6 percent larger than horizontal tail  $H_1$ . This is confirmed by comparison of figures 8(d) and 10. The horizontal-tail volume-coefficients, calculated using the values of table I, indicate that horizontal tail  $H_1$  has a volume coefficient approximately 26 percent larger than that of horizontal tail  $H_2$ . Thus, horizontal tail  $H_1$  should have approximately 20 percent larger control capability than horizontal tail  $H_2$ . Comparison of figures 8(d) and 10 shows that the horizontal tail  $H_1$  has control capability approximately 37 percent greater.

On figures 8(d) and 10 the constructed lines at constant angle of attack confirm the assumed geometric horizontal-tail length-ratios presented in table I, i.e., the aerodynamic center of the horizontal tails is at their respective quarter mean-aerodynamic-chord locations. Calculations based on the test data indicate that  $\partial \epsilon / \partial \alpha$  was .68 for both tail configurations; however, at  $\alpha = 0^\circ$  horizontal tail  $H_2$  had a downwash angle  $1.5^\circ$  greater than horizontal tail  $H_1$ . Thus, the fact that the control capability of the horizontal tail  $H_1$  was significantly greater than was estimated indicates that the effective dynamic pressure over the two horizontal tails was significantly different. This result appears unlikely, and the anomaly is not understood.

Effect of fuselage forebody strakes. - The fuselage-forebody strakes of reference 4, which were only intended to investigate the effects on lateral-directional characteristics, produced an increased level of longitudinal

instability. (See figure 11, which has been replotted from the data of reference 4, converted to coefficients based on reference dimensions.) The redesigned strakes tested in the present investigation were found to produce only a slight increase in the level of longitudinal instability at high angles of attack (figure 12).

### Lateral-Directional Characteristics

Since reference 4 contains the results of comprehensive static lateral-directional stability-and-control tests of a similar smaller scale model, only selected static lateral-directional stability tests were conducted during the present investigation. Lateral-directional testing was limited to configurations with the trailing-edge flaps  $\delta f$  set at  $0^\circ/0^\circ/5^\circ$ .

Effect of wing leading-edge devices. - In the section entitled "longitudinal aerodynamic characteristics", it was demonstrated that deflection of the leading-edge wing-apex and outboard wing-panel flaps produced favorable static longitudinal stability results. The effect on static lateral-directional stability of these leading-edge flaps is presented in figure 13. Note that the basic configuration is directionally stable to approximately  $19^\circ$  angle of attack. Deflection of the wing leading-edge flaps significantly reduces the level of positive directional stability, and also reduces the angle of attack at which the configuration becomes directionally unstable (approximately  $6^\circ$ ). The level of positive dihedral effect remains essentially unchanged.

Model component build-up. Figures 14 through 16 present the variation of lateral-directional stability derivatives with angle of attack for various model combinations. From figure 14 it can be seen that the outboard vertical fins provide a stabilizing increment to static directional stability with essentially no change in positive dihedral effect. Figure 15 presents the contribution of each of the wing leading-edge flaps to lateral-directional stability. Note that the outboard wing panel leading-edge flaps increase the level of directional stability, and that deflection of the wing-apex flaps significantly reduces the configuration directional stability. Addition of the vertical tail and ventral fin increases the level of positive lateral-directional stability (figure 16) so that the configuration is directionally stable to approximately  $10^\circ$  angle of

attack. The horizontal tail further increases the level of directional stability up to approximately  $11^\circ$  angle of attack.

Effect of fuselage forebody strakes. - Asymmetrically displaced vortices may originate from long slender forebodies. Such asymmetric vortices can result (reference 4) in large out-of-trim yawing moments at high angles of attack. Since the present model incorporated a drooped forebody to comply with low-speed pilot-vision requirements, it was anticipated that asymmetric vortices and their attendant large moments would not be encountered for  $\beta = 0^\circ$ . Nevertheless, two fuselage-forebody strakes were tested to ascertain the change in configuration static lateral-directional stability. As can be seen from figure 17, strake configuration  $S_2$  was effective, and  $S_1$  ineffective, in producing the desired directional stability characteristics at the expense of a modest increase in positive dihedral effect.

Effect of deflected fuselage forebody (nose-droop). The model of reference 4 did not incorporate a simulated drooped nose on the fuselage forebody. As a consequence of the undeflected long, slender, fuselage forebody, large out-of-trim yawing moments occurred at  $\beta = 0^\circ$  for angles of attack above approximately  $15^\circ$ . Figure 18 compares the lateral-directional characteristics of the present drooped-nose model to the equivalent results for the undrooped-nose model of reference 4. It is clearly evident that the drooped nose significantly improves the lateral-directional characteristics at  $\beta = 0^\circ$ .

#### SUMMARY OF RESULTS

The results of the low-speed wind tunnel investigations of an advanced supersonic arrow-wing configuration may be summarized as follows:

- (1) Deflection of the wing leading-edge flaps downward to suppress the wing-apex vortices resulted in improved longitudinal stability at high angles of attack, but significantly reduced the level of positive directional stability.
- (2) For  $\alpha < 10^\circ$ , deflecting the plain trailing-edge flap system from  $0^\circ$  to  $30^\circ$  resulted in an essentially linear increase in  $C_L$  with  $\delta_f$ ;

however, for higher angles of attack, and for larger flap deflections, the effectiveness of the plain trailing-edge flap system was reduced.

- (3) A single-slotted trailing-edge flap system was found to be significantly more effective than an unslotted plain-flap system.
- (4) The horizontal tails were effective in providing longitudinal control over the angle of attack range. They also provided an increase in static longitudinal stability, especially at high angles of attack.
- (5) The outboard vertical fins and vertical tail provided a stabilizing increase in static directional stability. The addition of the horizontal tail provided a significant increase in static directional stability at low angles of attack.
- (6) The use of selected fuselage forebody strakes was found to provide a significant increase in static directional stability with only a slight destabilizing increment in static longitudinal stability at high angles of attack.
- (7) Drooping the fuselage nose, which is required for low-speed pilot vision, significantly improved the lateral-directional trim characteristics.

## REFERENCES

1. Morris, Odell A. and Patterson, James C., Jr.: Transonic Aerodynamic Characteristics of a Supersonic Transport Model with a Fixed, Warped Wing Having 74 Degree Sweep. NASA TM X-1167, 1965.
2. Morris, Odell A. and Fournier, Roger H.: Aerodynamic Characteristics at Mach Numbers 2.30, 2.60, 2.96 of a Supersonic Transport Model Having a Fixed, Warped Wing. NASA TM X-1115, 1965.
3. Coe, Paul L., Jr.; McLemore, H. Clyde; and Shivers, James P.: Effects of Upper Surface Blowing and Thrust Vectoring on Low-Speed Aerodynamic Characteristics of a Large-Scale Supersonic Transport Model. NASA TN D-8296, 1976.
4. Coe, Paul L., Jr.; Smith, Paul M.; and Parlett, Lysle P.: Low-Speed Wind Tunnel Investigation of an Advanced Supersonic Cruise Arrow-Wing Configuration. NASA TM-74043, 1977.
5. Grantham, William D. and Nguyen, Luat T.: Recent Ground-Based and In-Flight Simulator Studies of Low-Speed Handling Characteristics of Supersonic Cruise Transport Aircraft. Presented at the AIAA Fourth Atmospheric Flight Mechanics Conference, Hollywood, Florida, August 1977.
6. McLemore, H. Clyde; Parlett, Lysle P.; and Sewall, William G.: Low-Speed Wind-Tunnel Tests of a 1/9-Scale Model of a Variable-Sweep Advanced Supersonic Transport. NASA TM X-71960, May 1974.
7. Heyson, Harry H.: Use of Superposition in Digital Computers to Obtain Wind Tunnel Interference Factors for Arbitrary Configurations, with Particular Reference to V/STOL Models. NASA TR R-302, 1969.
8. Lockwood, Vernard E.: Effect of Leading-Edge Contour and Vertical-Tail Configuration on the Low-Speed Stability Characteristics of a Supersonic Transport Model Having a Highly-Swept Arrow-Wing. NASA TM-78683, 1978 (Supersedes NASA LWP-1101, 1973)
9. De-Young, John and Harper, Charles W.: Theoretical Symmetric Span Loading at Subsonic Speeds for Wings Having Arbitrary Planform. NACA Report 921, 1948.

TABLE I. - DIMENSIONAL CHARACTERISTICS OF MODEL

Wing:

Reference area, $m^2(ft^2)$ . . . . .	9.264	(99.690)
Span, m(ft) . . . . .	4.200	(13.778)
Reference aspect ratio . . . . .		1.904
Root chord, m(ft) . . . . .	5.589	(18.338)
Tip chord, m(ft) . . . . .	0.538	( 1.764)
Reference mean aerodynamic chord, m(ft) . . . . .	2.933	( 9.624)
Leading-edge sweep, deg:		
At body station 1.275 m (4.184 ft) . . . . .		74
At body station 4.758 m (15.609 ft) . . . . .		70.84
At body station 6.283 m (20.615 ft) . . . . .		60

Vertical tail:

Exposed area, $m^2(ft^2)$ . . . . .	0.101	( 1.090)
Span, m(ft) . . . . .	0.232	( 0.760)
Aspect ratio . . . . .		0.530
Root chord, m(ft) . . . . .	0.707	( 2.320)
Tip chord, m(ft) . . . . .	0.168	( 0.550)
Leading-edge sweep, deg . . . . .		68.2

Ventral fin:

Exposed area, $m^2(ft^2)$ . . . . .	0.087	( 0.932)
Span, m(ft) . . . . .	0.105	( 0.346)
Aspect ratio . . . . .		0.128

Vertical fins (two):

Exposed area/fin, $m^2(ft^2)$ . . . . .	0.217	( 2.333)
Span, m(ft) . . . . .	0.328	( 1.075)
Aspect ratio . . . . .		0.495
Root chord, m(ft) . . . . .	1.164	( 3.820)
Tip chord, m(ft) . . . . .	0.158	( 0.520)
Leading-edge sweep, deg . . . . .		73.4

ORIGINAL PAGE IS  
OF POOR QUALITY

TABLE I. CONCLUDED

Horizontal tail H<sub>1</sub>:

Gross area, m <sup>2</sup> (ft <sup>2</sup> ) . . . . .	0.711	( 7.652)
Span, m(ft) . . . . .	0.975	( 3.200)
Aspect ratio . . . . .		1.338
Root chord, m(ft) . . . . .	1.200	( 3.938)
Tip chord, m(ft) . . . . .	0.258	( 0.845)
Leading-edge sweep, deg . . . . .		54.9
Dihedral angle, deg . . . . .		-15
Moment center to horizontal tail 1/4 mean aerodynamic chord divided by wing reference mean aerodynamic chord . . . . .		1.111

Horizontal tail H<sub>2</sub>:

Gross area, m <sup>2</sup> (ft) . . . . .	0.538	( 5.794)
Span, m(ft) . . . . .	0.942	( 3.090)
Aspect ratio . . . . .		1.707
Root chord, m(ft) . . . . .	0.933	( 3.060)
Tip chord, m(ft) . . . . .	0.210	( 0.690)
Leading-edge sweep, deg . . . . .		60.6
Dihedral angle, deg . . . . .		-15
Moment center to horizontal tail 1/4 mean aerodynamic chord divided by wing reference mean aerodynamic chord . . . . .		1.165



ORIGINAL PAGE IS  
OF POOR QUALITY

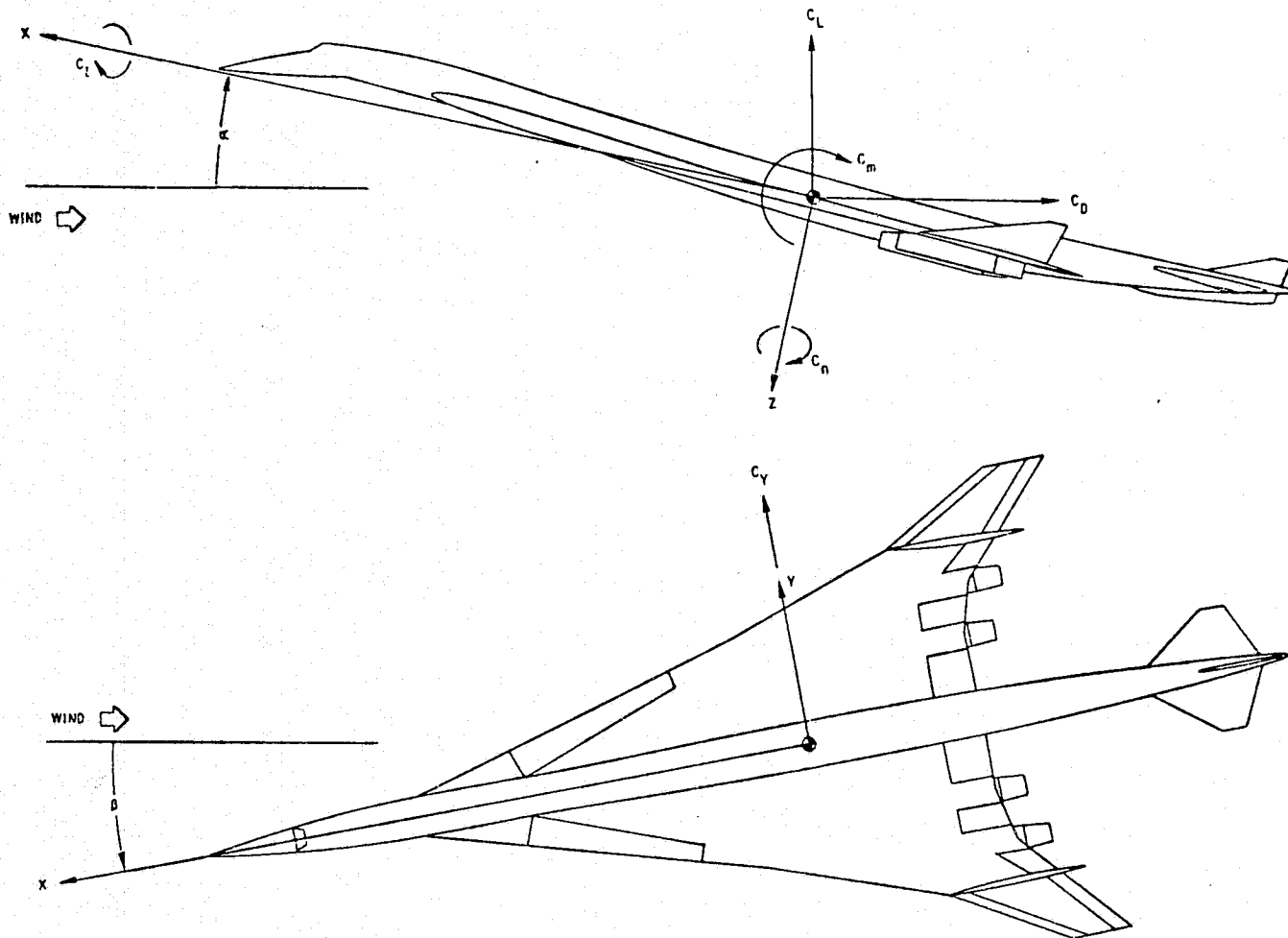
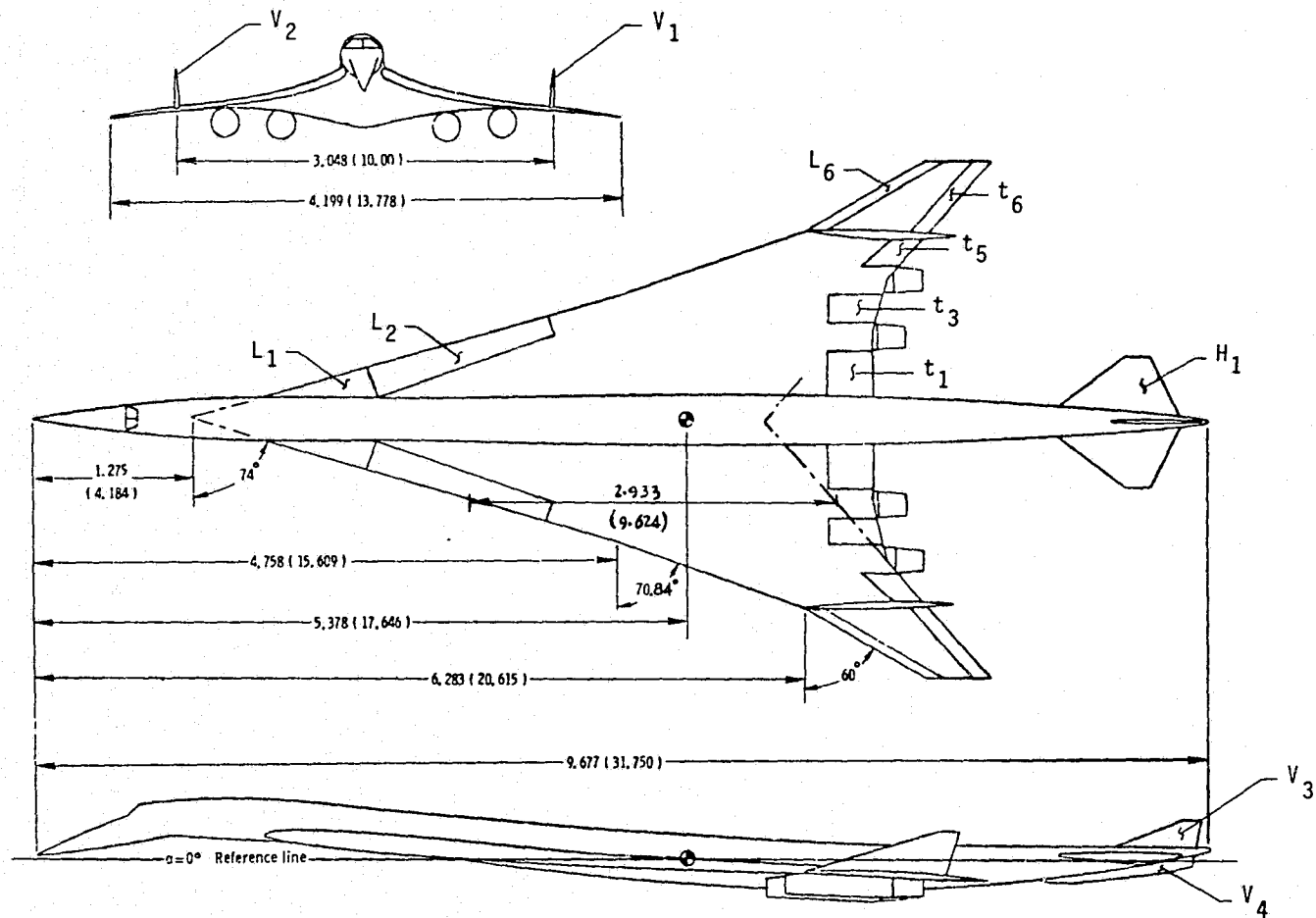
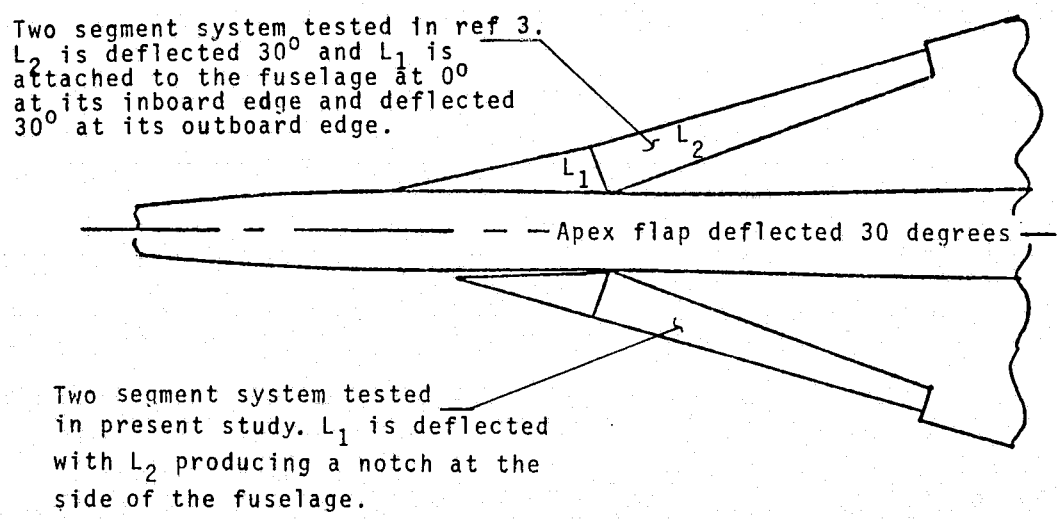
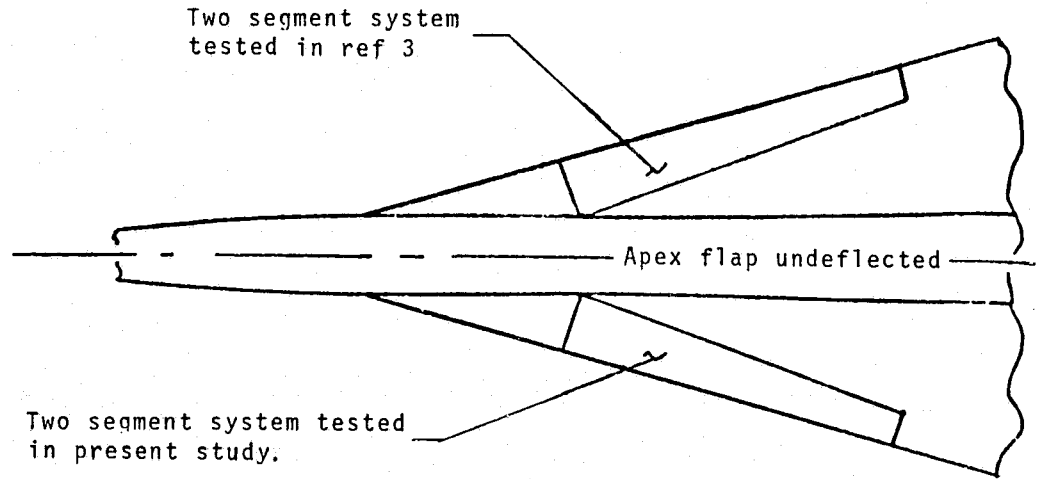


Figure 1.- The body system of axes.



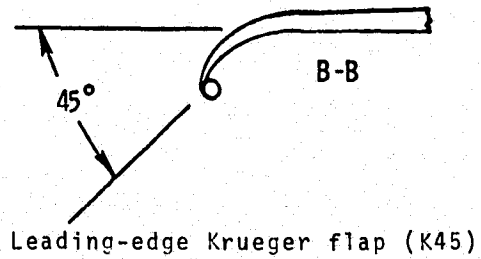
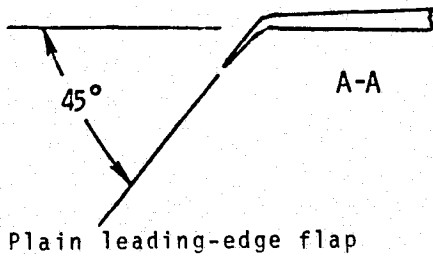
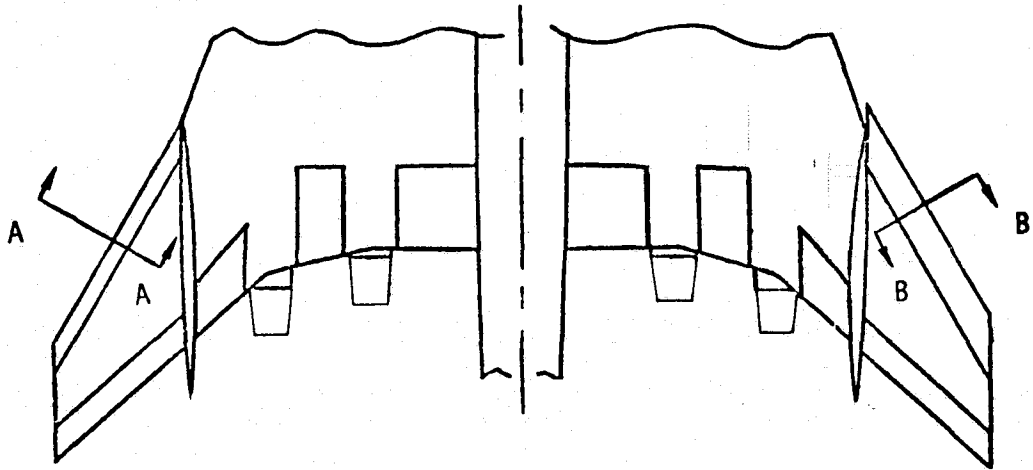
(a) Three-view sketch of model with conventionally located engines.  
Dimensions are in meters (feet).

Figure 2.- Geometric characteristics of model.



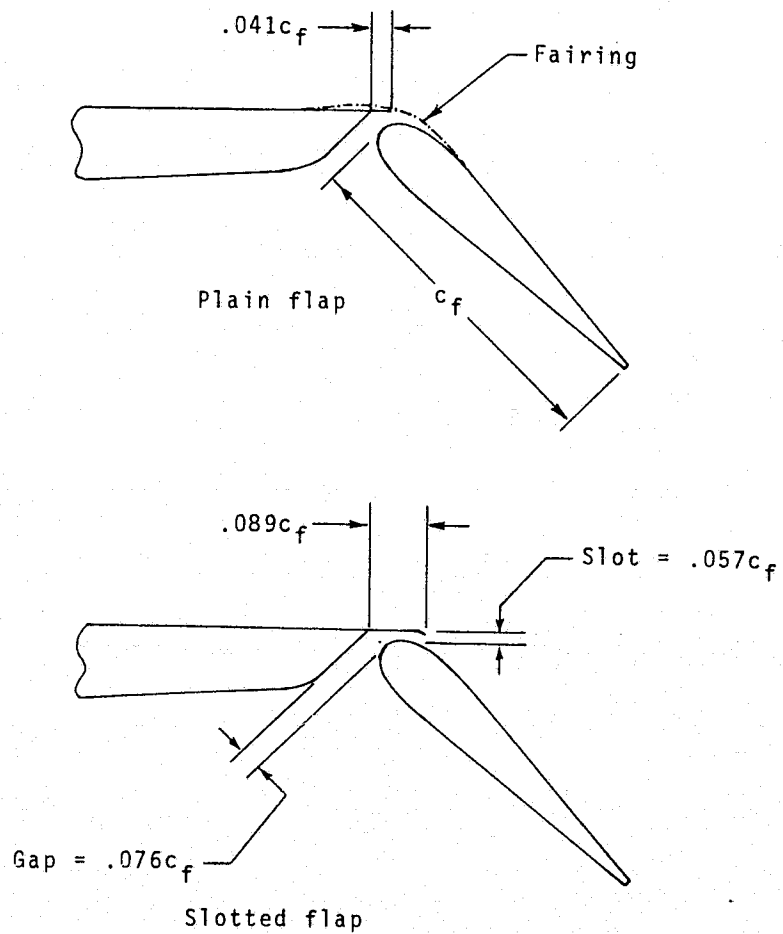
(b) Sketch of leading-edge apex flap system

Figure 2.- Continued



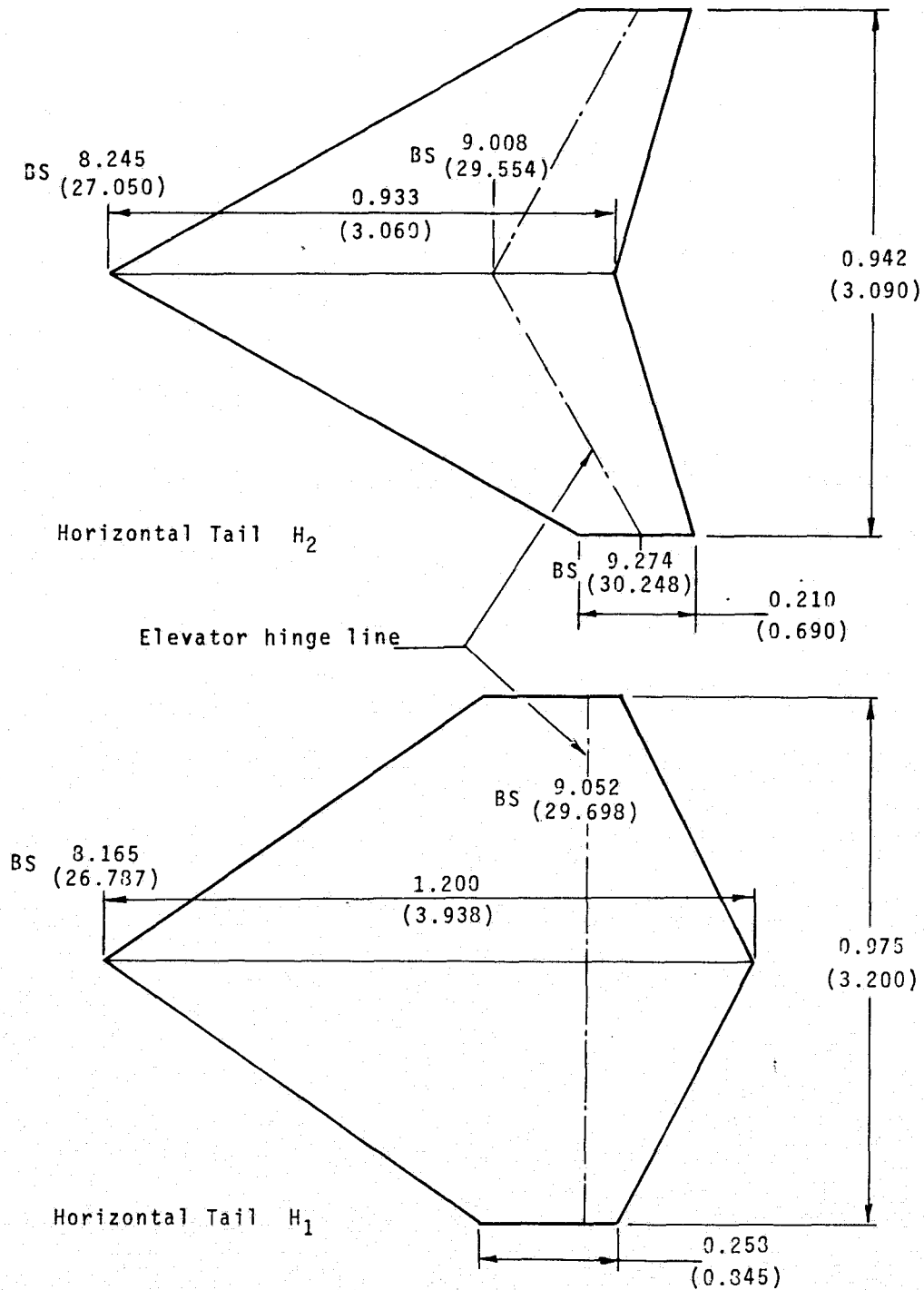
(c) Sketch of outboard wing-panel leading-edge flaps

Figure 2.- Continued



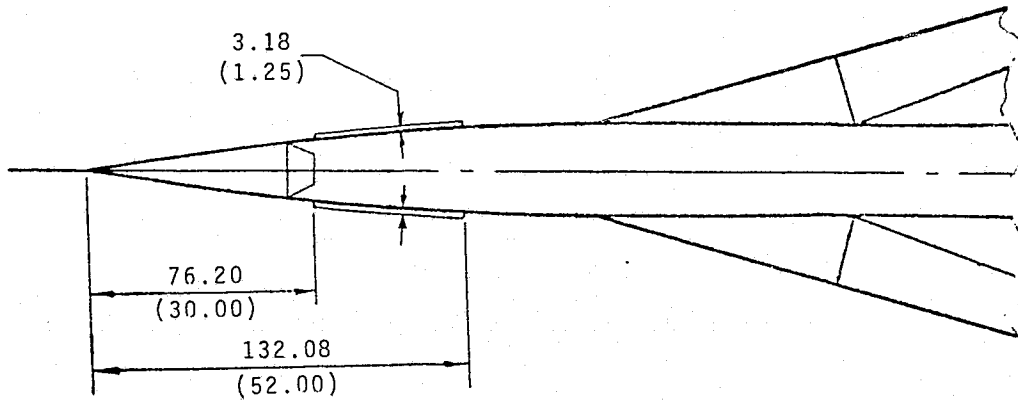
(d) Sketch of plain and slotted trailing-edge flaps  $t_1$  and  $t_3$ .

Figure 2.- Continued

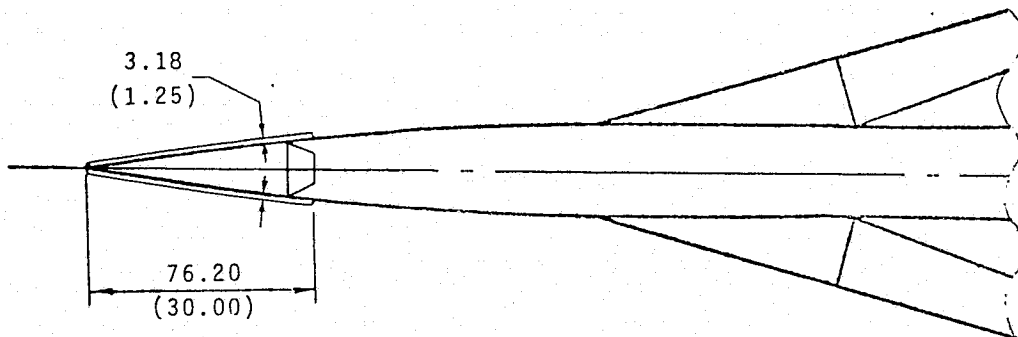


(e) Sketch of horizontal tails. Dimensions are in meters (feet).

Figure 2. - Continued



Strake S<sub>2</sub>



Strake S<sub>1</sub>

(f) Sketch of fuselage forebody strakes. Dimensions are in centimeters (inches).

Figure 2.- Concluded.

ORIGINAL PAGE IS  
OF POOR QUALITY

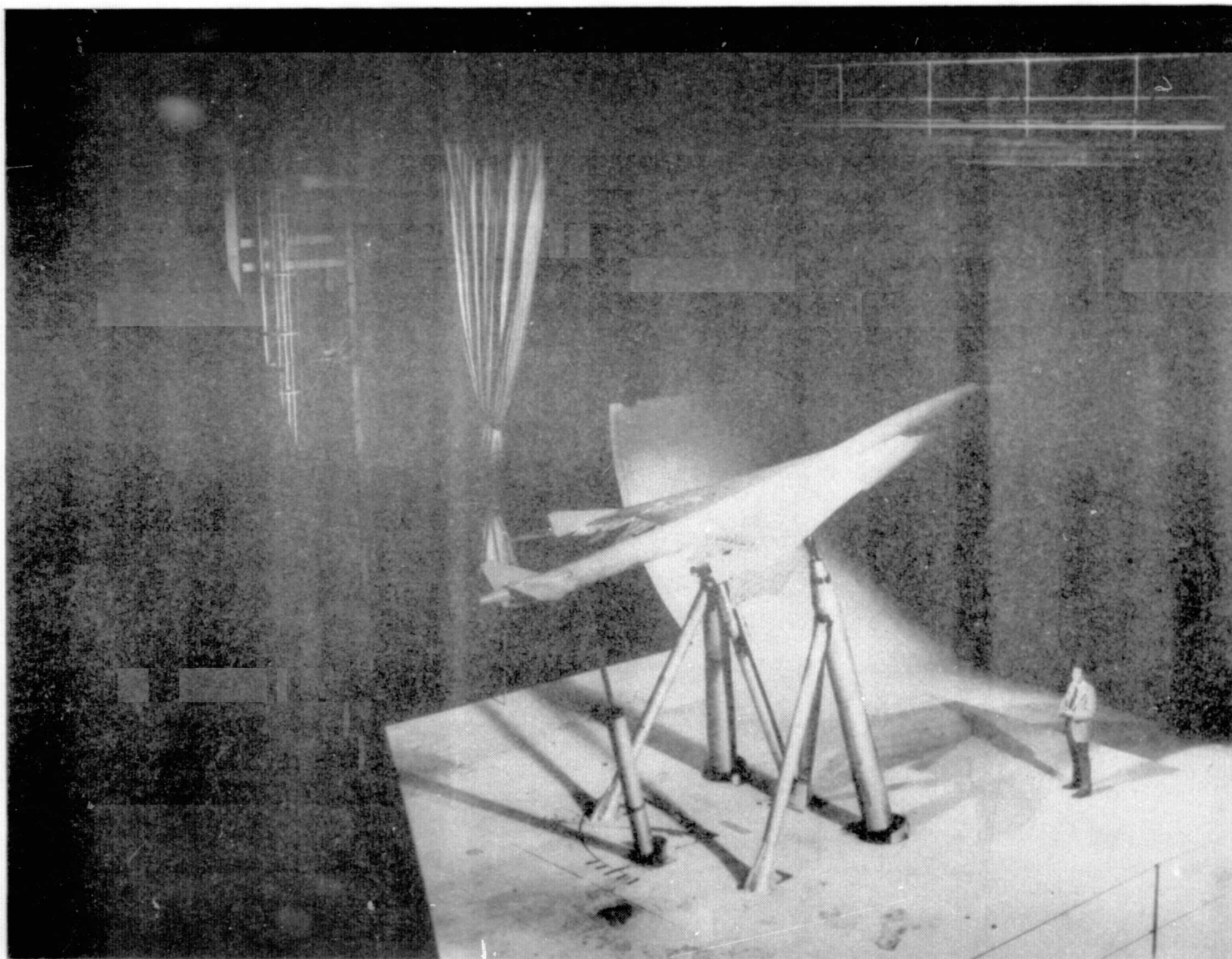


Figure 3.- Photograph of the model mounted for tests in the Langley Full-Scale Tunnel



ORIGINAL PAGE IS  
OF POOR QUALITY

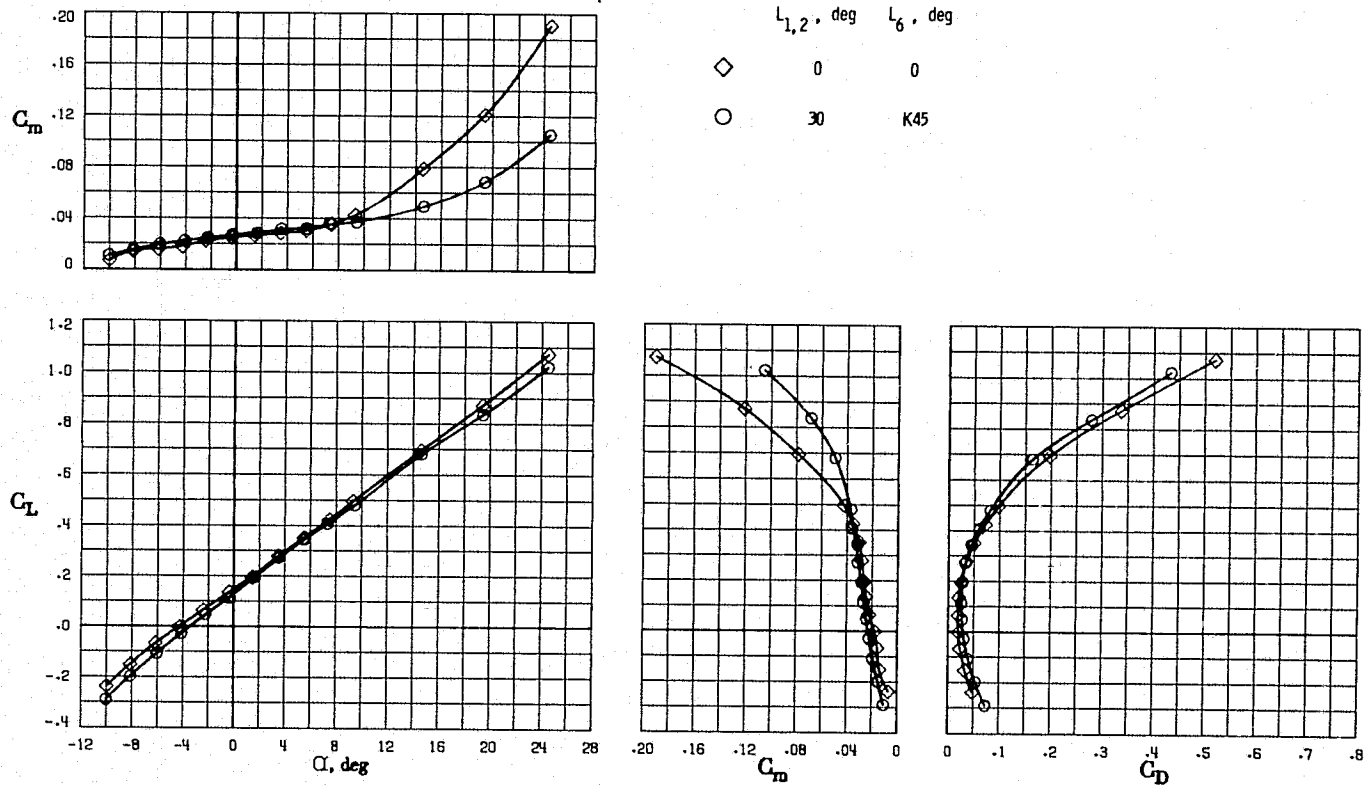


Figure 4 - Effect of wing leading-edge devices on the longitudinal aerodynamic characteristics of the basic configuration plus ventral fin  $V_3$  and vertical tail  $V_4$ ,  $\delta_f = 0^\circ, 0^\circ, 5^\circ$ .

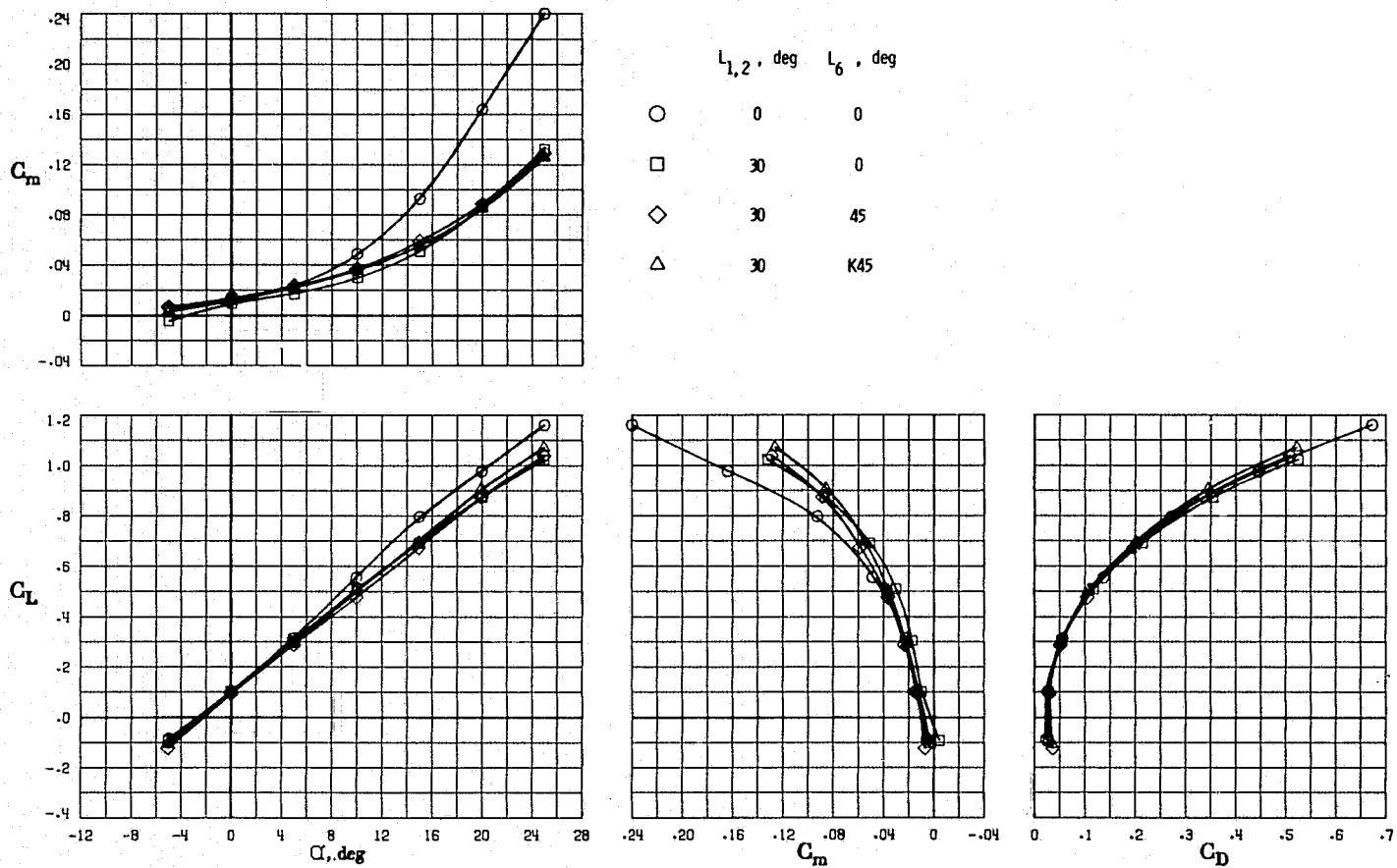


Figure 5. - Effect of wing leading-edge devices on the basic longitudinal aerodynamic characteristics of the configuration,  $\delta_f = 0^0 / 0^0 / 5^0$  (reference 4).

ORIGINAL PAGE IS  
OF POOR QUALITY.

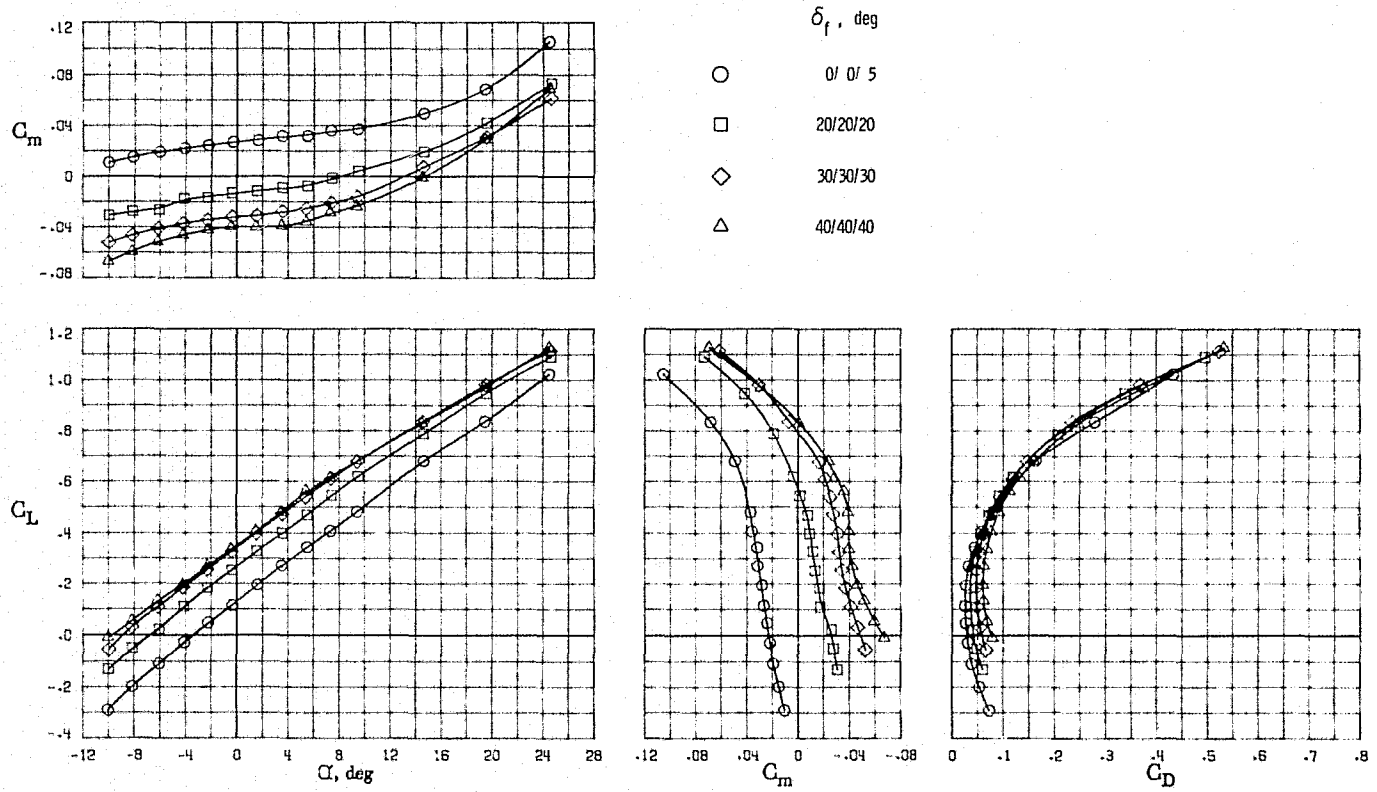


Figure 6. - Effect of trailing-edge flaps on the longitudinal aerodynamic characteristics of the basic configuration plus  $V_3$  and  $V_4$ .  $L_{1,2} = 30^\circ$ ,  $L_6 = K45^\circ$ .

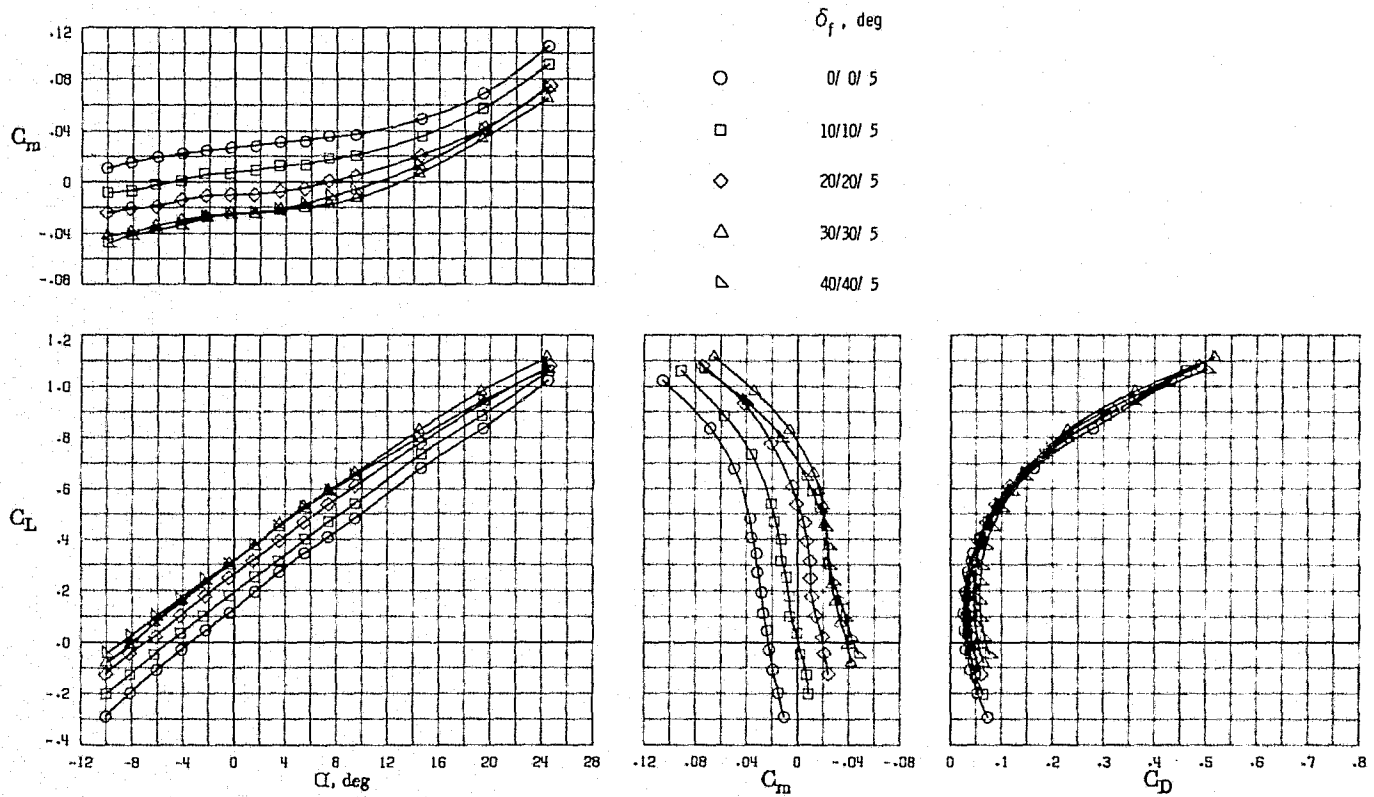
(b)  $\delta_f$  fixed

Figure 6 . - Concluded .

ORIGINAL PAGE IS  
OF POOR QUALITY

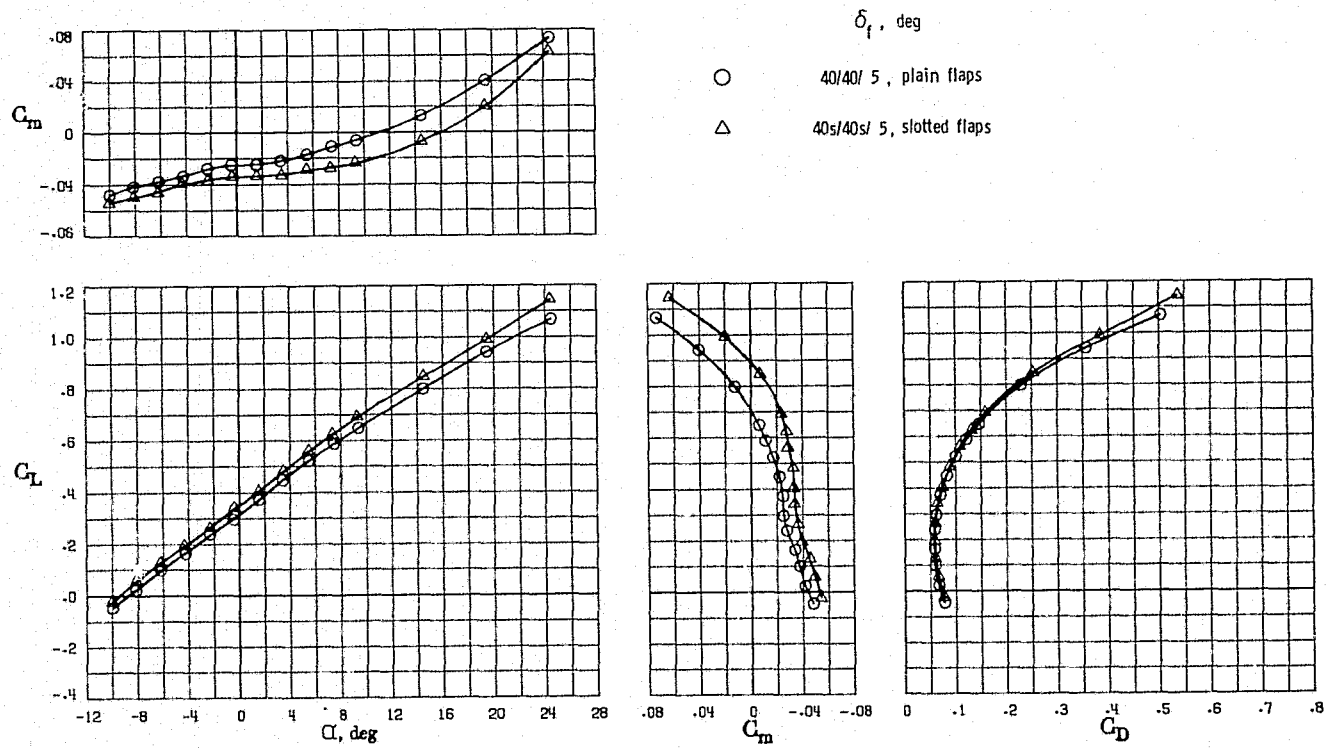


Figure 7. - Effect of single-slotted trailing-edge flaps on the longitudinal aerodynamic characteristics of the basic configuration plus  $V_3$  and  $V_4$ .  $L_{1,2} = 30^\circ$ ,  $L_6 = K45^\circ$ .

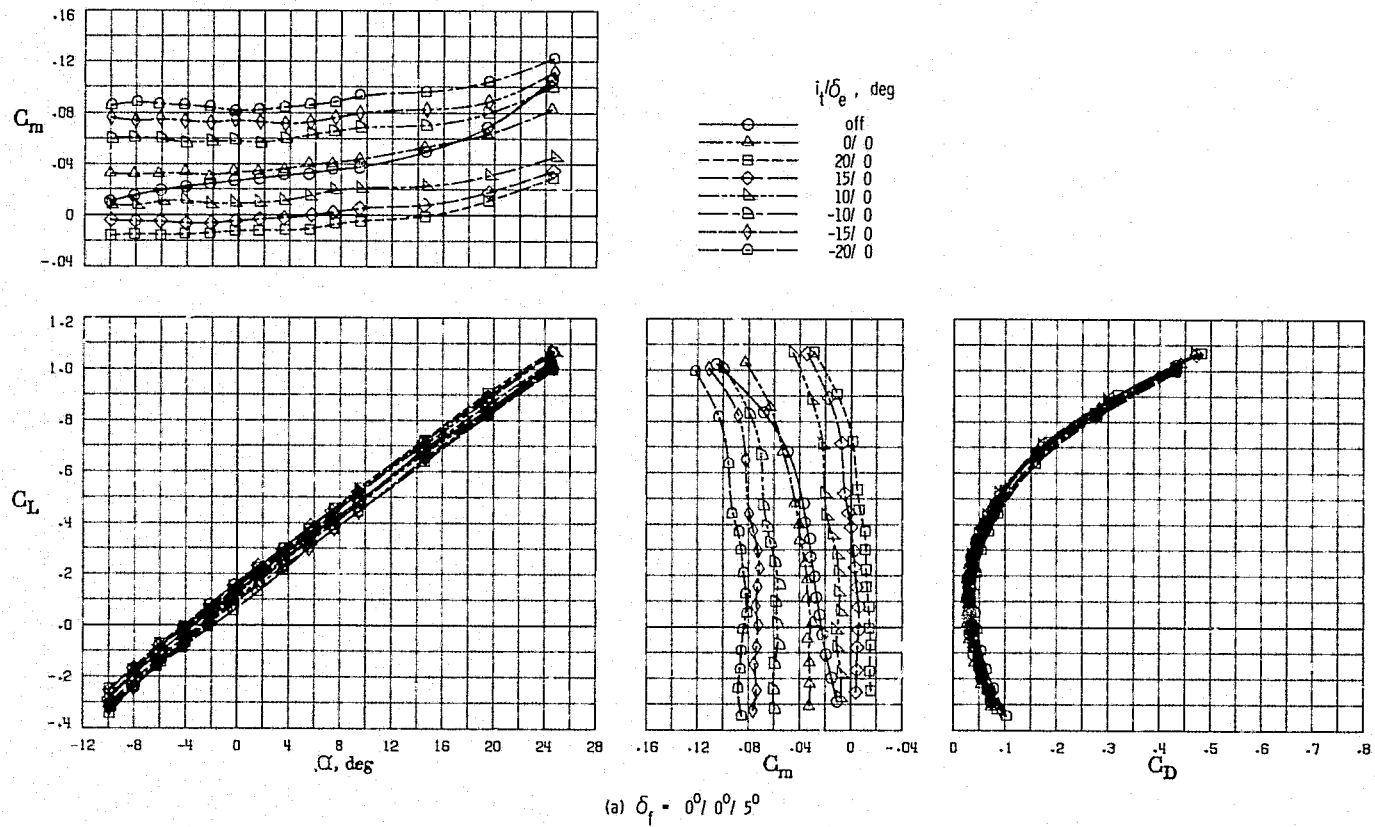
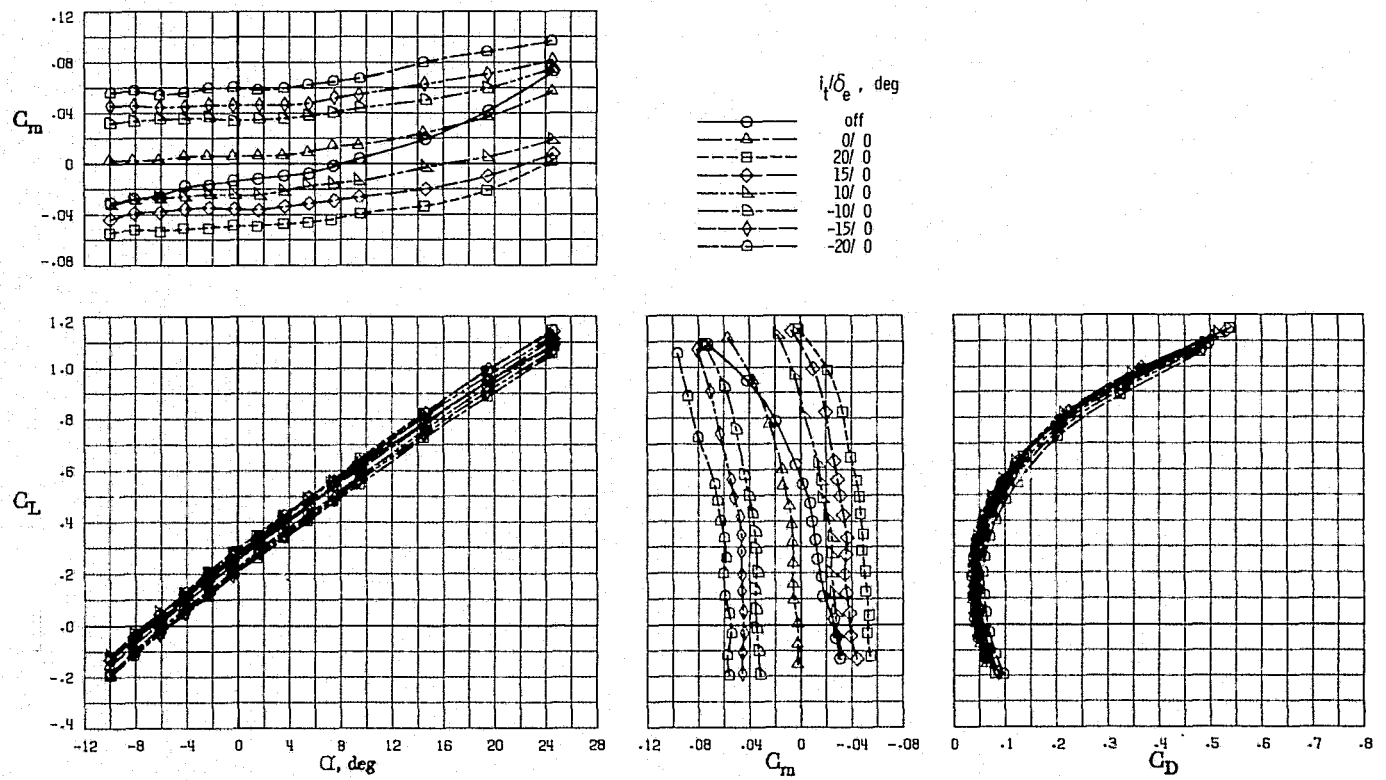


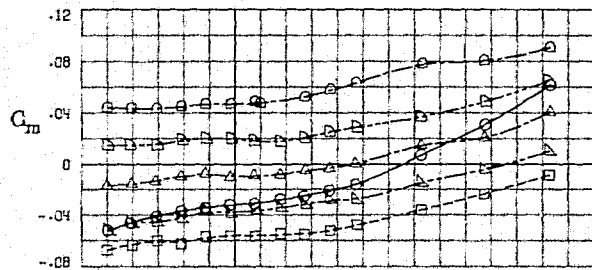
Figure 8. - Effect of deflection of the horizontal tail  $H_1$  on the longitudinal aerodynamic characteristics of the basic configuration plus  $V_3$  and  $V_4$ ,  $L_{1,2} = 30^\circ$ ,  $L_6 = 45^\circ$ .

ORIGINAL PAGE IS  
OF POOR QUALITY

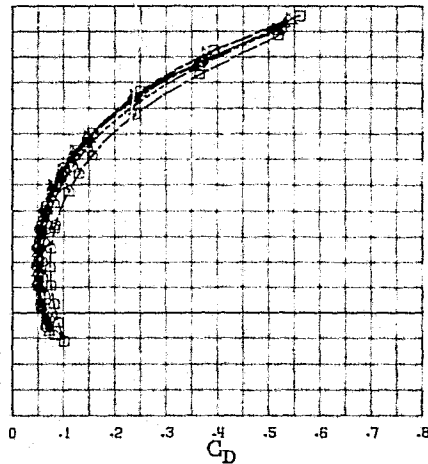
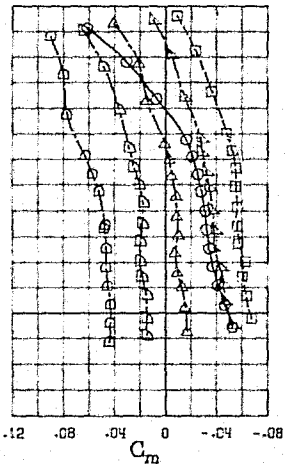
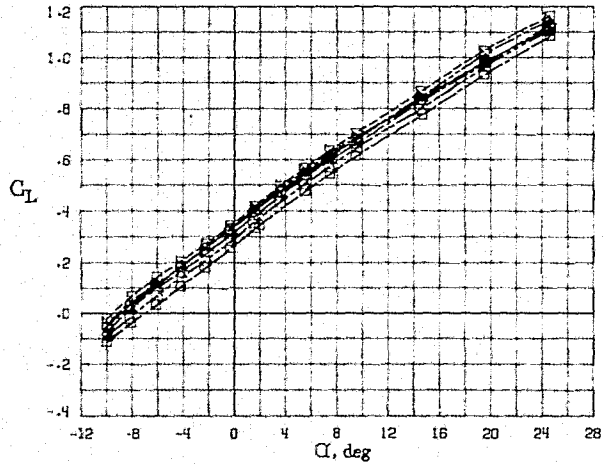


(b)  $\delta_f = 20^\circ/20^\circ/20^\circ$

Figure 8. - Continued.



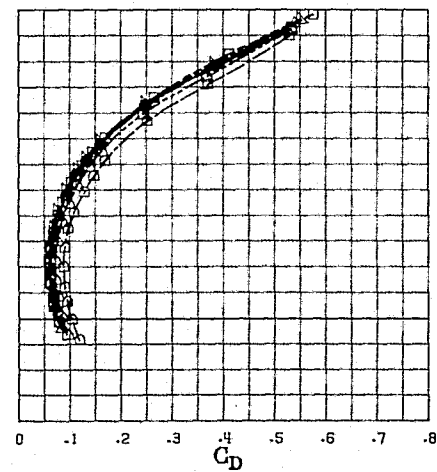
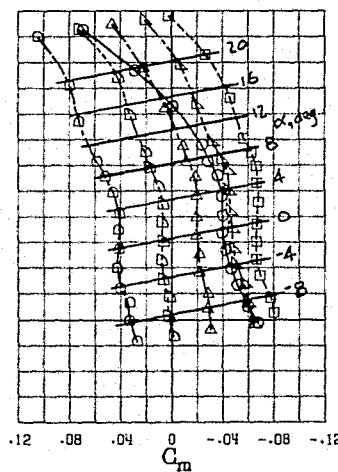
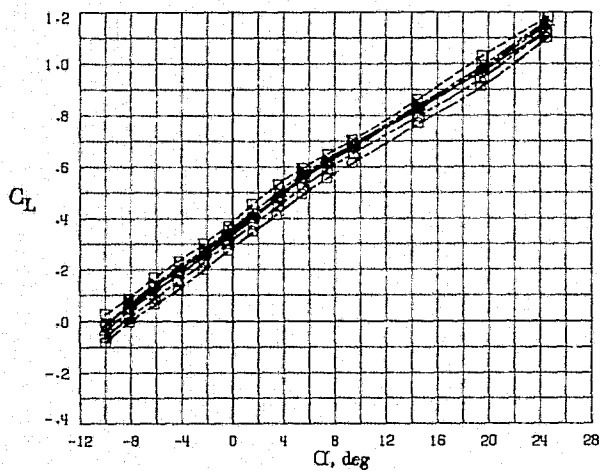
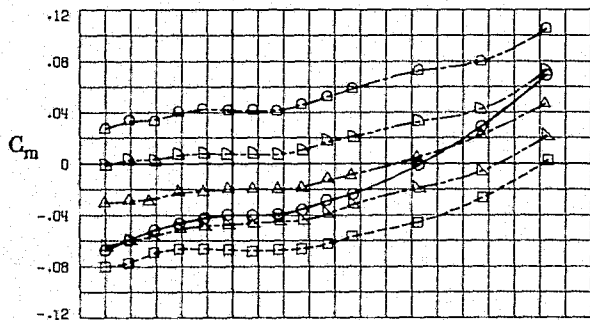
$i/D_e$ , deg	Symbol
off	○
0/0	△
20/0	□
10/0	▽
-10/0	◇
-20/0	○



(c)  $\delta_f = 30^\circ/30^\circ/30^\circ$   
 Figure 8 . - Continued .

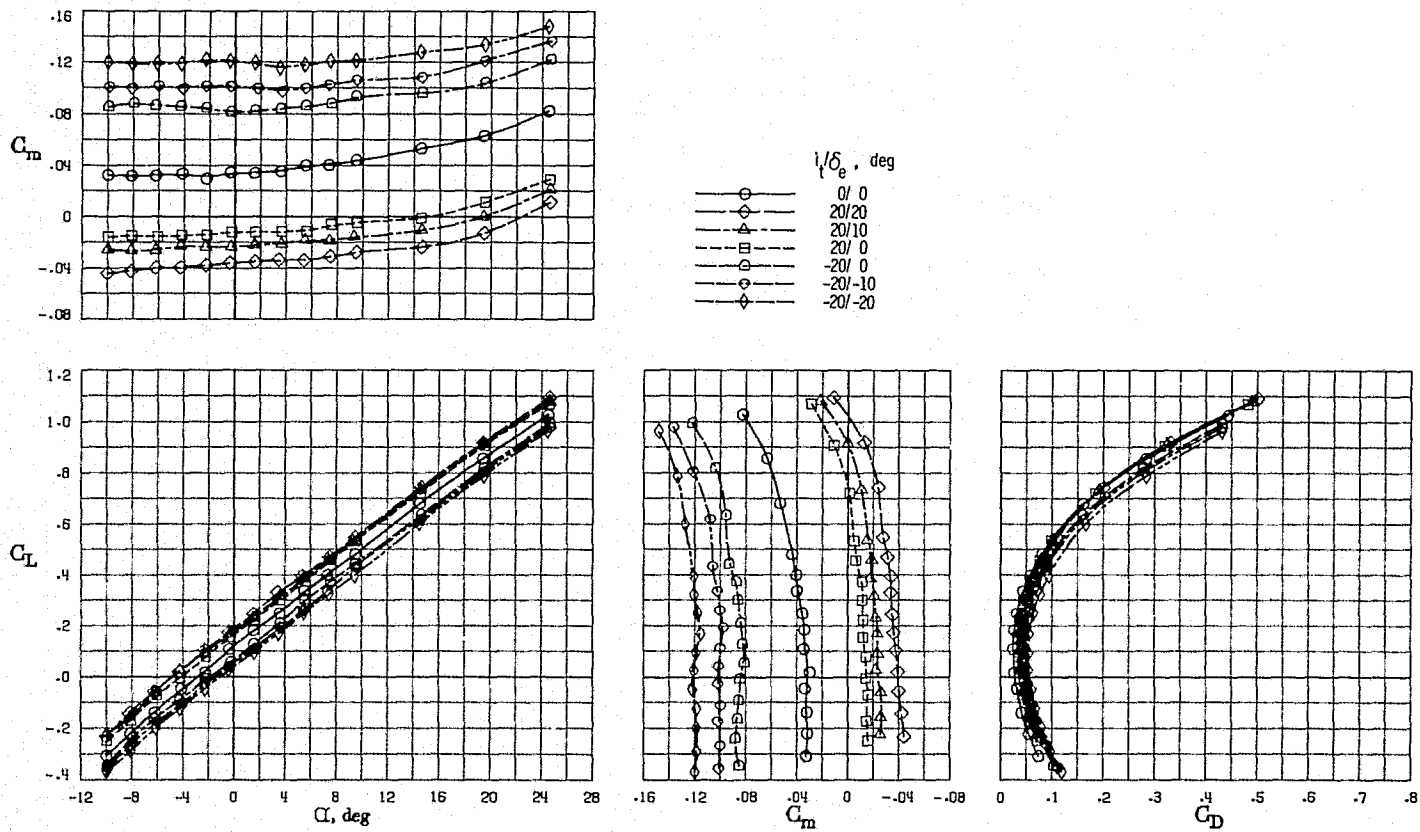


ORIGINAL PAGE IS  
OF POOR QUALITY



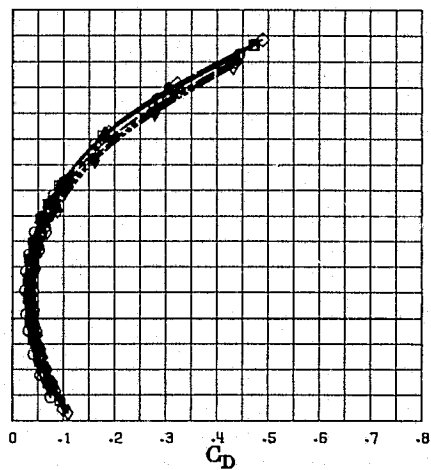
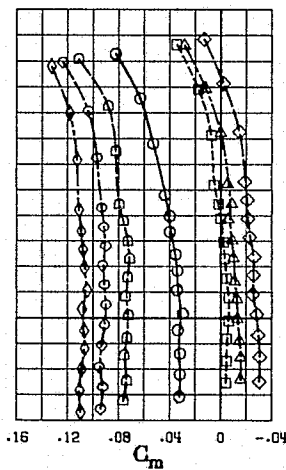
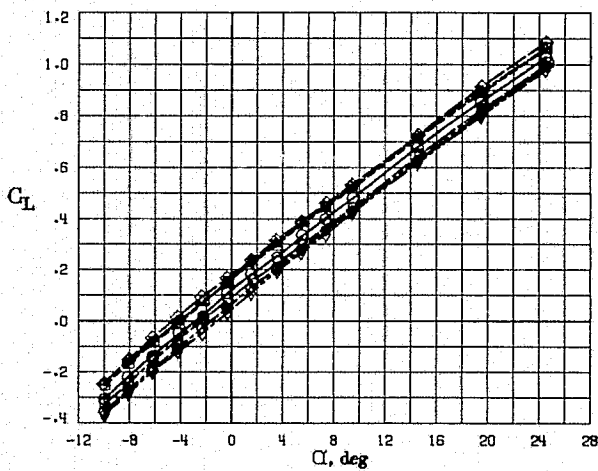
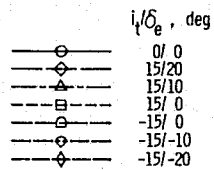
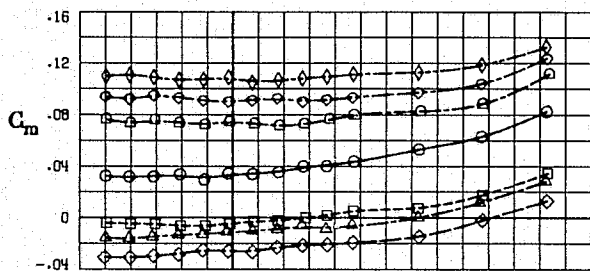
(d)  $\delta_i = 40^\circ/140^\circ/140^\circ$

Figure 8. - Concluded.



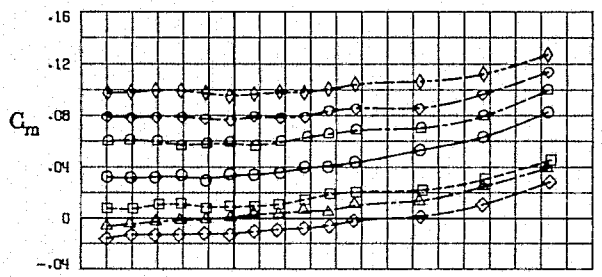
(a)  $\delta_f = 0^\circ/0^\circ/5^\circ, i_f = 20^\circ, 0^\circ \text{ and } -20^\circ$

Figure 9. - Effect of deflection of the horizontal tail  $H_1$  and elevator on the longitudinal aerodynamic characteristics of the basic configuration plus  $V_3$  and  $V_4$ .  $L_{1,2} = 30^\circ, L_6 = K45^\circ$ .

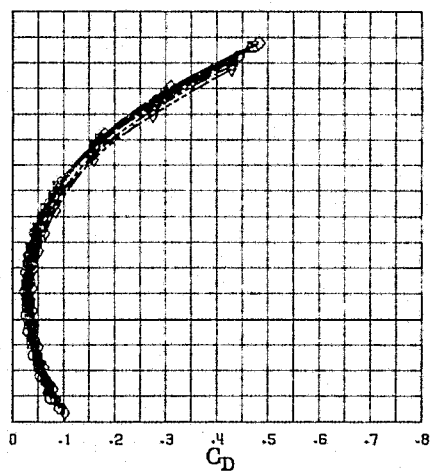
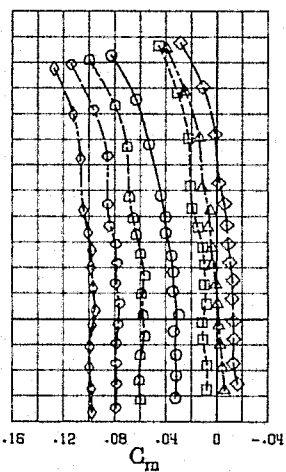
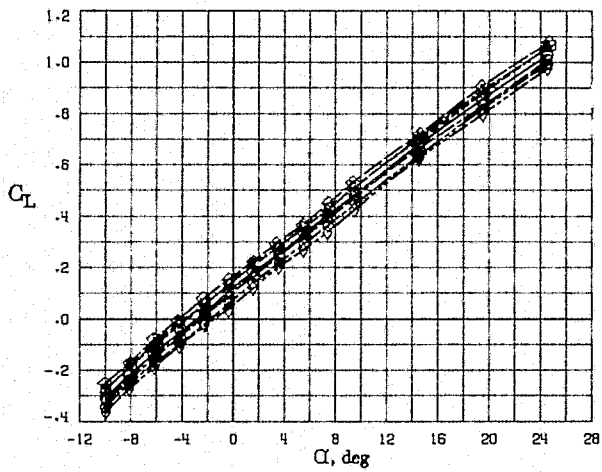


(b)  $i_e = 15^\circ, 0^\circ$  and  $-15^\circ$

Figure 9. - Continued.

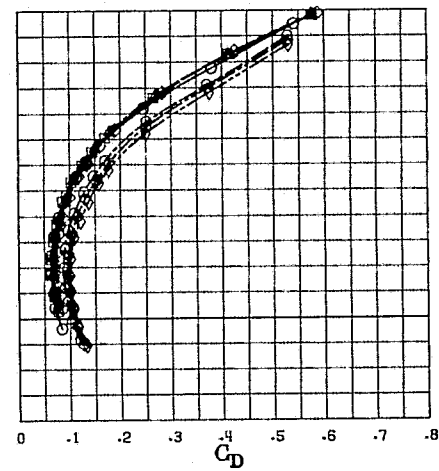
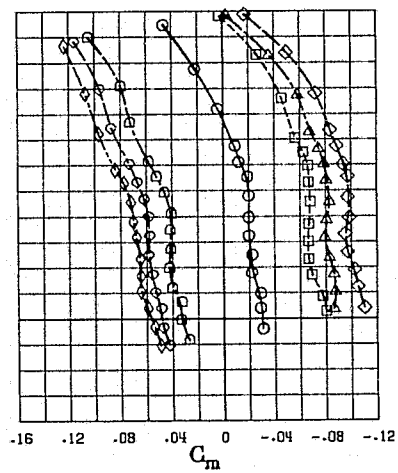
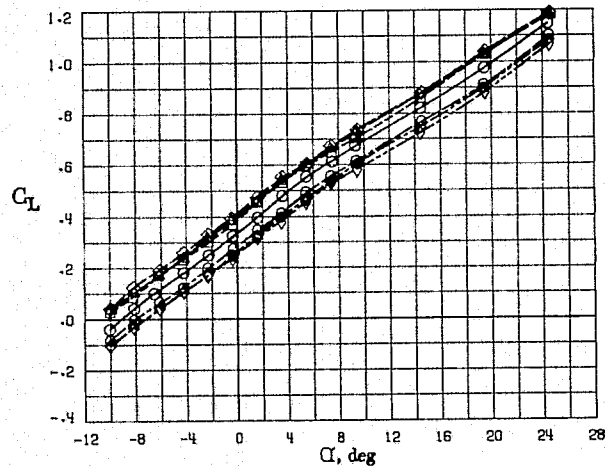
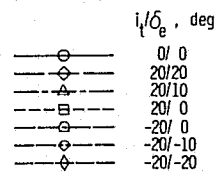
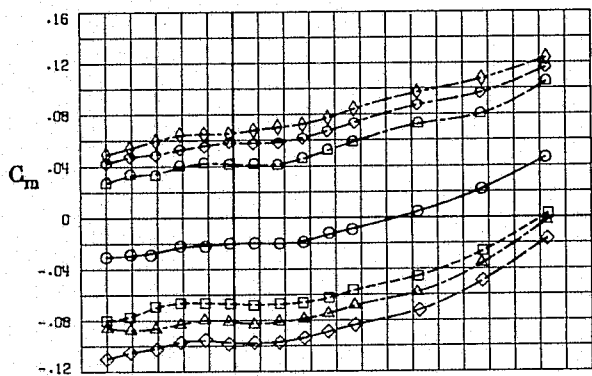


- $i_t/c_e$ , deg
- 0/0
  - ◇— 10/20
  - △— 10/10
  - 10/0
  - -10/0
  - ◇— -10/-10
  - ◇— -10/-20



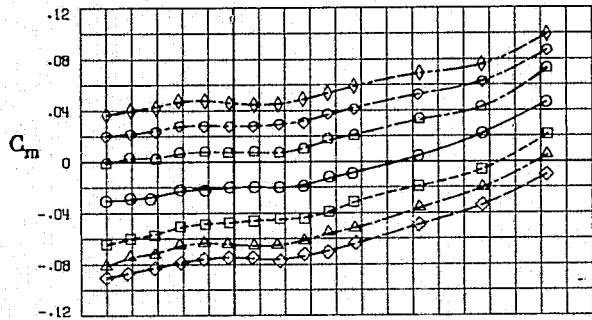
(c)  $i_t = 10^0, 0^0$  and  $-10^0$   
 Figure 9. - Continued.

ORIGINAL PAGE IS  
OF POOR QUALITY

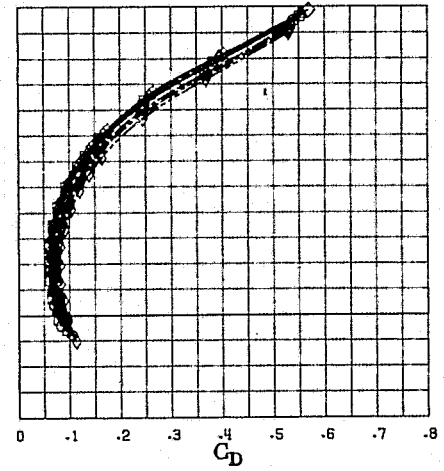
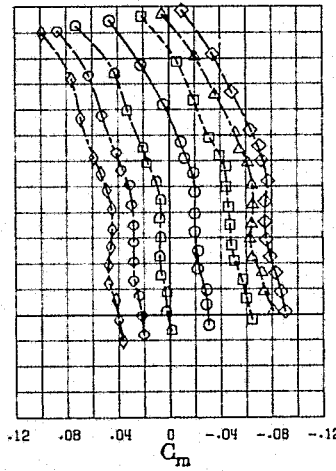
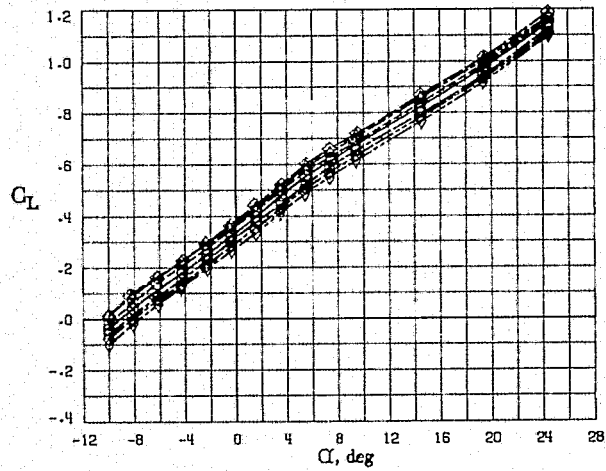


(d)  $\delta_f = 40^\circ/40^\circ/40^\circ$ ,  $i_t = 20^\circ, 0^\circ$  and  $-20^\circ$

Figure 9. - Continued.



- $i/\delta_e$ , deg
- 0/0
  - ◇— 10/20
  - △— 10/10
  - 10/0
  - -10/0
  - ◇— -10/-10
  - ◇— -10/-20



(e)  $\delta_t = 40^\circ/40^\circ/40^\circ$ ,  $i_t = 10^\circ, 0^\circ$  and  $-10^\circ$

Figure 9. - Concluded.

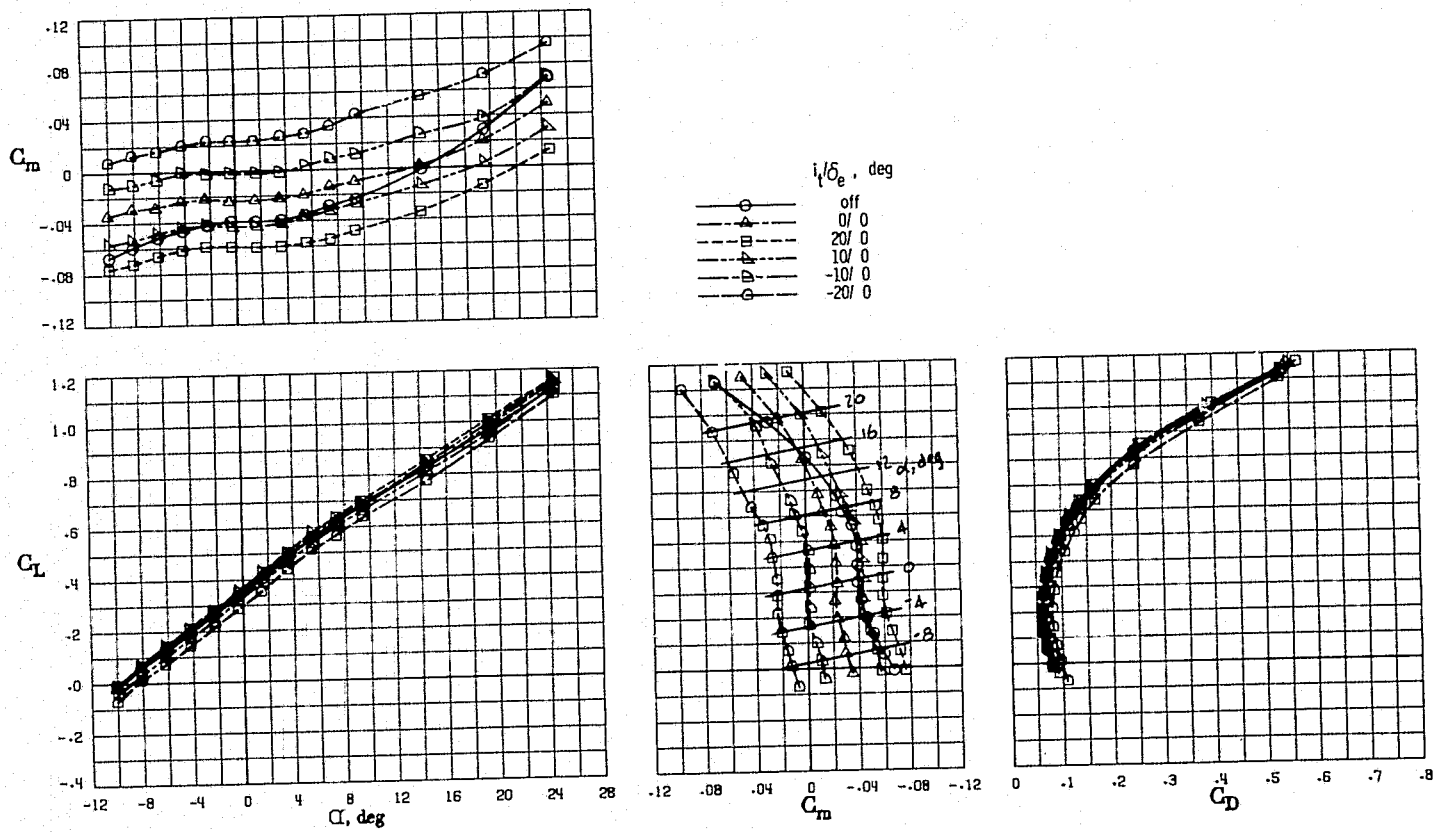


Figure 10. - Effect of deflection of the horizontal tail  $H_2$  on the longitudinal aerodynamic characteristics of the basic configuration plus  $V_3$  and  $V_4$ ,  $L_{1,2} = 30^\circ$ ,  $L_6 = K45^\circ$ ,  $\delta_f = 40^\circ/40^\circ/40^\circ$ .

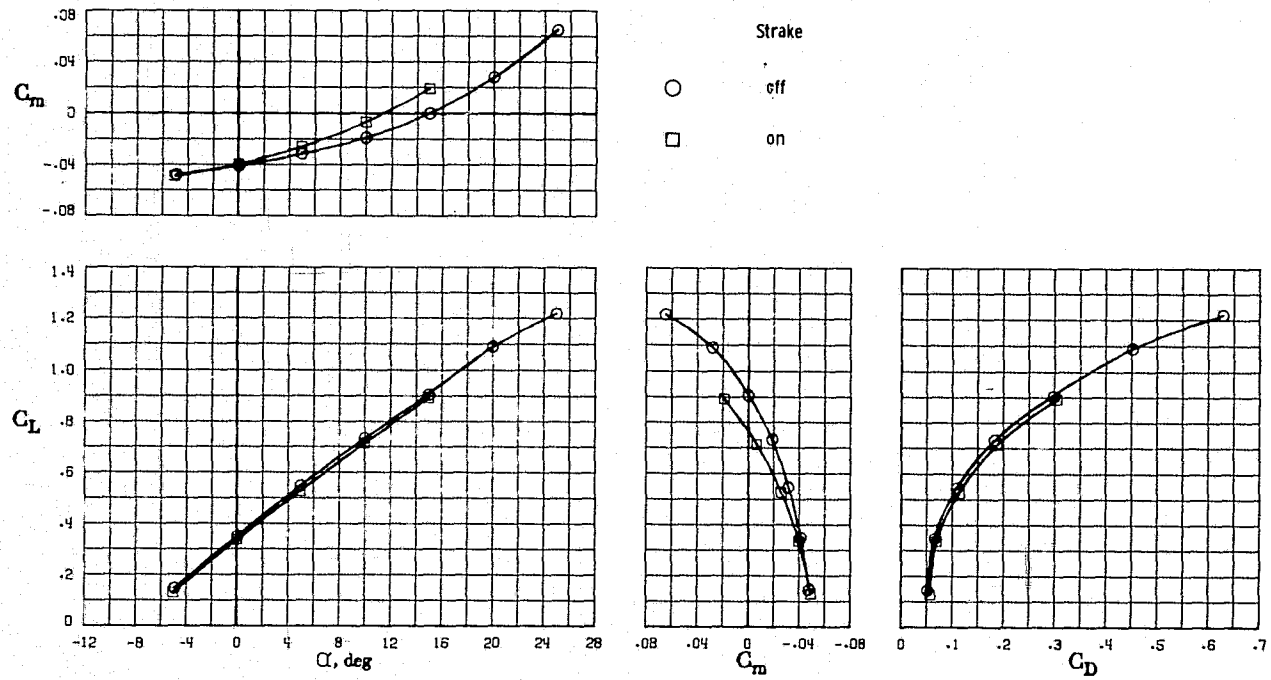


Figure 11. - Effect of fuselage forebody strakes on the longitudinal aerodynamic characteristics of the basic configuration,  $L_{1,2} = 30^\circ$ ,  $L_6 = K 45^\circ$  (reference 4).



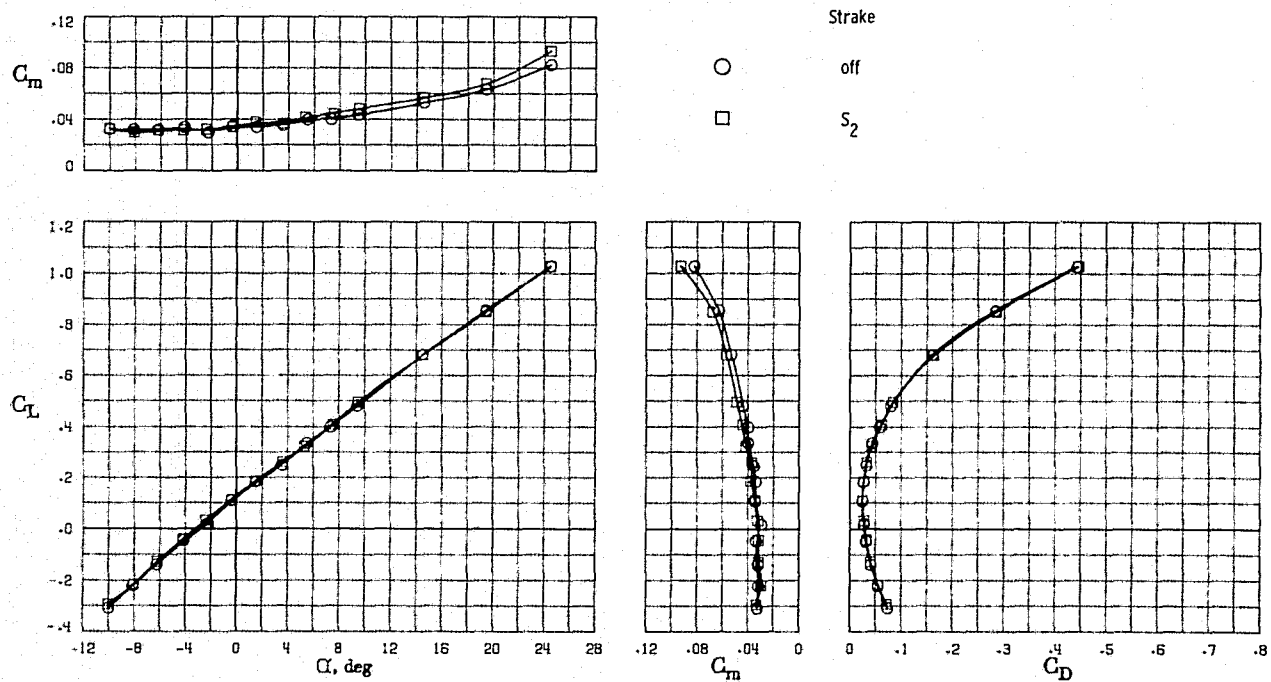


Figure 12 . - Effect of selected fuselage forebody strakes on the longitudinal aerodynamic characteristics of the basic configuration plus  $V_3$ ,  $V_4$  and  $H_1$  at  $i/\delta_e = 0^\circ$ ,  $L_{1,2} = 30^\circ$ ,  $L_6 = K45^\circ$ ,  $\delta_f = 0^\circ/0^\circ/5^\circ$ .

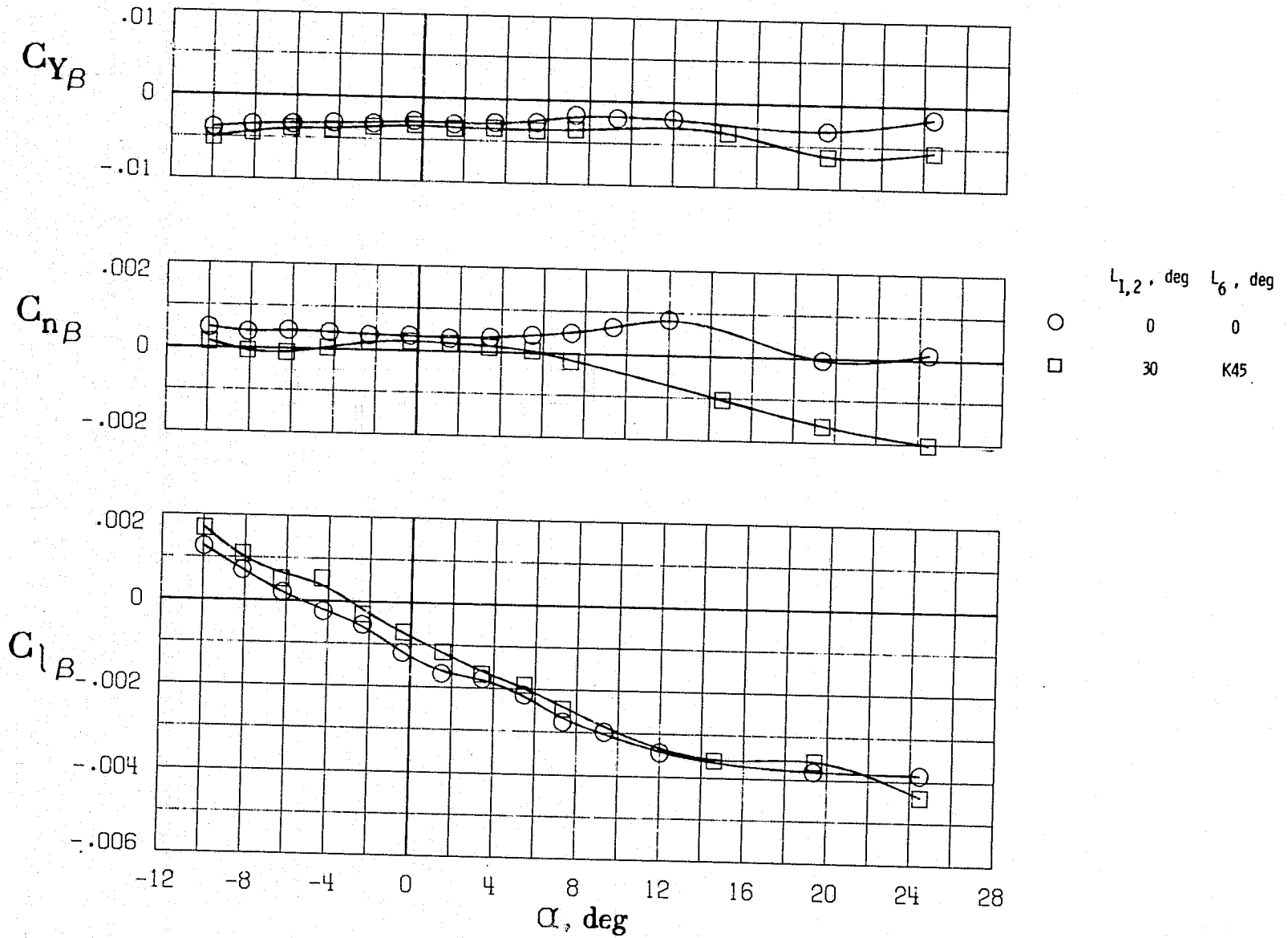


Figure 13. - Effect of deflecting the leading-edge flaps on the lateral-directional stability characteristics of the basic configuration,  $\delta_f = 0, 0, 5^\circ$ .

ORIGINAL PAGE IS  
OF POOR QUALITY

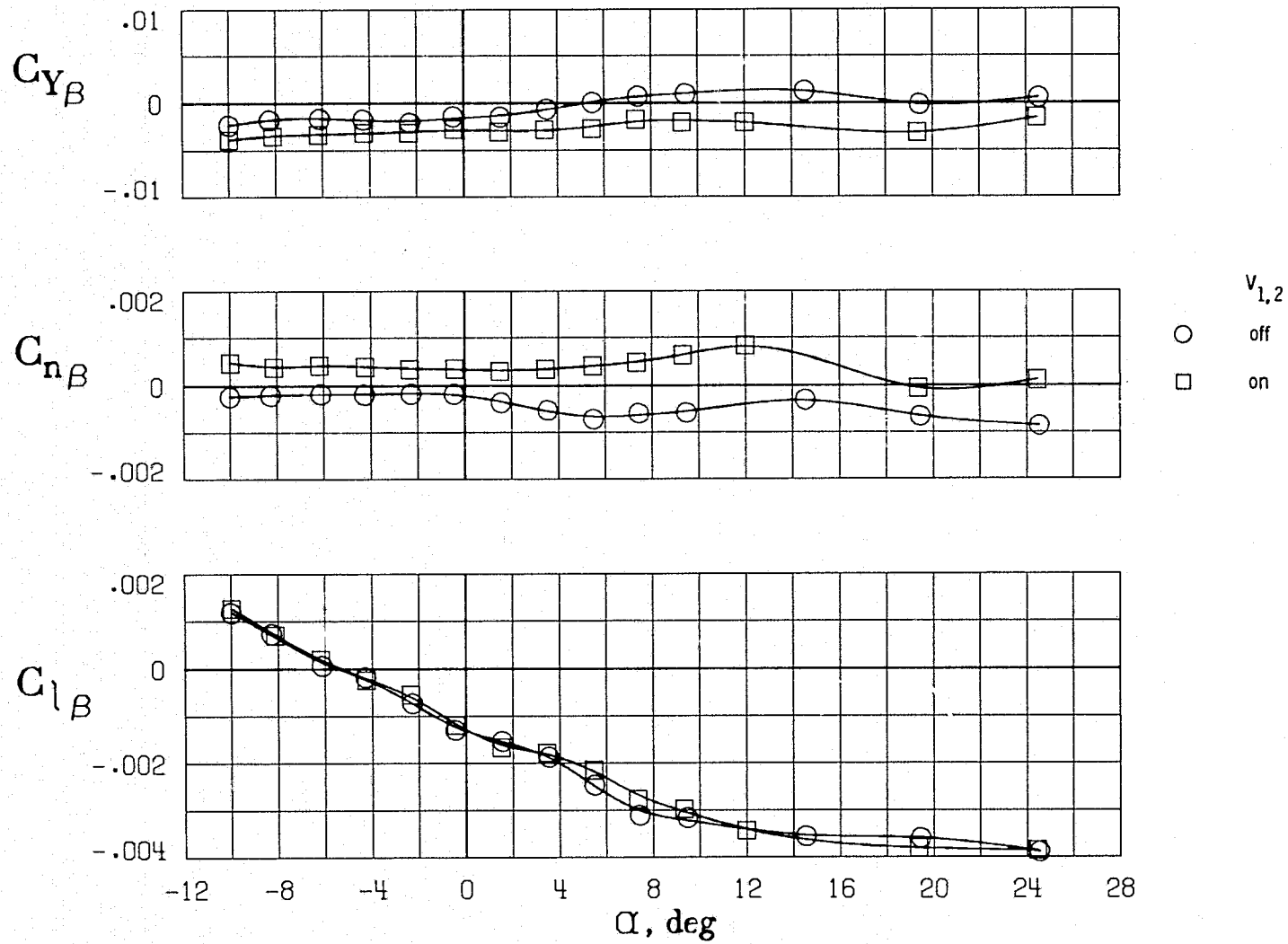


Figure 14. - Effect of wing fins on the lateral-directional stability characteristics of the wing-body-nacelle configuration,  $\delta_f = 0^\circ / 0^\circ / 5^\circ$ .

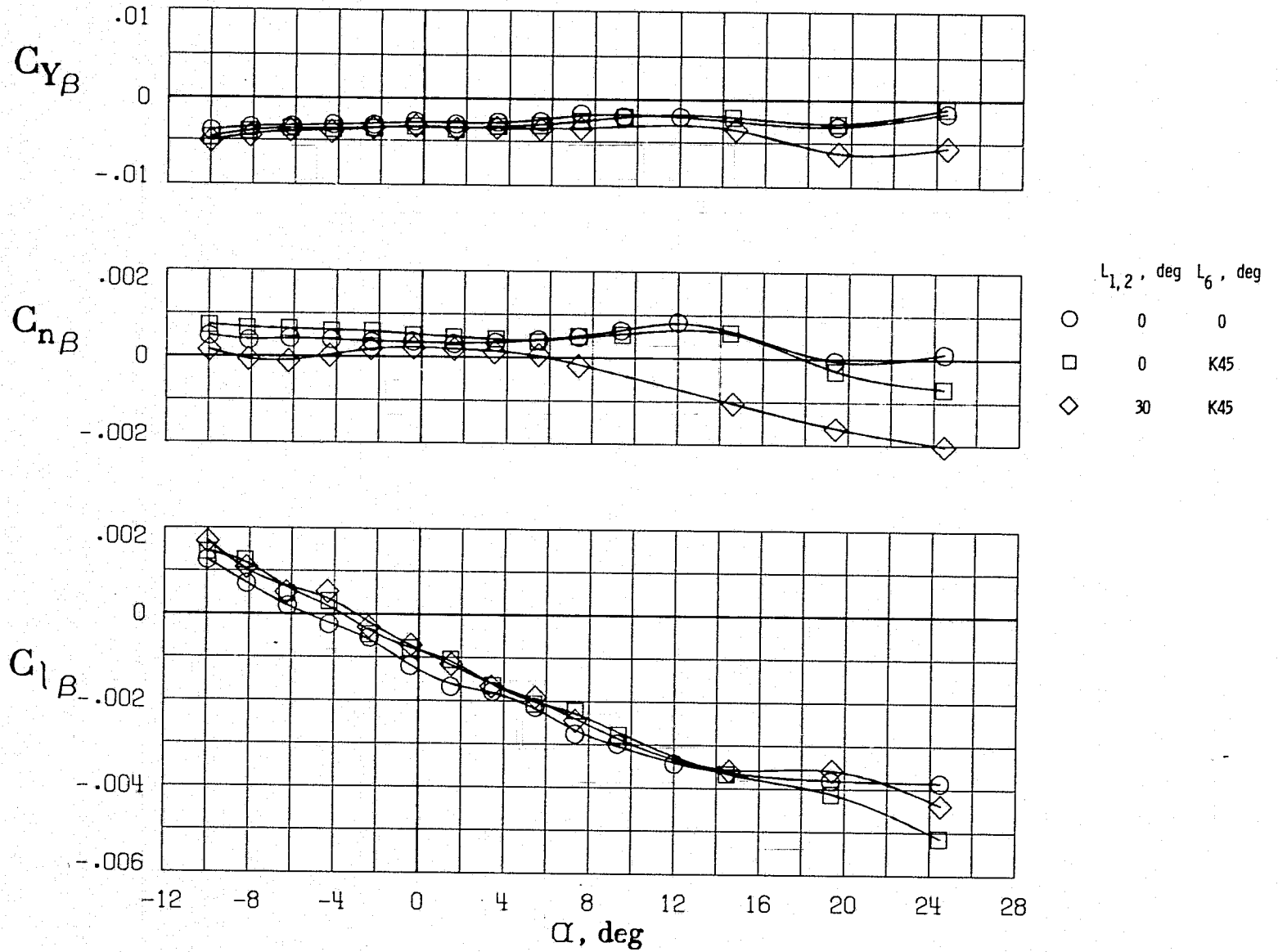


Figure 15 . - Effect of individual wing leading-edge devices on the lateral-directional stability characteristics of the basic configuration,  $\delta_f = 0^\circ / 0^\circ / 5^\circ$ .

ORIGINAL PAGE IS  
OF POOR QUALITY

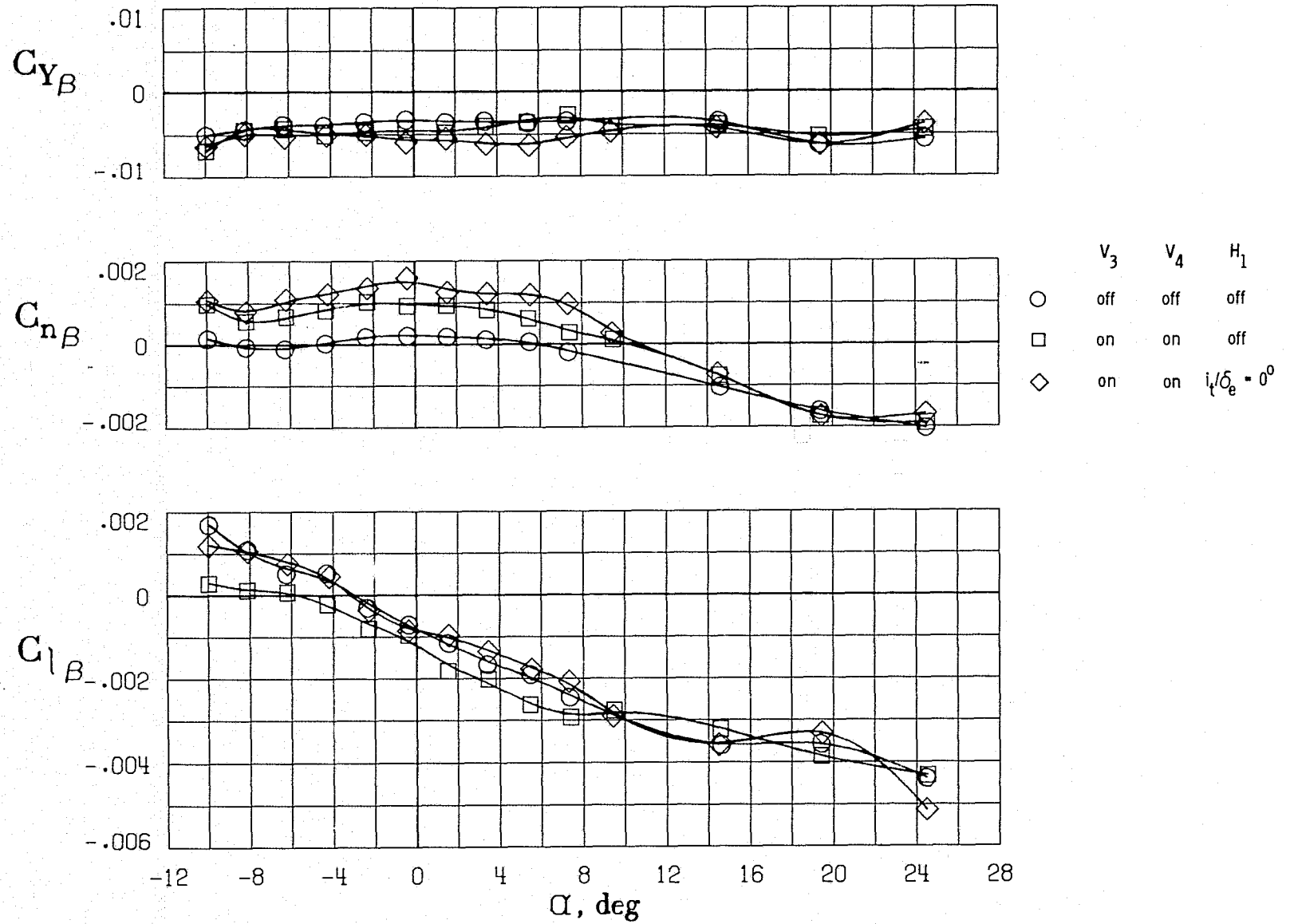


Figure 16. - Effect of empennage surfaces on the lateral-directional stability characteristics of the basic configuration,  $L_{1,2} = 30^\circ$ ,  $L_6 = K45^\circ$ ,  $\delta_f = 0^\circ/0^\circ/5^\circ$ .

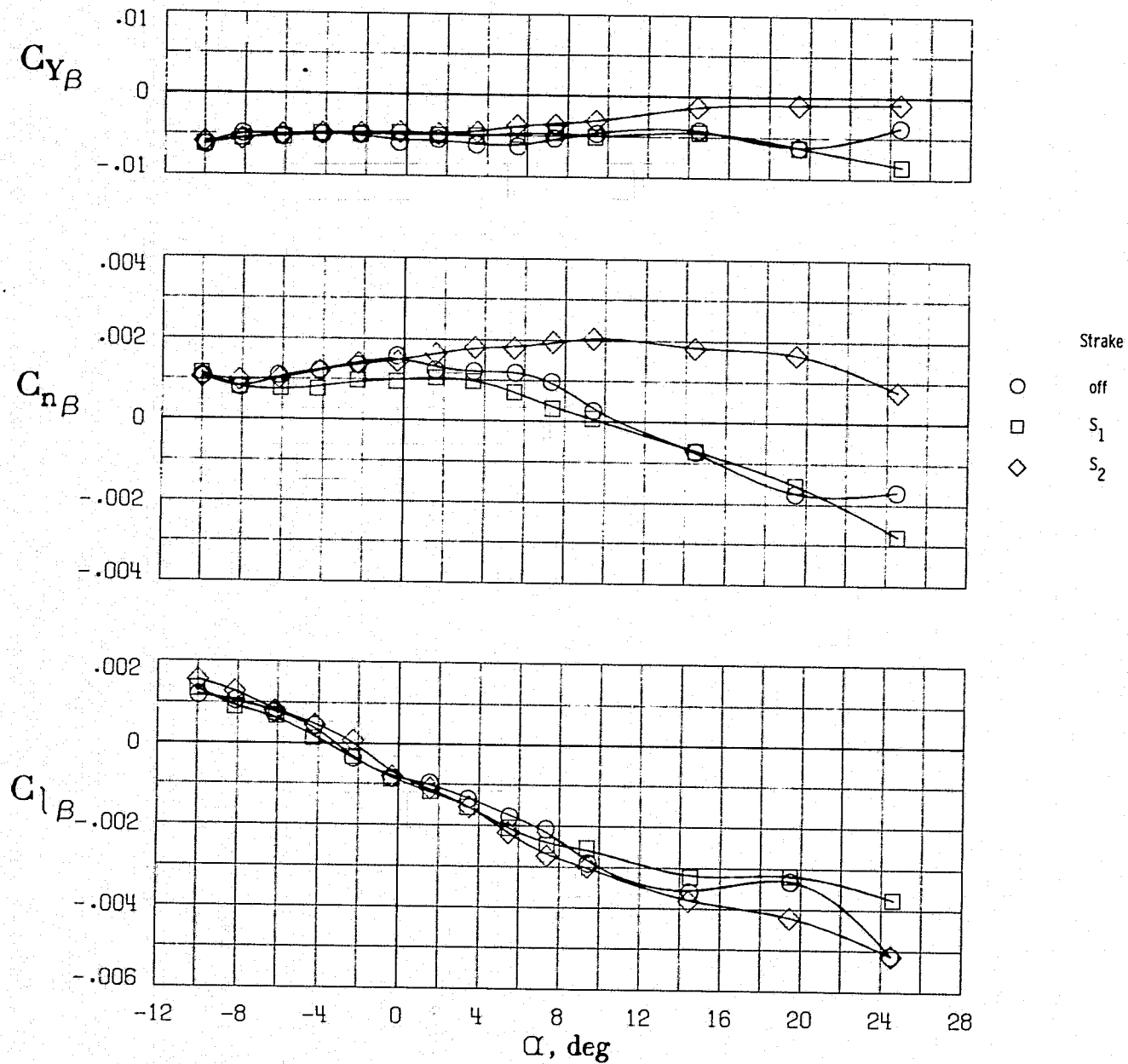


Figure 17. - Effect of fuselage forebody strakes on the lateral-directional stability characteristics of the basic configuration plus  $V_3$ ,  $V_4$  and  $H_1$  at  $i/\delta_e = 0^\circ$ ,  $L_{1,2} = 30^\circ$ ,  $L_6 = 45^\circ$ ,  $\delta_i = 0^\circ/0^\circ/5^\circ$ .

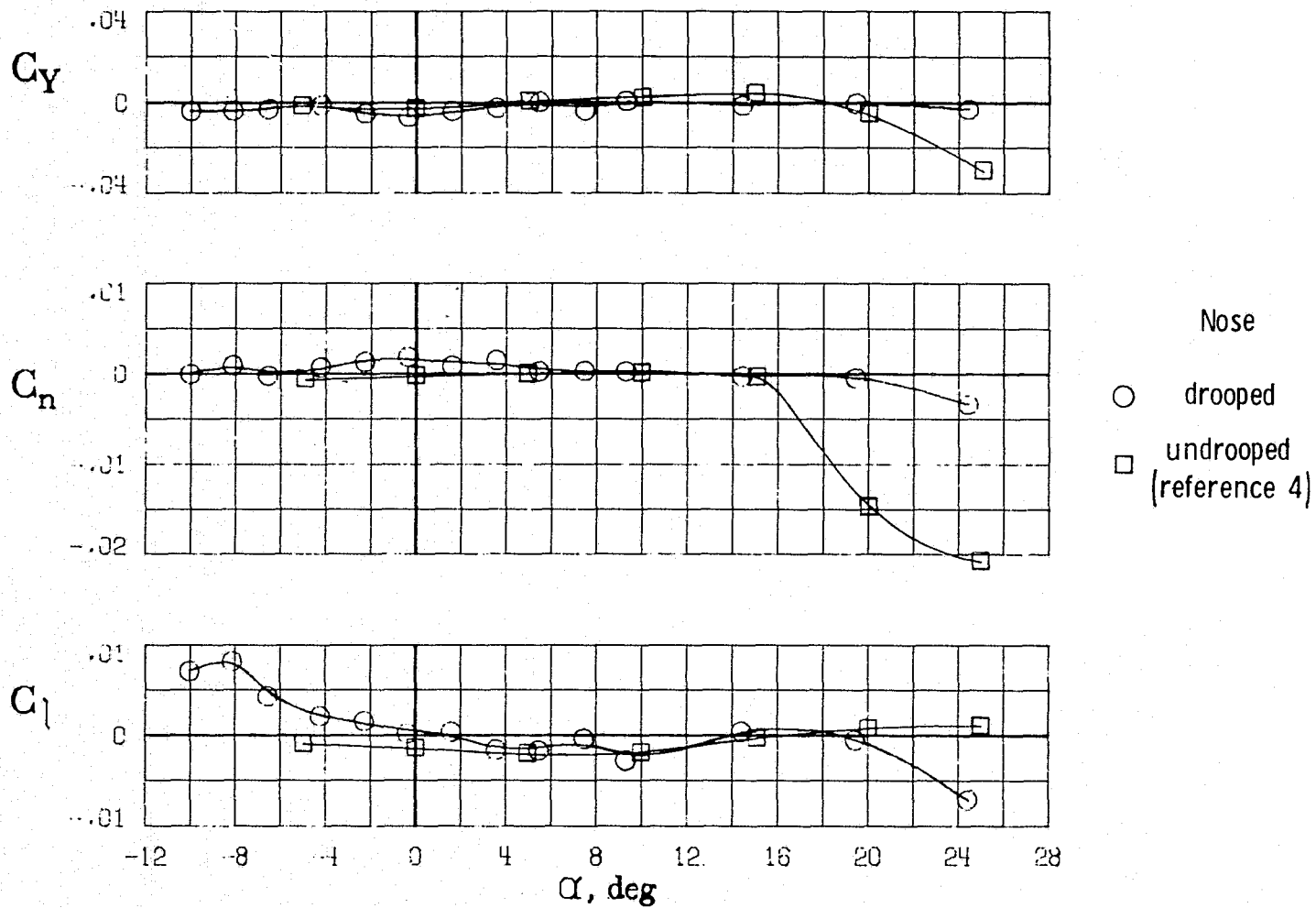


Figure 18 . - Effect of nose droop on the lateral-directional trim characteristics of the complete configuration ,  $L_{1,2} = 30^\circ$ ,  $L_6 = K45^\circ$ ,  $\delta_f = 0^\circ / 0^\circ / 5^\circ$ ,  $\beta = 0^\circ$ .

APPENDIX A.- TEST PROGRAM

RUN	$\beta$ DEG	L <sub>1,2</sub> DEG	L <sub>6</sub> DEG	$\delta_f$ , DEG				V <sub>1,2</sub>	V <sub>3</sub>	V <sub>4</sub>	HORIZ TAIL		STRAKE	NOM q <sub>T</sub> LBF/FT <sup>2</sup>
				t <sub>1</sub>	t <sub>3</sub>	t <sub>5</sub>	t <sub>6</sub>				i <sub>t</sub> <sup>o</sup> /δ <sub>e</sub> <sup>o</sup>	TYPE		
450	0	0	0	0	0	5	5	OFF	OFF	OFF	OFF	-	OFF	11
451	-5											-		
452	-10											-		
453	5											-		
454	10											-		
455	0							ON				-		
456	10											-		
457	5											-		
459	-5											-		
460	-10											-		
461	-10		K45									-		
462	-5											-		
464	0											-		
465	5											-		
466	10											-		
467	10	30										-		
468	5											-		
469	-10											-		
470	-5											-		
471	0											-		
473	0								ON	ON		-		
474	5											-		
475	10											-		
476	10										0/0	H <sub>1</sub>		
477	5													
478	0													
479	0												S <sub>1</sub>	
480	-5													
481	5													
482	10													
483	10												S <sub>2</sub>	
484	5													
485	0													
486	-5													
487											20/0		OFF	
488											15/0			
489											10/0			
490											-10/0			
491											-15/0			
492											-20/0			
493											-20/-10			
494											-20/-20			
495											-15/-20			
496											-15/-10			
497											-10/-10			
498											-10/-20			
499											10/10			
500											10/20			
501											20/20			
502											20/10			
503											15/10			

PRECEDING PAGE BLANK NOT REAS



APPENDIX A. — TEST PROGRAM  
(CONCLUDED)

RUN	$\beta$ DEG	L <sub>1</sub> , L <sub>2</sub> DEG	L <sub>6</sub> DEG	$\delta_f$ , DEG				V <sub>1,2</sub>	V <sub>3</sub>	V <sub>4</sub>	HORIZ TAIL		STRAKE	NOM $q_T$ LBF/FT <sup>2</sup>
				t <sub>1</sub>	t <sub>3</sub>	t <sub>5</sub>	t <sub>6</sub>				i <sub>t</sub> <sup>o</sup> / $\delta_e$ <sup>o</sup>	TYPE		
504	0	30	K45	0	0	5	5	ON	ON	ON	15/20	H <sub>1</sub>	OFF	11
507				30	30	30					OFF	-		
510				40	40	5						-		
515				20	20	5						-		
517						20						-		
518											0/0	H <sub>1</sub>		
519											-10/0			
520											-15/0			
521											-20/0			
522											10/0			
523											15/0			
524											20/0			
533				* 40s	* 40s	5					OFF	-		
537				40	40	40					20/0	H <sub>1</sub>		
538											20/10			
539											20/20			
540											10/20			
541											10/10			
542											10/0			
543											0/0			
544											-10/0			
545											-10/-10			
546											-10/-20			
547											-20/-20			
548											-20/-10			
549											-20/0			
550											OFF	-		
552											10/0	H <sub>2</sub>		
553											0/0			
554											-10/0			
555											-10/-10			
556											-20/-10			
557											-20/-20			
559											-20/0			
560											20/0			
561											20/10			
562											20/20			
564											10/10			
578				0	0	5					OFF	-		
586			45									-		
593		0	0									-		3
594												-		7
595												-		11
596												-		26
600		30	K45	10	10							-		11
607				30	30	30					-20/0	H <sub>1</sub>		
608											-10/0			
609											0/0			
610											10/0			
611											20/0			
617						5					OFF	-		

\* SINGLE SLOTTED FLAP

ORIGINAL PAGE IS  
OF POOR QUALITY

## APPENDIX B - PRESENTATION OF TABULATED DATA

The symbols used in the data tabulation are defined as follows:

ALPHA	Angle of attack, deg
BETA	Angle of sideslip, deg
CD	Drag force coefficient; stability axis
CL	Lift force coefficient; stability axis
CPM	Pitching moment coefficient; stability axis
CRM	Rolling moment coefficient; body axis
CSF	Side force coefficient; body axis
CYM	Yawing moment coefficient; body axis
MACH	Free-stream Mach number
Q	Free-stream dynamic pressure, (lbf/ft <sup>2</sup> )

TABLE B.- TABULATED DATA

## RUN 450

POINT	MACH	Q	BETA	ALPHA	CL	CD	CPM	CRM	CYM	CSF
101	.097	13.860	0.00	-9.90	-.2353	.0453	.0060	.0028	-.0018	.0030
102	.097	13.892	0.00	-8.08	-.1427	.0312	.0121	.0021	-.0014	.0022
103	.097	13.856	0.00	-6.15	-.0714	.0222	.0143	.0019	-.0012	.0024
104	.097	13.836	0.00	-4.22	-.0075	.0189	.0127	.0010	-.0012	.0026
105	.097	13.867	0.00	-2.29	.0644	.0179	.0184	-.0007	-.0013	.0022
106	.096	13.816	0.00	-.37	.1314	.0189	.0205	.0004	-.0014	-.0015
107	.096	13.822	0.00	1.68	.2084	.0238	.0234	.0004	-.0019	.0003
108	.096	13.691	0.00	3.60	.2734	.0335	.0237	-.0018	-.0025	.0030
109	.096	13.789	0.00	5.61	.3618	.0521	.0289	-.0033	-.0023	.0045
110	.096	13.809	0.00	7.43	.4348	.0738	.0348	-.0044	-.0021	.0037
111	.097	13.872	0.00	9.49	.5077	.1016	.0512	-.0053	-.0009	.0063
112	.097	13.948	0.00	14.70	.7209	.2089	.0959	-.0032	-.0003	.0042
113	.097	13.932	0.00	19.50	.9154	.3586	.1368	-.0053	-.0018	-.0002
114	.097	13.903	0.00	24.62	1.1311	.5506	.2086	-.0029	-.0047	-.0022

## RUN 451

POINT	MACH	Q	BETA	ALPHA	CL	CD	CPM	CRM	CYM	CSF
185	.097	13.857	-5.00	-10.01	-.2342	.0452	.0105	-.0030	-.0008	.0165
186	.096	13.735	-5.00	-8.15	-.1448	.0306	.0144	-.0003	-.0005	.0108
187	.096	13.785	-5.00	-6.15	-.0677	.0216	.0159	.0018	-.0004	.0095
188	.096	13.697	-5.00	-4.32	-.0191	.0188	.0170	.0020	-.0005	.0093
189	.096	13.735	-5.00	-2.41	.0717	.0166	.0245	.0039	-.0000	.0098
190	.096	13.598	-5.00	-.37	.1318	.0186	.0230	.0060	-.0001	.0060
191	.096	13.646	-5.00	1.55	.1987	.0230	.0265	.0067	.0004	.0063
192	.096	13.679	-5.00	3.41	.2798	.0340	.0257	.0077	.0009	.0043
193	.096	13.674	-5.00	5.52	.3586	.0511	.0360	.0102	.0016	.0022
194	.096	13.769	-5.00	7.35	.4305	.0724	.0447	.0119	.0017	.0003
195	.096	13.761	-5.00	9.38	.5102	.1011	.0571	.0103	.0020	-.0003
196	.097	13.852	-5.00	14.53	.7113	.2038	.0950	.0125	.0015	-.0006
197	.097	13.909	-5.00	19.40	.9045	.3509	.1375	.0153	.0017	.0018
198	.096	13.758	-5.00	24.53	1.1303	.5469	.2031	.0153	.0068	.0068

ORIGINAL PAGE IS  
OF POOR QUALITY

TABLE B.- CONTINUED

RUN 452

POINT	MACH	Q	BETA	ALPHA	CL	CD	CPM	CRM	CYM	CSF
269	.096	13.738	-10.00	-9.99	-.2241	.0430	.0072	-.0083	.0025	.0250
270	.096	13.753	-10.00	-8.14	-.1410	.0291	.0149	-.0056	.0019	.0213
271	.096	13.596	-10.00	-6.16	-.0739	.0217	.0143	-.0028	.0014	.0202
272	.096	13.621	-10.00	-4.27	.0051	.0174	.0166	.0012	.0015	.0195
273	.096	13.632	-10.00	-2.25	.0727	.0168	.0218	.0054	.0016	.0184
274	.096	13.651	-10.00	-.47	.1249	.0192	.0230	.0095	.0020	.0177
275	.096	13.647	-10.00	1.52	.2060	.0248	.0307	.0134	.0030	.0159
276	.096	13.713	-10.00	3.48	.2886	.0353	.0351	.0181	.0040	.0105
277	.096	13.746	-10.00	5.44	.3534	.0507	.0414	.0201	.0051	.0071
278	.096	13.651	-10.00	7.40	.4345	.0726	.0531	.0215	.0041	.0023
279	.096	13.699	-10.00	9.37	.5063	.0979	.0668	.0263	.0040	-.0007
280	.096	13.804	-10.00	14.52	.6952	.1956	.1038	.0300	.0050	.0017
281	.097	13.852	-10.00	19.37	.8744	.3346	.1467	.0334	.0059	.0086
282	.096	13.648	-10.00	24.35	1.0635	.5100	.2035	.0327	.0021	.0054

RUN 453

POINT	MACH	Q	BETA	ALPHA	CL	CD	CPM	CRM	CYM	CSF
353	.086	10.926	5.00	-10.01	-.2264	.0422	.0107	.0087	-.0031	-.0067
354	.086	10.993	5.00	-8.28	-.1475	.0298	.0148	.0070	-.0025	-.0069
355	.086	10.927	5.00	-6.13	-.0654	.0204	.0165	.0024	-.0021	-.0068
356	.086	10.951	5.00	-4.29	.0074	.0167	.0203	.0003	-.0023	-.0078
357	.086	10.889	5.00	-2.29	.0693	.0166	.0218	-.0034	-.0017	-.0108
358	.086	10.918	5.00	-.47	.1313	.0191	.0258	-.0070	-.0018	-.0081
359	.086	10.872	5.00	1.54	.2038	.0245	.0272	-.0086	-.0031	-.0082
360	.085	10.851	5.00	3.53	.2836	.0341	.0318	-.0110	-.0042	-.0017
361	.085	10.861	5.00	5.49	.3541	.0491	.0370	-.0144	-.0054	.0028
362	.086	10.894	5.00	7.43	.4242	.0704	.0429	-.0192	-.0042	.0073
363	.086	10.969	5.00	9.47	.5164	.1013	.0577	-.0213	-.0037	.0090
364	.086	11.004	5.00	14.53	.6988	.1987	.0903	-.0231	-.0015	.0120
365	.086	11.060	5.00	19.43	.9051	.3515	.1367	-.0206	-.0046	.0001
366	.086	10.905	5.00	24.53	1.0995	.5486	.1966	-.0235	-.0018	.0122

TABLE B.- CONTINUED

## RUN 454

POINT	MACH	Q	BETA	ALPHA	CL	CD	CPM	CRM	CYM	CSF
437	.086	10.937	10.00	-10.04	-.2196	.0403	.0044	.0157	-.0047	-.0132
438	.086	10.931	10.00	-8.27	-.1473	.0286	.0075	.0106	-.0036	-.0163
439	.085	10.848	10.00	-6.22	-.0668	.0198	.0121	.0068	-.0035	-.0171
440	.086	10.872	10.00	-4.33	-.0077	.0162	.0144	-.0004	-.0035	-.0182
441	.085	10.841	10.00	-2.39	.0676	.0162	.0198	-.0058	-.0037	-.0196
442	.086	10.937	10.00	-.47	.1362	.0190	.0243	-.0106	-.0030	-.0175
443	.086	10.889	10.00	1.40	.2047	.0247	.0282	-.0176	-.0050	-.0163
444	.086	10.927	10.00	3.49	.2779	.0353	.0342	-.0212	-.0059	-.0108
445	.086	10.893	10.00	5.36	.3567	.0486	.0413	-.0277	-.0066	-.0005
446	.086	10.940	10.00	7.31	.4210	.0661	.0522	-.0305	-.0069	.0054
447	.086	11.017	10.00	9.29	.4943	.0917	.0646	-.0323	-.0056	.0104
448	.086	11.020	10.00	14.49	.6884	.1909	.0996	-.0392	-.0024	.0118
449	.086	10.943	10.00	19.36	.8726	.3333	.1451	-.0413	-.0038	.0023
450	.086	10.880	10.00	24.50	1.0315	.5073	.1971	-.0464	-.0036	.0084

## RUN 455

POINT	MACH	Q	BETA	ALPHA	CL	CD	CPM	CRM	CYM	CSF
551	.085	10.655	0.00	-9.99	-.2269	.0451	.0092	.0074	-.0007	.0020
552	.086	10.933	0.00	-8.67	-.1779	.0353	.0093	.0076	-.0005	-.0006
553	.086	10.911	0.00	-6.20	-.0658	.0222	.0135	.0068	-.0000	-.0013
554	.086	10.940	0.00	-4.23	-.0034	.0187	.0151	.0048	.0003	-.0013
555	.086	10.861	0.00	-2.33	.0672	.0183	.0190	.0040	.0004	-.0048
556	.086	10.864	0.00	-.39	.1325	.0199	.0199	.0038	.0009	-.0053
557	.086	10.863	0.00	1.50	.1963	.0244	.0228	.0011	.0005	-.0014
558	.086	10.817	0.00	3.50	.2811	.0339	.0246	.0026	.0006	-.0034
559	.086	10.882	0.00	5.46	.3557	.0494	.0274	.0003	.0004	-.0016
560	.086	10.887	0.00	7.35	.4423	.0721	.0351	-.0029	.0012	.0016
561	.086	10.938	0.00	9.37	.5161	.1002	.0450	-.0012	.0012	-.0005
562	.087	11.020	0.00	14.48	.6960	.1956	.0786	-.0021	.0015	.0022
563	.087	11.061	0.00	19.39	.8911	.3417	.1310	-.0019	-.0019	-.0010
564	.086	10.910	0.00	24.47	1.0520	.5197	.1862	-.0017	-.0005	-.0014

TABLE B.- CONTINUED

RUN 456

POINT	MACH	Q	BETA	ALPHA	CL	CD	CPM	CRM	CYM	CSF
635	.086	10.975	10.00	-10.01	-.2179	.0410	.0092	.0182	.0029	-.0328
636	.086	10.863	10.00	-8.16	-.1389	.0289	.0148	.0123	.0045	-.0352
637	.086	10.855	10.00	-6.21	-.0731	.0214	.0173	.0104	.0043	-.0363
638	.086	10.883	10.00	-4.26	.0040	.0174	.0224	.0031	.0036	-.0377
639	.086	10.898	10.00	-2.34	.0620	.0178	.0236	-.0019	.0037	-.0389
640	.086	10.869	10.00	-.43	.1203	.0205	.0278	-.0063	.0044	-.0408
641	.086	10.880	10.00	1.49	.1933	.0266	.0335	-.0135	.0040	-.0411
642	.086	10.897	10.00	3.47	.2702	.0367	.0398	-.0177	.0044	-.0380
643	.086	10.926	10.00	5.44	.3450	.0513	.0481	-.0227	.0050	-.0366
644	.087	11.031	10.00	7.36	.4085	.0681	.0508	-.0273	.0042	-.0285
645	.087	11.041	10.00	9.34	.4791	.0910	.0588	-.0330	.0044	-.0154
646	.087	11.022	10.00	14.46	.6740	.1858	.0984	-.0380	.0058	-.0102
647	.087	11.015	10.00	14.46	.6742	.1866	.0951	-.0346	.0054	-.0145
648	.087	11.083	10.00	19.33	.8441	.3213	.1452	-.0358	.0025	-.0268
649	.086	10.939	10.00	24.44	.9993	.4903	.1961	-.0390	.0078	-.0137

RUN 457

POINT	MACH	Q	BETA	ALPHA	CL	CD	CPM	CRM	CYM	CSF
720	.087	10.973	5.00	-9.99	-.2317	.0448	.0035	.0121	.0012	-.0158
721	.086	10.855	5.00	-8.13	-.1547	.0313	.0088	.0107	.0018	-.0190
722	.086	10.868	5.00	-6.19	-.0691	.0213	.0128	.0061	.0022	-.0184
723	.086	10.916	5.00	-4.25	.0018	.0178	.0149	.0038	.0019	-.0172
724	.086	10.893	5.00	-2.35	.0686	.0172	.0192	.0006	.0021	-.0194
725	.086	10.894	5.00	-.42	.1325	.0192	.0244	-.0030	.0024	-.0181
726	.086	10.872	5.00	1.49	.2014	.0252	.0256	-.0058	.0021	-.0205
727	.086	10.908	5.00	3.45	.2752	.0348	.0293	-.0066	.0027	-.0216
728	.086	10.922	5.00	5.46	.3550	.0499	.0342	-.0122	.0025	-.0160
729	.087	10.976	5.00	7.34	.4236	.0694	.0406	-.0153	.0027	-.0106
730	.086	10.945	5.00	9.33	.4894	.0941	.0486	-.0177	.0034	-.0102
731	.087	11.004	5.00	11.99	.5980	.1398	.0661	-.0213	.0049	-.0059
732	.087	11.022	5.00	19.34	.8728	.3335	.1368	-.0203	-.0010	-.0177
733	.087	10.974	5.00	24.45	1.0293	.5089	.1903	-.0191	.0054	-.0046

ORIGINAL PAGE IS  
OF POOR QUALITY

TABLE B.- CONTINUED

## RUN 459

POINT	MACH	Q	BETA	ALPHA	CL	CD	CPM	CRM	CYM	CSF
881	.086	10.953	-5.00	-9.98	-.2408	.0463	.0063	-.0005	-.0036	.0229
882	.086	10.929	-5.00	-8.21	-.1546	.0316	.0126	.0036	-.0021	.0156
883	.086	10.948	-5.00	-6.19	-.0758	.0226	.0139	.0042	-.0021	.0150
884	.086	10.919	-5.00	-4.23	-.0035	.0185	.0153	.0062	-.0021	.0139
885	.086	10.916	-5.00	-2.33	.0661	.0176	.0213	.0061	-.0014	.0121
886	.086	10.901	-5.00	-.39	.1302	.0193	.0218	.0090	-.0011	.0092
887	.086	10.905	-5.00	1.51	.2079	.0237	.0271	.0109	-.0010	.0099
888	.086	10.913	-5.00	3.51	.2805	.0341	.0226	.0112	-.0007	.0062
889	.086	10.899	-5.00	5.42	.3502	.0495	.0308	.0093	-.0016	.0107
890	.086	10.904	-5.00	7.38	.4231	.0699	.0354	.0123	-.0022	.0067
891	.086	10.911	-5.00	9.45	.5179	.1016	.0506	.0121	-.0030	.0101
892	.087	11.079	-5.00	14.52	.7099	.2004	.0853	.0130	-.0035	.0143
893	.087	11.059	-5.00	19.38	.8751	.3354	.1296	.0178	-.0005	.0137
894	.087	10.973	-5.00	24.47	1.0449	.5156	.1868	.0195	.0042	.0108

## RUN 460

POINT	MACH	Q	BETA	ALPHA	CL	CD	CPM	CRM	CYM	CSF
995	.086	10.924	-10.00	-10.10	-.2234	.0466	.0040	-.0059	-.0047	.0395
996	.086	10.910	-10.00	-8.26	-.1351	.0311	.0118	-.0014	-.0040	.0335
997	.086	10.869	-10.00	-6.14	-.0567	.0225	.0107	.0011	-.0040	.0324
998	.086	10.905	-10.00	-4.38	.0042	.0194	.0133	.0059	-.0040	.0313
999	.086	10.862	-10.00	-2.43	.0648	.0190	.0174	.0097	-.0032	.0278
1000	.086	10.811	-10.00	-.41	.1326	.0220	.0210	.0115	-.0034	.0290
1001	.086	10.832	-10.00	1.54	.1994	.0272	.0251	.0163	-.0031	.0287
1002	.086	10.797	-10.00	3.54	.2741	.0385	.0305	.0192	-.0032	.0287
1003	.086	10.776	-10.00	5.44	.3446	.0529	.0350	.0228	-.0043	.0251
1004	.086	10.891	-10.00	7.27	.4235	.0722	.0474	.0260	-.0049	.0249
1005	.086	10.836	-10.00	9.30	.5116	.1009	.0580	.0256	-.0056	.0223
1006	.086	10.906	-10.00	14.48	.6892	.1931	.0938	.0323	-.0035	.0199
1007	.086	10.959	-10.00	19.29	.8552	.3263	.1413	.0355	-.0009	.0298
1008	.086	10.924	-10.00	24.61	1.0177	.5024	.1963	.0364	-.0027	.0300

TABLE B.- CONTINUED

RUN 461

POINT	MACH	Q	BETA	ALPHA	CL	CD	CPM	CRM	CYM	CSF
1079	.086	10.883	-10.00	-10.03	-.2638	.0637	.0094	-.0062	-.0059	.0452
1080	.086	10.840	-10.00	-8.16	-.1700	.0466	.0160	-.0037	-.0052	.0379
1081	.086	10.865	-10.00	-6.22	-.0898	.0359	.0178	-.0002	-.0051	.0365
1082	.086	10.797	-10.00	-4.42	-.0267	.0309	.0185	.0003	-.0051	.0362
1083	.086	10.843	-10.00	-2.46	.0543	.0265	.0201	.0068	-.0043	.0310
1084	.086	10.819	-10.00	-.38	.1104	.0270	.0203	.0083	-.0040	.0319
1085	.086	10.808	-10.00	1.31	.1825	.0293	.0248	.0141	-.0030	.0297
1086	.086	10.806	-10.00	3.49	.2729	.0370	.0348	.0183	-.0038	.0288
1087	.086	10.832	-10.00	5.46	.3486	.0497	.0402	.0222	-.0022	.0221
1088	.086	10.838	-10.00	7.31	.4254	.0672	.0492	.0252	-.0028	.0176
1089	.086	10.846	-10.00	9.41	.5007	.0924	.0569	.0276	-.0028	.0182
1090	.086	10.929	-10.00	14.49	.6997	.1838	.0920	.0323	-.0017	.0214
1091	.087	10.991	-10.00	19.33	.8712	.3131	.1315	.0393	.0044	.0242
1092	.086	10.929	-10.00	24.41	1.0288	.4761	.1767	.0456	.0095	.0186

RUN 462

POINT	MACH	Q	BETA	ALPHA	CL	CD	CPM	CRM	CYM	CSF
1163	.086	10.865	-5.00	-9.90	-.2739	.0627	.0229	-.0008	-.0047	.0268
1164	.086	10.848	-5.00	-8.12	-.1863	.0466	.0266	.0006	-.0027	.0181
1165	.086	10.852	-5.00	-6.23	-.1080	.0354	.0253	.0053	-.0024	.0149
1166	.086	10.830	-5.00	-4.26	-.0298	.0292	.0246	.0054	-.0021	.0131
1167	.086	10.809	-5.00	-2.33	.0505	.0245	.0263	.0076	-.0020	.0116
1168	.086	10.785	-5.00	-.44	.1172	.0236	.0280	.0084	-.0014	.0093
1169	.086	10.798	-5.00	1.45	.1990	.0257	.0308	.0077	-.0013	.0136
1170	.086	10.765	-5.00	3.51	.2594	.0328	.0315	.0101	-.0006	.0084
1171	.086	10.770	-5.00	5.47	.3437	.0461	.0392	.0124	-.0007	.0108
1172	.086	10.869	-5.00	7.39	.4268	.0659	.0468	.0125	-.0015	.0109
1173	.086	10.877	-5.00	9.37	.5138	.0929	.0562	.0122	-.0022	.0113
1174	.086	10.935	-5.00	14.54	.7113	.1875	.0907	.0148	-.0022	.0138
1175	.086	10.907	-5.00	19.39	.9010	.3243	.1296	.0177	.0012	.0126
1176	.086	10.877	-5.00	24.54	1.0660	.4959	.1786	.0230	.0068	.0086



TABLE B.- CONTINUED

## RUN 464

POINT	MACH	Q	BETA	ALPHA	CL	CD	CPM	CRM	CYM	CSF
1254	.086	10.743	0.00	-10.01	-.2754	.0614	.0237	.0109	.0012	.0012
1255	.086	10.702	0.00	-8.15	-.1982	.0480	.0236	.0081	.0007	-.0031
1256	.086	10.705	0.00	-6.22	-.1168	.0365	.0243	.0087	.0008	-.0044
1257	.086	10.779	0.00	-4.25	-.0193	.0283	.0249	.0066	.0008	-.0047
1258	.086	10.720	0.00	-2.33	.0429	.0255	.0240	.0053	.0011	-.0057
1259	.085	10.665	0.00	-.42	.1118	.0241	.0253	.0047	.0011	-.0082
1260	.085	10.674	0.00	1.50	.1849	.0266	.0278	.0038	.0008	-.0067
1261	.085	10.629	0.00	3.50	.2640	.0326	.0314	.0018	.0009	-.0048
1262	.086	10.771	0.00	5.41	.3457	.0453	.0357	-.0003	-.0000	-.0016
1263	.086	10.712	0.00	7.36	.4259	.0649	.0401	-.0002	.0015	-.0030
1264	.086	10.779	0.00	9.38	.5112	.0917	.0496	-.0026	.0016	-.0015
1265	.086	10.808	0.00	12.01	.6065	.1326	.0647	-.0017	.0015	-.0008
1266	.086	10.807	0.00	19.39	.9037	.3251	.1264	-.0026	-.0008	.0001
1267	.086	10.787	0.00	24.46	1.0785	.5020	.1731	-.0018	-.0012	-.0033

## RUN 465

POINT	MACH	Q	BETA	ALPHA	CL	CD	CPM	CRM	CYM	CSF
1338	.086	10.750	5.00	-9.99	-.2696	.0614	.0189	.0137	.0026	-.0199
1339	.086	10.748	5.00	-8.21	-.1983	.0482	.0223	.0132	.0039	-.0212
1340	.086	10.708	5.00	-6.24	-.1050	.0353	.0237	.0101	.0042	-.0208
1341	.086	10.772	5.00	-4.26	-.0336	.0283	.0222	.0085	.0039	-.0237
1342	.086	10.749	5.00	-2.32	.0456	.0254	.0240	.0029	.0041	-.0238
1343	.086	10.778	5.00	-.41	.1207	.0250	.0261	.0006	.0037	-.0240
1344	.086	10.772	5.00	1.49	.1899	.0272	.0302	-.0027	.0034	-.0224
1345	.086	10.694	5.00	3.48	.2581	.0338	.0313	-.0063	.0036	-.0245
1346	.085	10.651	5.00	5.42	.3315	.0448	.0389	-.0083	.0029	-.0205
1347	.086	10.786	5.00	7.35	.4163	.0633	.0454	-.0097	.0034	-.0155
1348	.086	10.874	5.00	9.40	.5036	.0900	.0533	-.0156	.0031	-.0094
1349	.086	10.837	5.00	14.45	.7061	.1847	.0876	-.0219	.0037	-.0069
1350	.086	10.864	5.00	19.37	.8968	.3226	.1289	-.0235	-.0016	-.0156
1351	.086	10.777	5.00	24.43	1.0669	.4957	.1769	-.0284	-.0001	-.0018

ORIGINAL PAGE IS  
OF POOR QUALITY

TABLE B.- CONTINUED

RUN 466

POINT	MACH	Q	BETA	ALPHA	CL	CD	CPM	CRM	CYM	CSF
1422	.086	10.797	10.00	-9.98	-.2479	.0574	.0146	.0211	.0055	-.0402
1423	.086	10.754	10.00	-8.18	-.1743	.0455	.0200	.0171	.0073	-.0419
1424	.086	10.751	10.00	-6.25	-.1027	.0349	.0219	.0125	.0073	-.0423
1425	.086	10.805	10.00	-4.27	-.0276	.0284	.0235	.0101	.0074	-.0446
1426	.086	10.737	10.00	-2.34	.0378	.0264	.0250	.0033	.0077	-.0466
1427	.086	10.775	10.00	-.42	.1099	.0266	.0281	-.0048	.0071	-.0445
1428	.086	10.736	10.00	1.50	.1745	.0301	.0330	-.0100	.0066	-.0457
1429	.086	10.791	10.00	3.53	.2667	.0390	.0436	-.0157	.0066	-.0438
1430	.086	10.818	10.00	5.48	.3442	.0495	.0480	-.0203	.0053	-.0335
1431	.086	10.826	10.00	7.38	.4145	.0652	.0559	-.0286	.0046	-.0263
1432	.086	10.892	10.00	9.35	.4852	.0863	.0624	-.0313	.0025	-.0163
1433	.086	10.889	10.00	14.46	.6875	.1783	.0939	-.0361	.0034	-.0152
1434	.086	10.871	10.00	19.38	.8490	.3044	.1297	-.0453	-.0016	-.0143
1435	.086	10.843	10.00	24.49	1.0198	.4737	.1769	-.0492	-.0037	-.0020

RUN 467

POINT	MACH	Q	BETA	ALPHA	CL	CD	CPM	CRM	CYM	CSF
1537	.087	10.991	10.00	-10.09	-.2591	.0692	-.0016	.0210	-.0005	-.0555
1538	.086	10.928	10.00	-8.21	-.1696	.0524	.0052	.0151	.0002	-.0497
1539	.086	10.968	10.00	-6.23	-.0954	.0411	.0063	.0119	.0007	-.0491
1540	.086	10.958	10.00	-4.29	-.0129	.0325	.0133	.0074	.0020	-.0481
1541	.086	10.915	10.00	-2.37	.0471	.0291	.0151	.0020	.0020	-.0501
1542	.086	10.930	10.00	-.42	.1033	.0292	.0174	-.0023	.0025	-.0445
1543	.087	11.006	10.00	1.46	.1880	.0313	.0278	-.0077	.0026	-.0482
1544	.087	10.982	10.00	3.51	.2576	.0374	.0288	-.0145	.0007	-.0441
1545	.086	10.936	10.00	5.40	.3337	.0477	.0337	-.0222	-.0004	-.0440
1546	.087	11.021	10.00	7.34	.3945	.0603	.0387	-.0236	-.0018	-.0427
1547	.087	11.100	10.00	9.27	.4703	.0790	.0449	-.0297	-.0051	-.0319
1548	.087	11.106	10.00	14.39	.6453	.1544	.0616	-.0362	-.0091	-.0346
1549	.087	11.139	10.00	19.45	.8140	.2773	.0837	-.0386	-.0157	-.0551
1550	.087	11.008	10.00	24.36	.9756	.4269	.1110	-.0424	-.0198	-.0511

TABLE B .- CONTINUED

## RUN 468

POINT	MACH	Q	BETA	ALPHA	CL	CD	CPM	CRM	CYM	CSF
1621	.087	10.979	5.00	-9.98	-.2784	.0693	.0071	.0157	-.0006	-.0262
1622	.086	10.888	5.00	-8.13	-.1824	.0517	.0105	.0128	-.0006	-.0245
1623	.086	10.823	5.00	-6.27	-.1118	.0388	.0129	.0072	-.0005	-.0212
1624	.086	10.800	5.00	-4.32	-.0414	.0311	.0155	.0072	.0000	-.0248
1625	.086	10.891	5.00	-2.37	.0392	.0269	.0200	.0015	.0010	-.0210
1626	.086	10.888	5.00	-.38	.1174	.0256	.0231	.0002	.0020	-.0235
1627	.086	10.859	5.00	1.52	.1925	.0279	.0261	-.0041	.0014	-.0227
1628	.086	10.906	5.00	3.40	.2518	.0327	.0294	-.0070	.0012	-.0221
1629	.086	10.906	5.00	5.47	.3391	.0432	.0316	-.0080	.0007	-.0262
1630	.086	10.911	5.00	7.33	.4022	.0575	.0367	-.0138	-.0016	-.0239
1631	.086	10.960	5.00	9.40	.4840	.0796	.0416	-.0135	-.0013	-.0193
1632	.087	11.020	5.00	14.59	.6681	.1593	.0565	-.0215	-.0051	-.0181
1633	.087	11.014	5.00	19.40	.8426	.2828	.0806	-.0205	-.0089	-.0368
1634	.086	10.953	5.00	24.48	1.0073	.4356	.1099	-.0229	-.0064	-.0236

## RUN 469

POINT	MACH	Q	BETA	ALPHA	CL	CD	CPM	CRM	CYM	CSF
1705	.086	10.918	-10.00	-9.93	-.2561	.0694	.0006	-.0078	-.0018	.0526
1706	.086	10.815	-10.00	-8.14	-.1878	.0539	.0070	-.0035	-.0009	.0441
1707	.086	10.820	-10.00	-6.19	-.1107	.0425	.0062	-.0026	.0000	.0399
1708	.086	10.856	-10.00	-4.19	-.0256	.0336	.0115	.0010	-.0008	.0371
1709	.086	10.819	-10.00	-2.33	.0478	.0288	.0130	.0057	-.0005	.0360
1710	.086	10.776	-10.00	-.44	.1133	.0275	.0154	.0113	.0003	.0311
1711	.086	10.774	-10.00	1.52	.1885	.0309	.0246	.0117	-.0007	.0345
1712	.086	10.725	-10.00	3.51	.2568	.0366	.0248	.0167	.0012	.0327
1713	.086	10.717	-10.00	5.43	.3275	.0471	.0289	.0200	.0018	.0308
1714	.086	10.700	-10.00	7.38	.3983	.0627	.0349	.0217	.0031	.0298
1715	.086	10.765	-10.00	9.46	.4742	.0836	.0435	.0250	.0039	.0295
1716	.086	10.867	-10.00	14.48	.6526	.1594	.0581	.0276	.0111	.0443
1717	.086	10.840	-10.00	19.37	.8218	.2751	.0790	.0342	.0176	.0557
1718	.086	10.896	-10.00	24.46	.9873	.4328	.1140	.0388	.0253	.0665

TABLE B.- CONTINUED

## RUN 470

POINT	MACH	Q	BETA	ALPHA	CL	CD	CPM	CRM	CYM	CSF
1789	.085	10.674	-5.00	-9.96	-.2900	.0731	.0045	-.0012	-.0021	.0244
1790	.086	10.744	-5.00	-8.16	-.1947	.0533	.0091	.0018	-.0000	.0199
1791	.086	10.726	-5.00	-6.11	-.1063	.0396	.0125	.0021	.0005	.0170
1792	.086	10.712	-5.00	-4.15	-.0243	.0314	.0168	.0018	-.0003	.0146
1793	.086	10.712	-5.00	-2.32	.0521	.0268	.0199	.0045	-.0009	.0142
1794	.085	10.658	-5.00	-.27	.1170	.0255	.0185	.0072	-.0001	.0090
1795	.085	10.620	-5.00	1.52	.1912	.0271	.0247	.0074	-.0005	.0130
1796	.085	10.653	-5.00	3.50	.2685	.0330	.0254	.0097	.0000	.0122
1797	.085	10.637	-5.00	5.49	.3451	.0449	.0303	.0111	.0001	.0099
1798	.086	10.678	-5.00	7.37	.4064	.0605	.0316	.0107	.0003	.0104
1800	.086	10.868	-5.00	14.54	.6821	.1631	.0552	.0144	.0053	.0170
1801	.086	10.828	-5.00	19.51	.8517	.2838	.0750	.0152	.0072	.0254
1802	.086	10.796	-5.00	24.52	1.0076	.4342	.1061	.0209	.0139	.0320

## RUN 471

POINT	MACH	Q	BETA	ALPHA	CL	CD	CPM	CRM	CYM	CSF
1873	.086	10.695	0.00	-9.96	-.2775	.0714	.0091	.0074	-.0009	.0012
1874	.086	10.686	0.00	-8.12	-.2021	.0533	.0137	.0072	.0000	-.0027
1875	.086	10.703	0.00	-6.11	-.1107	.0389	.0156	.0040	.0003	-.0025
1876	.086	10.694	0.00	-4.24	-.0365	.0304	.0196	.0077	.0007	-.0049
1877	.085	10.609	0.00	-2.35	.0391	.0260	.0189	.0064	.0015	-.0066
1878	.085	10.629	0.00	-.45	.1128	.0242	.0239	.0036	.0016	-.0045
1879	.086	10.692	0.00	1.51	.1924	.0260	.0249	.0048	.0013	-.0086
1880	.086	10.694	0.00	3.47	.2642	.0323	.0258	.0028	.0003	-.0068
1881	.085	10.660	0.00	5.47	.3413	.0444	.0302	.0016	.0007	-.0037
1882	.086	10.697	0.00	7.36	.4077	.0592	.0315	-.0028	-.0004	-.0017
1883	.086	10.693	0.00	9.41	.4906	.0815	.0371	-.0020	.0005	-.0035
1884	.086	10.829	0.00	14.52	.6769	.1602	.0527	-.0022	.0012	-.0020
1885	.086	10.805	0.00	19.49	.8554	.2837	.0776	-.0011	-.0014	-.0055
1886	.086	10.689	0.00	24.49	1.0204	.4363	.1035	-.0013	.0013	-.0031

TABLE B .- CONTINUED

## RUN 473

POINT	MACH	Q	BETA	ALPHA	CL	CD	CPM	CRM	CYM	CSF
1964	.087	10.997	0.00	-9.88	-.2798	.0702	.0070	.0091	-.0007	.0015
1965	.086	10.911	0.00	-8.05	-.2008	.0529	.0103	.0082	.0001	-.0034
1966	.087	10.980	0.00	-6.17	-.1216	.0396	.0117	.0088	.0011	-.0085
1967	.086	10.911	0.00	-4.09	-.0383	.0303	.0175	.0062	.0011	-.0041
1968	.086	10.892	0.00	-2.24	.0404	.0264	.0219	.0063	.0015	-.0069
1969	.086	10.943	0.00	-.37	.0993	.0257	.0183	.0027	.0017	-.0059
1970	.086	10.875	0.00	1.55	.1839	.0266	.0221	.0034	.0022	-.0072
1971	.086	10.866	0.00	3.50	.2559	.0328	.0236	.0025	.0016	-.0084
1972	.087	10.947	0.00	5.51	.3381	.0445	.0272	.0003	.0012	-.0047
1973	.087	10.973	0.00	7.41	.4067	.0593	.0306	-.0000	.0013	-.0057
1974	.087	11.029	0.00	9.39	.4892	.0815	.0343	-.0019	.0010	-.0007
1975	.087	11.086	0.00	14.52	.6625	.1568	.0449	-.0033	-.0002	-.0009
1976	.087	11.090	0.00	19.47	.8493	.2816	.0696	-.0016	-.0017	-.0033
1977	.087	11.072	0.00	24.50	1.0120	.4344	.0997	-.0009	-.0002	-.0009

## RUN 474

POINT	MACH	Q	BETA	ALPHA	CL	CD	CPM	CRM	CYM	CSF
2078	.087	11.304	5.00	-9.98	-.2611	.0679	.0089	.0105	.0042	-.0329
2079	.087	11.252	5.00	-8.13	-.1827	.0519	.0094	.0089	.0029	-.0259
2081	.087	11.272	5.00	-6.20	-.1059	.0403	.0081	.0091	.0045	-.0299
2082	.087	11.308	5.00	-4.29	-.0137	.0311	.0159	.0051	.0052	-.0293
2083	.087	11.327	5.00	-2.31	.0493	.0272	.0165	.0023	.0067	-.0303
2084	.087	11.297	5.00	-.39	.1242	.0264	.0200	-.0021	.0064	-.0279
2085	.087	11.239	5.00	1.51	.1934	.0286	.0219	-.0057	.0069	-.0311
2086	.087	11.272	5.00	3.46	.2675	.0346	.0268	-.0076	.0058	-.0284
2087	.087	11.258	5.00	5.44	.3276	.0425	.0268	-.0128	.0043	-.0225
2088	.087	11.328	5.00	7.39	.4021	.0584	.0329	-.0146	.0027	-.0192
2089	.088	11.426	5.00	9.46	.4811	.0801	.0381	-.0157	.0015	-.0213
2090	.088	11.421	5.00	14.56	.6646	.1590	.0511	-.0194	-.0040	-.0201
2091	.088	11.407	5.00	19.40	.8388	.2808	.0744	-.0208	-.0104	-.0296
2092	.088	11.389	5.00	24.53	.9925	.4304	.0997	-.0225	-.0098	-.0230

ORIGINAL PAGE IS  
OF POOR QUALITY

TABLE B .- CONTINUED

RUN 475

POINT	MACH	Q	BETA	ALPHA	CL	CD	CPM	CRM	CYM	CSF
2163	.087	11.315	10.00	-9.91	-.2549	.0688	.0020	.0152	.0094	-.0507
2164	.087	11.234	10.00	-8.22	-.1783	.0536	.0064	.0119	.0088	-.0605
2165	.087	11.242	10.00	-6.17	-.0899	.0403	.0117	.0094	.0097	-.0581
2166	.087	11.178	10.00	-4.17	-.0173	.0339	.0139	.0052	.0109	-.0571
2167	.087	11.214	10.00	-2.24	.0469	.0309	.0167	-.0012	.0116	-.0585
2168	.087	11.274	10.00	-.36	.1162	.0303	.0212	-.0059	.0118	-.0584
2169	.087	11.288	10.00	1.57	.1901	.0318	.0271	-.0113	.0114	-.0556
2170	.087	11.232	10.00	3.52	.2537	.0383	.0311	-.0155	.0112	-.0581
2171	.087	11.262	10.00	5.50	.3224	.0468	.0353	-.0231	.0093	-.0514
2172	.087	11.299	10.00	7.44	.3903	.0602	.0402	-.0279	.0069	-.0500
2173	.087	11.347	10.00	9.47	.4686	.0795	.0480	-.0309	.0045	-.0409
2174	.088	11.428	10.00	14.57	.6400	.1545	.0626	-.0351	-.0050	-.0449
2175	.088	11.399	10.00	19.47	.8063	.2724	.0848	-.0410	-.0162	-.0501
2176	.088	11.380	10.00	24.50	.9650	.4222	.1102	-.0446	-.0221	-.0450

RUN 476

POINT	MACH	Q	BETA	ALPHA	CL	CD	CPM	CRM	CYM	CSF
2247	.087	11.187	10.00	-9.98	-.2693	.0724	.0192	.0196	.0115	-.0659
2248	.087	11.139	10.00	-7.89	-.1860	.0552	.0182	.0174	.0124	-.0675
2249	.087	11.153	10.00	-5.88	-.1038	.0427	.0208	.0119	.0125	-.0604
2250	.087	11.096	10.00	-4.04	-.0395	.0358	.0205	.0075	.0140	-.0634
2251	.087	11.143	10.00	-2.13	.0374	.0316	.0244	.0037	.0147	-.0604
2252	.087	11.071	10.00	-.36	.1007	.0306	.0282	-.0024	.0144	-.0593
2253	.086	11.066	10.00	1.77	.1704	.0337	.0325	-.0083	.0140	-.0640
2254	.087	11.098	10.00	3.60	.2547	.0393	.0383	-.0137	.0126	-.0595
2255	.087	11.154	10.00	5.67	.3287	.0493	.0409	-.0210	.0107	-.0580
2256	.087	11.233	10.00	7.32	.3842	.0596	.0438	-.0256	.0095	-.0533
2257	.087	11.278	10.00	9.29	.4614	.0784	.0500	-.0266	.0080	-.0459
2258	.087	11.291	10.00	14.58	.6436	.1565	.0578	-.0349	-.0025	-.0454
2259	.087	11.322	10.00	19.54	.8201	.2798	.0692	-.0423	-.0164	-.0534
2260	.087	11.232	10.00	24.49	1.0005	.4374	.0812	-.0459	-.0222	-.0429

TABLE B .- CONTINUED

## RUN 477

POINT	MACH	Q	BETA	ALPHA	CL	CD	CPM	CRM	CYM	CSF
2331	.086	11.003	5.00	-9.97	-.2956	.0729	.0291	.0145	.0047	-.0327
2332	.087	11.121	5.00	-8.13	-.2034	.0543	.0283	.0129	.0047	-.0298
2333	.086	11.042	5.00	-6.21	-.1258	.0413	.0274	.0089	.0060	-.0305
2334	.087	11.075	5.00	-4.20	-.0359	.0319	.0260	.0075	.0073	-.0313
2335	.086	11.008	5.00	-2.29	.0349	.0270	.0277	.0031	.0084	-.0311
2336	.087	11.070	5.00	-.37	.1157	.0266	.0297	-.0005	.0093	-.0344
2337	.086	11.019	5.00	1.53	.1770	.0283	.0318	-.0024	.0084	-.0354
2338	.086	11.040	5.00	3.45	.2507	.0344	.0345	-.0055	.0074	-.0339
2339	.086	11.028	5.00	5.52	.3341	.0442	.0397	-.0091	.0064	-.0343
2340	.086	11.029	5.00	7.33	.3945	.0582	.0387	-.0132	.0058	-.0322
2341	.087	11.078	5.00	9.42	.4750	.0801	.0454	-.0146	.0027	-.0297
2342	.087	11.204	5.00	14.48	.6695	.1596	.0556	-.0202	-.0041	-.0218
2343	.087	11.204	5.00	19.45	.8424	.2827	.0659	-.0203	-.0102	-.0340
2344	.087	11.149	5.00	24.49	1.0142	.4379	.0809	-.0253	-.0090	-.0192

## RUN 478

POINT	MACH	Q	BETA	ALPHA	CL	CD	CPM	CRM	CYM	CSF
2415	.087	11.249	0.00	-9.97	-.3076	.0741	.0325	.0086	-.0007	-.0010
2416	.087	11.170	0.00	-8.15	-.2206	.0546	.0319	.0076	.0007	-.0052
2417	.087	11.133	0.00	-6.22	-.1383	.0411	.0319	.0051	.0005	-.0044
2418	.087	11.146	0.00	-4.16	-.0463	.0314	.0337	.0053	.0012	-.0064
2419	.087	11.251	0.00	-2.26	.0171	.0267	.0297	.0050	.0015	-.0062
2420	.087	11.259	0.00	-.37	.1084	.0246	.0344	.0037	.0013	-.0048
2421	.087	11.232	0.00	1.52	.1831	.0263	.0340	.0024	.0021	-.0082
2422	.087	11.157	0.00	3.57	.2473	.0318	.0354	.0012	.0013	-.0034
2423	.087	11.249	0.00	5.49	.3357	.0432	.0400	-.0003	.0004	-.0030
2424	.087	11.128	0.00	7.32	.3987	.0581	.0401	-.0029	.0009	-.0058
2425	.087	11.227	0.00	9.45	.4815	.0803	.0438	-.0001	.0014	-.0064
2426	.088	11.339	0.00	14.53	.6812	.1613	.0531	-.0023	-.0005	-.0008
2427	.088	11.444	0.00	19.42	.8555	.2835	.0633	-.0038	-.0015	-.0029
2428	.087	11.285	0.00	24.50	1.0281	.4424	.0826	-.0003	-.0006	-.0006

TABLE B.- CONTINUED

RUN 479

POINT	MACH	Q	BETA	ALPHA	CL	CD	CPM	CRM	CYM	CSF
2429	.087	11.228	0.00	-9.98	-.3040	.0731	.0279	.0092	-.0006	-.0028
2430	.088	11.378	0.00	-8.16	-.2202	.0554	.0293	.0071	.0005	-.0026
2431	.087	11.271	0.00	-6.21	-.1314	.0412	.0247	.0098	.0004	-.0085
2432	.087	11.290	0.00	-4.18	-.0654	.0327	.0256	.0065	.0012	-.0078
2433	.087	11.279	0.00	-2.25	.0364	.0265	.0321	.0070	.0009	-.0061
2434	.087	11.221	0.00	-.41	.0872	.0257	.0295	.0044	.0015	-.0075
2435	.087	11.296	0.00	1.56	.1757	.0261	.0321	.0065	.0019	-.0113
2436	.087	11.293	0.00	3.48	.2518	.0317	.0336	.0039	.0016	-.0074
2437	.087	11.286	0.00	5.51	.3357	.0432	.0370	.0022	.0012	-.0052
2438	.087	11.301	0.00	7.44	.4088	.0593	.0391	.0026	.0015	-.0089
2439	.087	11.274	0.00	9.49	.4830	.0809	.0419	-.0026	.0000	-.0056
2440	.088	11.461	0.00	14.50	.6653	.1575	.0454	-.0030	-.0009	.0004
2441	.089	11.499	0.00	19.41	.8458	.2801	.0613	-.0007	-.0025	-.0067
2442	.088	11.436	0.00	24.56	1.0351	.4456	.0831	.0007	-.0056	-.0060

RUN 480

POINT	MACH	Q	BETA	ALPHA	CL	CD	CPM	CRM	CYM	CSF
2513	.088	11.353	-5.00	-10.00	-.3008	.0757	.0228	-.0005	-.0057	.0318
2514	.087	11.305	-5.00	-8.07	-.2027	.0557	.0243	.0047	-.0031	.0255
2515	.088	11.347	-5.00	-6.02	-.1196	.0420	.0245	.0026	-.0035	.0228
2516	.088	11.360	-5.00	-4.27	-.0472	.0338	.0246	.0043	-.0025	.0196
2517	.087	11.274	-5.00	-2.36	.0342	.0292	.0269	.0047	-.0038	.0196
2518	.087	11.259	-5.00	-.29	.1074	.0269	.0275	.0069	-.0024	.0153
2519	.087	11.219	-5.00	1.52	.1722	.0283	.0284	.0088	-.0026	.0156
2520	.087	11.275	-5.00	3.46	.2569	.0340	.0335	.0098	-.0027	.0173
2521	.087	11.321	-5.00	5.45	.3288	.0451	.0353	.0116	-.0013	.0156
2522	.087	11.280	-5.00	7.47	.3997	.0618	.0395	.0107	-.0005	.0190
2523	.087	11.335	-5.00	9.35	.4791	.0835	.0412	.0097	.0013	.0235
2524	.088	11.473	-5.00	14.43	.6624	.1580	.0524	.0132	.0052	.0211
2525	.088	11.422	-5.00	19.38	.8482	.2804	.0626	.0133	.0077	.0277
2526	.088	11.411	-5.00	24.57	1.0258	.4461	.0811	.0177	.0155	.0412

ORIGINAL PAGE IS  
OF POOR QUALITY



## RUN 481

POINT	MACH	Q	BETA	ALPHA	CL	CD	CPM	CRM	CYM	CSF
2597	.087	11.309	5.00	-10.03	-.3080	.0742	.0248	.0129	.0057	-.0310
2598	.087	11.315	5.00	-8.15	-.2113	.0558	.0215	.0137	.0049	-.0296
2599	.087	11.256	5.00	-6.09	-.1289	.0414	.0220	.0095	.0042	-.0306
2600	.087	11.243	5.00	-4.27	-.0415	.0329	.0264	.0057	.0052	-.0289
2601	.087	11.309	5.00	-2.30	.0259	.0286	.0266	.0014	.0061	-.0299
2602	.087	11.256	5.00	-.40	.1003	.0262	.0270	-.0019	.0072	-.0321
2603	.087	11.290	5.00	1.57	.1808	.0290	.0315	-.0028	.0080	-.0342
2604	.087	11.312	5.00	3.44	.2503	.0338	.0348	-.0057	.0071	-.0324
2605	.087	11.267	5.00	5.48	.3293	.0440	.0393	-.0088	.0059	-.0328
2606	.088	11.359	5.00	7.40	.4052	.0584	.0425	-.0139	.0027	-.0269
2607	.088	11.360	5.00	9.36	.4713	.0785	.0436	-.0155	.0020	-.0272
2608	.088	11.469	5.00	14.50	.6445	.1529	.0510	-.0189	-.0020	-.0231
2609	.088	11.441	5.00	19.44	.8450	.2827	.0691	-.0184	-.0077	-.0351
2610	.088	11.396	5.00	24.55	1.0259	.4469	.0898	-.0198	-.0124	-.0440

## RUN 482

POINT	MACH	Q	BETA	ALPHA	CL	CD	CPM	CRM	CYM	CSF
2681	.087	11.186	10.00	-9.98	-.2734	.0749	.0020	.0221	.0127	-.0661
2682	.087	11.224	10.00	-8.13	-.1978	.0577	.0076	.0165	.0120	-.0660
2683	.087	11.220	10.00	-6.15	-.1159	.0450	.0126	.0124	.0120	-.0642
2684	.087	11.235	10.00	-4.29	-.0445	.0360	.0170	.0078	.0124	-.0639
2685	.087	11.296	10.00	-2.36	.0320	.0316	.0206	.0035	.0131	-.0646
2686	.087	11.238	10.00	-.35	.1004	.0306	.0248	-.0024	.0128	-.0656
2687	.087	11.269	10.00	1.56	.1740	.0326	.0317	-.0086	.0126	-.0596
2688	.087	11.239	10.00	3.45	.2426	.0384	.0352	-.0156	.0115	-.0616
2689	.087	11.294	10.00	5.51	.3236	.0487	.0407	-.0196	.0101	-.0607
2690	.088	11.365	10.00	7.39	.3889	.0618	.0437	-.0240	.0079	-.0619
2691	.088	11.401	10.00	9.36	.4509	.0779	.0460	-.0286	.0044	-.0515
2692	.088	11.427	10.00	14.54	.6419	.1552	.0598	-.0358	-.0034	-.0446
2693	.088	11.443	10.00	19.43	.8201	.2752	.0752	-.0368	-.0142	-.0551
2694	.088	11.361	10.00	24.53	.9842	.4325	.0894	-.0396	-.0265	-.0679

TABLE B.- CONTINUED

RUN 483

POINT	MACH	Q	BETA	ALPHA	CL	CD	CPM	CRM	CYM	CSF
2695	.088	11.393	10.00	-9.97	-.2812	.0742	.0172	.0204	.0109	-.0657
2696	.088	11.356	10.00	-8.16	-.2003	.0569	.0183	.0153	.0110	-.0642
2697	.087	11.333	10.00	-6.15	-.1127	.0426	.0222	.0129	.0125	-.0578
2698	.087	11.277	10.00	-4.26	-.0319	.0359	.0247	.0077	.0150	-.0603
2699	.087	11.305	10.00	-2.34	.0305	.0319	.0263	.0015	.0162	-.0605
2700	.087	11.274	10.00	-.40	.0939	.0307	.0300	-.0040	.0170	-.0592
2701	.088	11.352	10.00	1.56	.1786	.0332	.0361	-.0093	.0178	-.0575
2702	.087	11.320	10.00	3.48	.2572	.0384	.0404	-.0166	.0181	-.0507
2703	.087	11.315	10.00	5.50	.3184	.0480	.0419	-.0227	.0165	-.0479
2704	.088	11.401	10.00	7.35	.3940	.0626	.0495	-.0269	.0174	-.0448
2705	.088	11.463	10.00	9.46	.4717	.0813	.0547	-.0330	.0160	-.0243
2706	.088	11.467	10.00	14.48	.6441	.1557	.0678	-.0422	.0119	-.0098
2707	.088	11.443	10.00	19.49	.8311	.2827	.0879	-.0444	.0074	-.0096
2708	.088	11.389	10.00	24.54	.9978	.4409	.1009	-.0486	-.0013	-.0051

RUN 484

POINT	MACH	Q	BETA	ALPHA	CL	CD	CPM	CRM	CYM	CSF
2779	.088	11.356	5.00	-10.00	-.3100	.0757	.0264	.0130	.0042	-.0297
2780	.087	11.264	5.00	-8.16	-.2086	.0555	.0265	.0134	.0054	-.0323
2781	.087	11.255	5.00	-6.16	-.1263	.0409	.0266	.0078	.0053	-.0269
2782	.087	11.203	5.00	-4.18	-.0429	.0323	.0291	.0068	.0069	-.0290
2783	.087	11.277	5.00	-2.27	.0258	.0281	.0307	.0047	.0090	-.0300
2784	.087	11.231	5.00	-.34	.0995	.0262	.0299	-.0024	.0094	-.0310
2785	.087	11.312	5.00	1.56	.1866	.0288	.0354	-.0027	.0106	-.0322
2786	.087	11.250	5.00	3.49	.2511	.0341	.0396	-.0073	.0112	-.0296
2787	.088	11.373	5.00	5.46	.3246	.0441	.0423	-.0121	.0101	-.0209
2788	.088	11.344	5.00	7.39	.4027	.0594	.0432	-.0151	.0110	-.0213
2789	.088	11.349	5.00	9.39	.4718	.0802	.0482	-.0169	.0095	-.0169
2790	.088	11.495	5.00	14.43	.6564	.1567	.0606	-.0222	.0069	-.0092
2791	.088	11.525	5.00	19.44	.8380	.2826	.0751	-.0229	.0047	-.0086
2792	.087	11.293	5.00	24.49	1.0099	.4402	.0954	-.0271	-.0005	-.0057

## RUN 485

POINT	MACH	Q	BETA	ALPHA	CL	CD	CPM	CRM	CYM	CSF
2893	.088	11.356	0.00	-10.00	-.2934	.0728	.0330	.0075	-.0018	-.0005
2894	.088	11.358	0.00	-8.08	-.2185	.0553	.0296	.0055	-.0006	-.0031
2895	.087	11.332	0.00	-6.20	-.1276	.0409	.0315	.0038	.0001	-.0040
2896	.087	11.262	0.00	-4.19	-.0425	.0322	.0315	.0059	.0014	-.0064
2897	.087	11.324	0.00	-2.40	.0322	.0278	.0322	.0019	.0000	-.0040
2898	.087	11.279	0.00	-.35	.1101	.0252	.0340	.0038	.0011	-.0071
2899	.087	11.320	0.00	1.43	.1853	.0264	.0378	.0021	.0000	-.0041
2900	.087	11.275	0.00	3.65	.2594	.0331	.0366	-.0001	.0007	-.0061
2901	.087	11.327	0.00	5.30	.3224	.0425	.0418	.0022	.0003	-.0062
2902	.087	11.257	0.00	7.53	.4085	.0614	.0444	-.0050	-.0003	-.0024
2903	.088	11.419	0.00	9.49	.4946	.0842	.0486	-.0021	-.0024	-.0009
2904	.088	11.450	0.00	14.53	.6777	.1632	.0568	-.0030	-.0045	-.0034
2905	.088	11.466	0.00	19.44	.8508	.2851	.0678	-.0045	-.0037	-.0017
2906	.088	11.421	0.00	24.50	1.0274	.4455	.0931	-.0020	-.0014	-.0016

## RUN 486

POINT	MACH	Q	BETA	ALPHA	CL	CD	CPM	CRM	CYM	CSF
2977	.087	11.243	-5.00	-9.99	-.2950	.0743	.0298	-.0025	-.0063	.0297
2978	.088	11.378	-5.00	-8.20	-.2042	.0543	.0319	.0006	-.0044	.0236
2979	.087	11.318	-5.00	-6.16	-.1152	.0409	.0330	-.0003	-.0049	.0231
2980	.087	11.346	-5.00	-4.29	-.0287	.0311	.0302	.0021	-.0052	.0195
2981	.087	11.252	-5.00	-2.40	.0278	.0283	.0286	.0038	-.0051	.0178
2982	.087	11.300	-5.00	-.43	.1140	.0250	.0313	.0056	-.0053	.0155
2983	.087	11.217	-5.00	1.48	.1890	.0268	.0349	.0081	-.0060	.0158
2984	.087	11.305	-5.00	3.39	.2642	.0331	.0398	.0081	-.0069	.0161
2985	.087	11.252	-5.00	5.31	.3275	.0449	.0403	.0096	-.0080	.0160
2986	.087	11.263	-5.00	7.42	.4104	.0630	.0456	.0121	-.0086	.0147
2987	.087	11.334	-5.00	9.49	.5075	.0885	.0533	.0129	-.0110	.0135
2988	.088	11.425	-5.00	14.41	.6662	.1596	.0592	.0159	-.0114	.0041
2989	.088	11.435	-5.00	19.45	.8457	.2840	.0712	.0192	-.0120	.0014
2990	.088	11.358	-5.00	24.50	1.0215	.4459	.0892	.0242	-.0083	.0027

ORIGINAL PAGE IS  
OF POOR QUALITY

TABLE B. - CONTINUED

RUN 487

POINT	MACH	Q	BETA	ALPHA	CL	CD	CPM	CRM	CYM	CSF
3051	.087	11.322	0.00	-9.93	-.2474	.0717	-.0158	.0053	-.0012	-.0017
3062	.087	11.264	0.00	-8.12	-.1712	.0552	-.0147	.0056	-.0009	-.0006
3063	.087	11.257	0.00	-6.07	-.0707	.0420	-.0157	.0059	.0005	-.0058
3064	.087	11.252	0.00	-4.20	-.0052	.0362	-.0144	.0036	.0010	-.0051
3065	.087	11.222	0.00	-2.24	.0780	.0334	-.0143	.0011	.0005	-.0045
3066	.087	11.199	0.00	-.28	.1554	.0330	-.0121	.0023	.0004	-.0026
3067	.087	11.253	0.00	1.58	.2227	.0361	-.0121	.0016	.0012	-.0057
3068	.087	11.266	0.00	3.63	.2997	.0439	-.0114	-.0020	.0000	-.0020
3069	.087	11.313	0.00	5.56	.3737	.0568	-.0115	-.0014	.0000	-.0018
3070	.088	11.359	0.00	7.55	.4568	.0755	-.0062	-.0046	-.0007	.0005
3071	.088	11.358	0.00	9.52	.5341	.0995	-.0051	-.0047	-.0007	.0030
3072	.088	11.416	0.00	14.57	.7213	.1847	-.0012	-.0031	-.0015	.0010
3073	.088	11.430	0.00	19.55	.9072	.3190	.0111	-.0024	-.0034	-.0001
3074	.087	11.219	0.00	24.60	1.0705	.4820	.0291	.0016	-.0036	-.0038

RUN 488

POINT	MACH	Q	BETA	ALPHA	CL	CD	CPM	CRM	CYM	CSF
3075	.087	11.286	0.00	-9.90	-.2533	.0694	-.0041	.0050	-.0017	.0024
3076	.087	11.257	0.00	-8.05	-.1676	.0522	-.0047	.0048	-.0008	-.0024
3077	.087	11.242	0.00	-6.09	-.0794	.0398	-.0048	.0039	-.0003	-.0044
3078	.087	11.259	0.00	-4.11	-.0115	.0336	-.0063	.0034	-.0005	-.0044
3079	.087	11.207	0.00	-2.15	.0785	.0304	-.0062	.0017	-.0001	-.0044
3080	.087	11.254	0.00	-.25	.1537	.0301	-.0046	-.0003	.0001	-.0027
3081	.087	11.217	0.00	1.63	.2305	.0326	-.0029	-.0012	.0003	-.0041
3082	.087	11.253	0.00	3.55	.2944	.0398	-.0024	-.0006	-.0004	-.0021
3083	.087	11.246	0.00	5.70	.3886	.0550	.0001	-.0030	-.0010	.0009
3084	.088	11.368	0.00	7.37	.4445	.0690	.0018	-.0056	-.0016	.0023
3085	.087	11.351	0.00	9.42	.5196	.0921	.0052	-.0045	-.0024	.0050
3086	.088	11.383	0.00	14.49	.7131	.1759	.0075	-.0033	-.0024	.0003
3087	.087	11.344	0.00	19.52	.8921	.3066	.0177	-.0029	-.0019	-.0007
3088	.087	11.263	0.00	24.61	1.0642	.4715	.0345	-.0009	.0004	.0023

## TABLE B.- CONTINUED

## RUN 489

POINT	MACH	Q	BETA	ALPHA	CL	CD	CPM	CRM	CYM	CSF
3089	.087	11.196	0.00	-9.93	-.2757	.0707	.0079	.0041	-.0024	.0002
3090	.087	11.218	0.00	-7.94	-.1804	.0509	.0076	.0036	-.0012	-.0033
3091	.087	11.161	0.00	-5.91	-.0787	.0366	.0109	.0025	-.0012	-.0032
3092	.087	11.171	0.00	-4.16	-.0119	.0308	.0117	.0033	-.0010	-.0018
3093	.087	11.234	0.00	-2.19	.0592	.0277	.0080	.0009	-.0005	-.0034
3094	.087	11.133	0.00	-.32	.1336	.0268	.0096	-.0007	-.0001	-.0020
3095	.087	11.137	0.00	1.61	.2122	.0292	.0094	-.0025	-.0006	-.0031
3096	.087	11.166	0.00	3.50	.2794	.0348	.0110	-.0019	-.0009	-.0044
3097	.087	11.142	0.00	5.55	.3577	.0475	.0146	-.0038	-.0021	.0005
3098	.087	11.255	0.00	7.52	.4320	.0643	.0194	-.0042	-.0018	.0002
3099	.087	11.327	0.00	9.55	.5185	.0883	.0206	-.0050	-.0032	.0035
3100	.088	11.356	0.00	14.73	.7057	.1719	.0222	-.0037	-.0025	-.0009
3101	.087	11.344	0.00	19.62	.8833	.2990	.0308	-.0057	-.0028	.0013
3102	.087	11.293	0.00	24.76	1.0660	.4696	.0455	-.0031	-.0003	.0028

## RUN 490

POINT	MACH	Q	BETA	ALPHA	CL	CD	CPM	CRM	CYM	CSF
3103	.087	11.192	0.00	-9.88	-.3182	.0840	.0598	.0036	-.0045	.0045
3104	.087	11.170	0.00	-8.20	-.2426	.0654	.0606	.0042	-.0025	-.0018
3105	.087	11.108	0.00	-6.04	-.1430	.0481	.0599	.0031	-.0021	-.0029
3106	.087	11.135	0.00	-4.15	-.0684	.0391	.0562	.0012	-.0021	-.0036
3107	.087	11.124	0.00	-2.15	.0143	.0323	.0578	-.0000	-.0020	-.0019
3108	.087	11.097	0.00	-.34	.0961	.0294	.0589	.0021	-.0010	-.0077
3109	.087	11.198	0.00	1.68	.1653	.0301	.0560	-.0007	-.0007	-.0079
3110	.087	11.156	0.00	3.66	.2525	.0354	.0596	-.0017	-.0023	-.0036
3111	.087	11.167	0.00	5.70	.3267	.0467	.0629	-.0041	-.0037	-.0039
3112	.087	11.104	0.00	7.40	.3907	.0599	.0654	-.0053	-.0037	.0027
3113	.086	11.086	0.00	9.53	.4728	.0811	.0685	-.0043	-.0035	.0008
3114	.087	11.182	0.00	14.61	.6691	.1594	.0700	-.0061	-.0040	-.0019
3115	.087	11.295	0.00	19.50	.8306	.2747	.0796	-.0080	-.0059	.0034
3116	.087	11.254	0.00	24.50	1.0082	.4306	.0998	-.0007	-.0014	.0014

TABLE B.- CONTINUED

RUN 491

POINT	MACH	Q	BETA	ALPHA	CL	CD	CPM	CRM	CYM	CSF
3117	.087	11.129	0.00	-9.94	-.3241	.0925	.0765	.0021	-.0027	-.0000
3118	.087	11.140	0.00	-8.06	-.2467	.0731	.0735	.0021	-.0021	-.0034
3119	.087	11.173	0.00	-6.13	-.1468	.0548	.0758	.0029	-.0020	-.0029
3120	.087	11.174	0.00	-4.22	-.0774	.0450	.0735	.0012	-.0019	-.0032
3121	.087	11.117	0.00	-2.21	.0085	.0377	.0722	-.0014	-.0012	-.0046
3122	.086	11.037	0.00	-.29	.0822	.0349	.0746	-.0013	-.0017	-.0037
3123	.087	11.111	0.00	1.67	.1567	.0347	.0730	-.0027	-.0020	-.0035
3124	.086	11.071	0.00	3.62	.2274	.0394	.0714	-.0016	-.0018	-.0108
3125	.086	11.051	0.00	5.59	.2975	.0482	.0728	-.0026	-.0028	-.0096
3126	.086	11.091	0.00	7.55	.3771	.0633	.0764	-.0042	-.0036	-.0031
3127	.087	11.098	0.00	9.46	.4418	.0809	.0798	-.0073	-.0039	.0007
3128	.087	11.198	0.00	14.67	.6498	.1588	.0824	-.0077	-.0044	-.0020
3129	.087	11.220	0.00	19.52	.8236	.2760	.0883	-.0078	-.0069	-.0007
3130	.087	11.209	0.00	24.71	1.0057	.4340	.1114	-.0022	-.0038	-.0002

RUN 492

POINT	MACH	Q	BETA	ALPHA	CL	CD	CPM	CRM	CYM	CSF
3131	.086	11.084	0.00	-9.92	-.3459	.1037	.0854	.0014	-.0039	.0030
3132	.087	11.108	0.00	-7.96	-.2386	.0785	.0881	.0006	-.0027	.0008
3133	.087	11.126	0.00	-6.27	-.1643	.0637	.0863	.0005	-.0020	-.0018
3134	.087	11.133	0.00	-4.28	-.0929	.0534	.0857	.0014	-.0016	-.0054
3135	.086	11.054	0.00	-2.27	-.0097	.0457	.0845	.0003	-.0014	-.0046
3136	.087	11.125	0.00	-.32	.0548	.0423	.0812	-.0033	-.0019	-.0025
3137	.086	11.059	0.00	1.55	.1274	.0407	.0822	-.0029	-.0016	-.0060
3138	.086	11.074	0.00	3.55	.2086	.0446	.0838	-.0038	-.0027	-.0064
3139	.086	11.082	0.00	5.54	.2989	.0543	.0861	-.0032	-.0033	-.0023
3140	.087	11.111	0.00	7.52	.3709	.0682	.0874	-.0055	-.0038	-.0079
3141	.086	11.065	0.00	9.44	.4416	.0863	.0931	-.0066	-.0036	-.0007
3142	.087	11.115	0.00	14.60	.6338	.1594	.0956	-.0076	-.0048	-.0037
3143	.087	11.213	0.00	19.53	.8181	.2783	.1037	-.0085	-.0092	-.0016
3144	.087	11.228	0.00	24.63	.9938	.4315	.1219	-.0028	-.0060	.0013

## TABLE B.- CONTINUED

RUN 493

POINT	MACH	Q	BETA	ALPHA	CL	CD	CPM	CRM	CYM	CSF
3145	.087	11.128	0.00	-9.89	-.3534	.1113	.1012	.0015	-.0038	.0028
3146	.087	11.162	0.00	-8.12	-.2655	.0899	.0999	-.0013	-.0023	.0021
3147	.087	11.125	0.00	-6.03	-.1723	.0705	.1018	.0008	-.0018	-.0019
3148	.086	11.074	0.00	-4.10	-.1098	.0604	.0998	-.0009	-.0024	-.0020
3149	.086	11.021	0.00	-2.28	-.0250	.0521	.1017	-.0021	-.0022	-.0006
3150	.086	11.032	0.00	-.38	.0427	.0479	.1013	-.0014	-.0017	-.0051
3151	.086	11.091	0.00	1.73	.1148	.0469	.0999	-.0035	-.0023	-.0023
3152	.087	11.121	0.00	3.65	.1948	.0495	.0976	-.0028	-.0023	-.0088
3153	.086	11.039	0.00	5.49	.2610	.0566	.1001	-.0043	-.0037	-.0050
3154	.086	11.089	0.00	7.34	.3366	.0688	.1023	-.0077	-.0044	.0032
3155	.086	10.986	0.00	9.50	.4337	.0907	.1059	-.0081	-.0046	-.0015
3156	.087	11.167	0.00	14.60	.6202	.1612	.1081	-.0097	-.0064	-.0012
3157	.087	11.175	0.00	19.51	.8062	.2796	.1212	-.0093	-.0086	.0013
3158	.087	11.185	0.00	24.70	.9802	.4319	.1367	-.0042	-.0061	.0004

RUN 494

POINT	MACH	Q	BETA	ALPHA	CL	CD	CPM	CRM	CYM	CSF
3229	.087	11.171	0.00	-9.97	-.3664	.1189	.1200	.0105	-.0000	-.0015
3230	.087	11.164	0.00	-8.08	-.2879	.0976	.1185	.0088	.0013	-.0039
3231	.087	11.219	0.00	-6.14	-.1969	.0786	.1190	.0074	.0013	-.0038
3232	.087	11.197	0.00	-4.24	-.1232	.0673	.1186	.0057	.0019	-.0042
3233	.086	11.096	0.00	-2.32	-.0473	.0597	.1222	.0054	.0028	-.0071
3234	.087	11.142	0.00	-.43	.0283	.0542	.1207	.0052	.0027	-.0094
3235	.087	11.151	0.00	1.55	.0961	.0538	.1194	.0036	.0020	-.0062
3236	.087	11.142	0.00	3.50	.1699	.0552	.1153	.0037	.0021	-.0090
3237	.086	11.064	0.00	5.45	.2513	.0632	.1178	.0002	.0011	-.0084
3238	.086	11.078	0.00	7.42	.3234	.0763	.1207	.0006	.0014	-.0037
3239	.086	11.091	0.00	9.42	.3971	.0937	.1208	.0006	.0024	-.0075
3240	.087	11.171	0.00	14.48	.6024	.1655	.1277	-.0039	.0005	-.0048
3241	.087	11.297	0.00	19.49	.7891	.2827	.1338	-.0053	-.0019	-.0019
3242	.087	11.240	0.00	24.47	.9646	.4309	.1483	-.0015	.0015	-.0017

TABLE B.- CONTINUED

RUN 495

POINT	MACH	Q	BETA	ALPHA	CL	CD	CPM	CRM	CYM	CSF
3243	.087	11.244	0.00	-9.97	-.3688	.1086	.1098	.0076	-.0007	.0006
3244	.087	11.227	0.00	-8.13	-.2830	.0857	.1106	.0087	.0006	-.0014
3245	.087	11.275	0.00	-6.22	-.2000	.0680	.1089	.0069	.0016	-.0028
3246	.087	11.158	0.00	-4.25	-.1188	.0556	.1067	.0078	.0015	-.0064
3247	.087	11.132	0.00	-2.34	-.0483	.0490	.1071	.0061	.0026	-.0090
3248	.087	11.167	0.00	-.36	.0349	.0443	.1088	.0037	.0024	-.0054
3249	.087	11.219	0.00	1.50	.1080	.0424	.1048	.0060	.0032	-.0110
3250	.087	11.197	0.00	3.55	.1951	.0460	.1069	.0051	.0029	-.0108
3251	.087	11.166	0.00	5.43	.2667	.0543	.1079	.0014	.0017	-.0053
3252	.087	11.218	0.00	7.34	.3385	.0675	.1093	.0005	.0016	-.0030
3253	.087	11.163	0.00	9.39	.4229	.0877	.1112	-.0002	.0019	-.0066
3254	.087	11.234	0.00	14.51	.6180	.1610	.1127	-.0026	.0000	-.0038
3255	.087	11.304	0.00	19.42	.7999	.2774	.1185	-.0051	.0001	-.0024
3256	.087	11.277	0.00	24.47	.9806	.4307	.1327	.0021	-.0003	-.0052

RUN 496

POINT	MACH	Q	BETA	ALPHA	CL	CD	CPM	CRM	CYM	CSF
3257	.087	11.183	0.00	-9.99	-.3543	.0979	.0940	.0130	-.0003	-.0021
3258	.087	11.252	0.00	-8.12	-.2704	.0777	.0922	.0110	.0010	-.0044
3259	.087	11.234	0.00	-6.22	-.1911	.0611	.0952	.0082	.0015	-.0029
3260	.087	11.223	0.00	-4.27	-.1057	.0492	.0931	.0092	.0024	-.0058
3261	.087	11.193	0.00	-2.33	-.0265	.0421	.0909	.0084	.0030	-.0100
3262	.087	11.202	0.00	-.35	.0517	.0379	.0899	.0085	.0033	-.0086
3263	.087	11.216	0.00	1.49	.1290	.0375	.0912	.0054	.0026	-.0088
3264	.087	11.188	0.00	3.48	.2042	.0418	.0925	.0056	.0028	-.0100
3265	.087	11.248	0.00	5.45	.2808	.0506	.0901	.0040	.0025	-.0087
3266	.087	11.131	0.00	7.35	.3547	.0647	.0918	.0034	.0024	-.0070
3267	.087	11.189	0.00	9.36	.4301	.0833	.0933	.0020	.0026	-.0063
3268	.087	11.204	0.00	14.49	.6258	.1576	.0972	-.0021	.0008	-.0077
3269	.088	11.375	0.00	19.41	.8075	.2746	.1039	-.0026	-.0013	-.0025
3270	.087	11.329	0.00	24.54	.9966	.4350	.1238	.0029	-.0022	-.0077



TABLE B.- CONTINUED

## RUN 497

POINT	MACH	Q	BETA	ALPHA	CL	CD	CPM	CRM	CYM	CSF
3341	.088	11.411	0.00	-9.98	-.3462	.0910	.0790	.0089	-.0020	.0017
3342	.087	11.351	0.00	-8.15	-.2536	.0696	.0784	.0097	.0007	-.0043
3343	.087	11.255	0.00	-6.13	-.1726	.0531	.0788	.0102	.0017	-.0075
3344	.087	11.310	0.00	-4.14	-.0950	.0432	.0788	.0069	.0012	-.0074
3345	.087	11.279	0.00	-2.30	-.0200	.0366	.0775	.0058	.0018	-.0057
3346	.087	11.322	0.00	-.30	.0622	.0321	.0760	.0068	.0021	-.0063
3347	.087	11.320	0.00	1.53	.1385	.0332	.0794	.0041	.0017	-.0055
3348	.087	11.288	0.00	3.59	.2180	.0373	.0781	.0043	.0022	-.0088
3349	.087	11.250	0.00	5.52	.2930	.0464	.0789	.0016	.0017	-.0077
3350	.087	11.320	0.00	7.41	.3640	.0610	.0840	.0003	.0010	-.0013
3351	.087	11.258	0.00	9.53	.4473	.0824	.0854	-.0009	.0010	-.0031
3352	.088	11.405	0.00	14.48	.6352	.1552	.0855	-.0028	-.0004	-.0027
3353	.088	11.423	0.00	19.39	.8163	.2743	.0966	-.0023	-.0024	-.0042
3354	.088	11.421	0.00	24.53	.9932	.4307	.1140	.0028	.0019	-.0026

## RUN 498

POINT	MACH	Q	BETA	ALPHA	CL	CD	CPM	CRM	CYM	CSF
3355	.087	11.306	0.00	-9.95	-.3630	.1018	.0977	.0092	-.0009	.0022
3356	.087	11.366	0.00	-8.13	-.2736	.0795	.0983	.0084	.0002	-.0035
3357	.087	11.327	0.00	-6.19	-.1878	.0621	.0996	.0087	.0020	-.0061
3358	.087	11.307	0.00	-4.21	-.1070	.0510	.0994	.0052	.0015	-.0040
3359	.087	11.283	0.00	-2.27	-.0218	.0433	.0976	.0052	.0018	-.0048
3360	.087	11.359	0.00	-.39	.0351	.0392	.0949	.0072	.0034	-.0105
3361	.087	11.305	0.00	1.53	.1195	.0385	.0967	.0059	.0031	-.0106
3362	.087	11.314	0.00	3.54	.2013	.0424	.0985	.0035	.0016	-.0062
3363	.087	11.260	0.00	5.46	.2677	.0512	.0978	.0010	.0018	-.0065
3364	.087	11.310	0.00	7.37	.3372	.0635	.1007	.0018	.0012	-.0050
3365	.087	11.312	0.00	9.45	.4247	.0846	.1044	.0007	.0018	-.0049
3366	.088	11.398	0.00	14.51	.6254	.1592	.1065	-.0013	.0016	-.0051
3367	.088	11.465	0.00	19.45	.7980	.2744	.1123	-.0025	-.0015	-.0026
3368	.088	11.442	0.00	24.51	.9761	.4282	.1272	.0015	-.0001	-.0043

TABLE B.- CONTINUED

RUN 499

POINT	MACH	Q	BETA	ALPHA	CL	CD	CPM	CRM	CYM	CSF
3369	.087	11.366	0.00	-9.98	-.2782	.0705	-.0061	.0108	-.0006	-.0010
3370	.087	11.370	0.00	-8.20	-.1921	.0537	-.0047	.0095	.0007	-.0043
3371	.088	11.404	0.00	-6.15	-.0991	.0392	-.0028	.0095	.0014	-.0055
3372	.087	11.366	0.00	-4.23	-.0250	.0329	-.0016	.0051	.0007	-.0037
3373	.087	11.371	0.00	-2.22	.0587	.0285	-.0009	.0085	.0022	-.0077
3374	.087	11.349	0.00	-.29	.1339	.0285	.0005	.0051	.0023	-.0071
3375	.087	11.363	0.00	1.55	.2098	.0304	.0032	.0032	.0017	-.0056
3376	.088	11.430	0.00	3.51	.2772	.0369	.0034	.0024	.0013	-.0020
3377	.087	11.393	0.00	5.46	.3566	.0495	.0065	-.0001	.0011	-.0040
3378	.088	11.477	0.00	7.38	.4216	.0655	.0049	-.0012	.0019	-.0027
3379	.088	11.567	0.00	9.43	.5104	.0902	.0112	-.0004	.0006	.0013
3380	.088	11.434	0.00	14.49	.7065	.1737	.0135	.0004	-.0001	-.0021
3381	.088	11.483	0.00	19.44	.8874	.3026	.0250	-.0008	-.0004	-.0039
3382	.088	11.425	0.00	24.48	1.0551	.4640	.0392	.0019	.0019	-.0038

RUN 500

POINT	MACH	Q	BETA	ALPHA	CL	CD	CPM	CRM	CYM	CSF
3483	.088	11.689	0.00	-10.01	-.2524	.0697	-.0162	.0088	-.0008	-.0018
3484	.088	11.601	0.00	-8.08	-.1714	.0527	-.0130	.0051	-.0003	-.0044
3485	.088	11.638	0.00	-6.25	-.0762	.0400	-.0132	.0079	.0008	-.0050
3486	.088	11.612	0.00	-4.36	-.0064	.0339	-.0131	.0044	.0005	-.0038
3487	.088	11.655	0.00	-2.35	.0804	.0304	-.0119	.0054	.0012	-.0068
3488	.088	11.600	0.00	-.35	.1519	.0309	-.0130	.0029	.0008	-.0037
3489	.087	11.496	0.00	1.53	.2221	.0337	-.0102	.0006	.0014	-.0067
3490	.088	11.658	0.00	3.32	.2939	.0401	-.0091	.0024	.0012	-.0055
3491	.088	11.692	0.00	5.44	.3662	.0532	-.0078	-.0000	.0015	-.0048
3492	.089	11.779	0.00	7.45	.4505	.0716	-.0061	-.0007	.0007	-.0063
3493	.088	11.692	0.00	9.33	.5293	.0945	-.0016	-.0029	-.0003	.0032
3494	.089	11.791	0.00	14.56	.7220	.1803	.0014	-.0002	-.0008	-.0029
3495	.088	11.691	0.00	19.42	.9048	.3104	.0109	-.0015	-.0032	-.0031
3496	.088	11.671	0.00	24.64	1.0781	.4815	.0286	.0000	-.0014	-.0034

TABLE B.- CONTINUED

## RUN 501

POINT	MACH	Q	BETA	ALPHA	CL	CD	CPM	CRM	CYM	CSF
3497	.088	11.582	0.00	-10.00	-.2313	.0778	-.0440	.0069	-.0026	-.0011
3498	.088	11.584	0.00	-8.20	-.1419	.0612	-.0422	.0040	-.0013	-.0016
3499	.088	11.599	0.00	-6.26	-.0558	.0493	-.0397	.0041	-.0014	-.0018
3500	.088	11.503	0.00	-4.31	.0197	.0441	-.0394	.0031	-.0001	-.0068
3501	.088	11.558	0.00	-2.31	.1030	.0409	-.0378	.0025	.0001	-.0038
3502	.088	11.580	0.00	-.43	.1739	.0418	-.0360	-.0006	-.0000	-.0042
3503	.088	11.578	0.00	1.55	.2442	.0457	-.0351	-.0010	-.0008	-.0026
3504	.088	11.744	0.00	3.40	.3298	.0535	-.0333	-.0026	-.0012	-.0005
3505	.088	11.725	0.00	5.36	.3948	.0667	-.0340	-.0025	-.0017	.0017
3506	.088	11.730	0.00	7.42	.4693	.0853	-.0309	-.0036	-.0009	.0016
3507	.088	11.740	0.00	9.46	.5486	.1102	-.0276	-.0036	-.0018	.0027
3508	.088	11.761	0.00	14.59	.7430	.1997	-.0236	-.0036	-.0029	.0004
3509	.088	11.699	0.00	19.43	.9178	.3298	-.0126	-.0030	-.0049	-.0000
3510	.088	11.609	0.00	24.59	1.0930	.5008	.0112	.0028	-.0043	-.0035

## RUN 502

POINT	MACH	Q	BETA	ALPHA	CL	CD	CPM	CRM	CYM	CSF
3511	.088	11.602	0.00	-9.95	-.2229	.0714	-.0255	.0039	-.0020	-.0018
3512	.088	11.530	0.00	-8.14	-.1577	.0575	-.0263	.0036	-.0006	-.0023
3513	.088	11.623	0.00	-6.21	-.0598	.0451	-.0261	.0036	-.0005	-.0041
3514	.088	11.511	0.00	-4.24	.0263	.0383	-.0225	.0021	-.0003	-.0058
3515	.088	11.518	0.00	-2.31	.0911	.0359	-.0237	.0018	.0001	-.0061
3516	.088	11.536	0.00	-.30	.1691	.0359	-.0235	.0009	.0001	-.0077
3517	.088	11.590	0.00	1.54	.2299	.0400	-.0220	-.0020	-.0009	-.0009
3518	.088	11.517	0.00	3.64	.3150	.0484	-.0211	-.0026	-.0006	-.0022
3519	.088	11.716	0.00	5.49	.3846	.0608	-.0182	-.0040	-.0019	.0012
3520	.088	11.689	0.00	7.40	.4577	.0787	-.0190	-.0029	-.0012	.0030
3521	.089	11.772	0.00	9.31	.5362	.1016	-.0156	-.0056	-.0027	.0056
3522	.088	11.726	0.00	14.61	.7335	.1915	-.0107	-.0023	-.0025	-.0000
3523	.088	11.738	0.00	19.48	.9135	.3239	.0002	-.0029	-.0045	-.0019
3524	.088	11.667	0.00	24.65	1.0795	.4901	.0214	.0007	-.0057	-.0040

ORIGINAL PAGE IS  
OF POOR QUALITY

TABLE B.- CONTINUED

RUN 503

POINT	MACH	Q	BETA	ALPHA	CL	CD	CPM	CRM	CYM	CSF
3525	.088	11.548	0.00	-9.95	-.2419	.0691	-.0157	.0032	-.0032	.0019
3526	.088	11.596	0.00	-8.12	-.1543	.0532	-.0158	.0029	-.0018	-.0044
3527	.088	11.525	0.00	-6.30	-.0892	.0424	-.0148	.0011	-.0018	-.0009
3528	.088	11.581	0.00	-4.26	-.0027	.0351	-.0132	-.0002	-.0022	-.0008
3529	.088	11.528	0.00	-2.34	.0729	.0316	-.0129	.0014	-.0013	-.0034
3530	.088	11.502	0.00	-.46	.1407	.0316	-.0111	.0002	-.0013	-.0051
3531	.088	11.518	0.00	1.57	.2326	.0337	-.0102	-.0010	-.0012	-.0063
3532	.088	11.569	0.00	3.51	.3013	.0416	-.0092	-.0005	-.0016	-.0056
3533	.088	11.678	0.00	5.43	.3854	.0545	-.0060	-.0044	-.0038	.0028
3534	.088	11.689	0.00	7.33	.4452	.0708	-.0089	-.0043	-.0026	-.0023
3535	.088	11.703	0.00	9.35	.5244	.0947	-.0056	-.0061	-.0035	.0052
3536	.088	11.747	0.00	14.51	.7224	.1810	-.0000	-.0054	-.0054	.0018
3537	.088	11.683	0.00	19.33	.8943	.3062	.0118	-.0044	-.0074	-.0017
3538	.088	11.589	0.00	24.47	1.0609	.4702	.0283	-.0018	-.0060	-.0019

RUN 504

POINT	MACH	Q	BETA	ALPHA	CL	CD	CPM	CRM	CYM	CSF
3539	.087	11.480	0.00	-10.03	-.2479	.0748	-.0303	.0020	-.0037	-.0004
3540	.087	11.489	0.00	-8.07	-.1510	.0560	-.0308	.0026	-.0029	-.0001
3541	.087	11.460	0.00	-6.23	-.0647	.0452	-.0292	.0009	-.0029	-.0035
3542	.088	11.524	0.00	-4.28	.0145	.0383	-.0284	.0015	-.0029	.0000
3543	.088	11.542	0.00	-2.37	.0924	.0355	-.0250	-.0006	-.0026	-.0026
3544	.088	11.544	0.00	-.36	.1659	.0361	-.0256	-.0020	-.0031	.0021
3545	.088	11.564	0.00	1.54	.2369	.0394	-.0264	-.0020	-.0019	-.0030
3546	.088	11.594	0.00	3.47	.3149	.0466	-.0226	-.0032	-.0033	.0008
3547	.088	11.609	0.00	5.46	.3884	.0599	-.0214	-.0036	-.0034	-.0007
3548	.088	11.545	0.00	7.41	.4614	.0780	-.0208	-.0057	-.0045	.0058
3549	.088	11.618	0.00	9.40	.5335	.1008	-.0191	-.0073	-.0050	.0062
3550	.088	11.722	0.00	14.56	.7269	.1872	-.0146	-.0062	-.0061	.0018
3551	.088	11.651	0.00	19.50	.9145	.3213	-.0020	-.0070	-.0066	.0023
3552	.088	11.539	0.00	24.53	1.0849	.4882	.0130	-.0041	-.0085	.0000

TABLE B.- CONTINUED

RUN 507

POINT	MACH	Q	BETA	ALPHA	CL	CD	CPM	CRM	CYM	CSF
3751	.086	11.015	0.00	-9.98	-.0546	.0655	-.0522	.0095	-.0007	-.0035
3752	.086	11.019	0.00	-8.21	.0314	.0552	-.0463	.0052	-.0002	-.0039
3753	.086	10.993	0.00	-6.16	.1099	.0490	-.0411	.0049	.0012	-.0075
3754	.086	11.052	0.00	-4.22	.1845	.0475	-.0369	.0026	.0012	-.0039
3755	.086	11.006	0.00	-2.34	.2548	.0483	-.0344	.0023	.0021	-.0072
3756	.087	11.061	0.00	-.41	.3272	.0533	-.0319	.0015	.0024	-.0062
3757	.086	11.055	0.00	1.52	.3991	.0631	-.0312	-.0019	.0006	.0002
3758	.087	11.065	0.00	3.56	.4732	.0770	-.0278	-.0033	.0007	.0017
3759	.087	11.083	0.00	5.41	.5393	.0957	-.0253	-.0031	.0014	-.0024
3760	.087	11.097	0.00	7.35	.6107	.1189	-.0209	-.0022	.0003	.0005
3761	.087	11.136	0.00	9.41	.6777	.1465	-.0163	-.0027	.0005	-.0012
3762	.087	11.206	0.00	14.52	.8348	.2349	.0072	-.0022	-.0003	-.0022
3763	.087	11.127	0.00	19.49	.9809	.3688	.0307	-.0013	-.0023	-.0025
3764	.087	11.091	0.00	24.58	1.1132	.5237	.0616	-.0013	-.0026	-.0013

RUN 510

POINT	MACH	Q	BETA	ALPHA	CL	CD	CPM	CRM	CYM	CSF
3893	.087	10.988	0.00	-9.98	-.0454	.0765	-.0477	.0089	-.0015	-.0039
3894	.086	10.975	0.00	-8.14	.0227	.0663	-.0418	.0025	-.0007	-.0022
3895	.086	10.981	0.00	-6.17	.0992	.0596	-.0376	.0027	-.0002	-.0034
3896	.086	10.901	0.00	-4.27	.1635	.0577	-.0337	.0025	.0001	-.0059
3897	.086	10.977	0.00	-2.33	.2394	.0583	-.0276	.0005	-.0007	-.0022
3898	.086	10.946	0.00	-.45	.2971	.0617	-.0250	-.0016	.0002	-.0026
3899	.087	11.000	0.00	1.52	.3736	.0693	-.0246	.0003	.0011	-.0078
3900	.086	10.974	0.00	3.41	.4475	.0827	-.0221	-.0030	.0004	-.0022
3901	.087	10.993	0.00	5.49	.5224	.1011	-.0173	-.0027	-.0000	-.0007
3902	.087	11.083	0.00	7.43	.5869	.1210	-.0111	-.0047	-.0003	.0010
3903	.087	11.120	0.00	9.38	.6485	.1463	-.0064	-.0061	-.0010	.0044
3904	.087	11.132	0.00	14.42	.7981	.2287	.0127	-.0021	-.0008	-.0024
3905	.087	11.097	0.00	19.43	.9420	.3574	.0402	-.0028	-.0041	-.0005
3906	.087	11.067	0.00	24.44	1.0676	.5035	.0735	-.0012	-.0026	.0014

ORIGINAL PAGE IS  
OF POOR QUALITY

TABLE B.- CONTINUED

RUN 515

POINT	MACH	Q	BETA	ALPHA	CL	CD	CPM	CRM	CYM	CSF
4133	.088	11.634	0.00	-10.02	-.1249	.0601	-.0240	.0042	-.0024	-.0020
4134	.088	11.599	0.00	-8.22	-.0436	.0469	-.0208	.0016	-.0020	-.0015
4135	.088	11.611	0.00	-6.19	.0221	.0397	-.0192	.0022	-.0016	-.0051
4136	.088	11.608	0.00	-4.24	.1042	.0355	-.0140	.0001	-.0017	-.0002
4137	.088	11.573	0.00	-2.32	.1778	.0346	-.0109	.0003	-.0007	-.0066
4138	.088	11.634	0.00	-.44	.2485	.0372	-.0098	-.0002	-.0016	-.0036
4139	.088	11.616	0.00	1.46	.3134	.0434	-.0100	-.0035	-.0021	-.0003
4140	.088	11.557	0.00	3.50	.3937	.0541	-.0070	-.0032	-.0019	-.0016
4141	.088	11.679	0.00	5.45	.4658	.0698	-.0055	-.0033	-.0027	.0021
4142	.088	11.759	0.00	7.35	.5375	.0894	.0007	-.0044	-.0029	.0037
4143	.089	11.775	0.00	9.45	.6102	.1159	.0043	-.0053	-.0022	.0001
4144	.088	11.739	0.00	14.52	.7773	.2014	.0208	-.0049	-.0041	.0032
4145	.088	11.723	0.00	19.51	.9338	.3313	.0421	-.0034	-.0038	-.0000
4146	.088	11.655	0.00	24.64	1.0798	.4873	.0745	-.0017	-.0067	.0030

RUN 517

POINT	MACH	Q	BETA	ALPHA	CL	CD	CPM	CRM	CYM	CSF
4241	.087	11.319	0.00	-9.96	-.1304	.0602	-.0306	.0092	-.0008	-.0022
4242	.087	11.317	0.00	-8.16	-.0507	.0473	-.0273	.0075	.0010	-.0063
4243	.087	11.233	0.00	-6.07	.0232	.0405	-.0260	.0065	.0009	-.0060
4244	.087	11.333	0.00	-4.15	.1106	.0367	-.0172	.0040	.0010	-.0038
4245	.087	11.329	0.00	-2.27	.1836	.0360	-.0167	.0032	.0010	-.0068
4246	.087	11.328	0.00	-.38	.2528	.0385	-.0132	.0015	.0013	-.0052
4247	.087	11.322	0.00	1.55	.3279	.0447	-.0117	.0013	.0013	-.0080
4248	.087	11.341	0.00	3.57	.3986	.0558	-.0091	.0004	.0005	-.0061
4249	.087	11.340	0.00	5.53	.4699	.0727	-.0076	-.0032	.0007	-.0008
4250	.087	11.404	0.00	7.43	.5450	.0929	-.0015	-.0007	.0008	-.0006
4251	.087	11.448	0.00	9.48	.6188	.1195	.0040	-.0038	-.0001	.0026
4252	.088	11.500	0.00	14.61	.7878	.2071	.0193	-.0020	-.0005	-.0017
4253	.088	11.587	0.00	19.53	.9476	.3384	.0419	-.0022	-.0025	-.0021
4254	.088	11.506	0.00	24.64	1.0908	.4957	.0732	-.0000	-.0029	-.0030

## RUN 518

POINT	MACH	Q	BETA	ALPHA	CL	CD	CPM	CRM	CYM	CSF
4355	.088	11.719	0.00	-9.99	-.1543	.0649	.0024	.0072	-.0012	-.0014
4356	.088	11.704	0.00	-8.21	-.0748	.0518	.0025	.0061	-.0003	-.0053
4357	.088	11.581	0.00	-6.17	.0038	.0431	.0024	.0041	-.0006	-.0054
4358	.088	11.617	0.00	-4.21	.0948	.0370	.0058	.0050	.0008	-.0072
4359	.088	11.559	0.00	-2.41	.1547	.0372	.0061	.0024	-.0000	-.0046
4360	.088	11.619	0.00	-.41	.2368	.0383	.0056	.0038	.0009	-.0072
4361	.088	11.563	0.00	1.57	.3175	.0442	.0062	.0013	.0008	-.0065
4362	.088	11.671	0.00	3.45	.3846	.0549	.0064	-.0002	.0001	-.0002
4363	.088	11.649	0.00	5.44	.4585	.0714	.0086	-.0017	-.0007	.0033
4364	.088	11.685	0.00	7.37	.5369	.0913	.0140	-.0038	-.0005	.0012
4365	.088	11.738	0.00	9.39	.6007	.1159	.0141	-.0018	-.0000	-.0002
4366	.088	11.766	0.00	14.44	.7752	.2018	.0243	-.0031	-.0019	.0000
4367	.088	11.753	0.00	19.50	.9469	.3386	.0369	-.0002	-.0015	-.0025
4368	.088	11.611	0.00	24.52	1.1143	.5038	.0570	-.0013	-.0049	-.0023

## RUN 519

POINT	MACH	Q	BETA	ALPHA	CL	CD	CPM	CRM	CYM	CSF
4369	.088	11.569	0.00	-10.00	-.1928	.0796	.0318	.0035	-.0023	-.0025
4370	.088	11.599	0.00	-8.18	-.0997	.0632	.0332	.0020	-.0018	-.0040
4371	.088	11.648	0.00	-6.15	-.0117	.0517	.0349	-.0011	-.0027	.0016
4372	.088	11.577	0.00	-4.27	.0621	.0470	.0351	-.0022	-.0014	-.0019
4373	.088	11.626	0.00	-2.32	.1385	.0434	.0366	-.0030	-.0023	-.0006
4374	.088	11.595	0.00	-.38	.2056	.0438	.0334	-.0011	-.0005	-.0070
4375	.088	11.691	0.00	1.59	.2947	.0489	.0352	-.0029	-.0025	.0001
4376	.088	11.695	0.00	3.52	.3605	.0579	.0354	-.0046	-.0027	-.0012
4377	.088	11.644	0.00	5.46	.4322	.0726	.0379	-.0054	-.0031	.0021
4378	.088	11.700	0.00	7.37	.4999	.0914	.0404	-.0053	-.0024	.0016
4379	.088	11.747	0.00	9.50	.5805	.1176	.0441	-.0078	-.0035	.0000
4380	.089	11.851	0.00	14.58	.7576	.2008	.0503	-.0062	-.0050	.0017
4381	.088	11.728	0.00	19.42	.9250	.3299	.0595	-.0056	-.0077	.0026
4382	.088	11.725	0.00	24.50	1.0850	.4891	.0750	-.0019	-.0078	.0009

TABLE B.- CONTINUED

## RUN 520

POINT	MACH	Q	BETA	ALPHA	CL	CD	CPM	CRM	CYM	CSF
4383	.088	11.624	0.00	-10.00	-.1886	.0864	.0456	-.0008	-.0044	.0007
4384	.088	11.701	0.00	-8.17	-.1045	.0701	.0458	-.0005	-.0037	.0007
4385	.088	11.623	0.00	-6.17	-.0295	.0592	.0444	-.0029	-.0035	.0J01
4386	.088	11.605	0.00	-4.19	.0525	.0527	.0451	-.0024	-.0030	-.0034
4387	.088	11.581	0.00	-2.31	.1321	.0491	.0467	-.0045	-.0038	.0014
4388	.088	11.638	0.00	-.44	.1931	.0498	.0460	-.0057	-.0037	.0018
4389	.088	11.577	0.00	1.64	.2832	.0540	.0464	-.0059	-.0042	.0001
4390	.088	11.630	0.00	3.61	.3488	.0639	.0466	-.0062	-.0044	-.0016
4391	.088	11.676	0.00	5.46	.4182	.0769	.0473	-.0081	-.0043	.0055
4392	.088	11.664	0.00	7.47	.4934	.0962	.0527	-.0086	-.0058	.0081
4393	.088	11.674	0.00	9.39	.5625	.1187	.0544	-.0091	-.0055	.0028
4394	.088	11.751	0.00	14.49	.7400	.2008	.0631	-.0055	-.0066	.0024
4395	.088	11.775	0.00	19.43	.9058	.3254	.0707	-.0061	-.0089	.0011
4396	.088	11.758	0.00	24.56	1.0705	.4849	.0815	-.0056	-.0051	.0063

## RUN 521

POINT	MACH	Q	BETA	ALPHA	CL	CD	CPM	CRM	CYM	CSF
4397	.087	11.457	0.00	-9.98	-.1968	.0965	.0560	-.0011	-.0049	.0014
4398	.087	11.433	0.00	-8.17	-.1173	.0816	.0575	-.0032	-.0044	.0010
4399	.087	11.427	0.00	-6.17	-.0323	.0690	.0539	-.0020	-.0033	-.0002
4400	.087	11.401	0.00	-4.28	.0451	.0627	.0560	-.0046	-.0043	.0003
4401	.087	11.351	0.00	-2.37	.1101	.0591	.0596	-.0045	-.0038	-.0006
4402	.087	11.419	0.00	-.45	.1981	.0575	.0602	-.0068	-.0047	.0030
4403	.087	11.415	0.00	1.47	.2577	.0606	.0581	-.0075	-.0046	-.0005
4404	.087	11.479	0.00	3.52	.3353	.0704	.0596	-.0067	-.0051	-.0003
4405	.087	11.507	0.00	5.40	.4004	.0825	.0625	-.0101	-.0061	.0043
4406	.087	11.460	0.00	7.39	.4791	.1017	.0651	-.0112	-.0069	.0086
4407	.087	11.432	0.00	9.45	.5448	.1239	.0671	-.0103	-.0061	.0035
4408	.088	11.556	0.00	14.45	.7245	.2031	.0799	-.0097	-.0083	.0038
4409	.088	11.603	0.00	19.43	.8849	.3249	.0881	-.0072	-.0097	.0043
4410	.088	11.580	0.00	24.48	1.0543	.4803	.0965	-.0046	-.0111	-.0002

ORIGINAL PAGE IS  
OF POOR QUALITY



TABLE B.- CONTINUED

## RUN 522

POINT	MACH	Q	BETA	ALPHA	CL	CD	CPM	CRM	CYM	CSF
4411	.087	11.457	0.00	-9.99	-.1185	.0616	-.0323	-.0040	-.0046	.0037
4412	.087	11.417	0.00	-8.15	-.0333	.0481	-.0284	-.0048	-.0042	-.0000
4413	.087	11.459	0.00	-6.19	.0481	.0400	-.0273	-.0033	-.0033	-.0024
4414	.087	11.396	0.00	-4.22	.1204	.0378	-.0257	-.0053	-.0039	-.0017
4415	.087	11.530	0.00	-2.29	.1986	.0367	-.0240	-.0053	-.0037	-.0021
4416	.087	11.524	0.00	-.36	.2726	.0401	-.0243	-.0063	-.0038	-.0016
4417	.087	11.518	0.00	1.57	.3363	.0463	-.0249	-.0075	-.0037	-.0023
4418	.087	11.511	0.00	3.54	.4162	.0584	-.0215	-.0089	-.0052	.0032
4419	.088	11.581	0.00	5.43	.4870	.0737	-.0169	-.0109	-.0058	.0057
4420	.088	11.554	0.00	7.40	.5557	.0954	-.0157	-.0116	-.0064	.0070
4421	.088	11.639	0.00	9.38	.6250	.1205	-.0136	-.0104	-.0061	.0064
4422	.088	11.709	0.00	14.62	.8119	.2146	-.0028	-.0078	-.0075	.0036
4423	.088	11.669	0.00	19.44	.9672	.3462	.0049	-.0061	-.0083	.0015
4424	.087	11.532	0.00	24.55	1.1262	.5142	.0183	-.0067	-.0089	.0046

## RUN 523

POINT	MACH	Q	BETA	ALPHA	CL	CD	CPM	CRM	CYM	CSF
4495	.087	11.300	0.00	-9.98	-.1319	.0632	-.0440	.0060	.0015	-.0049
4496	.087	11.352	0.00	-8.14	-.0422	.0487	-.0389	.0075	.0027	-.0085
4497	.087	11.362	0.00	-6.13	.0447	.0410	-.0383	.0074	.0030	-.0100
4498	.087	11.345	0.00	-4.17	.1225	.0389	-.0355	.0033	.0022	-.0055
4499	.087	11.368	0.00	-2.31	.1931	.0388	-.0346	.0057	.0033	-.0100
4500	.087	11.319	0.00	-.33	.2692	.0426	-.0355	.0028	.0037	-.0088
4501	.087	11.326	0.00	1.56	.3348	.0494	-.0366	.0017	.0031	-.0101
4502	.087	11.445	0.00	3.59	.4225	.0629	-.0334	-.0001	.0018	-.0011
4503	.087	11.515	0.00	5.50	.4982	.0797	-.0310	-.0013	.0016	-.0018
4504	.087	11.504	0.00	7.46	.5615	.1011	-.0289	-.0028	.0016	.0029
4505	.088	11.558	0.00	9.42	.6329	.1270	-.0261	-.0009	.0020	-.0019
4506	.088	11.579	0.00	14.63	.8226	.2239	-.0197	-.0018	.0003	-.0036
4507	.087	11.499	0.00	19.49	.9940	.3651	-.0097	-.0011	-.0002	-.0044
4508	.087	11.398	0.00	24.59	1.1419	.5329	.0073	-.0008	-.0018	-.0035

TABLE B.- CONTINUED

RUN 524

POINT	MACH	Q	BETA	ALPHA	CL	CD	CPM	CRM	CYM	CSF
4509	.086	11.238	0.00	-10.01	-.1210	.0635	-.0545	.0081	.0012	-.0057
4510	.086	11.198	0.00	-8.10	-.0295	.0505	-.0519	.0070	.0020	-.0065
4511	.086	11.166	0.00	-6.09	.0374	.0451	-.0537	.0052	.0021	-.0082
4512	.086	11.206	0.00	-4.29	.1289	.0424	-.0508	.0039	.0020	-.0051
4513	.086	11.140	0.00	-2.31	.2075	.0444	-.0509	.0014	.0021	-.0054
4514	.086	11.255	0.00	-.41	.2860	.0472	-.0482	.0024	.0014	-.0051
4515	.087	11.320	0.00	1.46	.3503	.0551	-.0492	.0015	.0027	-.0084
4516	.087	11.318	0.00	3.52	.4278	.0679	-.0470	-.0007	.0016	-.0057
4517	.087	11.336	0.00	5.44	.4958	.0848	-.0460	-.0016	.0001	.0028
4518	.087	11.366	0.00	7.25	.5590	.1049	-.0438	-.0042	.0004	.0036
4519	.087	11.385	0.00	9.49	.6482	.1355	-.0389	-.0014	.0013	-.0023
4520	.087	11.442	0.00	14.51	.8235	.2290	-.0332	-.0016	.0004	-.0039
4521	.087	11.306	0.00	19.42	.9889	.3685	-.0211	-.0020	-.0001	-.0045
4522	.086	11.249	0.00	24.48	1.1479	.5386	.0019	-.0010	.0008	-.0062

RUN 533

POINT	MACH	Q	BETA	ALPHA	CL	CD	CPM	CRM	CYM	CSF
5005	.086	11.009	0.00	-10.00	-.0240	.0765	-.0541	.0028	.0005	-.0031
5006	.086	11.033	0.00	-8.09	.0564	.0659	-.0495	.0009	-.0004	-.0032
5007	.086	11.154	0.00	-6.18	.1276	.0601	-.0459	.0021	-.0000	.0007
5008	.086	11.125	0.00	-4.31	.1949	.0590	-.0393	-.0015	-.0000	-.0006
5009	.086	11.119	0.00	-2.28	.2630	.0603	-.0368	-.0011	-.0000	-.0014
5010	.086	11.166	0.00	-.37	.3417	.0644	-.0339	-.0014	.0004	-.0010
5011	.086	11.056	0.00	1.55	.4045	.0746	-.0333	-.0034	.0003	.0003
5012	.086	11.132	0.00	3.52	.4817	.0894	-.0331	-.0047	.0006	-.0011
5013	.087	11.225	0.00	5.49	.5604	.1090	-.0286	-.0065	-.0012	.0080
5014	.087	11.235	0.00	7.37	.6232	.1321	-.0280	-.0069	-.0010	.0033
5015	.087	11.197	0.00	9.30	.6914	.1598	-.0237	-.0038	-.0013	.0043
5016	.087	11.290	0.00	14.50	.8461	.2532	-.0074	-.0002	-.0007	.0011
5017	.087	11.214	0.00	19.43	.9903	.3848	.0198	-.0017	-.0037	.0022
5018	.086	11.139	0.00	24.40	1.1440	.5375	.0629	-.0089	-.0108	-.0014

ORIGINAL PAGE IS  
OF POOR QUALITY

TABLE B.- CONTINUED

## RUN 537

POINT	MACH	Q	BETA	ALPHA	CL	CD	CPM	CRM	CYM	CSF
5231	.087	11.039	0.00	-10.01	.0279	.0756	-.0800	.0045	.0020	-.0042
5232	.086	10.973	0.00	-8.19	.0871	.0691	-.0775	.0009	.0006	-.0025
5233	.087	11.052	0.00	-6.21	.1694	.0629	-.0689	.0007	.0013	-.0022
5234	.087	11.102	0.00	-4.24	.2319	.0629	-.0664	.0001	.0000	.0008
5235	.087	11.019	0.00	-2.31	.3015	.0673	-.0664	.0006	.0002	-.0017
5236	.087	11.153	0.00	-.34	.3702	.0742	-.0666	-.0017	-.0003	.0023
5237	.087	11.242	0.00	1.52	.4570	.0862	-.0680	-.0023	.0001	.0024
5238	.087	11.267	0.00	3.58	.5313	.1034	-.0668	-.0024	-.0013	.0084
5239	.088	11.340	0.00	5.40	.5973	.1239	-.0662	-.0029	-.0006	.0069
5240	.088	11.340	0.00	7.43	.6477	.1445	-.0625	-.0017	.0005	.0035
5241	.088	11.320	0.00	9.35	.7044	.1699	-.0563	-.0007	-.0001	.0046
5242	.088	11.338	0.00	14.46	.8612	.2651	-.0456	.0025	-.0000	.0004
5243	.087	11.258	0.00	19.51	1.0301	.4116	-.0264	-.0006	-.0021	-.0005
5244	.087	11.165	0.00	24.62	1.1814	.5752	.0025	-.0077	-.0048	.0044

## RUN 538

POINT	MACH	Q	BETA	ALPHA	CL	CD	CPM	CRM	CYM	CSF
5245	.086	10.999	0.00	-9.92	.0375	.0763	-.0860	.0036	.0023	-.0031
5246	.086	10.991	0.00	-8.11	.1033	.0709	-.0874	-.0007	.0015	-.0001
5247	.086	11.008	0.00	-6.14	.1720	.0681	-.0865	.0005	.0013	-.0041
5248	.086	10.975	0.00	-4.22	.2374	.0681	-.0829	.0007	.0021	-.0038
5249	.086	11.000	0.00	-2.34	.3175	.0714	-.0795	-.0013	.0007	-.0003
5250	.087	11.050	0.00	-.42	.3848	.0793	-.0809	-.0002	.0004	.0010
5251	.087	11.085	0.00	1.57	.4559	.0913	-.0832	-.0021	.0005	.0019
5252	.087	11.095	0.00	3.52	.5395	.1087	-.0808	-.0042	-.0010	.0088
5253	.087	11.140	0.00	5.47	.6018	.1283	-.0789	-.0025	-.0004	.0068
5254	.087	11.165	0.00	7.38	.6625	.1510	-.0747	-.0019	.0006	.0029
5255	.087	11.171	0.00	9.45	.7287	.1797	-.0679	-.0011	.0002	.0027
5256	.087	11.120	0.00	14.39	.8740	.2714	-.0584	.0027	.0007	.0005
5257	.087	11.135	0.00	19.43	1.0275	.4123	-.0361	.0002	-.0011	-.0010
5258	.087	11.059	0.00	24.54	1.1832	.5759	-.0028	-.0062	-.0037	-.0003

TABLE B.- CONTINUED

RUN 539

POINT	MACH	Q	BETA	ALPHA	CL	CD	CPM	CRM	CYM	CSF
5259	.087	11.090	0.00	-10.01	.0413	.0849	-.1099	.0005	.0018	-.0002
5260	.087	11.021	0.00	-8.18	.1239	.0763	-.1051	-.0009	.0021	-.0023
5261	.087	11.041	0.00	-6.13	.1904	.0735	-.1023	.0000	.0014	-.0025
5262	.087	11.133	0.00	-4.23	.2595	.0741	-.0969	-.0011	.0014	-.0019
5263	.087	11.149	0.00	-2.29	.3309	.0777	-.0951	-.0019	.0011	-.0014
5264	.087	11.125	0.00	-.47	.3945	.0856	-.0983	-.0028	.0006	.0012
5265	.087	11.165	0.00	1.56	.4740	.0980	-.0974	-.0019	.0016	-.0035
5266	.087	11.194	0.00	3.52	.5532	.1166	-.0973	-.0046	-.0003	.0057
5267	.087	11.253	0.00	5.52	.6025	.1345	-.0936	-.0026	.0006	.0025
5268	.087	11.241	0.00	7.37	.6729	.1589	-.0888	-.0024	.0002	.0015
5269	.087	11.227	0.00	9.47	.7360	.1890	-.0835	-.0007	.0009	.0019
5270	.087	11.174	0.00	14.51	.8821	.2823	-.0722	.0023	.0011	-.0017
5271	.087	11.113	0.00	19.47	1.0391	.4241	-.0494	-.0014	-.0040	.0002
5272	.087	11.106	0.00	24.54	1.1881	.5855	-.0170	-.0098	-.0076	.0025

RUN 540

POINT	MACH	Q	BETA	ALPHA	CL	CD	CPM	CRM	CYM	CSF
5273	.086	10.873	0.00	-10.00	.0126	.0793	-.0904	.0030	.0014	-.0036
5274	.086	10.828	0.00	-8.36	.0907	.0699	-.0870	-.0008	.0010	-.0011
5275	.086	10.848	0.00	-6.22	.1638	.0657	-.0828	-.0006	.0005	-.0024
5276	.086	10.877	0.00	-4.18	.2267	.0657	-.0786	-.0009	.0010	-.0019
5277	.086	10.921	0.00	-2.41	.2938	.0680	-.0758	-.0014	-.0003	-.0014
5278	.086	10.900	0.00	-.46	.3627	.0738	-.0747	-.0032	.0004	-.0015
5279	.086	10.970	0.00	1.44	.4424	.0844	-.0746	-.0030	.0002	-.0004
5280	.086	10.951	0.00	3.58	.5210	.1029	-.0774	-.0055	.0003	.0006
5281	.086	10.939	0.00	5.49	.6020	.1255	-.0720	-.0049	-.0010	.0065
5282	.086	11.031	0.00	7.33	.6589	.1471	-.0705	-.0058	-.0008	.0027
5283	.086	11.033	0.00	9.52	.7194	.1747	-.0634	-.0028	-.0004	.0008
5284	.086	11.035	0.00	14.48	.8684	.2651	-.0490	.0005	-.0002	-.0009
5285	.086	10.964	0.00	19.44	1.0167	.4017	-.0339	-.0010	-.0029	-.0035
5286	.086	10.823	0.00	24.42	1.1860	.5682	-.0102	-.0115	-.0082	-.0007

TABLE B.- CONTINUED

## RUN 541

POINT	MACH	Q	BETA	ALPHA	CL	CD	CPM	CRM	CYM	CSF
5287	.086	10.867	0.00	-10.00	.0158	.0763	-.0813	.0010	-.0003	.0035
5288	.086	10.877	0.00	-8.15	.0903	.0667	-.0741	.0010	.0013	-.0039
5289	.086	10.868	0.00	-6.18	.1630	.0635	-.0723	-.0008	.0002	-.0022
5290	.086	10.819	0.00	-4.25	.2226	.0615	-.0649	-.0006	.0009	-.0050
5291	.086	10.817	0.00	-2.34	.2960	.0641	-.0632	.0010	-.0008	-.0020
5292	.086	10.898	0.00	-.50	.3539	.0703	-.0644	-.0012	-.0000	-.0036
5293	.086	10.841	0.00	1.57	.4292	.0810	-.0653	-.0026	.0013	-.0070
5294	.086	10.893	0.00	3.40	.5060	.0972	-.0649	-.0030	.0001	-.0012
5295	.086	10.945	0.00	5.52	.5921	.1205	-.0617	-.0050	.0001	.0006
5296	.087	11.042	0.00	7.42	.6439	.1396	-.0550	-.0048	-.0012	.0063
5297	.086	11.017	0.00	9.49	.7092	.1680	-.0521	-.0037	-.0005	.0015
5298	.087	11.042	0.00	14.53	.8575	.2584	-.0360	-.0006	-.0015	-.0001
5299	.086	10.966	0.00	19.48	1.0069	.3937	-.0203	-.0012	-.0023	.0005
5300	.086	10.920	0.00	24.49	1.1695	.5560	.0049	-.0077	-.0035	-.0005

## RUN 542

POINT	MACH	Q	BETA	ALPHA	CL	CD	CPM	CRM	CYM	CSF
5301	.085	10.775	0.00	-10.00	-.0160	.0772	-.0645	.0050	.0006	-.0023
5302	.086	10.839	0.00	-8.13	.0649	.0656	-.0598	.0022	.0001	-.0007
5303	.086	10.864	0.00	-6.25	.1374	.0614	-.0573	-.0002	.0009	-.0023
5304	.086	10.838	0.00	-4.22	.2118	.0600	-.0502	-.0000	-.0009	.0013
5305	.086	10.869	0.00	-2.27	.2724	.0609	-.0486	.0027	.0008	-.0073
5306	.086	10.852	0.00	-.40	.3525	.0675	-.0473	-.0007	-.0001	-.0020
5307	.086	10.848	0.00	1.55	.4212	.0764	-.0461	-.0013	.0015	-.0073
5308	.086	10.840	0.00	3.62	.4997	.0931	-.0444	-.0039	-.0009	.0032
5309	.086	10.893	0.00	5.49	.5793	.1157	-.0442	-.0047	-.0009	.0036
5310	.086	10.973	0.00	7.42	.6219	.1320	-.0390	-.0030	.0004	-.0013
5311	.086	10.970	0.00	9.41	.6913	.1604	-.0314	-.0030	-.0009	.0034
5312	.086	10.961	0.00	14.47	.8362	.2478	-.0192	-.0001	-.0008	-.0014
5313	.086	10.958	0.00	19.38	.9884	.3823	-.0061	-.0013	-.0014	.0007
5314	.086	10.903	0.00	24.53	1.1634	.5514	.0213	-.0086	-.0049	-.0020

ORIGINAL PAGE IS  
OF POOR QUALITY

TABLE B.- CONTINUED

RUN 543

POINT	MACH	Q	BETA	ALPHA	CL	CD	CPM	CRM	CYM	CSF
5395	.085	10.664	0.00	-10.02	-.0387	.0834	-.0306	.0071	.0000	-.0036
5396	.085	10.684	0.00	-8.14	.0417	.0702	-.0285	.0082	.0009	-.0035
5397	.085	10.588	0.00	-6.56	.0989	.0680	-.0289	.0043	-.0002	-.0028
5398	.085	10.719	0.00	-4.24	.1802	.0633	-.0218	.0021	.0007	-.0012
5399	.085	10.702	0.00	-2.28	.2500	.0641	-.0221	.0016	.0013	-.0048
5400	.085	10.696	0.00	-.37	.3250	.0699	-.0197	.0002	.0019	-.0064
5401	.086	10.772	0.00	1.59	.3969	.0786	-.0197	.0004	.0009	-.0038
5402	.085	10.706	0.00	3.55	.4807	.0937	-.0198	-.0016	.0015	-.0023
5403	.085	10.690	0.00	5.44	.5545	.1135	-.0189	-.0016	.0003	.0003
5404	.085	10.751	0.00	7.46	.6118	.1327	-.0119	-.0004	.0003	-.0034
5405	.086	10.788	0.00	9.29	.6743	.1592	-.0092	-.0028	.0003	.0009
5406	.086	10.832	0.00	14.42	.8204	.2448	.0046	.0005	-.0002	-.0011
5407	.086	10.837	0.00	19.43	.9763	.3793	.0220	-.0005	-.0004	-.0001
5408	.085	10.724	0.00	24.42	1.1469	.5400	.0463	-.0071	-.0033	-.0029

RUN 544

POINT	MACH	Q	BETA	ALPHA	CL	CD	CPM	CRM	CYM	CSF
5409	.085	10.728	0.00	-10.02	-.0614	.0945	-.0014	.0110	-.0007	-.0023
5410	.085	10.725	0.00	-8.20	.0120	.0830	.0028	.0050	-.0003	-.0001
5411	.085	10.692	0.00	-6.15	.0881	.0752	.0020	.0062	.0006	-.0047
5412	.085	10.718	0.00	-4.31	.1525	.0706	.0069	.0068	.0012	-.0050
5413	.085	10.763	0.00	-2.29	.2262	.0709	.0078	.0075	.0011	-.0062
5414	.086	10.827	0.00	-.48	.3010	.0746	.0068	.0032	.0012	-.0068
5415	.086	10.796	0.00	1.57	.3766	.0832	.0078	.0001	.0010	-.0008
5416	.086	10.848	0.00	3.53	.4474	.0977	.0068	.0007	.0015	-.0036
5417	.086	10.831	0.00	5.45	.5178	.1148	.0100	-.0002	.0010	.0011
5418	.086	10.794	0.00	7.35	.5905	.1364	.0177	-.0005	.0010	.0034
5419	.086	10.784	0.00	9.42	.6510	.1616	.0203	-.0004	.0008	.0002
5420	.086	10.947	0.00	14.50	.7955	.2422	.0329	.0013	.0013	-.0027
5421	.086	10.845	0.00	19.32	.9409	.3667	.0422	.0011	.0022	-.0028
5422	.086	10.772	0.00	24.46	1.1256	.5327	.0724	-.0070	-.0027	-.0006

ORIGINAL PAGE IS  
OF POOR QUALITY

TABLE B.- CONTINUED

## RUN 545

POINT	MACH	Q	BETA	ALPHA	CL	CD	CPM	CRM	CYM	CSF
5423	.085	10.636	0.00	-10.02	-.0760	.1044	.0204	.0066	-.0004	-.0030
5424	.085	10.706	0.00	-8.14	-.0014	.0907	.0221	.0064	.0006	-.0031
5425	.085	10.754	0.00	-6.15	.0761	.0818	.0238	.0039	.0005	-.0036
5426	.085	10.718	0.00	-4.29	.1343	.0757	.0282	.0058	.0007	-.0046
5427	.085	10.734	0.00	-2.35	.2085	.0759	.0282	.0045	.0011	-.0053
5428	.085	10.759	0.00	-.37	.2844	.0785	.0280	.0040	.0018	-.0090
5429	.086	10.803	0.00	1.51	.3508	.0858	.0279	.0023	.0019	-.0058
5430	.086	10.815	0.00	3.52	.4308	.1003	.0297	-.0001	.0007	.0004
5431	.086	10.855	0.00	5.45	.5079	.1189	.0308	-.0018	.0003	.0026
5432	.086	10.850	0.00	7.36	.5650	.1354	.0375	-.0010	.0010	.0018
5433	.086	10.878	0.00	9.42	.6335	.1613	.0414	-.0015	.0007	-.0018
5434	.086	10.877	0.00	14.39	.7785	.2406	.0527	.0010	.0001	-.0021
5435	.086	10.865	0.00	19.44	.9353	.3711	.0627	.0009	.0008	-.0004
5436	.086	10.836	0.00	24.48	1.1081	.5283	.0869	-.0060	-.0022	-.0016

## RUN 546

POINT	MACH	Q	BETA	ALPHA	CL	CD	CPM	CRM	CYM	CSF
5437	.085	10.697	0.00	-9.99	-.1007	.1121	.0366	.0113	-.0001	-.0061
5438	.085	10.702	0.00	-8.08	-.0183	.0965	.0400	.0079	.0006	-.0030
5439	.085	10.694	0.00	-6.12	.0585	.0884	.0420	.0044	.0006	-.0043
5440	.085	10.720	0.00	-4.34	.1226	.0825	.0477	.0044	.0005	-.0023
5441	.085	10.733	0.00	-2.28	.1965	.0816	.0478	.0051	.0014	-.0046
5442	.086	10.773	0.00	-.36	.2658	.0825	.0458	.0049	.0028	-.0089
5443	.085	10.767	0.00	1.58	.3340	.0906	.0447	.0046	.0025	-.0085
5444	.086	10.797	0.00	3.47	.4128	.1032	.0450	.0021	.0036	-.0099
5445	.086	10.841	0.00	5.41	.4863	.1198	.0489	-.0014	.0013	.0019
5446	.085	10.767	0.00	7.36	.5501	.1393	.0535	-.0012	.0012	.0012
5447	.086	10.819	0.00	9.40	.6139	.1638	.0589	-.0007	.0016	-.0010
5448	.086	10.844	0.00	14.55	.7672	.2446	.0692	.0002	.0016	-.0036
5449	.086	10.836	0.00	19.38	.9185	.3685	.0759	.0002	-.0012	-.0021
5450	.086	10.331	0.00	24.46	1.1001	.5292	.0992	-.0074	-.0049	-.0033

TABLE B.- CONTINUED

RUN 547

POINT	MACH	Q	BETA	ALPHA	CL	CD	CPM	CRM	CYM	CSF
5451	.085	10.717	0.00	-10.00	-.1041	.1319	.0493	.0082	-.0021	.0017
5452	.086	10.804	0.00	-8.17	-.0306	.1168	.0541	.0073	-.0001	.0005
5453	.085	10.688	0.00	-6.14	.0423	.1081	.0593	.0072	-.0008	-.0042
5454	.086	10.771	0.00	-4.23	.1082	.1023	.0646	.0066	.0001	-.0031
5455	.085	10.702	0.00	-2.34	.1681	.1002	.0647	.0060	.0007	-.0055
5456	.085	10.763	0.00	-.40	.2356	.1015	.0651	.0078	.0016	-.0080
5457	.086	10.844	0.00	1.55	.3196	.1089	.0678	.0040	.0021	-.0085
5458	.086	10.860	0.00	3.46	.3818	.1210	.0703	.0035	.0021	-.0044
5459	.086	10.829	0.00	5.39	.4561	.1369	.0721	.0009	.0017	-.0034
5460	.086	10.824	0.00	7.40	.5303	.1580	.0774	-.0002	.0013	-.0001
5461	.086	10.810	0.00	9.45	.5815	.1766	.0843	.0018	.0024	-.0018
5462	.086	10.905	0.00	14.39	.7238	.2502	.0969	.0023	.0021	-.0020
5463	.086	10.883	0.00	19.46	.8825	.3746	.1075	.0004	.0000	-.0009
5464	.086	10.826	0.00	24.51	1.0664	.5295	.1238	-.0062	-.0016	-.0002

ORIGINAL PAGE IS  
OF POOR QUALITY

RUN 548

POINT	MACH	Q	BETA	ALPHA	CL	CD	CPM	CRM	CYM	CSF
5535	.086	10.802	0.00	-9.98	-.1008	.1257	.0424	.0078	-.0018	.0034
5536	.085	10.745	0.00	-8.18	-.0315	.1133	.0473	.0046	-.0003	.0002
5537	.085	10.760	0.00	-6.12	.0421	.1046	.0488	.0039	-.0000	-.0037
5538	.085	10.754	0.00	-4.24	.1037	.0980	.0534	.0031	.0001	-.0030
5539	.086	10.793	0.00	-2.29	.1738	.0957	.0553	.0050	.0011	-.0050
5540	.086	10.788	0.00	-.38	.2497	.0978	.0586	.0012	.0013	-.0044
5541	.086	10.838	0.00	1.55	.3263	.1036	.0576	.0014	.0015	-.0043
5542	.086	10.941	0.00	3.51	.4022	.1150	.0584	.0001	.0013	-.0045
5543	.086	10.934	0.00	5.41	.4689	.1304	.0618	-.0015	.0017	-.0017
5544	.086	10.911	0.00	7.37	.5349	.1523	.0671	-.0019	.0005	.0027
5545	.086	10.906	0.00	9.49	.6069	.1770	.0734	-.0042	.0002	.0024
5546	.086	10.901	0.00	14.43	.7477	.2504	.0873	-.0007	-.0004	-.0030
5547	.086	10.933	0.00	19.36	.9008	.3724	.0963	-.0020	-.0019	-.0031
5548	.086	10.853	0.00	24.48	1.0841	.5293	.1160	-.0115	-.0058	.0004



## TABLE B.- CONTINUED

RUN 549

POINT	MACH	Q	BETA	ALPHA	CL	CD	CPM	CRM	CYM	CSF
5549	.085	10.744	0.00	-9.99	-.0831	.1188	.0270	.0059	-.0009	.0003
5550	.086	10.818	0.00	-8.14	-.0041	.1037	.0334	.0033	.0000	-.0003
5551	.086	10.797	0.00	-6.16	.0639	.0950	.0327	.0054	.0009	-.0032
5552	.086	10.839	0.00	-4.27	.1189	.0904	.0401	.0018	.0002	-.0001
5553	.086	10.814	0.00	-2.36	.1973	.0878	.0425	.0032	.0016	-.0064
5554	.086	10.859	0.00	-.38	.2720	.0903	.0412	.0029	.0015	-.0056
5555	.086	10.950	0.00	1.58	.3470	.0967	.0417	.0012	.0013	-.0037
5556	.086	10.926	0.00	3.44	.4111	.1086	.0408	-.0022	.0012	-.0024
5557	.086	10.923	0.00	5.39	.4920	.1284	.0460	-.0036	-.0005	.0049
5558	.086	10.969	0.00	7.38	.5543	.1470	.0521	-.0027	-.0002	.0041
5559	.086	10.959	0.00	9.35	.6130	.1690	.0584	-.0034	-.0001	.0013
5560	.087	11.025	0.00	14.50	.7671	.2506	.0725	-.0004	.0004	-.0005
5561	.086	10.977	0.00	19.38	.9089	.3697	.0798	-.0008	.0004	-.0007
5562	.086	10.905	0.00	24.50	1.0980	.5283	.1047	-.0097	-.0072	-.0019

RUN 550

POINT	MACH	Q	BETA	ALPHA	CL	CD	CPM	CRM	CYM	CSF
5633	.086	10.816	0.00	-10.01	-.0101	.0787	-.0672	.0082	-.0013	-.0022
5634	.086	10.824	0.00	-8.18	.0537	.0686	-.0595	.0049	-.0000	-.0040
5635	.086	10.881	0.00	-6.17	.1335	.0618	-.0516	.0039	.0005	-.0032
5636	.086	10.866	0.00	-4.22	.1956	.0611	-.0464	.0019	.0004	-.0040
5637	.086	10.867	0.00	-2.26	.2697	.0630	-.0424	.0027	-.0001	-.0031
5638	.086	10.872	0.00	-.42	.3374	.0685	-.0397	.0006	.0005	-.0038
5639	.086	10.893	0.00	1.51	.4051	.0775	-.0400	.0011	.0013	-.0050
5640	.086	10.918	0.00	3.54	.4806	.0928	-.0393	-.0008	.0016	-.0037
5641	.086	10.970	0.00	5.43	.5622	.1131	-.0359	.0000	.0018	-.0029
5642	.086	11.012	0.00	7.32	.6142	.1332	-.0285	-.0007	.0008	-.0002
5643	.086	10.990	0.00	9.39	.6799	.1600	-.0238	-.0008	.0002	.0012
5644	.086	11.021	0.00	14.53	.8295	.2472	-.0009	.0005	.0003	-.0009
5645	.087	11.054	0.00	19.43	.9694	.3754	.0289	.0020	-.0004	-.0016
5646	.086	10.945	0.00	24.51	1.1268	.5333	.0692	-.0093	-.0030	.0021

TABLE B.- CONTINUED

## RUN 552

POINT	MACH	Q	BETA	ALPHA	CL	CD	CPM	CRM	CYM	CSF
5831	.086	10.998	0.00	-10.01	-.0150	.0767	-.0568	.0069	-.0012	.0003
5832	.086	11.016	0.00	-8.20	.0672	.0664	-.0534	.0034	-.0010	.0003
5833	.086	10.978	0.00	-6.23	.1421	.0615	-.0486	.0035	-.0004	-.0023
5834	.086	10.984	0.00	-4.28	.2063	.0598	-.0445	.0025	.0001	-.0031
5835	.086	10.931	0.00	-2.36	.2736	.0627	-.0428	.0014	-.0008	-.0013
5836	.086	10.944	0.00	-.35	.3534	.0679	-.0442	.0008	.0001	-.0050
5837	.086	10.970	0.00	1.53	.4290	.0791	-.0434	-.0007	-.0013	.0016
5838	.086	10.956	0.00	3.52	.4977	.0944	-.0423	-.0010	-.0001	-.0025
5839	.086	10.971	0.00	5.49	.5795	.1166	-.0373	-.0033	-.0013	.0060
5840	.087	11.088	0.00	7.33	.6307	.1358	-.0327	-.0021	-.0011	.0040
5841	.087	11.107	0.00	9.42	.6879	.1613	-.0273	-.0034	-.0008	.0046
5842	.087	11.121	0.00	14.51	.8420	.2526	-.0135	.0014	-.0011	-.0014
5843	.087	11.116	0.00	19.44	.9958	.3884	.0030	-.0005	-.0034	.0016
5844	.086	10.961	0.00	24.46	1.1584	.5496	.0296	-.0077	-.0036	.0005

## RUN 553

POINT	MACH	Q	BETA	ALPHA	CL	CD	CPM	CRM	CYM	CSF
5845	.086	10.912	0.00	-10.05	-.0209	.0800	-.0348	.0032	-.0026	.0014
5846	.086	10.949	0.00	-8.15	.0578	.0686	-.0297	.0008	-.0024	-.0002
5847	.086	10.898	0.00	-6.27	.1167	.0644	-.0289	-.0007	-.0035	-.0003
5848	.086	10.936	0.00	-4.25	.1942	.0608	-.0237	.0024	-.0004	-.0076
5849	.086	10.973	0.00	-2.38	.2634	.0627	-.0218	-.0016	-.0032	.0023
5850	.086	10.982	0.00	-.47	.3316	.0687	-.0242	-.0032	-.0027	.0014
5851	.086	10.999	0.00	1.56	.4138	.0778	-.0234	-.0023	-.0017	-.0023
5852	.086	11.015	0.00	3.47	.4845	.0923	-.0221	-.0031	-.0026	.0055
5853	.086	10.989	0.00	5.38	.5571	.1120	-.0197	-.0050	-.0023	.0039
5854	.086	11.008	0.00	7.40	.6150	.1324	-.0134	-.0032	-.0024	.0020
5855	.087	11.055	0.00	9.36	.6844	.1598	-.0100	-.0046	-.0030	.0055
5856	.087	11.084	0.00	14.42	.8218	.2442	.0017	.0005	-.0032	.0003
5857	.086	11.007	0.00	19.39	.9806	.3791	.0205	-.0008	-.0047	.0034
5858	.086	10.987	0.00	24.46	1.1471	.5400	.0486	-.0122	-.0108	.0045

TABLE B.-CONTINUED

## RUN 554

POINT	MACH	Q	BETA	ALPHA	CL	CD	CPM	CRM	CYM	CSF
5859	.086	10.956	0.00	-9.95	-.0406	.0910	-.0127	.0006	-.0032	.0014
5860	.086	10.994	0.00	-8.11	.0304	.0792	-.0101	-.0003	-.0028	.0016
5861	.087	11.046	0.00	-6.21	.1003	.0715	-.0068	-.0007	-.0033	.0009
5862	.087	11.057	0.00	-4.26	.1724	.0670	-.0008	-.0024	-.0033	.0006
5863	.086	11.006	0.00	-2.33	.2383	.0687	-.0023	-.0024	-.0029	.0005
5864	.087	11.067	0.00	-.45	.3194	.0718	-.0018	.0007	-.0017	-.0057
5865	.087	11.121	0.00	1.58	.3917	.0815	-.0020	-.0046	-.0023	-.0013
5866	.087	11.147	0.00	3.45	.4650	.0947	-.0016	-.0058	-.0033	.0047
5867	.087	11.161	0.00	5.48	.5382	.1145	.0030	-.0059	-.0037	.0041
5868	.087	11.142	0.00	7.40	.6053	.1356	.0086	-.0078	-.0042	.0090
5869	.087	11.109	0.00	9.43	.6611	.1604	.0113	-.0060	-.0036	.0027
5870	.087	11.214	0.00	14.46	.8077	.2436	.0263	-.0011	-.0050	.0037
5871	.087	11.220	0.00	19.41	.9546	.3717	.0379	-.0038	-.0073	.0056
5872	.087	11.106	0.00	24.45	1.1324	.5326	.0697	-.0111	-.0111	.0036

## RUN 555

POINT	MACH	Q	BETA	ALPHA	CL	CD	CPM	CRM	CYM	CSF
5873	.086	10.930	0.00	-10.05	-.0553	.0947	-.0010	.0011	-.0032	.0025
5874	.086	10.926	0.00	-8.19	.0230	.0825	.0022	-.0008	-.0032	.0026
5875	.086	10.869	0.00	-6.21	.0874	.0752	.0048	.0000	-.0039	-.0004
5876	.086	10.914	0.00	-4.24	.1580	.0701	.0099	-.0004	-.0025	-.0017
5877	.086	10.888	0.00	-2.30	.2307	.0697	.0121	-.0023	-.0030	-.0013
5878	.086	10.914	0.00	-.36	.3050	.0733	.0081	.0006	-.0013	-.0080
5879	.086	10.971	0.00	1.49	.3728	.0817	.0098	-.0021	-.0028	-.0011
5880	.087	11.050	0.00	3.52	.4420	.0959	.0102	-.0040	-.0021	-.0007
5881	.086	10.966	0.00	5.58	.5312	.1164	.0166	-.0057	-.0032	.0035
5882	.086	11.039	0.00	7.19	.5800	.1329	.0219	-.0049	-.0032	.0062
5883	.087	11.069	0.00	9.32	.6493	.1577	.0271	-.0047	-.0036	.0059
5884	.087	11.057	0.00	14.55	.7997	.2441	.0379	-.0016	-.0041	.0023
5885	.087	11.076	0.00	19.39	.9510	.3724	.0498	-.0028	-.0080	.0021
5886	.086	10.947	0.00	24.48	1.1167	.5273	.0795	-.0100	-.0120	.0022

ORIGINAL PAGE IS  
OF POOR QUALITY

TABLE B.- CONTINUED

RUN 556

POINT	MACH	Q	BETA	ALPHA	CL	CD	CPM	CRM	CYM	CSF
5887	.086	11.029	0.00	-10.00	-.0653	.1098	.0164	.0034	-.0043	.0057
5888	.086	10.934	0.00	-8.14	.0002	.1007	.0190	.0014	-.0041	.0008
5889	.086	10.970	0.00	-6.13	.0836	.0899	.0249	.0013	-.0034	.0002
5890	.086	11.005	0.00	-4.29	.1407	.0857	.0276	.0018	-.0033	-.0012
5891	.086	10.993	0.00	-2.31	.2084	.0863	.0334	.0000	-.0037	-.0011
5892	.087	11.060	0.00	-.37	.2769	.0903	.0309	-.0019	-.0033	-.0016
5893	.087	11.118	0.00	1.54	.3586	.0973	.0324	-.0005	-.0030	-.0023
5894	.087	11.134	0.00	3.52	.4283	.1104	.0352	-.0043	-.0029	.0018
5895	.087	11.083	0.00	5.44	.4962	.1281	.0368	-.0045	-.0032	.0061
5896	.087	11.052	0.00	7.42	.5720	.1485	.0453	-.0047	-.0040	.0052
5897	.087	11.100	0.00	9.42	.6258	.1699	.0490	-.0028	-.0027	.0003
5898	.087	11.139	0.00	14.53	.7692	.2500	.0619	-.0040	-.0039	-.0001
5899	.087	11.161	0.00	19.28	.9128	.3686	.0763	-.0032	-.0056	.0049
5900	.087	11.064	0.00	24.50	1.0858	.5240	.1045	-.0096	-.0084	.0037

RUN 557

POINT	MACH	Q	BETA	ALPHA	CL	CD	CPM	CRM	CYM	CSF
5901	.086	11.045	0.00	-10.02	-.0699	.1157	.0154	.0016	-.0056	.0037
5902	.086	11.008	0.00	-8.32	-.0148	.1054	.0169	.0013	-.0041	.0000
5903	.086	11.030	0.00	-6.06	.0762	.0953	.0279	-.0004	-.0034	.0001
5904	.086	11.013	0.00	-4.21	.1336	.0928	.0339	-.0010	-.0039	.0012
5905	.087	11.079	0.00	-2.38	.2039	.0906	.0379	-.0005	-.0034	-.0005
5906	.087	11.081	0.00	-.45	.2658	.0925	.0352	-.0012	-.0035	-.0022
5907	.086	11.044	0.00	1.38	.3236	.1005	.0342	-.0032	-.0022	-.0045
5908	.087	11.102	0.00	3.44	.4064	.1121	.0392	-.0010	-.0025	-.0008
5909	.087	11.127	0.00	5.43	.4838	.1285	.0431	-.0037	-.0024	-.0008
5910	.086	11.050	0.00	7.31	.5544	.1502	.0510	-.0051	-.0033	.0037
5911	.087	11.134	0.00	9.38	.6108	.1731	.0542	-.0043	-.0028	.0009
5912	.087	11.235	0.00	14.43	.7521	.2476	.0709	-.0033	-.0050	.0037
5913	.087	11.171	0.00	19.45	.9113	.3762	.0857	-.0026	-.0069	.0003
5914	.087	11.120	0.00	24.45	1.0792	.5262	.1068	-.0109	-.0070	.0048

TABLE B.- CONTINUED

RUN 559

POINT	MACH	Q	BETA	ALPHA	CL	CD	CPM	CRM	CYM	CSF
5999	.086	10.891	0.00	-10.00	-.0718	.1078	.0075	.0081	-.0017	-.0008
6000	.086	10.856	0.00	-8.15	.0089	.0956	.0128	.0041	-.0005	-.0014
6001	.085	10.813	0.00	-6.21	.0693	.0876	.0156	.0046	.0006	-.0016
6002	.086	10.881	0.00	-4.23	.1405	.0814	.0203	.0058	.0008	-.0043
6003	.086	10.909	0.00	-2.27	.2151	.0804	.0234	.0039	.0006	-.0039
6004	.086	10.923	0.00	-.42	.2846	.0847	.0235	.0038	.0014	-.0058
6005	.086	10.952	0.00	1.42	.3505	.0908	.0230	.0019	.0024	-.0072
6006	.086	10.910	0.00	3.50	.4366	.1069	.0266	-.0006	.0015	-.0029
6007	.086	10.952	0.00	5.43	.5117	.1257	.0279	-.0032	.0007	.0026
6008	.086	10.961	0.00	7.37	.5632	.1411	.0336	-.0011	.0008	.0000
6009	.086	11.005	0.00	9.45	.6366	.1680	.0423	-.0011	.0007	.0014
6010	.086	11.017	0.00	14.47	.7714	.2450	.0556	.0008	.0007	-.0032
6011	.086	10.994	0.00	19.42	.9321	.3743	.0717	-.0005	-.0012	-.0025
6012	.086	10.974	0.00	24.51	1.1006	.5297	.0955	-.0082	-.0027	.0006

RUN 560

POINT	MACH	Q	BETA	ALPHA	CL	CD	CPM	CRM	CYM	CSF
6013	.086	10.886	0.00	-10.03	-.0109	.0791	-.0761	.0081	.0016	-.0053
6014	.086	10.955	0.00	-8.14	.0661	.0690	-.0720	.0066	.0019	-.0048
6015	.086	10.929	0.00	-6.16	.1435	.0640	-.0659	.0039	.0012	-.0024
6016	.086	10.951	0.00	-4.25	.2127	.0621	-.0616	.0048	.0027	-.0068
6017	.086	10.902	0.00	-2.39	.2829	.0643	-.0590	.0060	.0038	-.0113
6018	.086	10.964	0.00	-.37	.3519	.0715	-.0594	.0032	.0021	-.0046
6019	.086	10.948	0.00	1.57	.4290	.0832	-.0599	.0015	.0024	-.0048
6020	.086	11.020	0.00	3.53	.5053	.0989	-.0598	-.0004	.0034	-.0078
6021	.086	11.055	0.00	5.46	.5812	.1209	-.0571	-.0030	.0016	.0003
6022	.087	11.105	0.00	7.38	.6381	.1431	-.0547	-.0018	.0012	.0002
6023	.086	11.056	0.00	9.30	.6990	.1685	-.0482	-.0003	.0025	-.0023
6024	.087	11.096	0.00	14.47	.8565	.2616	-.0346	.0021	.0029	-.0045
6025	.086	11.072	0.00	19.34	1.0084	.3987	-.0139	.0016	.0007	-.0060
6026	.086	10.944	0.00	24.56	1.1661	.5647	.0124	-.0114	-.0023	.0022

ORIGINAL PAGE IS  
OF POOR QUALITY

TABLE B.- CONTINUED

RUN 561

POINT	MACH	Q	BETA	ALPHA	CL	CD	CPM	CRM	CYM	CSF
6027	.086	10.922	0.00	-10.02	.0030	.0797	-.0830	.0069	-.0004	-.0029
6028	.086	10.981	0.00	-8.16	.0745	.0709	-.0806	.0053	.0002	-.0019
6029	.086	10.925	0.00	-6.09	.1493	.0657	-.0742	.0050	.0007	-.0026
6030	.086	10.962	0.00	-4.19	.2158	.0647	-.0698	.0053	.0016	-.0044
6031	.086	10.962	0.00	-2.31	.2893	.0678	-.0700	.0045	.0015	-.0064
6032	.086	11.041	0.00	-.40	.3687	.0737	-.0670	.0032	.0018	-.0046
6033	.086	11.000	0.00	1.60	.4315	.0850	-.0675	.0018	.0027	-.0067
6034	.086	11.040	0.00	3.47	.5088	.1004	-.0661	-.0001	.0029	-.0047
6035	.086	11.089	0.00	5.41	.5769	.1224	-.0661	-.0007	.0015	-.0003
6036	.086	11.083	0.00	7.37	.6386	.1445	-.0629	.0005	.0023	-.0018
6037	.087	11.158	0.00	9.42	.7004	.1713	-.0572	.0011	.0022	-.0027
6038	.087	11.102	0.00	14.45	.8558	.2629	-.0409	.0026	.0027	-.0037
6039	.087	11.094	0.00	19.41	.9985	.3975	-.0213	.0025	.0012	-.0055
6040	.086	10.947	0.00	24.49	1.1759	.5703	.0095	-.0081	-.0022	-.0024

RUN 562

POINT	MACH	Q	BETA	ALPHA	CL	CD	CPM	CRM	CYM	CSF
6041	.086	10.905	0.00	-10.03	.0155	.0818	-.0923	.0081	.0004	-.0027
6042	.086	10.913	0.00	-8.00	.0887	.0724	-.0886	.0075	.0014	-.0055
6043	.086	10.925	0.00	-6.17	.1561	.0689	-.0832	.0034	.0010	-.0009
6044	.086	10.943	0.00	-4.17	.2254	.0685	-.0802	.0042	.0027	-.0087
6045	.086	10.983	0.00	-2.21	.3067	.0716	-.0775	.0042	.0028	-.0082
6046	.086	11.025	0.00	-.34	.3698	.0778	-.0768	.0023	.0034	-.0082
6047	.086	11.025	0.00	1.61	.4401	.0893	-.0777	.0036	.0028	-.0087
6048	.087	11.098	0.00	3.54	.5173	.1055	-.0781	-.0002	.0025	-.0032
6049	.087	11.095	0.00	5.43	.5972	.1279	-.0746	-.0008	.0013	.0007
6050	.087	11.183	0.00	7.34	.6496	.1495	-.0702	-.0012	.0014	.0012
6051	.087	11.173	0.00	9.45	.7188	.1786	-.0631	.0000	.0018	-.0002
6052	.087	11.121	0.00	14.59	.8698	.2723	-.0466	.0030	.0021	-.0027
6053	.086	11.052	0.00	19.42	1.0174	.4091	-.0289	.0015	.0004	-.0052
6054	.086	10.989	0.00	24.47	1.1742	.5715	.0042	-.0066	-.0024	-.0032

TABLE B.- CONTINUED

## RUN 564

POINT	MACH	Q	BETA	ALPHA	CL	CD	CPM	CRM	CYM	CSF
6069	.086	10.978	0.00	-9.97	-.0126	.0776	-.0626	.0084	.0000	-.0024
6070	.086	10.964	0.00	-8.12	.0546	.0678	-.0604	.0069	.0012	-.0063
6071	.086	10.956	0.00	-6.08	.1355	.0615	-.0506	.0064	.0009	-.0031
6072	.086	10.933	0.00	-4.21	.2037	.0608	-.0483	.0054	.0011	-.0042
6073	.086	10.981	0.00	-2.22	.2688	.0628	-.0461	.0043	.0012	-.0037
6074	.086	11.008	0.00	-.30	.3462	.0687	-.0450	.0022	.0017	-.0025
6075	.086	11.034	0.00	1.59	.4118	.0792	-.0487	-.0001	.0026	-.0080
6076	.086	11.086	0.00	3.51	.4916	.0937	-.0465	.0004	.0021	-.0048
6077	.086	11.053	0.00	5.47	.5677	.1153	-.0442	.0002	.0020	-.0059
6078	.087	11.141	0.00	7.35	.6178	.1340	-.0372	-.0003	.0009	.0009
6079	.087	11.182	0.00	9.37	.6865	.1626	-.0339	.0006	.0004	-.0015
6080	.086	11.100	0.00	14.44	.8386	.2515	-.0210	.0009	.0006	-.0019
6081	.087	11.173	0.00	19.39	.9881	.3858	-.0011	.0007	.0002	-.0030
6082	.086	11.040	0.00	24.55	1.1675	.5562	.0277	-.0076	-.0061	-.0028

## RUN 578

POINT	MACH	Q	BETA	ALPHA	CL	CD	CPM	CRM	CYM	CSF
6563	.087	11.243	0.00	-10.03	-.2908	.0724	.0107	.0078	-.0006	-.0009
6564	.087	11.191	0.00	-8.15	-.1984	.0535	.0151	.0090	.0018	-.0088
6565	.087	11.170	0.00	-6.07	-.1078	.0386	.0195	.0064	.0022	-.0081
6566	.087	11.220	0.00	-4.13	-.0282	.0309	.0221	.0075	.0022	-.0080
6567	.087	11.182	0.00	-2.26	.0481	.0268	.0244	.0050	.0028	-.0089
6568	.087	11.210	0.00	-.34	.1136	.0254	.0270	.0046	.0028	-.0086
6569	.087	11.174	0.00	1.62	.1948	.0273	.0283	.0020	.0025	-.0093
6570	.087	11.164	0.00	3.51	.2713	.0330	.0317	.0031	.0021	-.0077
6571	.086	11.101	0.00	5.49	.3436	.0448	.0318	.0018	.0020	-.0113
6572	.087	11.189	0.00	7.33	.4069	.0598	.0361	-.0003	.0018	-.0066
6573	.087	11.136	0.00	9.43	.4812	.0810	.0370	-.0012	.0025	-.0076
6574	.087	11.290	0.00	14.60	.6806	.1635	.0496	-.0026	.0014	-.0030
6575	.087	11.341	0.00	19.41	.8354	.2787	.0686	-.0002	.0001	-.0027
6576	.087	11.354	0.00	24.50	1.0225	.4330	.1054	-.0083	-.0039	-.0024

ORIGINAL PAGE IS  
OF POOR QUALITY

TABLE B.- CONTINUED

RUN 586

POINT	MACH	Q	BETA	ALPHA	CL	CD	CPM	CRM	CYM	CSF
6845	.087	11.281	0.00	-9.94	-.2461	.0592	.0055	.0047	-.0011	-.0001
6846	.086	11.163	0.00	-8.47	-.1949	.0474	.0116	.0035	-.0010	-.0022
6847	.086	11.132	0.00	-6.05	-.0888	.0319	.0142	.0022	-.0005	-.0054
6848	.087	11.236	0.00	-4.18	-.0158	.0252	.0163	.0053	-.0002	-.0050
6849	.086	11.159	0.00	-2.20	.0440	.0220	.0179	.0029	.0001	-.0075
6850	.086	11.135	0.00	-.34	.1281	.0212	.0197	.0017	.0003	-.0078
6851	.086	11.120	0.00	1.64	.1900	.0238	.0225	.0018	.0004	-.0075
6852	.086	11.200	0.00	3.55	.2527	.0296	.0254	.0004	-.0004	-.0048
6853	.086	11.161	0.00	5.59	.3285	.0415	.0297	-.0001	-.0009	-.0038
6854	.086	11.213	0.00	7.48	.3949	.0563	.0364	-.0009	-.0012	-.0025
6855	.087	11.293	0.00	9.55	.4722	.0791	.0401	-.0028	-.0014	-.0016
6856	.087	11.254	0.00	14.71	.6644	.1604	.0549	-.0036	-.0022	.0003
6857	.087	11.325	0.00	19.59	.8201	.2811	.0739	-.0023	-.0046	.0013
6858	.087	11.276	0.00	24.50	.9906	.4328	.1117	-.0043	-.0029	.0006

RUN 593

POINT	MACH	Q	BETA	ALPHA	CL	CD	CPM	CRM	CYM	CSF
7146	.045	3.016	0.00	-10.04	-.2688	.0470	.0092	.0097	-.0008	-.0006
7147	.045	3.008	0.00	-9.07	-.1956	.0339	.0138	.0068	.0010	-.0029
7148	.045	3.018	0.00	-6.19	-.1198	.0235	.0135	.0080	.0013	-.0046
7149	.045	3.022	0.00	-4.24	-.0415	.0204	.0128	.0033	.0010	-.0038
7150	.045	3.019	0.00	-2.32	.0269	.0200	.0130	.0018	.0018	-.0047
7151	.045	3.019	0.00	-.29	.0941	.0225	.0140	.0005	.0016	-.0073
7152	.045	3.024	0.00	1.60	.1705	.0273	.0211	-.0032	.0008	-.0018
7153	.045	3.035	0.00	3.60	.2346	.0356	.0187	-.0029	.0011	-.0049
7154	.045	3.028	0.00	5.58	.3177	.0495	.0242	-.0022	-.0006	-.0063
7155	.045	3.013	0.00	7.36	.3824	.0673	.0233	-.0026	.0007	-.0034
7156	.045	3.025	0.00	9.47	.4771	.0968	.0356	-.0034	.0003	-.0019
7157	.045	3.031	0.00	14.51	.6817	.1951	.0635	-.0039	.0027	-.0027
7158	.045	3.031	0.00	19.35	.8342	.3214	.0920	-.0062	.0039	-.0011
7159	.045	3.022	0.00	24.63	1.0516	.5216	.1724	-.0053	.0033	.0053



TABLE B.- CONTINUED

RUN 594

POINT	MACH	Q	BETA	ALPHA	CL	CD	CPM	CRM	CYM	CSF
7160	.069	7.115	0.00	-9.98	-.2484	.0485	.0070	.0073	.0001	-.0012
7161	.069	7.145	0.00	-8.17	-.1671	.0338	.0106	.0090	.0015	-.0041
7162	.069	7.133	0.00	-6.17	-.0741	.0238	.0146	.0062	.0012	-.0039
7163	.069	7.101	0.00	-4.31	-.0032	.0201	.0174	.0050	.0015	-.0049
7164	.069	7.136	0.00	-2.33	.0629	.0187	.0224	.0074	.0014	-.0074
7165	.069	7.096	0.00	-.43	.1234	.0212	.0235	.0042	.0019	-.0082
7166	.069	7.070	0.00	1.51	.1940	.0258	.0256	.0042	.0020	-.0065
7167	.069	7.102	0.00	3.49	.2712	.0345	.0269	.0031	.0023	-.0085
7168	.069	7.088	0.00	5.46	.3502	.0507	.0287	.0025	.0022	-.0079
7169	.069	7.125	0.00	7.39	.4217	.0719	.0333	.0014	.0024	-.0059
7170	.069	7.094	0.00	9.35	.5042	.1003	.0420	-.0003	.0028	-.0067
7171	.069	7.136	0.00	14.44	.6930	.1963	.0724	-.0049	.0035	-.0021
7172	.070	7.216	0.00	19.37	.8726	.3371	.1184	.0018	.0036	.0013
7173	.069	7.140	0.00	24.43	1.0465	.5167	.1803	.0019	.0043	.0010

RUN 595

POINT	MACH	Q	BETA	ALPHA	CL	CD	CPM	CRM	CYM	CSF
7174	.087	11.230	0.00	-9.96	-.2378	.0472	.0069	.0055	-.0004	.0009
7175	.087	11.224	0.00	-8.12	-.1518	.0328	.0142	.0052	.0009	-.0024
7176	.087	11.248	0.00	-6.16	-.0667	.0230	.0157	.0076	.0008	-.0019
7177	.087	11.256	0.00	-4.28	-.0012	.0200	.0176	.0045	.0012	-.0047
7178	.087	11.211	0.00	-2.43	.0647	.0194	.0225	.0028	.0009	-.0036
7179	.087	11.244	0.00	-.39	.1358	.0200	.0249	.0045	.0018	-.0109
7180	.087	11.208	0.00	1.43	.1943	.0253	.0264	.0012	.0018	-.0076
7181	.087	11.226	0.00	3.47	.2787	.0340	.0284	.0019	.0013	-.0055
7182	.087	11.278	0.00	5.49	.3507	.0502	.0302	.0013	.0014	-.0011
7183	.087	11.237	0.00	7.46	.4230	.0717	.0353	-.0026	.0019	.0002
7184	.087	11.309	0.00	9.29	.4963	.0969	.0425	-.0021	.0024	-.0031
7185	.087	11.348	0.00	14.57	.6941	.1972	.0787	-.0021	.0022	.0018
7186	.087	11.393	0.00	19.38	.8724	.3366	.1211	-.0005	-.0001	-.0012
7187	.087	11.259	0.00	24.49	1.0725	.5189	.1906	-.0086	-.0041	-.0014

ORIGINAL PAGE IS  
OF POOR QUALITY

TABLE B.- CONTINUED

## RUN 596

POINT	MACH	Q	BETA	ALPHA	CL	CD	CPM	CRM	CYM	CSF
7188	.133	26.347	0.00	-6.33	-.0725	.0231	.0151	.0039	.0011	-.0028
7189	.133	26.209	0.00	-4.37	.0027	.0186	.0182	.0032	.0010	-.0038
7190	.133	26.218	0.00	-2.32	.0691	.0176	.0235	.0012	.0011	-.0028
7191	.133	26.304	0.00	-.38	.1330	.0194	.0245	.0019	.0011	-.0042
7192	.133	26.182	0.00	1.56	.1992	.0237	.0246	.0022	.0016	-.0076
7193	.133	26.223	0.00	3.50	.2698	.0327	.0267	.0011	.0009	-.0049
7194	.133	26.304	0.00	5.48	.3474	.0481	.0294	.0020	.0015	-.0048

## RUN 600

POINT	MACH	Q	BETA	ALPHA	CL	CD	CPM	CRM	CYM	CSF
7338	.087	11.174	0.00	-10.00	-.2011	.0632	-.0083	.0052	-.0011	-.0027
7339	.086	11.103	0.00	-8.15	-.1263	.0488	-.0072	.0049	-.0003	-.0042
7340	.087	11.197	0.00	-6.28	-.0466	.0387	-.0021	.0049	-.0002	-.0051
7341	.086	11.114	0.00	-4.22	.0366	.0325	.0006	.0019	.0000	-.0068
7342	.086	11.101	0.00	-2.41	.1011	.0303	.0063	-.0000	-.0003	-.0026
7343	.086	11.107	0.00	-.41	.1800	.0298	.0065	.0026	.0012	-.0106
7344	.087	11.136	0.00	1.60	.2524	.0338	.0090	.0007	.0007	-.0078
7345	.087	11.198	0.00	3.46	.3137	.0420	.0128	.0008	-.0002	-.0022
7346	.086	11.113	0.00	5.54	.4007	.0570	.0129	-.0041	-.0003	-.0020
7347	.087	11.265	0.00	7.38	.4677	.0735	.0184	-.0027	-.0001	-.0020
7348	.087	11.213	0.00	9.45	.5403	.0976	.0203	-.0059	-.0002	-.0020
7349	.087	11.207	0.00	14.59	.7349	.1852	.0360	-.0024	-.0008	-.0012
7350	.087	11.330	0.00	19.37	.8860	.3054	.0575	-.0031	-.0035	.0003
7351	.087	11.199	0.00	24.55	1.0609	.4628	.0912	-.0091	-.0071	-.0022

TABLE B.- CONTINUED

RUN 607

POINT	MACH	Q	BETA	ALPHA	CL	CD	CPM	CRM	CYM	CSF
7676	.087	11.326	0.00	-10.00	-.1153	.1011	.0439	.0066	-.0012	-.0013
7677	.087	11.279	0.00	-8.14	-.0413	.0901	.0434	.0055	-.0006	-.0031
7678	.087	11.306	0.00	-6.14	.0324	.0817	.0423	.0033	-.0004	-.0028
7679	.087	11.279	0.00	-4.21	.1036	.0757	.0453	.0012	-.0001	-.0039
7680	.088	11.407	0.00	-2.32	.1775	.0742	.0466	.0027	.0009	-.0037
7681	.087	11.332	0.00	-.34	.2521	.0750	.0464	-.0003	.0014	-.0054
7682	.087	11.389	0.00	1.57	.3303	.0817	.0483	-.0002	.0019	-.0059
7683	.087	11.354	0.00	1.97	.3431	.0842	.0471	-.0025	.0007	.0001
7684	.088	11.416	0.00	5.47	.4723	.1099	.0522	-.0032	.0001	.0041
7685	.088	11.439	0.00	7.43	.5408	.1297	.0577	-.0027	-.0004	.0050
7686	.088	11.448	0.00	9.44	.6120	.1558	.0629	-.0022	.0000	.0027
7687	.087	11.370	0.00	14.61	.7734	.2391	.0778	-.0026	-.0018	.0012
7688	.088	11.423	0.00	19.44	.9292	.3642	.0802	-.0056	-.0043	.0040
7689	.087	11.362	0.00	24.55	1.0806	.5175	.0904	-.0020	-.0065	.0009

RUN 608

POINT	MACH	Q	BETA	ALPHA	CL	CD	CPM	CRM	CYM	CSF
7690	.087	11.154	0.00	-9.99	-.0902	.0817	.0147	.0070	-.0011	-.0021
7691	.087	11.188	0.00	-8.25	-.0210	.0704	.0149	.0048	.0001	-.0040
7692	.087	11.209	0.00	-6.13	.0712	.0615	.0148	.0040	.0000	-.0047
7693	.087	11.177	0.00	-4.17	.1425	.0573	.0187	.0034	.0008	-.0064
7694	.087	11.156	0.00	-2.27	.2049	.0569	.0199	.0002	.0011	-.0062
7695	.087	11.169	0.00	-.33	.2816	.0610	.0198	-.0031	.0007	-.0028
7696	.087	11.244	0.00	1.46	.3501	.0664	.0182	-.0042	.0006	-.0025
7697	.087	11.262	0.00	3.52	.4322	.0804	.0174	-.0019	-.0000	-.0029
7698	.087	11.290	0.00	5.40	.4997	.0968	.0205	-.0040	-.0010	.0008
7699	.087	11.269	0.00	7.35	.5693	.1180	.0251	-.0047	-.0015	.0059
7700	.087	11.251	0.00	9.48	.6456	.1464	.0285	-.0036	-.0010	.0011
7701	.087	11.318	0.00	14.47	.7953	.2280	.0366	-.0035	-.0019	-.0002
7702	.087	11.292	0.00	19.50	.9618	.3641	.0485	-.0026	-.0037	.0024
7703	.087	11.275	0.00	24.45	1.1042	.5167	.0645	-.0016	-.0048	.0019

ORIGINAL PAGE  
OF POOR QUALITY

TABLE B.- CONTINUED

RUN 609

POINT	MACH	Q	BETA	ALPHA	CL	CD	CPM	CRM	CYM	CSF
7704	.086	11.067	0.00	-9.99	-.0767	.0718	-.0169	.0038	-.0013	-.0027
7705	.087	11.150	0.00	-8.09	.0182	.0584	-.0155	.0032	.0000	-.0022
7706	.087	11.156	0.00	-6.19	.1010	.0525	-.0133	.0024	.0005	-.0054
7707	.087	11.148	0.00	-4.20	.1571	.0500	-.0092	-.0019	.0004	-.0048
7708	.087	11.173	0.00	-2.31	.2353	.0496	-.0074	-.0027	.0004	-.0015
7709	.087	11.152	0.00	-.34	.3040	.0546	-.0103	-.0038	.0023	-.0085
7710	.087	11.221	0.00	1.51	.3768	.0613	-.0089	-.0055	.0003	-.0008
7711	.087	11.230	0.00	3.55	.4543	.0763	-.0086	-.0053	-.0002	-.0016
7712	.087	11.214	0.00	5.50	.5320	.0950	-.0049	-.0070	-.0018	.0057
7713	.087	11.283	0.00	7.39	.5957	.1163	-.0036	-.0063	-.0008	.0024
7714	.087	11.214	0.00	9.41	.6584	.1429	.0002	-.0055	-.0015	.0058
7715	.087	11.321	0.00	14.54	.8269	.2329	.0147	-.0043	-.0027	.0022
7716	.087	11.282	0.00	19.48	.9724	.3645	.0207	-.0056	-.0038	.0040
7717	.087	11.202	0.00	24.61	1.1299	.5313	.0405	-.0043	-.0074	.0005

RUN 610

POINT	MACH	Q	BETA	ALPHA	CL	CD	CPM	CRM	CYM	CSF
7718	.086	11.064	0.00	-9.98	-.0478	.0663	-.0527	.0033	-.0010	-.0046
7719	.087	11.147	0.00	-8.14	.0469	.0541	-.0467	.0013	.0004	-.0031
7720	.086	11.046	0.00	-6.17	.1123	.0506	-.0458	-.0032	-.0002	-.0012
7721	.086	11.117	0.00	-4.23	.1814	.0486	-.0433	-.0033	-.0001	-.0013
7722	.087	11.224	0.00	-2.25	.2592	.0495	-.0366	-.0052	.0003	.0000
7723	.087	11.162	0.00	-.35	.3235	.0549	-.0392	-.0057	.0001	-.0016
7724	.087	11.149	0.00	1.58	.4023	.0638	-.0365	-.0074	-.0002	.0013
7725	.087	11.142	0.00	3.54	.4892	.0785	-.0343	-.0083	-.0020	.0052
7726	.087	11.165	0.00	5.49	.5511	.0973	-.0320	-.0077	-.0017	.0057
7727	.087	11.232	0.00	7.40	.6275	.1214	-.0281	-.0078	-.0019	.0069
7728	.087	11.227	0.00	9.44	.6833	.1480	-.0283	-.0069	-.0012	.0049
7729	.087	11.247	0.00	14.50	.8424	.2378	-.0146	-.0048	-.0024	.0002
7730	.087	11.242	0.00	19.40	1.0080	.3791	-.0045	-.0066	-.0046	.0032
7731	.087	11.149	0.00	24.49	1.1446	.5412	.0098	-.0061	-.0080	.0043

TABLE B.- CONCLUDED

## RUN 611

POINT	MACH	Q	BETA	ALPHA	CL	CD	CPM	CRM	CYM	CSF
7732	.087	11.147	0.00	-10.00	-.0222	.0661	-.0674	-.0008	-.0001	-.0031
7733	.087	11.235	0.00	-8.06	.0677	.0552	-.0635	-.0031	.0004	.0005
7734	.087	11.255	0.00	-6.10	.1431	.0511	-.0600	-.0039	.0006	-.0016
7735	.087	11.190	0.00	-4.24	.2035	.0516	-.0625	-.0031	.0011	-.0039
7736	.087	11.196	0.00	-2.26	.2728	.0530	-.0572	-.0062	.0021	-.0049
7737	.087	11.181	0.00	-.37	.3409	.0579	-.0563	-.0070	.0004	-.0004
7738	.087	11.263	0.00	1.58	.4166	.0687	-.0568	-.0087	.0002	-.0012
7739	.087	11.212	0.00	3.56	.4956	.0845	-.0548	-.0096	-.0008	.0026
7740	.087	11.322	0.00	5.43	.5647	.1034	-.0553	-.0098	-.0025	.0039
7741	.087	11.358	0.00	7.42	.6347	.1278	-.0522	-.0084	-.0016	.0064
7742	.087	11.358	0.00	9.49	.7036	.1568	-.0481	-.0077	-.0024	.0065
7743	.087	11.394	0.00	14.52	.8644	.2504	-.0362	-.0068	-.0019	.0009
7744	.087	11.361	0.00	19.43	1.0257	.3936	-.0236	-.0061	-.0050	.0016
7745	.087	11.217	0.00	24.52	1.1617	.5598	-.0088	-.0055	-.0092	.0023

## RUN 617

POINT	MACH	Q	BETA	ALPHA	CL	CD	CPM	CRM	CYM	CSF
7956	.086	10.880	0.00	-9.49	-.0804	.0649	-.0420	.0095	.0007	-.0047
7957	.085	10.838	0.00	-8.16	-.0092	.0551	-.0390	.0076	.0004	-.0066
7958	.086	10.846	0.00	-6.21	.0765	.0485	-.0338	.0065	.0010	-.0065
7959	.086	10.870	0.00	-4.18	.1576	.0451	-.0295	.0062	.0018	-.0073
7960	.086	10.878	0.00	-2.28	.2225	.0468	-.0268	.0031	.0015	-.0045
7961	.086	10.924	0.00	-.32	.3050	.0506	-.0238	.0026	.0018	-.0068
7962	.086	10.921	0.00	1.60	.3721	.0588	-.0246	-.0003	.0025	-.0065
7963	.086	10.903	0.00	3.58	.4595	.0735	-.0211	-.0004	.0011	-.0042
7964	.086	10.916	0.00	5.48	.5319	.0913	-.0204	-.0018	.0012	-.0021
7965	.086	10.918	0.00	7.38	.5928	.1135	-.0169	-.0027	.0017	-.0056
7966	.086	11.038	0.00	9.49	.6615	.1419	-.0127	-.0039	-.0000	.0029
7967	.086	11.009	0.00	14.45	.8285	.2298	.0064	-.0028	-.0011	-.0024
7968	.086	10.976	0.00	19.32	.9807	.3626	.0337	-.0018	-.0024	-.0025
7969	.086	10.922	0.00	24.45	1.1131	.5176	.0650	.0003	-.0033	-.0028

1. Report No. NASA CR-145280		2. Government Accession No.		3. Recipient's Catalog No.	
4. Title and Subtitle LOW-SPEED AERODYNAMIC CHARACTERISTICS FROM WIND-TUNNEL TESTS OF A LARGE-SCALE ADVANCED ARROW-WING SUPERSONIC CRUISE TRANSPORT CONCEPT				5. Report Date April 1978	
				6. Performing Organization Code	
7. Author(s) Paul M. Smith				8. Performing Organization Report No.	
9. Performing Organization Name and Address Vought Corporation Hampton Technical Center 3221 North Armistead Avenue Hampton, Virginia 23666				10. Work Unit No. 743-04-13-02	
				11. Contract or Grant No. NAS1-13500	
12. Sponsoring Agency Name and Address National Aeronautics & Space Administration Washington, DC 20546				13. Type of Report and Period Covered Contractor Report	
				14. Sponsoring Agency Code	
15. Supplementary Notes  Langley Technical Monitor: Cornelius Driver					
16. Abstract  <p>Tests have been conducted in the Langley Full-Scale Wind Tunnel to extend the existing low-speed aerodynamic data base of advanced supersonic-cruise arrow-wing configurations. Principle configuration variables included wing leading-edge flap deflection, wing trailing-edge flap deflection, horizontal tail effectiveness, and fuselage forebody strakes. A limited investigation was also conducted to determine the low-speed aerodynamic effects due to slotted training-flaps.</p> <p>Results of this investigation demonstrated that deflecting the wing leading-edge flaps downward to suppress the wing apex vortices provided improved static longitudinal stability; however, it also resulted in significantly reduced static directional stability. The use of a selected fuselage forebody strakes was found to be effective in increasing the level of positive static directional stability, throughout the tested angle of attack range, with a slight attendant decrement in static longitudinal stability at high angles of attack. Drooping the fuselage nose, which is required for low-speed pilot vision, significantly improved the lateral-directional trim characteristics.</p>					
17. Key Words (Suggested by Author(s)) Arrow wing Low speed High lift Static stability Longitudinal control			18. Distribution Statement  Unclassified - Unlimited  STAR 02 Aerodynamics		
19. Security Classif. (of this report) Unclassified		20. Security Classif. (of this page) Unclassified		21. No. of Pages 100	22. Price* \$6.00