

BOEING



(NASA-CR-150357) EFFECTS OF DAMPING ON MODE SHAPES, VOLUME 1 Final Report (Boeing Aerospace Co., Seattle, Wash.) : 322 p
HC A14/MF A01 CSCL 20K UNCLAS 40789
N77-295 G3/39

AUG 1977
RECEIVED
NASA STI FACILITY
INPUT BRANCH

D180-20572-1
FINAL REPORT
CONTRACT NAS8-31369

EFFECTS OF DAMPING ON MODE SHAPES - VOLUME I

JUNE 27, 1977

PREPARED BY
BOEING AEROSPACE COMPANY
MISSILE AND ARMAMENT DIVISION
SEATTLE, WASHINGTON 98124



RICHARD M. GATES



D. H. MERCHANT, TECHNICAL LEADER



J. L. ARNQUIST, PROGRAM LEADER

PREPARED FOR
NATIONAL AERONAUTICS AND SPACE ADMINISTRATION
MARSHALL SPACE FLIGHT CENTER, ALABAMA 35812

ABSTRACT

Displacement, velocity, and acceleration admittances were calculated for a realistic NASTRAN structural model of Space Shuttle for three conditions: liftoff, maximum dynamic pressure and end of Solid Rocket Booster burn. The realistic model of the Orbiter, External Tank, and Solid Rocket Motors included the representation of structural joint transmissibilities by finite stiffness and damping elements. Data values for the finite damping elements were assigned to duplicate overall low-frequency modal damping values taken from tests of similar vehicles. For comparison with the calculated admittances, position and rate gains were computed for a conventional Shuttle model for the liftoff condition.

KEY WORDS

finite-element structural model
structural joints
damping
normal modes
Space Shuttle
admittances

ACKNOWLEDGMENTS

The work described in this report was sponsored by the George C. Marshall Space Flight Center under NASA Contract NAS8-31369. The work was performed under the technical direction of George L. von Pragenau and Richard W. Schock of the MSFC Systems Dynamics Laboratory. A NASTRAN structural model of the Orbiter was provided by C. Thomas Modlin of the Structural Mechanics Division of the Johnson Space Center. The computer programming was performed by Malcolm W. Ice of Boeing Computer Services, Inc. The authors gratefully acknowledge the contributions made by each of these individuals toward the successful completion of this contract.

TABLE OF CONTENTS - VOLUME I

<u>Section</u>	<u>Page</u>
ABSTRACT AND KEY WORDS	ii
ACKNOWLEDGMENTS	iii
ILLUSTRATIONS	v
TABLES	vii
1.0 INTRODUCTION	1
2.0 TECHNICAL APPROACH	3
2.1 Structural Joint Modeling	3
2.2 Joint Damping Prediction	18
2.3 Admittance Matrix Calculation	21
3.0 REALISTIC STRUCTURAL MODEL	26
3.1 Space Shuttle Structural Models	26
3.2 Structural Joints and Damping	72
3.3 Solid Rocket Motor Propellant Dynamics	94
3.4 Space Shuttle Modes and Modal Damping	104
4.0 CRITICAL RESONANCES FROM CONVENTIONAL MODEL (LIFTOFF)	108
5.0 CRITICAL RESONANCES FROM REALISTIC MODEL	162
5.1 Critical Modes	162
5.2 Critical Resonances	162
6.0 ADMITTANCE METHOD COMPARISON AND MODAL EXCITABILITY CRITERIA	164
6.1 Comparison of Realistic and Conventional Approaches	164
6.2 Criteria for the Excitability of Modes	187
7.0 COMPUTER TIME ESTIMATES	188
7.1 Orbiter	188
7.2 Space Shuttle	188
8.0 CONCLUSIONS AND RECOMMENDATIONS	190
8.1 Conclusions	190
8.2 Recommendations	190
APPENDIX I - PREPROCESSOR COMPUTER PROGRAM	192
APPENDIX II - JOINT DAMPING PREDICTOR COMPUTER PROGRAM	246
APPENDIX III - POSTPROCESSOR COMPUTER PROGRAM	261
REFERENCES	312

ILLUSTRATIONS

<u>Figure</u>		<u>Page</u>
2-1	Schematic of Single Degree-of-Freedom Voigt Joint Model	4
2-2	NASTRAN Rod Joint Damping Model	8
2-3	NASTRAN BAR Joint Damping Model	11
2-4	Plate Joint Damping Model Schematic	15
3-1	Space Shuttle Coordinate Systems	27
3-2	External Tank Gridpoint Numbering	29
3-3	External Tank Bar and Rod Numbering	30
3-4	External Tank Plate Numbering	31
3-5	Aft Orbiter Attachment Fitting	33
3-6	Solid Rocket Motor Math Model	35
3-7	Orbiter Math Model	41
3-8	Orbiter-- Forward Fuselage	42
3-9	Orbiter-- Fuselage Payload Section	48
3-10	Orbiter-- Thrust Structure	61
3-11	Orbiter-- Wing	67
3-12	Orbiter-- Vertical Tail	70
3-13	Payload Math Model	73
3-14	Boeing 747 Structural Damping Data	77
3-15	External Tank Intertank Joints	81
3-16	SRM Case Joint Locations	86
3-17	Orbiter Fuselage Panel Joint Locations	89
3-18	Orbiter Wing Panel Joint Locations	90
3-19	Orbiter Wing and Vertical Tail Root Joint Locations	92
3-20	SRM Propellant Complex Shear Modulus	95
3-21	Maxwell Model for SRM Propellant	96
3-22	Complex Shear Modulus, Maxwell Model	98
3-23	Finite Element Model, SRM Propellant	100

ILLUSTRATIONS (Continued)

<u>Figure</u>		<u>Page</u>
6-1	Comparison of Conventional and Realistic Models, Displacement Response	165
6-2	Comparison of Conventional and Realistic Models, Velocity Response	171
6-3	Comparison of Conventional and Realistic Models, Acceleration Response	183
I-1	NASTRAN Joint Damping Model Schematics	196
III-1	Postprocessor Program Flow	262

TABLES

<u>Table</u>	<u>Page</u>	
3-1	Space Shuttle Coordinate Systems	28
3-2	External Tank Mass Data	34
3-3	SRM Mass Properties (Liftoff)	38
3-4	SRM Mass Properties (Max Q)	39
3-5	SRM Mass Properties (SRB Cut-Off)	40
3-6	Orbiter Mass Data	71
3-7	Payload and OMS Mass Data	74
3-8	Structural Joint Damping Parameters	83
3-9	Comparison of Desired and Actual Orbiter Modal Damping	93
3-10	SRM Propellant Modal Data	101
3-11	SRM Free-Free Modal Parameters and Damping Data	103
3-12	Space Shuttle Data Data, Liftoff	105
3-13	Space Shuttle Modal Data, Max q	106
3-14	Space Shuttle Modal Data, SRM Cutoff	107
4-1	Space Shuttle Response and Excitation Locations	110
4-2	Rate Coefficients for Conventional Model	111
4-3	Position Coefficients for Conventional Model	138

I-1	DMAP ALTER Statements for the Preprocessor Computer Program	194

1.0 INTRODUCTION

The presence of distributed damping in aerospace structures may significantly affect predicted dynamic responses, particularly of high-order modes. The development and implementation of a general methodology framework for evaluating the effect of distributed structural damping on spacecraft structures was begun under Contract NAS8-30655, the results of which are reported in Reference 1.

The purpose of the present study is to assess the influence of discrete damping elements on a structural model of the Space Shuttle using admittance techniques. The following three phases of the study are summarized herein:

Phase I - Develop a realistic NASTRAN structural model using a preprocessor for describing joint transmissibilities and a postprocessor for selecting significant resonances.

Phase II - Develop a conventional normal-mode structural model; compare realistic and conventional models; and establish criteria for the excitability of high-order modes.

Phase III - Update the mass, stiffness, and damping effects in the Space Shuttle structural model; calculate admittances at liftoff, max. Q, and SRB cut-off; and simplify the Space Shuttle structural models for use in attitude control, POGO stability, dynamic loads and vibration analyses.

These objectives were accomplished primarily through the calculation of admittances for a realistic NASTRAN structural model of the Space Shuttle. The admittances were computed with a postprocessor computer program using modal characteristics, including a coupled modal damping matrix, from a NASTRAN restart tape. The damping characteristics were included in the structural model with the aid of a preprocessor computer program. Damping parameters for the joints in the Orbiter were calculated using a joint damping predictor computer program.

The results of this study are presented in two volumes. Volume I contains the technical approach used in describing distributed joint damping in a finite element model of the Space Shuttle, the method used to calculate individual joint damping parameters to provide realistic modal damping, and the techniques for calculating structural admittances using a coupled modal damping matrix. The

computer programs developed to perform these tasks are described in Section 2.0, with program descriptions and listings included in Appendices I, II and III. The finite element model of the Space Shuttle vehicle is described in Section 3.0. Sections 4.0 and 5.0 present critical resonances for the conventional and realistic models for the liftoff condition, respectively. Section 6.0 contains a comparison of the realistic and conventional approaches. Section 7.0 presents computer time estimates, and conclusions of all three phases of the study are presented in Section 8.0.

Volume II, Section 2.0, contains the structural dynamic characteristics of the Space Shuttle vehicle at liftoff, max q and SRB cutoff, including mode shapes at selected freedoms, modal frequencies, generalized masses, and coupled generalized modal viscous damping coefficients. Admittances for the three mass conditions are shown in Section 3.0 of Volume II.

2.0 TECHNICAL APPROACH

Methodology for developing the realistic NASTRAN Shuttle structural model is contained in a preprocessor computer program to generate joint damping and transmissibility data, a joint damping predictor computer program to calculate joint damping constants which will result in specified modal damping, and a postprocessor computer program to select significant resonances by the admittance approach. The methodology developed for each of these three computer programs is described in Sections 2.1, 2.2 and 2.3, respectively.

2.1 STRUCTURAL JOINT MODELING

Structural damping is comprised of both material (hysteretic) damping and energy dissipation in structural joints. Material damping may be represented in linear dynamic response analyses by uncoupled modal viscous damping ratios ($\delta = C/C_c$). Energy dissipation in structural joints, which is a nonlinear function of many parameters, must also be represented by linear models so that linear analysis techniques may be used. According to Mead (Reference 2), representing joint damping by equivalent viscous damping is justifiable for structures subjected to sinusoidal excitation since sinusoidal response is not appreciably affected by damping nonlinearities. The linear model used successfully in Reference 1 to represent structural joint transmissibility of beams is the Voigt model.

The two-parameter Voigt unit, shown schematically in Figure 2-1, consists of a spring in parallel with a viscous damper. It is the simplest complex-notation model and possesses hysteretic properties characteristic of damping in materials and structural joints. For sinusoidal excitation, the equivalent damping and stiffness coefficients for the Voigt model, in series with a spring, C_T and K_T , are functions both of the structural parameters (K, K_j, C_j) and of the forcing frequency (β):

$$C_T = \frac{C_j K^2}{(K+K_j)^2 + C_j^2 \beta^2} \quad (1)$$

$$K_T = \frac{K K_j (K+K_j) + C_j^2 \beta^2 K}{(K+K_j)^2 + C_j^2 \beta^2} \quad (2)$$

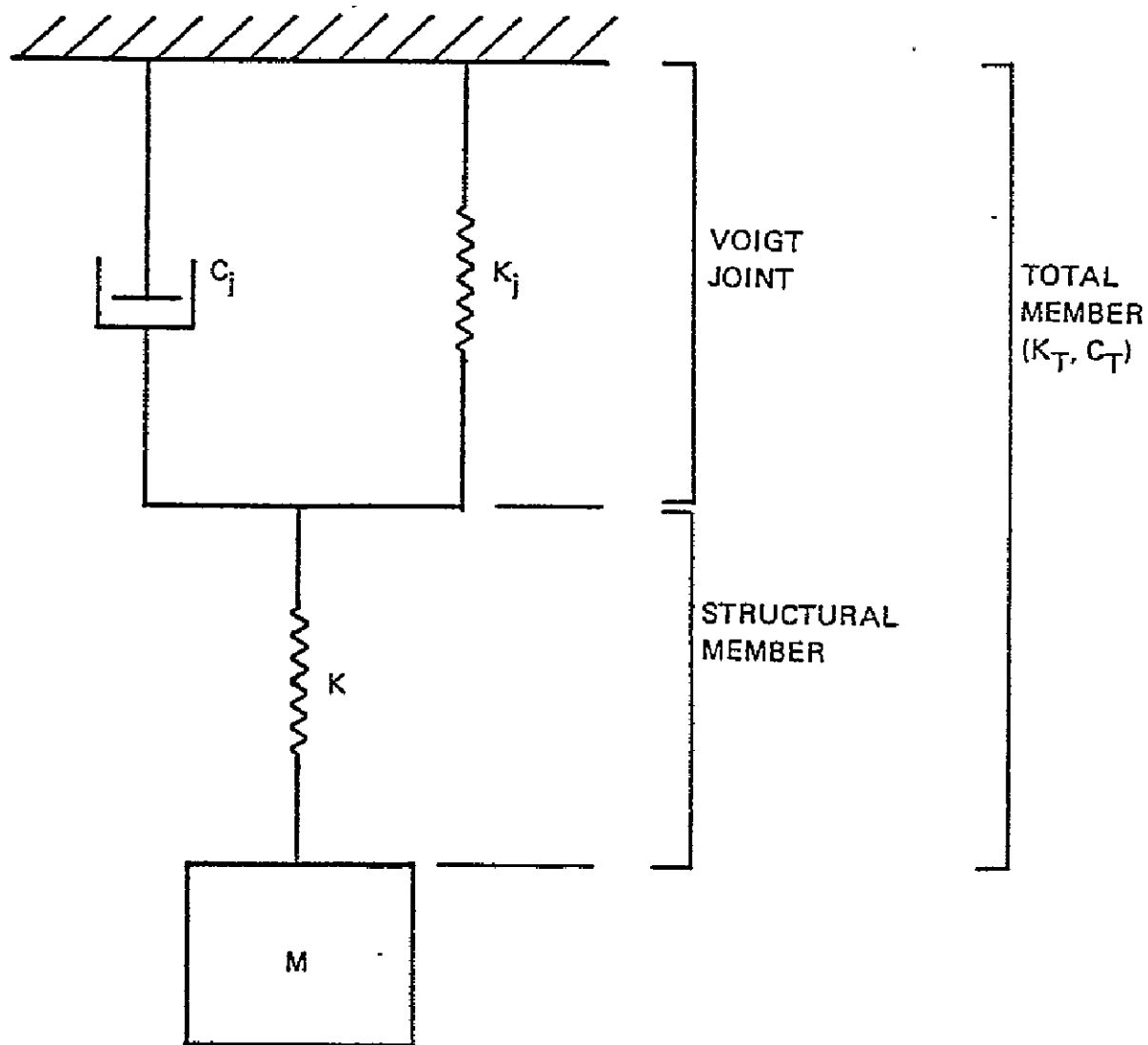

Figure 2-1. Schematic of Single Degree-of-Freedom Voigt Joint Model

For very low frequencies,

$$C_T(\beta=0) = C_j \left(\frac{K}{K+K_j} \right)^2 \quad (3)$$

$$K_T(\beta=0) = K_j \left(\frac{K}{K+K_j} \right) \quad (4)$$

Equations (3) and (4) indicate that the total Voigt joint/member stiffness coefficient at very low frequencies is equal to the static stiffness of the series spring arrangement.

For very high frequencies,

$$C_T(\beta=\infty) = 0 \quad (5)$$

$$K_T(\beta=\infty) = K \quad (6)$$

Equations (5) and (6) indicate that at very high frequencies the damper becomes rigid. These frequency-dependent characteristics of the Voigt model are consistent with the physical observations made by Ungar (Reference 3, page 149).

The preprocessor computer program was developed to implement this methodology by adding structural damping representations to a NASTRAN finite-element structural model. The original preprocessor described in Reference 1 modifies the input data for a conventional finite-element structural model and generates additional inputs necessary to incorporate the Voigt joint damping model at the ends of specified BAR and ROD elements.

The original preprocessor has been updated by several modifications. The major modification is the additional capability for modeling riveted or bolted joints in quadrilateral plate elements. The minor modifications include improving the ROD joint model, the generation of double-field PBAR and PVISC cards, which eliminates certain format limitations, and providing the capability of accepting gridpoints defined in arbitrary cylindrical coordinate systems. By the latter

modification, all gridpoint coordinates defined in cylindrical and rectangular coordinate systems are simply converted into the basic NASTRAN rectangular coordinate system.

The procedure used for modeling riveted or bolted joints in plate elements is consistent with the damping mechanism described by Mead (Reference 2). According to this theory, energy loss between two adjacent plates compressed by rivet forming or bolt tightness occurs in three distinct stages determined by amplitude of the motion:

- (1) elastic hysteresis or material damping due to small motions in the elastic range;
- (2) local plastic deformation in the area of the attachment due to motions in the plastic range;
- (3) dynamic friction losses due to local relative slipping.

A detailed description of the input and output features of the preprocessor computer program is presented in Appendix I.

The extreme complexity of the stress distributions and friction characteristics in the contact areas may preclude the theoretical prediction of local joint energy losses. The problem of assigning data values to parameters of the NASTRAN joint model corresponding to this theoretical damping mechanism will therefore be addressed by reference to major substructure modal damping data rather than to joint damping data.

2.1.1 Rod Joints

This section describes the procedures used by the preprocessor computer program to add structural joint models to NASTRAN ROD elements. The preprocessor modifies the input data for a conventional finite-element structural model and generates additional inputs necessary to incorporate a Voigt joint damping model at one end of each specified ROD element. The damping characteristics of ROD joints are modeled by modifying the ROD properties and by including material damping.

A schematic of a NASTRAN ROD element with a structural joint at one end is shown in Figure 2-2. When the user requests a joint to be incorporated at gridpoint A, the preprocessor establishes the model as follows:

- a. Properties of the original ROD are modified to incorporate the effect of the joint stiffness characteristics.
- b. Material damping in the ROD is incorporated based on the damping constant supplied by the user.
- c. A VISC element is added between gridpoints a and b if torsional damping is required.

The original preprocessor described in Reference 1 constructed a ROD joint by inserting a new gridpoint at c, modifying the properties of the ROD from a to c, and inserting a VISC element from a to c.

Modifications were made to the preprocessor to eliminate the need for the additional gridpoint (c). The user still specifies the length of the joint as a fraction of the original ROD length, the properties of the joint as fractions of the original ROD properties, and the damping constant of the viscous damper between gridpoints a and c. The preprocessor now modifies the properties of the original ROD to incorporate the joint stiffness and damping effects and incorporates a VISC damping element between gridpoints a and b only if a torsional damping value is speci

The equivalent ROD area (A') and torsional constant (J') are calculated based on springs in series.

$$A' = A \left[\frac{KA}{KG(1-KA) + KA} \right] \quad (7)$$

$$J' = J \left[\frac{KJ}{KG(1-KJ) + KJ} \right] \quad (8)$$

where: KG = joint length factor
KA = joint area factor
KJ = joint torsional constant factor
A = original ROD area
J = original ROD torsional constant.

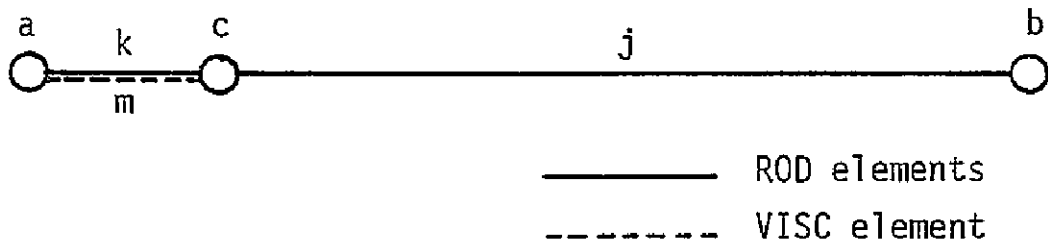

a) Schematic of Desired ROD Joint

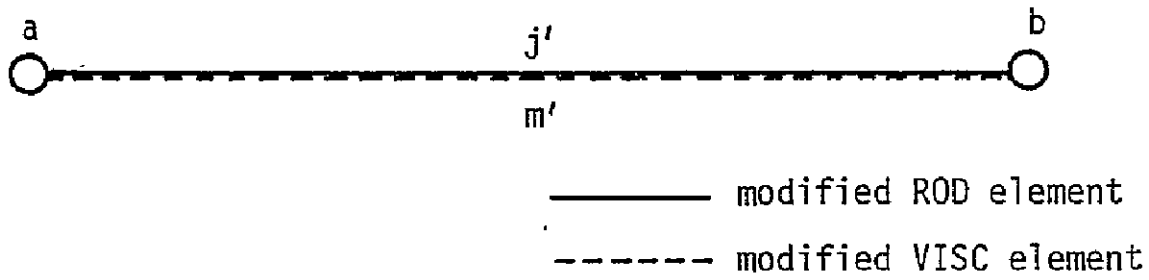

b) Modified ROD Joint Schematic

FIGURE 2-2: NASTRAN ROD JOINT DAMPING MODEL

If axial damping is requested ($C1 \neq 0.$), a new material card (MAT1) is generated for the rod which includes material damping (GE).

$$GE = \frac{C1' \cdot \ell}{A \cdot E} \quad (9)$$

where: $C1' = C1 \left[\frac{KG}{KG(1-KA) + KA} \right]$
 ℓ = original ROD length
 E = Young's modulus
 $C1$ = original axial damping constant.

If torsional damping is requested ($C2 \neq 0.$), a VISC element is inserted between gridpoints a and b. The damping constants for this VISC element are:

$$C1' = 0.$$

$$C2' = C2 \left[\frac{KG}{KG(1-KJ) + KJ} \right] \quad (10)$$

where $C2$ is the original torsional damping constant.

This allows different damping constants to be specified for axial and torsional motions.

Default values are automatically specified by the preprocessor for the NASTRAN data describing ROD joints. The default value specifying joint length results in ROD parameters equivalent to a joint whose length is ten percent of the original element length. Default values specifying joint member area and torsional constant are unity; i.e., the area and torsional constant of the equivalent ROD (with joint effects included) are the same as the original element. However, joint flexibility effects can be included using different joint factors.

The VISC elements and parameters chosen to define the joint damping characteristics must result in a physical damping matrix which satisfies kinematic compatibility. The compatibility relations for the damping matrix are represented by

$$[BGG]\{\phi_R\} = \{0\} \quad (11)$$

where $[BGG]$ is the NASTRAN viscous damping matrix in physical coordinates, and

$\{\phi_R\}$ is an arbitrary vector of rigid-body translations and rotations. Equation (11) ensures that no damping forces are generated by rigid-body motions. With regard to kinematic compatibility, the NASTRAN VISC damping element is limited to two applications:

- a. With translational damping, the compatibility relations are satisfied only when the axis of the VISC element is aligned with an axis of the displacement coordinate system.
- b. Without translational damping, the compatibility relations involving only rotational damping are satisfied for any orientation of the VISC element.

For the general case of an arbitrarily oriented element having both translational and rotational damping components, the present NASTRAN VISC element does not provide the translation/rotation damping coupling terms required by Equation (11). Therefore, since VISC elements are used only for rotational damping in the ROD joint, kinematic compatibility is assured.

2.1.2 Bar Joints

This section describes the procedures used by the preprocessor computer program to add structural joint models to NASTRAN BAR elements. The preprocessor modifies the input data for a conventional finite-element structural model and generates additional inputs necessary to incorporate a Voigt joint damping model at one end of each specified BAR element. The damping characteristics of the joints are modeled with the material damping in ROD elements.

A schematic of a NASTRAN BAR element with joint damping model included at one end is shown in Figure 2-3. The original element lies between gridpoints a and b. When the user requests a joint damping model to be included at gridpoint a, the preprocessor establishes the model as follows:

- a. Gridpoint c is introduced on the BAR axis at a specified distance from gridpoint a.

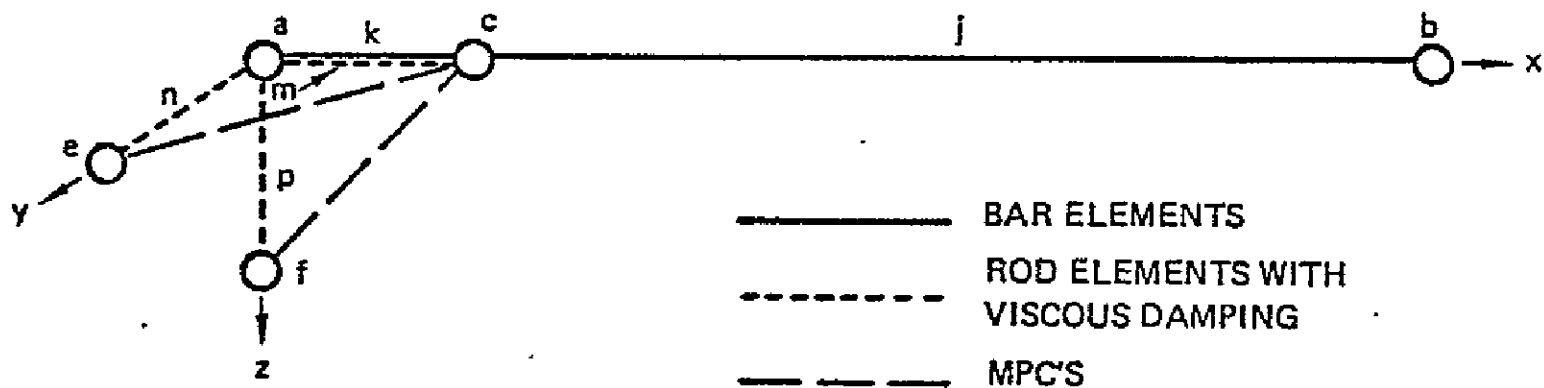

FIGURE 2-3: NASTRAN BAR JOINT DAMPING MODEL

- b. Properties of the BAR between gridpoints a and c are altered as specified, either by direct input or by default values, to provide desired joint stiffness characteristics.
- c. For the BAR element, gridpoints e and f are established such that gridpoints a, b, e and f form an orthogonal axis system at gridpoint a. Gridpoint e is in plane 1 of the BAR element, and gridpoint f is in plane 2. The distances from gridpoint a to gridpoints c, e and f are identical.
- d. ROD elements (m, n and p) with desired material damping properties are inserted between gridpoints a and c, a and e, and a and f.
- e. Gridpoints e and f are multipoint constrained to gridpoint c.

Material damping in a ROD element provides damping along its axis and in torsion about its axis. Therefore, for a BAR element, three ROD elements are required at each gridpoint to provide damping for all six degrees of freedom. The locations of gridpoints e and f in Figure 2-3 are calculated, in the rectangular coordinate system, by vector analysis. \bar{V}_b and \bar{V}_R are defined as position vectors from gridpoint a to gridpoint b and from gridpoint a to the BAR orientation gridpoint, respectively. The components of \bar{V}_b , for example, are

$$\begin{Bmatrix} V_{b1} \\ V_{b2} \\ V_{b3} \end{Bmatrix} = \begin{Bmatrix} x_b \\ y_b \\ z_b \end{Bmatrix} - \begin{Bmatrix} x_a \\ y_a \\ z_a \end{Bmatrix} \quad (12)$$

The vector from gridpoint a in the direction of gridpoint f is calculated as the vector cross product

$$\bar{V}_{f_0} = \bar{V}_b \times \bar{V}_R \quad (13)$$

This results in a vector which is perpendicular to plane 1 of the original BAR element. The vector from gridpoint a to gridpoint F (\bar{V}_f), is normalized such that its magnitude is the same as the magnitude of the vector from a to c ($|\bar{V}_c|$).

$$\bar{V}_f = \bar{V}_{f_0} (|\bar{V}_c| / |\bar{V}_{f_0}|) \quad (14)$$

The location of gridpoint f is then calculated by

$$\begin{Bmatrix} x_f \\ y_f \\ z_f \end{Bmatrix} = \begin{Bmatrix} x_a \\ y_a \\ z_a \end{Bmatrix} + \begin{Bmatrix} V_{f1} \\ V_{f2} \\ V_{f3} \end{Bmatrix} \quad (15)$$

The vector from gridpoint a in the direction of gridpoint e is calculated using the cross product of \bar{V}_f and \bar{V}_b .

$$\bar{V}_{e_0} = \bar{V}_f \times \bar{V}_b \quad (16)$$

The vector from gridpoint a to gridpoint e (\bar{V}_e) is also normalized such that its magnitude is the same as the magnitude of the vector from a to c.

$$\bar{V}_e = \bar{V}_{e_0} (|\bar{V}_c| / |\bar{V}_{e_0}|) \quad (17)$$

The location of gridpoint e is then calculated by

$$\begin{Bmatrix} x_e \\ y_e \\ z_e \end{Bmatrix} = \begin{Bmatrix} x_a \\ y_a \\ z_a \end{Bmatrix} + \begin{Bmatrix} V_{e1} \\ V_{e2} \\ V_{e3} \end{Bmatrix} \quad (18)$$

Default values are automatically specified by the preprocessor for the NASTRAN data describing BAR joints. The default value specifying joint length results in a joint member whose length is ten percent of the original element length. The default values specifying joint member area, moments of inertia, and torsional constant are unity; i.e., the joint member has the same area and moments of inertia as the parent member. However, factors different from unity can be used to increase flexibility in the joint.

Damping in the joint is obtained from material damping in the ROD elements (m, n and p). Material damping in NASTRAN is proportional to the element stiffness in each degree of freedom. The proportionality constant, GE, is input on the material property card. Using one value of the material damping factor (GE) for all of the RODS in the joint representation, the effective

damping for each degree of freedom can be made different by changing their stiffnesses, i.e., cross-sectional areas and area moments. The material damping factor (GE) is based on the specified joint damping constants and is made arbitrarily large so that the stiffnesses of individual joint RODS are small and do not affect the joint stiffness.

$$GE = \frac{C_t \cdot l_k \cdot 10^8}{E \cdot KA \cdot A} \quad (19)$$

where $C_t = C1m + C1n + C1p + C2m + C2n + C2p$

Then the individual ROD properties are:

$$\begin{aligned} A_m &= C1m \left(\frac{l_k}{E \cdot GE} \right), & J_m &= C2m \left(\frac{l_k}{G \cdot GE} \right) \\ A_n &= C1n \left(\frac{l_k}{E \cdot GE} \right), & J_n &= C2n \left(\frac{l_k}{G \cdot GE} \right) \\ A_p &= C1p \left(\frac{l_k}{E \cdot GE} \right), & J_p &= C2p \left(\frac{l_k}{G \cdot GE} \right) \end{aligned} \quad (20)$$

2.1.3 Plate Joints

This section describes the procedures used by the preprocessor computer program to add structural joint models along one edge of some types of NASTRAN plate elements. A schematic of a NASTRAN quadrilateral plate element with a joint damping model included along one edge is shown in Figure 2-4. The plate elements may be referenced by any of the following NASTRAN connection cards: CQUAD1, CQUAD2, CQDMEM, or CSHEAR. For QUAD1 or QUAD2 plate elements having both inplane and bending stiffness, when the user requests a joint damping model to be included along the edge between gridpoints a and b, the preprocessor establishes the model as follows:

- a. Gridpoints c and d are introduced along the plate edges at a specified distance from gridpoints a and b.
- b. ROD or BAR elements, if any, located along these edges are attached to the introduced gridpoints (c and d) for continuity.
- c. ROD or BAR elements, if any, located along the joint between gridpoints a and b are each divided into two members located between gridpoints a and b and between c and d; each of these elements has half of the original element stiffness.

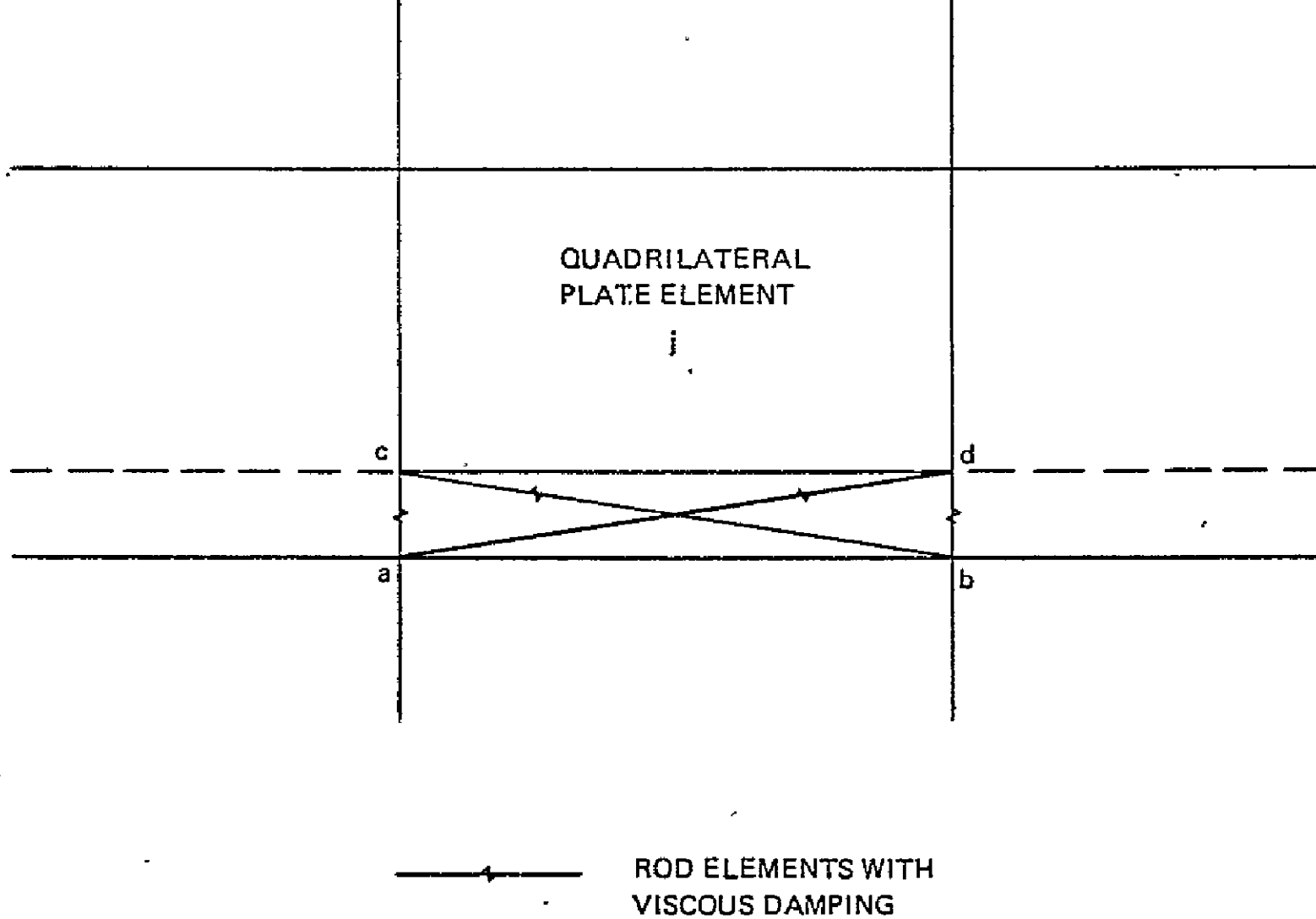

Figure 2-A. Plate Joint Damping Model Schematic

- d. Axial ROD elements having axial stiffness and damping are introduced between gridpoints a and c and between b and d to provide desired stiffness and damping characteristics.
- e. Diagonal ROD elements having axial stiffness and damping are introduced between gridpoints a and d and between b and c to provide desired stiffness and damping characteristics.
- f. The out-of-plane (transverse) shear stiffness is considered a negligible quantity and is therefore not explicitly treated in this model.
- g. Depending on the structural characteristics of the joint being represented, the local moment can be transferred across the joint if desired by multipoint constraint equations using gridpoints a and b as independent freedoms and gridpoints c and d as dependent freedoms.

The preprocessor model for QDMEM and SHEAR plate elements, having only inplane stiffness, is identical to that just described except that the rotational freedoms must be multipoint constrained across the joint except when BAR elements are used as edge members. In addition, when adjacent plate elements lie in a plane, the out-of-plane translational freedom must also be multipoint constrained except when BAR edge members are used. This is to eliminate singularities resulting from the absence of bending and shear stiffnesses in these plate elements.

The preprocessor model for SHEAR plate elements also includes ROD elements across the joint between gridpoints a and c and between b and d to provide axial viscous damping.

The multipoint constraint (MPC) equation for the out-of-plane translational freedom across a joint is automatically generated even when the plane elements are inclined to the basic rectangular coordinate system. The MPC equation is determined by transforming the standard "rigid-body" constraint matrix by the direction cosines defining the vector normal to the plate elements. The direction cosines are determined from the scalar components of the vector cross-product of the position vectors on the plate corner gridpoints adjacent to the specified joint gridpoint. The dependent freedom is chosen from the grid across the joint from the specified joint gridpoint as that freedom having the largest direction cosine. The MPC feature for the out-of-plane

translational freedom is, of course; not required when the plates along the joint meet at an angle and thereby transfer shear forces by permissible shell membrane action.

Default values are automatically specified by the preprocessor for the NASTRAN data describing the structural joints. For the riveted or bolted joints in quadrilateral plate elements, numerical default values are specified for joint width, area for axial ROD elements, and area for diagonal ROD elements. The joint width is specified as five percent of the distance between gridpoints a and b. The nominal areas for both the axial and diagonal ROD elements are defined so as to duplicate the inplane axial and shear stiffnesses of the original plate. The default values for these ROD areas are unity. However, other joint factors based on estimated effectivity associated with the stress distribution in the contact area near the individual rivets or bolts can be specified if required.

2.1.4 Data Preparation for Joint Damping Predictor

Specialized NASTRAN input is automatically generated by the preprocessor for generating uncoupled partitions of the element damping matrix required for the joint damping predictor computer program. This input is described in the following section.

2.2 JOINT DAMPING PREDICTION

This section describes the procedures used by the joint damping predictor (JDP) computer program to determine data values for the local NASTRAN damping elements. The specific purpose of the JDP is to evaluate coefficients for NASTRAN VISC and ROD elements such that specified damping ratios are obtained for selected total vehicle or major substructure modes. This approach accounts for the fact that a given local damping element may contribute significantly to the damping of several different vehicle modes. The JDP program used with the preprocessor program and such vehicle low-frequency modal damping equations as those presented in References 4 and 5 permits the rational prediction of structural damping for the higher-frequency modes.

The JDP program operates on damping data not readily available from NASTRAN. Required BULK DATA for this specialized use of NASTRAN is prepared automatically by the preprocessor; specialized NASTRAN DMAP ALTER statements are also required. The output of this unique preprocessor/NASTRAN run is used as input by the JDP program. The JDP program reads the following data from the NASTRAN checkpoint/restart tape:

- [ϕ] the matrix of overall vehicle mode shapes
- [BGG] the overall vehicle element damping matrix
- [DMIG] the partition vector used for separating matrices into selected subsets.

The JDP computer program requires sets of local damping elements to be separated from each other so that an influence coefficient approach may be employed. Thus, when two or more damping elements from different damping sets attach to the same gridpoint, duplicate gridpoints (having the same coordinates) must be defined. Modified element connections are then defined to attach damping elements to the duplicate gridpoints as required. To assure that the basic stiffness and mass characteristics of the structure are not affected by these operations, multipoint constraint equations are required to constrain the duplicate gridpoints to move with the original gridpoint.

The preprocessor computer program automatically generates NASTRAN data for the duplicate gridpoints, modified element connections, and multipoint constraint equations required to generate uncoupled partitions of the element damping matrix

without modifying the dynamic characteristics of the structure. The element damping matrix [BGG] is then partitioned into distinct damping sets [BGG_j]. The set corresponding to j=0 contains damping elements with parameters known. The other sets (j=1...n) contain damping elements with arbitrarily assumed parameter values.

Overall vehicle damping values may be determined from equations of energy loss per cycle vs. modal kinetic energy such as described in References 4 and 5. These equations, which are based on aerospace modal test data, enable realistic damping values to be predicted for selected fundamental vehicle modes. From these total modal damping ratios for m selected low-frequency modes and from the partitioned damping sets, scale factors can be calculated for the damping sets with the assumed values. The joint damping predictor automatically performs the following operations:

- a. Calculate the contribution to the diagonal of the overall vehicle modal damping matrix D* due to the damping elements in sets j=1,...,n.

$$\{D^*\} = \{2(\zeta - \zeta_m)\omega M^*\} - \{BHHO\} \quad (21)$$

where ζ_i is the desired total modal damping ratio for the i^{th} selected mode

ζ_{mi} is the modal damping ratio representing the material damping

ω_j is the frequency of the i^{th} mode

M^*_i is the generalized mass of the i^{th} mode

{BHHO} is the diagonal of the generalized damping matrix calculated using the element damping matrix with known parameters [BGG₀] and the partition of the matrix of mode shapes corresponding to these freedoms and the selected modes.

- b. Calculate a matrix of damping influence coefficients [C*] such that

$$\{D^*\} = [C^*]\{A\} \quad (22)$$

where {A} is a vector of scale factors

$C^*_{ij} = \{\phi_j\}_i^T [BGG_j] \{\phi_j\}_i$ is the unit generalized damping contribution of the j^{th} damping set and the i^{th} selected mode.

- c. Solve for the scale-factor vector {A} using the standard least-squares approach:

$$\{A\} = ([C^*]^T [C^*])^{-1} [C^*]^T \{D^*\} \quad (23)$$

- d. Multiply the element damping sets by A_j ($j=1, \dots, n$) and calculate the updated generalized damping matrix for verification of the analysis.

The basic output of the joint damping predictor computer program is the scale-factor vector $\{A\}$ by which the damping parameter values assumed for the initial preprocessor/NASTRAN run are multiplied. The vector $\{A\}$ is calculated such that rationally specified modal damping values for selected fundamental vehicle modes are obtained in the NASTRAN model. Subsequent system dynamic characteristics of this model, combined with other models similarly calibrated, comprise realistic and consistent damping ratios for the higher-order modes.

2.3 ADMITTANCE MATRIX CALCULATION

The original post-processor computer program was developed to select critical modes for low-frequency control-system studies and higher frequency vibration analyses of the Large Space Telescope (Reference 1) using structural dynamic characteristics obtained from a NASTRAN restart tape. The basic calculations were performed, for ease of computation, using uncoupled normal modes. A study indicated that the effects of modal velocity coupling could be significant to responses in certain frequency ranges (Reference 6). The original postprocessor has therefore been updated to use admittance techniques for selecting critical resonances for subsequent dynamic response and loads studies. The NASTRAN calculation of the required coupled modal damping matrix is accomplished with DMAP ALTER statements in the NASTRAN EXECUTIVE CONTROL deck.

The postprocessor reads the following structural dynamic characteristics from the NASTRAN checkpoint/restart tape:

- [ϕ] the matrix of mode shapes for selected modes and freedoms
- {M*} the matrix of generalized masses for selected modes
- [D*] the matrix of generalized coupled modal damping terms for selected modes
- { ω } the matrix of modal frequencies for selected modes

The coupled modal damping matrix is calculated by applying the modal transformation to the viscous damping matrix BGG generated by NASTRAN in physical coordinates

$$[D^*] = [\phi]^T [BGG] [\phi] \quad (24)$$

The postprocessor computer program accepts this data and, with options 4-6, selects critical resonances within a specified frequency range, using an admittance approach. Discussions of the methodology for options 1-3 may be found in Reference 1 and in Appendix III as part of the user's manual. The computations for the admittance approach are performed primarily in generalized modal coordinates for maximum numerical efficiency. The admittance matrices are then transformed back to physical coordinates for the selection process. Each term in the complex admittance matrix, in physical coordinates for a specified frequency (β) is

defined as the response at one degree-of-freedom due to a unit sinusoidal input of frequency β applied at another degree-of-freedom. The responses of interest are assumed to be either displacement or velocity, and the unit input could be either force or moment. The displacement admittance matrix for frequency β in physical coordinates is defined by

$$\{X(j\beta)\} = [A_D^{(P)}(j\beta)]\{F(\beta)\} \quad (25)$$

where:

$\{X(j\beta)\}$ = column of complex physical displacements at the response freedoms at frequency β ,

$[A_D^{(P)}(j\beta)]$ = complex displacement admittance matrix in physical coordinates,

$\{F(\beta)\}$ = column of unit sinusoidal inputs at frequency β applied at the input freedoms.

The admittance matrix in physical coordinates is related to the corresponding matrix in modal coordinates as follows:

$$[A_D^{(P)}(j\beta)] = [\phi_R][A_D^{(M)}(j\beta)][\phi_I]^T \quad (26)$$

where:

$[\phi_R]$ = matrix of mode shapes by column for the response freedoms,

$[\phi_I]^T$ = matrix of mode shapes by row for the input freedoms.

The modal displacement admittance matrix is expressed in terms of the dynamic characteristics output on the NASTRAN restart tape as follows:

$$[A_D^{(M)}(j\beta)] = \left[[-(\omega^2 - \beta^2)M^*] + j\beta[D^*] \right]^{-1} \quad (27)$$

where:

ω_j = modal frequency of the i^{th} mode,

M_{ii}^* = generalized mass of the i^{th} mode,

D_{ik}^* = generalized damping term coupling the i^{th} and k^{th} modes.

If desired for computational purposes, an optional screening may be performed to identify modes with potentially significant coupling for inclusion in the subsequent calculation. The screening process is based upon the presumption that potential coupling exists if the magnitude of an off-diagonal term in the coupled damping matrix is sufficiently large in comparison with the diagonal term and if the frequency of the mode associated with that off-diagonal damping term is sufficiently close to the excitation frequency. Potential coupling exists if

$$\frac{|D_{ij}^*|}{D_{ii}^*} > \gamma_1 \quad (28)$$

and if,

$$1 - \gamma_2 \zeta_j < \frac{\beta}{\omega_j} < 1 + \gamma_2 \zeta_j \quad (29)$$

where γ_1 and γ_2 are constants used to specify the degree of coupling for the screening process and

$$\zeta_j = \frac{D_{jj}^*}{2\omega_j M_{jj}^*}$$

is an equivalent modal viscous damping coefficient.

Reference 7 presents a similar modal coupling assessment criterion for lightly damped modes. Coupling can be ignored if

$$2\zeta_j / [(\beta/\omega_j)^2 - 1]^{1/2} \ll 1 \quad (30)$$

for $\beta/\omega_j > 1$ and provided that $D_{ij}^*/D_{ii}^* \sim 1$ or smaller.

Inverting Equation (27) by partitions results in the following expression for the modal displacement admittance matrix:

$$[A_D^{(M)}(j\beta)] = [C_D^{(M)}] + j[D_D^{(M)}] \quad (31)$$

where:

$$[D_D^{(M)}] = -[B_D] + [A_D][B_D]^{-1}[A_D]^{-1} \quad [A_D] = [-(\omega^2 - \beta^2)M^*]$$

$$[C_D^{(M)}] = -[D_D^{(M)}][A_D][B_D]^{-1} \quad [B_D] = \beta[D^*]$$

Transforming back to physical coordinates using Equation (26) results in a computational expression for the displacement admittance matrix in physical coordinates.

$$\begin{aligned} [A_D^{(P)}(j\beta)] &= [\phi_R][C_D^{(M)}][\phi_I]^T + j[\phi_R][D_D^{(M)}][\phi_I]^T \\ &= [C_D^{(P)}] + j[D_D^{(P)}] \end{aligned} \quad (32)$$

The derivation for the velocity admittances is, of course, directly analogous. The modal velocity admittance matrix is

$$[A_V^{(M)}(j\beta)] = [C_V^{(M)}] + j[D_V^{(M)}] \quad (33)$$

where:

$$\begin{aligned} [C_V^{(M)}] &= \left[[B_V] + [A_V][B_V]^{-1}[A_V] \right]^{-1} & [B_V] &= [D^*] \\ [D_V^{(M)}] &= - [B_V]^{-1}[A_V][C_V^{(M)}] & [A_V] &= - \frac{1}{\beta} [(\omega^2 - \beta^2)M^*] \end{aligned}$$

and the velocity admittance matrix in physical coordinates is

$$\begin{aligned} [A_V^{(P)}(j\beta)] &= [\phi_R][C_V^{(M)}][\phi_I]^T + j[\phi_R][D_V^{(M)}][\phi_I]^T \\ &= [C_V^{(P)}] + j[D_V^{(P)}] \end{aligned} \quad (34)$$

For both displacement and velocity admittances, the desired amplitudes and lead phase angles are determined from either Equation (32) or Equation (34) as follows:

$$\begin{aligned} |A_{ij}^{(P)}(\beta)| &= \left[C_{ij}^{(P)}(\beta)^2 + D_{ij}^{(P)}(\beta)^2 \right]^{\frac{1}{2}} \\ \theta_{ij}(\beta) &= \tan^{-1} \left[D_{ij}^{(P)}(\beta) / C_{ij}^{(P)}(\beta) \right] \end{aligned}$$

where i and j are indices referring to selected response and input freedoms.

For each pair of response and input freedoms, the admittance amplitudes and lead phase angles (defined from 0° to $+180^\circ$) are tabulated versus increasing frequency (β) as the primary output of the postprocessor. The rank corresponding to each admittance amplitude is also included in this data tabulation.

Acceleration admittances are calculated from the corresponding displacement admittances. The displacement amplitudes are multiplied by β^2 and the displacement phase angles are shifted $\pm 180^\circ$ for the acceleration admittances.

For each pair of response and input freedoms, the admittance amplitudes and lead phase angles (defined from 0° to $\pm 180^\circ$) are tabulated versus increasing frequency (β) as the primary output of the postprocessor. The rank corresponding to each admittance amplitude is also included in this data tabulation.

3.0 REALISTIC STRUCTURAL MODEL

A realistic NASTRAN structural model of the Space Shuttle was developed using the preprocessor to incorporate structural joint stiffness and damping characteristics. The objective of the modeling task was to develop a sufficiently detailed structural model to accurately represent the dynamics of the structure below approximately 25 Hz while keeping the mass degrees-of-freedom to a reasonable number for computational efficiency. The number of mass degrees-of-freedom established as a goal for each of the three Space Shuttle half-model components were: External Tank (ET), 100; Solid Rocket Motor (SRM), 50; and Orbiter, 150.

Detailed descriptions of each of the Space Shuttle component models including structural joints are presented in the following sections along with a description of the model developed to represent SRM propellant dynamics.

3.1 SPACE SHUTTLE STRUCTURAL MODELS

External Tank and Solid Rocket Motor models were developed using structural drawings supplied by MSFC and the NASTRAN model of the Orbiter was obtained from JSC/SMD, Reference 5, and modified for use in this study. Solid Rocket Motor propellant data and Space Shuttle mass data were supplied by MSFC.

Each of the three vehicles in the Space Shuttle half-model has its own coordinate system. The relation of each coordinate system to the overall coordinate system is shown in Figure 3-1 and Table 3-1.

3.1.1 External Tank

The External Tank (ET) half-model consists of 86 gridpoints, 484 stiffness degrees-of-freedom and 96 retained freedoms. The tank shell, and intertank structure were modeled using QUAD1, QUAD2, TRIA1 and TRIA2 NASTRAN plate elements. Ring stiffeners were modeled using BAR elements. BAR and ROD elements were used to represent the Orbiter support structure. The gridpoint, BAR and ROD, and plate identification numberings are shown in Figures 3-2 through 3-4, respectively.

The forward and aft elliptical LH₂ tank domes are modeled using constant thickness plate elements (QUAD2 and TRIA2). Nonhomogeneous plate elements (QUAD1 and TRIA1) are used to model the cylindrical LH₂ tank skin to account

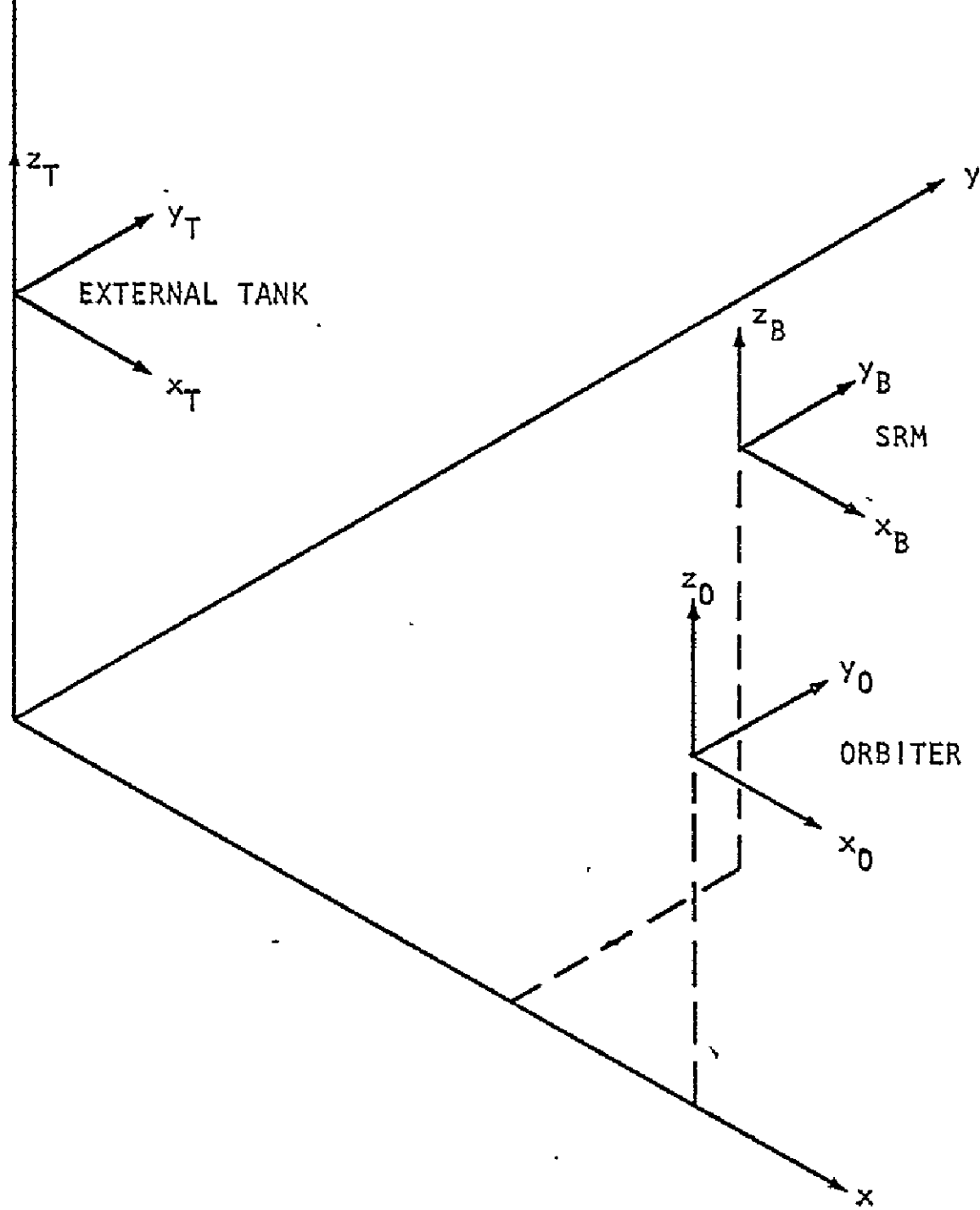

FIGURE 3-1: SPACE SHUTTLE COORDINATE SYSTEMS

TABLE 3-1 SPACE SHUTTLE COORDINATE SYSTEMS

VEHICLE	COORDINATE ORIGIN		
	X, m (in.)	Y, m (in.)	Z, m (in.)
EXTERNAL TANK	0(0)	0(0)	10.16 (400.)
SOLID ROCKET MOTOR	13.89 (547.)	6.36 (250.5)	10.16 (400.)
ORBITER	19.08 (751.)	0(0)	8.51 (335.)

The range of gridpoint numbers for each vehicle is as follows:

External Tank (ET)	0 - 499
Solid Rocket Motor (SRM)	500 - 999
Orbiter	
forward fuselage	11000 - 11999
fuselage payload section	12000 - 12999
wing	13000 - 13999
thrust structure	14000 - 14999
vertical tail	5000 - 5999
payload	6000 - 6999

NOTE: The preprocessor inserts gridpoints with numbers in the range 7000 - 9000 for the structural joints.

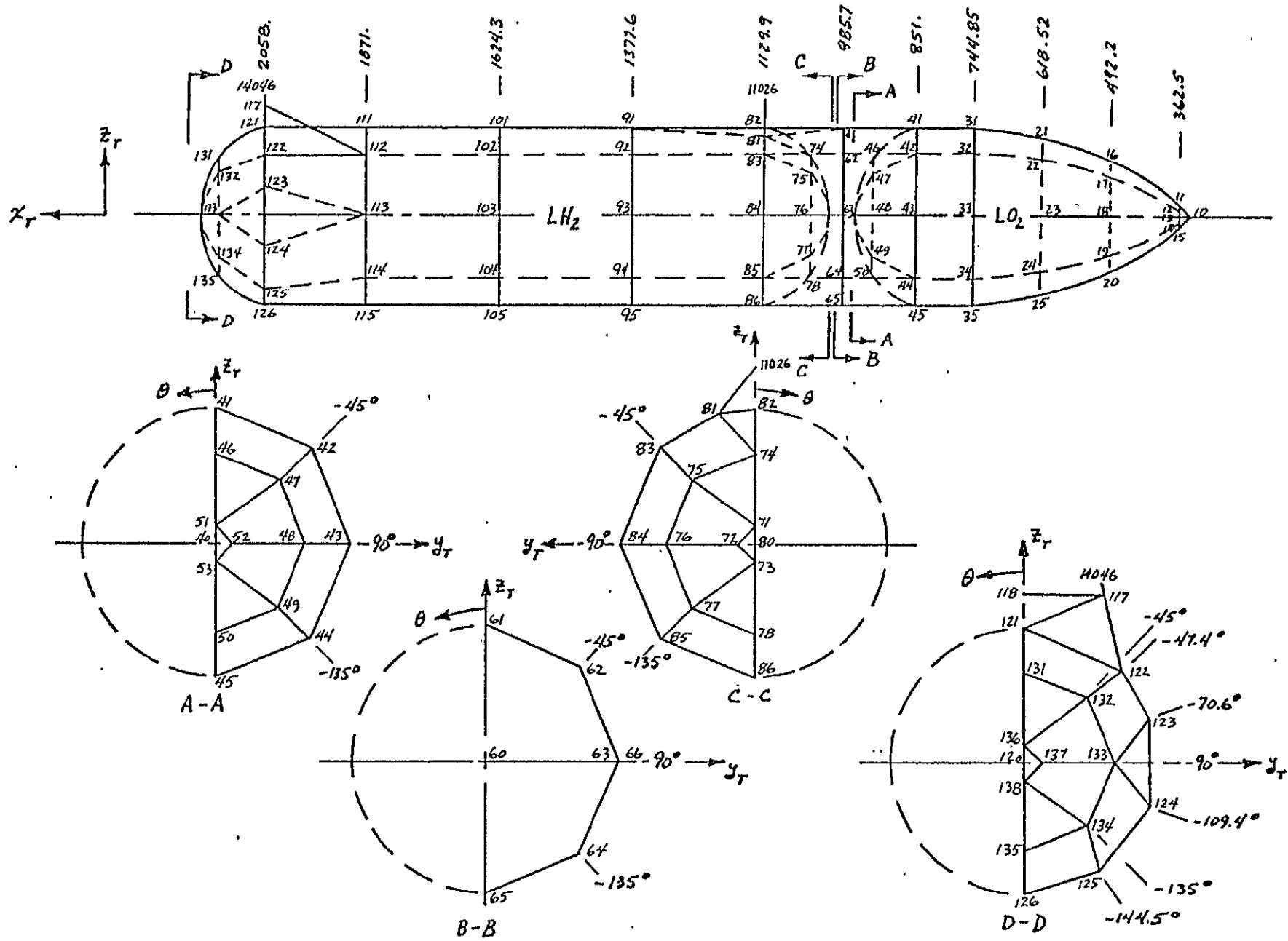

FIGURE 2-2. EXTERNAL TANK GRID POINT NUMBERING

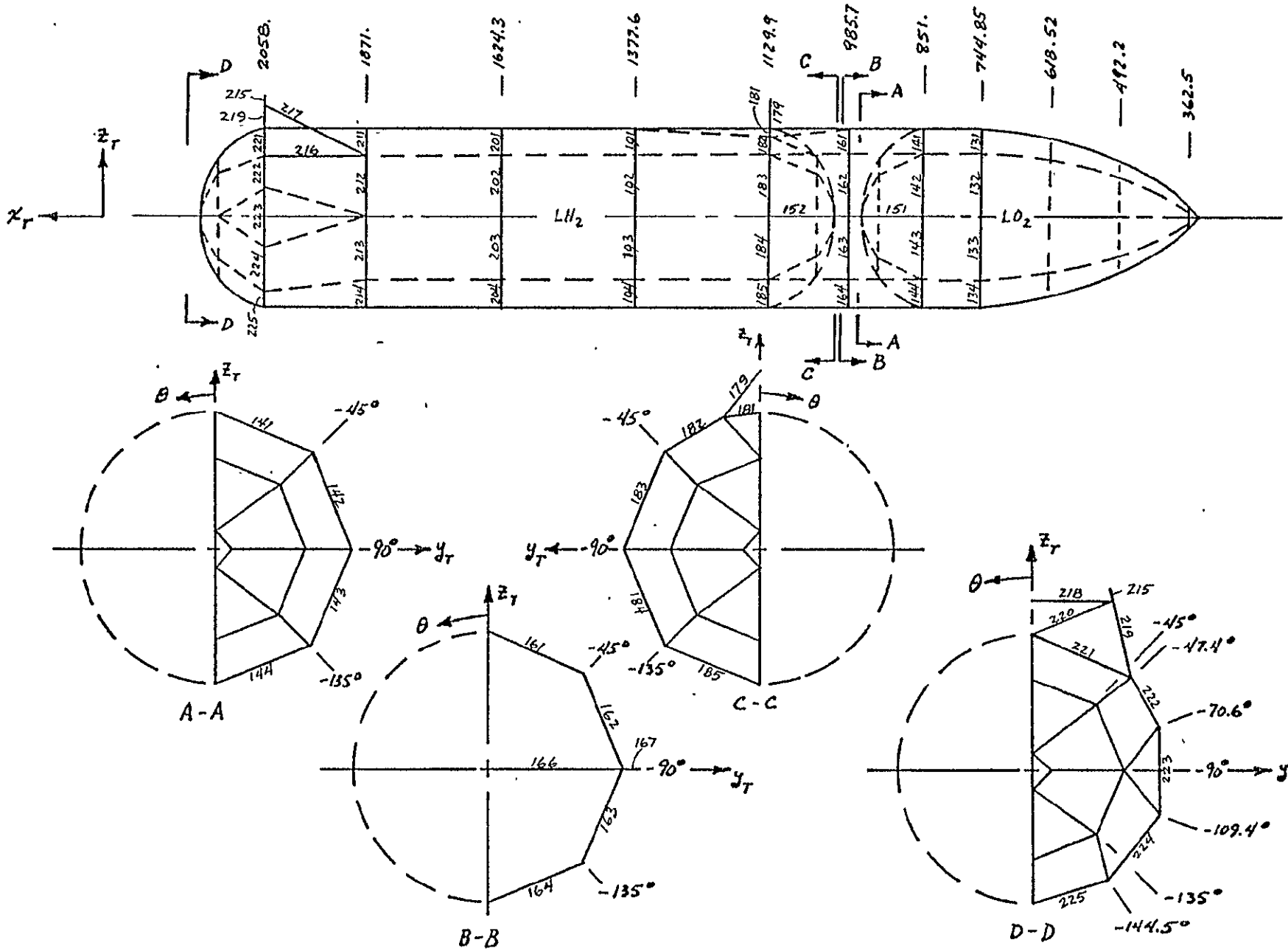

FIGURE 3-3: EXTERNAL TANK BAR AND ROD NUMBERING

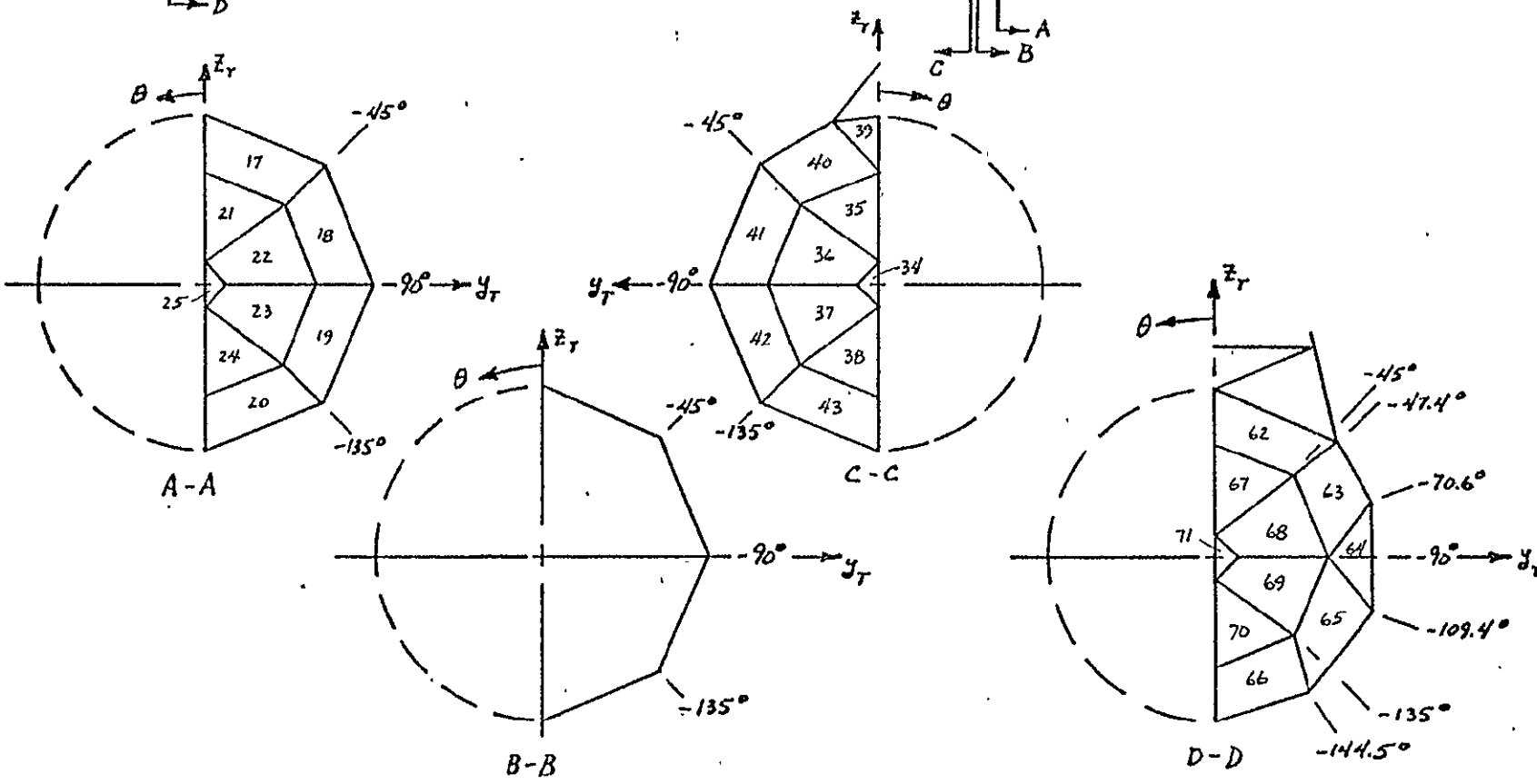
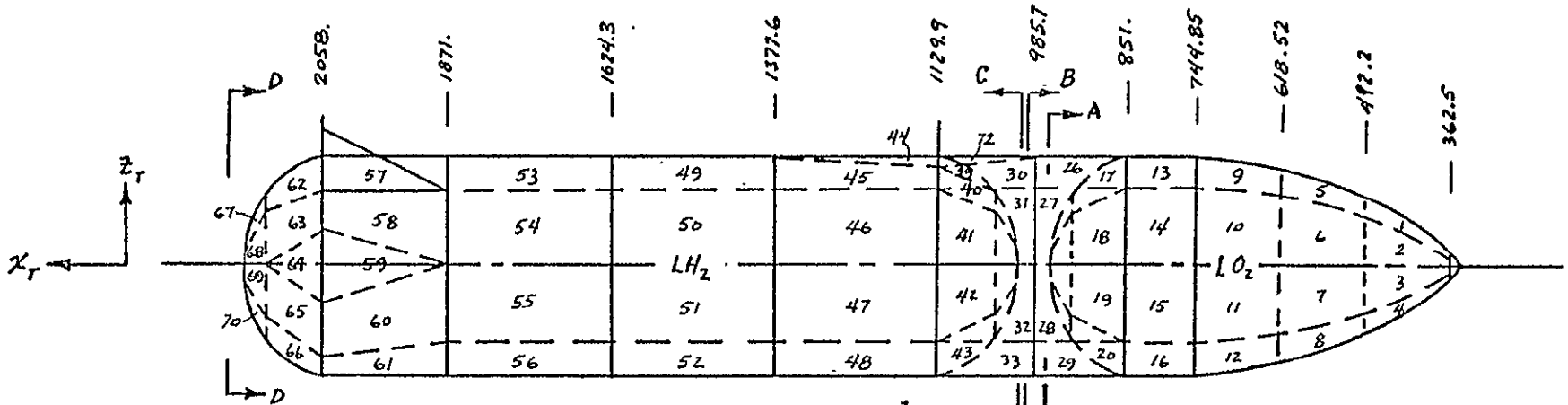

FIGURE 3-4: EXTERNAL TANK PLATE NUMBERING

for the longitudinal stiffeners machined into the skin panels. The ring stiffeners at stations $x_T = 1129.9, 1377.6, 1624.3, 1871.0,$ and 2058.0 and the longeron at the aft Orbiter attachment fitting are represented by BAR elements.

The LO_2 tank skin is modeled using homogeneous plate elements (QUAD2 and TRIA2). Ring stiffeners at stations $x_T = 744.85$ and 851.0 are modeled using BAR elements and include the effect of the sash baffles attached to them.

The ET intertank structure consists of skin panels stiffened longitudinally by external hat section stiffeners and, in the area of the SRM attachment beam, by stiffeners machined into the panels. The effect of 4 of the 5 internal ring stiffeners are included in the properties of the QUAD1 and TRIA1 elements used to represent the stiffened intertank skin panels. The ring stiffener at station $x_T = 985.7$ and the SRM attachment beam running through the intertank are modeled with BAR elements.

ROD elements are used to represent the Orbiter forward attachment struts at station $x_T = 1129.9$.

Details of the aft Orbiter attachment fittings are shown in Figure 3-5. Truss members are modeled using BAR and ROD elements. Ball joint and pin joint characteristics in the Orbiter attachment truss are modeled by appropriate joint and member parameters.

External Tank and liquid propellant weights are lumped at 37 gridpoints. Lumped masses for liftoff, max q and SRB cut-off conditions are shown in Table 3-2. The propellant is assumed to be "frozen" to the ET structure.

3.1.2 Solid Rocket Motor

Each Solid Rocket Motor (SRM) consists of 9 cylindrical propellant case segments with a nose cone and forward compartment attached at the forward end, and a tail cone and rocket nozzle attached at the aft end. The steel SRM case is represented by a single beam along its centerline using BAR elements as shown in Figure 3-6. The SRM attachment points are constrained to the centerline model using multipoint constraint (MPC) equations.

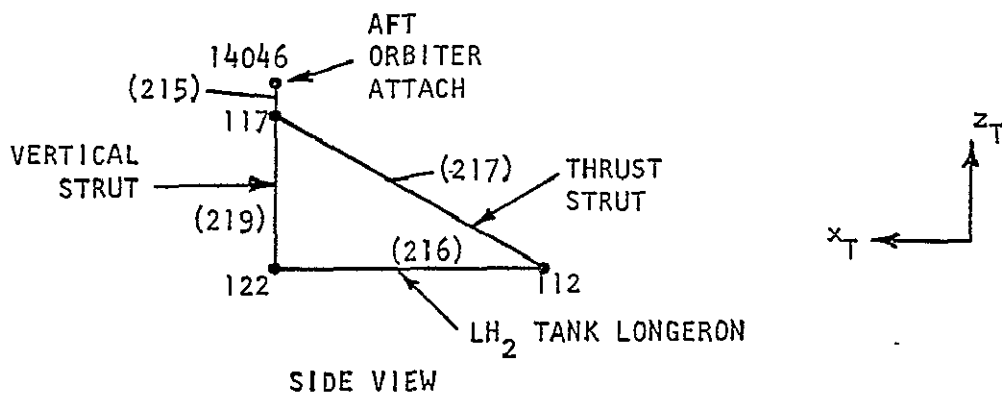
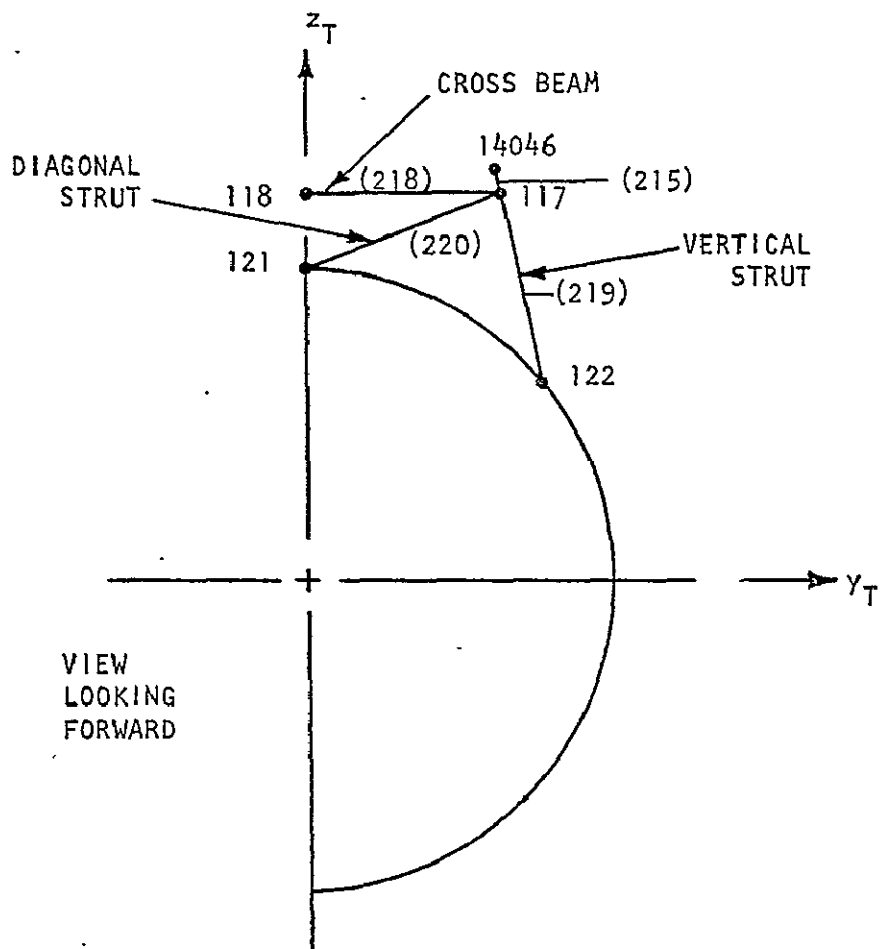
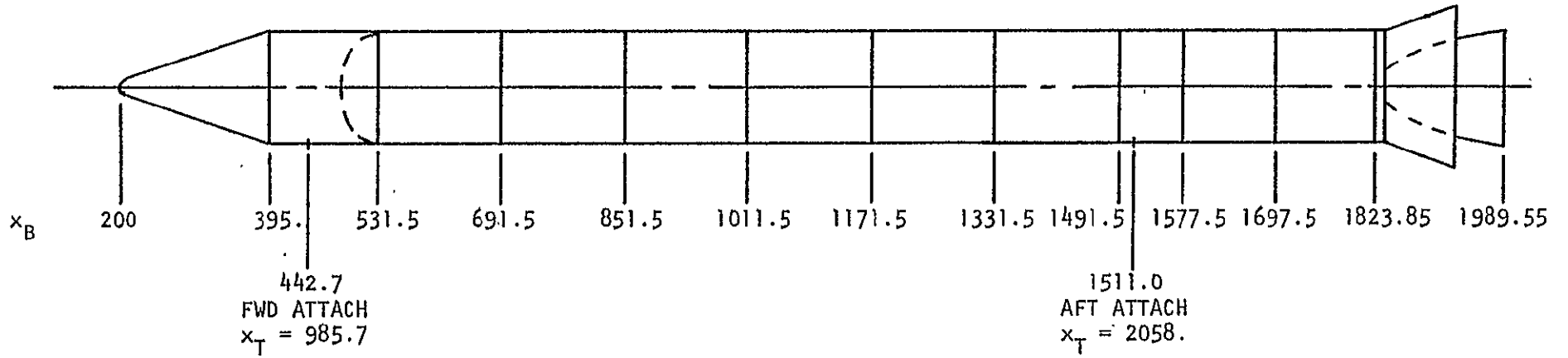

FIGURE 3-5: AFT ORBITER ATTACHMENT FITTING

Table 3-2: External Tank Mass Data
 Half-Vehicle Mass, kg (lb-sec²/in)

GRID NUMBER	LIFTOFF	MAX Q	SRB CUT-OFF
10	152. (0.9)	145. (0.8)	145. (0.8)
16	10200. (58.2)	5981. (34.1)	1111. (6.3)
17	20400. (116.4)	11963. (68.3)	2221. (12.7)
18	20400. (116.4)	11963. (68.3)	2221. (12.7)
19	20400. (116.4)	11963. (68.3)	2221. (12.7)
20	10200. (58.2)	5981. (34.1)	1111. (6.3)
31	20766. (118.5)		
32	41531. (237.0)		
33	41531. (237.0)		
34	41531. (237.0)		
35	20766. (118.5)		
46	7370. (42.1)		
47	14740. (84.1)		
48	14740. (84.1)		
49	14740. (84.1)		
50	7370. (42.1)		
82	2255. (12.9)	946. (8.6)	660. (3.8)
83	4511. (25.7)	1892. (17.3)	1319. (7.5)
84	4511. (25.7)	1892. (17.3)	1319. (7.5)
85	4511. (25.7)	1892. (17.3)	1319. (7.5)
86	2255. (12.9)	946. (8.6)	660. (3.8)
101	3490. (19.9)		
102	6979. (39.8)		
103	6979. (39.8)		
104	6979. (39.8)		
105	3490. (19.9)		
121	1645. (9.4)		
122	3289. (18.8)		
123	3289. (18.8)		
124	3289. (18.8)		
125	3289. (18.8)		
126	1645. (9.4)		
131	301. (1.7)		
132	603. (3.4)		
133	603. (3.4)		
134	603. (3.4)		
135	301. (1.7)		

all other masses are the same as liftoff



35

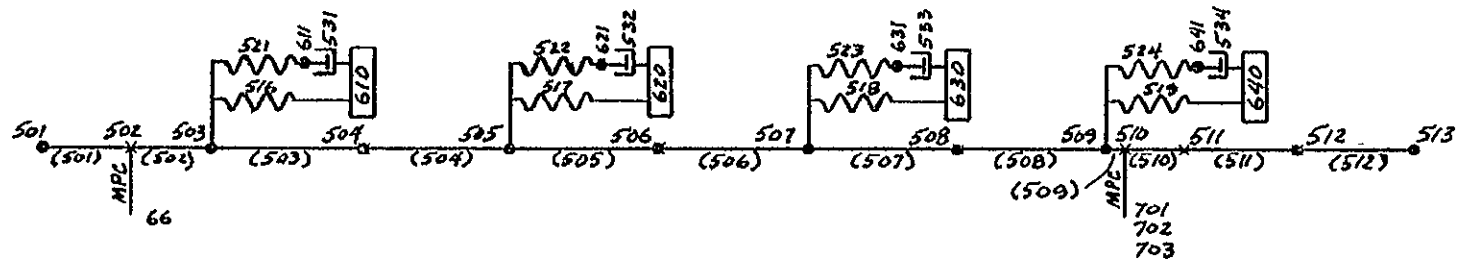
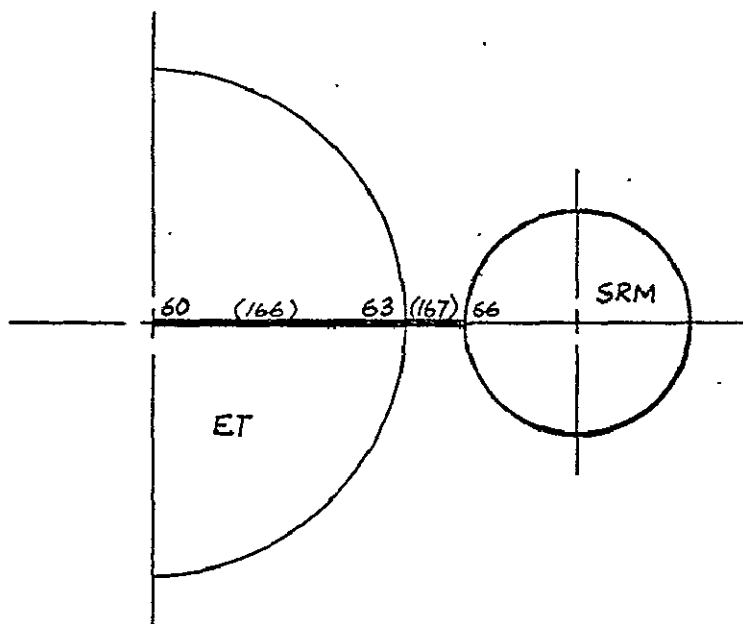
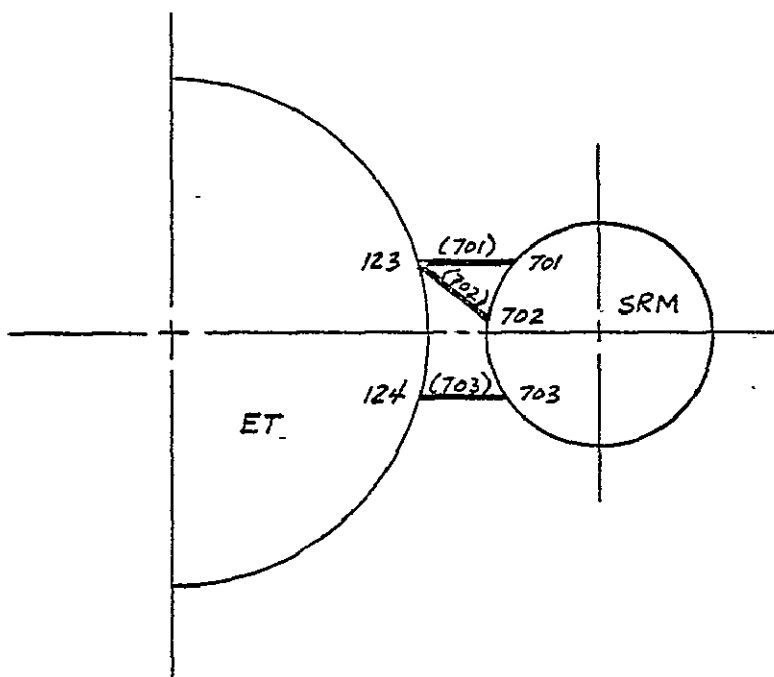

FIGURE 3-6: SOLID ROCKET MOTOR MATH MODEL



FORWARD ATTACHMENT FITTING



AFT ATTACHMENT FITTING

FIGURE 3-6: SOLID ROCKET MOTOR MATH MODEL (CONTINUED)

Also shown in Figure 3-6 are the Maxwell-type viscoelastic models used to represent the complex modulus of the solid rocket propellant in the axial and torsional directions. Propellant masses and spring constants are derived in Section 3.3.3.

The SRM model consists of 24 gridpoints, 86 stiffness degrees-of-freedom and 60 retained freedoms. SRM case and propellant weights lumped at 10 gridpoints along the centerline are shown in Tables 3-3 through 3-5 for liftoff, max q and SRB cut-off, respectively. SRM nozzle weight is not included in the model.

3.1.3 Orbiter

A NASTRAN finite element model of an early version of the Space Shuttle Orbiter was obtained from NASA/JSC (Reference 8) and was modified for this study. The model consists primarily of shear plates (SHEAR) and membrane elements (TRMEM and QDMEM) with BAR elements along their edges. Gridpoint and element numbers for the Orbiter model are shown in Figures 3-7 through 3-12. The vertical tail and wing are attached to the fuselage with BAR elements.

The Orbiter model consists of 462 gridpoints, 2460 stiffness degrees-of-freedom and 136 retained freedoms. Orbiter weights are lumped at 48 gridpoints as shown in Table 3-6. Space Shuttle Main Engine (SSME) weights are not included in the model.

Table 3-3: SRM Mass Properties (Liftoff)

GRID NUMBER	MASS		I_{xx}		$I_{yy}=I_{zz}$	
	kg	(lb-sec ² /in)	kg-m ²	(in-lb-sec ²)	kg-m ²	(in-lb-sec ²)
501	5982.	(34.1)	2.50E3	(2.21E4)	1.17E4	(1.04E5)
503	56249.	(300.4)	1.66E5	(1.47E6)	5.14E5	(4.54E6)
504(L)	46833.	(267.2)	0		0	
610(A)	46833.	(267.2)	40.4	(357.1)	0	
611(A)	468.	(2.7)	.40	(3.6)	0	
505	91562.	(522.5)	2.96E5	(2.62E6)	9.16E5	(8.10E6)
506(L)	46833.	(267.2)	0		0	
620(A)	46833.	(267.2)	40.4	(357.1)	0	
621(A)	468.	(2.7)	.40	(3.6)	0	
507	91332.	(521.2)	3.01E5	(2.66E6)	9.09E5	(8.04E6)
508(L)	46833.	(267.2)	0		0	
630(A)	46833.	(267.2)	40.4	(357.1)	0	
631(A)	468.	(2.7)	.40	(3.6)	0	
509	93117.	(531.4)	3.10E5	(2.74E6)	9.20E5	(8.13E6)
512(L)	46833.	(267.2)	0		0	
640(A)	46833.	(267.2)	40.4	(357.1)	0	
641(A)	468.	(2.7)	.40	(3.6)	0	
513	53002.	(302.5)	1.82E5	(1.61E6)	5.01E5	(4.43E6)

(L) = lateral mass
(A) = axial mass

Table 3-4: SRM Mass Properties (Max. Q)

GRID NUMBER	MASS		I_{xx}		$I_{yy} = I_{zz}$	
	kg	(lb-sec ² /in)	kg-m ²	(in-lb-sec ²)	kg-m ²	(in-lb-sec ²)
501	5982.	(34.1)	2.50E3	(2.21E4)	1.17E4	(1.04E5)
503	36422.	(207.9)	1.17E5	(1.03E6)	2.76E5	(2.44E6)
504(L)	6100.	(34.8)	0		0	
610(A)	6100.	(34.8)	0		0	
611(A)	59.	(0.3)	0		0	
505	63174.	(360.5)	2.01E5	(1.78E6)	4.82E5	(4.26E6)
506(L)	6100.	(34.8)	0		0	
620(A)	6100.	(34.8)	0		0	
621(A)	59.	(0.3)	0		0	
507	64478.	(368.0)	2.05E5	(1.81E6)	4.91E5	(4.34E6)
508(L)	6100.	(34.8)	0		0	
630(A)	6100.	(34.8)	0		0	
631(A)	59.	(0.3)	0		0	
509	67038.	(382.5)	2.14E5	(1.89E6)	5.10E5	(4.51E6)
512(L)	6100.	(34.8)	0		0	
640(A)	6100.	(34.8)	0		0	
641(A)	59.	(0.3)	0		0	
513	41609.	(237.4)	1.34E5	(1.19E6)	3.14E5	(2.77E6)

(L) = lateral mass
(A) = axial mass

Table 3-5: SRM Mass Properties (SRB Cut-Off)

GRID NUMBER	MASS		I_{xx}		$I_{yy}=I_{zz}$	
	kg(lb-sec ² /in)	()	kg-m ² (in-lb-sec ²)	()	kg-m ² (in-lb-sec ²)	()
501	5982.	(34.1)	2.50E3	(2.21E4)	1.17E4	(1.04E5)
503	10258.	(58.5)	3.52E4	(3.12E5)	7.41E4	(6.56E5)
504 (L)	0		0		0	
610 (A)	0		0		0	
611 (A)	0		0		0	
505	10836.	(61.8)	3.73E4	(3.30E5)	7.83E4	(6.92E5)
506 (L)	0		0		0	
620 (A)	0		0		0	
621 (A)	0		0		0	
507	12140.	(69.3)	4.18E4	(3.69E5)	8.77E4	(7.76E5)
508 (L)	0		0		0	
630 (A)	0		0		0	
631 (A)	0		0		0	
509	14700.	(83.9)	5.05E4	(4.47E5)	1.06E5	(9.39E5)
512 (L)	0		0		0	
640 (A)	0		0		0	
641 (A)	0		0		0	
513	15436.	(88.1)	5.31E4	(4.69E5)	1.12E5	(9.86E5)

(L) = lateral mass
(A) = axial mass

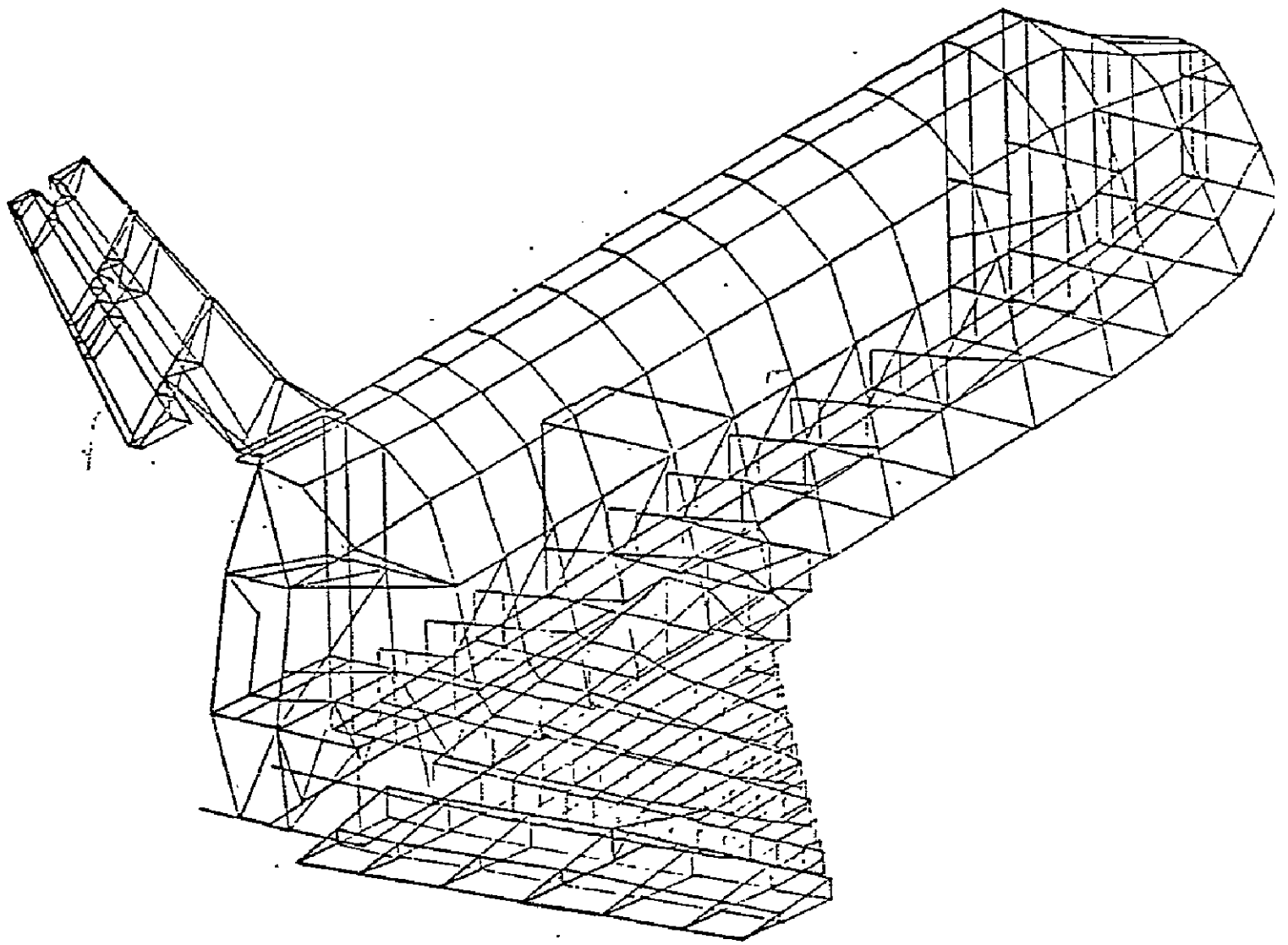

FIGURE 3-7: ORBITER MATH MODEL

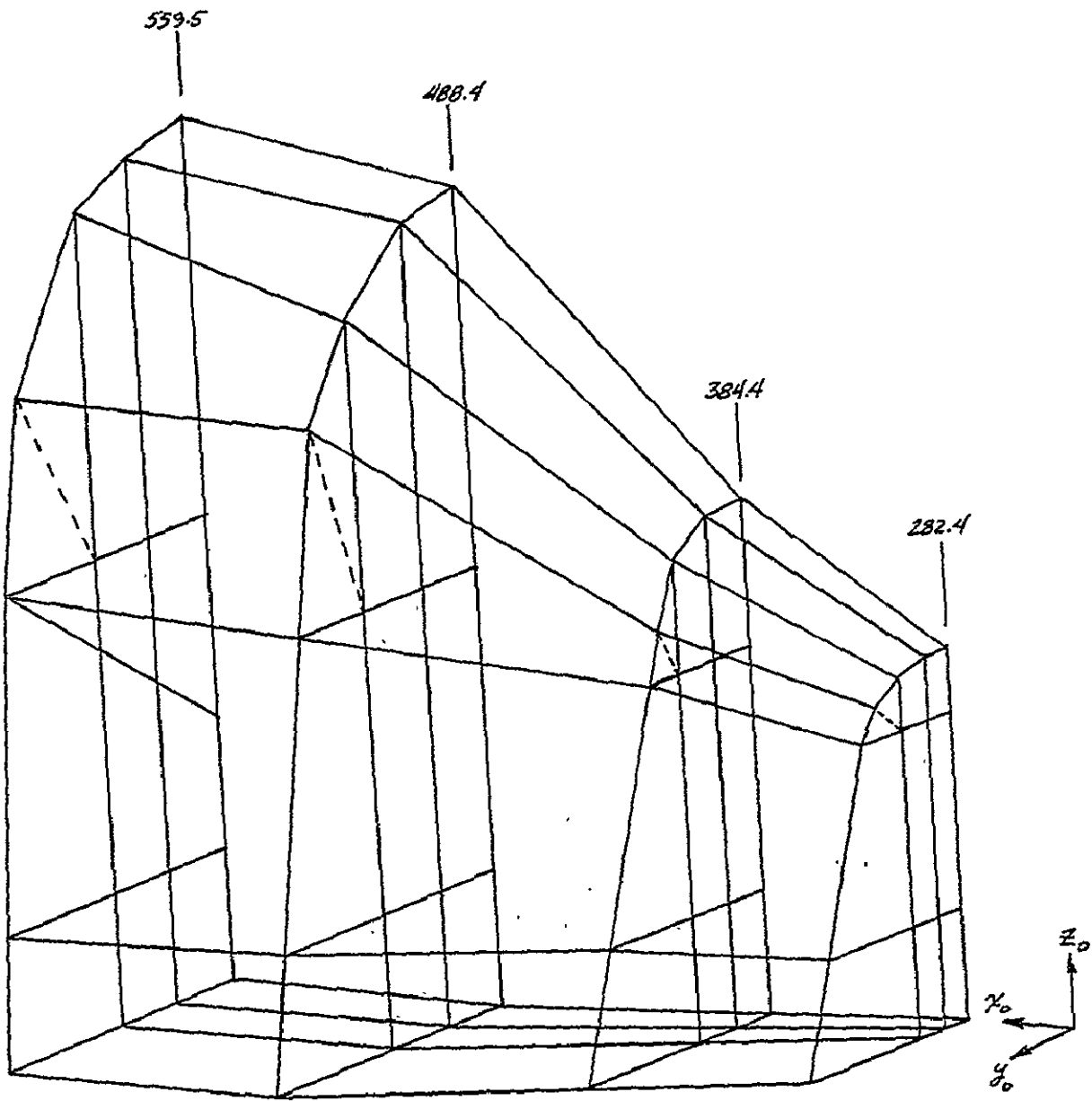

FIGURE 3-8: ORBITER - FORWARD FUSELAGE

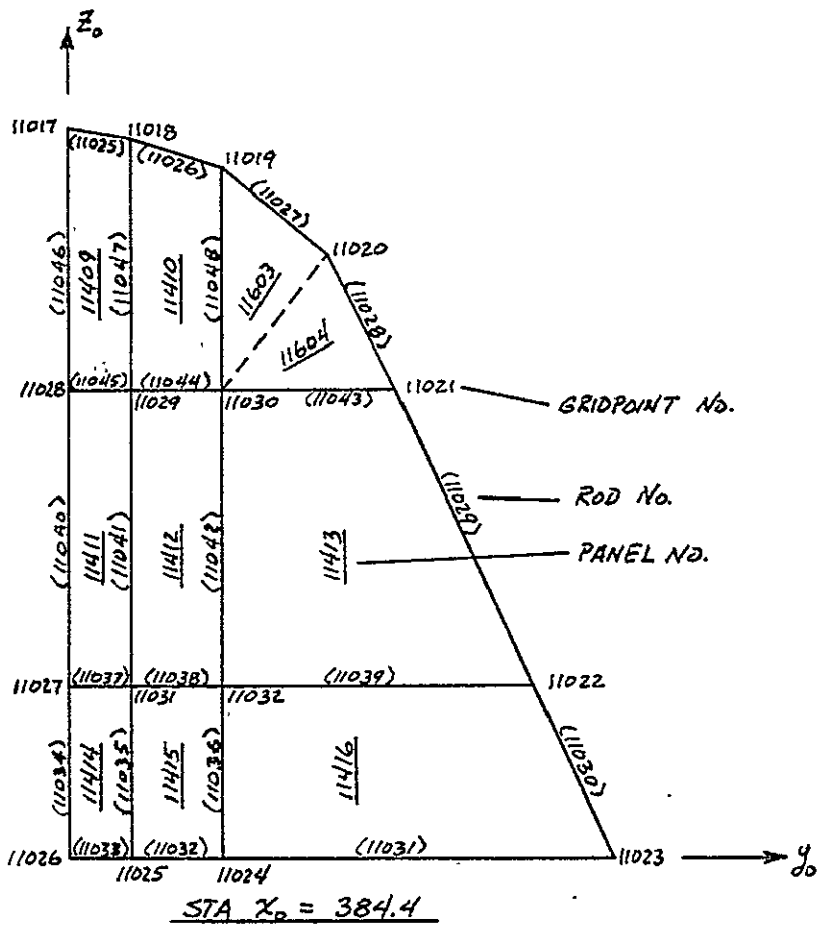
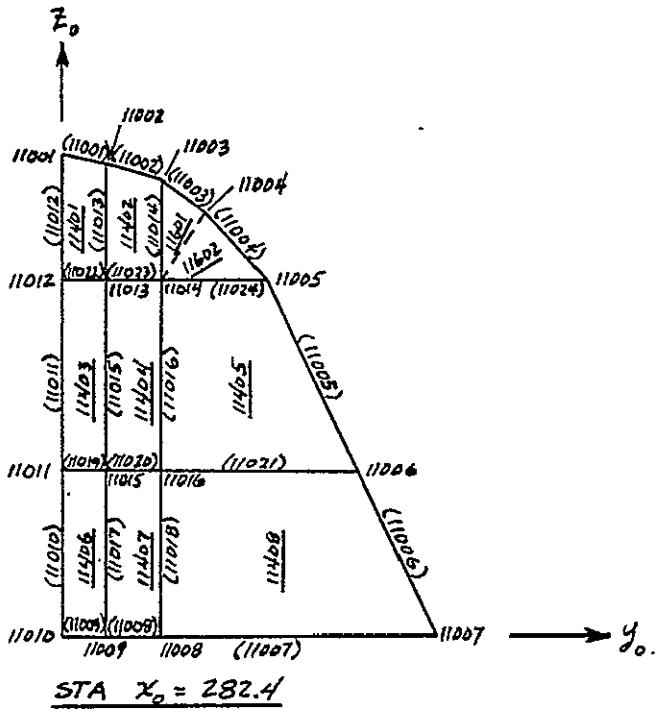

FIGURE 3-8: ORBITER - FORWARD FUSELAGE (Continued)

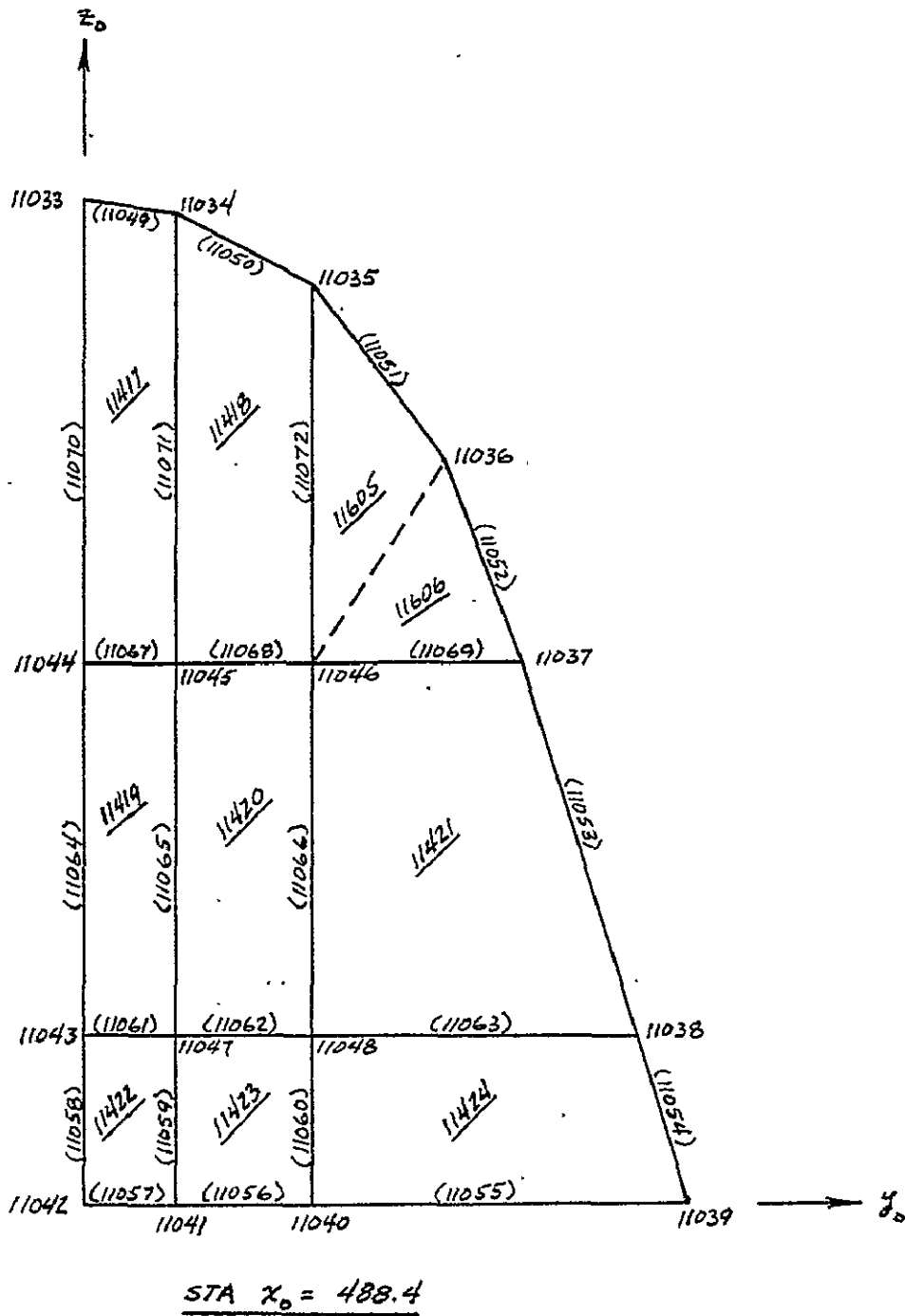

FIGURE 3-8: ORBITER - FORWARD FUSELAGE (Continued)

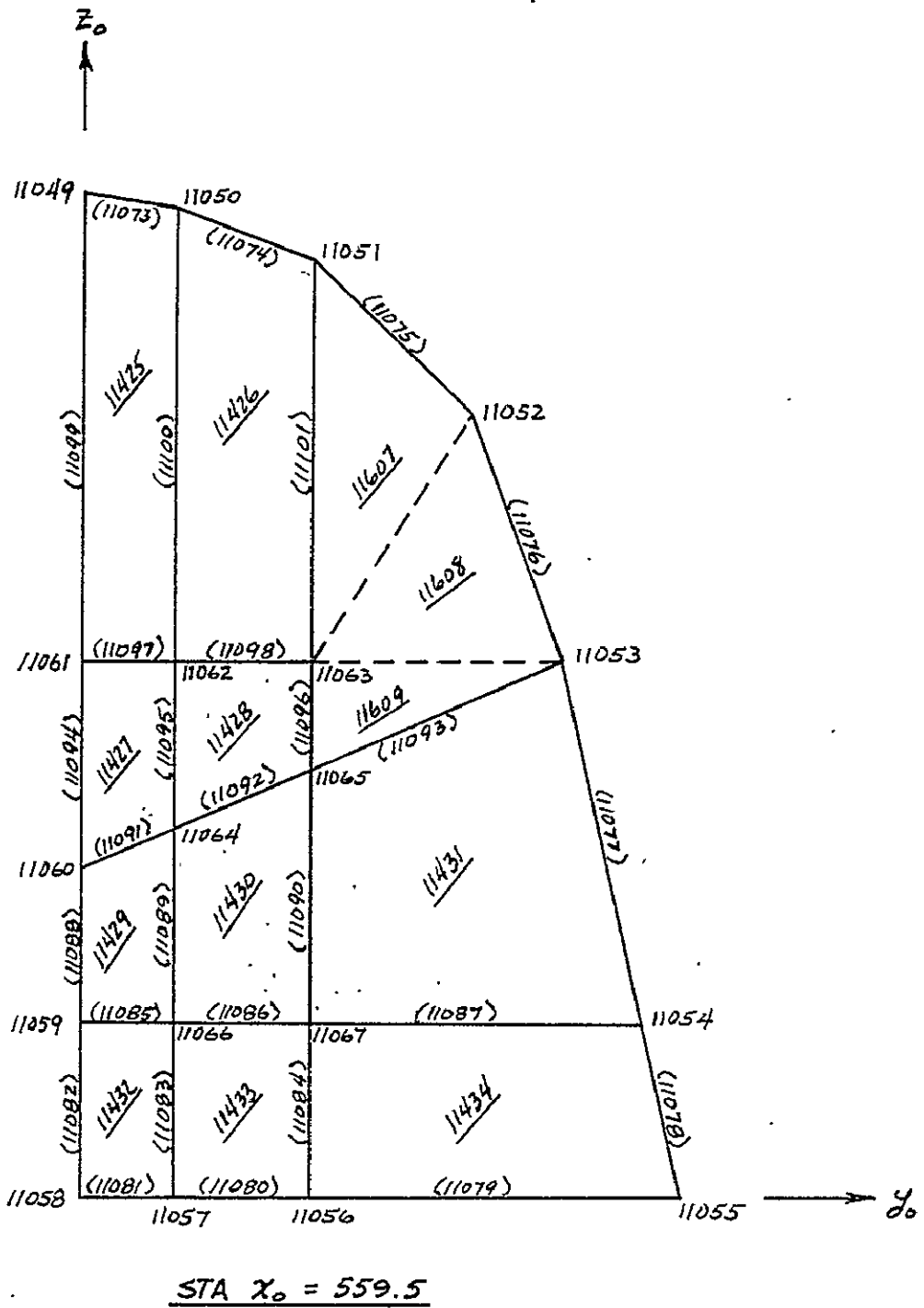

FIGURE 3-8: ORBITER - FORWARD FUSELAGE (Continued)

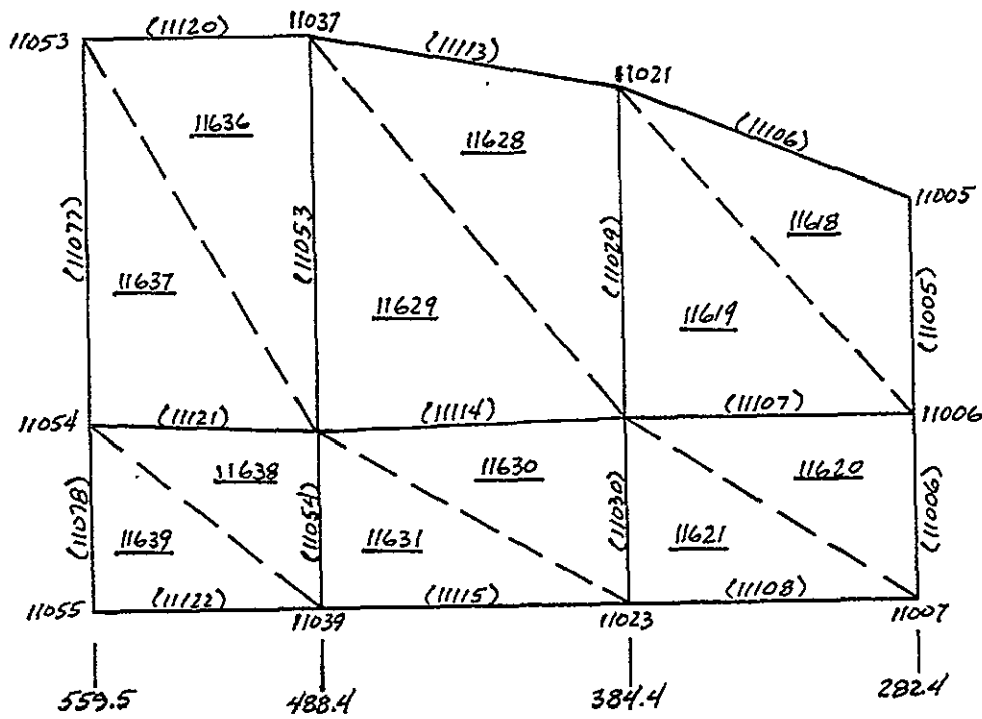
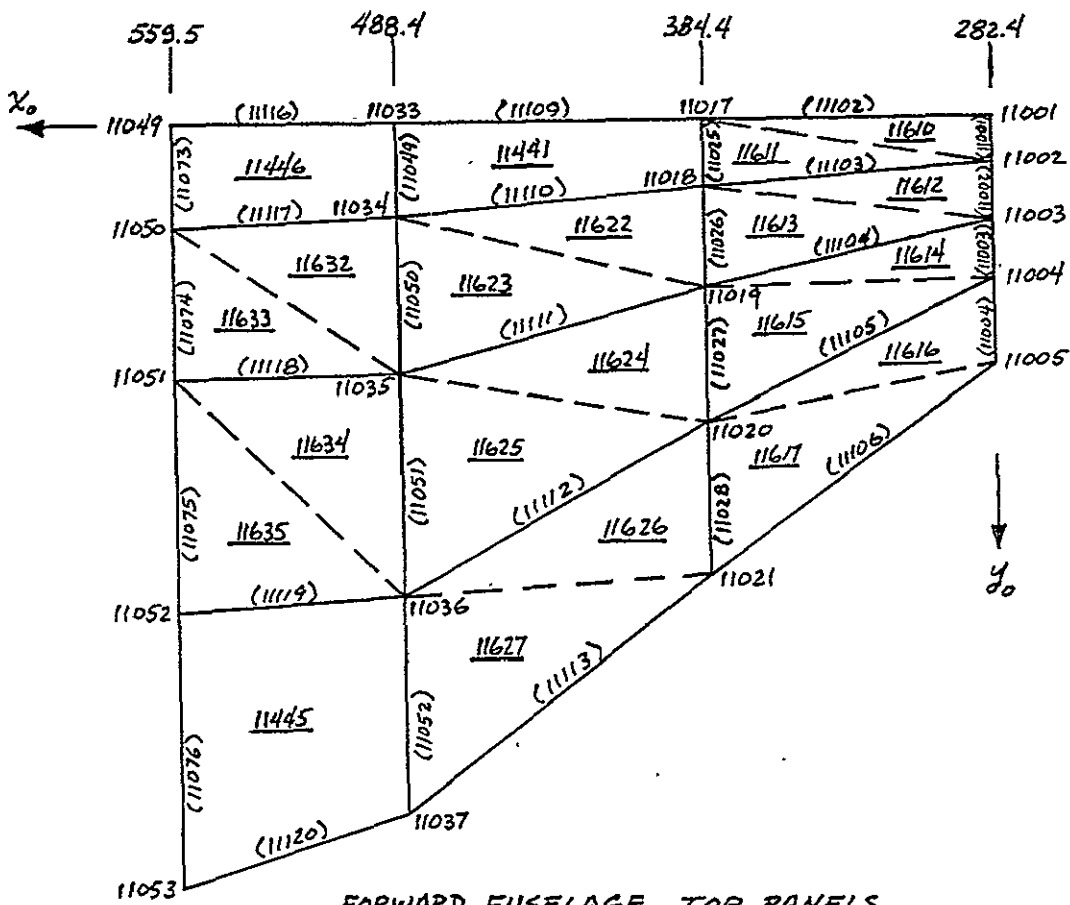
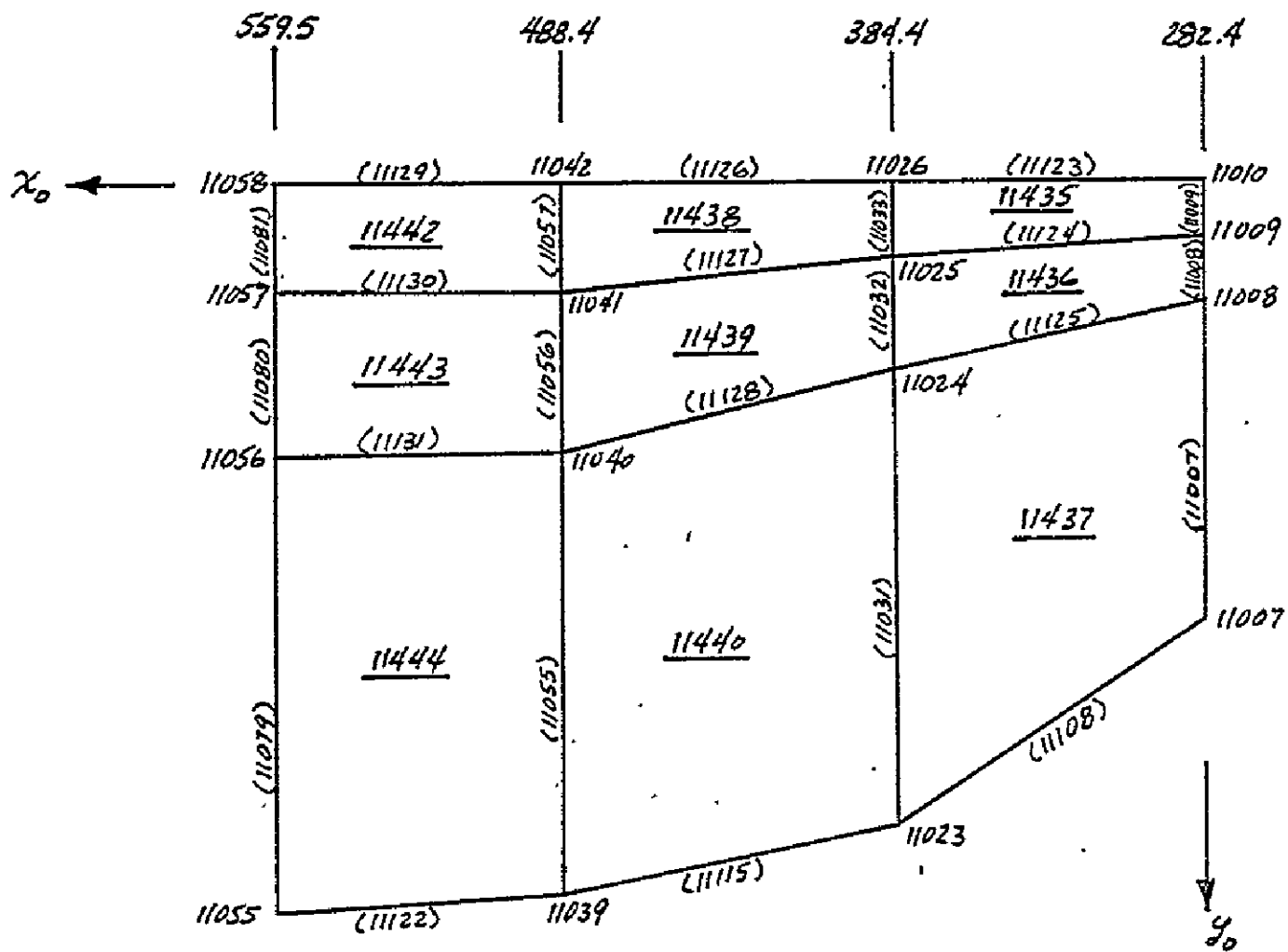

FIGURE 3-8: ORBITER - FORWARD FUSELAGE (Continued)



FORWARD FUSELAGE BOTTOM PANELS

FIGURE 3-8: ORBITER - FORWARD FUSELAGE (Continued)

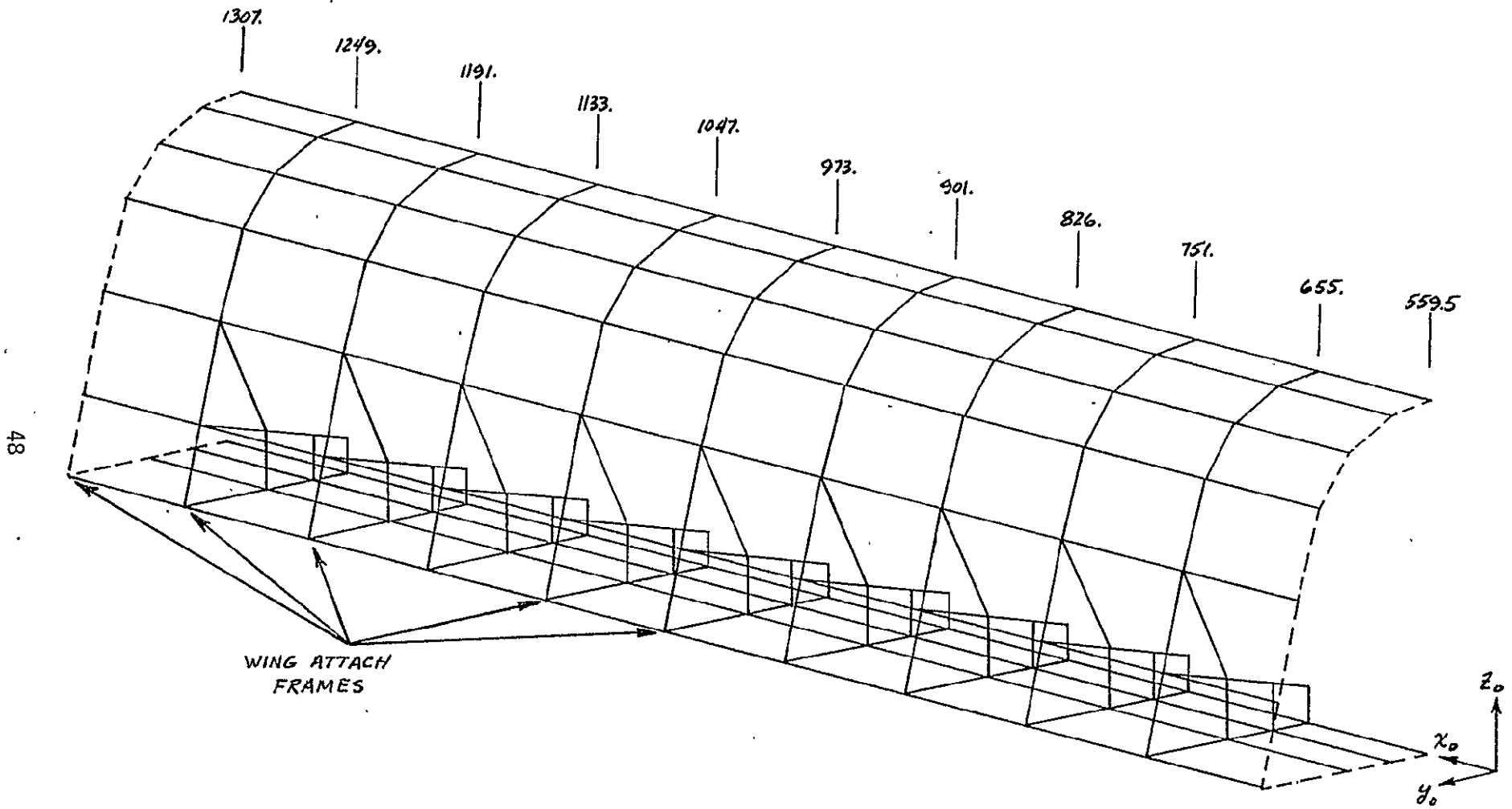

FIGURE 3-9: ORBITER - FUSELAGE PAYLOAD SECTION

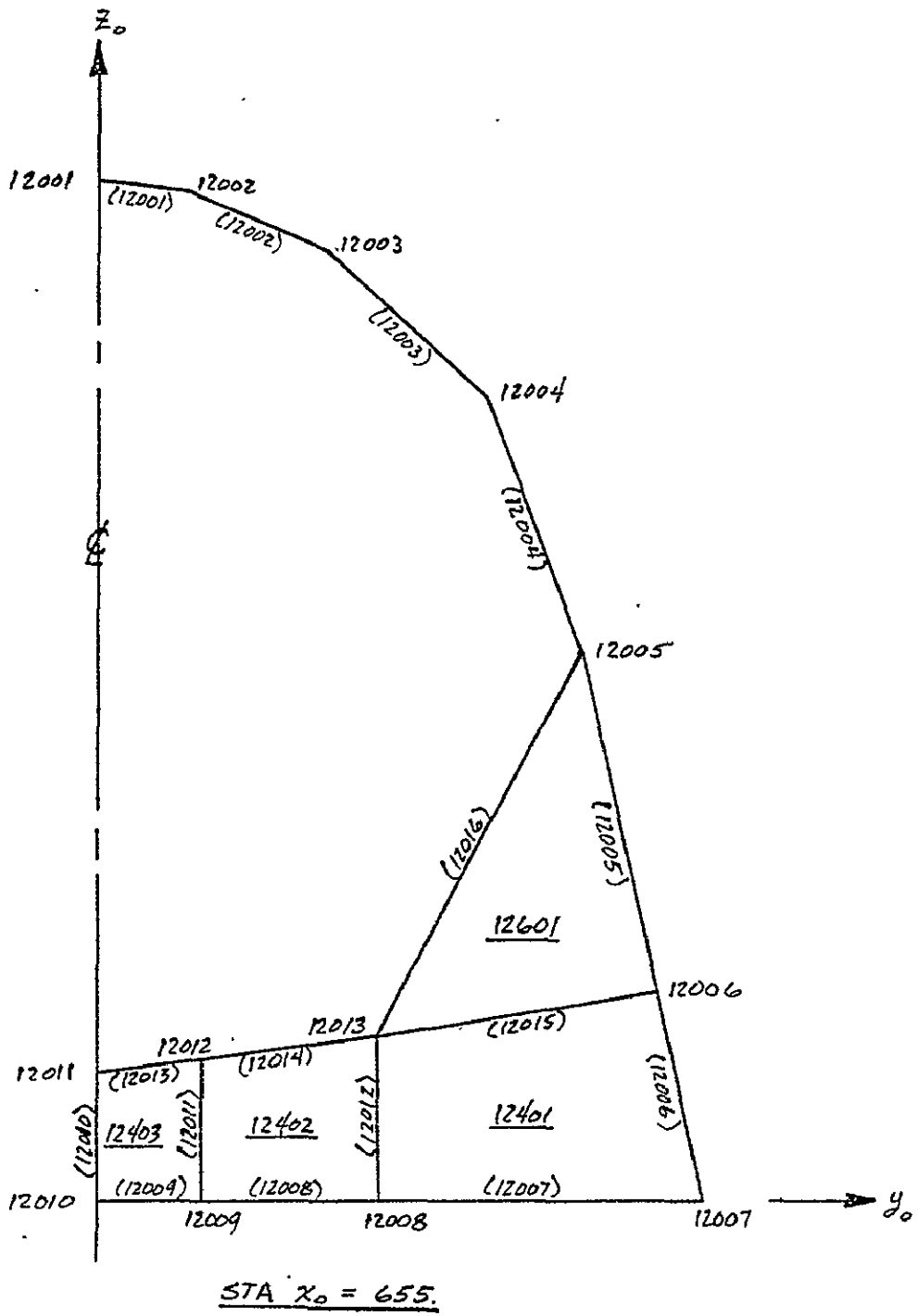

FIGURE 3-9: ORBITER - FUSELAGE PAYLOAD SECTION (Continued)

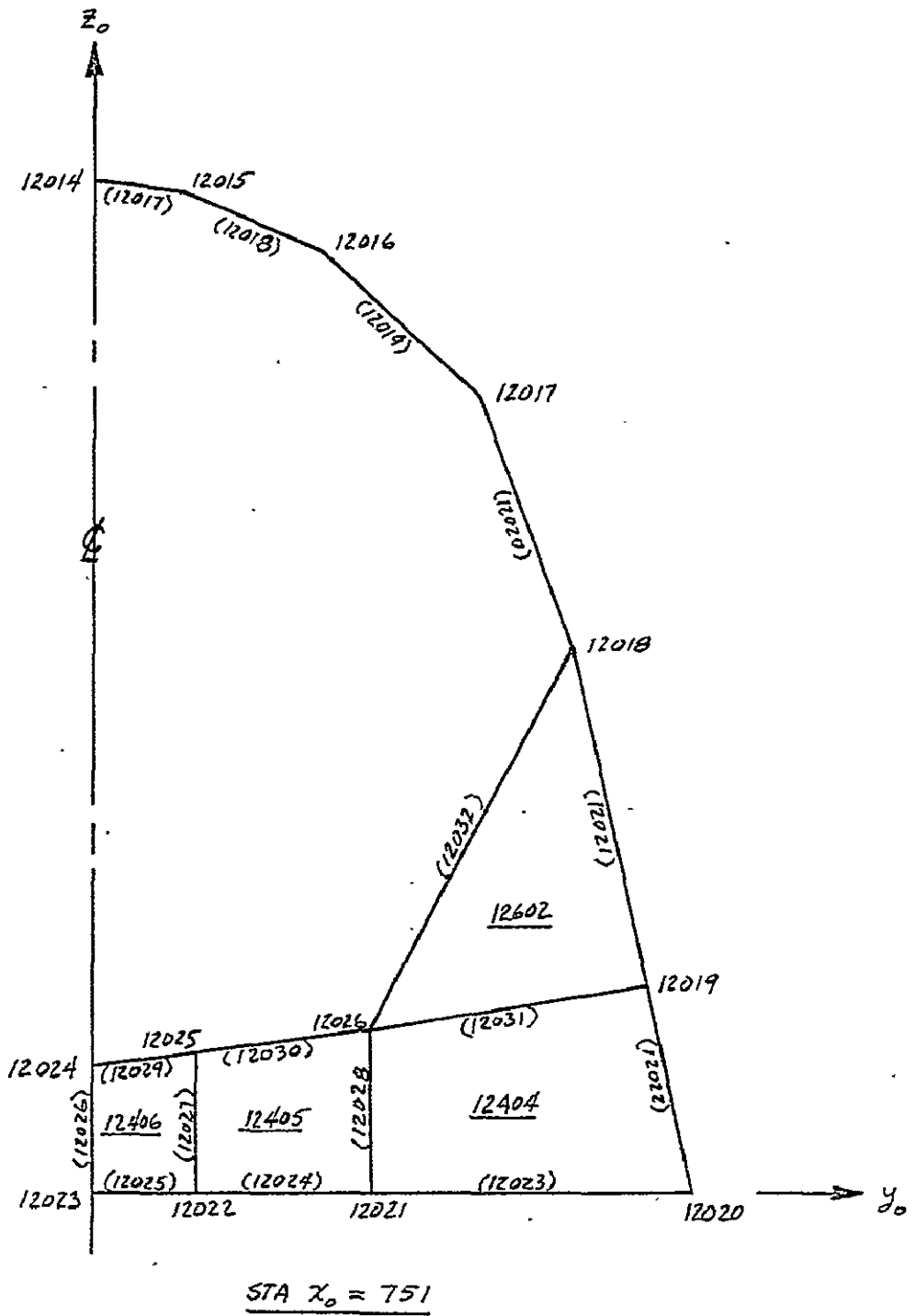

FIGURE 3-9: ORBITER + FUSELAGE PAYLOAD SECTION (Continued)

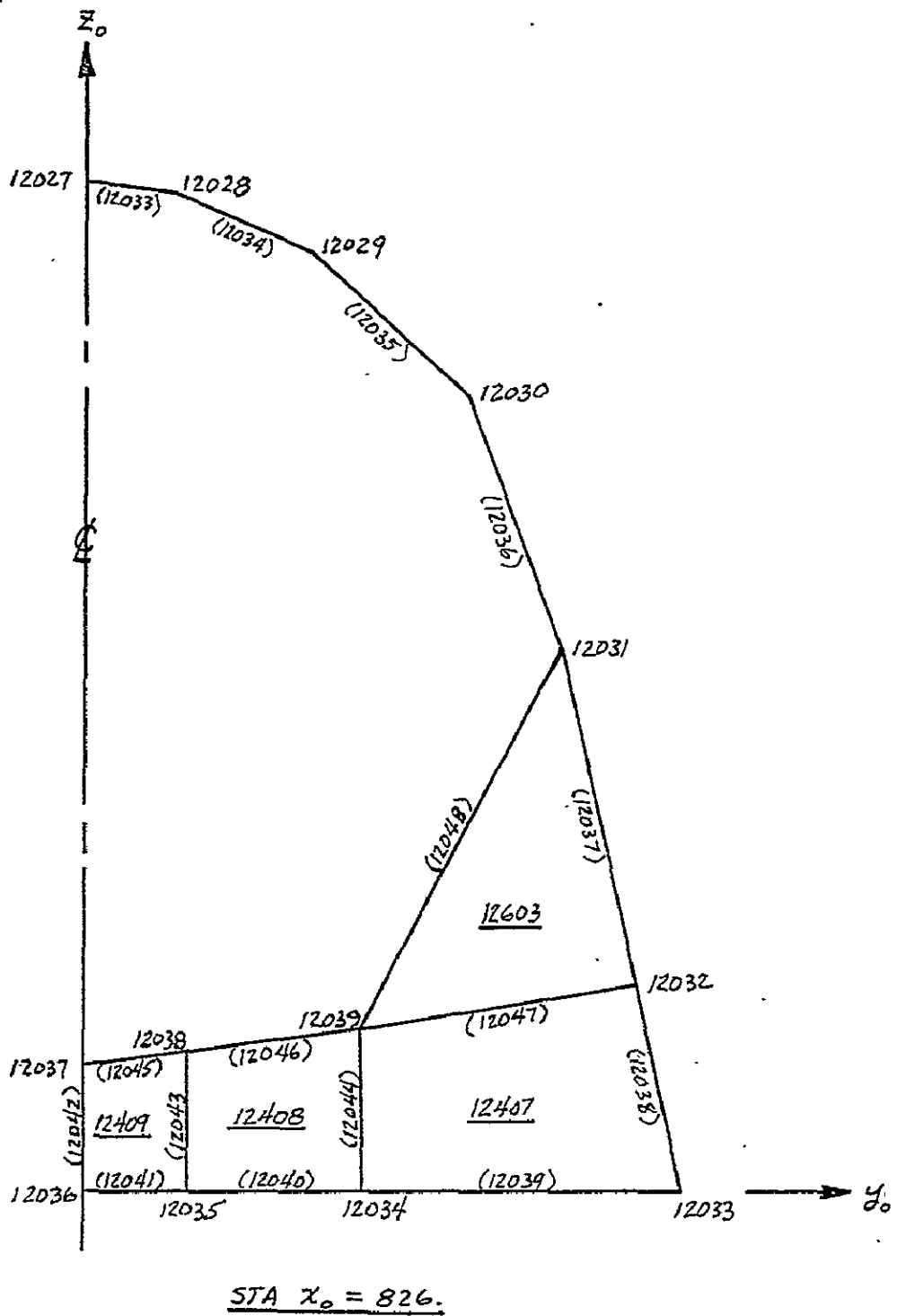

FIGURE 3-9: ORBITER - FUSELAGE PAYLOAD SECTION (Continued)

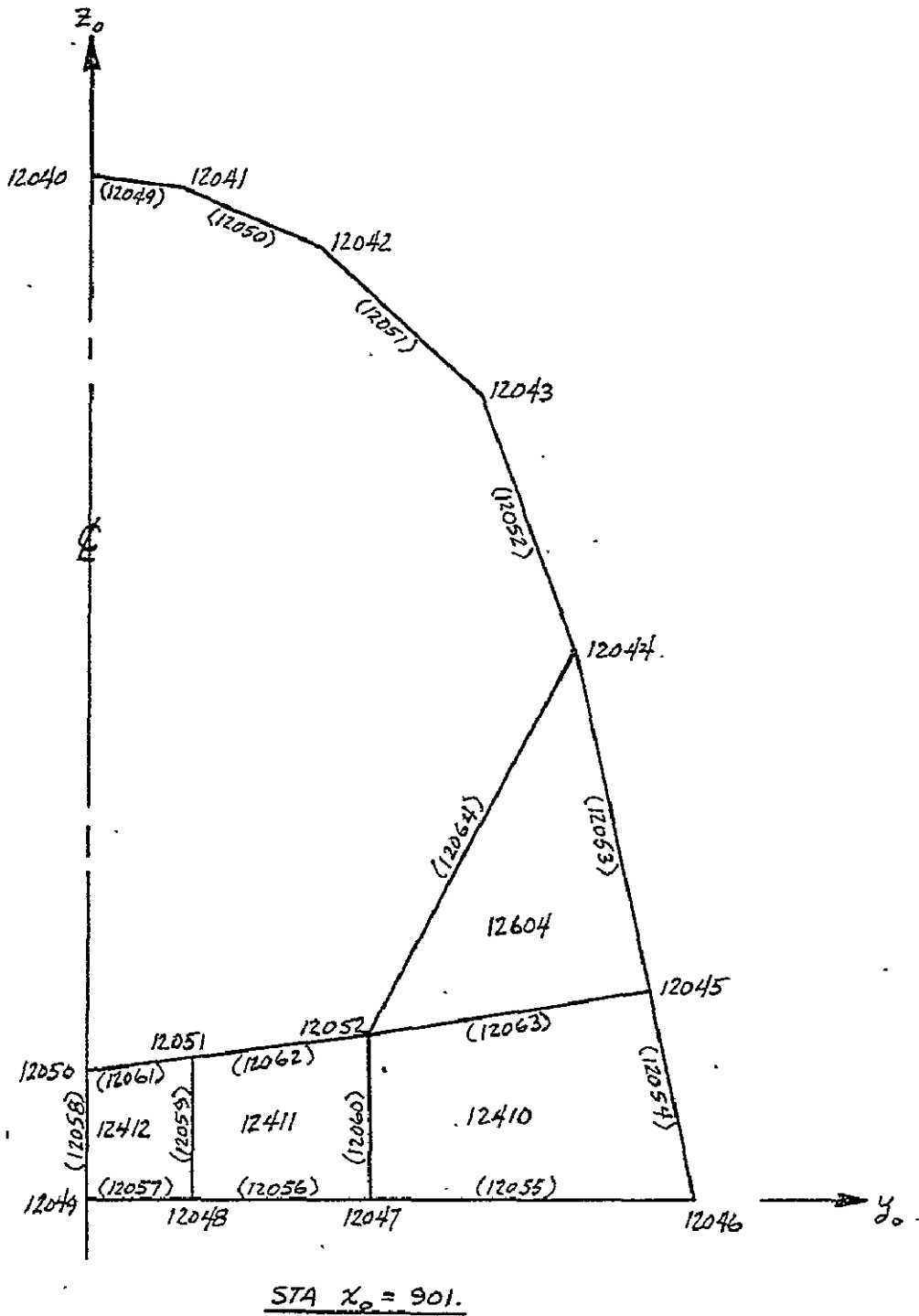

FIGURE 3-9: ORBITER - FUSELAGE PAYLOAD SECTION (Continued)

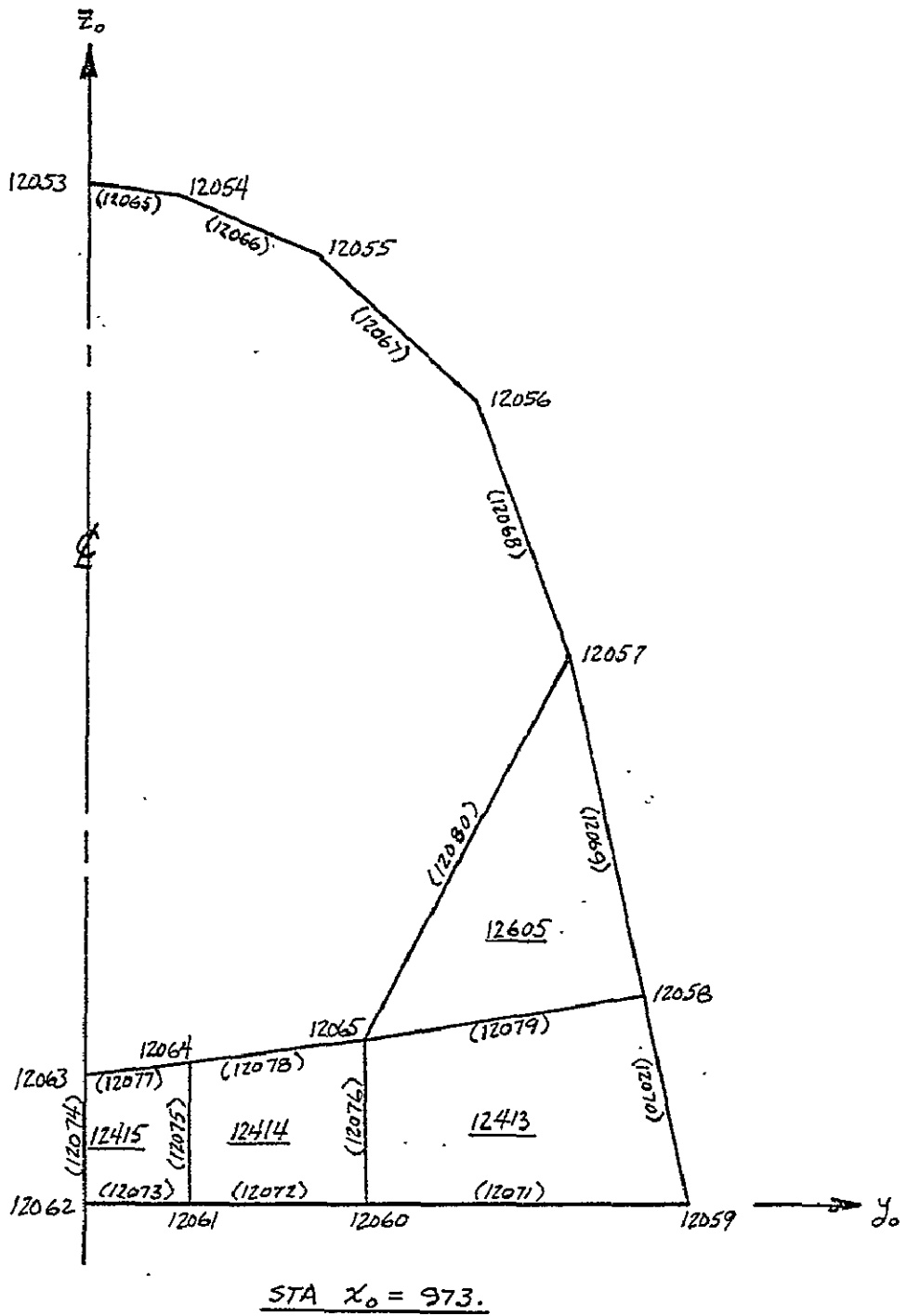

FIGURE 3-9: ORBITER - FUSELAGE PAYLOAD SECTION (Continued)

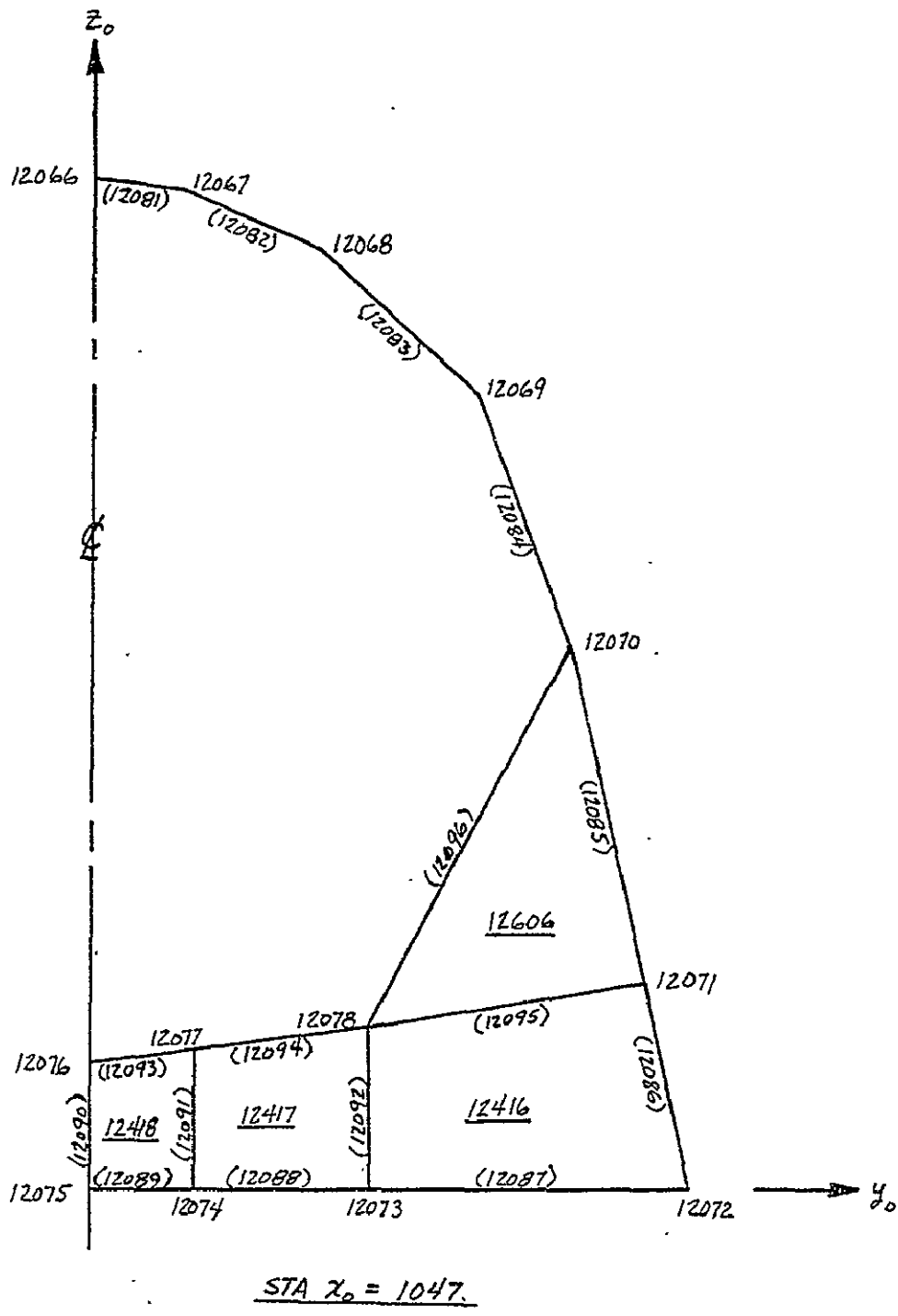

FIGURE 3-9: ORBITER - FUSELAGE PAYLOAD SECTION (Continued)

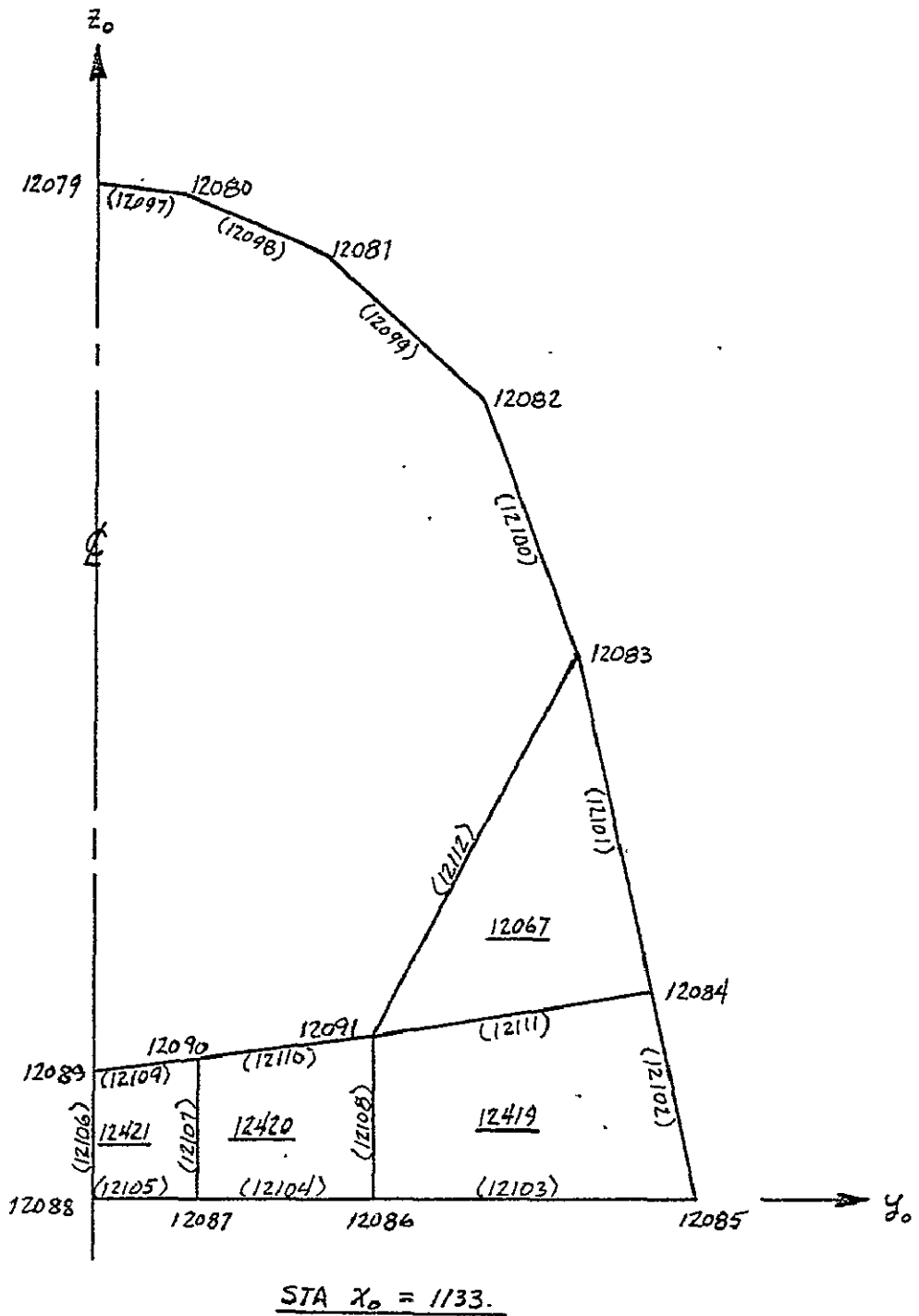

FIGURE 3-9: ORBITER - FUSELAGE PAYLOAD SECTION (Continued)

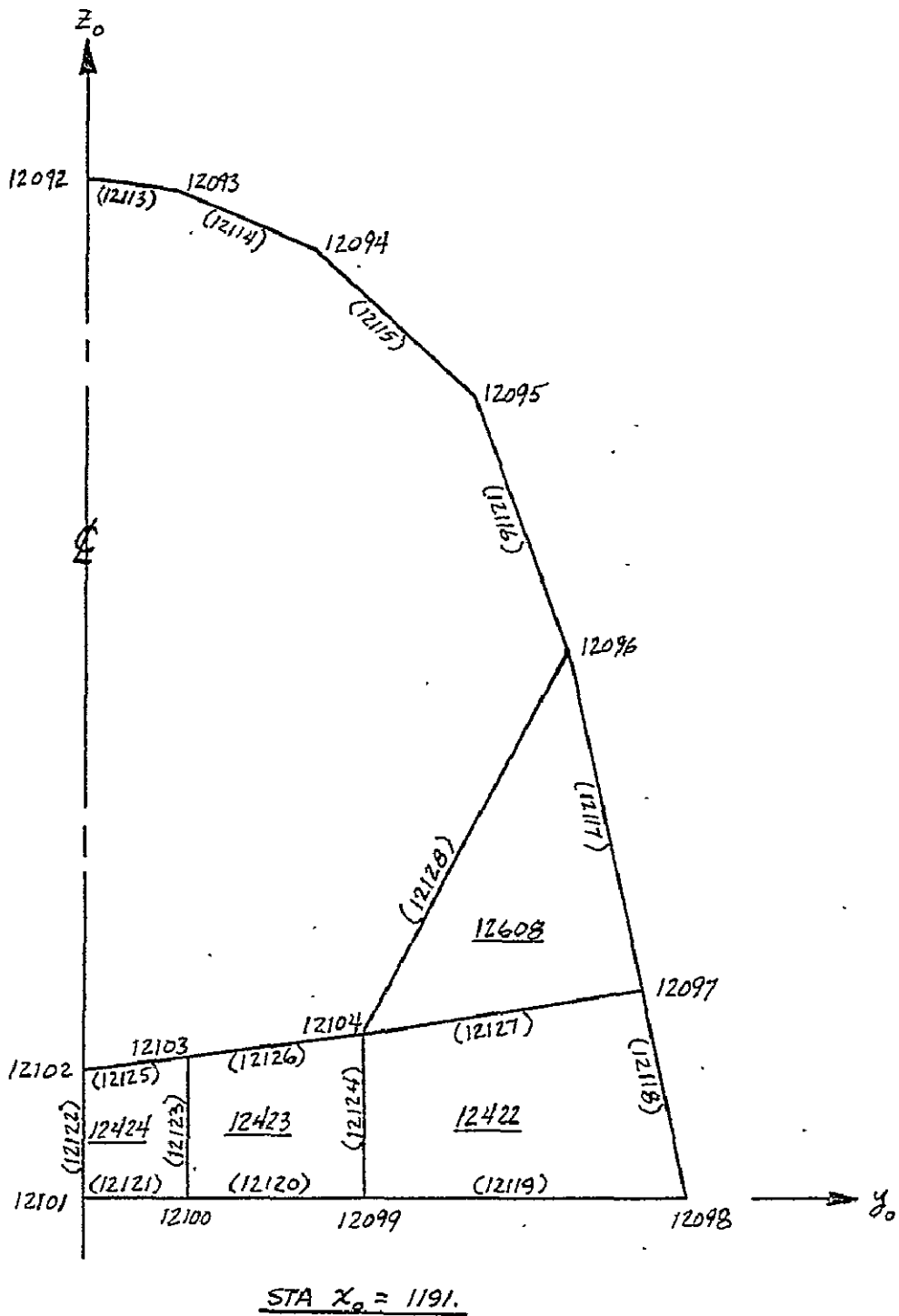

FIGURE 3-9: ORBITER - FUSELAGE PAYLOAD SECTION (Continued)

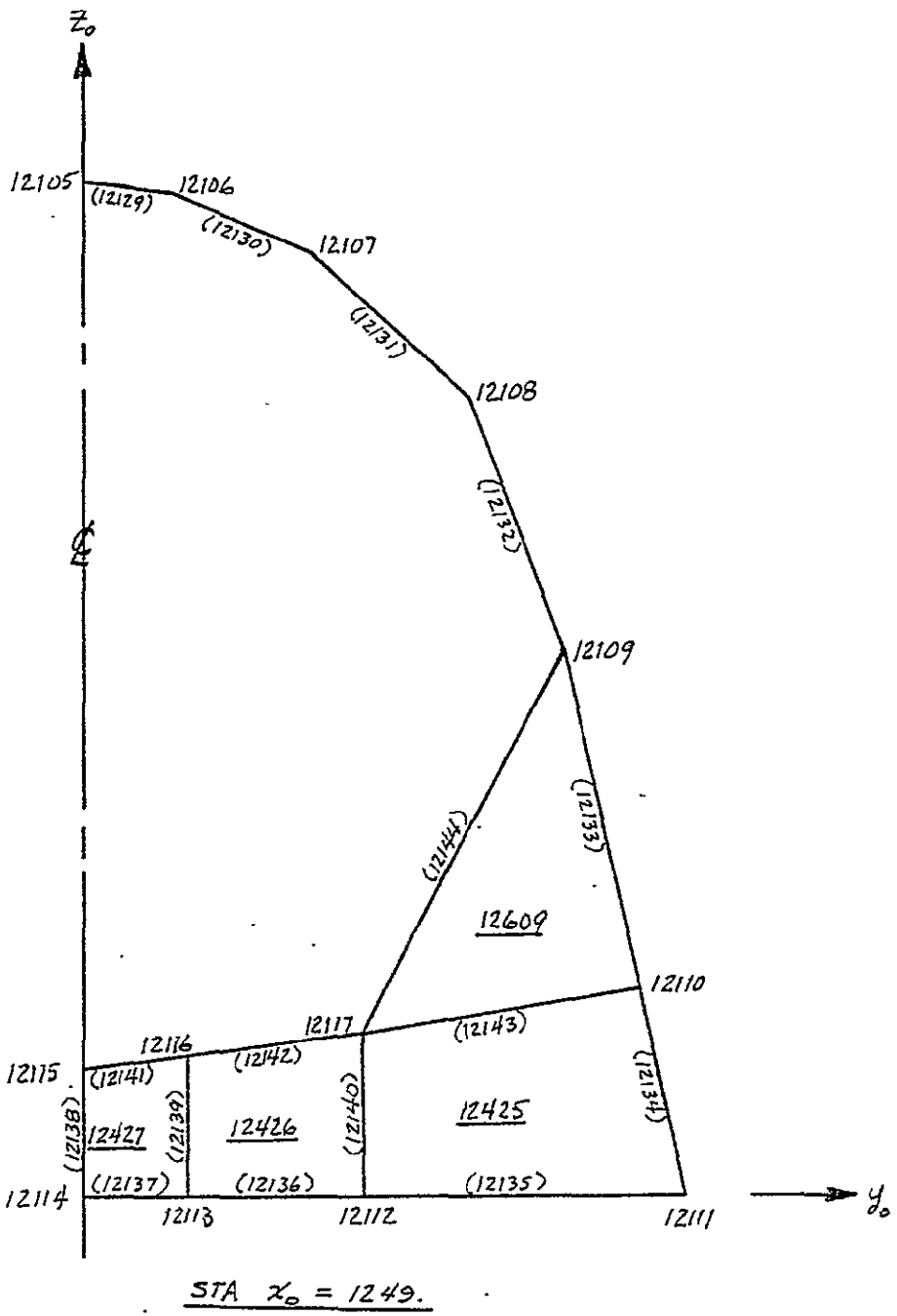

FIGURE 3-9: ORBITER - FUSELAGE PAYLOAD SECTION (Continued)

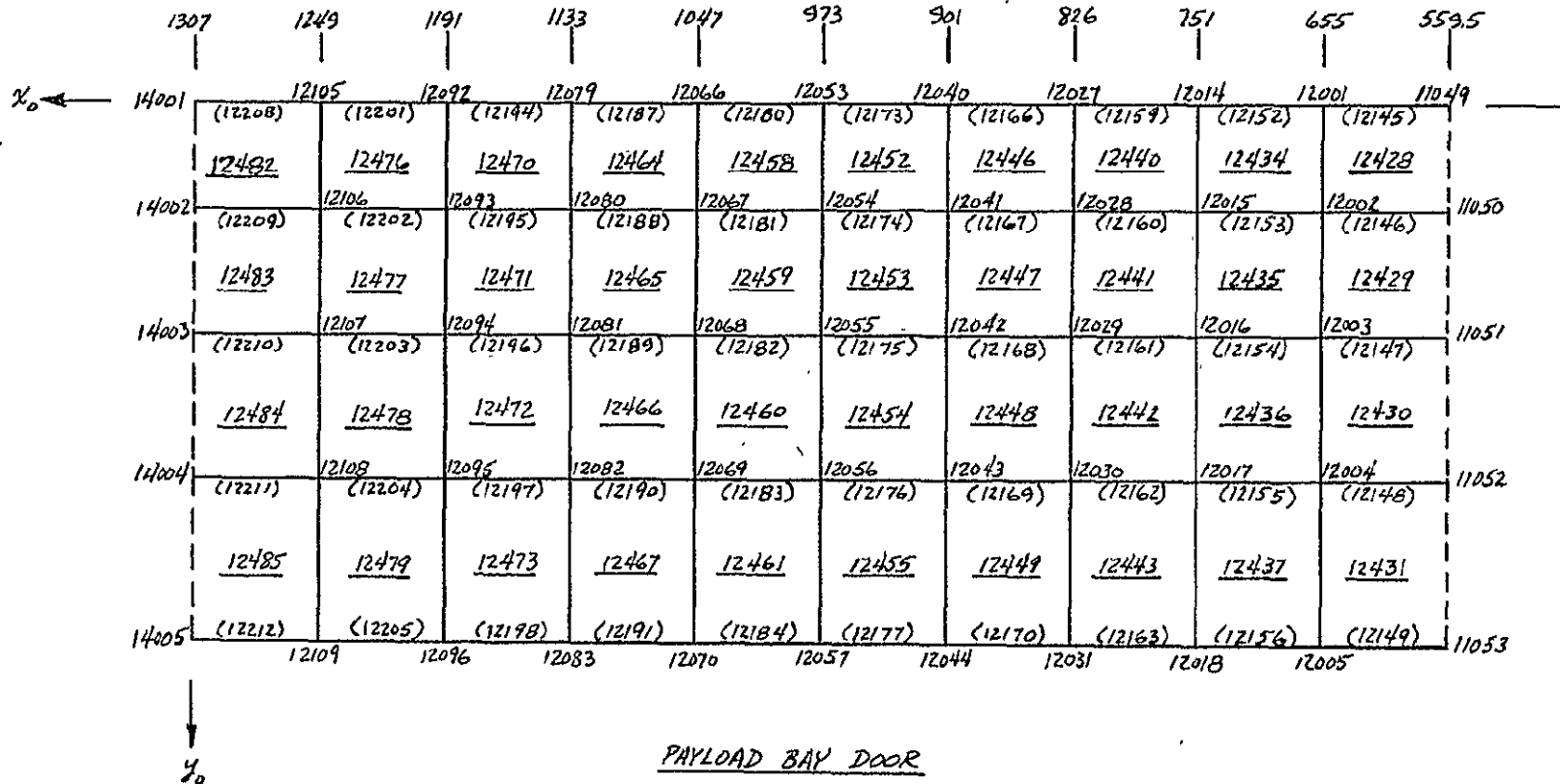

FIGURE 3-9: ORBITER - FUSELAGE PAYLOAD SECTION (Continued)

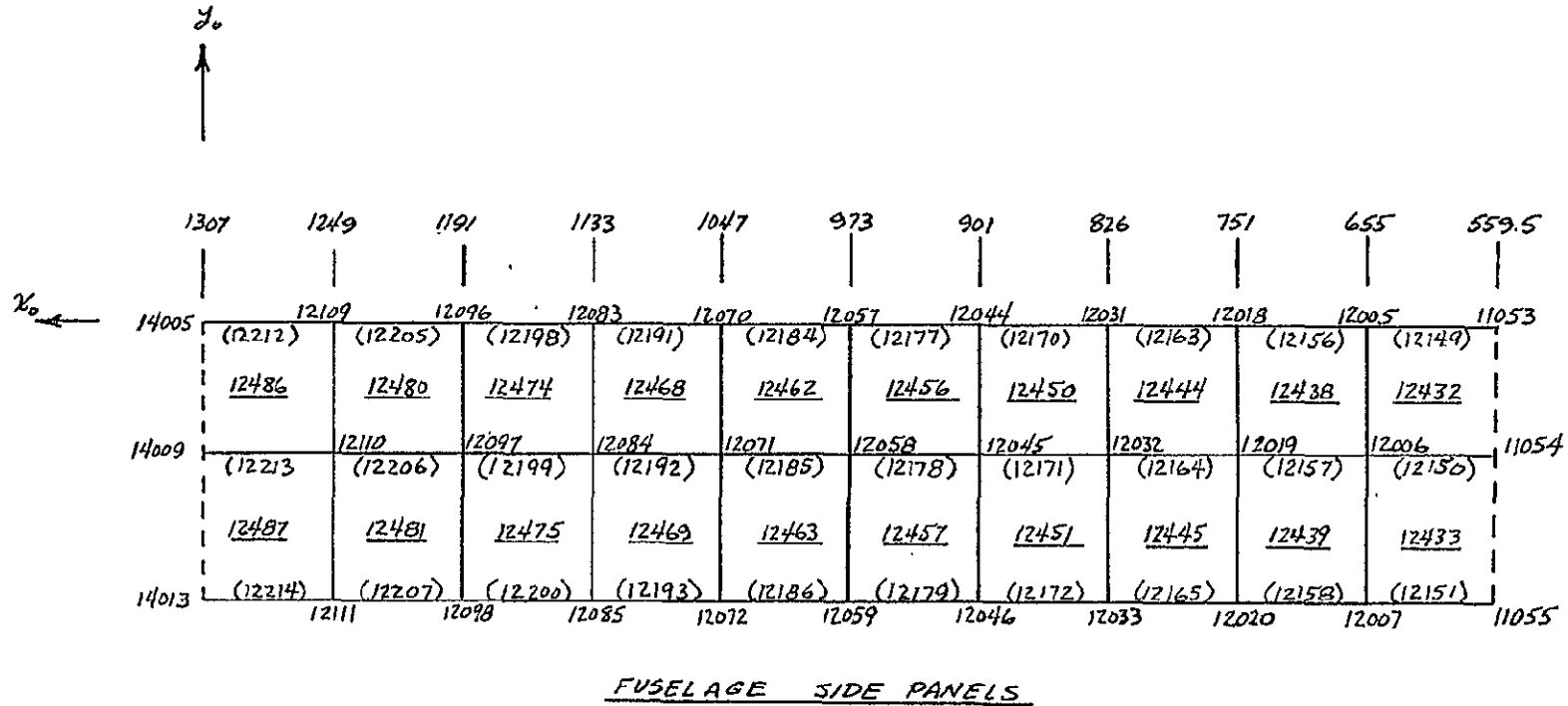

FIGURE 3-9: ORBITER - FUSELAGE PAYLOAD SECTION (Continued)

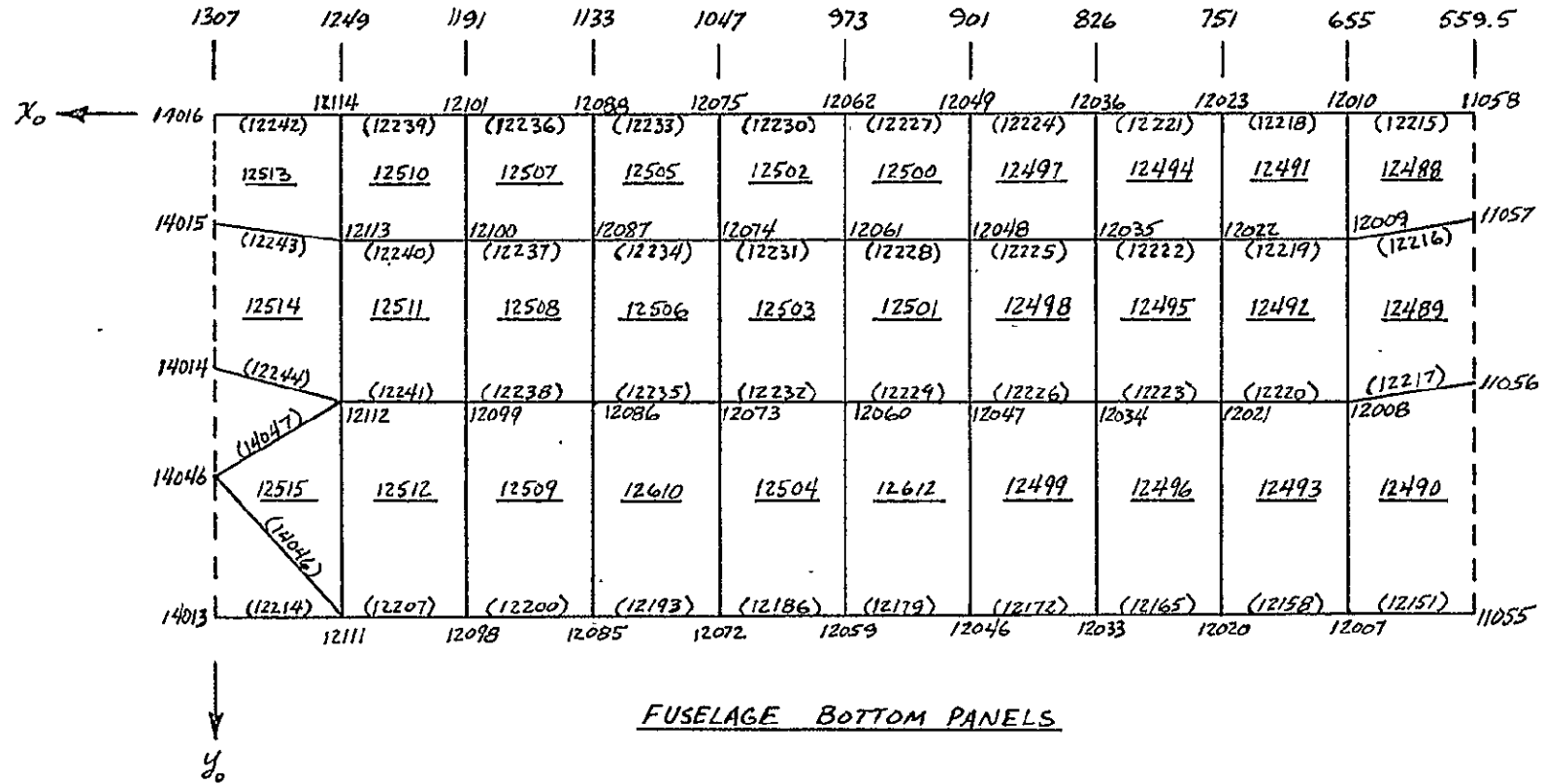

FIGURE 3-9: ORBITER - FUSELAGE PAYLOAD SECTION (Continued)

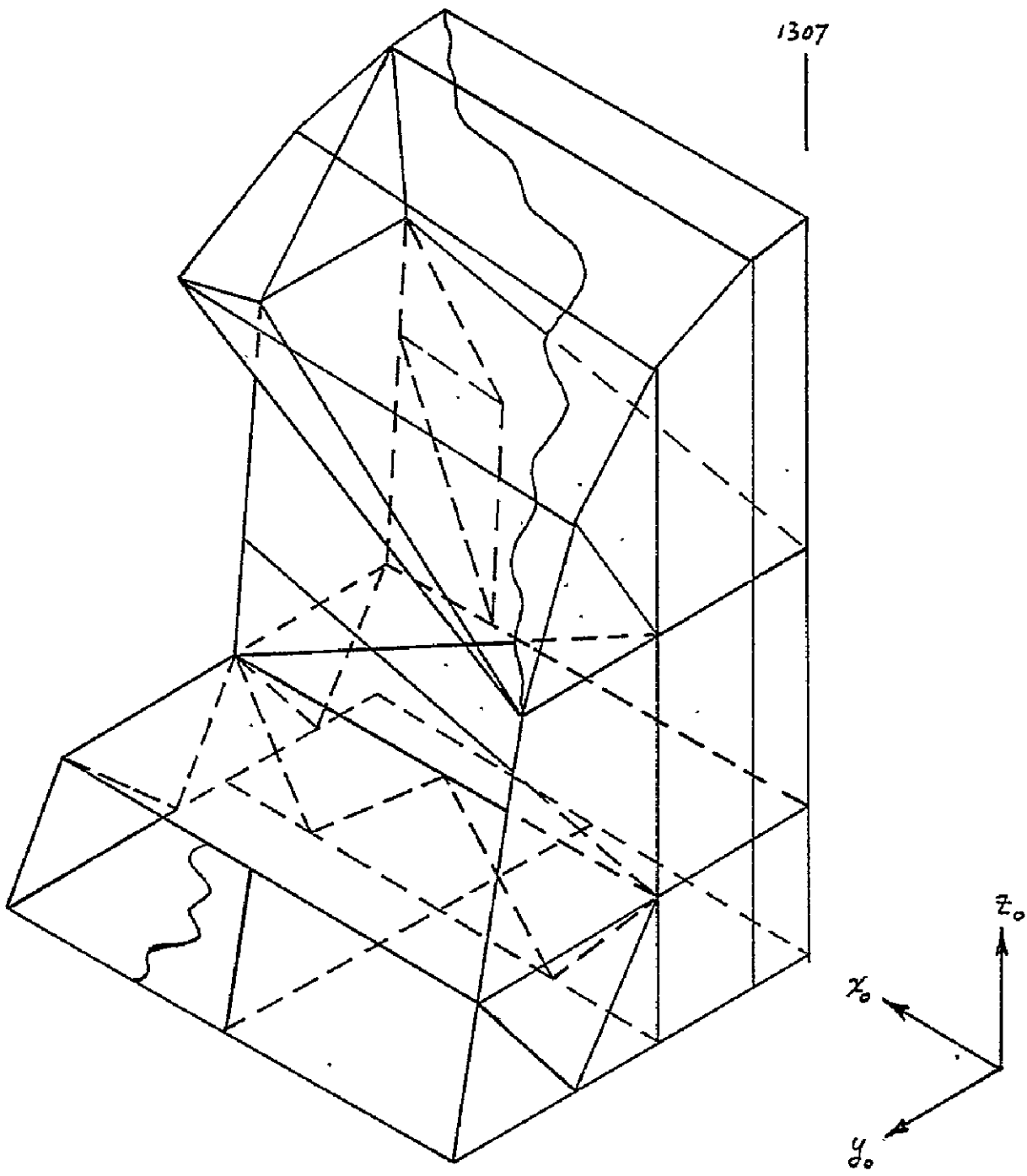
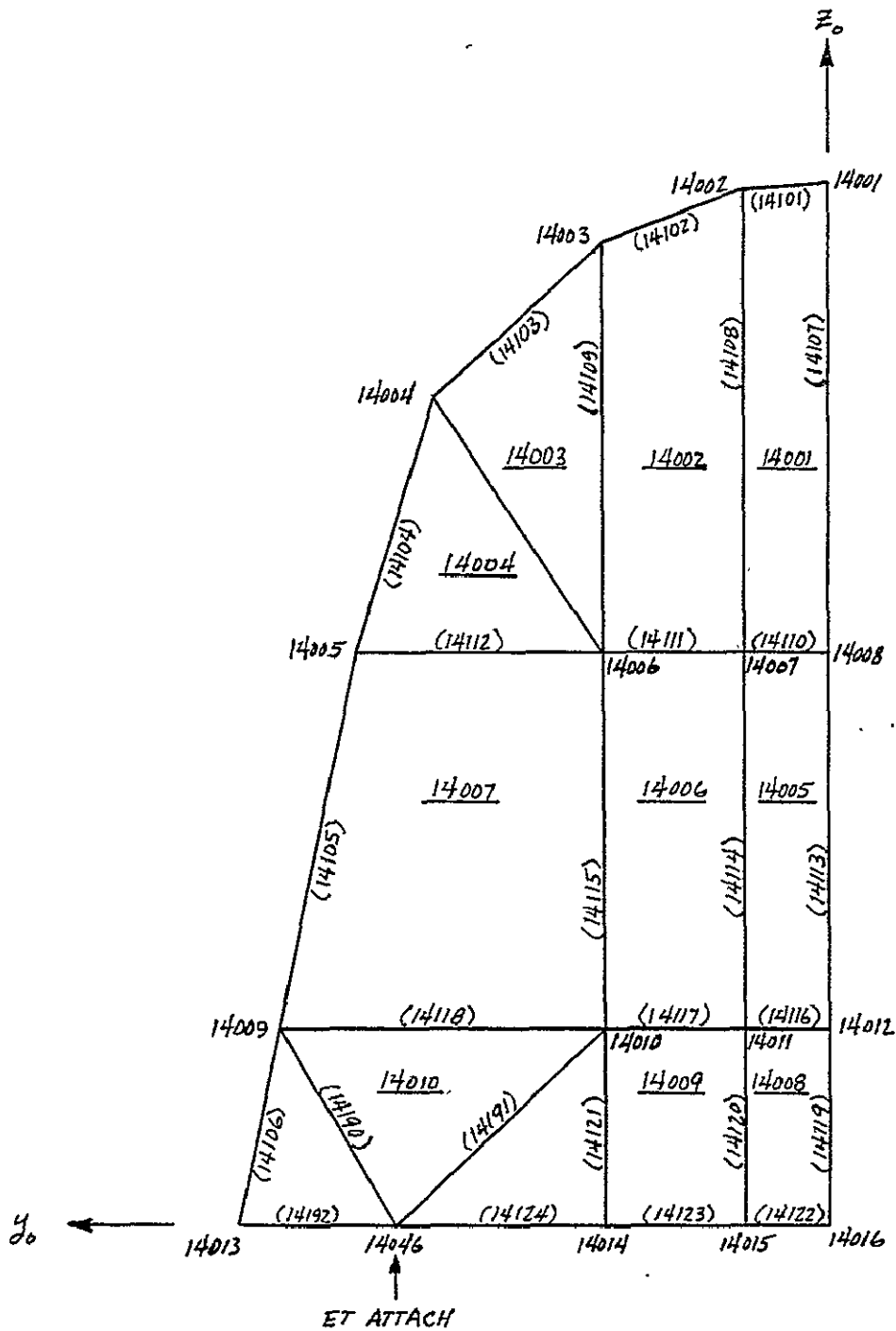

FIGURE 3-10: ORBITER - THRUST STRUCTURE



BULKHEAD STA X₀ = 1307

FIGURE 3-10: ORBITER - THRUST STRUCTURE (Continued)

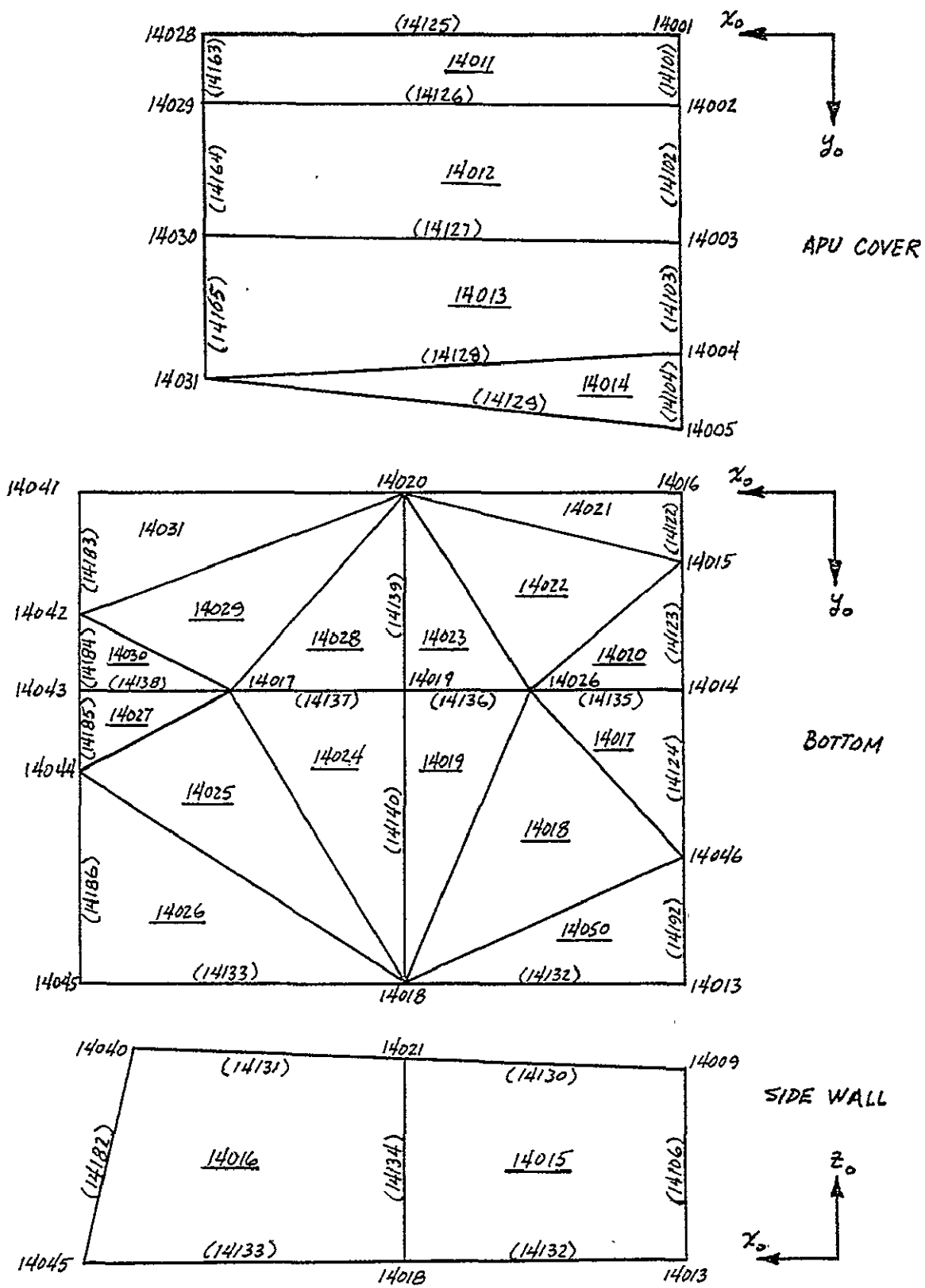
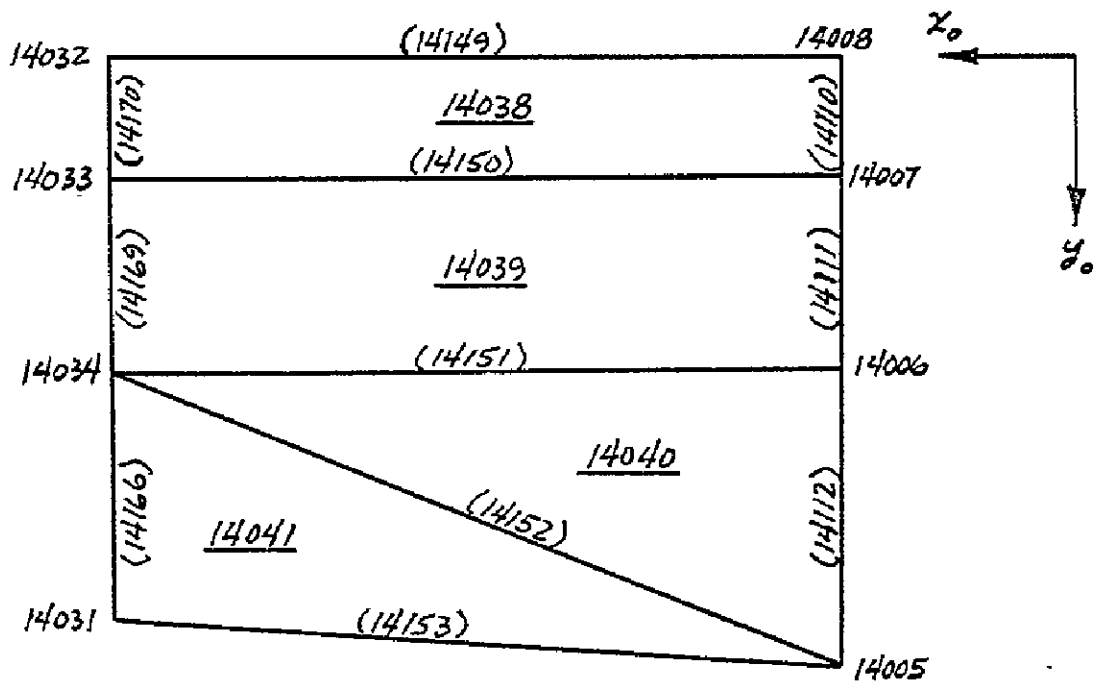

FIGURE 3-10: ORBITER - THRUST STRUCTURE (Continued)



UPPER THRUST SHELF

FIGURE 3-10: ORBITER - THRUST STRUCTURE (Continued)

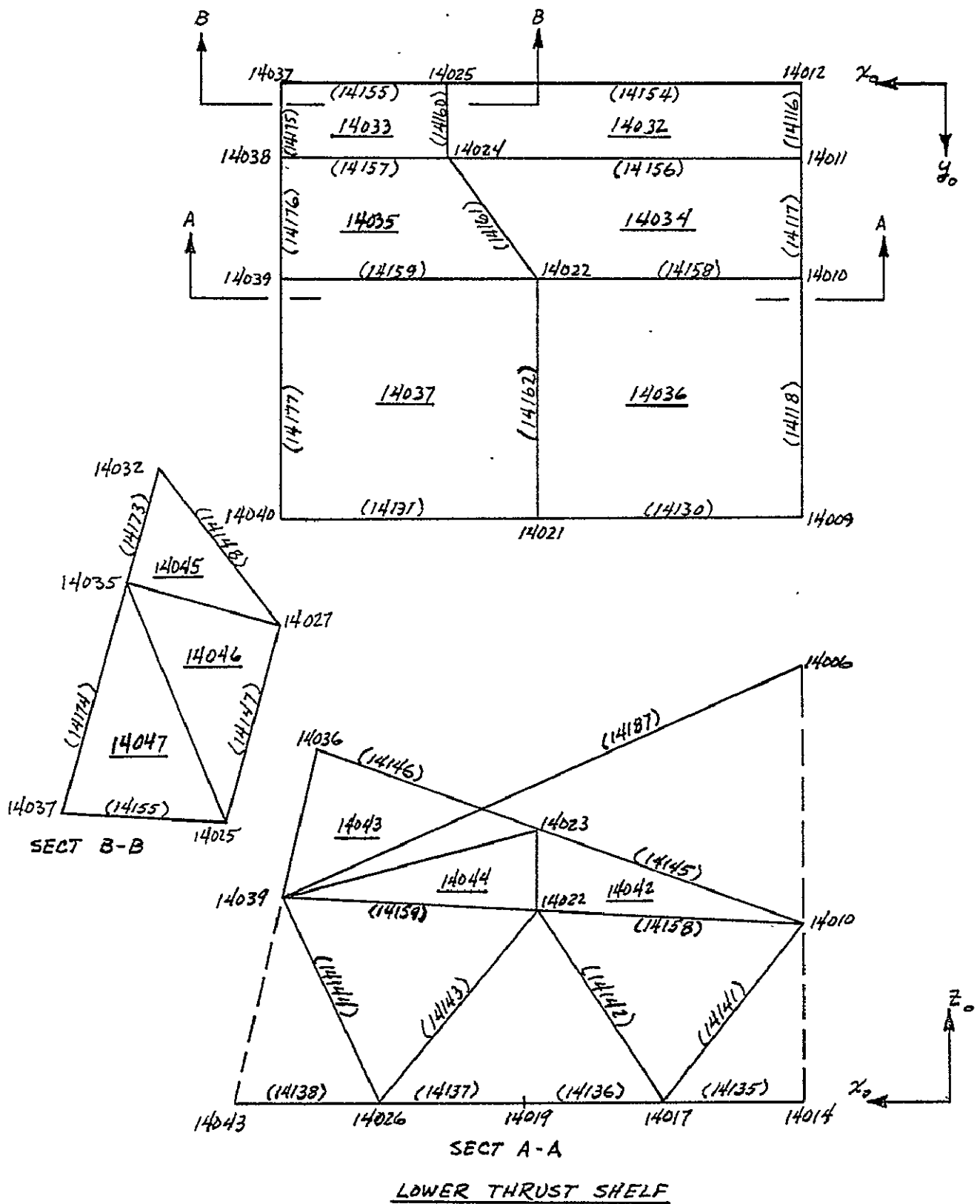

FIGURE 3-10: ORBITER - THRUST STRUCTURE (Continued)

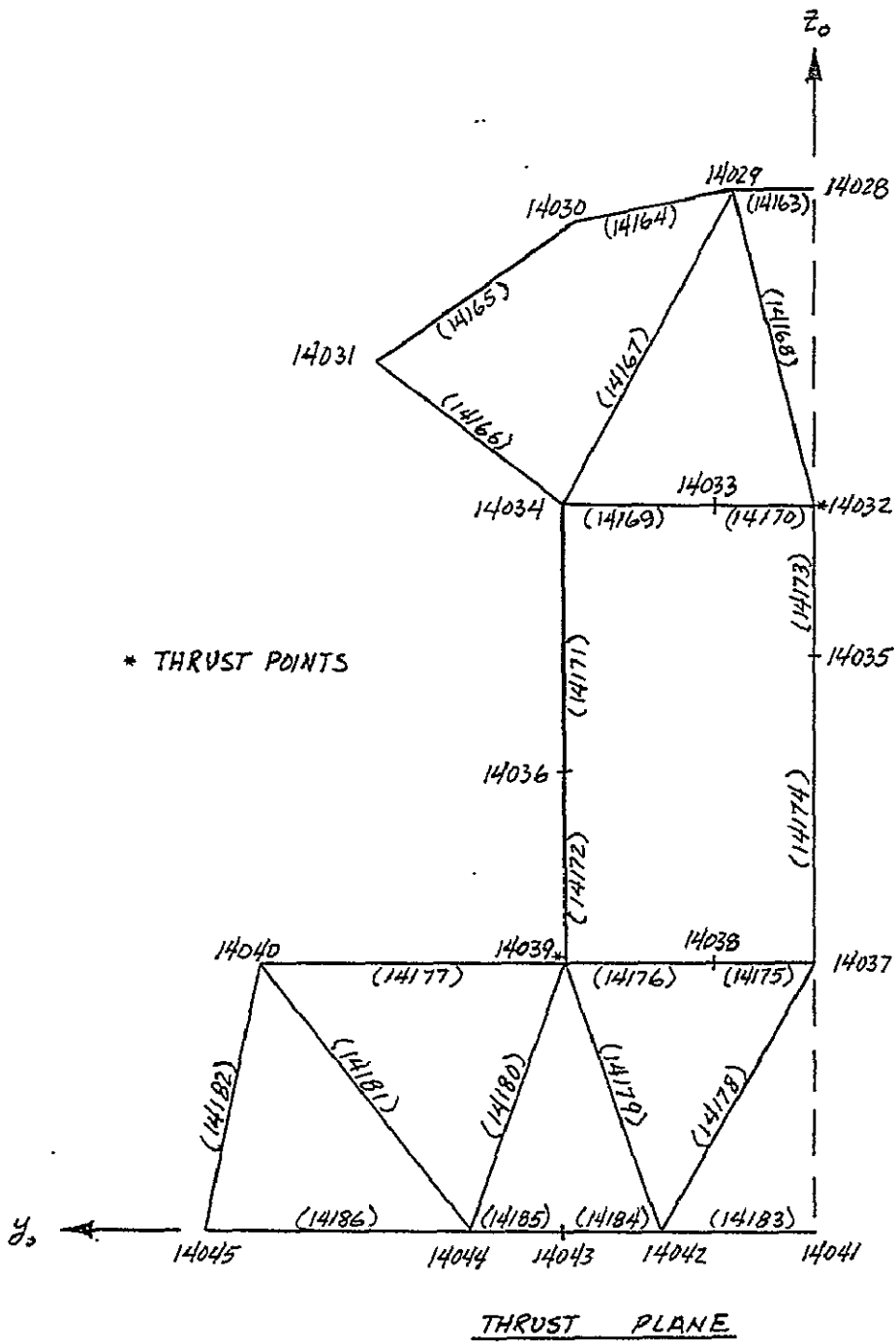

FIGURE 3-10: ORBITER - THRUST STRUCTURE (Continued)

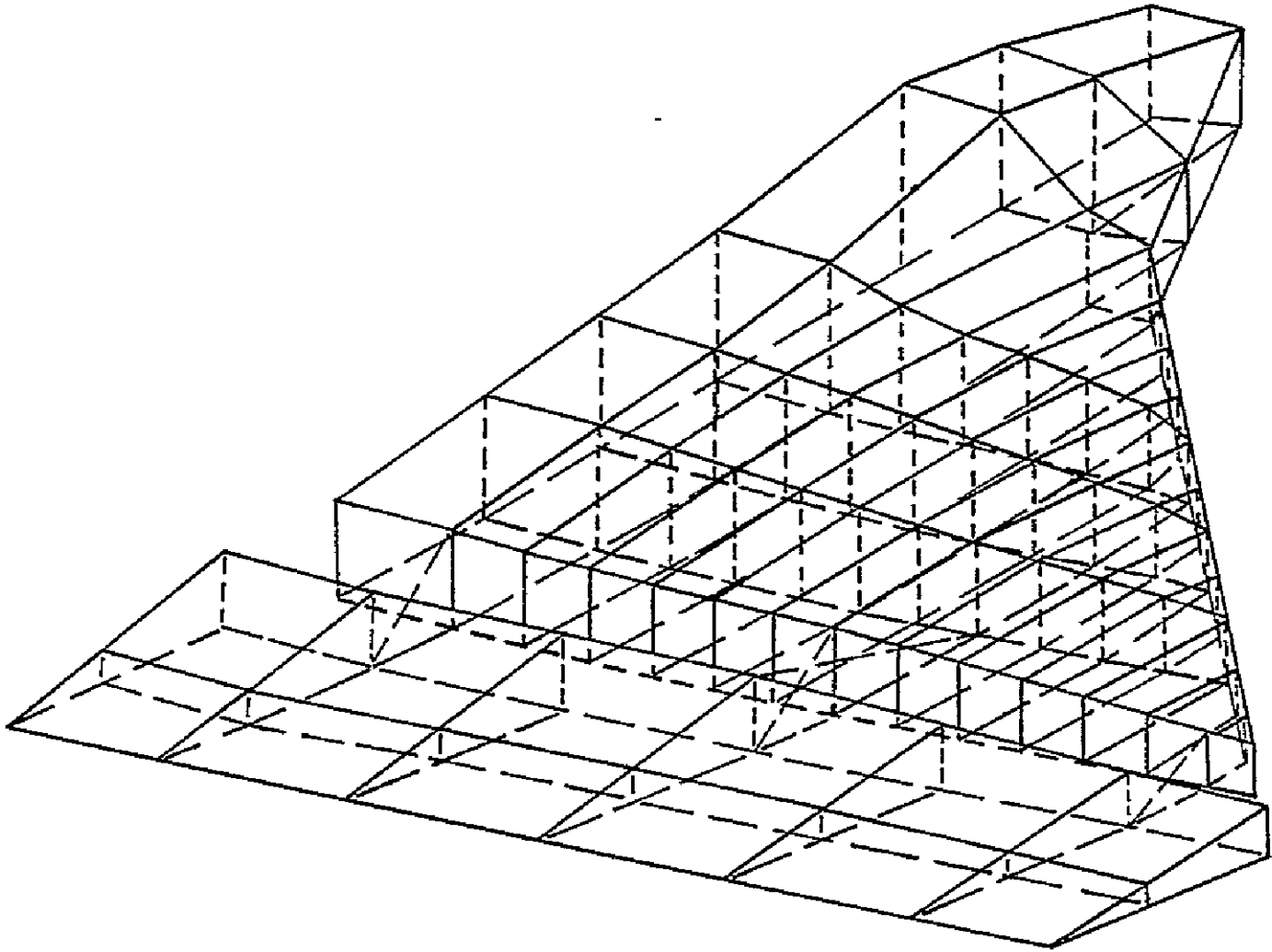

FIGURE 3-11: ORBITER - WING

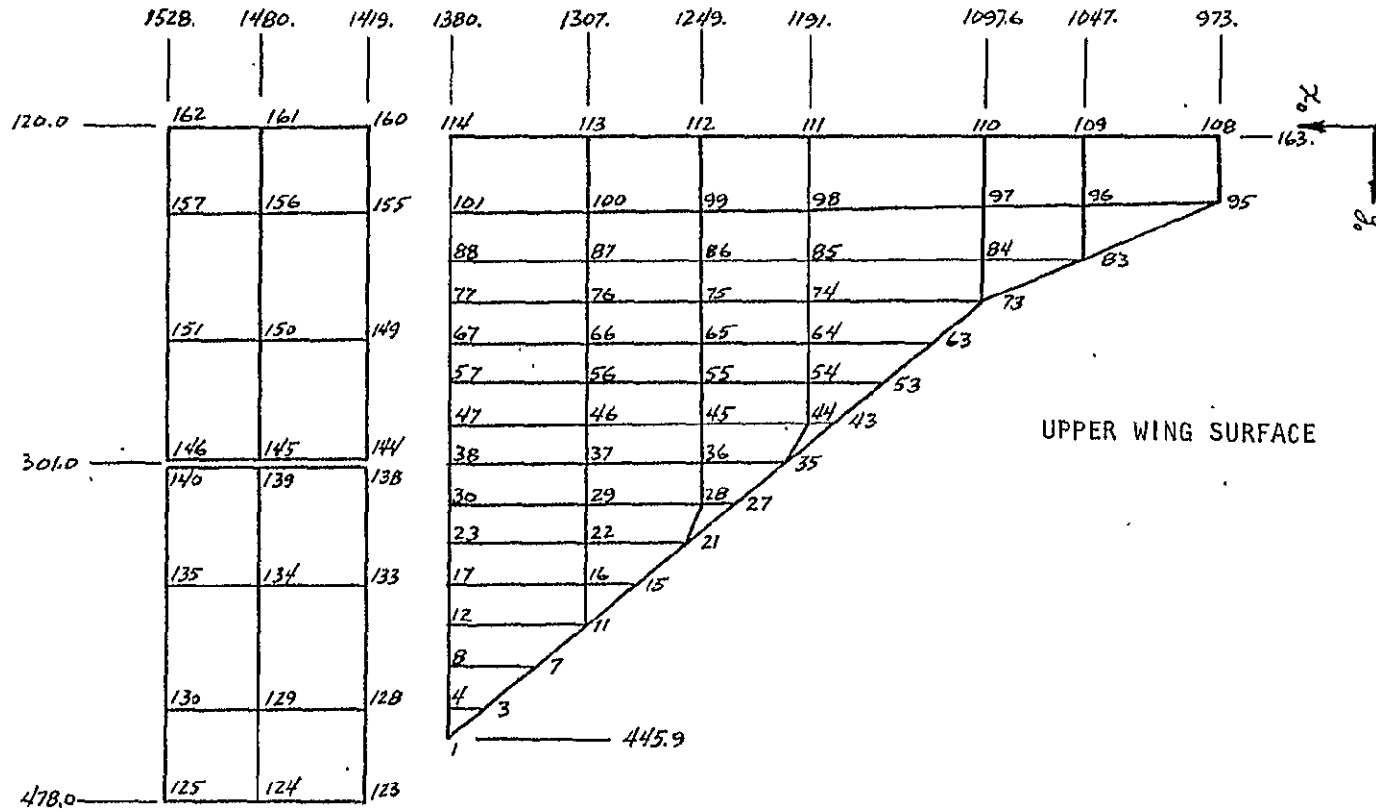

FIGURE 3-11: ORBITER - WING (Continued)

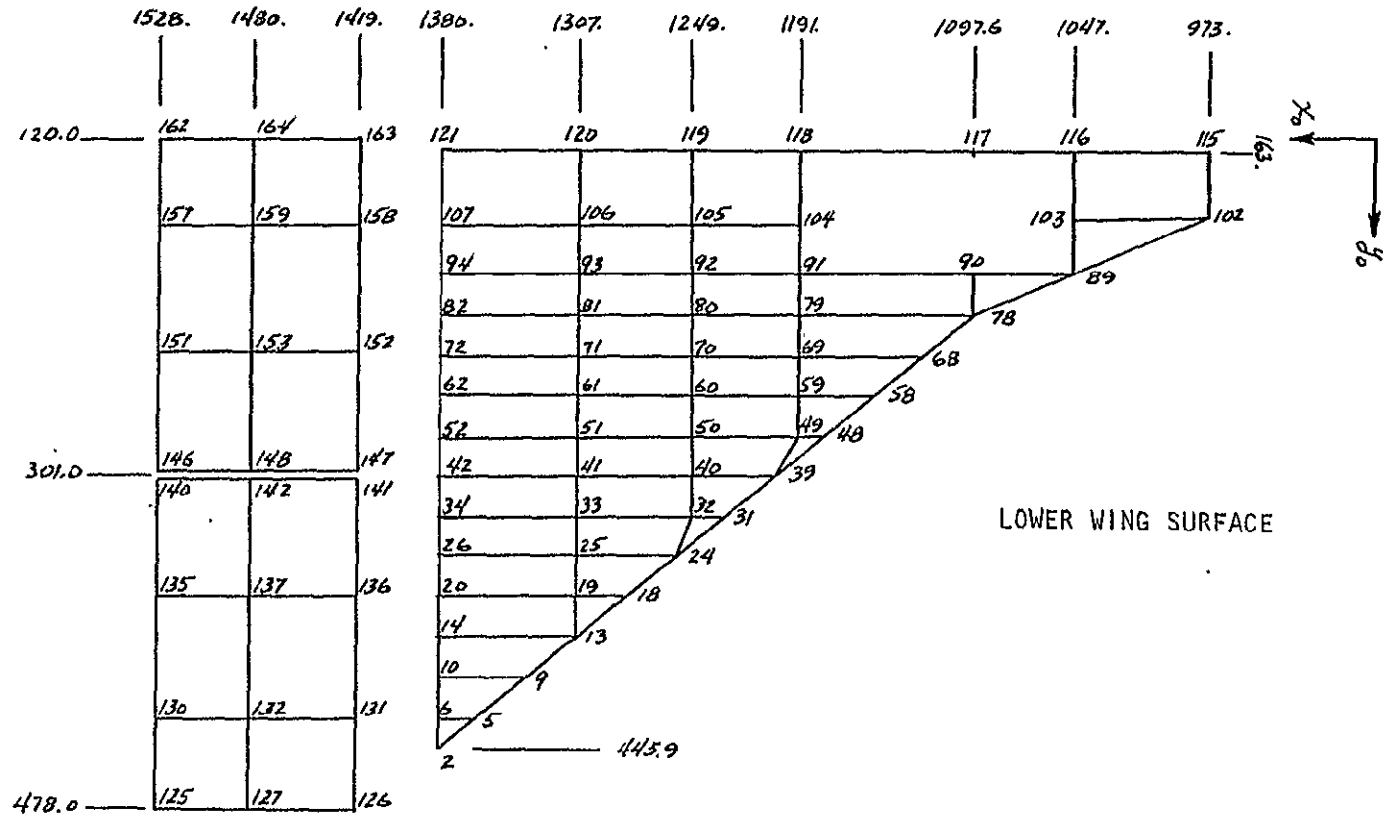

FIGURE 3-11: ORBITER - WING (Continued)

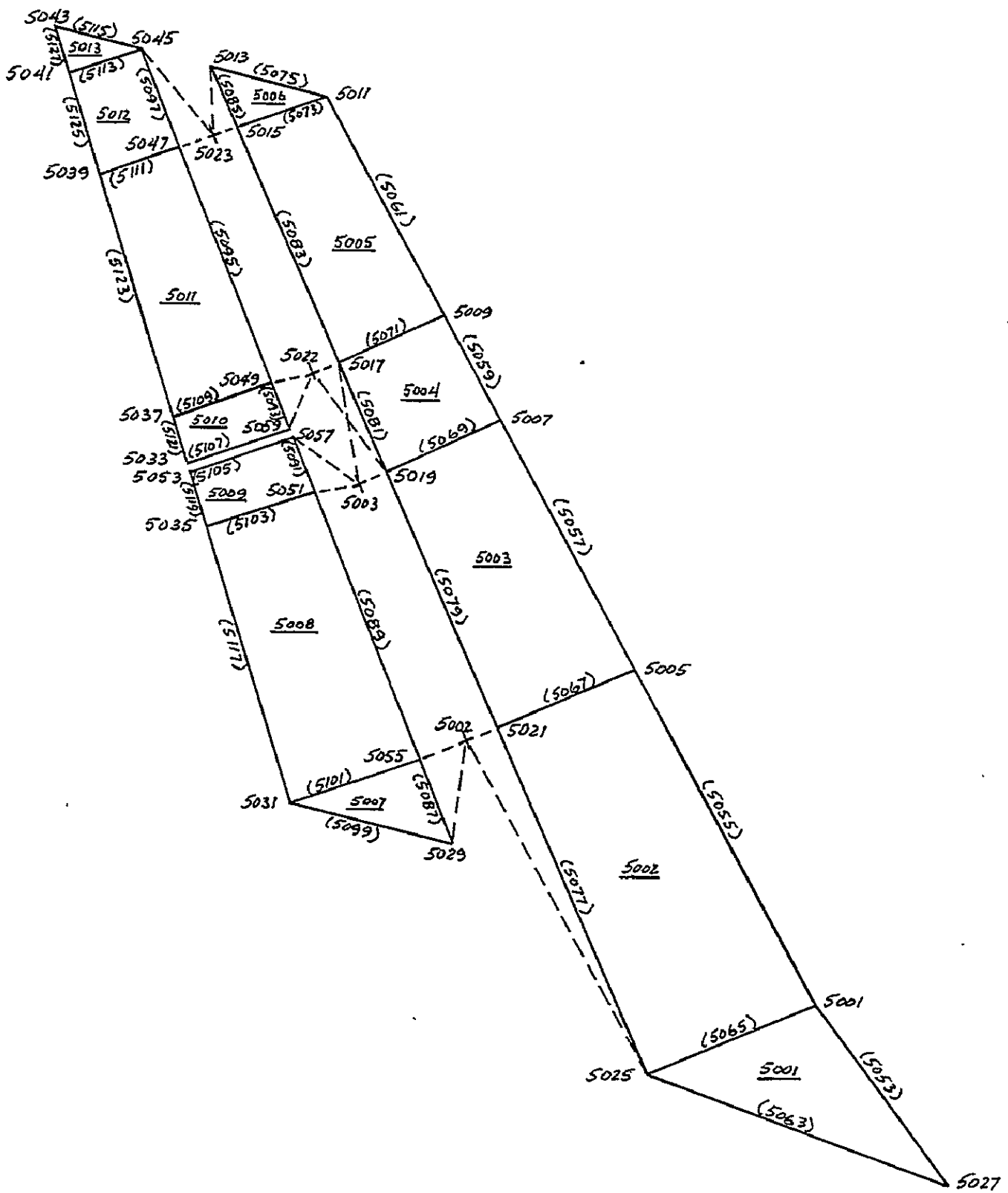

FIGURE 3-12: ORBITER - VERTICAL TAIL

Table 3-6: Orbiter Mass Data

GRID NUMBER	MASS kg(1b-sec ² /in)	GRID NUMBER	MASS kg(1b-sec ² /in)
11017	1290.5 (7.37)	13037	688.4 (3.93)
11021	390.3 (2.23)	13064	559.0 (3.19)
11023	1212.1 (6.92)	13066	605.1 (3.46)
11026	642.3 (3.67)	13096	500.1 (2.85)
11049	227.5 (1.30)	13098	618.8 (3.53)
11053	1791.7 (10.23)	13100	899.3 (5.13)
11055	837.5 (4.78)	13134	357.0 (2.04)
11058	670.8 (3.83)	13156	355.0 (2.04)
12018	2695.8 (15.40)	14001	287.3 (1.64)
12020	661.9 (3.78)	14005	2208.4 (12.61)*
12023	384.4 (2.20)	14013	748.2 (4.27)
12044	2651.7 (15.14)	14016	1420.0 (8.11)*
12046	564.9 (3.23)	14029	94.1 (0.54)
12049	231.4 (1.32)	14032	399.1 (2.28)
12070	2289.8 (13.08)	14034	2759.6 (15.76)
12072	663.9 (3.79)	14039	719.8 (4.11)
12075	204.0 (1.16)	14042	446.2 (2.55)
12096	1720.1 (9.82)	14045	546.2 (3.12)
12098	667.8 (3.81)	5001	553.1 (3.16)
12101	182.4 (1.04)	5005	105.9 (0.61)
13001	111.8 (0.64)	5007	100.0 (0.57)
13016	424.6 (2.43)	5011	424.6 (2.42)
13035	233.4 (1.33)	5015	88.2 (0.50)
		5019	196.1 (1.12)
		5021	140.2 (0.80)

* Includes OMS Kit Mass

3.1.4 Payload

The payload is modeled as a rigid body as shown in Figure 3-13. Its mass properties represent the Large Space Telescope (LST). The attachment structure is modeled using BAR elements with pin flags to represent the statically determinant payload supports. The weight of the Orbital Maneuvering Subsystem (OMS) kit in the aft portion of the payload bay is included in the weights on the aft bulkhead (forward bulkhead of the thrust structure). Payload and OMS kit mass properties are shown in Table 3-7.

3.2 STRUCTURAL JOINTS AND DAMPING

Structural joints were included in each of the three half-model vehicles. The joints were inserted in the structure by the preprocessor computer program. Free-free mode shapes of each vehicle were obtained with arbitrary damping in the joints to provide a starting point for the determination of proper joint damping coefficients. ET and SRM damping constants were calculated by hand while the damping coefficients for the orbiter were calculated using the joint damping predictor computer program. All damping parameters were calculated at liftoff.

A study was performed to determine the extent of Coulomb type damping in the SRM/ET forward attachment ball joint and the orbiter/ET aft attachment ball joint. An equivalent viscous damping coefficient (Reference 9) was calculated for the SRM/ET forward attachment as follows:

$$C = \frac{4F}{\pi A \omega} \quad (35)$$

where:

- F = μF_n = friction force
- A = amplitude of motion
- ω = frequency of vibration
- μ = friction coefficient
- F_n = normal force

For rotational motion, the friction force in Equation (35) is replaced by the friction moment and the amplitude of motion is in radians. Using the moment due

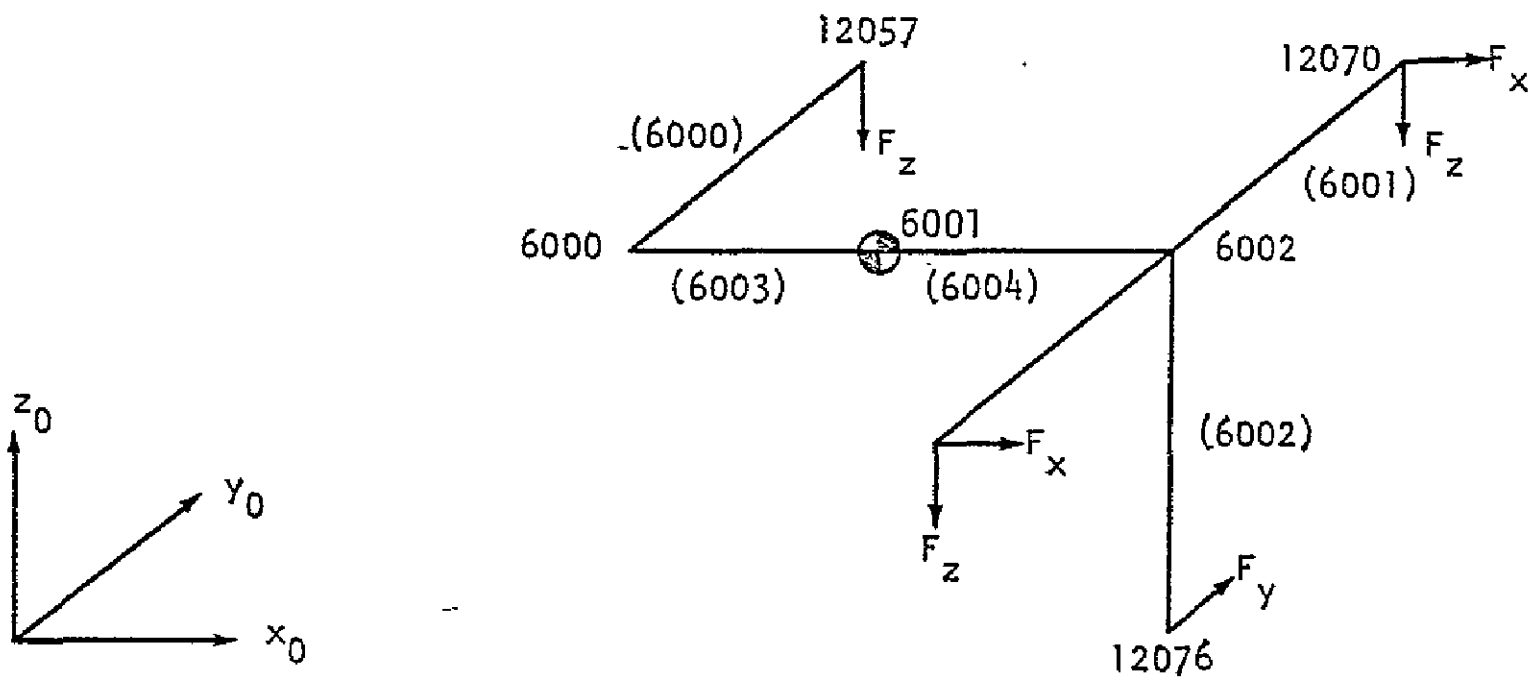

FIGURE 3-13: PAYLOAD MATH MODEL

Table 3-7: Payload and OMS Mass Data

PAYLOAD (half-model)

W	-	3715. kg	(21.2 lb-sec ² /in.)
I _x	-	2657. kg-m ²	(50040. lb-in-sec ²)
I _y	-	28850. kg-m ²	(2.552x10 ⁵ lb-in-sec ²)
I _z	-	28850. kg-m ²	(2.552x10 ⁵ lb-in-sec ²)

OMS KIT (half-model)

W	-	2723. kg	(15.54 lb-sec ² /in.)
---	---	----------	----------------------------------

to the preload in the ball joint bolt (8.9×10^6 N x .178 m), a friction coefficient of 0.46, an estimated amplitude of rotation of 2.43×10^{-3} radians, and a frequency of 18.8 rad/sec, the equivalent viscous damping coefficient is 2.0×10^7 N-m/rad/sec. Applying this damping to the Space Shuttle modes given in Reference 10, results in unrealistically high modal damping for some of the modes. It is concluded that the high preloads in the ball joints preclude joint motion and therefore no coulomb damping is generated. Further, it is assumed that the spherical bearings designed into the SRM/ET aft attachment struts, the Orbiter/ET forward struts and the Orbiter/ET aft support truss contribute negligible damping to structural deformations. Therefore all structural damping is assumed to be generated by internal structural deformations of the joints in the Shuttle components and by material damping.

Desired modal damping values were obtained from the empirical damping study performed for the Space Shuttle in Reference 4. In that study, expressions were derived which relate energy dissipation per cycle (D) to the kinetic energy (T) of the vehicle based on data obtained from existing space vehicles. Two expressions were derived for bending: One which includes Saturn I data and one which does not.

For bending (without Saturn I data):

$$D = .153 T^{.893} \quad (36)$$

For bending (with Saturn I data included):

$$D = .286 T^{.746} \quad (37)$$

For longitudinal modes:

$$D = .057 T^{1.104} \quad (38)$$

For torsion modes:

$$D = .101 T^{1.279} \quad (39)$$

where D and T are in SI units.

Equivalent viscous damping is related to energy dissipation per cycle and kinetic energy.

$$\zeta = \frac{D}{4\pi T} \quad (40)$$

Therefore, an expression for equivalent viscous damping can be obtained for bending, longitudinal motion and torsion from Equations (36) - (39).

For bending (with Saturn I data):

$$\zeta_{B1} = \frac{.286}{4\pi} T^{-.254} \quad (41)$$

For bending (without Saturn I data):

$$\zeta_{B2} = \frac{.153}{4\pi} T^{-.110} \quad (42)$$

For longitudinal motion:

$$\zeta_L = \frac{.057}{4\pi} T^{.104} \quad (43)$$

For torsional motion:

$$\zeta_T = \frac{.101}{4\pi} T^{.279} \quad (44)$$

Kinetic energy, written in terms of modal parameters, is:

$$T = \frac{1}{2} M_{\omega}^2 X^2 \quad (45)$$

where M is the generalized mass in kilogram, ω is the modal frequency in radians per second, and X is the modal displacement in meters.

A similar study was performed for a Boeing 747 airplane, and the results are documented in Reference 5. Energy dissipation versus kinetic energy are shown in Figure 3-14. The best straight line fit through these data points was found using linear least-squares regression and is shown in Figure 3-14. The equation of this line is:

$$D = .2196(T)^{.911} \quad (46)$$

Also shown in the figure is the line derived by Chang (Reference 11) whose equation is:

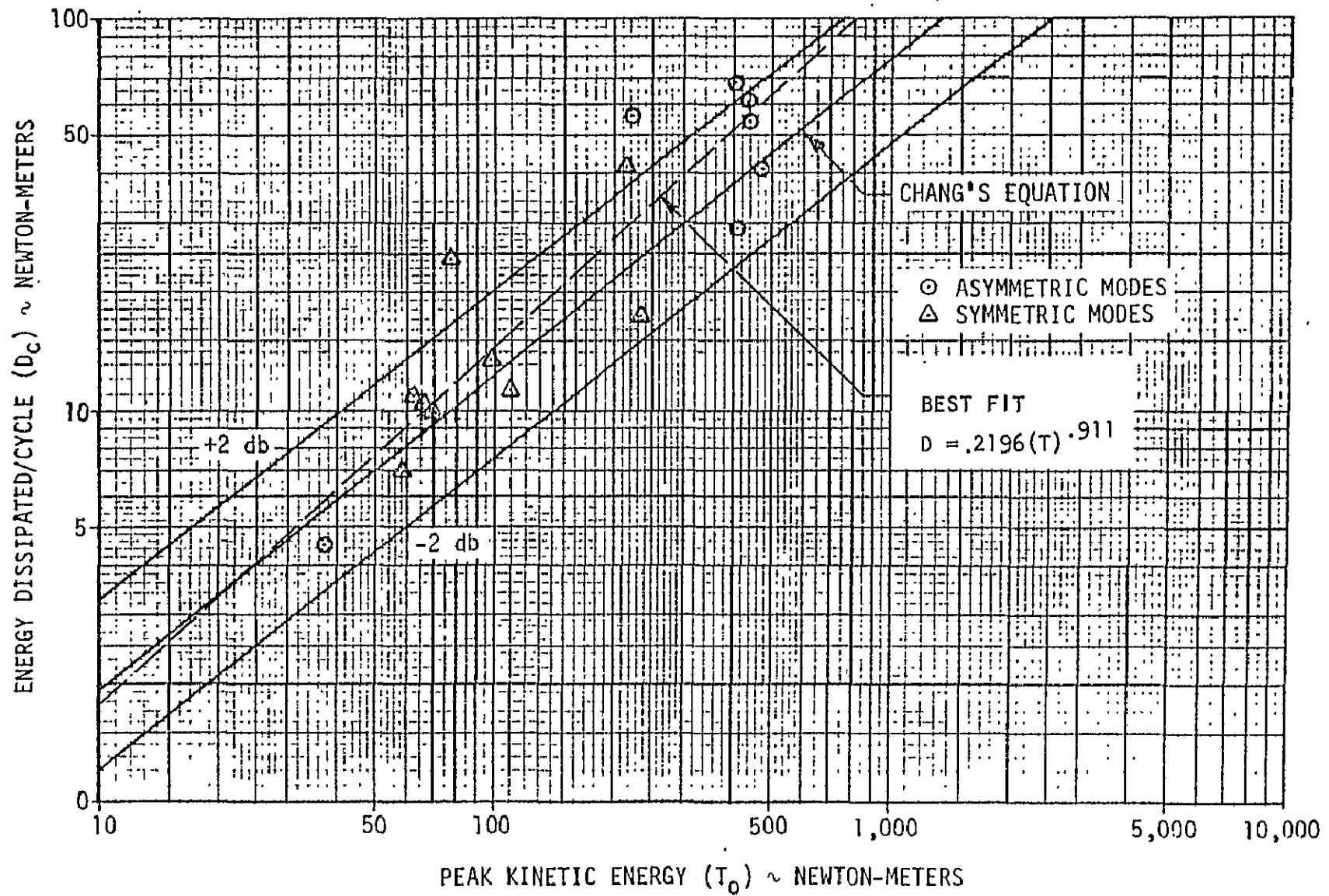

FIGURE 3-14: BOEING 747 STRUCTURAL DAMPING DATA

$$D = .313(T)^{.80} \quad (47)$$

Equation (46) was used to determine the equivalent modal damping for the Orbiter.

$$\zeta = \frac{.2196}{4\pi} T^{-.089} \quad (48)$$

The calculation of realistic modal damping from these equations is, therefore, dependent upon the determination of the kinetic energy, T, for that mode. This is, according to Equation (45), equivalent to determining the maximum modal deflection which can only be determined from the dynamic analysis for which the model is being constructed. Therefore a rational method must be used to determine the kinetic energy to be used in the damping equations.

One method which could be used is based upon the determination of the modal deflection which results in the maximum allowable strain in a critical element. For tension and compression of aluminum or steel structures, the ultimate allowable strain (Reference 12) is:

$$\epsilon_a = .002$$

For torsion of a thin-walled circular tube, the material is in a state of pure shear where the stresses and strains are:

$$\begin{aligned} \gamma &= r\theta \\ S_s &= G\gamma \end{aligned} \quad (49)$$

Here θ is the angle of twist per unit length of the shaft and r is the radius to the outer fiber. From a uniaxial tensile test, the yield stress is

$$\sigma_y = E\epsilon_y \quad (50)$$

According to the Mises yield condition, the allowable shear stress (τ_y) and the allowable normal stress (σ_y) are related by

$$\tau_y = \sigma_y / \sqrt{3} \quad (51)$$

or

$$S_s = E\epsilon_y / \sqrt{3} \equiv Gr\theta \quad (52)$$

Therefore, since $G = E/2(1+\mu)$, the allowable angle of twist per unit length is:

$$\theta_a = \epsilon_y \frac{2(1+\mu)}{r \sqrt{3}} \quad (53)$$

For $\epsilon_y = .002$ and $\mu = .3$

$$\theta_a = .118/r \quad (\text{rad/m}) \quad (54)$$

Limit allowable strain and angle of twist can be obtained by dividing by the ultimate factor of safety (F.S.).

$$\begin{aligned} \epsilon_y^! &= \epsilon_y / \text{F.S.} \\ \theta_a^! &= \theta_a / \text{F.S.} \end{aligned} \quad (55)$$

Subtracting the strains caused by static forces gives the limit allowable strain for dynamic loading. The maximum allowable deflection of the predominant mode can then be found by calculating the ratio of allowable dynamic strain to the strain in the critical element due to a unit modal deflection. Then the kinetic energy of that mode can be calculated from Equation (45).

Structural joints and damping values for each vehicle are discussed in the following sections.

3.2.1 External Tank

The only mechanical joints on the ET are at each end of the intertank shell where it is attached to the LH₂ and LO₂ tanks. These joints consist of two flanges bolted together as shown in Figure 3-15. Plate joints were inserted at both interfaces using the preprocessor computer program. Free-free mode shapes and modal damping matrix were obtained using arbitrary damping values in the structural joints. Final damping parameters were calculated by ratioing these arbitrary values based on estimated kinetic energy in appropriate modes.

Damping parameters for the axial joint members were derived from the first free-free ET bending mode ($f = 3.7$ Hz) and Equation (41).

The maximum strain for this mode occurs in the interstage, forward of the ET/SRB attachment beam. The limit allowable strain is:

$$\epsilon'_a = \frac{.002}{\text{F.S.}} = \frac{.002}{1.5} = .00133 \quad (56)$$

The static strain in the forward interstage due to 1.7 g longitudinal acceleration at liftoff is:

$$\epsilon'_{st} = .00115 \quad (57)$$

Therefore, the limit allowable strain for dynamic events is:

$$\epsilon'_d = .00018 \quad (58)$$

Assuming that the dynamic strain due to bending and axial motion are the same, we have:

$$\epsilon'_b = \epsilon'_{ax} = 9.0 \times 10^{-5} \quad (59)$$

The strain in the interstage due to a unit (1.0 m) deflection of the first ET bending mode is 0.0445. Therefore, the modal deflection (q) which results in the limit allowable bending strain is:

$$q = \frac{9.0 \times 10^{-5}}{.0445} = 2.02 \times 10^{-3} \text{ m} \quad (60)$$

The kinetic energy of this mode is then

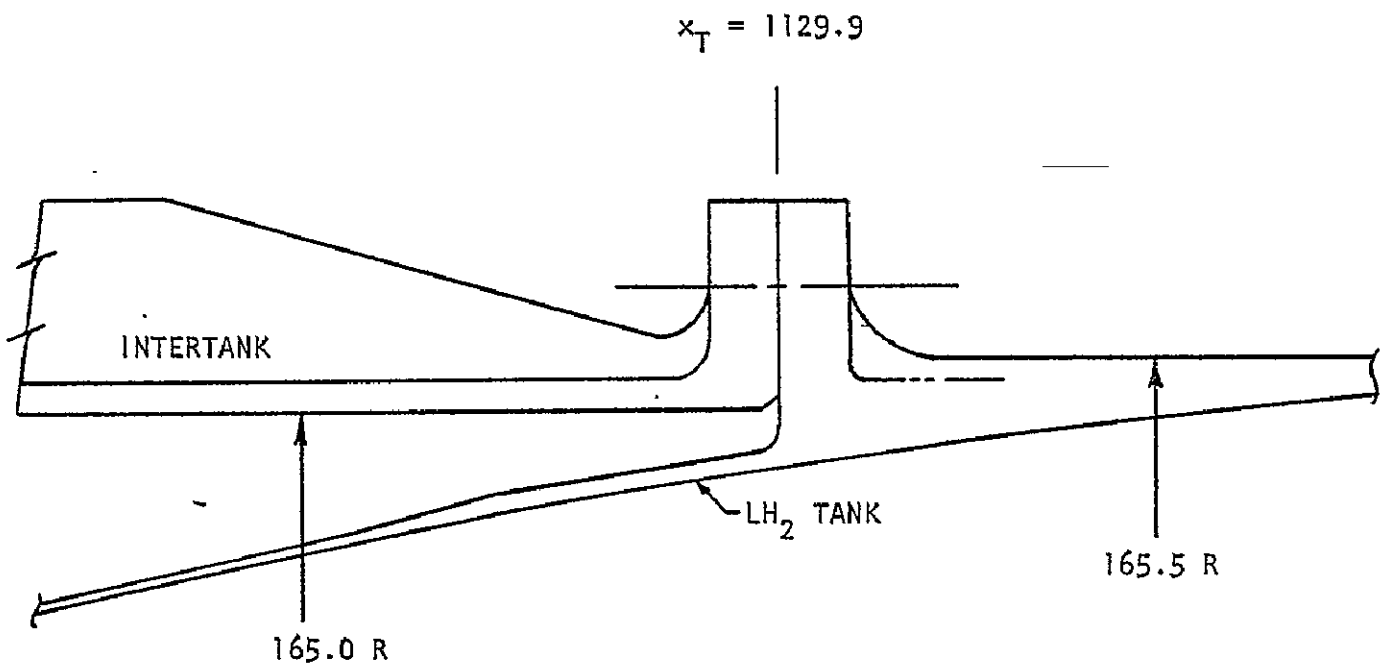
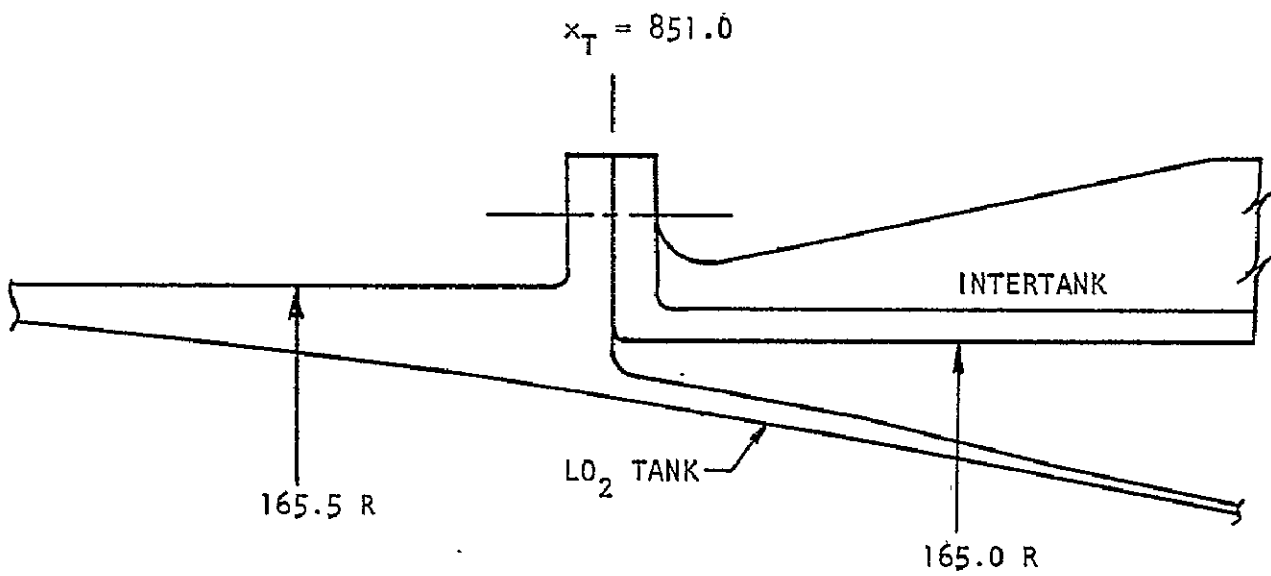

FIGURE 3-15: EXTERNAL TANK INTERTANK JOINTS

$$\begin{aligned}
 T &= \frac{1}{2} M_b \omega^2 q^2 = \frac{1}{2} K_b q^2 \\
 &= \frac{1}{2} (3.15 \times 10^7) (2.02 \times 10^{-3})^2 = 64.3 \text{ N-m} \quad (61)
 \end{aligned}$$

Then, using Equation (41), the desired damping ratio for the first ET bending mode is

$$\zeta = .0228 T^{-.254} = .0079 \quad (62)$$

The damping parameter for the axial joint members in the ET intertank joints is then calculated by multiplying the damping parameter used in the "unit" damping case by the ratio of the desired damping ratio shown above to the damping ratio obtained in the arbitrary damping case. This calculation gives $C_A = 4.68 \times 10^6$ N/m/sec.

Using this damping value, the modal viscous damping ratio for the first ET free-free longitudinal mode (10.0 Hz) is $\zeta = .013$.

Calculations of the damping parameters for the diagonal joint members based on allowable torsional motion of the ET resulted in unreasonably high modal damping values. Therefore a representative value of torsional kinetic energy was selected from the test data used in Reference 4 to develop the torsional damping equation, Equation (39). The range of kinetic energy used in Reference 4 results in ET torsional mode damping from $\zeta = .008$ to $\zeta = .024$. For conservatism, the low value of kinetic energy was used as a representative value for the external tank resulting in modal damping of:

$$\zeta = .008 \quad (63)$$

Based on the arbitrary damping case, the damping constant for the diagonal plate joint members which would give this value of modal damping is:

$$C_D = 2.084 \times 10^5 \text{ N/m/sec} \quad (64)$$

Joint damping parameters are summarized in Table 3-8. All damping parameters are assumed to remain constant for all flight conditions.

TABLE 3-8: STRUCTURAL JOINT DAMPING PARAMETERS

BAR JOINTS

JOINT LOCATION	ELEMENT I.D.	C1m	C1n	C1p	C2m	C2n	C2p
SRM CASE JOINTS	502 - 508 & 510 - 512	2.99×10^9 (1.71×10^7)	0	0	0	1.34×10^{10} (1.19×10^{11})	1.34×10^{10} (1.19×10^{11})
ORBITER WING ROOT	3108, 3109, 3111, 3112, 3113, 3115, 3116, 3118, 3119, 3120, 3121	0	0	0	3.428×10^6 (3.034×10^7)	3.428×10^6 (3.034×10^7)	3.428×10^6 (3.034×10^7)
VERTICAL TAIL ROOT	15024 - 15027 15030 - 15037	0	0	0	2.302×10^5 (2.037×10^6)	2.302×10^5 (2.037×10^6)	2.302×10^5 (2.037×10^6)

UNITS: C1 = N/m/sec (lb/in/sec)
C2 = N-m-sec (lb-in-sec)

TABLE 3-8: STRUCTURAL JOINT DAMPING PARAMETERS (Continued)

PLATE JOINTS

JOINT LOCATION	ELEMENT I.D.	CA	CD
ET INTERTANK JOINTS	26 through 33	4.68×10^6 N/m/sec (26,700 lb/in/sec)	2.08×10^5 N/m/sec (1190. lb/in/sec)
ORBITER FUSELAGE JOINTS	12432, 12433, 12438, 12439, 12444, 12445, 12450, 12451, 12456, 12457, 12462, 12463, 12468, 12469, 12474, 12475, 12480, 12481, 12486 - 12515, 12610, 12612,	7442. N/m/sec (42.5 lb/in/sec)	1.159×10^8 N/m/sec (6.62×10^5 lb/in/sec)
ORBITER WING JOINTS	13019 - 13021, 13036 - 13040, 13065 - 13067, 13082 - 13084	35860. N/m/sec (204.8 lb/in/sec)	35860. N/m/sec (204.8 lb/in/sec)

3.2.2 Solid Rocket Motor

The nine cylindrical SRM case segments are connected together using pin/clevis joints as shown in Figure 3-16. Ten joints were inserted in the centerline representation of the SRM using the preprocessor computer program. Damping constants were supplied to provide damping in the axial and the two beam bending directions. Free-free SRM modes and modal damping coefficients were calculated using arbitrary damping in the structural joints to provide the basis for kinetic energy and damping parameter calculations.

Damping constants for bending were calculated using the first free-free bending mode and Equation (41). The limit allowable strain is:

$$\epsilon'_a = \frac{.002}{F.S.} = .00133 \quad (65)$$

The static strain in the SRM case is caused by thrust loads and internal pressure loads.

$$\epsilon'_{st} = .00119 \quad (66)$$

Then the limit allowable strain for axial and bending dynamics is:

$$\epsilon'_d = .00014 \quad (68)$$

Assuming that the dynamic strain due to bending and axial motion are equal:

$$\epsilon'_b = \epsilon'_{ax} = .00007 \quad (69)$$

The maximum strain in the SRM case due to a unit (1.0 m) deflection of the first bending mode is 0.0187. Therefore, the modal deflection (q) which results in the limit allowable bending strain is:

$$q = \frac{7.0 \times 10^{-5}}{.0187} = 3.74 \times 10^{-3} \text{ m} \quad (69)$$

Using Equation (45) to calculate the kinetic energy for this mode:

$$T = \frac{1}{2} (7.38 \times 10^7) (3.74 \times 10^{-3})^2 = 516. \text{ N-m} \quad (70)$$

Then, from Equation (41), the desired damping ratio for the first SRM bending mode is:

$$\zeta = .0228T^{-.254} = .0047 \quad (71)$$

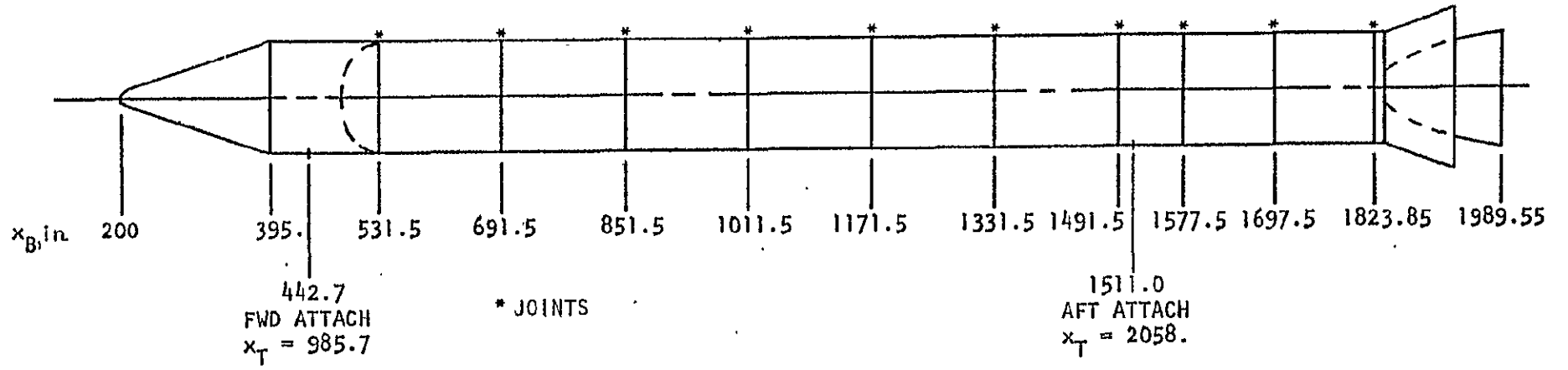

98

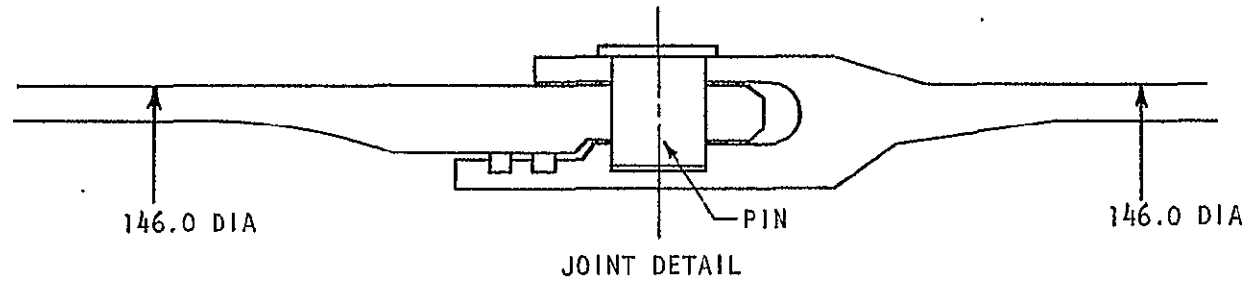

FIGURE 3-16: SRM CASE JOINT LOCATIONS

The modal damping produced by the arbitrary joint damping values is $\zeta = .00287$. Therefore, the damping constant necessary to give the desired modal damping in bending is:

$$C_{2n} = C_{2p} = \frac{.0047}{.00287} C_{arb} = 1.34 \times 10^{10} \text{ N-m/rad/sec} \quad (72)$$

For axial motion, the damping constants were calculated using the first longitudinal SRM mode and Equation (43). The maximum strain in the SRM case due to a unit (1.0 m) deflection of the longitudinal mode is 0.106. Therefore, the modal deflection (q) which results in the limit allowable axial strain is

$$q = \frac{7.0 \times 10^{-5}}{.106} = 6.60 \times 10^{-4} \text{ m} \quad (73)$$

From Equation (45), the kinetic energy for the longitudinal mode is:

$$T = \frac{1}{2} (5.06 \times 10^9) (6.60 \times 10^{-4})^2 = 1102. \text{ N-m} \quad (74)$$

Then the desired modal damping ratio for the first longitudinal mode, from Equation (43), is:

$$\zeta = .00454 T^{.104} = .0094 \quad (75)$$

The modal damping produced by the arbitrary joint damping values is $\zeta = 4.06 \times 10^{-6}$. Therefore, the damping constant necessary to give the desired modal damping is:

$$C_{1m} = \frac{.0094}{4.06 \times 10^{-6}} C_{unit} = 2.99 \times 10^9 \text{ N/m/sec} \quad (76)$$

Joint damping parameters are summarized in Table 3-8. All joint damping parameters are assumed to be constant for all flight conditions.

3.2.3 Orbiter

Structural joints were inserted in the Orbiter structure at ten stations along the fuselage, at two spanwise stations in the wing and at the wing and vertical tail roots. The fuselage joints are located in the payload section side panels and fuselage bottom panels at stations $x_0 = 559.5, 655., 751., 826., 901., 973., 1047., 1133., 1191.,$ and $1249.$, as shown in Figure 3-17. Wing panel joints are located in the upper and lower surface panels at stations $y_0 = 195.0$ and 280.2 , as shown in Figure 3-18. Wing and vertical tail root joints were inserted in the BARS which attach the wing and vertical tail to the fuselage as shown in Figure 3-19.

Symmetric and antisymmetric orbiter modes were calculated with structural joints included. The damping elements in each joint were assigned to one of five damping sets and arbitrary damping parameter values were used. These data were used by the joint damping predictor computer program to calculate proper damping parameter values necessary to obtain proper modal damping in specified modes. Details of the methodology used in the joint damping predictor computer program are found in Section 2.2.

The number of modes for which desired modal damping is specified must be equal to, or greater than, the number of damping sets. Therefore, for this case, desired damping for at least five modes is required. The five selected modes, the desired modal damping and the modal damping resulting from the damping parameters calculated by the joint damping prediction computer program are shown in Table 3-9. Damping parameter values calculated for Orbiter joints are shown in Table 3-8.

3.2.4 Payload

Damping at the payload attachment fittings was not modeled because its resonant frequency is higher than 50 Hz, and would not contribute significantly to the damping at frequencies corresponding to the first 50 Space Shuttle modes.

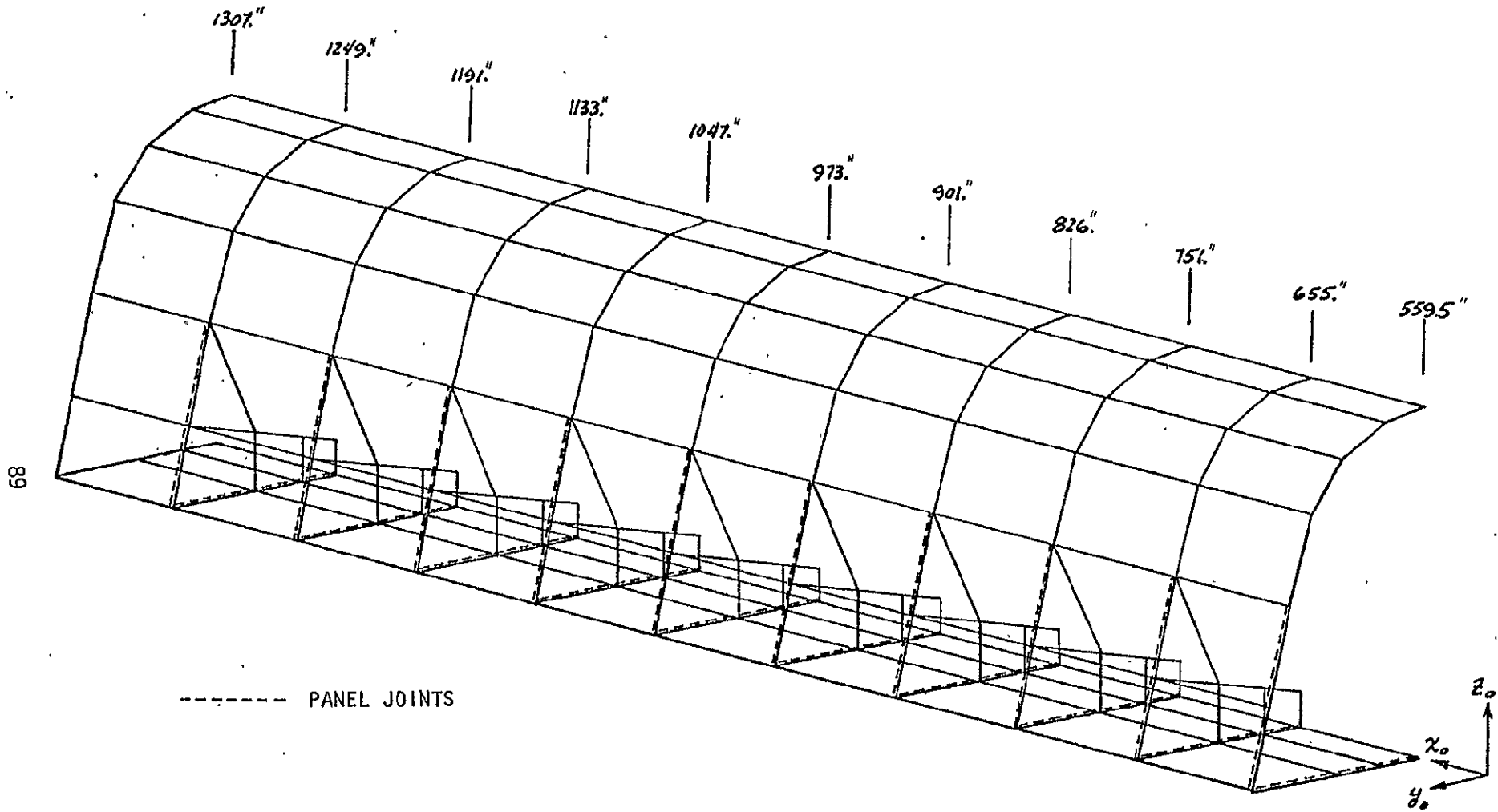

FIGURE 3-17: ORBITER FUSELAGE PANEL JOINT LOCATIONS

1-2

06

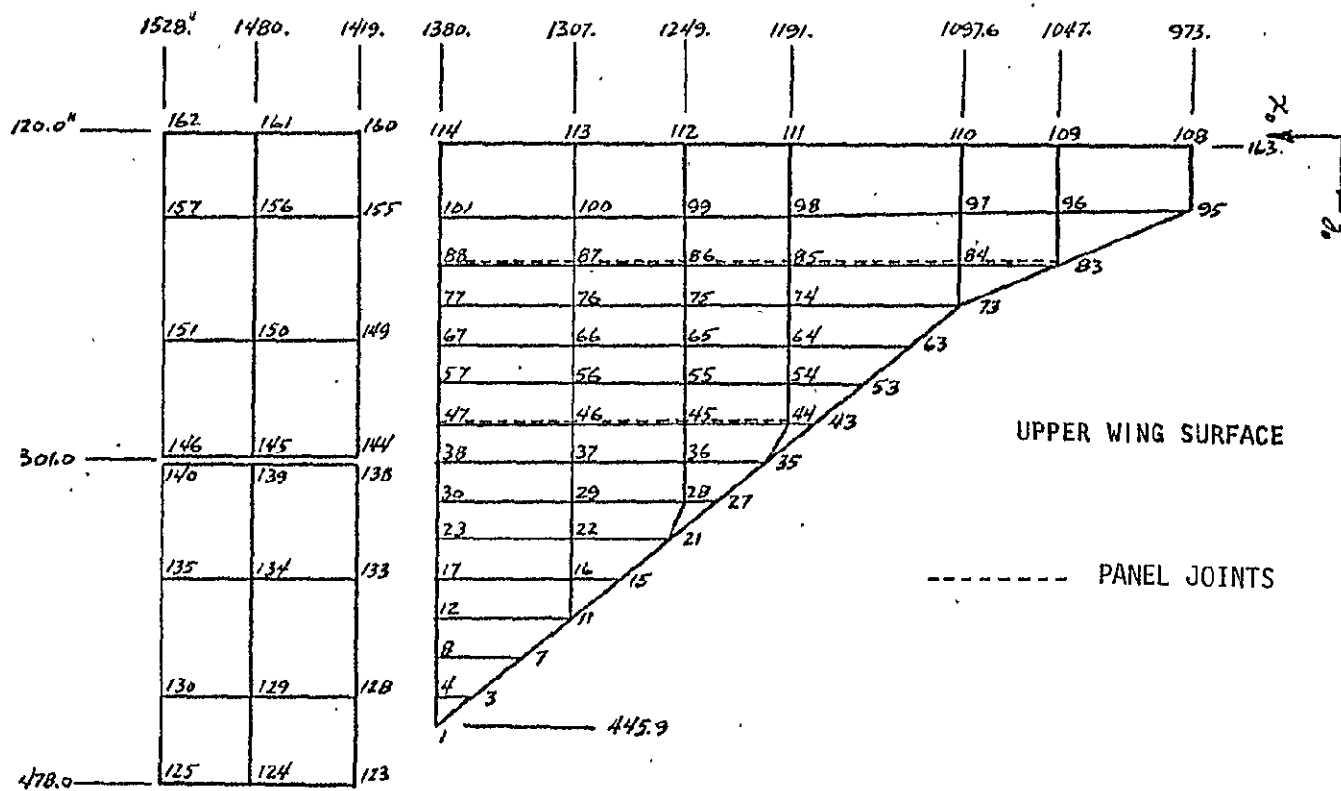

FIGURE 3-18: ORBITER WING PANEL JOINT LOCATIONS

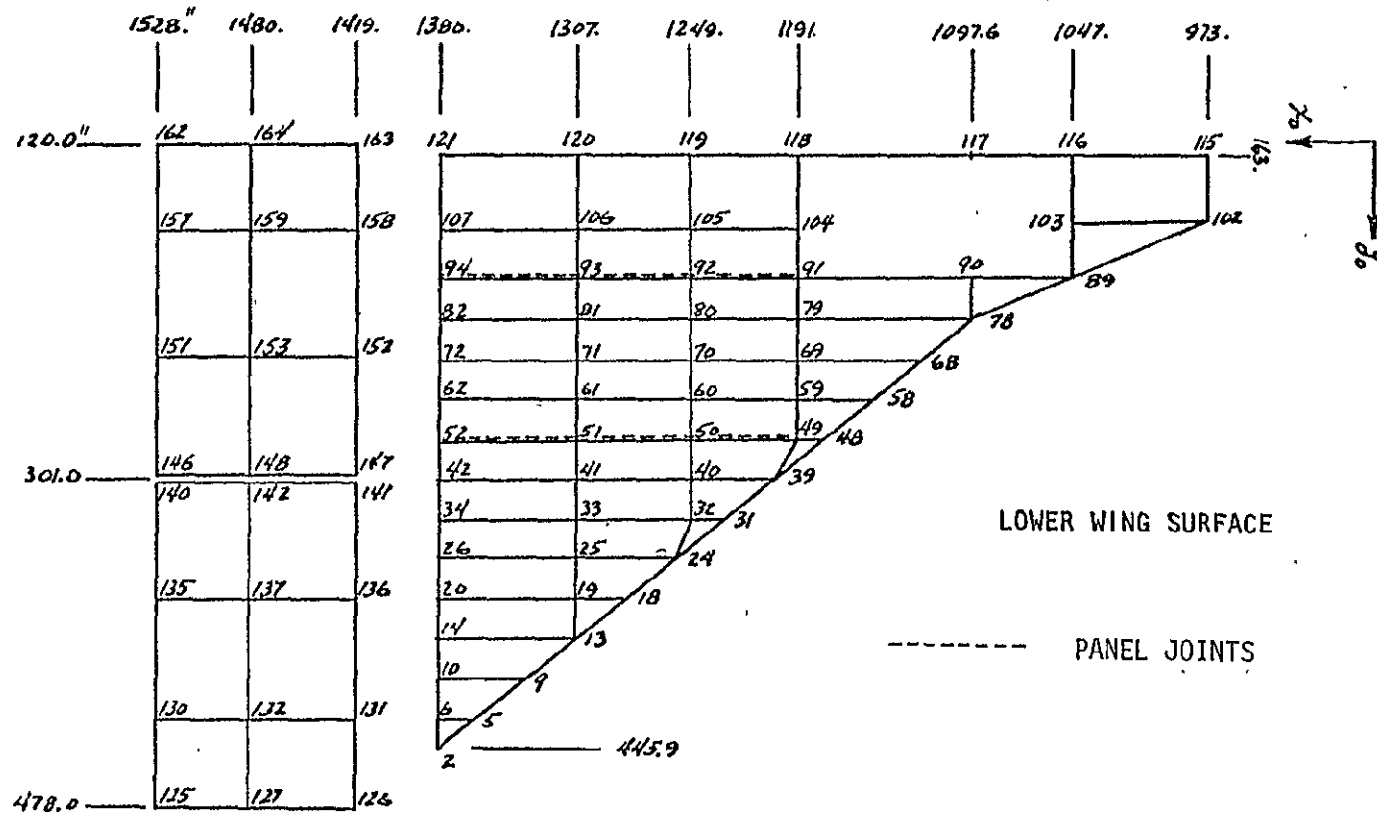

FIGURE 3-18: ORBITER WING PANEL JOINT LOCATIONS (continued)

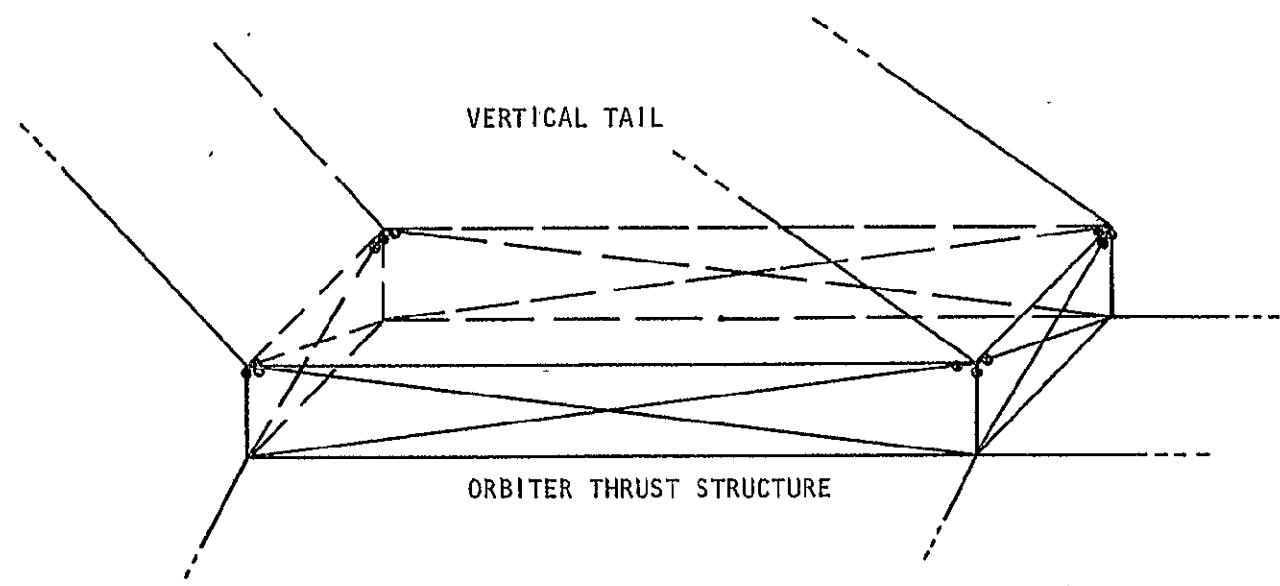
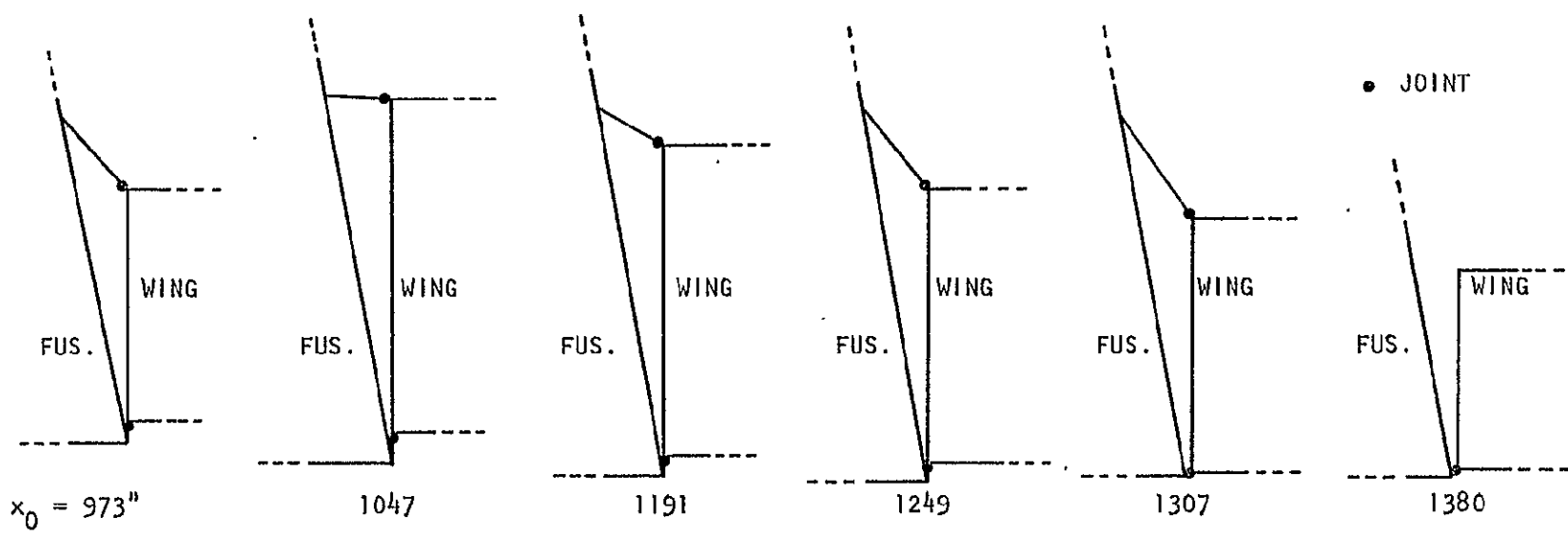

FIGURE 3-19: ORBITER WING AND VERTICAL TAIL ROOT JOINT LOCATIONS

Table 3-9: Comparison of Desired and Actual Orbiter
Modal Damping

<u>Mode</u>	<u>Description</u>	<u>Modal Damping (ζ)</u>	
		<u>Desired</u>	<u>Actual</u>
4	Sym. wing bending	.0110	.0110
5	first sym. fuselage bending	.0088	.0088
34	vertical tail bending	.0105	.0105
36	first antisym. fuselage bending	.0101	.0101
37	first fuselage torsion	.0065	.0065

3.3 SOLID ROCKET MOTOR PROPELLANT DYNAMICS

The dynamics of the solid rocket motor propellant could have a significant effect on total vehicle dynamics. The propellant is a viscoelastic material whose properties are characterized by complex elastic moduli. Finite-element modeling of the solid propellant using a Maxwell-type viscoelastic model is described in Section 3.3.3. Parametric values used in this Maxwell model were determined from two studies. Section 3.3.1 demonstrates that a Maxwell-type viscoelastic model can accurately represent the observed frequency-dependent stiffness characteristics of the solid propellant. Relationships between the Maxwell parameters and the propellant shear modulus are presented. Section 3.3.2 presents a modal analysis of a solid propellant segment using solid finite elements.

3.3.1 MODELING OF COMPLEX MODULUS

The complex shear modulus of a viscoelastic material is written:

$$G = G' + j G'' \quad (77)$$

Test data for the TP-H1123 propellant used in the SRM were provided by NASA/MSFC and are shown in Figure 3-20. The fact that stiffness increases as the frequency increases suggested the applicability of a Maxwell-type structural model (Reference 13) to represent these characteristics (Figure 3-21).

For the Maxwell model, the complex shear stiffness is:

$$K(j\beta) = K'_S + jK''_S \quad (78)$$

and is proportional to the complex shear modulus

$$K(j\beta) = \frac{A}{L} (G' + jG'') \quad (79)$$

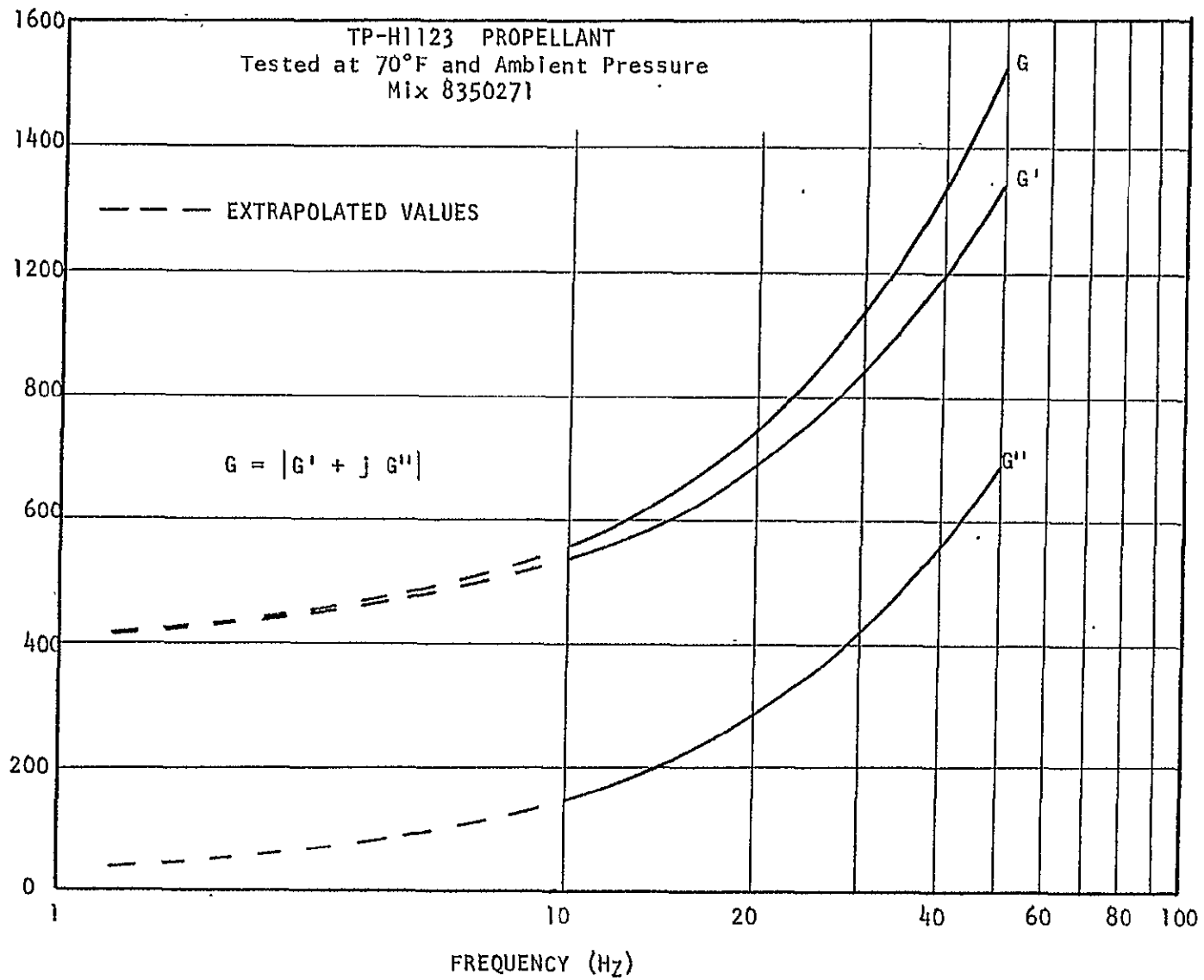

FIGURE 3-20: SRM PROPELLANT COMPLEX SHEAR MODULUS

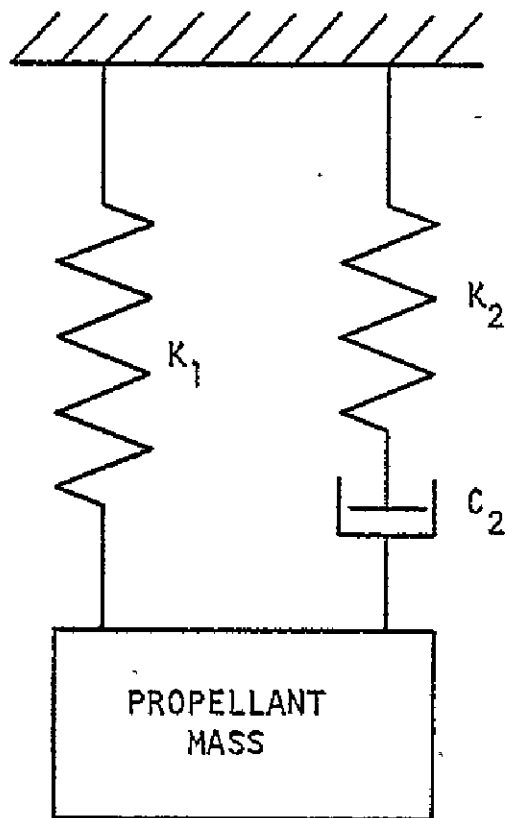

FIGURE 3-21: MAXWELL MODEL FOR SRM PROPELLANT

The real and imaginary components of the Maxwell model stiffness are given in Reference 13 as follows:

$$K_s' = K_1 + K_2 \eta_2^2 (1 + \eta_2^2)^{-1} \quad (80)$$

$$K_s'' = K_2 \eta_2 (1 + \eta_2^2)^{-1} \quad (81)$$

where η_2 , the loss factor, is:

$$\eta_2 = \frac{c_2 \beta}{K_2} \quad (82)$$

Substituting Equation (82) into Equations (80) and (81):

$$K_s' = K_1 \left\{ 1 + \frac{K_2}{K_1} \left(\frac{c_2 \beta}{K_2} \right)^2 \left[1 + \left(\frac{c_2 \beta}{K_2} \right)^2 \right]^{-1} \right\} \quad (83)$$

$$K_s'' = c_2 \beta \left[1 + \left(\frac{c_2 \beta}{K_2} \right)^2 \right]^{-1} \quad (84)$$

As shown in Equation (79), for a block of propellant having unit area and unit length, the stiffness components given by Equations (83) and (84) are numerically identical to the shear modulus components of Equation (33). Therefore Equations (83) and (84), with known data values of G' and G'' substituted for K_s' and K_s'' , may be used to find the Maxwell parameters K_1 , K_2 and C_2 which closely match the complex shear modulus characteristics. The Maxwell model accurately represents either the real or imaginary component of the shear modulus as shown in Figure 3-22. The parameters of Case A were chosen to be used for the SRM propellant because the imaginary component matches the test data very closely and the real component is only 6.3 percent below the test data at the frequency of the first longitudinal propellant mode (11.6 Hz).

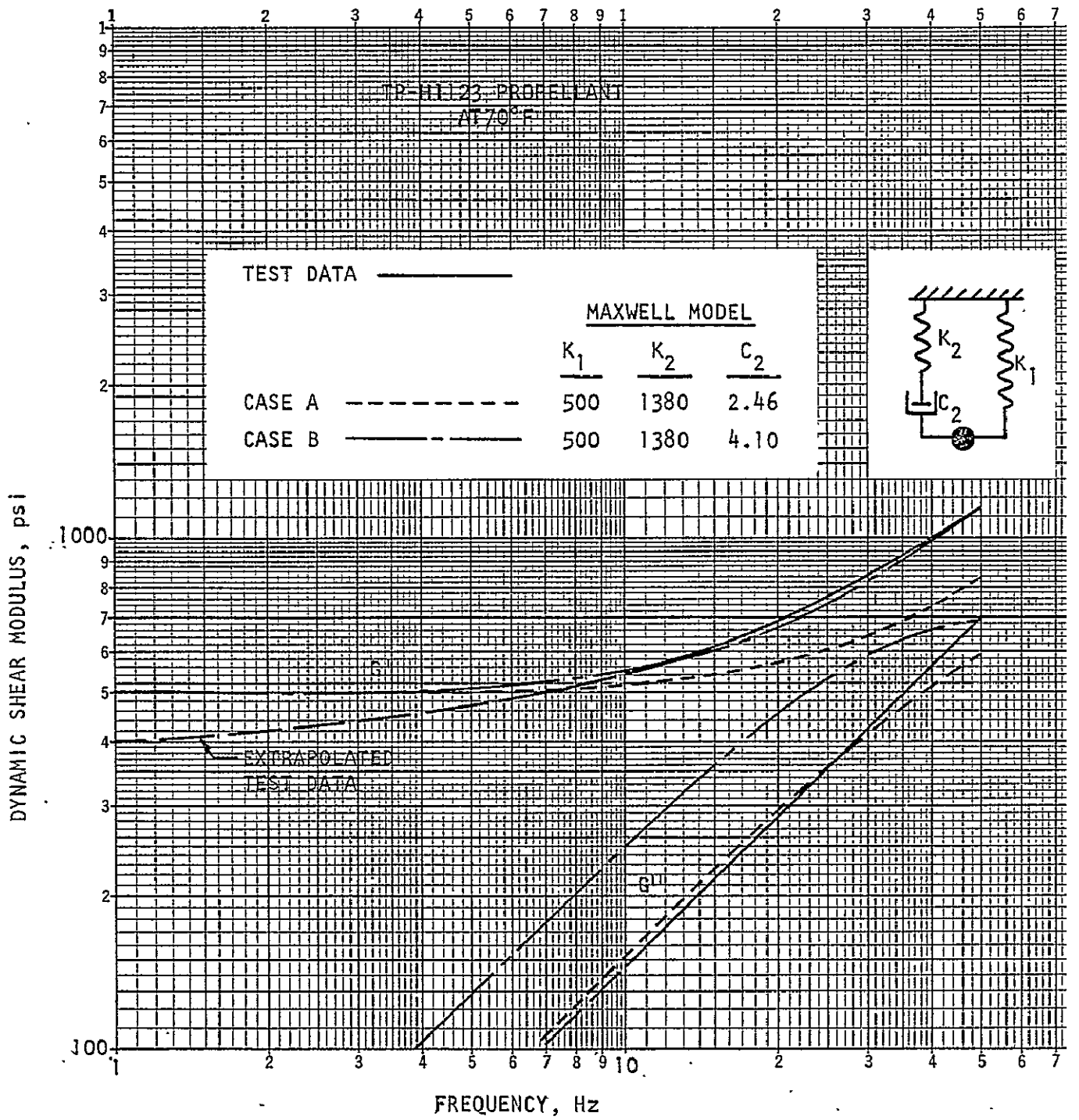

FIGURE 3-22: COMPLEX SHEAR MODULUS, MAXWELL MODEL

3.3.2 Propellant Modes

The dynamic characteristics of the solid propellant were determined from a solid finite-element model of a propellant segment 406.4 cm (160 in.) in length. The propellant, cantilevered from a rigid tank wall, was modeled using the NASTRAN WEDGE element as shown in Figure 3-23. The propellant density is 1.772 g/cm^3 ($1.657\text{E-}4 \frac{\text{lb sec}^2}{\text{in}^4}$). The shear modulus at zero frequency, 344.7 N/cm^2 (500 psi), was used for propellant mode calculations. The Young's modulus of 1034.2 N/cm^2 (1500 psi) was used with a Poisson's ratio of 0.45.

Symmetric and antisymmetric modes and frequencies were calculated and are tabulated in Table 3-10. The first longitudinal mode frequency is 11.6 Hz and the first torsional mode frequency is 16.7 Hz.

3.3.3 Propellant Structural Model

The SRM consists of four individual propellant sections. Three of these segments are 812.8 cm (320. in.) long and the fourth is 343.3 cm (332. in.) long. The analysis of Section 3.3.1 shows that the Maxwell-type model accurately represents the complex modulus of the viscoelastic propellant. Therefore Maxwell structural models were used to model each of the four propellant segments as shown in Figure 3-6. The propellant masses are connected to the centerline structural model using NASTRAN ROD and VISC elements. The mass freedoms were specified to allow propellant motion in the X and RX directions only.

The propellant masses and primary spring constants (K_1) were established to represent the first longitudinal and torsional propellant modes as determined in the propellant mode study (Section 3.3.2). Propellant masses were determined by multiplying the generalized mass of the first mode by the ratio of total propellant segment mass to propellant mass used in the modal analysis. The remaining propellant mass was added to the SRM centerline mass points. Total segment masses were obtained from the SRM weight breakdown supplied by NASA/MSFC (Reference 14). The values of K_1 (axial and torsional propellant stiffness at zero frequency) were obtained from the generalized stiffness (k_g) of the first longitudinal and torsional propellant modes and were assumed to be constant for each of the four propellant segments.

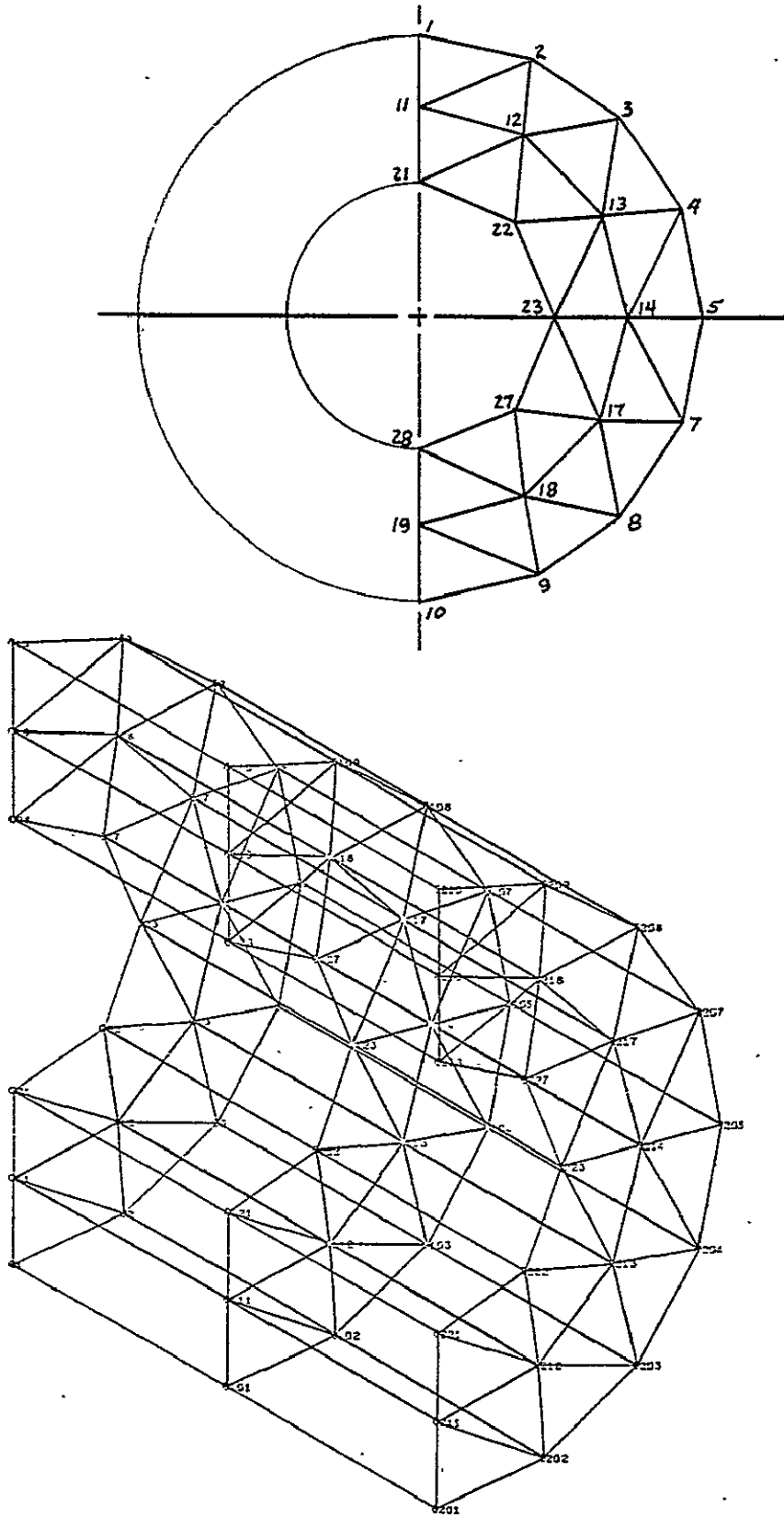







FIGURE 3-23: FINITE ELEMENT MODEL, SRM PROPELLANT

TABLE 3-10: SRM PROPELLANT MODAL DATA

MODE NUMBER		FREQUENCY Hz	GENERALIZED MASS kg (lb-sec ² /in.)		TYPE*
1		11.6	10300.	(58.8)	A
2		13.3	5400.	(30.8)	A
3		16.3	7250.	(41.4)	A
4		16.7	4330.	(24.7)	A,L
5	SYMMETRIC	18.2	4730	(27.0)	A,L
6		19.0	3960.	(22.6)	A,L
7		20.1	9250.	(52.8)	A
8		21.5	5960.	(34.0)	A
9		22.1	4340.	(24.8)	A,L
10		23.0	5380.	(30.7)	A,L
11		13.3	5710.	(32.6)	A
12		16.3	4450.	(25.4)	A,L
13		16.7	15600.	(89.2)	T
14		17.4	5900.	(33.7)	A
15	ANTI-	19.2	3920.	(22.4)	A,L
16	SYMMETRIC	20.1	8410.	(48.0)	A
17		21.8	3140.	(17.9)	A,L
18		22.9	4820.	(27.5)	A,L
19		23.5	8220.	(46.9)	A
20		23.6	3940.	(22.5)	A,L

* A - axial mode
 L - lateral mode
 T - torsion mode

$$(K_1)_X = 4 (k_g)_{1X} = 2.492 \times 10^7 \text{ N/m } (1.4235 \times 10^6 \text{ lb/in.})$$

$$(K_1)_{RX} = 4 (k_g)_{1RX} = 4.417 \times 10^5 \text{ N-m/rad } (3.91 \times 10^6 \text{ in-lb/rad})$$

The Maxwell parameters, K_2 and C_2 , were determined from the results of the complex modulus study (Section 3.3.1). From Equations (83) and (84), the components of the complex stiffness are defined when K_1 , η and K_2/K_1 are known. Using the results of the complex modulus study

$$K_2/K_1 = 2.76$$

and

$$\eta = 1.7826 \times 10^{-3} \beta$$

Therefore, using the values of K_1 calculated above,

$$(K_2)_X = 6.880 \times 10^7 \text{ N/m } (3.9289 \times 10^6 \text{ lb/in.})$$

$$(K_2)_{RX} = 1.219 \times 10^6 \text{ N-m/rad } (1.079 \times 10^7 \text{ in-lb/rad})$$

And, assuming a constant loss factor (η):

$$(C_2)_X = 122630. \text{ N-sec/m } (7003.6 \text{ lb-sec/in.}) \text{ ---}$$

$$(C_2)_{RX} = 2173. \text{ N-m/rad/sec } (19234. \text{ in-lb/rad/sec})$$

SRM free-free modes were calculated with the four propellant models included. The resulting modal parameters for the first twenty flexible modes are summarized in Table 3-11. Mode numbers five through eight are the longitudinal modes associated with each of the four propellant segments and modes 9 through 13 are propellant torsion modes.

TABLE 3-11: SRM FREE-FREE MODAL PARAMETERS

<u>MODE NUMBER</u>	<u>FREQUENCY Hz</u>	<u>GENERALIZED MASS kg (lb-sec²/in.)</u>	<u>TYPE</u>
1	4.43	9.57E4 (546.0)	1st bend, pitch
2	4.43	9.57E4 (546.0)	1st bend, yaw
3	10.16	9.68E4 (552.5)	2nd bend, pitch
4	10.16	9.68E4 (552.5)	2nd bend, yaw
5	10.92	1.07E5 (612.6)	axial, propel
6	11.43	1.76E5 (1006.2)	axial, propel
7	11.51	1.09E5 (619.6)	axial, propel
8	14.02	2.14E5 (1219.8)	axial, propel
9	15.58	1.51E7 (86016.)	tors, propel
10	16.66	1.31E5 (748.6)	tors, propel
11	16.66	1.17E5 (666.4)	tors, propel
12	16.66	1.00E5 (571.3)	tors, propel
13	16.66	1.21E5 (690.2)	tors, propel
14	16.81	1.23E5 (703.1)	3rd bend, pitch
15	16.81	1.23E5 (703.1)	3rd bend, yaw
16	23.35	1.77E5 (1010.8)	4th bend, pitch
17	23.35	1.77E5 (1010.8)	4th bend, yaw
18	25.74	1.93E5 (1102.5)	1st long., case
19	28.04	2.97E5 (1693.0)	5th bend, pitch
20	28.04	2.97E5 (1693.0)	5th bend, yaw

3.4 SPACE SHUTTLE MODES AND MODAL DAMPING

Sixty free-free modes were calculated for the Space Shuttle half-model at each of the three trajectory times using NASTRAN; 30 symmetric modes and 30 anti-symmetric modes. Antisymmetric modes were calculated first, and DMAP ALTER statements were used to write the modal information on a user tape. DMAP ALTER statements were also added to the symmetric modes run which combined the anti-symmetric modal data from the user tape with the symmetric modal data and wrote the combined set of modes and the merged modal damping matrix (BHH) on the NASTRAN checkpoint/restart tape. The symmetric modes were written first, then the antisymmetric modes.

The first 25 symmetric flexible modes and 25 antisymmetric flexible modes were selected to be used by the postprocessor computer program to determine critical resonances. The frequencies and generalized masses for these 50 modes for each mass condition are listed in Tables 3-12 through 3-14. A complete set of structural dynamic characteristics for each mass condition including frequencies, generalized mass, modal damping and mode shapes at selected points on the Space Shuttle structure are listed in Section 2.0 of Volume II.

The equivalent modal viscous damping ratios for the liftoff condition shown in Table 3-12 are calculated from the diagonal terms in the coupled modal damping matrix (BHH). The structural joints incorporated in the model result in modal damping ratios in the range of .002 to .020 for the primary structural modes while some of the higher frequency modes have damping ratios greater than 1.0. The modes are local modes characterized by large amplitude motion in the joints which contribute large amounts of damping.

The joint damping parameters were assumed to be constant for all trajectory time points. Equivalent modal viscous damping ratios for the max q and SRB cutoff conditions are tabulated in Tables 3-13 and 3-14, respectively. The damping in the primary modes at max q are somewhat higher than at liftoff and are even higher for SRB cutoff. This suggests that joint damping parameters do not remain constant throughout flight and that they should be recalculated for each mass condition.

Table 3-12: SPACE SHUTTLE MODAL DATA, LIFTOFF

MODE NUMBER	FREQUENCY*	GENERALIZED MASS**	EQUIVALENT DAMPING RATIO
4	0.13764230E 02	0.31418E 06	.003
5	0.17524689E 02	0.53878E 06	.005
6	0.18133037E 02	0.20166E 06	.048
7	0.19370438E 02	0.23247E 06	.003
8	0.22939240E 02	0.19507E 05	.289
9	0.25795609E 02	0.71901E 05	.170
10	0.26701675E 02	0.34791E 05	.306
11	0.26944275E 02	0.38672E 05	.007
12	0.30096359E 02	0.29977E 05	.098
13	0.31603180E 02	0.32339E 05	.012
14	0.32383667E 02	0.35672E 05	.967
15	0.32729385E 02	0.17819E 06	.056
16	0.34836258E 02	0.33781E 06	.014
17	0.36577789E 02	0.13810E 04	.387
18	0.38610626E 02	0.10745E 05	.292
19	0.38318588E 02	0.48755E 04	.124
20	0.41914459E 02	0.10181E 05	.349
21	0.48224747E 02	0.12909E 06	.267
22	0.49329636E 02	0.76124E 04	4.316
23	0.51461975E 02	0.13862E 06	.388
24	0.52124176E 02	0.48587E 05	.001
25	0.52243576E 02	0.54716E 05	.005
26	0.52839355E 02	0.89283E 05	.004
27	0.52912048E 02	0.93129E 04	4.154
28	0.55803299E 02	0.39785E 05	3.082
34	0.11956779E 02	0.95077E 05	.017
35	0.12445990E 02	0.56738E 06	.002
36	0.16801208E 02	0.48963E 05	.160
37	0.17309418E 02	0.48436E 06	.007
38	0.20951965E 02	0.62331E 05	.671
39	0.23871979E 02	0.68545E 04	.935
40	0.27019867E 02	0.15617E 06	.525
41	0.29155258E 02	0.71354E 04	.164
42	0.30047516E 02	0.36676E 06	.035
43	0.30799728E 02	0.51000E 04	.300
44	0.31635300E 02	0.48226E 04	1.563
45	0.32753357E 02	0.12161E 05	.381
46	0.33122925E 02	0.19105E 05	.721
47	0.36919678E 02	0.10426E 05	.275
48	0.37888138E 02	0.40696E 04	3.051
49	0.38871368E 02	0.64075E 04	.742
50	0.43467697E 02	0.75786E 05	.234
51	0.45840668E 02	0.98341E 04	1.291
52	0.51102036E 02	0.32159E 05	2.064
53	0.52131180E 02	0.47597E 05	.001
54	0.52227005E 02	0.10977E 06	.007
55	0.59475189E 02	0.19469E 06	.005
56	0.60747559E 02	0.78698E 04	6.525
57	0.65134735E 02	0.23504E 05	.829
58	0.67310837E 02	0.12183E 06	.358

↑
SYMMETRIC

↓
ANTISYMMETRIC

* rad/sec

** kilograms

Table 3-13: SPACE SHUTTLE MODAL DATA, MAX Q

NODE NUMBER	FREQUENCY*	GENERALIZED MASS**	EQUIVALENT DAMPING RATIO
4	0.15798579E 02	0.16388E 06	.014
5	0.19863358E 02	0.26006E 06	.063
6	0.22897659E 02	0.10801E 06	.020
7	0.24014236E 02	0.18544E 05	.371
8	0.25154358E 02	0.10913E 06	.055
9	0.28750290E 02	0.27003E 05	.186
10	0.29368500E 02	0.19652E 06	.232
11	0.29516068E 02	0.24377E 06	.025
12	0.30276810E 02	0.34978E 05	.052
13	0.32514328E 02	0.18386E 06	.048
14	0.32923279E 02	0.33558E 05	.241
15	0.33142456E 02	0.25770E 05	.698
16	0.34732986E 02	0.36005E 06	.002
17	0.37009567E 02	0.13292E 04	.377
18	0.39742020E 02	0.27215E 04	.424
19	0.42457657E 02	0.41007E 05	.369
20	0.44433228E 02	0.66609E 05	.116
21	0.47920227E 02	0.59381E 05	.001
22	0.48343109E 02	0.66023E 05	.001
23	0.48527176E 02	0.10363E 06	.001
24	0.49307709E 02	0.73052E 04	4.480
25	0.52916168E 02	0.84754E 04	4.540
26	0.55562759E 02	0.53302E 05	1.870
27	0.56489227E 02	0.10038E 06	1.410
28	0.58523239E 02	0.20368E 06	.108
34	0.13293739E 02	0.62323E 05	.029
35	0.15512980E 02	0.39855E 06	.011
36	0.18812180E 02	0.27646E 05	.414
37	0.20997528E 02	0.11191E 06	.051
38	0.23715759E 02	0.28859E 05	1.420
39	0.25793839E 02	0.55375E 04	1.240
40	0.28850006E 02	0.37731E 05	.052
41	0.29790405E 02	0.35870E 06	.038
42	0.30732376E 02	0.18739E 05	.203
43	0.31451477E 02	0.36952E 04	.085
44	0.32414566E 02	0.71497E 04	2.730
45	0.33011047E 02	0.71085E 05	.300
46	0.35498917E 02	0.55165E 04	.567
47	0.38564667E 02	0.38636E 04	1.250
48	0.38901428E 02	0.46699E 04	2.430
49	0.44856186E 02	0.11183E 06	.329
50	0.46534348E 02	0.14940E 05	1.140
51	0.47931808E 02	0.57895E 05	.002
52	0.48243439E 02	0.13857E 06	.024
53	0.51123520E 02	0.45802E 05	1.230
54	0.56279968E 02	0.27750E 05	2.110
55	0.58737076E 02	0.18500E 06	.004
56	0.62650467E 02	0.80243E 04	8.840
57	0.67074478E 02	0.18895E 05	7.170
58	0.71453018E 02	0.28199E 05	3.390

* rad/sec ** kilograms

Table 3-14: SPACE SHUTTLE MODAL DATA, SRB CUTOFF

MODE NUMBER	FREQUENCY*	GENERALIZED MASS**	EQUIVALENT DAMPING RATIO
4	0.20559067E 02	0.25567E 05	.190
5	0.26607239E 02	0.39178E 05	.258
6	0.27987335E 02	0.27441E 05	.154
7	0.28858627E 02	0.27970E 05	.242
8	0.30375336E 02	0.50671E 05	.117
9	0.31237579E 02	0.13397E 06	.003
10	0.32712769E 02	0.63435E 05	.955
11	0.33140091E 02	0.19225E 07	.022
12	0.35107529E 02	0.50324E 04	.153
13	0.35248657E 02	0.32385E 06	.001
14	0.37567795E 02	0.17005E 04	.263
15	0.40280258E 02	0.32143E 04	.385
16	0.44707397E 02	0.32038E 05	.463
17	0.46505005E 02	0.44722E 05	.102
18	0.49328049E 02	0.74425E 04	4.440
19	0.52415176E 02	0.12404E 05	3.480
20	0.54798798E 02	0.20719E 05	2.300
21	0.56951309E 02	0.11173E 06	.823
22	0.57882385E 02	0.70118E 05	1.305
23	0.64516739E 02	0.14556E 06	.481
24	0.65359177E 02	0.34289E 05	2.070
25	0.71718246E 02	0.75959E 04	1.430
26	0.73347260E 02	0.45761E 04	1.710
27	0.76281036E 02	0.20253E 05	.622
28	0.76884216E 02	0.46221E 05	.090
34	0.15647510E 02	0.23900E 05	.115
35	0.22611206E 02	0.24693E 05	1.309
36	0.25484436E 02	0.99066E 04	.310
37	0.26599609E 02	0.11383E 05	1.070
38	0.29311096E 02	0.24523E 05	.058
39	0.30888367E 02	0.31855E 05	.031
40	0.31821198E 02	0.33824E 04	.099
41	0.33145477E 02	0.10697E 05	1.100
42	0.33365005E 02	0.39287E 05	.503
43	0.33950378E 02	0.61392E 04	.695
44	0.38024887E 02	0.46639E 04	3.860
45	0.40358887E 02	0.35964E 04	.988
46	0.43295227E 02	0.13758E 06	.390
47	0.49701279E 02	0.15029E 05	1.527
48	0.50916428E 02	0.48697E 05	1.698
49	0.55457657E 02	0.10987E 06	.367
50	0.62247055E 02	0.82898E 04	6.500
51	0.65659256E 02	0.22044E 05	8.120
52	0.66961060E 02	0.14647E 06	.759
53	0.71676025E 02	0.25396E 05	9.420
54	0.75262177E 02	0.28321E 04	4.390
55	0.81694839E 02	0.44440E 04	1.605
56	0.83266098E 02	0.14946E 05	1.826
57	0.85406967E 02	0.12034E 05	6.950
58	0.86414337E 02	0.92264E 04	4.030

* rad/sec.

** kilograms

4.0 CRITICAL RESONANCES FROM CONVENTIONAL MODEL (LIFTOFF)

3

Critical resonances for the Space Shuttle at liftoff were obtained using uniform modal damping and conventional modal selection techniques. The conventional model was obtained by removing the distributed structural joint damping from the realistic model. A uniform modal viscous damping ratio, $\zeta = .010$, was used to represent structural damping in all the modes. Modal resonances were ranked according to rate or position coefficients calculated using post-processor Option 1. The coefficients represent the steady-state dynamic amplification at resonance which occurs at a point on the structure due to a sinusoidal force input at another point. Rate or position coefficients for the j^{th} requested mode are calculated for the selected freedoms as in the following examples:

$$R(140323, 7014)_j = \frac{\phi_{140323,j} \phi_{7014,j}}{(2\zeta_j) \omega_j M^*_j} \quad (85)$$

$$P(140322, 110264)_j = \frac{\phi_{140322,j} \phi_{110264,j}}{(2\zeta_j) \omega_j^2 M^*_j} \quad (86)$$

where R and P denote rate and position coefficients, respectively. Gridpoint freedoms for the input point and response point are specified in parentheses. The last digit of each I.D. is the input or output freedom specified at the gridpoint indicated by the preceding digits. For example, $P(140322, 110264)_j$ is the position coefficient calculated for the j^{th} mode at gridpoint 11026 in the freedom 4 (θ_x) direction due to a unit sinusoidal force at gridpoint 14032 in the freedom 2 (y) direction.

At the resonance condition, the modal displacement response always lags the input generalized force by 90 degrees and the modal velocity response is always in phase with the input generalized force. If the mode shapes at the response point and the input force point have the same sign, then the physical displacement response lags the input force and the physical velocity response is in phase with the input force. The positive or negative sign on the coefficients shows whether the physical response is in phase or out of phase with the modal response, respectively. The positive sign on the coefficients indicates, of course, that the mode shapes at the response point and the input force point have the same sign.

The excitation and response degrees of freedom chosen for this study are shown in Table 4-1. One outboard SSME gimbal and one SRB gimbal were chosen as the excitation points (three degrees-of-freedom each). The response points were chosen to demonstrate the application of critical resonance selection using admittance techniques for three technical disciplines; guidance and control, POGO, and dynamic loads. Position gyro, rate gyro and accelerometer responses are calculated for use in attitude control studies, LOX tank aft dome acceleration admittances for POGO investigations are calculated, and payload attachment acceleration admittances are calculated to demonstrate the use of the method for dynamic loads calculations.

The ranking of rate and position coefficients for the selected excitation/response points are shown in Tables 4-2 and 4-3, respectively. The zero coefficients shown in some of the rankings indicate that the mode shape of either the excitation freedom or response freedom is zero for that mode. For example, if the excitation point is on the plane of symmetry (e.g., gridpoint 14032), the symmetric modes (modes 4 through 28) will not be excited for a force in the y-direction because the centerline gridpoints are constrained in the y-direction for symmetric modes. Therefore, only antisymmetric modes (modes 34-58) will be excited by this force. Likewise, coefficients for response points on the plane of symmetry (e.g., gridpoint 9005) are zero for either symmetric or antisymmetric modes.

Acceleration coefficients are determined by multiplying the position coefficients by $-\omega^2$.

TABLE 4-1: SPACE SHUTTLE RESPONSE AND EXCITATION LOCATIONS

<u>LOCATION</u>	<u>x</u>	<u>y</u>	<u>z</u>	<u>GRIDPOINT</u>	<u>DIRECTIONS</u>
Excitation Points					
SRM Gimbal*(+y)	1823.8	0.	0.	513	x,y,z
SSME (+y) gimbal**	1450.	53.0	334.0	14039	x,y,z
Response Point (displacement)					
IMU**	414.0	0.	419.0	9005	R _x ,R _y ,R _z
Response Points (velocity)					
SRM forward rate gyro*	483.25	-30.5	52.8	901	R _x ,R _y ,R _z
SRM aft rate gyro*	11511.0	0.	73.0	902	R _x ,R _y ,R _z
Orbiter rate gyro**	1312.5	5.8	407.3	9004	R _x ,R _y ,R _z
Response Points (acceleration)					
Crew comp. inst. unit**	380.6	10.0	406.5	9001	x,y,z
LOX tank aft dome ***	962.1	21.7	0.	52	x
Payload keel support **	1047.	0.	307.0	12076	y

* SRM coordinate system (in.)

** Orbiter coordinate system (in.)

*** ET coordinate system (in.)

Table 4-2: RATE COEFFICIENTS FOR CONVENTIONAL MODEL

RATE COEFFICIENTS. RESPONSE FRDM = 9014 INPUT FRDM = 5131				RATE COEFFICIENTS. RESPONSE FRDM = 9015 INPUT FRDM = 5131			
FREQUENCY	MODE NO.	COEFFICIENT	RANK	FREQUENCY	MODE NO.	COEFFICIENT	RANK
0.13764E 02	4	-0.24174E-07	8	0.13764E 02	4	0.51351E-09	29
0.17525E 02	5	-0.15796E-07	14	0.17525E 02	5	0.82126E-10	38
0.18133E 02	6	0.72467E-07	1	0.18133E 02	6	-0.17162E-08	23
0.19370E 02	7	-0.19169E-08	26	0.19370E 02	7	0.33006E-10	44
0.22939E 02	8	-0.65894E-07	3	0.22939E 02	8	-0.19824E-07	1
0.25796E 02	9	0.21146E-07	10	0.25796E 02	9	0.15329E-07	4
0.28702E 02	10	0.14266E-08	29	0.28702E 02	10	-0.45245E-10	41
0.28944E 02	11	0.52910E-08	22	0.28944E 02	11	0.25162E-08	19
0.30096E 02	12	-0.10401E-08	35	0.30096E 02	12	-0.36190E-09	33
0.31603E 02	13	0.27622E-09	40	0.31603E 02	13	0.92099E-10	37
0.32334E 02	14	0.22211E-07	9	0.32334E 02	14	0.67389E-08	9
0.32729E 02	15	0.13654E-08	30	0.32729E 02	15	0.72649E-09	28
0.34836E 02	16	-0.12600E-08	31	0.34836E 02	16	-0.26155E-09	35
0.36578E 02	17	-0.57213E-08	21	0.36578E 02	17	-0.18290E-08	21
0.38611E 02	18	-0.31470E-07	7	0.38611E 02	18	-0.74482E-08	8
0.38819E 02	19	0.10417E-07	18	0.38819E 02	19	0.11403E-07	7
0.41914E 02	20	0.12213E-07	15	0.41914E 02	20	-0.48860E-08	13
0.48225E 02	21	-0.12111E-08	32	0.48225E 02	21	-0.41437E-09	31
0.49330E 02	22	-0.34072E-10	45	0.49330E 02	22	-0.17341E-10	46
0.51462E 02	23	0.11490E-08	34	0.51462E 02	23	0.40217E-09	32
0.52124E 02	24	-0.45962E-12	50	0.52124E 02	24	-0.74653E-12	50
0.52244E 02	25	-0.96646E-10	44	0.52244E 02	25	-0.57974E-10	40
0.52839E 02	26	-0.60853E-11	47	0.52839E 02	26	-0.31594E-11	48
0.52912E 02	27	-0.46347E-09	38	0.52912E 02	27	-0.20369E-09	36
0.55803E 02	28	-0.97199E-10	43	0.55803E 02	28	-0.34677E-10	42
0.11957E 02	34	-0.96098E-09	36	0.11957E 02	34	0.34364E-08	15
0.12446E 02	35	0.22841E-08	24	0.12446E 02	35	-0.42555E-08	14
0.16801E 02	36	-0.48307E-07	5	0.16801E 02	36	0.59748E-08	10
0.17309E 02	37	0.66416E-07	2	0.17309E 02	37	-0.13144E-07	5
0.20952E 02	38	0.18881E-07	11	0.20952E 02	38	0.16858E-07	3
0.23872E 02	39	-0.63954E-07	4	0.23872E 02	39	-0.17914E-07	2
0.27020E 02	40	0.40000E-07	6	0.27020E 02	40	0.11656E-07	6
0.29155E 02	41	-0.11101E-07	16	0.29155E 02	41	-0.30352E-08	17
0.30048E 02	42	-0.65835E-09	37	0.30048E 02	42	-0.20863E-10	45
0.30800E 02	43	0.71583E-08	19	0.30800E 02	43	0.17423E-08	22
0.31635E 02	44	0.59649E-08	20	0.31635E 02	44	0.15191E-08	27
0.32753E 02	45	0.23014E-09	41	0.32753E 02	45	0.66971E-10	39
0.33123E 02	46	-0.10975E-07	17	0.33123E 02	46	-0.33288E-08	16
0.36920E 02	47	-0.17046E-07	12	0.36920E 02	47	-0.55764E-08	11
0.37888E 02	48	0.16720E-07	13	0.37888E 02	48	0.50562E-08	12
0.38871E 02	49	-0.31508E-08	23	0.38871E 02	49	-0.50095E-09	30
0.43468E 02	50	0.11887E-08	33	0.43468E 02	50	-0.29637E-09	34
0.45841E 02	51	0.22192E-08	25	0.45841E 02	51	0.16358E-08	25
0.51102E 02	52	0.15369E-08	27	0.51102E 02	52	0.15776E-08	26
0.52131E 02	53	0.32374E-11	48	0.52131E 02	53	0.29936E-11	49
0.52227E 02	54	-0.74939E-12	49	0.52227E 02	54	0.64946E-11	47
0.59475E 02	55	0.19550E-10	46	0.59475E 02	55	0.33190E-10	43
0.60748E 02	56	-0.40134E-09	39	0.60748E 02	56	-0.16897E-08	24
0.65135E 02	57	-0.99571E-10	42	0.65135E 02	57	-0.20911E-08	20
0.67311E 02	58	-0.14542E-08	28	0.67311E 02	58	0.27156E-08	18

RATE COEFFICIENTS. RESPONSE FRDM = 9014 INPUT FRDM = 5131

FREQUENCY	MODE NO.	COEFFICIENT	RANK
0.13764E 02	4	-0.20589E-09	33
0.17525E 02	5	-0.36886E-07	4
0.18133E 02	6	-0.40149E-08	15
0.19370E 02	7	-0.79132E-09	24
0.22237E 02	8	0.13453E-09	36
0.25796E 02	9	-0.59878E-09	26
0.28702E 02	10	-0.10458E-09	38
0.28944E 02	11	-0.59551E-09	27
0.30096E 02	12	-0.32152E-09	30
0.31603E 02	13	0.99123E-09	21
0.32304E 02	14	-0.40392E-08	14
0.32729E 02	15	-0.30882E-09	31
0.34836E 02	16	-0.10076E-08	20
0.36578E 02	17	-0.60581E-09	25
0.38611E 02	18	-0.40672E-07	3
0.38819E 02	19	-0.60283E-08	9
0.41914E 02	20	-0.41174E-08	13
0.48225E 02	21	-0.55752E-10	40
0.49330E 02	22	0.44190E-12	49
0.51462E 02	23	0.12297E-08	18
0.52124E 02	24	0.84710E-13	50
0.52244E 02	25	-0.25105E-09	32
0.52339E 02	26	-0.40717E-11	47
0.52912E 02	27	0.70595E-10	39
0.55803E 02	28	0.43689E-11	46
0.11957E 02	34	-0.14932E-09	35
0.12446E 02	35	0.79225E-08	8
0.16801E 02	36	0.93646E-09	22
0.17309E 02	37	-0.58609E-07	2
0.20952E 02	38	-0.56027E-08	10
0.23872E 02	39	-0.25541E-07	5
0.27020E 02	40	-0.59628E-07	1
0.29155E 02	41	-0.51649E-08	11
0.30048E 02	42	-0.19935E-10	44
0.30800E 02	43	0.41632E-10	43
0.31635E 02	44	-0.37248E-09	29
0.32753E 02	45	0.47859E-10	41
0.33123E 02	46	0.18738E-08	16
0.36920E 02	47	0.11671E-07	7
0.37888E 02	48	0.49354E-08	12
0.38871E 02	49	-0.92069E-09	23
0.43468E 02	50	0.15324E-09	34
0.45841E 02	51	0.11942E-08	19
0.51102E 02	52	0.44374E-10	42
0.52131E 02	53	-0.84467E-11	45
0.52227E 02	54	-0.45671E-12	48
0.59475E 02	55	-0.13027E-09	37
0.60748E 02	56	0.17475E-08	17
0.65135E 02	57	0.51410E-09	28
0.67311E 02	58	0.20336E-07	6

112

RATE COEFFICIENTS. RESPONSE FRDM = 9014 INPUT FRDM = 5132

FREQUENCY	MODE NO.	COEFFICIENT	RANK
0.13764E 02	4	0.12475E-08	37
0.17525E 02	5	0.24800E-07	13
0.18133E 02	6	0.39027E-06	2
0.19370E 02	7	-0.47924E-06	1
0.22237E 02	8	0.16076E-07	18
0.25796E 02	9	-0.35910E-07	11
0.28702E 02	10	0.26076E-08	33
0.28944E 02	11	0.10907E-07	21
0.30096E 02	12	0.78343E-08	27
0.31603E 02	13	0.18193E-08	35
0.32304E 02	14	-0.13115E-07	20
0.32729E 02	15	-0.10471E-08	39
0.34836E 02	16	0.14444E-08	36
0.36578E 02	17	0.24339E-07	14
0.38611E 02	18	0.22117E-07	16
0.38819E 02	19	-0.70626E-09	41
0.41914E 02	20	-0.12368E-08	38
0.48225E 02	21	0.70446E-08	28
0.49330E 02	22	-0.14562E-09	44
0.51462E 02	23	0.17940E-07	17
0.52124E 02	24	-0.91270E-11	48
0.52244E 02	25	0.12558E-09	45
0.52339E 02	26	-0.30615E-11	49
0.52912E 02	27	-0.79146E-08	25
0.55803E 02	28	-0.19739E-08	34
0.11957E 02	34	-0.85381E-09	40
0.12446E 02	35	0.95954E-08	22
0.16801E 02	36	-0.86143E-07	6
0.17309E 02	37	0.40272E-08	31
0.20952E 02	38	-0.83914E-08	24
0.23872E 02	39	-0.12757E-06	4
0.27020E 02	40	0.12819E-06	3
0.29155E 02	41	-0.55933E-07	7
0.30048E 02	42	-0.79110E-08	26
0.30800E 02	43	-0.13163E-07	19
0.31635E 02	44	-0.55310E-07	8
0.32753E 02	45	0.66957E-09	42
0.33123E 02	46	0.10040E-06	5
0.36920E 02	47	0.48476E-07	9
0.37888E 02	48	-0.40070E-07	10
0.38871E 02	49	-0.56082E-08	30
0.43468E 02	50	0.23865E-07	15
0.45841E 02	51	0.26497E-07	12
0.51102E 02	52	0.29070E-08	32
0.52131E 02	53	-0.11068E-10	47
0.52227E 02	54	0.16823E-11	50
0.59475E 02	55	-0.11935E-09	46
0.60748E 02	56	-0.61526E-08	29
0.65135E 02	57	-0.52065E-09	43
0.67311E 02	58	-0.93532E-08	23

RATE COEFFICIENTS. RESPONSE FRDM = 9015 INPUT FRDM = 5132

RATE COEFFICIENTS. RESPONSE FRDM = 9016 INPUT FRDM = 5132

FREQUENCY	MODE NO.	COEFFICIENT	RANK
0.13764E 02	4	-0.26500E-10	46
0.17525E 02	5	-0.12894E-09	42
0.18133E 02	6	-0.92171E-08	15
0.19370E 02	7	0.82516E-08	16
0.22939E 02	8	0.48364E-08	23
0.25796E 02	9	-0.26032E-07	4
0.28702E 02	10	-0.82705E-10	43
0.28944E 02	11	0.51871E-08	22
0.30096E 02	12	0.27260E-08	29
0.31603E 02	13	0.61186E-09	35
0.32384E 02	14	-0.39790E-08	24
0.32729E 02	15	-0.54910E-09	36
0.34036E 02	16	0.29982E-09	38
0.36578E 02	17	0.77804E-08	17
0.38611E 02	18	0.52345E-08	21
0.38819E 02	19	-0.77314E-09	33
0.41914E 02	20	0.49479E-09	37
0.48225E 02	21	0.24102E-08	30
0.49330E 02	22	-0.74113E-10	45
0.51462E 02	23	0.62794E-08	19
0.52124E 02	24	-0.14824E-10	47
0.52244E 02	25	0.75334E-10	44
0.52039E 02	26	-0.15895E-11	50
0.52912E 02	27	-0.34784E-08	25
0.55803E 02	28	-0.70423E-09	34
0.11957E 02	34	0.30532E-08	27
0.12446E 02	35	-0.17877E-07	7
0.16801E 02	36	0.10655E-07	14
0.17309E 02	37	-0.79701E-09	32
0.20952E 02	38	-0.74922E-08	18
0.23872E 02	39	-0.35732E-07	2
0.27020E 02	40	0.37355E-07	1
0.29155E 02	41	-0.15292E-07	10
0.30048E 02	42	-0.25069E-09	39
0.30800E 02	43	-0.32039E-08	26
0.31635E 02	44	-0.14085E-07	11
0.32753E 02	45	0.19485E-09	41
0.33123E 02	46	0.30451E-07	3
0.36920E 02	47	0.15859E-07	9
0.37889E 02	48	-0.12117E-07	12
0.38871E 02	49	-0.89166E-09	31
0.43468E 02	50	-0.59502E-08	20
0.45841E 02	51	0.19532E-07	6
0.51102E 02	52	0.29041E-08	28
0.52131E 02	53	-0.10235E-10	49
0.52227E 02	54	-0.14580E-10	48
0.59475E 02	55	-0.20262E-09	40
0.60748E 02	56	-0.25904E-07	5
0.65135E 02	57	-0.10934E-07	13
0.67311E 02	58	0.17467E-07	8

FREQUENCY	MODE NO.	COEFFICIENT	RANK
0.13764E 02	4	0.10625E-10	46
0.17525E 02	5	0.57913E-07	4
0.18133E 02	6	-0.21563E-07	11
0.19370E 02	7	-0.19783E-06	1
0.22939E 02	8	-0.32813E-10	44
0.25796E 02	9	0.10168E-08	30
0.28702E 02	10	-0.19117E-09	38
0.28944E 02	11	-0.12276E-08	27
0.30096E 02	12	0.24218E-08	23
0.31603E 02	13	0.65286E-08	16
0.32384E 02	14	0.23849E-08	24
0.32729E 02	15	0.23341E-09	37
0.34836E 02	16	0.11551E-08	29
0.36578E 02	17	0.25771E-08	21
0.38611E 02	18	0.28564E-07	8
0.38819E 02	19	0.40871E-09	33
0.41914E 02	20	0.41695E-09	32
0.48225E 02	21	0.32428E-09	35
0.49330E 02	22	0.18886E-11	48
0.51462E 02	23	0.19200E-07	12
0.52124E 02	24	0.16321E-11	49
0.52244E 02	25	0.32622E-09	34
0.52839E 02	26	-0.20585E-11	47
0.52912E 02	27	0.12055E-08	28
0.55803E 02	28	0.88724E-10	41
0.11957E 02	34	-0.13267E-09	40
0.12446E 02	35	0.33281E-07	6
0.16801E 02	36	0.16699E-08	25
0.17309E 02	37	-0.35538E-08	17
0.20952E 02	38	0.24901E-08	22
0.23872E 02	39	-0.50946E-07	5
0.27020E 02	40	-0.19109E-06	2
0.29155E 02	41	-0.26022E-07	10
0.30048E 02	42	-0.23955E-09	36
0.30800E 02	43	-0.76556E-10	43
0.31635E 02	44	0.34539E-08	18
0.32753E 02	45	0.13924E-09	39
0.33123E 02	46	-0.17142E-07	13
0.36920E 02	47	-0.33192E-07	7
0.37889E 02	48	-0.11828E-07	15
0.38871E 02	49	-0.16388E-08	26
0.43468E 02	50	0.30765E-08	19
0.45841E 02	51	0.14260E-07	14
0.51102E 02	52	0.83938E-10	42
0.52131E 02	53	0.28877E-10	45
0.52227E 02	54	0.10252E-11	50
0.59475E 02	55	0.79527E-09	31
0.60748E 02	56	0.26790E-07	9
0.65135E 02	57	0.26882E-08	20
0.67311E 02	58	0.13080E-06	3

RATE COEFFICIENTS. RESPONSE FRDM = 9014 INPUT FRDM = 5133

FREQUENCY	MODE NO.	COEFFICIENT	RANK
0.13764E 02	4	-0.81937E-06	1
0.17525E 02	5	0.16782E-07	16
0.18133E 02	6	0.22422E-06	6
0.19370E 02	7	-0.96611E-09	39
0.22939E 02	8	0.42900E-06	3
0.25796E 02	9	0.24995E-06	4
0.28702E 02	10	-0.16385E-08	33
0.28944E 02	11	0.20595E-08	29
0.30096E 02	12	-0.12151E-10	46
0.31603E 02	13	0.75688E-10	44
0.32384E 02	14	-0.19975E-08	31
0.32729E 02	15	0.67671E-09	40
0.34836E 02	16	-0.26986E-09	42
0.36578E 02	17	-0.17374E-07	15
0.38611E 02	18	-0.75513E-08	20
0.38819E 02	19	0.74137E-08	21
0.41914E 02	20	-0.44123E-07	11
0.48225E 02	21	-0.10459E-06	9
0.49330E 02	22	-0.14698E-08	35
0.51462E 02	23	-0.48970E-09	41
0.52124E 02	24	-0.26757E-10	47
0.52244E 02	25	-0.74604E-10	45
0.52839E 02	26	-0.11268E-10	49
0.52912E 02	27	-0.45982E-08	25
0.55803E 02	28	-0.51964E-08	24
0.11957E 02	34	0.53790E-07	10
0.12446E 02	35	0.11724E-08	37
0.16801E 02	36	-0.43667E-06	2
0.17309E 02	37	-0.13727E-07	17
0.20952E 02	38	0.22966E-06	5
0.23872E 02	39	0.13687E-06	7
0.27020E 02	40	-0.28410E-08	28
0.29155E 02	41	-0.78659E-08	19
0.30048E 02	42	-0.85894E-08	18
0.30800E 02	43	-0.11861E-08	36
0.31635E 02	44	0.41228E-07	13
0.32753E 02	45	-0.15751E-08	34
0.33123E 02	46	0.54056E-08	22
0.36920E 02	47	-0.35464E-08	26
0.37888E 02	48	-0.32497E-07	14
0.38871E 02	49	-0.31348E-08	27
0.43468E 02	50	-0.11459E-06	8
0.45841E 02	51	-0.20026E-08	30
0.51102E 02	52	-0.42338E-07	12
0.52131E 02	53	-0.54404E-11	50
0.52227E 02	54	0.81537E-10	43
0.59475E 02	55	-0.44038E-10	46
0.60748E 02	56	-0.52757E-08	23
0.65135E 02	57	-0.16961E-08	32
0.67311E 02	58	0.10093E-08	38

RATE COEFFICIENTS. RESPONSE FRDM = 9015 INPUT FRDM = 5133

FREQUENCY	MODE NO.	COEFFICIENT	RANK
0.13764E 02	4	0.17405E-07	13
0.17525E 02	5	-0.87254E-10	40
0.18133E 02	6	-0.52955E-08	18
0.19370E 02	7	0.16635E-10	47
0.22939E 02	8	0.12906E-06	4
0.25796E 02	9	0.18119E-06	3
0.28702E 02	10	0.51966E-10	43
0.28944E 02	11	0.97943E-09	29
0.30096E 02	12	-0.42281E-11	50
0.31603E 02	13	0.25456E-10	46
0.32384E 02	14	-0.60605E-09	33
0.32729E 02	15	0.35487E-09	36
0.34836E 02	16	-0.56016E-10	42
0.36578E 02	17	-0.55540E-08	17
0.38611E 02	18	-0.17872E-08	25
0.38819E 02	19	0.81158E-08	16
0.41914E 02	20	0.17651E-07	12
0.48225E 02	21	-0.35782E-07	8
0.49330E 02	22	-0.74806E-09	31
0.51462E 02	23	-0.17140E-09	39
0.52124E 02	24	-0.43460E-10	45
0.52244E 02	25	-0.44752E-10	44
0.52839E 02	26	-0.58501E-11	48
0.52912E 02	27	-0.20209E-08	22
0.55803E 02	28	-0.18539E-08	24
0.11957E 02	34	-0.19235E-06	2
0.12446E 02	35	-0.21841E-08	20
0.16801E 02	36	0.54010E-07	5
0.17309E 02	37	0.27168E-08	19
0.20952E 02	38	0.20505E-06	1
0.23872E 02	39	0.38339E-07	7
0.27020E 02	40	-0.82798E-09	30
0.29155E 02	41	-0.21506E-08	21
0.30048E 02	42	-0.27219E-09	38
0.30800E 02	43	-0.28870E-09	37
0.31635E 02	44	0.10499E-07	14
0.32753E 02	45	-0.45637E-09	35
0.33123E 02	46	0.16396E-08	26
0.36920E 02	47	-0.11602E-08	28
0.37888E 02	48	-0.98274E-08	15
0.38871E 02	49	-0.49842E-09	34
0.43468E 02	50	0.26571E-07	10
0.45841E 02	51	-0.14762E-08	27
0.51102E 02	52	-0.43460E-07	6
0.52131E 02	53	-0.50309E-11	49
0.52227E 02	54	-0.70664E-09	32
0.59475E 02	55	-0.74763E-10	41
0.60748E 02	56	-0.22212E-07	11
0.65135E 02	57	-0.35619E-07	9
0.67311E 02	58	-0.18849E-08	23

RATE COEFFICIENTS. RESPONSE FRDM = 9016 INPUT FRDM = 5133

RATE COEFFICIENTS. RESPONSE FRDM = 9024 INPUT FRDM = 5131

FREQUENCY	MODE NO.	COEFFICIENT	RANK
0.13764E 02	4	-0.69787E-08	14
0.17525E 02	5	0.39189E-07	3
0.18133E 02	6	-0.12389E-07	8
0.19370E 02	7	-0.39882E-09	32
0.22939E 02	8	-0.87563E-09	29
0.25796E 02	9	-0.70776E-08	15
0.28702E 02	10	0.12012E-09	43
0.28944E 02	11	-0.23180E-09	39
0.30096E 02	12	-0.37563E-11	50
0.31603E 02	13	0.27161E-09	36
0.32384E 02	14	0.36326E-09	33
0.32729E 02	15	-0.15085E-09	42
0.34836E 02	16	-0.21580E-09	40
0.36579E 02	17	-0.18397E-08	24
0.38611E 02	18	-0.97592E-08	10
0.38819E 02	19	-0.42903E-08	18
0.41914E 02	20	0.14875E-07	5
0.48225E 02	21	-0.48143E-08	17
0.49330E 02	22	0.19063E-10	45
0.51462E 02	23	-0.52409E-09	31
0.52124E 02	24	0.49315E-11	49
0.52244E 02	25	-0.19379E-09	41
0.52839E 02	26	-0.75763E-11	47
0.52912E 02	27	0.70039E-09	30
0.55203E 02	28	0.23357E-09	38
0.11957E 02	34	0.83581E-08	14
0.12446E 02	35	0.40663E-08	20
0.16801E 02	36	0.84652E-08	13
0.17309E 02	37	0.12114E-07	9
0.20952E 02	38	-0.68151E-07	1
0.23872E 02	39	0.54663E-07	2
0.27020E 02	40	0.42351E-08	19
0.29155E 02	41	-0.36596E-08	21
0.30048E 02	42	-0.26009E-09	37
0.30800E 02	43	-0.68984E-11	48
0.31635E 02	44	-0.25745E-08	22
0.32753E 02	45	-0.32756E-09	34
0.33123E 02	46	-0.92296E-09	27
0.36920E 02	47	0.24283E-08	23
0.37888E 02	48	-0.95926E-08	11
0.38871E 02	49	-0.91603E-09	28
0.43468E 02	50	-0.14772E-07	6
0.45841E 02	51	-0.10777E-08	26
0.51102E 02	52	-0.12225E-08	25
0.52131E 02	53	0.14195E-10	46
0.52227E 02	54	0.49692E-10	44
0.59475E 02	55	0.29345E-09	35
0.60748E 02	56	0.22971E-07	4
0.65135E 02	57	0.87571E-08	12
0.67311E 02	58	-0.14115E-07	7

FREQUENCY	MODE NO.	COEFFICIENT	RANK
0.13764E 02	4	-0.19498E-07	11
0.17525E 02	5	-0.15805E-07	13
0.18133E 02	6	0.67241E-07	2
0.19370E 02	7	-0.17486E-08	30
0.22939E 02	8	-0.69650E-07	1
0.25796E 02	9	0.21509E-07	9
0.28702E 02	10	0.15220E-08	31
0.28944E 02	11	0.40525E-08	22
0.30096E 02	12	-0.83027E-09	34
0.31603E 02	13	0.77875E-10	41
0.32384E 02	14	0.16114E-07	12
0.32729E 02	15	0.84829E-09	33
0.34836E 02	16	-0.87395E-09	32
0.36579E 02	17	-0.35331E-08	24
0.38611E 02	18	-0.20359E-07	10
0.38819E 02	19	-0.37591E-08	23
0.41914E 02	20	0.24278E-07	8
0.48225E 02	21	-0.23057E-08	28
0.49330E 02	22	-0.73391E-10	42
0.51462E 02	23	-0.43299E-09	39
0.52124E 02	24	-0.16786E-11	50
0.52244E 02	25	-0.62750E-10	43
0.52839E 02	26	-0.19725E-11	49
0.52912E 02	27	-0.42991E-10	44
0.55303E 02	28	0.24135E-10	45
0.11957E 02	34	-0.45363E-08	20
0.12446E 02	35	0.66063E-08	18
0.16801E 02	36	-0.42478E-07	5
0.17309E 02	37	0.51256E-07	4
0.20952E 02	38	0.30119E-07	7
0.23872E 02	39	-0.66956E-07	3
0.27020E 02	40	0.37714E-07	6
0.29155E 02	41	-0.96293E-08	16
0.30048E 02	42	-0.59829E-09	36
0.30800E 02	43	0.58580E-08	19
0.31635E 02	44	0.43499E-08	21
0.32753E 02	45	0.17130E-09	40
0.33123E 02	46	-0.78467E-08	17
0.36920E 02	47	-0.11161E-07	15
0.37888E 02	48	0.11273E-07	14
0.38871E 02	49	-0.26203E-08	25
0.43468E 02	50	0.25584E-08	26
0.45841E 02	51	-0.18227E-08	29
0.51102E 02	52	0.24190E-08	27
0.52131E 02	53	0.25636E-11	48
0.52227E 02	54	0.16747E-10	46
0.59475E 02	55	0.26816E-11	47
0.60748E 02	56	-0.47164E-09	37
0.65135E 02	57	0.61975E-09	35
0.67311E 02	58	0.44685E-09	38

REPRODUCIBILITY OF THE ORIGINAL PAGE IS POOR

RATE COEFFICIENTS. RESPONSE FRDM = 9025 INPUT FRDM = 5131

FREQUENCY	MODE NO.	COEFFICIENT	RANK
0.13764E 02	4	-0.90565E-08	9
0.17525E 02	5	0.27860E-08	13
0.16133E 02	6	-0.22602E-09	34
0.19370E 02	7	-0.42491E-10	38
0.22939E 02	8	0.24063E-07	3
0.25796E 02	9	-0.12235E-07	5
0.28702E 02	10	0.82552E-09	22
0.28944E 02	11	-0.21153E-08	15
0.30096E 02	12	0.13799E-09	36
0.31603E 02	13	-0.13331E-09	37
0.32384E 02	14	-0.23697E-08	14
0.32729E 02	15	-0.33497E-09	30
0.34036E 02	16	-0.45779E-11	46
0.36578E 02	17	0.25207E-09	32
0.38611E 02	18	-0.11672E-08	17
0.38819E 02	19	-0.70789E-08	11
0.41914E 02	20	0.92132E-08	7
0.48225E 02	21	-0.75071E-09	25
0.49330E 02	22	-0.24516E-10	39
0.51462E 02	23	-0.15515E-09	35
0.52124E 02	24	-0.44343E-12	50
0.52244E 02	25	-0.24405E-10	40
0.52839E 02	26	-0.82926E-12	49
0.52912E 02	27	-0.23541E-10	42
0.55803E 02	28	0.27456E-11	47
0.11957E 02	34	0.72126E-08	10
0.12446E 02	35	-0.92067E-06	8
0.16801E 02	36	-0.11070E-07	6
0.17309E 02	37	0.28253E-07	1
0.20952E 02	38	-0.26969E-07	2
0.23872E 02	39	0.15710E-07	4
0.27020E 02	40	-0.42032E-08	12
0.29155E 02	41	0.83496E-09	21
0.30048E 02	42	-0.16951E-10	43
0.30800E 02	43	-0.63704E-09	26
0.31635E 02	44	-0.11074E-08	18
0.32753E 02	45	-0.23699E-10	41
0.33123E 02	46	0.15257E-08	16
0.36920E 02	47	0.26667E-09	31
0.37888E 02	48	0.23493E-09	33
0.38871E 02	49	-0.35843E-09	29
0.43468E 02	50	0.79592E-09	24
0.45841E 02	51	-0.80737E-09	23
0.51102E 02	52	0.99164E-09	19
0.52131E 02	53	0.12375E-11	48
0.52227E 02	54	0.67956E-11	45
0.59475E 02	55	0.90277E-11	44
0.40748E 02	56	-0.59774E-09	27
0.65135E 02	57	-0.54578E-09	28
0.67311E 02	58	0.92444E-09	20

RATE COEFFICIENTS. RESPONSE FRDM = 9026 INPUT FRDM = 5131

FREQUENCY	MODE NO.	COEFFICIENT	RANK
0.13764E 02	4	0.95170E-10	36
0.17525E 02	5	0.21771E-07	5
0.16133E 02	6	0.41990E-08	8
0.19370E 02	7	0.30342E-08	13
0.22939E 02	8	-0.28909E-08	14
0.25796E 02	9	-0.11294E-08	21
0.28702E 02	10	0.52278E-09	20
0.28944E 02	11	0.28605E-08	15
0.30096E 02	12	-0.36613E-09	30
0.31603E 02	13	0.20099E-08	18
0.32384E 02	14	-0.26439E-08	16
0.32729E 02	15	-0.20523E-09	33
0.34036E 02	16	-0.65600E-09	24
0.36578E 02	17	-0.60884E-09	25
0.38611E 02	18	-0.18759E-07	6
0.38819E 02	19	-0.17219E-08	19
0.41914E 02	20	-0.11440E-08	20
0.48225E 02	21	-0.55049E-10	39
0.49330E 02	22	0.19757E-11	47
0.51462E 02	23	0.49828E-09	11
0.52124E 02	24	0.33021E-12	49
0.52244E 02	25	-0.93221E-10	37
0.52839E 02	26	0.13135E-11	48
0.52912E 02	27	0.31124E-09	32
0.55803E 02	28	0.17791E-10	44
0.11957E 02	34	0.57035E-07	26
0.12446E 02	35	0.11152E-06	1
0.16801E 02	36	-0.31808E-09	31
0.17309E 02	37	-0.34106E-07	3
0.20952E 02	38	0.89739E-09	22
0.23872E 02	39	0.14587E-07	7
0.27020E 02	40	0.33210E-07	4
0.29155E 02	41	0.32305E-08	12
0.30048E 02	42	0.32369E-10	42
0.30800E 02	43	-0.75163E-10	38
0.31635E 02	44	-0.69110E-09	23
0.32753E 02	45	-0.16478E-10	45
0.33123E 02	46	-0.23027E-08	17
0.36920E 02	47	-0.39912E-07	2
0.37888E 02	48	-0.59570E-08	9
0.38871E 02	49	0.56931E-09	27
0.43468E 02	50	0.54889E-10	50
0.45841E 02	51	0.15359E-09	35
0.51102E 02	52	-0.23727E-10	43
0.52131E 02	53	-0.49111E-11	46
0.52227E 02	54	-0.35208E-13	50
0.59475E 02	55	-0.44876E-10	41
0.40748E 02	56	0.42028E-09	29
0.65135E 02	57	0.16284E-09	34
0.67311E 02	58	0.56753E-08	10

RATE COEFFICIENTS. RESPONSE FRDM = 9024 INPUT FRDM = 5132

FREQUENCY	MODE NO.	COEFFICIENT	RANK
0.13764E 02	4	0.10062E-08	36
0.17525E 02	5	0.24814E-07	14
0.18133E 02	6	0.36113E-06	2
0.19370E 02	7	-0.43715E-06	1
0.22939E 02	8	0.16993E-07	16
0.25796E 02	9	-0.36526E-07	10
0.28702E 02	10	0.27821E-08	34
0.28944E 02	11	0.83542E-08	23
0.30096E 02	12	0.62539E-08	27
0.31603E 02	13	0.51291E-09	40
0.32384E 02	14	-0.95144E-08	22
0.32729E 02	15	-0.64116E-09	39
0.34836E 02	16	0.10018E-08	37
0.36578E 02	17	0.15030E-07	17
0.38611E 02	18	0.14308E-07	18
0.38819E 02	19	0.25486E-09	44
0.41914E 02	20	-0.24586E-08	35
0.48225E 02	21	0.13411E-07	19
0.49330E 02	22	-0.31366E-09	43
0.51462E 02	23	-0.67607E-08	26
0.52124E 02	24	-0.33333E-10	47
0.52244E 02	25	0.81539E-10	45
0.52839E 02	26	-0.99237E-12	50
0.52912E 02	27	-0.73416E-09	38
0.55803E 02	28	0.49013E-09	42
0.11957E 02	34	-0.40304E-08	30
0.12446E 02	35	0.27752E-07	12
0.16801E 02	36	-0.75749E-07	5
0.17309E 02	37	0.31080E-08	32
0.20952E 02	38	-0.13386E-07	20
0.23872E 02	39	-0.13355E-06	3
0.27020E 02	40	0.12086E-06	4
0.29155E 02	41	-0.48516E-07	8
0.30048E 02	42	-0.71893E-08	25
0.30800E 02	43	-0.10772E-07	21
0.31635E 02	44	-0.40335E-07	9
0.32753E 02	45	0.49839E-09	41
0.33123E 02	46	0.71781E-07	6
0.36920E 02	47	0.31742E-07	11
0.37888E 02	48	-0.27017E-07	13
0.38871E 02	49	-0.46640E-08	28
0.43468E 02	50	0.51364E-07	7
0.45841E 02	51	-0.21763E-07	15
0.51102E 02	52	0.45755E-08	29
0.52131E 02	53	-0.87644E-11	49
0.52227E 02	54	-0.37596E-10	46
0.59475E 02	55	-0.16370E-10	48
0.60748E 02	56	-0.72304E-08	24
0.65135E 02	57	0.32407E-08	31
0.67311E 02	58	0.28742E-08	33

RATE COEFFICIENTS. RESPONSE FRDM = 9025 INPUT FRDM = 5132

FREQUENCY	MODE NO.	COEFFICIENT	RANK
0.13764E 02	4	0.46736E-09	37
0.17525E 02	5	-0.43741E-08	16
0.18133E 02	6	-0.12182E-08	26
0.19370E 02	7	-0.10623E-07	9
0.22939E 02	8	-0.58705E-08	15
0.25796E 02	9	0.20777E-07	3
0.28702E 02	10	0.15090E-08	24
0.28944E 02	11	-0.43617E-08	18
0.30096E 02	12	-0.10394E-08	29
0.31603E 02	13	-0.87801E-09	31
0.32384E 02	14	0.13992E-08	25
0.32729E 02	15	0.25318E-09	39
0.34836E 02	16	0.52478E-11	48
0.36578E 02	17	-0.10723E-08	28
0.38611E 02	18	0.82028E-09	32
0.38819E 02	19	0.47994E-09	36
0.41914E 02	20	-0.93298E-09	30
0.48225E 02	21	0.43665E-08	17
0.49330E 02	22	-0.10478E-09	41
0.51462E 02	23	-0.24225E-08	21
0.52124E 02	24	-0.12777E-10	47
0.52244E 02	25	0.31712E-10	45
0.52839E 02	26	-0.41720E-12	50
0.52912E 02	27	-0.40201E-09	38
0.55803E 02	28	0.55758E-10	44
0.11957E 02	34	0.64083E-08	13
0.12446E 02	35	-0.38676E-07	1
0.16801E 02	36	-0.19740E-07	4
0.17309E 02	37	0.17131E-08	23
0.20952E 02	38	0.11986E-07	8
0.23872E 02	39	0.31335E-07	2
0.27020E 02	40	-0.13726E-07	6
0.29155E 02	41	0.42068E-08	19
0.30048E 02	42	-0.20369E-09	40
0.30800E 02	43	0.11715E-08	27
0.31635E 02	44	0.10268E-07	10
0.32753E 02	45	-0.68950E-10	42
0.33123E 02	46	-0.12127E-07	7
0.36920E 02	47	-0.75837E-09	33
0.37888E 02	48	-0.56302E-09	35
0.38871E 02	49	-0.63798E-09	34
0.43468E 02	50	0.15979E-07	5
0.45841E 02	51	-0.96402E-08	11
0.51102E 02	52	0.18757E-08	22
0.52131E 02	53	-0.42308E-11	49
0.52227E 02	54	-0.15255E-10	46
0.59475E 02	55	-0.59996E-10	43
0.60748E 02	56	-0.91941E-08	12
0.65135E 02	57	-0.28538E-08	20
0.67311E 02	58	0.59460E-08	14

RATE COEFFICIENTS. RESPONSE FRDM = 9026 INPUT FRDM = 5132

FREQUENCY	MODE NO.	COEFFICIENT	RANK
0.13764E 02	4	-0.49112E-11	48
0.17525E 02	5	-0.34182E-07	7
0.18133E 02	6	0.33293E-07	8
0.19370E 02	7	0.75855E-06	1
0.22939E 02	8	0.70530E-09	30
0.25796E 02	9	0.19179E-08	22
0.28702E 02	10	0.95561E-09	27
0.28944E 02	11	0.58968E-08	17
0.30096E 02	12	0.27578E-08	19
0.31603E 02	13	0.13238E-07	13
0.32384E 02	14	0.15611E-08	24
0.32729E 02	15	0.15512E-09	38
0.34836E 02	16	0.75200E-09	29
0.36578E 02	17	0.25900E-08	20
0.38611E 02	18	0.13184E-07	14
0.38819E 02	19	0.11675E-09	41
0.41914E 02	20	0.11585E-09	42
0.48225E 02	21	0.32019E-09	36
0.49330E 02	22	0.84438E-11	46
0.51462E 02	23	0.77801E-07	5
0.52124E 02	24	0.65572E-11	47
0.52244E 02	25	0.12113E-09	40
0.52839E 02	26	0.66082E-12	49
0.52912E 02	27	0.53150E-08	18
0.55803E 02	28	0.36130E-09	35
0.11957E 02	34	0.50674E-09	32
0.12446E 02	35	0.46848E-06	2
0.16801E 02	36	-0.56722E-09	31
0.17309E 02	37	-0.20680E-08	21
0.20952E 02	38	-0.39834E-09	33
0.23872E 02	39	0.29096E-07	9
0.27020E 02	40	0.10643E-06	4
0.29155E 02	41	0.16276E-07	11
0.30048E 02	42	0.38896E-09	34
0.30800E 02	43	0.13822E-09	39
0.31635E 02	44	0.64083E-08	16
0.32753E 02	45	-0.47943E-10	43
0.33123E 02	46	0.21065E-07	10
0.36920E 02	47	0.11351E-06	3
0.37888E 02	48	0.14276E-07	12
0.38871E 02	49	0.10133E-08	26
0.43468E 02	50	0.11020E-08	25
0.45841E 02	51	0.18339E-08	23
0.51102E 02	52	-0.44881E-10	44
0.52131E 02	53	0.16790E-10	45
0.52227E 02	54	0.79038E-13	50
0.59475E 02	55	0.27395E-09	37
0.60748E 02	56	0.64429E-08	15
0.65135E 02	57	0.85146E-09	28
0.67311E 02	58	0.36504E-07	6

RATE COEFFICIENTS. RESPONSE FRDM = 9024 INPUT FRDM = 5133

FREQUENCY	MODE NO.	COEFFICIENT	RANK
0.13764E 02	4	-0.66090E-06	1
0.17525E 02	5	0.16791E-07	15
0.18133E 02	6	0.20748E-06	8
0.19370E 02	7	-0.88126E-09	38
0.22939E 02	8	0.45346E-06	2
0.25796E 02	9	0.25424E-06	5
0.28702E 02	10	-0.17401E-08	31
0.28944E 02	11	0.15775E-08	33
0.30096E 02	12	-0.96999E-11	47
0.31603E 02	13	0.21339E-10	46
0.32384E 02	14	-0.14492E-08	34
0.32729E 02	15	0.41436E-09	40
0.34836E 02	16	-0.18717E-09	42
0.36578E 02	17	-0.10729E-07	16
0.38611E 02	18	-0.48852E-08	22
0.38819E 02	19	-0.26753E-08	27
0.41914E 02	20	-0.87710E-07	11
0.48225E 02	21	-0.19910E-06	9
0.49330E 02	22	-0.31659E-08	25
0.51462E 02	23	0.18454E-09	43
0.52124E 02	24	-0.97722E-10	44
0.52244E 02	25	-0.48438E-10	45
0.52839E 02	26	-0.36524E-11	50
0.52912E 02	27	-0.42653E-09	39
0.55803E 02	28	0.12903E-08	35
0.11957E 02	34	0.25392E-06	6
0.12446E 02	35	0.33907E-08	24
0.16801E 02	36	-0.38398E-06	3
0.17309E 02	37	-0.10594E-07	17
0.20952E 02	38	0.36636E-06	4
0.23872E 02	39	0.14330E-06	10
0.27020E 02	40	-0.26787E-08	26
0.29155E 02	41	-0.68229E-08	20
0.30048E 02	42	-0.78058E-08	19
0.30800E 02	43	-0.97067E-09	37
0.31635E 02	44	0.30066E-07	13
0.32753E 02	45	-0.11725E-08	36
0.33123E 02	46	0.38650E-08	23
0.36920E 02	47	-0.23222E-08	29
0.37888E 02	48	-0.21911E-07	14
0.38871E 02	49	-0.26071E-08	28
0.43468E 02	50	-0.24664E-06	7
0.45841E 02	51	0.16448E-08	32
0.51102E 02	52	-0.66637E-07	12
0.52131E 02	53	-0.43082E-11	49
0.52227E 02	54	-0.16222E-08	30
0.59475E 02	55	-0.60405E-11	48
0.60748E 02	56	-0.61998E-08	21
0.65135E 02	57	0.10557E-07	18
0.67311E 02	58	-0.31016E-09	41

RATE COEFFICIENTS. RESPONSE FRDM = 9025 INPUT FRDM = 5133

FREQUENCY	MODE NO.	COEFFICIENT	RANK
0.13764E 02	4	-0.30697E-06	3
0.17525E 02	5	-0.29599E-08	18
0.18133E 02	6	-0.69988E-09	25
0.19370E 02	7	-0.21415E-10	45
0.22939E 02	8	-0.15666E-06	4
0.25796E 02	9	-0.14462E-06	5
0.28702E 02	10	-0.94815E-09	20
0.28944E 02	11	-0.82358E-09	21
0.30096E 02	12	0.16122E-11	48
0.31603E 02	13	-0.36528E-10	43
0.32384E 02	14	0.21312E-09	35
0.32729E 02	15	-0.16362E-09	36
0.34836E 02	16	-0.98045E-12	50
0.34570E 02	17	0.76545E-09	22
0.38611E 02	18	-0.28006E-09	32
0.38819E 02	19	-0.50380E-08	16
0.41914E 02	20	-0.33284E-07	10
0.48225E 02	21	-0.64826E-07	0
0.49330E 02	22	-0.10576E-08	19
0.51462E 02	23	0.66124E-10	40
0.52124E 02	24	-0.37458E-10	42
0.52244E 02	25	-0.18839E-10	46
0.52839E 02	26	-0.15355E-11	49
0.52912E 02	27	-0.23356E-09	33
0.55803E 02	28	0.14678E-09	38
0.11957E 02	34	-0.48373E-06	1
0.12446E 02	35	-0.47254E-08	17
0.16801E 02	36	-0.10007E-06	6
0.17309E 02	37	-0.58395E-08	15
0.20952E 02	38	-0.32804E-06	2
0.23872E 02	39	-0.33622E-07	9
0.27020E 02	40	0.30422E-09	31
0.29155E 02	41	0.59161E-09	28
0.30048E 02	42	-0.22116E-09	34
0.30800E 02	43	0.10556E-09	39
0.31635E 02	44	-0.76540E-08	14
0.32753E 02	45	0.16220E-09	37
0.33123E 02	46	-0.65297E-09	26
0.36920E 02	47	0.55480E-10	41
0.37888E 02	48	-0.45662E-09	29
0.38871E 02	49	-0.35661E-09	30
0.43468E 02	50	-0.76729E-07	7
0.45041E 02	51	0.72860E-09	24
0.51102E 02	52	-0.27318E-07	11
0.52131E 02	53	-0.20797E-11	47
0.52227E 02	54	-0.73938E-09	23
0.59475E 02	55	-0.22138E-10	44
0.60748E 02	56	-0.78837E-08	13
0.65135E 02	57	-0.92968E-08	12
0.67311E 02	58	-0.64165E-09	27

RATE COEFFICIENTS. RESPONSE FRDM = 9026 INPUT FRDM = 5133

FREQUENCY	MODE NO.	COEFFICIENT	RANK
0.13764E 02	4	0.32258E-08	19
0.17525E 02	5	-0.23131E-07	4
0.18133E 02	6	0.19128E-07	5
0.19370E 02	7	0.15292E-08	27
0.22939E 02	8	0.18821E-07	6
0.25796E 02	9	-0.13350E-07	7
0.28702E 02	10	-0.60044E-09	33
0.28944E 02	11	0.11134E-08	30
0.30096E 02	12	-0.42775E-11	48
0.31603E 02	13	0.55075E-09	35
0.32384E 02	14	0.23778E-09	37
0.32729E 02	15	-0.10025E-09	42
0.34836E 02	16	-0.14050E-09	38
0.34570E 02	17	-0.18486E-08	26
0.38611E 02	18	-0.45012E-08	16
0.38819E 02	19	-0.12255E-08	28
0.41914E 02	20	0.41330E-08	17
0.48225E 02	21	-0.47536E-08	15
0.49330E 02	22	0.85227E-10	43
0.51462E 02	23	-0.21236E-08	25
0.52124E 02	24	0.19224E-10	45
0.52244E 02	25	-0.71959E-10	44
0.52839E 02	26	0.24321E-11	50
0.52912E 02	27	0.30879E-08	20
0.55803E 02	28	0.95112E-09	31
0.11957E 02	34	-0.31925E-07	2
0.12446E 02	35	0.57239E-07	1
0.16801E 02	36	-0.28753E-08	21
0.17309E 02	37	0.70492E-08	11
0.20952E 02	38	0.10916E-07	9
0.23872E 02	39	-0.31219E-07	3
0.27020E 02	40	-0.23587E-08	23
0.29155E 02	41	0.22890E-08	24
0.30048E 02	42	0.42232E-09	36
0.30800E 02	43	0.12454E-10	46
0.31635E 02	44	-0.47767E-08	14
0.32753E 02	45	0.11278E-09	40
0.33123E 02	46	0.11342E-08	29
0.36920E 02	47	-0.83038E-08	10
0.37888E 02	48	0.11578E-07	8
0.38871E 02	49	0.56643E-09	34
0.43468E 02	50	-0.52914E-08	13
0.45041E 02	51	-0.13860E-09	39
0.51102E 02	52	0.65364E-09	32
0.52131E 02	53	0.82531E-11	47
0.52227E 02	54	0.38308E-11	49
0.59475E 02	55	0.10109E-09	41
0.60748E 02	56	0.55246E-08	12
0.65135E 02	57	0.27737E-08	22
0.67311E 02	58	-0.39392E-08	18

RATE COEFFICIENTS. RESPONSE FRDM = 90044 INPUT FRDM = 5131

RATE COEFFICIENTS. RESPONSE FRDM = 90045 INPUT FRDM = 5131

FREQUENCY	MODE NO.	COEFFICIENT	RANK
0.13764E 02	4	0.0	50
0.17525E 02	5	0.0	49
0.18133E 02	6	0.0	48
0.19370E 02	7	0.0	47
0.22939E 02	8	0.0	46
0.25796E 02	9	0.0	45
0.28702E 02	10	0.0	44
0.28944E 02	11	0.0	43
0.30096E 02	12	0.0	42
0.31603E 02	13	0.0	41
0.32384E 02	14	0.0	40
0.32729E 02	15	0.0	39
0.34336E 02	16	0.0	38
0.36578E 02	17	0.0	37
0.38611E 02	18	0.0	36
0.38819E 02	19	0.0	35
0.41914E 02	20	0.0	34
0.48225E 02	21	0.0	33
0.49330E 02	22	0.0	32
0.51462E 02	23	0.0	31
0.52124E 02	24	0.0	30
0.52244E 02	25	0.0	29
0.52839E 02	26	0.0	28
0.52912E 02	27	0.0	27
0.55803E 02	28	0.0	26
0.11957E 02	34	-0.14079E-07	6
0.12446E 02	35	0.12932E-07	8
0.14680E 02	36	0.41334E-07	4
0.17309E 02	37	-0.63734E-07	2
0.20952E 02	38	-0.51899E-07	3
0.23872E 02	39	0.84947E-07	1
0.27020E 02	40	-0.83170E-08	12
0.29155E 02	41	-0.15102E-07	5
0.30048E 02	42	-0.28645E-09	19
0.30800E 02	43	0.32968E-08	15
0.31635E 02	44	0.59412E-08	13
0.32753E 02	45	-0.88392E-10	21
0.33123E 02	46	0.35342E-08	14
0.36920E 02	47	0.13010E-07	7
0.37888E 02	48	-0.11282E-07	9
0.38671E 02	49	-0.25866E-08	17
0.43468E 02	50	-0.12186E-09	20
0.45841E 02	51	-0.10699E-10	23
0.51102E 02	52	-0.27683E-08	16
0.52131E 02	53	0.22733E-11	25
0.52227E 02	54	-0.62986E-11	24
0.59475E 02	55	0.76419E-10	22
0.60748E 02	56	-0.94277E-08	11
0.65135E 02	57	0.22672E-08	18
0.67311E 02	58	0.10517E-07	10

FREQUENCY	MODE NO.	COEFFICIENT	RANK
0.13764E 02	4	-0.54056E-08	9
0.17525E 02	5	-0.16462E-08	15
0.18133E 02	6	-0.16567E-07	6
0.19370E 02	7	0.51215E-09	19
0.22939E 02	8	-0.69202E-07	1
0.25796E 02	9	-0.15557E-07	7
0.28702E 02	10	0.28182E-07	5
0.28944E 02	11	-0.34513E-08	10
0.30096E 02	12	-0.34299E-08	11
0.31603E 02	13	-0.29800E-08	13
0.32384E 02	14	0.49854E-07	2
0.32729E 02	15	0.28488E-08	14
0.34836E 02	16	-0.74061E-09	16
0.36578E 02	17	0.31229E-08	12
0.38611E 02	18	0.48754E-07	3
0.38819E 02	19	-0.38078E-07	4
0.41914E 02	20	-0.82595E-08	8
0.48225E 02	21	0.12561E-09	20
0.49330E 02	22	0.12134E-09	21
0.51462E 02	23	-0.54018E-09	18
0.52124E 02	24	0.63324E-13	25
0.52244E 02	25	0.52076E-10	23
0.52839E 02	26	-0.42938E-11	24
0.52912E 02	27	-0.69719E-09	17
0.55803E 02	28	0.96308E-10	22
0.11957E 02	34	0.0	50
0.12446E 02	35	0.0	49
0.14680E 02	36	0.0	48
0.17309E 02	37	0.0	47
0.20952E 02	38	0.0	46
0.23872E 02	39	0.0	45
0.27020E 02	40	0.0	44
0.29155E 02	41	0.0	43
0.30048E 02	42	0.0	42
0.30800E 02	43	0.0	41
0.31635E 02	44	0.0	40
0.32753E 02	45	0.0	39
0.33123E 02	46	0.0	38
0.36920E 02	47	0.0	37
0.37888E 02	48	0.0	36
0.38671E 02	49	0.0	35
0.43468E 02	50	0.0	34
0.45841E 02	51	0.0	33
0.51102E 02	52	0.0	32
0.52131E 02	53	0.0	31
0.52227E 02	54	0.0	30
0.59475E 02	55	0.0	29
0.60748E 02	56	0.0	28
0.65135E 02	57	0.0	27
0.67311E 02	58	0.0	26

RATE COEFFICIENTS. RESPONSE FRDM = 90046 INPUT FRDM = 5131

RATE COEFFICIENTS. RESPONSE FRDM = 90044 INPUT FRDM = 5132

FREQUENCY	MODE NO.	COEFFICIENT	RANK
0.13764E 02	4	0.0	50
0.17525E 02	5	0.0	49
0.18133E 02	6	0.0	48
0.19370E 02	7	0.0	47
0.22939E 02	8	0.0	46
0.25796E 02	9	0.0	45
0.28702E 02	10	0.0	44
0.28944E 02	11	0.0	43
0.30096E 02	12	0.0	42
0.31603E 02	13	0.0	41
0.32384E 02	14	0.0	40
0.32729E 02	15	0.0	39
0.34836E 02	16	0.0	38
0.36578E 02	17	0.0	37
0.38611E 02	18	0.0	36
0.38819E 02	19	0.0	35
0.41914E 02	20	0.0	34
0.48225E 02	21	0.0	33
0.49330E 02	22	0.0	32
0.51462E 02	23	0.0	31
0.52124E 02	24	0.0	30
0.52244E 02	25	0.0	29
0.52839E 02	26	0.0	28
0.52912E 02	27	0.0	27
0.55803E 02	28	0.0	26
0.11957E 02	34	0.40438E-08	16
0.12446E 02	35	0.33674E-07	5
0.16801E 02	36	0.91195E-08	9
0.17309E 02	37	0.95788E-07	1
0.20952E 02	38	-0.27658E-07	7
0.23872E 02	39	-0.93995E-07	2
0.27020E 02	40	0.30053E-07	6
0.29155E 02	41	0.52135E-08	13
0.30048E 02	42	-0.19543E-09	21
0.30800E 02	43	0.26246E-09	20
0.31635E 02	44	0.84415E-08	10
0.32753E 02	45	-0.98292E-10	22
0.33123E 02	46	0.29638E-08	17
0.36920E 02	47	0.35646E-07	3
0.37886E 02	48	-0.34872E-07	4
0.38871E 02	49	0.62712E-08	12
0.43468E 02	50	-0.12920E-08	19
0.45841E 02	51	-0.10508E-07	8
0.51102E 02	52	0.19933E-08	18
0.52131E 02	53	-0.96994E-11	25
0.52227E 02	54	0.10924E-10	24
0.59475E 02	55	-0.69002E-10	23
0.60748E 02	56	0.42721E-08	15
0.65135E 02	57	-0.45913E-08	14
0.67311E 02	58	0.70564E-08	11

FREQUENCY	MODE NO.	COEFFICIENT	RANK
0.13764E 02	4	0.0	50
0.17525E 02	5	0.0	49
0.18133E 02	6	0.0	48
0.19370E 02	7	0.0	47
0.22939E 02	8	0.0	46
0.25796E 02	9	0.0	45
0.28702E 02	10	0.0	44
0.28944E 02	11	0.0	43
0.30096E 02	12	0.0	42
0.31603E 02	13	0.0	41
0.32384E 02	14	0.0	40
0.32729E 02	15	0.0	39
0.34836E 02	16	0.0	38
0.36578E 02	17	0.0	37
0.38611E 02	18	0.0	36
0.38819E 02	19	0.0	35
0.41914E 02	20	0.0	34
0.48225E 02	21	0.0	33
0.49330E 02	22	0.0	32
0.51462E 02	23	0.0	31
0.52124E 02	24	0.0	30
0.52244E 02	25	0.0	29
0.52839E 02	26	0.0	28
0.52912E 02	27	0.0	27
0.55803E 02	28	0.0	26
0.11957E 02	34	-0.12509E-07	13
0.12446E 02	35	0.54324E-07	7
0.16801E 02	36	0.73710E-07	4
0.17309E 02	37	-0.38646E-08	18
0.20952E 02	38	0.23066E-07	12
0.23872E 02	39	0.16944E-06	1
0.27020E 02	40	-0.26653E-07	11
0.29155E 02	41	-0.76090E-07	3
0.30048E 02	42	-0.34421E-08	19
0.30800E 02	43	-0.60624E-08	15
0.31635E 02	44	-0.55090E-07	6
0.32753E 02	45	-0.25717E-09	22
0.33123E 02	46	-0.32330E-07	9
0.36920E 02	47	-0.36999E-07	8
0.37886E 02	48	0.27038E-07	10
0.38871E 02	49	-0.46039E-08	17
0.43468E 02	50	-0.24465E-08	20
0.45841E 02	51	-0.12775E-09	23
0.51102E 02	52	-0.52362E-08	16
0.52131E 02	53	-0.77719E-11	25
0.52227E 02	54	0.14139E-10	24
0.59475E 02	55	-0.46652E-09	21
0.60748E 02	56	-0.14453E-06	2
0.65135E 02	57	0.11855E-07	14
0.67311E 02	58	0.67647E-07	5

RATE COEFFICIENTS. RESPONSE FRDM = 90045 INPUT FRDM = 5132

RATE COEFFICIENTS. RESPONSE FRDM = 90046 INPUT FRDM = 5132

FREQUENCY	MODE NO.	COEFFICIENT	RANK
0.13764E 02	4	0.27896E-09	22
0.17525E 02	5	0.25845E-08	14
0.18133E 02	6	-0.88975E-07	2
0.19370E 02	7	0.12804E-06	1
0.22939E 02	8	0.16083E-07	9
0.25796E 02	9	0.26418E-07	6
0.28702E 02	10	0.51516E-07	3
0.28944E 02	11	-0.71148E-08	13
0.30096E 02	12	0.25835E-07	7
0.31603E 02	13	-0.19627E-07	8
0.32384E 02	14	-0.29436E-07	5
0.32729E 02	15	-0.21532E-08	16
0.34836E 02	16	0.04899E-09	18
0.36578E 02	17	-0.13285E-07	10
0.38611E 02	18	-0.34264E-07	4
0.38819E 02	19	0.25817E-08	15
0.41914E 02	20	0.83641E-09	19
0.48225E 02	21	-0.73061E-09	20
0.49330E 02	22	0.51860E-09	21
0.51462E 02	23	-0.84343E-08	12
0.52124E 02	24	0.12575E-11	25
0.52244E 02	25	-0.67469E-10	23
0.52839E 02	26	-0.21602E-11	24
0.52912E 02	27	-0.11906E-07	11
0.55803E 02	28	0.19558E-08	17
0.11957E 02	34	0.0	50
0.12446E 02	35	0.0	49
0.16801E 02	36	0.0	48
0.17309E 02	37	0.0	47
0.20952E 02	38	0.0	46
0.23872E 02	39	0.0	45
0.27020E 02	40	0.0	44
0.29155E 02	41	0.0	43
0.30048E 02	42	0.0	42
0.30800E 02	43	0.0	41
0.31635E 02	44	0.0	40
0.32753E 02	45	0.0	39
0.33123E 02	46	0.0	38
0.36920E 02	47	0.0	37
0.37888E 02	48	0.0	36
0.38671E 02	49	0.0	35
0.43468E 02	50	0.0	34
0.45841E 02	51	0.0	33
0.51102E 02	52	0.0	32
0.52131E 02	53	0.0	31
0.52227E 02	54	0.0	30
0.59475E 02	55	0.0	29
0.60748E 02	56	0.0	28
0.65135E 02	57	0.0	27
0.67311E 02	58	0.0	26

FREQUENCY	MODE NO.	COEFFICIENT	RANK
0.13764E 02	4	0.0	50
0.17525E 02	5	0.0	49
0.18133E 02	6	0.0	48
0.19370E 02	7	0.0	47
0.22939E 02	8	0.0	46
0.25796E 02	9	0.0	45
0.28702E 02	10	0.0	44
0.28944E 02	11	0.0	43
0.30096E 02	12	0.0	42
0.31603E 02	13	0.0	41
0.32384E 02	14	0.0	40
0.32729E 02	15	0.0	39
0.34836E 02	16	0.0	38
0.36578E 02	17	0.0	37
0.38611E 02	18	0.0	36
0.38819E 02	19	0.0	35
0.41914E 02	20	0.0	34
0.48225E 02	21	0.0	33
0.49330E 02	22	0.0	32
0.51462E 02	23	0.0	31
0.52124E 02	24	0.0	30
0.52244E 02	25	0.0	29
0.52839E 02	26	0.0	28
0.52912E 02	27	0.0	27
0.55803E 02	28	0.0	26
0.11957E 02	34	0.35929E-08	19
0.12446E 02	35	0.14146E-06	2
0.16801E 02	36	0.16262E-07	14
0.17309E 02	37	0.58082E-08	17
0.20952E 02	38	0.12293E-07	15
0.23872E 02	39	-0.18749E-06	1
0.27020E 02	40	0.96309E-07	5
0.29155E 02	41	0.26267E-07	11
0.30048E 02	42	-0.23483E-08	20
0.30800E 02	43	-0.48264E-09	21
0.31635E 02	44	-0.78274E-07	7
0.32753E 02	45	-0.28597E-09	23
0.33123E 02	46	-0.27113E-07	10
0.36920E 02	47	-0.10137E-06	4
0.37888E 02	48	0.83573E-07	6
0.38671E 02	49	0.11162E-07	16
0.43468E 02	50	-0.25939E-07	12
0.45841E 02	51	-0.12547E-06	3
0.51102E 02	52	0.37703E-08	18
0.52131E 02	53	0.33160E-10	24
0.52227E 02	54	-0.24523E-10	25
0.59475E 02	55	0.42124E-09	22
0.60748E 02	56	0.65493E-07	8
0.65135E 02	57	-0.24008E-07	13
0.67311E 02	58	0.45387E-07	9

RATE COEFFICIENTS. RESPONSE FRDM = 90044 INPUT FRDM = 5133

RATE COEFFICIENTS. RESPONSE FRDM = 90045 INPUT FRDM = 5133

FREQUENCY	MODE NO.	COEFFICIENT	RANK
0.13764E 02	4	0.0	50
0.17525E 02	5	0.0	49
0.18133E 02	6	0.0	48
0.19370E 02	7	0.0	47
0.22939E 02	8	0.0	46
0.25796E 02	9	0.0	45
0.28702E 02	10	0.0	44
0.28944E 02	11	0.0	43
0.30096E 02	12	0.0	42
0.31603E 02	13	0.0	41
0.32384E 02	14	0.0	40
0.32729E 02	15	0.0	39
0.34836E 02	16	0.0	38
0.36578E 02	17	0.0	37
0.38611E 02	18	0.0	36
0.38819E 02	19	0.0	35
0.41914E 02	20	0.0	34
0.48225E 02	21	0.0	33
0.49330E 02	22	0.0	32
0.51462E 02	23	0.0	31
0.52124E 02	24	0.0	30
0.52244E 02	25	0.0	29
0.52839E 02	26	0.0	28
0.52912E 02	27	0.0	27
0.55803E 02	28	0.0	26
0.11957E 02	34	0.78806E-06	1
0.12446E 02	35	0.66373E-08	14
0.16801E 02	36	0.37365E-06	3
0.17309E 02	37	0.13173E-07	10
0.20952E 02	38	-0.63130E-06	2
0.23872E 02	39	-0.18180E-06	4
0.27020E 02	40	0.59072E-09	21
0.29155E 02	41	-0.10701E-07	12
0.30048E 02	42	-0.37373E-08	15
0.30800E 02	43	-0.54628E-09	22
0.31635E 02	44	0.41064E-07	7
0.32753E 02	45	0.60498E-09	20
0.33123E 02	46	-0.17408E-08	18
0.36920E 02	47	0.27067E-08	16
0.37888E 02	48	0.21928E-07	9
0.38871E 02	49	-0.25735E-08	17
0.43468E 02	50	0.11747E-07	11
0.45841E 02	51	0.96553E-11	24
0.51102E 02	52	0.76260E-07	6
0.52131E 02	53	-0.38203E-11	25
0.52227E 02	54	0.68531E-09	19
0.59475E 02	55	-0.17214E-09	23
0.60748E 02	56	-0.12393E-06	5
0.65135E 02	57	0.38619E-07	8
0.67311E 02	58	-0.72999E-08	13

FREQUENCY	MODE NO.	COEFFICIENT	RANK
0.13764E 02	4	-0.18322E-06	3
0.17525E 02	5	0.17489E-08	15
0.18133E 02	6	-0.51119E-07	4
0.19370E 02	7	0.25812E-09	19
0.22939E 02	8	0.45053E-06	1
0.25796E 02	9	-0.18388E-06	2
0.28702E 02	10	-0.32369E-07	5
0.28944E 02	11	-0.13434E-08	17
0.30096E 02	12	-0.40071E-10	23
0.31603E 02	13	-0.81657E-09	18
0.32384E 02	14	-0.44835E-08	14
0.32729E 02	15	0.13915E-08	16
0.34836E 02	16	-0.15862E-09	21
0.36578E 02	17	0.94833E-08	10
0.38611E 02	18	0.11693E-07	8
0.38819E 02	19	-0.27100E-07	7
0.41914E 02	20	0.29839E-07	6
0.48225E 02	21	0.10847E-07	9
0.49330E 02	22	0.52345E-08	12
0.51462E 02	23	0.23022E-09	20
0.52124E 02	24	0.36865E-11	25
0.52244E 02	25	0.40199E-10	22
0.52839E 02	26	-0.79505E-11	24
0.52912E 02	27	-0.69171E-08	11
0.55803E 02	28	0.51488E-08	13
0.11957E 02	34	0.0	50
0.12446E 02	35	0.0	49
0.16801E 02	36	0.0	48
0.17309E 02	37	0.0	47
0.20952E 02	38	0.0	46
0.23872E 02	39	0.0	45
0.27020E 02	40	0.0	44
0.29155E 02	41	0.0	43
0.30048E 02	42	0.0	42
0.30800E 02	43	0.0	41
0.31635E 02	44	0.0	40
0.32753E 02	45	0.0	39
0.33123E 02	46	0.0	38
0.36920E 02	47	0.0	37
0.37888E 02	48	0.0	36
0.38871E 02	49	0.0	35
0.43468E 02	50	0.0	34
0.45841E 02	51	0.0	33
0.51102E 02	52	0.0	32
0.52131E 02	53	0.0	31
0.52227E 02	54	0.0	30
0.59475E 02	55	0.0	29
0.60748E 02	56	0.0	28
0.65135E 02	57	0.0	27
0.67311E 02	58	0.0	26

RATE COEFFICIENTS. RESPONSE FRDM = 90046 INPUT FRDM = 5133

RATE COEFFICIENTS. RESPONSE FRDM = 9014 INPUT FRDM = 140391

FREQUENCY	MODE NO.	COEFFICIENT	RANK
0.13764E 02	4	0.0	50
0.17525E 02	5	0.0	49
0.18133E 02	6	0.0	48
0.19370E 02	7	0.0	47
0.22939E 02	8	0.0	46
0.25796E 02	9	0.0	45
0.28702E 02	10	0.0	44
0.28944E 02	11	0.0	43
0.30096E 02	12	0.0	42
0.31603E 02	13	0.0	41
0.32384E 02	14	0.0	40
0.32729E 02	15	0.0	39
0.34836E 02	16	0.0	38
0.36578E 02	17	0.0	37
0.38611E 02	18	0.0	36
0.38819E 02	19	0.0	35
0.41914E 02	20	0.0	34
0.48225E 02	21	0.0	33
0.49330E 02	22	0.0	32
0.51462E 02	23	0.0	31
0.52124E 02	24	0.0	30
0.52244E 02	25	0.0	29
0.52839E 02	26	0.0	28
0.52912E 02	27	0.0	27
0.55803E 02	28	0.0	26
0.11957E 02	34	-0.22635E-06	2
0.12446E 02	35	0.17284E-07	12
0.16801E 02	36	0.82437E-07	5
0.17309E 02	37	-0.19798E-07	11
0.20952E 02	38	-0.33643E-06	1
0.23872E 02	39	0.20117E-06	3
0.27020E 02	40	-0.21345E-08	19
0.29155E 02	41	0.36940E-08	17
0.39048E 02	42	-0.25497E-08	18
0.30800E 02	43	-0.43490E-10	24
0.31635E 02	44	0.58345E-07	8
0.32753E 02	45	0.67274E-09	22
0.33123E 02	46	-0.14898E-08	20
0.36920E 02	47	0.74162E-08	14
0.37888E 02	48	0.67779E-07	7
0.38871E 02	49	0.62395E-08	15
0.43468E 02	50	0.12455E-06	4
0.45841E 02	51	0.94827E-08	13
0.51102E 02	52	-0.54911E-07	10
0.52131E 02	53	0.16300E-10	25
0.52227E 02	54	-0.11886E-08	21
0.59475E 02	55	0.15543E-09	23
0.60748E 02	56	0.56158E-07	9
0.65135E 02	57	-0.78209E-07	6
0.67311E 02	58	-0.48970E-08	16

FREQUENCY	MODE NO.	COEFFICIENT	RANK
0.13764E 02	4	0.39423E-06	3
0.17525E 02	5	0.29316E-07	14
0.18133E 02	6	-0.87413E-06	2
0.19370E 02	7	-0.29917E-07	13
0.22939E 02	8	0.98228E-06	1
0.25796E 02	9	-0.28991E-06	4
0.28702E 02	10	-0.10283E-07	23
0.28944E 02	11	-0.61543E-08	27
0.30096E 02	12	-0.23355E-07	19
0.31603E 02	13	-0.31429E-09	41
0.32384E 02	14	-0.20576E-06	5
0.32729E 02	15	-0.11954E-07	22
0.34836E 02	16	-0.30533E-08	32
0.36578E 02	17	0.15380E-07	21
0.38611E 02	18	0.17759E-08	36
0.38819E 02	19	0.30781E-07	12
0.41914E 02	20	0.75344E-07	7
0.48225E 02	21	-0.47675E-07	9
0.49330E 02	22	-0.11670E-08	39
0.51462E 02	23	-0.43157E-10	45
0.52124E 02	24	-0.26487E-11	50
0.52244E 02	25	-0.10807E-09	44
0.52839E 02	26	-0.10704E-10	47
0.52912E 02	27	-0.24482E-08	33
0.55803E 02	28	-0.22969E-09	43
0.11957E 02	34	0.18382E-08	35
0.12446E 02	35	-0.31422E-09	42
0.16801E 02	36	0.73406E-07	8
0.17309E 02	37	-0.56544E-08	28
0.20952E 02	38	0.32792E-07	11
0.23872E 02	39	-0.12506E-06	6
0.27020E 02	40	-0.23956E-07	17
0.29155E 02	41	0.85858E-08	24
0.39048E 02	42	-0.35660E-08	30
0.30800E 02	43	-0.23553E-07	18
0.31635E 02	44	-0.26876E-07	16
0.32753E 02	45	0.31941E-08	31
0.33123E 02	46	0.79403E-08	25
0.36920E 02	47	0.53285E-08	29
0.37888E 02	48	0.27112E-07	15
0.38871E 02	49	0.20451E-08	34
0.43468E 02	50	0.16472E-07	20
0.45841E 02	51	0.37069E-07	10
0.51102E 02	52	0.68040E-08	26
0.52131E 02	53	0.30120E-11	49
0.52227E 02	54	0.63442E-11	48
0.59475E 02	55	0.14246E-10	46
0.60748E 02	56	0.16541E-08	37
0.65135E 02	57	-0.11809E-08	38
0.67311E 02	58	0.11341E-08	40

124

REPRODUCIBILITY OF THE ORIGINAL PAGE IS POOR

RATE COEFFICIENTS. RESPONSE FRDM = 9015 INPUT FRDM = 140391

RATE COEFFICIENTS. RESPONSE FRDM = 9016 INPUT FRDM = 140391

FREQUENCY	MODE NO.	COEFFICIENT	RANK
0.13764E 02	4	-0.83744E-08	13
0.17525E 02	5	-0.15242E-09	41
0.18133E 02	6	0.20644E-07	10
0.19370E 02	7	0.51512E-09	36
0.22939E 02	8	0.29552E-06	1
0.25796E 02	9	-0.21016E-06	2
0.28702E 02	10	0.32612E-09	38
0.28944E 02	11	-0.29268E-08	25
0.30096E 02	12	-0.81263E-08	15
0.31603E 02	13	-0.17297E-09	40
0.32384E 02	14	-0.62427E-07	3
0.32729E 02	15	-0.62687E-08	21
0.34836E 02	16	-0.63378E-09	33
0.36578E 02	17	0.49166E-08	23
0.38611E 02	18	0.42030E-09	37
0.38819E 02	19	0.33696E-07	5
0.41914E 02	20	-0.30142E-07	6
0.48225E 02	21	-0.16311E-07	11
0.49330E 02	22	-0.59395E-09	34
0.51462E 02	23	-0.15106E-10	47
0.52124E 02	24	-0.43020E-11	49
0.52244E 02	25	-0.64826E-10	44
0.52839E 02	26	-0.55574E-11	48
0.52912E 02	27	-0.10759E-08	31
0.55803E 02	28	-0.81946E-10	43
0.11957E 02	34	-0.65735E-08	20
0.12446E 02	35	0.50541E-09	35
0.16801E 02	36	-0.90791E-08	12
0.17309E 02	37	0.11191E-08	30
0.20952E 02	38	0.29278E-07	7
0.23872E 02	39	-0.35029E-07	4
0.27020E 02	40	-0.69810E-08	17
0.29155E 02	41	0.23474E-08	27
0.30048E 02	42	-0.11364E-09	42
0.30800E 02	43	-0.57326E-08	22
0.31635E 02	44	-0.68444E-08	19
0.32753E 02	45	0.92950E-09	32
0.33123E 02	46	0.24084E-08	26
0.36920E 02	47	0.17432E-08	29
0.37888E 02	48	0.81990E-08	14
0.38871E 02	49	0.32515E-09	39
0.43468E 02	50	-0.41070E-08	24
0.45841E 02	51	0.27325E-07	8
0.51102E 02	52	0.69844E-08	16
0.52131E 02	53	0.27853E-11	50
0.52227E 02	54	-0.54982E-10	45
0.59475E 02	55	0.24185E-10	46
0.60748E 02	56	0.69642E-08	18
0.65135E 02	57	-0.24799E-07	9
0.67311E 02	58	-0.21178E-08	28

FREQUENCY	MODE NO.	COEFFICIENT	RANK
0.13764E 02	4	0.33577E-08	20
0.17525E 02	5	0.68459E-07	1
0.18133E 02	6	0.48296E-07	3
0.19370E 02	7	-0.12350E-07	10
0.22939E 02	8	-0.20049E-08	26
0.25796E 02	9	0.02093E-08	12
0.28702E 02	10	0.75382E-09	33
0.28944E 02	11	0.69267E-09	34
0.30096E 02	12	-0.72196E-08	14
0.31603E 02	13	-0.18456E-08	27
0.32384E 02	14	0.37417E-07	4
0.32729E 02	15	0.26647E-08	21
0.34836E 02	16	-0.24417E-08	22
0.36578E 02	17	0.16285E-08	29
0.38611E 02	18	0.22951E-08	23
0.38819E 02	19	-0.17813E-07	8
0.41914E 02	20	-0.25400E-07	6
0.48225E 02	21	-0.21946E-08	24
0.49330E 02	22	0.15136E-10	45
0.51462E 02	23	-0.44188E-10	44
0.52124E 02	24	0.48816E-12	50
0.52244E 02	25	-0.28072E-09	39
0.52839E 02	26	-0.71972E-11	48
0.52912E 02	27	0.37290E-09	37
0.55803E 02	28	0.10324E-10	46
0.11957E 02	34	0.28563E-09	38
0.12446E 02	35	-0.10899E-08	32
0.16801E 02	36	-0.14230E-08	30
0.17309E 02	37	0.49899E-08	17
0.20952E 02	38	-0.97309E-08	11
0.23872E 02	39	-0.49943E-07	2
0.27020E 02	40	0.35711E-07	5
0.29155E 02	41	0.39945E-08	18
0.30048E 02	42	-0.10859E-09	42
0.30800E 02	43	-0.13698E-09	41
0.31635E 02	44	0.16783E-08	28
0.32753E 02	45	0.66424E-09	35
0.33123E 02	46	-0.13557E-08	31
0.36920E 02	47	-0.36485E-08	19
0.37888E 02	48	0.80031E-08	13
0.38871E 02	49	0.59759E-09	36
0.43468E 02	50	0.21235E-08	25
0.45841E 02	51	0.19949E-07	7
0.51102E 02	52	0.19646E-09	40
0.52131E 02	53	-0.78587E-11	47
0.52227E 02	54	0.38664E-11	49
0.59475E 02	55	-0.94928E-10	43
0.60748E 02	56	-0.72023E-08	15
0.65135E 02	57	0.60970E-08	16
0.67311E 02	58	-0.15860E-07	9

RATE COEFFICIENTS. RESPONSE FRDM = 9014 INPUT FRDM = 140392

RATE COEFFICIENTS. RESPONSE FRDM = 9015 INPUT FRDM = 140392

FREQUENCY	MODE NO.	COEFFICIENT	RANK
0.13764E 02	4	-0.10583E-08	30
0.17525E 02	5	-0.81293E-10	39
0.18133E 02	6	-0.10175E-08	31
0.19370E 02	7	0.18371E-09	37
0.22939E 02	8	-0.41204E-08	23
0.25796E 02	9	0.64891E-09	33
0.28702E 02	10	-0.21627E-09	35
0.28944E 02	11	-0.12462E-10	43
0.30096E 02	12	-0.30349E-09	34
0.31603E 02	13	0.73633E-11	44
0.32384E 02	14	-0.27681E-08	27
0.32729E 02	15	-0.13828E-09	38
0.34836E 02	16	0.43712E-11	48
0.36578E 02	17	0.21448E-08	29
0.38611E 02	18	0.41278E-08	24
0.38819E 02	19	0.49434E-08	22
0.41914E 02	20	0.66472E-08	20
0.48225E 02	21	-0.26995E-08	26
0.49330E 02	22	-0.20917E-09	36
0.51462E 02	23	0.48360E-11	47
0.52124E 02	24	-0.80878E-13	50
0.52244E 02	25	-0.51593E-11	45
0.52839E 02	26	0.50317E-12	49
0.52912E 02	27	0.76591E-09	32
0.55803E 02	28	-0.19004E-10	42
0.11957E 02	34	-0.33298E-07	15
0.12446E 02	35	0.30464E-08	25
0.16801E 02	36	0.24236E-06	4
0.17309E 02	37	0.39411E-07	13
0.20952E 02	38	-0.66260E-07	10
0.23872E 02	39	0.50190E-06	1
0.27020E 02	40	0.78443E-07	9
0.29155E 02	41	0.45076E-07	12
0.30048E 02	42	0.39380E-07	14
0.30800E 02	43	0.44078E-06	2
0.31635E 02	44	0.23997E-06	5
0.32753E 02	45	-0.49590E-08	21
0.33123E 02	46	-0.32828E-07	16
0.36920E 02	47	-0.49482E-07	11
0.37888E 02	48	-0.18455E-06	6
0.38871E 02	49	-0.10015E-07	19
0.43468E 02	50	-0.10930E-06	8
0.45841E 02	51	-0.29399E-06	3
0.51102E 02	52	-0.17053E-06	7
0.52131E 02	53	-0.21573E-10	41
0.52227E 02	54	0.57358E-10	40
0.59475E 02	55	0.49277E-11	46
0.60743E 02	56	0.25025E-07	17
0.65135E 02	57	0.24236E-08	28
0.67311E 02	58	-0.12898E-07	18

FREQUENCY	MODE NO.	COEFFICIENT	RANK
0.13764E 02	4	0.22482E-10	37
0.17525E 02	5	0.42266E-12	48
0.18133E 02	6	0.24030E-10	36
0.19370E 02	7	-0.31632E-11	43
0.22939E 02	8	-0.12420E-08	25
0.25796E 02	9	0.47041E-09	31
0.28702E 02	10	0.68592E-11	40
0.28944E 02	11	-0.59265E-11	42
0.30096E 02	12	-0.10560E-09	34
0.31603E 02	13	0.24764E-11	45
0.32384E 02	14	-0.83985E-09	28
0.32729E 02	15	-0.72513E-10	35
0.34836E 02	16	0.90734E-12	47
0.36578E 02	17	0.68563E-09	29
0.38611E 02	18	0.97694E-09	27
0.38819E 02	19	0.54115E-08	20
0.41914E 02	20	-0.26593E-08	21
0.48225E 02	21	-0.99202E-09	26
0.49330E 02	22	-0.10646E-09	33
0.51462E 02	23	0.16927E-11	46
0.52124E 02	24	-0.13136E-12	50
0.52244E 02	25	-0.30949E-11	44
0.52839E 02	26	0.26124E-12	49
0.52912E 02	27	0.33661E-09	32
0.55803E 02	28	-0.67800E-11	41
0.11957E 02	34	0.11907E-06	4
0.12446E 02	35	-0.56755E-08	19
0.16801E 02	36	-0.29976E-07	11
0.17309E 02	37	-0.77997E-08	18
0.20952E 02	38	-0.59178E-07	8
0.23872E 02	39	0.14058E-06	3
0.27020E 02	40	0.22859E-07	14
0.29155E 02	41	0.12324E-07	16
0.30048E 02	42	0.12479E-08	24
0.30800E 02	43	0.10728E-06	5
0.31635E 02	44	0.61112E-07	7
0.32753E 02	45	-0.14431E-08	23
0.33123E 02	46	-0.99571E-08	17
0.36920E 02	47	-0.16188E-07	15
0.37888E 02	48	-0.55810E-07	9
0.38871E 02	49	-0.15924E-08	22
0.43468E 02	50	0.27253E-07	12
0.45841E 02	51	-0.21671E-06	1
0.51102E 02	52	-0.17505E-06	2
0.52131E 02	53	-0.19948E-10	38
0.52227E 02	54	-0.49710E-09	30
0.59475E 02	55	0.83658E-11	39
0.60743E 02	56	0.10536E-06	6
0.65135E 02	57	0.50897E-07	10
0.67311E 02	58	0.24087E-07	13

RATE COEFFICIENTS. RESPONSE FRDM * 9016 INPUT FRDM * 140392

RATE COEFFICIENTS. RESPONSE FRDM = 9014 INPUT FRDM = 140393

FREQUENCY	MODE NO.	COEFFICIENT	RANK
0.13764E 02	4	-0.90141E-11	42
0.17525E 02	5	-0.18983E-09	28
0.18133E 02	6	0.56218E-10	34
0.19370E 02	7	0.75837E-10	32
0.22939E 02	8	0.84265E-11	43
0.25796E 02	9	-0.18375E-10	39
0.28702E 02	10	0.15855E-10	40
0.28944E 02	11	0.14026E-11	47
0.30096E 02	12	-0.93817E-10	31
0.31603E 02	13	0.26423E-10	38
0.32384E 02	14	0.50339E-09	26
0.32729E 02	15	0.30824E-10	37
0.34836E 02	16	0.34956E-11	45
0.36578E 02	17	0.22710E-09	27
0.38611E 02	18	0.53347E-08	16
0.38819E 02	19	-0.28607E-08	21
0.41914E 02	20	-0.22409E-08	23
0.48225E 02	21	-0.13347E-09	29
0.49330E 02	22	0.27128E-11	46
0.51462E 02	23	0.51756E-11	44
0.52124E 02	24	0.14906E-13	50
0.52244E 02	25	-0.13402E-10	41
0.52839E 02	26	0.33833E-12	49
0.52912E 02	27	-0.11666E-09	30
0.55803E 02	28	0.85419E-12	48
0.11957E 02	34	-0.51740E-08	17
0.12446E 02	35	0.10566E-07	14
0.16801E 02	36	-0.46984E-08	19
0.17309E 02	37	-0.34778E-07	7
0.20952E 02	38	0.19668E-07	10
0.23872E 02	39	0.20044E-06	1
0.27020E 02	40	-0.11694E-06	4
0.29155E 02	41	0.20971E-07	9
0.30048E 02	42	0.11925E-08	24
0.30800E 02	43	0.25635E-08	22
0.31635E 02	44	-0.14985E-07	11
0.32753E 02	45	-0.10313E-08	25
0.33123E 02	46	0.56050E-08	15
0.36920E 02	47	0.33881E-07	8
0.37883E 02	48	-0.54477E-07	6
0.38871E 02	49	-0.29266E-08	20
0.43468E 02	50	-0.14091E-07	12
0.45841E 02	51	-0.15821E-06	3
0.51102E 02	52	-0.49238E-08	18
0.52131E 02	53	0.56285E-10	33
0.52227E 02	54	0.34956E-10	35
0.59475E 02	55	-0.32836E-10	36
0.60748E 02	56	-0.10897E-06	5
0.65135E 02	57	-0.12513E-07	13
0.67311E 02	58	0.18038E-06	2

FREQUENCY	MODE NO.	COEFFICIENT	RANK
0.13764E 02	4	-0.66442E-06	2
0.17525E 02	5	-0.48002E-07	15
0.18133E 02	6	-0.20170E-06	4
0.19370E 02	7	0.72227E-07	12
0.22939E 02	8	-0.79302E-06	1
0.25796E 02	9	0.70178E-07	13
0.28702E 02	10	-0.13118E-07	27
0.28944E 02	11	-0.11529E-08	39
0.30096E 02	12	-0.15218E-07	25
0.31603E 02	13	0.37949E-09	41
0.32384E 02	14	-0.10669E-06	6
0.32729E 02	15	-0.49577E-08	34
0.34836E 02	16	0.64116E-09	40
0.36578E 02	17	0.93656E-07	7
0.38611E 02	18	0.87123E-07	9
0.38819E 02	19	0.93229E-07	8
0.41914E 02	20	0.73376E-07	11
0.48225E 02	21	0.26777E-07	23
0.49330E 02	22	0.85709E-10	44
0.51462E 02	23	0.12727E-07	28
0.52124E 02	24	0.84840E-11	48
0.52244E 02	25	0.21926E-09	42
0.52839E 02	26	0.22813E-10	45
0.52912E 02	27	0.62854E-08	33
0.55803E 02	28	0.32571E-07	21
0.11957E 02	34	0.74527E-08	32
0.12446E 02	35	0.14131E-09	43
0.16801E 02	36	-0.24903E-06	3
0.17309E 02	37	-0.34619E-08	37
0.20952E 02	38	-0.40940E-07	17
0.23872E 02	39	-0.12674E-06	5
0.27020E 02	40	-0.17369E-07	24
0.29155E 02	41	0.38033E-07	18
0.30048E 02	42	0.79902E-08	29
0.30800E 02	43	0.86870E-07	10
0.31635E 02	44	0.68784E-07	14
0.32753E 02	45	-0.14314E-07	26
0.33123E 02	46	-0.28179E-07	22
0.36920E 02	47	-0.33363E-08	38
0.37883E 02	48	-0.44228E-07	16
0.38871E 02	49	-0.44523E-08	36
0.43468E 02	50	-0.33106E-07	20
0.45841E 02	51	-0.34384E-07	19
0.51102E 02	52	0.77994E-08	30
0.52131E 02	53	-0.13675E-11	50
0.52227E 02	54	-0.11178E-10	47
0.59475E 02	55	0.84531E-11	49
0.60748E 02	56	0.76680E-08	31
0.65135E 02	57	-0.15329E-10	46
0.67311E 02	58	-0.47031E-08	35

RATE COEFFICIENTS. RESPONSE FRDM = 9015 INPUT FRDM = 140393

RATE COEFFICIENTS. RESPONSE FRDM = 9016 INPUT FRDM = 140393

FREQUENCY	NODE NO.	COEFFICIENT	RANK
0.13764E 02	4	0.14114E-07	16
0.17525E 02	5	0.24957E-09	41
0.18133E 02	6	0.47635E-08	27
0.19370E 02	7	-0.12436E-08	32
0.22939E 02	8	-0.23858E-06	1
0.25756E 02	9	0.50873E-07	3
0.28702E 02	10	0.41606E-09	37
0.28944E 02	11	-0.54828E-09	36
0.30096E 02	12	-0.52953E-08	25
0.31603E 02	13	0.12763E-09	44
0.32384E 02	14	-0.32370E-07	6
0.32729E 02	15	-0.25990E-08	31
0.34836E 02	16	0.13309E-09	42
0.36578E 02	17	0.29940E-07	9
0.38611E 02	18	0.20620E-07	14
0.38819E 02	19	0.10206E-06	2
0.41914E 02	20	-0.29354E-07	10
0.48225E 02	21	0.91612E-08	20
0.49330E 02	22	0.43663E-10	46
0.51462E 02	23	0.44547E-08	28
0.52124E 02	24	0.13780E-10	48
0.52244E 02	25	0.13152E-09	43
0.52839E 02	26	0.11844E-10	49
0.52912E 02	27	0.27624E-08	30
0.55803E 02	28	0.11620E-07	18
0.11957E 02	34	-0.26650E-07	11
0.12446E 02	35	-0.26326E-09	39
0.16801E 02	36	0.30801E-07	8
0.17309E 02	37	0.68513E-09	35
0.20952E 02	38	-0.36553E-07	4
0.23872E 02	39	-0.35500E-07	5
0.27020E 02	40	-0.50615E-08	26
0.29155E 02	41	0.10399E-07	19
0.30048E 02	42	0.25320E-09	40
0.30800E 02	43	0.21144E-07	13
0.31635E 02	44	0.17517E-07	15
0.32753E 02	45	-0.41655E-08	29
0.33123E 02	46	-0.85472E-08	22
0.36920E 02	47	-0.10914E-08	33
0.37888E 02	48	-0.13375E-07	17
0.38871E 02	49	-0.70788E-09	34
0.43468E 02	50	0.82543E-08	23
0.45841E 02	51	-0.25346E-07	12
0.51102E 02	52	0.80062E-08	24
0.52131E 02	53	-0.12645E-11	50
0.52227E 02	54	0.96871E-10	45
0.59475E 02	55	0.14351E-10	47
0.60748E 02	56	0.32284E-07	7
0.65135E 02	57	-0.32192E-09	38
0.67311E 02	58	0.87829E-08	21

FREQUENCY	NODE NO.	COEFFICIENT	RANK
0.13764E 02	4	-0.56590E-08	18
0.17525E 02	5	-0.11209E-06	2
0.18133E 02	6	0.11144E-07	16
0.19370E 02	7	0.29816E-07	7
0.22939E 02	8	0.16186E-08	28
0.25796E 02	9	-0.19872E-08	27
0.28702E 02	10	0.96170E-09	35
0.28944E 02	11	0.12976E-09	43
0.30096E 02	12	-0.47045E-08	21
0.31603E 02	13	0.13618E-08	30
0.32384E 02	14	0.19402E-07	10
0.32729E 02	15	0.11051E-08	34
0.34836E 02	16	0.51272E-09	38
0.36578E 02	17	0.99169E-08	17
0.38611E 02	18	0.11260E-06	1
0.38819E 02	19	-0.53952E-07	4
0.41914E 02	20	-0.24736E-07	9
0.48225E 02	21	0.12326E-08	32
0.49330E 02	22	-0.11127E-11	50
0.51462E 02	23	0.13621E-07	13
0.52124E 02	24	-0.15636E-11	49
0.52244E 02	25	0.56954E-09	37
0.52839E 02	26	0.15339E-10	46
0.52912E 02	27	-0.95738E-09	36
0.55803E 02	28	-0.14640E-08	29
0.11957E 02	34	0.11580E-08	33
0.12446E 02	35	0.49013E-09	40
0.16801E 02	36	0.48276E-08	19
0.17309E 02	37	0.30549E-08	24
0.20952E 02	38	0.12149E-07	15
0.23872E 02	39	-0.50615E-07	5
0.27020E 02	40	0.25892E-07	8
0.29155E 02	41	0.17695E-07	12
0.30048E 02	42	0.24195E-09	41
0.30800E 02	43	0.50522E-09	39
0.31635E 02	44	-0.42953E-08	22
0.32753E 02	45	-0.29767E-08	25
0.33123E 02	46	0.48113E-08	20
0.36920E 02	47	0.22844E-08	26
0.37888E 02	48	-0.13055E-07	14
0.38871E 02	49	-0.13010E-08	31
0.43468E 02	50	-0.42679E-08	23
0.45841E 02	51	-0.18504E-07	11
0.51102E 02	52	0.22520E-09	42
0.52131E 02	53	0.35679E-11	48
0.52227E 02	54	-0.60120E-11	47
0.59475E 02	55	-0.56327E-10	45
0.60748E 02	56	-0.33388E-07	6
0.65135E 02	57	0.79145E-10	44
0.67311E 02	58	0.65772E-07	3

RATE COEFFICIENTS. RESPONSE FRDM = 9024 INPUT FRDM = 140391

RATE COEFFICIENTS. RESPONSE FRDM = 9025 INPUT FRDM = 140391

FREQUENCY	MODE NO.	COEFFICIENT	RANK
0.13764E 02	4	0.31798E-06	3
0.17525E 02	5	0.29333E-07	13
0.18133E 02	6	-0.80866E-05	2
0.19370E 02	7	-0.27290E-07	14
0.277939E 02	8	0.10383E-05	1
0.25796E 02	9	-0.29489E-06	4
0.28702E 02	10	-0.10971E-07	21
0.28944E 02	11	-0.47138E-08	29
0.30096E 02	12	-0.18643E-07	18
0.31603E 02	13	-0.14500E-09	42
0.32384E 02	14	-0.14927E-06	6
0.32729E 02	15	-0.73196E-08	27
0.34836E 02	16	-0.21177E-08	35
0.36578E 02	17	0.94974E-08	23
0.38611E 02	18	0.11489E-08	38
0.38819E 02	19	-0.11108E-07	20
0.41914E 02	20	0.14977E-06	5
0.48225E 02	21	-0.90759E-07	8
0.49330E 02	22	-0.25137E-08	33
0.51462E 02	23	0.16264E-10	46
0.52124E 02	24	-0.96732E-11	47
0.52244E 02	25	-0.70166E-10	44
0.52839E 02	26	-0.34696E-11	48
0.52912E 02	27	-0.22709E-09	41
0.55803E 02	28	0.57032E-10	45
0.11957E 02	34	0.86774E-08	24
0.12446E 02	35	-0.90880E-09	39
0.16201E 02	36	0.64549E-07	9
0.17309E 02	37	-0.43639E-08	30
0.20952E 02	38	0.52311E-07	10
0.23872E 02	39	-0.13092E-06	7
0.27020E 02	40	-0.22507E-07	15
0.29155E 02	41	0.74473E-08	25
0.30048E 02	42	-0.32589E-08	32
0.30800E 02	43	-0.19274E-07	17
0.31635E 02	44	-0.19600E-07	16
0.32753E 02	45	0.23775E-08	34
0.33123E 02	46	0.56772E-08	28
0.36920E 02	47	0.34891E-08	31
0.37888E 02	48	0.18280E-07	19
0.38871E 02	49	0.17008E-08	37
0.43468E 02	50	0.35453E-07	11
0.45241E 02	51	-0.30446E-07	12
0.51102E 02	52	0.10709E-07	22
0.52131E 02	53	0.23851E-11	49
0.52227E 02	54	-0.14178E-09	43
0.59475E 02	55	0.19541E-11	50
0.60748E 02	56	0.19439E-08	36
0.65135E 02	57	0.73500E-08	26
0.67311E 02	58	-0.34849E-09	40

FREQUENCY	MODE NO.	COEFFICIENT	RANK
0.13764E 02	4	0.14769E-06	3
0.17525E 02	5	-0.51706E-08	16
0.18133E 02	6	0.27285E-08	21
0.19370E 02	7	-0.66316E-09	32
0.22939E 02	8	-0.35870E-06	1
0.25796E 02	9	0.16774E-06	2
0.28702E 02	10	-0.59503E-08	15
0.28944E 02	11	0.24610E-08	24
0.30096E 02	12	0.30986E-08	19
0.31603E 02	13	0.24821E-09	36
0.32384E 02	14	0.21952E-07	8
0.32729E 02	15	0.28904E-08	20
0.34836E 02	16	-0.11093E-10	44
0.36578E 02	17	-0.67760E-09	31
0.38611E 02	18	0.65864E-10	41
0.38819E 02	19	-0.20918E-07	9
0.41914E 02	20	0.56836E-07	4
0.48225E 02	21	-0.29550E-07	7
0.49330E 02	22	-0.83971E-09	29
0.51462E 02	23	0.58276E-11	47
0.52124E 02	24	-0.37079E-11	48
0.52244E 02	25	-0.27289E-10	43
0.52839E 02	26	-0.14586E-11	49
0.52912E 02	27	-0.12435E-09	38
0.55803E 02	28	0.64881E-11	46
0.11957E 02	34	-0.13797E-07	11
0.12446E 02	35	0.12665E-08	27
0.16201E 02	36	0.16822E-07	10
0.17309E 02	37	-0.24054E-08	25
0.20952E 02	38	-0.46840E-07	5
0.23872E 02	39	0.30719E-07	6
0.27020E 02	40	0.25652E-08	22
0.29155E 02	41	-0.64575E-09	33
0.30048E 02	42	-0.92334E-10	39
0.30800E 02	43	0.20960E-08	26
0.31635E 02	44	0.49896E-08	17
0.32753E 02	45	-0.32892E-09	35
0.33123E 02	46	-0.95915E-09	28
0.36920E 02	47	-0.83360E-10	40
0.37888E 02	48	0.38095E-09	34
0.38871E 02	49	0.23264E-09	37
0.43468E 02	50	0.11030E-07	13
0.45241E 02	51	-0.13486E-07	12
0.51102E 02	52	0.43902E-08	18
0.52131E 02	53	0.11514E-11	50
0.52227E 02	54	-0.57530E-10	42
0.59475E 02	55	0.71615E-11	45
0.60748E 02	56	0.24718E-08	23
0.65135E 02	57	-0.64727E-08	14
0.67311E 02	58	-0.72095E-09	30

RATE COEFFICIENTS, RESPONSE FRDM = 9026 INPUT FRDM = 140391

RATE COEFFICIENTS, RESPONSE FRDM = 9024 INPUT FRDM = 140392

FREQUENCY	MODE NO.	COEFFICIENT	RANK
0.13764E 02	4	-0.15520E-08	32
0.17525E 02	5	-0.40406E-07	4
0.18133E 02	6	-0.74569E-07	1
0.19370E 02	7	0.47354E-07	2
0.22939E 02	8	0.43095E-07	3
0.25796E 02	9	0.15484E-07	8
0.28702E 02	10	-0.37682E-08	16
0.28944E 02	11	-0.33272E-08	18
0.30096E 02	12	-0.82213E-08	12
0.31603E 02	13	-0.37423E-08	17
0.32384E 02	14	0.24492E-07	6
0.32729E 02	15	0.17709E-08	25
0.34836E 02	16	-0.15896E-08	30
0.36578E 02	17	0.16366E-08	29
0.38611E 02	18	0.10586E-08	34
0.38819E 02	19	-0.50882E-08	14
0.41914E 02	20	-0.70575E-08	13
0.48225E 02	21	-0.21669E-08	23
0.49330E 02	22	0.67670E-10	44
0.51462E 02	23	-0.18716E-09	40
0.52124E 02	24	0.19029E-11	49
0.52244E 02	25	-0.10424E-09	43
0.52839E 02	26	0.23104E-11	48
0.52912E 02	27	0.16440E-08	28
0.55803E 02	28	0.42042E-10	45
0.11957E 02	34	-0.10910E-08	33
0.12446E 02	35	-0.15342E-07	9
0.16801E 02	36	0.48335E-09	36
0.17309E 02	37	0.29037E-08	20
0.20952E 02	38	0.15586E-08	31
0.23872E 02	39	0.28524E-07	5
0.27020E 02	40	-0.19889E-07	7
0.29155E 02	41	-0.24984E-08	22
0.30048E 02	42	0.17631E-09	41
0.30800E 02	43	0.24731E-09	38
0.31635E 02	44	0.31139E-08	19
0.32753E 02	45	-0.22871E-09	39
0.33123E 02	46	0.16660E-08	27
0.36920E 02	47	0.12477E-07	10
0.37888E 02	48	-0.96596E-08	11
0.38371E 02	49	-0.36952E-09	37
0.43468E 02	50	0.76063E-09	35
0.45841E 02	51	0.25655E-08	21
0.51102E 02	52	-0.10505E-09	42
0.52131E 02	53	-0.45692E-11	47
0.52227E 02	54	0.29806E-12	50
0.59475E 02	55	-0.32701E-10	46
0.60748E 02	56	-0.17322E-08	26
0.65135E 02	57	0.19312E-08	24
0.67311E 02	58	-0.44261E-08	15

FREQUENCY	MODE NO.	COEFFICIENT	RANK
0.13764E 02	4	-0.85365E-09	32
0.17525E 02	5	-0.81339E-10	39
0.18133E 02	6	-0.94152E-09	31
0.19370E 02	7	0.16758E-09	37
0.22939E 02	8	-0.43638E-08	23
0.25796E 02	9	0.66006E-09	33
0.28702E 02	10	-0.23074E-09	36
0.28944E 02	11	-0.95450E-11	42
0.30096E 02	12	-0.24227E-09	35
0.31603E 02	13	0.20759E-11	46
0.32384E 02	14	-0.20082E-08	27
0.32729E 02	15	-0.84671E-10	38
0.34836E 02	16	0.30318E-11	45
0.36578E 02	17	0.13244E-08	29
0.38611E 02	18	0.26704E-08	26
0.38819E 02	19	-0.17839E-08	28
0.41914E 02	20	0.13214E-07	19
0.48225E 02	21	-0.55199E-08	22
0.49330E 02	22	-0.45054E-09	34
0.51462E 02	23	-0.18224E-11	47
0.52124E 02	24	-0.29537E-12	49
0.52244E 02	25	-0.33498E-11	44
0.52839E 02	26	0.16310E-12	50
0.52912E 02	27	0.71046E-10	40
0.55803E 02	28	0.47187E-11	43
0.11957E 02	34	-0.15718E-06	8
0.12446E 02	35	0.88108E-08	20
0.16801E 02	36	0.21312E-06	6
0.17309E 02	37	0.30415E-07	15
0.20952E 02	38	-0.10573E-06	10
0.23872E 02	39	0.52545E-06	1
0.27020E 02	40	0.73961E-07	11
0.29155E 02	41	0.39099E-07	12
0.30048E 02	42	0.35788E-07	13
0.30800E 02	43	0.36071E-06	2
0.31635E 02	44	0.17500E-06	7
0.32753E 02	45	-0.36912E-08	25
0.33123E 02	46	-0.23471E-07	17
0.36920E 02	47	-0.32400E-07	14
0.37888E 02	48	-0.12443E-06	9
0.38371E 02	49	-0.83292E-08	21
0.43468E 02	50	-0.23526E-06	5
0.45841E 02	51	0.24146E-06	4
0.51102E 02	52	-0.26840E-06	3
0.52131E 02	53	-0.17083E-10	41
0.52227E 02	54	-0.12818E-08	30
0.59475E 02	55	0.67591E-12	48
0.60748E 02	56	0.29409E-07	16
0.65135E 02	57	-0.15085E-07	18
0.67311E 02	58	0.39635E-08	24

RATE COEFFICIENTS. RESPONSE FRDM = 9025 INPUT FRDM = 140392

RATE COEFFICIENTS. RESPONSE FRDM = 9026 INPUT FRDM = 140392

FREQUENCY	MODE NO.	COEFFICIENT	RANK
0.13764E 02	4	-0.39650E-09	28
0.17525E 02	5	0.14330E-10	38
0.18133E 02	6	0.31760E-11	43
0.19370E 02	7	0.40722E-11	41
0.22939E 02	8	0.15076E-08	22
0.25796E 02	9	-0.37545E-09	29
0.28702E 02	10	-0.12515E-09	33
0.28944E 02	11	0.49834E-11	40
0.30096E 02	12	0.40266E-10	35
0.31603E 02	13	-0.35536E-11	42
0.32384E 02	14	0.29533E-09	30
0.32729E 02	15	0.33435E-10	37
0.34836E 02	16	0.15881E-13	50
0.36578E 02	17	-0.94493E-10	34
0.38611E 02	18	0.15309E-09	31
0.38819E 02	19	-0.33593E-08	19
0.41914E 02	20	0.50144E-08	16
0.48225E 02	21	-0.17972E-08	21
0.49330E 02	22	-0.15051E-09	32
0.51462E 02	23	-0.65300E-12	46
0.52124E 02	24	-0.11322E-12	48
0.52244E 02	25	-0.13028E-11	45
0.52839E 02	26	0.68569E-13	49
0.52912E 02	27	0.38903E-10	36
0.55803E 02	28	0.53681E-12	47
0.11957E 02	34	0.24992E-06	1
0.12446E 02	35	-0.12279E-07	13
0.16801E 02	36	0.55539E-07	7
0.17309E 02	37	0.16765E-07	11
0.20952E 02	38	0.94674E-07	5
0.23872E 02	39	-0.12329E-06	2
0.27020E 02	40	-0.83998E-08	14
0.29155E 02	41	-0.33902E-08	18
0.30048E 02	42	0.10140E-08	24
0.30800E 02	43	-0.39227E-07	9
0.31635E 02	44	-0.44551E-07	8
0.32753E 02	45	0.51066E-09	27
0.33123E 02	46	0.39654E-08	17
0.36920E 02	47	0.77410E-09	25
0.37888E 02	48	-0.25931E-08	20
0.38871E 02	49	-0.11393E-08	23
0.43468E 02	50	-0.73189E-07	6
0.45841E 02	51	0.10696E-06	4
0.51102E 02	52	-0.11003E-06	3
0.52131E 02	53	-0.82463E-11	39
0.52227E 02	54	-0.52013E-09	26
0.59475E 02	55	0.24771E-11	44
0.60748E 02	56	0.37397E-07	10
0.65135E 02	57	0.13284E-07	12
0.67311E 02	58	0.81995E-08	15

FREQUENCY	MODE NO.	COEFFICIENT	RANK
0.13764E 02	4	0.41666E-11	45
0.17525E 02	5	0.11205E-09	32
0.18133E 02	6	-0.86799E-10	34
0.19370E 02	7	-0.29078E-09	28
0.22939E 02	8	-0.18112E-09	30
0.25796E 02	9	-0.34658E-10	37
0.28702E 02	10	-0.79255E-10	35
0.28944E 02	11	-0.67373E-11	43
0.30096E 02	12	-0.10683E-09	33
0.31603E 02	13	0.53579E-10	36
0.32384E 02	14	0.32950E-09	27
0.32729E 02	15	0.20485E-10	40
0.34836E 02	16	0.22757E-11	48
0.36578E 02	17	0.22823E-09	29
0.38611E 02	18	0.24605E-08	19
0.38819E 02	19	-0.81715E-09	23
0.41914E 02	20	-0.62265E-09	24
0.48225E 02	21	-0.13179E-09	31
0.49330E 02	22	0.12129E-10	41
0.51462E 02	23	0.20972E-10	39
0.52124E 02	24	0.58106E-13	50
0.52244E 02	25	-0.49764E-11	44
0.52839E 02	26	-0.10861E-12	49
0.52912E 02	27	-0.51434E-09	25
0.55803E 02	28	0.34784E-11	46
0.11957E 02	34	0.19763E-07	11
0.12446E 02	35	0.14874E-06	1
0.16801E 02	36	0.15959E-08	22
0.17309E 02	37	-0.20238E-07	10
0.20952E 02	38	-0.31503E-08	17
0.23872E 02	39	-0.11448E-06	3
0.27020E 02	40	0.65127E-07	5
0.29155E 02	41	-0.13117E-07	12
0.30048E 02	42	-0.19362E-08	20
0.30800E 02	43	-0.46202E-08	15
0.31635E 02	44	-0.27803E-07	7
0.32753E 02	45	0.35507E-09	26
0.33123E 02	46	-0.68880E-08	13
0.36920E 02	47	-0.11586E-06	2
0.37888E 02	48	0.65753E-07	4
0.38871E 02	49	0.18097E-08	21
0.43468E 02	50	-0.50473E-08	14
0.45841E 02	51	-0.20347E-07	9
0.51102E 02	52	0.26327E-08	18
0.52131E 02	53	0.32725E-10	38
0.52227E 02	54	0.26948E-11	47
0.59475E 02	55	-0.11311E-10	42
0.60748E 02	56	-0.26206E-07	8
0.65135E 02	57	-0.39634E-08	16
0.67311E 02	58	0.50339E-07	6

REPRODUCIBILITY OF THE ORIGINAL PAGE IS POOR

RATE COEFFICIENTS. RESPONSE FRDM = 9024 INPUT FRDM = 140393

FREQUENCY	MODE NO.	COEFFICIENT	RANK
0.13764E 02	4	-0.53592E-06	2
0.17525E 02	5	-0.48029E-07	17
0.18133E 02	6	-0.18664E-06	4
0.19370E 02	7	0.65883E-07	11
0.22939E 02	8	-0.83324E-06	1
0.25796E 02	9	0.71383E-07	8
0.28702E 02	10	-0.13996E-07	25
0.28944E 02	11	-0.88304E-09	38
0.30096E 02	12	-0.12148E-07	27
0.31603E 02	13	0.10699E-09	45
0.32384E 02	14	-0.77401E-07	7
0.32729E 02	15	-0.30357E-08	34
0.34836E 02	16	0.44470E-09	40
0.36578E 02	17	0.57835E-07	13
0.38611E 02	18	0.56363E-07	14
0.38819E 02	19	-0.33643E-07	19
0.41914E 02	20	0.14566E-06	5
0.48225E 02	21	0.50976E-07	15
0.49330E 02	22	0.18479E-09	43
0.51462E 02	23	-0.47961E-08	32
0.52124E 02	24	0.30984E-10	47
0.52244E 02	25	0.14236E-09	44
0.52839E 02	26	0.73946E-11	48
0.52912E 02	27	0.58303E-09	39
0.55803E 02	28	-0.80875E-08	30
0.11957E 02	34	0.35180E-07	18
0.12446E 02	35	0.40870E-09	41
0.16801E 02	36	-0.21898E-06	3
0.17309E 02	37	-0.26717E-08	35
0.20952E 02	38	-0.65308E-07	12
0.23872E 02	39	-0.13269E-06	6
0.27020E 02	40	-0.16376E-07	24
0.29155E 02	41	0.32990E-07	20
0.30048E 02	42	0.72612E-08	31
0.30800E 02	43	0.71090E-07	10
0.31635E 02	44	0.50161E-07	16
0.32753E 02	45	-0.10655E-07	28
0.33123E 02	46	-0.20148E-07	23
0.36920E 02	47	-0.21846E-08	36
0.37888E 02	48	-0.29821E-07	21
0.38871E 02	49	-0.37027E-08	33
0.43468E 02	50	-0.71255E-07	9
0.45841E 02	51	0.28240E-07	22
0.51102E 02	52	0.12276E-07	26
0.52131E 02	53	-0.10829E-11	50
0.52227E 02	54	0.24980E-09	42
0.59475E 02	55	0.11595E-11	49
0.60748E 02	56	0.90112E-08	29
0.65135E 02	57	0.95411E-10	46
0.67311E 02	58	0.14452E-08	37

RATE COEFFICIENTS. RESPONSE FRDM = 9025 INPUT FRDM = 140393

FREQUENCY	MODE NO.	COEFFICIENT	RANK
0.13764E 02	4	-0.24892E-06	2
0.17525E 02	5	0.84664E-08	16
0.18133E 02	6	0.62957E-09	33
0.19370E 02	7	0.16010E-08	28
0.22939E 02	8	0.28959E-06	1
0.25796E 02	9	-0.40604E-07	8
0.28702E 02	10	-0.75913E-08	18
0.28944E 02	11	0.46103E-09	37
0.30096E 02	12	0.20191E-08	25
0.31603E 02	13	-0.18315E-09	40
0.32384E 02	14	0.11383E-07	15
0.32729E 02	15	0.11987E-08	31
0.34836E 02	16	0.23294E-11	49
0.36578E 02	17	-0.41263E-08	20
0.38611E 02	18	0.32312E-08	22
0.38819E 02	19	-0.63355E-07	3
0.41914E 02	20	0.55351E-07	7
0.48225E 02	21	0.16597E-07	11
0.49330E 02	22	0.61729E-10	43
0.51462E 02	23	-0.17185E-08	27
0.52124E 02	24	0.11877E-10	46
0.52244E 02	25	0.55366E-10	44
0.52839E 02	26	0.31087E-11	48
0.52912E 02	27	0.31925E-09	38
0.55803E 02	28	-0.92005E-09	32
0.11957E 02	34	-0.55936E-07	6
0.12446E 02	35	-0.56957E-09	35
0.16801E 02	36	-0.57067E-07	5
0.17309E 02	37	-0.14726E-08	30
0.20952E 02	38	0.58478E-07	4
0.23872E 02	39	0.31132E-07	9
0.27020E 02	40	0.18599E-08	26
0.29155E 02	41	-0.28806E-08	24
0.30048E 02	42	0.20573E-09	39
0.30800E 02	43	-0.77309E-08	17
0.31635E 02	44	-0.12770E-07	12
0.32753E 02	45	0.14740E-08	29
0.33123E 02	46	0.34039E-08	21
0.36920E 02	47	0.52193E-10	45
0.37888E 02	48	-0.62145E-09	34
0.38871E 02	49	-0.50649E-09	36
0.43468E 02	50	-0.22167E-07	10
0.45841E 02	51	0.12510E-07	13
0.51102E 02	52	0.50324E-08	19
0.52131E 02	53	-0.52273E-12	50
0.52227E 02	54	0.10136E-09	41
0.59475E 02	55	0.42496E-11	47
0.60748E 02	56	0.11459E-07	14
0.65135E 02	57	-0.84022E-10	42
0.67311E 02	58	0.29899E-08	23

RATE COEFFICIENTS. RESPONSE FRDM = 9026 INPUT FRDM = 140393

RATE COEFFICIENTS. RESPONSE FRDM = 90044 INPUT FRDM = 140391

FREQUENCY	MODE NO.	COEFFICIENT	RANK
0.13764E 02	4	0.26158E-08	28
0.17525E 02	5	0.66161E-07	2
0.18133E 02	6	-0.17206E-07	8
0.19370E 02	7	-0.11432E-06	1
0.22939E 02	8	-0.34792E-07	5
0.25796E 02	9	-0.37482E-08	26
0.28702E 02	10	-0.48074E-08	23
0.28944E 02	11	-0.62329E-09	39
0.30096E 02	12	-0.53572E-08	22
0.31603E 02	13	0.27614E-08	27
0.32384E 02	14	0.12700E-07	12
0.32729E 02	15	0.73444E-09	38
0.34836E 02	16	0.33380E-09	41
0.36578E 02	17	0.99644E-08	14
0.38611E 02	18	0.51932E-07	4
0.38819E 02	19	-0.15411E-07	10
0.41914E 02	20	-0.68732E-08	19
0.48225E 02	21	0.12171E-08	34
0.49330E 02	22	-0.49746E-11	47
0.51462E 02	23	0.55193E-07	3
0.52124E 02	24	-0.60952E-11	46
0.52244E 02	25	0.21149E-09	42
0.52839E 02	26	-0.49240E-11	48
0.52912E 02	27	-0.42209E-08	25
0.55803E 02	28	-0.59617E-08	20
0.11957E 02	34	-0.44232E-08	24
0.12444E 02	35	0.68993E-08	18
0.16801E 02	36	-0.16398E-08	32
0.17309E 02	37	0.17777E-08	31
0.20952E 02	38	-0.19459E-08	30
0.23872E 02	39	0.28907E-07	6
0.27020E 02	40	-0.14420E-07	11
0.29155E 02	41	-0.11068E-07	13
0.30040E 02	42	-0.39285E-09	40
0.30800E 02	43	-0.91214E-09	36
0.31635E 02	44	-0.79694E-08	16
0.32753E 02	45	0.10249E-08	35
0.33123E 02	46	-0.59126E-08	21
0.36920E 02	47	-0.78118E-08	17
0.37888E 02	48	0.15758E-07	9
0.38871E 02	49	0.80468E-09	37
0.43468E 02	50	-0.15287E-08	33
0.45841E 02	51	-0.23797E-08	29
0.51102E 02	52	-0.12041E-09	43
0.52131E 02	53	0.20745E-11	49
0.52227E 02	54	-0.52515E-12	50
0.59475E 02	55	-0.19404E-10	45
0.60748E 02	56	-0.80298E-08	15
0.65135E 02	57	0.25068E-10	44
0.67311E 02	58	0.18355E-07	7

FREQUENCY	MODE NO.	COEFFICIENT	RANK
0.13764E 02	4	0.0	50
0.17525E 02	5	0.0	49
0.18133E 02	6	0.0	48
0.19370E 02	7	0.0	47
0.22939E 02	8	0.0	46
0.25796E 02	9	0.0	45
0.28702E 02	10	0.0	44
0.28944E 02	11	0.0	43
0.30096E 02	12	0.0	42
0.31603E 02	13	0.0	41
0.32384E 02	14	0.0	40
0.32729E 02	15	0.0	39
0.34836E 02	16	0.0	38
0.36578E 02	17	0.0	37
0.38611E 02	18	0.0	36
0.38819E 02	19	0.0	35
0.41914E 02	20	0.0	34
0.48225E 02	21	0.0	33
0.49330E 02	22	0.0	32
0.51462E 02	23	0.0	31
0.52124E 02	24	0.0	30
0.52244E 02	25	0.0	29
0.52839E 02	26	0.0	28
0.52912E 02	27	0.0	27
0.55803E 02	28	0.0	26
0.11957E 02	34	0.26931E-07	5
0.12444E 02	35	-0.17790E-08	17
0.16801E 02	36	-0.62811E-07	3
0.17309E 02	37	0.54263E-08	13
0.20952E 02	38	-0.90140E-07	2
0.23872E 02	39	0.16610E-06	1
0.27020E 02	40	0.49811E-08	14
0.29155E 02	41	0.11680E-07	10
0.30040E 02	42	-0.15603E-09	20
0.30800E 02	43	-0.10847E-07	11
0.31635E 02	44	-0.26769E-07	7
0.32753E 02	45	-0.12268E-08	21
0.33123E 02	46	-0.25570E-08	16
0.36920E 02	47	-0.40669E-08	15
0.37888E 02	48	-0.18294E-07	8
0.38871E 02	49	0.16789E-08	19
0.43468E 02	50	-0.16887E-08	18
0.45841E 02	51	-0.17872E-09	22
0.51102E 02	52	-0.12256E-07	9
0.52131E 02	53	0.21150E-11	25
0.52227E 02	54	0.53322E-10	24
0.59475E 02	55	0.55687E-10	23
0.60748E 02	56	0.38856E-07	4
0.65135E 02	57	0.26888E-07	6
0.67311E 02	58	-0.82021E-08	12

RATE COEFFICIENTS. RESPONSE FRDM = 90045 INPUT FRDM = 140391

FREQUENCY	MODE NO.	COEFFICIENT	RANK
0.13764E 02	4	0.88156E-07	7
0.17525E 02	5	0.30552E-08	18
0.18133E 02	6	0.19928E-06	5
0.19370E 02	7	0.79930E-08	12
0.22539E 02	8	0.10316E-05	1
0.25796E 02	9	0.21328E-06	3
0.28702E 02	10	-0.20314E-06	4
0.28944E 02	11	0.40144E-08	16
0.30096E 02	12	-0.77017E-07	8
0.31603E 02	13	0.55485E-08	13
0.32384E 02	14	-0.46183E-06	2
0.32729E 02	15	-0.24581E-07	10
0.34836E 02	16	-0.17946E-08	20
0.36578E 02	17	-0.83949E-08	11
0.38611E 02	18	-0.27512E-08	19
0.38819E 02	19	-0.11252E-06	6
0.41914E 02	20	-0.50953E-07	9
0.48225E 02	21	0.49444E-08	14
0.49330E 02	22	0.41562E-08	15
0.51462E 02	23	0.20290E-10	23
0.52124E 02	24	0.36492E-12	25
0.52244E 02	25	0.58230E-10	22
0.52839E 02	26	-0.75527E-11	24
0.52912E 02	27	-0.36828E-08	17
0.55803E 02	28	0.22759E-09	21
0.11957E 02	34	0.0	50
0.12446E 02	35	0.0	49
0.16801E 02	36	0.0	48
0.17309E 02	37	0.0	47
0.20952E 02	38	0.0	46
0.23872E 02	39	0.0	45
0.27020E 02	40	0.0	44
0.29155E 02	41	0.0	43
0.30048E 02	42	0.0	42
0.30800E 02	43	0.0	41
0.31635E 02	44	0.0	40
0.32753E 02	45	0.0	39
0.33123E 02	46	0.0	38
0.36920E 02	47	0.0	37
0.37888E 02	48	0.0	36
0.38871E 02	49	0.0	35
0.43468E 02	50	0.0	34
0.45841E 02	51	0.0	33
0.51102E 02	52	0.0	32
0.52131E 02	53	0.0	31
0.52227E 02	54	0.0	30
0.59475E 02	55	0.0	29
0.60748E 02	56	0.0	28
0.65135E 02	57	0.0	27
0.67311E 02	58	0.0	26

RATE COEFFICIENTS. RESPONSE FRDM = 90046 INPUT FRDM = 140391

FREQUENCY	MODE NO.	COEFFICIENT	RANK
0.13764E 02	4	0.0	50
0.17525E 02	5	0.0	49
0.18133E 02	6	0.0	48
0.19370E 02	7	0.0	47
0.22939E 02	8	0.0	46
0.25796E 02	9	0.0	45
0.28702E 02	10	0.0	44
0.28944E 02	11	0.0	43
0.30096E 02	12	0.0	42
0.31603E 02	13	0.0	41
0.32384E 02	14	0.0	40
0.32729E 02	15	0.0	39
0.34836E 02	16	0.0	38
0.36578E 02	17	0.0	37
0.38611E 02	18	0.0	36
0.38819E 02	19	0.0	35
0.41914E 02	20	0.0	34
0.48225E 02	21	0.0	33
0.49330E 02	22	0.0	32
0.51462E 02	23	0.0	31
0.52124E 02	24	0.0	30
0.52244E 02	25	0.0	29
0.52839E 02	26	0.0	28
0.52912E 02	27	0.0	27
0.55803E 02	28	0.0	26
0.11957E 02	34	-0.77354E-08	14
0.12446E 02	35	-0.46324E-08	16
0.16801E 02	36	-0.13858E-07	10
0.17309E 02	37	-0.81554E-06	13
0.20952E 02	38	-0.48037E-07	5
0.23872E 02	39	-0.18380E-06	1
0.27020E 02	40	-0.17998E-07	7
0.29155E 02	41	-0.40321E-08	18
0.30048E 02	42	-0.10645E-08	21
0.30800E 02	43	-0.86357E-09	22
0.31635E 02	44	-0.38035E-07	6
0.32753E 02	45	-0.13642E-08	20
0.33123E 02	46	-0.21444E-08	19
0.36920E 02	47	-0.11143E-07	11
0.37888E 02	48	-0.56548E-07	3
0.38871E 02	49	-0.40705E-08	17
0.43468E 02	50	-0.17904E-07	8
0.45841E 02	51	-0.17552E-06	2
0.51102E 02	52	0.88247E-08	12
0.52131E 02	53	-0.90243E-11	25
0.52227E 02	54	-0.92479E-10	23
0.59475E 02	55	-0.50282E-10	24
0.60748E 02	56	-0.17607E-07	9
0.65135E 02	57	-0.54451E-07	4
0.67311E 02	58	-0.55032E-08	15

REPRODUCIBILITY OF THE
 ORIGINAL PAGE IS POOR

RATE COEFFICIENTS. RESPONSE FRDM = 90044 INPUT FRDM = 140392

RATE COEFFICIENTS. RESPONSE FRDM = 90045 INPUT FRDM = 140392

FREQUENCY	MODE NO.	COEFFICIENT	RANK
0.13764E 02	4	0.0	50
0.17525E 02	5	0.0	49
0.18133E 02	6	0.0	48
0.19370E 02	7	0.0	47
0.22939E 02	8	0.0	46
0.25796E 02	9	0.0	45
0.28702E 02	10	0.0	44
0.28944E 02	11	0.0	43
0.30096E 02	12	0.0	42
0.31603E 02	13	0.0	41
0.32384E 02	14	0.0	40
0.32729E 02	15	0.0	39
0.34836E 02	16	0.0	38
0.36578E 02	17	0.0	37
0.38611E 02	18	0.0	36
0.38819E 02	19	0.0	35
0.41914E 02	20	0.0	34
0.48225E 02	21	0.0	33
0.49330E 02	22	0.0	32
0.51462E 02	23	0.0	31
0.52124E 02	24	0.0	30
0.52244E 02	25	0.0	29
0.52839E 02	26	0.0	28
0.52912E 02	27	0.0	27
0.55803E 02	28	0.0	26
0.11957E 02	34	-0.48784E-06	3
0.12446E 02	35	0.17247E-07	15
0.16801E 02	36	-0.20730E-06	6
0.17309E 02	37	-0.37819E-07	13
0.20952E 02	38	0.18219E-06	8
0.23872E 02	39	-0.66664E-06	1
0.27020E 02	40	-0.16311E-07	17
0.29155E 02	41	0.61321E-07	11
0.30048E 02	42	0.17135E-07	16
0.30800E 02	43	0.20300E-06	7
0.31635E 02	44	0.23901E-06	5
0.32753E 02	45	0.19047E-08	21
0.33123E 02	46	0.10572E-07	19
0.36920E 02	47	0.37766E-07	14
0.37888E 02	48	0.12453E-06	9
0.38871E 02	49	-0.82219E-08	20
0.43468E 02	50	0.11205E-07	18
0.45841E 02	51	0.14174E-08	22
0.51102E 02	52	0.30716E-06	4
0.52131E 02	53	-0.15148E-10	25
0.52227E 02	54	0.46209E-09	23
0.59475E 02	55	0.19262E-10	24
0.60748E 02	56	0.58787E-06	2
0.65135E 02	57	-0.55184E-07	12
0.67311E 02	58	0.93204E-07	10

FREQUENCY	MODE NO.	COEFFICIENT	RANK
0.13764E 02	4	-0.23666E-09	14
0.17525E 02	5	-0.24720E-11	19
0.18133E 02	6	0.23197E-09	15
0.19370E 02	7	-0.49082E-10	17
0.22939E 02	8	-0.43357E-08	5
0.25796E 02	9	-0.47740E-09	11
0.28702E 02	10	-0.42725E-08	6
0.28944E 02	11	0.81289E-11	20
0.30096E 02	12	-0.10008E-08	9
0.31603E 02	13	-0.79439E-10	16
0.32384E 02	14	-0.62131E-08	3
0.32729E 02	15	-0.28435E-09	13
0.34836E 02	16	0.25693E-11	22
0.36578E 02	17	-0.11707E-08	7
0.38611E 02	18	-0.63948E-08	2
0.38819E 02	19	-0.18070E-07	1
0.41914E 02	20	-0.44953E-08	4
0.48225E 02	21	0.30072E-09	12
0.49330E 02	22	0.74493E-09	10
0.51462E 02	23	-0.22736E-11	23
0.52124E 02	24	0.11143E-13	25
0.52244E 02	25	0.27800E-11	21
0.52839E 02	26	0.35504E-12	24
0.52912E 02	27	0.11522E-08	8
0.55803E 02	28	0.18030E-10	18
0.11957E 02	34	0.0	50
0.12446E 02	35	0.0	49
0.16801E 02	36	0.0	48
0.17309E 02	37	0.0	47
0.20952E 02	38	0.0	46
0.23872E 02	39	0.0	45
0.27020E 02	40	0.0	44
0.29155E 02	41	0.0	43
0.30048E 02	42	0.0	42
0.30800E 02	43	0.0	41
0.31635E 02	44	0.0	40
0.32753E 02	45	0.0	39
0.33123E 02	46	0.0	38
0.36920E 02	47	0.0	37
0.37888E 02	48	0.0	36
0.38871E 02	49	0.0	35
0.43468E 02	50	0.0	34
0.45841E 02	51	0.0	33
0.51102E 02	52	0.0	32
0.52131E 02	53	0.0	31
0.52227E 02	54	0.0	30
0.59475E 02	55	0.0	29
0.60748E 02	56	0.0	28
0.65135E 02	57	0.0	27
0.67311E 02	58	0.0	26

RATE COEFFICIENTS. RESPONSE FRDM = 90046 INPUT FRDM = 140392

RATE COEFFICIENTS. RESPONSE FRDM = 90044 INPUT FRDM = 140393

FREQUENCY	MODE NO.	COEFFICIENT	RANK
0.13764E 02	4	0.0	50
0.17525E 02	5	0.0	49
0.18133E 02	6	0.0	48
0.19370E 02	7	0.0	47
0.22939E 02	8	0.0	46
0.25796E 02	9	0.0	45
0.28702E 02	10	0.0	44
0.28944E 02	11	0.0	43
0.30096E 02	12	0.0	42
0.31603E 02	13	0.0	41
0.32384E 02	14	0.0	40
0.32729E 02	15	0.0	39
0.34836E 02	16	0.0	38
0.36578E 02	17	0.0	37
0.38611E 02	18	0.0	36
0.38819E 02	19	0.0	35
0.41914E 02	20	0.0	34
0.48225E 02	21	0.0	33
0.49330E 02	22	0.0	32
0.51462E 02	23	0.0	31
0.52124E 02	24	0.0	30
0.52244E 02	25	0.0	29
0.52839E 02	26	0.0	28
0.52912E 02	27	0.0	27
0.55803E 02	28	0.0	26
0.11957E 02	34	0.14012E-06	7
0.12446E 02	35	0.44911E-07	16
0.14801E 02	36	-0.45754E-07	15
0.17309E 02	37	0.56840E-07	14
0.20952E 02	38	0.97994E-07	11
0.23872E 02	39	0.73766E-06	2
0.27020E 02	40	0.58936E-07	13
0.29155E 02	41	-0.21169E-07	17
0.30048E 02	42	0.11690E-07	20
0.30800E 02	43	0.16161E-07	19
0.31635E 02	44	0.33960E-06	4
0.32753E 02	45	0.21180E-08	22
0.33123E 02	46	0.88654E-08	21
0.36920E 02	47	0.10348E-06	10
0.37888E 02	48	0.38492E-06	3
0.38871E 02	49	0.19934E-07	18
0.43468E 02	50	0.11880E-06	8
0.45841E 02	51	0.13921E-05	1
0.51102E 02	52	-0.22117E-06	6
0.52131E 02	53	0.64633E-10	24
0.52227E 02	54	0.83611E-09	23
0.59475E 02	55	0.17392E-10	25
0.60748E 02	56	0.24639E-06	5
0.65135E 02	57	0.11175E-06	9
0.67311E 02	58	0.62589E-07	12

FREQUENCY	MODE NO.	COEFFICIENT	RANK
0.13764E 02	4	0.0	50
0.17525E 02	5	0.0	49
0.18133E 02	6	0.0	48
0.19370E 02	7	0.0	47
0.22939E 02	8	0.0	46
0.25796E 02	9	0.0	45
0.28702E 02	10	0.0	44
0.28944E 02	11	0.0	43
0.30096E 02	12	0.0	42
0.31603E 02	13	0.0	41
0.32384E 02	14	0.0	40
0.32729E 02	15	0.0	39
0.34836E 02	16	0.0	38
0.36578E 02	17	0.0	37
0.38611E 02	18	0.0	36
0.38819E 02	19	0.0	35
0.41914E 02	20	0.0	34
0.48225E 02	21	0.0	33
0.49330E 02	22	0.0	32
0.51462E 02	23	0.0	31
0.52124E 02	24	0.0	30
0.52244E 02	25	0.0	29
0.52839E 02	26	0.0	28
0.52912E 02	27	0.0	27
0.55803E 02	28	0.0	26
0.11957E 02	34	0.10919E-06	5
0.12446E 02	35	0.80002E-09	20
0.14801E 02	36	0.21309E-06	1
0.17309E 02	37	0.33221E-08	18
0.20952E 02	38	0.11254E-06	4
0.23872E 02	39	0.16834E-06	3
0.27020E 02	40	0.36114E-08	15
0.29155E 02	41	0.51740E-07	7
0.30048E 02	42	0.34766E-08	16
0.30800E 02	43	0.40008E-07	8
0.31635E 02	44	0.68510E-07	6
0.32753E 02	45	0.54978E-08	13
0.33123E 02	46	0.90746E-08	12
0.36920E 02	47	0.25463E-08	19
0.37888E 02	48	0.29844E-07	10
0.38871E 02	49	-0.36550E-08	14
0.43468E 02	50	0.33939E-08	17
0.45841E 02	51	0.16578E-07	22
0.51102E 02	52	-0.14049E-07	11
0.52131E 02	53	-0.94025E-12	25
0.52227E 02	54	-0.93947E-10	23
0.59475E 02	55	0.33043E-10	24
0.60748E 02	56	0.18013E-06	2
0.65135E 02	57	0.34903E-09	21
0.67311E 02	58	0.34015E-07	9

RATE COEFFICIENTS. RESPONSE FRDM = 90045 INPUT FRDM = 140393

FREQUENCY	MODE NO.	COEFFICIENT	RANK
0.13764E 02	4	-0.14857E-06	5
0.17525E 02	5	-0.50026E-08	17
0.18133E 02	6	0.45983E-07	11
0.19370E 02	7	-0.19297E-07	13
0.22939E 02	8	-0.83284E-06	1
0.25796E 02	9	-0.51629E-07	7
0.28702E 02	10	-0.25916E-06	3
0.28944E 02	11	0.75203E-09	20
0.30096E 02	12	-0.50186E-07	9
0.31603E 02	13	-0.40942E-08	18
0.32384E 02	14	-0.23947E-06	4
0.32729E 02	15	-0.10195E-07	14
0.34836E 02	16	0.37685E-09	21
0.36578E 02	17	-0.51121E-07	8
0.33611E 02	18	-0.13497E-06	6
0.38819E 02	19	-0.34079E-06	2
0.41914E 02	20	-0.49622E-07	10
0.48225E 02	21	-0.27771E-08	19
0.49330E 02	22	-0.30553E-09	22
0.51462E 02	23	-0.59835E-08	16
0.52124E 02	24	-0.11689E-11	25
0.52244E 02	25	-0.11814E-09	23
0.52839E 02	26	0.16097E-10	24
0.52912E 02	27	0.94551E-08	15
0.55803E 02	28	-0.32273E-07	12
0.11957E 02	34	0.0	50
0.12446E 02	35	0.0	49
0.16801E 02	36	0.0	48
0.17309E 02	37	0.0	47
0.20952E 02	38	0.0	46
0.23872E 02	39	0.0	45
0.27020E 02	40	0.0	44
0.29155E 02	41	0.0	43
0.30048E 02	42	0.0	42
0.30800E 02	43	0.0	41
0.31635E 02	44	0.0	40
0.32753E 02	45	0.0	39
0.33123E 02	46	0.0	38
0.36920E 02	47	0.0	37
0.37888E 02	48	0.0	36
0.38871E 02	49	0.0	35
0.43468E 02	50	0.0	34
0.45841E 02	51	0.0	33
0.51102E 02	52	0.0	32
0.52131E 02	53	0.0	31
0.52227E 02	54	0.0	30
0.59475E 02	55	0.0	29
0.60748E 02	56	0.0	28
0.65135E 02	57	0.0	27
0.67311E 02	58	0.0	26

RATE COEFFICIENTS. RESPONSE FRDM = 90046 INPUT FRDM = 140393

FREQUENCY	MODE NO.	COEFFICIENT	RANK
0.13764E 02	4	0.0	50
0.17525E 02	5	0.0	49
0.18133E 02	6	0.0	48
0.19370E 02	7	0.0	47
0.22939E 02	8	0.0	46
0.25796E 02	9	0.0	45
0.28702E 02	10	0.0	44
0.28944E 02	11	0.0	43
0.30096E 02	12	0.0	42
0.31603E 02	13	0.0	41
0.32384E 02	14	0.0	40
0.32729E 02	15	0.0	39
0.34836E 02	16	0.0	38
0.36578E 02	17	0.0	37
0.33611E 02	18	0.0	36
0.38819E 02	19	0.0	35
0.41914E 02	20	0.0	34
0.48225E 02	21	0.0	33
0.49330E 02	22	0.0	32
0.51462E 02	23	0.0	31
0.52124E 02	24	0.0	30
0.52244E 02	25	0.0	29
0.52839E 02	26	0.0	28
0.52912E 02	27	0.0	27
0.55803E 02	28	0.0	26
0.11957E 02	34	-0.31361E-07	9
0.12446E 02	35	0.20833E-08	21
0.16801E 02	36	0.47013E-07	7
0.17309E 02	37	-0.49929E-08	18
0.20952E 02	38	0.59973E-07	6
0.23872E 02	39	-0.18627E-06	1
0.27020E 02	40	-0.13050E-07	12
0.29155E 02	41	-0.17861E-07	11
0.30048E 02	42	0.23718E-08	20
0.30800E 02	43	0.31851E-08	19
0.31635E 02	44	0.97342E-07	3
0.32753E 02	45	0.61135E-08	17
0.33123E 02	46	0.76101E-08	15
0.36920E 02	47	0.69768E-08	16
0.37888E 02	48	0.92247E-07	4
0.38871E 02	49	0.88617E-08	14
0.43468E 02	50	0.35983E-07	8
0.45841E 02	51	0.16281E-06	2
0.51102E 02	52	0.10116E-07	13
0.52131E 02	53	0.40971E-11	25
0.52227E 02	54	0.16293E-09	23
0.59475E 02	55	-0.29836E-10	24
0.60748E 02	56	-0.81624E-07	5
0.65135E 02	57	-0.70683E-09	22
0.67311E 02	58	0.22822E-07	10

Table 4-3: POSITION COEFFICIENTS FOR CONVENTIONAL MODEL

POSITION (GYRO) COEFFICIENTS. RESPONSE FRDM = 90011 INPUT FRDM = 5131				POSITION (GYRO) COEFFICIENTS. RESPONSE FRDM = 90012 INPUT FRDM = 5131			
FRCQUENCY	MODE NO.	COEFFICIENT	RANK	FRCQUENCY	MODE NO.	COEFFICIENT	RANK
0.13764E 02	4	-0.41025E-08	6	0.13764E 02	4	0.54148E-11	39
0.17525E 02	5	-0.53414E-08	4	0.17525E 02	5	-0.13895E-10	31
0.18133E 02	6	-0.94556E-08	3	0.18133E 02	6	0.61105E-10	26
0.19370E 02	7	0.18543E-09	22	0.19370E 02	7	-0.61447E-12	45
0.22939E 02	8	-0.29899E-07	1	0.22939E 02	8	0.15392E-09	21
0.25796E 02	9	-0.53363E-08	5	0.25796E 02	9	0.48445E-10	27
0.28702E 02	10	-0.29347E-08	9	0.28702E 02	10	-0.82794E-10	24
0.28944E 02	11	-0.22034E-08	10	0.28944E 02	11	0.11008E-10	32
0.30096E 02	12	0.72821E-09	14	0.30096E 02	12	0.10917E-10	33
0.31603E 02	13	-0.48440E-09	18	0.31603E 02	13	0.60931E-11	38
0.32364E 02	14	-0.11596E-07	2	0.32364E 02	14	-0.17106E-09	20
0.32729E 02	15	-0.75751E-09	13	0.32729E 02	15	-0.10385E-10	34
0.34836E 02	16	0.54170E-09	16	0.34836E 02	16	0.61643E-11	37
0.36573E 02	17	-0.71544E-10	28	0.36573E 02	17	0.66065E-11	35
0.38611E 02	18	0.11798E-08	11	0.38611E 02	18	0.10298E-09	23
0.38819E 02	19	0.30783E-08	8	0.38819E 02	19	-0.17118E-10	30
0.41914E 02	20	0.33426E-08	7	0.41914E 02	20	-0.19517E-10	29
0.43225E 02	21	0.92496E-10	24	0.43225E 02	21	0.56799E-12	47
0.49330E 02	22	0.78547E-11	39	0.49330E 02	22	-0.62484E-12	44
0.51462E 02	23	-0.50654E-10	29	0.51462E 02	23	0.66037E-11	36
0.52124E 02	24	0.22932E-13	49	0.52124E 02	24	-0.50102E-15	50
0.52244E 02	25	0.16132E-10	36	0.52244E 02	25	-0.65340E-13	48
0.52839E 02	26	0.44864E-12	46	0.52839E 02	26	0.20583E-14	49
0.52912E 02	27	0.70864E-11	40	0.52912E 02	27	0.57140E-12	46
0.52803E 02	28	0.47983E-11	41	0.52803E 02	28	-0.62847E-12	43
0.11957E 02	34	-0.87258E-10	25	0.11957E 02	34	-0.33203E-09	17
0.12446E 02	35	-0.64262E-09	15	0.12446E 02	35	-0.36200E-07	3
0.16801E 02	36	-0.12316E-09	23	0.16801E 02	36	-0.23661E-07	5
0.17309E 02	37	-0.11609E-06	12	0.17309E 02	37	-0.73773E-07	1
0.20952E 02	38	0.24735E-09	20	0.20952E 02	38	0.33066E-07	4
0.23872E 02	39	0.48985E-09	17	0.23872E 02	39	0.38874E-07	2
0.27020E 02	40	-0.72168E-10	27	0.27020E 02	40	-0.76171E-08	8
0.29155E 02	41	0.27721E-10	31	0.29155E 02	41	0.66468E-09	13
0.30048E 02	42	0.21913E-11	44	0.30048E 02	42	0.11541E-09	22
0.30860E 02	43	-0.16657E-10	34	0.30860E 02	43	-0.63930E-09	14
0.31635E 02	44	-0.74314E-10	26	0.31635E 02	44	-0.35697E-08	9
0.32753E 02	45	0.10086E-11	45	0.32753E 02	45	0.26574E-10	28
0.33123E 02	46	-0.39215E-10	30	0.33123E 02	46	-0.91372E-09	12
0.36920E 02	47	-0.22132E-09	21	0.36920E 02	47	-0.90021E-08	7
0.37868E 02	48	0.31673E-09	19	0.37868E 02	48	0.14457E-07	6
0.38871E 02	49	-0.22239E-10	32	0.38871E 02	49	-0.28919E-08	10
0.43468E 02	50	0.32168E-11	43	0.43468E 02	50	0.30322E-09	18
0.45841E 02	51	0.94730E-11	38	0.45841E 02	51	0.10682E-09	19
0.51102E 02	52	-0.15196E-10	37	0.51102E 02	52	-0.22112E-08	11
0.52131E 02	53	0.90711E-14	50	0.52131E 02	53	-0.86542E-12	41
0.52227E 02	54	-0.30651E-13	48	0.52227E 02	54	-0.32080E-11	40
0.59475E 02	55	0.16321E-12	47	0.59475E 02	55	0.85613E-12	42
0.60748E 02	56	-0.16180E-10	35	0.60748E 02	56	-0.44766E-09	16
0.65135E 02	57	0.16878E-10	33	0.65135E 02	57	0.81605E-10	25
0.67311E 02	58	0.40452E-11	42	0.67311E 02	58	0.49847E-09	15

FREQUENCY	MODE NO.	COEFFICIENT	RANK
0.13764E 02	4	-0.28259E-08	9
0.17525E 02	5	0.65495E-08	4
0.18133E 02	6	-0.13405E-07	1
0.19370E 02	7	0.14894E-09	31
0.22939E 02	8	-0.59638E-08	6
0.25796E 02	9	0.58969E-09	20
0.26702E 02	10	0.64773E-08	5
0.28944E 02	11	0.24880E-08	10
0.30096E 02	12	-0.96322E-09	16
0.31603E 02	13	0.91475E-09	17
0.32384E 02	14	0.78998E-08	2
0.32729E 02	15	0.49262E-09	23
0.34836E 02	16	-0.28709E-09	28
0.36578E 02	17	-0.49698E-09	22
0.38819E 02	18	-0.39719E-08	8
0.38819E 02	19	0.78382E-08	3
0.41914E 02	20	-0.52314E-08	7
0.46225E 02	21	-0.19229E-09	29
0.49330E 02	22	0.20486E-10	40
0.51462E 02	23	-0.60451E-09	19
0.52124E 02	24	0.62762E-13	49
0.52244E 02	25	-0.14451E-10	42
0.52839E 02	26	-0.32207E-12	47
0.52912E 02	27	-0.38731E-10	38
0.55803E 02	28	0.40346E-10	37
0.11957E 02	34	-0.39485E-09	24
0.12446E 02	35	0.49771E-09	21
0.16601E 02	36	0.11438E-08	13
0.17309E 02	37	-0.36269E-09	25
0.20952E 02	38	-0.19847E-08	11
0.23872E 02	39	-0.71488E-09	18
0.27020E 02	40	0.14209E-08	12
0.29155E 02	41	-0.14025E-09	32
0.30048E 02	42	-0.11394E-10	43
0.30600E 02	43	0.83527E-10	35
0.31635E 02	44	0.32782E-09	27
0.32753E 02	45	-0.56229E-11	45
0.33123E 02	46	0.16932E-09	30
0.36920E 02	47	0.99110E-09	15
0.37888E 02	48	-0.99673E-09	14
0.38871E 02	49	-0.33252E-09	26
0.43468E 02	50	0.79544E-11	44
0.45541E 02	51	0.19154E-10	41
0.51102E 02	52	0.46323E-10	36
0.52131E 02	53	-0.53351E-13	50
0.52227E 02	54	0.12513E-12	48
0.59475E 02	55	-0.10975E-11	46
0.60748E 02	56	0.12026E-09	33
0.65135E 02	57	-0.28174E-10	39
0.67311E 02	58	-0.11897E-09	34

FREQUENCY	MODE NO.	COEFFICIENT	RANK
0.13764E 02	4	0.21171E-09	27
0.17525E 02	5	0.83862E-08	4
0.18133E 02	6	-0.50783E-07	1
0.19370E 02	7	0.46358E-07	2
0.22939E 02	8	0.72945E-08	5
0.25796E 02	9	0.90621E-08	3
0.26702E 02	10	-0.53645E-08	8
0.28944E 02	11	-0.45423E-08	9
0.30096E 02	12	-0.54852E-08	7
0.31603E 02	13	-0.31904E-08	10
0.32384E 02	14	0.68467E-08	6
0.32729E 02	15	0.57255E-09	19
0.34836E 02	16	-0.62097E-09	18
0.36578E 02	17	0.30436E-09	23
0.38819E 02	18	-0.82914E-09	13
0.38819E 02	19	-0.20870E-09	28
0.41914E 02	20	-0.33849E-09	22
0.46225E 02	21	-0.53800E-09	20
0.49330E 02	22	0.33570E-10	39
0.51462E 02	23	-0.79091E-09	14
0.52124E 02	24	0.45538E-12	47
0.52244E 02	25	-0.70942E-10	46
0.52839E 02	26	0.22571E-12	48
0.52912E 02	27	0.12101E-09	30
0.55803E 02	28	0.97444E-10	33
0.11957E 02	34	-0.77527E-10	35
0.12446E 02	35	-0.26996E-08	11
0.16601E 02	36	-0.21963E-09	26
0.17309E 02	37	-0.70394E-10	36
0.20952E 02	38	-0.10993E-09	32
0.23872E 02	39	0.97507E-09	12
0.27020E 02	40	-0.23128E-09	25
0.29155E 02	41	0.13947E-09	29
0.30048E 02	42	0.26531E-10	42
0.30600E 02	43	0.30631E-10	40
0.31635E 02	44	0.68908E-09	16
0.32753E 02	45	0.29345E-11	49
0.33123E 02	46	0.35874E-09	21
0.36920E 02	47	0.62942E-09	17
0.37888E 02	48	-0.75905E-09	15
0.38871E 02	49	-0.39584E-10	38
0.43468E 02	50	0.64582E-10	37
0.45541E 02	51	0.11311E-09	31
0.51102E 02	52	-0.28744E-10	41
0.52131E 02	53	-0.31012E-13	50
0.52227E 02	54	0.68808E-13	49
0.59475E 02	55	-0.99614E-12	46
0.60748E 02	56	-0.24805E-09	24
0.65135E 02	57	0.88256E-10	34
0.67311E 02	58	0.26019E-10	43

POSITION (GYRO) COEFFICIENTS. RESPONSE FRDM = 90012 INPUT FRDM = 5132 POSITION (GYRO) COEFFICIENTS. RESPONSE FRDM = 90013 INPUT FRDM = 5132

FREQUENCY	NODE NO.	COEFFICIENT	RANK
0.13764E 02	4	-0.27943E-12	47
0.17525E 02	5	0.21816E-10	35
0.18133E 02	6	0.32817E-09	21
0.19370E 02	7	-0.15362E-09	23
0.22939E 02	8	-0.37552E-10	32
0.25796E 02	9	-0.02269E-10	28
0.28702E 02	10	-0.15134E-09	24
0.23944E 02	11	0.22693E-10	34
0.30096E 02	12	-0.02220E-10	29
0.31603E 02	13	0.40131E-10	31
0.32384E 02	14	0.10100E-09	26
0.32729E 02	15	0.78495E-11	38
0.34836E 02	16	-0.70663E-11	40
0.36578E 02	17	-0.28104E-10	33
0.38611E 02	18	-0.72374E-10	30
0.30819E 02	19	0.11606E-11	46
0.41914E 02	20	0.19765E-11	45
0.48225E 02	21	-0.33037E-11	42
0.49330E 02	22	-0.26705E-11	44
0.51462E 02	23	0.10311E-09	25
0.52124E 02	24	-0.99490E-14	49
0.52264E 02	25	0.04904E-13	48
0.52039E 02	26	0.10355E-14	50
0.52912E 02	27	0.97578E-11	37
0.55803E 02	28	-0.12763E-10	36
0.11957E 02	34	-0.29500E-09	22
0.12446E 02	35	-0.14207E-06	1
0.16801E 02	36	-0.42193E-07	3
0.17309E 02	37	-0.44733E-08	13
0.20952E 02	38	-0.14696E-07	8
0.23872E 02	39	0.77539E-07	2
0.27020E 02	40	-0.24410E-07	7
0.29155E 02	41	0.33489E-08	15
0.30048E 02	42	0.13868E-08	18
0.30800E 02	43	0.11756E-08	19
0.31635E 02	44	0.33100E-07	5
0.32753E 02	45	0.03133E-10	27
0.33123E 02	46	0.03586E-08	9
0.36920E 02	47	0.25601E-07	6
0.37588E 02	48	-0.39440E-07	4
0.38871E 02	49	-0.51474E-09	12
0.43468E 02	50	0.60877E-08	11
0.45841E 02	51	0.22306E-08	17
0.51102E 02	52	-0.41825E-08	14
0.52131E 02	53	0.29507E-11	43
0.52227E 02	54	0.72015E-11	39
0.59475E 02	55	-0.52265E-11	41
0.60748E 02	56	-0.68625E-08	10
0.65135E 02	57	0.42671E-09	20
0.67311E 02	58	0.32059E-08	16

FREQUENCY	MODE NO.	COEFFICIENT	RANK
0.13764E 02	4	0.14583E-09	39
0.17525E 02	5	-0.10283E-07	4
0.18133E 02	6	-0.71993E-07	1
0.19370E 02	7	0.37236E-07	2
0.22939E 02	8	0.14599E-08	20
0.25796E 02	9	-0.10014E-08	23
0.28702E 02	10	0.11840E-07	3
0.28944E 02	11	0.51289E-08	8
0.30096E 02	12	0.72554E-08	6
0.31603E 02	13	0.60248E-08	7
0.32384E 02	14	-0.46644E-08	9
0.32729E 02	15	-0.37234E-09	32
0.34836E 02	16	0.32910E-07	34
0.36578E 02	17	0.21142E-08	15
0.38611E 02	18	0.27914E-08	13
0.30819E 02	19	-0.53481E-09	30
0.41914E 02	20	0.52977E-09	31
0.48225E 02	21	0.11184E-08	22
0.49330E 02	22	0.07552E-10	42
0.51462E 02	23	-0.94387E-08	5
0.52124E 02	24	0.12463E-11	47
0.52264E 02	25	0.10779E-10	44
0.52039E 02	26	-0.16203E-12	50
0.52912E 02	27	-0.66141E-09	28
0.55803E 02	28	0.01934E-09	25
0.11957E 02	34	-0.35082E-07	33
0.12446E 02	35	0.20908E-08	16
0.16801E 02	36	0.20397E-08	17
0.17309E 02	37	-0.21992E-10	43
0.20952E 02	38	0.08210E-07	24
0.23872E 02	39	-0.14259E-08	21
0.27020E 02	40	0.45536E-08	10
0.29155E 02	41	-0.70661E-09	27
0.30048E 02	42	-0.13692E-09	40
0.30800E 02	43	-0.15360E-09	37
0.31635E 02	44	-0.30397E-08	11
0.32753E 02	45	-0.16399E-10	45
0.33123E 02	46	-0.15489E-08	19
0.36920E 02	47	-0.20106E-08	12
0.37588E 02	48	0.23087E-08	14
0.38871E 02	49	-0.59187E-09	29
0.43468E 02	50	0.15970E-09	36
0.45841E 02	51	0.22871E-09	35
0.51102E 02	52	0.07621E-10	41
0.52131E 02	53	0.18240E-12	49
0.52227E 02	54	-0.20089E-12	48
0.59475E 02	55	0.67000E-11	46
0.60748E 02	56	0.18437E-08	18
0.65135E 02	57	-0.14732E-09	38
0.67311E 02	58	-0.76523E-07	26

POSITION (GYRO) COEFFICIENTS. RESPONSE FRDM = 90011 INPUT FRDM = 5133

POSITION (GYRO) COEFFICIENTS. RESPONSE FRDM = 90012 INPUT FRDM = 5133

FREQUENCY	MODE NO.	COEFFICIENT	RANK
0.13764E 02	4	-0.13905E-06	2
0.17525E 02	5	0.56749E-08	7
0.18133E 02	6	-0.29177E-07	4
0.19370E 02	7	0.93454E-10	31
0.22939E 02	8	0.19446E-06	1
0.25796E 02	9	-0.63076E-07	3
0.28702E 02	10	0.33707E-08	9
0.28944E 02	11	-0.85768E-09	15
0.30096E 02	12	0.85076E-11	41
0.31603E 02	13	-0.13273E-09	29
0.32384E 02	14	0.10428E-08	14
0.32729E 02	15	-0.37002E-09	19
0.34836E 02	16	0.11602E-09	30
0.36578E 02	17	-0.21726E-09	27
0.38611E 02	18	0.28309E-09	24
0.38819E 02	19	0.21908E-08	11
0.41914E 02	20	-0.12076E-07	5
0.48225E 02	21	0.79873E-08	6
0.49330E 02	22	0.33884E-09	20
0.51462E 02	23	0.21569E-10	36
0.52124E 02	24	0.13350E-11	47
0.52244E 02	25	0.12453E-10	39
0.52539E 02	26	0.83071E-12	48
0.52912E 02	27	0.70306E-10	32
0.55803E 02	28	0.25652E-09	25
0.11957E 02	34	0.48843E-08	8
0.12446E 02	35	-0.32983E-09	21
0.16801E 02	36	-0.11133E-08	12
0.17309E 02	37	0.23995E-09	26
0.20952E 02	38	0.30087E-08	10
0.23672E 02	39	-0.10462E-08	13
0.27020E 02	40	0.51258E-11	43
0.29155E 02	41	0.19642E-10	37
0.30048E 02	42	0.20589E-10	34
0.30330E 02	43	0.27601E-11	46
0.31635E 02	44	-0.51364E-09	17
0.32753E 02	45	-0.69033E-11	42
0.33123E 02	46	0.19316E-10	38
0.36920E 02	47	-0.46047E-10	33
0.37835E 02	48	-0.61560E-09	16
0.38871E 02	49	-0.22126E-10	35
0.43469E 02	50	-0.31010E-09	22
0.45841E 02	51	-0.85488E-11	40
0.51102E 02	52	0.41862E-09	18
0.52131E 02	53	-0.15244E-13	50
0.52227E 02	54	0.33350E-11	44
0.59475E 02	55	-0.36764E-12	49
0.60748E 02	56	-0.21269E-09	28
0.65135E 02	57	0.28751E-09	23
0.67311E 02	58	-0.28078E-11	45

FREQUENCY	MODE NO.	COEFFICIENT	RANK
0.13764E 02	4	0.18353E-09	25
0.17525E 02	5	0.14762E-10	36
0.18133E 02	6	0.18855E-09	24
0.19370E 02	7	-0.30969E-12	46
0.22939E 02	8	-0.10021E-08	16
0.25796E 02	9	0.57263E-09	17
0.28702E 02	10	0.95093E-10	28
0.28944E 02	11	0.42849E-11	40
0.30096E 02	12	0.12754E-12	47
0.31603E 02	13	0.16676E-11	43
0.32384E 02	14	0.15384E-10	35
0.32729E 02	15	-0.50729E-11	39
0.34836E 02	16	0.13202E-11	45
0.36578E 02	17	0.20062E-10	34
0.38611E 02	18	0.24710E-10	33
0.38819E 02	19	-0.12182E-10	37
0.41914E 02	20	0.70510E-10	29
0.48225E 02	21	0.49047E-10	30
0.49330E 02	22	-0.26955E-10	32
0.51462E 02	23	-0.28145E-11	41
0.52124E 02	24	-0.29167E-13	49
0.52244E 02	25	-0.50437E-13	48
0.52539E 02	26	0.38112E-14	50
0.52912E 02	27	0.56691E-11	38
0.55803E 02	28	-0.33599E-10	31
0.11957E 02	34	0.18585E-07	8
0.12446E 02	35	-0.18580E-07	9
0.16801E 02	36	-0.21389E-06	2
0.17309E 02	37	0.15248E-07	10
0.20952E 02	38	0.40720E-06	1
0.23672E 02	39	-0.83197E-07	3
0.27020E 02	40	0.54100E-09	18
0.29155E 02	41	0.47096E-09	19
0.30048E 02	42	0.15057E-08	14
0.30800E 02	43	0.10593E-09	27
0.31635E 02	44	-0.24673E-07	7
0.32753E 02	45	-0.19557E-09	23
0.33123E 02	46	0.45006E-09	20
0.36920E 02	47	-0.18729E-08	13
0.37835E 02	48	-0.31986E-07	5
0.38871E 02	49	-0.28773E-08	12
0.43468E 02	50	-0.29231E-07	6
0.45841E 02	51	-0.16859E-09	26
0.51102E 02	52	0.60714E-07	4
0.52131E 02	53	0.14544E-11	44
0.52227E 02	54	0.34904E-09	21
0.59475E 02	55	-0.19285E-11	42
0.60748E 02	56	-0.58844E-08	11
0.65135E 02	57	0.13901E-08	15
0.67311E 02	58	-0.34595E-09	22

POSITION (GYRO) COEFFICIENTS. RESPONSE FRDM = 70013 INPUT FRDM = 5133

POSITION (GYRO) COEFFICIENTS. RESPONSE FRDM = 90054 INPUT FRDM = 5131

FREQUENCY	MODE NO.	COEFFICIENT	RANK
0.13764E 02	4	-0.95732E-07	1
0.17525E 02	5	-0.49584E-08	11
0.18133E 02	6	-0.41362E-07	2
0.19370E 02	7	0.75064E-10	38
0.22739E 02	8	0.38957E-07	3
0.25796E 02	9	0.69702E-08	10
0.28702E 02	10	-0.74395E-08	9
0.28944E 02	11	0.96845E-09	20
0.30096E 02	12	-0.11753E-10	45
0.31603E 02	13	0.25069E-09	30
0.32304E 02	14	-0.71045E-09	24
0.32729E 02	15	0.24063E-09	31
0.34836E 02	16	-0.61486E-10	40
0.36578E 02	17	-0.15092E-08	18
0.38611E 02	18	-0.95304E-09	21
0.38819E 02	19	0.56140E-08	12
0.41914E 02	20	0.18899E-07	6
0.48225E 02	21	-0.16604E-07	7
0.49330E 02	22	0.88371E-09	22
0.51462E 02	23	0.25764E-09	28
0.52124E 02	24	0.36538E-11	47
0.52244E 02	25	-0.11155E-10	46
0.52839E 02	26	-0.59635E-12	49
0.52912E 02	27	-0.38426E-09	26
0.55803E 02	28	0.21569E-08	14
0.11957E 02	34	0.22102E-07	5
0.12446E 02	35	0.35545E-09	29
0.16801E 02	36	0.10339E-07	8
0.17309E 02	37	0.74964E-10	39
0.20952E 02	38	-0.24142E-07	4
0.23872E 02	39	0.15300E-08	17
0.27020E 02	40	-0.10092E-09	34
0.29155E 02	41	-0.99372E-10	35
0.30848E 02	42	-0.14866E-09	33
0.30800E 02	43	-0.13840E-10	43
0.31635E 02	44	0.22658E-08	13
0.32753E 02	45	0.36405E-10	41
0.33123E 02	46	-0.83400E-10	36
0.36920E 02	47	0.20620E-09	32
0.37888E 02	48	0.19373E-08	15
0.38871E 02	49	-0.33084E-09	27
0.43468E 02	50	-0.76682E-09	23
0.45841E 02	51	-0.17285E-10	42
0.51102E 02	52	-0.12761E-08	19
0.52131E 02	53	0.89698E-13	50
0.52227E 02	54	-0.13614E-10	44
0.59475E 02	55	0.24722E-11	48
0.60748E 02	56	0.15809E-08	16
0.65135E 02	57	-0.47991E-09	25
0.67311E 02	58	0.82578E-10	37

FREQUENCY	MODE NO.	COEFFICIENT	RANK
0.13764E 02	4	0.0	50
0.17525E 02	5	0.0	49
0.18133E 02	6	0.0	48
0.19370E 02	7	0.0	47
0.22739E 02	8	0.0	46
0.25796E 02	9	0.0	45
0.28702E 02	10	0.0	44
0.28944E 02	11	0.0	43
0.30096E 02	12	0.0	42
0.31603E 02	13	0.0	41
0.32384E 02	14	0.0	40
0.32729E 02	15	0.0	39
0.34836E 02	16	0.0	38
0.36578E 02	17	0.0	37
0.38611E 02	18	0.0	36
0.38819E 02	19	0.0	35
0.41914E 02	20	0.0	34
0.48225E 02	21	0.0	33
0.49330E 02	22	0.0	32
0.51462E 02	23	0.0	31
0.52124E 02	24	0.0	30
0.52244E 02	25	0.0	29
0.52839E 02	26	0.0	28
0.52912E 02	27	0.0	27
0.55803E 02	28	0.0	26
0.11957E 02	34	-0.15548E-08	8
0.12446E 02	35	0.19540E-08	7
0.16801E 02	36	0.44987E-08	3
0.17309E 02	37	-0.14470E-08	9
0.20952E 02	38	-0.78031E-08	1
0.23872E 02	39	-0.28001E-08	6
0.27020E 02	40	0.55922E-08	2
0.29155E 02	41	-0.55030E-09	13
0.30848E 02	42	-0.64723E-10	20
0.30800E 02	43	0.32788E-09	16
0.31635E 02	44	0.12852E-08	11
0.32753E 02	45	-0.22057E-10	22
0.33123E 02	46	0.66365E-09	12
0.36920E 02	47	0.38860E-08	5
0.37888E 02	48	-0.38915E-08	4
0.38871E 02	49	-0.13133E-08	10
0.43468E 02	50	0.31911E-10	21
0.45841E 02	51	0.75626E-10	19
0.51102E 02	52	0.17535E-09	17
0.52131E 02	53	-0.21190E-12	25
0.52227E 02	54	0.48111E-12	24
0.59475E 02	55	-0.42967E-11	23
0.60748E 02	56	0.46925E-09	14
0.65135E 02	57	-0.10943E-09	18
0.67311E 02	58	-0.46324E-09	15

POSITION (GYRO) COEFFICIENTS: RESPONSE FRDM = 90055 INPUT FRDM = 5131

POSITION (GYRO) COEFFICIENTS. RESPONSE FRDM = 90056 INPUT FRDM = 5131

FREQUENCY	MODE NO.	COEFFICIENT	RANK
0.13764E 02	4	-0.20634E-09	6
0.17525E 02	5	-0.13474E-09	10
0.18133E 02	6	-0.39314E-10	15
0.19370E 02	7	0.14613E-10	19
0.22939E 02	8	0.15181E-09	9
0.25796E 02	9	0.37429E-09	5
0.28702E 02	10	-0.20169E-09	8
0.28944E 02	11	0.23695E-09	7
0.30096E 02	12	0.23086E-10	17
0.31603E 02	13	0.94370E-10	11
0.32354E 02	14	-0.82792E-09	1
0.32729E 02	15	-0.51066E-10	13
0.34836E 02	16	0.37700E-10	16
0.36578E 02	17	0.46772E-10	14
0.38611E 02	18	0.75238E-09	2
0.38819E 02	19	0.38159E-09	4
0.41914E 02	20	-0.50758E-09	3
0.48275E 02	21	-0.84252E-11	20
0.49330E 02	22	-0.16047E-11	21
0.51462E 02	23	-0.55942E-10	12
0.52174E 02	24	0.63614E-14	25
0.52244E 02	25	0.42926E-12	23
0.52839E 02	26	0.16742E-12	24
0.52912E 02	27	0.16655E-10	18
0.55803E 02	28	0.86994E-12	22
0.11957E 02	34	0.0	50
0.12446E 02	35	0.0	49
0.16801E 02	36	0.0	48
0.17309E 02	37	0.0	47
0.20952E 02	38	0.0	46
0.23872E 02	39	0.0	45
0.27020E 02	40	0.0	44
0.29155E 02	41	0.0	43
0.30048E 02	42	0.0	42
0.30800E 02	43	0.0	41
0.31635E 02	44	0.0	40
0.32753E 02	45	0.0	39
0.33123E 02	46	0.0	38
0.36920E 02	47	0.0	37
0.37888E 02	48	0.0	36
0.38871E 02	49	0.0	35
0.43446E 02	50	0.0	34
0.45841E 02	51	0.0	33
0.51102E 02	52	0.0	32
0.52131E 02	53	0.0	31
0.52227E 02	54	0.0	30
0.59475E 02	55	0.0	29
0.60748E 02	56	0.0	28
0.65135E 02	57	0.0	27
0.67311E 02	58	0.0	26

FREQUENCY	MODE NO.	COEFFICIENT	RANK
0.13764E 02	4	0.0	50
0.17525E 02	5	0.0	49
0.18133E 02	6	0.0	48
0.19370E 02	7	0.0	47
0.22939E 02	8	0.0	46
0.25796E 02	9	0.0	45
0.28702E 02	10	0.0	44
0.28944E 02	11	0.0	43
0.30096E 02	12	0.0	42
0.31603E 02	13	0.0	41
0.32354E 02	14	0.0	40
0.32729E 02	15	0.0	39
0.34836E 02	16	0.0	38
0.36578E 02	17	0.0	37
0.38611E 02	18	0.0	36
0.38819E 02	19	0.0	35
0.41914E 02	20	0.0	34
0.48275E 02	21	0.0	33
0.49330E 02	22	0.0	32
0.51462E 02	23	0.0	31
0.52174E 02	24	0.0	30
0.52244E 02	25	0.0	29
0.52839E 02	26	0.0	28
0.52912E 02	27	0.0	27
0.55803E 02	28	0.0	26
0.11957E 02	34	0.33966E-09	9
0.12446E 02	35	0.25300E-08	2
0.16801E 02	36	0.50563E-09	7
0.17309E 02	37	0.45791E-08	1
0.20952E 02	38	-0.10231E-08	5
0.23872E 02	39	-0.19886E-08	3
0.27020E 02	40	0.34119E-09	8
0.29155E 02	41	-0.10178E-09	12
0.30048E 02	42	-0.86016E-11	20
0.30800E 02	43	0.64579E-10	14
0.31635E 02	44	0.28511E-09	10
0.32753E 02	45	-0.37229E-11	22
0.33123E 02	46	0.14328E-09	11
0.36920E 02	47	0.87317E-09	6
0.37888E 02	48	-0.12028E-08	4
0.38871E 02	49	0.73999E-10	13
0.43446E 02	50	-0.11866E-10	19
0.45841E 02	51	-0.37668E-10	18
0.51102E 02	52	0.51634E-10	17
0.52131E 02	53	-0.36602E-13	25
0.52227E 02	54	0.10615E-12	24
0.59475E 02	55	-0.58273E-12	23
0.60748E 02	56	0.55560E-10	16
0.65135E 02	57	-0.60252E-10	15
0.67311E 02	58	-0.84199E-11	21

REPRODUCIBILITY OF THE ORIGINAL PAGE IS POOR

POSITION (GYRO) COEFFICIENTS. RESPONSE FRDM = 90054 INPUT FRDM = 5132

POSITION (GYRO) COEFFICIENTS. RESPONSE FRDM = 90055 INPUT FRDM = 5132

FREQUENCY	MODE NO.	COEFFICIENT	RANK
0.13764E 02	4	0.0	50
0.17525E 02	5	0.0	49
0.18133E 02	6	0.0	48
0.19370E 02	7	0.0	47
0.21939E 02	8	0.0	46
0.25796E 02	9	0.0	45
0.28702E 02	10	0.0	44
0.28944E 02	11	0.0	43
0.30096E 02	12	0.0	42
0.31603E 02	13	0.0	41
0.32384E 02	14	0.0	40
0.32729E 02	15	0.0	39
0.34836E 02	16	0.0	38
0.36578E 02	17	0.0	37
0.38611E 02	18	0.0	36
0.38819E 02	19	0.0	35
0.41914E 02	20	0.0	34
0.48225E 02	21	0.0	33
0.49330E 02	22	0.0	32
0.51462E 02	23	0.0	31
0.52124E 02	24	0.0	30
0.52244E 02	25	0.0	29
0.52339E 02	26	0.0	28
0.52912E 02	27	0.0	27
0.55803E 02	28	0.0	26
0.11957E 02	34	-0.13814E-08	14
0.12446E 02	35	0.82085E-08	5
0.16801E 02	36	0.80215E-08	6
0.17309E 02	37	-0.87741E-10	21
0.20952E 02	38	0.34681E-08	10
0.23872E 02	39	-0.55851E-08	9
0.27020E 02	40	0.17921E-07	1
0.29155E 02	41	-0.27726E-08	12
0.30048E 02	42	-0.53740E-09	19
0.30800E 02	43	-0.60293E-09	17
0.31635E 02	44	-0.11917E-07	2
0.32753E 02	45	-0.64173E-10	22
0.33123E 02	46	-0.60711E-08	8
0.36920E 02	47	-0.11051E-07	3
0.37555E 02	48	0.93261E-08	4
0.38871E 02	49	-0.23375E-08	13
0.43468E 02	50	0.64067E-09	16
0.45841E 02	51	0.90299E-09	15
0.51102E 02	52	0.33168E-09	20
0.52131E 02	53	0.72444E-12	25
0.52227E 02	54	-0.10800E-11	24
0.59475E 02	55	0.26230E-10	23
0.60748E 02	56	0.71938E-08	7
0.65135E 02	57	-0.57218E-09	18
0.67311E 02	58	-0.29796E-08	11

FREQUENCY	MODE NO.	COEFFICIENT	RANK
0.13764E 02	4	0.14777E-10	21
0.17525E 02	5	0.21154E-09	10
0.18133E 02	6	-0.21115E-09	11
0.19370E 02	7	0.36532E-08	1
0.22939E 02	8	-0.37038E-10	18
0.25796E 02	9	-0.63562E-09	3
0.28702E 02	10	-0.36867E-09	8
0.28944E 02	11	0.48846E-09	7
0.30096E 02	12	-0.17390E-09	13
0.31603E 02	13	0.62155E-09	4
0.32384E 02	14	0.48884E-09	6
0.32729E 02	15	0.38599E-10	17
0.34836E 02	16	-0.43216E-10	16
0.36578E 02	17	-0.19897E-09	12
0.38611E 02	18	-0.52876E-09	5
0.38819E 02	19	-0.25871E-10	19
0.41914E 02	20	0.51401E-10	14
0.48225E 02	21	0.49005E-10	15
0.49330E 02	22	-0.68580E-11	22
0.51462E 02	23	-0.87348E-09	2
0.52124E 02	24	0.12632E-12	24
0.52244E 02	25	-0.81765E-12	23
0.52339E 02	26	0.84230E-13	25
0.52912E 02	27	0.28442E-09	9
0.55803E 02	28	0.17667E-10	20
0.11957E 02	34	0.0	50
0.12446E 02	35	0.0	49
0.16801E 02	36	0.0	48
0.17309E 02	37	0.0	47
0.20952E 02	38	0.0	46
0.23872E 02	39	0.0	45
0.27020E 02	40	0.0	44
0.29155E 02	41	0.0	43
0.30048E 02	42	0.0	42
0.30800E 02	43	0.0	41
0.31635E 02	44	0.0	40
0.32753E 02	45	0.0	39
0.33123E 02	46	0.0	38
0.36920E 02	47	0.0	37
0.37555E 02	48	0.0	36
0.38871E 02	49	0.0	35
0.43468E 02	50	0.0	34
0.45841E 02	51	0.0	33
0.51102E 02	52	0.0	32
0.52131E 02	53	0.0	31
0.52227E 02	54	0.0	30
0.59475E 02	55	0.0	29
0.60748E 02	56	0.0	28
0.65135E 02	57	0.0	27
0.67311E 02	58	0.0	26

POSITION (GYRD) COEFFICIENTS. RESPONSE FRDM = 90056 INPUT FRDM = 5132 POSITION (GYRD) COEFFICIENTS. RESPONSE FRDM = 90054 INPUT FRDM = 5133

FREQUENCY	MODE NO.	COEFFICIENT	RANK
0.13764E 02	4	0.0	50
0.17525E 02	5	0.0	49
0.18133E 02	6	0.0	48
0.19370E 02	7	0.0	47
0.22939E 02	8	0.0	46
0.25796E 02	9	0.0	45
0.28702E 02	10	0.0	44
0.28944E 02	11	0.0	43
0.30096E 02	12	0.0	42
0.31603E 02	13	0.0	41
0.32384E 02	14	0.0	40
0.32729E 02	15	0.0	39
0.34036E 02	16	0.0	38
0.36578E 02	17	0.0	37
0.38611E 02	18	0.0	36
0.38819E 02	19	0.0	35
0.41914E 02	20	0.0	34
0.40225E 02	21	0.0	33
0.49330E 02	22	0.0	32
0.51462E 02	23	0.0	31
0.52124E 02	24	0.0	30
0.52244E 02	25	0.0	29
0.52839E 02	26	0.0	28
0.52912E 02	27	0.0	27
0.55803E 02	28	0.0	26
0.11957E 02	34	0.30178E-09	14
0.12446E 02	35	0.10628E-07	1
0.16801E 02	36	0.90164E-09	8
0.17309E 02	37	0.27766E-09	15
0.20952E 02	38	0.45473E-09	11
0.23872E 02	39	-0.39666E-08	2
0.27020E 02	40	0.10934E-08	7
0.29155E 02	41	-0.51279E-09	10
0.30048E 02	42	-0.10336E-09	19
0.30809E 02	43	-0.11875E-09	18
0.31635E 02	44	-0.26437E-08	4
0.32753E 02	45	-0.10832E-10	22
0.33123E 02	46	-0.13107E-08	6
0.36920E 02	47	-0.24032E-08	5
0.37828E 02	48	0.28826E-08	3
0.38371E 02	49	0.13171E-09	17
0.43468E 02	50	-0.23823E-09	16
0.45841E 02	51	-0.44977E-09	12
0.51102E 02	52	0.97666E-10	20
0.52131E 02	53	0.12516E-12	25
0.52227E 02	54	-0.23330E-12	24
0.59475E 02	55	0.35574E-11	23
0.60748E 02	56	0.85174E-09	9
0.65135E 02	57	-0.31506E-09	13
0.67311E 02	58	-0.54158E-10	21

FREQUENCY	MODE NO.	COEFFICIENT	RANK
0.13764E 02	4	0.0	50
0.17525E 02	5	0.0	49
0.18133E 02	6	0.0	48
0.19370E 02	7	0.0	47
0.22939E 02	8	0.0	46
0.25796E 02	9	0.0	45
0.28702E 02	10	0.0	44
0.28944E 02	11	0.0	43
0.30096E 02	12	0.0	42
0.31603E 02	13	0.0	41
0.32384E 02	14	0.0	40
0.32729E 02	15	0.0	39
0.34036E 02	16	0.0	38
0.36578E 02	17	0.0	37
0.38611E 02	18	0.0	36
0.38819E 02	19	0.0	35
0.41914E 02	20	0.0	34
0.40225E 02	21	0.0	33
0.49330E 02	22	0.0	32
0.51462E 02	23	0.0	31
0.52124E 02	24	0.0	30
0.52244E 02	25	0.0	29
0.52839E 02	26	0.0	28
0.52912E 02	27	0.0	27
0.55803E 02	28	0.0	26
0.11957E 02	34	0.87030E-07	2
0.12446E 02	35	0.10029E-08	12
0.16801E 02	36	0.40662E-07	3
0.17309E 02	37	0.29908E-09	19
0.20952E 02	38	-0.94916E-07	1
0.23872E 02	39	0.59226E-08	7
0.27020E 02	40	-0.39719E-09	15
0.29155E 02	41	-0.38992E-09	16
0.30048E 02	42	-0.58349E-09	14
0.30809E 02	43	-0.54329E-10	22
0.31635E 02	44	0.88831E-08	4
0.32753E 02	45	0.15097E-09	20
0.33123E 02	46	-0.32689E-09	17
0.36920E 02	47	0.80849E-09	13
0.37828E 02	48	0.75636E-08	5
0.38371E 02	49	-0.13066E-08	11
0.43468E 02	50	-0.30763E-08	9
0.45841E 02	51	-0.68247E-10	21
0.51102E 02	52	-0.48306E-08	8
0.52131E 02	53	0.35610E-12	25
0.52227E 02	54	-0.52346E-10	23
0.59475E 02	55	0.96786E-11	24
0.60748E 02	56	0.61684E-08	6
0.65135E 02	57	-0.18639E-08	10
0.67311E 02	58	0.32154E-09	18

POSITION (GYRO) COEFFICIENTS. RESPONSE FRDM = 90055 INPUT FRDM = 5133

POSITION (GYRO) COEFFICIENTS. RESPONSE FRDM = 90056 INPUT FRDM = 5133

146

FREQUENCY	MODE NO.	COEFFICIENT	RANK
0.13764E 02	4	-0.97056E-08	1
0.17525E 02	5	0.14315E-09	10
0.18133E 02	6	-0.12131E-09	12
0.19370E 02	7	0.73644E-11	21
0.22939E 02	8	-0.98838E-09	4
0.25796E 02	9	0.44242E-08	2
0.23702E 02	10	0.23165E-09	7
0.28444E 02	11	0.92234E-10	13
0.30096E 02	12	0.26972E-12	25
0.31603E 02	13	0.25859E-10	17
0.32384E 02	14	0.74458E-10	14
0.32729E 02	15	-0.24945E-10	18
0.34836E 02	16	0.80741E-11	20
0.34578E 02	17	0.14203E-09	11
0.38611E 02	18	0.18053E-09	8
0.3C819E 02	19	0.27157E-09	6
0.41914E 02	20	0.18337E-08	3
0.48225E 02	21	-0.72754E-09	5
0.49330E 02	22	-0.69222E-10	15
0.51462E 02	23	0.23842E-10	19
0.52124E 02	24	0.37034E-12	23
0.52244E 02	25	0.48572E-12	22
0.52839E 02	26	0.31001E-12	24
0.52912E 02	27	0.16524E-09	9
0.55303E 02	28	0.46508E-10	16
0.11957E 02	34	0.0	50
0.12446E 02	35	0.0	49
0.16801E 02	36	0.0	48
0.17309E 02	37	0.0	47
0.20952E 02	38	0.0	46
0.23372E 02	39	0.0	45
0.27020E 02	40	0.0	44
0.29155E 02	41	0.0	43
0.30046E 02	42	0.0	42
0.30800E 02	43	0.0	41
0.31635E 02	44	0.0	40
0.32753E 02	45	0.0	39
0.33123E 02	46	0.0	38
0.36920E 02	47	0.0	37
0.37888E 02	48	0.0	36
0.38871E 02	49	0.0	35
0.43468E 02	50	0.0	34
0.45841E 02	51	0.0	33
0.51102E 02	52	0.0	32
0.52131E 02	53	0.0	31
0.52227E 02	54	0.0	30
0.59475E 02	55	0.0	29
0.60748E 02	56	0.0	28
0.65135E 02	57	0.0	27
0.67311E 02	58	0.0	26

FREQUENCY	MODE NO.	COEFFICIENT	RANK
0.13764E 02	4	0.0	50
0.17525E 02	5	0.0	49
0.18133E 02	6	0.0	48
0.19370E 02	7	0.0	47
0.22939E 02	8	0.0	46
0.25796E 02	9	0.0	45
0.28702E 02	10	0.0	44
0.28944E 02	11	0.0	43
0.30096E 02	12	0.0	42
0.31603E 02	13	0.0	41
0.32384E 02	14	0.0	40
0.32729E 02	15	0.0	39
0.34836E 02	16	0.0	38
0.34578E 02	17	0.0	37
0.38611E 02	18	0.0	36
0.38819E 02	19	0.0	35
0.41914E 02	20	0.0	34
0.48225E 02	21	0.0	33
0.49330E 02	22	0.0	32
0.51462E 02	23	0.0	31
0.52124E 02	24	0.0	30
0.52244E 02	25	0.0	29
0.52839E 02	26	0.0	28
0.52912E 02	27	0.0	27
0.55303E 02	28	0.0	26
0.11957E 02	34	-0.19012E-07	1
0.12446E 02	35	0.12985E-08	8
0.16801E 02	36	0.45707E-08	3
0.17309E 02	37	-0.94645E-09	11
0.20952E 02	38	-0.12445E-07	2
0.23372E 02	39	0.42540E-08	4
0.27020E 02	40	-0.24233E-10	20
0.29155E 02	41	-0.72115E-10	16
0.30046E 02	42	-0.11222E-09	14
0.30800E 02	43	-0.10701E-10	22
0.31635E 02	44	0.19706E-08	6
0.32753E 02	45	0.25481E-10	19
0.33123E 02	46	-0.70574E-10	17
0.36920E 02	47	0.18166E-09	13
0.37888E 02	48	0.23379E-08	5
0.38871E 02	49	0.73624E-10	15
0.43468E 02	50	0.11439E-08	9
0.45841E 02	51	0.33993E-10	18
0.51102E 02	52	-0.14224E-08	7
0.52131E 02	53	0.61521E-13	25
0.52227E 02	54	-0.11550E-10	21
0.59475E 02	55	0.13127E-11	24
0.60748E 02	56	0.73034E-09	12
0.65135E 02	57	-0.10243E-08	10
0.67311E 02	58	0.58443E-11	23

POSITION (GYRO) COEFFICIENTS. RESPONSE FRDM = 521 INPUT FRDM = 5131

POSITION (GYRO) COEFFICIENTS. RESPONSE FRDM = 521 INPUT FRDM = 5132

FREQUENCY	MODE NO.	COEFFICIENT	RANK
0.13764E 02	4	0.10965E-09	17
0.17525E 02	5	-0.38894E-08	3
0.18133E 02	6	0.29487E-11	38
0.19370E 02	7	-0.44059E-10	22
0.27939E 02	8	0.11434E-08	8
0.25796E 02	9	0.22152E-09	15
0.28702E 02	10	-0.34026E-09	12
0.28944E 02	11	-0.22957E-08	5
0.30096E 02	12	-0.13467E-09	16
0.31603E 02	13	-0.25565E-09	13
0.32384E 02	14	-0.40948E-09	10
0.32729E 02	15	-0.32597E-10	24
0.34836E 02	16	-0.40456E-09	11
0.36578E 02	17	-0.87446E-10	19
0.38611E 02	18	-0.94400E-08	1
0.38819E 02	19	-0.16392E-08	6
0.41914E 02	20	-0.12739E-08	7
0.46225E 02	21	-0.20877E-10	28
0.49330E 02	22	-0.13751E-11	41
0.51452E 02	23	-0.72806E-10	20
0.52124E 02	24	-0.51212E-14	49
0.52244E 02	25	-0.14204E-11	40
0.52839E 02	26	-0.28056E-12	47
0.52912E 02	27	-0.36580E-11	36
0.55803E 02	28	0.63381E-13	48
0.11957E 02	34	0.22997E-10	27
0.12446E 02	35	0.37699E-08	4
0.16801E 02	36	0.72788E-10	21
0.17309E 02	37	0.61043E-08	2
0.20952E 02	38	-0.98120E-11	32
0.23872E 02	39	-0.25269E-09	14
0.27020E 02	40	-0.71714E-09	9
0.29155E 02	41	-0.38839E-10	23
0.30048E 02	42	0.74985E-12	44
0.30800E 02	43	0.76828E-11	34
0.31635E 02	44	-0.12674E-10	30
0.32753E 02	45	-0.10285E-11	42
0.33123E 02	46	0.35112E-11	37
0.36920E 02	47	-0.20653E-10	29
0.37888E 02	48	0.26010E-10	25
0.38871E 02	49	-0.24715E-10	26
0.43468E 02	50	0.61624E-12	45
0.45841E 02	51	0.59888E-11	35
0.51102E 02	52	-0.96343E-12	43
0.52131E 02	53	-0.42752E-12	46
0.52227E 02	54	-0.22076E-14	50
0.59475E 02	55	0.10155E-10	31
0.60748E 02	56	0.88164E-11	33
0.65135E 02	57	0.18621E-11	39
0.67311E 02	58	0.99423E-10	18

FREQUENCY	MODE NO.	COEFFICIENT	RANK
0.13764E 02	4	-0.56587E-11	41
0.17525E 02	5	0.61066E-08	4
0.18133E 02	6	0.15836E-10	35
0.19370E 02	7	-0.11015E-07	2
0.27939E 02	8	-0.27096E-09	17
0.25796E 02	9	-0.37618E-09	14
0.28702E 02	10	-0.62198E-09	11
0.28944E 02	11	-0.47326E-08	5
0.30096E 02	12	0.10144E-08	9
0.31603E 02	13	-0.16230E-08	7
0.32384E 02	14	0.24178E-09	18
0.32729E 02	15	0.24638E-10	33
0.34836E 02	16	0.46376E-09	13
0.36578E 02	17	0.37199E-09	15
0.38611E 02	18	0.66343E-08	3
0.38819E 02	19	0.11114E-09	25
0.41914E 02	20	0.12901E-09	22
0.46225E 02	21	0.12143E-09	23
0.49330E 02	22	-0.58770E-11	40
0.51462E 02	23	-0.11368E-08	8
0.52124E 02	24	-0.10170E-12	49
0.52244E 02	25	0.18457E-11	44
0.52839E 02	26	-0.14115E-12	48
0.52912E 02	27	-0.62468E-10	27
0.55803E 02	28	0.12871E-11	47
0.11957E 02	34	0.20433E-10	34
0.12446E 02	35	0.15837E-07	1
0.16801E 02	36	0.12980E-09	21
0.17309E 02	37	0.37014E-09	16
0.20952E 02	38	0.43609E-11	42
0.23872E 02	39	-0.50403E-09	12
0.27020E 02	40	-0.22982E-08	6
0.29155E 02	41	-0.19568E-09	19
0.30048E 02	42	0.90104E-11	39
0.30800E 02	43	-0.14496E-10	36
0.31635E 02	44	0.11752E-09	24
0.32753E 02	45	-0.29924E-11	43
0.33123E 02	46	-0.32120E-10	32
0.36920E 02	47	0.58734E-10	30
0.37888E 02	48	-0.62333E-10	28
0.38871E 02	49	-0.43991E-10	31
0.43468E 02	50	0.12372E-10	37
0.45841E 02	51	0.71507E-10	26
0.51102E 02	52	-0.18223E-11	45
0.52131E 02	53	0.14616E-11	46
0.52227E 02	54	0.51353E-14	50
0.59475E 02	55	-0.61992E-10	29
0.60748E 02	56	0.13516E-09	20
0.65135E 02	57	0.97367E-11	38
0.67311E 02	58	0.63949E-09	10

POSITION (GYRO) COEFFICIENTS. RESPONSE FRDM = 521 INPUT FRDM = 5133 POSITION (GYRO) COEFFICIENTS. RESPONSE FROM = 120762 INPUT FRDM = 5131

FREQUENCY	MODE NO.	COEFFICIENT	RANK
0.13764E 02	4	0.37167E-08	4
0.17525E 02	5	0.41323E-08	3
0.18133E 02	6	0.90986E-11	38
0.19370E 02	7	-0.22205E-10	35
0.22939E 02	8	-0.74441E-08	1
0.25796E 02	9	0.26184E-08	5
0.28702E 02	10	0.39081E-09	15
0.28944E 02	11	-0.89363E-09	12
0.30096E 02	12	-0.15733E-11	44
0.31603E 02	13	-0.70052E-10	21
0.32384E 02	14	0.36826E-10	27
0.32729E 02	15	-0.15923E-10	36
0.34836E 02	16	-0.86645E-10	20
0.36578E 02	17	-0.26554E-09	16
0.38611E 02	18	-0.22651E-08	6
0.38819E 02	19	-0.11666E-08	11
0.41914E 02	20	0.46023E-08	2
0.48225E 02	21	-0.18027E-08	8
0.49330E 02	22	-0.59320E-10	24
0.51462E 02	23	0.31030E-10	30
0.52124E 02	24	-0.29814E-12	49
0.52244E 02	25	-0.10964E-11	46
0.52839E 02	26	-0.51949E-12	48
0.52912E 02	27	-0.36293E-10	28
0.55803E 02	28	0.33884E-11	42
0.11957E 02	34	-0.12873E-08	9
0.12446E 02	35	0.19349E-08	7
0.14801E 02	36	0.65798E-09	13
0.17309E 02	37	-0.12617E-08	10
0.20952E 02	38	-0.11935E-09	17
0.23872E 02	39	0.54081E-09	14
0.27020E 02	40	0.50935E-10	25
0.29155E 02	41	-0.27520E-10	31
0.30048E 02	42	0.97832E-11	37
0.30800E 02	43	-0.13062E-11	45
0.31635E 02	44	-0.87602E-10	19
0.32753E 02	45	0.70394E-11	39
0.33123E 02	46	-0.17295E-11	43
0.36920E 02	47	-0.42968E-11	41
0.37888E 02	48	-0.50553E-10	26
0.38871E 02	49	-0.24590E-10	33
0.43468E 02	50	-0.59407E-10	23
0.45841E 02	51	-0.54045E-11	40
0.51102E 02	52	0.26540E-10	32
0.52131E 02	53	0.71846E-12	47
0.52227E 02	54	0.24890E-12	50
0.59475E 02	55	-0.22874E-10	34
0.60748E 02	56	0.11509E-09	18
0.65135E 02	57	0.31719E-10	29
0.67311E 02	58	-0.69009E-10	22

FREQUENCY	MODE NO.	COEFFICIENT	RANK
0.13764E 02	4	0.0	50
0.17525E 02	5	0.0	49
0.18133E 02	6	0.0	48
0.19370E 02	7	0.0	47
0.22939E 02	8	0.0	46
0.25796E 02	9	0.0	45
0.28702E 02	10	0.0	44
0.28944E 02	11	0.0	43
0.30096E 02	12	0.0	42
0.31603E 02	13	0.0	41
0.32384E 02	14	0.0	40
0.32729E 02	15	0.0	39
0.34836E 02	16	0.0	38
0.36578E 02	17	0.0	37
0.38611E 02	18	0.0	36
0.38819E 02	19	0.0	35
0.41914E 02	20	0.0	34
0.48225E 02	21	0.0	33
0.49330E 02	22	0.0	32
0.51462E 02	23	0.0	31
0.52124E 02	24	0.0	30
0.52244E 02	25	0.0	29
0.52839E 02	26	0.0	28
0.52912E 02	27	0.0	27
0.55803E 02	28	0.0	26
0.11957E 02	34	0.30834E-08	11
0.12446E 02	35	0.91186E-08	6
0.14801E 02	36	-0.10949E-07	4
0.17309E 02	37	-0.75214E-08	7
0.20952E 02	38	0.15915E-07	2
0.23872E 02	39	0.28144E-07	1
0.27020E 02	40	-0.13876E-07	3
0.29155E 02	41	-0.40207E-08	8
0.30048E 02	42	-0.65940E-10	21
0.30800E 02	43	0.91026E-09	14
0.31635E 02	44	0.29667E-08	12
0.32753E 02	45	-0.72809E-10	20
0.33123E 02	46	0.31228E-08	10
0.36920E 02	47	0.32627E-08	9
0.37888E 02	48	-0.99993E-08	5
0.38871E 02	49	0.10900E-08	13
0.43468E 02	50	-0.49376E-10	22
0.45841E 02	51	0.25523E-09	19
0.51102E 02	52	0.32111E-09	18
0.52131E 02	53	0.36297E-12	24
0.52227E 02	54	0.23409E-12	25
0.59475E 02	55	0.54600E-11	23
0.60748E 02	56	-0.57329E-09	16
0.65135E 02	57	0.75666E-09	15
0.67311E 02	58	0.34026E-09	17

POSITION (GYRO) COEFFICIENTS. RESPONSE FRDM = 120762 INPUT FRDM = 5132 POSITION (GYRO) COEFFICIENTS. RESPONSE FRDM = 120762 INPUT FRDM = 5133

FREQUENCY	MODE NO.	COEFFICIENT	RANK
0.13764E 02	4	0.0	50
0.17525E 02	5	0.0	49
0.18133E 02	6	0.0	48
0.19370E 02	7	0.0	47
0.22939E 02	8	0.0	46
0.25796E 02	9	0.0	45
0.28702E 02	10	0.0	44
0.28944E 02	11	0.0	43
0.30096E 02	12	0.0	42
0.31603E 02	13	0.0	41
0.32384E 02	14	0.0	40
0.32729E 02	15	0.0	39
0.34036E 02	16	0.0	38
0.36578E 02	17	0.0	37
0.38611E 02	18	0.0	36
0.38819E 02	19	0.0	35
0.41914E 02	20	0.0	34
0.48225E 02	21	0.0	33
0.49330E 02	22	0.0	32
0.51462E 02	23	0.0	31
0.52124E 02	24	0.0	30
0.52244E 02	25	0.0	29
0.52839E 02	26	0.0	28
0.52912E 02	27	0.0	27
0.55803E 02	28	0.0	26
0.11957E 02	34	0.27395E-08	14
0.12446E 02	35	0.38306E-07	3
0.16801E 02	36	-0.19525E-07	8
0.17309E 02	37	-0.45606E-09	21
0.20952E 02	38	-0.70732E-08	11
0.23372E 02	39	0.56136E-07	1
0.27020E 02	40	-0.44467E-07	2
0.29155E 02	41	-0.20258E-07	7
0.30048E 02	42	-0.79236E-09	19
0.30800E 02	43	-0.16739E-08	17
0.31635E 02	44	-0.27508E-07	5
0.32753E 02	45	-0.21183E-09	22
0.33123E 02	46	-0.28567E-07	4
0.36920E 02	47	-0.92788E-08	9
0.37888E 02	48	0.23964E-07	6
0.38871E 02	49	0.19401E-08	16
0.43468E 02	50	-0.99130E-09	18
0.45841E 02	51	0.30475E-08	13
0.51102E 02	52	0.60739E-09	20
0.52131E 02	53	-0.12409E-11	24
0.52227E 02	54	-0.52550E-12	25
0.59475E 02	55	-0.33332E-10	23
0.60748E 02	56	-0.87887E-08	10
0.65135E 02	57	0.39565E-08	12
0.67311E 02	58	0.22400E-08	15

FREQUENCY	MODE NO.	COEFFICIENT	RANK
0.13764E 02	4	0.0	50
0.17525E 02	5	0.0	49
0.18133E 02	6	0.0	48
0.19370E 02	7	0.0	47
0.22939E 02	8	0.0	46
0.25796E 02	9	0.0	45
0.28702E 02	10	0.0	44
0.28944E 02	11	0.0	43
0.30096E 02	12	0.0	42
0.31603E 02	13	0.0	41
0.32384E 02	14	0.0	40
0.32729E 02	15	0.0	39
0.34036E 02	16	0.0	38
0.36578E 02	17	0.0	37
0.38611E 02	18	0.0	36
0.38819E 02	19	0.0	35
0.41914E 02	20	0.0	34
0.48225E 02	21	0.0	33
0.49330E 02	22	0.0	32
0.51462E 02	23	0.0	31
0.52124E 02	24	0.0	30
0.52244E 02	25	0.0	29
0.52839E 02	26	0.0	28
0.52912E 02	27	0.0	27
0.55803E 02	28	0.0	26
0.11957E 02	34	-0.17259E-06	2
0.12446E 02	35	0.46802E-08	11
0.16801E 02	36	-0.98977E-07	3
0.17309E 02	37	0.15546E-08	13
0.20952E 02	38	0.17350E-06	1
0.23372E 02	39	-0.60233E-07	4
0.27020E 02	40	0.98553E-09	16
0.29155E 02	41	-0.28489E-08	12
0.30048E 02	42	-0.86031E-09	17
0.30800E 02	43	-0.15083E-09	22
0.31635E 02	44	0.20505E-07	5
0.32753E 02	45	0.49833E-09	19
0.33123E 02	46	-0.15382E-08	14
0.36920E 02	47	0.67881E-09	18
0.37888E 02	48	0.19435E-07	6
0.38871E 02	49	0.18845E-08	15
0.43468E 02	50	0.47599E-08	10
0.45841E 02	51	-0.23033E-09	21
0.51102E 02	52	-0.88460E-08	8
0.52131E 02	53	-0.60997E-12	25
0.52227E 02	54	-0.25470E-10	23
0.59475E 02	55	-0.12299E-10	24
0.60748E 02	56	-0.75360E-08	9
0.65135E 02	57	0.12889E-07	7
0.67311E 02	58	-0.24172E-09	20

149

POSITION (GYRO) COEFFICIENTS, RESPONSE FRDM = 90014 INPUT FRDM = 140391 POSITION (GYRO) COEFFICIENTS, RESPONSE FRDM = 90015 INPUT FRDM = 140391

FREQUENCY	MODE NO.	COEFFICIENT	RANK
0.13764E 02	4	0.11034E-09	30
0.17525E 02	5	-0.27204E-10	33
0.18133E 02	6	0.89901E-09	15
0.19370E 02	7	0.11926E-10	32
0.22939E 02	8	0.39004E-08	7
0.25796E 02	9	0.87757E-09	16
0.28702E 02	10	-0.71166E-09	19
0.28944E 02	11	0.20001E-10	36
0.30096E 02	12	-0.28426E-09	25
0.31603E 02	13	0.16800E-10	38
0.32384E 02	14	-0.18817E-08	10
0.32729E 02	15	-0.10562E-09	31
0.34836E 02	16	-0.17249E-10	37
0.36573E 02	17	0.20355E-10	35
0.38611E 02	18	0.67750E-11	40
0.38819E 02	19	0.27209E-10	32
0.41914E 02	20	0.22530E-09	28
0.48225E 02	21	-0.53222E-11	41
0.49330E 02	22	0.25171E-10	34
0.51462E 02	23	0.24624E-12	46
0.52124E 02	24	0.27175E-14	50
0.52244E 02	25	0.15680E-12	48
0.52839E 02	26	-0.30782E-14	49
0.52912E 02	27	-0.35520E-11	43
0.55803E 02	28	0.18740E-11	45
0.11957E 02	34	0.29762E-08	8
0.12446E 02	35	-0.27050E-09	26
0.16801E 02	36	-0.68652E-08	2
0.17309E 02	37	0.11906E-09	29
0.20952E 02	38	-0.13631E-07	1
0.23072E 02	39	-0.56035E-08	5
0.27020E 02	40	-0.33674E-08	6
0.29155E 02	41	0.42538E-09	22
0.30040E 02	42	-0.24500E-09	27
0.30800E 02	43	-0.10833E-08	14
0.31635E 02	44	-0.58241E-08	4
0.32753E 02	45	-0.30673E-09	24
0.33123E 02	46	-0.48071E-09	20
0.36920E 02	47	-0.12250E-08	13
0.37888E 02	48	-0.63860E-08	3
0.38871E 02	49	0.84968E-09	17
0.43468E 02	50	0.42828E-09	21
0.45841E 02	51	0.12420E-08	12
0.51102E 02	52	0.82533E-09	13
0.52131E 02	53	-0.19390E-12	47
0.52227E 02	54	-0.42224E-11	42
0.59475E 02	55	-0.31439E-11	44
0.60748E 02	56	-0.19523E-08	9
0.65135E 02	57	-0.13001E-08	11
0.67311E 02	58	0.36610E-09	23

FREQUENCY	MODE NO.	COEFFICIENT	RANK
0.13764E 02	4	0.47291E-08	3
0.17525E 02	5	0.24551E-09	13
0.18133E 02	6	0.71959E-09	8
0.19370E 02	7	0.23458E-09	14
0.22939E 02	8	-0.14026E-08	5
0.25796E 02	9	-0.49785E-08	2
0.28702E 02	10	0.12529E-08	6
0.28944E 02	11	-0.27705E-09	12
0.30096E 02	12	0.43575E-09	9
0.31603E 02	13	-0.17505E-09	15
0.32384E 02	14	0.72617E-08	1
0.32729E 02	15	0.41867E-09	10
0.34836E 02	16	0.89901E-09	17
0.36573E 02	17	-0.12965E-09	16
0.38611E 02	18	-0.47162E-10	20
0.38819E 02	19	0.10305E-08	7
0.41914E 02	20	-0.34509E-08	4
0.48225E 02	21	-0.39317E-09	11
0.49330E 02	22	-0.52207E-10	19
0.51462E 02	23	0.21571E-11	34
0.52124E 02	24	0.38131E-13	47
0.52244E 02	25	0.41497E-12	42
0.52839E 02	26	0.26448E-12	43
0.52912E 02	27	0.78687E-10	18
0.55803E 02	28	0.28519E-11	32
0.11957E 02	34	-0.16495E-11	36
0.12446E 02	35	-0.95048E-13	45
0.16801E 02	36	0.52822E-11	29
0.17309E 02	37	-0.58523E-13	46
0.20952E 02	38	0.15168E-10	24
0.23072E 02	39	0.24302E-10	21
0.27020E 02	40	0.73941E-11	28
0.29155E 02	41	0.15002E-11	37
0.30040E 02	42	-0.12917E-12	44
0.30800E 02	43	-0.11731E-11	39
0.31635E 02	44	-0.99361E-11	26
0.32753E 02	45	-0.82401E-12	40
0.33123E 02	46	-0.18877E-11	35
0.36920E 02	47	-0.42620E-12	41
0.37888E 02	48	-0.21843E-10	22
0.38871E 02	49	-0.22603E-11	33
0.43468E 02	50	-0.33099E-11	31
0.45841E 02	51	0.43788E-11	30
0.51102E 02	52	0.11690E-10	25
0.52131E 02	53	0.68998E-15	50
0.52227E 02	54	-0.36243E-13	48
0.59475E 02	55	-0.91291E-14	49
0.60748E 02	56	-0.80667E-11	27
0.65135E 02	57	-0.18339E-10	23
0.67311E 02	58	0.14939E-11	38

POSITION (GYRO) COEFFICIENTS. RESPONSE FRDM = 90016 INPUT FRDM = 140391

POSITION (GYRO) COEFFICIENTS. RESPONSE FRDM = 90014 INPUT FRDM = 140392

FREQUENCY	MODE NO.	COEFFICIENT	RANK
0.13764E 02	4	-0.32747E-10	29
0.17525E 02	5	0.15480E-10	32
0.18133E 02	6	-0.32730E-09	13
0.19370E 02	7	-0.38307E-11	40
0.22939E 02	8	-0.91490E-09	5
0.25796E 02	9	-0.27927E-09	17
0.28702E 02	10	0.31031E-09	14
0.28944E 02	11	-0.41093E-11	39
0.30096E 02	12	0.13444E-09	22
0.31603E 02	13	-0.46873E-11	38
0.32384E 02	14	0.87960E-09	6
0.32729E 02	15	0.50249E-10	27
0.34836E 02	16	0.86047E-11	33
0.36578E 02	17	-0.68605E-11	35
0.35611E 02	18	-0.25307E-11	41
0.35819E 02	19	-0.24713E-11	42
0.41914E 02	20	-0.60069E-11	36
0.48225E 02	21	0.18235E-10	30
0.49330E 02	22	-0.50204E-11	37
0.51462E 02	23	-0.61751E-13	47
0.52124E 02	24	-0.59501E-15	50
0.52244E 02	25	0.10692E-12	46
0.52839E 02	26	0.21358E-13	49
0.52912E 02	27	0.71600E-11	34
0.55803E 02	28	-0.77654E-12	44
0.11957E 02	34	-0.65986E-09	9
0.12446E 02	35	-0.34845E-09	12
0.16801E 02	36	-0.73043E-09	8
0.17309E 02	37	0.38982E-09	11
0.20952E 02	38	-0.16731E-08	3
0.23372E 02	39	-0.37394E-08	1
0.27020E 02	40	-0.15960E-09	21
0.29155E 02	41	0.86840E-10	24
0.30048E 02	42	-0.47379E-10	28
0.30000E 02	43	-0.21826E-09	19
0.31635E 02	44	-0.13405E-08	4
0.32753E 02	45	-0.56729E-10	26
0.33123E 02	46	-0.11529E-09	23
0.36920E 02	47	-0.27448E-09	18
0.37558E 02	48	-0.20708E-08	2
0.38271E 02	49	-0.61339E-10	25
0.43468E 02	50	-0.18355E-09	20
0.45841E 02	51	-0.62369E-09	10
0.51102E 02	52	0.29211E-09	15
0.52131E 02	53	-0.31985E-13	48
0.52227E 02	54	-0.11070E-11	43
0.59475E 02	55	-0.48957E-12	45
0.60748E 02	56	-0.28111E-09	16
0.65135E 02	57	-0.82392E-09	7
0.67311E 02	58	0.15925E-10	31

FREQUENCY	MODE NO.	COEFFICIENT	RANK
0.13764E 02	4	-0.29623E-12	40
0.17525E 02	5	0.75436E-13	43
0.18133E 02	6	0.10465E-11	38
0.19370E 02	7	-0.73235E-13	44
0.22939E 02	8	-0.12610E-10	28
0.25796E 02	9	-0.19643E-11	33
0.28702E 02	10	-0.14968E-10	27
0.28944E 02	11	0.40500E-13	45
0.30096E 02	12	-0.36938E-11	31
0.31603E 02	13	-0.24053E-12	41
0.32384E 02	14	-0.25315E-10	24
0.32729E 02	15	-0.12241E-11	35
0.34836E 02	16	0.24695E-13	47
0.36578E 02	17	0.28306E-11	32
0.38611E 02	18	0.15748E-10	26
0.38819E 02	19	0.43697E-11	30
0.41914E 02	20	0.19877E-10	25
0.48225E 02	21	-0.32369E-12	39
0.49330E 02	22	0.45115E-11	29
0.51462E 02	23	-0.27592E-13	46
0.52124E 02	24	0.82980E-16	50
0.52244E 02	25	0.74856E-14	48
0.52839E 02	26	0.14470E-15	49
0.52912E 02	27	0.11112E-11	36
0.55803E 02	28	0.13023E-12	42
0.11957E 02	34	-0.53912E-07	1
0.12446E 02	35	0.26225E-08	18
0.16801E 02	36	-0.22667E-07	6
0.17309E 02	37	-0.82982E-09	21
0.20952E 02	38	0.27551E-07	5
0.23372E 02	39	0.22489E-07	7
0.27020E 02	40	0.11027E-07	11
0.29155E 02	41	0.22333E-08	19
0.30048E 02	42	0.26904E-08	16
0.30000E 02	43	0.20773E-07	9
0.31635E 02	44	0.52002E-07	2
0.32753E 02	45	0.47621E-09	22
0.33123E 02	46	0.19874E-08	20
0.36920E 02	47	0.11376E-07	10
0.37558E 02	48	0.43469E-07	3
0.38271E 02	49	-0.41611E-08	14
0.43468E 02	50	-0.20419E-08	15
0.45841E 02	51	-0.28504E-08	12
0.51102E 02	52	-0.20685E-07	8
0.52131E 02	53	0.13087E-11	34
0.52227E 02	54	-0.38175E-10	23
0.59475E 02	55	-0.10875E-11	37
0.60748E 02	56	-0.29537E-07	4
0.65135E 02	57	0.26682E-08	17
0.67311E 02	58	-0.41637E-08	13

POSITION (GYRO) COEFFICIENTS. RESPONSE FRDM = 90015 INPUT FRDM = 140392

FREQUENCY	MODE NO.	COEFFICIENT	RANK
0.13764E 02	4	-0.12696E-10	23
0.17525E 02	5	-0.68079E-12	39
0.18133E 02	6	0.83761E-12	38
0.19370E 02	7	-0.14405E-11	34
0.22939E 02	8	0.58949E-11	29
0.25796E 02	9	0.11164E-10	24
0.28702E 02	10	0.26351E-10	14
0.28944E 02	11	-0.56101E-12	40
0.30096E 02	12	0.56625E-11	30
0.31603E 02	13	0.25062E-11	33
0.32384E 02	14	0.97695E-10	7
0.32729E 02	15	0.48431E-11	31
0.34836E 02	16	-0.12872E-12	45
0.36575E 02	17	-0.18080E-10	20
0.38611E 02	18	-0.10962E-09	6
0.38819E 02	19	0.16678E-09	3
0.41914E 02	20	-0.30446E-09	1
0.48225E 02	21	-0.23912E-10	17
0.49330E 02	22	-0.93573E-11	26
0.51462E 02	23	-0.24171E-12	43
0.52124E 02	24	0.11643E-14	50
0.52244E 02	25	0.19811E-13	46
0.52939E 02	26	-0.12433E-13	47
0.52912E 02	27	-0.24617E-10	15
0.55803E 02	28	0.23596E-12	44
0.11957E 02	34	0.29880E-10	13
0.12446E 02	35	0.92924E-12	37
0.16891E 02	36	0.17440E-10	21
0.17309E 02	37	0.40789E-12	41
0.20952E 02	38	-0.30658E-10	12
0.23872E 02	39	-0.97534E-10	8
0.27020E 02	40	-0.24212E-10	16
0.29155E 02	41	0.78764E-11	27
0.30043E 02	42	0.14184E-11	35
0.33800E 02	43	0.21953E-10	19
0.31635E 02	44	0.88717E-10	9
0.32753E 02	45	0.12793E-11	36
0.33123E 02	46	0.78042E-11	28
0.36920E 02	47	0.39578E-11	32
0.37888E 02	48	0.14869E-09	4
0.38871E 02	49	0.11069E-10	25
0.43465E 02	50	0.21963E-10	18
0.45841E 02	51	-0.34728E-10	11
0.51102E 02	52	-0.29298E-09	2
0.52131E 02	53	-0.49417E-14	48
0.52227E 02	54	-0.32767E-12	42
0.59475E 02	55	-0.31577E-14	49
0.60748E 02	56	-0.12204E-09	5
0.65135E 02	57	0.37638E-10	10
0.67311E 02	58	-0.16990E-10	22

POSITION (GYRO) COEFFICIENTS. RESPONSE FRDM = 90016 INPUT FRDM = 140392

FREQUENCY	MODE NO.	COEFFICIENT	RANK
0.13764E 02	4	0.87913E-13	40
0.17525E 02	5	-0.42925E-13	43
0.18133E 02	6	-0.32099E-12	37
0.19370E 02	7	0.23523E-13	44
0.22939E 02	8	0.38452E-11	27
0.25796E 02	9	0.42511E-12	33
0.28702E 02	10	0.65266E-11	25
0.28944E 02	11	-0.83211E-14	46
0.30096E 02	12	0.17470E-11	29
0.31603E 02	13	0.67110E-13	41
0.32384E 02	14	0.11834E-10	23
0.32729E 02	15	0.58127E-12	34
0.34836E 02	16	-0.12319E-13	45
0.36575E 02	17	-0.95672E-12	31
0.38611E 02	18	-0.58822E-11	26
0.38819E 02	19	-0.39688E-12	36
0.41914E 02	20	-0.52996E-12	35
0.48225E 02	21	0.11151E-11	30
0.49330E 02	22	-0.89983E-12	32
0.51462E 02	23	0.69194E-14	47
0.52124E 02	24	-0.18169E-16	50
0.52244E 02	25	0.51043E-14	48
0.52839E 02	26	-0.10040E-14	49
0.52912E 02	27	-0.22400E-11	28
0.55803E 02	28	-0.64273E-13	42
0.11957E 02	34	0.11953E-07	4
0.12446E 02	35	0.33782E-08	10
0.16891E 02	36	-0.24117E-08	13
0.17309E 02	37	0.27169E-08	11
0.20952E 02	38	0.33817E-08	9
0.23872E 02	39	0.15008E-07	1
0.27020E 02	40	0.52260E-09	16
0.29155E 02	41	0.45592E-09	19
0.30043E 02	42	0.52030E-09	17
0.33800E 02	43	0.40847E-08	8
0.31635E 02	44	0.11969E-07	3
0.32753E 02	45	0.88074E-10	22
0.33123E 02	46	0.47664E-09	18
0.36920E 02	47	0.25489E-08	12
0.37888E 02	48	0.14096E-07	2
0.38871E 02	49	0.30039E-09	20
0.43465E 02	50	0.12180E-08	15
0.45841E 02	51	0.49464E-08	6
0.51102E 02	52	-0.73210E-08	5
0.52131E 02	53	0.22908E-12	38
0.52227E 02	54	-0.10027E-10	24
0.59475E 02	55	-0.16934E-12	39
0.60748E 02	56	-0.42530E-08	7
0.65135E 02	57	0.16910E-08	14
0.67311E 02	58	-0.18112E-09	21

REPRODUCIBILITY OF THE
ORIGINAL PAGE IS POOR

POSITION (GYRO) COEFFICIENTS. RESPONSE FRDM = 90014 INPUT FRDM = 140393

FREQUENCY	MODE NO.	COEFFICIENT	RANK
0.13764E 02	4	-0.18597E-09	28
0.17525E 02	5	0.44544E-10	35
0.18133E 02	5	0.20744E-09	27
0.19370E 02	7	-0.28793E-10	37
0.22539E 02	8	-0.24223E-08	10
0.25796E 02	9	-0.21243E-09	26
0.28702E 02	10	-0.90792E-09	19
0.28944E 02	11	0.37468E-11	42
0.30096E 02	12	-0.18523E-09	29
0.31603E 02	13	-0.12397E-10	39
0.32384E 02	14	-0.97569E-09	17
0.32729E 02	15	-0.43686E-10	36
0.34536E 02	16	0.36221E-11	43
0.36578E 02	17	0.12395E-09	30
0.35611E 02	13	0.33237E-09	23
0.38519E 02	19	0.82410E-10	32
0.41914E 02	20	0.21941E-09	25
0.48225E 02	21	0.29893E-11	44
0.49330E 02	22	-0.18504E-11	46
0.51462E 02	23	-0.72615E-10	34
0.52124E 02	24	-0.87045E-14	49
0.52244E 02	25	-0.31812E-12	47
0.52839E 02	26	0.65605E-14	50
0.52912E 02	27	0.91193E-11	40
0.55803E 02	28	-0.22320E-09	24
0.11957E 02	34	0.12066E-07	4
0.12446E 02	35	0.12165E-09	31
0.16301E 02	36	0.23290E-07	1
0.17309E 02	37	0.72892E-10	33
0.20952E 02	38	0.17018E-07	2
0.23572E 02	39	-0.56788E-08	7
0.27020E 02	40	-0.24415E-08	9
0.29155E 02	41	0.18844E-08	11
0.30045E 02	42	0.54588E-09	22
0.30800E 02	43	0.39955E-08	8
0.31635E 02	44	0.14906E-07	3
0.32753E 02	45	0.13746E-08	15
0.33123E 02	46	0.17060E-08	13
0.35920E 02	47	0.76701E-09	21
0.37593E 02	48	0.10418E-07	5
0.38871E 02	49	-0.18498E-08	12
0.43465E 02	50	-0.86076E-09	20
0.45841E 02	51	-0.11521E-08	16
0.51102E 02	52	0.94607E-09	18
0.52131E 02	53	0.88032E-13	48
0.52227E 02	54	0.74392E-11	41
0.59475E 02	55	-0.18655E-11	45
0.60749E 02	56	-0.90503E-08	6
0.65135E 02	57	-0.16876E-10	38
0.67311E 02	58	-0.15182E-08	14

153

POSITION (GYRO) COEFFICIENTS. RESPONSE FRDM = 90015 INPUT FRDM = 140393

FREQUENCY	MODE NO.	COEFFICIENT	RANK
0.13764E 02	4	-0.79703E-08	1
0.17525E 02	5	-0.40199E-09	13
0.18133E 02	6	0.16604E-09	18
0.19370E 02	7	-0.56633E-09	11
0.22939E 02	8	0.11324E-08	8
0.25796E 02	9	0.12051E-08	7
0.28702E 02	10	0.15984E-08	6
0.28944E 02	11	-0.51901E-10	20
0.30096E 02	12	0.28395E-09	14
0.31603E 02	13	0.12917E-09	19
0.32384E 02	14	0.37653E-08	2
0.32729E 02	15	0.17364E-09	17
0.34536E 02	16	-0.18880E-10	26
0.36578E 02	17	-0.78950E-09	9
0.38611E 02	18	-0.23137E-08	5
0.38819E 02	19	0.31454E-08	4
0.41914E 02	20	-0.33607E-08	3
0.48225E 02	21	0.22083E-09	15
0.49330E 02	22	0.38370E-11	38
0.51462E 02	23	-0.63613E-09	10
0.52124E 02	24	-0.12214E-12	45
0.52244E 02	25	-0.84192E-12	40
0.52839E 02	26	-0.56367E-12	41
0.52912E 02	27	-0.20202E-09	16
0.55803E 02	28	-0.40642E-09	12
0.11957E 02	34	-0.66875E-11	30
0.12446E 02	35	0.43104E-13	47
0.16801E 02	36	-0.17920E-10	27
0.17309E 02	37	-0.35829E-13	48
0.20952E 02	38	-0.18937E-10	25
0.23872E 02	39	0.24629E-10	24
0.27020E 02	40	0.53610E-11	34
0.29155E 02	41	0.66458E-11	32
0.30045E 02	42	0.28780E-12	42
0.30800E 02	43	0.43267E-11	36
0.31635E 02	44	0.25429E-10	23
0.32753E 02	45	0.36927E-11	39
0.33123E 02	46	0.66991E-11	29
0.36920E 02	47	0.26685E-12	43
0.37888E 02	48	0.35633E-10	22
0.38871E 02	49	0.49208E-11	35
0.43466E 02	50	0.66522E-11	31
0.45841E 02	51	-0.40616E-11	37
0.51102E 02	52	0.13400E-10	28
0.52131E 02	53	-0.31325E-15	50
0.52227E 02	54	0.63855E-13	46
0.59475E 02	55	-0.54169E-14	49
0.60749E 02	56	-0.37395E-10	21
0.65135E 02	57	-0.23806E-12	44
0.67311E 02	58	-0.61953E-11	33

FREQUENCY	MODE NO.	COEFFICIENT	RANK	FREQUENCY	MODE NO.	COEFFICIENT	RANK
0.13764E 02	4	0.55191E-10	30	0.13764E 02	4	0.0	50
0.17525E 02	5	-0.25346E-10	32	0.17525E 02	5	0.0	49
0.18133E 02	6	-0.75522E-10	27	0.18133E 02	6	0.0	48
0.19370E 02	7	0.92480E-11	38	0.19370E 02	7	0.0	47
0.22939E 02	8	0.73563E-09	9	0.22939E 02	8	0.0	46
0.25796E 02	9	0.67603E-10	28	0.25796E 02	9	0.0	45
0.25702E 02	10	0.39589E-09	13	0.28702E 02	10	0.0	44
0.28944E 02	11	-0.76981E-12	44	0.28944E 02	11	0.0	43
0.30095E 02	12	0.87605E-10	26	0.30096E 02	12	0.0	42
0.31603E 02	13	0.34587E-11	41	0.31603E 02	13	0.0	41
0.32384E 02	14	0.45609E-09	11	0.32384E 02	14	0.0	40
0.32729E 02	15	0.20840E-10	33	0.32729E 02	15	0.0	39
0.34836E 02	16	-0.18069E-11	43	0.34836E 02	16	0.0	38
0.36578E 02	17	-0.41777E-10	31	0.36578E 02	17	0.0	37
0.38611E 02	18	-0.12415E-09	22	0.38611E 02	18	0.0	36
0.38819E 02	19	-0.74850E-11	39	0.38819E 02	19	0.0	35
0.41914E 02	20	-0.58499E-11	40	0.41914E 02	20	0.0	34
0.48225E 02	21	-0.10298E-10	37	0.48225E 02	21	0.0	33
0.49330E 02	22	0.36904E-12	45	0.49330E 02	22	0.0	32
0.51462E 02	23	0.18210E-10	35	0.51462E 02	23	0.0	31
0.52124E 02	24	0.19059E-14	50	0.52124E 02	24	0.0	30
0.52244E 02	25	-0.21692E-12	47	0.52244E 02	25	0.0	29
0.52839E 02	26	-0.45519E-13	48	0.52839E 02	26	0.0	28
0.52912E 02	27	-0.18383E-10	34	0.52912E 02	27	0.0	27
0.55803E 02	28	0.11016E-09	24	0.55803E 02	28	0.0	26
0.11957E 02	34	-0.26752E-08	4	0.11957E 02	34	0.29742E-08	7
0.12446E 02	35	0.15670E-09	20	0.12446E 02	35	-0.26881E-09	20
0.16801E 02	36	0.24780E-08	5	0.16801E 02	36	-0.68355E-08	2
0.17309E 02	37	-0.23865E-09	18	0.17309E 02	37	0.12320E-09	22
0.20952E 02	38	0.20888E-08	6	0.20952E 02	38	-0.13553E-07	1
0.23872E 02	39	-0.37097E-08	1	0.23872E 02	39	-0.54752E-08	5
0.27020E 02	40	-0.11571E-09	23	0.27020E 02	40	-0.33492E-08	6
0.29155E 02	41	0.38469E-09	14	0.29155E 02	41	0.42560E-09	17
0.30048E 02	42	0.10557E-09	25	0.30048E 02	42	-0.24360E-09	21
0.30800E 02	43	0.80502E-09	8	0.30800E 02	43	-0.10788E-08	12
0.31635E 02	44	0.34308E-08	2	0.31635E 02	44	-0.57909E-08	4
0.32753E 02	45	0.25423E-09	17	0.32753E 02	45	-0.30613E-09	19
0.33123E 02	46	0.40915E-09	12	0.33123E 02	46	-0.48016E-09	15
0.36920E 02	47	0.17186E-09	19	0.36920E 02	47	-0.12148E-08	11
0.37888E 02	48	0.33781E-08	3	0.37888E 02	48	-0.63103E-08	3
0.38871E 02	49	0.13354E-09	21	0.38871E 02	49	0.89239E-09	13
0.43468E 02	50	0.36889E-09	15	0.43468E 02	50	0.44221E-09	16
0.45841E 02	51	0.57851E-09	10	0.45841E 02	51	0.12633E-08	10
0.51102E 02	52	0.33484E-09	16	0.51102E 02	52	0.77632E-09	14
0.52131E 02	53	0.14522E-13	49	0.52131E 02	53	-0.19715E-12	25
0.52227E 02	54	0.19540E-11	42	0.52227E 02	54	-0.40729E-11	23
0.59475E 02	55	-0.29050E-12	46	0.59475E 02	55	-0.31310E-11	24
0.60748E 02	56	-0.13031E-08	7	0.60748E 02	56	-0.19340E-08	8
0.65135E 02	57	-0.10695E-10	36	0.65135E 02	57	-0.12977E-08	9
0.67311E 02	58	-0.66043E-10	29	0.67311E 02	58	0.36127E-09	18

POSITION (GYRO) COEFFICIENTS, RESPONSE FRDM = 90055 INPUT FRDM = 140391

POSITION (GYRO) COEFFICIENTS, RESPONSE FRDM = 90056 INPUT FRDM = 140391

FREQUENCY	MODE NO.	COEFFICIENT	RANK
0.13764E 02	4	0.46697E-08	3
0.17525E 02	5	0.25007E-09	13
0.18133E 02	6	0.47292E-09	9
0.19370E 02	7	0.22806E-09	14
0.22939E 02	8	-0.22631E-08	5
0.25796E 02	9	-0.51315E-08	2
0.28702E 02	10	0.14537E-08	6
0.28944E 02	11	-0.27561E-09	12
0.30096E 02	12	0.51840E-09	8
0.31603E 02	13	-0.17571E-09	15
0.32384E 02	14	0.76696E-08	1
0.32729E 02	15	0.44065E-09	10
0.34636E 02	16	0.91353E-10	17
0.36573E 02	17	-0.12573E-09	16
0.38611E 02	18	-0.42456E-10	20
0.38819E 02	19	0.11276E-08	7
0.41914E 02	20	-0.31313E-08	4
0.48225E 02	21	-0.33164E-09	11
0.49330E 02	22	-0.54962E-10	19
0.51462E 02	23	0.21012E-11	21
0.52124E 02	24	0.36659E-13	25
0.52244E 02	25	0.70360E-12	23
0.52839E 02	26	0.29449E-12	24
0.52912E 02	27	0.87978E-10	10
0.55803E 02	28	0.20558E-11	22
0.11957E 02	34	0.0	50
0.12446E 02	35	0.0	49
0.16801E 02	36	0.0	48
0.17309E 02	37	0.0	47
0.20952E 02	38	0.0	46
0.23872E 02	39	0.0	45
0.27020E 02	40	0.0	44
0.29155E 02	41	0.0	43
0.30048E 02	42	0.0	42
0.30800E 02	43	0.0	41
0.31635E 02	44	0.0	40
0.32753E 02	45	0.0	39
0.33123E 02	46	0.0	38
0.36920E 02	47	0.0	37
0.37888E 02	48	0.0	36
0.38871E 02	49	0.0	35
0.43468E 02	50	0.0	34
0.45841E 02	51	0.0	33
0.51102E 02	52	0.0	32
0.52131E 02	53	0.0	31
0.52227E 02	54	0.0	30
0.54755E 02	55	0.0	29
0.60748E 02	56	0.0	28
0.65135E 02	57	0.0	27
0.67311E 02	58	0.0	26

FREQUENCY	MODE NO.	COEFFICIENT	RANK
0.13764E 02	4	0.0	50
0.17525E 02	5	0.0	49
0.18133E 02	6	0.0	48
0.19370E 02	7	0.0	47
0.22939E 02	8	0.0	46
0.25796E 02	9	0.0	45
0.28702E 02	10	0.0	44
0.28944E 02	11	0.0	43
0.30096E 02	12	0.0	42
0.31603E 02	13	0.0	41
0.32384E 02	14	0.0	40
0.32729E 02	15	0.0	39
0.34836E 02	16	0.0	38
0.36578E 02	17	0.0	37
0.38611E 02	18	0.0	36
0.38819E 02	19	0.0	35
0.41914E 02	20	0.0	34
0.48225E 02	21	0.0	33
0.49330E 02	22	0.0	32
0.51462E 02	23	0.0	31
0.52124E 02	24	0.0	30
0.52244E 02	25	0.0	29
0.52839E 02	26	0.0	28
0.52912E 02	27	0.0	27
0.55803E 02	28	0.0	26
0.11957E 02	34	-0.64973E-09	7
0.12446E 02	35	-0.34804E-09	10
0.16801E 02	36	-0.76834E-09	5
0.17309E 02	37	-0.38986E-09	9
0.20952E 02	38	-0.17770E-08	3
0.23872E 02	39	-0.38886E-08	1
0.27020E 02	40	-0.20434E-09	15
0.29155E 02	41	0.78714E-10	18
0.30048E 02	42	-0.46853E-10	21
0.30800E 02	43	-0.21248E-09	14
0.31635E 02	44	-0.12846E-08	4
0.32753E 02	45	-0.51671E-10	19
0.33123E 02	46	-0.10366E-09	17
0.36920E 02	47	-0.27295E-09	11
0.37888E 02	48	-0.19505E-08	2
0.38871E 02	49	-0.48030E-10	20
0.43468E 02	50	-0.16443E-09	16
0.45841E 02	51	-0.62921E-09	8
0.51102E 02	52	0.22859E-09	13
0.52131E 02	53	-0.34060E-13	25
0.52227E 02	54	-0.89866E-12	23
0.54755E 02	55	-0.42464E-12	24
0.60748E 02	56	-0.22899E-09	12
0.65135E 02	57	-0.71457E-09	6
0.67311E 02	58	0.65666E-11	22

POSITION (GYRO) COEFFICIENTS. RESPONSE FRDM = 90054 INPUT FRDM = 140392

FREQUENCY	MODE NO.	COEFFICIENT	RANK
0.13764E 02	4	0.0	50
0.17525E 02	5	0.0	49
0.18133E 02	6	0.0	48
0.19370E 02	7	0.0	47
0.22739E 02	8	0.0	46
0.25796E 02	9	0.0	45
0.26702E 02	10	0.0	44
0.28944E 02	11	0.0	43
0.30096E 02	12	0.0	42
0.31603E 02	13	0.0	41
0.32384E 02	14	0.0	40
0.32729E 02	15	0.0	39
0.34336E 02	16	0.0	38
0.36573E 02	17	0.0	37
0.38611E 02	18	0.0	36
0.35312E 02	19	0.0	35
0.41914E 02	20	0.0	34
0.43225E 02	21	0.0	33
0.49330E 02	22	0.0	32
0.51462E 02	23	0.0	31
0.52124E 02	24	0.0	30
0.52244E 02	25	0.0	29
0.52839E 02	26	0.0	28
0.52912E 02	27	0.0	27
0.55803E 02	28	0.0	26
0.11957E 02	34	-0.53875E-07	1
0.12446E 02	35	0.26041E-08	18
0.16801E 02	36	-0.22569E-07	6
0.17309E 02	37	-0.85865E-09	21
0.20952E 02	38	0.27393E-07	5
0.23372E 02	39	0.21974E-07	7
0.27020E 02	40	0.10967E-07	11
0.29155E 02	41	0.22344E-08	19
0.30048E 02	42	0.26752E-08	16
0.30800E 02	43	0.20102E-07	8
0.31635E 02	44	0.51705E-07	2
0.32753E 02	45	0.47528E-09	22
0.33123E 02	46	0.19851E-08	20
0.36920E 02	47	0.11281E-07	10
0.37350E 02	48	0.42954E-07	3
0.35871E 02	49	-0.41744E-08	13
0.43468E 02	50	-0.29344E-08	15
0.45841E 02	51	-0.10019E-07	12
0.51102E 02	52	-0.19457E-07	9
0.52131E 02	53	0.14120E-11	24
0.52227E 02	54	-0.36824E-10	23
0.59475E 02	55	-0.10830E-11	25
0.60748E 02	56	-0.29260E-07	4
0.65135E 02	57	0.26634E-08	17
0.67311E 02	58	-0.41088E-08	14

POSITION (GYRO) COEFFICIENTS. RESPONSE FRDM = 90055 INPUT FRDM = 140392

FREQUENCY	MODE NO.	COEFFICIENT	RANK
0.13764E 02	4	-0.12536E-10	9
0.17525E 02	5	-0.69343E-12	17
0.18133E 02	6	0.95049E-12	19
0.19370E 02	7	-0.14004E-11	16
0.22939E 02	8	0.95115E-11	12
0.25796E 02	9	0.11486E-10	10
0.28702E 02	10	0.30576E-10	5
0.28944E 02	11	-0.55809E-12	18
0.30096E 02	12	0.67364E-11	13
0.31603E 02	13	0.25157E-11	15
0.32384E 02	14	0.10318E-09	3
0.32729E 02	15	0.50973E-11	14
0.34336E 02	16	-0.13078E-12	22
0.36573E 02	17	-0.17533E-10	8
0.38611E 02	18	-0.98685E-10	4
0.38819E 02	19	0.18108E-09	2
0.41914E 02	20	-0.27626E-09	1
0.48225E 02	21	-0.20170E-10	7
0.49330E 02	22	-0.98510E-11	11
0.51462E 02	23	-0.23545E-12	20
0.52124E 02	24	0.11194E-14	25
0.52244E 02	25	0.33591E-13	23
0.52839E 02	26	-0.13844E-13	24
0.52912E 02	27	-0.27524E-10	6
0.55803E 02	28	0.17009E-12	21
0.11957E 02	34	0.0	50
0.12446E 02	35	0.0	49
0.16801E 02	36	0.0	48
0.17309E 02	37	0.0	47
0.20952E 02	38	0.0	46
0.23372E 02	39	0.0	45
0.27020E 02	40	0.0	44
0.29155E 02	41	0.0	43
0.30048E 02	42	0.0	42
0.30800E 02	43	0.0	41
0.31635E 02	44	0.0	40
0.32753E 02	45	0.0	39
0.33123E 02	46	0.0	38
0.36920E 02	47	0.0	37
0.37350E 02	48	0.0	36
0.35871E 02	49	0.0	35
0.43468E 02	50	0.0	34
0.45841E 02	51	0.0	33
0.51102E 02	52	0.0	32
0.52131E 02	53	0.0	31
0.52227E 02	54	0.0	30
0.59475E 02	55	0.0	29
0.60748E 02	56	0.0	28
0.65135E 02	57	0.0	27
0.67311E 02	58	0.0	26

POSITION (GYRO) COEFFICIENTS. RESPONSE FRDM = 90056 INPUT FRDM = 140392

POSITION (GYRO) COEFFICIENTS. RESPONSE FRDM = 90054 INPUT FRDM = 140393

FREQUENCY	MODE NO.	COEFFICIENT	RANK
0.13764E 02	4	0.0	50
0.17525E 02	5	0.0	49
0.18133E 02	6	0.0	48
0.19370E 02	7	0.0	47
0.22939E 02	8	0.0	46
0.25796E 02	9	0.0	45
0.28702E 02	10	0.0	44
0.28944E 02	11	0.0	43
0.30096E 02	12	0.0	42
0.31603E 02	13	0.0	41
0.32334E 02	14	0.0	40
0.32729E 02	15	0.0	39
0.34336E 02	16	0.0	38
0.36578E 02	17	0.0	37
0.38611E 02	18	0.0	36
0.38819E 02	19	0.0	35
0.41914E 02	20	0.0	34
0.43225E 02	21	0.0	33
0.49330E 02	22	0.0	32
0.51462E 02	23	0.0	31
0.52124E 02	24	0.0	30
0.52244E 02	25	0.0	29
0.52839E 02	26	0.0	28
0.52912E 02	27	0.0	27
0.55803E 02	28	0.0	26
0.11957E 02	34	0.11769E-07	3
0.12446E 02	35	0.33743E-08	10
0.16801E 02	36	-0.25368E-08	12
0.17309E 02	37	0.27172E-08	11
0.20952E 02	38	0.35918E-08	8
0.23872E 02	39	0.15604E-07	1
0.27020E 02	40	0.66910E-09	16
0.29155E 02	41	0.41324E-09	19
0.30048E 02	42	0.51452E-09	17
0.30800E 02	43	0.39765E-08	7
0.31635E 02	44	0.11470E-07	4
0.32753E 02	45	0.80221E-10	21
0.33123E 02	46	0.42858E-09	18
0.36920E 02	47	0.25347E-08	13
0.37888E 02	48	0.13277E-07	2
0.38871E 02	49	0.23522E-09	20
0.43468E 02	50	0.10911E-08	15
0.45841E 02	51	0.49903E-08	6
0.51102E 02	52	-0.57291E-08	5
0.52131E 02	53	0.24394E-12	24
0.52227E 02	54	-0.81249E-11	23
0.59475E 02	55	-0.14690E-12	25
0.60748E 02	56	-0.34644E-08	9
0.65135E 02	57	0.14666E-08	14
0.67311E 02	58	-0.74683E-10	22

FREQUENCY	MODE NO.	COEFFICIENT	RANK
0.13764E 02	4	0.0	50
0.17525E 02	5	0.0	49
0.18133E 02	6	0.0	48
0.19370E 02	7	0.0	47
0.22939E 02	8	0.0	46
0.25796E 02	9	0.0	45
0.28702E 02	10	0.0	44
0.28944E 02	11	0.0	43
0.30096E 02	12	0.0	42
0.31603E 02	13	0.0	41
0.32334E 02	14	0.0	40
0.32729E 02	15	0.0	39
0.34336E 02	16	0.0	38
0.36578E 02	17	0.0	37
0.38611E 02	18	0.0	36
0.38819E 02	19	0.0	35
0.41914E 02	20	0.0	34
0.43225E 02	21	0.0	33
0.49330E 02	22	0.0	32
0.51462E 02	23	0.0	31
0.52124E 02	24	0.0	30
0.52244E 02	25	0.0	29
0.52839E 02	26	0.0	28
0.52912E 02	27	0.0	27
0.55803E 02	28	0.0	26
0.11957E 02	34	0.12058E-07	4
0.12446E 02	35	0.12089E-09	20
0.16801E 02	36	0.23189E-07	1
0.17309E 02	37	0.75424E-10	21
0.20952E 02	38	0.16920E-07	2
0.23872E 02	39	-0.55489E-08	7
0.27020E 02	40	-0.24283E-08	9
0.29155E 02	41	0.18853E-08	10
0.30048E 02	42	0.54278E-09	19
0.30800E 02	43	0.39790E-08	8
0.31635E 02	44	0.14820E-07	3
0.32753E 02	45	0.13719E-08	14
0.33123E 02	46	0.17040E-08	12
0.36920E 02	47	0.76059E-07	18
0.37888E 02	48	0.10294E-07	5
0.38871E 02	49	-0.18557E-08	11
0.43468E 02	50	-0.88876E-09	17
0.45841E 02	51	-0.11718E-08	15
0.51102E 02	52	0.88987E-09	16
0.52131E 02	53	0.89507E-13	25
0.52227E 02	54	0.71759E-11	23
0.59475E 02	55	-0.18578E-11	24
0.60748E 02	56	-0.09654E-08	6
0.65135E 02	57	-0.16846E-10	22
0.67311E 02	58	-0.14982E-08	13

POSITION (GYRD) COEFFICIENTS. RESPONSE FRDM = 90055 INPUT FRDM = 140393

FREQUENCY	MODE NO.	COEFFICIENT	RANK
0.13764E 02	4	-0.78702E-03	1
0.17525E 02	5	-0.40946E-09	12
0.18133E 02	6	0.10912E-09	19
0.19370E 02	7	-0.55058E-09	11
0.22939E 02	8	0.18271E-08	7
0.25796E 02	9	0.12422E-08	8
0.28702E 02	10	0.18546E-08	6
0.28944E 02	11	-0.51631E-10	20
0.30094E 02	12	0.33780E-09	13
0.31603E 02	13	0.12965E-09	18
0.32384E 02	14	0.39768E-08	2
0.32729E 02	15	0.18275E-09	17
0.34836E 02	16	-0.19183E-10	21
0.36573E 02	17	-0.76563E-07	9
0.38611E 02	18	-0.20829E-08	5
0.33819E 02	19	0.34151E-08	3
0.41914E 02	20	-0.30495E-08	4
0.48225E 02	21	0.18627E-09	16
0.49330E 02	22	0.40403E-11	22
0.51462E 02	23	-0.61966E-09	10
0.52124E 02	24	-0.11742E-12	25
0.52244E 02	25	-0.14275E-11	23
0.52839E 02	26	-0.62764E-12	24
0.52912E 02	27	-0.22587E-09	15
0.55803E 02	28	-0.29152E-09	14
0.11957E 02	34	0.0	50
0.12446E 02	35	0.0	49
0.16801E 02	36	0.0	48
0.17309E 02	37	0.0	47
0.20952E 02	38	0.0	46
0.23872E 02	39	0.0	45
0.27020E 02	40	0.0	44
0.29155E 02	41	0.0	43
0.30048E 02	42	0.0	42
0.30800E 02	43	0.0	41
0.31635E 02	44	0.0	40
0.32753E 02	45	0.0	39
0.33123E 02	46	0.0	38
0.36920E 02	47	0.0	37
0.37888E 02	48	0.0	36
0.38871E 02	49	0.0	35
0.43468E 02	50	0.0	34
0.45841E 02	51	0.0	33
0.51102E 02	52	0.0	32
0.52131E 02	53	0.0	31
0.52227E 02	54	0.0	30
0.59475E 02	55	0.0	29
0.60748E 02	56	0.0	28
0.65135E 02	57	0.0	27
0.67311E 02	58	0.0	26

POSITION (GYRD) COEFFICIENTS. RESPONSE FRDM = 90056 INPUT FRDM = 140393

FREQUENCY	MODE NO.	COEFFICIENT	RANK
0.13764E 02	4	0.0	50
0.17525E 02	5	0.0	49
0.18133E 02	6	0.0	48
0.19370E 02	7	0.0	47
0.22939E 02	8	0.0	46
0.25796E 02	9	0.0	45
0.28702E 02	10	0.0	44
0.28944E 02	11	0.0	43
0.30094E 02	12	0.0	42
0.31603E 02	13	0.0	41
0.32384E 02	14	0.0	40
0.32729E 02	15	0.0	39
0.34836E 02	16	0.0	38
0.36573E 02	17	0.0	37
0.38611E 02	18	0.0	36
0.38819E 02	19	0.0	35
0.41914E 02	20	0.0	34
0.48225E 02	21	0.0	33
0.49330E 02	22	0.0	32
0.51462E 02	23	0.0	31
0.52124E 02	24	0.0	30
0.52244E 02	25	0.0	29
0.52839E 02	26	0.0	28
0.52912E 02	27	0.0	27
0.55803E 02	28	0.0	26
0.11957E 02	34	-0.26342E-08	4
0.12446E 02	35	0.15652E-09	17
0.16801E 02	36	0.26066E-08	5
0.17309E 02	37	-0.23868E-09	14
0.20952E 02	38	0.22186E-08	6
0.23872E 02	39	-0.39409E-08	1
0.27020E 02	40	-0.14815E-09	18
0.29155E 02	41	0.34869E-09	11
0.30048E 02	42	0.10439E-09	20
0.30800E 02	43	0.78370E-09	8
0.31635E 02	44	0.32077E-08	2
0.32753E 02	45	0.23156E-09	15
0.33123E 02	46	0.36789E-09	10
0.36920E 02	47	0.17090E-09	16
0.37888E 02	48	0.31618E-08	3
0.38871E 02	49	0.10457E-09	19
0.43468E 02	50	0.33048E-09	12
0.45841E 02	51	0.58364E-09	9
0.51102E 02	52	0.26203E-09	13
0.52131E 02	53	0.15464E-13	25
0.52227E 02	54	0.15833E-11	23
0.59475E 02	55	-0.25197E-12	24
0.60748E 02	56	-0.10615E-08	7
0.65135E 02	57	-0.92758E-11	22
0.67311E 02	58	-0.27232E-10	21

FREQUENCY	MODE NO.	COEFFICIENT	RANK
0.13764E 02	4	-0.17883E-08	10
0.17525E 02	5	0.72186E-08	3
0.18133E 02	6	-0.35470E-10	30
0.19370E 02	7	-0.68763E-09	13
0.22939E 02	8	-0.17045E-07	1
0.25796E 02	9	-0.30370E-03	6
0.28702E 02	10	0.24526E-08	9
0.28944E 02	11	0.26703E-08	8
0.30096E 02	12	-0.30239E-08	7
0.31603E 02	13	0.47600E-09	18
0.32384E 02	14	0.37933E-08	5
0.32729E 02	15	0.28127E-09	20
0.34836E 02	16	-0.98032E-09	11
0.36578E 02	17	0.23507E-09	21
0.38611E 02	18	0.53270E-09	14
0.38819E 02	19	-0.48437E-08	4
0.41914E 02	20	-0.78599E-08	2
0.48225E 02	21	-0.82177E-09	12
0.49330E 02	22	-0.47100E-10	26
0.51462E 02	23	0.27347E-11	43
0.52124E 02	24	-0.29512E-13	49
0.52244E 02	25	-0.15883E-11	45
0.52839E 02	26	-0.49349E-12	46
0.52912E 02	27	-0.19323E-10	34
0.55803E 02	28	0.14977E-12	48
0.11957E 02	34	0.43991E-10	27
0.12446E 02	35	-0.51861E-09	16
0.16601E 02	36	-0.11061E-09	22
0.17309E 02	37	-0.51972E-09	15
0.20952E 02	38	-0.17042E-10	35
0.23372E 02	39	-0.49411E-09	17
0.27020E 02	40	0.42950E-09	19
0.29155E 02	41	0.30038E-10	31
0.30848E 02	42	0.40844E-11	42
0.30809E 02	43	-0.25937E-10	32
0.31635E 02	44	0.57107E-10	25
0.32753E 02	45	-0.14275E-10	37
0.33123E 02	46	-0.25404E-11	44
0.36920E 02	47	0.64560E-11	40
0.37883E 02	48	0.42176E-10	28
0.38871E 02	49	0.16042E-10	36
0.43468E 02	50	0.85396E-11	38
0.45841E 02	51	0.10004E-09	23
0.51102E 02	52	-0.42653E-11	41
0.52131E 02	53	-0.39776E-12	47
0.52227E 02	54	0.19366E-13	50
0.57475E 02	55	0.73997E-11	39
0.60748E 02	56	-0.36336E-10	29
0.65135E 02	57	0.22083E-10	33
0.67311E 02	58	-0.77538E-10	24

FREQUENCY	MODE NO.	COEFFICIENT	RANK
0.13764E 02	4	0.40007E-11	38
0.17525E 02	5	-0.20017E-10	31
0.18133E 02	6	-0.41208E-13	47
0.19370E 02	7	0.42225E-11	39
0.22939E 02	8	0.71637E-10	19
0.25796E 02	9	0.67979E-11	35
0.28702E 02	10	0.51504E-10	22
0.28944E 02	11	0.54072E-11	37
0.30096E 02	12	-0.39295E-10	27
0.31603E 02	13	-0.68150E-11	34
0.32384E 02	14	0.51033E-10	23
0.32729E 02	15	0.32536E-11	40
0.34836E 02	16	0.14035E-11	43
0.36578E 02	17	0.32781E-10	29
0.38611E 02	18	0.12382E-08	5
0.38819E 02	19	-0.77788E-09	9
0.41914E 02	20	-0.69335E-09	10
0.48225E 02	21	-0.49979E-10	24
0.49330E 02	22	-0.84419E-11	33
0.51462E 02	23	-0.30643E-12	44
0.52124E 02	24	-0.90116E-15	50
0.52244E 02	25	-0.75825E-13	46
0.52839E 02	26	0.23198E-13	48
0.52912E 02	27	0.60452E-11	36
0.55803E 02	28	0.12392E-13	49
0.11957E 02	34	0.79687E-09	7
0.12446E 02	35	0.50279E-08	1
0.16601E 02	36	-0.36519E-09	14
0.17309E 02	37	0.36223E-08	2
0.20952E 02	38	0.34445E-10	28
0.23372E 02	39	0.19831E-08	3
0.27020E 02	40	-0.14064E-08	4
0.29155E 02	41	0.15770E-09	16
0.30848E 02	42	-0.44851E-10	26
0.30809E 02	43	0.48539E-09	13
0.31635E 02	44	-0.50989E-09	12
0.32753E 02	45	0.22162E-10	30
0.33123E 02	46	0.10503E-10	32
0.36920E 02	47	-0.57952E-10	20
0.37883E 02	48	-0.28709E-09	15
0.38871E 02	49	-0.78562E-10	18
0.43468E 02	50	-0.56666E-10	21
0.45841E 02	51	-0.79338E-09	8
0.51102E 02	52	0.10690E-09	17
0.52131E 02	53	0.28488E-11	41
0.52227E 02	54	0.17509E-12	45
0.57475E 02	55	0.25594E-11	42
0.60748E 02	56	-0.54975E-09	11
0.65135E 02	57	-0.45323E-10	25
0.67311E 02	58	0.88186E-09	6

159

REPRODUCIBILITY OF ORIGINAL PAGE IS POOR

POSITION (GYRO) COEFFICIENTS. RESPONSE FRDM = 521 INPUT FRDM = 140393

POSITION (GYRO) COEFFICIENTS. RESPONSE FRDM = 120762 INPUT FRDM = 140391

FREQUENCY	MODE NO.	COEFFICIENT	RANK
0.13764E 02	4	0.30139E-08	7
0.17525E 02	5	-0.11820E-07	4
0.18133E 02	6	-0.81844E-11	40
0.19370E 02	7	0.16601E-08	10
0.22939E 02	8	0.13761E-07	3
0.25796E 02	9	0.73517E-09	13
0.28702E 02	10	0.31290E-08	6
0.28944E 02	11	0.50024E-09	15
0.30096E 02	12	-0.19704E-08	8
0.31603E 02	13	-0.39124E-09	18
0.32334E 02	14	0.19669E-08	9
0.32729E 02	15	0.11665E-09	28
0.34536E 02	16	0.20584E-09	23
0.36578E 02	17	0.14315E-08	11
0.38611E 02	18	0.26134E-07	1
0.38819E 02	19	-0.14670E-07	2
0.41914E 02	20	-0.76534E-08	5
0.43225E 02	21	0.46156E-09	16
0.49330E 02	22	0.34624E-11	44
0.51462E 02	23	-0.80643E-09	12
0.52124E 02	24	0.94531E-13	49
0.52244E 02	25	0.32224E-11	45
0.52839E 02	26	0.10517E-11	46
0.52912E 02	27	0.49409E-10	33
0.55803E 02	28	-0.21239E-10	36
0.11957E 02	34	-0.17835E-09	24
0.12446E 02	35	0.23323E-09	22
0.16801E 02	36	0.37524E-09	17
0.17309E 02	37	-0.31818E-09	20
0.20734E 02	38	0.21276E-10	39
0.23872E 02	39	-0.50076E-09	14
0.27020E 02	40	0.31140E-09	21
0.29155E 02	41	0.13306E-09	27
0.30048E 02	42	-0.91006E-11	35
0.30800E 02	43	0.95662E-10	29
0.31635E 02	44	-0.14615E-09	26
0.32753E 02	45	0.63971E-10	32
0.33123E 02	46	0.90154E-11	39
0.36920E 02	47	-0.40422E-11	43
0.37558E 02	48	-0.68803E-10	31
0.38571E 02	49	-0.34924E-10	34
0.43468E 02	50	-0.17163E-10	37
0.45641E 02	51	-0.92791E-10	30
0.51102E 02	52	-0.48893E-11	41
0.52131E 02	53	0.18059E-12	48
0.52227E 02	54	-0.34120E-13	50
0.59475E 02	55	0.43908E-11	42
0.60748E 02	56	-0.16845E-09	25
0.65135E 02	57	0.28667E-12	47
0.67311E 02	58	0.32156E-09	19

FREQUENCY	MODE NO.	COEFFICIENT	RANK
0.13764E 02	4	0.0	50
0.17525E 02	5	0.0	49
0.18133E 02	6	0.0	48
0.19370E 02	7	0.0	47
0.22939E 02	8	0.0	46
0.25796E 02	9	0.0	45
0.28702E 02	10	0.0	44
0.28944E 02	11	0.0	43
0.30096E 02	12	0.0	42
0.31603E 02	13	0.0	41
0.32334E 02	14	0.0	40
0.32729E 02	15	0.0	39
0.34536E 02	16	0.0	38
0.36578E 02	17	0.0	37
0.38611E 02	18	0.0	36
0.38819E 02	19	0.0	35
0.41914E 02	20	0.0	34
0.43225E 02	21	0.0	33
0.49330E 02	22	0.0	32
0.51462E 02	23	0.0	31
0.52124E 02	24	0.0	30
0.52244E 02	25	0.0	29
0.52839E 02	26	0.0	28
0.52912E 02	27	0.0	27
0.55803E 02	28	0.0	26
0.11957E 02	34	-0.50982E-08	8
0.12446E 02	35	-0.12544E-08	15
0.16801E 02	36	0.16638E-07	3
0.17309E 02	37	0.64036E-09	20
0.20734E 02	38	0.27641E-07	2
0.23872E 02	39	0.55032E-07	1
0.27020E 02	40	0.83102E-08	7
0.29155E 02	41	0.31096E-08	10
0.30048E 02	42	-0.33917E-07	21
0.30800E 02	43	-0.29950E-08	11
0.31635E 02	44	-0.13367E-07	5
0.32753E 02	45	-0.10105E-08	17
0.33123E 02	46	-0.22594E-08	13
0.36920E 02	47	-0.10199E-08	14
0.37558E 02	48	-0.16214E-07	4
0.38571E 02	49	-0.70749E-09	18
0.43468E 02	50	-0.68423E-09	19
0.45641E 02	51	0.42633E-08	9
0.51102E 02	52	0.14216E-08	14
0.52131E 02	53	0.33770E-12	25
0.52227E 02	54	-0.19818E-11	24
0.59475E 02	55	0.39787E-11	23
0.60748E 02	56	0.23628E-08	12
0.65135E 02	57	0.89737E-08	6
0.67311E 02	58	-0.27160E-09	22

181

POSITION (GYRO) COEFFICIENTS. RESPONSE FRDM = 120762 INPUT FRDM = 140392

POSITION (GYRO) COEFFICIENTS. RESPONSE FRDM = 120762 INPUT FRDM = 140393

FREQUENCY	MODE NO.	COEFFICIENT	RANK
0.13764E 02	4	0.0	50
0.17525E 02	5	0.0	49
0.13133E 02	6	0.0	48
0.19370E 02	7	0.0	47
0.22939E 02	8	0.0	46
0.25796E 02	9	0.0	45
0.28702E 02	10	0.0	44
0.28944E 02	11	0.0	43
0.30096E 02	12	0.0	42
0.31603E 02	13	0.0	41
0.32384E 02	14	0.0	40
0.32729E 02	15	0.0	39
0.34836E 02	16	0.0	38
0.36578E 02	17	0.0	37
0.38611E 02	18	0.0	36
0.38819E 02	19	0.0	35
0.41914E 02	20	0.0	34
0.42225E 02	21	0.0	33
0.49330E 02	22	0.0	32
0.51462E 02	23	0.0	31
0.52124E 02	24	0.0	30
0.52244E 02	25	0.0	29
0.52839E 02	26	0.0	28
0.52912E 02	27	0.0	27
0.55803E 02	28	0.0	26
0.11957E 02	34	0.10684E-06	4
0.12446E 02	35	0.12162E-07	14
0.16301E 02	36	0.54935E-07	7
0.17309E 02	37	-0.44631E-08	18
0.20952E 02	38	-0.55869E-07	6
0.23872E 02	39	-0.22087E-06	1
0.27020E 02	40	-0.27212E-07	11
0.29155E 02	41	0.16325E-07	13
0.30043E 02	42	0.39443E-08	19
0.30300E 02	43	0.56050E-07	5
0.31635E 02	44	0.11935E-06	2
0.32753E 02	45	0.15689E-08	22
0.33123E 02	46	0.93410E-08	16
0.36920E 02	47	0.94713E-08	15
0.37585E 02	48	0.11037E-06	3
0.38871E 02	49	0.34648E-08	20
0.43468E 02	50	0.45403E-08	17
0.45841E 02	51	-0.33812E-07	10
0.51102E 02	52	-0.35630E-07	9
0.52131E 02	53	-0.24187E-11	24
0.52227E 02	54	-0.17917E-10	23
0.59475E 02	55	0.13762E-11	25
0.60748E 02	56	0.35748E-07	8
0.65135E 02	57	-0.18417E-07	12
0.67311E 02	58	0.30890E-08	21

FREQUENCY	MODE NO.	COEFFICIENT	RANK
0.13764E 02	4	0.0	50
0.17525E 02	5	0.0	49
0.18133E 02	6	0.0	48
0.19370E 02	7	0.0	47
0.22939E 02	8	0.0	46
0.25796E 02	9	0.0	45
0.28702E 02	10	0.0	44
0.28944E 02	11	0.0	43
0.30096E 02	12	0.0	42
0.31603E 02	13	0.0	41
0.32384E 02	14	0.0	40
0.32729E 02	15	0.0	39
0.34836E 02	16	0.0	38
0.36578E 02	17	0.0	37
0.38611E 02	18	0.0	36
0.38819E 02	19	0.0	35
0.41914E 02	20	0.0	34
0.42225E 02	21	0.0	33
0.49330E 02	22	0.0	32
0.51462E 02	23	0.0	31
0.52124E 02	24	0.0	30
0.52244E 02	25	0.0	29
0.52839E 02	26	0.0	28
0.52912E 02	27	0.0	27
0.55803E 02	28	0.0	26
0.11957E 02	34	-0.23913E-07	6
0.12446E 02	35	0.56413E-09	20
0.16801E 02	36	-0.56446E-07	1
0.17309E 02	37	0.39204E-09	21
0.20952E 02	38	-0.34509E-07	3
0.23872E 02	39	0.55772E-07	2
0.27020E 02	40	0.60252E-08	11
0.29155E 02	41	0.13775E-07	7
0.30043E 02	42	0.80029E-09	18
0.30800E 02	43	0.11046E-07	8
0.31635E 02	44	0.34210E-07	4
0.32753E 02	45	0.45286E-06	12
0.33123E 02	46	0.80183E-08	10
0.36920E 02	47	0.63859E-09	19
0.37088E 02	48	0.26451E-07	5
0.38871E 02	49	0.15403E-08	15
0.43468E 02	50	0.13752E-08	16
0.45841E 02	51	-0.39546E-08	13
0.51102E 02	52	0.16296E-08	14
0.52131E 02	53	-0.15332E-12	25
0.52227E 02	54	0.34916E-11	23
0.59475E 02	55	0.24608E-11	24
0.60748E 02	56	0.10953E-07	9
0.65135E 02	57	0.11649E-09	22
0.67311E 02	58	0.11264E-08	17

5.0 CRITICAL RESONANCES FROM REALISTIC MODELS

The determination of critical resonances for the realistic Space Shuttle model at liftoff, max q and SRB cutoff was accomplished by calculating structural admittances for each of the input/response pairs previously identified in Table 4-1 using postprocessor Option 6.

5.1 SELECTION OF ANALYSIS FREQUENCIES

In general, the admittance peaks do not occur at modal frequencies. For example, the peak displacement admittance for a damped single degree-of-freedom system occurs at a frequency $\beta = \omega\sqrt{1-\zeta^2}$ and the acceleration admittance peak occurs at $\beta = \omega/\sqrt{1-\zeta^2}$ where ω is the modal frequency and ζ is the equivalent modal viscous damping ratio. For a multi-degree-of-freedom system, the proximity of other modes causes further shifts in peak resonances, particularly when modal coupling is significant. Therefore, to find the resonance peaks for the Space Shuttle, admittances must be calculated for several frequencies in the vicinity of each modal frequency and between modal frequencies.

The analysis frequencies (β) chosen for each modal frequency (ω) are as follows:

$$\omega, \omega\sqrt{1-\zeta^2}, \omega/\sqrt{1-\zeta^2}, \omega \pm .1, \omega \pm .2 \text{ rps.}$$

Some of these frequencies were omitted for closely spaced modal frequencies, and additional analysis frequencies were included between widely spaced modal frequencies.

5.2 CRITICAL RESONANCES

Displacement, velocity and acceleration admittances (amplitude and phase angle) for the input/response freedoms shown in Table 4-1 were calculated and ranked using postprocessor Option 6. The complete set of tabulated data for liftoff, max q and SRB cutoff are contained in Section 3.0 of Volume II. These tables indicate which resonances are the primary contributors to the structural response of each response freedom due to excitation at each input freedom.

Selected response/excitation pairs for the liftoff condition are used in Section 6.0 for the comparison of the admittance technique with the conventional modal selection method.

6.0 ADMITTANCE METHOD COMPARISON AND MODAL EXCITABILITY CRITERION

The ranking of critical resonances for the realistic model at liftoff using the admittance approach was compared with the ranking of critical modes for the conventional model. There are significant differences in the rankings resulting from the coupling introduced by discrete joint damping in the structural model. A criterion for assessing the effect of damping in structural joints on the excitability of structural modes is presented.

6.1 COMPARISON OF REALISTIC AND CONVENTIONAL MODELS

The most significant result obtained from the comparison of the realistic and conventional models is that the damping in structural joints produces significant modal coupling. Figures 6-1 through 6-3 show displacement, rate and acceleration admittances for several response freedoms due to excitation at one outboard Space Shuttle main engine (gridpoint 14039) and at one SRB engine (gridpoint 513) for both the realistic and conventional models. The frequency range was reduced for these comparisons to provide better definition of frequency shifts resulting from modal coupling. The curves shown in the figures are displacement admittances for the position gyro in the Orbiter inertial measurement unit (IMU), rate admittances for the SRM forward and aft rate gyros, and the Orbiter rate gyro, and acceleration admittances for the aft dome of the ET LOX tank and the crew compartment instrument unit for the realistic model. Shown as points on these curves are the admittances calculated for the conventional model using two methods for comparison: (a) using a uniform damping ratio of .01 for all the modes and (b) using the damping ratio determined from the diagonal term in the coupled modal damping matrix.

For some resonance peaks, the conventional model using method (b) (damping calculated from the diagonal term of the coupled modal damping matrix) comes close to the realistic model admittances. But for the resonance peaks which show strong modal coupling, the conventional model admittances are significantly lower than the realistic model. In fact the conventional model admittances are zero for some resonances which are significant in the realistic model. As an example, for the position gyro response in the pitch (θ_y) direction (Figure 6-1), the admittance peak at approximately 18.2 rad/sec is the second highest peak for the realistic model; but for the conventional model, the mode at 18.1 rad/sec ranks fourth in criticality. Therefore modal coupling due to

RESPONSE FREEDOM 90054 DUE TO 5133

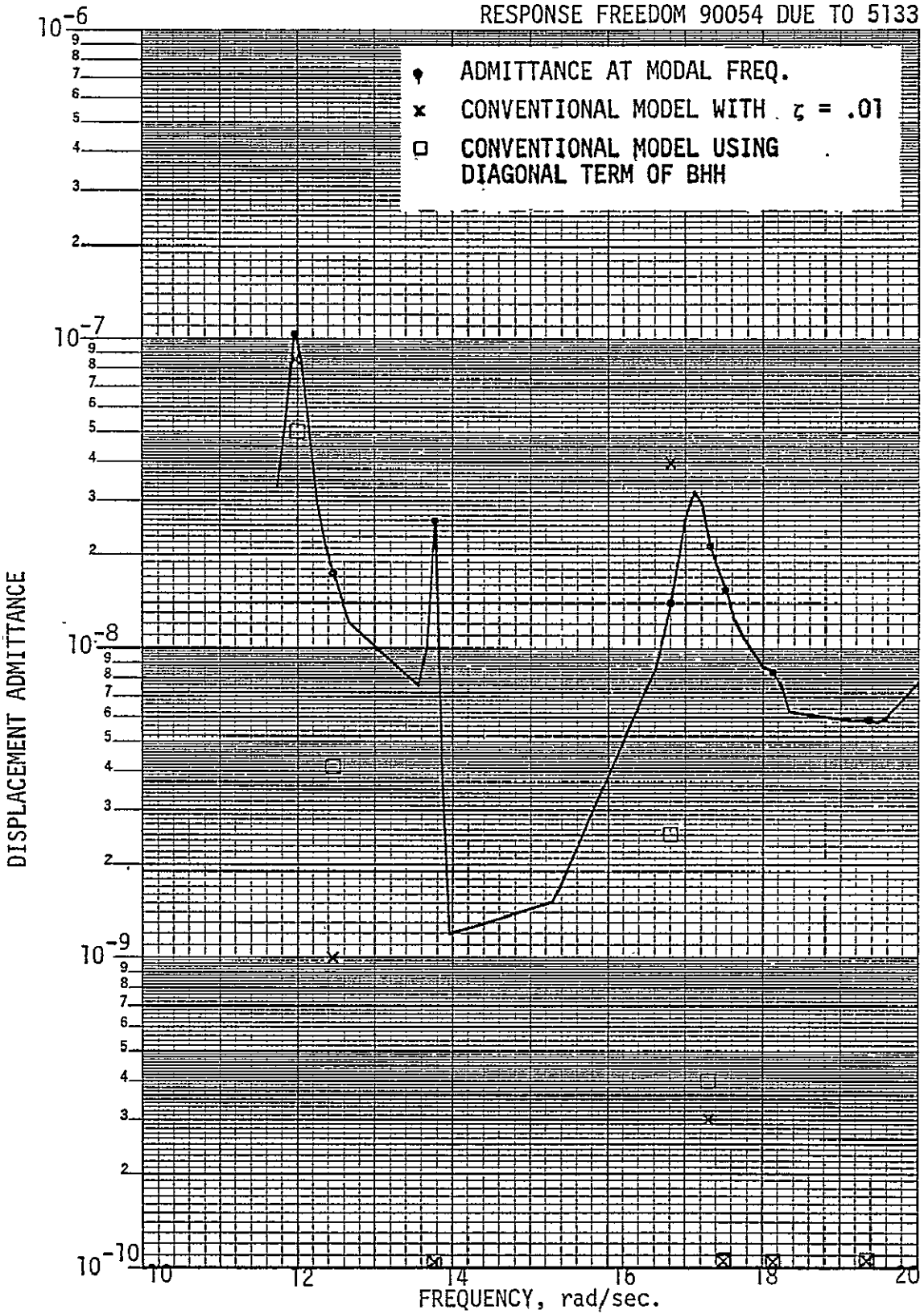

FIGURE 6-1: COMPARISON OF CONVENTIONAL AND REALISTIC MODELS, DISPLACEMENT RESPONSE

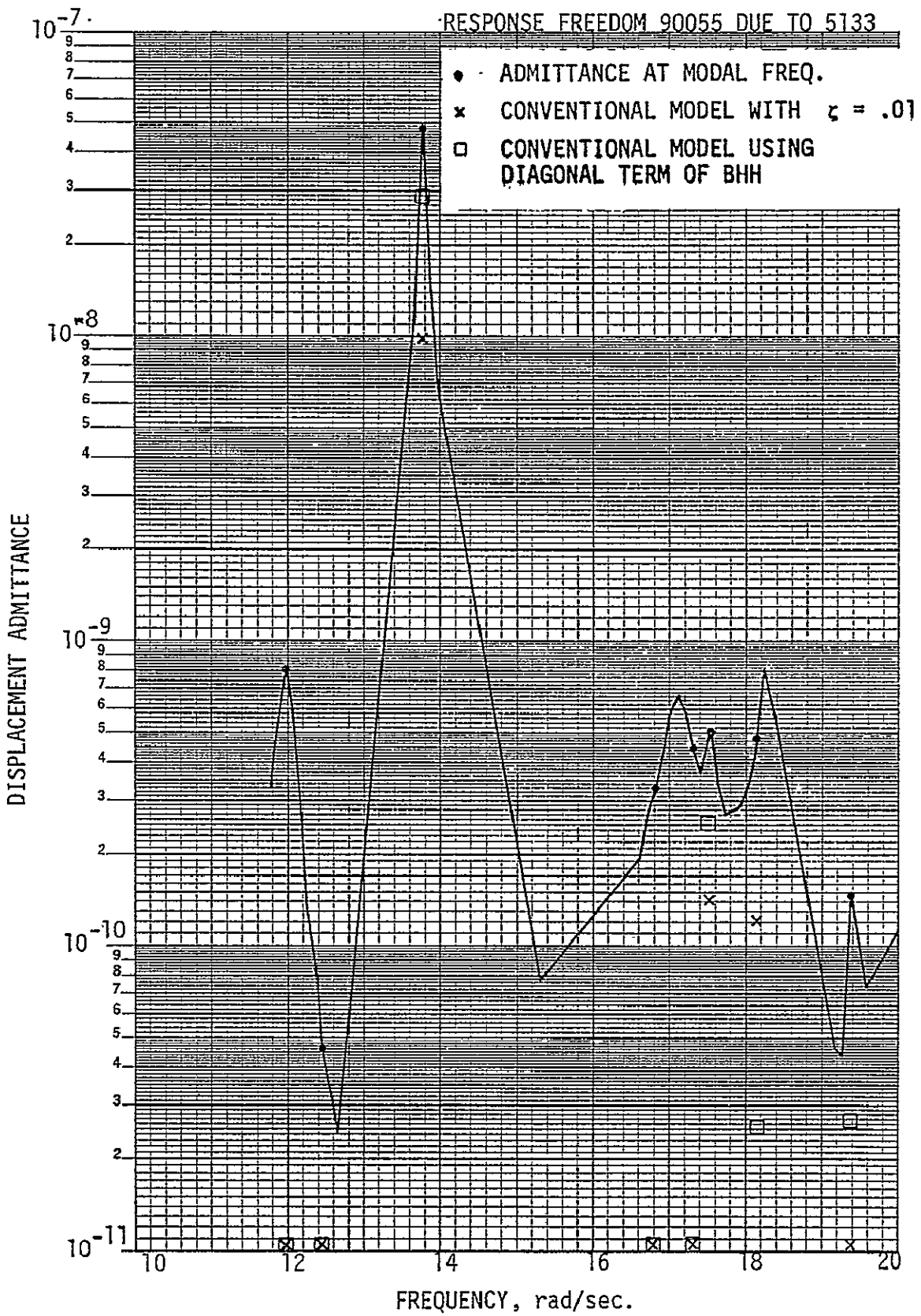

FIGURE 6-1: COMPARISON OF CONVENTIONAL AND REALISTIC MODELS, DISPLACEMENT RESPONSE (continued)

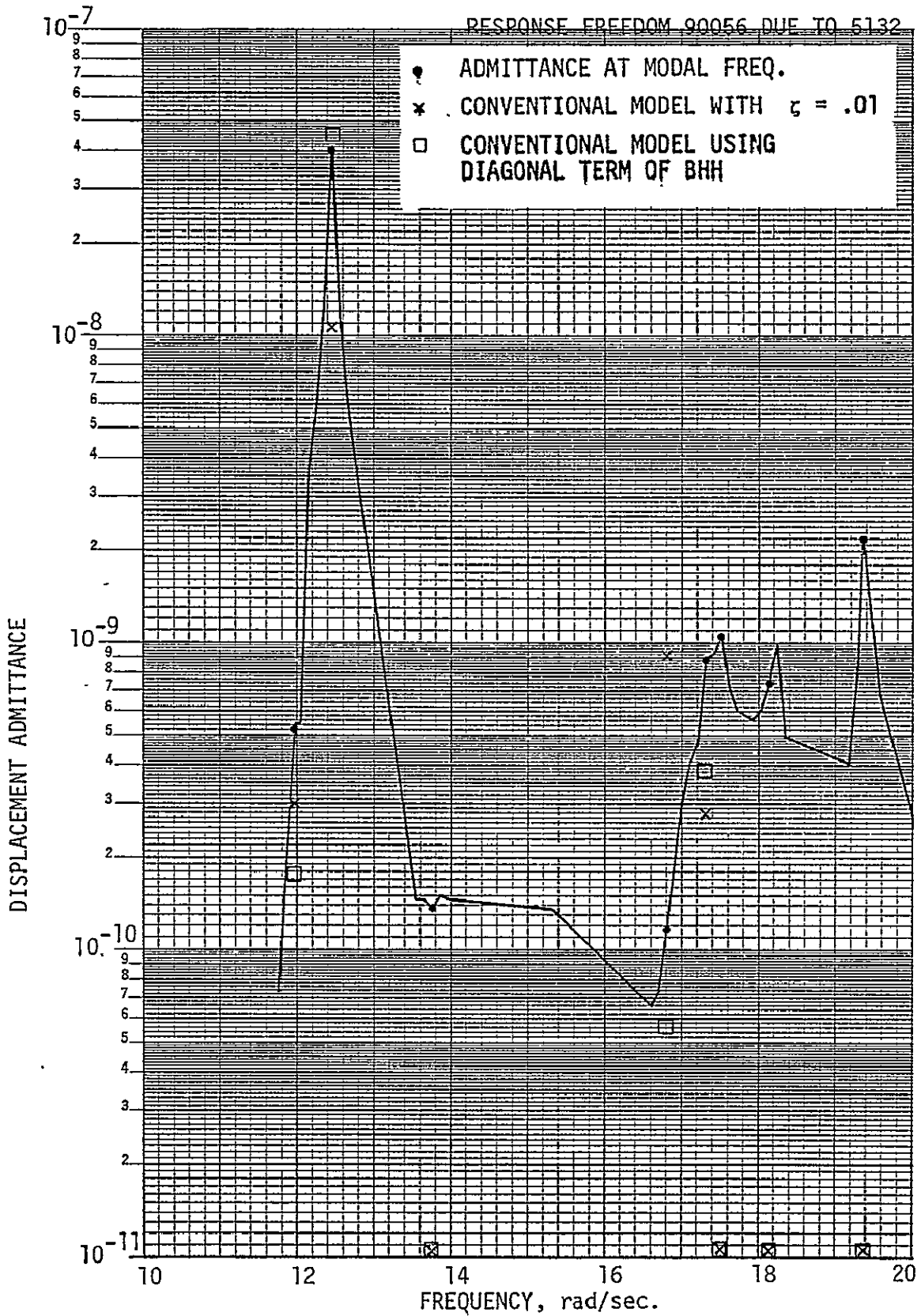

FIGURE 6-1: COMPARISON OF CONVENTIONAL AND REALISTIC MODELS, DISPLACEMENT RESPONSE (continued)

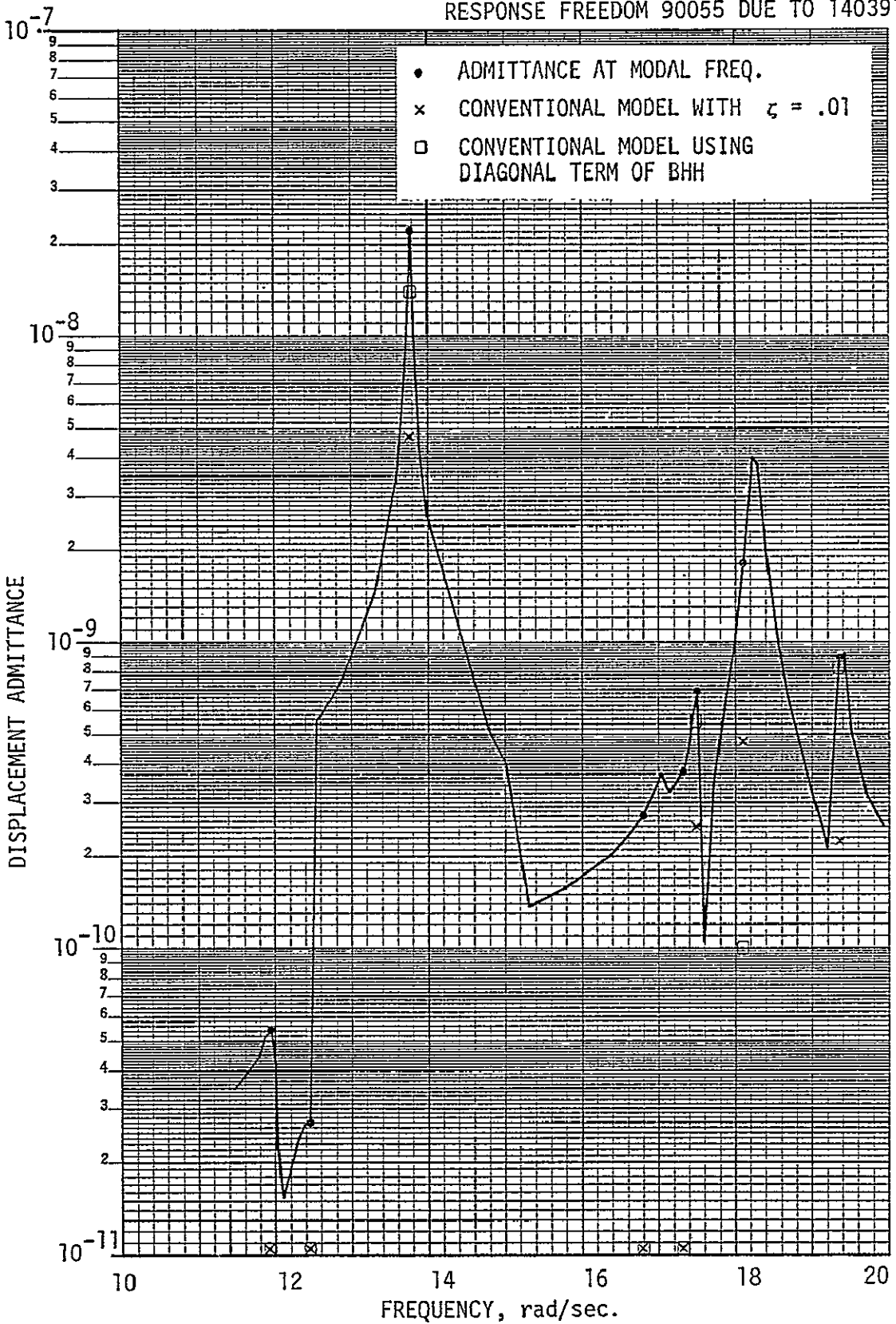

FIGURE 6-1: COMPARISON OF CONVENTIONAL AND REALISTIC MODELS, DISPLACEMENT RESPONSE (continued)

RESPONSE FREEDOM 90055 DUE TO 140393

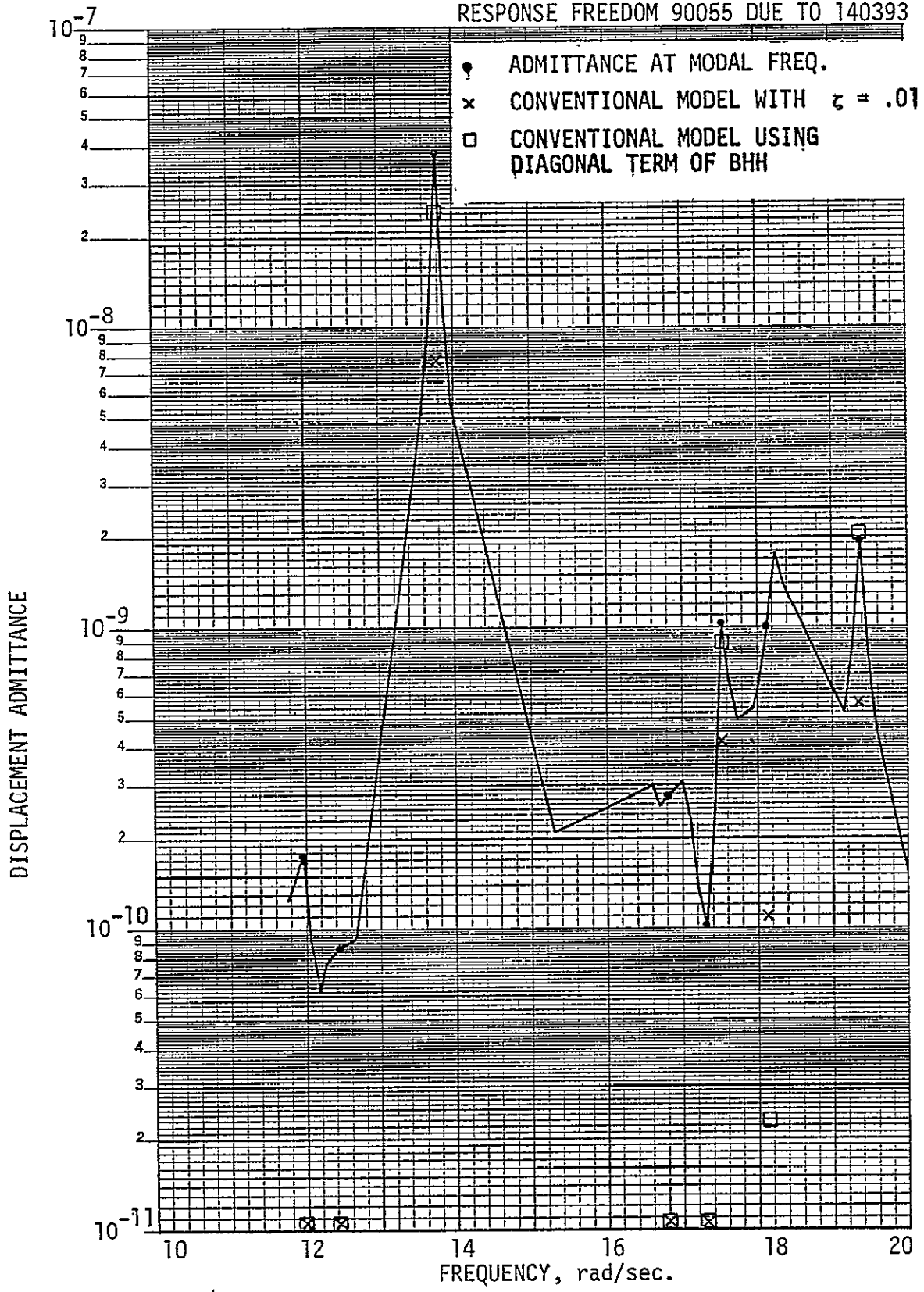

FIGURE 6-1: COMPARISON OF CONVENTIONAL AND REALISTIC MODELS, DISPLACEMENT RESPONSE (continued)

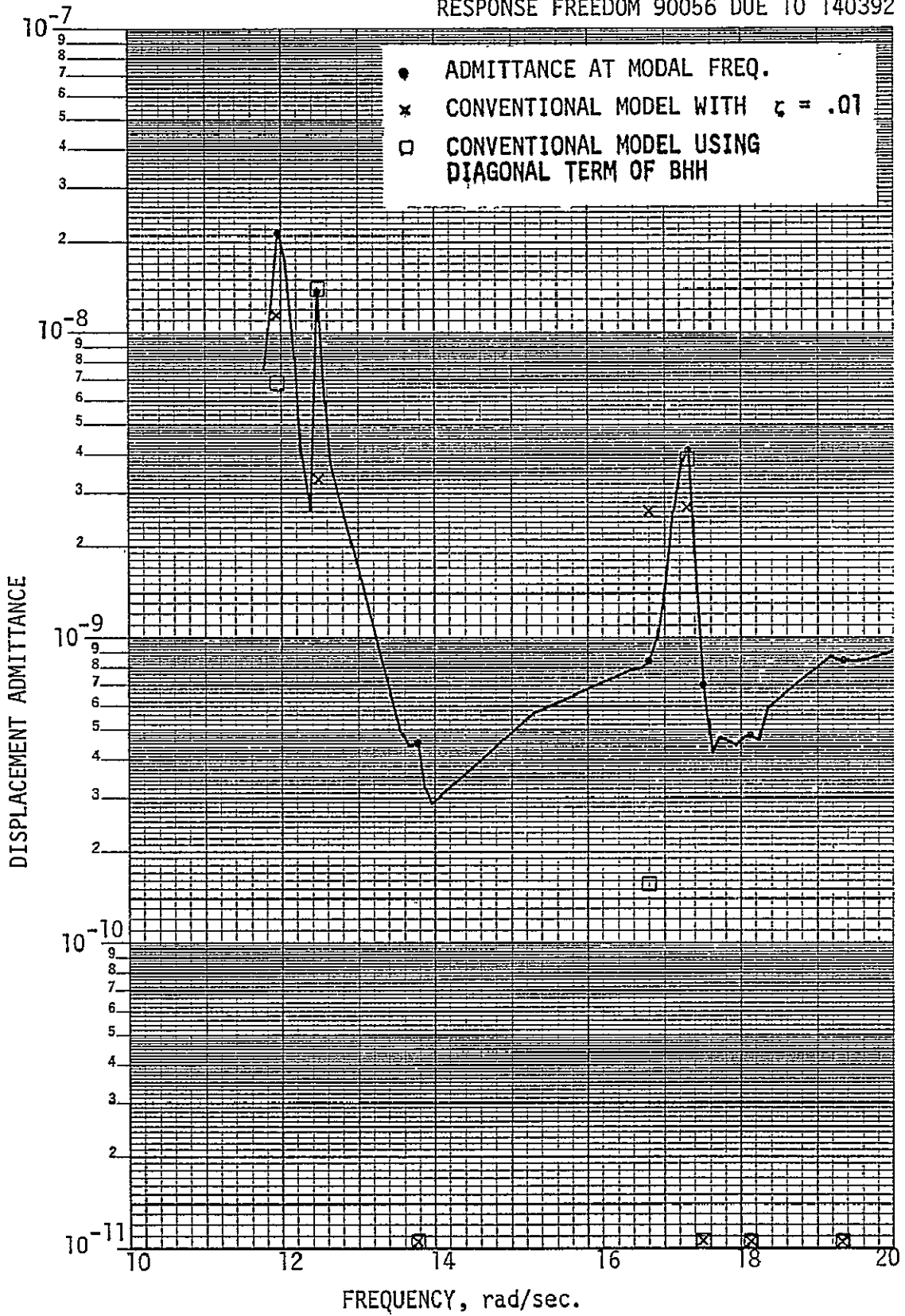

FIGURE 6-1: COMPARISON OF CONVENTIONAL AND REALISTIC MODELS, DISPLACEMENT RESPONSE (continued)

RESPONSE FREEDOM 9015 DUE TO 140391

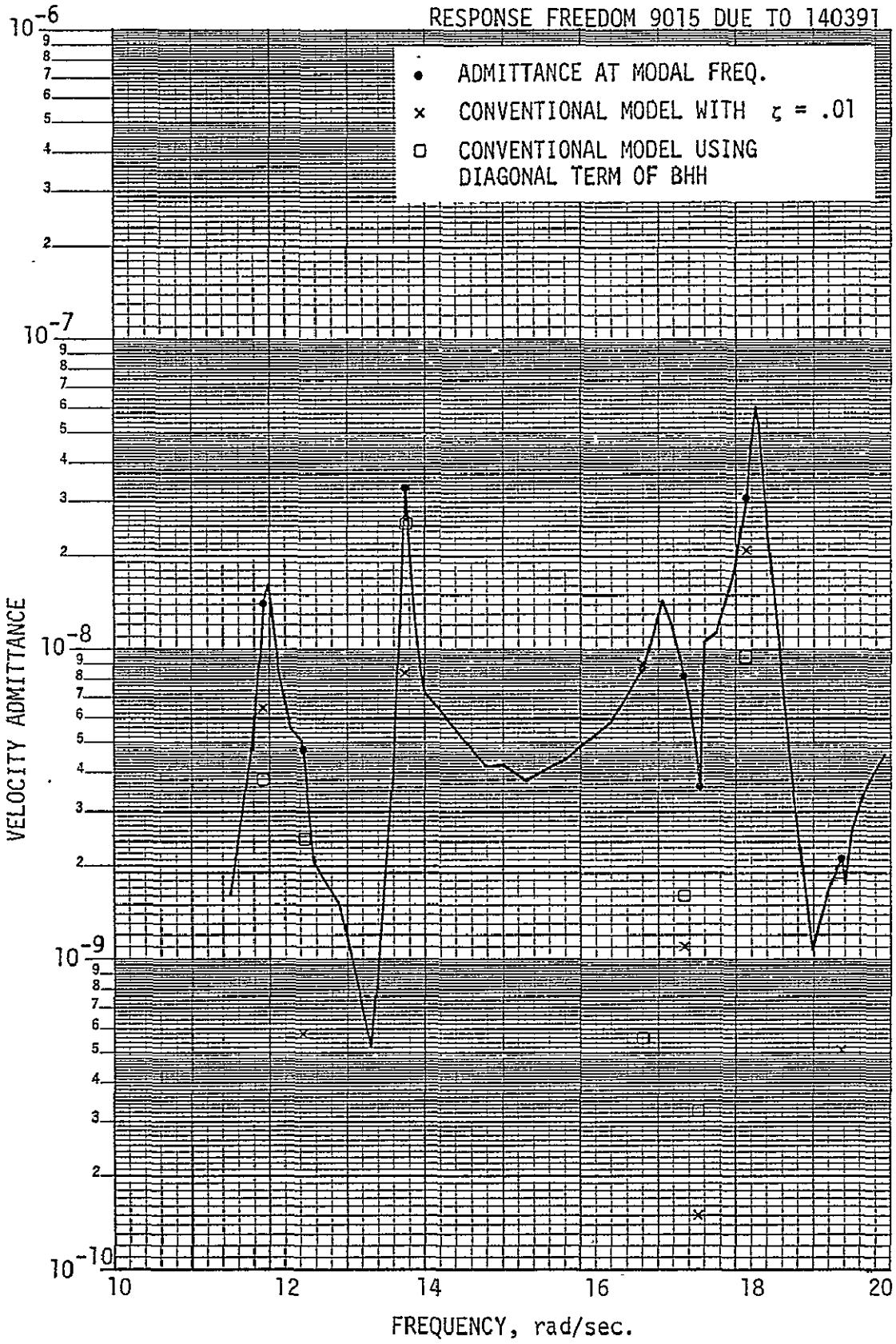

FIGURE 6-2: COMPARISON OF CONVENTIONAL AND REALISTIC MODELS, VELOCITY RESPONSE

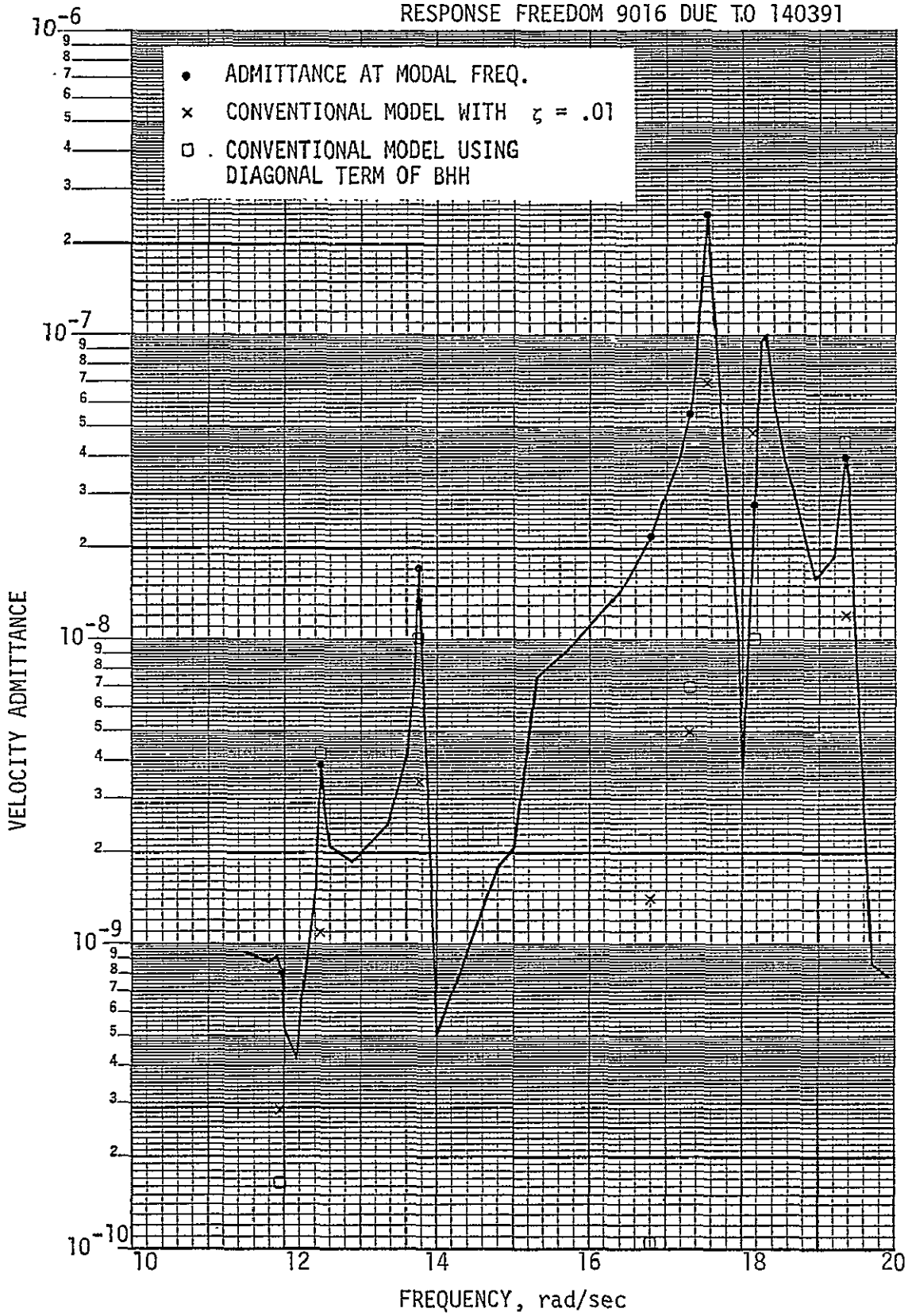

FIGURE 6-2: COMPARISON OF CONVENTIONAL AND REALISTIC MODELS, VELOCITY RESPONSE (continued)

REPRODUCIBILITY OF THE ORIGINAL PAGE IS POOR

RESPONSE FREEDOM 9024 DUE TO 5133

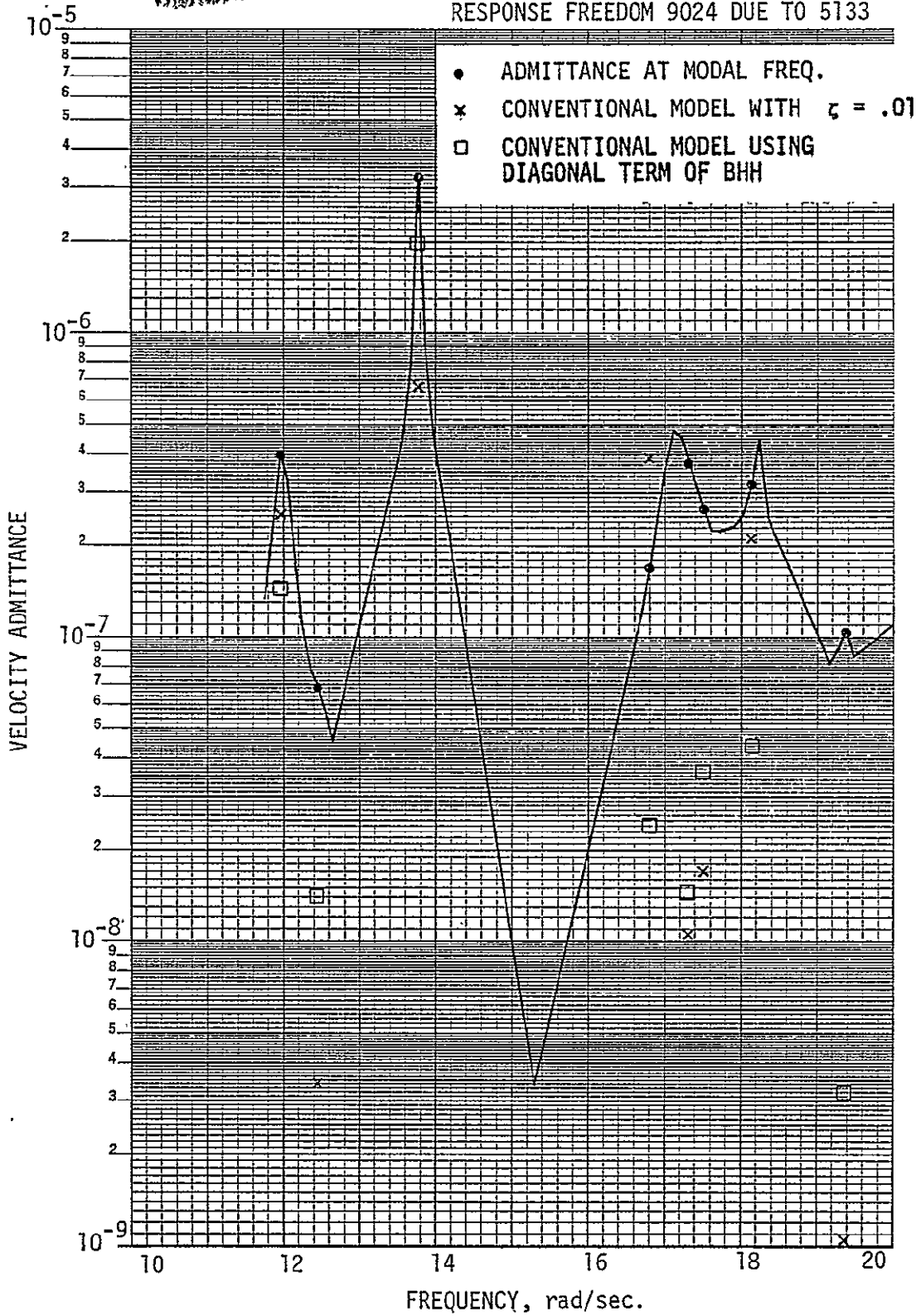

FIGURE 6-2: COMPARISON OF CONVENTIONAL AND REALISTIC MODELS, VELOCITY RESPONSE (continued)

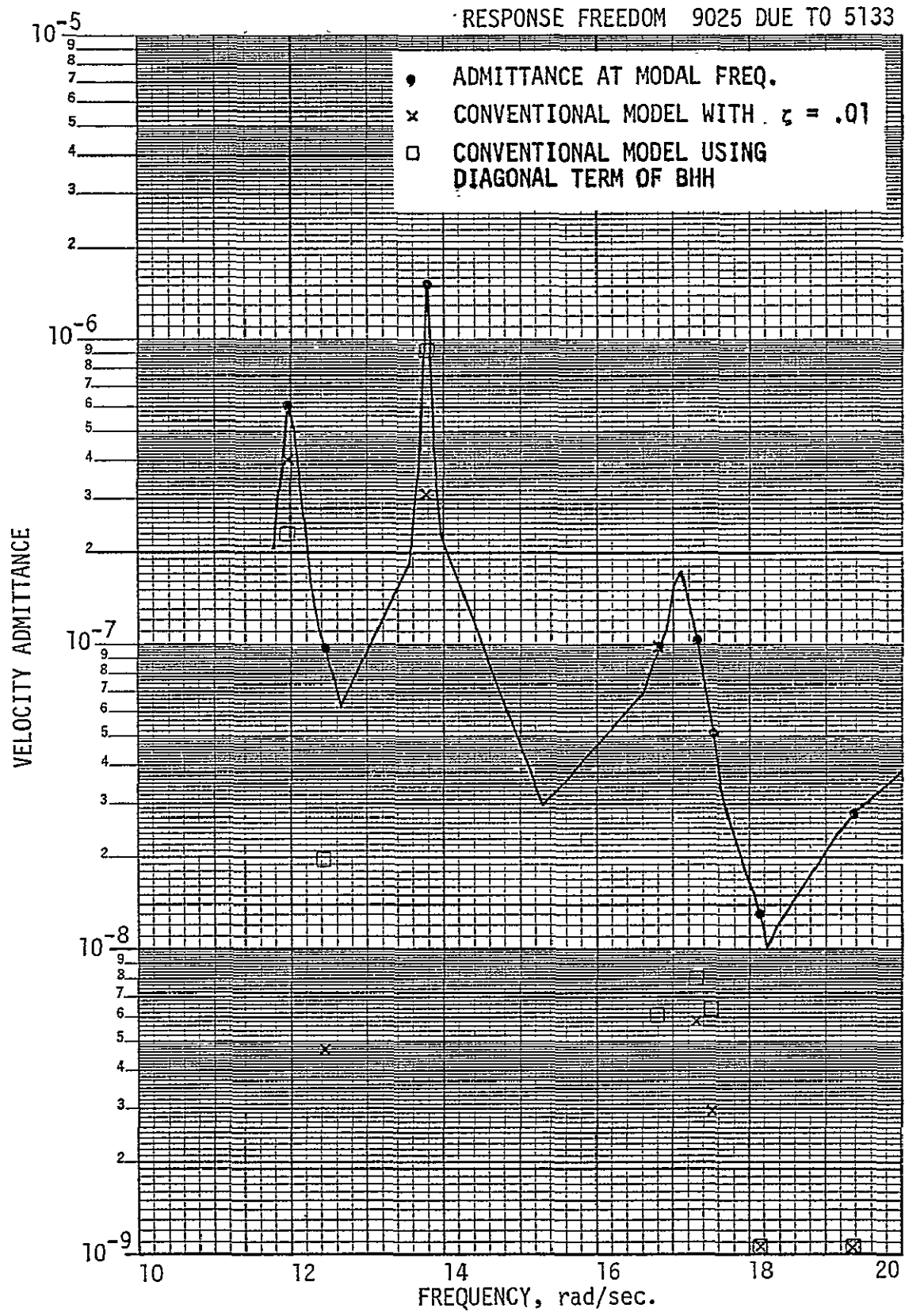

FIGURE 6-2: COMPARISON OF CONVENTIONAL AND REALISTIC MODELS, VELOCITY RESPONSE (continued)

RESPONSE FREEDOM 9026 DUE TO 5132

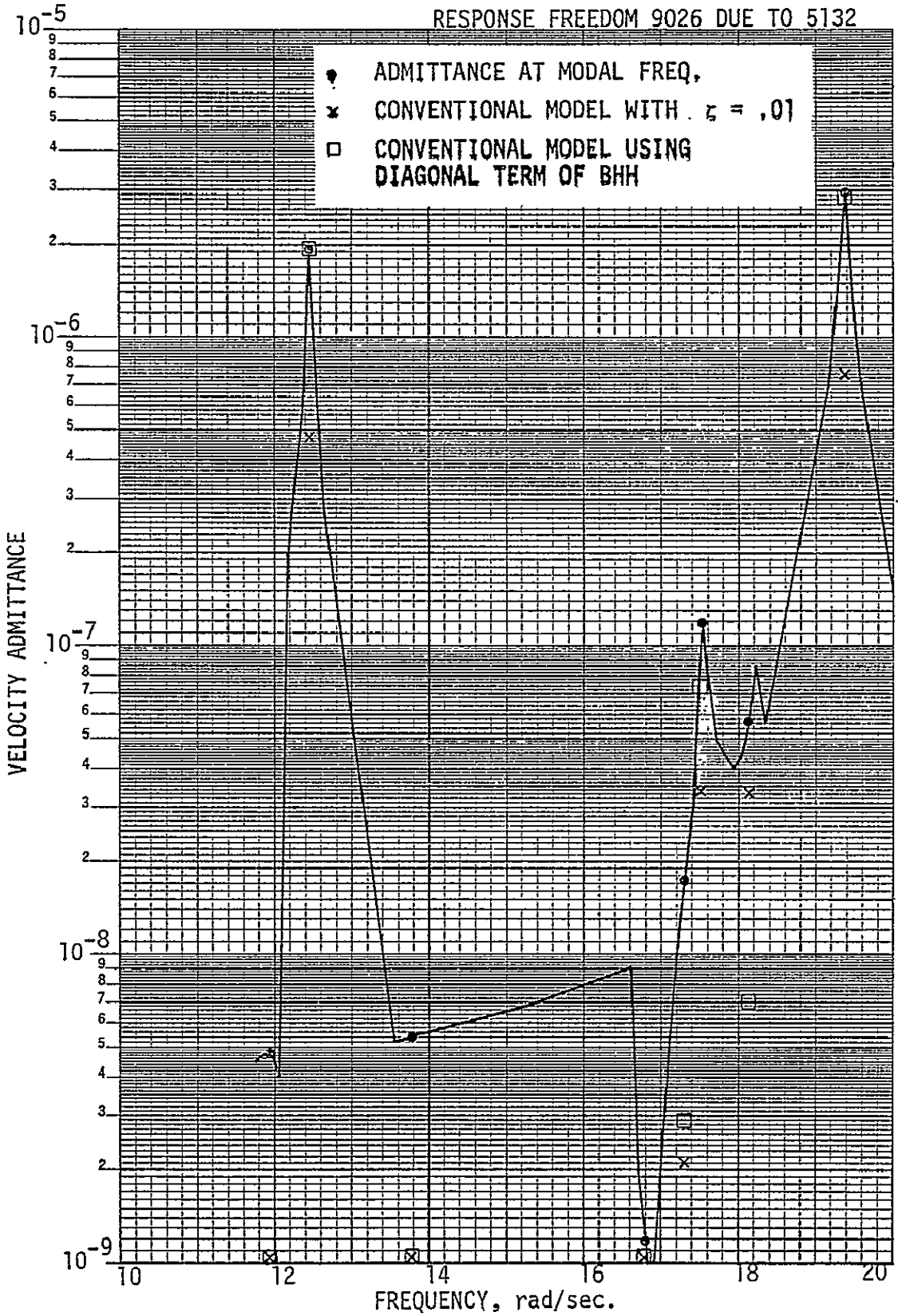

FIGURE 6-2: COMPARISON OF CONVENTIONAL AND REALISTIC MODELS, VELOCITY RESPONSE (Continued)

RESPONSE FREEDOM 9025 DUE TO 140393

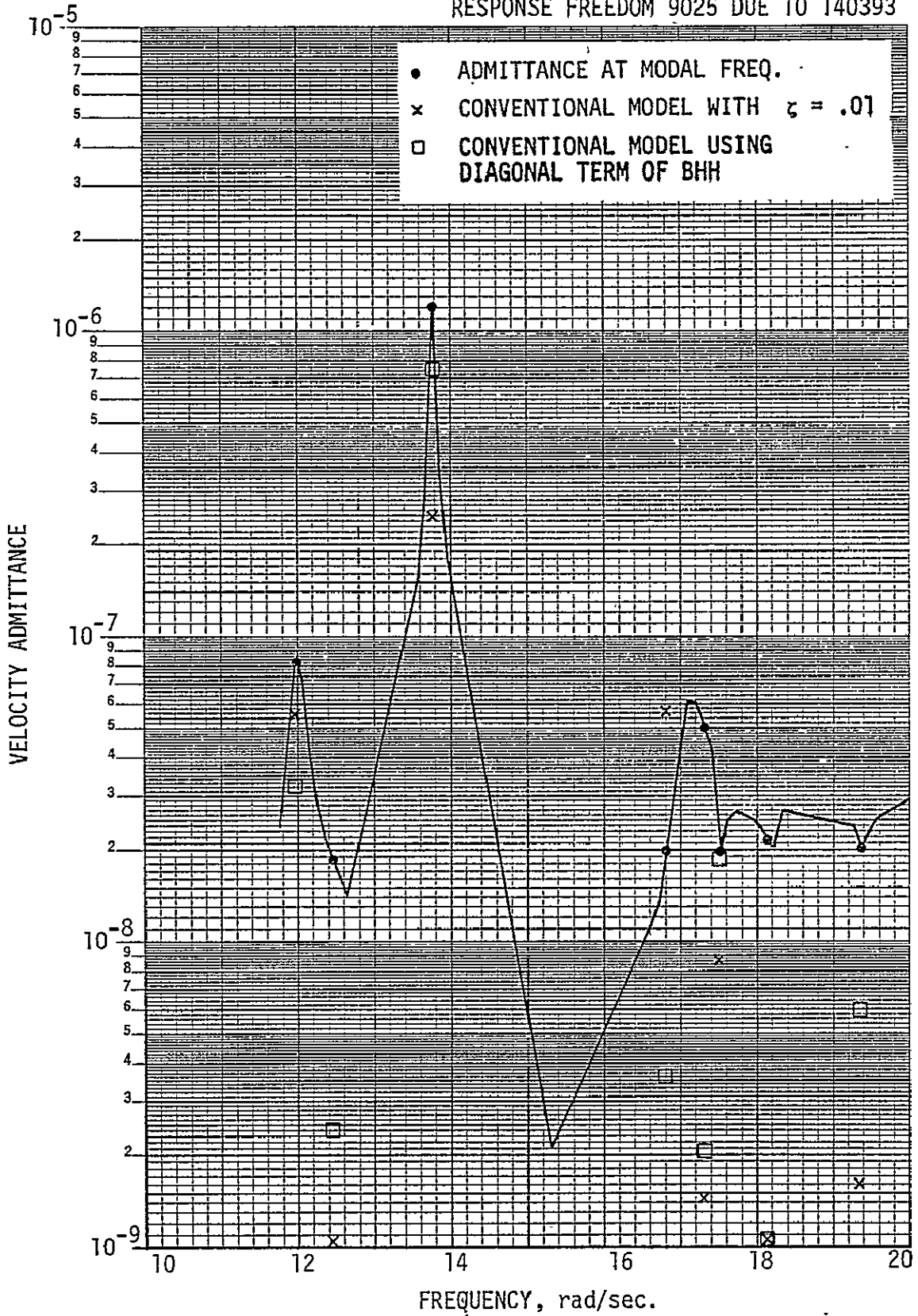

FIGURE 6-2: COMPARISON OF CONVENTIONAL AND REALISTIC MODELS, VELOCITY RESPONSE (continued)

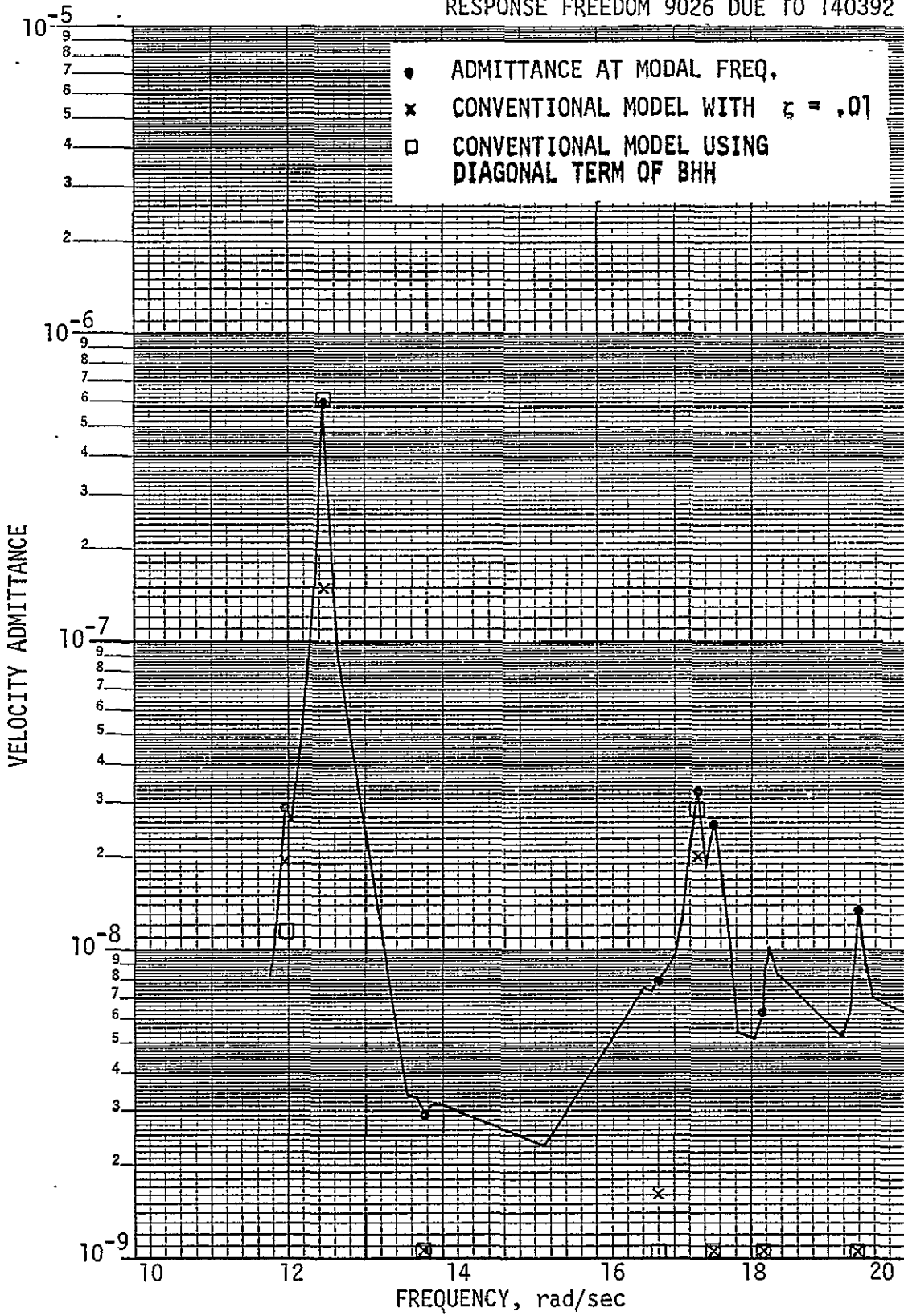

FIGURE 6-2: COMPARISON OF CONVENTIONAL AND REALISTIC MODELS, VELOCITY RESPONSE (continued)

RESPONSE FREEDOM 90044 DUE TO 5133

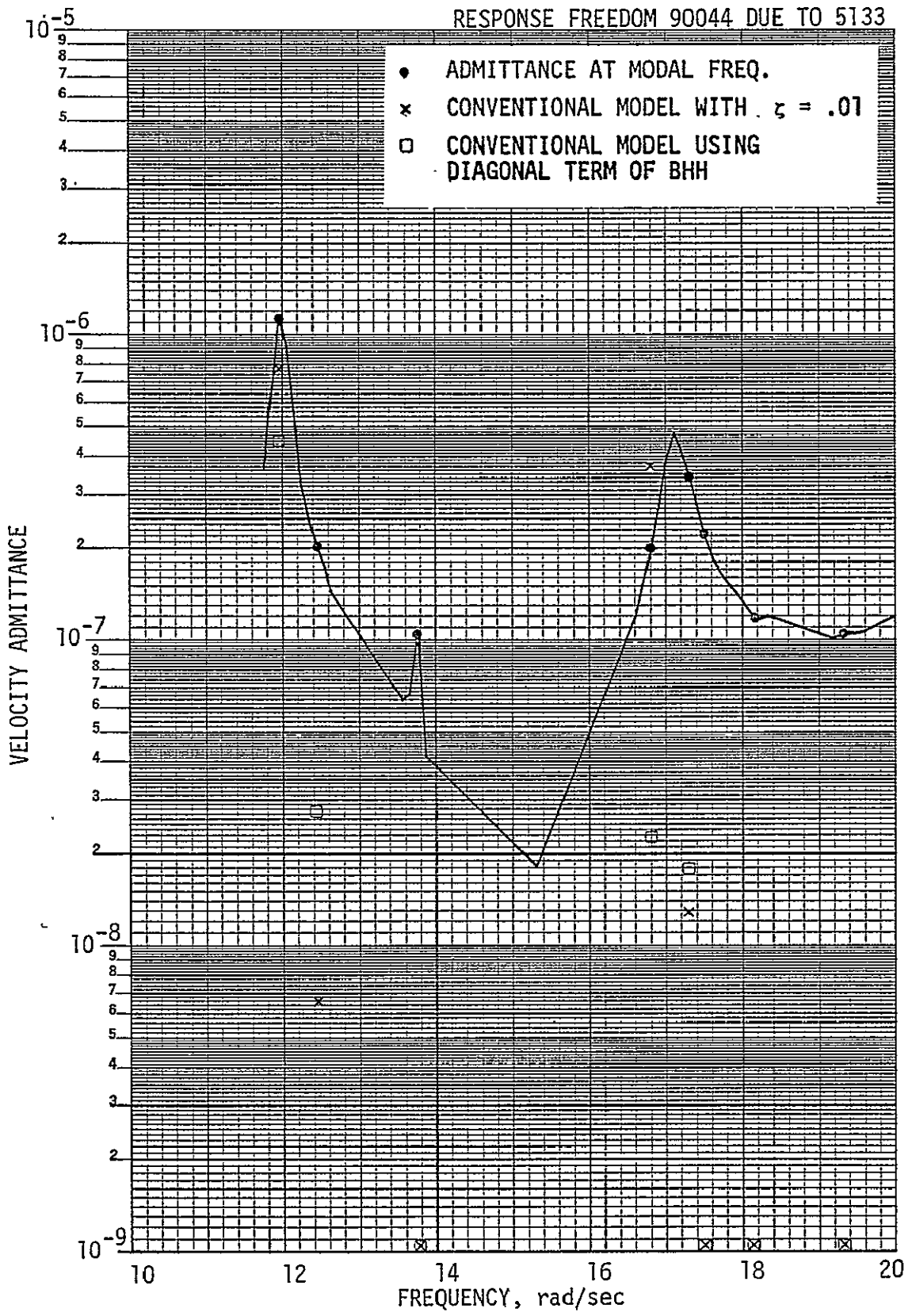

FIGURE 6-2: COMPARISON OF CONVENTIONAL AND REALISTIC MODELS, VELOCITY RESPONSE (continued)

RESPONSE FREEDOM 90045 DUE TO 5133

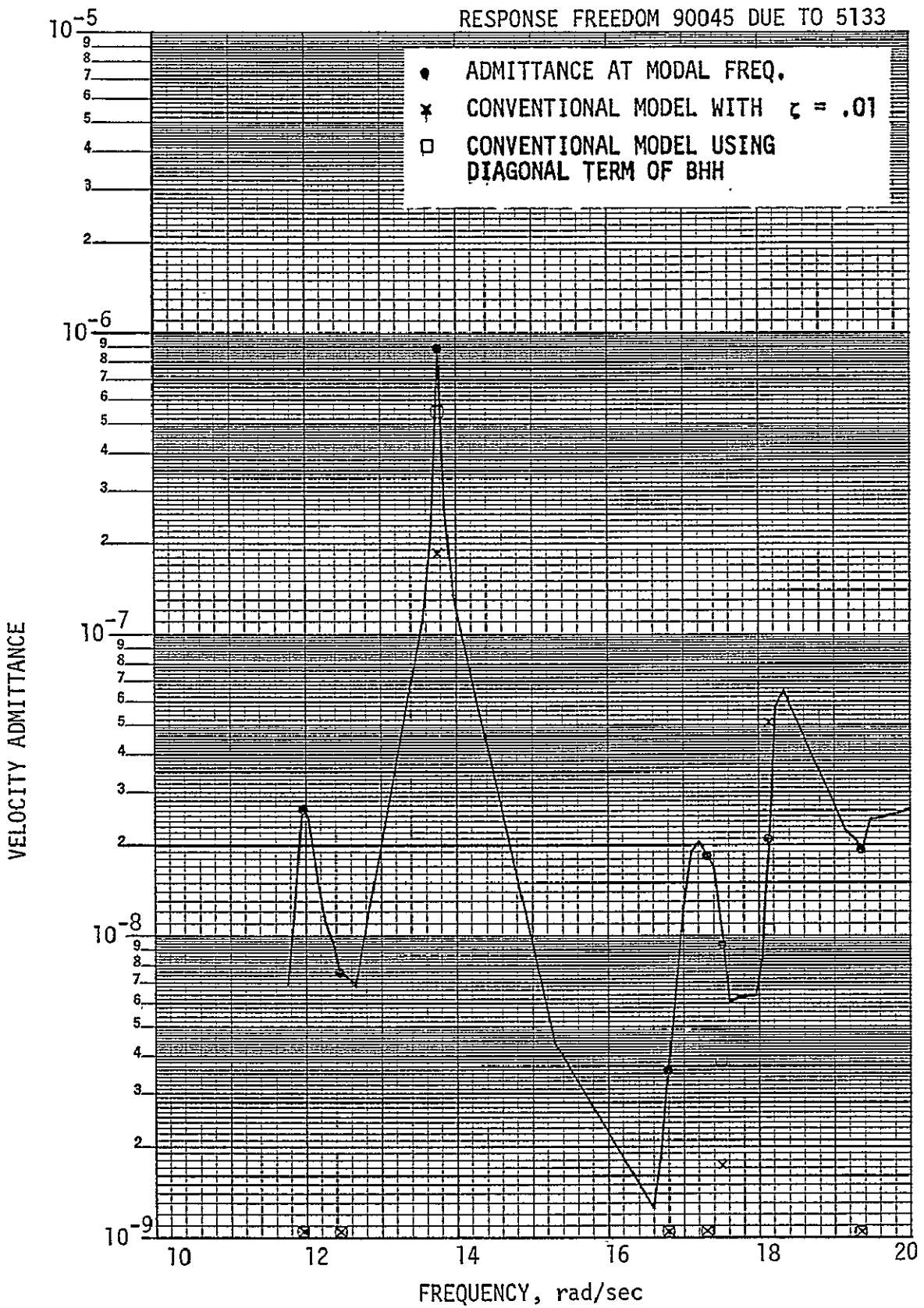

FIGURE 6-2: COMPARISON OF CONVENTIONAL AND REALISTIC MODELS, VELOCITY RESPONSE (continued)

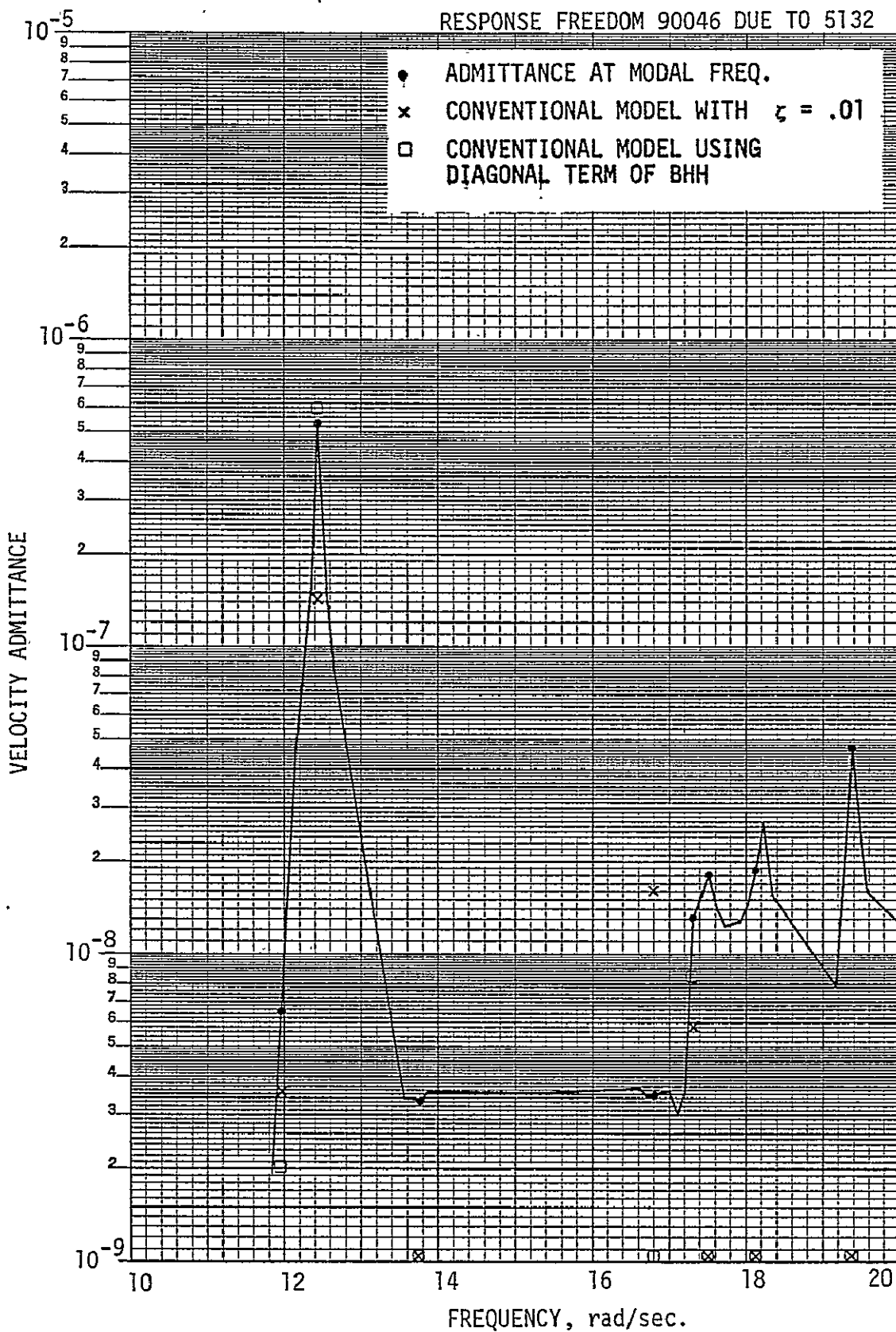

FIGURE 6-2: COMPARISON OF CONVENTIONAL AND REALISTIC MODELS, VELOCITY RESPONSE (continued)

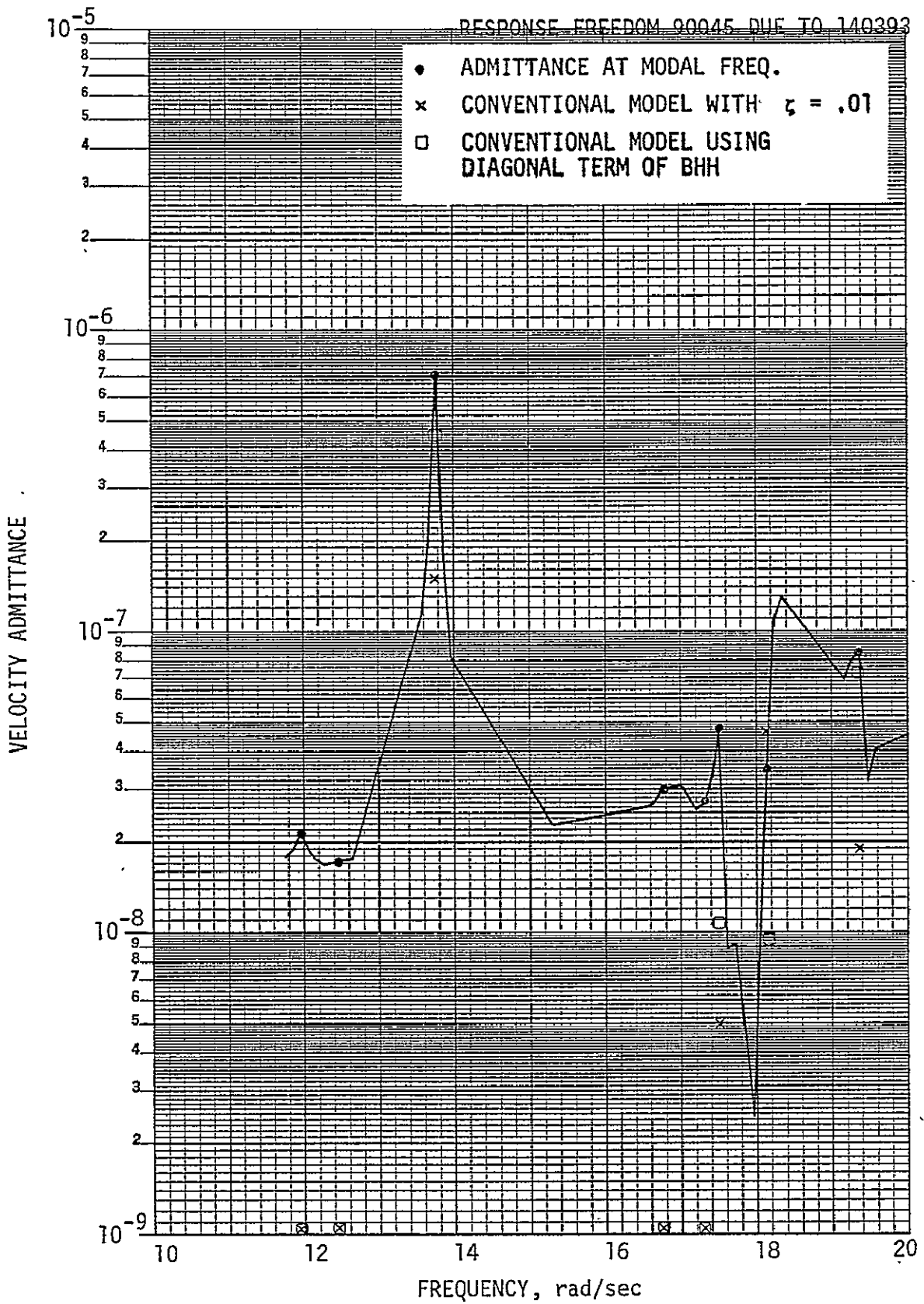

FIGURE 6-2: COMPARISON OF CONVENTIONAL AND REALISTIC MODELS, VELOCITY RESPONSE (continued)

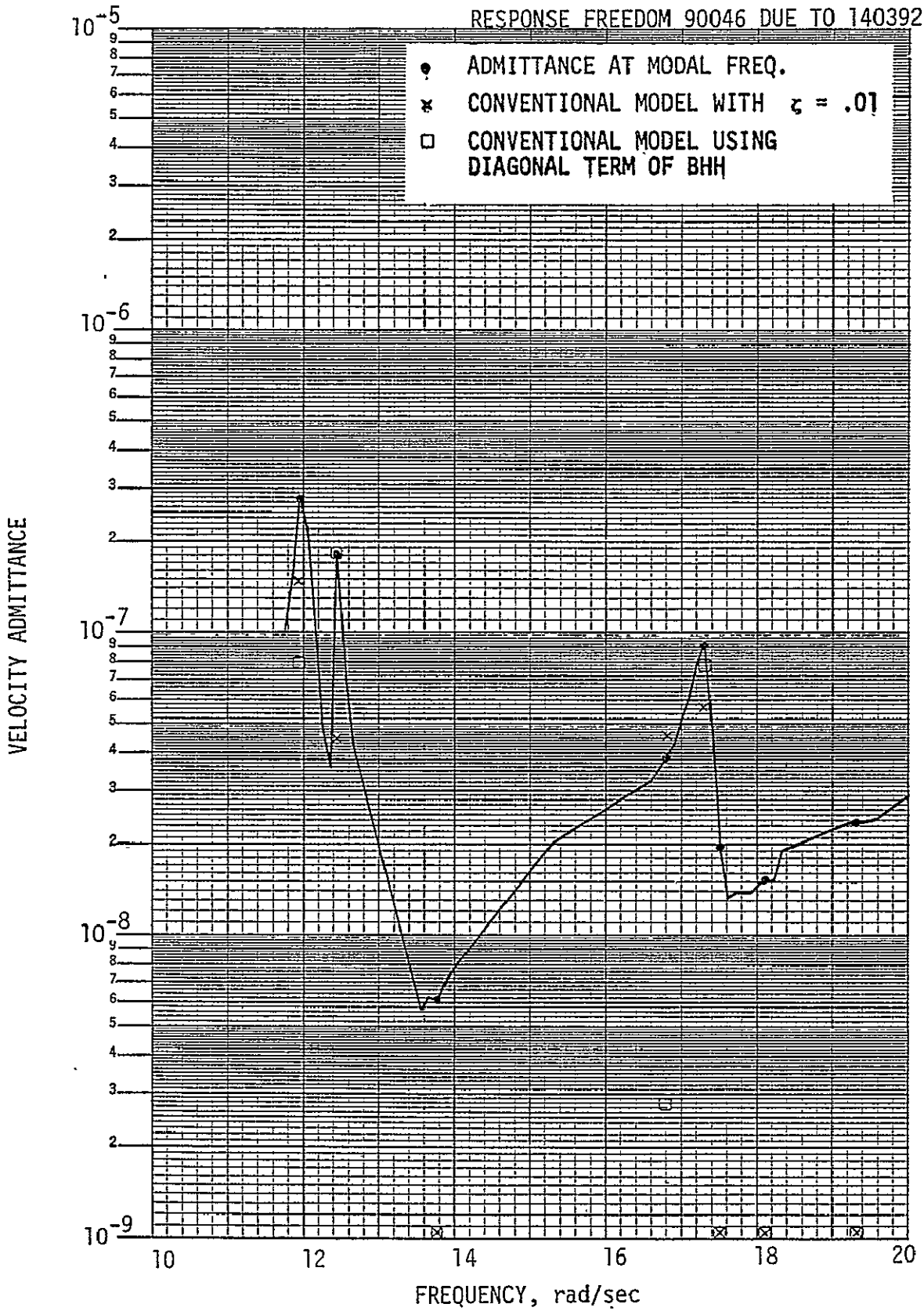

FIGURE 6-2: COMPARISON OF CONVENTIONAL AND REALISTIC MODELS, VELOCITY RESPONSE (continued)

RESPONSE FREEDOM 521 DUE TO 140391

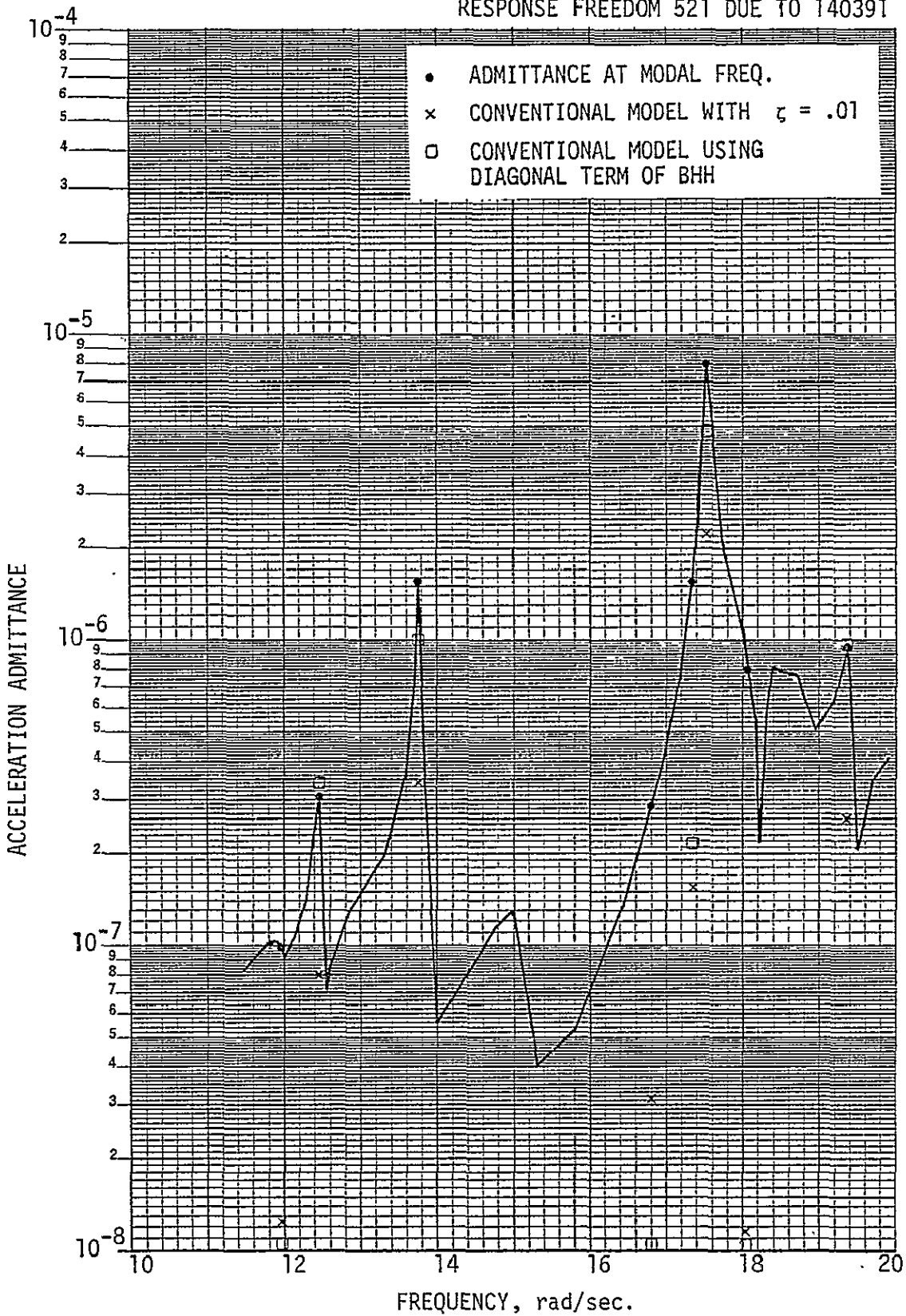

FIGURE 6-3: COMPARISON OF CONVENTIONAL AND REALISTIC MODELS, ACCELERATION RESPONSE

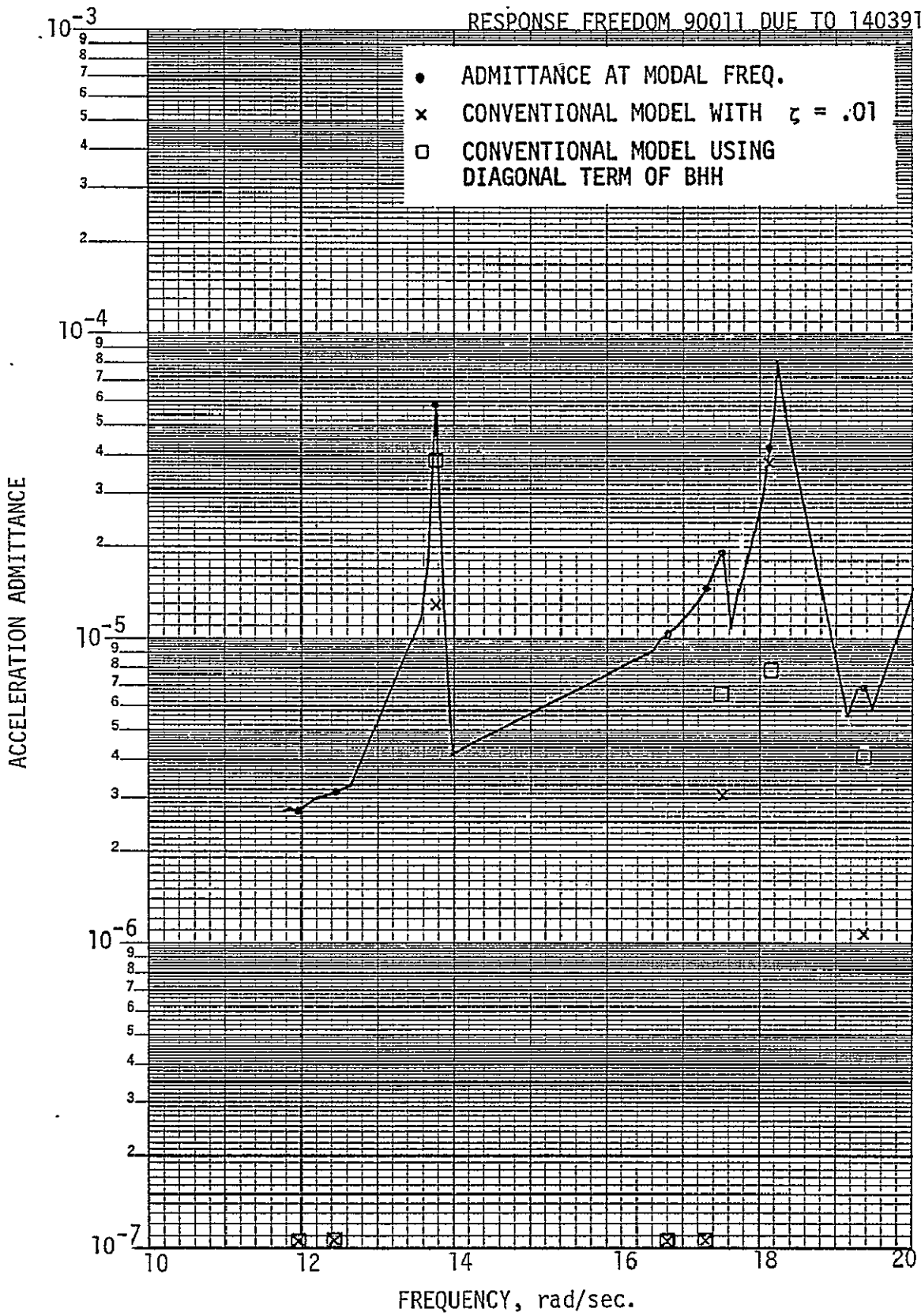

FIGURE 6-3: COMPARISON OF CONVENTIONAL AND REALISTIC MODELS, ACCELERATION RESPONSE (continued)

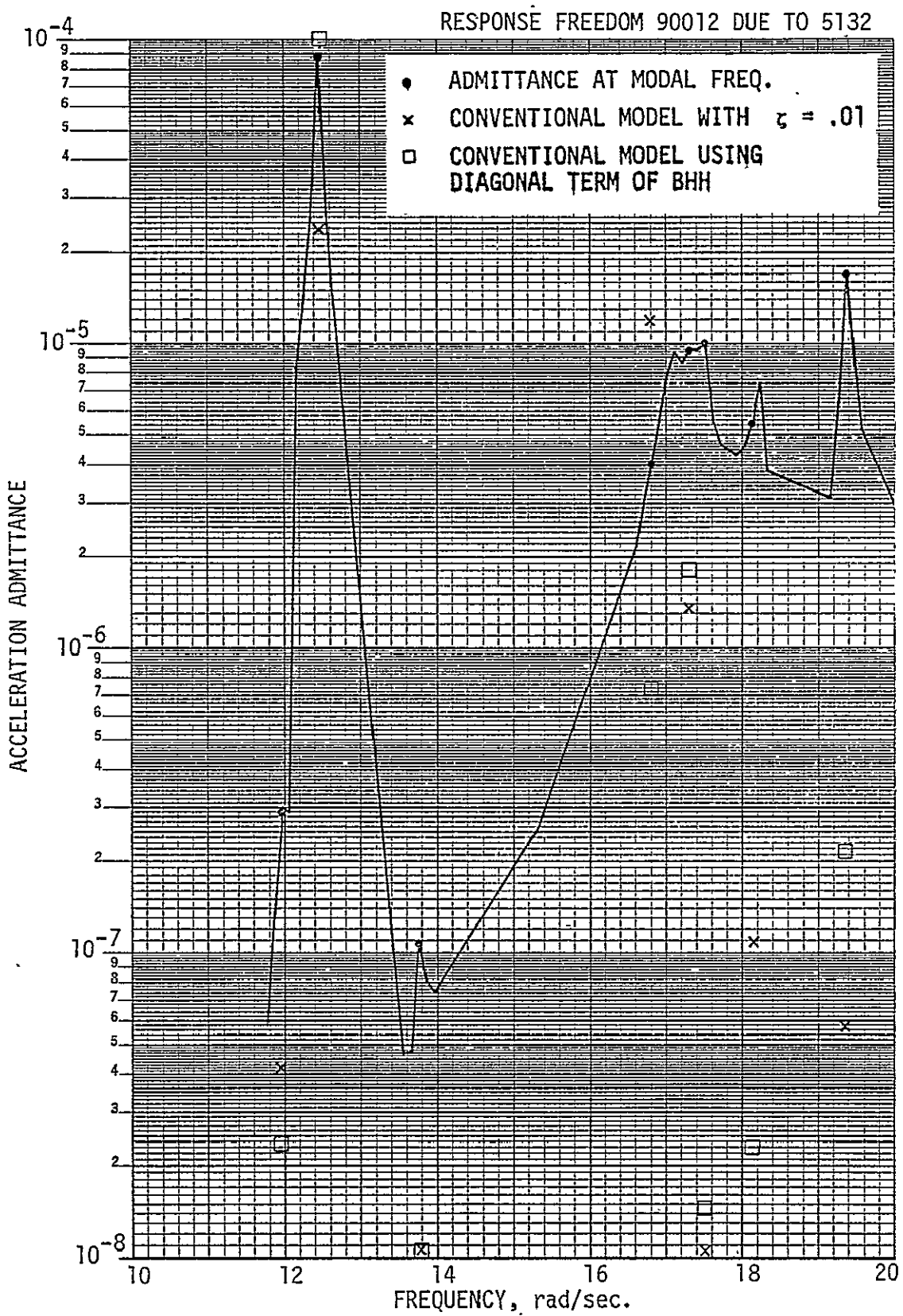

FIGURE 6-3: COMPARISON OF CONVENTIONAL AND REALISTIC MODELS, ACCELERATION RESPONSE (Continued)

RESPONSE FREEDOM 90013 DUE TO 5133.

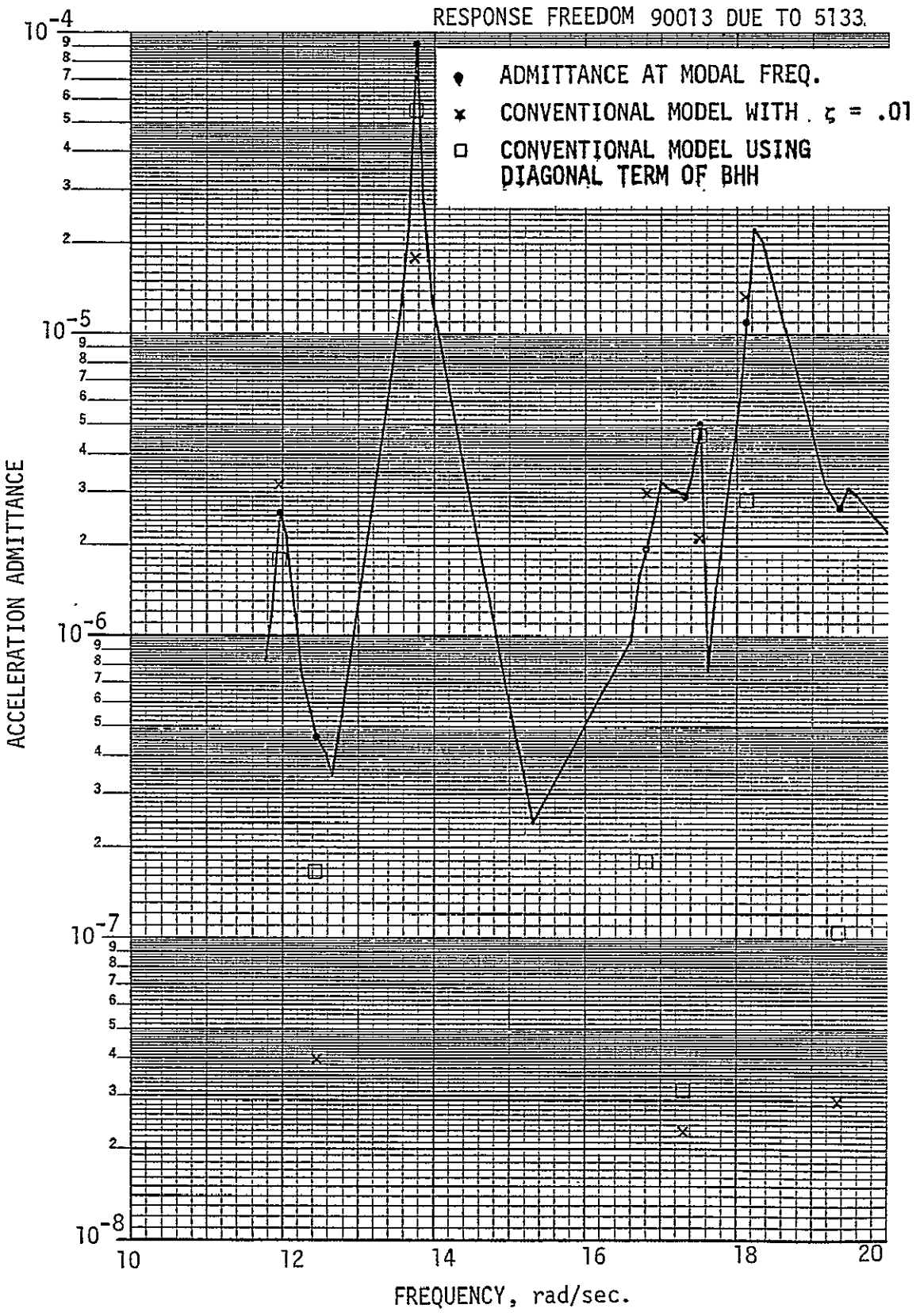

FIGURE 6-3: COMPARISON OF CONVENTIONAL AND REALISTIC MODELS, ACCELERATION RESPONSE (continued)

structural joints can have a significant effect on identifying the resonances which are critical for dynamic analyses.

6.2 CRITERIA FOR THE EXCITABILITY OF MODES

The admittance matrix for selected response/excitation pairs can be used to identify critical resonant frequencies for points of interest throughout the structure. The frequency of the admittance peak is used to identify the dominant mode associated with that peak. The peak admittance amplitude is used to calculate an equivalent modal viscous damping ratio for this dominant mode. For displacement admittances:

$$\zeta_k = \frac{|\phi_{I_k} \cdot \phi_{R_k}|}{|A_D^{(P)}| \cdot 2 \cdot \omega_k^2 \cdot m_k} \quad (42)$$

and for velocity admittance:

$$\zeta_k = \frac{|\phi_{I_k} \cdot \phi_{R_k}|}{|A_V^{(P)}| \cdot 2 \cdot \omega_k \cdot m_k} \quad (43)$$

where:

- ω_k = frequency of dominant mode
- m_k = generalized mass of dominant mode
- ϕ_{I_k} = k^{th} mode shape for input freedom
- ϕ_{R_k} = k^{th} mode shape for response freedom
- $|A_D^{(P)}|$ = peak displacement admittance
- $|A_V^{(P)}|$ = peak velocity admittance
- ζ_k = equivalent modal viscous damping ratio for dominant mode.

This method could be used as a criteria for the selection of a set of critical modes for dynamic analyses and to establish the equivalent viscous damping ratios to use with these modes.

7.0 COMPUTER TIME ESTIMATES

Estimates of the computer time required to perform various parts of the analysis are given in the following paragraphs. The computer time is given in computer resource units (CRU).

7.1 ORBITER

The incorporation of structural joints (23 BAR joints and 64 plate joints) into the Orbiter finite element model using the preprocessor requires approximately 250 CRU's. This includes the generation of the additional data necessary for the joint damping predictor (JDP) computer program. The calculation of 30 Orbiter free-free symmetric and antisymmetric modes with 125 retained degrees-of-freedom using NASTRAN is approximately 350 CRU's each.

The joint damping predictor computer program used to calculate Orbiter damping parameters for four damping sets required approximately 160 CRU's.

7.2 SPACE SHUTTLE

The computer time required by the preprocessor to incorporate 33 BAR joints and 77 plate joints in the Space Shuttle model and create the NASTRAN BULK DATA set is approximately 300 CRU's (computer resource units). The original NASTRAN calculation of 30 antisymmetric Space Shuttle modes with 292 retained degrees-of-freedom and the generation of a special user tape containing these modes is approximately 700 CRU's. Approximately 800 CRU's are required to calculate 30 symmetric modes (using NASTRAN's restart capability) merge these modes with the antisymmetric modes and calculate the coupled nodal damping matrix (BHH).

The calculation of modes and the coupled damping matrix for additional mass conditions required less computer time since the NASTRAN restart capability was used and, therefore, the stiffness matrix and elemental damping matrix did not need to be recalculated. Using the restart tape from the original NASTRAN antisymmetric modes run, approximately 300 CRU's are required for the calculation of antisymmetric modes for a new mass condition and approximately

600 CRU's are required to calculate symmetric modes and the merged modal damping matrix (BHH).

Postprocessor computer costs depend upon the option used. For the conventional model, Option 1 requires approximately 30 CRU's to calculate structural gains for 50 modes and 180 response/excitation pairs for each mass condition. Using Option 6 to calculate structural admittances for the realistic model, the computer time is primarily a function of the number of frequencies (β) for which admittances are desired. The number of response/excitation pairs has a much smaller effect on computer time. The computer cost for Options 4, 5 and 6 are given by the following expression:

$$\text{CRU} = 10 + \text{NBETA}$$

where NBETA is the number of admittance frequencies (β).

8.0 CONCLUSION AND RECOMMENDATIONS

8.1 CONCLUSIONS

Significant differences were found in the dynamic responses at various points on the Space Shuttle structure between the conventional model and the realistic model (Figures 6-1 through 6-3). Equivalent modal viscous damping was used in the conventional model, and the critical modes were determined using the uncoupled modal response to calculate physical transmissibilities between the excitation and response freedoms. The realistic model incorporated local damping effects due to structural joints, and admittances were calculated using the resulting coupled modal damping matrix.

Results of this analysis show that coupling of modes through local joint damping is important and can significantly affect the identification of critical resonances for dynamic response studies. For modes whose frequencies are close together and which are coupled, the frequency at which the maximum admittance occurs will be different from the modal frequencies. Therefore, frequencies between modal frequencies should also be used to locate the admittance peaks for each response/excitation pair. For example, in Figure 6-2 (SRM rate gyro, 9015/140391), the two modes at 16.8 and 17.3 rad/sec are coupled to produce an admittance peak at 17.0 rad/sec which is more significant than either mode using the conventional model.

The equivalent modal viscous damping ratios calculated for the SRB cutoff condition using the same joint damping parameters used for the liftoff condition are higher than expected for the primary modes. Therefore it is necessary to recalculate the joint damping parameters for each flight condition to achieve realistic vehicle damping.

8.2 RECOMMENDATIONS

It is recommended that distributed damping resulting from structural joints be included in dynamic analyses of complex structures to preclude the omission of critical resonances which could significantly affect the analytical results.

It is also recommended that further studies be conducted to verify the

conclusions found in this study by comparing analytical results with test data. Studies should also be conducted to determine the practical limits for the methods described herein, i.e., how many structural joints are required to obtain a sufficiently accurate representation of modal damping over a given frequency range?

Additional studies are required to investigate the cause of the higher than expected equivalent modal damping for the SRB cutoff mass condition. The investigation should determine the effect of total mass on the joint damping parameters. This study may involve the previously mentioned study to determine the number of structural joints required to give a realistic damping representation over a range of frequencies (or masses).

APPENDIX I PREPROCESSOR COMPUTER PROGRAM

Introduction

This program, written in FORTRAN IV, was developed to incorporate structural joint damping models at selected points in a NASTRAN finite-element model. The user specifies the location and properties of the desired structural joint. The locations for joints are limited to the ends of BAR and ROD elements and edges of QUAD1, QUAD2, QDMEM, and SHEAR plates. Gridpoints at the joints must be located either in the basic rectangular coordinate system or in an arbitrary cylindrical or rectangular coordinate system referenced to the basic system. Displacements of the joints must be defined in the basic rectangular coordinate system. The preprocessor reads the NASTRAN BULK DATA deck for the original model and outputs a revised data deck containing additional BULK DATA card images necessary for the inclusion of the specified Voigt damping models. The revised BULK DATA is used by NASTRAN to calculate modal characteristics of the structural model and the coupled generalized modal damping matrix using rigid format 3.

The number of structural joints which can be implemented is limited to 1000 BAR joints, ROD joints and 200 plate joints. A maximum of 1000 cards for each of the various types of NASTRAN data (GRID, CBAR, PBAR, C plate, P plate, etc.) may be stored by the preprocessor for joint implementation. If the original model has more than 1000 of any of these data cards, the additional cards will be passed through the preprocessor without modification. Gridpoint, element, property, and material identification numbers from 7000 through 9000 are used by the preprocessor for the gridpoints and elements of the joint models and cannot be used in the original structural model.

Input Description

The input data required by the preprocessor consists of a NASTRAN BULK DATA card set describing a structural model and punched cards which describe the locations and properties of the structural joints to be incorporated into

the model. The DMAP ALTER statements which must be included in the NASTRAN EXECUTIVE CONTROL deck depend upon the purpose for which the results are desired. A complete list of ALTER statements is shown in Table I-1.

Structural joint damping models for BAR, ROD and plate elements are shown schematically in Figure I-1. The location of a structural joint is specified by giving the element identification and gridpoint identification numbers for the desired joint location. The locations of the added gridpoints are specified in terms of the locations of the gridpoints at the ends of the structural elements:

for BAR and ROD elements

$$|G(c) - G(a)| = KG \quad |G(b) - G(a)| = KG \cdot \overline{ab}$$

for plate elements

$$|G(c) - G(a)| = KG \quad |G(d) - G(b)| = KG \cdot \overline{ab}$$

where $G(a)$, $G(b)$, $G(c)$ and $G(d)$ are the locations of gridpoints a , b , c , and d , respectively, KG is a factor specified either by the user or by default, and \overline{ab} is the length between gridpoints a and b . The formation sequence of the added gridpoints are reidentified using the SEQGP feature of NASTRAN to improve matrix bandwidth.

Section properties of the revised elements, are specified by multiplying the original element section properties by appropriate factors specified either by the user or by default.

for BAR and ROD elements,

$$A(k) = KA \cdot A(j)$$

$$J(k) = KJ \cdot J(j)$$

$$I1(k) = KI1 \cdot I1(j) \quad - \text{BAR joints only}$$

$$I2(k) = KI2 \cdot I2(j) \quad - \text{BAR joints only}$$

TABLE I-1: NASTRAN DMAP ALTER Statements for the Preprocessor Computer Program

For calculating the damping set data as input to the joint damping predictor:

```

ALTER 26,26
SMA1---CSTM,MPT,ECPT,GPCT,DIT/KGGX,K4GG,GPST/V,N,NOGENL/V,N,NOK4GG-5
ALTER 28,29
SMA2 CSTM,MPT,ECPT,GPCT,DIT/MGG,BXX/V,Y,WTHASS#1.C/V,N,NOMGG/V,N,NOBGG/
-----V,Y,CDUPMASS/V,Y,CPEAR/V,Y,CPROD/V,Y,CPQUAD1/V,Y,CPQUAD2/V,
Y,CPTRIA1/V,Y,CPTRIA2/V,Y,CPUBE/V,Y,CPQDPLT/V,Y,CPTRPLT/V,
Y,CPTRBSC $
SAVE--NOMGG,NOBGG-5
ADD K4GG,BXX/BGG $
MTRXIN, ,MATPOOL,EQEXIN,SIL,/PV00,PV01,PV02/V,N,LUSET/V,N,NOPV00/V,
-----N,NOPV01/V,N,NOPV02-5
PARTN BGG,PV00, /,,,BGG00/C,N,-1 $
CHKPNT PV00,BGG00 $
PARTN --BGG,PV01, /,,,BGG01/C,N,-1-5
CHKPNT PV01,BGG01 $
PARTN BGG,PV02, /,,,BGG02/C,N,-1 $
CHKPNT PV02,BGG02-5
MTRXIN, ,MATPOOL,EQEXIN,SIL,/PV03,PV04,PV05/V,N,LUSET/V,N,NOPV03/V,
N,NOPV04/V,N,NOPV05 $
PARTN ---BGG,PV03, /,,,BGG03/C,N,-1-5
CHKPNT PV03,BGG03 $
PARTN BGG,PV04, /,,,BGG04/C,N,-1 $
CHKPNT --PV04,BGG04-5
PARTN BGG,PV05, /,,,BGG05/C,N,-1 $
CHKPNT PV05,BGG05 $
ALTER-74
MATGPR GPL,USET,SIL,MAA//C,N,AS
MATGPR GPL,USET,SIL,BGG//C,N,GS
ALTER -96
OUTPUT1 PHIG,,,,/C,N,-1/C,N,0 1
ENDALTER

```

TABLE I-1: NASTRAN DMAP ALTER Statements for the Preprocessor Computer Program (Cont'd.)

For calculating symmetric or antisymmetric modes and writing on a user tape:

```
ALTER 74
MATGPR GPL, USET, SIL, MAA//C,N,A$
ALTER -96
OUTPUT1 PHIG, , , , //C,N, -1/C,N, 0 $
ENDALTER
```

For calculating symmetric modes, merging previously calculated antisymmetric modes and calculating coupled modal damping matrix:

```
ALTER 26,26
SMA1 CSTM, MPT, ECPT, GPCT, DIT/KGGX, K4GG, GPST/V,N, NCGENL/V,N, NUK4GG $
ALTER 28,29
SMA2 CSTM, MPT, ECPT, GPCT, DIT/MGG, BXX/V, Y, WTMASS=1.0/V, N, NOMGG/V, N, NOBGG/
V, Y, COUPMASS/V, Y, CPBAR/V, Y, CPRD/V, Y, CPQUAD1/V, Y, CPQUAD2/V, Y,
CPTRIA1/V, Y, CPTRIA2/V, Y, CPTUBE/V, Y, CPQDPLT/V, Y, CPTRPLT/V,
Y, CPTRBSC $
SAVE NCMGG, NOBGG $
ADD K4GG, BXX/BGG $
CHKPNT BGG $
ALTER 74
MATGPR GPL, USET, SIL, MAA//C,N,A$
MATGPR GPL, USET, SIL, BGG//C,N,G$
ALTER 95,96
SDR1 USLT, , PHIA, , , , GO, GM, , KFS, , /PHIGX, , QG/C,N, 1/C,N, REIG $
CHKPNT QG $
INPUT1 /PHIGY, , , , /C,N, -1/C,N, 0 $
MERGE PHIGX, , PHIGY, , CP, /PHIG/C,N, 1 $
CHKPNT PHIG $
MPYAD PHIG, BGG, /XX/C,N, 1/C,N, 1/C,N, 0 $
MPYAD XX, PHIG, /BHH/C,N, 0/C,N, 1/C,N, 0 $
CHKPNT BHH $
MATPRN BHH, , , , // $
ENDALTER
```

REPRODUCIBILITY OF THE ORIGINAL PAGE IS POOR

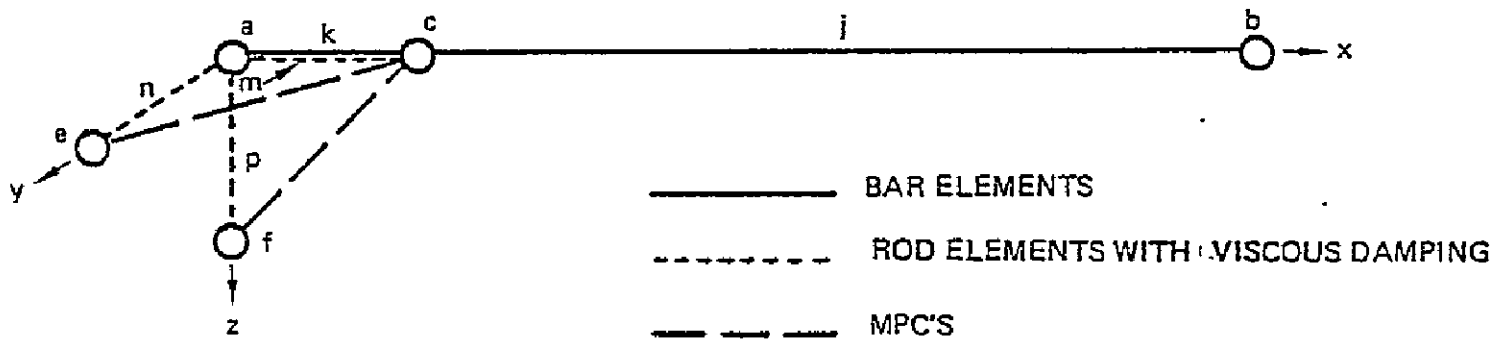

A) BAR JOINT SCHEMATIC

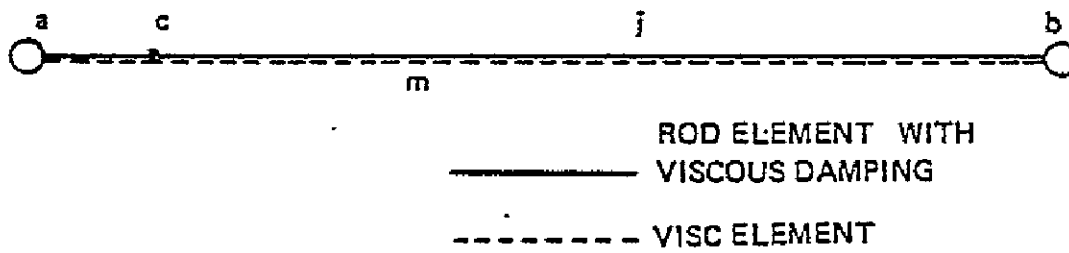

B) ROD JOINT SCHEMATIC

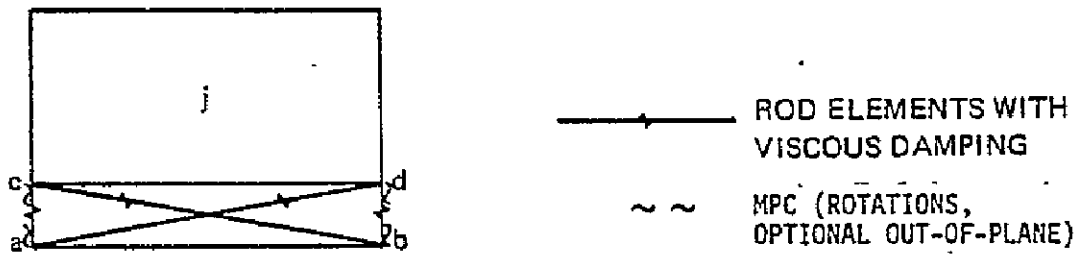

C) PLATE JOINT SCHEMATIC

Figure I-1. NASTRAN Joint Damping Model Schematics

where $A(j)$, $J(j)$, $I1(j)$ and $I2(j)$ are the cross sectional area, torsional constant, and area moments of inertia of the original BAR or ROD element (j).

Similarly for plate elements,

$$A(ac) = A(bd) = KA \cdot \frac{(\overline{ab} \cdot t_j)}{2}$$

$$A(ad) = A(bc) = KS \cdot \frac{(\overline{ab} \cdot t_j)}{2} \frac{(G_j)}{E_j}$$

where t_j , G_j , and E_j are the membrane thickness, shear modulus, and elastic modulus of the original plate element (j).

Damping values for the BAR elements are input by specifying the C1 (axial) and C2 (torsional) damping constants for each ROD element denoted by m, n, and p in Figure I-1 input as if the RODS were VISC elements. Damping values for ROD joints are input as the damping constant of a VISC element between gridpoints a and c. Damping values for the plate elements are as if they were C1 damping constants for VISC elements. The following conversions are performed to calculate the structural damping coefficient (GE) required for the MAT1 card for all damping except axial damping with SHEAR plates:

for axial ROD elements

$$GEA = \frac{C1A \cdot \overline{ac}}{A(ac) \cdot E}$$

for diagonal ROD elements

$$GED = \frac{C1D \cdot \overline{ad}}{A(ad) \cdot E}$$

where \overline{ac} and \overline{ad} are the lengths between gridpoints a and c and between a and d, respectively. These structural damping coefficients are automatically converted to viscous damping coefficients since the preprocessor sets $W4 = 1.0$ on a PARAM card (Reference 15, page I.6-3).

Detailed preprocessor input descriptions and examples for BAR, ROD and plate element joint damping models are shown in the following pages. The card format is the NASTRAN single-field format. The "\$BAR", "\$ROD" and "\$PLATE" must begin in column one, but the rest of the input may be located anywhere within the 8 column fields. The element I.D. and gridpoint I.D. are integers and the rest are decimal input. The preprocessor data cards may be placed anywhere in the NASTRAN BULK DATA deck.

PREPROCESSOR DATA DECK

Input Data Card \$BAR Joint Damping Element (BAR)

Description: Defines a Voigt damping model to be included at the end of a BAR element.

Format and Example:

1	2	3	4	5	6	7	8	9	10
\$BAR	IDBR	IDGB	C1m	C1n	C1p	C2m	C2n	C2p	abc
\$BAR	801	185	8090.	8090.	8090.	512906.	512906.	512906.	+D801

+bc	KG	KA	KJ	KI1	KI2	MPC ID	ØMTB	DSNØ	
+D801	.08		.75					1	

Field

Contents

- IDBR Identification number of the BAR element to which a joint is being added
- IDGB Gridpoint identification number which defines the location of the joint
- C1m,C1n,C1p Translational damping constants for the joint in the local element x, y and z directions, respectively
- C2m,C2n,C2p Rotational damping constants for the joint in the local element RX, RY and RZ directions, respectively
- KG Joint length factor (default = .1)
- KA Joint area factor (default = 1.0)

<u>Field</u>	<u>Contents</u>
KJ	Joint torsional constant factor (default = 1.0)
KI1,KI2	Joint area moment of inertia factors (default = 1.0)
MPC ID	Set I.D. into which generated MPC's will be placed (default = 1)
ØMTB	Indicator used to include generated joint freedoms in the ØMIT set: ØMIT - include joint freedoms in ØMIT set blank- do not include joint freedoms in ØMIT set
DSNØ	Damping set number
Remarks:	<ol style="list-style-type: none"> 1. Every input on the first card is required; no default values exist. 2. The second card is optional; default values are provided for blank fields. 3. Joint factors (KG,KA,KJ,KI1,KI2) are used to define joint properties: length of joint = KG x length of original element area of joint = KA x area of original element, etc. 4. Freedoms generated for the joint should not be included in the analysis set. If an ØMIT set is used for other freedoms in the NASTRAN model, input "ØMIT" in field 8 of card 2. If an analysis set (ASET) is used elsewhere in the model, leave this field blank. 5. Identification numbers for the gridpoints, element connections, properties, and materials generated by the preprocessor are in the range 7000-9000. These I.D. numbers may therefore not be used in the original NASTRAN structural model.

6. Multipoint constraint sets must be selected in the CASE CONTROL deck (MPC = MPC ID) to be used by NASTRAN.
7. DSNØ specifies the damping set into which the joint damping parameters are placed for use in the joint damping predictor computer program.

DSNØ = 0 if damping values are known.
DSNØ = 1,2 --- if damping parameters are unknown
8. DSNØ must be input. No default value is provided.
9. All damping elements in a BAR joint are in the same damping set.

Input Data Card \$RØD Joint Damping Element (ROD)

Description: Defines a Voigt damping model to be included at the end of a RØD element.

Format and Example:

1	2	3	4	5	6	7	8	9	10
\$RØD	IDR	IDGR	C1	C2	KG	KA	KJ	ØMIT	abcd
\$RØD	4	3	26.1	92.7	.2		.4	ØMIT	+R04
+bcd	DSNØ								
+R04	0								

Field

Contents

- IDR Identification number of the ROD element to which a joint is being added
- IDGR Gridpoint identification number which defines the location of the joint
- C1,C2 Axial and torsional damping constants for the ROD joint
- KG Joint length factor (default = .1)
- KA Joint area factor (default = 1.0)
- KJ Joint torsional constant factor (default = 1.0)
- ØMIT Indicator used to include joint freedoms in the ØMIT set:
 ØMIT - include joint freedoms in ØMIT set
 blank - do not include joint freedoms in ØMIT set
- DSNØ Damping set number

Remarks:

1. Joint factors (KG, KA, KJ)-are used to define joint properties:
length of joint = KG x length of original element
area of joint = KA x area of original element, etc.
2. Freedoms generated for the joint should not be included in the analysis set. If an OMIT set is used for other freedoms in the model input "OMIT" in field 9. If an ASET is used elsewhere in the model, leave this field blank.
3. Identification numbers for the grid point, ROD element, ROD properties, and VISC element generated by the pre-processor are in the range 7000-7999. These I.D. numbers may not be used in the original NASTRAN structural model.
4. DSNØ specifies the damping set into which the joint damping parameters are placed for use in the joint damping predictor computer program.
DSNØ = 0 if damping values are known
DSNØ = 1,2 ... if damping parameters are unknown.
5. DSNØ must be input. No default value is provided.
6. Both the VISC element, if used, and the damping in the rod element are in the same damping set.

Input Data Card: \$PLATE Joint Damping Element (QUAD1, QUAD2, QDMEM, and SHEAR)

Description: Defines a Voigt damping model to be included along an edge of a quadrilateral plate element.

Format and Example:

1	2	3	4	5	6	7	8	9	10
\$PLATE	IDPJ	IDGE	IDGB	C1A	C1D	KG	KA	KS	abc
\$PLATE	805	186	188	2582.	3591.		.75	.9	+805

+bc	MPC ID	OMTB	MPCN1	MPCN2	DSNØD	DSNØA			
+805	2				0	1			

FIELD

CONTENTS

- IDPJ Identification number of the quadrilateral plate element to which a joint is being added
- IDGA, IDGB Gridpoint identification numbers which define the location of the joint
- C1A Translational damping constant for the joint in the axial directions defined by gridpoints ac and bd of Figure I-1.
- C1D Translational damping constant for the joint in the diagonal directions defined by gridpoints ad and bc of Figure I-1.
- KG Joint length factor (default = .05)
- KA Joint axial area factor (default = 1.0)

FIELDCONTENTS

- KS Joint shear area factor (default = 1.0)
- MPC ID Set I.D. into which generated rotational MPC's will be placed; a blank indicates no rotational MPC equations are to be generated.
- ØMTB Indicator used to include generated joint freedoms in the ØMIT set:
ØMIT - include joint freedoms in ØMIT set
blank - do not include joint freedoms in ØMIT set
- MPCN1, MPCN2 Gridpoints to which added plate grids (N1 & N2) are to be MPC'd to provide out-of-plane stiffness. The MPC set I.D. is the same as MPCID; if MPCID is blank, MPC set default is 1.
- DSNØD, DSNØA damping set number into which the diagonal and axial damping elements are placed.
- Remarks:
1. Joint factors (KG, KA, KS) are used to define joint properties:
width of joint = $KG \times \text{length of joint}$
axial area of joint = $KA \times \text{axial area of original element}$
shear area of joint = $KS \times \text{shear area of original element}$.
 2. Translational damping constants (C1A and C1D) are input as if the axial and diagonal elements are VISC elements.

3. Out-of-plane translation and rotational MPC equations are optional for QUAD1 and QUAD2 plate elements but are required for QDMEM and SHEAR plate elements unless BAR elements are used as edge members. Multipoint constraint sets must be selected in the CASE CONTROL deck (MPC = MPC ID) to be used by NASTRAN.
4. Freedoms generated for the joint should not be included in the analysis set. If an OMIT set is used for other freedoms in the NASTRAN model, input "OMIT" in field 3 of card 2. If an analysis set (ASET) is used elsewhere in the model, leave this field blank.
5. Identification numbers for the gridpoints, element connections, properties, materials generated by the preprocessor are in the range 7000-9000. These I.D. numbers may therefore not be used in the original NASTRAN structural model.
6. DSNØ specifies the damping set into which the joint damping parameters are placed for use in the joint damping predictor computer program.

DSNØ = 0 if damping values are known
DSNØ = 1,2 ... if damping parameters are unknown.
7. DSNØD and DSNØA must be input. No default values are provided.
8. Damping in the diagonal rods are always in the same damping set.
9. Damping in the axial rods are always in the same damping set.

REPRODUCIBILITY OF THE
ORIGINAL PAGE IS POOR

Preprocessor Listing

```
//STP2 EXEC FORTHCLG,PARM.FORT='MAP, ID',
// REGION.FORT=200K,PARM.LKED='XREF,LIST,OVLY',
// REGION.GO=260K,TIME.GO=2
//FORT.SYSIN DD *
C
C ** NASTRAN PRE PROCESSOR PROGRAM FOR CREATING FLEXIBLE JOINTS
C
C
REAL*8 CD, BULK, HDR(17)
INTEGER*2 OMIT
INTEGER*2 OMTB
INTEGER OMP
COMMON/ IMAGE / CD(10)
COMMON/ BROD / IDR(20), IDGR(20), RPARAM(20,5), OMIT(20), NROO
COMMON/ BGRID / IGD(1000), IPCG(1000), GCD(1000,3), NGD, DUMM
X ,IXCD(1000),IXPS(1000)
REAL*8 IXCD, IXPS
COMMON/ BCROD / IDRD(1000,4), NCRD
COMMON/ BPROD / IDPRD(1000), IDMP(1000), JPRDP(1000,4), NRPD
COMMON/ BNEW / NGRD, IDEX, IPEX, IEDCM, IDCX, IMEX
COMMON/ BCOMM / XC(3,5), I1, I2, INCP
COMMON/ BDEFLT / AKGPD, AKGSD, AKMO, AKAPD, AKASD, BKMD, BKGPD,
1 BKGSD, BKAPD, BKASD, BKJPD, BKJSD, BKIIPD, BKIISD, BKIIPD, BKIISD, BKIIPD, BKIISD
COMMON/ BSQGP / NWGRD(40), SEGTX(40), NSQGP
COMMON/ BIMG / NIMG(20,40), IMG
COMMON/ BCBAR / IDB(1000), IPB(1000), IBA(1000), IBB(1000),
1 IBREC(1000), NBAR, NBREC
COMMON/ BBAR / IDBR(50), IDGB(50), BPARAM(50,12), OMTB(50), NBR
COMMON/ BPBAR / IDPB(1000), IPREC(1000), NPBAR, NPREC
COMMON/BPLATE/ IDP(200),IDGPLT(200,2),PLTPRM(200,5),MPCID(200),
X OMP(200),NPLT
X ,MPCPA(200),MPCPB(200)
COMMON/BCPLT/ IDCP(1000),IPID(1000),NG(1000,4),TH(1000),INC(1000),
X NCPLT
COMMON/BPPLT/ IDPP(1000),INP(1000),THICK(1000),IMID(1000),NPPLT
COMMON/BMAT1/ IDMAT(100),E(100),G(100),NMAT1
COMMON/BCORD/ IDCOR(20),IF1OR2(20),XPP(20,9),NCRD
DATA HDR / 8HSROD , 8HSBAR , 8HCROD , 8HPROD ,
1 SHGRID , 8HCBAR , 8HPBAR , 8HPROD* , 8HGRID* ,
2 8HCBAR* , 8HPBAR* , 8HPROD* , 8HGRID* , 8HCBAR* ,
3 8HPBAR* , 8HENDDATA , 8H ENDDATA /
REAL*8 HDR2(20)
DATA HDR2/ 8HSPLATE ,8HCQUAD1 ,8HCQUAD2 ,8HCQDMEM ,6HCSHEAR,
X 8HPQUAD1 ,8HPQUAD1* ,8HPQUAD1* ,
X 8HPQUAD2 ,8HPQUAD2* ,8HPQUAD2* ,
X 8HPQDMEM ,8HPQDMEM* ,8HPQDMEM* ,
X 8HPSHEAR ,8HPSHEAR* ,8HPSHEAR* ,
X 8HMAT1 ,8HMAT1* ,8HMAT1* /
REAL*8 HDR3(4)
DATA HDR3/ 8HCORD1C , 8HCORD2C , 8HCORD1R , 8HCORD2R /
C
10 CONTINUE
C
C ** READ NASTRAN DECK CARD IMAGES
C
```

```

    READ(5,7000,END=200) CD
15  CONTINUE
    GO TO 30
20  CONTINUE
C
C ** WRITE CARD IMAGE ON DISK DATA SET FOR INPUT TO NASTRAN
C
    WRITE(9,7000) CD
    GO TO 10
30  CONTINUE
C
C ** TEST CARD IMAGE FOR DESIRED BULK DATA SUBSET
C
    DO 50 I = 1, 17
    IF(CD(I) .EQ. HDR(I)) GO TO 60
50  CONTINUE
    DO 56 K=1,20
    IF(CD(I) .NE. HDR2(K)) GO TO 56
    I=K
    GO TO 145
56  CONTINUE
    DO 58 I=1,4
    IF(CD(I) .NE. HDR3(I)) GO TO 58
C
C   COORD SYS
C
    WRITE(9,7000) CD
    CALL RADJ(3,IDX)
    CALL CORSYS(I)
    GO TO 10
58  CONTINUE
C
C ** NOT ONE OF DESIRED SUBSET
C
    GO TO 20
60  CONTINUE
    IF(I .GE. 16) GO TO 10
    IF(I .GE. 12) I = I - 4
    WRITE(9,7000) CD
    CALL RADJ(I, IDX)
    GO TO (130, 140, 90, 100, 80, 110, 120, 100, 80, 110, 120), I
80  CONTINUE
C ** GRID CARD
    CALL GRID(IDX, I)
    GO TO 10
90  CONTINUE
C ** CROD CARD
    CALL CROD
    GO TO 10
100 CONTINUE
C ** PROD CARD
    CALL PROD(I, IDX)
    GO TO 10
110 CONTINUE
C ** CBAR CARD

```

```

      CALL CBAR(I, IDX, &15, &200)
      GO TO 10
120  CONTINUE
C **  PBAR CARD
      CALL PBAR(I, IDX, &15, &200)
      GO TO 10
130  CONTINUE
C **  $ROD CARD
      CALL ROD
      GO TO 10
C **  $BAR CARD
140  CONTINUE
      CALL BAR(I, IDX, &15)
      GO TO 10
145  CONTINUE
C
C **  PROCESS CARDS PERTAINING TO PLATE JOINTS
C
      IF(I.LE.5) GO TO 148
C
C   THESE BULK DATA CARDS WILL NOT BE MODIFIED AND CAN
C   THEREFORE BE WRITTEN TO THE NASTRAN FILE NOW
C
      WRITE(9,7000) CD
148  CONTINUE
      K=10
      IF(I.LE.6) K=3
      IF(I.EQ.9 .OR. I.EQ.12 .OR. I.EQ.15 .OR. I.EQ.18) K=3
      IF(I.EQ.1) K=1
      WRITE(0,7000) CD
      CALL RADJ(K,IDX)
      IF(I.NE.1) GO TO 150
C **  $PLATE CARD
      CALL PLATE(&15)
      GO TO 10
150  CONTINUE
      IF(I.GT.5) GO TO 155
C **  CQUAD1,CQUAD2,CQDMEM, OR CSHEAR CARD
      CALL CPLATE(I)
      GO TO 10
155  CONTINUE
      IF(I.GT.17) GO TO 160
C **  PQAD1,PQUAD2,PQDMEM, OR PSHEAR CARD
      CALL PPLATE(I)
      GO TO 10
160  CONTINUE
C **  MAT1 CARD
      CALL MAT1(I)
      GO TO 10
200  CONTINUE
C
C   PRINT JOINT INPUT DATA
C
      WRITE(6,7010) NROD, NBR, NPLT
      IF(NRCD.LE.0) GO TO 212

```

REPRODUCIBILITY OF THE
ORIGINAL PAGE IS POOR

```
WRITE(6,7100)
DO 210 I=1,NRCD
WRITE(6,7110) I, IDR(I), IDGR(I), (RPARM(I,J),J=1,5), OMIT(I)
210 CONTINUE
212 CONTINUE
IF( NBR.LE.0) GO TO 222
WRITE(6,7120)
DO 220 I = 1, NBR
WRITE(6,7130) I, IDBR(I), IDGB(I), (BPARM(I,J), J=1,12), OMTB(I)
220 CONTINUE
222 CONTINUE
IF(NPLT.LE.0) GO TO 232
WRITE(6,7140)
DO 230 I=1,NPLT
WRITE(6,7150) I, IDP(I), IDGPLT(I,1), IDGPLT(I,2),
X (PLTPRM(I,J),J=1,5), MPCID(I), OMP(I), MPCPA(I), MPCPB(I)
230 CONTINUE
232 CONTINUE
C
C CONVERT GRID COORDS FROM CYL COORD SYS
C
C CALL GCONV
C
C ** CREATE NEW BULK DATA FOR PLATE JOINTS
C
C CALL PJ
C
C ** CREATE NEW BULK DATA CARDS FOR ROD JOINTS
C
C CALL RODJT
C
C ** CREATE NEW BULK DATA CARDS FOR BAR JOINTS
C
C CALL BARJT
C
C ** CLEAN UP
C
C ** WRITE CBAR IMAGES ON DISK
C
REWIND 3
IRC = 0
300 CONTINUE
READ(3,7000,END=350) CD
IF(CD(1) .EQ. HDR(6)) GO TO 310
IF(CD(1) .EQ. HDR(10)) GO TO 305
IF(CD(1) .NE. HDR(14)) GO TO 320
305 CONTINUE
C ** DOUBLE FIELD IMAGE
IRC = IRC + 1
WRITE(0,7001) (CD(L),L=1,3), IPB(IRC), IBA(IRC), IBB(IRC), CD(10)
READ(0,7000) CD
GO TO 320
310 CONTINUE
C ** SINGLE FIELD IMAGE
```

```

IRC = IRC + 1
WRITE(0,7002) (CD(L),L=1,2), IPB(IRC), IBA(IRC), IBB(IRC),
X (CD(L),L=6,10)
READ(0,7000) CD
320 CONTINUE
C ** WRITE CARD IMAGE ON DISK
WRITE(9,7000) CD
GO TO 300
350 CONTINUE
C
C ** WRITE CRCD IMAGES ON DISK
C
IF(NCRD .LE. 0) GO TO 450
DO 400 I = 1, NCRD
WRITE(0,7004) HDR(3), (IDRD(I,L),L=1,4)
IMG = 0
CALL STORE( 10 )
WRITE(9,7003) (NIMG(L,1),L=1,20)
400 CONTINUE
450 CONTINUE
C
C ** WRITE C(PLATE) IMAGES TO DISK
C
IF(NCPLT.LE.0) GO TO 480
DO 470 I=1,NCPLT
NE=INC(I)
IF(NE.EQ.5) GO TO 460
WRITE(9,7005) HDR2(NE),IDCP(I),IPID(I),(NG(I,J),J=1,4),
X TH(I)
GO TO 470
460 WRITE(9,7005) HDR2( 5),IDCP(I),IPID(I),(NG(I,J),J=1,4)
470 CONTINUE
480 CONTINUE
C
C ** PUT ENDDATA IMAGE AT END OF DATA SET ON DISK
C
IMG = 0
WRITE(0,7000) HDR( 16 )
CALL STORE( 2 )
WRITE(9,7003) (NIMG(L,1),L=1,20)
STOP
C
7000 FORMAT(10A8)
7001 FORMAT(3A8,3I16,A8)
7002 FORMAT(2A8,3I8,5A8)
7003 FORMAT(20A4)
7004 FORMAT(A8, 4I8)
7005 FORMAT( A8,6I8,F8.3 )
7010 FORMAT(1H1/1H0, 65(2H* ) /1H0,46X,38HNO. ROD ELEMENT JOINTS TO BE
IMCDIFIED ,14/47X,38HNO. BAR ELEMENT JOINTS TO BE MODIFIED ,14 /
X 47X,40HNO. PLATE ELEMENT JOINTS TO BE MODIFIED ,12 /
2 1H0,65(2H* ) )
7100 FORMAT(1HC,54X,22H*** ROD JOINTS *** /)
7110 FORMAT(20X,I2,2I10, 5E13.5, I5)
7120 FORMAT(1H0/55X,22H*** BAR JOINTS *** /)

```

```

7130 FORMAT(20X,12, 2110, 5E13.5 /24X, E13.5, 5F13.3, A8, 15)
7140 FORMAT(1H0/55X,22H*** PLATE JOINTS *** / )
7150 FORMAT(13X,12,3I7, 5F13.3, 4I7 )
END
BLOCK DATA

```

C

```

INTEGER*2 OMIT
INTEGER*2 OMITB
COMMON/ BRD / IDR(20), IDGR(20), RPARM(20,5), OMIT(20), NROD
COMMON/ BGRID / IGD(1000), IPCG(1000), GCD(1000,3), NGD, DUMM
X ,IXCD(1000),IXPS(1000)
REAL*8 IXCD, IXPS
COMMON/ BCROD / IDRD(1000,4), NCRD
COMMON/ BPROD / IDPRD(1000), IDMP(1000), JPRDP(1000,4), NRPD
COMMON/ BNEW / NGRD, IDEX, IPEX, IEDCM, IDCY, IMEX
COMMON/ BCOMM / XC(3,5), I1, I2, INCP
COMMON/ BDEFLT / AKGPD, AKGSD, AKMD, AKAPD, AKJPD, BKMD, BKGPD,
1 BKGSD, BKAPD, BKASD, BKJPD, BKJSD, BKI1PD, BKI1SD, BKI2PD, BKI2SD
COMMON/ BSQGP / NWGRD(40), SEGMY(40), NSQGP
COMMON/ BIMG / NIMG(20,40), IMG
COMMON/ BCBAR / IDB(1000), IPB(1000), IBA(1000), IBB(1000),
1 IBREC(1000), NBAR, NBREC
COMMON/ BBAR / IDBR(50), IDGB(50), BPARM(50,12), OMTB(50), NBR
COMMON/ BPBAR / IDPB(1000), IPREC(1000), NPBAR, NPREC

```

C

```

DATA NROD, OMIT / 21*0 /
DATA NGD / 0 /
DATA NCRD / 0 /
DATA NRPD / 0 /
DATA NGRD, IDEX, IPEX, IEDCM, IDCY / 7000, 7300, 7500, 7600, 7700/
DATA IMEX/7000/
DATA AKGPD, AKJPD, AKMD, AKAPD / 0.1, 1.00, 0.1, 1.00 /
DATA BKGPD, BKAPD, BKJPD, BKJSD, BKI1PD, BKI2PD /
1 0.1, 1.00, 1.00, 1.00, 1.00, 1.00 /
DATA BKMD, BKGSD, BKASD, BKJSD, BKI1SD, BKI2SD /
1 0.1, 0.1, 0.1, 0.1, 0.1, 0.1 /
DATA NSQGP/ 0 /
DATA NBAR, NBREC / 0, 0 /
DATA NBR / 0 /
DATA OMTB / 50 * 0 /
DATA NPBAR, NPREC / 0, 0 /
DATA RPARM / 100*-1.0 /
DATA BPARM / 600*-1.0 /
COMMON/BMAT1/ IDMAT(100),E(100),G(100),NMAT1
COMMON/BCPLT/ IDCP(1000),IPID(1000),NG(1000,4),TH(1000),INC(1000),
X NCPLT
COMMON/BPLATE/ IDP(200),IDGPLT(200,2),PLTPRM(200,5),MPCID(200),
X OMP(200),NPLT
X ,MPCPA(200),MPCPB(200)
COMMON/BPPLT/ IDPP(1000),INP(1000),THICK(1000),IMID(1000),NPPLT
DATA NMAT1,NCPLT,NPLT,NPPLT / 0,0,0,0 /
COMMON/BCORD/ IDCOR(20),IFLOR2(20),XPP(20,9),NCORD
DATA NCORD/0/
END
SUBROUTINE RADJ(II, IDX)

```



```

C
C ** RIGHT ADJUST NASTRAN BULK DATA IN FIELD
C
LOGICAL*1 CD, CC(64), DMY(4), BLNK
COMMON/ IMAGE / CD(80)
DATA DMY /1H0, 1H., 1H1, 1H- /, BLNK / 1H /
DO 10 I = 1, 64
CC(I) = BLNK
10 CONTINUE
C
C ** TEST FOR SINGLE OR DOUBLE FIELD
C
IF(II .GT. 7) GO TO 20
C ** SINGLE FIELD
IDX = 8
IDY = 8
GO TO 30
20 CONTINUE
C ** DOUBLE FIELD
IDX = 4
IDY = 16
30 CONTINUE
C
READ(0,7000) CD
C
C ** RIGHT ADJUST DATA IN FIELDS
C
DO 100 J = 1, IDX
IBLNK = 0
K2 = J * IDY
K1 = K2 + 8
DO 50 L = 1, IDY
IF(CD(K1) .EQ. BLNK) GO TO 40
IBLNK = 1
CC(K2) = CD(K1)
K2 = K2 - 1
40 K1 = K1 - 1
50 CONTINUE
IF(II .GT. 2) GO TO 100
IF(IBLNK .NE. 0) GO TO 100
DO 60 L = 1, 4
CC(K2) = DMY(L)
K2 = K2 - 1
60 CONTINUE
100 CONTINUE
DO 120 J = 1, 64
CD(J+8) = CC(J)
120 CONTINUE
WRITE(0,7000) CD
RETURN
7000 FORMAT(80A1)
7010 FORMAT(26X, 80A1)
END
SUBROUTINE SEQGEN(IDG, IGC)
COMMON/ BSQGP / NWGRD(40), SEQMX(40), NSQGP

```

REPRODUCIBILITY OF THE
ORIGINAL PAGE IS POOR

```

REAL*8 TLC
DATA TLC / 8HSEQGP /
IF(NSQGP .EQ. 0) GO TO 130
DO 120 L = 1, NSQGP
IF(IDG .NE. NWGRD(L)) GO TO 120
LS = L
GO TO 140
120 CONTINUE
130 CONTINUE
NSQGP = NSQGP + 1
NWGRD(NSQGP) = IDG
SEQMX(NSQGP) = IDG
LS = NSQGP
140 CONTINUE
SEQC = SEQMX(LS) + 0.1
SEQMX(LS) = SEQC
WRITE(0,7000) TLC,IGC, SEQC
CALL STORE( 6 )
RETURN
C
7000 FORMAT(A8, I8, F8.1)
END
SUBROUTINE GRID(IDX, II)
DIMENSION B(5)
REAL*8 BB(4), A,CONT
COMMON/ IMAGE / CARD(20)
COMMON/ BGRID / IDG(1000), ICP(1000), GCD(1000,3), NGD, DUMM
X ,IXCD(1000),IXPS(1000)
REAL*8 IXCD, IXPS, K, J
DATA MAX / -1 /
C
IF(IDX .EC. 4) GO TO 20
READ(0,7001) A, B, K, J
GO TO 50
C
C ** DOUBLE FIELD CARD
C
20 CONTINUE
READ(0,7002) A, BB, CONT,
DO 30 I = 1, 4
B(I) = BB(I)
30 CONTINUE
IF(B(2).LE.0.) WRITE(9,7000) CARD
READ(5,7000,END=200) CARD
WRITE(0,7000) CARD
CALL RADJ(II, IDX)
READ(0,7004) A, B(5), K, J
50 CONTINUE
C
C ** STORE DATA IN COMMON
C
NGD = NGD + 1
IF(NGD .LE. 1000) GO TO 75
IF(MAX .GE. 0) GO TO 100
MAX = 1

```

```

WRITE(6,7003)
GO TO 100
75  IDG(NGD) = B(1)
    ICP(NGD) = B(2)
    GCD(NGD,1) = B(3)
    GCD(NGD,2) = B(4)
    GCD(NGD,3) = B(5)
    IXCD(NGD)=K
    IXP(NGD)=J
    IF(ICP(NGD).GT.0) GO TO 108
100  WRITE(9,7000) CARD
108  CONTINUE
    RETURN
C ** SUBROUTINE GRID - INSERT
200  CONTINUE
    WRITE(6,7010) A, BB, CONT
    STOP
7000 FORMAT(20A4)
7001  FORMAT(A8, 5F8.0, 2A8)
7002  FORMAT(A8, 4F16.0, A8)
7003  FORMAT(1H0,22X,86H*** MORE THAN 1000 GRID POINTS. NO MORE WILL B
    IE STORED FOR JOINT PRE-PROCESSOR *** /1H0)
7004  FORMAT(A8,F16.0,2(8X,A8))
7010  FORMAT(1H0,46X,40H*** END OF FILE ON INPUT IN GRID *** /
    1 26X, A8, 4F16.5, A8)
    END
    SUBROUTINE OMT(N, OMTI, OM)
    INTEGER*2 OMTI(1)
    LOGICAL*1 OM(8), OMT(4), 8LNK
    DATA OMT, 8LNK / 4HOMIT, 1H /
    EQUIVALENCE (OMT(1), OMTF)
C
    K1 = 8
    K2 = 4
65  IF(K1 .EQ. 0) GO TO 100
    IF(OM(K1) .EQ. 8LNK) GO TO 70
    OMT(K2) = OM(K1)
    K2 = K2 - 1
    IF(K2 .EQ. 0) GO TO 80
70  K1 = K1 - 1
    GO TO 65
80  CONTINUE
C
    IF(OMTF .EQ. OMT) OMTI(N) = 1
C
100  CONTINUE
    RETURN
    END
    SUBROUTINE ROD
    INTEGER*2 OMIT
    COMMON/ BROD / IDR(20), IDGR(20), RPARM(20,5), OMIT(20), NROD
    DIMENSION B(9)
    LOGICAL*1 OM(8)
C
    READ(0,7000) B, OM

```

```

NRCD = NRCD + 1
IF(NROD .LE. 20) GO TO 50
WRITE(6,7001) NROD, B, OM
GC TO 100
50  IDR(NROD) = B(3)
    IDGR(NROD) = B(4)
    DC 60 I = 1, 5
    RPARAM(NROD,I) = B(I+4)
60  CONTINUE
    CALL OMTC(NROD, OMIT, OM)
100 RETURN
7000 FORMAT(2A4, 7F8.0, 8A1)
7001 FORMAT(1H0, 39H*** THE NUMBER OF ROD ELEMENT JOINTS, I2, 1X,
116HEXCEEDS 20 *** / 2X, 2A4, 7F8.4, 8A1//)
END
SUBROUTINE BAR(II, IDX, *)
INTEGER*2 OMTB
LOGICAL*1 CARD, PLUS
LOGICAL*1 C(8), BLNK
COMMON/ BBAR / IDBR(50), IDGB(50), BPARAM(50,12), OMTB(50), NBAR
COMMON/ IMAGE / CARD(80)
REAL*8 A
DIMENSION B(8), BO(6)
EQUIVALENCE (B(1), BO(1))
DATA PLUS/ 1H+ /
DATA BLNK / 1H /
C
READ(0,7000) A, B, C
NBAR = NBAR + 1
IF(NBAR .LE. 50) GO TO 25
WRITE(6,7010) NBAR, B
GO TO 200
25  CCONTINUE
    IDBR(NBAR) = B(1)
    IDGB(NBAR) = B(2)
    DC 40 I = 1, 6
    BPARAM(NBAR,I) = B(I+2)
40  CCONTINUE
C
C ** CONTINUATION CARD
C
READ(5,7001,END=300) CARD
IF(CARD(1) .NE. PLUS) RETURN I
WRITE(0,7001) CARD
CALL RADJ(II, IDX)
READ(0,7002) A, BO, C
DO 125 I = 1, 6
BPARAM(NBAR, I+6) = B(I)
125 CCONTINUE
CALL OMTC(NBAR, OMTB, C)
200 RETURN
C
C ** CONTINUATION CARD EXPECTED - END OF FILE ON INPUT DATA SET
C
300 CCONTINUE

```

```

WRITE(6,7020) A, B, C
STOP
7000 FORMAT(A8, 8F8.0, 8A1)
7001 FORMAT(80A1)
7002 FORMAT(A8, 5F8.0, A8, 8A1)
7010 FORMAT(1H0,39H*** THE NUMBER OF BAR ELEMENT JOINTS ,I2,
117H EXCEEDS 50 *** / 2X,8F8.4)
7020 FORMAT(1H0,46X,39H*** END OF FILE ON INPUT IN BAR *** /
126X,A8, 8F8.4, 8A1)
END
SUBROUTINE CROD
REAL*8 A
COMMON/ IMAGE / CD(20)
COMMON/ BCROD / ID(1000,4), NCRD
DIMENSION B(8)
DATA MFLG / -1 /

C
READ(0,7000) A, B
I1 = -4
10 CONTINUE
I1 = I1 + 4
IF(I1 .GT. 4) GO TO 75
IF(B(I1+1) .EQ. 0.0) GO TO 75
NCRD = NCRD + 1
IF(NCRD .GT. 1000) GO TO 50
DO 25 I = 1, 4
ID(NCRD,I) = B(I+I1)
25 CONTINUE
GO TO 10
50 CONTINUE

C
C ** TABLE FULL
C
IF(MFLG .GE. 0) GO TO 75
WRITE(6,7010) CD
MFLG = 1
75 IF(MFLG.GT.0) WRITE(9,7001) CD
100 RETURN
7000 FORMAT(A8, 8F8.0)
7001 FORMAT(20A4)
7010 FORMAT(1H0,31X,69H*** CROD STORAGE FULL - NO MORE CROD CARD DATA
1 WILL BE STORED *** /26X, 20A4)
END
SUBROUTINE PROD(I1, IDX)
COMMON/ IMAGE / CD(20)
COMMON/ BPROD / IDP(1000), IDM(1000), PROP(1000,4), NPRD
REAL*8 A
DIMENSION B(6)
DATA MFLG / -1 /

C
READ(0,7000) A, B
NPRD = NPRD + 1
IF(NPRD .GT. 1000) GO TO 200
IDP(NPRD) = B(1)
IDM(NPRD) = B(2)

```

```

DO 25 I = 1, 4
  PROP(NPRD,I) = B(I+2)
25 CONTINUE
  GO TO 250
200 CONTINUE
  IF(MFLG .GE. 0) GO TO 250
  WRITE(6,7010) CD
  MFLG = 1
250 CONTINUE
C
C ** WRITE PROD IMAGE ON DISK
C
  WRITE(9,7001) CD
300 RETURN
7000 FORMAT(A8, 6F8.0)
7001 FORMAT(20A4)
7010 FORMAT(1H0,31X,69H*** PROD STORAGE FULL - NO MORE PROD CARD DATA
1 WILL BE STORED *** /26X,20A4)
  END
  SUBROUTINE CBAR(II, IDX, *, *)
  LOGICAL*1 CD, PLUS, STAR
  COMMON/ IMAGE / CD(80)
  COMMON/ BCBAR / IDB(1000), IPB(1000), IBA(1000), IBB(1000),
1 IBREC(1000), NBAR, NBREC
  REAL*8 A, BB(4)
  DIMENSION B(4)
  DATA PLUS, STAR / 1H+, 1H* /, MFLG / -1 /
C
  IF(IDX .EQ. 4) GO TO 20
C
  SINGLE FIELD CARD
  READ(0,7001) A, B
  GO TO 40
20 CONTINUE
C
  DOUBLE FIELD CARD
  READ(0,7002) A, BB
  DO 30 I = 1, 4
  B(I) = BB(I)
30 CONTINUE
40 CONTINUE
  NBAR = NBAR + 1
  IF(NBAR .LE. 1000) GO TO 75
  IF(MFLG .GE. 0) GO TO 60
  WRITE(6,7010) CD
  MFLG = 1
60 CONTINUE
  WRITE(9,7000) CD
  RETURN
75 CONTINUE
  IDB(NBAR) = B(1)
  IPB(NBAR) = B(2)
  IBA(NBAR) = B(3)
  IBB(NBAR) = B(4)
  IBREC(NBAR) = NBREC + 1
C
C ** SEARCH FOR CONTINUATION CARDS.

```

```

C
80  CONTINUE
    NBREC = NBREC + 1
    WRITE(3,7000) CD
    READ(5,7000,END=200) CD
    IF(CD(1) .EQ. PLUS) GO TO 100
    IF(CD(1) .EQ. STAR) GO TO 100
    RETURN 1
100  CONTINUE
    WRITE(0,7000) CD
    CALL RADJ(III, IDX)
    GO TO 80
200  CONTINUE
C
C **  END OF BULK DATA SET
C
    RETURN 2
7000 FORMAT(80A1)
7001 FORMAT(A8, 4F8.0)
7002 FORMAT(A8, 4E16.0)
7010 FORMAT(1H0,35X,61H***  CBAR TABLE FULL - NO MORE CBAR DATA WILL B
    IE SAVED  *** /26X, 80A1)
    END
    SUBROUTINE PBAR(II, IDX, *, *)
    LOGICAL*1 CD, PLUS, STAR
    COMMON/ IMAGE / CD(80)
    COMMON/ BPBAR / IDP(1000), IPREC(1000), NPBR, NPREC
    REAL*8 A
    DATA PLUS, STAR, MFLG / 1H+, 1H*, -1 /
C
    IF(IDX .EQ. 4) GO TO 20
C **  SINGLE FIELD CARD
    READ(0,7001) A, I
    GO TO 40
20  CONTINUE
    READ(0,7002) A, I
40  CONTINUE
    NPBR = NPBR + 1
    IF(NPBR .LE. 1000) GO TO 75
    IF(MFLG .LT. 0) GO TO 50
    WRITE(6,7010) CD
    MFLG = 1
50  CONTINUE
    WRITE(9,7000) CD
    RETURN
75  CONTINUE
    IDP(NPBR) = I
    IPREC(NPBR) = NPREC + 1
80  CONTINUE
C
C **  WRITE PBAR IMAGE ON DISK
C
    WRITE(9,7000) CD
C
C **  SEARCH FOR CONTINUATION CARDS

```

```

C
  NPREC = NPREC + 1
  WRITE(4,7000) CD
  READ(5,7000,END=100) CD
  IF(CD(1) .EQ. PLUS) GO TO 90
  IF(CD(1) .EQ. STAR) GO TO 90
  RETURN 1
90  CONTINUE
  WRITE(0,7000) CD
  CALL RADJ(II,IDX)
  GO TO 80
100 CONTINUE
C
C ** END OF BULK DATA SET
C
  RETURN 2
7000 FORMAT(80A1)
7001 FORMAT(A8, I8)
7002 FORMAT(A8, I16)
7010 FORMAT(1H0,35X,61H*** PBAR TABLE FULL - NO MORE PBAR DATA WILL B
  IE SAVED *** /26X,80A1)
  END
  SUBROUTINE RODJT
  LOGICAL*1 CD
  INTEGER*2 OMIT
  COMMON/ IMAGE / CD(80)
  COMMON/ BRD / IDR(20), IDGR(20), RPARM(20,5), OMIT(20), NRDD
  COMMON/ BGRID / IGDN(1000), IPCG(1000), GCD(1000,3),NGD
  COMMON/ BCROD / IDRD(1000,4), NCRD
  COMMON/ BPROD / IDPRD(1000), IDMP(1000), PRDP(1000,4), NPRD
  COMMON/ BNEW / NGRD, IDEX, IPEX, IEDCM, IDCV
  X , IMEX
  COMMON/8MAT1/ IDMAT(100),E(100),G(100),NMAT1
  COMMON/ 8COMM / XC(3,5), I1, I2, INCP
  COMMON/ 8DEFLT / AKGPD, AKGSD, AKMD, AKAPD, AKJPD
  COMMON/ BSQGP / NWGRD(40), SEQMX(40), NSQGP
  COMMON/ BIMG / NIMG(20,40), IMG
  REAL*8 TLC(9)
  DATA TLC / 8HGRID , 8HCROD , 8HCONM2 , 8HOMIT1 ,
1 8H 123456, 8HSEQGP , 8HPROD , 8HCVISC , 8HPVISC /
C
  IF(NRDD .LE. 0) RETURN
C
C ** START LOOP THROUGH NO. OF ROD ELEMENT JOINTS TO BE MODIFIED
C
  DO 500 NR = 1, NRDD
  IMG = 0
  IDE = IDR(NR)
  IDG = IDGR(NR)
  C1=RPARM(NR,1)
  C2=RPARM(NR,2)
  DO 20 L = 1, NCRD
  IF(IDE .NE. IDRD(L,1)) GO TO 20
  LL = L
  GO TO 30

```



```

20 CONTINUE
WRITE(6,7010) IDE
GO TO 500
30 CONTINUE
IGA = IDRD(LL,3)
IGB = IDRD(LL,4)
CALL CCORD(IGA, IGB, IDG, 500)
AKGP = RPARM(NR,3)
IF(AKGP .LT. 0.0) AKGP = AKGPD
C
IDP = IDRD(LL,2)
IF(IDP .EQ. 0) IDP = IDE
C
C ** SEARCH FOR PROD CARD IMAGE
C
DO 150 L = 1, NPRD
IF(IDP .NE. IDPRD(L)) GO TO 150
LP = L
GO TO 160
150 CCNTINUE
WRITE(6,7020) IDP
GO TO 500
160 CONTINUE
AKAP = RPARM(NR,4)
IF(AKAP .LT. 0.0) AKAP = AKAPD
AKJP = RPARM(NR, 5)
IF(AKJP .LT. 0.0) AKJP = AKJPD
AC = AKAP * PRDP(LP,1)
X / (AKGP*(1.-AKAP) + AKAP)
TC = AKJP * PRDP(LP,2)
X / (AKGP*(1.-AKJP) + AKJP)
MID=IDMP(LP)
IF(C1.LE.0.) GO TO 175
C
C CHANGE MATERIAL PROPS TO INCLUDE DAMPING COEFF.
C
XE=E(MID)
XG=G(MID)
MID=IMEX
IMEX=IMEX+1
XL=SQRT((XC(1,2)-XC(1,1))**2 +
X (XC(2,2)-XC(2,1))**2 +
X (XC(3,2)-XC(3,1))**2 )
GE=C1*XL/(AC*XE)/(1.-AKAP+AKAP/AKGP)
WRITE(0,7008) MID,XE,XG,MID
CALL STORE( 20 )
WRITE(0,7009) MID,GE
CALL STORE( 18 )
175 CONTINUE
C
C CHANGE ROD TO REFERENCE NEW PROPERTY CARD AND WRITE NEW CARD
C
IDRD(LL,2)=IPEX
WRITE(0,7005) TLC(7), IPEX, MID, AC, TC, (PRDP(LP,L),L=3,4)
CALL STORE( 14 )

```

```

IF(C2.LE.0.) GO TO 180
C
C ** GENERATE CVISC CARD IMAGE
C
WRITE(0,7006) TLC(8), IDCV, IDCV, IGA, IGB
CALL STORE( 10 )
C
C ** GENERATE PVISC CARD IMAGE
C
C2=C2/(1.-AKJP+AKJP/AKGP)
WRITE(0,7011) IDCV,C2,IDCV
CALL STORE(20)
WRITE(0,7012) IDCV
CALL STORE(2)
180 CONTINUE
WRITE(6,7050) NR
WRITE(6,7080)
DO 200 L = 1, IMG
WRITE(9,7002) (NIMG(K,L),K=1,20)
WRITE(6,7090) L,(NIMG(K,L),K=1,20)
200 CONTINUE
IDEX = IDEX + 1
IPEX = IPEX + 1
IDCV = IDCV + 1
500 CONTINUE
RETURN
C
C ** FORMATS
C
7001 FORMAT(A8, 2I8, 3F8.2)
7002 FORMAT(20A4)
7003 FORMAT(A8, 8I8)
7004 FORMAT(2A8, 7I8)
7005 FORMAT(A8, 2I8, 4F8.2)
7006 FORMAT(A8,4I8)
7007 FORMAT(A8, I8, 2F8.1)
7008 FORMAT( 8HMT1* ,I16,2E16.6,16X, 3H*M1, I5 )
7009 FORMAT( 3H*M1, I5 ,48X, E16.6 )
7010 FORMAT(1H0,33X,31H*** SPECIFIED ROD ELEMENT ID ,I5,39H DOES NOT
IMATCH ANY CROD ELEMENTS ***/)
7011 FCRMAT( 8HPVISC* , I16,14X,2H0.,E16.8,16X, 3H*PV, I5 )
7012 FORMAT( 3H*PV, I5 )
7020 FCRMAT(1H0,32X,24H*** SPECIFIED PBAR ID ,I5,38HDOES NOT MATCH AN
IY PBAR ELEMENTS *** /)
7050 FORMAT(1H1,47X,28H***** ROD ELEMENT JOINT - ,I2, 8H *****/)
7080 FORMAT(1H0,46X,39H* * * * * NEW CARD IMAGES * * * * */)
7090 FORMAT(29X,I2,10X,20A4)
END
SUBROUTINE BARJT
LOGICAL*1 CD, STAR
INTEGER*2 OMTB
COMMON/ IMAGE / CD(80)
COMMON/ BCBAR / IDB(1000), IPB(1000), IBA(1000), IBB(1000),
1 IBREC(1000), NBAR, NBREC
COMMON/ 8BAR / IDBR(50), IDGB(50), BPARAM(50,12), OMTB(50), NBR

```

```

COMMON/ BGRID / IDGN(1000), ICP(1000), GCD(1000,3), NGD
COMMON/ BDEFLT / RDFLT(5), BKMD, BKGP, BKGS, BKAP, BKASD,
1 BKJPD, BKJSD, BKIPD, BKISD, BKIPD, BKISD
COMMON/ BIMG / NIMG(20,40), IMG
COMMON/ BCOMM / XC(3,5), I1, I2, INCP
COMMON/ BNEW / NGRD, IDEX, IPEX, IEDCM, IDCX
X ,IMEX
COMMON/BMAT1/ IDMAT(100),E(100),G(100),NMAT1.
COMMON/ BPBAR / IDPB(1000), IPREC(1000), NPBAR, NPREC
REAL*8 TLC(6), BB(4), A1, A2
REAL*8 RLC(2)
DIMENSION B(8)
DATA RLC / 8HOMIT1 , 8H 123456 /
DATA TLC / 8HGRID , 8HCBAR , 8H , 8HPBAR ,
1 8HCVISC , 8HPVISC /
DATA STAR / 1H* /
DATA CNE, DFLT / 4H 1, 4H-1.0 /

```

C

```
IF(NBR .LE. 0) RETURN
```

C

```
C ** START LOOP THROUGH BAR ELEMENT JOINTS
```

C

```

DO 400 NB = 1, NBR
IMG = 0
IDE = IDB(NB)
IDG = IDG(NB)
DO 20 L = 1, NBAR
IF(IDE .NE. IDB(L)) GO TO 20
LL = L
GO TO 30
20 CONTINUE
WRITE(6,7010) IDE
GC TO 400
30 CONTINUE
IGA = IBA(LL)
IGB = IBB(LL)
CALL COORD(IGA, IGB, IDG, &400)
BKGP = BPARM(NB,7)
IF(BKGP .LT. 0.0) BKGP = BKGP

```

C

```
C ** COMPUTE NEW GRID POINT -C- COORDINATES
```

C

```

DO 40 L = 1, 3
XC(L,3) = XC(L,I1) + BKGP * (XC(L,I2) - XC(L,I1))
40 CONTINUE
IGC = NGRD
NGRD = NGRD + 1
WRITE(6,7001) TLC(1), IGC, INCP, (XC(L,3),L =1,3)
CALL STORE(16)

```

C

```
C ** ESTABLISH GRID POINTS E & F
```

C

```

IGE = NGRD
IGF = NGRD + 1
NGRD = NGRD + 2

```

```

C
  CALL SEQGEN(IDG, IGC)
  CALL SEGGEN(IDG, IGE)
  CALL SEQGEN(IDG, IGF)
C
C ** TEST FOR CMIT CARD GENERATION
C
  IF(OMTB(NB) .EQ. 0) GO TO 50
  WRITE(0,7003) RLC(1), RLC(2), IGC, IGE, IGF
  CALL STORE(10 )
50  CONTINUE
C
C ** CALCULATE E & F COORDINATES
C
  CALL EFCL(LL, B, BB, £400)
C
  WRITE(0,7001) TLC(1), IGE, INCP, (XC(L,4),L=1,3)
  CALL STORE(16)
  WRITE(0,7001) TLC(1), IGF, INCP, (XC(L,5),L=1,3)
  CALL STORE(16)
C
C ** INSERT NEW GRID POINT I.D. IN ELEMENT LL
C
  IF(I1 .NE. 1) GO TO 60
  IBA(LL) = IGC
  GO TO 70
60  IBB(LL) = IGC
70  CONTINUE
C
C ** GENERATE ELEMENT CARD FOR NEW BAR ELEMENT
C
  I3 = B(8)
  IF(I3 .EQ. 2) GO TO 87
  WRITE(0,7002) TLC(2), IDEX, IPEX, IDG, IGC, (B(L+4),L=1,4)
  GO TO 89
87  CONTINUE
  IDP = B(5)
  WRITE(0,7009) TLC(2), IDEX, IPEX, IDG, IGC, IDP, I3
89  CONTINUE
  CALL STORE( 18 )
C
C ** ESTABLISH PROPERTIES OF THE NEW ELEMENTS
C
  IDP = IPB(LL)
  IF(IDP .LE. 0) IDP = IDE
C ** SEARCH FOR PBAR IMAGE
  DO 90 L = 1, NPBAR
  IF(IDP .NE. IDPB(L)) GO TO 90
  LP = L
  GO TO 100
90  CONTINUE
  WRITE(6,7020) IDP
  GO TO 400
100 CONTINUE

```

```

NRECD = IPRÉC(LP)
RE*IND 4
DO 120 L = 1, NRECD
READ(4,7004) CD
120 CONTINUE
WRITE(0,7004) CD
IF(CD(5) .EQ. STAR) GO TO 140
IF(CD(8) .EQ. STAR) GO TO 140
C ** SINGLE FIELD WORD
READ(0,7005) A1, B
GC TC 180
140 CONTINUE
C ** DOUBLE FIELD WORD
READ(0,7006) A1, BB
DO 145 L = 1, 4
B(L) = BB(L)
145 CONTINUE
READ(4,7004) CD
WRITE(0,7004) CD
READ(0,7006) A1, BB
DC 150 L = 1, 4
B(L+4) = BB(L)
150 CONTINUE
NRECD = NRECD + 1
180 CONTINUE
BKAP = BPARM(NB,8)
BKJP = BPARM(NB,9)
BK11P = BPARM(NB,10)
BK12P = BPARM(NB,11)
IF(BKAP .LT. 0.0) BKAP = BKAPD
IF(BKJP .LT. 0.0) BKJP = BKJPD
IF(BK11P .LT. 0.0) BK11P = BK11PD
IF(BK12P .LT. 0.0) BK12P = BK12PD
I3 = B(2)
B(1) = B(3) * BKAP
B(2) = B(4) * BK11P
B(3) = B(5) * BK12P
B(4) = B(6) * BKJP
C
WRITE(0,7021) IPEX,I3,B(1),B(2),IPEX
CALL STORE(20)
WRITE(0,7022) IPEX,B(3),B(4)
CALL STORE(10)
C
C
C
GENERATE RODS WITH DAMPING FACTORS ON MATL CARD
C
DO 184 L=1,NMAT1
IF(IDMAT(L).NE.I3) GO TO 184
XE=E(L)
XG=G(L)
GC TO 185
184 CONTINUE
STOP 231
185 XL=BKGP*SQRT((XC(1,1)-XC(1,2))**2 +
X (XC(2,1)-XC(2,2))**2 +

```

```

X      (XC(3,1)-XC(3,2))**2 )
SUMC=0.
DO 187 L=1,6
187 SUMC=SUMC+BPARM(NB,L)
GE=XL*SUMC/(XE*1.E-8*B(1))
MID=IMEX
IMEX=IMEX+1
WRITE(0,7011) MID,XE,XG,MID
CALL STORE( 20 )
WRITE(0,7012) MID,GE
CALL STORE( 18 )
F1=XL/(XE*GE)
F2=XL/(XG*GE)
XAM=F1*BPARM(NB,1)
XAN=F1*BPARM(NB,2)
XAP=F1*BPARM(NB,3)
XJM=F2*BPARM(NB,4)
XJN=F2*BPARM(NB,5)
XJP=F2*BPARM(NB,6)
WRITE(0,7013) IDEX,IPEX,IDG,IGC
CALL STORE( 10 )
WRITE(0,7014) IPEX,MID, XAM,XJM,IPEX
CALL STORE( 20 )
WRITE(0,7015) IPEX
CALL STORE( 2 )
IDEX=IDEX+1
IPEX=IPEX+1
WRITE(0,7013) IDEX,IPEX,IDG,IGE
CALL STORE( 10 )
WRITE(0,7014) IPEX,MID, XAN,XJN,IPEX
CALL STORE( 20 )
WRITE(0,7015) IPEX
CALL STORE( 2 )
IDEX=IDEX+1
IPEX=IPEX+1
WRITE(0,7013) IDEX,IPEX,IDG,IGF
CALL STORE( 10 )
WRITE(0,7014) IPEX,MID, XAP,XJP,IPEX
CALL STORE( 20 )
WRITE(0,7015) IPEX
CALL STORE( 2 )
IDEX=IDEX+1
IPEX=IPEX+1
C
C ** GENERATE MULTIPPOINT CONSTRAINT CARDS
C
HID = BPARM(NB, 12)
IF(HID .EQ. DFLT) HID = ONE
CALL MPCGEN(IGC, IGE, IGE, HID)
C
C ** PRINT OUT JOINT INFORMATION AND NEW BULK DATA CARDS
C
WRITE(6,7100) NB
WRITE(6,7130)
DO 300 L = 1, IMG

```

```

WRITE(9,7000) (NIMG(K,L),K=1,20)
WRITE(6,7140) L, (NIMG(K,L),K=1,20)
300 CONTINUE
   IDEX = IDEX + 1
   IPEX = IPEX + 1
400 CONTINUE
   RETURN
C
C **          FORMATS
C
7000 FORMAT(20A4)
7001 FORMAT(A8,2I8, 3F8.2,2(7X,1H0))
7002 FORMAT(A8,4I8, 4F8.3)
7003 FORMAT(2A8, 7I8)
7004 FORMAT(80A1)
7005 FORMAT(A8, 8F8.0)
7006 FORMAT(A8, 4F16.0)
7007 FORMAT(A8, 4I8)
7008 FORMAT(A8, 18, 2F8.1)
7009 FORMAT(A8, 5I8, 124)
7010 FORMAT(1H0,28X,31H*** SPECIFIED BAR ELEMENT ID , I5,
140H DOES NOT MATCH ANY CBAR ELEMENTS *** /)
7011 FORMAT( 8H*MI* , I16, 2E16.6, 16X, 3H*MI, I5)
7012 FORMAT( 3H*MI, I5 , 48X, E16.6)
7013 FORMAT( 8HCROD , 4I8 )
7014 FORMAT( 8HPRD* , 2I16, 2E16.8, 3H*PR, I5 )
7015 FORMAT( 3H*PR, I5 )
7020 FORMAT(1H0,25X,36H*** SPECIFIED PROPERTY ELEMENT ID , I5,
140H DOES NOT MATCH ANY PBAR ELEMENTS *** /)
7021 FORMAT( 8HPBAR* , 2I16, 2E16.8, 3H*PB,I5)
7022 FORMAT( 3H*PB, I5 , 2E16.8 )
7100 FORMAT(1H1,47X,28H***** BAR ELEMENT JOINT - , I2, 8H ***** /)
7130 FORMAT(1H0,46X,39H* * * * NEW CARD IMAGES * * * * * /)
7140 FORMAT(20X,I2, 10X, 20A4)
END
SUBROUTINE EFC( LL, B, BB, *)
COMMON/ BCBAR / IDB(1000), IPB(1000), IBA(1000), IBB(1000),
1 IBREC(1000), NBAR, NBREC
COMMON/ BGRID / IDGN(1000), ICP(1000), GCD(1000,3), NGD
COMMON/ BCOMM / XC(3,5), I1, I2
COMMON / IMAGE / CD(80)
LOGICAL*1 CD, STAR
REAL*8 A1, BB(4)
DIMENSION B(8), V1(3), V2(3), V3(3)
DATA STAR / 1H* /
C
C ** SEARCH FOR CBAR
C
IDP = IBREC(LL)
REWIND 3
DO 10 L = 1, IDP
READ(3,7000) CD
10 CONTINUE
IF(CD(5) .EQ. STAR) GO TO 30
IF(CD(8) .EQ. STAR) GO TO 30

```

REPRODUCIBILITY OF THE
ORIGINAL PAGE IS POOR

```
C ** SINGLE FIELD CARD
WRITE(0,7000) CD
READ(0,7001) A1, B
GC TO 50
30 CONTINUE
C ** DOUBLE FIELD
READ(3,7000) CD
WRITE(0,7000) CD
READ(0,7002) A1, BB
DC 40 L = 1, 4
B(L+4) = BB(L)
40 CONTINUE
50 CONTINUE
IDP = B(8)
IF(IDP .EQ. 2) GO TO 60
V2(1) = B(5)
V2(2) = B(6)
V2(3) = B(7)
GO TO 70
60 CONTINUE
IDP = B(5)
DO 65 L = 1, NGD
IF(IDP .NE. IDGN(L)) GO TO 65
V2(1) = GCD(L,1) - XC(1,I1)
V2(2) = GCD(L,2) - XC(2,I1)
V2(3) = GCD(L,3) - XC(3,I1)
GO TO 70
65 CONTINUE
WRITE(6,7010) IDP
RETURN 1
70 CONTINUE
V1(1) = XC(1,I2) - XC(1,I1)
V1(2) = XC(2,I2) - XC(2,I1)
V1(3) = XC(3,I2) - XC(3,I1)
C
C ** F COORDINATES
C
AC=SQRT((XC(1,3)-XC(1,I1))**2+(XC(2,3)-XC(2,I1))**2+(XC(3,3)-XC(3,
I1))**2)
V3(1) = V1(2) * V2(3) - V1(3) * V2(2)
V3(2) = V1(3) * V2(1) - V1(1) * V2(3)
V3(3) = V1(1) * V2(2) - V1(2) * V2(1)
AMG=SQRT(V3(1)**2+V3(2)**2+V3(3)**2)
XC(1,5) = XC(1,I1) + V3(1)*AC/AMG
XC(2,5) = XC(2,I1) + V3(2)*AC/AMG
XC(3,5) = XC(3,I1) + V3(3)*AC/AMG
C
C ** E COORDINATES
C
V2(1) = V3(2) * V1(3) - V3(3) * V1(2)
V2(2) = V3(3) * V1(1) - V3(1) * V1(3)
V2(3) = V3(1) * V1(2) - V3(2) * V1(1)
AMG=SQRT(V2(1)**2+V2(2)**2+V2(3)**2)
XC(1,4) = XC(1,I1) + V2(1)*AC/AMG
XC(2,4) = XC(2,I1) + V2(2)*AC/AMG
```



```

XC(3,4) = XC(3,11) + V2(3)*AC/AMG
RETURN
7000 FORMAT(80A1)
7001 FORMAT(A8, 8F8.0)
7002 FORMAT(A8, 4F16.0)
7010 FORMAT(1H0,13X,94H***  COULD NOT LOCATE GRID POINT FOR REFERENCE
ICCOORDINATE SYSTEM - SUBROUTINE EFC - GRID NO. ,I5, 6H  *** /)
END
SUBROUTINE COCRD(IGA, IGB, IDG, *)
COMMON/ BGRID /IDGR(1000), ICP(1000), GCD(1000,3), NGD
COMMON/ BCOMM / XC(3,5), I1, I2, INCP
C
C ** COMPARE INPUT GRID POINTS FOR VALIDITY AND ORDER
C
I1 = 1
I2 = 2
IF(IDG .EQ. IGA) GO TO 20
I1 = 2
I2 = 1
IF(IDG .EQ. IGB) GO TO 20
WRITE(6,7000) IDG, IGA, IGB
RETURN 1
20 CONTINUE
C
C ** SEARCH GRID TABLE FOR COORDINATES
C
DO 30 L = 1,NGD
IF(IGA .NE. IDGR(L)) GO TO 30
DO 25 K = 1, 3
XC(K, 1) = GCD(L,K)
25 CONTINUE
IF(I1 .EQ. 1) INCP = ICP(L)
GO TO 40
30 CONTINUE
WRITE(6,7010) IGA
RETURN 1
40 CONTINUE
DO 50 L = 1, NGD
IF(IGB .NE. IDGR(L)) GO TO 50
DO 45 K = 1, 3
XC(K, 2) = GCD(L,K)
45 CONTINUE
IF(I2 .EQ. 1) INCP = ICP(L)
GO TO 60
50 CONTINUE
WRITE(6,7010) IGB
RETURN 1
60 CONTINUE
RETURN
7000 FORMAT(1H0,29X,72H***  ELEMENT GRID POINTS DO NOT COMPARE WITH SP
1ECIFIED GRID POINT  *** /38X,12H SPECIFIED = ,I5, 10X,12HELEMENT -
2 A ,I5, 7H  B ,I5 /)
7010 FORMAT(1H0,18X,48H***  NO MATCH FOUND FOR THE ELEMENT GRID POINT
1 , I5,42H  IN THE GRID POINT COORDINATE TABLE  *** /)
END

```

```

SUBROUTINE MPCGEN(IC, IE, IF, HID)
COMMON/ BCOMM / XC(3,5), I1, I2
DIMENSION C(3)
DIMENSION TLC(10)
DATA TLC./ 4H MPC , 4H 1, 4H MPC, 4H+MPC, 4H 1, 4H 2, 4H 3,
1 4H 4, 4H 5 , 4H 6 /
DATA ICNT, A1, A2 / .990, 1.0, -1.0 /
C
I1 = IE
I2 = 4
DO 100 I = 1, 2
C
N1 = 5
N2 = 3
N3 = 10
N4 = 9
N5 = 2
C
DO 10 L = 1, 3
C(L) = XC(L,3) - XC(L,I2)
10 CONTINUE
C(2) = -C(2)
C
DO 50 J = 1, 3
ICNT = ICNT + 10
C
C ** FIRST/THIRD/FIFTH CARD IMAGES
C
WRITE(0,7001) TLC(1), HID, I1, TLC(N1), A1, IC, TLC(N1),
1 A2, TLC(3), ICNT
CALL STORE( 20 )
C
C ** SECONd/FOURTH/SIXTH CARD IMAGES
C
ICNT1 = ICNT
ICNT = ICNT + 10
WRITE(0,7002) TLC(4), ICNT1, IC, TLC(N4), C(N2), IC, TLC(N3),C(N5)
CALL STORE( 18 )
C
N1 = N1 + 1
IF(J .GT. 1) GO TO 40
N5 = N5 - 1
N4 = N4 - 1
C(3) = -C(3)
GO TO 50
40 CONTINUE
N3 = N3 - 1
N2 = N2 - 1
C(1) = -C(1)
C(2) = -C(2)
50 CONTINUE
C
C ** SEVENTH/EIGHTH/NINTH CARD IMAGES
C
DO 75 J = 8, 10

```

```

WRITE(0,7001) TLC(I), HID, I1, TLC(J), A1, IC, TLC(J), A2
CALL STORE( 16 )
75 CONTINUE
I1 = IF
I2 = 5

```

C

```

100 CONTINUE
RETURN
7001 FORMAT(A4, A12, I8, A8, F8.1, I8, A8, F8.1, A12, I4)
7002 FORMAT(A4, I4, I16, A8, F8.3, I8, A8, F8.3, A12, I4)
END
SUBROUTINE STORE( N )
COMMON/ BIMG / NIMG(20,40), IMG
DATA IBLNK/ 4H /

```

C

```

IMG = IMG + 1
IF(N - 20) 20, 40, 10

```

10 CONTINUE

C ** N GT 20 NOT PERMITTED

N = 20

GO TO 40

20 CONTINUE

C ** BLANK OUT UNUSED PART OF IMAGE

I1 = N + 1

DO 30 L = I1, 20

NIMG(L,IMG) = IBLNK

30 CONTINUE

40 CONTINUE

C

C ** READ IN CURRENT CARD IMAGE

C

READ(0,7000) (NIMG(L, IMG), L= 1,N)

RETURN

7000 FORMAT(20A4)

END

SUBROUTINE MAT1(K)

C

C ROUTINE TO STORE MATERIAL PROPERTIES E AND G

C

COMMON/BMAT1/ IDMAT(100),E(100),G(100),NMAT1

IF(NMAT1.EQ.100) STOP 30

NMAT1=NMAT1+1

IF(K.NE.18) GO TO 20

READ(0,7001) IDMAT(NMAT1),E(NMAT1),XG,XNU

7001 FORMAT(8X, I8, 3F8.0)

GO TO 30

20 READ(0,7002) IDMAT(NMAT1),E(NMAT1),XG,XNU

7002 FORMAT(8X, I16, 3F16.0)

30 CONTINUE

IF(XG.GT.0.) GO TO 40

IF(XNU.GT.0.) GO TO 33

XG=0.

GO TO 40

33 CCNTINUE

XG=E(NMAT1)/(2.*(1.+XNU))

```

40 CONTINUE
G(NPAT1)=XG
RETURN
END
SUBROUTINE CPLATE(NE)

```

```

C
C ROUTINE TO PROCESS A CQUAD1,CQUAD2, OR CODMEM ELEMENT
C CONNECTION, DEPENDING IF NE=2,3, OR 4. STORE INFO SO
C THAT CONNECTION CARDS CAN BE ALTERED IF JOINTS INTRODUCED
C

```

```

COMMON/BCPLT/ IDCP(1000),IPID(1000),NG(1000,4),TH(1000),INC(1000),

```

```

X NCPLT

```

```

DATA IFMSG/-1/

```

```

COMMON/IMAGE/ CD(20)

```

```

IF(NCPLT.EQ.1000) GO TO 80

```

```

NCPLT=NCPLT+1

```

```

READ(0,7000) IDCP(NCPLT),IPID(NCPLT),(NG(NCPLT,J),J=1,4),

```

```

X TH(NCPLT)

```

```

7000 FORMAT( 8X, .6I8, F8.0 )

```

```

INC(NCPLT)=NE

```

```

GO TO 90

```

```

80 IF(IFMSG.GT.0) GO TO 86

```

```

IFMSG=1

```

```

WRITE(6,7002) CD

```

```

7002 FORMAT(129H0*** PLATE CONNECTION TABLE FULL. ALL PLATE CONNECTI

```

```

XONS FROM FOLLOWING CARD ON ARE NOT CONSIDERED BY PREPROCESSOR ** /

```

```

X 20X, 20A4 )

```

```

86 CONTINUE

```

```

WRITE(9,7004) CD

```

```

7004 FORMAT( 20A4 )

```

```

90 CONTINUE

```

```

RETURN

```

```

END

```

```

SUBROUTINE PLATE(#)

```

```

C
C THIS ROUTINE PROCESSES THE $PLATE CARD AND STORES
C THE INPUT DATA IN COMMON BLOCK /BPLATE/
C

```

```

COMMON/BPLATE/ IDP(200),IDGPLT(200,2),PLTPRM(200,5),MPCID(200),

```

```

X CMP(200),NPLT

```

```

X ,MPCPA(200),MPCPB(200)

```

```

COMMON/IMAGE/ CD(80)

```

```

DATA PLUS/1H+/

```

```

INTEGER OMP

```

```

DIMENSION A(12)

```

```

READ(0,7000) {A(I),I=1,5}

```

```

7000 FORMAT(8X,8F8.0)

```

```

READ(5,7001) CD

```

```

7001 FORMAT( 80A1)

```

```

WRITE(0,7001) CD

```

```

IF(CD(1).EQ.PLUS) GO TO 20

```

```

C
C CONTINUATION CARD NOT GIVEN
C

```

```

DO 8 I=6,12

```

```

      8 A(I)=0.
        A(6)=-.05
        A(7)=-.5
        A(8)=-.5
        READ(0,7002){CD(I),I=1,20}
7002 FORMAT( 20A4 )
        J=1
        GO TO 30
20 CONTINUE

```

C
C
C

PROCESS CONTINUATION CARD

```

CALL RADJ(1,IDX)
READ(0,7000) (A(I),I=6,12)
IF(A(6).EQ.-1.) A(6)=-.05
IF(A(7).EQ.-1.) A(7)=-.5
IF(A(8).EQ.-1.) A(8)=-.5
IF(A(9).EQ.-1.) A(9)=0.
IF(A(10).EQ.-1.) A(10)=0.
IF(A(11).EQ.-1.) A(11)=0.
IF(A(12).EQ.-1.) A(12)=0.
J=0
30 CCNTINUE
IF(NPLT.LT.200) GO TO 35
WRITE(6,7009)

```

```

7009 FORMAT( 49H0** THE NUMBER OF PLATE JOINTS EXCEEDS 200 ** )
GO TO 80

```

```

35 CONTINUE
NPLT=NPLT+1
IDP(NPLT)=A(1)
IDGPLT(NPLT,1)=A(2)
IDGPLT(NPLT,2)=A(3)
DO 40 I=1,5
40 PLTPRM(NPLT,I)=A(I+3)
MPCID(NPLT)=A(9)
OMP(NPLT)=A(10)
MPCPA(NPLT)=A(11)
MPCPB(NPLT)=A(12)
80 CONTINUE
IF(J.NE.0) RETURN 1
RETURN
END
SUBROUTINE PPLATE(NP)

```

C
C
C
C

ROUTINE TO STORE PLATE THICKNESS AND MATERIAL CODE FROM
PROPERTY CARDS

```

COMMON/BPPLT/ (DPP(1000),INP(1000),THICK(1000),IMID(1000),NPPLT
COMMON/IMAGE/ CD(20)
IF(NPPLT.LT.1000) GO TO 8
WRITE(6,7000) CD
7000 FORMAT( 55H0*** PLATE PROPERTY TABLE FILLED. CANNOT CONTINUE ***
X / 20X, 20A4 )
STOP 20
8 CONTINUE

```

```

NPPLT=NPPLT+1
IF(NP.EQ.6 .OR. NP.EQ.9 .OR. NP.EQ.12 .OR. NP.EQ.15) GO TO 20
READ(0,7002) IDPP(NPPLT),IMID(NPPLT),THICK(NPPLT)
7002 FORMAT( 8X, 2I16, F16.0)
GO TO 30
20 READ(0,7004) IDPP(NPPLT),IMID(NPPLT),THICK(NPPLT)
7004 FORMAT( 8X, 2I8, F8.0)
30 CONTINUE
K=5
IF(NP.GE.6 .AND. NP.LE.8) K=2
IF(NP.GE.9 .AND. NP.LE.11)K=3
IF(NP.GE.12 .AND. NP.LE.14) K=4
INP(NPPLT)=K
RETURN
END
SUBROUTINE PJ

```

C
C
C

PRODUCE PLATE JOINTS

```

COMMON/BNW/ NGRD, IDEX, IPEX, IEDCM, IDCX, IMEX
COMMON/BCCMM/ XC(3,5), I11, I12, INCP
COMMON/SPATE/ IDP(200), IDGPLT(200,2), PLTPRM(200,5), MPCID(200),
X OMP(200), NPLT
X , MPCPA(200), MPCPB(200)
COMMON/BCPLT/ IDCP(1000), IPID(1000), NG(1000,4), TH(1000), INC(1000),
X NCPLT
COMMON/SPPLT/ IDPP(1000), INP(1000), THICK(1000), IMID(1000), NPPLT
COMMON/BMAT1/ IDMAT(100), E(100), G(100), NMAT1
COMMON/BCROD / IORD(1000,4), NCRD
COMMON/BPROD / IDX(1000), IDM(1000), PRDP(1000,4), NPRD
COMMON/BCBAR / IDB(1000), IPB(1000), IBA(1000), IBB(1000),
I IBREC(1000), NBAR, NBREC
COMMON/BPBAR / IDY(1000), IPREC(1000), NPBR, NPREC
LOGICAL NEWGAP, NEWGBP
INTEGER GA, GB, GC, GD, GAP, GBP
DOUBLE PRECISION BB(10)
INTEGER EDGE(200,3)
DATA KSTR/1H*/
DATA IPLS/1H+/
DIMENSION AX(5)
REAL*8 CC(10), WW(10)
IF(NPLT.LE.0) RETURN
LEDGE=0
WRITE(9,6999)
6999 FORMAT( 18HPARAM W4 1. )
DO 800 KK=1, NPLT
J=IDP(KK)
KA=IDGPLT(KK,1)
KB=IDGPLT(KK,2)
DO 10 I=1, NCPLT
IF(IDCP(I).NE.J) GO TO 10
K=I
KKK=I
GO TO 12
10 CONTINUE

```

```

GO TC 800
12 CONTINUE
DO 20 I=1,4
  IF(NG(K,I).EQ.KA) J1=I
  IF(NG(K,I).EQ.KB) J2=I
20 CONTINUE
  JA=MINO(J1,J2)
  JB=MAXO(J1,J2)
  IF(.NOT.(JA.EQ.1.AND.JB.EQ.4)) GO TO 21
  JD=2
  JC=3
  GO TO 22
21 CONTINUE
  JD=JA-1
  IF(JD.EQ.0) JD=4
  JC=JB+1
  IF(JC.EQ.5) JC=1
22 CONTINUE
  GA=NG(K,JA)
  GB=NG(K,JB)
  GC=NG(K,JC)
  GD=NG(K,JD)
C
C CHECK TO SEE IF EDGE A-D ALREADY HINGED, AND THE EDGE B-C
C
  NEWGAP=.TRUE.
  NEWGBP=.TRUE.
  IF(LEGE.EQ.0) GO TO 206
  DO 205 I=1,LEGE
  IF(.NOT.(GA.EQ.EDGE(I,1).AND.GD.EQ.EDGE(I,2)))GO TO 205
  GAP=EDGE(I,3)
  NEWGAP=.FALSE.
  GO TO 207
205 CONTINUE
206 CONTINUE
  GAP=NGRD
  NGRD=NGRD+1
  LEGE=LEGE+1
  EDGE(LEGE,1)=GA
  EDGE(LEGE,2)=GD
  EDGE(LEGE,3)=GAP
207 DO 208 I=1,LEGE
  IF(.NOT.(GB.EQ.EDGE(I,1).AND.GC.EQ.EDGE(I,2)))GO TO 208
  GBP=EDGE(I,3)
  NEWGBP=.FALSE.
  GO TO 209
208 CONTINUE
  GBP=NGRD
  NGRD=NGRD+1
  LEGE=LEGE+1
  EDGE(LEGE,1)=GB
  EDGE(LEGE,2)=GC
  EDGE(LEGE,3)=GBP
209 CONTINUE
  NG(K,JA)=GAP

```

```

NG(K,JB)=GBP
C
C SEARCH ROD TABLE FOR RODS ALONG EDGES GA-GD OR GB-GC
C IF FOUND, CHANGE TO BE GA-GAP-GD OR GB-GBP-GC
C
IF(NCRD.LE.0) GO TO 42
NCRDX=NCRD
DO 40 I=1,NCRDX
IF(.NOT.(IDRD(I,3).EQ.GA.AND.IDRD(I,4).EQ.GD))GO TO 24
IF(.NOT.NEWGAP) GO TO 40
IDRD(I,3)=GAP
GO TO 32
24 IF(.NOT.(IDRD(I,4).EQ.GA.AND.IDRD(I,3).EQ.GD))GO TO 26
IF(.NOT.NEWGAP) GO TO 40
IDRD(I,4)=GAP
GO TO 32
26 IF(.NOT.(IDRD(I,3).EQ.GB.AND.IDRD(I,4).EQ.GC))GO TO 28
IF(.NOT.NEWGBP) GO TO 40
IDRD(I,3)=GBP
GO TO 30
28 IF(.NOT.(IDRD(I,4).EQ.GB.AND.IDRD(I,3).EQ.GC))GO TO 40
IF(.NOT.NEWGBP)..GO TO 40
IDRD(I,4)=GBP
30 CONTINUE
J1=GB
J2=GBP
GO TO 34
32 J1=GA
J2=GAP
34 CONTINUE
NCRD=NCRD+1
IF(NCRD.GT.1000) STOP 98
IDRD(NCRD,1)=IDEX
IDEX=IDEX+1
IDRD(NCRD,2)=IDRD(I,2)
IDRD(NCRD,3)=J1
IDRD(NCRD,4)=J2
40 CONTINUE
42 CONTINUE-
C
C SEARCH BAR TABLE FOR BARS ALONG EDGES GA-GD OR GB-GC
C IF FOUND, CHANGE TO BE GA-GAP-GD OR GB-GBP-GC
C
IF(NBAR.LE.0)GO TO 75
REWIND 3
DO 70 I=1,NBAR
43 CONTINUE
READ(3,7000) BB
WRITE(0,7000) BB(1)
READ(0,7030) K
IF(K.EQ.IPLS) GO TO 43
7000 FORMAT( 10A8 )
IF(.NOT.(IBA(I).EQ.GA.AND.IBB(I).EQ.GD))GO TO 44
IF(.NOT.NEWGAP) GO TO 70
IBA(I)=GAP

```



```

GC TO 52
44 IF(.NOT.(IBB(I).EQ.GA.AND.IBA(I).EQ.GD))GO TO 46
   IF(.NOT.NEWGAP) GO TO 70
   IBB(I)=GAP
   GO TO 52
46 IF(.NOT.(IBA(I).EQ.GB.AND.IBB(I).EQ.GC))GO TO 48
   IF(.NOT.NEWGBP) GO TO 70
   IBA(I)=GBP
   GO TO 50
48 IF(.NOT.(IBB(I).EQ.GB.AND.IBA(I).EQ.GC))GO TO 70
   IF(.NOT.NEWGBP) GO TO 70
   IBB(I)=GBP
50 CONTINUE
   J1=GB
   J2=GBP
   GO TO 54
52 J1=GA
   J2=GAP
54 CONTINUE

```

C
C
C

```

   OUTPUT NEW CBAR CARD
   WRITE(9,7001)IBB(1),IDEX,IBB(3),J1,J2,(BB(J),J=6,9)
7001 FCRMAT( A8,I8,A8,2I8,4A8 )
   IDEX=IDEX+1
70 CONTINUE
75 CONTINUE

```

C
C
C
C

```

   SEARCH FOR RODS OR BARS ALONG EDGE GA-GB. IF FOUND, HALVE
   THE PROPERTIES AND ALSO PUT SAME ALONG GAP-GBP

   IF(NCRD.LE.0) GO TO 740
   DC 730 I=1,NCRD
   IF(GA.EQ.IDRD(I,3).AND.GB.EQ.IDRD(I,4)) GO TO 708
   IF(.NOT.(GA.EQ.IDRD(I,4).AND.GB.EQ.IDRD(I,3))) GO TO 730
708 J=IDRD(I,2)
   IDRDI,I,2)=IPEX
   DO 710 K=1,NPRO
   IF(J.NE.IDX(K)) GO TO 710
   JJ=K
   GO TO 712
710 CONTINUE
712 CCNTINUE
   DC 720 K=1,4
720 AX(K)=0.5*PRDP(JJ,K)
   WRITE(9,7004) IPEX,ICM(JJ),(AX(K),K=1,3)
   WRITE(9,7003) IDEX,IPEX,GAP,GBP
   IDEX=IDEX+1
   IPEX=IPEX+1
   GO TO 740
730 CONTINUE
740 CCNTINUE
   IF(NBAR.LE.0) GO TO 785
   REWIND 3
   DO 780 I=1,NBAR

```

```

743 CONTINUE
  READ(3,7000) WW
  WRITE(0,7000) WW(1)
  READ(0,7030) K
  IF(K.EQ.IPLS) GO TO 743
  IF(GA.EQ.IBA(I).AND.GB.EQ.IBB(I)) GO TO 748
  IF(.NOT.(GA.EQ.IBB(I).AND.GB.EQ.IBA(I))) GO TO 780
748 J=IPB(I)
  IPB(I)=IPEX
  REWIND 4
  DO 750 K=1,NPBR
  IF(IDY(K).NE.J) GO TO 750
  JJ=IPREC(K)-1
  GO TO 752
750 CONTINUE
752 IF(JJ.LE.0) GO TO 758
  DO 756 K=1,JJ
756 READ(4,7000) BB
758 READ(4,7000) BB
  READ(4,7000) CC
  WRITE(0,7000) CC(1)
  READ(0,7030) K
7030 FORMAT( A1 )
  IF(K.NE.KSTR) GO TO 762
C
C
C
  WRITE(0,7000) BB
  READ(0,7031) MID,{AX(K),K=1,2}
7031 FORMAT( 24X,116,2F16.0)
  WRITE(0,7000) CC
  READ(0,7032) {AX(K),K=3,5}
7032 FORMAT( 8X,4F16.0)
  GO TO 766
762 CONTINUE
C
C
C
  WRITE(0,7000) BB
  READ(0,7033) MID,{AX(K),K=1,5}
7033 FORMAT( 16X,18,5F8.0)
766 CONTINUE
  DO 767 K=1,5
767 AX(K)=0.5*AX(K)
  WRITE(9,7034) IDEX,IPEX,GAP,GBP,(WW(K),K=6,9)
7034 FORMAT( 8HCBAR ,4I8, 4A8 )
  WRITE(9,7035) IPEX,MID,AX(1),AX(2),IPEX,IPEX,{AX(K),K=3,5}
7035 FORMAT( 8HPBAR* ,2I16,2E16.8, 3H*PB, 15/ 3H*PB, 15, 3E16.8 )
  IPEX=IPEX+1
  IDEX=IDEX+1
  GO TO 785
780 CONTINUE
785 CONTINUE
C
C
  GET MATERIAL PROPERTIES AND THICKNESS FOR CPLATE K

```

C

```
J=IPID(KKK)
NE=INC(KKK)
DO 80 I=1,NPPLT
IF(IDPP(I).NE.J) GO TO 80
IF(INP(I).NE.NE) GO TO 80
IP=I
GO TO 82
80 CONTINUE
STOP 97
82 CONTINUE
T=THICK(IP)
J=IMID(IP)
DO 86 I=1,NMAT1
IF(IDMAT(I).NE.J) GO TO 86
IM=I
GO TO 88
86 CONTINUE
STOP 96
88 CONTINUE
EE=E(IM)
GG=G(IM)
```

C

C GET CCORDS OF GRIDS A AND B. CALC DISTANCE BETWEEN

C

```
CALL COORD(GA,GB,GA,&800)
XAB=XC(1,2)-XC(1,1)
YAB=XC(2,2)-XC(2,1)
ZAB=XC(3,2)-XC(3,1)
XLAB=SQRT(XAB**2+YAB**2+ZAB**2)
AAP=PLTPRM(KK,3)*XLAB
IF(.NOT.NEWGAP) GO TO 89
```

C

C CALC POSITION OF GRID GAP BETWEEN GRIDS A AND D

C

```
CALL COORD(GA,GD,GA,&800)
XX=XC(1,2)-XC(1,1)
YY=XC(2,2)-XC(2,1)
ZZ=XC(3,2)-XC(3,1)
XL=SQRT(XX**2+YY**2+ZZ**2)
XP=XC(1,1)+AAP*XX/XL
YP=XC(2,1)+AAP*YY/XL
ZP=XC(3,1)+AAP*ZZ/XL
```

C

C OUTPUT GRID GAP

C

```
WRITE(9,7002) GAP,INCP,XP,YP,ZP
7002 FORMAT( 8HGRID , 2I8, 3F8.3 ,2(7X,1H0))
```

C

C IF NORMAL DOF IS TO BE MPC-ED, CALCULATE COORDINATES OF NORMAL

C

```
IDMPCA=0
IF(.NOT.(MPCPA(KK).EQ.GA .OR. MPCPB(KK).EQ.GA)) GO TO 89
ANORMX=YY*ZAB-YAB*ZZ
ANORMY=ZZ*XAB-ZAB*XX
```

```

ANORMZ=XX*YAB-XAB*YY
IDMPCA=GA
89 IF(.NOT.NEWGBP) GO TO 90

```

C
C
C

```

CALC SAME FOR GBP

```

```

CALL CGORD(GB,GC,GB,&800)
XX=XC(1,2)-XC(1,1)
YY=XC(2,2)-XC(2,1)
ZZ=XC(3,2)-XC(3,1)
XL=SQRT(XX**2+YY**2+ZZ**2)
XP=XC(1,1)+AAP*XX/XL
YP=XC(2,1)+AAP*YY/XL
ZP=XC(3,1)+AAP*ZZ/XL
WRITE(9,7002) GBP,INCP,XP,YP,ZP

```

C
C
C

```

IF NORMAL DOF IS TO BE MPC-ED, CALCULATE COORDINATES OF NORMAL

```

```

IDMPCB=0
IF(.NOT.(MPCPA(KK).EQ.GB .OR. MPCPB(KK).EQ.GB)) GO TO 90
BNORMX=-(YY*ZAB-YAB*ZZ)
BNORMY=-(ZZ*XAB-ZAB*XX)
BNORMZ=-(XX*YAB-XAB*YY)
IDMPCB=GB

```

```

90 CONTINUE
IF(NE.EQ.5) GO TO 96

```

C
C
C

```

GENERATE CONNECTIONS FOR SIDE RODS

```

```

I=IDEX+1
WRITE(9,7003) IDEX,IPEX,GA,GAP,I,IPEX,GB,GBP
7003 FORMAT( 8HCROD , 8I8 )
IDEX=IDEX+2

```

C
C
C

```

GENERATE PROPERTY CARD FOR SIDE RODS

```

```

AREA=.5*PLTPRM(KK,4)*XLAB*T
WRITE(9,7004) IPEX,IMEX,AREA
7004 FORMAT( 8HPROD , 2I8, 4F8.4 )
IPEX=IPEX+1

```

C
C
C

```

GENERATE MAT1 CARD

```

```

DAMP=PLTPRM(KK,1)*AAP/(AREA*EE)
WRITE(9,7005) IMEX,EE,GG,IMEX,IMEX,DAMP
7005 FORMAT( 5HMAT1#,1I9,2E16.8,.16X,.3H#M1,15_/ 3H#M1,15,.48X,E16.8)
IMEX=IMEX+1
96 CONTINUE

```

C
C
C

```

GENERATE DIAGONAL RODS

```

```

I=IDEX+1
WRITE(9,7003) IDEX,IPEX,GA,GBP,I,IPEX,GAP,GB
IDEX=IDEX+2
AREA=.5*PLTPRM(KK,5)*XLAB*T*GG/EE

```

REPRODUCIBILITY OF THE
ORIGINAL PAGE IS POOR

```
WRITE(9,7004) IPEX,IMEX,AREA  
IPEX=IPEX+1  
XDIAG=SQRT(AAP**2+XLAB**2)  
DAMP=PLTPRM(KK,2)*XDIAG/(AREA*EE)  
WRITE(9,7005) IMEX,EE,GG,IMEX,IMEX,DAMP  
IMEX=IMEX+1  
IF(NE.NE.5) GO TO 99
```

```
C  
C  
C GENERATE VISC ELEMENTS FOR SHEAR PLATES
```

```
-----  
I=IDEX+1  
WRITE(9,7010) IDEX,IPEX,GA,GAP,I,IPEX,GB,GBP  
7010 FORMAT( 8HCVISC , 8I8 )  
-----  
IDEX=IDEX+1  
WRITE(9,7011) IPEX,PLTPRM(KK,1),IPEX,IPEX  
IPEX=IPEX+1  
7011 FORMAT( 8HPVISC* , I16, E16.7, 32X, 3H*PV, I5 / 3H*PV, I5 )  
99 CONTINUE  
IF(MPCID(KK).EQ.0) GO TO 120
```

```
C  
C  
C GENERATE MPC EQNS FOR NORMAL DOF IF REQD
```

```
-----  
JFRDMA=123  
IF(IDMPCA.GT.0 .AND. NEWGAP)  
* CALL PLTMPC(MPCID(KK),ANORMX,ANORMY,ANORMZ,JFRDMA,GA,GAP)  
JFRDMB=123  
IF(IDMPCB.GT.0 .AND. NEWGBP)  
X CALL PLTMPC(MPCID(KK),BNORMX,BNORMY,BNORMZ,JFRDMB,GB,GBP)
```

```
C  
C  
C GENERATE MPC EQNS FOR ROTATIONS
```

```
-----  
DO 110 I=4,6  
IF(NEWGAP)  
X WRITE(9,7007) MPCID(KK),GAP,I,GA,I  
IF(NEWGBP)  
X WRITE(9,7007) MPCID(KK),GBP,I,GB,I  
110 CONTINUE  
7007 FORMAT( 8HMPC , 3I8, 5X,3H-1., 2I8,6X,2H1. )  
120 CONTINUE  
IF(OMP(KK).EQ.0.) GO TO 130
```

```
C  
C  
C GENERATE OMITTS FOR NEW GRIDS
```

```
-----  
IF(NEWGAP) WRITE(9,7008) JFRDMA,GAP  
IF(NEWGBP) WRITE(9,7008) JFRDMB,GBP  
7008 FORMAT( 8HOMIT1 , I3,3H456, I10 )  
130 CONTINUE  
800 CONTINUE
```

```
C  
C  
C GENERATE SEQUENCE CARD FOR NEW GRIDS
```

```
-----  
DO 840 I=1,LEDGE  
GA=MINO(EDGE(I,1),EDGE(I,2))  
GAP=EDGE(I,3)
```

```
C
```

```

WRITE(9,7006) GAP,GA
C
840 CONTINUE
7006 FORMAT( 8HSEQGP , I8, I6, 2H.5)
RETURN
END
SUBROUTINE CORSYS(K)
C
C READ AND STORE CORD1C CARD (K=1) OR CORD2C CARD (K=2)
C READ AND STORE CORD1R CARD (K=3) OR CORD2R CARD (K=4)
C
COMMON/BCORD/ IDCOR(20),IF1OR2(20),XPP(20,9),NCORD
DIMENSION JPP(20,9)
EQUIVALENCE (JPP(1,1),XPP(1,1))
COMMON/IMAGE/ CD(20)
IF(NCORD.GE.20) STOP 47
NCORD=NCORD+1
IF(K.EQ.2 .OR. K.EQ.4) GO TO 40
READ(0,7000) IDCOR(NCORD),(JPP(NCORD,I),I=1,3)
IF1OR2(NCORD)=K
GO TO 60
40 CONTINUE
READ(0,7001) IDCOR(NCORD),(XPP(NCORD,I),I=1,6)
READ(5,7002) CD
WRITE(0,7002) CD
WRITE(9,7002) CD
CALL RADJ(3,I)
READ(0,7003) (XPP(NCORD,I), I=7,9)
IF1OR2(NCORD)=K
60 CONTINUE
RETURN
7000 FORMAT(8X,4I8)
7001 FORMAT(8X,18,8X,6F8.0)
7002 FORMAT(20A4)
7003 FORMAT(8X,3F8.0)
END
SUBROUTINE GCONV
C
C ROUTINE TO CONVERT ANY GRID POINTS(INVOLVED IN BAR JOINTS)
C TO BASIC COORDS
C
DIMENSION JPP(20,1),JJ(3),TN(3,3),VI(3),VJ(3),VK(3),Z(3),W(3)
EQUIVALENCE (JPP(1,1),XPP(1,1))
COMMON/ BGRID / IDG(1000), ICP(1000), GCD(1000,3), NGD, DUMM
X ,IXCD(1000),IXPS(1000)
REAL*8 IXCD, IXPS
COMMON/BCORD/ IDCOR(20),IF1OR2(20),XPP(20,9),NCORD
EQUIVALENCE (TN(1,1),VI(1)),(TN(1,2),VJ(1)),(TN(1,3),VK(1))
IF(NCCRD.LE.0) GO TO 801
DO 800 IC=1,NCORD
IDC=IDCOR(IC)
KIND=IF1OR2(IC)
IF(KIND.EQ.2 .OR. KIND.EQ.4) GO TO 20
DO 4 I=1,3
4 JJ(I)=JPP(IC,I)

```

```

DO 8 I=1,NGD
IF(JJ(1).NE.IDG(I)) GO TO 5
XPP(IC,1)=GCD(I,1)
XPP(IC,2)=GCD(I,2)
XPP(IC,3)=GCD(I,3)
GO TO 8
5 IF(JJ(2).NE.IDG(I)) GO TO 6
XPP(IC,4)=GCD(I,1)
XPP(IC,5)=GCD(I,2)
XPP(IC,6)=GCD(I,3)
GO TO 8
6 IF(JJ(3).NE.IDG(I)) GO TO 8
XPP(IC,7)=GCD(I,1)
XPP(IC,8)=GCD(I,2)
XPP(IC,9)=GCD(I,3)
8 CONTINUE
20 CONTINUE
VK(1)=XPP(IC,4)-XPP(IC,1)
VK(2)=XPP(IC,5)-XPP(IC,2)
VK(3)=XPP(IC,6)-XPP(IC,3)
X=SQRT(VK(1)**2+VK(2)**2+VK(3)**2)
VK(1)=VK(1)/X
VK(2)=VK(2)/X
VK(3)=VK(3)/X
VI(1)=XPP(IC,7)-XPP(IC,1)
VI(2)=XPP(IC,8)-XPP(IC,2)
VI(3)=XPP(IC,9)-XPP(IC,3)
VJ(1)=VK(2)*VI(3)-VK(3)*VI(2)
VJ(2)=VK(3)*VI(1)-VK(1)*VI(3)
VJ(3)=VK(1)*VI(2)-VK(2)*VI(1)
X=SQRT(VJ(1)**2+VJ(2)**2+VJ(3)**2)
VJ(1)=VJ(1)/X
VJ(2)=VJ(2)/X
VJ(3)=VJ(3)/X
VI(1)=VJ(2)*VK(3)-VJ(3)*VK(2)
VI(2)=VJ(3)*VK(1)-VJ(1)*VK(3)
VI(3)=VJ(1)*VK(2)-VJ(2)*VK(1)
DO 60 I=1,NGD
IF(IDC.NE.ICP(I)) GO TO 60
IF(KIND.EQ.1 .OR. KIND.EQ.2) GO TO 25
Z(1)=GCD(I,1)
Z(2)=GCD(I,2)
GO TO 26
25 Z(1)=GCD(I,1)*COS( GCD(I,2)*.0174533 )
Z(2)=GCD(I,1)*SIN( GCD(I,2)*.0174533 )
26 CONTINUE
Z(3)=GCD(I,3)
W(1)=XPP(IC,1)
W(2)=XPP(IC,2)
W(3)=XPP(IC,3)
DO 30 J=1,3
DO 28 K=1,3
28 W(J)=W(J)+TN(J,K)*Z(K)
30 CONTINUE
WRITE(9,7000) IDG(I),W(1),W(2),IDG(I),IDG(I),W(3),IXCD(I),EXPS(I)

```

```

      ICP(I)=0
      GCD(I,1)=W(1)
      GCD(I,2)=W(2)
      GCD(I,3)=W(3)
60  CCNTINUE
800 CONTINUE
801 CONTINUE
C
C   OUTPUT ALL GRIDS NOW HAVING NON-ZERO LOCATION COORD SYS FLAG
C
      DO 880 I=1,NGD
      IF(ICP(I).LE.0) GO TO 880
      WRITE(9,7001) IDG(I),ICP(I),GCD(I,1),GCD(I,2),IDG(I),IDG(I),
X     GCD(I,3),IXCD(I),IXPS(I)
880  CONTINUE
      RETURN
7000 FORMAT( 8HGRID#   ,I16,15X,1H0,2E16.8, 2H*G,I6 / 2H*G,I6,
X     E16.8,2(8X,A8))
7001 FORMAT( 8HGRID#   , 2I16,2E16.8,2H*G,I6/2H*G,I6,E16.8,2(8X,A8))
      END
      SUBROUTINE PLTMPC(MPID,X,Y,Z,JFRDOM,IDA,IDAP)
C
C   WRITE MPC EQN FOR NORMAL DOF FOR PLATE JOINT
C
      DIMENSION DC(3),DCM(3)
      EQUIVALENCE (DC(1),A),(DC(2),B),(DC(3),C)
      XL=SQRT(X**2+Y**2+Z**2)
      A=X/XL
      B=Y/XL
      C=Z/XL
      R=C
      I=3
      J=1
      K=2
      IF(B.LE.R) GO TO 8
      R=B
      I=2
      J=1
      K=3
8     IF(A.LE.R) GO TO 10
      R=A
      I=1
      J=2
      K=3
10    CONTINUE
      JFRDOM=10*J+K
      DO 12 M=1,3
12    DCM(M)=DC(M)
      WRITE(9,7000) MPID,IDAP,I,DC(I),IDA,I,DCM(I),IDAP,
X     IDAP,IDAP,J,DC(J),IDA,J,DCM(J),IDAP,
X     IDAP,IDAP,K,DC(K),IDA,K,DCM(K)
7000 FORMAT( 8HMPC   ,I8,2(I8,I8,F8.5),8X, 3H+MR,I5 /
X     3H+MR,I5,      8X,2(I8,I8,F8.5),8X, 3H+MS,I5 /
X     3H+MS,I5,      8X,2(I8,I8,F8.5)      )
      RETURN

```



```

      END
/*
//LKED.SYSIN DD *
INCLUDE SYSLIB(HQRWZERO)
ENTRY MAIN
OVERLAY A
INSERT RADJ
INSERT GRID
INSERT OMTC
INSERT RCD
INSERT BAR
INSERT CROD
INSERT PRCD
INSERT CBAR
INSERT PBAR
INSERT MAT1,CPLATE,PPLATE,PLATE
OVERLAY A
INSERT SEQGEN
INSERT CCCRD
INSERT STORE
OVERLAY B
INSERT BARJT
INSERT MPCGEN
OVERLAY B
INSERT RODJT
OVERLAY B
INSERT PJ
//GO.FT03F001 DD DSN=&CBAR,DISP=(NEW,DELETE),UNIT=SYSDA,
//    SPACE=(80,(1200,50))
//GO.FT04F001 DD DSN=&PBAR,DISP=(NEW,DELETE),UNIT=SYSDA,
//    SPACE=(80,(1200,50))
//GO.FT09F001 DD DSN=&&BULK,DISP=(NEW,PASS,DELETE),UNIT=SYSDA,
//    DCB=(RECFM=FB,LRECL=80,BLKSIZE=800),
//    SPACE=(80,(3000,100))
//GO.SYSUDUMP DD SYSOUT=A,SPACE=(TRK,(0,60),RLSE)
//GO.SYSIN DD DSN=*.MRG.GO.FT01F001,UNIT=SYSDA,DISP=(OLD,DELETE)
//    EXEC PGM=IEBTPCH,COND=EVEN
//SYSPRINT DD SYSOUT=A
//SYSUT1 DD DSN=&&BULK,DISP=(OLD,PASS)
//SYSUT2 DD SYSOUT=A
//SYSIN DD *
      PRINT TYPCRG=PS,MAXFLDS=1,MAXLINE=55
      RECORD FIELD=(80)
/*

```

2134

APPENDIX II
JOINT DAMPING PREDICTOR COMPUTER PROGRAM

Introduction

This program, written in FORTRAN IV, was developed to calculate individual joint damping parameters necessary to provide prescribed modal damping in specific flexible modes. The preprocessor computer program (Appendix I) separates joints with similar damping properties into groups called damping sets. Elemental damping matrix partitions are generated for each damping set using arbitrarily specified damping parameters for each set whose damping parameters are unknown a priori. The joint damping predictor (JDP) computer program ignores all damping not input by the preprocessor. The user identifies the modes for which modal damping is specified (at least one mode per damping set) and inputs the desired modal damping for each mode. The JDP then calculates scale factors by which the damping parameters for each damping set must be multiplied to obtain the desired modal damping. If the damping is specified for more modes than the number of damping sets, the JDP performs a least squares fit in the calculation of the scale factors. The JDP requires gridpoint number 1 to be used in the structural model. Details of the JDP calculations are given in Section 2.2.

Input Description

The input data required by the joint damping predictor (JDP) computer program consist of punched cards and a NASTRAN restart tape. The NASTRAN tape contains the following structural dynamic data in matrix format:

- a. modal eigenvectors (gridpoint #1 must be in the model)
- b. elemental damping matrix partitions-- one for each damping set.

The punched-card input required for the JDP is as follows:

1. NUMB - format (16I5)
NUMB = number of damping sets whose damping parameters are to be determined.
2. IMODE(I), I = 1, LMODES - format (16I5)
IMODE = mode number for which modal damping is specified.
3. DAMP(I), I = 1, LMODES - format (8F10.0)
DAMP(I) = specified modal viscous damping ratio (not including material damping)

4. $XXM(I), XXF(I), I = 1, LMODES$ - format (2F10.0)
 XXM = generalized mass
 XXF = modal frequency (rad/sec)
 (input modal parameters for each mode on separate card)

Output Description

The JDP prints out a scale factor for each damping set which, when multiplied by the respective arbitrary joint damping parameter used for each set in the pre-processor input, gives the desired modal viscous damping. The output also includes the coupled modal viscous damping matrix for those modes used in the calculations. The diagonal terms of this matrix are:

$$C_{ij} = 2 \zeta_j \omega_j m_j$$

where:

- ζ_j = modal viscous damping ratio
- ω_j = modal frequency (rad/sec)
- m_j = modal generalized mass.

Joint Damping Predictor Listing

```

DOUBLE PRECISION AA,ANAM1,ANAM2
DIMENSION NAR(4)
REAL*8 PVS,SUBS
DIMENSION SUBS( 9),PVS( 9),IDUM(16),MODID(20),WM(20),A(20)
DIMENSION S1(1803),S2(4000),X(1),IX(1),BHH(20,20),OI(20)
DIMENSION DUM(20,20),CSTR(20,20),BB(20),DUM2(20,20)
DIMENSION DAMP(20)
DIMENSION L12(100),L11(20)
DATA SUBS/ 5HBGG00, 5HBGG01, 5HBGG02, 5HBGG03, 5HBGG04,
X 5HBGG05, 5HBGG06, 5HBGG07, 5HBGG08 /
DATA PVS / 5HPV00 , 5HPV01 , 5HPV02 , 5HPV03 , 5HPV04 ,
X 5HPV05 , 5HPV06 , 5HPV07 , 5HPV08 /
DATA ANAM1/4HLAMA /, ANAM2/4HPHIG /
COMMON/WORK/ XX(48000)
COMMON/NGUTU/ KKK
EQUIVALENCE (S1(1),XX(1)),(S2(1),XX(2001)),(X(1),IX(1),XX(14001))
X (DUM(1,1),S2(1)),(BB(1),S2(2001)),(DUM2(1,1),S2(2100))
IU=31
NBUF=1603
MAX XX=48000

```

C
C INPUT NUMBER OF B-SUBSETS.

C
C READ(5,9) NUMB
9 FORMAT(16I5)

C
C READ LIST OF MODES TO USE

C
LMODES=0
8 READ(5,9) IDUM
DO 15 I=1,16
IF(IDUM(I).LE.0) GO TO 16
LMODES=LMODES+1
MODID(LMODES)=IDUM(I)
15 CONTINUE
GO TO 8
16 CONTINUE
CALL ISORT(MODID,LMODES)
MODID(LMODES+1)=-1

C
C INPUT DAMPING FACTORS

C
C READ(5,3) (DAMP(I),I=1,LMODES)
3 FORMAT(8F10.0)
IF(IU.EQ.-6789) GO TO 3960

C
C READ GEN MASS AND FREQS FROM CARDS

C
DO 3958 I=1,LMODES
READ(5,3) XXM,XXF
WM(I)=XXM*XXF
3958 CONTINUE
GO TO 22
3960 CONTINUE

REPRODUCIBILITY OF THE
ORIGINAL PAGE IS POOR

C GET LAMA TABLE FROM CHECKPOINT TAPE. FORM ARRAY OF
C OMEGA*GENMASS IN WM
C

CALL NFETCH(NBUF,ANAM1,X,I,J,2500,1,S1,IU,S2,K,1,2)
IF(K.GE.0) GO TO 17
STOP 30
17 CONTINUE
I=I+2500
J=2501
K=1
19 MODN=IX(J)
IF(MODN.NE.MODID(K)) GO TO 20
WM(K)=X(J+3)*X(J+5)
K=K+1
IF(K.GT.LMODES) GO TO 22
20 J=J+7
IF(J.LT.I) GO TO 19
STOP 31
22 CONTINUE

C
C COPY MODE SHAPES FROM CHECKPOINT TAPE TO UNIT KKK
C

KKK=20
CALL NFETCH(NBUF,ANAM2,X,I,J,7000,1,S1,IU,S2,K,1,3)
IF(K.GE.0) GO TO 25
STOP 32
25 REWIND KKK

C
C PLACE THE MODES OF INTEREST ON UNITS 11, AND ALL MODES ON 12
C

K=1
LMTOT=0
LPHI=0
26 READ(KKK,END=30) AA,J,JJ,L
IF(L.EQ.0) GO TO 26
LPHI=MAX0(LPHI,L)
READ(KKK) (X(I),I=1,L)
IF(J.NE.MODID(K)) GO TO 26
WRITE(12) (X(I),I=1,L)
LMTOT=LMTOT+1
L12(LMTOT)=L
IF(J.NE.MCDID(K)) GO TO 26
WRITE(11) (X(I),I=1,L)
L11(K)=L
K=K+1
GO TO 26
30 CONTINUE
34 CONTINUE

C
C READ PARTITION VECTOR FOR A-SUBSET (PV00), AND BUILD
C ARRAY OF INDICES
C

IU=32
REWIND KKK
CALL NFETCH(NBUF,PVS(1),X,I,J,7000,1,S1,IU,S2,K,1,3)

```

IF(K.GE.0) GO TO 40
STOP 34
40 CONTINUE
REWIND KKK
READ(KKK) AA,J,JJ,L
READ(KKK) (X(I),I=1,L)
J=0
DO 44 K=1,L
IF(X(K).EQ.0.) GO TO 44
J=J+1
IX(J)=K
44 CONTINUE
WRITE(6,4001) (IX(K),K=1,J)
4001 FORMAT( 'INDEX ARRAY, PVOO' / (10I8) )
J1=J+1
L=J
C
C FORM MATRIX PRODUCT (PHI)T * BGG00 * PHI = BHH
C
REWIND KKK
CALL NFETCH(NBUF,SUBS(1),X(J1),I,J,7000,0,S1,IU,S2,K,1,3)
IF(K.LE.0) STOP 36
REWIND KKK
J2=J1+LMODES*L
CALL PHIMUL(11,KKK,X,L,X(J1),X(J2),BHH,20,L11,LMODES)
C
C FORM DI COLUMN
C
DO 50 I=1,LMODES
50 DI(I)=2.*DAMP(I)*WM(I) - BHH(I,I)
C
C FOR EACH B-SUBSET, CALCULATE (PHI)T * BGGNN * PHI
C AND BUILD C-STAR MATRIX
C
NNB=NUMB+1
DO 100 JJ=2,NNB
C
C PROCESS PARTITION VECTOR
C
REWIND KKK
CALL NFETCH(NBUF,PVS(JJ),X,I,J,7000,0,S1,IU,S2,K,1,3)
IF(K.LE.0) STOP 38
REWIND KKK
READ(KKK) AA,J,JQ,L
READ(KKK) (X(I),I=1,L)
J=0
DO 54 K=1,L
IF(X(K).EQ.0.) GO TO 54
J=J+1
IX(J)=K
54 CONTINUE
J1=J+1
L=J
C
C FORM MATRIX PRODUCT (PHI)T * BGGNN * PHI

```

```

C
REWIND KKK
CALL NFETCH(NBUF,SUBS(JJ),X(J1),I,J,7000,0,S1,IU,S2,K,1,3)
IF(K.LE.0) STOP 40
REWIND KKK
J2=J1+LMODES*L
CALL PHIMUL(11,KKK,X,L,X(J1),X(J2),DUM,20,L11,LMODES)
DO 60 I=1,LMODES
60 CSTR(I,JJ-1)=DUM(I,I)
100 CONTINUE

C
C CALCULATE BB = (C-STAR)T * DI
C
DO 108 I=1,NUMB
BB(I)=0.
DO 108 K=1,LMODES
108 BB(I)=BB(I)+CSTR(K,I)*DI(K)

C
C CALCULATE DUM2 = (C-STAR)T * C-STAR
C
DO 114 I=1,NUMB
DO 114 J=1,NUMB
DUM2(I,J)=0.
DO 112 K=1,LMODES
112 DUM2(I,J)=DUM2(I,J)+CSTR(K,I)*CSTR(K,J)
114 CONTINUE
NAR(1)=NUMB
NAR(2)=1
NAR(3)=0
NAR(4)=0
CALL LNG(8900,DUM2,A,BB,DUM,X(100),20,1.,NAR,X(1000))

C
C THERE ARE NOW NUMB SCALE FACTORS IN A. FORM FINAL BHH BY
C SUMMING THE MATRIX PRODUCTS FOR EACH SCALED SUBSET.
C BHH = SUMMATION( (PHI)T * A(I)*BGGNN * PHI )
C HERE PHI IS COMPLET SET OF MODES ON UNIT 12
C
WRITE(6,124) (A(I),I=1,NUMB)
124 FORMAT( 22H1DAMPING SCALE FACTORS / (8E15.5))
LMTCT2=LMTOT*LMTOT
JO=LMTOT*LMTOT+1
IRWND=1
DO 130 I=1,LMTOT2
130 X(I)=0.
DO 200 JJ=1,NNB

C
C PROCESS PARTITION VECTORS
C
REWIND KKK
CALL NFETCH(NBUF,PYS(JJ),X(J0),I,J,7000,IRWND,S1,IU,S2,K,1,3)
IF(K.LE.0) STOP 42
IRWND=0
REWIND KKK
READ(KKK) AA,J,JQ,L
READ(KKK) (X(J0+I),I=1,L)

```

REPRODUCIBILITY OF THE
ORIGINAL PAGE IS POOR

```

J=J0-1
DO 154 K=1,L
IF(X(J0+K).EQ.0.) GO TO 154
J=J+1
IX(J)=K
154 CONTINUE
J1=J+1
L=J1-J0

```

```

C
C   FORM MATRIX PRODUCT (PHI)T * BGGNN * PHI
C

```

```

REWIND KKK
CALL NFETCH(NBUF,SUBS(JJ),X(J1),L,J,7000,0,S1,IU,SZ,K,1,3)
IF(K.LE.0) STOP 44
REWIND KKK

```

```

C
C   STORAGE ARRAY MAP
C   NAME      ADDRESS      LENGTH
C   BHH      X( 1)      LMTOT*LMTOT
C   RC       X(J0)       L
C   SCRATCH  X(J1)      L*LMTOT
C   SCRATCH  X(J2)      L+LPHI
C   SCRATCH  X(J3)      LMTOT*LMTOT
C

```

```

J2=J1+L*LMTOT
J3=J2+L+LPHI
J4=J3+LMTOT*LMTOT +6000
IF(J4.LE.MAXXX) GO TO 165
WRITE(6,161) J4,L,LMTOT,LPHI
161 FORMAT( 25HICORE OVERFLOW. LENGTH =, 16, 9H REQUIRED /
X      16H  L,LMTOT,LPHI =, 3I6 )

```

```

STOP 46

```

```

165 CONTINUE

```

```

CALL PHIMUL(12,KKK,X(J0),L,X(J1),X(J2),X(J3),LMTOT,L12,.,LMTOT)
IF(JJ.GT.1) GO TO 170

```

```

FAC=1.

```

```

GO TO 180

```

```

170 FAC=A(JJ-1)

```

```

180 CONTINUE

```

```

DO 184 I=1,LMTOT2

```

```

184 X(I)=X(I) + FAC*X(J3+I-1)

```

```

CALL BPRNT(X,LMTOT)

```

```

200 CONTINUE

```

```

RETURN

```

```

900 STOP 81

```

```

END

```

```

SUBROUTINE PHIMUL(IUPHI,IUB,RC,LRC,X,Z,BHH,IBHH,LPHI,NMODES)

```

```

C
C   FORM MATRIX PRODUCT (PHI)T * B * PHI = BHH
C

```

```

C   IUPHI - UNIT CONTAINING PHI

```

```

C   IUB   - UNIT CONTAINING B

```

```

C   RC   - ROW/COLUMN INDICES FOR B SUBSET OF PHI

```

```

C   LRC  - LENGTH OF RC

```

```

C   X    - STORAGE FOR (PHI)T * B PART (LENGTH=LRC*NMODES)

```



```

C      Z      - SCRATCH
C      BHH    - PRODUCT RETURNED HERE
C
      DIMENSION X(1),Z(1),BHH(1BHH,1BHH)
      DIMENSION LPHI(1)
      INTEGER RC(1)
      DOUBLE PRECISION AA
C
C      FORM (PHI)T * B IN X (TRANPOSE ACTUALLY STORED)
C

```

```

      REWIND IUPHI
      II=0
      KP=0
8     KP=KP+1
      LPHE=LPHI(KP)
      READ(IUPHI,END=80) (Z(I),I=1,LPHE)
18    READ(IUB,END=60) AA,J,K,L
      II=II+1
      IF(L.GT.0) GO TO 22
      X(II)=0.
      GO TO 36
22    READ(IUB) (Z(LPHE+I),I=1,L)
      A=0.
      DO 30 I=1,LRC
      IF(I.GT.L) GO TO 32
      J=RC(I)
      IF(J.GT.LPHE) GO TO 30
      A=A+Z(J)*Z(LPHE+I)
30    CONTINUE
32    X(II)=A
36    CONTINUE
      GO TO 18
60    CONTINUE
      REWIND IUB
      GO TO 8
80    CONTINUE
      IF(II.NE.LRC*NMODES) STOP 51
      REWIND IUPHI

```

```

C
C      COMPLETE MATRIX MULTIPLY
C

```

```

      J=0
      KP=0
82    KP=KP+1
      LPHE=LPHI(KP)
      READ(IUPHI,END=120) (Z(I),I=1,LPHE)
      J=J+1
      II=0
      DO 90 I=1,NMODES
      BHH(I,J)=0.
      DO 84 K=1,LRC
      II=II+1
      KK=RC(K)
      IF(KK.GT.LPHE) GO TO 84
      BHH(I,J) = BHH(I,J) + X(II)*Z(KK)

```

84 CONTINUE
 90 CONTINUE
 GO TO 82
 120 CONTINUE

REPRODUCIBILITY OF THE
 ORIGINAL PAGE IS POOR

RETURN
 END
 SUBROUTINE BPRNT(X,L)
 DIMENSION X(L,L)
 WRITE(6,9)
 DO 20 J=1,L
 20 WRITE(6,8) J,(X(I,J), I=1,L)
 8 FORMAT(5HMODE, I3, 2X, 10E12.5 / (10X, 10E12.5))
 9 FORMAT(17H1FINAL_BHH_MATRIX)
 RETURN
 END

SUBROUTINE PVPRNT(AA,X,L)
 REAL*8 AA
 DIMENSION X(L)
 WRITE(6,2) AA
 2 FORMAT('OPARTITION VECTOR ', A8)
 WRITE(6,4) X
 4 FORMAT(.10E10.2)
 RETURN
 END

SUBROUTINE NFETCH(MO,AA,AS,I,J,IDIM,IRWD,SS,IU,S2,ISUC,IPREC,KIND)

C		PVEC0815
C	ROUTINE TO READ MATRIX FROM NASTRAN SAVE TAPE	PVEC0816
C	MO - NASTRAN BUFFSIZE USED TO GENERATE TAPE	PVEC0817
C	AA - FILE NAME OF MATRIX	PVEC0818
C	AS - MATRIX (OR TABLE) RETURNED HERE	PVEC0819
C	I,J - MATRIX SIZE (RETURNED)	PVEC0820
C	IDIM - DIMENSION OF AS ARRAY	PVEC0821
C	IRWD - IF =1, REWIND TAPE BEFORE SEARCH BEGINS	PVEC0822
C	=0, DO NOT REPOSITION TAPE BEFORE SEARCH	PVEC0823
C	SS - SCRATCH ARRAY OF LENGTH MO	PVEC0824
C	IU - FORTRAN UNIT CONTAINING TAPE	PVEC0825
C	S2 - SCRATCH ARRAY OF LENGTH 2*IDIM*MO	PVEC0826
C	ISUC - IF SUCCESS, RETURNED =1 IF FAILURE, RETURNED =-1	PVEC0827
C	IPREC - IF =1, RETURN S.P. RESULTS, IF =2, RETURN D.P.	PVEC0828
C	KIND - IF =1, READ FILE AS MATRIX	PVEC0829
C	=2, READ FILE AS TABLE, STORE EACH RECORD AS A COLUMN	PVEC0830
C	OF MATRIX AS (IDIM,GE.LONGEST RECORD OF TABLE)	PVEC0831
C	=3, READ FILE AS MATRIX, WRITE FULL COLUMNS ON UNIT IOUT,	PVEC0832
C	DO NOT RETURN MATRIX IN AS, USE COL 1 OF AS FOR WORK	PVEC0833
C	=4, READ FILE AS A TABLE, WRITE EACH RECORD ON UNIT IOUT	PVEC0834
C	DO NOT RETURN TABLE IN AS, USE AS FOR WORK	PVEC0835
C		PVEC0836

C	COMMON/NOUTU/IOUT	
C	COMMON/ XXUNPA / LSP	PVEC0838
C	INTEGER AA(2),AS(IDIM,1),SS(1),S2(1),COLEND	PVEC0839
C	DATA IEOF/'EOF',IEND/'ENDD',COLEND/ZOOFFFFF/	PVEC0840
C	DATA K1/4/, IPRNT1/6/, ITRLR/ZOO010000/	
C	INTEGER*2 KKO(2),KK2	PVEC0841
C	EQUIVALENCE (KKK,KKO(1)),(KK2,KKO(2))	PVEC0842
C	M1=MO-3	PVEC0843

	MEND=M1-2	PVEC0844
	IF(IRWD.EQ.0)GO TO 22	PVEC0845
	REWIND IU	PVEC0846
20	CONTINUE	PVEC0847
	CALL RX(SS(1),M1,IU,II)	PVEC0848
	K1=4	
	IF(II.LT.0)GO TO 960	PVEC0849
22	CONTINUE	PVEC0850
	NBLOCK=SS(1)	PVEC0851
30	CONTINUE	PVEC0853
	LL=SS(K1)	PVEC0854
	L=LL/4	PVEC0855
	IF(L.EQ.0) GO TO 900	PVEC0856
	IF(L.NE.2)GO TO 38	PVEC0857
C	ENCOUNTERED FILE NAME---COMPARE WITH AA	PVEC0858
	WRITE(IPRNT1,1)SS(K1+1),SS(K1+2)	PVEC0859
	1 FORMAT('OFDUND FILE ', 2A4)	PVEC0860
	38 CONTINUE	PVEC0861
	IF(SS(K1+1).NE.AA(1))GO TO 40	PVEC0862
C	POSSIBILITY OF NAME BEING CONTINUED TO NEXT BLOCK	PVEC0863
	IF(L.NE.1) GO TO 39	PVEC0864
	IF(K1.NE.(MEND-1)) GO TO 39	PVEC0865
C	INPUT NEXT BLOCK	PVEC0866
	CALL RX(SS(1),M1,IU,II)	PVEC0867
	IF(II.LT.0)GO TO 960	PVEC0868
	NBLOCK=SS(1)	
	K1=4	PVEC0869
	LL=SS(4)	PVEC0870
	L=LL/4	PVEC0871
	IF(L.EQ.0) GO TO 900	PVEC0872
	IF(SS(K1+1).EQ.AA(2)) GO TO 60	PVEC0873
	GO TO 40	PVEC0874
39	CONTINUE	PVEC0875
	IF(SS(K1+2).EQ.AA(2))GO TO 60	PVEC0876
40	CONTINUE	PVEC0877
	IF(LL.NE.IEOF)GO TO 46	PVEC0878
	WRITE(IPRNT1,2)	PVEC0879
	2 FORMAT('0** EOF **')	PVEC0880
	K1=K1+1	PVEC0881
	GO TO 48	PVEC0882
46	CONTINUE	PVEC0883
	IF(LL.EQ.IEND)GO TO 20	PVEC0884
C	SKIP OVER LOGICAL RECORD	PVEC0885
	47 CONTINUE	PVEC0886
	K1=K1+L+2	PVEC0887
48	CONTINUE	PVEC0888
	IF(K1.LT.MEND)GO TO 30	PVEC0889
C	CHECK POSSIBILITY OF UNUSED WORDS AT END OF BLOCK	PVEC0890
	DO 50 II=K1,M1	PVEC0891
	L=SS(II)	PVEC0892
	IF(L.EQ.IEOF) WRITE(IPRNT1,2)	
	IF(L.EQ.IEND) GO TO 20	PVEC0894
50	CONTINUE	PVEC0895
	GO TO 20	PVEC0896
60	CONTINUE	PVEC0897

C		PVEC0898
C#	FOUND REQUESTED FILE	PVEC0899
C		PVEC0900
	WRITE(IPRNT1,3) AA,NBLOCK.	
3	FORMAT('OBEGIN PROCESSING FILE ', 2A4, ' BLOCK NO. =', I4)	
	I=0	PVEC0903
	J=0	PVEC0904
	K1=K1+L+2	PVEC0905
	IF(K1.LT.MEND)GO TO 61	PVEC0906
	CALL RX(SS(1),M1,IU,II)	PVEC0907
	IF(II.LT.C)GO TO 960	PVEC0908
	K1=4	PVEC0909
61	CONTINUE	PVEC0910
	L=SS(K1)	PVEC0911
	IF(L.EQ.IEOF)GO TO 800	PVEC0912
	L=L/4	PVEC0913
	GO TO (62,200,62,200), KIND	PVEC0914
62	CONTINUE	PVEC0915
C		PVEC0916
C#	PROCESS FILE AS PACKED MATRIX	PVEC0917
C	CHECK FOR MATRIX TRAILER AND CHECK TO	
C	SKIP OVER 4-WORD PREAMBLE OF PLOT VECTORS (E.G. PPHIG)	
C		PVEC0918
	IF(SS(K1+2).GE.ITRLR) GO TO 100	
	IF(L.GE.6 .AND. IABS(SS(K1+6)).LT.COLEND) K1=K1+4	
	KK=1	PVEC0919
64	CONTINUE	PVEC0920
	K1=K1+1	PVEC0921
	L=L-1	PVEC0922
	IF(L.LT.0) GO TO 82	
	JJ=SS(K1)	PVEC0924
	IF(JJ.EQ.COLEND)GO TO 70	PVEC0925
C	STORE TERM IN SCRATCH	PVEC0926
	S2(KK)=JJ	PVEC0927
	KK=KK+1	PVEC0928
	GO TO 64	PVEC0929
70	CONTINUE	PVEC0930
	S2(KK)=COLEND	PVEC0931
	J=J+1	PVEC0932
	IF(KIND.EQ.3)GO TO 74	PVEC0933
C	UNPACK COLUMN J, STORE IN AS	PVEC0934
	CALL XXUNP(AS(1,J),S2(1),M,IDIM,IPREC)	PVEC0935
	IF(M.GT.1)I=M	PVEC0936
	GO TO 80	
74	CONTINUE	PVEC0938
C	UNPACK COLUMN J, OUTPUT ON UNIT IQUT	PVEC0939
	CALL XXUNP(AS(1,1),S2(1),M,IDIM,IPREC)	PVEC0940
	IF(M.GT.1)I=M	PVEC0941
	WRITE(IQUT) AA,J,IPREC,M	PVEC0942
	IF(LSP.EQ.0)GO TO 80	
	WRITE(IQUT) (AS(N,1),N=1,LSP)	PVEC0944
80	CONTINUE	PVEC0946
	IF(L.GT.0) GO TO 62	
	K1=K1+1	
82	K1=K1+1	

	L=SS(K1)	PVEC0948
	IF(L.EQ.IEDF)GO TO 100	PVEC0949
	L=L/4	PVEC0950
	IF(K1.LT.MEND) GO TO 62	
C	INPUT NEXT BLOCK	PVEC0952
	CALL RX(SS(1),M1,IU,II)	PVEC0953
	IF(II.LT.0)GO TO 960	PVEC0954
	K1=4	PVEC0955
	L=SS(K1)/4	PVEC0956
	GO TO 64	
100	CONTINUE	PVEC0958
C	GET ROW SIZE FROM MATRIX TRAILER	PVEC0959
	KKK=S2(1)	PVEC0960
	I=KK2	PVEC0961
	GO TO 800	PVEC0962
200	CONTINUE	PVEC0963
C		PVEC0964
C*	PROCESS FILE AS TABLE	PVEC0965
C		PVEC0966
	J=J+1	PVEC0967
	M=J	PVEC0968
	IF(KIND.EQ.4)M=1	PVEC0969
	KK=0	PVEC0970
202	CONTINUE	PVEC0971
	K1=K1+1	PVEC0972
	L=L-1	PVEC0973
	IF(L.LT.0)GO TO 220	PVEC0974
	KK=KK+1	PVEC0975
	IF(IDIM.LT.KK) GO TO 940	MAY31 73
	AS(KK,M)=SS(K1)	PVEC0976
	GO TO 202	PVEC0977
220	CONTINUE	PVEC0978
	JJ=SS(K1)	PVEC0979
	IF(KK.GT.I)I=KK	PVEC0980
	K1=K1+1	PVEC0981
	L=SS(K1)	PVEC0982
	IF(L.EQ.IEDF)GO TO 250	PVEC0983
	L=L/4	PVEC0984
	IF(K1.LT.MEND)GO TO 230	PVEC0985
	CALL RX(SS(1),M1,IU,II)	PVEC0986
	IF(II.LT.0)GO TO 960	PVEC0987
	K1=4	PVEC0988
	L=SS(K1)/4	PVEC0989
C	CHECK IF LAST RECORD WAS CONTINUED	PVEC0990
	II=MOD(JJ,2)	PVEC0991
	IF(II.NE.0)GO TO 202	PVEC0992
230	CONTINUE	PVEC0993
	IF(KIND.EQ.2)GO TO 200	PVEC0994
	WRITE(IOUT) AA,J,KK	PVEC0995
	WRITE(IOUT) (AS(II,1), II=1,KK)	PVEC0996
	GC TO 200	PVEC0997
250	CONTINUE	PVEC0998
	IF(KIND.EQ.2)GO TO 800	PVEC0999
	WRITE(IOUT) AA,J,KK	PVEC1000
	WRITE(IOUT) (AS(II,1), II=1,KK)	PVEC1001

800	CONTINUE	PVEC1002
	WRITE(IPRNT1,4)	PVEC1003
4	FORMAT('OFINISHED PROCESSING')	PVEC1004
	GO TO 999	PVEC1005
900	CONTINUE	PVEC1006
CC	WRITE(IPRNT1,5)	PVEC1007
	WRITE(IPRINT,5) IU	MAY29 73
CC 5	FORMAT('0** END OF DATA ON TAPE **')	PVEC1008
5	FORMAT('0** END OF DATA ON TAPE ** UNIT=',I3)	MAY29 73
	GO TO 996	PVEC1009
940	CONTINUE	MAY31 73
	WRITE(IPRINT,7) AA,IU,IDIM	MAY31 73
7	FORMAT('0** SCRATCH SPACE REQUIRED BY XFETCH TO PROCESS ',2A4,	MAY31 73
	X ' ON TAPE UNIT',I3, ' IS GREATER THAN ',I10, 'WORDS')	MAY31 73
	GO TO 996	MAY31 73
960	CONTINUE	PVEC1010
CC	WRITE(IPRNT1,6)	PVEC1011
	WRITE(IPRINT,6) IU	MAY29 73
CC 6	FORMAT('0** PHYSICAL END OF FILE **')	PVEC1012
6	FORMAT('0** PHYSICAL END OF FILE ** UNIT=',I3)	MAY29 73
996	CONTINUE	PVEC1013
	ISUC=-1	PVEC1014
	RETURN	PVEC1015
999	CONTINUE	PVEC1016
	ISUC=1	PVEC1017
	RETURN	PVEC1018
	END	PVEC1019
	SUBROUTINE RX(A,K,IU,II)	PVEC1020
	DIMENSION A(K)	PVEC1021
	II=1	PVEC1022
	READ(IU,1,END=9) A	PVEC1023
1	FORMAT(10(200A4))	PVEC1024
	RETURN	PVEC1025
9	II=-1	PVEC1026
	RETURN	PVEC1027
	END	PVEC1028
	SUBROUTINE XXUNP(C,S,LC,IMAX,IPREC)	PVEC1029
C		PVEC1030
C	ROUTINE TO UNPACK NASTRAN COLUMN IN S AND PLACE IN C	PVEC1031
C	ACCUMULATE LC AS MAX LENGTH OF COLUMN	PVEC1032
C		PVEC1033
	DIMENSION C(1),S(1)	PVEC1034
	INTEGER C,S	PVEC1035
	DATA IEND/ Z00FFFFFF /	PVEC1036
	COMMON/ XXUNPA / LSP	PVEC1037
	LSP=0	PVEC1038
	LC=0	PVEC1039
	DO 20 I=1,IMAX	PVEC1040
20	C(I)=0	PVEC1041
	IF(S(1).EQ.IEND)GO TO 96	PVEC1042
	IB=IPREC+2*S(2)-2	PVEC1043
	IF(IB.GT.4)GO TO 100	PVEC1044
	GC TC (22,23,24,25), IB	PVEC1045
C	S.P. TO S.P.	PVEC1046
22	K1=1	PVEC1047

	K2=1	PVEC1048
	GO TO 28	PVEC1049
C	S.P. TO D.P.	PVEC1050
23	K1=1	PVEC1051
	K2=2	PVEC1052
	GO TO 28	PVEC1053
C	D.P. TO S.P.	PVEC1054
24	K1=2	PVEC1055
	K2=1	PVEC1056
	GO TO 28	PVEC1057
C	D.P. TO D.P.	PVEC1058
25	K1=2	PVEC1059
	K2=2	PVEC1060
28	CONTINUE	PVEC1061
	II=(S(1)-1)*K2+1	PVEC1062
	I=6-K1	PVEC1063
30	CONTINUE	PVEC1064
	I=I+K1	PVEC1065
32	CONTINUE	PVEC1066
	J=S(I)	PVEC1067
	IF(J.EQ.IEND)GO TO 90	PVEC1068
	IF(J.LE.0)GO TO 40	PVEC1069
	IF(J.GT.IEND)GO TO 40	PVEC1070
	II=(J-1)*K2+1	PVEC1071
	I=I+1	PVEC1072
	GO TO 32	PVEC1073
40	CONTINUE	PVEC1074
	C(II)=J	PVEC1075
	IF(18.LT.4)GO TO 50	PVEC1076
	IF(18.NE.4)GO TO 42	PVEC1077
	C(II+1)=S(I+1)	PVEC1078
	GO TO 50	PVEC1079
42	CONTINUE	PVEC1080
	GO TO (44,45,46,47), 188	PVEC1081
44	C(II+1)=S(I+1)	PVEC1082
	GO TO 50	PVEC1083
45	C(II+2)=S(I+1)	PVEC1084
	GO TO 50	PVEC1085
46	C(II+1)=S(I+2)	PVEC1086
	GO TO 50	PVEC1087
47	C(II+1)=S(I+1)	PVEC1088
	C(II+2)=S(I+2)	PVEC1089
	C(II+3)=S(I+3)	PVEC1090
50	CONTINUE	PVEC1091
	II=II+K2	PVEC1092
	GO TO 30	PVEC1093
90	CONTINUE	PVEC1094
	LSP=II-1	PVEC1095
	LC=LSP/K2	PVEC1096
96	CONTINUE	PVEC1097
	RETURN	PVEC1098
100	188=18-4	PVEC1099
	GO TO (122,123,124,125), 188	PVEC1100
C	COMPLEX S.P. TO S.P.	PVEC1101
122	K1=2	PVEC1102

```

      K2=2
      GO TO 28
C     COMPLEX S.P. TO D.P.
123  K1=2
      K2=4
      GO TO 28
C     COMPLEX D.P. TO S.P.
124  K1=4
      K2=2
      GO TO 28
C     COMPLEX D.P. TO D.P.
125  K1=4
      K2=4
      GO TO 28
      END

```

```

PVEC1103
PVEC1104
PVEC1105
PVEC1106
PVEC1107
PVEC1108
PVEC1109
PVEC1110
PVEC1111
PVEC1112
PVEC1113
PVEC1114
PVEC1115
PVEC1116
PVEC1117

```

```

/*
//LKED.A DD DSN=NASTRAN.FETCH,DISP=SHR,UNIT=2314,VOL=SER=NASTRA
//LKED.SYSIN DD *
INCLUDE_A(NFETCH)

```

```

/*
//GO.FT31F001 DD UNIT=2400-3,VOL=SER=091559,DSN=NEWPROB,
//          LABEL=(, , IN),DISP=(OLD,KEEP),DCB=(RECFM=U,LRECL=6400)
//GO.FT32F001 DD UNIT=2400-3,VOL=SER=016814,DSN=NEWPROB,
//          LABEL=(, , IN),DISP=(OLD,KEEP),DCB=(RECFM=U,LRECL=6400)
//GO.FT11F001 DD UNIT=SYSDA,SPACE=(3208,(40,40)),
//          DCB=(RECFM=VBS,LRECL=400,BLKSIZE=1604)
//GO.FT12F001 DD UNIT=SYSDA,SPACE=(3208,(80,40)),
//          DCB=(RECFM=VBS,LRECL=400,BLKSIZE=1604)
//GO.FT20F001 DD UNIT=SYSDA,SPACE=(3208,(80,40)),
//          DCB=(RECFM=VBS,LRECL=400,BLKSIZE=1604)
//GC.SYSUDUMP DD SYSOUT=A
//GO.SYSIN DD *

```

```

      5
      4      5      34      36      37
C.0105      0.0083      0.0100      0.0096      0.0060
5.188973    37.60782
12.82131    37.86710
4.176762    31.68718
15.53610    40.49898
8.626393    53.21353

```

```

/*
//
/*EOF

```

070:

APPENDIX III
POSTPROCESSOR COMPUTER PROGRAM

Introduction

This program, written in Fortran IV, was developed to provide a rational means of selecting critical modes for low-frequency control-system studies, for higher-frequency vibration analyses, and for POGO stability and dynamic loads analyses. Mode selection for these various requirements is accomplished by six options. Mode selection for control-system studies may be accomplished in Option 1 with calculated rate and position coefficients for gyro sensors and/or position coefficients for an optical sensor. Mode selection for vibration analyses may be accomplished in Option 2 with calculated peak image motions due to sinusoidal excitation or root-mean-square (RMS) image motions due to random power-spectral density (PSD) excitation. Option 3 includes both of these sets of calculations. The calculations of Options 1-3 are performed using uncoupled normal modes. The computer program therefore includes a provision for approximately assessing the effects of a coupled modal viscous damping matrix in Options 1-3 and for using the coupled damping matrix directly in mode selection by admittance techniques (Options 4-6). The program also includes a provision for converting the dimensional units of the NASTRAN modal data on the restart tape. The general logic flow of the postprocessor computer program is shown in Figure III-1.

The program is limited to a maximum of 100 gridpoints of interest and of 300 eigenvectors taken from the NASTRAN restart tape. A maximum of 20 pairs of numbers may be used to define the ranges of eigenvectors of interest for selection from the NASTRAN tape. A maximum of 20 gridpoints (120 degrees of freedom) may be used to define the optical amplification matrix. There are no limitations to the number of rate (gyro), position (gyro), and position (optical) gain coefficients which may be calculated in Options 1 or 3. A maximum of 20 gridpoints (120 degrees of freedom) may be loaded by sinusoidal or random (PSD) loads in Options 2 or 3. The input load PSD is defined with frequency in Hz.

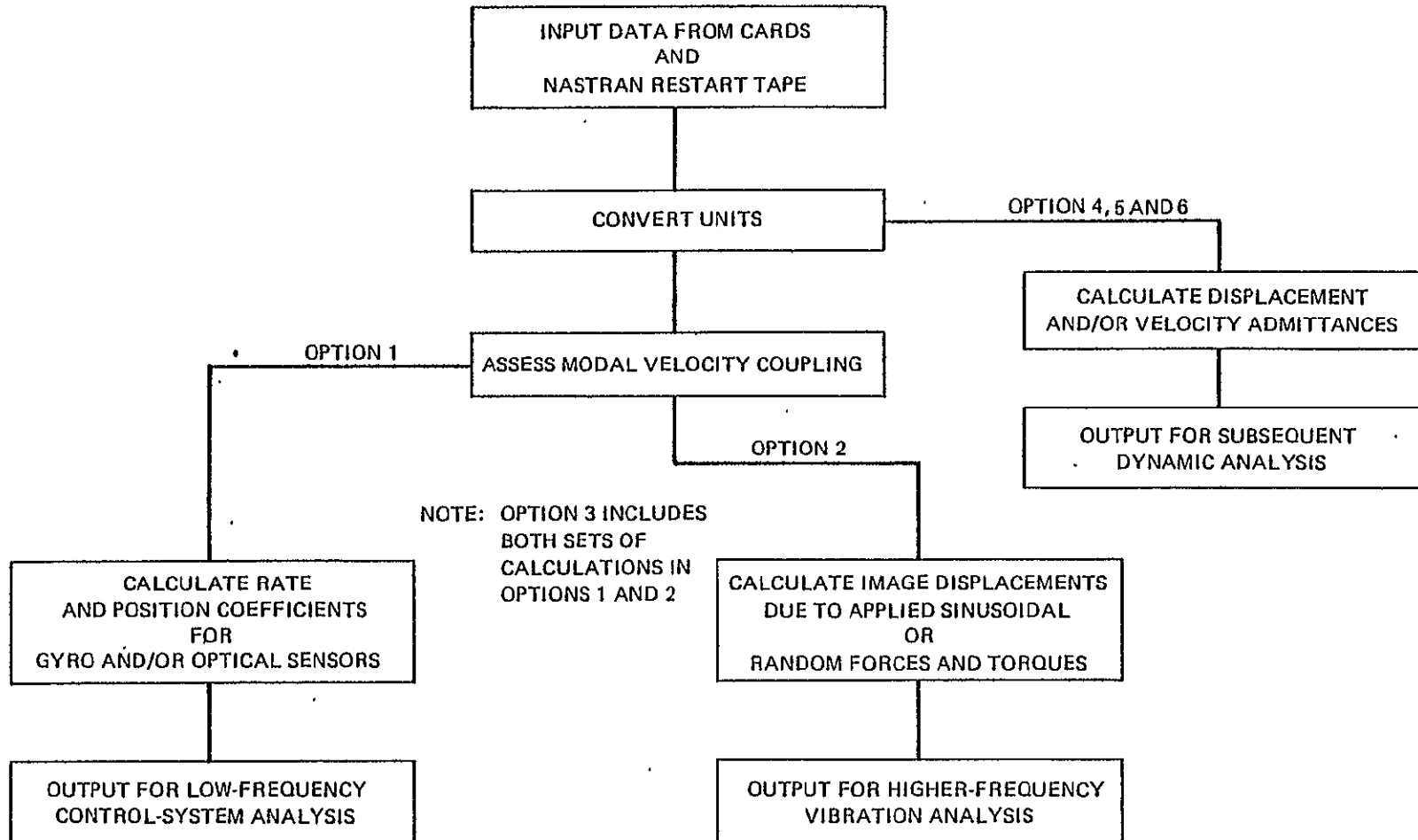

Figure III-1. Postprocessor Program Flow

Input Description

The input data required by the postprocessor consist of punched cards and a NASTRAN restart tape. The NASTRAN tape contains the following structural dynamic data in matrix format:

- a. modal frequencies in radians per second
- b. eigenvectors
- c. generalized masses
- d. generalized modal viscous damping terms.

The NASTRAN run which generates the modal data must include one or more discrete viscous damping elements and sufficient DMAP instructions to calculate and output the coupled generalized damping matrix. The necessary DMAP ALTER statements are included in the EXECUTIVE CONTROL deck as shown previously in Appendix I, Table I-1.

The punched-card input required for the postprocessor is prepared in fourteen distinct data sets as follows:

1. Overall problem control card. Format (2I10, 3F10.0)

- A. NOPT = 1, perform low-frequency control-system calculations
= 2, perform higher-frequency fine-stabilization calculations
= 3, perform both of above calculations
= 4, calculate displacement admittances
= 5, calculate velocity admittances
= 6, calculate both displacement and velocity admittances
- B. NØPLOT = 0, generate plots
1, do not generate plots

- G. NCONV = 0, no conversion of units
 = 1, convert from inch-slinch-second to foot-slug second
 = 2, convert from inch-slinch-second to meter-kilogram-second
 = 3, convert from foot-slug-second to meter-kilogram-second
- D. DFAC: Multiplying factor for modifying the damping matrix obtained from the NASTRAN restart tape.
- E. ALF1: Damping magnitude ratio for potential modal velocity coupling (typical value is 0.01).
- F. ALF2: Frequency factor for potential modal velocity coupling (typical value is 10.0).
- G. SYM = 0, complete structural model
 = 1, half-model described by symmetric and anti-symmetric modes

2. A list of gridpoint ID's used to select the row subset of the $[\phi]$ matrix of eigenvectors on the NASTRAN tape. Only the rows corresponding to the six degrees of freedom for each of the gridpoints of this list will be retained by the postprocessor. All other rows of $[\phi]$ are discarded to save core storage. Note that every gridpoint of interest and used in subsequent data sets must be given in this list. Format (8I 10 until a blank field is encountered. If a row ID occurs in column 80 of a card, a blank card must follow).
3. A set of data used to select the column subset of eigenvectors from the $[\phi]$ matrix from the NASTRAN tape. Columns are selected by giving pairs of numbers which indicate either a range of mode numbers or a range of frequency values.

- A. Control parameters: IMODE, LMODES. Format (2I10). If IMODE is input as 1, pairs of mode numbers must be given. If IMODE is input as 2, frequencies in radians per second must be given. LMODES is the number of pairs of values to be input.
- B. Pairs of numbers to select columns from the $[\phi]$ matrix. Format (2I10 or]F10.0 depending upon the value of IMODE).
4. Mode number, frequency, and generalized mass for each mode selected for the analysis. Format (2(I10, F10.0, F10.0) until a blank field is encountered). This data set is required only if SYM = 1.
5. A set of user-supplied damping coefficients for adding modal viscous damping terms to the damping matrix obtained from the NASTRAN restart tape. Four terms per card are input giving mode number (i) and damping value ($\zeta_i = C_i/C_c$) for each mode. The term $C_i = 2\zeta_i \omega_i M_i$ is calculated automatically and added to the diagonal of the modal damping matrix. If no user-supplied damping is desired, insert a blank card. Format (4(I10, F10.0) until a blank field is encountered).
6. A set of gridpoint ID's denoting degrees of freedom for calculating a generalized damping force (F_k) used in assessing the degree of modal velocity coupling. Six degrees of freedom per gridpoint are assumed.

$$F_k = \sum_{\ell=1}^m |\phi_{k\ell}| \quad \begin{array}{l} m = \text{number of degrees of freedom,} \\ k = \text{mode number} \end{array}$$

Format (8I10 until a blank field is encountered).

Note: If NOPT input on the first control card is 4, 5, or 6, the next input is described under data set 12. Otherwise, data sets 7 through 11 are used.

7. The optical amplification matrix (B_o) input by rows.
 - A. List of gridpoint ID's identifying the columns of the matrix. Six degrees of freedom per gridpoint are assumed. Format (8I10 until a blank field is encountered).
 - B. The three rows of the matrix. The units for the optical amplification matrix must agree with the output system of units specified by NCONV on the first control card. Each row must begin a new card. Format (8F10.0).
8. If NOPT input on the first control card is 2 or 3, applied load data is read next. This data is used to form generalized forces for calculating image motions due to sinusoidal or random (PSD) excitations.
 - A. List of gridpoint ID's that are loaded. Format (8I10 until a blank field is encountered).
 - B. Length of force vs. frequency tables and type indicator. Input type = 0 for sinusoidal loads and type = 1 for PSD loads. Format (2I10).
 - C. Table of frequencies in radians per second, table of forces, and table of torques. Each table must begin a new card. The units for the force and torque tables must agree with the output system of units specified by NCONV on the first control card. The PSD is defined with frequency in Hz. Format (8F10.0).
9. If NOPT is 1 or 3, two tables of importance factors as functions of frequency are read next. The table of rate factors is input first followed by the table of position factors. These factors are multiplied by the calculated rate and/or position gains to account

for the frequency-dependent characteristics of the control system. A blank card for this data set results in factors of unity at all frequencies.

- A. Table lengths, NR and NP. NR is the number of pairs of rate factors and frequencies to be input while NP is the number of pairs of position factors and frequencies.
- B. Table of rate factors. NR pairs of frequency/rate factors are read (Format 8F10.0).
- C. Table of position factors. NP pairs of frequency/position factors are read (Format 8F10.0).

10. If NOPT input on the first control card is 1 or 3, groups of 4 integers are read next. These integers indicate freedoms for which rate coefficients are calculated. Values for M1, M2, M3, and M4 are input. If no rate coefficients are desired, insert a blank card. If M2=M4=0, then rate coefficient R(M1, M3) is calculated. Otherwise the following rate coefficients are calculated:

$$\begin{array}{l}
 R(M1, M3), R(M1, M3+1), R(M1, M3+2), \dots, R(M1, M4) \\
 R(M1+1, M3), R(M1+1, M3+1), \dots, R(M1+1, M4) \\
 \cdot \qquad \qquad \qquad \qquad \qquad \cdot \\
 \cdot \qquad \qquad \qquad \qquad \qquad \cdot \\
 \cdot \qquad \qquad \qquad \qquad \qquad \cdot \\
 R(M2, M3), R(M2, M3+1), \dots, R(M2, M4)
 \end{array}$$

Groups of M1, M2, M3, M4 are read in the 4I10 format until a blank card is encountered.

11. In NOPT input on the first control card is 1 or 3, groups of 4 integers are again read. These integers indicate freedoms for which position coefficients are calculated. Values for M1, M2, M3 and M4 are input. If no position coefficients are desired, insert a blank card. The following calculations are made, depending upon the combination of non-zero values for M1, M2, M3 and M4.

- A. M2=M4=0, M1 and M3 nonzero. Position coefficient P(M1, M3) is calculated.
- B. M1, M2, M3, and M4 nonzero. The following position coefficients are calculated:

P(M1, M3), P(M1, M3+1), ..., P(M1, M4)
 P(M1+1, M3), P(M1+1, M3+1), ..., P(M1+1, M4)
 .
 .
 .
 P(M2, M3), P(M2, M3+1), ..., P(M2, M4)

- C. M2=M3=M4=0, M1 nonzero. The position coefficient using optical sensors P(M1,) is calculated.
- D. M3=M4=0, M1 and M2 nonzero. The following position coefficients using optical sensors are calculated:

P(M1,), P(M1+1,), ..., P(M2,)

Format (4I10 until a blank card is encountered).

Note: If NOPT input is 1, 2, or 3, the input is now complete. For values of NOPT of 4, 5, or 6, the following input is read next.

12. If NOPT is 4 or 6, pairs of freedoms for displacement and acceleration admittances are input next. The ordering for each pair of freedoms is response freedom followed by the input freedom. Format (8I10 until a blank field is encountered).
13. If NOPT is 5 or 6, pairs of freedoms for velocity admittances are input next. The order for each pair is response freedom followed by the input freedom. Format (8I10 until a blank field is encountered).
14. GAMMA 1 and GAMMA 2 are read next. GAMMA 1 is the damping magnitude ratio for potential modal velocity coupling equivalent to ALF2 in Options 1-3. GAMMA 2 is the frequency factor for potential modal velocity coupling equivalent to ALF2 in Options 1-3. If GAMMA 1 and GAMMA 2 are zero, all modes selected by card set 3 will be used in the admittance calculations. Format (2F10.0)
15. A list of analysis frequencies in radians per second are read next. Format (8F10.0 until a blank field is read).

Table III-1: DMAP ALTER Statements for
Damping Matrix Formulation

N A S T R A N E X E C U T I V E C O N T R O L D E C K

```

ID      LST, MODES 1
APP    DISPLACEMENT
SQL    3,0
CHKPNT YES
TIME   30
ALTER  28,29
SHA2   CSTM, HPT, ECPT, CPCT, CIT/HGG, BGG/V, Y, HTMASS#1, 0/V, N, NOMBG/V, N, NOBGG/
      V, Y, COUPMASS/V, Y, CPBAR/V, Y, CPROD/V, Y, CPQUAD1/V, Y, CPQUAD2/V,
      Y, CPTRIA1/V, Y, CPTRIA2/V, Y, CPTUFE/V, Y, CPQDPLT/V, Y, CPTRPLT/V,
      Y, CPTRPS, S
SAVE   NOMBG, NOBGG S
ALTER  74
MATPR  GPL, USET, SIL, MAA//C, N, AS
MATPR  GPL, USET, SIL, FGG//C, N, GS
ALTER  96
MPYAD  PHIG, BGG, /XY/C, N, 1/C, N, 1/C, N, 0 S
MPYAD  XX, PHIG, /BHH/C, I, 0/C, N, 1/C, N, 0 S
CHKPNT BHH S
MATPRN BHH, , , // S
ENDALTER
CEND

```

Postprocessor Listing

```
DOUBLE PRECISION A1,A2,A3,A4,AA
DATA A1/ 8HBHH /
DATA A2/ 8HLAMA /
DATA A3/ 8HPHIG /
DATA A4/ 8HEQEXIN /
DIMENSION PLOTID(12)
DATA PLOTID/ 'HGEB','21/ ','M.W.','ICE/','87-A','2 ','6*' /
DIMENSION IDFREQ(300),FREQ(300),GMASS(300),XX(43000),DAMP(300)
DIMENSION FK(300)
DIMENSION KMODES(20,2),XMODES(20,2)
DIMENSION S1(1803),S2(4000),Z(4000),KGRID(100,2),KDUM(8),IZ(1)
DIMENSION IDBR(20),IDBRX(20)
DIMENSION IDFF(20)
INTEGER, SYM
EQUIVALENCE (Z(1),IZ(1),XX(12001)),(KMODES(1,1),XMODES(1,1))
EQUIVALENCE (XX(1),S1(1)),(XX(2001),S2(1))
COMMON/NOUTU/ KKK
COMMON/SYSCNTL/ NOPT,NOPLT,KINDF,SYM
COMMON/XSPECS/ SS(75),BB(126)
COMMON/WORK/XX
COMMON/FACTOR/DFAC,ALF1,ALF2
DIMENSION ISS(1)
EQUIVALENCE (ISS(1),SS(1))
NBUF=1603
READ(5,101) NOPT,NOPLT,NCONV,DFAC,ALF1,ALF2,SYM
101 FORMAT( 3I10,3F10.0,I10 )
1 FORMAT( 8I10 )
2 FORMAT( 8F10.0 )
C
C IF NOPT=1, PERFORM LOW-FREQUENCY CONTROL CALCULATIONS
C =2, PERFORM HI-FREQ FINE STABILIZATION CALCS
C =3, DO BOTH
C =4, CALCULATE DISPLACEMENT ADMITTANCE
C =5, CALCULATE VELOCITY ADMITTANCE
C =6, CALCULATE BOTH ADMITTANCES
C IF NOPLT=1, DO NOT PRODUCE PLOTS
C =0, PRODUCE PLOTS
C IF NCONV=0, DO NOT CONVERT UNITS FOR PHI,MASS,DAMPING
C =1, CONVERT I-S-S TO F-S-S
C =2, CONVERT I-S-S TO M-K-S
C =3, CONVERT F-S-S TO M-K-S
C
WRITE (6,5001) NOPT,NOPLT,NCONV,DFAC,ALF1,ALF2,SYM
5001 FORMAT( 42HINASTRAN POST PROCESSOR FOR MODE SELECTION / 1X / 1H0,
X 12X, 8HOPTION =, I13 /
X 13X, 8HNOPLT =, I13 /
X 13X, 8H NCONV =, I13 /
X 13X, 8H DFAC =, E13.5/
X 13X, 8H ALF1 =, E13.5/
X 13X, 8H ALF2 =, E13.5/
```

```

X 13X, 8H SYM =, I13 )
IF(NOPLOT.GT.0) GO TO 3
C
C INITIALIZE FOR PLOTTING
C
DO 3001 I=1,75
3001 SS(I)=0.
DO 3002 I=1,126
3002 BB(I)=0.
CALL STSPEX(SS,PLOTID)
CALL SC42DN(SS)
3 CONTINUE
F1=1.
F2=1.
IF(NCONV-1) 3012,3006,3008
3006 F1=12.
F2=12.
GO TO 3012
3008 IF(NCONV.NE.2) GO TO 3010
F1=39.37008
F2=175.1268
GO TO 3012
3010 F1=3.28084
F2=14.5939
3012 CONTINUE
C
C INPUT LIST OF GRIDS OF INTEREST
C
LG=0
4 READ(5,1) KDUM
DO 8 I=1,8
IF(KDUM(I).LE.0) GO TO 10
LG=LG+1
KGRID(LG,1)=KDUM(I)
KGRID(LG,2)=200000
8 CONTINUE
GO TO 4
10 CONTINUE
C
C GET TABLE RELATING GRID TO POSITION IN GROSS MATRICES (EQEXIN)
C
CALL NTREAD(NBUF,A4,Z,I,J,2500,1,S1,1,S2,K,1,2)
IF(K.LT.0) GO TO 900
L=2501
I=I/2
DO 20 K=1,I
JJ=IZ(L)
DO 14 J=1,LG
IF(JJ.NE.KGRID(J,1)) GO TO 14
KGRID(J,2)=IZ(L+1)/10
GO TO 15
14 CONTINUE

```

```

15 CONTINUE
   L=L+2
20 CONTINUE
C
C   ORDER GRIDS BASED ON INTERNAL ORDER OF NASTRAN MATRICES
C
   CALL ISHELL(KGRID(1,2),S2,LG)
   CALL SHELLX(KGRID(1,1),S2,LG)
22 IF(KGRID(LG,2).LT.200000) GO TO 30
   WRITE(6,24) KGRID(LG,1)
24 FORMAT( 12H0GRID NUMBER, I11, 62H   REMOVED FROM LIST BECAUSE IT W
*AS NOT PRESENT IN NASTRAN LIST  )
   LG=LG-1
   GO TO 22
30 CONTINUE
   IF(LG.LE.0) STOP
C
C   PRINT TABLE OF GRIDS
C
   WRITE(6,32) (KGRID(I,1),KGRID(I,2), I=1,LG)
32 FORMAT( 39HINPUT TABLE OF GRID POINTS OF INTEREST /
*          39H0          LOCATION OF TERMS          /
*          39H   GRID ID          IN NASTRAN MATRICES   / (I10,I17) )
   LG6=6*LG
C
C   INPUT DATA TO INDICATE WHICH MODES ARE OF INTEREST
C   READ CONTROL FLAG, IMODE, AND NUMBER OF PAIRS, LMODES
C   IF IMODE=1, READ PAIRS OF INTEGERS FOR RANGE OF MODE NUMBERS
C   =2, READ PAIRS OF FREQUENCIES FOR RANGE OF MODES
C
   READ(5,1) IMODE,LMODES
   WRITE(6,5002) IMODE,LMODES
5002 FORMAT( 59H1THE FOLLOWING DATA WAS INPUT TO INDICATE MODES OF INTE
XREST / 10H0 IMODE =, I2, 4X, 8HLMODES =, I3 /
X.      36H0 RANGE OF MODE NOS. OR FREQUENCIES )
   IF(IMODE.NE.1) GO TO 35
   DO 34 I=1,LMODES
34 READ(5,1) KMODES(I,1),KMODES(I,2)
   WRITE(6,5003) (KMODES(I,1),KMODES(I,2), I=1,LMODES)
5003 FORMAT( 5X, 2I5 )
   GO TO 50
35 IF(IMODE.NE.2) GO TO 38
   DO 37 I=1,LMODES
37 READ(5,2) XMODES(I,1),XMODES(I,2)
   WRITE(6,5004) (XMODES(I,1),XMODES(I,2), I=1,LMODES)
5004 FORMAT( 5X, 2E14.5 )
   GO TO 50
38 CONTINUE
   WRITE(6,49) IMODE ,LMODES
49 FORMAT( 44H1*ERROR* BAD VALUE FOR IMODE. IMODE,LMODES= , 2I10 )
   GO TO 999
50 CONTINUE

```

```

C
C   READ TABLE OF EIGENVALUE DATA, LAMA
C
      LFREQ=0
      IF(SYM.EQ.0)GO TO 51
7000 READ(5,7001) (KDUM(I),SS(I),BB(I), I=1,2)
7001 FORMAT( 2(5X,I5,2F10.0) )
      DO 7003 I=1,2
      IF(KDUM(I).LE.0) GO TO 51
      LFREQ=LFREQ+1
      IDFREQ(LFREQ)=KDUM(I)
      FREQ(LFREQ)=SS(I)
      GMASS(LFREQ)=BB(I)*F2*2.
7003 CONTINUE
      GO TO 7000
51 CONTINUE
      IF(SYM.GT.0)GO TO 71
      CALL NTHREAD(NBUF,A2,Z,I,J,2500,0,S1,1,S2,K,1,2)
      IF(K.LT.0) GO TO 900
      I=I+2500
      J=2501
53 CONTINUE
      MODEN=IZ(J)
      OMEGA=Z(J+3)
      GENMAS=Z(J+5)
      GO TO (56,60), IMODE
56 CONTINUE
      DO 58 K=1,LNODES
      IF(MODEN.GE.KMODES(K,1) .AND. MODEN.LE.KMODES(K,2)) GO TO 66
58 CONTINUE
      GO TO 70
60 CONTINUE
      DO 64 K=1,LNODES
      IF(OMEGA.GE.XMODES(K,1) .AND. OMEGA.LE.XMODES(K,2)) GO TO 66
64 CONTINUE
      GO TO 70
66 CONTINUE
      LFREQ=LFREQ+1
      IDFREQ(LFREQ)=MODEN
      FREQ(LFREQ)=OMEGA
      GMASS(LFREQ)=GENMAS*F2
70 CONTINUE
      J=J+7
      IF(J.LT.I) GO TO 53
71 CONTINUE
C
C   PRINT TABLE OF EIGENVALUE DATA
C
      WRITE(6,72) (IDFREQ(I),FREQ(I),GMASS(I), I=1,LFREQ)
72 FORMAT( 54H1THE FOLLOWING EIGENVALUE DATA HAS BEEN TAKEN FROM THE
* /      31H NASTRAN TAPE FOR THIS ANALYSIS /
*      47HOMODE NUMBER          FREQUENCY    GENERALIZED MASS /

```

```

*      (I7,E22.8,E15.5))
C
C      COPY MODE SHAPES TO SCRATCH UNIT KKK=50
C
      KKK=50
      REWIND KKK
      CALL NTREAD(NBUF,A3,Z,I,J,10000,1,S1,1,S2,K,1,3)
      REWIND KKK
      IF(K.LT.0) GO TO 900
C
C      COPY DAMPING MATRIX TO SCRATCH UNIT KKK=52
C
      KKK=52
      REWIND KKK
      CALL NTREAD(NBUF,A1,Z,I,J,10000,0,S1,1,S2,K,1,3)
      REWIND KKK
      IF(K.LT.0) GO TO 900
C
C      ADD ANY USER SUPPLIED DAMPING TERMS TO MATRIX AND
C      REWRITE TO UNIT 51
C
      XF2=F2
      IF(SYM.GT.0)XF2=2*F2
      CALL DADD(S2,S1,Z,Z(500),Z(1000),IDFREQ,LFREQ,XF2,FREQ,GMASS)
C
C      BUILD A LG6 BY LFREQ SUBMATRIX OF MODE SHAPES FROM PHIG
C
      KKK=50
      KK=1
      JJ=0
80 CONTINUE
      READ(KKK,END=120) AA,J,K,L
      IF(L.EQ.0) GO TO 80
      READ(KKK) (XX(JJ+I),I=1,L)
C
C      SEE IF THIS MODE IS DESIRED
C
      IF(J.LT.IDFREQ(KK)) GO TO 80
      IF(J.EQ.IDFREQ(KK)) GO TO 84
      STOP 98
84 CONTINUE
      JJX=JJ
      DO 88 I=1,LG
      J=KGRID(I,2)
      XX(JJ+1)=XX(JJX+J)
      XX(JJ+2)=XX(JJX+J+1)
      XX(JJ+3)=XX(JJX+J+2)
      XX(JJ+4)=XX(JJX+J+3)*F1
      XX(JJ+5)=XX(JJX+J+4)*F1
      XX(JJ+6)=XX(JJX+J+5)*F1
      JJ=JJ+6
88 CONTINUE

```

REPRODUCIBILITY OF THE
ORIGINAL PAGE IS POOR

```

      KK=KK+1
      IF(KK.LE.LFREQ) GO TO 80
120  CONTINUE
C
C   PRINT MATRIX OF MODE SHAPES
C
      WRITE(6,121)
121  FORMAT( 74H1 THE FOLLOWING SUBSET OF MODE SHAPES HAS BEEN TAKEN FR
      *OM THE NASTRAN TAPE )
      JJ=1
      DO 124 I=1,LFREQ
      CALL COLPRT(XX(JJ),LG,IDFREQ(I),KGRID)
124  JJ=JJ+LG6
C
C   ROUTINE MVD CALCULATES EQUIVALENT MODAL VISCOUS DAMPING AND
C   RETURNS LFREQ VALUES IN ARRAY DAMP
C
      KKK=51
      CALL FXCALC(XX,LG6,LFREQ,KGRID,LG,FK)
      CALL MVD(KKK,XX(JJ+1),IDFREQ,FREQ,GMASS,DAMP,LFREQ,XX(JJ+1),FK)
C
C   IF ADMITTANCES ARE TO BE CALCULATED, JUMP OUT TO THAT SECTION OF
C   PROGRAM
C
      IF(NOPT.GE.4 .AND. NOPT.LE.6) GO TO 6000
C
C   INPUT OPTICAL AMPLIFICATION MATRIX, BR (3 BY LBR6).
C   FIRST INPUT LIST OF GRID IDS DEFINING COLUMNS,
C   THEN MATRIX BY ROWS. STORE MATRIX BR(TRANSPPOSE) FROM
C   XX(IBR) BY COLMNS (EQUIV TO BR BY ROWS).
C
      IBR=JJ+1
      LBR=0
128  READ(5,1) KDUM
      DO 130 I=1,8
      IF(KDUM(I).LE.0) GO TO 132
      LBR=LBR+1
      IDBR(LBR)=KDUM(I)
130  CONTINUE
      GO TO 128
132  CONTINUE
      LBR6=6*LBR
      DO 135 I=1,3
      READ(5,2) (XX(JJ+K), K=1,LBR6)
      JJ=JJ+LBR6
135  CONTINUE
C
C   ROUTINE BREORD REORDERS THE BR MATRIX TO COINCIDE WITH
C   NASTRAN MATRIX ORDER
C
      CALL BREORD(XX(IBR),XX(JJ+1),LBR6,IDBR,KGRID(1,1),LG,IDBRX)
      LIDFF=0

```



```

      IFTBL=JJ+1
      IF(NOPT.EQ.1) GO TO 181
C
C   READ IN GRIDS THAT ARE LOADED
C
238 READ(5,1) KDUM
      DO 240 I=1,8
      IF(KDUM(I).LE.0)GO TO 242
      LIDFF=LIDFF+1
      IDFF(LIDFF)=KDUM(I)
240 CONTINUE
      GO TO 238
242 CONTINUE
      WRITE(6,5008) (IDFF(I), I=1,LIDFF)
5008 FORMAT( 18H1APPLIED LOAD DATA / 1X / 12H0 GRIDPOINTS / ( 8I6 ))
C
C   READ IN FREQUENCY, FORCE, AND TORQUE TABLES.  STORE FROM XX(IFTBL)
C   IF KINDF=0, TABELS ARE ORDINARY LOADS
C   =1, TABLES ARE FORCE PSD
C
      READ(5,1) LTBL,KINDF
      DO 180 I=1,3
      READ(5,2)(XX(JJ+K), K=1,LTBL)
180 JJ=JJ+LTBL
      WRITE(6,5009) LTBL,KINDF
5009 FORMAT( 1X/ 21H0LOAD TABLE, LENGTH =, I3, 9H, TYPE =, I2 /
X 44H   FREQUENCY           FORCE           TORQUE   )
      J=IFTBL
      DO 1801 I=1,LTBL
      WRITE(6,5010) XX(J),XX(J+LTBL),XX(J+2*LTBL)
5010 FORMAT( 3E15.5 )
1801 J=J+1
      IF(NOPT.EQ.2) GO TO 330
181 CONTINUE
C
C   READ IN IMPORTANCE TABLES
C
      CALL RPREAD
C
C   SCRATCH AREA NOW FROM XX(JJ+1)
C
C   READ IN GROUPS OF 4 INTEGERS INDICATING FREEDOMS FOR RATE
C   CALCULATION  M1,M2,M3,M4
C   IF M2=M4=0, CALCULATE RATE (M1,M3)
C   OTHERWISE, CALCULATE RATE (M1,M3),(M1,M3+1),(M1,M3+2),...
C   (M1+1,M3),(M1+1,M3+1),...
C
      KJUMP=1
182 READ(5,1)M1,M2,M3,M4
      IF(M1.LE.0) GO TO 230
      I=M1
184 MX1=I/10

```

```

      NX1=MOD(I,10)
      J=M3
186  MX3=J/10
      NX3=MOD(J,10)
C
C   FORM RATE CALC. FOR GRID/FREEDOM   (MX1/NX1,MX3/NX3)   FOR ALL
C   MODE SHAPES
C
      JJ1=0
      JJ2=0
      DO 190 II=1,LG
      IF(KGRID(II,1).EQ.MX1) JJ1=(II-1)*6 + NX1
      IF(KGRID(II,1).EQ.MX3) JJ2=(II-1)*6 + NX3
      IF(JJ1.GT.0 .AND. JJ2.GT.0) GO TO 196
190  CONTINUE
      WRITE(6,192) MX1,MX3
192  FORMAT( 80H1*ERROR* ATTEMPT TO CALCULATE RATE AT GRID NOT IDENTIFI
      *ED AS A POINT OF INTEREST , 2I6 )
      GO TO 224
196  CONTINUE
      DO 220 II=1,LFREQ
      KK=(II-1)*LG6
      XX(JJ+II)=XX(KK+JJ1)*XX(KK+JJ2)/(2.*DAMP(II)*FREQ(II)*GMASS(II))
      IF(KJUMP.EQ.1) GO TO 220
C
C   CHANGE RATE CALCULATION TO POSITION GAIN
C
      XX(JJ+II)=XX(JJ+II)/FREQ(II)
220  CONTINUE
C
C   ROUTINE PRPLT PRINTS AND PLOTS RATE AS FUNCTION OF FREQUENCY
C
      CALL PRPLT(      KJUMP,XX(JJ+1),FREQ,IDFREQ,LFREQ,MX1,NX1,MX3,NX3)
224  CONTINUE
      J=J+1
      IF(J.LE.M4) GO TO 186
      I=I+1
      IF(I.LE.M2) GO TO 184
      GO TO (182,282), KJUMP
230  CONTINUE
      KJUMP=2
C
C   READ IN PAIRS OF INTEGERS INDICATING FREEDOMS FOR POSITION
C   COEFFICIENT CALCULATION
C
282  READ(5,1)M1,M2,M3,M4
      IF(M1.LE.0) GO TO 330
      I=M1
      IF(M3.GT.0) GO TO 184
284  MX1=I/10
      NX1=MOD(I,10)
      CALL POSN(XX(1),LG6,LFREQ,XX(1BR),IDBR,LBR6,XX(IFTBL),LTBL,KGRID,

```

```

X   IDFF,LIDFF,
X   DAMP,FREQ,IDFREQ,GMASS,XX(JJ+1),MX1,NX1)
  I=I+1
  IF(I.LE.M2) GO TO 284
  GO TO 282
330 CONTINUE
  IF(NOPT.EQ.1) GO TO 400
  CALL POSN(XX(1),LG6,LFREQ,XX(IBR),IDBR,LBR6,XX(IFTBL),LTBL,KGRID,
X   IDFF,LIDFF,
X   DAMP,FREQ,IDFREQ,GMASS,XX(JJ+1),0,0)
400 CONTINUE
  CALL PNCHI(FREQ,LFREQ,2,1)
  WRITE(7,2000)
2000 FORMAT( 4H END )
  CALL PNCHI(DAMP,LFREQ,2,1)
  WRITE(7,2000)

C
C   BUILD COLUMNS OF /PHITT/ OR /PHET/ FROM XX(JJ+1)
C
  NTIME=1
500 CONTINUE
  K=1
  IF(NOPT.EQ.1) K=4
  IF(NOPT.EQ.3 .AND. NTIME.EQ.1) K=4
  KROW=0
1001 CONTINUE
  READ(5,1) KDUM
  DO 1008 I=1,8
  IF(KDUM(I).LE.0) GO TO 1010
  DO 1002 J=1,LG
  IF(KGRID(J,1).NE.KDUM(I)) GO TO 1002
  JJ1=(J-1)*6
  GO TO 1003
1002 CONTINUE
  GO TO 1008
1003 CONTINUE
  DO 1007 J=K,6
  KKK=JJ1
  DO 1006 JJ2=1,LFREQ
  XX(JJ+JJ2)=XX(KKK+J)
  KKK=KKK+LG6
1006 CONTINUE
  KROW=KROW+1
  CALL PNCHI(XX(JJ+1),LFREQ,2,KROW)
1007 CONTINUE
1008 CONTINUE
  GO TO 1001
1010 CONTINUE
  WRITE(7,2000)
  NTIME=NTIME+1
  IF(NOPT.EQ.3 .AND. NTIME.EQ.2) GO TO 500
  IF(NOPT.EQ.2) GO TO 1030

```

REPRODUCIBILITY OF THE
ORIGINAL PAGE IS POOR

```

C   READ GRID IDS FOR GYRO AND CMG
C
C   READ(5,1) KGYRO,(KDUM(I),I=1,4)
C
CALL PNCH2(XX(1),LG6,FREQ,GMASS,LFREQ,KDUM,4,XX(JJ+1),KGRID,LG)
1030 CONTINUE
    J=0
    DO 1036 I=1,LBR
      DO 1034 K=1,LG
        IF(IDBR(I).NE.KGRID(K,1)) GO TO 1034
      DO 1033 KKK=1,6
1033  ISS(J+KKK)=(K-1)*6+KKK
        J=J+6
        GO TO 1036
1034 CONTINUE
1036 CONTINUE
    JJ1=1
    KKK=IBR-1
1040 DO 1060 K=1,LFREQ
      BB(K)=0.
      DO 1050 I=1,LBR6
        J=(K-1)*LG6+ISS(I)
1050  BB(K)=BB(K)+XX(KKK+I)*XX(J)
1060 CONTINUE
      DO 1070 I=1,LFREQ
1070  BB(I)=BB(I)/(FREQ(I)**2*GMASS(I))
      CALL PNCH1(BB,LFREQ,1,JJ1)
      KKK=KKK+LBR6
      JJ1=JJ1+1
      IF(JJ1.LE.3) GO TO 1040
      WRITE(7,2000)
      IF(NOPT.EQ.2) GO TO 1080
      CALL PNCH2(XX(1),LG6,FREQ,GMASS,LFREQ,KGYRO,1,XX(JJ+1),KGRID,LG)
1080 CONTINUE
    900 CONTINUE
    999 CONTINUE
    RETURN
6000 CALL ADMIT(IDFREQ,FREQ,GMASS,DAMP,LFREQ,XX(1),LG6,KGRID,LG,
X   XX(JJ+1),XX(JJ+LFREQ+1),XX(JJ+LFREQ+1),51)
    RETURN
    END

```

```

SUBROUTINE MVD(KKK,X, IDFREQ,FREQ,GMASS,DAMP,LFREQ,IX,F)
C
C   RCUTINE TC FROM EQUIVALENT MODAL VISCOUS DAMPING
C
C   KKK - UNIT CONTAINING NTREAD COPY OF DAMPING MATRIX BHH
C   X,IX - SCRATCH ARRAY
C   IDFREQ,FREQ,GMASS - ARRAYS CONTAINING MODE NOS., FREQUENCIES,
C   AND GENERALIZED MASS. LENGTH = LFREQ
C   DAMP- DAMPING COEFFICIENTS RETURNED HERE
C
COMMON/SYSCTL/ NOPT
COMMON/FACTOR/DFAC,ALF1,ALF2
DIMENSION X(1),IDFREQ(1),FREQ(1),GMASS(1),DAMP(1),IX(1)
DIMENSION F(1)
DOUBLE PRECISION AA
3  FORMAT( 33H1EQUIVALENT MODAL VISCOUS DAMPING / 1X /
* 48H0 MODE          DAMPING          COUPLED/UNCOUPLED          /
* 48H NUMBER        COEFFICIENT        RESPONSE RATIO          )
30 FORMAT( 15, E17.5, E24.5)
WRITE(6,1)
1  FORMAT(1H1)
L=1
LLMAX=0
18 ID=IDFREQ(L)
20 READ(KKK,END=90) AA,J,K,LL
IF(LL.EQ.0) GO TO 20
READ(KKK) (X(I),I=1,LL)
IF(J.LT.ID) GO TO 20
IF(J.EQ.ID) GO TO 23
STOP 99
23 CONTINUE
IF(LL.GT.LLMAX) LLMAX=LL
DAMP(L)=X(J)/(2.*FREQ(L)*GMASS(L))
L=L+1
IF(L.LE.LFREQ) GO TO 18
90 CONTINUE
IF(NOPT.GE.4 .AND. NOPT.LE.6) RETURN
C
C   CALCULATE COUPLED/UNCOUPLED VELOCITY RESPONSE
C   STORE FROM X(JRI+1)
C
JRI=LLMAX
KO=JRI+LFREQ
KI=KO+LFREQ
DO 200 L=1,LFREQ
X(JRI+L)=0.
ID=IDFREQ(L)
REWIND KKK
120 READ(KKK,END=220) AA,I,K,LL
IF(LL.EQ.0) GO TO 120
READ(KKK) (X(J), J=1,LL)
IF(I.NE.ID) GO TO 120
C
C   FIND MODES WHICH POTENTIALLY COUPLE WITH I-TH MODE
C   STORE INDICES FROM IX(KI+1)

```

REPRODUCIBILITY OF THE ORIGINAL PAGE IS POOR

```

C
NC=0
DO 124 J=1,LFREQ
IF(FREQ(L)/FREQ(J) .LT. (1.-ALF2*DAMP(J))) GO TO 124
IF(FREQ(L)/FREQ(J) .GT. (1.+ALF2*DAMP(J))) GO TO 124
JJ=IDFREQ(J)
IF(X(I).EQ.0.) GO TO 124
IF(X(JJ)/X(I) .LT. ALF1) GO TO 124
NC=NC+1
X(KO+NC)=F(J)
IX(K1+NC)=JJ
124 CONTINUE
IF(NC.LE.1) GO TO 200

C
C
C   THERE ARE NC NODE NUMBERS WHICH COUPLE STORED FROM IX(K1+1)

REWIND KKK
K2=K1+NC
KD=K2+1
DC 140 J=1,NC
JJ=IX(K1+J)
130 READ(KKK,END=300) AA,II,K,LL
IF(LL.EQ.0) GO TO 130
READ(KKK) (X(K),K=1,LL)
IF(II.NE.JJ) GO TO 130
DO 136 K=1,NC
JJ=IX(K1+K)
K2=K2+1
X(K2)=X(JJ)*FREQ(L)
136 CONTINUE
140 CONTINUE

C
C
C   A NC BY NC DAMPING MATRIX IS NOW STORED AT X(KD)

KM=KD+NC*NC
K2=KM-1
DO 160 K=1,NC
JJ=IX(K1+K)
DO 144 LL=1,LFREQ
IF(IDFREQ(LL).NE.JJ) GO TO 144
XM=GMASS(LL)
XF=FREQ(LL)
GO TO 146
144 CONTINUE
146 CONTINUE
LL=(K-1)*NC+K+K2
X(LL)=XM*(XF**2-FREQ(L)**2)
160 CONTINUE

C
C
C   A NC BY NC DIAGONAL MASS MATRIX IS NOW STORED FROM X(KM)

LL=KM+NC*NC
K=LL+NC*NC
JJ=K+NC*NC

C
A      B      S1      S2      S3      S4

```

```

      CALL MCRAP(X(KM),X(KD),X(LL),X(K),NC,X(JJ),X(JJ+NC),X(JRI+L),
X      X(KO+1),
X      IX(KI+1),ID)
200 CONTINUE
220 CONTINUE
      WRITE(6,3)
      DO 300 I=1,LFREQ
300 WRITE(6,30) IDFREQ(I),DAMP(I),X(JRI+I)
      RETURN
      END
      SUBROUTINE MCRAP(A,B,S1,S2,NC,S3,S4,RI,F,
X      IW,ID)
      DIMENSION A(NC,NC),B(NC,NC),S1(NC,NC),S2(NC,NC),S3(NC),S4(NC)
      DIMENSION F(1)
      INTEGER S3,IW(1)
      S3(1)=NC
      S3(2)=0
C
C      INVERT B INTO S1
C
      CALL GMI(8900,B,S2,S1,NC,S3,S4)
C
C      FORM A=B(INV) IN S1 ( A IS DIAGONAL )
C
      DO 20 I=1,NC
      DO 20 J=1,NC
20 S1(I,J)=A(I,I)*S1(I,J)
C
C      FORM ( B + S1*A ) IN S2
C
      DO 30 I=1,NC
      DO 30 J=1,NC
30 S2(I,J)=B(I,J)+S1(I,J)*A(J,J)
C
C      INVERT S2 IN S2
C
      S3(1)=NC
      S3(2)=0
      CALL GMI(8900,S2,A,S2,NC,S3,S4)
      DO 40 I=1,NC
      DO 40 J=1,NC
      A(I,J)=0.
      DO 40 K=1,NC
40 A(I,J)=A(I,J) + S2(I,K)*S1(K,J)
      DO 44 I=1,NC
      DO 44 J=1,NC
44 S2(I,J)=-S2(I,J)
C
C      MATRIX C IS IN A, MATRIX D IS IN S2
C
      DO 46 J=1,NC
      IF(IW(J).NE.ID) GO TO 46
      I=J
      GC TC 48
46 CONTINUE

```

```

48 CONTINUE
SUM1=0.
SUM2=0.
DO 50 J=1,NC
SUM1=SUM1+A(I,J)*F(J)
SUM2=SUM2+S2(I,J)*F(J)
50 CONTINUE
RI=B(I,I)*SCRT(SUM1**2 + SUM2**2)/F(I)
CALL MMPRNT(IW,ID,NC,A,4HC )
CALL MMPRNT(IW,ID,NC,S2,4HD )
RETURN
900 STOP 31
END
SUBROUTINE MMPRNT(IW,ID,NC,A,XNAM)

```

C
C
C

```

MATRIX PRINT

DIMENSION IW(NC),A(NC,NC)
WRITE(6,1) XNAM,ID
1 FORMAT( 20H0 I-TH ROW OF MATRIX , A2, 16HFOR MODE I, I =, I3 )
DC 10 I=1,NC
IF(IW(I).NE.ID) GO TO 10
J=I
GC TO 12
10 CONTINUE
RETURN
12 CONTINUE
J1=1
8 J2=J1+7
IF(J2.GT.NC) J2=NC
WRITE(6,2) (IW(I),I=J1,J2)
2 FORMAT( 9HMODE NO., I11, 7I13 / )
WRITE(6,3) (A(J,I), I=J1,J2)
3 FORMAT( 6H VALUE, 6X, 8E13.5 )
J1=J2+1
IF(J1.LE.NC) GO TO 8
RETURN
END
SUBROUTINE COLPRT(A,N,ID,KGRID)

```

C
C
C

```

ROUTINE TO PRINT ONE COLUMN OF MODE SHAPE MATRIX

DIMENSION A(6,N),KGRID(N)
WRITE(6,20) ID,(KGRID(J),(A(I,J), I=1,6), J=1,N)
20 FORMAT( 13H1 MODE NUMBER, I5 /
* 7H0 GRID, 11X,2HT1,13X,2HT2,13X,2HT3,13X,2HR1,13X,2HR2,13X,2HR3
* / ( I7, 2X, 6E15.5 ))
RETURN
END
SUBROUTINE FKCALC(PHI,LL,LFREQ,KGRID,LG,FK)

```

C
C
C
C

```

INPUT A LIST OF GRID IDS FOR CALCULATING A
GENERALIZED DAMPING FORCE, AND CALCULATE THE FORCE IN FK

DIMENSION PHI(LL,LFREQ),KGRID(100,2),FK(1),KDUM(8)

```

4

```
DO 8 I=1,LFREQ
8 FK(I)=0.
```

C
C
C

```
WRITE (6,60)
60 FCRMAT( 5GHIGRIDPOINTS FOR MODAL VELOCITY COUPLING ASSESSMENT )
10 READ(5,11) KDUM
11 FORMAT( 8I10)
DC 28 I=1,8
IF(KDUM(I).LE.0) GO TO 40
II=I
DC 16 J=1,LG
IF(KDUM(I).NE.KGRID(J,1)) GO TO 16
K=(J-1)*6
GO TO 18
16 CONTINUE
GO TO 28
18 CONTINUE
DO 22 J=1,LFREQ
DO 22 JJ=1,6
FK(J)=FK(J)+ABS(PHI(K+JJ,J))
22 CONTINUE
28 CONTINUE
WRITE(6,61) KDUM
61 FORMAT( 8I10 )
GO TO 10
40 CONTINUE
WRITE(6,61) (KDUM(J),J=1,II)
RETURN
END
SUBROUTINE PNCHI(AA,LA,IRC,IRCNO)
DIMENSION A(5),AA(1),IE(5),SIGN(5)
DATA EP,EM/ 2HE+,2HE- /
```

C
C
C

```
ROUTINE TO PUNCH A ROW, COLUMN, OR DIAGONAL IN SEAL FORMAT

J1=1
8 J2=J1+4
IF(J2.GT.LA) J2=LA
I=0
DC 20 J=J1,J2
I=I+1
IE(I)=0
V=AA(J)
IF(ABS(V).GE.1.)GO TO 16
SIGN(I)=EM
12 V=V*10.
IE(I)=IE(I)+1
IF(IE(I).EQ.9) GO TO 19
IF(ABS(V).GT.1.)GO TO 19
GO TO 12
16 SIGN(I)=EP
17 IF(ABS(V).LT.10.)GO TO 19
V=V/10.
```

```

        IE(I)=IE(I)+1
        IF(IE(I).EQ.9) GO TO 19
        GO TO 17
19      A(I)=V
20      CONTINUE
        GO TO (30,40,50),IRC
30      CONTINUE
        WRITE(7,32) IRCNO,J1,(A(J),SIGN(J),IE(J), J=1,I)
32      FORMAT( 3H R(,I3,1H,I3,1H),1X, 5(1X,F8.5,A2,I1) )
        GO TO 60
40      CONTINUE
        WRITE(7,42) J1,IRCNO,(A(J),SIGN(J),IE(J), J=1,I)
42      FORMAT( 3H C(,I3,1H,I3,1H),1X, 5(1X,F8.5,A2,I1) )
        GO TO 60
50      CONTINUE
        WRITE(7,52) J1,J1,(A(J),SIGN(J),IE(J), J=1,I)
52      FORMAT( 3H D(,I3,1H,I3,1H),1X, 5(1X,F8.5,A2,I1) )
60      CONTINUE
        J1=J2+1
        IF(J1.LE.LA) GO TO 8
        RETURN
        END
        SUBROUTINE PNCH2(PHI,IP,FREQ,GM,LFREQ,IDG,LLID,X,KGRID,LG)
        DIMENSION PHI(IP,1),FREQ(1),GM(1),IDG(1),X(1),KGRID(1)
        KKK=0
        K=1
30      DO 60 I=1,LG
        IF(IDG(K).NE.KGRID(I))GO TO 60
        L=(I-1)*6
        GO TO 62
        60      CONTINUE
        GO TO 800
        62      CONTINUE
        DG 100 I=4,6
        KKK=KKK+1
        DO 90 J=1,LFREQ
90      X(J)=PHI(L+I,J)/(FREQ(J)**2*GM(J))
        CALL PNCHI(X,LFREQ,1,KKK)
100     CONTINUE
800     K=K+1
        IF(K.LE.LLID) GO TO 30
        WRITE(7,2000)
2000    FORMAT( 4H END )
        RETURN
        END
        SUBROUTINE PRPLT(KK,X,FREQ,IDFREQ,LFREQ,M1,N1,M2,N2)
C
C      ROUTINE TO PRINT AND PLOT ARRAY X AS FUNCTION OF FREQUENCY
C      ROUTINE USES WRITE/READ 0 TO FORM PLOT TITLES
C
        DIMENSION X(LFREQ,1),FREQ(LFREQ),IDFREQ(LFREQ),T(15),TL(3)
        DIMENSION TRGT(5),TLRGT(6)
        DATA TRGT/4HFREQ,4HUENC,4HY,RA,4HD/SE,4HC /
        DATA BLANK/4H /
        DATA TR1/ 4H RAT /, TP1/ 4H POS /

```

REPRODUCIBILITY OF THE ORIGINAL PAGE IS POOR

```

DATA TL/ 4HCOEF,4HFICI,4HENTS /
EQUIVALENCE (IQ,Q),(J,AJ)
COMMON/SYSCTL/ NOPT,NOPLT
COMMON/XSPECS/ SS(75),BB(126)
COMMON/RPFACT/ RPF(20,4),NR,NP
DO 9892 I=1,126
9892 BB(I)=BLANK
    IIK=3
    L=NP
    IF(KK.GT.2) GO TO 10
    IF(KK.EQ.2) GO TO 2000
    WRITE(6,1) M2,N2,M1,N1
    1 FORMAT( 37H1RATE COEFFICIENTS.    RESPONSE FRDM =, 16,11,
X 16H    INPUT FRDM =, 16,11 )
    WRITE(0,1) M2,N2,M1,N1
    REAC(0,3) T
    T(1)=TR1
    IIK=1
    L=NR
    GO TO 2008
2000 CONTINUE
    WRITE(6,1006) M2,N2,M1,N1
    .WRITE(0,1006) M2,N2,M1,N1
    REAC(0,3) T
    T(1)=TPI
1006 FORMAT( 30H1POSITION (GYRO) COEFFICIENTS. ,
X 18H    RESPONSE FRDM =, 16,11, 16H    INPUT FRDM =, 16,11 )
2008 CONTINUE
    WRITE(6,1001)
1001 FORMAT( 46H0 FREQUENCY    MODE NO.    COEFFICIENT    RANK )
    2 FORMAT( E13.5, I7, 6X, E13.5, I6 )
    3 FORMAT( 20A4 )
    XSAVE=RPF(1,IIK)
    N=1
    DO 4 I=1,LFREQ
    Y=TBLP(RPF(1,IIK),RPF(1,IIK+1),FREQ(I),XSAVE,L,N,M)
    X(I,1)=Y*X(I,1)
    4 X(I,2)=ABS(X(I,1))
    IF(NCPLCT.GT.0) GO TO 7
    X1=1.
    IX2=FREQ(LFREQ)
    X2=FLCAT(IX2+99)
    Y1= 1.E20
    Y2=-1.E20
    DO 5 I=1,LFREQ
    IF(X(I,2).GT.Y2) Y2=X(I,2)
    IF(X(I,2).LT.Y1) Y1=X(I,2)
    5 CONTINUE
    CALL STSUBJ(X1,X2,Y1,Y2,SS)
    CALL STNPTS(LFREQ,SS)
    CALL GDLGLG(BB,SS)
    CALL STSYMB( 1,SS)
    CALL STCHSZ(.014,.014,SS)
    CALL PSLGLG(FREQ,X(1,2),BB,SS)
    CALL STNCHR(48,SS)

```

```

CALL TITLEB(T,BB,SS)
CALL STNCFR(12,SS)
CALL TITLEL(TL,BB,SS)
CALL ADVANC(1.0,SS)
7 CONTINUE
CALL FSHELL(X(1,2),X(1,3),LFREQ)
I=LFREQ
J=1
9 Q=X(1,3)
X(IQ,2)=AJ
J=J+1
I=I-1
IF(I.GT.0) GO TO 9
WRITE(6,2) (FREQ(I),IDFREQ(I),X(I,1),X(I,2), I=1,LFREQ)
GC TC 80
10 CONTINUE
IF(KK.NE.3) GO TO 30
WRITE(6,11) M1,N1
WRITE(0,11) M1,N1
READ(0,3) T
T(1)=TP1
WRITE(6,1011)
11 FORMAT( 33H1POSITION (OPTICAL) COEFFICIENTS. ,
X 20H RESPONSE FRDM = U, 16H INPUT FRDM =, I6,I1 )
1011 FORMAT( 1H0, 24X, 3(15H COEFFICIENTS, 6X) /
X 23H FREQUENCY MODE NO., 7X, 12HU=X RANK, 9X,
X 12HU=Y RANK, 9X, 12HU=Z RANK )
XSAVE=RPF(1,I(K))
N=1
DO 14 I=1,LFREQ
Y=TBLP(RPF(1,I(K)),RPF(1,I(K+1)),FREQ(I),XSAVE,L,N,M)
DO 14 K=1,3
X(I,K)=Y*X(I,K)
14 X(I,K+3)=ABS(X(I,K))
IF(NOPLOT.GT.0) GO TO 17
X1=1.
IX2=FREQ(LFREQ)
X2=FLOAT(IX2+99)
Y1= 1.E20
Y2=-1.E20
DC 15 I=1,LFREQ
DO 15 J=4,6
IF(X(I,J).GT.Y2) Y2=X(I,J)
IF(X(I,J).LT.Y1) Y1=X(I,J)
15 CONTINUE
CALL STSUBJ(X1,X2,Y1,Y2,SS)
CALL STNPTS(LFREQ,SS)
CALL GDLGLG(BB,SS)
CALL STSYMB( 1,SS)
CALL STCHSZ(.014,.014,SS)
CALL PSLGLG(FREQ,X(1,4),BB,SS)
CALL STSYMB( 4,SS)
CALL PSLGLG(FREQ,X(1,5),BB,SS)
CALL STSYMB( 5,SS)
CALL PSLGLG(FREQ,X(1,6),BB,SS)

```

REPRODUCIBILITY OF THE
ORIGINAL PAGE IS POOR

```

CALL STNCHR(48,SS)
CALL TITLEB(T,8B,SS)
CALL STNCHR(12,SS)
CALL TITLEL(TL,8B,SS)
CALL ADVANC (1.0,SS)
17 CONTINUE
DC 25 K=1,3
CALL FSHELL(X(1,K+3),X(1,7),LFREQ)
I=LFREQ
J=1
22 Q=X(1,7)
X(IQ,K+3)=AJ
J=J+1
I=I-1
IF(I.GT.0) GO TO 22
25 CONTINUE
DC 28 I=1,LFREQ
WRITE(6,27) FREQ(I),IDFREQ(I),X(I,1),X(I,4),X(I,2),X(I,5),
X      X(I,3),X(I,6)
27 FORMAT( E13.5, I7, 5X, 3( E12.5, I4, 5X) )
28 CONTINUE
GO TO 80
30 CCNTINUE
IF(KK.NE.4) GO TO 80
WRITE(6,31)
31 FORMAT( 14HIIMAGE MOTIONS /
X 23HO FREQUENCY MODE NO., 7X, 12H X RANK, 9X,
X 12H Y RANK, 9X, 12H Z RANK )
DO 34 I=1,LFREQ
DC 34 K=1,3
34 X(I,K+3)=ABS(X(I,K))
GO TO 17
80 CONTINUE

```

C
C
C

```

NEW CODE MOD FOR ADMITTANCE PLOTS

IF(.NOT.(KK.GE.5.AND.KK.LE.10))GO TO 90
IF(KK.EQ.9.OR.KK.EQ.10)
XWRITE(0,2003)M1,M2
IF(KK.EQ.5.OR.KK.EQ.6)
XWRITE(0,2001)M1,M2
IF(KK.EQ.7.OR.KK.EQ.8)
XWRITE(0,2002)M1,M2
2001 FORMAT('DISPL. ADMITTANCE FOR FROM', I7, ' DUE TO', I7)
2002 FORMAT('ACCEL. ADMITTANCE FOR FRDM', I7, 'DUE TO', I7)
READ(0,3)T
IF(KK.EQ.5 )WRITE(0,2005)
IF(KK.EQ.6 )WRITE(0,2006)
IF(KK.EQ.7 )WRITE(0,2007)
IF(KK.EQ.8 )WRITE(0,3008)
IF(KK.EQ.9 )WRITE(0,2009)
IF(KK.EQ.10)WRITE(0,2010)
2003 FORMAT('VEL. ADMITTANCE FOR FROM',I7,'DUE TO FRDM', I7)
2005 FORMAT ('DISPLACEMENT ADMITTANCE ')
2006 FORPAT ('DISPLACEMENT PHASE ANGLE')

```

```

2007 FORMAT ('ACCELERATION ADMITTANCE ')
3008 FORMAT ('ACCELERATION PHASE ANGLE')
2009 FORMAT ('VELOCITY ADMITTANCE ')
2010 FORMAT ('VELOCITY PHASE ANGLE ')
REAC(0,3)TLRGT
IF(ACPLOT.GT.0)GO TO 85
X1=10
X3=FREQ(LFREQ)+10
IX2=AIN(X3/10)
X2=FLOAT(10*IX2)
NDIV=IX2-1
Y1=1.0E20
Y2=-1.0E20
DO 84 I=1,LFREQ
IF(X(I,1).GT.Y2)Y2=X(I,1)
IF(X(I,1).LT.Y1)Y1=X(I,1)
84 CONTINUE
DO 9893 IIE=1,41
I=IIE-21
IF(10**(I-1).LT.ABS(Y1).AND.10**I.GE.ABS(Y1))Y1=10**I
IF(10**(I-1).LT.ABS(Y2).AND.10**I.GE.ABS(Y2))Y2=10**(I-1)
9893 CONTINUE
IF(KK.EQ.6.OR.
X KK.EQ.8.OR.
X KK.EQ.10)Y2=180.0
IF(KK.EQ.6.OR.
X KK.EQ.8.OR.
X KK.EQ.10)Y1=-180.0
CALL STSUBJ(X1,X2,Y1,Y2,SS)
CALL STS208(.25,.95,.25,-9,SS)
CALL STNPTS(LFREQ,SS)
CALL STNDIV(NDIV,12,SS)
IF(.NOT.(KK.EQ.5.OR.KK.EQ.7.OR.KK.EQ.9))GO TO 8401
CALL GDLILG(BB,SS)
CALL NCLGL(BB,SS)
CALL NODLIB(BB,SS)
GO TO 8402
8401 IF(.NOT.(KK.EQ.6.OR.KK.EQ.8.OR.KK.EQ.10))GO TO 8402
CALL GDLILI(BB,SS)
CALL NODLIL(BB,SS)
CALL NODLIB(BB,SS)
8402 CONTINUE
CALL STSYMB(1,SS)
CALL STCHSZ(.014,.014,SS)
IF(KK.EQ.5.OR.
X KK.EQ.7.OR.
X KK.EQ.9) CALL SLLILG(FREQ,X(1,1),BB,SS)
IF(KK.EQ.6.OR.
X KK.EQ.8.OR.
X KK.EQ.10) CALL SLLILI(FREQ,X(1,1),BB,SS)
CALL STNCHR(48,SS)
CALL TITLET(T,BB,SS)
CALL STNCHR(20,SS)
CALL TITLBT(TRGT,BB,SS)
CALL STNCHR(24,SS)

```

REPRODUCIBILITY OF THIS
ORIGINAL PAGE IS POOR

```

      CALL TITLEL(TLRGT,BB,SS)
      CALL ADVANC(1.0,SS)
85  CONTINUE
90  CONTINUE
      RETURN
      END
      SUBROUTINE RPREAD
C
C  ROUTINE TO READ IMPORTANCE FACTOR TABLES AS FUNCTION OF FREQ
C
      COMMON/RPFACT/ RFREQ(20),RFAC(20),PFREQ(20),PFAC(20),NR,NP
C
C  READ NUMBER OF PAIRS IN EACH TABLE
C
      READ(5,1) NR,NP
1  FORMAT( 2I5 )
      IF(NR.LE.0) GO TO 20
      READ(5,2) (RFREQ(I),RFAC(I), I=1,NR)
2  FORMAT( 8F10.0 )
      GO TO 40
20  NR=2
      RFREQ(1)=0.
      RFREQ(2)=1.
      RFAC(1)=1.
      RFAC(2)=1.
40  IF(NP.LE.0) GO TO 60
      READ(5,2) (PFREQ(I),PFAC(I), I=1,NP)
      GO TO 80
60  NP=2
      PFREQ(1)=0.
      PFREQ(2)=1.
      PFAC(1)=1.
      PFAC(2)=1.
80  CONTINUE
      RETURN
      END
      SUBROUTINE BREORD(BR,X,NN,IDBR,KGRID,LG,ISCR)
C
C  ROUTINE TO REORDER THE ROWS OF BR (IN 6 ROW BLOCKS) TO
C  COINCIDE WITH THE GRID ORDER OF KGRID.  GRID IDS FOR BR
C  ARE GIVEN IN IDBR.  X AND ISCR ARE SCRATCH ARRAYS.
C
      DIMENSION BR(NN,3),X(NN,3),IDBR(1),KGRID(1),ISCR(1)
      NBR=NN/6
      L=0
      K1=0
      DO 80 KK=1,LG
      DO 20 J=1,NBR
      IF(IDBR(J).NE.KGRID(KK)) GO TO 20
      L=L+1
      ISCR(L)=IDBR(J)
      IDBR(J)=-1
      J1=(J-1)*6 + 1
      J2=J1+5
      DO 16 I=J1,J2

```

```

      K1=K1+1
      X(K1,1)=BR(I,1)
      X(K1,2)=BR(I,2)
      X(K1,3)=BR(I,3)
16  CONTINUE
20  CONTINUE
80  CONTINUE
     IF(L.EQ.NBR)GO TO 90
     WRITE(6,82)
82  FCRMAT( 81H1*ERROR* THE FOLLOWING GRID IDS FOR MATRIX BR ARE NOT F
     *GUND IN NASTRAN MATRIX IDS  )
     DO 85 I=1,NBR
     IF(IDBR(I).LT.0) GO TO 85
     WRITE(6,84) IDBR(I)
84  FORMAT( I15 )
85  CCNTINUE
     STOP
90  CONTINUE
     DC 98 I=1,K1
     BR(I,1)=X(I,1)
     BR(I,2)=X(I,2)
     BR(I,3)=X(I,3)
98  CONTINUE
     DO 100 I=1,NBR
100 IDBR(I)=ISCR(I)
     WRITE(6,200)
200 FORMAT( 45HOPTICAL AMPLIFICATION MATRIX, BR (TRANSPOSE)
     X      49H (RE-ORDERED AS NECESSARY TO MATCH NASTRAN ORDER)
     X      44HO FREECOM      COL 1      COL 2      COL 3
     K1=0
     DO 208 I=1,NBR
     DC 206 J=1,6
     K1=K1+1
     WRITE(6,201) IDBR(I),J,BR(K1,1),BR(K1,2),BR(K1,3)
201 FCRMAT( I6, I2, 2X, 3E12.4 )
206 CONTINUE
208 CONTINUE
     RETURN
     END
     SUBROUTINE POSN(PHI,NPHI,NFREQ,BR, IDBR, LB6, FTABLE, LFTBL, KGRID, IDF,
     XLID, CAMP, FREQ, IDFREQ, GMASS, SCR, M1, N1)

```

C
C
C
C
C
C
C
C
C
C
C

```

ROUTINE TO CALCULATE POSITION COEFFICIENTS FOR FREEDOM M1/N1

PHI---MODE SHAPE ARRAY DIMENSIONED PHI(NPHI,NFREQ)
BR---OPTICAL AMPLIFICATION MATRIX (TRANSPPOSED), DIMEN. LB6 BY 3
IDBR---ARRAY OF GRID IDS FOR BR, LENGTH=LBR
FTABLE---TABLE CF FREQ, FORCE, AND TORQUE
KGRID---GRID IDS DEFINING ORDER OF PHI (6 ROWS PER ID)
IDF---GRID IDS DEFINING LOAD POINTS, LENGTH=LID
DAMP, FREQ, GMASS---DAMPING, FREQUENCY, AND GENERALIZED MASS
SCR---SCRATCH ARRAY

DIMENSION PHI(NPHI,NFREQ),BR(LB6,1), IDBR( 1), FTABLE(LFTBL,3),
X  DAMP(1), FREQ(1), GMASS(1), IDF(1) ,KGRID(1),X(3),

```



```

X   SCR(NFREQ,1),IDFREQ(1)
  COMPCN/SYSCTL/ NOPT,NOPLOT,KINDF
  LG=NPHI/6
  LBR=L86/6
  IF(M1.EQ.0) GC TO 26
  SCRIPF=1.

```

C
C
C

```

  LOCATE POSITION IN PHI FOR FREEDOM M1/M1

```

```

  DO 20 I=1,LG
  IF(KGRID(I).NE.M1) GO TO 20
  KMN=(I-1)*6+N1
  GO TO 26
20 CONTINUE
  WRITE(6,22) M1,N1
22 FORMAT( 63H1*ERROR* POSITION COEFFICIENT REQUESTED AT NON-EXISTING
  X FREEDOM, I5,I2 )
  RETURN
26 CONTINUE
  DO 200 J=1,NFREQ

```

C
C
C

```

  FORM (BR)(PHI) FOR J-TH MODE

```

```

  DO 50 I=1,3
  X(I)=0.
  K1=0
  L1=1
  DO 40 K=1,LBR
  DO 30 L=L1,LG
  IF(KGRID(L).NE.IDBR(K)) GO TO 30
  K2=(L-1)*6
  L1=L+1
  GO TO 32
30 CONTINUE
32 CONTINUE
  DO 34 L=L1,6
34 X(I)=X(I)+BR(K1+L,I)*PHI(K2+L,J)
  K1=K1+6
40 CONTINUE
50 CONTINUE
  IF(M1.GT.0) GO TO 98

```

REPRODUCIBILITY OF THE
ORIGINAL PAGE IS POOR

C
C
C

```

  FORM LCAD FOR MODE J (SCRIPT F)

```

```

  SCRIPF=0.
  XS=FTABLE(1,1)
  N=1
  FF=TBLP(FTABLE(1,1),FTABLE(1,2),FREQ(J),XS,LFTBL,N,M)
  QQ=TBLP(FTABLE(1,1),FTABLE(1,3),FREQ(J),XS,LFTBL,N,M)
  DO 80 I=1,LID
  DO 70 K=1,LG
  IF(KGRID(K).NE.IDF(I)) GO TO 70
  FORM PSD LOAD
  K1=(K-1)*6
  DO 60 L=1,3

```

C

```

      IF(KINDF.LE.0) GO TO 56
C
C
      SCRIPF=SCRIPF+FF*PHI(K1+L,J)**2+QQ*PHI(K1+L+3,J)**2
      GO TO 60
56 CONTINUE
C
C
      ORDINARY LOADS
C
      SCRIPF=AMAX1(SCRIPF,ABS(PHI(K1+L,J))*FF)
      SCRIPF=AMAX1(SCRIPF,ABS(PHI(K1+3+L,J))*QQ)
60 CONTINUE
      GO TO 80
70 CONTINUE
80 CONTINUE
96 CONTINUE
      IF(KINDF.LE.0) GO TO 98
      SCRIPF=SQRT( 0.5*FREQ(J)*DAMP(J)*SCRIPF )
98 CONTINUE
      A=SCRIPF/(2.*DAMP(J)*FREQ(J)*FREQ(J)*GMASS(J))
      IF(N1.NE.0) A=A*PHI(KMN,J)
      DO 100 I=1,3
100 SCR(J,I)=X(I)*A
200 CONTINUE
      IF(N1.EQ.0) GO TO 220
      CALL PRPLT( 3,SCR,FREQ,IDFREQ,NFREQ,M1,N1,0,0)
      GO TO 300
220 CALL PRPLT( 4,SCR,FREQ,IDFREQ,NFREQ,0,0,0,0)
300 CONTINUE
      RETURN
      END
      SUBROUTINE DADD(DIN,DOUT,IC,D,X,IDFREQ,LFREQ,F2,FREQ,GMASS)
C
C
      ROUTINE TO READ USER SUPPLIED DAMPING AND ADD TO
      DAMPING MATRIX FROM NASTRAN
C
C
      DIN-UNIT CONTAINING NASTRAN MATRIX BHH
      DOUT-UNIT TO CONTAIN NEW MATRIX
      ID,D,X-SCRATCH ARRAYS
C
      INTEGER DIN,DOUT
      DIMENSION FREQ(1),GMASS(1)
      DIMENSION ID(1),D(1),X(1),IDFREQ(1),JJ(4),BB(4)
      DOUBLE PRECISION AA
C
C
      READ IN USER SUPPLIED DAMPING
C
      COMPCN/FACTOR/DFAC,ALF1,ALF2
      LID=0
8 READ(5,9) (JJ(I),BB(I), I=1,4)
9 FORMAT( 4(I10,F10.0) )
      DO 14 I=1,4
      IF(JJ(I).LE.0) GO TO 20
      LID=LID+1
      ID(LID)=JJ(I)

```

```

      D(LID)=88(I)
14  CONTINUE
      GO TO 8
20  CONTINUE
      IF(LID.EQ.0) GO TO 24
      WRITE(6,22)
      DO 21 I=1,LID
      DO 201 J=1,LFREQ
      IF(ID(I).NE.IDFREQ(J))GO TO 201
      DIII=D(I)*FREQ(J)*GMASS(J)*2.
      GO TO 202
201  CONTINUE
202  WRITE(6,23) ID(I),D(I),DIII
      23  FORMAT( I6, E15.5, E17.5 )
      D(I)=DIII
      21  CONTINUE
22  FORMAT( 28H1USER SUPPLIED DAMPING TERMS /
X      38H      ID      INPUT COEF.      DAMPING TERM      )
24  CONTINUE
      REWIND DIN
      REWIND DCUT
      WRITE(6,400) F2,DFAC
400  FORMAT( 59H1NASTRAN MODAL DAMPING MATRIX (8HH), SCALED BY THE FACT
XORS  , E12.4, 6H AND , E12.4 /
X 5HGMODE, 30X, 6HVALUES )
      L=1
28  IDX=IDFREQ(L)
30  READ(DIN,END=90) AA,J,K,LL
      IF(LL.GT.0) GO TO 32
      DO 31 I=1,J
31  X(I)=0.
      LL=J
      GO TO 321
32  CONTINUE
      READ(DIN) (X(I),I=1,LL)
321  CONTINUE
      IF(J.LT.IDX)GO TO 30
      IF(J.EQ.IDX)GO TO 33
      STOP 98
33  CONTINUE
      DO 37 I=1,LL
37  X(I)=X(I)*F2*DFAC
      IF(MOD(L,3).EQ.1.AND.L.NE.1) WRITE(6,400) F2,DFAC
      WRITE(6,401) J,(X(I),I=1,LL)
401  FORMAT(1H0,I3,5X,8E14.5 / (9X,8E14.5))
      IF(LID.EQ.0) GO TO 50
      DO 40 I=1,LID
      IF(ID(I).NE.IDX)GO TO 40
      X(J)=X(J)+ D(I)
      GO TO 50
40  CONTINUE
50  WRITE(DOUT) AA,J,K,LL
      WRITE(DCUT) (X(I),I=1,LL)
      L=L+1
      IF(L.LE.LFREQ) GO TO 28

```

REPRODUCIBILITY OF THE
ORIGINAL PAGE IS POOR

```

90 REWIND DCUT
RETURN
END
SUBROUTINE NTREAD(M0,AA,AS,I,J, IDIM, IRWD, SS, IU, S2, ISUC, IPREC, KIND)
COMMON/NOUUT/IDUT
COMMON/ XXUNPA / LSP
INTEGER AA(2),AS{(IDIM,1)},SS(1),S2(1),COLEND
DATA IEOF/'EOF '/,IEND/'ENDD'/,COLEND/Z00FFFFFF/
DATA K1/4/, IPRNT1/9/, ITRLR/Z00010000/
INTEGER*2 KKO(2),KK2
EQUIVALENCE (KKK,KKO(1)),(KK2,KKO(2)),(IPRNT1,IPRINT)
M1=M0-3
MENC=M1-2
IF(IRWD.EC.0)GO TO 22
REWIND IU
20 CONTINUE
CALL RX(SS(1),M1,IU,II)
K1=4
IF(II.LT.0)GO TO 960
22 CONTINUE
NBLOCK=SS(1)
30 CONTINUE
LL=SS(K1)
L=LL/4
IF(L.EQ.0) GO TO 900
IF(L.NE.2)GO TO 38
C ENCOUNTERED FILE NAME---COMPARE WITH AA
WRITE(IPRNT1,1)SS(K1+1),SS(K1+2)
1 FORMAT( 'OFOUND FILE ', 2A4 )
38 CONTINUE
IF(SS(K1+1).NE.AA(1))GO TO 40
C POSSIBILITY OF NAME BEING CONTINUED TO NEXT BLOCK
IF(L.NE.1) GO TO 39
IF(K1.NE.(MENC-1)) GO TO 39
C INPUT NEXT BLOCK
CALL RX(SS(1),M1,IU,II)
IF(II.LT.0)GO TO 960
NBLOCK=SS(1)
K1=4
LL=SS(4)
L=LL/4
IF(L.EQ.0) GO TO 900
IF(SS(K1+1).EQ.AA(2)) GO TO 60
GO TO 40
39 CONTINUE
IF(SS(K1+2).EQ.AA(2))GO TO 60
40 CONTINUE
IF(LL.NE.IEOF)GO TO 46
WRITE(IPRNT1,2)
2 FORMAT( 'O** EOF **' )
K1=K1+1
GO TO 48
46 CONTINUE
IF(LL.EQ.IEND)GO TO 20
C SKIP OVER LOGICAL RECORD

```

```

PVEC0838
PVEC0839
PVEC0840
PVEC0841
PVEC0842
PVEC0843
PVEC0844
PVEC0845
PVEC0846
PVEC0847
PVEC0848
PVEC0849
PVEC0850
PVEC0851
PVEC0853
PVEC0854
PVEC0855
PVEC0856
PVEC0857
PVEC0858
PVEC0859
PVEC0860
PVEC0861
PVEC0862
PVEC0863
PVEC0864
PVEC0865
PVEC0866
PVEC0867
PVEC0868
PVEC0869
PVEC0870
PVEC0871
PVEC0872
PVEC0873
PVEC0874
PVEC0875
PVEC0876
PVEC0877
PVEC0878
PVEC0879
PVEC0880
PVEC0881
PVEC0882
PVEC0883
PVEC0884
PVEC0885

```

47	CONTINUE	PVEC0886
	K1=K1+L+2	PVEC0887
48	CCONTINUE	PVEC0888
	IF(K1.LT.MEND)GO TO 30	PVEC0889
C	CHECK POSSIBILITY OF UNUSED WORDS AT END OF BLOCK	PVEC0890
	DC 50 II=K1,M1	PVEC0891
	L=SS(II)	PVEC0892
	IF(L.EQ.IEOF) WRITE(IPRNT1,2)	
	IF(L.EQ.IEND) GO TO 20	PVEC0894
50	CONTINUE	PVEC0895
	GO TO 20	PVEC0896
60	CCONTINUE	PVEC0897
C		PVEC0898
C*	FOUND REQUESTED FILE	PVEC0899
C		PVEC0900
	WRITE(IPRNT1,3) AA,NBLOCK	
3	FORMAT('QBEGIN PROCESSING FILE ', 2A4, ' BLOCK NO. =', 14)	
	I=0	PVEC0903
	J=0	PVEC0904
	K1=K1+L+2	PVEC0905
	IF(K1.LT.MEND)GO TO 61	PVEC0906
	CALL RX(SS(1),M1,IU,II)	PVEC0907
	IF(II.LT.0)GO TO 960	PVEC0908
	K1=4	PVEC0909
61	CONTINUE	PVEC0910
	L=SS(K1)	PVEC0911
	IF(L.EQ.IEOF)GO TO 800	PVEC0912
	L=L/4	PVEC0913
	GO TO (62,200,62,200), KIND	PVEC0914
62	CONTINUE	PVEC0915
C		PVEC0916
C*	PROCESS FILE AS PACKED MATRIX	PVEC0917
C	CHECK FOR MATRIX TRAILER AND CHECK TO	
C	SKIP OVER 4-WORD PREAMBLE OF PLOT VECTORS (E.G. PPHIG)	
C		PVEC0918
	KK=1	PVEC0919
64	CONTINUE	PVEC0920
	K1=K1+1	PVEC0921
	L=L-1	PVEC0922
	IF(L.LT.0) GO TO 82	
	JJ=SS(K1)	PVEC0924
	IF(JJ.EQ.COLEND)GO TO 70	PVEC0925
C	STORE TERM IN SCRATCH	PVEC0926
	S2(KK)=JJ	PVEC0927
	KK=KK+1	PVEC0928
	GO TO 64	PVEC0929
70	CCONTINUE	PVEC0930
	S2(KK)=COLEND	PVEC0931
	J=J+1	PVEC0932
	IF(KIND.EQ.3)GO TO 74	PVEC0933
C	UNPACK COLUMN J, STORE IN AS	PVEC0934
	CALL XXUNP(AS(1,J),S2(1),M,IDIM,IPREC)	PVEC0935
	IF(M.GT.1)I=M	PVEC0936
	GO TO 80	
74	CONTINUE	PVEC0938

C	UNPACK COLUMN J, OUTPUT ON UNIT IOUT	PVEC0939
	CALL XXUNP(AS(1,1),S2(1),M,IDIM,IPREC)	PVEC0940
	IF(M.GT.1)I=M	PVEC0941
	WRITE(IOUT) AA,J,IPREC,M	PVEC0942
	IF(LSP.EQ.0)GO TO 80	
	WRITE(IOUT) (AS(N,1),N=1,LSP)	PVEC0944
80	CONTINUE	PVEC0946
	KK=1	
	IF(L.GT.0) GO TO 62	
	KI=K1+1	
82	K1=K1+1	
	L=SS(K1)	PVEC0948
	IF(L.EQ.IEOF)GO TO 100	PVEC0949
	L=L/4	PVEC0950
	IF(K1.LT.MEND) GO TO 62	
C	INPUT NEXT BLOCK	PVEC0952
	CALL RX(SS(1),M1,IU,II)	PVEC0953
	IF(II.LT.0)GO TO 960	PVEC0954
	K1=4	PVEC0955
	L=SS(K1)/4	PVEC0956
	GO TO 64	PVEC0957
100	CONTINUE	PVEC0958
C	GET ROW SIZE FROM MATRIX TRAILER	PVEC0959
	KKK=S2(1)	PVEC0960
	I=KK2	PVEC0961
	GO TO 800	PVEC0962
200	CONTINUE	PVEC0963
C		PVEC0964
C#	PROCESS FILE AS TABLE	PVEC0965
C		PVEC0966
	J=J+1	PVEC0967
	M=J	PVEC0968
	IF(KIND.EQ.4)M=1	PVEC0969
	KK=0	PVEC0970
202	CONTINUE	PVEC0971
	K1=K1+1	PVEC0972
	L=L-1	PVEC0973
	IF(L.LT.0)GO TO 220	PVEC0974
	KK=KK+1	PVEC0975
	IF(IDIM.LT.KK) GO TO 940	MAY31 73
	AS(KK,M)=SS(K1)	PVEC0976
	GO TO 202	PVEC0977
220	CONTINUE	PVEC0978
	JJ=SS(K1)	PVEC0979
	IF(KK.GT.1)I=KK	PVEC0980
	K1=K1+1	PVEC0981
	L=SS(K1)	PVEC0982
	IF(L.EQ.IEOF)GO TO 250	PVEC0983
	L=L/4	PVEC0984
	IF(K1.LT.MEND)GO TO 230	PVEC0985
	CALL RX(SS(1),M1,IU,II)	PVEC0986
	IF(II.LT.0)GO TO 960	PVEC0987
	K1=4	PVEC0988
	L=SS(K1)/4	PVEC0989
C	CHECK IF LAST RECORD WAS CONTINUED	PVEC0990

REPRODUCIBILITY OF THE
ORIGINAL PAGE IS POOR

```
II=MOD(JJ,2)
IF(II.NE.0)GO TO 202
230 CONTINUE
IF(KIND.EQ.2)GO TO 200
WRITE(IOUT) AA,J,KK
WRITE(IOUT) (AS(II,1), II=1,KK)
GO TO 200
250 CONTINUE
IF(KIND.EQ.2)GO TO 800
WRITE(ICUT) AA,J,KK
WRITE(IOUT) (AS(II,1), II=1,KK)
800 CONTINUE
WRITE(IPRNT1,4)
4 FORMAT( 'OFINISHED PROCESSING' )
GO TO 999
900 CONTINUE
CC WRITE(IPRNT1,5)
WRITE(IPRINT,5) IU
CC 5 FORMAT( '0** END OF DATA ON TAPE **' )
5 FORMAT( '0** END OF DATA ON TAPE ** UNIT=',I3 )
GO TO 996
940 CONTINUE
WRITE(IPRINT,7) AA,IU,IDIM
7 FORMAT( '0** SCRATCH SPACE REQUIRED BY XFETCH TO PROCESS ',2A4,
X ' ON TAPE UNIT',I3,' IS GREATER THAN ',I10,'WORDS' )
GO TO 996
960 CONTINUE
CC WRITE(IPRNT1,6)
WRITE(IPRINT,6) IU
CC 6 FORMAT( '0** PHYSICAL END OF FILE **' )
6 FORMAT( '0** PHYSICAL END OF FILE ** UNIT=',I3 )
996 CCNTINJE
ISUC=-1
RETURN
999 CONTINUE
ISUC=1
RETURN
END
SUBROUTINE RX(A,K,IU,II)
DIMENSION A(K)
II=1
READ(IU,1,END=9) A
1 FORMAT( 1C(200A4))
RETURN
9 II=-1
RETURN
END
SUBRCUTINE XXUNP(C,S,LC,IMAX,IPREC)
C
C ROUTINE TO UNPACK NASTRAN COLUMN IN S AND PLACE IN C
C ACCUMULATE LC AS MAX LENGTH OF COLUMN
C
DIMENSION C(1),S(1)
INTEGER C,S
DATA IEND/ Z00FFFFFF /
```

PVEC0991
PVEC0992
PVEC0993
PVEC0994
PVEC0995
PVEC0996
PVEC0997
PVEC0998
PVEC0999
PVEC1000
PVEC1001
PVEC1002
PVEC1003
PVEC1004
PVEC1005
PVEC1006
PVEC1007
MAY29 73
PVEC1008
MAY29 73
PVEC1009
MAY31 73
MAY31 73
MAY31 73
MAY31 73
MAY31 73
PVEC1010
PVEC1011
MAY29 73
PVEC1012
MAY29 73
PVEC1013
PVEC1014
PVEC1015
PVEC1016
PVEC1017
PVEC1018
PVEC1019
PVEC1020
PVEC1021
PVEC1022
PVEC1023
PVEC1024
PVEC1025
PVEC1026
PVEC1027
PVEC1028
PVEC1029
PVEC1030
PVEC1031
PVEC1032
PVEC1033
PVEC1034
PVEC1035
PVEC1036

```

COMMON/ XXUNPA / LSP
LSP=0
LC=0
DO 20 I=1,IMAX
20 C(I)=0
IF(S(I).EQ.IEND)GO TO 96
IB=IPREC+2*S(2)-2
IF(IB.GT.4)GO TO 100
GO TO (22,23,24,25), IB
C
22 K1=1
K2=1
GO TO 28
C
23 K1=1
K2=2
GO TO 28
C
24 K1=2
K2=1
GO TO 28
C
25 K1=2
K2=2
28 CONTINUE
II=(S(I)-1)*K2+1
I=6-K1
30 CONTINUE
I=I+K1
32 CONTINUE
J=S(I)
IF(J.EQ.IEND)GO TO 90
IF(J.LE.0)GO TO 40
IF(J.GT.IEND)GO TO 40
II=(J-1)*K2+1
I=I+1
GO TO 32
40 CONTINUE
C(II)=J
IF(IB.LT.4)GO TO 50
IF(IB.EQ.4)GO TO 42
C(II+1)=S(I+1)
GO TO 50
42 CONTINUE
GO TO (44,45,46,47), IBB
44 C(II+1)=S(I+1)
GO TO 50
45 C(II+2)=S(I+1)
GO TO 50
46 C(II+1)=S(I+2)
GO TO 50
47 C(II+1)=S(I+1)
C(II+2)=S(I+2)
C(II+3)=S(I+3)
50 CONTINUE

```

```

PVEC1037
PVEC1038
PVEC1039
PVEC1040
PVEC1041
PVEC1042
PVEC1043
PVEC1044
PVEC1045
PVEC1046
PVEC1047
PVEC1048
PVEC1049
PVEC1050
PVEC1051
PVEC1052
PVEC1053
PVEC1054
PVEC1055
PVEC1056
PVEC1057
PVEC1058
PVEC1059
PVEC1060
PVEC1061
PVEC1062
PVEC1063
PVEC1064
PVEC1065
PVEC1066
PVEC1067
PVEC1068
PVEC1069
PVEC1070
PVEC1071
PVEC1072
PVEC1073
PVEC1074
PVEC1075
PVEC1076
PVEC1077
PVEC1078
PVEC1079
PVEC1080
PVEC1081
PVEC1082
PVEC1083
PVEC1084
PVEC1085
PVEC1086
PVEC1087
PVEC1088
PVEC1089
PVEC1090
PVEC1091

```

	II=II+K2	PVEC1092
	GO TO 30	PVEC1093
90	CONTINUE	PVEC1094
	LSP=II-1	PVEC1095
	LC=LSP/K2	PVEC1096
96	CONTINUE	PVEC1097
	RETURN	PVEC1098
100	IBB=IB-4	PVEC1099
	GO TO (122,123,124,125), IBB	PVEC1100
C	COMPLEX S.P. TO S.P.	PVEC1101
122	K1=2	PVEC1102
	K2=2	PVEC1103
	GO TO 28	PVEC1104
C	COMPLEX S.P. TO D.P.	PVEC1105
123	K1=2	PVEC1106
	K2=4	PVEC1107
	GO TO 28	PVEC1108
C	COMPLEX D.P. TO S.P.	PVEC1109
124	K1=4	PVEC1110
	K2=2	PVEC1111
	GO TO 28	PVEC1112
C	COMPLEX D.P. TO D.P.	PVEC1113
125	K1=4	PVEC1114
	K2=4	PVEC1115
	GO TO 28	PVEC1116
	END	PVEC1117
	SUBROUTINE ADMIT(IDFREQ,FREQ,GMASS,DAMP,LFREQ,PHI,LPHI,KGRID,LG,	
X	JJJ,IX,X,KKK)	
C		
C	THIS ROUTINE CALCULATES DISPLACEMENT AND/OR VELOCITY	
C	ADMITTANCES, DEPENDING ON THE VALUE OF NOPT	
C	NCPT=4, DISP	
C	NOPT=5, VEL	
C	NOPT=6, BOTH	
C		
	DIMENSION FREQ(1),GMASS(1),DAMP(1),IDFREQ(1),PHI(LPHI,1),	
X	KGRID(100,2),X(1),IX(2,1),IDUM(8),DUM(8),JJJ(1)	
	EQUIVALENCE (IDUM(1),DUM(1))	
	DOUBLE PRECISION AA	
	COMMON/SYSCTL/ NOPT	
	COMMON/CADMIT/ KKD,KKV,NBETA	
	KKD=61	
	KKV=62	
	NBETA=0	
	IDFRD=1	
	IVFRD=1	
	JDFRD=IDFRD-1	
	IF(NCPT.EC.5) GO TO 20	
C		
C	INPUT FREEDOM PAIRS FOR DISPL ADMITTANCES	
C	ORDER IS RESPONSE/INPUT FOR EACH PAIR	
C		
	4 READ(5,1) IDUM	
	1 FORMAT(8(10)	
	DG 6 I=1,7,2	

```

      IF(IDUM(I).LE.0) GO TO 8
      CALL FCHK(IDUM(I),KGRID,LG,J)
      IF(J.NE.0) GO TO 6
      JDFRD=JDFRD+1
      IX(1,JDFRD)=IDUM(I)
      IX(2,JDFRD)=IDUM(I+1)
6 CONTINUE
      GO TO 4
      8 CONTINUE
      IVFRD=JDFRD+1
      L=2*JDFRD+1
20 CONTINUE
      JVFRD=IVFRD-1
      IF(NOPT.EQ.4) GO TO 40
C
C INPUT FREEDOM PAIRS FOR VELOC ADMITTANCE
C
24 READ(5,1) IDUM
      DO 26 I=1,7,2
      IF(IDUM(I).LE.0) GO TO 28
      CALL FCHK(IDUM(I),KGRID,LG,J)
      IF(J.NE.0) GO TO 26
      JVFRD=JVFRD+1
      IX(1,JVFRD)=IDUM(I)
      IX(2,JVFRD)=IDUM(I+1)
26 CONTINUE
      GO TO 24
      28 CONTINUE
      L=2*JVFRD+1
40 CONTINUE
C
C DISPL FREEDOMS ARE IX( ,IDFRD) THRU IX( ,JDFRD)
C VELOC FREEDOMS ARE IX( ,IVFRD) THRU IX( ,JVFRD)
C
C FORM LISTS OF UNIQUE INPUT AND RESPONSE FREEDOMS
C
      INP=L
      CALL ALIST(IX(1,IDFRD),JDFRD-IDFRD+1,IX(1,IVFRD),JVFRD-IVFRD+1,
X      X(INP),LINP,2)
      L=L+LINP
      IRES=L
      CALL ALIST(IX(1,IDFRD),JDFRD-IDFRD+1,IX(1,IVFRD),JVFRD-IVFRD+1,
X      X(IRES),LIRE,1)
      L=L+LIRE
C
C SCRATCH AREA FROM X(L)
C
C READ IN GAMMA1 AND GAMMA2 FOR SELECTING POTENTIAL COUPLING MODES
C
      READ(5,42) GMA1,GMA2
42 FORMAT( 8F10.0 )
      LTEMP=L
C
C READ SET OF INPUT FREQUEN. FOR WHICH ADMITTANCES ARE TO BE CALC.
C

```

```

50 READ(5,42) DUM
   DO 600 I=1,8
   L=LTEMP
   BETA=DUM(I)
   IF(BETA.LE.0) GO TO 604
   NBETA=NBETA+1

```

REPRODUCIBILITY OF THE
ORIGINAL PAGE IS POOR

C
C
C

```

FIND MODE WHOSE FREQUENCY IS CLOSEST TO BETA

```

```

A=1.E6
DO 54 J=1,LFREQ
B=ABS(FREQ(J)-BETA)
IF(B.GE.A) GO TO 54
I=J
A=B

```

```

54 CONTINUE

```

C
C
C
C

```

DETERMINE THE SET OF POTENTIAL COUPLING MODES.  BUILD ARRAY JJJ
SO THAT FOR K-TH MODE, JJJ(K)=1 MEANS COUPL, =0 MEANS NOT

```

```

IF(GMA1.GT.0 .OR. GMA2.GT.0) GO TO 60
DO 58 J=1,LFREQ
58 JJJ(J)=1
GO TO 80
60 CONTINUE
DO 62 J=1,LFREQ
62 JJJ(J)=0
   ID=IDFREQ(J)
   JJJ(I)=1

```

C
C
C

```

READ COLUMN ID OF DAMPING MATRIX

```

```

REWIND KKK
64 READ(KKK,END=75) AA,J,K,LL
   IF(LL.EQ.0) GO TO 64
   READ(KKK) (X(L+KK), KK=1,LL)
   IF(J.NE.ID) GO TO 64

```

C
C
C

```

CHECK FOR MODES SATISFYING SELECTION CRITERIA

```

```

DO 70 J=1,LFREQ
IF(BETA/FREQ(J) .LE. (1.-GMA2*DAMP(J)) ) GO TO 70
IF(BETA/FREQ(J) .GE. (1.+GMA2*DAMP(J)) ) GO TO 70
IF(X(L+ID).EQ.0) GO TO 70
KK=IDFREQ(J)
IF(ABS(X(L+KK))/X(L+ID) .LE. GMA1) GO TO 70
JJJ(J)=1
70 CONTINUE
GO TO 80
75 STOP 75
80 CONTINUE
MSIZE=0
DO 84 J=1,LFREQ
IF(JJJ(J).NE.0) MSIZE=MSIZE+1
84 CCNTINUE

```

```

      IF(MSIZE.GT.1) GO TO 87
      WRITE(6,86) BETA
86  FORMAT(36HONO MODES COUPLE FOR INPUT FREQUENCY, E15.6 )
      GO TO 600
87  CONTINUE
      IIA=(L/2)*2+1
      MSIZE2=2*MSIZE
      IIB=L+MSIZE*MSIZE2
      IIC=IIB+MSIZE*MSIZE2
      IF(NCPT.EC.5) GO TO 300

C
C  CALCULATE DISPLACEMENT ADMITTANCES
C
      DO 90 J=IIA,IIB
90  X(J)=0.
      LL=IIA
      DO 99 J=1,LFREQ
      IF(JJJ(J).EQ.0) GO TO 99
      X(LL)=(FREQ(J)**2-BETA**2)*GMASS(J)
      X(LL+1)=0.
      LL=LL+MSIZE2+2
99  CONTINUE

C
C  FORM B MATRIX FROM X(IIB)
C
      REWIND KKK
      L=IIB
      DO 120 J=1,LFREQ
      IF(JJJ(J).EQ.0) GO TO 120
      KK=IDFREQ(J)
103  READ(KKK) AA,II,K,LL
      IF(LL.EQ.0)GO TO 103
      READ(KKK) (X(IIC+K), K=1,LL)
      IF(II.NE.KK) GO TO 103
      DO 108 K=1,LFREQ
      IF(JJJ(K).EQ.0)GO TO 108
      KK=IDFREQ(K)
      X(L)=X(IIC+KK)*BETA
      X(L+1)=0.
      L=L+2
108  CONTINUE
120  CCNTINUE
      IID=IIC+MSIZE*MSIZE2
      IIE=IID+MSIZE*MSIZE2
      IIF=IIE+MSIZE2
      IIG=IIF+MSIZE2
      CALL MCRPP(X(IIA),X(IIB),X(IIC),X(IID),MSIZE,X(IIE),X(IIF),X(IIG))

C
C  MATRIX C RETURNED AT X(IIA)
C  MATRIX D RETURNED AT X(IIB)
C
      CALL ADM1(X(IIA),LL1, MSIZE,PHI,LPHI, X(INP),LINP, X(IRES),
X LIRES,X(IIC),JJJ,LFREQ,KGRID,LG)
      IID=IIC+LL1
      CALL ADM1(X(IIB),LL1, MSIZE,PHI,LPHI, X(INP),LINP, X(IRES),

```

```

X    LIRES,X(IID),JJJ,LFREQ,KGRID,LG)
    IIE=IID+LL1
    CALL ADMOUT( X(IRES),LIRES, X(INP),LINP,X(IIC),X(IID),BETA,X(IIE),
X    1,IX(1,IDFRD),JDFRD-IDFRD+1)
300 CONTINUE
    IF(NCPT.EC.4) GO TO 600
C
C    CALCULATE VELOCITY ADMITTANCE
C
C    FORM A MATRIX
C
    L=IIA
    REWIND KKK
    DO 320 J=1,LFREQ
    IF(JJJ(J).EQ.0) GO TO 320
    KK=IDFREQ(J)
303 READ(KKK) AA,II,K,LL
    IF(LL.EQ.0) GO TO 303
    READ(KKK)(X(IIC+K), K=1,LL)
    IF(II.NE.KK) GO TO 303
    DO 308 K=1,LFREQ
    IF(JJJ(K).EQ.0) GO TO 308
    KK=IDFREQ(K)
    X(L)=X(IIC+KK)
    X(L+1)=0.
    L=L+2
308 CCNTINUE
320 CCNTINUE
C
C    FORM B MATRIX
C
    DO 324 J=IIB,IIC
324 X(J)=0.
    L=IIB
    DO 340 J=1,LFREQ
    IF(JJJ(J).EQ.0) GO TO 340
    X(L)=-GHASS(J)*(FREQ(J)**2-BETA**2)/BETA
    X(L+1)=0.
    L=L+MSIZE2+2
340 CONTINUE
    IID=IIC+MSIZE*MSIZE2
    IIE=IID+MSIZE*MSIZE2
    IIF=IIE+MSIZE2
    IIG=IIF+MSIZE2
    CALL YCRPQ(X(IIB),X(IIA),X(IIC),X(IID),MSIZE,X(IIE),X(IIF),X(IIG))
    CALL ADM1(X(IIB),LL1,MSIZE,PHI,LPHI, X(INP),LINP, X(IRES),
X    LIRES,X(IIC),JJJ,LFREQ,KGRID,LG)
    IID=IIC+LL1
    CALL ADM1(X(IIA),LL1,MSIZE,PHI,LPHI, X(INP),LINP, X(IRES),
X    LIRES,X(IID),JJJ,LFREQ,KGRID,LG)
    IIE=IID+LL1
    CALL ADMOUT( X(IRES),LIRES, X(INP),LINP,X(IIC),X(IID),BETA,X(IIE),
X    2,IX(1,IVFRD),JVFRD-IVFRD+1)
600 CONTINUE
    GO TO 50

```

```

604 CONTINUE
C
C RE-SORT ADMITTANCES AND PRINT
C
JJ=0
IF(NOPT.EQ.5) GO TO 608
CALL ASORT(KKD,1,X(JJ+1),X(JJ+401),X(JJ+401+NBETA),NBETA)
608 IF(NOPT.EQ.4) GO TO 612
CALL ASORT(KKV,2,X(JJ+1),X(JJ+401),X(JJ+401+NBETA),NBETA)
612 CONTINUE
RETURN
END
SUBROUTINE ADM1(CD,LL,MSIZE,PHI,LPHI,INPF,LINPF,RESF,LRESF,X,JJJ,
X LRFREQ,KGRID,LG)
DOUBLE PRECISION CD
DIMENSION CD(MSIZE,MSIZE),PHI(LPHI,1),X(1)
INTEGER INPF(1),RESF(1),JJJ(1),KGRID(100,2)
LL=LINPF*LRESF+1
C
C FORM (CD)*(PHI I)TRANSP
C
L=LL
DO 20 J=1,LINPF
M1=INPF(J)/10
N1=MOD(INPF(J),10)
DO 8 K=1,LG
IF(KGRID(K,1).NE.M1) GO TO 8
KK=(K-1)*6+N1
GO TO 10
8 CONTINUE
10 CONTINUE
DO 20 I=1,MSIZE
A=0.
JJ=0
DO 18 K=1,LRFREQ
IF(JJJ(K).EQ.0) GO TO 18
JJ=JJ+1
A=A+CD(I,JJ)*PHI(KK,K)
18 CONTINUE
L=L+1
X(L)=A
20 CONTINUE
C
C FORM (PHI R) * ( )
C
L=0
DO 50 J=1,LINPF
DO 50 I=1,LRESF
M1=RESF(I)/10
N1=MOD(RESF(I),10)
DO 28 K=1,LG
IF(KGRID(K,1).NE.M1) GO TO 28
KK=(K-1)*6+N1
GO TO 30
28 CCNTINUE

```

```

30 CONTINUE
  JJ=(J-1)*MSIZE+LL
  A=0.
  DO 40 K=1,LFREQ
    IF(JJJ(K).EQ.0)GO TO 40
    JJ=JJ+1
    A=A+PHI(KK,K)*X(JJ)
40 CONTINUE
  L=L+1
  X(L)=A
50 CONTINUE
  RETURN
  END
  SUBROUTINE ADMOUT(RESF,LRES,INPF,LINP,CDP,DDP,BETA,X,KK,IF,LIF)
C
C   PRINT ADMITTANCES, OUTPUT ADMITTANCES FOR LATER SORT
C
  DIMENSION CDP(LRES,LINP),DDP(LRES,LINP),X(1),TTITLE(3,2),OUTREC(5)
  INTEGER RESF(1),INPF(1),FRDM1,FRDM2,IF(2,1)
  EQUIVALENCE (FRDM1,OUTREC(1)),(FRDM2,OUTREC(2)),(AMP,OUTREC(4)),
X      (PHASE,OUTREC(5))
  DATA TTITLE/4HDISP,4HPLACE,4HMENT,
X      4H      ,4HVELO,4HCITY, /
  COMMON/CADMIT/ KKD,KKV
  OUTREC(3)=BETA
  DO 40 II=1,LIF
    FRDM1=IF(1,II)
    FRDM2=IF(2,II)
    DO 10 I=1,LRES
      IF( FRDM1 .NE. RESF(I)) GO TO 10
      K=I
      GO TO 12
10 CONTINUE
12 CONTINUE
    DO 30 J=1,LINP
      IF( FRDM2 .NE. INPF(J)) GO TO 30
      AMP=SQRT(CDP(K,J)**2 + DDP(K,J)**2)
      PHASE=ATAN2(DDP(K,J),CDP(K,J))*57.29578
      IF(KK.NE.1) GO TO 20
C      WRITE DISPL ADMITTANCE
      WRITE(KKD) OUTREC
      GO TO 25
20 CONTINUE
C      WRITE VELOC ADMITTANCE
      WRITE(KKV) OUTREC
25 CONTINUE
      WRITE(6,27)(TTITLE(I,KK),I=1,3),OUTREC
27 FORMAT( 1X,3A4,' ADMITTANCE. RESPONSE/INPUT FREEDOMS =',2I6,
X ' BETA =',E14.7, ' AMPLITUDE,PHASE =', 2E13.5 )
30 CONTINUE
40 CONTINUE
  RETURN
  END
  SUBROUTINE ALIST(IFR1,L1,IFR2,L2,LIST,LL,K)
  DIMENSION IFR1(2,1),IFR2(2,1),LIST(1)

```

```

LL=0
IF(LL.EQ.0) GO TO 22
LL=1
LIST(1)=IFR1(K,1)
DC 20 I=2,LL
J=IFR1(K,I)
DG 12 M=1,LL
IF(J.EQ.LIST(M)) GO TO 20
12 CONTINUE
LL=LL+1
LIST(LL)=J
20 CONTINUE
IF(L2.EQ.0) RETURN
22 DC 40 I=1,L2
J=IFR2(K,I)
DO 30 M=1,LL
IF(J.EQ.LIST(M)) GO TO 40
30 CCNTINUE
LL=LL+1
LIST(LL)=J
40 CCNTIAUE
RETURN
END
SUBROUTINE ASORT(KKK,M,FRDM,BETA,X,NBETA)
INTEGER FRDM(2,1),F1,F2
DIMENSION BETA(1),X(1),REC(5)
DIMENSION DZ1(300),DZ2(300)
EQUIVALENCE (F1,REC(1)),(F2,REC(2)),(B,REC(3)),(R,IR)
BL=0.
L=0
REWIND KKK
4 READ(KKK,END=100) REC
IF(B.EQ.BL) GO TO 10
BL=B
L=L+1
BETA(L)=B
LFRD=0
10 CONTINUE
IF(L.GT.1) GO TO 20
LFRD=LFRD+1
FRDM(1,LFRD)=F1
FRDM(2,LFRD)=F2
GO TO 30
20 CONTINUE
LFRD=LFRD+1
30 CCNTINUE
LL=(LFRD-1)*NBETA*2
X(LL+L)=REC(4)
X(LL+L+NBETA)=REC(5)
GO TO 4
100 CONTINUE
LL=LFRD*NBETA*2
MM=LL+NBETA
DG 200 I=1,LFRD
K=(I-1)*NBETA*2

```

REPRODUCIBILITY OF THE
ORIGINAL PAGE IS EQUAL

```

DO 110 J=1,NBETA
IR=J
X(LL+J)=R
110 X(MM+J      )=X(K+J)
CALL FSHELL(X(MM+1),X(LL+2*NBETA+1),NBETA)
CALL SHELLX(X(LL+1),X(LL+2*NBETA+1),NBETA)
DO 120 J=1,NBETA
R=X(LL+J)
120 X(MM+IR      )=NBETA-J+1
IF(M.EQ.1) WRITE(6,121) FRDM(1,I),FRDM(2,I)
IF(M.EQ.2) WRITE(6,122) FRDM(1,I),FRDM(2,I)
121 FORMAT(42H1DISPLACEMENT/ACCELERATION ADMITTANCES FOR, I7, 1H,, I6)
122 FORMAT( 33H1      VELOCITY ADMITTANCES FOR, I7, 1H,, I6 )
WRITE(6,123)
123 FORMAT(1H0,27X,27HDISPLACEMENT  DISPLACEMENT      ,
X 6X,27HACCELERATION  ACCELERATION      /
X 57H  FREQUENCY     RANK      AMPLITUDE    LEAD PHASE ANG. ,
X 5X,28HAMPLITUDE    LEAD PHASE ANG.    )
DO 140 J=1,NBETA
Z1=ABS(X(K+J))*BETA(J)**2
IF(X(K+J+NBETA).GT.0. ) GO TO 127
Z2=X(K+J+NBETA)+180.
GO TO 128
127 Z2=X(K+J+NBETA)-180.
128 CONTINUE
DZ1(J)=Z1
DZ2(J)=Z2
131 FORMAT( E15.7,F6.0,2(E18.4, E15.4) )
140 WRITE(6,131) BETA(J),X(MM+J),X(K+J),X(K+J+NBETA),Z1,Z2
IF(M.EQ.1) CALL PRPLT(5 ,X(K+1),BETA,BETA,NBETA,
X                      FRDM(1,I),DUM,FRDM(2,I),DUM)
IF(M.EQ.1) CALL PRPLT(6 ,X(K+NBETA+1),BETA,BETA,NBETA,
X                      FRDM(1,I),DUM,FRDM(2,I),DUM)
IF(M.EQ.1) CALL PRPLT(7 ,DZ1,BETA,BETA,NBETA,
X                      FRDM(1,I),DUM,FRDM(2,I),DUM)
IF(M.EQ.1) CALL PRPLT(8 ,DZ2,BETA,BETA,NBETA,
X                      FRDM(1,I),DUM,FRDM(2,I),DUM)
IF(M.EQ.2) CALL PRPLT(9 ,X(K+1),BETA,BETA,NBETA,
X                      FRDM(1,I),DUM,FRDM(2,I),DUM)
IF(M.EQ.2) CALL PRPLT(10,X(K+NBETA+1),BETA,BETA,NBETA,
X                      FRDM(1,I),DUM,FRDM(2,I),DUM)
200 CONTINUE
RETURN
END
SUBROUTINE MCRPP(A,B,S1,S2,NC,S3,S4,S5)
DOUBLE PRECISION A,B,S1,S2,S4,S5
DIMENSION A(NC,NC),B(NC,NC),S1(NC,NC),S2(NC,NC),S3(NC),S4(NC)
X ,S5(NC,NC)
INTEGER S3
S3(1)=NC
S3(2)=0
C
C   INVERT B INTO S5
C
CALL DGM1(&900,B,S2,S5,NC,S3,S4)

```

```

C
C   FORM  A*B(INV) IN S1
C
  DO 20 I=1,NC
  DO 20 J=1,NC
  S1(I,J)=0.
  DO 20 K=1,NC
20  S1(I,J)=S1(I,J)+A(I,K)*S5(K,J)
C
C   FORM  ( B + S1*A ) IN S2
C
  DC 30 I=1,NC
  DO 30 J=1,NC
30  S2(I,J)=B(I,J)+S1(I,J)*A(J,J)
C
C   INVERT S2 IN S2
C
  S3(1)=NC
  S3(2)=0
  CALL DGML(&900,S2,A,S2,NC,S3,S4)
  DC 40 I=1,NC
  DO 40 J=1,NC
  A(I,J)=0.
  DO 40 K=1,NC
40  A(I,J)=A(I,J) + S2(I,K)*S1(K,J)
  DO 44 I=1,NC
  DO 44 J=1,NC
44  S2(I,J)=-S2(I,J)
C
C   MATRIX C IS IN A, MATRIX D IS IN S2
C   STORE D IN B
C
  DO 46 I=1,NC
  DC 46 J=1,NC
  B(I,J)=S2(I,J)
46  CONTINUE
  RETURN
900 STOP 31
  END -
  SUBROUTINE MCRPQ(A,B,S1,S2,NC,S3,S4,S5)
  DOUBLE PRECISION A,B,S1,S2,S4,S5
  DIMENSION A(NC,NC),B(NC,NC),S1(NC,NC),S2(NC,NC),S3(NC),S4(NC)
  X ,S5(NC,NC)
  INTEGER S3
  S3(1)=NC
  S3(2)=0
C
C   INVERT B INTO S5
C
  CALL DGML(&900,B,S2,S5,NC,S3,S4)
C
C   FORM  B(INV)*A IN S1
C
  DO 20 I=1,NC
  DO 20 J=1,NC

```

```

      S1(I,J)=0.
      DO 20 K=1,NC
C     20 S1(I,J)=S1(I,J)+S5(I,K)*A(K,J)
C
C     FORM ( B + A*S1 ) IN S2
C
      DC 30 I=1,NC
      DO 30 J=1,NC
C     30 S2(I,J)=B(I,J)+A(I,I)*S1(I,J)
C
C     INVERT S2 IN S2
C
      S3(1)=NC
      S3(2)=0
      CALL DGMI(8900,S2,A,S2,NC,S3,S4)
      DO 40 I=1,NC
      DO 40 J=1,NC
      B(I,J)=0.
      DO 40 K=1,NC
C     40 B(I,J)=B(I,J) - S1(I,K)*S2(K,J)
C
C     MATRIX D IS IN B, MATRIX C IS IN S2
C     STORE C IN A
C
      DO 46 I=1,NC
      DO 46 J=1,NC
      A(I,J)=S2(I,J)
C     46 CONTINUE
      RETURN
C     900 STOP 31
      END
      SUBROUTINE FCHK(II,KGRID,LG,J)
C
C     CHECK TO SEE IF PAIR OF FREEDOMS, II(1)/II(2), ARE VALID
C
      DIMENSION II(2),KGRID(LG)
      J=0
      DO 20 K=1,2
      M=II(K)/10
      DO 18 I=1,LG
      IF(KGRID(I).EQ.M) GO TO 20
C     18 CONTINUE
      WRITE(6,3) II
      3 FORMAT( 48HINVALID PAIR OF INPUT FREEDOMS WILL BE IGNORED ,216)
      J=1
      GO TO 30
C     20 CONTINUE
C     30 CONTINUE
      RETURN
      END
/*

```

REPRODUCIBILITY OF THE
ORIGINAL PAGE IS POOR

REFERENCES

1. D. H. Merchant and R. M. Gates, "Effect of Damping on Excitability of High-Order Normal Modes," Boeing Document D180-18835-1, May 30, 1975.
2. D. J. Mead, "The Internal Damping Due to Structural Joints and Techniques for General Damping Measurement," Aeronautical Research Council Current Paper No. 452, 31 January 1958
3. E. E. Ungar, "The Status of Engineering Knowledge Concerning the Damping of Built-up Structures," Journal of Sound and Vibration, Vol. 26, No. 1, January 8, 1973, pp. 141-154.
4. E. L. Bernstein, "Investigation of Empirical Damping Laws for the Space Shuttle," Contract NAS8-28513 Final Report, March 14, 1973.
5. G. F. Riley, "Structural Damping of Winged Structures," Saturn Engineering Report 5-9430-H-698, August 12, 1971.
6. D. H. Merchant, et al, "The Effects of Localized Damping on Structural Response," NASTRAN: Users' Experiences, NASA TM X-3278, September 1975, pp. 301-320.
7. T. K. Hasselman, "Modal Coupling in Lightly Damped Structures," Technical Note, AIAA Journal, Vol. 14, No. 11, November 1976.
8. NASA/JSC Structures Branch Report 73-ES2-2, Orbiter Trade Studies Part 1, Structural Modeling, March 1973.
9. S. Timoshenko, Vibration Problems in Engineering, D. van Nostrand Co., Inc., Princeton, New Jersey, 1955.
10. D. H. Merchant and R. M. Gates, "Effects of Damping on Excitability of High Order Modes," Final Report - Phases I and II, Contract NAS8-31369, March 26, 1976.

REFERENCES (Continued)

11. C. S. Chang, "Damping in Multi-Beam Vibration Analysis, Part II," Lockheed HREC Report TM54/20-12, November 1964.
12. S. Timoshenko and G. H. MacCullough, Elements of Strength of Materials, D. van Nostrand Co., Inc., Princeton, New Jersey, 1959.
13. B. J. Lazan, Damping of Materials and Members in Structural Mechanics, Pergamon Press, 1968.
14. J. Aberg/EL52, letter to EL43/M. Patterson, "Solid Rocket Booster and External Tank Mass Distributions," EL52 (35-75), February 24, 1975.
15. C. W. McCormick, ed., "The NASTRAN User's Manual (Level 15)," NASA SP-222(01), June 1972.