

**NASA TECHNICAL
MEMORANDUM**

NASA TM X-73500

NASA TM X-73500

(NASA-TM-X-73500)- EMISSIONS OF AN AVCO
LYCOMING O-320-DIAD AIR COOLED LIGHT
AIRCRAFT ENGINE AS A FUNCTION OF FUEL-AIR
RATIO, TIMING, AND AIR TEMPERATURE AND
HUMIDITY (NASA) 206 p HC A10/MF A01

N77-10058

Unclas

G3/07 08008

EMISSIONS OF AN AVCO LYCOMING O-320-DIAD AIR COOLED LIGHT
AIRCRAFT ENGINE AS A FUNCTION OF FUEL-AIR RATIO, TIMING,
AND AIR TEMPERATURE AND HUMIDITY

by Phillip R. Meng, Michael Skorobatchkyi, Donald V. Cosgrove,
and Erwin E. Kempke
Lewis Research Center
Cleveland, Ohio 44135
August 1976



1. Report No. NASA T M X -73500		2. Government Accession No.		3. Recipient's Catalog No.	
4. Title and Subtitle EMISSIONS OF AN AVCO LYCOMING O-320-DIAD AIR COOLED LIGHT AIRCRAFT ENGINE AS A FUNCTION OF FUEL-AIR RATIO, TIMING, AND AIR TEMPERATURE AND HUMIDITY				5. Report Date August 1976	
				6. Performing Organization Code	
7. Author(s) Phillip R. Meng, Michael Skorobatchkyi, Donald V. Cosgrove, and Erwin E. Kempke				8. Performing Organization Report No.	
9. Performing Organization Name and Address Lewis Research Center National Aeronautics and Space Administration Cleveland, Ohio 44135				10. Work Unit No.	
				11. Contract or Grant No.	
				13. Type of Report and Period Covered Technical Memorandum	
12. Sponsoring Agency Name and Address National Aeronautics and Space Administration Washington, D. C. 20546				14. Sponsoring Agency Code	
15. Supplementary Notes					
16. Abstract A carbureted aircraft engine was operated over a range of test conditions to establish the exhaust levels over the EPA seven-mode emissions cycle. Baseline (full rich production limit) exhaust emissions at an induction air temperature of 59° F and near zero relative humidity were 90 percent of the EPA standard for HC, 35 percent for NO _x , and 161 percent for CO. Changes in ignition timing around the standard 25° BTDC from 30° BTDC to 20° BTDC had little effect on the exhaust emissions. Retarding the timing to 15° BTDC increased both the HC and CO emissions and decreased NO _x emissions. HC and CO emissions decreased as the carburetor was leaned out, while NO _x emissions increased. The EPA emission standards were marginally achieved at two leanout conditions. Variations in the quantity of cooling air flow over the engine had no effect on exhaust emissions. Temperature-humidity effects at the higher values of air temperature and relative humidity tested indicated that the HC and CO emissions increased significantly, while the NO _x emissions decreased.					
17. Key Words (Suggested by Author(s)) Aircraft piston engine Emissions Ambient effects on emissions			18. Distribution Statement Unclassified - unlimited		
19. Security Classif. (of this report) Unclassified		20. Security Classif. (of this page) Unclassified		21. No. of Pages	22. Price*

EMISSIONS OF AN AVCO LYCOMING O-320-DIAD AIR COOLED LIGHT AIRCRAFT
ENGINE AS A FUNCTION OF FUEL-AIR RATIO, TIMING, AND
AIR TEMPERATURE AND HUMIDITY

by Phillip R. Meng, Michael Skorobatchkyi,
Donald V. Cosgrove, and Erwin E. Kempke

Lewis Research Center

SUMMARY

A carburetted four-cylinder air-cooled Lycoming O-320 DIAD aircraft engine was operated over a range of test conditions to establish the exhaust emission levels over the Environmental Protection Agency (EPA) seven-mode emissions cycle. The test program included: baseline performance and emissions, ignition timing changes, carburetor leanout, cooling air flow variations, and temperature-humidity effects.

The baseline exhaust emissions at an induction air temperature of 59° F and near-zero relative humidity were 90 percent of the EPA standard for hydrocarbons (HC), 35 percent of the standard for oxides of nitrogen (NO_x), and 161 percent of the standard for carbon monoxide (CO). Changes in ignition timing around the standard 25° BTDC from 30° to 20° BTDC had little effect on the exhaust emissions. As the timing was retarded to 15° BTDC, both the HC and CO emissions increased to exceed the EPA standard while the NO_x decreased slightly. The HC and CO emissions decreased as the carburetor was leaned out, while the NO_x emissions increased over a series of seven-mode cycle tests. The EPA emission standards were marginally achieved at two lean-out conditions where, as the engine was leaned out, the CO emissions dropped below the standard before the NO_x emissions rose above the standard. Variations in the quantity of cooling air flow over the engine had essentially no effect on exhaust emissions at either of the two air temperatures tested. Temperature-humidity effects at the higher values of air temperature and relative humidity indicate that the HC and CO emissions increased significantly, while the NO_x emissions decrease. However, these changes in emissions were primarily the result of the richer fuel-air ratios which resulted from the decrease in air density with increased temperatures and the volume of air displaced by water vapor at the higher relative humidity.

INTRODUCTION

NASA is involved in a research and technology program related to general aviation engines. The overall objective of the program is to

establish and demonstrate the technology which will safely reduce general-aviation piston-engine exhaust emissions to the levels required by the EPA 1979 emissions standards.

One element of the above program is a joint FAA/NASA General Aviation Piston Engine Emissions Reduction effort. Funded studies are now under way by the two primary engine firms building general aviation piston engines, AVCO-Lycoming and Teledyne - Continental. In phase I of their three-phase programs each contractor is testing five different engine models to experimentally characterize emissions and to determine the effects of variation in fuel-air ratio and spark timing on emissions levels and other operating characteristics such as cooling, misfiring, roughness, power acceleration, etc. The FAA is using its NAFEC facility to perform independent checks on each of the engines the contractors are testing in phase I.

Test results of the same engines at these different geographical locations have shown different levels of emissions and performance which make it difficult to make comparisons. Ambient temperature and humidity are known to affect test results and there are no known correlations of temperature and humidity effects. NASA-Lewis Research Center has undertaken a series of aircraft engine tests to develop such a correlation. Two engines, models identical to ones in the FAA/NASA program, were selected for testing. The engines were from two manufacturers; the first was an Avco-Lycoming model O-320-DIAD, four-cylinder, naturally aspirated engine, and the second was a Teledyne-Continental Model TS10-360, a six-cylinder, turbocharged, fuel-injected engine.

This report presents the initial performance and emissions test results on the Lycoming O-320 DIAD engine as a function of fuel-air ratio, timing, and air temperature and humidity.

APPARATUS AND PROCEDURE

Test Facility

The aircraft engine is shown schematically in figure 1 and photographically on the test stand in figure 2. The engine was coupled to a 300-hp dynamometer through a fluid coupling in the drive shaft which was located under a safety shield. Engine cooling and induction air were both supplied by a laboratory air distribution system. The cooling and induction air system, as shown in figure 3, can be controlled to deliver air to the engine over a temperature range of from 50° to 120° F and over a range of relative humidity from 0 to 80 percent. The cooling air was directed down over the engine by an air distribution hood. This hood was the same as that which was used by the engine manufacturer in their engine testing. The engine cooling air was removed from the test cell by a high capacity, facility altitude exhaust system which had the inlet located beneath the engine. An additional cell exhaust fan was used to

maintain a slightly negative pressure in the test cell. This was done to vent off any combustible or toxic gases which may have been present in the test cell during engine operation.

The engine exhaust was manifolded together in a standard configuration with the emission sample probe located downstream of the manifold. The exhaust was then ducted out of the cell through the roof as shown in figure 2. Care was taken to insure that the exhaust system was leak-proof. A leak-proof system was necessary to prevent air dilution of the gas sample which would result in erroneous emission measurements.

Engine description. - The O-320-DIAD is a horizontally opposed, four-cylinder, direct-drive, air-cooled engine. The engine has a bore of 5.125 inches and a stroke of 3.875 inches with the resulting total piston displacement being 319.8 cubic inches. The compression ratio is 8.50:1. The engine is rated 160 bhp at 2700 rpm and 0.51 bsfc. Fuel metering is performed by a Marvel-Schebler MA4SPA carburetor using grade 100/130 aviation gasoline. A carburetor intake air box was used to insure uniform pressure distribution across the throat. The carburetor was calibrated for full-rich operation at the factory, typical of what might be expected as the rich limit of production engines. The carburetor, at this calibration, constituted the baseline for the engine. The fuel used was standardized reference fuel conforming to the requirements of the ASTM Committee on Aviation Reference Fuels and Certification. Ignition was supplied by a dual Bendix Magneto timed to 25° BTDC. The engine is further described in AVCO Lycoming Specification 2283-C (ref. 1).

Engine exhaust system. - There are two major areas of consideration that can affect the accuracy of emission measurements. These are the leak tightness of the engine exhaust system and the handling of the exhaust gas sample through the gas analyzer.

In order to obtain a representative exhaust gas sample for emissions analysis the individual cylinder exhaust tubes were brought together under the engine to a common header. Allowing for proper mixing, the gas sample probe was located 4 to 6 feet downstream in the common header. To establish what could be expected by way of qualitative and quantitative composition, a sample probe was initially inserted beneath each cylinder exhaust port. The exhaust gas of each cylinder was then analyzed and a correlation made as to the expected mixed gas analysis. In this way it was established that an increase in the oxygen content of the gas as measured by the oxygen meter of the gas analyzer would indicate a leak in the exhaust system. Great care was taken in the design, fabrication, and installation of the exhaust system so that it would not leak. It was found that the combination of exhaust gas temperature and engine vibration necessitated a number of changes in the exhaust gas system before an acceptable leak-proof system was obtained.

Exhaust gas sample handling. - The criteria for exhaust gas analysis were twofold. The sample had to be representative of a complete mixing

from all cylinders and the temperature of the gas sample at the analyzer had to be at least 300° F. The sample line from the exhaust gas manifold to the gas analyzer was heated to 300° F using an electrical tape type heater. The Scott analyzer (see fig. 4) contained the following five analysis meters:

- (1) Beckman Model 864 Infrared CO Analyzer
- (2) Beckman Model 864 Infrared CO₂ Analyzer
- (3) Scott Model 125 Chemiluminescent NO/NO_x Analyzer. The Scott NO/NO_x Analyzer was modified at NASA-Lewis as discussed in reference 2.
- (4) Scott Model 415 Flame Ionization Detector for HC
- (5) Scott Model 250 Paramagnetic O₂ Detector

Careful daily monitoring of these sensitive instruments indicated a need for frequent adjustments. It was necessary to zero and span calibrate these instruments with known gases at least once for each hour of operation. A complete console calibration was carried out at least once a month.

Instrumentation. - The engine instrumentation and control panel is shown in figure 5. The major measured parameters and estimated system accuracies for this investigation are listed below:

Parameter	Instrumentation	System accuracy
Fuel flow	Hydraulic Wheatstone bridge flowmeter	±0.5 %
Induction air flow	Turbine-type flow meter	±0.6 %
Induction air pressure	Absolute transducer	±0.50 %
Cooling air flow	Orifice ΔP transducer	±1.5 %
Cooling air pressure	Absolute transducer	±0.50 %
Dew point	Temperature controlled mirrored photoelectric sensor	±0.7° F
Engine torque	Shaft mounted rotary transducer type	±0.5 %
Dyno. torque	Load cell	±0.5 %
Speed	Magnetic pickup	±0.25 %
Exhaust gas temperature	Chromel-Alumel thermocouple	±0.5 %
Cyl. Hd. temperature	Iron-constantan thermocouple	±0.5 %

All instrumentation was connected to the CADDE (Central Automatic Digital Data Encoder) central data acquisition system and the data processed on a 360/67 time-sharing computer.

Test Procedure

The engine testing procedure was conducted as specified by the Environmental Protection Agency in the Federal Register, Vol. 38, No. 136, dated Tuesday, July 17, 1973 (ref. 3), except for the separation of the idle and taxi time in and out modes as shown below:

Mode	Mode description	Power level, %	Speed, rpm	Time in mode, min
1	Idle out	---	600	1.0
2	Taxi out	---	1200	11.0
3	Takeoff	(Full power) 100	2700	.3
4	Climb	80	2430	5.0
5	Approach	40	2350	6.0
6	Taxi in	---	1200	3.0
7	Idle in	---	600	1.0

Prior to the start of a seven-mode cycle test the engine was warmed up at 2000 rpm for approximately 10 minutes until all parts were temperature stabilized and all cylinder head temperatures were at least 300° F.

In general all parts were temperature stabilized for at least 5 minutes. Then at the start of the cycle, the engine speed was reduced to 600 rpm with the cooling air off and data were taken after the speed and emissions were stabilized. Engine speed was then increased to 1200 rpm and the taxi mode emissions were taken after engine speed and emissions stabilized. The rest of the seven-mode cycle was run without interruption. Cooling air flow over the engine was set at a differential pressure of 3 inches of water and resulted in a flow of 2100 cfm. This air flow (pressure drop) is the same as used by the engine manufacturer for their tests. The exhaust emissions for the takeoff, climb, and approach modes were taken sequentially. The taxi in and idle in mode emissions were taken after the cooling air was turned off and the engine cylinder head temperature stabilized at both the taxi and idle speeds. A minimum of three complete seven-mode data cycles were taken at each test condition to insure data repeatability. The test parameters such as ignition timing changes, variation of cooling air flow, etc., were varied one at a time and the seven-mode emission cycle was run for each test parameter condition. The test procedure for each of these test series is presented at the beginning of each test parameter data section.

The test procedure was changed slightly for the carburetor lean out data. The seven-mode cycle was separated into two operations because the carburetor has separate fuel-air ratio adjustments in the idle/taxi modes from the other modes. The idle/taxi modes were leaned out by adjusting the "idle mixture screw," and the takeoff, climb, and approach

modes were leaned out by using the carburetor mixture control. The individual data points for the two types of mixture settings were combined to make up a seven-mode emissions cycle for the leanout, although the cycle was not run through the modes sequentially.

DATA AND RESULTS

Test Data

Baseline propeller-load curve. - The full-rich propeller-load performance from 2700 to 1800 rpm is shown in figure 6. These data (tables I(a) to (h)) were taken at steady-state full-throttle settings with 10-percent power decrements from full-power to 30-percent power.

Baseline performance. - Ten identical full-rich seven-mode emission-cycle engine tests were conducted to establish baseline performance and emissions. The data were taken at stabilized engine conditions with standard ignition timing of 25° BTDC, nominal air temperature of 59° F and at nominally 0 percent relative humidity. This nominal value was always less than 5 percent relative humidity. The results shown in tables II(a) to (j) were repeatable and were averaged to give the percent of exhaust emissions with respect to the EPA standards (ref. 1) as follows:

Hydrocarbons (HC), 90% of standard

Carbon monoxide (CO), 161% of standard

Oxides of nitrogen (NO_x), 35% of standard

Ignition timing. - Full-rich performance and emissions data with the ignition timing both advanced and retarded from the standard setting of 25° BTDC were taken over the seven-mode test cycle. Four identical cycles with ignition timing retarded to 15° BTDC were taken and are presented in tables III(a) to (d). Similar repeated cycles were taken at 20° BTDC and 30° BTDC ignition timing and are presented in tables IV(a) to (c) and tables V(a) to (d), respectively. The results of these tests are plotted for each of the individual modes in figures 7 to 11. The hydrocarbon (HC) emission data for the idle mode (fig. 7) and taxi mode (fig. 8) indicate that retarding the ignition timing caused the HC emissions to decrease in the idle mode. The opposite occurs in the taxi mode where the HC emissions increase significantly as the timing is retarded. Carbon monoxide emissions show almost no decrease as the timing is advanced in the idle and taxi modes. The CO emissions increase by approximately 25 percent as the timing is retarded to 15° BTDC in the idle mode and increase approximately 40 percent in the taxi mode with the retarded timing.

During the climb mode (fig. 10) with the ignition timing advanced

or retarded 5° from the standard 25° BTDC, only slight changes in emission values occurred. However, when the timing was retarded to 15° BTDC, the HC and CO emissions increased and the NO_x decreased by significant amounts. The NO_x emissions in the other modes indicate very little change with variation of the ignition timing.

The effect of ignition timing on the overall cycle emissions is shown in figure 12. There appears to be almost no effect on emissions as the ignition timing is advanced to 30° BTDC. However, when the timing is retarded to 15° BTDC, the CO emissions increase by 35 percent, the HC emissions increase by 20 percent, while the NO_x emissions decrease by approximately 10 percent.

Leanout. - The carburetor leanout data are presented in tables VI to IX. These data were obtained by incrementally decreasing the fuel flow in the takeoff mode in steps of approximately 5 lb/hr from 81 lb/hr at full rich conditions to 61 lb/hr. The engine's leanest test point was limited in general by lean misfire and a loss of power in the takeoff mode. The mixture control was kept in the lean position for the climb and approach modes; therefore, the fuel flow was proportionally reduced from that value corresponding to the full rich fuel flow in these modes. The leanout tests conducted at the standard ignition timing of 25° BTDC are presented in tables VI(a) to (h), and, at a retarded ignition timing of 20° BTDC in tables VII(a) to (p), at a retarded ignition timing of 15° BTDC in tables VIII(a) to (k), and at an advanced ignition timing of 30° BTDC in tables IX(a) to (o).

The exhaust emission data for the leanout tests are shown for the four ignition timing settings, 25° , 20° , 15° , and 30° BTDC in figures 13 to 16, respectively. The data are presented in bar chart form as a percentage of the seven-mode emission cycle standards for each of the pollutants. The pollutants are shown for a range of values of reduced fuel flows from the full rich value at the takeoff condition for a constant value of ignition timing. In all cases the HC and CO emissions decrease and the NO_x emissions increase as the carburetor is leaned out. In only two cases, 25° BTDC at 73 lb/hr in figure 13 and 15° BTDC at 68 lb/hr in figure 15, did the CO emissions decrease to below the EPA standard before the NO_x emissions increased sufficiently to exceed the standard. In these cases the power was 156 and 132 hp, respectively. The engine power in the full rich takeoff mode with standard ignition timing of 25° BTDC was 156 hp. As the ignition timing was varied, the corresponding takeoff power was as follows:

Ignition timing, deg. BTDC	hp at takeoff
25	156
20	148
15	142
30	157

The takeoff power decreased as the mixture was leaned out to the extremely lean conditions as shown by the data in tables VI to IX.

Effect of varying cooling air on emissions. - A series of data runs were conducted to determine if the quantity of cooling air flow over the engine has an effect on the exhaust emissions. The data runs were made with four different cooling air flow rates varying from approximately 1700 scfm to slightly over 3200 scfm. The air flow rates were set by establishing a differential pressure across the engine between the cooling hood and the test cell. The performance and emission data presented thus far in this report were taken with a cooling air flow rate of approximately 2100 scfm (3 in. H₂O ΔP) in the takeoff, climb, and approach modes. The cooling air was off during the idle and taxi modes.

The results of these tests at an air temperature of 59° F are shown in figures 17 to 19 where the exhaust emissions for the takeoff, climb, and approach modes are shown as a function of cooling air flow rate for full rich and a leanout condition of 66 lb/hr fuel flow. The cooling air data runs are presented in tables X(a) to (m) for differential pressures, ΔP, of 2, 3, 6, and 9 in. of water. The data show that the quantity of cooling air over the engine has essentially no effect on the exhaust emissions for the conditions which were tested. Similar data (table X(i) to (m)) were obtained at 100° F over the same range of cooling air flows. Again, the results (not shown herein) also indicate that the quantity of cooling air flow did not affect the emissions over the range tested.

Air temperature and humidity effects. - Baseline seven-mode emission cycle data tests were conducted over a range of air temperatures and relative humidities. The induction air and cooling air temperatures were the same and were held at nominal values of 50°, 59°, 70°, 80°, 90°, and 100° F at relative humidities of 0, 30, 60, and 80 percent.

The HC, CO, and NO_x emissions for each of the seven-mode cycles are presented as a function of air temperature for each value of relative humidity in tables XI to XVI. The air temperature shown on these tables is the nominal value. In some cases the actual induction air temperature did vary several degrees around the nominal value over the seven mode cycle due to the large changes in air flow at the various modes of the cycle.

The emissions data for each of the four values of relative humidity are shown as a percent of the emissions standard, as a function of air temperatures in figures 20 to 23. These data are then summarized as cross-plots in figures 24 and 25. In these figures the four values of relative humidity are shown as a function of air temperature for each of the pollutants. The data show that the quantity of emissions produced is strongly affected by relative humidity and that this effect increases with increasing induction air temperature. The HC and CO emissions increase considerably at the higher values of air temperature and relative humidity, while at the same conditions the NO_x emissions show a signifi-

cant decrease. A comparison of the temperature and humidity test results at 100° F and 80 percent to those at 50° and 0 percent shows that as the temperature and humidity are increased, the CO increases by a factor of 1.6, the HC increases by a factor of 2.2, and the NO_x decreases by a factor of 3.5.

The change in the exhaust emissions are primarily the result of richer fuel-air ratios which occur at the higher air temperatures and relative humidities, because of the decrease in air density at 100° F (10 percent) and the volume of air that is displaced by water vapor in the fuel-air mixture.

Data Reduction

The LeRC emission data reduction procedures are as specified by the EPA in the Federal Register (ref. 3). Shown in figure 26 is the flow diagram outlining the data reduction process. Some of the intermediate steps used in the raw emission data reduction which are not explicitly defined in the Federal Register are summarized below and presented in the appendix.

Five exhaust products are measured by the emission analyzers. The HC and NO_x are measured on a "wet" basis. The other three, CO, CO₂, and O₂ are measured on a "dry" basis and as a result their volumetric percentages must be corrected for the water removal. The water correction factor (K_W) used for this conversion is defined as

$$K_W = 1 - (H_2O)$$

where H₂O represents the total water vapor contained in the products of combustion. The water correction factor is based on a chemical reaction including water vapor, oxygen and carbon balance, measured fuel/air ratio and water/dry air mass ratio. This factor as used was obtained from Teledyne Continental Motors and is included in the appendix.

The Federal Register (ref. 3) states that the total engine exhaust volume flow rate is to be used in the computation of the pollutant emission rate. The appendix contains the procedure used in obtaining the exhaust volume flow rate. Primarily, it is based on the total intake mass flow rate and the exhaust gas density. The exhaust gas density is calculated from the exhaust molecular weight, air molecular weight, and air density at 68° F and 760 mm Hg pressure. The pollutant emission rate and mass per mode is then calculated per Federal Register (ref. 3).

To verify the exhaust gas products concentrations, the Spindt procedure (ref. 4) was used. In this procedure, the fuel/air ratio is based on the measured exhaust gas products. This calculated fuel/air ratio, as presented in appendix A, is then compared to the measured fuel/air ratio. The percent difference between the measured to calculated is defined as:

$$\text{Percent difference} = \frac{\text{Calculated fuel/air} - \text{Measured fuel/air}}{\text{Measured fuel/air}}$$

CONCLUDING REMARKS

A carburetted four-cylinder air-cooled O-320 DIAD Lycoming aircraft engine was tested over a wide range of conditions to establish the exhaust-emission levels over the EPA seven-mode test cycle. The test conditions included: baseline engine performance, ignition timing changes, carburetor leanout, changes in cooling air flow and temperature, and changes in air temperature and relative humidity. The results of these tests are discussed for each of the conditions tested.

Baseline Engine Performance

The baseline full rich exhaust emissions at standard test conditions of 59° F induction air temperature at near zero relative humidity for the engine under test were

HC	90% of EPA standard
NO _x	35% of EPA standard
CO	161% of EPA standard

Ignition Timing

There appears to be almost no effect on emissions as the timing was advanced from the standard 25° BTDC to 30° BTDC and only a moderate increase in HC and CO (20 and 35 percent, respectively), while the NO_x emissions decreased by approximately 10 percent as the timing was retarded to 15° BTDC. Engine power at full rich takeoff decreased from 156 to 142 hp as the ignition timing was retarded from 25° to 15° BTDC.

Leanout

As the engine was leaned out in the takeoff mode, the HC and CO emissions decreased, while the NO_x emissions increased. The exhaust emission standards were marginally achieved at two test conditions; one at a standard ignition timing of 25° BTDC and the other at a retarded timing of 15° BTDC. At one condition with the standard timing, the engine maintained takeoff power of 156 hp at 73 lb/hr fuel flow. At the retarded condition, the power decreased to 132 hp at 68 lb/hr fuel flow.

Air Temperature and Humidity

The quantity of the emissions produced is strongly affected by relative humidity and this effect increases with increasing induction air temperature. The HC and CO exhaust emissions increased considerably at the higher values of induction air temperature and relative humidity. NO_x emissions generally decreased with increasing induction air and relative humidity.

Cooling Air

In a series of tests where the quantity and temperature of the cooling air supplied to the engine was varied, little or no effect on the exhaust emissions was observed.

APPENDIX - INTERMEDIATE EQUATIONS USED IN THE
RAW EMISSIONS DATA REDUCTION

The basic computational procedures on emission data reduction are specified in the Federal Register (ref. 3). Presented are only those equations and calculations which are not explicitly defined in the Federal Register.

SYMBOLS

A	air flow, lb/hr
Ar	argon
a	moles of air
C_eH_b	molecular formula of the fuel
c	mass fraction of carbon in the fuel
D	density of exhaust products, lb/ft ³
E	exhaust molecular weight, lb/(lb-mole)
F	fuel flow, lb/hr
f	moles of fuel
h	mass fraction of hydrogen in fuel
M	molecular weight of air, 28.96 lb/(lb-mole)
m_n	mole fraction of the compound n
P	equals $(CO) + (CO_2) / [(CO) + (CO_2) + (HC)]$
Q	equals $(O_2) / (CO_2)$
R	equals $(CO) / (CO_2)$
W	water flow rate, lb/hr
V	exhaust volume flow rate, ft ³ /hr
ρ	density of air at 68° F and 760 mm Hg pressure, 0.075 lb/ft ³

Subscripts:

- b number of hydrogen atoms in one molecule of fuel
 d measured on the "dry" basis water removed
 e number of carbon atoms in one molecule of fuel
 n identifies the individual constituent fraction

I. Water Correction Factor

The chemical reaction including water vapor in the air may be written as:

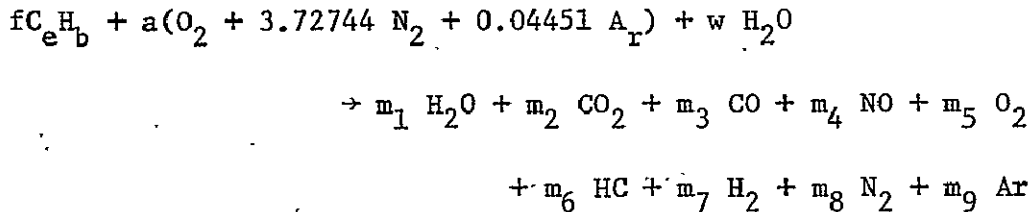

An oxygen balance results in equation (1).

$$m_1 = 2a + w - 2m_2 - m_3 - m_4 - 2m_5 \quad (1)$$

A carbon balance results in equation (2).

$$f = \frac{m_2 + m_3 + m_6}{3} \quad (2)$$

The fuel-air mass ratio may be defined as

$$\frac{F}{A} = \frac{f(12.01 a + 1.008 b)}{a(138.2689)} \quad (3)$$

The water - dry air mass ratio may be defined as

$$\frac{W}{A} = \frac{w(18.016)}{a(138.2689)} \quad (4)$$

Substituting equations (2) to (4) into equation (1) and rearranging results in

$$m_1 = \left(2.0 + 7.67478 \frac{W}{A} \right) \left[\frac{(m_2 + m_3 + m_6)(12.01 + 1.008 b/e)}{138.2689 \frac{F}{A}} \right]$$

$$- 2 m_5 - m_6 - m_7 - 2 m_9 \quad (5)$$

For clarity equation (5) may be written using chemical symbols to represent the mole fraction for each constituent

$$\begin{aligned}
 (H_2O) = & \left(2.0 + 7.67478 \frac{W}{A} \right) \left[\frac{(\text{CO}_2) + (\text{CO}) + (\text{HC}) \left(12.01 + 1.008 \frac{b}{e} \right)}{138.2648 \frac{F}{A}} \right] \\
 & - 2(\text{CO}_2) - (\text{CO}) - (\text{NO}) - 2(\text{O}_2) \quad (6)
 \end{aligned}$$

The above equation (6), represents the total water vapor contained in the products of combustion with each constituent measured on a "wet" basis. Since CO, CO₂, and O₂ are measured dry and since the water correction factor is defined as

$$K_w = 1.0 - (H_2O) \quad (7)$$

equation (6) may be written in terms of dry measurements as

$$\begin{aligned}
 \frac{H_2O}{1 - (H_2O)} = & \left(2.0 + 7.67478 \frac{W}{A} \right) \left\{ \frac{\left[(\text{CO}_2)_d + \frac{(\text{HC})}{1 - (H_2O)} \right] \left[\left(12.01 + 1.008 \frac{b}{e} \right) \right]}{\left(138.2648 \frac{F}{A} \right)} \right\} \\
 & - 2(\text{CO}_2)_d - (\text{CO})_d - \frac{\text{NO}}{1 - (H_2O)} - 2(\text{O}_2)_d \quad (8)
 \end{aligned}$$

The solution to equation (8) for H₂O is an iteration process since HC and NO are measured wet. The water correction factor is then calculated using equation (7).

II. Exhaust Volume Flow Rate

The exhaust volume flow rate can be equated as:

$$V = \frac{A + W + F}{D}$$

The exhaust density can be expressed as

$$D = \frac{PXE}{M}$$

Figure A1 shows the relation between the exhaust molecular weight and F/A ratio obtained from "computer program for calculation of complex chemical equilibrium composition" NASA SP-273 (ref. 5). The pollution production rate is then calculated as specified in the Federal Register (ref. 3).

III. Fuel Air Ratio Based on Exhaust Gas Components
and Procedure of Spindt (Ref. .4)

The F/A ratio can be expressed as:

$$F/A = \frac{1}{P \left[11.492 c \left(1.0 + \frac{\frac{R}{2} + Q}{1 + R} \right) + \left(\frac{120 h}{3.5 + R} \right) \right]}$$

REFERENCES

1. Detailed Specification for Engine, Aircraft, Model O-320-DIA, - D2A, - DIB, - D2B, - DIC, - D2C, - D2G. 160 Horse Power Direct Drive, Spec. No. 2283C, Avco-Lycoming, 1974.
2. Summers, Robert: NO_x Destruction by CO in NO_x to NO Converters of Chemiluminescence NO analysers. NASA TM X 73480, July 1976..
3. Control of Air Pollution from Aircraft and Aircraft Engines. Fed. Register, vol. 38, no. 136, Pt. II, Tuesday, July 17, 1973, pp. 19088-19103.
4. Spindt, R. S.: Air Fuel Ratio from Exhaust Gas Analysis. SAE Paper 650507, May 1965.
5. Gordon, Sanford; and McBride, Bonnie J.: Computer Program for Calculation of Complex Chemical Equilibrium Compositions, Rocket Performance, Incident and Reflected Shocks and Chapman - Jouguet Detonations. NASA SP-273, 1971.

NASA-LEWIS

12/11/75

CADDETT

REC 12/11/75 19:10:59.527

FAC SEX15

PGM C003

RDG 0295

PROP LOAD CURVE

MODE = 1.0000

NO. SCANS = 5

ENGINE TIMING = 25.000

DEG.

BAROMETRIC PRESSURE = 29.270

RATED HP. = 160.00

HC RATIO = 2.1250

COMB. AIR

TEMP

PRESS

CFM

DRY FLOW

VAPOR FLOW

PRESS TOTAL

63.500

28.829

216.04

952.41

0.24136

14.119

COMB. FUEL

TEMP

PRESS

DENSITY

TURBO FLOW

FLOW TRON

FPIP

64.013

4.8308

45.071

82.321

81.545

5.5190

COOLING AIR

TEMP

INDEL-HOOD

DEL-HOOD

FLOW

REL-HUM

63.977

6.3931

7.3916

14248.

2.3375

REL-HUM

1

2

% H2O VAPOR CORRECTED HP

2.3375

-0.072007

0.040736

149.15

ENG. COND.

F/A DRY

F/A WET

EQU. RATIO

RPM-1

RPM-2

TORQUE

BHP

0.085620

0.085598

1.2779

2704.0

2708.0

289.74

149.17

WET CORRECTION FACTOR = 0.99857

EXHAUST MOLE. WT. = 27.242

EXHAUST DENSITY = 0.070537

EXHAUST FLOW RATE = 14661.

MEASURED CONC.

PART PER MILLION WET

PER CENT

HC PPM

NOX PPM

CO DRY

CO2 DRY

O2 DRY

0.00000

0.00000

0.090009

0.18289

0.026903

CORRECTED CONC. TO WET BASIS

0.089880

0.18263

0.026864

EMISSION RATE

HC

NOX

CO

0.00000

0.00000

0.95671

EMISSION MASS/MODE

0.00000

0.00000

0.015945

EMISSION MASS/RATED HP

0.00000

0.00000

9.9658E-05

MODE FMIS./STD. CYCLE %

0.00000

0.00000

0.23728

CAL. FUEL AIR RATIO = 0.0014183

MEAS. FUEL AIR RATIO = 0.085620

DIFF MEAS. & CAL. F/A PERCENT = -98.343

CYL TEMP DEG.F

CYL-1

CYL-2

CYL-3

CYL-4

356.51

375.83

369.86

401.89

EXT GAS TEMP DEG.F

EXT-1

EXT-2

EXT-3

EXT-4

SEXT-1

SEXT-2

1855.0

1956.1

1945.5

465.11

1401.5

820.81

ENGINE OIL

EOILT

SOILT

OILP

MANIFOLD PRESSURE = 27.259

131.79

150.18

76.364

DYN0 COND.

TORQUE

RPM

CYL. BACK PRESSURE = 29.201

291.44

2659.1

INDUCTION AIR

TAIRT1

TAIRT2

TAIRT1

TAIRT2

63.428

63.500

66.952

58.852

ORIFICE AIR

TEMP

DELTAP

ORFP

FLOW

90.202

2.9692

53.674

2363.3

CELL TEMP. = 65.332

HEATER TEMP = 99.295

COOLER TEMP = 62.113

ENG. VIBRATION IN G'S

X1

X2

Y1

Y2

Z1

Z2

-25.878

-43.528

-43.279

-28.458

-22.363

-39.918

PISTON SPEED = 1746.3

VOL. EFF. = 86.355

SPEC. FUEL CON. = 0.54666

IND. HP = 1.0917 *

TABLE 10 FUEL RICH PROPELLER LOAD CURVE

ORIGINAL PAGE IS
OF POOR QUALITY

NASA-LEWIS 12/11/75 CADDEIT RFC 12/11/75 19:18:51.328 FAC SEX15 PGM C003 RDG 0296

PROP LOAD CURVE MODE = 1.0000 NO. SCANS = 5

ENGINE TIMING = 25.000 DEG. BAROMETRIC PRESSURE = 29.280 RATED HP = 160.00 HC RATIO = 2.1250

COMB. AIR	TEMP	PRESS	CFM	DRY FLOW	VAPOR FLOW	PRESS TOTAL
	63.365	29.182	199.97	912.96	0.23369	14.619

COMB. FUEL	TEMP	PRESS	DENSITY	TURBO FLOW	FLOW TRON	FPIP
	60.330	4.8668	45.170	74.437	74.482	5.5335

COOLING AIR	TEMP	UDEL-HOOD	DEL-HOOD	FLOW	REL-HUM
	63.752	6.0532	6.9026	14000.	2.4527

REL-HUM	1	2	% H2O VAPOR	CORRECTED HP
	2.4527	-0.070007	0.041146	133.45

ENG. COND.	F/A DRY	F/A WET	EQU. RATIO	RPM-1	RPM-2	TORQUE	BHP
	0.081583	0.081562	1.2177	2607.1	2611.2	268.89	133.48

WET CORRECTION FACTOR = 0.99778 EXHAUST MOLE. WT. = 27.555 EXHAUST DENSITY = 0.071346 EXHAUST FLOW RATE = 13843.

MEASURED CONC.	PART PER MILLION WET			PER CENT	
	HC PPM	NOX PPM	CO DRY	CO2 DRY	O2 DRY
	0.00000	0.080008	0.10276	0.18077	0.012541
CORRECTED CONC. TO WET BASIS			0.10253	0.18037	0.012513

	HC	NOX	CO
EMISSION RATE	0.00000	0.00013180	1.0305
EMISSION MASS/MODE	0.00000	2.1967E-06	0.017174
EMISSION MASS/RATED HP	0.00000	1.3730E-08	0.00010734
MODE FMIS./STD. CYCLE %	0.00000	0.00091530	0.25557

18

CAL. FUEL AIR RATIO = 0.0014559 MFAS. FUEL AIR RATIO = 0.081583 DIFF MEAS. & CAL. F/A PERCENT = -98.215

CYL TEMP DEG.F	CYL-1	CYL-2	CYL-3	CYL-4
	324.12	345.14	391.61	414.14

EXT GAS TEMP DEG.F	EXT-1	EXT-2	EXT-3	FXT-4	SFXT-1	SEXT-2
	1924.7	1828.8	662.55	1230.4	1435.3	1335.8

ENGINE OIL	EOILT	SOILT	OILP	MANIFOLD PRESSURE = 26.388
	153.84	171.22	73.419	

DYNO COND.	TORQUE	RPM	CYL. BACK PRESSURE = 29.189
	266.98	2532.3	

INDUCTION AIR	IAIRT1	IAIRT2	TAIRT1	TAIRT2
	63.338	63.365	66.833	58.760

ORIFICE AIR	TEMP	DELTAP	ORFP	FLOW
	90.324	3.0148	53.598	2380.4

CELL TEMP. = 63.689 HEATER TEMP = 91.456 COOLER TEMP = 63.600

ENG. VIBRATION IN G'S	X1	X2	Y1	Y2	Z1	Z2
	1.5932	-28.152	-20.683	-44.518	-38.711	-9.7090

PISTON SPEED = 1683.7 VOL. EFF. = 82.906 SPEC. FUEL CON. = 0.55801 IND. HP = 1.0525 *

TARIE 14 CHIL DTIC DDOBELLED LOAD CURVE

NASA-LEWIS		12/11/75	CADDEIT	REC 12/11/75 19:28:25.955	FAC SEX15	PGM C003	RDG 0297
PROP LOAD CURVE		MODE = 1.0000		NO. SCANS = 5			
ENGINE TIMING = 25.000		DEG.	BAROMETRIC PRESSURE = 29.280		RATED HP = 160.00		HC RATIO = 2.1250
COMB. AIR	TEMP	PRESS	CFM	DRY FLOW	VAPOR FLOW	PRESS TOTAL	
	63.383	29.161	176.26	807.16	0.20930	14.662	
COMB. FUEL	TEMP	PRESS	DENSITY	TURBO FLOW	FLOW TRON	FPIP	
	60.556	4.9100	45.164	65.256	64.314	5.5845	
COOLING AIR	TEMP	UDEL-HOOD	DEL-HOOD	FLOW	REL-HUM		
	63.680	5.8681	6.9973	13848.	2.4986		
REL-HUM	1	2	% H2O VAPOR CORRECTED HP				
	2.4986	-0.064006	0.041681	118.91			
ENG. COND.	F/A DRY	F/A WET	EQU. RATIO	RPM-1	RPM-2	TORQUE	BHP
	0.079680	0.079659	1.1893	2505.0	2509.3	249.39	118.95
WET CORRECTION FACTOR = 0.99768		EXHAUST MJLE. WT. = 27.706		EXHAUST DENSITY = 0.071738		EXHAUST FLOW RATE = 12150.	
MEASURED CONC.	PART PER MILLION WET		PER CENT				
	HC PPM	NOX PPM	CO DRY	CO2 DRY	O2 DRY		
	0.00000	0.00000	0.092478	0.17754	0.0072607		
CORRECTED CONC. TO WET BASIS			0.092264	0.17713	0.0072439		
	HC	NOX	CO				
EMISSION RATE	0.00000	0.00000	0.81391		19		
EMISSION MASS/MODE	0.00000	0.00000	0.013565				
EMISSION MASS/RATED HP	0.00000	0.00000	8.4783E-05				
MODE EMIS./STD. CYCLE %	0.00000	0.00000	0.20186				
CAL.FUEL AIR RATIO = 0.0013786		MEAS. FUEL AIR RATIO = 0.079680		DIFF MEAS.& CAL. F/A PERCENT = -98.270			
CYL TEMP DEG.F	CYL-1	CYL-2	CYL-3	CYL-4			
	320.06	339.74	370.52	392.78			
EXT GAS TEMP DEG.F	EXT-1	EXT-2	EXT-3	EXT-4	SEXT-1	SEXT-2	
	1968.5	1814.9	2203.9	1125.7	1402.2	949.91	
ENGINE OIL	EOILT	SOILT	OILP	MANIFOLD PRESSURE = 25.165			
	163.83	179.58	72.255				
DYNO COND.	TORQUE	RPM	CYL.BACK PRESSURE = 29.195				
	254.29	2434.9					
INDUCTION AIR	IAIRT1	IAIRT2	TAIRT1	TAIRT2			
	63.374	63.383	66.574	58.683			
ORIFICE AIR	TEMP	DELTAP	ORFP	FLOW			
	90.437	4.9276	53.648	3021.3			
CELL TEMP. = 64.273	HEATER TEMP = 89.915		COOLER TEMP = 63.474				
ENG. VIBRATION IN G'S	X1	X2	Y1	Y2	Z1	Z2	
	12.694	-22.785	-4.4644	-40.569	-13.683	-13.785	
PISTON SPEED = 1617.8	VOL. EFF. = 76.052	SPEC. FUEL CON. = 0.54068	IND. HP = 1.0113	*			

TARIF 1 c. FULL RICH PROPELLER LOAD CURVE

NASA-LEWIS		12/11/75	CADDEII	REC 12/11/75 19:35:35.522	FAC SEX15	PGM C003	RDG 0298
PROP LOAD CURVE		MODE = 1.0000		NO. SCANS = 5			
ENGINE TIMING = 25.000		DEG.	BAROMETRIC PRESSURE = 29.280		RATED HP. = 160.00		HC RATIO = 2.1250
COMB. AIR	TEMP	PRESS	CFM	DRY FLOW	VAPOR FLOW	PRESS TOTAL	
	63.356	29.184	153.05	706.27	0.18387	14.772	
COMB. FUEL	TEMP	PRESS	DENSITY	TURBO FLOW	FLOW TRON	FPIP	
	61.520	4.9379	45.138	57.618	56.232	5.5418	
COOLING AIR	TEMP	UDEL-HOOD	DEL-HOOD	FLOW	REL-HUM		
	63.581	6.0322	6.8434	13984.	2.5384		
REL-HUM	1	2	% H ₂ O VAPOR CORRECTED HP				
	2.5384	-0.060006	0.041848	103.59			
ENG. COND.	F/A DRY	F/A WET	EQU. RATIO	RPM-1	RPM-2	TORQUE	BHP
	0.079618	0.079597	1.1883	2394.0	2397.8	227.36	103.63
WET CORRECTION FACTOR = 0.99753		EXHAUST MOLE. WT. = 27.711		EXHAUST DENSITY = 0.071751		EXHAUST FLOW RATE = 10629.	
MEASURED CONC.	PART PER MILLION WET		PER CENT				
	HC PPM	NOX PPM	CO DRY	CO ₂ DRY	O ₂ DRY		
	0.00000	0.00000	0.097406	0.17705	0.0037404		
CORRECTED CONC. TO WET BASIS			0.097166	0.17661	0.0037311		
EMISSION RATE	HC	NOX	CO				
	0.00000	0.00000	0.74984				
EMISSION MASS/MODE	0.00000	0.00000	0.012497				
EMISSION MASS/RATED HP	0.00000	0.00000	7.8108E-05				
MODE EMIS./STD. CYCLE %	0.00000	0.00000	0.18597				
CAL. FUEL AIR RATIO = 0.0014009		MEAS. FUEL AIR RATIO = 0.079618		DIFF MEAS. & CAL. F/A PERCENT = -98.240			
CYL TEMP DEG.F	CYL-1	CYL-2	CYL-3	CYL-4			
	320.28	337.91	348.69	373.48			
EXT GAS TEMP DEG.F	EXT-1	EXT-2	EXT-3	EXT-4	SEXT-1	SEXT-2	
	1375.2	2101.8	2087.9	1008.1	1365.9	1821.7	
ENGINE OIL	EOILT	SOILT	OILP	MANIFOLD PRESSURE = 23.724			
	166.99	182.06	73.867				
DYNO COND.	TORQUE	RPM	CYL. BACK PRESSURE = 29.336				
	223.06	2330.9					
INDUCTION AIR	IAIRT1	IAIRT2	TAIRT1	TAIRT2			
	63.356	63.356	66.517	58.562			
ORIFICE AIR	TEMP	DELTAP	ORFP	FLOW			
	90.524	2.0045	53.667	1962.8			
CELL TEMP. = 64.372		HEATER TEMP = 89.369		COOLER TEMP = 62.364			
ENG. VIBRATION IN G'S	X1	X2	Y1	Y2	Z1	Z2	
	-28.893	-42.500	-20.178	-22.046	-19.825	-23.444	
PISTON SPED = 1546.1	VOL. EFF. = 69.098	SPEC. FUEL CON. = 0.54259		IND. HP = 0.96652 *			

TABLE I d. FIII RICH PROPFETER IONAN CURVE

NASA-LEWIS		12/11/75		CADDEII		REC 12/11/75 19:44:09.265		FAC SEX15		PGM C003		RDC 0299			
PROP LOAD CURVE				MODE = 1.0000				NO. SCANS = 5							
ENGINE TIMING = 25.000		DEG.		BAROMETRIC PRESSURE = 29.280				RATED HP. = 160.00		HC RATIO = 2.1250					
COMB. AIR		TEMP	PRESS	CFM	DRY FLOW	VAPOR FLOW	PRESS TOTAL								
		63.545	29.186	139.92	610.21	0.16949	14.591								
COMB. FUEL		TEMP	PRESS	DENSITY	TURBO FLOW	FLOW TRON	FPIP								
		62.799	4.9745	45.104	49.153	48.695	5.5073								
COOLING AIR		TEMP	UDEL-HOOD	DEL-HOOD	FLOW	REL-HUM									
		63.590	6.0250	6.8899	13978.	2.6562									
REL-HUM		1	2	% H2O VAPOR CORRECTED HP											
		2.6562	-0.062006	0.044648 89.407											
ENG. COND.		F/A DRY	F/A WET	EQU. RATIO	RPM-1	RPM-2	TORQUE	BHP							
		0.079800	0.079778	1.1910	2272.8	2276.4	206.65	89.428							
WET CORRECTION FACTOR = 1.0000				EXHAUST MOLE. WT. = 27.696				EXHAUST DENSITY = 0.071713				EXHAUST FLOW RATE = 9190.5			
MEASURED CONC.		PART PER MILLION WET			PER CENT										
		HC PPM	NOX PPM	CO DRY	CO2 DRY	CO DRY									
		0.00000	0.00000	-0.033975	-0.021188	0.00032003									
CORRECTED CONC. TO WET BASIS					-0.033975	-0.021188	0.00032003								
		HC	NOX	CO											
EMISSION RATE		0.00000	0.00000	-0.22669											
EMISSION MASS/MODE		0.00000	0.00000	-0.0037781											
EMISSION MASS/RATED HP		0.00000	0.00000	-2.3613E-05											
MODE EMIS./STD. CYCLE %		0.00000	0.00000	-0.056222											
CAL. FUEL AIR RATIO = -0.00028173				MEAS. FUEL AIR RATIO = 0.079800				DIFF MEAS. & CAL. F/A PERCENT = -100.35							
CYL TEMP DEG.F		CYL-1	CYL-2	CYL-3	CYL-4										
		309.19	322.15	326.23	349.76										
EXT GAS TEMP DEG.F		EXT-1	EXT-2	EXT-3	EXT-4	SEXT-1	SEXT-2								
		2044.6	1756.0	2028.0	1058.3	1314.9	2272.9								
ENGINE OIL		EOILT	SOILT	OILP	MANIFOLD PRESSURE = 22.192										
		166.85	181.50	73.483											
DYNO COND.		TORQUE	RPM	CYL. BACK PRESSURE = 29.167											
		207.52	2213.9												
INDUCTION AIR		IAIRT1	IAIRT2	TAIRT1	TAIRT2										
		63.554	63.545	66.394	58.760										
ORIFICE ATR		TEMP	DELTAP	ORFP	FLOW										
		90.542	2.0177	53.703	1968.9										
CELL TEMP. = 64.408		HEATER TEMP = 89.037				COOLER TEMP = 62.991									
ENG. VIBRATION IN G'S		X1	X2	Y1	Y2	Z1	Z2								
		-21.360	-22.059	-37.604	-26.835	-23.482	-29.836								
PISTON SPEED = 1467.9		VOL. EFF. = 63.686		SPEC. FUEL CON. = 0.54452		IND. HP = 0.91760 *									

21

TARIF Te. FIIL RICH PROPETTER LOAD CURVE

NASA-LEWIS		12/11/75		CADDETTI		REC 12/11/75 19:52:42.915		FAC SEX15		PGM C003		RDG 0300	
PROP LOAD CURVE				MODE = 1.0000				NO. SCANS = 5					
ENGINE TIMING = 25.000				DEG.		BAROMETRIC PRESSURE = 29.280				RATED HP. = 160.00		HC RATIO = 2.1250	
COMB. AIR		TEMP	PRESS	CFM	DRY FLOW	VAPOR FLOW	PRESS TOTAL						
		63.437	29.186	115.12	521.69	0.13938	14.503						
COMB. FUEL		TEMP	PRESS	DENSITY	TURBO FLOW	FLOW TRON	FPIP						
		63.905	4.9913	45.074	43.779	42.868	5.6142						
COOLING AIR		TEMP	UDEL-HOOD	DEL-HOOD	FLOW	REL-HUM							
		62.898	5.9470	6.7493	13914.	2.5685							
REL-HUM		1	2	% H2O VAPOR CORRECTED HP									
		2.5685	-0.060006	0.042946	74.225								
ENG. COND.		F/A DRY	F/A WET	EQU. RATIO	RPM-1	RPM-2	TORQUE	BHP					
		0.082172	0.082150	1.2264	2134.7	2137.7	182.72	74.265					
WET CORRECTION FACTOR = 1.0000				EXHAUST MOLE. WT. = 27.508		EXHAUST DENSITY = 0.071226		EXHAUST FLOW RATE = 7928.3					
MEASURED CONC.		PART PER MILLION WET		PER CENT									
		HC PPM	NOX PPM	CO DRY	CO2 DRY	CO DRY							
		0.00000	0.00000	-0.038333	-0.00289700	0.012461							
CORRECTED CONC. TO WET BASIS				-0.038333	-0.0028970	0.012461							
EMISSION RATE		HC	NOX	CO									
		0.00000	0.00000	-0.22064									
EMISSION MASS/MODE		0.00000	0.00000	-0.0036774									
EMISSION MASS/RATED HP		0.00000	0.00000	-2.2984E-05									
MODE EMIS./STD. CYCLE %		0.00000	0.00000	-0.054723									
CAL. FUEL AIR RATIO = -0.00021203				MEAS. FUEL AIR RATIO = 0.082172		DIFF MEAS. & CAL. F/A PERCENT = -100.26							
CYL TEMP DEG.F		CYL-1	CYL-2	CYL-3	CYL-4								
		291.61	298.00	299.96	320.85								
EXT GAS TEMP DEG.F		EXT-1	EXT-2	EXT-3	EXT-4	SEXT-1	SEXT-2						
		1986.1	1765.0	1964.0	1018.7	1241.4	2176.3						
ENGINE OIL		EOILT	SOILT	OILP	MANIFOLD PRESSURE = 20.474								
		162.21	176.17	72.231									
DYNQ COND.		TORQUE	RPM	CYL. BACK PRESSURE = 29.279									
		179.74	2084.4										
INDUCTION AIR		IAIRT1	IAIRT2	TAIRT1	TAIRT2								
		63.401	63.437	66.401	58.443								
ORIFICE AIR		TEMP	DELTA P	ORFP	FLOW								
		90.568	1.0232	53.654	1416.4								
CELL TEMP. = 64.758		HEATER TEMP = 88.781		COOLER TEMP = 61.002									
ENG. VIBRATION IN G'S		X1	X2	Y1	Y2	Z1	Z2						
		12.023	-37.222	-19.027	-24.707	-31.701	-18.051						
PISTON SPEED = 1378.6		VOL. EFF. = 58.289		SPEC. FUEL CON. = 0.57723		IND. HP = 0.86181 *							

TABLE I A. FULL RICH PROPELLER LOAD CURVE

NASA-LEWIS

12/11/75

CADDEII

REC 12/11/75 19:59:08.804

FAC SEX15

PGM C003

RDG 0301

PROP LOAD CURVE

MODE = 1.0000

NO. SCANS = 5

ENGINE TIMING = 25.000

DEG.

BAROMETRIC PRESSURE = 29.280

RATED HP. = 160.00

HC RATIO = 2.1250

COMB. AIR

TEMP
63.599PRESS
29.173CFM
97.165DRY FLOW
437.29VAPOR FLOW
0.12028PRESS TOTAL
14.411

COMB. FUEL

TEMP
64.551PRESS
5.0093DENSITY
45.057TURBO FLOW
39.260FLOW TRON
38.194FPIP
5.6139

COOLING AIR

TEMP
62.754JDEL-HOOD
5.8590DEL-HOOD
6.7100FLOW
13840.REL-HUM
2.6007

REL-HUM

1
2.60072
-0.060006% H2O VAPOR CORRECTED HP
0.044214 58.842

ENG. COND.

F/A DRY
0.087343F/A WET
0.087319EQU. RATIO
1.3036RPM-1
1981.2RPM-2
1984.1TORQUE
156.02BHP
58.857

WET CORRECTION FACTOR = 0.99653

EXHAUST MOLE. WT. = 27.113

EXHAUST DENSITY = 0.070201

EXHAUST FLOW RATE = 6774.8

MEASURED CONC.

PART PER MILLION WET
HC PPM
830.08NOX PPM
0.00000CO DRY
0.059308PER CENT
CO2 DRY
0.17159O2 DRY
0.00000

CORRECTED CONC. TO WET BASIS

0.059068

0.17099

0.00003

EMISSION RATE

HC

NOX

CO

0.20657

0.00000

0.00000

0.33971

EMISSION MASS/MODE

0.0034429

0.00000

0.00000

0.0056618

EMISSION MASS/RATED HP

2.1518E-05

0.00000

0.00000

3.5386E-05

MODE EMIS./STD. CYCLE %

1.1325

0.00000

0.00000

0.084253

CAL. FUEL AIR RATIO = 0.0016905

MEAS. FUEL AIR RATIO = 0.087343

DIFF MEAS. & CAL. F/A PERCENT = -98.064

CYL TEMP DEG.F

CYL-1
272.49CYL-2
277.07CYL-3
273.66CYL-4
293.68

EXT GAS TEMP DEG.F

EXT-1
1743.3EXT-2
2238.0EXT-3
1982.1EXT-4
1025.7SEXT-1
1158.4SEXT-2
2075.4

ENGINE OIL

E OILT
156.89S OILT
170.48OILP
68.487

MANIFOLD PRESSURE = 18.791

DYNO COND.

TORQUE
160.24RPM
1930.5

CYL. BACK PRESSURE = 29.457

INDUCTION AIR

IAIRT1
63.554IAIRT2
63.599TAIRT1
66.218TAIRT2
58.729

ORIFICE AIR

TEMP
90.664DELTAP
2.9689ORFP
53.619FLOW
2362.2

CELL TEMP. = 64.435

HEATER TEMP = 88.712

COOLER TEMP = 62.221

ENG. VIBRATION IN G'S

X1
40.902X2
-41.790Y1
13.988Y2
-30.313Z1
-22.666Z2
-38.124

PISTON SPEED = 1279.5

VOL. EFF. = 53.008

SPEC. FUEL CON. = 0.64893

IND. HP = 0.79987 *

TABLE I q. FULL RICH PROPELLER LOAD CURVE

ORIGINAL PAGE IS
OF POOR QUALITY

23

NASA-LEWIS

12/11/75

CADDE11

REC 12/11/75 20:00:59.084

FAC SEX15

PGM C003

RDG 0302

PROP LOAD CURVE

MODE = 1.0000

NO. SCANS = 5

ENGINE TIMING = 25.000

DEG.

BAROMETRIC PRESSURE = 29.280

RATED HP. = 160.00

HC RATIO = 2.1250

COMB. AIR

TEMP
63.671PRESS
29.183CFM
78.360DRY FLOW
352.22VAPOR FLOW
0.097746PRESS TOTAL
14.394

COMB. FUEL

TEMP
64.955PRESS
5.0327DENSITY
45.046TURBO FLOW
34.710FLOW TRON
33.756FPIP
5.6013

COOLING AIR

TEMP
62.457UDEL-HOOD
5.8786DEL-HOOD
6.6762FLOW
13857.REL-HUM
2.6168

REL-HUM

1
2.61682
-0.060006% H2O VAPOR CORRECTED HP
0.044609 44.282

ENG. COND.

F/A DRY
0.095839F/A WET
0.095812EQU. RATIO
1.4304RPM-1
1813.0RPM-2
1816.0TORQUE
128.30BHP
44.291

WET CORRECTION FACTOR = 0.99922

EXHAUST MOLE. WT. = 26.504

EXHAUST DENSITY = 0.068626

EXHAUST FLOW RATE = 5625.7

MEASURED CONC.

PART PER MILLION WET
HC PPM
0.00000NOX PPM
0.00000CO DRY
0.071762PER CENT
CO2 DRY
0.17667O2 DRY
0.013861

CORRECTED CONC. TO WET BASIS

0.00000

0.00000

0.071705

0.17653

0.013851

EMISSION RATE

HC
0.00000NOX
0.00000CO
0.29286

EMISSION MASS/MODE

0.00000

0.00000

0.0048811

EMISSION MASS/RATED HP

0.00000

0.00000

3.0507E-05

MODE EMIS./STD. CYCLE %

0.00000

0.00000

0.072635

CAL. FUEL AIR RATIO = 0.0013277

MEAS. FUEL AIR RATIO = 0.095839

DIFF MEAS. & CAL. F/A PERCENT = -98.615

CYL TEMP DEG.F

CYL-1
252.12CYL-2
255.75CYL-3
251.44CYL-4
265.41

EXT GAS TEMP DEG.F

EXT-1
1903.4EXT-2
1427.8EXT-3
2089.8EXT-4
941.46SEXT-1
1078.5SEXT-2
1812.3

ENGINE OIL

EOILT
154.13SOILT
166.96OILP
66.403

MANIFOLD PRESSURE = 16.786

DYNQ COND.

TORQUE
130.01RPM
1769.9

CYL. BACK PRESSURE = 29.408

INDUCTION AIR

IAIRT1
63.662IAIRT2
63.671TAIRT1
66.031TAIRT2
58.774

ORIFICE AIR

TEMP
90.681DELTA P
2.9489ORFP
53.577FLOW
2354.6

CELL TEMP. = 64.138

HEATER TEMP = 88.698

COOLER TEMP = 61.217

ENG. VIBRATION IN G'S

X1
37.304X2
-19.316Y1
14.607Y2
-18.828Z1
27.190Z2
-34.766

PISTON SPEED = 1170.9

VOL. EFF. = 46.715

SPEC. FUEL CON. = 0.76214

IND. HP = 0.73196 *

TABLE 1A. FULL RICH PROPELLER LOAD CURVE

24

CYCLE NO. 329		CELL-17		DATE 12/16/76		ENGINE - LYCOMING O-320-DIAD			
BASELINE FR, CHT 300F IN CLIMB BEFORE IDLE									
ENGINE TIMING		25.000 DEG. BTDC		RATED H.P. 160.		H.C. RATIO		2.125	
	UNITS	IDLE	TAXI	TAKE OFF	CLIMB	APPROACH	TAXI	IDLE	
RUN NUMBER		329	330	331	332	333	335	336	
TIME IN MODE	MIN.	1.00	11.00	0.30	5.00	6.00	3.00	1.00	
ENGINE SPEED	RPM	602.34	1202.76	2698.29	2434.74	2350.43	1199.94	602.76	
OBS. HORSEPOWER	HP	0.37064	1.30518	154.53879	120.24400	64.89958	1.61289	0.81795	
MANIFOLD PRESS.	IN.HG.	0.00	0.00	0.00	0.00	0.00	0.00	0.00	
F/A RATIO MEAS.	- - -	0.1000	0.0981	0.0850	0.0838	0.0906	0.0955	0.0889	
F/A RATIO CALC.	- - -	0.0930	0.0973	0.0834	0.0809	0.0873	0.0974	0.0921	
% DIFF. IN F/A	%	-6.944	-0.786	-1.975	-3.485	-3.569	1.962	3.512	
AIR FLOW	LBS/HR	55.28	90.33	944.75	741.51	457.81	88.99	60.02	
FUEL FLOW	LBS/HR	5.53	8.86	80.34	62.15	41.46	8.50	5.34	
VAPOR FLOW	LBS/HR	0.01372	0.02354	0.27494	0.20570	0.11561	0.02368	0.01593	
HUMIDITY GR H2O/LB DRY AIR		0.000	0.000	0.000	0.000	0.000	0.000	0.000	
DEW POINT	DEG.F	0.000	0.000	0.000	0.000	0.000	0.000	0.000	
RELATIVE HUMIDITY.	%	2.35	2.38	2.73	2.57	2.36	2.25	2.54	
BAROMETER	IN.HG.	29.20	29.19	29.19	29.19	29.19	29.19	29.19	
IND. AIR PRESS.	IN.HG.	0.00	0.00	0.00	0.00	0.00	0.00	0.00	
IND. AIR TEMP.	DEG.F	65.31	65.71	63.55	63.68	63.59	64.59	64.69	
MAX. CHT	DEG.F	267.61	275.33	415.26	447.40	370.21	291.31	258.99	25
HC WET	PPM	35419.51	10685.06	1411.34	1377.34	1811.78	10487.05	33515.32	
NOX WET	PPM	3.85	15.58	329.41	577.48	162.79	15.97	4.25	
CO WET	%	8.3743	9.7433	6.5149	5.7011	7.8936	9.5593	7.7689	
CO2 WET	%	5.7957	7.0505	9.1967	9.7437	8.5347	7.0628	5.7631	
O2 WET	%	4.2016	0.4933	0.0931	0.1164	0.1068	0.3775	3.9609	
H2O CORRECTION	- - -	0.92069	0.87515	0.86924	0.87382	0.87612	0.86547	0.88314	
HC MASS/MODE	LB/MODE	0.01942	0.10463	0.00376	0.04781	0.04776	0.02735	0.01919	
NOX MASS/MODE	LB/MODE	0.000007	0.000494	0.002845	0.064933	0.013901	0.000135	0.000008	
CO MASS/MODE	LB/MODE	0.09075	1.88569	0.34322	3.91087	4.11245	0.49271	0.08792	
HC MODE/STD.CYCLE	%	6.388	34.418	1.237	15.725	15.710	8.996	6.313	
NOX MODE/STD.CYCLE	%	0.003	0.206	1.185	27.055	5.792	0.056	0.003	
CO MODE/STD.CYCLE	%	1.350	28.061	5.107	58.197	61.197	7.332	1.308	
HC EMISSION PER HP CYCLE =	0.00169 LB/HP CYCLE		PERCENT OF ALLOWABLE HC =			88.79			
NOX EMISSION PER HP CYCLE =	0.00051 LB/HP CYCLE		PERCENT OF ALLOWABLE NOX =			34.30			
CO EMISSION PER HP CYCLE =	0.06827 LB/HP CYCLE		PERCENT OF ALLOWABLE CO =			162.55			

TABLE IIa. BASELINE CYCLE DATA

CYCLE NO. 338 CELL-17 DATE 12/16/75

BASELINE ER. CHT 300F IN CLIMB BEFORE IDLE

ENGINE - LYCOMING O-320-D1AD

ENGINE TIMING 25.000 DEG. BTDC RATED H.P. 160 H.C. RATIO 2.125

	UNITS	IDLE	TAXI	TAKE OFF	CLIMB	APPROACH	TAXI	IDLE
PUM NUMBER		338	339	340	341	342	343	344
TIME IN MODE	MIN.	1.00	11.00	0.30	5.00	6.00	3.00	1.00
ENGINE SPEED	PDM	605.88	1207.86	2706.09	2430.36	2359.49	1712.30	605.70
CRS. HORSEPOWER	HP	0.43625	1.58346	154.27814	120.30644	66.01613	1.37535	0.10766
F/A RATIO MEAS.	- - -	0.0910	0.0977	0.0863	0.0840	0.0902	0.0965	0.0934
F/A RATIO CALC.	- - -	0.0937	0.0964	0.0831	0.0806	0.0869	0.0976	0.0913
% DIFF. IN F/A	%	2.925	-1.304	-3.721	-3.982	-3.626	1.183	-2.322
AIR FLOW	LBS/HR	57.55	88.76	940.87	741.47	467.28	89.49	57.51
FUEL FLOW	LBS/HR	5.24	8.67	81.18	62.26	42.15	8.63	5.37
VAPOR FLOW	LBS/HR	0.01670	0.02561	0.30098	0.22619	0.12970	0.02519	0.01671
RELATIVE HUMIDITY	%	2.87	2.86	3.21	3.08	2.80	2.81	2.89
BAROMETER	IN.HG.	29.19	29.19	29.19	29.19	29.19	29.19	29.19
IND. AIR TEMP.	DEG.F	62.41	62.13	61.11	61.21	61.41	62.02	62.20
MAX. CHT	DEG.F	331.15	292.19	448.81	447.84	387.19	307.99	253.17
HC WET	PDM	35105.47	10205.01	1417.84	1430.24	1864.79	11117.11	37357.70
NOX WET	PDM	3.96	17.15	298.27	651.76	173.16	15.70	4.63
CO WET	%	8.1312	9.5516	6.5004	5.6056	7.7440	9.5262	7.6389
CO2 WET	%	5.9730	7.1851	9.3257	9.8285	8.5884	7.1267	5.7327
O2 WET	%	4.0562	0.4631	0.1108	0.1188	0.1127	0.7547	4.5144
H2O CORRECTION	- - -	0.88632	0.87613	0.87475	0.87545	0.87639	0.86764	0.86613
HC MASS/MODE	LB/MODE	0.01942	0.09807	0.00378	0.04967	0.05010	0.02925	0.02083
NOX MASS/MODE	LB/MODE	0.00001	0.00053	0.00258	0.07335	0.01507	0.00013	0.00001
CO MASS/MODE	LB/MODE	0.08871	1.81420	0.34264	3.84749	4.11283	0.49539	0.08419
HC MODE/STD. CYCLE	%	6.389	32.260	1.744	16.338	16.480	9.622	5.852
NOX MODE/STD. CYCLE	%	0.003	0.222	1.074	30.562	6.281	0.056	0.003
CO MODE/STD. CYCLE	%	1.323	26.997	5.099	57.254	61.203	7.372	1.253
HC EMISSION PER HP CYCLE =	0.00169 LB/HP CYCLE				PERCENT OF ALLOWABLE HC =	89.19		
NOX EMISSION PER HP CYCLE =	0.00057 LB/HP CYCLE				PERCENT OF ALLOWABLE NOX =	38.20		
CO EMISSION PER HP CYCLE =	0.06741 LB/HP CYCLE				PERCENT OF ALLOWABLE CO =	160.50		

26

TABLE IIb. BASELINE CYCLE DATA

CYCLE NO. 345		CFIL-17		DATE 12/16/75		ENGINE - LYCOMING C-320-DIAD		
BASELINE FR. CHT 300F IN CLIMB BEFORE IDLE								
ENGINE TIMING		25.000 DEG.	AJDC	RATED H.P. 160.		H.C. RATIO 2.125		
	UNITS	IDLE	TAXI	TAKE OFF	CLIMB	APPROACH	TAXI	IDLE
RUN NUMBER		345	346	347	348	349	350	351
TIME IN MODE	MIN.	1.00	11.00	0.30	5.00	6.00	3.00	1.00
ENGINE SPEED	RPM	608.58	1204.60	2710.83	2433.30	2351.63	1211.58	507.44
CRS. HORSEPOWER	HP	0.61117	2.16504	155.67722	120.29706	63.24561	2.01201	0.47954
F/A RATIO MEAS.	- - -	0.0935	0.0970	0.0854	0.0833	0.0898	0.0942	0.0927
F/A RATIO CALC.	- - -	0.0992	0.0977	0.0829	0.0807	0.0872	0.0965	0.0917
% DIFF. IN F/A	%	6.111	0.759	-2.875	-3.165	-2.929	2.426	-1.087
AIR FLOW	LBS/HR	56.59	88.53	948.90	744.93	463.35	88.16	57.54
FUEL FLOW	LBS/HR	5.29	8.59	81.00	62.07	41.62	8.30	5.33
VAPOR FLOW	LBS/HR	0.01641	0.02615	0.31729	0.22705	0.13063	0.02553	0.01495
RELATIVE HUMIDITY	%	2.87	2.93	3.36	3.11	2.85	2.90	2.98
BAROMETER	IN. HG.	29.19	29.19	29.19	29.19	29.20	29.20	29.20
IND. AIR TEMP.	DEG. F	61.94	61.80	61.24	61.47	61.55	62.20	62.70
MAX. CHT	DEG. F	326.83	293.48	428.60	449.88	395.16	313.68	265.75
HC WET	PPM	37525.72	11503.14	1415.44	1394.94	1828.88	9865.98	35609.52
NOX WET	PPM	3.72	15.45	322.15	658.15	177.77	17.07	4.54
CO WET	%	7.9786	9.5638	6.4396	5.6395	7.8206	9.4382	7.7785
CO2 WET	%	5.4137	7.0571	9.3130	9.7894	8.5292	7.0952	5.8230
O2 WET	%	3.2972	0.4299	0.1247	0.1269	0.1116	0.4355	4.2400
H2O CORRECTION	- - -	0.87832	0.86094	0.87186	0.87245	0.87395	0.84377	0.89967
HC MASS/MODE	LB/MODE	0.02060	0.10998	0.00379	0.04855	0.04367	0.02537	0.01992
NOX MASS/MODE	LB/MODE	0.00001	0.00048	0.00280	0.07421	0.01528	0.00014	0.00001
CO MASS/MODE	LB/MODE	0.08655	1.80720	0.34117	3.87944	4.11772	0.47960	0.09555
HC MODE/STD. CYCLE	%	6.775	36.177	1.248	15.971	16.008	8.344	6.518
NOX MODE/STD. CYCLE	%	0.003	0.199	1.166	30.921	6.367	0.059	0.004
CO MODE/STD. CYCLE	%	1.288	26.893	5.077	57.730	61.276	7.137	1.273
HC EMISSION PER HP CYCLE =	0.00173 LB/HP CYCLE	PERCENT OF ALLOWABLE HC =				91.04		
NOX EMISSION PER HP CYCLE =	0.00058 LB/HP CYCLE	PERCENT OF ALLOWABLE NOX =				38.72		
CO EMISSION PER HP CYCLE =	0.06748 LB/HP CYCLE	PERCENT OF ALLOWABLE CO =				160.67		

27

TABLE II c. BASELINE CYCLE DATA

CYCLE NO. 396

CELL-17

DATE 12/17/75

BASELINE FR. CHT 300F. CLIMB BEFORE IDLE

ENGINE - LYCOMING O-320-D1AD

ENGINE TIMING

25.000 DEG. BTDC

RATED H.P. 160.

H.C. RATIO 2.125

	UNITS	IDLE	TAXI	TAKE OFF	CLIMB	APPROACH	TAXI	IDLE	
PIIM NUMBER		396	397	398	399	400	401	402	
TIME IN MODE	MIN.	1.00	11.00	0.30	5.00	6.00	3.00	1.00	
ENGINE SPEED	PPM	608.64	1711.76	2714.67	2440.26	2350.31	1217.30	614.04	
CRS. HOPSEPOWER	HP	0.45448	1.45553	155.37697	119.57021	65.31276	1.46763	0.18279	
F/A RATIO MEAS.	- - -	0.0908	0.0954	0.0860	0.0876	0.0900	0.0954	0.0902	
F/A RATIO CALC.	- - -	0.0931	0.0964	0.0920	0.0799	0.0961	0.0964	0.0915	
% DIFF. IN F/A	%	2.560	1.081	-4.571	-3.317	-4.295	1.058	1.355	
AIR FLOW	LBS/HR	59.97	94.11	943.49	728.36	459.44	87.25	59.62	
FUEL FLOW	LBS/HR	5.45	8.98	81.11	60.20	41.35	8.32	5.38	
VAPOR FLOW	LBS/HR	0.01491	0.02341	0.25068	0.18414	0.10899	0.02068	0.01406	
RELATIVE HUMIDITY	%	2.51	2.49	2.69	2.57	2.40	2.38	2.37	
BAROMETER	IN. HG.	29.18	29.18	29.18	29.18	29.18	29.18	29.18	
IMP. AIR TEMP.	DEG. F	63.38	62.99	61.09	61.22	61.56	62.83	63.52	
MAX. CHT	DEG. F	286.97	272.98	440.25	443.19	376.48	300.97	257.58	
HC WFT	PPM	39137.89	12068.20	1539.28	1534.35	2011.10	12106.20	38900.85	
NOX WFT	PPM	4.73	15.55	321.93	594.46	180.89	16.42	4.05	
CO WFT	%	7.7915	9.6270	6.4312	5.5545	7.7693	9.4092	7.5164	
CO2 WFT	%	5.9744	7.3836	10.1374	10.5805	9.2038	7.6526	5.1389	
O2 WFT	%	4.2575	0.5760	0.0836	0.0780	0.0778	0.3609	4.3922	
H2O CORRECTION	- - -	0.88365	0.86428	0.87048	0.86549	0.87258	0.86190	0.88738	
HC MASS/MODE	LB/MODE	0.02254	0.12198	0.00411	0.05208	0.05309	0.03094	0.02223	
NOX MASS/MODE	LB/MODE	0.00001	0.00051	0.00779	0.06559	0.01547	0.00014	0.00001	
CO MASS/MODE	LB/MODE	0.08870	1.92323	0.33952	3.72639	4.05397	0.47523	0.09489	
HC MODE/STD. CYCLE	%	7.415	40.126	1.352	17.132	17.465	10.177	7.313	
NOX MODE/STD. CYCLE	%	0.004	0.212	1.161	27.329	6.446	0.057	0.003	
CO MODE/STD. CYCLE	%	1.320	28.619	5.052	55.452	60.327	7.072	1.263	
HC EMISSION PER HP CYCLE =	0.00192 LB/HP CYCLE					PERCENT OF ALLOWABLE HC =	100.98		
NOX EMISSION PER HP CYCLE =	0.00053 LB/HP CYCLE					PERCENT OF ALLOWABLE NOX =	35.21		
CO EMISSION PER HP CYCLE =	0.06682 LB/HP CYCLE					PERCENT OF ALLOWABLE CO =	159.11		

TABLE II d. BASELINE CYCLE DATA

CYCLE NO. 482

CELL-17

DATE 12/19/75

BASELINE FR, CHT 300F IN CLIMB BEFORE IDLE

ENGINE - LYCOMING O-320-D1AD

ENGINE TIMING 25.000 DEG. BTDC

RATED H.P. 160.

H.C. RATIO 2.125

	UNITS	IDLE	TAXI	TAKE OFF	CLIMB	APPROACH	TAXI	IDLE
PUN NUMBER		482	483	484	486	487	488	489
TIME IN MODE	MIN.	1.00	11.00	0.30	5.00	5.00	3.00	1.00
ENGINE SPEED	RPM	511.40	1199.52	2598.17	2431.86	2348.33	1206.30	613.26
PRS. HOPS/FTWHR	HP	0.32506	1.15263	156.22891	119.74420	65.59515	1.02946	0.35864
F/A RATIO MEAS.	- - -	0.0944	0.0950	0.0876	0.0846	0.0919	0.0977	0.0959
F/A RATIO CALC.	- - -	0.0944	0.0951	0.0839	0.0812	0.0876	0.0960	0.0910
% DIFF. IN F/A	%	-0.063	1.238	-4.226	-4.020	-4.678	-1.720	-6.035
AIR FLOW	LBS/HR	52.15	39.46	932.80	722.30	454.08	86.15	50.92
FUEL FLOW	LBS/HR	4.93	8.49	81.69	61.13	41.77	8.41	4.93
VAPOR FLOW	LBS/HR	0.01269	0.02213	0.25584	0.19328	0.11185	0.02127	0.01277
RELATIVE HUMIDITY	%	2.36	2.40	2.59	2.63	2.41	2.39	2.42
BAROMETER	IN.HG.	29.25	29.24	29.24	29.23	29.23	29.23	29.23
IND. AIR TEMP.	DEG.F	62.55	61.77	61.23	61.43	61.64	62.02	62.14
MAX. CHT	DEG.F	285.94	295.90	414.38	440.50	352.42	305.39	257.72
HC WFT	PPM	36973.67	11780.17	1563.91	1544.15	1985.10	10101.00	36444.64
NOX WFT	PPM	5.28	15.83	337.62	528.95	148.09	17.19	6.02
CO WFT	%	7.8086	9.3911	5.7204	5.7818	8.0690	9.5003	7.6026
CO2 WFT	%	6.2033	7.2496	9.4291	9.9674	8.7102	7.5283	6.4182
O2 WFT	%	3.6480	0.5992	0.0044	0.0296	0.0716	0.3341	4.1099
H2O CORRECTION	- - -	0.89091	0.86640	0.87470	0.87321	0.87789	0.87378	0.91287
HC MASS/MODE	LB/MODE	0.01877	0.11299	0.00415	0.05236	0.05215	0.02569	0.01822
NOX MASS/MODE	LB/MODE	0.00001	0.00052	0.00291	0.05811	0.01260	0.00014	0.00001
CO MASS/MODE	LB/MODE	0.07833	1.78033	0.35286	3.87524	4.18946	0.47752	0.07509
HC MODE/STD. CYCLE	%	5.173	37.159	1.367	17.225	17.154	8.450	5.994
NOX MODE/STD. CYCLE	%	0.004	0.218	1.211	24.213	5.251	0.059	0.004
CO MODE/STD. CYCLE	%	1.166	26.493	5.251	57.667	62.343	7.106	1.117
HC EMISSION PER HP CYCLE =	0.00178 LB/HP CYCLE				PERCENT OF ALLOWABLE HC =	93.53		
NOX EMISSION PER HP CYCLE =	0.00046 LB/HP CYCLE				PERCENT OF ALLOWABLE NOX =	30.96		
CO EMISSION PER HP CYCLE =	0.06768 LB/HP CYCLE				PERCENT OF ALLOWABLE CO. =	161.14		

29

ORIGINAL PAGE IS
OF POOR QUALITY

TABLE IIe. BASELINE CYCLE DATA

CYCLE NO. 524

CFLL-17

DATE 12/19/75

BASELINE FR. CHT 300F IN CLIMB BEFORE IDLE

ENGINE - LYCOMING O-320-D1AD

ENGINE TIMING 25.000 DEG. BTDC RATED H.P. 160. H.C. RATIO 2.125

	UNITS	IDLE	TAXI	TAKE OFF	CLIMB	APPROACH	TAXI	IDLE
RUN NUMBER		524	523	525	526	527	528	530
TIME IN MODE	MIN.	1.00	11.00	0.30	5.00	6.00	3.00	1.00
ENGINE SPEED	RPM	593.52	1203.84	2701.59	2433.84	2353.37	1199.52	606.00
OBS. HORSEPOWER	HP	0.35567	0.39601	156.59903	119.43405	65.11578	1.63172	0.37807
F/A RATIO MEAS.	- - -	0.0886	0.0937	0.0870	0.0841	0.0922	0.0927	0.0800
F/A RATIO CALC.	- - -	0.0892	0.0960	0.0831	0.0810	0.0876	0.0952	0.0904
% DIFF. IN F/A	%	0.638	2.503	-4.525	-3.775	-4.909	2.769	0.574
AIR FLOW	LBS/HR	57.16	89.87	932.93	724.75	452.86	89.71	55.52
FUEL FLOW	LBS/HR	5.06	8.41	81.18	61.17	41.73	8.31	4.99
VAPOR FLOW	LBS/HR	0.01466	0.02253	0.25427	0.19866	0.11408	0.02260	0.01430
RELATIVE HUMIDITY	%	2.50	2.45	2.77	2.68	2.48	2.49	2.52
BAROMETER	IN. HG.	29.21	29.21	29.20	29.20	29.19	29.19	29.19
IND. AIR TEMP.	DEG. F	62.65	62.34	61.47	61.66	61.77	62.44	62.81
MAX. CHT	DEG. F	227.61	277.89	438.83	444.78	353.86	287.93	221.05
HC WET	PPM	35192.47	10997.09	1510.85	1540.85	1990.90	10633.05	36207.59
NOX WET	PPM	4.76	17.86	294.39	511.71	154.58	18.05	5.60
CO WET	%	7.1065	9.2612	6.5568	5.7519	8.0464	9.0790	7.1054
CO2 WET	%	6.2365	7.3154	9.5034	9.9009	8.6172	7.3842	6.3267
O2 WET	%	4.2455	0.4547	0.0890	0.0979	0.0909	0.4634	4.0557
H2O CORRECTION	- - -	0.89073	0.96134	0.87592	0.87307	0.87986	0.86024	0.88988
HC MASS/MODE	LB/MODE	0.01917	0.10543	0.00401	0.05249	0.05221	0.02767	0.01924
NOX MASS/MODE	LB/MODE	0.00001	0.00055	0.00253	0.05648	0.01313	0.00015	0.00001
CO MASS/MODE	LB/MODE	0.07650	1.75487	0.34360	3.87298	4.17066	0.46698	0.07465
HC MODE/STD. CYCLE	%	6.305	34.681	1.318	17.268	17.175	9.103	6.330
NOX MODE/STD. CYCLE	%	0.003	0.231	1.054	23.532	5.472	0.053	0.004
CO MODE/STD. CYCLE	%	1.138	25.114	5.113	57.634	62.063	6.949	1.111
HC EMISSION PER HP CYCLE =	0.00175 LB/HP CYCLE				PERCENT OF ALLOWABLE HC =	92.18		
NOX EMISSION PER HP CYCLE =	0.00046 LB/HP CYCLE				PERCENT OF ALLOWABLE NOX =	30.36		
CO EMISSION PER HP CYCLE =	0.06725 LB/HP CYCLE				PERCENT OF ALLOWABLE CO =	160.12		

TABLE IIF BASELINE CYCLE DATA

CYCLE NO. 546

CFLL-17

DATE 12/19/75

FR. CHT 300F IN CLIMB BEFORE IDLE

ENGINE - LYCOMING O-320-DIAD

ENGINE TIMING 25.000 DEG. BTDC RATED H.P. 160. H.C. RATIO 2.125

	UNITS	IDLE	TAXI	TAKE OFF	CLIMB	APPROACH	TAXI	IDLE
RUN NUMBER		546	547	548	549	550	552	554
TIME IN MODE	MIN.	1.00	11.00	0.30	5.30	6.00	3.00	1.00
ENGINE SPEED	RPM	603.78	1205.58	2701.41	2431.26	2352.59	1204.62	596.52
CRS. HORSEPOWER	HP	0.78925	1.05715	154.85744	120.41704	64.71295	1.59185	0.43247
F/A RATIO MEAS.	- - -	0.0917	0.0930	0.0866	0.0833	0.0901	0.0911	0.0892
F/A RATIO CALC.	- - -	0.0906	0.0951	0.0823	0.0802	0.0864	0.0941	0.0895
% DIFF. IN F/A	%	-1.380	2.270	-4.939	-3.702	-4.136	3.237	0.459
AIR FLOW	LBS/HR	54.84	93.80	934.65	731.28	458.34	90.33	55.04
FUEL FLOW	LBS/HR	5.04	8.72	80.89	60.92	41.29	8.23	4.91
VAPOR FLOW	LBS/HR	0.01586	0.02699	0.29856	0.27283	0.13001	0.02560	0.01560
RELATIVE HUMIDITY	%	2.80	2.79	3.14	3.01	2.79	2.76	2.75
BAROMETER	IN.HG.	29.15	29.15	29.15	29.15	29.14	29.14	29.14
IND. AIR TEMP.	DEG.F	63.23	62.83	61.57	61.56	61.88	62.96	63.41
MAX. CHT	DEG.F	232.29	256.89	447.74	447.62	371.07	250.11	222.55
HC WFT	PPM	36677.64	10827.07	1507.25	1500.05	1908.19	10926.09	38812.86
NOX WFT	PPM	5.24	18.05	300.66	565.94	155.97	17.81	4.33
CO WFT	%	7.3046	9.3400	6.5433	5.7399	7.9198	9.0179	7.0134
CO2 WFT	%	6.7470	7.6461	10.0193	10.4594	9.1420	7.7645	6.5003
O2 WFT	%	3.9461	0.4478	0.1111	0.1160	0.1066	0.5014	4.4037
H2O CORRECTION	- - -	0.89161	0.85745	0.87258	0.86727	0.87185	0.85359	0.88854
HC MASS/MODE	LB/MODE	0.01939	0.10815	0.00400	0.05125	0.05027	0.02847	0.02040
NOX MASS/MODE	LB/MODE	0.00001	0.00058	0.00258	0.06264	0.01330	0.00015	0.00001
CO MASS/MODE	LB/MODE	0.07634	1.84389	0.34295	3.87596	4.12389	0.46449	0.07285
HC MODE/STD. CYCLE	%	6.379	35.575	1.315	16.859	16.537	9.367	6.710
NOX MODE/STD. CYCLE	%	0.004	0.243	1.076	26.100	5.543	0.063	0.003
CO MODE/STD. CYCLE	%	1.136	27.439	5.103	57.678	61.367	6.912	1.084
HC EMISSION PER HP CYCLE =	0.00176 LB/HP CYCLE	PERCENT OF ALLOWABLE HC =		92.74				
NOX EMISSION PER HP CYCLE =	0.00050 LB/HP CYCLE	PERCENT OF ALLOWABLE NOX =		33.03				
CO EMISSION PER HP CYCLE =	0.06750 LB/HP CYCLE	PERCENT OF ALLOWABLE CO =		160.72				

TABLE II g. BASELINE CYCLE DATA

CYCLE NO. 718

CELL-17

DATE 1/ 8/75

BASELINE FR, CHT 300F IN CLIMB BEFORE IDLE

ENGINE - LYCOMING O-320-D1AD

ENGINE TIMING 25.000 DEG. BTDC

RATED H.P. 160.

H.C. RATIO 2.125

	UNITS	IDLE	TAXI	TAKF OFF	CLIMB	APPROACH	TAXI	IDLE	
RUN NUMBER		718	719	720	721	722	723	724	
TIME IN MODE	MIN.	1.00	11.00	0.30	5.00	6.00	3.00	1.00	
ENGINE SPEED	PPM	589.02	1200.49	2710.47	2431.92	2351.51	1206.72	589.69	
BS. HORSEPOWER	HP	0.47504	0.87143	156.40343	120.09872	63.90393	1.93909	0.14337	
F/A RATIO MEAS.	- - -	0.0888	0.0953	0.0850	0.0823	0.0891	0.0989	0.0936	
F/A RATIO CALC.	- - -	0.0893	0.0961	0.0833	0.0812	0.0882	0.0980	0.0900	
% DIFF. IN F/A	?	0.530	0.807	-2.015	-1.404	-0.980	-0.945	-3.778	
AIR FLOW	LBS/HR	59.20	96.33	959.46	738.16	460.42	97.81	56.41	
FUEL FLOW	LBS/HR	5.26	9.18	81.54	60.76	41.03	9.18	5.28	
VADOP FLOW	LBS/HR	0.00914	0.01360	0.16007	0.11974	0.06901	0.01396	0.01837	
RELATIVE HUMIDITY	?	1.64	1.48	1.74	1.70	1.56	1.55	1.53	
BAROMETR	IN. HG.	29.22	29.22	29.22	29.22	29.22	29.22	29.22	
IND. AIR TEMP.	DEG. F	60.75	60.61	60.28	60.38	60.56	60.88	60.95	
MAX. CHT	DEG. F	263.91	278.41	403.31	475.79	338.35	250.14	223.54	
HC WET	PPM	34229.39	10451.04	1740.92	1670.86	2061.70	11127.11	36845.65	
NOX WET	PPM	5.62	16.57	321.41	520.49	147.41	14.88	5.00	
CO WET	%	7.5433	9.7433	6.4156	5.6246	8.0294	9.7559	7.4282	
CO2 WET	%	5.5965	6.7651	9.3049	9.6783	8.3398	7.1256	5.9034	
O2 WET	?	4.6091	0.8667	0.0704	0.0727	0.0758	0.3759	4.5466	
H2O CORRECTION	- - -	0.88750	0.87301	0.86889	0.86680	0.86777	0.87490	0.91075	
HC MASS/MODE	LB/MODE	0.01932	0.10809	0.00471	0.05740	0.05437	0.03061	0.02016	
NOX MASS/MODE	LB/MODE	0.00001	0.00056	0.00282	0.05793	0.01259	0.00013	0.00001	
CO MASS/MODE	LB/MODE	0.08415	1.99165	0.34314	3.81894	4.18468	0.53049	0.09033	
HC MODE/STD. CYCLE	?	6.355	35.556	1.550	18.881	17.883	10.070	6.631	
NOX MODE/STD. CYCLE	%	0.004	0.231	1.174	24.136	5.247	0.055	0.004	
CO MODE/STD. CYCLE	?	1.252	29.638	5.106	56.829	62.272	7.894	1.195	
HC EMISSION PER HP CYCLE =	0.00184 LB/HP CYCLE					PERCENT OF ALLOWABLE HC =	96.93		
NOX EMISSION PER HP CYCLE =	0.00046 LB/HP CYCLE					PERCENT OF ALLOWABLE NOX =	30.85		
CO EMISSION PER HP CYCLE =	0.06896 LB/HP CYCLE					PERCENT OF ALLOWABLE CO =	164.19		

TABLE IIh BASELINE CYCLE DATA

CYCLE NO: 1926

CELL-17

DATE 2/25/76

BASELINE FR, 25 BTDC, 59 DEG.F, 0% REL HUMIDITY

ENGINE - LYCOMING O-320-D1A0

ENGINE TIMING 25.000 DEG. BTDC

RATED H.P. 160.

H.C. RATIO 2.125

	UNITS	IDLE	TAXI	TAKE OFF	CLIMB	APPROACH	TAXI	IDLE
RUN NUMBER		1926	1927	1928	1929	1930	1931	1925
TIME IN MODE	MIN.	1.00	11.00	0.30	5.00	6.00	3.00	1.00
ENGINE SPEED	RPM	608.39	1199.16	2706.93	2438.70	2352.95	1209.18	601.44
OBS. HORSEPOWER	HP	0.50996	0.74321	154.38768	120.92256	64.53828	1.40672	0.19218
F/A RATIO MEAS.	- - -	0.0931	0.0924	0.0859	0.0806	0.0862	0.0917	0.0975
F/A RATIO CALC.	- - -	0.0938	0.0932	0.0819	0.0799	0.0858	0.0932	0.0919
% DIFF. IN F/A	%	0.731	0.871	-4.684	-0.891	-0.489	1.663	-5.858
AIR FLOW	LBS/HR	52.95	88.25	941.31	752.29	466.47	86.12	50.65
FUEL FLOW	LBS/HR	4.93	8.15	80.88	60.65	40.23	7.89	4.94
VAPOR FLOW	LBS/HR	0.02329	0.03678	0.45735	0.36249	0.21133	0.03909	0.02139
HUMIDITY GR H2O/LB DRY AIR		3.079	2.917	3.401	3.373	3.171	3.177	2.955
DEW POINT	DEG.F	-7.259	-7.975	-5.370	-5.275	-6.375	-6.355	-7.650
RELATIVE HUMIDITY	%	3.97	3.81	4.75	4.64	4.24	4.11	4.19
BAROMETER	IN.HG.	29.17	29.17	29.17	29.17	29.17	29.17	29.16
IND. AIR TEMP.	DEG.F	59.30	59.27	57.45	58.23	58.92	59.84	57.13
MAX. CHT	DEG.F	277.30	270.74	424.15	435.25	350.31	282.36	246.43
HC WET	PPM	32975.77	8210.81	1419.54	1372.54	1911.29	8736.87	33746.34
NOX WET	PPM	4.01	20.12	361.40	735.93	192.26	22.11	4.76
CO WET	%	8.1603	9.3801	6.5895	5.7355	7.8709	9.2250	8.0039
CO2 WET	%	6.8082	8.1982	10.4048	10.6701	9.3245	8.2382	6.9899
O2 WET	%	3.1400	0.3105	0.0981	0.1225	0.1437	0.2874	3.4941
H2O CORRECTION	- - -	0.87847	0.85559	0.86729	0.85315	0.85481	0.85254	0.90386
HC MASS/MODE	LB/MODE	0.01691	0.07700	0.00378	0.04776	0.05054	0.02175	0.01682
NOX MASS/MODE	LB/MODE	0.00001	0.00061	0.00312	0.08297	0.01647	0.00018	0.00001
CO MASS/MODE	LB/MODE	0.08272	1.73860	0.34708	3.94470	4.11348	0.45393	0.07885
HC MODE/STD. CYCLE	%	5.564	25.329	1.244	15.711	16.625	7.155	5.533
NOX MODE/STD. CYCLE	%	0.003	0.255	1.300	34.569	6.862	0.074	0.003
CO MODE/STD. CYCLE	%	1.231	25.872	5.165	58.701	61.212	6.755	1.173
HC EMISSION PER HP CYCLE =	0.00147 LB/HP CYCLE	PERCENT OF ALLOWABLE HC =			77.16			
NOX EMISSION PER HP CYCLE =	0.00065 LB/HP CYCLE	PERCENT OF ALLOWABLE NOX =			43.07			
CO EMISSION PER HP CYCLE =	0.06725 LB/HP CYCLE	PERCENT OF ALLOWABLE CO =			160.11			

TABLE II: BASELINE CYCLE DATA

CYCLE NO. 1941 CELL-17 DATE 2/26/76

BASELINE FR, 25 BTDC, 59 DEG.F, 0% REL HUMIDITY ENGINE - LYCOMING O-320-D1AD

ENGINE TIMING 25.000 DEG. BTDC RATED H.P. 160. H.C. RATIO 2.125

	UNITS	IDLE	TAXI	TAKE OFF	CLIMB	APPROACH	TAXI	IDLE
RUN NUMBER		1941	1942	1943	1944	1945	1947	1948
TIME IN MODE	MIN.	1.00	11.00	0.30	5.00	6.00	3.00	1.00
ENGINE SPEED	RPM	599.10	1203.60	2697.75	2428.80	2350.97	1201.92	614.22
OBS. HOP SEPOWER	HP	0.65796	0.89678	154.25876	118.94084	65.43564	1.30826	0.35544
F/A RATIO MEAS.		0.0981	0.0926	0.0840	0.0838	0.0869	0.0948	0.0952
F/A RATIO CALC.		0.0971	0.0973	0.0843	0.0825	0.0884	0.0970	0.0976
% DIFF. IN F/A	%	-1.060	4.993	0.455	-1.554	1.708	2.354	2.509
AIR FLOW	LBS/HR	50.47	87.96	949.68	747.90	470.12	85.02	52.42
FUEL FLOW	LBS/HR	4.95	8.15	79.73	62.68	40.88	8.06	4.99
VAPOR FLOW	LBS/HR	0.00254	0.00456	0.06610	0.03741	0.01856	0.00432	0.00318
HUMIDITY GR H2O/LB DRY AIR		0.352	0.363	0.487	0.350	0.276	0.355	0.424
DEW POINT	DEG.F	-28.757	-28.637	-27.557	-28.707	-29.332	-28.697	-28.117
RELATIVE HUMIDITY	%	0.43	0.46	0.66	0.47	0.37	0.45	0.52
BAROMETER	IN.HG.	29.04	29.04	29.04	29.03	29.03	29.03	29.03
IND.AIR TEMP.	DEG.F	60.82	60.32	58.67	58.71	59.09	60.19	60.99
MAX. CHT	DEG.F	275.25	270.06	417.41	430.77	344.08	282.61	250.69
HC WET	PPM	36023.57	8620.86	1593.76	1533.85	2030.20	8726.87	37107.67
NOX WET	PPM	3.11	17.91	350.76	618.46	184.32	16.35	0.74
CO WET	%	8.3884	9.5302	6.6078	6.0738	7.9046	9.5037	8.2235
CO2 WET	%	5.9303	6.9958	8.8485	9.2205	8.1062	7.1214	5.7773
O2 WET	%	3.3833	0.2392	0.0552	0.0909	0.0780	0.2165	3.4152
H2O CORRECTION		0.89610	0.85573	0.86365	0.87021	0.86113	0.86383	0.88535
HC MASS/MODE	LB/MODE	0.01791	0.08063	0.00425	0.05368	0.05423	0.02168	0.01898
NOX MASS/MODE	LB/MODE	0.00001	0.00054	0.00303	0.07013	0.01595	0.00013	0.00000
CO MASS/MODE	LB/MODE	0.08244	1.76172	0.34845	4.20156	4.17281	0.46667	0.08312
HC MODE/STD.CYCLE	%	5.893	26.523	1.399	17.660	17.837	7.132	6.242
NOX MODE/STD.CYCLE	%	0.002	0.226	1.263	29.219	6.645	0.055	0.001
CO MODE/STD.CYCLE	%	1.227	26.216	5.185	62.523	62.095	6.944	1.237
HC EMISSION PER HP CYCLE =	0.00157 LB/HP CYCLE	PERCENT OF ALLOWABLE HC =		82.69				
NOX EMISSION PER HP CYCLE =	0.00056 LB/HP CYCLE	PERCENT OF ALLOWABLE NOX =		37.41				
CO EMISSION PER HP CYCLE =	0.06948 LB/HP CYCLE	PERCENT OF ALLOWABLE CO =		165.43				
ERR2 = 1 NO DATA PRESENT FOR RDG. =***								

34

TABLE III. BASELINE CYCLE DATA

CYCLE NO. 734 CELL-17 DATE 1/ 8/75

TIMING 15 BTDC

ENGINE - LYCOMING O-320-DIAD

ENGINE TIMING 15.000 DEG. BTDC RATED H.P. 160. H.C. RATIO 2.125

	UNITS	IDLE	TAXI	TAKE OFF	CLIMB	APPROACH	TAXI	IDLE
RUN NUMBER		734	735	736	737	738	739	740
TIME IN MODE	MIN.	1.00	11.00	0.30	5.00	6.00	3.00	1.00
ENGINE SPEED	PPM	608.82	1205.34	2709.15	2435.58	2350.37	1196.76	586.56
OBS. HORSPPOWER	HP	0.62263	1.24585	139.73686	119.75404	65.20992	1.80639	0.82904
F/A RATIO MFAS.	- - -	0.0959	0.1056	0.0845	0.0835	0.0855	0.1052	0.0968
F/A RATIO CALC.	- - -	0.0960	0.1048	0.0839	0.0858	0.0858	0.1049	0.0969
% DIFF. IN F/A	?	0.179	-0.746	-0.711	2.750	0.352	-0.287	0.075
AIR FLOW	LBS/HR	61.56	114.45	965.08	866.05	511.49	106.82	56.65
FUEL FLOW	LBS/HR	5.90	12.08	81.57	72.33	43.72	11.73	5.49
VAPOR FLOW	LBS/HR	0.01066	0.01945	0.18691	0.16191	0.08561	0.01791	0.00954
RELATIVE HUMIDITY	?	1.77	1.76	2.04	1.99	1.77	1.76	1.77
BAROMETER	IN.HG.	29.25	29.25	29.25	29.25	29.25	29.25	29.25
IND.AIR TEMP.	DEG.F	59.85	59.84	59.84	59.92	60.01	60.10	60.08
MAX. CHT	DEG.F	260.29	285.31	420.71	427.56	350.67	303.18	249.58
HC WFT	PPM	21398.11	13274.31	1371.64	1476.35	1581.36	12220.21	27358.97
NOX WFT	PPM	0.98	4.81	137.99	254.99	84.90	2.82	0.62
CO WET	%	8.8542	11.0714	6.4382	6.9955	7.0035	10.9930	8.5497
CO2 WET	%	6.3978	6.2157	8.9607	8.5419	8.5789	6.3499	6.3253
O2 WET	?	1.9283	0.3686	0.0040	0.0018	0.0135	0.1334	2.3212
H2O CORRECTION	- - -	0.88345	0.88122	0.86727	0.85637	0.86473	0.87799	0.88595
HC MASS/MODE	LB/MODE	0.01288	0.16888	0.00373	0.05978	0.04571	0.03952	0.01571
NOX MASS/MODE	LB/MODE	0.00000	0.00020	0.00121	0.03345	0.00795	0.00003	0.00000
CO MASS/MODE	LB/MODE	0.10534	2.78383	0.34578	5.59817	4.00103	0.70265	0.09393
HC MODE/STD.CYCLE	%	4.237	55.552	1.226	19.664	15.036	13.000	5.003
NOX MODE/STD.CYCLE	%	0.001	0.083	0.506	13.936	3.313	0.012	0.000
CO MODE/STD.CYCLE	%	1.568	41.426	5.146	83.306	59.539	10.456	1.398
HC EMISSION PER HP CYCLE =	0.00216 LB/HP CYCLE			PERCENT OF ALLOWABLE HC =	113.72			
NOX EMISSION PER HP CYCLE =	0.00027 LB/HP CYCLE			PERCENT OF ALLOWABLE NOX =	17.85			
CO EMISSION PER HP CYCLE =	0.08519 LB/HP CYCLE			PERCENT OF ALLOWABLE CO =	202.84			

35

ORIGINAL PAGE IS OF POOR QUALITY

TABLE IIIa. IGNITION TIMING, 15° BTDC

(A)

CYCLE NO. 742

CELL-17

DATE 1/ 8/75

TIMING 15 BTDC

ENGINE - LYCOMING O-320-DIAD

ENGINE TIMING 15.000 DEG. BTDC RATED H.P. 160. H.C. RATIO 2.125

	UNITS	IDLE	TAXI	TAKE OFF	CLIMB	APPROACH	TAXI	IDLE
PUN NUMBER		742	743	744	745	746	747	748
TIME IN MODE	MIN.	1.00	11.00	0.30	5.00	6.00	3.00	1.00
ENGINE SPEED	RPM	590.76	1202.22	2710.11	2429.64	2353.58	1202.22	605.74
CRS. HORSEPOWER	HP	0.57265	1.45742	141.53168	118.17441	64.35333	1.67078	0.15597
F/A RATIO MEAS.	- - -	0.0965	0.1059	0.0846	0.0842	0.0864	0.1019	0.1002
F/A RATIO CALC.	- - -	0.0961	0.1054	0.0840	0.0857	0.0858	0.1041	0.0954
% DIFF. IN F/A	"	-0.351	-0.471	-0.650	1.809	-0.722	2.209	-4.792
AIP FLOW	LBS/HR	60.67	114.30	963.16	860.33	504.69	106.35	59.65
FUEL FLOW	LBS/HR	5.85	12.11	81.46	72.44	43.62	10.83	5.98
VAPOR FLOW	LBS/HR	0.01045	0.02020	0.18485	0.16202	0.08336	0.01760	0.00992
RELATIVE HUMIDITY	%	1.80	1.84	2.03	2.00	1.74	1.74	1.74
BAROMETER	IN.HG.	29.25	29.25	29.25	29.25	29.26	29.26	29.26
IND. AIR TEMP.	DEG.F	59.99	59.92	59.84	60.00	60.11	60.13	60.02
MAX. CHT	DEG.F	223.65	270.42	431.93	431.18	350.02	318.47	229.19
HC WET	PPM	24228.66	13886.38	1317.23	1455.52	1540.15	12197.21	24127.39
NOX WET	PPM	1.04	5.31	116.77	272.33	84.01	4.69	1.31
CO WET	%	8.5776	10.9983	6.5148	6.9955	7.1169	10.7873	8.6637
CO2 WET	%	6.4385	6.1867	8.8739	8.5792	8.5638	6.3438	6.4763
O2 WET	%	2.0829	0.3164	0.0401	0.0056	0.0056	0.1988	2.2244
H2O CORRECTION	- - -	0.88598	0.88084	0.86761	0.85945	0.86840	0.86976	0.90193
HC MASS/MODE	LB/MODE	0.01441	0.17664	0.00357	0.05869	0.04408	0.03884	0.01429
NOX MASS/MODE	LB/MODE	0.00000	0.00022	0.00103	0.03558	0.00779	0.00005	0.00000
CO MASS/MODE	LB/MODE	0.10080	2.76501	0.34926	5.57536	4.02616	0.67899	0.10138
HC MODE/STD.CYCLE	%	4.739	58.104	1.175	19.307	14.501	12.778	4.699
NOX MODE/STD.CYCLE	%	0.001	0.091	0.428	14.823	3.246	0.020	0.001
CO MODE/STD.CYCLE	%	1.500	41.146	5.197	82.967	59.913	10.104	1.509
HC EMISSION PER HP CYCLE =	0.00219 LB/HP CYCLE				PERCENT OF ALLOWABLE HC =	115.30		
NOX EMISSION PER HP CYCLE =	0.00078 LB/HP CYCLE				PERCENT OF ALLOWABLE NOX =	18.61		
CO EMISSION PER HP CYCLE =	0.08498 LB/HP CYCLE				PERCENT OF ALLOWABLE CO =	202.34		

36

TABLE IIIb. IGNITION TIMING, 15° BTDC

CYCLE NO. 816 CELL-17 DATE 1/12/75

TIMING 15 BTDC CHT300

ENGINE - LYCOMING O-320-DIAD

ENGINE TIMING 15.000 DEG. BTDC RATED H.P. 160. H.C. RATIO 2.125

	UNITS	IDLE	TAXI	TAKE OFF	CLIMB	APPROACH	TAXI	IDLE
RUN NUMBER		816	817	818	819	820	821	822
TIME IN MODE	MIN.	1.00	11.00	0.30	5.00	6.00	3.00	3.00
ENGINE SPEED	RPM	595.38	1200.66	2707.53	2430.69	2357.27	1210.44	585.96
CRS. HORSEPOWER	HP	0.48525	1.27698	136.49146	119.40184	66.08980	1.15835	0.62673
F/A RATIO MEAS.	- - -	0.0892	0.1003	0.0840	0.0846	0.0853	0.1036	0.0900
F/A RATIO CALC.	- - -	0.0882	0.1014	0.0849	0.0885	0.0866	0.1059	0.0923
% DIFF. IN F/A	%	-1.058	1.015	1.068	4.553	1.513	2.174	2.527
AIR FLOW	LBS/HR	64.51	115.18	964.19	875.15	513.12	105.92	59.76
FUEL FLOW	LBS/HR	5.75	11.56	81.00	74.04	43.77	10.98	5.38
VAPOR FLOW	LBS/HR	0.01826	0.03246	0.30736	0.28024	0.14730	0.03120	0.01832
RELATIVE HUMIDITY	%	2.89	2.95	3.39	3.41	3.01	3.06	3.18
BAROMETER	IN. HG.	29.22	29.22	29.22	29.22	29.22	29.22	29.21
IND. AIR TEMP.	DEG. F	63.01	62.23	60.26	60.21	60.71	61.62	62.43
MAX. CHT	DEG. F	266.56	284.01	417.90	417.33	381.51	301.14	229.78
HC WFT	PPM	20743.06	11877.18	1223.92	1588.66	1600.36	11745.16	25446.52
NOX WFT	PPM	8.81	13.55	221.13	246.06	116.01	8.27	4.32
CO WFT	%	7.9754	10.2811	6.2376	7.1857	6.6731	10.4742	7.7028
CO2 WFT	%	5.1702	5.2467	7.8476	7.2860	7.5667	5.5939	5.3356
O2 WFT	%	3.6788	1.2253	0.0847	0.0733	0.0966	0.2950	3.2133
H2O CORRECTION	- - -	0.90691	0.89089	0.87462	0.86485	0.87417	0.88158	0.89324
HC MASS/MODE	LB/MODE	0.01278	0.14945	0.00332	0.06527	0.04638	0.03748	0.04370
NOX MASS/MODE	LB/MODE	0.00002	0.00055	0.00194	0.03275	0.01089	0.00009	0.00002
CO MASS/MODE	LB/MODE	0.09709	2.55678	0.33409	5.83514	3.82240	0.66062	0.26142
HC MODE/STD. CYCLE	%	4.203	49.160	1.091	21.471	15.257	12.329	14.374
NOX MODE/STD. CYCLE	%	0.007	0.230	0.809	13.647	4.538	0.036	0.010
CO MODE/STD. CYCLE	%	1.445	38.047	4.972	86.832	56.881	9.831	3.890
HC EMISSION PER HP CYCLE =	0.00224 LB/HP CYCLE				PERCENT OF ALLOWABLE HC =	117.88		
NOX EMISSION PER HP CYCLE =	0.00029 LB/HP CYCLE				PERCENT OF ALLOWABLE NOX =	19.28		
CO EMISSION PER HP CYCLE =	0.08480 LB/HP CYCLE				PERCENT OF ALLOWABLE CO =	201.90		

37

TABLE IIIc. IGNITION TIMING, 15⁰ BTDC

CYCLE NO. 894		CELL-17		DATE 1/14/75				
15 BTDC			ENGINE - LYCOMING O-320-D1AD					
ENGINE TIMING		15.000 DEG. BTDC		RATED H.P. 160.		H.C. RATIO 2.125		
	UNITS	IDLE	TAXI	TAKE OFF	CLIMB	APPROACH	TAXI	IDLE
RUN NUMBER		894	896	897	898	899	901	902
TIME IN MODE	MIN.	1.00	11.00	0.30	5.00	5.00	3.00	1.00
ENGINE SPEED	RPM	608.94	1235.04	2698.17	2428.08	2358.05	1211.16	586.80
GROSS HORSEPOWER	HP	0.81210	1.09074	137.68324	116.16975	65.56764	1.35530	0.48289
F/A RATIO MEAS.	- - -	0.0882	0.1024	0.0845	0.0841	0.0847	0.1008	0.0904
F/A RATIO CALC.	- - -	0.0921	0.1036	0.0835	0.0855	0.0850	0.1043	0.0930
% DIFF. IN F/A	%	4.423	1.226	-1.154	1.703	0.322	3.504	2.944
AIR FLOW	LBS/HR	68.15	116.22	963.71	856.38	517.55	118.18	63.95
FUEL FLOW	LBS/HR	6.01	11.90	81.39	72.00	43.84	11.91	5.78
VAPOR FLOW	LBS/HR	0.01954	0.03312	0.30966	0.27214	0.14982	0.03411	0.01905
RELATIVE HUMIDITY	%	2.96	2.94	3.33	3.28	2.99	2.97	3.05
BAROMETER	IN. HG.	29.30	29.30	29.30	29.30	29.30	29.30	29.30
IND. AIR TEMP.	DEG. F	62.16	61.87	60.88	61.09	61.40	62.21	52.91
MAX. CHT	-DEG. F	259.99	280.28	406.70	409.11	348.61	308.73	247.06
HC WET	PPM	21810.16	12914.28	1346.83	1404.54	1484.85	12415.23	25173.48
NOX WET	PPM	3.28	8.39	148.47	293.96	96.33	11.12	7.56
CO WET	%	8.5383	10.9707	5.2803	7.0308	6.8466	10.9454	8.3837
CO2 WET	%	5.9524	6.1773	9.1389	8.6736	8.7529	6.1709	6.0485
O2 WET	%	2.8653	0.4951	0.0138	0.0255	0.0370	0.3556	2.9412
H2O CORRECTION	- - -	0.87448	0.87510	0.86711	0.85835	0.86333	0.86676	0.87025
HC MASS/MODE	LB/MODE	0.01414	0.16510	0.00365	0.05636	0.04331	0.04378	0.01544
NOX MASS/MODE	LB/MODE	0.00001	0.00035	0.00131	0.03821	0.00910	0.00013	0.00002
CO MASS/MODE	LB/MODE	0.10944	2.74677	0.34213	5.57601	3.94698	0.76285	0.10162
HC MODE/STD. CYCLE	%	4.653	54.310	1.202	18.539	14.247	14.402	5.078
NOX MODE/STD. CYCLE	%	0.003	0.145	0.544	15.922	3.793	0.053	0.006
CO MODE/STD. CYCLE	%	1.629	40.875	5.091	82.976	58.735	11.352	1.512
HC EMISSION PER HP CYCLE =	0.00214 LB/HP CYCLE	PERCENT OF ALLOWABLE HC =				112.43		
NOX EMISSION PER HP CYCLE =	0.00031 LB/HP CYCLE	PERCENT OF ALLOWABLE NOX =				20.47		
CO EMISSION PER HP CYCLE =	0.08491 LB/HP CYCLE	PERCENT OF ALLOWABLE CO =				202.17		

TABLE III d. IGNITION TIMING, 15° BTDC

CYCLE NO. 905

CELL-17

DATE 1/15/75

TIMING 20 BTDC

ENGINE - LYCOMING O-320-DIAD

ENGINE TIMING	20.000	DEG.	BTDC	RATED H.P.	160.	H.C. RATIO	2.125		
	UNITS	IDLE	TAXI	TAKE OFF	CLIMB	APPROACH	TAXI	IDLE	
RUN NUMBER		905	906	907	908	909	910	911	
TIME IN MODE	MIN.	1.00	11.00	0.30	5.00	6.00	3.00	1.00	
ENGINE SPEED	RPM	584.16	1197.30	2708.01	2434.80	2359.19	1207.92	613.68	
BS. HOPSPPOWER	HP	0.75984	1.42137	149.73727	120.84033	66.31520	1.78547	0.52929	
F/A RATIO MEAS.	- - -	0.0930	0.1032	0.0851	0.0824	0.0881	0.0992	0.0943	
F/A RATIO CALC.	- - -	0.0906	0.1015	0.0827	0.0814	0.0858	0.0993	0.0891	
% DIFF. IN F/A	%	-2.507	-1.687	-2.754	-1.274	-2.592	0.114	-5.486	
AIR FLOW	LBS/HR	62.07	110.13	950.37	786.85	489.48	93.97	60.71	
FUEL FLOW	LBS/HR	5.77	11.37	80.85	64.84	43.12	9.32	5.72	
VAPOR FLOW	LBS/HR	0.03139	0.05176	0.41896	0.30359	0.16556	0.02914	0.01778	
RELATIVE HUMIDITY	%	5.08	4.75	4.53	4.01	3.48	3.17	2.98	
BAROMETER	IN. HG.	29.32	29.32	29.32	29.32	29.31	29.31	29.31	
IND. AIR TEMP.	DEG. F	61.82	61.58	60.58	60.75	61.11	61.91	62.38	
MAX. CHT	DEG. F	210.49	233.68	399.98	411.06	525.91	314.00	222.35	
HC WFT	PPM	2769.73	13603.35	1482.75	1426.44	1739.47	9738.97	28271.81	39
NOX WFT	PPM	8.76	14.20	280.03	674.63	164.97	15.60	5.95	
CO WFT	%	8.2154	10.7935	6.3615	5.8480	7.4280	10.2707	8.1512	
CO2 WFT	%	6.0231	6.4156	9.3906	9.6196	8.7992	6.8951	5.9939	
O2 WFT	%	3.6603	0.7679	0.1145	0.1196	0.1269	0.2840	4.0386	
H2O CORRECTION	- - -	0.90057	0.88270	0.87073	0.86557	0.87140	0.87169	0.91328	
HC MASS/MODE	LB/MODE	0.01664	0.16528	0.00398	0.05226	0.04859	0.02716	0.01669	
NOX MASS/MODE	LB/MODE	0.00002	0.00056	0.00243	0.08008	0.01493	0.00014	0.00001	
CO MASS/MODE	LB/MODE	0.09757	2.58948	0.33721	4.23492	4.10114	0.56617	0.09513	
HC MODE/STD. CYCLE	%	5.474	54.368	1.308	17.192	15.984	8.936	5.491	
NOX MODE/STD. CYCLE	%	0.007	0.233	1.014	33.365	6.221	0.059	0.005	
CO MODE/STD. CYCLE	%	1.452	38.534	5.018	63.018	61.029	8.425	1.416	
HC EMISSION PER HP CYCLE *	0.00207 LB/HP CYCLE	PERCENT OF ALLOWABLE HC =				108.75			
NOX EMISSION PER HP CYCLE *	0.00061 LB/HP CYCLE	PERCENT OF ALLOWABLE NOX =				40.90			
CO EMISSION PER HP CYCLE *	0.07513 LB/HP CYCLE	PERCENT OF ALLOWABLE CO =				178.89			

TABLE IVa. IGNITION TIMING, 20° BTDC

ORIGINAL PAGE IS
OF POOR QUALITY

CYCLE NO. 912 CELL-17 DATE 1/15/75

TIMING 20 BTDC

ENGINE - LYCOMING O-320-D1AD

ENGINE TIMING 20.000 DEG. BTDC RATED H.P. 160. H.C. RATIO 2.125

	UNITS	IDLE	TAXI	TAKE OFF	CLIMB	APPROACH	TAXI	IDLE	
RUN NUMBER		912	913	914	915	917	918	920	
TIME IN MODE	MIN.	1.00	11.00	0.30	5.00	6.00	3.00	1.00	
ENGINE SPEED	RPM	616.86	1204.02	2703.69	2432.52	2358.77	1706.78	589.32	
OBS. HORSEPOWER	HP	0.52689	1.47638	147.49088	120.15056	66.36600	1.17736	0.98368	
F/A RATIO MEAS.	- - -	0.0960	0.0972	0.0855	0.0824	0.0874	0.1043	0.0932	
F/A RATIO CALC.	- - -	0.0938	0.0977	0.0834	0.0817	0.0859	0.1006	0.0885	
% DIFF. IN F/A	%	-2.315	0.486	-2.493	-0.768	-1.695	-3.601	-5.038	
AIR FLOW	LB/HR	57.15	97.76	950.29	796.69	488.01	103.97	51.28	
FUEL FLOW	LB/HR	5.49	9.50	81.28	65.63	42.65	10.85	5.71	
VAPOR FLOW	LB/HR	0.01567	0.02613	0.27408	0.21743	0.11851	0.02400	0.01417	
RELATIVE HUMIDITY	"	2.81	2.75	2.75	2.86	2.50	2.37	2.36	
BAROMETER	IN. HG.	29.30	29.30	29.30	29.29	29.28	29.29	29.28	
IND. AIR TEMP.	DEG. F	62.23	62.04	62.43	60.89	61.32	62.47	53.31	
MAX. CHT	DEG. F	323.66	288.44	428.04	421.57	339.62	219.64	178.50	
HC WFT	PPM	29286.90	9884.98	1411.44	1403.04	1719.67	12684.26	28841.85	40
NOX WFT	PPM	5.82	16.16	210.20	591.06	147.97	9.39	3.24	
CO WFT	%	8.7198	10.1012	6.5459	5.9592	7.4426	10.5424	7.8610	
CO2 WFT	%	5.8379	6.7762	9.2326	9.5089	8.6758	6.7327	6.1045	
O2 WFT	%	3.4897	0.6315	0.0843	0.1094	0.1571	0.5484	4.0479	
H2O CORRECTION	- - -	0.90055	0.87253	0.87059	0.86428	0.86931	0.88694	0.91136	
HC MASS/MODE	LB/MODE	0.01638	0.10444	0.00379	0.05204	0.04777	0.03982	0.01712	
NOX MASS/MODE	LB/MODE	0.00001	0.00055	0.00183	0.07102	0.01332	0.00010	0.00001	
CO MASS/MODE	LB/MODE	0.09637	2.10925	0.34752	4.36849	4.08591	0.65417	0.09224	
HC MODE/STD. CYCLE	%	5.387	34.354	1.247	17.118	15.713	13.100	5.632	
NOX MODE/STD. CYCLE	%	0.004	0.230	0.762	29.592	5.548	0.040	0.003	
CO MODE/STD. CYCLE	%	1.434	31.388	5.171	65.007	60.802	9.735	1.373	
HC EMISSION PER HP CYCLE =	0.00176 LB/HP CYCLE	PERCENT OF ALLOWABLE HC =		92.55					
NOX EMISSION PER HP CYCLE =	0.00054 LB/HP CYCLE	PERCENT OF ALLOWABLE NOX =		36.18					
CO EMISSION PER HP CYCLE =	0.07346 LB/HP CYCLE	PERCENT OF ALLOWABLE CO =		174.91					

TABLE IVb. IGNITION TIMING, 20° BTDC

CYCLE NO. 921

CELL-17

DATE 1/15/75

TIMING 20 BTDC

ENGINE - LYCOMING O-320-DIAD

ENGINE TIMING	20.000 DEG. BTDC	RATED H.P. 160.			H.C. RATIO 2.125			
	UNITS	IDLE	TAXI	TAKE OFF	CLIMB	APPROACH	TAXI	IDLE
RUN NUMBER		921	922	923	924	925	926	930
TIME IN MODE	MIN.	1.00	11.00	0.30	5.00	6.00	3.00	1.00
ENGINE SPEED	PPM	593.94	1198.86	2706.63	2428.50	2356.61	1712.66	588.42
CRS. HORSEPOWER	HP	0.37387	2.24260	14.59322	118.67082	66.00064	2.04180	0.18688
F/A RATIO MEAS.	- - -	0.0922	0.0995	0.0866	0.0807	0.0854	0.0953	0.0900
F/A RATIO CALC.	- - -	0.0915	0.0982	0.0829	0.0814	0.0860	0.0984	0.0909
% DIFF. IN F/A	%	-0.816	-1.377	-4.199	0.975	0.710	3.263	1.037
AIR FLOW	LBS/HR	59.57	95.88	941.30	798.09	491.57	95.35	62.24
FUEL FLOW	LBS/HR	5.49	9.54	81.49	64.37	41.98	9.09	5.60
VAPOR FLOW	LBS/HR	0.01323	0.02187	0.24619	0.19358	0.10915	0.02077	0.01803
RELATIVE HUMIDITY	%	2.26	2.29	2.66	2.57	2.31	2.25	2.92
BAROMETER	IN. HG.	29.28	29.28	29.28	29.28	29.27	29.27	29.11
IND. AIR TEMP.	DEG. F	62.92	62.60	60.89	60.92	61.42	62.71	63.27
MAX. CHT	DEG. F	256.44	257.81	406.92	422.27	337.81	285.97	239.88
HC WFT	PPM	29236.91	10341.03	1370.94	1358.13	1674.07	9425.93	29851.95
NOX WFT	PPM	3.29	13.89	237.95	584.46	165.21	16.03	5.15
CO WFT	%	8.2299	10.2039	6.4366	5.7973	7.2943	10.0173	7.8078
CO2 WFT	%	5.8292	6.8088	9.3952	9.5229	8.6453	6.8128	5.5422
O2 WFT	%	3.7625	0.6000	0.0832	0.0928	0.0761	0.3880	3.9086
H2O CORRECTION	- - -	0.89686	0.87879	0.87622	0.85826	0.86112	0.86218	0.89515
HC MASS/MODE	LB/MODE	0.01681	0.10802	0.00366	0.05013	0.04649	0.02631	0.01779
NOX MASS/MODE	LB/MODE	0.00001	0.00047	0.00202	0.06989	0.01486	0.00015	0.00001
CO MASS/MODE	LB/MODE	0.09354	2.10653	0.31977	4.22962	4.00405	0.55273	0.09199
HC MODE/STD. CYCLE	%	5.530	35.531	1.204	16.492	15.294	8.656	5.853
NOX MODE/STD. CYCLE	%	0.003	0.196	0.840	29.122	6.194	0.060	0.004
CO MODE/STD. CYCLE	%	1.392	31.347	5.056	62.941	59.684	8.225	1.369
HC EMISSION PER HP CYCLE =	0.00168 LB/HP CYCLE	PERCENT OF ALLOWABLE HC =			88.56			
NOX EMISSION PER HP CYCLE =	0.00055 LB/HP CYCLE	PERCENT OF ALLOWABLE NOX =			36.42			
CO EMISSION PER HP CYCLE =	0.07136 LB/HP CYCLE	PERCENT OF ALLOWABLE CO =			169.91			

TABLE IVc IGNITION TIMING, 20° BTDC

CYCLE NO. 1105		CELL-17	DATE 1/23/76						
BASELINE FR 30 BTDC					ENGINE - LYCOMING O-320-DIAD				
ENGINE TIMING		30.000 DEG. BTDC	RATED H.P. 160.		H.C. RATIO 2.125				
	UNITS	IDLE	TAXI	TAKE OFF	CLIMB	APPROACH	TAXI	IDLE	
PUM NUMBER		1105	1180	1181	1182	1183	1186	1101	
TIME IN MODE	MIN.	1.00	11.00	0.30	5.00	6.00	3.00	1.00	
ENGINE SPEED	RPM	600.96	1201.44	2704.47	2429.40	2348.81	1200.78	601.74	
CRS. HORSEPOWER	HP	0.38076	0.97019	157.07390	119.19603	64.70592	1.22528	0.42010	
MANIFOLD PRESS.	IN.HG.	0.00	0.00	0.00	0.00	0.00	0.00	0.00	
F/A RATIO MEAS.	- - -	0.0868	0.0933	0.0831	0.0811	0.0894	0.0941	0.0908	
F/A RATIO CALC.	- - -	0.0900	0.0962	0.0842	0.0822	0.0899	0.0951	0.0859	
% DIFF. IN F/A	%	3.639	3.118	1.325	1.473	0.561	1.135	-4.284	
AIR FLOW	LBS/HR	61.97	87.66	961.41	742.12	457.62	81.77	54.13	
FUEL FLOW	LBS/HR	5.37	8.18	79.88	60.15	40.89	7.69	4.92	
VAPOR FLOW	LBS/HR	0.01510	0.03442	0.42050	0.29742	0.16836	0.03131	0.00998	
HUMIDITY GR H2O/1B DRY AIR		0.000	0.000	0.000	0.000	0.000	0.000	0.000	
DEW POINT	DEG.F	0.000	0.000	0.000	0.000	0.000	0.000	0.000	
RELATIVE HUMIDITY	%	2.47	3.93	4.43	4.03	3.68	3.57	1.82	
BAROMETR	IN.HG.	28.74	29.12	29.11	29.11	29.11	29.11	29.72	
IND. AIR PRESS.	IN.HG.	0.00	0.00	0.00	0.00	0.00	0.00	0.00	
IND. AIR TEMP.	DEG.F	62.39	64.99	62.02	62.13	62.59	64.90	62.38	
MAX. CHT	DEG.F	281.19	252.11	427.95	437.48	346.92	273.61	281.49	
HC WET	PPM	41030.07	7911.79	1459.14	1405.44	2025.10	7728.77	38985.86	†
NOX WET	PPM	3.11	23.65	426.35	699.63	207.47	22.38	2.92	
CO WET	%	7.6336	9.4901	6.6647	6.0410	8.5243	9.2800	7.3878	
CO2 WET	%	4.4992	7.1011	8.7415	9.3401	7.7920	7.2094	5.1182	
O2 WET	%	5.8320	0.2852	0.1359	0.1783	0.1813	0.3400	5.8226	
H2O CORRECTION	- - -	0.89991	0.86081	0.86083	0.86045	0.86595	0.86765	0.92276	
HC MASS/MODE	LB/MODE	0.02403	0.07395	0.00393	0.04832	0.05313	0.01843	0.02027	
NOX MASS/MODE	LB/MODE	0.000006	0.000716	0.003720	0.077926	0.017635	0.000173	0.000005	
CO MASS/MODE	LB/MODE	0.08838	1.75318	0.35475	4.10501	4.42042	0.43729	0.07593	
HC MODE/STD.CYCLE	%	7.906	24.326	1.293	15.895	17.478	6.062	6.559	
NOX MODE/STD.CYCLE	%	0.002	0.298	1.550	32.469	7.348	0.072	0.002	
CO MODE/STD.CYCLE	%	1.315	26.089	5.279	61.086	65.780	6.507	1.130	
HC EMISSION PER HP CYCLE =	0.00151 LB/HP CYCLE	PERCENT OF ALLOWABLE HC =				79.63			
NOX EMISSION PER HP CYCLE =	0.00063 LB/HP CYCLE	PERCENT OF ALLOWABLE NOX =				41.74			
CO EMISSION PER HP CYCLE =	0.07022 LB/HP CYCLE	PERCENT OF ALLOWABLE CO =				167.19			

TABLE V a. IGNITION TIMING, 30° BTDC

CYCLE NO. 1190

CELL-17

DATE 2/ 9/75

30 BTDC

ENGINE - LYCOMING O-320-DIAD

ENGINE TIMING 30.000 DEG. BTDC

RATED H.P. 160.

H.C. RATIO 2.125

UNITS		IDLE	TAXI	TAKOFF	CLIMB	APPROACH	TAXI	IDLE
RUN NUMBER		1190	1191	1192	1193	1194	1195	1198
TIME IN MODE	MIN.	1.00	11.00	0.30	5.00	6.00	3.00	1.00
ENGINE SPEED	RPM	589.62	1200.42	2703.93	2429.28	2352.35	1200.96	615.60
OBS. HCPSEPOWER	HP	0.44928	1.11425	156.55890	119.10829	66.04071	0.84031	0.55616
F/A RATIO MEAS.	- - -	0.0905	0.0935	0.0842	0.0819	0.0876	0.0942	0.0889
F/A RATIO CALC.	- - -	0.0919	0.0950	0.0842	0.0819	0.0893	0.0951	0.0913
% DIFF. IN F/A	%	1.578	1.535	-0.055	-0.000	1.911	0.909	2.682
AIR FLOW	LBS/HR	49.04	80.51	960.46	735.58	464.35	77.77	51.15
FUEL FLOW	LBS/HR	4.44	7.53	80.90	60.23	40.68	7.33	4.55
VAPOR FLOW	LBS/HR	0.01790	0.02973	0.38807	0.28233	0.16058	0.02713	0.01899
RELATIVE HUMIDITY	%	3.75	3.73	4.11	3.90	3.47	3.58	3.72
BAROMETER	IN.HG.	29.12	29.12	29.12	29.12	29.11	29.12	29.11
IND.AIR TEMP.	DEG.F	65.22	64.72	61.83	62.05	62.65	63.25	65.29
MAX. CHT	DEG.F	258.05	276.99	446.31	441.77	352.55	305.28	257.14
HC WET	PPM	33004.27	7548.75	1442.64	1393.84	2037.50	8454.84	32193.19
NOX WET	PPM	5.99	26.14	412.84	728.53	215.52	25.73	5.90
CO WET	%	7.3199	9.1091	6.6149	5.8757	8.2115	8.8526	7.2500
CO2 WET	%	6.2756	7.2970	8.7707	9.1569	7.8432	7.2278	6.2342
O2 WET	%	3.4856	0.2404	0.1118	0.1439	0.1501	0.2558	3.5118
H2O CORRECTION	- - -	0.88569	0.86581	0.86591	0.86566	0.86174	0.87012	0.88230
HC MASS/MODE	LB/MODE	0.01553	0.06485	0.00390	0.04765	0.05390	0.01918	0.01571
NOX MASS/MODE	LB/MODE	0.00001	0.00073	0.00361	0.08068	0.01847	0.00019	0.00001
CO MASS/MODE	LB/MODE	0.06807	1.54658	0.35432	3.96999	4.29308	0.39697	0.06993
HC MODE/STD.CYCLE	%	5.108	21.331	1.282	15.674	17.729	6.310	5.168
NOX MODE/STD.CYCLE	%	0.004	0.303	1.506	33.618	7.695	0.079	0.004
CO MODE/STD.CYCLE	%	1.013	23.015	5.273	59.077	63.885	5.907	1.041
HC EMISSION PER HP CYCLE =	0.00138 LB/HP CYCLE	PERCENT OF ALLOWABLE HC =		72.60				
NOX EMISSION PER HP CYCLE =	0.00065 LB/HP CYCLE	PERCENT OF ALLOWABLE NOX =		43.21				
CO EMISSION PER HP CYCLE =	0.06687 LB/HP CYCLE	PERCENT OF ALLOWABLE CO =		159.21				

43

ORIGINAL PAGE IS
OF POOR QUALITY

TABLE V b. IGNITION TIMING, 30° BTDC

CYCLE NO. 1178

CELL-17

DATE 2/ 9/75

30 BTDC

ENGINE - LYCOMING O-320-D1AD

ENGINE TIMING	30.000 DEG. BTDC	RATED H.P. 160.			H.C. RATIO 2.125			
UNITS	IDLE	TAXI	TAKF OFF	CLIMB	APPROACH	TAXI	IDLE	
RUN NUMBER	1178	1180	1181	1182	1183	1186	1187	
TIME IN MODE	1.00	11.00	0.30	5.00	6.00	3.00	1.00	
ENGINE SPEED	581.98	1201.44	2704.47	2429.40	2348.81	1200.78	611.76	
CRS. HPPSEPOWER	0.77673	0.87019	157.07390	119.19603	64.70592	1.22528	0.49228	
F/A RATIO MFAS.	0.0966	0.0933	0.0831	0.0811	0.0894	0.0941	0.0913	
F/A RATIO CALC.	0.0924	0.0962	0.0842	0.0822	0.0899	0.0951	0.0927	
% DIFF. IN F/A	-4.340	3.118	1.325	1.473	0.561	1.135	1.587	
AIR FLOW	46.17	87.66	961.41	742.12	457.62	81.77	50.03	
FUEL FLOW	4.46	8.18	79.88	60.15	40.89	7.69	4.57	
VAPOR FLOW	0.01812	0.03442	0.42050	0.29742	0.16836	0.03131	0.01929	
RELATIVE HUMIDITY	4.12	3.93	4.43	4.03	3.68	3.67	3.77	
BAROMETER	29.15	29.12	29.11	29.11	29.11	29.11	29.11	
IND. AIR TEMP.	64.61	64.99	62.02	62.13	62.59	64.90	65.36	
MAX. CHT	268.14	252.11	427.95	437.48	346.92	273.61	241.16	
HC WET	34808.45	7911.79	1459.14	1405.44	2025.10	7728.77	33125.29	
NOX WET	5.26	23.65	426.36	699.63	207.47	22.38	5.25	
CO WET	7.7931	9.4901	6.6647	6.0410	8.5243	9.2800	7.5229	
CC2 WET	6.1739	7.1011	8.7415	9.0401	7.7920	7.2084	6.1811	
O2 WET	3.8327	0.2832	0.1359	0.1783	0.1813	0.3400	3.4440	
H2O CORRECTION	0.90769	0.86081	0.86083	0.86045	0.86595	0.86765	0.88595	
HC MASS/MODE	0.01576	0.07395	0.00393	0.04832	0.05313	0.01843	0.01595	
NOX MASS/MODE	0.00001	0.00077	0.00372	0.07793	0.01763	0.00017	0.00001	
CO MASS/MODE	0.06973	1.75218	0.35475	4.10501	4.42042	0.43729	0.07158	
HC MODE/STD. CYCLE	5.184	24.326	1.293	15.895	17.478	6.062	5.246	
NOX MODE/STD. CYCLE	0.003	0.298	1.550	32.469	7.348	0.072	0.003	
CO MODE/STD. CYCLE	1.038	26.089	5.279	61.086	65.780	6.507	1.065	
HC EMISSION PER HP CYCLE =	0.00143 LB/HP CYCLE				PERCENT OF ALLOWABLE HC =	75.48		
NOX EMISSION PER HP CYCLE =	0.00063 LB/HP CYCLE				PERCENT OF ALLOWABLE NOX =	41.74		
CO EMISSION PER HP CYCLE =	0.07007 LB/HP CYCLE				PERCENT OF ALLOWABLE CO =	166.84		

TABLE V a IGNITION TIMING, 30° BTDC

CYCLE NO. 1170

CELL-17

DATE 2/ 9/75

30 BTDC

ENGINE - LYCOMING O-370-DIAD

ENGINE TIMING	30.000 DEG.	BTDC	RATED H.P.	160.	H.C. RATIO	2.125				
	UNITS	IDLE	TAXI	TAKE OFF	CLIMB	APPROACH	TAXI	IDLE		
RUN NUMBER		1170	1171	1172	1173	1174	1176	1177		
TIME IN MODE	MIN.	1.00	11.00	0.30	5.00	6.00	3.00	1.00		
ENGINE SPEED	RPM	613.19	1197.30	2704.77	2431.74	2353.96	1202.04	587.10		
OBS. HHPSEPOWER	HP	0.66532	1.84873	156.68916	119.18997	65.29181	0.97242	1.30323		
F/A RATIO MEAS.		0.0918	0.0932	0.0841	0.0808	0.0886	0.0932	0.0973		
F/A RATIO CALC.		0.0927	0.0957	0.0843	0.0823	0.0899	0.0956	0.0931		
% DIFF. IN F/A	%	0.978	2.671	0.316	1.913	1.523	2.490	-4.326		
AIR FLOW	LRS/HR	49.91	84.77	960.96	738.73	462.48	80.12	45.86		
FUEL FLOW	LBS/HR	4.58	7.90	80.79	59.69	40.96	7.47	4.56		
VAPOR FLOW	LRS/HR	0.02290	0.03740	0.45955	0.32693	0.18554	0.03359	0.01928		
RELATIVE HUMIDITY	%	4.53	4.52	4.49	4.33	3.96	3.97	4.24		
BAROMETER	IN.HG.	29.16	29.16	29.16	29.16	29.16	29.16	29.15		
INC. AIR TEMP.	DEG.F	64.60	63.95	63.49	62.72	62.86	64.90	64.82		
MAX. CHT	DEG.F	268.98	259.03	427.91	439.25	353.48	299.87	257.90		
HC WET	PPM	33339.56	7801.77	1469.15	1470.15	2058.20	7806.77	34753.45	45	
NOX WET	PPM	6.51	23.82	421.70	735.67	211.65	23.88	5.81		
CO WET	%	7.6975	9.3775	6.7467	5.9841	8.4796	9.3028	7.6724		
CO2 WET	%	6.1623	7.2849	8.9765	9.1592	7.8954	7.2041	6.3646		
O2 WET	%	3.5679	0.2380	0.0927	0.0985	0.1070	0.2275	3.5301		
H2O CORRECTION		0.88760	0.86044	0.86260	0.85769	0.86121	0.86134	0.90566		
HC MASS/MODE	LB/MODE	0.01604	0.07049	0.00397	0.05027	0.05442	0.01818	0.01601		
NOX MASS/MODE	LB/MODE	0.00001	0.00070	0.00369	0.008149	0.01813	0.00018	0.00001		
CO MASS/MODE	LB/MODE	0.07321	1.67456	0.36029	4.04402	4.43122	0.42827	0.06985		
HC MODE/STD. CYCLE	%	5.278	23.187	1.306	16.536	17.901	5.982	5.266		
NOX MODE/STD. CYCLE	%	0.004	0.291	1.538	33.955	7.554	0.075	0.004		
CO MODE/STD. CYCLE	%	1.089	24.919	5.361	60.179	65.941	6.373	1.040		
HC EMISSION PER HP CYCLE =	0.00143 LB/HP CYCLE					PERCENT OF ALLOWABLE HC =	75.46			
NOX EMISSION PER HP CYCLE =	0.00065 LB/HP CYCLE					PERCENT OF ALLOWABLE NOX =	43.42			
CO EMISSION PER HP CYCLE =	0.06926 LB/HP CYCLE					PERCENT OF ALLOWABLE CO =	164.90			

TABLE V-D TABLE V d. IGNITION TIMING, 30° BTDC

CYCLE NO. 410		CELL-17		DATE 12/17/76				
LEAN-OUT IDLE				ENGINE - LYCOMING 0-320-DIAD				
ENGINE TIMING		25.000 DEG. BTDC		RATED H.P., 160.		H.C. RATIO 2.125		
	UNITS	IDLE	TAXI	TAKE OFF	CLIMB	APPROACH	TAXI	IDLE
RUN NUMBER		410	411	412	413	414	415	416
TIME IN MODE	MIN.	1.00	11.00	0.30	5.00	6.00	3.00	1.00
ENGINE SPEED	RPM	610.26	1205.10	2718.87	2442.72	2354.93	1200.66	601.74
OBS. HORSEPOWER	HP	0.30846	1.13108	156.02188	120.62402	64.49254	1.13142	0.75312
MANIFOLD PRESS.	IN.HG.	0.00	0.00	0.00	0.00	0.00	0.00	0.00
F/A RATIO MEAS.	- - -	0.0873	0.0932	0.0850	0.0829	0.0893	0.0913	0.0890
F/A RATIO CALC.	- - -	0.0899	0.0939	0.0814	0.0795	0.0859	0.0940	0.0913
% DIFF. IN F/A	%	2.992	0.799	-4.161	-4.095	-3.883	3.000	2.639
AIR FLOW	LBS/HR	59.32	95.88	959.25	748.39	463.42	88.10	56.58
FUEL FLOW	LBS/HR	5.18	8.93	81.52	62.02	41.40	8.04	5.03
VAPOR FLOW	LBS/HR	0.00819	0.01318	0.16014	0.12613	0.07624	0.01464	0.00959
HUMIDITY GR H2O/LB DRY AIR		0.000	0.000	0.000	0.000	0.000	0.000	0.000
DEW POINT	DEG.F	0.000	0.000	0.000	0.000	0.000	0.000	0.000
RELATIVE HUMIDITY	%	1.42	1.46	1.77	1.80	1.74	1.73	1.78
BAROMETER	IN.HG.	29.19	29.19	29.19	29.19	29.19	29.19	29.19
IND. AIR PRESS.	IN.HG.	0.00	0.00	0.00	0.00	0.00	0.00	0.00
IND. AIR TEMP.	DEG.F	63.34	62.56	60.23	60.25	60.57	61.80	62.52
MAX. CHT	DEG.F	262.28	264.80	416.41	437.98	376.10	310.36	260.43
HC WET	PPM	32778.25	10924.09	1579.26	1613.86	2322.61	10421.04	39301.90
NOX WET	PPM	4.95	17.69	323.23	628.30	164.14	18.40	5.83
CO WET	%	7.2931	9.2277	6.2812	5.5207	7.7804	9.0134	7.0955
CO2 WET	%	6.8087	7.8498	10.3712	10.8479	9.3665	7.9503	6.5865
O2 WET	%	3.6306	0.5740	0.0991	0.1149	0.1206	0.3584	4.0720
H2O CORRECTION	- - -	0.87375	0.86131	0.86734	0.86649	0.86927	0.85235	0.87870
HC MASS/MODE	LB/MODE	0.01843	0.11158	0.00427	0.05633	0.06170	0.02650	0.02122
NOX MASS/MODE	LB/MODE	0.000009	0.000586	0.002833	0.071043	0.014125	0.000152	0.000010
CO MASS/MODE	LB/MODE	0.08106	1.86289	0.33587	3.80836	4.08486	0.45303	0.07570
HC MODE/STD.CYCLE	%	6.064	36.705	1.405	18.529	20.295	8.717	6.979
NOX MODE/STD.CYCLE	%	0.004	0.244	1.180	29.601	5.886	0.063	0.004
CO MODE/STD.CYCLE	%	1.206	27.722	4.998	56.672	60.787	6.741	1.127
HC EMISSION PER HP CYCLE =	0.00188 LB/HP CYCLE					PERCENT OF ALLOWABLE HC =	98.69	
NOX EMISSION PER HP CYCLE =	0.00055 LB/HP CYCLE					PERCENT OF ALLOWABLE NOX =	36.98	
CO EMISSION PER HP CYCLE =	0.06689 LB/HP CYCLE					PERCENT OF ALLOWABLE CO =	159.25	

TABLE VI a. LEANOUT DATA, 81 LB/HR FUEL FLOW

CYCLE NO. 432

CFLL-17

DATE 12/17/75

TURN IDLE SCREW BACK 1/2 TURN

ENGINE - LYCOMING O-320-DIAD

ENGINE TIMING

25.000 DEG. BTDC

RATED H.P. 160.

H.C. RATIO 2.125

	UNITS	IDLE	TAXI	TAKE OFF	CLIMB	APPROACH	TAXI	IDLE
RLN NUMPFP		432	433	434	435	436	437	438
TIME IN MODE	MIN.	1.00	11.00	0.30	5.00	6.00	3.00	1.00
ENGINE SPEED	RPM	614.01	1192.92	2719.53	2441.10	2353.25	1212.30	611.34
OBS. HHPSEPOWER	HP	0.00000	1.04445	156.84239	120.19070	65.00076	0.72979	0.19544
F/A RATIO MEAS.	- - -	0.0897	0.0944	0.0852	0.0817	0.0894	0.0933	0.0909
F/A RATIO CALC.	- - -	0.0920	0.0980	0.0825	0.0802	0.0860	0.0970	0.0961
% DIFF. IN F/A	%	2.569	3.795	-3.088	-1.836	-3.774	3.887	5.748
AIR FLOW	LBS/HR	60.19	95.56	960.61	741.01	465.26	90.45	59.95
FUEL FLOW	LBS/HR	5.40	9.02	81.82	60.54	41.58	8.44	5.45
VAPOR FLOW	LBS/HR	0.01414	0.02281	0.26005	0.19326	0.11506	0.02225	0.01452
RELATIVE HUMIDITY	%	2.44	2.51	2.89	2.77	2.61	2.58	2.56
BAROMETER	IN. HG.	29.20	29.20	29.19	29.19	29.20	29.20	29.20
INC. AIR TEMP.	DEG. F	62.38	62.01	60.12	60.29	60.57	61.64	62.29
MAX. GHT	DEG. F	313.92	288.37	425.10	427.97	351.45	302.82	249.07
HC WET	PPM	32589.48	13546.35	1616.86	1551.55	2120.61	12244.21	44856.46
NOX WET	PPM	3.84	13.98	324.58	559.52	158.02	12.70	3.94
CO WET	%	8.0239	9.4404	6.3675	5.5340	7.7672	9.5069	7.5262
CO2 WET	%	5.8184	7.2315	9.7949	10.2505	9.3232	7.5647	5.9671
O2 WET	%	3.9516	0.4499	0.0451	0.0950	0.0778	0.3448	4.1777
H2O CORRECTION	- - -	0.88489	0.85682	0.86809	0.86283	0.86916	0.85164	0.87275
HC MASS/MODE	LR/MODE	0.01876	0.13854	0.00438	0.05339	0.05657	0.03220	0.02584
NOX MASS/MODE	LR/MODE	0.00001	0.00046	0.00285	0.06237	0.01365	0.00011	0.00001
CO MASS/MODE	LB/MODE	0.09130	1.90819	0.34125	3.76360	4.09485	0.49419	0.08567
HC MODE/STD. CYCLE	%	6.172	45.572	1.442	17.562	18.607	10.593	8.499
NOX MODE/STD. CYCLE	%	0.003	0.193	1.188	25.988	5.689	0.045	0.003
CO MODE/STD. CYCLE	%	1.359	28.396	5.078	56.006	60.935	7.354	1.275
HC EMISSION PER HP CYCLE =	0.00206 LR/HP CYCLE				PERCENT OF ALLOWABLE HC =	108.45		
NOX EMISSION PER HP CYCLE =	0.00050 LB/HP CYCLE				PERCENT OF ALLOWABLE NOX =	33.11		
CO EMISSION PER HP CYCLE =	0.06737 LB/HP CYCLE				PERCENT OF ALLOWABLE CO =	160.40		

TABLE VI b. LEANOUT DATA, 81 LB/HR FUEL FLOW

ORIGINAL PAGE IS
OF POOR QUALITY

CYCLE NO. 463 CELL-17 DATE 12/18/75

LEAN OUT, DECREASE FUEL 5 LB/HR AT TAKEOFF

ENGINE - LYCOMING O-320-DIAD

ENGINE TIMING 25.000 DEG. BADC PATED. H.P. 160. H.C. RATIO 2.125

	UNITS	IDLE	TAXI	TAKE OFF	CLIMB	APPROACH	TAXI	IDLE
RUN NUMBER		463	462	456	457	458	459	450
TIME IN MODE	MIN.	1.00	11.00	0.30	5.00	6.00	3.00	1.00
ENGINE SPEED	PPH	601.74	1201.24	2699.85	2437.37	2351.57	1206.48	600.00
CRS. HORSEPOWER	HP	1.51360	0.90624	156.55193	120.18227	65.21274	1.15904	1.05747
F/A RATIO MEAS.	- - -	0.0803	0.0905	0.0913	0.0796	0.0857	0.0963	0.0877
F/A RATIO CALC.	- - -	0.0796	0.0909	0.0787	0.0764	0.0823	0.0938	0.0895
% DIFF. IN F/A	%	-0.935	0.408	-3.729	-3.995	-3.879	-2.577	2.202
AIR FLOW	LBS/HR	58.36	84.17	941.92	730.38	452.46	88.52	57.18
FUEL FLOW	LBS/HR	4.69	7.42	76.56	58.13	38.76	8.52	5.01
VAPOR FLOW	LBS/HR	0.01247	0.01754	0.21271	0.16311	0.10002	0.01812	0.01177
RELATIVE HUMIDITY	%	2.19	2.14	2.37	2.35	2.31	2.13	2.14
BAROMETER	IN. HG.	29.25	29.24	29.23	29.23	29.24	29.24	29.24
IND. AIR TEMP.	DEG. F	60.75	60.90	60.01	60.13	60.38	61.08	61.36
MAX. CHT	DEG. E	248.72	284.82	455.95	432.45	351.66	287.17	240.35
HC WET	PPM	31603.14	8658.84	1368.64	1319.76	1764.38	10076.00	37950.76
NOX WET	PPM	11.01	28.71	521.07	954.12	332.58	21.02	5.11
CO WET	%	5.6098	8.2578	4.8744	4.0066	6.1628	8.9526	6.8241
CO2 WET	%	6.7205	7.9225	10.3370	10.8848	9.6054	7.6846	6.1853
O2 WET	%	5.1322	0.5274	0.1013	0.1038	0.0772	0.4843	4.3662
H2O CORRECTION	- - -	0.89819	0.86618	0.87116	0.87405	0.87430	0.87751	0.88666
HC MASS/MODE	LB/MODE	0.01704	0.07514	0.00359	0.04440	0.04515	0.07621	0.02061
NOX MASS/MODE	LB/MODE	0.00002	0.00083	0.00442	0.10399	0.02757	0.00018	0.00001
CO MASS/MODE	LB/MODE	0.05979	1.44971	0.25242	2.66415	3.11685	0.46074	0.07323
HC MODE/STD. CYCLE	%	5.606	24.716	1.180	14.606	14.852	8.620	6.778
NOX MODE/STD. CYCLE	%	0.008	0.344	1.843	43.330	11.488	0.074	0.004
CO MODE/STD. CYCLE	%	0.990	21.573	3.756	39.645	46.382	6.849	1.090
HC EMISSION PER HP CYCLE =	0.00145 LB/HP CYCLE				PERCENT OF ALLOWABLE HC =	76.36		
NOX EMISSION PER HP CYCLE =	0.00086 LB/HP CYCLE				PERCENT OF ALLOWABLE NOX =	57.09		
CO EMISSION PER HP CYCLE =	0.05048 LB/HP CYCLE				PERCENT OF ALLOWABLE CO =	120.18		

TABLE VI c. LEANOUT DATA, 76 LB/HR FUEL FLOW

CYCLE NO. 574

CELL-17

DATE 12/23/76.

LEAN OUT, 25 BTDC, DFC. FUEL 5#/HR. @ TQ

ENGINE - LYCOMING O-320-DIAD

ENGINE TIMING	25.000	DEG. BTDC	RATED H.P. 160.			H.C. RATIO 2.125		
	UNITS	IDLE	TAXI	TAKE OFF	CLIMB	APPROACH	TAXI	IDLE
RUN NUMBER		574	575	576	577	578	579	580
TIME IN MODE	MIN.	1.00	11.00	0.30	5.00	6.00	3.00	1.00
ENGINE SPEED	RPM	602.04	1200.06	2694.93	2435.10	2345.45	1204.14	614.40
OBS. HORSEPOWER	HP	0.38879	0.98071	157.10912	120.84125	65.57414	1.75261	0.11753
F/A RATIO MEAS.	-- --	0.0867	0.0897	0.0809	0.0779	0.0841	0.0910	0.0822
F/A RATIO CALC.	-- --	0.0874	0.0933	0.0775	0.0753	0.0809	0.0936	0.0842
% DIFF. IN F/A	%	0.720	4.105	-4.226	-3.318	-3.775	2.812	2.447
AIR FLOW	LBS/HR	55.45	92.90	946.47	739.10	456.15	87.52	59.33
FUEL FLOW	LBS/HR	4.81	8.33	76.57	57.59	38.36	7.97	4.88
VAPOR FLOW	LBS/HR	0.01027	0.01728	0.17587	0.13671	0.08442	0.01626	0.01108
RELATIVE HUMIDITY	%	1.88	1.88	1.89	1.90	1.89	1.88	1.88
PANOMETER	IN. HG.	29.39	29.40	29.40	29.40	29.41	29.41	29.41
IND. AIR TEMP.	DEG. F	62.24	52.12	61.01	61.11	61.31	62.15	62.65
MAX. CHT	DEG. F	268.79	271.16	431.71	440.37	373.77	309.50	250.87
HC WET	PPM	32194.19	8420.83	1139.71	1133.21	1487.65	7817.78	28454.82
NOX WET	PPM	6.92	19.78	670.53	1179.92	385.74	18.08	4.73
CO WET	%	7.1262	8.8703	4.4334	3.6294	5.7782	8.586	6.9111
CO ₂ WET	%	6.2184	7.4602	10.7472	11.1308	9.9434	7.5288	6.2465
O ₂ WET	%	4.3107	0.4839	0.0511	0.1140	0.1005	0.3693	4.4579
H ₂ O CORRECTION	-- --	0.89065	0.85524	0.87370	0.87135	0.87252	0.85875	0.88452
HC MASS/MODE	LB/MODE	0.01689	0.08230	0.00300	0.03833	0.03815	0.01973	0.01571
NOX MASS/MODE	LB/MODE	0.00001	0.00063	0.00571	0.12930	0.03205	0.00015	0.00001
CO MASS/MODE	LB/MODE	0.07390	1.71350	0.23035	2.42652	2.92903	0.44798	0.07541
HC MODE/STD. CYCLE	%	5.557	27.073	0.986	12.610	12.551	6.491	5.168
NOX MODE/STD. CYCLE	%	0.005	0.261	2.379	53.876	13.354	0.062	0.004
CO MODE/STD. CYCLE	%	1.100	25.498	3.428	36.109	43.587	6.666	1.122
HC EMISSION PER HP CYCLE =	0.00134 LB/HP CYCLE				PERCENT OF ALLOWABLE HC =	70.43		
NOX EMISSION PER HP CYCLE =	0.00105 LB/HP CYCLE				PERCENT OF ALLOWABLE NOX =	69.94		
CO EMISSION PER HP CYCLE =	0.04935 LB/HP CYCLE				PERCENT OF ALLOWABLE CO =	117.51		

TABLE VI d. LEANOUT DATA, 76 LB/HR FUEL FLOW

CYCLE NO. 463		CELL-17		DATE 12/18/76					
LEANOUT, DECREASE FUEL 10 LB/HR AT T.P.				ENGINE - LYCOMING O-320-DIAD					
ENGINE TIMING		25.000 DEG. BTDC		RATED H.P. 160.		H.C. RATIO 2.125			
	UNITS	IDLE	TAXI	TAKE OFF	CLIMB	APPROACH	TAXI	IDLE	
QUN NUMBER		463	471	465	466	467	459	460	
TIME IN MODE	MIN.	1.00	11.00	0.30	5.00	6.00	3.00	1.00	
ENGINE SPEED	RPM	601.74	1199.22	2694.51	2432.88	2349.29	1206.48	600.00	
SPS. HORSEPOWER	HP	1.51360	1.36655	155.76730	120.18187	63.56549	1.15904	1.05547	
MANIFOLD PRESS.	IN.HG.	0.00	0.00	0.00	0.00	0.00	0.00	0.00	
F/A RATIO MEAS.	- - -	0.0803	0.0919	0.0774	0.0753	0.0811	0.0963	0.0877	
F/A RATIO CALC.	- - -	0.0796	0.0952	0.0748	0.0735	0.0779	0.0938	0.0896	
% DIFF. IN F/A	%	-0.935	3.593	-3.357	-2.481	-3.865	-2.577	2.202	
AIR FLOW	LBS/HR	58.36	92.15	938.83	734.46	449.11	88.52	57.18	
FUEL FLOW	LPS/HR	4.69	8.47	72.67	55.33	36.41	8.52	5.01	
VAPOR FLOW	LBS/HR	0.01247	0.02056	0.21169	0.16153	0.09429	0.01812	0.01177	
HUMIDITY GR H2O/LB DRY AIR		0.000	0.000	0.000	0.000	0.000	0.000	0.000	
DEW POINT	DEG.F	0.000	0.000	0.000	0.000	0.000	0.000	0.000	
RELATIVE HUMIDITY	%	2.19	2.25	2.28	2.23	2.13	2.13	2.14	
BAROMETER	IN.HG.	29.25	29.27	29.25	29.25	29.26	29.24	29.24	
IND. AIR PRESS.	IN.HG.	0.00	0.00	0.00	0.00	0.00	0.00	0.00	
IND. AIR TEMP.	DEG.F	60.75	61.17	60.79	60.82	61.02	61.08	61.36	
MAX. CHT	DEG.F	248.72	280.92	454.10	442.77	363.98	287.17	240.35	st 0
HC WET	PPM	31603.14	10328.03	1203.32	1238.92	1651.36	10076.00	37950.76	
NOX WET	PPM	11.01	19.62	982.70	1477.55	596.52	21.02	5.11	
CO WET	%	5.6098	9.1079	3.3836	2.8691	4.5890	8.9536	6.8241	
CO2 WET	%	6.7205	7.3399	11.2438	11.4526	10.5609	7.6846	6.1863	
O2 WET	%	5.1322	0.4765	0.1120	0.1627	0.1246	0.4843	4.3662	
H2O CORRECTION	- - -	0.89819	0.85763	0.87160	0.86963	0.87316	0.87751	0.88666	
HC MASS/MODE	LB/MODE	0.01704	0.10094	0.00310	0.04123	0.04123	0.02621	0.02061	
NOX MASS/MODE	LB/MODE	0.000019	0.000621	0.008192	0.159303	0.048243	0.000177	0.000009	
CO MASS/MODE	LB/MODE	0.05979	1.75936	0.17207	1.88719	2.26423	0.46024	0.07323	
HC MODE/STD.CYCLE	%	5.606	33.205	1.019	13.503	13.561	8.620	6.778	
NOX MODE/STD.CYCLE	%	0.008	0.259	3.413	66.376	20.101	0.074	0.004	
CO MODE/STD.CYCLE	%	0.890	26.181	2.561	28.083	33.694	6.849	1.090	
HC EMISSION PER HP CYCLE =	0.00156 LB/HP CYCLE	PERCENT OF ALLOWABLE HC =			82.35				
NOX EMISSION PER HP CYCLE =	0.00135 LB/HP CYCLE	PERCENT OF ALLOWABLE NOX =			90.24				
CO EMISSION PER HP CYCLE =	0.04173 LB/HP CYCLE	PERCENT OF ALLOWABLE CO =			99.35				

TABLE VI e. LEANOUT DATA, 73 LB/HR FUEL FLOW

CYCLE NO. 515

CELL-17

DATE 12/19/75

LEAN-OUT, DECREASE FUEL TO LB/HR AT 10

ENGINE - LYCOMING O-320-D1AD

ENGINE TIMING	25.000 DEG. BTDC	RATED H.P. 160.		H.C. RATIO 2.125				
UNITS	IDLE	TAXI	TAKE OFF	CLIMB	APPROACH	TAXI	IDLE	
RUN NUMBER	515	501	502	503	504	505	516	
TIME IN MODE	MIN.	1.00	11.00	0.30	5.00	6.00	3.00	1.00
ENGINE SPEED	RPM	598.98	1194.72	2701.71	2434.38	2350.13	1204.50	594.24
GRS. HORSEPOWER	HP	0.40026	1.38153	155.59607	119.28857	65.55382	1.48554	0.31798
F/A RATIO MEAS.	- - -	0.0869	0.0908	0.0757	0.0730	0.0787	0.0931	0.0857
F/A RATIO CALC.	- - -	0.0901	0.0941	0.0737	0.0725	0.0771	0.0951	0.0891
% DIFF. IN F/A	%	3.745	3.700	-2.652	-0.698	-2.095	2.236	3.877
AIR FLOW	LBS/HR	53.81	91.24	936.34	734.73	451.87	82.92	56.62
FUEL FLOW	LBS/HR	4.67	9.28	70.91	53.56	35.56	7.72	4.85
VAPOR FLOW	LBS/HR	0.01395	0.01676	0.10700	0.15585	0.09359	0.01722	0.01428
RELATIVE HUMIDITY	%	2.53	1.79	2.07	2.11	2.04	2.03	2.48
BAROMETER	IN. HG.	29.22	29.22	29.22	29.22	29.22	29.21	29.22
IND. AIR TEMP.	DEG. F	62.57	62.16	61.51	61.60	61.75	62.29	62.64
MAX. CHT	DEG. F	270.91	259.62	447.18	447.12	373.60	312.90	232.52
HC WET	PPM	37972.76	10158.01	1126.31	1048.40	1405.54	9317.93	38285.81
NOX WET	PPM	9.00	23.75	1395.64	1952.49	779.52	19.15	5.68
CO WET	%	6.7193	8.9833	2.9473	2.5075	4.2379	9.0802	6.6948
CO2 WET	%	7.4271	7.4121	11.4112	11.5024	10.6699	7.5485	7.1074
O2 WET	%	3.6477	0.5788	0.1266	0.1809	0.1130	0.2517	4.0554
H2O CORRECTION	- - -	0.86543	0.85682	0.87016	0.86478	0.86709	0.86025	0.86889
HC MASS/MODE	LB/MODE	0.01935	0.09791	0.00287	0.03459	0.03501	0.02244	0.02044
NOX MASS/MODE	LB/MODE	0.00001	0.00074	0.01154	0.02870	0.06286	0.00015	0.00001
CO MASS/MODE	LB/MODE	0.06766	1.71141	0.14852	1.63513	2.08500	0.43226	0.27054
HC MODE/STD. CYCLE	%	6.364	32.208	0.945	11.379	11.517	7.383	6.723
NOX MODE/STD. CYCLE	%	0.006	0.309	4.807	86.958	26.193	0.062	0.004
CO MODE/STD. CYCLE	%	1.007	25.467	2.210	24.332	31.027	6.432	1.051
HC EMISSION PER HP CYCLE =	0.00145 LB/HP CYCLE	PERCENT OF ALLOWABLE HC =		76.52				
NOX EMISSION PER HP CYCLE =	0.00178 LB/HP CYCLE	PERCENT OF ALLOWABLE NOX =		118.34				
CO EMISSION PER HP CYCLE =	0.03844 LB/HP CYCLE	PERCENT OF ALLOWABLE CO =		91.53				

TABLE VI. LEANOUT DATA, 71 LB/HR FUEL FLOW

CYCLE NO. 508

CELL-17

DATE 12/19/75

LEAN-OUT, DECREASE FUEL 15 LB/HR AT TO

ENGINE - LYCOMING O-320-D1AD

ENGINE TIMING 25.000 DEG. BTDC

RATED H.P. 160.

F.C. RATIO 2.125

	UNITS	IDLE	TAXI	TAKE OFF	CLIMB	APPROACH	TAXI	IDLE
RUN NUMBER		508	509	510	511	512	513	514
TIME IN MODE	MIN.	1.00	11.00	0.30	5.00	6.00	3.00	1.00
ENGINE SPEED	RPM	608.28	1200.54	2701.73	2434.14	2348.99	1205.16	597.90
CRS. HORSEPOWER	HP	0.04831	1.42172	153.80876	119.52271	64.83350	1.26452	0.53888
F/A RATIO MEAS.	- - -	0.0894	0.0899	0.0711	0.0711	0.0737	0.0931	0.0905
F/A RATIO CALC.	- - -	0.0894	0.0942	0.0693	0.0688	0.0712	0.0914	0.0901
DIFF. IN F/A	%	-0.017	4.779	-2.493	-3.229	-3.388	-1.813	-0.455
AIR FLOW	LBS/HR	55.37	91.24	938.46	754.13	447.38	85.97	54.89
FUEL FLOW	LBS/HP	4.95	8.21	66.72	53.63	32.99	8.00	4.97
VAPOR FLOW	LBS/HR	0.01797	0.02108	0.25865	0.20201	0.11035	0.02154	0.01436
RELATIVE HUMIDITY	%	2.32	2.25	2.71	2.52	2.43	2.44	2.55
BAROMETER	IN. HG.	29.22	29.22	29.22	29.22	29.22	29.22	29.22
IND. AIR TEMP.	DEG. F	62.50	57.41	61.57	61.64	61.75	62.47	62.71
MAX. CHT	DEG. F	225.89	246.02	443.84	427.33	373.75	268.34	236.85
HC WET	PPM	35109.56	9722.96	907.59	460.25	1054.80	9230.91	34423.42
NOX WET	PPM	5.88	20.58	2595.26	2521.56	1513.75	15.30	2.15
CO WET	%	6.9238	9.0234	1.2952	1.3774	2.1998	8.7443	7.0888
CO2 WET	%	5.3394	7.3666	13.7465	13.5905	13.1585	8.6967	7.3166
O2 WET	%	4.1736	0.5537	0.1928	0.3505	0.2014	0.3272	3.4459
H2O CORRECTION	- - -	0.89285	0.85312	0.85820	0.86260	0.86097	0.86364	0.88211
HC MASS/MODE	LB/MODE	0.01911	0.09343	0.00276	0.01547	0.02550	0.02305	0.01813
NOX MASS/MODE	LB/MODE	0.00001	0.00064	0.02111	0.28545	0.11855	0.00012	0.00000
CO MASS/MODE	LB/MODE	0.07240	1.71380	0.06424	0.91497	1.05104	0.43164	0.37379
HC MODE/STD. CYCLE	%	6.285	30.735	0.745	5.099	8.388	7.584	5.964
NOX MODE/STD. CYCLE	%	0.004	0.268	8.794	118.937	49.396	0.052	0.002
CO MODE/STD. CYCLE	%	1.077	25.503	0.956	13.616	15.641	6.423	1.098
HC EMISSION PER HP CYCLE =	0.00123 LB/HP CYCLE	PERCENT OF ALLOWABLE HC =				64.79		
NOX EMISSION PER HP CYCLE =	0.00266 LB/HP CYCLE	PERCENT OF ALLOWABLE NOX =				177.45		
CO EMISSION PER HP CYCLE =	0.02701 LB/HP CYCLE	PERCENT OF ALLOWABLE CO =				64.31		

TABLE VIg. LEANOUT DATA, 66 LB/HR FUEL FLOW

CYCLE NO. 470 CELL-17 DATE 12/18/75

LEAN-CUT, DECREASE FUEL 20 LB/HR AT TO ENGINE - LYCOMING O-320-DIAD

ENGINE TIMING 25.000 DEG. BTDC RATED H.P. 160 H.C. RATIO 2.125

UNITS IDLE TAXI TAKE OFF CLIMB APPROACH TAXI IDLE

RUN NUMBER 470 471 477 478 479 480 481
 TIME IN MODE MIN. 1.00 11.00 0.30 5.00 6.00 3.00 3.00

ENGINE SPEED RPM 613.94 1199.22 2699.39 2436.84 2349.41 1205.82 611.70
 OBS. HORSEPOWER HP 0.28110 1.36455 143.74554 117.97134 64.72946 0.82680 0.31573

F/A RATIO MEAS. - - - 0.0846 0.0919 0.0646 0.0633 0.0647 0.0869 0.0853
 F/A RATIO CALC. - - - 0.0947 0.0952 0.0643 0.0650 0.0634 0.0932 0.0926
 % DIFF. IN F/A % 11.929 3.593 -0.503 2.661 -2.004 7.225 8.661

AIR FLOW LBS/HR 60.13 92.15 945.00 842.38 502.77 92.68 57.25
 FUEL FLOW LBS/HR 5.09 8.47 61.03 53.34 32.54 8.06 4.88
 VAPOR FLOW LBS/HR 0.01330 0.02056 0.22284 0.17475 0.10964 0.01943 0.01299
 RELATIVE HUMIDITY % 2.22 2.25 2.42 2.37 2.23 2.14 2.32
 BAROMETER IN.HG 29.26 29.27 29.27 29.27 29.27 29.28 29.28
 IND. AIR TEMP. DEG.F 61.30 61.17 60.82 60.91 61.08 61.85 62.05
 MAX. CHT DEG.F 286.26 280.92 486.30 423.01 370.43 249.23 243.62

HC WET PPM 37076.19 10328.03 271.63 25.28 712.05 9157.91 34849.46
 NOX WET PPM 5.30 19.62 3899.64 1822.18 1889.59 17.70 8.82
 CO WET % 7.3066 9.1079 0.2480 0.2932 0.3692 8.231 6.9246
 CO2 WET % 6.0132 7.3399 12.3568 12.2777 12.1851 7.8628 6.5016
 O2 WET % 3.5164 0.4765 1.0078 0.7656 1.3409 0.1437 3.2750
 H2O CORRECTION - - - 0.85118 0.85763 0.87291 0.85876 0.87798 0.84153 0.85843

HC MASS/MODE LB/MODE 0.02093 0.10094 0.00067 0.00093 0.00560 0.02411 0.05634
 NOX MASS/MODE LB/MODE 0.00001 0.00062 0.03133 0.21699 0.16156 0.00015 0.00005
 CO MASS/MODE LB/MODE 0.08152 1.75936 0.01215 0.21299 0.19257 0.42833 0.22124

HC MODE/STD. CYCLE % 6.885 33.205 0.222 0.306 1.841 7.932 18.531
 NOX MODE/STD. CYCLE % 0.004 0.259 13.053 90.413 67.315 0.053 0.019
 CO MODE/STD. CYCLE % 1.213 26.181 0.181 3.170 2.866 6.374 3.292

HC EMISSION PER HP CYCLE = 0.00131 LB/HP CYCLE PERCENT OF ALLOWABLE HC = 68.92
 NOX EMISSION PER HP CYCLE = 0.00257 LB/HP CYCLE PERCENT OF ALLOWABLE NOX = 171.13
 CO EMISSION PER HP CYCLE = 0.01818 LB/HP CYCLE PERCENT OF ALLOWABLE CO = 43.28

TABLE VIh LEANOUT DATA, 61 LB/HR FUEL FLOW

53 ORIGINAL PAGE IS OF POOR QUALITY

CYCLE NO. 912		CELL-17		DATE 1/15/75				
TIMING 20 BTDC				ENGINE - LYCOMING O-320-D1AD				
ENGINE TIMING 20.000 DEG. BTDC		RATED H.P. 160.			H.C. RATIO 2.125			
	UNITS	IDLE	TAXI	TAKE OFF	CLIMB	APPROACH	TAXI	IDLE
RUN NUMBER		912	913	914	915	917	918	920
TIME IN MODE	MIN.	1.00	11.00	0.30	5.00	6.00	3.00	1.00
ENGINE SPEED	RPM	616.86	1204.02	2703.69	2432.52	2358.77	1206.78	589.32
CRS. HORSEPOWER	HP	0.52689	1.47638	147.49088	120.15056	66.36600	1.17736	0.98368
F/A RATIO MEAS.	- - -	0.0960	0.0972	0.0855	0.0824	0.0874	0.1043	0.0932
F/A RATIO CALC.	- - -	0.0938	0.0977	0.0834	0.0817	0.0859	0.1006	0.0885
% DIFF. IN F/A	%	-2.315	0.486	-2.493	-0.768	-1.695	-3.601	-5.038
AIR FLOW	LBS/HR	57.15	97.76	950.29	796.69	488.01	103.97	61.28
FUEL FLOW	LBS/HR	5.49	9.50	81.28	65.63	42.65	10.85	5.71
VAPOR FLOW	LBS/HR	0.01567	0.02613	0.27408	0.21743	0.11851	0.02400	0.01417
RELATIVE HUMIDITY	%	2.81	2.75	2.75	2.86	2.50	2.37	2.36
BAROMETER	IN. HG.	29.30	29.30	29.30	29.29	29.28	29.29	29.28
IND. AIR TEMP.	DEG. F	62.23	62.04	62.43	60.89	61.32	62.47	63.31
MAX. CHT	DEG. F	323.66	288.44	428.04	421.57	339.62	219.64	178.50
HC WET	PPM	29286.90	9884.98	1411.44	1403.04	1719.67	12684.26	28841.85
NOX WET	PPM	5.82	16.16	210.20	591.06	147.97	9.39	3.24
CO WET	%	8.7198	10.1012	6.5459	5.9592	7.4426	10.5424	7.8610
CO2 WET	%	5.8379	6.7762	9.2336	9.5089	8.6758	6.7327	6.1045
O2 WET	%	3.4897	0.6315	0.0843	0.1094	0.1571	0.5484	4.0479
H2O CORRECTION	- - -	0.90055	0.87253	0.87059	0.86428	0.86931	0.88694	0.91136
HC MASS/MODE	LB/MODE	0.01638	0.10444	0.00379	0.05204	0.04777	0.03982	0.01712
NOX MASS/MODE	LB/MODE	0.00001	0.00055	0.00183	0.07102	0.01332	0.00010	0.00001
CO MASS/MODE	LB/MODE	0.09637	2.10925	0.34752	4.36849	4.08591	0.65417	0.09224
HC MODE/STD. CYCLE	%	5.387	34.354	1.247	17.118	15.713	13.100	5.632
NOX MODE/STD. CYCLE	%	0.004	0.230	0.762	29.592	5.548	0.040	0.003
CO MODE/STD. CYCLE	%	1.434	31.388	5.171	65.007	60.802	9.735	1.373
HC EMISSION PER HP CYCLE =	0.00176 LB/HP CYCLE	PERCENT OF ALLOWABLE HC =			92.55			
NOX EMISSION PER HP CYCLE =	0.00054 LB/HP CYCLE	PERCENT OF ALLOWABLE NOX =			36.18			
CO EMISSION PER HP CYCLE =	0.07346 LB/HP CYCLE	PERCENT OF ALLOWABLE CO =			174.91			

54

TABLE VIIa. LEANOUT DATA, 81 LB/HR, 20° BTDC

CYCLE NO. 921		CELL-17		DATE 1/15/75				
LEAN-OUT T.O. CL. APP. , TIMING 20 BTDC				ENGINE - LYCOMING O-320-DIAD				
ENGINE TIMING 20.000 DEG. BTDC		RATED H.P. 160.		H.C. RATIO 2.125				
	UNITS	IDLE	TAXI	TAKE OFF	CLIMB	APPROACH	TAXI	IDLE
PUN. NUMBER		921	922	931	936	937	926	930
TIME IN MODE	MIN.	1.00	11.00	0.30	5.00	6.00	3.00	1.00
ENGINE SPEED	RPM	593.94	1198.86	2697.63	2433.54	2355.17	1212.66	588.42
ORS. HORSEPOWER	HP	0.37387	2.24260	147.87700	119.21857	66.06090	2.04180	0.13488
F/A RATIO MEAS.	- - -	0.0922	0.0995	0.0819	0.0795	0.0819	0.0953	0.0900
F/A RATIO CALC.	- - -	0.0915	0.0982	0.0809	0.0794	0.0823	0.0984	0.0909
% DIFF. IN F/A	%	-0.816	-1.377	-1.207	-0.138	0.465	3.263	1.037
AIR FLOW	LBS/HR	59.57	95.88	946.94	800.52	489.82	95.35	62.24
FUEL FLOW	LBS/HR	5.49	9.54	77.58	63.64	40.12	9.09	5.60
VAPOR FLOW	LBS/HR	0.01323	0.02187	0.30624	0.24899	0.13625	0.02077	0.01803
RELATIVE HUMIDITY	%	2.26	2.29	3.31	3.21	2.93	2.25	2.92
BAROMETER	IN. HG.	29.28	29.28	29.10	29.09	29.09	29.27	29.11
IND. AIR TEMP.	DEG. F	62.92	62.60	61.02	61.25	61.19	62.71	63.27
MAX. CHT	DEG. F	256.44	267.81	426.49	429.69	369.78	285.97	239.88
HC WET	PPM	29236.91	10341.03	1363.63	1311.93	1559.15	9425.93	29851.95
NOX WET	PPM	3.29	13.89	349.45	816.08	227.74	16.03	5.15
CO WET	%	8.2299	10.2039	5.3154	4.8391	5.8191	10.0173	7.8078
CO2 WET	%	5.8292	6.8088	9.3500	9.5020	8.9344	6.8128	5.5422
O2 WET	%	3.7625	0.6000	0.0319	0.1091	0.1168	0.3880	3.9086
H2O CORRECTION	- - -	0.89686	0.87879	0.87083	0.86833	0.86640	0.86218	0.85515
HC MASS/MODE	LB/MODE	0.01681	0.10802	0.00360	0.04836	0.04259	0.02631	0.01779
NOX MASS/MODE	LB/MODE	0.00001	0.00047	0.00299	0.09746	0.02015	0.00015	0.00001
CO MASS/MODE	LB/MODE	0.09354	2.10653	0.27742	3.52586	3.14163	0.55273	0.09199
HC MODE/STD. CYCLE	%	5.530	35.531	1.185	15.909	14.010	8.656	5.853
NOX MODE/STD. CYCLE	%	0.003	0.196	1.246	40.610	8.397	0.060	0.004
CO MODE/STD. CYCLE	%	1.392	31.347	4.128	52.468	46.750	8.225	1.369
HC EMISSION PER HP CYCLE =	0.00165 LB/HP CYCLE	PERCENT OF ALLOWABLE HC =				86.68		
NOX EMISSION PER HP CYCLE =	0.00076 LB/HP CYCLE	PERCENT OF ALLOWABLE NOX =				50.52		
CO EMISSION PER HP CYCLE =	0.06119 LB/HP CYCLE	PERCENT OF ALLOWABLE CO =				145.68		

TABLE VIIb LEANOUT DATA, 77 LB/HR, 20° BTDC

CYCLE NO. 921 CELL-17 DATE 1/15/75

LEAN-OUT T.O. CL. APP., TIMING 20 BTDC

ENGINE - LYCOMING O-320-DIAD

ENGINE TIMING 20.000 DEG. BTDC RATED H.P. 160. H.C. RATIO 2.125

	UNITS	IDLE	TAXI	TAKE OFF	CLIMB	APPROACH	TAXI	IDLE
RUN NUMBER		921	922	934	938	937	926	930
TIME IN MODE	MIN.	1.00	11.00	0.30	5.00	6.00	3.00	1.00
ENGINE SPEED	RPM	593.94	1198.86	2697.57	2436.84	2355.17	1212.66	588.42
OBS. HORSEPOWER	HP	0.37387	2.24260	145.72185	119.32094	66.06090	2.04180	0.18488
F/A RATIO MEAS.	- - -	0.0922	0.0995	0.0806	0.0794	0.0819	0.0953	0.0900
F/A RATIO CALC.	- - -	0.0915	0.0982	0.0808	0.0791	0.0823	0.0984	0.0909
% DIFF. IN F/A	%	-0.816	-1.377	0.241	-0.376	0.465	3.263	1.037
AIR FLOW	LBS/HR	59.57	95.88	953.78	798.27	489.82	95.35	62.24
FUFL FLOW	LBS/HR	5.49	9.54	76.92	63.42	40.12	9.09	5.60
VAPOR FLOW	LBS/HR	0.01323	0.02187	0.30870	0.25000	0.13625	0.02077	0.01803
RELATIVE HUMIDITY	%	2.26	2.29	3.34	3.26	2.93	2.25	2.92
BAROMETER	IN.HG.	29.28	29.28	29.09	29.10	29.09	29.27	29.11
IND. AIR TEMP.	DEG.F	62.92	62.60	61.08	61.09	61.19	62.71	63.27
MAX. CHT	* DEG.F	256.44	267.81	425.81	421.53	369.78	285.97	239.88
HC WFT	PPM	29236.91	10341.03	1273.73	1268.83	1559.15	9425.93	29851.95
NOX WFT	PPM	3.29	13.89	295.77	901.17	227.74	16.03	5.15
CO WFT	%	8.2299	10.2039	5.3032	4.8383	5.8191	10.0173	7.8078
CO2 WFT	%	5.8292	6.8088	9.2463	9.5057	8.9344	6.8128	5.5422
O2 WFT	%	3.7625	0.6000	0.0662	0.1596	0.1168	0.3880	3.9086
H2O CORRECTION	- - -	0.89686	0.87879	0.86657	0.86927	0.86640	0.86218	0.89515
HC MASS/MODE	LB/MODE	0.01681	0.10807	0.00337	0.04653	0.04259	0.02631	0.01779
NOX MASS/MODE	LB/MODE	0.00001	0.00047	0.00254	0.10730	0.02015	0.00015	0.00001
CO MASS/MODE	LB/MODE	0.09354	2.10653	0.27744	3.51463	3.14163	0.55273	0.69199
HC MODE/STD.CYCLE	%	5.530	35.531	1.109	15.340	14.010	8.656	5.853
NOX MODE/STD.CYCLE	%	0.002	0.196	1.057	44.709	8.397	0.060	0.004
CO MODE/STD.CYCLE	%	1.392	31.347	4.129	52.301	46.750	8.225	1.369
HC EMISSION PER HP CYCLE =	0.00163 LB/HP CYCLE	PERCENT OF ALLOWABLE HC =			86.03			
NOX EMISSION PER HP CYCLE =	0.00082 LB/HP CYCLE	PERCENT OF ALLOWABLE NOX =			54.43			
CO EMISSION PER HP CYCLE =	0.06112 LB/HP CYCLE	PERCENT OF ALLOWABLE CO =			145.51			

TABLE VIIc. LEANOUT DATA, 77 LB/HR, 20° BTDC

CYCLE NO. 921 CELL-17 DATE 1/15/75

LEAN-OUT T.O. CL. APP., TIMING 20 BTDC ENGINE - LYCOMING O-320-DIAD

ENGINE TIMING 20.000 DEG. BTDC PATED H.P. 160. H.C. RATIO 2.125

	UNITS	IDLE	TAXI	TAKE OFF	CLIMB	APPROACH	TAXI	IDLE
RUN NUMBER		921	922	939	940	941	926	930
TIME IN MODE	MIN.	1.00	11.00	0.30	5.00	6.00	3.00	1.00
ENGINE SPEED	RPM	593.94	1198.86	2701.23	2430.12	2352.11	1212.66	589.42
OBS. HORSEPOWER	HP	0.37387	2.24260	147.26962	117.68355	65.29041	2.04180	0.18688
F/A RATIO MEAS.	- - -	0.0922	0.0995	0.0803	0.0783	0.0828	0.0953	0.0900
F/A RATIO CALC.	- - -	0.0915	0.0982	0.0805	0.0792	0.0826	0.0984	0.0909
% DIFF. IN F/A	%	-0.816	-1.377	0.286	1.117	-0.331	3.263	1.037
AIR FLOW	LBS/HR	59.57	95.88	961.34	796.83	485.53	95.35	52.24
FUEL FLOW	LBS/HR	5.49	9.54	77.17	62.42	40.22	9.09	5.50
VAPOR FLOW	LBS/HP	0.01323	0.02187	0.30504	0.24906	0.13550	0.02077	0.01803
RELATIVE HUMIDITY	%	2.26	2.29	3.34	3.24	2.93	2.25	2.92
BAROMETER	IN. HG.	29.28	29.28	29.10	29.10	29.10	29.27	29.11
IND. AIR TEMP.	DEG. F	62.92	62.60	60.89	61.28	61.29	62.71	63.27
MAX. CHT	DEG. F	256.44	257.81	440.69	429.00	366.34	285.97	239.88
HC WFT	PPM	29236.91	10341.03	1192.52	1209.92	1541.65	9425.93	29851.95
NOX WET	PPM	3.29	13.89	287.64	805.48	219.41	16.03	5.15
CO WET	%	8.2299	10.2039	5.2046	4.7204	5.8658	10.0173	7.8078
CO2 WET	%	5.8292	6.8098	9.2614	9.4823	8.9359	6.8128	5.5422
O2 WFT	%	3.7625	0.6000	0.0804	0.0826	0.0734	0.3880	3.9086
H2O CORRECTION	- - -	0.89686	0.87879	0.86680	0.86456	0.86908	0.86218	0.89515
HC MASS/MODE	LB/MODE	0.01681	0.10802	0.00318	0.04420	0.04189	0.02631	0.01779
NOX MASS/MODE	LB/MODE	0.00031	0.00047	0.00248	0.09533	0.01931	0.00015	0.00001
CO MASS/MODE	LB/MODE	0.09354	2.10653	0.27405	3.40830	3.15018	0.55273	0.09199
HC MODE/STD. CYCLE	%	5.530	35.531	1.045	14.540	13.780	8.656	5.853
NOX MODE/STD. CYCLE	%	0.003	0.196	1.034	39.720	8.048	0.060	0.004
CO MODE/STD. CYCLE	%	1.392	31.347	4.078	50.719	46.878	8.225	1.369
HC EMISSION PER HP CYCLE =	0.00161 LB/HP CYCLE			PERCENT OF ALLOWABLE HC =			84.94	
NOX EMISSION PER HP CYCLE =	0.00074 LB/HP CYCLE			PERCENT OF ALLOWABLE NOX =			49.06	
CO EMISSION PER HP CYCLE =	0.06048 LB/HP CYCLE			PERCENT OF ALLOWABLE CO =			144.01	

57

ORIGINAL PAGE IS
OF POOR QUALITY

TABLE VIIId. LEANOUT DATA, 77 LB/HR, 20° BTDC

CYCLE NO. 921		CELL-17		DATE 1/15/75				
LEAN-OUT T.O. CL. APP., TIMING 20 BTDC				ENGINE - LYCOMING O-320-DIAD				
ENGINE TIMING 20.000 DEG. BTDC		RATED H.P. 160.		H.C. RATIO 2.125				
	UNITS	IDLE	TAXI	TAKE OFF	CLIMP	APPROACH	TAXI	IDLE
RUN NUMBER		921	922	942	943	944	926	930
TIME IN MODE	MIN.	1.00	11.00	0.30	5.00	6.00	3.00	1.00
ENGINE SPEED	RPM	593.94	1198.86	2699.01	2430.72	2351.87	1712.66	588.42
GRS. HHPSEPOWER	HP	0.37387	2.24260	147.31038	118.78423	64.88269	2.04180	0.18688
F/A RATIO MEAS.	- - -	0.0922	0.0995	0.0767	0.0750	0.0782	0.0953	0.0900
F/A RATIO CALC.	- - -	0.0915	0.0982	0.0770	0.0766	0.0794	0.0984	0.0909
% DIFF. IN F/A	%	-0.816	-1.377	0.400	2.158	1.514	3.263	1.037
AIR FLOW	LBS/HR	59.57	95.88	956.28	812.04	484.36	95.35	62.24
FUEL FLOW	LBS/HR	5.49	9.54	73.32	60.89	37.86	9.09	5.60
VAPOR FLOW	LBS/HR	0.01323	0.02187	0.30673	0.25440	0.13449	0.02077	0.01803
RELATIVE HUMIDITY	%	2.26	2.29	3.34	3.26	2.92	2.25	2.92
BAROMETR	IN.HG.	29.78	29.28	29.10	29.09	29.09	29.27	29.11
IND. AIR TEMP.	DEG.F	62.92	62.60	61.10	61.31	61.41	62.71	63.27
MAX. CHT	*DEG.F	256.44	257.81	439.23	427.89	367.67	285.97	239.88
HC WFT	PPM	29236.91	10341.03	1105.71	926.39	1347.13	9425.93	29851.95
NOX WFT	PPM	3.29	13.89	564.46	1103.71	356.24	16.03	5.15
CO WFT	%	8.2299	10.2039	3.8792	3.8599	4.7450	10.0173	7.8078
CO2 WFT	%	5.8292	6.8088	9.9661	9.9004	9.4432	6.8128	5.5422
O2 WFT	%	3.7625	0.6000	0.0543	0.1260	0.0894	0.3880	3.9086
H2O CORRECTION	- - -	0.89686	0.97879	0.86669	0.86156	0.86299	0.86218	0.89515
HC MASS/MODE	LB/MODE	0.01681	0.10802	0.00289	0.03404	0.03587	0.02631	0.01779
NOX MASS/MODE	LB/MODE	0.00001	0.00047	0.00478	0.13140	0.03073	0.00015	0.00001
CO MASS/MODE	LB/MODE	0.09354	2.10653	0.20039	2.80343	2.49739	0.55273	0.09199
HC MODE/STD. CYCLE	%	5.530	35.531	0.951	11.198	11.801	8.656	5.853
NOX MODE/STD. CYCLE	%	0.003	0.196	1.991	54.748	12.805	0.060	0.004
CO MODE/STD. CYCLE	%	1.392	31.347	2.982	41.718	37.164	8.225	1.369
HC EMISSION PER HP CYCLE =	0.00151 LB/HP CYCLE	PERCENT OF ALLOWABLE HC =				79.52		
NOX EMISSION PER HP CYCLE =	0.00105 LB/HP CYCLE	PERCENT OF ALLOWABLE NOX =				69.81		
CO EMISSION PER HP CYCLE =	0.05216 LB/HP CYCLE	PERCENT OF ALLOWABLE CO =				124.20		

TABLE VIIe. LEANOUT DATA, 73 LB/HR, 20° BTDC

CYCLE NO. 921		CELL-17		DATE 1/15/75				
LEAN-OUT T.O. CL. APP. , TIMING 20 BTDC				ENGINE - LYCOMING O-320-DIAD				
ENGINE TIMING		20.000 DEG. BTDC		RATED H.P. 160.		H.C. RATIO 2.125		
	UNITS	IDLE	TAXI	TAKE OFF	CLIMB	APPROACH	TAXI	IDLE
RUN NUMBER		921	922	945	946	947	926	930
TIME IN MODE	MIN.	1.00	11.00	0.30	5.00	6.00	3.00	1.00
ENGINE SPEED	RPM	593.94	1198.86	2697.33	2432.22	2349.47	1212.66	588.42
OBS. HORSEPOWER	HP	0.37387	2.24260	147.72523	118.97322	64.08667	2.04180	0.18588
F/A RATIO MEAS.	- - -	0.0922	0.0995	0.0764	0.0752	0.0791	0.0953	0.0900
F/A RATIO CALC.	- - -	0.0915	0.0782	0.0771	0.0767	0.0795	0.0984	0.0909
% DIFF. IN F/A	%	-0.816	-1.377	0.871	1.923	0.399	3.263	1.037
AIR FLOW	LBS/HR	59.57	95.88	960.16	817.37	485.25	95.35	62.24
FUEL FLOW	LBS/HR	5.49	9.54	73.36	61.50	38.40	9.09	5.60
VAPOR FLOW	LBS/HR	0.01323	0.02187	0.31003	0.26056	0.14053	0.02077	0.01803
RELATIVE HUMIDITY	%	2.26	2.29	3.40	3.33	3.02	2.25	2.92
BAROMETER	IN. HG.	29.28	29.28	29.09	29.09	29.09	29.27	29.11
IND. AIR TEMP.	DEG. F	62.92	62.60	60.91	61.23	61.60	62.71	63.27
MAX. CHT	DEG. F	256.44	267.81	433.71	428.86	359.64	285.97	239.88
HC WFT	PPM	29236.91	10341.03	1139.51	888.09	1396.14	9425.93	29851.95
NOX WFT	PPM	3.29	13.89	603.54	1135.31	372.20	16.03	5.15
CO WFT	%	8.2299	10.2039	3.9021	3.9105	4.7478	10.0172	7.8078
CO2 WFT	%	5.8292	6.8088	9.9068	9.7826	9.3108	6.8128	5.5422
O2 WFT	%	3.7625	0.6000	0.0604	0.1512	0.1083	0.3880	3.9086
H2O CORRECTION	- - -	0.89686	0.87879	0.86550	0.86348	0.86858	0.86218	0.89515
HC MASS/MODE	LB/MODE	0.01681	0.10802	0.00299	0.03288	0.03739	0.07631	0.01779
NOX MASS/MODE	LB/MODE	0.00001	0.00047	0.00513	0.13618	0.03229	0.00015	0.00001
CO MASS/MODE	LB/MODE	0.09354	2.10653	0.20218	2.86174	2.51286	0.55273	0.09199
HC MODE/STD. CYCLE	%	5.530	35.531	0.983	10.817	12.298	8.656	5.853
NOX MODE/STD. CYCLE	%	0.003	0.196	2.136	56.743	13.454	0.060	0.004
CO MODE/STD. CYCLE	%	1.392	31.347	3.009	42.585	37.394	8.225	1.369
HC EMISSION PER HP CYCLE =	0.00151 LB/HP CYCLE	PERCENT OF ALLOWABLE HC =				79.67		
NOX EMISSION PER HP CYCLE =	0.00109 LB/HP CYCLE	PERCENT OF ALLOWABLE NOX =				72.60		
CO EMISSION PER HP CYCLE =	0.05263 LB/HP CYCLE	PERCENT OF ALLOWABLE CO =				125.32		

TABLE VIIF. LEANOUT DATA, 73 LB/HR, 20° BTDC

CYCLE NO. 921		CFL-17		DATE 1/15/75				
LEAN-OUT T.O. CL. APP. , TIMING 20 BTDC				ENGINE - LYCOMING O-320-DIAD				
ENGINE TIMING 20.000 DEG. BTDC		RATED H.P. 160.		H.C. RATIO 2.125				
	UNITS	IDLE	TAXI	TAKE OFF	CLIMB	APPROACH	TAXI	IDLE
RUN NUMBER		921	922	948	949	950	926	930
TIME IN MODE	MIN.	1.00	11.00	0.30	5.00	6.00	3.00	1.00
ENGINE SPEED	RPM	593.94	1198.86	2700.39	2433.30	2352.35	1212.66	588.42
BS. H.P. SEPOWER	HP	0.37387	7.24260	147.22426	118.69473	65.59152	2.04180	0.18688
F/A RATIO MEAS.	- - -	0.0922	0.0995	0.0760	0.0747	0.0801	0.0953	0.0900
F/A RATIO CALC.	- - -	0.0915	0.0982	0.0772	0.0769	0.0797	0.0984	0.0909
DIFF. IN F/A	%	-0.816	-1.377	1.523	2.937	-0.492	3.263	1.037
AIR FLOW	LBS/HR	59.57	95.88	962.11	816.57	488.07	95.35	62.24
FUEL FLOW	LBS/HR	5.49	9.54	73.14	60.99	39.07	9.09	5.60
VAPOR FLOW	LBS/HR	0.01323	0.02187	0.31952	0.26284	0.14116	0.02077	0.01803
RELATIVE HUMIDITY	%	2.26	2.29	3.47	3.34	2.99	2.25	2.92
BAROMETP	IN. HG.	29.28	29.28	29.09	29.09	29.08	29.27	29.11
IND. AIR TEMP.	DEG. F	62.92	62.60	61.14	61.33	61.75	62.71	63.27
MAX. CHT	DEG. F	256.44	267.81	422.26	428.37	360.08	285.97	239.88
HC WET	PPM	29236.91	10341.03	1174.32	877.49	1402.34	9425.93	29851.95
NOX WET	PPM	3.29	13.89	632.86	1175.42	383.52	16.03	5.15
CO WET	%	8.2299	10.2039	3.8858	3.9185	4.7817	10.0173	7.9078
CO2 WET	%	5.8292	6.8088	9.6913	9.5560	9.1939	6.8128	5.5422
O2 WET	%	3.7625	0.6000	0.0771	0.1533	0.1100	0.3880	3.9086
H2O CORRECTION	- - -	0.89686	0.87879	0.86565	0.86240	0.87295	0.86218	0.89515
HC MASS/MODE	LB/MODE	0.01681	0.10802	0.00308	0.03239	0.03790	0.02631	0.01779
NOX MASS/MODE	LB/MODE	0.00001	0.00047	0.00538	0.14056	0.03358	0.00015	0.00001
CO MASS/MODE	LB/MODE	0.00354	2.10653	0.20145	2.85877	2.55439	0.55273	0.09199
HC MODE/STD. CYCLE	%	5.530	35.531	1.013	10.655	12.468	8.656	5.853
NOX MODE/STD. CYCLE	%	0.003	0.196	2.241	58.566	13.992	0.060	0.004
CO MODE/STD. CYCLE	%	1.392	31.347	2.998	42.541	38.012	8.225	1.369
HC EMISSION PER HP CYCLE =	0.00151 LB/HP CYCLE	PERCENT OF ALLOWABLE HC =				79.71		
NOX EMISSION PER HP CYCLE =	0.00113 LB/HP CYCLE	PERCENT OF ALLOWABLE NOX =				75.06		
CO EMISSION PER HP CYCLE =	0.05287 LB/HP CYCLE	PERCENT OF ALLOWABLE CO =				125.88		

TABLE VIIg. LEANOUT DATA, 73 LB/HR, 20° BTDC

CYCLE NO. 921		CELL-17		DATE 1/15/75				
LEANOUT T.O. CL. APP. • TIMING 20 BTDC					ENGINE - LYCOMING O-320-DIAD			
ENGINE TIMING		20.000 DEG. BTDC		RATED H.P. 160.		H.C. RATIO 2.125		
	UNITS	IDLE	TAXI	TAKE OFF	CLIMB	APPROACH	TAXI	IDLE
PUM NUMBER		921	922	957	958	959	926	930
TIME IN MODE	MIN.	1.00	11.00	0.30	5.00	6.00	3.00	1.00
ENGINE SPEED	RPM	593.94	1198.86	2701.29	2427.54	2352.35	1212.66	588.42
CRS. HORSEPOWER	HP	0.37387	2.24260	146.13089	118.07510	66.00812	2.04180	0.18688
F/A RATIO MEAS.	- - -	0.0922	0.0995	0.0738	0.0726	0.0761	0.0953	0.0900
F/A RATIO CALC.	- - -	0.0915	0.0982	0.0745	0.0752	0.0767	0.0984	0.0909
% DIFF. IN F/A	%	-0.816	-1.377	0.985	3.595	0.751	3.263	1.037
AIR FLOW	LB/HR	59.57	95.88	959.59	821.25	488.14	95.35	62.24
FUEL FLOW	LB/HR	5.49	9.54	70.78	59.65	37.16	9.09	5.60
VAPOR FLOW	LB/HR	0.01323	0.02187	0.31739	0.26838	0.14198	0.02077	0.01803
RELATIVE HUMIDITY	%	2.26	2.29	3.50	3.98	3.07	2.25	2.92
BAROMETER	IN. HG.	29.28	29.28	29.06	29.06	29.06	29.27	29.11
IND. AIR TEMP.	DEG. F	62.92	62.60	60.94	61.39	61.13	62.71	53.27
MAX. CHT	DEG. F	256.44	257.81	433.90	422.55	358.68	285.97	239.88
HC WFT	PPM	29236.91	10341.03	1030.20	631.36	1260.62	9425.93	29851.95
NOX WFT	PPM	3.29	13.89	1057.70	1276.13	593.74	16.03	5.15
CO WFT	%	8.2299	10.2039	2.8889	3.2937	3.6893	10.0173	7.8078
CO2 WFT	%	5.8292	6.8088	9.8979	9.5595	9.4606	6.8128	5.5422
O2 WFT	%	3.7625	0.6000	0.1204	0.1691	0.1498	0.3880	3.9086
H2O CORRECTION	- - -	0.89686	0.87879	0.87217	0.86430	0.87228	0.86218	0.89515
HC MASS/MODE	LB/MODE	0.01681	0.10802	0.00267	0.02325	0.03356	0.02631	0.01779
NOX MASS/MODE	LB/MODE	0.00001	0.00047	0.00888	0.15224	0.05171	0.00015	0.00001
CO MASS/MODE	LB/MODE	0.09354	2.10453	0.14806	2.39720	1.94143	0.55273	0.09199
HC MODE/STD. CYCLE	%	5.530	35.531	0.879	7.648	11.041	8.656	5.853
NOX MODE/STD. CYCLE	%	0.003	0.196	3.701	63.432	21.339	0.060	0.004
CO MODE/STD. CYCLE	%	1.392	31.347	2.203	35.673	28.890	8.225	1.369
HC EMISSION PER HP CYCLE =	0.00143 LB/HP CYCLE			PERCENT OF ALLOWABLE HC =	75.14			
NOX EMISSION PER HP CYCLE =	0.00133 LB/HP CYCLE			PERCENT OF ALLOWABLE NOX =	88.73			
CO EMISSION PER HP CYCLE =	0.04582 LB/HP CYCLE			PERCENT OF ALLOWABLE CO =	109.10			

ORIGINAL FACTORY
OF POOR QUALITY

TABLE VIIh. LEANOUT DATA, 71 LB/HR, 20° BTDC

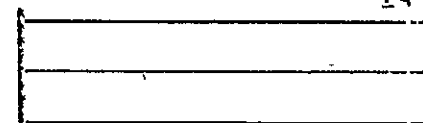

CYCLE NO. 921		CELL-17		DATE 1/15/75					
LEAN-OUT T.O. CL. APP. , TIMING 20 BTDC				ENGINE - LYCOMING O-320-DIAD					
ENGINE TIMING		20.000 DEG. BTDC		RATED H.P. 160.		H.C. RATIO 2.125			
UNITS		IDLE	TAXI	TAKE OFF	CLIMB	APPROACH	TAXI	IDLE	
RUN NUMBER		921	922	951	952	953	926	930	
TIME IN MODE	MIN.	1.00	11.00	0.30	5.00	6.00	3.00	1.00	
ENGINE SPEED	RPM	593.94	1198.86	2693.49	2432.28	2352.05	1212.66	588.42	
OBS. HORSEPOWER	HP	0.37387	2.24260	145.55794	119.13013	64.83997	2.04180	0.18688	
F/A RATIO MEAS.	- - -	0.0922	0.0995	0.0738	0.0731	0.0757	0.0953	0.0900	
F/A RATIO CALC.	- - -	0.0915	0.0982	0.0745	0.0751	0.0767	0.0984	0.0909	
% DIFF. IN F/A	%	-0.816	-1.377	0.898	2.719	1.334	3.263	1.037	
AIR FLOW	LBS/HR	59.57	95.88	952.87	822.91	488.70	95.35	52.24	
FUEL FLOW	LBS/HR	5.49	9.54	70.35	60.15	36.97	9.09	5.60	
VAPOR FLOW	LRS/HR	0.01323	0.02187	0.31399	0.26666	0.13910	0.02077	0.01803	
RELATIVE HUMIDITY	%	2.26	2.29	3.46	3.36	3.03	2.25	2.92	
BAROMETER	IN. HG.	29.28	29.28	29.07	29.06	29.06	29.27	29.11	
IND. AIR TEMP.	DEG. F	62.92	62.60	60.97	61.37	61.29	62.71	63.27	
MAX. CHT	DEG. F	256.44	257.81	452.04	418.25	374.15	285.97	239.88	
HC WET	PPM	29236.91	10341.03	998.70	627.16	1211.72	9425.93	29851.95	
NOX WET	PPM	3.29	13.89	950.59	1206.92	552.35	16.03	5.15	
CO WET	%	8.2299	10.2039	2.8776	3.2304	3.6289	10.0173	7.8078	
CO2 WET	%	5.8292	6.8098	10.0106	9.7080	9.5251	6.8128	5.5422	
O2 WET	%	3.7525	0.6000	0.0899	0.1444	0.1034	0.3880	3.9086	
H2O CORRECTION	- - -	0.89686	0.87879	0.87119	0.86602	0.86983	0.86218	0.895.5	
HC MASS/MODE	LB/MODE	0.01681	0.10802	0.00257	0.02318	0.03724	0.02631	0.01779	
NOX MASS/MODE	LB/MODE	0.00001	0.00047	0.00793	0.14454	0.04761	0.00015	0.00001	
CO MASS/MODE	LB/MODE	0.09354	2.10553	0.14649	2.36023	1.90841	0.55273	0.09199	
HC MODE/STD. CYCLE	%	5.530	35.531	0.846	7.626	10.606	8.656	5.853	
NOX MODE/STD. CYCLE	%	0.003	0.196	3.305	60.224	19.839	0.060	0.004	
CO MODE/STD. CYCLE	%	1.392	31.347	2.180	35.122	28.399	8.225	1.369	
HC EMISSION PER HP CYCLE =	0.00142 LB/HP CYCLE					PERCENT OF ALLOWABLE HC =	74.65		
NOX EMISSION PER HP CYCLE =	0.00125 LB/HP CYCLE					PERCENT OF ALLOWABLE NOX =	83.63		
CO EMISSION PER HP CYCLE =	0.04537 LB/HP CYCLE					PERCENT OF ALLOWABLE CO =	108.03		

TABLE VIII. LEANOUT DATA, 71 LB/HR, 20° BTDC

CYCLE NO. 921		CELL-17		DATE 1/15/75				
LEAN-OUT T.O. CL. APP., TIMING 20 BTDC				ENGINE - LYCOMING O-320-DIAD				
ENGINE TIMING 20.000 DEG. BTDC		RATED H.P. 160.		H.C. RATIO 2.125				
UNITS	IDLE	TAXI	TAKE OFF	CLIMB	APPROACH	TAXI	IDLE	
RUN NUMBER	021	922	954	955	956	926	930	
TIME IN MODE	MIN. 1.00	11.00	0.30	5.00	6.00	3.00	1.00	
ENGINE SPEED	RPM 593.94	1198.86	2701.65	2437.02	2350.31	1212.66	588.42	
OPS. HORSEPOWER	HP 0.37387	2.24260	146.12988	120.06557	64.51874	2.04180	0.18688	
F/A RATIO MEAS.	- - - 0.0922	0.0995	0.0736	0.0734	0.0781	0.0953	0.0900	
F/A RATIO CALC.	- - - 0.0915	0.0987	0.0745	0.0756	0.0767	0.0984	0.0909	
% DIFF. IN F/A	7 -0.816	-1.377	1.326	3.008	-1.834	3.263	1.037	
AIR FLOW	LBS/HR 59.57	95.88	959.69	828.72	483.07	95.35	62.24	
FUEL FLOW	LBS/HR 5.49	9.54	70.59	60.83	37.74	9.09	5.60	
VAPOR FLOW	LBS/HR 0.01323	0.02187	0.31551	0.27152	0.14108	0.02077	0.01803	
RELATIVE HUMIDITY	% 2.26	2.29	3.49	3.40	3.06	2.25	2.92	
BAROMETER	IN.HG. 29.28	29.28	29.07	29.07	29.07	29.27	29.11	
IND. AIR TEMP.	DEG.F 62.92	62.60	60.88	61.34	61.59	62.71	63.27	
MAX. CHT	*DEG.F 256.44	257.81	438.92	427.12	368.38	285.97	239.88	
HC WET	PPM 29236.91	10341.03	1009.50	633.56	1227.82	9425.93	29851.95	
NOX WET	PPM 3.29	13.89	1009.90	1242.42	572.10	16.03	5.15	
CO WET	% 8.2299	10.2039	2.8730	3.4205	3.7094	10.0173	7.8078	
CO2 WET	% 5.8292	6.8088	9.8844	9.5531	9.6159	6.8128	5.5422	
O2 WET	% 3.7625	0.6000	0.1006	0.1525	0.1223	0.3880	3.9086	
H2O CORRECTION	- - - 0.89686	0.87879	0.87116	0.86555	0.87969	0.86218	0.89515	
HC MASS/MODE	LB/MODE 0.01681	0.10802	0.00262	0.02361	0.03260	0.02631	0.01779	
NOX MASS/MODE	LB/MODE 0.00001	0.00047	0.00848	0.15002	0.04922	0.00015	0.00001	
CO MASS/MODE	LB/MODE 0.09354	2.10653	0.14715	2.51977	1.94681	0.55273	0.09199	
HC MODE/STD. CYCLE	% 5.530	35.531	0.861	7.768	10.725	8.656	5.853	
NOX MODE/STD. CYCLE	% 0.003	0.196	3.533	62.509	20.506	0.060	0.004	
CO MODE/STD. CYCLE	% 1.392	31.347	2.190	37.497	28.970	8.225	1.369	
HC EMISSION PER HP CYCLE =	0.00142 LB/HP CYCLE			PERCENT OF ALLOWABLE HC =	74.93			
NOX EMISSION PER HP CYCLE =	0.00130 LB/HP CYCLE			PERCENT OF ALLOWABLE NOX =	86.81			
CO EMISSION PER HP CYCLE =	0.04662 LB/HP CYCLE			PERCENT OF ALLOWABLE CO =	110.99			

TABLE VIIJ. LEANOUT DATA, 71 LB/HR, 20° BTDC

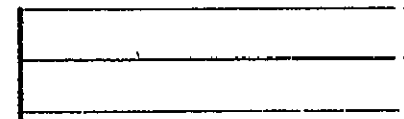

CYCLE NO. 921		CELL-17		DATE 1/15/75					
LEAN-OUT T.O. CL. APP. , TIMING 20 BTDC				ENGINE - LYCOMING O-320-DIAD					
ENGINE TIMING		20.000 DEG. BTDC		RATED H.P. 160.		H.C. RATIO 2.125			
	UNITS	IDLE	TAXI	TAKE OFF	CLIMB	APPROACH	TAXI	IDLE	
RUN NUMBER		921	922	960	969	962	926	930	
TIME IN MODE	MIN.	1.00	11.00	0.30	5.00	6.00	3.00	1.00	
ENGINE SPEED	RPM	593.94	1194.86	2689.23	2427.18	2351.87	1212.66	588.42	
CRS. HORSEPOWER	HP	0.37387	2.24260	141.71951	118.14255	65.04013	2.04180	0.18588	
F/A RATIO MEAS.	- - -	0.0922	0.0995	0.0688	0.0702	0.0709	0.0953	0.0900	
F/A RATIO CALC.	- - -	0.0915	0.0982	0.0707	0.0715	0.0713	0.0984	0.0909	
% DIFF. IN F/A	-	-0.816	-1.377	2.793	1.878	0.564	3.263	1.037	
AIR FLOW	LBS/HR	59.57	95.88	965.44	839.10	498.84	95.35	62.24	
FUEL FLOW	LBS/HR	5.49	9.54	66.39	58.89	35.35	9.09	5.60	
VAPOR FLOW	LBS/HR	0.01323	0.02197	0.31539	0.31182	0.14583	0.02077	0.01803	
RELATIVE HUMIDITY	%	2.26	7.29	3.48	3.82	3.10	2.25	2.92	
BAROMETER	IN.HG.	29.28	29.28	29.05	29.04	29.05	29.27	29.11	
IND. AIR TEMP.	DEG.F	62.92	62.60	60.93	61.31	61.05	62.71	63.27	
MAX. CHT	DEG.F	256.44	267.91	456.30	406.71	373.48	285.97	239.88	
HC WET	PPM	29236.91	10341.03	799.18	174.24	801.28	9425.93	29851.95	
NOX WET	PPM	3.29	13.89	2107.31	1481.95	1285.33	16.03	5.15	
CO WET	%	9.2299	10.2039	1.5081	1.9808	1.8386	10.0173	7.8078	
CO2 WET	%	5.8292	6.8088	10.4054	10.9028	10.2374	6.8128	5.5472	
O2 WET	%	3.7625	0.6000	0.1513	0.0917	0.2204	0.3880	3.9076	
H2O CORRECTION	- - -	0.89686	0.87879	0.87084	0.86433	0.87732	0.86218	0.89515	
HC MASS/MODE	LB/MODE	0.01681	0.10802	0.00205	0.00649	0.02136	0.02631	0.01779	
NOX MASS/MODE	LR/MODE	0.00001	0.00047	0.01750	0.17889	0.11098	0.00015	0.00001	
CO MASS/MODE	LB/MODE	0.09354	2.10653	0.07641	1.45874	0.96853	0.55273	0.09199	
HC MODE/STD. CYCLE	%	5.530	35.531	0.674	2.136	7.025	8.656	5.853	
NOX MODE/STD. CYCLE	%	0.003	0.196	7.293	74.538	46.243	0.060	0.004	
CO MODE/STD. CYCLE	%	1.392	31.347	1.137	21.707	14.413	8.225	1.369	
HC EMISSION PER HP CYCLE =	0.00124 LB/HP CYCLE	PERCENT OF ALLOWABLE HC =				65.41			
NOX EMISSION PER HP CYCLE =	0.00193 LB/HP CYCLE	PERCENT OF ALLOWABLE NOX =				128.34			
CO EMISSION PER HP CYCLE =	0.03343 LB/HP CYCLE	PERCENT OF ALLOWABLE CO =				79.59			

64

TABLE VIIK. LEANOUT DATA, 65 LB/HR, 20° BTDC

CYCLE NO. 921		CELL-17		DATE 1/15/75				
LEAN-OUT T.O. CL. APP., TIMING 20 BTDC					ENGINE - LYCOMING O-320-D1AD			
ENGINE TIMING 20.000 DEG. BTDC		RATED H.P. 160.		H.C. RATIO 2.125				
	UNITS	IDLE	TAXI	TAKE OFF	CLIMB	APPROACH	TAXI	IDLE
RUN NUMBER		921	922	963	964	965	926	930
TIME IN MODE	MIN.	1.00	11.00	0.30	5.00	6.00	3.00	1.00
ENGINE SPEED	RPM	593.94	1198.86	2696.07	2423.82	2348.15	1212.66	588.42
CRS. HORSEPOWER	HP	0.37387	2.24260	142.76881	117.66196	64.47594	2.04180	0.18688
F/A RATIO MEAS.	- - -	0.0922	0.0995	0.0700	0.0696	0.0718	0.0953	0.0900
F/A RATIO CALC.	- - -	0.0915	0.0982	0.0703	0.0713	0.0710	0.0984	0.0909
% DIFF. IN F/A	%	-0.816	-1.377	0.468	2.376	-1.054	3.263	1.037
AIP FLOW	LBS/HR	59.57	95.88	951.52	843.17	494.89	95.35	62.24
FUEL FLOW	LBS/HR	5.49	9.54	66.61	58.72	35.51	9.09	5.60
VAPOR FLOW	LBS/HR	0.01323	0.02187	0.32231	0.28538	0.15375	0.02077	0.01803
RELATIVE HUMIDITY	%	2.26	2.29	3.55	3.51	3.23	2.25	2.92
BAROMETER	IN. HG.	29.28	29.28	29.05	29.05	29.04	29.27	29.11
IND. AIP TEMP.	DEG. F	62.92	62.60	60.65	61.25	61.11	62.71	63.27
MAX. CHT	DEG. F	256.44	267.81	462.66	416.59	369.61	285.97	239.88
HC WET	PPM	29236.91	10341.03	772.46	163.92	851.08	9425.93	29851.95
NOX WET	PPM	3.29	13.89	2157.01	1253.52	1233.82	16.03	5.15
CO WET	%	8.2299	10.2039	1.4954	1.9013	1.8024	10.0173	7.8078
CO2 WET	%	5.8292	6.8088	11.2350	10.9554	10.9905	6.8128	5.5422
O2 WET	%	3.7625	4.0600	0.1641	0.0912	0.2057	0.3880	3.9036
H2O CORRECTION	- - -	0.89686	0.87879	0.87009	0.86229	0.87535	0.86218	0.89515
HC MASS/MODE	LB/MODE	0.01681	0.10802	0.00196	0.00614	0.02258	0.02631	0.01779
NOX MASS/MODE	LB/MODE	0.00001	0.00047	0.01770	0.15211	0.10607	0.00015	0.00001
CO MASS/MODE	LB/MODE	0.09354	2.10653	0.07487	1.40747	0.94530	0.55273	0.09199
HC MODE/STD. CYCLE	%	5.530	35.531	0.644	2.020	7.429	8.656	5.853
NOX MODE/STD. CYCLE	%	0.003	0.196	7.376	63.380	44.194	0.060	0.004
CO MODE/STD. CYCLE	%	1.392	31.347	1.114	20.944	14.067	8.225	1.369
HC EMISSION PER HP CYCLE =	0.00125 LB/HP CYCLE			PERCENT OF ALLOWABLE HC =	65.66			
NOX EMISSION PER HP CYCLE =	0.00173 LB/HP CYCLE			PERCENT OF ALLOWABLE NOX =	115.21			
CO EMISSION PER HP CYCLE =	0.03295 LB/HP CYCLE			PERCENT OF ALLOWABLE CO =	78.46			

65

ORIGINAL PAGE IS
 OF POOR QUALITY

TABLE VIII. LEANOUT DATA, 65 LB/HR, 20° BTDC

CYCLE NO. 921		CELL-17		DATE 1/15/75					
LEAN-OUT T.O. CL. APP. , TIMING 20 BTDC				ENGINE - LYCOMING O-320-DIAD					
ENGINE TIMING 20.000 DEG. BTDC		RATED H.P. 160.		H.C. RATIO 2.125					
	UNITS	IDLE	TAXI	TAKE OFF	CLIMB	APPROACH	TAXI	IDLE	
RUN NUMBER		921	922	966	967	968	926	930	
TIME IN MODE	MIN.	1.00	11.00	0.30	5.00	6.00	3.00	1.00	
ENGINE SPEED	RPM	593.94	1198.86	2695.65	2425.80	2351.39	1212.66	588.42	
OBS. HORSEPOWER	HP	0.37387	2.24260	142.38882	119.88766	63.58942	2.04180	0.18688	
F/A RATIO MEAS.	- - -	0.0922	0.0995	0.0700	0.0688	0.0712	0.0953	0.0900	
F/A RATIO CALC.	- - -	0.0915	0.0982	0.0702	0.0711	0.0708	0.0984	0.0909	
% DIFF. IN F/A	%	-0.816	-1.377	0.257	3.333	-0.586	3.263	1.037	
AIR FLOW	LBS/HR	59.57	95.98	952.39	846.66	494.04	95.35	52.24	
FUEL FLOW	LBS/HR	5.49	9.54	66.66	58.26	35.17	9.09	5.60	
VAPOR FLOW	LPS/HR	0.01323	0.07187	0.34156	0.29848	0.15838	0.02077	0.01803	
RELATIVE HUMIDITY	%	2.26	2.29	3.74	3.65	3.36	2.25	2.92	
BAROMETER	IN. HG.	29.28	29.28	29.04	29.04	29.04	29.27	29.11	
IND. AIR TEMP.	DEG. F	62.92	62.60	60.93	61.34	61.13	62.71	63.27	
MAX. CHT	DEG. F	256.44	257.81	450.06	412.33	365.88	285.97	239.88	
HC WET	PPM	29236.91	10341.03	774.70	151.98	827.88	9425.93	29851.95	96
NOX WET	PPM	3.29	13.89	2250.62	1322.23	1277.53	16.03	5.15	
CO WET	%	8.2799	10.2039	1.4360	1.8312	1.8160	10.0173	7.8078	
CO2 WET	%	5.8292	6.8098	11.2404	10.9708	11.0582	6.8128	5.5422	
O2 WET	%	3.7625	0.6000	0.1700	0.0938	0.2617	0.3880	3.9085	
H2O CORRECTION	- - -	0.89686	0.87879	0.87130	0.85913	0.87284	0.86218	0.89515	
HC MASS/MODE	LR/MODE	0.01681	0.10802	0.00197	0.00570	0.02188	0.02631	0.01779	
NOX MASS/MODE	LR/MODE	0.00001	0.00047	0.01854	0.16055	0.10939	0.00015	0.00001	
CO MASS/MODE	LR/MODE	0.09354	2.10653	0.07216	1.35653	0.94866	0.55273	0.09199	
HC MODE/STD. CYCLE	%	5.530	35.531	0.648	1.874	7.198	8.656	5.853	
NOX MODE/STD. CYCLE	%	0.003	0.196	7.724	66.895	45.580	0.060	0.004	
CO MODE/STD. CYCLE	%	1.392	31.347	1.074	20.186	14.117	8.275	1.369	
HC EMISSION PER HP CYCLE =	0.00124 LB/HP CYCLE				PERCENT OF ALLOWABLE HC =	65.29			
NOX EMISSION PER HP CYCLE =	0.00181 LB/HP CYCLE				PERCENT OF ALLOWABLE NOX =	120.46			
CO EMISSION PER HP CYCLE =	0.03264 LB/HP CYCLE				PERCENT OF ALLOWABLE CO =	77.71			

TABLE VII_m. LEANOUT DATA, 66 LB/HR, 20° BTDC

CYCLE NO. 921		CFLL-17		DATE 1/15/75				
LEAN-OUT T.O. CL. APP., TIMING 20 BTDC				ENGINE - LYCOMING O-320-D1AD				
ENGINE TIMING 20.000 DEG. BTDC		RATED H.P. 160.		H.C. RATIO 2.125				
	UNITS	IDLE	TAXI	TAKE OFF	CLIMB	APPROACH	TAXI	IDLE
PUN NUMBER		921	922	976	977	978	926	930
TIME IN MODE	MIN.	1.00	11.00	0.30	5.00	6.00	3.00	1.00
ENGINE SPEED	RPM	593.04	1198.86	2703.51	2421.66	2350.55	1212.66	588.42
OBS. HORSEPOWER	HP	0.37387	2.24260	139.81818	116.01779	64.07449	2.04180	0.18588
F/A RATIO MEAS.	- - -	0.0922	0.0995	0.0673	0.0666	0.0653	0.0953	0.0900
F/A RATIO CALC.	- - -	0.0915	0.0982	0.0671	0.0686	0.0651	0.0984	0.0909
% DIFF. IN F/A	%	-0.816	-1.377	-0.235	3.048	1.327	3.263	1.037
AIR FLOW	LBS/HR	59.57	95.88	955.57	853.06	523.58	95.35	62.24
FUEL FLOW	LBS/HR	5.49	9.54	64.29	56.83	34.17	9.09	5.60
VAPOR FLOW	LBS/HR	0.01373	0.22187	0.45000	0.40101	0.22729	0.02077	0.01803
RELATIVE HUMIDITY	%	2.26	2.29	4.92	4.94	4.50	2.25	2.92
BAROMETER	IN. HG.	29.28	29.28	29.03	29.03	29.03	29.27	29.11
IND. AIR TEMP.	DEG. F	62.92	62.60	60.91	61.02	61.30	62.71	63.27
MAX. CHT	DEG. F	256.44	267.81	446.45	410.54	372.93	285.97	239.88
HC WFT	PPM	29236.91	10341.03	344.27	55.40	252.56	9425.93	29851.95
NOX WFT	PPM	3.29	13.89	2829.48	1797.18	1602.26	16.03	5.15
CO WFT	%	8.2299	10.2039	0.5126	0.9174	0.5189	10.0173	7.8078
CO2 WFT	%	5.8292	5.8088	11.6177	11.3506	11.4045	6.8128	5.5422
O2 WFT	%	3.7625	0.6000	0.3361	0.1437	0.6000	0.3880	3.9086
H2O CORRECTION	- - -	0.89686	0.87879	0.87623	0.86301	0.87148	0.86218	0.89515
HC MASS/MODE	LB/MODE	0.01681	0.10802	0.00087	0.00208	0.00695	0.02631	0.01779
NOX MASS/MODE	LB/MODE	0.00001	0.00047	0.02314	0.21829	0.14285	0.00015	0.00001
CO MASS/MODE	LB/MODE	0.09354	2.10653	0.07558	0.67982	0.28223	0.55273	0.09199
HC MODE/STD. CYCLE	%	5.530	35.531	0.286	0.683	2.286	8.656	5.853
NOX MODE/STD. CYCLE	%	0.003	0.196	9.643	90.953	59.523	0.060	0.004
CO MODE/STD. CYCLE	%	1.392	31.347	0.381	10.116	4.200	8.225	1.369
HC EMISSION PER HP CYCLE =	0.00112 LB/HP CYCLE	PERCENT OF ALLOWABLE HC =				58.83		
NOX EMISSION PER HP CYCLE =	0.00241 LB/HP CYCLE	PERCENT OF ALLOWABLE NOX =				160.38		
CO EMISSION PER HP CYCLE =	0.02395 LB/HP CYCLE	PERCENT OF ALLOWABLE CO =				57.03		

67

TABLE VII n. LEANOUT DATA, 64 LB/HR, 20° BTDC

CYCLE NO. 921		CELL-L7		DATE 1/15/75				
LEAN-OUT T.O. CL. APP. . TIMING 20 BTDC				ENGINE - LYCOMING O-320-DIAD				
ENGINE TIMING		20.000 DEG. BTDC		RATED H.P. 160.		H.C. RATIO 2.125		
	UNITS	IDLE	TAXI	TAKE OFF	CLIMB	APPROACH	TAXI	IDLE
RUN NUMBER		921	922	970	971	972	926	930
TIME IN MODE	MIN.	1.00	11.00	0.30	5.00	6.00	3.00	1.00
ENGINE SPEED	RPM	593.94	1198.86	2709.39	2444.10	2351.99	1212.66	588.42
OBS. HORSEPOWER	HP	0.37387	2.24260	140.94124	120.43333	65.45584	2.04180	0.18688
F/A RATIO MEAS.	- - -	0.0922	0.0995	0.0673	0.0675	0.0666	0.0953	0.0900
F/A RATIO CALC.	- - -	0.0915	0.0982	0.0669	0.0691	0.0659	0.0984	0.0909
% DIFF. IN F/A	%	-0.816	-1.377	-0.477	2.427	-1.129	3.253	1.037
AIR FLOW	LBS/HR	59.57	95.88	955.80	859.56	522.94	95.35	62.24
FUEL FLOW	LBS/HR	5.49	9.54	64.28	58.02	34.84	9.09	5.60
VAPOR FLOW	LBS/HR	0.01323	0.02187	0.35900	0.34950	0.19337	0.02077	0.01803
RELATIVE HUMIDITY	%	2.26	2.29	3.91	4.19	3.87	2.25	2.92
BAROMETER	IN.HG.	29.28	29.28	29.04	29.03	29.03	29.27	29.11
IND. AIR TEMP.	DEG.F	62.92	62.60	60.91	61.07	60.93	62.71	53.27
MAX. CHT	DEG.F	256.44	267.81	457.20	409.03	376.50	285.97	239.88
HC WFT	PPM	29236.91	10341.03	293.83	96.80	185.58	9425.93	29851.95
NOX WFT	PPM	3.29	13.89	7840.08	1808.68	1606.96	16.03	5.15
CO WFT	%	8.2799	10.2039	0.4859	1.0657	0.4574	10.0173	7.8078
CO2 WFT	%	5.8292	6.8088	11.6354	11.2955	11.5134	6.8128	5.5422
O2 WFT	%	3.7625	0.6000	0.3619	0.1130	0.6245	0.3880	3.9086
H2O CORRECTION	- - -	0.89686	0.87879	0.87729	0.86490	0.88001	0.86218	0.89515
HC MASS/MODE	LB/MODE	0.01581	0.10802	0.00074	0.00367	0.00512	0.02631	0.01779
NOX MASS/MODE	LB/MODE	0.00001	0.00047	0.02323	0.22193	0.14357	0.00015	0.00001
CO MASS/MODE	LB/MODE	0.09354	2.10653	0.02425	0.79780	0.24932	0.55273	0.09199
HC MODE/STD.CYCLE	%	5.530	35.531	0.244	1.206	1.684	8.656	5.853
NOX MODE/STD.CYCLE	%	0.003	0.196	9.680	92.472	59.820	0.060	0.004
CO MODE/STD.CYCLE	%	1.392	31.347	0.361	11.872	3.710	8.225	1.369
HC EMISSION PER HP CYCLE =	0.00112 LB/HP CYCLE		PERCENT OF ALLOWABLE HC =			58.71		
NOX EMISSION PER HP CYCLE =	0.00243 LB/HP CYCLE		PERCENT OF ALLOWABLE NOX =			162.24		
CO EMISSION PER HP CYCLE =	0.02448 LB/HP CYCLE		PERCENT OF ALLOWABLE CO =			58.28		

68

TABLE VII o. LEANOUT DATA, 64 LB/HR, 20° BTDC

CYCLE NO. 921		CELL-17		DATE 1/15/75					
LEAN-OUT T.O. CL. APP. , TIMING 20 BTDC					ENGINE - LYCOMING O-320-D1AD				
ENGINE TIMING		20.000	DEG. BTDC	RATED H.P. 160.		H.G. RATIO 2.125			
		UNITS	IDLE	TAXI	TAKE OFF	CLIMB	APPROACH	TAXI	IDLE
SUN NUMBER			921	922	973	974	975	926	930
TIME IN MODE	MIN.		1.00	11.00	0.30	5.00	6.00	3.00	1.00
ENGINE SPEED	RPM		593.94	1198.86	2702.85	2436.84	2357.33	1212.66	588.42
PRS. HORSEPOWER	HP		0.37387	2.24260	139.73007	119.16124	65.38005	2.04180	0.18688
F/A RATIO MEAS.	- - -		0.0922	0.0995	0.0668	0.0669	0.0666	0.0953	0.0900
F/A RATIO CALC.	- - -		0.0915	0.0982	0.0669	0.0686	0.0658	0.0984	0.0909
% DIFF. IN F/A	%		-0.816	-1.377	0.182	2.581	-1.184	3.263	1.037
AIR FLOW	LBS/HR		59.57	95.88	955.04	861.62	525.56	95.35	62.24
FUEL FLOW	LBS/HR		5.49	9.54	63.81	57.64	35.00	9.09	5.60
VAPOR FLOW	LBS/HR		0.01323	0.02187	0.41014	0.37642	0.21366	0.02077	0.01803
RELATIVE HUMIDITY	%		2.26	2.29	4.48	4.51	4.18	2.25	2.92
BAROMETER	IN. HG.		29.28	29.28	29.04	29.04	29.04	29.27	29.11
IND. AIR TEMP.	DEG. F		62.92	62.60	60.75	61.05	61.18	62.71	63.27
MAX. CHT	DEG. F		256.44	257.81	444.82	411.32	371.59	285.97	239.88
HC WET	PPM		29236.91	10341.03	334.47	65.81	219.83	9425.93	29851.95
NOX WET	PPM		3.29	13.89	2870.29	1947.79	1593.06	16.03	5.15
CO WET	%		8.2209	10.2039	0.4747	0.8889	0.4849	10.0173	7.8078
CO2 WET	%		5.9292	6.8088	11.5878	11.3825	11.5032	6.8128	5.5422
O2 WET	%		3.7625	0.6000	0.3600	0.1309	0.6642	0.3880	3.9086
H2O CORRECTION	- - -		0.89686	0.87879	0.87538	0.86479	0.88007	0.86218	0.89515
HC MASS/MODE	LB/MODE		0.01681	0.10802	0.00084	0.00249	0.00609	0.02631	0.01779
NOX MASS/MODE	LB/MODE		0.00001	0.00047	0.02343	0.23914	0.14304	0.00015	0.00001
CO MASS/MODE	LB/MODE		0.09354	2.10553	0.02364	0.66585	0.26563	0.55273	0.09199
HC MODE/STD. CYCLE	%		5.530	35.531	0.277	0.820	2.004	8.656	5.853
NOX MODE/STD. CYCLE	%		0.003	0.196	9.763	99.642	59.599	0.060	0.004
CO MODE/STD. CYCLE	%		1.392	31.347	0.352	9.908	3.953	8.225	1.369
HC EMISSION PER HP CYCLE =			0.00111 LB/HP CYCLE				PERCENT OF ALLOWABLE HC =	58.67	
NOX EMISSION PER HP CYCLE =			0.00254 LB/HP CYCLE				PERCENT OF ALLOWABLE NOX =	169.27	
CO EMISSION PER HP CYCLE =			0.02375 LB/HP CYCLE				PERCENT OF ALLOWABLE CO =	56.55	

TABLE VII p. LEANOUT DATA, 64 LB/HR, 20° BTDC

ORIGINAL PAGE IS
 OF POOR QUALITY

CYCLE NO. 742		CELL-17		DATE 1/ 8/76				
15DFG BTDC LEANOUT TO,CL,APP 81.0#/HR				ENGINE - LYCOMING O-320-DIAD				
ENGINE TIMING 15.000 DEG. BTDC		RATED H.P. 160.		H.C. RATIO 2.125				
	UNITS	IDLE	TAXI	TAKE OFF	CLIMB	APPROACH	TAXI	IDLE
PUN NUMREP		742	743	777	779	780	747	748
TIME IN MODE	MIN.	1.00	11.00	0.30	5.00	6.00	3.00	1.00
ENGINE SPEED	RPM	590.76	1202.22	2699.73	2425.52	2352.35	1202.22	505.74
CRS. HORSEPOWER	HP	0.57265	1.45742	141.86967	116.18546	64.42284	1.67078	0.15597
MANIFOLD PRESS.	IN.HG.	0.00	0.00	0.00	0.00	0.00	0.00	0.00
F/A RATIO MFAS.	- - -	0.0965	0.1059	0.0842	0.0833	0.0851	0.1019	0.1002
F/A RATIO CALC.	- - -	0.0961	0.1054	0.0829	0.0840	0.0852	0.1041	0.0954
% DIFF. IN F/A	%	-0.351	-0.471	-1.532	0.752	0.151	2.209	-4.792
AIR FLOW	LBS/HR	60.67	114.30	958.54	857.82	509.67	106.35	59.65
FUEL FLOW	LRS/HR	5.85	12.11	80.70	71.50	43.38	10.83	5.98
VAPOR FLOW	LBS/HR	0.01045	0.02020	0.18547	0.16092	0.08702	0.01760	0.00992
HUMIDITY GR H2O/LB DRY AIR		0.000	0.000	0.000	0.000	0.000	0.000	0.000
DEW POINT	DEG.F	0.000	0.000	0.000	0.000	0.000	0.000	0.000
RELATIVE HUMIDITY	%	1.80	1.84	2.04	2.01	1.82	1.74	1.74
BAROMETER	IN.HG.	29.25	29.25	29.41	29.41	29.41	29.26	29.26
IND. AIR PRESS.	IN.HG.	0.00	0.00	0.00	0.00	0.00	0.00	0.00
IND. AIR TEMP.	DEG.F	59.99	59.92	59.66	59.87	59.89	60.13	60.02
MAX. CHT	DEG.F	223.65	270.42	408.45	427.05	347.84	318.47	229.19
HC WET	PPM	24228.66	13886.38	1208.52	1191.62	1350.53	12197.21	24127.27
NOX WET	PPM	1.04	5.31	125.17	339.37	83.35	4.69	1.31
CO WET	%	8.5776	10.9983	6.1325	6.4840	6.8332	10.7873	8.6637
CO2 WET	%	6.4385	6.1867	9.0345	8.8110	8.5677	6.3438	6.4763
O2 WET	%	2.0829	0.3164	0.0490	0.0438	0.0317	0.1988	2.2244
H2O CORFECTION	- - -	0.88598	0.88084	0.87113	0.86343	0.86647	0.86976	0.90193
HC MASS/MODE	LB/MODE	0.01441	0.17664	0.00326	0.04776	0.03885	0.03884	0.01429
NOX MASS/MODE	LB/MODE	0.000002	0.000219	0.001093	0.044065	0.007767	0.000048	0.000003
CO MASS/MODE	LB/MODE	0.10080	2.76501	0.32672	5.13629	3.88461	0.67899	0.10138
HC MODE/STD.CYCLE	%	4.739	58.104	1.072	15.710	12.778	12.778	4.699
NOX MODE/STD.CYCLE	%	0.001	0.091	0.455	18.360	3.236	0.020	0.001
CO MODE/STD.CYCLE	%	1.500	41.146	4.862	76.433	57.807	10.104	1.509
HC EMISSION PER HP CYCLE =	0.00209 LB/HP CYCLE	PERCENT OF ALLOWABLE HC =			109.88			
NOX EMISSION PER HP CYCLE =	0.00033 LB/HP CYCLE	PERCENT OF ALLOWABLE NOX =			22.17			
CO EMISSION PER HP CYCLE =	0.08121 LB/HP CYCLE	PERCENT OF ALLOWABLE CO =			193.36			

TABLE VIIIa. LEANOUT DATA, 81 LB/HR, 15° BTDC

CYCLE NO. 742 CELL-17 DATE 1/ 8/76

15DEG BTDC LEANOUT TO,CL,APP 76.0#/HR

ENGINE - LYCOMING O-320-DIAD

ENGINE TIMING 15.000 DEG. BTDC RATED H.P. 160. I.C. RATIO 2.125

	UNITS	IDLE	TAXI	TAKE OFF	CLIMB	APPROACH	TAXI	IDLE
PUN NUMBER		742	743	787	788	789	747	748
TIME IN MODE	MIN.	1.00	11.00	0.30	5.00	6.00	3.00	1.00
ENGINE SPEED	RPM	590.76	1202.22	2700.93	2434.98	2359.79	1202.22	606.74
NET HORSEPOWER	HP	0.57265	1.45742	142.23750	118.71770	65.24017	1.67078	0.15597
MANIFOLD PRESS.	IN.HG.	0.00	0.00	0.00	0.00	0.00	0.00	0.00
F/A RATIO MEAS.	- - -	0.0965	0.1059	0.0786	0.0780	0.0801	0.1019	0.1002
F/A RATIO CALC.	- - -	0.0961	0.1054	0.0787	0.0797	0.0797	0.1041	0.0954
% DIFF. IN F/A	%	-0.351	-0.471	0.128	2.126	-0.415	2.209	-4.792
AIR FLOW	LBS/HR	60.67	114.30	964.56	860.29	505.44	106.35	59.55
FUEL FLOW	LBS/HR	5.85	12.11	75.81	67.12	40.46	10.83	5.98
VAPOR FLOW	LBS/HR	0.01045	0.02020	0.18419	0.15716	0.08276	0.01760	0.00992
HUMIDITY GR H2O/LB DRY AIR		0.000	0.000	0.000	0.000	0.000	0.000	0.000
DEW POINT	DEG.F	0.000	0.000	0.000	0.000	0.000	0.000	0.000
RELATIVE HUMIDITY	%	1.80	1.84	2.02	1.94	1.73	1.74	1.74
BAROMETER	IN.HG.	29.25	29.25	29.42	29.42	29.42	29.26	29.26
IND. AIR PRESS.	IN.HG.	0.00	0.00	0.00	0.00	0.00	0.00	0.00
IND. AIR TEMP.	DEG.F	59.99	59.92	59.89	60.04	60.03	60.13	60.02
MAX. CHT	DEG.F	223.65	270.42	433.55	416.01	348.40	318.47	229.19
HC WET	PPM	24228.66	13886.38	920.89	834.08	1104.51	12197.21	24127.39
NOX WET	PPM	1.04	5.31	220.37	495.59	178.84	4.69	1.31
CO WET	%	8.5776	10.9983	4.5638	4.9907	4.9623	10.7873	8.6637
CO2 WET	%	6.4385	6.1867	9.7612	9.4688	9.5580	6.3438	6.4763
O2 WET	%	2.0829	0.3164	0.0165	0.0630	0.0506	0.1988	2.2244
H2O CORRECTION	- - -	0.88598	0.88084	0.86566	0.85922	0.86762	0.86976	0.90193
HC MASS/MODE	LB/MODE	0.01441	0.17664	0.00245	0.03285	0.03091	0.03884	0.01429
NOX MASS/MODE	LB/MODE	0.000002	0.000219	0.001896	0.063240	0.016215	0.000048	0.000003
CO MASS/MODE	LB/MODE	0.10080	2.76501	0.23955	3.88523	2.74486	0.67899	0.10138
HC MODE/STD.CYCLE	%	4.739	58.104	0.804	10.807	10.168	12.778	4.599
NOX MODE/STD.CYCLE	%	0.001	0.091	0.790	26.350	6.756	0.020	0.001
CO MODE/STD.CYCLE	%	1.500	41.146	3.565	57.816	40.846	10.104	1.509
HC EMISSION PER HP CYCLE =	0.00194 LB/HP CYCLE	PERCENT OF ALLOWABLE HC =			102.10			
NOX EMISSION PER HP CYCLE =	0.00051 LB/HP CYCLE	PERCENT OF ALLOWABLE NOX =			34.01			
CO EMISSION PER HP CYCLE =	0.06572 LB/HP CYCLE	PERCENT OF ALLOWABLE CO =			156.49			

71

TABLE VIII b. LEANOUT DATA, 76 LB/HR, 15° BTDC

CYCLE NO. 742		CELL-17		DATE 1/ 8/76					
15DEG BTDC LEANOUT TO,CL,APP 76.0#/HR				ENGINE - LYCOMING O-320-DIAD					
ENGINE TIMING 15.000 DEG. BTDC		RATED H.P. 160.		H.C. RATIO 2.125					
	UNITS	IDLE	TAXI	TAKE OFF	CLIMB	APPROACH	TAXI	IDLE	
RUN NUMBER		742	743	790	791	792	747	748	
TIME IN MODE	MIN.	1.00	11.00	0.30	5.00	6.00	3.00	1.00	
ENGINE SPEED	RPM	590.76	1202.22	2705.19	2431.98	2354.27	1202.22	606.74	
CRS. HOPSEPOWER	HP	0.57265	1.45742	144.06602	120.36650	64.91112	1.67078	0.15597	
MANIFOLD PRESS.	IN.HG.	0.00	0.00	0.00	0.00	0.00	0.00	0.00	
F/A RATIO MEAS.	- - -	0.0965	0.1059	0.0786	0.0773	0.0797	0.1019	0.1002	
F/A RATIO CALC.	- - -	0.0961	0.1054	0.0788	0.0800	0.0799	0.1041	0.0954	
% DIFF. IN F/A	%	-0.351	-3.471	0.247	3.383	0.313	2.209	-4.792	
AIR FLOW	LBS/HR	60.67	114.30	967.94	867.61	507.37	106.35	59.65	
FUEL FLOW	LBS/HR	5.85	12.11	76.10	67.10	40.41	10.83	5.98	
VAPOR FLOW	LBS/HR	0.01045	0.02020	0.17793	0.15792	0.08075	0.01760	0.00992	
HUMIDITY GR H2O/LB DRY AIR		0.000	0.000	0.000	0.000	0.000	0.000	0.000	
DEW POINT	DEG.F	0.000	0.000	0.000	0.000	0.000	0.000	0.000	
RELATIVE HUMIDITY	%	1.80	1.84	1.96	1.95	1.70	1.74	1.74	
BAROMETER	IN.HG.	29.25	29.25	29.43	29.43	29.43	29.26	29.26	
IND. AIR PRESS.	IN.HG.	0.00	0.00	0.00	0.00	0.00	0.00	0.00	72
IND. AIR TEMP.	DEG.F	59.99	59.92	59.98	60.01	60.11	60.13	60.02	
MAX. CHT	DEG.F	223.65	270.42	438.68	434.11	356.67	318.47	229.19	
HC WET	PPM	24228.66	13886.38	835.68	891.89	1166.32	12197.21	24127.39	
NOX WET	PPM	1.04	5.31	215.98	467.47	164.57	4.69	1.31	
CO WET	%	8.5776	10.9983	4.6450	5.0576	5.0064	10.7873	8.6537	
CO2 WET	%	6.4385	6.1867	9.7297	9.4001	9.4980	6.3438	6.4763	
O2 WET	%	2.0829	0.3164	0.0270	0.0596	0.0537	0.1988	2.2244	
H2O CORRECTION	- - -	0.88598	0.88084	0.86508	0.85491	0.86529	0.86976	0.90193	
HC MASS/MODE	LB/MODE	0.01441	0.17664	0.00223	0.03534	0.03272	0.03884	0.01429	
NOX MASS/MODE	LB/MODE	0.000002	0.000219	0.001865	0.059999	0.014955	0.000048	0.000003	
CO MASS/MODE	LB/MODE	0.10080	2.76501	0.24468	3.96027	2.77555	0.67899	0.10138	
HC MODE/STD.CYCLE	%	4.739	58.104	0.733	11.624	10.762	12.778	4.699	
NOX MODE/STD.CYCLE	%	0.001	3.091	0.777	25.000	6.231	0.020	0.001	
CO MODE/STD.CYCLE	%	1.500	41.146	3.641	58.933	41.303	10.104	1.509	
HC EMISSION PER HP CYCLE =	0.00197 LB/HP CYCLE	PERCENT OF ALLOWABLE HC =				103.44			
NOX EMISSION PER HP CYCLE =	0.00048 LB/HP CYCLE	PERCENT OF ALLOWABLE NOX =				32.12			
CO EMISSION PER HP CYCLE =	0.06642 LB/HP CYCLE	PERCENT OF ALLOWABLE CO =				158.13			

TABLE VIII c. LEANOUT DATA, 76 LB/HR, 15° BTDC

CYCLE NO. 742

CELL-17

DATE 1/ 8/76

15DEG BTDC LEANOUT TO, CL, APP 76.04/HR

ENGINE - LYCOMING O-320-DIAD

ENGINE TIMING	15.00G DEG. BTDC	RATED H.P. 160.			I.C. RATIO 2.125			
	UNITS	IDLE	TAXI	TAKE OFF	CLIMB	APPROACH	TAXI	IDLE
RLN NUMBER		742	740	793	794	795	747	748
TIME IN MODE	MIN.	1.00	11.00	0.30	5.00	6.00	3.00	1.00
ENGINE SPEED	RPM	590.76	1202.22	2700.27	2439.00	2357.45	1202.22	606.74
CRS. HORSEPOWER	HP	0.57265	1.45742	142.25923	119.63818	64.29356	1.67078	0.15597
MANIFOLD PRESS.	IN.HG.	0.00	0.00	0.00	0.00	0.00	0.00	0.00
F/A RATIO MEAS.	- - -	0.0965	0.1059	0.0781	0.0773	0.0797	0.1019	0.1002
F/A RATIO CALC.	- - -	0.0961	0.1054	0.0788	0.0798	0.0798	0.1041	0.0954
% DIFF. IN F/A	%	-0.351	-0.471	0.899	3.308	0.081	2.209	-4.792
AIR FLOW	LBS/HR	60.67	114.30	970.14	867.37	503.61	106.35	59.55
FUEL FLOW	LBS/HR	5.85	12.11	75.81	67.03	40.16	10.83	5.98
VAPOR FLOW	LBS/HR	0.01045	0.02020	0.17515	0.15554	0.08033	0.01760	0.00992
HUMIDITY GR H2O/LB DRY AIR		0.000	0.000	0.000	0.000	0.000	0.000	0.000
DEW POINT	DEG.F	0.000	0.000	0.000	0.000	0.000	0.000	0.000
RELATIVE HUMIDITY	%	1.80	1.84	1.93	1.93	1.70	1.74	1.74
BAROMETER	IN.HG.	29.25	29.25	29.43	29.43	29.43	29.26	29.26
IND. AIR PRESS.	IN.HG.	0.00	0.00	0.00	0.00	0.00	0.00	0.00
IND. AIR TEMP.	DEG.F	59.99	59.92	59.98	60.00	60.10	60.13	60.02
MAX. CHT	DEG.F	223.65	270.42	435.34	430.77	366.16	318.47	229.19
HC WET	PPM	24228.66	13886.38	923.09	933.39	1214.72	12197.21	24127.39
NOX WET	PPM	1.04	5.31	216.52	459.85	159.67	4.69	1.31
CO WET	%	8.5776	10.9983	4.6539	5.0023	4.9645	10.7873	8.6637
CO2 WET	%	6.4385	6.1867	9.6944	9.4078	9.4875	6.3438	6.4753
O2 WET	%	2.0829	0.3164	0.0441	0.0620	0.0631	0.1988	2.2244
H2O CORRECTION	- - -	0.88598	0.88084	0.86298	0.85543	0.86651	0.86976	0.90193
HC MASS/MODE	LB/MODE	0.01441	0.17664	0.00246	0.03696	0.03383	0.03884	0.01429
NOX MASS/MODE	LB/MODE	0.000002	0.000219	0.001870	0.058992	0.014407	0.000048	0.000003
CO MASS/MODE	LB/MODE	0.10080	2.76501	0.24526	3.91507	2.73293	0.67899	0.10138
HC MODE/STD. CYCLE	%	4.739	53.104	0.810	12.158	11.129	12.778	4.699
NOX MODE/STD. CYCLE	%	0.001	0.091	0.779	24.580	6.003	0.020	0.001
CO MODE/STD. CYCLE	%	1.500	41.146	3.650	58.260	40.669	10.104	1.509
HC EMISSION PER HP CYCLE =	0.00198 LB/HP CYCLE	PERCENT OF ALLOWABLE HC =			104.42			
NOX EMISSION PER HP CYCLE =	0.00047 LB/HP CYCLE	PERCENT OF ALLOWABLE NOX =			31.48			
CO EMISSION PER HP CYCLE =	0.06587 LB/HP CYCLE	PERCENT OF ALLOWABLE CO =			156.84			

TABLE VIII d LEANOUT DATA, 76 LB/HR, 15° BTDC

ORIGINAL PAGE IS
OF POOR
QUALITY

CYCLE NO. 742

CELL-17

DATE 1/ 8/76

15DEG BTDC LEANOUT TO,CL,APP 71.0#/HR

ENGINE - LYCOMING O-320-DIAD

ENGINE TIMING 15.000 DEG. BTDC

RATED H.P. 160.

H.C. RATIO 2.125

	UNITS	IDLE	TAXI	TAKE OFF	CLIMB	APPROACH	TAXI	IDLE
RUN NUMBER		742	743	805	811	808	747	748
TIME IN MODE	MIN.	1.00	11.00	0.30	5.00	6.00	3.00	1.00
ENGINE SPEED	RPM	590.76	1202.22	2702.55	2428.02	2353.37	1202.22	606.74
OPS. HORSEPOWER	HP	0.57265	1.45742	141.56726	118.11464	64.92163	1.67078	0.15597
MANIFOLD PRESS.	IN.HG.	0.00	0.00	0.00	0.00	0.00	0.00	0.00
F/A RATIO MEAS.	- - -	0.0965	0.1059	0.0741	0.0730	0.0750	0.1019	0.1002
F/A RATIO CALC.	- - -	0.0961	0.1054	0.0739	0.0746	0.0731	0.1041	0.0954
% DIFF. IN F/A	%	-0.351	-0.471	-0.312	2.198	-2.514	2.209	-4.792
AIR FLOW	LBS/HR	60.67	114.30	967.47	871.06	505.65	106.35	59.65
FUEL FLOW	LBS/HR	5.85	12.11	71.73	63.59	37.94	10.83	5.99
VAPOR FLOW	LPS/HR	0.01045	0.02020	0.19523	0.18194	0.08994	0.01760	0.00992
HUMIDITY GR H2O/LB DRY AIR		0.000	0.000	0.000	0.000	0.000	0.000	0.000
DEW POINT	DEG.F	0.000	0.000	0.000	0.000	0.000	0.000	0.000
RELATIVE HUMIDITY	%	1.80	1.84	2.15	2.23	1.90	1.74	1.74
BAROMETER	IN.HG.	29.25	29.25	29.43	29.44	29.44	29.26	29.25
IND. AIR PRESS.	IN.HG.	0.00	0.00	0.00	0.00	0.00	0.00	0.00
IND. AIR TEMP.	DEG.F	59.99	59.92	59.81	59.93	59.96	60.13	60.02
MAX. CHT	DEG.F	223.65	270.42	428.43	420.99	371.76	318.47	229.19
HC WET	PPM	24228.66	13886.38	871.49	508.65	626.16	12197.21	24127.39
NOX WET	PPM	1.04	5.31	681.43	686.39	321.21	4.69	1.31
CO WET	%	8.5776	10.9983	7.8100	3.0990	2.5419	10.7873	8.6637
CO2 WET	%	6.4385	6.1367	10.7174	10.4186	10.9391	6.3438	6.4763
O2 WET	%	2.0829	4.3164	0.0693	0.0499	0.0495	0.1988	2.2744
H2O CORRECTION	- - -	0.88598	0.88084	0.86832	0.86028	0.87576	0.86976	0.90193
HC MASS/MODE	LB/MODE	0.01441	0.17664	0.00228	0.01989	0.01720	0.03884	0.01429
NOX MASS/MODE	LB/MODE	0.000002	0.000219	0.005779	0.086968	0.028576	0.000048	0.000003
CO MASS/MODE	LB/MODE	0.10080	2.76501	0.14540	2.39550	1.37960	0.67899	0.10138
HC MODE/STD.CYCLE	%	4.739	58.104	0.751	6.544	5.656	12.778	4.699
NOX MODE/STD.CYCLE	%	0.001	0.091	2.408	36.237	11.907	0.020	0.001
CO MODE/STD.CYCLE	%	1.500	41.146	2.164	35.647	20.530	10.104	1.509
HC EMISSION PER HP CYCLE =	0.00177 LB/HP CYCLE				PERCENT OF ALLOWABLE HC =	93.27		
NOX EMISSION PER HP CYCLE =	0.00076 LB/HP CYCLE				PERCENT OF ALLOWABLE NOX =	50.66		
CO EMISSION PER HP CYCLE =	0.04729 LB/HP CYCLE				PERCENT OF ALLOWABLE CO =	112.60		

TABLE VIIIe. LEANOUT DATA, 71 LB/HR, 15° BTDC

CYCLE NO. 742		CELL-17		DATE 1/ 8/76				
15DEG BTDC LEANOUT TO,CL,APP 71.0#/HR				ENGINE - LYCOMING 0-320-DIAD				
ENGINE TIMING 15.000 DEG. BTDC		PATED H.P. 160.		H.C. RATIO 2.125				
	UNITS	IDLE	TAXI	TAKF OFF	CLIMB	APPROACH	TAXI	IDLE
RUN NUMBER		742	743	805	812	809	747	748
TIME IN MODE	MIN.	1.00	11.00	0.30	5.00	6.00	3.00	1.00
ENGINE SPEED	RPM	590.76	1202.22	2696.91	2427.48	2351.99	1202.22	605.74
CRS. HOPSEPOWER	HP	0.57265	1.45742	140.81746	119.71761	66.04535	1.67078	0.15597
MANIFOLD PRESS.	IN.HG.	0.00	0.00	0.00	0.00	0.00	0.00	0.00
F/A RATIO MEAS.	- - -	0.0965	0.1059	0.0739	0.0728	0.0744	0.1019	0.1002
F/A RATIO CALC.	- - -	0.0961	0.1054	0.0738	0.0744	0.0730	0.1041	0.0954
% DIFF. IN F/A	%	-0.351	-0.471	-0.127	2.199	-1.829	2.209	-4.792
AIR FLOW	LBS/HR	60.67	114.30	968.00	875.58	508.54	106.35	59.65
FUEL FLOW	LBS/HR	5.85	12.11	71.52	63.73	37.82	10.83	5.99
VAPOR FLOW	LBS/HR	0.01045	0.02020	0.19351	0.17613	0.09459	0.01760	0.00992
HUMIDITY GR. H2O/LB DRY AIR		0.000	0.000	0.000	0.000	0.000	0.000	0.000
DEW POINT	DEG.F	0.000	0.000	0.000	0.000	0.000	0.000	0.000
RELATIVE HUMIDITY	%	1.80	1.84	2.14	2.16	1.98	1.74	1.74
BAROMETR	IN.HG.	29.25	29.25	29.43	29.44	29.44	29.26	29.26
IND. AIR PRESS.	IN.HG.	0.00	0.00	0.00	0.00	0.00	0.00	0.00
IND. AIR TEMP.	DEG.F	59.99	59.92	59.91	59.99	59.91	60.13	60.02
MAX. CHT	DEG.F	223.65	270.42	450.56	445.27	367.86	318.47	229.19
HC WET	PPM	24228.66	13986.38	809.18	460.45	608.06	12197.21	24127.39
NOX WET	PPM	1.04	5.31	624.88	587.76	352.27	4.69	1.31
CO WET	%	8.5776	10.9983	2.7471	3.0095	2.4888	10.7873	8.6637
CO2 WET	%	6.4385	6.1867	10.7184	10.4638	10.8825	6.3438	6.4763
O2 WET	%	2.0829	0.3164	0.0544	0.0424	0.0565	0.1988	2.2244
H2O CORRECTION	- - -	0.88598	0.88084	0.86797	0.86029	0.87410	0.86976	0.90193
HC MASS/MODE	LB/MODE	0.01441	0.17664	0.00217	0.01809	0.01675	0.03884	0.01429
NOX MASS/MODE	LB/MODE	0.000007	0.000219	0.005298	0.074793	0.031439	0.000048	0.000003
CO MASS/MODE	LB/MODE	0.10080	2.76501	0.14208	2.33639	1.35507	0.67899	0.10138
HC MODE/STD.CYCLE	%	4.739	58.104	0.697	5.949	5.510	12.778	4.699
NOX MODE/STD.CYCLE	%	0.001	0.091	2.207	31.164	13.099	0.020	0.001
CO MODE/STD.CYCLE	%	1.500	41.146	2.114	34.768	20.165	10.104	1.509
HC EMISSION PER HP CYCLE =	0.00176 LB/HP CYCLE	PERCENT OF ALLOWABLE HC =			92.48			
NOX EMISSION PER HP CYCLE =	0.00070 LB/HP CYCLE	PERCENT OF ALLOWABLE NOX =			46.58			
CO EMISSION PER HP CYCLE =	0.04675 LB/HP CYCLE	PERCENT OF ALLOWABLE CO =			111.31			

TABLE VIII-f LEANOUT DATA, 71 LB/HR, 15° BTDC

CYCLE NO. 742

CELL-17

DATE 1/ 8/76

15DEG BTDC LEANOUT TO,CL,APP 71.0#/HR

ENGINE - LYCOMING O-320-DIAP

ENGINE TIMING 15.000 DEG. BTDC PATED.H.P. 160. I.C. RATIO 2.125

	UNITS	IDLE	TAXI	TAKE OFF	CLIMB	APPROACH	TAXI	IDLE
PUN NUMBER		742	743	807	813	810	747	748
TIME IN MODE	MIN.	1.00	11.00	0.30	5.00	6.00	3.00	1.00
ENGINE SPEED	RPM	590.76	1202.22	2696.43	2428.62	2351.93	1202.22	606.74
OBS. HORSEPOWER	HP	0.57265	1.45742	139.69905	119.10049	64.62991	1.67078	0.15597
MANIFOLD PRESS.	IN.HG.	0.00	0.00	0.00	0.00	0.00	0.00	0.00
F/A RATIO MEAS.	- - -	0.0965	0.1059	0.0734	0.0727	0.0753	0.1019	0.1002
F/A RATIO CALC.	- - -	0.0961	0.1054	0.0737	0.0734	0.0730	0.1041	0.0954
% DIFF. IN F/A	%	-0.351	-0.471	0.429	0.957	-2.930	2.209	-4.792
AIR FLOW	LBS/HR	60.67	114.30	967.10	873.61	505.86	106.35	59.55
FUEL FLOW	LBS/HR	5.85	12.11	70.97	63.48	38.07	10.83	5.98
VAPOR FLOW	LBS/HR	0.01045	0.02020	0.19106	0.17363	0.09160	0.01760	0.00992
HUMIDITY GR H2O/LB DRY AIR		0.000	0.000	0.000	0.000	0.000	0.000	0.000
DEW POINT	DEG.F	0.000	0.000	0.000	0.000	0.000	0.000	0.000
RELATIVE HUMIDITY	%	1.80	1.84	2.12	2.13	1.93	1.74	1.74
BAROMETER	IN.HG.	29.25	29.25	29.44	29.44	29.44	29.26	29.26
IND. AIR PRESS.	IN.HG.	0.00	0.00	0.00	0.00	0.00	0.00	0.00
IND. AIR TEMP.	DEG.F	59.99	59.92	59.87	59.99	59.97	60.13	60.02
MAX. CHT	DEG.F	223.65	270.42	459.76	449.88	367.91	318.47	229.19
HC WET	PPM	24228.66	13886.38	720.67	282.03	623.46	12197.21	24127.39
NOX WET	PPM	1.04	5.31	566.16	518.17	381.22	4.69	1.31
CO WET	%	8.5776	10.9903	2.6988	2.6449	2.5458	10.7873	8.6637
CO2 WET	%	6.4385	6.1867	10.7166	10.7220	10.9489	6.3438	6.4763
O2 WET	%	2.0829	0.3164	0.0401	0.0348	0.0745	0.1988	2.2744
H2O CORRECTION	- - -	0.88598	0.38084	0.86617	0.86444	0.87729	0.86976	0.90193
HC MASS/MODE	LB/MODE	0.01441	0.17664	0.00188	0.01105	0.01714	0.03884	0.01429
NOX MASS/MODE	LB/MODE	0.000002	0.000219	0.004785	0.005757	0.003958	0.000048	0.000003
CO MASS/MODE	LB/MODE	0.10080	2.76501	0.13918	2.04773	1.38350	0.67899	0.10138
HC MODE/STD.CYCLE	%	4.739	58.104	0.619	3.634	5.639	12.778	4.699
NOX MODE/STD.CYCLE	%	0.001	0.091	1.994	27.399	14.149	0.020	0.001
CO MODE/STD.CYCLE	%	1.500	41.146	2.071	30.472	20.588	10.104	1.509
HC EMISSION PER HP CYCLE =	0.00171 LB/HP CYCLE				PERCENT OF ALLOWABLE HC =	90.21		
NOX EMISSION PER HP CYCLE =	0.00065 LB/HP CYCLE				PERCENT OF ALLOWABLE NOX =	43.66		
CO EMISSION PER HP CYCLE =	0.04510 LB/HP CYCLE				PERCENT OF ALLOWABLE CO =	107.39		

TABLE VIIIg. LEANOUT DATA, 71 LB/HR, 15° BTDC

CYCLE NO. 816 CELL-17 DATE 1/12/76

150FG BTDC LEANOUT TO, CL, APP 71.0#/HR

ENGINE - LYCOMING O-320-DIAD

ENGINE TIMING 15.000 DEG. BTDC RATED H.P. 160. H.C. RATIO 2.125

	UNITS	IDLE	TAXI	TAKE OFF	CLIMB	APPROACH	TAXI	IDLE
RUN NUMBER		816	817	826	827	828	821	822
TIME IN MODE	MIN.	1.00	11.00	0.30	5.00	6.00	3.00	3.00
ENGINE SPEED	RPM	595.38	1200.66	2702.07	2431.80	2360.63	1210.44	585.96
CRS. HORSEPOWER	HP	0.48525	1.27698	136.79893	120.88689	66.25111	1.15835	0.62673
MANIFOLD PRESS.	IN. HG.	0.00	0.00	0.00	0.00	0.00	0.00	0.00
F/A RATIO MEAS.	- - -	0.0892	0.1003	0.0750	0.0749	0.0751	0.1036	0.0900
F/A RATIO CALC.	- - -	0.0992	0.1014	0.0753	0.0790	0.0756	0.1059	0.0923
% DIFF. IN F/A	%	-1.058	1.015	0.398	5.496	0.645	2.174	2.527
AIR FLOW	LBS/HR	64.51	115.18	946.70	867.85	512.48	105.92	59.76
FUEL FLOW	LBS/HP	5.75	11.56	71.04	64.96	38.50	10.98	5.38
VAPOR FLOW	LBS/HR	0.01826	0.03246	0.31476	0.28954	0.14677	0.03120	0.01832
HUMIDITY GR H2O/LB DRY AIR		0.000	0.000	0.000	0.000	0.000	0.000	0.000
DEW POINT	DEG. F	0.000	0.000	0.000	0.000	0.000	0.000	0.000
RELATIVE HUMIDITY	%	2.89	2.95	3.50	3.48	3.01	3.06	3.18
RAPIDMETER	IN. HG.	29.22	29.22	29.20	29.20	29.20	29.22	29.21
IND. AIR PRESS.	IN. HG.	0.00	0.00	0.00	0.00	0.00	0.00	0.00
IND. AIR TEMP.	DEG. F	63.01	52.23	60.29	50.61	60.84	61.62	62.43
MAX. CHT	DEG. F	266.56	284.01	451.80	433.09	376.42	301.14	229.78
HC WET	PPM	20743.06	11877.18	879.99	985.30	932.09	11745.16	25446.52
NOX WET	PPM	8.81	13.55	495.07	536.69	367.42	8.27	4.32
CO WET	%	7.9754	10.2811	2.9662	4.1751	3.1006	10.4742	7.7028
CO2 WET	%	5.1702	5.2467	9.3212	8.5861	9.2185	5.5939	5.3356
O2 WET	%	3.6788	1.2253	0.0469	0.0629	0.0849	0.2950	3.2133
H2O CORRECTION	- - -	0.90691	0.89089	0.87948	0.86312	0.87884	0.88158	0.89324
HC MASS/MODE	LB/MODE	0.01278	0.14945	0.00226	0.03868	0.02595	0.03748	0.04370
NOX MASS/MODE	LB/MODE	0.000018	0.000552	0.004124	0.068252	0.033143	0.000086	0.000024
CO MASS/MODE	LB/MODE	0.09709	2.55678	0.15073	3.23922	1.70634	0.66062	0.26142
HC MODE/STD. CYCLE	%	4.203	49.160	0.744	12.723	8.537	12.329	14.374
NOX MODE/STD. CYCLE	%	0.007	0.230	1.718	28.438	13.810	0.036	0.010
CO MODE/STD. CYCLE	%	1.445	38.047	2.243	48.203	25.392	9.831	3.890
HC EMISSION PER HP CYCLE =	0.00194 LB/HP CYCLE	PERCENT OF ALLOWABLE HC =			102.07			
NOX EMISSION PER HP CYCLE =	0.00066 LB/HP CYCLE	PERCENT OF ALLOWABLE NOX =			44.25			
CO EMISSION PER HP CYCLE =	0.05420 LB/HP CYCLE	PERCENT OF ALLOWABLE CO =			129.05			

ORIGINAL PAGE IS OF POOR QUALITY

TABLE VIIIh. LEANOUT DATA, 71 LB/HR, 15° BTDC

CYCLE NO. 742

CELL-17

DATE 1/ 8/76

15DEG BTDC LEANOUT TD,CL,APP 68.0#/HR

ENGINE - LYCOMING O-320-DIAD

ENGINE TIMING 15.000 DEG. BTDC RATED H.P. 160. H.C. RATIO 2.125

	UNITS	IDLE	TAXI	TAKE OFF	CLIMB	APPROACH	TAXI	IDLE
RLN NUMBER		742	743	835	836	837	747	748
TIME IN MODE	MIN.	1.00	11.00	0.30	5.00	6.00	3.00	1.00
ENGINE SPEED	RPM	590.76	1202.22	2710.95	2432.28	2351.75	1202.22	605.74
CRS. HORSP POWER	HP	0.57265	1.45742	133.28123	119.67102	64.45346	1.67078	0.15597
MANIFOLD PRESS.	IN.HG.	0.00	0.00	0.00	0.00	0.00	0.00	0.00
F/A RATIO MEAS.	- - -	0.0965	0.1059	0.0722	0.0713	0.0725	0.1019	0.1002
F/A RATIO CALC.	- - -	0.0961	0.1054	0.0715	0.0745	0.0710	0.1041	0.0954
% DIFF. IN F/A	%	-0.351	-0.471	-1.036	4.520	-2.097	2.209	-4.792
AIP FLOW	LBS/HR	60.67	114.30	929.19	860.14	509.84	166.35	59.65
FUEL FLOW	LBS/HR	5.85	12.11	67.11	61.32	36.95	10.83	5.98
VAPOR FLOW	LBS/HR	0.01045	0.02020	0.30068	0.27768	0.14477	0.01760	0.00992
HUMIDITY GR H2O/LB DRY AIR		0.000	0.000	0.000	0.000	0.000	0.000	0.000
DEW POINT	DEG.F	0.000	0.000	0.000	0.000	0.000	0.000	0.000
RELATIVE HUMIDITY	%	1.80	1.84	3.33	3.39	2.97	1.74	1.74
BAROMETER	IN.HG.	29.25	29.25	29.18	29.18	29.18	29.26	29.26
IND. AIR PRESS.	IN.HG.	0.00	0.00	0.00	0.00	0.00	0.00	0.00
IND. AIR TEMP.	DEG.F	59.99	59.92	60.54	60.31	60.84	60.13	60.02
MAX. CHT	DEG.F	223.65	270.42	461.44	435.90	387.14	318.47	229.19
HC WET	PPM	24228.66	13886.38	669.97	547.85	495.21	12197.21	24127.39
NOX WET	PPM	1.04	5.31	1016.84	741.37	842.38	4.69	1.31
CO WET	%	8.5776	10.9983	1.6673	2.7373	1.6087	10.7873	8.6637
CC2 WET	%	6.4385	6.1867	9.8816	9.2229	9.9425	6.3438	5.4753
C2 WET	%	2.0829	0.3164	0.0857	0.0748	0.1405	0.1988	2.2244
H2O CORRECTION	- - -	0.88598	0.88084	0.88741	0.86866	0.89061	0.86976	0.90193
HC MASS/MODE	LB/MODE	0.01441	0.17664	0.00167	0.02102	0.01358	0.03884	0.01429
NOX MASS/MODE	LB/MODE	0.000002	0.000219	0.008222	0.092142	0.074817	0.000048	0.000003
CO MASS/MODE	LB/MODE	0.10080	2.76501	0.08224	2.07551	0.87169	0.67899	0.10138
HC MODE/STD.CYCLE	%	4.739	59.104	0.550	6.914	4.466	12.778	4.699
NOX MODE/STD.CYCLE	%	0.001	0.091	3.426	38.392	31.174	0.020	0.001
CO MODE/STD.CYCLE	%	1.500	41.146	1.224	30.886	12.972	10.104	1.509
HC EMISSION PER HP CYCLE =	0.00175 LB/HP CYCLE					PERCENT OF ALLOWABLE HC =	92.25	
NOX EMISSION PER HP CYCLE =	0.00110 LB/HP CYCLE					PERCENT OF ALLOWABLE NOX =	73.11	
CO EMISSION PER HP CYCLE =	0.04172 LB/HP CYCLE					PERCENT OF ALLOWABLE CO =	99.34	

TABLE VIII. LEANOUT DATA, 68 LB/HR, 15° BTDC

CYCLE NO. 742 CFLL-17 DATE 1/ 8/76

15DEG BTDC LEANOUT TO, CL, APP 68.0#/HR

ENGINE - LYCOMING O-320-DIAD

ENGINE TIMING 15.000 DEG. BTDC RATED H.P. 160. H.C. RATIO 2.125

	UNITS	IDLE	TAXI	TAKE OFF	CLIMB	APPROACH	TAXI	IDLE
RUN NUMPER		742	743	838	839	840	747	748
TIME IN MODE	MIN.	1.00	11.00	0.30	5.00	6.00	3.00	1.00
ENGINE SPEED	RPM	590.76	1202.22	2711.07	2425.68	2356.67	1202.22	606.74
OPS. HORSPPOWER	HP	0.57265	1.45742	131.85023	117.57364	63.30225	1.67078	0.15597
MANIFOLD PRESS.	IN.HG.	0.00	0.00	0.00	0.00	0.00	0.00	0.00
F/A RATIO MEAS.	- - -	0.0965	0.1059	0.0716	0.0712	0.0712	0.1019	0.1002
F/A RATIO CALC.	- - -	0.0961	0.1054	0.0715	0.0744	0.0710	0.1041	0.0954
% DIFF. IN F/A	%	-0.351	-0.471	-0.233	4.587	-0.402	2.209	-4.792
AIR FLOW	LBS/HR	60.67	114.30	941.93	859.34	511.75	106.35	59.65
FUEL FLOW	LBS/HP	5.85	12.11	67.49	61.16	36.46	10.83	5.98
VAPOR FLOW	LBS/HR	0.01045	0.02020	0.31539	0.29800	0.14332	0.01760	0.00992
HUMIDITY GR. H2O/LB DRY AIR		0.000	0.000	0.000	0.000	0.000	0.000	0.000
DEW POINT	DEG.F	0.000	0.000	0.000	0.000	0.000	0.000	0.000
RELATIVE HUMIDITY	%	1.80	1.84	3.53	3.59	2.94	1.74	1.74
BAROMETER	IN.HG.	29.25	29.25	29.18	29.18	29.18	29.26	29.25
IND. AIR PRESS.	IN.HG.	0.00	0.00	0.00	0.00	0.00	0.00	0.00
IND. AIR TEMP.	DEG.F	59.99	59.92	60.35	60.82	60.97	60.13	60.02
MAX. CHT	DEG.F	223.65	270.42	460.06	487.79	378.51	318.47	229.19
HC WET	PPM	24228.66	13886.38	669.85	422.66	523.89	12197.21	24127.39
NOX WET	PPM	1.04	5.31	1342.93	734.07	833.98	4.69	1.31
CO WET	%	8.5776	10.9983	1.6864	2.7437	1.6108	10.7873	8.6637
CO2 WET	%	6.4385	6.1867	9.8712	9.2623	9.8860	6.3438	6.4763
O2 WET	%	2.0829	0.3164	0.0966	0.0716	0.1533	0.1988	2.2244
H2O CORRECTION	- - -	0.88598	0.88084	0.88503	0.86787	0.88552	0.86976	0.90193
HC MASS/MODE	LB/MODE	0.01441	0.17664	0.00169	0.01619	0.01435	0.03884	0.01429
NOX MASS/MODE	LB/MODE	0.000002	0.000219	0.010982	0.091109	0.073974	0.000048	0.000003
CO MASS/MODE	LB/MODE	0.10080	2.76501	0.08414	2.07756	0.87177	0.67899	0.10138
HC MODE/STD. CYCLE	%	4.739	58.104	0.556	5.327	4.719	12.778	4.599
NOX MODE/STD. CYCLE	%	0.001	0.091	4.576	37.962	30.823	0.020	0.001
CO MODE/STD. CYCLE	%	1.500	41.146	1.252	30.916	12.973	10.104	1.509
HC EMISSION PER HP CYCLE =	0.00173 LB/HP CYCLE				PERCENT OF ALLOWABLE HC =	90.92		
NOX EMISSION PER HP CYCLE =	0.00110 LB/HP CYCLE				PERCENT OF ALLOWABLE NOX =	73.47		
CO EMISSION PER HP CYCLE =	0.04175 LB/HP CYCLE				PERCENT OF ALLOWABLE CO =	99.40		

TABLE VIIIj. LEANOUT DATA, 68 LB/HR, 15° BTDC

CYCLE NO. 742 CELL-17 DATE 1/ 8/76
 15DEG BTDC LEANOUT TO, CL, APP 64.0#/HR ENGINE - LYCOMING O-320-DIAD

ENGINE TIMING		RATED H.P. 160.			H.C. RATIO 2.125			
	UNITS	IDLE	TAXI	TAKE OFF	CLIMB	APPROACH	TAXI	IDLE
RUN NUMBER		742	743	850	851	852	747	748
TIME IN MODE	MIN.	1.00	11.00	0.30	5.00	6.00	3.00	1.00
ENGINE SPEED	RPM	590.76	1202.22	2704.71	2439.99	2349.98	1202.22	606.74
OPS. HOPSEPOWER	HP	0.57265	1.45742	126.49059	122.64912	66.38776	1.67078	0.15597
MANIFOLD PRESS.	IN.HG.	0.00	0.00	0.00	0.00	0.00	0.00	0.00
F/A RATIO MEAS.	- - -	0.0965	0.1059	0.0691	0.0684	0.0671	0.1019	0.1002
F/A RATIO CALC.	- - -	0.0961	0.1054	0.0686	0.0710	0.0664	0.1041	0.0954
% DIFF. IN F/A	%	-0.351	-0.471	-0.719	3.918	-1.050	2.209	-4.792
AIR FLOW	LBS/HR	60.67	114.30	929.30	875.67	533.77	106.35	59.65
FUEL FLOW	LBS/HR	5.85	12.11	64.22	59.86	35.80	10.83	5.98
VAPOR FLOW	LBS/HR	0.01045	0.02020	0.30388	0.29755	0.18696	0.01760	0.00992
HUMIDITY GR H2O/LB DRY AIR		0.000	0.000	0.000	0.000	0.000	0.000	0.000
DEW POINT	DEG.F	0.000	0.000	0.000	0.000	0.000	0.000	0.000
RELATIVE HUMIDITY	%	1.80	1.84	3.30	3.37	3.50	1.74	1.74
BAROMETER	IN.HG.	29.25	29.25	28.63	28.60	28.59	29.26	29.26
IND. AIR PRESS.	IN.HG.	0.00	0.00	0.00	0.00	0.00	0.00	0.00
IND. AIR TEMP.	DEG.F	59.99	59.92	61.40	61.79	62.12	60.13	60.02
MAX. CHT	DEG.F	223.65	270.42	464.92	444.85	373.91	318.47	229.19
HC WET	PPM	24228.66	13886.38	309.71	776.70	124.59	12197.21	24127.39
NOX WET	PPM	1.04	5.31	1946.89	1510.77	1074.61	4.69	1.31
CO WET	%	8.5776	10.9983	0.7806	1.6411	0.3725	10.7873	8.6537
CO2 WET	%	6.4385	6.1867	11.3674	10.6814	11.3854	6.3438	6.4763
O2 WET	%	2.0829	0.3164	0.1040	0.1170	0.4128	0.1988	2.2744
H2O CORRECTION	- - -	0.88598	0.88084	0.87798	0.86205	0.88110	0.86976	0.90193
HC MASS/MODE	LB/MODE	0.01441	0.17664	0.00077	0.03006	0.00351	0.03884	0.01429
NOX MASS/MODE	LB/MODE	0.000002	0.000219	0.015586	0.189394	0.098124	0.000048	0.000003
CO MASS/MODE	LB/MODE	0.10090	2.76501	0.03813	1.25517	0.20749	0.67899	0.10138
HC MODE/STD.CYCLE	%	4.739	58.104	0.252	9.887	1.155	12.778	4.699
NOX MODE/STD.CYCLE	%	0.001	0.091	6.494	78.914	40.885	0.020	0.001
CO MODE/STD.CYCLE	%	1.500	41.146	0.567	18.678	3.088	10.104	1.509
HC EMISSION PER HP CYCLE =	0.00174 LB/HP CYCLE				PERCENT OF ALLOWABLE HC =	91.61		
NOX EMISSION PER HP CYCLE =	0.00190 LB/HP CYCLE				PERCENT OF ALLOWABLE NOX =	126.41		
CO EMISSION PER HP CYCLE =	0.03217 LB/HP CYCLE				PERCENT OF ALLOWABLE CO =	76.59		

TABLE VIIIK. LEANOUT DATA, 64 LB/HR, 15° BTDC

CYCLE NO. 1170

CELL-17

DATE 2/ 9/75

30 BTDC

ENGINE - LYCOMING O-320-D1A0

ENGINE TIMING	30,000 DEG. BTDC	RATED H.P. 160			H.C. RATIO 2.125		
UNITS	IDLE	TAXI	TAKE OFF	CLIMB	APPROACH	TAXI	IDLE
RUN NUMBER	1170	1171	1172	1173	1174	1176	1177
TIME IN MODE	1.00	11.00	0.30	5.00	6.00	3.00	1.00
ENGINE SPEED	613.19	1197.30	2704.77	2431.74	2353.96	1202.04	587.10
OBS. HORSEPOWER	0.66532	1.84873	156.68916	119.18997	65.29181	0.97242	1.30323
F/A RATIO MEAS.	0.0918	0.0932	0.0841	0.0808	0.0886	0.0932	0.0973
F/A RATIO CALC.	0.0927	0.0957	0.0843	0.0823	0.0899	0.0956	0.0931
% DIFF. IN F/A	0.978	2.671	0.316	1.913	1.523	2.490	-4.326
AIR FLOW	49.91	84.77	960.96	738.73	462.48	80.12	45.86
FUEL FLOW	4.58	7.90	80.79	59.69	40.96	7.47	4.56
VAPOR FLOW	0.02200	0.03740	0.45955	0.32693	0.18554	0.03359	0.01928
RELATIVE HUMIDITY	4.53	4.52	4.49	4.33	3.96	3.97	4.24
BAROMETER	29.16	29.16	29.16	29.16	29.16	29.16	29.15
IND. AIR TEMP.	64.60	63.95	63.49	62.72	62.86	64.90	64.82
MAX. CHT	268.98	259.03	427.91	439.25	353.48	299.87	257.90
HC WET	33339.56	7801.77	1469.15	1470.15	2058.20	7806.77	34753.45
NOX WET	6.51	23.82	421.70	735.67	211.65	23.88	5.81
CO WET	7.6975	9.3775	6.7467	5.9841	8.4796	9.3028	7.6724
CO2 WET	6.1623	7.2849	8.8765	9.1592	7.8954	7.2941	6.3646
O2 WET	3.5679	0.2380	0.0927	0.0985	0.1070	0.2275	3.5301
H2O CORRECTION	0.88760	0.86044	0.86260	0.85769	0.86121	0.86136	0.90566
HC MASS/MODE	0.01604	0.07049	0.00397	0.05027	0.05442	0.01818	0.01601
NOX MASS/MODE	0.00001	0.00070	0.00369	0.08149	0.01813	0.00018	0.00001
CO MASS/MODE	0.07321	1.67456	0.36029	4.04402	4.43122	0.42827	0.06985
HC MODE/STD. CYCLE	5.278	23.187	1.306	16.536	17.901	5.982	5.266
NOX MODE/STD. CYCLE	0.004	0.291	1.538	33.955	7.554	0.075	0.004
CO MODE/STD. CYCLE	1.089	24.919	5.361	60.179	65.941	6.373	1.040
HC EMISSION PER HP CYCLE =	0.00143 LB/HP CYCLE					PERCENT OF ALLOWABLE HC =	75.46
NOX EMISSION PER HP CYCLE =	0.00065 LB/HP CYCLE					PERCENT OF ALLOWABLE NOX =	43.42
CO EMISSION PER HP CYCLE =	0.06926 LB/HP CYCLE					PERCENT OF ALLOWABLE CO =	164.90

TABLE IX a. LEANOUT DATA, 81 LB/HR, 30° BTDC

ORIGINAL PAGE IS
OF POOR QUALITY

81

CYCLE NO. 1190

CELL-17

DATE 2/ 9/76

30DEG BTDC LEANOUT TO,CL,APP 77.0#/HR

ENGINE - LYCOMING O-320-DIAD

ENGINE TIMING 30.000 DEG. BTDC RATED H.P. 160. H.C. RATIO 2.125

	UNITS	IDLE	TAXI	TAKF OFF	CLIMB	APPROACH	TAXI	IDLE
PLN NUMBER		1190	1191	1140	1141	1142	1195	1198
TIME IN MODE	MIN.	1.00	11.00	0.30	5.00	6.00	3.00	1.00
ENGINE SPEED	RPM	589.62	1200.42	2707.47	2435.64	2352.71	1200.96	615.60
CRS. HCPSEPOWER	HP	0.44928	1.11425	155.21184	119.86304	65.61165	0.84031	0.55616
MANIFOLD PRESS.	IN.HG.	0.00	0.00	0.00	0.00	0.00	0.00	0.00
F/A RATIO MEAS.	- - -	0.0905	0.0935	0.0824	0.0793	0.0852	0.0942	0.0889
F/A RATIO CALC.	- - -	0.0919	0.0950	0.0815	0.0797	0.0859	0.0951	0.0913
% DIFF. IN F/A	%	1.578	1.535	-1.182	0.534	0.835	0.909	2.682
AIR FLOW	LBS/HR	49.04	80.51	928.56	738.92	456.73	77.77	51.15
FUEL FLOW	LBS/HR	4.44	7.53	76.55	58.61	38.91	7.33	4.55
VAPOR FLOW	LBS/HR	0.01790	0.02973	0.26147	0.25551	0.15687	0.02713	0.01899
HUMIDITY GR H2O/LB DRY AIR		0.000	0.000	0.000	0.000	0.000	0.000	0.000
DEW POINT	DEG.F	0.000	0.000	0.000	0.000	0.000	0.000	0.000
RELATIVE HUMIDITY	%	3.75	3.73	2.79	3.41	3.49	3.58	3.72
BAROMETER	IN.HG.	29.12	29.12	28.92	28.93	28.93	29.12	29.11
IND. AIR PRESS.	IN.HG.	0.00	0.00	0.00	0.00	0.00	0.00	0.00
IND. AIR TEMP.	DEG.F	65.22	64.72	61.56	62.19	62.20	63.25	65.29
MAX. CHT	DEG.F	258.05	276.99	444.34	445.11	370.04	305.28	257.14
HC WET	PPM	33004.27	7548.75	1324.13	1354.73	1912.69	8454.84	32193.19
NOX WET	PPM	5.99	26.14	603.26	1033.50	338.03	25.73	5.90
CO WET	%	7.3199	9.1091	5.7322	5.1316	7.2145	8.8526	7.2500
CO2 WET	%	6.2756	7.2970	9.3507	9.5268	8.4291	7.2278	6.2342
O2 WET	%	3.4856	0.2404	0.1056	0.1716	0.1743	0.2558	3.5118
H2O CORRECTION	- - -	0.88569	0.86581	0.86882	0.86400	0.86360	0.87012	0.89238
HC MASS/MODE	LB/MODE	0.01553	0.06485	0.00344	0.04607	0.04933	0.01918	0.01571
NOX MASS/MODE	LB/MODE	0.000009	0.000727	0.005070	0.113856	0.028242	0.000189	0.000009
CO MASS/MODE	LB/MODE	0.06807	1.54658	0.29393	3.44898	3.67727	0.39697	0.06993
HC MODE/STD.CYCLE	%	5.108	21.331	1.130	15.154	16.226	6.310	5.168
NOX MODE/STD.CYCLE	%	0.004	0.303	2.113	47.440	11.767	0.079	0.004
CO MODE/STD.CYCLE	%	1.013	23.015	4.374	51.324	54.721	5.907	1.041
HC EMISSION PER HP CYCLE =	0.00134 LB/HP CYCLE				PERCENT OF ALLOWABLE HC =	70.43		
NOX EMISSION PER HP CYCLE =	0.00093 LB/HP CYCLE				PERCENT OF ALLOWABLE NOX =	61.71		
CO EMISSION PER HP CYCLE =	0.05939 LB/HP CYCLE				PERCENT OF ALLOWABLE CO =	141.39		

TABLE IXB. LEANOUT DATA, 77 LB/HR, 30° BTDC

CYCLE NO. 1190

CELL-17

DATE 2/ 9/76

30DEG BTDC LEANOUT TO,CL,APP 77.0#/HR

ENGINE - LYCOMING O-320-DIAD

ENGINE TIMING 30.000 DEG. BTDC

RATED H.P. 160.

M.C. RATIO 2.125

	UNITS	IDLE	TAXI	TAKE OFF	CLIMB	APPROACH	TAXI	IDLE	
RUN NUMBER		1190	1191	1143	1144	1145	1195	1198	
TIME IN MODE	MIN.	1.00	11.00	0.30	5.00	6.00	3.00	1.00	
ENGINE SPEED	RPM	589.62	1200.42	2702.37	2431.86	2352.65	1200.96	615.60	
OBS. HORSEPOWER	HP	0.44928	1.11425	153.67889	119.17294	64.89508	0.84031	0.55616	
MANIFOLD PRESS.	IN.HG.	0.00	0.00	0.00	0.00	0.00	0.00	0.00	
F/A RATIO MEAS.	- - -	0.0905	0.0935	0.0811	0.0784	0.0849	0.0942	0.0889	
F/A RATIO CALC.	- - -	0.0919	0.0950	0.0819	0.0799	0.0862	0.0951	0.0913	
% DIFF. IN F/A	%	1.578	1.535	0.931	1.941	1.539	0.909	2.682	
AIR FLOW	LBS/HR	49.04	80.51	942.81	746.02	455.74	77.77	51.15	
FUEL FLOW	LBS/HR	4.44	7.53	76.46	58.47	38.68	7.33	4.55	
VAPOR FLOW	LBS/HR	0.01790	0.02973	0.37751	0.29503	0.16541	0.02713	0.01899	
HUMIDITY GR H2O/LB DRY AIR		0.000	0.000	0.000	0.000	0.000	0.000	0.000	
DEW POINT	DEG.F	0.000	0.000	0.000	0.000	0.000	0.000	0.000	
RELATIVE HUMIDITY	%	3.75	3.73	4.09	3.94	3.65	3.58	3.72	
BAROMETER	IN.HG.	29.12	29.12	28.94	28.94	28.95	29.12	29.11	
IND. AIR PRESS.	IN.HG.	0.00	0.00	0.00	0.00	0.00	0.00	0.00	
IND. AIR TEMP.	DEG.F	65.22	64.72	61.57	62.25	62.62	63.25	65.29	
MAX. CHT	DEG.F	258.05	276.99	460.20	447.28	367.16	305.28	257.14	
HC WET	PPM	33004.27	7548.75	1322.33	1394.04	2056.80	8454.94	32193.19	
NOX WET	PPM	5.99	26.14	571.36	1017.40	334.93	25.73	5.90	
CO WET	%	7.3199	9.1091	5.7937	5.1097	7.2610	8.8526	7.2500	
CO2 WET	%	6.2756	7.2970	9.2002	9.4467	8.3703	7.2278	6.2342	
O2 WET	%	3.4856	0.2404	0.0890	0.1509	0.1753	0.2558	3.5118	
H2O CORRECTION	- - -	0.88569	0.86581	0.86191	0.85963	0.86139	0.87012	0.88238	
HC MASS/MODE	LB/MODE	0.01553	0.06485	0.00347	0.04759	0.05287	0.01918	0.01571	
NOX MASS/MODE	LB/MODE	0.000009	0.000727	0.004852	0.112755	0.027889	0.000189	0.000009	
CO MASS/MODE	LB/MODE	0.06807	1.54658	0.30015	3.45488	3.68855	0.39697	0.06993	
HC MODE/STD.CYCLE	%	5.108	21.331	1.140	15.688	17.390	6.310	5.168	
NOX MODE/STD.CYCLE	%	0.004	3.303	2.022	46.981	11.620	0.079	0.004	
CO MODE/STD.CYCLE	%	1.013	23.015	4.467	51.412	54.889	5.907	1.041	
HC EMISSION PER HP CYCLE =	0.00137 LB/HP CYCLE	PERCENT OF ALLOWABLE HC =				72.13			
NOX EMISSION PER HP CYCLE =	0.00092 LB/HP CYCLE	PERCENT OF ALLOWABLE NOX =				61.01			
CO EMISSION PER HP CYCLE =	0.05953 LB/HP CYCLE	PERCENT OF ALLOWABLE CO =				141.74			

TABLE IXc. LEANOUT DATA, 77 LB/HR, 30° BTDC

CYCLE NO. 1190

CELL-17

DATE 2/ 9/76

30DEG BTDC LEANOUT TO,CL,APP 77.0#/HR

ENGINE - LYCOMING O-320-DIAD

ENGINE TIMING 30.000 DEG. BTDC RATED H.P. 160. H.C. RATIO 2.125

	UNITS	IDLE	TAXI	TAKE OFF	CLIMB	APPROACH	TAXI	IDLE
RUN NUMBER		1190	1191	1146	1147	1148	1195	1198
TIME IN MODE	MIN.	1.00	11.00	0.30	5.00	6.00	3.00	1.00
ENGINE SPEED	RPM	589.62	1200.42	2697.69	2432.82	2355.41	1200.96	615.50
G.B.S. HORSEPOWER	HP	0.44928	1.11425	153.35696	119.39186	66.74710	0.84031	0.55616
MANIFOLD PRESS.	IN.HG.	0.00	0.00	0.00	0.00	0.00	0.00	0.00
F/A RATIO MEAS.	- - -	0.0905	0.0935	0.0797	0.0774	0.0852	0.0942	0.0889
F/A RATIO CALC.	- - -	0.0919	0.0950	0.0818	0.0796	0.0857	0.0951	0.0913
% DIFF. IN F/A	%	1.578	1.535	2.662	2.839	0.513	0.909	2.582
AIR FLOW	LBS/HR	49.04	80.51	952.05	748.42	459.91	77.77	51.15
FUEL FLOW	LBS/HR	4.44	7.53	75.86	57.95	39.19	7.33	4.55
VAPOR FLOW	LBS/HR	0.01790	0.02973	0.38445	0.30074	0.17392	0.02713	0.01899
HUMIDITY GR H2O/LB DRY AIR		0.000	0.000	0.000	0.000	0.000	0.000	0.000
DEW POINT	DEG.F	0.000	0.000	0.000	0.000	0.000	0.000	0.000
RELATIVE HUMIDITY	%	3.75	3.73	4.14	4.01	3.80	3.58	3.72
BAROMETER	IN.HG.	29.12	29.12	28.95	28.95	28.96	29.12	29.11
IND. AIR PRESS.	IN.HG.	0.00	0.00	0.00	0.00	0.00	0.00	0.00
IND. AIR TEMP.	DEG.F	65.22	64.72	61.74	62.29	62.83	63.25	65.29
MAX. CHT	DEG.F	258.05	276.99	464.58	453.56	358.76	305.28	257.14
HC WET	PPM	33004.27	7548.75	1304.13	1391.24	1940.19	8454.84	32193.19
NOX WET	PPM	5.99	26.14	540.05	1053.30	351.64	25.73	5.90
CO WET	%	7.3199	9.1091	5.7632	5.0542	7.1477	8.8526	7.2500
CO2 WET	%	6.2756	7.2970	9.1474	9.5277	8.5093	7.2278	6.2342
O2 WET	%	3.4856	0.2404	0.1018	0.1643	0.1731	0.2558	3.5118
H2O CORRECTION	- - -	0.88569	0.86581	0.85612	0.85563	0.86417	0.87012	0.88238
HC MASS/MODE	LB/MODE	0.01553	0.06485	0.00343	0.04757	0.05039	0.01918	0.01571
NOX MASS/MODE	LB/MODE	0.000009	0.000727	0.004606	0.116685	0.029585	0.000189	0.000009
CO MASS/MODE	LB/MODE	0.06807	1.54658	0.29987	3.41590	3.66892	0.39697	0.06993
HC MODE/STD.CYCLE	%	5.108	21.331	1.129	15.649	16.575	6.310	5.168
NOX MODE/STD.CYCLE	%	0.004	0.303	1.919	48.619	12.327	0.079	0.004
CO MODE/STD.CYCLE	%	1.013	23.015	4.462	50.832	54.597	5.907	1.041
HC EMISSION PER HP CYCLE =	0.00135 LB/HP CYCLE	PERCENT OF ALLOWABLE HC =			71.27			
NOX EMISSION PER HP CYCLE =	0.00095 LB/HP CYCLE	PERCENT OF ALLOWABLE NOX =			63.25			
CO EMISSION PER HP CYCLE =	0.05916 LB/HP CYCLE	PERCENT OF ALLOWABLE CO =			140.87			

TABLE IXd. LEANOUT DATA, 77 LB/HR, 30° BTDC

CYCLE NO. 1190

CELL-17

DATE 2/ 9/76

30DEG RTDC LEANOUT TO,CL,APP 73.0#/HR

ENGINE - LYCOMING O-320-DIAD

ENGINE TIMING 30.000 DEG. BTDC RATED H.P. 160. J.C. RATIO 2.125

	UNITS	IDLE	TAXI	TAKE OFF	CLIMB	APPROACH	TAXI	IDLE
RUN NUMBR		1190	1191	1149	1150	1151	1195	1198
TIME IN MODE	MIN.	1.00	11.00	0.30	5.00	6.00	3.00	1.00
ENGINE SPEED	RPM	589.62	1200.42	2697.21	2433.00	2352.83	1200.96	615.60
OBS. HORSEPOWER	HP	0.44928	1.11425	153.47768	119.31900	66.01755	0.84031	0.55616
MANIFOLD PRESS.	IN.HG.	0.00	0.00	0.00	0.00	0.00	0.00	0.00
F/A RATIO MEAS.	- - -	0.0905	0.0935	0.0781	0.0763	0.0819	0.0942	0.0889
F/A RATIO CALC.	- - -	0.0919	0.0950	0.0791	0.0778	0.0836	0.0951	0.0913
% DIFF. IN F/A	%	1.578	1.535	1.213	2.023	2.122	0.909	2.682
AIR FLOW	LBS/HP	49.04	80.51	940.92	748.43	456.76	77.77	51.15
FUEL FLOW	LBS/HR	4.44	7.53	73.50	57.07	37.41	7.33	4.55
VAPOR FLOW	LBS/HR	0.01790	0.02973	0.39236	0.29903	0.16953	0.02713	0.01899
HUMIDITY GR H2O/LB DRY AIR		0.000	0.000	0.000	0.000	0.000	0.000	0.000
DEW POINT	DEG.F	0.000	0.000	0.000	0.000	0.000	0.000	0.000
RELATIVE HUMIDITY	%	3.75	3.73	4.25	3.99	3.76	3.58	3.72
BAROMETER	IN.HG.	29.12	29.12	28.96	28.96	28.96	29.12	29.11
IND. AIR PRESS.	IN.HG.	0.00	0.00	0.00	0.00	0.00	0.00	0.00
IND. AIR TEMP.	DEG.F	65.22	64.72	61.74	62.18	62.19	63.25	55.29
MAX. CHT	DEG.F	258.05	276.99	474.05	455.76	375.13	305.28	257.14
HC WET	PPM	33004.27	7548.75	1244.32	1326.83	1861.69	8454.84	32193.19
NOX WET	PPM	5.99	26.14	774.08	1253.32	447.74	25.73	5.90
CO WET	%	7.3199	9.1091	4.8177	4.4085	6.4079	8.8526	7.2500
CO2 WET	%	6.2756	7.2970	9.7031	9.8548	8.7990	7.2278	6.2342
O2 WET	%	3.4856	0.2404	0.1137	0.1864	0.1709	0.2558	3.5118
H2O CORRECTION	- - -	0.88569	0.86581	0.86091	0.85909	0.85862	0.87012	0.88238
HC MASS/MODE	LB/MODE	0.01553	0.06485	0.00322	0.04517	0.04742	0.01918	0.01571
NOX MASS/MODE	LB/MODE	0.000009	0.000727	0.006486	0.138214	0.036951	0.000189	0.000009
CO MASS/MODE	LB/MODE	0.06807	1.54658	0.24627	2.96597	3.22623	0.39697	0.06993
HC MODE/STD.CYCLE	%	5.108	21.331	1.059	14.857	15.600	6.310	5.168
NOX MODE/STD.CYCLE	%	0.004	0.303	2.702	57.589	15.396	0.079	0.004
CO MODE/STD.CYCLE	%	1.013	23.015	3.665	44.136	48.009	5.907	1.041
HC EMISSION PER HP CYCLE =	0.00132 LB/HP CYCLE	PERCENT OF ALLOWABLE HC =			69.43			
NOX EMISSION PER HP CYCLE =	0.00114 LB/HP CYCLE	PERCENT OF ALLOWABLE NOX =			76.08			
CO EMISSION PER HP CYCLE =	0.05325 LB/HP CYCLE	PERCENT OF ALLOWABLE CO =			126.79			

ORIGINAL PAGE IS
OF POOR QUALITY

TABLE IXe. LEANOUT DATA, 73 LB/HR, 30° BTDC

CYCLE NO. 1190

CFLL-17

DATE 2/ 9/76

30DEG BTDC LEANOUT TO,CL,APP 73.0#/HR

ENGINE - LYCOMING O-320-DIAD

ENGINE TIMING 30.000 DEG. BTDC RATED H.P. 160. H.C. RATIO 2.125

	UNITS	IDLE	TAXI	TAKE OFF	CLIMB	APPROACH	TAXI	IDLE	
RUN NUMBER		1190	1191	1152	1153	1154	1195	1198	
TIME IN MODE	MIN.	1.00	11.00	0.30	5.00	6.00	3.00	1.00	
ENGINE SPEED	RPM	589.62	1200.42	2697.09	2433.90	2352.41	1200.96	615.60	
CRS. HORSEPOWER	HP	0.44928	1.11425	154.30351	119.48869	65.62567	0.84031	0.55616	
MANIFOLD PRESS.	IN.HG.	0.00	0.00	0.00	0.00	0.00	0.00	0.00	
F/A RATIO MEAS.	- - -	0.0965	0.0935	0.0789	0.0770	0.0829	0.0942	0.0889	
F/A RATIO CALC.	- - -	0.0919	0.0950	0.0796	0.0779	0.0835	0.0951	0.0913	
% DIFF. IN F/A	%	1.578	1.535	0.891	1.180	0.738	0.909	2.682	
AIP FLOW	LBS/HR	49.04	80.51	941.81	747.19	458.97	77.77	51.15	
FUEL FLOW	LBS/HP	4.44	7.53	74.27	57.50	38.05	7.33	4.55	
VAPOR FLOW	LBS/HR	0.01790	0.02973	0.40578	0.31110	0.17789	0.02713	0.01899	
HUMIDITY GR H2O/LB DRY AIR		0.000	0.000	0.000	0.000	0.000	0.000	0.000	
DEW POINT	DEG.F	0.000	0.000	0.000	0.000	0.000	0.000	0.000	
RELATIVE HUMIDITY	%	3.75	3.73	4.29	4.16	3.88	3.58	3.72	
BAROMETER	IN.HG.	29.12	29.12	28.96	28.96	28.97	29.12	29.11	
IND. AIP PRESS.	IN.HG.	0.00	0.00	0.00	0.00	0.00	0.00	0.00	
IND. AIR TEMP.	DEG.F	65.22	64.72	62.05	62.26	62.61	63.25	65.29	
MAX. CHT	DEG.F	258.05	276.99	452.87	454.13	371.02	305.28	257.14	
HC WET	PPM	33004.27	7548.75	1240.02	1276.03	1954.19	8454.84	32193.19	
NOX WET	PPM	5.99	26.14	735.87	1203.82	398.24	25.73	5.90	
CO WET	%	7.3199	9.1091	5.0195	4.4324	6.4432	8.8526	7.2500	
CO2 WET	%	6.2756	7.2970	9.6022	9.7871	8.7600	7.2278	6.2342	
O2 WET	%	3.4856	0.2404	0.1220	0.1907	0.2396	0.2558	3.5118	
H2O CORRECTION	- - -	0.88569	0.86581	0.86202	0.86284	0.86403	0.87012	0.88238	
HC MASS/MODE	LB/MODE	0.01553	0.06485	0.00322	0.04348	0.05021	0.01918	0.01571	
NOX MASS/MODE	LB/MODE	0.000009	0.000727	0.006189	0.132899	0.033150	0.000189	0.000009	
CO MASS/MODE	LB/MODE	0.06807	1.54658	0.25756	2.98530	3.27210	0.39697	0.06993	
HC MODE/STD.CYCLE	%	5.108	21.331	1.059	14.304	16.517	6.310	5.168	
NOX MODE/STD.CYCLE	%	0.004	0.303	2.579	55.375	13.812	0.079	0.004	
CO MODE/STD.CYCLE	%	1.013	23.015	3.833	44.424	48.692	5.907	1.041	
HC EMISSION PER HP CYCLE =	0.00133 LB/HP CYCLE					PERCENT OF ALLOWABLE HC =	69.80		
NOX EMISSION PER HP CYCLE =	0.00108 LB/HP CYCLE					PERCENT OF ALLOWABLE NOX =	72.16		
CO EMISSION PER HP CYCLE =	0.05373 LB/HP CYCLE					PERCENT OF ALLOWABLE CO =	127.92		

TABLE IX-F. LEANOUT DATA, 73 LB/HR, 30° BTDC

CYCLE NO. 1190

CELL-17

DATE 2/ 9/76

30DEG BTDC LEANOUT T3,CL,APP 73.5#/HR

ENGINE - LYCOMING C-320-DIAD

ENGINE TIMING 30.000 DEG. BTDC RATED H.P. 160. M.C. RATIO 2.125

	UNITS	IDLE	TAXI	TAKE OFF	CLIMB	APPROACH	TAXI	IDLE
RUN NUMBER		1190	1191	1199	1200	1201	1195	1198
TIME IN MODE	MIN.	1.00	11.00	0.30	5.00	6.00	3.00	1.00
ENGINE SPEED	RPM	589.62	1200.42	2699.73	2432.04	2351.09	1200.96	615.50
CRS. HOP SEPOWER	HP	0.44928	1.11425	157.23477	119.82025	64.80234	0.84031	0.55616
MANIFOLD PRESS.	IN.HG.	0.00	0.00	0.00	0.00	0.00	0.00	0.00
F/A RATIO MEAS.	- - -	0.0905	0.0935	0.0771	0.0751	0.0809	0.0942	0.0889
F/A RATIO CALC.	- - -	0.0919	0.0950	0.0774	0.0756	0.0820	0.0951	0.0913
% DIFF. IN F/A	%	1.578	1.535	0.381	0.714	1.441	0.909	2.682
AIR FLOW	LBS/HR	49.04	30.51	953.97	736.34	450.20	77.77	51.15
FUEL FLOW	LBS/HP	4.44	7.53	73.57	55.27	36.40	7.33	4.55
VAPOR FLOW	LBS/HR	0.01790	0.02973	0.36800	0.27042	0.15154	0.02713	0.01899
HUMIDITY GR H2O/LB DRY AIR		0.000	0.000	0.000	0.000	0.000	0.000	0.000
DEW POINT	DEG.F	0.000	0.000	0.000	0.000	0.000	0.000	0.000
RELATIVE HUMIDITY	%	3.75	3.73	4.05	3.73	3.42	3.58	3.72
BAROMETER	IN.HG.	29.12	29.12	29.11	29.11	29.10	29.12	29.11
IND. AIR PRESS.	IN.HG.	0.00	0.00	0.00	0.00	0.00	0.00	0.00
IND. AIR TEMP.	DEG.F	65.22	54.72	61.05	61.87	62.06	63.25	65.29
MAX. CHT	DEG.F	258.05	276.99	441.48	445.65	364.73	305.28	257.14
HC WFT	PPM	33004.27	7548.75	1034.70	992.35	1459.14	8454.84	32193.19
NOX WFT	PPM	5.99	26.14	982.10	1438.89	499.75	25.73	5.90
CO WFT	%	7.3199	9.1091	4.2756	3.6336	5.8775	8.8526	7.2500
CO2 WFT	%	6.2756	7.2970	9.9381	10.2305	9.0324	7.2278	6.2342
P2 WFT	%	3.4856	0.2404	0.1522	0.1961	0.1601	0.2558	3.5118
H2O CORRECTION	- - -	0.88569	0.86581	0.86495	0.86493	0.86147	0.87012	0.88238
HC MASS/MODE	LB/MODE	0.01553	0.06485	0.00270	0.03308	0.03649	0.01918	0.01571
NOX MASS/MODE	LB/MODE	0.000009	0.000727	0.008311	0.155393	0.040489	0.000189	0.000009
CO MASS/MODE	LB/MODE	0.06807	1.54658	0.22073	2.39391	2.90517	0.39697	0.06993
HC MODE/STD.CYCLE	%	5.108	21.331	0.889	10.881	12.004	6.310	5.168
NOX MODE/STD.CYCLE	%	0.004	0.303	3.463	64.743	16.870	0.079	0.004
CO MODE/STD.CYCLE	%	1.013	23.015	3.285	35.624	43.232	5.907	1.041
HC EMISSION PER HP CYCLE =	0.00117 LB/HP CYCLE				PERCENT OF ALLOWABLE HC =	61.69		
NOX EMISSION PER HP CYCLE =	0.00128 LB/HP CYCLE				PERCENT OF ALLOWABLE NOX =	85.47		
CO EMISSION PER HP CYCLE =	0.04751 LB/HP CYCLE				PERCENT OF ALLOWABLE CO =	113.12		

87

ORIGINAL PAGE IS
OF POOR QUALITY

TABLE IXg. LEANOUT DATA, 73 LB/HR, 30° BTDC

CYCLE NO. 1190

CELL-17

DATE 2/ 9/76

30DEG BTDC LEANOUT TO,CL,APP 73.5#/HR

ENGINE - LYCOMING O-320-DIAD

ENGINE TIMING 30.000 DEG. BTDC RATED H.P. 160. H.C. RATIO 2.125

	UNITS	IDLE	TAXI	TAKE OFF	CLIMB	APPROACH	TAXI	IDLE
RUN NUMBER		1190	1191	1202	1203	1204	1195	1198
TIME IN MODE	MIN.	1.00	11.00	0.30	5.00	6.00	3.00	1.00
ENGINE SPEED	RPM	589.62	1200.42	2698.65	2429.34	2350.91	1200.96	615.60
CRS. HORSEPOWER	HP	0.44028	1.11425	156.39050	119.46593	64.61800	0.84031	0.55515
MANIFOLD PRESS.	IN.HG.	0.00	0.00	0.00	0.00	0.00	0.00	0.00
F/A RATIO MEAS.	- - -	0.0905	0.0935	0.0767	0.0752	0.0812	0.0942	0.0889
F/A RATIO CALC.	- - -	0.0919	0.0950	0.0774	0.0759	0.0825	0.0951	0.0913
% DIFF. IN F/A	%	1.578	1.535	0.971	0.922	1.540	0.909	2.682
AIR FLOW	LBS/HR	49.04	80.51	951.92	736.68	456.56	77.77	51.15
FUEL FLOW	LBS/HR	4.44	7.53	72.97	55.43	37.08	7.33	4.55
VAPOR FLOW	LBS/HR	0.01790	0.02973	0.36983	0.26994	0.15393	0.02713	0.01899
HUMIDITY GR H2O/LB DRY AIR		0.000	0.000	0.000	0.000	0.000	0.000	0.000
DEW POINT	DEG.F	0.000	0.000	0.000	0.000	0.000	0.000	0.000
RELATIVE HUMIDITY	%	3.75	3.73	3.98	3.57	3.37	3.58	3.72
BAROMETER	IN.HG.	29.12	29.12	29.10	29.10	29.09	29.12	29.11
IND. AIR PRESS.	IN.HG.	0.00	0.00	0.00	0.00	0.00	0.00	0.00
IND. AIR TEMP.	DEG.F	65.22	64.72	61.62	62.04	62.49	63.25	65.29
MAX. CHT	DEG.F	258.05	276.99	455.28	446.74	359.67	305.28	257.14
HC WET	PPM	33004.27	7548.75	914.29	953.89	1523.15	8454.84	32193.19
NOX WET	PPM	5.99	26.14	963.90	1381.14	473.75	25.73	5.90
CO WET	%	7.3199	9.1091	4.2793	3.7675	6.0365	8.8526	7.2500
CO2 WET	%	6.2756	7.2970	9.9033	10.1217	8.9631	7.2278	6.2342
C2 WET	%	3.4856	0.2404	0.1488	0.1966	0.1659	0.2558	3.5118
H2O CORRECTION	- - -	0.88569	0.86581	0.86307	0.86445	0.86100	0.87012	0.88238
HC MASS/MODE	LB/MODE	0.01553	0.06485	0.00238	0.03184	0.03868	0.01918	0.01571
NOX MASS/MODE	LB/MODE	0.000009	0.000727	0.008125	0.149328	0.038977	0.000189	0.000009
CO MASS/MODE	LB/MODE	0.06807	1.54658	0.22006	2.48512	3.02991	0.39697	0.06993
HC MODE/STD. CYCLE	%	5.108	21.331	0.783	10.472	12.724	6.310	5.158
NOX MODE/STD. CYCLE	%	0.004	0.303	3.385	62.220	16.240	0.079	0.004
CO MODE/STD. CYCLE	%	1.013	23.015	3.275	36.981	45.088	5.907	1.041
HC EMISSION PER HP CYCLE =	0.00118 LB/HP CYCLE	PERCENT OF ALLOWABLE HC =			61.90			
NOX EMISSION PER HP CYCLE =	0.00123 LB/HP CYCLE	PERCENT OF ALLOWABLE NOX =			82.24			
CO EMISSION PER HP CYCLE =	0.04885 LB/HP CYCLE	PERCENT OF ALLOWABLE CO =			116.32			

TABLE IXh. LEANOUT DATA, 73 LB/HR, 30° BTDC

CYCLE NO. 1190 CELL-17 DATE 2/ 9/76

30DEG BTDC LEANOUT TO, CL, APP 73.5#/HR

ENGINE - LYCOMING O-320-DIAD

ENGINE TIMING	30.000 DEG. BTDC	RATED H.P. 160.			H.C. RATIO 2.125			
	UNITS	IDLE	TAXI	TAKE OFF	CLIMB	APPROACH	TAXI	IDLE
PUN NUMBER		1190	1191	1205	1206	1207	1195	1198
TIME IN MODE	MIN.	1.00	11.00	0.30	5.00	6.00	3.00	1.00
ENGINE SPEED	RPM	589.62	1200.42	2699.43	2433.24	2353.31	1200.96	615.60
CRS. HOPSEPOWER	HP	0.44928	1.11425	156.44237	119.42360	65.96486	0.84031	0.55616
MANIFOLD PRESS.	IN. HG.	0.00	0.00	0.00	0.00	0.00	0.00	0.00
F/A RATIO MEAS.	- - -	0.0905	0.0935	0.0767	0.0756	0.0819	0.0942	0.0889
F/A RATIO CALC.	- - -	0.0919	0.0950	0.0772	0.0760	0.0827	0.0951	0.0913
% DIFF. IN F/A	%	1.578	1.535	1.266	0.531	0.961	0.909	2.387
AIR FLOW	LBS/HR	49.04	80.51	950.11	739.33	453.64	77.77	51.15
FUEL FLOW	LBS/HR	4.44	7.53	72.41	55.92	37.15	7.33	4.55
VAPOR FLOW	LBS/HR	0.01790	0.32973	0.37363	0.27569	0.15030	0.02713	0.01899
HUMIDITY GR H2O/LB DRY AIR		0.000	0.000	0.000	0.000	0.000	0.000	0.000
DEW POINT	DEG. F	0.000	0.000	0.000	0.000	0.000	0.000	0.000
RELATIVE HUMIDITY	%	3.75	3.73	3.90	3.71	3.28	3.58	3.72
BAROMETEP	IN. HG.	29.12	29.12	29.09	29.09	29.09	29.12	29.11
IND. AIR PRESS.	IN. HG.	0.00	0.00	0.00	0.00	0.00	0.00	0.00
IND. AIR TEMP.	DEG. F	65.22	64.72	62.17	62.14	62.54	63.25	65.29
MAX. CHT	DEG. F	258.05	276.99	448.43	445.91	361.46	305.28	257.14
HC WET	PPM	33004.27	7548.75	918.89	975.50	1539.15	8454.84	32193.19
NOX WET	PPM	5.99	26.14	1012.50	1419.34	525.45	25.73	5.90
CO WET	%	7.3199	9.1091	4.1799	3.6701	5.8134	8.8526	7.2500
CO2 WET	%	6.2756	7.2070	9.9326	9.9467	8.8477	7.2278	6.2342
O2 WET	%	3.4856	0.2404	0.1468	0.1567	0.3506	0.2558	3.5118
H2O CORRECTION	- - -	0.88569	0.86581	0.86228	0.86850	0.86583	0.87012	0.88239
HC MASS/MODE	LB/MODE	0.01553	0.06485	0.00238	0.03272	0.03894	0.01918	0.01571
NOX MASS/MODE	LB/MODE	0.000009	0.000727	0.008503	0.154247	0.043065	0.000189	0.000009
CO MASS/MODE	LB/MODE	0.06807	1.54658	0.21416	2.43332	2.90675	0.39697	0.06993
HC MODE/STD. CYCLE	%	5.108	21.331	0.784	10.764	12.809	6.310	5.168
NOX MODE/STD. CYCLE	%	0.004	0.303	3.543	64.270	17.944	0.079	0.004
CO MODE/STD. CYCLE	%	1.013	23.015	3.187	36.210	43.255	5.907	1.041
HC EMISSION PER HP CYCLE =	0.00118 LB/HP CYCLE	PERCENT OF ALLOWABLE HC =			62.27			
NOX EMISSION PER HP CYCLE =	0.00129 LB/HP CYCLE	PERCENT OF ALLOWABLE NOX =			86.15			
CO EMISSION PER HP CYCLE =	0.04772 LB/HP CYCLE	PERCENT OF ALLOWABLE CO =			113.63			

89

ORIGINAL PAGE IS OF POOR QUALITY

TABLE IXi. LEANOUT DATA, 73 LB/HR, 30° BTDC

CYCLE NO. 119G		CELL-17		DATE 2/ 9/76				
30DEG BTDC LEANOUT TO,CL,APP 70.5#/HR				ENGINE - LYCOMING O-320-DIAD				
ENGINE TIMING 30.000 DEG. BTDC		RATED H.P. 160.			I.C. RATIO 2.125			
	UNITS	IDLE	TAXI	TAKE OFF	CLIMB	APPROACH	TAXI	IDLE
RLN NUMBER		1190	1191	1208	1209	1210	1195	1198
TIME IN MODE	MIN.	1.00	11.00	0.30	5.00	6.00	3.00	1.00
ENGINE SPEED	RPM	589.62	1200.42	2701.41	2431.82	2352.11	1200.96	615.60
OBS. HORSEPOWER	HP	0.44928	1.11425	153.64830	119.91452	65.92509	0.84031	0.55616
MANIFOLD PRESS.	IN.HG.	0.00	0.00	0.00	0.00	0.00	0.00	0.00
F/A RATIO MEAS.	- - -	0.0905	0.0935	0.0762	0.0738	0.0784	0.0942	0.0889
F/A RATIO CALC.	- - -	0.0919	0.0950	0.0749	0.0737	0.0790	0.0951	0.0913
% DIFF. IN F/A	%	1.578	1.535	-1.737	-0.059	0.770	0.909	2.682
AIR FLOW	LBS/HR	49.04	30.51	920.80	736.37	448.17	77.77	51.15
FUEL FLOW	LBS/HR	4.44	7.53	70.17	54.34	35.12	7.33	4.55
VAPOR FLOW	LBS/HR	0.01790	0.02973	0.16343	0.13804	0.08345	0.02713	0.01899
HUMIDITY GR H2O/LB DRY AIR		0.000	0.000	0.000	0.000	0.000	0.000	0.000
DEW POINT	DEG.F	0.000	0.000	0.000	0.000	0.000	0.000	0.000
RELATIVE HUMIDITY	%	3.75	3.73	1.73	1.83	1.86	3.58	3.72
BAROMETR	IN.HG.	29.12	29.12	28.79	28.79	28.79	29.12	29.11
IND. AIR PRESS.	IN.HG.	0.00	0.00	0.00	0.00	0.00	0.00	0.00
IND. AIR TEMP.	DEG.F	65.22	64.72	62.07	62.25	62.20	63.25	65.29
MAX. CHT	DEG.F	258.05	276.99	470.59	441.58	359.25	305.28	257.14
HC WET	PPM	33004.27	7548.75	1052.90	1041.35	1569.46	8454.84	32193.19
NOX WET	PPM	5.99	26.14	1443.04	1942.32	769.18	25.73	5.90
CO WET	%	7.3199	9.1091	3.1571	2.7899	4.6748	8.8526	7.2500
CO2 WET	%	6.2756	7.2970	10.3433	10.4060	9.7355	7.2278	6.2342
O2 WET	%	3.4856	0.2404	0.1012	0.1699	0.0973	0.2558	3.5118
H2O CORRECTION	- - -	0.88569	0.86581	0.87619	0.87214	0.86342	0.87012	0.89238
HC MASS/MODE	LB/MODE	0.01553	0.06485	0.00264	0.03454	0.03870	0.01918	0.01571
NOX MASS/MODE	LB/MODE	0.000009	0.000727	0.011743	0.208684	0.061441	0.000189	0.000009
CO MASS/MODE	LB/MODE	0.06807	1.54658	0.15674	1.82871	2.27815	0.39697	0.06993
HC MODE/STD.CYCLE	%	5.108	21.331	0.870	11.361	12.730	6.310	5.168
NOX MODE/STD.CYCLE	%	0.004	0.303	4.893	86.952	25.601	0.079	0.004
CO MODE/STD.CYCLE	%	1.013	23.015	2.332	27.213	33.901	5.907	1.041
HC EMISSION PER HP CYCLE =	0.00119 LB/HP CYCLE	PERCENT OF ALLOWABLE HC =			62.88			
NOX EMISSION PER HP CYCLE =	0.00177 LB/HP CYCLE	PERCENT OF ALLOWABLE NOX =			117.83			
CO EMISSION PER HP CYCLE =	0.03956 LB/HP CYCLE	PERCENT OF ALLOWABLE CO =			94.42			

TABLE IX.j. LEANOUT DATA, 71 LB/HR, 30° BTDC

CYCLE NO. 1190

CELL-17

DATE 2/ 9/76

300FG BTDC LEANOUT TO,CL,APP 70.5#/HR

ENGINE - LYCOMING O-320-DIAD

ENGINE TIMING	30.000 DEG. BTDC	RATED H.P. 160.			H.C. RATIO 2.125			
	UNITS	IDLE	TAXI	TAKE OFF	CLIMB	APPROACH	TAXI	IDLE
RUN MIN/PPH		1190	1191	1211	1212	1213	1195	1198
TIME IN MODE	MIN.	1.00	11.30	0.30	5.00	6.00	3.00	1.00
ENGINE SPEED	RPM	589.62	1200.42	2705.49	2430.30	2349.89	1200.96	615.60
OBS. HORSEPOWER	HP	0.44928	1.11425	153.22470	118.94760	65.69547	0.84031	0.55616
MANIFOLD PRESS.	IN.HG.	0.00	0.00	0.00	0.00	0.00	0.00	0.00
F/A RATIO MEAS.	- - -	0.0905	0.0935	0.0736	0.0718	0.0784	0.0942	0.0889
F/A RATIO CALC.	- - -	0.0919	0.0950	0.0744	0.0733	0.0788	0.0951	0.0913
% DIFF. IN F/A	%	1.578	1.535	1.033	2.094	0.441	0.909	2.682
AIP FLOW	LBS/HR	49.04	40.51	937.01	741.25	453.38	77.77	51.15
FUEL FLOW	LBS/HR	4.44	7.53	69.00	53.25	35.56	7.33	4.55
VAPOR FLOW	LBS/HR	0.01790	0.02973	0.19338	0.16374	0.09606	0.02713	0.01899
HUMIDITY GR H2O/LB DRY AIR		0.000	0.000	0.000	0.000	0.000	0.000	0.000
DEW POINT	DEG.F	0.000	0.000	0.000	0.000	0.000	0.000	0.000
RELATIVE HUMIDITY	%	3.75	3.73	2.16	2.25	2.18	3.58	3.72
BAROMETER	IN.HG.	29.12	29.12	28.78	28.77	28.77	29.12	29.11
IND. AIR PRESS.	IN.HG.	0.00	0.00	0.00	0.00	0.00	0.00	0.00
IND. AIR TEMP.	DEG.F	65.22	64.72	60.68	61.26	61.79	63.25	65.29
MAX. CHT	DEG.F	258.05	276.99	474.89	441.87	359.59	305.28	257.14
HC WFT	PPM	33004.27	7548.75	1000.90	1049.90	1573.96	8454.84	32193.19
NOX WFT	PPM	5.99	26.14	1497.65	1876.79	745.67	25.73	5.90
CO WFT	%	7.3199	9.1091	3.0151	2.7858	4.6519	8.8526	7.2500
CO2 WFT	%	6.2756	7.2970	10.5593	10.5715	9.7379	7.2278	6.2342
O2 WFT	%	3.4856	0.2404	0.1018	0.2483	0.1349	0.2558	3.5118
H2O CORRECTION	- - -	0.88569	0.36581	0.86443	0.86217	0.86470	0.87012	0.88238
HC MASS/MODE	LB/MODE	0.01553	0.06485	0.00253	0.03478	0.03927	0.01918	0.01571
NOX MASS/MODE	LB/MODE	0.00009	0.00027	0.012278	0.201427	0.060270	0.000189	0.00009
CO MASS/MODE	LB/MODE	0.06807	1.54658	0.15080	1.82406	2.29387	0.39697	0.06993
HC MODE/STD.CYCLE	%	5.108	21.331	0.833	11.442	12.918	6.310	5.168
NOX MODE/STD.CYCLE	%	0.004	0.303	5.116	83.928	25.113	0.079	0.004
CO MODE/STD.CYCLE	%	1.013	23.015	2.244	27.144	34.135	5.907	1.041
HC EMISSION PER HP CYCLE =	0.00120 LB/HP CYCLE	PERCENT OF ALLOWABLE HC =			63.11			
NOX EMISSION PER HP CYCLE =	0.00172 LB/HP CYCLE	PERCENT OF ALLOWABLE NOX =			114.55			
CO EMISSION PER HP CYCLE =	0.03969 LB/HP CYCLE	PERCENT OF ALLOWABLE CO =			94.50			

91

TABLE IXK. LEANOUT DATA, 71 LB/HR, 30° BTDC

CYCLE NO. 1190		CFLL-17		DATE 2/ 9/76				
30DEG BTDC LEANOUT TQ,CL,APP 70.5#/HR				ENGINE - LYCOMING O-320-DIAD				
ENGINE TIMING 30.000 DEG. BTDC		RATED H.P. 160.			H.C. RATIO 2.125			
	UNITS	IDLE	TAXI	TAKE OFF	CLIMB	APPROACH	TAXI	IDLE
RUN NUMBER		1190	1191	1214	1215	1216	1195	119A
TIME IN MODE	MIN.	1.00	11.00	0.30	5.00	6.00	3.00	1.00
ENGINE SPEED	RPM	589.62	1200.42	2700.33	2428.22	2350.85	1200.96	615.60
OBS. HOPSEPOWER	HP	0.44928	1.11425	152.34091	118.18958	65.45186	0.84031	0.55616
MANIFOLD PRESS.	IN.HG.	0.00	0.00	0.00	0.00	0.00	0.00	0.00
F/A RATIO MEAS.	- - -	0.0905	0.0935	0.0741	0.0726	0.0770	0.0942	0.0889
F/A RATIO CALC.	- - -	0.0919	0.0950	0.0745	0.0733	0.0787	0.0951	0.0913
% DIFF. IN F/A	%	1.578	1.535	0.436	0.953	2.143	0.909	2.582
AIP FLOW	LBS/HR	49.04	30.51	934.37	741.24	453.93	77.77	51.15
FUEL FLOW	LBS/HR	4.44	7.53	69.27	53.84	34.97	7.33	4.55
VAPOR FLOW	LBS/HR	0.01790	0.02973	0.22190	0.17366	0.10100	0.02713	0.01899
HUMIDITY GR H2O/LB DRY AIR		0.000	0.000	0.000	0.000	0.000	0.000	0.000
DEW POINT	DEG.F	0.000	0.000	0.000	0.000	0.000	0.000	0.000
RELATIVE HUMIDITY	%	3.75	3.73	2.47	2.38	2.28	3.58	3.72
BAROMETER	IN.HG.	29.12	29.12	28.77	28.77	28.77	29.12	29.11
IND. AIP PRESS.	IN.HG.	0.00	0.00	0.00	0.00	0.00	0.00	0.00
IND. AIR TEMP.	DEG.F	65.22	54.72	60.79	61.24	61.84	63.25	65.29
MAX. CHT	DEG.F	258.05	276.99	471.39	439.67	362.87	305.78	257.14
HC WET	PPM	33004.27	7548.75	1009.00	1053.73	1565.16	8454.84	32193.19
NOX WET	PPM	5.99	26.14	1464.24	1853.43	766.88	25.73	5.90
CO WET	%	7.3199	9.1091	3.0761	2.8151	4.6041	8.8526	7.2500
CO2 WET	%	6.2756	7.2970	10.5553	10.5816	9.6650	7.2278	6.2342
O2 WET	%	3.4856	0.2404	0.1212	0.2666	0.1451	0.2558	3.5118
H2O CORRECTION	- - -	0.88569	0.86581	0.86624	0.86610	0.85941	0.87012	0.88238
HC MASS/MODE	LB/MODE	0.01553	0.06485	0.00255	0.03502	0.03889	0.01918	0.01571
NOX MASS/MODE	LB/MODE	0.000000	0.000727	0.011994	0.199553	0.061731	0.000189	0.000009
CO MASS/MODE	LB/MODE	0.06807	1.54658	0.15372	1.84911	2.25108	0.39697	0.05993
HC MODE/STD.CYCLE	%	5.108	21.331	0.839	11.520	12.793	6.310	5.168
NOX MODE/STD.CYCLE	%	0.004	0.303	4.998	83.147	25.721	0.079	0.004
CO MODE/STD.CYCLE	%	1.013	23.015	2.288	27.516	33.647	5.907	1.041
HC EMISSION PER HP CYCLE =	0.00120 LB/HP CYCLE				PERCENT OF ALLOWABLE HC =	63.07		
NOX EMISSION PER HP CYCLE =	0.00171 LB/HP CYCLE				PERCENT OF ALLOWABLE NOX =	114.26		
CO EMISSION PER HP CYCLE =	0.03966 LB/HP CYCLE				PERCENT OF ALLOWABLE CO =	94.43		

92

TABLE IX I. LEANOUT DATA, 71 LB/HR, 30° BTDC

CYCLE NO. 1190

CFLL-17

DATE 2/ 9/76

30DEG BTDC LEANOUT TO,CL,APP 66.0#/HR

ENGINE - LYCOMING O-320-DIAD

ENGINE TIMING 30,000 DEG. BTDC RATED H.P. 160. H.C. RATIO 2.125

	UNITS	IDLE	TAXI	TAKE OFF	CLIMB	APPROACH	TAXI	IDLF
RUN NUMBER		1190	1191	1217	1218	1219	1195	1198
TIME IN MODE	MIN.	1.00	11.00	0.30	5.00	6.00	3.00	1.00
ENGINE SPEED	RPM	589.62	1200.42	2706.81	2426.46	2351.33	1200.96	615.60
BR. HOPSEPOWER	HP	0.44928	1.11425	150.73199	117.60164	65.32224	0.84031	0.55515
MANIFOLD PRESS.	IN.HG.	0.00	0.00	0.00	0.00	0.00	0.00	0.00
F/A RATIO MEAS.	- - -	0.0905	0.0935	0.0698	0.0688	0.0719	0.0942	0.0889
F/A RATIO CALC.	- - -	0.0919	0.0950	0.0702	0.0694	0.0725	0.0951	0.0913
% DIFF. IN F/A	%	1.578	1.535	0.596	0.855	0.840	0.909	2.682
AIR FLOW	LBS/HR	49.04	80.51	937.18	766.98	454.05	77.77	51.15
FUEL FLOW	LRS/HR	4.44	7.53	65.40	52.77	32.63	7.33	4.55
VAPOR FLOW	LBS/HR	0.01790	0.02973	0.22805	0.18062	0.10634	0.02713	0.01899
HUMIDITY GR H2O/LB DRY AIR		0.000	0.000	0.000	0.000	0.000	0.000	0.000
DEW POINT	DEG.F	0.000	0.000	0.000	0.000	0.000	0.000	0.000
RELATIVE HUMIDITY	%	3.75	3.73	2.53	2.41	2.40	3.58	3.72
BAROMETER	IN.HG.	29.12	29.12	28.77	28.77	28.76	29.12	29.11
IND. AIR PRESS.	IN.HG.	0.00	0.00	0.00	0.00	0.00	0.00	0.00
IND. AIR TEMP.	DEG.F	65.27	64.72	60.91	61.30	61.83	63.25	65.29
MAX. CHT	DEG.F	258.05	276.99	476.55	431.04	362.94	305.28	257.14
HC WET	PPM	33004.27	7548.75	823.18	741.57	1249.12	8454.84	32193.19
NOX WET	PPM	5.99	76.14	2327.13	2367.33	1403.04	25.73	5.99
CO WET	%	7.3199	9.1091	1.6300	1.9951	2.4345	8.8526	7.2500
CO2 WET	%	6.2756	7.2970	11.1314	10.7054	10.7017	7.2278	6.2342
O2 WET	%	3.4856	0.2404	0.2951	0.7549	0.2823	0.2558	3.5118
H2O CORRECTION	- - -	0.88569	0.86581	0.87007	0.87112	0.86733	0.87012	0.88238
HC MASS/MODE	LB/MODE	0.01553	0.06485	0.00206	0.02518	0.03042	0.01918	0.01571
NOX MASS/MODE	LB/MODE	0.00009	0.00027	0.018842	0.260358	0.110699	0.000189	0.00009
CO MASS/MODE	LB/MODE	0.06807	1.54658	0.08051	1.33866	1.17187	0.39697	0.06893
HC MODE/STD.CYCLE	%	5.108	21.331	0.677	8.281	10.007	6.310	5.158
NOX MODE/STD.CYCLE	%	0.004	0.303	7.851	108.482	46.125	0.079	0.004
CO MODE/STD.CYCLE	%	1.013	23.015	1.198	19.921	17.439	5.907	1.041
HC EMISSION PER HP CYCLE =	0.00108 LB/HP CYCLE				PERCENT OF ALLOWABLE HC =	56.88		
NOX EMISSION PER HP CYCLE =	0.00244 LB/HP CYCLE				PERCENT OF ALLOWABLE NOX =	162.85		
CO EMISSION PER HP CYCLE =	0.02920 LB/HP CYCLE				PERCENT OF ALLOWABLE CO =	69.53		

TABLE IXm. LEANOUT DATA, 66 LB/HR, 30° BTDC

ORIGINAL PAGE IS
OF POOR
QUALITY

CYCLE NO. 1190

CELL-17

DATE 2/ 9/76

30DEG BTDC LEANOUT TO, CL, APP 66.0#/HR

ENGINE - LYCOMING O-320-DIAD

ENGINE TIMING 30.000 DEG. BTDC

RATED H.P. 160.

H.C. RATIO 2.125

	UNITS	IDLE	TAXI	TAKE OFF	CLIMB	APPROACH	TAXI	IDLE
RUN NUMBER		1190	1191	1220	1221	1222	1195	1198
TIME IN MODE	MIN.	1.00	11.00	0.30	5.00	6.00	3.00	1.00
ENGINE SPEED	RPM	589.62	1200.42	2699.67	2432.34	2348.23	1200.96	615.60
CRS. HORSEPOWER	HP	0.44928	1.11425	151.41455	119.10890	65.00583	0.84031	0.55616
MANIFOLD PRESS.	IN.HG.	0.00	0.00	0.00	0.00	0.00	0.00	0.00
F/A RATIO MEAS.	- - -	0.0905	0.0935	0.0699	0.0688	0.0759	0.0942	0.0889
F/A RATIO CALC.	- - -	0.0919	0.0950	0.0701	0.0695	0.0729	0.0951	0.0913
% DIFF. IN F/A	%	1.578	1.535	0.276	1.045	-3.882	0.909	2.682
AIR FLOW	LBS/HR	49.04	80.51	930.23	769.00	454.92	77.77	51.15
FUEL FLOW	LBS/HR	4.44	7.53	65.02	52.90	34.51	7.33	4.55
VAPOR FLOW	LBS/HR	0.01790	0.02973	0.23083	0.18657	0.10676	0.02713	0.01899
HUMIDITY GR H2O/LB DRY AIR		0.000	0.000	0.000	0.000	0.000	0.000	0.000
DEW POINT	DEG.F	0.000	0.000	0.000	0.000	0.000	0.000	0.000
RELATIVE HUMIDITY	%	3.75	3.73	2.58	2.45	2.39	3.58	3.72
BAROMETER	IN.HG.	29.12	29.12	28.75	28.75	28.74	29.12	29.11
IND. AIR PRESS.	IN.HG.	0.00	0.00	0.00	0.00	0.00	0.00	0.00
IND. AIR TEMP.	DEG.F	65.22	54.72	60.86	61.45	61.99	63.25	65.29
MAX. CHT	DEG.F	258.05	276.99	473.49	432.04	368.49	305.28	257.14
HC WET	PPM	33004.27	7548.75	830.21	741.67	1246.96	8454.84	32193.19
NOX WET	PPM	5.99	26.14	2320.48	2276.53	1351.63	25.73	5.90
CO WET	%	7.3199	9.1091	1.5620	2.1536	2.5790	8.8526	7.2500
CO2 WET	%	6.2756	7.2970	11.1915	10.5551	10.8272	7.2278	6.2342
O2 WET	%	3.4856	0.2404	0.2795	0.8346	0.2340	0.2558	3.5118
H2O CORRECTION	- - -	0.88569	0.86581	0.87109	0.87087	0.88293	0.87012	0.88238
HC MASS/MODE	LB/MODE	0.01553	0.06485	0.00205	0.02524	0.03091	0.01918	0.01571
NOX MASS/MODE	LB/MODE	0.000009	0.000727	0.018659	0.251019	0.108538	0.000189	0.000009
CO MASS/MODE	LB/MODE	0.06807	1.54658	0.07662	1.44875	1.26346	0.39697	0.06993
HC MODE/STD. CYCLE	%	5.108	21.331	0.678	8.304	10.167	6.310	5.168
NOX MODE/STD. CYCLE	%	0.004	3.303	7.774	104.591	45.224	0.079	0.004
CO MODE/STD. CYCLE	%	1.013	23.015	1.140	21.559	18.802	5.907	1.041
HC EMISSION PER HP CYCLE =	0.00108 LB/HP CYCLE				PERCENT OF ALLOWABLE HC =	57.07		
NOX EMISSION PER HP CYCLE =	0.00237 LB/HP CYCLE				PERCENT OF ALLOWABLE NOX =	157.98		
CO EMISSION PER HP CYCLE =	0.03044 LB/HP CYCLE				PERCENT OF ALLOWABLE CO =	72.48		

94

TABLE IX n. LEANOUT DATA, 66 LB/HR, 30° BTDC

CYCLE NO. 1190

CELL-17

DATE 2/ 9/76

30DEG RTDC LEANOUT TD,CL,APP 66.04/HR

ENGINE - LYCOMING O-320-D1AD

ENGINE TIMING 30.000 DEG. BTDC RATED H.P. 160. I.C. RATIO 2.125

	UNITS	IDLE	TAXI	TAKE OFF	CLIMB	APPROACH	TAXI	IDLE
RUN NUMBER		1190	1191	1223	1224	1225	1195	1198
TIME IN MODE	MIN.	1.00	11.00	0.30	5.00	6.00	3.00	1.00
ENGINE SPEED	RPM	589.62	1200.42	2706.21	2433.90	2351.09	1200.96	615.60
FBS. HORSEPOWER	HP	0.44928	1.11425	151.06186	119.81889	65.67889	0.84031	0.55616
MANIFOLD PRESS.	IN.HG.	0.00	0.00	0.00	0.30	0.00	0.00	0.00
F/A RATIO MEAS.	- - -	0.0905	0.0935	0.0704	0.0691	0.0719	0.0942	0.0889
F/A RATIO CALC.	- - -	0.0919	0.0950	0.0704	0.0698	0.0725	0.0951	0.0913
% DIFF. IN F/A	%	1.578	1.535	-0.080	1.038	0.929	0.939	2.682
AIR FLOW	LBS/HR	49.04	80.51	931.96	766.53	458.97	77.77	51.15
FUEL FLOW	LRS/HR	4.44	7.53	65.62	52.95	32.99	7.33	4.55
VAPOR FLOW	LBS/HR	0.01790	0.02973	0.23587	0.19337	0.10785	0.02713	0.01899
HUMIDITY GR H2O/LB DRY AIR		0.000	0.000	0.000	0.000	0.000	0.000	0.000
DEW POINT	DEG.F	0.000	0.000	0.000	0.000	0.000	0.000	0.000
RELATIVE HUMIDITY	%	3.75	3.73	2.60	2.57	2.43	3.58	3.72
BAROMETER	IN.HG.	29.12	29.12	28.74	28.73	28.73	29.12	29.11
IND. AIR PRESS.	IN.HG.	0.00	0.00	0.00	0.00	0.00	0.00	0.00
IND. AIR TEMP.	DEG.F	65.22	64.72	61.26	61.57	61.95	63.25	65.29
MAX. CHT	DEG.F	258.05	276.99	485.48	432.32	368.38	305.28	257.14
HC WET	PPM	33004.27	7548.75	844.48	791.88	1186.22	8454.84	32193.19
NOX WET	PPM	5.99	26.14	2305.83	2360.83	1421.64	25.73	5.90
CO WET	%	7.3199	9.1091	1.6150	2.1057	2.4537	8.8526	7.2500
CO2 WET	%	6.2756	7.2970	11.1329	10.6063	10.6491	7.2278	5.2342
O2 WET	%	3.4856	0.2404	0.2497	0.7325	0.2692	0.2558	3.5118
H2O CORRECTION	- - -	0.88569	0.86581	0.87267	0.87075	0.86746	0.87012	0.88238
HC MASS/MODE	LB/MODE	0.01553	0.06485	0.00210	0.02690	0.02921	0.01918	0.01571
NOX MASS/MODE	LB/MODE	0.000009	0.000727	0.018564	0.259776	0.113392	0.000189	0.000009
CO MASS/MODE	LB/MODE	0.06807	1.54658	0.07932	1.41423	1.19401	0.39697	0.06993
HC MODE/STD. CYCLE	%	5.108	21.331	0.890	8.848	9.607	6.310	5.168
NOX MODE/STD. CYCLE	%	0.004	0.303	7.735	108.240	47.247	0.079	0.004
CO MODE/STD. CYCLE	%	1.013	23.015	1.180	21.045	17.768	5.907	1.041
HC EMISSION PER HP CYCLE =	0.00108 LB/HP CYCLE				PERCENT OF ALLOWABLE HC =	57.06		
NOX EMISSION PER HP CYCLE =	0.00245 LB/HP CYCLE				PERCENT OF ALLOWABLE NOX =	163.61		
CO EMISSION PER HP CYCLE =	0.02981 LB/HP CYCLE				PERCENT OF ALLOWABLE CO =	70.97		

TABLE IXo. LEANOUT DATA, 66 LB/HR, 30° BTDC

C.2

CYCLE NO. 524		CELL-17		DATE 12/19/76		ENGINE - LYCOMING O-320-DIAD			
COOLING AIR FLOW 59 DEG-HOOD DLP=2" 81.0#/HR		ENGINE TIMING 25.000 DEG. BTDC		RATED H.P. 160.		H.C. RATIO 2.125			
	UNITS	IDLE	TAXI	TAKE OFF	CLIMB	APPROACH	TAXI	IDLE	
PUN NUMBER		524	523	1304	1305	1306	528	530	
TIME IN MODE	MIN.	1.00	11.00	0.30	5.00	6.00	3.00	1.00	
ENGINE SPEED	RPM	593.52	1203.84	2701.77	2435.34	2358.65	1199.52	606.00	
Obs. HORSEPOWER	HP	0.35567	0.89601	149.97404	121.01115	65.57481	1.63172	0.37807	
MANIFOLD PRESS.	IN.HG.	0.00	0.00	0.00	0.00	0.00	0.00	0.00	
F/A RATIO MEAS.	- - -	0.0886	0.0937	0.0846	0.0819	0.0872	0.0927	0.0899	
F/A RATIO CALC.	- - -	0.0892	0.0960	0.0847	0.0833	0.0887	0.0952	0.0904	
% DIFF. IN F/A	%	0.638	2.503	0.126	1.766	1.769	2.769	0.574	
AIR FLOW	LBS/HR	57.16	89.82	937.18	772.13	473.18	89.71	55.52	
FUEL FLOW	LBS/HR	5.06	8.41	79.26	63.23	41.24	8.31	4.99	
VAPOR FLOW	LBS/HR	0.01466	0.02253	0.28512	0.24076	0.13088	0.02260	0.01439	
HUMIDITY GR H2O/LB DRY AIR		0.000	0.000	0.000	0.000	0.000	0.000	0.000	
DEW POINT	DEG.F	0.000	0.000	0.000	0.000	0.000	0.000	0.000	
RELATIVE HUMIDITY	%	2.50	2.45	3.15	3.18	2.85	2.49	2.52	
BAROMETER	IN.HG.	29.21	29.21	28.64	28.63	28.63	29.19	29.19	
IND. AIR PRESS.	IN.HG.	0.00	0.00	0.00	0.00	0.00	0.00	0.00	
IND. AIR TEMP.	DEG.F	62.65	62.34	61.28	61.94	62.53	62.44	62.81	
MAX. CHT	DEG.F	227.61	277.89	466.75	475.50	382.09	287.93	221.05	
HC WET	PPM	35192.47	10997.09	1355.53	1437.94	1880.99	10633.05	36207.59	
HC DRY	PPM	4.76	17.86	289.05	708.19	191.08	18.05	5.60	
CO WET	%	7.1065	9.2612	6.2559	6.2687	7.9553	9.0790	7.1064	
CO2 WET	%	6.2365	7.3154	8.7239	8.8944	7.9840	7.3842	6.3267	
CO2 DRY	%	4.2455	0.4547	0.0630	0.0892	0.0792	0.4634	4.0557	
H2O CORRECTION	- - -	0.89073	0.86134	0.86516	0.85997	0.86184	0.86024	0.88988	
HC MASS/MODE	LB/MODE	0.01917	0.10543	0.00358	0.05160	0.05062	0.02767	0.01924	
HCX MASS/MODE	LB/MODE	0.000008	0.000555	0.002472	0.002323	0.016658	0.000152	0.000010	
CO MASS/MODE	LB/MODE	0.07650	1.75487	0.35245	4.44564	4.23115	0.46698	0.07485	
HC MODE/STD.CYCLE	%	6.305	34.681	1.177	16.973	16.651	9.103	6.330	
HCX MODE/STD.CYCLE	%	0.003	0.231	1.030	34.301	6.941	0.063	0.004	
CO MODE/STD.CYCLE	%	1.138	26.114	5.245	66.155	62.964	6.949	1.111	
HC EMISSION PER HP CYCLE =	0.00173 LB/HP CYCLE	PERCENT OF ALLOWABLE HC =			91.22				
NOX EMISSION PER HP CYCLE =	0.00064 LB/HP CYCLE	PERCENT OF ALLOWABLE NOX =			42.57				
CO EMISSION PER HP CYCLE =	0.07126 LB/HP CYCLE	PERCENT OF ALLOWABLE CO =			169.68				

TABLE Xa. COOLING AIR, 59°F, ΔP2", RICH

CYCLE NO. 524 CELL-17 DATE 12/19/76

COOLING AIR FLOW 59DEG-HOOD DLP=2" 81.0#/HR ENGINE - LYCOMING O-320-DIAD

ENGINE TIMING 25.000 DEG. BTDC RATED H.P. 160. H.C. RATIO 2.125

	UNITS	IDLE	TAXI	TAKE OFF	CLIMB	APPROACH	TAXI	IDLE
RLN NUMBR		524	523	1307	1308	1309	528	530
TIME IN MODE	MIN.	1.00	11.00	0.30	5.00	6.00	3.00	1.00
ENGINE SPEED	RPM	593.52	1203.84	2702.19	2437.68	2358.41	1199.52	606.00
OBS. HORSE POWER	HP	0.35567	0.89601	150.71252	121.08699	65.29510	1.63172	0.37807
MANIFOLD PRESS.	IN.HG.	0.00	0.00	0.00	0.00	0.00	0.00	0.00
F/A RATIO MEAS.	- - -	0.0886	0.0937	0.0837	0.0822	0.0865	0.0927	0.0899
F/A RATIO CALC.	- - -	0.0892	0.0960	0.0850	0.0830	0.0890	0.0952	0.0904
% DIFF. IN F/A	%	0.638	2.503	1.473	0.999	2.835	2.769	0.574
AIR FLOW	LBS/HR	57.16	89.82	938.75	768.81	470.71	89.71	55.52
FUEL FLOW	LBS/HR	5.06	8.41	78.60	63.20	40.72	8.31	4.99
VAPOR FLOW	LBS/HR	0.01466	0.02253	0.29148	0.23217	0.12808	0.02260	0.01439
HUMIDITY GR H2O/LB DRY AIR		0.000	0.000	0.000	0.000	0.000	0.000	0.000
DEW POINT	DEG.F	0.000	0.000	0.000	0.000	0.000	0.000	0.000
RELATIVE HUMIDITY	%	2.50	2.45	3.26	3.18	2.82	2.49	2.52
BAROMETER	IN.HG.	29.21	29.21	28.63	28.64	28.64	29.19	29.19
IND. AIR PRESS.	IN.HG.	0.00	0.00	0.00	0.00	0.00	0.00	0.00
IND. AIR TEMP.	DEG.F	62.65	52.34	61.28	61.36	62.33	62.44	52.81
MAX. CHT	DEG.F	227.61	277.89	447.98	482.99	397.87	287.93	221.05
HC WET	PPM	35192.47	10997.09	1395.24	1420.54	1857.88	10633.05	36207.59
NOX WET	PPM	4.76	17.86	320.11	710.99	176.10	18.05	5.60
CO WET	%	7.1065	9.2612	6.7934	6.1692	8.0022	9.0790	7.1064
CO2 WET	%	6.2365	7.3154	8.5967	8.9767	7.9103	7.3842	6.3257
O2 WET	%	4.2455	0.4547	0.0669	0.0815	0.0736	0.4634	4.0557
H2O CORRECTION	- - -	0.89073	0.86134	0.86142	0.86246	0.85857	0.86024	0.88988
HC MASS/MODE	LB/MODE	0.01917	0.10543	0.00368	0.05081	0.04967	0.02767	0.01924
NOX MASS/MODE	LB/MODE	0.000008	0.000555	0.002733	0.082393	0.015235	0.000152	0.000010
CO MASS/MODE	LB/MODE	0.07650	1.75487	0.35390	4.36160	4.22377	0.46698	0.07465
HC MODE/STD.CYCLE	%	6.305	34.681	1.210	16.715	16.321	9.103	6.330
NOX MODE/STD.CYCLE	%	0.003	0.231	1.139	34.330	6.348	0.063	0.004
CO MODE/STD.CYCLE	%	1.138	26.114	5.266	64.905	62.854	6.949	1.111
HC EMISSION PER HP CYCLE =	0.00172 LB/HP CYCLE				PERCENT OF ALLOWABLE HC =	90.67		
NOX EMISSION PER HP CYCLE =	0.00063 LB/HP CYCLE				PERCENT OF ALLOWABLE NOX =	42.12		
CO EMISSION PER HP CYCLE =	0.07070 LB/HP CYCLE				PERCENT OF ALLOWABLE CO =	168.34		

97

ORIGINAL PAGE IS OF POOR QUALITY

TABLE Xb COOLING AIR, 59°F, Δ P2", RICH

CYCLE NO. 524		CELL-17		DATE 12/19/76					
COOLING AIR FLOW 59DEG-HOOD DLP=2" 66.0#/HR				ENGINE - LYCOMING O-320-DIAD					
ENGINE TUNING		25.000 DEG. BTDC		PATED. H.P. 160.		H.C. RATIO 2.125			
	UNITS	IDLE	TAXI	TAKE OFF	CLIMB	APPROACH	TAXI	IDLE	
RUN NUMBER		524	523	1316	1317	1318	528	530	
TIME IN MODE	MIN.	1.00	11.00	0.30	5.00	6.00	3.00	1.00	
ENGINE SPEED	RPM	593.52	1203.84	2685.21	2431.29	2353.25	1199.52	606.00	
CRS. HORSEPOWER	HP	0.35567	0.89601	147.65135	119.55719	63.25171	1.63172	0.37807	
MANIFOLD PRESS.	IN.HG.	0.00	0.00	0.00	0.00	0.00	0.00	0.00	
F/A RATIO MEAS.	- - -	0.0886	0.0937	0.0704	0.0690	0.0710	0.0927	0.0899	
F/A RATIO CALC.	- - -	0.0892	0.0960	0.0707	0.0713	0.0724	0.0952	0.0904	
% DIFF. IN F/A	%	0.638	2.503	0.452	3.352	2.098	2.769	0.574	
AIR FLOW	LBS/HR	57.16	89.82	933.94	815.47	466.34	89.71	55.52	
FUEL FLOW	LBS/HR	5.06	8.41	65.77	56.23	33.09	8.31	4.99	
VAPOR FLOW	LPS/HR	0.01466	0.02253	0.29489	0.25687	0.13580	0.02260	0.01439	
HUMIDITY GR H2O/LB DRY AIR		0.000	0.000	0.000	0.000	0.000	0.000	0.000	
DEW POINT	DEG.F	0.000	0.000	0.000	0.000	0.000	0.000	0.000	
RELATIVE HUMIDITY	%	2.50	2.45	3.27	3.35	3.01	2.49	2.52	
BAROMETER	IN.HG.	29.21	29.21	28.65	28.65	28.64	29.19	29.19	
IND. AIR PRESS.	IN.HG.	0.00	0.00	0.00	0.00	0.00	0.00	0.00	
IND. AIR TEMP.	DEG.F	62.65	62.34	61.47	61.20	62.41	62.44	62.81	
MAX. CHT	DEG.F	227.61	277.89	465.06	456.69	404.20	287.93	221.05	
HC WET	PPM	35192.47	10997.09	876.09	599.06	999.90	10633.05	36207.59	
NOX WET	PPM	4.76	17.86	2325.03	2166.46	1405.04	18.05	5.60	
CO WET	%	7.1065	9.2612	1.5903	2.6132	2.3823	9.0790	7.1064	
CO2 WET	%	6.2365	7.3154	11.2784	10.3886	10.7872	7.3842	6.3267	
O2 WET	%	4.2455	0.4547	0.1244	0.6438	0.2111	0.4634	4.0557	
H2O CORRECTION	- - -	0.89073	0.36134	0.86921	0.86071	0.86195	0.86024	0.88988	
HC MASS/MODE	LB/MODE	0.01917	0.10543	0.00218	0.02164	0.02492	0.02767	0.01924	
NOX MASS/MODE	LB/MODE	0.000008	0.030555	0.018760	0.253496	0.113457	0.090152	0.000010	
CO MASS/MODE	LB/MODE	0.07650	1.75487	0.07829	1.86541	1.17361	0.46698	0.07465	
HC MODE/STD.CYCLE	%	6.305	34.681	0.718	7.117	8.198	9.103	6.330	
NOX MODE/STD.CYCLE	%	0.003	0.231	7.817	105.623	47.274	0.063	0.004	
CO MODE/STD.CYCLE	%	1.138	25.114	1.165	27.759	17.464	6.949	1.111	
HC EMISSION PER HP CYCLE =	0.00138 LB/HP CYCLE	PERCENT OF ALLOWABLE HC =				72.45			
NOX EMISSION PER HP CYCLE =	0.00242 LB/HP CYCLE	PERCENT OF ALLOWABLE NOX =				161.02			
CO EMISSION PER HP CYCLE =	0.03431 LB/HP CYCLE	PERCENT OF ALLOWABLE CO =				81.70			

TABLE Xc. COOLING AIR, 59°F, ΔP2", LEAN

CYCLE NO. 1260		CELL-17		DATE 2/10/75					
BASE LINE FR 25 BTDC CHT 30UF. 59° HOOD = 3"				ENGINE - LYCOMING O-320-DIAD					
ENGINE TIMING 25.000 DEG. BTDC		RATED H.P. 160.		H.C. RATIO 2.125					
	UNITS	IDLE	TAXI	TAKE OFF	CLIMB	APPROACH	TAXI	IDLE	
RUN NUMBER		1260	1261	1262	1263	1264	1265	1267	
TIME IN MODE	MIN.	1.00	11.00	0.30	5.00	6.00	3.00	1.00	
ENGINE SPEED	RPM	600.78	1204.92	2692.23	2429.52	2352.47	1207.77	624.24	
CRS. HORSEPOWER	HP	0.45708	1.12855	152.74843	119.92880	65.38083	1.27898	0.57018	
F/A RATIO MEAS.	- - -	0.0886	0.0913	0.0846	0.0830	0.0893	0.0939	0.0897	
F/A RATIO CALC.	- - -	0.1002	0.1037	0.0846	0.0829	0.0889	0.1006	0.0963	
% DIFF. IN F/A	%	13.130	13.536	-0.046	-0.127	-0.529	7.216	7.411	
AIR FLOW	LBS/HR	56.72	102.06	939.89	756.58	470.29	90.97	58.26	
FUFL FLOW	LBS/HR	5.03	9.32	79.52	62.77	42.02	8.54	5.22	
VAPOR FLOW	LBS/HR	0.01345	0.02357	0.26053	0.20015	0.11651	0.02244	0.01476	
RELATIVE HUMIDITY	%	2.34	2.32	2.85	2.76	2.55	2.51	2.56	
BAROMETER	IN. HG.	28.60	28.61	28.60	28.61	28.61	28.61	28.61	
IND. AIR TEMP.	DEG. F	65.48	64.45	60.92	61.10	61.89	63.89	65.44	
MAX. CHT	DEG. F	245.19	253.42	409.15	426.09	350.34	258.06	233.44	
HC WET	PPM	35214.50	12289.22	1551.15	1523.75	1896.19	11813.68	34253.39	99
NOX WET	PPM	5.50	13.47	382.04	745.29	191.82	14.48	3.95	
CO WET	%	8.1142	10.2638	6.6590	6.1174	8.0666	9.8510	7.9478	
CO2 WET	%	5.6208	6.0840	8.7311	9.0139	8.0175	6.5483	5.6939	
O2 WET	%	2.7992	0.2937	0.0640	0.0951	0.0770	0.3341	3.3133	
H2O CORRECTION	- - -	0.85053	0.83593	0.86636	0.86665	0.86955	0.85243	0.86962	
HC MASS/MODE	LB/MODE	0.01903	0.13277	0.00411	0.05379	0.05112	0.03131	0.01909	
NOX MASS/MODE	LB/MODE	0.00001	0.00047	0.00328	0.08523	0.01675	0.00012	0.00001	
CO MASS/MODE	LB/MODE	0.08667	2.19156	0.34844	4.26817	4.29825	0.51598	0.08753	
HC MODE/STD. CYCLE	%	6.260	43.673	1.351	17.694	16.816	10.299	6.279	
NOX MODE/STD. CYCLE	%	0.004	0.196	1.365	35.514	6.981	0.052	0.003	
CO MODE/STD. CYCLE	%	1.290	32.612	5.185	63.514	63.962	7.678	1.303	
HC EMISSION PER HP CYCLE =	0.00195 LB/HP CYCLE	PERCENT OF ALLOWABLE HC =		102.37					
NOX EMISSION PER HP CYCLE =	0.00066 LB/HP CYCLE	PERCENT OF ALLOWABLE NOX =		44.12					
CO EMISSION PER HP CYCLE =	0.07373 LB/HP CYCLE	PERCENT OF ALLOWABLE CO =		175.54					

TABLE X d. COOLING AIR, 59°F, ΔP3", RICH

CYCLE NO. 1576

CFIL-17

DATE 2/18/75

BASELINE FR 25 BTDC 59 DEG HOOD = 3"

ENGINE - LYCOMING O-320-DIAD

ENGINE TIMING 25.000 DEG. BTDC

RATED H.P. 160.

H.C. RATIO 2.125

	UNITS	IDLE	TAXI	TAKE OFF	CLIMB	APPROACH	TAXI	IDLE
PUN NUMBER		1576	1577	1578	1579	1580	1581	1582
TIME IN MODE	MIN.	1.00	11.00	0.30	5.00	6.00	3.00	1.00
ENGINE SPEED	RPM	598.56	1200.84	2703.33	2424.36	2353.67	1206.06	607.50
OPS. HORSEPOWER	HP	0.49407	0.88732	151.96082	118.55855	65.83720	1.54714	0.85484
F/A RATIO MEAS.	- - -	0.1037	0.1012	0.0854	0.0826	0.0873	0.0988	0.1051
F/A RATIO CALC.	- - -	0.0994	0.1024	0.0847	0.0828	0.0889	0.0981	0.0983
% DIFF. IN F/A	%	-4.183	1.244	-0.873	0.250	1.839	-0.650	-6.460
AIR FLOW	LBS/HR	50.68	95.95	933.45	744.65	469.76	82.65	48.64
FUEL FLOW	LBS/HR	5.26	9.71	79.72	61.48	40.90	8.16	5.11
VAPOR FLOW	LBS/HP	0.01569	0.03092	0.38340	0.31232	0.19765	0.03789	0.02320
RELATIVE HUMIDITY	%	3.17	3.02	4.17	4.18	4.16	4.47	4.69
BAROMETER	IN. HG.	28.57	28.57	28.57	28.56	28.56	28.56	28.56
IND. AIR TEMP.	DEG. F	64.43	65.08	61.35	62.07	62.73	65.16	65.92
MAX. CHT	DEG. F	273.21	262.67	430.16	429.68	341.51	300.09	283.12
HC WET	PPM	38335.81	13053.30	1536.25	1539.65	1993.70	9673.96	36844.65
NOX WET	PPM	4.04	14.07	283.37	582.40	162.62	15.98	1.81
CO WET	%	8.8057	10.5042	6.7618	6.1025	8.0594	9.9001	8.7955
CO2 WET	%	5.8750	6.5324	8.8742	9.1931	8.1018	7.0998	6.1627
O2 WET	%	3.3559	0.3617	0.0357	0.0532	0.0503	0.2551	3.2299
H2O CORRECTION	- - -	0.90683	0.87144	0.86706	0.86287	0.85936	0.87311	0.91204
HC MASS/MODE	LB/MODE	0.01952	0.13722	0.00405	0.05342	0.05318	0.02370	0.01809
NOX MASS/MODE	LB/MODE	0.00001	0.00048	0.00242	0.06546	0.01405	0.00013	0.00000
CO MASS/MODE	LB/MODE	0.08860	2.18248	0.35249	4.18488	4.24856	0.47934	0.08534
HC MODE/STD. CYCLE	%	6.420	45.139	1.333	17.573	17.492	7.796	5.950
NOX MODE/STD. CYCLE	%	0.093	0.200	1.009	27.277	5.855	0.053	0.001
CO MODE/STD. CYCLE	%	1.319	32.477	5.245	62.275	63.223	7.133	1.270
HC EMISSION PER HP CYCLE =	0.00193 LB/HP CYCLE	PERCENT OF ALLOWABLE HC =				101.70		
NOX EMISSION PER HP CYCLE =	0.00052 LB/HP CYCLE	PERCENT OF ALLOWABLE NOX =				34.40		
CO EMISSION PER HP CYCLE =	0.07264 LB/HP CYCLE	PERCENT OF ALLOWABLE CO =				172.94		

TABLE X.e. COOLING AIR, 59°F, ΔP3", RICH

CYCLE NO. 524

CELL-17

DATE 12/19/75

BASFLINE FR 25 BTDC 59 DEG HOOD=6"

ENGINE - LYCOMING O-320-DIAD

ENGINE TIMING 25.000 DEG. BTDC RATED H.P. 160. H.C. RATIO 2.125

	UNITS	IDLE	TAXI	TAKE OFF	CLIMB	APPROACH	TAXI	IDLE
RUN NUMBER		524	523	1262	1263	1264	528	530
TIME IN MODE	MIN.	1.00	11.00	0.30	5.00	6.00	3.00	1.00
ENGINE SPEED	PPM	593.52	1203.84	2692.23	2429.52	2352.47	1199.52	606.00
OBS. HCPSEPOWER	HP	0.35567	0.89601	152.74843	119.92880	65.38083	1.63172	0.37807
F/A RATIO MEAS.	- - -	0.0886	0.0937	0.0846	0.0830	0.0993	0.0927	0.0899
F/A RATIO CALC.	- - -	0.0892	0.0960	0.0846	0.0829	0.0889	0.0952	0.0904
% DIFF. IN F/A	%	0.638	2.503	-0.046	-0.127	-0.529	2.769	0.574
AIR FLOW	LBS/HR	57.16	89.82	939.89	756.58	470.29	89.71	55.52
FUEL FLOW	LBS/HR	9.06	8.41	79.52	62.77	42.02	8.31	4.99
VAPOR FLOW	LBS/HR	0.01466	0.02253	0.26053	0.20015	0.11651	0.02260	0.01439
RELATIVE HUMIDITY	%	2.50	2.45	2.85	2.76	2.55	2.49	2.52
BAROMETER	IN. HG.	29.21	29.21	28.60	28.61	28.61	29.19	29.19
IND. AIR TEMP.	DEG. F	62.65	62.34	60.92	61.10	61.89	62.44	62.81
MAX. CHT	DEG. F	227.61	277.89	409.15	426.09	350.34	287.93	221.05
HC WET	PPM	35192.47	10997.09	1551.15	1573.75	1896.19	10633.05	36207.59
NOX WET	PPM	4.76	17.86	382.04	745.29	191.82	18.05	5.60
CO WET	%	7.1065	9.2612	6.6590	6.1174	8.0666	9.0790	7.1064
CO2 WET	%	6.2365	7.3154	8.7311	9.0139	8.0175	7.3842	6.3267
O2 WET	%	4.2455	0.4547	0.0640	0.0961	0.0770	0.4634	4.0557
H2O CORRECTION	- - -	0.89073	0.86134	0.86636	0.86665	0.86955	0.86024	0.88988
HC MASS/MODE	LB/MODE	0.01917	0.10543	0.00411	0.05379	0.05112	0.02767	0.01924
NOX MASS/MODE	LB/MODE	0.00001	0.00055	0.00328	0.08523	0.01675	0.00015	0.00001
CO MASS/MODE	LB/MODE	0.07650	1.75487	0.34844	4.26817	4.29825	0.46698	0.07465
HC MODE/STD. CYCLE	%	6.305	34.681	1.351	17.694	16.816	9.103	6.330
NOX MODE/STD. CYCLE	%	0.003	0.231	1.365	35.514	6.981	0.063	0.004
CO MODE/STD. CYCLE	%	1.138	26.114	5.185	63.514	63.962	6.949	1.111
HC EMISSION PER HP CYCLE =	0.00175 LB/HP CYCLE	PERCENT OF ALLOWABLE HC =			92.28			
NOX EMISSION PER HP CYCLE =	0.00066 LB/HP CYCLE	PERCENT OF ALLOWABLE NOX =			44.16			
CO EMISSION PER HP CYCLE =	0.07055 LB/HP CYCLE	PERCENT OF ALLOWABLE CO =			167.97			

ORIGINAL PAGE IS
OF POOR QUALITY

TABLE X f. COOLING AIR, 59°F, ΔP6", RICH

CYCLE NO. 524		CELL-17		DATE 12/19/76				
COOLING AIR 59 DEG HOOD DP=6" 66.0#/HR				ENGINE - LYCOMING O-320-DIAD				
ENGINE TIMING 25,000 DEG. BTDC		RATED H.P. 160.		H.C. RATIO 2.125				
	UNITS	IDLE	TAXI	TAKE OFF	CLIMB	APPROACH	TAXI	IDLE
FLY NUMBER		524	523	1283	1284	1285	528	530
TIME IN MODE	MIN.	1.00	11.00	0.30	5.00	6.00	3.00	1.00
ENGINE SPEED	RPM	593.52	1203.84	2703.09	2433.06	2358.53	1199.52	606.00
OPS. HORSEPOWER	HP	0.35567	0.89601	150.01738	118.77821	65.14967	1.63172	0.37807
MANIFOLD PRESS.	IN.HG.	0.00	0.00	0.00	0.00	0.00	0.00	0.00
F/A RATIO MEAS.	- - -	0.0896	0.0937	0.0692	0.0684	0.0694	0.0927	0.0899
F/A RATIO CALC.	- - -	0.0892	0.0960	0.0701	0.0702	0.0716	0.0952	0.0904
% DIFF. IN F/A	%	0.638	2.503	1.284	2.601	3.119	2.769	0.574
AIR FLOW	LBS/HR	57.16	89.82	946.64	808.98	477.03	89.71	55.52
FUEL FLOW	LBS/HR	5.06	8.41	65.53	55.36	33.12	8.31	4.99
VAPOR FLOW	LBS/HP	0.01466	0.02253	0.28618	0.24071	0.13030	0.02260	0.01439
HUMIDITY GR H2O/LB DRY AIR		0.000	0.000	0.000	0.000	0.000	0.000	0.000
DEW POINT	DEG.F	0.000	0.000	0.000	0.000	0.000	0.000	0.000
RELATIVE HUMIDITY	%	2.50	2.45	3.13	3.14	2.81	2.49	2.52
BAROMETER	IN.HG.	29.21	29.21	28.64	28.64	28.63	29.19	29.19
IND. AIR PRESS.	IN.HG.	0.00	0.00	0.00	0.00	0.00	0.00	0.00
IND. AIR TEMP.	DEG.F	62.65	62.34	61.55	61.39	62.33	62.44	62.81
MAX. CHT	DEG.F	227.61	277.89	410.59	374.35	332.24	287.93	221.05
HC WET	PPM	35192.47	10997.09	829.68	631.36	1005.80	10633.05	36207.59
NOX WET	PPM	4.76	17.86	2301.33	1928.79	1312.13	18.05	5.50
CO WET	%	7.1065	9.2612	1.5294	2.3782	2.0820	9.0790	7.1064
CO2 WET	%	6.2365	7.3154	11.2848	10.4717	10.8917	7.3842	6.3267
O2 WET	%	4.2455	0.4547	0.2481	0.7750	0.2461	0.4634	4.0557
H2O CORRECTION	- - -	0.89073	0.86134	0.86642	0.86396	0.85901	0.86024	0.88988
HC MASS/MODE	LB/MODE	0.01917	0.10543	0.00209	0.02258	0.02558	0.02767	0.01924
NOX MASS/MODE	LB/MODE	0.000008	0.000555	0.018776	0.223440	0.107985	0.000152	0.000010
CO MASS/MODE	LB/MODE	0.07650	1.75487	0.07613	1.68078	1.04533	0.46698	0.07465
HC MODE/STD.CYCLE	%	6.305	34.681	0.687	7.427	8.413	9.103	6.330
NOX MODE/STD.CYCLE	%	0.003	0.231	7.823	93.100	44.994	0.063	0.004
CO MODE/STD.CYCLE	%	1.138	26.114	1.133	25.012	15.555	6.949	1.111
HC EMISSION PER HP CYCLE =	0.00139 LB/HP CYCLE	PERCENT OF ALLOWABLE HC =			72.95			
NOX EMISSION PER HP CYCLE =	0.00219 LB/HP CYCLE	PERCENT OF ALLOWABLE NOX =			146.22			
CO EMISSION PER HP CYCLE =	0.03235 LB/HP CYCLE	PERCENT OF ALLOWABLE CO =			77.01			

TABLE Xg. COOLING AIR, 59°F, ΔP6", LEAN

CYCLE NO. 524		CELL-17		DATE 12/19/76					
FR 25 BTDC 100 DEG HOOD=9"				ENGINE - LYCOMING O-320-DIAD					
ENGINE TIMING		25.000 DEG. BTDC		RATED H.P. 160.		H.C. RATIO 2.125			
	UNITS	IDLE	TAXI	TAKE OFF	CLIMB	APPROACH	TAXI	IDLE	
RUN NUMBER		524	523	1329	1330	1331	528	530	
TIME IN MODE	MIN.	1.00	11.00	0.30	5.00	6.00	3.00	1.00	
ENGINE SPEED	RPM	593.52	1203.84	2696.97	2431.52	2349.61	1199.52	606.00	
OBS. HORSEPOWER	HP	0.35567	0.89601	147.57492	119.00304	65.51909	1.63172	0.37807	
MANIFOLD PRESS.	IN.HG.	0.00	0.00	0.00	0.00	0.00	0.00	0.00	
F/A RATIO MEAS.	- - -	0.0886	0.0937	0.0875	0.0823	0.0900	0.0927	0.0899	
F/A RATIO CALC.	- - -	0.0892	0.0960	0.0870	0.0846	0.0903	0.0952	0.0904	
% DIFF. IN F/A	%	0.638	2.503	-0.475	2.797	0.298	2.769	0.574	
AIR FLOW	LBS/HR	57.16	89.82	924.88	765.72	467.86	89.71	55.52	
FUEL FLOW	LBS/HR	5.06	8.41	80.89	63.01	42.11	8.31	4.99	
VAPOR FLOW	LBS/HR	0.01466	0.02253	0.32154	0.25540	0.15452	0.02260	0.01439	
HUMIDITY GR H2O/LB DRY AIR		0.000	0.000	0.000	0.000	0.000	0.000	0.000	
DEW POINT	DEG.F	0.000	0.000	0.000	0.000	0.000	0.000	0.000	
RELATIVE HUMIDITY	%	2.50	2.45	0.78	0.80	0.77	2.49	2.52	
BAROMETER	IN.HG.	29.21	29.21	29.11	29.11	29.12	29.19	29.19	
IND. AIR PRESS.	IN.HG.	0.00	0.00	0.00	0.00	0.00	0.00	0.00	
IND. AIR TEMP.	DEG.F	62.65	62.34	105.49	104.29	103.84	62.44	62.81	
MAX. CHT	DEG.F	227.61	277.89	406.64	402.83	321.79	287.93	221.05	
HC WET	PPM	35192.47	10997.09	1643.66	1566.66	1921.94	10633.05	36207.59	
NOX WET	PPM	4.76	17.86	256.80	613.06	180.52	18.05	5.60	
CO WET	%	7.1065	9.2612	7.6473	6.7616	8.6058	9.0790	7.1064	
CO2 WET	%	6.2365	7.3154	8.3916	8.6911	7.8495	7.3842	6.3267	
O2 WET	%	4.2455	0.4547	0.1002	0.1220	0.0894	0.4634	4.0557	
H2O CORRECTION	- - -	0.89073	0.86134	0.86682	0.85569	0.86591	0.86024	0.88988	
HC MASS/MODE	LB/MODE	0.01917	0.10543	0.00433	0.05583	0.05167	0.02767	0.01924	
NOX MASS/MODE	LB/MODE	0.000008	0.000555	0.002191	0.070782	0.015723	0.000152	0.000010	
CO MASS/MODE	LB/MODE	0.07650	1.75487	0.39797	4.76272	4.57311	0.46698	0.07465	
HC MODE/STD.CYCLE	%	6.305	34.681	1.424	18.366	16.998	9.103	6.330	
NOX MODE/STD.CYCLE	%	0.003	0.231	0.913	29.492	6.551	0.063	0.004	
CO MODE/STD.CYCLE	%	1.138	26.114	5.922	70.874	68.052	6.949	1.111	
HC EMISSION PER HP CYCLE =	0.00177 LB/HP CYCLE			PERCENT OF ALLOWABLE HC =			93.21		
NOX EMISSION PER HP CYCLE =	0.00056 LB/HP CYCLE			PERCENT OF ALLOWABLE NOX =			37.26		
CO EMISSION PER HP CYCLE =	0.07567 LB/HP CYCLE			PERCENT OF ALLOWABLE CO =			180.16		

103

TABLE X h. COOLING AIR, 59°F, Δ P9", RICH

CYCLE NO. 1379 CELL-17 DATE 2/11/75

25 BTDC 100 DEG HOOD = 3"

ENGINE - LYCOMING O-320-D1AD

ENGINE TIMING 25.000 DEG. BTDC RATED H.P. 160. H.C. RATIO 2.125

	UNITS	IDLE	TAXI	TAKE OFF	CLIMB	APPROACH	TAXI	IDLE	
RUN NUMBER		1379	1380	1381	1382	1383	1384	1385	
TIME IN MODE	MIN.	1.00	11.00	0.30	5.00	6.00	3.00	1.00	
ENGINE SPEED	RPM	606.21	1201.14	2698.95	2436.48	2356.88	1210.54	571.11	
OBS. HORSEPOWER	HP	0.87650	1.22545	146.05214	119.43063	64.82390	1.76215	1.30943	
F/A RATIO MEAS.		0.0994	0.0984	0.0867	0.0834	0.0895	0.0953	0.0982	
F/A RATIO CALC.		0.0965	0.0988	0.0873	0.0851	0.0903	0.0988	0.0962	
% DIFF. IN F/A	%	-2.978	0.392	0.647	2.089	0.858	3.656	-2.016	
AIR FLOW	LBS/HR	49.45	85.45	920.00	772.36	476.10	82.61	48.66	
FUEL FLOW	LBS/HR	4.92	8.41	79.80	64.40	42.61	7.87	4.78	
VAPOR FLOW	LBS/HR	0.02883	0.04855	0.56321	0.46711	0.26578	0.04661	0.02828	
RELATIVE HUMIDITY	%	1.27	1.50	1.48	1.45	1.76	1.34	1.32	
BAROMETER	IN. HG.	29.23	29.23	29.23	29.23	29.23	29.23	29.23	
IND. AIR TEMP.	DEG. F	93.48	93.27	103.47	103.99	102.82	98.22	94.14	
MAX. CHT	DEG. F	326.15	303.46	473.82	480.08	392.29	310.01	274.28	
HC WET	PPM	35813.56	9804.97	1545.75	1509.75	1816.93	9752.22	38018.77	
NOX WET	PPM	7.25	21.25	297.43	721.77	223.27	21.38	6.26	
CO WET	%	8.5951	10.0267	7.6854	8.9609	8.6053	9.9143	8.2058	
CO2 WET	%	5.7328	6.9723	8.3563	8.6755	7.8566	6.8999	5.7941	
O2 WET	%	3.6573	0.2625	0.0654	0.0931	0.0744	0.2658	3.7699	
H2O CORRECTION		0.90424	0.87021	0.86244	0.85720	0.86342	0.85952	0.90143	
HC MASS/MODE	LB/MODE	0.01754	0.09095	0.00404	0.05451	0.04963	0.02359	0.01824	
NOX MASS/MODE	LB/MODE	0.00001	0.00064	0.00252	0.08442	0.01976	0.00017	0.00001	
CO MASS/MODE	LB/MODE	0.08319	1.83831	0.39687	4.96720	4.64585	0.47406	0.07782	
HC MODE/STD. CYCLE	%	5.769	29.919	1.329	17.931	16.326	7.761	6.001	
NOX MODE/STD. CYCLE	%	0.005	0.266	1.049	35.176	8.233	0.070	0.004	
CO MODE/STD. CYCLE	%	1.238	27.356	5.906	73.917	69.135	7.054	1.158	
HC EMISSION PER HP CYCLE =	0.00162 LB/HP CYCLE	PERCENT OF ALLOWABLE HC =				85.04			
NOX EMISSION PER HP CYCLE =	0.00067 LB/HP CYCLE	PERCENT OF ALLOWABLE NOX =				44.80			
CO EMISSION PER HP CYCLE =	0.07802 LB/HP CYCLE	PERCENT OF ALLOWABLE CO =				185.76			

TABLE XI. COOLING AIR, 100°F, ΔP3", RICH

CYCLE NO. 1372 CELL-17 DATE 2/11/75

25 BTDC 100 DEG HOOD = 6"

ENGINE - LYCOMING O-320-DIAD

ENGINE TIMING 25.000 DEG. BTDC RATED H.P. 160. H.C. RATIO 2.125

UNITS	IDLE	TAXI	TAKE OFF	CLIMB	APPROACH	TAXI	IDLE
RUN NUMBER	1372	1373	1374	1375	1376	1377	1378
TIME IN MODE MIN.	1.00	11.00	0.30	5.00	6.00	3.00	1.00
ENGINE SPEED RPM	591.54	1204.26	2709.87	2430.30	2355.05	1201.09	619.02
OBS. HORSEPOWER HP	0.24270	0.86048	148.78554	119.39523	65.27167	1.42974	0.70375
F/A RATIO MEAS. - - -	0.1031	0.0987	0.0872	0.0836	0.0890	0.0956	0.1002
F/A RATIO CALC. - - -	0.1069	0.0969	0.0869	0.0845	0.0898	0.0990	0.0958
% DIFF. IN F/A %	3.683	-1.804	-0.390	1.080	0.817	3.504	-4.352
AIR FLOW LBS/HR	46.67	85.26	922.75	763.27	474.93	84.20	49.09
FUEL FLOW LBS/HR	4.81	8.41	80.48	63.79	42.29	8.05	4.92
VAPOR FLOW LBS/HR	0.02667	0.05044	0.57277	0.45924	0.26941	0.04898	0.02933
RELATIVE HUMIDITY %	1.31	1.48	1.50	1.43	1.34	1.38	1.41
BAROMETER IN.HG.	29.21	29.22	29.22	29.22	29.22	29.22	29.22
IND. AIR TEMP. DEG.F	96.95	94.05	103.29	104.01	103.13	98.47	94.40
MAX. CHT DEG.F	320.02	266.21	435.23	430.29	350.83	294.30	272.40
HC WET PPM	42445.21	9949.99	1509.65	1532.15	1889.19	9718.46	35195.48
NOX WET PPM	6.61	23.08	292.95	710.23	214.42	20.86	8.04
CO WET %	8.0574	9.6888	7.6269	6.7924	8.5033	9.6400	8.2401
CO2 WET %	5.2876	7.1950	8.4645	8.7958	7.9308	6.8791	6.1723
O2 WET %	2.6054	0.3924	0.0835	0.1194	0.1127	0.1429	3.3455
H2O CORRECTION - - -	0.88051	0.87693	0.86538	0.86048	0.86311	0.86163	0.90551
HC MASS/MODE LB/MODE	0.01986	0.09217	0.00396	0.05471	0.05139	0.02399	0.01715
NOX MASS/MODE LB/MODE	0.00001	0.00069	0.00249	0.08215	0.01890	0.00017	0.00001
CO MASS/MODE LB/MODE	0.07452	1.77392	0.39573	4.79340	4.57182	0.47039	0.07937
HC MODE/STD. CYCLE %	6.534	30.320	1.304	17.996	16.905	7.893	5.643
NOX MODE/STD. CYCLE %	0.004	0.289	1.038	34.231	7.874	0.070	0.005
CO MODE/STD. CYCLE %	1.109	26.398	5.889	71.330	68.033	7.000	1.181
HC EMISSION PER HP CYCLE =	0.00165 LB/HP CYCLE		PERCENT OF ALLOWABLE HC =			86.59	
NOX EMISSION PER HP CYCLE =	0.00065 LB/HP CYCLE		PERCENT OF ALLOWABLE NOX =			43.51	
CO EMISSION PER HP CYCLE =	0.07599 LB/HP CYCLE		PERCENT OF ALLOWABLE CO =			180.94	

105

ORIGINAL PAGE IS OF POOR QUALITY

TABLE Xj. COOLING AIR, 100°F, Δ P 3", RICH

CYCLE NO. 1322

CELL-17

DATE 2/11/75

25 BTDC 100 DEG. HOOD = 9"

ENGINE - LYCOMING O-320-DIAD

ENGINE TIMING

25.000 DEG. BTDC

RATED H.P. 160.

H.C. RATIO 2.125

	UNITS	IDLE	TAXI	TAKE OFF	CLIMB	APPROACH	TAXI	IDLE	
RUN NUMBER		1322	1323	1324	1325	1326	1327	1328	
TIME IN MODE	MIN.	1.00	11.00	0.30	5.00	6.00	3.00	1.00	
ENGINE SPEED	RPM	606.12	1203.90	2703.94	2431.56	2351.63	1202.46	602.34	
OBS. HOP SEPOWER	HP	0.53930	1.45237	148.70059	119.42076	65.17310	1.48693	0.22190	
F/A RATIO MEAS.	- - -	0.1006	0.0964	0.0881	0.0848	0.0903	0.0990	0.1000	
F/A RATIO CALC.	- - -	0.0977	0.0989	0.0867	0.0846	0.0899	0.0982	0.0958	
% DIFF. IN F/A	%	-2.915	2.548	-1.646	-0.269	-0.526	-0.851	-4.260	
AIR FLOW	LBS/HR	49.87	91.00	926.22	764.07	474.03	82.86	49.89	
FUEL FLOW	LBS/HR	5.02	8.78	81.61	64.83	42.83	8.20	4.99	
VAPOR FLOW	LBS/HR	0.01539	0.02898	0.31269	0.24598	0.14924	0.02721	0.01680	
RELATIVE HUMIDITY	%	0.71	0.79	0.80	0.77	0.77	0.78	0.76	
BAROMETER	IN. HG.	29.10	29.10	29.10	29.10	29.10	29.10	29.11	
IND. AIR TEMP.	DEG. F	97.60	97.14	104.11	104.08	102.98	100.01	96.68	
MAX. CHT	DEG. F	281.17	280.93	410.06	403.20	321.89	315.33	276.24	
HC WET	PPM	34909.46	9454.94	1527.15	1539.35	1926.49	9181.91	35180.48	106
NOX WET	PPM	8.09	24.15	274.08	656.99	190.26	18.39	3.33	
CO WET	%	8.7375	10.0582	7.5537	6.8575	8.5410	10.0110	8.4199	
CO2 WET	%	5.9788	6.8219	8.5049	8.8044	7.9151	6.9803	6.0116	
O2 WET	%	3.2441	0.3131	0.0837	0.1155	0.1168	0.3097	3.5.58	
H2O CORRECTION	- - -	0.90091	0.86445	0.87047	0.86557	0.86856	0.87515	0.90689	
HC MASS/MODE	LB/MODE	0.01730	0.09284	0.00404	0.05527	0.05254	0.02256	0.01741	
NOX MASS/MODE	LB/MODE	0.00001	0.00077	0.00235	0.07642	0.01681	0.00015	0.00001	
CO MASS/MODE	LB/MODE	0.08560	1.95004	0.39461	4.86624	4.60411	0.48624	0.08236	
HC MODE/STD. CYCLE	%	5.692	30.541	1.328	18.181	17.284	7.423	5.728	
NOX MODE/STD. CYCLE	%	0.005	0.320	0.978	31.841	7.005	0.061	0.002	
CO MODE/STD. CYCLE	%	1.274	29.018	5.872	72.414	68.514	7.236	1.226	
HC EMISSION PER HP CYCLE =	0.00164 LB/HP CYCLE	PERCENT OF ALLOWABLE HC =			86.18				
NOX EMISSION PER HP CYCLE =	0.00060 LB/HP CYCLE	PERCENT OF ALLOWABLE NOX =			40.21				
CO EMISSION PER HP CYCLE =	0.07793 LB/HP CYCLE	PERCENT OF ALLOWABLE CO =			185.55				

TABLE X.K. COOLING AIR, 100°F, ΔP9", RICH

CYCLE NO. 524 CELL-17 DATE 12/19/75

25 BTDC 100 DEG H_{COOL}=9"

ENGINE - LYCOMING O-320-D1AD

ENGINE TIMING 25.000 DEG. BTDC RATED H.P. 160. H.C. RATIO 2.125

	UNITS	IDLE	TAXI	TAKE OFF	CLIMB	APPROACH	TAXI	IDLE
RUN NUMBER		524	523	1329	1330	1331	528	530
TIME IN MODE	MIN.	1.00	11.00	0.30	5.00	6.00	3.00	1.00
ENGINE SPEED	RPM	593.52	1203.84	2696.97	2431.52	2349.61	1199.52	606.00
CRS. HORSEPOWER	HP	0.35567	0.82601	147.57492	119.00304	65.51909	1.63172	0.37807
F/A RATIO MEAS.	- - -	0.0886	0.0937	0.0875	0.0823	0.0900	0.0927	0.0899
F/A RATIO CALC.	- - -	0.0892	0.0960	0.0870	0.0846	0.0903	0.0952	0.0904
% DIFF. IN F/A	%	0.638	2.503	-0.475	2.797	0.298	2.769	0.574
AIR FLOW	LBS/HR	57.16	89.82	924.88	765.72	467.86	89.71	55.52
FUEL FLOW	LBS/HR	5.06	8.41	80.89	63.01	42.11	8.31	4.99
VAPOR FLOW	LBS/HR	0.01466	0.02253	0.32154	0.25540	0.15452	0.02260	0.01439
RELATIVE HUMIDITY	%	2.50	2.45	0.78	0.80	0.77	2.49	2.52
BAROMETER	IN. HG.	29.21	29.21	29.11	29.11	29.12	29.19	29.19
IND. AIR TEMP.	DEG. F	62.65	62.34	105.49	104.29	103.84	62.44	62.81
MAX. CHT	DEG. F	227.61	277.89	406.64	402.83	321.79	287.93	221.05
HC WET	PPM	35192.47	10997.09	1643.66	1566.66	1921.94	10633.05	36207.59
NOX WET	PPM	4.76	17.86	256.80	613.06	180.52	18.05	5.60
CO WET	%	7.1065	9.2612	7.6473	6.7616	8.6058	9.0790	7.1064
CO2 WET	%	6.2365	7.3154	8.3916	8.6911	7.8495	7.3842	6.3267
O2 WET	%	4.2455	0.4547	0.1002	0.1220	0.0894	0.4634	4.0557
H2O CORRECTION	- - -	0.89073	0.86134	0.86682	0.85569	0.86591	0.86024	0.88988
HC MASS/MODE	LB/MODE	0.01917	0.10543	0.00433	0.05583	0.05167	0.02767	0.01924
NOX MASS/MODE	LB/MODE	0.00001	0.00055	0.00219	0.07078	0.01572	0.00015	0.00001
CO MASS/MODE	LB/MODE	0.07650	1.75487	0.39797	4.76272	4.57311	0.46698	0.07465
HC MODE/STD. CYCLE	%	6.305	34.681	1.424	18.366	16.998	9.103	6.330
NOX MODE/STD. CYCLE	%	0.003	0.231	0.913	29.492	6.551	0.063	0.004
CO MODE/STD. CYCLE	%	1.138	26.114	5.922	70.874	68.052	6.949	1.111
HC EMISSION PER HP CYCLE =	0.00177 LB/HP CYCLE				PERCENT OF ALLOWABLE HC =	93.21		
NOX EMISSION PER HP CYCLE =	0.00056 LB/HP CYCLE				PERCENT OF ALLOWABLE NOX =	37.26		
CO EMISSION PER HP CYCLE =	0.07567 LB/HP CYCLE				PERCENT OF ALLOWABLE CO =	180.16		

107

TABLE X 1. COOLING AIR, 100°F, ΔP9", RICH

CYCLE NO. 1347

CELL-17

DATE 2/11/76

66 #/HP 25 BTDC 100 DEG HOOD = 9"

ENGINE - LYCOMING O-320-DIAD

ENGINE TIMING	25.000 DEG. BTDC	RATED H.P.	160.	H.C. RATIO	2.125			
UNITS	IDLE	TAXI	TAKE OFF	CLIMB	APPROACH	TAXI	IDLE	
PUM NUMBER	1347	1348	1349	1350	1351	1352	1353	
TIME IN MODE	MIN. 1.00	11.00	0.30	5.00	6.00	3.00	1.00	
ENGINE SPEED	RPM 593.53	1209.20	2702.85	2428.50	2349.53	1205.70	597.12	
CRS. HORSEPOWER	HP 0.05208	1.11455	147.34370	118.83554	65.11212	0.84686	0.55922	
F/A RATIO MEAS.	- - - 0.1014	0.0957	0.0718	0.0694	0.0764	0.0980	0.0936	
F/A RATIO CALC.	- - - 0.0978	0.0962	0.0725	0.0712	0.0733	0.0961	0.0937	
% DIFF. IN F/A	% -3.483	0.590	1.009	2.495	-4.109	-1.952	0.065	
AIP FLOW	LBS/HR 46.76	80.96	920.79	795.20	465.12	78.65	48.91	
FUFL FLOW	LBS/HR 4.74	7.74	66.07	55.21	35.56	7.71	4.58	
VAPOR FLOW	LBS/HR 0.01848	0.03259	0.41131	0.34759	0.19124	0.03254	0.02105	
RELATIVE HUMIDITY	% 0.92	1.02	1.07	1.07	1.00	0.98	0.97	
BAROMETER	IN. HG. 29.15	29.16	29.16	29.16	29.17	29.17	29.17	
IND. AIR TEMP.	DEG. F 96.96	96.36	103.92	103.54	102.81	98.84	94.85	
MAX. CHT	DEG. F 315.37	296.04	425.50	390.89	341.54	288.15	267.44	
HC WET	PPM 37276.20	8482.09	996.80	761.18	1069.11	8576.85	35779.54	108
NOX WET	PPM 9.03	26.11	1871.69	2156.71	1216.25	23.75	8.59	
CO WET	% 8.6358	9.4248	2.3432	7.5952	2.9089	9.502	7.5597	
CO2 WET	% 5.8385	7.2615	11.0740	10.5590	10.9850	7.3740	6.1197	
O2 WET	% 3.5040	0.2354	0.1451	0.6674	0.2712	0.2621	3.6544	
H2O CORRECTION	- - - 0.00513	0.86839	0.86340	0.86189	0.87995	0.87590	0.89177	
HC MASS/MODE	LB/MODE 0.01737	0.07383	0.00246	0.02687	0.02716	0.01994	0.01698	
NOX MASS/MODE	LB/MODE 0.00001	0.00074	0.01497	0.24660	0.10010	0.00018	0.00001	
CO MASS/MODE	LB/MODE 0.07955	1.52136	0.11434	1.81029	1.46060	0.44084	0.07194	
HC MODE/STD. CYCLE	% 5.715	24.286	0.810	8.837	8.935	6.560	5.586	
NOX MODE/STD. CYCLE	% 0.006	0.307	6.238	102.749	41.709	0.075	0.005	
CO MODE/STD. CYCLE	% 1.184	24.127	1.702	26.939	21.735	6.560	1.071	
HC EMISSION PER HP CYCLE =	0.00115 LB/HP CYCLE			PERCENT OF ALLOWABLE HC =	60.73			
NOX EMISSION PER HP CYCLE =	0.00227 LB/HP CYCLE			PERCENT OF ALLOWABLE NOX =	151.09			
CO EMISSION PER HP CYCLE =	0.03499 LB/HP CYCLE			PERCENT OF ALLOWABLE CO =	83.32			

TABLE X_m. COOLING AIR, 100°F, ΔP₉", LEANORIGINAL PAGE IS
OF POOR
QUALITY

CYCLE NO. 1801

CFLC-17

DATE 2724776

25 BTDC, 50 DEG. F, 0% REL. HUMIDITY

ENGINE - LYCOMING O-370-D1AD

ENGINE TIMING	25.000 DEG. BTDC	RATED H.P. 160.			H.C. RATIO 2.125			
	LIMITS	IDLE	TAXI	TAKE OFF	CLIMB	APPROACH	TAXI	IDLE
RUN NUMBER		1801	1802	1803	1804	1805	1806	1808
TIME IN MODE	MIN.	1.00	11.00	0.30	5.00	6.00	3.00	1.00
ENGINE SPEED	RPM	594.96	1202.34	2701.89	2433.66	2349.77	1198.56	599.76
CRS. HORSEPOWER	HP	0.28172	1.76153	157.34470	119.90598	64.48654	0.86063	0.33888
F/A RATIO MEAS.	- - -	0.0956	0.0930	0.0836	0.0821	0.0883	0.0925	0.0966
F/A RATIO CALC.	- - -	0.0944	0.0940	0.0812	0.0792	0.0858	0.0944	0.0963
% DIFF. IN F/A	%	-1.243	1.081	-2.884	-3.561	-2.776	2.071	-0.290
AIR FLOW	LBS/HR	51.97	90.38	961.52	743.53	468.01	88.39	53.02
FUEL FLOW	LBS/HR	4.97	8.41	80.41	61.06	41.31	8.18	5.12
VAPOR FLOW	LBS/HR	0.02314	0.04050	0.42969	0.32318	0.20433	0.03979	0.02445
HUMIDITY GR H2O/LB DRY AIR		3.116	3.137	3.128	3.043	3.056	3.151	3.228
DEW POINT	DEG. F	-6.755	-6.600	-6.530	-6.990	-6.950	-6.480	-6.145
RELATIVE HUMIDITY	%	4.99	5.13	5.88	5.77	5.63	5.44	5.28
BAROMETER	IN. HG.	29.23	29.22	29.22	29.22	29.22	29.22	29.21
IND. AIR TEMP.	DEG. F	53.78	53.27	49.59	49.49	50.20	51.91	53.26
MAX. CHT	DEG. F	284.28	268.59	430.09	421.28	342.22	279.12	306.51
HC WET	PPM	35502.52	8552.85	1519.05	1504.05	2015.30	9728.46	39797.95
NOX WET	PPM	4.54	20.10	384.60	638.30	170.70	16.27	2.95
CO WET	%	8.3495	9.5643	6.2807	5.5156	7.9178	4.4684	8.3597
CO2 WET	%	6.8353	8.2175	10.6603	11.1652	9.6069	8.1727	6.3845
O2 WET	%	3.3479	0.2257	0.0637	0.0893	0.0658	0.2557	3.5595
H2O CORRECTION	- - -	0.88531	0.85365	0.85856	0.86065	0.86103	0.85063	0.88699
HC MASS/MODE	LB/MODE	0.01803	0.08234	0.00410	0.05202	0.05387	0.02493	0.02069
NOX MASS/MODE	LB/MODE	<0.00001	0.00063	0.00336	0.07152	0.01478	0.00014	0.00000
CO MASS/MODE	LB/MODE	0.08391	1.81982	0.33504	3.77050	4.18276	0.47960	0.08590
HC MODE/STD. CYCLE	%	5.931	27.085	1.349	17.112	17.719	8.202	6.805
NOX MODE/STD. CYCLE	%	0.003	0.261	1.401	29.801	8.159	0.056	0.002
CO MODE/STD. CYCLE	%	1.247	27.081	4.986	56.109	62.243	7.137	1.278
HC EMISSION PER HP CYCLE =	0.00160 LB/HP CYCLE				PERCENT OF ALLOWABLE HC =	84.20		
NOX EMISSION PER HP CYCLE =	0.00057 LB/HP CYCLE				PERCENT OF ALLOWABLE NOX =	37.68		
CO EMISSION PER HP CYCLE =	0.06723 LB/HP CYCLE				PERCENT OF ALLOWABLE CO =	160.08		

109

ORIGINAL PAGE IS
OF POOR QUALITY

TABLE XI a. TEMP-HUMIDITY, 50°F, 0%

CYCLE NO. 1809

CELL-17

DATE 2/24/76

25 BTDC, 50 DEG.F, 30% REL.HUMIDITY

ENGINE - LYCOMING O-320-D1AD

ENGINE TIMING

25.000 DEG. BTDC

RATED H.P. 160.

H.C. RATIO 2.125

	UNITS	IDLE	TAXI	TAKE OFF	CLIMB	APPROACH	TAXI	IDLE
PUN NUMBER		1809	1810	1811	1812	1813	1814	1815
TIME IN MODE	MIN.	1.00	11.00	0.30	5.00	6.00	3.00	1.00
ENGINE SPEED	RPM	613.20	1202.76	2700.81	2432.88	2349.71	1204.26	605.82
OBS. HORSEPOWER	HP	0.35562	1.35716	157.92532	120.24646	65.41045	0.92119	0.38992
F/A RATIO MEAS.	- - -	0.0963	0.0972	0.0834	0.0822	0.0878	0.0961	0.0959
F/A RATIO CALC.	- - -	0.0959	0.0944	0.0811	0.0792	0.0854	0.0945	0.0941
% DIFF. IN F/A	%	-0.378	-2.875	-2.691	-3.635	-2.701	-1.642	-1.874
AIR FLOW	LBS/HR	53.47	97.93	62.40	74.76	470.30	86.63	54.45
FUEL FLOW	LPS/HR	5.15	8.54	80.24	61.24	41.30	8.33	5.22
VAPOR FLOW	LBS/HP	0.11536	0.18634	2.12908	1.62303	1.01455	0.18777	0.11879
HUMIDITY GR H2O/LB DRY AIR		15.104	14.850	15.486	15.755	15.101	15.172	15.271
DEW POINT	DEG.F	20.703	20.648	21.568	21.393	21.113	21.148	21.243
RELATIVE HUMIDITY	%	25.02	25.14	29.72	29.39	28.27	26.49	25.83
BAROMETER	IN.HG.	29.20	29.19	29.19	29.19	29.19	29.19	29.19
IND. AIR TEMP.	DEG.F	52.41	52.19	49.02	49.06	49.70	51.51	52.33
MAX. CHT	DEG.F	281.00	254.07	407.98	411.81	332.05	286.74	247.83
H ₂ O WET	PPM	36568.63	10089.00	1606.16	1515.15	1882.29	6788.67	35140.50
NOX WET	PPM	3.78	16.10	368.54	646.38	184.66	16.95	4.02
CO WET	%	8.3673	9.6341	6.2171	5.5217	7.8257	9.6414	8.1070
CO ₂ WET	%	6.6510	8.2648	10.5864	11.0954	9.6236	8.2264	7.0560
O ₂ WET	%	3.2478	0.3138	0.0884	0.1018	0.0939	0.2730	3.1738
H ₂ O CORRECTION	- - -	0.88138	0.86642	0.85599	0.85886	0.85827	0.86167	0.89253
H ₂ O MASS/MODE	LB/MODE	0.01918	0.09592	0.00434	0.05260	0.05055	0.02494	0.01875
NOX MASS/MODE	LB/MODE	<0.00001	0.00050	0.00323	0.07269	0.01607	0.00014	0.00001
CO MASS/MODE	LB/MODE	0.08674	1.81041	0.33217	3.78849	4.15409	0.48554	0.08548
H ₂ O MODE/STD.CYCLE	%	6.310	31.554	1.428	17.302	16.630	8.205	5.165
NOX MODE/STD.CYCLE	%	0.003	0.207	1.345	30.289	6.695	0.058	0.003
CO MODE/STD.CYCLE	%	1.291	26.941	4.943	56.376	61.817	7.225	1.272
H ₂ O EMISSION PER HP CYCLE =	0.00166 LB/HP CYCLE					PERCENT OF ALLOWABLE H ₂ O =	87.59	
NOX EMISSION PER HP CYCLE =	0.00058 LB/HP CYCLE					PERCENT OF ALLOWABLE NOX =	38.60	
CO EMISSION PER HP CYCLE =	0.06714 LB/HP CYCLE					PERCENT OF ALLOWABLE CO =	159.86	

110

TABLE XI b. TEMP-HUMIDITY, 50°F, 30%

CYCLE NO. 1817

CELL-17

DATE 2724776

25 BTDC, 50 DEG.F, 30% REL.HUMIDITY

ENGINE - LYCOMING O-320-D1AD

ENGINE TIMING 25.000 DEG. BTDC RATED H.P. 160. H.C. RATIO 2.125

	UNITS	IDLE	TAXI	TAKE OFF	CLIMB	APPROACH	TAXI	IDLE
RUN NUMBER		1817	1818	1819	1820	1821	1822	1824
TIME IN MODE	MIN.	1.00	11.00	0.30	5.00	6.00	3.00	1.00
ENGINE SPEED	RPM	593.76	1702.34	2703.87	2433.06	2352.29	1703.72	603.42
OBS. HORSEPOWER	HP	0.53149	1.22122	156.40175	119.18124	65.86949	1.89887	0.32667
F/A RATIO MEAS.	- - -	0.0924	0.0944	0.0844	0.0832	0.0873	0.0946	0.0986
F/A RATIO CALC.	- - -	0.0945	0.0944	0.0813	0.0792	0.0854	0.0943	0.0942
% DIFF. IN F/A	%	2.282	-0.013	-3.668	-4.777	-2.117	-0.350	-4.437
AIR FLOW	LBS/HR	54.96	89.13	959.28	742.35	472.98	86.29	50.54
FUEL FLOW	LBS/HR	5.08	8.42	80.98	61.74	41.29	8.16	4.98
VAPOR FLOW	LBS/HR	3.12162	0.19570	2.17064	1.64707	1.03929	0.18956	0.11005
HUMIDITY GR H2O/LB DRY AIR		15.489	15.369	15.839	15.531	15.381	15.377	15.242
DEW POINT	DEG.F	21.478	21.368	22.008	21.723	21.498	21.353	21.428
RELATIVE HUMIDITY	%	25.80	26.05	30.15	29.84	28.80	26.58	25.75
BAROMETER	IN.HG.	29.18	29.19	29.18	29.18	29.18	29.18	29.17
IND. AIR TEMP.	DEG.F	52.70	52.29	49.27	49.14	49.76	51.72	52.67
MAX. CHT	DEG.F	266.69	267.87	431.12	420.67	341.98	275.38	282.58
HC WFT	PPM	37178.70	9769.97	1554.55	1522.45	1936.69	9662.70	36167.59
NOX WFT	PPM	3.40	16.85	362.88	629.40	179.18	16.19	5.20
CO WFT	%	8.0388	9.4972	6.2676	5.4970	7.7477	9.5193	8.3027
CO2 WFT	%	6.4842	8.1837	10.5267	11.0959	9.5695	8.1865	6.8923
O2 WFT	%	3.5889	0.2670	0.0731	0.1027	0.0856	0.2908	3.4121
H2O CORRECTION	- - -	0.87413	0.85608	0.86047	0.86389	0.85668	0.85733	0.89532
HC MASS/MODE	LB/MODE	0.01977	0.09337	0.00421	0.05287	0.05221	0.02440	0.01908
NOX MASS/MODE	LB/MODE	<0.00001	0.00052	0.00318	0.07081	0.01556	0.00013	0.00001
CO MASS/MODE	LB/MODE	0.08450	1.79378	0.33511	3.77277	4.12813	0.47505	0.08202
HC MODE/STD.CYCLE	%	6.504	30.712	1.383	17.391	17.176	8.026	5.947
NOX MODE/STD.CYCLE	%	0.002	0.217	1.325	29.503	6.484	0.055	0.004
CO MODE/STD.CYCLE	%	1.257	26.693	4.987	56.142	61.430	7.069	1.221
HC EMISSION PER HP CYCLE =	0.00166 LB/HP CYCLE	PERCENT OF ALLOWABLE HC =				87.14		
NOX EMISSION PER HP CYCLE =	0.00056 LB/HP CYCLE	PERCENT OF ALLOWABLE NOX =				37.59		
CO EMISSION PER HP CYCLE =	0.06670 LB/HP CYCLE	PERCENT OF ALLOWABLE CO =				158.80		

111

TABLE XIc. TEMP-HUMIDITY, 50°F, 30%

CYCLE NO. 1832

CELL-17

DATE 2/24/76

25 BTDC, 50 DEG.F, 60% REL.HUMIDITY

ENGINE - LYCOMING O-320-DIAD

ENGINE TIMING	25.000 DEG. BTDC	RATED H.P. 160.			H.C. RATIO 2.125			
	UNITS	IDLE	TAXI	TAKE OFF	CLIMB	APPROACH	TAXI	IDLE
RUN NUMBER		1832	1833	1834	1835	1836	1837	1838
TIME IN MODE	MIN.	1.00	11.00	0.30	5.00	6.00	3.00	1.00
ENGINE SPEED	RPM	604.14	1199.52	2705.79	2435.34	2352.11	1204.32	508.52
OBS. HORSEPOWER	HP	0.79557	1.27543	155.77249	119.50359	65.97430	1.45177	0.86518
F/A RATIO MEAS.	- - -	0.0972	0.0940	0.0837	0.0828	0.0856	0.0935	0.0974
F/A RATIO CALC.	- - -	0.0943	0.0943	0.0816	0.0793	0.0833	0.0946	0.0947
% DIFF. IN F/A	%	-3.023	0.327	-2.496	-4.189	-2.657	1.200	-2.807
AIR FLOW	LBS/HR	51.78	90.43	970.16	754.92	470.95	85.64	53.02
FUEL FLOW	LBS/HR	5.03	8.50	81.19	62.51	40.32	8.00	5.16
VAPOR FLOW	LBS/HR	0.23122	0.40879	4.40068	3.35594	2.09418	0.37827	0.23430
HUMIDITY GR H2O/LB DRY AIR		31.260	31.643	31.752	31.118	31.127	30.919	30.933
DEW POINT	DEG.F	35.454	35.814	36.445	35.960	35.639	35.409	35.299
RELATIVE HUMIDITY	%	51.04	50.92	59.26	57.92	55.59	51.11	49.02
BAROMETER	IN.HG.	29.16	29.16	29.16	29.16	29.16	29.16	29.16
IND.AIR TEMP.	DEG.F	53.07	53.52	50.09	50.19	50.95	52.98	54.00
MAX. CHT.	DEG.F	277.81	266.68	423.95	413.07	331.42	318.95	285.56
HC WET	PPM	35386.51	9672.96	1451.74	1502.05	1836.08	9201.91	35696.55
NOX WET	PPM	6.10	19.40	375.30	657.81	232.84	19.60	5.36
CO WET	%	8.0720	9.5027	6.3781	5.5480	7.0146	9.5964	8.2539
CO2 WET	%	6.9204	8.1769	10.4383	11.0362	10.0597	8.0871	6.8338
O2 WET	%	3.2107	0.2921	0.0683	0.1017	0.0882	0.2540	3.2978
H2O CORRECTION	- - -	0.88654	0.85113	0.85218	0.85814	0.85370	0.84847	0.88588
HC MASS/MODE	LB/MODE	0.01807	0.09383	0.00397	0.05308	0.04909	0.02301	0.01868
NOX MASS/MODE	LB/MODE	0.00001	0.00061	0.00332	0.07531	0.02017	0.00016	0.00001
CO MASS/MODE	LB/MODE	0.08148	1.87187	0.34466	3.87493	3.70639	0.47432	0.08579
HC MODE/STD.CYCLE	%	5.945	30.865	1.306	17.461	16.147	7.570	6.144
NOX MODE/STD.CYCLE	%	0.004	0.254	1.385	31.378	8.403	0.066	0.004
CO MODE/STD.CYCLE	%	1.212	27.111	5.129	57.663	55.155	7.058	1.277
HC EMISSION PER HP CYCLE =	0.00162 LB/HP CYCLE	PERCENT OF ALLOWABLE HC =			85.44			
NOX EMISSION PER HP CYCLE =	0.00062 LB/HP CYCLE	PERCENT OF ALLOWABLE NOX =			41.49			
CO EMISSION PER HP CYCLE =	0.06493 LB/HP CYCLE	PERCENT OF ALLOWABLE CO =			154.60			

TABLE XI d. TEMP-HUMIDITY, 50°F, 60%

CYCLE NO. 1839

CELL-17

DATE 2/24/76

25 BTDC, 50 DEG.F, 60% REL.HUMIDITY

ENGINE - LYCOMING O-320-DIAD

ENGINE TIMING	25.000 DEG. BTDC	RATED H.P. 160.			H.C. RATIO 2.125			
	UNITS	IDLE	TAXI	TAKE OFF	CLIMB	APPROACH	TAXI	IDLE
RUN NUMBER		1839	1840	1841	1842	1843	1844	1845
TIME IN MODE	MIN.	1.00	11.00	0.30	5.00	6.00	3.00	1.00
ENGINE SPEED	RPM	610.02	1205.40	2706.39	2435.22	2351.63	1200.06	600.95
OBS. HORSEPOWER	HP	0.37118	1.19383	155.75819	119.35580	66.16856	0.80800	0.50457
F/A RATIO MEAS.	- - -	0.0986	0.0934	0.0838	0.0814	0.0857	0.0950	0.0952
F/A RATIO CALC.	- - -	0.0941	0.0939	0.0817	0.0795	0.0838	0.0960	0.0943
% DIFF. IN F/A	%	-4.511	0.571	-2.524	-2.308	-2.237	1.009	-0.917
AIR FLOW	LBS/HR	53.62	89.00	950.36	745.41	466.21	88.23	53.36
FUEL FLOW	LBS/HR	5.29	8.31	79.63	60.68	39.96	8.38	5.08
VAPOR FLOW	LBS/HR	0.23752	0.39342	4.33244	3.34750	2.08060	0.39050	0.23773
HUMIDITY GR H2O/LB DRY AIR		31.008	30.944	31.911	31.436	31.240	30.982	31.187
DEW POINT	DEG.F	35.174	35.219	36.140	35.930	35.674	35.349	35.359
RELATIVE HUMIDITY	%	48.73	49.63	56.99	56.59	54.33	49.76	47.72
BAROMETER	IN.HG.	29.15	29.16	29.15	29.15	29.15	29.15	29.15
IND. AIR TEMP.	DEG.F	54.03	53.57	50.82	50.78	51.61	53.65	54.80
MAX. CHT.	DEG.F	258.43	281.62	434.06	424.37	337.45	325.51	289.43
HC WET	PPM	35766.55	9178.91	1450.14	1466.04	1792.98	11098.10	36409.60
NOX WET	PPM	4.81	20.64	363.38	639.66	226.02	17.33	4.82
CO WET	%	8.2619	9.4427	6.4144	5.5850	7.1663	9.6904	8.1276
CO2 WET	%	6.9238	8.1832	10.4397	10.9271	9.9666	7.9307	6.7135
O2 WET	%	3.3540	0.2811	0.0653	0.0913	0.0711	0.2900	3.4460
H2O CORRECTION	- - -	0.89201	0.85048	0.85204	0.85075	0.85211	0.85081	0.88024
HC MASS/MODE	LB/MODE	0.01900	0.08745	0.00389	0.05089	0.04747	0.02875	0.01703
NOX MASS/MODE	LB/MODE	0.00001	0.00064	0.00315	0.07193	0.01939	0.00015	0.00001
CO MASS/MODE	LB/MODE	0.08676	1.77810	0.33968	3.83163	3.74976	0.49661	0.08394
HC MODE/STD.CYCLE	%	6.251	28.767	1.278	16.740	15.615	9.457	6.259
NOX MODE/STD.CYCLE	%	0.003	0.265	1.314	29.971	8.077	0.061	0.003
CO MODE/STD.CYCLE	%	1.291	25.460	5.055	57.018	55.800	7.390	1.249
HC EMISSION PER HP CYCLE =	0.00160 LB/HP CYCLE	PERCENT OF ALLOWABLE HC =				84.37		
NOX EMISSION PER HP CYCLE =	0.00060 LB/HP CYCLE	PERCENT OF ALLOWABLE NOX =				39.70		
CO EMISSION PER HP CYCLE =	0.06479 LB/HP CYCLE	PERCENT OF ALLOWABLE CO =				154.26		

TABLE XIc. TEMP-HUMIDITY, 50°F, 60%

CYCLE NO. 1832

CELL-17

DATE 2/24/76

25 BTDC, 50 DEG.F, 60% REL.HUMIDITY

ENGINE - LYCOMING O-320-D1AD

ENGINE TIMING

25.000

DEG.

BTDC

RATED H.P.

160.

H.C. RATIO

2.125

	UNITS	IDLE	TAXI	TAKE OFF	CLIMB	APPROACH	TAXI	IDLE
RUN NUMBER		1832	1847	1848	1849	1850	1851	1852
TIME IN MODE	MIN.	1.00	11.00	0.30	5.00	6.00	3.00	1.00
ENGINE SPEED	RPM	604.14	1203.06	2700.33	2434.98	2353.01	1202.88	610.68
OBS. HORSEPOWER	HP	0.79557	1.45957	155.27211	119.96956	65.03102	1.79889	0.43331
F/A RATIO MEAS.	- - -	0.0972	0.0916	0.0848	0.0822	0.0859	0.0935	0.0958
F/A RATIO CALC.	- - -	0.0943	0.0949	0.0816	0.0795	0.0826	0.0959	0.0930
% DIFF. IN F/A	%	-3.023	3.526	-3.805	-3.240	-3.781	2.516	-2.943
AIR FLOW	LBS/HR	51.78	92.40	952.94	744.36	468.02	87.58	53.64
FUEL FLOW	LBS/HR	5.03	8.47	80.80	61.17	40.20	8.19	5.14
VAPOR FLOW	LBS/HR	0.23122	0.40482	4.31143	3.30336	2.05169	0.38268	0.23548
HUMIDITY GR H2O/LB DRY AIR		31.260	30.669	31.671	31.065	30.686	30.586	30.730
DEW POINT	DEG.F	35.454	34.964	35.960	35.644	35.164	34.979	35.074
RELATIVE HUMIDITY	%	51.04	46.87	54.58	54.28	52.05	47.84	46.66
BAROMETER	IN.HG.	29.16	29.15	29.15	29.15	29.15	29.15	29.15
IND. AIR TEMP.	DEG.F	53.07	54.86	51.79	51.60	52.22	54.32	55.11
MAX. CHT	DEG.F	277.61	276.10	412.86	418.54	330.38	323.33	259.48
HC WET	PPM	35386.51	10368.03	1501.15	1452.04	1683.47	11607.16	38288.80
NOX WET	PPM	6.10	19.48	384.02	664.87	258.01	17.69	4.89
CO WET	%	8.0720	9.3687	6.4064	5.6078	6.8179	9.6681	7.8200
CO2 WET	%	6.9204	8.0321	10.5058	10.9691	10.2625	7.8555	6.7682
O2 WET	%	3.2107	0.2668	0.0772	0.0930	0.0912	0.3944	3.7929
H2O CORRECTION	- - -	0.88654	0.84089	0.85702	0.85436	0.85749	0.84587	0.88932
HC MASS/MODE	LB/MODE	0.01807	0.10190	0.00405	0.05048	0.04477	0.02969	0.02016
NOX MASS/MODE	LB/MODE	0.00001	0.00062	0.00335	0.07487	0.02223	0.00015	0.00001
CO MASS/MODE	LB/MODE	0.08148	1.81986	0.34144	3.85285	3.58342	0.48877	0.08136
HC MODE/STD.CYCLE	%	5.945	33.520	1.332	16.604	14.726	9.766	6.631
NOX MODE/STD.CYCLE	%	0.004	0.258	1.398	31.198	9.261	0.061	0.003
CO MODE/STD.CYCLE	%	1.212	27.081	5.081	57.334	53.325	7.273	1.211
HC EMISSION PER HP CYCLE =	0.00168 LB/HP CYCLE	PERCENT OF ALLOWABLE HC =			88.52			
NOX EMISSION PER HP CYCLE =	0.00063 LB/HP CYCLE	PERCENT OF ALLOWABLE NOX =			42.18			
CO EMISSION PER HP CYCLE =	0.06406 LB/HP CYCLE	PERCENT OF ALLOWABLE CO =			152.52			

TABLE XI-A. TEMP-HUMIDITY, 50°F, 60%

CYCLE NO. 1853

CELL-17

DATE 2/24/76

25 BTDC, 50 DEG.F, 80% REL.HUMIDITY

ENGINE - LYCOMING O-320-DIAD

ENGINE TIMING

25.000 DEG. BTDC

RATED H.P. 160.

H.C. RATIO 2.125

	UNITS	IDLE	TAXI	TAKE OFF	CLIMB	APPROACH	TAXI	IDLE
RUN NUMBER		1853	1854	1855	1864	1857	1858	1859
TIME IN MODE	MIN.	1.00	11.00	0.30	5.00	6.00	3.00	1.00
ENGINE SPEED	RPM	609.12	1205.10	2702.37	2432.82	2355.05	1206.90	593.82
GBS. HORSEPOWER	HP	0.43960	1.17032	154.70157	120.99529	65.51648	0.78034	0.79514
F/A RATIO MEAS.	- - -	0.0978	0.0950	0.0862	0.0837	0.0837	0.1106	0.0943
F/A RATIO CALC.	- - -	0.0935	0.0936	0.0819	0.0796	0.0820	0.1059	0.0920
% DIFF. IN F/A	%	-4.334	-1.418	-4.964	-4.911	-2.061	-4.311	-2.452
AIR FLOW	LBS/HR	52.63	87.39	945.26	746.39	467.33	108.76	53.50
FUEL FLOW	LBS/HR	5.15	8.30	81.44	62.45	39.11	12.00	5.05
VAPOR FLOW	LBS/HR	0.32060	0.52557	5.90950	4.66494	2.99026	0.69669	0.34684
HUMIDITY GR H2O/LB DRY AIR		42.641	42.098	43.762	43.750	44.790	44.577	45.378
DEW POINT	DEG.F	43.045	42.965	44.110	44.260	44.875	44.620	45.025
RELATIVE HUMIDITY	%	63.45	63.45	73.25	77.07	74.37	69.39	67.33
BAROMETER	IN.HG.	29.15	29.15	29.14	29.14	29.15	29.15	29.14
IND.AIR TEMP.	DEG.F	55.22	55.14	52.41	51.19	52.79	54.42	55.67
MAX. CHT	DEG.F	283.36	267.20	428.81	413.98	339.24	293.60	251.91
HC WET	PPM	36245.59	9767.97	1436.34	1447.74	1742.47	23193.24	34710.44
NOX WET	PPM	5.98	19.01	344.13	494.17	276.13	7.04	4.92
CO WET	%	8.0937	9.3360	6.5457	5.6672	6.5013	11.2461	7.8014
CO2 WET	%	6.8388	8.3055	10.4750	10.9704	10.3100	6.7326	6.9944
O2 WET	%	3.5202	0.3066	0.0621	0.1102	0.1060	0.8306	3.4912
H2O CORRECTION	- - -	0.89050	0.85516	0.85894	0.85834	0.84798	0.87895	0.88143
HC MASS/MODE	LB/MODE	0.01888	0.09203	0.00387	0.05083	0.04598	0.07795	0.01817
NOX MASS/MODE	LB/MODE	0.00001	0.00058	0.00300	0.05621	0.02360	0.00008	0.00001
CO MASS/MODE	LB/MODE	0.08332	1.73843	0.34836	3.93272	3.39050	0.74699	0.09059
HC MODE/STD.CYCLE	%	6.210	30.272	1.272	16.721	15.124	25.640	5.975
NOX MODE/STD.CYCLE	%	0.004	0.242	1.251	23.421	9.835	0.032	0.003
CO MODE/STD.CYCLE	%	1.240	25.869	5.184	58.523	50.454	11.116	1.201
HC EMISSION PER HP CYCLE =	0.00192 LB/HP CYCLE	PERCENT OF ALLOWABLE HC =			101.22			
NOX EMISSION PER HP CYCLE =	0.00052 LB/HP CYCLE	PERCENT OF ALLOWABLE NOX =			34.79			
CO EMISSION PER HP CYCLE =	0.06451 LB/HP CYCLE	PERCENT OF ALLOWABLE CO =			153.59			

115

ORIGINAL PAGE IS
OF POOR QUALITY

TABLE XIg

TEMP-HUMIDITY, 50°F, 80%

CYCLE NO. 1860 CELL-17 DATE 2/24/76

25 BTDC, 50 DEG.F, 80% REL.HUMIDITY

ENGINE - LYCOMING O-320-DIAD

ENGINE TIMING 25.000 DEG. BTDC RATED H.P. 160. H.C. RATIO 2.125

UNITS IDLE TAXI TAKE OFF CLIMB APPROACH TAXI IDLE

RUN NUMBER 1860 1861 1862 1863 1865 1866 1867
 TIME IN MODE MIN. 1.00 11.00 0.30 5.00 6.00 3.00 1.00

ENGINE SPEED RPM 597.42 1202.10 2704.77 2430.90 2353.61 1199.46 590.94
 OBS. HGRSFPOWER HP 0.20142 1.45811 154.26518 119.98242 64.55267 1.17736 0.29873

F/A RATIO MEAS. - - - 0.0949 0.0904 0.0855 0.0818 0.0793 0.1062 0.0936
 F/A RATIO CALC. - - - 0.0948 0.0936 0.0817 0.0796 0.0776 0.1018 0.0937
 % DIFF. IN F/A % -0.082 3.480 -4.483 -2.721 -2.126 -4.134 0.033

AIR FLOW LBS/HR 51.60 90.93 949.73 743.17 464.37 100.54 53.20
 FUEL FLOW LBS/HR 4.90 8.22 81.20 60.81 36.80 10.68 4.98
 VAPOR FLOW LBS/HR 0.32680 0.53824 5.98566 4.64616 2.87479 0.61894 0.32912
 HUMIDITY GR H2O/LB DRY AIR 44.333 41.436 44.117 43.763 43.336 43.091 43.306
 DEW POINT DEG.F 44.375 42.780 44.380 44.250 43.945 43.735 43.720
 RELATIVE HUMIDITY % 65.59 62.58 73.91 75.01 75.15 68.56 64.10
 BAROMETER IN.HG. 29.14 29.14 29.14 29.14 29.14 29.14 29.15
 IND.AIR TEMP. DEG.F 55.71 55.32 52.45 51.91 51.55 53.82 55.65
 MAX. CHT DEG.F 306.95 278.50 414.93 415.38 346.87 291.48 264.17

116

HC WET PPM 38762.84 9630.96 1475.55 1401.54 1599.76 19934.97 38674.84
 NOX WET PPM 4.47 18.78 351.71 547.11 577.60 10.77 4.61
 CO WET % 8.0171 9.1261 6.4990 5.6369 4.7529 10.5187 7.7288
 CO2 WFT % 6.5816 8.1412 10.4713 10.8375 11.3558 7.4182 6.7331
 O2 WET % 3.6273 0.3170 0.1015 0.1135 0.1177 0.6022 3.6759
 H2O CORRECTION - - - 0.87612 0.83829 0.85705 0.85033 0.84737 0.87238 0.87519

HC MASS/MODE LB/MODE 0.01960 0.09287 0.00398 0.04866 0.04124 0.06122 0.02007
 NOX MASS/MODE LB/MODE < 0.00001 0.00059 0.00308 0.06154 0.04823 0.00011 0.00001
 CO MASS/MODE LB/MODE 0.08013 1.73934 0.34669 3.86798 2.42142 0.63844 0.07927

HC MODE/STD.CYCLE % 6.448 30.550 1.310 16.006 13.565 20.138 6.602
 NOX MODE/STD.CYCLE % 0.003 0.244 1.281 25.640 20.097 0.045 0.003
 CO MODE/STD.CYCLE % 1.192 25.883 5.159 57.559 36.033 9.501 1.180

HC EMISSION PER HP CYCLE = 0.00180 LB/HP CYCLE PERCENT OF ALLOWABLE HC = 94.62

NOX EMISSION PER HP CYCLE = 0.00071 LB/HP CYCLE PERCENT OF ALLOWABLE NOX = 47.31

CO EMISSION PER HP CYCLE = 0.05733 LB/HP CYCLE PERCENT OF ALLOWABLE CO = 136.51

TABLE XIh. TEMP-HUMIDITY, 50°F, 80%

CYCLE NO. 1869 CELL-17 DATE 2/24/76

25 BTDC, 50 DEG.F, 80% REL.HUMIDITY

ENGINE - LYCOMING O-320-D1AD

ENGINE TIMING 25.000 DEG. BTDC RATED H.P. 160. H.C. RATIO 2.125

	UNITS	IDLE	TAXI	TAKE OFF	CLIMB	APPROACH	TAXI	IDLE
RUN NUMBER		1869	1876	1871	1872	1873	1874	1877
TIME IN MODE	MIN.	1.00	11.00	0.30	5.00	6.00	3.00	1.00
ENGINE SPEED	RPM	586.08	1202.28	2704.89	2432.40	2356.19	1196.58	579.78
OBS. HORSEPOWER	HP	0.72458	1.28576	155.61687	120.66841	65.99205	1.26440	0.36732
F/A RATIO MEAS.	- - -	0.0961	0.0963	0.0850	0.0810	0.0789	0.1018	0.0947
F/A RATIO CALC.	- - -	0.0929	0.0932	0.0817	0.0795	0.0776	0.1036	0.0926
% DIFF. IN F/A	%	-3.272	-3.164	-3.844	-1.824	-1.697	1.714	-2.169
AIR FLOW	LBS/HR	52.10	85.91	952.75	746.06	463.98	99.31	51.55
FUEL FLOW	LBS/HR	5.00	8.27	80.94	60.41	36.61	10.11	4.88
VAPOR FLOW	LBS/HR	0.32165	0.53397	6.14463	4.70782	2.91782	0.61463	0.32157
HUMIDITY GR H2O/LB DRY AIR		43.216	43.507	45.146	44.172	44.021	43.325	43.670
DEW POINT	DEG.F	43.830	43.805	45.015	44.585	44.280	43.815	43.905
RELATIVE HUMIDITY	%	63.57	65.29	75.62	75.65	73.18	67.93	63.54
BAROMETER	IN.HG.	29.15	29.15	29.15	29.15	29.15	29.15	29.15
IND. AIR TEMP.	DEG.F	56.00	55.24	52.48	52.03	52.61	54.16	55.09
MAX. CHT	DEG.F	256.34	271.16	414.34	412.32	342.09	297.86	246.10
HC WET	PPM	36951.67	9077.90	1542.55	1422.14	1510.05	18747.85	35947.56
NOX WET	PPM	4.90	18.37	364.84	504.69	569.10	8.48	4.72
CO WET	%	7.7276	9.4099	6.4613	5.5963	4.7882	10.9565	7.7369
CO2 WET	%	6.9342	8.4240	10.4343	10.8445	11.3250	6.7538	6.9192
O2 WET	%	3.5430	0.2888	0.0979	0.1224	0.1335	0.7109	3.5008
H2O CORRECTION	- - -	0.88635	0.86041	0.85462	0.84642	0.84544	0.85589	0.88183
HC MASS/MODE	LB/MODE	0.01894	0.08447	0.00417	0.04941	0.03884	0.05605	0.01814
NOX MASS/MODE	LB/MODE	0.00001	0.00055	0.00319	0.05680	0.04742	0.00008	0.00001
CO MASS/MODE	LB/MODE	0.07829	1.73060	0.34511	3.84278	2.43433	0.64744	0.07718
HC MODE/STD.CYCLE	%	6.231	27.787	1.371	16.253	12.777	18.438	5.969
NOX MODE/STD.CYCLE	%	0.003	0.231	1.331	23.668	19.760	0.034	0.003
CO MODE/STD.CYCLE	%	1.165	25.753	5.136	57.184	36.225	9.634	1.149
HC EMISSION PER HP CYCLE =	0.00169 LB/HP CYCLE	PERCENT OF ALLOWABLE HC =		88.83				
NOX EMISSION PER HP CYCLE =	0.00068 LB/HP CYCLE	PERCENT OF ALLOWABLE NOX =		45.03				
CO EMISSION PER HP CYCLE =	0.05722 LB/HP CYCLE	PERCENT OF ALLOWABLE CO =		136.25				

117

TABLE XII TEMP-HUMIDITY, 50°F, 80%

CYCLE NO. 1918		CELL-17	DATE 2/25/76		BASELINE FR, 25 BTDC, 59 DEG.F, 0% REL HUMIDITY					ENGINE - LYCOMING O-320-DIAD
ENGINE TIMING		25.000 DEG. BTDC	RATED H.P. 160.		H.C. RATIO 2.125					
	UNITS	IDLE	TAXI	TAKE OFF	CLIMB	APPROACH	TAXI	IDLE		
RUN NUMBER		1918	1920	1921	1922	1923	1924	1916		
TIME IN MODE	MIN.	1.00	11.00	0.30	5.00	6.00	3.00	1.00		
ENGINE SPEED	RPM	600.24	1197.72	2704.29	2431.92	2356.19	1211.04	587.16		
OBS. HORSEPOWER	HP	0.29525	1.10091	154.42387	120.32207	64.92270	1.41820	0.38092		
F/A RATIO MEAS.	- - -	0.0946	0.0940	0.0841	0.0815	0.0879	0.0924	0.0900		
F/A RATIO CALC.	- - -	0.0947	0.0930	0.0819	0.0796	0.0858	0.0927	0.0934		
% DIFF. IN F/A	%	0.102	-1.133	-2.615	-2.337	-2.347	0.323	3.788		
AIR FLOW	LBS/HR	50.63	84.09	951.01	745.07	468.10	85.34	52.89		
FUEL FLOW	LBS/HR	4.79	7.91	80.01	60.74	41.13	7.88	4.76		
VAPOR FLOW	LBS/HR	0.01939	0.03170	0.40373	0.31589	0.19125	0.03496	0.02042		
HUMIDITY GR H2O/LB DRY AIR		2.682	2.639	2.986	2.968	2.860	2.867	2.703		
DEW POINT	DEG.F	-9.230	-9.470	-7.380	-7.435	-8.110	-8.190	-9.070		
RELATIVE HUMIDITY	%	3.86	3.86	4.79	4.79	4.48	4.21	3.85		
BAROMETER	IN.HG.	29.16	29.16	29.16	29.16	29.16	29.16	29.16		
IND. AIR TEMP.	DEG.F	56.81	56.37	53.88	53.79	54.56	56.13	57.11		
MAX. CHT	DEG.F	323.43	283.69	443.16	436.04	344.38	279.87	253.50	118	
HC WET	PPM	33325.30	7593.75	1377.44	1382.34	1834.18	7820.78	34653.44		
NOX WET	PPM	4.53	22.86	383.26	737.67	203.84	22.10	4.22		
CO WET	%	8.3901	9.3348	6.4934	5.6502	7.9249	9.2315	7.7568		
CO2 WET	%	6.4217	8.2205	10.1621	10.6569	9.3501	8.2628	6.5300		
O2 WET	%	3.2816	0.2554	0.1147	0.1626	0.1513	0.2917	3.4077		
H2O CORRECTION	- - -	0.88495	0.86368	0.86156	0.86000	0.86209	0.85768	0.87185		
HC MASS/MODE	LB/MODE	0.01643	0.06826	0.00368	0.04780	0.04896	0.01934	0.01755		
NOX MASS/MODE	LB/MODE	0.00001	0.00067	0.00332	0.08264	0.01763	0.00018	0.00001		
CO MASS/MODE	LB/MODE	0.08176	1.65847	0.34323	3.86162	4.18097	0.45125	0.07765		
HC MODE/STD.CYCLE	%	5.405	22.455	1.212	15.724	16.105	6.363	5.774		
NOX MODE/STD.CYCLE	%	0.003	0.277	1.384	34.433	7.345	0.074	0.003		
CO MODE/STD.CYCLE	%	1.217	24.680	5.108	57.465	62.217	6.715	1.156		
HC EMISSION PER HP CYCLE =	0.00139 LB/HP CYCLE	PERCENT OF ALLOWABLE HC =				73.04				
NOX EMISSION PER HP CYCLE =	0.00065 LB/HP CYCLE	PERCENT OF ALLOWABLE NOX =				43.52				
CO EMISSION PER HP CYCLE =	0.06659 LB/HP CYCLE	PERCENT OF ALLOWABLE CO =				158.56				

TABLE XIIa TEMP-HUMIDITY, 59°F, 0%

CYCLE NO. 1926

CELL-17

DATE 2/25/76

BASELINE FR, 25 BTDC, 59 DEG.F, 0% REL HUMIDITY

ENGINE - LYCOMING 0-320-DIAD

ENGINE TIMING 25.000 DEG. BTDC RATED H.P. 160. H.C. RATIO 2.125

	UNITS	IDLE	TAXI	TAKE OFF	CLIMB	APPROACH	TAXI	IDLE
RUN NUMBER		1926	1927	1928	1929	1930	1931	1925
TIME IN MODE	MIN.	1.00	11.00	0.30	5.00	6.00	3.00	1.00
ENGINE SPEED	RPM	608.39	1199.16	2706.93	2438.70	2352.95	1209.18	601.44
OBS. HORSEPOWER	HP	0.50996	0.74321	154.38768	120.92256	64.53828	1.40672	0.19218
F/A RATIO MEAS.	- - -	0.0931	0.0924	0.0859	0.0806	0.0862	0.0917	0.0976
F/A RATIO CALC.	- - -	0.0938	0.0932	0.0819	0.0799	0.0858	0.0932	0.0919
% DIFF. IN F/A	%	0.731	0.871	-4.684	-0.891	-0.489	1.663	-5.858
AIR FLOW	LBS/HR	52.95	88.25	941.31	752.29	466.47	86.12	50.66
FUEL FLOW	LBS/HR	4.93	8.15	80.88	60.65	40.23	7.89	4.94
VAPOR FLOW	LBS/HR	0.02329	0.03678	0.45735	0.36249	0.21133	0.03909	0.02139
HUMIDITY GR H2O/LB DRY AIR		3.079	2.917	3.401	3.373	3.171	3.177	2.955
DEW POINT	DEG.F	-7.259	-7.975	-5.370	-5.275	-6.375	-6.355	-7.650
RELATIVE HUMIDITY	%	3.97	3.81	4.75	4.64	4.24	4.11	4.19
BAROMETER	IN.HG.	29.17	29.17	29.17	29.17	29.17	29.17	29.16
IND. AIR TEMP.	DEG.F	59.30	59.27	57.45	58.23	58.92	59.84	57.13
MAX. CHT	DEG.F	277.30	270.74	424.15	435.25	350.31	282.36	246.43
HC WET	PPM	32975.77	8210.81	1419.54	1372.54	1911.29	8736.87	33746.34
NOX WET	PPM	4.01	20.12	361.40	735.93	192.26	22.11	4.76
CO WET	%	8.1603	9.3801	6.5895	5.7355	7.8709	9.2250	8.0039
CO2 WET	%	6.8082	8.1982	10.4048	10.6701	9.3245	8.2382	6.9899
O2 WET	%	3.1400	0.3105	0.0981	0.1225	0.1437	0.2874	3.4941
H2O CORRECTION	- - -	0.87847	0.85559	0.86729	0.85315	0.85481	0.85254	0.90386
HC MASS/MODE	LB/MODE	0.01691	0.07700	0.00378	0.04776	0.05054	0.02175	0.01682
NOX MASS/MODE	LB/MODE	0.00001	0.00061	0.00312	0.08297	0.01647	0.00018	0.00001
CO MASS/MODE	LB/MODE	0.08272	1.73860	0.34708	3.94470	4.11348	0.45393	0.07885
HC MODE/STD.CYCLE	%	5.564	25.329	1.244	15.711	16.625	7.155	5.533
NOX MODE/STD.CYCLE	%	0.003	0.255	1.300	34.569	6.862	0.074	0.003
CO MODE/STD.CYCLE	%	1.231	25.872	5.165	58.701	61.212	6.755	1.173
HC EMISSION PER HP CYCLE =	0.00147 LB/HP CYCLE				PERCENT OF ALLOWABLE HC =	77.16		
NOX EMISSION PER HP CYCLE =	0.00065 LB/HP CYCLE				PERCENT OF ALLOWABLE NOX =	43.07		
CO EMISSION PER HP CYCLE =	0.06725 LB/HP CYCLE				PERCENT OF ALLOWABLE CO =	160.11		

114

ORIGINAL PAGE IS
OF POOR QUALITY

TABLE XIIb. TEMP-HUMIDITY, 59°F, 0%

CYCLE NO. 1941 CELL-17 DATE 2/26/76

BASELINE FR, 25 BTDC, 59 DEG.F, 0% REL HUMIDITY ENGINE - LYCOMING O-320-D1A0

ENGINE TIMING 25.000 DEG. BTDC RATED H.P. 160. H.C. RATIO 2.125

	UNITS	IDLE	TAXI	TAKE OFF	CLIMB	APPROACH	TAXI	IDLE
RUN NUMBER		1941	1942	1943	1944	1945	1947	1948
TIME IN MODE	MIN.	1.00	11.00	0.30	5.00	6.00	3.00	1.00
ENGINE SPEED	RPM	599.10	1203.60	2697.75	2428.80	2350.97	1201.92	514.22
OBS. HORSEPOWER	HP	0.65796	0.89678	154.25876	118.94084	65.43564	1.30826	0.35544
F/A RATIO MEAS.	- - -	0.0981	0.0926	0.0840	0.0838	0.0869	0.0948	0.0952
F/A RATIO CALC.	- - -	0.0971	0.0973	0.0843	0.0825	0.0884	0.0970	0.0976
% DIFF. IN F/A	%	-1.060	4.993	0.455	-1.554	1.708	2.354	2.509
AIR FLOW	LBS/HR	50.47	87.96	949.68	747.90	470.12	85.02	52.42
FUEL FLOW	LBS/HR	4.95	8.15	79.73	62.68	40.88	8.06	4.99
VAPOR FLOW	LBS/HR	0.00254	0.00456	0.06610	0.03741	0.01856	0.00432	0.00318
HUMIDITY GR H2O/LB DRY AIR		0.352	0.363	0.487	0.350	0.276	0.355	0.424
DEW POINT	DEG.F	-28.757	-28.637	-27.557	-28.707	-29.332	-28.697	-28.117
RELATIVE HUMIDITY	%	0.43	0.46	0.66	0.47	0.37	0.45	0.52
BAROMETER	IN.HG.	29.04	29.04	29.04	29.03	29.03	29.03	29.03
IND. AIR TEMP.	DEG.F	60.82	60.32	58.67	58.71	59.09	60.19	60.99
MAX. CHT	DEG.F	275.25	270.66	417.41	430.77	344.08	282.61	250.69
HC WET	PPM	36023.57	8620.86	1593.76	1533.85	2030.20	8726.87	37107.67
NOX WET	PPM	3.11	17.91	350.76	618.46	184.32	16.35	0.74
CO WET	%	8.3884	9.5302	6.6078	6.0738	7.9046	9.5037	8.2235
CO2 WET	%	5.9303	6.9958	8.8485	9.2205	8.1062	7.1214	5.7773
O2 WET	%	3.3833	0.2392	0.0552	0.0909	0.0780	0.2165	3.4152
H2O CORRECTION	- - -	0.89610	0.85573	0.86365	0.87021	0.86113	0.86383	0.88535
HC MASS/MODE	LB/MODE	0.01791	0.08063	0.00425	0.05368	0.05423	0.02168	0.01898
NOX MASS/MODE	LB/MODE	0.00001	0.00054	0.00303	0.07013	0.01595	0.00013	0.00900
CO MASS/MODE	LB/MODE	0.08244	1.76172	0.34845	4.20156	4.17281	0.46667	0.08312
HC MODE/STD.CYCLE	%	5.893	26.523	1.399	17.660	17.837	7.132	6.242
NOX MODE/STD.CYCLE	%	0.002	0.226	1.263	29.219	6.645	0.055	0.001
CO MODE/STD.CYCLE	%	1.227	26.216	5.185	62.523	62.095	6.944	1.237
HC EMISSION PER HP CYCLE =	0.00157 LB/HP CYCLE	PERCENT OF ALLOWABLE HC =			82.69			
NOX EMISSION PER HP CYCLE =	0.00056 LB/HP CYCLE	PERCENT OF ALLOWABLE NOX =			37.41			
CO EMISSION PER HP CYCLE =	0.06948 LB/HP CYCLE	PERCENT OF ALLOWABLE CO =			165.43			
ERR2 = 1 NO DATA PRESENT FOR ROD. =***								

TABLE XI!c. TEMP-HUMIDITY, 59°F, 0%

CYCLE NO. 1584 CELL-17 DATE 2/18/76

25 BTDC, 59 DEG.F, 30% REL HUMIDITY

ENGINE - LYCOMING O-320-D1AD

ENGINE TIMING 25.000 DEG. BTDC RATED H.P. 160. H.C. RATIO 2.125

	UNITS	IDLE	TAXI	TAKE OFF	CLIMB	APPROACH	TAXI	IDLE
RUN NUMBER		1584	1585	1586	1587	1588	1590	1591
TIME IN MODE	MIN.	1.00	11.00	0.30	5.00	6.00	3.00	1.00
ENGINE SPEED	RPM	596.76	1198.32	2704.71	2431.92	2351.21	1207.20	617.76
OBS. HORSEPOWER	HP	0.68328	1.32905	150.91007	119.84151	64.69710	1.83537	0.52465
F/A RATIO MEAS.	- - -	0.0998	0.0978	0.0955	0.0829	0.0883	0.0968	0.1003
F/A RATIO CALC.	- - -	0.0989	0.1008	0.0953	0.0835	0.0890	0.0997	0.0961
% DIFF. IN F/A	%	-0.947	3.084	-0.283	0.783	0.837	2.920	-4.115
AIR FLOW	LBS/HR	52.00	90.68	932.22	754.76	470.52	86.65	50.50
FUEL FLOW	LBS/HR	5.19	8.87	79.72	62.54	41.54	8.39	5.06
VAPOR FLOW	LBS/HR	0.16606	0.28591	3.05843	2.46034	1.51394	0.26816	0.15908
HUMIDITY GR H2O/LR DRY AIR		22.356	22.070	22.966	22.818	22.523	21.664	22.052
DEW POINT	DEG.F	27.829	27.654	28.529	28.499	28.239	27.454	27.826
RELATIVE HUMIDITY	%	22.65	22.60	27.51	26.69	25.50	22.28	21.91
BAROMETER	IN.HG.	28.53	28.51	28.51	28.51	28.51	28.50	28.49
IND. AIR TEMP.	DEG.F	65.80	65.59	61.30	62.11	63.02	65.70	66.75
MAX. CHT	DEG.F	305.28	272.38	416.74	426.60	336.14	303.20	252.95
HC WET	PPM	38157.79	10539.06	1620.86	1574.26	1998.90	10502.04	38491.33
NOX WET	PPM	3.68	14.64	281.95	592.72	158.30	16.68	4.13
CO WET	%	8.5249	10.1345	6.8284	6.2477	8.0114	9.8183	8.1872
CO2 WET	%	5.4742	6.5868	8.6292	8.9062	7.9881	6.7462	5.7094
O2 WET	%	3.5818	0.2541	0.0303	0.0543	0.0464	0.2393	3.8792
H2O CORRECTION	- - -	0.89659	0.86142	0.86314	0.85926	0.86073	0.86118	0.90695
HC MASS/MODE	LR/MODE	0.01972	0.10476	0.00428	0.05557	0.05386	0.02686	0.01935
NOX MASS/MODE	LR/MODE	0.00001	0.00047	0.00241	0.06778	0.01382	0.00014	0.00001
CO MASS/MODE	LR/MODE	0.08708	1.97228	0.39657	4.35874	4.26616	0.49626	0.08134
HC MODE/STD.CYCLE	%	6.487	34.460	1.409	18.279	17.716	8.835	6.365
NOX MODE/STD.CYCLE	%	0.003	0.195	1.006	28.242	5.757	0.058	0.003
CO MODE/STD.CYCLE	%	1.296	29.349	5.306	64.862	63.485	7.385	1.210
HC EMISSION PER HP CYCLE =	0.00178 LB/HP CYCLE	PERCENT OF ALLOWABLE HC =			93.55			
NOX EMISSION PER HP CYCLE =	0.00053 LB/HP CYCLE	PERCENT OF ALLOWABLE NOX =			35.26			
CO EMISSION PER HP CYCLE =	0.07262 LB/HP CYCLE	PERCENT OF ALLOWABLE CO =			172.89			

121

TABLE XII d. TEMP-HUMIDITY, 59°F, 30%

CYCLE NO. 1612 CELL-17 DATE 2/18/76

25 PTDC, 59 DEG.F, 30% REL HUMIDITY

ENGINE - LYCOMING O-320-D1AD

ENGINE TIMING	25.000 DEG. BTDC	RATED H.P. 160.			H.C. RATIO 2.125			
	UNITS	IDLE	TAXI	TAKE OFF	CLIMB	APPROACH	TAXI	IDLE
RUN NUMBER		1612	1593	1594	1595	1596	1597	1598
TIME IN MODE	MIN.	1.00	11.00	0.30	5.00	6.00	3.00	1.00
ENGINE SPEED	RPM	613.38	1199.52	2702.79	2436.78	2356.13	1214.52	601.08
OBS. HHP/SEPOWER	HP	0.87649	1.23417	149.99068	121.06781	65.26184	1.34397	0.52169
F/A RATIO MEAS.	- - -	0.0957	0.0972	0.0949	0.0824	0.0885	0.0946	0.0983
F/A RATIO CALC.	- - -	0.0976	0.1006	0.0953	0.0837	0.0889	0.0991	0.0948
% DIFF. IN F/A	%	1.000	3.472	0.479	1.547	0.445	4.687	-3.500
AIR FLOW	LR/HR	55.06	89.26	931.28	762.90	470.67	86.80	50.41
FUEL FLOW	LR/HR	5.27	8.68	79.05	67.89	41.68	8.21	4.95
VAPOR FLOW	LB/HR	0.18273	0.27457	2.95628	2.41847	1.48051	0.24836	0.15175
HUMIDITY GR H2O/LB DRY AIR		23.169	21.533	22.221	22.191	22.019	20.029	21.071
DEW POINT	DEG.F	28.479	27.249	27.974	27.984	27.734	25.874	26.829
RELATIVE HUMIDITY	%	21.61	21.79	25.90	25.76	24.61	20.44	20.72
BAROMETER	IN.HG.	28.56	28.48	28.48	28.48	28.48	28.48	28.48
IND. AIR TEMP.	DEG.F	68.14	56.03	62.19	62.36	63.28	65.78	66.95
MAX. CHT	DEG.F	239.48	271.92	436.83	426.09	340.05	273.56	239.56
HC WET	PPM	36472.61	11378.13	1589.76	1678.77	2017.40	10836.08	39335.91
NOX WET	PPM	4.74	14.82	279.65	650.84	167.12	15.19	3.67
CO WET	%	8.1706	9.9329	6.8285	6.2939	8.0046	9.6900	7.8866
CO2 WET	%	5.7812	4.6935	8.6634	8.8704	8.0125	6.7616	5.8443
O2 WET	%	3.3405	0.2294	0.0178	0.0534	0.0525	0.3298	4.0268
H2O CORRECTION	- - -	0.88311	0.95945	0.86024	0.85672	0.86205	0.85531	0.90445
HC MASS/MODE	LB/MODE	0.01968	0.11005	0.00419	0.05980	0.05442	0.02754	0.01960
NOX MASS/MODE	LB/MODE	0.00001	0.00046	0.00239	0.07511	0.01460	0.00013	0.00001
CO MASS/MODE	LB/MODE	0.08715	1.89885	0.35534	4.43104	4.26756	0.48675	0.07731
HC MODE/STD.CYCLE	%	6.475	36.202	1.377	19.671	17.901	9.059	6.448
NOX MODE/STD.CYCLE	%	0.003	0.194	0.994	31.294	6.085	0.052	0.002
CO MODE/STD.CYCLE	%	1.297	28.257	5.288	65.938	63.505	7.243	1.150
HC EMISSION PER HP CYCLE =	0.00185 LB/HP CYCLE	PERCENT OF ALLOWABLE HC =			97.13			
NOX EMISSION PER HP CYCLE =	0.00058 LB/HP CYCLE	PERCENT OF ALLOWABLE NOX =			38.62			
CO EMISSION PER HP CYCLE =	0.07252 LB/HP CYCLE	PERCENT OF ALLOWABLE CO =			172.68			

122

TABLE XIIE. TEMP-HUMIDITY, 59°F, 30%

CYCLE NO. 1612

CELL-17

DATE 2/18/76

25 BTDC, 59 DEG.F, 30% REL HUMIDITY

ENGINE - LYCOMING O-320-D1AD

ENGINE TIMING

25.000 DEG. BTDC

RATED H.P. 160.

H.C. RATIO 2.125

	UNITS	IDLE	TAXI	TAKE OFF	CLIMB	APPROACH	TAXI	IDLE
PUN NUMBER		1612	1600	1601	1602	1603	1604	1616
TIME IN MODE	MIN.	1.00	11.00	0.30	5.30	6.00	3.00	1.00
ENGINE SPEED	RPM	613.38	1201.80	2701.47	2442.90	2357.56	1203.66	619.41
OBS. HORSEPOWER	HP	0.87649	1.43179	147.12678	121.42096	66.12936	1.41370	0.90364
F/A RATIO MEAS.	--	0.0957	0.0995	0.0854	0.0835	0.0881	0.0980	0.0972
F/A RATIO CALC.	--	0.0976	0.0985	0.0854	0.0844	0.0887	0.0990	0.0992
% DIFF. IN F/A	%	1.900	-0.996	0.084	1.100	0.681	1.026	2.076
AIR FLOW	LBS/HP	55.06	85.45	970.71	782.67	473.25	83.58	53.76
FUEL FLOW	LBS/HR	5.27	8.50	78.60	65.33	41.68	8.19	5.22
VAPOR FLOW	LBS/HR	0.18223	0.27941	3.14983	2.66193	1.58388	0.27469	0.17603
HUMIDITY GR H2O/LB DRY AIR		23.169	22.898	23.948	23.808	23.428	23.007	22.922
DEW POINT	DEG.F	28.479	28.494	29.279	29.244	28.895	28.504	28.401
RELATIVE HUMIDITY	%	21.61	22.19	25.03	24.73	24.04	21.80	22.08
BAROMETER	IN.HG.	28.56	28.51	28.51	28.51	28.51	28.52	28.58
IND. AIR TEMP.	DEG.F	68.14	67.39	65.11	65.40	65.69	67.93	67.40
MAX. CHT	DEG.F	239.48	262.72	441.75	434.82	345.26	282.85	252.70
HC WET	PPM	34472.61	10583.05	1539.35	1701.43	2044.83	10667.06	34487.17
NOX WET	PPM	4.74	19.21	287.59	805.00	191.54	16.03	5.48
CO WET	%	8.1706	6.7943	6.9187	6.5722	7.9494	9.7495	8.3307
CO2 WET	%	5.7812	6.8853	8.5402	8.7117	8.0000	6.8567	6.0091
O2 WET	%	3.3405	0.3699	0.0579	0.0904	0.0941	0.2806	2.7461
H2O CORRECTION	--	0.88311	0.87358	0.86214	0.85860	0.86130	0.86662	0.87903
HC MASS/MODE	LB/MODE	0.01968	0.09878	0.00402	0.06243	0.05538	0.02643	0.01826
NOX MASS/MODE	LB/MODE	0.00001	0.00058	0.00243	0.00569	0.01680	0.00013	0.00001
CO MASS/MODE	LB/MODE	0.08715	1.80687	0.35668	4.76623	4.25482	0.47736	0.08719
HC MODE/STD.CYCLE	%	6.475	32.495	1.321	20.537	18.216	8.693	6.007
NOX MODE/STD.CYCLE	%	0.003	0.242	1.013	39.871	7.007	0.054	0.004
CO MODE/STD.CYCLE	%	1.297	26.888	5.308	70.926	63.316	7.104	1.298
HC EMISSION PER HP CYCLE =	0.00178 LB/HP CYCLE	PERCENT OF ALLOWABLE HC =				93.74		
NOX EMISSION PER HP CYCLE =	0.00072 LB/HP CYCLE	PERCENT OF ALLOWABLE NOX =				48.19		
CO EMISSION PER HP CYCLE =	0.07398 LB/HP CYCLE	PERCENT OF ALLOWABLE CO =				176.14		

TABLE XIIA. TEMP-HUMIDITY, 59°F, 30%

CYCLE NO. 1949

CELL-17

DATE 2/26/76

25 BTDC, 59 DEG.F, 30% REL.HUMIDITY

ENGINE = LYCOMING O-320-DIAD

ENGINE TIMING

25.000 DEG. BTDC

RATED H.P. 160.

H.C. RATIO 2.125

	UNITS	IDLE	TAXI	TAKE OFF	CLIMB	APPROACH	TAXI	IDLE
RUN NUMBER		1949	1950	1951	1952	1953	1954	1955
TIME IN MODE	MIN.	1.00	11.00	0.30	5.00	6.00	3.00	1.00
ENGINE SPEED	RPM	617.82	1203.00	2703.51	2434.32	2353.25	1199.34	600.60
OBS. HORSEPOWER	HP	0.63516	1.09395	152.77121	119.53033	65.87512	1.14860	0.32220
F/A RATIO MEAS.	- - -	0.0996	0.0973	0.0849	0.0852	0.0882	0.0957	0.0952
F/A RATIO CALC.	- - -	0.0982	0.0996	0.0845	0.0825	0.0883	0.0976	0.0974
% DIFF. IN F/A	%	-1.384	2.383	-0.479	-3.158	0.172	2.051	2.390
AIR FLOW	LBS/HR	53.28	94.20	944.34	752.48	470.80	86.62	53.43
FUEL FLOW	LBS/HR	5.30	9.17	80.21	64.10	41.51	8.29	5.09
VAPOR FLOW	LBS/HR	0.16425	0.28870	2.94320	2.30028	1.44050	0.26126	0.16263
HUMIDITY GR H2O/LB DRY AIR		21.581	21.453	21.817	21.398	21.418	21.112	21.304
DEW POINT	DEG.F	27.249	27.294	27.819	27.569	27.409	27.169	27.209
RELATIVE HUMIDITY	%	26.21	26.53	29.68	28.63	27.73	26.54	25.80
BAROMETER	IN.HG.	29.03	29.04	29.04	29.03	29.03	29.03	29.04
IND. AIR TEMP.	DEG.F	60.77	60.49	58.13	58.77	59.42	60.29	61.15
MAX. CHT	DEG.F	267.94	254.54	421.88	430.14	336.11	326.01	251.38
HC WET	PPM	32969.27	10383.04	1605.76	1559.75	2042.20	9562.95	36569.61
NOX WET	PPM	4.53	16.45	351.66	702.71	184.62	19.67	3.53
CO WET	%	8.5365	9.9643	6.6783	6.0880	7.8778	9.6010	8.0945
CO2 WET	%	6.0851	6.8407	8.8279	9.2698	8.1501	6.9962	5.9226
O2 WET	%	2.8044	0.2283	0.0525	0.0879	0.0747	0.2954	3.2635
H2O CORRECTION	- - -	0.89041	0.86124	0.86265	0.87158	0.86213	0.86191	0.88008
HC MASS/MODE	LB/MODE	0.01744	0.10601	0.00429	0.05536	0.05502	0.02435	0.01911
NOX MASS/MODE	LB/MODE	0.00001	0.00054	0.00304	0.08080	0.01611	0.00016	0.00001
CO MASS/MODE	LB/MODE	0.08926	2.01072	0.35246	4.27075	4.19490	0.48310	0.08361
HC MODE/STD.CYCLE	%	5.738	34.872	1.410	18.211	18.099	8.009	6.287
NOX MODE/STD.CYCLE	%	0.003	0.227	1.268	33.667	6.714	0.068	0.002
CO MODE/STD.CYCLE	%	1.328	29.921	5.245	63.553	62.424	7.189	1.244
HC EMISSION PER HP CYCLE =	0.00176 LB/HP CYCLE				PERCENT OF ALLOWABLE HC =	92.63		
NOX EMISSION PER HP CYCLE =	0.00063 LB/HP CYCLE				PERCENT OF ALLOWABLE NOX =	41.95		
CO EMISSION PER HP CYCLE =	0.07178 LB/HP CYCLE				PERCENT OF ALLOWABLE CO =	170.90		

124

TABLE XIIg. TEMP-HUMIDITY, 59°F, 30%

CYCLE NO. 1957

CELL-17

DATE 2/26/76

25 BTDC, 59 DEG.F, 30% REL.HUMIDITY

ENGINE - LYCOMING O-320-DIAD

ENGINE TIMING 25.000 DEG. BTDC RATED H.P. 160. H.C. RATIO 2.125

	UNITS	IDLE	TAXI	TAKE OFF	CLIMB	APPROACH	TAXI	IDLE
RUN NUMBER		1957	1958	1959	1963	1964	1965	1966
TIME IN MODE	MIN.	1.00	11.00	0.30	5.00	6.00	3.00	1.00
ENGINE SPEED	RPM	600.90	1200.06	2703.99	2431.20	2354.57	1202.58	606.54
OBS. HORSEPOWER	HP	0.68137	1.38299	153.16861	118.12029	64.98422	0.96216	0.53230
F/A RATIO MEAS.	- - -	0.1040	0.0950	0.0850	0.0831	0.0871	0.0971	0.0915
F/A RATIO CALC.	- - -	0.0997	0.0971	0.0843	0.0823	0.0882	0.0972	0.0973
% DIFF. IN F/A	%	-4.221	2.220	-0.836	-0.926	1.259	0.183	6.362
AIR FLOW	LBS/HR	48.45	88.64	940.39	738.19	470.26	80.25	54.73
FUEL FLOW	LBS/HR	5.04	8.42	79.94	61.34	40.98	7.79	5.01
VAPOR FLOW	LBS/HR	0.14900	0.27393	3.02761	2.27211	1.42230	0.23970	0.16545
HUMIDITY GR H2O/LB DRY AIR		21.529	21.632	22.537	21.546	21.171	20.908	21.162
DEW POINT	DEG.F	27.444	27.549	28.459	27.489	27.279	26.889	27.069
RELATIVE HUMIDITY	%	26.23	26.63	30.28	28.45	27.59	26.15	25.62
BAROMETER	IN.HG.	29.04	29.04	29.04	29.04	29.04	29.04	29.04
IND. AIR TEMP.	DEG.F	61.04	60.77	58.51	58.82	59.37	60.30	61.14
MAX. CHT	DEG.F	307.82	281.22	427.43	428.64	353.36	327.31	253.99
HC WET	PPM	36437.60	8927.88	1542.75	1505.45	1976.00	8990.89	37190.69
NOX WET	PPM	4.30	21.67	372.96	722.39	205.94	22.12	4.95
CO WET	%	8.8587	9.5243	6.6347	5.9904	7.7924	9.5688	7.8875
CO2 WET	%	5.9346	7.0991	8.8649	9.2036	8.0481	7.1335	5.7525
O2 WET	%	3.0889	0.2377	0.0644	0.0962	0.0895	0.2191	3.3785
H2O CORRECTION	- - -	0.90203	0.86013	0.86369	0.86414	0.85977	0.86727	0.86863
HC MASS/MODE	LB/MODE	0.01780	0.08509	0.00410	0.05201	0.05298	0.02131	0.01965
NOX MASS/MODE	LB/MODE	0.00001	0.00067	0.00321	0.08085	0.01789	0.00017	0.00001
CO MASS/MODE	LB/MODE	0.08551	1.79417	0.34882	4.09044	4.12913	0.44822	0.08236
HC MODE/STD.CYCLE	%	5.854	27.991	1.350	17.109	17.427	7.009	6.463
NOX MODE/STD.CYCLE	%	0.003	0.279	1.339	33.689	7.453	0.071	0.004
CO MODE/STD.CYCLE	%	1.272	26.699	5.191	60.870	61.445	6.670	1.226
HC EMISSION PER HP CYCLE =	0.00158 LB/HP CYCLE	PERCENT OF ALLOWABLE HC =			83.20			
NOX EMISSION PER HP CYCLE =	0.00064 LB/HP CYCLE	PERCENT OF ALLOWABLE NOX =			42.84			
CO EMISSION PER HP CYCLE =	0.06862 LB/HP CYCLE	PERCENT OF ALLOWABLE CO =			163.37			

125

TABLE XIII, TEMP-HUMIDITY, 59°F, 30%

CYCLE NO. 1659 CELL-17 DATE 2/19/76

25 RTDC, 59 DEG.F, 60% REL. HUMIDITY

ENGINE - LYCOMING O-320-01AD

ENGINE TIMING 25.000 DEG. RTDC RATED H.P. 160. H.C. RATIO 2.125

	UNITS	IDLE	TAXI	TAKE OFF	CLIMB	APPROACH	TAXI	IDLE
PUN NUMBER		1659	1660	1661	1662	1663	1665	1667
TIME IN MODE	MIN.	1.00	11.00	0.30	5.00	6.00	3.00	1.00
ENGINE SPEED	RPM	605.22	1202.70	2698.11	2430.24	2358.83	1207.68	613.04
OBS. HORSEPOWER	HP	0.20894	2.21042	151.08232	119.61038	65.73109	1.67211	0.61187
F/A RATIO MEAS.	- - -	0.0934	0.0951	0.0921	0.0818	0.0863	0.0959	0.0969
F/A RATIO CALC.	- - -	0.0970	0.0990	0.0942	0.0822	0.0864	0.0994	0.0957
* DIFF. IN F/A	%	3.895	4.127	2.505	0.489	0.171	2.528	-0.128
AIR FLOW	LPS/HR	53.48	89.34	946.35	758.27	475.17	86.57	54.05
FUEL FLOW	LBS/HR	4.99	8.49	77.71	62.03	41.00	8.30	5.24
VAPOR FLOW	LBS/HR	0.27567	0.45589	5.03217	4.00070	2.46698	0.44474	0.27893
HUMIDITY GR H2O/LP DRY AIR		36.086	35.721	37.222	36.920	36.342	35.963	36.123
DEW POINT	DEG.F	38.995	38.880	39.960	39.796	39.360	39.000	38.977
RELATIVE HUMIDITY	%	41.54	42.10	50.51	50.08	47.63	44.07	40.90
BARO METER	IN.HG.	28.96	28.96	28.96	28.96	28.95	28.97	28.97
IND. AIR TEMP.	DEG.F	62.67	62.17	58.23	58.29	59.22	61.01	63.10
MAX. CHT	DEG.F	300.50	296.88	435.56	432.13	348.13	329.55	245.95
HC WET	PPM	37921.74	10775.07	1508.95	1568.93	1822.78	10361.03	35448.52
NOX WET	PPM	4.20	17.03	343.49	720.45	213.80	18.55	4.02
CO WET	%	7.9886	9.6385	6.4733	5.8638	7.2694	9.6278	7.9640
CO2 WET	%	5.5934	6.8457	8.7602	9.1701	8.4287	6.9043	6.1516
O2 WET	%	3.6464	0.2694	0.0518	0.0829	0.0763	0.3055	3.1139
H2O CORRECTION	- - -	0.87620	0.85318	0.84996	0.85658	0.85871	0.85824	0.89398
HC MASS/MODE	LB/MODE	0.01975	0.10372	0.00400	0.05552	0.04932	0.02644	0.01889
NOX MASS/MODE	LB/MODE	0.00001	0.00053	0.00295	0.08259	0.01874	0.00015	0.00001
CO MASS/MODE	LB/MODE	0.00221	1.83374	0.33945	4.10129	3.88748	0.48553	0.08418
HC MODE/STD.CYCLE	%	6.495	34.119	1.317	18.263	16.224	8.696	6.213
NOX MODE/STD.CYCLE	%	0.003	0.221	1.230	34.414	7.809	0.044	0.003
CO MODE/STD.CYCLE	%	1.223	27.288	5.051	61.031	57.849	7.225	1.253
HC EMISSION PER HP CYCLE =	0.00174 LB/HP CYCLE				PERCENT OF ALLOWABLE HC =	91.33		
NOX EMISSION PER HP CYCLE =	0.00066 LB/HP CYCLE				PERCENT OF ALLOWABLE NOX =	43.74		
CO EMISSION PER HP CYCLE =	0.06759 LB/HP CYCLE				PERCENT OF ALLOWABLE CO =	160.92		

126

TABLE XII: TEMP-HUMIDITY, 59°F, 60%

CYCLE NO. 1671

CELL-17

DATE 7/19/76

25 PTDC, 59 DEG.F, 60% RFL. HUMIDITY

ENGINE - LYCOMING O-220-D1AD

ENGINE TIMING	25.000 DEG. BTDC	RATED H.P. 160.			H.C. RATIO 2.125			
	UNITS	IDLE	TAXI	TAKE OFF	CLIMB	APPROACH	TAXI	IDLE
RUN NUMBER		1671	1672	1673	1674	1675	1676	1677
TIME IN MODE	MIN.	1.00	11.00	0.30	5.00	6.00	3.00	1.00
ENGINE SPEED	RPM	607.07	1201.86	2702.67	2433.42	2350.25	1209.93	607.98
CRS. HORSEPOWER	HP	0.46594	1.24323	152.35329	121.14505	65.18585	1.54570	0.68497
F/A RATIO MEAS.	- - -	0.0957	0.0978	0.0819	0.0801	0.0851	0.0970	0.0949
F/A RATIO CALC.	- - -	0.0967	0.0992	0.0840	0.0820	0.0841	0.1008	0.0982
% DIFF. IN F/A	%	1.109	1.437	2.549	2.312	-1.220	3.960	3.479
AIP FLOW	LBS/HR	55.00	93.47	945.61	760.99	468.19	89.44	54.16
FUEL FLOW	LBS/HR	5.26	9.14	77.44	60.99	39.85	8.67	5.14
VAPOR FLOW	LBS/HR	0.28463	0.43400	5.03650	3.99320	2.43387	0.46011	0.27860
HUMIDITY GR H2O/LB DRY AIP		36.225	36.746	37.283	36.731	36.389	36.012	36.009
DRY POINT	DEG.F	39.050	39.090	39.945	39.765	39.435	39.115	39.090
RELATIVE HUMIDITY.	%	41.21	42.51	51.02	50.60	47.89	44.57	42.85
BAROMETER	IN.HG.	28.98	28.98	28.99	28.99	28.99	28.99	29.00
IND. AIP TEMP.	DEG.F	62.96	62.11	57.94	57.97	59.15	60.82	61.90
MAX. CHT	DEG.F	252.25	269.64	426.55	430.94	348.19	316.93	276.69
HC WFT	PPM	35753.55	10699.07	1554.35	1562.35	1771.77	11561.15	37577.72
NOX WFT	PPM	4.44	16.97	359.10	728.69	337.57	13.28	4.92
CO WFT	%	7.6998	0.8785	6.4078	5.7705	6.5779	10.0799	8.1699
CO2 WFT	%	6.0417	6.8744	8.7959	9.1245	8.8707	6.6329	5.7457
O2 WFT	%	3.2094	0.2041	0.0573	0.0977	0.1138	0.3051	3.3584
H2O CORRECTION	- - -	0.88064	0.86161	0.84972	0.85072	0.86251	0.85483	0.87502
HC MASS/MODE	LB/MODE	0.01930	0.10878	0.00412	0.05514	0.04703	0.03058	0.01992
NOX MASS/MODE	LB/MODE	0.00001	0.00056	0.00308	0.08331	0.02903	0.00011	0.00001
CO MASS/MODE	LB/MODE	0.08537	1.98501	0.33547	4.02509	3.45118	0.52704	0.08561
HC MODE/STD.CYCLE	%	6.350	35.782	1.354	18.138	15.471	10.061	6.554
NOX MODE/STD.CYCLE	%	0.003	0.233	1.284	34.714	12.095	0.047	0.004
CO MODE/STD.CYCLE	%	1.270	29.539	4.992	59.897	51.357	7.843	1.274
HC EMISSION PER HP CYCLE =	0.00178 LB/HP CYCLE	PERCENT OF ALLOWABLE HC =			93.71			
NOX EMISSION PER HP CYCLE =	0.00073 LB/HP CYCLE	PERCENT OF ALLOWABLE NOX =			48.38			
CO EMISSION PER HP CYCLE =	0.06559 LB/HP CYCLE	PERCENT OF ALLOWABLE CO =			156.17			

127

OF POOR QUALITY

TABLE XIIj. TEMP-HUMIDITY, 59°F, 60%

CYCLE NO. 1967

CELL-17

DATE 2/26/76

25 BTDC, 59 DEG.F, 60% REL.HUMIDITY

ENGINE - LYCOMING O-320-DIAD

ENGINE TIMING 25.000 DEG. BTDC RATED H.P. 160. H.C. RATIO 2:125

	UNITS	IDLE	TAXI	TAKE OFF	CLIMB	APPROACH	TAXI	IDLE
RUN NUMBER		1967	1968	1969	1970	1971	1972	1973
TIME IN MODE	MIN.	1.00	11.00	0.30	5.00	6.00	3.00	1.00
ENGINE SPEED	RPM	597.72	1203.66	2698.83	2438.22	2351.21	1198.68	502.52
OBS. HORSEPOWER	HP	0.22984	1.08637	151.01115	120.56445	65.57643	1.92599	0.14143
F/A RATIO MEAS.	- - -	0.0994	0.0962	0.0853	0.0832	0.0861	0.1032	0.0897
F/A RATIO CALC.	- - -	0.0956	0.0975	0.0847	0.0824	0.0847	0.1009	0.0961
% DIFF. IN F/A	%	-3.819	1.375	-0.700	-0.920	-1.651	-2.264	7.234
AIR FLOW	LBS/HR	50.78	90.26	935.44	754.44	468.38	87.76	55.35
FUEL FLOW	LBS/HR	5.05	8.68	79.82	62.78	40.35	9.06	4.96
VAPOR FLOW	LBS/HR	0.33094	0.58886	6.24381	4.93551	3.05025	0.55685	0.36301
HUMIDITY GR H2O/LB DRY AIR		45.623	45.668	46.723	45.794	45.586	44.417	45.912
DEW POINT	DEG.F	44.615	44.845	45.770	45.345	45.115	44.360	45.160
RELATIVE HUMIDITY	%	54.79	55.89	62.69	61.49	59.49	55.70	55.65
BAROMETR	IN.HG.	29.04	29.04	29.04	29.04	29.04	29.04	29.04
IND.AIR TEMP.	DEG.F	60.98	60.66	58.43	58.52	59.20	60.24	61.12
MAX. CHT	DEG.F	296.03	276.83	433.02	430.44	342.08	322.49	257.97
HC WET	PPM	35659.52	9682.96	1556.05	1554.45	1720.47	12526.25	37856.76
NOX WET	PPM	4.58	19.47	331.19	632.10	294.51	13.77	5.19
CO WET	%	8.2540	9.5425	6.7780	6.0109	6.8252	10.2945	7.5193
CO2 WET	%	5.9695	7.0379	8.6909	9.0971	8.7301	6.6880	5.7023
O2 WET	%	3.5489	0.2832	0.0967	0.1180	0.1274	0.4176	3.5837
H2O CORRECTION	- - -	0.89758	0.85909	0.85943	0.86013	0.86260	0.87474	0.86219
HC MASS/MODE	LB/MODE	0.01803	0.09466	0.00414	0.05509	0.04592	0.03326	0.02016
NOX MASS/MODE	LB/MODE	0.00001	0.00062	0.00285	0.07257	0.02546	0.00012	0.00001
CO MASS/MODE	LB/MODE	0.08248	1.34380	0.35602	4.21007	3.60030	0.54018	0.07966
HC MODE/STD.CYCLE	%	5.931	31.139	1.360	18.121	15.105	10.940	6.631
NOX MODE/STD.CYCLE	%	0.003	0.257	1.188	30.237	10.610	0.049	0.004
CO MODE/STD.CYCLE	%	1.227	27.437	5.298	62.650	53.576	8.038	1.185
HC EMISSION PER HP CYCLE =	0.00170 LB/HP CYCLE	PERCENT OF ALLOWABLE HC =				89.23		
NOX EMISSION PER HP CYCLE =	0.00064 LB/HP CYCLE	PERCENT OF ALLOWABLE NOX =				42.35		
CO EMISSION PER HP CYCLE =	0.06695 LB/HP CYCLE	PERCENT OF ALLOWABLE CO =				159.41		

128

TABLE XIIK. TEMP-HUMIDITY, 59°F, 60%

CYCLE NO. 1683

CELL-17

DATE 2/19/76

75 BTDC, 59 DEG.F, 80% REL. HUMIDITY

ENGINE - LYCOMING O-320-M1AD

ENGINE TIMING

25.000 DEG. BTDC

RATED H.P. 160.

H.C. RATIO 2.125

	UNITS	IDLE	TAXI	TAKE OFF	CLIMB	APPROACH	TAXI	IDLE
RUN NUMBER		1683	1684	1685	1686	1687	1688	1689
TIME IN MODE	MIN.	1.00	11.00	0.30	5.00	6.00	3.00	1.00
ENGINE SPEED	RPM	612.29	1705.22	2702.97	2435.58	2358.38	1206.12	586.86
DBS. HORSEPOWER	HP	0.67640	0.85914	152.25578	120.24307	66.63879	1.68408	0.59603
F/A RATIO MFAS.	- - -	0.0938	0.0951	0.0808	0.0809	0.0863	0.0950	0.0935
F/A RATIO CALC.	- - -	0.0970	0.0965	0.0817	0.0804	0.0840	0.0962	0.0943
% DIFF. IN F/A	%	3.471	1.495	1.127	-0.640	-2.682	1.239	0.861
AIR FLOW	LB/HR	55.22	92.77	954.81	770.24	478.00	91.31	54.09
FUEL FLOW	LB/HR	5.18	8.82	77.10	62.33	41.27	8.67	5.06
VAPOR FLOW	LB/HR	0.41070	0.59084	7.30258	5.79265	3.35247	0.63256	0.37574
HUMIDITY GR H2O/LB DRY AIR		52.062	52.126	53.537	52.644	49.095	48.491	48.626
DEW POINT	DEG.F	48.377	48.616	49.551	49.226	47.247	46.856	46.897
RELATIVE HUMIDITY	%	57.93	59.70	70.74	70.27	65.07	59.68	56.57
BAROMETER	IN.HG.	29.03	29.03	29.03	29.03	29.03	29.03	29.04
IND. AIR TEMP.	DEG.F	63.42	62.83	59.03	58.88	58.97	60.96	62.52
MAX. CHT	DEG.F	335.88	304.45	393.39	425.54	356.37	294.76	270.17
HC WET	PPM	34872.20	10984.06	1633.86	1507.85	1888.31	10893.08	37945.02
NOX WET	PPM	5.10	16.79	352.88	695.53	220.75	15.79	5.13
CO WET	%	9.3596	9.8097	6.2279	5.8404	7.2221	9.8449	7.7428
CO2 WET	%	6.6624	7.7779	10.1486	10.5087	9.8338	7.7765	6.6836
O2 WET	%	2.8797	0.2856	0.0915	0.1095	0.0986	0.3654	3.4820
H2O CORRECTION	- - -	0.85795	0.84573	0.83595	0.84188	0.85121	0.84737	0.87134
HC MASS/MODE	LB/MODE	0.01882	0.11005	0.00436	0.05413	0.05149	0.02927	0.02003
NOX MASS/MODE	LB/MODE	0.00001	0.00055	0.00305	0.08090	0.01950	0.00014	0.00001
CO MASS/MODE	LB/MODE	0.08915	1.94235	0.32851	4.15060	3.89257	0.57282	0.08078
HC MODE/STD.CYCLE	%	6.190	36.199	1.434	17.807	16.939	9.628	6.588
NOX MODE/STD.CYCLE	%	0.004	0.227	1.271	33.706	8.126	0.057	0.004
CO MODE/STD.CYCLE	%	1.327	28.904	4.888	61.765	57.925	7.780	1.202
HC EMISSION PER HP CYCLE =	0.00180 LB/HP CYCLE	PERCENT OF ALLOWABLE HC =			94.79			
NOX EMISSION PER HP CYCLE =	0.00065 LB/HP CYCLE	PERCENT OF ALLOWABLE NOX =			43.40			
CO EMISSION PER HP CYCLE =	0.06879 LB/HP CYCLE	PERCENT OF ALLOWABLE CO =			163.79			

129

TABLE XIII. TEMP-HUMIDITY, 59°F, 80%

CYCLE NO. 1702

CELL-17

DATE 2/19/76

25 BTDC, 59 DEG.F, 80% REL. HUMIDITY

ENGINE - LYCOMING O-320-DIAP

ENGINE TIMING 25.000 DEG. BTDC RATED H.P. 160. H.C. RATIO 2.125

	UNITS	IDLE	TAXI	TAKE OFF	CLIMB	APPROACH	TAXI	IDLE
RUN NUMBER		1702	1703	1702	1705	1712	1707	1708
TIME IN MODE	MIN.	1.00	11.00	0.30	5.00	6.00	3.00	1.00
ENGINE SPEED	RPM	595.80	1201.44	2702.43	2435.70	2348.45	1201.20	587.91
CRS. HORSEPOWER	HP	0.50818	2.09538	152.35153	120.97751	63.96046	1.70323	0.41403
F/A RATIO MEAS.	- - -	0.0961	0.0954	0.0793	0.0819	0.0787	0.0964	0.0930
F/A RATIO CALC.	- - -	0.0951	0.0960	0.0816	0.0803	0.0777	0.0949	0.0934
% DIFF. IN F/A	%	-1.020	0.670	2.888	-1.926	-1.297	-1.554	0.378
AIR FLOW	LBS/HR	53.34	94.31	952.56	767.20	464.09	88.66	54.14
FUEL FLOW	LBS/HR	5.12	8.99	75.51	67.83	36.54	8.55	5.04
VAPOR FLOW	LBS/HR	0.36718	0.64583	6.79138	5.34151	3.20512	0.60702	0.37164
HUMIDITY GR H2O/LR DRY AIR		48.186	47.935	49.407	48.736	48.345	47.929	48.051
DEW POINT	DEG.F	46.596	46.511	47.656	47.186	46.891	46.566	46.591
RELATIVE HUMIDITY	%	53.41	55.21	65.89	65.64	60.73	58.34	55.11
BAROMETER	IN.HG.	29.05	29.05	29.04	29.05	29.06	29.06	29.06
IND. AIR TEMP.	DEG.F	63.83	62.80	50.03	58.64	60.91	61.30	62.94
MAX. CHT	DEG.F	288.48	281.79	390.44	430.56	344.34	298.94	289.70
HC WET	PPM	35235.50	10785.07	1567.66	1512.55	1485.45	10251.07	38868.86
NOX WET	PPM	5.62	16.15	361.54	693.65	493.17	18.27	4.84
CO WET	%	8.2094	9.7399	5.1641	5.8631	4.7450	9.5787	7.6513
CO2 WET	%	6.8947	7.9226	10.1309	10.6493	11.2282	8.1434	6.5993
O2 WET	%	3.0895	0.2664	0.0840	0.1160	0.0879	0.2612	3.7945
H2O CORRECTION	- - -	0.87440	0.84838	0.82984	0.84697	0.84397	0.85541	0.87479
HC MASS/MODE	LB/MODE	0.01850	0.10988	0.00415	0.05426	0.03822	0.02687	0.02050
NOX MASS/MODE	LB/MODE	0.00001	0.00053	0.00310	0.08061	0.04110	0.00016	0.00001
CO MASS/MODE	LB/MODE	0.08521	1.96134	0.32240	4.15697	2.41271	0.49631	0.07975
HC MODE/STD.CYCLE	%	6.087	36.146	1.365	17.849	12.571	8.840	6.743
NOX MODE/STD.CYCLE	%	0.004	0.722	1.291	33.588	17.126	0.065	0.003
CO MODE/STD.CYCLE	%	1.268	29.187	4.798	61.860	35.903	7.386	1.187
HC EMISSION PER HP CYCLE =	0.00170 LB/HP CYCLE	PERCENT OF ALLOWABLE HC =			89.60			
NOX EMISSION PER HP CYCLE =	0.00078 LB/HP CYCLE	PERCENT OF ALLOWABLE NOX =			52.30			
CO EMISSION PER HP CYCLE =	0.05947 LB/HP CYCLE	PERCENT OF ALLOWABLE CO =			141.59			

TABLE XII m. TEMP-HUMIDITY, 59°F, 80%

CYCLE NO. 1988

CELL-17

DATE 2/26/76

25 BTDC, 59 DEG.F, 80% REL.HUMIDITY

ENGINE - LYCOMING O-320-DIAD

ENGINE TIMING 25.000 DEG. BTDC RATED H.P. 160. H.C. RATIO 2.125

	UNITS	IDLE	TAXI	TAKE OFF	CLIMB	APPROACH	TAXI	IDLE
RUN NUMBER		1988	1989	1990	1993	1994	1995	1997
TIME IN MODE	MIN.	1.00	11.00	0.30	5.00	6.00	3.00	1.00
ENGINE SPEED	RPM	602.70	1205.16	2699.79	2425.38	2351.27	1204.20	607.50
OBS. HORSEPOWER	HP	0.41130	1.56687	151.13895	117.87744	66.25681	1.42078	0.18510
F/A RATIO MEAS.	- - -	0.0938	0.0967	0.0866	0.0846	0.0856	0.0958	0.0964
F/A RATIO CALC.	- - -	0.0959	0.0980	0.0844	0.0825	0.0834	0.0967	0.0999
% DIFF. IN F/A	%	2.180	1.307	-2.553	-2.520	-2.604	0.933	3.648
AIR FLOW	LBS/HR	54.81	91.74	939.68	725.52	464.04	82.64	52.29
FUEL FLOW	LBS/HR	5.14	8.87	81.39	61.40	39.72	7.92	5.04
VAPOR FLOW	LBS/HR	0.49476	0.82925	8.43328	6.61632	4.14308	0.72174	0.46377
HUMIDITY GR H2O/LB DRY AIR		63.183	63.275	62.822	63.835	62.498	61.137	62.083
DEW POINT	DEG.F	53.671	53.786	53.726	53.651	53.376	52.766	52.926
RELATIVE HUMIDITY	%	77.54	78.54	82.67	83.33	80.93	76.51	74.89
BAROMETER	IN.HG.	29.05	29.05	29.05	29.07	29.07	29.07	29.08
IND.AIR TEMP.	DEG.F	60.73	60.48	58.99	58.69	59.22	60.17	60.93
MAX. CHT	DEG.F	265.35	264.83	407.74	427.05	358.80	336.29	286.33
HC WET	PPM	38493.84	10849.08	1584.26	1587.48	1795.38	9088.90	38299.79
NOX WET	PPM	5.33	16.69	314.73	462.65	281.31	20.36	5.17
CO WET	%	7.7371	9.5687	6.7802	6.0656	6.3443	9.4503	8.2732
CO2 WET	%	5.7901	6.9919	8.8532	9.2092	9.0189	7.1341	5.7458
O2 WET	%	3.7189	0.3565	0.1157	0.1019	0.1183	0.2799	3.1505
H2O CORRECTION	- - -	0.87527	0.85621	0.86143	0.86093	0.86204	0.85668	0.85872
HC MASS/MODE	LB/MODE	0.02065	0.10824	0.00426	0.05451	0.04748	0.02220	0.01978
NOX MASS/MODE	LB/MODE	0.00001	0.00054	0.00274	0.05147	0.02410	0.00016	0.00001
CO MASS/MODE	LB/MODE	0.08203	1.88677	0.36022	4.11682	3.31634	0.45630	0.08443
HC MODE/STD.CYCLE	%	6.793	35.604	1.401	17.932	15.620	7.304	6.505
NOX MODE/STD.CYCLE	%	0.004	0.225	1.142	21.446	10.043	0.067	0.004
CO MODE/STD.CYCLE	%	1.221	23.077	5.360	61.262	49.350	6.790	1.256
HC EMISSION PER HP CYCLE =	0.00173 LB/HP CYCLE	PERCENT OF ALLOWABLE HC =			91.16			
NOX EMISSION PER HP CYCLE =	0.00049 LB/HP CYCLE	PERCENT OF ALLOWABLE NOX =			32.93			
CO EMISSION PER HP CYCLE =	0.06439 LB/HP CYCLE	PERCENT OF ALLOWABLE CO =			153.32			

131.

ORIGINAL PAGE IS
OF POOR QUALITY

TABLE XIIIn. TEMP-HUMIDITY, 59°F, 80%

CYCLE NO. 1700

CELL-17

DATE 2/19/76

25 BTDC, 59 DEG.F, 80% REL. HUMIDITY

ENGINE - LYCOMING O-32 C-DIAD

ENGINE TIMING

25.000 DEG. BTDC

RATED H.P. 160.

H.C. RATIO 2.125

	UNITS	IDLE	TAXI	TAKE OFF	CLIMB	APPROACH	TAXI	IDLE
RUN NUMBER		1700	1691	1692	1694	1696	1699	1690
TIME IN MODE	MIN.	1.00	11.00	0.30	5.00	6.00	3.00	1.00
ENGINE SPEED	RPM	586.78	1702.70	2702.43	2435.64	2351.51	1207.44	621.36
CRS. HORSEPOWER	HP	0.09328	1.09183	152.35153	120.99818	65.52953	0.55201	0.62861
F/A RATIO MEAS.	- - -	0.0751	0.0964	0.0793	0.0804	0.0786	0.0998	0.0939
F/A RATIO CALC.	- - -	0.0936	0.0957	0.0816	0.0802	0.0760	0.0951	0.0935
% DIFF. IN F/A	%	-1.535	-0.706	2.888	-0.264	-3.757	-4.703	-0.342
AIR FLOW	LR5/HR	53.90	93.72	952.56	764.61	468.77	89.77	57.82
FUEL FLOW	LR5/HR	5.12	9.03	75.51	61.51	36.84	8.96	5.43
VAPOR FLOW	LR5/HR	0.37140	0.64952	6.79138	5.34275	3.24147	0.62176	0.39959
HUMIDITY GR H2O/LR DRY AIR		48.236	48.515	49.907	48.913	48.404	48.481	48.377
DEW POINT	DEG.F	46.597	46.716	47.656	47.321	46.946	46.696	46.681
RELATIVE HUMIDITY	%	54.23	55.39	65.89	66.28	64.03	55.19	54.56
BAROMETER	IN.HG.	29.04	29.04	29.04	29.04	29.04	29.05	29.04
IND. AIR TEMP.	DEG.F	63.40	62.92	59.03	58.52	59.08	63.01	63.32
MAX. CHT	DEG.F	268.75	254.78	399.44	430.14	354.73	286.58	248.49
HC WFT	PPM	37109.94	11428.14	1567.66	1503.055	1403.64	10467.04	34337.40
NOX WFT	PPM	4.52	16.36	361.54	559.38	664.43	17.63	5.38
CO WFT	%	7.8074	9.6433	6.1641	5.7413	4.0981	9.7467	7.803
CO2 WFT	%	6.8178	7.9662	10.1309	10.5798	11.7634	8.1895	7.0002
O2 WFT	%	3.5037	0.3389	0.0840	0.0823	0.0941	0.2891	3.1385
H2O CORRECTION	- - -	0.87917	0.85374	0.82984	0.84080	0.85089	0.86720	0.87174
HC MASS/MODE	LB/MODE	0.01962	0.11612	0.00415	0.05344	0.03646	0.02811	0.01940
NOX MASS/MODE	LB/MODE	0.00001	0.00054	0.00310	0.06443	0.05591	0.00015	0.00001
CO MASS/MODE	LB/MODE	0.08159	1.93668	0.32240	4.03470	2.10369	0.51734	0.08787
HC MODE/STD.CYCLE	%	6.455	38.199	1.365	17.580	11.992	9.247	5.380
NOX MODE/STD.CYCLE	%	0.003	0.224	1.291	26.848	23.294	0.064	0.004
CO MODE/STD.CYCLE	%	1.214	28.820	4.798	60.040	31.305	7.699	1.308
HC EMISSION PER HP CYCLE =	0.00173 LB/HP CYCLE	PERCENT OF ALLOWABLE HC =			91.22			
NOX EMISSION PER HP CYCLE =	0.00078 LB/HP CYCLE	PERCENT OF ALLOWABLE NOX =			51.73			
CO EMISSION PER HP CYCLE =	0.05678 LB/HP CYCLE	PERCENT OF ALLOWABLE CO =			135.18			

TABLE XII. TEMP-HUMIDITY, 59°F, 80%

CYCLE NO. 1998

CELL-17

DATE 2/26/76

25 BTDC, 70 DEG.F, 0% REL.HUMIDITY

ENGINE - LYCOMING O-320-DIAD

ENGINE TIMING 25.000 DEG. BTDC RATED H.P. 160. H.C. RATIO 2.125

	UNITS	IDLE	TAXI	TAKE OFF	CLIMB	APPROACH	TAXI	IDLE	
RUN NUMBER		1998	1999	2000	2001	2002	2003	2004	
TIME IN MODE	MIN.	1.00	11.00	0.30	5.00	6.00	3.00	1.00	
ENGINE SPEED	RPM	601.08	1203.42	2706.21	2434.32	2352.29	1202.22	614.28	
DBS. HORSEPOWER	HP	0.30410	1.09766	152.25999	119.50876	65.14333	1.39108	0.44179	
F/A RATIO MEAS.	- - -	0.0977	0.0948	0.0852	0.0840	0.0912	0.0939	0.0942	
F/A RATIO CALC.	- - -	0.0978	0.0965	0.0850	0.0828	0.0887	0.0971	0.0988	
% DIFF. IN F/A	%	0.181	1.791	-0.215	-1.458	-2.756	3.407	4.933	
AIR FLOW	LBS/HR	49.80	83.86	931.47	744.85	464.51	81.48	53.12	
FUFL FLOW	LBS/HR	4.86	7.95	79.37	62.60	42.38	7.65	5.00	
VAPOR FLOW	LBS/HR	0.00137	0.00792	0.12316	0.10814	0.07172	0.01235	0.00873	
HUMIDITY GR H2O/LB DRY AIR		0.192	0.661	0.926	1.016	1.081	1.061	1.150	
DEW POINT	DEG.F	-30.047	-25.117	-23.666	-22.751	-22.186	-22.421	-21.611	
RELATIVE HUMIDITY	%	0.16	0.57	0.82	0.90	0.93	0.91	0.97	
BAROMETER	IN.HG.	29.08	29.08	29.09	29.09	29.09	29.10	29.10	
IND. AIR TEMP.	DEG.F	71.09	71.18	70.21	70.70	71.12	71.21	71.70	
MAX. CHT	DEG.F	301.96	280.75	407.89	441.70	348.54	322.91	265.96	
HC WET	PPM	34628.42	8656.86	1635.16	1544.26	2044.00	9031.89	37545.72	
NOX WET	PPM	7.45	24.05	354.78	733.71	215.96	23.29	5.43	
CO WET	%	8.5526	9.5029	6.9572	6.2810	8.2604	9.5933	8.2888	
CO2 WET	%	5.9530	7.2086	8.7638	9.2028	8.2229	7.0515	5.7705	
O2 WET	%	3.1317	0.2495	0.0955	0.1224	0.1186	0.3048	3.2696	
H2O CORRECTION	- - -	0.89052	0.86471	0.86530	0.86896	0.87502	0.86031	0.87614	
HC MASS/MODE	LB/MODE	0.01697	0.07780	0.00430	0.05388	0.05480	0.02144	0.01939	
NOX MASS/MODE	LB/MODE	0.00001	0.00070	0.00302	0.08294	0.01876	0.00018	0.00001	
CO MASS/MODE	LB/MODE	0.08282	1.68804	0.36153	4.33146	4.37678	0.45005	0.08459	
HC MODE/STD.CYCLE	%	5.581	25.593	1.414	17.724	18.025	7.052	6.377	
NOX MODE/STD.CYCLE	%	0.005	0.292	1.259	34.556	7.815	0.075	0.004	
CO MODE/STD.CYCLE	%	1.232	25.120	5.380	64.456	65.131	6.697	1.259	
HC EMISSION PER HP CYCLE =	0.00155 LB/HP CYCLE	PERCENT OF ALLOWABLE HC =				81.77			
NOX EMISSION PER HP CYCLE =	0.00066 LB/HP CYCLE	PERCENT OF ALLOWABLE NOX =				44.01			
CO EMISSION PER HP CYCLE =	0.07110 LB/HP CYCLE	PERCENT OF ALLOWABLE CO =				169.27			

TABLE XIIIa. TEMP-HUMIDITY, 70°F, 0%

CYCLE NO. 2005

CELL-17

DATE 2/26/76

25 BTDC, 70 DEG.F, 0% REL.HUMIDITY

ENGINE - LYCOMING O-320-DIAD

ENGINE TIMING

25.000 DEG. BTDC

RATED H.P.: 160.

H.C. RATIO 2.125

	UNITS	TOLE	TAXI	TAKE OFF	CLIMB	APPROACH	TAXI	TOLE
RUN NUMBER		2005	2006	2007	2008	2009	2010	2011
TIME IN MODE	MIN.	1.00	11.00	0.30	5.00	6.00	3.00	1.00
ENGINE SPEED	RPM	602.58	1205.40	2698.65	2430.00	2355.77	1204.50	607.02
OBS. HORSEPOWER	HP	0.40706	1.68240	152.53551	119.40726	65.43901	1.68374	0.45490
F/A RATIO MEAS.	- - -	0.0951	0.0958	0.0862	0.0820	0.0875	0.0961	0.0978
F/A RATIO CALC.	- - -	0.0981	0.0962	0.0848	0.0829	0.0885	0.0965	0.0972
% DIFF. IN F/A	%	3.162	0.482	-1.625	0.997	1.103	0.437	-0.651
AIR FLOW	LBS/HR	51.00	82.34	931.84	745.32	469.12	83.01	51.62
FUEL FLOW	LBS/HR	4.85	7.88	80.30	61.14	41.07	7.98	5.05
VAPOR FLOW	LBS/HR	0.00775	0.01129	0.13416	0.11709	0.07125	0.00988	0.00694
HUMIDITY GR H2O/LB DRY AIR		1.064	0.960	1.008	1.100	1.063	0.833	0.941
DEW POINT	DEG.F	-22.441	-23.386	-22.851	-21.921	-22.306	-24.482	-23.531
RELATIVE HUMIDITY	%	0.90	0.81	0.90	0.99	0.92	0.73	0.80
BAROMETER	IN.HG.	29.10	29.11	29.11	29.11	29.12	29.12	29.12
IND.AIR TEMP.	DEG.F	71.60	71.63	70.08	70.20	71.18	70.89	71.38
MAX. CHT	DEG.F	302.73	281.99	420.67	443.47	353.73	296.24	258.39
HC WET	PPM	38595.84	8773.87	1598.06	1548.85	1936.39	8637.80	36783.65
NOX WET	PPM	5.06	24.02	368.44	752.98	225.14	22.91	5.52
CO WET	%	8.3233	9.4912	6.9336	6.2463	8.0906	9.5867	8.3761
CO2 WET	%	5.7054	7.2775	8.8684	9.1172	8.1346	7.2523	5.9259
O2 WET	%	3.5557	0.2808	0.0982	0.1278	0.1170	0.2559	3.4362
H2O CORRECTION	- - -	0.88328	0.86870	0.86966	0.86065	0.86204	0.86883	0.89453
HC MASS/MODE	LB/MODE	0.01920	0.07768	0.00422	0.05367	0.05173	0.02105	0.01869
NOX MASS/MODE	LB/MODE	0.00001	0.00069	0.00315	0.08452	0.01948	0.00018	0.00001
CO MASS/MODE	LB/MODE	0.08183	1.66071	0.36175	4.27776	4.27183	0.46176	0.08413
HC MODE/STD.CYCLE	%	6.315	25.551	1.388	17.654	17.016	6.925	6.149
NOX MODE/STD.CYCLE	%	0.003	0.287	1.313	35.219	8.119	0.075	0.004
CO MODE/STD.CYCLE	%	1.218	24.713	5.383	63.657	63.569	6.871	1.252
HC EMISSION PER HP CYCLE =	0.00154 LB/HP CYCLE	PERCENT OF ALLOWABLE HC =			81.00			
NOX EMISSION PER HP CYCLE =	0.00068 LB/HP CYCLE	PERCENT OF ALLOWABLE NOX =			45.02			
CO EMISSION PER HP CYCLE =	0.07000 LB/HP CYCLE	PERCENT OF ALLOWABLE CO =			166.66			

TABLE XIIIb. TEMP-HUMIDITY, 70°F, 0%

CYCLE NO. 2012

CELL-17

DATE 2/26/76

25 BTDC, 70 DEG.F, 0% REL.HUMIDITY

ENGINE - LYCOMING O-320-D1AD

ENGINE TIMING

25.000 DEG. BTDC

RATED H.P. 160.

H.C. RATIO 2.125

	UNITS	IDLE	TAXI	TAKE OFF	CLIMB	APPROACH	TAXI	IDLE
RUN NUMBER		2012	2014	2015	2016	2017	2018	2021
TIME IN MODE	MIN.	1.00	11.00	0.30	5.00	6.00	3.00	1.00
ENGINE SPEED	RPM	597.90	1205.10	2700.09	2434.44	2357.21	1201.14	601.56
OBS. HORSEPOWER	HP	0.63652	1.10051	152.77026	119.28258	65.39929	1.68202	0.55308
F/A RATIO MEAS.	- - -	0.0975	0.0963	0.0854	0.0819	0.0927	0.0939	0.0948
F/A RATIO CALC.	- - -	0.0996	0.0970	0.0848	0.0828	0.0885	0.0977	0.0989
% DIFF. IN F/A	%	2.183	0.704	-0.680	1.100	-4.506	4.038	4.326
AIR FLOW	LBS/HR	50.34	81.15	931.07	747.62	467.60	80.94	52.35
FUEL FLOW	LBS/HR	4.91	7.81	79.50	61.22	43.35	7.60	4.97
VAPOR FLOW	LBS/HR	0.00721	0.00876	0.12917	0.08022	0.03843	0.00803	0.00455
HUMIDITY GR H2O/LB DRY AIR		1.002	0.756	0.971	0.751	0.575	0.694	0.609
DEW POINT	DEG.F	-22.976	-25.202	-23.171	-25.187	-26.802	-25.762	-26.542
RELATIVE HUMIDITY	%	0.86	0.66	0.89	0.69	0.52	0.62	0.53
BAROMETER	IN.HG.	29.13	29.13	29.13	29.13	29.13	29.13	29.14
IND.AIR TEMP.	DEG.F	71.23	70.64	69.65	69.73	69.99	70.38	70.67
MAX. CHT	DEG.F	302.67	330.41	433.06	446.55	357.44	344.07	313.20
HC WET	PPM	37915.75	8513.84	1563.05	1540.55	2013.30	9121.90	37553.71
NOX WET	PPM	5.01	23.47	372.24	783.98	230.87	22.72	4.70
CO WET	%	8.6430	9.7212	6.9071	6.1984	8.2563	9.7045	8.6121
CO2 WET	%	5.7420	7.1918	8.8327	9.1501	8.3044	7.0360	5.6313
O2 WET	%	3.2892	0.2423	0.0890	0.1095	0.1168	0.2453	3.4396
H2O CORRECTION	- - -	0.88527	0.86807	0.86656	0.86025	0.88103	0.85782	0.87895
HC MASS/MODE	LB/MODE	0.01877	0.07442	0.00411	0.05351	0.05462	0.02151	0.01915
NOX MASS/MODE	LB/MODE	0.00001	0.00066	0.00317	0.08822	0.02029	0.00017	0.00001
CO MASS/MODE	LB/MODE	0.08456	1.67934	0.35902	4.25539	4.42686	0.45231	0.08682
HC MODE/STD.CYCLE	%	6.174	24.479	1.352	17.603	17.966	7.076	6.301
NOX MODE/STD.CYCLE	%	0.003	0.277	1.321	36.759	8.454	0.072	0.003
CO MODE/STD.CYCLE	%	1.258	24.990	5.343	63.324	65.876	6.731	1.292
HC EMISSION PER HP CYCLE =	0.00154 LB/HP CYCLE	PERCENT OF ALLOWABLE HC =			80.95			
NOX EMISSION PER HP CYCLE =	0.00070 LB/HP CYCLE	PERCENT OF ALLOWABLE NOX =			46.89			
CO EMISSION PER HP CYCLE =	0.07090 LB/HP CYCLE	PERCENT OF ALLOWABLE CO =			168.81			

135

TABLE XIIIc. TEMP-HUMIDITY, 70°F, 0%

CYCLE NO. 2037

CELL-17

DATE 2/27/76

25 BTDC 70 DEG REL HUM = 30 %

ENGINE - LYCOMING O-320-D1AD

ENGINE TIMING 25.000 DEG. BTDC RATED H.P. 160. H.C. RATIO 2.125

	UNITS	IDLE	TAXI	TAKE OFF	CLIMB	APPROACH	TAXI	IDLE
RUN NUMBER		2037	2038	2039	2040	2041	2042	2043
TIME IN MODE	MTN.	1.00	11.00	0.30	5.30	6.00	3.00	1.00
ENGINE SPED	RPM	581.34	1206.48	2702.91	2433.36	2349.83	1208.94	602.52
OBS. HORSEPOWER	HP	0.48563	1.25059	151.89133	119.91351	63.36963	1.00687	0.49830
F/A RATIO MEAS.	- - -	0.0983	0.0954	0.0870	0.0801	0.0911	0.0948	0.0902
F/A RATIO CALC.	- - -	0.0966	0.0971	0.0847	0.0827	0.0883	0.0968	0.0965
% DIFF. IN F/A	%	-1.744	1.842	-2.629	3.297	-3.157	2.126	6.976
AIR FLOW	LBS/HR	48.85	87.84	928.25	747.09	463.34	86.11	53.49
FUEL FLOW	LBS/HR	4.80	8.38	80.73	59.81	42.22	8.16	4.82
VAPOR FLOW	LBS/HR	0.24522	0.44428	4.89663	3.88661	2.39324	0.44338	0.27495
RELATIVE HUMIDITY	%	30.59	30.89	33.59	32.95	32.41	31.65	31.71
BAROMETER	IN. HG.	29.26	29.26	29.26	29.26	29.25	29.25	29.25
IND. AIR TEMP.	DEG. F	70.53	70.57	69.40	69.74	69.92	70.50	70.67
MAX. CHT	DEG. F	298.15	279.02	415.05	435.32	349.05	301.59	253.49
H ₂ O WET	PPM	39209.90	9438.94	1673.57	1589.66	2005.80	9577.95	36782.66
NOX WET	PPM	4.28	18.92	298.63	642.36	168.54	14.06	4.86
CO WET	%	8.2563	9.5777	6.9302	6.1276	8.1330	9.4691	7.7605
CO ₂ WET	%	5.7981	7.1898	8.9398	9.0683	8.3292	7.2113	5.9956
O ₂ WET	%	3.8338	0.2629	0.1012	0.1280	0.1146	0.2789	3.3075
H ₂ O CORRECTION	- - -	0.89381	0.85719	0.86528	0.84541	0.86865	0.85615	0.86020
HC MASS/MODE	LB/MODE	0.01897	0.08989	0.00443	0.05506	0.05386	0.02421	0.01894
NOX MASS/MODE	LB/MODE	0.00001	0.00058	0.00256	0.07208	0.01466	0.00012	0.00001
CO MASS/MODE	LB/MODE	0.07896	1.79333	0.36294	4.19454	4.31653	0.47313	0.07898
HC MODE/STD. CYCLE	%	6.241	29.571	1.459	18.111	17.718	7.965	6.230
NOX MODE/STD. CYCLE	%	0.003	0.242	1.068	30.031	6.109	0.048	0.003
CO MODE/STD. CYCLE	%	1.175	26.686	5.401	62.419	64.234	7.041	1.175
HC EMISSION PER HP CYCLE =	0.00166 LB/HP CYCLE	PERCENT OF ALLOWABLE HC =			87.30			
NOX EMISSION PER HP CYCLE =	0.00056 LB/HP CYCLE	PERCENT OF ALLOWABLE NOX =			37.50			
CO EMISSION PER HP CYCLE =	0.07061 LB/HP CYCLE	PERCENT OF ALLOWABLE CO =			168.13			

136

TABLE XIIIId. TEMP-HUMIDITY, 70°F, 30%

CYCLE NO. 2029

CELL-17

DATE 2/27/76

25 BTDC 70 DEG REL HUM = 30 %

ENGINE - LYCOMING O-320-PIAD

ENGINE TIMING	25.000	DEG.	BTDC	RATED H.P.	160.	H.C. RATIO	2.125		
	UNITS	IDLE	TAXI	TAKE OFF	CLIMB	APPROACH	TAXI	IDLE	
RUN NUMBER		2029	2030	2031	2032	2033	2034	2035	
TIME IN MODE	MIN.	1.00	11.00	0.30	5.00	6.00	3.00	1.00	
ENGINE SPEED	RPM	606.42	1202.52	2700.27	2437.08	2355.17	1211.52	604.80	
OBS. HORSEPOWER	HP	0.21969	1.08317	150.91759	121.01205	65.34555	1.19275	0.33529	
F/A RATIO MEAS.	- - -	0.0985	0.0958	0.0876	0.0849	0.0890	0.0945	0.0996	
F/A RATIO CALC.	- - -	0.0986	0.0976	0.0848	0.0829	0.0881	0.0968	0.0951	
% DIFF. IN F/A	%	0.045	1.933	-3.187	-2.329	-1.008	2.397	-4.530	
AIR FLOW	LBS/HR	51.98	88.94	922.99	751.13	466.82	84.68	49.67	
FUEL FLOW	LBS/HP	5.12	8.52	80.82	63.74	41.56	8.00	4.95	
VAPOR FLOW	LBS/HR	0.26057	0.45321	4.82575	3.77000	2.31619	0.41954	0.25070	
RELATIVE HUMIDITY	%	30.39	31.39	33.42	31.94	31.16	30.42	30.63	
BAROMETER	IN.HG.	29.27	29.27	29.26	29.26	29.26	29.26	29.26	
IND. AIR TEMP.	* DEG.F	70.53	70.31	69.23	69.65	69.98	70.55	70.60	
MAX. CHT	DEG.F	286.27	274.91	430.56	435.07	347.84	300.16	242.11	
HC WET	PPM	35116.59	9553.96	1606.86	1624.96	2013.60	9701.96	32987.29	
NOX WET	PPM	2.58	17.20	308.13	661.49	183.20	18.57	3.44	
CO WET	%	8.5366	9.6626	6.9587	6.3136	8.0232	9.4440	8.1519	
CO2 WET	%	5.9705	7.0972	8.9056	9.2310	8.2634	7.1836	6.4468	
O2 WET	%	3.1267	0.2703	0.0967	0.1261	0.1252	0.3054	3.0733	
H2O CORRECTION	- - -	0.88366	0.85768	0.86781	0.86472	0.86183	0.85589	0.89687	
HC MASS/MODE	LB/MODE	0.01861	0.09284	0.00424	0.05760	0.05406	0.02409	0.01630	
NOX MASS/MODE	LB/MODE	0.00000	0.00054	0.00264	0.07597	0.01593	0.00015	0.00001	
CO MASS/MODE	LB/MODE	0.08693	1.83462	0.36315	4.42352	4.25688	0.46353	0.07972	
HC MODE/STD. CYCLE	%	6.121	30.539	1.396	18.949	17.781	7.926	5.363	
NOX MODE/STD. CYCLE	%	0.002	0.223	1.098	31.653	6.638	0.062	0.002	
CO MODE/STD. CYCLE	%	1.294	27.301	5.404	65.826	63.346	6.898	1.186	
HC EMISSION PER HP CYCLE =	0.00167 LB/HP CYCLE	PERCENT OF ALLOWABLE HC =				88.07			
NOX EMISSION PER HP CYCLE =	0.00060 LB/HP CYCLE	PERCENT OF ALLOWABLE NOX =				39.68			
CO EMISSION PER HP CYCLE =	0.07193 LB/HP CYCLE	PERCENT OF ALLOWABLE CO =				171.26			

TABLE XIIIe. TEMP-HUMIDITY, 70°F, 30%

ORIGINAL PAGE IS
OF POOR QUALITY

CYCLE NO. 2022 CELL=17 DATE 2/27/76

25 BTDC 70 DEG REL HUM = 30 %

ENGINE - LYCOMING O-320-01AD

ENGINE TIMING 25.000 DEG. BTDC RATED H.P. 160. H.C. RATIO 2.125

	UNITS	IDLE	TAXI	TAKE OFF	CLIMB	APPROACH	TAXI	INLE
RUN NUMBER		2022	2023	2024	2025	2026	2027	2028
TIME IN MODE	MIN.	1.00	11.00	0.30	5.00	6.00	3.00	1.00
ENGINE SPEED	RPM	609.24	1200.90	2700.21	2436.36	2358.53	1203.48	604.44
BSG. HORSEPOWER	HP	0.45492	1.19109	151.65921	119.92661	66.51221	2.06717	0.49773
F/A RATIO MEAS.	- - -	0.0989	0.0923	0.0872	0.0843	0.0916	0.0964	0.0937
F/A RATIO CALC.	- - -	0.0995	0.0975	0.0850	0.0830	0.0884	0.0972	0.0980
% DIFF. IN F/A	%	0.640	5.721	-2.552	-1.477	-3.470	0.868	4.635
AIR FLOW	LBS/HR	50.13	89.33	936.99	757.91	472.39	85.10	54.46
FUEL FLOW	LBS/HR	4.96	8.24	81.74	63.88	43.26	8.20	5.10
VAPOR FLOW	LBS/HR	0.23653	0.41745	4.58044	3.66588	2.29193	0.41609	0.26849
RELATIVE HUMIDITY	%	29.24	29.34	31.53	31.24	30.73	30.20	30.43
BAROMETER	IN. HG.	29.27	29.27	29.27	29.27	29.27	29.27	29.27
IND. AIR TEMP.	DEG. F	70.16	70.09	69.37	69.49	69.89	70.38	70.37
MAX. CHT	DEG. F	314.67	289.80	431.12	438.43	353.99	289.38	250.74
HC WET	PPM	37710.75	9610.95	1635.06	1611.66	2049.50	9444.94	35513.63
NOX WET	PPM	4.68	21.06	325.33	720.45	185.52	16.1	3.01
CO WET	%	8.6554	9.4926	6.9759	6.3266	8.1553	9.5750	8.1058
CO2 WET	%	5.7711	6.9804	8.8169	9.1388	8.2914	7.1459	5.9878
O2 WET	%	3.2801	0.2970	0.0878	0.1234	0.1122	0.2699	3.1190
H2O CORRECTION	- - -	0.88399	0.84656	0.86672	0.86265	0.87072	0.86174	0.86800
HC MASS/MODE	LB/MODE	0.01876	0.09155	0.00438	0.05752	0.05619	0.02372	0.01938
NOX MASS/MODE	LB/MODE	0.00001	0.00065	0.00282	0.08330	0.01648	0.00015	0.00001
CO MASS/MODE	LB/MODE	0.08509	1.78716	0.36901	4.46246	4.41887	0.47528	0.08502
HC MODE/STD. CYCLE	%	6.170	30.116	1.440	18.920	18.483	7.803	6.374
NOX MODE/STD. CYCLE	%	0.003	0.271	1.175	34.706	6.865	0.062	0.002
CO MODE/STD. CYCLE	%	1.266	26.595	5.491	66.406	65.757	7.073	1.265
HC EMISSION PER HP CYCLE =	0.00170 LB/HP CYCLE	PERCENT OF ALLOWABLE HC =			89.31			
NOX EMISSION PER HP CYCLE =	0.00065 LB/HP CYCLE	PERCENT OF ALLOWABLE NOX =			43.08			
CO EMISSION PER HP CYCLE =	0.07302 LB/HP CYCLE	PERCENT OF ALLOWABLE CO =			173.85			

TABLE XIIIa. TEMP-HUMIDITY, 70°F, 30%

CYCLE NO. 2044

CELL-17

DATE 2/27/76

BTDC 70 DEG REL HUM = 60 %

ENGINE - LYCOMING O-320-DIAD

ENGINE TIMING	25.000 DEG. BTDC	RATED H.P. 160.			H.C. RATIO 2.125			
	UNITS	IDLE	TAXI	TAKE OFF	CLIMB	APPROACH	TAXI	IDLE
PUN NUMBER		2044	2045	2046	2054	2048	2049	2050
TIME IN MODE	MIN.	1.00	11.00	0.30	5.00	6.00	3.00	1.00
ENGINE SPEED	RPM	617.92	1197.54	2698.77	2435.28	2357.75	1212.42	607.56
OBS. HORSEPOWER	HP	1.02306	1.06247	148.85423	120.55492	66.08545	1.16726	0.54117
F/A RATIO MEAS.	- - -	0.0951	0.0969	0.0878	0.0844	0.0889	0.0981	0.0943
F/A RATIO CALC.	- - -	0.0974	0.1001	0.0848	0.0832	0.0882	0.0977	0.0946
% DIFF. IN F/A	%	2.339	3.331	-3.412	-1.344	-0.771	-0.379	0.290
AIP FLOW	LBS/HR	55.73	96.39	926.03	758.21	476.45	88.26	52.82
FUEL FLOW	LBS/HR	5.30	9.34	81.32	63.98	42.36	8.66	4.98
VAPOR FLOW	LBS/HR	0.53167	0.91554	9.23991	7.10793	4.62453	0.85667	0.51203
HUMIDITY GR H2O/LR DRY AIR		66.783	66.485	69.846	65.622	67.943	67.946	67.957
DEW POINT	DEG.F	55.151	55.256	56.487	54.926	55.901	55.696	55.726
RELATIVE HUMIDITY	%	57.94	58.93	63.95	59.99	61.44	59.66	59.09
BAROMETER	IN.HG.	29.24	29.23	29.22	29.19	29.22	29.21	29.21
IND. AIR TEMP.	DEG.F	70.66	70.28	69.19	69.40	69.74	70.39	70.70
MAX. CHT	DEG.F	275.03	275.73	433.96	438.39	343.47	289.03	247.36
HC WET	PPM	32358.21	11779.17	1654.36	1656.16	1984.00	11309.12	36477.63
NOX WET	PPM	5.15	14.02	274.01	632.26	152.68	16.39	4.09
CO WET	%	8.2499	9.9447	6.9718	6.3160	8.0028	9.5319	7.6742
CO2 WET	%	6.2639	6.8494	8.9296	9.0701	8.2374	7.1810	6.1435
O2 WET	%	2.6938	0.2740	0.0895	0.0998	0.1053	0.3316	3.5234
H2O CORRECTION	- - -	0.86574	0.84827	0.86150	0.85632	0.85440	0.85928	0.87718
HC MASS/MODE	LB/MODE	0.01774	0.12360	0.00441	0.05940	0.05457	0.02976	0.01890
NOX MASS/MODE	LB/MODE	0.00001	0.00048	0.00236	0.07346	0.01360	0.00014	0.00001
CO MASS/MODE	LB/MODE	0.08938	2.06239	0.36696	4.47689	4.35051	0.49577	0.07850
HC MODE/STD.CYCLE	%	5.835	40.657	1.449	19.538	17.951	9.790	6.218
NOX MODE/STD.CYCLE	%	0.004	0.199	0.985	30.608	5.668	0.058	0.003
CO MODE/STD.CYCLE	%	1.330	30.690	5.461	66.620	64.740	7.378	1.168
HC EMISSION PER HP CYCLE =	0.00193 LB/HP CYCLE	PERCENT OF ALLOWABLE HC =			101.44			
NOX EMISSION PER HP CYCLE =	0.00056 LB/HP CYCLE	PERCENT OF ALLOWABLE NOX =			37.52			
CO EMISSION PER HP CYCLE =	0.07450 LB/HP CYCLE	PERCENT OF ALLOWABLE CO =			177.39			

TABLE XIIIg. TEMP-HUMIDITY, 70°F, 60%

CYCLE NO. 2058

CELL-17

DATE 2/27/76

BASELINE FR 25 BTDC 70 DEG REL HUM = 60 %

ENGINE - LYCOMING O-320-DIAD

ENGINE TIMING 25.000 DEG. BTDC PATED H.P. 160. H.C. RATIO 2.125

UNITS IDLE TAXI TAKE OFF CLIMB APPROACH TAXI IDLE

UNIT	2058	2045	2060	2061	2062	2063	2064
RUN NUMBER							
TIME IN MODE	1.00	11.00	0.30	5.00	6.00	3.00	1.00

UNIT	590.70	1197.54	2706.57	2434.80	2354.27	1234.26	603.00
ENGINE SPEED	RPM						
OBS. HOPSEPOWER	HP	0.74770	1.06247	149.69363	120.06628	65.97813	1.75194

UNIT	0.0961	0.0969	0.0888	0.0860	0.0898	0.0964	0.0980
F/A RATIO MEAS.	- - -						
F/A RATIO CALC.	- - -	0.0960	0.1001	0.0847	0.0832	0.0881	0.1001
% DIFF. IN F/A	?	-0.025	3.331	-4.630	-3.330	-1.913	0.310

UNIT	51.44	96.39	909.11	746.82	466.15	84.17	51.57
AIR FLOW	LBS/HR						
FUEL FLOW	LBS/HR	4.94	9.34	80.77	64.26	41.87	8.11
VAPOR FLOW	LBS/HR	0.50266	0.91554	8.94075	7.22807	4.43143	0.83611
HUMIDITY GR H2O/LB DRY AIR		68.402	66.485	68.843	67.749	66.545	69.538
DEW POINT	DEG.F	55.291	55.256	55.526	55.376	54.831	55.921
RELATIVE HUMIDITY	%	58.06	58.93	61.48	60.28	58.98	60.44
BAROMETER	IN.HG.	29.18	29.23	29.17	29.17	29.17	29.15
IND. AIR TEMP.	DEG.F	70.75	70.28	69.32	69.74	69.80	70.24
MAX. CHT	DEG.F	281.09	275.73	417.22	436.72	343.19	299.67

UNIT	34492.42	11779.17	1725.47	1631.26	1900.59	9500.94	36167.59
HC WFT	PPM						
NOX WFT	PPM	4.35	14.02	268.23	616.34	156.68	17.04
CO WFT	?	8.0378	9.9447	6.9497	6.4169	7.9518	9.3549
CO2 WFT	?	6.1330	6.8494	8.8596	9.0793	8.1666	7.1448
O2 WFT	%	3.1742	0.2740	0.1335	0.1554	0.1340	0.3006
H2O CORRECTION	- - -	0.87698	0.84827	0.86751	0.86310	0.85028	0.85762

UNIT	0.01751	0.12360	0.00453	0.05800	0.05131	0.02371	0.01854
HC MASS/MODE	LB/MODE						
NOX MASS/MODE	LB/MODE	0.00001	0.00048	0.00228	0.07099	0.01370	0.00014
CO MASS/MODE	LB/MODE	0.08066	2.06239	0.36042	4.50914	4.24797	0.46136

UNIT	5.761	40.657	1.489	19.078	16.877	7.799	6.099
HC MODE/STD.CYCLE	?						
NOX MODE/STD.CYCLE	?	0.003	0.179	0.950	29.579	5.709	0.057
CO MODE/STD.CYCLE	?	1.200	30.690	5.363	67.100	63.214	6.866

HC EMISSION PER HP CYCLE =	0.00186 LB/HP CYCLE	PERCENT OF ALLOWABLE HC =	97.76
----------------------------	---------------------	---------------------------	-------

NOX EMISSION PER HP CYCLE =	0.00055 LB/HP CYCLE	PERCENT OF ALLOWABLE NOX =	36.50
-----------------------------	---------------------	----------------------------	-------

CO EMISSION PER HP CYCLE =	0.07380 LB/HP CYCLE	PERCENT OF ALLOWABLE CO =	175.72
----------------------------	---------------------	---------------------------	--------

TABLE XIII h. TEMP-HUMIDITY, 70°F, 60%

140

CYCLE NO. 2051

CCEL-17

DATE 2/27/76

25 BTDC, 70 DEG., 60% HUM

ENGINE - LYCOMING O-32C-DIAD

ENGINE TIMING

25.000 DEG. BTDC

RATED H.P. 160.

M.C. RATIO 2.125

	UNITS	IDLE	TAXI	TAKE OFF	CLIMB	APPROACH	TAXI	IDLE
--	-------	------	------	----------	-------	----------	------	------

RUN NUMBER		2051	2052	2053	2054	2055	2056	2057
TIME IN MODE	MIN.	1.00	11.00	0.30	5.00	6.00	3.00	1.00

ENGINE SPEED	RPM	604.26	1207.32	2694.69	2435.28	2352.95	1200.24	601.56
OPS. HOPSEPOWER	HP	0.09761	0.97356	148.71350	120.55492	65.06624	0.77102	0.28611

F/A RATIO MEAS.	- - -	0.0944	0.0958	0.0862	0.0844	0.0916	0.0943	0.0944
F/A RATIO CALC.	- - -	0.0969	0.0975	0.0849	0.0832	0.0885	0.0968	0.0980
% DIFF. IN F/A	%	2.697	1.802	-1.432	-1.344	-3.381	2.590	3.827

AIP FLOW	LBS/HR	53.86	91.03	921.84	758.21	467.82	86.24	52.85
FUEL FLOW	LBS/HR	5.08	8.72	79.44	63.98	42.84	8.13	4.99
VAPOR FLOW	LBS/HP	0.52336	0.88199	8.80892	7.10793	4.51634	0.84138	0.51075
HUMIDITY GR H2O/LB DRY AIR		68.018	67.821	66.891	65.622	67.579	68.291	67.651
DEW POINT	DEG.F	55.761	55.701	55.351	54.926	55.541	55.536	55.296
RELATIVE HUMIDITY	%	59.38	59.83	60.15	59.99	60.36	58.88	58.25
BAROMETER	IN.HG.	29.20	29.19	29.19	29.19	29.19	29.18	29.18
IND. AIP TEMP.	DEG.F	70.59	70.31	69.78	69.40	69.88	70.60	70.66
MAX. CHT	DEG.F	289.42	282.96	436.65	438.39	346.55	285.43	246.68

HC WET	PPM	37664.73	10622.05	1680.17	1656.16	1976.40	9979.99	38256.80
NOX WET	PPM	3.48	15.30	273.63	632.76	153.90	16.86	4.07
CO WET	%	7.9242	9.4078	6.8630	6.3160	8.1449	9.2947	7.7902
CO2 WET	%	5.8942	7.1098	8.7947	9.0701	8.1996	7.1513	5.9746
O2 WET	%	3.4376	0.2893	0.0648	0.0998	0.1236	0.3063	3.2057
H2O CORRECTION	- - -	0.87018	0.85251	0.85639	0.85632	0.86460	0.84932	0.86572

HC MASS/MODE	LB/MODE	0.01990	0.10489	0.00443	0.05940	0.05389	0.02533	0.01984
NOX MASS/MODE	LB/MODE	0.00001	0.00049	0.00234	0.07346	0.01359	0.00014	0.00001
CO MASS/MODE	LB/MODE	0.08277	1.83610	0.35730	4.47689	4.38953	0.46628	0.07983

HC MODE/STD. CYCLE	%	6.548	34.503	1.456	19.538	17.728	8.333	6.525
NOX MODE/STD. CYCLE	%	0.002	0.204	0.973	30.608	5.664	0.058	0.003
CO MODE/STD. CYCLE	%	1.232	27.323	5.317	66.620	65.320	6.939	1.188

HC EMISSION PER HP CYCLE =	0.00180 LB/HP CYCLE	PERCENT OF ALLOWABLE HC =	94.63
----------------------------	---------------------	---------------------------	-------

NOX EMISSION PER HP CYCLE =	0.00056 LB/HP CYCLE	PERCENT OF ALLOWABLE NOX =	37.51
-----------------------------	---------------------	----------------------------	-------

CO EMISSION PER HP CYCLE =	0.07305 LB/HP CYCLE	PERCENT OF ALLOWABLE CO =	173.94
----------------------------	---------------------	---------------------------	--------

TABLE XIII: TEMP-HUMIDITY, 70°F, 60%

ORIGINAL PAGE IS
OF POOR QUALITY

CYCLE NO. 2065

CELL-17

DATE 2/27/76

25 BTDC, 70 DEG., 80% HUM

ENGINE - LYCOMING O-320-D1AD

ENGINE TIMING	25.000 DEG. BTDC	RATED H.P. 160.			H.C. RATIO 2.125			
	UNITS	IDLE	TAXI	TAKE OFF	CLIMB	APPROACH	TAXI	IDLE
RUN NUMBER		2065	2066	2068	2069	2070	2071	2072
TIME IN MODE	MIN.	1.00	11.00	0.30	5.00	6.00	3.00	1.00
ENGINE SPEED	RPM	609.96	1701.62	2701.41	2430.66	2351.27	1200.54	617.82
BS. HOPSEPOWER	HP	0.31735	1.28516	146.47354	118.92770	65.20770	1.53892	0.75350
F/A RATIO MEAS.	- - -	0.0978	0.1027	0.0893	0.0864	0.0929	0.1008	0.1028
F/A RATIO CALC.	- - -	0.0981	0.0986	0.0856	0.0836	0.0886	0.0977	0.0969
% DIFF. IN F/A	%	0.268	-3.937	-4.163	-3.199	-4.563	-3.166	-5.766
A/F FLOW	LBS/HR	52.67	90.55	897.70	742.75	461.69	86.40	50.67
FUEL FLOW	LBS/HR	5.15	9.30	80.17	64.16	42.88	8.71	5.21
VAPOR FLOW	LBS/HR	0.67522	1.18472	11.63568	9.50794	5.86893	1.12395	0.67545
HUMIDITY GR H2O/LB DRY AIR		89.741	91.582	90.737	89.607	88.982	91.064	93.313
DEW POINT	DEG.F	62.482	63.712	63.322	62.767	62.522	63.277	63.762
RELATIVE HUMIDITY	%	75.95	78.14	79.87	79.07	77.65	78.42	79.25
BAROMETER	IN.HG.	29.15	29.15	29.15	29.12	29.11	29.11	29.10
IND. AIR TEMP.	DEG.F	70.42	70.34	69.82	69.54	69.82	70.31	70.49
MAX. CHT	DEG.F	276.64	269.22	444.77	433.04	347.37	292.02	305.11
HC WET	PPM	33770.35	11702.16	1617.86	1705.17	2035.10	10697.06	36425.61
NOX WET	PPM	4.23	12.94	196.84	627.02	155.16	16.35	4.90
CO WET	%	8.3413	9.7783	7.1063	6.4317	8.1341	9.5871	8.3751
CO2 WET	%	6.0719	7.0247	8.6808	8.9502	8.1198	7.1145	5.8923
O2 WET	%	2.8499	0.3731	0.0656	0.1391	0.1282	0.3353	3.4793
H2O CORRECTION	- - -	0.87122	0.86945	0.86242	0.85930	0.86601	0.86616	0.89629
HC MASS/MODE	LB/MODE	0.01771	0.11803	0.00421	0.06054	0.05517	0.02790	0.01870
NOX MASS/MODE	LB/MODE	< 0.00001	0.00042	0.00166	0.07212	0.01363	0.00014	0.00001
CO MASS/MODE	LB/MODE	0.08647	1.94935	0.36555	4.54825	4.35836	0.49424	0.08498
HC MODE/STD. CYCLE	%	5.826	38.827	1.385	19.914	18.149	9.178	6.152
NOX MODE/STD. CYCLE	%	0.003	0.176	0.692	30.050	5.678	0.058	0.003
CO MODE/STD. CYCLE	%	1.287	29.008	5.440	67.682	64.857	7.355	1.265
HC EMISSION PER HP CYCLE =	0.00189 LB/HP CYCLE	PERCENT OF ALLOWABLE HC =				99.43		
NOX EMISSION PER HP CYCLE =	0.00055 LB/HP CYCLE	PERCENT OF ALLOWABLE NOX =				36.66		
CO EMISSION PER HP CYCLE =	0.07430 LB/HP CYCLE	PERCENT OF ALLOWABLE CO =				176.89		

TABLE XIIIJ. TEMP-HUMIDITY, 70°F, 80%

CYCLE NO. 2073

CELL-17

DATE 2/27/76

P

RTDC, 70 DEG., 80% HUM

ENGINE - LYCOMING O-320-D1AD

ENGINE TIMING

25.000 DEG. BTDC

RATED H.P. 160.

H.C. RATIO 2.125

UNITS	IDLE	TAXI	TAKE OFF	CLIMB	APPROACH	TAXI	IDLE
RUN NUMBER	2073	2074	2075	2076	2077	2078	2079
TIME IN MODE	1.00	11.00	0.30	5.00	6.00	3.00	1.00
ENGINE SPED	599.23	1200.72	2705.55	2431.08	2353.85	1200.27	584.28
Obs. HPSEPOWER	0.48490	0.84467	147.90991	119.62651	65.01076	1.54180	0.47421
F/A RATIO MEAS.	0.0991	0.0995	0.0878	0.0872	0.0918	0.0941	0.0944
F/A RATIO CALC.	0.0975	0.0978	0.0852	0.0840	0.0886	0.0977	0.0967
% DIFF. IN F/A	-1.692	-1.683	-2.987	-3.696	-3.414	2.754	2.398
AIR FLOW	50.85	84.72	914.85	744.88	468.19	88.06	52.97
FUEL FLOW	5.04	8.63	80.37	64.95	42.96	8.37	5.00
VAPOR FLOW	0.67322	1.14475	12.01287	9.63908	5.93520	1.10266	0.65864
HUMIDITY GR H2O/LB DRY AIR	92.679	92.407	91.917	90.583	88.739	87.651	87.046
Dew POINT	63.742	63.832	63.902	63.162	62.652	62.198	62.067
RELATIVE HUMIDITY	79.34	79.98	83.45	81.48	77.86	75.69	74.58
BAROMETER	29.10	29.10	29.10	29.09	29.09	29.09	29.09
IND. AIR TEMP.	70.44	70.30	69.13	69.07	69.87	70.23	70.53
MAX. CHT	322.03	292.14	421.74	425.88	343.76	291.08	249.70
HC WET	38115.03	10948.09	1743.97	1723.87	2021.40	10857.33	39994.96
NOX WET	4.62	16.99	274.59	619.76	155.48	16.06	3.78
CO WET	8.2694	9.5164	6.9694	6.5441	8.1010	9.3275	7.5289
CO2 WET	5.7347	7.0733	8.6497	8.8415	8.0820	6.9706	5.7618
O2 WET	3.5984	0.3339	0.1123	0.1262	0.1301	0.3409	3.6954
H2O CORPECTION	0.88278	0.86096	0.85863	0.86203	0.86210	0.84718	0.87046
HC MASS/MODE	0.01939	0.10462	0.00460	0.06157	0.05535	0.02828	0.02084
NOX MASS/MODE	0.00061	0.00053	0.00235	0.07160	0.01379	0.00014	0.00001
CO MASS/MODE	0.08316	1.79742	0.36349	4.61976	4.38422	0.48024	0.07857
HC MODE/STD.CYCLE	6.380	34.416	1.514	20.254	18.207	9.304	6.856
NOX MODE/STD.CYCLE	0.003	0.219	0.978	29.832	5.747	0.056	0.003
CO MODE/STD.CYCLE	1.238	26.747	5.409	68.746	65.241	7.146	1.169
HC EMISSION PER HP CYCLE =	0.00184 LB/HP CYCLE		PERCENT OF ALLOWABLE HC =		96.93		
NOX EMISSION PER HP CYCLE =	0.00055 LB/HP CYCLE		PERCENT OF ALLOWABLE NOX =		36.84		
CO EMISSION PER HP CYCLE =	0.07379 LB/HP CYCLE		PERCENT OF ALLOWABLE CO =		175.70		

ORIGINAL PAGE IS OF POOR QUALITY 143

TABLE XIIIk. TEMP-HUMIDITY, 70°F, 80%

CYCLE NO. 2080

CFLL-17

DATE 2/21/76

25 BTDC, 70 DEG., 80% HUM

ENGINE - LYCOMING O-320-D1AD

ENGINE TIMING	25.000 DEG. BTDC	RATED H.P. 160.			H.C. RATIO 2.125			
	UNITS	IDLE	TAXI	TAKE OFF	CLIMB	APPROACH	TAXI	IDLE
RUN NUMBER		2080	2081	2082	2083	2084	2085	2086
TIME IN MODE	MIN.	1.00	11.00	0.30	5.00	6.00	3.00	1.00
ENGINE SPEED	RPM	595.20	1201.98	2700.39	2432.34	2355.83	1198.62	595.88
CBS. HHPSEPOWER	HP	0.70507	1.08998	146.87698	119.35069	65.63931	1.87761	0.69833
F/A RATIO MEAS.	- - -	0.0950	0.1002	0.0890	0.0861	0.0907	0.0950	0.0968
F/A RATIO CALC.	- - -	0.0971	0.0984	0.0856	0.0842	0.0887	0.0968	0.0986
% DIFF. IN F/A	%	2.173	-1.775	-3.765	-2.290	-2.203	1.899	1.941
AIR FLOW	LBS/HR	52.26	87.50	903.49	751.53	468.01	86.10	51.73
FUEL FLOW	LBS/HR	4.97	8.77	80.37	64.73	42.45	8.18	5.00
VAPOR FLOW	LBS/HR	0.65270	1.09159	11.66025	9.76220	5.94556	1.07535	0.63285
HUMIDITY GR H2O/LB DRY AIR		87.433	87.329	90.340	90.928	89.327	87.426	85.643
DEW POINT	DEG.F	62.127	62.097	63.267	63.482	62.787	62.207	61.652
REFLATIVE HUMIDITY	%	74.78	74.86	80.17	80.59	77.90	75.52	74.12
BAROMETER	IN. HG.	29.09	29.08	29.08	29.08	29.09	29.07	29.08
IND. AIR TEMP.	DEG.F	70.51	70.45	69.65	69.72	69.99	70.31	70.28
MAX. CHT	DEG.F	295.74	282.28	440.48	433.83	345.77	293.53	321.20
HC WET	PPM	38679.82	11474.14	1639.76	1728.57	2045.50	10248.02	39038.77
NOX WET	PPM	4.03	15.89	266.03	625.46	157.60	17.42	4.71
CO WET	%	7.8162	9.5781	7.0758	6.5963	8.0505	9.2376	8.2353
CO2 WET	%	5.7590	7.0002	8.5724	8.8035	8.0290	7.0703	5.6770
O2 WET	%	3.5503	0.3363	0.0012	0.1229	0.1165	0.3485	3.3899
H2O CORRECTION	- - -	0.87056	0.36306	0.86241	0.85654	0.85818	0.84945	0.87125
HC MASS/MODE	LB/MODE	0.01093	0.11084	0.00429	0.06205	0.05578	0.02615	0.01951
NOX MASS/MODE	LB/MODE	0.00001	0.00050	0.00225	0.07274	0.01392	0.00014	0.00001
CO MASS/MODE	LB/MODE	0.07959	1.82965	0.36586	4.67996	4.33900	0.46496	0.08349
HC MODE/STD. CYCLE	%	6.555	34.460	1.411	20.412	18.349	8.602	6.418
NOX MODE/STD. CYCLE	%	0.003	0.207	0.939	30.307	5.801	0.060	0.003
CO MODE/STD. CYCLE	%	1.184	27.212	5.444	69.642	64.568	6.919	1.242
HC EMISSION PER HP CYCLE =	0.00187 LB/HP CYCLE	PERCENT OF ALLOWABLE HC =			98.21			
NOX EMISSION PER HP CYCLE =	0.00056 LB/HP CYCLE	PERCENT OF ALLOWABLE NOX =			37.32			
CO EMISSION PER HP CYCLE =	0.07401 LB/HP CYCLE	PERCENT OF ALLOWABLE CO =			176.21			

TABLE XIII. TEMP-HUMIDITY, 70°F, 80%

CYCLE NO. 2102		CELL-17	DATE 7/27/76						
25 BTDC, 80 DEG., 0% HUM				ENGINE - LYCOMING O-320-D1AD					
ENGINE TIMING		25.000 DEG. BTDC	RATED H.P. 160.		M.C. RATIO 2.125				
	UNITS	IDLE	TAXI	TAKE OFF	CLIMB	APPROACH	TAXI	IDLE	
RUN NUMBER		2102	2103	2096	2097	2098	2099	2106	
TIME IN MODE	MIN.	1.00	11.00	0.30	5.00	6.00	3.00	1.00	
ENGINE SPEED	RPM	604.80	1203.78	2694.93	2430.66	2356.19	1198.92	615.72	
Obs. HPS/POWER	HP	0.08334	1.27837	147.73372	118.91029	65.62022	1.63765	0.27776	
F/A RATIO MEAS.	-- --	0.0952	0.0953	0.0862	0.0834	0.0895	0.0930	0.0998	
F/A RATIO CALC.	-- --	0.0994	0.0960	0.0855	0.0833	0.0887	0.0964	0.0977	
% DIFF. IN F/A	%	4.429	0.742	-0.837	-0.173	-0.877	3.562	-2.151	
AIR FLOW	LBS/HR	52.08	82.99	919.59	753.51	467.81	81.20	49.07	
FUEL FLOW	LPS/HR	4.96	7.91	79.26	62.88	41.85	7.55	4.99	
VAPOR FLOW	LBS/HR	0.00635	0.01009	0.09905	0.07679	0.04222	0.00798	0.00836	
HUMIDITY GR H2O/LB DRY AIR		0.853	0.851	0.746	0.713	0.632	0.679	1.171	
DEW POINT	DEG.F	-24.276	-24.311	-25.227	-25.517	-26.272	-25.897	-21.366	
RELATIVE HUMIDITY	%	0.54	0.54	0.48	0.46	0.40	0.44	0.74	
BAROMETER	IN.HG.	29.04	29.04	29.05	29.05	29.05	29.05	29.04	
IND. AIR TEMP.	DEG.F	80.39	80.36	80.26	80.38	80.75	79.99	80.40	
MAX. GHT	DEG.F	295.13	288.28	450.37	450.25	356.69	337.37	291.90	
HC WET	PPM	35243.50	8992.89	1569.76	1610.76	1977.40	8479.84	36955.67	
NOX WET	PPM	5.42	24.30	340.35	777.82	224.46	24.82	5.44	
CO WET	%	9.5148	9.4123	7.2139	6.4709	8.2439	9.4753	8.5226	
CO2 WET	%	5.9300	7.3167	8.7208	9.0975	8.1758	7.1955	5.9345	
O2 WET	%	2.9008	0.2896	0.1182	0.1438	0.1324	0.2636	3.4008	
H2O CORRECTION	-- --	0.87510	0.86757	0.86695	0.84430	0.86849	0.85839	0.89955	
HC MASS/MODE	LB/MODE	0.01790	0.038013	0.00409	0.05672	0.05304	0.02000	0.01831	
NOX MASS/MODE	LB/MODE	0.00001	0.00070	0.00287	0.09874	0.01951	0.00019	0.00001	
CO MASS/MODE	LB/MODE	0.08549	1.65749	0.37145	4.50386	4.37083	0.44162	0.08345	
HC MODE/STD.CYCLE	%	5.889	26.357	1.345	18.659	17.449	6.578	6.022	
NOX MODE/STD.CYCLE	%	0.004	0.292	1.197	36.974	8.128	0.079	0.004	
CO MODE/STD.CYCLE	%	1.272	24.665	5.527	67.022	65.042	6.572	1.242	
HC EMISSION PER HP CYCLE =	0.00156 LB/HP CYCLE	PERCENT OF ALLOWABLE HC =				82.30			
NOX EMISSION PER HP CYCLE =	0.00070 LB/HP CYCLE	PERCENT OF ALLOWABLE NOX =				46.68			
CO EMISSION PER HP CYCLE =	0.07196 LB/HP CYCLE	PERCENT OF ALLOWABLE CO =				171.34			

145

TABLE XIVA. TEMP-HUMIDITY, 80°F, 0%

CYCLE NO. 1713

CELL-17

DATE 2720776

25 BTDC, 80 DEG.F, 30% REL.HUMIDITY

ENGINE - LYCOMING O-320-D1AD

ENGINE TIMING

25.000 DEG. BTDC

RATED H.P. 160.

H.C. RATIO 2.125

	UNITS	IDLE	TAXI	TAKE OFF	CLIMB	APPROACH	TAXI	IDLE
RUN NUMBER		1713	1714	1715	1716	1717	1718	1719
TIME IN MODE	MIN.	1.00	11.00	0.30	5.00	6.00	3.00	1.00
ENGINE SPEED	RPM	589.98	1202.40	2708.70	2431.98	2350.07	1202.04	600.06
Obs. HOPSEPOWER	HP	0.77465	1.42120	150.36636	119.29573	64.50072	1.65261	0.86910
F/A RATIO MEAS.	- - -	0.0990	0.0991	0.0874	0.0834	0.0904	0.0941	0.0919
F/A RATIO CALC.	- - -	0.0942	0.0995	0.0853	0.0833	0.0893	0.0980	0.0965
% DIFF. IN F/A	%	-3.888	0.772	-2.467	-0.175	-1.214	4.122	4.974
AIR FLOW	LBS/HR	52.05	89.31	920.78	748.80	463.78	86.81	55.42
FUEL FLOW	LBS/HR	5.10	8.85	80.52	62.48	41.91	8.17	5.09
VAPOR FLOW	LBS/HR	0.36054	0.60743	6.21158	5.06920	3.06465	0.55737	0.35063
HUMIDITY GR H2O/LB DRY AIR		48.485	47.607	47.222	47.388	46.256	44.944	44.291
DEW POINT	DEG.F	46.766	45.670	46.096	46.371	45.775	44.940	44.560
RELATIVE HUMIDITY	%	28.52	25.92	25.62	25.90	26.69	26.10	25.99
BAROMETER	IN.HG.	29.28	29.28	29.28	29.28	29.28	29.28	29.28
IND. AIR TEMP.	DEG.F	82.08	83.16	85.21	85.19	83.56	83.26	82.95
MAX. CHT	DEG.F	270.70	280.56	447.89	445.70	360.48	308.79	267.58
HC WFT	PPM	37087.67	10686.06	1568.16	1595.96	1986.00	10169.01	37656.73
NOX WET	PPM	5.74	18.75	309.99	695.23	179.25	17.67	4.42
CO WFT	%	8.4170	10.0582	7.1052	6.3940	8.3550	9.5869	7.9286
CO2 WET	%	7.3900	6.9015	8.7735	9.0609	8.0819	6.9408	5.7582
O2 WET	%	3.2914	0.2829	0.0916	0.1197	0.0990	0.3251	3.5939
H2O CORRECTION	- - -	0.87951	0.86216	0.86355	0.85523	0.86091	0.85004	0.86829
HC MASS/MODE	LB/MODE	0.01914	0.10444	0.00413	0.05619	0.05330	0.02588	0.02024
NOX MASS/MODE	LB/MODE	0.00001	0.00058	0.00265	0.07930	0.01559	0.00015	0.00001
CO MASS/MODE	LB/MODE	0.08584	1.94291	0.37026	4.44972	4.43206	0.48223	0.08421
HC MODE/STD.CYCLE	%	6.295	34.355	1.360	18.485	17.534	8.513	6.657
NOX MODE/STD.CYCLE	%	0.004	0.242	1.103	33.043	6.494	0.061	0.003
CO MODE/STD.CYCLE	%	1.277	28.912	5.510	66.216	65.953	7.176	1.253
HC EMISSION PER HP CYCLE =	0.00177 LB/HP CYCLE	PERCENT OF ALLOWABLE HC =			93.20			
NOX EMISSION PER HP CYCLE =	0.00061 LB/HP CYCLE	PERCENT OF ALLOWABLE NOX =			40.95			
CO EMISSION PER HP CYCLE =	0.07405 LB/HP CYCLE	PERCENT OF ALLOWABLE CO =			176.30			

146

TABLE XIV. TEMP-HUMIDITY, 80°F, 30%

CYCLE NO. 1720 CELL-17 DATE 2/20/76

25 BTDC, 80 DEG.F, 30% REL.HUMIDITY

ENGINE - LYCOMING O-320-D1AD

ENGINE TIMING 25.000 DEG. BTDC RATED H.P. 160. H.C. RATIO 2.125

	UNITS	IDLE	TAXI	TAKE OFF	CLIMB	APPROACH	TAXI	IDLE
RUN NUMBER		1720	1729	1723	1724	1725	1726	1730
TIME IN MODE	MIN.	1.00	11.00	0.30	5.00	6.00	3.00	1.00
ENGINE SPEED	RPM	598.14	1198.80	2702.19	2426.28	2350.13	1199.94	507.38
Obs. HORSEPOWER	HP	0.56560	1.63096	150.29028	119.17101	63.03491	0.52290	0.58136
F/A RATIO MEAS.	- - -	0.0931	0.0934	0.0866	0.0842	0.0902	0.0938	0.1001
F/A RATIO CALC.	- - -	0.0976	0.0973	0.0852	0.0833	0.0894	0.0976	0.0967
% DIFF. IN F/A	%	4.859	4.126	-1.560	-0.999	-0.924	4.091	-3.449
AIR FLOW	LBS/HR	53.78	86.92	928.45	747.56	467.97	84.31	51.45
FUEL FLOW	LBS/HR	5.01	8.12	80.38	62.94	42.23	7.91	5.15
VAPOR FLOW	LBS/HR	0.34127	0.54188	6.02710	4.78535	2.92745	0.57405	0.32468
HUMIDITY GR H2O/LB DRY AIR		44.423	43.642	45.441	44.809	43.789	43.511	44.177
DEW POINT	DEG.F	44.580	44.235	45.295	45.010	44.435	44.055	44.195
RELATIVE HUMIDITY	%	26.33	25.64	26.44	26.06	25.47	25.62	26.34
BAROMETER	IN.HG.	29.28	29.28	29.28	29.28	29.28	29.28	29.28
IND. AIR TEMP.	DEG.F	82.57	82.99	83.28	83.39	83.43	82.79	82.10
MAX. CHT	DEG.F	291.82	295.66	433.45	446.43	363.76	321.02	236.92
HC WET	PPM	3796.377	9390.93	1532.35	1561.75	1951.09	9306.93	34896.45
NOX WET	PPM	3.11	15.03	292.59	603.82	172.00	14.91	1.18
CO WET	%	8.1410	9.3761	7.0460	6.3961	8.3351	9.5263	7.9599
CO2 WET	%	5.6444	7.0706	8.7487	9.0484	8.0030	6.9924	6.1517
O2 WET	%	3.5535	0.2160	0.0842	0.1084	0.0897	0.2481	3.0681
H2O CORRECTION	- - -	0.86945	0.84953	0.86092	0.85906	0.86135	0.85008	0.89502
HC MASS/MODE	LB/MODE	0.01988	0.08753	0.00406	0.05503	0.05280	0.02298	0.01791
NOX MASS/MODE	LB/MODE	0.00001	0.00045	0.00251	0.06893	0.01508	0.00012	0.00000
CO MASS/MODE	LB/MODE	0.08427	1.72725	0.36896	4.45475	4.45826	0.46479	0.08117
HC MODE/STD.CYCLE	%	6.540	28.793	1.335	18.104	17.369	7.558	5.893
NOX MODE/STD.CYCLE	%	0.002	0.189	1.046	28.722	6.283	0.050	0.001
CO MODE/STD.CYCLE	%	1.254	25.703	5.491	66.291	66.343	6.917	1.208
HC EMISSION PER HP CYCLE =	0.00163 LB/HP CYCLE				PERCENT OF ALLOWABLE HC =	85.59		
NOX EMISSION PER HP CYCLE =	0.00054 LB/HP CYCLE				PERCENT OF ALLOWABLE NOX =	36.29		
CO EMISSION PER HP CYCLE =	0.07275 LB/HP CYCLE				PERCENT OF ALLOWABLE CO =	173.21		

147

ORIGINAL PAGE IS
OF POOR QUALITY

TABLE XIVc. TEMP-HUMIDITY, 80°F, 30%

CYCLE NO. 1720

CELL-17

DATE 2/20/76

25 BTDC, 80 DEG.F, 30% REL.HUMIDITY

ENGINE - LYCOMING O-320-DIAD

ENGINE TIMING 25.000 DEG. BTDC RATED H.P. 160. H.C. RATIO 2.125

	UNITS	IDLE	TAXI	TAKE OFF	CLIMB	APPROACH	TAXI	IDLE
RUN NUMBER		1720	1732	1733	1734	1735	1736	1730
TIME IN MODE	MIN.	1.00	11.00	0.30	5.00	6.00	3.00	1.00
ENGINE SPEED	RPM	598.14	1201.02	2694.21	2432.22	2349.53	1210.50	607.38
OBS. HORSEPOWER	HP	0.56560	1.21296	150.50031	120.12238	65.81119	1.05446	0.58136
F/A RATIO MEAS.	- - -	0.0931	0.0952	0.0874	0.0849	0.0917	0.0919	0.1001
F/A RATIO CALC.	- - -	0.0976	0.0979	0.0854	0.0835	0.0894	0.0934	0.0967
% DIFF. IN F/A	✓	4.859	2.859	-2.299	-1.627	-2.526	-4.620	-3.449
AIR FLOW	LBS/HP	53.78	89.70	921.70	756.31	463.57	83.72	51.45
FUEL FLOW	LBS/HR	5.01	8.54	80.56	64.20	42.50	8.70	5.15
VAPOR FLOW	LBS/HR	0.34127	0.54794	5.91629	4.76533	2.89328	0.51743	0.32468
HUMIDITY GR H2O/LB DRY AIR		44.423	42.761	44.932	44.105	43.538	43.265	44.177
DEW POINT	DEG.F	44.580	43.520	44.810	44.570	44.020	43.755	44.195
RELATIVE HUMIDITY	%	26.33	25.54	25.80	25.60	25.00	25.24	26.34
BAROMETER	IN.HG.	29.28	29.28	29.27	29.27	29.27	29.27	29.28
IND. AIR TEMP.	DEG.F	82.57	82.23	83.47	83.43	83.51	82.00	82.10
MAX. CHT	DEG.F	291.82	264.92	430.53	447.05	351.48	295.86	236.92
HC WET	PPM	37963.77	9304.92	1566.66	1596.96	2078.61	1956.49	34896.45
NOX WET	PPM	3.11	13.71	268.73	626.20	155.16	11.28	1.18
CO WET	✓	8.1410	9.5036	7.0496	6.4143	8.3028	9.8673	7.9999
CO2 WET	✓	5.6444	6.9532	8.6832	9.0132	7.9977	7.2184	6.1517
O2 WET	✓	3.5535	0.2116	0.0437	0.0957	0.1023	0.2844	3.0681
H2O CORRECTION	- - -	0.86945	0.85556	0.86439	0.86199	0.86701	0.87888	0.89502
HC MASS/MODE	LB/MODE	0.01988	0.09004	0.00413	0.05708	0.05601	0.00487	0.01791
NOX MASS/MODE	LB/MODE	0.00001	0.00043	0.00230	0.07251	0.01354	0.00000	0.00000
CO MASS/MODE	LB/MODE	0.08427	1.81757	0.36756	4.53106	4.42187	0.48499	0.08117
HC MODF/STD.CYCLE	%	6.540	29.618	1.360	18.776	18.425	1.601	5.893
NOX MODF/STD.CYCLE	%	0.002	0.179	0.957	30.211	5.643	0.038	0.001
CO MODF/STD.CYCLE	%	1.254	27.047	5.470	67.426	65.802	7.217	1.208
HC EMISSION PER HP CYCLE =	0.00156 LB/HP CYCLE	PERCENT OF ALLOWABLE HC =				82.21		
NOX EMISSION PER HP CYCLE =	0.00056 LB/HP CYCLE	PERCENT OF ALLOWABLE NOX =				37.03		
CO EMISSION PER HP CYCLE =	0.07368 LB/HP CYCLE	PERCENT OF ALLOWABLE CO =				175.42		

TABLE XIVd. TEMP-HUMIDITY, 80°F, 30%

CYCLE NO. 1900 CELL-17 DATE 2/24/76

25 BTDC, 80 DEG.F, 60% REL.HUMIDITY

ENGINE - LYCOMING O-320-DIAD

ENGINE TIMING 25.000 DEG. BTDC RATED H.P. 160. H.C. RATIO 2.125

	UNITS	IDLE	TAXI	TAKE OFF	CLIMB	APPROACH	TAXI	IDLE
RUN NUMBER		1900	1901	1902	1904	1909	1906	1907
TIME IN MODE	MIN.	1.00	11.00	0.30	5.00	6.00	3.00	1.00
ENGINE SPEED	RPM	600.66	1205.76	2703.75	2435.88	2353.07	1205.04	604.26
OBS. HORSEPOWER	HP	0.33533	1.16796	147.00542	120.36865	64.74423	1.30164	0.58610
F/A RATIO MEAS.	- - -	0.0937	0.0922	0.0880	0.0866	0.0898	0.0941	0.0932
F/A RATIO CALC.	- - -	0.0956	0.0960	0.0837	0.0825	0.0864	0.0956	0.0929
% DIFF. IN F/A	%	2.016	4.138	-4.865	-4.673	-3.732	1.612	-0.393
AIR FLOW	LBS/HR	52.36	93.69	924.19	772.77	474.48	90.26	53.33
FUEL FLOW	LBS/HR	4.91	8.64	81.32	66.91	42.60	8.50	4.97
VAPOR FLOW	LBS/HR	0.65986	1.18120	12.06709	9.98209	6.07329	1.18426	0.70855
HUMIDITY GR H2O/LB DRY AIR		88.216	89.255	91.399	90.422	89.599	91.839	93.017
DEW POINT	DEG.F	63.117	63.177	64.272	63.952	63.612	64.207	64.372
RELATIVE HUMIDITY	%	57.68	57.67	58.81	58.92	57.06	59.69	60.12
BAROMETER	IN.HG.	29.18	29.18	29.18	29.18	29.18	29.18	29.18
IND.AIR TEMP.	DEG.F	79.32	79.39	79.97	79.57	80.19	79.45	79.40
MAX. CHT	DEG.F	335.12	301.58	426.77	439.80	345.92	298.63	259.04
HC WET	PPM	36847.65	11835.18	1579.36	1650.96	1980.80	11553.15	37149.67
NOX WET	PPM	4.64	14.21	235.47	561.88	135.49	13.60	4.25
CO WET	%	8.1550	9.4306	7.1715	6.7546	8.0976	9.4419	7.5681
CO2 WET	%	6.4636	7.7230	9.9103	10.1784	9.2900	7.8610	6.8354
O2 WET	%	3.3658	0.3711	0.0896	0.1086	0.1187	0.3508	3.5559
H2O CORRECTION	- - -	0.85914	0.82951	0.85076	0.84962	0.84858	0.83705	0.86556
HC MASS/MODE	LB/MODE	0.01894	0.11908	0.00421	0.06030	0.05458	0.03077	0.01942
NOX MASS/MODE	LB/MODE	0.00001	0.00046	0.00203	0.06730	0.01210	0.00012	0.00001
CO MASS/MODE	LB/MODE	0.08284	1.87540	0.37801	4.93567	4.41017	0.49695	0.07821
HC MODE/STD.CYCLE	%	6.230	39.172	1.386	19.835	17.955	10.120	6.389
NOX MODE/STD.CYCLE	%	0.003	0.193	0.848	28.040	5.040	0.049	0.003
CO MODE/STD.CYCLE	%	1.233	27.908	5.625	73.447	65.628	7.395	1.164
HC EMISSION PER HP CYCLE =	0.00192 LB/HP CYCLE	PERCENT OF ALLOWABLE HC =		101.09				
NOX EMISSION PER HP CYCLE =	0.00051 LB/HP CYCLE	PERCENT OF ALLOWABLE NOX =		34.18				
CO EMISSION PER HP CYCLE =	0.07661 LB/HP CYCLE	PERCENT OF ALLOWABLE CO =		182.40				

67

ORIGINAL PAGE IS OF POOR QUALITY

TABLE XIVE, TEMP-HUMIDITY, 80°F, 60%

CYCLE NO. 1892 CELL-17 DATE 2/24/76

25 BTDC, 80 DEG.F, 60% REL.HUMIDITY

ENGINE - LYCOMING O-320-DIAD

ENGINE TIMING 25.000 DEG. BTDC RATED H.P. 160. H.C. RATIO 2.125

	UNITS	IDLE	TAXI	TAKE OFF	CLIMB	APPROACH	TAXI	IDLE
RUN NUMBER		1892	1893	1895	1896	1897	1898	1899
TIME IN MODE	MIN.	1.00	11.00	0.30	5.00	6.00	3.00	1.00
ENGINE SPEED	RPM	608.94	1198.14	2702.37	2430.62	2355.05	1210.44	585.48
OBS. HORSEPOWER	HP	0.48933	1.71366	147.28726	119.30269	63.95313	1.83006	0.84246
F/A RATIO MEAS.	- - -	0.0924	0.1008	0.0875	0.0841	0.0894	0.0976	0.0965
F/A RATIO CALC.	- - -	0.0940	0.0971	0.0837	0.0822	0.0862	0.0959	0.0931
% DIFF. IN F/A	%	1.630	-3.633	-4.400	-2.196	-3.554	-1.717	-3.560
AIR FLOW	LBS/HR	55.85	93.96	923.48	763.26	477.55	91.34	51.23
FUEL FLOW	LBS/HR	5.16	9.47	80.84	64.16	42.69	8.92	4.94
VAPOR FLOW	LBS/HR	0.70279	1.18641	12.01739	9.91116	6.08343	1.15312	0.54838
HUMIDITY GR H2O/LB DRY AIR		88.079	88.384	91.092	90.897	89.172	88.371	88.600
DEW POINT	DEG.F	63.132	63.092	64.222	64.055	63.552	63.162	63.102
RELATIVE HUMIDITY	%	57.93	57.18	59.20	59.16	57.80	57.26	57.50
BAROMETER	IN.HG.	29.17	29.17	29.18	29.18	29.18	29.18	29.18
IND.AIR TEMP.	DEG.F	79.21	79.56	79.71	79.56	79.73	79.60	79.40
MAX. CHT	DEG.F	301.11	285.39	434.66	434.12	360.54	298.08	265.00
HC WET	PPM	35275.50	13597.35	1571.56	1630.41	1911.99	11895.18	38039.77
NOX WET	PPM	3.99	11.42	238.02	587.08	152.92	14.27	4.55
CO WET	%	7.8855	9.9028	7.1410	6.5739	7.9986	9.6469	7.7694
CO2 WET	%	6.6276	7.7379	9.8710	10.0926	9.3181	7.9206	6.7363
O2 WET	%	3.3551	0.4994	0.0934	0.1341	0.1060	0.3667	3.7422
H2O CORRECTION	- - -	0.85976	0.85912	0.84939	0.84057	0.84808	0.84986	0.88010
HC MASS/MODE	LB/MODE	0.01925	0.14135	0.00418	0.05899	0.05295	0.03243	0.01932
NOX MASS/MODE	LB/MODE	0.00001	0.00038	0.00205	0.06881	0.01372	0.00013	0.00001
CO MASS/MODE	LB/MODE	0.08505	2.03463	0.37548	4.70064	4.37811	0.51984	0.07797
HC MODE/STD.CYCLE	%	6.333	46.497	1.375	19.403	17.418	10.668	5.354
NOX MODE/STD.CYCLE	%	0.003	0.160	0.855	28.670	5.716	0.053	0.003
CO MODE/STD.CYCLE	%	1.266	30.277	5.588	69.950	65.150	7.736	1.160
HC EMISSION PER HP CYCLE =	0.00205 LB/HP CYCLE	PERCENT OF ALLOWABLE HC =			108.05			
NOX EMISSION PER HP CYCLE =	0.00053 LB/HP CYCLE	PERCENT OF ALLOWABLE NOX =			35.46			
CO EMISSION PER HP CYCLE =	0.07607 LB/HP CYCLE	PERCENT OF ALLOWABLE CO =			181.13			

150

TABLE XIVa. TEMP-HUMIDITY, 80°F, 60%

CYCLE NO. 1522

CELL-17

DATE 2/13/76

75 RTDC, 80 DEG.F, 80% REL. HUMIDITY

ENGINE - LYCOMING O-320-DIAD

ENGINE TIMING 75.000 DEG. RTDC

RATED H.P. 160.

H.C. RATIO 2.125

	UNITS	TOLDF	TAXI	TAKE OFF	CLIMB	APPROACH	TAXI	IDLE
PUN NUMBER		1522	1523	1524	1525	1526	1527	1528
TIME IN MODE	MIN.	1.00	11.00	0.30	5.30	6.00	3.00	1.00
ENGINE SPEED	RPM	614.04	1297.98	2696.55	2428.50	2354.09	1211.82	590.28
PAS. HOP SEP POWER	HP	0.55151	0.98459	148.00591	120.68347	65.43627	1.97399	0.39614
F/A RATIO MEAS.	- - -	0.0975	0.1027	0.0881	0.0856	0.0893	0.1010	0.0961
F/A RATIO CALC.	- - -	0.0960	0.1018	0.0863	0.0846	0.0886	0.1054	0.0950
% DIFF. IN F/A	%	-1.477	-0.948	-2.013	-1.181	-0.770	4.405	-1.135
AIR FLOW	LBS/HR	58.12	101.15	919.22	776.11	477.62	107.93	57.33
FUEL FLOW	LBS/HP	5.66	10.39	80.99	66.46	42.65	10.90	5.51
VAPOR FLOW	LBS/HR	1.08089	1.97320	18.03650	14.89845	9.05968	2.04443	1.08208
HUMIDITY GR H2O/LR DRY AIR		130.177	129.632	137.351	134.374	132.779	132.594	132.126
DEW POINT	DEG.F	74.453	74.298	76.098	75.758	75.308	75.123	74.908
RELATIVE HUMIDITY	%	78.16	75.78	73.79	73.62	72.24	76.67	90.84
PARTICULATE	TM.HG.	29.38	29.38	29.39	29.39	29.39	29.39	29.39
IND. AIR TEMP.	DEG.F	81.93	82.72	85.42	85.14	85.26	83.22	81.35
MAY. GHT	DEG.F	242.14	256.55	407.65	441.33	358.68	230.15	239.62
HC WET	PPM	35484.51	14613.45	1658.16	1628.56	1870.79	18084.80	39477.92
NOX WET	PPM	5.03	11.60	240.98	628.12	157.62	8.05	4.19
CO WET	%	8.0796	10.2573	7.3285	6.7695	8.0442	10.3314	7.7678
CO2 WET	%	5.9081	6.4868	8.3285	8.5978	7.9387	6.0909	5.5959
O2 WET	%	3.4258	0.5894	0.1429	0.1596	0.1559	0.5864	4.1040
H2O CORRECTION	- - -	0.87286	0.85563	0.84764	0.84438	0.84481	0.84048	0.87638
HC MASS/MODE	LB/MODE	0.02062	0.16549	0.00443	0.06060	0.05209	0.05927	0.02253
NOX MASS/MODE	LB/MODE	0.00001	0.00043	0.00208	0.07572	0.01422	0.00010	0.00001
CO MASS/MODE	LB/MODE	0.09279	2.29580	0.39667	4.97886	4.42707	0.66923	0.08762
HC MODE/STD. CYCLE	%	6.783	54.438	1.456	19.935	17.136	19.497	7.411
NOX MODE/STD. CYCLE	%	0.004	0.177	0.868	31.551	5.924	0.040	0.003
CO MODE/STD. CYCLE	%	1.381	34.164	5.754	74.090	65.879	9.959	1.304
HC EMISSION PER HP CYCLE =	0.00241 LB/HP CYCLE					PERCENT OF ALLOWABLE HC =	126.66	
NOX EMISSION PER HP CYCLE =	0.00058 LB/HP CYCLE					PERCENT OF ALLOWABLE NOX =	38.57	
CO EMISSION PER HP CYCLE =	0.08086 LB/HP CYCLE					PERCENT OF ALLOWABLE CO =	192.53	

TABLE XIVg. TEMP-HUMIDITY, 80°F, 80%

CYCLE NO. 152^a

CELL-17

DATE 2/13/76

25 BTDC, 80 DEG.F, 80% REL. HUMIDITY

ENGINE - LYCOMING O-320-DIAD

ENGINE TIMING 25.000 DEG. BTDC RATED H.P. 160. H.C. RATIO 2.125

	UNITS	IDLE	TAXI	TAKE OFF	CLIMB	APPROACH	TAXI	IDLE
RUN NUMBER		1529	1530	1531	1532	1533	1534	1535
TIME IN MODE	MIN.	1.00	11.00	0.30	5.00	6.00	3.00	1.00
ENGINE SPEED	RPM	586.50	1205.64	2702.73	2432.16	2352.71	1203.24	590.04
OPS. HORSEPOWER	HP	0.54310	1.66837	148.19733	119.40103	65.22093	1.44074	0.59887
F/A RATIO MEAS.	- - -	0.0949	0.1056	0.0879	0.0853	0.0890	0.0999	0.0921
F/A RATIO CALC.	- - -	0.0954	0.1038	0.0863	0.0849	0.0884	0.1024	0.0955
% DIFF. IN F/A	%	0.606	-1.741	-1.815	-0.436	-0.702	2.529	3.645
AIR FLOW	LBS/HR	60.19	104.75	926.24	777.36	474.76	97.07	57.37
FUEL FLOW	LBS/HR	5.71	11.06	81.38	66.30	42.25	9.69	5.29
VAPOR FLOW	LBS/HR	1.14460	1.99464	18.25377	15.12891	9.05596	1.85246	1.09022
HUMIDITY GR H2O/LB DRY AIR		133.119	133.299	137.952	136.234	133.524	133.580	133.019
DEW POINT	DEG.F	75.098	75.163	76.349	76.153	75.368	75.418	75.133
RELATIVE HUMIDITY	%	80.73	78.41	73.87	74.22	72.33	77.52	81.13
BAROMETER	IN.HG.	29.40	29.40	29.40	29.40	29.41	29.41	29.41
IND. AIR TEMP.	DEG.F	81.59	82.57	85.65	85.30	85.29	83.18	81.48
MAX. CHT	DEG.F	237.58	250.90	398.37	438.42	353.35	283.95	259.35
HC WET	PPM	36828.65	15815.57	1609.96	1617.56	1813.18	14941.48	38698.84
NOX WET	PPM	4.75	9.85	253.15	637.56	171.80	11.85	4.97
CO WET	%	7.7785	10.5864	7.2060	6.7504	7.9034	10.1692	7.6586
O2 WET	%	5.8133	6.3700	8.3581	8.5390	8.0015	6.3672	5.5380
O2 WET	%	3.6251	0.5367	0.0851	0.1071	0.1119	0.5634	3.9227
H2O CORRECTION	- - -	0.86659	0.95844	0.84709	0.84249	0.84436	0.84364	0.85902
HC MASS/MODE	LB/MODE	0.02197	0.18731	0.00433	0.06023	0.05014	0.04388	0.02180
NOX MASS/MODE	LB/MODE	0.00001	0.00038	0.00220	0.07690	0.01539	0.00011	0.00001
CO MASS/MODE	LB/MODE	0.09171	2.47808	0.38279	4.96756	4.31923	0.59028	0.08525
HC MODE/STD.CYCLE	%	7.227	61.617	1.423	19.812	16.492	14.435	7.170
NOX MODE/STD.CYCLE	%	0.004	0.157	0.918	32.043	6.412	0.047	0.004
CO MODE/STD.CYCLE	%	1.365	36.876	5.696	73.922	64.274	8.784	1.269
HC EMISSION PFR HP CYCLE =	0.00244 LB/HP CYCLE	PERCENT OF ALLOWABLE HC =			128.18			
NOX EMISSION PFR HP CYCLE =	0.00059 LR/HP CYCLE	PERCENT OF ALLOWABLE NOX =			39.59			
CO EMISSION PFR HP CYCLE =	0.08072 LR/HP CYCLE	PERCENT OF ALLOWABLE CO =			192.19			

TABLE XIVh. TEMP-HUMIDITY, 80°F, 80%

CYCLE NO. 2129 CELL-17 DATE 3/ 1/76

25 BTDC 90 DEG RFL HUM = 0 %

ENGINE - LYCOMING O-320-D1AN

ENGINE TIMING 25.000 DEG. BTDC PATED H.P. 160. H.C. RATIO 2.125

	UNITS	IDLE	TAXI	TAKE OFF	CLIMB	APPROACH	TAXI	IDLE
RUN NUMBER		2129	2130	2131	2132	2133	2134	2135
TIME IN MODE	MIN.	1.00	11.00	0.30	5.00	6.00	3.00	1.00
ENGINE SPEED	PPM	600.90	1203.36	2700.42	2431.08	2345.81	1206.54	592.86
CRS. HCPSEPOWER	HP	0.36780	1.85085	144.45166	119.94756	64.76999	0.79970	0.44805
F/A RATIO MEAS.	- - -	0.0931	0.0937	0.0884	0.0847	0.0910	0.0945	0.1000
F/A RATIO CALC.	- - -	0.0974	0.0977	0.0853	0.0839	0.0891	0.0986	0.0952
% DIFF. IN F/A	%	4.692	4.760	-3.507	-1.040	-2.158	4.365	-4.759
AIR FLOW	LPS/HR	52.04	85.91	916.14	766.07	465.99	84.37	49.06
FUEL FLOW	LBS/HP	4.84	8.01	80.99	64.91	42.42	7.97	4.91
VAPOR FLOW	LBS/HR	0.01645	0.02701	0.29332	0.23499	0.13918	0.02451	0.01341
HUMIDITY GR H2O/LB DRY AIR		2.213	2.201	2.241	2.147	2.091	2.033	1.914
DEW POINT	DEG.F	-12.485	-12.510	-12.228	-12.870	-13.330	-13.765	-14.831
RELATIVE HUMIDITY	%	1.10	1.09	1.01	0.97	0.97	0.97	0.94
BAROMETER	IN.HG.	29.17	29.17	29.17	29.17	29.17	29.18	29.18
IND.AIR TEMP.	DEG.F	88.02	88.26	91.34	91.20	90.48	89.51	88.42
MAX. CHT	DEG.F	301.68	287.65	444.43	454.42	367.34	316.19	250.61
HC WET	PPM	35660.54	9496.94	1636.79	1691.47	2141.71	9258.92	35958.57
NOX WET	PPM	8.14	23.21	277.68	798.60	180.32	16.82	1.73
CO WET	%	8.1981	9.4655	7.5383	6.7659	8.5290	9.8155	8.2120
O2 WET	%	5.8880	6.9448	9.3274	9.2567	8.3802	6.7640	6.1462
O2 WET	%	3.2306	0.2594	0.0836	0.1072	0.0998	0.2936	3.5498
H2O CORRECTION	- - -	0.87556	0.85721	0.86905	0.86410	0.86953	0.85966	0.90810
HC MASS/MODE	LB/MODE	0.01797	0.08696	0.00428	0.06086	0.05756	0.02281	0.01750
NOX MASS/MODE	LB/MODE	0.00001	0.00069	0.00235	0.09309	0.01570	0.00013	0.00000
CO MASS/MODE	LB/MODE	0.08165	1.71307	0.38991	4.81172	4.53064	0.47786	0.07899
HC MODE/STD.CYCLE	%	5.911	28.605	1.409	20.021	18.935	7.502	5.756
NOX MODE/STD.CYCLE	%	0.006	0.287	0.981	38.788	6.542	0.056	0.001
CO MODE/STD.CYCLE	%	1.215	25.491	5.802	71.603	67.420	7.111	1.175
HC EMISSION PER HP CYCLE =	0.00167 LB/HP CYCLE	PERCENT OF ALLOWABLE HC =			88.14			
NOX EMISSION PER HP CYCLE =	0.00070 LB/HP CYCLE	PERCENT OF ALLOWABLE NOX =			46.66			
CO EMISSION PER HP CYCLE =	0.07552 LB/HP CYCLE	PERCENT OF ALLOWABLE CO =			179.82			

153

ORIGINAL PAGE IS OF POOR QUALITY

TABLE XV a. TEMP-HUMIDITY, 90°F, 0%

CYCLE NO. 2137

CELL-17

DATE 3/ 1/76

25 BTDC 90 DEG REL HUM = 0 %

ENGINE - LYCOMING O-320-D1AD

ENGINE TIMING	25.000 DEG. BTDC	RATED H.P. 160.			H.C. RATIO 2.125			
	UNITS	IDLE	TAXI	TAKE OFF	CLIMB	APPROACH	TAXI	IDLE
RUN NUMBER		2137	2138	2139	2140	2141	2142	2143
TIME IN MODE	MIN.	1.00	11.00	0.30	5.00	6.00	3.00	1.00
ENGINE SPEED	RPM	610.50	1203.49	2704.59	2434.08	2348.03	1211.10	610.74
CRS. HORSEPOWER	HP	0.88785	0.98849	146.25673	120.41023	65.23134	1.87835	0.39147
F/A RATIO MEAS.	- - -	0.0938	0.0961	0.0882	0.0853	0.0918	0.0969	0.0930
F/A RATIO CALC.	- - -	0.0957	0.0972	0.0860	0.0842	0.0896	0.0973	0.0965
% DIFF. IN F/A	%	2.080	1.240	-2.477	-1.326	-2.410	0.453	3.752
AIR FLOW	LRS/HR	54.33	87.58	912.75	770.18	467.17	83.11	52.80
FUEL FLOW	LRS/HR	5.09	8.41	80.52	65.69	42.87	8.05	4.91
VAPOR FLOW	LRS/HR	0.01426	0.02315	0.25896	0.21233	0.12316	0.02203	0.01405
HUMIDITY GR H2O/LB DRY AIR		1.838	1.850	1.786	1.930	1.845	1.855	1.863
DEW POINT	DEG.F	-15.461	-15.327	-14.165	-14.546	-15.266	-15.211	-15.171
RELATIVE HUMIDITY	%	0.92	0.91	0.91	0.90	0.85	0.90	0.91
BAROMETER	IN.HG.	29.18	29.18	29.18	29.19	29.19	29.19	29.18
IND. AIR TEMP.	DEG.F	87.77	98.39	90.85	90.45	90.45	89.07	88.79
MAX. CHT	DEG.F	255.91	266.45	449.14	452.19	365.30	310.52	275.24
HC WET	PPM	34613.44	8837.13	1621.46	1627.56	2027.00	8882.88	35647.54
NOX WET	PPM	4.80	19.68	284.43	738.99	184.54	19.53	4.88
CO WET	%	8.0503	9.7211	7.4119	6.8108	8.5387	9.7674	8.0947
CO2 WET	%	6.0797	7.0993	8.6945	9.0202	8.0389	7.1384	6.1030
O2 WET	%	3.2843	0.2747	0.0963	0.1300	0.1356	0.2560	3.2429
H2O CORRECTION	- - -	0.88338	0.96704	0.87234	0.86761	0.87441	0.86928	0.87658
HC MASS/MODE	LB/MODE	0.01825	0.08331	0.00422	0.05900	0.05476	0.02174	0.01822
NOX MASS/MODE	LB/MODE	0.00001	0.00060	0.00240	0.08679	0.01615	0.00015	0.00001
CO MASS/MODE	LR/MODE	0.08391	1.81122	0.38170	4.87971	4.55943	0.47238	0.08178
HC MODE/STD. CYCLE	%	6.005	27.404	1.390	19.408	18.014	7.150	5.994
NOX MODE/STD. CYCLE	%	0.003	0.250	1.000	36.161	6.730	0.065	0.003
CO MODE/STD. CYCLE	%	1.249	26.953	5.680	72.615	67.849	7.029	1.217
HC EMISSION PER HP CYCLE =	0.00162 LB/HP CYCLE	PERCENT OF ALLOWABLE HC =			85.37			
NOX EMISSION PER HP CYCLE =	0.00066 LB/HP CYCLE	PERCENT OF ALLOWABLE NOX =			44.21			
CO EMISSION PER HP CYCLE =	0.07669 LB/HP CYCLE	PERCENT OF ALLOWABLE CO =			182.59			

154

TABLE XV b. TEMP-HUMIDITY, 90°F, 0%

CYCLE NO. 2144

CFL1-17

DATE 3/ 1/76

25 BTDC 90 DEG RPL HUM = 0 %

ENGINE - LYCOMING O-320-D1AD

ENGINE TIMING	25.000 DEG. BTDC	RATED H.P. 160.			H.C. RATIO 2.125			
	UNITS	IDLE	TAXI	TAKE OFF	CLIMB	APPROACH	TAXI	IDLE
RUN NUMBER		2144	2145	2146	2147	2148	2149	2151
TIME IN MODE	MIN.	1.00	11.00	0.30	5.00	6.00	3.00	1.00
ENGINE SPEED	RPM	606.06	1206.64	2693.85	2422.62	2346.65	1198.08	619.80
DEVS. HORSEPOWER	HP	0.68531	0.91926	146.35709	119.67929	65.49466	1.98170	0.26910
F/A RATIO MEAS.	- - -	0.0970	0.0951	0.0885	0.0843	0.0915	0.0956	0.0968
F/A RATIO CALC.	- - -	0.0981	0.0973	0.0860	0.0838	0.0911	0.0973	0.0966
% DIFF. IN F/A	%	1.163	2.388	-2.805	-0.506	-0.490	1.843	-0.225
AIR FLOW	LBS/HR	51.69	84.50	911.90	758.19	465.20	83.69	52.42
FUEL FLOW	LRS/HP	5.01	8.03	80.73	63.88	42.58	8.00	5.07
VAPOR FLOW	LRS/HR	0.01367	0.02237	0.25995	0.20661	0.11875	0.02133	0.01351
HUMIDITY GR H2O/LB DRY AIR		1.851	1.854	1.995	1.908	1.787	1.784	1.805
DEW POINT	DEG.F	-15.306	-15.266	-14.070	-14.716	-15.766	-15.821	-15.786
RELATIVE HUMIDITY	%	0.90	0.90	0.92	0.89	0.84	0.86	0.88
BAROMETER	IN.HG.	29.18	29.18	29.17	29.17	29.17	29.17	29.16
IND. AIR TEMP.	DEG.F	88.63	88.92	90.60	90.26	89.97	88.98	88.40
MAX. CHT	DEG.F	320.79	296.35	442.31	443.06	359.30	304.71	294.36
HC WET	PPM	35744.55	8682.11	1561.05	1563.15	1988.90	9525.95	33788.35
NOX WET	PPM	4.20	19.79	268.87	685.27	159.74	18.04	4.78
CO WET	%	8.7141	9.6843	7.4527	6.6393	8.6240	9.6851	8.3895
CO2 WET	%	5.9484	7.0556	8.7424	8.9725	7.4443	7.1221	5.8398
O2 WET	%	3.2519	0.2519	0.0874	0.1371	0.1344	0.3032	3.2948
H2O CORRECTION	- - -	0.88588	0.86350	0.87289	0.86578	0.87380	0.86464	0.89379
HC MASS/MODE	LB/MODE	0.01814	0.07870	0.00407	0.05557	0.05346	0.02337	0.01738
NOX MASS/MODE	LB/MODE	0.00001	0.00058	0.00227	0.07892	0.01391	0.00014	0.00001
CO MASS/MODE	LB/MODE	0.08740	1.73494	0.38387	4.66466	4.58145	0.46951	0.08528
HC MODE/STD.CYCLE	%	5.967	25.887	1.338	18.279	17.585	7.686	5.715
NOX MODE/STD.CYCLE	%	0.003	0.742	0.946	32.882	5.796	0.060	0.003
CO MODE/STD.CYCLE	%	1.301	25.818	5.712	69.415	68.176	6.987	1.269
HC EMISSION PER HP CYCLE =	0.00157 LB/HP CYCLE	PERCENT OF ALLOWABLE HC =			82.46			
NOX EMISSION PER HP CYCLE =	0.00060 LB/HP CYCLE	PERCENT OF ALLOWABLE NOX =			39.93			
CO EMISSION PER HP CYCLE =	0.07504 LB/HP CYCLE	PERCENT OF ALLOWABLE CO =			178.68			

TABLE XVc. TEMP-HUMIDITY, 90°F, 0%

CYCLE NO. 2152

CELL-17

DATE 3/ 1/76

25 BTDC 90 DEG REL HUM = 30 %

ENGINE - LYCOMING O-320-DIAD

ENGINE TIMING		25.000 DEG. BTDC			RATED H.P. 160.			H.C. RATIO 2.125	
	UNITS	IDLE	TAXI	TAKE OFF	CLIMB	APPROACH	TAXI	IDLE	
RUN NUMBER		2152	2153	2169	2155	2156	2157	2158	
TIME IN MODE	MIN.	1.00	11.00	0.30	5.00	6.00	3.00	1.00	
ENGINE SPEED	RPM	613.92	1201.74	2708.91	2436.47	2354.45	1206.78	615.72	
CRS. HORSEPOWER	HP	0.72065	1.23997	143.86111	121.12134	66.55074	1.78244	0.30277	
F/A RATIO MEAS.	- - -	0.0951	0.0996	0.0898	0.0862	0.0906	0.0950	0.0959	
F/A RATIO CALC.	- - -	0.0973	0.0979	0.0861	0.0863	0.0898	0.0979	0.0924	
% DIFF. IN F/A	?	2.328	-1.728	-4.118	0.039	-0.962	3.053	-3.649	
AIR FLOW	LBS/HR	53.95	90.21	908.56	794.76	475.92	89.89	53.43	
FUEL FLOW	LBS/HR	5.13	8.99	81.57	68.53	43.13	8.54	5.12	
VAPOR FLOW	LBS/HR	0.49178	0.82126	8.97048	7.66588	4.49672	0.85224	0.50647	
HUMIDITY GR H2O/LB DRY AIR		63.812	63.727	69.113	67.519	66.139	66.366	66.351	
DEW POINT	DEG.F	53.381	53.616	56.176	55.566	55.006	54.821	54.881	
RELATIVE HUMIDITY	?	30.46	30.15	31.23	30.56	30.51	31.50	32.09	
BAROMETER	IN.HG.	29.14	29.14	29.13	29.13	29.14	29.14	29.13	
IND. AIR TEMP.	DEG.F	88.30	98.90	90.75	90.74	90.13	88.91	88.39	
MAX. CHT	DEG.F	323.35	297.49	417.76	441.79	365.42	292.05	261.50	
HC WET	PPM	35517.52	11350.13	1654.56	1794.93	1972.60	10237.02	31373.11	
NOX WET	PPM	5.25	14.28	211.93	580.41	153.14	16.00	5.41	
CO WET	?	8.3776	9.8927	7.4896	7.2673	8.2653	9.5767	7.9240	
CO2 WET	%	6.0232	7.2491	8.7150	8.2882	7.7212	7.0294	7.1467	
O2 WET	%	3.2197	0.3801	0.1168	0.1619	0.1214	0.2950	3.0054	
H2O CORRECTION	- - -	0.86871	0.86296	0.86435	0.85490	0.86083	0.84839	0.87952	
HC MASS/MODE	LB/MODE	0.01884	0.11249	0.00435	0.06796	0.05452	0.02714	0.01653	
NOX MASS/MODE	LB/MODE	0.00001	0.00046	0.00181	0.07119	0.01371	0.00014	0.00001	
CO MASS/MODE	LB/MODE	0.08782	1.93773	0.38951	5.43810	4.51527	0.50176	0.08253	
HC MODE/STD.CYCLE	%	6.197	37.002	1.432	22.355	17.935	8.927	5.439	
NOX MODE/STD.CYCLE	?	0.004	0.191	0.753	29.662	5.713	0.057	0.004	
CO MODE/STD.CYCLE	%	1.307	29.935	5.796	80.924	67.191	7.467	1.228	
HC EMISSION PER HP CYCLE =	0.00189 LB/HP CYCLE	PERCENT OF ALLOWABLE HC =				99.29			
NOX EMISSION PER HP CYCLE =	0.00055 LB/HP CYCLE	PERCENT OF ALLOWABLE NOX =				36.38			
CO EMISSION PER HP CYCLE =	0.08095 LB/HP CYCLE	PERCENT OF ALLOWABLE CO =				192.75			

156

TABLE XVd. TEMP-HUMIDITY, 90°F, 30%

CYCLE NO. 2166		CELL-17		DATE 3/ 1/76					
25 BTDC 90 DEG REL HUM = 30 %				ENGINE - LYCOMING O-320-D1AD					
ENGINE TIMING		25.000 DEG. BTDC		RATED H.P. 160.		H.C. RATIO 2.125			
UNITS		IDLE	TAXI	TAKE OFF	CLIMB	APPROACH	TAXI	IDLE	
PUN NUMBER		2166	2160	2161	2162	2163	2164	2165	
TIME IN MODE	MIN.	1.00	11.00	0.30	5.00	6.00	3.00	1.00	
ENGINE SPEED	RPV	625.20	1203.36	2691.21	2431.50	2359.65	1210.32	608.58	
CRS. HORSEPOWER	HP	0.77721	1.18081	142.66629	110.09018	66.76169	1.03743	0.65360	
F/A RATIO MEAS.	- - -	0.0948	0.0997	0.0886	0.0856	0.0914	0.0947	0.0975	
F/A RATIO CALC.	- - -	0.0976	0.0986	0.0866	0.0857	0.0887	0.0978	0.0941	
% DIFF. IN F/A	- - -	2.932	-1.148	-2.329	0.196	-2.921	3.214	-3.529	
AIR FLOW	LBS/HR	54.34	89.49	701.82	788.76	478.74	91.53	52.83	
FUEL FLOW	LBS/HR	5.15	8.92	79.93	67.49	43.71	8.67	5.15	
VAPOR FLOW	LBS/HR	0.51843	0.84988	8.81250	7.61434	4.55633	0.86803	0.50430	
HUMIDITY GR H2O/LB DRY AIR		66.785	65.475	68.403	67.575	66.691	66.387	66.816	
DEW POINT	DEG.F	55.121	54.946	55.866	55.656	55.236	55.026	55.026	
RELATIVE HUMIDITY	%	32.13	31.82	30.95	30.93	30.68	31.47	32.09	
BAROMETER	IN.HG.	29.13	29.13	29.13	29.13	29.13	29.13	29.12	
IND. AIR TEMP.	DEG.F	88.62	88.74	90.68	90.45	90.23	89.17	88.55	
MAX. CHT	DEG.F	333.77	288.86	438.00	443.71	359.91	298.45	264.37	
HC WET	PPM	34942.46	10779.07	1636.16	1684.77	1898.69	10826.07	36180.59	
NOX WET	PPM	3.50	14.83	207.40	578.00	151.00	14.15	4.37	
CO WET	%	8.3846	9.8005	7.5632	7.1859	8.2134	9.5348	7.8420	
CO2 WET	%	5.7760	6.9892	8.6015	8.5959	8.1654	7.0576	6.1916	
O2 WET	%	3.2602	0.3209	0.0820	0.1096	0.1074	0.3397	3.6459	
H2O CORRECTION	- - -	0.86943	0.86402	0.85827	0.85081	0.86305	0.84749	0.89102	
HC MASS/MODE	LB/MODE	0.01866	0.10604	0.00426	0.06315	0.05288	0.02920	0.01896	
NOX MASS/MODE	LR/MODE	0.00001	0.00047	0.00175	0.07019	0.01362	0.00012	0.00001	
CO MASS/MODE	LB/MODE	0.08848	1.90551	0.38876	5.32344	4.52146	0.50826	0.08122	
HC MODE/STD.CYCLE	%	6.137	34.881	1.400	20.773	17.396	9.605	6.237	
NOX MODE/STD.CYCLE	%	0.003	0.197	0.778	29.244	5.677	0.052	0.003	
CO MODE/STD.CYCLE	%	1.317	28.356	5.785	79.218	67.284	7.563	1.209	
HC EMISSION PER HR CYCLE =	0.00183 LB/HP CYCLE		PERCENT OF ALLOWABLE HC =			96.43			
NOX EMISSION PER HP CYCLE =	0.00054 LB/HP CYCLE		PERCENT OF ALLOWABLE NOX =			35.90			
CO EMISSION PER HP CYCLE =	0.08011 LB/HP CYCLE		PERCENT OF ALLOWABLE CO =			190.73			

157

ORIGINAL PAGE IS
OF POOR QUALITY

TABLE XVe. TEMP-HUMIDITY, 90°F, 30%

CYCLE NO. 2175

CELL-17

DATE 3/ 1/76

25 PTDC 90 DEG RFL HUM = 30 %

ENGINE - LYCOMING O-320-DIAD

ENGINE TIMING

25.000 DEG. BTDC

RATED H.P. 160.

H.C. RATIO 2.125

	UNITS	IDLE	TAXI	TAKE OFF	CLIMB	APPROACH	TAXI	IDLE
RUN NUMBER		2175	2168	2170	2171	2172	2173	2174
TIME IN MODE	MIN.	1.00	11.00	0.30	5.00	6.00	3.00	1.00
ENGINE SPEED	RPM	585.88	1198.38	2704.39	2426.34	2353.43	1209.96	500.48
CRS. H.P. SEPOWER	HP	0.29450	1.37437	143.45305	119.75954	65.21518	1.46875	0.62279
F/A RATIO MEAS.	- - -	0.0915	0.0950	0.0882	0.0848	0.0903	0.0966	0.0962
F/A RATIO CALC.	- - -	0.0930	0.0978	0.0858	0.0839	0.0881	0.0961	0.0941
% DIFF. IN F/A	%	1.689	2.943	-2.754	-1.074	-2.366	-0.433	-2.169
AIR FLOW	LBS/HR	54.21	89.44	914.07	776.84	473.15	89.02	51.66
FUEL FLOW	LBS/HR	4.96	8.49	80.60	65.85	42.71	8.60	4.97
VAPOR FLOW	LBS/HR	0.51686	0.85222	8.92370	7.55917	4.54938	0.85329	0.49768
HUMIDITY GR H2O/LB DRY AIR		66.739	66.696	68.338	68.115	67.305	67.097	67.430
DEW POINT	DEG.F	55.223	55.116	56.104	55.861	55.454	55.246	55.291
RELATIVE HUMIDITY	%	32.44	32.02	31.49	30.87	30.93	31.44	32.53
BAROMETER	IN.HG.	29.14	29.13	29.14	29.16	29.16	29.15	29.14
IND. AIR TEMP.	DEG.F	88.44	89.73	90.30	90.75	90.23	89.46	89.43
MAX. CHT	DEG.F	268.98	295.81	423.70	442.95	357.59	300.77	273.58
HC WFT	PPM	36303.61	10805.07	1608.53	1697.17	2012.82	10663.06	35801.55
NOX WET	PPM	3.37	14.25	211.76	585.76	139.06	14.04	3.61
CO WET	%	7.6305	9.4686	7.4668	6.9862	8.2074	9.6049	7.8276
CO2 WET	%	6.8775	6.9724	8.8651	9.4902	8.4665	7.6144	6.6090
O2 WET	%	3.4434	0.3684	0.1180	0.1264	0.1159	0.3499	3.3734
H2O CORRECTION	- - -	0.86190	0.85001	0.85733	0.84579	0.85704	0.85344	0.88025
HC MASS/MODE	LB/MODE	0.01911	0.10451	0.00423	0.06247	0.05525	0.02815	0.01826
NOX MASS/MODE	LB/MODE	0.00001	0.00045	0.00181	0.06985	0.01237	0.00012	0.00001
CO MASS/MODE	LB/MODE	0.07938	1.81006	0.38838	5.08272	4.45249	0.50120	0.07891
HC MODE/STD.CYCLE	%	6.286	34.378	1.392	20.550	18.174	9.261	6.007
NOX MODE/STD.CYCLE	%	0.002	0.186	0.752	29.105	5.152	0.050	0.002
CO MODE/STD.CYCLE	%	1.181	26.935	5.779	75.636	66.257	7.458	1.174
HC EMISSION PER HP CYCLE =	0.00182 LB/HP CYCLE	PERCENT OF ALLOWABLE HC =		96.05				
NOX EMISSION PER HP CYCLE =	0.00053 LB/HP CYCLE	PERCENT OF ALLOWABLE NOX =		35.25				
CO EMISSION PER HP CYCLE =	0.07746 LB/HP CYCLE	PERCENT OF ALLOWABLE CO =		184.42				

158

TABLE XVf. TEMP-HUMIDITY, 90°F, 30%

CYCLE NO. 2249

CELL-17

DATE 3/3/76

25 BTDC 90 DEG REL HUM = 60 %

ENGINE - LYCOMING O-320-DIAD

ENGINE TIMING 25.000 DEG. BTDC

RATED H.P. 160.

H.C. RATIO 2.125

UNITS

IDLE

TAXI

TAKE OFF

CLIMB

APPROACH

TAXI

IDLE

RUN NUMBER

MIN.

2249

2257

2251

2252

2253

2254

2255

TIME IN MODE

1.00

11.00

0.30

5.00

6.00

3.00

1.00

ENGINE SPEED

RPM

606.06

1204.98

2705.07

2432.64

2353.97

1203.00

589.62

OBS. HORSEPOWER

HP

0.05671

1.28610

140.25963

119.13741

65.91774

1.22287

0.60172

F/A RATIO MEAS.

-

0.0998

0.0978

0.0901

0.0898

0.0925

0.1019

0.0941

F/A RATIO CALC.

-

0.0981

0.1024

0.0878

0.0888

0.0885

0.1019

0.0956

% DIFF. IN F/A

%

-1.732

4.654

-2.544

-1.131

-4.252

0.054

1.571

AIR FLOW

LBS/HR

56.44

102.40

897.51

808.19

479.70

94.64

54.31

FUEL FLOW

LBS/HR

5.63

10.02

80.84

72.61

44.36

9.64

5.11

VAPOR FLOW

LBS/HR

1.06501

1.88908

17.30479

15.26302

9.01612

1.74775

1.00617

HUMIDITY GR H2O/LB DRY AIR

132.082

129.142

134.967

132.197

131.569

129.275

129.674

DEW POINT

DEG.F

74.138

73.808

74.983

74.563

74.308

73.683

73.803

RELATIVE HUMIDITY

%

61.33

59.48

59.26

59.23

59.50

58.65

60.05

BAROMETER

IN.HG.

29.07

29.07

29.07

29.06

29.06

29.07

29.07

IND. AIR TEMP.

DEG.F

89.19

89.81

91.19

90.75

90.33

90.12

89.50

MAX. CHT

DEG.F

290.35

292.62

430.75

437.83

349.56

302.95

273.60

HC WET

PPM

36189.57

15553.54

1824.88

1911.69

1962.99

16581.65

37697.75

NOX WET

PPM

4.40

8.62

165.62

264.95

129.47

9.62

3.76

CO WET

%

8.3793

9.9081

7.6827

8.0095

8.0047

9.7465

7.5670

CO2 WET

%

5.6814

6.3169

6.1997

6.3197

6.0986

6.5189

5.8199

O2 WET

%

3.3449

0.5733

0.0580

0.0822

0.0932

0.5760

3.6032

H2O CORRECTION

-

0.87554

0.83853

0.85002

0.84621

0.85717

0.85365

0.86450

HC MASS/MODE

LB/MODE

0.02059

0.17535

0.00479

0.07521

0.05552

0.04777

0.02023

NOX MASS/MODE

LB/MODE

0.00001

0.00031

0.00141

0.03377

0.01186

0.00009

0.00001

CO MASS/MODE

LB/MODE

0.09424

2.20780

0.39849

6.22761

4.47450

0.55497

0.08027

HC MODE/STD. CYCLE

%

6.774

57.682

1.575

24.739

18.263

15.714

6.656

NOX MODE/STD. CYCLE

%

0.003

0.131

0.587

14.069

4.943

0.037

0.003

CO MODE/STD. CYCLE

%

1.402

32.854

5.930

92.673

66.585

8.258

1.195

HC EMISSION PER HP CYCLE = 0.00250 LB/HP CYCLE

PERCENT OF ALLOWABLE HC = 131.40

NOX EMISSION PER HP CYCLE = 0.00030 LB/HP CYCLE

PERCENT OF ALLOWABLE NOX = 19.77

CO EMISSION PER HP CYCLE = 0.08774 LB/HP CYCLE

PERCENT OF ALLOWABLE CO = 208.90

TABLE XVg. TEMP-HUMIDITY, 90°F, 60%

159

CYCLE NO. 2256

CELL-17

DATE 3/ 3/76

25 BTDC 90 DEG REL HUM = 60 %

ENGINE - LYCOMING O-320-D1AD

ENGINE TIMING	25.000 DEG. BTDC	RATED H.P. 160.			H.C. RATIO 2.125			
	UNITS	IDLE	TAXI	TAKE OFF	CLIMB	APPROACH	TAXI	IDLE
RUN NUMBER		2256	2258	2259	2250	2261	2262	2264
TIME IN MODE	MIN.	1.00	11.00	0.30	5.00	6.00	3.00	1.00
ENGINE SPEED	RPM	600.90	1206.84	2701.29	2430.84	2350.55	1705.64	610.32
CBS. HOPSEPOWER	HP	0.62359	0.89639	139.92603	118.92722	64.69829	0.96701	0.50438
F/A RATIO MEAS.	- - -	0.1011	0.1064	0.0901	0.0868	0.0907	0.1007	0.0962
F/A RATIO CALC.	- - -	0.0980	0.1020	0.0875	0.0881	0.0883	0.0999	0.0964
% DIFF. IN F/A	%	-3.051	-4.076	-2.890	1.537	-2.568	-0.796	0.755
AIR FLOW	LBS/HR	53.90	102.15	899.98	805.70	475.37	93.03	56.83
FUEL FLOW	LBS/HR	5.45	10.86	41.07	69.89	43.11	9.37	5.47
VAPOR FLOW	LBS/HR	0.99676	1.87716	17.32379	15.28290	8.91092	1.72948	1.05285
HUMIDITY GR H2O/LB DRY AIR		129.459	128.637	134.744	132.779	131.218	130.138	129.682
DEW POINT	DEG.F	73.798	73.753	75.193	74.783	74.089	73.878	73.793
RELATIVE HUMIDITY	%	60.07	59.05	60.58	59.66	58.46	59.27	59.76
BAROMETER	IN.HG.	29.06	29.06	29.07	29.07	29.07	29.07	29.07
IND. AIR TEMP.	DEG.F	89.49	89.98	90.71	90.76	90.66	90.03	89.64
MAX. CRT	DEG.F	108.19	272.95	418.16	433.41	353.18	314.52	283.91
HC WET	PPM	36332.61	15801.56	1784.98	1887.29	1952.89	15060.50	37374.69
NOX WET	PPM	3.80	8.73	163.24	315.75	128.47	10.67	3.56
CO WET	%	8.3344	10.1679	7.5908	7.7328	7.9095	9.6530	7.8920
CO2 WET	%	5.7749	6.5539	8.2274	7.9973	8.0819	6.6575	5.7014
O2 WET	%	3.3043	0.5919	0.0672	0.1090	0.0996	0.6634	3.5915
H2O CORRECTION	- - -	0.88017	0.86751	0.85158	0.83678	0.85115	0.85501	0.86985
HC MASS/MODE	LB/MODE	0.01982	0.18285	0.00470	0.07319	0.05438	0.04249	0.02111
NOX MASS/MODE	LB/MODE	0.00001	0.00033	0.00139	0.03967	0.01159	0.00010	0.00001
CO MASS/MODE	LB/MODE	0.08986	2.32540	0.39480	5.92729	4.35318	0.53029	0.08823
HC MODE/STD.CYCLE	%	6.520	60.146	1.545	24.077	17.889	13.978	5.943
NOX MODE/STD.CYCLE	%	0.003	0.136	0.580	16.530	4.829	0.041	0.003
CO MODE/STD.CYCLE	%	1.337	34.604	5.875	88.204	64.779	8.010	1.313
HC EMISSION PER HP CYCLE =	0.00249 LB/HP CYCLE	PERCENT OF ALLOWABLE HC =			131.10			
NOX EMISSION PER HP CYCLE =	0.00033 LB/HP CYCLE	PERCENT OF ALLOWABLE NOX =			22.12			
CO EMISSION PER HP CYCLE =	0.08573 LB/HP CYCLE	PERCENT OF ALLOWABLE CO =			204.12			

160

TABLE XVh. TEMP-HUMIDITY, 90°F, 60%

CYCLE NO. 2265

CELL-17

DATE 3/ 3/76

25 BTDC 90 DEG REL HUM = 60 %

ENGINE - LYCOMING O-320-DIAD

ENGINE TIMING	25.000 DEG. BTDC	RATED H.P. 160.			H.C. RATIO 2.125			
	UNITS	IDLE	TAXI	TAKE OFF	CLIMB	APPROACH	TAXI	IDLE
RUN NUMBER		2265	2266	2267	2268	2269	2270	2271
TIME IN MODE	MIN.	1.00	11.00	0.30	5.00	6.00	3.00	1.00
ENGINE SPEED	RPM	600.42	1202.76	2701.83	2436.54	2353.07	1701.38	601.56
OPS. HHPSEPOWER	HP	0.46905	1.17684	139.83336	120.08437	65.65889	0.81384	0.12483
F/A RATIO MEAS.	- - -	0.0941	0.1008	0.0905	0.0877	0.0900	0.0981	0.0950
F/A RATIO CALC.	- - -	0.0942	0.1008	0.0875	0.0886	0.0881	0.0999	0.0952
% DIFF. IN F/A	%	0.135	-0.006	-3.309	0.983	-2.080	1.904	0.166
AIR FLOW	LRS/HR	57.84	100.61	895.98	805.90	483.24	88.80	53.90
FUEL FLOW	LRS/HR	5.44	10.14	81.06	70.68	43.47	8.71	5.12
VAPOR FLOW	LBS/HR	1.08006	1.86377	17.25237	15.35547	8.99837	1.64427	1.00379
HUMIDITY GR H2O/LB DRY AIR		130.721	129.672	134.786	133.376	130.347	129.617	130.373
DEW POINT	DEG.F	74.038	73.968	75.098	74.773	74.318	74.003	74.023
RELATIVE HUMIDITY	%	60.17	59.75	59.98	59.42	58.85	59.21	59.98
BAROMETER	IN.HG.	29.07	29.07	29.07	29.07	29.06	29.07	29.07
IND. AIR TEMP.	DEG.F	89.69	89.84	90.93	90.87	90.70	90.17	89.77
MAX. CHT	DEG.F	285.42	286.62	427.04	440.31	359.06	353.08	282.16
HC WET	PPM	35787.54	16336.63	1769.38	1896.69	1924.99	12160.21	34681.45
NOX WET	PPM	3.71	9.24	160.96	281.18	132.99	11.09	4.04
CO WET	%	7.6970	9.6785	7.6672	7.8855	7.7954	9.6702	7.6950
CO2 WET	%	5.7714	6.5171	8.2197	7.9177	8.0855	6.7099	5.9952
O2 WET	%	3.7510	0.7370	0.1017	0.1082	0.1002	0.3386	3.3111
H2O CORRECTION	- - -	0.86980	0.85393	0.85292	0.83909	0.84993	0.84422	0.86705
HC MASS/MODE	LB/MODE	0.02045	0.18280	0.00464	0.07384	0.05435	0.03245	0.01853
NOX MASS/MODE	LB/MODE	0.00001	0.00034	0.00137	0.03546	0.01216	0.00010	0.00001
CO MASS/MODE	LB/MODE	0.08693	2.14043	0.39757	6.06752	4.34975	0.51004	0.08126
HC MODE/STD.CYCLE	%	6.727	60.131	1.527	24.290	17.877	10.675	6.096
NOX MODE/STD.CYCLE	%	0.003	0.140	0.570	14.776	5.068	0.040	0.003
CO MODE/STD.CYCLE	%	1.294	31.852	5.916	90.290	64.728	7.590	1.209
HC EMISSION PER HP CYCLE =	0.00242 LB/HP CYCLE	PERCENT OF ALLOWABLE HC =			127.32			
NOX EMISSION PER HP CYCLE =	0.00031 LB/HP CYCLE	PERCENT OF ALLOWABLE NOX =			20.60			
CO EMISSION PER HP CYCLE =	0.08521 LB/HP CYCLE	PERCENT OF ALLOWABLE CO =			202.88			

161

ORIGINAL PAGE IS
OF POOR QUALITY

TABLE XVI. TEMP-HUMIDITY, 90°F, 60%

CYCLE NO. 2296

CELL-17

DATE 3/10/76

25 BTDC 90 DEG REL HUM = 80 %

ENGINE - LYCOMING O-320-DIAD

ENGINE TIMING	25.000 DEG. BTDC	RATED H.P. 160.			H.C. RATIO 2.125			
	UNITS	IDLE	TAXI	TAKE OFF	CLIMB	APPROACH	TAXI	IDLE
RUN NUMBER		2296	2297	2298	2299	2300	2301	2303
TIME IN MODE	MIN.	1.00	11.00	0.30	5.00	6.00	3.00	1.00
ENGINE SPEED	RPM	603.36	1208.40	2706.33	2436.00	2354.87	1207.26	608.40
ORS. HORSEPOWER	HP	0.97314	1.20362	134.80760	119.69016	66.09357	1.44521	0.52677
F/A RATIO MEAS.	- - -	0.0982	0.1017	0.0931	0.0896	0.0906	0.1041	0.0980
F/A RATIO CALC.	- - -	0.0993	0.1038	0.0885	0.0904	0.0884	0.1052	0.0979
% DIFF. IN F/A	%	1.160	2.025	-4.858	0.840	-2.444	1.092	-0.104
AIR FLOW	LBS/HR	58.03	112.68	861.58	804.30	487.93	105.64	55.99
FUEL FLOW	LBS/HR	5.70	11.46	80.19	72.08	44.21	10.99	5.49
VAPOR FLOW	LBS/HR	1.50852	2.88486	22.70927	20.56792	11.87652	2.61884	1.37576
HUMIDITY GR H2O/LB DRY AIR		181.984	179.222	184.504	179.006	170.384	173.525	171.994
DEW POINT	DEG.F	83.209	83.094	83.464	82.999	81.714	82.349	82.114
RELATIVE HUMIDITY	%	79.58	78.60	79.61	78.53	74.57	76.62	77.13
BAROMETER	IN.HG.	29.00	29.00	29.02	29.02	29.02	29.02	29.02
IND. AIR TEMP.	DEG.F	90.39	90.67	90.65	90.60	90.93	90.72	90.26
MAX. CHT	DEG.F	323.61	300.55	416.35	413.81	356.94	328.60	321.76
HC WET	PPM	38131.79	18205.80	1833.28	2054.30	1977.50	20370.01	35109.47
NOX WET	PPM	4.44	8.04	110.91	98.17	98.54	7.41	3.89
CO WET	%	8.1501	9.9900	7.9449	8.2898	7.8121	10.1381	8.0796
CO2 WET	%	5.9236	6.1979	8.0220	7.5990	8.0080	6.0690	5.7354
O2 WET	%	3.3346	0.7073	0.0852	0.0709	0.0853	0.8076	3.1294
H2O CORRECTION	- - -	0.85774	0.83988	0.85055	0.83272	0.84436	0.84588	0.86209
HC MASS/MODE	LB/MODE	0.02232	0.23030	0.00470	0.08085	0.05679	0.06636	0.01980
NOX MASS/MODE	LB/MODE	0.00001	0.00033	0.00092	0.01252	0.00917	0.00008	0.00001
CO MASS/MODE	LB/MODE	0.09430	2.49766	0.40239	6.44800	4.43421	0.65278	0.09004
HC MODE/STD. CYCLE	%	7.343	75.757	1.545	26.594	18.681	21.830	6.512
NOX MODE/STD. CYCLE	%	0.004	0.137	0.384	5.215	3.820	0.033	0.003
CO MODE/STD. CYCLE	%	1.403	37.168	5.988	95.952	65.985	9.714	1.340
HC EMISSION PER HP CYCLE =	0.00301 LB/HP CYCLE	PERCENT OF ALLOWABLE HC =				158.26		
NOX EMISSION PER HP CYCLE =	0.00014 LB/HP CYCLE	PERCENT OF ALLOWABLE NOX =				9.60		
CO EMISSION PER HP CYCLE =	0.09137 LB/HP CYCLE	PERCENT OF ALLOWABLE CO =				217.55		

162

TABLE XVj. TEMP-HUMIDITY, 90°F, 80%

CYCLE NO. 2304

CELL-17

DATE 3/10/76

25 BTDC 90 DEG REL HUM = 80 %

ENGINE - LYCOMING O-320-DIAD

ENGINE TIMING	25.000 DEG. BTDC	RATED H.P. 160.			H.C. RATIO 2.125			
	UNITS	IDLE	TAXI	TAKE OFF	CLIMB	APPROACH	TAXI	IDLE
RUN NUMBER		2304	2305	2306	2307	2308	2309	2310
TIME IN MODE	MIN.	1.00	11.00	0.30	5.00	6.00	3.00	1.00
ENGINE SPEED	RPM	600.54	1197.78	2709.45	2427.12	2350.25	1205.64	592.98
OBS. HORSEPOWER	HP	0.04764	1.43478	135.39830	118.90361	64.74728	1.75673	0.80505
F/A RATIO MEAS.	- - -	0.1022	0.1018	0.0912	0.0894	0.0903	0.1075	0.0992
F/A RATIO CALC.	- - -	0.0977	0.1042	0.0890	0.0909	0.0891	0.1064	0.0962
% DIFF. IN F/A	%	-4.370	2.415	-2.447	1.660	-1.404	-1.008	-3.025
AIR FLOW	LBS/HR	53.09	111.55	890.16	810.44	485.05	108.55	54.99
FUEL FLOW	LBS/HR	5.42	11.35	81.19	72.48	43.81	11.67	5.46
VAPOR FLOW	LBS/HR	1.28472	2.64528	21.30072	20.10144	11.64530	2.64700	1.32644
HUMIDITY GR H2O/LB DRY AIR		169.404	165.991	167.504	173.622	168.058	170.696	168.852
DEW POINT	DEG.F	81.619	81.159	81.569	82.474	81.434	81.884	81.324
RELATIVE HUMIDITY	%	76.00	73.14	74.36	76.77	74.16	75.93	74.60
BAROMETER	IN.HG.	29.02	29.02	29.02	29.03	29.03	29.03	29.03
IND. AIR TEMP.	DEG.F	90.22	90.97	90.86	90.79	90.81	90.52	90.51
MAX. CHT	DEG.F	304.23	291.14	410.11	417.36	354.38	343.61	277.34
HC WET	PPM	37985.77	19558.94	1897.59	2113.21	2080.31	21092.10	37912.77
NOX WET	PPM	4.15	7.43	121.84	113.69	96.93	6.23	3.26
CO WET	%	8.0982	9.9394	7.9885	8.4142	7.9784	10.4959	7.8611
CO2 WET	%	5.7797	6.0970	7.9209	7.4771	7.8912	5.9541	5.7426
O2 WET	%	3.4459	0.8117	0.0669	0.0776	0.0801	0.8562	3.6556
H2O CORRECTION	- - -	0.87850	0.84275	0.84523	0.83171	0.84134	0.85477	0.87459
HC MASS/MODE	LB/MODE	0.02059	0.24461	0.00498	0.08369	0.05931	0.07138	0.02108
NOX MASS/MODE	LB/MODE	0.00001	0.00030	0.00104	0.01459	0.00895	0.00007	0.00001
CO MASS/MODE	LB/MODE	0.08675	7.45682	0.41435	6.58573	4.49607	0.70203	0.08637
HC MODE/STD.CYCLE	%	6.773	80.464	1.638	27.528	19.511	23.480	6.933
NOX MODE/STD.CYCLE	%	0.003	0.125	0.432	6.077	3.731	0.028	0.002
CO MODE/STD.CYCLE	%	1.291	36.560	6.166	98.002	66.906	10.447	1.285
HC EMISSION PER HP CYCLE =	0.00316 LB/HP CYCLE	PERCENT OF ALLOWABLE HC =			166.33			
NOX EMISSION PER HP CYCLE =	0.00016 LB/HP CYCLE	PERCENT OF ALLOWABLE NOX =			10.40			
CO EMISSION PER HP CYCLE =	0.09268 LB/HP CYCLE	PERCENT OF ALLOWABLE CO =			220.66			

TABLE XVK. TEMP-HUMIDITY, 90°F, 80%

CYCLE NO. 2312

CELL-17

DATE 3/10/76

25 BTDC 90 DEG REL HUM = 80 %

ENGINE - LYCOMING O-320-DIAD

ENGINE TIMING	25.000 DEG. BTDC	RATED H.P. 160.			H.C. RATIO 2.125			
	UNITS	IDLE	TAXI	TAKE OFF	CLIMB	APPROACH	TAXI	IDLE
RUN NUMBER		2312	2313	2314	2315	2316	2317	2318
TIME IN MODE	MIN.	1.00	11.00	0.30	5.00	6.00	3.00	1.00
ENGINE SPEED	RPM	608.88	1206.42	2713.89	2432.10	2353.01	1201.08	600.78
CRS. HOPSP/POWER	HP	0.46639	1.93642	135.85674	118.11488	65.07709	1.11414	0.49480
F/A RATIO MEAS.	--	0.0983	0.1065	0.0906	0.0903	0.0894	0.1100	0.0957
F/A RATIO CALC.	--	0.0967	0.1044	0.0886	0.0907	0.0886	0.1049	0.0963
% DIFF. IN F/A	%	-1.612	-1.942	-2.120	0.506	-0.968	-4.587	0.686
AIR FLOW	LBS/HR	58.32	110.09	888.95	810.29	486.80	105.48	57.06
FUEL FLOW	LBS/HR	5.73	11.72	80.51	73.14	43.54	11.60	5.46
VAPOR FLOW	LBS/HR	1.38946	2.60427	22.10342	19.98608	11.50149	2.54806	1.36117
HUMIDITY GR H2O/LB DRY AIR		166.762	165.589	174.053	172.658	165.386	169.099	166.995
DEW POINT	DEG.F	81.064	80.894	82.374	82.204	80.959	81.489	81.204
RELATIVE HUMIDITY	%	74.07	73.20	76.98	76.49	73.42	75.78	73.83
BAROMETER	IN.HG.	29.03	29.03	29.04	29.04	29.04	29.04	29.04
IND.AIR TEMP.	DEG.F	90.46	90.66	90.59	90.62	90.64	90.18	90.72
MAX. CHT	DEG.F	288.67	284.59	394.16	413.29	349.09	324.20	300.42
HC WET	PPM	34936.46	19764.96	1919.69	2076.31	2081.01	22252.21	39689.95
NOX WET	PPM	4.46	7.43	117.71	118.30	98.16	6.58	3.37
CO WET	%	8.1110	10.7409	7.9495	8.4886	7.9006	10.3260	7.6939
CO2 WET	%	5.7954	6.2537	7.9669	7.5451	7.9585	6.1384	5.5032
O2 WET	%	3.3190	0.7864	0.1002	0.1100	0.1169	1.0465	3.9084
H2O CORRECTION	--	0.86775	0.85588	0.84212	0.83495	0.83953	0.86681	0.86417
HC MASS/MODE	LB/MODE	0.02052	0.24774	0.00502	0.08245	0.05934	0.07373	0.02261
NOX MASS/MODE	LB/MODE	0.00001	0.00030	0.00100	0.01522	0.00907	0.00007	0.00001
CO MASS/MODE	LB/MODE	0.09417	2.53704	0.41118	6.66191	4.45265	0.67625	0.08661
HC MODE/STD.CYCLE	%	6.751	81.495	1.653	27.120	19.520	24.254	7.436
NOX MODE/STD.CYCLE	%	0.004	0.126	0.416	6.341	3.778	0.029	0.003
CO MODE/STD.CYCLE	%	1.401	37.754	6.119	99.136	66.260	10.063	1.289
HC EMISSION PER HP CYCLE =	0.00320 LB/HP CYCLE	PERCENT OF ALLOWABLE HC =				168.23		
NOX EMISSION PER HP CYCLE =	0.00016 LB/HP CYCLE	PERCENT OF ALLOWABLE NOX =				10.70		
CO EMISSION PER HP CYCLE =	0.09325 LB/HP CYCLE	PERCENT OF ALLOWABLE CO =				222.02		

164

TABLE XVI. TEMP-HUMIDITY, 90°F, 80%

CYCLE NO. 2286

CELL-17

DATE 3/ 3/76

25 BTDC 90 DEG REL HUM = 80 %

ENGINE - LYCOMING O-320-DIAD

ENGINE TIMING	25.000 DEG. BTDC	RATED H.P. 160.			H.C. RATIO		2.125	
	UNITS	IDLE	TAXI	TAKE OFF	CLIMB	APPROACH	TAXI	IDLE
RUN NUMBER		2286	2287	2288	2289	2290	2291	2293
TIME IN MODE	MIN.	1.00	11.00	0.30	5.00	6.00	3.00	1.00
ENGINE SPEED	RPM	600.00	1200.24	2698.05	2434.02	2352.95	1201.86	601.26
OPS. HCPSEPOWER	HP	0.60930	0.81842	136.22235	119.78102	65.02197	1.35844	0.70457
F/A RATIO MEAS.	- - -	0.0988	0.1053	0.0901	0.0898	0.0922	0.1078	0.0984
F/A RATIO CALC.	- - -	0.0964	0.1011	0.0875	0.0895	0.0877	0.1048	0.0965
% DIFF. IN F/A	%	-2.409	-3.987	-2.812	-0.342	-4.923	-2.809	-1.908
AIR FLOW	LBS/HR	55.40	103.43	883.24	808.75	480.59	108.09	55.21
FUEL FLOW	LBS/HR	5.47	10.89	79.54	72.65	44.31	11.66	5.43
VAPOR FLOW	LBS/HR	1.40095	2.61908	22.92877	21.06743	12.36106	2.72481	1.39919
HUMIDITY GR H2O/LB DRY AIR		177.019	177.261	181.718	182.345	180.045	176.463	177.440
DEW POINT	DEG.F	82.864	82.879	83.789	83.979	83.309	82.659	82.949
RELATIVE HUMIDITY	%	80.02	80.00	79.44	80.65	77.44	79.11	79.83
BAROMETER	IN.HG.	29.09	29.09	29.09	29.10	29.11	29.12	29.15
IND. AIR TEMP.	DEG.F	89.86	89.89	91.05	90.76	91.37	90.02	90.03
MAX. CHT	DEG.F	289.47	285.98	408.87	427.64	335.89	300.65	317.69
HC WET	PPM	36867.66	17726.76	1787.98	1905.39	1878.19	23060.27	38150.79
NOX WET	PPM	3.68	7.63	137.22	160.49	104.18	5.80	3.27
CO WET	%	7.8615	9.8326	7.6288	8.2236	7.7334	10.2097	7.9868
CO2 WET	%	5.7852	6.5006	8.1370	7.7380	8.1597	6.0314	5.5858
O2 WET	%	7.4894	0.9822	0.1118	0.1349	0.1270	1.1839	3.7704
H2O CORRECTION	- - -	0.87006	0.85972	0.84285	0.83501	0.85093	0.86029	0.86996
HC MASS/MODE	LB/MODE	0.02064	0.20824	0.00465	0.07549	0.05350	0.07795	0.02125
NOX MASS/MODE	LB/MODE	0.00001	0.00029	0.00115	0.02060	0.00961	0.00006	0.00001
CO MASS/MODE	LB/MODE	0.08697	2.28284	0.39172	6.43956	4.35379	0.68118	0.08793
HC MODE/STD. CYCLE	%	6.788	69.499	1.528	24.833	17.599	25.607	5.990
NOX MODE/STD. CYCLE	%	0.003	0.121	0.481	8.583	4.006	0.026	0.002
CO MODE/STD. CYCLE	%	1.294	33.971	5.829	95.827	64.789	10.137	1.308
HC EMISSION PER HP CYCLE =	0.00289 LB/HP CYCLE	PERCENT OF ALLOWABLE HC =			151.84			
NOX EMISSION PER HP CYCLE =	0.00020 LB/HP CYCLE	PERCENT OF ALLOWABLE NOX =			13.22			
CO EMISSION PER HP CYCLE =	0.08952 LB/HP CYCLE	PERCENT OF ALLOWABLE CO =			213.15			

165

ORIGINAL PAGE IS
OF POOR QUALITY

TABLE XVm. TEMP-HUMIDITY, 90°F, 80%

CYCLE NO. 2279

CELL-17

DATE 3/ 3/76

25 BTDC 90 DEG REL HUM = 80 %

ENGINE - LYCOMING O-320-D1AD

ENGINE TIMING 25.000 DEG. BTDC RATED H.P. 160. H.C. RATIO 2.125

	UNITS	IDLE	TAXI	TAKE OFF	CLIMB	APPROACH	TAXI	IDLE
RUN NUMBER		2279	2280	2281	2282	2283	2284	2285
TIME IN MODE	MIN.	1.00	11.00	0.30	5.00	6.00	3.00	1.00
ENGINE SPEED	RPM	588.66	1204.74	2706.49	2425.86	2349.53	1201.68	611.82
CRS. HCPSEPOWER	HP	0.45087	1.21878	136.80893	118.63515	64.60893	1.31654	0.25494
F/A RATIO MFAS.	- - -	0.0970	0.1074	0.0905	0.0905	0.0888	0.1018	0.0979
F/A RATIO CALC.	- - -	0.0967	0.1028	0.0878	0.0902	0.0883	0.1016	0.0953
% DIFF. IN F/A	%	-0.287	-4.287	-2.945	-0.393	-0.564	-0.197	-2.604
AIR FLOW	LB/HR	55.57	104.63	883.73	808.99	480.40	101.50	56.36
FUEL FLOW	LB/HR	5.39	11.74	79.98	73.23	42.66	10.33	5.51
VAPOR FLOW	LB/HR	1.40378	2.63922	23.15318	21.09412	12.28867	2.56145	1.42012
HUMIDITY GR H2O/LB DRY AIR		176.989	176.572	183.396	182.522	179.060	176.650	176.395
DEW POINT	DEG.F	82.759	82.729	83.963	83.914	83.334	82.884	82.784
RELATIVE HUMIDITY	%	79.95	79.78	80.17	79.57	78.59	78.34	80.17
BAROMETER	IN.HG.	29.08	29.07	29.07	29.08	29.08	29.09	29.10
IND. AIR TEMP.	DEG.F	89.78	89.82	90.93	91.13	90.92	90.56	89.74
MAX. CHT	DEG.F	308.86	294.23	422.21	429.16	356.52	297.26	267.33
HC WET	PPM	38316.80	18283.81	1765.05	1946.59	1940.69	18494.82	35001.47
NOX WET	PPM	3.59	7.46	132.19	124.81	102.93	7.76	3.75
CO WET	%	7.9057	10.1090	7.7578	8.3693	7.7919	9.6086	7.6484
CO2 WET	%	5.5585	6.4075	8.0902	7.6479	7.9523	6.4474	6.0312
O2 WET	%	3.7306	0.7906	0.1185	0.1108	0.1127	0.8265	3.2851
H2O CORRECTION	- - -	0.86442	0.86134	0.84297	0.83570	0.83589	0.84666	0.86867
HC MASS/MODE	LB/MODE	0.02136	0.21875	0.00460	0.07734	0.05458	0.05748	0.01986
NOX MASS/MODE	LB/MODE	0.00001	0.00029	0.00112	0.01606	0.00938	0.00008	0.00001
CO MASS/MODE	LB/MODE	0.08712	2.39045	0.39929	6.57197	4.33130	0.59022	0.08579
HC MODE/STD.CYCLE	%	7.027	71.959	1.512	25.441	17.955	18.908	6.534
NOX MODE/STD.CYCLE	%	0.003	0.121	0.465	6.694	3.908	0.033	0.003
CO MODE/STD.CYCLE	%	1.296	35.572	5.942	97.797	64.454	8.783	1.277
HC EMISSION PER HP CYCLE =	0.00284 LB/HP CYCLE	PERCENT OF ALLOWABLE HC =				149.34		
NOX EMISSION PER HP CYCLE =	0.00017 LB/HP CYCLE	PERCENT OF ALLOWABLE NOX =				11.22		
CO EMISSION PER HP CYCLE =	0.09035 LB/HP CYCLE	PERCENT OF ALLOWABLE CO =				215.12		

166

TABLE XVn. TEMP-HUMIDITY, 90°F, 80%

CYCLE NO. 2111

CELL-17

DATE 2/27/76

25 RTDC, 100 DEG., 0% HUM

ENGINE - LYCOMING O-320-D1AD

ENGINE TIMING

25.000

DEG. BTDC

RATED H.P. 160.

H.C. RATIO

2.125

UNITS

IDLF

TAXI

TAKE OFF

CLIMB

APPROACH

TAXI

IDLE

RUN NUMBER

2111

2112

2113

2114

2115

2119

2120

TIME IN MODE

MIN.

1.00

11.00

0.30

5.00

6.00

3.00

1.00

ENGINE SPEED

RPM

603.18

1203.84

2704.29

2431.74

2349.89

1199.22

600.66

BRS. HCPSEPOWER

HP

0.74911

1.40785

145.38794

118.70442

64.44937

1.51531

0.60038

F/A RATIO MEAS.

0.0993

0.0962

0.0879

0.0860

0.0904

0.0899

0.0971

F/A RATIO CALC.

0.0968

0.0974

0.0880

0.0856

0.0905

0.0925

0.0969

% DIFF. IN F/A

%

-2.501

1.296

0.096

-0.411

0.120

2.902

-0.219

AIR FLOW

LBS/HR

48.21

84.49

905.88

762.97

464.25

77.84

49.51

FUEL FLOW

LBS/HR

4.79

8.13

79.61

65.60

41.97

7.00

4.81

VAPOR FLOW

LBS/HR

0.01316

0.02363

0.30702

0.24817

0.12574

0.02193

0.01356

HUMIDITY GR H2O/LB DRY AIR

1.910

1.958

2.372

2.277

1.896

1.972

1.917

DEW POINT

DEG.F

-14.836

-14.406

-11.295

-11.915

-14.846

-14.346

-14.846

RELATIVE HUMIDITY

%

0.67

0.66

0.76

0.75

0.63

0.66

0.65

BAROMETER

IN.HG.

29.01

29.01

29.01

29.01

29.00

29.00

29.00

IND. AIR TEMP.

DEG.F

99.07

100.55

102.64

101.69

101.36

100.79

100.02

MAX. CHT

DEG.F

298.13

290.32

452.59

460.57

367.98

305.35

268.41

HC WET

PPM

35712.54

8984.89

1707.47

1684.97

2048.70

6060.60

34040.38

NOX WET

PPM

5.87

23.87

282.65

688.13

221.48

34.65

5.60

CO WET

%

8.4542

9.6915

7.8488

7.1598

8.5700

8.5164

8.2505

CO2 WET

%

5.9328

6.9853

8.1288

8.5669

7.6956

7.5473

5.9960

O2 WET

%

3.4241

0.3077

0.1074

0.1336

0.1131

0.2035

3.1084

H2O CORRECTION

0.90100

0.86842

0.86684

0.86736

0.86874

0.86032

0.89228

HC MASS/MODE

LB/MODE

0.01703

0.08176

0.00441

0.06066

0.05473

0.01355

0.01655

NOX MASS/MODE

LB/MODE

0.00001

0.00070

0.00237

0.08026

0.01917

0.00025

0.00001

CO MASS/MODE

LB/MODE

0.07970

1.74295

0.40067

5.09477

4.52520

0.37636

0.07930

HC MODE/STD.CYCLE

%

5.604

26.894

1.451

19.955

18.004

4.458

5.446

NOX MODE/STD.CYCLE

%

0.004

0.293

0.985

33.442

7.987

0.105

0.004

CO MODE/STD.CYCLE

%

1.186

25.937

5.962

75.815

67.339

5.601

1.180

HC EMISSION PER HP CYCLE =

0.00155 LB/HP CYCLE

PERCENT OF ALLOWABLE HC =

81.81

NOX EMISSION PER HP CYCLE =

0.00064 LB/HP CYCLE

PERCENT OF ALLOWABLE NOX =

42.82

CO EMISSION PER HP CYCLE =

0.07687 LB/HP CYCLE

PERCENT OF ALLOWABLE CO =

183.02

TABLE XVI a. TEMP-HUMIDITY, 100°F, 0%

167

CYCLE NO. 2121 CHLL-17 DATE 2/27/76

25 BTDC, 100 DEG., 0%HUP

ENGINE - LYCOMING O-320-D1AD

ENGINE TIMING 25.000 DEG. BTDC RATED H.P. 160. H.C. RATIO 2.125

	UNITS	IDLE	TAXI	TAKE OFF	CLIMB	APPROACH	TAXI	IDLE
RUN NUMBER		.2121	2122	2124	2125	2125	2127	2128
TIME IN MODE	MIN.	1.00	11.00	0.30	5.00	6.00	3.00	1.00
ENGINE SPEED	RPM	592.56	1205.64	2709.03	2434.92	2354.41	1201.98	592.32
CRS. HORSEPOWER	HP	0.44721	0.87419	144.52446	120.44476	65.42136	1.15136	0.53198
F/A RATIO MEAS.	- - -	0.0962	0.0930	0.0883	0.0843	0.0920	0.0960	0.0998
F/A RATIO CALC.	- - -	0.0989	0.0968	0.0884	0.0859	0.0900	0.0971	0.0972
% DIFF. IN F/A	%	2.794	4.083	0.040	1.889	-2.157	1.095	-2.556
AIR FLOW	LBS/HR	48.45	83.95	901.73	760.28	464.87	79.26	46.38
FUEL FLOW	LBS/HR	4.66	7.81	79.67	64.09	42.77	7.61	4.63
VAPOR FLOW	LBS/HR	0.01393	0.02294	0.27869	0.23150	0.12262	0.02292	0.01555
HUMIDITY GR H2O/LB DRY AIR		2.012	1.913	2.163	2.131	1.846	2.024	2.347
DEW POINT	DEG.F	-14.080	-14.851	-12.815	-13.045	-15.341	-13.985	-11.635
RELATIVE HUMIDITY	%	0.70	0.65	0.70	0.72	0.62	0.69	0.82
BAROMETER	IN.HG.	28.99	28.99	28.99	28.99	28.98	28.99	28.99
IND. AIR TEMP.	DEG.F	99.51	100.03	101.97	100.48	100.57	100.13	99.42
MAX. CHT	DEG.F	315.60	296.23	468.21	466.80	372.12	318.49	281.77
HC WET	PPM	35499.51	8355.83	1603.86	1699.67	2167.71	8761.87	36443.61
NOX WET	PPM	5.50	24.48	257.75	651.36	216.27	24.10	5.44
CO WET	%	8.5528	9.4870	7.9273	7.1098	8.5182	9.5507	8.3499
CO2 WET	%	5.6177	7.0746	8.0619	8.4330	7.8803	7.0584	6.0772
O2 WET	%	3.2185	0.2399	0.0680	0.1062	0.1197	0.2657	3.3055
H2O CORRECTION	- - -	0.88492	0.85784	0.86750	0.86051	0.87535	0.86878	0.90008
HC MASS/MODE	LB/MODE	0.01684	0.07470	0.00413	0.06060	0.05832	0.02038	0.01676
NOX MASS/MODE	LB/MODE	0.00001	0.00071	0.00215	0.07523	0.01885	0.00018	0.00001
CO MASS/MODE	LB/MODE	0.08019	1.67617	0.40351	5.00984	4.52981	0.43913	0.07588
HC MODE/STD.CYCLE	%	5.540	24.571	1.359	19.933	19.186	6.705	5.512
NOX MODE/STD.CYCLE	%	0.004	0.295	0.896	31.346	7.855	0.076	0.003
CO MODE/STD.CYCLE	%	1.193	24.943	6.005	74.551	67.408	6.535	1.129
HC EMISSION PER HP CYCLE =	0.00157 LB/HP CYCLE	PERCENT OF ALLOWABLE HC =			82.81			
NOX EMISSION PER HP CYCLE =	0.00061 LB/HP CYCLE	PERCENT OF ALLOWABLE NOX =			40.47			
CO EMISSION PER HP CYCLE =	0.07634 LB/HP CYCLE	PERCENT OF ALLOWABLE CO =			181.76			

168

TABLE XVI b. TEMP-HUMIDITY, 100°F, 0%

CYCLE NO. 1486

CFLL-17

DATE 2/13/76

25 BTDC, 100 DEG.F, 30% REL. HUMIDITY

ENGINE - LYCOMING O-320-D1AD

ENGINE TIMING

25.000 DEG. BTDC

RATED H.P. 160.

H.C. RATIO 2.125

	UNITS	TOLE	TAXI	TAKE OFF	CLIMB	APPROACH	TAXI	IDLE
RUN NUMBER		1486	1480	1481	1482	1483	1484	1485
TIME IN MODE	MIN.	1.00	11.00	0.30	5.00	6.00	3.00	1.00
ENGINE SPEED	RPM	577.50	1196.76	2689.41	2433.24	2355.11	1199.88	617.99
OBS. HORSEPOWER	HP	0.43485	1.25587	140.26958	120.15779	65.65944	1.34223	0.50122
F/A RATIO MEAS.	- - -	0.0983	0.1033	0.0894	0.0972	0.0901	0.0978	0.0975
F/A RATIO CALC.	- - -	0.0935	0.1027	0.0883	0.0889	0.0897	0.0983	0.0950
% DIFF. IN F/A	%	-4.910	-0.661	-1.265	1.911	-0.420	0.472	-2.574
AIR FLOW	LBS/HR	49.84	95.08	896.04	809.15	479.94	85.47	52.11
FUEL FLOW	LBS/HR	4.90	9.83	80.14	70.55	43.26	8.36	5.08
VAPOR FLOW	LBS/HR	0.63563	1.16308	11.74018	10.57488	6.15779	1.08946	0.66593
HUMIDITY GR H2O/LB DRY AIR		89.271	85.627	91.716	91.484	89.812	89.226	89.460
DEW POINT	DEG.F	63.577	62.162	64.252	64.382	63.872	63.577	63.586
RELATIVE HUMIDITY	%	34.50	31.96	26.12	27.23	27.52	30.22	33.43
BAROMETR	IN.HG.	29.24	29.23	29.24	29.24	29.23	29.24	29.24
IND. AIR TEMP.	DEG.F	96.06	96.93	106.13	104.87	103.90	100.43	97.10
MAX. CHT	DEG.F	281.60	302.83	449.94	470.65	384.71	331.36	298.85
HC WFT	PPM	38329.80	13483.34	1680.77	1762.07	1930.09	10292.02	34495.94
NOX WFT	PPM	2.47	17.97	189.36	363.92	147.73	14.80	2.83
CO WFT	%	7.8037	10.7508	8.0360	8.1663	8.4797	9.8672	8.1152
CO2 WFT	%	5.9295	6.4968	8.1788	7.9849	7.9092	7.0112	6.1063
O2 WFT	%	4.1272	0.4703	0.0901	0.1226	0.1201	0.3302	3.4213
H2O CORRECTION	- - -	0.89548	0.86123	0.85209	0.84160	0.85036	0.85249	0.89260
HC MASS/MODE	LB/MODE	0.01906	0.14301	0.00437	0.06837	0.05387	0.02628	0.01788
NOX MASS/MODE	LB/MODE	0.00000	0.00045	0.00159	0.04575	0.01336	0.00012	0.00000
CO MASS/MODE	LB/MODE	0.07668	2.25766	0.41287	6.26290	4.67749	0.49796	0.08314
HC MODE/STD.CYCLE	%	6.268	47.043	1.437	22.491	17.720	8.645	5.882
NOX MODE/STD.CYCLE	%	0.002	0.186	0.664	19.061	5.566	0.051	0.002
CO MODE/STD.CYCLE	%	1.141	33.537	6.144	93.198	69.605	7.410	1.237
HC EMISSION PFR HP CYCLE =	0.00208 LB/HP CYCLE	PERCENT OF ALLOWABLE HC =			109.49			
NOX EMISSION PFR HP CYCLE =	0.00038 LB/HP CYCLE	PERCENT OF ALLOWABLE NOX =			25.53			
CO EMISSION PER HP CYCLE =	0.08915 LB/HP CYCLE	PERCENT OF ALLOWABLE CO =			212.27			

TABLE XVI c. TEMP-HUMIDITY, 100°F, 30%

ORIGINAL PAGE IS
OF POOR QUALITY

CYCLE NO. 1494

CFLL-17

DATE 2/13/76

25 BTDC, 100 DEG.F, 30R REL. HUMIDITY

ENGINE - LYCOMING O-320-DIAD

ENGINE TIMING 25.000 DEG. BTDC RATED H.P. 160. H.C. RATIO 2.125

	UNITS	IDLE	TAXI	TAKE OFF	CLIMB	APPROACH	TAXI	IDLE
RUN NUMREP		1494	1488	1489	1490	1491	1492	1493
TIME IN MODE	MIN.	1.00	11.00	0.30	5.00	6.00	3.00	1.00
ENGINE SPEED	RPM	604.62	1207.76	2681.85	2429.82	2354.69	1199.74	601.20
OBS. HORSEPOWER	HP	0.43144	1.20451	139.72835	119.59615	64.76433	1.70686	0.79631
F/A RATIO MEAS.	- - -	0.0971	0.1017	0.0887	0.0849	0.0884	0.1009	0.1008
F/A RATIO CALC.	- - -	0.0942	0.0983	0.0886	0.0877	0.0899	0.1004	0.0958
% DIFF. IN F/A	γ	-3.006	-3.372	-0.104	3.252	1.711	-0.526	-4.954
AIR FLOW	LBS/HR	53.42	85.98	904.34	797.93	478.20	96.35	52.20
FUEL FLOW	LBS/HR	5.19	8.75	80.18	67.74	42.29	9.72	5.26
VAPOR FLOW	LBS/HR	0.71347	1.09707	12.09490	10.64774	6.29711	1.27360	0.69351
HUMIDITY GR H2O/LB DRY AIR		93.494	89.318	93.620	93.409	92.179	92.531	92.999
DEW POINT	DEG.F	64.857	63.707	65.112	65.132	64.692	64.605	64.672
RELATIVE HUMIDITY	%	36.29	33.53	25.72	28.10	28.81	32.94	35.61
BAROMETER	IN.HG.	29.26	29.25	29.25	29.25	29.25	29.25	29.26
IND. AIR TEMP.	DEG.F	95.87	97.14	107.68	104.69	103.33	98.76	96.27
MAX. CHT	DEG.F	789.27	324.09	442.36	474.20	389.99	232.39	297.04
HC WET	PPM	37075.67	10465.04	1686.17	1699.77	1900.79	14171.41	37477.71
NOX WET	PPM	1.28	13.73	181.67	465.25	142.71	8.38	1.80
CO WET	%	7.9526	10.1282	8.1688	7.7465	8.4785	10.1100	8.2063
CO2 WET	%	5.9327	7.0599	8.0775	8.1668	7.8242	6.7869	6.1125
O2 WET	%	3.9001	0.4113	0.1356	0.1108	0.1138	0.5650	3.6104
H2O CORRECTION	- - -	0.88633	0.86581	0.84767	0.83584	0.84262	0.85762	0.89098
HC MASS/MODE	LB/MODE	0.01968	0.09987	0.00441	0.06451	0.05255	0.04124	0.01969
NOX MASS/MODE	LB/MODE	0.00000	0.00042	0.00154	0.05720	0.01278	0.00008	0.00000
CO MASS/MODE	LB/MODE	0.08345	1.91041	0.42248	5.81077	4.63280	0.58195	0.08521
HC MODE/STD.CYCLE	%	6.475	32.853	1.451	21.221	17.286	13.564	5.477
NOX MODE/STD.CYCLE	%	0.001	0.177	0.642	73.835	5.326	0.033	0.001
CO MODE/STD.CYCLE	%	1.242	28.429	6.287	86.470	68.940	8.660	1.268
HC EMISSION PER HP CYCLE =	0.00189 LB/HP CYCLE	PERCENT OF ALLOWABLE HC =				99.33		
NOX EMISSION PER HP CYCLE =	0.00045 LB/HP CYCLE	PERCENT OF ALLOWABLE NOX =				30.01		
CO EMISSION PER HP CYCLE =	0.08454 LB/HP CYCLE	PERCENT OF ALLOWABLE CO =				201.30		

170

TABLE XVI d. TEMP-HUMIDITY, 100°F, 30%

CYCLE NO. 1511		CELL-17		DATE 2/13/76		25 BTDC, 100 DEG.F, 30% REL. HUMIDITY			ENGINE - LYCOMING O-320-D1AD		
ENGINE TIMING		25.000 DEG. BTDC		RATED H.P. 160.		H.C. RATIO 2.125					
		UNITS	IDLE	TAXI	TAKE OFF	CLIMB	APPROACH	TAXI	IDLE		
RUN NUMBER			1511	1502	1503	1506	1507	1508	1510		
TIME IN MODE	MIN.		1.00	11.00	0.30	5.00	6.00	3.00	1.00		
ENGINE SPEED	RPM		592.00	1196.04	2712.21	2433.96	2356.97	1206.54	595.92		
CPS. HORSEPOWER	HP		0.57781	1.49238	142.54568	119.95354	67.14340	0.94445	0.71125		
F/A RATIO MEAS.	- - -		0.0937	0.1042	0.0899	0.0839	0.0903	0.0988	0.0945		
F/A RATIO CALC.	- - -		0.0948	0.1013	0.0871	0.0866	0.0894	0.0988	0.0961		
% DIFF. IN F/A	%		1.187	-2.823	-1.992	3.264	-0.944	0.042	1.614		
AIR FLOW	LBS/HR		55.25	95.52	900.71	789.99	487.49	86.44	55.54		
FUEL FLOW	LPS/HR		5.18	9.95	80.07	64.25	44.00	8.54	5.25		
VAPOR FLOW	LBS/HR		0.64839	1.17550	11.32006	9.90544	6.02276	1.05457	0.54901		
HUMIDITY GR H2O/LB DRY AIR			82.153	86.143	87.976	87.771	86.483	85.400	81.798		
DEW POINT	DEG.F		61.337	62.487	63.307	63.582	63.057	62.622	61.272		
RELATIVE HUMIDITY	%		33.61	33.73	27.68	26.97	27.65	31.26	32.61		
BAROMETER	IN.HG.		29.34	29.32	29.32	29.33	29.33	29.33	29.34		
IND. AIR TEMP.	DEG.F		94.33	95.55	103.05	104.25	102.79	98.19	95.24		
MAX. CHT	DEG.F		269.00	259.23	417.13	469.65	381.96	311.21	295.20		
HC WFT	PPM		36706.64	13733.31	1671.36	1716.37	1902.59	10740.07	36447.60		
NOX WFT	PPM		1.52	8.29	246.18	455.91	154.70	11.32	1.49		
CO WFT	%		7.9490	10.6649	7.8387	7.3653	8.4401	10.0782	8.1704		
CO2 WFT	%		5.8287	6.7939	8.4316	8.4020	8.0480	6.9852	5.8280		
O2 WFT	%		3.7953	0.4765	0.1529	0.0793	0.1093	0.3652	3.5010		
H2O CORRECTION	- - -		0.87353	0.86573	0.85357	0.83594	0.85150	0.85435	0.87111		
HC MASS/MODE	LB/MODE		0.01989	0.14142	0.00436	0.06420	0.05394	0.02781	0.01991		
NOX MASS/MODE	LB/MODE		0.00000	0.00029	0.00208	0.05524	0.01421	0.00009	0.00000		
CO MASS/MODE	LB/MODE		0.08511	2.25267	0.40384	5.44461	4.72905	0.51581	0.08821		
HC MODE/STD.CYCLE	%		6.541	46.521	1.433	21.117	17.743	9.149	6.549		
NOX MODE/STD.CYCLE	%		0.001	0.120	0.866	23.017	5.920	0.040	0.001		
CO MODE/STD.CYCLE	%		1.267	33.522	6.010	81.021	70.373	7.676	1.313		
HC EMISSION PER HP CYCLE =	0.00207 LB/HP CYCLE			PERCENT OF ALLOWABLE HC =			109.05				
NOX EMISSION PER HP CYCLE =	0.00045 LB/HP CYCLE			PERCENT OF ALLOWABLE NOX =			29.96				
CO EMISSION PER HP CYCLE =	0.08450 LB/HP CYCLE			PERCENT OF ALLOWABLE CO =			201.18				

171

TABLE XVI e. TEMP-HUMIDITY, 100°F, 30%

CYCLE NO. 1775

CELL-17

DATE 2/23/76

25 PTDC, 100 DEG.F, 60% REL.HUMIDITY

ENGINE - LYCOMING O-320-DIAD

ENGINE TIMING 25.000 DEG. BTDC

RATED H.P. 160.

C.C. RATIO 2.125

	UNITS	IDLE	TAXI	TAKE OFF	CLIMB	APPROACH	TAXI	IDLE
RUN NUMBER		1775	1777	1778	1779	1780	1781	1782
TIME IN MODE	MIN.	1.00	11.00	0.30	5.00	6.00	3.00	1.00
ENGINE SPEED	RPM	589.62	1200.84	2707.99	2431.98	2358.83	1206.60	578.64
OBS. HHPSEPOWER	HP	0.54505	1.55687	139.03847	119.47133	65.52869	1.76143	0.57623
F/A RATIO MEAS.	- - -	0.1012	0.1037	0.0907	0.0880	0.0891	0.1041	0.0982
F/A RATIO CALC.	- - -	0.0986	0.1015	0.0868	0.0884	0.0865	0.1021	0.0991
% DIFF. IN F/A	%	-2.621	-2.120	-4.307	0.498	-2.925	-1.916	0.831
AIR FLOW	LPS/HR	55.67	108.74	896.90	818.90	484.00	107.39	55.86
FUEL FLOW	LBS/HR	5.63	11.28	81.31	72.06	43.13	11.18	5.49
VAPOR FLOW	LRS/HR	1.34975	2.59735	22.11830	19.97110	11.61053	2.54601	1.33189
HUMIDITY GR H2O/LB DRY AIR		169.721	167.195	172.626	170.714	167.920	165.950	166.907
DEW POINT	DEG.F	81.464	81.464	82.594	82.399	81.859	81.474	81.499
RELATIVE HUMIDITY	%	58.26	58.23	56.86	55.14	54.77	55.73	59.14
BAROMETER	IN.HG.	29.27	29.27	29.27	29.27	29.27	29.27	29.26
IND. AIR TEMP.	DEG.F	98.69	98.70	100.71	101.52	101.16	100.17	98.79
MAX. CHT	DEG.F	341.09	298.08	421.35	439.89	369.36	313.32	271.23
HC WET	PPM	39841.96	17904.77	1847.56	2046.70	2074.11	21752.15	41880.15
NOX WET	PPM	3.50	6.71	139.06	204.00	123.03	6.53	2.88
CO WET	%	9.6741	11.9824	9.0271	9.4651	8.8467	11.7801	8.6796
CO2 WET	%	6.8989	7.8070	10.1323	9.5886	10.1521	7.5757	6.9008
O2 WET	%	3.3544	0.6823	0.0923	0.1008	0.0982	1.0263	3.1236
H2O CORRECTION	- - -	0.84737	0.82464	0.81678	0.79870	0.81176	0.82791	0.83769
HC MASS/MODE	LB/MODE	0.02257	0.21973	0.00488	0.08144	0.05875	0.07198	0.02356
NOX MASS/MODE	LB/MODE	0.00001	0.00027	0.00119	0.02630	0.01129	0.00007	0.00001
CO MASS/MODE	LB/MODE	0.10833	2.90634	0.47116	7.44381	4.95273	0.77043	0.09551
HC MODE/STD.CYCLE	%	7.426	72.279	1.605	26.790	19.326	23.677	7.751
NOX MODE/STD.CYCLE	%	0.003	0.111	0.496	10.957	4.704	0.029	0.002
CO MODE/STD.CYCLE	%	1.612	43.249	7.011	110.771	73.701	11.465	1.436
HC EMISSION PER HP CYCLE =	0.00302 LB/HP CYCLE	PERCENT OF ALLOWABLE HC =				158.85		
NOX EMISSION PER HP CYCLE =	0.00024 LB/HP CYCLE	PERCENT OF ALLOWABLE NOX =				16.30		
CO EMISSION PER HP CYCLE =	0.10468 LB/HP CYCLE	PERCENT OF ALLOWABLE CO =				249.25		

172

TABLE XVII. TEMP-HUMIDITY, 100°F, 60%

CYCLE NO. 1783

CELL-17

DATE 2/23/76

25 BTDC, 100 DEG.F, 60% REL.HUMIDITY

ENGINE - LYCOMING O-320-D1AD

ENGINE TIMING 25.000 DEG. BTDC RATED H.P. 150. H.C. RATIO 2.125

	UNITS	IDLE	TAXI	TAKE OFF	CLIMB	APPROACH	TAXI	IDLE
RUN NUMBER		1783	1784	1785	1786	1787	1788	1790
TIME IN MODE	MIN.	1.00	11.00	0.30	5.00	6.00	3.00	1.00
ENGINE SPEED	RPM	616.62	1199.76	2709.75	2433.24	2353.91	1210.02	596.70
OBS. HHPSEPOWER	HP	0.70240	1.55225	139.74837	119.58363	67.57912	1.38523	0.58943
F/A RATIO MEAS.	- - -	0.0969	0.1038	0.0900	0.0875	0.0891	0.1052	0.0977
F/A RATIO CALC.	- - -	0.0972	0.1012	0.0869	0.0984	0.0870	0.1019	0.0940
% DIFF. IN F/A	%	0.250	-2.549	-3.446	0.993	-2.363	-3.095	-3.821
AIR FLOW	LBS/HR	60.15	109.07	895.26	819.89	482.90	105.60	56.36
FUEL FLOW	LBS/HR	5.83	11.32	80.61	71.76	43.01	11.11	5.51
VAPOR FLOW	LBS/HR	1.43602	2.59667	22.10556	20.00006	11.54762	2.51272	1.33964
HUMIDITY GR H2O/LB DRY AIR		167.131	166.658	172.842	170.755	167.390	166.561	166.393
DEW POINT	DEG.F	81.534	81.519	82.519	82.414	81.869	81.549	81.434
RELATIVE HUMIDITY	%	58.18	57.04	56.42	55.24	54.88	57.20	58.52
BAROMETER	IN.HG.	29.26	29.26	29.26	29.26	29.26	29.26	29.25
IND. AIR TEMP.	DEG.F	98.81	99.45	101.00	101.48	101.11	99.39	98.51
MAX. CHT	DEG.F	289.59	283.17	422.90	438.65	363.60	307.28	252.06
HC WET	PPM	37514.72	19927.97	1830.18	2091.61	1971.30	19495.94	38287.80
NOX WET	PPM	3.49	6.64	135.73	209.00	115.57	6.77	3.17
CO WET	%	9.3351	11.6539	9.0951	9.3986	9.0083	11.9689	8.8565
CO2 WFT	%	7.1831	7.7970	10.0849	9.5645	10.0252	7.7558	7.2673
O2 WET	%	3.1297	0.8563	0.0895	0.0984	0.0890	0.7803	3.7035
H2O CORRECTION	- - -	0.83231	0.82816	0.81268	0.79705	0.80991	0.83007	0.85200
HC MASS/MODE	LB/MODE	0.02262	0.24535	0.00481	0.08319	0.05570	0.06367	0.02169
NOX MASS/MODE	LB/MODE	0.00001	0.00026	0.00116	0.02693	0.01058	0.00007	0.00001
CO MASS/MODE	LB/MODE	0.11126	2.83584	0.47281	7.38779	5.03057	0.77252	0.09918
HC MODE/STD.CYCLE	%	7.442	80.708	1.584	27.364	18.322	20.943	7.136
NOX MODE/STD.CYCLE	%	0.003	0.110	0.482	11.220	4.408	0.030	0.002
CO MODE/STD.CYCLE	%	1.656	42.200	7.036	109.937	74.860	11.496	1.476
HC EMISSION PER HP CYCLE =	0.00311 LB/HP CYCLE	PERCENT OF ALLOWABLE HC =			163.50			
NOX EMISSION PER HP CYCLE =	0.00024 LB/HP CYCLE	PERCENT OF ALLOWABLE NOX =			16.26			
CO EMISSION PER HP CYCLE =	0.10444 LB/HP CYCLE	PERCENT OF ALLOWABLE CO =			248.66			

173

ORIGINAL PAGE IS OF POOR QUALITY

TABLE XVIg. TEMP-HUMIDITY, 100°F, 60%

CYCLE NO. 1791

CELL-17

DATE 2/23/76

25 RTDC, 100 DEG.F, 60% REL.HUMIDITY

ENGINE - LYCOMING O-320-DIAD

ENGINE TIMING	25.000	DEG.	RTDC	RATED H.P.	160.	H.C. RATIO	2.125		
	UNITS	IDLE	TAXI	TAKE OFF	CLIMB	APPROACH	TAXI	IDLE	
RUN NUMBER		1791	1792	1793	1794	1795	1796	1797	
TIME IN MODE	MIN.	1.00	11.00	0.30	5.00	6.00	3.00	1.00	
ENGINE SPEED	RPM	583.80	1207.88	2708.13	2434.62	2359.25	1208.34	590.46	
OBS. HCPSEPOWER	HP	0.18914	1.64696	139.62575	120.23401	66.14572	1.02452	0.19646	
F/A RATIO MEAS.	- - -	0.0991	0.1042	0.0913	0.0875	0.0901	0.1037	0.1004	
F/A RATIO CALC.	- - -	0.0977	0.1015	0.0869	0.0885	0.0866	0.1022	0.0966	
% DIFF. IN F/A	%	-1.402	-2.561	-4.804	1.194	-3.873	-1.405	-3.831	
AIR FLOW	LBS/HR	53.45	105.61	900.64	823.24	487.86	105.42	53.71	
FUEL FLOW	LBS/HR	5.30	11.01	82.26	72.01	43.97	10.93	5.39	
VAPOR FLOW	LBS/HR	1.26570	2.49729	22.03484	19.93092	11.62730	2.49311	1.27574	
HUMIDITY GR H2O/LB DRY AIR		165.763	165.526	171.260	169.473	166.832	165.540	166.254	
DEW POINT	DEG.F	81.404	81.389	82.539	82.339	81.824	81.439	81.439	
RELATIVE HUMIDITY	%	57.90	57.04	56.96	55.69	55.08	56.14	58.18	
BAROMETER	IN.HG.	29.25	29.24	29.24	29.24	29.24	29.24	29.24	
IND. AIR TEMP.	DEG.F	98.83	99.31	100.59	101.13	100.94	99.89	98.70	
MAX. CHT	DEG.F	340.41	305.39	428.63	442.38	370.37	304.42	275.30	174
HC WET	PPM	40290.01	19014.89	1850.98	2043.10	2006.00	19672.95	40632.02	
NOX WET	PPM	3.76	7.01	136.97	198.60	119.49	6.87	3.24	
CO WET	%	9.4689	11.6745	9.1372	9.4552	8.9513	11.8601	9.0968	
CO2 WET	%	6.8715	7.7652	10.1233	9.5283	10.1625	7.7695	7.2669	
O2 WET	%	3.5240	0.7130	0.0924	0.1022	0.0955	0.6968	3.4574	
H2O CORRECTION	- - -	0.84377	0.82904	0.81911	0.79658	0.81600	0.82269	0.85116	
HC MASS/MODE	LB/MODE	0.02175	0.22695	0.00492	0.08156	0.05748	0.06381	0.02214	
NOX MASS/MODE	LB/MODE	0.00001	0.00027	0.00118	0.02568	0.01109	0.00007	0.00001	
CO MASS/MODE	LB/MODE	0.10104	2.75392	0.47998	7.45988	5.06919	0.76027	0.09799	
HC MODE/STD.CYCLE	%	7.155	74.653	1.618	26.829	18.907	20.989	7.284	
NOX MODE/STD.CYCLE	%	0.003	0.113	0.491	10.701	4.622	0.030	0.002	
CO MODE/STD.CYCLE	%	1.504	40.981	7.143	111.010	75.434	11.313	1.458	
HC EMISSION PER HP CYCLE =	0.00299 LB/HP CYCLE					PERCENT OF ALLOWABLE HC =	157.44		
NOX EMISSION PER HP CYCLE =	0.00024 LB/HP CYCLE					PERCENT OF ALLOWABLE NOX =	15.96		
CO EMISSION PER HP CYCLE =	0.10451 LB/HP CYCLE					PERCENT OF ALLOWABLE CO =	248.84		

TABLE XVI h. TEMP-HUMIDITY, 100°F, 60%

CYCLE NO. 1739 CELL-17 DATE 2/23/76

75 BTDC, 100 DEG.F, 80% REL.HUMIDITY

ENGINE - LYCOMING O-320-D1AD

ENGINE TIMING 25.000 DEG. BTDC RATED H.P. 160. H.C. RATIO 2.125

	UNITS	IDLE	TAXI	TAKE OFF	CLIMB	APPROACH	TAXI	IDLE
RUN NUMBER		1739	1740	1741	1742	1743	1749	1748
TIME IN MODE	MIN.	1.00	11.00	0.30	5.00	6.00	3.00	1.00
ENGINE SPEED	RPM	595.08	1200.30	2703.45	2432.58	2355.47	1205.28	608.94
OBS. HORSPPOWER	HP	0.52837	1.09797	137.93446	120.88283	66.15331	0.48341	0.00000
F/A RATIO MEAS.	- - -	0.1029	0.1102	0.0921	0.0886	0.0912	0.1077	0.1004
F/A RATIO CALC.	- - -	0.1002	0.1083	0.0875	0.0894	0.0873	0.1044	0.0974
% DIFF. IN F/A	%	-2.532	-1.721	-4.976	0.948	-4.214	-3.052	-3.035
AIR FLOW	LBS/HR	59.19	114.55	880.27	811.38	481.07	115.83	61.91
FUEL FLOW	LBS/HR	6.09	12.62	81.06	71.89	43.86	12.48	6.22
VAPOR FLOW	LBS/HR	1.88280	3.60502	28.83069	26.45226	15.42732	3.65760	1.97493
HUMIDITY GR H2O/LB DRY AIR		222.676	220.290	229.264	228.211	224.433	221.039	223.317
DEW POINT	DEG.F	89.815	89.745	91.065	91.110	90.550	90.040	90.230
RELATIVE HUMIDITY	%	77.46	76.30	73.09	73.78	73.36	75.83	78.10
BAROMETER	IN.HG.	29.31	29.31	29.31	29.31	29.31	29.31	29.31
IND.AIR TEMP.	DEG.F	98.09	98.51	101.32	101.05	100.65	99.02	98.25
MAX. CHT	DEG.F	273.45	272.46	437.18	436.46	353.42	274.83	268.32
HC WET	PPM	44069.36	23077.29	1948.19	2147.51	2186.72	22460.22	39408.91
NOX WET	PPM	4.44	6.82	127.21	156.68	103.33	6.52	3.99
CO WET	%	9.4681	11.8009	9.1295	9.5686	8.9929	12.0901	9.3104
CO2 WET	%	6.7879	7.4464	9.8119	9.1771	9.8506	7.3478	6.8544
O2 WET	%	3.4274	0.0183	0.0855	0.0897	0.0843	0.8605	3.4657
H2O CORRECTION	- - -	0.83755	0.81839	0.81052	0.78831	0.80804	0.82310	0.83950
HC MASS/MODE	LB/MODE	0.02687	0.30665	0.00511	0.08548	0.06247	0.08168	0.02493
NOX MASS/MODE	LB/MODE	0.00001	0.00029	0.00108	0.02020	0.00956	0.00008	0.00001
CO MASS/MODE	LB/MODE	0.11410	3.09926	0.47346	7.52775	5.07776	0.86896	0.11641
HC MODE/STD.CYCLE	%	8.839	100.873	1.682	28.119	20.550	26.868	8.201
NOX MODE/STD.CYCLE	%	0.004	0.122	0.451	8.418	3.985	0.032	0.003
CO MODE/STD.CYCLE	%	1.698	46.120	7.046	112.020	75.562	12.931	1.732
HC EMISSION PER HP CYCLE =	0.00371 LB/HP CYCLE				PERCENT OF ALLOWABLE HC =	195.13		
NOX EMISSION PER HP CYCLE =	0.00020 LB/HP CYCLE				PERCENT OF ALLOWABLE NOX =	13.01		
CO EMISSION PER HP CYCLE =	0.10799 LB/HP CYCLE				PERCENT OF ALLOWABLE CO =	257.11		

175

TABLE XVII. TEMP-HUMIDITY, 100°F, 80%

CYCLE NO. 1750

CELL-17

DATE 2723/76

25 RTDC, 100 DEG.F, 80% PFL HUMIDITY

ENGINE - LYCOMING O-320-D1AD

ENGINE TIMING 25.000 DEG. BTDC RATED H.P. 160. H.C. RATIO 7.125

	UNITS	IDLE	TAXI	TAKE OFF	CLIMB	APPROACH	TAXI	IDLE
RUN NUMBER		1750	1752	1753	1754	1755	1771	1759
TIME IN MODE	MIN.	1.00	11.00	0.30	5.00	6.00	3.00	1.00
ENGINE SPEED	RPM	602.82	1208.46	2708.07	2429.64	2354.03	1205.04	624.36
OBS. HORSEPOWER	HP	0.66881	0.75278	139.45107	119.84109	65.49182	0.94492	0.40346
F/A RATIO MEAS.	- - -	0.0999	0.1081	0.0909	0.0881	0.0911	0.1061	0.0992
F/A RATIO CALC.	- - -	0.0984	0.1036	0.0872	0.0893	0.0873	0.1011	0.0963
% DIFF. IN F/A	%	-1.534	-4.107	-4.154	1.259	-4.105	-4.701	-2.975
AIP FLOW	LBS/HP	59.79	115.14	881.30	811.67	479.88	106.28	60.45
FUEL FLOW	LBS/HR	5.97	12.44	80.15	71.55	43.71	11.28	6.00
VAPOR FLOW	LBS/HR	1.88986	3.61425	28.98100	26.32190	15.41111	3.38768	1.91662
HUMIDITY GR H2O/LB DRY AIR		221.749	219.726	230.189	227.006	224.801	223.130	221.938
DEW POINT	DEG.F	89.950	89.790	91.100	90.925	90.525	90.160	89.890
RELATIVE HUMIDITY	%	77.77	76.35	74.16	73.31	72.40	76.50	77.09
BAROMETER	IN.HG.	29.31	29.31	29.31	29.31	29.31	29.28	29.31
IND.AIR TEMP.	DEG.F	98.10	98.54	100.87	101.07	101.07	98.86	98.32
MAX. CHT	DEG.F	290.75	257.27	420.72	436.20	364.28	279.58	270.32
HC WET	PPM	37005.69	21647.15	1902.89	2156.61	2043.80	19027.89	36450.61
NOX WET	PPM	3.72	6.20	134.59	164.02	110.09	6.88	3.57
CO WET	%	9.4701	12.0565	8.9453	9.5027	9.0433	11.6547	9.1911
CO2 WET	%	6.9831	7.4584	9.8703	9.2009	9.8526	7.8754	7.0971
O2 WET	%	2.9787	0.8627	0.0616	0.0965	0.0832	0.7308	3.2135
H2O CORRECTION	- - -	0.83092	0.82683	0.80647	0.78711	0.80710	0.82451	0.83682
HC MASS/MODE	LB/MODE	0.02257	0.28718	0.00498	0.08572	0.05823	0.06317	0.02242
NOX MASS/MODE	LB/MODE	0.00001	0.00027	0.00114	0.02112	0.01016	0.00007	0.00001
CO MASS/MODE	LB/MODE	0.11414	3.16130	0.46263	7.46516	5.09234	0.76487	0.11175
HC MODE/STD.CYCLE	%	7.423	94.469	1.638	28.197	19.155	20.780	7.376
NOX MODE/STD.CYCLE	%	0.003	0.111	0.475	8.800	4.234	0.031	0.003
CO MODE/STD.CYCLE	%	1.699	47.043	6.884	111.089	75.779	11.382	1.663
HC EMISSION PER HP CYCLE =	0.00340 LB/HP CYCLE	PERCENT OF ALLOWABLE HC =				179.04		
NOX EMISSION PER HP CYCLE =	0.00020 LB/HP CYCLE	PERCENT OF ALLOWABLE NOX =				13.66		
CO EMISSION PER HP CYCLE =	0.10733 LB/HP CYCLE	PERCENT OF ALLOWABLE CO =				255.54		

176

TABLE XVI j. TEMP-HUMIDITY, 100°F, 80%

CYCLE NO. 1774

CELL-17

DATE 2723776

25 PTDC, 100 DEG.F, 80% REL.HUMIDITY

ENGINE - LYCOMING O-320-D1AD

ENGINE TIMING	25.000 DEG. BTDC	RATED H.P. 160.			4.C. RATIO 2.125			
	UNITS	IDLE	TAXI	TAKE OFF	CLIMB	APPROACH	TAXI	IDLE
PCN NUMBER		1774	1763	1773	1766	1767	1768	1770
TIME IN MODE	MIN.	1.00	11.00	0.30	5.00	6.00	3.00	1.00
ENGINE SPEED	RPM	610.92	1199.88	2711.43	2433.77	2350.37	1209.12	616.68
OBS. HORSEPOWER	HP	0.72633	1.01040	139.27615	120.47377	65.13777	1.34938	0.67695
F/A RATIO MEAS.	- - -	0.1001	0.1069	0.0910	0.0921	0.0917	0.1070	0.0960
F/A RATIO CALC.	- - -	0.0955	0.1029	0.0867	0.0893	0.0873	0.1030	0.0952
% DIFF. IN F/A	%	-4.646	-3.704	-4.786	-3.029	-4.822	-3.736	-0.816
AIR FLOW	LBS/HR	57.49	113.33	891.89	813.55	477.48	103.06	59.22
FUEL FLOW	LBS/HR	5.76	12.11	81.19	74.95	43.78	11.03	5.69
VAPOR FLOW	LBS/HR	1.81955	3.54646	29.18987	26.52515	15.32703	3.29686	1.88943
HUMIDITY GR H2O/LB DRY AIR		221.551	219.043	229.096	228.231	224.700	223.038	223.348
DEW POINT	DEG.F	89.975	89.475	91.145	91.051	90.535	90.365	90.135
RELATIVE HUMIDITY	%	77.32	74.52	74.14	72.31	72.14	74.74	77.67
BAROMETER	IN.HG.	29.27	29.29	29.27	29.29	29.29	29.28	29.28
IND. AIR TEMP.	DEG.F	98.32	99.07	100.92	101.66	101.20	99.94	98.33
MAX. CHT	DEG.F	278.64	274.37	390.24	434.95	368.58	320.59	266.08
HC WFT	PPM	36504.64	21630.14	2057.30	2107.83	2108.91	22600.25	36980.66
NOX WFT	PPM	3.05	6.46	134.89	148.76	111.65	6.38	3.55
CO WFT	%	9.2503	11.8412	8.8301	9.7887	9.0466	11.8646	8.7904
CO2 WFT	%	7.3317	7.5969	10.0073	9.3787	9.9243	7.4655	7.1744
O2 WFT	%	3.2817	0.8486	0.1019	0.1128	0.0829	1.0227	3.3108
H2O CORRECTION	- - -	0.84101	0.82389	0.80860	0.80343	0.80971	0.82463	0.82705
HC MASS/MODE	LB/MODE	0.02142	0.28135	0.00545	0.08520	0.05991	0.07298	0.02205
NOX MASS/MODE	LB/MODE	0.00001	0.00027	0.00116	0.01948	0.01028	0.00007	0.00001
CO MASS/MODE	LB/MODE	0.10729	3.04418	0.46223	7.81962	5.07955	0.75719	0.10357
HC MODE/STD.CYCLE	%	7.047	92.551	1.792	28.025	19.708	24.005	7.253
NOX MODE/STD.CYCLE	%	0.003	0.113	0.482	8.116	4.282	0.028	0.003
CO MODE/STD.CYCLE	%	1.597	45.300	6.878	116.363	75.589	11.268	1.541
HC EMISSION PER HP CYCLE =	0.00343 LB/HP CYCLE	PERCENT OF ALLOWABLE HC =		180.38				
NOX EMISSION PER HP CYCLE =	0.00020 LB/HP CYCLE	PERCENT OF ALLOWABLE NOX =		13.03				
CO EMISSION PER HP CYCLE =	0.10859 LB/HP CYCLE	PERCENT OF ALLOWABLE CO =		258.54				

177

ORIGINAL PAGE IS
OF POOR QUALITY

TABLE XVIK. TEMP-HUMIDITY, 100°F, 80%

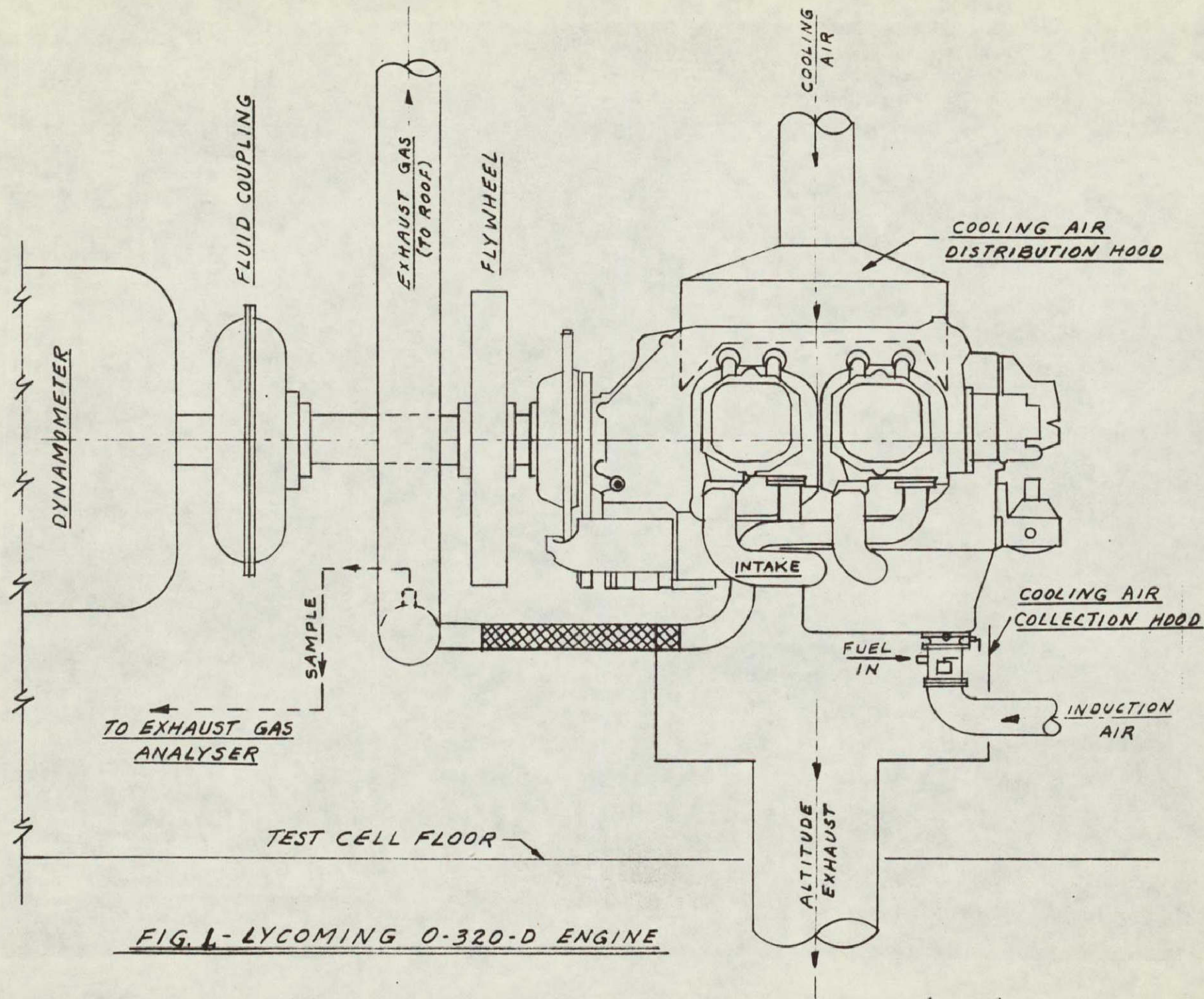

FIG. 1 - LYCOMING O-320-D ENGINE

PRECEDING PAGE BLANK NOT FILMED

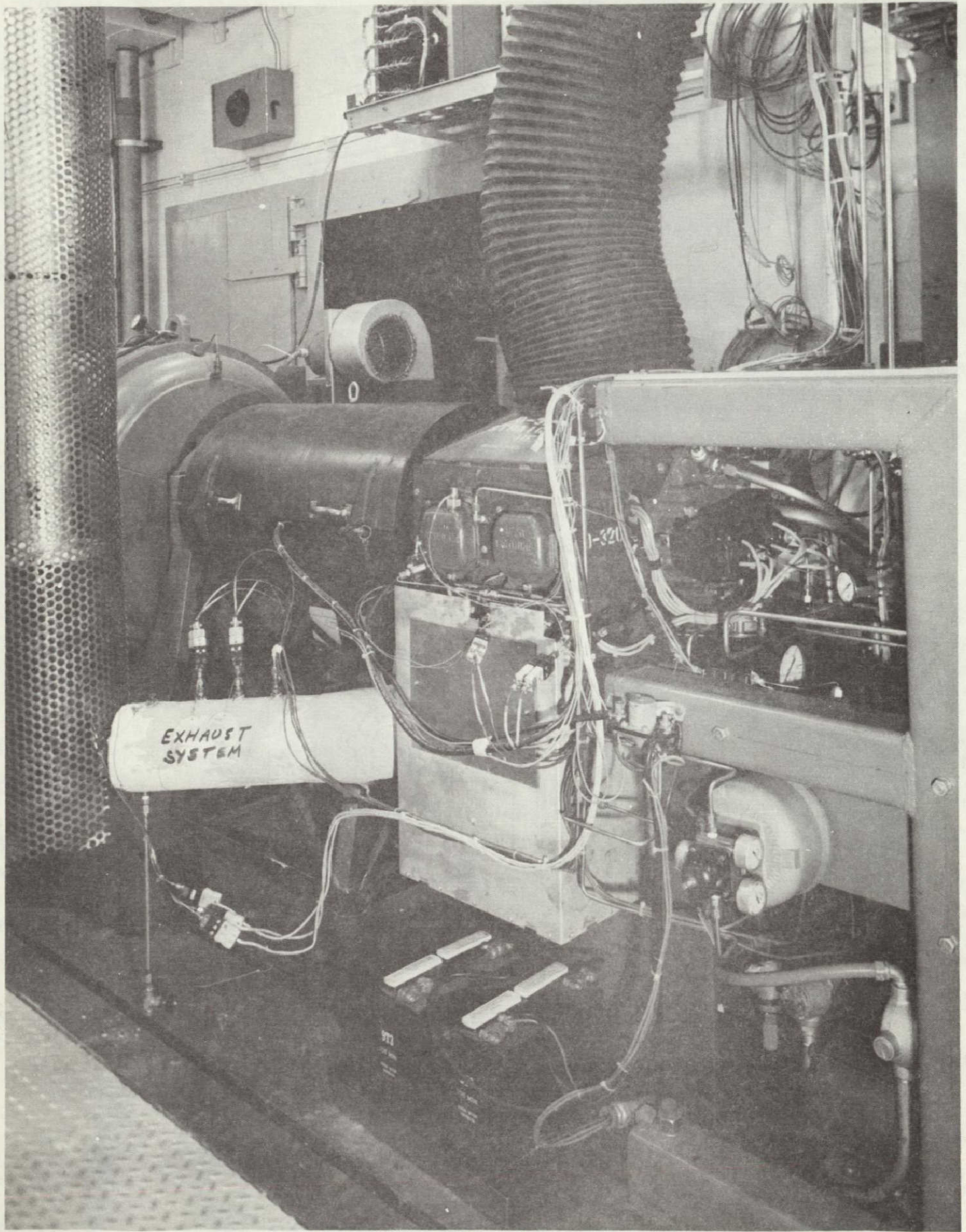
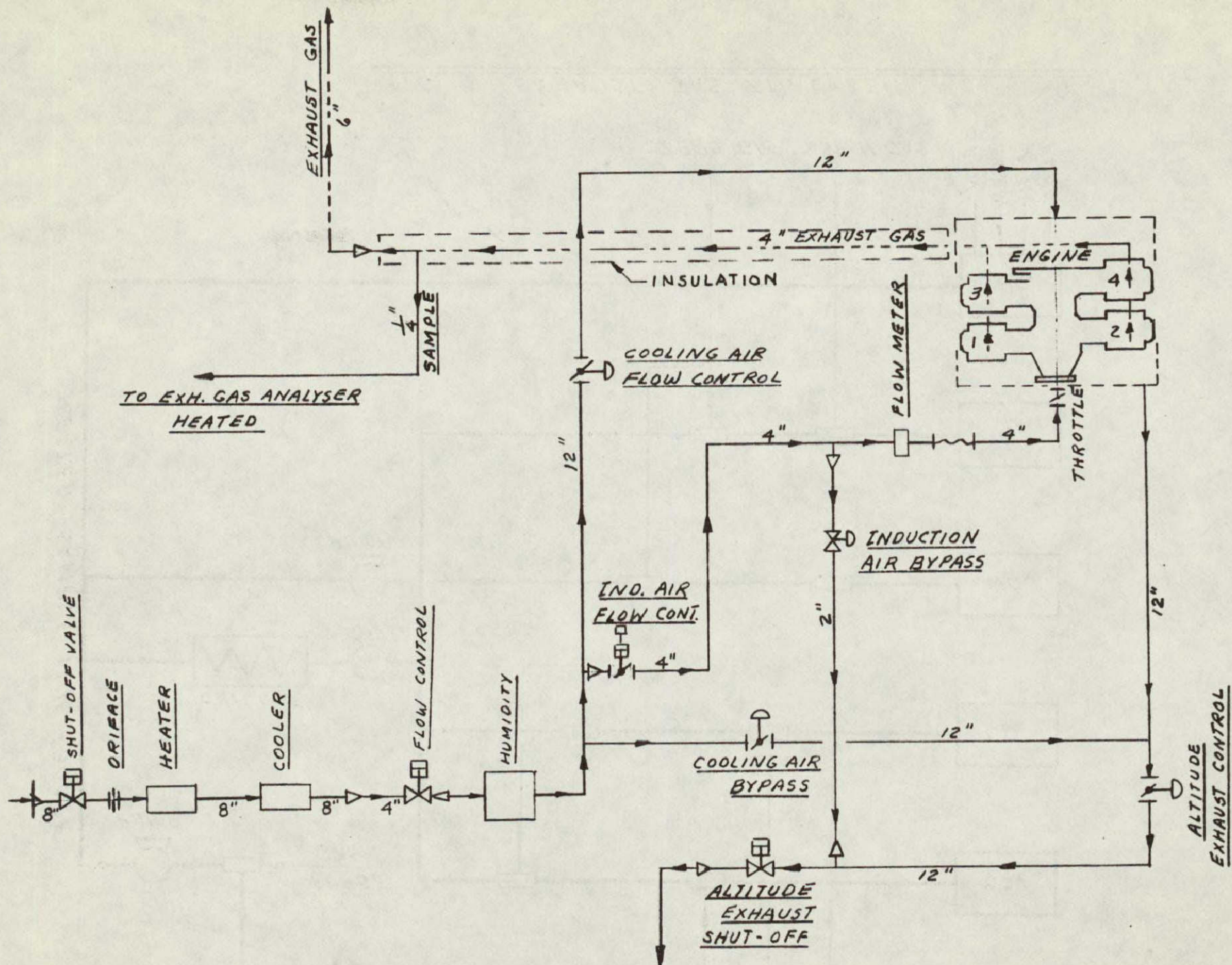

FIGURE 2. ENGINE DYNAMOMETER TEST STAND



ORIGINAL PAGE IS
OF POOR QUALITY

FIGURE 3. ENGINE TEST STAND FACILITY SYSTEMS

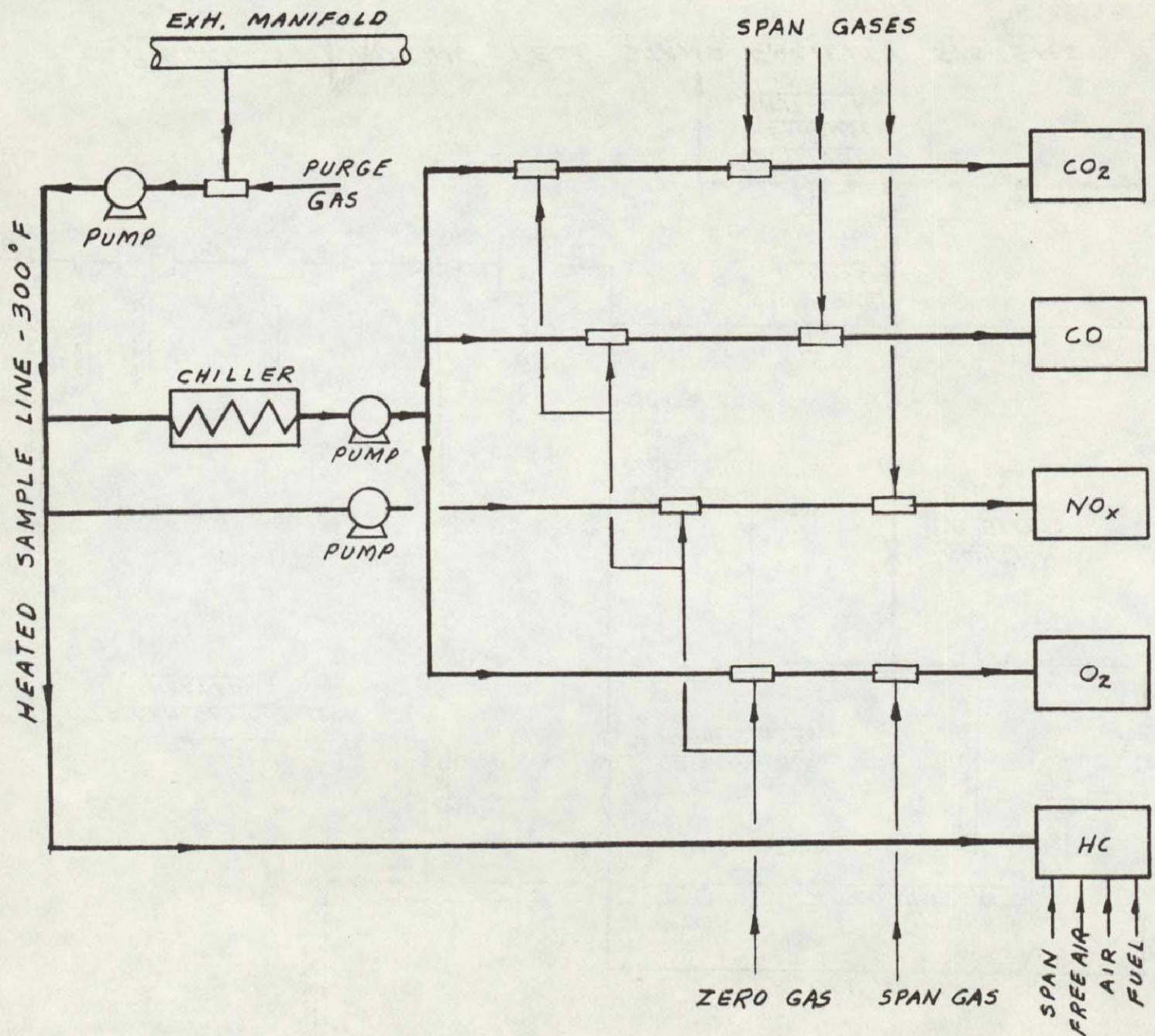

FIG. 4 EXHAUST GAS ANALYZER

ORIGINAL PAGE IS
OF POOR QUALITY

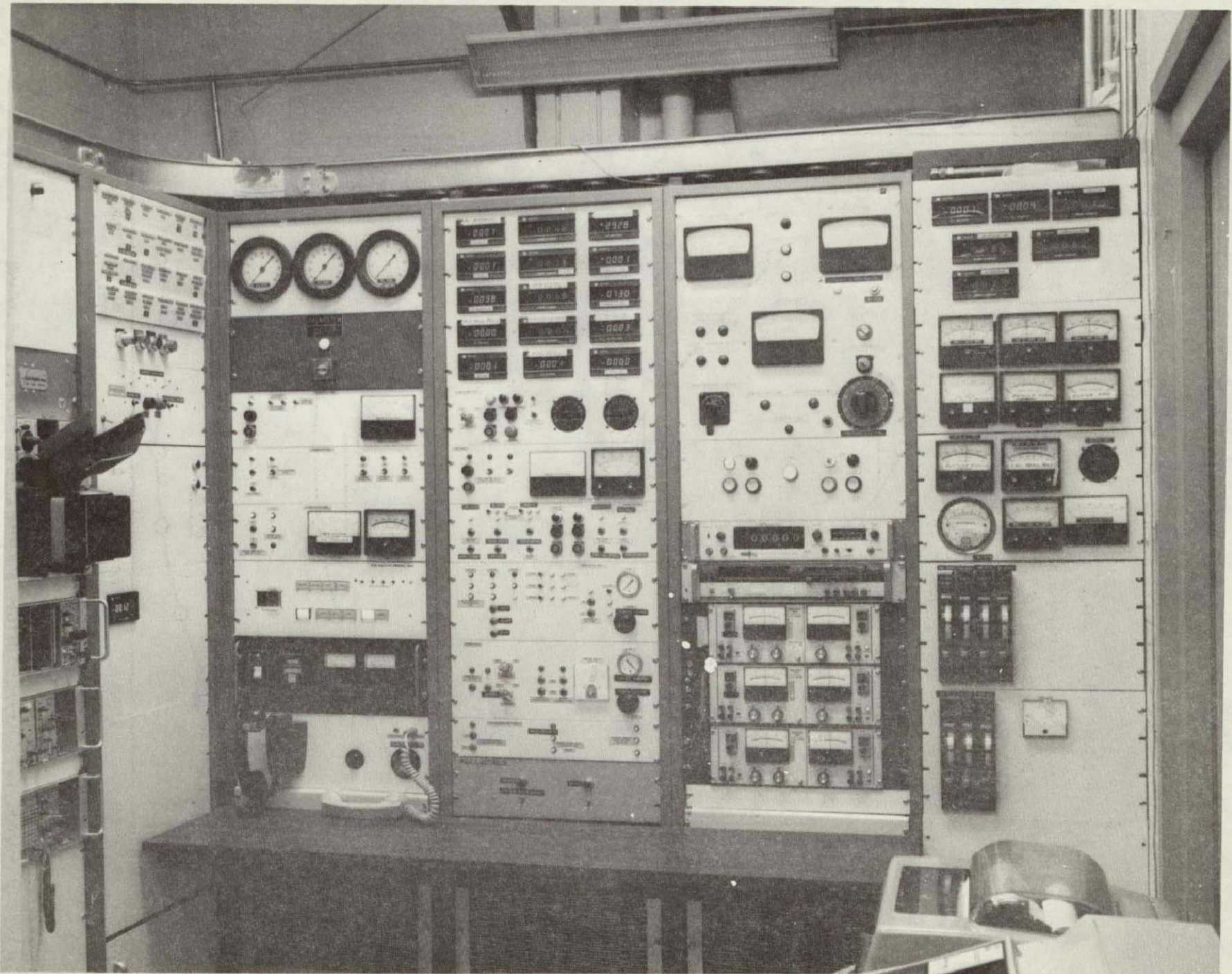

FIGURE 5. ENGINE INSTRUMENTATION AND CONTROL PANEL

RDGS 295-302
 25° BTDC TIMING
 AIR TEMP, 63°F

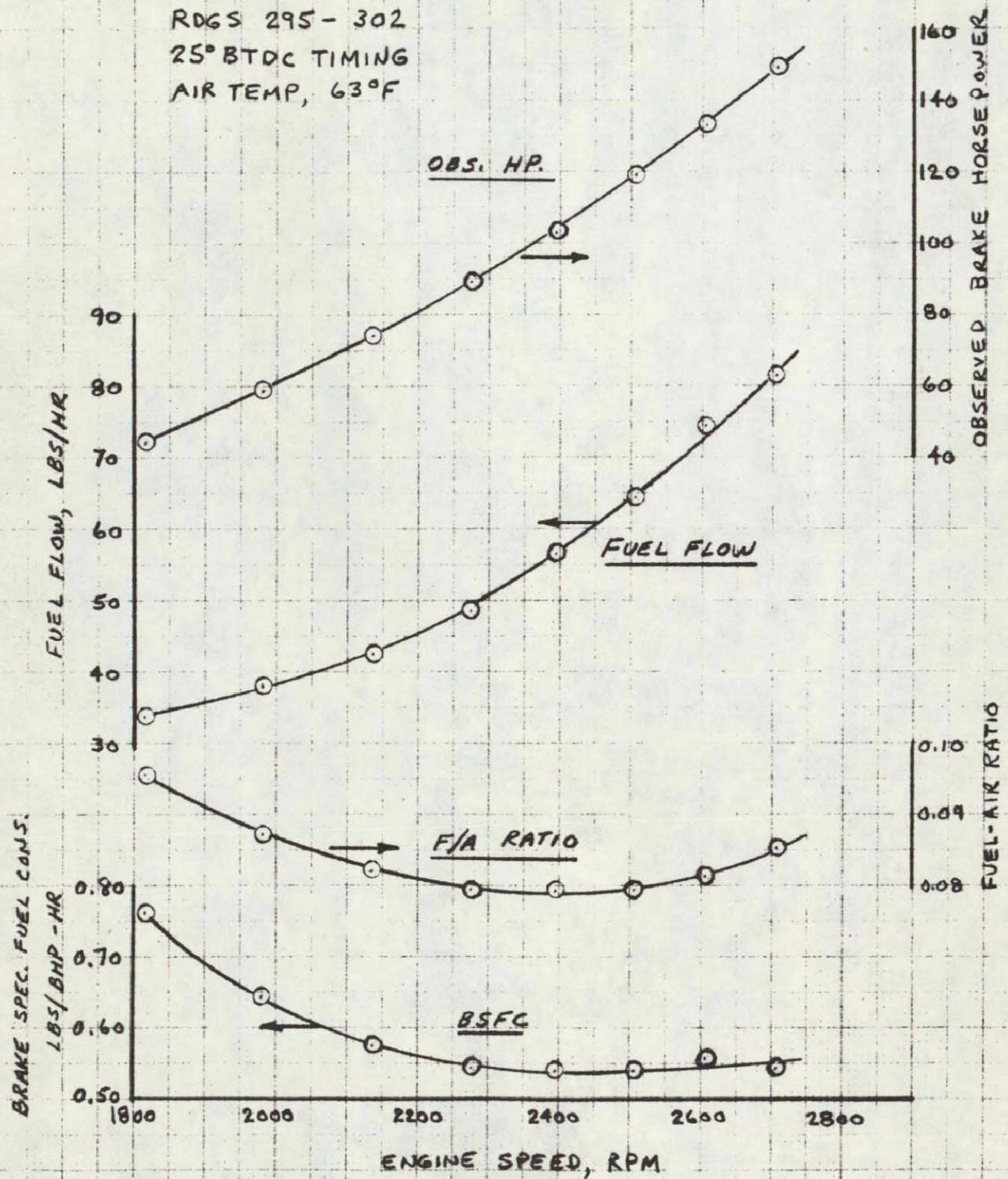
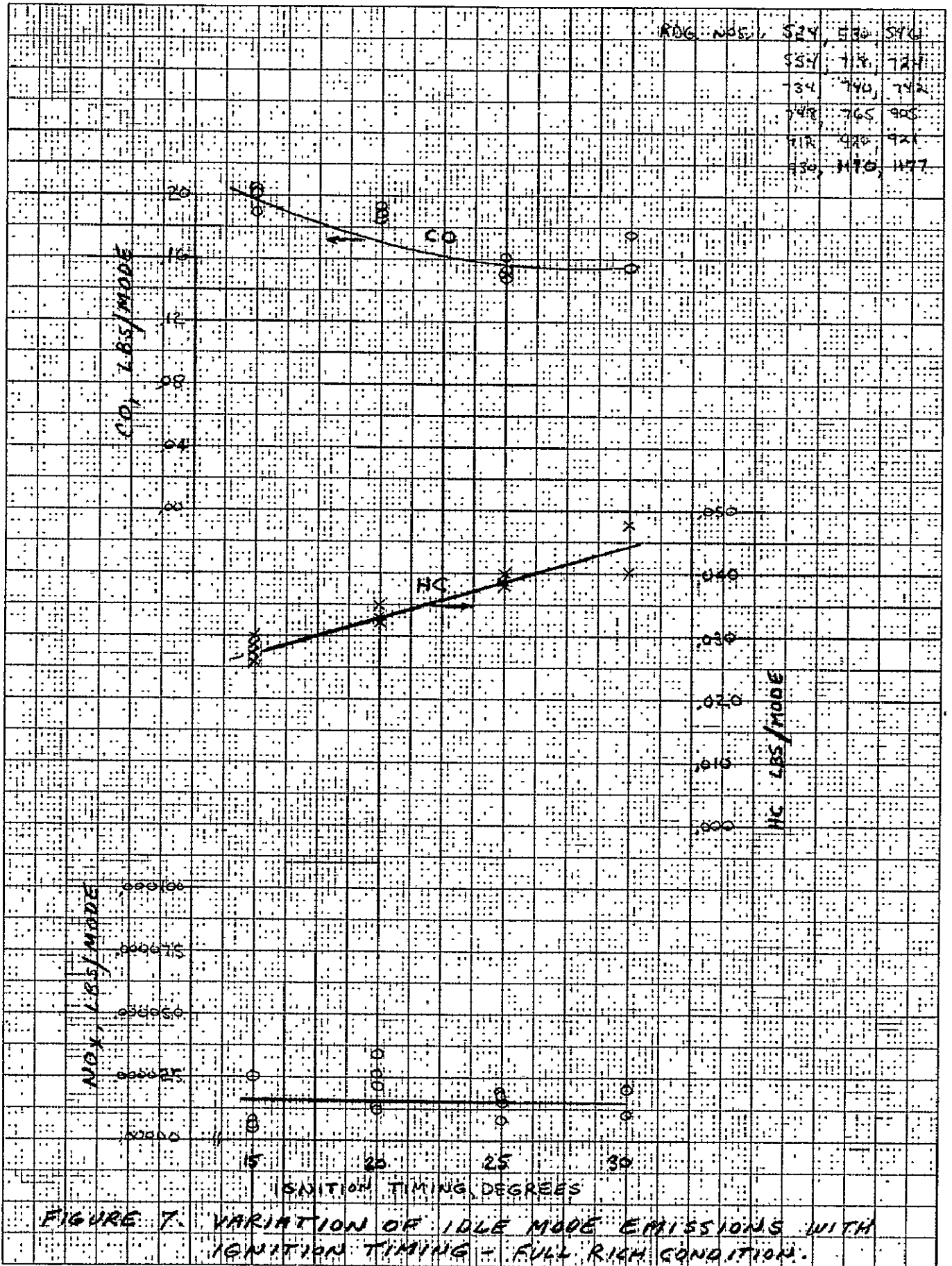

FIGURE 6. FULL RICH PROPELLER LOAD CURVE



RDG	NBS	524	530	540
		554	718	724
		734	740	742
		748	765	805
		818	840	821
		830	870	1177

FIGURE 7. VARIATION OF IDLE MODE EMISSIONS WITH IGNITION TIMING - FULL RICH CONDITION.

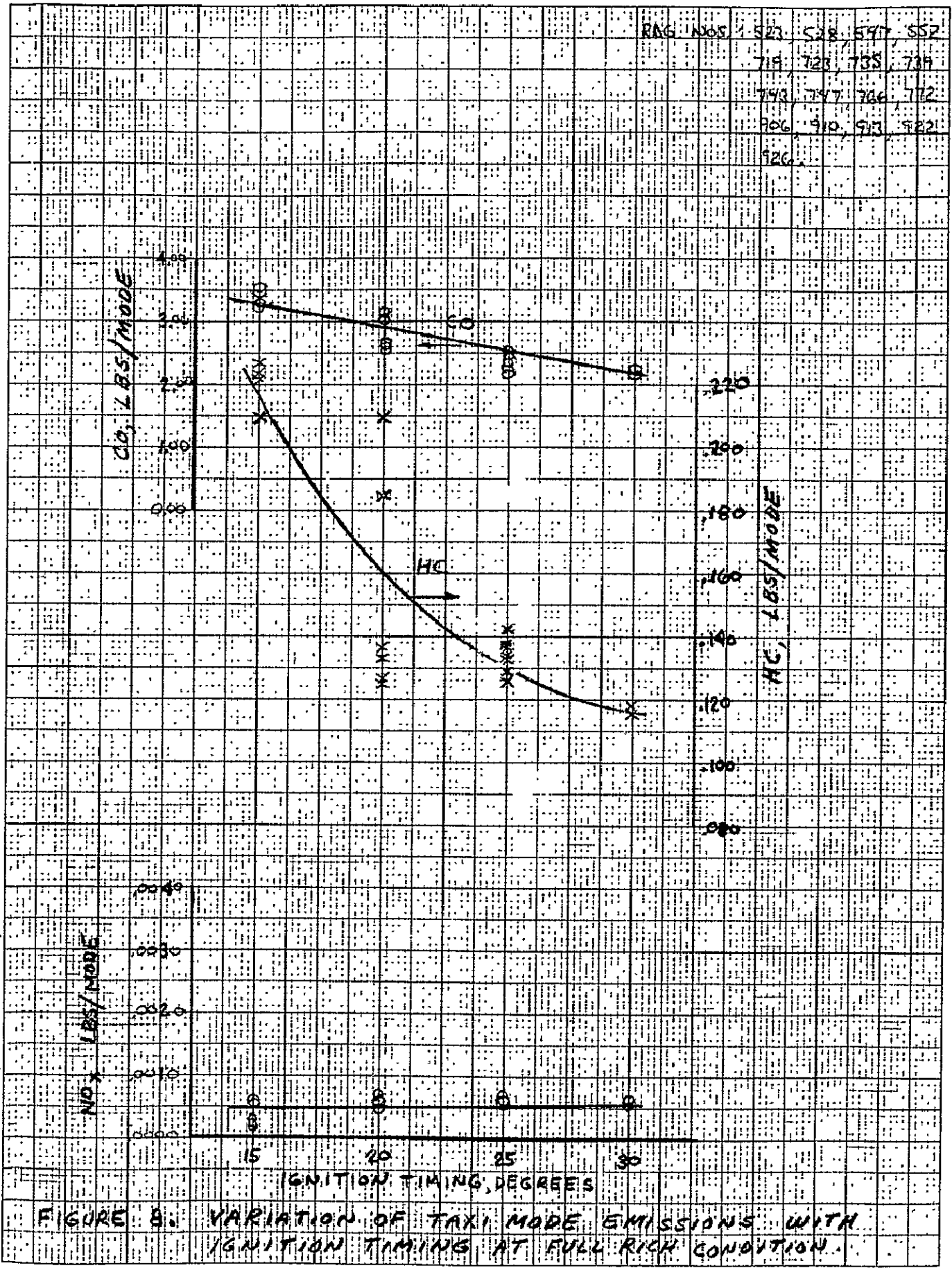

FIGURE 8: VARIATION OF TAXI MODE EMISSIONS WITH IGNITION TIMING AT FULL RICH CONDITION.

FIGURE 8

RNG. NOS.: 525 518 720 736
507 914 923
1172, 1192

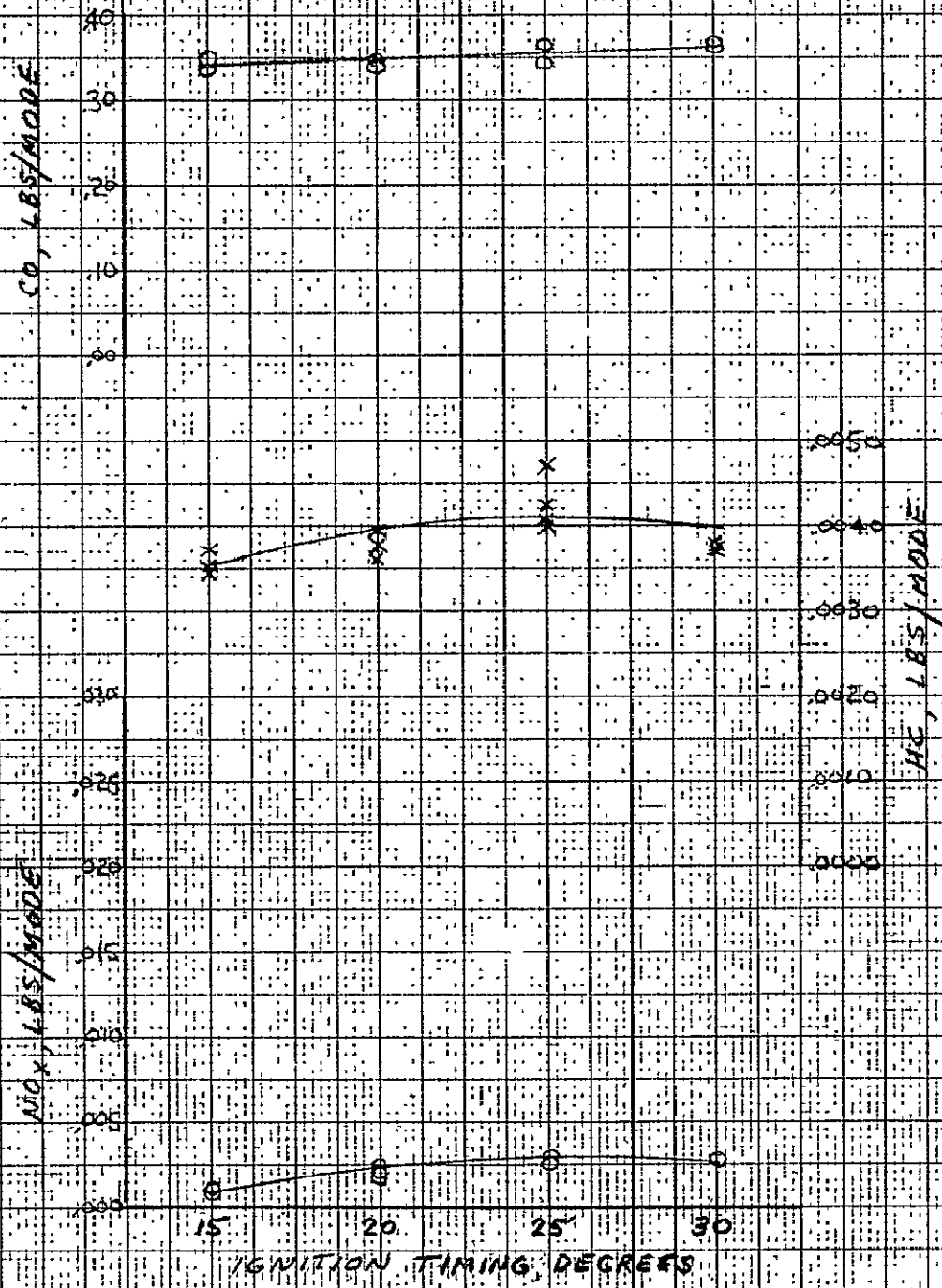

FIGURE 9. VARIATION OF TAKE OFF MODE EMISSIONS WITH IGNITION TIMING AT FULL RICH CONDITIONS.

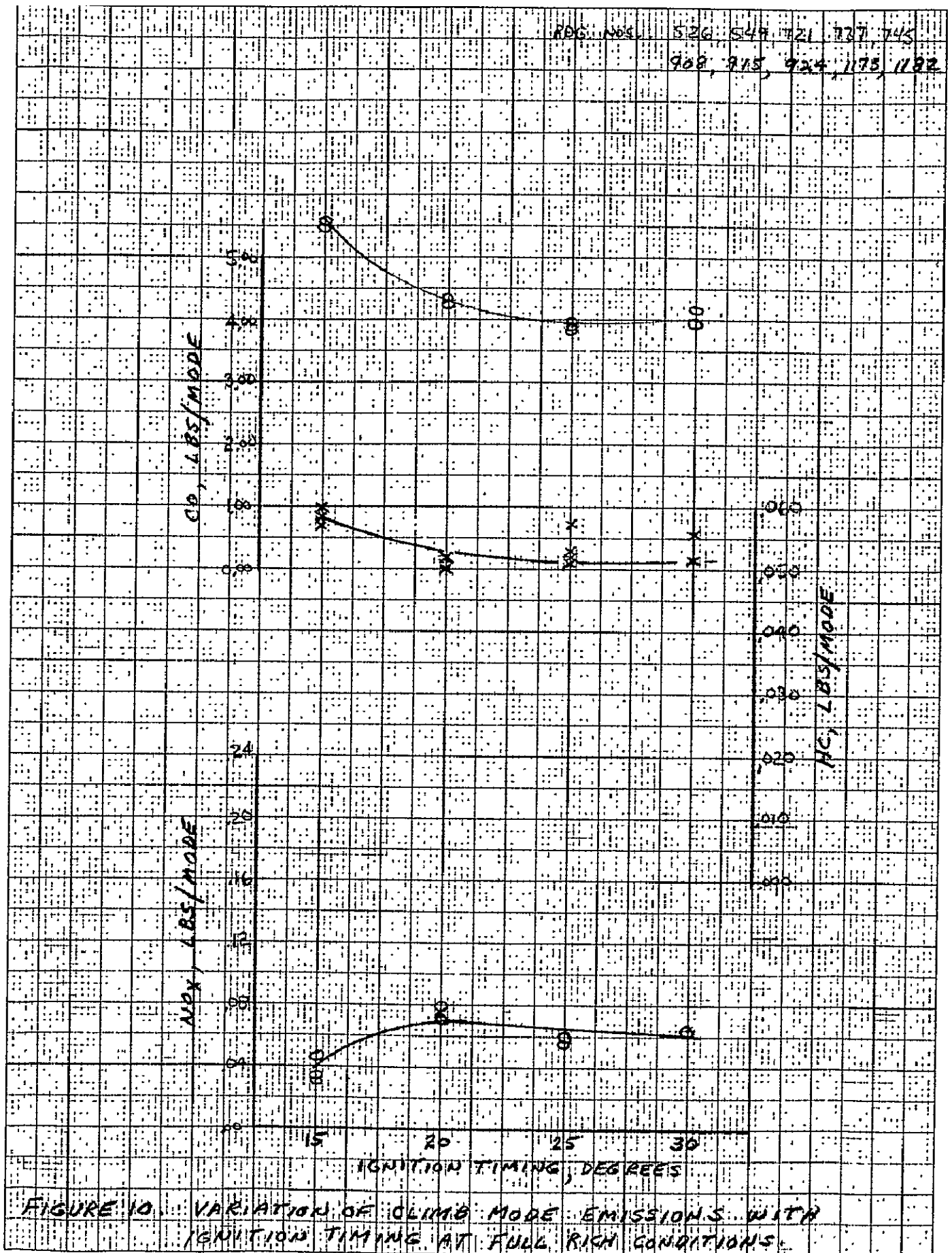

FIGURE 10. VARIATION OF CLIMB MODE EMISSIONS WITH IGNITION TIMING AT FULL RICH CONDITIONS.

RDG. NOS. 1: 527, 550, 722, 738
 746, 909, 917, 925
 1174, 1183

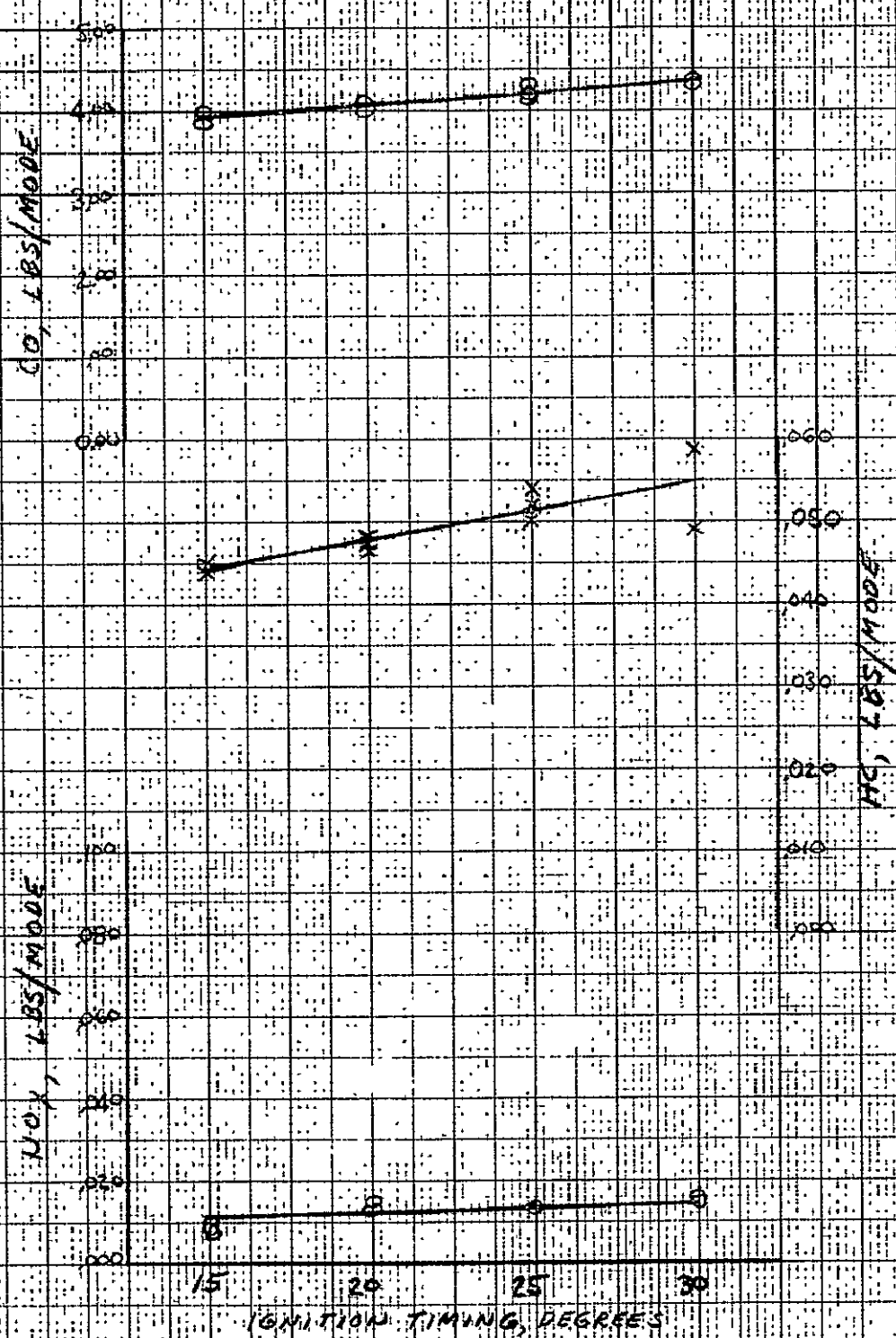
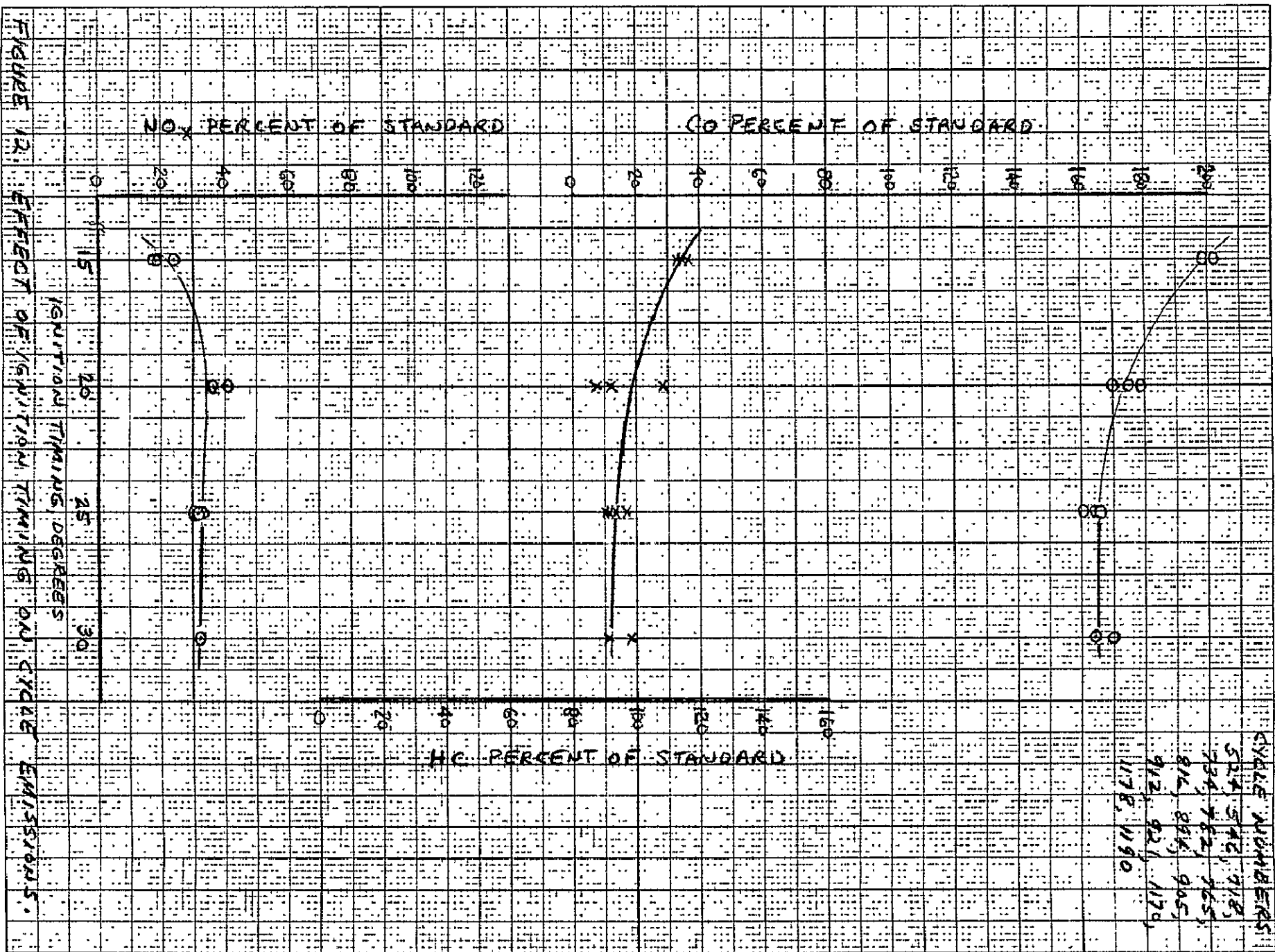
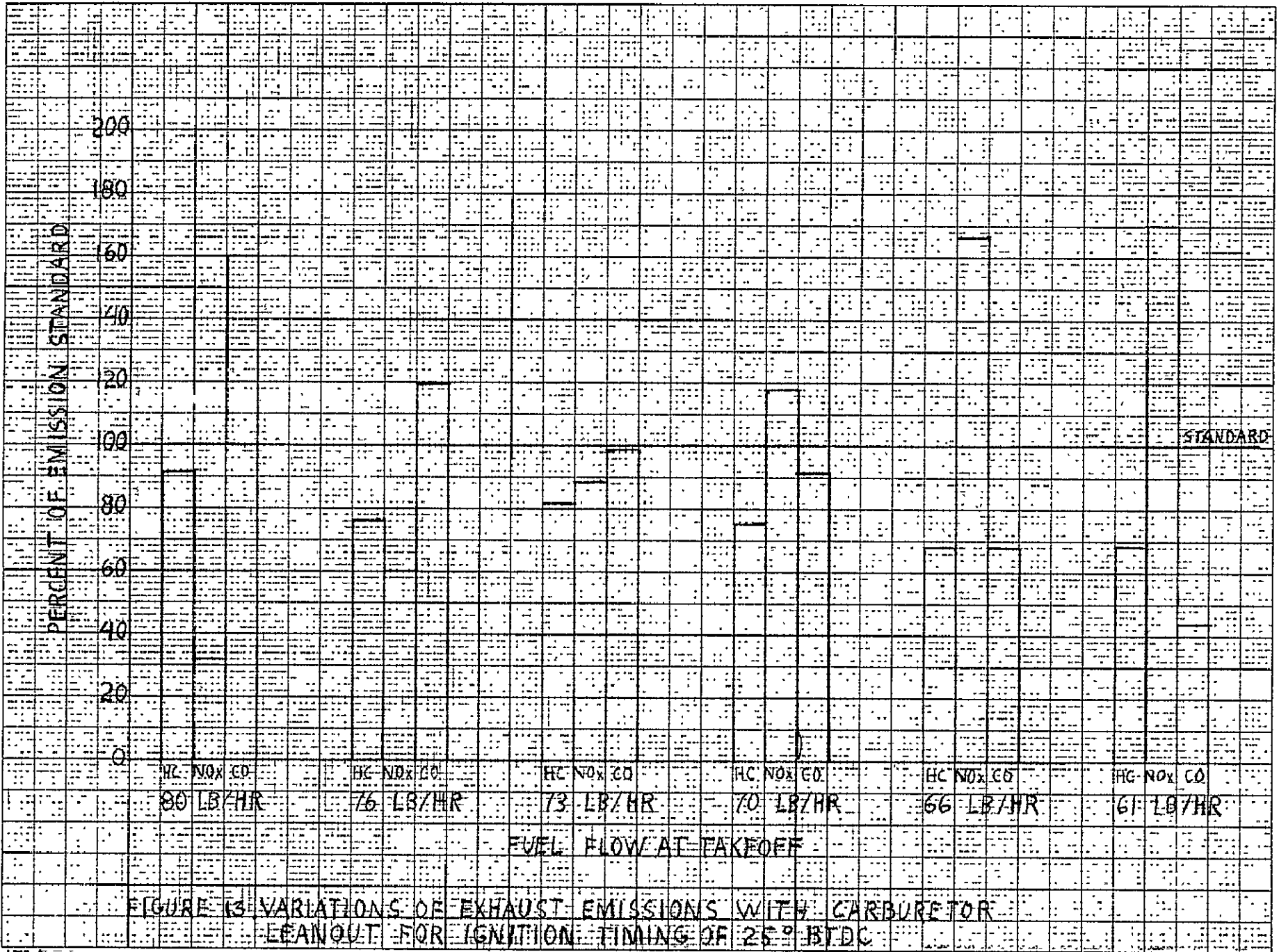
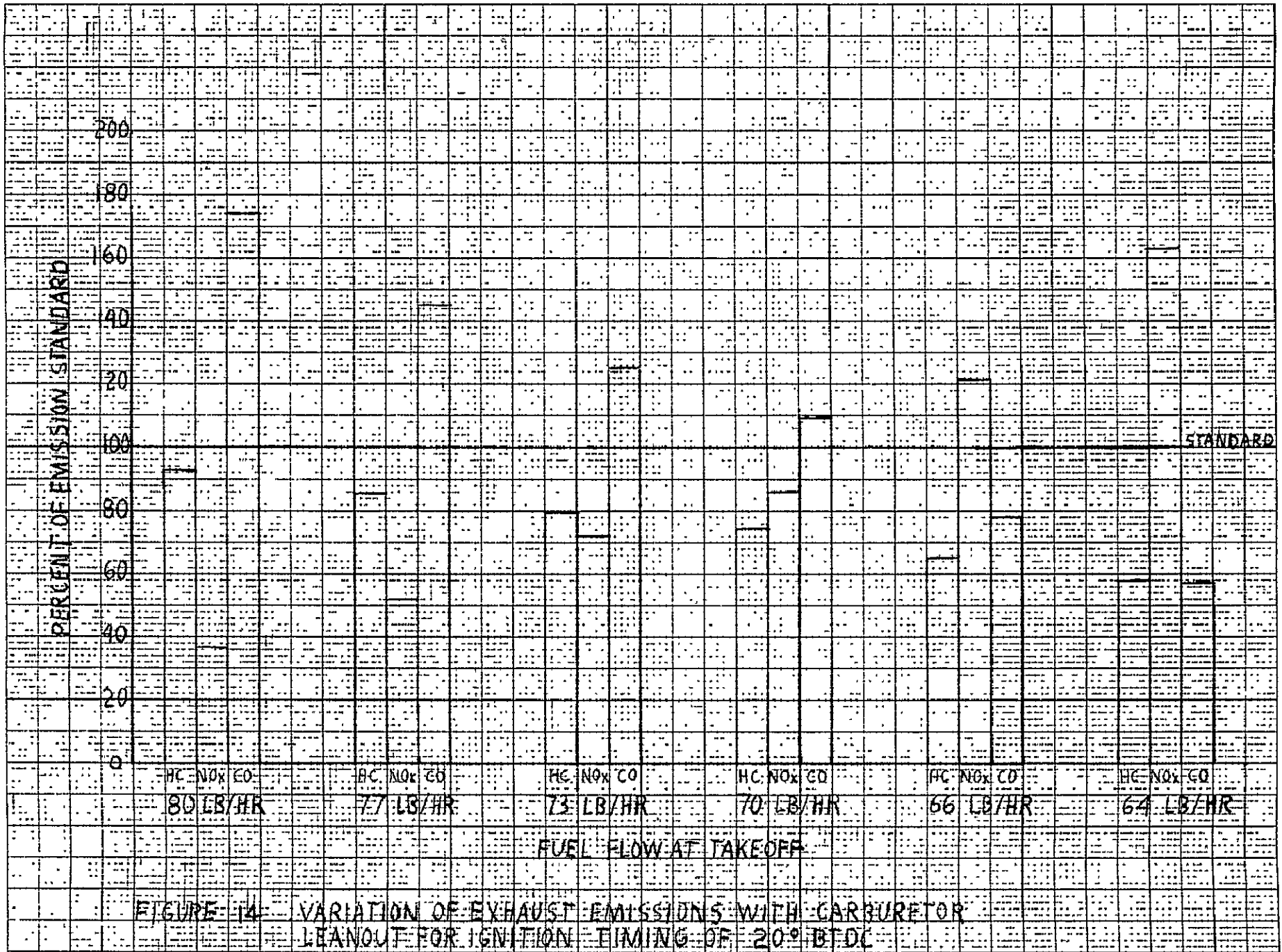
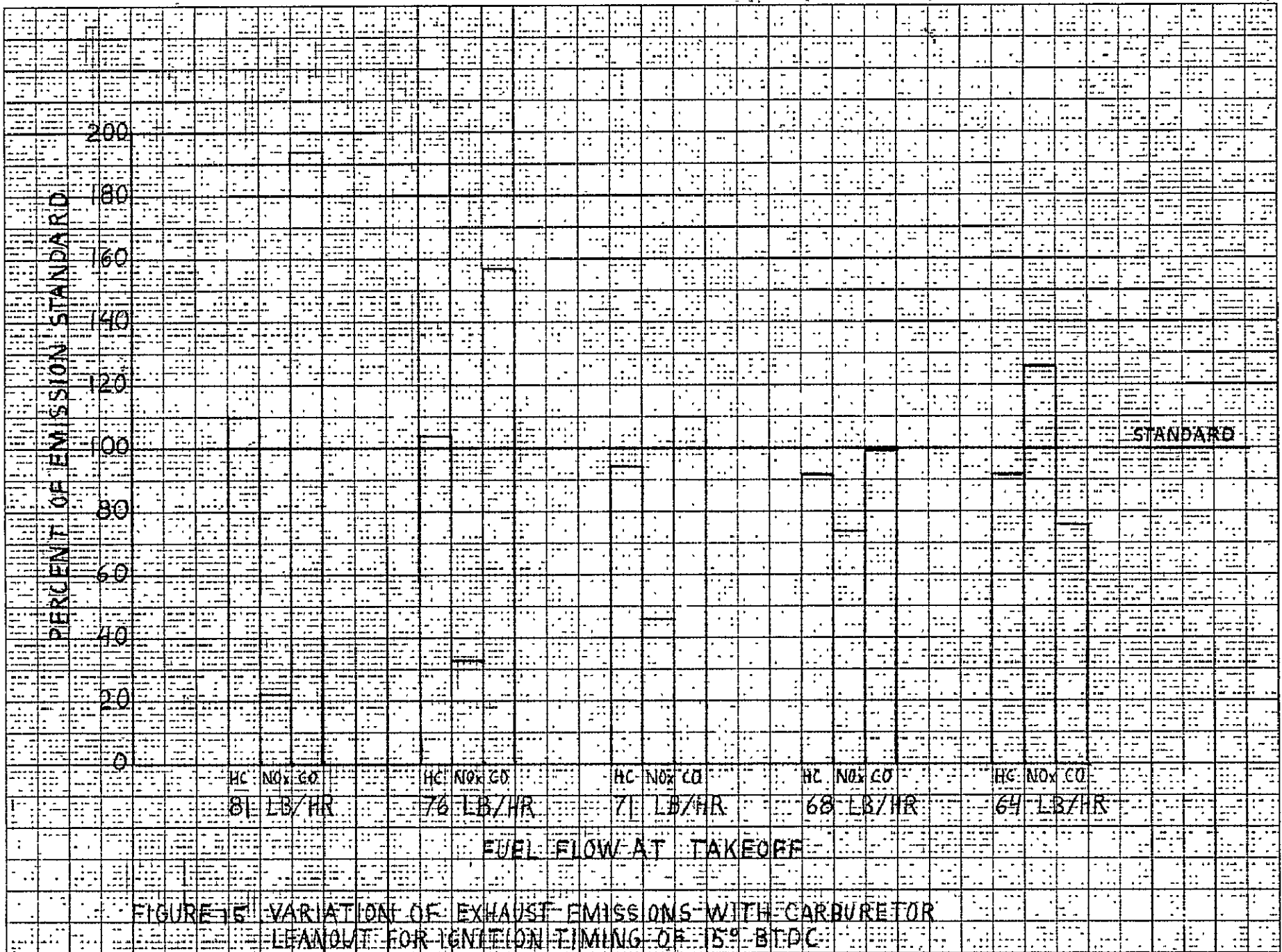

FIGURE 11. VARIATION OF APPROACH MODE EMISSIONS WITH IGNITION TIMING AT FULL RICH CONDITIONS.









3-D

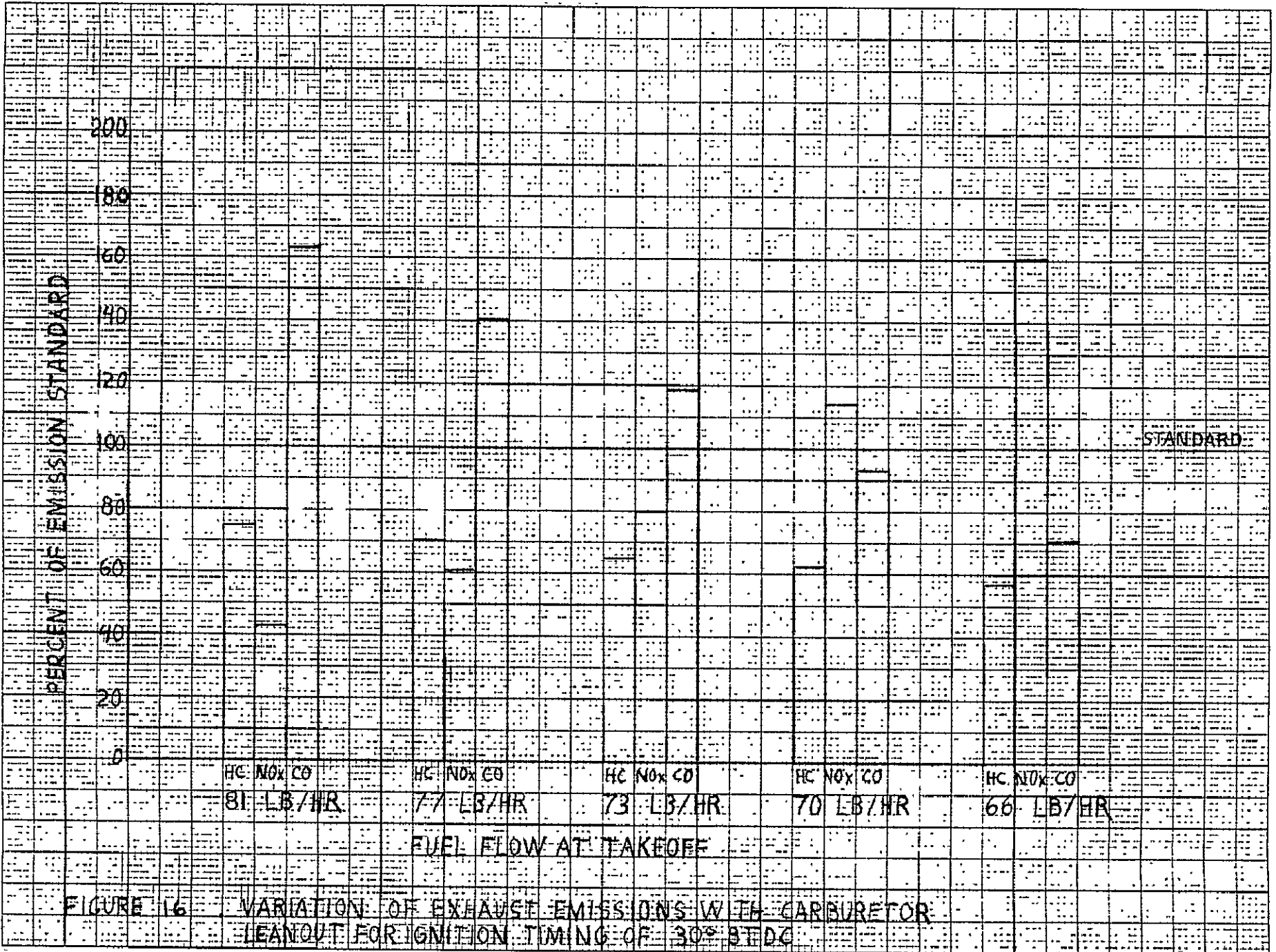

FIGURE 16 VARIATION OF EXHAUST EMISSIONS WITH CARBURETOR LEANOUT FOR IGNITION TIMING OF 30° BTDC

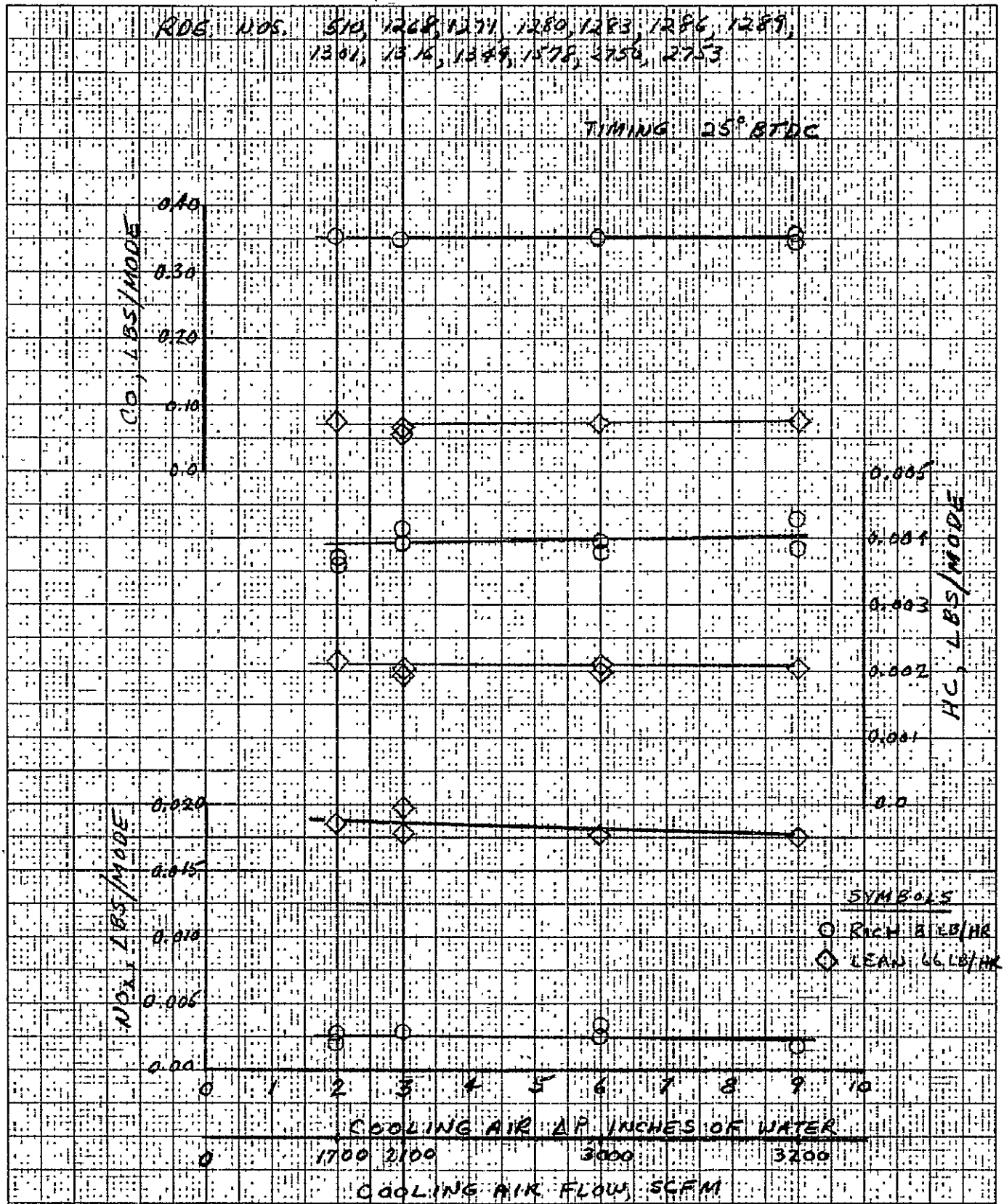

FIGURE 17. EFFECT OF COOLING AIR FLOW ON EXHAUST EMISSIONS - TAKE OFF MODE - 59° TEMP.

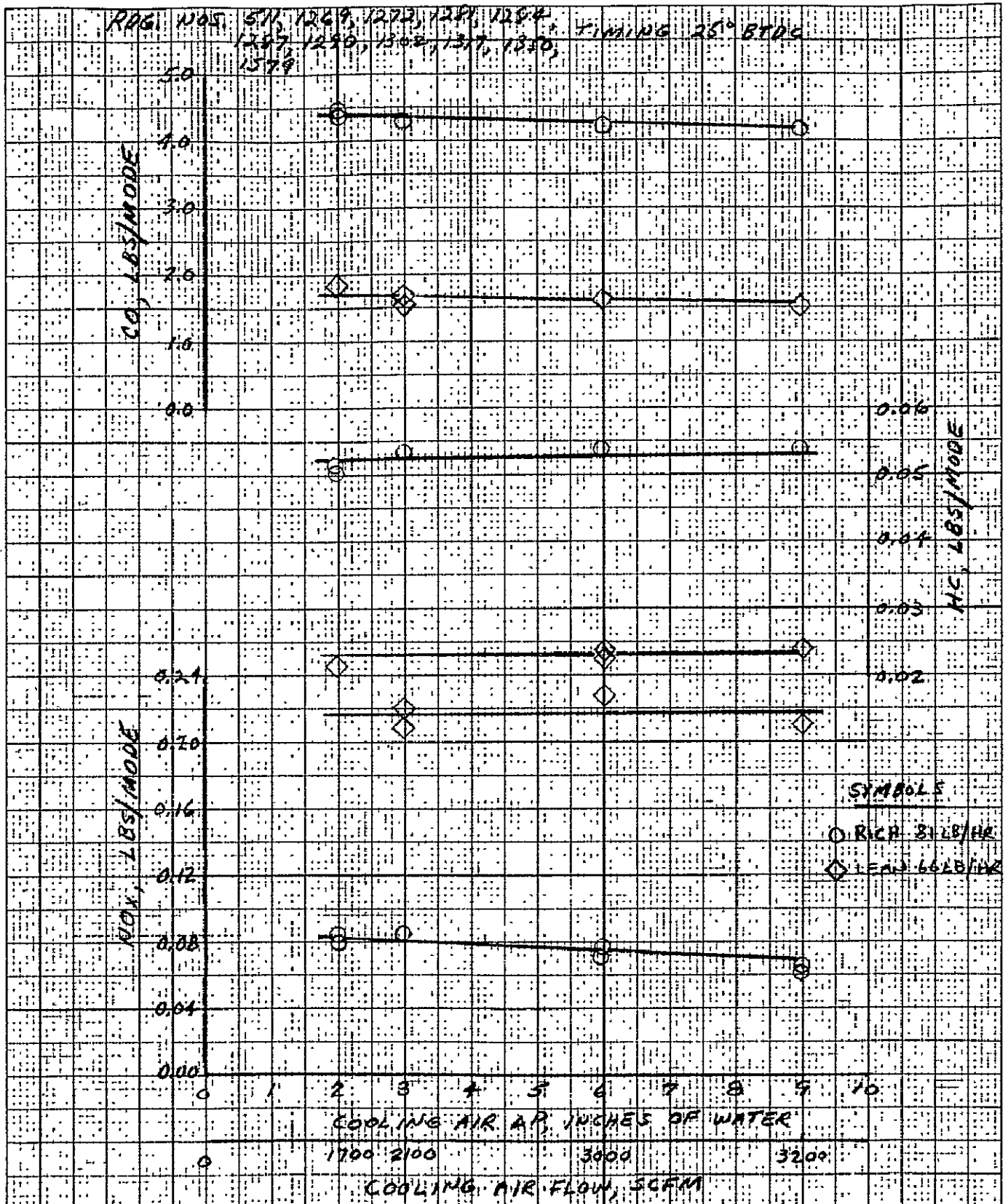

FIGURE 18. EFFECT OF COOLING AIR FLOW ON EXHAUST EMISSIONS - CLIMB MODE - 59° TEMP.

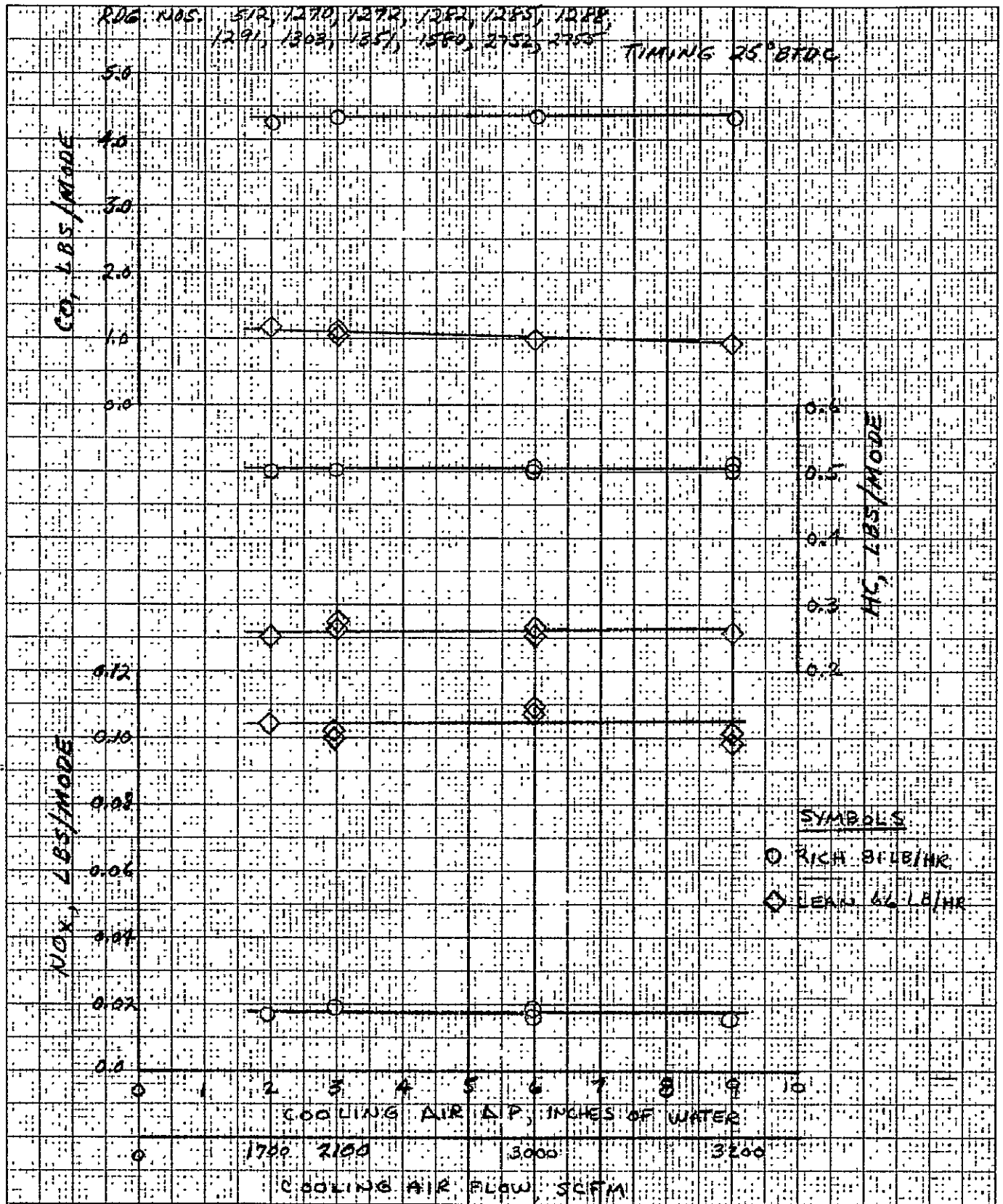

FIGURE 19. EFFECT OF COOLING AIR FLOW ON EXHAUST EMISSIONS - APPROACH MODE - 59°F TEMP.

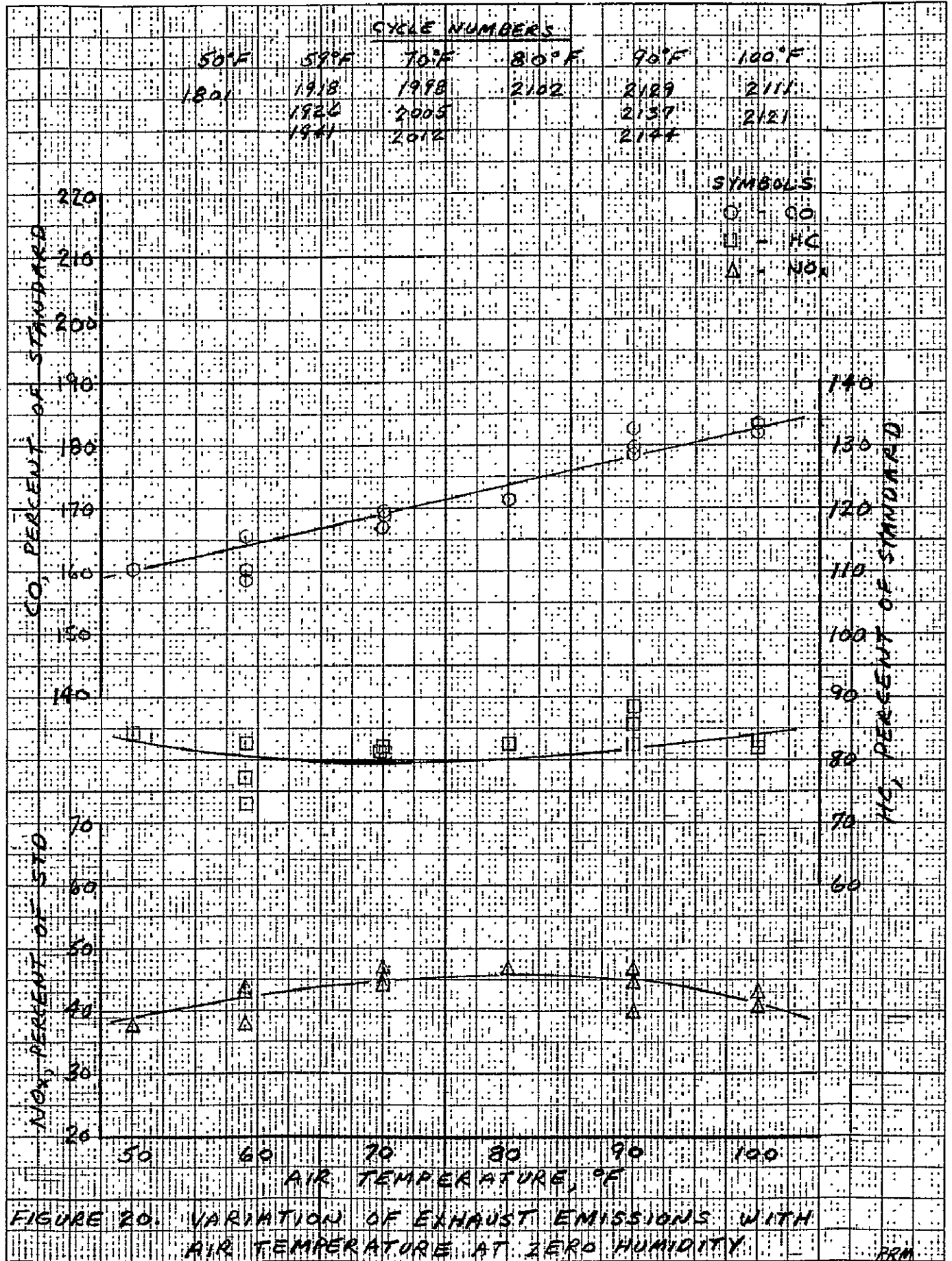

FIGURE 20. VARIATION OF EXHAUST EMISSIONS WITH AIR TEMPERATURE AT ZERO HUMIDITY

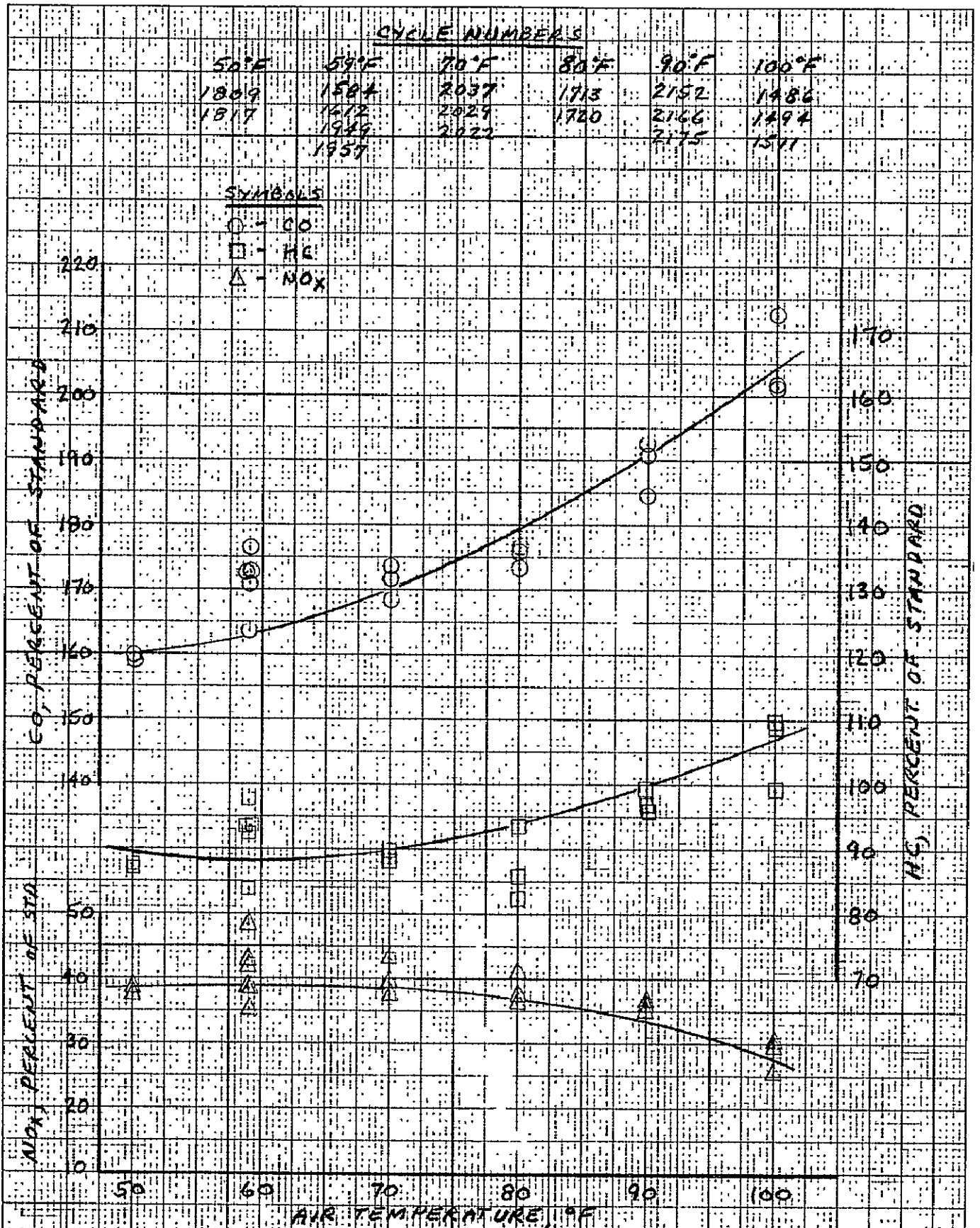

FIGURE R1. VARIATION OF EXHAUST EMISSIONS WITH AIR TEMPERATURE AT 30 PERCENT HUMIDITY. P.M.

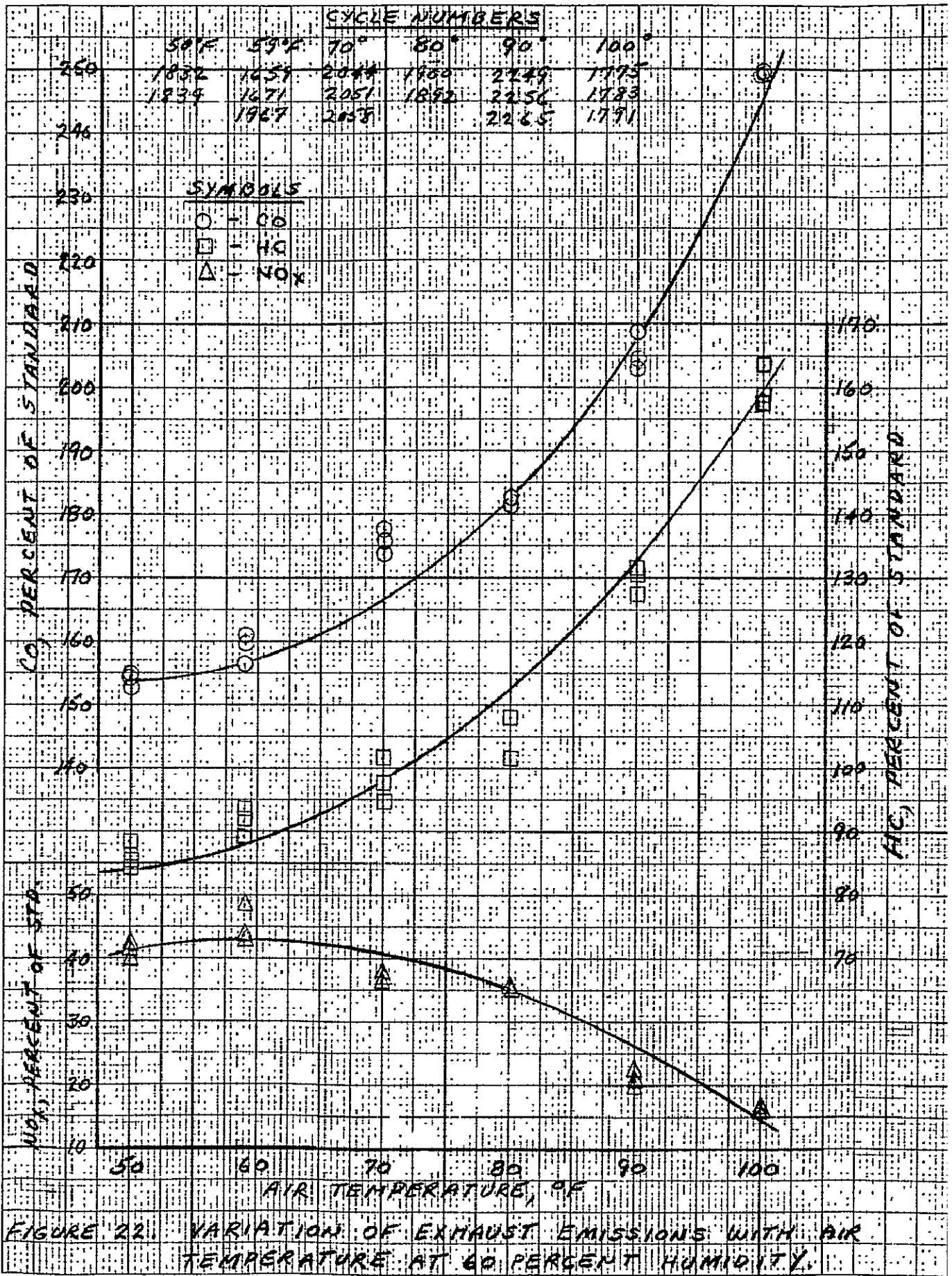

FIGURE 22. VARIATION OF EXHAUST EMISSIONS WITH AIR TEMPERATURE AT 60 PERCENT HUMIDITY.

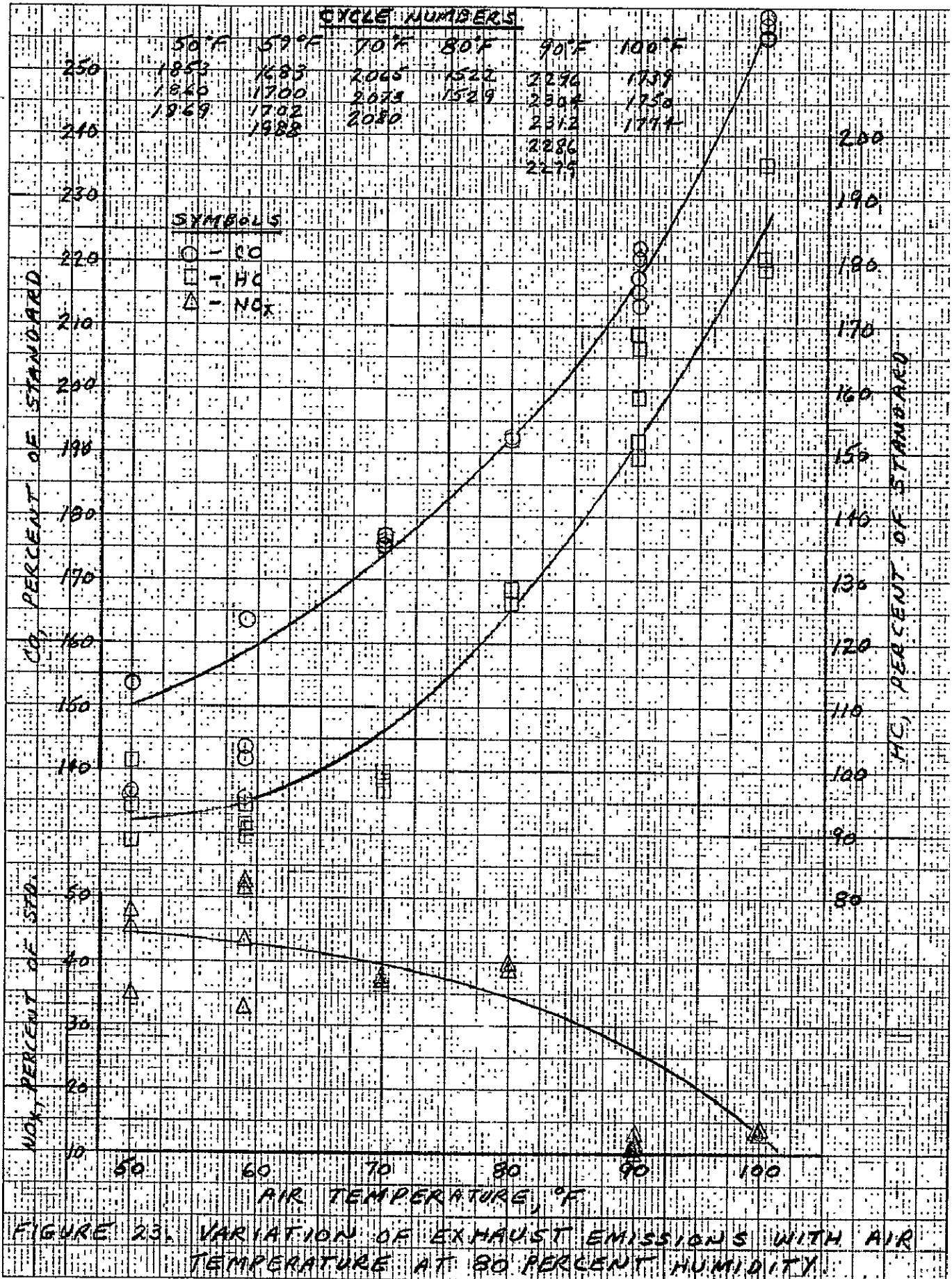

FIGURE 23. VARIATION OF EXHAUST EMISSIONS WITH AIR TEMPERATURE AT 80 PERCENT HUMIDITY.

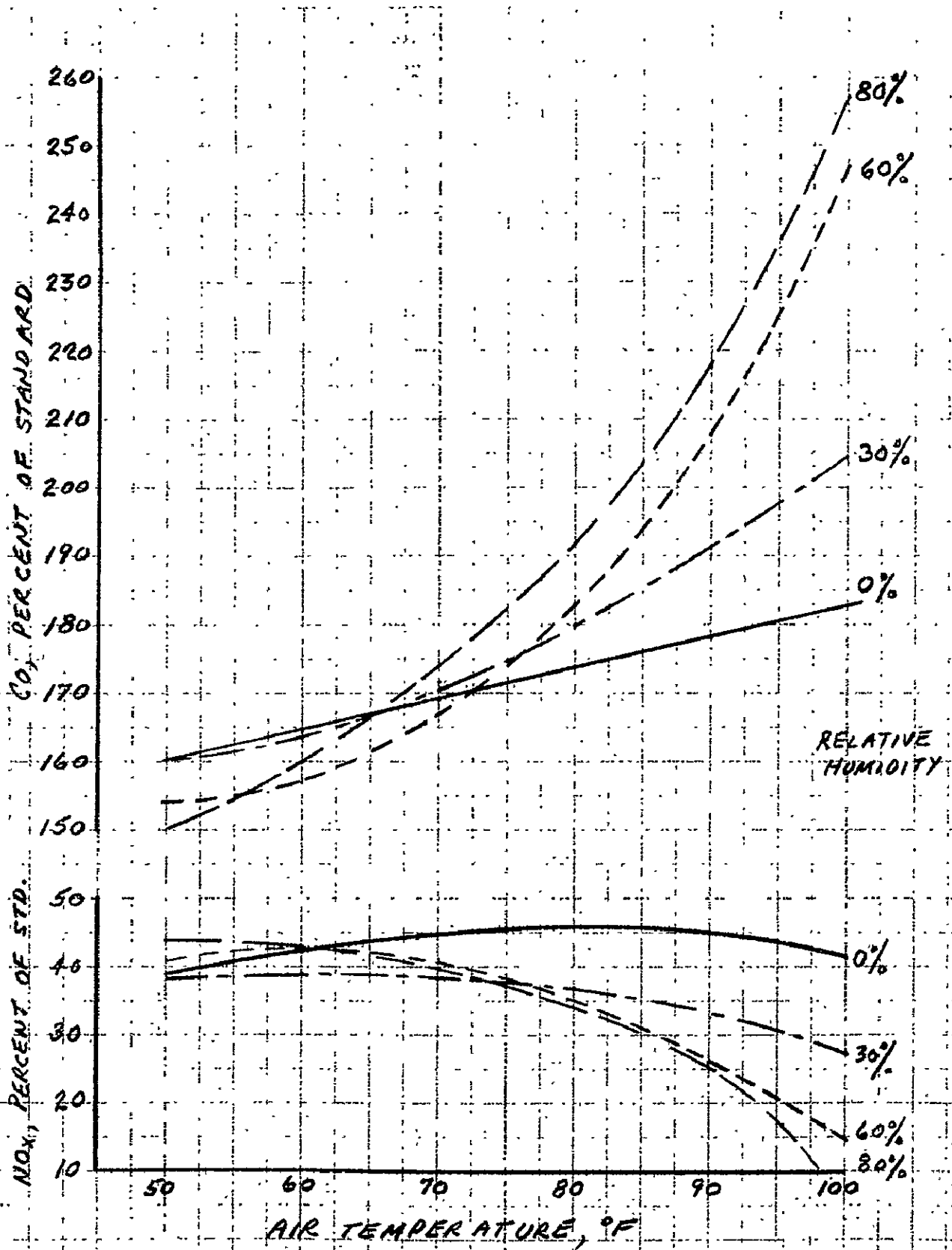

FIGURE 24. SUMMARY PLOT OF CARBON MONOXIDE AND OXIDES OF NITROGEN WITH AIR TEMPERATURE AND RELATIVE HUMIDITY.

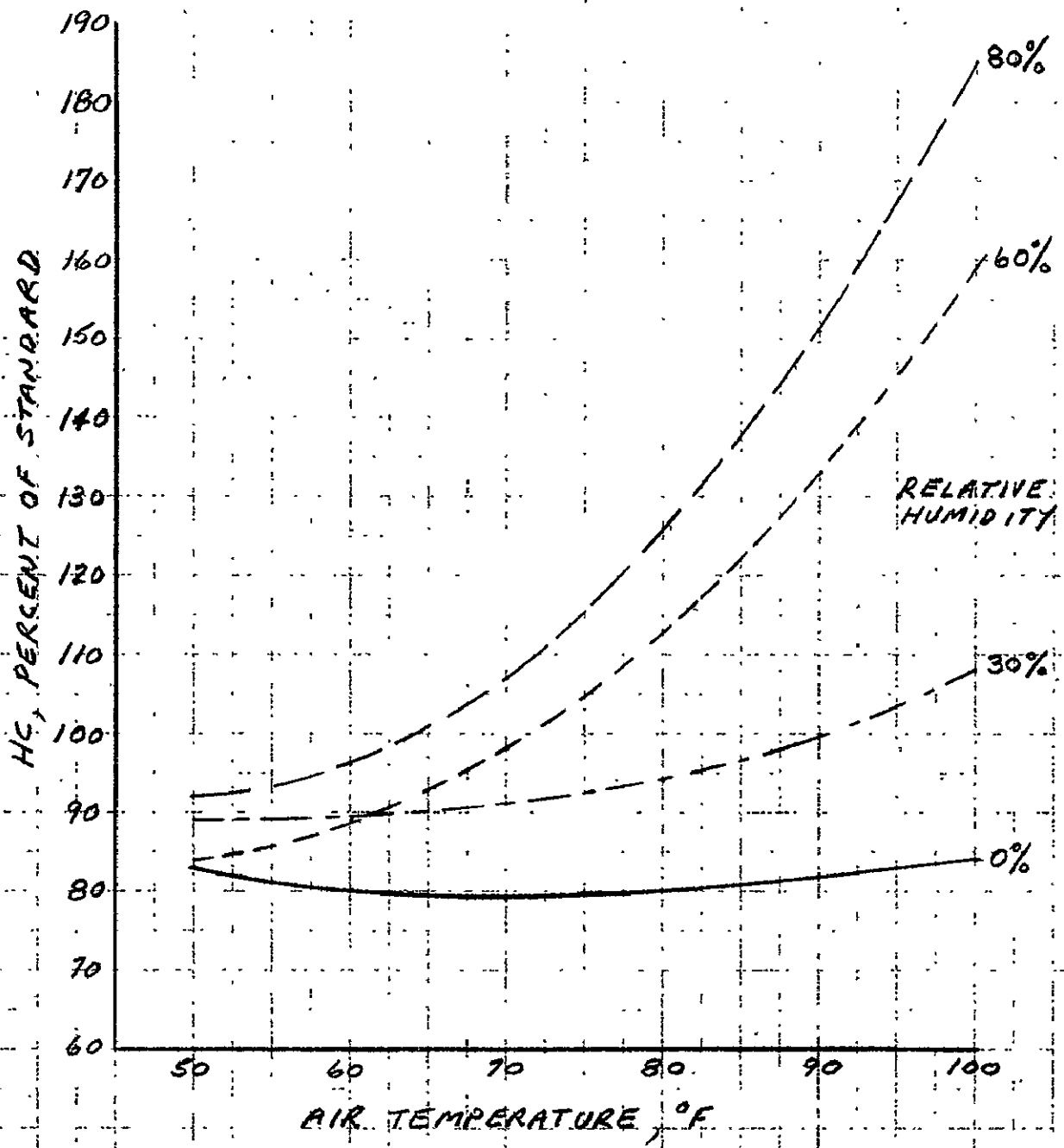
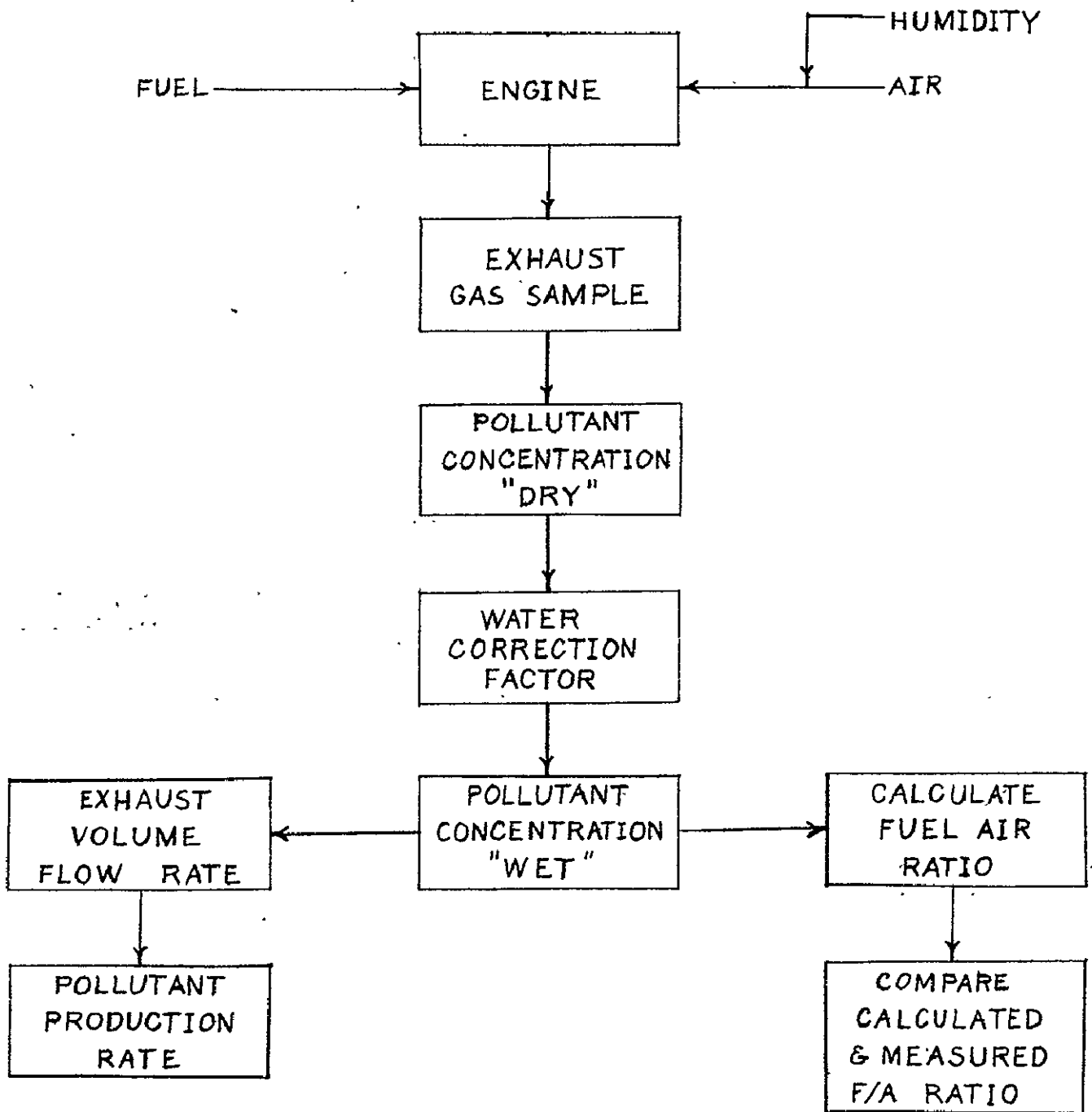

FIGURE 25. SUMMARY PLOT OF HYDROCARBON EMISSIONS WITH AIR TEMPERATURE AND RELATIVE HUMIDITY.



EXHAUST EMISSION
DATA REDUCTION FLOW CHART

FIGURE 26

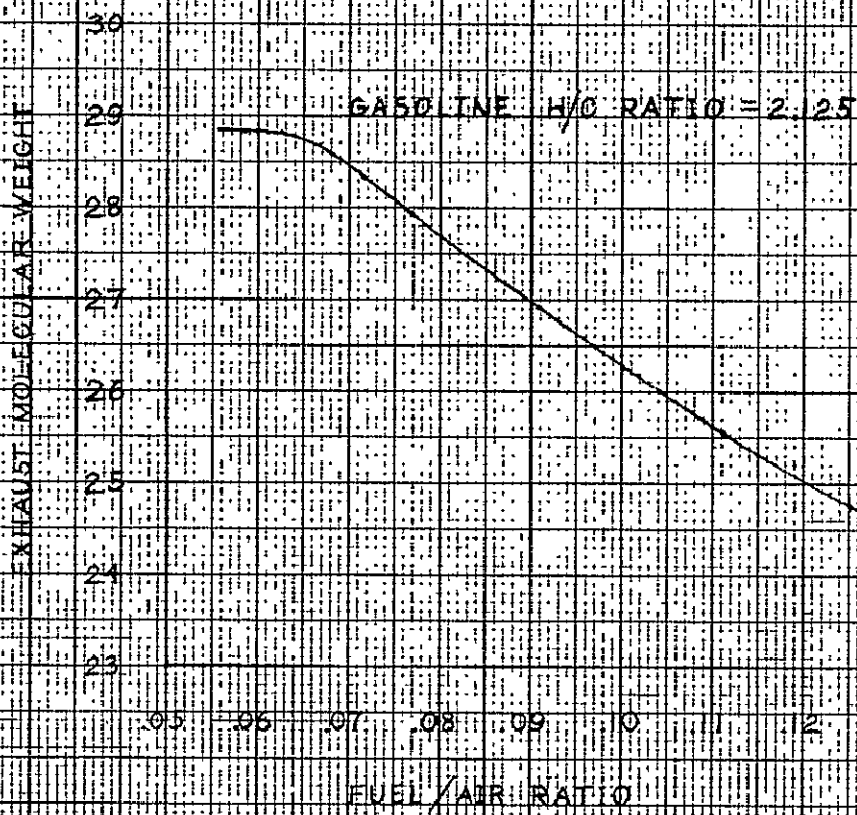

FIGURE A1 - EXHAUST MOLECULAR WEIGHT AS A FUNCTION OF FUEL AIR RATIO FOR AVIATION GASOLINE