

NASA CONTRACTOR  
REPORT

NASA CR-2728

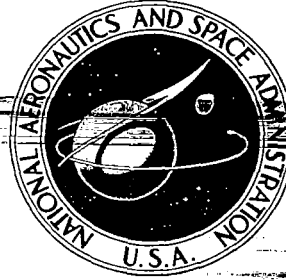

NASA CR 2728

LOAN COPY  
AFWL TECHNICAL  
KIRTLAND AFB

NASA  
CR  
2727  
v. 2  
c. 1



TECH LIBRARY KAFB, NM

# ANALYSIS OF STRUCTURAL DYNAMIC DATA FROM SKYLAB

Volume II - Skylab Analytical  
and Test Modal Data

*Leonard Demchak and Harry Harcrow*

Prepared by  
MARTIN MARIETTA CORPORATION  
Denver, Co. 80201  
for George C. Marshall Space Flight Center

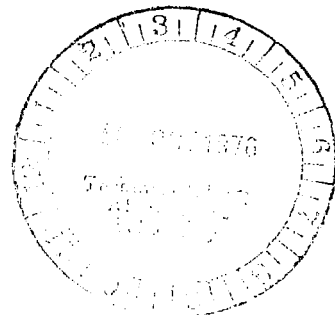



TECHNICAL REPORT STANDARD TITLE PAGE

0061449

1. REPORT NO. NASA CR-2728		2. GOVERNMENT ACCESSION NO.		3. RECIPIENT'S CATALOG NO.	
4. TITLE AND SUBTITLE Analysis of Structural Dynamic Data from Skylab Volume II - Skylab Analytical and Test Modal Data				5. REPORT DATE August, 1976	
				6. PERFORMING ORGANIZATION CODE M-175	
7. AUTHOR(S) Leonard Demchak and Harry Harcrow				8. PERFORMING ORGANIZATION REPORT #	
9. PERFORMING ORGANIZATION NAME AND ADDRESS Martin Marietta Corporation P. O. Box 179 Denver, Colorado 80201				10. WORK UNIT NO.	
				11. CONTRACT OR GRANT NO. NAS8-31224	
12. SPONSORING AGENCY NAME AND ADDRESS National Aeronautics and Space Administration Washington, D. C. 20546				13. TYPE OF REPORT & PERIOD COVERED Contractor Report Final	
				14. SPONSORING AGENCY CODE	
15. SUPPLEMENTARY NOTES					
16. ABSTRACT  <p>This volume is a compendium of the orbital configuration test modal data, analytical test modal data, analytical test correlation modal data and analytical flight configuration 1.2 modal data. Section A presents tables showing the generalized mass contributions (GMC's) for each of the thirty test modes. Section B presents the two-dimensional mode shape plots for the thirty test modes. Tables of GMC's for the test correlated analytical modes are presented in Section C. These analytical modes were generated from a model that was adjusted to match test results by use of the methodology discussed in Sections 2.3 and 5.4 of Volume I of this report. Section D presents the two-dimensional mode shape plots for the analytical modes. Sections E and F contain the uncoupled and coupled modes of the orbital flight configuration 1.2 at three development phases of the model. These phases of the model--initial, pretest, and final--are described in detail in Section I of Volume I of this report.</p> <p>This analysis is published in two volumes:</p> <p>Volume I - Technical Discussion - NASA CR-2727</p> <p>Volume II - Skylab Analytical and Test Modal Data - NASA CR-2728</p>					
17. KEY WORDS			18. DISTRIBUTION STATEMENT  STAR Category 15		
19. SECURITY CLASSIF. (of this report) Unclassified		20. SECURITY CLASSIF. (of this page) Unclassified		21. NO. OF PAGES 214	22. PRICE \$7.25

SECTION A

Test Modes GMC Tables



The following Tables A-1 through A-60 show the generalized mass contributions (GMC's) for each of the thirty test modes. Two types of tables are given for each mode. The first table gives a summary of GMC's for major structural components while the second table shows the GMC for each of the 193 degrees of freedom contained in the reduced test data. These GMC data were calculated using a 193 x 193 discrete mass matrix derived using static collapse of analytical component mass matrices. It should be noted that the GMC distribution shown for Mode 02A is highly distorted due to apparent bad accelerometer data for the AFT OWS Skirt station 3100.

TABLE A-1 ORBITAL CONFIGURATION MODAL SURVEY

## TEST MODES GENERALIZED MASS CONTRIBUTION SUMMARY

TEST MODE NO. 01A

TEST FREQUENCY = .31 HZ.

COMPONENT NAME	GMC (DX)	GMC (DY)	GMC (DZ)	GMC (TX)	GMC (TY)	GMC (TZ)
RR/OWS SKIRT/IU/FAS	.0060	.0013	.2069	.0001	.0036	.0086
6-FAS O2 TANKS	.0019	.0026	.1123	0.	0.	0.
MDA/STS/AM	.0003	.0022	.1385	.0002	.0023	.0003
6-AM N2 TANKS	.0002	.0005	.0228	0.	0.	0.
COMMAND/SERVICE MOD.	.0003	.0065	.2541	.0003	-.0001	.0001
DEPLOYMENT ASSEMBLY	.0001	.0007	.0237	0.	0.	0.
ATM-RACK,CMGS,4-SAS	.0014	.0027	.1335	.0006	.0004	.0000
ATM-SPAR CENTER	.0002	.0005	.0298	.0001	.0000	0.
ATM-GRA/CAN CENTER	.0001	.0000	.0243	.0003	.0000	.0001
	---	---	---	---	---	---
SUM	.0106	.0171	.9559	.0009	.0062	.0092

## TOTAL GM CONTRIBUTION FOR EACH COMPONENT

RR/OWS SKIRT/IU/FAS	.2266
6-FAS O2 TANKS	.1167
MDA/STS/AM	.1439
6-AM N2 TANKS	.0235
COMMAND/SERVICE MOD.	.2713
DEPLOYMENT ASSEMBLY	.0245
ATM-RACK,CMGS,4-SAS	.1381
ATM-SPAR CENTER	.0306
ATM-GRA/CAN CENTER	.0248

TABLE A-2 GENERALIZED MASS CONTRIBUTIONS BY DEGREE OF FREEDOM

TEST MODE		01A		RUN NO. 333		FREQUENCY = .31		
NODE NO.	GMC (DX)	GMC (DY)	GMC (DZ)	GMC (TX)	GMC (TY)	GMC (TZ)	NODE DESCRIPTION	
1	.0056	-.0001	.0869	.0001	.0030	.0086	BASE RNG/DWS SKIRT	
2	.0001	.0002	.0209	.0000	-.0006	.0000	OWS/IU INTERFACE	
3	-.0000	.0004	.0625	.0000	.0012	-.0000	IU/FAS INTERFACE	
4	.0001	.0010	.0174	0.	0.	0.	FAS 02 BOTL1,+Y +Z	
5	.0006	.0004	.0264	0.	0.	0.	FAS 02 BOTL2,+Y +Z	
6	.0011	.0004	.0246	0.	0.	0.	FAS 02 BOTL3,-Y +Z	
7	.0001	.0004	.0239	0.	0.	0.	FAS 02 BOTL4,-Y +Z	
8	.0001	.0003	.0039	0.	0.	0.	FAS 02 BOTL5,-Y -Z	
9	.0000	.0001	.0162	0.	0.	0.	FAS 02 BOTL6,-Y -Z	
10	.0000	.0000	.0068	0.	0.	0.	FAS/AM/DA IF, +Y	
11	.0004	.0005	.0098	0.	0.	0.	FAS/AM/DA IF, +Z	
12	-.0000	.0002	.0107	0.	0.	0.	FAS/AM/DA IF, -Y	
13	-.0000	.0000	.0033	0.	0.	0.	FAS/DA IF, -Y -Z	
14	.0000	.0000	.0051	0.	0.	0.	FAS/AM IF, -Z	
15	.0000	-.0000	.0010	0.	0.	0.	FAS/DA IF, +Y -Z	
16	.0002	.0003	.0168	.0001	.0002	.0003	AM TUNNEL/SHEAR WB	
17	.0000	.0008	.0180	.0003	.0001	.0000	AM TUNNEL/STS IF	
18	.0000	.0009	.0578	.0000	.0019	.0000	MDA/STS INTERFACE	
19	.0000	.0002	.0460	-.0002	.0001	-.0000	MDA CONE/CYL ITRFC	
20	.0000	.0001	.0038	0.	0.	0.	N2 TANK, +Y, LOWER	
21	.0000	.0001	.0045	0.	0.	0.	N2 TANK, +Y, UPPER	
22	.0001	.0001	.0025	0.	0.	0.	N2 TANK, +Z, LOWER	
23	.0000	.0001	.0040	0.	0.	0.	N2 TANK, +Z, UPPER	
24	.0000	.0001	.0036	0.	0.	0.	N2 TANK -Z, LOWER	
25	.0000	.0000	.0043	0.	0.	0.	N2 TANK, -Z, UPPER	
26	.0000	.0009	.0470	-.0000	-.0000	.0000	CM, FWD BULKHEAD	
27	.0002	.0030	.0836	-.0000	-.0001	.0000	CM, AFT BULKHEAD	
28	.0001	.0013	.0592	.0003	-.0000	.0001	SM, FWD BULKHEAD	
29	.0000	.0014	.0743	.0001	-.0000	-.0000	SM, AFT BULKHEAD	
30	.0001	.0002	.0035	0.	0.	0.	LOWER D LATCH, DA	
31	.0000	.0006	.0071	0.	0.	0.	LOWER +Y TRUNNION	
32	-.0000	-.0001	.0106	0.	0.	0.	LOWER -Y TRUNNION	
33	.0000	.0001	.0025	0.	0.	0.	FREP PACKAGE C.G.	
34	.0002	-.0001	.0283	0.	0.	0.	ATM PN 6,7 IF,OUTR	
35	.0009	-.0001	.0118	0.	0.	0.	ATM PN 4,5 IF,OUTR	
36	.0000	.0001	.0160	0.	0.	0.	ATM PN 8,1 IF,OUTR	
37	.0004	.0005	.0163	0.	0.	0.	ATM PN 2,3 IF,OUTP	
38	-.0000	.0009	.0167	0.	0.	0.	ATM PN 6,7 IF,INNER	
39	-.0002	.0006	.0066	0.	0.	0.	ATM PN 4,5 IF,INNER	
40	.0000	.0004	.0122	0.	0.	0.	ATM PN 8,1 IF,INNER	
41	.0001	.0004	.0154	0.	0.	0.	ATM PN 2,3 IF,INNER	
42	-.0000	.0000	.0047	.0000	.0000	.0000	CMG, -Y SIDE	
43	.0000	.0001	.0047	.0000	-.0000	-.0000	CMG, +Y SIDE	
44	.0001	-.0000	.0008	-.0000	.0004	.0000	CMG, +X SIDE	
45	-.0000	-.0000	0.	0.	0.	0.	ATM SAS, PN 1	
46	.0000	.0000	0.	0.	0.	0.	ATM SAS, PN 3	
47	.0001	.0001	0.	0.	0.	0.	ATM SAS, PN 5	
48	-.0000	-.0000	0.	0.	0.	0.	ATM SAS, PN 7	
49	.0002	.0005	.0298	.0000	.0000	.0002	SPAR CENTER	
50	.0001	.0000	.0243	.0003	.0000	.0001	GRA/CAN CENTER	
SUM	.0106	.0171	.9559	.0009	.0062	.0094		

TABLE A-3 ORBITAL CONFIGURATION MODAL SURVEY

## TEST MODES GENERALIZED MASS CONTRIBUTION SUMMARY

TEST MODE NO. 02A

TEST FREQUENCY = .31 HZ.

COMPONENT NAME	GMC (DX)	GMC (DY)	GMC (DZ)	GMC (TX)	GMC (TY)	GMC (TZ)
BR/OWS SKIRT/IU/FAS	.2014	.0318	.3930	.0008	.1701	.1036
6-FAS 02 TANKS	.0004	.0310	.0009	0.	0.	0.
MDA/STS/AM	.0000	.0418	.0001	-.0001	.0000	.0004
6-AM N2 TANKS	.0000	.0074	.0001	0.	0.	0.
COMMAND/SERVICE MOD.	.0001	.0525	.0040	.0011	.0000	.0000
DEPLOYMENT ASSEMBLY	.0003	.0056	.0001	0.	0.	0.
ATM-RACK,CMGS,4-SAS	.0005	.0351	.0006	.0000	.0000	.0000
ATM-SPAR CENTER	.0000	.0094	.0004	-.0000	.0000	0.
ATM-GRA/CAN CENTER	.0000	.0074	.0003	.0000	.0000	.0000
	----	----	----	----	----	----
SUM	.2027	.2219	.3995	.0018	.0702	.1040

## TOTAL GM CONTRIBUTION FOR EACH COMPONENT

BR/OWS SKIRT/IU/FAS	.8007
6-FAS 02 TANKS	.0323
MDA/STS/AM	.0422
6-AM N2 TANKS	.0076
COMMAND/SERVICE MOD.	.0576
DEPLOYMENT ASSEMBLY	.0060
ATM-RACK,CMGS,4-SAS	.0362
ATM-SPAR CENTER	.0098
ATM-GRA/CAN CENTER	.0077



TABLE A-4 GENERALIZED MASS CONTRIBUTIONS BY DEGREE OF FREEDOM

TEST MODE 02A RUN NO. 336 FREQUENCY = .31

NODE NO.	GMC (DX)	GMC (DY)	GMC (DZ)	GMC (TX)	GMC (TY)	GMC (TZ)	NODE DESCRIPTION
1	.2011	.0058	.3928	.0007	.0701	.1033	BASE RNG/DWS SKIRT
2	-.1000	.0056	-.0001	.0000	.0000	-.0001	DWS/TU INTERFACE
3	.0000	.0104	.0002	.0001	.0000	.0004	TU/FAS INTERFACE
4	.0000	.0042	.0004	0.	0.	0.	FAS 02 BOTL1,+Y +Z
5	.0001	.0051	-.0000	0.	0.	0.	FAS 02 BOTL2,+Y +Z
6	.0000	.0057	.0002	0.	0.	0.	FAS 02 BOTL3,-Y +Z
7	.0003	.0054	.0000	0.	0.	0.	FAS 02 BOTL4,-Y +Z
8	-.0000	.0058	.0000	0.	0.	0.	FAS 02 BOTL5,-Y -Z
9	-.0000	.0049	.0001	0.	0.	0.	FAS 02 BOTL6,-Y -Z
10	.0001	.0019	-.0000	0.	0.	0.	FAS/AM/DA IF, +Y
11	.0001	.0027	-.0000	0.	0.	0.	FAS/AM/DA IF, +Z
12	-.0000	.0029	.0001	0.	0.	0.	FAS/AM/DA IF, -Y
13	-.0000	.0003	-.0000	0.	0.	0.	FAS/DA IF, -Y -Z
14	.0000	.0018	.0000	0.	0.	0.	FAS/AM IF, -Z
15	.0000	.0003	-.0000	0.	0.	0.	FAS/DA IF, +Y -Z
16	.0000	.0040	.0000	.0000	.0000	.0002	AM TUNNEL/SHEAR WB
17	.0000	.0088	.0000	.0000	.0000	-.0000	AM TUNNEL/STS IF
18	.0000	.0147	-.0000	-.0001	.0000	.0001	MDA/STS INTERFACE
19	.0000	.0143	.0001	-.0000	-.0000	.0001	MDA CONE/CYL ITRFC
20	.0000	.0009	.0000	0.	0.	0.	N2 TANK, +Y, LOWER
21	-.0000	.0010	.0000	0.	0.	0.	N2 TANK, +Y, UPPER
22	.0000	.0011	.0001	0.	0.	0.	N2 TANK, +Z, LOWER
23	.0000	.0019	.0000	0.	0.	0.	N2 TANK, +Z, UPPER
24	.0000	.0013	.0000	0.	0.	0.	N2 TANK, -Z, LOWER
25	.0000	.0012	.0000	0.	0.	0.	N2 TANK, -Z, UPPER
26	-.0000	.0094	.0009	.0007	.0000	.0000	CM, FWD RJLKHEAD
27	-.0000	.0142	.0000	.0002	.0000	-.0000	CM, AFT RJLKHEAD
28	.0000	.0101	.0001	.0002	.0000	-.0000	SM, FWD RJLKHEAD
29	.0001	.0188	.0030	.0000	.0000	.0000	SM, AFT RJLKHEAD
30	.0000	.0042	.0000	0.	0.	0.	LOWER D LATCH, DA
31	.0002	.0003	.0001	0.	0.	0.	LOWER +Y TRUNNION
32	.0001	.0003	-.0000	0.	0.	0.	LOWER -Y TRUNNION
33	-.0000	.0007	.0000	0.	0.	0.	EREP PACKAGE C.G.
34	.0001	.0050	.0001	0.	0.	0.	ATM PN 6,7 IF,OUTR
35	-.0000	.0030	-.0000	0.	0.	0.	ATM PN 4,5 IF,OUTR
36	-.0001	.0032	.0002	0.	0.	0.	ATM PN 8,1 IF,OUTR
37	.0001	.0058	.0001	0.	0.	0.	ATM PN 2,3 IF,OUTR
38	.0000	.0050	.0000	0.	0.	0.	ATM PN 6,7 IF,INNER
39	-.0000	.0009	.0000	0.	0.	0.	ATM PN 4,5 IF,INNER
40	-.0001	.0015	.0001	0.	0.	0.	ATM PN 8,1 IF,INNER
41	.0000	.0054	.0000	0.	0.	0.	ATM PN 2,3 IF,INNER
42	.0000	.0013	.0000	.0000	.0000	-.0000	CMG, -Y SIDE
43	.0000	.0013	.0001	-.0000	.0000	.0000	CMG, +Y SIDE
44	.0000	.0013	.0000	.0000	-.0000	.0000	CMG, +X SIDE
45	.0001	.0001	0.	0.	0.	0.	ATM SAS, PN 1
46	.0001	.0001	0.	0.	0.	0.	ATM SAS, PN 3
47	.0001	.0001	0.	0.	0.	0.	ATM SAS, PN 5
48	.0001	.0001	0.	0.	0.	0.	ATM SAS, PN 7
49	.0000	.0094	.0004	-.0000	.0000	.0000	SPAR CENTER
50	.0000	.0074	.0003	.0000	.0000	.0000	GRA/CAN CENTER
SUM	.2027	.2219	.3995	.0018	.0702	.1040	

TABLE A-5 ORBITAL CONFIGURATION MODAL SURVEY

## TEST MODES GENERALIZED MASS CONTRIBUTION SUMMARY

TEST MODE NO. 03B

TEST FREQUENCY = 1.31 HZ.

COMPONENT NAME	GMC (DX)	GMC (DY)	GMC (DZ)	GMC (TX)	GMC (TY)	GMC (TZ)
BR/OWS SKIRT/IU/FAS	.0180	.0001	.0152	.0000	.0102	.0000
6-FAS O2 TANKS	.0209	.0000	.0025	0.	0.	0.
MDA/STS/AM	.0111	.0000	.0130	.0000	.0007	.0000
6-AM N2 TANKS	.0034	.0000	.0007	0.	0.	0.
COMMAND/SERVICE MOD.	.0135	.0001	.4132	.0004	.0078	.0013
DEPLOYMENT ASSEMBLY	.0032	-.0002	.0099	0.	0.	0.
ATM-RACK, CMGS, 4-SAS	.1423	.0026	.1187	.0000	.0001	-.0000
ATM-SPAR CENTER	.0536	.0001	.0246	.0000	.0026	0.
ATM-GRA/CAN CENTER	.0506	.0000	.0163	.0000	.0033	.0000
	----	----	----	----	----	----
SUM	.3567	.0026	.6142	.0004	.0247	.0013

## TOTAL GM CONTRIBUTION FOR EACH COMPONENT

BR/OWS SKIRT/IU/FAS	.0435
6-FAS O2 TANKS	.0234
MDA/STS/AM	.0249
6-AM N2 TANKS	.0042
COMMAND/SERVICE MOD.	.4362
DEPLOYMENT ASSEMBLY	.0129
ATM-RACK, CMGS, 4-SAS	.3037
ATM-SPAR CENTER	.0810
ATM-GRA/CAN CENTER	.0702

A-9  
TABLE A-6 GENERALIZED MASS CONTRIBUTIONS BY DEGREE OF FREEDOM

TEST MODE 03B      RUN NO. 614      FREQUENCY = 1.31

MODE NO.	GMC (DX)	GMC (DY)	GMC (DZ)	GMC (TX)	GMC (TY)	GMC (TZ)	MODE DESCRIPTION
1	.0072	.0000	.0134	.0000	.0058	-.0000	BASE RNG/DWS SKIRT
2	.0019	.0000	.0002	.0000	.0013	.0000	DWS/IJ INTERFACE
3	.0047	.0000	-.0000	.0000	.0032	.0000	IJ/FAS INTERFACE
4	.0045	.0000	.0004	0.	0.	0.	FAS 02 BOTL1,+Y +Z
5	.0062	.0000	.0004	0.	0.	0.	FAS 02 BOTL2,+Y +Z
6	.0053	.0000	.0003	0.	0.	0.	FAS 02 BOTL3,-Y +Z
7	.0037	.0000	.0005	0.	0.	0.	FAS 02 BOTL4,-Y +Z
8	.0010	.0000	.0005	0.	0.	0.	FAS 02 BOTL5,-Y -Z
9	.0001	.0000	.0003	0.	0.	0.	FAS 02 BOTL6,-Y -Z
10	.0003	.0000	.0003	0.	0.	0.	FAS/AM/DA IF, +Y
11	.0033	.0000	.0004	0.	0.	0.	FAS/AM/DA IF, +Z
12	.0005	.0000	.0007	0.	0.	0.	FAS/AM/DA IF, -Y
13	.0000	-.0000	.0001	0.	0.	0.	FAS/DA IF, -Y -Z
14	.0000	-.0000	.0001	0.	0.	0.	FAS/AM IF, -Z
15	.0000	.0000	.0001	0.	0.	0.	FAS/DA IF, +Y -Z
16	.0017	.0000	.0002	.0000	.0002	.0000	AM TUNNEL/SHEAR WB
17	.0027	.0000	.0020	.0000	.0000	.0000	AM TUNNEL/STS IF
18	.0038	.0000	.0049	.0000	.0004	.0000	MDA/STS INTERFACE
19	.0030	.0000	.0058	.0000	.0001	-.0000	MDA CONE/CYL ITRFC
20	.0006	.0000	.0000	0.	0.	0.	N2 TANK, +Y, LOWER
21	.0004	.0000	.0002	0.	0.	0.	N2 TANK, +Y, UPPER
22	.0009	.0000	.0001	0.	0.	0.	N2 TANK, +Z, LOWER
23	.0013	.0000	.0002	0.	0.	0.	N2 TANK, +Z, UPPER
24	.0001	.0000	.0003	0.	0.	0.	N2 TANK, -Z, LOWER
25	.0001	.0000	.0002	0.	0.	0.	N2 TANK, -Z, UPPER
26	.0029	.0000	.0001	-.0000	.0000	.0000	CM, FWD BJLKHEAD
27	.0023	.0000	.0303	-.0000	.0006	.0001	CM, AFT BJLKHEAD
28	.0031	.0000	.0346	.0001	.0012	.0011	SM, FWD BJLKHEAD
29	.0051	.0000	.3481	.0003	.0059	.0001	SM, AFT BJLKHEAD
30	.0001	-.0000	-.0001	0.	0.	0.	LOWER D LATCH, DA
31	.0006	-.0001	.0046	0.	0.	0.	LOWER +Y TRUNNION
32	.0004	-.0001	.0047	0.	0.	0.	LOWER -Y TRUNNION
33	.0022	.0000	.0006	0.	0.	0.	EREP PACKAGE C.G.
34	.0225	-.0000	.0029	0.	0.	0.	ATM PN 6,7 IF,OUTR
35	.0393	-.0000	.0056	0.	0.	0.	ATM PN 4,5 IF,OUTR
36	.0407	-.0001	.0153	0.	0.	0.	ATM PN 8,1 IF,OUTR
37	.0347	.0003	.0379	0.	0.	0.	ATM PN 2,3 IF,OUTR
38	.0042	.0000	.0042	0.	0.	0.	ATM PN 5,7 IF,INNER
39	.0112	-.0001	.0037	0.	0.	0.	ATM PN 4,5 IF,INNER
40	.0110	-.0002	.0105	0.	0.	0.	ATM PN 8,1 IF,INNER
41	.0044	.0006	.0237	0.	0.	0.	ATM PN 2,3 IF,INNER
42	.0036	-.0000	.0039	-.0000	.0001	-.0000	CMG, -Y SIDE
43	.0040	.0000	.0027	-.0000	-.0000	-.0000	CMG, +Y SIDE
44	.0046	-.0000	.0082	.0000	.0000	-.0000	CMG, +X SIDE
45	.0002	.0002	0.	0.	0.	0.	ATM SAS, PN 1
46	.0002	.0002	0.	0.	0.	0.	ATM SAS, PN 3
47	.0009	.0009	0.	0.	0.	0.	ATM SAS, PN 5
48	.0008	.0008	0.	0.	0.	0.	ATM SAS, PN 7
49	.0536	.0001	.0246	.0000	.0026	.0536	SPAR CENTER
50	.0506	.0000	.0163	.0000	.0033	.0000	GRA/CAN CENTER
SUM	.3567	.0026	.6142	.0004	.0247	.0550	

TABLE A-7 ORBITAL CONFIGURATION MODAL SURVEY

## TEST MODES GENERALIZED MASS CONTRIBUTION SUMMARY

TEST MODE NO. 04A

TEST FREQUENCY = 1.43 HZ.

COMPONENT NAME	GMC (DX)	GMC (DY)	GMC (DZ)	GMC (TX)	GMC (TY)	GMC (TZ)
BR/OWS SKIRT/IU/FAS	.0021	.0249	.0024	.0147	.0000	.0096
6-FAS O2 TANKS	.0030	.0028	.0048	0.	0.	0.
MDA/STS/AM	.0001	.0096	.0000	.0029	-.0000	.0007
6-AM N2 TANKS	.0003	.0008	.0002	0.	0.	0.
COMMAND/SERVICE MOD.	.0004	.1988	.0001	.0027	.0001	.0063
DEPLOYMENT ASSEMBLY	.0035	.0007	.0015	0.	0.	0.
ATM-RACK,CMGS,4-SAS	.2094	.3753	.0552	.0005	.0001	.0011
ATM-SPAR CENTER	.0010	.0032	.0000	.0105	.0004	0.
ATM-GRA/CAN CENTER	.0007	.0023	-.0000	.0211	.0004	.0257
	---	---	---	---	---	---
SUM	.2205	.6185	.0641	.0524	.0010	.0434

## TOTAL GM CONTRIBUTION FOR EACH COMPONENT

BR/OWS SKIRT/IU/FAS	.0538
6-FAS O2 TANKS	.0107
MDA/STS/AM	.0133
6-AM N2 TANKS	.0014
COMMAND/SERVICE MOD.	.2085
DEPLOYMENT ASSEMBLY	.0057
ATM-RACK,CMGS,4-SAS	.6414
ATM-SPAR CENTER	.0151
ATM-GRA/CAN CENTER	.0512

A-11  
TABLE A-8 GENERALIZED MASS CONTRIBUTIONS BY DEGREE OF FREEDOM

TEST MODE 04A      RUN NO. 378      FREQUENCY = 1.43

MODE NO.	GMC (DX)	GMC (DY)	GMC (DZ)	GMC (TX)	GMC (TY)	GMC (TZ)	MODE DESCRIPTION
1	.0000	.0214	.0000	.0077	.0000	.0054	BASE RNG/DWS SKIRT
2	.0000	.0012	.0000	.0027	.0000	.0017	OWS/TJ INTERFACE
3	.0000	.0005	.0004	.0043	.0000	.0024	IU/FAS INTERFACE
4	.0012	.0003	.0011	0.	0.	0.	FAS 02 BOTL1,+Y +Z
5	.0001	.0006	.0002	0.	0.	0.	FAS 02 BOTL2,+Y +Z
6	.0000	.0011	.0004	0.	0.	0.	FAS 02 BOTL3,-Y +Z
7	.0009	.0003	.0013	0.	0.	0.	FAS 02 BOTL4,-Y +Z
8	.0006	.0001	.0016	0.	0.	0.	FAS 02 BOTL5,-Y -Z
9	.0001	.0005	.0004	0.	0.	0.	FAS 02 BOTL6,-Y -Z
10	.0010	.0001	.0005	0.	0.	0.	FAS/AM/DA IF, +Y
11	.0000	.0017	.0000	0.	0.	0.	FAS/AM/DA IF, +Z
12	.0010	.0000	.0014	0.	0.	0.	FAS/AM/DA IF, -Y
13	.0000	-.0000	.0001	0.	0.	0.	FAS/DA IF, -Y -Z
14	.0000	.0001	-.0000	0.	0.	0.	FAS/AM IF, -Z
15	.0001	-.0000	.0000	0.	0.	0.	FAS/DA IF, +Y -Z
16	.0000	.0000	.0000	.0002	.0000	.0002	AM TUNNEL/SHEAR W9
17	.0000	.0011	.0000	.0007	.0000	.0001	AM TUNNEL/STS IF
18	.0000	.0029	.0000	.0010	-.0000	.0005	MDA/STS INTERFACE
19	.0000	.0056	.0000	.0010	-.0000	.0000	MDA CONE/CYL ITRFC
20	.0002	.0000	.0001	0.	0.	0.	N2 TANK, +Y, LOWER
21	.0001	.0000	.0001	0.	0.	0.	N2 TANK, +Y, UPPER
22	.0000	.0001	.0000	0.	0.	0.	N2 TANK, +Z, LOWER
23	.0000	.0005	.0000	0.	0.	0.	N2 TANK, +Z, UPPER
24	.0000	.0031	.0000	0.	0.	0.	N2 TANK -Z, LOWER
25	.0000	.0000	.0000	0.	0.	0.	N2 TANK, -Z, UPPER
26	.0000	.0010	-.0000	.0003	.0000	.0003	CM, FWD BJLKHEAD
27	.0000	.0070	.0000	.0006	-.0000	.0006	CM, AFT BJLKHEAD
28	-.0000	.0144	-.0000	.0007	.0000	.0003	SM, FWD BJLKHEAD
29	.0004	.1765	.0001	.0012	.0001	.0052	SM, AFT BJLKHEAD
30	.0000	.0017	.0000	0.	0.	0.	LOWER D LATCH, DA
31	.0021	-.0008	.0007	0.	0.	0.	LOWER +Y TRUNNION
32	.0013	-.0008	.0007	0.	0.	0.	LOWER -Y TRUNNION
33	.0000	.0007	.0000	0.	0.	0.	EREP PACKAGE C.G.
34	.0027	.0026	.0041	0.	0.	0.	ATM PN 5,7 IF,OUTR
35	.0505	.0022	.0069	0.	0.	0.	ATM PN 4,5 IF,OUTR
36	.0425	.0067	.0172	0.	0.	0.	ATM PN 8,1 IF,OUTR
37	.0100	.0658	.0021	0.	0.	0.	ATM PN 2,3 IF,OUTR
38	-.0010	-.0003	.0012	0.	0.	0.	ATM PN 6,7 IF,INNER
39	.0139	.0059	.0056	0.	0.	0.	ATM PN 4,5 IF,INNER
40	.0511	.0407	.0071	0.	0.	0.	ATM PN 8,1 IF,INNER
41	.0125	.1694	.0010	0.	0.	0.	ATM PN 2,3 IF,INNER
42	.0095	.0061	.0044	.0002	.0001	.0004	CMG, -Y SIDE
43	.0117	.0059	.0055	.0002	-.0000	.0004	CMG, +Y SIDE
44	.0000	.0391	-.0000	.0001	-.0000	.0002	CMG, +X SIDE
45	.0004	.0004	0.	0.	0.	0.	ATM SAS, PN 1
46	.0002	.0002	0.	0.	0.	0.	ATM SAS, PN 3
47	.0004	.0004	0.	0.	0.	0.	ATM SAS, PN 5
48	.0001	.0001	0.	0.	0.	0.	ATM SAS, PN 7
49	.0010	.0032	.0000	.0105	.0004	.0010	SPAR CENTER
50	.0007	.0023	-.0000	.0211	.0004	.0257	GRA/CAN CENTER
SUM	.2205	.6185	.0641	.0524	.0010	.0444	

TABLE A-9 ORBITAL CONFIGURATION MODAL SURVEY  
TEST MODES GENERALIZED MASS CONTRIBUTION SUMMARY

TEST MODE NO. 05A

TEST FREQUENCY = 1.66 HZ.

COMPONENT NAME	GMC (OX)	GMC (OY)	GMC (OZ)	GMC (TX)	GMC (TY)	GMC (TZ)
BR/OWS SKIRT/IU/FAS	.0084	.0888	.0162	.0671	.0005	.0333
6-FAS O2 TANKS	.0141	.0174	.0149	0.	0.	0.
MDA/STS/AM	.0002	.0528	.0004	.0128	.0001	.0057
6-AM N2 TANKS	.0007	.0036	.0016	0.	0.	0.
COMMAND/SERVICE MOD.	.0004	.2882	.0021	.0187	-.0001	.0125
DEPLOYMENT ASSEMBLY	.0078	.0041	.0018	0.	0.	0.
ATM-RACK,CMGS,4-SAS	.0773	.1172	.0560	.0003	.0000	.0004
ATM-SPAR CENTER	.0030	.0184	.0009	.0075	.0005	0.
ATM-GRA/CAN CENTER	.0018	.0168	.0009	.0159	.0005	.0087
	----	----	----	----	----	----
SUM	.1138	.6074	.0946	.1222	.0015	.0605

## TOTAL GM CONTRIBUTION FOR EACH COMPONENT

BR/OWS SKIRT/IU/FAS	.2142
6-FAS O2 TANKS	.0465
MDA/STS/AM	.0718
6-AM N2 TANKS	.0059
COMMAND/SERVICE MOD.	.3219
DEPLOYMENT ASSEMBLY	.0137
ATM-RACK,CMGS,4-SAS	.2513
ATM-SPAR CENTER	.0303
ATM-GRA/CAN CENTER	.0445

A-13  
TABLE A-10 GENERALIZED MASS CONTRIBUTIONS BY DEGREE OF FREEDOM

TEST MODE 05A      RUN NO. 385      FREQUENCY = 1.65

MODE NO.	GMC (DX)	GMC (DY)	GMC (DZ)	GMC (TX)	GMC (TY)	GMC (TZ)	MODE DESCRIPTION
1	.0001	.0741	.0041	.0345	.0004	.0178	BASE RNG/DWS SKIRT
2	.0001	.0046	.0003	.0121	.0001	.0065	DWS/IU INTERFACE
3	.0001	.0020	.0047	.0204	.0001	.0090	IU/FAS INTERFACE
4	.0040	.0017	.0062	0.	0.	0.	FAS 02 BOTL1,+Y +Z
5	.0003	.0045	.0021	0.	0.	0.	FAS 02 BOTL2,+Y +Z
6	.0002	.0051	.0005	0.	0.	0.	FAS 02 BOTL3,-Y +Z
7	.0043	.0014	.0024	0.	0.	0.	FAS 02 BOTL4,-Y +Z
8	.0037	.0011	.0029	0.	0.	0.	FAS 02 BOTL5,-Y -Z
9	.0018	.0037	.0007	0.	0.	0.	FAS 02 BOTL6,-Y -Z
10	.0029	.0002	.0029	0.	0.	0.	FAS/AM/DA IF, +Y
11	-.0000	.0069	.0000	0.	0.	0.	FAS/AM/DA IF, +Z
12	.0049	.0003	.0039	0.	0.	0.	FAS/AM/DA IF, -Y
13	.0002	-.0000	.0001	0.	0.	0.	FAS/DA IF, -Y -Z
14	.0000	.0008	.0000	0.	0.	0.	FAS/AM IF, -Z
15	.0001	-.0001	.0001	0.	0.	0.	FAS/DA IF, +Y -Z
16	.0000	.0001	.0001	.0010	.0000	.0012	AM TUNNEL/SHEAR WB
17	.0000	.0038	.0000	.0030	.0000	.0006	AM TUNNEL/STS IF
18	.0001	.0157	.0000	.0048	.0000	.0037	MDA/STS INTERFACE
19	.0001	.0332	.0002	.0039	.0000	.0001	MDA CONE/CYL ITRFC
20	.0004	.0000	.0008	0.	0.	0.	N2 TANK, +Y, LOWER
21	.0003	.0002	.0007	0.	0.	0.	N2 TANK, +Y, UPPER
22	.0000	.0003	.0000	0.	0.	0.	N2 TANK, +Z, LOWER
23	.0000	.0024	.0000	0.	0.	0.	N2 TANK, +Z, UPPER
24	.0000	.0007	.0000	0.	0.	0.	N2 TANK, -Z, LOWER
25	.0000	.0001	.0000	0.	0.	0.	N2 TANK, -Z, UPPER
26	.0001	.0169	.0000	.0034	.0000	.0007	CM, FWD RJLKHEAD
27	.0001	.0008	.0003	.0043	.0000	.0009	CM, AFT RJLKHEAD
28	.0004	.0073	.0000	.0051	-.0000	.0013	SM, FWD RJLKHEAD
29	-.0001	.2633	.0018	.0059	-.0002	.0096	SM, AFT RJLKHEAD
30	.0000	.0017	.0004	0.	0.	0.	LOWER D LATCH, DA
31	.0044	.0004	.0003	0.	0.	0.	LOWER +Y TRUNNION
32	.0034	-.0010	.0011	0.	0.	0.	LOWER -Y TRUNNION
33	.0000	.0030	.0000	0.	0.	0.	EREP PACKAGE C.G.
34	.0005	.0073	.0092	0.	0.	0.	ATM PN 6,7 IF,OUTR
35	.0294	.0178	.0054	0.	0.	0.	ATM PN 4,5 IF,OUTR
36	.0069	.0040	.0196	0.	0.	0.	ATM PN 8,1 IF,OUTR
37	.0037	.0001	.0010	0.	0.	0.	ATM PN 2,3 IF,OUTR
38	.0002	.0083	.0029	0.	0.	0.	ATM PN 6,7 IF,INNER
39	.0130	.0000	.0014	0.	0.	0.	ATM PN 4,5 IF,INNER
40	.0123	.0029	.0083	0.	0.	0.	ATM PN 8,1 IF,INNER
41	.0038	.0227	.0003	0.	0.	0.	ATM PN 2,3 IF,INNER
42	.0042	.0000	.0024	.0001	.0000	.0001	CMG, -Y SIDE
43	.0031	.0000	.0055	.0002	.0000	.0002	CMG, +Y SIDE
44	.0001	.0040	.0000	.0001	-.0000	.0001	CMG, +X SIDE
45	-.0000	-.0000	0.	0.	0.	0.	ATM SAS, PN 1
46	.0002	.0002	0.	0.	0.	0.	ATM SAS, PN 3
47	.0000	.0000	0.	0.	0.	0.	ATM SAS, PN 5
48	.0001	.0001	0.	0.	0.	0.	ATM SAS, PN 7
49	.0030	.0184	.0009	.0075	.0005	.0030	SPAR CENTER
50	.0018	.0168	.0009	.0159	.0005	.0087	GRA/CAN CENTER
SUM	.1138	.6074	.0946	.1222	.0015	.0635	

TABLE A-11 ORBITAL CONFIGURATION MODAL SURVEY

## TEST MODES GENERALIZED MASS CONTRIBUTION SUMMARY

TEST MODE NO. 16A

TEST FREQUENCY = 1.72 HZ.

COMPONENT NAME	GMC (DX)	GMC (DY)	GMC (DZ)	GMC (TX)	GMC (TY)	GMC (TZ)
BR/OWS SKIRT/IU/FAS	.0174	.0214	.0650	.0122	.1127	.0053
6-FAS O2 TANKS	.0091	.0026	.0129	0.	0.	0.
MDA/STS/AM	.0062	.0187	.0059	.0132	.0024	.0763
6-AM N2 TANKS	.0340	.0307	.0007	0.	0.	0.
COMMAND/SERVICE MOD.	.0562	.0571	.0497	.0368	.1058	.0109
DEPLOYMENT ASSEMBLY	.0130	.0062	.0117	0.	0.	0.
ATM-RACK,CMGS,4-SAS	.1460	.0415	.1375	.0301	.0001	.0002
ATM-SPAR CENTER	.0375	.0361	.0166	.0032	.0027	0.
ATM-GRA/CAN CENTER	.0331	.0058	.0209	.0046	.0055	.0048
	----	----	----	----	----	----
SUM	.3625	.1600	.3210	.0299	.0292	.0974

## TOTAL GM CONTRIBUTION FOR EACH COMPONENT

BR/OWS SKIRT/IU/FAS	.1339
6-FAS O2 TANKS	.0246
MDA/STS/AM	.1126
6-AM N2 TANKS	.0354
COMMAND/SERVICE MOD.	.1965
DEPLOYMENT ASSEMBLY	.0308
ATM-RACK,CMGS,4-SAS	.3254
ATM-SPAR CENTER	.0661
ATM-GRA/CAN CENTER	.0746



TABLE A-12 GENERALIZED MASS CONTRIBUTIONS BY DEGREE OF FREEDOM

TEST MODE		06A		RUN NO. 434		FREQUENCY = 1.72		
MODE NO.	GMC (OX)	GMC (OY)	GMC (OZ)	GMC (TX)	GMC (TY)	GMC (TZ)	MODE DESCRIPTION	
1	.0078	.0183	.0515	.0059	.0073	.0036	BASE RNG/OHS SKIRT	
2	.0125	.0009	.0052	.0026	.0028	-.0000	OHS/IU INTERFACE	
3	.0029	.0005	.0058	.0038	.0026	.0018	IU/FAS INTERFACE	
4	.0031	.0001	.0000	0.	0.	0.	FAS 02 BOTL1,+Y +Z	
5	.0005	.0010	.0005	0.	0.	0.	FAS 02 BOTL2,+Y +Z	
6	-.0000	.0008	.0031	0.	0.	0.	FAS 02 BOTL3,-Y +Z	
7	.0001	.0005	.0045	0.	0.	0.	FAS 02 BOTL4,-Y +Z	
8	.0008	.0001	.0030	0.	0.	0.	FAS 02 BOTL5,-Y -Z	
9	.0046	.0001	.0017	0.	0.	0.	FAS 02 BOTL6,-Y -Z	
10	.0024	.0000	.0002	0.	0.	0.	FAS/AM/DA IF, +Y	
11	-.0000	.0013	.0003	0.	0.	0.	FAS/AM/DA IF, +Z	
12	.0001	.0001	.0020	0.	0.	0.	FAS/AM/DA IF, -Y	
13	.0001	-.0000	.0003	0.	0.	0.	FAS/DA IF, -Y -Z	
14	.0012	.0003	.0000	0.	0.	0.	FAS/AM IF, -Z	
15	.0005	.0001	.0000	0.	0.	0.	FAS/DA IF, +Y -Z	
16	.0014	.0002	.0012	.0003	.0002	.0008	AM TUNNEL/SHEAR WB	
17	.0019	.0008	.0001	.0006	.0003	.0464	AM TUNNEL/STS IF	
18	.0010	.0007	.0007	.0013	.0018	.0291	MDA/STS INTERFACE	
19	.0019	.0110	.0038	.0009	.0001	-.0000	MDA CONE/CYL ITRFC	
20	.0148	-.0000	.0000	0.	0.	0.	N2 TANK, +Y, LOWER	
21	.0064	.0000	.0000	0.	0.	0.	N2 TANK, +Y, UPPER	
22	.0031	.0001	.0003	0.	0.	0.	N2 TANK, +Z, LOWER	
23	.0001	.0004	.0001	0.	0.	0.	N2 TANK, +Z, UPPER	
24	.0032	.0002	.0003	0.	0.	0.	N2 TANK, -Z, LOWER	
25	.0005	.0000	.0000	0.	0.	0.	N2 TANK, -Z, UPPER	
26	.0144	.0030	.0025	.0016	-.0004	.0003	CM, FWD BULKHEAD	
27	.0271	.0003	.0001	.0008	.0038	.0057	CM, AFT BULKHEAD	
28	.0195	.0010	.0011	.0021	.0003	.0014	SM, FWD BULKHEAD	
29	.0051	.0028	.0460	.0023	.0020	.0036	SM, AFT BULKHEAD	
30	.0009	.0009	.0081	0.	0.	0.	LOWER D LATCH, DA	
31	.0113	.0028	.0033	0.	0.	0.	LOWER +Y TRUNNION	
32	.0007	.0018	.0003	0.	0.	0.	LOWER -Y TRUNNION	
33	-.0000	.0006	.0000	0.	0.	0.	EREIP PACKAGE C.G.	
34	.0287	.0237	.0498	0.	0.	0.	ATM PN 5,7 IF,OUTR	
35	.0043	.0056	.0294	0.	0.	0.	ATM PN 4,5 IF,OUTR	
36	.0513	-.0006	.0001	0.	0.	0.	ATM PN 8,1 IF,OUTR	
37	.0151	-.0004	.0013	0.	0.	0.	ATM PN 2,3 IF,OUTR	
38	.0065	.0015	.0282	0.	0.	0.	ATM PN 5,7 IF,INNER	
39	-.0010	.0001	.0122	0.	0.	0.	ATM PN 4,5 IF,INNER	
40	.0246	.0037	.0019	0.	0.	0.	ATM PN 8,1 IF,INNER	
41	-.0004	.0057	.0048	0.	0.	0.	ATM PN 2,3 IF,INNER	
42	.0002	-.0000	.0085	.0000	-.0000	.0000	CMG, -Y SIDE	
43	.0032	.0000	.0009	.0000	.0001	.0000	CMG, +Y SIDE	
44	.0021	.0010	.0006	.0000	.0000	.0001	CMG, +X SIDE	
45	.0008	.0008	0.	0.	0.	0.	ATM SAS, PN 1	
46	.0004	.0004	0.	0.	0.	0.	ATM SAS, PN 3	
47	.0000	.0000	0.	0.	0.	0.	ATM SAS, PN 5	
48	.0000	.0000	0.	0.	0.	0.	ATM SAS, PN 7	
49	.0375	.0061	.0166	.0032	.0027	.0375	SPAR CENTER	
50	.0331	.0058	.0209	.0046	.0055	.0048	GRA/CAN CENTER	
SUM	.3625	.1600	.3210	.0299	.0292	.1349		

TABLE A-13 ORBITAL CONFIGURATION MODAL SURVEY

## TEST MODES GENERALIZED MASS CONTRIBUTION SUMMARY

TEST MODE NO. 06B

TEST FREQUENCY = 1.74 HZ.

COMPONENT NAME	GMC (DX)	GMC (DY)	GMC (DZ)	GMC (TX)	GMC (TY)	GMC (TZ)
BR/OWS SKIRT/IU/FAS	.0248	.0711	.1103	.0000	.0178	.0001
6-FAS O2 TANKS	.0157	.0004	.0127	0.	0.	0.
MDA/STS/AM	.0135	.0005	.0095	.0001	.0019	.0001
6-AM N2 TANKS	.0043	.0001	.0011	0.	0.	0.
COMMAND/SERVICE MOD.	.0283	.0006	.0700	.0004	.0029	.0026
DEPLOYMENT ASSEMBLY	.0020	.0141	.0163	0.	0.	0.
ATM-RACK, CMGS, 4-SAS	.2192	.0064	.2156	-.0000	.0002	.0000
ATM-SPAR CENTER	.0725	.0007	.0253	.0006	.0059	0.
ATM-GRA/CAN CENTER	.0591	.0008	.0319	.0000	.0097	.0010
	----	----	----	----	----	----
SUM	.4395	.0245	.4927	.0011	.0384	.0038

## TOTAL GM CONTRIBUTION FOR EACH COMPONENT

BR/OWS SKIRT/IU/FAS	.1540
6-FAS O2 TANKS	.0298
MDA/STS/AM	.0256
6-AM N2 TANKS	.0055
COMMAND/SERVICE MOD.	.1048
DEPLOYMENT ASSEMBLY	.0324
ATM-RACK, CMGS, 4-SAS	.4413
ATM-SPAR CENTER	.1050
ATM-GRA/CAN CENTER	.1025

TABLE A-14 GENERALIZED MASS CONTRIBUTIONS BY DEGREE OF FREEDOM

TEST MODE		068		RUN NO. 610		FREQUENCY = 1.74	
MODE NO.	GMC (DX)	GMC (DY)	GMC (DZ)	GMC (TX)	GMC (TY)	GMC (TZ)	MODE DESCRIPTION
1	.0118	.0008	.0859	-.0000	.0104	.0000	BASE RNG/OWS SKIRT
2	.0040	.0001	.0092	.0000	.0043	.0000	OWS/IJ INTERFACE
3	.0051	.0000	.0143	.0000	.0031	.0000	IU/FAS INTERFACE
4	.0015	.0001	.0027	0.	0.	0.	FAS 02 BOTL1,+Y +Z
5	.0001	.0000	.0023	0.	0.	0.	FAS 02 BOTL2,+Y +Z
6	-.0000	-.0000	.0023	0.	0.	0.	FAS 02 BOTL3,-Y +Z
7	.0011	.0000	.0027	0.	0.	0.	FAS 02 BOTL4,-Y +Z
8	.0034	.0001	.0015	0.	0.	0.	FAS 02 BOTL5,-Y -Z
9	.0096	.0002	.0005	0.	0.	0.	FAS 02 BOTL6,-Y -Z
10	.0010	.0000	.0003	0.	0.	0.	FAS/AM/OA IF, +Y
11	-.0000	.0000	.0002	0.	0.	0.	FAS/AM/OA IF, +Z
12	.0004	.0000	.0003	0.	0.	0.	FAS/AM/OA IF, -Y
13	.0003	.0000	.0000	0.	0.	0.	FAS/OA IF, -Y -Z
14	.0019	.0000	.0001	0.	0.	0.	FAS/AM IF, -Z
15	.0003	.0000	.0000	0.	0.	0.	FAS/OA IF, +Y -Z
16	.0023	.0000	.0018	.0000	.0003	.0001	AM TUNNEL/SHEAR WB
17	.0031	.0000	.0000	.0000	.0003	.0000	AM TUNNEL/STS IF
18	.0044	.0000	.0025	.0000	.0012	.0000	MDA/STS INTERFACE
19	.0037	.0004	.0052	.0000	.0001	-.0000	MDA CONE/CYL ITRFC
20	.0009	.0000	.0004	0.	0.	0.	N2 TANK, +Y, LOWER
21	.0005	.0000	.0002	0.	0.	0.	N2 TANK, +Y, UPPER
22	.0001	.0000	.0002	0.	0.	0.	N2 TANK, +Z, LOWER
23	.0002	.0000	.0000	0.	0.	0.	N2 TANK, +Z, UPPER
24	.0013	.0000	.0003	0.	0.	0.	N2 TANK -Z, LOWER
25	.0013	.0000	.0000	0.	0.	0.	N2 TANK, -Z, UPPER
26	.0049	.0002	.0059	.0002	.0004	-.0000	CM, FWD BJLKHEAD
27	.0060	.0001	.0000	.0000	.0003	-.0000	CM, AFT BJLKHEAD
28	.0104	.0000	.0001	.0001	.0002	.0023	SM, FWD BJLKHEAD
29	.0071	.0002	.0639	.0001	.0019	.0003	SM, AFT BJLKHEAD
30	.0015	.0000	.0121	0.	0.	0.	LOWER D LATCH, OA
31	.0002	.0057	.0012	0.	0.	0.	LOWER +Y TRUNNION
32	.0003	.0083	.0029	0.	0.	0.	LOWER -Y TRUNNION
33	-.0000	.0000	.0001	0.	0.	0.	EREP PACKAGE C.G.
34	.0319	.0022	.0948	0.	0.	0.	ATM PN 6,7 IF,OUTR
35	.0321	.0004	.0251	0.	0.	0.	ATM PN 4,5 IF,OUTR
36	.0692	.0001	.0077	0.	0.	0.	ATM PN 3,1 IF,OUTR
37	.0334	-.0006	-.0000	0.	0.	0.	ATM PN 2,3 IF,OUTR
38	.0080	-.0000	.0498	0.	0.	0.	ATM PN 6,7 IF,INNER
39	.0093	.0002	.0115	0.	0.	0.	ATM PN 4,5 IF,INNER
40	.0189	.0017	.0102	0.	0.	0.	ATM PN 3,1 IF,INNER
41	.0018	-.0001	.0040	0.	0.	0.	ATM PN 2,3 IF,INNER
42	.0023	.0000	.0064	-.0000	.0000	-.0000	CMG, -Y SIDE
43	.0063	.0000	.0052	-.0000	.0001	.0000	CMG, +Y SIDE
44	.0036	.0002	.0008	.0000	.0000	.0000	CMG, +X SIDE
45	.0011	.0011	0.	0.	0.	0.	ATM SAS, PN 1
46	.0010	.0010	0.	0.	0.	0.	ATM SAS, PN 3
47	.0001	.0001	0.	0.	0.	0.	ATM SAS, PN 5
48	.0001	.0001	0.	0.	0.	0.	ATM SAS, PN 7
49	.0725	.0007	.0253	.0006	.0059	.0725	SPAR CENTER
50	.0591	.0008	.0319	.0000	.0097	.0010	GRA/CAN CENTER
SJM	.4395	.0245	.4927	.0011	.0384	.0763	

TABLE A-15 ORBITAL CONFIGURATION MODAL SURVEY

## TEST MODES GENERALIZED MASS CONTRIBUTION SUMMARY

TEST MODE NO. 07A

TEST FREQUENCY = 2.51 HZ.

COMPONENT NAME	GMC (DX)	GMC (DY)	GMC (DZ)	GMC (TX)	GMC (TY)	GMC (TZ)
BR/OWS SKIRT/IU/FAS	.0027	.0339	.0183	.1284	.0000	.0335
6-FAS O2 TANKS	.0062	.0270	.0391	0.	0.	0.
MDA/STS/AM	.0001	.0867	.0005	.0237	.0001	.0039
6-AM N2 TANKS	.0011	.0090	.0032	0.	0.	0.
COMMAND/SERVICE MOD.	.0003	.1740	.0009	.0861	-.0001	.0106
DEPLOYMENT ASSEMBLY	.0073	.0249	-.0002	0.	0.	0.
ATM-RACK,CMGS,4-SAS	.0152	.1270	.0364	.0002	.0000	.0001
ATM-SPAR CENTER	.0000	.0417	-.0000	.0079	.0000	0.
ATM-GRA/CAN CENTER	.0001	.0378	.0000	.0110	-.0000	.0012
	----	----	----	----	----	----
SUM	.0331	.5621	.0983	.2573	.0001	.0493

## TOTAL GM CONTRIBUTION FOR EACH COMPONENT

BR/OWS SKIRT/IU/FAS	.2169
6-FAS O2 TANKS	.0723
MDA/STS/AM	.1149
6-AM N2 TANKS	.0134
COMMAND/SERVICE MOD.	.2719
DEPLOYMENT ASSEMBLY	.0320
ATM-RACK,CMGS,4-SAS	.1789
ATM-SPAR CENTER	.0496
ATM-GRA/CAN CENTER	.0501

TABLE A-16 GENERALIZED MASS CONTRIBUTIONS BY DEGREE OF FREEDOM

TEST MODE 07A RUN NO. 431 FREQUENCY = 2.51

MODE NO.	GMC (DX)	GMC (DY)	GMC (DZ)	GMC (TX)	GMC (TY)	GMC (TZ)	MODE DESCRIPTION
1	.0000	.0200	.0001	.0681	.0000	.0129	BASE RNG/OWS SKIRT
2	.0000	-.0001	.0001	.0223	-.0000	.0023	OWS/IU INTERFACE
3	-.0000	.0005	.0057	.0380	.0000	.0183	IU/FAS INTERFACE
4	.0018	-.0000	.0117	0.	0.	0.	FAS 02 BOTL1,+Y +Z
5	.0010	.0021	.0043	0.	0.	0.	FAS 02 BOTL2,+Y +Z
6	.0006	.0016	.0028	0.	0.	0.	FAS 02 BOTL3,-Y +Z
7	.0009	.0000	.0079	0.	0.	0.	FAS 02 BOTL4,-Y +Z
8	.0020	.0083	.0105	0.	0.	0.	FAS 02 BOTL5,-Y -Z
9	-.0001	.0149	.0019	0.	0.	0.	FAS 02 BOTL6,-Y -Z
10	.0012	.0012	.0049	0.	0.	0.	FAS/AM/OA IF, +Y
11	.0001	.0021	.0001	0.	0.	0.	FAS/AM/OA IF, +Z
12	.0012	.0024	.0075	0.	0.	0.	FAS/AM/OA IF, -Y
13	.0001	.0015	-.0004	0.	0.	0.	FAS/OA IF, -Y -Z
14	-.0000	.0059	.0000	0.	0.	0.	FAS/AM IF, -Z
15	.0001	.0005	.0001	0.	0.	0.	FAS/OA IF, +Y -Z
16	.0000	.0015	.0000	.0023	-.0000	.0004	AM TUNNEL/SHEAR W9
17	-.0000	.0106	.0001	.0077	.0000	.0059	AM TUNNEL/STS IF
18	.0001	.0235	.0001	.0090	.0001	-.0021	MDA/STS INTERFACE
19	.0000	.0510	.0003	.0047	-.0000	-.0003	MDA CONE/CYL ITRFC
20	.0001	.0004	.0016	0.	0.	0.	N2 TANK, +Y, LOWER
21	.0003	.0010	.0017	0.	0.	0.	N2 TANK, +Y, UPPER
22	.0000	.0002	.0000	0.	0.	0.	N2 TANK, +Z, LOWER
23	.0003	.0000	.0000	0.	0.	0.	N2 TANK, +Z, UPPER
24	.0004	.0027	.0000	0.	0.	0.	N2 TANK -Z, LOWER
25	.0000	.0045	.0000	0.	0.	0.	N2 TANK, -Z, UPPER
26	-.0000	.0578	.0000	.0085	.0000	.0007	CM, FWD BJLKHEAD
27	.0004	.0181	.0009	.0144	-.0000	.0026	CM, AFT BJLKHEAD
28	-.0001	.0050	.0000	.0268	.0000	.0001	SM, FWD BJLKHEAD
29	-.0001	.0931	.0000	.0365	-.0001	.0072	SM, AFT BJLKHEAD
30	.0000	.0263	.0000	0.	0.	0.	LOWER D LATCH, DA
31	.0052	-.0008	-.0001	0.	0.	0.	LOWER +Y TRUNNION
32	.0021	-.0008	-.0002	0.	0.	0.	LOWER -Y TRUNNION
33	-.0000	.0002	.0000	0.	0.	0.	EREP PACKAGE C.G.
34	-.0003	.0156	.0007	0.	0.	0.	ATM PN 6,7 IF,OUTR
35	.0010	.0161	.0119	0.	0.	0.	ATM PN 4,5 IF,OUTR
36	.0042	.0228	.0097	0.	0.	0.	ATM PN 3,1 IF,OUTR
37	.0012	.0551	.0008	0.	0.	0.	ATM PN 2,3 IF,OUTR
38	.0001	-.0001	.0002	0.	0.	0.	ATM PN 6,7 IF,INNER
39	.0025	-.0001	.0019	0.	0.	0.	ATM PN 4,5 IF,INNER
40	.0034	.0024	.0050	0.	0.	0.	ATM PN 3,1 IF,INNER
41	.0005	.0081	.0003	0.	0.	0.	ATM PN 2,3 IF,INNER
42	.0007	.0012	.0030	.0000	-.0000	.0000	CMG, -Y SIDE
43	.0007	.0012	.0027	.0001	.0000	.0000	CMG, +Y SIDE
44	.0000	.0036	-.0000	.0001	.0000	.0000	CMG, +X SIDE
45	.0003	.0003	0.	0.	0.	0.	ATM SAS, PN 1
46	.0003	.0003	0.	0.	0.	0.	ATM SAS, PN 3
47	.0003	.0003	0.	0.	0.	0.	ATM SAS, PN 5
48	.0003	.0003	0.	0.	0.	0.	ATM SAS, PN 7
49	.0000	.0417	-.0000	.0079	.0000	.0000	SPAR CENTER
50	.0001	.0378	.0000	.0110	-.0000	.0012	GRA/CAN CENTER
SJM	.0331	.5621	.0983	.2573	.0001	.0493	

TABLE A-17 ORBITAL CONFIGURATION MODAL SURVEY

## TEST MODES GENERALIZED MASS CONTRIBUTION SUMMARY

TEST MODE NO. 08A

TEST FREQUENCY = 3.06 HZ.

COMPONENT NAME	GMC (DX)	GMC (DY)	GMC (DZ)	GMC (TX)	GMC (TY)	GMC (TZ)
RR/OWS SKIRT/IU/FAS	.0072	.0000	.0177	.0000	.0070	.0015
6-FAS O2 TANKS	.0344	.0023	.0060	0.	0.	0.
MDA/STS/AM	.0008	.0001	.1888	-.0001	.0324	.0002
6-AM N2 TANKS	.0005	.0000	.0030	0.	0.	0.
COMMAND/SERVICE MOD.	.0064	.0002	.3611	.0002	.0158	.0008
DEPLOYMENT ASSEMBLY	.0006	.0135	.0077	0.	0.	0.
ATM-RACK,CMGS,4-SAS	.0066	.0017	.1986	.0000	.0000	-.0000
ATM-SPAR CENTER	.0015	.0001	.0441	.0002	.0004	0.
ATM-GRA/CAN CENTER	.0016	.0002	.0361	-.0000	.0006	.0000
	----	----	----	----	----	----
SUM	.0596	.0182	.8630	.0003	.0562	.0026

## TOTAL GM CONTRIBUTION FOR EACH COMPONENT

RR/OWS SKIRT/IU/FAS	.0334
6-FAS O2 TANKS	.0427
MDA/STS/AM	.2223
6-AM N2 TANKS	.0035
COMMAND/SERVICE MOD.	.3845
DEPLOYMENT ASSEMBLY	.0218
ATM-RACK,CMGS,4-SAS	.2070
ATM-SPAR CENTER	.0454
ATM-GRA/CAN CENTER	.0385

A-21  
TABLE A-18 GENERALIZED MASS CONTRIBUTIONS BY DEGREE OF FREEDOM

TEST MODE 08A      RUN NO. 452      FREQUENCY = 3.05

NODE NO.	GMC (DX)	GMC (DY)	GMC (DZ)	GMC (TX)	GMC (TY)	GMC (TZ)	NODE DESCRIPTION
1	.0005	.0001	.0149	.0000	.0055	.0000	BASE RNG/DWS SKIRT
2	.0013	.0000	.0003	.0000	.0036	.0004	DWS/IJ' INTERFACE
3	.0037	.0000	-.0009	-.0000	-.0002	.0011	IJ/FAS INTERFACE
4	.0001	.0003	.0005	0.	0.	0.	FAS 02 BOTL1,+Y +Z
5	.0007	.0003	.0015	0.	0.	0.	FAS 02 BOTL2,+Y +Z
6	.0012	.0006	.0015	0.	0.	0.	FAS 02 BOTL3,-Y +Z
7	.0002	.0003	.0008	0.	0.	0.	FAS 02 BOTL4,-Y +Z
8	-.0015	.0004	.0009	0.	0.	0.	FAS 02 BOTL5,-Y -Z
9	.0339	.0003	.0009	0.	0.	0.	FAS 02 BOTL6,-Y -Z
10	.0001	.0000	.0001	0.	0.	0.	FAS/AM/DA IF, +Y
11	.0011	.0000	.0019	0.	0.	0.	FAS/AM/DA IF, +Z
12	.0001	-.0000	.0005	0.	0.	0.	FAS/AM/DA IF, -Y
13	.0009	-.0002	-.0000	0.	0.	0.	FAS/DA IF, -Y -Z
14	.0005	.0001	.0001	0.	0.	0.	FAS/AM IF, -Z
15	.0009	-.0000	.0009	0.	0.	0.	FAS/DA IF, +Y -Z
16	.0001	.0000	.0005	.0000	.0007	.0000	AM TUNNEL/SHEAR WB
17	.0002	.0000	.0075	.0000	.0015	.0000	AM TUNNEL/STS IF
18	.0004	-.0000	.0535	-.0000	.0291	.0003	M0A/STS INTERFACE
19	.0001	.0001	.1273	-.0001	.0021	-.0000	M0A CONE/CYL YTRFC
20	.0000	.0000	.0001	0.	0.	0.	N2 TANK, +Y, LOWER
21	.0000	.0000	.0004	0.	0.	0.	N2 TANK, +Y, UPPER
22	.0001	.0000	.0004	0.	0.	0.	N2 TANK, +Z, LOWER
23	.0000	.0000	.0009	0.	0.	0.	N2 TANK, +Z, UPPER
24	.0003	.0000	.0004	0.	0.	0.	N2 TANK, -Z, LOWER
25	.0000	.0000	.0009	0.	0.	0.	N2 TANK, -Z, UPPER
26	.0016	.0000	.1309	.0004	.0041	.0003	CM, FWD BULKHEAD
27	.0006	.0001	.0757	-.0001	-.0005	-.0000	CM, AFT BULKHEAD
28	.0035	-.0000	.0185	-.0000	.0031	.0004	SM, FWD BULKHEAD
29	.0007	.0000	.1363	-.0001	.0031	.0002	SM, AFT BULKHEAD
30	-.0001	.0000	.0071	0.	0.	0.	LOWER D LATCH, DA
31	.0004	.0066	-.0000	0.	0.	0.	LOWER +Y TRUNNION
32	.0003	.0069	-.0000	0.	0.	0.	LOWER -Y TRUNNION
33	.0000	.0000	.0007	0.	0.	0.	EREP PACKAGE C.G.
34	-.0001	.0007	.0481	0.	0.	0.	ATM PN 5,7 IF,OUTR
35	.0014	.0004	.0189	0.	0.	0.	ATM PN 4,5 IF,OUTR
36	.0007	.0002	.0177	0.	0.	0.	ATM PN 8,1 IF,OUTR
37	.0019	-.0000	.0209	0.	0.	0.	ATM PN 2,3 IF,OUTR
38	-.0001	.0001	.0308	0.	0.	0.	ATM PN 5,7 IF,INNER
39	.0001	.0000	.0099	0.	0.	0.	ATM PN 4,5 IF,INNER
40	.0015	.0000	.0151	0.	0.	0.	ATM PN 8,1 IF,INNER
41	.0008	.0000	.0182	0.	0.	0.	ATM PN 2,3 IF,INNER
42	.0003	.0000	.0072	-.0000	-.0000	.0000	CMG, -Y SIDE
43	.0003	-.0000	.0061	-.0000	.0000	-.0000	CMG, +Y SIDE
44	.0005	.0000	.0058	.0000	.0000	.0000	CMG, +X SIDE
45	-.0000	-.0000	0.	0.	0.	0.	ATM SAS, PN 1
46	-.0001	-.0001	0.	0.	0.	0.	ATM SAS, PN 3
47	.0002	.0002	0.	0.	0.	0.	ATM SAS, PN 5
48	.0001	.0001	0.	0.	0.	0.	ATM SAS, PN 7
49	.0015	.0001	.0441	.0002	.0004	.0015	SPAR CENTER
50	.0015	.0002	.0361	-.0000	.0006	.0000	GRA/CAN CENTER
SUM	.0596	.0182	.8630	.0003	.0562	.0041	

TABLE A-19 ORBITAL CONFIGURATION MODAL SURVEY

## TEST MODES GENERALIZED MASS CONTRIBUTION SUMMARY

TEST MODE NO. 09A

TEST FREQUENCY = 4.10 HZ.

COMPONENT NAME	GMC (DX)	GMC (DY)	GMC (DZ)	GMC (TX)	GMC (TY)	GMC (TZ)
BR/OWS SKIRT/IU/FAS	.0002	.0059	.0052	.0539	-.0000	.0009
6-FAS O2 TANKS	.0004	.0299	.0237	0.	0.	0.
MDA/STS/AM	.0000	.0005	.0003	.0094	.0000	.0061
6-AM N2 TANKS	.0001	.0007	.0002	0.	0.	0.
COMMAND/SERVICE MOD.	.0032	.0019	.0008	.7972	.0001	.0015
DEPLOYMENT ASSEMBLY	.0008	.0019	.0026	0.	0.	0.
ATM-RACK,CMGS,4-SAS	.0169	.0114	.0073	.0001	.0000	.0000
ATM-SPAR CENTER	.0000	.0007	.0006	.0121	.0000	0.
ATM-GRA/CAN CENTER	.0000	.0005	.0000	.0028	.0000	.0009
	---	---	---	---	---	---
SUM	.0215	.0534	.0401	.8755	.0001	.0094

## TOTAL GM CONTRIBUTION FOR EACH COMPONENT

BR/OWS SKIRT/IU/FAS	.0761
6-FAS O2 TANKS	.0540
MDA/STS/AM	.0163
6-AM N2 TANKS	.0010
COMMAND/SERVICE MOD.	.8047
DEPLOYMENT ASSEMBLY	.0053
ATM-RACK,CMGS,4-SAS	.0356
ATM-SPAR CENTER	.0028
ATM-GRA/CAN CENTER	.0043



TABLE A-20 GENERALIZED MASS CONTRIBUTIONS BY DEGREE OF FREEDOM

TEST MODE 09A RUN NO. 443 FREQUENCY = 4.11

MODE NO.	GMC (DX)	GMC (DY)	GMC (DZ)	GMC (TX)	GMC (TY)	GMC (TZ)	MODE DESCRIPTION
1	.0000	.0005	.0000	.1324	.0000	.0001	BASE RNG/OWS SKIRT
2	.0000	.0000	-.0009	.0113	.0000	.0001	OWS/TU INTERFACE
3	.0000	-.0009	.0012	.0202	-.0000	.0007	IU/FAS INTERFACE
4	.0000	.0035	.0064	0.	0.	0.	FAS 02 BOTL1,+Y +Z
5	.0000	.0082	.0027	0.	0.	0.	FAS 02 BOTL2,+Y +Z
6	.0000	.0061	.0021	0.	0.	0.	FAS 02 BOTL3,-Y +Z
7	.0000	.0034	.0056	0.	0.	0.	FAS 02 BOTL4,-Y +Z
8	.0002	.0024	.0052	0.	0.	0.	FAS 02 BOTL5,-Y -Z
9	.0000	.0063	.0019	0.	0.	0.	FAS 02 BOTL6,-Y -Z
10	.0000	.0000	.0016	0.	0.	0.	FAS/AM/DA IF, +Y
11	-.0000	.0039	.0000	0.	0.	0.	FAS/AM/DA IF, +Z
12	.0001	.0000	.0023	0.	0.	0.	FAS/AM/DA IF, -Y
13	.0000	.0004	-.0001	0.	0.	0.	FAS/DA IF, -Y -Z
14	-.0000	.0010	-.0000	0.	0.	0.	FAS/AM IF, -Z
15	.0000	.0001	.0001	0.	0.	0.	FAS/DA IF, +Y -Z
16	.0000	.0000	.0000	.0002	.0000	.0000	AM TUNNEL/SHEAR WB
17	.0000	.0001	.0001	.0020	.0000	.0043	AM TUNNEL/STS IF
18	.0000	-.0000	.0000	.0037	-.0000	.0017	MDA/STS INTERFACE
19	.0000	.0005	.0002	.0035	-.0000	.0001	MDA CONE/CYL ITRFC
20	-.0000	.0000	.0002	0.	0.	0.	N2 TANK, +Y, LOWER
21	.0000	.0000	.0000	0.	0.	0.	N2 TANK, +Y, UPPER
22	.0000	.0003	.0000	0.	0.	0.	N2 TANK, +Z, LOWER
23	.0000	.0001	.0000	0.	0.	0.	N2 TANK, +Z, UPPER
24	.0000	.0002	.0000	0.	0.	0.	N2 TANK, -Z, LOWER
25	.0000	.0000	.0000	0.	0.	0.	N2 TANK, -Z, UPPER
26	.0002	.0009	-.0001	.0829	.0000	.0000	CM, FWD BULKHEAD
27	.0004	-.0001	.0028	.1376	.0001	.0000	CM, AFT BULKHEAD
28	.0026	.0000	-.0009	.2353	-.0000	.0014	SM, FWD BULKHEAD
29	.0000	.0011	-.0012	.3415	.0000	-.0000	SM, AFT BULKHEAD
30	.0000	.0002	.0000	0.	0.	0.	LOWER O LATCH, DA
31	.0008	.0001	.0013	0.	0.	0.	LOWER +Y TRUNNION
32	.0000	-.0000	.0012	0.	0.	0.	LOWER -Y TRUNNION
33	.0000	.0017	.0000	0.	0.	0.	EREP PACKAGE C.G.
34	.0011	-.0000	.0001	0.	0.	0.	ATM PN 6,7 IF,OUTR
35	.0100	.0006	.0019	0.	0.	0.	ATM PN 4,5 IF,OUTR
36	.0022	.0011	.0014	0.	0.	0.	ATM PN 8,1 IF,OUTR
37	.0003	.0037	-.0000	0.	0.	0.	ATM PN 2,3 IF,OUTR
38	.0006	.0052	.0000	0.	0.	0.	ATM PN 6,7 IF,INNER
39	.0004	.0009	.0009	0.	0.	0.	ATM PN 4,5 IF,INNER
40	.0016	-.0003	.0013	0.	0.	0.	ATM PN 8,1 IF,INNER
41	-.0000	.0001	.0004	0.	0.	0.	ATM PN 2,3 IF,INNER
42	.0003	.0001	.0007	.0000	.0000	.0000	CMG, -Y SIDE
43	.0004	.0001	.0005	.0000	-.0000	.0000	CMG, +Y SIDE
44	.0000	.0000	-.0000	.0000	.0000	.0000	CMG, +X SIDE
45	-.0000	-.0000	0.	0.	0.	0.	ATM SAS, PN 1
46	.0000	.0000	0.	0.	0.	0.	ATM SAS, PN 3
47	-.0000	-.0000	0.	0.	0.	0.	ATM SAS, PN 5
48	-.0000	-.0000	0.	0.	0.	0.	ATM SAS, PN 7
49	.0000	.0007	.0000	.0021	.0000	.0000	SPAR CENTER
50	.0000	.0005	.0000	.0028	.0000	.0009	GRA/CAN CENTER
SUM	.0215	.0534	.0401	.8755	.0001	.0094	

TABLE A-21 ORBITAL CONFIGURATION MODAL SURVEY

## TEST MODES GENERALIZED MASS CONTRIBUTION SUMMARY

TEST MODE NO. 10A

TEST FREQUENCY = 4.50 HZ.

COMPONENT NAME	GMC (DX)	GMC (DY)	GMC (DZ)	GMC (TX)	GMC (TY)	GMC (TZ)
BR/OVS SKIRT/IU/FAS	.0004	.0115	.0133	.0209	.0001	.0044
6-FAS O2 TANKS	.0018	.0315	.0201	0.	0.	0.
MDA/STS/AM	.0000	.0352	.0001	-.0000	-.0000	.0060
6-AM N2 TANKS	.0000	.0003	.0008	0.	0.	0.
COMMAND/SERVICE MOD.	.0000	.1116	.0010	.0290	.0000	.0042
DEPLOYMENT ASSEMBLY	.0022	.0054	.0025	0.	0.	0.
ATM-RACK,CMGS,4-SAS	.1477	.3392	.1462	.0309	-.0000	.0006
ATM-SPAR CENTER	.0004	-.0000	-.0000	.0455	.0006	0.
ATM-GRA/CAN CENTER	.0003	.0005	.0000	.0485	.0003	.0269
	----	----	----	----	----	----
SUM	.1528	.4752	.1840	.1449	.0010	.0420

## TOTAL GM CONTRIBUTION FOR EACH COMPONENT

BR/OVS SKIRT/IU/FAS	.0536
6-FAS O2 TANKS	.0235
MDA/STS/AM	.0412
6-AM N2 TANKS	.0011
COMMAND/SERVICE MOD.	.1459
DEPLOYMENT ASSEMBLY	.0101
ATM-RACK,CMGS,4-SAS	.6046
ATM-SPAR CENTER	.0465
ATM-GRA/CAN CENTER	.0765

TABLE A-22 GENERALIZED MASS CONTRIBUTIONS BY DEGREE OF FREEDOM

TEST MODE	10A	RUN NO. 482			FREQUENCY = 4.53		
NODE NO.	GMC (OX)	GMC (OY)	GMC (OZ)	GMC (TX)	GMC (TY)	GMC (TZ)	NODE DESCRIPTION
1	.0001	.0099	.0010	.0142	.0001	.0025	BASE RNG/DWS SKIPT
2	-.0000	.0003	.0008	.0027	.0000	.0007	DWS/IJ INTERFACE
3	.0000	.0000	.0056	.0039	-.0000	.0011	IU/FAS INTERFACE
4	.0009	.0000	.0049	0.	0.	0.	FAS 02 BOTL1,+Y +Z
5	.0001	.0009	.0017	0.	0.	0.	FAS 02 BOTL2,+Y +Z
6	-.0000	.0006	.0009	0.	0.	0.	FAS 02 BOTL3,-Y +Z
7	.0006	-.0000	.0031	0.	0.	0.	FAS 02 BOTL4,-Y +Z
8	.0003	.0000	.0073	0.	0.	0.	FAS 02 BOTL5,-Y -Z
9	-.0000	-.0000	.0023	0.	0.	0.	FAS 02 BOTL6,-Y -Z
10	.0002	.0000	.0019	0.	0.	0.	FAS/AM/OA IF, +Y
11	-.0000	.0010	.0000	0.	0.	0.	FAS/AM/OA IF, +Z
12	.0001	.0000	.0029	0.	0.	0.	FAS/AM/OA IF, -Y
13	-.0000	.0002	.0007	0.	0.	0.	FAS/OA IF, -Y -Z
14	.0000	-.0000	-.0000	0.	0.	0.	FAS/AM IF, -Z
15	.0001	.0000	.0003	0.	0.	0.	FAS/OA IF, +Y -Z
16	.0000	.0001	.0000	.0001	.0000	.0000	AM TUNNEL/SHEAR WR
17	.0000	.0001	.0000	.0001	-.0000	.0008	AM TUNNEL/STS IF
18	.0000	.0056	.0000	-.0001	.0000	.0048	MDA/STS INTERFACE
19	-.0000	.0294	.0001	-.0001	-.0000	.0004	MDA CONE/CYL ITRFC
20	.0000	.0000	.0005	0.	0.	0.	N2 TANK, +Y, LOWER
21	.0000	.0000	.0003	0.	0.	0.	N2 TANK, +Y, UPPER
22	.0000	.0001	.0000	0.	0.	0.	N2 TANK, +Z, LOWER
23	.0000	.0001	.0000	0.	0.	0.	N2 TANK, +Z, UPPER
24	.0000	.0000	.0000	0.	0.	0.	N2 TANK, -Z, LOWER
25	.0000	.0000	.0000	0.	0.	0.	N2 TANK, -Z, UPPER
26	-.0000	.0461	-.0000	.0034	-.0000	.0002	CM, FWD BULKHEAD
27	.0000	.0207	.0011	.0060	.0000	-.0002	CM, AFT BULKHEAD
28	.0001	.0097	-.0000	.0069	.0000	.0002	SM, FWD BULKHEAD
29	-.0000	.0351	-.0000	.0127	.0000	.0039	SM, AFT BULKHEAD
30	.0000	.0041	.0002	0.	0.	0.	LOWER O LATCH, DA
31	.0013	.0006	.0015	0.	0.	0.	LOWER +Y TRUNNION
32	.0008	.0001	.0007	0.	0.	0.	LOWER -Y TRUNNION
33	.0000	.0005	.0000	0.	0.	0.	EREP PACKAGE C.G.
34	.0006	.0191	.0017	0.	0.	0.	ATM PN 6,7 IF,OUTR
35	.0314	.0002	.0372	0.	0.	0.	ATM PN 4,5 IF,OUTR
36	.0316	.0059	.0318	0.	0.	0.	ATM PN 8,1 IF,OUTR
37	.0073	.0422	.0017	0.	0.	0.	ATM PN 2,3 IF,OUTR
38	.0111	.1861	.0039	0.	0.	0.	ATM PN 6,7 IF,INNER
39	.0292	.0300	.0147	0.	0.	0.	ATM PN 4,5 IF,INNER
40	.0198	.0013	.0295	0.	0.	0.	ATM PN 8,1 IF,INNER
41	-.0012	.0078	.0019	0.	0.	0.	ATM PN 2,3 IF,INNER
42	.0071	.0073	.0107	.0002	.0000	.0001	CMG, -Y SIDE
43	.0095	.0078	.0129	.0005	-.0000	.0003	CMG, +Y SIDE
44	.0000	.0001	.0001	.0002	.0000	.0002	CMG, +X SIDE
45	.0003	.0003	0.	0.	0.	0.	ATM SAS, PN 1
46	.0003	.0003	0.	0.	0.	0.	ATM SAS, PN 3
47	.0003	.0003	0.	0.	0.	0.	ATM SAS, PN 5
48	.0003	.0003	0.	0.	0.	0.	ATM SAS, PN 7
49	.0004	-.0000	-.0000	.0455	.0005	.0004	SPAR CENTER
50	.0003	.0005	.0000	.0485	.0003	.0269	GRA/CAN CENTER
SUM	.1528	.4752	.1840	.1449	.0010	.0424	

TABLE A-23 ORBITAL CONFIGURATION MODAL SURVEY

## TEST MODES GENERALIZED MASS CONTRIBUTION SUMMARY

TEST MODE NO. 108

TEST FREQUENCY = 4.55 HZ.

COMPONENT NAME	GMC (DX)	GMC (DY)	GMC (DZ)	GMC (TX)	GMC (TY)	GMC (TZ)
BR/OWS SKIRT/IU/FAS	.0004	.0102	.0130	.0218	.0000	.0045
6-FAS O2 TANKS	.0023	.0013	.0207	0.	0.	0.
MDA/STS/AM	.0000	.0367	.0002	-.0000	-.0000	.0068
6-AM N2 TANKS	.0000	.0002	.0008	0.	0.	0.
COMMAND/SERVICE MOD.	-.0000	.1127	.0011	.0265	.0000	.0037
DEPLOYMENT ASSEMBLY	.0025	.0055	.0033	0.	0.	0.
ATM-RACK,CMGS,4-SAS	.1468	.3103	.1478	.0010	-.0000	.0007
ATM-SPAR CENTER	.0006	-.0000	.0000	.0478	.0005	0.
ATM-GRA/CAN CENTER	.0001	.0003	.0000	.0423	.0001	.0273
	----	----	----	----	----	----
SUM	.1528	.4772	.1870	.1394	.0006	.0430

## TOTAL GM CONTRIBUTION FOR EACH COMPONENT

BR/OWS SKIRT/IU/FAS	.0500
6-FAS O2 TANKS	.0243
MDA/STS/AM	.0436
6-AM N2 TANKS	.0011
COMMAND/SERVICE MOD.	.1441
DEPLOYMENT ASSEMBLY	.0113
ATM-RACK,CMGS,4-SAS	.6066
ATM-SPAR CENTER	.0490
ATM-GRA/CAN CENTER	.0701

A-27  
TABLE A-24 GENERALIZED MASS CONTRIBUTIONS BY DEGREE OF FREEDOM

TEST MODE 10B      RUN NO. 619      FREQUENCY = 4.55

MODE NO.	GMC (DX)	GMC (DY)	GMC (DZ)	GMC (TX)	GMC (TY)	GMC (TZ)	NODE DESCRIPTION
1	.0000	.0387	.0001	.0149	.0030	.0028	BASE RNG/JWS SKIRT
2	-.0000	.0004	.0009	.0029	.0000	.0008	OWS/IU INTERFACE
3	.0000	.0000	.0063	.0039	-.0000	.0009	IU/FAS INTERFACE
4	.0012	.0000	.0045	0.	0.	0.	FAS 02 BOTL1,+Y +Z
5	-.0000	.0005	.0025	0.	0.	0.	FAS 02 BOTL2,+Y +Z
6	.0002	.0008	.0013	0.	0.	0.	FAS 02 BOTL3,-Y +Z
7	.0005	-.0000	.0032	0.	0.	0.	FAS 02 BOTL4,-Y +Z
8	.0005	.0000	.0075	0.	0.	0.	FAS 02 BOTL5,-Y -Z
9	-.0000	.0000	.0017	0.	0.	0.	FAS 02 BOTL5,-Y -Z
10	.0002	.0000	.0017	0.	0.	0.	FAS/AM/DA IF, +Y
11	-.0000	.0008	.0000	0.	0.	0.	FAS/AM/DA IF, +Z
12	.0002	.0001	.0027	0.	0.	0.	FAS/AM/DA IF, -Y
13	-.0010	.0003	.0009	0.	0.	0.	FAS/DA IF, -Y -Z
14	-.0000	-.0000	-.0000	0.	0.	0.	FAS/AM IF, -Z
15	.0001	.0001	.0004	0.	0.	0.	FAS/DA IF, +Y -Z
16	.0000	.0000	.0002	.0000	.0000	.0001	AM TUNNEL/SHEAR WB
17	.0000	.0001	.0000	.0001	.0000	.0009	AM TUNNEL/STS IF
18	.0000	.0063	.0000	-.0001	-.0000	.0052	MDA/STS INTERFACE
19	.0000	.0302	.0000	-.0001	-.0000	.0006	MDA CONE/CYL ITRFC
20	.0000	.0000	.0005	0.	0.	0.	N2 TANK, +Y, LOWER
21	.0000	.0000	.0003	0.	0.	0.	N2 TANK, +Y, UPPER
22	.0000	.0001	.0000	0.	0.	0.	N2 TANK, +Z, LOWER
23	.0000	.0001	.0000	0.	0.	0.	N2 TANK, +Z, UPPER
24	.0000	.0000	.0000	0.	0.	0.	N2 TANK -Z, LOWER
25	.0000	.0000	.0000	0.	0.	0.	N2 TANK, -Z, UPPER
26	-.0000	.0482	-.0000	.0035	-.0000	.0002	CM, FWD BULKHEAD
27	-.0000	.0217	.0011	.0063	.0000	-.0002	CM, AFT BULKHEAD
28	.0000	.0113	.0000	.0039	-.0000	.0002	SM, FWD BULKHEAD
29	-.0000	.0715	-.0000	.0129	.0000	.0035	SM, AFT BULKHEAD
30	.0000	.0047	.0001	0.	0.	0.	LOWER D LATCH, DA
31	.0014	.0003	.0023	0.	0.	0.	LOWER +Y TRUNNION
32	.0010	-.0001	.0008	0.	0.	0.	LOWER -Y TRUNNION
33	.0000	.0206	.0000	0.	0.	0.	EREP PACKAGE C.G.
34	.0005	.0194	.0020	0.	0.	0.	ATM PN 6,7 IF,OUTR
35	.0318	.0002	.0366	0.	0.	0.	ATM PN 4,5 IF,OUTR
36	.0330	.0057	.0326	0.	0.	0.	ATM PN 8,1 IF,OUTR
37	.0071	.0414	.0017	0.	0.	0.	ATM PN 2,3 IF,OUTR
38	.0108	.1862	.0043	0.	0.	0.	ATM PN 6,7 IF,INNER
39	.0295	.0310	.0146	0.	0.	0.	ATM PN 4,5 IF,INNER
40	.0170	.0021	.0302	0.	0.	0.	ATM PN 8,1 IF,INNER
41	-.0011	.0074	.0020	0.	0.	0.	ATM PN 2,3 IF,INNER
42	.0075	.0074	.0109	.0002	.0000	.0001	CMG, -Y SIDE
43	.0093	.0080	.0127	.0005	-.0000	.0003	CMG, +Y SIDE
44	.0000	.0001	.0001	.0002	.0000	.0002	CMG, +X SIDE
45	.0004	.0004	0.	0.	0.	0.	ATM SAS, PN 1
46	.0003	.0003	0.	0.	0.	0.	ATM SAS, PN 3
47	.0004	.0004	0.	0.	0.	0.	ATM SAS, PN 5
48	.0003	.0003	0.	0.	0.	0.	ATM SAS, PN 7
49	.0005	-.0000	.0000	.0478	.0005	.0006	SPAR CENTER
50	.0001	.0003	.0000	.0423	.0001	.0273	GRA/CAN CENTER
SUM	.1528	.4772	.1870	.1394	.0006	.0436	

TABLE A-25 ORBITAL CONFIGURATION MODAL SURVEY

## TEST MODES GENERALIZED MASS CONTRIBUTION SUMMARY

TEST MODE NO. 11A

TEST FREQUENCY = 5.03 HZ.

COMPONENT NAME	GMC (DX)	GMC (DY)	GMC (DZ)	GMC (TX)	GMC (TY)	GMC (TZ)
BR/OWS SKIRT/IU/FAS	.0026	.0002	.0026	.0001	.0010	.0000
6-FAS O2 TANKS	.0029	.0005	.0003	0.	0.	0.
MDA/STS/AM	.0057	.0005	.0028	.0000	.0010	.0001
6-AM N2 TANKS	.0010	.0001	.0000	0.	0.	0.
COMMAND/SERVICE MOD.	.0173	.0023	.0133	.0000	.0002	.0016
DEPLOYMENT ASSEMBLY	.0006	.0093	.0099	0.	0.	0.
ATM-RACK,CMGS,4-SAS	.3288	.0046	.3862	.0000	.0018	.0000
ATM-SPAR CENTER	.0005	.0000	.0048	.0001	.0869	0.
ATM-GRA/CAN CENTER	.0002	-.0000	.0001	-.0001	.1097	.0003
	---	----	----	----	----	----
SUM	.3596	.0176	.4199	.0002	.2007	.0021

## TOTAL GM CONTRIBUTION FOR EACH COMPONENT

BR/OWS SKIRT/IU/FAS	.0066
6-FAS O2 TANKS	.0037
MDA/STS/AM	.0102
6-AM N2 TANKS	.0011
COMMAND/SERVICE MOD.	.0346
DEPLOYMENT ASSEMBLY	.0197
ATM-RACK,CMGS,4-SAS	.7215
ATM-SPAR CENTER	.0923
ATM-GRA/CAN CENTER	.1102

A-29  
TABLE A-26 GENERALIZED MASS CONTRIBUTIONS BY DEGREE OF FREEDOM

TEST MODE 11A      RUN NO. 536      FREQUENCY = 5.03

MODE NO.	GMC (DX)	GMC (DY)	GMC (DZ)	GMC (TX)	GMC (TY)	GMC (TZ)	MODE DESCRIPTION
1	.0012	.0001	.0024	.0001	.0006	-.0000	BASE RNG/OWS SKIRT
2	.1004	-.0000	.0001	.0000	.0002	.0000	OWS/TU INTERFACE
3	.0004	.0000	.0001	.0000	.0003	.0000	IU/FAS INTERFACE
4	.0001	.0000	.0003	0.	0.	0.	FAS 02 BOTL1,+Y +Z
5	.0001	.0000	.0001	0.	0.	0.	FAS 02 BOTL2,+Y +Z
6	.0003	.0002	.0001	0.	0.	0.	FAS 02 BOTL3,-Y +Z
7	.0004	.0001	.0000	0.	0.	0.	FAS 02 BOTL4,-Y +Z
8	.0010	.0002	.0000	0.	0.	0.	FAS 02 BOTL5,-Y -Z
9	.0010	.0001	-.0000	0.	0.	0.	FAS 02 BOTL6,-Y -Z
10	.0001	-.0000	.0000	0.	0.	0.	FAS/AM/DA IF, +Y
11	-.0000	.0001	.0000	0.	0.	0.	FAS/AM/DA IF, +Z
12	.0004	.0000	.0000	0.	0.	0.	FAS/AM/DA IF, -Y
13	.0000	.0000	-.0000	0.	0.	0.	FAS/DA IF, -Y -Z
14	.0002	.0000	.0000	0.	0.	0.	FAS/AM IF, -Z
15	.0000	-.0000	.0000	0.	0.	0.	FAS/DA IF, +Y -Z
16	.0006	.0001	.0000	.0000	.0000	.0000	AM TUNNEL/SHEAR WB
17	.0012	.0001	.0001	.0000	.0001	.0000	AM TUNNEL/STS IF
18	.0021	-.0000	.0001	.0000	.0005	.0001	MDA/STS INTERFACE
19	.0018	.0003	.0026	.0000	.0003	.0000	MDA CONE/CYL ITRFC
20	.0002	.0000	.0000	0.	0.	0.	N2 TANK, +Y, LOWER
21	.0002	.0000	.0000	0.	0.	0.	N2 TANK, +Y, UPPER
22	.0001	.0000	.0000	0.	0.	0.	N2 TANK, +Z, LOWER
23	.0002	.0000	.0000	0.	0.	0.	N2 TANK, +Z, UPPER
24	.0002	.0000	.0000	0.	0.	0.	N2 TANK -Z, LOWER
25	.0001	.0000	.0000	0.	0.	0.	N2 TANK, -Z, UPPER
26	.0027	.0008	.0049	.0000	-.0000	-.0000	CM, FWD BULKHEAD
27	.0033	.0008	.0037	-.0000	-.0001	-.0000	CM, AFT BULKHEAD
28	.0054	.0003	.0009	.0000	.0002	.0013	SM, FWD BULKHEAD
29	.0058	.0004	.0037	.0000	.0001	.0003	SM, AFT BULKHEAD
30	-.0001	.0003	.0073	0.	0.	0.	LOWER D LATCH, DA
31	-.0000	.0037	.0007	0.	0.	0.	LOWER +Y TRUNNION
32	.0002	.0053	.0010	0.	0.	0.	LOWER -Y TRUNNION
33	.0004	.0000	.0009	0.	0.	0.	EREP PACKAGE C.G.
34	.0021	.0014	.1128	0.	0.	0.	ATM PN 6,7 IF,OUTR
35	-.0003	.0001	.0013	0.	0.	0.	ATM PN 4,5 IF,OUTR
36	.0050	.0006	.0062	0.	0.	0.	ATM PN 8,1 IF,OUTR
37	.0050	-.0002	.0917	0.	0.	0.	ATM PN 2,3 IF,OUTR
38	.0365	-.0043	.0659	0.	0.	0.	ATM PN 6,7 IF,INNER
39	.0896	.0018	-.0001	0.	0.	0.	ATM PN 4,5 IF,INNER
40	.0860	.0039	.0069	0.	0.	0.	ATM PN 8,1 IF,INNER
41	.0612	-.0012	.0766	0.	0.	0.	ATM PN 2,3 IF,INNER
42	.0158	.0001	.0007	.0000	.0006	.0000	CMG, -Y SIDE
43	.0125	.0001	.0001	.0000	.0007	-.0000	CMG, +Y SIDE
44	.0120	-.0000	.0240	.0000	.0005	.0000	CMG, +X SIDE
45	.0005	.0006	0.	0.	0.	0.	ATM SAS, PN 1
46	.0008	.0008	0.	0.	0.	0.	ATM SAS, PN 3
47	.0006	.0006	0.	0.	0.	0.	ATM SAS, PN 5
48	.0004	.0004	0.	0.	0.	0.	ATM SAS, PN 7
49	.0005	.0000	.0048	.0001	.0869	.0005	SPAR CENTER
50	.0002	-.0000	.0001	-.0001	.1097	.0003	GRA/CAN CENTER
SUM	.3526	.0176	.4199	.0002	.2007	.0025	

TABLE A-27 ORBITAL CONFIGURATION MODAL SURVEY

## TEST MODES GENERALIZED MASS CONTRIBUTION SUMMARY

TEST MODE NO. 12A

TEST FREQUENCY = 5.86 HZ.

COMPONENT NAME	GMC (DX)	GMC (DY)	GMC (DZ)	GMC (TX)	GMC (TY)	GMC (TZ)
BR/OWS SKIRT/IU/FAS	.0108	.1058	.0706	.0078	.0001	.0718
6-FAS O2 TANKS	.0222	.1398	.1185	0.	0.	0.
MDA/STS/AM	.0003	.0503	.0001	.0017	.0001	.0159
6-AM N2 TANKS	.0005	.0296	.0029	0.	0.	0.
COMMAND/SERVICE MOD.	.0006	.2275	.0019	.0116	.0001	.0078
DEPLOYMENT ASSEMBLY	.0102	.0444	.0003	0.	0.	0.
ATM-RACK,CMGS,4-SAS	.0062	.0163	.0073	.0000	.0000	.0000
ATM-SPAR CENTER	.0000	.0004	.0000	.0021	.0001	0.
ATM-GRA/CAN CENTER	.0000	.0006	.0000	.0020	.0002	.0013
	----	----	----	----	----	----
SUM	.0509	.6246	.2016	.0254	.0006	.0969

## TOTAL GM CONTRIBUTION FOR EACH COMPONENT

BR/OWS SKIRT/IU/FAS	.2669
6-FAS O2 TANKS	.2804
MDA/STS/AM	.0786
6-AM N2 TANKS	.0330
COMMAND/SERVICE MOD.	.2495
DEPLOYMENT ASSEMBLY	.0549
ATM-RACK,CMGS,4-SAS	.0299
ATM-SPAR CENTER	.0127
ATM-GRA/CAN CENTER	.0041



TABLE A-28 GENERALIZED MASS CONTRIBUTIONS BY DEGREE OF FREEDOM

TEST MODE 12A RUN NO. 574 FREQUENCY = 15.85

MODE NO.	GMC (DX)	GMC (DY)	GMC (DZ)	GMC (TX)	GMC (TY)	GMC (TZ)	NODE DESCRIPTION
1	.0003	.0727	.0008	.0065	.0000	.0404	BASE RNG/DWS SKIRT
2	.0001	.0000	.0120	.0001	.0002	.0095	OWS/IJ INTERFACE
3	-.0000	.0047	.0440	.0012	-.0001	.0219	IU/FAS INTERFACE
4	.0064	.0207	.0364	0.	0.	0.	FAS 02 BOTL1,+Y +Z
5	.0011	.0435	.0179	0.	0.	0.	FAS 02 BOTL2,+Y +Z
6	.0005	.0445	.0104	0.	0.	0.	FAS 02 BOTL3,-Y +Z
7	.0042	.0700	.0282	0.	0.	0.	FAS 02 BOTL4,-Y +Z
8	.0090	.0007	.0209	0.	0.	0.	FAS 02 BOTL5,-Y -Z
9	.0011	.0003	.0056	0.	0.	0.	FAS 02 BOTL6,-Y -Z
10	.0047	.0023	.0041	0.	0.	0.	FAS/AM/DA IF, +Y
11	.0000	.0208	.0000	0.	0.	0.	FAS/AM/DA IF, +Z
12	.0053	.0046	.0097	0.	0.	0.	FAS/AM/DA IF, -Y
13	.0002	.0001	-.0005	0.	0.	0.	FAS/DA IF, -Y -Z
14	-.0001	.0005	.0000	0.	0.	0.	FAS/AM IF, -Z
15	.0003	-.0000	.0005	0.	0.	0.	FAS/DA IF, +Y -Z
16	.0001	.0092	.0001	.0000	.0000	.0000	AM TUNNEL/SHEAR WB
17	.0000	.0224	.0000	.0004	.0000	.0043	AM TUNNEL/STS IF
18	.0001	-.0008	.0000	.0005	.0000	.0086	MDA/STS INTERFACE
19	.0001	.0296	-.0000	.0007	-.0000	.0030	MDA CONE/CYL ITRFC
20	.0004	.0027	.0016	0.	0.	0.	N2 TANK, +Y, LOWER
21	.0000	.0038	.0013	0.	0.	0.	N2 TANK, +Y, UPPER
22	.0000	.0067	.0000	0.	0.	0.	N2 TANK, +Z, LOWER
23	.0000	.0112	.0000	0.	0.	0.	N2 TANK, +Z, UPPER
24	.0000	.0019	.0000	0.	0.	0.	N2 TANK -Z, LOWER
25	.0000	.0033	.0000	0.	0.	0.	N2 TANK, -Z, UPPER
26	.0001	.0097	.0000	.0007	-.0000	.0002	CM, FWD BULKHEAD
27	.0001	.0089	.0017	.0006	.0000	-.0004	CM, AFT BULKHEAD
28	.0004	.0267	.0001	.0040	-.0000	.0006	SM, FWD BULKHEAD
29	-.0000	.0021	.0001	.0064	.0001	.0074	SM, AFT BULKHEAD
30	.0001	.0142	.0000	0.	0.	0.	LOWER D LATCH, DA
31	.0066	-.0002	.0000	0.	0.	0.	LOWER +Y TRUNNION
32	.0035	.0000	.0003	0.	0.	0.	LOWER -Y TRUNNION
33	.0001	.0304	.0000	0.	0.	0.	ERP PACKAGE C.G.
34	.0001	.0019	.0008	0.	0.	0.	ATM PN 6,7 IF,OUTR
35	.0012	.0002	.0012	0.	0.	0.	ATM PN 4,5 IF,OUTR
36	.0013	.0000	.0009	0.	0.	0.	ATM PN 8,1 IF,OUTR
37	.0001	.0006	.0006	0.	0.	0.	ATM PN 2,3 IF,OUTR
38	-.0001	.0088	.0008	0.	0.	0.	ATM PN 6,7 IF,INNER
39	.0025	.0018	.0005	0.	0.	0.	ATM PN 4,5 IF,INNER
40	.0000	.0006	.0010	0.	0.	0.	ATM PN 8,1 IF,INNER
41	-.0000	.0009	.0005	0.	0.	0.	ATM PN 2,3 IF,INNER
42	.0005	.0005	.0004	.0000	.0000	.0000	CMG, -Y SIDE
43	.0031	.0006	.0005	.0000	.0000	.0000	CMG, +Y SIDE
44	.0000	.0001	.0000	.0000	.0000	.0000	CMG, +X SIDE
45	.0000	.0000	0.	0.	0.	0.	ATM SAS, PN 1
46	.0031	.0001	0.	0.	0.	0.	ATM SAS, PN 3
47	.0000	.0000	0.	0.	0.	0.	ATM SAS, PN 5
48	.0001	.0001	0.	0.	0.	0.	ATM SAS, PN 7
49	.0000	.0004	.0000	.0021	.0001	.0000	SPAR CENTER
50	.0000	.0006	.0000	.0020	.0002	.0013	GRA/CAN CENTER
SUM	.0509	.6246	.2016	.0254	.0006	.0969	

TABLE A-29 ORBITAL CONFIGURATION MODAL SURVEY

## TEST MODES GENERALIZED MASS CONTRIBUTION SUMMARY

TEST MODE NO. 13A

TEST FREQUENCY = 6.25 HZ.

COMPONENT NAME	GMC (DX)	GMC (DY)	GMC (DZ)	GMC (TX)	GMC (TY)	GMC (TZ)
BR/OWS SKIRT/IU/FAS	.0125	.0039	.1834	.0063	.1252	.0007
6-FAS O2 TANKS	.0445	.0141	.1350	0.	0.	0.
MDA/STS/AM	.0005	.0036	.1085	.0021	.0224	.0009
6-AM N2 TANKS	.0006	.0017	.0550	0.	0.	0.
COMMAND/SERVICE MOD.	.0016	.0087	.1120	.0049	.0085	-.0002
DEPLOYMENT ASSEMBLY	.0024	.0154	.0564	0.	0.	0.
ATM-RACK,CMGS,4-SAS	.0108	.0036	.0352	.0000	.0001	.0000
ATM-SPAR CENTER	.0007	.0000	.0075	.0003	.0028	0.
ATM-GRA/CAN CENTER	.0009	.0000	.0040	.0002	.0040	.0002
	----	----	----	----	----	----
SUM	.0737	.0510	.6970	.0137	.1630	.0017

## TOTAL GM CONTRIBUTION FOR EACH COMPONENT

BR/OWS SKIRT/IU/FAS	.3319
6-FAS O2 TANKS	.1935
MDA/STS/AM	.1379
6-AM N2 TANKS	.0574
COMMAND/SERVICE MOD.	.1349
DEPLOYMENT ASSEMBLY	.0741
ATM-RACK,CMGS,4-SAS	.0497
ATM-SPAR CENTER	.0113
ATM-GRA/CAN CENTER	.0093

A-33  
TABLE A-30 GENERALIZED MASS CONTRIBUTIONS BY DEGREE OF FREEDOM

TEST MODE 13A      RUN NO. 491      FREQUENCY = 6.25

MODE NO.	GMC (OX)	GMC (OY)	GMC (OZ)	GMC (TX)	GMC (TY)	GMC (TZ)	MODE DESCRIPTION
1	.0000	.0003	.1487	.0025	.0713	.0005	RASE RNG/DWS SKIRT
2	-.0001	.0002	.0010	.0014	.0174	-.0001	DWS/IU INTERFACE
3	.0003	.0006	.0022	.0024	.0365	.0003	IU/FAS INTERFACE
4	.0078	.0023	.0257	0.	0.	0.	FAS 02 BOTL1,+Y +Z
5	.0104	.0046	.0300	0.	0.	0.	FAS 02 BOTL2,+Y +Z
6	.0080	.0033	.0255	0.	0.	0.	FAS 02 BOTL3,-Y +Z
7	.0026	.0022	.0192	0.	0.	0.	FAS 02 BOTL4,-Y +Z
8	.0073	.0004	.0162	0.	0.	0.	FAS 02 BOTL5,-Y -Z
9	.0083	.0012	.0183	0.	0.	0.	FAS 02 BOTL6,-Y -Z
10	-.0000	.0000	.0045	0.	0.	0.	FAS/AM/OA IF, +Y
11	.0001	.0001	.0130	0.	0.	0.	FAS/AM/OA IF, +Z
12	.0005	.0005	.0061	0.	0.	0.	FAS/AM/OA IF, -Y
13	.0002	.0002	.0020	0.	0.	0.	FAS/OA IF, -Y -Z
14	.0033	.0018	.0055	0.	0.	0.	FAS/AM IF, -Z
15	.0003	.0001	.0005	0.	0.	0.	FAS/OA IF, +Y -Z
16	.0000	.0005	.0254	.0001	.0001	.0002	AM TUNNEL/SHEAR WB
17	.0000	.0021	.0503	.0014	.0064	.0002	AM TUNNEL/STS IF
18	.0002	.0000	.0171	.0001	.0066	.0003	MDA/STS INTERFACE
19	.0002	.0010	.0157	.0004	.0093	.0001	MDA CONE/CYL ITRFC
20	.0000	.0001	.0071	0.	0.	0.	N2 TANK, +Y, LOWER
21	.0001	.0002	.0097	0.	0.	0.	N2 TANK, +Y, UPPER
22	.0002	.0001	.0099	0.	0.	0.	N2 TANK, +Z, LOWER
23	.0001	.0000	.0122	0.	0.	0.	N2 TANK, +Z, UPPER
24	.0002	.0007	.0061	0.	0.	0.	N2 TANK, -Z, LOWER
25	.0001	.0006	.0101	0.	0.	0.	N2 TANK, -Z, UPPER
26	.0001	.0027	-.0000	.0007	-.0000	.0000	CM, FWD RJLKHEAD
27	.0001	.0035	.0000	.0002	.0002	-.0000	CM, AFT RJLKHEAD
28	.0001	.0015	.0294	.0005	.0020	-.0000	SM, FWD RJLKHEAD
29	.0007	.0010	.0826	.0035	.0053	-.0001	SM, AFT RJLKHEAD
30	.0013	.0014	.0014	0.	0.	0.	LOWER D LATCH, OA
31	-.0000	.0014	.0195	0.	0.	0.	LOWER +Y TRUNNION
32	.0012	.0123	.0112	0.	0.	0.	LOWER -Y TRUNNION
33	-.0001	.0002	.0243	0.	0.	0.	EREP PACKAGE C.G.
34	.0005	.0003	-.0000	0.	0.	0.	ATM PN 5,7 IF,OUTR
35	.0001	-.0001	.0021	0.	0.	0.	ATM PN 4,5 IF,OUTR
36	.0020	.0001	.0025	0.	0.	0.	ATM PN 8,1 IF,OUTR
37	.0008	.0000	.0125	0.	0.	0.	ATM PN 2,3 IF,OUTR
38	.0004	.0014	-.0001	0.	0.	0.	ATM PN 5,7 IF,INNER
39	.0037	.0010	.0012	0.	0.	0.	ATM PN 4,5 IF,INNER
40	.0011	.0006	.0019	0.	0.	0.	ATM PN 8,1 IF,INNER
41	.0012	-.0001	.0103	0.	0.	0.	ATM PN 2,3 IF,INNER
42	.0005	.0001	.0014	.0000	.0000	.0000	CMG, -Y SIDE
43	.0001	.0001	.0002	.0000	.0000	.0000	CMG, +Y SIDE
44	.0001	-.0000	.0031	.0000	.0000	.0000	CMG, +X SIDE
45	.0000	.0000	0.	0.	0.	0.	ATM SAS, PN 1
46	.0001	.0001	0.	0.	0.	0.	ATM SAS, PN 3
47	.0000	.0000	0.	0.	0.	0.	ATM SAS, PN 5
48	.0000	.0000	0.	0.	0.	0.	ATM SAS, PN 7
49	.0007	.0000	.0075	.0003	.0028	.0007	SPAR CENTER
50	.0009	.0000	.0040	.0002	.0040	.0002	GRA/CAN CENTER
SUM	.0737	.0510	.6970	.0137	.1630	.0024	

TABLE A-31 ORBITAL CONFIGURATION MODAL SURVEY

## TEST MODES GENERALIZED MASS CONTRIBUTION SUMMARY

TEST MODE NO. 13B

TEST FREQUENCY = 6.36 HZ.

COMPONENT NAME	GMC (DX)	GMC (DY)	GMC (DZ)	GMC (TX)	GMC (TY)	GMC (TZ)
BR/OWS SKIRT/IU/FAS	.0097	.0033	.1540	.0068	.0974	.0001
6-FAS O2 TANKS	.0336	.0165	.1204	0.	0.	0.
MDA/STS/AM	.0004	.0021	.0880	.0015	.0203	.0004
6-AM N2 TANKS	.0004	.0014	.0413	0.	0.	0.
COMMAND/SERVICE MOD.	.0008	.0025	.2771	.0011	.0071	-.0001
DEPLOYMENT ASSEMBLY	.0017	.0135	.0445	0.	0.	0.
ATM-RACK,CMGS,4-SAS	.0081	.0021	.0276	.0000	.0000	.0000
ATM-SPAR CENTER	.0006	.0000	.0052	.0001	.0024	0.
ATM-GRA/CAN CENTER	.0006	.0000	.0035	.0001	.0034	.0002
	----	----	----	----	----	----
SUM	.0560	.0415	.7615	.0096	.1307	.0007

## TOTAL GM CONTRIBUTION FOR EACH COMPONENT

BR/OWS SKIRT/IU/FAS	.2713
6-FAS O2 TANKS	.1704
MDA/STS/AM	.1127
6-AM N2 TANKS	.0431
COMMAND/SERVICE MOD.	.2886
DEPLOYMENT ASSEMBLY	.0597
ATM-RACK,CMGS,4-SAS	.0379
ATM-SPAR CENTER	.0084
ATM-GRA/CAN CENTER	.0078

TABLE A-32 GENERALIZED MASS CONTRIBUTIONS BY DEGREE OF FREEDOM

TEST MODE 13R RUN NO. 657 FREQUENCY = 6.35

NODE NO.	GMC (OX)	GMC (DY)	GMC (DZ)	GMC (TX)	GMC (TY)	GMC (TZ)	NODE DESCRIPTION
1	.0000	-.0000	.1247	.0017	.0558	.0001	BASE RNG/DWS SKIPT
2	-.0001	.0002	.0023	.0016	.0142	-.0000	DWS/IU INTERFACE
3	.0003	.0003	-.0001	.0035	.0274	.0000	IU/FAS INTERFACE
4	.0055	.0039	.0117	0.	0.	0.	FAS 02 BOTL1,+Y +Z
5	.0086	.0082	.0180	0.	0.	0.	FAS 02 BOTL2,+Y +Z
6	.0057	.0004	.0265	0.	0.	0.	FAS 02 BOTL3,-Y +Z
7	.0024	.0006	.0265	0.	0.	0.	FAS 02 BOTL4,-Y +Z
8	.0043	.0010	.0182	0.	0.	0.	FAS 02 BOTL5,-Y -Z
9	.0071	.0023	.0194	0.	0.	0.	FAS 02 BOTL6,-Y -Z
10	-.0000	.0000	.0022	0.	0.	0.	FAS/AM/DA IF, +Y
11	.0070	.0002	.0111	0.	0.	0.	FAS/AM/DA IF, +Z
12	.0002	.0003	.0074	0.	0.	0.	FAS/AM/DA IF, -Y
13	.0001	.0005	.0022	0.	0.	0.	FAS/DA IF, -Y -Z
14	.0020	.0017	.0040	0.	0.	0.	FAS/AM IF, -Z
15	.0002	.0001	.0002	0.	0.	0.	FAS/DA IF, +Y -Z
16	.0000	.0004	.0207	.0001	.0000	.0001	AM TUNNEL/SHEAR WB
17	.0000	.0014	.0411	.0011	.0055	.0001	AM TUNNEL/STS IF
18	.0002	.0002	.0102	.0001	.0070	.0001	MDA/STS INTERFACE
19	.0002	.0002	.0160	.0003	.0077	.0001	MDA CONE/CYL ITRFC
20	.0000	.0000	.0051	0.	0.	0.	N2 TANK, +Y, LOWER
21	.0001	.0001	.0066	0.	0.	0.	N2 TANK, +Y, UPPER
22	.0001	.0000	.0074	0.	0.	0.	N2 TANK, +Z, LOWER
23	.0000	.0000	.0096	0.	0.	0.	N2 TANK, +Z, UPPER
24	.0001	.0007	.0048	0.	0.	0.	N2 TANK -Z, LOWER
25	.0001	.0006	.0077	0.	0.	0.	N2 TANK, -Z, UPPER
26	.0001	.0007	.0794	.0004	.0000	-.0000	CM, FWD BJLKHEAD
27	.0000	.0013	.1101	.0000	-.0002	-.0000	CM, AFT BJLKHEAD
28	.0000	.0002	.0312	-.0001	.0025	.0000	SM, FWD BJLKHEAD
29	.0008	.0003	.0564	.0008	.0049	-.0001	SM, AFT BJLKHEAD
30	.0000	.0015	.0013	0.	0.	0.	LOWER D LATCH, DA
31	-.0000	.0017	.0127	0.	0.	0.	LOWER +Y TRUNNION
32	.0010	.0102	.0088	0.	0.	0.	LOWER -Y TRUNNION
33	-.0002	.0001	.0217	0.	0.	0.	EREP PACKAGE C.G.
34	.0004	.0001	-.0000	0.	0.	0.	ATM PN 6,7 IF,OUTR
35	.0002	-.0000	.0015	0.	0.	0.	ATM PN 4,5 IF,OUTR
36	.0014	.0001	.0020	0.	0.	0.	ATM PN 8,1 IF,OUTR
37	.0007	-.0000	.0098	0.	0.	0.	ATM PN 2,3 IF,OUTR
38	.0004	.0008	-.0000	0.	0.	0.	ATM PN 6,7 IF,INNER
39	.0026	.0005	.0009	0.	0.	0.	ATM PN 4,5 IF,INNER
40	.0009	.0004	.0017	0.	0.	0.	ATM PN 8,1 IF,INNER
41	.0009	-.0001	.0081	0.	0.	0.	ATM PN 2,3 IF,INNER
42	.0003	.0000	.0011	.0000	.0000	.0000	CMG, -Y SIDE
43	.0001	.0001	.0002	.0000	.0000	.0000	CMG, +Y SIDE
44	.0011	-.0000	.0024	.0000	.0000	.0000	CMG, +X SIDE
45	.0000	.0000	0.	0.	0.	0.	ATM SAS, PN 1
46	.0001	.0001	0.	0.	0.	0.	ATM SAS, PN 3
47	.0000	.0000	0.	0.	0.	0.	ATM SAS, PN 5
48	.0000	.0000	0.	0.	0.	0.	ATM SAS, PN 7
49	.0006	.0000	.0052	.0001	.0024	.0006	SPAR CENTER
50	.0006	.0000	.0035	.0001	.0034	.0002	GRA/CAN CENTER
SUM	.0560	.0415	.7615	.0096	.1307	.0013	

TABLE A-33 ORBITAL CONFIGURATION MODAL SURVEY

## TEST MODES GENERALIZED MASS CONTRIBUTION SUMMARY

TEST MODE NO. 14A

TEST FREQUENCY = 6.73 HZ.

COMPONENT NAME	GMC (DX)	GMC (DY)	GMC (DZ)	GMC (TX)	GMC (TY)	GMC (TZ)
BR/OWS SKIRT/IU/FAS	.0016	.0557	.1169	.0398	.0020	.0255
6-FAS O2 TANKS	.0125	.2577	.2102	0.	0.	0.
MDA/STS/AM	.0001	.0336	.0058	.0002	.0006	.0299
6-AM N2 TANKS	.0026	.0231	.0095	0.	0.	0.
COMMAND/SERVICE MOD.	.0019	.0534	.0144	.0007	.0007	.0038
DEPLOYMENT ASSEMBLY	.0081	.0502	.0043	0.	0.	0.
ATM-RACK,CMGS,4-SAS	.0073	.0146	.0056	.0000	-.0000	.0000
ATM-SPAR CENTER	.0000	.0002	.0000	.0026	.0001	0.
ATM-GRA/CAN CENTER	.0000	.0004	.0000	.0024	.0001	.0019
	----	----	----	----	----	----
SUM	.0341	.4890	.3666	.0457	.0035	.0611

## TOTAL GM CONTRIBUTION FOR EACH COMPONENT

BR/OWS SKIRT/IU/FAS	.2416
6-FAS O2 TANKS	.4803
MDA/STS/AM	.0702
6-AM N2 TANKS	.0352
COMMAND/SERVICE MOD.	.0749
DEPLOYMENT ASSEMBLY	.0625
ATM-RACK,CMGS,4-SAS	.0276
ATM-SPAR CENTER	.0030
ATM-GRA/CAN CENTER	.0048

TABLE A-34 GENERALIZED MASS CONTRIBUTIONS BY DEGREE OF FREEDOM

TEST MODE 14A RUN NO. 474 FREQUENCY = 6.73

NODE NO.	GMC (OX)	GMC (OY)	GMC (OZ)	GMC (TX)	GMC (TY)	GMC (TZ)	NODE DESCRIPTION
1	.0000	.0142	.0029	.0014	.0008	.0084	BASE RNG/OWS SKIPT
2	-.0000	-.0001	.0203	.0107	-.0006	-.0001	OWS/TJ INTERFACE
3	-.0000	.0002	.0703	.0278	.0019	.0172	IU/FAS INTERFACE
4	-.0002	.0001	.0766	0.	0.	0.	FAS 02 BOTL1,+Y +Z
5	.0029	.0136	.0494	0.	0.	0.	FAS 02 BOTL2,+Y +Z
6	.0019	.0022	.0116	0.	0.	0.	FAS 02 BOTL3,-Y +Z
7	.0044	.0101	.0652	0.	0.	0.	FAS 02 BOTL4,-Y +Z
8	.0014	.0727	.0073	0.	0.	0.	FAS 02 BOTL5,-Y -Z
9	.0021	.1689	.0002	0.	0.	0.	FAS 02 BOTL6,-Y -Z
10	.0005	.0041	.0029	0.	0.	0.	FAS/AM/DA IF, +Y
11	.0001	.0118	.0013	0.	0.	0.	FAS/AM/DA IF, +Z
12	.0005	.0038	.0152	0.	0.	0.	FAS/AM/DA IF, -Y
13	-.0000	.0118	.0029	0.	0.	0.	FAS/DA IF, -Y -Z
14	.0002	.0074	.0010	0.	0.	0.	FAS/AM IF, -Z
15	.0003	.0027	.0001	0.	0.	0.	FAS/DA IF, +Y -Z
16	.0000	.0113	.0029	.0000	-.0000	-.0000	AM TUNNEL/SHEAR WB
17	-.0000	.0170	.0013	.0000	.0003	.0151	AM TUNNEL/STS IF
18	-.0000	.0023	.0014	.0000	-.0001	.0133	MDA/STS INTERFACE
19	.0000	.0030	.0002	.0001	.0004	.0015	MDA CONE/CYL ITRFC
20	.0005	.0046	.0028	0.	0.	0.	N2 TANK, +Y, LOWER
21	.0001	.0044	.0019	0.	0.	0.	N2 TANK, +Y, UPPER
22	.0000	.0001	.0014	0.	0.	0.	N2 TANK, +Z, LOWER
23	.0019	.0000	.0012	0.	0.	0.	N2 TANK, +Z, UPPER
24	.0000	.0073	.0011	0.	0.	0.	N2 TANK -Z, LOWER
25	.0000	.0066	.0011	0.	0.	0.	N2 TANK, -Z, UPPER
26	-.0000	.0177	.0031	-.0000	-.0000	.0000	CM, FWD BULKHEAD
27	.0001	.0165	.0075	-.0001	-.0000	.0020	CM, AFT BULKHEAD
28	.0019	.0058	.0010	.0003	.0002	-.0003	SM, FWD BULKHEAD
29	-.0000	.0134	.0027	.0005	.0005	.0020	SM, AFT BULKHEAD
30	.0000	.0390	.0000	0.	0.	0.	LOWER D LATCH, DA
31	.0061	.0037	.0035	0.	0.	0.	LOWER +Y TRUNNION
32	.0020	.0005	-.0003	0.	0.	0.	LOWER -Y TRUNNION
33	.0000	.0070	.0010	0.	0.	0.	EREP PACKAGE C.G.
34	.0012	.0017	.0002	0.	0.	0.	ATM PN 6,7 IF,OUTR
35	.0012	.0001	.0012	0.	0.	0.	ATM PN 4,5 IF,OUTR
36	.0013	.0000	.0012	0.	0.	0.	ATM PN 8,1 IF,OUTR
37	.0002	.0009	.0000	0.	0.	0.	ATM PN 2,3 IF,OUTR
38	.0007	.0086	.0002	0.	0.	0.	ATM PN 6,7 IF,INNER
39	.0007	.0011	.0005	0.	0.	0.	ATM PN 4,5 IF,INNER
40	.0010	.0001	.0014	0.	0.	0.	ATM PN 8,1 IF,INNER
41	-.0000	.0007	.0000	0.	0.	0.	ATM PN 2,3 IF,INNER
42	.0002	.0004	.0003	.0000	.0000	.0000	CMG, -Y SIDE
43	.0004	.0005	.0006	.0000	-.0000	.0000	CMG, +Y SIDE
44	.0000	.0001	.0000	.0000	.0000	.0000	CMG, +X SIDE
45	.0001	.0001	0.	0.	0.	0.	ATM SAS, PN 1
46	.0001	.0001	0.	0.	0.	0.	ATM SAS, PN 3
47	.0001	.0001	0.	0.	0.	0.	ATM SAS, PN 5
48	.0000	.0000	0.	0.	0.	0.	ATM SAS, PN 7
49	.0000	.0002	.0000	.0026	.0001	.0000	SPAR CENTER
50	.0000	.0004	.0000	.0024	.0001	.0019	GRA/CAN CENTER
SUM	.0341	.4890	.3666	.0457	.0035	.0612	

TABLE A-35 ORBITAL CONFIGURATION MODAL SURVEY

## TEST MODES GENERALIZED MASS CONTRIBUTION SUMMARY

TEST MODE NO. 15A

TEST FREQUENCY = 7.59 HZ.

COMPONENT NAME	GMC (DX)	GMC (DY)	GMC (DZ)	GMC (TX)	GMC (TY)	GMC (TZ)
BR/OVS SKIRT/IU/FAS	.0021	.0377	.0165	.0143	.0002	.0039
6-FAS O2 TANKS	.0120	.0935	.1186	0.	0.	0.
MDA/STS/AM	.0000	.0500	.0002	.0008	.0000	.0029
6-AM N2 TANKS	.0001	.0188	.0005	0.	0.	0.
COMMAND/SERVICE MOD.	.0006	.0291	.0101	.0006	.0004	.0018
DEPLOYMENT ASSEMBLY	.0015	.0171	.0051	0.	0.	0.
ATM-RACK,CMGS,4-SAS	.0147	.2018	.1794	.0013	.0000	.0001
ATM-SPAR CENTER	.0003	.0013	.0000	.0666	.0012	0.
ATM-GRA/CAN CENTER	.0001	.0006	.0000	.0876	.0004	.0061
	----	----	----	----	----	----
SUM	.0315	.4499	.3304	.1712	.0023	.0147

## TOTAL GM CONTRIBUTION FOR EACH COMPONENT

BR/OVS SKIRT/IU/FAS	.0747
6-FAS O2 TANKS	.2242
MDA/STS/AM	.0540
6-AM N2 TANKS	.0194
COMMAND/SERVICE MOD.	.0426
DEPLOYMENT ASSEMBLY	.0236
ATM-RACK,CMGS,4-SAS	.3973
ATM-SPAR CENTER	.0695
ATM-GRA/CAN CENTER	.0948



TABLE A-36 GENERALIZED MASS CONTRIBUTIONS BY DEGREE OF FREEDOM

TEST MODE		15A		RUN NO. 600		FREQUENCY = 7.53	
MODE NO.	GMC (OX)	GMC (OY)	GMC (OZ)	GMC (TX)	GMC (TY)	GMC (TZ)	MODE DESCRIPTION
1	.0001	.0202	.0037	.0027	.0031	.0010	BASE RNG/OWS SKIPT
2	-.0000	.0004	.0024	.0039	-.0000	.0010	OWS/IU INTERFACE
3	.0000	.0002	.0069	.0082	.0002	.0019	IU/FAS INTERFACE
4	-.0003	.0051	.0314	0.	0.	0.	FAS 02 BOTL1,+Y +Z
5	.0046	.0012	.0233	0.	0.	0.	FAS 02 BOTL2,+Y +Z
6	.0026	.0144	.0119	0.	0.	0.	FAS 02 BOTL3,-Y +Z
7	.0013	.0009	.0412	0.	0.	0.	FAS 02 BOTL4,-Y +Z
8	.0011	.0462	.0068	0.	0.	0.	FAS 02 BOTL5,-Y -Z
9	.0027	.0257	.0041	0.	0.	0.	FAS 02 BOTL5,-Y -Z
10	.0003	.0039	.0009	0.	0.	0.	FAS/AM/DA IF, +Y
11	.0004	.0031	.0009	0.	0.	0.	FAS/AM/DA IF, +Z
12	.0013	.0087	.0037	0.	0.	0.	FAS/AM/DA IF, -Y
13	.0000	.0005	.0002	0.	0.	0.	FAS/DA IF, -Y -Z
14	.0000	.0006	.0002	0.	0.	0.	FAS/AM IF, -Z
15	.0000	.0001	-.0000	0.	0.	0.	FAS/DA IF, +Y -Z
16	.0000	.0165	.0000	.0000	.0000	.0005	AM TUNNEL/SHEAR WB
17	.0000	.0227	.0001	.0001	.0000	.0016	AM TUNNEL/STS IF
18	.0000	.0107	-.0000	.0006	.0000	-.0004	MDA/STS INTERFACE
19	-.0000	.0001	.0001	.0000	.0000	.0013	MDA CONE/CYL ITRFC
20	-.0000	.0059	.0001	0.	0.	0.	N2 TANK, +Y, LOWER
21	.0001	.0054	.0000	0.	0.	0.	N2 TANK, +Y, UPPER
22	.0000	.0001	.0000	0.	0.	0.	N2 TANK, +Z, LOWER
23	.0000	.0009	.0001	0.	0.	0.	N2 TANK, +Z, UPPER
24	.0000	.0033	.0002	0.	0.	0.	N2 TANK -Z, LOWER
25	.0000	.0033	.0001	0.	0.	0.	N2 TANK, -Z, UPPER
26	.0000	.0087	.0016	-.0000	-.0000	-.0000	CM, FWD BJLKHEAD
27	.0000	.0090	.0047	-.0000	-.0000	-.0000	CM, AFT BJLKHEAD
28	-.0000	.0017	.0006	.0000	.0000	.0000	SM, FWD BJLKHEAD
29	.0006	.0098	.0033	.0006	.0004	.0017	SM, AFT BJLKHEAD
30	.0001	.0037	.0004	0.	0.	0.	LOWER D LATCH, DA
31	.0008	.0004	.0027	0.	0.	0.	LOWER +Y TRUNNION
32	.0002	-.0003	.0012	0.	0.	0.	LOWER -Y TRUNNION
33	.0005	.0133	.0007	0.	0.	0.	EREP PACKAGE C.G.
34	.0001	.0005	.0044	0.	0.	0.	ATM PN 6,7 IF,OUTR
35	.0009	.0024	.0416	0.	0.	0.	ATM PN 4,5 IF,OUTR
36	.0011	.0039	.0510	0.	0.	0.	ATM PN 8,1 IF,OUTR
37	.0012	.0089	.0022	0.	0.	0.	ATM PN 2,3 IF,OUTR
38	.0029	.0862	.0044	0.	0.	0.	ATM PN 6,7 IF,INNER
39	.0016	.0205	.0159	0.	0.	0.	ATM PN 4,5 IF,INNER
40	-.0004	.0096	.0300	0.	0.	0.	ATM PN 8,1 IF,INNER
41	-.0003	.0439	.0021	0.	0.	0.	ATM PN 2,3 IF,INNER
42	.0002	.0065	.0125	.0004	.0000	.0000	CMG, -Y SIDE
43	.0004	.0066	.0150	.0006	-.0000	.0000	CMG, +Y SIDE
44	.0000	.0056	.0002	.0003	.0000	.0000	CMG, +X SIDE
45	.0028	.0028	0.	0.	0.	0.	ATM SAS, PN 1
46	.0013	.0013	0.	0.	0.	0.	ATM SAS, PN 3
47	.0025	.0025	0.	0.	0.	0.	ATM SAS, PN 5
48	.0005	.0005	0.	0.	0.	0.	ATM SAS, PN 7
49	.0003	.0013	-.0000	.0666	.0012	.0003	SPAR CENTER
50	.0001	.0006	.0000	.0876	.0004	.0061	GRA/CAN CENTER
SJM	.0315	.4499	.3304	.1712	.0023	.0150	

TABLE A-37 ORBITAL CONFIGURATION MODAL SURVEY

## TEST MODES GENERALIZED MASS CONTRIBUTION SUMMARY

TEST MODE NO. 16A

TEST FREQUENCY = 8.85 HZ.

COMPONENT NAME	GMC (DX)	GMC (DY)	GMC (DZ)	GMC (TX)	GMC (TY)	GMC (TZ)
BR/OWS SKIRT/IU/FAS	.1359	.0037	.0084	.0006	.0013	.0002
6-FAS O2 TANKS	.1466	.0056	.0210	0.	0.	0.
MDA/STS/AM	.0021	.0009	.0016	.0001	.0002	.0001
6-AM N2 TANKS	.0040	.0004	.0013	0.	0.	0.
COMMAND/SERVICE MOD.	.5776	.0012	.0012	.0003	-.0001	.0610
DEPLOYMENT ASSEMBLY	.0111	.0014	.0075	0.	0.	0.
ATM-RACK,CMGS,4-SAS	.0016	.0006	.0015	.0000	.0000	.0000
ATM-SPAR CENTER	.0000	.0000	.0000	.0001	.0007	0.
ATM-GRA/CAN CENTER	.0100	.0000	.0001	.0001	.0007	.0000
	----	----	----	----	----	----
SUM	.8781	.0139	.0427	.0012	.0029	.0613

## TOTAL GM CONTRIBUTION FOR EACH COMPONENT

BR/OWS SKIRT/IU/FAS	.1492
6-FAS O2 TANKS	.1732
MDA/STS/AM	.0049
6-AM N2 TANKS	.0057
COMMAND/SERVICE MOD.	.6413
DEPLOYMENT ASSEMBLY	.0200
ATM-RACK,CMGS,4-SAS	.0038
ATM-SPAR CENTER	.0009
ATM-GRA/CAN CENTER	.0009

TABLE A-38 GENERALIZED MASS CONTRIBUTIONS BY DEGREE OF FREEDOM

TEST MODE		16A		RUN NO. 347		FREQUENCY = 8.85	
MODE NO.	GMC (OX)	GMC (OY)	GMC (OZ)	GMC (TX)	GMC (TY)	GMC (TZ)	MODE DESCRIPTION
1	.0758	.0004	.0042	.0000	.0006	.0001	PASE RNG/DWS SKIRT
2	.0215	.0004	.0012	.0002	.0005	.0000	OWS/IU INTERFACE
3	.0234	.0010	.0021	.0004	.0002	.0000	IU/FAS INTERFACE
4	.0177	.0003	-.0000	0.	0.	0.	FAS 02 BOTL1,+Y +Z
5	.0282	.0011	.0011	0.	0.	0.	FAS 02 BOTL2,+Y +Z
6	.0202	.0009	-.0000	0.	0.	0.	FAS 02 BOTL3,-Y +Z
7	.0264	.0007	.0031	0.	0.	0.	FAS 02 BOTL4,-Y +Z
8	.0369	.0020	.0128	0.	0.	0.	FAS 02 BOTL5,-Y -Z
9	.0174	.0005	.0039	0.	0.	0.	FAS 02 BOTL6,-Y -Z
10	.0027	.0001	-.0000	0.	0.	0.	FAS/AM/DA IF, +Y
11	.0043	.0002	.0003	0.	0.	0.	FAS/AM/DA IF, +Z
12	.0044	.0008	.0000	0.	0.	0.	FAS/AM/DA IF, -Y
13	.0004	.0002	.0005	0.	0.	0.	FAS/DA IF, -Y -Z
14	.0018	.0005	.0000	0.	0.	0.	FAS/AM IF, -Z
15	.0007	.0001	.0000	0.	0.	0.	FAS/DA IF, +Y -Z
16	.0007	.0000	.0005	.0000	.0000	.0000	AM TUNNEL/SHEAR WB
17	.0000	.0000	.0000	.0000	.0001	.0000	AM TUNNEL/STS IF
18	.0005	.0003	.0003	.0000	.0000	.0000	MDA/STS INTERFACE
19	.0008	.0005	.0000	.0000	.0001	.0000	MDA CONE/CYL ITRFC
20	.0008	.0000	.0000	0.	0.	0.	N2 TANK, +Y, LOWER
21	.0005	.0000	.0000	0.	0.	0.	N2 TANK, +Y, UPPER
22	.0006	.0000	.0007	0.	0.	0.	N2 TANK, +Z, LOWER
23	.0011	.0000	.0005	0.	0.	0.	N2 TANK, +Z, UPPER
24	.0005	.0003	.0000	0.	0.	0.	N2 TANK -Z, LOWER
25	.0005	.0001	.0000	0.	0.	0.	N2 TANK, -Z, UPPER
26	.0538	.0008	.0010	.0001	.0004	.0002	CM, FWD BULKHEAD
27	.0621	-.0000	.0000	.0000	-.0003	.0004	CM, AFT BULKHEAD
28	.2326	.0004	.0000	.0002	-.0004	.0593	SM, FWD BULKHEAD
29	.2292	.0000	.0002	.0000	.0002	.0010	SM, AFT BULKHEAD
30	.0045	.0002	-.0001	0.	0.	0.	LOWER D LATCH, DA
31	.0037	.0006	-.0001	0.	0.	0.	LOWER +Y TRUNNION
32	.0030	.0005	.0001	0.	0.	0.	LOWER -Y TRUNNION
33	-.0001	.0001	.0075	0.	0.	0.	EPEP PACKAGE C.G.
34	.0000	-.0000	.0005	0.	0.	0.	ATM PN 6,7 IF,OUTR
35	-.0000	.0000	.0002	0.	0.	0.	ATM PN 4,5 IF,OUTR
36	-.0000	-.0000	.0000	0.	0.	0.	ATM PN 8,1 IF,OUTR
37	.0000	.0000	.0001	0.	0.	0.	ATM PN 2,3 IF,OUTR
38	.0001	.0000	.0004	0.	0.	0.	ATM PN 5,7 IF,INNER
39	.0002	-.0000	.0001	0.	0.	0.	ATM PN 4,5 IF,INNER
40	.0004	.0000	.0000	0.	0.	0.	ATM PN 8,1 IF,INNER
41	.0002	-.0000	.0001	0.	0.	0.	ATM PN 2,3 IF,INNER
42	.0000	-.0000	.0000	.0000	.0000	.0000	CMG, -Y SIDE
43	.0001	.0000	.0000	.0000	.0000	.0000	CMG, +Y SIDE
44	.0000	-.0000	.0000	-.0000	.0000	-.0000	CMG, +X SIDE
45	.0001	.0001	0.	0.	0.	0.	ATM SAS, PN 1
46	.0000	.0000	0.	0.	0.	0.	ATM SAS, PN 3
47	.0004	.0004	0.	0.	0.	0.	ATM SAS, PN 5
48	.0000	.0000	0.	0.	0.	0.	ATM SAS, PN 7
49	.0000	.0000	.0000	.0001	.0007	.0000	SPAR CENTER
50	.0000	.0000	.0001	.0001	.0007	.0000	GRA/CAN CENTER
SUM	.8781	.0139	.0427	.0012	.0029	.0613	

TABLE A-39 ORBITAL CONFIGURATION MODAL SURVEY

## TEST MODES GENERALIZED MASS CONTRIBUTION SUMMARY

TEST MODE NO. 17A

TEST FREQUENCY = 11.59 HZ.

COMPONENT NAME	GMC (DX)	GMC (DY)	GMC (DZ)	GMC (TX)	GMC (TY)	GMC (TZ)
BR/OWS SKIRT/IU/FAS	-.0003	.0318	.0130	.0112	.0044	.0044
6-FAS O2 TANKS	.0012	.2412	.3261	0.	0.	0.
MDA/STS/AM	.0001	.1013	.0084	.0169	.0001	-.0003
6-AM N2 TANKS	.0016	.0932	.0259	0.	0.	0.
COMMAND/SERVICE MOD.	.0001	.0191	.0044	.0002	.0004	.0013
DEPLOYMENT ASSEMBLY	-.0011	.0943	.0041	0.	0.	0.
ATM-RACK,CMGS,4-SAS	.0015	.0017	.0015	.0000	.0000	.0000
ATM-SPAR CENTER	.0002	.0002	.0002	.0005	.0001	0.
ATM-GRA/CAN CENTER	.0000	.0000	.0001	.0007	.0001	.0000
	----	----	----	----	----	----
SUM	.0033	.5830	.3838	.0195	.0050	.0055

## TOTAL GM CONTRIBUTION FOR EACH COMPONENT

BR/OWS SKIRT/IU/FAS	.0544
6-FAS O2 TANKS	.5685
MDA/STS/AM	.1265
6-AM N2 TANKS	.1238
COMMAND/SERVICE MOD.	.0256
DEPLOYMENT ASSEMBLY	.0973
ATM-RACK,CMGS,4-SAS	.0047
ATM-SPAR CENTER	.0012
ATM-GRA/CAN CENTER	.0010

TABLE A-40 GENERALIZED MASS CONTRIBUTIONS BY DEGREE OF FREEDOM

TEST MODE		17A		RUN NO. 549		FREQUENCY = 11.53		
MODE NO.	GMC (OX)	GMC (OY)	GMC (OZ)	GMC (TX)	GMC (TY)	GMC (TZ)	MODE DESCRIPTION	
1	.0001	.0012	.0003	.0006	.0022	.0013	BASE RNG/CWS SKIRT	
2	.0000	.0058	.0001	.0001	.0005	-.0003	OWS/IU INTERFACE	
3	.0000	.0117	.0000	.0006	.0016	.0034	IU/FAS INTERFACE	
4	.0002	.0397	.0675	0.	0.	0.	FAS 02 BOTL1,+Y +Z	
5	.0001	.0005	.0415	0.	0.	0.	FAS 02 BOTL2,+Y +Z	
6	.0009	.0337	.1508	0.	0.	0.	FAS 02 BOTL3,-Y +Z	
7	-.0000	.1606	.0581	0.	0.	0.	FAS 02 BOTL4,-Y +Z	
8	-.0001	.0004	.0077	0.	0.	0.	FAS 02 BOTL5,-Y -Z	
9	.0002	.0064	.0004	0.	0.	0.	FAS 02 BOTL6,-Y -Z	
10	-.0007	.0016	-.0001	0.	0.	0.	FAS/AM/DA IF, +Y	
11	.0001	.0052	.0001	0.	0.	0.	FAS/AM/DA IF, +Z	
12	-.0003	.0016	.0117	0.	0.	0.	FAS/AM/DA IF, -Y	
13	-.0000	.0010	-.0005	0.	0.	0.	FAS/DA IF, -Y -Z	
14	.0001	.0021	.0002	0.	0.	0.	FAS/AM IF, -Z	
15	.0003	.0006	.0013	0.	0.	0.	FAS/DA IF, +Y -Z	
16	.0009	.0249	.0018	.0014	.0000	.0001	AM TUNNEL/SHEAR WB	
17	.0000	.0234	.0009	.0040	-.0000	.0004	AM TUNNEL/STS IF	
18	.0000	.0350	.0026	.0071	.0001	-.0010	MDA/STS INTERFACE	
19	.0000	.0181	.0031	.0044	.0000	.0002	MDA CONE/CYL ITRFC	
20	.0001	.0621	.0018	0.	0.	0.	N2 TANK, +Y, LOWER	
21	.0009	.0253	.0014	0.	0.	0.	N2 TANK, +Y, UPPER	
22	.0000	.0014	.0143	0.	0.	0.	N2 TANK, +Z, LOWER	
23	.0003	.0028	.0034	0.	0.	0.	N2 TANK, +Z, UPPER	
24	.0001	.0009	.0035	0.	0.	0.	N2 TANK, -Z, LOWER	
25	.0002	.0007	.0013	0.	0.	0.	N2 TANK, -Z, UPPER	
26	.0000	.0000	.0001	.0002	.0001	.0003	CM, FWD BULKHEAD	
27	.0000	.0097	.0036	-.0000	.0002	.0005	CM, AFT BULKHEAD	
28	.0001	.0007	.0000	.0000	.0000	.0000	SM, FWD BULKHEAD	
29	-.0000	.0087	.0007	.0000	.0001	.0006	SM, AFT BULKHEAD	
30	.0005	-.0073	.0002	0.	0.	0.	LOWER D LATCH, DA	
31	-.0032	.0624	.0038	0.	0.	0.	LOWER +Y TRUNNION	
32	.0009	.0328	-.0010	0.	0.	0.	LOWER -Y TRUNNION	
33	.0009	.0065	.0011	0.	0.	0.	EREP PACKAGE C.G.	
34	.0000	.0001	.0001	0.	0.	0.	ATM PN 6,7 IF,OUTR	
35	.0002	.0000	.0002	0.	0.	0.	ATM PN 4,5 IF,OUTR	
36	.0002	.0000	.0004	0.	0.	0.	ATM PN 8,1 IF,OUTR	
37	.0001	.0002	.0001	0.	0.	0.	ATM PN 2,3 IF,OUTR	
38	.0002	.0009	.0001	0.	0.	0.	ATM PN 6,7 IF,INNER	
39	.0000	.0001	.0000	0.	0.	0.	ATM PN 4,5 IF,INNER	
40	.0004	-.0000	.0004	0.	0.	0.	ATM PN 8,1 IF,INNER	
41	.0001	.0001	.0001	0.	0.	0.	ATM PN 2,3 IF,INNER	
42	.0000	.0000	.0000	.0000	.0000	.0000	CMG, -Y SIDE	
43	.0001	.0000	.0001	.0000	.0000	.0000	CMG, +Y SIDE	
44	.0000	.0000	.0001	.0000	.0000	.0000	CMG, +X SIDE	
45	.0001	.0001	0.	0.	0.	0.	ATM SAS, PN 1	
46	.0000	.0000	0.	0.	0.	0.	ATM SAS, PN 3	
47	.0000	.0000	0.	0.	0.	0.	ATM SAS, PN 5	
48	.0001	.0001	0.	0.	0.	0.	ATM SAS, PN 7	
49	.0002	.0002	.0002	.0005	.0001	.0002	SPAR CENTER	
50	.0000	.0000	.0001	.0007	.0001	.0000	GRA/CAN CENTER	
SUM	.0033	.5830	.3838	.0195	.0050	.0056		

## TABLE A-41 ORBITAL CONFIGURATION MODAL SURVEY

## TEST MODES GENERALIZED MASS CONTRIBUTION SUMMARY

TEST MODE NO. 18A

TEST FREQUENCY = 12.65 HZ.

COMPONENT NAME	GMC (DX)	GMC (DY)	GMC (DZ)	GMC (TX)	GMC (TY)	GMC (TZ)
BR/OWS SKIRT/IU/FAS	.0000	.0075	.0115	.0865	.0005	.0003
6-FAS O2 TANKS	.0306	.0202	.0155	0.	0.	0.
MDA/STS/AM	.0004	-.0008	.0015	.6722	.0003	.0010
6-AM N2 TANKS	.0003	.0345	.0383	0.	0.	0.
COMMAND/SERVICE MOD.	.0000	.0050	.0016	.0603	.0004	-.0000
DEPLOYMENT ASSEMBLY	.0005	.0056	.0053	0.	0.	0.
ATM-RACK,CMGS,4-SAS	.0001	.0003	.0002	.0000	.0000	.0000
ATM-SPAR CENTER	.0000	.0000	.0000	.0001	.0000	0.
ATM-GRA/CAN CENTER	.0000	.0001	.0000	.0001	.0001	.0000
	----	----	----	----	----	----
SUM	.0320	.0723	.0739	.8192	.0013	.0013

## TOTAL GM CONTRIBUTION FOR EACH COMPONENT

BR/OWS SKIRT/IU/FAS	.1063
6-FAS O2 TANKS	.0663
MDA/STS/AM	.6744
6-AM N2 TANKS	.0731
COMMAND/SERVICE MOD.	.0673
DEPLOYMENT ASSEMBLY	.0114
ATM-RACK,CMGS,4-SAS	.0006
ATM-SPAR CENTER	.0002
ATM-GRA/CAN CENTER	.0003

TABLE A-42 GENERALIZED MASS CONTRIBUTIONS BY DEGREE OF FREEDOM

TEST MODE 18A RUN NO. 526 FREQUENCY = 12.65

MODE NO.	GMC (OX)	GMC (OY)	GMC (OZ)	GMC (TX)	GMC (TY)	GMC (TZ)	NODE DESCRIPTION
1	.0000	.0002	.0001	.0609	.0003	.0003	BASE RNG/DWS SKIPT
2	.0000	.0002	.0002	.0104	-.0000	.0000	DWS/IU INTERFACE
3	-.0000	.0002	.0035	.0152	.0002	.0000	IU/FAS INTERFACE
4	.0018	.0065	.0051	0.	0.	0.	FAS 02 BOTL1,+Y +Z
5	.0103	.0018	.0013	0.	0.	0.	FAS 02 BOTL2,+Y +Z
6	.0051	.0041	.0021	0.	0.	0.	FAS 02 BOTL3,-Y +Z
7	.0051	.0025	.0021	0.	0.	0.	FAS 02 BOTL4,-Y +Z
8	.0055	.0023	.0003	0.	0.	0.	FAS 02 BOTL5,-Y -Z
9	.0017	.0030	.0045	0.	0.	0.	FAS 02 BOTL6,-Y -Z
10	-.0000	.0001	.0019	0.	0.	0.	FAS/AM/DA IF, +Y
11	.0000	.0048	-.0000	0.	0.	0.	FAS/AM/DA IF, +Z
12	-.0000	.0000	.0051	0.	0.	0.	FAS/AM/DA IF, -Y
13	.0000	-.0000	-.0000	0.	0.	0.	FAS/DA IF, -Y -Z
14	.0000	.0018	.0004	0.	0.	0.	FAS/AM IF, -Z
15	.0000	.0002	.0002	0.	0.	0.	FAS/DA IF, +Y -Z
16	.0001	.0000	.0002	.0448	.0002	.0007	AM TUNNEL/SHEAR WB
17	.0003	.0004	.0001	.1749	.0000	.0002	AM TUNNEL/STS IF
18	.0000	-.0006	.0011	.2504	-.0000	-.0000	MDA/STS INTERFACE
19	.0000	-.0007	.0001	.2021	.0001	.0001	MDA CONE/CYL ITRFC
20	.0000	.0004	.0018	0.	0.	0.	N2 TANK, +Y, LOWER
21	.0002	.0001	.0153	0.	0.	0.	N2 TANK, +Y, UPPER
22	.0000	.0008	.0204	0.	0.	0.	N2 TANK, +Z, LOWER
23	.0000	.0117	.0002	0.	0.	0.	N2 TANK, +Z, UPPER
24	.0000	.0010	.0005	0.	0.	0.	N2 TANK, -Z, LOWER
25	.0001	.0205	.0001	0.	0.	0.	N2 TANK, -Z, UPPER
26	.0000	.0023	.0001	.0056	.0000	.0000	CM, FWD BULKHEAD
27	.0000	.0019	.0000	.0025	-.0000	-.0000	CM, AFT BULKHEAD
28	.0000	.0005	.0000	.0182	.0001	-.0000	SM, FWD BULKHEAD
29	.0000	.0003	.0014	.0341	.0003	-.0000	SM, AFT BULKHEAD
30	.0003	-.0001	-.0000	0.	0.	0.	LOWER D LATCH, DA
31	.0000	.0000	.0043	0.	0.	0.	LOWER +Y TRUNNION
32	-.0001	.0045	.0010	0.	0.	0.	LOWER -Y TRUNNION
33	.0003	.0012	.0000	0.	0.	0.	EREP PACKAGE C.G.
34	.0000	.0000	.0000	0.	0.	0.	ATM PN 6,7 IF,OUTR
35	.0000	.0000	.0001	0.	0.	0.	ATM PN 4,5 IF,OUTR
36	.0000	.0000	.0000	0.	0.	0.	ATM PN 8,1 IF,OUTR
37	.0000	.0000	.0000	0.	0.	0.	ATM PN 2,3 IF,OUTR
38	.0000	.0002	.0000	0.	0.	0.	ATM PN 5,7 IF,INNER
39	.0000	.0000	.0000	0.	0.	0.	ATM PN 4,5 IF,INNER
40	.0000	.0000	.0000	0.	0.	0.	ATM PN 8,1 IF,INNER
41	-.0000	.0000	.0000	0.	0.	0.	ATM PN 2,3 IF,INNER
42	.0000	.0000	.0000	.0000	-.0000	-.0000	CMG, -Y SIDE
43	.0000	.0000	.0000	.0000	-.0000	.0000	CMG, +Y SIDE
44	.0000	.0000	.0000	.0000	.0000	.0000	CMG, +X SIDE
45	.0000	.0000	0.	0.	0.	0.	ATM SAS, PN 1
46	.0000	.0000	0.	0.	0.	0.	ATM SAS, PN 3
47	.0000	.0000	0.	0.	0.	0.	ATM SAS, PN 5
48	-.0000	-.0000	0.	0.	0.	0.	ATM SAS, PN 7
49	.0000	.0000	.0000	.0001	.0000	.0000	SPAR CENTER
50	.0000	.0001	.0000	.0001	.0001	.0000	GRA/CAN CENTER
SUM	.0320	.0723	.0739	.8192	.0013	.0013	

TABLE A-43 ORBITAL CONFIGURATION MODAL SURVEY

## TEST MODES GENERALIZED MASS CONTRIBUTION SUMMARY

TEST MODE NO. 188

TEST FREQUENCY = 12.87 HZ.

COMPONENT NAME	GMC (DX)	GMC (DY)	GMC (DZ)	GMC (TX)	GMC (TY)	GMC (TZ)
BR/OWS SKIRT/IU/FAS	.0001	.0073	.0185	.0530	.0013	.0008
6-FAS O2 TANKS	.0240	.0176	.0096	0.	0.	0.
MDA/STS/AM	.0004	.0407	.0009	.5413	.0008	.0102
6-AM N2 TANKS	.0004	.1026	.0248	0.	0.	0.
COMMAND/SERVICE MOD.	.0011	.0644	.0116	.0336	.0004	.0036
DEPLOYMENT ASSEMBLY	.0014	.0131	.0157	0.	0.	0.
ATM-RACK,CMGS,4-SAS	.0000	.0001	.0001	.0000	.0000	.0000
ATM-SPAR CENTER	.0000	.0000	.0000	.0000	.0002	0.
ATM-GRA/CAN CENTER	.0000	.0000	.0000	.0000	.0002	.0000
	----	----	----	----	----	----
SUM	.0276	.2459	.0812	.6278	.0029	.0147

## TOTAL GM CONTRIBUTION FOR EACH COMPONENT

BR/OWS SKIRT/IU/FAS	.0810
6-FAS O2 TANKS	.0512
MDA/STS/AM	.5943
6-AM N2 TANKS	.1278
COMMAND/SERVICE MOD.	.1147
DEPLOYMENT ASSEMBLY	.0302
ATM-RACK,CMGS,4-SAS	.0001
ATM-SPAR CENTER	.0003
ATM-GRA/CAN CENTER	.0003



TABLE A-44 GENERALIZED MASS CONTRIBUTIONS BY DEGREE OF FREEDOM

TEST MODE		18R		RUN NO. 663		FREQUENCY = 12.87	
MODE NO.	GMC (DX)	GMC (DY)	GMC (DZ)	GMC (TX)	GMC (TY)	GMC (TZ)	MODE DESCRIPTION
1	.0000	.0012	.0001	.0401	.0007	.0004	BASE RNG/OWS SKIPT
2	-.0000	-.0000	.0015	.0053	-.0001	.0000	OWS/IJ INTERFACE
3	.0001	.0002	.0098	.0076	.0007	.0004	IU/FAS INTERFACE
4	.0043	.0056	.0023	0.	0.	0.	FAS 02 BOTL1,+Y +Z
5	.0094	.0013	-.0000	0.	0.	0.	FAS 02 BOTL2,+Y +Z
6	.0018	.0011	.0053	0.	0.	0.	FAS 02 BOTL3,-Y +Z
7	.0044	-.0000	.0013	0.	0.	0.	FAS 02 BOTL4,-Y +Z
8	.0038	.0039	.0008	0.	0.	0.	FAS 02 BOTL5,-Y -Z
9	.0004	.0048	-.0000	0.	0.	0.	FAS 02 BOTL6,-Y -Z
10	.0000	.0000	.0041	0.	0.	0.	FAS/AM/DA IF, +Y
11	.0000	.0060	-.0000	0.	0.	0.	FAS/AM/DA IF, +Z
12	.0000	.0000	.0024	0.	0.	0.	FAS/AM/DA IF, -Y
13	-.0000	-.0000	-.0002	0.	0.	0.	FAS/DA IF, -Y -Z
14	.0000	.0000	.0001	0.	0.	0.	FAS/AM IF, -Z
15	.0000	-.0000	.0006	0.	0.	0.	FAS/DA IF, +Y -Z
16	.0001	.0018	.0000	.0347	.0001	.0023	AM TUNNEL/SHEAR W9
17	.0002	.0001	.0003	.1439	.0001	.0016	AM TUNNEL/STS IF
18	.0000	.0068	.0000	.2060	.0003	.0056	MDA/STS INTERFACE
19	.0001	.0321	.0005	.1566	.0004	.0008	MDA CONE/CYL ITRFC
20	.0000	.0519	.0004	0.	0.	0.	N2 TANK, +Y, LOWER
21	.0003	.0027	.0099	0.	0.	0.	N2 TANK, +Y, UPPER
22	-.0000	.0026	.0139	0.	0.	0.	N2 TANK, +Z, LOWER
23	.0000	.0061	.0001	0.	0.	0.	N2 TANK, +Z, UPPER
24	.0000	.0120	.0005	0.	0.	0.	N2 TANK -Z, LOWER
25	.0000	.0274	.0001	0.	0.	0.	N2 TANK, -Z, UPPER
26	.0000	-.0000	.0003	.0036	.0001	.0007	CM, FWD RJLKHEAD
27	.0000	.0422	.0101	.0023	.0002	.0018	CM, AFT RJLKHEAD
28	.0005	.0048	.0003	.0089	.0000	.0003	SM, FWD RJLKHEAD
29	.0005	.0174	.0008	.0188	.0001	.0008	SM, AFT RJLKHEAD
30	-.0001	.0021	.0005	0.	0.	0.	LOWER D LATCH, DA
31	.0003	-.0029	.0142	0.	0.	0.	LOWER +Y TRUNNION
32	.0004	.0120	.0008	0.	0.	0.	LOWER -Y TRUNNION
33	.0008	.0019	.0002	0.	0.	0.	EREP PACKAGE C.G.
34	.0000	.0000	.0000	0.	0.	0.	ATM PN 6,7 IF,OUTR
35	.0000	.0000	.0000	0.	0.	0.	ATM PN 4,5 IF,OUTR
36	.0000	.0000	.0000	0.	0.	0.	ATM PN 8,1 IF,OUTR
37	.0000	.0000	.0000	0.	0.	0.	ATM PN 2,3 IF,OUTR
38	-.0000	.0000	.0000	0.	0.	0.	ATM PN 6,7 IF,INNR
39	.0000	.0000	.0000	0.	0.	0.	ATM PN 4,5 IF,INNR
40	.0000	.0000	.0000	0.	0.	0.	ATM PN 8,1 IF,INNR
41	.0000	.0000	.0000	0.	0.	0.	ATM PN 2,3 IF,INNR
42	.0000	.0000	.0000	.0000	.0000	.0000	CMG, -Y SIDE
43	.0000	.0000	.0000	.0000	.0000	.0000	CMG, +Y SIDE
44	.0000	.0000	.0000	.0000	.0000	.0000	CMG, +X SIDE
45	.0000	.0000	0.	0.	0.	0.	ATM SAS, PN 1
46	.0000	.0000	0.	0.	0.	0.	ATM SAS, PN 3
47	-.0000	-.0000	0.	0.	0.	0.	ATM SAS, PN 5
48	-.0000	-.0000	0.	0.	0.	0.	ATM SAS, PN 7
49	.0000	.0000	.0000	.0000	.0002	.0000	SPAR CENTER
50	.0000	.0000	.0000	.0000	.0002	.0000	GRA/CAN CENTER
SUM	.0276	.2459	.0812	.6278	.0029	.0147	

TABLE A-45 ORBITAL CONFIGURATION MODAL SURVEY

## TEST MODES GENERALIZED MASS CONTRIBUTION SUMMARY

TEST MODE NO. 19A

TEST FREQUENCY = 13.30 HZ.

COMPONENT NAME	GMC (DX)	GMC (DY)	GMC (DZ)	GMC (TX)	GMC (TY)	GMC (TZ)
BR/OWS SKIRT/IU/FAS	.0002	.0117	.0065	.0004	.0005	.0029
6-FAS O2 TANKS	.0023	.0110	.0178	0.	0.	0.
MDA/STS/AM	.0006	.1268	.0172	.0063	.0059	.0124
6-AM N2 TANKS	.0004	.4473	.0840	0.	0.	0.
COMMAND/SERVICE MOD.	.0029	.1507	.0611	.0005	.0029	.0109
DEPLOYMENT ASSEMBLY	.0010	.0097	.0035	0.	0.	0.
ATM-RACK,CMGS,4-SAS	.0000	.0001	.0000	.0000	.0000	.0000
ATM-SPAR CENTER	.0000	.0000	.0000	.0004	.0007	0.
ATM-GRA/CAN CENTER	.0000	.0000	.0000	.0005	.0007	.0000
	----	----	----	----	----	----
SUM	.0075	.7573	.1902	.0081	.0107	.0262

## TOTAL GM CONTRIBUTION FOR EACH COMPONENT

BR/OWS SKIRT/IU/FAS	.0222
6-FAS O2 TANKS	.0311
MDA/STS/AM	.1693
6-AM N2 TANKS	.5316
COMMAND/SERVICE MOD.	.2290
DEPLOYMENT ASSEMBLY	.0142
ATM-RACK,CMGS,4-SAS	.0001
ATM-SPAR CENTER	.0011
ATM-GRA/CAN CENTER	.0013

TABLE A-46 GENERALIZED MASS CONTRIBUTIONS BY DEGREE OF FREEDOM

TEST MODE		19A		RUN NO. 586		FREQUENCY = 13.39		
NODE NO.	GMC (OX)	GMC (OY)	GMC (OZ)	GMC (TX)	GMC (TY)	GMC (TZ)	NODE DESCRIPTION	
1	.0000	.0049	.0003	.0000	.0004	.0013	BASE RNG/DWS SKIRT	
2	.0000	.0010	.0013	.0001	-.0001	.0001	DWS/IU INTERFACE	
3	.0002	.0025	.0038	.0003	.0002	.0015	IU/FAS INTERFACE	
4	.0001	.0001	.0008	0.	0.	0.	FAS 02 BOTL1,+Y +Z	
5	.0003	.0016	.0017	0.	0.	0.	FAS 02 BOTL2,+Y +Z	
6	.0022	.0020	.0048	0.	0.	0.	FAS 02 BOTL3,-Y +Z	
7	-.0000	.0018	.0013	0.	0.	0.	FAS 02 BOTL4,-Y +Z	
8	.0000	.0038	.0010	0.	0.	0.	FAS 02 BOTL5,-Y -Z	
9	.0000	.0018	.0081	0.	0.	0.	FAS 02 BOTL6,-Y -Z	
10	-.0000	.0000	.0006	0.	0.	0.	FAS/AM/DA IF, +Y	
11	-.0000	.0007	.0000	0.	0.	0.	FAS/AM/DA IF, +Z	
12	.0000	.0009	-.0000	0.	0.	0.	FAS/AM/DA IF, -Y	
13	.0000	-.0000	.0000	0.	0.	0.	FAS/DA IF, -Y -Z	
14	.0000	.0014	.0000	0.	0.	0.	FAS/AM IF, -Z	
15	.0000	.0002	.0004	0.	0.	0.	FAS/DA IF, +Y -Z	
16	.0000	.0003	.0004	.0006	.0000	.0007	AM TUNNEL/SHEAR WB	
17	.0001	.0071	.0002	.0011	.0013	.0017	AM TUNNEL/STS IF	
18	.0001	.0024	.0039	.0029	.0036	.0100	MDA/STS INTERFACE	
19	.0004	.0070	.0128	.0017	.0009	-.0000	MDA CONE/CYL ITRFC	
20	.0000	.4251	.0182	0.	0.	0.	N2 TANK, +Y, LOWER	
21	.0000	.0013	.0005	0.	0.	0.	N2 TANK, +Y, UPPER	
22	.0001	.0081	.0102	0.	0.	0.	N2 TANK, +Z, LOWER	
23	.0003	.0000	.0041	0.	0.	0.	N2 TANK, +Z, UPPER	
24	.0000	.0122	.0003	0.	0.	0.	N2 TANK -Z, LOWER	
25	.0000	.0006	.0005	0.	0.	0.	N2 TANK, -Z, UPPER	
26	.0001	.0005	.0033	.0004	.0010	.0021	CM, FWD BULKHEAD	
27	.0002	.1011	.0446	-.0003	.0007	.0057	CM, AFT BULKHEAD	
28	.0014	.0091	.0022	.0005	.0001	.0006	SM, FWD BULKHEAD	
29	.0012	.0099	.0111	.0000	.0011	.0024	SM, AFT BULKHEAD	
30	-.0001	.0089	.0007	0.	0.	0.	LOWER D LATCH, DA	
31	-.0001	-.0019	.0035	0.	0.	0.	LOWER +Y TRUNNION	
32	.0008	.0025	-.0007	0.	0.	0.	LOWER -Y TRUNNION	
33	.0003	.0002	.0001	0.	0.	0.	EREP PACKAGE C.G.	
34	.0000	.0000	.0000	0.	0.	0.	ATM PN 6,7 IF,OUTR	
35	.0000	.0000	.0000	0.	0.	0.	ATM PN 4,5 IF,OUTR	
36	.0000	.0000	.0000	0.	0.	0.	ATM PN 3,1 IF,OUTR	
37	-.0000	.0000	.0000	0.	0.	0.	ATM PN 2,3 IF,OUTR	
38	.0000	.0000	.0000	0.	0.	0.	ATM PN 6,7 IF,INNER	
39	.0000	.0000	.0000	0.	0.	0.	ATM PN 4,5 IF,INNER	
40	.0000	.0000	.0000	0.	0.	0.	ATM PN 3,1 IF,INNER	
41	.0000	.0000	.0000	0.	0.	0.	ATM PN 2,3 IF,INNER	
42	.0000	.0000	.0000	.0000	.0000	.0000	CMG, -Y SIDE	
43	.0000	.0000	.0000	.0000	.0000	.0000	CMG, +Y SIDE	
44	.0000	.0000	.0000	.0000	.0000	.0000	CMG, +X SIDE	
45	.0000	.0000	0.	0.	0.	0.	ATM SAS, PN 1	
46	.0000	.0000	0.	0.	0.	0.	ATM SAS, PN 3	
47	.0000	.0000	0.	0.	0.	0.	ATM SAS, PN 5	
48	-.0000	-.0000	0.	0.	0.	0.	ATM SAS, PN 7	
49	.0000	.0000	.0000	.0004	.0007	.0000	SPAR CENTER	
50	.0000	.0000	.0000	.0005	.0007	.0000	GRA/CAN CENTER	
SUM	.0075	.7573	.1902	.0081	.0107	.0262		

TABLE A-47 ORBITAL CONFIGURATION MODAL SURVEY

## TEST MODES GENERALIZED MASS CONTRIBUTION SUMMARY

TEST MODE NO. 20A

TEST FREQUENCY = 13.68 HZ.

COMPONENT NAME	GMC (DX)	GMC (DY)	GMC (DZ)	GMC (TX)	GMC (TY)	GMC (TZ)
BR/OWS SKIRT/IU/FAS	.0007	.0381	.0087	.0013	.0001	.0013
6-FAS O2 TANKS	.0043	.0145	.0137	0.	0.	0.
MDA/STS/AM	.0010	.0612	.1494	.0005	.0293	.0019
6-AM N2 TANKS	.0040	.3089	.1519	0.	0.	0.
COMMAND/SERVICE MOD.	.0019	.0367	.1665	.0008	.0063	.0011
DEPLOYMENT ASSEMBLY	.0003	.0031	.0012	0.	0.	0.
ATM-RACK,CMGS,4-SAS	.0025	.0003	.0021	.0000	.0000	.0000
ATM-SPAR CENTER	.0000	.0006	.0000	.0010	.0065	0.
ATM-GRA/CAN CENTER	.0001	.0000	.0001	.0014	.0054	.0012
	----	----	----	----	----	----
SUM	.0148	.4335	.4936	.0049	.0475	.0056

## TOTAL GM CONTRIBUTION FOR EACH COMPONENT

BR/OWS SKIRT/IU/FAS	.0202
6-FAS O2 TANKS	.0324
MDA/STS/AM	.2433
6-AM N2 TANKS	.4649
COMMAND/SERVICE MOD.	.2133
DEPLOYMENT ASSEMBLY	.0046
ATM-RACK,CMGS,4-SAS	.0050
ATM-SPAR CENTER	.0081
ATM-GRA/CAN CENTER	.0082

TABLE A-48 GENERALIZED MASS CONTRIBUTIONS BY DEGREE OF FREEDOM

TEST MODE		20A		RUN NO. 627		FREQUENCY = 13.63		
MODE NO.	GMC (OX)	GMC (OY)	GMC (OZ)	GMC (TX)	GMC (TY)	GMC (TZ)	MODE DESCRIPTION	
1	.0002	.0027	.0058	.0003	.0001	.0009	BASE RNG/DWS SKIPT	
2	.0000	.0008	.0011	.0005	-.0000	-.0000	DWS/IU INTEPFACE	
3	.0000	.0014	.0013	.0004	-.0000	.0005	IU/FAS INTERFACE	
4	.0001	.0003	.0002	0.	0.	0.	FAS 02 BOTL1,+Y +Z	
5	.0008	.0016	.0038	0.	0.	0.	FAS 02 BOTL2,+Y +Z	
6	.0022	.0023	.0012	0.	0.	0.	FAS 02 BOTL3,-Y +Z	
7	.0011	.0018	.0048	0.	0.	0.	FAS 02 BOTL4,-Y +Z	
8	-.0000	.0050	-.0000	0.	0.	0.	FAS 02 BOTL5,-Y -Z	
9	.0001	.0035	.0038	0.	0.	0.	FAS 02 BOTL6,-Y -Z	
10	-.0001	.0005	-.0000	0.	0.	0.	FAS/AM/DA IF, +Y	
11	.0002	-.0000	.0001	0.	0.	0.	FAS/AM/DA IF, +Z	
12	.0000	.0013	.0000	0.	0.	0.	FAS/AM/DA IF, -Y	
13	.0000	.0002	.0001	0.	0.	0.	FAS/DA IF, -Y -Z	
14	.0002	.0012	.0001	0.	0.	0.	FAS/AM IF, -Z	
15	.0000	.0001	.0003	0.	0.	0.	FAS/DA IF, +Y -Z	
16	.0000	.0010	.0062	-.0000	.0012	.0002	AM TUNNEL/SHEAR WB	
17	.0002	.0113	.0013	.0007	.0038	.0000	AM TUNNEL/STS IF	
18	.0003	.0234	.0317	.0004	.0197	.0018	MDA/STS INTERFACE	
19	.0004	.0255	.1102	-.0006	.0046	-.0000	MDA CONE/CYL ITRFC	
20	.0005	.2638	.0255	0.	0.	0.	N2 TANK, +Y, LOWER	
21	.0001	.0361	.0002	0.	0.	0.	N2 TANK, +Y, UPPER	
22	.0008	.0049	.0095	0.	0.	0.	N2 TANK, +Z, LOWER	
23	.0019	.0001	.0123	0.	0.	0.	N2 TANK, +Z, UPPER	
24	.0002	.0031	.0907	0.	0.	0.	N2 TANK -Z, LOWER	
25	.0004	.0009	.0135	0.	0.	0.	N2 TANK, -Z, UPPER	
26	-.0001	.0005	.0165	.0001	.0034	.0007	CM, FWD BULKHEAD	
27	.0020	.0243	.1074	.0000	.0013	.0001	CM, AFT BULKHEAD	
28	.0000	.0021	.0055	.0000	.0005	-.0000	SM, FWD BULKHEAD	
29	.0000	.0098	.0369	.0007	.0011	.0004	SM, AFT BULKHEAD	
30	.0000	.0039	-.0000	0.	0.	0.	LOWER D LATCH, DA	
31	.0001	-.0005	.0014	0.	0.	0.	LOWER +Y TRUNNION	
32	.0002	-.0003	-.0002	0.	0.	0.	LOWER -Y TRUNNION	
33	.0000	.0000	.0000	0.	0.	0.	EREP PACKAGE C.G.	
34	.0000	.0000	.0007	0.	0.	0.	ATM PN 6,7 IF,OUTR	
35	.0000	.0000	.0003	0.	0.	0.	ATM PN 4,5 IF,OUTR	
36	.0000	.0000	.0001	0.	0.	0.	ATM PN 8,1 IF,OUTR	
37	.0000	.0000	.0002	0.	0.	0.	ATM PN 2,3 IF,OUTR	
38	.0004	.0001	.0004	0.	0.	0.	ATM PN 6,7 IF,INNER	
39	.0005	-.0000	.0001	0.	0.	0.	ATM PN 4,5 IF,INNER	
40	.0008	-.0001	.0000	0.	0.	0.	ATM PN 8,1 IF,INNER	
41	.0004	.0002	.0001	0.	0.	0.	ATM PN 2,3 IF,INNER	
42	.0001	.0000	.0000	-.0000	.0000	.0000	CMG, -Y SIDE	
43	.0001	.0000	.0000	.0000	.0000	.0000	CMG, +Y SIDE	
44	.0001	.0000	.0001	.0000	.0000	.0000	CMG, +X SIDE	
45	.0000	.0000	0.	0.	0.	0.	ATM SAS, PN 1	
46	.0000	.0000	0.	0.	0.	0.	ATM SAS, PN 3	
47	.0000	.0000	0.	0.	0.	0.	ATM SAS, PN 5	
48	.0000	.0000	0.	0.	0.	0.	ATM SAS, PN 7	
49	.0000	.0006	.0000	.0010	.0055	.0000	SPAP CENTER	
50	.0001	.0000	.0001	.0014	.0054	.0012	GRA/CAN CENTER	
SJM	.0148	.4335	.4936	.0049	.0475	.0056		

TABLE A-49 ORBITAL CONFIGURATION MODAL SURVEY

## TEST MODES GENERALIZED MASS CONTRIBUTION SUMMARY

TEST MODE NO. 21A

TEST FREQUENCY = 14.55 HZ.

COMPONENT NAME	GMC (OX)	GMC (OY)	GMC (OZ)	GMC (TX)	GMC (TY)	GMC (TZ)
RR/OWS SKIRT/IU/FAS	.0001	.0123	.0032	.0000	.0001	.0005
6-FAS O2 TANKS	.0025	.0058	.0078	0.	0.	0.
MDA/STS/AM	.0000	.1102	.0400	.0216	.0041	.0160
6-AM N2 TANKS	.0023	.5918	.0310	0.	0.	0.
COMMAND/SERVICE MOD.	.0027	.1168	.0210	.0056	.0013	.0074
DEPLOYMENT ASSEMBLY	.0001	.0001	.0045	0.	0.	0.
ATM-RACK,CMGS,4-SAS	.0002	.0001	.0003	.0000	.0000	.0000
ATM-SPAR CENTER	.0000	.0000	.0000	.0000	.0003	0.
ATM-GRA/CAN CENTER	.0000	.0001	.0001	.0001	.0004	.0000
	----	----	----	----	----	----
SUM	.0079	.8269	.1080	.0273	.0061	.0239

## TOTAL GM CONTRIBUTION FOR EACH COMPONENT

RR/OWS SKIRT/IU/FAS	.0063
6-FAS O2 TANKS	.0161
MDA/STS/AM	.1919
6-AM N2 TANKS	.6251
COMMAND/SERVICE MOD.	.1547
DEPLOYMENT ASSEMBLY	.0044
ATM-RACK,CMGS,4-SAS	.0076
ATM-SPAR CENTER	.0003
ATM-GRA/CAN CENTER	.0007

A-53  
TABLE A-50 GENERALIZED MASS CONTRIBUTIONS BY DEGREE OF FREEDOM

TEST MODE 21A      RUN NO. 633      FREQUENCY = 14.55

NODE NO.	GMC (DX)	GMC (DY)	GMC (DZ)	GMC (TX)	GMC (TY)	GMC (TZ)	NODE DESCRIPTION
1	.0000	.0004	.0023	-.0000	.0000	.0002	BASE RNG/DWS SKIRT
2	.0000	.0004	.0001	.0000	-.0000	-.0000	DWS/TU INTERFACE
3	.0000	.0008	.0007	.0000	.0001	.0003	TU/FAS INTERFACE
4	.0002	.0014	.0005	0.	0.	0.	FAS 02 BOTL1,+Y +Z
5	.0000	.0002	.0018	0.	0.	0.	FAS 02 BOTL2,+Y +Z
6	.0007	.0014	.0015	0.	0.	0.	FAS 02 BOTL3,-Y +Z
7	.0012	.0001	.0011	0.	0.	0.	FAS 02 BOTL4,-Y +Z
8	.0002	.0025	.0004	0.	0.	0.	FAS 02 BOTL5,-Y -Z
9	.0000	.0002	.0025	0.	0.	0.	FAS 02 BOTL6,-Y -Z
10	-.0000	.0000	-.0000	0.	0.	0.	FAS/AM/DA IF, +Y
11	.0000	.0004	.0000	0.	0.	0.	FAS/AM/DA IF, +Z
12	-.0000	.0001	.0001	0.	0.	0.	FAS/AM/DA IF, -Y
13	-.0000	.0001	.0001	0.	0.	0.	FAS/DA IF, -Y -Z
14	.0000	.0001	.0000	0.	0.	0.	FAS/AM IF, -Z
15	.0000	-.0000	.0000	0.	0.	0.	FAS/DA IF, +Y -Z
16	.0000	.0000	.0001	.0032	.0001	.0003	AM TUNNEL/SHEAR WB
17	.0000	.0016	.0010	.0090	.0005	.0026	AM TUNNEL/STS IF
18	.0000	.0254	.0153	.0054	.0030	.0127	MDA/STS INTERFACE
19	.0000	.0832	.0237	.0039	.0004	.0005	MDA CONE/CYL ITRFC
20	.0003	.0015	.0036	0.	0.	0.	N2 TANK, +Y, LOWER
21	.0016	.0264	.0019	0.	0.	0.	N2 TANK, +Y, UPPER
22	.0001	.0583	.0000	0.	0.	0.	N2 TANK, +Z, LOWER
23	.0001	.0007	.0231	0.	0.	0.	N2 TANK, +Z, UPPER
24	.0001	.0030	.0018	0.	0.	0.	N2 TANK -Z, LOWER
25	.0002	.0020	.0005	0.	0.	0.	N2 TANK, -Z, UPPER
26	.0001	.0068	.0022	.0005	.0005	.0027	CM, FWD BULKHEAD
27	-.0000	.0797	.0114	.0009	.0005	.0036	CM, AFT BULKHEAD
28	.0014	.0050	.0022	.0013	.0001	.0005	SM, FWD BULKHEAD
29	.0012	.0253	.0052	.0029	.0000	.0006	SM, AFT BULKHEAD
30	.0000	-.0003	-.0003	0.	0.	0.	LOWER D LATCH, DA
31	-.0001	.0001	.0007	0.	0.	0.	LOWER +Y TRUNNION
32	.0001	.0001	.0037	0.	0.	0.	LOWER -Y TRUNNION
33	.0000	.0001	.0000	0.	0.	0.	EPEP PACKAGE C.G.
34	.0000	.0000	-.0000	0.	0.	0.	ATM PN 6,7 IF,OUTR
35	-.0000	.0000	.0000	0.	0.	0.	ATM PN 4,5 IF,OUTR
36	-.0000	.0000	.0002	0.	0.	0.	ATM PN 8,1 IF,OUTR
37	.0000	.0000	.0000	0.	0.	0.	ATM PN 2,3 IF,OUTR
38	.0000	.0000	-.0000	0.	0.	0.	ATM PN 6,7 IF,INNER
39	.0000	.0000	-.0000	0.	0.	0.	ATM PN 4,5 IF,INNER
40	.0001	-.0000	.0000	0.	0.	0.	ATM PN 8,1 IF,INNER
41	.0000	.0000	.0000	0.	0.	0.	ATM PN 2,3 IF,INNER
42	.0000	.0000	-.0000	.0000	.0000	.0000	CMG, -Y SIDE
43	.0000	.0000	.0000	.0000	.0000	.0000	CMG, +Y SIDE
44	.0000	.0000	.0000	-.0000	.0000	.0000	CMG, +X SIDE
45	-.0000	-.0000	0.	0.	0.	0.	ATM SAS, PN 1
46	.0000	.0700	0.	0.	0.	0.	ATM SAS, PN 3
47	.0000	.0000	0.	0.	0.	0.	ATM SAS, PN 5
48	.0000	.0000	0.	0.	0.	0.	ATM SAS, PN 7
49	.0000	.0000	.0000	.0000	.0003	.0000	SPAR CENTER
50	.0000	.0001	.0001	.0001	.0004	.0000	GRA/CAN CENTER
SUM	.0079	.8269	.1080	.0273	.0051	.0239	

TABLE A-51 ORBITAL CONFIGURATION MODAL SURVEY

## TEST MODES GENERALIZED MASS CONTRIBUTION SUMMARY

TEST MODE NO. 22B

TEST FREQUENCY = 15.40 HZ.

COMPONENT NAME	GMC (DX)	GMC (DY)	GMC (DZ)	GMC (TX)	GMC (TY)	GMC (TZ)
BR/OWS SKIRT/IU/FAS	.0010	.0108	.0119	.0051	.0029	.0048
6-FAS O2 TANKS	.1326	.0593	.0686	0.	0.	0.
MDA/STS/AM	.0002	.1203	.0154	.0750	.0051	.0295
6-AM N2 TANKS	.0002	.1360	.1081	0.	0.	0.
COMMAND/SERVICE MOD.	.0023	.1155	.0236	.0108	.0007	.0102
DEPLOYMENT ASSEMBLY	.0138	.0260	.0048	0.	0.	0.
ATM-RACK,CMGS,4-SAS	.0002	.0001	.0002	.0000	.0000	.0000
ATM-SPAR CENTER	.0000	.0000	-.0000	.0021	.0000	0.
ATM-GRA/CAN CENTER	.0001	.0001	.0000	.0128	.0000	.0000
	---	---	---	---	---	---
SUM	.1503	.4681	.2327	.0957	.0088	.0445

## TOTAL GM CONTRIBUTION FOR EACH COMPONENT

BR/OWS SKIRT/IU/FAS	.0364
6-FAS O2 TANKS	.2606
MDA/STS/AM	.2455
6-AM N2 TANKS	.2443
COMMAND/SERVICE MOD.	.1630
DEPLOYMENT ASSEMBLY	.0446
ATM-RACK,CMGS,4-SAS	.0004
ATM-SPAR CENTER	.0021
ATM-GRA/CAN CENTER	.0030



A-55  
TABLE A-52 GENERALIZED MASS CONTRIBUTIONS BY DEGREE OF FREEDOM

TEST MODE 22R      RUN NO. 654      FREQUENCY = 15.4)

MODE NO.	GMC (DX)	GMC (DY)	GMC (DZ)	GMC (TX)	GMC (TY)	GMC (TZ)	MODE DESCRIPTION
1	.0000	.0001	.0031	.0048	.0016	.0039	BASE RNG/DWS SKIRT
2	-.0000	.0024	.0028	.0001	.0008	.0009	OWS/IU INTERFACE
3	.0004	.0018	.0038	.0002	.0005	-.0000	IU/FAS INTERFACE
4	.0099	.0138	.0075	0.	0.	0.	FAS 02 BOTL1,+Y +Z
5	.0406	.0082	.0150	0.	0.	0.	FAS 02 BOTL2,+Y +Z
6	.0098	.0009	-.0000	0.	0.	0.	FAS 02 BOTL3,-Y +Z
7	.0024	-.0000	.0021	0.	0.	0.	FAS 02 BOTL4,-Y +Z
8	.0426	.0180	.0166	0.	0.	0.	FAS 02 BOTL5,-Y -Z
9	.0363	.0184	.0274	0.	0.	0.	FAS 02 BOTL6,-Y -Z
10	.0002	.0004	-.0000	0.	0.	0.	FAS/AM/DA IF, +Y
11	.0002	.0012	.0015	0.	0.	0.	FAS/AM/DA IF, +Z
12	.0001	.0027	.0017	0.	0.	0.	FAS/AM/DA IF, -Y
13	-.0000	.0016	-.0010	0.	0.	0.	FAS/DA IF, -Y -Z
14	.0001	.0006	.0001	0.	0.	0.	FAS/AM IF, -Z
15	.0000	.0000	.0000	0.	0.	0.	FAS/DA IF, +Y -Z
16	.0000	.0062	.0021	.0079	.0000	.0001	AM TUNNEL/SHEAR WB
17	.0000	.0046	.0064	.0259	.0012	.0069	AM TUNNEL/STS IF
18	.0001	.0093	.0000	.0251	.0021	.0211	MDA/STS INTERFACE
19	.0000	.0003	.0068	.0162	.0017	.0014	MDA CONE/CYL ITRFC
20	.0000	.0047	.0172	0.	0.	0.	N2 TANK, +Y, LOWER
21	.0001	.0330	.0110	0.	0.	0.	N2 TANK, +Y, UPPER
22	.0000	.0417	.0005	0.	0.	0.	N2 TANK, +Z, LOWER
23	.0000	.0302	.0180	0.	0.	0.	N2 TANK, +Z, UPPER
24	.0001	.0261	.0366	0.	0.	0.	N2 TANK -Z, LOWER
25	.0000	.0002	.0248	0.	0.	0.	N2 TANK, -Z, UPPER
26	.0000	.0260	.0047	.0022	.0004	.0038	CM, FWD BJLKHEAD
27	-.0000	.0672	.0175	.0044	.0002	.0057	CM, AFT BJLKHEAD
28	.0018	.0012	.0001	.0002	-.0000	.0004	SM, FWD BJLKHEAD
29	.0005	.0211	.0013	.0041	.0001	.0003	SM, AFT BJLKHEAD
30	.0004	.0301	.0000	0.	0.	0.	LOWER D LATCH, DA
31	.0100	-.0006	.0060	0.	0.	0.	LOWER +Y TRUNNION
32	.0031	-.0038	-.0014	0.	0.	0.	LOWER -Y TRUNNION
33	.0003	.0002	.0002	0.	0.	0.	EREP PACKAGE C.G.
34	.0000	.0000	.0001	0.	0.	0.	ATM PN 6,7 IF,OUTR
35	-.0000	.0000	.0000	0.	0.	0.	ATM PN 4,5 IF,OUTP
36	.0000	.0000	.0000	0.	0.	0.	ATM PN 8,1 IF,OUTR
37	.0000	.0000	.0000	0.	0.	0.	ATM PN 2,3 IF,OUTR
38	.0000	.0000	.0000	0.	0.	0.	ATM PN 6,7 IF,INNER
39	.0000	.0000	.0000	0.	0.	0.	ATM PN 4,5 IF,INNER
40	.0000	.0000	.0000	0.	0.	0.	ATM PN 8,1 IF,INNER
41	.0000	.0000	.0000	0.	0.	0.	ATM PN 2,3 IF,INNER
42	.0000	.0000	.0000	.0000	.0000	.0000	CMG, -Y SIDE
43	.0000	.0000	.0000	-.0000	.0000	.0000	CMG, +Y SIDE
44	.0000	.0000	.0000	-.0000	.0000	.0000	CMG, +X SIDE
45	-.0000	-.0000	0.	0.	0.	0.	ATM SAS, PN 1
46	.0000	.0000	0.	0.	0.	0.	ATM SAS, PN 3
47	.0000	.0000	0.	0.	0.	0.	ATM SAS, PN 5
48	.0000	.0000	0.	0.	0.	0.	ATM SAS, PN 7
49	.0000	.0000	-.0000	.0021	.0000	.0000	SPAR CENTER
50	.0001	.0001	.0000	.0028	.0000	.0000	GRA/CAN CENTER
SUM	.1503	.4681	.2327	.0957	.0388	.0445	

TABLE A-53 ORBITAL CONFIGURATION MODAL SURVEY  
 TEST MODES GENERALIZED MASS CONTRIBUTION SUMMARY

TEST MODE NO. 22A

TEST FREQUENCY = 15.78 HZ.

COMPONENT NAME	GMC (DX)	GMC (DY)	GMC (DZ)	GMC (TX)	GMC (TY)	GMC (TZ)
BR/OWS SKIRT/IU/FAS	.0039	.0111	.0166	.0712	.0100	.0054
6-FAS O2 TANKS	.2309	.0753	.0449	0.	0.	0.
MDA/STS/AM	.0030	.1061	.0592	.0100	.0225	.0165
6-AM N2 TANKS	.0011	.0170	.0747	0.	0.	0.
COMMAND/SERVICE MOD.	.0113	.1545	.0340	.0225	.0056	.0158
DEPLOYMENT ASSEMBLY	.0192	.0183	.0015	0.	0.	0.
ATM-RACK,CMGS,4-SAS	.0013	.0022	.0011	.0000	.0000	.0000
ATM-SPAR CENTER	.0002	.0000	.0000	.0006	.0007	0.
ATM-GRA/CAN CENTER	.0003	.0002	.0001	.0008	.0007	.0002
	----	----	----	----	----	----
SUM	.2703	.3849	.2322	.0352	.0395	.0379

TOTAL GM CONTRIBUTION FOR EACH COMPONENT

BR/OWS SKIRT/IU/FAS	.0474
6-FAS O2 TANKS	.3511
MDA/STS/AM	.2173
6-AM N2 TANKS	.0928
COMMAND/SERVICE MOD.	.2437
DEPLOYMENT ASSEMBLY	.0390
ATM-RACK,CMGS,4-SAS	.0047
ATM-SPAR CENTER	.0015
ATM-GRA/CAN CENTER	.0023

TABLE A-54 GENERALIZED MASS CONTRIBUTIONS BY DEGREE OF FREEDOM

TEST MODE 22A RUN NO. 506 FREQUENCY = 15.78

MODE NO.	GMC (DX)	GMC (DY)	GMC (DZ)	GMC (TX)	GMC (TY)	GMC (TZ)	MODE DESCRIPTION
1	.1003	.0008	.0035	.0012	.0058	.0044	BASE RNG/DWS SKIPT
2	-.0001	.0038	.0035	.0000	.0021	.0009	DWS/TU INTERFACE
3	.0019	.0034	.0022	-.0000	.0012	.0001	TU/FAS INTERFACE
4	.0085	.0174	.0052	0.	0.	0.	FAS 02 BOTL1,+Y +Z
5	.0801	.0055	.0175	0.	0.	0.	FAS 02 BOTL2,+Y +Z
6	.0001	.0006	.0019	0.	0.	0.	FAS 02 BOTL3,-Y +Z
7	.0146	-.0000	.0081	0.	0.	0.	FAS 02 BOTL4,-Y +Z
8	.0738	.0379	.0121	0.	0.	0.	FAS 02 BOTL5,-Y -Z
9	.0538	.0139	.0001	0.	0.	0.	FAS 02 BOTL6,-Y -Z
10	.0003	-.0001	.0006	0.	0.	0.	FAS/AM/DA IF, +Y
11	.0003	.0029	.0019	0.	0.	0.	FAS/AM/DA IF, +Z
12	.0001	.0007	.0042	0.	0.	0.	FAS/AM/DA IF, -Y
13	.0000	-.0013	.0006	0.	0.	0.	FAS/DA IF, -Y -Z
14	.0001	.0010	.0001	0.	0.	0.	FAS/AM IF, -Z
15	.0000	-.0000	.0001	0.	0.	0.	FAS/DA IF, +Y -Z
16	.0002	.0002	.0032	.0014	.0000	.0000	AM TUNNEL/SHEAR WB
17	.0004	.0002	.0042	.0045	.0042	.0030	AM TUNNEL/STS IF
18	.0012	.0235	.0003	.0021	.0129	.0132	MDA/STS INTERFACE
19	.0012	.0822	.0515	.0021	.0355	.0002	MDA CONE/CYL ITRFC
20	.0006	.0000	.0115	0.	0.	0.	N2 TANK, +Y, LOWER
21	.0001	.0000	.0079	0.	0.	0.	N2 TANK, +Y, UPPER
22	.0001	.0076	.0014	0.	0.	0.	N2 TANK, +Z, LOWER
23	.0000	.0082	.0105	0.	0.	0.	N2 TANK, +Z, UPPER
24	.0000	.0010	.0193	0.	0.	0.	N2 TANK, -Z, LOWER
25	.0002	.0001	.0240	0.	0.	0.	N2 TANK, -Z, UPPER
26	.0045	.0061	.0001	.0082	.0012	.0050	CM, FWD RJLKHEAD
27	-.0000	.0062	.0001	.0080	-.0000	.0052	CM, AFT RJLKHEAD
28	.0049	.0148	.0004	.0002	.0005	.0013	SM, FWD RJLKHEAD
29	.0020	.0374	.0333	.0061	.0039	.0043	SM, AFT RJLKHEAD
30	.0021	.0231	.0019	0.	0.	0.	LOWER D LATCH, DA
31	.0137	.0003	-.0004	0.	0.	0.	LOWER +Y TRUNNION
32	.0014	-.0051	-.0001	0.	0.	0.	LOWER -Y TRUNNION
33	.0020	.0000	-.0000	0.	0.	0.	EREP PACKAGE C.G.
34	.0001	-.0000	.0001	0.	0.	0.	ATM PN 5,7 IF,OUTR
35	.0004	-.0000	.0001	0.	0.	0.	ATM PN 4,5 IF,OUTR
36	.0000	.0000	.0003	0.	0.	0.	ATM PN 8,1 IF,OUTR
37	.0003	.0002	.0000	0.	0.	0.	ATM PN 2,3 IF,OUTR
38	-.0000	.0012	.0000	0.	0.	0.	ATM PN 5,7 IF,INNER
39	.0004	.0003	.0001	0.	0.	0.	ATM PN 4,5 IF,INNER
40	-.0000	.0001	.0002	0.	0.	0.	ATM PN 8,1 IF,INNER
41	-.0000	.0001	.0000	0.	0.	0.	ATM PN 2,3 IF,INNER
42	.0001	.0001	.0000	.0000	-.0000	.0000	CMG, -Y SIDE
43	.0000	.0001	.0001	.0000	.0000	.0000	CMG, +Y SIDE
44	.0000	.0000	.0000	.0000	.0000	.0000	CMG, +X SIDE
45	.0000	.0000	0.	0.	0.	0.	ATM SAS, PN 1
46	.0000	.0000	0.	0.	0.	0.	ATM SAS, PN 3
47	-.0000	-.0000	0.	0.	0.	0.	ATM SAS, PN 5
48	.0000	.0000	0.	0.	0.	0.	ATM SAS, PN 7
49	.0002	.0000	.0000	.0006	.0007	.0002	SPAR CENTER
50	.0003	.0002	.0001	.0008	.0007	.0002	GRA/CAN CENTER
SJM	.2703	.3849	.2322	.0352	.0395	.0381	

TABLE A-55 ORBITAL CONFIGURATION MODAL SURVEY

## TEST MODES GENERALIZED MASS CONTRIBUTION SUMMARY

TEST MODE NO. 23A

TEST FREQUENCY = 16.20 HZ.

COMPONENT NAME	GMC (DX)	GMC (DY)	GMC (DZ)	GMC (TX)	GMC (TY)	GMC (TZ)
BR/OWS SKIRT/IU/FAS	.0042	.0090	.0348	.0078	.0127	.0018
6-FAS O2 TANKS	.1797	.0532	.0872	0.	0.	0.
MDA/STS/AM	.0009	.0023	.0858	.0042	.0386	.0004
6-AM N2 TANKS	.0031	.0126	.2980	0.	0.	0.
COMMAND/SERVICE MOD.	.0019	.0035	.1123	.0091	.0041	.0002
DEPLOYMENT ASSEMBLY	.0108	.0073	.0008	0.	0.	0.
ATM-RACK,CMGS,4-SAS	.0027	.0040	.0036	.0000	.0000	.0000
ATM-SPAR CENTER	.0002	.0002	.0001	.0013	.0012	0.
ATM-GRA/CAN CENTER	.0001	.0013	.0000	.0015	.0024	.0040
	----	----	----	----	----	----
SUM	.1946	.0932	.6228	.0239	.0591	.0065

## TOTAL GM CONTRIBUTION FOR EACH COMPONENT

BR/OWS SKIRT/IU/FAS	.0702
6-FAS O2 TANKS	.3111
MDA/STS/AM	.1323
6-AM N2 TANKS	.3137
COMMAND/SERVICE MOD.	.1312
DEPLOYMENT ASSEMBLY	.0189
ATM-RACK,CMGS,4-SAS	.0103
ATM-SPAR CENTER	.0030
ATM-GRA/CAN CENTER	.0093

TABLE A-56 GENERALIZED MASS CONTRIBUTIONS BY DEGREE OF FREEDOM

TEST MODE		23A	RUN NO. 645		FREQUENCY = 16.20		
NODE NO.	GMC (OX)	GMC (OY)	GMC (OZ)	GMC (TX)	GMC (TY)	GMC (TZ)	NODE DESCRIPTION
1	.0011	.0016	.0018	.0004	.0087	.0015	BASE RNG/DWS SKIRT
2	-.0001	.0001	.0035	.0026	.0027	.0001	OWS/IJ INTERFACE
3	.0013	-.0001	.0012	.0048	.0013	.0001	IJ/FAS INTERFACE
4	.0087	.0034	.0033	0.	0.	0.	FAS 02 30TL1,+Y +Z
5	.0002	.0076	.0130	0.	0.	0.	FAS 02 30TL2,+Y +Z
6	.0490	.0051	.0162	0.	0.	0.	FAS 02 30TL3,-Y +Z
7	.0099	.0252	.0121	0.	0.	0.	FAS 02 30TL4,-Y +Z
8	.0050	.0123	.0254	0.	0.	0.	FAS 02 30TL5,-Y -Z
9	-.0012	-.0003	.0172	0.	0.	0.	FAS 02 30TL6,-Y -Z
10	.0001	.0010	.0037	0.	0.	0.	FAS/AM/OA IF, +Y
11	.0011	.0021	.0066	0.	0.	0.	FAS/AM/OA IF, +Z
12	.0007	.0001	.0064	0.	0.	0.	FAS/AM/OA IF, -Y
13	-.0001	.0030	.0068	0.	0.	0.	FAS/OA IF, -Y -Z
14	.0011	.0008	.0044	0.	0.	0.	FAS/AM IF, -Z
15	.0000	.0004	.0002	0.	0.	0.	FAS/OA IF, +Y -Z
16	.0001	.0000	.0102	.0005	.0000	.0001	AM TUNNEL/SHEAR WR
17	.0002	.0006	.0253	.0013	.0065	.0001	AM TUNNEL/STS IF
18	.0003	-.0001	-.0034	.0007	.0191	.0003	MOA/STS INTERFACE
19	.0003	.0017	.0535	.0017	.0130	-.0000	MOA CONE/CYL ITRFC
20	.0015	.0001	.0500	0.	0.	0.	N2 TANK, +Y, LOWER
21	.0000	.0021	.0304	0.	0.	0.	N2 TANK, +Y, UPPER
22	.0002	.0000	.0085	0.	0.	0.	N2 TANK, +Z, LOWER
23	.0005	.0010	.0369	0.	0.	0.	N2 TANK, +Z, UPPER
24	.0007	.0049	.1248	0.	0.	0.	N2 TANK -Z, LOWER
25	.0000	.0044	.0475	0.	0.	0.	N2 TANK, -Z, UPPER
26	-.0002	.0001	.0324	.0012	.0022	.0000	CM, FWD BJLKHEAD
27	.0015	.0014	.0307	.0081	.0004	.0002	CM, AFT BJLKHEAD
28	.0001	.0005	.0033	-.0000	.0003	-.0000	SM, FWD BJLKHEAD
29	.0003	.0015	.0460	-.0002	.0013	.0000	SM, AFT BJLKHEAD
30	.0003	.0006	.0001	0.	0.	0.	LOWER D LATCH, OA
31	-.0002	-.0024	.0005	0.	0.	0.	LOWER +Y TRUNNION
32	.0006	-.0004	.0000	0.	0.	0.	LOWER -Y TRUNNION
33	.0021	.0004	.0000	0.	0.	0.	EREP PACKAGE C.G.
34	.0002	.0003	.0009	0.	0.	0.	ATM PN 6,7 IF,OUTR
35	.0004	.0001	.0007	0.	0.	0.	ATM PN 4,5 IF,OUTR
36	.0011	.0001	.0005	0.	0.	0.	ATM PN 8,1 IF,OUTR
37	.0010	-.0000	.0002	0.	0.	0.	ATM PN 2,3 IF,OUTR
38	.0000	.0010	.0005	0.	0.	0.	ATM PN 6,7 IF,INNER
39	-.0001	.0003	.0003	0.	0.	0.	ATM PN 4,5 IF,INNER
40	-.0001	.0004	.0002	0.	0.	0.	ATM PN 8,1 IF,INNER
41	.0000	.0009	.0001	0.	0.	0.	ATM PN 2,3 IF,INNER
42	-.0000	.0002	.0001	.0000	.0000	.0000	CMG, -Y SIDE
43	.0000	.0002	.0000	.0000	.0000	.0000	CMG, +Y SIDE
44	.0000	.0002	.0001	.0000	.0000	.0000	CMG, +X SIDE
45	.0001	.0001	0.	0.	0.	0.	ATM SAS, PN 1
46	.0000	.0000	0.	0.	0.	0.	ATM SAS, PN 3
47	.0000	.0000	0.	0.	0.	0.	ATM SAS, PN 5
48	.0000	.0000	0.	0.	0.	0.	ATM SAS, PN 7
49	.0002	.0002	.0001	.0013	.0012	.0002	SPAR CENTER
50	.0001	.0013	.0000	.0015	.0024	.0040	GRA/CAN CENTER
SUM	.1946	.0932	.6228	.0239	.0591	.0066	

TABLE A-57 ORBITAL CONFIGURATION MODAL SURVEY

## TEST MODES GENERALIZED MASS CONTRIBUTION SUMMARY

TEST MODE NO. 24A

TEST FREQUENCY = 16.53 HZ.

COMPONENT NAME	GMC (DX)	GMC (DY)	GMC (DZ)	GMC (TX)	GMC (TY)	GMC (TZ)
BR/OWS SKIRT/IU/FAS	.0021	.0461	.0245	.0077	-.0012	.0013
6-FAS O2 TANKS	.2163	.0512	.0280	0.	0.	0.
MDA/STS/AM	.0025	.0757	.0015	.0006	.0005	.0090
6-AM N2 TANKS	.0028	.3252	.0008	0.	0.	0.
COMMAND/SERVICE MOD.	.0010	.0110	.0012	.0007	.0001	.0010
DEPLOYMENT ASSEMBLY	.0394	.0556	.0048	0.	0.	0.
ATM-RACK,CMGS,4-SAS	.0172	.0234	.0177	.0001	.0000	.0001
ATM-SPAR CENTER	.0003	.0002	.0001	.0013	.0112	0.
ATM-GRA/CAN CENTER	.0010	.0003	.0007	.0015	.0104	.0052
	----	----	----	----	----	----
SUM	.2824	.5888	.0792	.0119	.0210	.0166

## TOTAL GM CONTRIBUTION FOR EACH COMPONENT

BR/OWS SKIRT/IU/FAS	.0806
6-FAS O2 TANKS	.2954
MDA/STS/AM	.0898
6-AM N2 TANKS	.3288
COMMAND/SERVICE MOD.	.0149
DEPLOYMENT ASSEMBLY	.0998
ATM-RACK,CMGS,4-SAS	.0585
ATM-SPAR CENTER	.0130
ATM-GRA/CAN CENTER	.0190

A-61  
TABLE A-58 GENERALIZED MASS CONTRIBUTIONS BY DEGREE OF FREEDOM

TEST MODE 24A      RUN NO. 638      FREQUENCY = 16.53

MODE NO.	GMC (DX)	GMC (DY)	GMC (DZ)	GMC (TX)	GMC (TY)	GMC (TZ)	MODE DESCRIPTION
1	.0005	.0001	.0135	.0000	-.0001	.0010	BASE RNG/DWS SKIPT
2	.0001	.0110	.0919	.0043	.0002	.0002	DWS/IJ INTERFACE
3	.0009	.0119	.0012	.0035	-.0013	.0001	IU/FAS INTERFACE
4	.0298	.0005	.0070	0.	0.	0.	FAS 02 BOTL1,+Y +Z
5	.0120	.0010	.0055	0.	0.	0.	FAS 02 BOTL2,+Y +Z
6	.0056	.0038	.0073	0.	0.	0.	FAS 02 BOTL3,-Y +Z
7	.0170	.0075	.0004	0.	0.	0.	FAS 02 BOTL4,-Y +Z
8	.0017	.0183	.0004	0.	0.	0.	FAS 02 BOTL5,-Y -Z
9	.1591	.0201	.0072	0.	0.	0.	FAS 02 BOTL6,-Y -Z
10	.0004	.0015	.0000	0.	0.	0.	FAS/AM/DA IF, +Y
11	.0002	.0006	.0002	0.	0.	0.	FAS/AM/DA IF, +Z
12	.0000	.0017	.0008	0.	0.	0.	FAS/AM/DA IF, -Y
13	-.0000	.0174	.0074	0.	0.	0.	FAS/DA IF, -Y -Z
14	-.0001	.0018	-.0004	0.	0.	0.	FAS/AM IF, -Z
15	.0000	.0001	-.0001	0.	0.	0.	FAS/DA IF, +Y -Z
16	.0003	.0361	.0000	.0000	.0000	.0014	AM TUNNEL/SHEAR W3
17	.0002	.0270	.0000	.0001	.0001	.0034	AM TUNNEL/STS IF
18	.0009	.0088	.0002	.0005	.0003	.0018	MQA/STS INTERFACE
19	.0009	.0039	.0013	-.0000	.0001	.0024	MQA CONE/CYL ITRFC
20	.0021	.0288	.0005	0.	0.	0.	N2 TANK, +Y, LOWER
21	.0005	.0737	.0000	0.	0.	0.	N2 TANK, +Y, UPPER
22	.0001	.0155	.0001	0.	0.	0.	N2 TANK, +Z, LOWER
23	.0000	.0514	.0000	0.	0.	0.	N2 TANK, +Z, UPPER
24	.0000	.0143	.0001	0.	0.	0.	N2 TANK -Z, LOWER
25	.0000	.1415	.0001	0.	0.	0.	N2 TANK, -Z, UPPER
26	.0000	.0032	.0009	.0003	.0000	.0003	CM, FWD RJLKHEAD
27	.0000	.0059	.0001	.0003	.0000	.0005	CM, AFT RJLKHEAD
28	.0005	.0001	.0000	.0000	-.0000	.0001	SM, FWD RJLKHEAD
29	.0005	.0018	.0001	.0001	.0000	.0000	SM, AFT RJLKHEAD
30	.0080	.0623	.0009	0.	0.	0.	LOWER D LATCH, DA
31	.0173	-.0015	.0051	0.	0.	0.	LOWER +Y TRUNNION
32	.0138	-.0052	-.0012	0.	0.	0.	LOWER -Y TRUNNION
33	.0003	.0000	-.0000	0.	0.	0.	EREP PACKAGE C.G.
34	.0019	-.0001	.0021	0.	0.	0.	ATM PN 6,7 IF,OUTR
35	.0062	.0001	.0048	0.	0.	0.	ATM PN 4,5 IF,OUTR
36	.0005	.0007	.0040	0.	0.	0.	ATM PN 8,1 IF,OUTR
37	.0041	.0033	.0002	0.	0.	0.	ATM PN 2,3 IF,OUTR
38	.0002	.0121	.0007	0.	0.	0.	ATM PN 6,7 IF,INNER
39	.0030	.0031	.0017	0.	0.	0.	ATM PN 4,5 IF,INNER
40	.0002	.0003	.0022	0.	0.	0.	ATM PN 8,1 IF,INNER
41	-.0002	.0018	.0001	0.	0.	0.	ATM PN 2,3 IF,INNER
42	.0008	.0009	.0009	.0000	.0000	-.0000	CMG, -Y SIDE
43	.0002	.0007	.0008	.0001	-.0000	.0000	CMG, +Y SIDE
44	.0000	.0002	.0002	.0000	.0000	.0001	CMG, +X SIDE
45	.0001	.0001	0.	0.	0.	0.	ATM SAS, PN 1
46	.0000	.0000	0.	0.	0.	0.	ATM SAS, PN 3
47	.0001	.0001	0.	0.	0.	0.	ATM SAS, PN 5
48	.0002	.0002	0.	0.	0.	0.	ATM SAS, PN 7
49	.0003	.0002	.0001	.0013	.0112	.0003	SPAC CENTER
50	.0010	.0003	.0007	.0015	.0104	.0052	GRA/CAN CENTER
SUM	.2824	.5888	.0792	.0119	.0210	.0169	

TABLE A-59 ORBITAL CONFIGURATION MODAL SURVEY

## TEST MODES GENERALIZED MASS CONTRIBUTION SUMMARY

TEST MODE NO. 25A

TEST FREQUENCY = 17.01 HZ.

COMPONENT NAME	GMC (DX)	GMC (DY)	GMC (DZ)	GMC (TX)	GMC (TY)	GMC (TZ)
BR/OWS SKIRT/IU/FAS	.0171	.0007	.0411	.0020	-.0005	.0044
6-FAS O2 TANKS	.2948	.0227	.0292	0.	0.	0.
MDA/STS/AM	.3382	.0072	.0037	.0000	-.0003	.0005
6-AM N2 TANKS	.0768	.0154	.0178	0.	0.	0.
COMMAND/SERVICE MOD.	.0937	.0078	.0019	.0006	.0034	.0094
DEPLOYMENT ASSEMBLY	.0038	.0024	.0009	0.	0.	0.
ATM-RACK,CMGS,4-SAS	.0011	.0004	.0005	.0000	.0000	.0000
ATM-SPAR CENTER	.0001	.0001	.0001	.0002	.0009	0.
ATM-GRA/CAN CENTER	.0000	.0002	.0000	.0003	.0008	.0004
	----	----	----	----	----	----
SUM	.8257	.0568	.0952	.0032	.0044	.0148

## TOTAL GM CONTRIBUTION FOR EACH COMPONENT

BR/OWS SKIRT/IU/FAS	.0648
6-FAS O2 TANKS	.3467
MDA/STS/AM	.3493
6-AM N2 TANKS	.1101
COMMAND/SERVICE MOD.	.1169
DEPLOYMENT ASSEMBLY	.0071
ATM-RACK,CMGS,4-SAS	.0019
ATM-SPAR CENTER	.0013
ATM-GRA/CAN CENTER	.0018



A-63  
TABLE A-60 GENERALIZED MASS CONTRIBUTIONS BY DEGREE OF FREEDOM

TEST MODE		25A		RUN NO. 499		FREQUENCY = 17.01	
MODE NO.	GMC (OX)	GMC (OY)	GMC (OZ)	GMC (TX)	GMC (TY)	GMC (TZ)	MODE DESCRIPTION
1	.0375	.0000	.0178	.0015	-.0001	.0000	BASE RNG/DWS SKIRT
2	.0028	.0001	.0051	.0002	-.0002	.0000	OWS/IU INTERFACE
3	.0063	.0004	.0113	.0003	-.0002	.0044	IU/FAS INTERFACE
4	.1430	.0022	.0082	0.	0.	0.	FAS 02 BOTL1,+Y +Z
5	.0532	.0035	.0080	0.	0.	0.	FAS 02 BOTL2,+Y +Z
6	.0113	.0012	.0007	0.	0.	0.	FAS 02 BOTL3,-Y +Z
7	.0429	.0003	.0021	0.	0.	0.	FAS 02 BOTL4,-Y +Z
8	.0455	.0141	.0078	0.	0.	0.	FAS 02 BOTL5,-Y -Z
9	-.0010	.0014	.0024	0.	0.	0.	FAS 02 BOTL5,-Y -Z
10	.0000	-.0002	.0003	0.	0.	0.	FAS/AM/DA IF, +Y
11	-.0002	.0000	.0043	0.	0.	0.	FAS/AM/DA IF, +Z
12	.0000	.0006	-.0000	0.	0.	0.	FAS/AM/DA IF, -Y
13	.0002	-.0005	.0012	0.	0.	0.	FAS/DA IF, -Y -Z
14	.0003	.0001	.0010	0.	0.	0.	FAS/AM IF, -Z
15	.0002	.0001	.0001	0.	0.	0.	FAS/DA IF, +Y -Z
16	.0319	.0033	.0009	-.0000	.0001	.0002	AM TUNNEL/SHEAR WB
17	.0714	.0015	.0017	.0000	.0002	.0004	AM TUNNEL/STS IF
18	.1347	-.0001	.0003	.0000	-.0002	.0000	MDA/STS INTERFACE
19	.1002	.0024	.0007	.0000	-.0002	-.0000	MDA CONE/CYL ITRFC
20	.0185	.0003	.0051	0.	0.	0.	N2 TANK, +Y, LOWER
21	.0073	.0010	.0020	0.	0.	0.	N2 TANK, +Y, UPPER
22	.0099	.0001	.0012	0.	0.	0.	N2 TANK, +Z, LOWER
23	.0151	.0056	.0065	0.	0.	0.	N2 TANK, +Z, UPPER
24	.0145	.0004	.0017	0.	0.	0.	N2 TANK -Z, LOWER
25	.0116	.0081	.0012	0.	0.	0.	N2 TANK, -Z, UPPER
26	.0072	.0025	.0000	.0001	.0015	.0005	CM, FWD BULKHEAD
27	.0089	-.0000	.0000	.0001	.0015	.0007	CM, AFT BULKHEAD
28	.0193	.0044	.0001	.0004	.0000	.0047	SM, FWD BULKHEAD
29	.0083	.0008	.0018	.0001	.0003	.0035	SM, AFT BULKHEAD
30	.0032	.0006	-.0002	0.	0.	0.	LOWER D LATCH, DA
31	.0003	.0005	-.0001	0.	0.	0.	LOWER +Y TRUNNION
32	.0001	.0013	.0012	0.	0.	0.	LOWER -Y TRUNNION
33	.0002	.0000	.0000	0.	0.	0.	EREP PACKAGE C.G.
34	.0001	.0000	.0000	0.	0.	0.	ATM PN 6,7 IF,OUTR
35	.0004	-.0000	.0000	0.	0.	0.	ATM PN 4,5 IF,OUTR
36	.0003	.0000	.0001	0.	0.	0.	ATM PN 8,1 IF,OUTR
37	.0001	.0001	.0000	0.	0.	0.	ATM PN 2,3 IF,OUTR
38	.0000	.0001	.0000	0.	0.	0.	ATM PN 6,7 IF,INNER
39	.0001	.0001	.0000	0.	0.	0.	ATM PN 4,5 IF,INNER
40	-.0000	.0000	.0001	0.	0.	0.	ATM PN 8,1 IF,INNER
41	.0000	.0000	.0000	0.	0.	0.	ATM PN 2,3 IF,INNER
42	.0000	.0000	.0000	.0000	.0000	.0000	CMG, -Y SIDE
43	.0000	.0000	.0000	.0000	.0000	.0000	CMG, +Y SIDE
44	.0000	.0000	.0000	.0000	.0000	.0000	CMG, +X SIDE
45	.0000	.0000	0.	0.	0.	0.	ATM SAS, PN 1
46	-.0000	-.0000	0.	0.	0.	0.	ATM SAS, PN 3
47	.0000	.0000	0.	0.	0.	0.	ATM SAS, PN 5
48	.0000	.0000	0.	0.	0.	0.	ATM SAS, PN 7
49	.0001	.0001	.0001	.0002	.0009	.0001	SPAR CENTER
50	.0000	.0002	.0000	.0003	.0008	.0004	GRA/CAN CENTER
SUM	.8257	.9568	.0952	.0032	.0044	.0149	

B-1

SECTION B

Two-Dimensional Plots of Test Modes

ORBITAL CONFIGURATION MODAL SURVEY  
DEGREE OF FREEDOM TABLE FOR MODE SHAPES AND DISCRETE MASS MATRIX

NODE	DEGREES OF FREEDOM						LOCATION			DESCRIPTION
	NO.	DX	DY	DZ	TX	TY	TZ	X	Y	
1	1	2	3	4	5	6	3100.00	0.000	0.000	BASE RNG/OWS SKIRT
2	7	8	9	10	11	12	3223.000	0.000	0.000	OWS/IU INTERFACE
3	13	14	15	15	17	18	3258.555	0.000	0.000	IU/FAS INTERFACE
4	19	20	21				3316.555	81.473	46.683	FAS 02 BOTL1,+Y +Z
5	22	23	24				3316.555	46.683	81.473	FAS 02 BOTL2,+Y +Z
6	25	26	27				3316.555	-46.683	81.473	FAS 02 BOTL3,-Y +Z
7	28	29	30				3316.555	-81.473	46.683	FAS 02 BOTL4,-Y +Z
8	31	32	33				3316.555	-81.473	-46.683	FAS 02 BOTL5,-Y -Z
9	34	35	36				3316.555	-46.683	-81.473	FAS 02 BOTL6,-Y -Z
10	37	38	39				3341.615	116.060	0.000	FAS/AM/DA IF, +Y
11	40	41	42				3341.615	0.000	116.060	FAS/AM/DA IF, +Z
12	43	44	45				3341.615	-116.060	0.000	FAS/AM/DA IF, -Y
13	46	47	48				3355.700	-82.345	-81.488	FAS/DA IF, -Y -Z
14	49	50	51				3341.615	0.000	-116.060	FAS/AM IF, -Z
15	52	53	54				3341.615	83.0143	-83.0143	FAS/DA IF, +Y -Z
16	55	56	57	58	59	60	3282.365	0.000	0.000	AM TUNNEL/SHEAR WB
17	61	62	63	64	65	66	3394.615	0.000	0.000	AM TUNNEL/STS IF
18	67	68	69	70	71	72	3441.765	0.000	0.000	MDA/STS INTERFACE
19	73	74	75	76	77	78	3605.000	0.000	0.000	MDA CONE/CYL ITRFC
20	79	80	81				3297.665	69.050	0.000	N2 TANK, +Y, LOWER
21	82	83	84				3348.365	69.050	0.000	N2 TANK, +Y, UPPER
22	85	86	87				3297.665	0.000	69.050	N2 TANK, +Z, LOWER
23	88	89	90				3348.365	0.000	69.050	N2 TANK, +Z, UPPER
24	91	92	93				3297.665	0.000	-69.050	N2 TANK -Z, LOWER
25	94	95	96				3348.365	0.000	-69.050	N2 TANK, -Z, UPPER
26	97	98	99	100	101	102	3678.000	0.000	0.000	CM, FWD BULKHEAD
27	103	104	105	105	107	108	3751.600	0.000	0.000	CM, AFT BULKHEAD
28	109	110	111	112	113	114	3766.500	0.000	0.000	SM, FWD BULKHEAD
29	115	116	117	118	119	120	3921.500	0.000	0.000	SM, AFT BULKHEAD
30	121	122	123				3454.765	0.000	-90.000	LOWER D LATCH, DA
31	124	125	126				3532.915	113.500	-11.850	LOWER +Y TRUNNION
32	127	128	129				3532.915	-113.500	-11.850	LOWER -Y TRUNNION
33	130	131	132				3418.765	0.000	100.000	EREP PACKAGE C.G.
34	133	134	135				3479.094	27.293	-252.500	ATM PN 6,7 IF,OUTR
35	136	137	138				3517.701	-65.905	-252.500	ATM PN 4,5 IF,OUTR
36	139	140	141				3572.299	65.905	-252.500	ATM PN 8,1 IF,OUTR
37	142	143	144				3610.906	-27.293	-252.500	ATM PN 2,3 IF,OUTR
38	145	146	147				3479.094	27.293	-158.000	ATM PN 6,7 IF,INNER
39	148	149	150				3517.701	-65.905	-158.000	ATM PN 4,5 IF,INNER
40	151	152	153				3572.299	65.905	-158.000	ATM PN 8,1 IF,INNER
41	154	155	156				3610.906	-27.293	-158.000	ATM PN 2,3 IF,INNER
42	157	158	159	150	161	162	3545.000	-65.905	-181.9925	CMG, -Y SIDE
43	163	164	165	166	167	168	3545.000	67.834	-181.995	CMG, +Y SIDE
44	169	170	171	172	173	174	3610.906	0.000	-182.000	CMG, +X SIDE
45	175	176					3599.9301	54.9301	-207.490	ATM SAS ,PN 1
46	177	178					3599.9301	-54.9301	-207.490	ATM SAS, PN 3
47	179	180					3490.0699	-54.9301	-207.490	ATM SAS, PN 5
48	181	182					3490.0699	54.9301	-207.490	ATM SAS, PN 7
49	183	184	185	186	187		3545.000	0.000	-240.709	SPAR CENTER
50	188	189	190	191	192	193	3545.000	0.000	-240.709	GRA/CAN CENTER

Two dimensional plots of each of the thirth test modes are presented in this section. The data plotted is the translated test quadratures normalized to the 193 x 193 discrete mass matrix. A least squares transformation from all ATM degrees of freedom at nodes 34 through 41 was used to define the three ATM center of gravity rotations given by Node 51. All of the resulting node points included in the plotted data are defined in the degree of freedom table presented on page B-2 of this section.

All nodes are plotted versus x station. In the plotted data the ATM is represented by two intersecting lines in each of the planes at the inner and outer ATM Z stations. At the outer ATM Z station the plane is defined by the intersection lines from node 34 to node 37 and from node 35 to node 36. At the inner ATM Z station the plane is defined by the intersection of lines from node 38 to node 41 and from node 39 to node 40. The line connecting node 3 to node 16 is a plotting error and should be ignored.

Plot B-1

ORBITAL CONFIGURATION MEDIAL SURVEY - NORMALIZED TEST MODES 40  
 MODE 3 FREQ = 1.310 Hz RUN NO. = 07498 DATE = 06SEP72

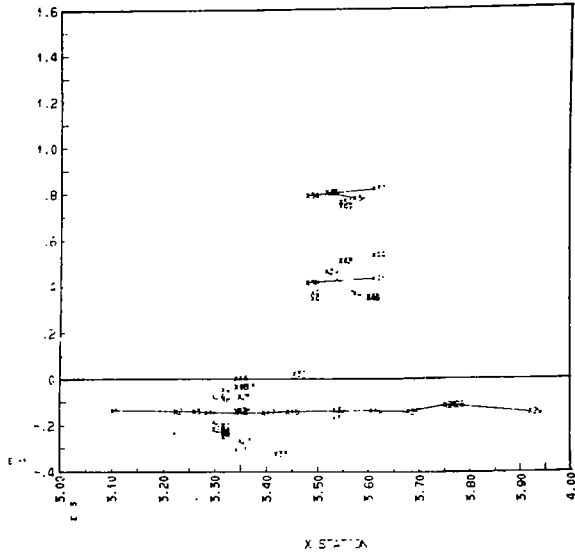

ORBITAL CONFIGURATION MEDIAL SURVEY - NORMALIZED TEST MODES 40  
 MODE 3 FREQ = 1.310 Hz RUN NO. = 07498 DATE = 06SEP72

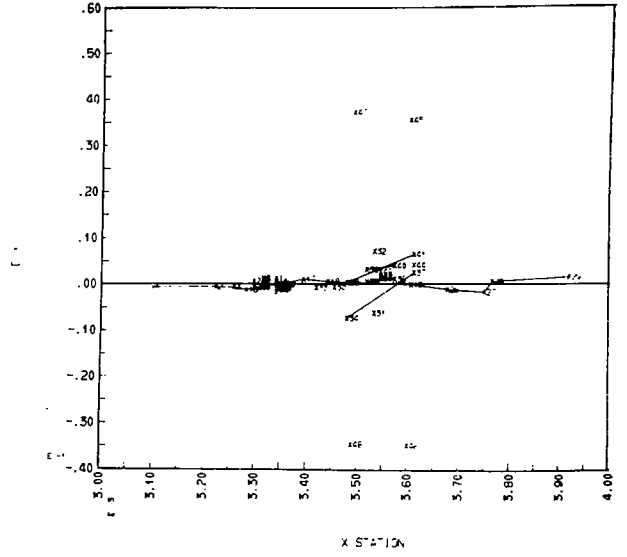

ORBITAL CONFIGURATION MEDIAL SURVEY - NORMALIZED TEST MODES 40  
 MODE 3 FREQ = 1.310 Hz RUN NO. = 07498 DATE = 06SEP72

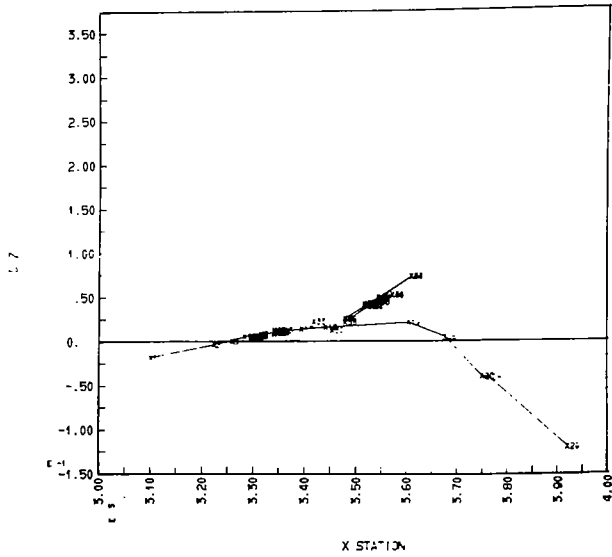

ORBITAL CONFIGURATION MEDIAL SURVEY - NORMALIZED TEST MODES 40  
 MODE 3 FREQ = 1.310 Hz RUN NO. = 07498 DATE = 06SEP72

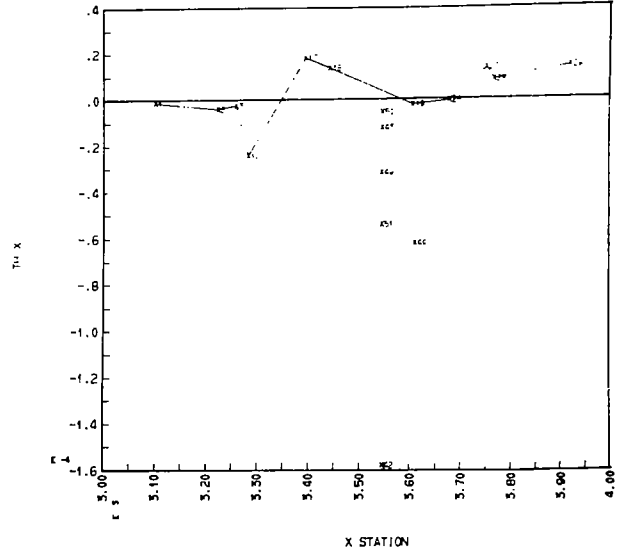

Plot B-1

ORBITAL CONFIGURATION MODAL SURVEY - NORMALIZED TEST MODES (4C)  
 MODE 3 FREQ = 1.310 HZ RUN NO. = DTAOR8 DATE = 06SE72

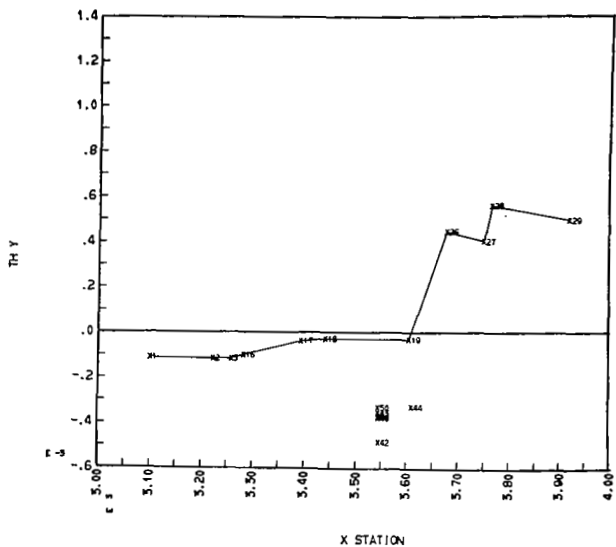

ORBITAL CONFIGURATION MODAL SURVEY - NORMALIZED TEST MODES (4C)  
 MODE 3 FREQ = 1.310 HZ RUN NO. = DTAOR8 DATE = 06SE72

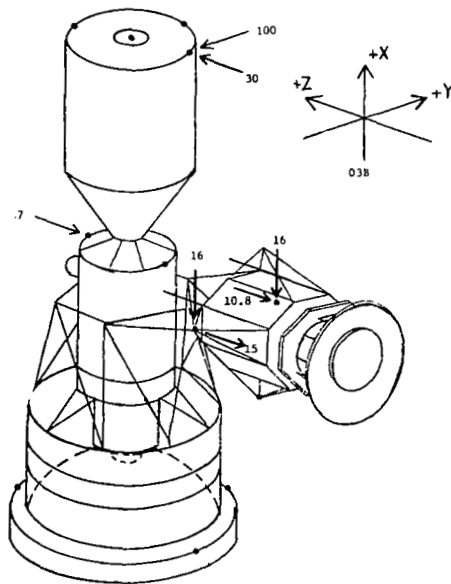
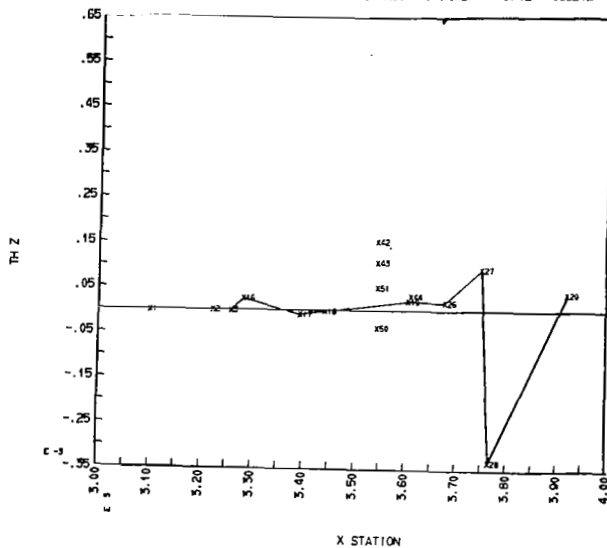

Plot B-2

ORBITAL CONFIGURATION MODAL SURVEY - NORMALIZED TEST MODES (4C)  
MODE 4 FREQ = 1.430 HZ RUN NO. = DTAORB DATE = 06SE72

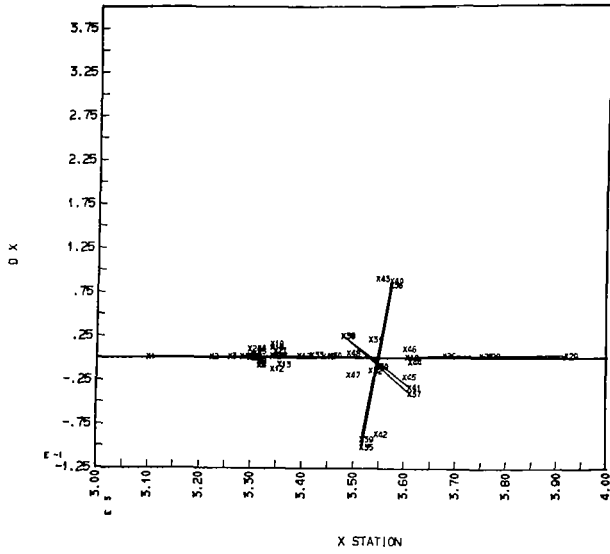

ORBITAL CONFIGURATION MODAL SURVEY - NORMALIZED TEST MODES (4C)  
MODE 4 FREQ = 1.430 HZ RUN NO. = DTAORB DATE = 06SE72

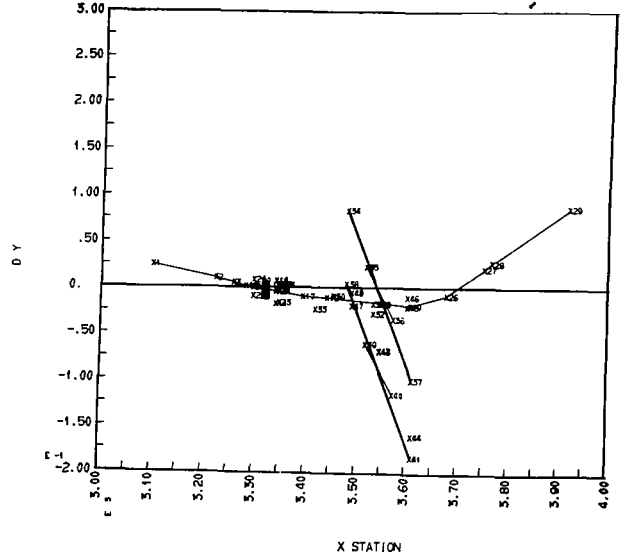

ORBITAL CONFIGURATION MODAL SURVEY - NORMALIZED TEST MODES (4C)  
MODE 4 FREQ = 1.430 HZ RUN NO. = DTAORB DATE = 06SE72

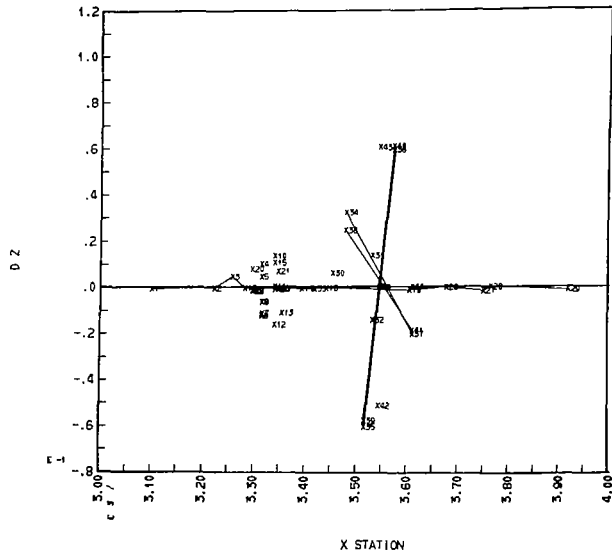

ORBITAL CONFIGURATION MODAL SURVEY - NORMALIZED TEST MODES (4C)  
MODE 4 FREQ = 1.430 HZ RUN NO. = DTAORB DATE = 06SE72

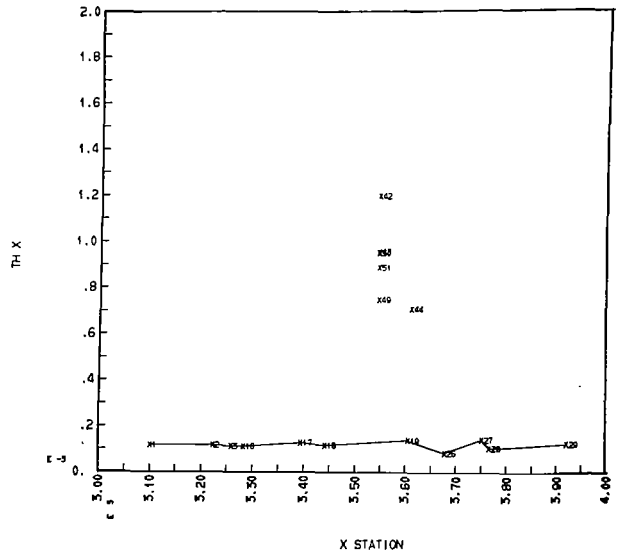

Plot B-2

ORBITAL CONFIGURATION MODAL SURVEY - NORMALIZED TEST MODES (4C)  
 MODE 4 FREQ = 1.430 HZ RUN NO. = DTAORB DATE = 06SETZ

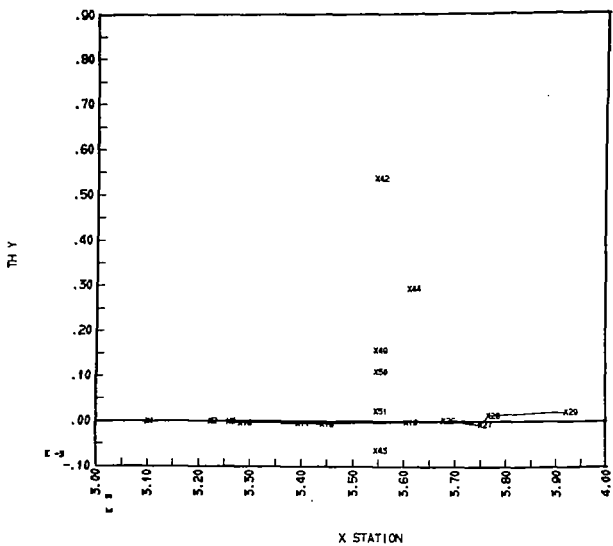

ORBITAL CONFIGURATION MODAL SURVEY - NORMALIZED TEST MODES (4C)  
 MODE 4 FREQ = 1.430 HZ RUN NO. = DTAORB DATE = 06SETZ

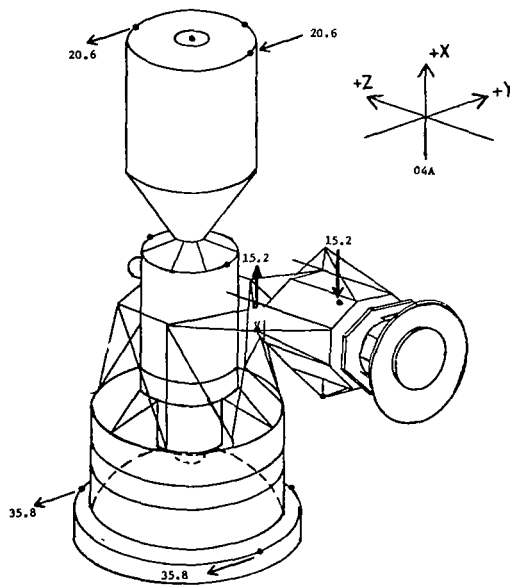
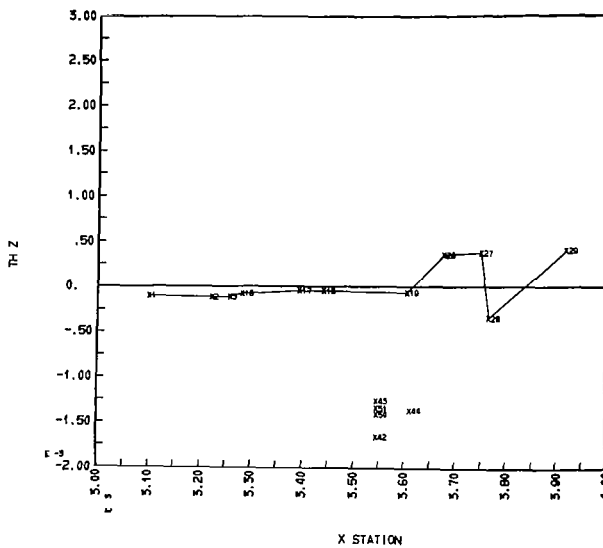



Plot B-3

ORBITAL CONFIGURATION MODAL SURVEY - NORMALIZED TEST MODES (4C)  
MODE 5 FREQ = 1.660 HZ RUN NO. = DTAORB DATE = 06SET2

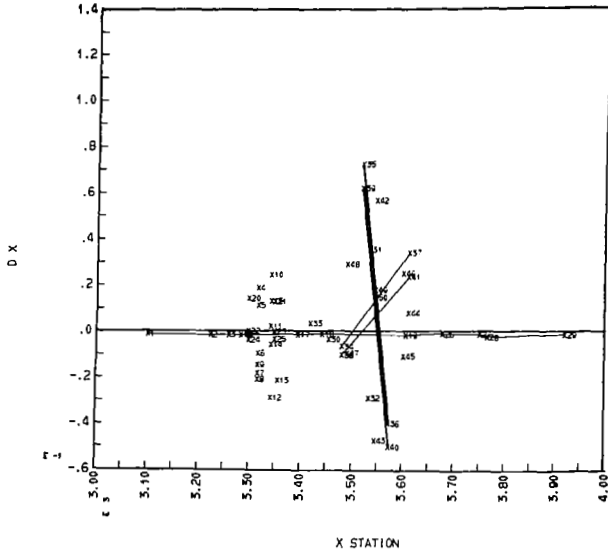

ORBITAL CONFIGURATION MODAL SURVEY - NORMALIZED TEST MODES (4C)  
MODE 5 FREQ = 1.660 HZ RUN NO. = DTAORB DATE = 06SET2

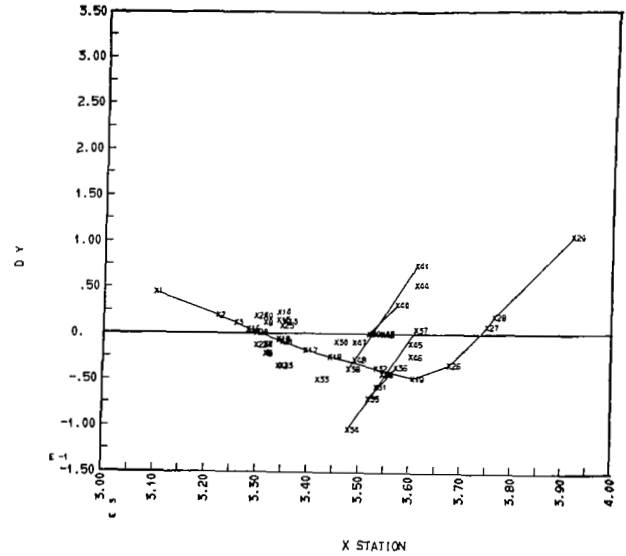

ORBITAL CONFIGURATION MODAL SURVEY - NORMALIZED TEST MODES (4C)  
MODE 5 FREQ = 1.660 HZ RUN NO. = DTAORB DATE = 06SET2

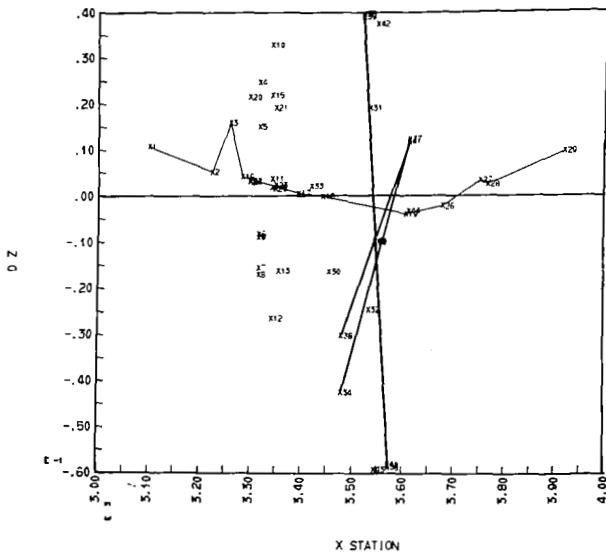

ORBITAL CONFIGURATION MODAL SURVEY - NORMALIZED TEST MODES (4C)  
MODE 5 FREQ = 1.660 HZ RUN NO. = DTAORB DATE = 06SET2

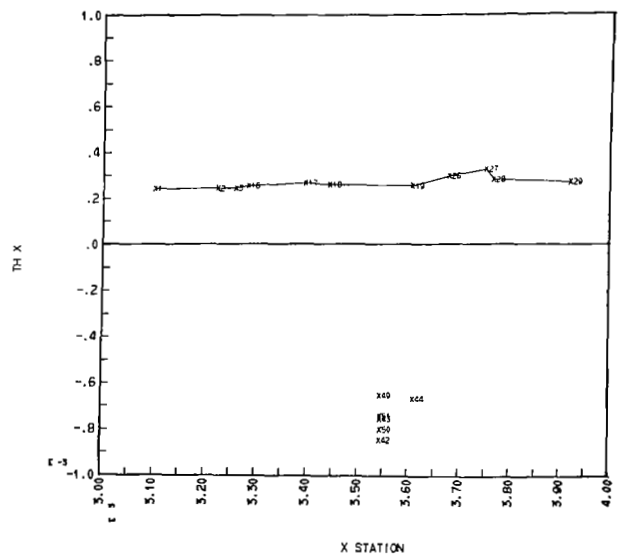

Plot B-3

ORBITAL CONFIGURATION MODAL SURVEY - NORMALIZED TEST MODES (4C)  
 MODE 5 FREQ = 1.660 HZ RUN NO. = DTAORB DATE = 06SE72

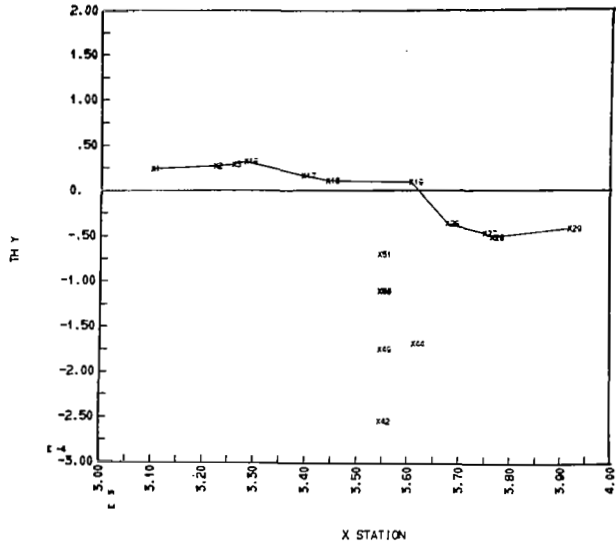

ORBITAL CONFIGURATION MODAL SURVEY - NORMALIZED TEST MODES (4C)  
 MODE 5 FREQ = 1.660 HZ RUN NO. = DTAORB DATE = 06SE72

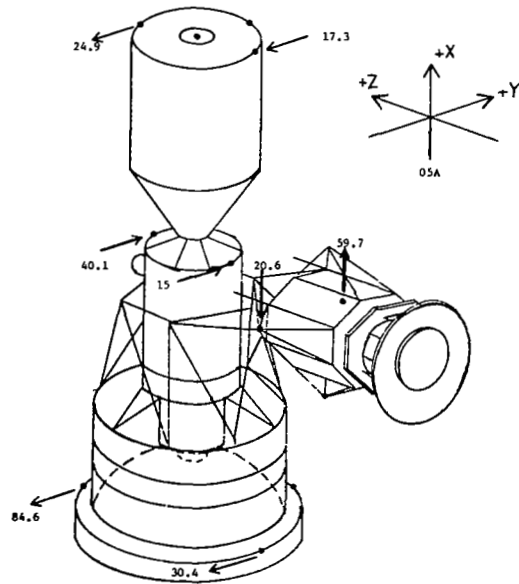
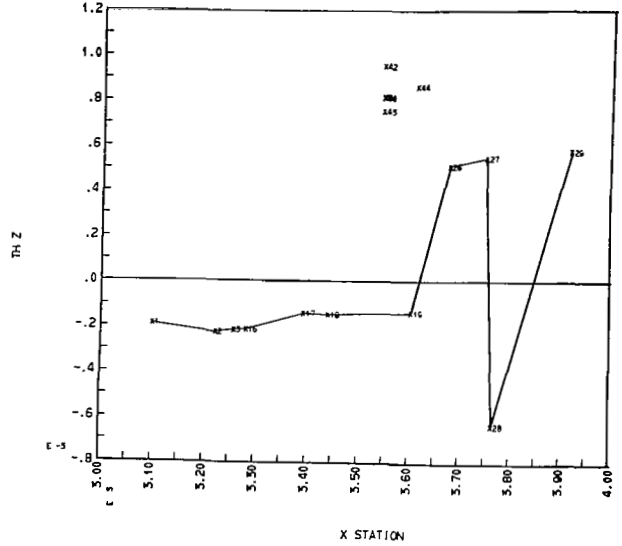

Plot B-4

ORBITAL CONFIGURATION MODAL SURVEY - NORMALIZED TEST MODES (4C)  
 MODE 6 FREQ = 1.720 HZ RUN NO. = DTAOR8 DATE = 06SE72

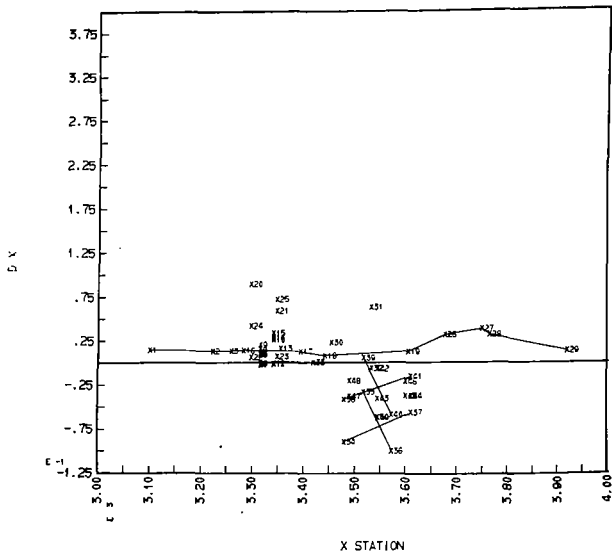

ORBITAL CONFIGURATION MODAL SURVEY - NORMALIZED TEST MODES (4C)  
 MODE 6 FREQ = 1.720 HZ RUN NO. = DTAOR8 DATE = 06SE72

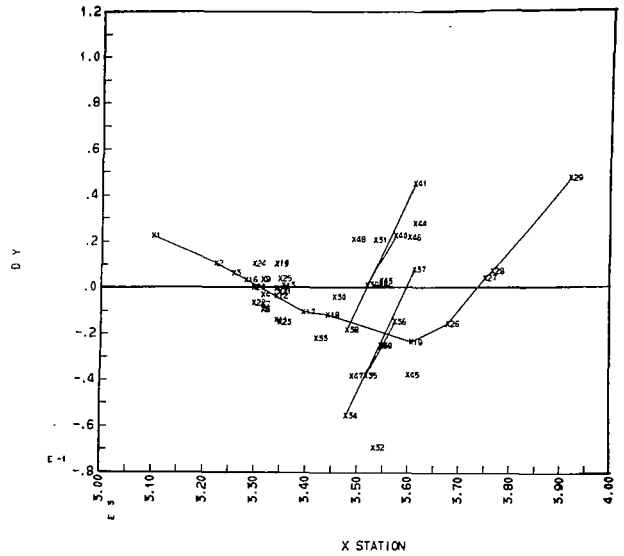

ORBITAL CONFIGURATION MODAL SURVEY - NORMALIZED TEST MODES (4C)  
 MODE 6 FREQ = 1.720 HZ RUN NO. = DTAOR8 DATE = 06SE72

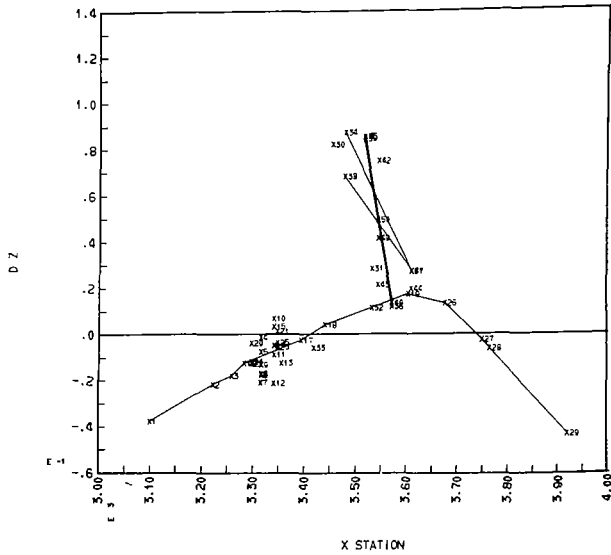

ORBITAL CONFIGURATION MODAL SURVEY - NORMALIZED TEST MODES (4C)  
 MODE 6 FREQ = 1.720 HZ RUN NO. = DTAOR8 DATE = 06SE72

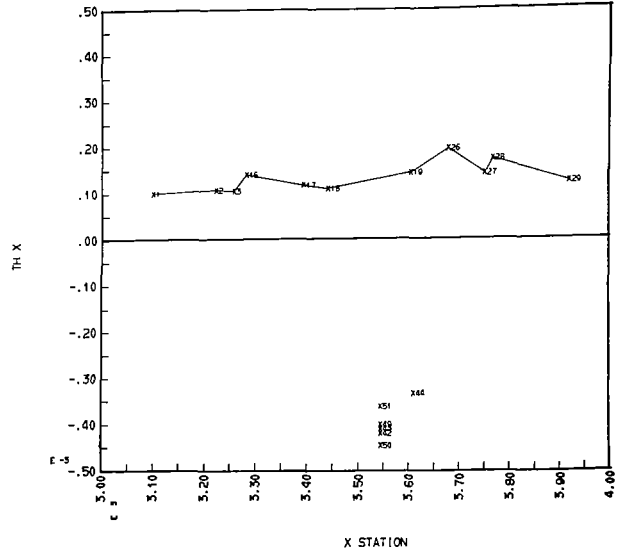

Plot B-4

ORBITAL CONFIGURATION MODAL SURVEY - NORMALIZED TEST MODES (4C)  
 MODE 6 FREQ = 1.720 HZ RUN NO. = DTAOR6 DATE = 06SE72

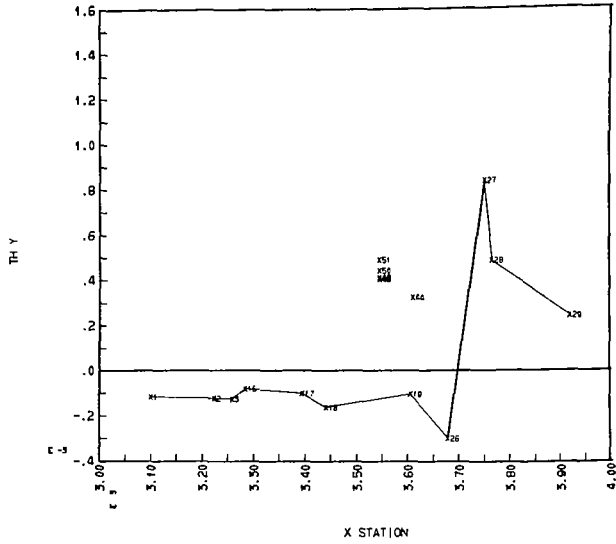

ORBITAL CONFIGURATION MODAL SURVEY - NORMALIZED TEST MODES (4C)  
 MODE 6 FREQ = 1.720 HZ RUN NO. = DTAOR6 DATE = 06SE72

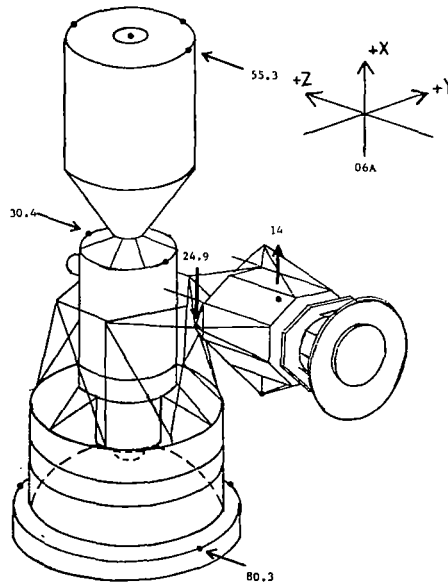
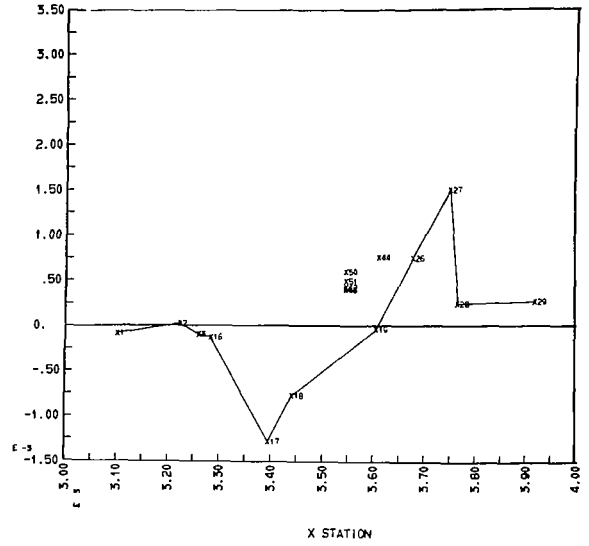

Plot B-5

ORBITAL CONFIGURATION MODAL SURVEY - NORMALIZED TEST MODES (4C)  
MODE 7 FREQ = 1.740 HZ RUN NO. = DTAORB DATE = 06SE72

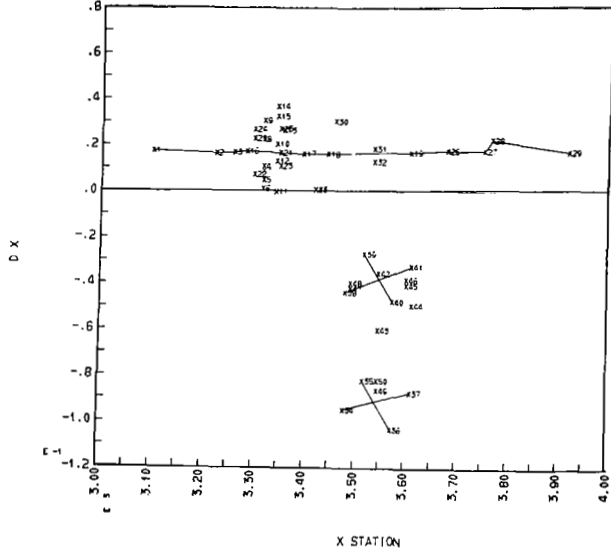

ORBITAL CONFIGURATION MODAL SURVEY - NORMALIZED TEST MODES (4C)  
MODE 7 FREQ = 1.740 HZ RUN NO. = DTAORB DATE = 06SE72

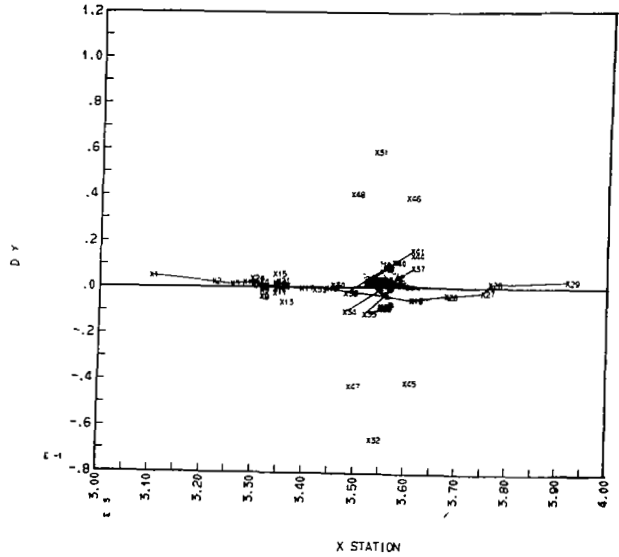

ORBITAL CONFIGURATION MODAL SURVEY - NORMALIZED TEST MODES (4C)  
MODE 7 FREQ = 1.740 HZ RUN NO. = DTAORB DATE = 06SE72

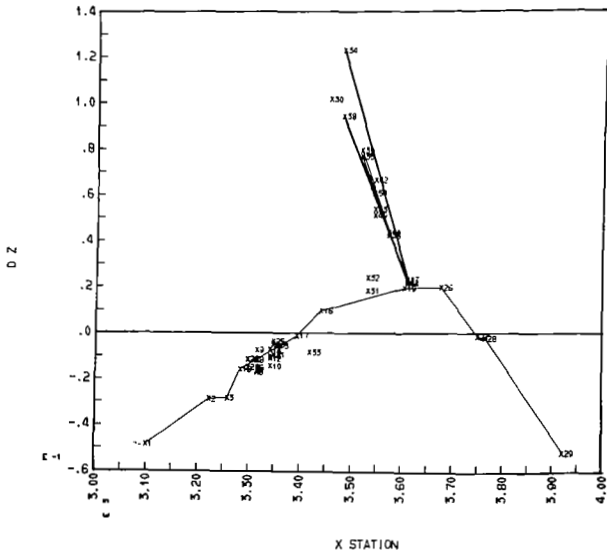

ORBITAL CONFIGURATION MODAL SURVEY - NORMALIZED TEST MODES (4C)  
MODE 7 FREQ = 1.740 HZ RUN NO. = DTAORB DATE = 06SE72

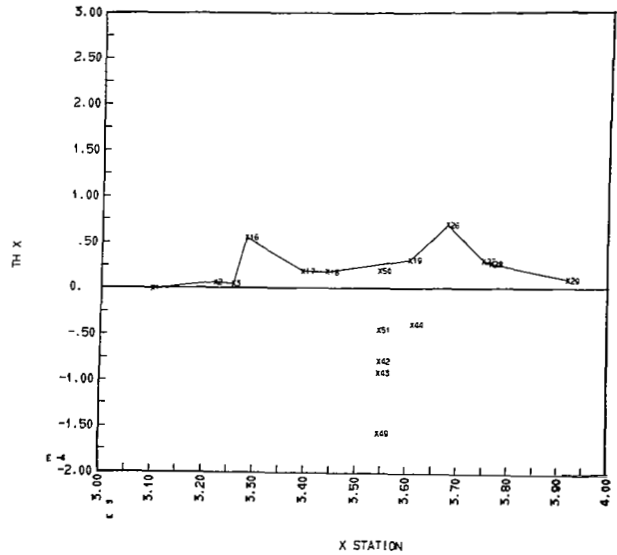

Plot B-5

ORBITAL CONFIGURATION MODAL SURVEY - NORMALIZED TEST MODES (4C)  
 MODE 7 FREQ = 1.740 HZ RUN NO. = DTAOR8 DATE = 06SE72

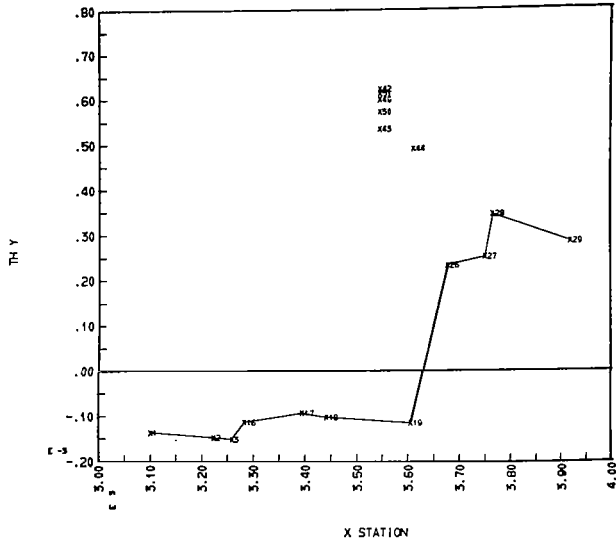

ORBITAL CONFIGURATION MODAL SURVEY - NORMALIZED TEST MODES (4C)  
 MODE 7 FREQ = 1.740 HZ RUN NO. = DTAOR8 DATE = 06SE72

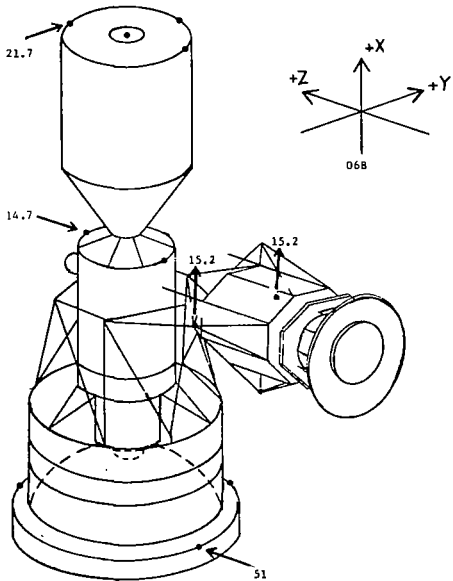
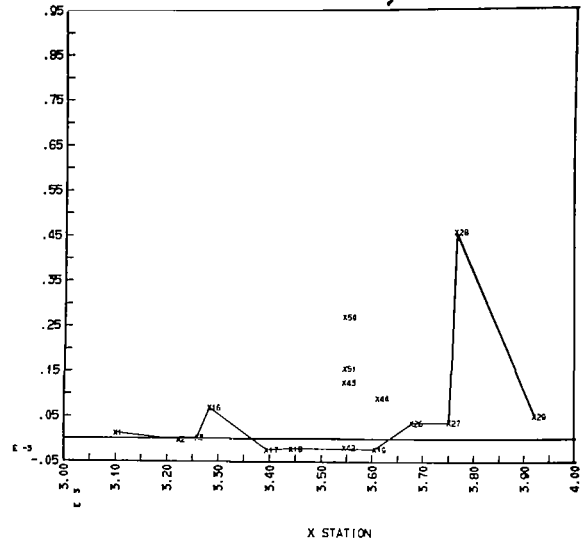

Plot B-6

ORBITAL CONFIGURATION MODAL SURVEY - NORMALIZED TEST MODES (4C)  
MODE 8 FREQ = 2.510 HZ RUN NO. = DTAORB DATE = 06SE72

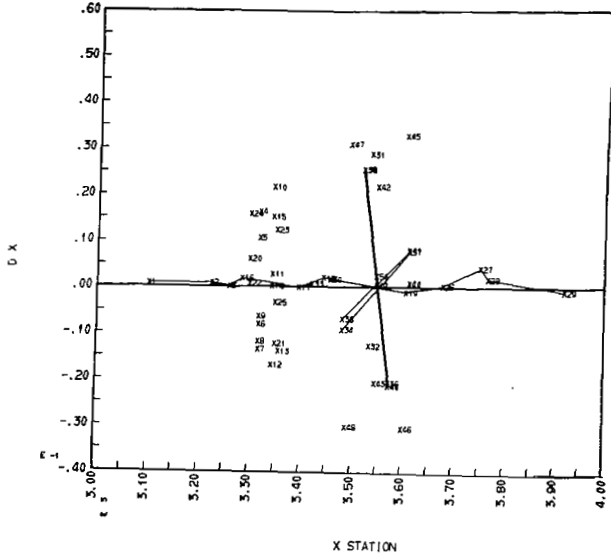

ORBITAL CONFIGURATION MODAL SURVEY - NORMALIZED TEST MODES (4C)  
MODE 8 FREQ = 2.510 HZ RUN NO. = DTAORB DATE = 06SE72

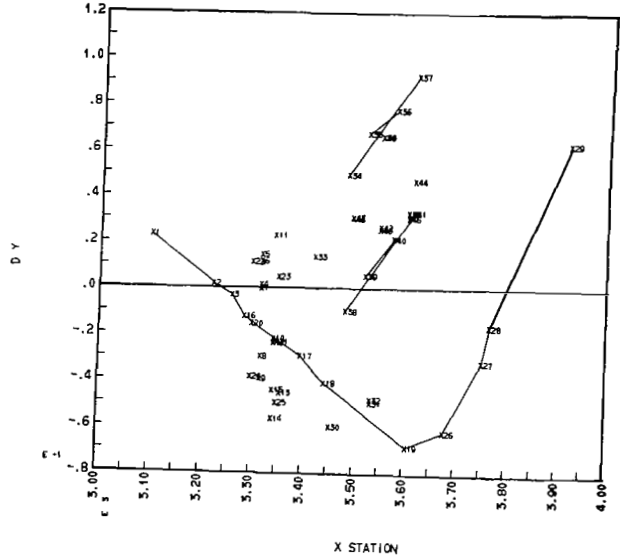

ORBITAL CONFIGURATION MODAL SURVEY - NORMALIZED TEST MODES (4C)  
MODE 8 FREQ = 2.510 HZ RUN NO. = DTAORB DATE = 06SE72

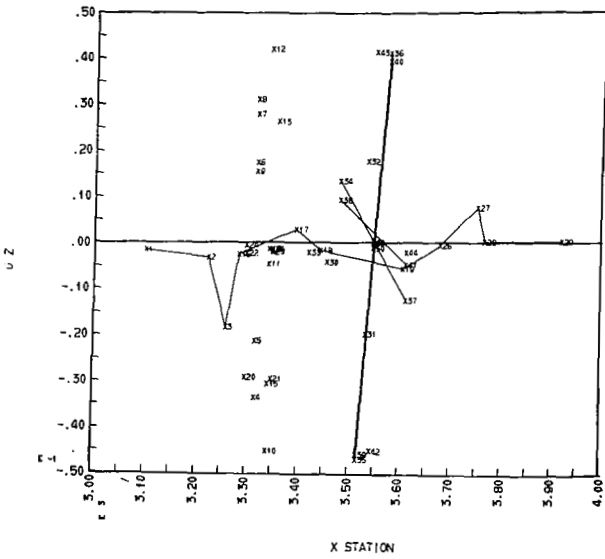

ORBITAL CONFIGURATION MODAL SURVEY - NORMALIZED TEST MODES (4C)  
MODE 8 FREQ = 2.510 HZ RUN NO. = DTAORB DATE = 06SE72

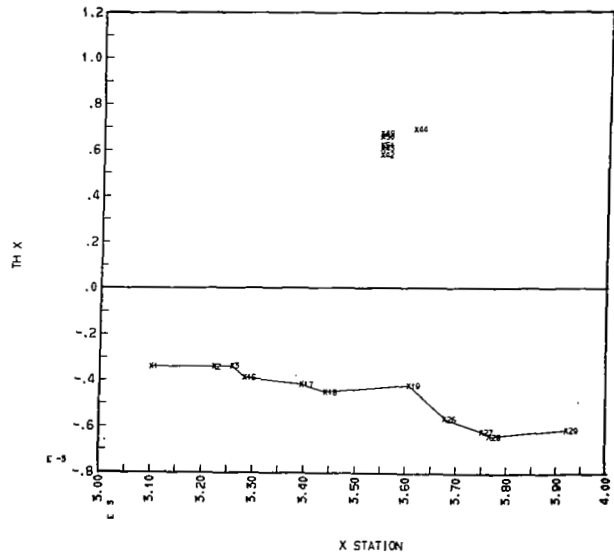

Plot B-6

ORBITAL CONFIGURATION MODAL SURVEY - NORMALIZED TEST MODES (4C)  
 MODE 8 FREQ = 2.510 HZ RUN NO. = DTAORB DATE = 06SE72

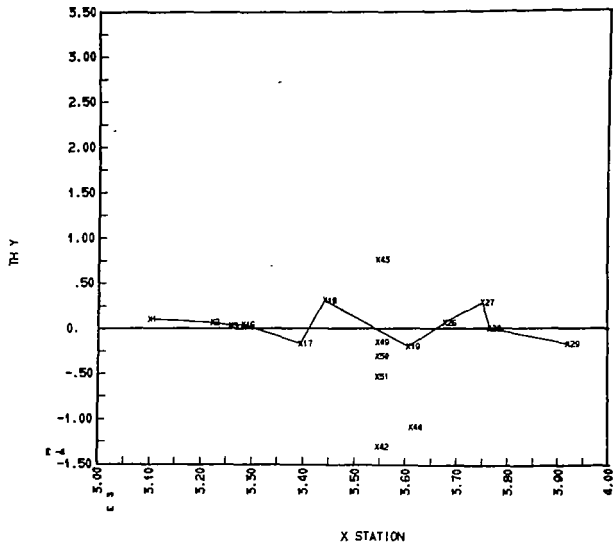

ORBITAL CONFIGURATION MODAL SURVEY - NORMALIZED TEST MODES (4C)  
 MODE 8 FREQ = 2.510 HZ RUN NO. = DTAORB DATE = 06SE72

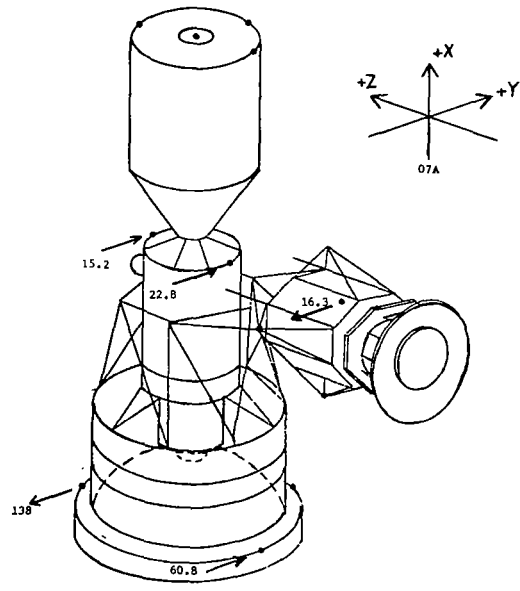
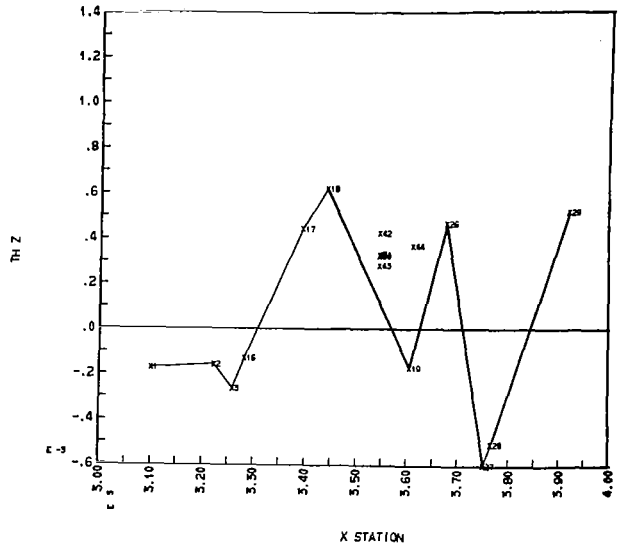



Plot B-7

ORBITAL CONFIGURATION MODAL SURVEY - NORMALIZED TEST MODES (4C)  
MODE 9 FREQ = 3.060 HZ RUN NO. = DTAORB DATE = 06SE72

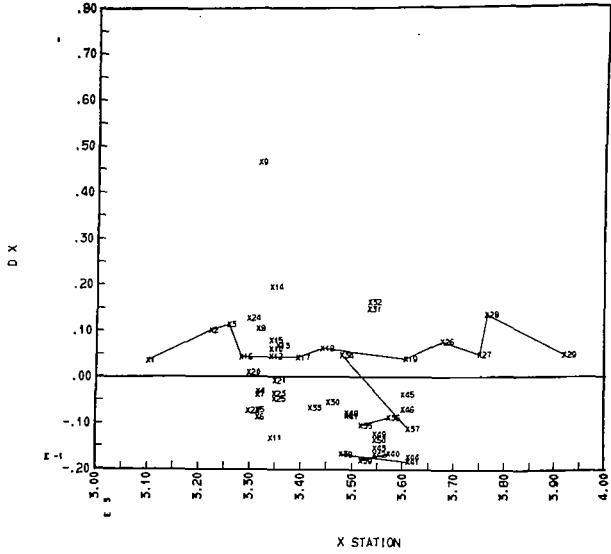

ORBITAL CONFIGURATION MODAL SURVEY - NORMALIZED TEST MODES (4C)  
MODE 9 FREQ = 3.060 HZ RUN NO. = DTAORB DATE = 06SE72

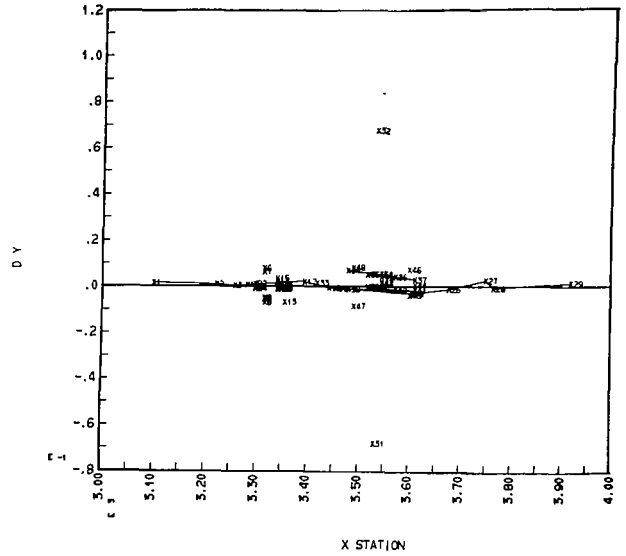

ORBITAL CONFIGURATION MODAL SURVEY - NORMALIZED TEST MODES (4C)  
MODE 9 FREQ = 3.060 HZ RUN NO. = DTAORB DATE = 06SE72

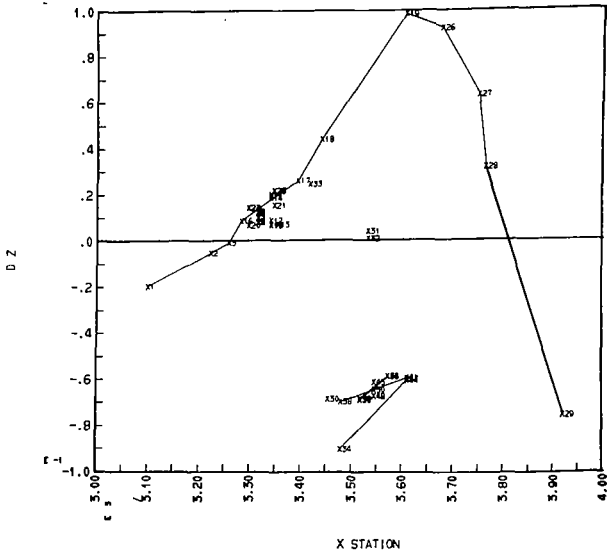

ORBITAL CONFIGURATION MODAL SURVEY - NORMALIZED TEST MODES (4C)  
MODE 9 FREQ = 3.060 HZ RUN NO. = DTAORB DATE = 06SE72

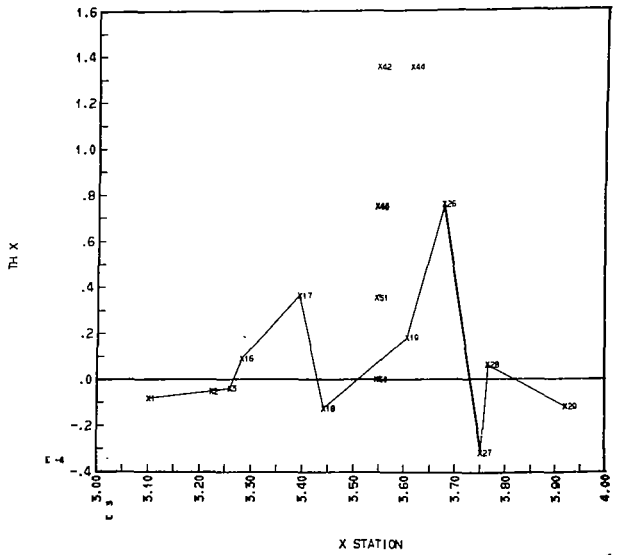

Plot B-7

ORBITAL CONFIGURATION MODAL SURVEY - NORMALIZED TEST MODES (4C)  
 MODE 9 FREQ = 3.060 HZ RUN NO. = DTAORB DATE = 06SET2

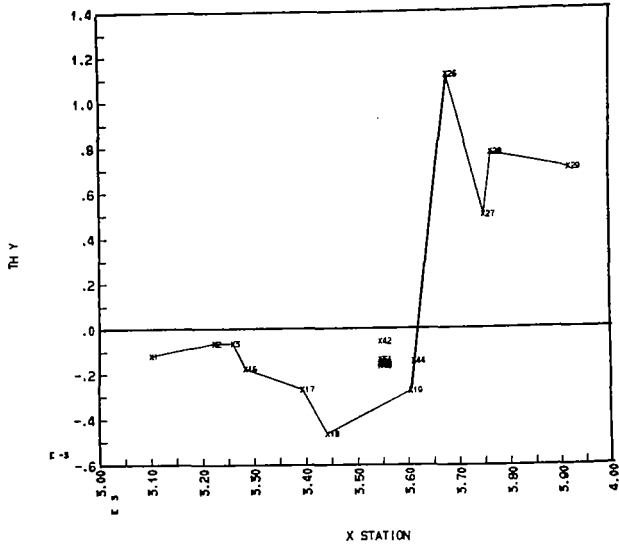

ORBITAL CONFIGURATION MODAL SURVEY - NORMALIZED TEST MODES (4C)  
 MODE 9 FREQ = 3.060 HZ RUN NO. = DTAORB DATE = 06SET2

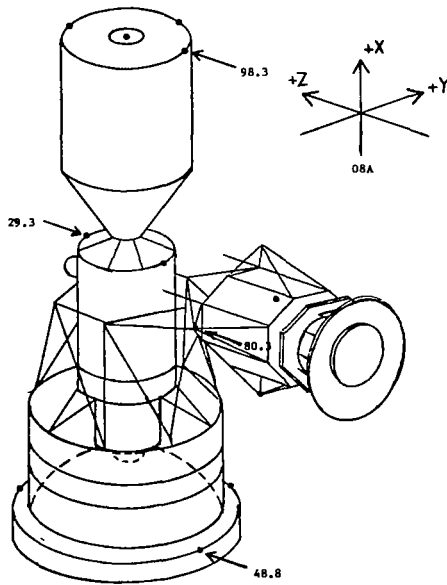
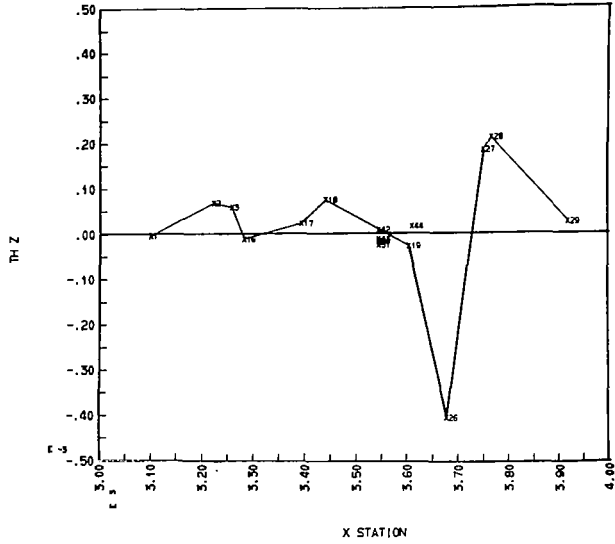

Plot B-8

ORBITAL CONFIGURATION MODAL SURVEY - NORMALIZED TEST MODES (4C)  
MODE 10 FREQ = 4.100 HZ RUN NO. = DTAORB DATE = 06SE72

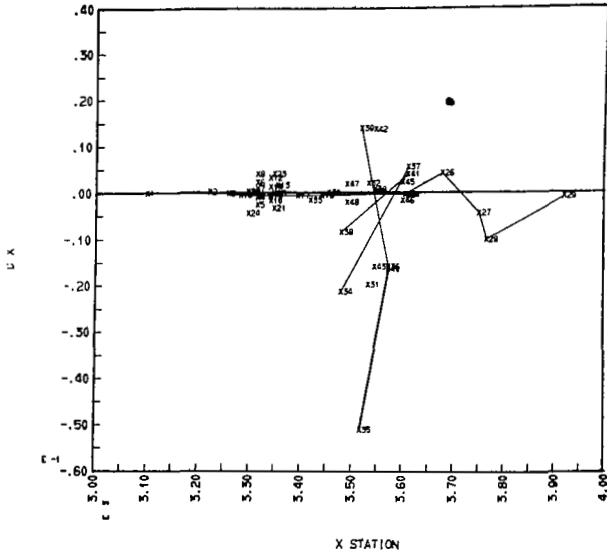

ORBITAL CONFIGURATION MODAL SURVEY - NORMALIZED TEST MODES (4C)  
MODE 10 FREQ = 4.100 HZ RUN NO. = DTAORB DATE = 06SE72

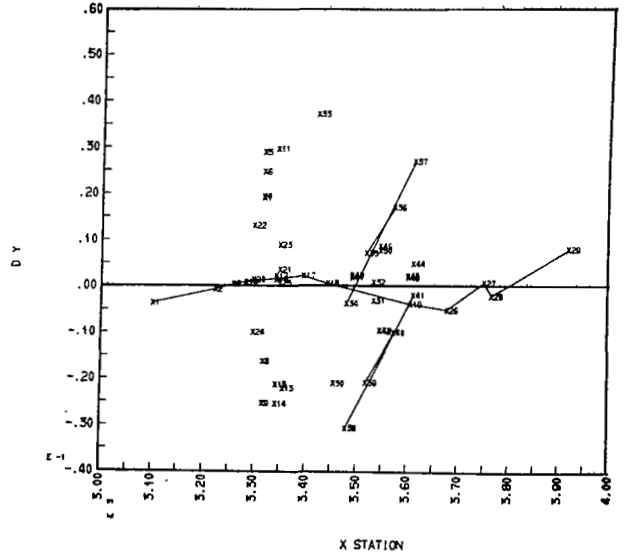

ORBITAL CONFIGURATION MODAL SURVEY - NORMALIZED TEST MODES (4C)  
MODE 10 FREQ = 4.100 HZ RUN NO. = DTAORB DATE = 06SE72

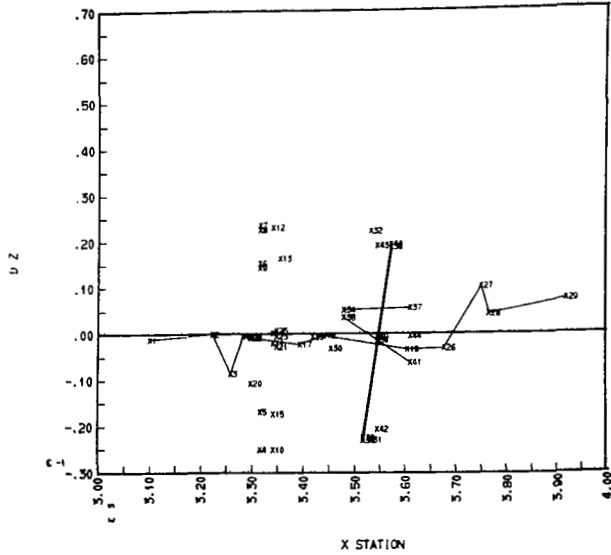

ORBITAL CONFIGURATION MODAL SURVEY - NORMALIZED TEST MODES (4C)  
MODE 10 FREQ = 4.100 HZ RUN NO. = DTAORB DATE = 06SE72

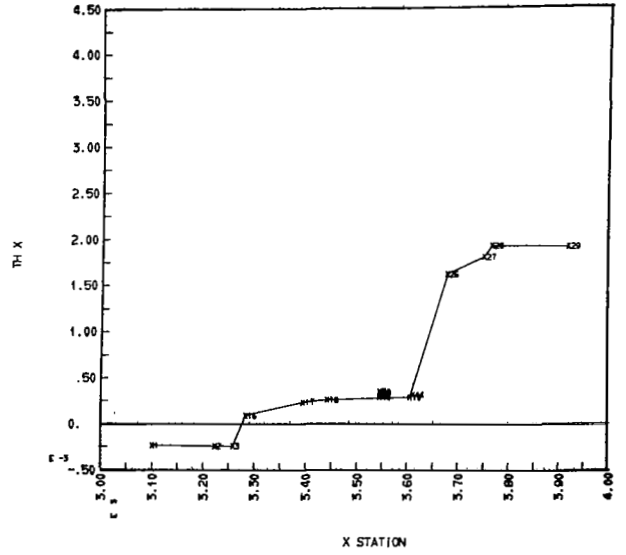

Plot B-8

ORBITAL CONFIGURATION MODAL SURVEY - NORMALIZED TEST MODES (4C)  
 MODE 10 FREQ = 4.100 HZ RUN NO. = DTACRB DATE = 06SE72

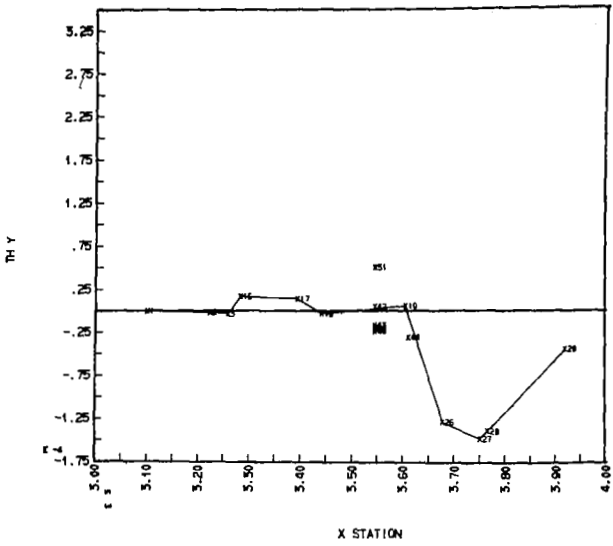

ORBITAL CONFIGURATION MODAL SURVEY - NORMALIZED TEST MODES (4C)  
 MODE 10 FREQ = 4.100 HZ RUN NO. = DTACRB DATE = 06SE72

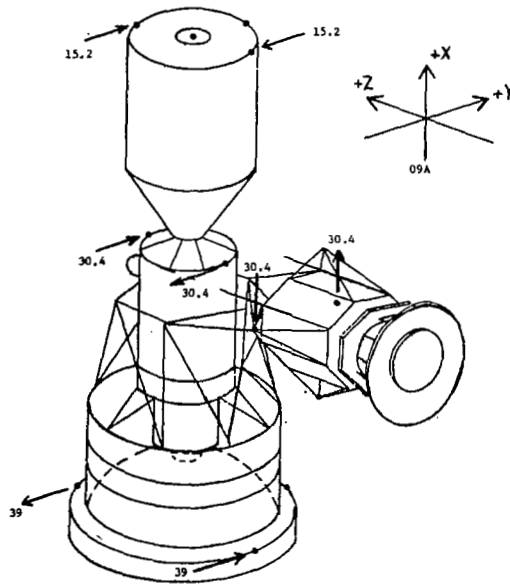
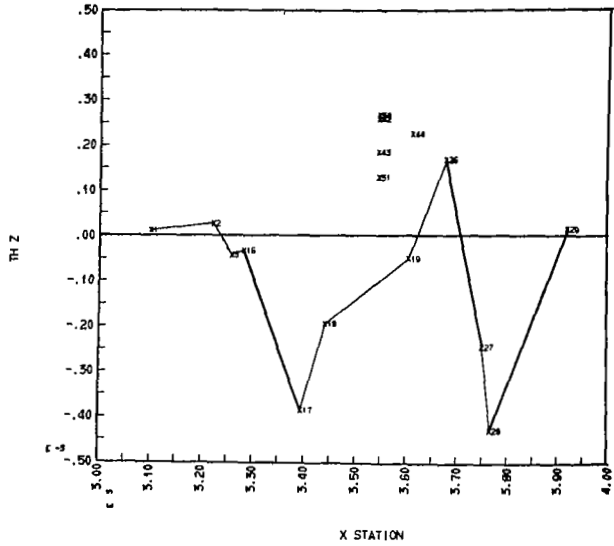

Plot B-9

ORBITAL CONFIGURATION MODAL SURVEY - NORMALIZED TEST MODES (4C)  
MODE 11 FREQ = 4.500 HZ RUN NO. = DTAOR8 DATE = 06SE72

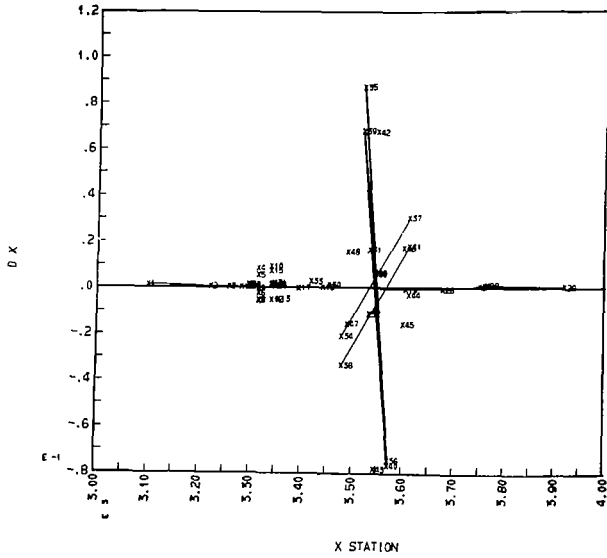

ORBITAL CONFIGURATION MODAL SURVEY - NORMALIZED TEST MODES (4C)  
MODE 11 FREQ = 4.500 HZ RUN NO. = DTAOR8 DATE = 06SE72

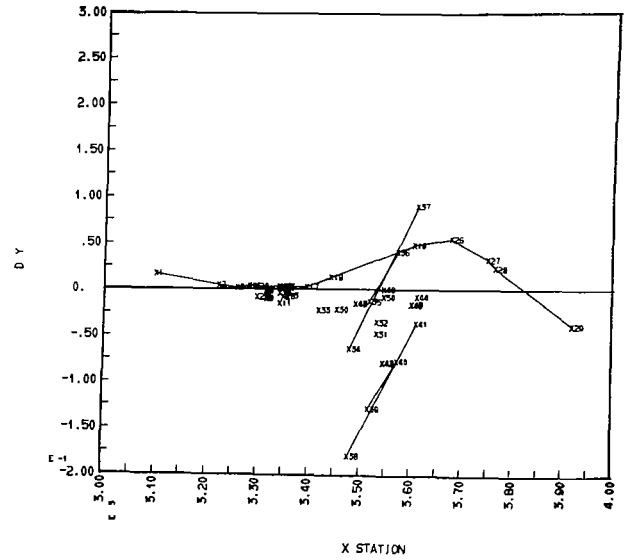

ORBITAL CONFIGURATION MODAL SURVEY - NORMALIZED TEST MODES (4C)  
MODE 11 FREQ = 4.500 HZ RUN NO. = DTAOR8 DATE = 06SE72

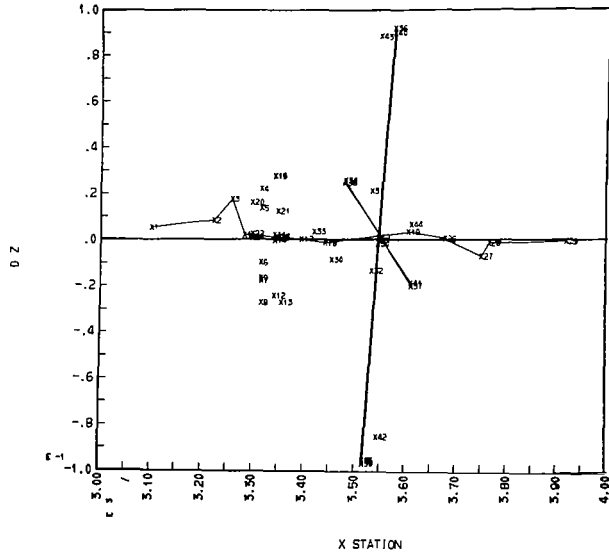

ORBITAL CONFIGURATION MODAL SURVEY - NORMALIZED TEST MODES (4C)  
MODE 11 FREQ = 4.500 HZ RUN NO. = DTAOR8 DATE = 06SE72

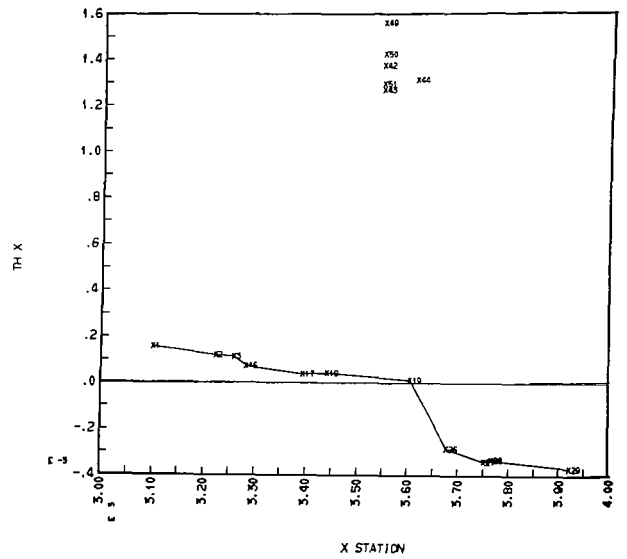

Plot B-9

ORBITAL CONFIGURATION MODAL SURVEY - NORMALIZED TEST MODES (4C)  
 MODE 11 FREQ = 4.500 HZ RUN NO. = DTAOR8 DATE = 06SE72

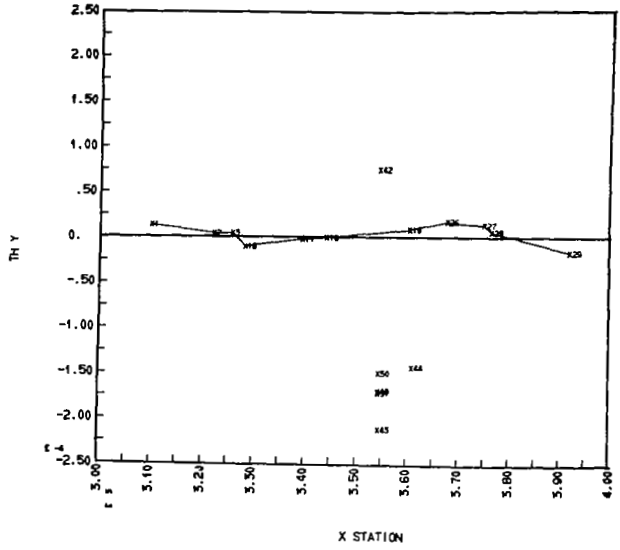

ORBITAL CONFIGURATION MODAL SURVEY - NORMALIZED TEST MODES (4C)  
 MODE 11 FREQ = 4.500 HZ RUN NO. = DTAOR8 DATE = 06SE72

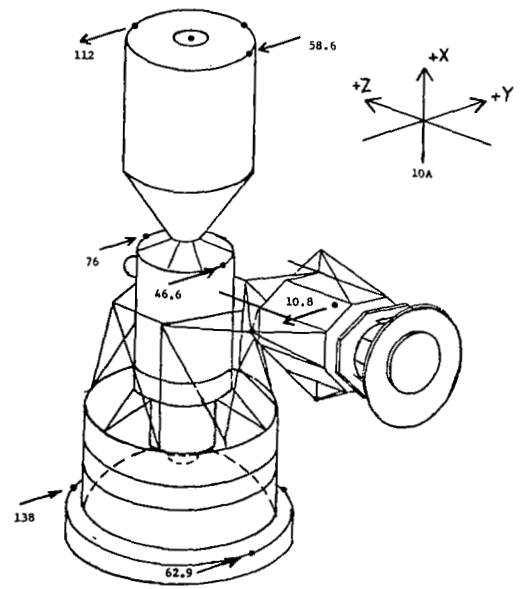
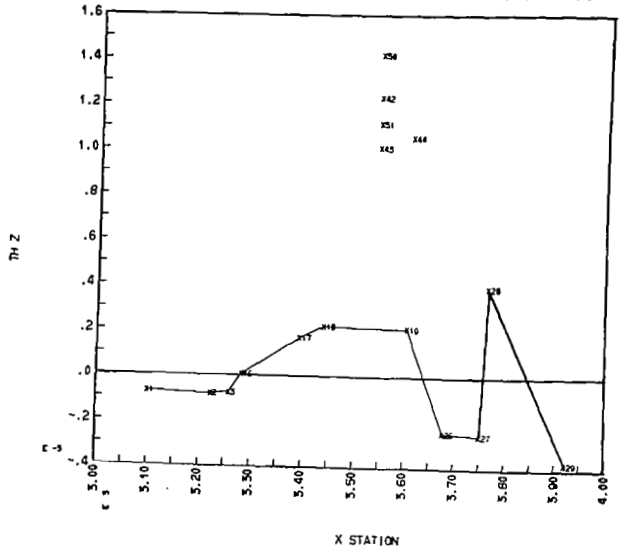

Plot B-10

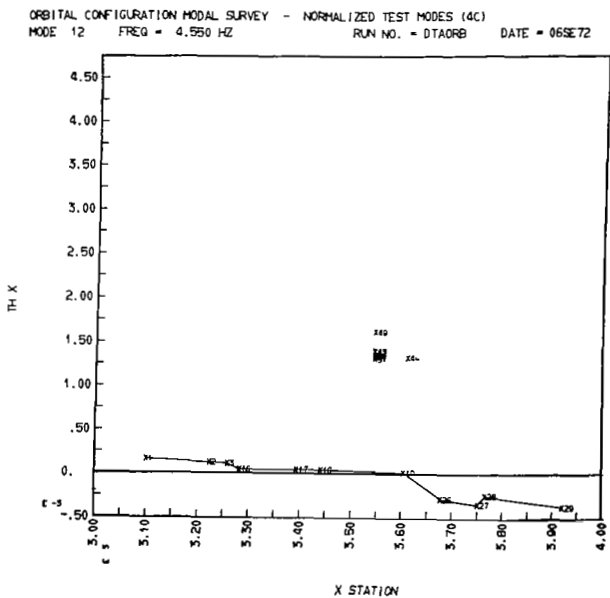
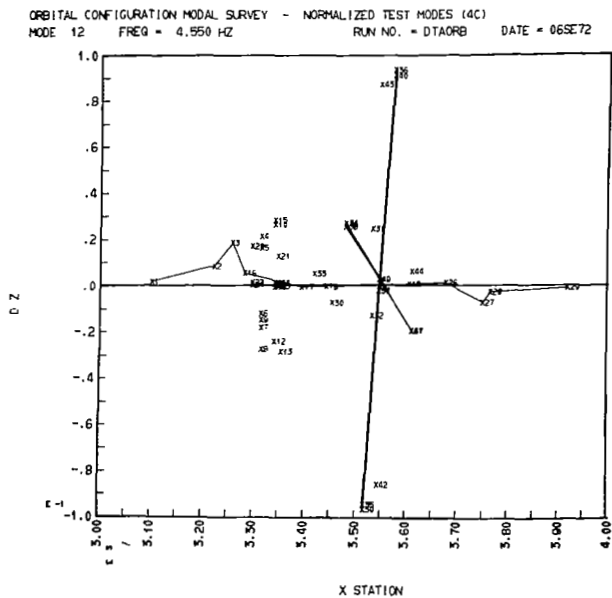
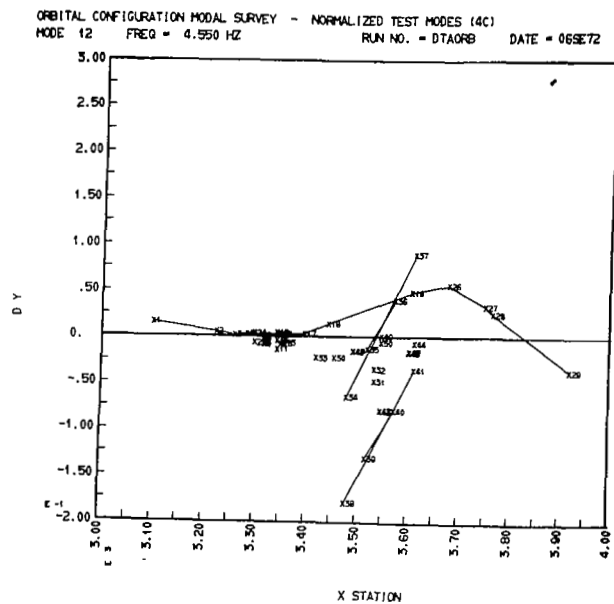
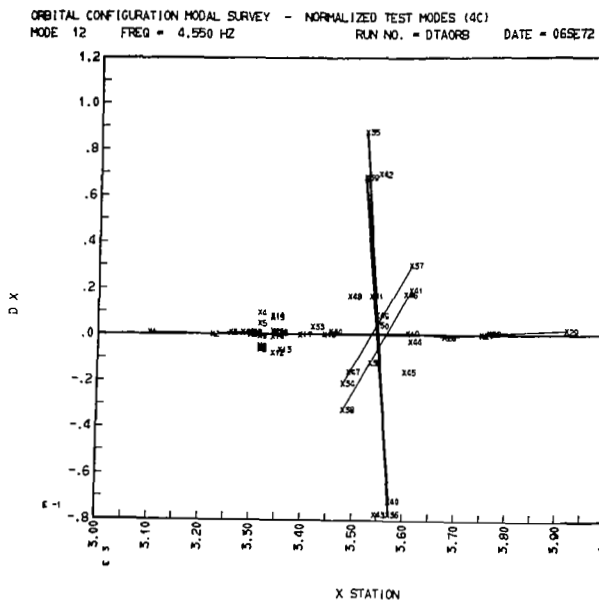

Plot B-10

ORBITAL CONFIGURATION MODAL SURVEY - NORMALIZED TEST MODES (4C)  
 MODE 12 FREQ = 4.550 HZ RUN NO. = DTAOR8 DATE = 06SE72

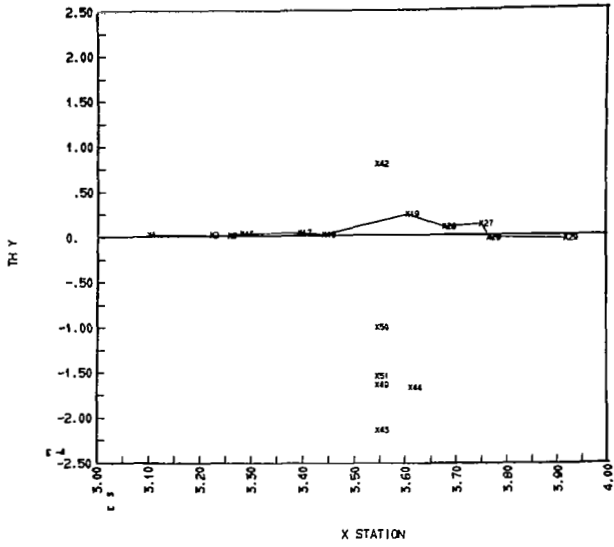

ORBITAL CONFIGURATION MODAL SURVEY - NORMALIZED TEST MODES (4C)  
 MODE 12 FREQ = 4.550 HZ RUN NO. = DTAOR8 DATE = 06SE72

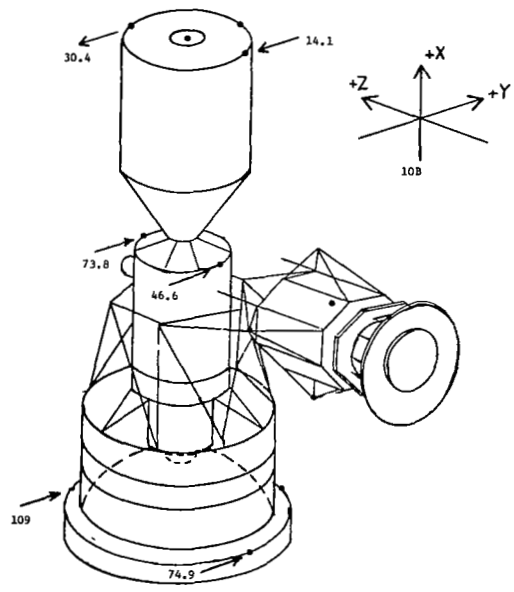
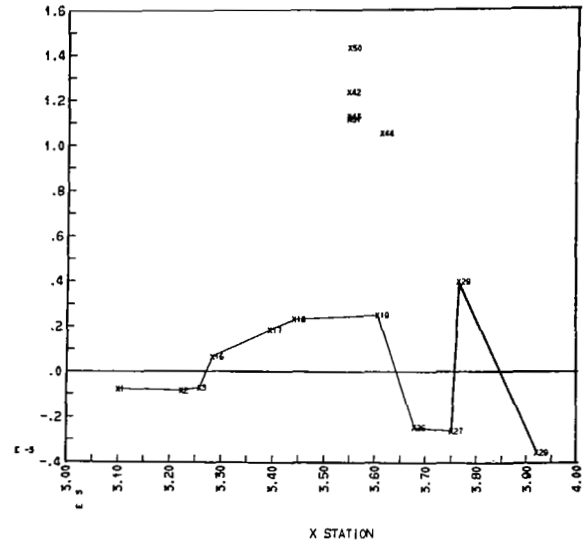



Plot B-II

ORBITAL CONFIGURATION MODAL SURVEY - NORMALIZED TEST MODES (4C)  
 MODE 13 FREQ = 5.030 HZ RUN NO. = DTAOR8 DATE = 06SE72

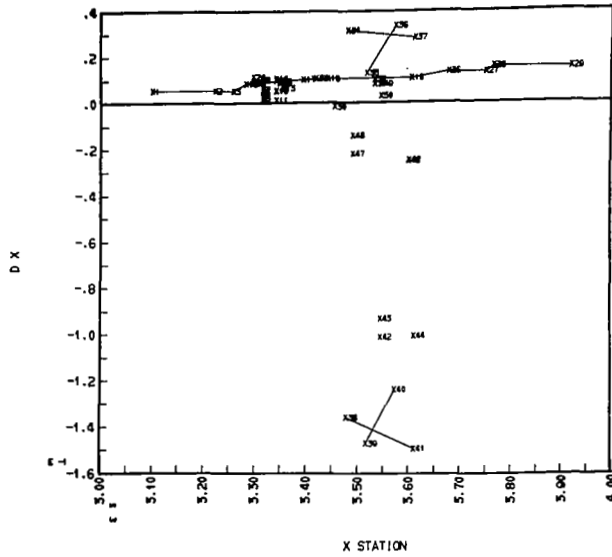

ORBITAL CONFIGURATION MODAL SURVEY - NORMALIZED TEST MODES (4C)  
 MODE 13 FREQ = 5.030 HZ RUN NO. = DTAOR8 DATE = 06SE72

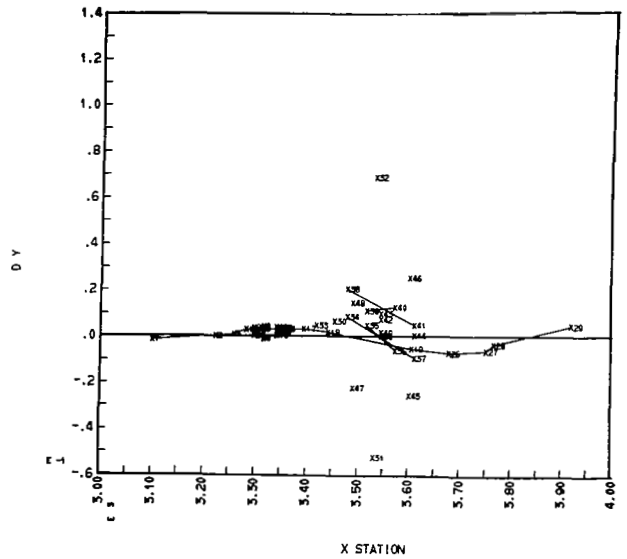

ORBITAL CONFIGURATION MODAL SURVEY - NORMALIZED TEST MODES (4C)  
 MODE 13 FREQ = 5.030 HZ RUN NO. = DTAOR8 DATE = 06SE72

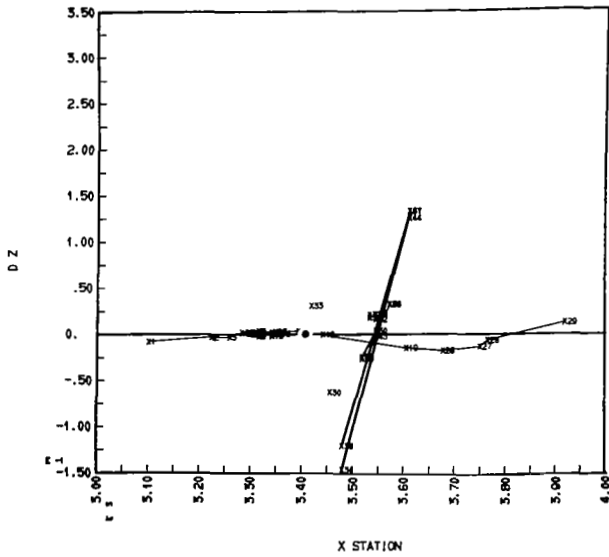

ORBITAL CONFIGURATION MODAL SURVEY - NORMALIZED TEST MODES (4C)  
 MODE 13 FREQ = 5.030 HZ RUN NO. = DTAOR8 DATE = 06SE72

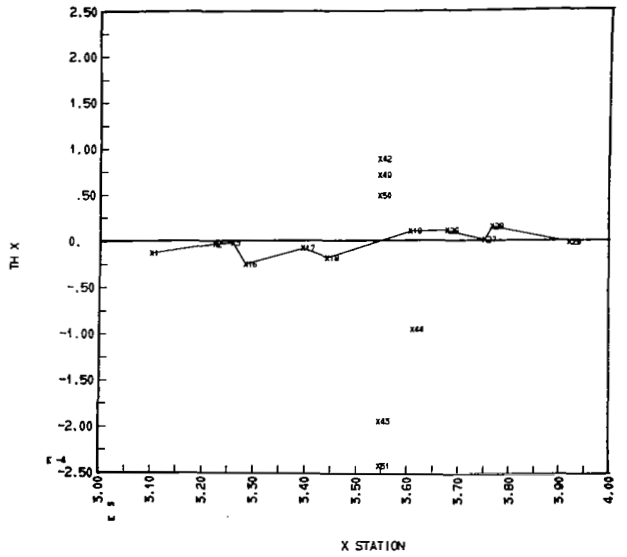

Plot 3-11

ORBITAL CONFIGURATION MODAL SURVEY - NORMALIZED TEST MODES (4C)  
 MODE 13 FREQ = 5.050 HZ RUN NO. = DTAORB DATE = 06SE72

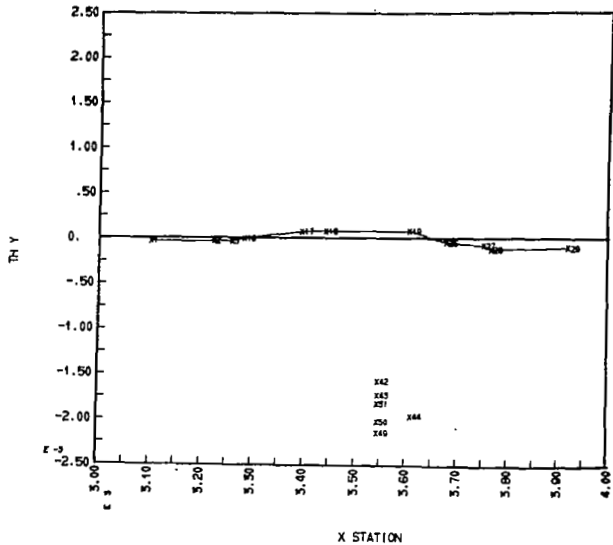

ORBITAL CONFIGURATION MODAL SURVEY - NORMALIZED TEST MODES (4C)  
 MODE 13 FREQ = 5.050 HZ RUN NO. = DTAORB DATE = 06SE72

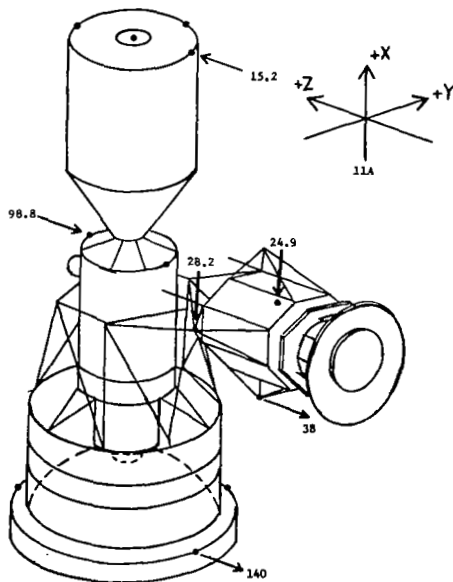
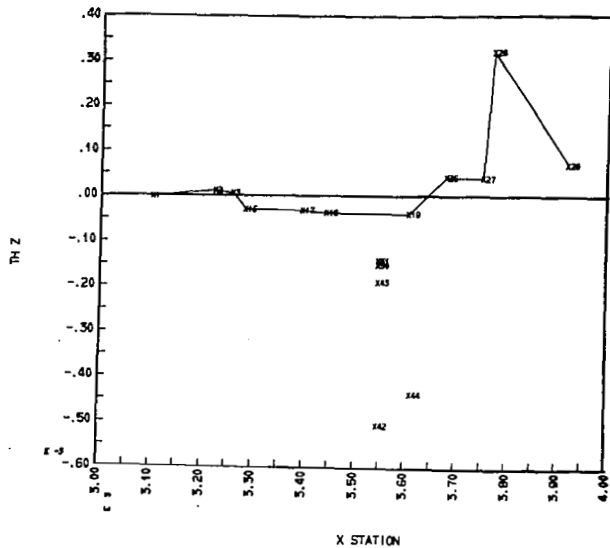

Plot B-12

ORBITAL CONFIGURATION MODAL SURVEY - NORMALIZED TEST MODES (4C)  
 MODE 14 FREQ = 5.860 HZ RUN NO. = DTAORB DATE = 06SE72

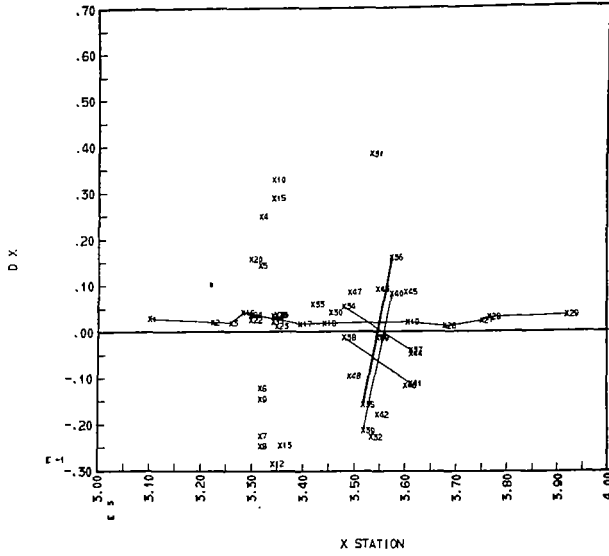

ORBITAL CONFIGURATION MODAL SURVEY - NORMALIZED TEST MODES (4C)  
 MODE 14 FREQ = 5.860 HZ RUN NO. = DTAORB DATE = 06SE72

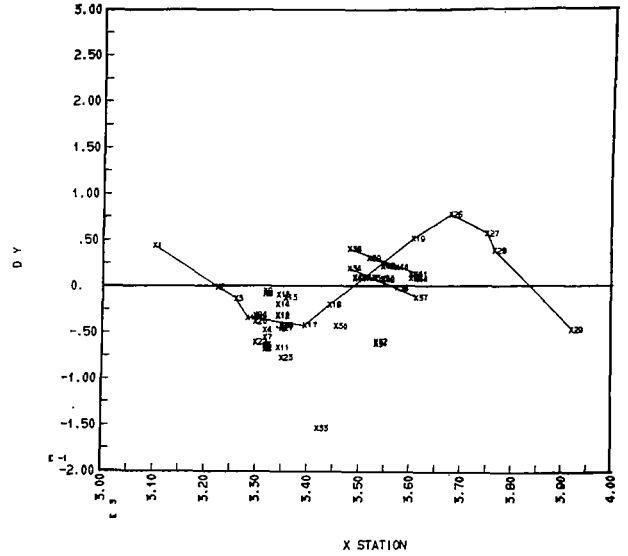

ORBITAL CONFIGURATION MODAL SURVEY - NORMALIZED TEST MODES (4C)  
 MODE 14 FREQ = 5.860 HZ RUN NO. = DTAORB DATE = 06SE72

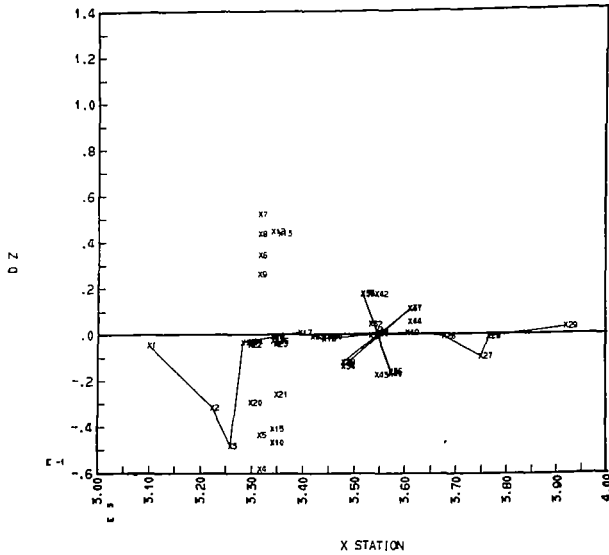

ORBITAL CONFIGURATION MODAL SURVEY - NORMALIZED TEST MODES (4C)  
 MODE 14 FREQ = 5.860 HZ RUN NO. = DTAORB DATE = 06SE72

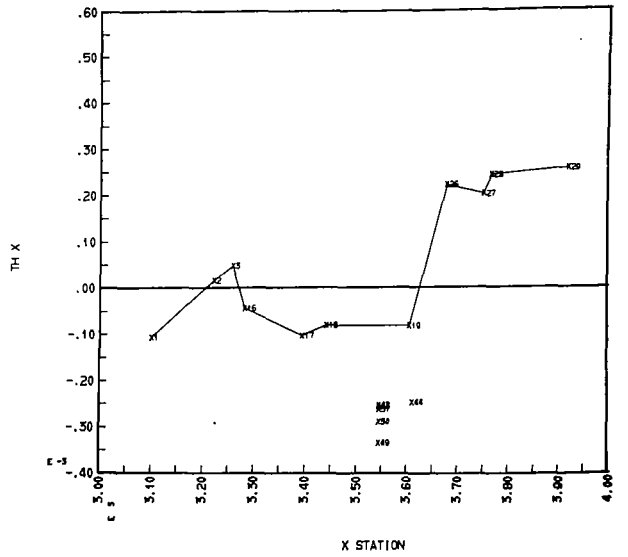

Plot B-12

ORBITAL CONFIGURATION MODAL SURVEY - NORMALIZED TEST MODES (4C)  
 MODE 14 FREQ = 5.860 HZ RUN NO. = DTAOR8 DATE = 06SE72

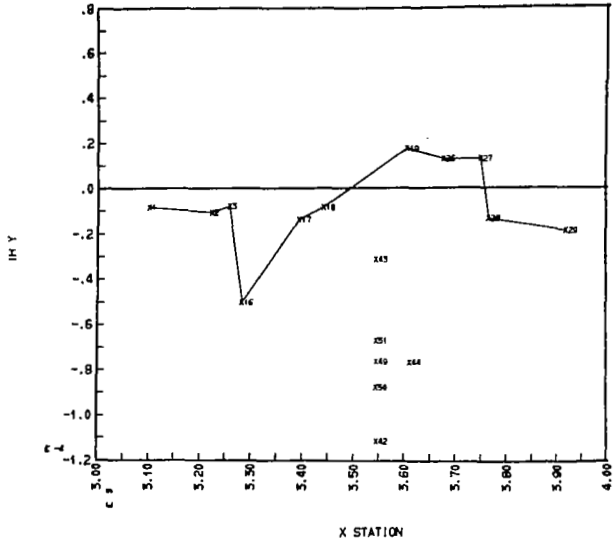

ORBITAL CONFIGURATION MODAL SURVEY - NORMALIZED TEST MODES (4C)  
 MODE 14 FREQ = 5.860 HZ RUN NO. = DTAOR8 DATE = 06SE72

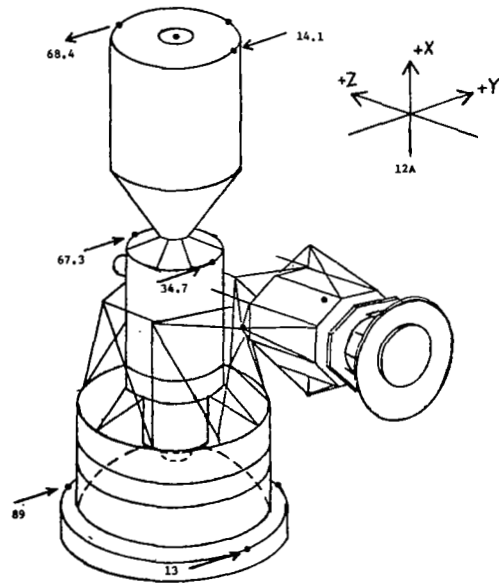
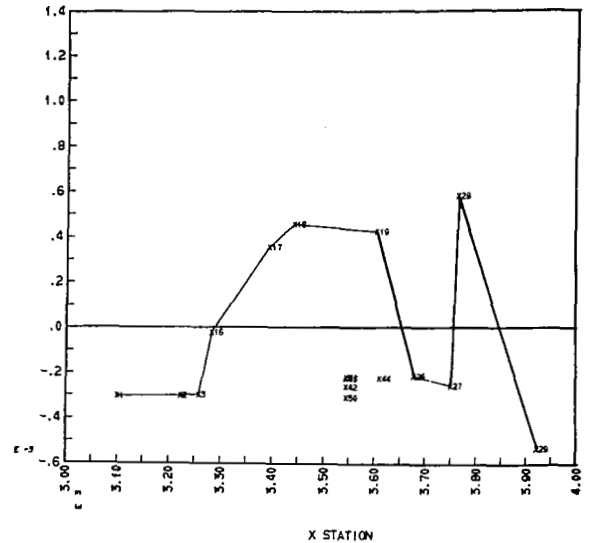

Plot B-13

ORBITAL CONFIGURATION MODAL SURVEY - NORMALIZED TEST MODES (4C)  
 MODE 15 FREQ = 6.250 HZ RUN NO. = DTAORB DATE = 06SE72

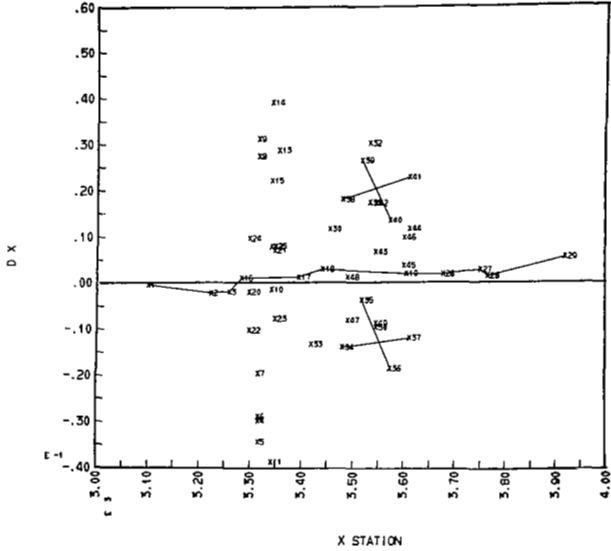

ORBITAL CONFIGURATION MODAL SURVEY - NORMALIZED TEST MODES (4C)  
 MODE 15 FREQ = 6.250 HZ RUN NO. = DTAORB DATE = 06SE72

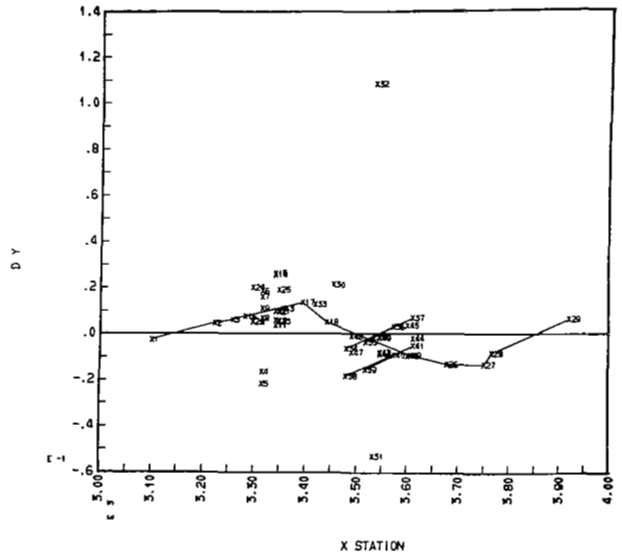

ORBITAL CONFIGURATION MODAL SURVEY - NORMALIZED TEST MODES (4C)  
 MODE 15 FREQ = 6.250 HZ RUN NO. = DTAORB DATE = 06SE72

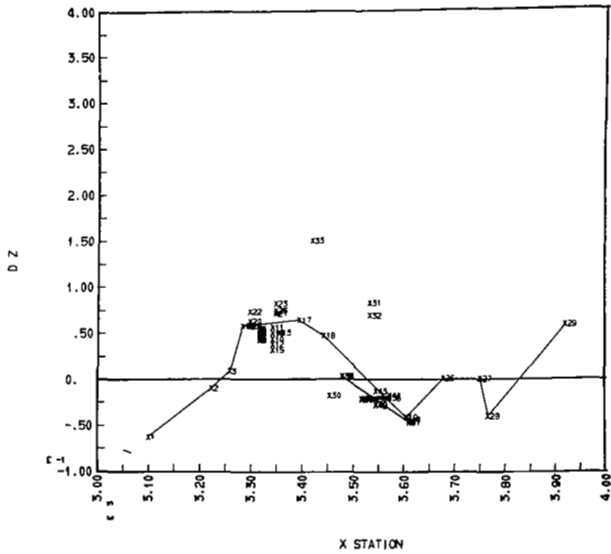

ORBITAL CONFIGURATION MODAL SURVEY - NORMALIZED TEST MODES (4C)  
 MODE 15 FREQ = 6.250 HZ RUN NO. = DTAORB DATE = 06SE72

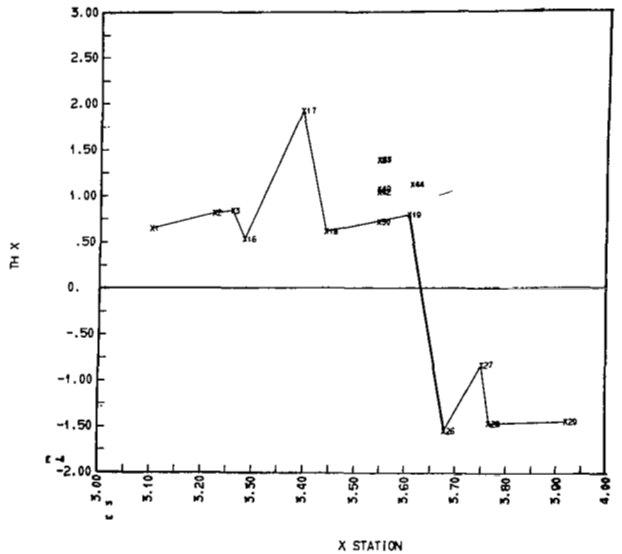

Plot B-13

ORBITAL CONFIGURATION MODAL SURVEY - NORMALIZED TEST MODES (4C)  
 MODE 15 FREQ = 6.250 HZ RUN NO. = DTAOR6 DATE = 06SE72

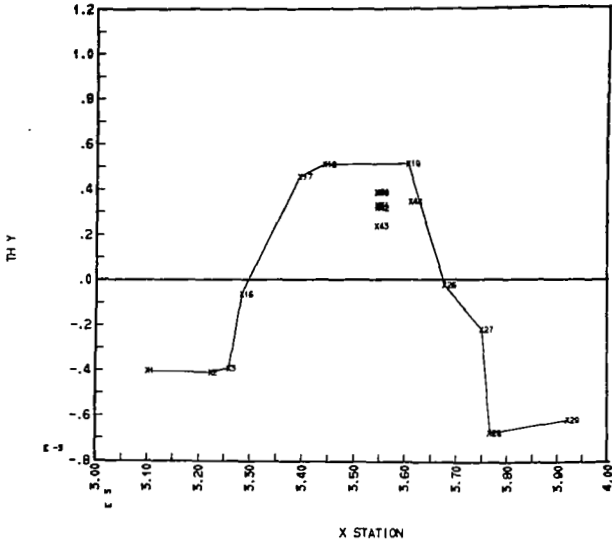

ORBITAL CONFIGURATION MODAL SURVEY - NORMALIZED TEST MODES (4C)  
 MODE 15 FREQ = 6.250 HZ RUN NO. = DTAOR6 DATE = 06SE72

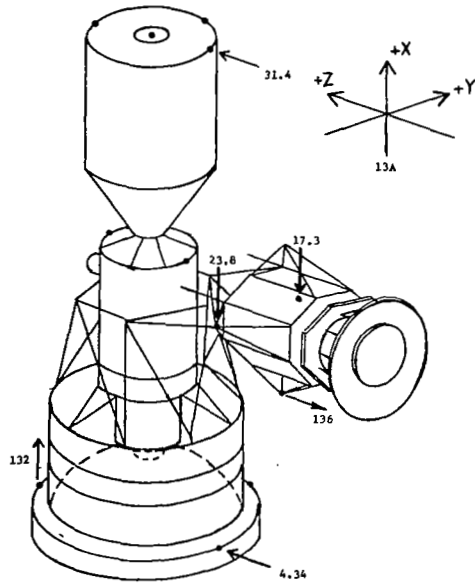
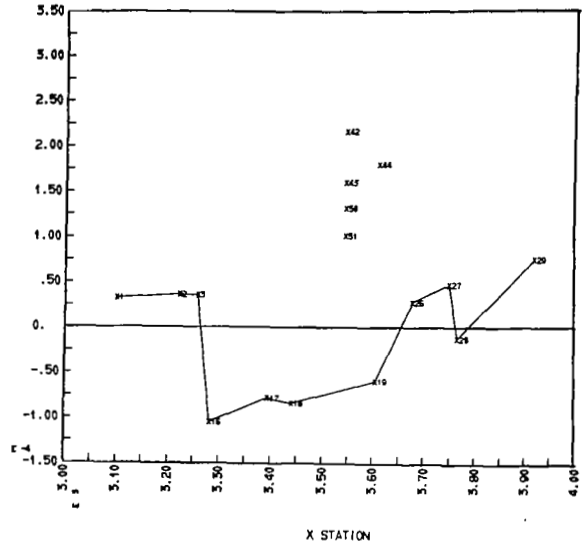

Plot B-14

ORBITAL CONFIGURATION MODAL SURVEY - NORMALIZED TEST MODES (4C)  
MODE 16 FREQ = 6.360 HZ RUN NO. = DTAORB DATE = 06SE72

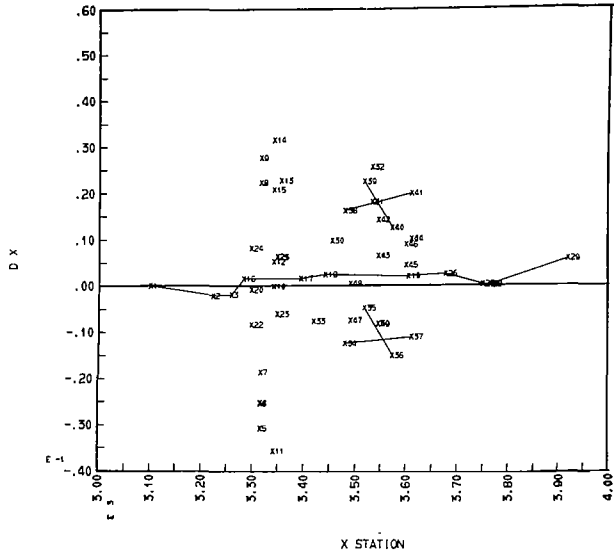

ORBITAL CONFIGURATION MODAL SURVEY - NORMALIZED TEST MODES (4C)  
MODE 16 FREQ = 6.360 HZ RUN NO. = DTAORB DATE = 06SE72

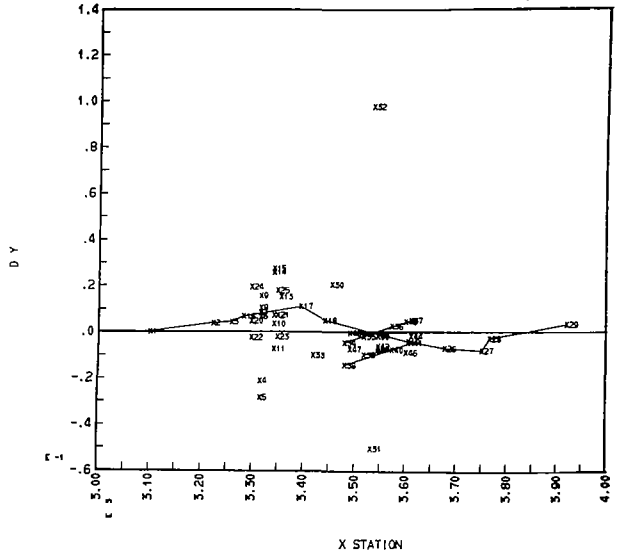

ORBITAL CONFIGURATION MODAL SURVEY - NORMALIZED TEST MODES (4C)  
MODE 16 FREQ = 6.360 HZ RUN NO. = DTAORB DATE = 06SE72

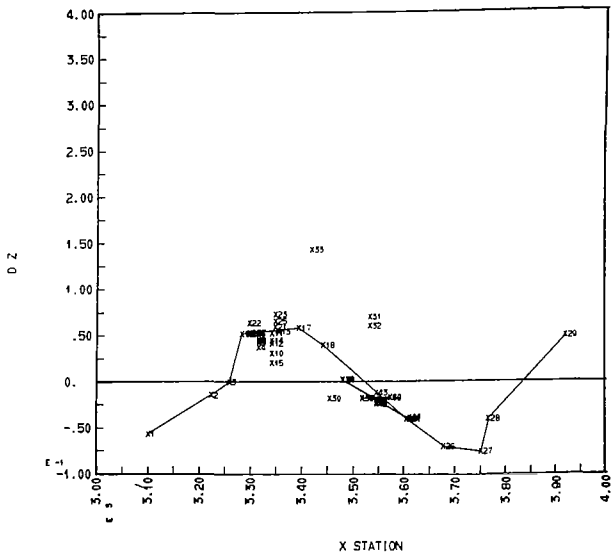

ORBITAL CONFIGURATION MODAL SURVEY - NORMALIZED TEST MODES (4C)  
MODE 16 FREQ = 6.360 HZ RUN NO. = DTAORB DATE = 06SE72

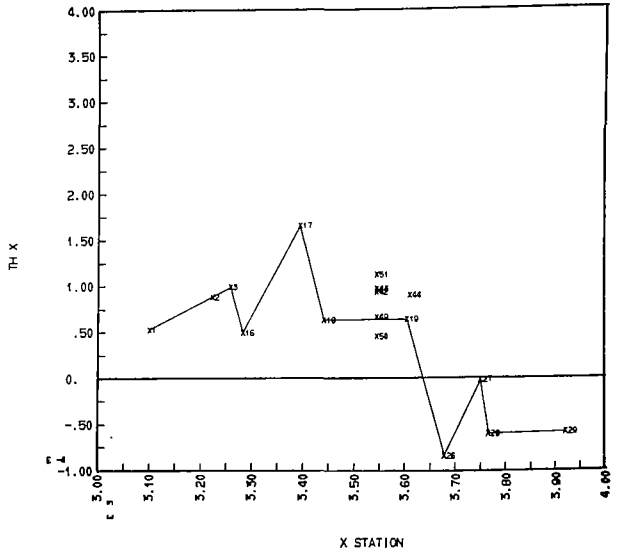

Plot B-14

ORBITAL CONFIGURATION MODAL SURVEY - NORMALIZED TEST MODES (4C)  
 MODE 16 FREQ = 6.360 HZ RUN NO. = DTAORB DATE = 06SE72

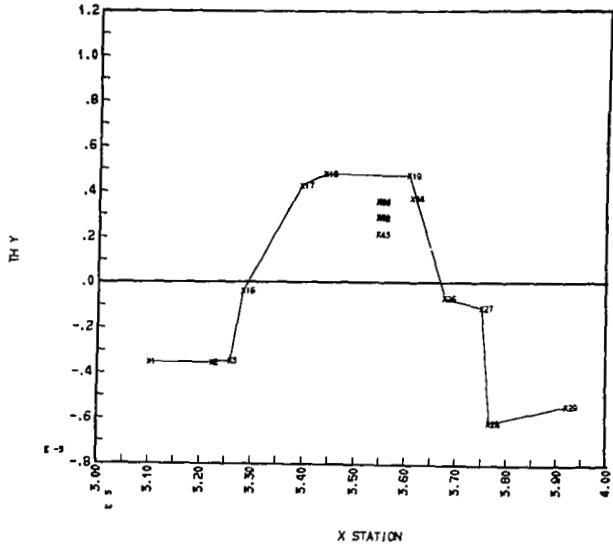

ORBITAL CONFIGURATION MODAL SURVEY - NORMALIZED TEST MODES (4C)  
 MODE 16 FREQ = 6.360 HZ RUN NO. = DTAORB DATE = 06SE72

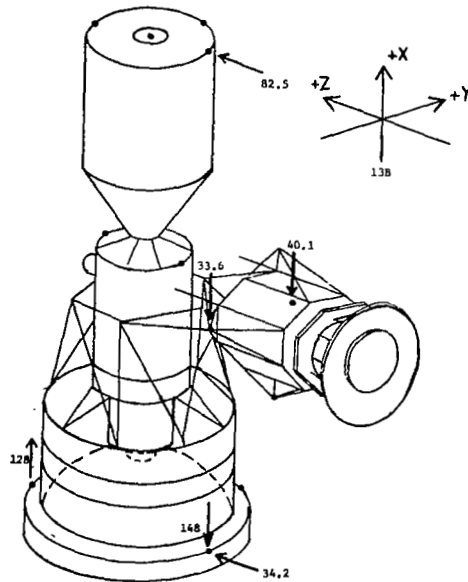
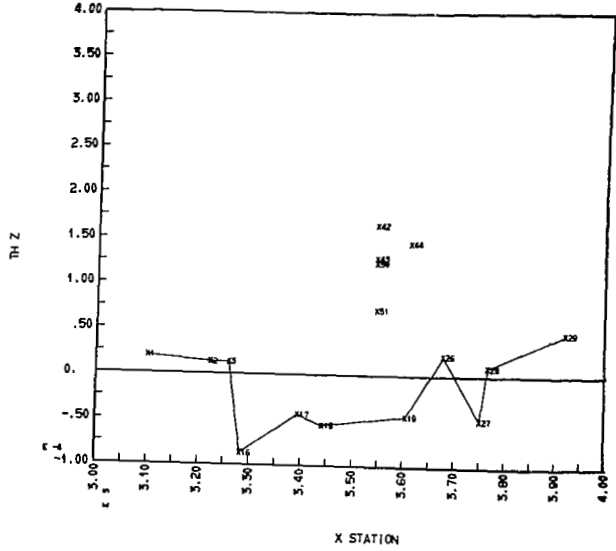



Plot B-15

ORBITAL CONFIGURATION MODAL SURVEY - NORMALIZED TEST MODES (4C)  
MODE 17 FREQ = 6.750 HZ RUN NO. = DTAOR8 DATE = 06SE72

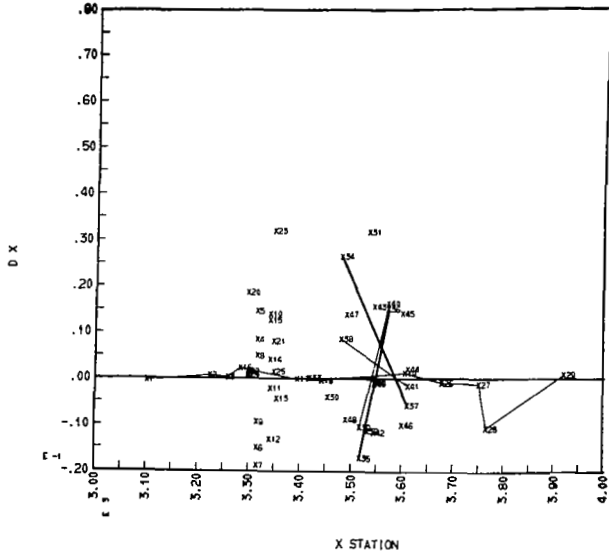

ORBITAL CONFIGURATION MODAL SURVEY - NORMALIZED TEST MODES (4C)  
MODE 17 FREQ = 6.750 HZ RUN NO. = DTAOR8 DATE = 06SE72

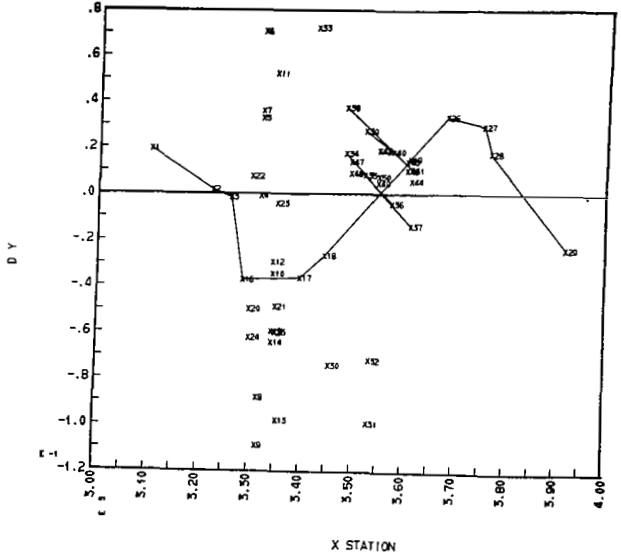

ORBITAL CONFIGURATION MODAL SURVEY - NORMALIZED TEST MODES (4C)  
MODE 17 FREQ = 6.750 HZ RUN NO. = DTAOR8 DATE = 06SE72

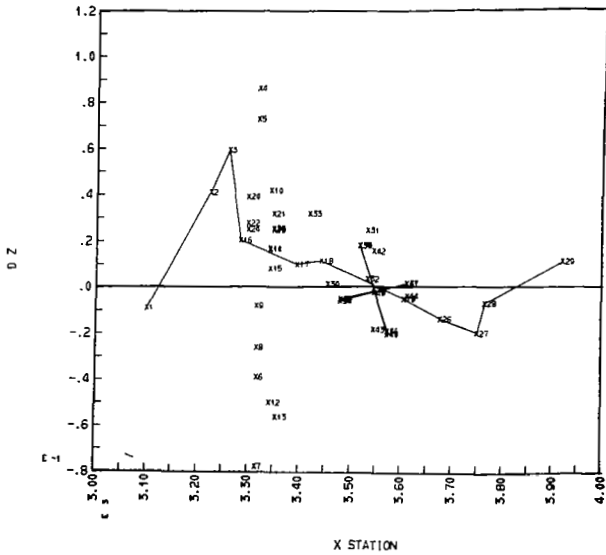

ORBITAL CONFIGURATION MODAL SURVEY - NORMALIZED TEST MODES (4C)  
MODE 17 FREQ = 6.750 HZ RUN NO. = DTAOR8 DATE = 06SE72

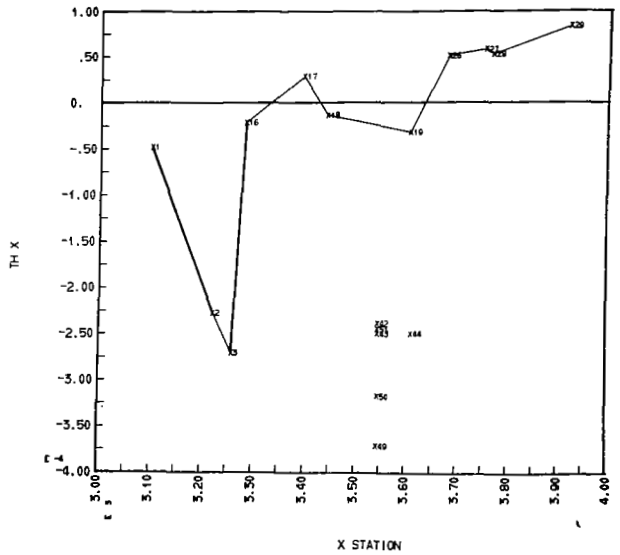

Plat R-15

ORBITAL CONFIGURATION MODAL SURVEY - NORMALIZED TEST MODES (4C)  
 MODE 17 FREQ = 6.730 HZ RUN NO. = DTAOR8 DATE = 06SE72

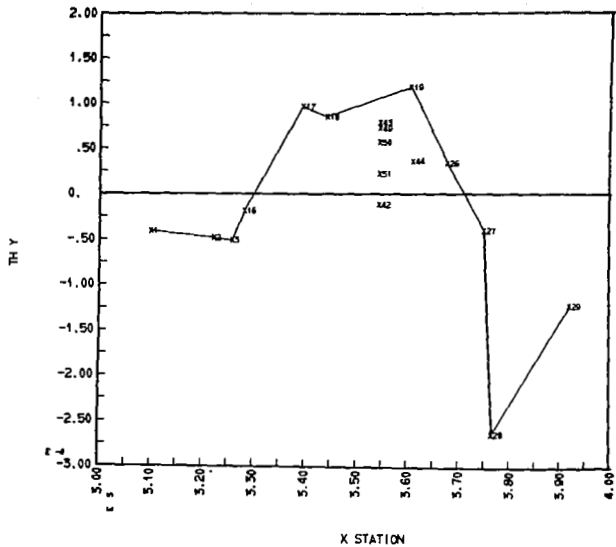

ORBITAL CONFIGURATION MODAL SURVEY - NORMALIZED TEST MODES (4C)  
 MODE 17 FREQ = 6.730 HZ RUN NO. = DTAOR8 DATE = 06SE72

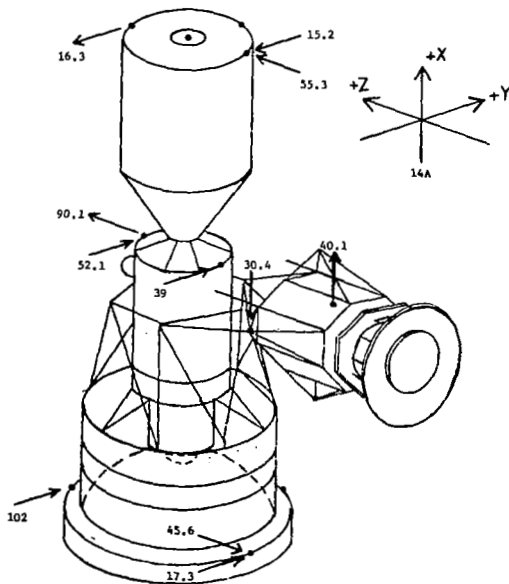
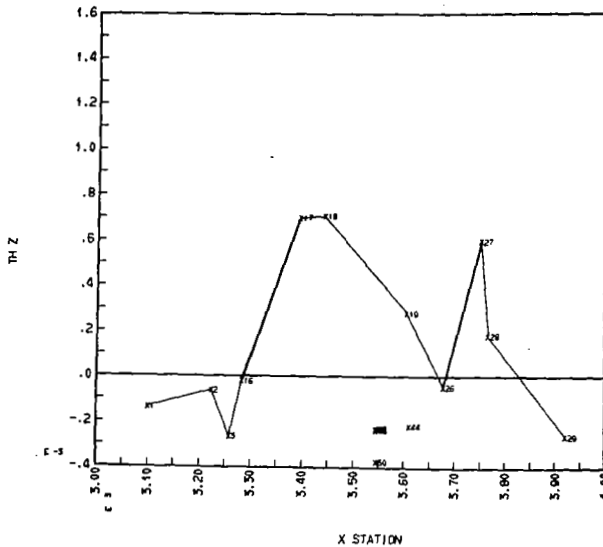

Plot B-16

ORBITAL CONFIGURATION MODAL SURVEY - NORMALIZED TEST MODES (4C)  
MODE 18 FREQ = 7.590 HZ RUN NO. = DTAOR8 DATE = 06SE72

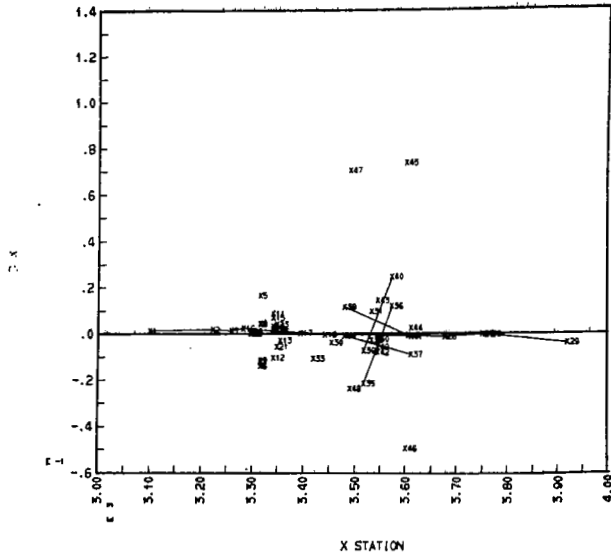

ORBITAL CONFIGURATION MODAL SURVEY - NORMALIZED TEST MODES (4C)  
MODE 18 FREQ = 7.590 HZ RUN NO. = DTAOR8 DATE = 06SE72

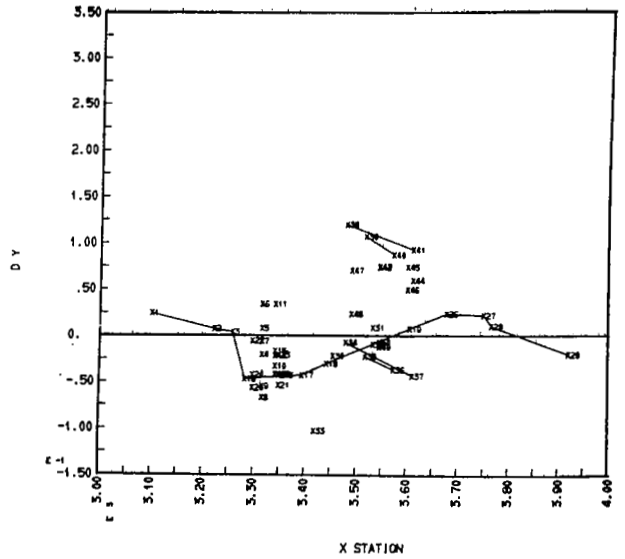

ORBITAL CONFIGURATION MODAL SURVEY - NORMALIZED TEST MODES (4C)  
MODE 18 FREQ = 7.590 HZ RUN NO. = DTAOR8 DATE = 06SE72

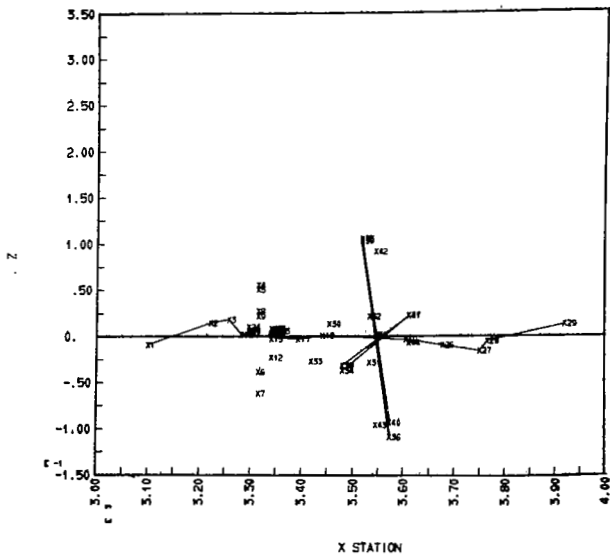

ORBITAL CONFIGURATION MODAL SURVEY - NORMALIZED TEST MODES (4C)  
MODE 18 FREQ = 7.590 HZ RUN NO. = DTAOR8 DATE = 06SE72

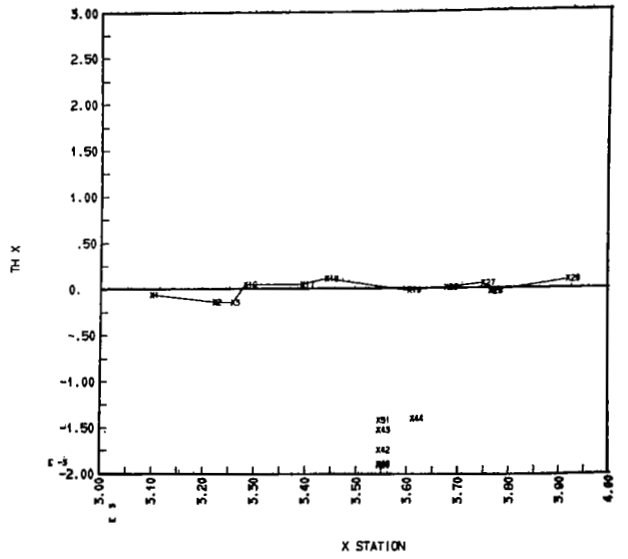

Plot B-16

ORBITAL CONFIGURATION MODAL SURVEY - NORMALIZED TEST MODES (4C)  
 MODE 18 FREQ = 7.590 HZ RUN NO. = 0TAORB DATE = 06SE72

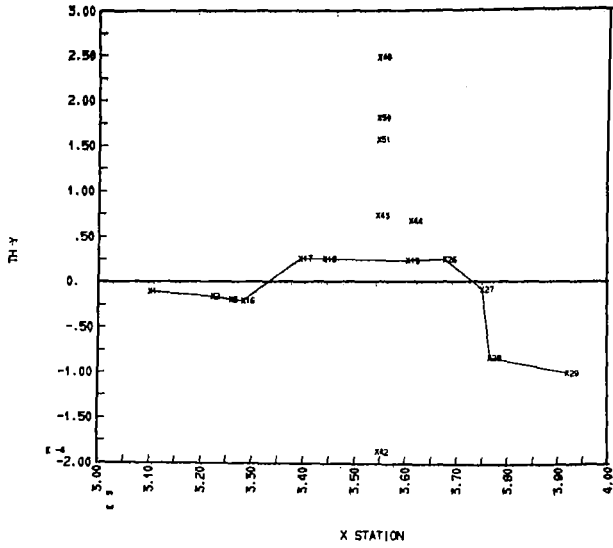

ORBITAL CONFIGURATION MODAL SURVEY - NORMALIZED TEST MODES (4C)  
 MODE 18 FREQ = 7.590 HZ RUN NO. = 0TAORB DATE = 06SE72

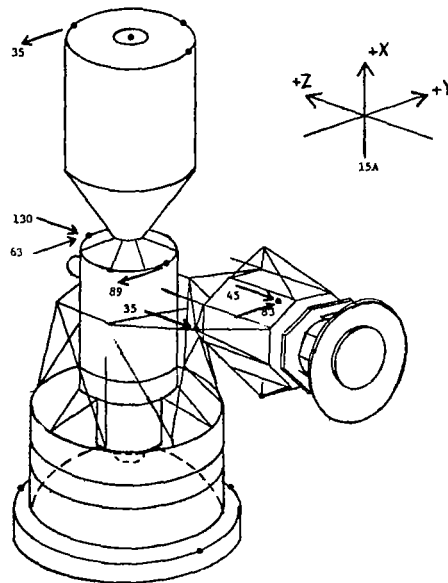
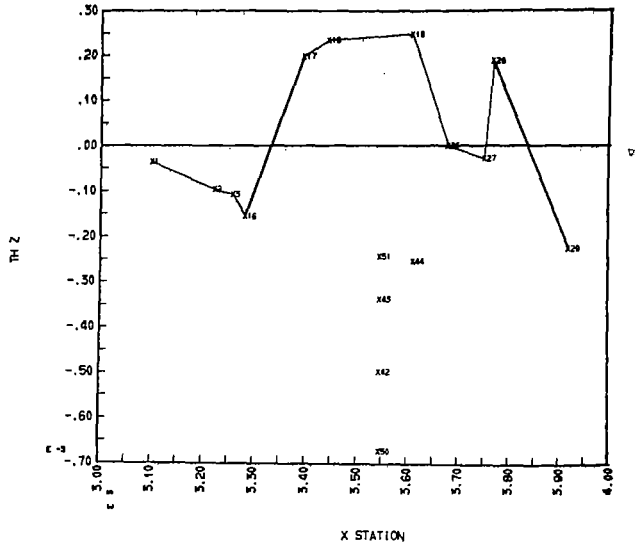

Plot B-17

ORBITAL CONFIGURATION MODAL SURVEY - NORMALIZED TEST MODES (4C)  
 MODE 19 FREQ = 8.850 HZ RUN NO. = DTAORB DATE = 06SE72

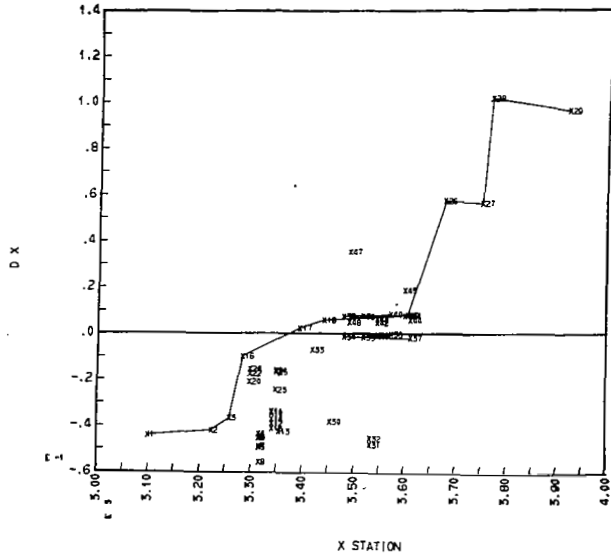

ORBITAL CONFIGURATION MODAL SURVEY - NORMALIZED TEST MODES (4C)  
 MODE 19 FREQ = 8.850 HZ RUN NO. = DTAORB DATE = 06SE72

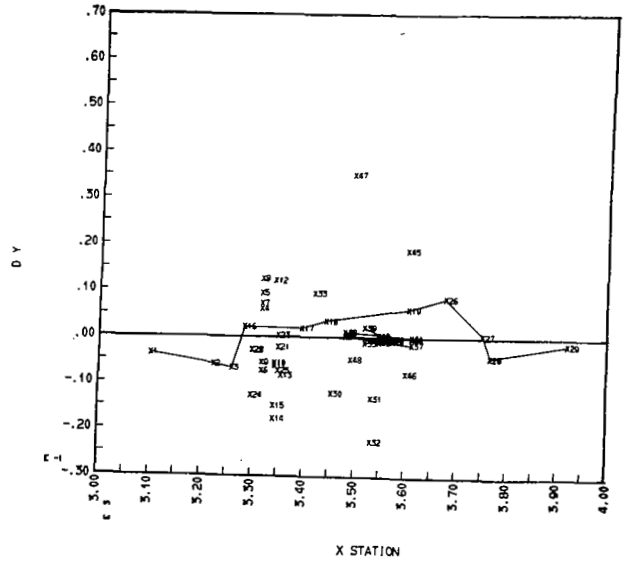

ORBITAL CONFIGURATION MODAL SURVEY - NORMALIZED TEST MODES (4C)  
 MODE 19 FREQ = 8.850 HZ RUN NO. = DTAORB DATE = 06SE72

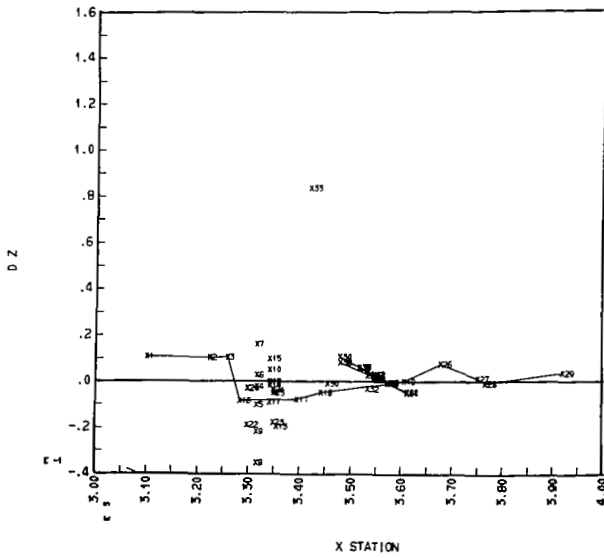

ORBITAL CONFIGURATION MODAL SURVEY - NORMALIZED TEST MODES (4C)  
 MODE 19 FREQ = 8.850 HZ RUN NO. = DTAORB DATE = 06SE72

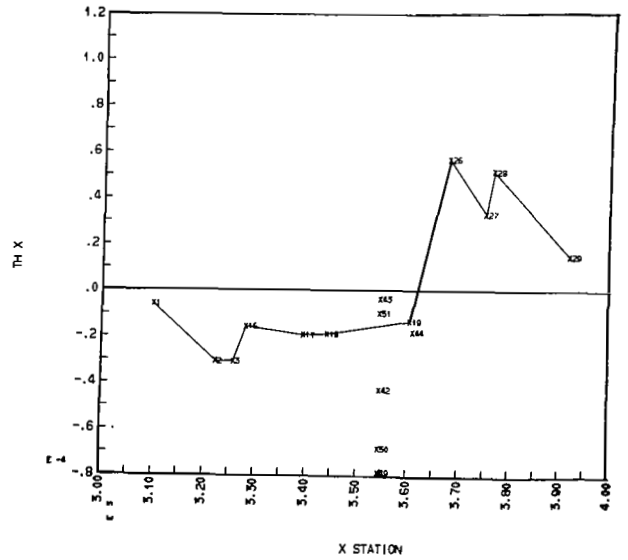

Plot B-17

ORBITAL CONFIGURATION MODAL SURVEY - NORMALIZED TEST MODES (4C)  
 MODE 19 FREQ = 8.850 HZ RUN NO. = DTA09B DATE = 06SE72

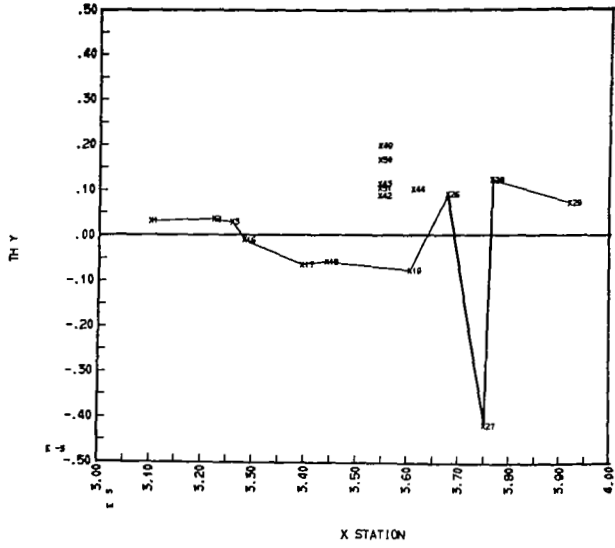

ORBITAL CONFIGURATION MODAL SURVEY - NORMALIZED TEST MODES (4C)  
 MODE 19 FREQ = 8.850 HZ RUN NO. = DTA09B DATE = 06SE72

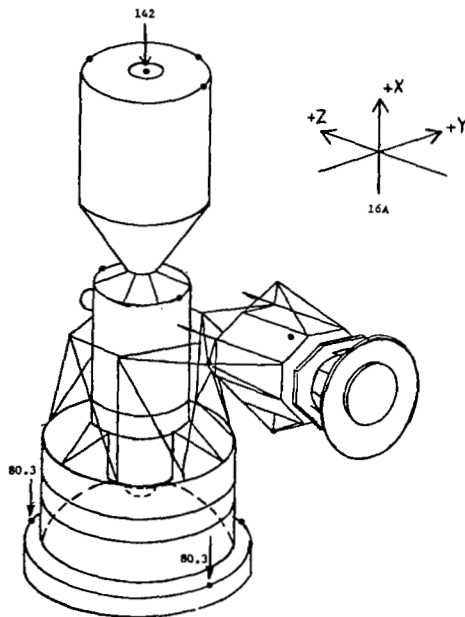
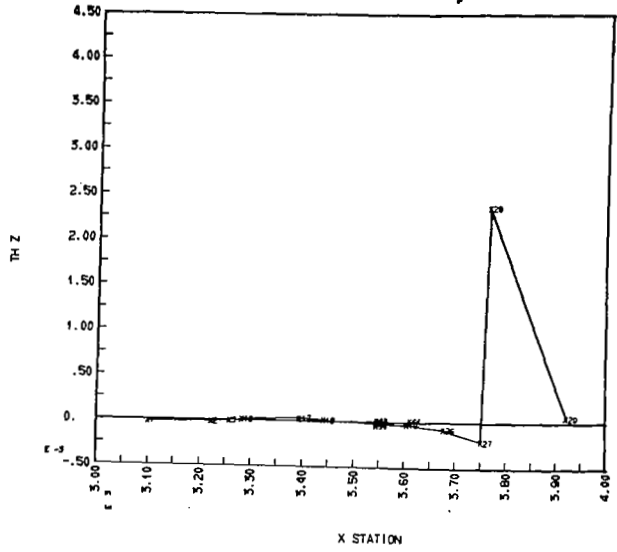

Plot B-18

ORBITAL CONFIGURATION MODAL SURVEY - NORMALIZED TEST MODES (4C)  
 MODE 20 FREQ = 11.590 HZ RUN NO. = DTAORB DATE = 06SE72

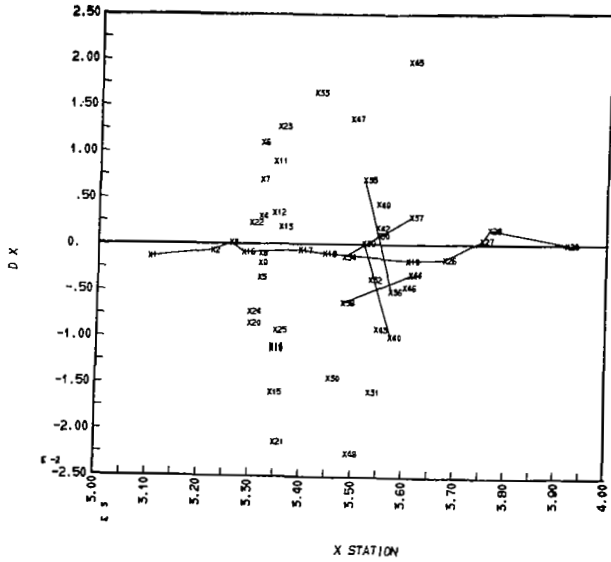

ORBITAL CONFIGURATION MODAL SURVEY - NORMALIZED TEST MODES (4C)  
 MODE 20 FREQ = 11.590 HZ RUN NO. = DTAORB DATE = 06SE72

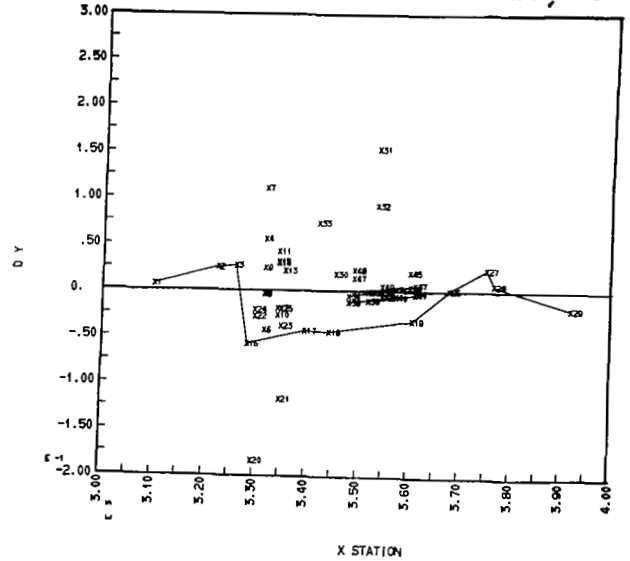

ORBITAL CONFIGURATION MODAL SURVEY - NORMALIZED TEST MODES (4C)  
 MODE 20 FREQ = 11.590 HZ RUN NO. = DTAORB DATE = 06SE72

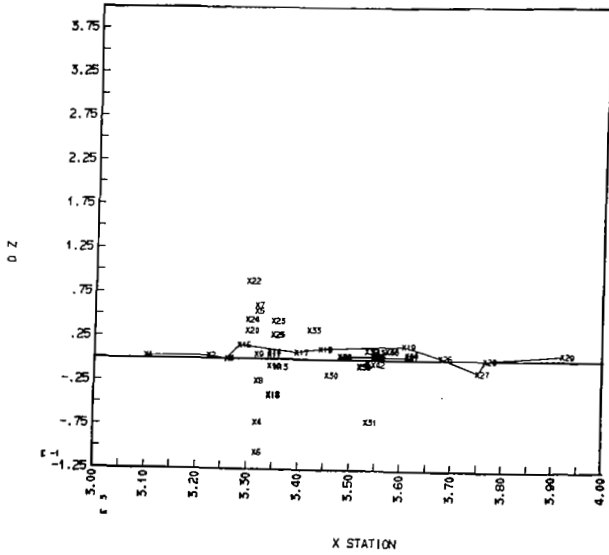

ORBITAL CONFIGURATION MODAL SURVEY - NORMALIZED TEST MODES (4C)  
 MODE 20 FREQ = 11.590 HZ RUN NO. = DTAORB DATE = 06SE72

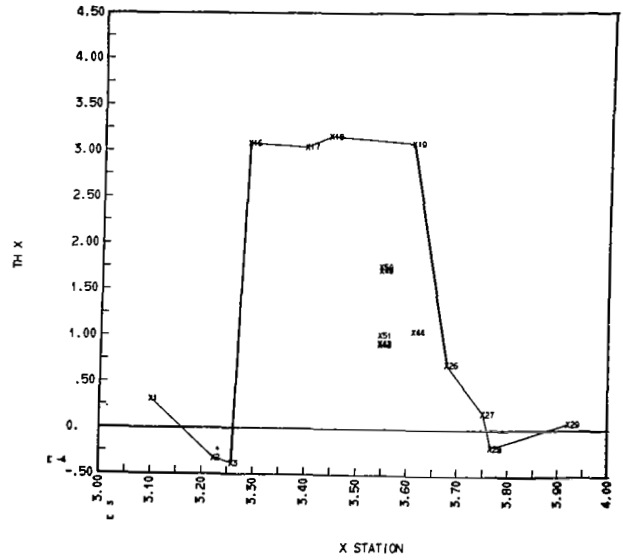

Plot B-18

ORBITAL CONFIGURATION MODAL SURVEY - NORMALIZED TEST MODES (4C)  
 MODE 20 FREQ = 11.590 HZ RUN NO. = DTAOR6 DATE = 06SE72

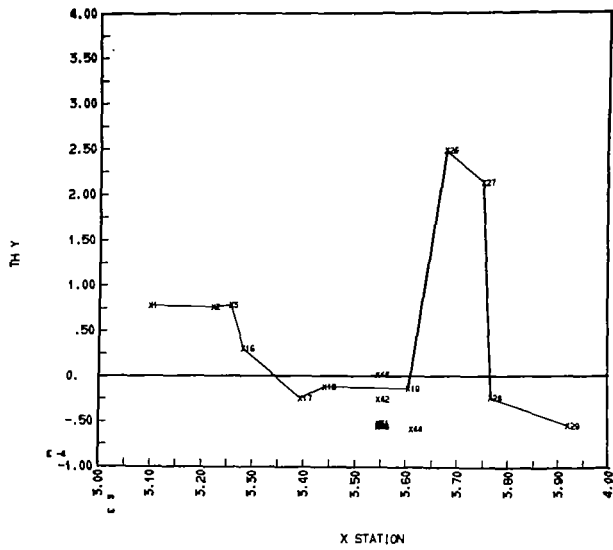

ORBITAL CONFIGURATION MODAL SURVEY - NORMALIZED TEST MODES (4C)  
 MODE 20 FREQ = 11.590 HZ RUN NO. = DTAOR6 DATE = 06SE72

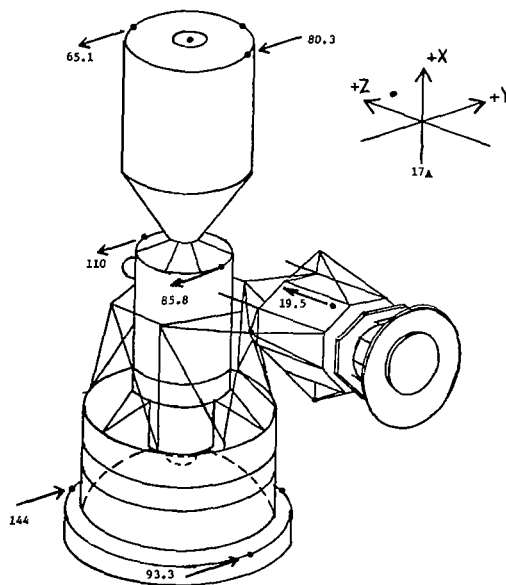
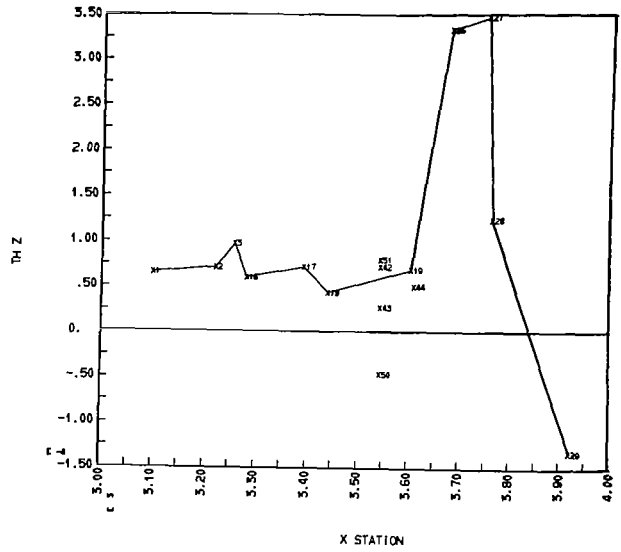



Plot B-19

ORBITAL CONFIGURATION MODAL SURVEY - NORMALIZED TEST MODES (4C)  
 MODE 21 FREQ = 12.650 HZ RUN NO. = DTAORB DATE = 06SE72

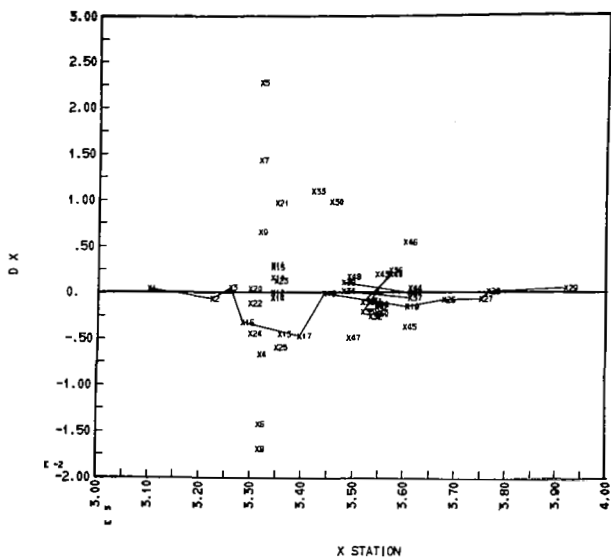

ORBITAL CONFIGURATION MODAL SURVEY - NORMALIZED TEST MODES (4C)  
 MODE 21 FREQ = 12.650 HZ RUN NO. = DTAORB DATE = 06SE72

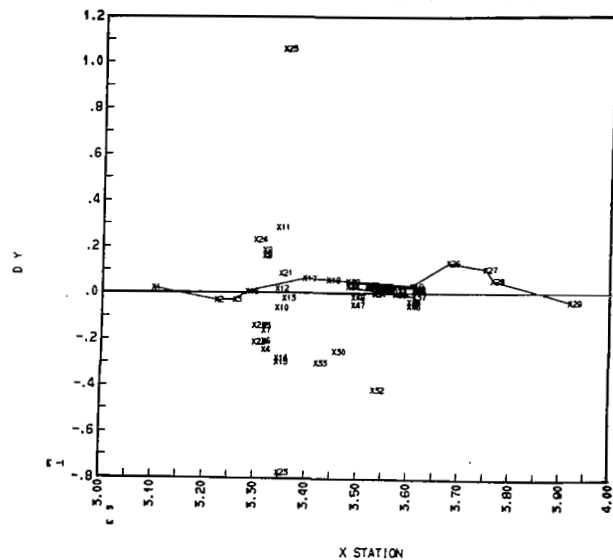

ORBITAL CONFIGURATION MODAL SURVEY - NORMALIZED TEST MODES (4C)  
 MODE 21 FREQ = 12.650 HZ RUN NO. = DTAORB DATE = 06SE72

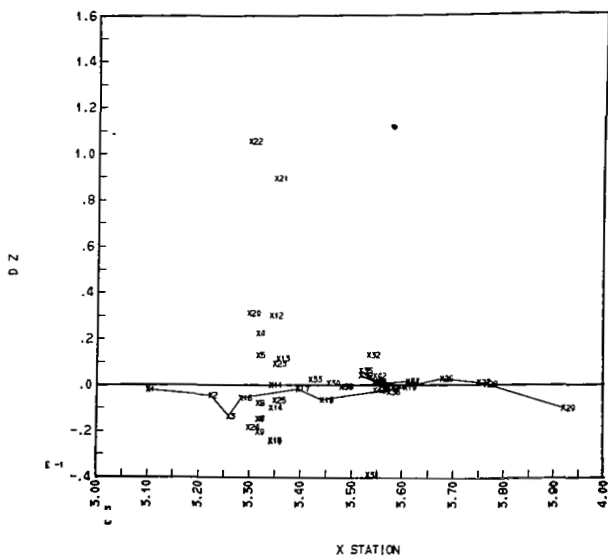

ORBITAL CONFIGURATION MODAL SURVEY - NORMALIZED TEST MODES (4C)  
 MODE 21 FREQ = 12.650 HZ RUN NO. = DTAORB DATE = 06SE72

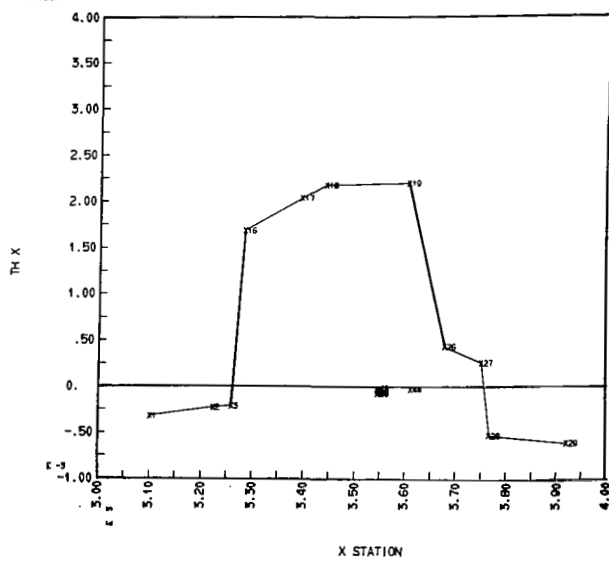

Plot B-19

ORBITAL CONFIGURATION MODAL SURVEY - NORMALIZED TEST MODES (4C)  
 MODE 21 FREQ = 12.650 HZ RUN NO. = DTAORB DATE = 06SE72

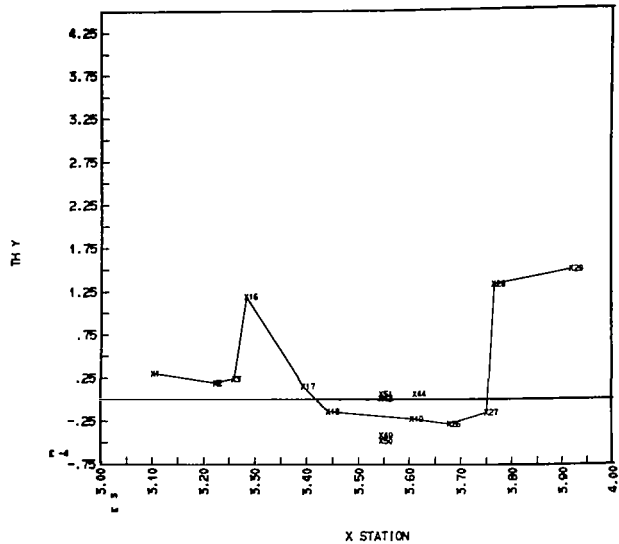

ORBITAL CONFIGURATION MODAL SURVEY - NORMALIZED TEST MODES (4C)  
 MODE 21 FREQ = 12.650 HZ RUN NO. = DTAORB DATE = 06SE72

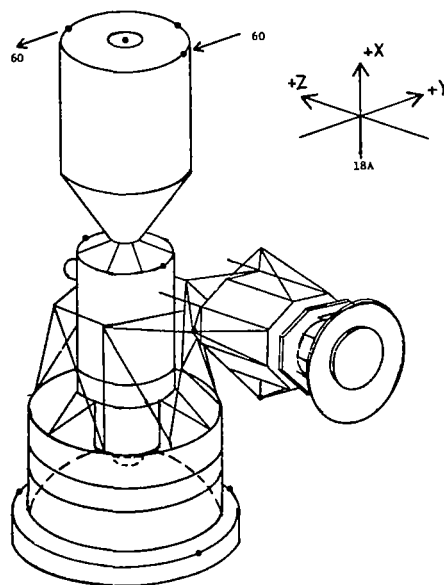
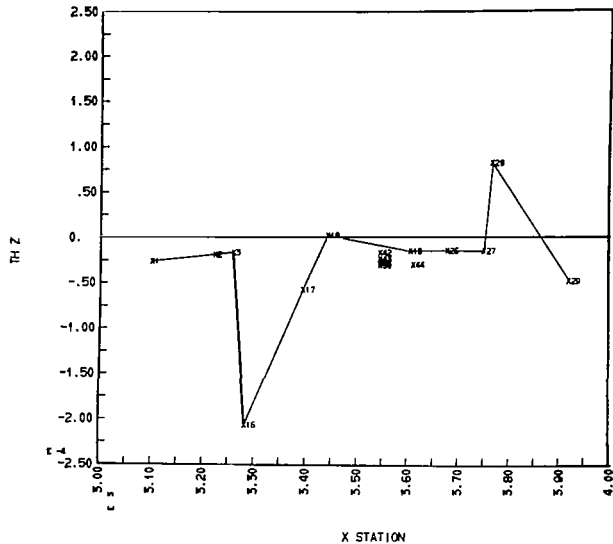

Plot B-20

ORBITAL CONFIGURATION MODAL SURVEY - NORMALIZED TEST MODES (4C)  
MODE 22 FREQ = 12.870 HZ RUN NO. = DTAOR8 DATE = 06SE72

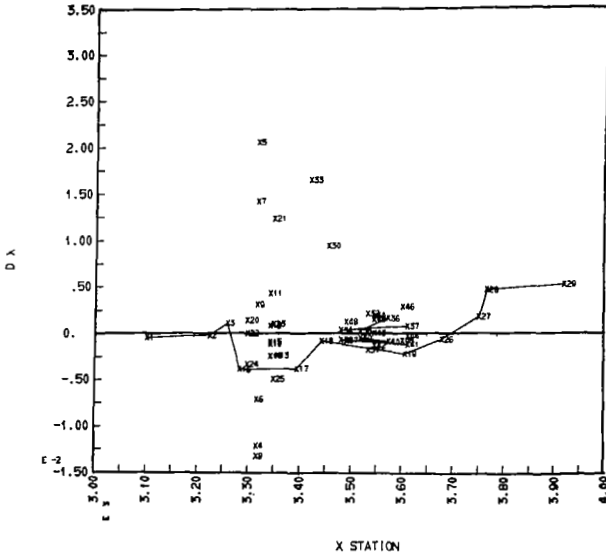

ORBITAL CONFIGURATION MODAL SURVEY - NORMALIZED TEST MODES (4C)  
MODE 22 FREQ = 12.870 HZ RUN NO. = DTAOR8 DATE = 06SE72

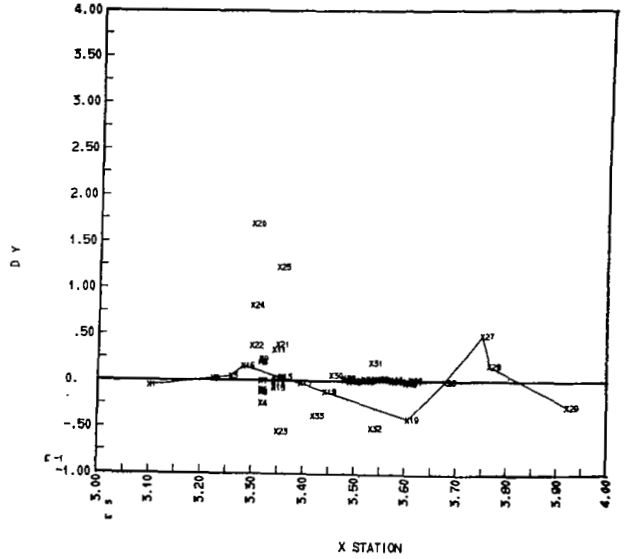

ORBITAL CONFIGURATION MODAL SURVEY - NORMALIZED TEST MODES (4C)  
MODE 22 FREQ = 12.870 HZ RUN NO. = DTAOR8 DATE = 06SE72

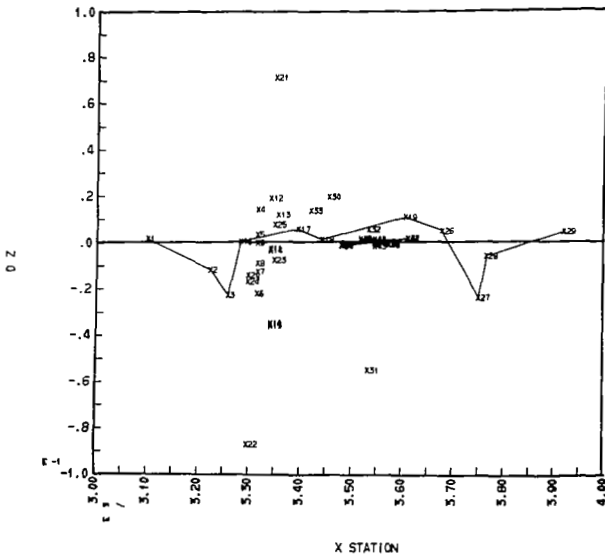

ORBITAL CONFIGURATION MODAL SURVEY - NORMALIZED TEST MODES (4C)  
MODE 22 FREQ = 12.870 HZ RUN NO. = DTAOR8 DATE = 06SE72

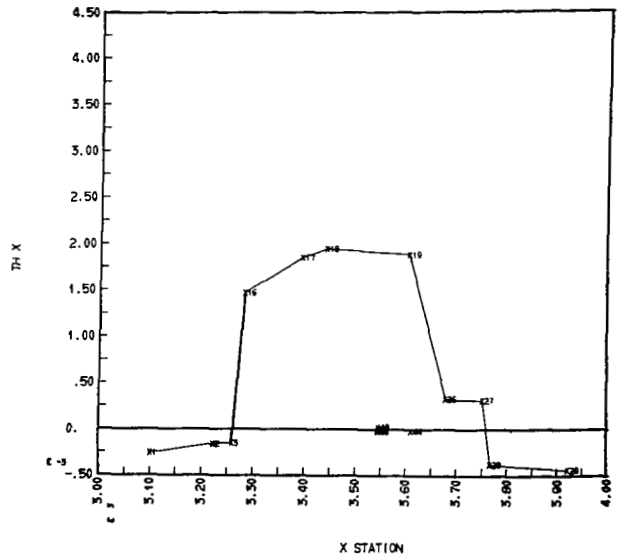

Plot B-20

ORBITAL CONFIGURATION MODAL SURVEY - NORMALIZED TEST MODES (4C)  
 MODE 22 FREQ = 12.870 HZ RUN NO. = DTAOR8 DATE = 06SE72

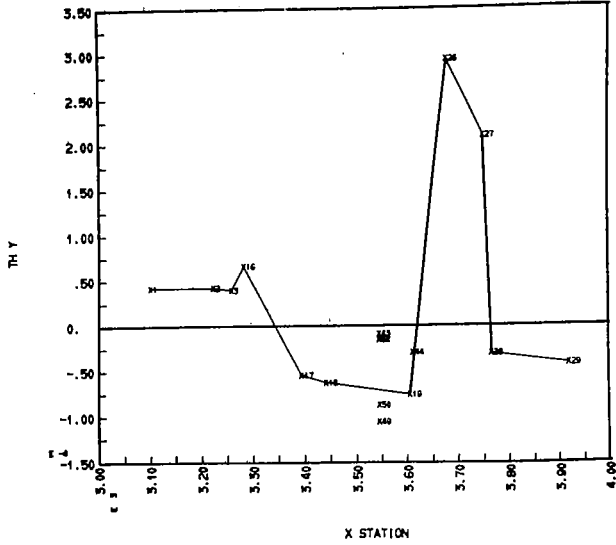

ORBITAL CONFIGURATION MODAL SURVEY - NORMALIZED TEST MODES (4C)  
 MODE 22 FREQ = 12.870 HZ RUN NO. = DTAOR8 DATE = 06SE72

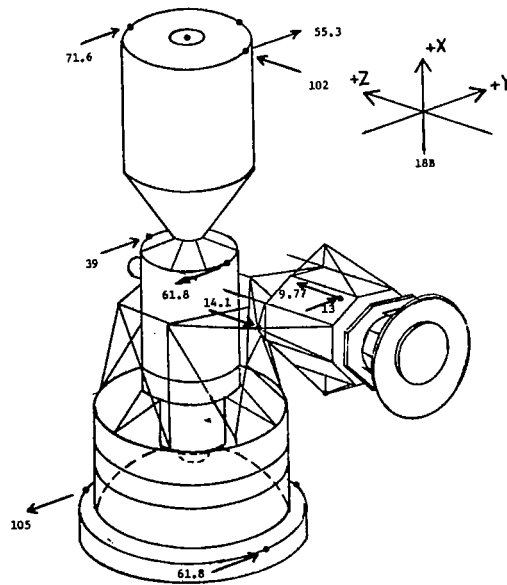
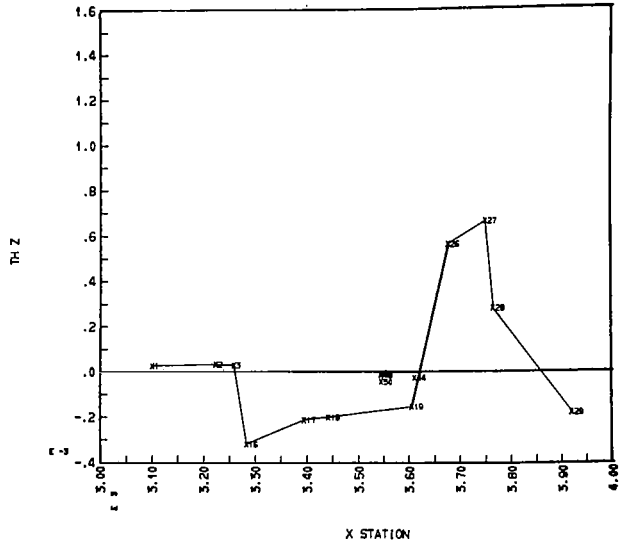

Plot B-21

ORBITAL CONFIGURATION MODAL SURVEY - NORMALIZED TEST MODES (4C)  
 MODE 25 FREQ = 13.300 HZ RUN NO. = DTAORB DATE = 06SE72

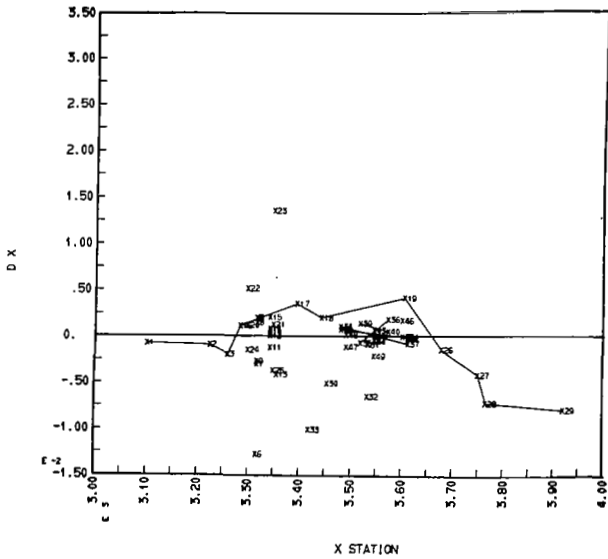

ORBITAL CONFIGURATION MODAL SURVEY - NORMALIZED TEST MODES (4C)  
 MODE 25 FREQ = 13.300 HZ RUN NO. = DTAORB DATE = 06SE72

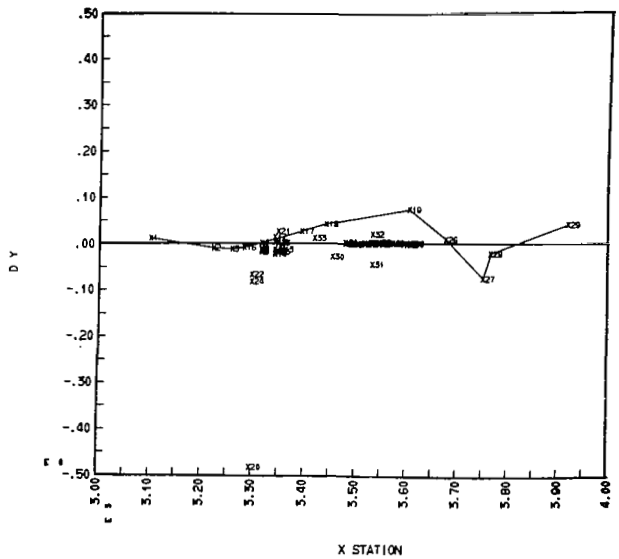

ORBITAL CONFIGURATION MODAL SURVEY - NORMALIZED TEST MODES (4C)  
 MODE 25 FREQ = 13.300 HZ RUN NO. = DTAORB DATE = 06SE72

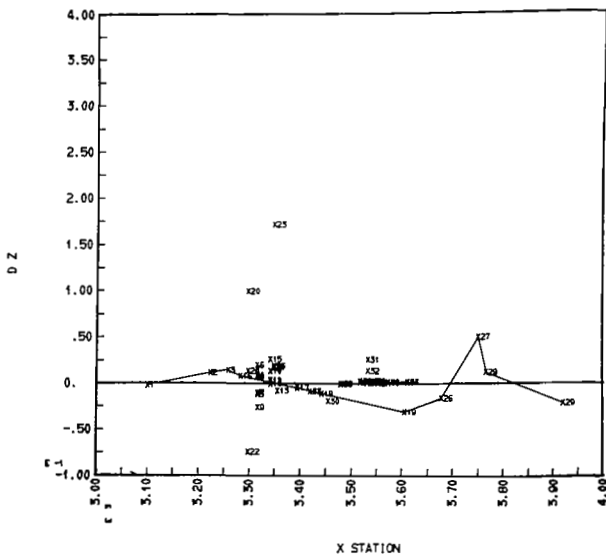

ORBITAL CONFIGURATION MODAL SURVEY - NORMALIZED TEST MODES (4C)  
 MODE 25 FREQ = 13.300 HZ RUN NO. = DTAORB DATE = 06SE72

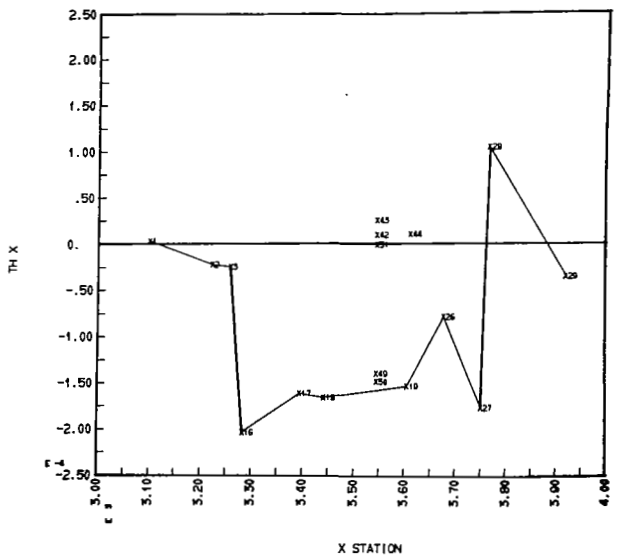

Plot B-21

ORBITAL CONFIGURATION MODAL SURVEY - NORMALIZED TEST MODES (4C)  
 MODE 25 FREQ = 15.300 HZ RUN NO. = DTAORB DATE = 06SE72

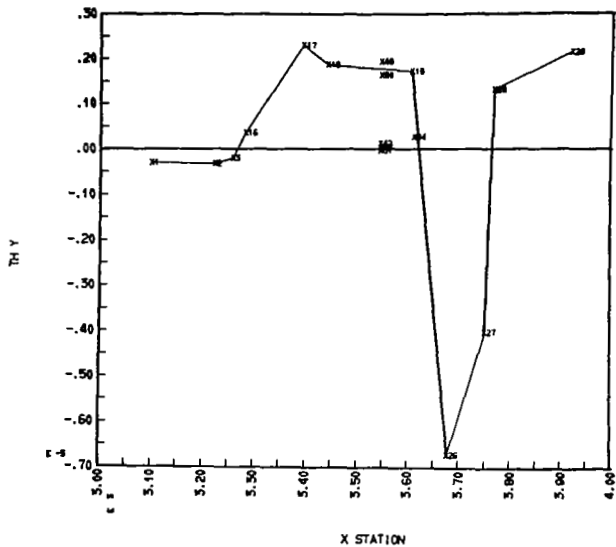

ORBITAL CONFIGURATION MODAL SURVEY - NORMALIZED TEST MODES (4C)  
 MODE 25 FREQ = 15.300 HZ RUN NO. = DTAORB DATE = 06SE72

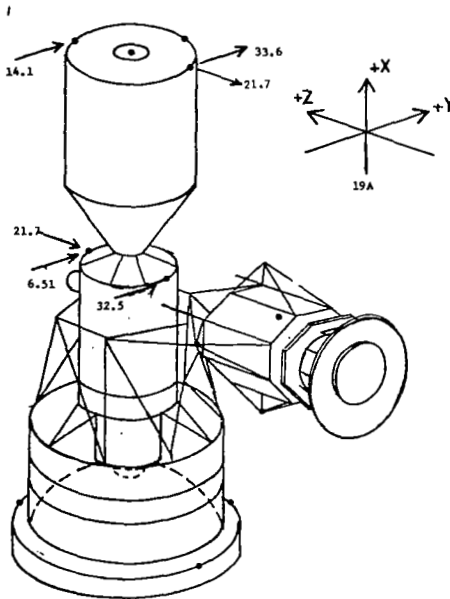
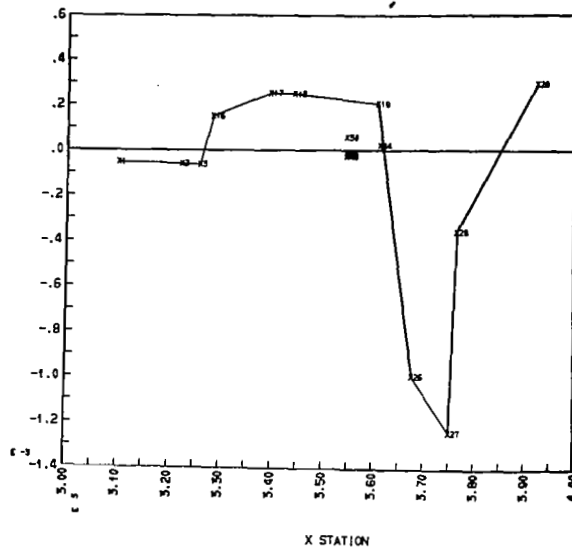

Plot B-22

ORBITAL CONFIGURATION MODAL SURVEY - NORMALIZED TEST MODES (4C)  
 MODE 24 FREQ = 13.680 HZ RUN NO. = DTAOR8 DATE = 06SE72

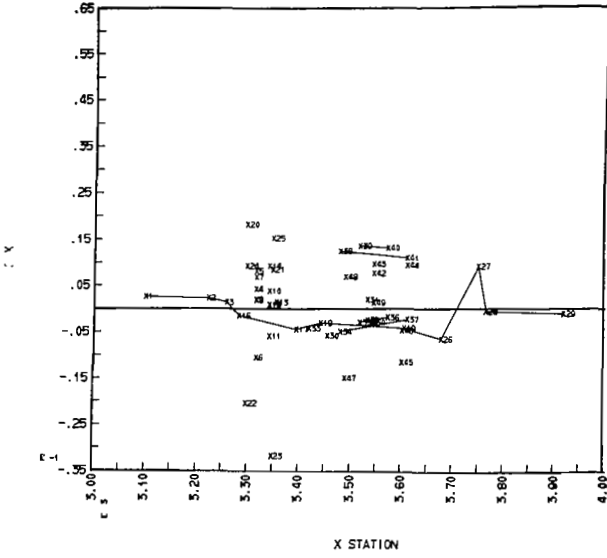

ORBITAL CONFIGURATION MODAL SURVEY - NORMALIZED TEST MODES (4C)  
 MODE 24 FREQ = 13.680 HZ RUN NO. = DTAOR8 DATE = 06SE72

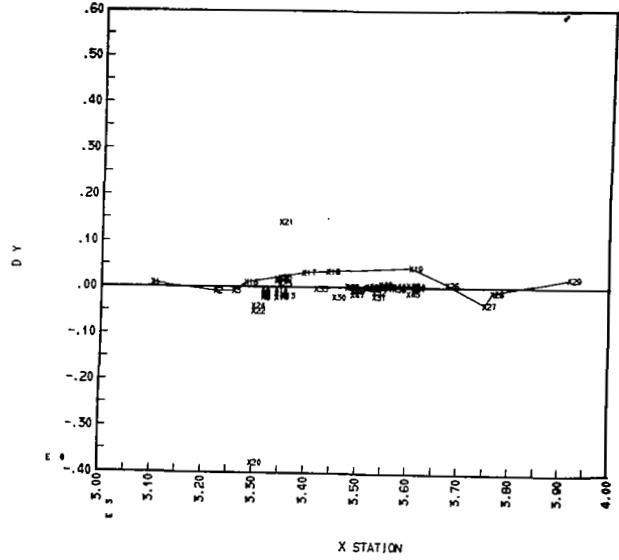

ORBITAL CONFIGURATION MODAL SURVEY - NORMALIZED TEST MODES (4C)  
 MODE 24 FREQ = 13.680 HZ RUN NO. = DTAOR8 DATE = 06SE72

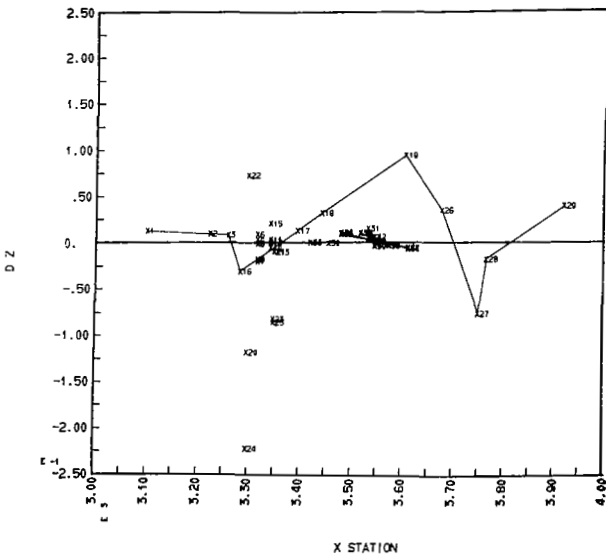

ORBITAL CONFIGURATION MODAL SURVEY - NORMALIZED TEST MODES (4C)  
 MODE 24 FREQ = 13.680 HZ RUN NO. = DTAOR8 DATE = 06SE72

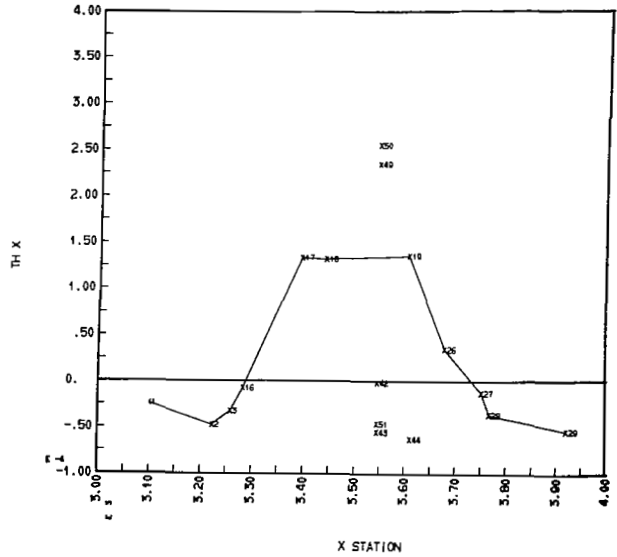

Plot B-22

ORBITAL CONFIGURATION MODAL SURVEY - NORMALIZED TEST MODES (4C)  
 MODE 24 FREQ = 13.680 HZ RUN NO. = DTAOPB DATE = 06SE72

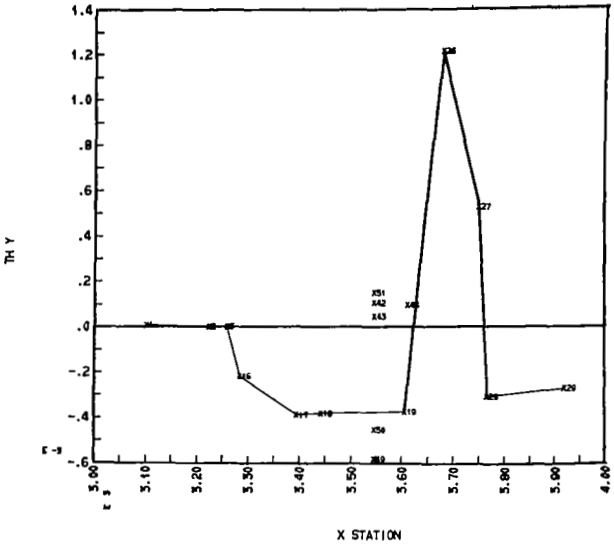

ORBITAL CONFIGURATION MODAL SURVEY - NORMALIZED TEST MODES (4C)  
 MODE 24 FREQ = 13.680 HZ RUN NO. = DTAOPB DATE = 06SE72

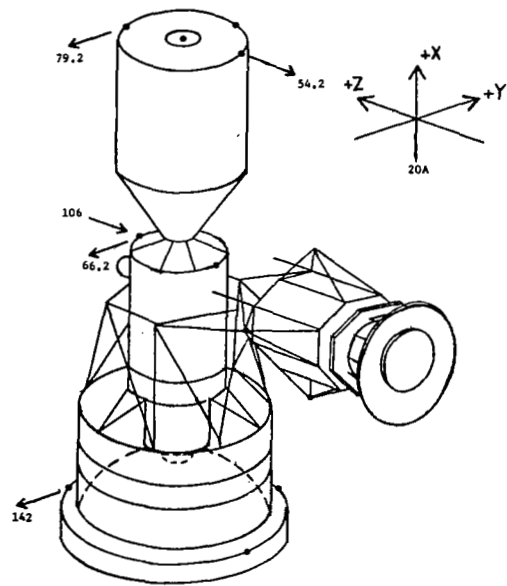
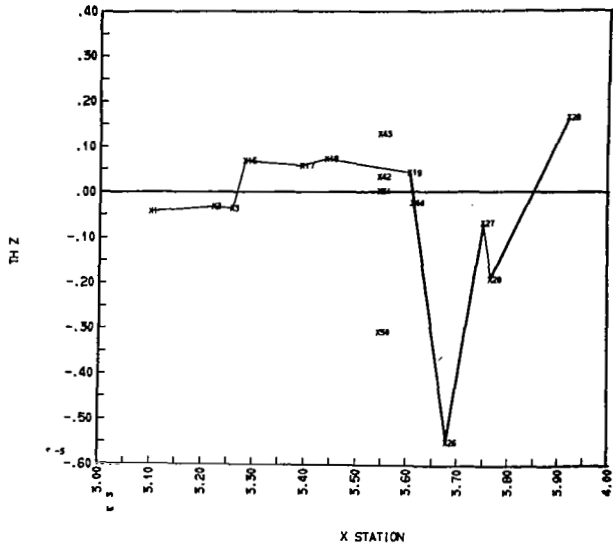



Plot B-23

ORBITAL CONFIGURATION MODAL SURVEY - NORMALIZED TEST MODES (4C)  
 MODE 25 FREQ = 14.950 HZ RUN NO. = DTAOR8 DATE = 06SE72

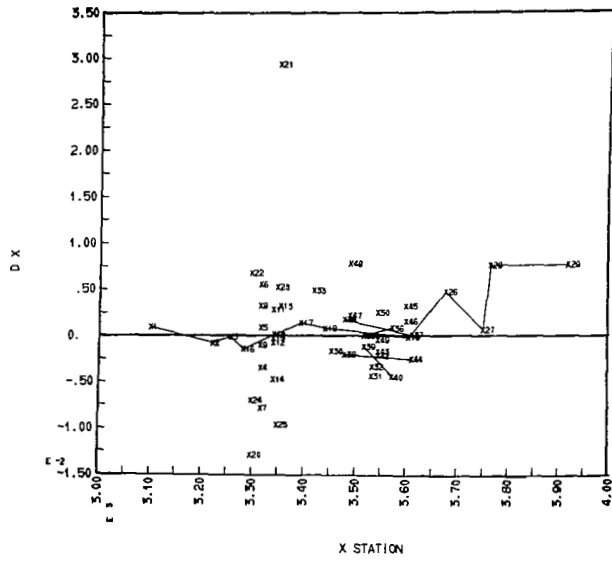

ORBITAL CONFIGURATION MODAL SURVEY - NORMALIZED TEST MODES (4C)  
 MODE 25 FREQ = 14.950 HZ RUN NO. = DTAOR8 DATE = 06SE72

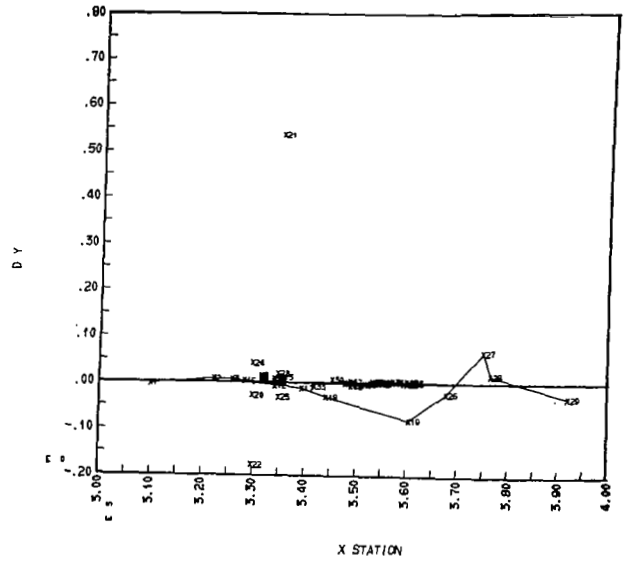

ORBITAL CONFIGURATION MODAL SURVEY - NORMALIZED TEST MODES (4C)  
 MODE 25 FREQ = 14.950 HZ RUN NO. = DTAOR8 DATE = 06SE72

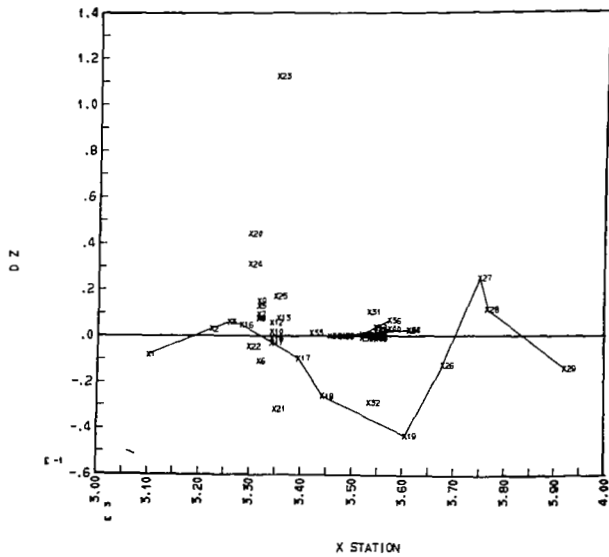

ORBITAL CONFIGURATION MODAL SURVEY - NORMALIZED TEST MODES (4C)  
 MODE 25 FREQ = 14.950 HZ RUN NO. = DTAOR8 DATE = 06SE72

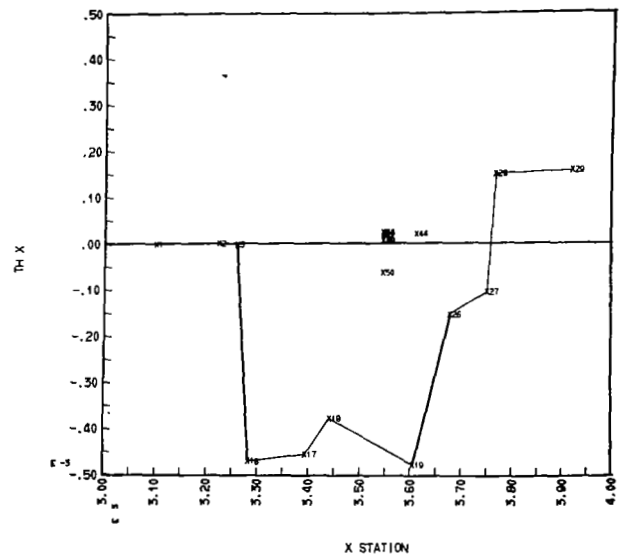

Plot B-23

ORBITAL CONFIGURATION MODAL SURVEY - NORMALIZED TEST MODES (4C)  
 MODE 25 FREQ = 14.550 HZ RUN NO. = DTA0FB DATE = 06SE72

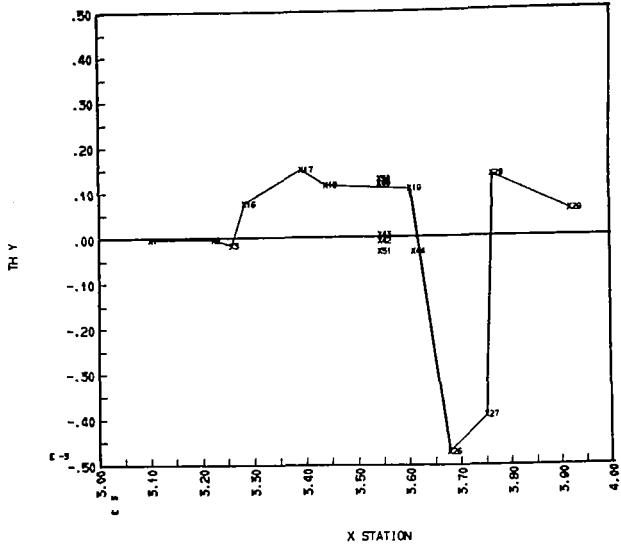

ORBITAL CONFIGURATION MODAL SURVEY - NORMALIZED TEST MODES (4C)  
 MODE 25 FREQ = 14.550 HZ RUN NO. = DTA0FB DATE = 06SE72

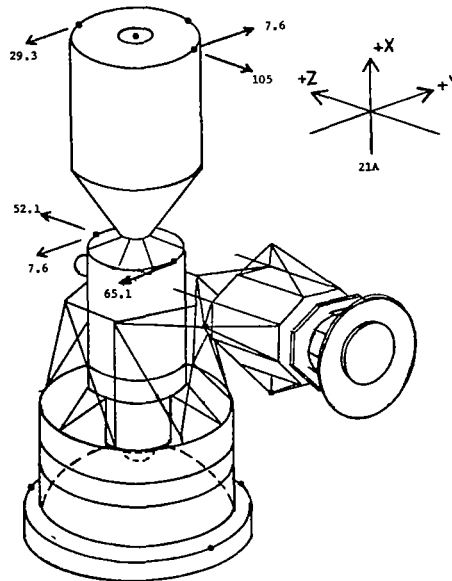
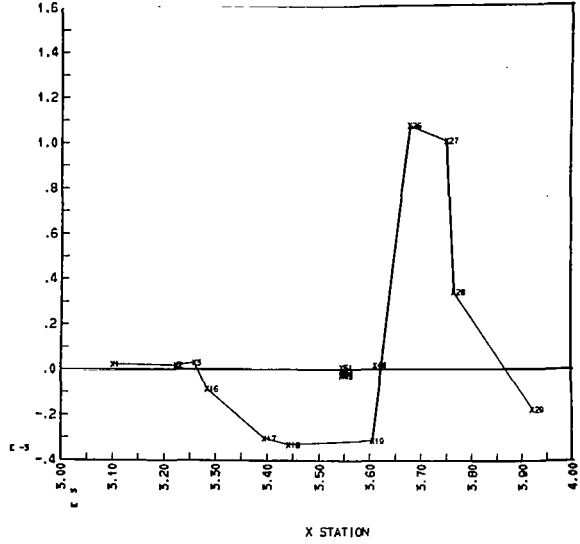

Plot B-24

ORBITAL CONFIGURATION MODAL SURVEY - NORMALIZED TEST MODES (4C)  
 MODE 26 FREQ = 15.400 HZ RUN NO. = DTAORB DATE = 06SE72

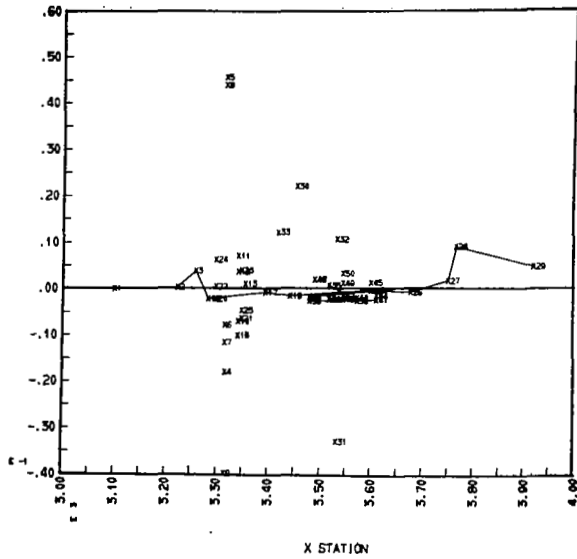

ORBITAL CONFIGURATION MODAL SURVEY - NORMALIZED TEST MODES (4C)  
 MODE 26 FREQ = 15.400 HZ RUN NO. = DTAORB DATE = 06SE72

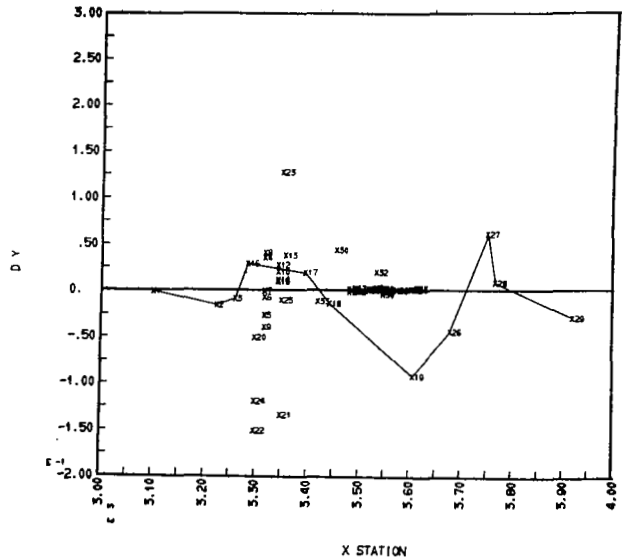

ORBITAL CONFIGURATION MODAL SURVEY - NORMALIZED TEST MODES (4C)  
 MODE 26 FREQ = 15.400 HZ RUN NO. = DTAORB DATE = 06SE72

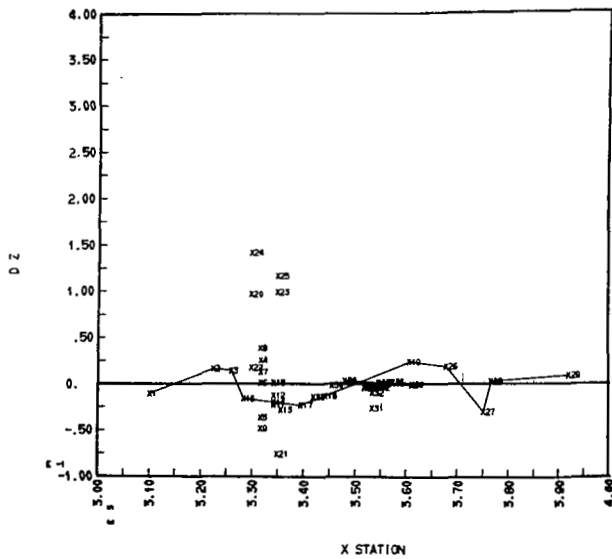

ORBITAL CONFIGURATION MODAL SURVEY - NORMALIZED TEST MODES (4C)  
 MODE 26 FREQ = 15.400 HZ RUN NO. = DTAORB DATE = 06SE72

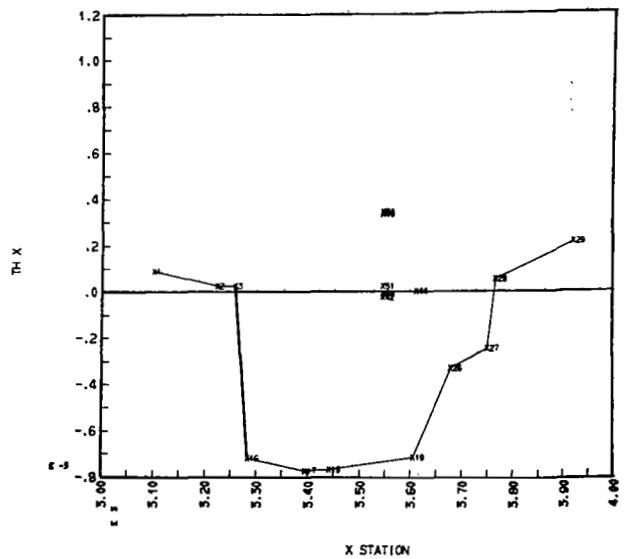

Plot B-24

ORBITAL CONFIGURATION MODAL SURVEY - NORMALIZED TEST MODES (4C)  
 MODE 26 FREQ = 15.400 HZ RUN NO. = DTACRB DATE = 06SE72

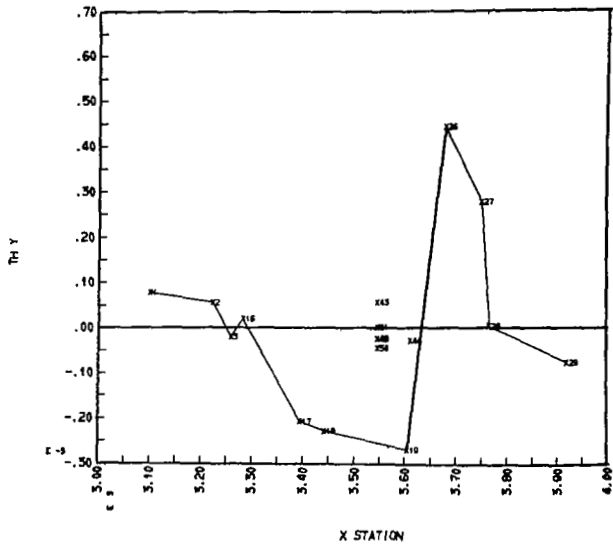

ORBITAL CONFIGURATION MODAL SURVEY - NORMALIZED TEST MODES (4C)  
 MODE 26 FREQ = 15.400 HZ RUN NO. = DTACRB DATE = 06SE72

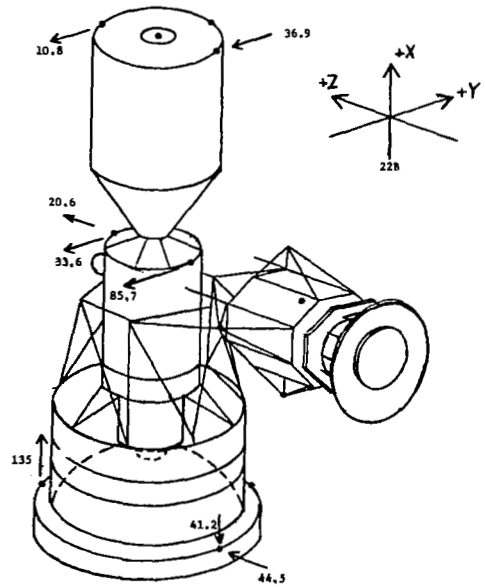
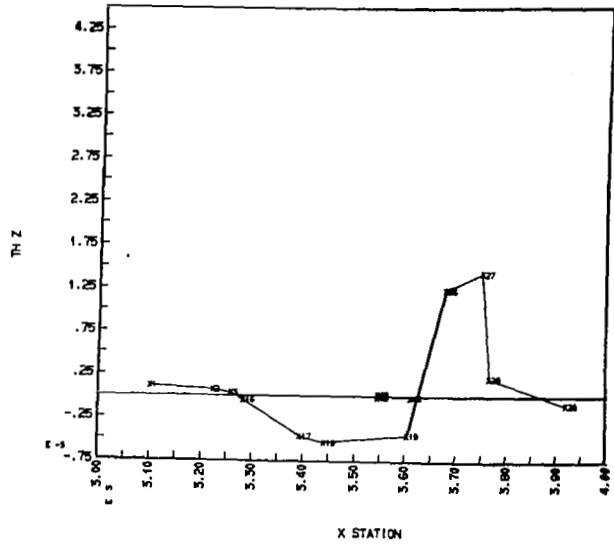

Plot B-25

ORBITAL CONFIGURATION MODAL SURVEY - NORMALIZED TEST MODES (4C)  
 MODE 27 FREQ = 15.780 HZ RUN NO. = DTAORB DATE = 06SE72

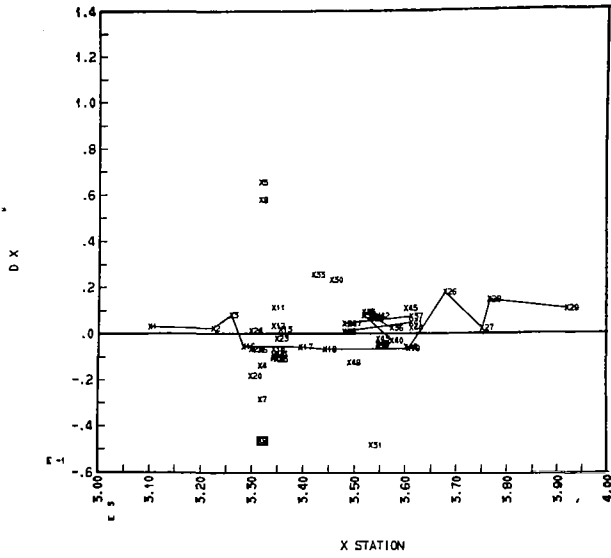

ORBITAL CONFIGURATION MODAL SURVEY - NORMALIZED TEST MODES (4C)  
 MODE 27 FREQ = 15.780 HZ RUN NO. = DTAORB DATE = 06SE72

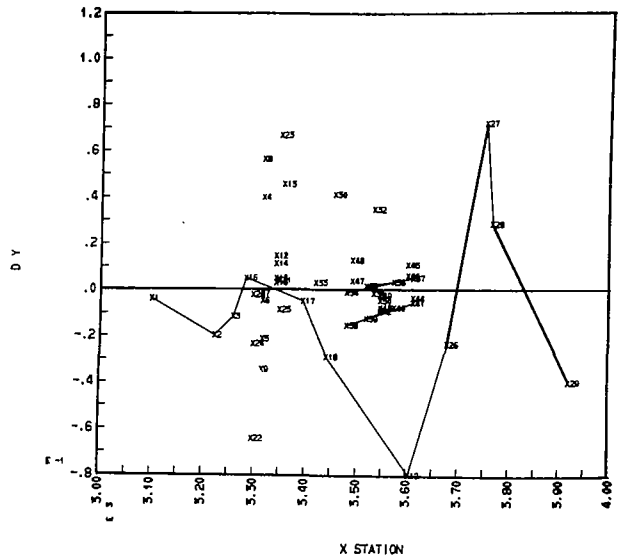

ORBITAL CONFIGURATION MODAL SURVEY - NORMALIZED TEST MODES (4C)  
 MODE 27 FREQ = 15.780 HZ RUN NO. = DTAORB DATE = 06SE72

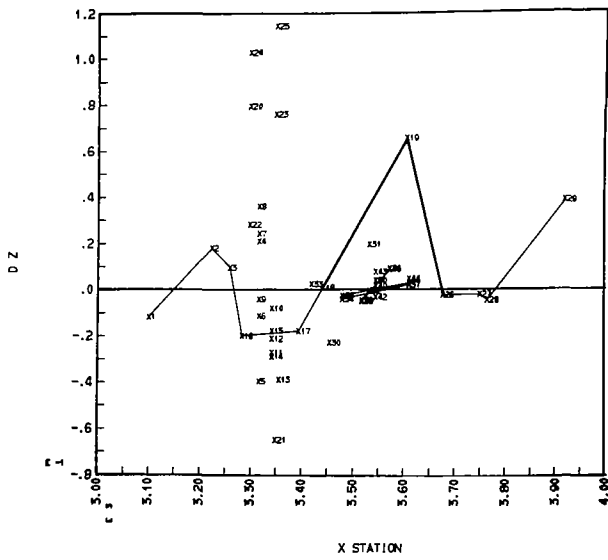

ORBITAL CONFIGURATION MODAL SURVEY - NORMALIZED TEST MODES (4C)  
 MODE 27 FREQ = 15.780 HZ RUN NO. = DTAORB DATE = 06SE72

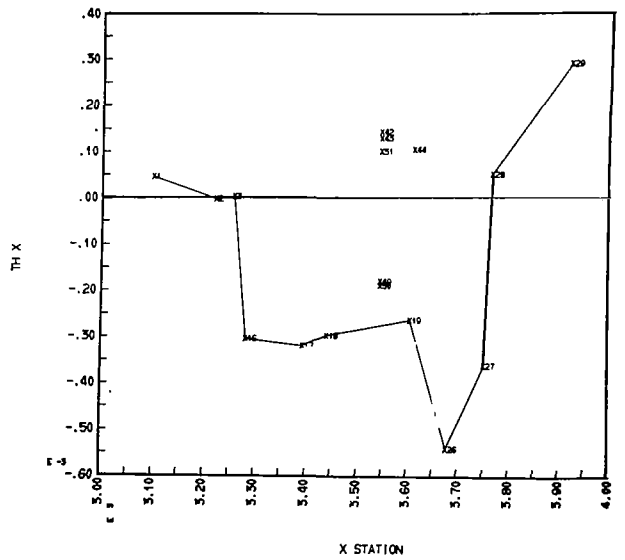

Plot B-25

ORBITAL CONFIGURATION MODAL SURVEY - NORMALIZED TEST MODES (4C)  
 MODE 27 FREQ = 15.780 HZ RUN NO. = DTACRB DATE = 06SE72

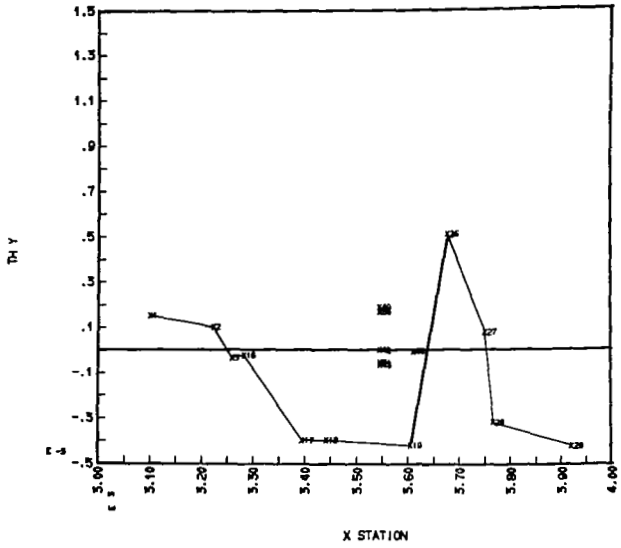

ORBITAL CONFIGURATION MODAL SURVEY - NORMALIZED TEST MODES (4C)  
 MODE 27 FREQ = 15.780 HZ RUN NO. = DTACRB DATE = 06SE72

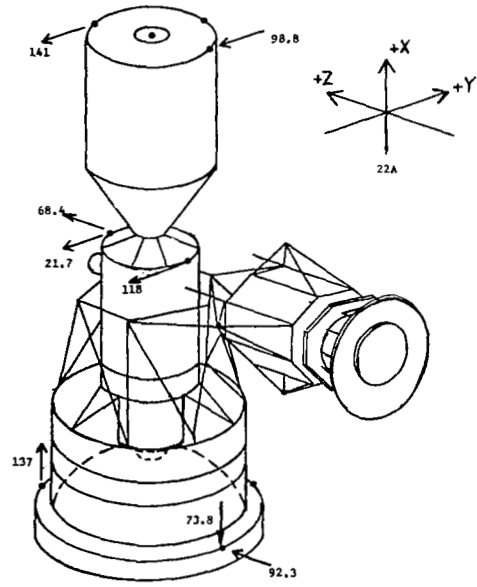
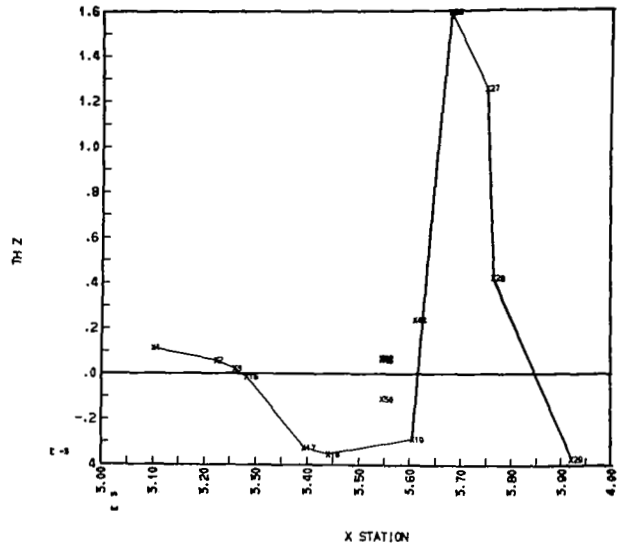

Plot B-26

ORBITAL CONFIGURATION MODAL SURVEY - NORMALIZED TEST MODES (4C)  
MODE 28 FREQ = 16.200 HZ RUN NO. = DTAORB DATE = 06SE72

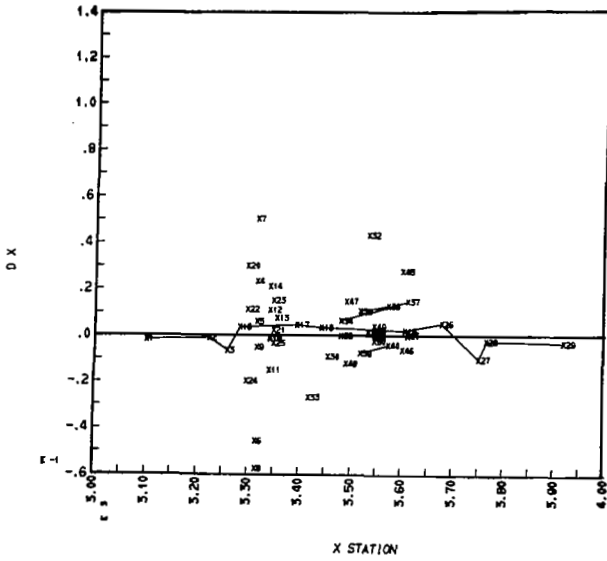

ORBITAL CONFIGURATION MODAL SURVEY - NORMALIZED TEST MODES (4C)  
MODE 28 FREQ = 16.200 HZ RUN NO. = DTAORB DATE = 06SE72

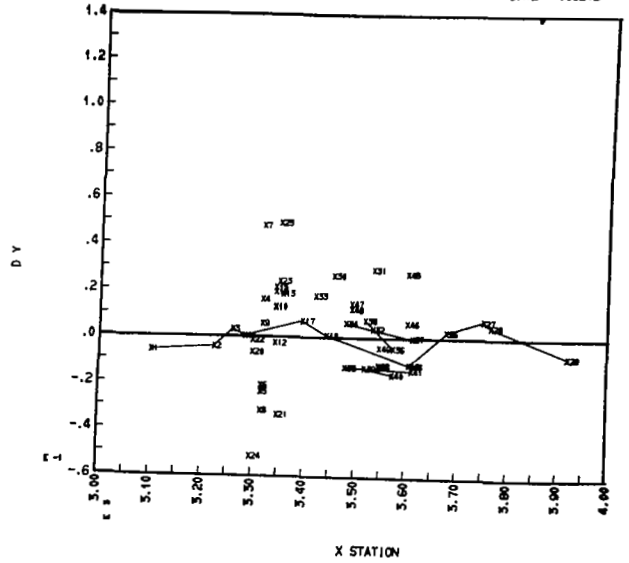

ORBITAL CONFIGURATION MODAL SURVEY - NORMALIZED TEST MODES (4C)  
MODE 28 FREQ = 16.200 HZ RUN NO. = DTAORB DATE = 06SE72

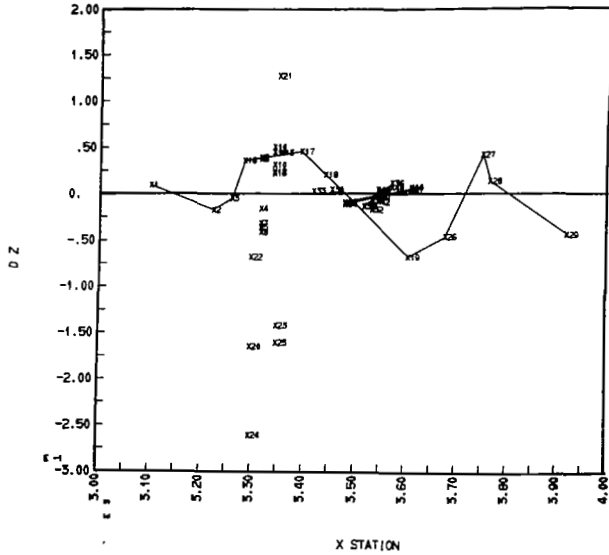

ORBITAL CONFIGURATION MODAL SURVEY - NORMALIZED TEST MODES (4C)  
MODE 28 FREQ = 16.200 HZ RUN NO. = DTAORB DATE = 06SE72

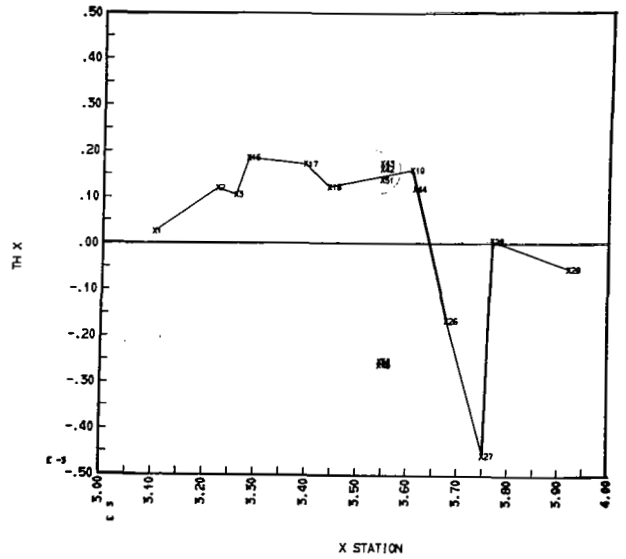

Plot B-26

ORBITAL CONFIGURATION MODAL SURVEY - NORMALIZED TEST MODES (4C)  
 MODE 28 FREQ = 16.200 HZ RUN NO. = DTA09S DATE = 06SE72

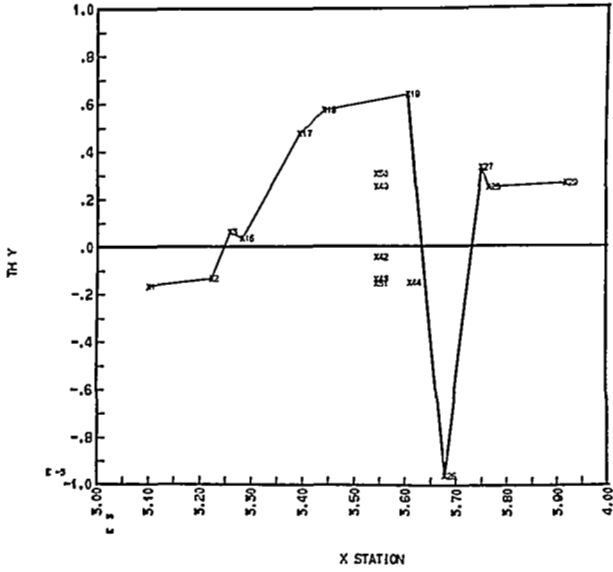

ORBITAL CONFIGURATION MODAL SURVEY - NORMALIZED TEST MODES (4C)  
 MODE 28 FREQ = 16.200 HZ RUN NO. = DTA09S DATE = 06SE72

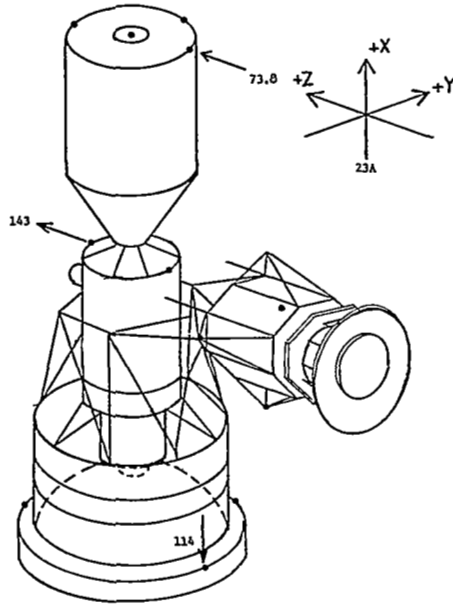
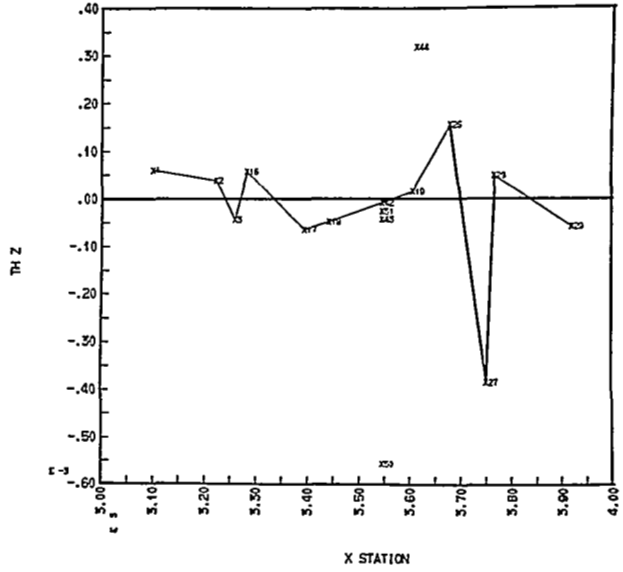



Plot B-27

ORBITAL CONFIGURATION MODAL SURVEY - NORMALIZED TEST MODES (4C)  
MODE 29 FREQ = 16.530 HZ RUN NO. = DTAQFB DATE = 06SE72

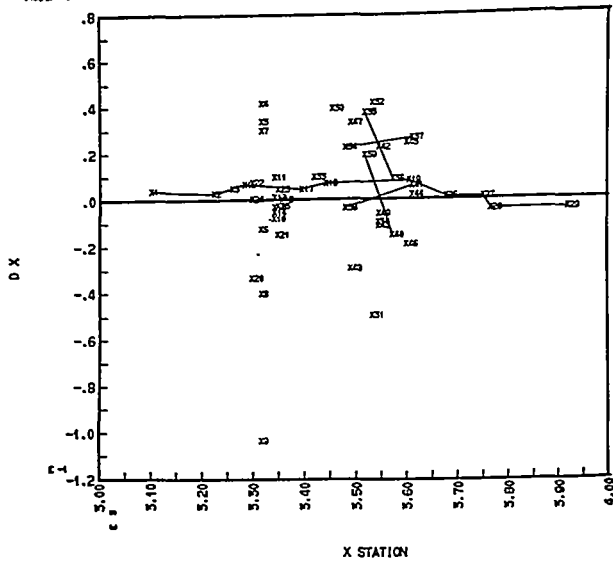

ORBITAL CONFIGURATION MODAL SURVEY - NORMALIZED TEST MODES (4C)  
MODE 29 FREQ = 16.530 HZ RUN NO. = DTAQFB DATE = 06SE72

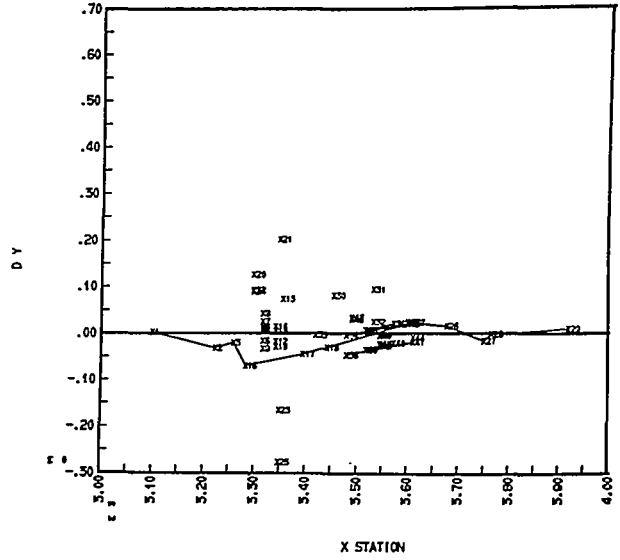

ORBITAL CONFIGURATION MODAL SURVEY - NORMALIZED TEST MODES (4C)  
MODE 29 FREQ = 16.530 HZ RUN NO. = DTAQFB DATE = 06SE72

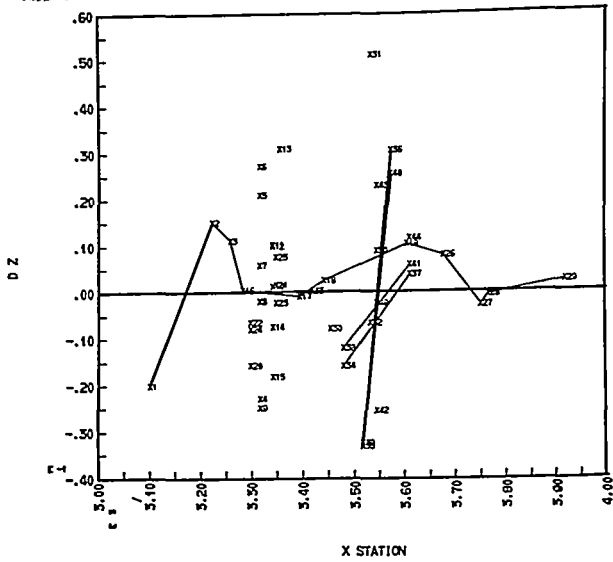

ORBITAL CONFIGURATION MODAL SURVEY - NORMALIZED TEST MODES (4C)  
MODE 29 FREQ = 16.530 HZ RUN NO. = DTAQFB DATE = 06SE72

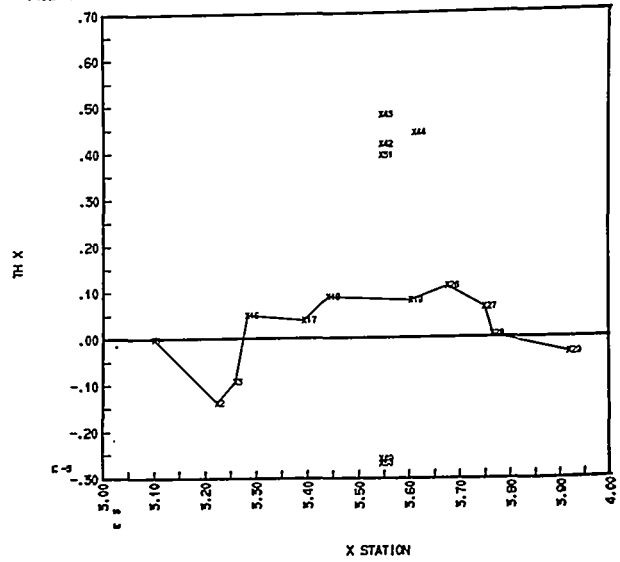

Plot B-27

ORBITAL CONFIGURATION MODAL SURVEY - NORMALIZED TEST MODES (4C)  
 MODE 29 FREQ = 16.530 HZ RUN NO. = 01A0RB DATE = 06SE72

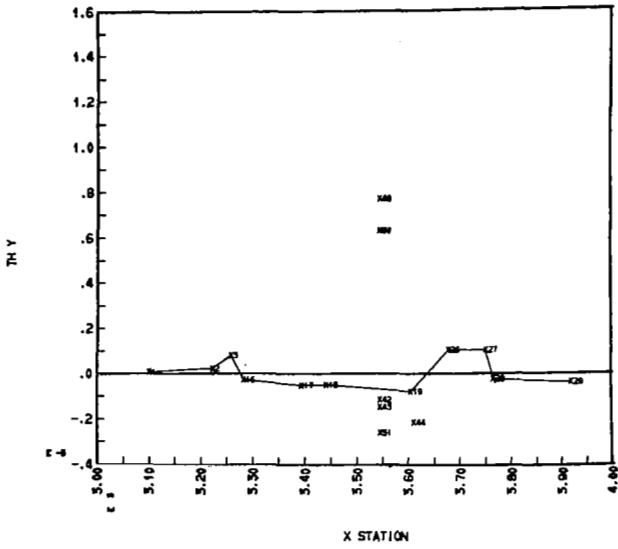

ORBITAL CONFIGURATION MODAL SURVEY - NORMALIZED TEST MODES (4C)  
 MODE 29 FREQ = 16.530 HZ RUN NO. = 01A0RB DATE = 06SE72

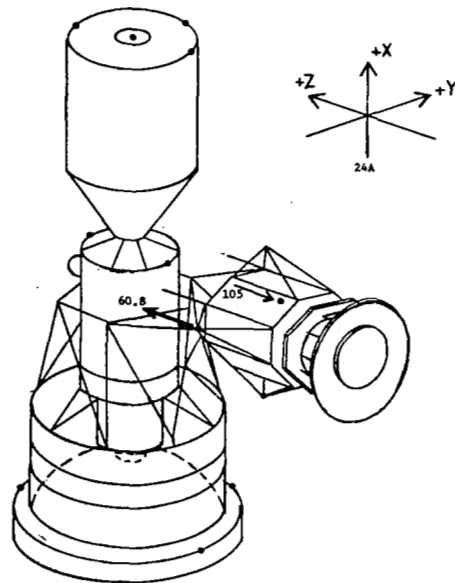
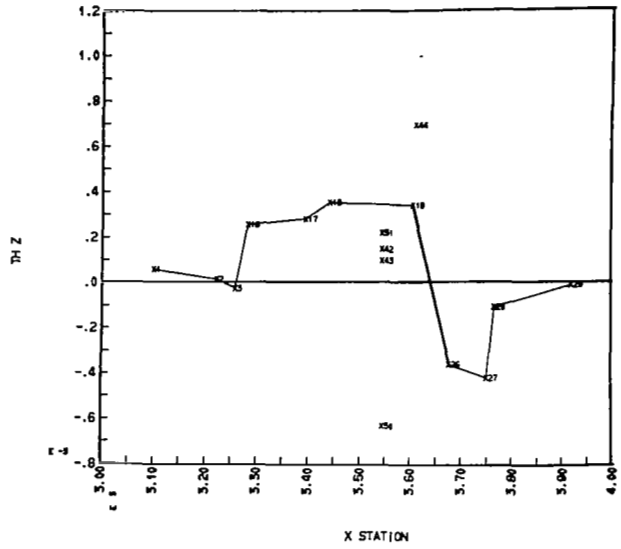

Plot B-28

ORBITAL CONFIGURATION MODAL SURVEY - NORMALIZED TEST MODES (4C)  
MODE 30 FREQ = 17.010 HZ RUN NO. = DTAORB DATE = 06SE72

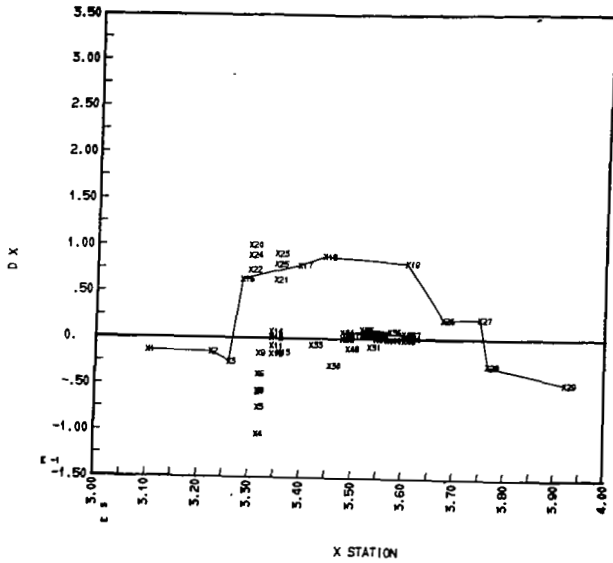

ORBITAL CONFIGURATION MODAL SURVEY - NORMALIZED TEST MODES (4C)  
MODE 30 FREQ = 17.010 HZ RUN NO. = DTAORB DATE = 06SE72

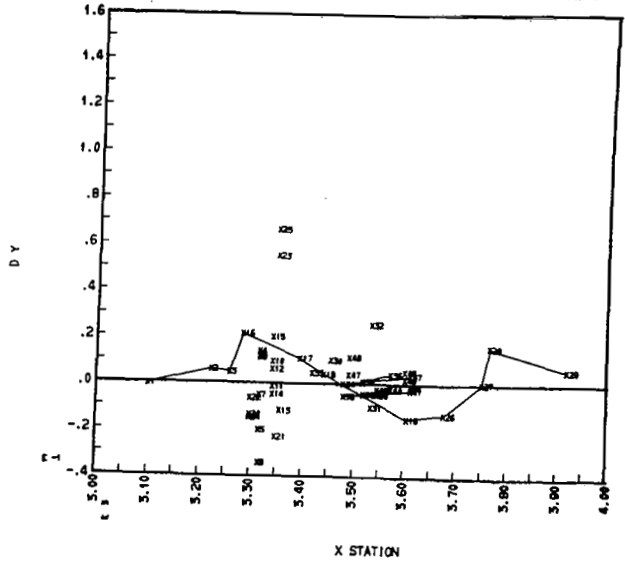

ORBITAL CONFIGURATION MODAL SURVEY - NORMALIZED TEST MODES (4C)  
MODE 30 FREQ = 17.010 HZ RUN NO. = DTAORB DATE = 06SE72

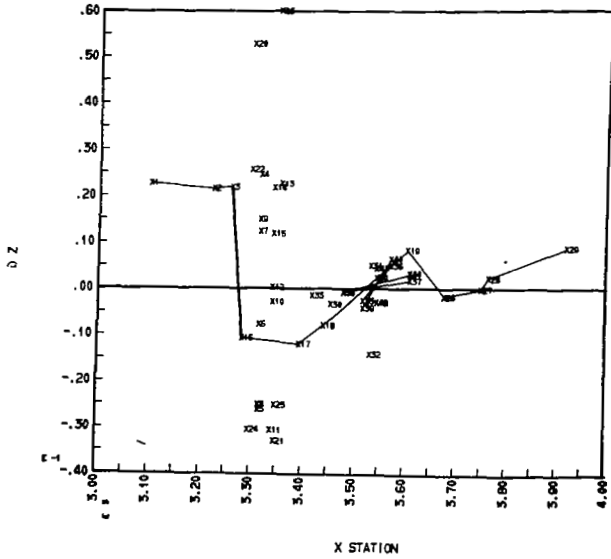

ORBITAL CONFIGURATION MODAL SURVEY - NORMALIZED TEST MODES (4C)  
MODE 30 FREQ = 17.010 HZ RUN NO. = DTAORB DATE = 06SE72

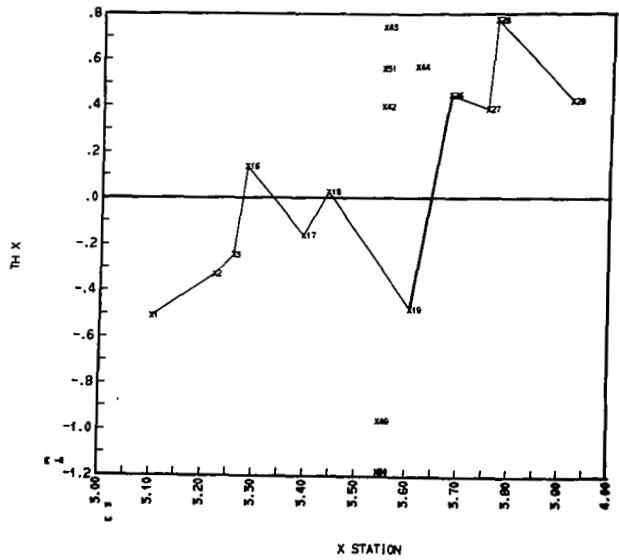

Plot B-28

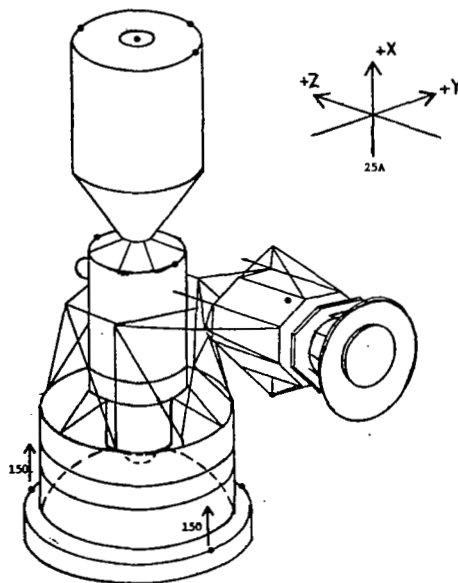
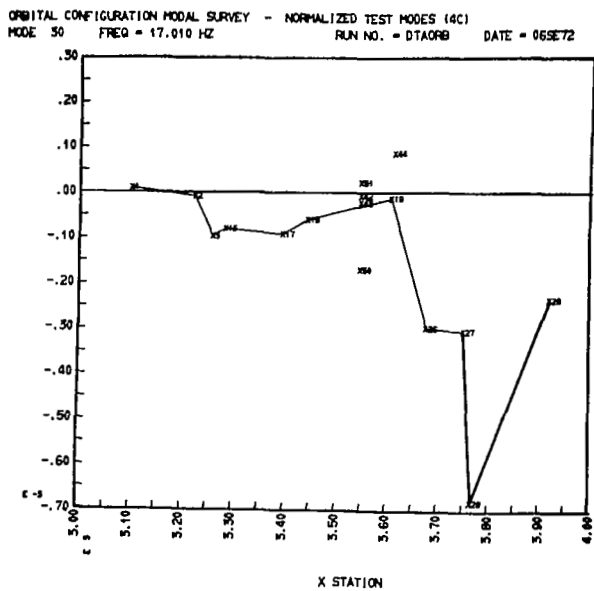
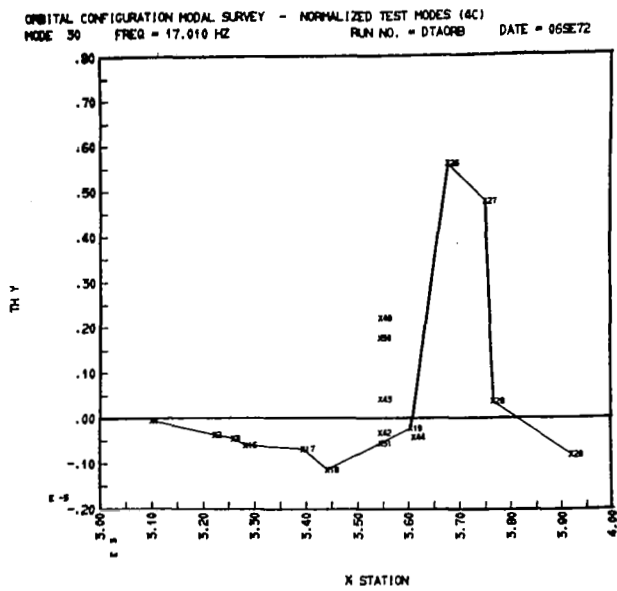

SECTION C

Analytical Modes GMC Tables



The following Tables C-1 through C-40 show GMC data for each of the correlated analytical modes presented in Table 5.17 in the main text of this report. These data are presented in the same manner as the corresponding test data presented in Section A.

TABLE C-1

ORBITAL CONFIGURATION MODAL SURVEY  
ANALYTICAL MODES GENERALIZED MASS CONTRIBUTION SUMMARY

ANALYTICAL MODE 7

ANALYTICAL FREQUENCY = 1.279 HZ.

COMPONENT NAME	GMC (DX)	GMC (DY)	GMC (DZ)	GMC (TX)	GMC (TY)	GMC (TZ)
BP/DWS SKIRT/IU/FAS	.0260	.0001	.0059	.0001	.0053	.0000
6-FAS O2 TANKS	.0229	.0001	.0046	0.	0.	0.
MJA/STS/AM	.0170	.0000	.0094	.0000	.0001	-.0000
6-AM N2 TANKS	.0036	.0000	.0012	0.	0.	0.
COMMAND/SERVICE MOD.	.0253	.0008	.3135	.0010	.0054	-.0000
DEPLOYMENT ASSEMBLY	.0021	.0000	.0066	0.	0.	0.
ATM-RACK, CMGS, 4-SAS	.2914	.0052	.0680	-.0000	.0001	.0000
ATM-SPAR CENTER	.0839	.0001	.0094	.0001	.0027	0.
ATM-GRA/CAN CENTER	.0750	.0000	.0083	.0001	.0048	.0001
	----	----	----	----	----	----
SUM	.5471	.0063	.4269	.0012	.0184	.0002

TOTAL GM CONTRIBUTION FOR EACH COMPONENT

BP/DWS SKIRT/IU/FAS	.0374
6-FAS O2 TANKS	.0275
MJA/STS/AM	.0255
6-AM N2 TANKS	.0048
COMMAND/SERVICE MOD.	.3459
DEPLOYMENT ASSEMBLY	.0087
ATM-RACK, CMGS, 4-SAS	.3646
ATM-SPAR CENTER	.0952
ATM-GRA/CAN CENTER	.0883



C-5  
TABLE C-2

GENERALIZED MASS CONTRIBUTIONS BY DEGREE OF FREEDOM

ANALYTICAL MODE 7

FREQUENCY= 1.28 1Z.

NODE NO.	GMC (DX)	GMC (DY)	GMC (DZ)	GMC (TX)	GMC (TY)	GMC (TZ)	NOJE DESCRIPTION
1	.0115	.0000	.0035	.0000	.0030	.0000	BASE RNG/OWS SKIRT
2	.0032	-.0000	.0000	.0000	.0004	.0000	OWS/IU INTERFACE
3	.0068	.0000	.0004	.0000	.0019	.0000	IU/FAS INTERFACE
4	.0038	-.0000	.0010	0.	0.	0.	FAS 02 BJTL1,+Y +Z
5	.0060	-.0000	.0009	0.	0.	0.	FAS 02 BJTL2,+Y +Z
6	.0060	.0000	.0008	0.	0.	0.	FAS 02 BJTL3,-Y +Z
7	.0040	.0000	.0007	0.	0.	0.	FAS 02 BJTL4,-Y +Z
8	.0021	.0000	.0007	0.	0.	0.	FAS 02 BJTL5,-Y -Z
9	.0010	.0001	.0005	0.	0.	0.	FAS 02 BJTL6,-Y -Z
10	.0005	.0000	.0005	0.	0.	0.	FAS/AM/DA IF, +Y
11	.0028	.0000	.0005	0.	0.	0.	FAS/AM/DA IF, +Z
12	.0010	-.0000	.0005	0.	0.	0.	FAS/AM/DA IF, -Y
13	.0001	.0000	.0002	0.	0.	0.	FAS/DA IF, -Y -Z
14	.0000	.0000	.0002	0.	0.	0.	FAS/AM IF, -Z
15	.0000	.0000	.0001	0.	0.	0.	FAS/DA IF, +Y -Z
16	.0025	.0000	.0005	.0000	.0001	.0000	AM TUNNEL/SHEAR WB
17	.0039	.0000	.0025	.0000	-.0000	.0000	AM TUNNEL/STS IF
18	.0058	.0000	.0038	.0000	.0000	-.0000	MDA/STS INTERFACE
19	.0048	.0000	.0027	-.0000	-.0000	-.0000	MDA CONE/CYL ITRFC
20	.0006	.0000	.0002	0.	0.	0.	N2 TANK, +Y, LOWER
21	.0006	.0000	.0003	0.	0.	0.	N2 TANK, +Y, UPPER
22	.0009	.0000	.0001	0.	0.	0.	N2 TANK, +Z, LOWER
23	.0010	.0000	.0002	0.	0.	0.	N2 TANK, +Z, UPPER
24	.0003	.0000	.0001	0.	0.	0.	N2 TANK -Z, LOWER
25	.0003	.0000	.0002	0.	0.	0.	N2 TANK, -Z, UPPER
26	.0049	.0000	.0000	.0000	-.0001	.0000	CM, FWD BULKHEAD
27	.0058	.0001	.0166	-.0000	.0004	.0000	CM, AFT BULKHEAD
28	.0065	.0001	.0299	.0002	.0008	-.0000	SM, FWD BULKHEAD
29	.0081	.0006	.2671	.0007	.0044	.0000	SM, AFT BULKHEAD
30	-.0002	.0000	.0002	0.	0.	0.	LOWER D LATC4, DA
31	.0004	-.0000	.0031	0.	0.	0.	LOWER +Y TRUNNION
32	.0006	.0000	.0029	0.	0.	0.	LOWER -Y TRUNNION
33	.0013	.0000	.0005	0.	0.	0.	EREP PACKAGE C.G.
34	.0367	.0004	-.0001	0.	0.	0.	ATM PN 6,7 IF,OUTR
35	.0488	-.0001	.0006	0.	0.	0.	ATM PN 4,5 IF,OUTR
36	.0737	.0007	.0121	0.	0.	0.	ATM PN 8,1 IF,OUTR
37	.0446	-.0008	.0259	0.	0.	0.	ATM PN 2,3 IF,OUTR
38	.0093	.0000	.0005	0.	0.	0.	ATM PN 6,7 IF,INNR
39	.0168	.0004	.0007	0.	0.	0.	ATM PN 4,5 IF,INNR
40	.0315	.0014	.0067	0.	0.	0.	ATM PN 8,1 IF,INNR
41	.0055	-.0003	.0135	0.	0.	0.	ATM PN 2,3 IF,INNR
42	.0054	.0001	.0012	.0000	.0001	.0000	CMG, -Y SIDE
43	.0088	.0000	.0016	-.0000	.0000	.0000	CMG, +Y SIDE
44	.0072	.0003	.0054	-.0000	.0000	.0000	CMG, +X SIDE
45	.0004	.0004	0.	0.	0.	0.	ATM SAS, PN 1
46	.0006	.0006	0.	0.	0.	0.	ATM SAS, PN 3
47	.0009	.0009	0.	0.	0.	0.	ATM SAS, PN 5
48	.0011	.0011	0.	0.	0.	0.	ATM SAS, PN 7
49	.0839	.0001	.0094	.0001	.0027	0.	SPAR CENTER
50	.0750	.0000	.0083	.0001	.0048	.0001	GRA/CAN CENTER
SUM	.5471	.0063	.4269	.0012	.0184	.0002	

TABLE C-3

ORBITAL CONFIGURATION MODAL SURVEY  
ANALYTICAL MODES GENERALIZED MASS CONTRIBUTION SUMMARY

ANALYTICAL MODE 8

ANALYTICAL FREQUENCY = 1.377 HZ.

COMPONENT NAME	GMC (OX)	GMC (OY)	GMC (OZ)	GMC (TX)	GMC (TY)	GMC (TZ)
BR/OWS SKIRT/IJ/FAS	.0010	.0159	.0015	.0127	.0001	.0057
6-FAS O2 TANKS	.0018	.0027	.0030	0.	0.	0.
MDA/STS/AM	.0001	.0032	.0001	.0021	.0000	.0003
6-AM N2 TANKS	.0002	.0005	.0002	0.	0.	0.
COMMAND/SERVICE MOD.	.0002	.1140	.0025	.0028	-.0000	.0033
DEPLOYMENT ASSEMBLY	.0014	.0002	.0013	0.	0.	0.
ATM-RACK,CMGS,4-SAS	.2751	.4167	.0556	.0004	.0000	.0112
ATM-SPAR CENTER	.0007	.0016	.0001	.0153	.0000	0.
ATM-GRA/CAN CENTER	.0006	.0013	.0001	.0195	.0003	.0348
	----	----	----	----	----	----
SUM	.2810	.5561	.0644	.0527	.0004	.0454

TOTAL GM CONTRIBUTION FOR EACH COMPONENT

BR/OWS SKIRT/IJ/FAS	.0359
6-FAS O2 TANKS	.0076
MDA/STS/AM	.0058
6-AM N2 TANKS	.0008
COMMAND/SERVICE MOD.	.1228
DEPLOYMENT ASSEMBLY	.0028
ATM-RACK,CMGS,4-SAS	.7430
ATM-SPAR CENTER	.0177
ATM-GRA/CAN CENTER	.0566

C-7  
TABLE C-4

GENERALIZED MASS CONTRIBUTIONS BY DEGREE OF FREEDOM

ANALYTICAL MODE 3

FREQUENCY= 1.38 HZ.

NODE NO.	GMC (DX)	GMC (DY)	GMC (DZ)	GMC (TX)	GMC (TY)	GMC (TZ)	NODE DESCRIPTION
1	.0001	.0133	.0002	.0066	.0001	.0035	BASE RNG/OWS SKIRT
2	-.0000	.0009	-.0000	.0023	.0000	.0010	OWS/IU INTERFACE
3	.0000	.0005	.0000	.0038	.0000	.0013	IU/FAS INTERFACE
4	.0008	.0002	.0007	0.	0.	0.	FAS 02 BJT1,+Y +Z
5	.0002	.0007	.0002	0.	0.	0.	FAS 02 BJT2,+Y +Z
6	-.0000	.0007	.0002	0.	0.	0.	FAS 02 BJT3,-Y +Z
7	.0004	.0002	.0008	0.	0.	0.	FAS 02 BJT4,-Y +Z
8	.0003	.0003	.0008	0.	0.	0.	FAS 02 BJT5,-Y -Z
9	.0001	.0008	.0002	0.	0.	0.	FAS 02 BJT6,-Y -Z
10	.0005	.0000	.0004	0.	0.	0.	FAS/AM/DA IF, +Y
11	.0000	.0010	.0000	0.	0.	0.	FAS/AM/DA IF, +Z
12	.0004	.0000	.0008	0.	0.	0.	FAS/AM/DA IF, -Y
13	.0000	-.0000	.0001	0.	0.	0.	FAS/DA IF, -Y -Z
14	-.0000	.0002	-.0000	0.	0.	0.	FAS/AM IF, -Z
15	.0000	.0000	.0000	0.	0.	0.	FAS/DA IF, +Y -Z
16	.0000	.0000	.0000	.0002	.0000	.0001	AM TUNNEL/SHEAR WB
17	.0000	.0003	.0000	.0005	.0000	.0000	AM TUNNEL/STS IF
18	.0000	.0010	.0000	.0008	.0000	.0002	MDA/STS INTERFACE
19	.0000	.0019	.0000	.0006	.0000	.0000	MDA CONE/CYL ITRFC
20	.0001	.0000	.0001	0.	0.	0.	N2 TANK, +Y, LOWER
21	.0001	.0000	.0001	0.	0.	0.	N2 TANK, +Y, UPPER
22	.0000	.0001	.0000	0.	0.	0.	N2 TANK, +Z, LOWER
23	.0000	.0002	.0000	0.	0.	0.	N2 TANK, +Z, UPPER
24	.0000	.0001	.0000	0.	0.	0.	N2 TANK, -Z, LOWER
25	.0000	.0000	.0000	0.	0.	0.	N2 TANK, -Z, UPPER
26	.0000	.0001	.0000	.0005	.0000	.0001	CM, FWD BULKHEAD
27	.0000	.0046	.0001	.0004	.0000	.0003	CM, AFT BULKHEAD
28	.0001	.0093	.0002	.0009	.0000	.0005	SM, FWD BULKHEAD
29	.0001	.1000	.0022	.0010	-.0001	.0025	SM, AFT BULKHEAD
30	.0000	.0006	.0000	0.	0.	0.	LOWER D LATC4, DA
31	.0008	-.0004	.0004	0.	0.	0.	LOWER +Y TRUNNION
32	.0006	-.0005	.0009	0.	0.	0.	LOWER -Y TRUNNION
33	.0000	.0005	.0000	0.	0.	0.	EREP PACKAGE C.G.
34	.0045	.0480	.0023	0.	0.	0.	ATM PN 6,7 IF,OUTR
35	.0618	.0057	.0083	0.	0.	0.	ATM PN 4,5 IF,OUTR
36	.0538	.0091	.0149	0.	0.	0.	ATM PN 8,1 IF,OUTR
37	.0148	.0704	.0049	0.	0.	0.	ATM PN 2,3 IF,OUTR
38	-.0002	-.0001	.0004	0.	0.	0.	ATM PN 6,7 IF,INNER
39	.0275	.0033	.0053	0.	0.	0.	ATM PN 4,5 IF,INNER
40	.0629	.0507	.0047	0.	0.	0.	ATM PN 8,1 IF,INNER
41	.0190	.1756	.0024	0.	0.	0.	ATM PN 2,3 IF,INNER
42	.0148	.0055	.0053	.0001	.0000	.0004	CMG, -Y SIDE
43	.0145	.0051	.0050	.0002	.0000	.0006	CMG, +Y SIDE
44	.0001	.0417	.0001	.0001	-.0000	.0003	CMG, +X SIDE
45	.0005	.0005	0.	0.	0.	0.	ATM SAS, PN 1
46	.0003	.0003	0.	0.	0.	0.	ATM SAS, PN 3
47	.0005	.0005	0.	0.	0.	0.	ATM SAS, PN 5
48	.0003	.0003	0.	0.	0.	0.	ATM SAS, PN 7
49	.0007	.0016	.0001	.0153	.0000	0.	SPAR CENTER
50	.0006	.0013	.0001	.0195	.0003	.0348	GRA/CAN CENTER
---	---	---	---	---	---	---	---
SJM	.2810	.5561	.0644	.0527	.0004	.0454	

TABLE C-5

ORBITAL CONFIGURATION MODAL SURVEY  
ANALYTICAL MODES GENERALIZED MASS CONTRIBUTION SUMMARY

ANALYTICAL MODE 9

ANALYTICAL FREQUENCY = 1.643 HZ.

COMPONENT NAME	GMC (DX)	GMC (DY)	GMC (DZ)	GMC (TX)	GMC (TY)	GMC (TZ)
BR/OWS SKIRT/IU/FAS	.0123	.0387	.0975	.0428	.0223	.0134
6-FAS O2 TANKS	.0187	.0114	.0120	0.	0.	0.
MDA/STS/AM	.0050	.0136	.0081	.0177	.0018	.0017
6-AM N2 TANKS	.0015	.0015	.0027	0.	0.	0.
COMMAND/SERVICE MOD.	.0076	.1007	.1006	.0092	.0025	.0026
DEPLOYMENT ASSEMBLY	.0026	.0111	.0129	0.	0.	0.
ATM-RACK,CMGS,4-SAS	.0983	.0408	.1594	.0101	.0001	.0001
ATM-SPAR CENTER	.0264	.0108	.0287	.0028	.0011	0.
ATM-GRA/CAN CENTER	.0251	.0084	.0256	.0143	.0026	.0129
	----	----	----	----	----	----
SUM	.1974	.2372	.4475	.0669	.0303	.0206

## TOTAL GM CONTRIBUTION FOR EACH COMPONENT

BR/OWS SKIRT/IU/FAS	.2239
6-FAS O2 TANKS	.0421
MDA/STS/AM	.0379
6-AM N2 TANKS	.0058
COMMAND/SERVICE MOD.	.2232
DEPLOYMENT ASSEMBLY	.0257
ATM-RACK,CMGS,4-SAS	.2988
ATM-SPAR CENTER	.0637
ATM-GRA/CAN CENTER	.0639

C-9  
TABLE C-6

GENERALIZED MASS CONTRIBUTIONS BY DEGREE OF FREEDOM

ANALYTICAL MODE 3 FREQUENCY= 1.64 HZ.

NODE NO.	GMC (DX)	GMC (DY)	GMC (DZ)	GMC (TX)	GMC (TY)	GMC (TZ)	NODE DESCRIPTION
1	.0038	.0316	.0790	.0223	.0137	.0081	BASE RNG/OWS SKIRT
2	.0019	.0022	.0069	.0074	.0042	.0020	OWS/IU INTERFACE
3	.0015	.0012	.0075	.0130	.0043	.0032	IU/FAS INTERFACE
4	.0006	.0006	.0075	0.	0.	0.	FAS 02 B3TL1,+Y +Z
5	.0004	.0023	.0039	0.	0.	0.	FAS 02 B3TL2,+Y +Z
6	-.0001	.0024	.0000	0.	0.	0.	FAS 02 B3TL3,-Y +Z
7	.0024	.0007	.0003	0.	0.	0.	FAS 02 B3TL4,-Y +Z
8	.0066	.0011	.0002	0.	0.	0.	FAS 02 B3TL5,-Y -Z
9	.0087	.0043	.0000	0.	0.	0.	FAS 02 B3TL6,-Y -Z
10	.0003	.0000	.0021	0.	0.	0.	FAS/AM/DA IF, +Y
11	.0002	.0033	.0001	0.	0.	0.	FAS/AM/DA IF, +Z
12	.0030	.0001	.0014	0.	0.	0.	FAS/AM/DA IF, -Y
13	.0004	-.0002	.0002	0.	0.	0.	FAS/DA IF, -Y -Z
14	.0011	.0006	.0001	0.	0.	0.	FAS/AM IF, -Z
15	.0001	-.0000	.0001	0.	0.	0.	FAS/DA IF, +Y -Z
16	.0008	.0001	.0014	.0006	.0004	.0003	AM TUNNEL/SHEAR WB
17	.0012	.0008	.0000	.0018	.0003	.0002	AM TUNNEL/STS IF
18	.0017	.0039	.0012	.0027	.0010	.0010	MDA/STS INTERFACE
19	.0014	.0088	.0055	.0026	.0001	.0001	MDA CONE/CYL ITRFC
20	.0000	.0000	.0012	0.	0.	0.	N2 TANK, +Y, LOWER
21	.0000	.0000	.0007	0.	0.	0.	N2 TANK, +Y, UPPER
22	-.0000	.0002	.0003	0.	0.	0.	N2 TANK, +Z, LOWER
23	.0000	.0006	.0001	0.	0.	0.	N2 TANK, +Z, UPPER
24	.0007	.0005	.0003	0.	0.	0.	N2 TANK, -Z, LOWER
25	.0008	.0002	.0001	0.	0.	0.	N2 TANK, -Z, UPPER
26	.0018	.0045	.0029	.0018	.0003	.0003	CM, FWD BULKHEAD
27	.0023	.0003	.0009	.0022	.0004	.0003	CM, AFT BULKHEAD
28	.0014	.0028	.0034	.0030	.0004	.0002	SM, FWD BULKHEAD
29	.0020	.0931	.0934	.0022	.0014	.0018	SM, AFT BULKHEAD
30	.0014	.0000	.0066	0.	0.	0.	LOWER O LATCH, DA
31	.0001	.0085	.0017	0.	0.	0.	LOWER +Y TRUNNION
32	.0010	.0009	.0046	0.	0.	0.	LOWER -Y TRUNNION
33	.0000	.0017	.0000	0.	0.	0.	EREP PACKAGE C.G.
34	.0046	.0179	.0475	0.	0.	0.	ATM PN 6,7 IF,OUTR
35	.0371	.0074	.0049	0.	0.	0.	ATM PN 4,5 IF,OUTR
36	.0059	.0037	.0293	0.	0.	0.	ATM PN 8,1 IF,OUTR
37	.0162	.0000	.0014	0.	0.	0.	ATM PN 2,3 IF,OUTR
38	.0013	.0045	.0332	0.	0.	0.	ATM PN 6,7 IF,INNER
39	.0192	.0009	.0031	0.	0.	0.	ATM PN 4,5 IF,INNER
40	-.0001	-.0007	.0212	0.	0.	0.	ATM PN 8,1 IF,INNER
41	.0054	.0050	.0044	0.	0.	0.	ATM PN 2,3 IF,INNER
42	.0060	.0001	.0010	.0000	.0000	.0000	CMG, -Y SIDE
43	.0001	.0002	.0114	.0001	.0001	.0001	CMG, +Y SIDE
44	.0016	.0007	.0021	.0000	.0000	.0000	CMG, +X SIDE
45	.0002	.0002	0.	0.	0.	0.	ATM SAS, PN 1
46	.0007	.0007	0.	0.	0.	0.	ATM SAS, PN 3
47	-.0000	-.0000	0.	0.	0.	0.	ATM SAS, PN 5
48	.0000	.0000	0.	0.	0.	0.	ATM SAS, PN 7
49	.0264	.0108	.0287	.0028	.0011	0.	SPAR CENTER
50	.0251	.0084	.0256	.0043	.0026	.0029	GRA/CAN CENTER
---	---	---	---	---	---	---	---
SUM	.1974	.2372	.4475	.0669	.0303	.0206	

TABLE C-7

ORBITAL CONFIGURATION MODAL SURVEY  
ANALYTICAL MODES GENERALIZED MASS CONTRIBUTION SUMMARY

ANALYTICAL MODE 10

ANALYTICAL FREQUENCY = 1.670 HZ.

COMPONENT NAME	GMC (OX)	GMC (OY)	GMC (OZ)	GMC (TX)	GMC (TY)	GMC (TZ)
BR/OWS SKIRT/IU/FAS	.0107	.0688	.0585	.0575	.0146	.0232
6-FAS O2 TANKS	.0070	.0113	.0190	0.	0.	0.
MDA/STS/AM	.0040	.0226	.0066	.0103	.0013	.0026
6-AM N2 TANKS	.0025	.0021	.0008	0.	0.	0.
COMMAND/SERVICE MOD.	.0077	.1608	.0617	.0260	.0029	.0089
DEPLOYMENT ASSEMBLY	.0030	.0094	.0087	0.	0.	0.
ATM-RACK, CMGS, 4-SAS	.0842	.0796	.1013	.0001	.0000	.0002
ATM-SPAR CENTER	.0165	.0185	.0195	.0058	.0007	0.
ATM-GRA/CAN CENTER	.0133	.0183	.0169	.0079	.0008	.0041
	----	----	----	----	----	----
SUM	.1490	.3913	.2930	.1176	.0202	.0390

TOTAL GM CONTRIBUTION FOR EACH COMPONENT

BR/OWS SKIRT/IU/FAS	.2334
6-FAS O2 TANKS	.1372
MDA/STS/AM	.0474
6-AM N2 TANKS	.0054
COMMAND/SERVICE MOD.	.2630
DEPLOYMENT ASSEMBLY	.0211
ATM-RACK, CMGS, 4-SAS	.2654
ATM-SPAR CENTER	.0609
ATM-GRA/CAN CENTER	.0613

C-11  
TABLE C-8

GENERALIZED MASS CONTRIBUTIONS BY DEGREE OF FREEDOM

ANALYTICAL MODE 10

FREQUENCY= 1.67 Hz.

NODE NO.	GMC (DX)	GMC (DY)	GMC (DZ)	GMC (TX)	GMC (TY)	GMC (TZ)	NODE DESCRIPTION
1	.0030	.0570	.0454	.0298	.0386	.0140	BASE RNG/OWS SKIRT
2	.0011	.0040	.0041	.0106	.0031	.0043	OWS/IU INTERFACE
3	.0011	.0023	.0034	.0171	.0029	.0048	IU/FAS INTERFACE
4	.0037	.0007	.0014	0.	0.	0.	FAS 02 B0TL1,+Y +Z
5	-.0001	.0029	.0001	0.	0.	0.	FAS 02 B0TL2,+Y +Z
6	.0003	.0027	.0028	0.	0.	0.	FAS 02 B0TL3,-Y +Z
7	.0013	.0007	.0065	0.	0.	0.	FAS 02 B0TL4,-Y +Z
8	-.0000	.0013	.0061	0.	0.	0.	FAS 02 B0TL5,-Y -Z
9	.0017	.0030	.0020	0.	0.	0.	FAS 02 B0TL6,-Y -Z
10	.0030	.0000	.0016	0.	0.	0.	FAS/AM/DA IF, +Y
11	.0001	.0043	.0000	0.	0.	0.	FAS/AM/DA IF, +Z
12	.0010	.0001	.0037	0.	0.	0.	FAS/AM/DA IF, -Y
13	.0000	-.0001	.0002	0.	0.	0.	FAS/DA IF, -Y -Z
14	.0009	.0011	.0000	0.	0.	0.	FAS/AM IF, -Z
15	.0005	.0001	.0001	0.	0.	0.	FAS/DA IF, +Y -Z
16	.0006	.0002	.0006	.0008	.0003	.0006	AM TUNNEL/SHEAR WB
17	.0010	.0013	.0001	.0025	.0002	.0004	AM TUNNEL/STS IF
18	.0014	.0063	.0014	.0040	.0007	.0017	MDA/STS INTERFACE
19	.0011	.0148	.0045	.0030	.0001	.0000	MDA CONE/CYL ITRFC
20	.0007	.0000	.0001	0.	0.	0.	N2 TANK, +Y, LOWER
21	.0007	.0000	.0004	0.	0.	0.	N2 TANK, +Y, UPPER
22	.0000	.0003	.0001	0.	0.	0.	N2 TANK, +Z, LOWER
23	.0000	.0008	.0000	0.	0.	0.	N2 TANK, +Z, UPPER
24	.0005	.0007	.0001	0.	0.	0.	N2 TANK -Z, LOWER
25	.0006	.0003	.0000	0.	0.	0.	N2 TANK, -Z, UPPER
26	.0013	.0078	.0033	.0035	.0002	.0002	CM, FWD BULKHEAD
27	.0015	.0003	.0000	.0038	.0002	.0003	CM, AFT BULKHEAD
28	.0021	.0044	.0018	.0070	.0001	.0015	SM, FWD BULKHEAD
29	.0027	.1483	.0567	.0118	.0023	.0070	SM, AFT BULKHEAD
30	.0010	.0001	.0042	0.	0.	0.	LOWER D LATCH, DA
31	.0015	-.0001	.0038	0.	0.	0.	LOWER +Y TRUNNION
32	.0004	.0071	.0007	0.	0.	0.	LOWER -Y TRUNNION
33	.0000	.0024	.0000	0.	0.	0.	EREP PACKAGE C.G.
34	.0134	.0466	.0145	0.	0.	0.	ATM PN 6,7 IF,OUTR
35	-.0003	.0160	.0317	0.	0.	0.	ATM PN 4,5 IF,OUTR
36	.0336	.0026	-.0001	0.	0.	0.	ATM PN 8,1 IF,OUTR
37	.0047	.0027	.0082	0.	0.	0.	ATM PN 2,3 IF,OUTR
38	.0055	.0065	.0129	0.	0.	0.	ATM PN 6,7 IF,INNER
39	-.0013	-.0010	.0117	0.	0.	0.	ATM PN 4,5 IF,INNER
40	.0205	.0023	.0003	0.	0.	0.	ATM PN 8,1 IF,INNER
41	-.0002	.0022	.0104	0.	0.	0.	ATM PN 2,3 IF,INNER
42	-.0000	.0003	.0102	.0000	-.0000	.0000	CMG, -Y SIDE
43	.0064	.0002	.0001	.0000	.0000	.0001	CMG, +Y SIDE
44	.0011	.0005	.0014	.0001	.0000	.0001	CMG, +X SIDE
45	.0006	.0006	0.	0.	0.	0.	ATM SAS, PN 1
46	.0001	.0001	0.	0.	0.	0.	ATM SAS, PN 3
47	.0000	.0000	0.	0.	0.	0.	ATM SAS, PN 5
48	-.0000	-.0000	0.	0.	0.	0.	ATM SAS, PN 7
49	.0165	.0185	.0195	.0058	.0007	0.	SPAR CENTER
50	.0133	.0183	.0169	.0079	.0008	.0041	GRA/CAN CENTER
	----	----	----	----	----	----	
SUM	.1490	.3913	.2930	.1076	.0202	.0390	

TABLE C-9

ORBITAL CONFIGURATION MODAL SURVEY  
ANALYTICAL MODES GENERALIZED MASS CONTRIBUTION SUMMARY

ANALYTICAL MODE 11

ANALYTICAL FREQUENCY = 2.338 HZ.

COMPONENT NAME	GMC (DX)	GMC (DY)	GMC (DZ)	GMC (TX)	GMC (TY)	GMC (TZ)
BR/OWS SKIRT/IU/FAS	.0037	.0483	.0080	.1154	.0000	.0320
6-FAS O2 TANKS	.0101	.0248	.0251	0.	0.	0.
MDA/STS/AM	.0000	.1250	.0007	.0155	.0001	.0081
6-AM N2 TANKS	.0006	.0078	.0024	0.	0.	0.
COMMAND/SERVICE MOD.	-.0000	.2101	.0009	.0877	-.0001	.0119
DEPLOYMENT ASSEMBLY	.0069	.0286	-.0006	0.	0.	0.
ATM-PACK,CMGS,4-SAS	.0147	.1049	.0357	.0002	.0000	.0000
ATM-SPAR CENTER	.0001	.0330	.0000	.0065	.0000	0.
ATM-GRA/CAN CENTER	.0000	.0303	.0000	.0193	.0001	.0021
	----	----	----	----	----	----
SUM	.0361	.6128	.0723	.2246	.0001	.0541

TOTAL GM CONTRIBUTION FOR EACH COMPONENT

BR/OWS SKIRT/IU/FAS	.1973
6-FAS O2 TANKS	.0630
MDA/STS/AM	.1493
6-AM N2 TANKS	.0108
COMMAND/SERVICE MOD.	.3106
DEPLOYMENT ASSEMBLY	.0349
ATM-RACK,CMGS,4-SAS	.1557
ATM-SPAR CENTER	.0395
ATM-GRA/CAN CENTER	.0419



GENERALIZED MASS CONTRIBUTIONS BY DEGREE OF FREEDOM

ANALYTICAL MODE 11

FREQUENCY= 2.34 1Z.

NODE NO.	GMC (OX)	GMC (DY)	GMC (DZ)	GMC (TX)	GMC (TY)	GMC (TZ)	NODE DESCRIPTION
1	.0000	.0363	.0001	.0561	.0000	.0182	BASE RNG/OWS SKIRT
2	.0000	-.0000	-.0000	.0180	-.0000	.0044	OWS/IU INTERFACE
3	.0000	.0002	.0001	.0313	.0000	.0094	IU/FAS INTERFACE
4	.0024	-.0000	.0076	0.	0.	0.	FAS 02 BJT11,+Y +Z
5	.0008	.0017	.0028	0.	0.	0.	FAS 02 BJT12,+Y +Z
6	.0007	.0017	.0015	0.	0.	0.	FAS 02 BJT13,-Y +Z
7	.0023	-.0000	.0054	0.	0.	0.	FAS 02 BJT14,-Y +Z
8	.0037	.0080	.0066	0.	0.	0.	FAS 02 BJT15,-Y -Z
9	.0003	.0134	.0011	0.	0.	0.	FAS 02 BJT16,-Y -Z
10	.0013	.0013	.0036	0.	0.	0.	FAS/AM/DA IF, +Y
11	.0000	.0011	.0000	0.	0.	0.	FAS/AM/DA IF, +Z
12	.0020	.0019	.0043	0.	0.	0.	FAS/AM/DA IF, -Y
13	.0001	.0012	-.0002	0.	0.	0.	FAS/DA IF, -Y -Z
14	.0000	.0055	.0000	0.	0.	0.	FAS/AM IF, -Z
15	.0002	.0007	.0001	0.	0.	0.	FAS/DA IF, +Y -Z
16	-.0000	.0011	.0000	.0017	.0000	.0010	AM TUNNEL/SHEAR WB
17	.0000	.0126	.0001	.0058	.0000	.0008	AM TUNNEL/STS IF
18	.0000	.0406	.0002	.0046	.0000	.0066	MDA/STS INTERFACE
19	.0000	.0706	.0003	.0033	.0000	-.0002	MDA CONE/CYL ITRFC
20	.0003	.0004	.0011	0.	0.	0.	N2 TANK, +Y, LOWER
21	.0003	.0011	.0012	0.	0.	0.	N2 TANK, +Y, UPPER
22	.0000	.0002	.0000	0.	0.	0.	N2 TANK, +Z, LOWER
23	.0000	.0000	.0000	0.	0.	0.	N2 TANK, +Z, UPPER
24	.0000	.0022	.0000	0.	0.	0.	N2 TANK -Z, LOWER
25	.0000	.0040	.0000	0.	0.	0.	N2 TANK, -Z, UPPER
26	.0000	.0612	.0006	.0088	-.0000	.0005	CM, FWD BULKHEAD
27	.0000	.0143	.0005	.0137	.0000	-.0003	CM, AFT BULKHEAD
28	-.0000	.0041	-.0000	.0258	.0000	.0023	SM, FWD BULKHEAD
29	-.0000	.1305	-.0001	.0394	-.0001	.0093	SM, AFT BULKHEAD
30	.0000	.0299	.0000	0.	0.	0.	LOWER D LATCH, DA
31	.0034	-.0010	-.0003	0.	0.	0.	LOWER +Y TRUNNION
32	.0035	-.0004	-.0003	0.	0.	0.	LOWER -Y TRUNNION
33	-.0000	.0001	.0000	0.	0.	0.	EREP PACKAGE C.G.
34	-.0002	.0120	.0019	0.	0.	0.	ATM PN 6,7 IF,OUTR
35	.0011	.0115	.0082	0.	0.	0.	ATM PN 4,5 IF,OUTR
36	.0037	.0203	.0099	0.	0.	0.	ATM PN 8,1 IF,OUTR
37	.0018	.0479	.0011	0.	0.	0.	ATM PN 2,3 IF,OUTR
38	.0001	.0002	.0014	0.	0.	0.	ATM PN 6,7 IF,INNER
39	.0029	.0001	.0014	0.	0.	0.	ATM PN 4,5 IF,INNER
40	.0022	.0013	.0055	0.	0.	0.	ATM PN 8,1 IF,INNER
41	.0010	.0064	.0011	0.	0.	0.	ATM PN 2,3 IF,INNER
42	.0009	.0008	.0022	.0001	.0000	.0000	CMG, -Y SIDE
43	.0006	.0009	.0031	.0001	.0000	.0000	CMG, +Y SIDE
44	.0000	.0031	.0000	.0001	.0000	.0000	CMG, +X SIDE
45	.0001	.0001	0.	0.	0.	0.	ATM SAS, PN 1
46	.0001	.0001	0.	0.	0.	0.	ATM SAS, PN 3
47	.0002	.0002	0.	0.	0.	0.	ATM SAS, PN 5
48	.0001	.0001	0.	0.	0.	0.	ATM SAS, PN 7
49	.0001	.0330	.0000	.0065	.0000	0.	SPAR CENTER
50	.0000	.0303	.0000	.0093	.0001	.0021	GRA/CAN CENTER
SUM	.0361	.6128	.0723	.2246	.0001	.0541	

TABLE C-11

ORBITAL CONFIGURATION MODAL SURVEY  
ANALYTICAL MODES GENERALIZED MASS CONTRIBUTION SUMMARY

ANALYTICAL MODE 12

ANALYTICAL FREQUENCY = 3.151 HZ.

COMPONENT NAME	GMC (OX)	GMC (OY)	GMC (OZ)	G4C (TX)	GMC (TY)	G4C (TZ)
BR/OWS SKIRT/IU/FAS	.0019	.0002	.0155	.0325	.0104	.0000
6-FAS O2 TANKS	.0027	.0012	.0045	0.	0.	0.
MDA/STS/AM	.0008	.0003	.1875	.0301	.0221	-.0000
6-AM N2 TANKS	.0010	.0001	.0020	0.	0.	0.
COMMAND/SERVICE MOD.	.0027	.0008	.3629	.0101	.0121	.0002
DEPLOYMENT ASSEMBLY	.0004	.0240	.0137	0.	0.	0.
ATM-RACK, CMGS, 4-SAS	.0159	.0028	.2054	.0000	.0001	.0000
ATM-SPAR CENTER	.0007	.0003	.0476	.0002	.0018	0.
ATM-GRA/CAN CENTER	.0006	.0002	.0420	.0102	.0025	-.0000
	----	----	----	----	----	----
SUM	.0268	.0298	.8811	.0130	.0490	.0003

TOTAL GM CONTRIBUTION FOR EACH COMPONENT

BR/OWS SKIRT/IU/FAS	.0306
6-FAS O2 TANKS	.0084
MDA/STS/AM	.2109
6-AM N2 TANKS	.0030
COMMAND/SERVICE MOD.	.3888
DEPLOYMENT ASSEMBLY	.0391
ATM-RACK, CMGS, 4-SAS	.2242
ATM-SPAR CENTER	.0505
ATM-GRA/CAN CENTER	.0455

C-15  
TABLE C-12

GENERALIZED MASS CONTRIBUTIONS BY DEGREE OF FREEDOM

ANALYTICAL MODE 12

FREQUENCY= 3.15 1Z.

NODE NO.	GMC (OX)	GMC (OY)	GMC (OZ)	GMC (TX)	GMC (TY)	GMC (TZ)	NODE DESCRIPTION
1	.0002	.0000	.0133	.0013	.0360	.0000	BASE RNG/OWS SKIRT
2	.0001	-.0000	.0001	.0004	.0015	.0000	OWS/IU INTERFACE
3	.0001	-.0000	.0000	.0008	.0030	.0000	IU/FAS INTERFACE
4	.0000	.0000	.0000	0.	0.	0.	FAS 02 BDTL1,+Y +Z
5	.0004	.0000	.0004	0.	0.	0.	FAS 02 BDTL2,+Y +Z
6	.0005	.0005	.0014	0.	0.	0.	FAS 02 BDTL3,-Y +Z
7	.0000	.0001	.0011	0.	0.	0.	FAS 02 BDTL4,-Y +Z
8	.0004	.0002	.0008	0.	0.	0.	FAS 02 BDTL5,-Y -Z
9	.0012	.0004	.0008	0.	0.	0.	FAS 02 BDTL6,-Y -Z
10	.0001	-.0000	.0000	0.	0.	0.	FAS/AM/DA IF, +Y
11	.0007	.0001	.0009	0.	0.	0.	FAS/AM/DA IF, +Z
12	.0001	-.0000	.0008	0.	0.	0.	FAS/AM/DA IF, -Y
13	.0000	.0000	-.0000	0.	0.	0.	FAS/DA IF, -Y -Z
14	.0006	.0000	.0004	0.	0.	0.	FAS/AM IF, -Z
15	.0000	.0000	-.0000	0.	0.	0.	FAS/DA IF, +Y -Z
16	.0002	.0000	.0002	.0000	.0009	.0000	AM TUNNEL/SHEAR WB
17	.0003	.0000	.0078	.0000	.0018	.0000	AM TUNNEL/STS IF
18	.0002	.0001	.0550	-.0000	.0169	.0000	MDA/STS INTERFACE
19	.0002	.0002	.1246	.0001	.0025	-.0000	MDA CONE/CYL ITRFC
20	.0000	.0000	.0000	0.	0.	0.	N2 TANK, +Y, LOWER
21	.0000	.0000	.0003	0.	0.	0.	N2 TANK, +Y, UPPER
22	.0001	.0000	.0002	0.	0.	0.	N2 TANK, +Z, LOWER
23	.0001	.0000	.0007	0.	0.	0.	N2 TANK, +Z, UPPER
24	.0004	.0000	.0002	0.	0.	0.	N2 TANK -Z, LOWER
25	.0003	.0000	.0007	0.	0.	0.	N2 TANK, -Z, UPPER
26	.0006	.0003	.1428	.0011	.0008	.0000	CM, FWD BULKHEAD
27	.0008	.0002	.0631	.0015	-.0005	-.0000	CM, AFT BULKHEAD
28	.0005	.0000	.0237	.0013	.0028	-.0000	SM, FWD BULKHEAD
29	.0008	.0003	.1333	.0061	.0090	.0002	SM, AFT BULKHEAD
30	-.0001	.0003	.0123	0.	0.	0.	LOWER D LATCH, DA
31	.0004	.0122	.0002	0.	0.	0.	LOWER +Y TRUNNION
32	.0001	.0114	-.0001	0.	0.	0.	LOWER -Y TRUNNION
33	.0000	.0000	.0014	0.	0.	0.	EREP PACKAGE C.G.
34	.0002	.0007	.0480	0.	0.	0.	ATM PN 6,7 IF,OUTR
35	.0006	.0006	.0255	0.	0.	0.	ATM PN 4,5 IF,OUTR
36	.0003	.0002	.0153	0.	0.	0.	ATM PN 8,1 IF,OUTR
37	.0003	.0001	.0158	0.	0.	0.	ATM PN 2,3 IF,OUTR
38	.0012	.0003	.0424	0.	0.	0.	ATM PN 6,7 IF,INNER
39	.0019	.0000	.0125	0.	0.	0.	ATM PN 4,5 IF,INNER
40	.0057	-.0001	.0128	0.	0.	0.	ATM PN 8,1 IF,INNER
41	.0025	.0001	.0142	0.	0.	0.	ATM PN 2,3 IF,INNER
42	.0007	.0000	.0084	-.0000	-.0000	.0000	CMG, -Y SIDE
43	.0008	.0000	.0065	-.0000	.0001	.0000	CMG, +Y SIDE
44	.0010	.0000	.0040	.0000	.0000	.0000	CMG, +X SIDE
45	-.0000	-.0000	0.	0.	0.	0.	ATM SAS, PN 1
46	-.0000	-.0000	0.	0.	0.	0.	ATM SAS, PN 3
47	.0004	.0004	0.	0.	0.	0.	ATM SAS, PN 5
48	.0005	.0005	0.	0.	0.	0.	ATM SAS, PN 7
49	.0007	.0003	.0476	.0002	.0018	0.	SPAR CENTER
50	.0006	.0002	.0420	.0002	.0025	-.0000	GRA/CAN CENTER
SUM	.0268	.0298	.8811	.0130	.0490	.0003	

TABLE C-13

ORBITAL CONFIGURATION MODAL SURVEY  
ANALYTICAL MODES GENERALIZED MASS CONTRIBUTION SUMMARY

ANALYTICAL MODE 13

ANALYTICAL FREQUENCY = 3.532 HZ.

COMPONENT NAME	GMC (DX)	GMC (DY)	GMC (DZ)	GMC (TX)	GMC (TY)	GMC (TZ)
BR/OWS SKIRT/IU/FAS	.0001	.0064	.0066	.0802	.0003	.0001
6-FAS O2 TANKS	.0000	.0261	.0248	0.	0.	0.
MDA/STS/AM	.0000	.0005	.0048	.0017	.0003	.0001
6-AM N2 TANKS	.0000	.0014	.0012	0.	0.	0.
COMMAND/SERVICE MOD.	.0001	.0031	.0072	.8014	.0005	.0000
DEPLOYMENT ASSEMBLY	-.0001	.0058	.0010	0.	0.	0.
ATM-RACK,CMGS,4-SAS	.0032	.0073	.0091	.0000	.0000	.0000
ATM-SPAR CENTER	.0000	.0007	.0004	.0014	.0001	0.
ATM-GRA/CAN CENTER	.0000	.0007	.0003	.0019	.0002	.0008
	----	----	----	----	----	----
SUM	.0034	.0521	.0555	.8366	.0014	.0010

TOTAL GM CONTRIBUTION FOR EACH COMPONENT

BR/OWS SKIRT/IU/FAS	.0937
6-FAS O2 TANKS	.0519
MDA/STS/AM	.0075
6-AM N2 TANKS	.0027
COMMAND/SERVICE MOD.	.8123
DEPLOYMENT ASSEMBLY	.0057
ATM-RACK,CMGS,4-SAS	.0137
ATM-SPAR CENTER	.0026
ATM-GRA/CAN CENTER	.0040

C-17  
TABLE C-14

GENERALIZED MASS CONTRIBUTIONS BY DEGREE OF FREEDOM

ANALYTICAL MODE 13

FREQUENCY= 3.53 Hz.

NODE NO.	GMC (DX)	GMC (DY)	GMC (DZ)	GMC (TX)	GMC (TY)	GMC (TZ)	NOJE DESCRIPTION
1	.0000	.0002	.0001	.0420	.0002	.0000	BASE RNG/OWS SKIRT
2	.0000	.0001	-.0000	.0139	.0000	.0000	OWS/IU INTERFACE
3	.0000	.0003	.0001	.0243	.0031	.0000	IU/FAS INTERFACE
4	-.0000	.0022	.0083	0.	0.	0.	FAS 02 BDTL1,+Y +Z
5	-.0000	.0068	.0034	0.	0.	0.	FAS 02 BDTL2,+Y +Z
6	.0000	.0063	.0014	0.	0.	0.	FAS 02 BDTL3,-Y +Z
7	.0000	.0021	.0052	0.	0.	0.	FAS 02 BDTL4,-Y +Z
8	.0000	.0023	.0052	0.	0.	0.	FAS 02 BDTL5,-Y -Z
9	.0000	.0064	.0013	0.	0.	0.	FAS 02 BDTL5,-Y -Z
10	.0031	-.0000	.0030	0.	0.	0.	FAS/AM/DA IF, +Y
11	.0000	.0041	.0001	0.	0.	0.	FAS/AM/DA IF, +Z
12	.0000	-.0000	.0031	0.	0.	0.	FAS/AM/DA IF, -Y
13	.0000	.0001	.0001	0.	0.	0.	FAS/DA IF, -Y -Z
14	.0000	.0018	.0001	0.	0.	0.	FAS/AM IF, -Z
15	.0000	.0001	.0002	0.	0.	0.	FAS/DA IF, +Y -Z
16	.0000	.0000	.0001	.0001	.0000	.0000	AM TUNNEL/SHEAR WB
17	.0000	.0000	.0004	.0001	.0000	.0000	AM TUNNEL/STS IF
18	.0000	.0001	.0017	.0006	.0003	.0001	MDA/STS INTERFACE
19	.0000	.0004	.0027	.0008	.0000	.0000	MDA CONE/CYL ITRFC
20	.0000	.0000	.0007	0.	0.	0.	N2 TANK, +Y, LOWER
21	.0000	.0000	.0004	0.	0.	0.	N2 TANK, +Y, UPPER
22	.0000	.0005	.0000	0.	0.	0.	N2 TANK, +Z, LOWER
23	.0000	.0002	.0000	0.	0.	0.	N2 TANK, +Z, UPPER
24	.0000	.0006	.0000	0.	0.	0.	N2 TANK, -Z, LOWER
25	.0000	.0002	.0000	0.	0.	0.	N2 TANK, -Z, UPPER
26	.0000	.0011	.0013	.0749	.0001	-.0000	CM, FWD BULKHEAD
27	.0000	.0007	-.0001	.1144	-.0000	.0000	CM, AFT BULKHEAD
28	.0000	-.0000	-.0005	.2463	.0001	.0000	SM, FWD BULKHEAD
29	.0000	.0013	.0065	.3658	.0004	.0000	SM, AFT BULKHEAD
30	-.0000	.0031	.0002	0.	0.	0.	LOWER D -ATC-, DA
31	-.0001	.0002	.0005	0.	0.	0.	LOWER +Y TRUNNION
32	-.0000	.0002	.0002	0.	0.	0.	LOWER -Y TRUNNION
33	-.0000	.0023	.0001	0.	0.	0.	ERP PACKAGE C.G.
34	-.0000	.0000	.0015	0.	0.	0.	ATM PN 6,7 IF,OUTR
35	.0005	.0002	.0006	0.	0.	0.	ATM PN 4,5 IF,OUTR
36	.0006	.0009	.0023	0.	0.	0.	ATM PN 8,1 IF,OUTR
37	.0003	.0028	.0031	0.	0.	0.	ATM PN 2,3 IF,OUTR
38	-.0000	.0026	.0014	0.	0.	0.	ATM PN 6,7 IF,INNER
39	.0013	.0007	.0002	0.	0.	0.	ATM PN 4,5 IF,INNER
40	.0000	.0001	.0017	0.	0.	0.	ATM PN 8,1 IF,INNER
41	.0031	.0000	.0001	0.	0.	0.	ATM PN 2,3 IF,INNER
42	.0003	.0001	.0002	.0000	.0000	.0000	CMG, -Y SIDE
43	.0001	.0000	.0010	.0000	.0000	.0000	CMG, +Y SIDE
44	.0000	.0000	.0000	.0000	.0000	.0000	CMG, +X SIDE
45	-.0000	-.0000	0.	0.	0.	0.	ATM SAS, PN 1
46	.0000	.0000	0.	0.	0.	0.	ATM SAS, PN 3
47	.0000	.0000	0.	0.	0.	0.	ATM SAS, PN 5
48	.0000	.0000	0.	0.	0.	0.	ATM SAS, PN 7
49	.0000	.0007	.0004	.0014	.0001	0.	SPAR CENTER
50	.0000	.0007	.0003	.0019	.0002	.0008	GRA/CAN CENTER
SUM	.0034	.0521	.0555	.8866	.0014	.0010	

TABLE C-15

ORBITAL CONFIGURATION MODAL SURVEY  
ANALYTICAL MODES GENERALIZED MASS CONTRIBUTION SUMMARY

ANALYTICAL MODE 14

ANALYTICAL FREQUENCY = 4.323 HZ.

COMPONENT NAME	GMC (DX)	GMC (DY)	GMC (DZ)	G4C (TX)	GMC (TY)	G4C (TZ)
BR/OWS SKIRT/IU/FAS	.0004	.0133	.0018	.0177	.0000	.0052
6-FAS O2 TANKS	.0014	.0051	.0049	0.	0.	0.
MDA/STS/AM	.0001	.0419	.0000	.0304	-.0000	.0056
6-AM N2 TANKS	.0000	.0007	.0003	0.	0.	0.
COMMAND/SERVICE MOD.	.0000	.1180	.0000	.0342	-.0000	.0047
DEPLOYMENT ASSEMBLY	.0015	.0058	.0031	0.	0.	0.
ATM-RACK,CMGS,4-SAS	.1007	.3191	.1737	.0311	-.0000	.0004
ATM-SPAR CENTER	.0000	.0007	-.0000	.0437	-.0000	0.
ATM-GRA/CAN CENTER	.0000	.0002	-.0000	.0554	.0003	.0586
	----	----	----	----	----	----
SUM	.1041	.5049	.1839	.1224	.0003	.0845

TOTAL GM CONTRIBUTION FOR EACH COMPONENT

BR/OWS SKIRT/IU/FAS	.0383
6-FAS O2 TANKS	.0114
MDA/STS/AM	.0430
6-AM N2 TANKS	.0011
COMMAND/SERVICE MOD.	.1270
DEPLOYMENT ASSEMBLY	.0103
ATM-RACK,CMGS,4-SAS	.5949
ATM-SPAR CENTER	.0445
ATM-GRA/CAN CENTER	.1245

C-19  
TABLE C-16

GENERALIZED MASS CONTRIBUTIONS BY DEGREE OF FREEDOM

ANALYTICAL MODE 14

FREQUENCY= 4.32 Hz.

NODE NO.	GMC (DX)	GMC (DY)	GMC (DZ)	GMC (TX)	GMC (TY)	GMC (TZ)	NODE DESCRIPTION
1	.0000	.0112	.0000	.0094	-.0000	.0032	BASE RNG/OWS SKIRT
2	.0000	.0005	-.0000	.0031	.0000	.0008	OWS/IU INTERFACE
3	.0000	.0001	.0000	.0052	.0000	.0012	IU/FAS INTERFACE
4	.0007	.0005	.0012	0.	0.	0.	FAS 02 B0TL1,+Y +Z
5	.0001	.0020	.0005	0.	0.	0.	FAS 02 B0TL2,+Y +Z
6	-.0000	.0019	.0003	0.	0.	0.	FAS 02 B0TL3,-Y +Z
7	.0004	.0004	.0009	0.	0.	0.	FAS 02 B0TL4,-Y +Z
8	.0003	.0003	.0020	0.	0.	0.	FAS 02 B0TL5,-Y -Z
9	.0000	.0000	.0001	0.	0.	0.	FAS 02 B0TL6,-Y -Z
10	.0001	.0000	.0005	0.	0.	0.	FAS/AM/DA IF, +Y
11	.0000	.0012	.0000	0.	0.	0.	FAS/AM/DA IF, +Z
12	.0002	.0000	.0008	0.	0.	0.	FAS/AM/DA IF, -Y
13	-.0000	.0001	.0004	0.	0.	0.	FAS/DA IF, -Y -Z
14	.0000	.0002	.0000	0.	0.	0.	FAS/AM IF, -Z
15	.0000	-.0000	.0000	0.	0.	0.	FAS/DA IF, +Y -Z
16	.0000	.0000	.0000	.0002	-.0000	.0000	AM TUNNEL/SHEAR WB
17	.0000	.0001	.0000	.0004	.0000	.0008	AM TUNNEL/STS IF
18	.0000	.0085	.0000	.0000	-.0000	.0045	MDA/STS INTERFACE
19	.0000	.0333	.0000	-.0001	-.0000	.0003	MDA CONE/CYL ITRFC
20	.0000	.0000	.0002	0.	0.	0.	N2 TANK, +Y, LOWER
21	.0000	.0000	.0002	0.	0.	0.	N2 TANK, +Y, UPPER
22	.0000	.0003	.0000	0.	0.	0.	N2 TANK, +Z, LOWER
23	.0000	.0002	.0000	0.	0.	0.	N2 TANK, +Z, UPPER
24	.0000	.0001	.0000	0.	0.	0.	N2 TANK -Z, LOWER
25	.0000	.0001	.0000	0.	0.	0.	N2 TANK, -Z, UPPER
26	.0000	.0484	-.0000	.0005	-.0000	.0001	CM, FWD BULKHEAD
27	.0000	.0287	.0000	.0008	.0000	-.0003	CM, AFT BULKHEAD
28	-.0000	.0118	-.0000	.0011	.0000	.0010	SM, FWD BULKHEAD
29	-.0000	.0291	.0000	.0018	-.0000	.0038	SM, AFT BULKHEAD
30	.0000	.0050	.0000	0.	0.	0.	LOWER D LATCH, DA
31	.0008	.0003	.0016	0.	0.	0.	LOWER +Y TRUNNION
32	.0006	-.0000	.0015	0.	0.	0.	LOWER -Y TRUNNION
33	.0000	.0006	.0000	0.	0.	0.	EREP PACKAGE C.G.
34	.0003	.0147	.0025	0.	0.	0.	ATM PN 6,7 IF,OUTR
35	.0180	.0003	.0435	0.	0.	0.	ATM PN 4,5 IF,OUTR
36	.0186	.0035	.0342	0.	0.	0.	ATM PN 0,1 IF,OUTR
37	.0062	.0226	.0045	0.	0.	0.	ATM PN 2,3 IF,OUTR
38	.0127	.1814	.0045	0.	0.	0.	ATM PN 6,7 IF,INNER
39	.0166	.0354	.0187	0.	0.	0.	ATM PN 4,5 IF,INNER
40	.0113	.0076	.0308	0.	0.	0.	ATM PN 0,1 IF,INNER
41	-.0015	.0249	.0049	0.	0.	0.	ATM PN 2,3 IF,INNER
42	.0043	.0101	.0151	.0002	-.0000	.0001	CMG, -Y SIDE
43	.0072	.0100	.0148	.0006	-.0000	.0002	CMG, +Y SIDE
44	.0001	.0017	.0001	.0003	.0000	.0002	CMG, +X SIDE
45	.0019	.0019	0.	0.	0.	0.	ATM SAS, PN 1
46	.0016	.0016	0.	0.	0.	0.	ATM SAS, PN 3
47	.0019	.0019	0.	0.	0.	0.	ATM SAS, PN 5
48	.0014	.0014	0.	0.	0.	0.	ATM SAS, PN 7
49	.0000	.0007	-.0000	.0437	-.0000	0.	SPAR CENTER
50	.0000	.0002	-.0000	.0554	.0003	.0686	GRA/CAN CENTER
SUM	.1041	.5049	.1839	.1224	.0003	.0845	

TABLE C-17

ORBITAL CONFIGURATION MODAL SURVEY  
ANALYTICAL MODES GENERALIZED MASS CONTRIBUTION SUMMARY

ANALYTICAL MODE 15

ANALYTICAL FREQUENCY = 4.868 HZ.

COMPONENT NAME	GMC (DX)	GMC (DY)	GMC (DZ)	GMC (TX)	GMC (TY)	GMC (TZ)
BR/OWS SKIRT/IU/FAS	.0027	.0004	.0069	.0000	.0056	.0002
6-FAS O2 TANKS	.0027	.0005	.0041	0.	0.	0.
MQA/STS/AM	.0030	.0004	.0113	.0000	.0034	.0001
6-AM N2 TANKS	.0005	.0000	.0007	0.	0.	0.
COMMAND/SERVICE MOD.	.0066	.0012	.0451	.0001	.0010	.0001
DEPLOYMENT ASSEMBLY	.0012	.0181	.0328	0.	0.	0.
ATM-RACK,CMGS,4-SAS	.3376	.0134	.3322	.0000	.0022	-.0000
ATM-SPAR CENTER	.0008	.0000	.0002	-.0000	.0674	0.
ATM-GRA/CAN CENTER	.0012	.0000	.0002	-.0000	.0958	.0001
	----	----	----	----	----	----
SUM	.3563	.0341	.4335	.0001	.1755	.0004

TOTAL GM CONTRIBUTION FOR EACH COMPONENT

BR/OWS SKIRT/IU/FAS	.0158
6-FAS O2 TANKS	.0072
MQA/STS/AM	.0191
6-AM N2 TANKS	.0013
COMMAND/SERVICE MOD.	.0542
DEPLOYMENT ASSEMBLY	.0522
ATM-RACK,CMGS,4-SAS	.6855
ATM-SPAR CENTER	.0634
ATM-GRA/CAN CENTER	.0973



C-21  
TABLE C-18

GENERALIZED MASS CONTRIBUTIONS BY DEGREE OF FREEDOM

ANALYTICAL MODE 15

FREQUENCY= 4.87 HZ.

NODE NO.	GMC (DX)	GMC (DY)	GMC (DZ)	GMC (TX)	GMC (TY)	GMC (TZ)	NODE DESCRIPTION
1	.0010	.0002	.0052	.0000	.0032	.0001	BASE RNG/OWS SKIRT
2	.0004	.0000	-.0000	.0000	.0007	.0000	OWS/IU INTERFACE
3	.0004	.0000	.0002	.0000	.0017	.0000	IU/FAS INTERFACE
4	.0000	.0000	.0009	0.	0.	0.	FAS 02 B0TL1,+Y +Z
5	.0001	.0001	.0005	0.	0.	0.	FAS 02 B0TL2,+Y +Z
6	.0000	.0000	.0007	0.	0.	0.	FAS 02 B0TL3,-Y +Z
7	.0002	.0000	.0011	0.	0.	0.	FAS 02 B0TL4,-Y +Z
8	.0007	.0000	.0007	0.	0.	0.	FAS 02 B0TL5,-Y -Z
9	.0017	.0003	.0002	0.	0.	0.	FAS 02 B0TL6,-Y -Z
10	.0001	-.0000	.0003	0.	0.	0.	FAS/AM/DA IF, +Y
11	.0002	.0000	.0003	0.	0.	0.	FAS/AM/DA IF, +Z
12	.0003	.0000	.0006	0.	0.	0.	FAS/AM/DA IF, -Y
13	.0000	.0001	.0002	0.	0.	0.	FAS/DA IF, -Y -Z
14	.0004	.0000	.0001	0.	0.	0.	FAS/AM IF, -Z
15	.0001	.0000	.0000	0.	0.	0.	FAS/DA IF, +Y -Z
16	.0004	.0000	.0006	-.0000	-.0000	.0000	AM TUNNEL/SHEAR WB
17	.0006	.0000	.0009	.0000	.0004	.0000	AM TUNNEL/STS IF
18	.0010	.0000	.0005	.0000	.0021	.0001	MDA/STS INTERFACE
19	.0010	.0003	.0003	.0000	.0009	.0000	MDA CONE/CYL ITRFC
20	.0001	.0000	.0002	0.	0.	0.	N2 TANK, +Y, LOWER
21	.0001	.0000	.0002	0.	0.	0.	N2 TANK, +Y, UPPER
22	.0000	.0000	.0001	0.	0.	0.	N2 TANK, +Z, LOWER
23	.0000	.0000	.0001	0.	0.	0.	N2 TANK, +Z, UPPER
24	.0002	.0000	.0001	0.	0.	0.	N2 TANK -Z, LOWER
25	.0002	.0000	.0001	0.	0.	0.	N2 TANK, -Z, UPPER
26	.0011	.0005	.0175	.0000	-.0000	-.0000	CM, FWD BULKHEAD
27	.0015	.0003	.0123	.0000	-.0001	-.0000	CM, AFT BULKHEAD
28	.0017	.0002	.0047	.0001	.0004	.0001	SM, FWD BULKHEAD
29	.0022	.0003	.0106	-.0000	.0008	.0000	SM, AFT BULKHEAD
30	.0011	.0000	.0196	0.	0.	0.	LOWER D LATCH, DA
31	-.0000	.0083	.0039	0.	0.	0.	LOWER +Y TRUNNION
32	.0001	.0097	.0049	0.	0.	0.	LOWER -Y TRUNNION
33	.0000	.0000	.0043	0.	0.	0.	ERP PACKAGE C.G.
34	.0019	.0007	.0695	0.	0.	0.	ATM PN 6,7 IF,OUTR
35	.0007	.0001	.0061	0.	0.	0.	ATM PN 4,5 IF,OUTR
36	.0056	.0003	.0117	0.	0.	0.	ATM PN 8,1 IF,OUTR
37	.0051	-.0003	.0856	0.	0.	0.	ATM PN 2,3 IF,OUTR
38	.0324	-.0020	.0507	0.	0.	0.	ATM PN 6,7 IF,INNER
39	.0795	-.0012	.0008	0.	0.	0.	ATM PN 4,5 IF,INNER
40	.0934	.0058	.0114	0.	0.	0.	ATM PN 8,1 IF,INNER
41	.0672	.0004	.0714	0.	0.	0.	ATM PN 2,3 IF,INNER
42	.0147	.0001	-.0000	.0000	.0007	-.0000	CMG, -Y SIDE
43	.0122	.0002	.0001	.0000	.0007	-.0000	CMG, +Y SIDE
44	.0146	.0001	.0250	.0000	.0008	-.0000	CMG, +X SIDE
45	.0023	.0023	0.	0.	0.	0.	ATM SAS, PN 1
46	.0026	.0026	0.	0.	0.	0.	ATM SAS, PN 3
47	.0021	.0021	0.	0.	0.	0.	ATM SAS, PN 5
48	.0023	.0023	0.	0.	0.	0.	ATM SAS, PN 7
49	.0008	.0000	.0002	-.0000	.0574	0.	SPAR CENTER
50	.0012	.0000	.0002	-.0000	.0958	.0001	GRA/CAN CENTER
SUM	.3563	.0741	.4335	.0001	.1755	.0004	

TABLE C-19

ORBITAL CONFIGURATION MODAL SURVEY  
ANALYTICAL MODES GENERALIZED MASS CONTRIBUTION SUMMARY

ANALYTICAL MODE 18

ANALYTICAL FREQUENCY = 5.706 HZ.

COMPONENT NAME	GMC (DX)	GMC (DY)	GMC (DZ)	G4C (TX)	GMC (TY)	G4C (TZ)
BR/OWS SKIRT/IU/FAS	.0099	.0988	.0002	.0135	.0001	.0696
6-FAS O2 TANKS	.0200	.0601	.0023	0.	0.	0.
MDA/STS/AM	.0003	.0587	.0000	.0014	-.0000	.0120
6-AM N2 TANKS	.0004	.0176	.0001	0.	0.	0.
COMMAND/SERVICE MOD.	.0002	.2062	.0002	.0020	.0001	.0071
DEPLOYMENT ASSEMBLY	.0117	.0820	.0002	0.	0.	0.
ATM-RACK,CMGS,4-SAS	.0497	.0443	-.0000	.0000	-.0000	.0002
ATM-SPAR CENTER	.0006	.0003	-.0000	.0000	.0001	0.
ATM-GRA/CAN CENTER	.0005	.0004	-.0000	.0000	.0001	.2392
	----	----	----	----	----	----
SUM	.0934	.5683	.0030	.0169	.0003	.3281

TOTAL GM CONTRIBUTION FOR EACH COMPONENT

BR/OWS SKIRT/IU/FAS	.1821
6-FAS O2 TANKS	.0824
MDA/STS/AM	.0724
6-AM N2 TANKS	.0131
COMMAND/SERVICE MOD.	.2158
DEPLOYMENT ASSEMBLY	.0939
ATM-RACK,CMGS,4-SAS	.0942
ATM-SPAR CENTER	.0009
ATM-GRA/CAN CENTER	.2402

C-23  
TABLE C-20

GENERALIZED MASS CONTRIBUTIONS BY DEGREE OF FREEDOM

ANALYTICAL MODE 18

FREQUENCY= 5.71 HZ.

NODE NO.	GMC (OX)	GMC (DY)	GMC (DZ)	GMC (TX)	GMC (TY)	GMC (TZ)	NOJE DESCRIPTION
1	.0001	.0768	.0003	.0020	.0001	.0407	BASE RNG/OWS SKIRT
2	-.0003	-.0000	.0000	.0006	.0000	.0086	OWS/IU INTERFACE
3	-.0000	.0025	-.0000	.0009	.0000	.0203	IU/FAS INTERFACE
4	.0060	.0078	.0001	0.	0.	0.	FAS 02 BJTLL1,+Y +Z
5	.0014	.0084	.0000	0.	0.	0.	FAS 02 BJTLL2,+Y +Z
6	.0012	.0076	.0000	0.	0.	0.	FAS 02 BJTLL3,-Y +Z
7	.0054	.0073	.0001	0.	0.	0.	FAS 02 BJTLL4,-Y +Z
8	.0048	.0124	.0014	0.	0.	0.	FAS 02 BJTLL5,-Y -Z
9	.0013	.0166	.0008	0.	0.	0.	FAS 02 BJTLL6,-Y -Z
10	.0043	.0036	.0000	0.	0.	0.	FAS/AM/DA IF, +Y
11	.0000	.0044	.0000	0.	0.	0.	FAS/AM/DA IF, +Z
12	.0049	.0053	.0000	0.	0.	0.	FAS/AM/DA IF, -Y
13	.0001	.0022	-.0001	0.	0.	0.	FAS/DA IF, -Y -Z
14	.0000	.0030	-.0000	0.	0.	0.	FAS/AM IF, -Z
15	.0005	.0009	-.0000	0.	0.	0.	FAS/DA IF, +Y -Z
16	.0000	.0118	.0000	.0001	.0000	.0000	AM TUNNEL/SHEAR WB
17	.0001	.0203	.0000	.0002	.0000	.0033	AM TUNNEL/STS IF
18	.0001	-.0014	.0000	.0004	-.0000	.0063	MDA/STS INTERFACE
19	.0001	.0279	-.0000	.0006	-.0000	.0024	MDA CONE/CYL ITRFC
20	.0002	.0022	.0000	0.	0.	0.	N2 TANK, +Y, LOWER
21	.0003	.0025	.0000	0.	0.	0.	N2 TANK, +Y, UPPER
22	.0000	.0028	.0000	0.	0.	0.	N2 TANK, +Z, LOWER
23	.0000	.0030	.0000	0.	0.	0.	N2 TANK, +Z, UPPER
24	.0000	.0032	.0000	0.	0.	0.	N2 TANK -Z, LOWER
25	.0000	.0039	.0000	0.	0.	0.	N2 TANK, -Z, UPPER
26	.0001	.0768	.0000	-.0001	-.0000	.0001	CM, FWD BULKHEAD
27	.0001	.0639	.0001	-.0002	.0000	-.0004	CM, AFT BULKHEAD
28	-.0001	.0234	.0000	.0009	-.0000	.0014	SM, FWD BULKHEAD
29	-.0000	.0421	.0000	.0014	.0001	.0060	SM, AFT BULKHEAD
30	.0000	.0352	.0000	0.	0.	0.	LOWER D LATCH, DA
31	.0053	.0037	-.0000	0.	0.	0.	LOWER +Y TRUNNION
32	.0054	.0029	.0000	0.	0.	0.	LOWER -Y TRUNNION
33	.0000	.0402	.0002	0.	0.	0.	EREP PACKAGE C.G.
34	.0008	.0078	.0000	0.	0.	0.	ATM PN 6,7 IF,OUTR
35	.0101	.0006	-.0001	0.	0.	0.	ATM PN 4,5 IF,OUTR
36	.0089	.0012	-.0000	0.	0.	0.	ATM PN 8,1 IF,OUTR
37	.0029	.0108	.0000	0.	0.	0.	ATM PN 2,3 IF,OUTR
38	.0010	.0104	-.0000	0.	0.	0.	ATM PN 6,7 IF,INNER
39	.0090	.0007	-.0000	0.	0.	0.	ATM PN 4,5 IF,INNER
40	.0086	.0014	.0000	0.	0.	0.	ATM PN 8,1 IF,INNER
41	.0024	.0086	-.0000	0.	0.	0.	ATM PN 2,3 IF,INNER
42	.0032	-.0000	.0000	.0003	-.0000	.0000	CMG, -Y SIDE
43	.0028	.0000	-.0000	-.0000	-.0000	.0001	CMG, +Y SIDE
44	.0000	.0026	.0000	-.0000	-.0000	.0001	CMG, +X SIDE
45	.0000	.0000	0.	0.	0.	0.	ATM SAS, PN 1
46	.0000	.0000	0.	0.	0.	0.	ATM SAS, PN 3
47	.0000	.0000	0.	0.	0.	0.	ATM SAS, PN 5
48	.0000	.0000	0.	0.	0.	0.	ATM SAS, PN 7
49	.0006	.0003	-.0000	.0000	.0001	0.	SPAR CENTER
50	.0005	.0004	-.0000	.0000	.0001	.2392	GRA/CAN CENTER
----	----	----	----	----	----	----	
SJM	.0934	.5683	.0030	.0069	.0003	.3281	

TABLE C-21

ORBITAL CONFIGURATION MODAL SURVEY  
ANALYTICAL MODES GENERALIZED MASS CONTRIBUTION SUMMARY

ANALYTICAL MODE 21

ANALYTICAL FREQUENCY = 6.552 HZ.

COMPONENT NAME	GMC (DX)	GMC (DY)	GMC (DZ)	GMC (TX)	GMC (TY)	GMC (TZ)
BP/OVS SKIRT/IU/FAS	.0081	.0005	.1849	.0016	.1203	.0000
6-FAS O2 TANKS	.0370	.0156	.1307	0.	0.	0.
MDA/STS/AM	.0004	.0003	.1037	.0007	.0130	.0001
6-AM N2 TANKS	.0011	.0003	.0457	0.	0.	0.
COMMAND/SERVICE MOD.	.0004	.0002	.1644	-.0000	.0036	-.0000
DEPLOYMENT ASSEMBLY	.0172	.0184	.0416	0.	0.	0.
ATM-RACK, CMGS, 4-SAS	.0195	.0029	.0461	.0000	.0001	.0000
ATM-SPAR CENTER	.0007	-.0000	.0061	.0000	.0035	0.
ATM-GRA/CAN CENTER	.0008	.0000	.0053	-.0000	.0050	.0000
	----	----	----	----	----	----
SUM	.0852	.0383	.7285	.0023	.1456	.0001

TOTAL GM CONTRIBUTION FOR EACH COMPONENT

BP/OVS SKIRT/IU/FAS	.3156
6-FAS O2 TANKS	.1833
MDA/STS/AM	.1131
6-AM N2 TANKS	.0471
COMMAND/SERVICE MOD.	.1686
DEPLOYMENT ASSEMBLY	.0772
ATM-RACK, CMGS, 4-SAS	.0696
ATM-SPAR CENTER	.0103
ATM-GRA/CAN CENTER	.0111

GENERALIZED MASS CONTRIBUTIONS BY DEGREE OF FREEDOM

ANALYTICAL MODE 21

FREQUENCY= 6.55 Hz.

NODE NO.	GMC (OX)	GMC (DY)	GMC (DZ)	GMC (TX)	GMC (TY)	GMC (TZ)	NODE DESCRIPTION
1	.0000	.0000	.1533	.0010	.0711	.0000	BASE RNG/OWS SKIRT
2	-.0000	.0001	.0002	.0003	.0150	-.0000	OWS/IU INTERFACE
3	.0000	.0001	.0030	.0004	.0342	.0000	IU/FAS INTERFACE
4	.0045	.0013	.0271	0.	0.	0.	FAS 02 BJT1, +Y +Z
5	.0077	.0043	.0257	0.	0.	0.	FAS 02 BJT2, +Y +Z
6	.0078	.0051	.0227	0.	0.	0.	FAS 02 BJT3, -Y +Z
7	.0043	.0019	.0178	0.	0.	0.	FAS 02 BJT4, -Y +Z
8	.0053	.0008	.0156	0.	0.	0.	FAS 02 BJT5, -Y -Z
9	.0074	.0021	.0208	0.	0.	0.	FAS 02 BJT6, -Y -Z
10	.0001	-.0000	.0056	0.	0.	0.	FAS/AM/DA IF, +Y
11	.0040	-.0000	.0099	0.	0.	0.	FAS/AM/DA IF, +Z
12	.0002	.0001	.0050	0.	0.	0.	FAS/AM/DA IF, -Y
13	.0002	-.0000	.0009	0.	0.	0.	FAS/DA IF, -Y -Z
14	.0033	.0004	.0062	0.	0.	0.	FAS/AM IF, -Z
15	.0004	-.0000	.0008	0.	0.	0.	FAS/DA IF, +Y -Z
16	.0000	.0001	.0298	.0001	.0001	.0000	AM TJNNE./SHEAR WB
17	.0000	.0001	.0530	.0002	.0037	.0000	AM TJNNE./STS IF
18	.0001	.0000	.0139	.0002	.0030	.0000	MDA/STS INTERFACE
19	.0002	.0001	.0071	.0003	.0061	.0000	MDA CONE/CYL ITRFC
20	.0000	.0000	.0081	0.	0.	0.	N2 TANK, +Y, LOWER
21	.0000	.0000	.0096	0.	0.	0.	N2 TANK, +Y, UPPER
22	.0001	.0000	.0069	0.	0.	0.	N2 TANK, +Z, LOWER
23	.0002	.0000	.0079	0.	0.	0.	N2 TANK, +Z, UPPER
24	.0004	.0001	.0060	0.	0.	0.	N2 TANK -Z, LOWER
25	.0004	.0001	.0073	0.	0.	0.	N2 TANK, -Z, UPPER
26	.0001	.0001	.0529	-.0000	.0000	-.0000	CM, FWD BULKHEAD
27	.0001	.0000	.0608	-.0000	-.0001	.0000	CM, AFT BULKHEAD
28	.0001	.0000	.0179	.0001	.0010	.0000	SM, FWD BULKHEAD
29	.0001	.0000	.0327	-.0001	.0028	-.0000	SM, AFT BULKHEAD
30	.0002	.0000	.0005	0.	0.	0.	LOWER D LATCH, DA
31	.0001	.0084	.0090	0.	0.	0.	LOWER +Y TRUNNION
32	.0004	.0077	.0088	0.	0.	0.	LOWER -Y TRUNNION
33	.0166	.0023	.0234	0.	0.	0.	EREP PACKAGE C.G.
34	.0005	.0000	-.0000	0.	0.	0.	ATM PN 6,7 IF,OUTR
35	.0007	-.0000	.0005	0.	0.	0.	ATM PN 4,5 IF,OUTR
36	.0011	.0001	.0047	0.	0.	0.	ATM PN 8,1 IF,OUTR
37	.0012	-.0001	.0167	0.	0.	0.	ATM PN 2,3 IF,OUTR
38	.0009	.0000	-.0000	0.	0.	0.	ATM PN 6,7 IF,INNER
39	.0038	-.0002	.0004	0.	0.	0.	ATM PN 4,5 IF,INNER
40	.0037	.0013	.0039	0.	0.	0.	ATM PN 8,1 IF,INNER
41	.0041	-.0001	.0141	0.	0.	0.	ATM PN 2,3 IF,INNER
42	.0005	.0001	.0008	.0000	.0000	.0000	CMG, -Y SIDE
43	.0005	.0001	.0004	.0000	.0000	.0000	CMG, +Y SIDE
44	.0008	-.0000	.0047	.0000	.0001	.0000	CMG, +X SIDE
45	.0007	.0007	0.	0.	0.	0.	ATM SAS, PN 1
46	.0009	.0009	0.	0.	0.	0.	ATM SAS, PN 3
47	.0000	.0000	0.	0.	0.	0.	ATM SAS, PN 5
48	.0000	.0000	0.	0.	0.	0.	ATM SAS, PN 7
49	.0007	-.0000	.0061	.0000	.0035	0.	SPAR CENTER
50	.0008	.0000	.0053	-.0000	.0050	.0000	GRA/CAN CENTER
SUM	.0852	.0383	.7285	.0023	.1456	.0001	

TABLE C-23

ORBITAL CONFIGURATION MODAL SURVEY  
ANALYTICAL MODES GENERALIZED MASS CONTRIBUTION SUMMARY

ANALYTICAL MODE 28

ANALYTICAL FREQUENCY = 9.192 HZ.

COMPONENT NAME	GMC (DX)	GMC (DY)	GMC (DZ)	GMC (TX)	GMC (TY)	GMC (TZ)
BR/OWS SKIRT/IU/FAS	.0004	.0089	.0138	.0104	.0055	.0015
6-FAS O2 TANKS	.0178	.4652	.4440	0.	0.	0.
MDA/STS/AM	.0000	.0044	.0073	.0009	.0004	.0002
6-AM N2 TANKS	.0010	.0016	.0075	0.	0.	0.
COMMAND/SERVICE MOD.	.0002	.0000	.0003	.0001	.0000	.0000
DEPLOYMENT ASSEMBLY	.0013	.0059	.0035	0.	0.	0.
ATM-RACK,CMGS,4-SAS	.0031	.0024	.0013	.0000	.0000	.0000
ATM-SPAR CENTER	.0000	.0001	.0001	.0002	.0001	0.
ATM-GRA/CAN CENTER	.0000	.0001	.0001	.0002	.0001	.0000
	----	----	----	----	----	----
SUM	.0237	.4885	.4779	.0319	.0061	.0019

TOTAL GM CONTRIBUTION FOR EACH COMPONENT

BR/OWS SKIRT/IU/FAS	.0316
6-FAS O2 TANKS	.9270
MDA/STS/AM	.0133
6-AM N2 TANKS	.0132
COMMAND/SERVICE MOD.	.0003
DEPLOYMENT ASSEMBLY	.0138
ATM-RACK,CMGS,4-SAS	.0058
ATM-SPAR CENTER	.0005
ATM-GRA/CAN CENTER	.0005

C-27  
TABLE C-24

GENERALIZED MASS CONTRIBUTIONS BY DEGREE OF FREEDOM

ANALYTICAL MODE 28

FREQUENCY= 9.19 Hz.

NODE NO.	GMC (DX)	GMC (DY)	GMC (DZ)	GMC (TX)	GMC (TY)	GMC (TZ)	NOJE DESCRIPTION
1	.0000	.0001	.0004	.0003	.0323	.0006	BASE RNG/OWS SKIRT
2	.0000	.0005	.0007	.0000	.0002	.0000	OWS/IU INTERFACE
3	.0000	.0022	.0039	.0001	.0329	.0010	IU/FAS INTERFACE
4	.0053	.0004	.0007	0.	0.	0.	FAS 02 BOTL1,+Y +Z
5	.0056	.0521	.0235	0.	0.	0.	FAS 02 BOTL2,+Y +Z
5	.0004	.3625	.0393	0.	0.	0.	FAS 02 BOTL3,-Y +Z
7	.0007	.0431	.3756	0.	0.	0.	FAS 02 BOTL4,-Y +Z
8	.0022	.0066	.0046	0.	0.	0.	FAS 02 BOTL5,-Y -Z
9	.0036	.0004	.0003	0.	0.	0.	FAS 02 BOTL6,-Y -Z
10	.0004	-.0000	.0024	0.	0.	0.	FAS/AM/DA IF, +Y
11	-.0002	.0020	.0045	0.	0.	0.	FAS/AM/DA IF, +Z
12	-.0002	.0031	.0015	0.	0.	0.	FAS/AM/DA IF, -Y
13	.0000	.0002	-.0000	0.	0.	0.	FAS/DA IF, -Y -Z
14	.0003	.0006	.0000	0.	0.	0.	FAS/AM IF, -Z
15	.0001	.0003	.0004	0.	0.	0.	FAS/DA IF, +Y -Z
15	.0000	.0023	.0041	.0000	.0003	.0001	AM TUNNEL/SHEAR WB
17	.0000	.0011	.0015	.0003	.0002	.0001	AM TJNNEL/STS IF
18	.0000	.0010	.0016	.0003	-.0001	-.0001	MDA/STS INTERFACE
19	.0000	.0001	.0001	.0003	.0001	.0001	MDA CONE/CYL ITRFC
20	.0001	.0009	.0000	0.	0.	0.	N2 TANK, +Y, LOWER
21	.0001	.0004	.0000	0.	0.	0.	N2 TANK, +Y, UPPER
22	.0002	.0000	.0039	0.	0.	0.	N2 TANK, +Z, LOWER
23	.0002	.0000	.0024	0.	0.	0.	N2 TANK, +Z, UPPER
24	.0002	.0001	.0010	0.	0.	0.	N2 TANK -Z, LOWER
25	.0002	.0002	.0003	0.	0.	0.	N2 TANK, -Z, UPPER
26	.0000	.0000	.0000	.0000	.0000	-.0000	CM, FWD BULKHEAD
27	.0000	.0000	.0000	.0000	.0000	-.0000	CM, AFT BULKHEAD
28	.0000	.0000	.0000	.0000	-.0000	.0000	SM, FWD BULKHEAD
29	.0001	.0000	.0000	.0001	.0000	.0000	SM, AFT BULKHEAD
30	.0001	.0017	.0002	0.	0.	0.	LOWER D LATCH, DA
31	.0004	.0037	.0026	0.	0.	0.	LOWER +Y TRUNNION
32	.0003	.0000	.0008	0.	0.	0.	LOWER -Y TRUNNION
33	.0005	.0005	.0000	0.	0.	0.	EREP PACKAGE C.G.
34	.0000	.0001	-.0000	0.	0.	0.	ATM PN 6,7 IF,OUTR
35	.0001	.0000	.0001	0.	0.	0.	ATM PN 4,5 IF,OUTR
36	.0000	.0000	.0002	0.	0.	0.	ATM PN 8,1 IF,OUTR
37	.0001	.0000	.0003	0.	0.	0.	ATM PN 2,3 IF,OUTR
38	.0001	.0002	.0000	0.	0.	0.	ATM PN 6,7 IF,INNER
39	.0001	.0000	.0000	0.	0.	0.	ATM PN 4,5 IF,INNER
40	.0003	-.0000	.0002	0.	0.	0.	ATM PN 8,1 IF,INNER
41	.0004	.0002	.0003	0.	0.	0.	ATM PN 2,3 IF,INNER
42	.0000	.0001	.0000	.0000	.0000	-.0000	CMG, -Y SIDE
43	.0001	.0000	.0000	.0000	-.0000	.0000	CMG, +Y SIDE
44	.0001	.0000	.0002	-.0000	.0000	.0000	CMG, +X SIDE
45	.0013	.0013	0.	0.	0.	0.	ATM SAS, PN 1
46	.0000	.0000	0.	0.	0.	0.	ATM SAS, PN 3
47	.0004	.0004	0.	0.	0.	0.	ATM SAS, PN 5
48	.0001	.0001	0.	0.	0.	0.	ATM SAS, PN 7
49	.0000	.0001	.0001	.0002	.0001	0.	SPAR CENTER
50	.0000	.0001	.0001	.0002	.0001	.0000	GRA/CAN CENTER
---	---	---	---	---	---	---	---
SUM	.0237	.4885	.4779	.0019	.0051	.0019	

TABLE C-25

ORBITAL CONFIGURATION MODAL SURVEY  
ANALYTICAL MODES GENERALIZED MASS CONTRIBUTION SUMMARY

ANALYTICAL MODE 30

ANALYTICAL FREQUENCY = 9.405 HZ.

COMPONENT NAME	GMC (DX)	GMC (DY)	GMC (DZ)	GMC (TX)	GMC (TY)	GMC (TZ)
BP/OWS SKIRT/IU/FAS	.1688	.0023	.0021	.0000	.0003	.0001
6-FAS O2 TANKS	.1842	.0154	.0161	0.	0.	0.
MDA/STS/AM	.0089	.0009	.0008	-.0000	-.0000	-.0000
6-AM N2 TANKS	.0019	.0006	.0026	0.	0.	0.
COMMAND/SERVICE MOD.	.5696	.0004	.0000	.0000	.0002	.0001
DEPLOYMENT ASSEMBLY	.0148	.0003	.0011	0.	0.	0.
ATM-RACK,CMGS,4-SAS	.0022	.0011	.0006	.0000	.0000	.0000
ATM-SPAR CENTER	.0001	.0001	.0000	.0000	.0002	0.
ATM-GRA/CAN CENTER	.0001	.0001	.0000	.0000	.0003	.0035
	----	----	----	----	----	----
SUM	.9506	.0212	.0235	.0000	.0011	.0035

TOTAL GM CONTRIBUTION FOR EACH COMPONENT

BP/OWS SKIRT/IU/FAS	.1737
6-FAS O2 TANKS	.2157
MDA/STS/AM	.0136
6-AM N2 TANKS	.0052
COMMAND/SERVICE MOD.	.5703
DEPLOYMENT ASSEMBLY	.0152
ATM-RACK,CMGS,4-SAS	.0039
ATM-SPAR CENTER	.0004
ATM-GRA/CAN CENTER	.0040



G-29  
TABLE C-26

GENERALIZED MASS CONTRIBUTIONS BY DEGREE OF FREEDOM

ANALYTICAL MODE 3)

FREQUENCY= 9.41 Hz.

NODE NO.	GMC (DX)	GMC (DY)	GMC (DZ)	GMC (TX)	GMC (TY)	GMC (TZ)	NODE DESCRIPTION
1	.0834	.0012	.0016	.0000	.0001	.0001	BASE RNG/OWS SKIRT
2	.0241	.0001	.0000	.0000	.0001	-.0000	OWS/IU INTERFACE
3	.0410	.0001	.0000	-.0000	.0001	-.0000	IU/FAS INTERFACE
4	.0321	.0021	.0105	0.	0.	0.	FAS 02 B0TL1,+Y +Z
5	.0347	.0066	.0006	0.	0.	0.	FAS 02 B0TL2,+Y +Z
6	.0252	.0003	-.0000	0.	0.	0.	FAS 02 B0TL3,-Y +Z
7	.0292	.0004	.0017	0.	0.	0.	FAS 02 B0TL4,-Y +Z
8	.0345	-.0000	.0014	0.	0.	0.	FAS 02 B0TL5,-Y -Z
9	.0284	.0060	.0019	0.	0.	0.	FAS 02 B0TL6,-Y -Z
10	.0038	.0000	.0000	0.	0.	0.	FAS/AM/DA IF, +Y
11	.0054	.0000	.0000	0.	0.	0.	FAS/AM/DA IF, +Z
12	.0057	.0001	-.0000	0.	0.	0.	FAS/AM/DA IF, -Y
13	.0014	.0007	.0004	0.	0.	0.	FAS/DA IF, -Y -Z
14	.0027	.0000	.0000	0.	0.	0.	FAS/AM IF, -Z
15	.0012	.0000	.0000	0.	0.	0.	FAS/DA IF, +Y -Z
16	.0000	.0001	.0002	.0000	.0000	.0000	AM TUNNEL/SHEAR WB
17	.0013	.0002	.0001	.0000	.0000	-.0000	AM TUNNEL/STS IF
18	.0035	.0004	.0003	-.0000	-.0000	-.0000	MDA/STS INTERFACE
19	.0039	.0003	.0002	-.0000	-.0000	-.0000	MDA CONE/CYL ITRFC
20	.0002	.0003	.0001	0.	0.	0.	N2 TANK, +Y, LOWER
21	.0004	.0003	.0000	0.	0.	0.	N2 TANK, +Y, UPPER
22	.0002	.0000	.0012	0.	0.	0.	N2 TANK, +Z, LOWER
23	.0004	.0000	.0010	0.	0.	0.	N2 TANK, +Z, UPPER
24	.0004	.0000	.0002	0.	0.	0.	N2 TANK -Z, LOWER
25	.0005	.0000	.0002	0.	0.	0.	N2 TANK, -Z, UPPER
26	.0780	.0000	-.0000	.0000	.0001	.0002	CM, FWD BULKHEAD
27	.1293	.0001	-.0000	.0000	.0001	.0001	CM, AFT BULKHEAD
28	.1477	.0000	.0000	-.0000	-.0000	-.0002	SM, FWD BULKHEAD
29	.2146	.0002	.0000	-.0000	.0000	-.0001	SM, AFT BULKHEAD
30	.0063	.0003	.0002	0.	0.	0.	LOWER D LATCH, DA
31	.0035	-.0001	.0003	0.	0.	0.	LOWER +Y TRUNNION
32	.0027	.0000	.0002	0.	0.	0.	LOWER -Y TRUNNION
33	.0023	.0000	.0003	0.	0.	0.	EREP PACKAGE C.G.
34	.0000	.0001	.0002	0.	0.	0.	ATM PN 6,7 IF,OUTR
35	.0000	.0000	-.0000	0.	0.	0.	ATM PN 4,5 IF,OUTR
36	.0000	.0000	.0000	0.	0.	0.	ATM PN 8,1 IF,OUTR
37	.0000	.0000	.0001	0.	0.	0.	ATM PN 2,3 IF,OUTR
38	.0001	.0000	.0002	0.	0.	0.	ATM PN 6,7 IF,INNER
39	.0001	-.0000	.0000	0.	0.	0.	ATM PN 4,5 IF,INNER
40	.0004	.0000	.0000	0.	0.	0.	ATM PN 8,1 IF,INNER
41	.0002	-.0000	.0001	0.	0.	0.	ATM PN 2,3 IF,INNER
42	.0000	.0000	.0000	.0000	.0000	.0000	CMG, -Y SIDE
43	.0001	-.0000	.0000	.0000	.0000	.0000	CMG, +Y SIDE
44	.0001	.0000	.0000	.0000	.0000	.0000	CMG, +X SIDE
45	.0002	.0002	0.	0.	0.	0.	ATM SAS, PN 1
46	.0001	.0001	0.	0.	0.	0.	ATM SAS, PN 3
47	.0004	.0004	0.	0.	0.	0.	ATM SAS, PN 5
48	.0003	.0003	0.	0.	0.	0.	ATM SAS, PN 7
49	.0001	.0001	.0000	.0000	.0002	0.	SPAR CENTER
50	.0001	.0001	.0000	.0000	.0003	.0035	GRA/CAN CENTER
SUM	.9506	.0212	.0235	.0000	.0011	.0036	

TABLE C-27

ORBITAL CONFIGURATION MODAL SURVEY  
ANALYTICAL MODES GENERALIZED MASS CONTRIBUTION SUMMARY

ANALYTICAL MODE 38

ANALYTICAL FREQUENCY = 12.072 HZ.

COMPONENT NAME	GMC (DX)	GMC (DY)	GMC (DZ)	GMC (TX)	GMC (TY)	GMC (TZ)
BR/OWS SKIRT/IU/FAS	.0004	.0194	.0178	.1245	.0001	.0003
6-FAS O2 TANKS	.0316	.0314	.0341	0.	0.	0.
MDA/STS/AM	-.0000	.0106	.0006	.6156	.0000	.0014
6-AM N2 TANKS	.0000	.0175	.0083	0.	0.	0.
COMMAND/SERVICE MOD.	.0001	.0221	.0005	.0702	.0000	.0008
DEPLOYMENT ASSEMBLY	.0001	.0015	.0004	0.	0.	0.
ATM-RACK,CMGS,4-SAS	.0001	.0001	.0001	.0100	.0000	.0000
ATM-SPAR CENTER	.0000	.0000	.0000	.0001	.0000	0.
ATM-GRA/CAN CENTER	.0000	.0000	.0000	.0001	.0000	.0000
	----	----	----	----	----	----
SUM	.0323	.1027	.0619	.8105	.0002	.0025

## TOTAL GM CONTRIBUTION FOR EACH COMPONENT

BR/OWS SKIRT/IU/FAS	.1624
6-FAS O2 TANKS	.0971
MDA/STS/AM	.6132
6-AM N2 TANKS	.0258
COMMAND/SERVICE MOD.	.0938
DEPLOYMENT ASSEMBLY	.0021
ATM-RACK,CMGS,4-SAS	.0003
ATM-SPAR CENTER	.0001
ATM-GRA/CAN CENTER	.0002

C-31  
TABLE C-28

GENERALIZED MASS CONTRIBUTIONS BY DEGREE OF FREEDOM

ANALYTICAL MODE 33

FREQUENCY= 12.07 HZ.

NODE NO.	GMC (DX)	GMC (DY)	GMC (DZ)	GMC (TX)	GMC (TY)	GMC (TZ)	NODE DESCRIPTION
1	.0000	.0001	.0000	.0769	.0000	.0001	BASE RNG/OWS SKIRT
2	.0000	-.0000	.0001	.0185	.0000	.0000	OWS/IU INTERFACE
3	-.0000	.0003	.0001	.0291	.0000	.0001	IU/FAS INTERFACE
4	.0052	.0007	.0037	0.	0.	0.	FAS 02 BJT11,+Y +Z
5	.0047	.0070	.0140	0.	0.	0.	FAS 02 BJT12,+Y +Z
6	.0063	.0038	.0062	0.	0.	0.	FAS 02 BJT13,-Y +Z
7	.0060	.0039	.0041	0.	0.	0.	FAS 02 BJT14,-Y +Z
8	.0047	.0131	.0050	0.	0.	0.	FAS 02 BJT15,-Y -Z
9	.0046	.0028	.0011	0.	0.	0.	FAS 02 BJT16,-Y -Z
10	.0002	.0000	.0042	0.	0.	0.	FAS/AM/DA IF, +Y
11	.0000	.0164	.0000	0.	0.	0.	FAS/AM/DA IF, +Z
12	.0002	.0002	.0132	0.	0.	0.	FAS/AM/DA IF, -Y
13	.0000	-.0000	-.0001	0.	0.	0.	FAS/DA IF, -Y -Z
14	-.0000	.0023	.0000	0.	0.	0.	FAS/AM IF, -Z
15	.0000	.0001	.0001	0.	0.	0.	FAS/DA IF, +Y -Z
16	.0000	.0003	.0000	.0121	.0000	.0000	AM TUNNEL/SHEAR WB
17	.0000	.0002	.0000	.1454	.0000	.0001	AM TUNNEL/STS IF
18	.0000	.0022	.0003	.2420	-.0000	.0010	MDA/STS INTERFACE
19	-.0000	.0080	.0002	.2061	.0000	.0002	MDA CONE/CYL ITRFC
20	.0000	.0003	.0000	0.	0.	0.	N2 TANK, +Y, LOWER
21	-.0000	.0002	.0082	0.	0.	0.	N2 TANK, +Y, UPPER
22	.0000	.0015	.0000	0.	0.	0.	N2 TANK, +Z, LOWER
23	.0000	.0048	.0000	0.	0.	0.	N2 TANK, +Z, UPPER
24	.0000	.0002	.0000	0.	0.	0.	N2 TANK -Z, LOWER
25	.0000	.0106	.0000	0.	0.	0.	N2 TANK, -Z, UPPER
26	.0000	.0005	.0001	.0170	.0000	.0002	CM, FWD BULKHEAD
27	.0000	.0168	.0001	.0108	.0000	.0004	CM, AFT BULKHEAD
28	.0000	.0015	-.0000	.0125	.0000	.0000	SM, FWD BULKHEAD
29	.0000	.0032	.0004	.0298	.0000	.0002	SM, AFT BULKHEAD
30	.0001	.0005	.0001	0.	0.	0.	LOWER D LATCH, DA
31	.0000	.0002	-.0002	0.	0.	0.	LOWER +Y TRUNNION
32	.0000	-.0001	.0005	0.	0.	0.	LOWER -Y TRUNNION
33	.0000	.0010	-.0000	0.	0.	0.	EREP PACKAGE C.G.
34	.0000	.0000	-.0000	0.	0.	0.	ATM PN 6,7 IF,OUTR
35	.0000	.0000	.0001	0.	0.	0.	ATM PN 4,5 IF,OUTR
36	.0000	.0000	.0000	0.	0.	0.	ATM PN 8,1 IF,OUTR
37	.0000	.0000	.0000	0.	0.	0.	ATM PN 2,3 IF,OUTR
38	.0000	.0000	.0000	0.	0.	0.	ATM PN 6,7 IF,INNER
39	.0000	.0000	.0000	0.	0.	0.	ATM PN 4,5 IF,INNER
40	.0000	-.0000	.0000	0.	0.	0.	ATM PN 8,1 IF,INNER
41	.0000	.0000	.0000	0.	0.	0.	ATM PN 2,3 IF,INNER
42	.0000	.0000	.0000	.0000	.0000	.0000	CMG, -Y SIDE
43	.0000	.0000	.0000	.0000	.0000	.0000	CMG, +Y SIDE
44	.0000	.0000	.0000	.0000	.0000	.0000	CMG, +X SIDE
45	.0000	.0000	0.	0.	0.	0.	ATM SAS, PN 1
46	.0000	.0000	0.	0.	0.	0.	ATM SAS, PN 3
47	.0000	.0000	0.	0.	0.	0.	ATM SAS, PN 5
48	.0000	.0000	0.	0.	0.	0.	ATM SAS, PN 7
49	.0000	.0000	.0000	.0001	.0000	0.	SPAR CENTER
50	.0000	.0000	.0000	.0001	.0000	.0000	GRA/CAN CENTER
SUM	.0323	.1027	.0619	.8005	.0002	.0025	

TABLE C-29

ORBITAL CONFIGURATION MODAL SURVEY  
ANALYTICAL MODES GENERALIZED MASS CONTRIBUTION SUMMARY

## ANALYTICAL MODE 39

ANALYTICAL FREQUENCY = 12.568 HZ.

COMPONENT NAME	GMC (DX)	GMC (DY)	GMC (DZ)	GMC (TX)	GMC (TY)	GMC (TZ)
BR/OHS SKIRT/IU/FAS	.0109	.0771	.0235	.0001	.0040	.0128
6-FAS O2 TANKS	.0619	.0933	.1114	0.	0.	0.
MDA/STS/AM	.0000	.0908	.0141	.0003	.0004	.0125
6-AM N2 TANKS	.0064	.3082	.0437	0.	0.	0.
COMMAND/SERVICE MOD.	.0000	.0060	.0012	.0003	.0001	.0003
DEPLOYMENT ASSEMBLY	.0107	.0868	.0153	0.	0.	0.
ATM-RACK,CMGS,4-SAS	.0039	.0015	.0034	.0000	.0001	.0000
ATM-SPAR CENTER	.0004	.0005	-.0000	.0128	.0004	0.
ATM-GRA/CAN CENTER	.0004	.0004	.0000	.0034	.0008	-.0000
	----	----	----	----	----	----
SUM	.0946	.6646	.2126	.0069	.0058	.0156

## TOTAL GM CONTRIBUTION FOR EACH COMPONENT

BR/OHS SKIRT/IU/FAS	.1284
6-FAS O2 TANKS	.2655
MDA/STS/AM	.1081
6-AM N2 TANKS	.3533
COMMAND/SERVICE MOD.	.0078
DEPLOYMENT ASSEMBLY	.1129
ATM-RACK,CMGS,4-SAS	.0088
ATM-SPAR CENTER	.0041
ATM-GRA/CAN CENTER	.0051

C-33  
TABLE C-30

GENERALIZED MASS CONTRIBUTIONS BY DEGREE OF FREEDOM

ANALYTICAL MODE 33

FREQUENCY= 12.57 Hz.

NODE NO.	GMC (DX)	GMC (DY)	GMC (DZ)	GMC (TX)	GMC (TY)	GMC (TZ)	NOJE DESCRIPTION
1	.0001	.0128	.0016	.0001	.0020	.0054	BASE RNG/OWS SKIRT
2	.0000	.0096	.0029	.0000	-.0000	.0000	OWS/IU INTERFACE
3	-.0001	.0197	.0058	.0000	.0020	.0074	IU/FAS INTERFACE
4	.0166	.0050	.0024	0.	0.	0.	FAS 02 BJT11,+Y +Z
5	.0876	.0022	.0106	0.	0.	0.	FAS 02 BJT12,+Y +Z
6	-.0004	.0067	.0747	0.	0.	0.	FAS 02 BJT13,-Y +Z
7	.0046	.0704	.0056	0.	0.	0.	FAS 02 BJT14,-Y +Z
8	.0182	.0024	-.0002	0.	0.	0.	FAS 02 BJT15,-Y -Z
9	.0152	.0065	.0183	0.	0.	0.	FAS 02 BJT16,-Y -Z
10	.0050	.0004	.0048	0.	0.	0.	FAS/AM/DA IF, +Y
11	.0008	.0208	.0000	0.	0.	0.	FAS/AM/DA IF, +Z
12	.0039	.0002	.0059	0.	0.	0.	FAS/AM/DA IF, -Y
13	.0001	.0002	-.0003	0.	0.	0.	FAS/DA IF, -Y -Z
14	.0004	.0100	.0004	0.	0.	0.	FAS/AM IF, -Z
15	.0005	.0034	.0014	0.	0.	0.	FAS/DA IF, +Y -Z
16	.0000	.0394	.0055	.0000	.0005	.0022	AM TUNNEL/SHEAR WB
17	.0000	.0163	.0019	.0002	.0002	.0016	AM TUNNEL/STS IF
18	.0000	.0281	.0042	-.0000	-.0003	-.0021	MDA/STS INTERFACE
19	.0000	.0069	.0014	.0002	.0001	.0008	MDA CONE/CYL ITRFC
20	.0011	.1861	.0001	0.	0.	0.	N2 TANK, +Y, LOWER
21	.0034	.1139	.0000	0.	0.	0.	N2 TANK, +Y, UPPER
22	.0003	.0025	.0217	0.	0.	0.	N2 TANK, +Z, LOWER
23	.0006	.0007	.0111	0.	0.	0.	N2 TANK, +Z, UPPER
24	.0004	.0023	.0070	0.	0.	0.	N2 TANK -Z, LOWER
25	.0005	.0026	.0038	0.	0.	0.	N2 TANK, -Z, UPPER
26	.0000	-.0000	.0000	.0000	.0000	.0001	CM, FWD BULKHEAD
27	.0000	.0050	.0010	.0001	.0000	.0001	CM, AFT BULKHEAD
28	.0000	.0002	.0000	.0001	-.0000	.0000	SM, FWD BULKHEAD
29	.0000	.0008	.0001	.0001	.0000	.0000	SM, AFT BULKHEAD
30	.0006	.0317	.0018	0.	0.	0.	LOWER D LATC4, DA
31	.0054	.0486	.0016	0.	0.	0.	LOWER +Y TRUNNION
32	.0039	.0058	.0119	0.	0.	0.	LOWER -Y TRUNNION
33	.0009	.0009	.0000	0.	0.	0.	EREP PACKAGE C.G.
34	.0000	.0003	-.0000	0.	0.	0.	ATM PN 6,7 IF,OUTR
35	.0005	-.0000	.0018	0.	0.	0.	ATM PN 4,5 IF,OUTR
36	-.0000	-.0000	.0002	0.	0.	0.	ATM PN 8,1 IF,OUTR
37	.0003	.0001	.0000	0.	0.	0.	ATM PN 2,3 IF,OUTR
38	.0002	.0002	.0000	0.	0.	0.	ATM PN 6,7 IF,INNER
39	.0002	.0000	.0006	0.	0.	0.	ATM PN 4,5 IF,INNER
40	.0007	-.0000	.0001	0.	0.	0.	ATM PN 8,1 IF,INNER
41	.0010	.0005	.0000	0.	0.	0.	ATM PN 2,3 IF,INNER
42	.0000	.0003	.0005	.0000	.0000	.0000	CMG, -Y SIDE
43	.0003	.0000	.0000	-.0000	.0000	.0000	CMG, +Y SIDE
44	.0004	.0000	.0001	.0000	.0000	.0000	CMG, +X SIDE
45	.0000	.0000	0.	0.	0.	0.	ATM SAS, PN 1
46	.0000	.0000	0.	0.	0.	0.	ATM SAS, PN 3
47	.0000	.0000	0.	0.	0.	0.	ATM SAS, PN 5
48	.0000	.0000	0.	0.	0.	0.	ATM SAS, PN 7
49	.0004	.0005	-.0000	.0028	.0004	0.	SPAR CENTER
50	.0004	.0004	.0000	.0034	.0008	-.0000	GRA/CAN CENTER
SUM	.0946	.6546	.2126	.0069	.0058	.0156	

TABLE C-31

ORBITAL CONFIGURATION MODAL SURVEY  
ANALYTICAL MODES GENERALIZED MASS CONTRIBUTION SUMMARY

ANALYTICAL MODE 41

ANALYTICAL FREQUENCY = 13.323 HZ.

COMPONENT NAME	GMC (DX)	GMC (DY)	GMC (DZ)	GMC (TX)	GMC (TY)	GMC (TZ)
BR/OWS SKIRT/IU/FAS	.0001	.0026	.0088	.0005	.0035	.0310
5-FAS O2 TANKS	.0041	.0062	.0030	0.	0.	0.
MDA/STS/AM	-.0000	.0804	.2239	.0311	.0257	.0080
6-AM N2 TANKS	.0005	.0555	.1286	0.	0.	0.
COMMAND/SERVICE MOD.	-.0000	.1048	.3079	.0347	.0146	.0048
DEPLOYMENT ASSEMBLY	.0003	.0042	.0041	0.	0.	0.
ATM-RACK,CMGS,4-SAS	.0004	.0001	.0002	.0000	.0000	.0000
ATM-SPAR CENTER	.0000	.0000	.0000	.0001	.0000	0.
ATM-GRA/CAN CENTER	.0001	.0000	.0000	.0001	.0000	.0000
	----	----	----	----	----	----
SUM	.0054	.2538	.6766	.0365	.0438	.0139

TOTAL GM CONTRIBUTION FOR EACH COMPONENT

BR/OWS SKIRT/IU/FAS	.0166
6-FAS O2 TANKS	.0133
MDA/STS/AM	.3391
6-AM N2 TANKS	.1845
COMMAND/SERVICE MOD.	.4358
DEPLOYMENT ASSEMBLY	.0036
ATM-RACK,CMGS,4-SAS	.0017
ATM-SPAR CENTER	.0002
ATM-GRA/CAN CENTER	.0003

C-35  
TABLE C-32

GENERALIZED MASS CONTRIBUTIONS BY DEGREE OF FREEDOM

ANALYTICAL MODE 41

FREQUENCY= 13.32 4Z.

MODE NO.	GMC (DX)	GMC (DY)	GMC (DZ)	GMC (TX)	GMC (TY)	GMC (TZ)	MODE DESCRIPTION
1	.0000	.0014	.0043	.0003	.0022	.0007	BASE RNG/OWS SKIRT
2	.0000	.0001	.0002	.0001	.0003	.0001	OWS/IU INTERFACE
3	-.0000	.0003	.0011	.0001	.0010	.0003	IU/FAS INTERFACE
4	.0004	.0004	.0001	0.	0.	0.	FAS 02 B0TL1,+Y +Z
5	.0005	.0003	.0002	0.	0.	0.	FAS 02 B0TL2,+Y +Z
6	.0004	.0005	.0027	0.	0.	0.	FAS 02 B0TL3,-Y +Z
7	-.0000	.0039	-.0000	0.	0.	0.	FAS 02 B0TL4,-Y +Z
8	.0008	.0009	.0001	0.	0.	0.	FAS 02 B0TL5,-Y -Z
9	.0019	.0003	.0000	0.	0.	0.	FAS 02 B0TL6,-Y -Z
10	.0000	.0001	.0006	0.	0.	0.	FAS/AM/DA IF, +Y
11	.0000	.0003	.0004	0.	0.	0.	FAS/AM/DA IF, +Z
12	-.0000	.0001	.0019	0.	0.	0.	FAS/AM/DA IF, -Y
13	.0000	-.0000	.0000	0.	0.	0.	FAS/DA IF, -Y -Z
14	.0000	.0003	.0001	0.	0.	0.	FAS/AM IF, -Z
15	.0000	.0001	.0001	0.	0.	0.	FAS/DA IF, +Y -Z
16	.0000	.0019	.0037	.0001	.0011	.0005	AM TUNNEL/SHEAR WB
17	.0000	.0000	.0003	.0005	.0027	.0013	AM TUNNEL/STS IF
18	-.0000	.0223	.0702	-.0002	.0198	.0063	MOA/STS INTERFACE
19	-.0000	.0561	.1496	.0008	.0022	-.0002	MOA CONE/CYL ITRFC
20	.0000	.0326	.0078	0.	0.	0.	N2 TANK, +Y, LOWER
21	.0001	.0169	.0010	0.	0.	0.	N2 TANK, +Y, UPPER
22	.0000	.0035	.0768	0.	0.	0.	N2 TANK, +Z, LOWER
23	.0002	.0006	.0390	0.	0.	0.	N2 TANK, +Z, UPPER
24	.0001	.0017	.0036	0.	0.	0.	N2 TANK -Z, LOWER
25	.0000	.0001	.0004	0.	0.	0.	N2 TANK, -Z, UPPER
26	-.0000	.0018	.0038	.0000	.0051	.0015	CM, FWD BULKHEAD
27	-.0000	.0906	.2644	.0020	.0085	.0027	CM, AFT BULKHEAD
28	.0000	.0018	.0053	.0013	.0000	.0000	SM, FWD BULKHEAD
29	.0000	.0107	.0345	.0013	.0010	.0006	SM, AFT BULKHEAD
30	.0001	.0007	.0004	0.	0.	0.	LOWER D LATCH, DA
31	.0001	.0030	.0012	0.	0.	0.	LOWER +Y TRUNNION
32	-.0000	.0005	.0026	0.	0.	0.	LOWER -Y TRUNNION
33	.0001	.0000	-.0000	0.	0.	0.	EREP PACKAGE C.G.
34	.0000	.0000	-.0000	0.	0.	0.	ATM PN 6,7 IF,OUTR
35	.0000	.0000	.0001	0.	0.	0.	ATM PN 4,5 IF,OUTR
36	.0000	.0000	-.0000	0.	0.	0.	ATM PN 8,1 IF,OUTR
37	.0000	.0000	.0000	0.	0.	0.	ATM PN 2,3 IF,OUTR
38	.0000	.0000	-.0000	0.	0.	0.	ATM PN 6,7 IF,INNR
39	.0000	-.0000	.0000	0.	0.	0.	ATM PN 4,5 IF,INNR
40	.0001	.0000	-.0000	0.	0.	0.	ATM PN 8,1 IF,INNR
41	.0001	.0000	.0000	0.	0.	0.	ATM PN 2,3 IF,INNR
42	.0000	.0000	.0000	.0000	.0000	.0000	CMG, -Y SIDE
43	.0000	.0000	.0000	.0000	.0000	.0000	CMG, +Y SIDE
44	.0001	.0000	.0000	.0000	.0000	.0000	CMG, +X SIDE
45	.0000	.0000	0.	0.	0.	0.	ATM SAS, PN 1
46	-.0000	-.0000	0.	0.	0.	0.	ATM SAS, PN 3
47	.0000	.0000	0.	0.	0.	0.	ATM SAS, PN 5
48	-.0000	-.0000	0.	0.	0.	0.	ATM SAS, PN 7
49	.0000	.0000	.0000	.0001	.0000	0.	SPAR CENTER
50	.0001	.0000	.0000	.0001	.0000	.0000	GRA/CAN CENTER
SUM	.0054	.2538	.6766	.0065	.0438	.0139	

TABLE C-33

ORBITAL CONFIGURATION MODAL SURVEY  
ANALYTICAL MODES GENERALIZED MASS CONTRIBUTION SUMMARY

ANALYTICAL MODE 45

ANALYTICAL FREQUENCY = 14.855 HZ.

COMPONENT NAME	GMC (DX)	GMC (DY)	GMC (DZ)	GMC (TX)	GMC (TY)	GMC (TZ)
RR/OWS SKIRT/IU/FAS	.0024	.0216	.0005	.0113	.0000	.0003
6-FAS O2 TANKS	.0078	.0061	.0100	0.	0.	0.
MDA/STS/AM	.0005	.1437	.0059	.0112	.0013	.0274
6-AM N2 TANKS	.0075	.5540	.0191	0.	0.	0.
COMMAND/SERVICE MOD.	.0005	.0922	.0087	.0142	.0005	.0044
DEPLOYMENT ASSEMBLY	.0013	.0338	.0024	0.	0.	0.
ATM-RACK,CMGS,4-SAS	.0050	.0007	.0016	.0000	.0001	.0000
ATM-SPAR CENTER	.0008	.0008	-.0000	.0040	.0045	0.
ATM-GRA/CAN CENTER	.0010	.0006	.0000	.0049	.0071	.0001
	----	----	----	----	----	----
SUM	.0269	.8534	.0482	.0257	.0136	.0323

TOTAL GM CONTRIBUTION FOR EACH COMPONENT

RR/OWS SKIRT/IU/FAS	.0251
6-FAS O2 TANKS	.0239
MDA/STS/AM	.1801
6-AM N2 TANKS	.5806
COMMAND/SERVICE MOD.	.1216
DEPLOYMENT ASSEMBLY	.0374
ATM-RACK,CMGS,4-SAS	.0074
ATM-SPAR CENTER	.0101
ATM-GRA/CAN CENTER	.0138



C-37  
TABLE C-34

GENERALIZED MASS CONTRIBUTIONS BY DEGREE OF FREEDOM

ANALYTICAL MODE 45

FREQUENCY= 14.85 Hz.

NODE NO.	GMC (OX)	GMC (OY)	GMC (OZ)	GMC (TX)	GMC (TY)	GMC (TZ)	NOJE DESCRIPTION
1	.0000	.0133	.0001	.0010	.0000	-.0001	BASE RNG/OWS SKIRT
2	.0000	.0009	.0000	.0001	.0000	-.0000	OWS/IU INTERFACE
3	.0000	.0014	.0000	.0002	.0000	.0004	IU/FAS INTERFACE
4	.0026	.0009	.0003	0.	0.	0.	FAS O2 BJT1, +Y +Z
5	-.0031	.0001	.0012	0.	0.	0.	FAS O2 BJT2, +Y +Z
6	.0031	.0000	.0013	0.	0.	0.	FAS O2 BJT3, -Y +Z
7	.0034	.0009	.0013	0.	0.	0.	FAS O2 BJT4, -Y +Z
8	.0014	.0036	.0016	0.	0.	0.	FAS O2 BJT5, -Y -Z
9	.0004	.0006	.0044	0.	0.	0.	FAS O2 BJT6, -Y -Z
10	.0010	.0011	.0001	0.	0.	0.	FAS/AM/DA IF, +Y
11	.0000	.0015	.0000	0.	0.	0.	FAS/AM/DA IF, +Z
12	.0013	.0022	.0002	0.	0.	0.	FAS/AM/DA IF, -Y
13	.0000	.0003	-.0000	0.	0.	0.	FAS/DA IF, -Y -Z
14	.0000	.0005	-.0000	0.	0.	0.	FAS/AM IF, -Z
15	.0001	.0004	.0000	0.	0.	0.	FAS/DA IF, +Y -Z
16	.0000	.0785	.0011	.0001	.0001	.0034	AM TUNNEL/SHEAR WB
17	.0002	.0269	.0001	.0006	.0002	.0100	AM TUNNEL/STS IF
18	.0002	-.0018	.0010	.0007	.0008	.0107	MDA/STS INTERFACE
19	.0001	.0401	.0038	-.0003	.0003	.0034	MDA CONE/CYL ITRFC
20	.0061	.0887	.0027	0.	0.	0.	N2 TANK, +Y, LOWER
21	.0011	.2065	.0000	0.	0.	0.	N2 TANK, +Y, UPPER
22	.0002	.1550	.0002	0.	0.	0.	N2 TANK, +Z, LOWER
23	.0000	.0267	.0027	0.	0.	0.	N2 TANK, +Z, UPPER
24	.0000	.0486	.0074	0.	0.	0.	N2 TANK -Z, LOWER
25	.0001	.0285	.0051	0.	0.	0.	N2 TANK, -Z, UPPER
26	.0001	.0034	.0000	.0037	.0002	.0018	CM, FWD BULKHEAD
27	.0002	.0788	.0076	.0063	.0003	.0024	CM, AFT BULKHEAD
28	.0001	.0011	.0002	.0008	.0000	-.0000	SM, FWD BULKHEAD
29	.0002	.0089	.0009	.0034	.0000	.0002	SM, AFT BULKHEAD
30	.0001	.0049	.0006	0.	0.	0.	LOWER D LATCH, DA
31	.0006	.0156	.0011	0.	0.	0.	LOWER +Y TRUNNION
32	.0006	.0131	.0006	0.	0.	0.	LOWER -Y TRUNNION
33	.0000	.0000	.0000	0.	0.	0.	EREP PACKAGE C.G.
34	-.0000	.0003	.0000	0.	0.	0.	ATM PN 6,7 IF,OUTR
35	.0001	-.0000	.0010	0.	0.	0.	ATM PN 4,5 IF,OUTR
36	.0000	-.0000	.0000	0.	0.	0.	ATM PN 8,1 IF,OUTR
37	-.0000	.0000	.0000	0.	0.	0.	ATM PN 2,3 IF,OUTR
38	.0004	.0002	.0000	0.	0.	0.	ATM PN 6,7 IF,INNER
39	.0016	.0002	.0003	0.	0.	0.	ATM PN 4,5 IF,INNER
40	.0009	.0000	-.0000	0.	0.	0.	ATM PN 8,1 IF,INNER
41	.0008	.0000	-.0000	0.	0.	0.	ATM PN 2,3 IF,INNER
42	.0033	.0000	.0003	.0000	.0000	.0000	CMG, -Y SIDE
43	.0004	.0000	.0000	.0000	.0000	.0000	CMG, +Y SIDE
44	.0005	.0000	.0000	.0000	.0000	.0000	CMG, +X SIDE
45	.0000	.0000	0.	0.	0.	0.	ATM SAS, PN 1
46	.0000	.0000	0.	0.	0.	0.	ATM SAS, PN 3
47	.0000	.0000	0.	0.	0.	0.	ATM SAS, PN 5
48	-.0000	-.0000	0.	0.	0.	0.	ATM SAS, PN 7
49	.0008	.0008	-.0000	.0040	.0045	0.	SPAR CENTER
50	.0010	.0006	.0000	.0049	.0071	.0001	GRA/CAN CENTER
SUM	.0269	.8534	.0482	.0257	.0136	.0323	

TABLE C-35

ORBITAL CONFIGURATION MODAL SURVEY  
ANALYTICAL MODES GENERALIZED MASS CONTRIBUTION SUMMARY

ANALYTICAL MODE 56

ANALYTICAL FREQUENCY = 17.553 HZ.

COMPONENT NAME	GMC (DX)	GMC (DY)	GMC (DZ)	G4C (TX)	GMC (TY)	G4C (TZ)
BR/OWS SKIRT/IJ/FAS	.0001	.0037	.0150	.0000	.0010	-.0000
6-FAS O2 TANKS	.0239	.0181	.0158	0.	0.	0.
MDA/STS/AM	.0010	.0017	.1869	.0009	.0317	.0005
6-AM N2 TANKS	.0101	.0041	.6078	0.	0.	0.
COMMAND/SERVICE MOD.	.0001	.0016	.0545	.0010	.0031	.0001
DEPLOYMENT ASSEMBLY	.0014	.0121	.0007	0.	0.	0.
ATM-RACK,CMGS,4-SAS	.0007	.0013	.0005	.0001	.0000	.0000
ATM-SPAR CENTER	.0000	.0000	.0000	.0000	.0000	0.
ATM-GRA/CAN CENTER	.0001	.0001	.0000	.0000	.0001	.0000
	----	----	----	----	----	----
SUM	.0374	.0426	.8814	.0021	.0359	.0005

TOTAL GM CONTRIBUTION FOR EACH COMPONENT

BR/OWS SKIRT/IJ/FAS	.0137
6-FAS O2 TANKS	.0579
MDA/STS/AM	.2227
6-AM N2 TANKS	.6220
COMMAND/SERVICE MOD.	.0615
DEPLOYMENT ASSEMBLY	.0142
ATM-RACK,CMGS,4-SAS	.0026
ATM-SPAR CENTER	.0002
ATM-GRA/CAN CENTER	.0012

C-39  
TABLE C-36

GENERALIZED MASS CONTRIBUTIONS BY DEGREE OF FREEDOM

ANALYTICAL MODE 55

FREQUENCY= 17.55 Hz.

NODE NO.	GMC (DX)	GMC (DY)	GMC (DZ)	GMC (TX)	GMC (TY)	GMC (TZ)	NODE DESCRIPTION
1	.0000	.0023	.0012	.0000	.0006	.0000	BASE RNG/OWS SKIRT
2	-.0000	.0000	.0003	.0000	.0000	.0000	OWS/IU INTERFACE
3	-.0000	.0000	.0005	-.0000	.0004	-.0001	IU/FAS INTERFACE
4	.0141	.0104	.0022	0.	0.	0.	FAS 02 B2TL1,+Y +Z
5	.0013	.0005	.0085	0.	0.	0.	FAS 02 B2TL2,+Y +Z
6	.0042	.0027	.0004	0.	0.	0.	FAS 02 B2TL3,-Y +Z
7	.0007	.0010	.0012	0.	0.	0.	FAS 02 B2TL4,-Y +Z
8	.0038	.0033	.0003	0.	0.	0.	FAS 02 B2TL5,-Y -Z
9	-.0002	.0002	.0032	0.	0.	0.	FAS 02 B2TL6,-Y -Z
10	.0000	-.0000	.0025	0.	0.	0.	FAS/AM/DA IF, +Y
11	.0000	.0006	.0057	0.	0.	0.	FAS/AM/DA IF, +Z
12	.0000	.0000	.0020	0.	0.	0.	FAS/AM/DA IF, -Y
13	-.0000	.0005	.0008	0.	0.	0.	FAS/DA IF, -Y -Z
14	.0001	-.0000	.0020	0.	0.	0.	FAS/AM IF, -Z
15	.0000	.0002	.0000	0.	0.	0.	FAS/DA IF, +Y -Z
16	.0001	.0005	.0723	.0003	.0007	.0000	AM TUNNEL/SHEAR WB
17	.0001	.0003	.0680	.0002	.0104	.0001	AM TUNNEL/STS IF
18	.0003	-.0000	.0338	.0004	.0064	.0002	MDA/STS INTERFACE
19	.0005	.0009	.0127	.0001	.0143	.0001	MDA CONE/CYL ITRFC
20	.0001	.0001	.3439	0.	0.	0.	N2 TANK, +Y, LOWER
21	.0000	.0000	.0869	0.	0.	0.	N2 TANK, +Y, UPPER
22	.0038	.0020	.0163	0.	0.	0.	N2 TANK, +Z, LOWER
23	.0016	.0005	.0117	0.	0.	0.	N2 TANK, +Z, UPPER
24	.0042	.0009	.1095	0.	0.	0.	N2 TANK -Z, LOWER
25	.0003	.0005	.0395	0.	0.	0.	N2 TANK, -Z, UPPER
26	-.0000	.0001	.0137	.0002	.0012	.0000	CM, FWD BULKHEAD
27	.0001	.0014	.0385	.0006	.0019	.0001	CM, AFT BULKHEAD
28	.0000	.0000	.0003	.0001	.0000	-.0000	SM, FWD BULKHEAD
29	.0000	.0002	.0020	.0002	.0000	.0000	SM, AFT BULKHEAD
30	.0016	-.0004	-.0001	0.	0.	0.	LOWER D LATCH, DA
31	-.0001	.0001	.0009	0.	0.	0.	LOWER +Y TRUNNION
32	-.0001	.0124	-.0000	0.	0.	0.	LOWER -Y TRUNNION
33	-.0000	.0000	.0000	0.	0.	0.	EREP PACKAGE C.G.
34	.0000	.0000	.0002	0.	0.	0.	ATM PN 6,7 IF,OUTR
35	.0000	.0000	.0001	0.	0.	0.	ATM PN 4,5 IF,OUTR
36	.0000	.0000	.0001	0.	0.	0.	ATM PN 8,1 IF,OUTR
37	.0001	-.0000	.0000	0.	0.	0.	ATM PN 2,3 IF,OUTR
38	.0000	.0004	.0001	0.	0.	0.	ATM PN 6,7 IF,INNER
39	.0003	.0003	.0000	0.	0.	0.	ATM PN 4,5 IF,INNER
40	.0002	-.0000	.0000	0.	0.	0.	ATM PN 8,1 IF,INNER
41	-.0000	.0001	.0000	0.	0.	0.	ATM PN 2,3 IF,INNER
42	.0000	.0005	.0000	.0001	.0000	.0000	CMG, -Y SIDE
43	.0000	.0000	.0000	.0000	.0000	.0000	CMG, +Y SIDE
44	.0000	.0000	.0000	.0000	.0000	.0000	CMG, +X SIDE
45	.0000	.0000	0.	0.	0.	0.	ATM SAS, PN 1
46	-.0000	-.0000	0.	0.	0.	0.	ATM SAS, PN 3
47	.0000	.0000	0.	0.	0.	0.	ATM SAS, PN 5
48	.0000	.0000	0.	0.	0.	0.	ATM SAS, PN 7
49	.0000	.0000	.0000	.0000	.0000	0.	SPAR CENTER
50	.0001	.0001	.0000	.0000	.0001	.0000	GRA/CAN CENTER
SJM	.0374	.0426	.8814	.0021	.0359	.0005	

TABLE C-37

ORBITAL CONFIGURATION MODAL SURVEY  
ANALYTICAL MODES GENERALIZED MASS CONTRIBUTION SUMMARY

ANALYTICAL MODE 58

ANALYTICAL FREQUENCY = 18.361 HZ.

COMPONENT NAME	GMC (OX)	GMC (OY)	GMC (OZ)	GMC (TX)	GMC (TY)	GMC (TZ)
BR/OWS SKIRT/IU/FAS	.0013	.0390	.0130	.0117	-.0004	-.0017
6-FAS O2 TANKS	.1976	.0191	.0202	0.	0.	0.
MDA/STS/AM	.0005	.0421	.0016	.0020	.0001	.0054
6-AM N2 TANKS	.0011	.5097	.0038	0.	0.	0.
COMMAND/SERVICE MOD.	.0002	.0182	.0000	.0004	.0000	.0009
DEPLOYMENT ASSEMBLY	.0009	.0056	.0051	0.	0.	0.
ATM-RACK, CMGS, 4-SAS	.0180	.0064	.0072	.0002	.0005	.0000
ATM-SPAR CENTER	.0079	.0016	.0000	.0072	.0154	0.
ATM-GRA/CAN CENTER	.0126	.0004	.0000	.0092	.0188	.0057
	----	----	----	----	----	----
SUM	.2402	.6422	.0511	.0207	.0344	.0113

## TOTAL GM CONTRIBUTION FOR EACH COMPONENT

BR/OWS SKIRT/IJ/FAS	.0530
6-FAS O2 TANKS	.2369
MDA/STS/AM	.0526
6-AM N2 TANKS	.5146
COMMAND/SERVICE MOD.	.0198
DEPLOYMENT ASSEMBLY	.0116
ATM-RACK, CMGS, 4-SAS	.0324
ATM-SPAR CENTER	.0322
ATM-GRA/CAN CENTER	.0458

C-41  
TABLE C-38

GENERALIZED MASS CONTRIBUTIONS BY DEGREE OF FREEDOM

ANALYTICAL MODE 53

FREQUENCY= 18.36 Hz.

NODE NO.	GMC (DX)	GMC (DY)	GMC (DZ)	GMC (TX)	GMC (TY)	GMC (TZ)	NODE DESCRIPTION
1	.0000	.0264	.0074	.0014	.0002	-.0002	BASE RNG/OWS SKIRT
2	-.0000	.0000	.0001	.0002	.0001	.0002	OWS/IU INTERFACE
3	-.0000	-.0001	.0002	.0002	-.0007	-.0017	IU/FAS INTERFACE
4	.0384	.0062	-.0001	0.	0.	0.	FAS 02 B3TL1,+Y +Z
5	.0715	.0016	.0081	0.	0.	0.	FAS 02 B3TL2,+Y +Z
6	.0051	.0024	.0053	0.	0.	0.	FAS 02 B3TL3,-Y +Z
7	.0051	.0025	.0007	0.	0.	0.	FAS 02 B3TL4,-Y +Z
8	.0326	.0047	.0005	0.	0.	0.	FAS 02 B3TL5,-Y -Z
9	.0449	.0017	.0057	0.	0.	0.	FAS 02 B3TL6,-Y -Z
10	.0003	.0018	.0001	0.	0.	0.	FAS/AM/DA IF, +Y
11	.0003	.0034	-.0000	0.	0.	0.	FAS/AM/DA IF, +Z
12	.0004	.0020	.0000	0.	0.	0.	FAS/AM/DA IF, -Y
13	.0004	.0047	.0050	0.	0.	0.	FAS/DA IF, -Y -Z
14	.0000	.0007	-.0000	0.	0.	0.	FAS/AM IF, -Z
15	.0000	.0001	.0002	0.	0.	0.	FAS/DA IF, +Y -Z
16	.0000	.0104	.0007	.0000	.0001	.0000	AM TUNNEL/SHEAR WB
17	.0001	.0200	.0002	.0002	.0000	.0025	AM TUNNEL/STS IF
18	.0002	.0058	.0006	.0006	-.0001	.0017	MDA/STS INTERFACE
19	.0002	.0059	.0001	.0011	.0000	.0021	MDA CONE/CYL ITRFC
20	.0001	.0010	.0023	0.	0.	0.	N2 TANK, +Y, LOWER
21	.0000	.0031	.0007	0.	0.	0.	N2 TANK, +Y, UPPER
22	.0006	.0104	.0001	0.	0.	0.	N2 TANK, +Z, LOWER
23	.0002	.0653	.0000	0.	0.	0.	N2 TANK, +Z, UPPER
24	.0002	.4266	.0006	0.	0.	0.	N2 TANK -Z, LOWER
25	.0001	.0034	.0001	0.	0.	0.	N2 TANK, -Z, UPPER
26	-.0000	.0052	.0000	-.0000	.0000	.0004	CM, FWD BULKHEAD
27	-.0000	.0123	.0000	.0003	-.0000	.0005	CM, AFT BULKHEAD
28	.0001	.0001	.0000	.0000	.0000	.0000	SM, FWD BULKHEAD
29	.0001	.0006	.0000	.0001	.0000	.0000	SM, AFT BULKHEAD
30	.0007	.0001	.0049	0.	0.	0.	LOWER D LATCH, DA
31	.0000	.0056	-.0000	0.	0.	0.	LOWER +Y TRUNNION
32	.0001	-.0001	.0002	0.	0.	0.	LOWER -Y TRUNNION
33	.0001	.0000	.0000	0.	0.	0.	EREP PACKAGE C.G.
34	.0004	.0000	.0001	0.	0.	0.	ATM PN 6,7 IF,OUTR
35	-.0001	-.0000	.0039	0.	0.	0.	ATM PN 4,5 IF,OUTR
36	.0007	.0000	-.0000	0.	0.	0.	ATM PN 8,1 IF,OUTR
37	.0002	.0002	.0003	0.	0.	0.	ATM PN 2,3 IF,OUTR
38	.0013	.0003	.0000	0.	0.	0.	ATM PN 6,7 IF,INNER
39	.0027	-.0002	.0015	0.	0.	0.	ATM PN 4,5 IF,INNER
40	.0026	-.0002	.0000	0.	0.	0.	ATM PN 8,1 IF,INNER
41	.0034	.0030	.0001	0.	0.	0.	ATM PN 2,3 IF,INNER
42	.0005	.0026	.0014	.0000	.0001	.0000	CMG, -Y SIDE
43	.0016	.0004	-.0000	-.0000	.0000	.0000	CMG, +Y SIDE
44	.0048	.0002	.0000	.0001	.0004	.0000	CMG, +X SIDE
45	-.0000	-.0000	0.	0.	0.	0.	ATM SAS, PN 1
46	-.0000	-.0000	0.	0.	0.	0.	ATM SAS, PN 3
47	-.0000	-.0000	0.	0.	0.	0.	ATM SAS, PN 5
48	.0000	.0000	0.	0.	0.	0.	ATM SAS, PN 7
49	.0079	.0016	.0000	.0072	.0154	0.	SPAR CENTER
50	.0126	.0004	.0000	.0092	.0188	.0057	GRA/CAN CENTER
SUM	.2402	.6422	.0511	.0207	.0344	.0113	

TABLE C-39

ORBITAL CONFIGURATION MODAL SURVEY  
ANALYTICAL MODES GENERALIZED MASS CONTRIBUTION SUMMARY

ANALYTICAL MODE 65

ANALYTICAL FREQUENCY = 19.644 HZ.

COMPONENT NAME	GMC (DX)	GMC (DY)	GMC (DZ)	GMC (TX)	GMC (TY)	GMC (TZ)
BP/OWS SKIRT/IU/FAS	.0001	.0257	.0081	.0161	.0000	.0030
6-FAS O2 TANKS	.2075	.0268	.0210	0.	0.	0.
MJA/STS/AM	.2092	.0005	.0037	.0005	.0017	.0001
6-AM N2 TANKS	.1053	.0363	.0617	0.	0.	0.
COMMAND/SERVICE MOD.	.0584	.0002	.0015	.0001	.0004	.0001
DEPLOYMENT ASSEMBLY	-.0092	.0957	.0554	0.	0.	0.
ATM-RACK, CMGS, 4-SAS	.0014	.0427	.0024	.0075	.0004	.0003
ATM-SPAR CENTER	.0002	.0047	.0002	.0002	.0001	0.
ATM-GRA/CAN CENTER	.0000	.0093	.0001	.0002	.0001	.0001
	----	----	----	----	----	----
SUM	.5729	.2419	.1542	.0246	.0027	.0037

TOTAL GM CONTRIBUTION FOR EACH COMPONENT

BP/OWS SKIRT/IU/FAS	.0531
6-FAS O2 TANKS	.2553
MJA/STS/AM	.2157
6-AM N2 TANKS	.2034
COMMAND/SERVICE MOD.	.0608
DEPLOYMENT ASSEMBLY	.1419
ATM-RACK, CMGS, 4-SAS	.0547
ATM-SPAR CENTER	.0053
ATM-GRA/CAN CENTER	.0099

C-43  
TABLE C-40

GENERALIZED MASS CONTRIBUTIONS BY DEGREE OF FREEDOM

ANALYTICAL MODE 55

FREQUENCY= 19.64 Hz

NODE NO.	GMC (DX)	GMC (DY)	GMC (DZ)	GMC (TX)	GMC (TY)	GMC (TZ)	NODE DESCRIPTION
1	.0000	.0060	.0015	.0143	.0001	.0031	BASE RNG/OWS SKIRT
2	.0000	.0023	.0000	.0008	-.0000	-.0000	OWS/IU INTERFACE
3	-.0005	.0064	.0000	.0010	-.0000	-.0001	IU/FAS INTERFACE
4	.1374	.0013	.0018	0.	0.	0.	FAS 02 BJT1, +Y +Z
5	.0303	.0002	.0027	0.	0.	0.	FAS 02 BJT2, +Y +Z
6	.0049	.0007	.0048	0.	0.	0.	FAS 02 BJT3, -Y +Z
7	-.0001	.0078	.0011	0.	0.	0.	FAS 02 BJT4, -Y +Z
8	.0101	.0117	.0012	0.	0.	0.	FAS 02 BJT5, -Y -Z
9	.0249	.0051	.0094	0.	0.	0.	FAS 02 BJT6, -Y -Z
10	.0001	-.0002	.0022	0.	0.	0.	FAS/AM/DA IF, +Y
11	.0002	.0007	-.0000	0.	0.	0.	FAS/AM/DA IF, +Z
12	.0001	.0011	-.0001	0.	0.	0.	FAS/AM/DA IF, -Y
13	.0001	.0032	.0032	0.	0.	0.	FAS/DA IF, -Y -Z
14	.0001	.0062	.0004	0.	0.	0.	FAS/AM IF, -Z
15	-.0000	-.0001	.0007	0.	0.	0.	FAS/DA IF, +Y -Z
16	.0243	.0001	.0007	.0001	.0000	.0000	AM TUNNEL/SHEAR WB
17	.0452	.0001	.0008	.0001	.0001	.0000	AM TUNNEL/STS IF
18	.0743	.0003	.0022	.0002	.0002	.0000	MDA/STS INTERFACE
19	.0654	.0000	-.0000	.0002	.0014	.0001	MDA CONE/CYL ITRFC
20	.0324	.0003	.0003	0.	0.	0.	N2 TANK, +Y, LOWER
21	.0027	.0000	.0575	0.	0.	0.	N2 TANK, +Y, UPPER
22	.0372	.0000	.0001	0.	0.	0.	N2 TANK, +Z, LOWER
23	.0038	.0112	.0000	0.	0.	0.	N2 TANK, +Z, UPPER
24	.0263	.0195	.0032	0.	0.	0.	N2 TANK -Z, LOWER
25	.0028	.0052	.0005	0.	0.	0.	N2 TANK, -Z, UPPER
26	.0001	.0000	.0005	.0000	.0001	.0000	CM, FWD BULKHEAD
27	.0068	.0001	.0010	.0000	.0003	-.0000	CM, AFT BULKHEAD
28	.0151	.0000	.0001	.0000	-.0000	.0000	SM, FWD BULKHEAD
29	.0354	.0001	.0000	.0000	.0000	.0001	SM, AFT BULKHEAD
30	.0010	-.0263	.0017	0.	0.	0.	LOWER D _ATCH, DA
31	-.0052	.0669	.0244	0.	0.	0.	LOWER +Y TRUNNION
32	-.0050	.0551	.0292	0.	0.	0.	LOWER -Y TRUNNION
33	.0001	.0000	.0000	0.	0.	0.	EREP PACKAGE C.G.
34	.0000	.0017	-.0000	0.	0.	0.	ATM PN 6,7 IF,OUTR
35	.0003	.0008	.0010	0.	0.	0.	ATM PN 4,5 IF,OUTR
36	-.0001	.0008	.0001	0.	0.	0.	ATM PN 8,1 IF,OUTR
37	.0001	.0003	.0000	0.	0.	0.	ATM PN 2,3 IF,OUTR
38	-.0005	.0084	.0001	0.	0.	0.	ATM PN 6,7 IF,INNER
39	.0001	.0040	.0007	0.	0.	0.	ATM PN 4,5 IF,INNER
40	.0000	.0007	.0001	0.	0.	0.	ATM PN 8,1 IF,INNER
41	.0007	.0054	-.0000	0.	0.	0.	ATM PN 2,3 IF,INNER
42	-.0000	.0167	.0004	.0073	.0001	.0002	CMG, -Y SIDE
43	.0000	.0029	.0001	.0000	.0001	.0000	CMG, +Y SIDE
44	.0007	.0010	.0000	.0001	.0002	.0002	CMG, +X SIDE
45	.0000	.0000	0.	0.	0.	0.	ATM SAS, PN 1
46	-.0000	-.0000	0.	0.	0.	0.	ATM SAS, PN 3
47	-.0000	-.0000	0.	0.	0.	0.	ATM SAS, PN 5
48	.0000	.0000	0.	0.	0.	0.	ATM SAS, PN 7
49	.0002	.0047	.0002	.0002	.0001	0.	SPAR CENTER
50	.0000	.0093	.0001	.0002	.0001	.0001	GRA/CAN CENTER
SUM	.5729	.2419	.1542	.0246	.0027	.0037	

SECTION D

Two-Dimensional Plots of Analytical Modes



ORBITAL CONFIGURATION MODAL SURVEY  
DEGREE OF FREEDOM TABLE FOR MODE SHAPES AND DISCRETE MASS MATRIX

NODE NO.	DEGREES OF FREEDOM							LOCATION			DESCRIPTION
	DX	DY	DZ	TX	TY	TZ	X	Y	Z		
1	1	2	3	4	5	6	3100.00	0.000	0.000	BASE RNG/OWS SKIRT	
2	7	8	9	10	11	12	3223.000	0.000	0.000	OWS/IU INTERFACE	
3	13	14	15	16	17	18	3258.555	0.000	0.000	IU/FAS INTERFACE	
4	19	20	21				3316.555	81.473	45.683	FAS 02 BOTL1,+Y +Z	
5	22	23	24				3316.555	46.683	81.473	FAS 02 BOTL2,+Y +Z	
6	25	26	27				3316.555	-46.683	81.473	FAS 02 BOTL3,-Y +Z	
7	28	29	30				3316.555	-81.473	46.683	FAS 02 BOTL4,-Y +Z	
8	31	32	33				3316.555	-81.473	-46.683	FAS 02 BOTL5,-Y -Z	
9	34	35	36				3316.555	-46.683	-81.473	FAS 02 BOTL6,-Y -Z	
10	37	38	39				3341.615	116.060	0.000	FAS/AM/DA IF, +Y	
11	40	41	42				3341.615	0.000	115.060	FAS/AM/DA IF, +Z	
12	43	44	45				3341.615	-116.060	0.000	FAS/AM/DA IF, -Y	
13	46	47	48				3355.700	-82.346	-81.488	FAS/DA IF, -Y -Z	
14	49	50	51				3341.615	0.000	-115.060	FAS/AM IF, -Z	
15	52	53	54				3341.615	83.0143	-83.0143	FAS/DA IF, +Y -Z	
16	55	56	57	58	59	60	3282.365	0.000	0.000	AM TUNNEL/SHEAR WB	
17	51	62	63	64	65	66	3394.615	0.000	0.000	AM TUNNEL/STS IF	
18	67	68	69	70	71	72	3441.765	0.000	0.000	MDA/STS INTERFACE	
19	73	74	75	76	77	78	3505.000	0.000	0.000	MDA CONE/CYL ITRFC	
20	79	80	81				3297.665	69.050	0.000	N2 TANK, +Y, LOWER	
21	82	83	84				3348.365	69.050	0.000	N2 TANK, +Y, UPPER	
22	85	86	87				3297.665	0.000	69.050	N2 TANK, +Z, LOWER	
23	88	89	90				3348.365	0.000	69.050	N2 TANK, +Z, UPPER	
24	91	92	93				3297.665	0.000	-69.050	N2 TANK -Z, LOWER	
25	94	95	96				3348.365	0.000	-69.050	N2 TANK, -Z, UPPER	
26	97	98	99	100	101	102	3578.000	0.000	0.000	CM, FWD BULKHEAD	
27	103	104	105	106	107	108	3751.600	0.000	0.000	CM, AFT BULKHEAD	
28	109	110	111	112	113	114	3766.500	0.000	0.000	SM, FWD BULKHEAD	
29	115	116	117	118	119	120	3921.500	0.000	0.000	SM, AFT BULKHEAD	
30	121	122	123				3454.765	0.000	-90.000	LOWER D LATCH, DA	
31	124	125	126				3532.915	113.500	-11.850	LOWER +Y TRUNNION	
32	127	128	129				3532.915	-113.500	-11.850	LOWER -Y TRUNNION	
33	130	131	132				3418.765	0.000	100.000	EREP PACKAGE C.G.	
34	133	134	135				3479.094	27.299	-252.500	ATM PN 6,7 IF,OUTR	
35	136	137	138				3517.701	-65.906	-252.500	ATM PN 4,5 IF,OUTR	
36	139	140	141				3572.299	65.906	-252.500	ATM PN 8,1 IF,OUTR	
37	142	143	144				3510.906	-27.299	-252.500	ATM PN 2,3 IF,OUTR	
38	145	146	147				3479.094	27.299	-158.000	ATM PN 6,7 IF,INNER	
39	148	149	150				3517.701	-65.906	-158.000	ATM PN 4,5 IF,INNER	
40	151	152	153				3572.299	65.906	-158.000	ATM PN 8,1 IF,INNER	
41	154	155	156				3510.906	-27.299	-158.000	ATM PN 2,3 IF,INNER	
42	157	158	159	160	161	162	3545.000	-65.906	-181.9925	CMG, -Y SIDE	
43	163	164	165	166	167	168	3545.000	67.834	-181.995	CMG, +Y SIDE	
44	169	170	171	172	173	174	3510.906	0.000	-182.000	CMG, +X SIDE	
45	175	176					3599.9301	54.9301	-207.490	ATM SAS, PN 1	
46	177	178					3599.9301	-54.9301	-207.490	ATM SAS, PN 3	
47	179	180					3490.0699	-54.9301	-207.490	ATM SAS, PN 5	
48	181	182					3490.0699	54.9301	-207.490	ATM SAS, PN 7	
49	183	184	185	186	187		3545.000	0.000	-240.709	SPAR CENTER	
50	188	189	190	191	192	193	3545.000	0.000	-240.709	GRA/CAN CENTER	

Two dimensional plots of the correlated analytical modes as defined in Table 5.17 of the main text are presented in this section. The plots are presented in the same manner as the test mode plots contained in Section A with the following exceptions:

1. Analytical modes are plotted correctly between node 3 and node 16.
2. Node 50 is plotted with the incorrect sign in the X, Y, TH X, and TH Y planes.

The plotted node points and associated degrees of freedom are defined on page D-2 of this section.

Plot D-1

D-1 A ORBIT CONFIGURATION - 8TH CYCLE ANALYTICAL MODES  
MODE 1 FREQ = 1.279 HZ RUN NO. = D7A08 DATE = 060072

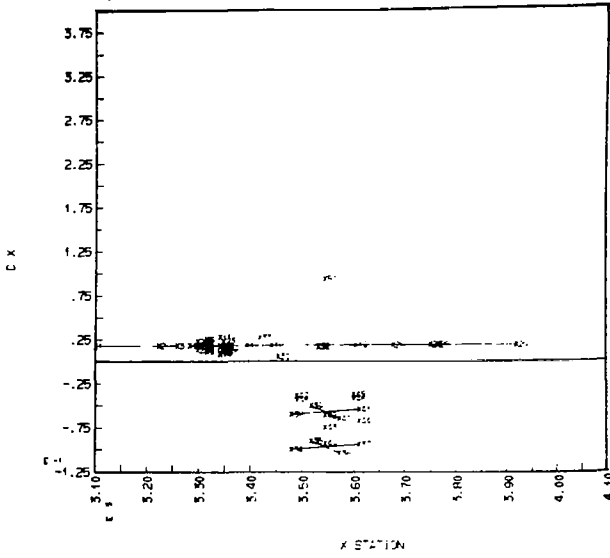

D-1 A ORBIT CONFIGURATION - 8TH CYCLE ANALYTICAL MODES  
MODE 1 FREQ = 1.279 HZ RUN NO. = D7A08 DATE = 060072

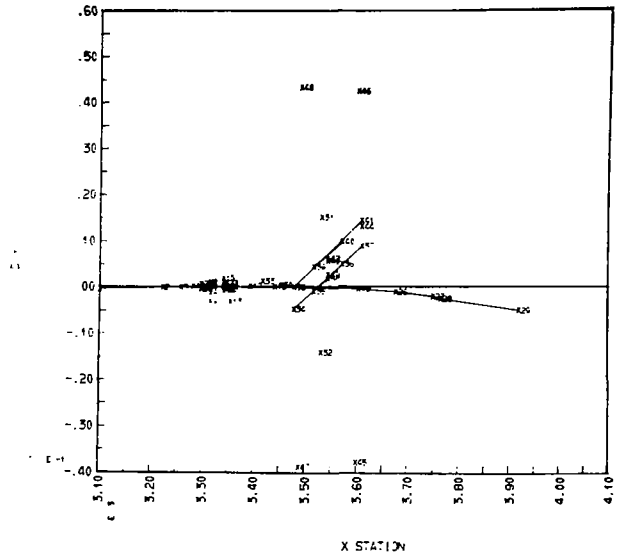

D-1 A ORBIT CONFIGURATION - 8TH CYCLE ANALYTICAL MODES  
MODE 1 FREQ = 1.279 HZ RUN NO. = D7A08 DATE = 060072

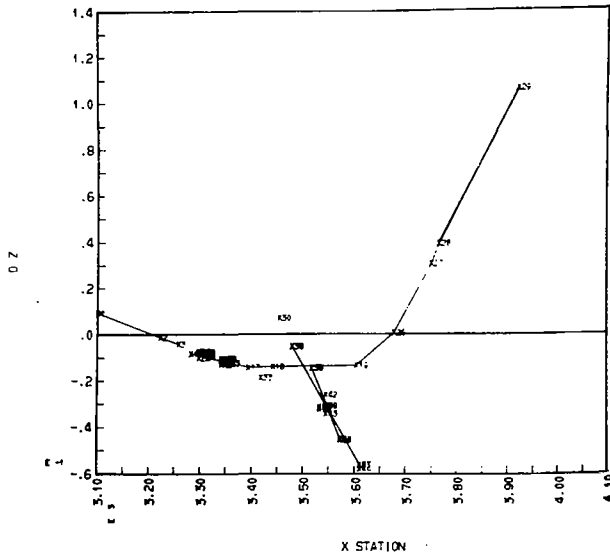

D-1 A ORBIT CONFIGURATION - 8TH CYCLE ANALYTICAL MODES  
MODE 1 FREQ = 1.279 HZ RUN NO. = D7A08 DATE = 060072

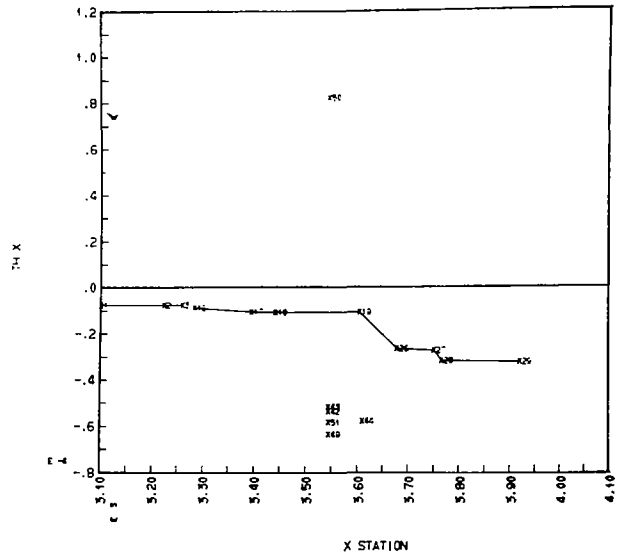

Plot D-1

D T A ORBIT CONFIGURATION - 8TH CYCLE ANALYTICAL MODES  
MODE 7 FREQ = 1.279 HZ RUN NO. = DTA08 DATE = 060C72

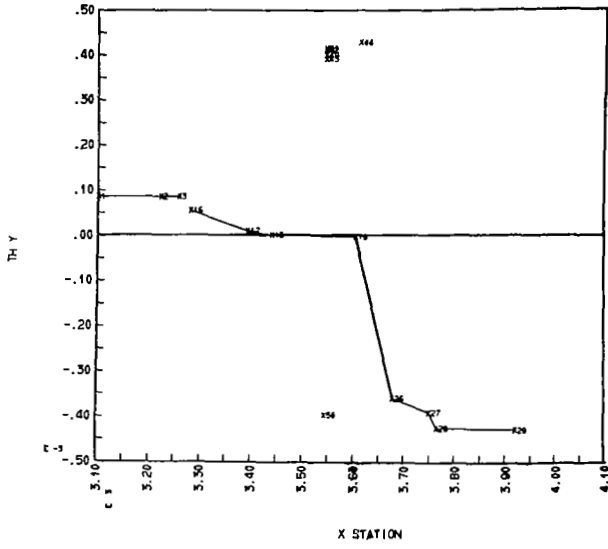

D T A ORBIT CONFIGURATION - 8TH CYCLE ANALYTICAL MODES  
MODE 7 FREQ = 1.279 HZ RUN NO. = DTA08 DATE = 060C72

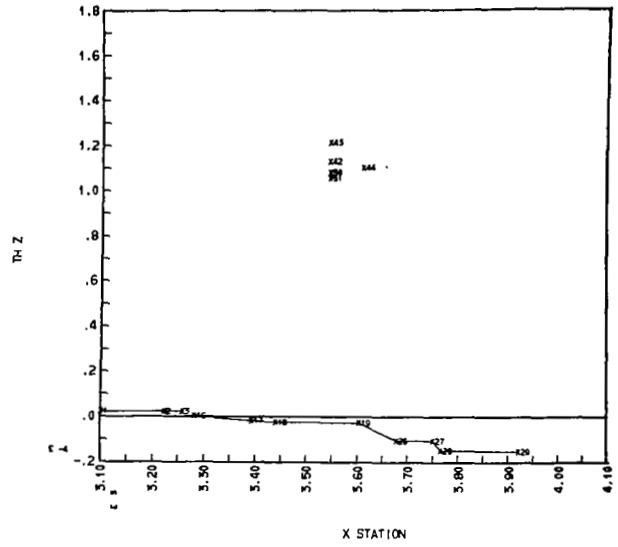

Plot D-2

D T A ORBIT CONFIGURATION - 8TH CYCLE ANALYTICAL MODES  
 MODE B FREQ = 1.377 HZ RUN NO. = DTA08 DATE = 060C72

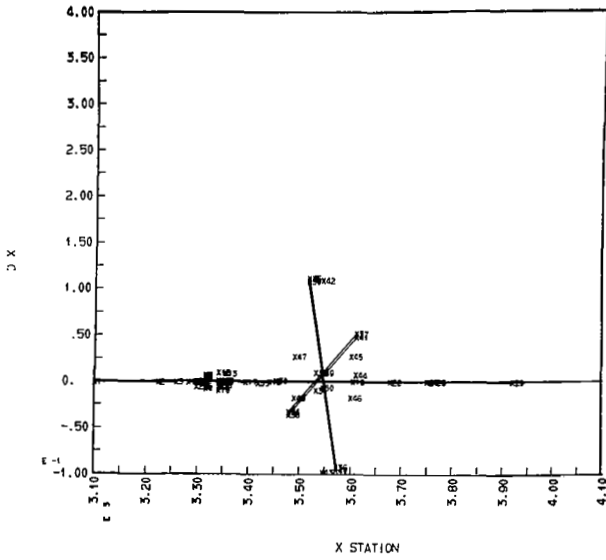

D T A ORBIT CONFIGURATION - 8TH CYCLE ANALYTICAL MODES  
 MODE B FREQ = 1.377 HZ RUN NO. = DTA08 DATE = 060C72

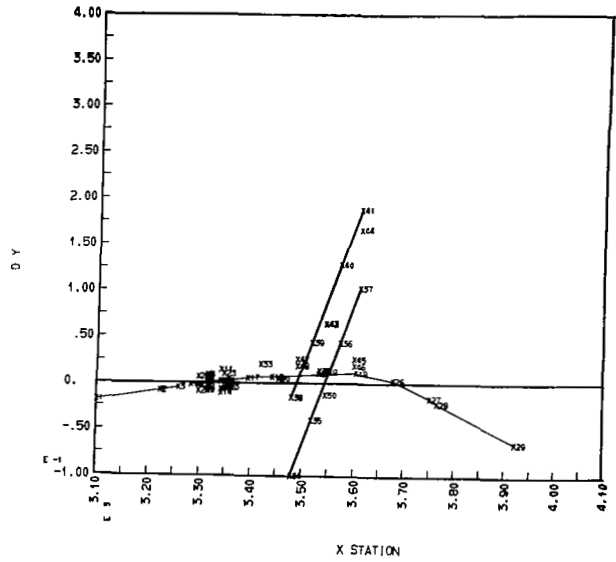

D T A ORBIT CONFIGURATION - 8TH CYCLE ANALYTICAL MODES  
 MODE B FREQ = 1.377 HZ RUN NO. = DTA08 DATE = 060C72

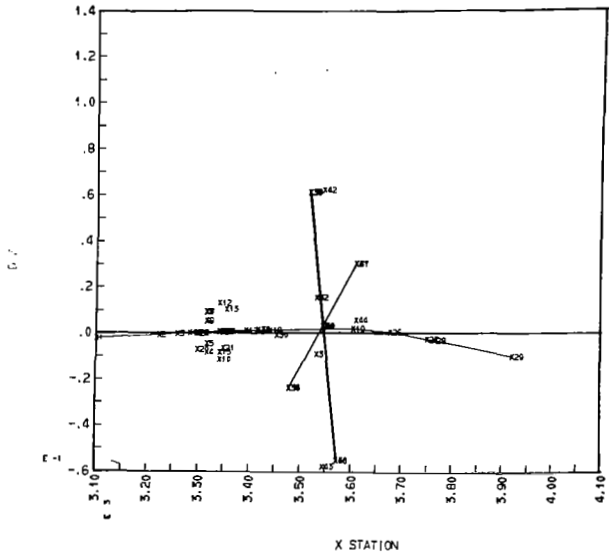

D T A ORBIT CONFIGURATION - 8TH CYCLE ANALYTICAL MODES  
 MODE B FREQ = 1.377 HZ RUN NO. = DTA08 DATE = 060C72

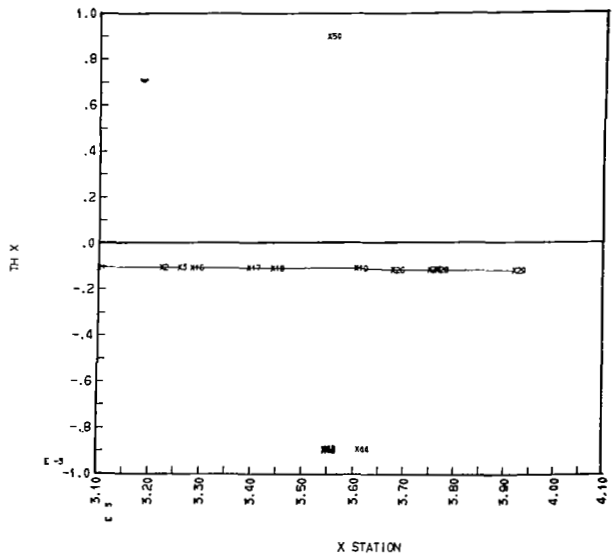

Plot D-2

D T A ORBIT CONFIGURATION - 8TH CYCLE ANALYTICAL MODES  
 MODE B FREQ = 1.377 HZ RUN NO. = DTA08 DATE = 060C72

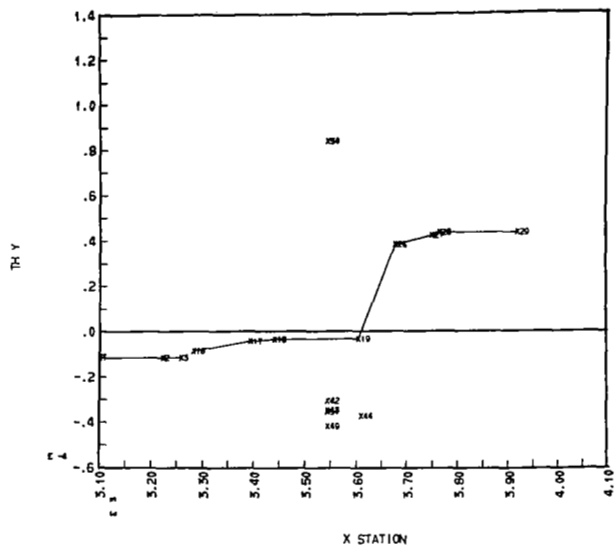

D T A ORBIT CONFIGURATION - 8TH CYCLE ANALYTICAL MODES  
 MODE B FREQ = 1.377 HZ RUN NO. = DTA08 DATE = 060C72

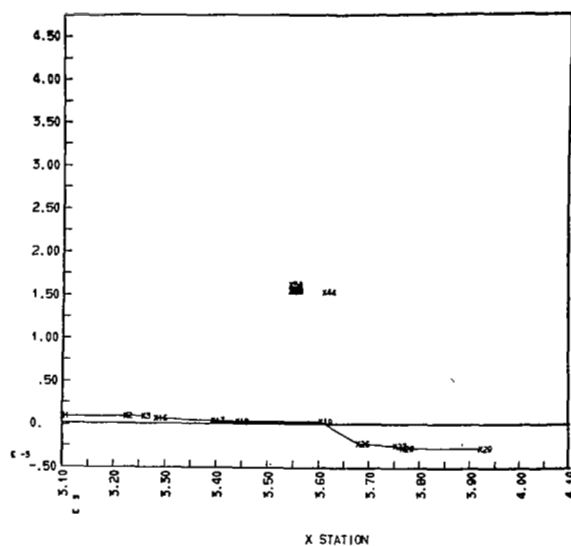

Plot D-3

D T A ORBIT CONFIGURATION - 8TH CYCLE ANALYTICAL MODES  
 MODE 9 FREQ = 1.643 HZ RUN NO. = DTA08 DATE = 060C72

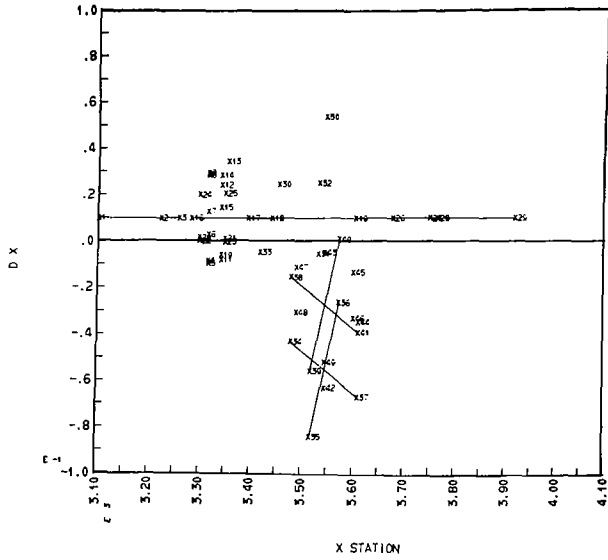

D T A ORBIT CONFIGURATION - 8TH CYCLE ANALYTICAL MODES  
 MODE 9 FREQ = 1.643 HZ RUN NO. = DTA08 DATE = 060C72

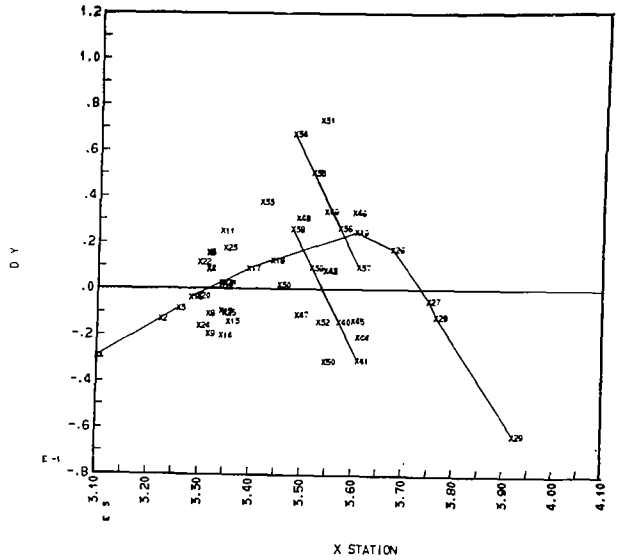

D T A ORBIT CONFIGURATION - 8TH CYCLE ANALYTICAL MODES  
 MODE 9 FREQ = 1.643 HZ RUN NO. = DTA08 DATE = 060C72

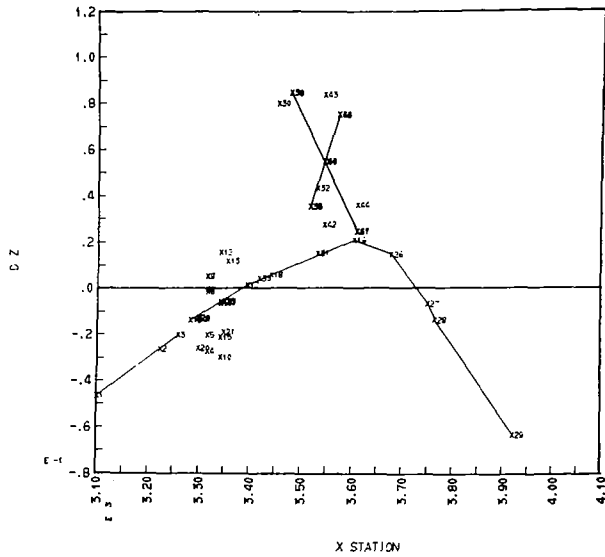

D T A ORBIT CONFIGURATION - 8TH CYCLE ANALYTICAL MODES  
 MODE 9 FREQ = 1.643 HZ RUN NO. = DTA08 DATE = 060C72

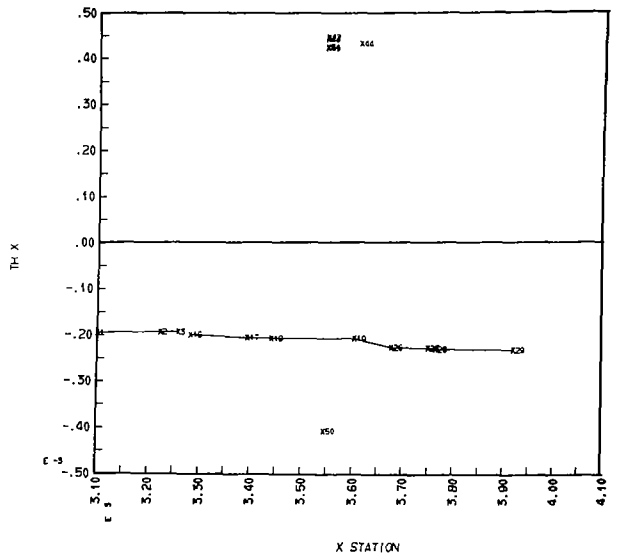

PLOT D-3

DATA ORBIT CONFIGURATION - 8TH CYCLE ANALYTICAL MODES  
MODE 9 FREQ = 1.643 HZ RUN NO. = DTA08 DATE = 060C72

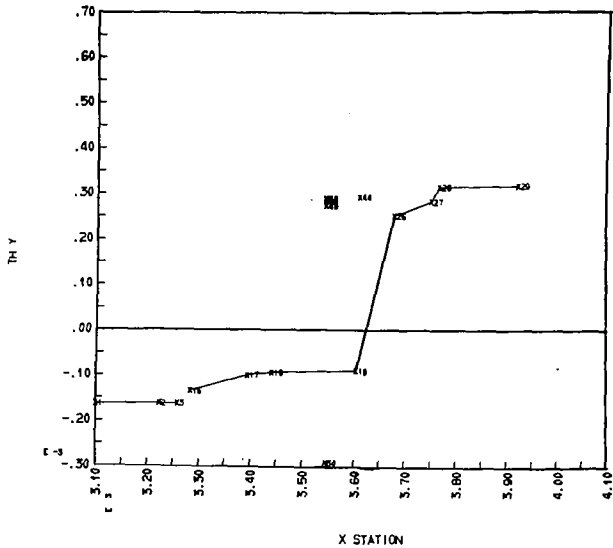

DATA ORBIT CONFIGURATION - 8TH CYCLE ANALYTICAL MODES  
MODE 9 FREQ = 1.643 HZ RUN NO. = DTA08 DATE = 060C72

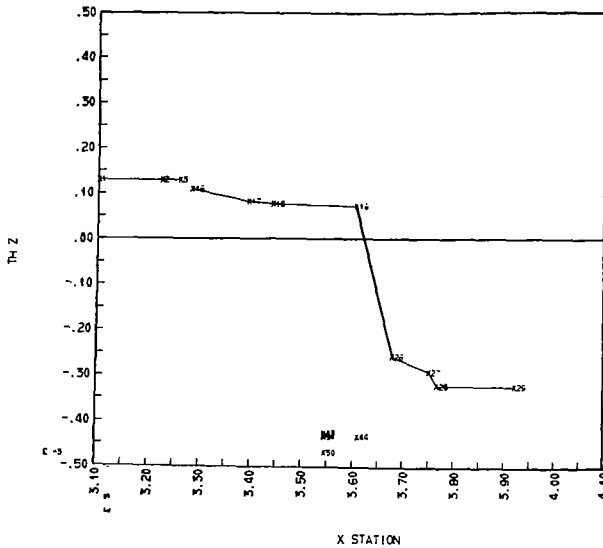





Plot D-4

D T A ORBIT CONFIGURATION - 8TH CYCLE ANALYTICAL MODES  
MODE 10 FREQ = 1.670 HZ RUN NO. = DTA09 DATE = 062272

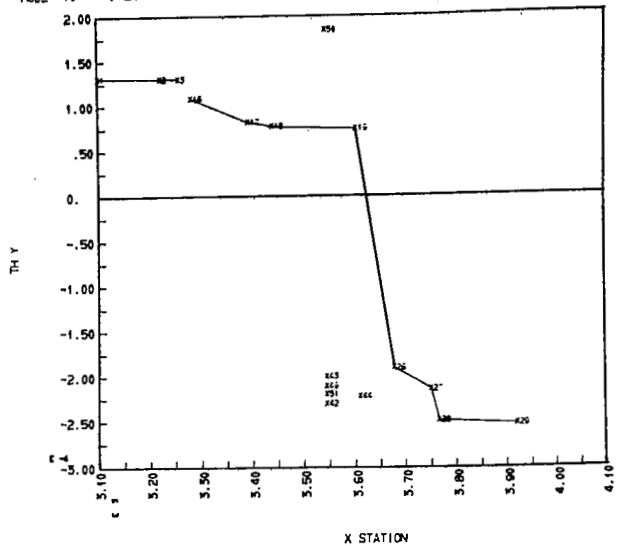

D T A ORBIT CONFIGURATION - 8TH CYCLE ANALYTICAL MODES  
MODE 10 FREQ = 1.670 HZ RUN NO. = DTA08 DATE = 062272

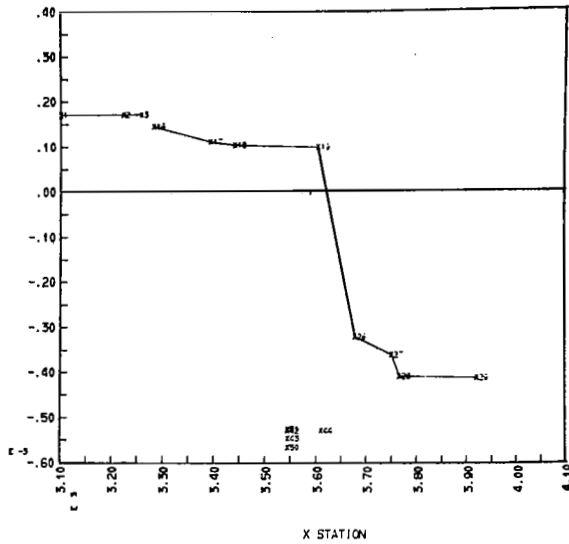

Plot D-5

D T A ORBIT CONFIGURATION - 8TH CYCLE ANALYTICAL MODES  
 NUCE 11 FREQ = 2.338 HZ RUN NO. = DTA08 DATE = 060072

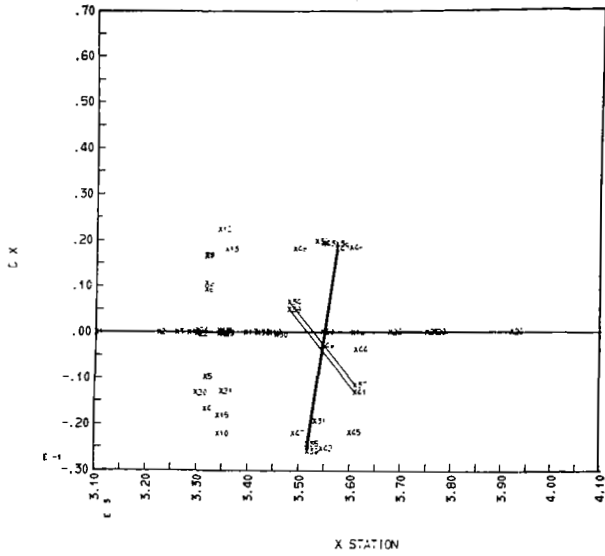

D T A ORBIT CONFIGURATION - 8TH CYCLE ANALYTICAL MODES  
 NUCE 11 FREQ = 2.338 HZ RUN NO. = DTA08 DATE = 060072

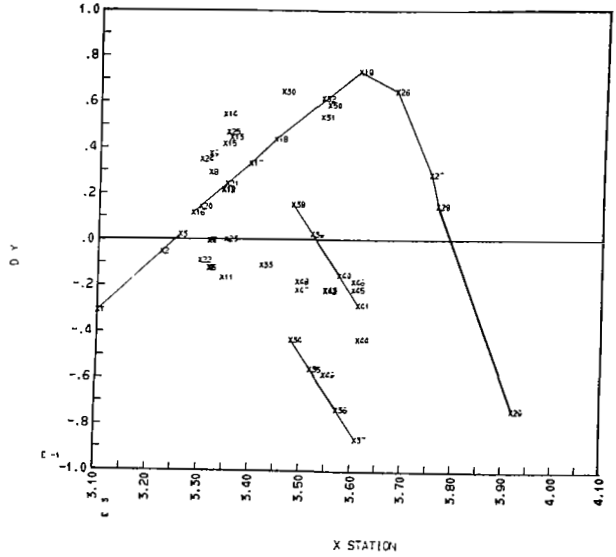

D T A ORBIT CONFIGURATION - 8TH CYCLE ANALYTICAL MODES  
 NUCE 11 FREQ = 2.338 HZ RUN NO. = DTA08 DATE = 060072

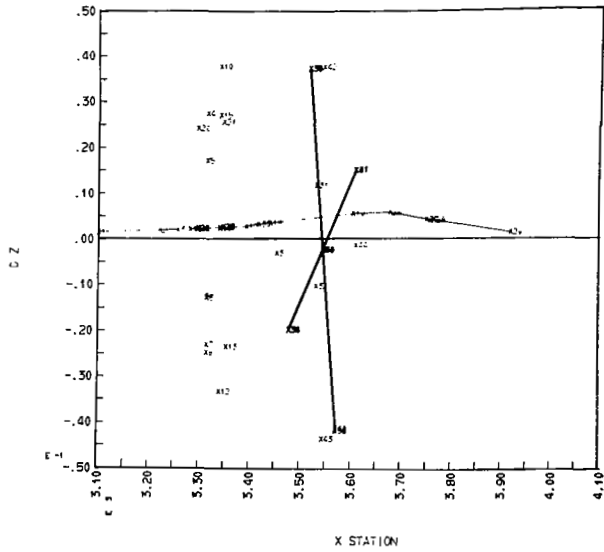

D T A ORBIT CONFIGURATION - 8TH CYCLE ANALYTICAL MODES  
 NUCE 11 FREQ = 2.338 HZ RUN NO. = DTA08 DATE = 060072

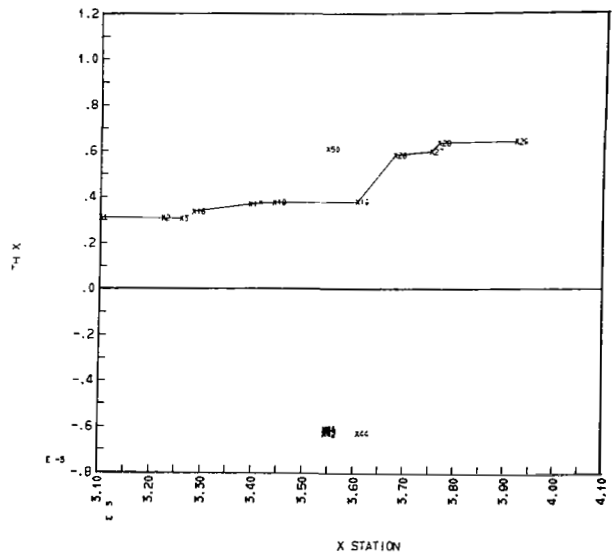

Plot D-5

D T A ORBIT CONFIGURATION - 8TH CYCLE ANALYTICAL MODES  
MODE 11 FREQ = 2.338 HZ RUN NO. = DTA08 DATE = 060672

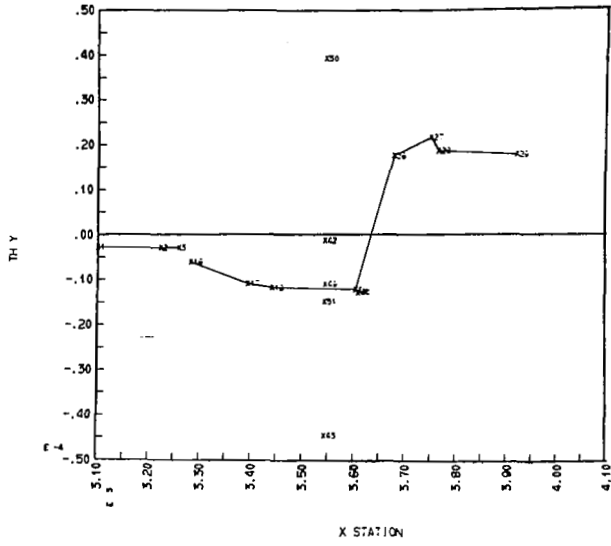

D T A ORBIT CONFIGURATION - 8TH CYCLE ANALYTICAL MODES  
MODE 11 FREQ = 2.338 HZ RUN NO. = DTA08 DATE = 060672

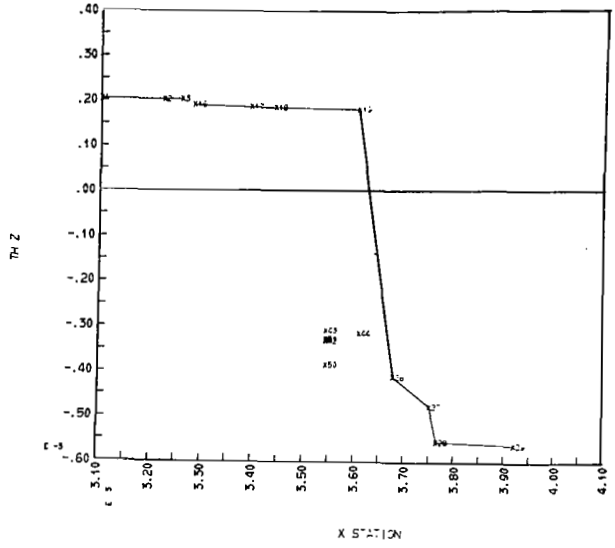

Plot D-6

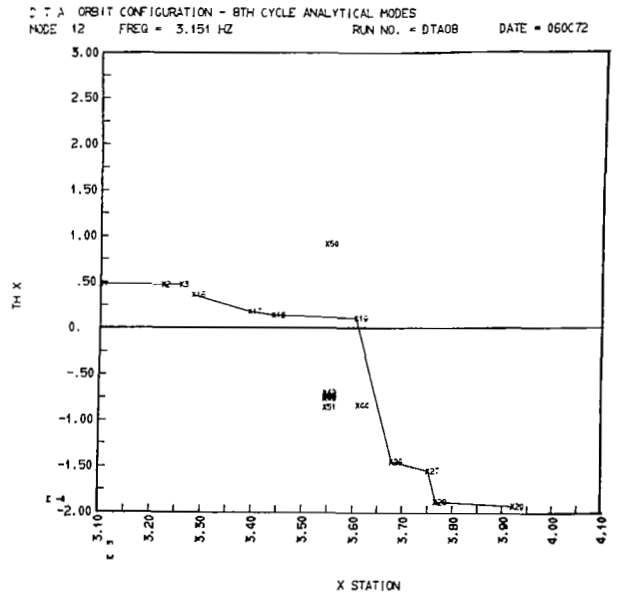
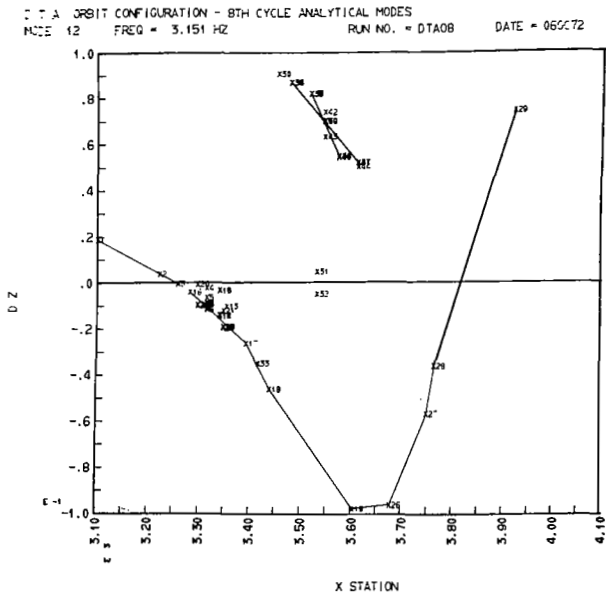
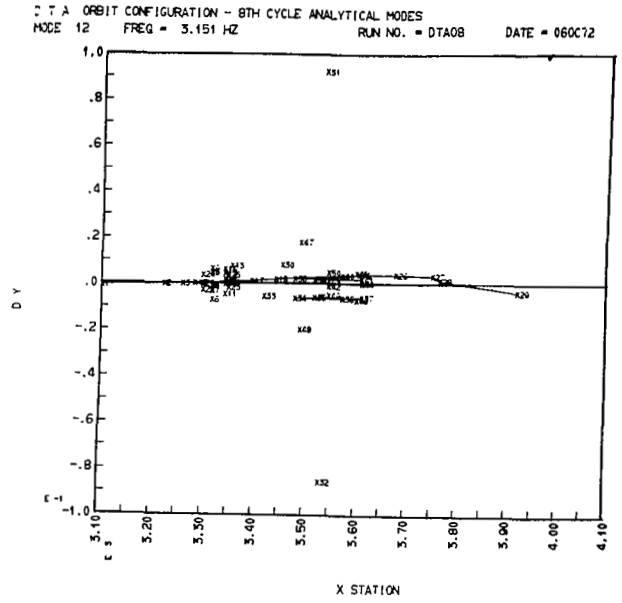
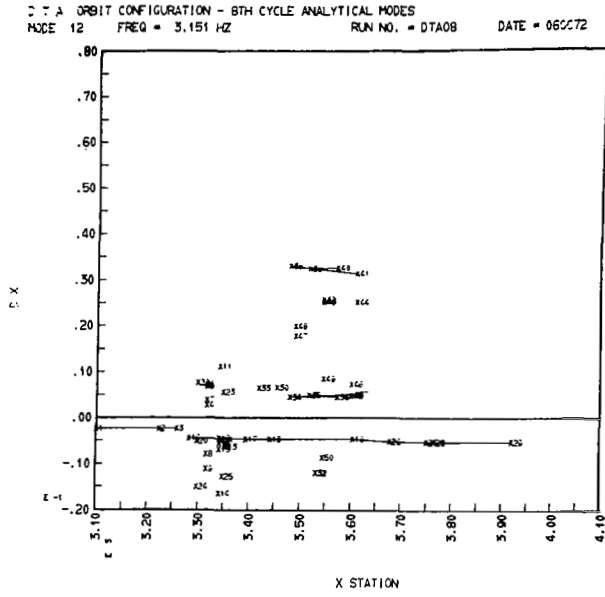

Plot D-6

D T A ORBIT CONFIGURATION - 8TH CYCLE ANALYTICAL MODES  
 MODE 12 FREQ = 3.151 HZ RUN NO. = DTA08 DATE = 060672

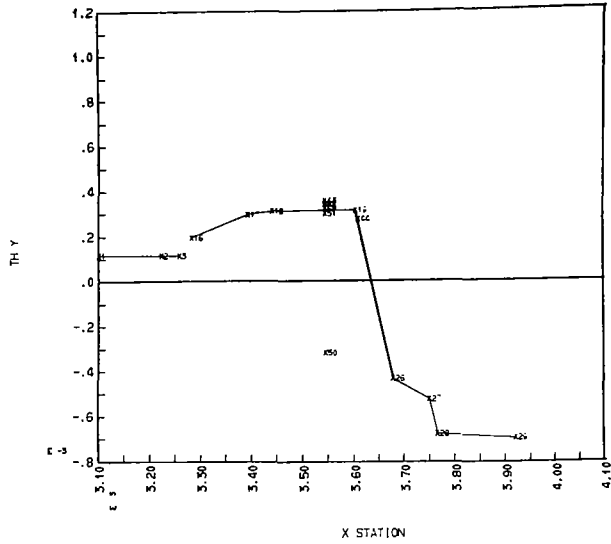

D T A ORBIT CONFIGURATION - 8TH CYCLE ANALYTICAL MODES  
 MODE 12 FREQ = 3.151 HZ RUN NO. = DTA08 DATE = 060672

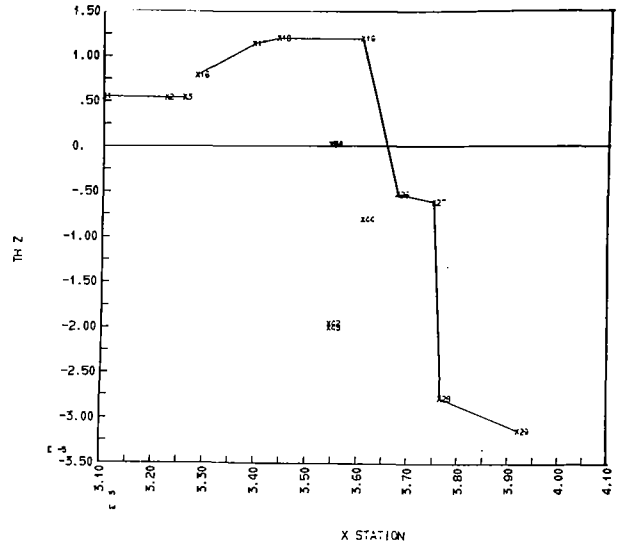

Plot D-7

D T A ORBIT CONFIGURATION - 8TH CYCLE ANALYTICAL MODES  
 MODE 13 FREQ = 3.532 HZ RUN NO. = DTA08 DATE = 060C72

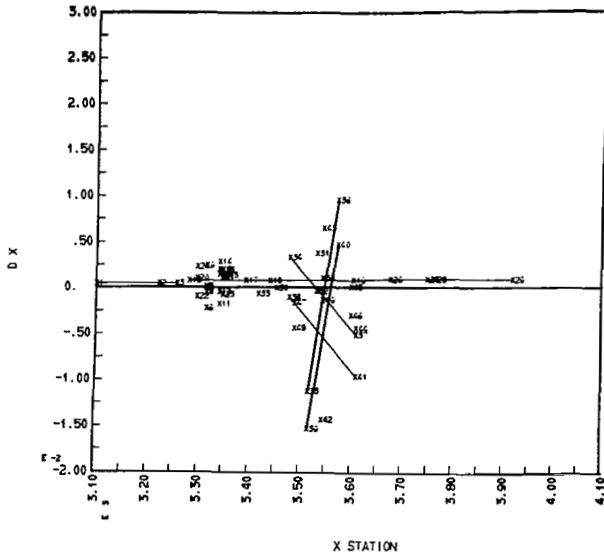

D T A ORBIT CONFIGURATION - 8TH CYCLE ANALYTICAL MODES  
 MODE 13 FREQ = 3.532 HZ RUN NO. = DTA08 DATE = 060C72

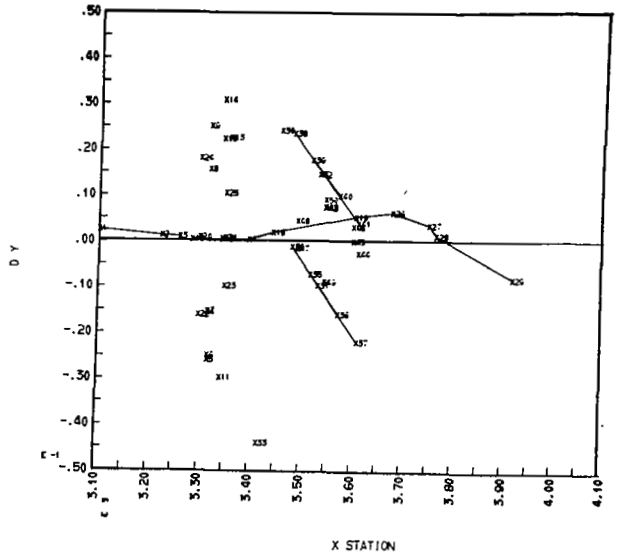

D T A ORBIT CONFIGURATION - 8TH CYCLE ANALYTICAL MODES  
 MODE 13 FREQ = 3.532 HZ RUN NO. = DTA08 DATE = 060C72

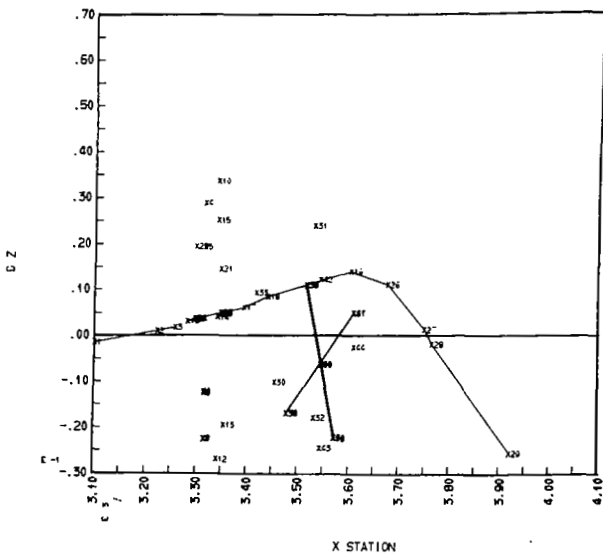

D T A ORBIT CONFIGURATION - 8TH CYCLE ANALYTICAL MODES  
 MODE 13 FREQ = 3.532 HZ RUN NO. = DTA08 DATE = 060C72

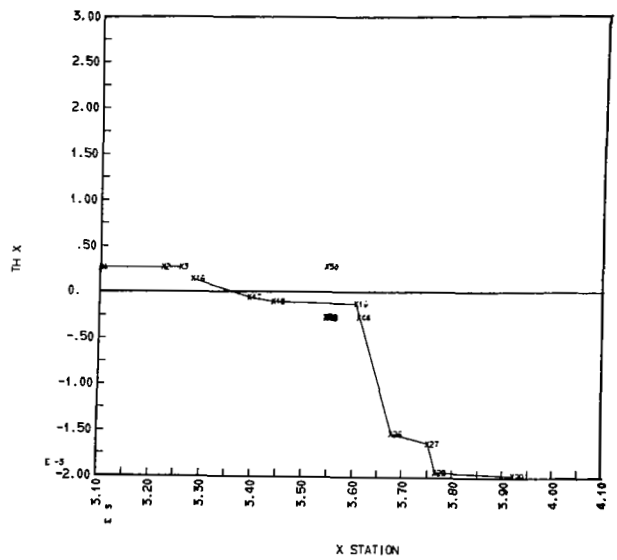

Plot D-7

D T A ORBIT CONFIGURATION - 8TH CYCLE ANALYTICAL MODES  
 MODE 13 FREQ = 3.532 KZ RUN NO. = DTA08 DATE = 060072

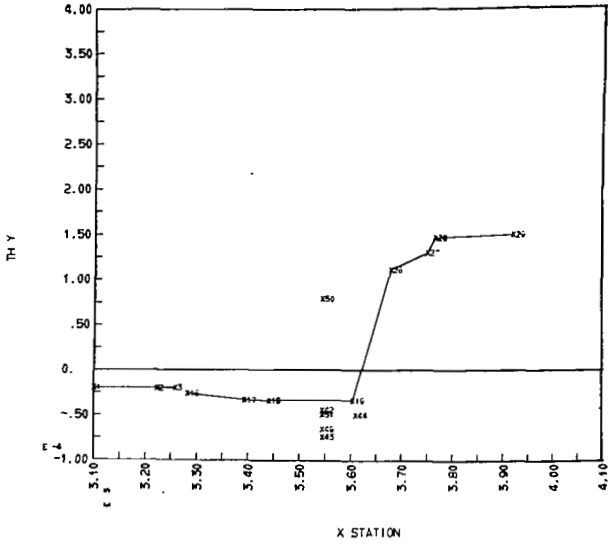

D T A ORBIT CONFIGURATION - 8TH CYCLE ANALYTICAL MODES  
 MODE 13 FREQ = 3.532 KZ RUN NO. = DTA08 DATE = 060072

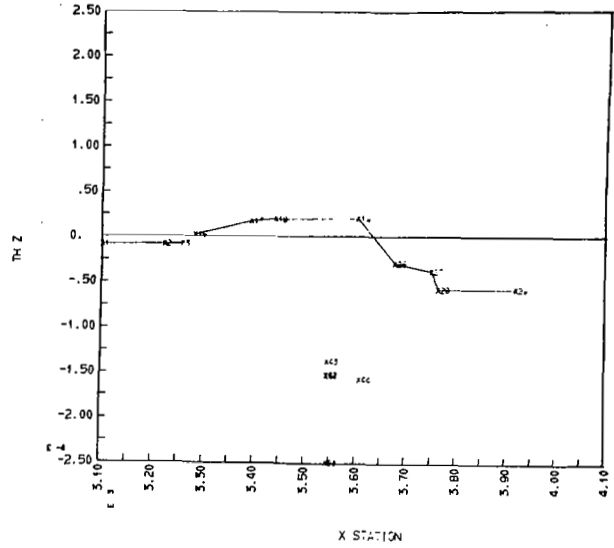



Plot D-8

DATA ORBIT CONFIGURATION - 8TH CYCLE ANALYTICAL MODES  
 MODE 14 FREQ = 4.323 HZ RUN NO. = DTA08 DATE = 060672

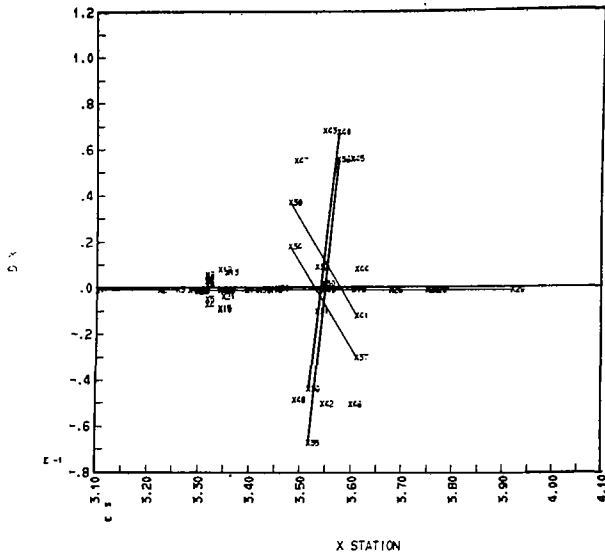

DATA ORBIT CONFIGURATION - 8TH CYCLE ANALYTICAL MODES  
 MODE 14 FREQ = 4.323 HZ RUN NO. = DTA08 DATE = 060672

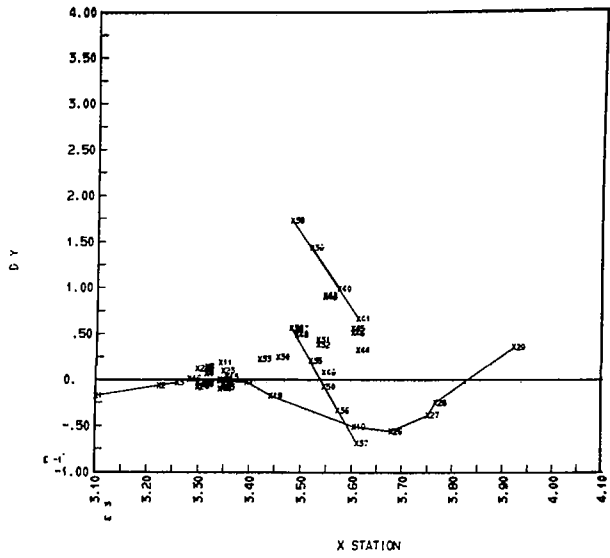

DATA ORBIT CONFIGURATION - 8TH CYCLE ANALYTICAL MODES  
 MODE 14 FREQ = 4.323 HZ RUN NO. = DTA08 DATE = 060672

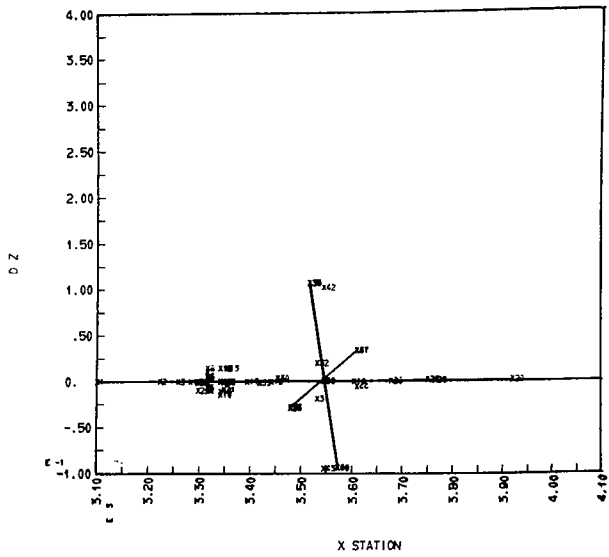

DATA ORBIT CONFIGURATION - 8TH CYCLE ANALYTICAL MODES  
 MODE 14 FREQ = 4.323 HZ RUN NO. = DTA08 DATE = 060672

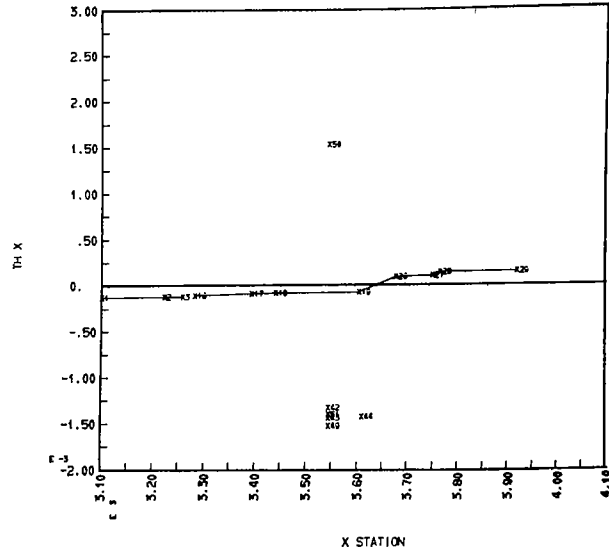

Plot D-8

DTA ORBIT CONFIGURATION - 8TH CYCLE ANALYTICAL MODES  
 MODE 14 FREQ = 4.323 HZ RUN NO. = DTA08 DATE = 06/2/72

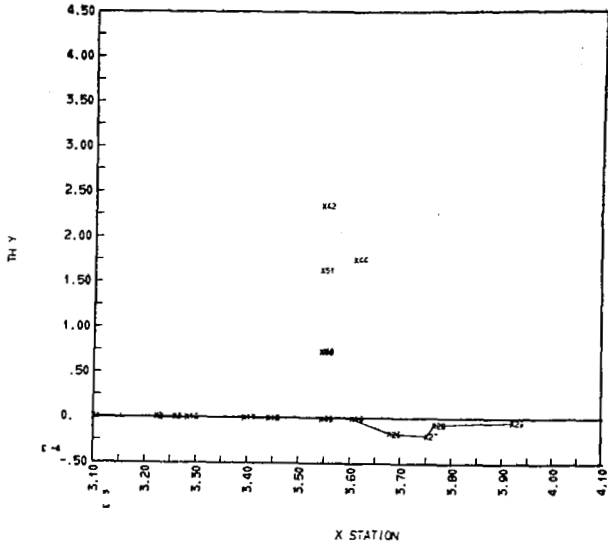

DTA ORBIT CONFIGURATION - 8TH CYCLE ANALYTICAL MODES  
 MODE 14 FREQ = 4.323 HZ RUN NO. = DTA08 DATE = 06/2/72

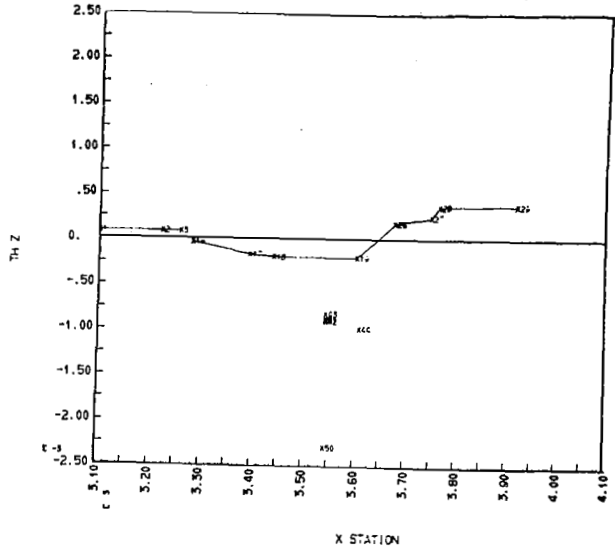

Plot D-9

ORBIT CONFIGURATION - 8TH CYCLE ANALYTICAL MODES  
 NUCE 15 FREQ = 4.868 HZ RUN NO. = DTA08 DATE = 060C72

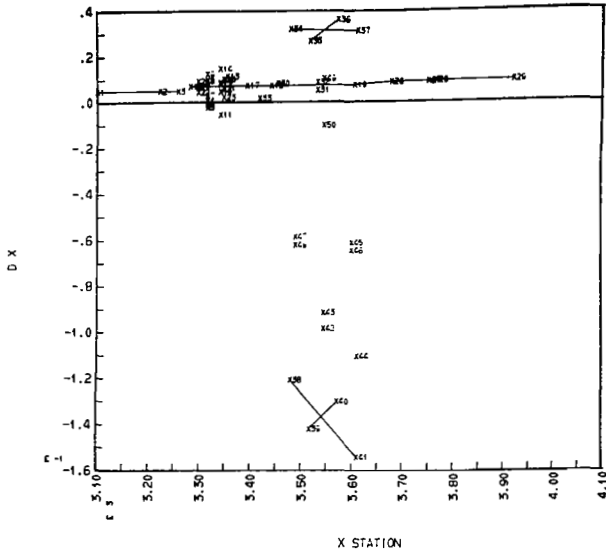

ORBIT CONFIGURATION - 8TH CYCLE ANALYTICAL MODES  
 NUCE 15 FREQ = 4.868 HZ RUN NO. = DTA08 DATE = 060C72

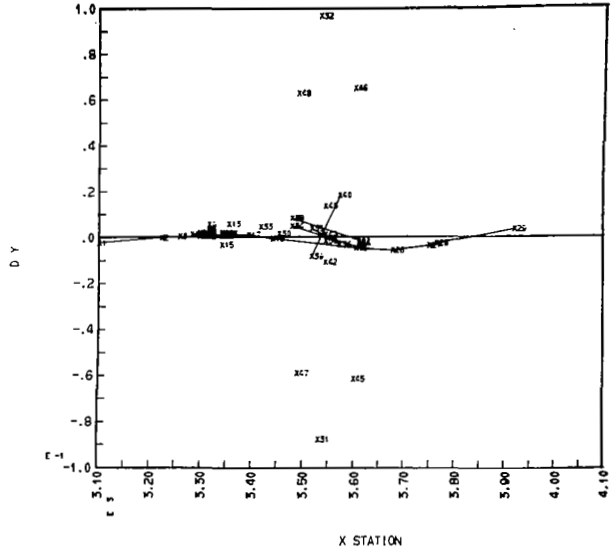

ORBIT CONFIGURATION - 8TH CYCLE ANALYTICAL MODES  
 NUCE 15 FREQ = 4.868 HZ RUN NO. = DTA08 DATE = 060C72

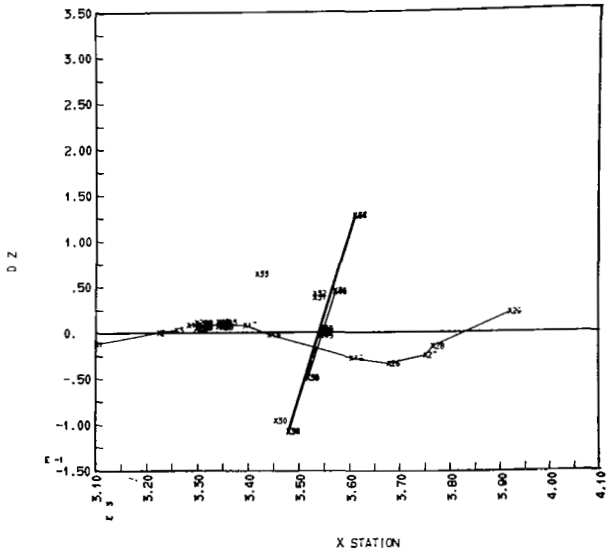

ORBIT CONFIGURATION - 8TH CYCLE ANALYTICAL MODES  
 NUCE 15 FREQ = 4.868 HZ RUN NO. = DTA08 DATE = 060C72

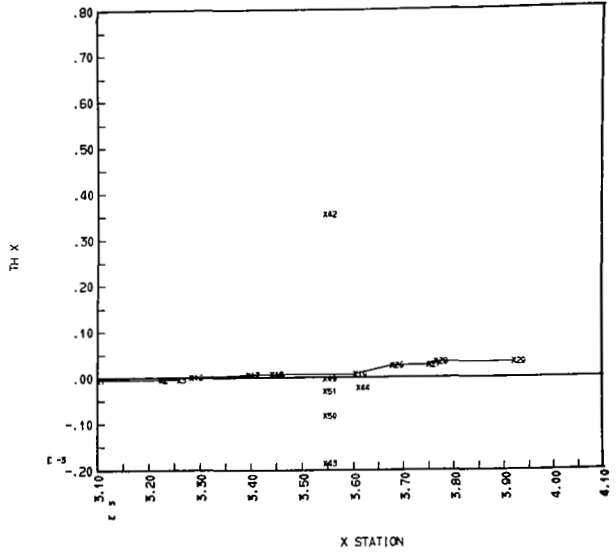

Plot D-9

D T A ORBIT CONFIGURATION - 8TH CYCLE ANALYTICAL MODES  
MODE 15 FREQ = 4.868 HZ RUN NO. = DTA08 DATE = 060072

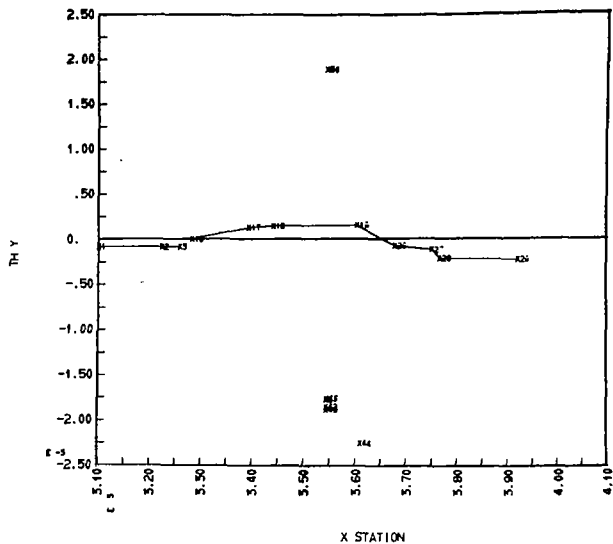

D T A ORBIT CONFIGURATION - 8TH CYCLE ANALYTICAL MODES  
MODE 15 FREQ = 4.868 HZ RUN NO. = DTA08 DATE = 060072

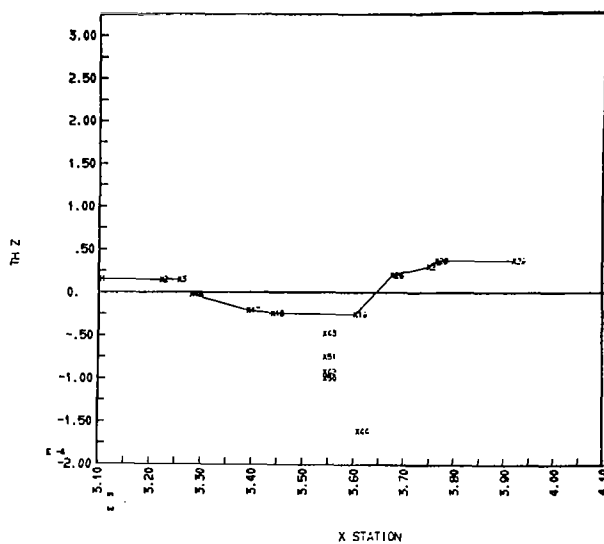

Plot D-10

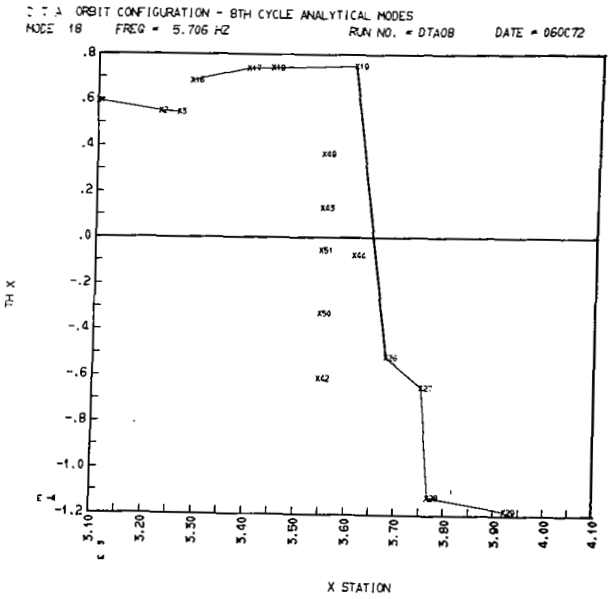
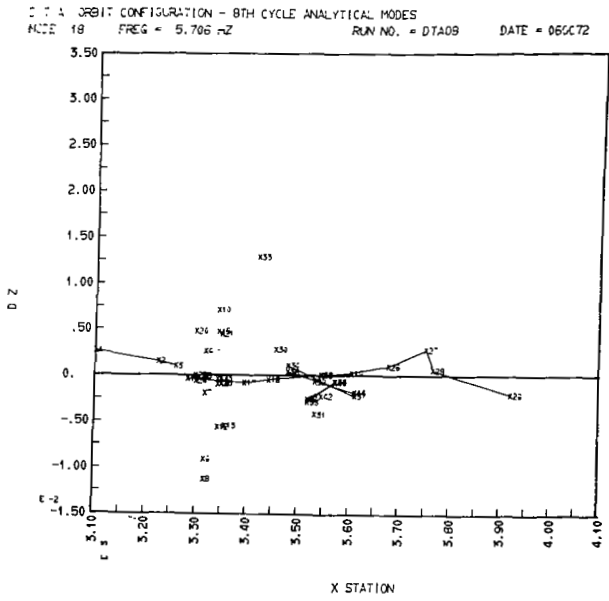
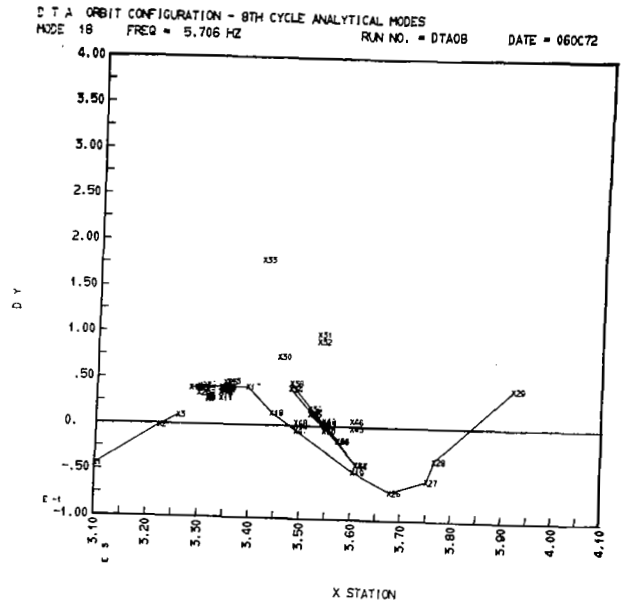
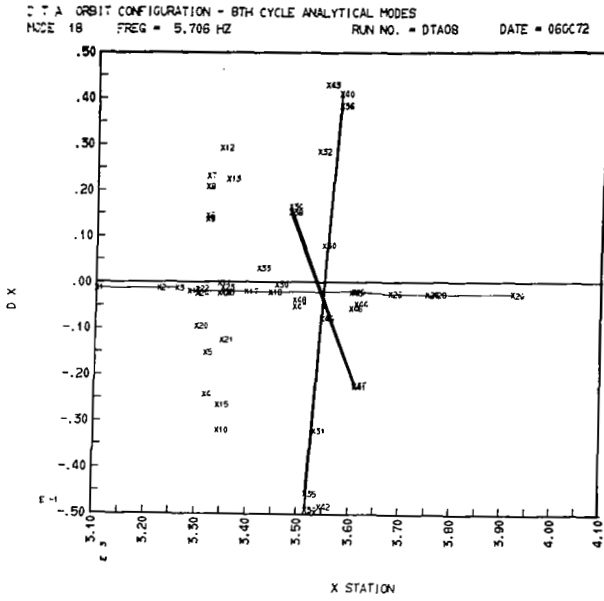

Plot D-10

D T A ORBIT CONFIGURATION - 8TH CYCLE ANALYTICAL MODES  
 MODE 18 FREQ = 5.706 HZ RUN NO. = DTA08 DATE = 06/27/72

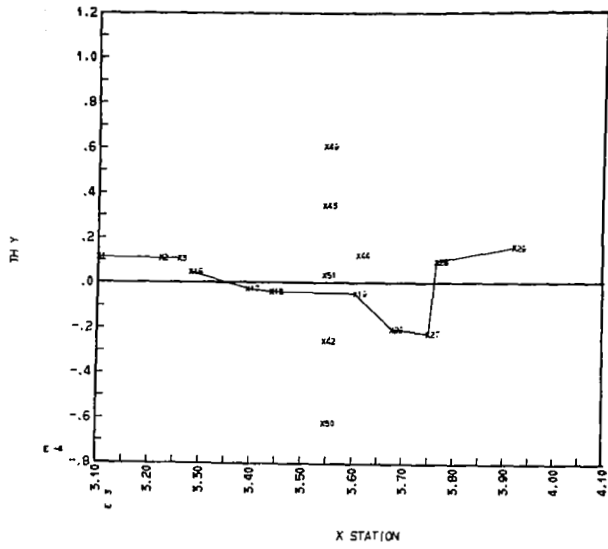

D T A ORBIT CONFIGURATION - 8TH CYCLE ANALYTICAL MODES  
 MODE 18 FREQ = 5.706 HZ RUN NO. = DTA08 DATE = 06/27/72

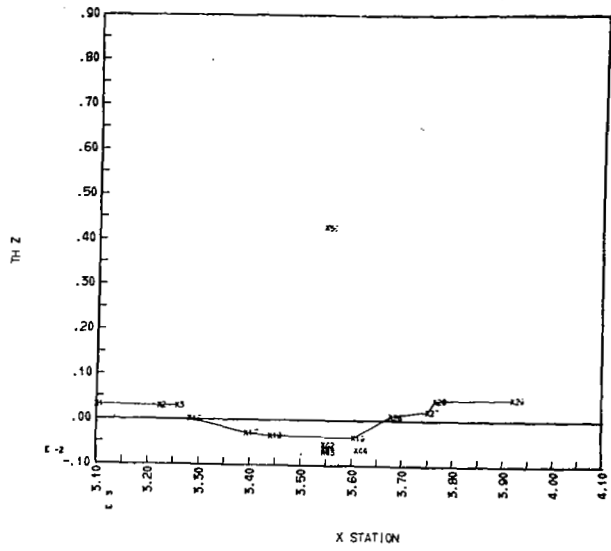

Plot D-II

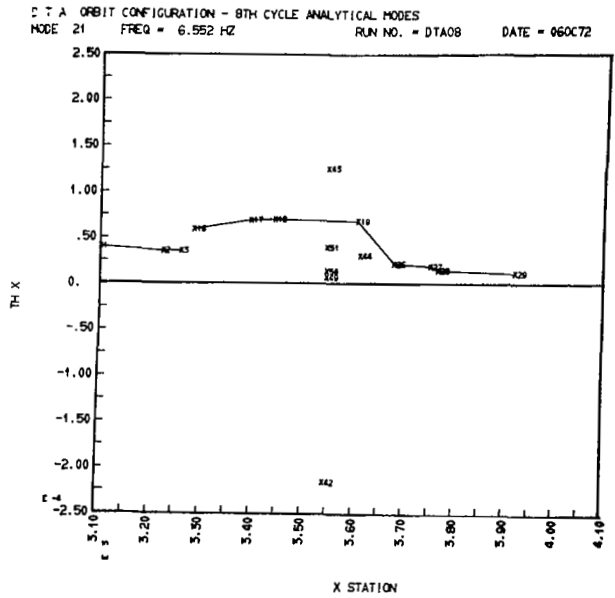
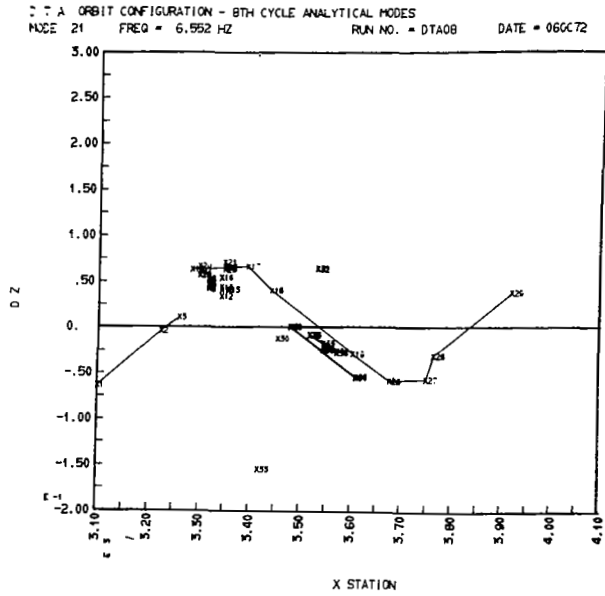
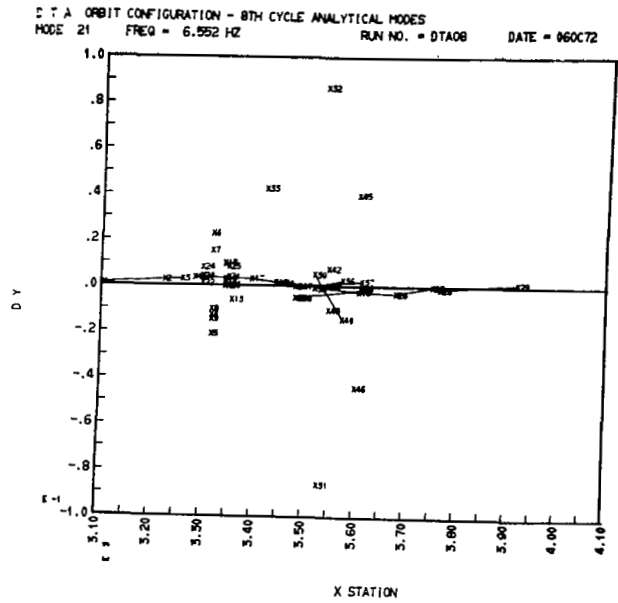
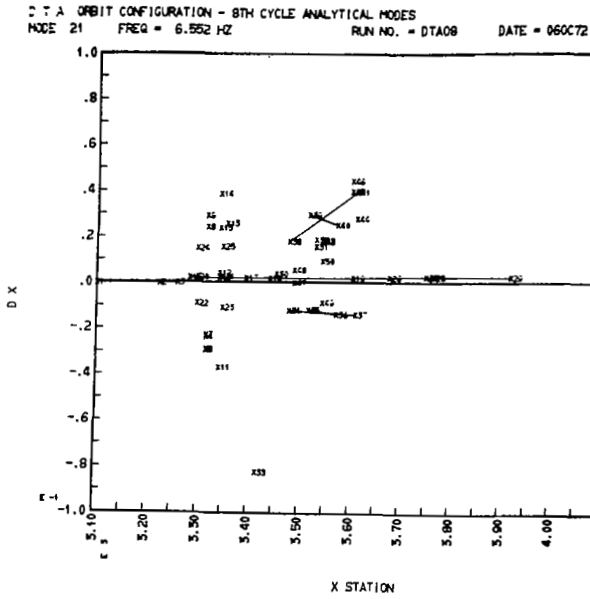

Plot D-II

D T A ORBIT CONFIGURATION - 8TH CYCLE ANALYTICAL MODES  
MODE 21 FREQ = 6.552 HZ RUN NO. = DTA08 DATE = 060672

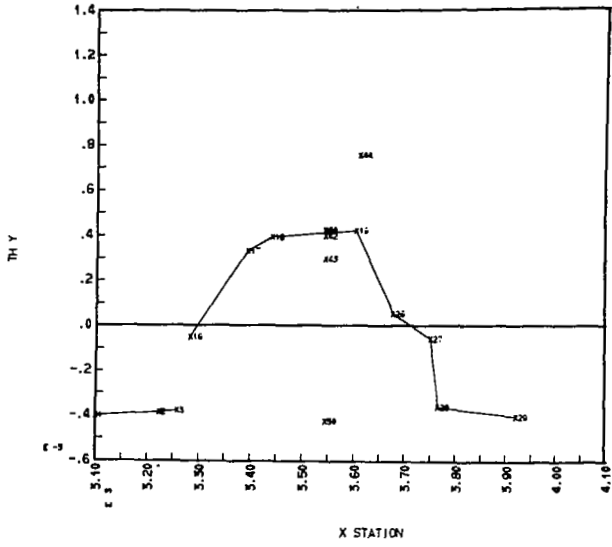

D T A ORBIT CONFIGURATION - 8TH CYCLE ANALYTICAL MODES  
MODE 21 FREQ = 6.552 HZ RUN NO. = DTA08 DATE = 060672

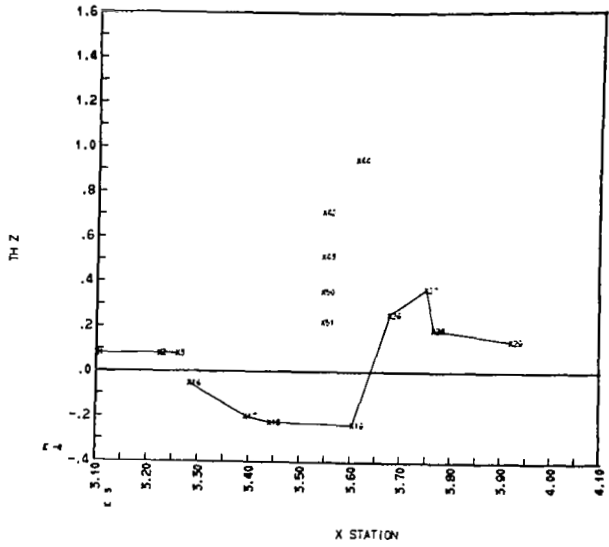



Plot D-12

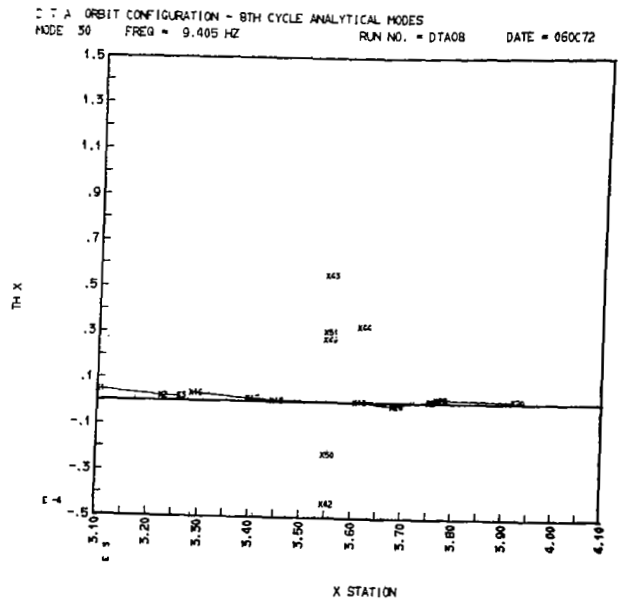
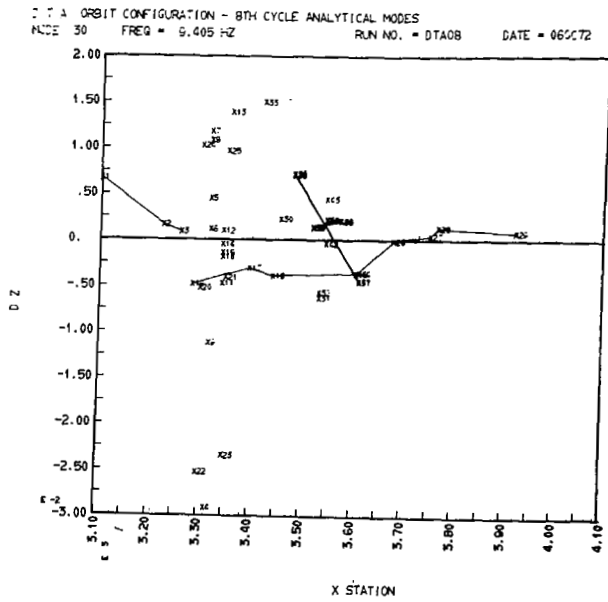
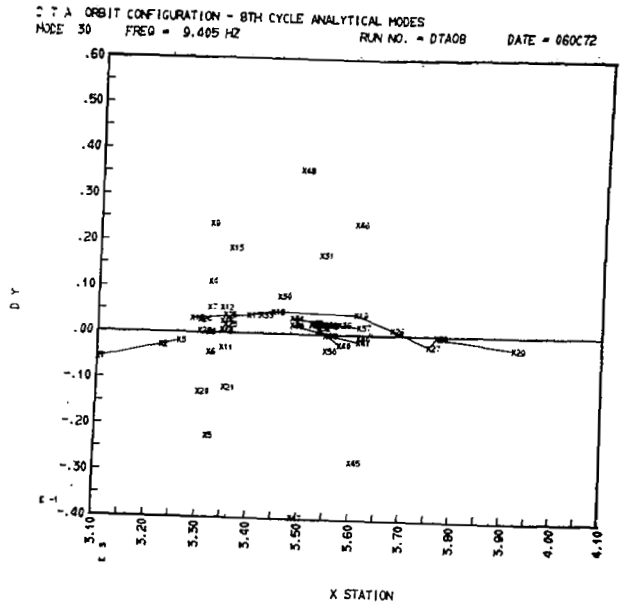
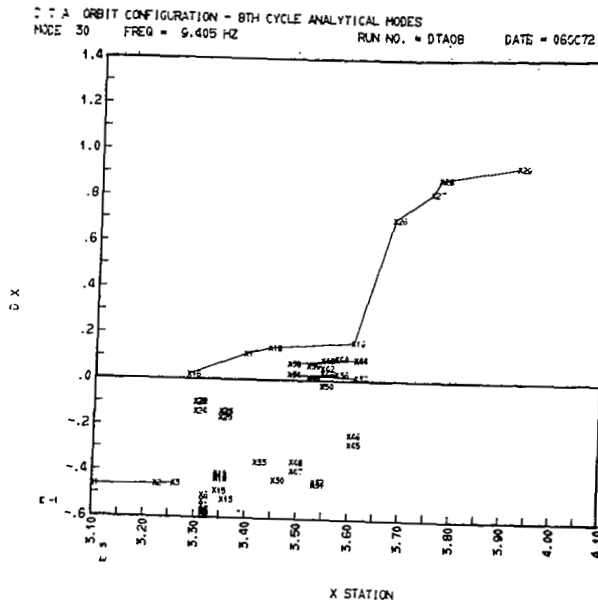

Plot D-12

D T A ORBIT CONFIGURATION - 8TH CYCLE ANALYTICAL MODES  
MODE 50 FREQ = 9.405 HZ RUN NO. = DTA08 DATE = 060672

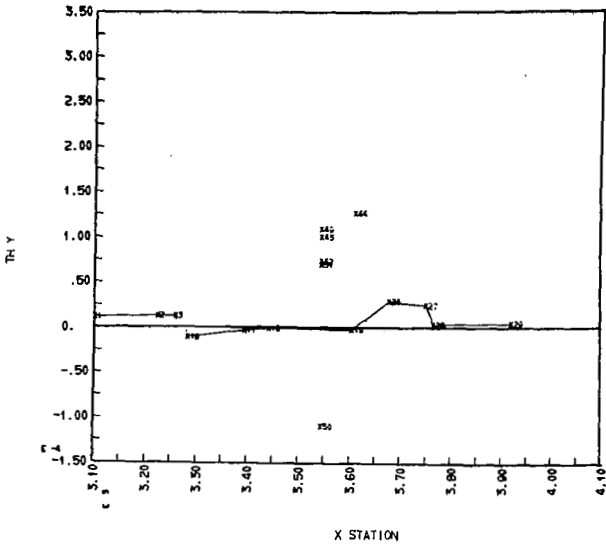

D T A ORBIT CONFIGURATION - 8TH CYCLE ANALYTICAL MODES  
MODE 50 FREQ = 9.405 HZ RUN NO. = DTA08 DATE = 060672

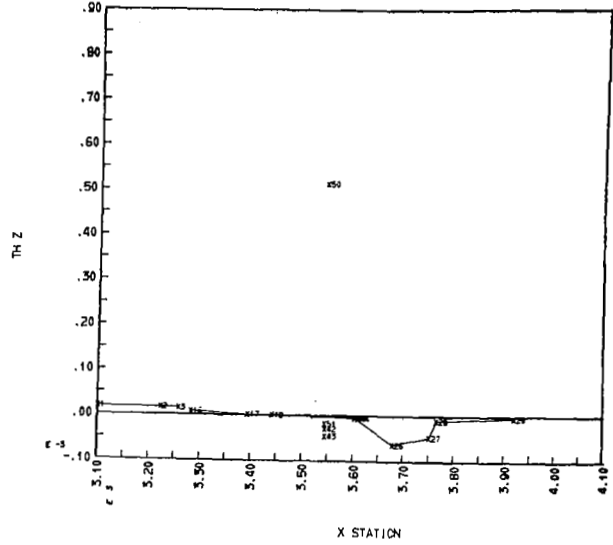

Plot D-13

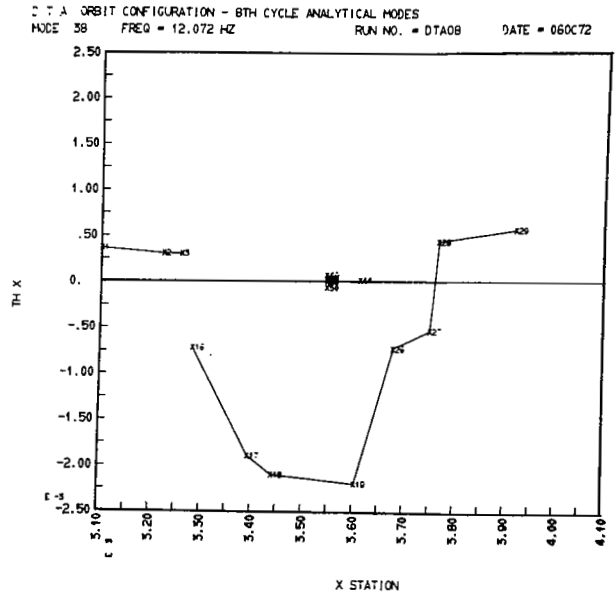
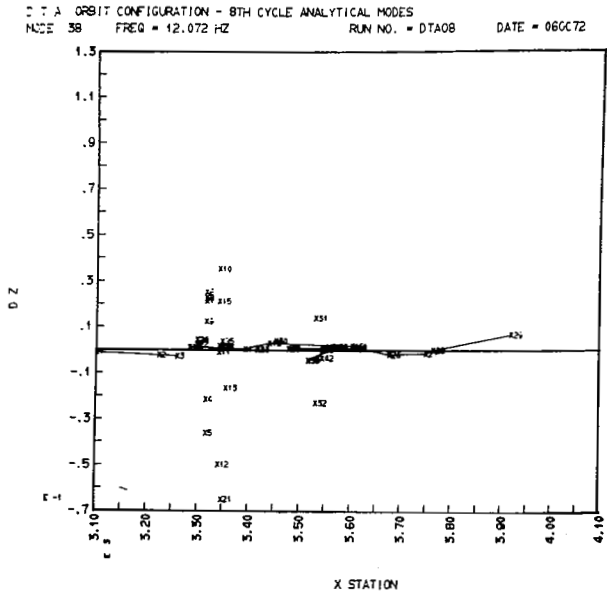
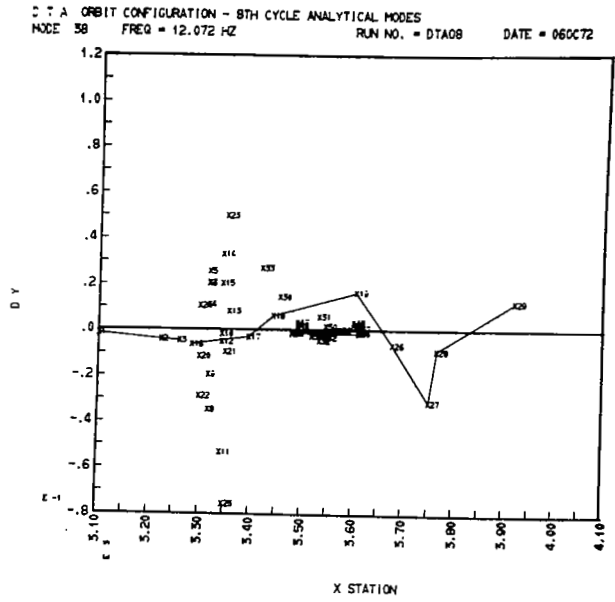
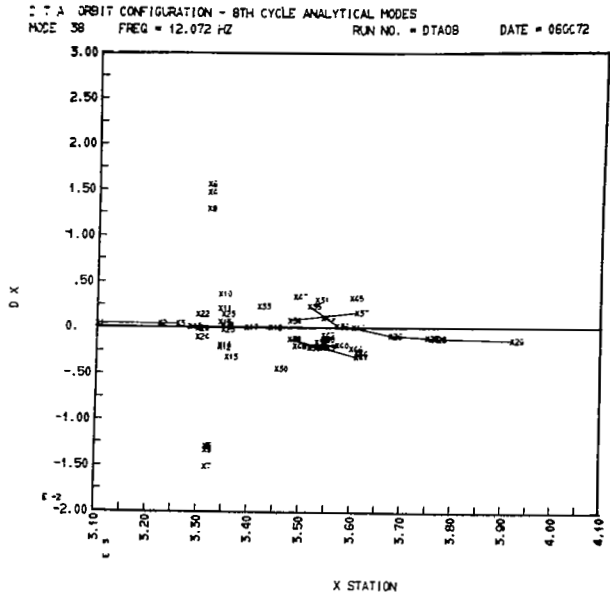

Plot D-13

D T A ORBIT CONFIGURATION - 8TH CYCLE ANALYTICAL MODES  
MODE 38 FREQ = 12.072 HZ RUN NO. = DTA08 DATE = 060772

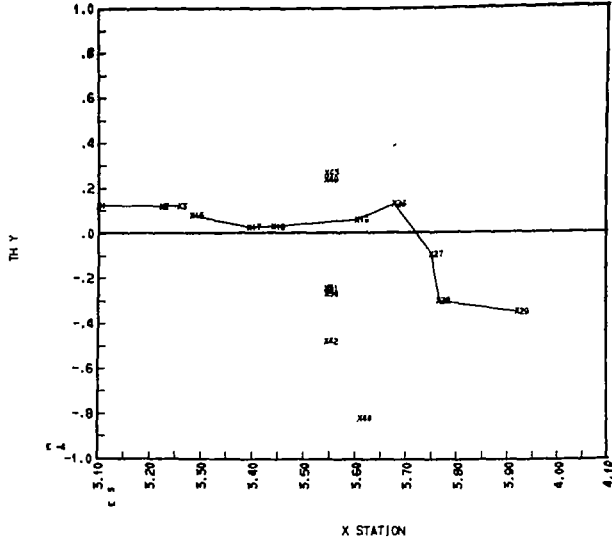

D T A ORBIT CONFIGURATION - 8TH CYCLE ANALYTICAL MODES  
MODE 38 FREQ = 12.072 HZ RUN NO. = DTA08 DATE = 060772

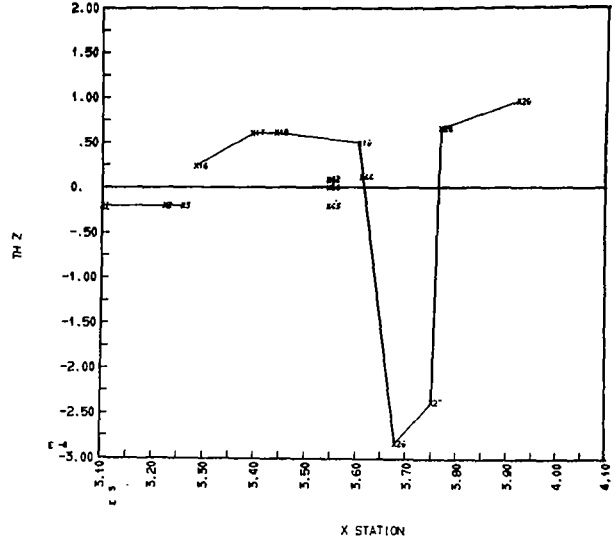

Plot D-14

D T A ORBIT CONFIGURATION - 8TH CYCLE ANALYTICAL MODES  
MODE 41 FREQ = 13.325 HZ RUN NO. = DTA08 DATE = 060C72

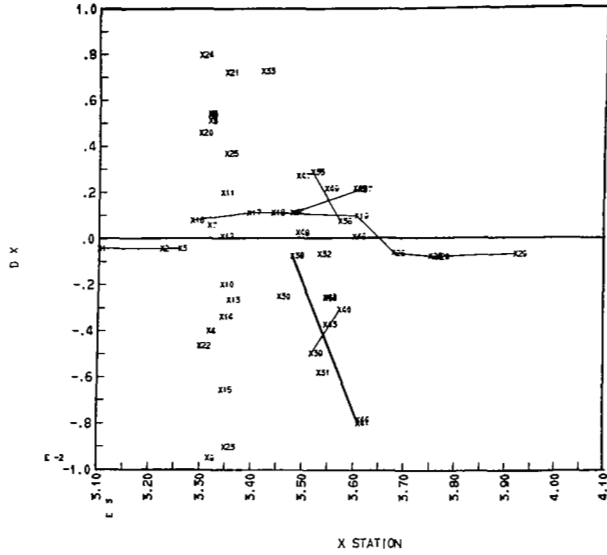

D T A ORBIT CONFIGURATION - 8TH CYCLE ANALYTICAL MODES  
MODE 41 FREQ = 13.325 HZ RUN NO. = DTA08 DATE = 060C72

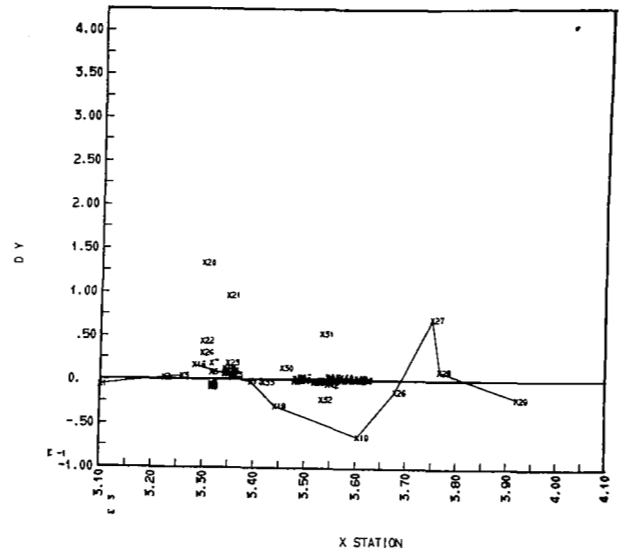

D T A ORBIT CONFIGURATION - 8TH CYCLE ANALYTICAL MODES  
MODE 41 FREQ = 13.325 HZ RUN NO. = DTA08 DATE = 060C72

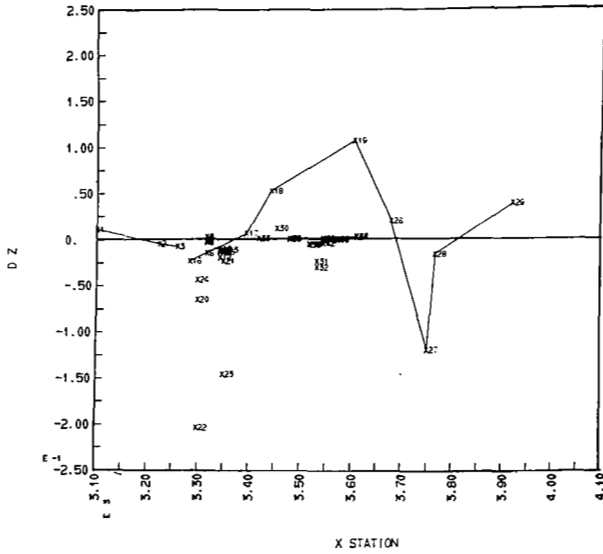

D T A ORBIT CONFIGURATION - 8TH CYCLE ANALYTICAL MODES  
MODE 41 FREQ = 13.325 HZ RUN NO. = DTA08 DATE = 060C72

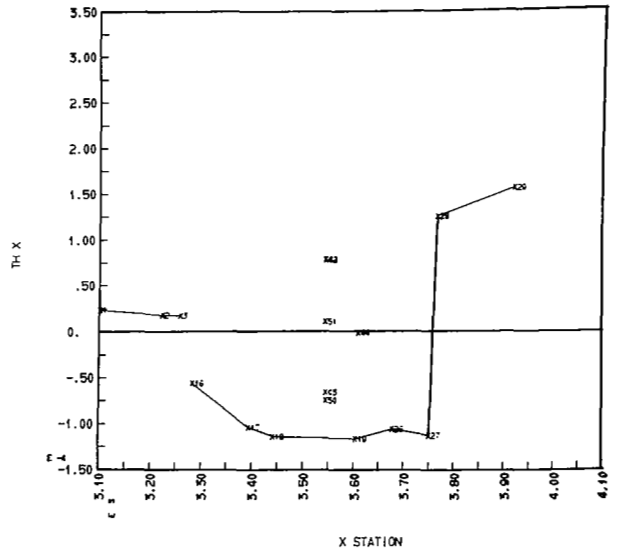

Plot D-14

D T A ORBIT CONFIGURATION - 8TH CYCLE ANALYTICAL MODES  
 MODE 41 FREQ = 15.325 HZ RUN NO. = DTA08 DATE = 060672

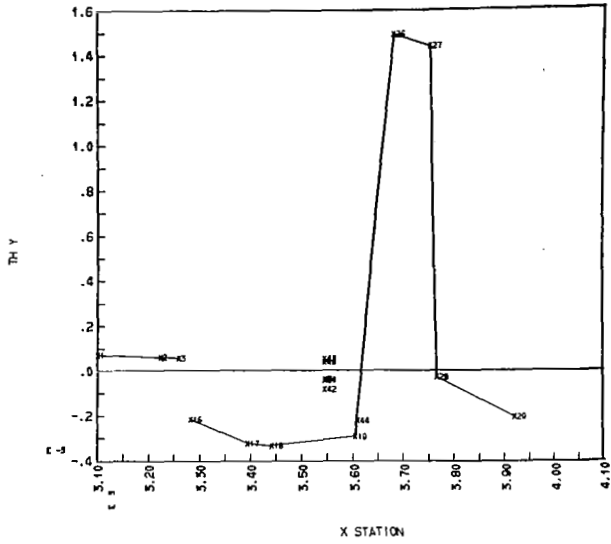

D T A ORBIT CONFIGURATION - 8TH CYCLE ANALYTICAL MODES  
 MODE 41 FREQ = 15.325 HZ RUN NO. = DTA08 DATE = 060672

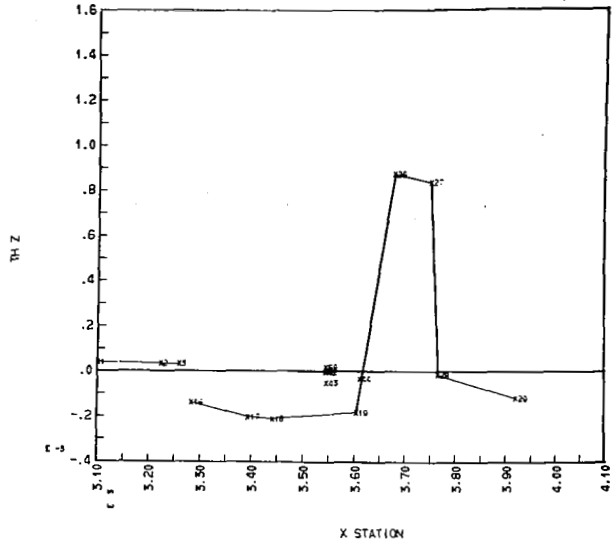

Plot D-15

DTA ORBIT CONFIGURATION - 8TH CYCLE ANALYTICAL MODES  
MODE 45 FREQ = 14.895 HZ RUN NO. = DTA08 DATE = 060C72

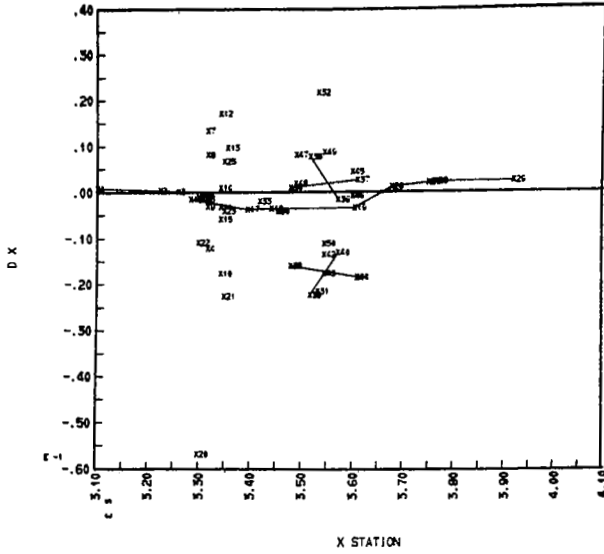

DTA ORBIT CONFIGURATION - 8TH CYCLE ANALYTICAL MODES  
MODE 45 FREQ = 14.895 HZ RUN NO. = DTA08 DATE = 060C72

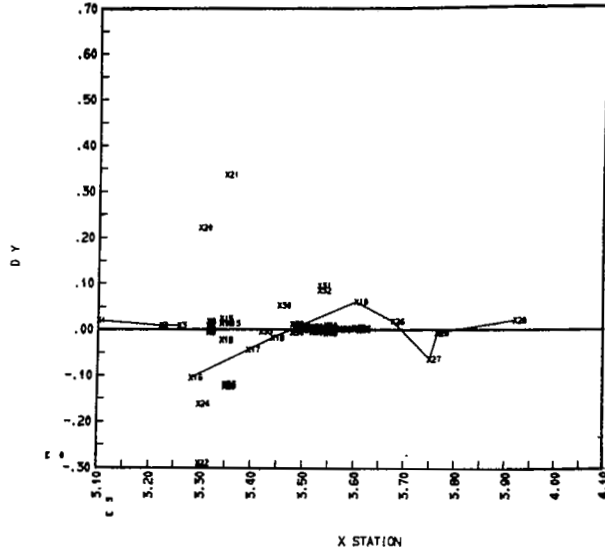

DTA ORBIT CONFIGURATION - 8TH CYCLE ANALYTICAL MODES  
MODE 45 FREQ = 14.895 HZ RUN NO. = DTA08 DATE = 060C72

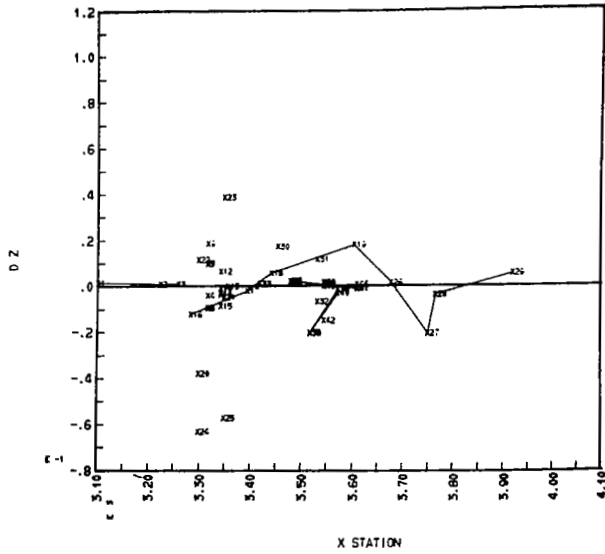

DTA ORBIT CONFIGURATION - 8TH CYCLE ANALYTICAL MODES  
MODE 45 FREQ = 14.895 HZ RUN NO. = DTA08 DATE = 060C72

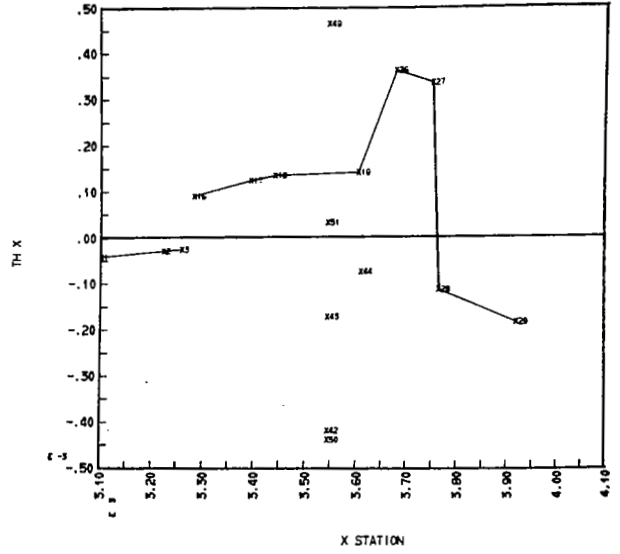

Plot D-15

D T A ORBIT CONFIGURATION - 8TH CYCLE ANALYTICAL MODES  
 MODE 45 FREQ = 14.855 HZ RUN NO. = DTA08 DATE = 060672

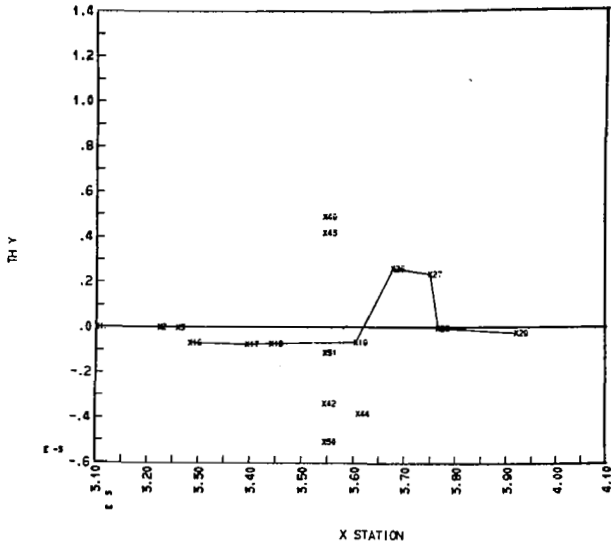

D T A ORBIT CONFIGURATION - 8TH CYCLE ANALYTICAL MODES  
 MODE 45 FREQ = 14.855 HZ RUN NO. = DTA08 DATE = 060672

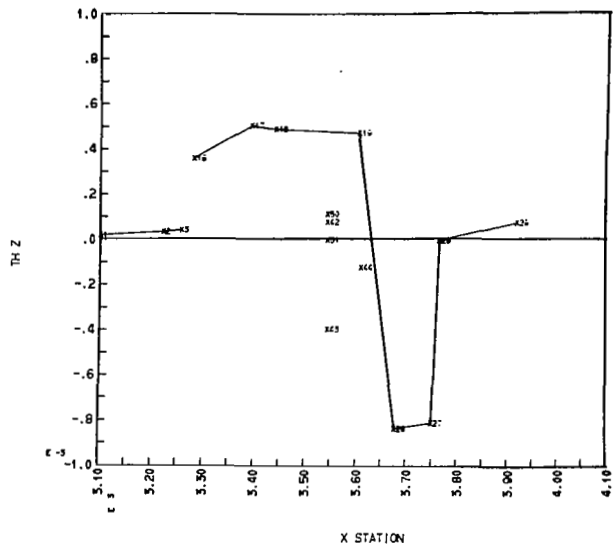



Plot D-16

C T A ORBIT CONFIGURATION - 8TH CYCLE ANALYTICAL MODES  
MODE 65 FREQ = 19.644 HZ RUN NO. = DTA08 DATE = 060C72

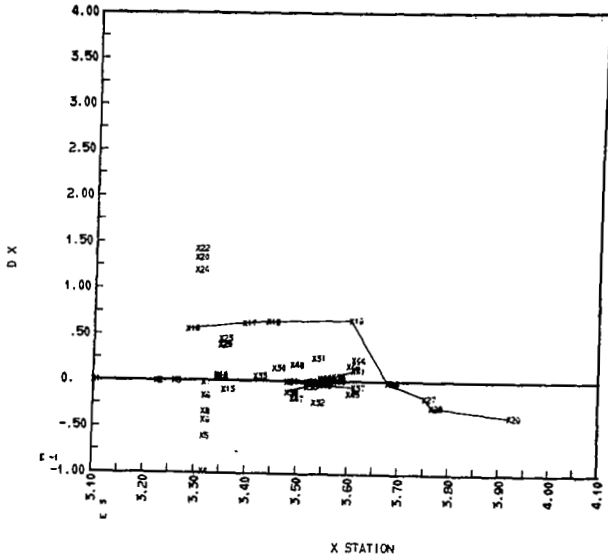

C T A ORBIT CONFIGURATION - 8TH CYCLE ANALYTICAL MODES  
MODE 65 FREQ = 19.644 HZ RUN NO. = DTA08 DATE = 060C72

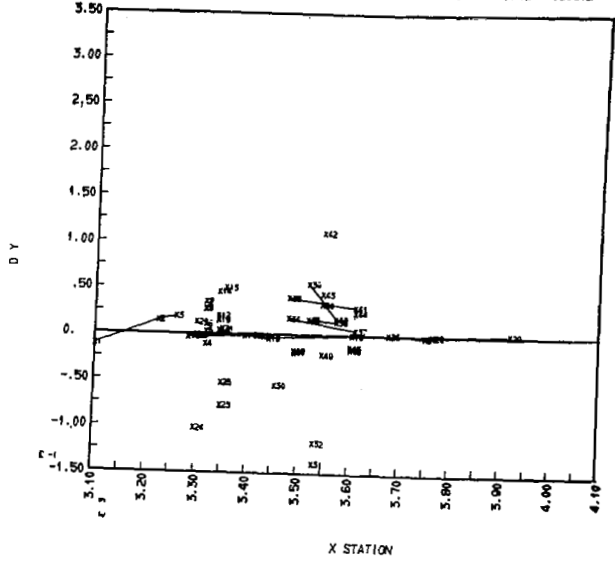

C T A ORBIT CONFIGURATION - 8TH CYCLE ANALYTICAL MODES  
MODE 65 FREQ = 19.644 HZ RUN NO. = DTA08 DATE = 060C72

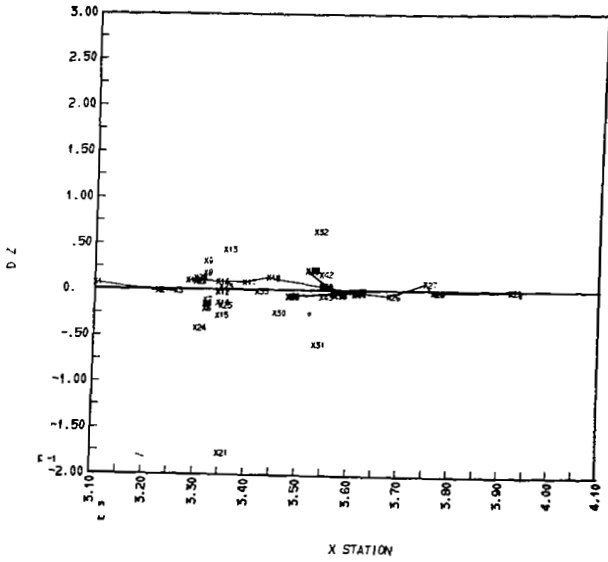

C T A ORBIT CONFIGURATION - 8TH CYCLE ANALYTICAL MODES  
MODE 65 FREQ = 19.644 HZ RUN NO. = DTA08 DATE = 060C72

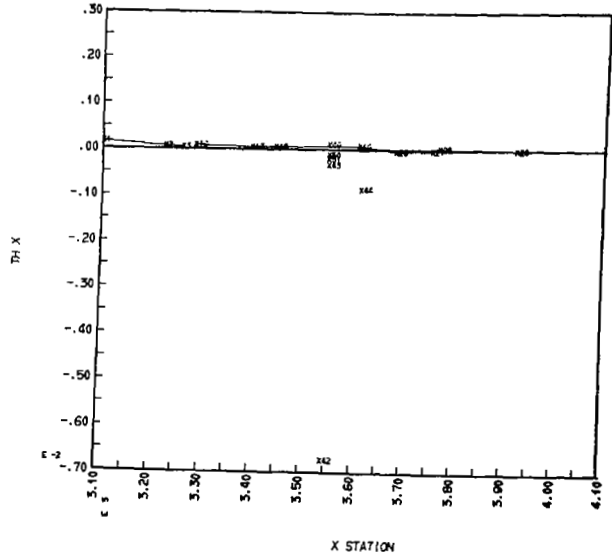

Plot D-16

D T A ORBIT CONFIGURATION - 8TH CYCLE ANALYTICAL MODES  
MODE 65 FREQ = 19.644 HZ RUN NO. = DTA08 DATE = 060072

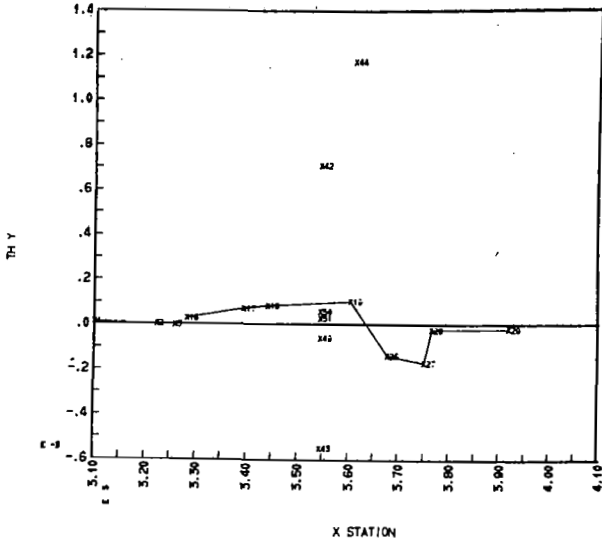

D T A ORBIT CONFIGURATION - 8TH CYCLE ANALYTICAL MODES  
MODE 65 FREQ = 19.644 HZ RUN NO. = DTA08 DATE = 060072

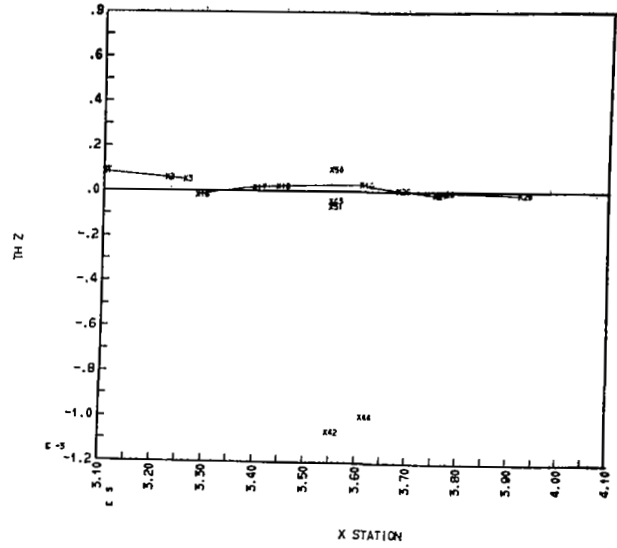

Section E

UNCOUPLED MODES FLIGHT CONFIGURATION 1.2

In this section (E-1 through E-7) the Skylab uncoupled component modal data are presented in terms of frequency data. The data are arranged according to three model development cycles; initial, pretest and final. During the development of the model, major subcomponents were subdivided according to areas of major concern. This evolution of model components is depicted where applicable.

## Uncoupled Modes Flight Configuration 1.2

Main (OWS/IU/FAS/AM/STS/MDA) Modes

(Hz)

Six Rigid Body (0. Hz)

2.712  
3.142  
5.064

Initial

FAS/IU/OWS  
(Hz)MDA/STS/AM  
(Hz)

Six Rigid Body (0. Hz)

3.260  
5.501  
5.5521.833  
2.019  
7.700

Pretest

FAS/IU/OWS  
(Hz)MDA/STS/AM  
(Hz)

Six Rigid Body (0. Hz)

1.058  
1.077  
1.501  
1.611  
3.271  
5.006  
5.756  
7.628  
8.025  
8.351  
9.102  
9.290  
9.330  
9.360  
9.575  
9.921  
10.449  
12.018  
13.903  
14.480  
16.0901.373  
1.428  
6.194  
9.200  
11.496  
11.528  
13.740  
13.746  
15.378  
15.560  
15.856  
16.251

Final

ATM (ATM Rack, GRA, Spar/Canister, DA) Modes  
(Hz)

.821  
1.163  
1.242  
1.362  
1.395  
2.595  
2.774  
3.166  
3.526  
3.664  
4.709  
4.866  
4.987

Initial

ATM/DA (ATM Rack, GRA, Spar/Canister, DA (Depl.)) Modes  
(Hz)

.868  
1.126  
1.252  
1.408  
1.573  
2.689  
2.839  
3.276  
3.306  
3.503  
3.889  
4.501  
4.878  
5.512  
5.782

Pretest

<u>DA (Depl.)</u> (Hz)	<u>Rack (OL)</u> (Hz)	<u>Spar/GRA</u> (Hz)	<u>Canister</u> (Hz)
.569	2.900	1.069	6.120
1.081	3.057	1.182	7.197
1.108	3.284	4.320	9.385
2.516	3.344	5.339	10.578
2.704	3.835	5.556	10.578
3.236	4.255	6.171	14.058
5.550	5.063	6.749	14.492
6.443	5.120	13.294	15.448
10.675	6.496	18.739	
12.535	7.033		
16.815	9.700		
	10.557		
	11.306		
	11.928		
	13.369		
	15.265		

Final

## Uncoupled Modes Flight Configuration 1.2

Farside (+Y) OWS Solar Array Modes (OWSFS)

<u>Initial</u> (Hz)	<u>Pretest</u> (Hz)	<u>Final</u> (Hz)
.349	.456	.383
.475	.563	.446
.489	.733	.458
.557	.759	.522
.954	1.059	.909
1.198	1.064	.910
1.301	1.065	.910
1.323	1.279	2.003
2.539	3.581	2.235
2.566	4.057	2.569
2.621	4.246	2.597
3.229	4.347	2.955
3.996	4.650	3.105
4.421	4.654	3.209
4.436	4.664	3.210
4.483	4.767	3.229
5.353	8.621	3.660
6.061		6.139
6.175		6.471
6.209		7.783
		9.647
		13.540
		13.730
		13.828
		16.926

## Uncoupled Modes Flight Configuration 1.2

Nearside (-Y) OWS Solar Array Modes (OWSNS)

<u>Initial</u> (Hz)	<u>Pretest</u> (Hz)	<u>Final</u> (Hz)
.349	.465	.385
.475	.561	.447
.489	.733	.458
.557	.759	.530
.934	1.059	.909
1.298	1.064	.910
1.301	1.065	.910
1.323	1.276	1.985
2.539	2.307	2.280
2.566	3.590	2.567
2.621	4.054	2.598
3.229	4.246	2.948
3.996	4.347	3.083
4.421	4.650	3.209
4.436	4.654	3.210
4.483	4.663	3.226
5.353	4.815	3.722
6.061	9.047	6.102
6.175		6.471
6.209		8.675
		9.317
		13.569
		13.720
		13.833
		17.679



## Uncoupled Modes Flight Configuration 1.2

Axial-Docked CSM Modes

<u>Initial</u> (Hz)	<u>Pretest</u> (Hz)	<u>Final</u> (Hz)
1.089	1.050	1.050
1.117	1.068	1.069
2.956	2.952	3.662
5.624	5.623	5.623
6.523		6.520
		9.037
		9.637
		10.627
		10.998
		14.322
		16.020

ATM Solar Array Modes Forward Farside (Bay 1)

.206	.200	.184
.740	.607	.558
.987	.727	.663
1.839	.957	.893
2.368	1.424	1.336
2.546	2.314	2.037
3.371	2.627	2.532
3.964	3.326	3.065
4.713	3.704	3.372
5.490	4.639	4.034
5.792	4.911	4.715
6.862	6.631	6.097
		8.674
		9.149
		9.365
		9.879
		11.057
		12.903
		15.762

ATM Solar Array modes for:

forward nearside (Bay 3)  
aft nearside (Bay 5)  
aft farside (Bay 7)

Same as modes for forward farside (Bay 1)

F-1

Section F

COUPLED MODES FLIGHT CONFIGURATION 1.2

The following table shows the coupled modes for the analytical model of flight configuration 1.2. These modes are presented for three model phases; initial, pretest and final. For each model phase, the mode number, major contribution and coupled frequency are presented. A frequency cutoff of 15 Hz was used in order to stay within computer size limitations.

## Coupled Modes Flight Configuration 1.2

Initial			Pretest			Final		
Mode	Major Contributor	Coupled Frequency	Mode	Major Contributor	Coupled Frequency	Mode	Major Contributor	Coupled Frequency
1	Main 1	0.	1	FAS/IU/OWS 1	0.	1	FAS/IU/OWS 1	0.
2	Main 3	0.	2	FAS/IU/OWS 2	0.	2	FAS/IU/OWS 2	0.
3	Main 3	0.	3	FAS/IU/OWS 3	0.	3	FAS/IU/OWS 3	0.
4	Main 4	0.	4	FAS/IU/OWS 4	0.	4	FAS/IU/OWS 4	0.
5	Main 5	0.	5	FAS/IU/OWS 5	0.	5	FAS/IU/OWS 5	0.
6	Main 2	0.	6	FAS/IU/OWS 6	0.	6	FAS/IU/OWS 6	0.
7	SP5-1	.206	7	ATMSA5 1	.200	7	ATM/SA5-1	.183
8	SP7-1	.206	8	ATMSA7 1	.200	8	ATM/SA7-1	.183
9	SP3-1	.207	9	ATMSA3 1	.202	9	ATM/SA3-1	.185
10	SP7-1	.211	10	ATMSA1 1	.205	10	ATM/SA1-1	.188
11	OWSNS1	.353	11	OWSFS1	.465	11	OWSFS1	.377
12	OWSFS1	.369	12	OWSNS1	.479	12	OWSNS1	.385
13	OWSNS2	.475	13	OWSNS2	.570	13	OWSFS2	.444
14	OWSFS2	.476	14	OWSFS2	.575	14	OWSNS2	.445
15	OWSNS3	.489	15	ATMSA5-2	.607	15	OWSFS3	.458
16	OWSFS3	.489	16	ATMSA7-2	.607	16	OWSNS3	.458
17	OWSFS4	.561	17	ATMSA3-2	.607	17	OWSFS4	.499
18	OWSNS4	.566	18	ATMSA1-2	.608	18	OWSNS4	.505
19	SP7-2	.739	19	ATMSA5-3	.725	19	ATM/SA3-2	.553
20	SP1-2	.740	20	ATMSA1-3	.725	20	ATM/SA5-2	.557
21	SP5-2	.740	21	ATMSA7-3	.725	21	ATM/SA7-2	.557
22	SP3-2	.740	22	ATMSA7-3	.727	22	ATM/SA1-2	.558
23	ATM-1	.839	23	OWSNS3	.733	23	DA (DEPL) 1	.595
24	SP5-3	.884	24	OWSFS3	.734	24	ATM/SA5-3	.660
25	SP7-3	.886	25	OWSFS	.760	25	ATM/SA5-3	.661
26	SP1-3	.887	26	OWSNS	.760	26	ATM/SA7-3	.661
27	SP7-3	.889	27	ATM/DA-1	.880	27	ATM/SA1-3	.662
28	OWSFS5	.957	28	ATMSA5-4	.954	28	ATM/SA5-4	.888
29	OWSNS5	.977	29	ATMSA1-4	.956	29	ATM/SA3-4	.892
30	ATM-2	1.175	30	ATMSA3-4	.956	30	ATM/SA7-4	.892
31	CSM-1	1.271	31	ATMSA3-4	.962	31	ATM/SA1-4	.892
32	OWSFS6	1.298	32	OWSNS5	1.059	32	OWSFS5	.907
33	OWSNS6	1.298	33	OWSFS5	1.060	33	OWSNS5	.907
34	OWSFS7	1.301	34	OWSNS6	1.064	34	OWSFS6	.910
35	OWSNS7	1.301	35	OWSFS6	1.064	35	OWSNS6	.910
36	OWSNS8	1.320	36	OWSNS7	1.065	36	OWSNS7	.910
37	OWSFS8	1.323	37	OWSFS7	1.065	37	OWSFS7	.910
38	ATM-5	1.335	38	ATM/DA 2	1.129	38	SPAR/GRA1	1.034
39	CSM-2	1.404	39	CSMAX-1	1.222	39	CSMAX-2	1.109
40	ATM-4	1.568	40	CSMAX-1	1.243	40	CSMAX-1	1.142
41	SP1-4	1.829	41	OWSFS8	1.285	41	SPAR/GRA2	1.142
42	SP5-4	1.837	42	ATM/DA-3	1.309	42	DA (DEPL) 2	1.275

Initial			Pretest			Final		
Mode	Major Contributor	Coupled Frequency	Mode	Major Contributor	Coupled Frequency	Mode	Major Contributor	Coupled Frequency
43	SP1-4	1.838	43	CSMAX-2	1.403	43	FAS/IU/OWS7	1.283
44	SP5-4	1.845	44	ATMSA5-5	1.415	44	ATM/SA7-5	1.331
45	ATM-3	2.266	45	ATMSA7-5	1.423	45	ATM/SA7-5	1.335
46	SP5-5	2.367	46	ATMSA3-5	1.424	46	ATM/SA1-5	1.339
47	SP1-5	2.368	47	ATMSA1-5	1.428	47	ATM/SA5-5	1.355
48	SP3-5	2.369	48	ATM/DA-4	1.569	48	FAS/IU/OWS8	1.389
49	SP7-5	2.373	49	ATMSA5-6	2.276	49	DA (DEPL) 3	1.956
50	OWSNS9	2.539	50	OWSFS9	2.283	50	ATM/SA5-6	2.062
51	OWSFS9	2.540	51	ATMSA5-6	2.302	51	ATM/SA5-6	2.077
52	SP5-6	2.545	52	ATMSA1-6	2.302	52	ATM/SA7-6	2.078
53	SP3-6	2.546	53	OWSNS9	2.305	53	ATM/SA1-6	2.082
54	SP7-6	2.546	54	ATMSA1-6	2.315	54	OWSFS9	2.205
55	SP3-6	2.546	55	ATM/DA 5	2.425	55	OWSNS9	2.236
56	OWSNS10	2.567	56	ATM/DA 10	2.513	56	RACK(OL)4	2.314
57	OWSFS10	2.568	57	ATMSA5-7	2.616	57	ATM/SA5-7	2.505
58	OWSNS11	2.621	58	ATMSA7-7	2.621	58	ATM/SA7-7	2.511
59	OWSFS11	2.622	59	ATMSA3-7	2.627	59	ATM/SA3-7	2.521
60	CSM-3	3.078	60	ATMSA7-7	2.634	60	ATM/SA7-7	2.526
61	OWSNS12	3.214	61	CSMAX-3	2.973	61	OWSNS10	2.560
62	OWSFS12	3.231	62	CSMAX-3	2.982	62	OWSFS10	2.565
63	OWSNS12	3.238	63	ATMSA7-8	3.055	63	OWSFS11	2.597
64	SP5-7	3.349	64	ATM/DA 9	3.520	64	OWSNS11	2.597
65	SP1-7	3.357	65	OWSFS10	3.582	65	OWSNS13	2.644
66	SP3-7	3.366	66	OWSNS10	3.590	66	OWSFS13	2.657
67	SP3-7	3.371	67	ATMSA5-9	3.662	67	ATM/SA3-8	2.793
68	ATM-10	3.523	68	ATMSA3-9	3.679	68	ATM/SA1-8	2.824
69	ATM-8	3.694	69	ATMSA1-9	3.690	69	DA (DEPL) 5	2.946
70	SP3-8	3.959	70	ATMSA3-9	3.698	70	OWSFS12	2.992
71	SP5-8	3.968	71	ATM/DA 11	3.921	71	OWSNS12	2.993
72	SP3-8	3.970	72	OWSNS11	4.054	72	OWSNS14	3.208
73	SP1-8	3.974	73	OWSFS11	4.058	73	OWSFS14	3.208
74	OWSFS13	3.996	74	OWSFS12	4.247	74	OWSNS15	3.210
75	OWSNS13	3.996	75	OWSNS12	4.251	75	OWSFS15	3.210
76	ATM-11	4.264	76	OWSFS13	4.347	76	OWSFS16	3.213
77	OWSFS14	4.422	77	OWSNS13	4.348	77	OWSNS16	3.213
78	OWSNS14	4.423	78	ATMSA7-10	4.638	78	ATM/SA5-9	3.333
79	OWSNS15	4.436	79	ATMSA5-10	4.638	79	ATM/SA3-9	3.352
80	OWSFS15	4.436	80	ATMSA1-10	4.639	80	ATM/SA1-9	3.356
81	OWSFS16	4.483	81	ATMSA3-10	4.639	81	ATM/SA1-9	3.360
82	OWSNS16	4.483	82	OWSFS14	4.650	82	CSMAX-3	3.432
83	SP5-9	5.064	83	OWSNS14	4.650	83	OWSFS17	3.621
84	OWSFS17	5.363	84	OWSFS15	4.654	84	OWSNS17	3.682
85	OWSNS17	5.382	85	OWSNS15	4.654	85	DA (DEPL) 4	3.902
86	SP3-10	5.456	86	OWSNS16	4.663	86	ATM/SA3-10	4.033
87	SP5-10	5.481	87	OWSFS16	4.664	87	ATM/SA5-10	4.033
88	SP1-10	5.485	88	OWSFS17	4.783	88	ATM/SA1-10	4.034



Final		
Mode	Major Contributor	Coupled Frequency
134	ATM/SA1-21	9.367
135	ATM/SA3-21	9.368
136	CANISTER-3	9.497
137	OWSFS25	9.551
138	FAS/IU/OWS22	9.563
139	CANISTER4	9.661
140	FAS/IU/OWS21	9.668
141	FAS/IU/OWS23	9.827
142	ATM/SA5-22	9.871
143	ATM/SA1-22	9.874
144	ATM/SA7-22	9.874
145	ATM/SA3-22	9.882
146	DA(DEPL)9	10.406
147	CANISTER5	10.608
148	CSMAX-9	10.628
149	ATM/SA3-25	11.057
150	ATM/SA3-25	11.057
151	ATM/SA5-25	11.057
152	ATM/SA7-25	11.057
153	MDA/STS/AM-3	11.288
154	SPAR/GRA-8	11.352
155	MDA/STS/AM-3	11.441
156	MDA/STS/AM-5	11.723
157	FAS/IU/OWS25	12.085
158	ATM/SA1-27	12.897
159	ATM/SA5-27	13.013
160	ATM/SA3-27	13.102
161	OWSNS27	13.130
162	MDA/STS/AM-8	13.185
163	ATM/SA1-27	13.412
164	MDA/STS/AM-7	13.479
165	OWSFS26	13.539
166	OWSNS26	13.602
167	OWSFS28	13.801
168	OWSNS28	13.820
169	CANISTER-6	14.084
170	CSMAX-10	14.280
171	CANISTER-7	14.543
172	MDA/STS/AM-8	14.602

Frequency  
Cutoff 15 Hz