

M-ASTN-74-4

APRIL 1974

[Handwritten signature]

DATA BOOK FOR 12.5-INCH DIAMETER
SRB THERMAL MODEL WATER FLOTATION
TEST - 1.29 PSIA, SERIES P022

NASA/MSFC

(NASA-TM-X-70407) DATA BOOK FOR 12.5-INCH
DIAMETER SRB THERMAL MODEL WATER FLOTATION
TEST; 1.29 psia, SERIES P022 (NASA) 220 p
HC \$7.25 CSCL 21H

N75-19346

Unclas
G3/20 12401

FLUID MECHANICS SECTION
FLUID MECHANICS & DYNAMICS BRANCH
PROPULSION & THERMODYNAMICS DIVISION
ASTRONAUTICS LABORATORY

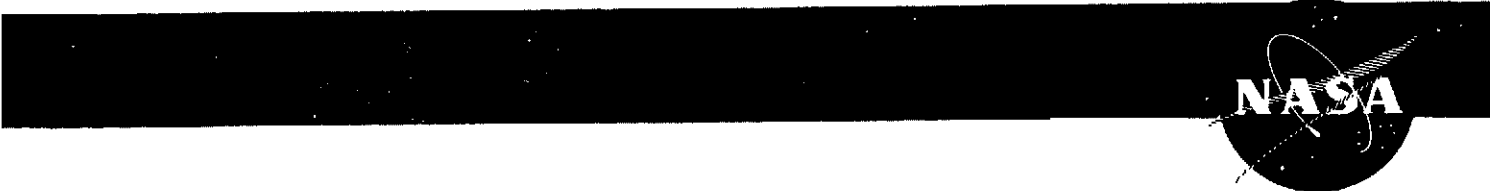

1. REPORT NO. M-ASTN-74-4		2. GOVERNMENT ACCESSION NO.		3. RECIPIENT'S CATALOG NO.	
4. TITLE AND SUBTITLE Data Book for 12.5-Inch Diameter SRB Thermal Model Water Flotation Test - 1.29 PSIA, Series P022				5. REPORT DATE April 1974	
				6. PERFORMING ORGANIZATION CODE	
7. AUTHOR(S) Steve L. Allums				8. PERFORMING ORGANIZATION REPORT #	
9. PERFORMING ORGANIZATION NAME AND ADDRESS George C. Marshall Space Flight Center Marshall Space Flight Center, AL 35812				10. WORK UNIT NO.	
				11. CONTRACT OR GRANT NO.	
				13. TYPE OF REPORT & PERIOD COVERED Miscellaneous	
12. SPONSORING AGENCY NAME AND ADDRESS National Aeronautics and Space Administration Washington, DC 20546				14. SPONSORING AGENCY CODE	
15. SUPPLEMENTARY NOTES Prepared by Astronautics Laboratory, Science & Engineering					
16. ABSTRACT <p>This report presents data acquired from tests conducted to determine how thermal conditions affect SRB (Space Shuttle Solid Rocket Booster) flotation at a scaled pressure of 1.29 psia. Included are acceleration, pressure, and temperature data recorded from initial water impact to final flotation position using a 12.5-inch diameter thermal model of the SRB. Nineteen valid tests were conducted during September 20-27, 1973. These thermal tests indicated the following basic differences relative to the ambient temperature and pressure model tests.</p> <ol style="list-style-type: none"> 1. More water was taken on board during penetration. 2. Model flotation/sinking was temperature sensitive. 					
17. KEY WORDS thermal effects on rocket water impact thermal effects on rocket flotation scaled low pressure rocket flotation			18. DISTRIBUTION STATEMENT Unclassified-Unlimited <i>James D Ledbetter</i> A. L. Worlund Chief, Fluid Mechanics & Dynamics Branch		
19. SECURITY CLASSIF. (of this report) Unclassified		20. SECURITY CLASSIF. (of this page) Unclassified		21. NO. OF PAGES 200	22. PRICE NTIS

TABLE OF CONTENTS

		<u>PAGE</u>
SECTION I	INTRODUCTION	2
SECTION II	MODEL DESCRIPTION	3
SECTION III	TEST PROCEDURE	5
SECTION IV	DATA ACQUISITION AND INSTRUMENTATION	6
SECTION V	DATA PROCESSING AND EVALUATION	7
SECTION VI	DATA PRESENTATION	8
APPENDIX A	IMPACT PARAMETERS	A-i
APPENDIX B	TEST DATA	B-i

PRECEDING PAGE BLANK NOT FILMED

LIST OF ILLUSTRATIONS

<u>FIGURE</u>	<u>TITLE</u>	<u>PAGE</u>
1	SRB TEST MODEL	10
2	MODEL DIMENSIONS	11
3	MODEL COORDINATE SYSTEM AND PARAMETER DEFINITION	12
4	ACCELEROMETER LOCATIONS	13
5	PRESSURE TRANSDUCER AND TEMPERATURE THERMOCOUPLE LOCATIONS	14

LIST OF TABLES

<u>TABLE</u>	<u>TITLE</u>	<u>PAGE</u>
I	INSTRUMENTATION PROGRAM	9

SUMMARY

This report presents data acquired from tests conducted to determine how thermal conditions affect SRB (Space Shuttle Solid Rocket Booster) flotation at a scaled pressure of 1.29 psia. Included are acceleration, pressure, and temperature data recorded from initial water impact to final flotation position using a 12.5-inch diameter thermal model of the SRB. Nineteen valid tests were conducted during September 20-27, 1973. These thermal tests indicated the following basic differences relative to the ambient temperature and pressure model tests.

1. More water was taken on board during penetration.
2. Model flotation/sinking was temperature sensitive.

SECTION I. INTRODUCTION

This report presents processed acceleration, pressure, strain, and photographic data recorded during water impact tests using a 12.5-inch thermal model of the Space Shuttle Solid Rocket Booster (SRB); see Figure 1. These tests were conducted from September 20-27, 1973. A description of the model, test procedure, instrumentation, and data acquisition systems is included.

These tests investigated thermal effects on a scale model SRB during impact, penetration, slapdown and final flotation at 1.29 psia by varying the model temperature at water entry. Entry dynamic conditions were varied by using different combinations of vertical velocities and water impact angles. Results from these tests will be used to develop analytical models for the full scale SRB and to indicate potential problem areas.

Nineteen valid drop tests were conducted.

SECTION II. MODEL DESCRIPTION

The test specimen was a model of the 142-inch diameter Space Shuttle SRB with a flared skirt and a full length nozzle. The model was a rigid body constructed of aluminum alloy 2219-T87 and contained three sections:

1. Cylindrical Section (four segments)
2. Motor Nozzle Section
3. Flared Skirt Section

Two model configurations were used:

1. Full Length Nozzle
2. Short Nozzle

Figure 2 shows the dimensions for each model configuration. The short nozzle was used to simulate the ejection of the nozzle extension. The dimensions and mass characteristics of the model were:

- Length:
 - Full Length Nozzle: 136.9 inches
 - Short Nozzle: 132.3 inches
- Body Diameter: 12.5 inches
- Skirt Diameter: 16.5 inches
- Weight:
 - Full Length Nozzle: 109.0 lbs
 - Short Nozzle: 105.8 lbs
- Pitch Mass Moment of Inertia:
 - Full Length Nozzle: 40.8 slug-ft²
 - Short Nozzle: 40.6
- C.G. Location (aft of the nose plate)
 - Full Length Nozzle: 73.06 inches
 - Short Nozzle: 70.94 inches

Geometric patterns were placed on the model to aid in photographic data reduction. Twenty-four 120-watt heater strips (2.0-inch width) were placed around the cylindrical sections. Four 45-watt heaters were on the long nozzle and two on the short nozzle. The aft bulkhead had four 45-watt heaters installed. The power source was 208 volts, 3-phase (Y), 100 amps, 60 Hz. No heater strips were placed on the flared skirt. External insulation (Dow Corning Silicon Paint 93-027) was sprayed on the external surface of the model to a depth of .02 inch.

SECTION III. TEST PROCEDURE

Testing of the 12.5-inch diameter thermal model was conducted at the Naval Ordnance Laboratory (NOL) hydroballistics facility in White Oaks, Maryland. The model was suspended inside the NOL facility with a quick release device at the specific initial angle. The model height above the water surface was varied to yield the specified impact velocity. After the test tank was pumped down to 1.29 psia, power was applied to the heater strips. When the model reached the test temperature, the release mechanism was activated. The model was allowed to fall freely. The model impacted tail first with nominal vertical impact velocities of 23 to 30 ft/sec. The nominal off-vertical pitch angles were 0, 20, and 31 degrees. Average wall temperatures ranged from ambient to 153°F.

The procedure for drying out the inside of the model after each test was as follows:

1. Lift model from the water with the vent valve open.
2. Rotate model to horizontal position and attach a purge hose to vent valve.
3. Flow dry missile-grade air through model (13.4 ft³/min) while applying power to heater strips.
4. After model reaches 212°F, continue purge for 10 minutes.

The test run number, nominal vertical velocity, initial impact angles and temperatures are shown in Appendix A. Figure 3 shows the coordinate system and defines the parameters used in the test program.

SECTION IV. DATA ACQUISITION AND INSTRUMENTATION

The data acquisition system consisted of acceleration, pressure, and strain gage transducers with associated signal conditioning electronics, multiplexing equipment, and analog tape recording system. An oscillograph recorder was used to display online measurements during each test.

Instrumentation consisted of six accelerometers, two ullage pressure transducers, two ullage and six wall mounted thermocouples, and one vacuum chamber pressure transducer.

Measurement identification numbers, transducer types, and other pertinent instrumentation details are given in Table I. Figures 4 and 5 show the instrumentation locations.

Two camera systems were used for photographic coverage. Two high speed (250 frames/second) cameras 90 degrees apart (in a horizontal plane) filmed impact and splashdown. The lens were centered at the water level for above and below water coverage. A low speed (40 frames/second) camera operated from impact until final flotation position.

All data acquisition systems were calibrated in accordance with approved laboratory practices and calibrations were maintained as required.

SECTION V. DATA PROCESSING AND EVALUATION

Onsite data evaluation was performed after each drop. All oscillograms were reviewed to determine the validity of each measurement and time slices were selected for time history plots. Analog data tapes from each test were sent to MSFC Computation Laboratory for reduction. A digitized time history plot for each valid data channel was made with a sufficient time slice to include model release, water impact, slapdown, and rebound conditions. An additional time history plot was made for the pressure and temperature channels which extended the previous time history plots to a total time of 15 to 30 seconds.

SECTION VI. DATA PRESENTATION

Model impact parameters obtained from photographic data reduction are presented in Appendix A. Parameters included are:

- Vertical impact angle (deg)
- Maximum penetration depth (ft)
- Vertical angle at maximum penetration (deg)

The impact velocities were calculated from accelerometer data which indicates release time and impact time.

Acceleration, pressure, and temperature data time history plots are presented in Appendix B. Acceleration (g), pressure (psig), and temperature ($^{\circ}$ F) are presented as a function of time.

TABLE I. INSTRUMENTATION PROGRAM

MEASUREMENT NUMBER	MEASUREMENT TYPE	FREQUENCY RESPONSE (Hz)	FULL SCALE RANGE	SENSITIVE AXIS
EP001	Accelerometer	2-400	$\pm 25G$	Pitch
EY002	"	"	"	Yaw
EA003	"	"	"	Axial
EP004	"	"	"	Pitch
EY005	"	"	"	Yaw
EA006	"	"	"	Axial
D0001	Pressure	"	± 5.00 psig	Internal
D0002	"	"	"	"
D0003	"	"	± 5.00 psig	Chamber
C0001	Thermocouple	"	150°F	External Wall
C0002	"	"	"	Internal Wall
C0003	"	"	"	Ullage
C0004	"	"	"	Internal Wall
C0005	"	"	"	Ullage
C0006	"	"	"	Internal Wall
C0007	"	"	"	" "
C0008	"	"	"	" "

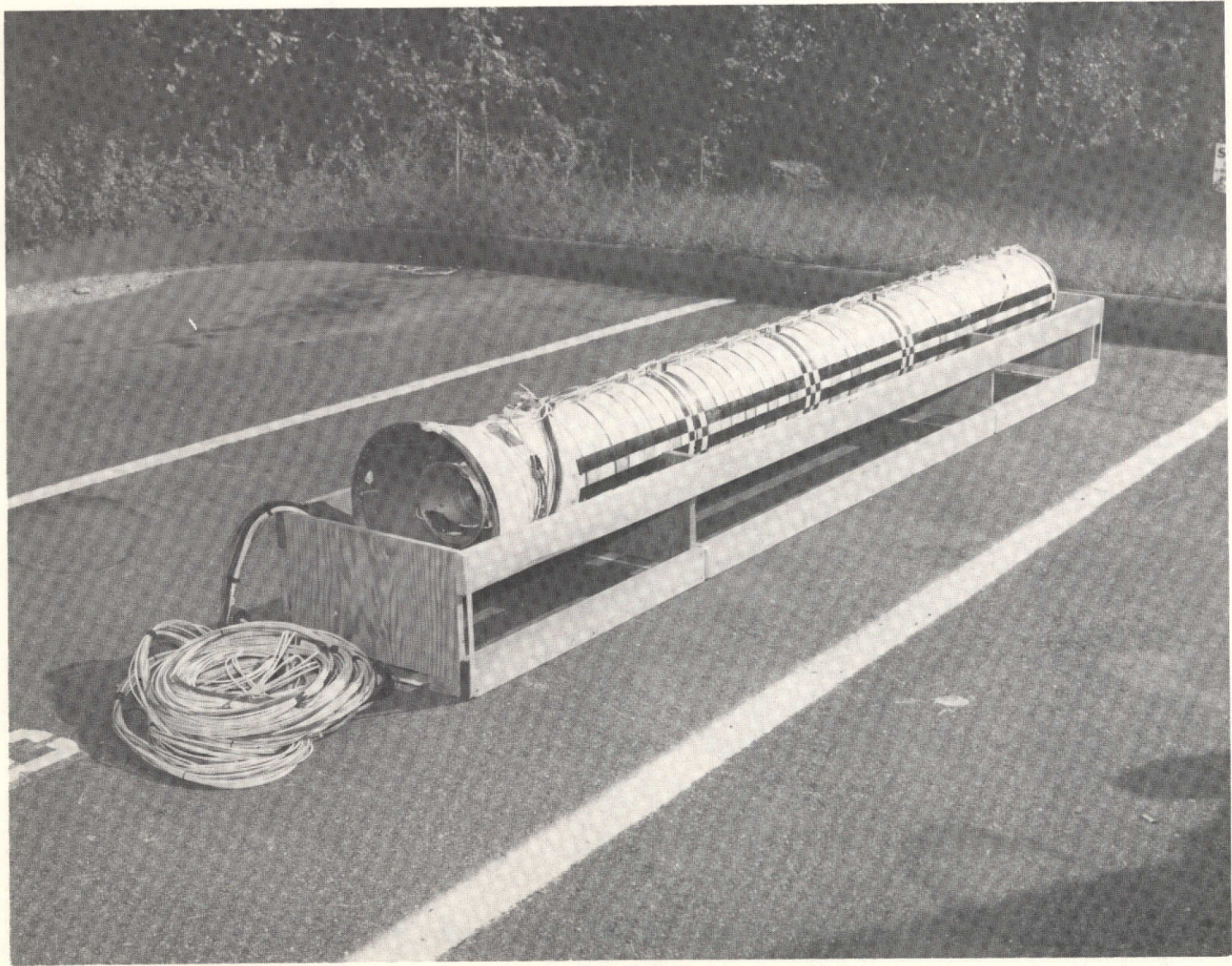
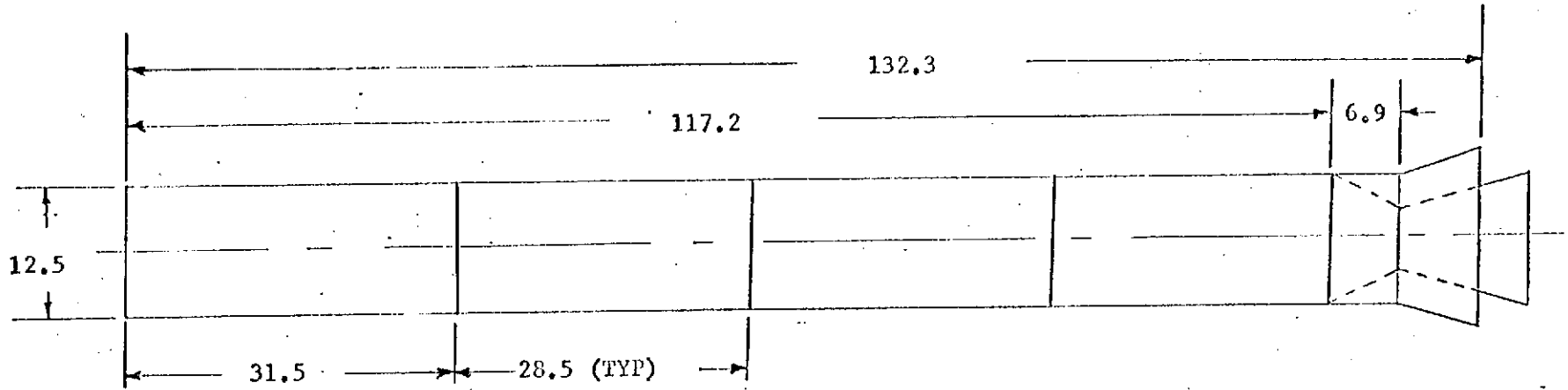
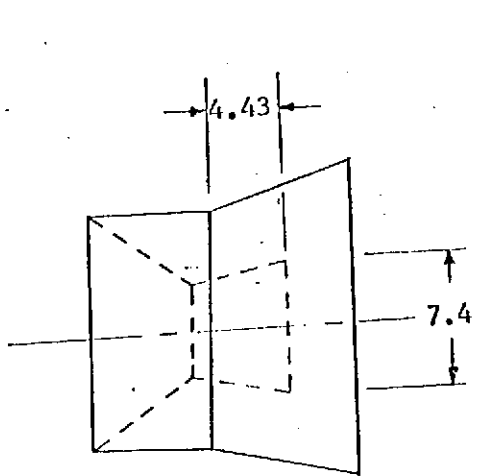

FIGURE 1. 12.5-INCH SRB THERMAL MODEL



- 11 -



Short Nozzle

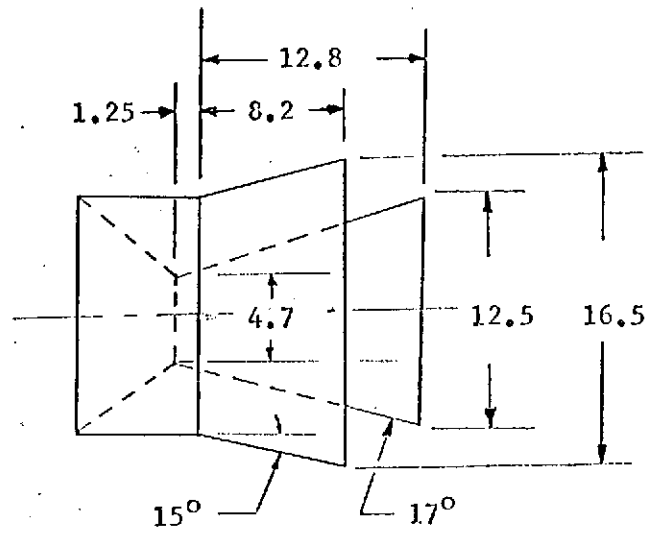

LONG NOZZLE

ORIGINAL PAGE IS
OF POOR QUALITY

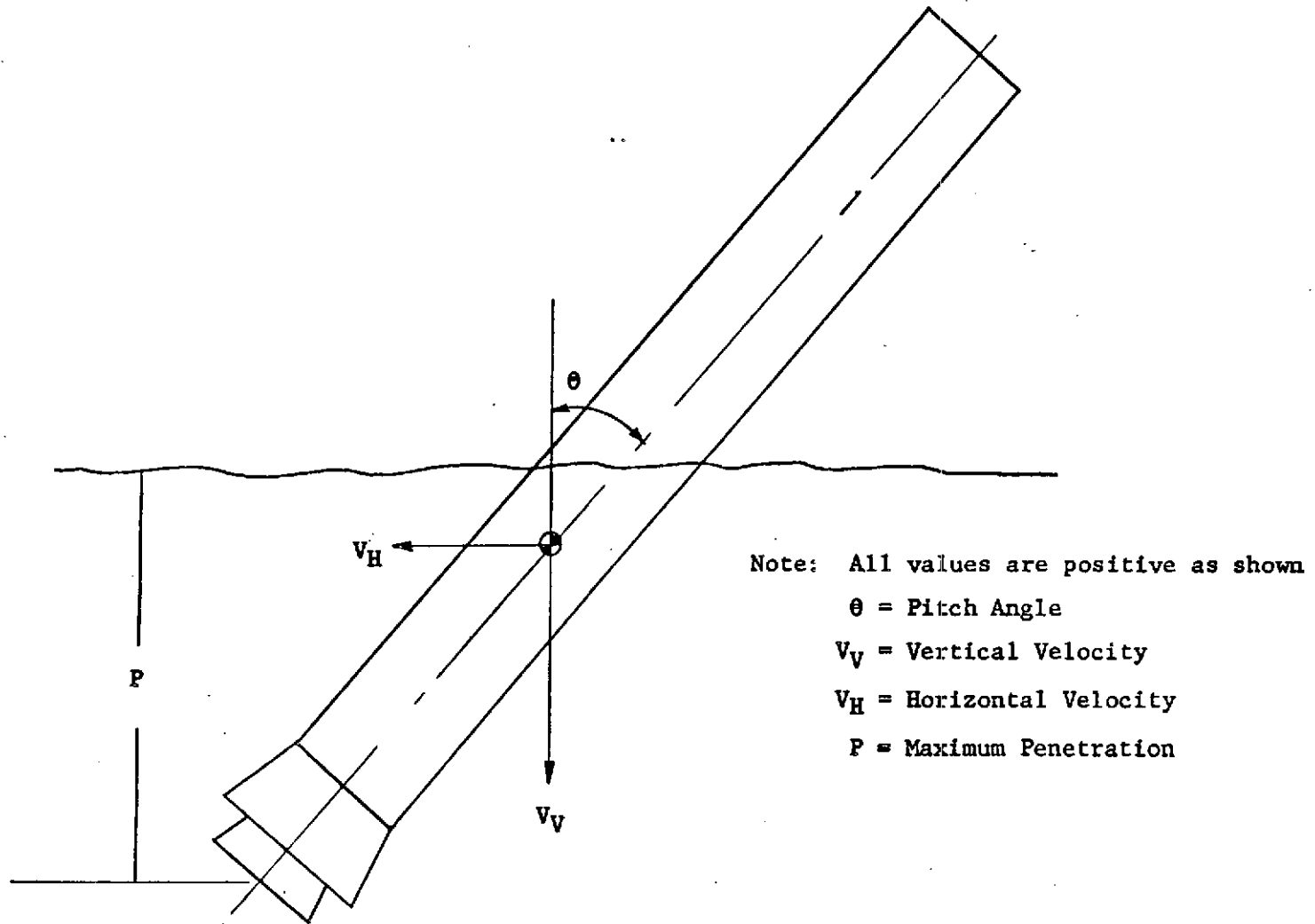

FIGURE 3. MODEL COORDINATE SYSTEM AND PARAMETER DEFINITION

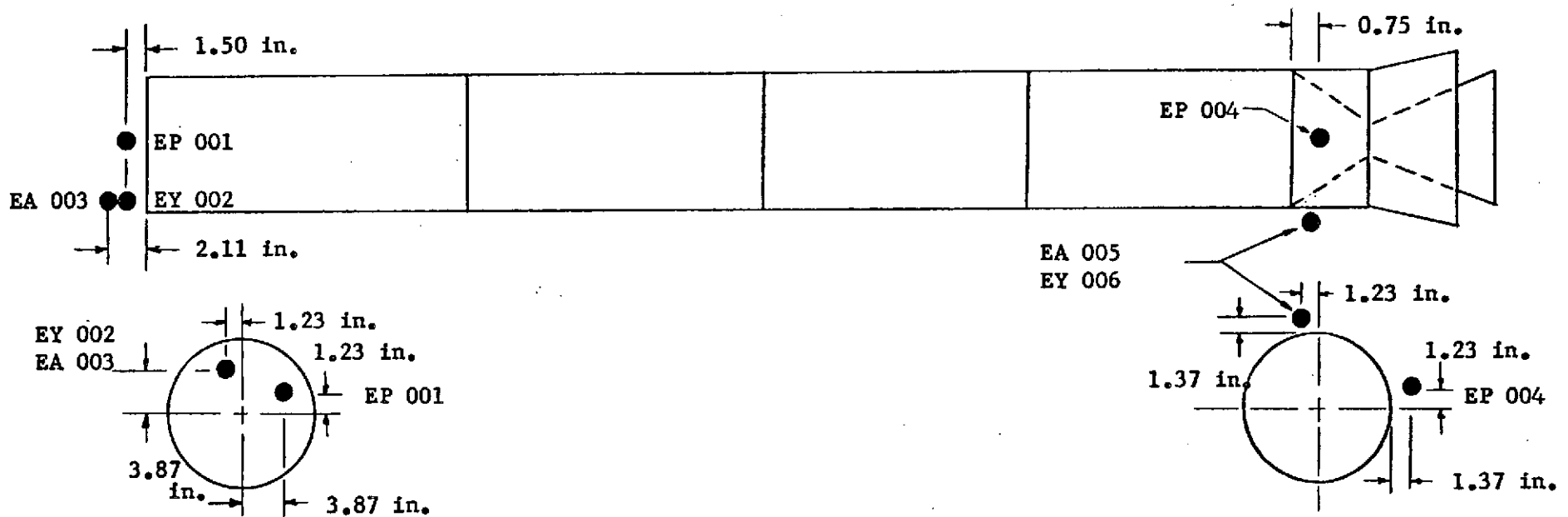

FIGURE 4. 12.5-INCH SRB THERMAL MODEL ACCELEROMETER LOCATIONS

14

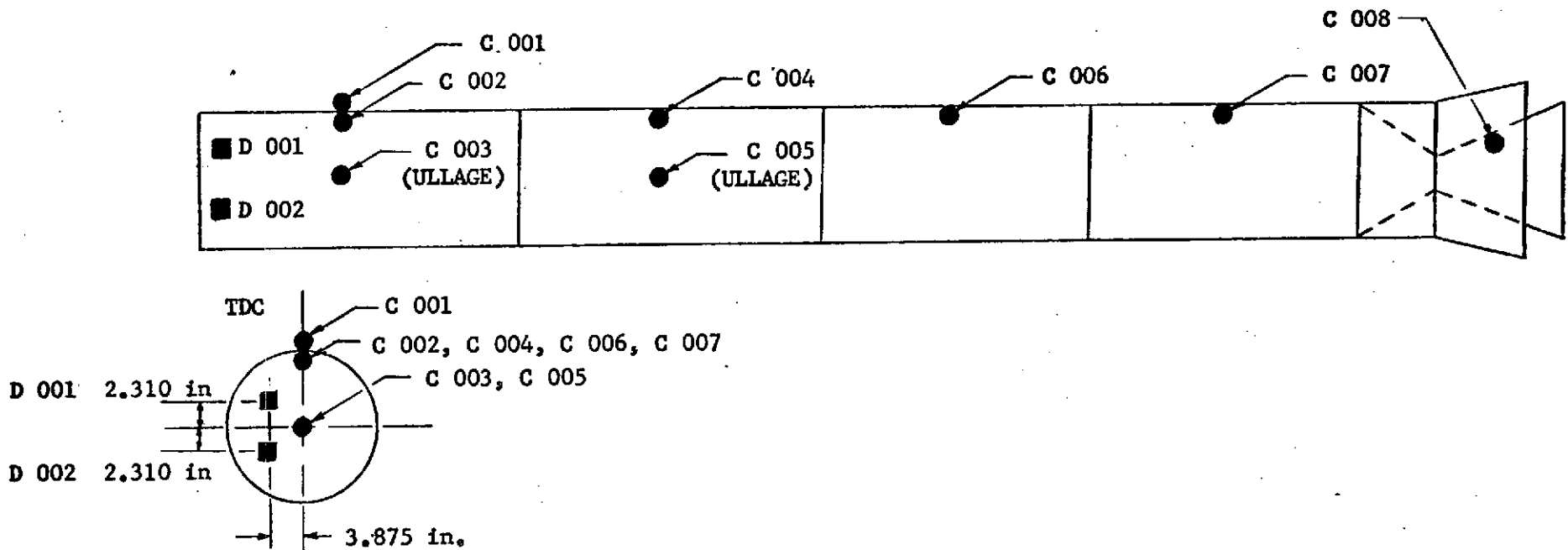

FIGURE 5. 12.5-INCH THERMAL SRB MODEL PRESSURE AND TEMPERATURE LOCATIONS

APPENDIX A

IMPACT AND PENETRATION DATA

12.5-INCH THERMAL MODEL SRB

TABLE I. IMPACT PARAMETERS

TEST NO.	IMPACT VELOCITY ft/sec	HORIZONTAL VELOCITY ft/sec	IMPACT ANGLE degrees	ANGLE AT MAXIMUM PENETRATION degrees	MAXIMUM PENETRATION		AVERAGE WALL ULLAGE TEMPERATURE		NOZZLE CONFIGURATION
					ft	TIME / sec	°F	°F	
31	23.64	0	0.20	2.70	4.04	0.748	130.5	128.5	SHORT NOZZLE ↓ LONG NOZZLE
32	23.64	0	-0.199	3.70	4.48	0.748	124.75	128.0	
33	23.74	0	32.10	60.10	2.14	0.30	130.5	134.5	
34	23.64	0	0.10	4.40	5.4	0.855	AMBIENT		
35	23.74	0	32.40	60.00	2.24	0.30	AMBIENT		
36	23.87	0	21.20	52.20	2.85	0.396	130.0	132.5	
37	23.74	0	0.40	7.10	4.93	1.00	118.5	119.5	
38	23.84	0	32.60	65.10	2.28	0.332	124.2	128.0	
39	23.74	0.21	0.20	3.70	3.79	0.632	158.3	164.5	
40	24.00	0	32.90	59.50	2.21	0.296	159.5	166.0	
43	29.53	0	32.5	58.90	2.32	.244	118.5	123.5	
44	29.76	0.91	32.20	62.70	2.4	0.280	130.7	137.5	
45	23.81	0	0	1.80	4.42	0.756	120.2	129.0	
46	29.63	0	0.40	4.0	4.97	0.756	120.5	126.5	
47	23.16	0	0	1.20	6.33	0.868	118.5	121.0	
48	24.06	0.71	31.80	68.60	2.58	0.396	118.2	122.0	
49	29.66	0	0.299	1.40	6.72	0.87	119.5	128.0	
50	30.30	0	31.20	61.20	2.67	0.288	118.7	117.0	
51	29.60	0	0.70	7.30	6.31	0.772	127.5	131.0	

APPENDIX B

**ACCELERATION, PRESSURE, AND
TEMPERATURE DATA**

APPENDIX B

TABLE OF CONTENTS

<u>Test Run No.</u>	<u>Page</u>
P022-31	B-2
32	B-10
33	B-18
34	B-27
35	B-37
36	B-47
37	B-57
38	B-67
39	B-77
40	B-85
43	B-114
44	B-124
45	B-134
46	B-144
47	B-149
48	B-159
49	B-169
50	B-179
51	B-189



SEQ. = 0028

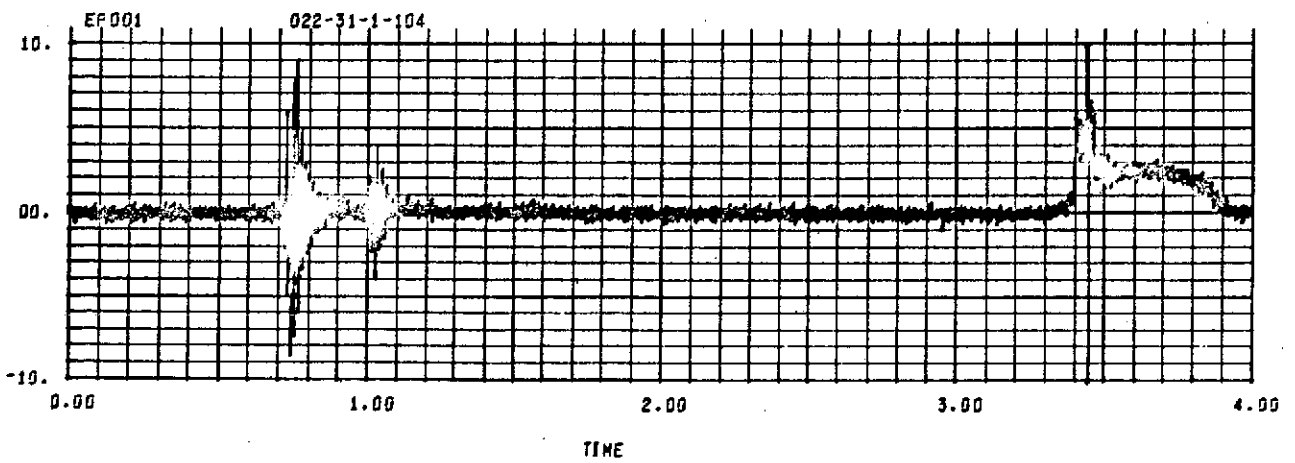
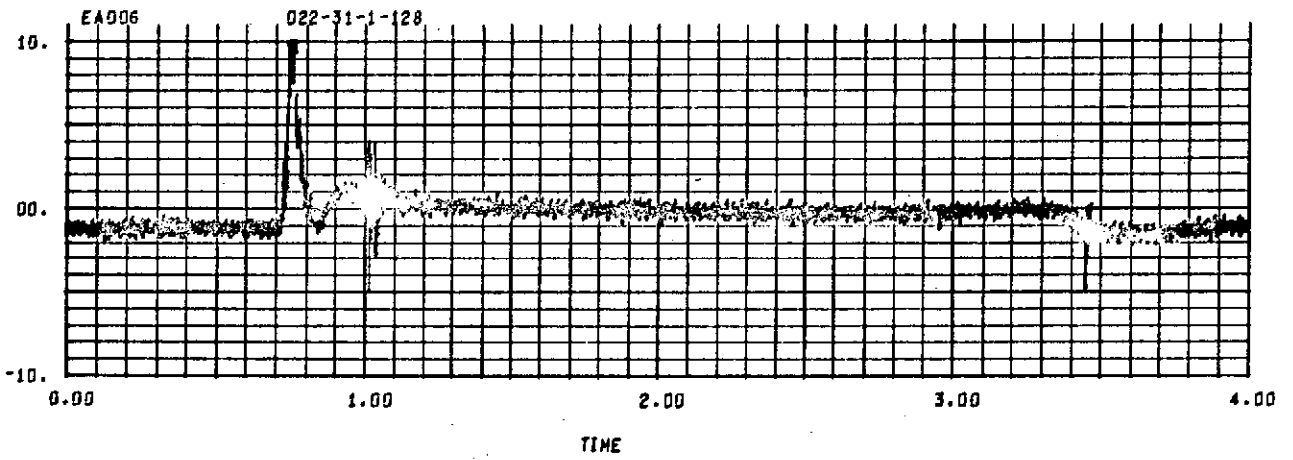
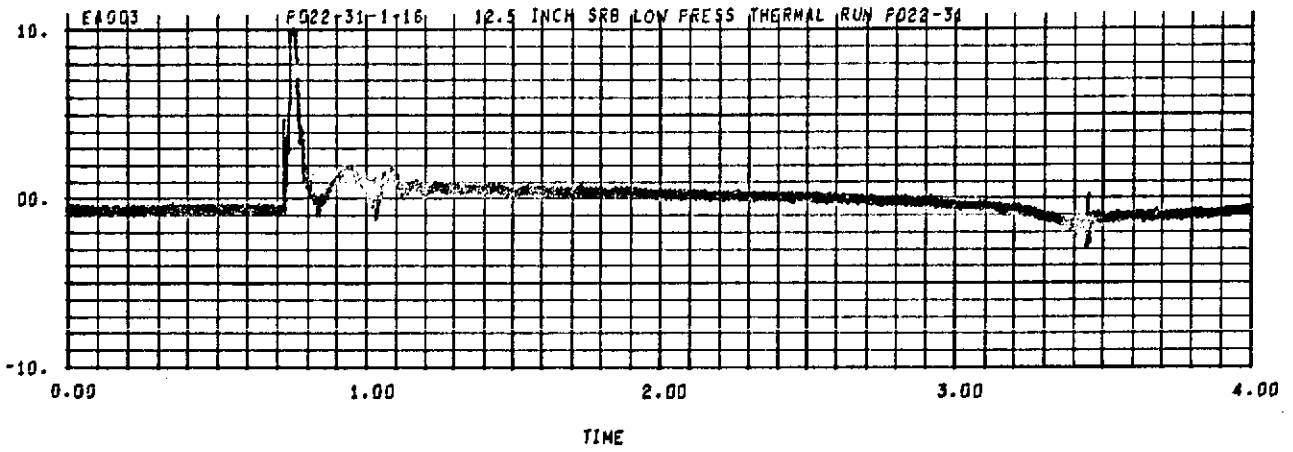



SEQ. = 0020

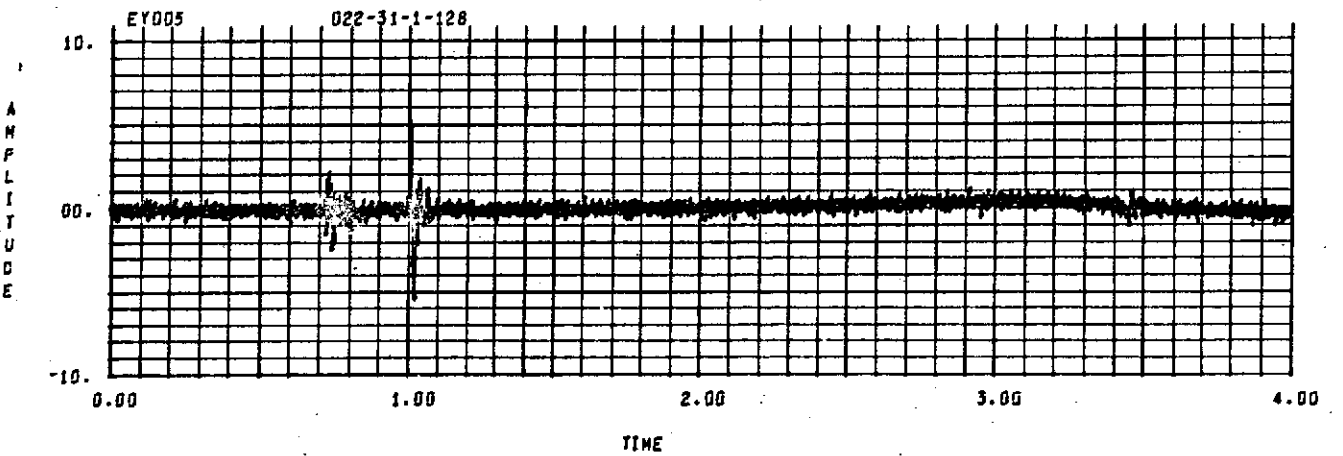
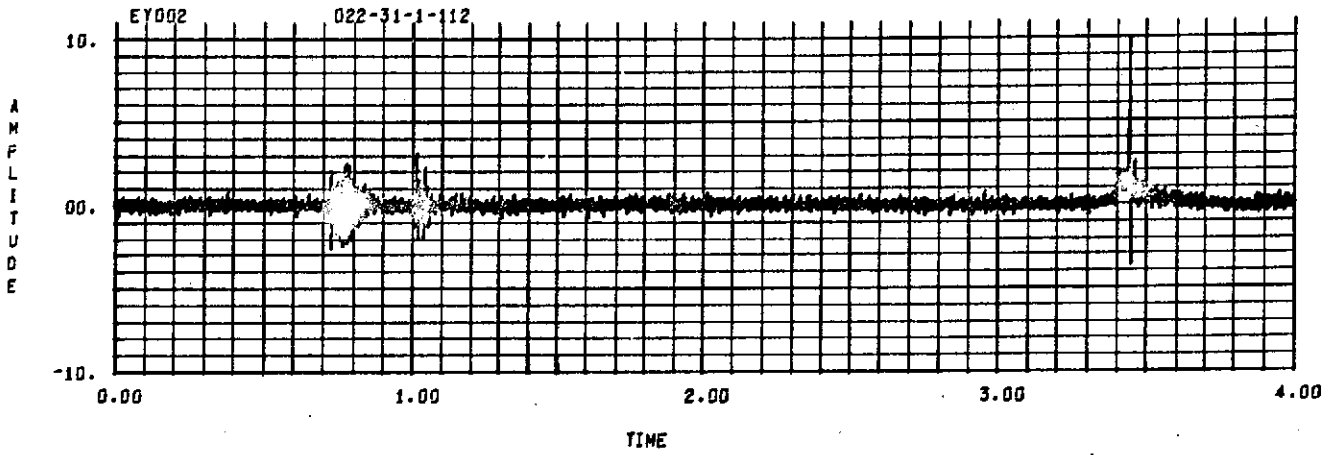
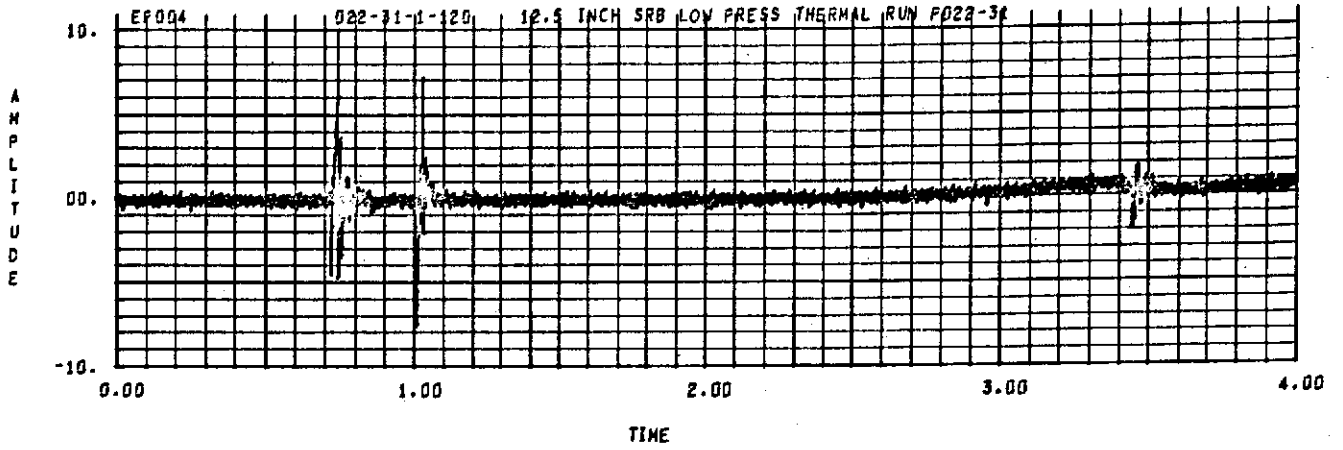

SEQ. = 0028

1

C0001 F022-31-1-46 12.5 INCH SRB LOW PRESS THERMAL RUN F022-31

A
M
P
L
I
T
U
D
E

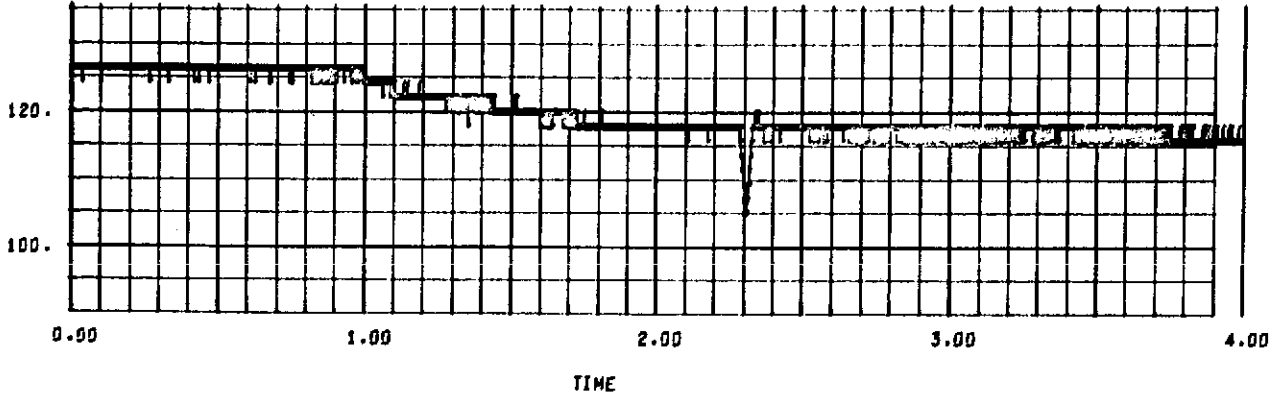

C0002 F022-31-1-48

A
M
P
L
I
T
U
D
E

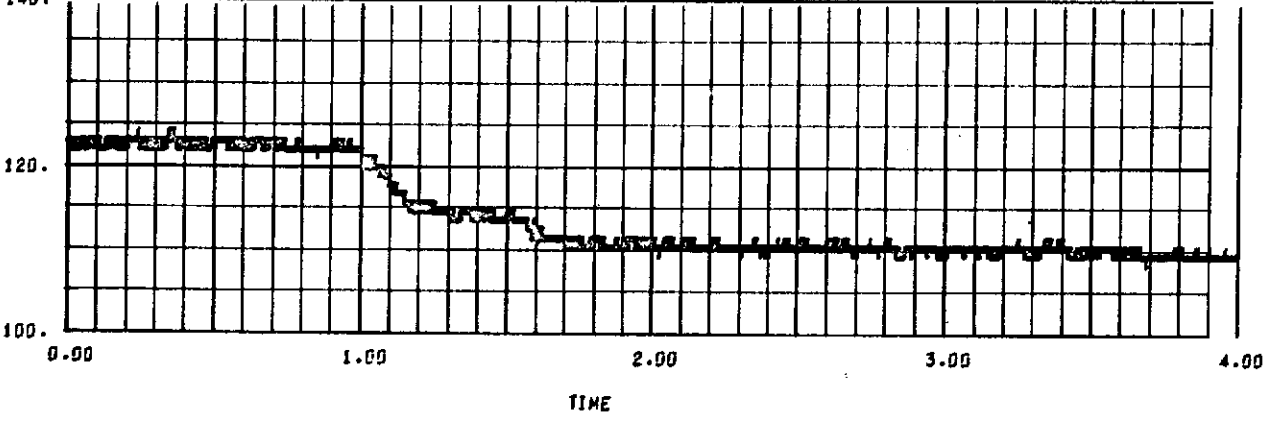

C0003 F022-31-1-56

A
M
P
L
I
T
U
D
E

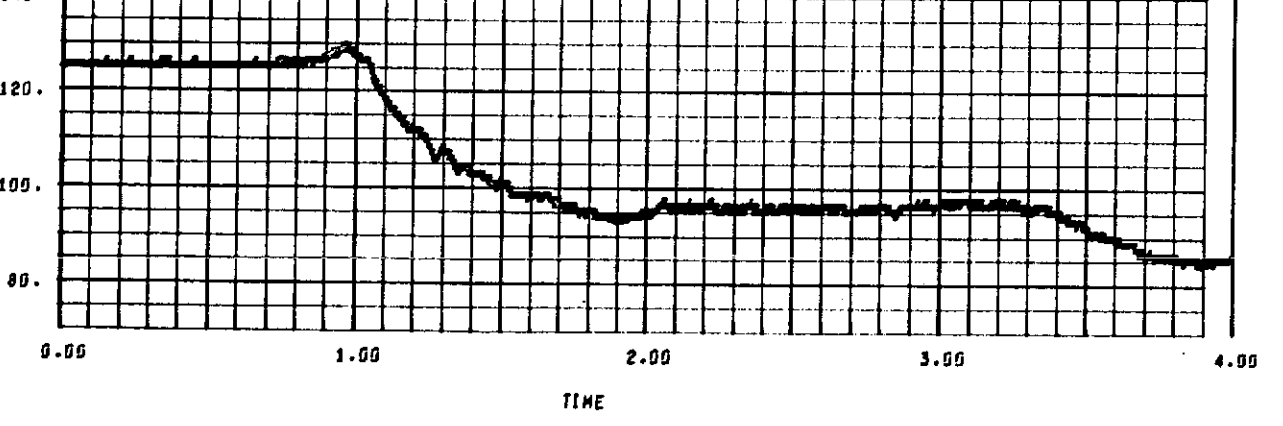



SEQ. = 0028

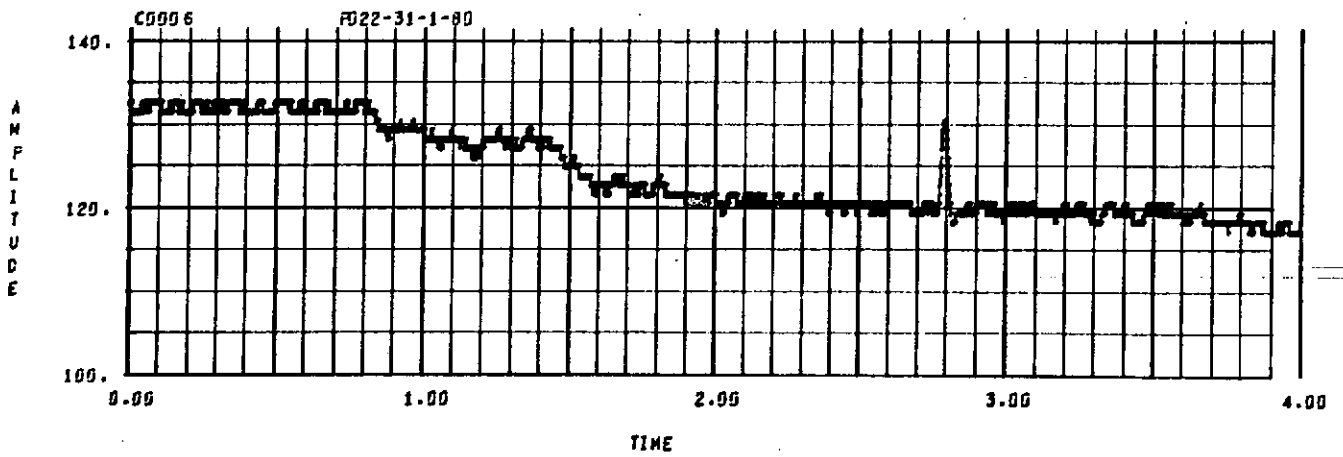
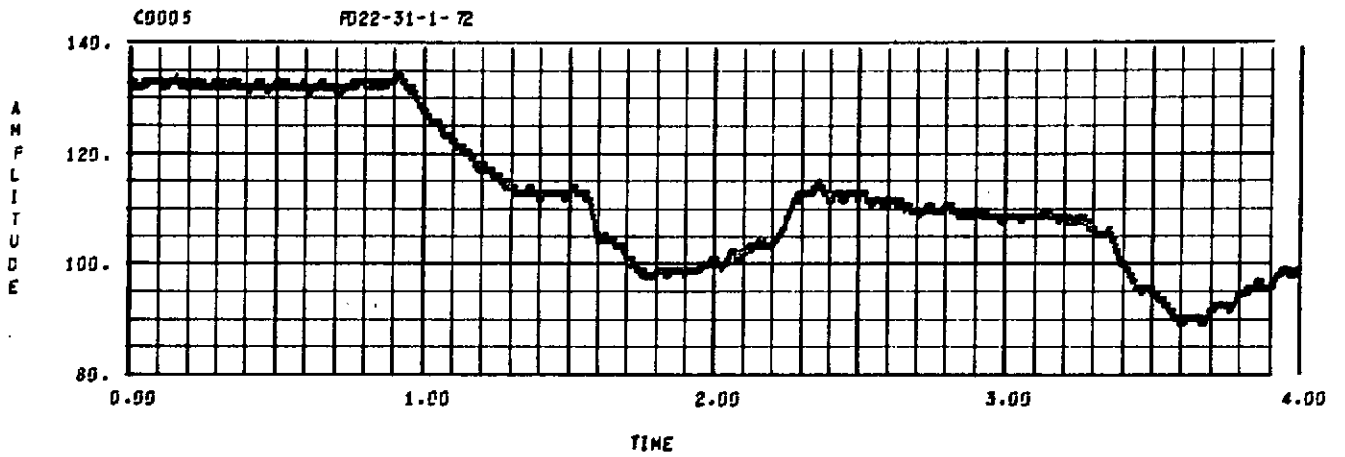
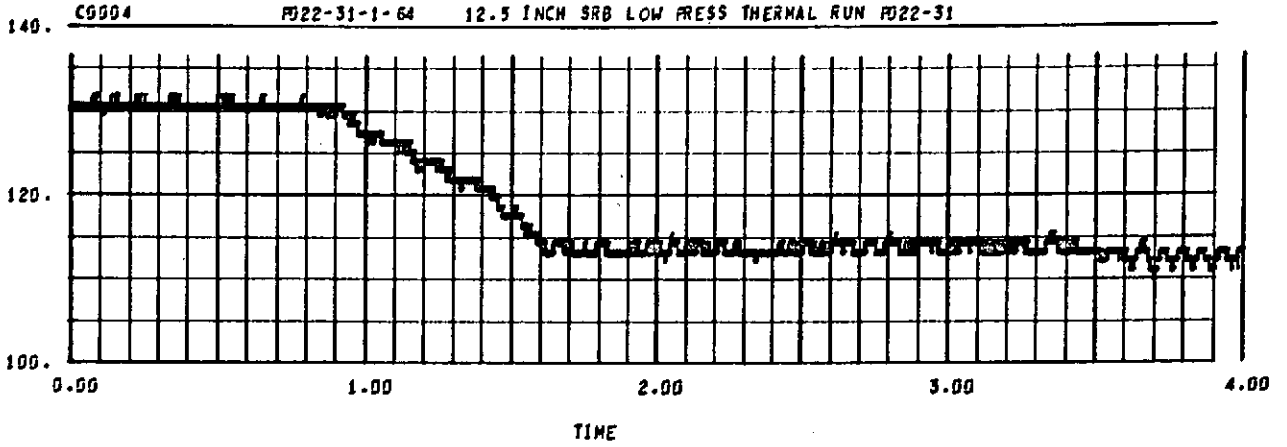

SEQ. = 0028

3

140. C0007 PD22-31-1-88 12.5 INCH SRB LOW PRESS THERMAL RUN PD22-31

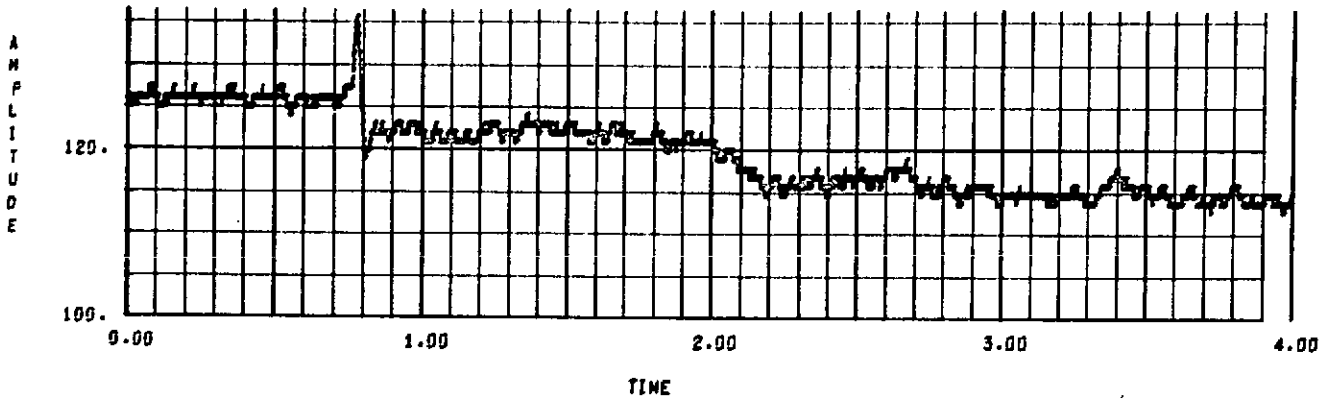

SEQ. = 0028

1

00001 PD22-31-1-24 12.5 INCH SRB LOW PRESS THERMAL RUN PD22-31

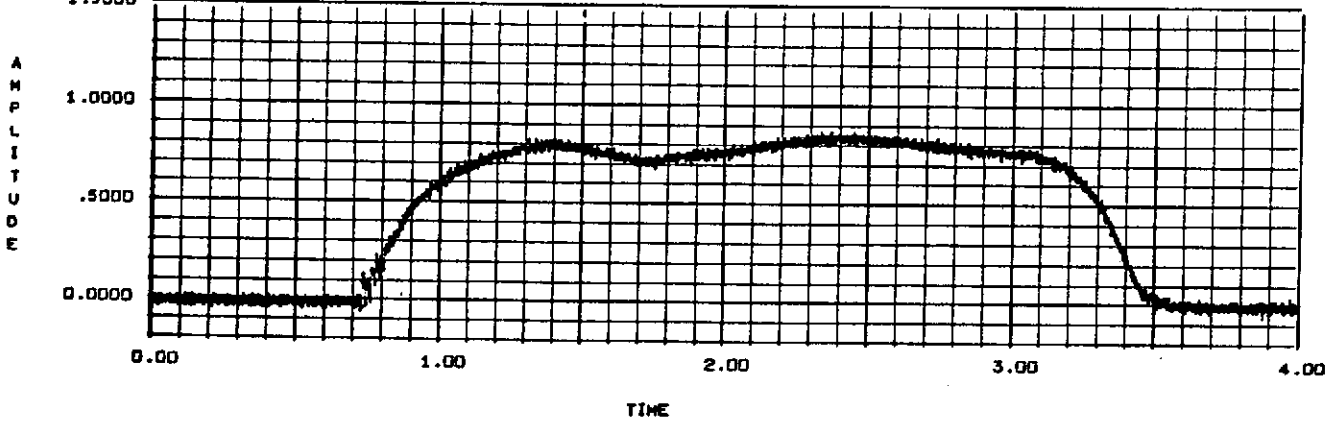

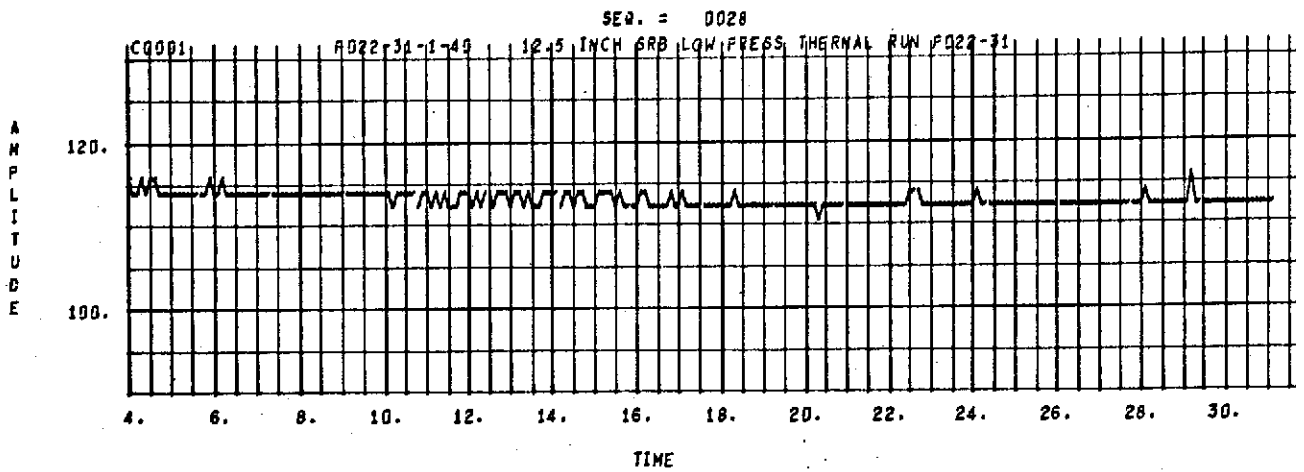
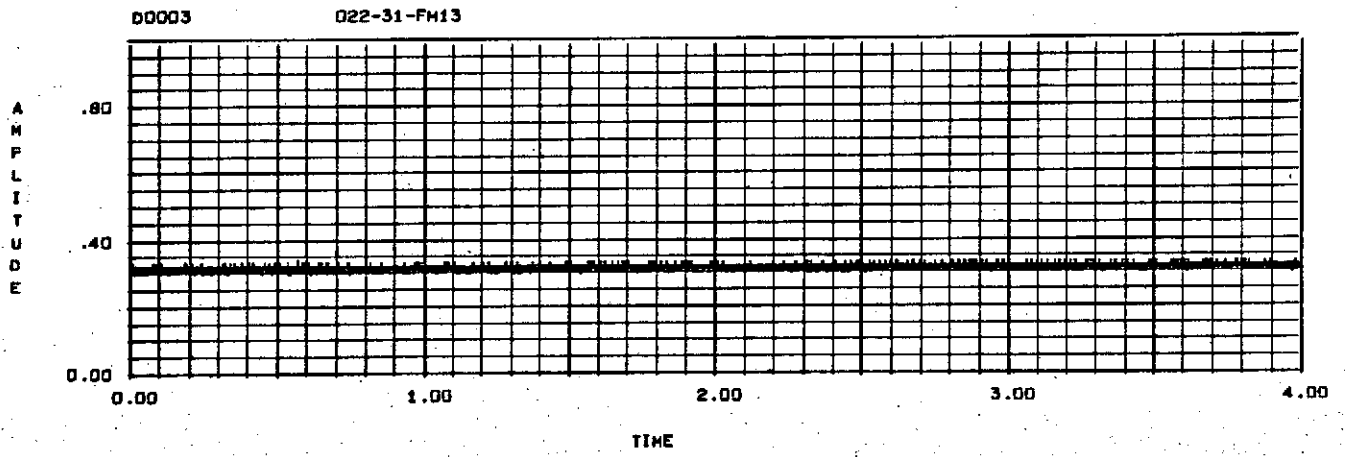
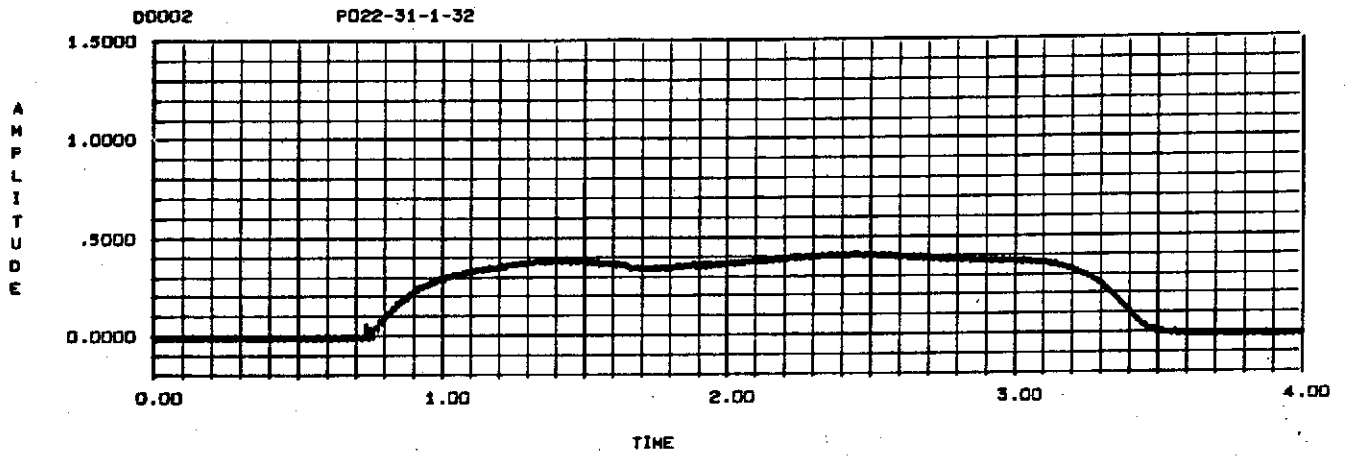

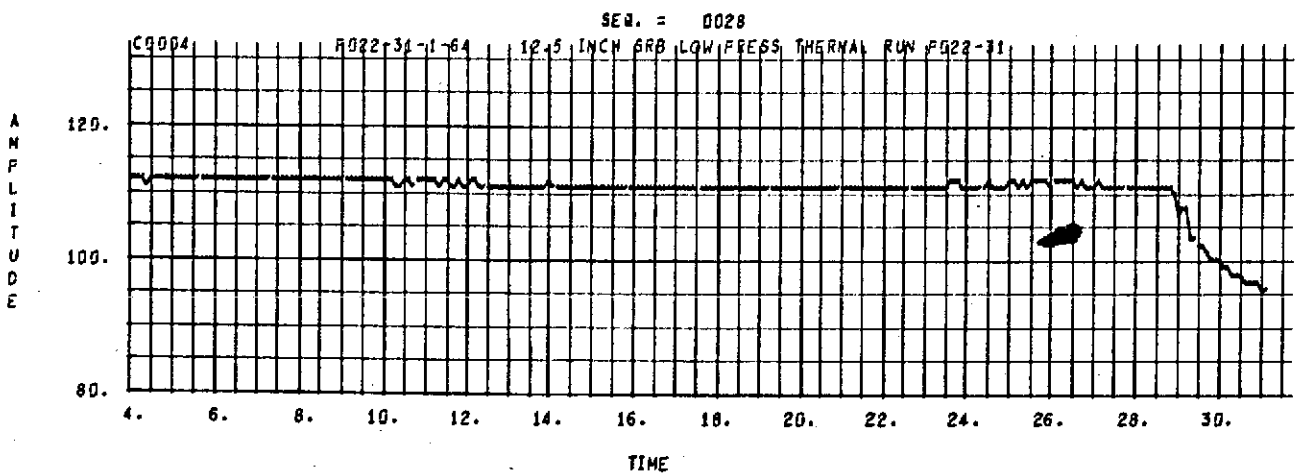
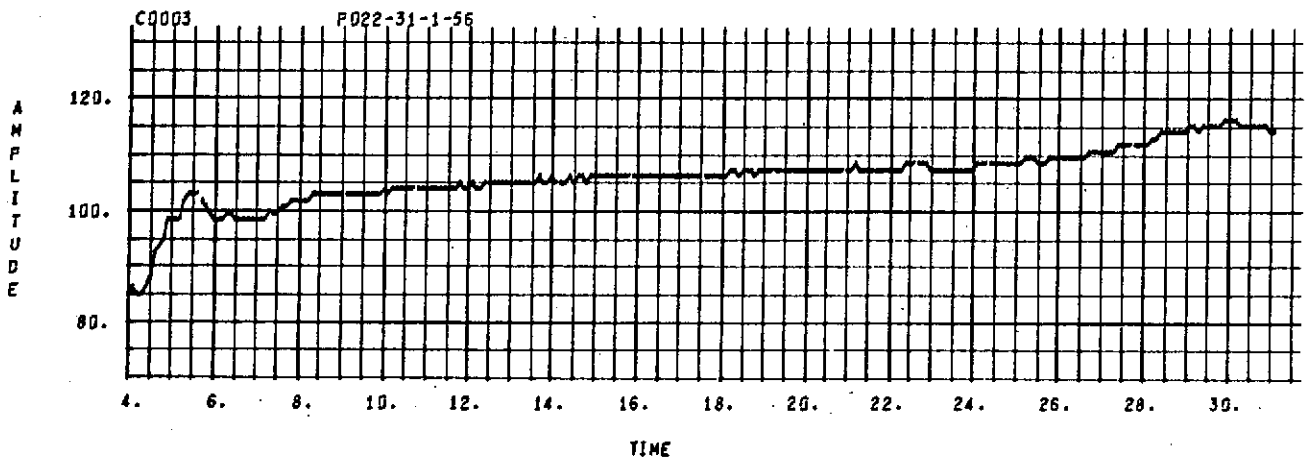
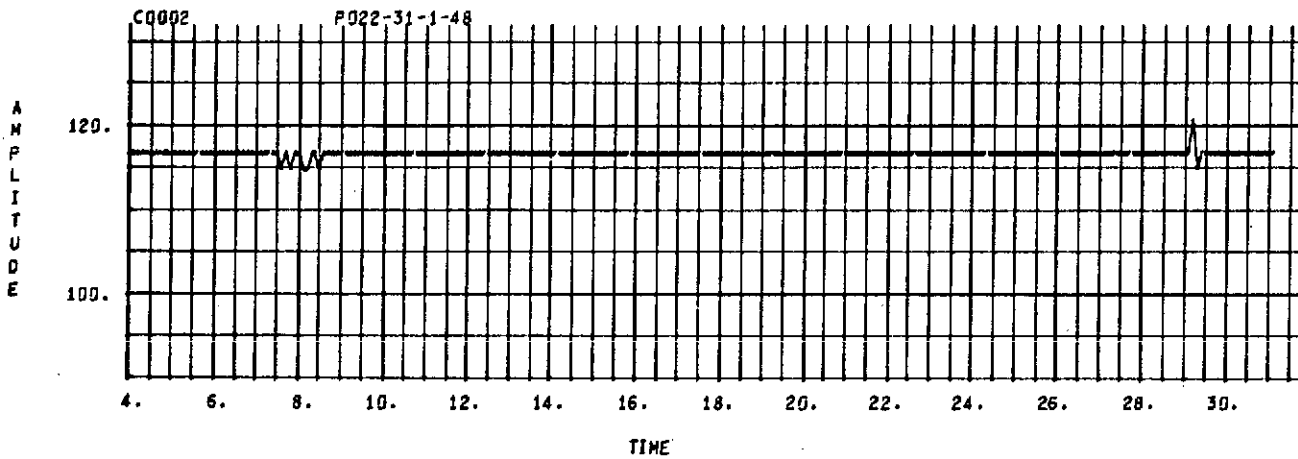



SEQ. = 0020

D0001 F022-31-1-24 12.5 INCH SRB LOW PRESS THERMAL RUN F022-31

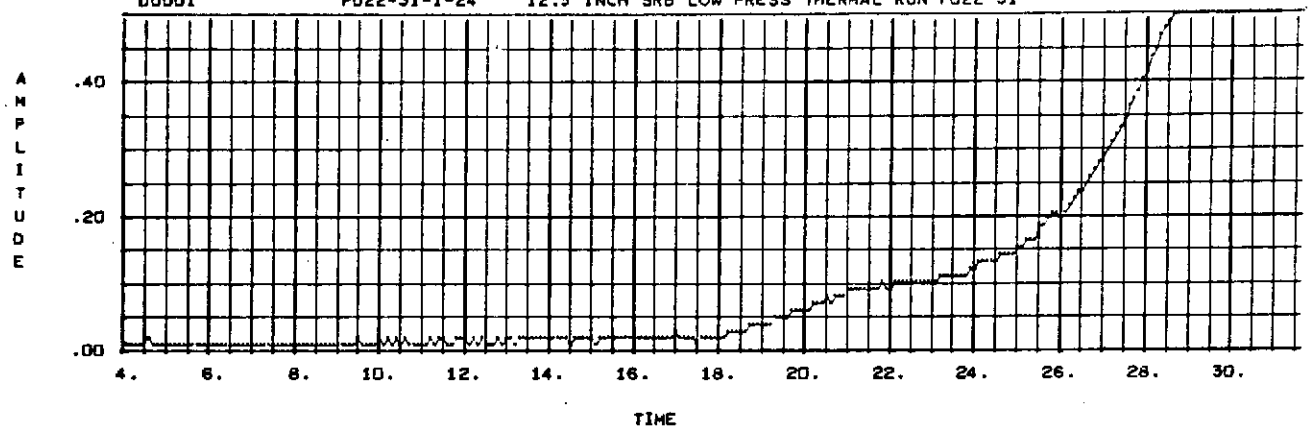

D0003 022-31-FM13

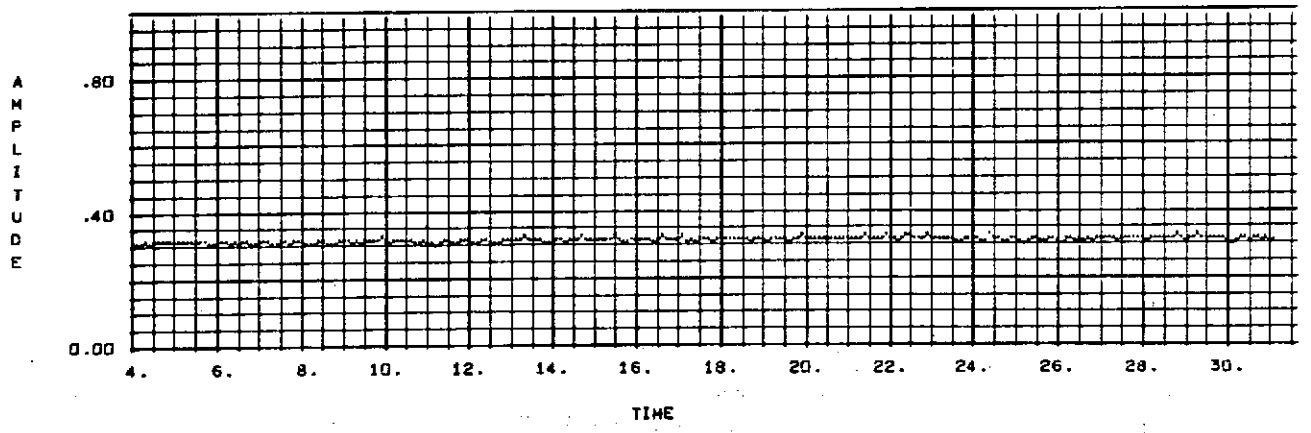

SEQ. = 0029

1

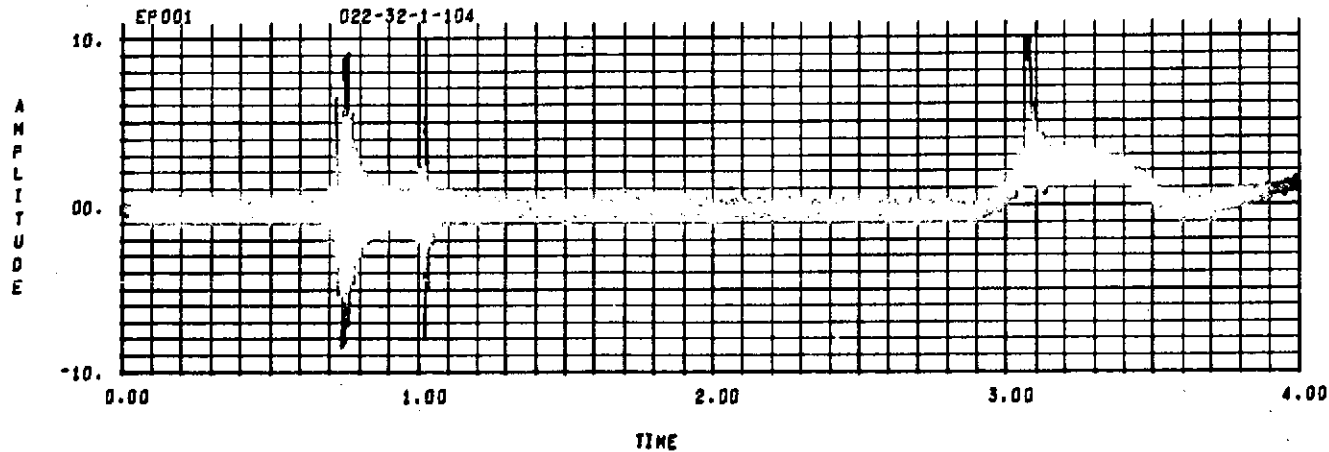
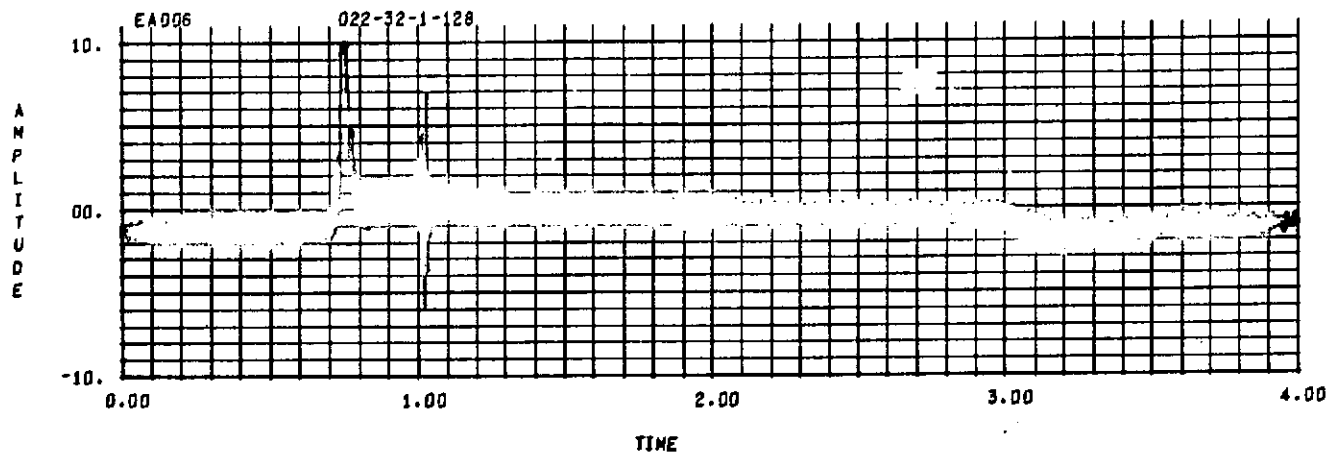
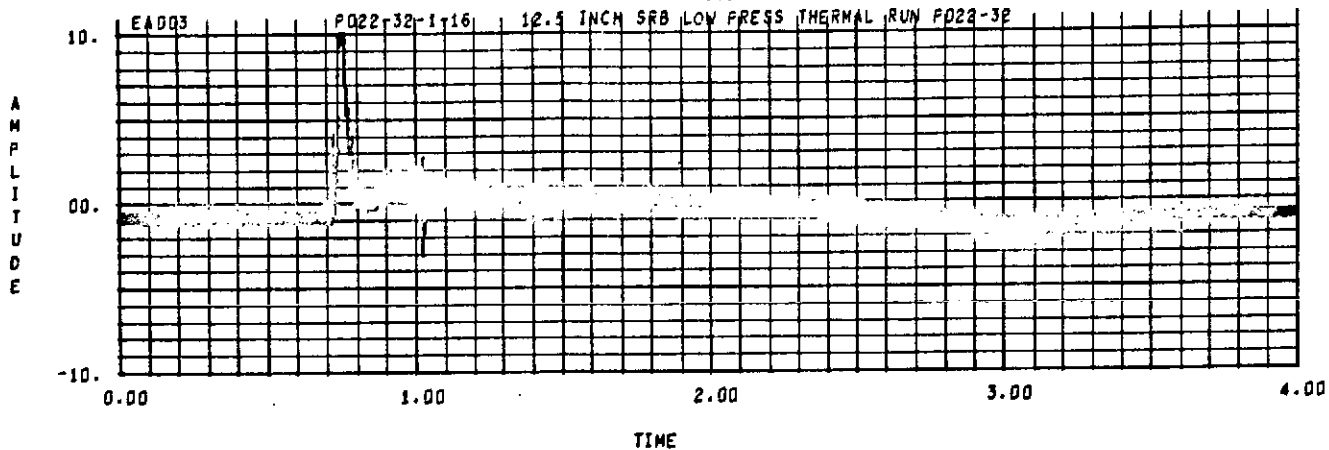

SER. = 0029

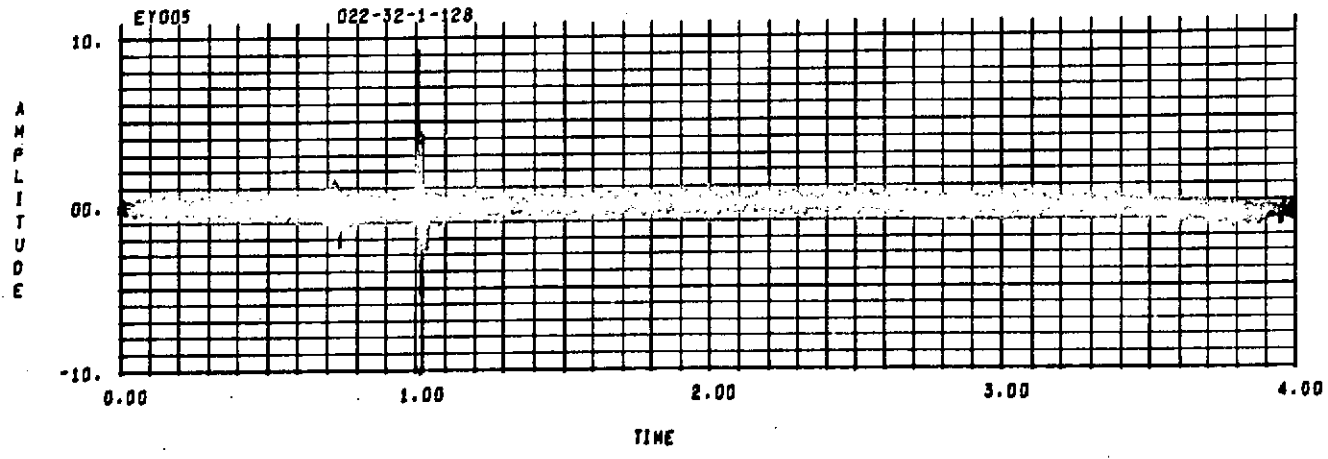
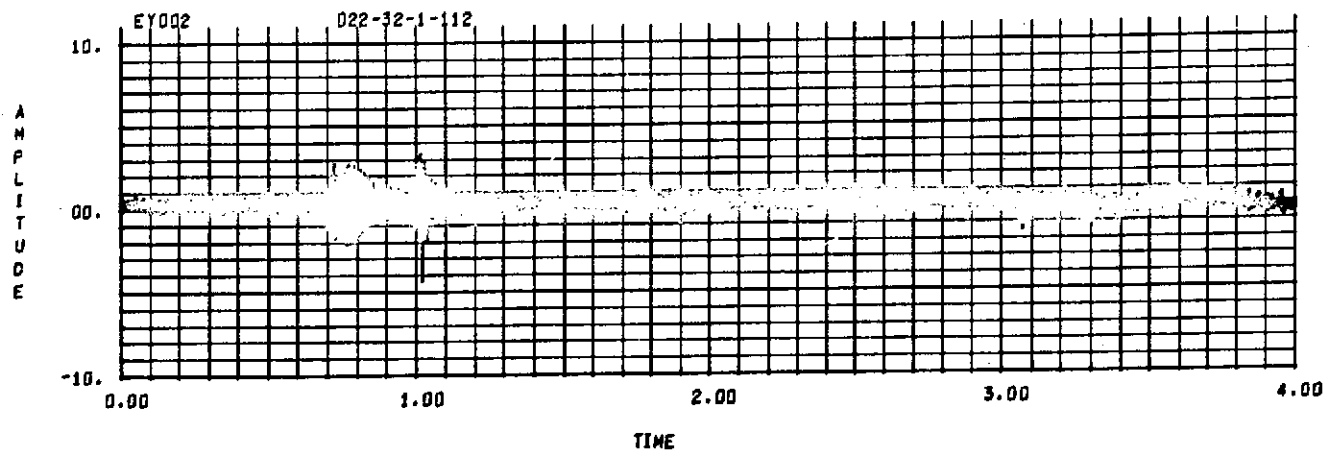
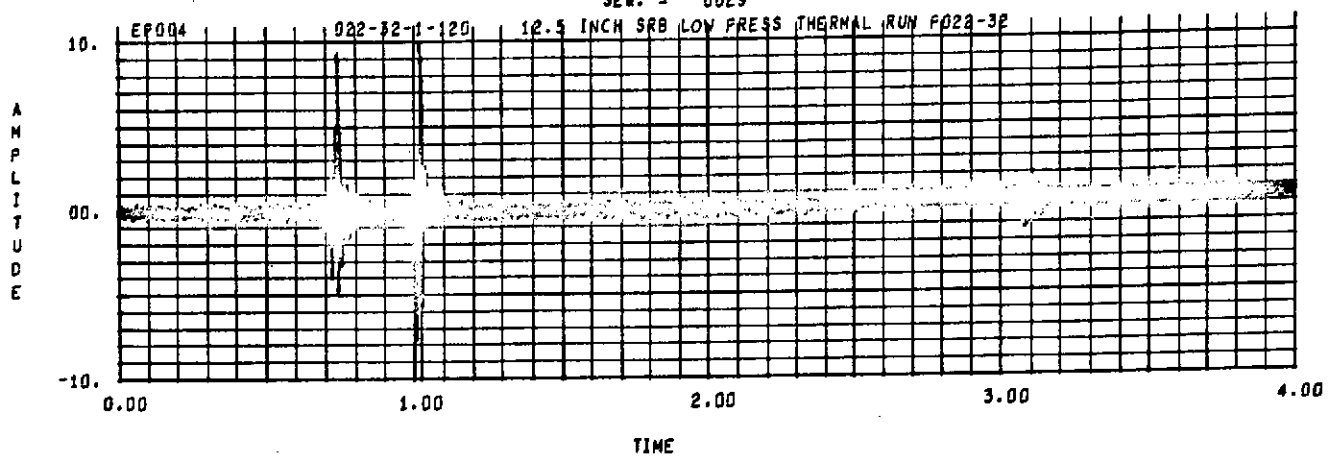



SEQ. = 0029

1

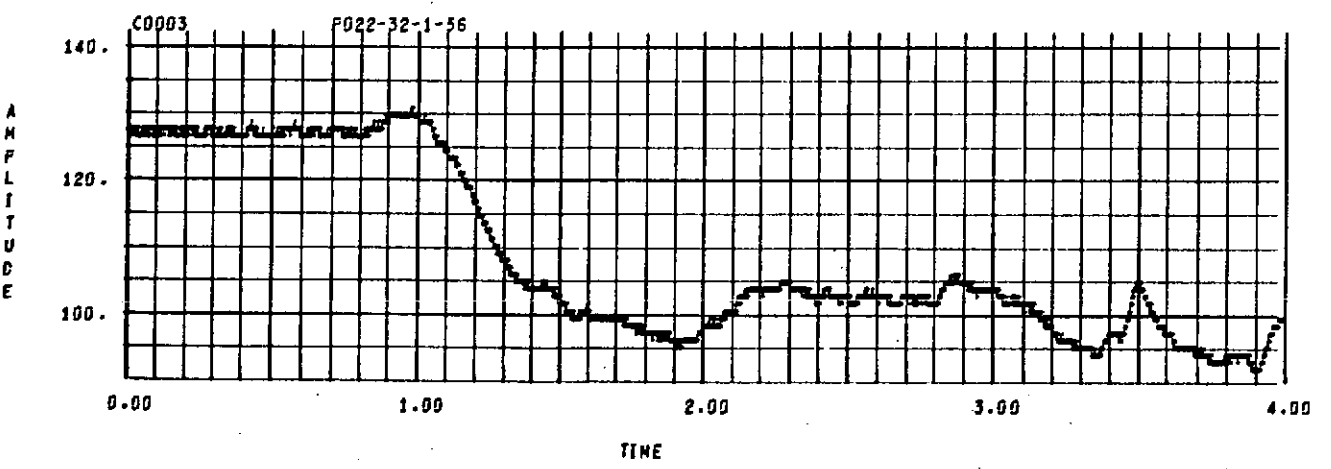
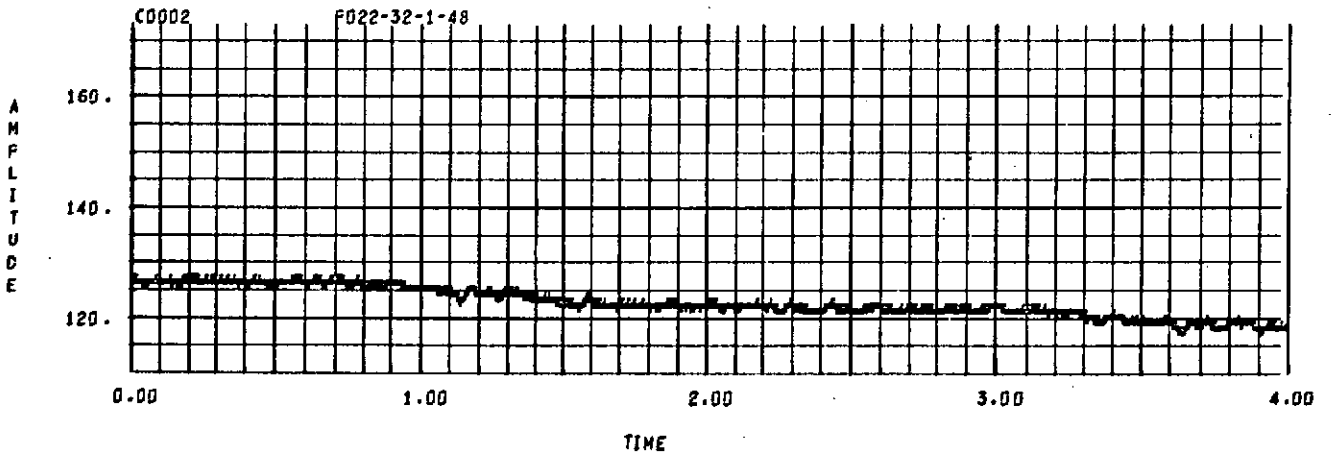
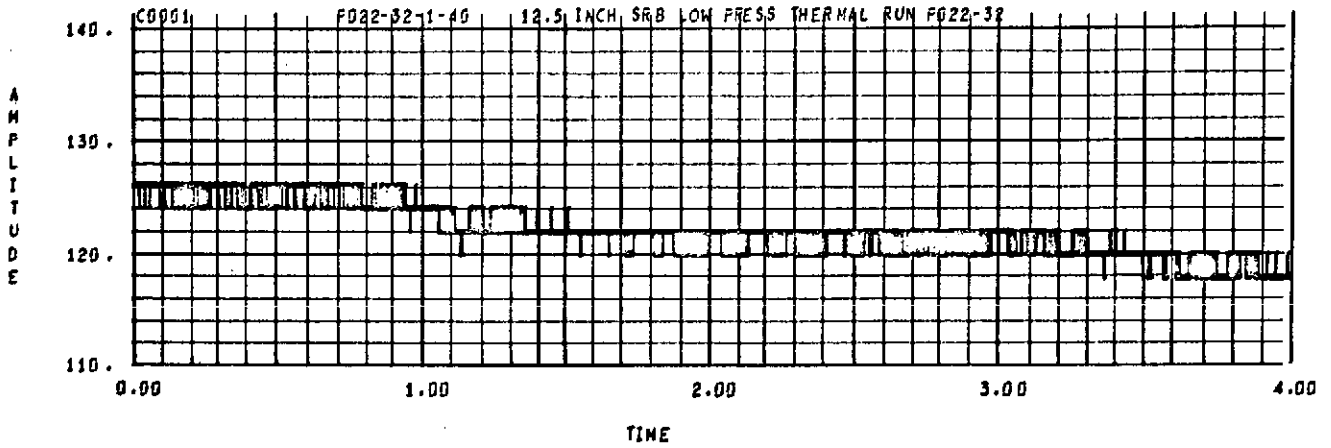

SEQ. = 0029

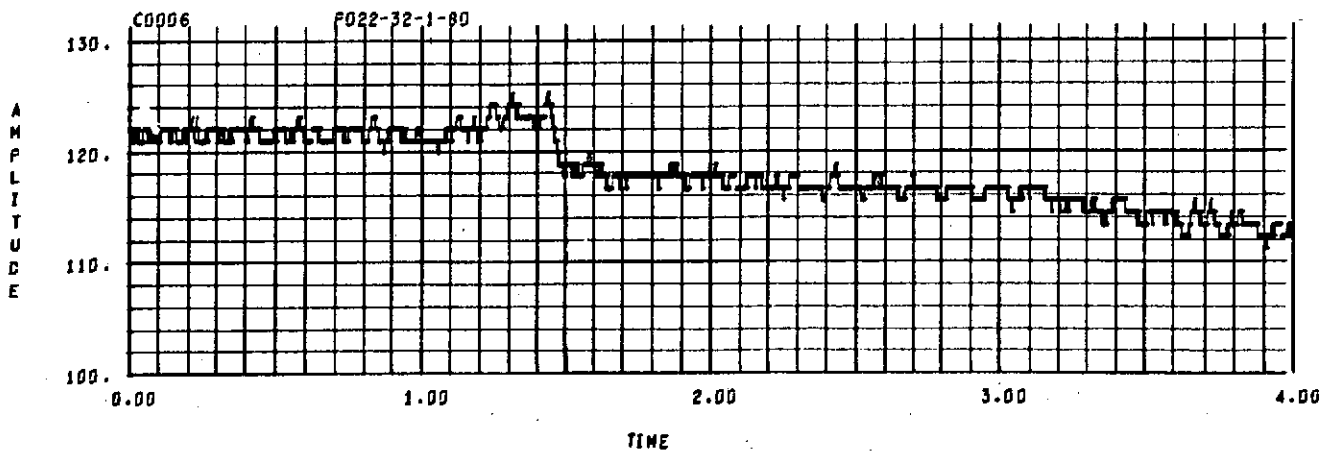
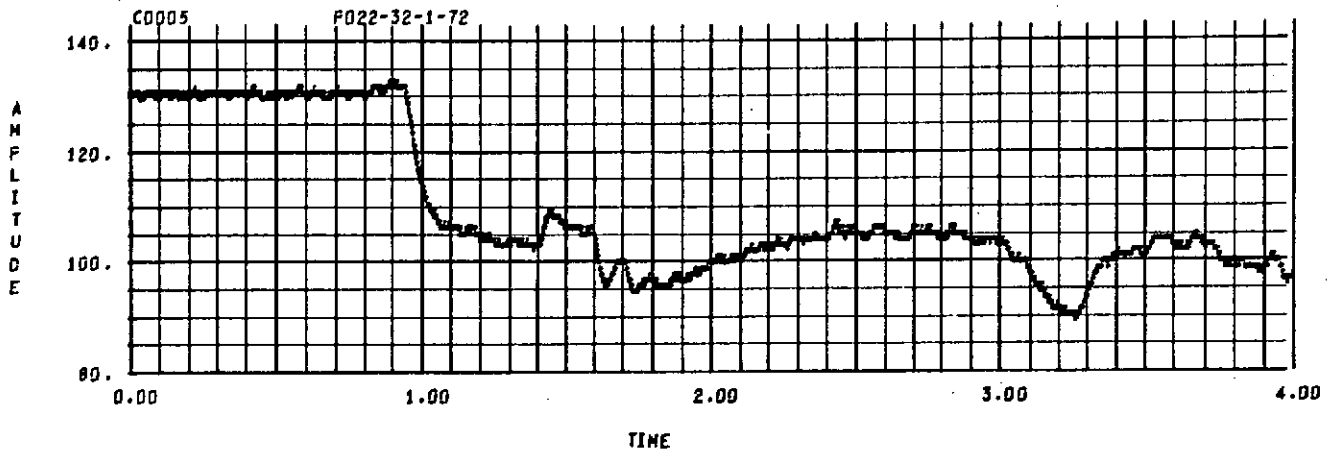
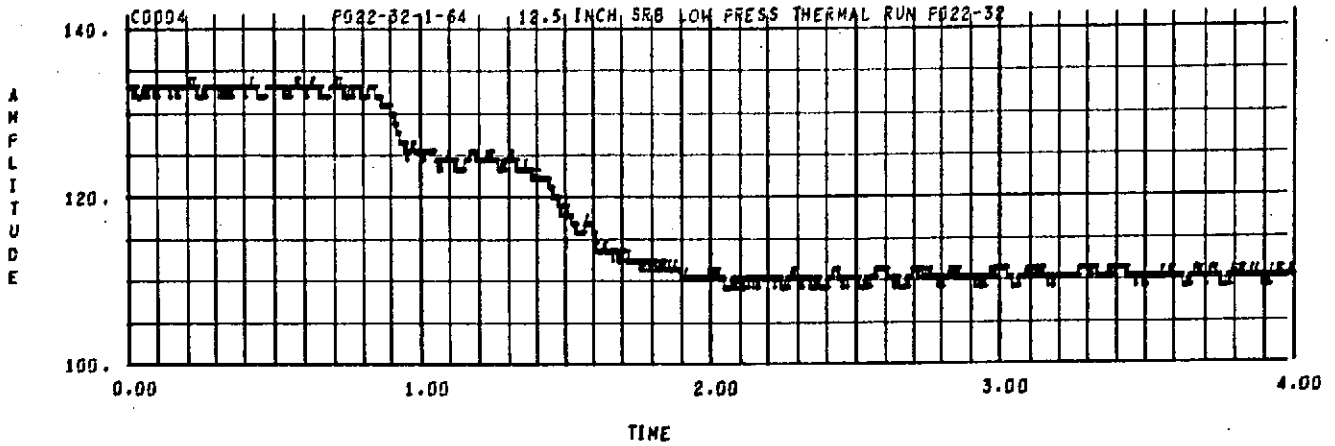

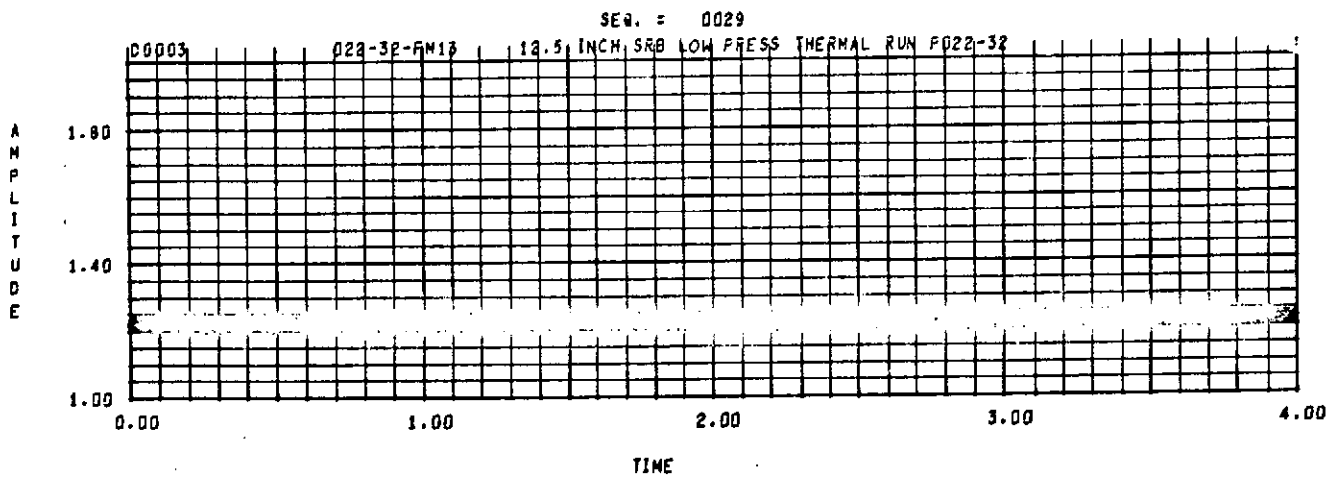
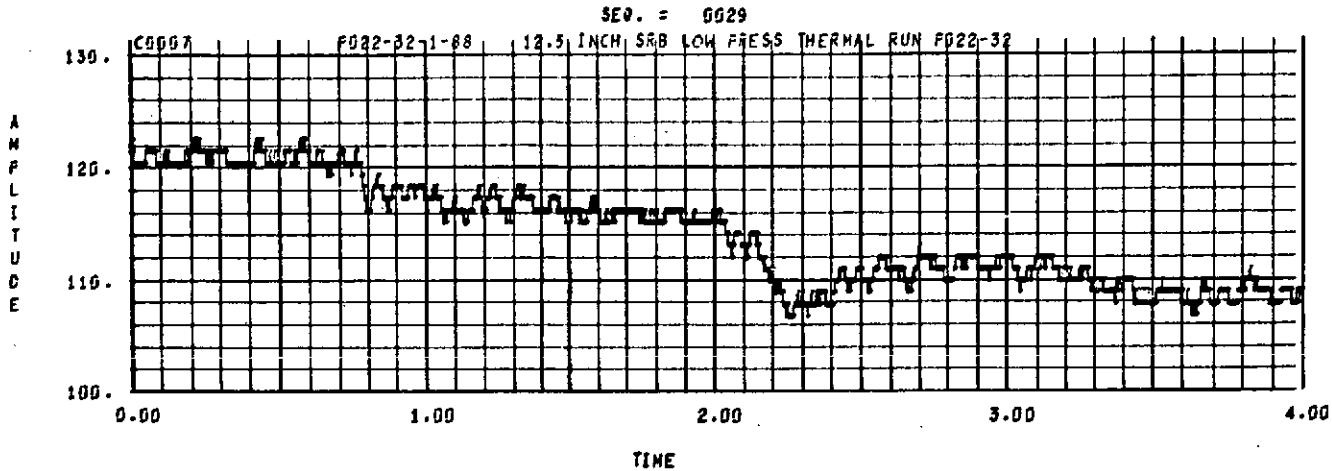

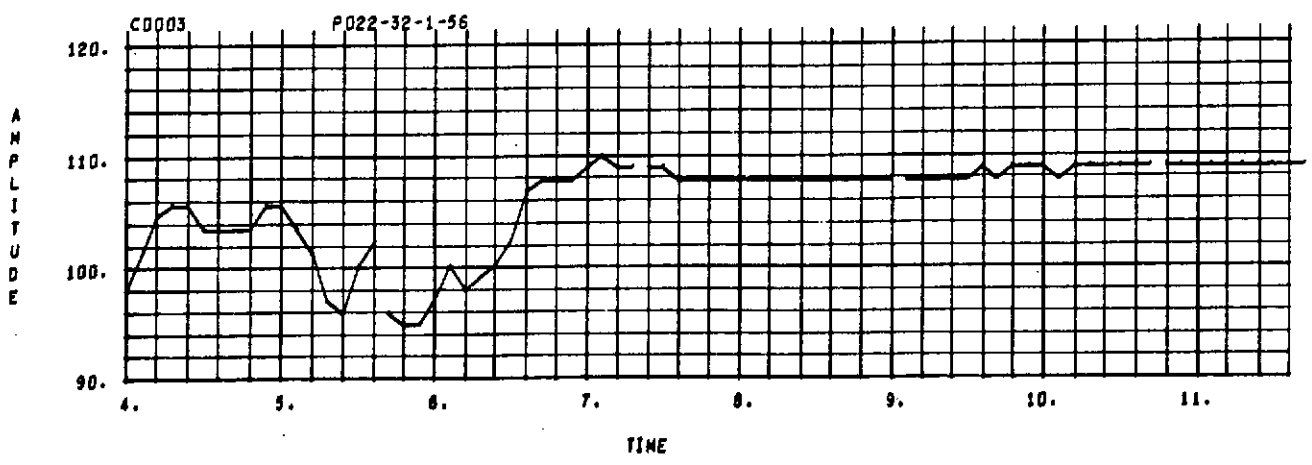
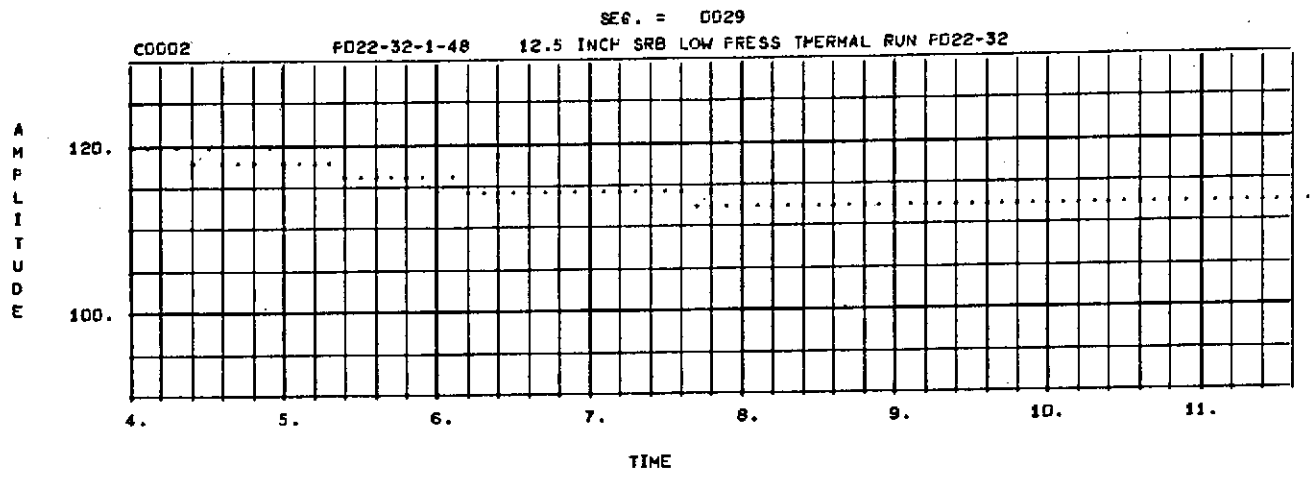
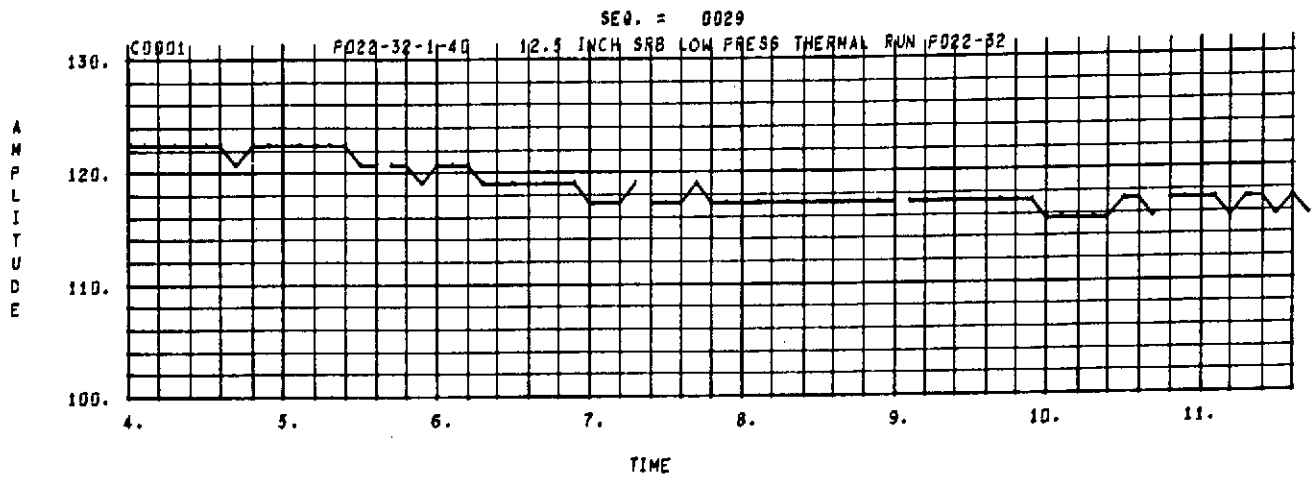

SEQ. = 0029

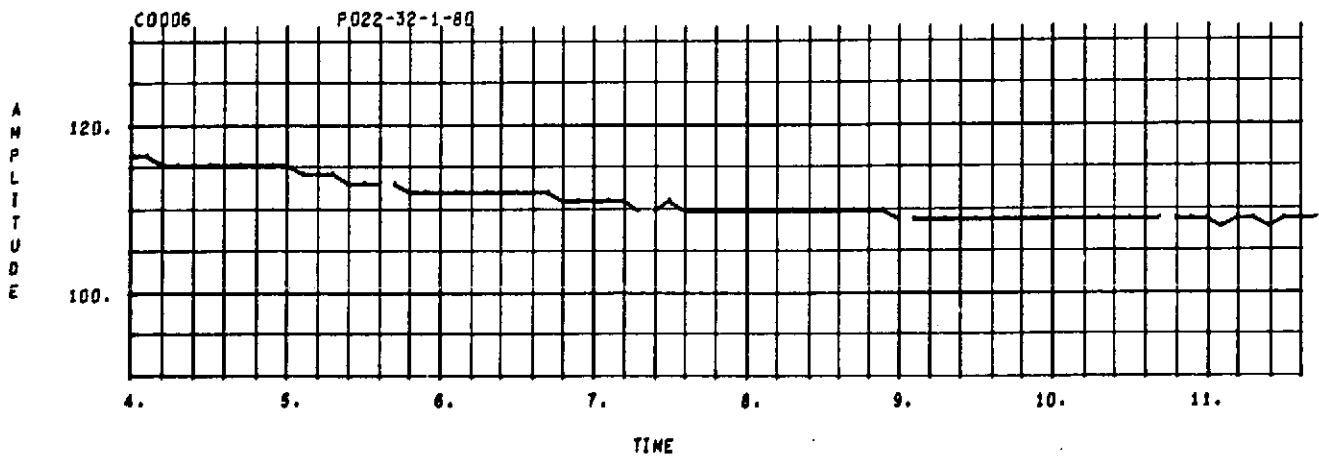
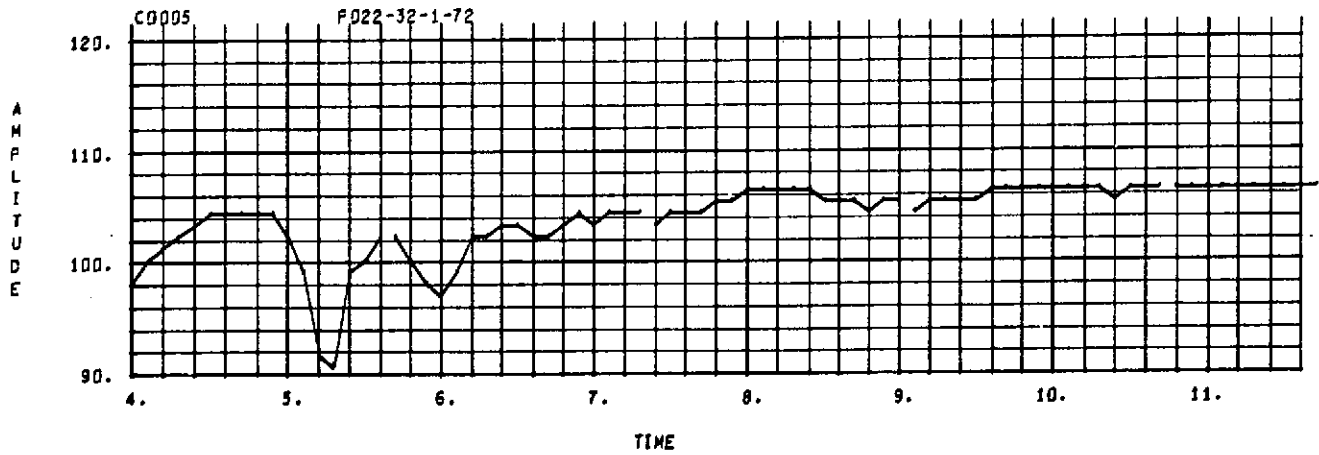
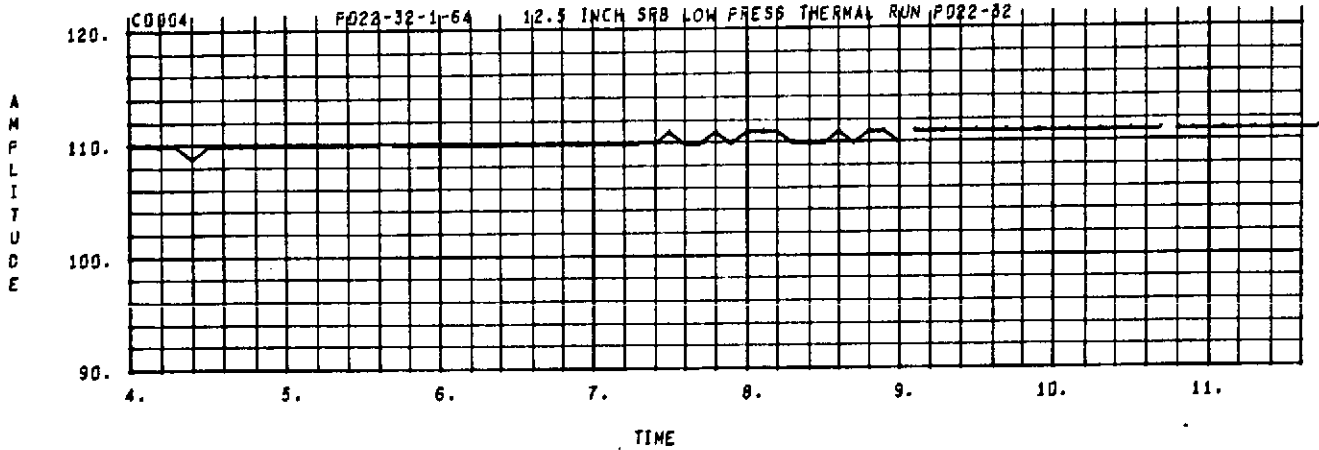

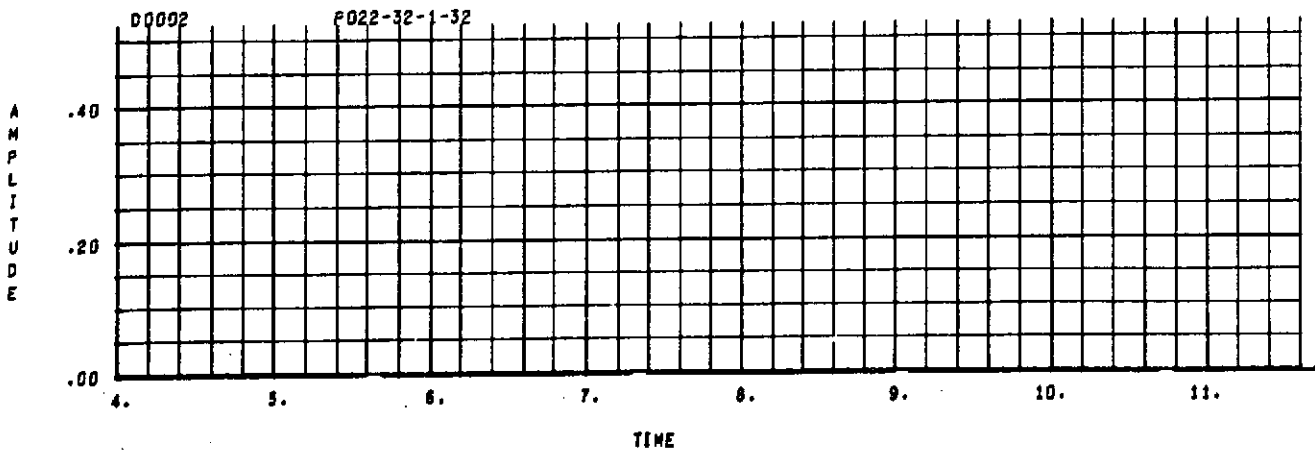
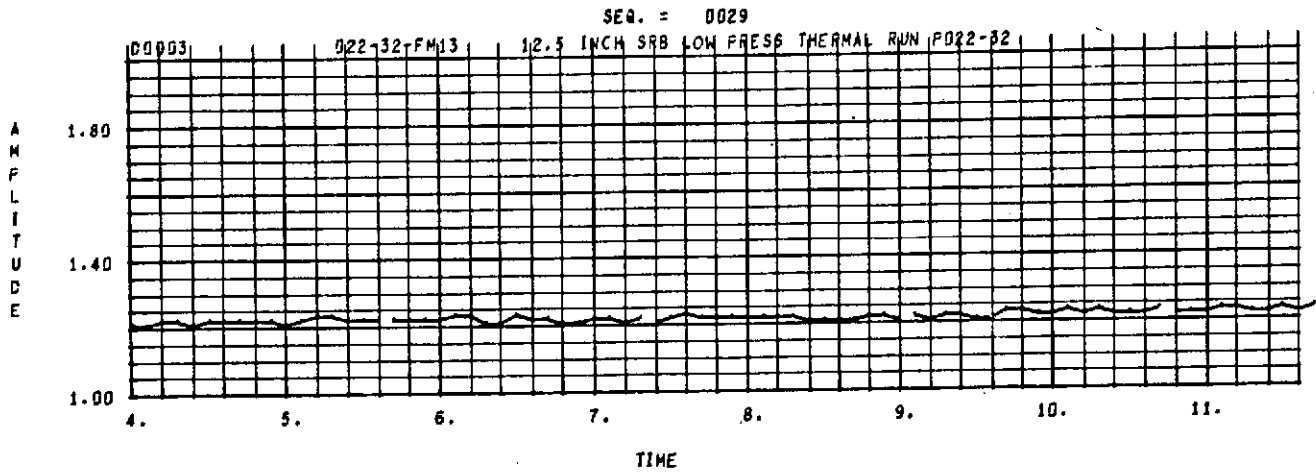
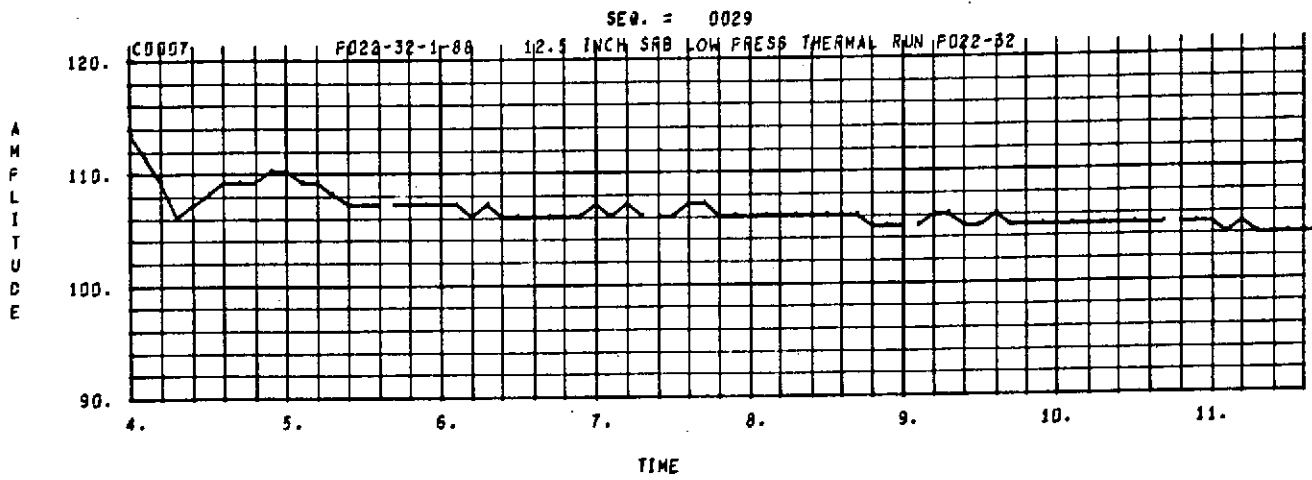

SEQ. = 0030

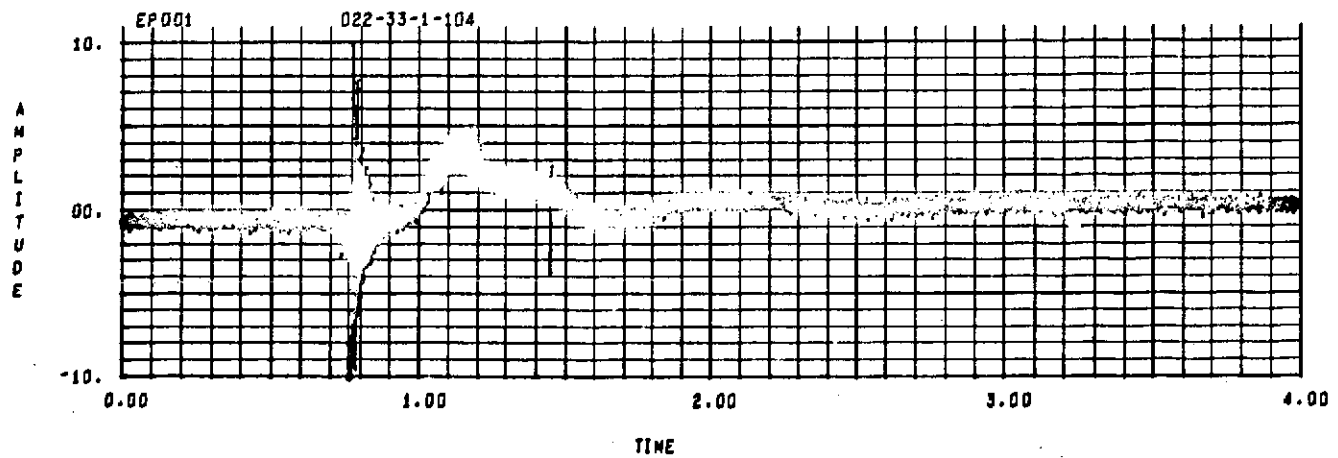
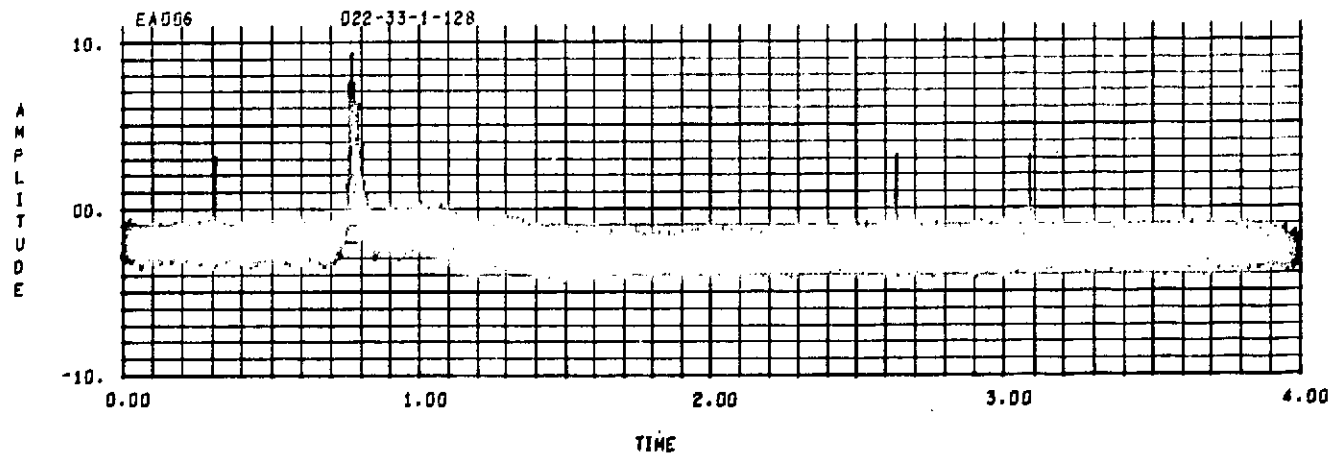
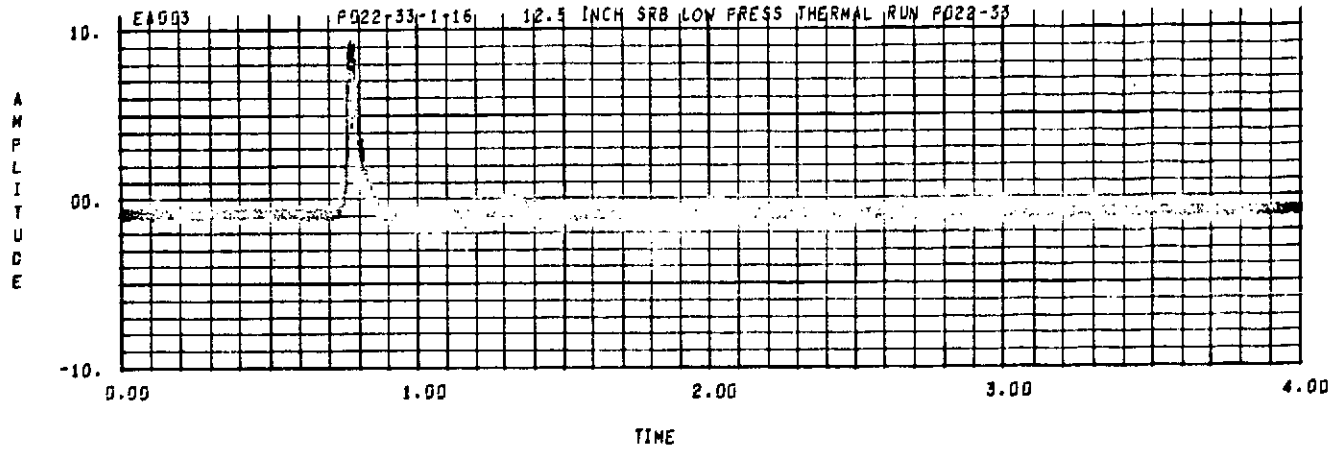

SEQ. = 0030

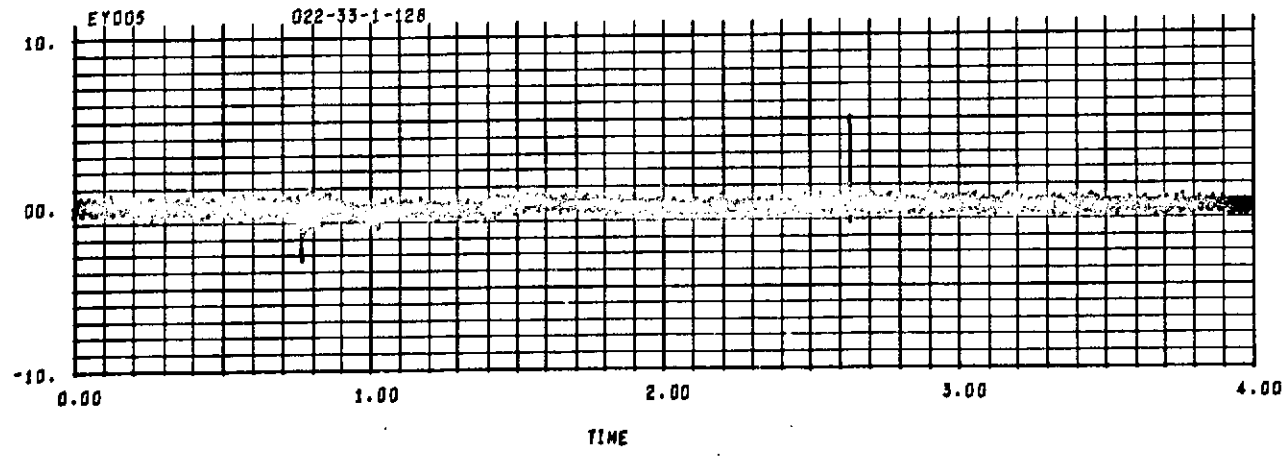
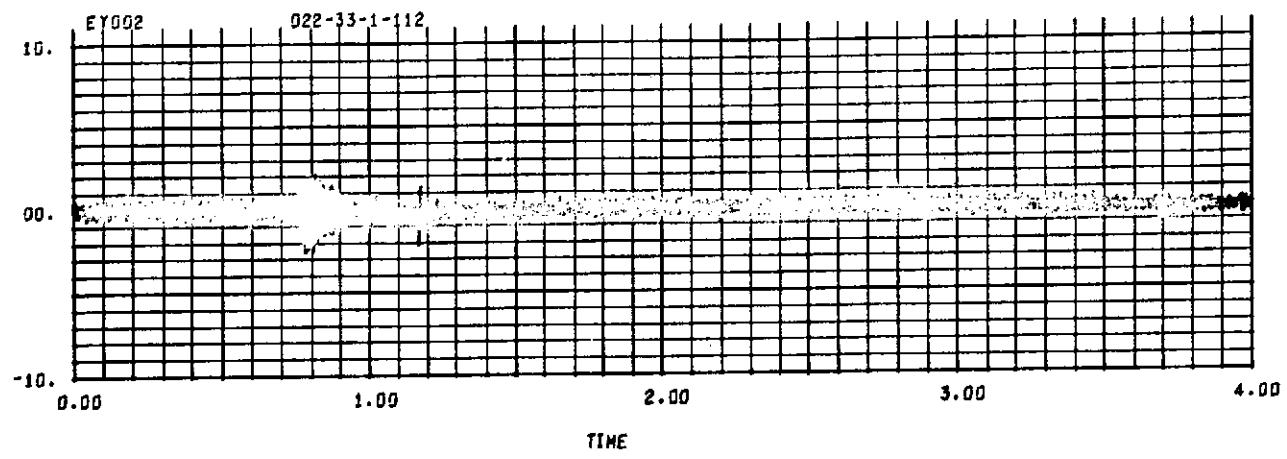
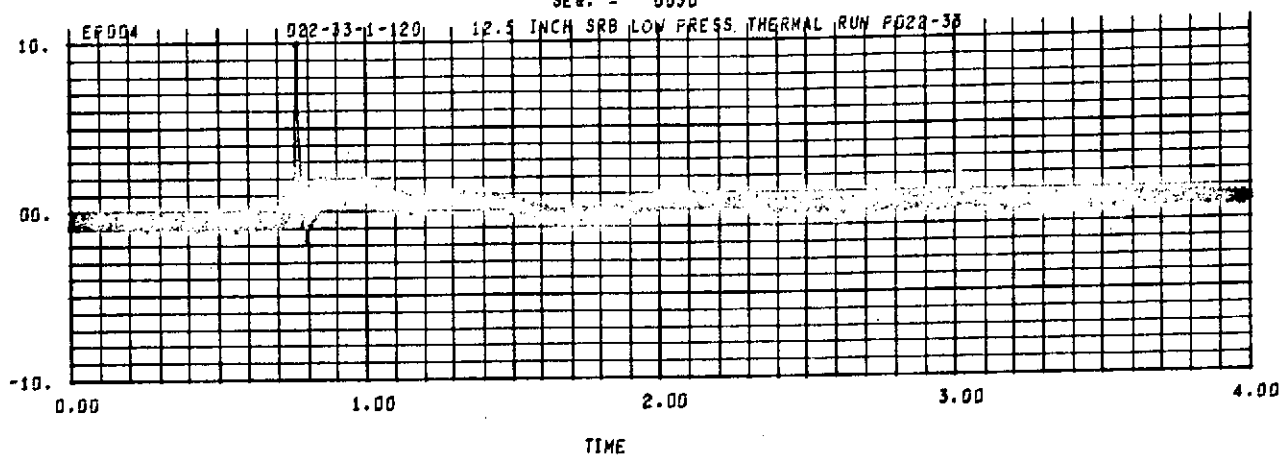

SEQ. = 0030

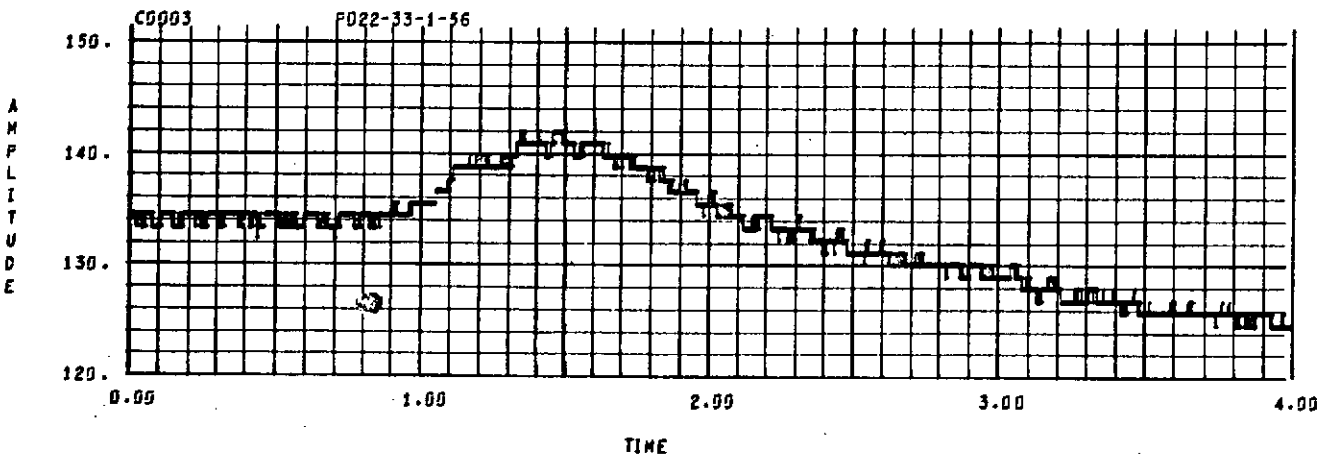
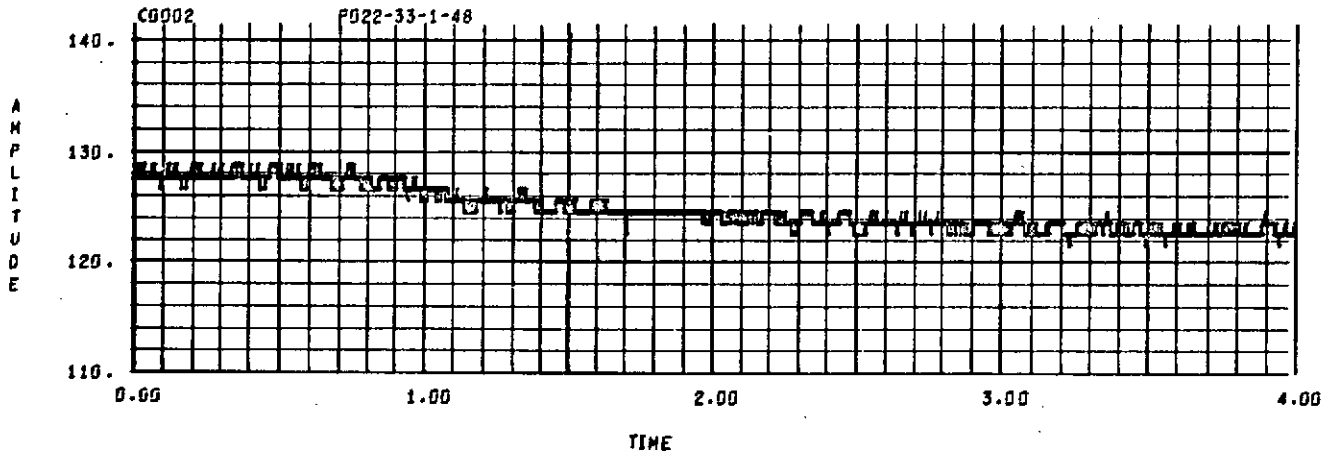
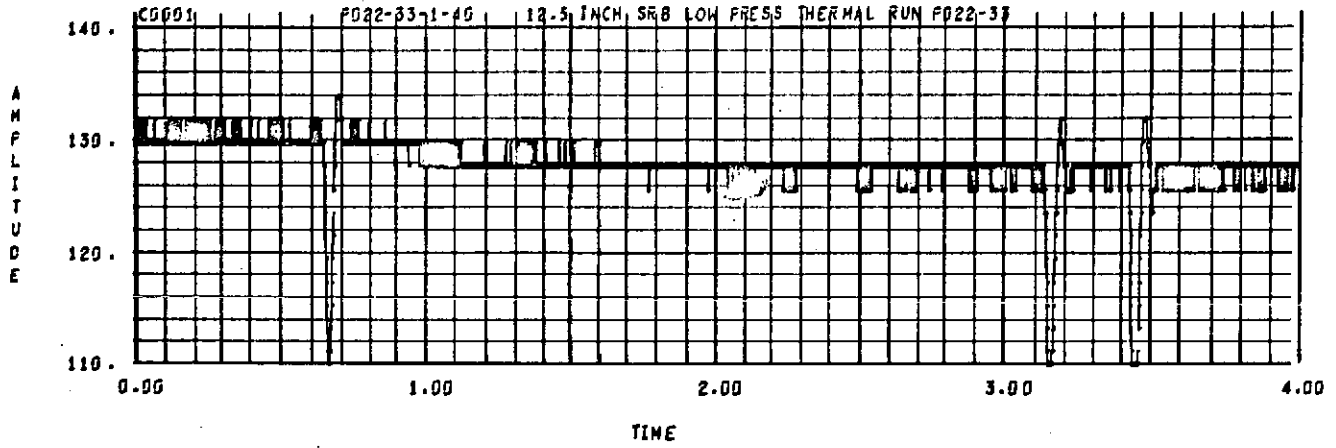

SEQ. = 0030

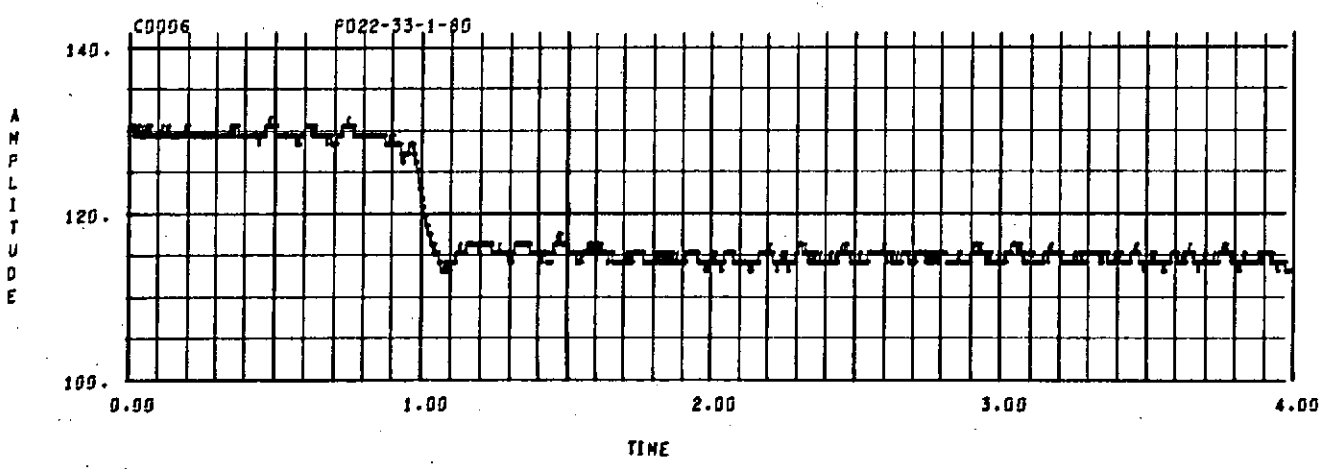
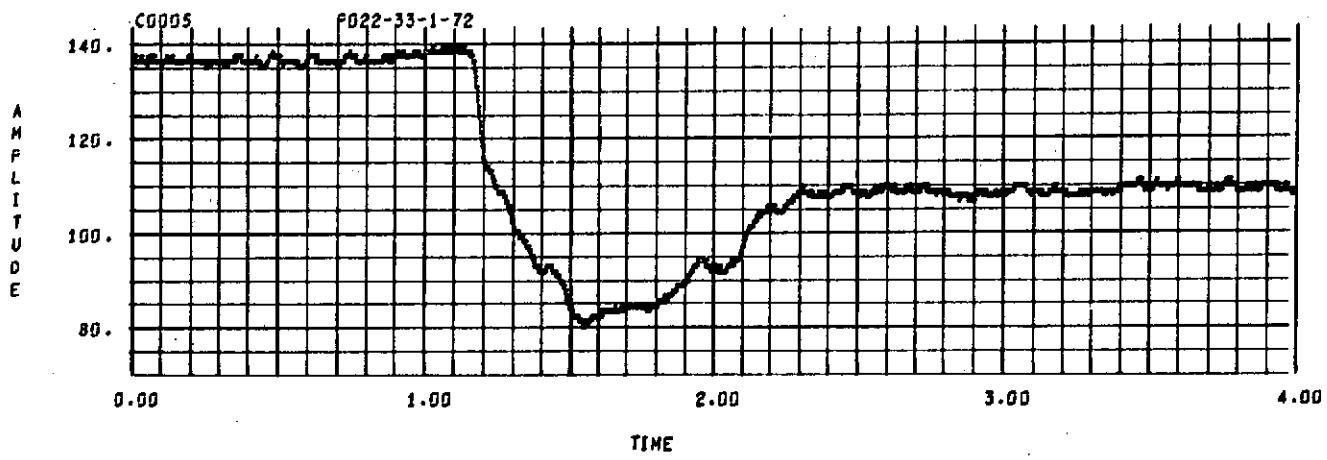
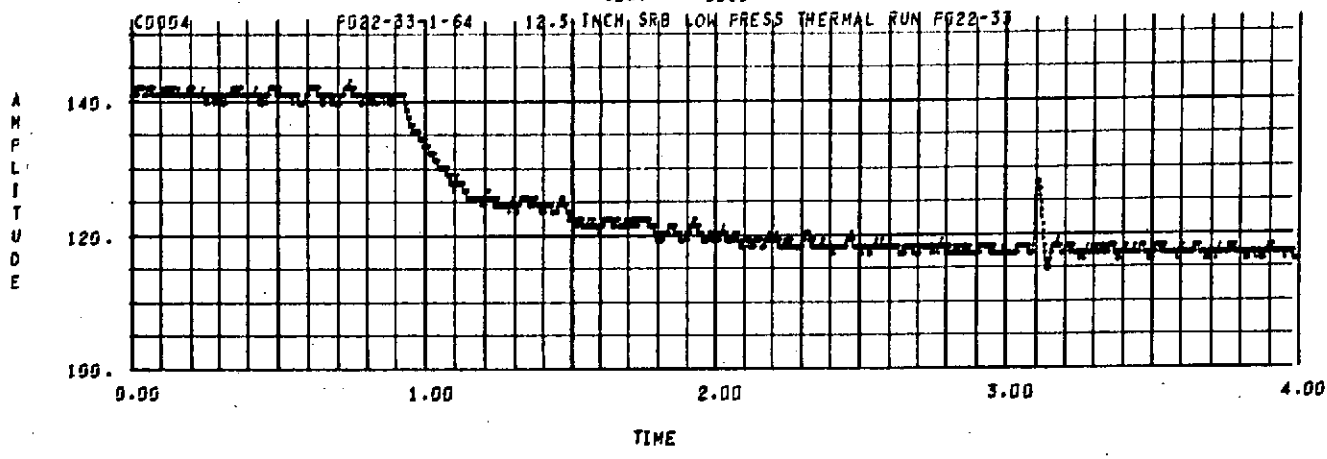

SEQ. = 0030

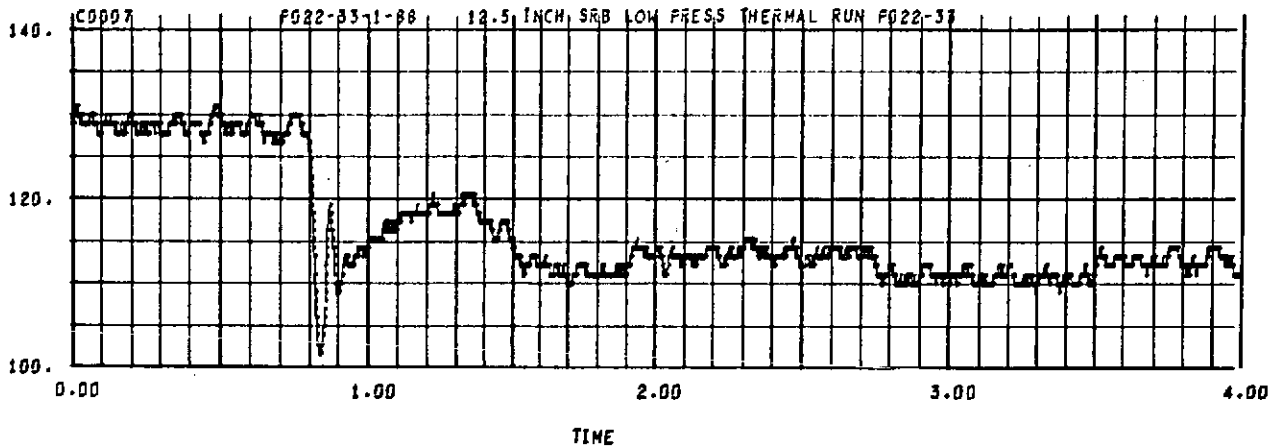

SEQ. = 0030

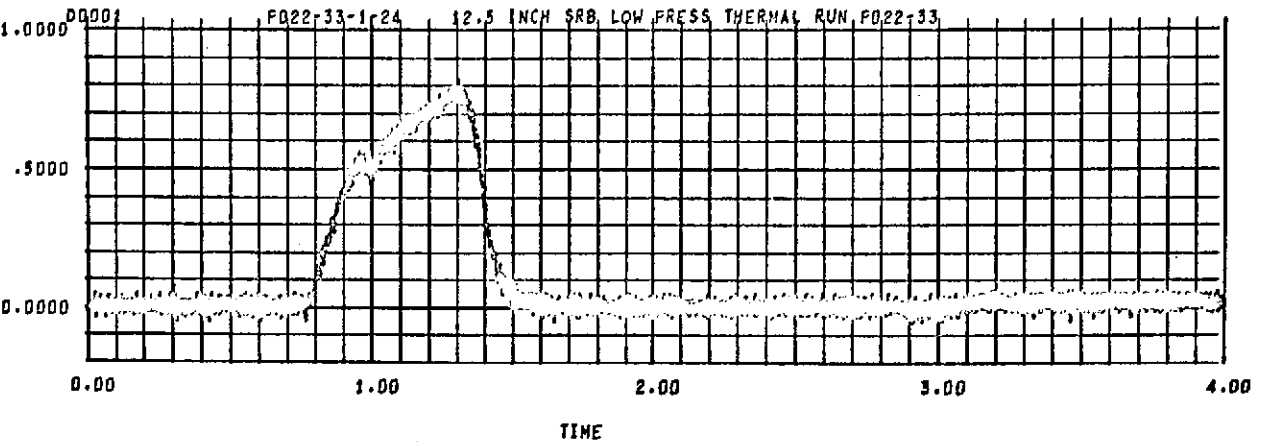

B-22

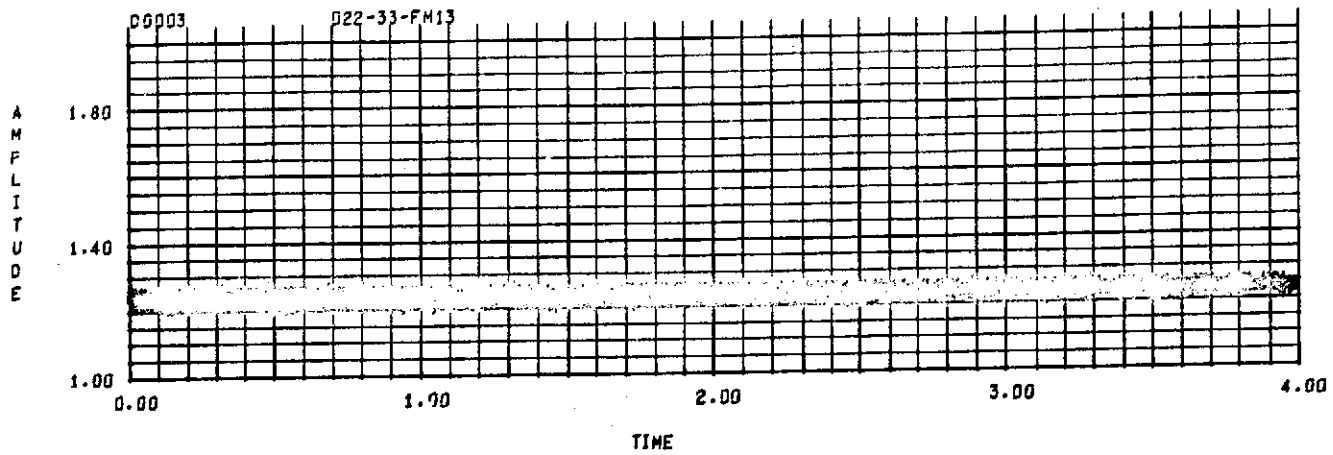

SEQ. = 0030

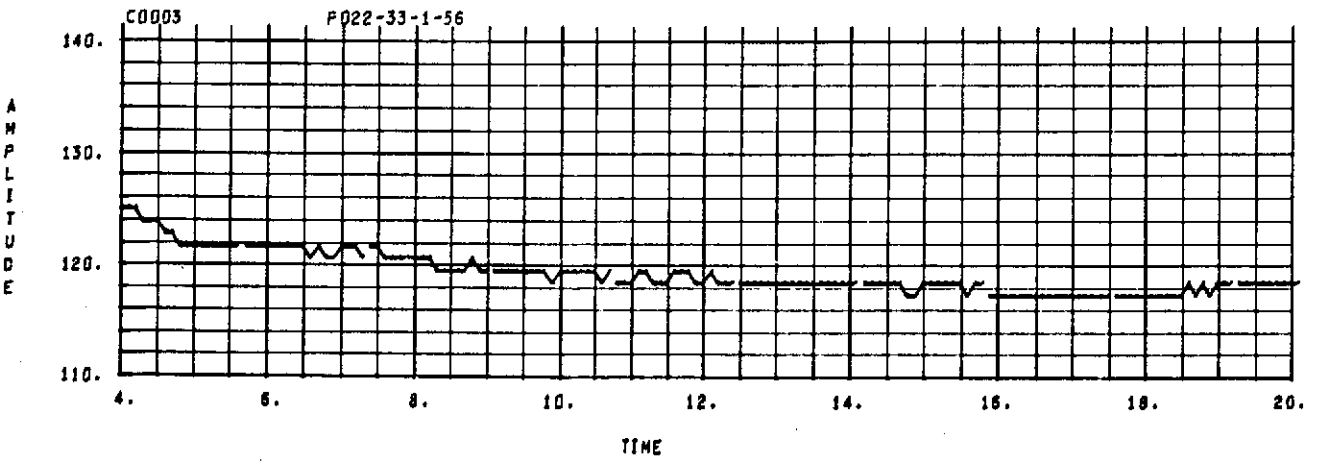
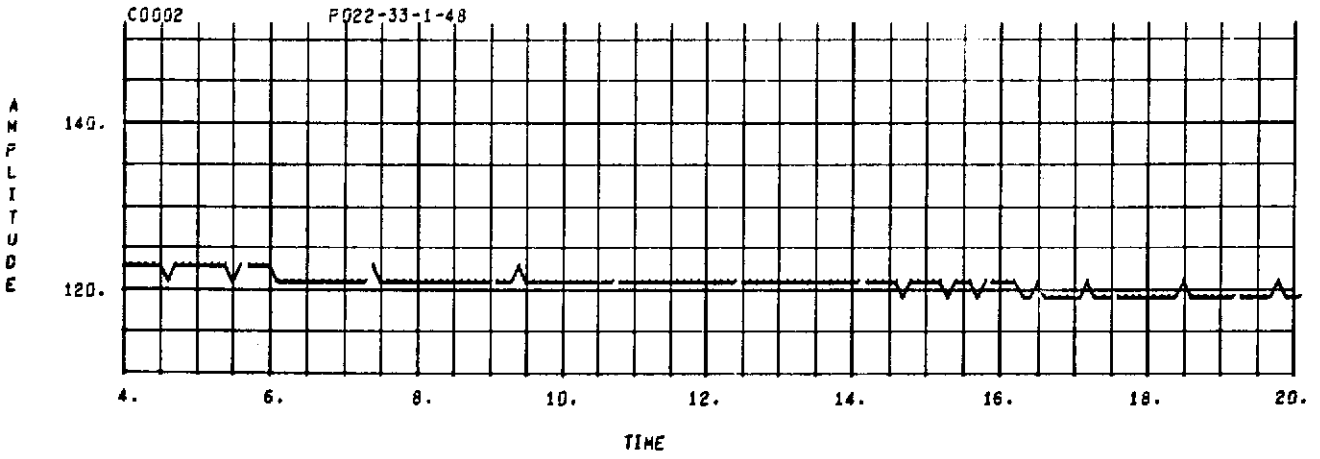
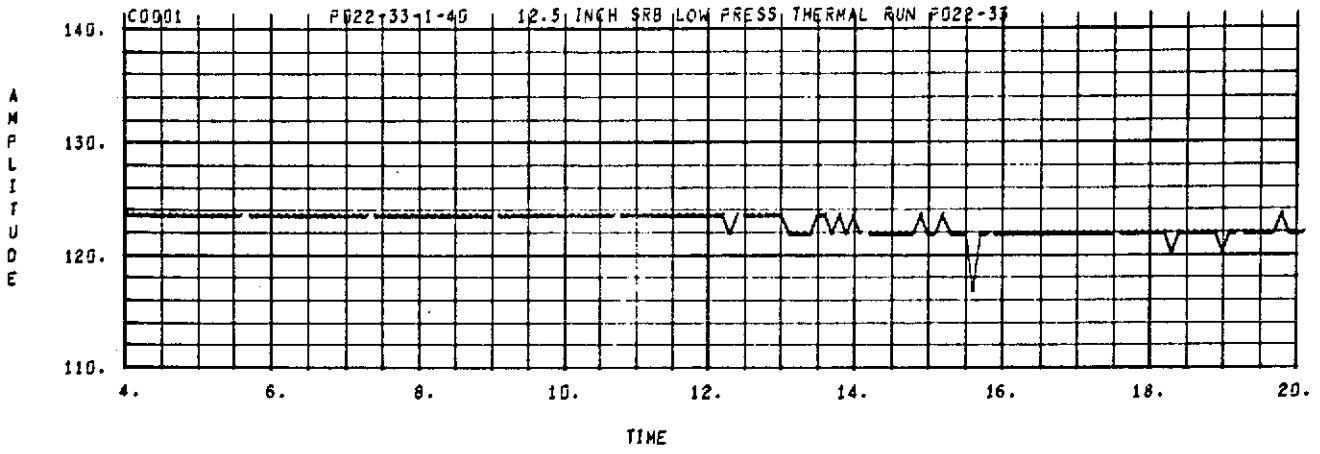

SEQ. = 0030

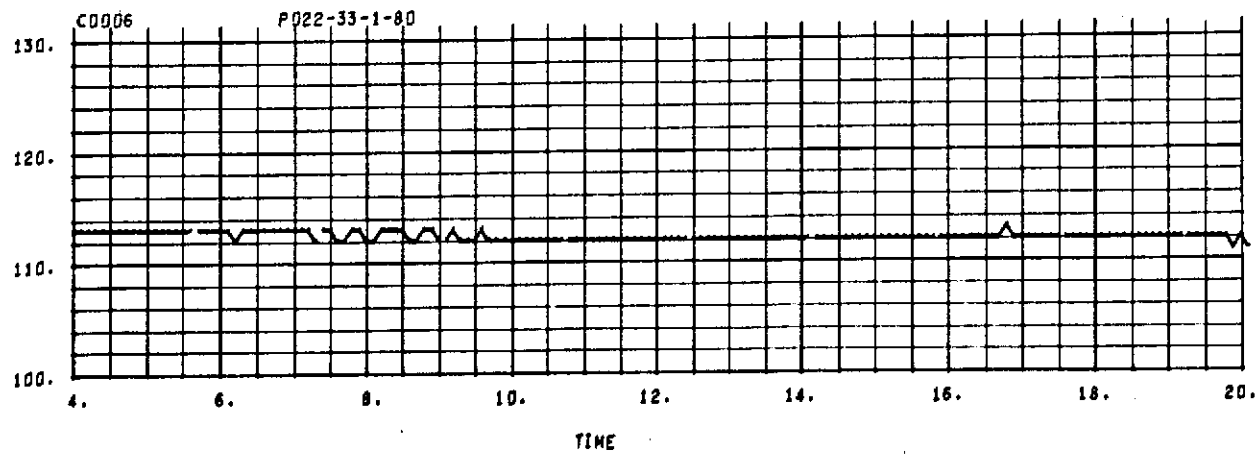
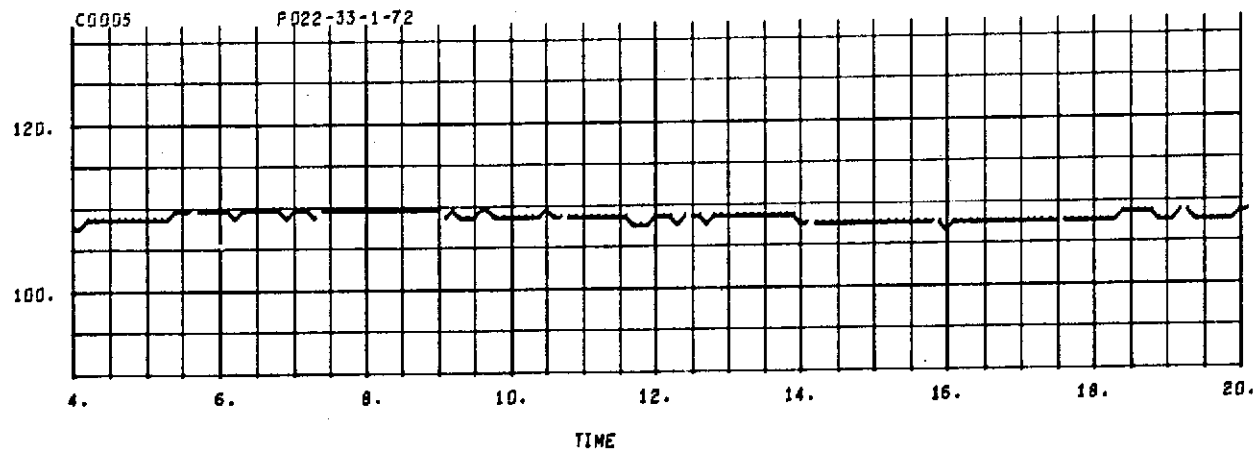
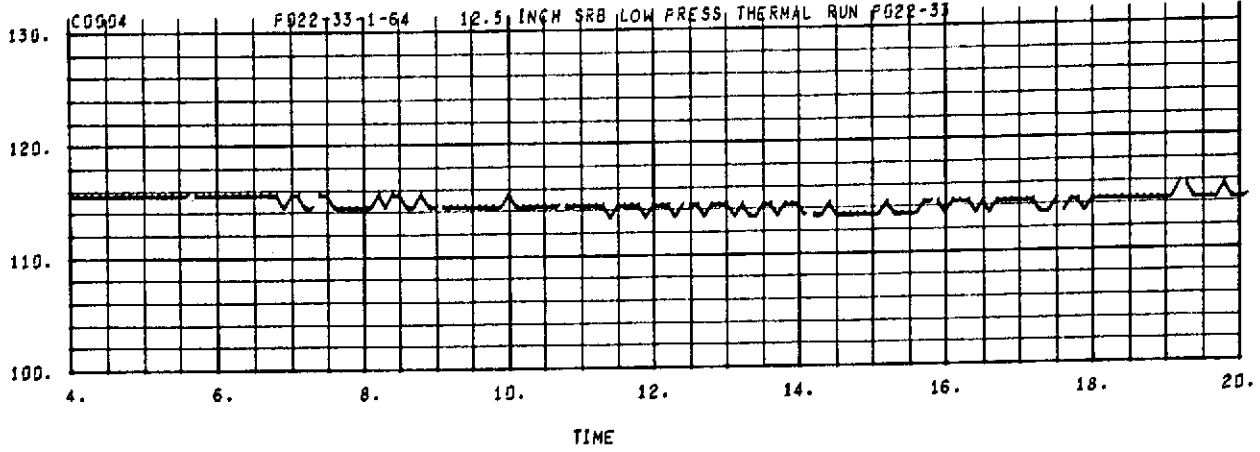

SEQ. = 0030

00001 R022-33-1-24 12.5 INCH SRB, LOW PRESS THERMAL RUN P022-33

A
M
P
L
I
T
U
D
E

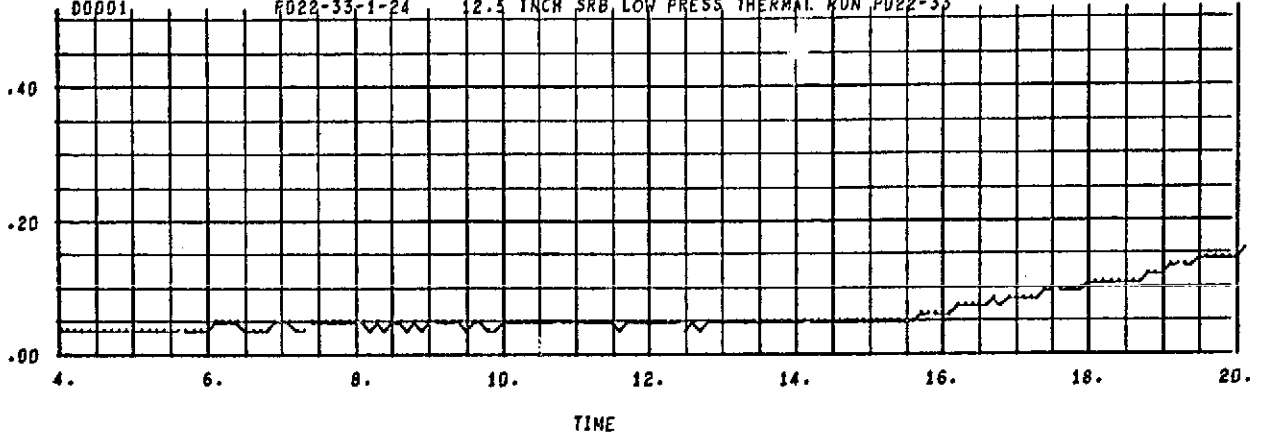

00003 022-33-FM13

A
M
P
L
I
T
U
D
E

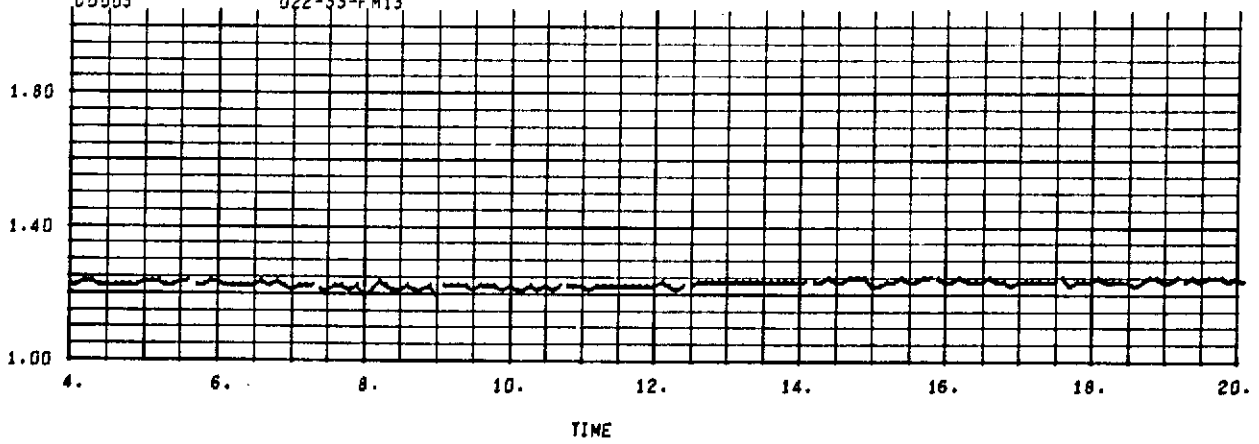

SEQ. = 0030

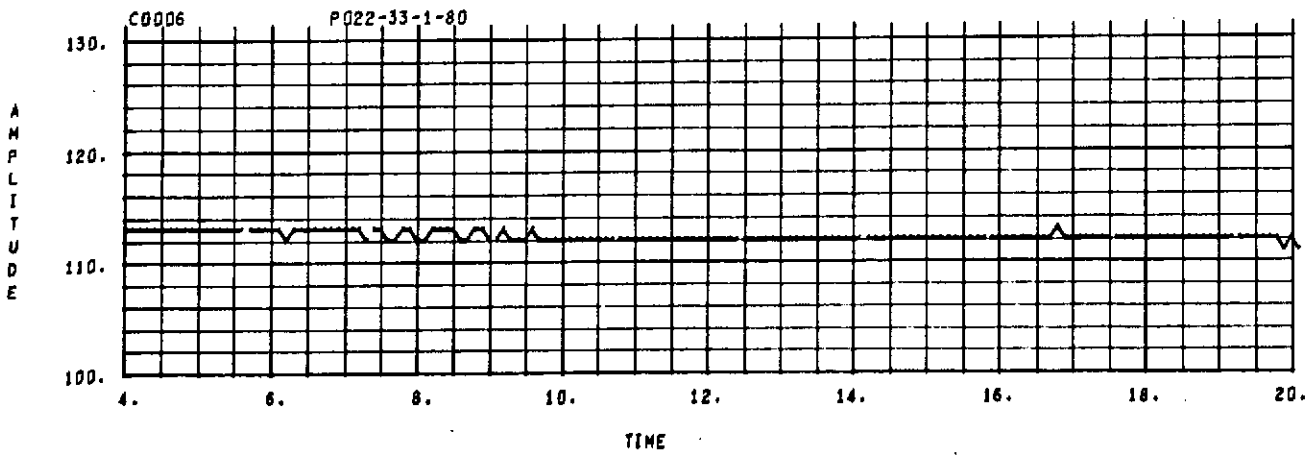
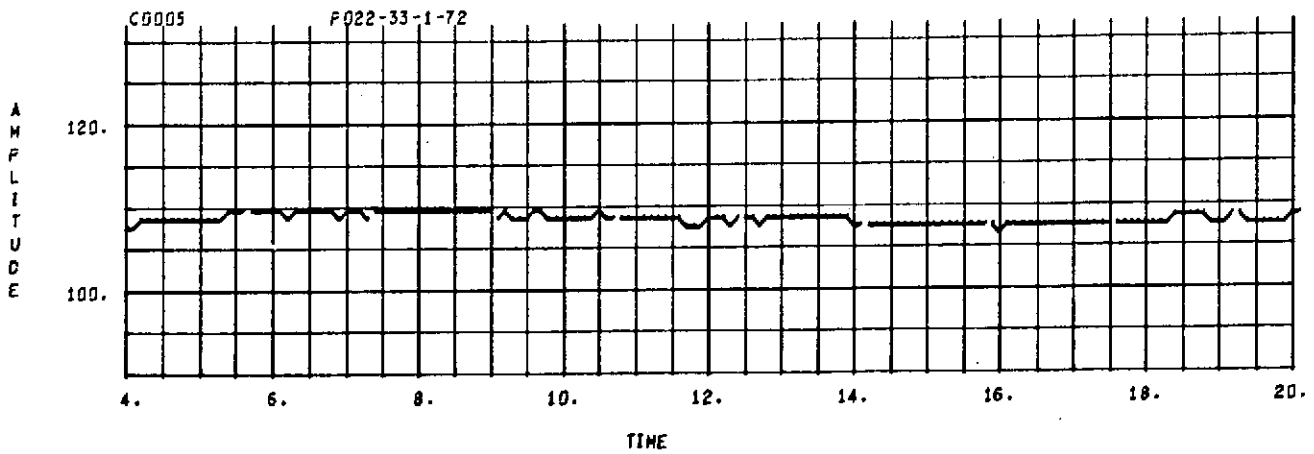
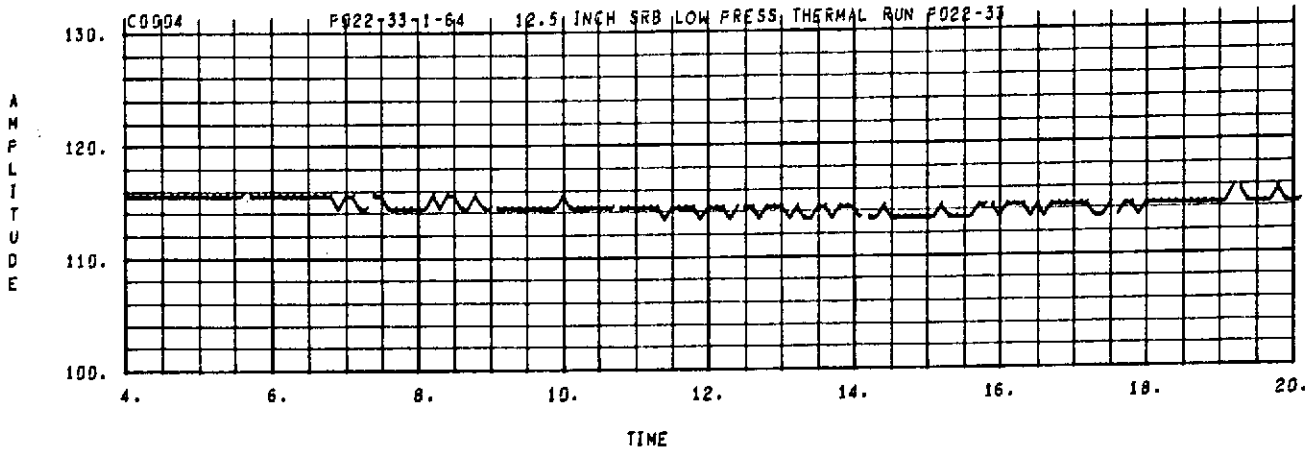

SEQ. = 0030

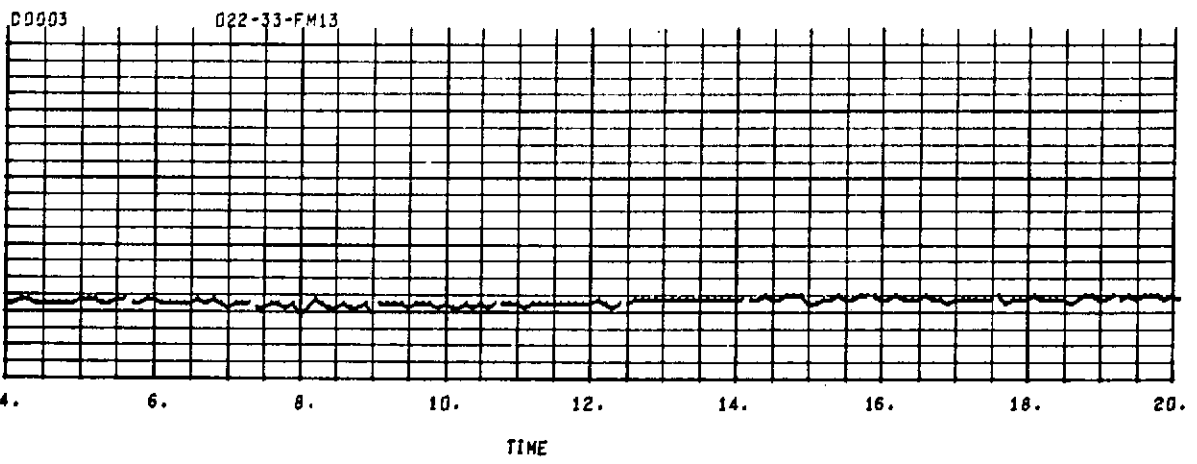
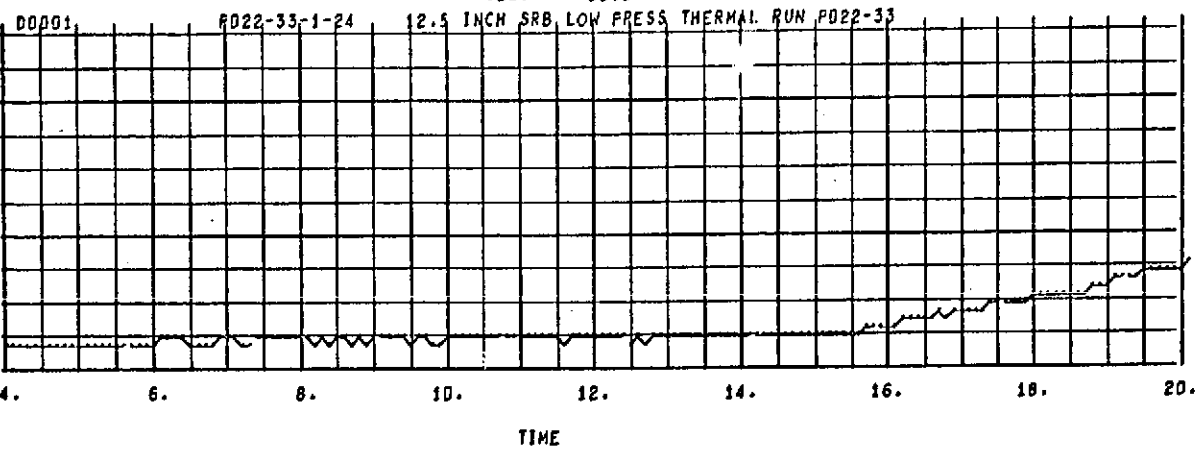



SEQ. = 0031

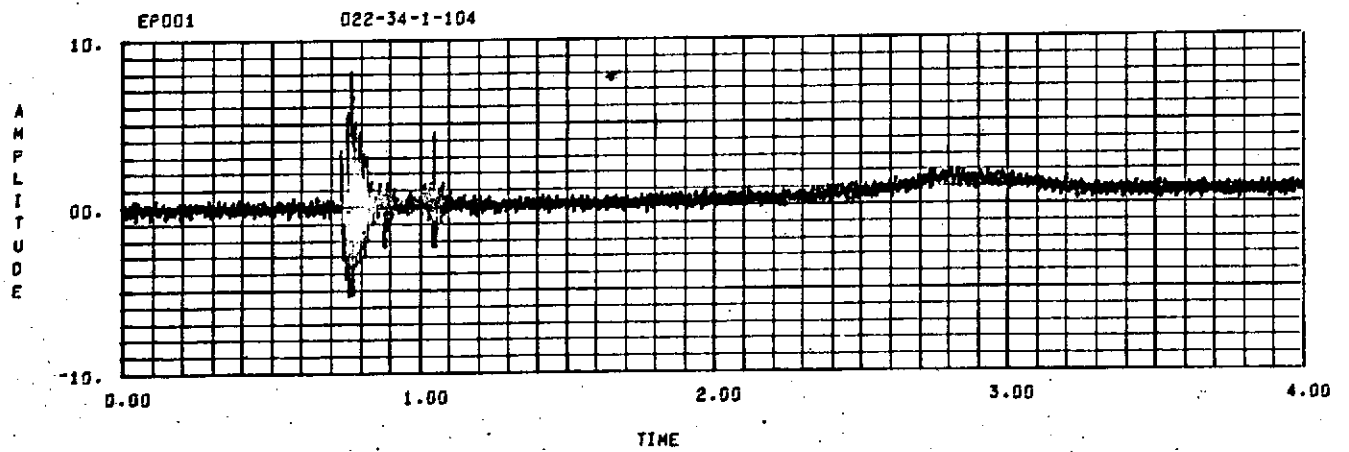
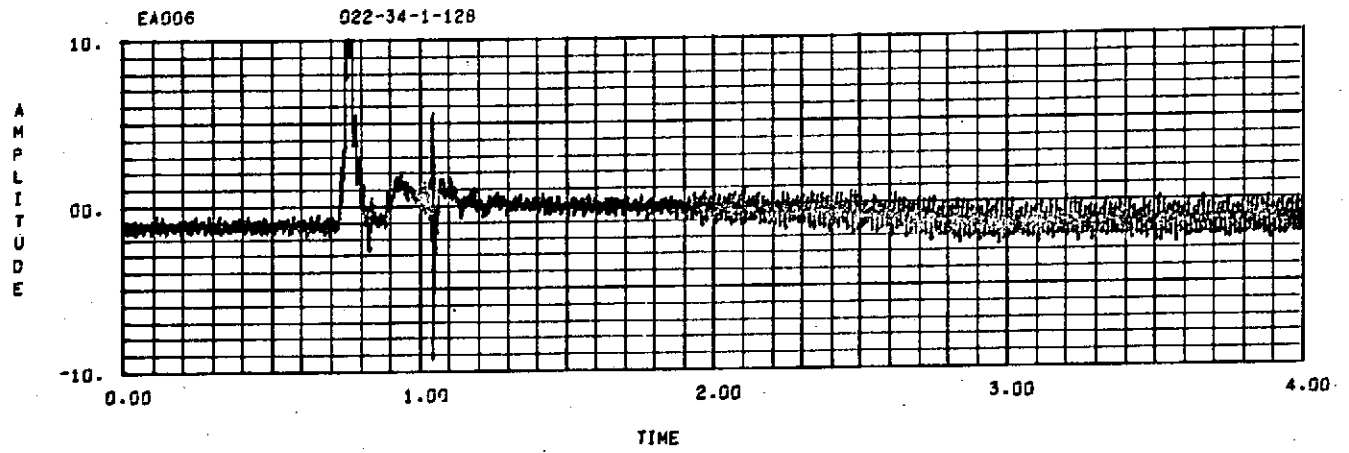
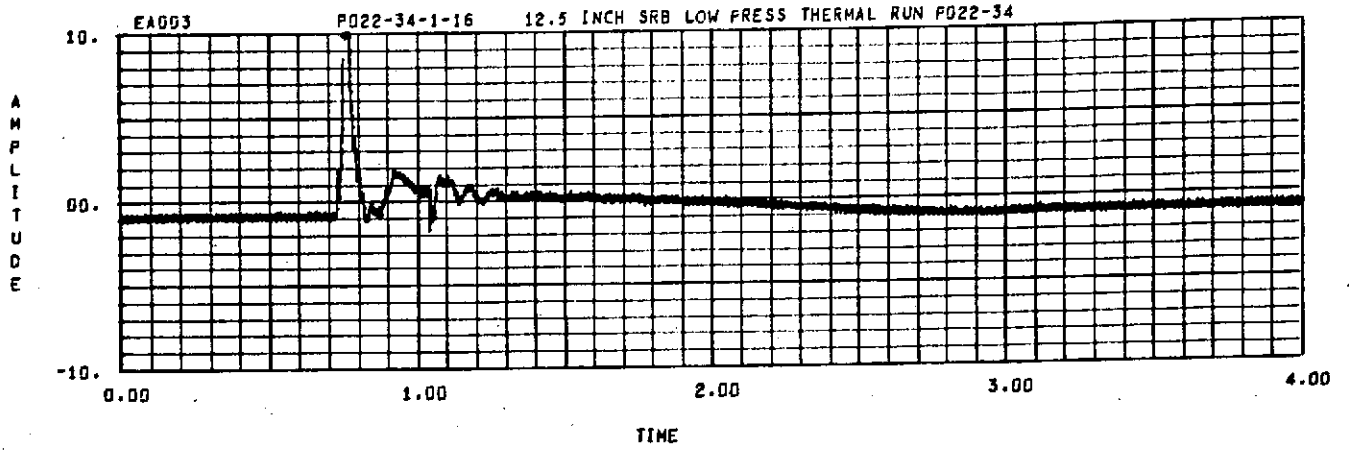

SEQ. = 0031

EP004 022-34-1-120 12.5 INCH SRB LOW PRESS THERMAL RUN F022-34

A
M
P
L
I
T
U
D
E

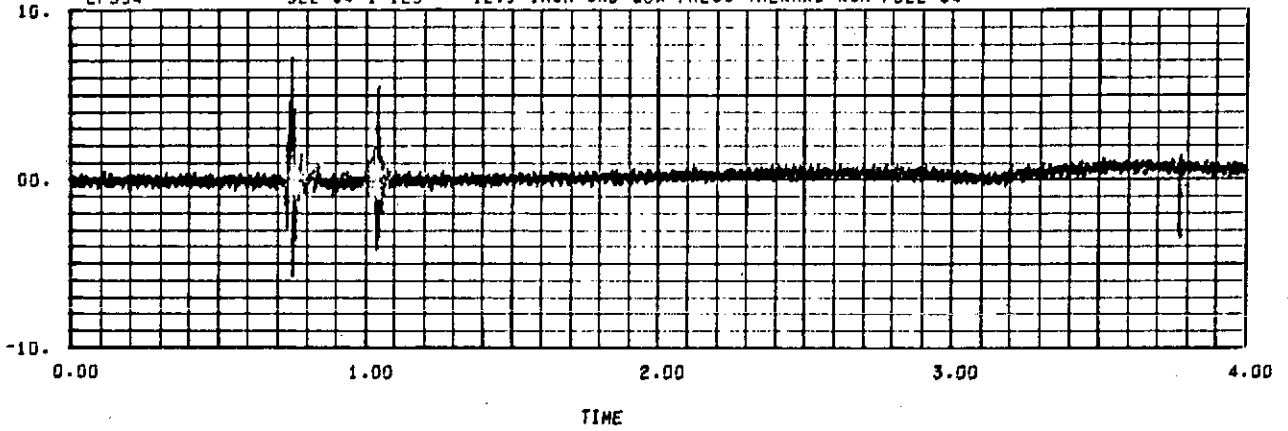

EY002 022-34-1-112

A
M
P
L
I
T
U
D
E



EY005 022-34-1-128

A
M
P
L
I
T
U
D
E

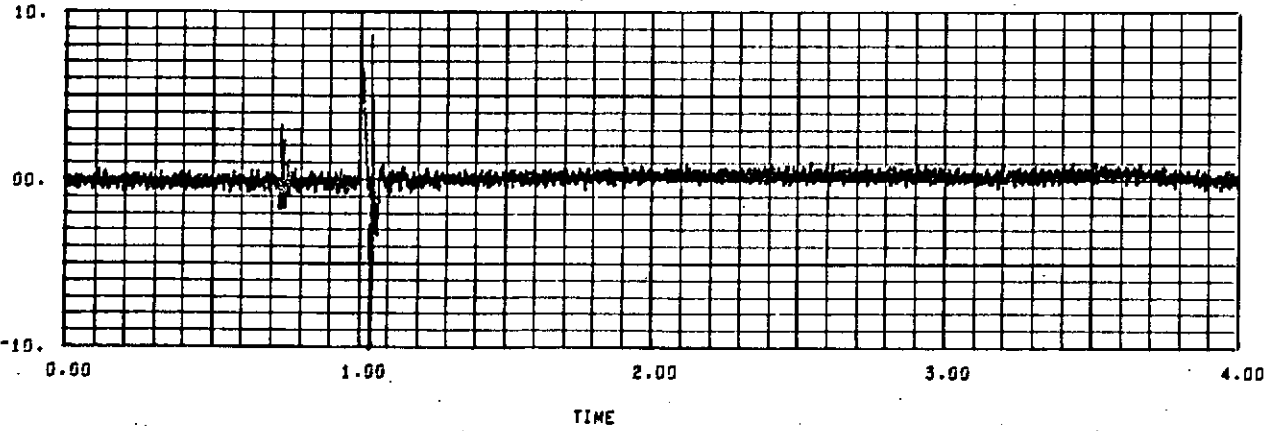

SEQ. = 0031

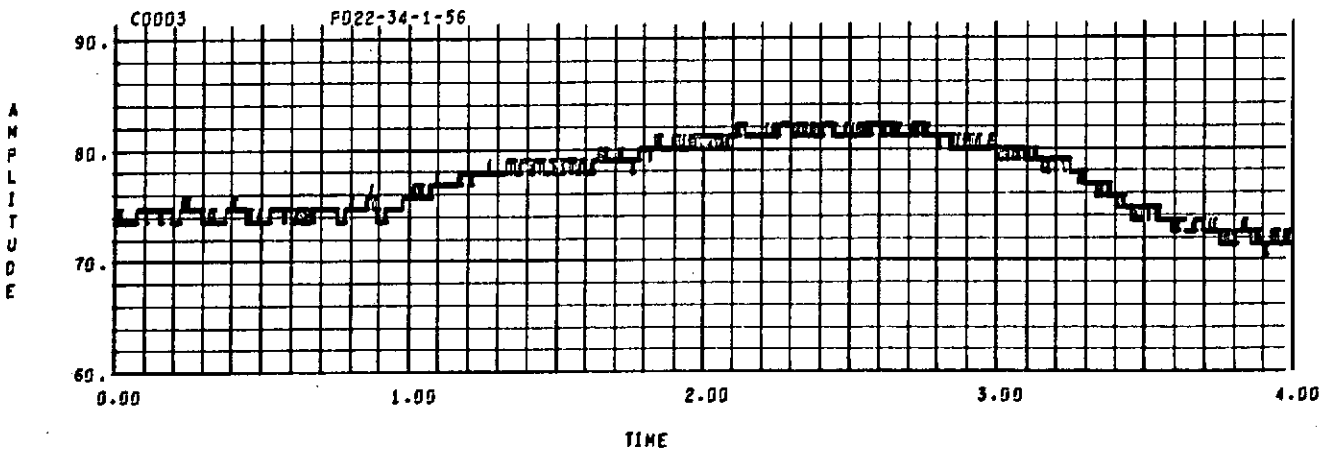
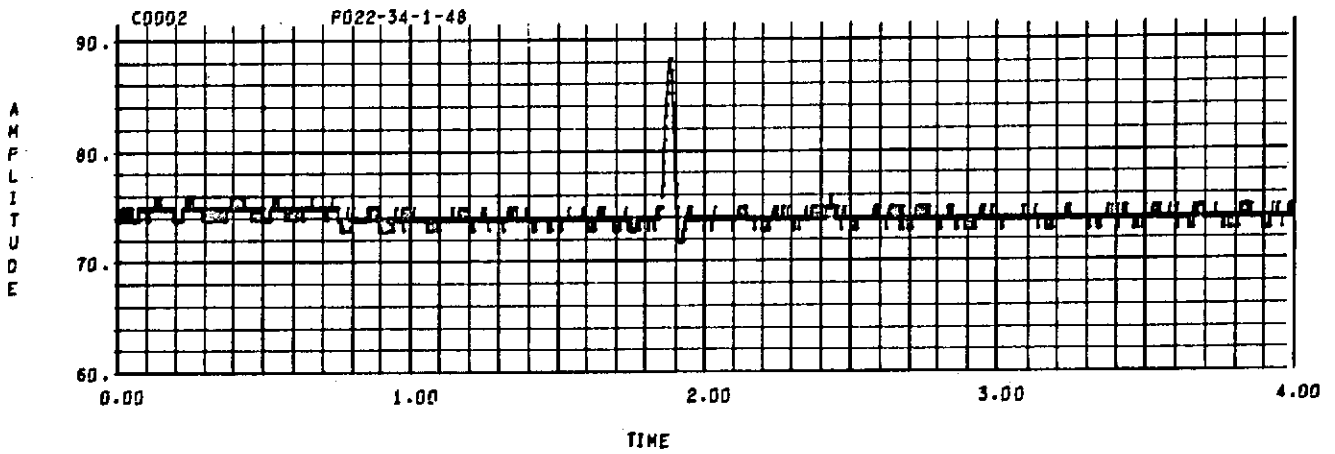
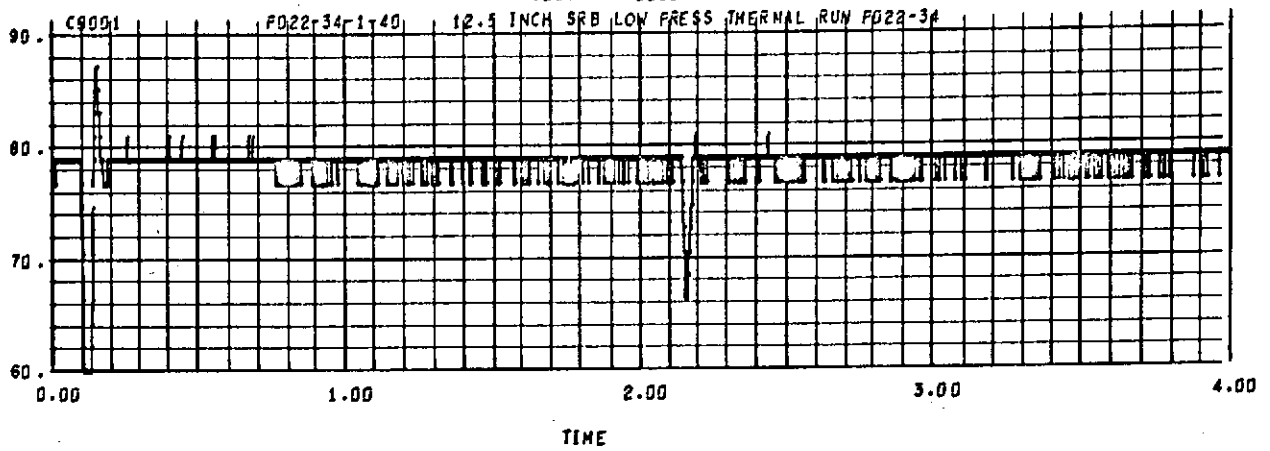

SEQ. = 0031

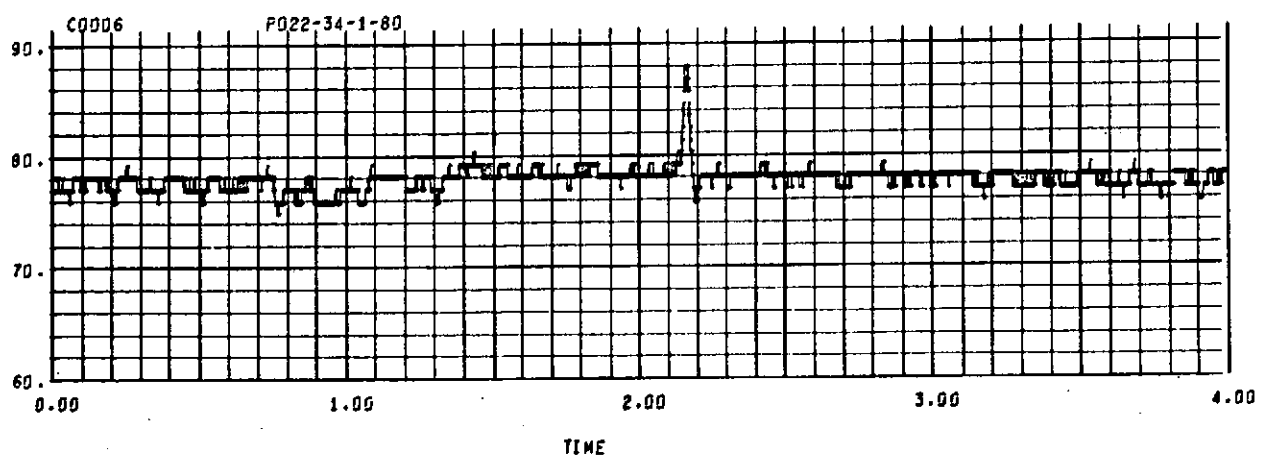
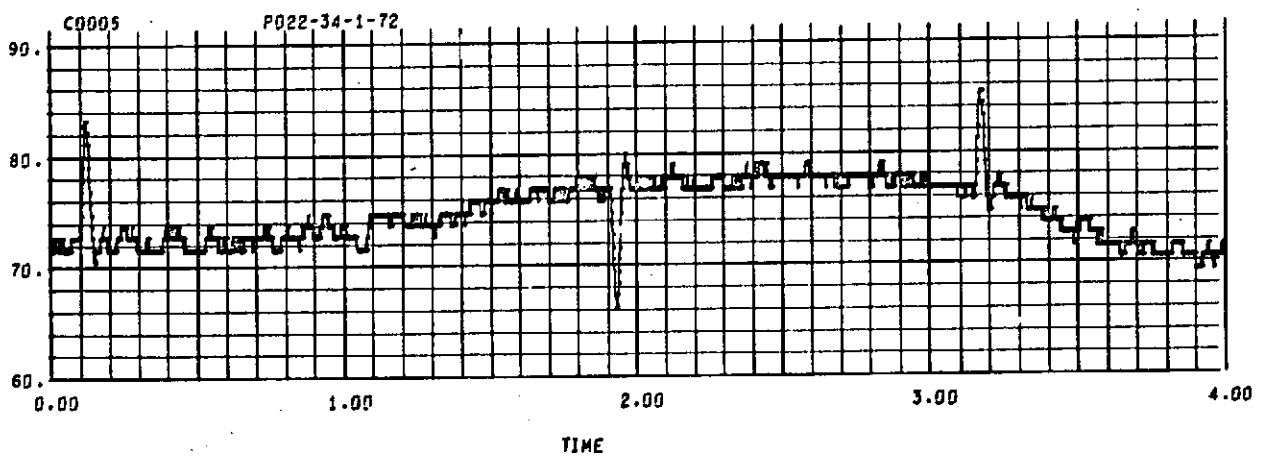
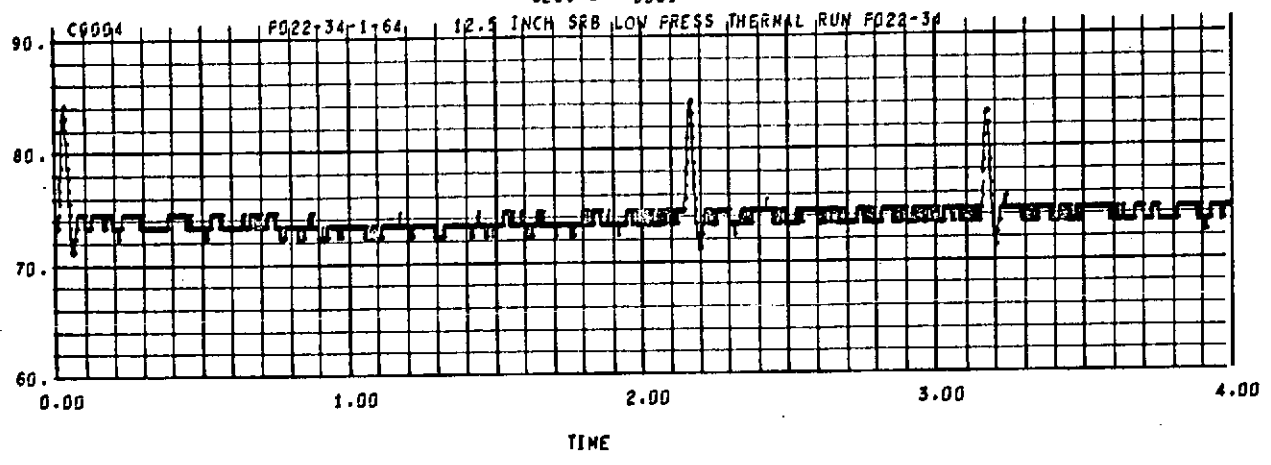

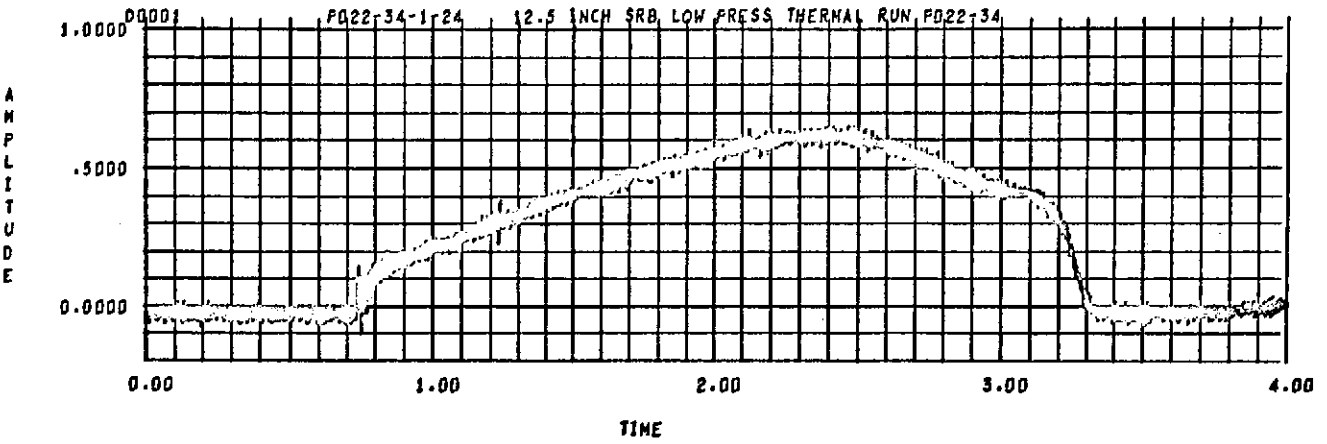
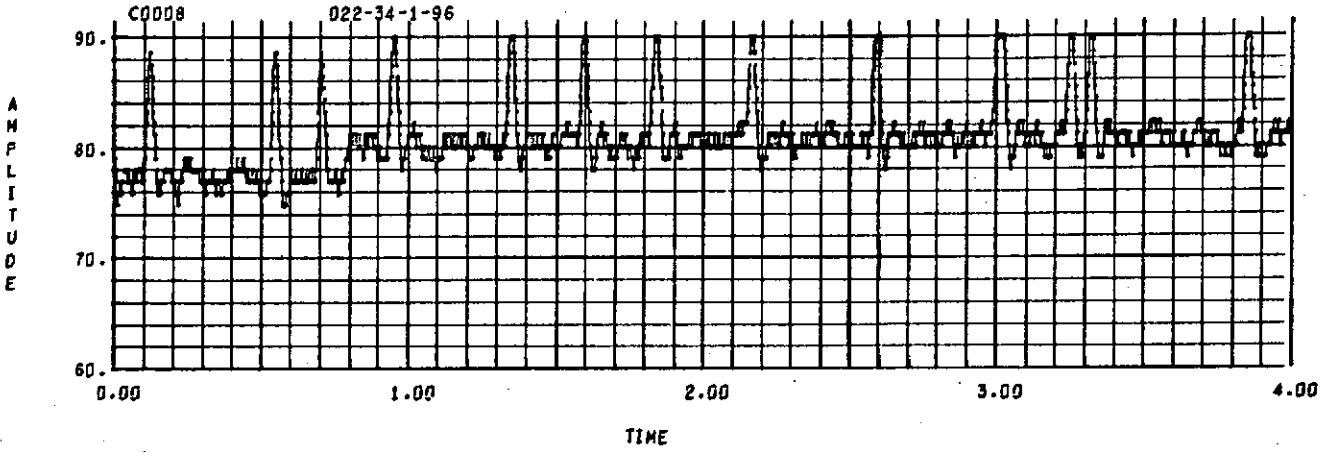
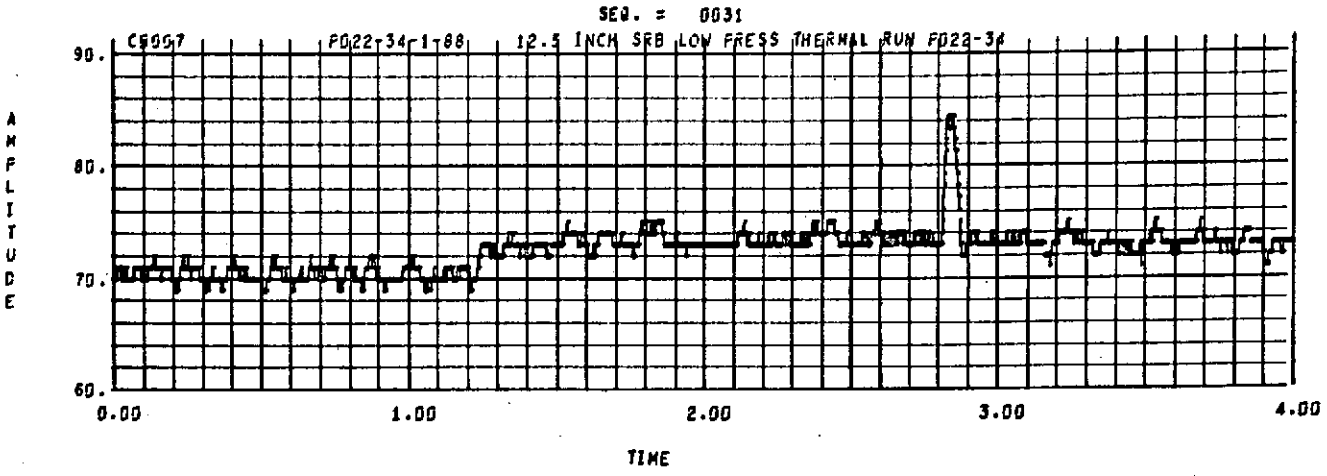

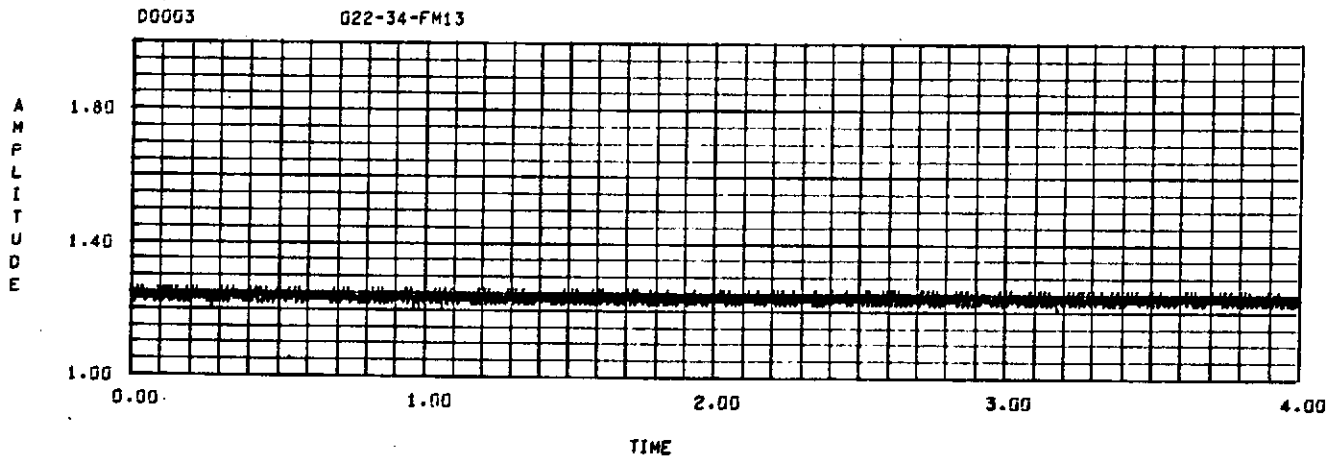
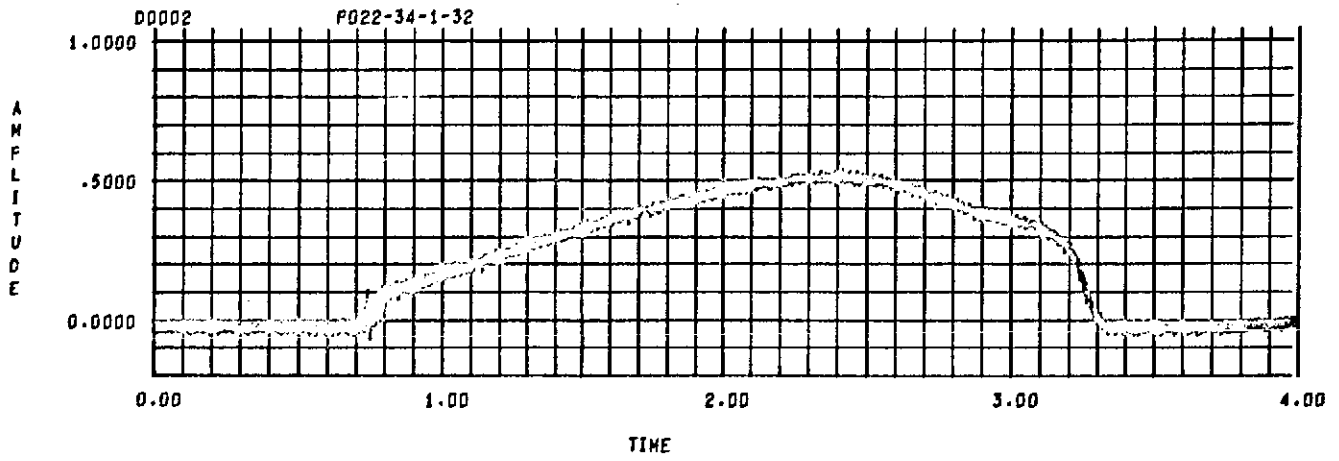



SEQ. = 0031

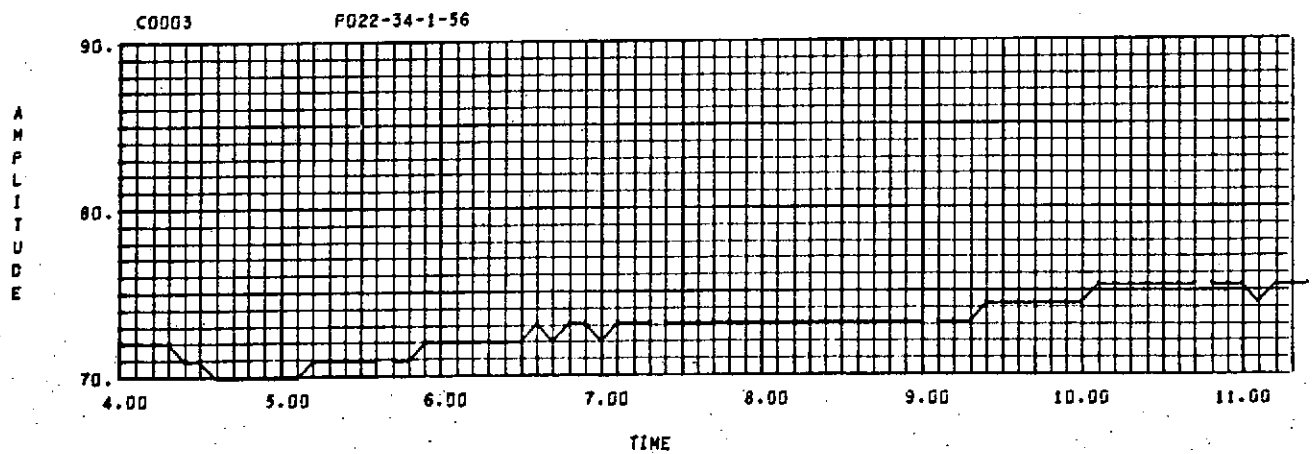
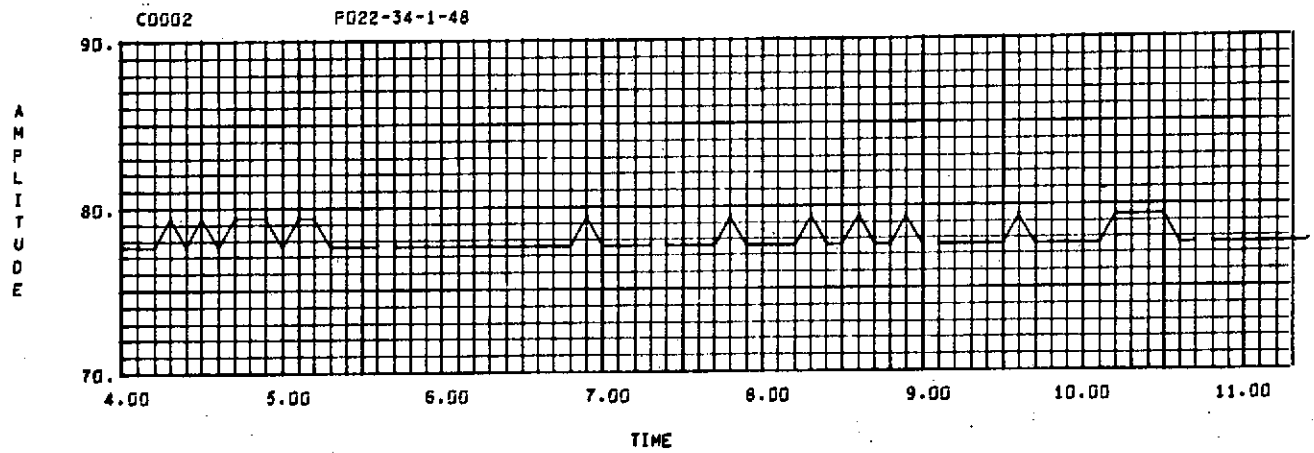
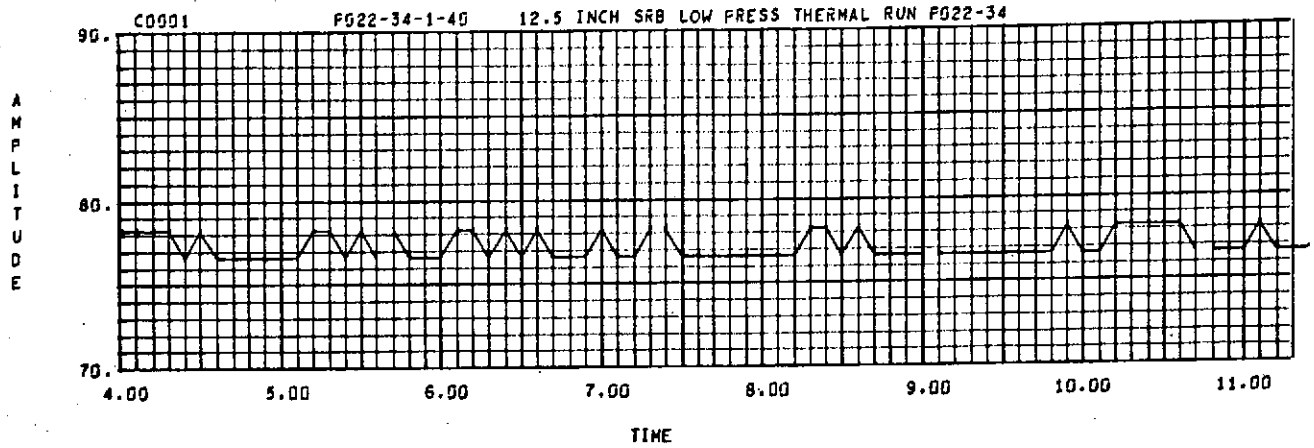



SEQ. = 0031

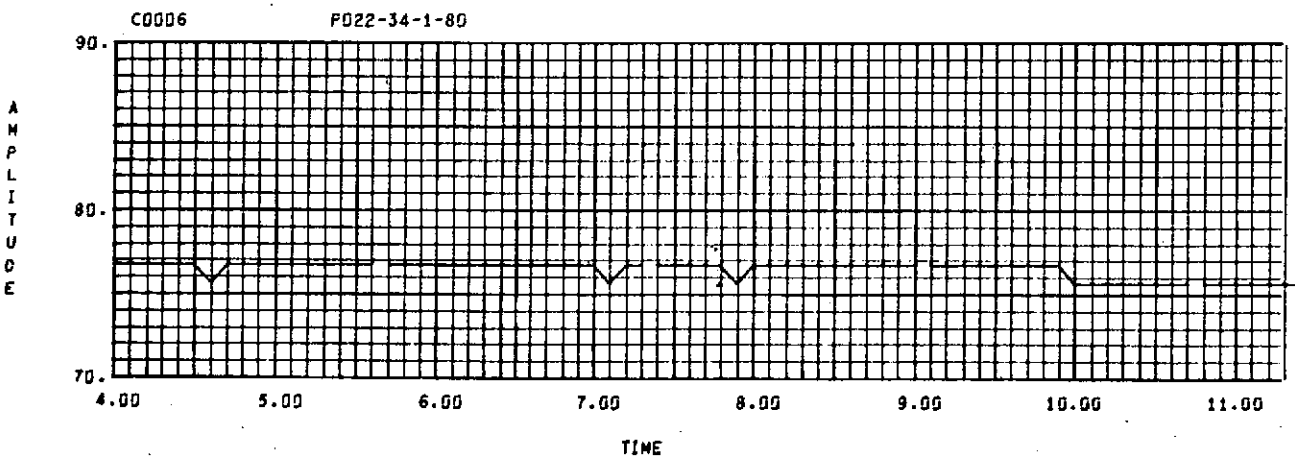
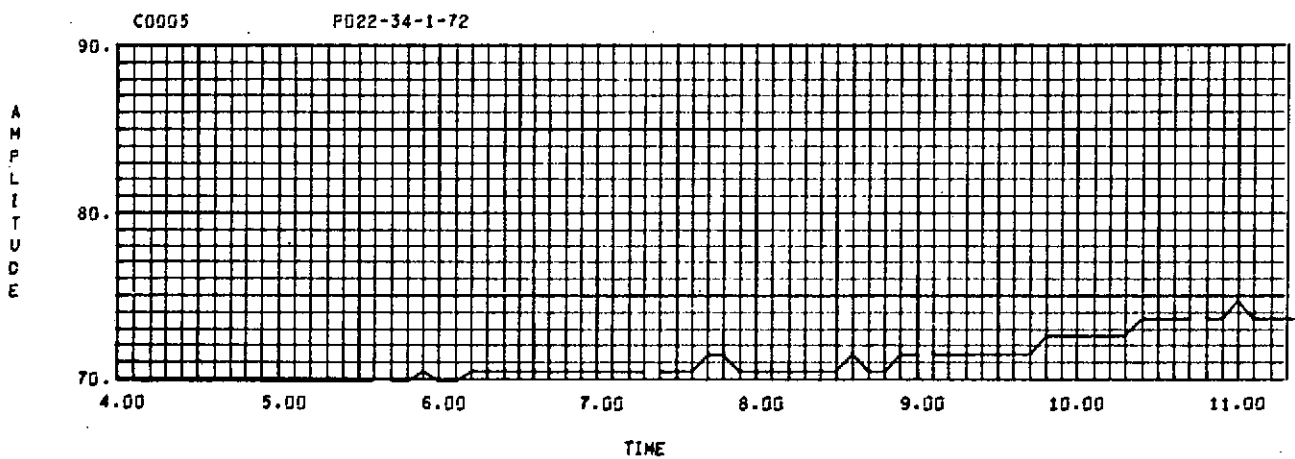
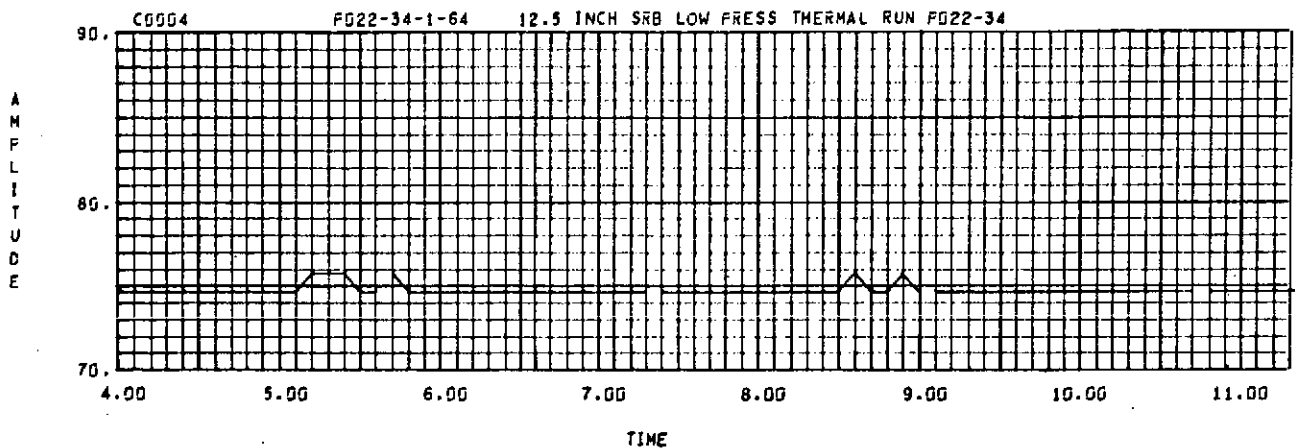

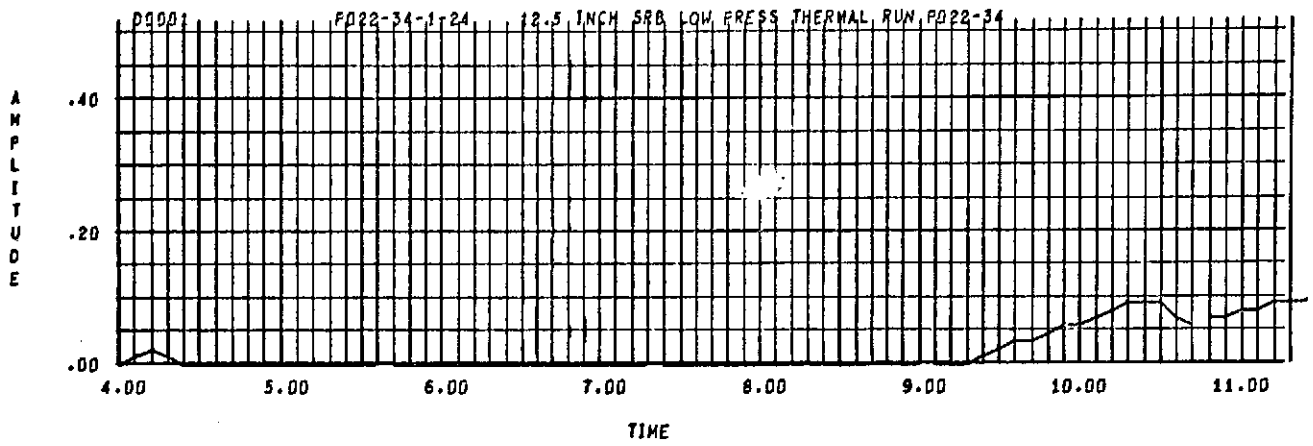
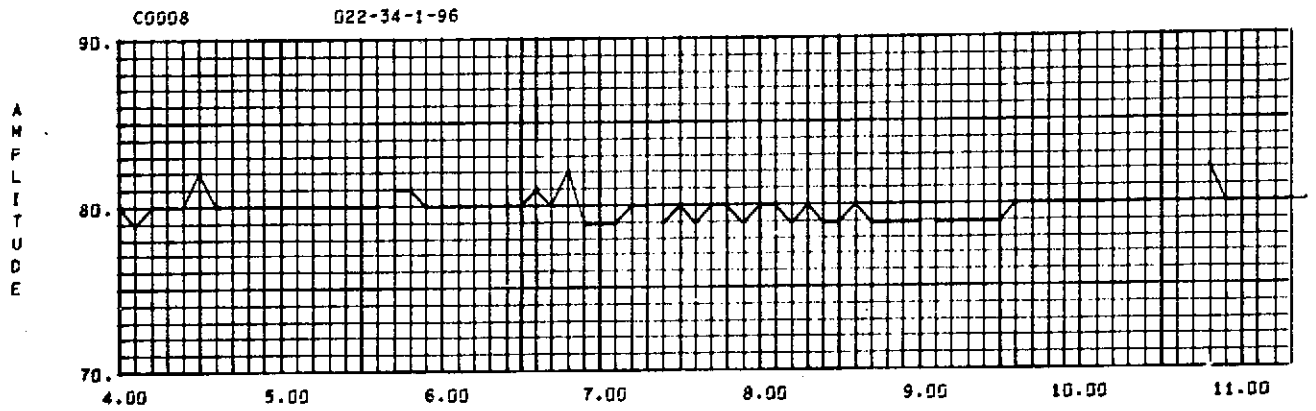
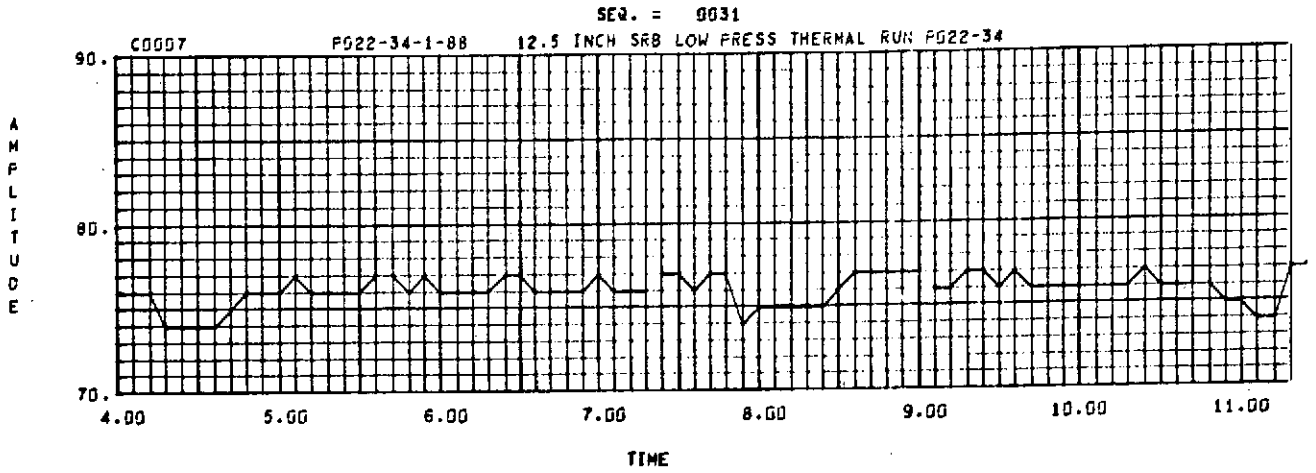

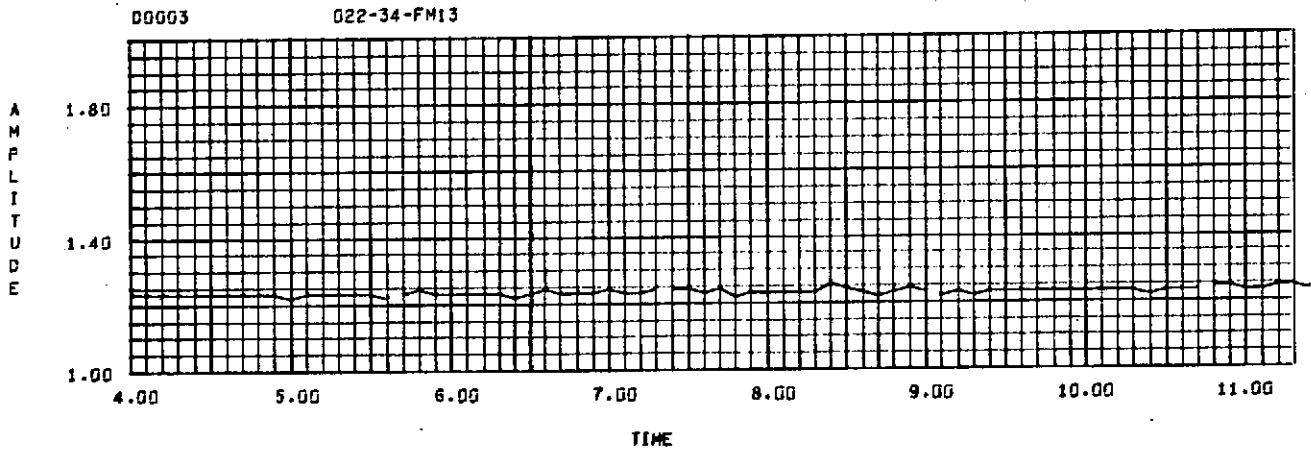
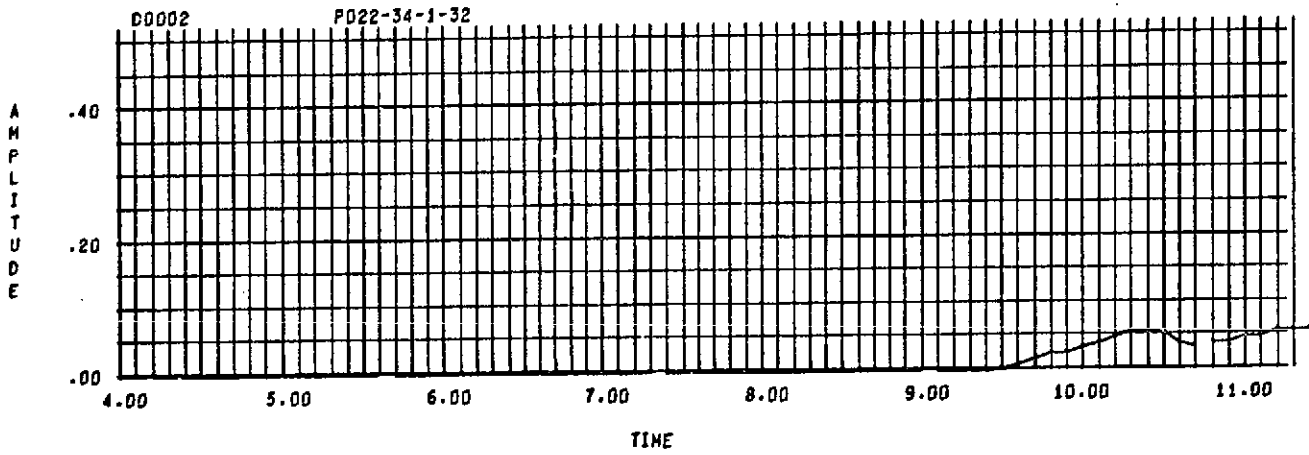



SEQ. = 0032

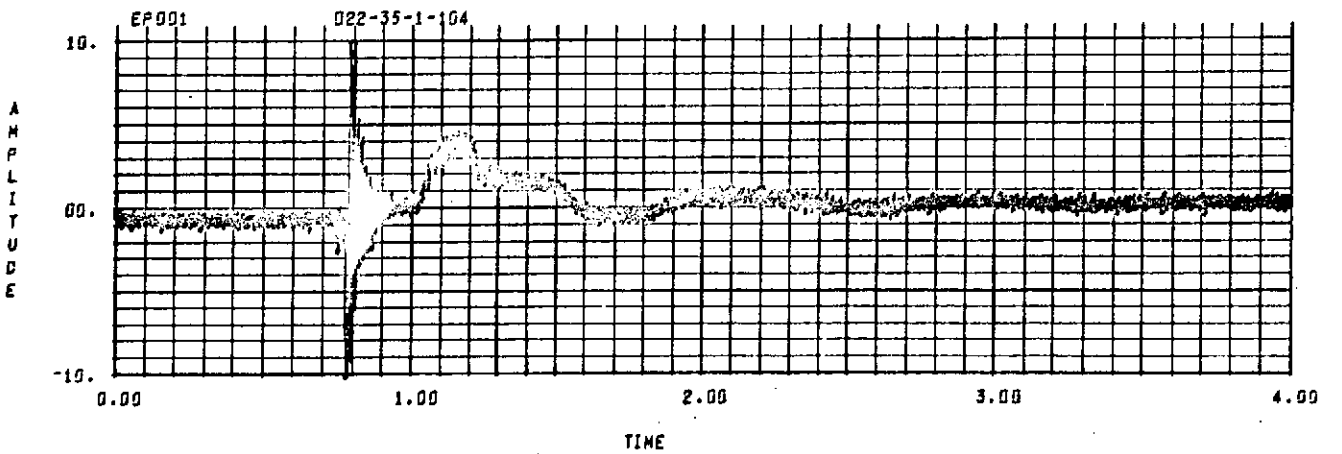
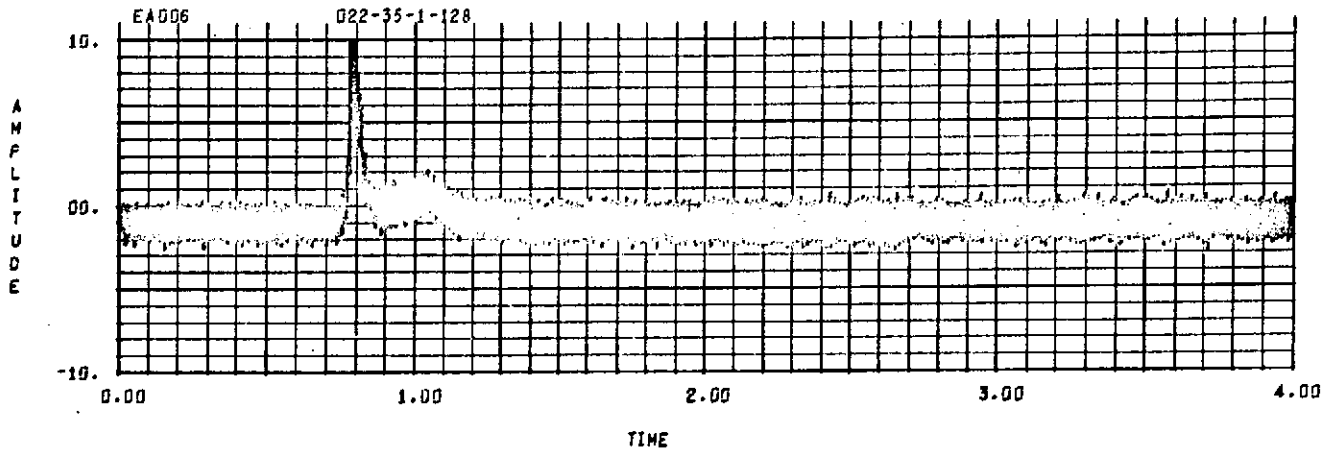
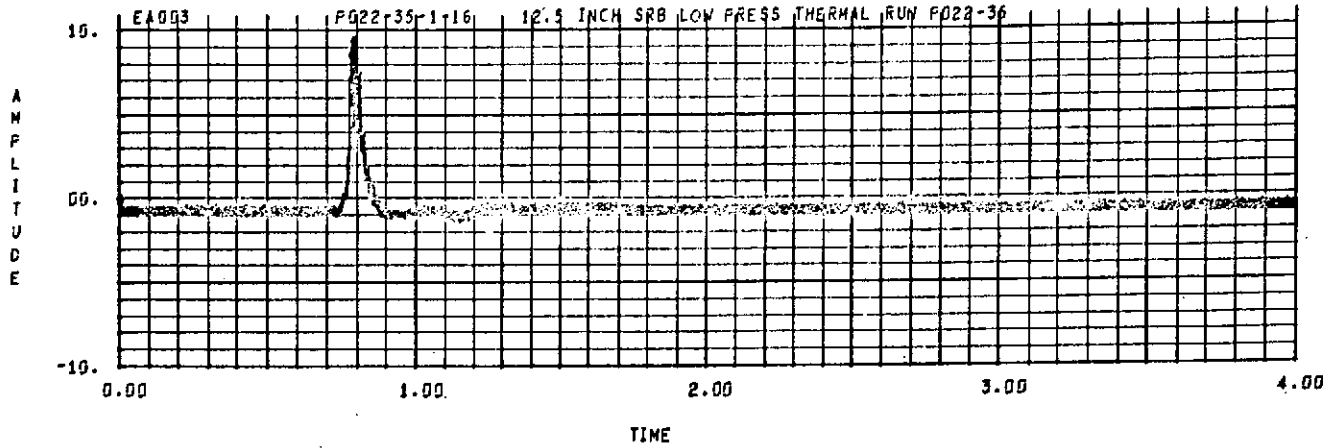



SEQ. = 0032

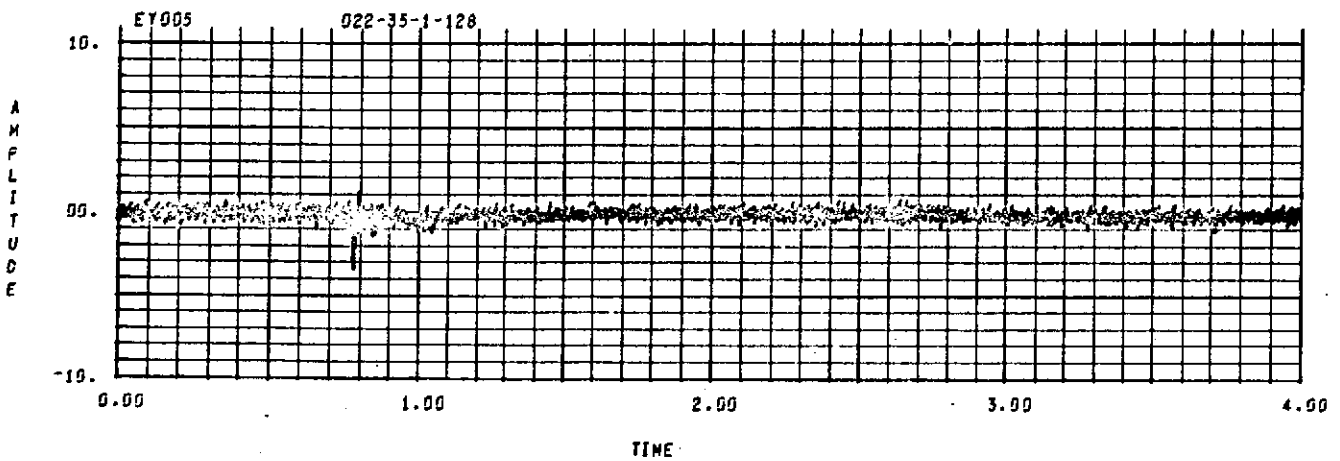
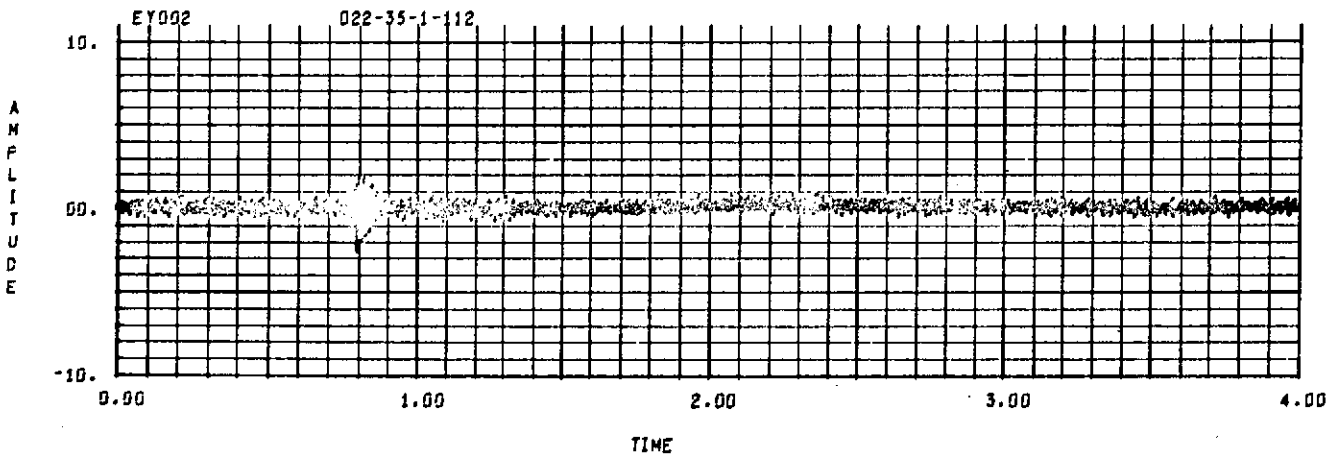
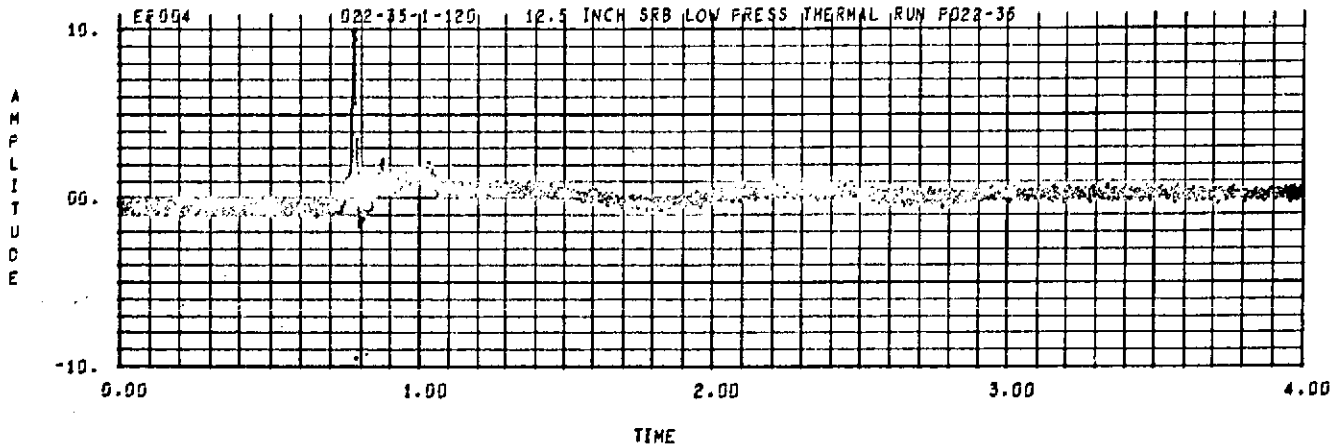



SEQ. = 0032

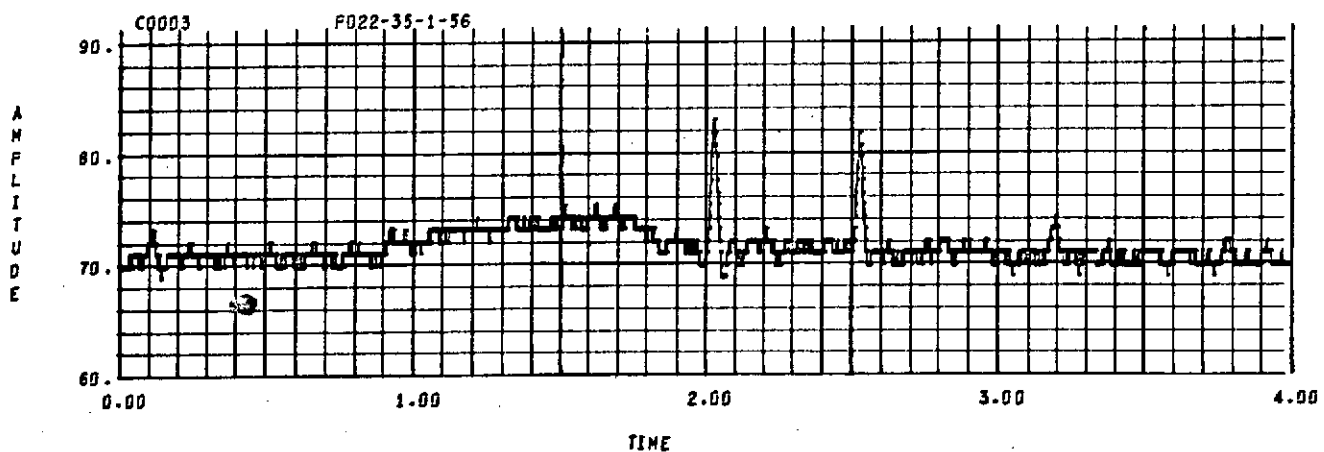
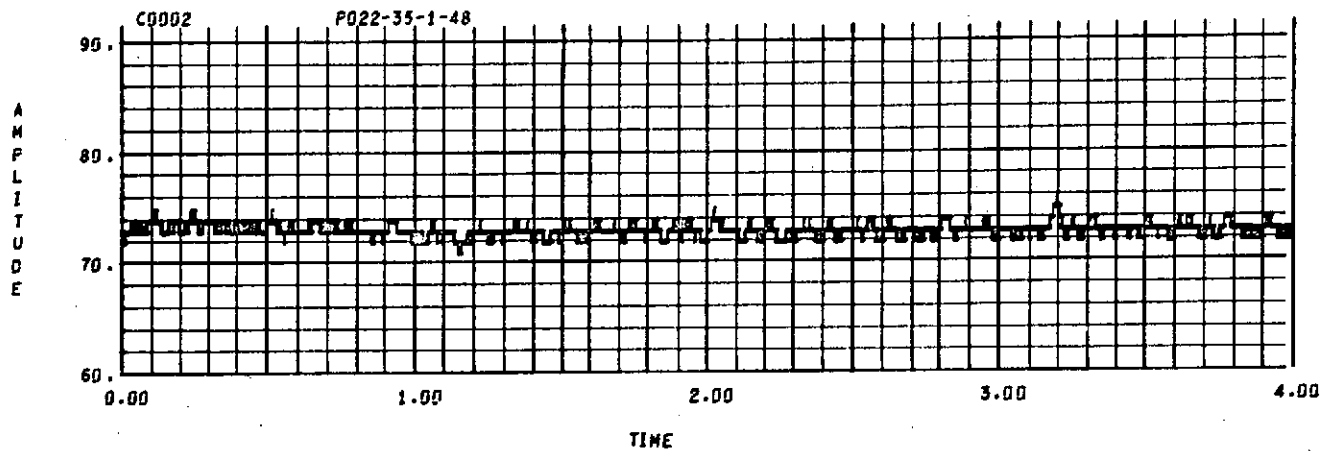
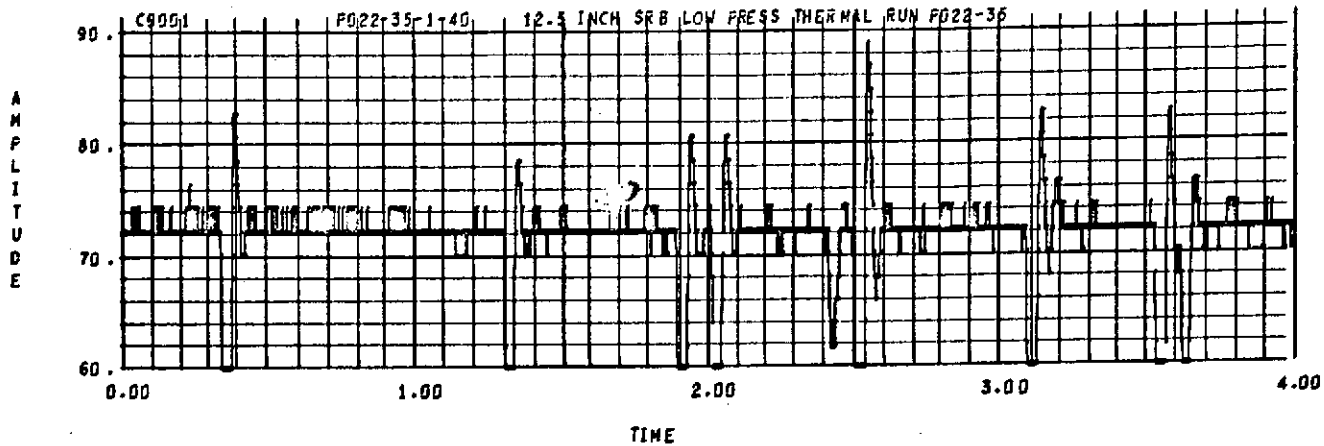

SEQ. = 0032

A
M
P
L
I
T
U
D
E

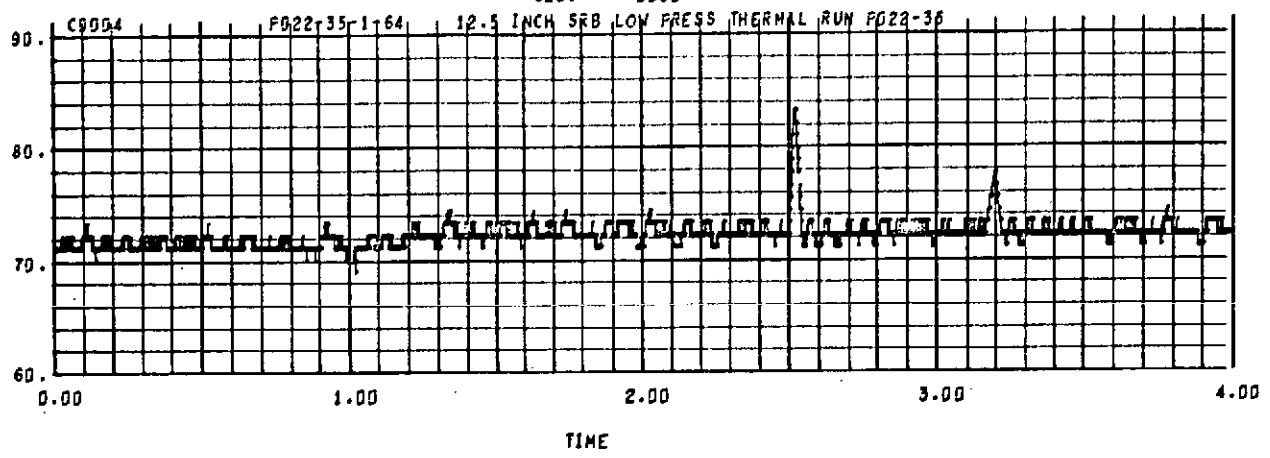

A
M
P
L
I
T
U
D
E

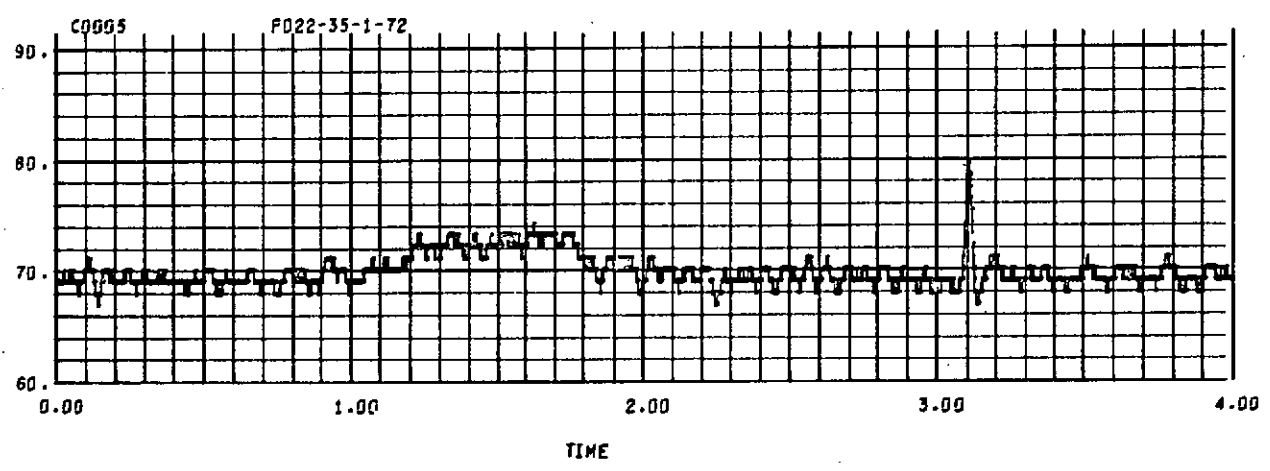

A
M
P
L
I
T
U
D
E

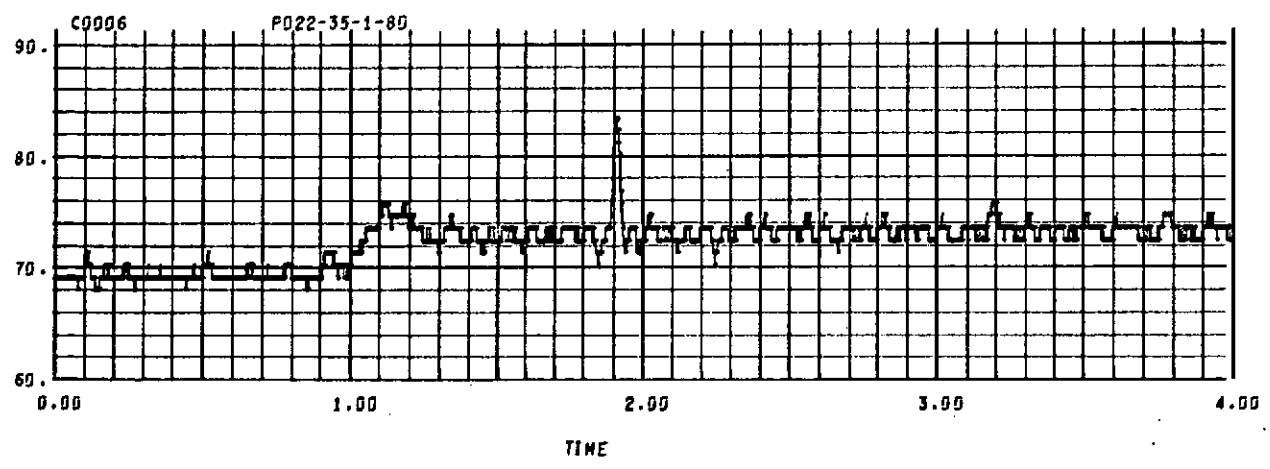



SEQ. = 0032

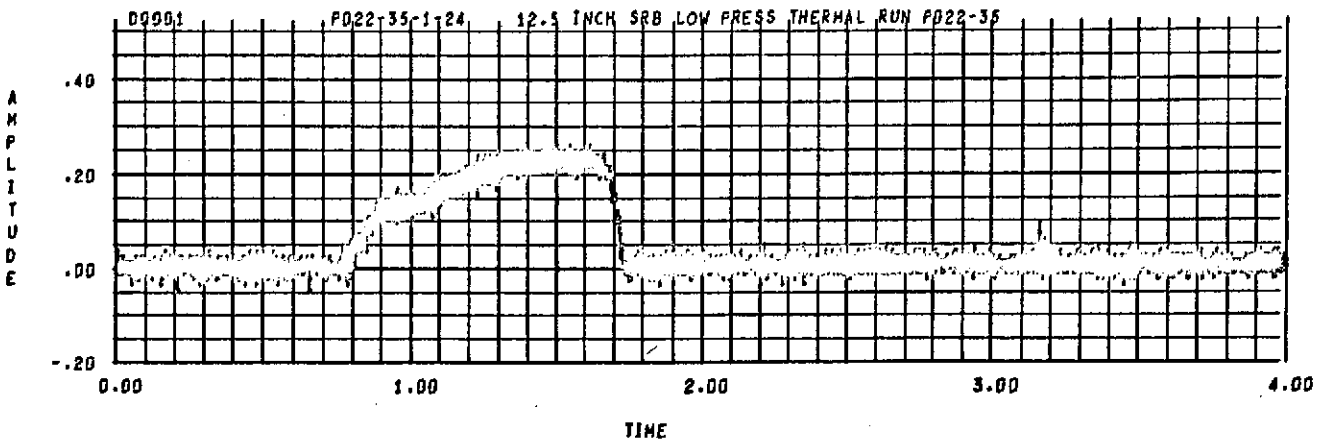
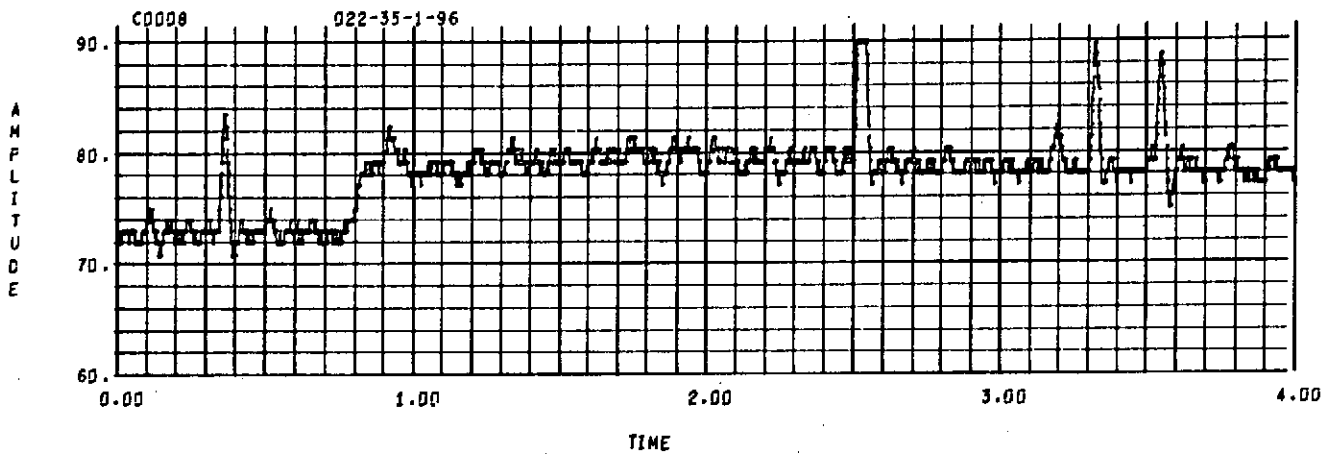
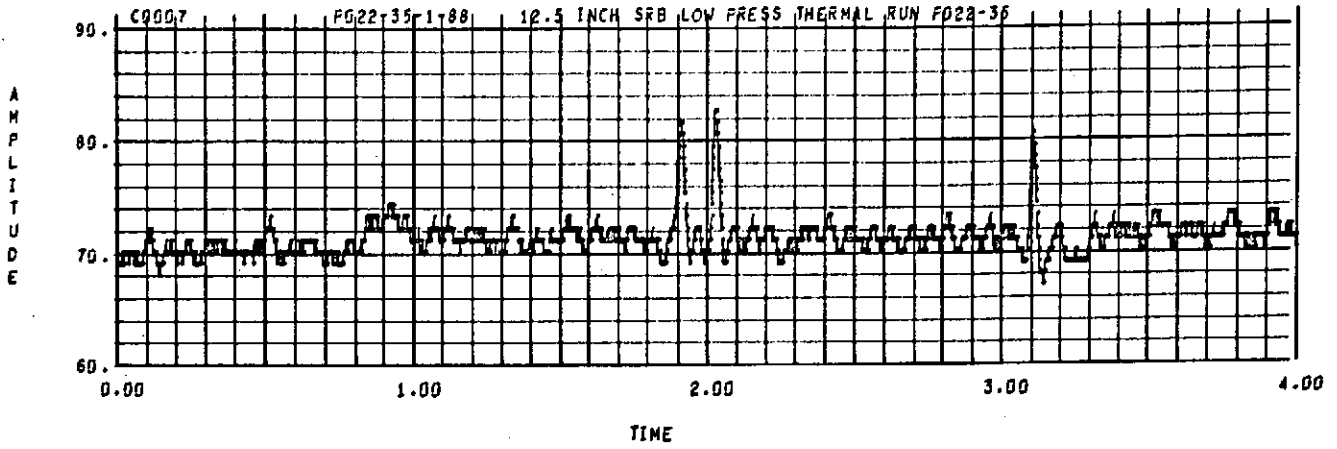

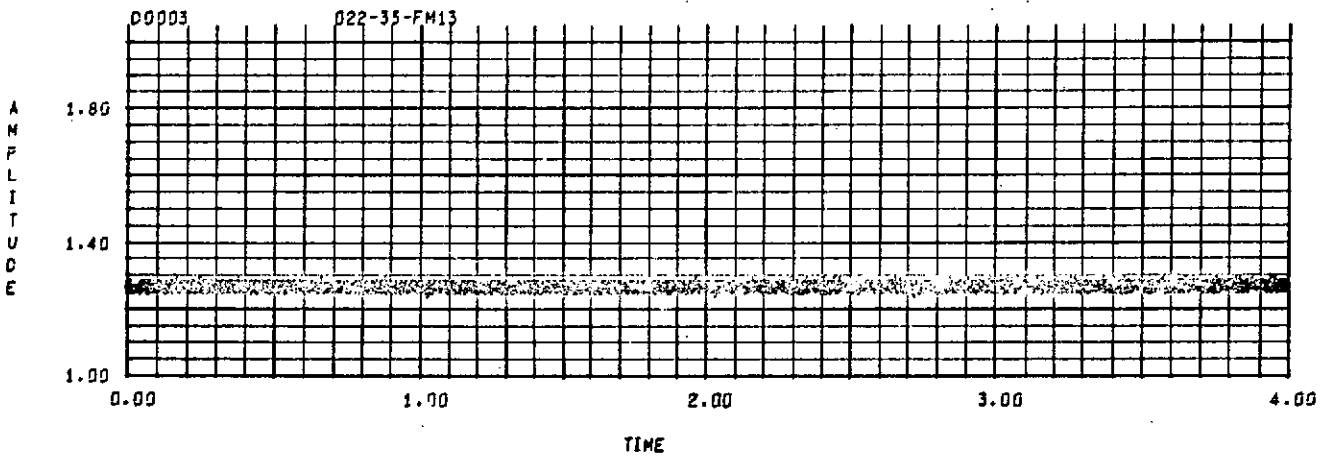
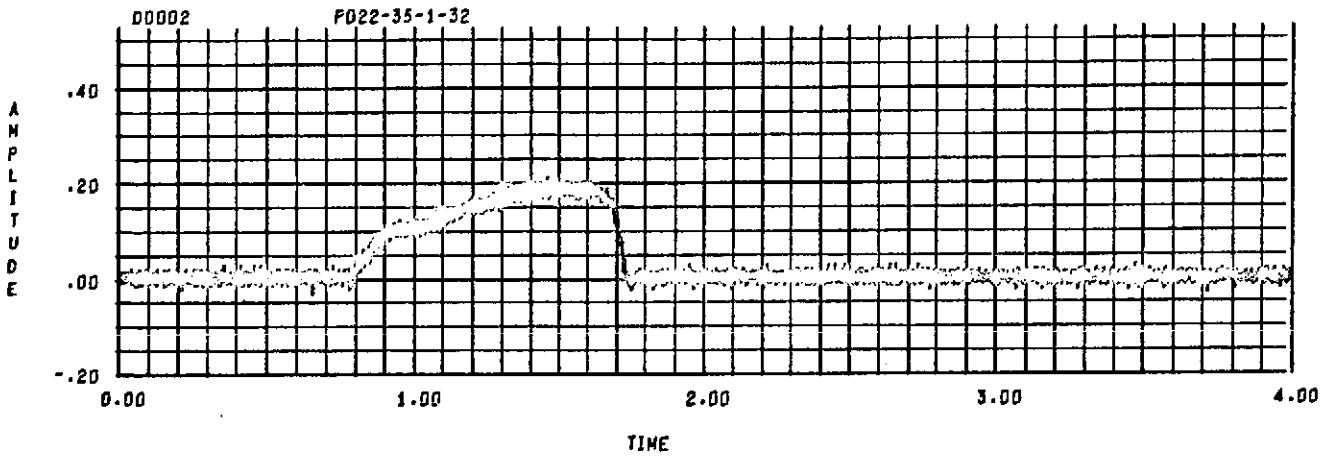

11/11/77
11/11/77
11/11/77
11/11/77

SEC. = D032

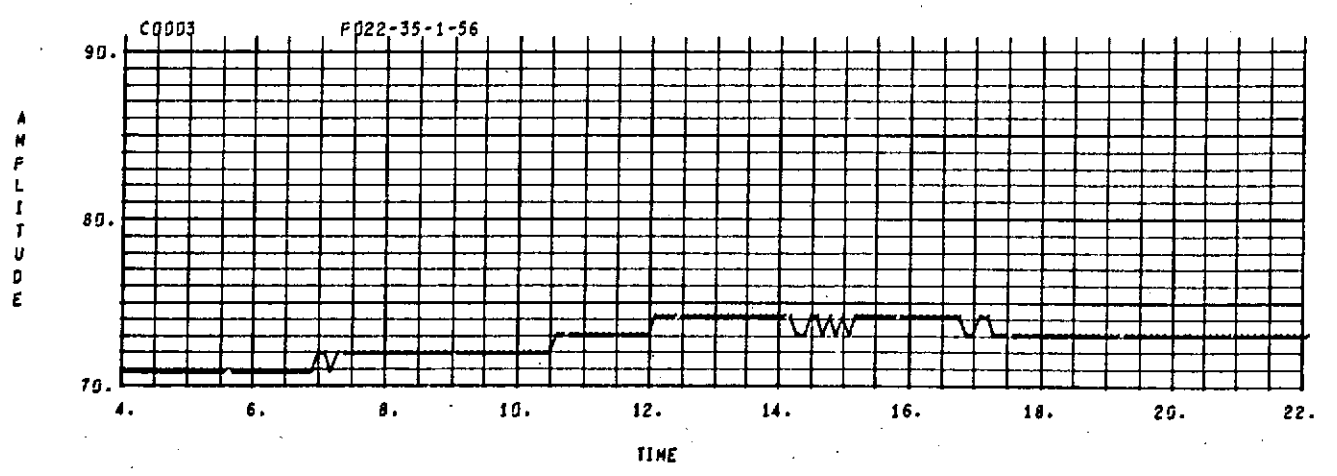
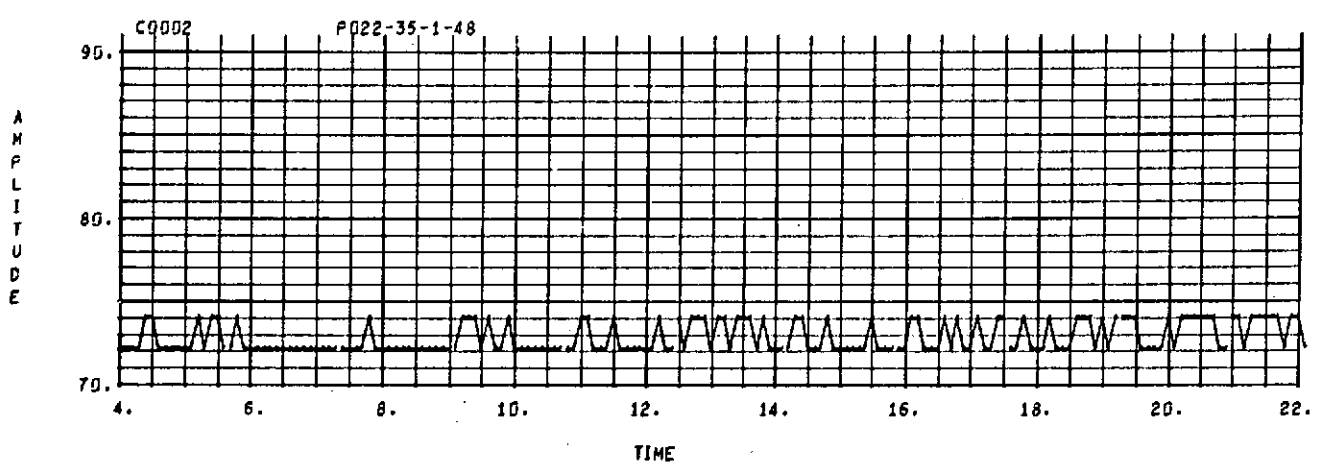
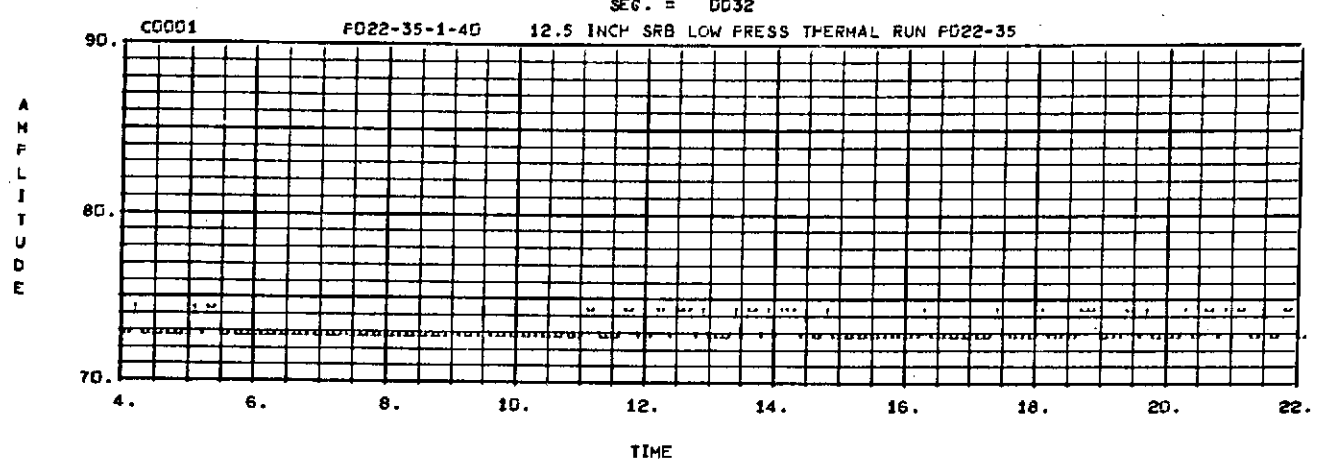

SEQ. = 0032

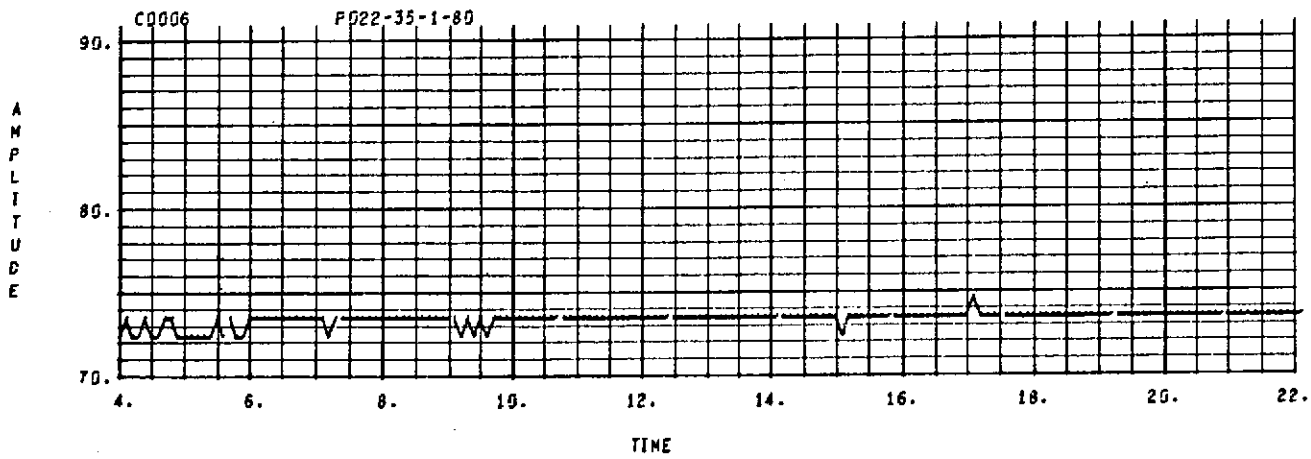
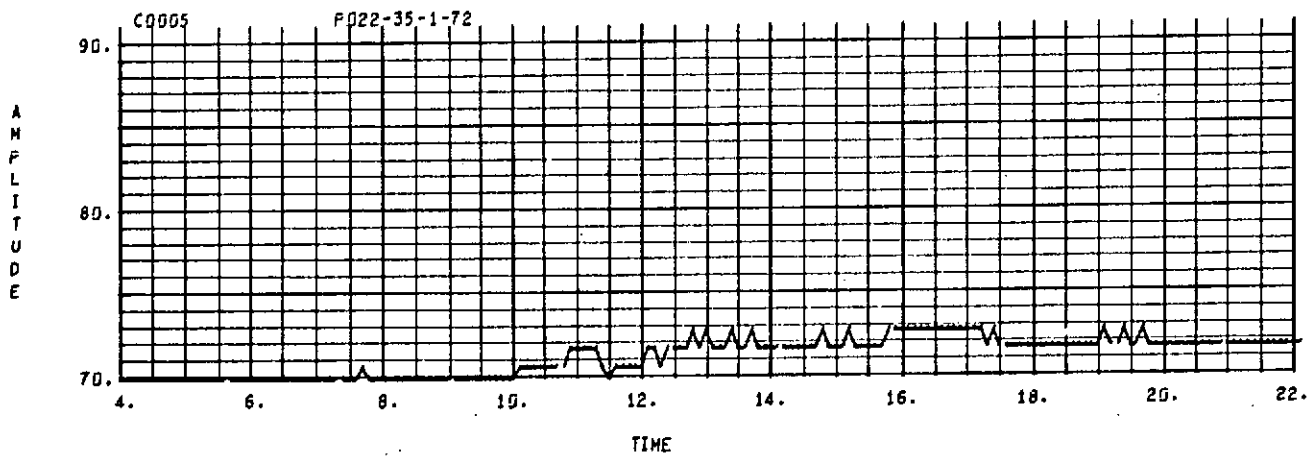
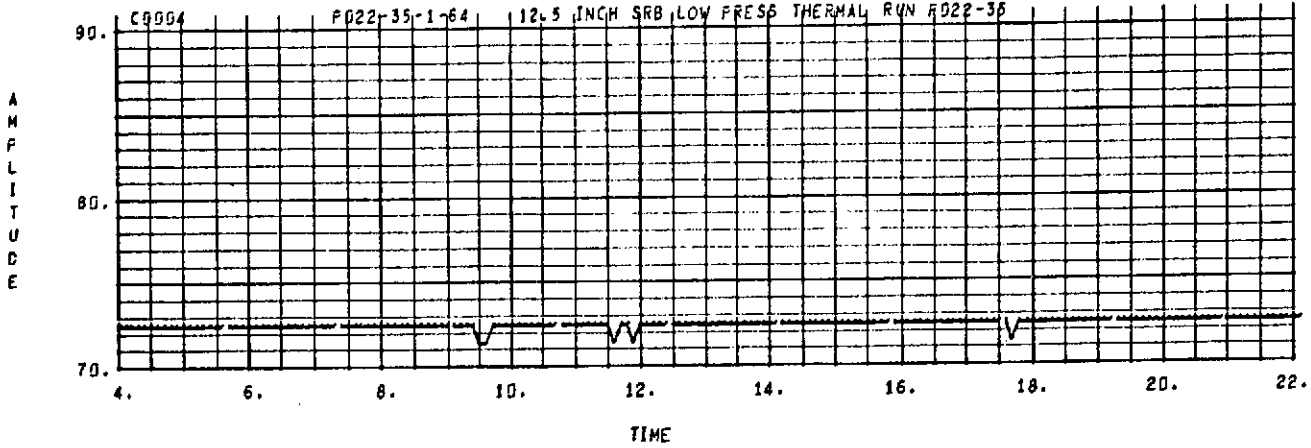



SEQ. = 0032

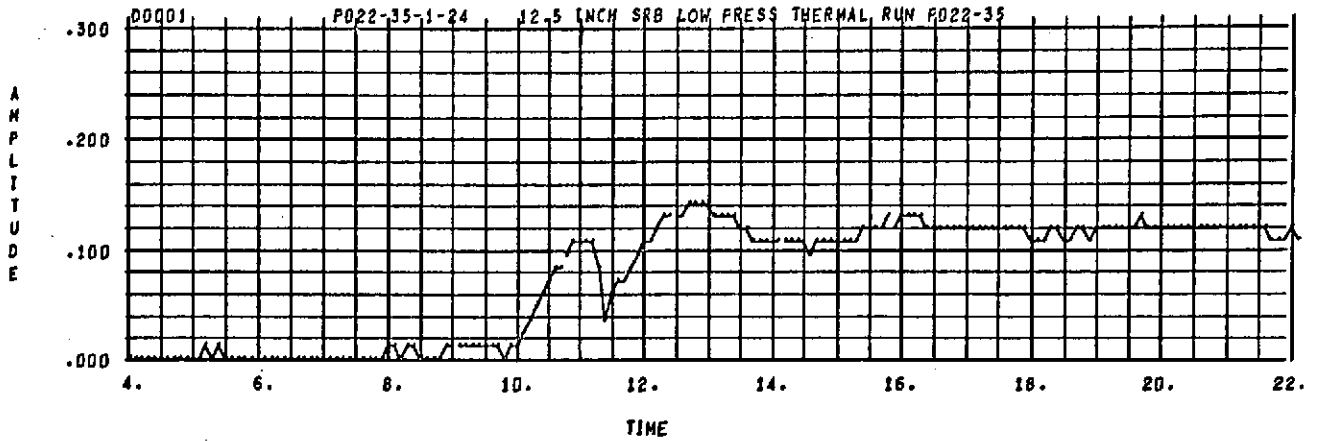
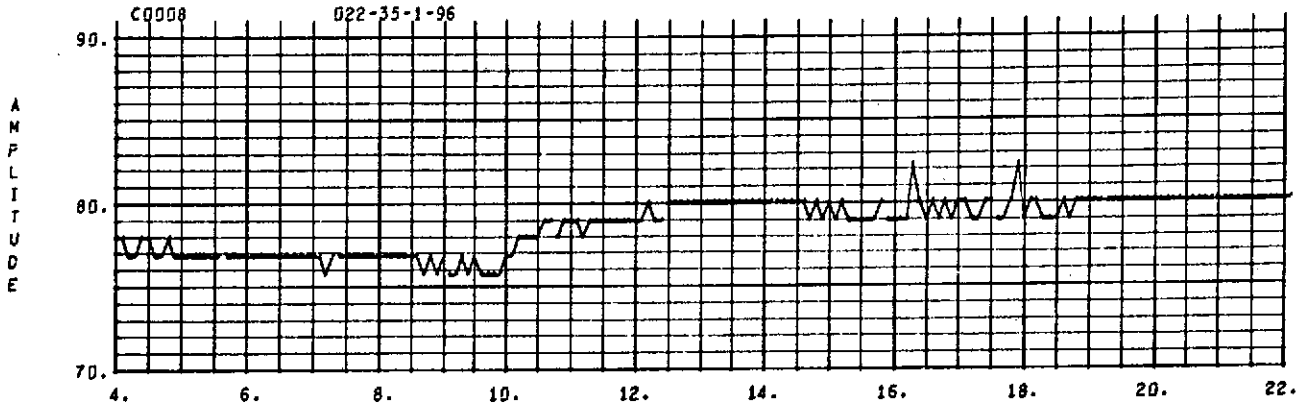
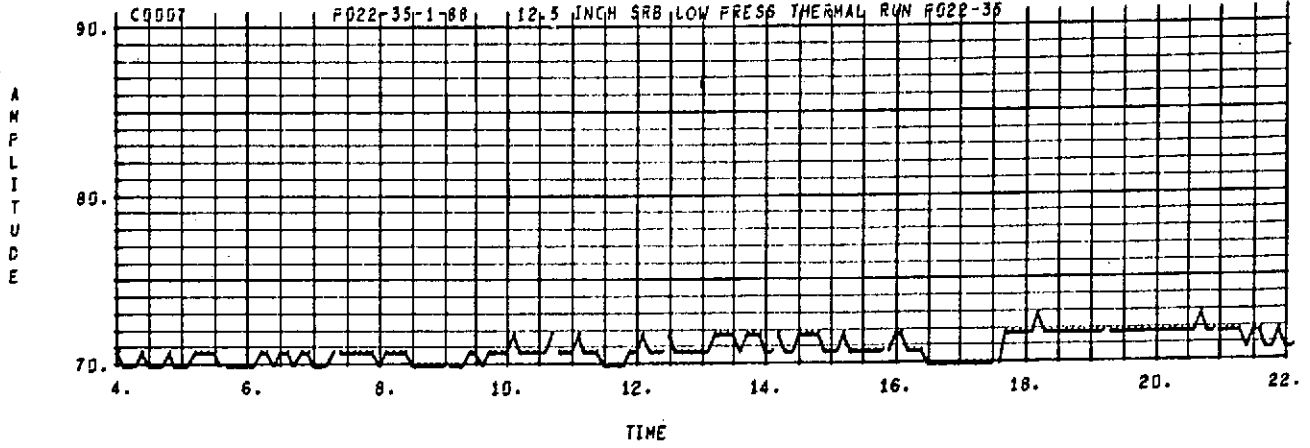

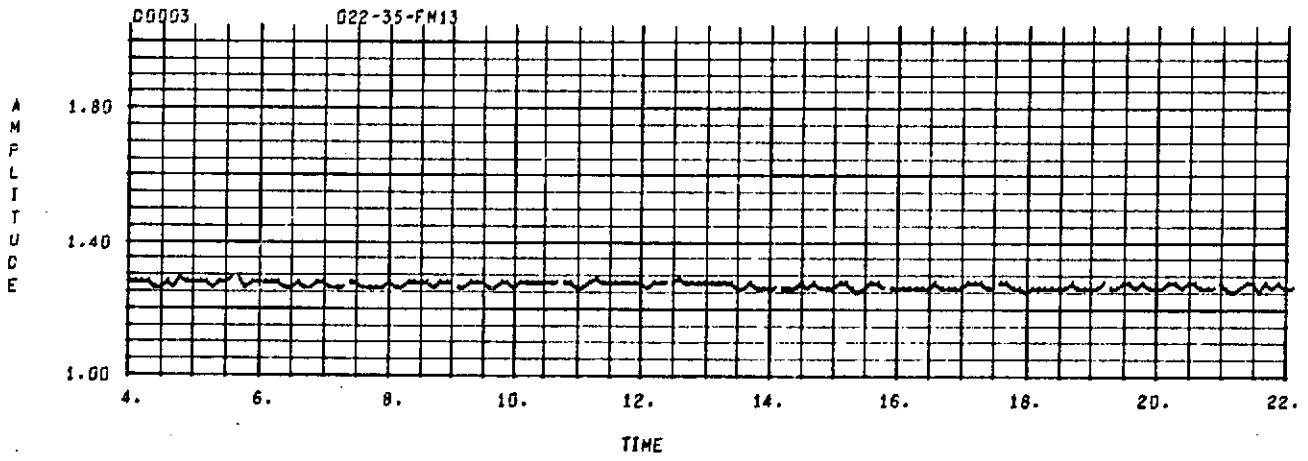
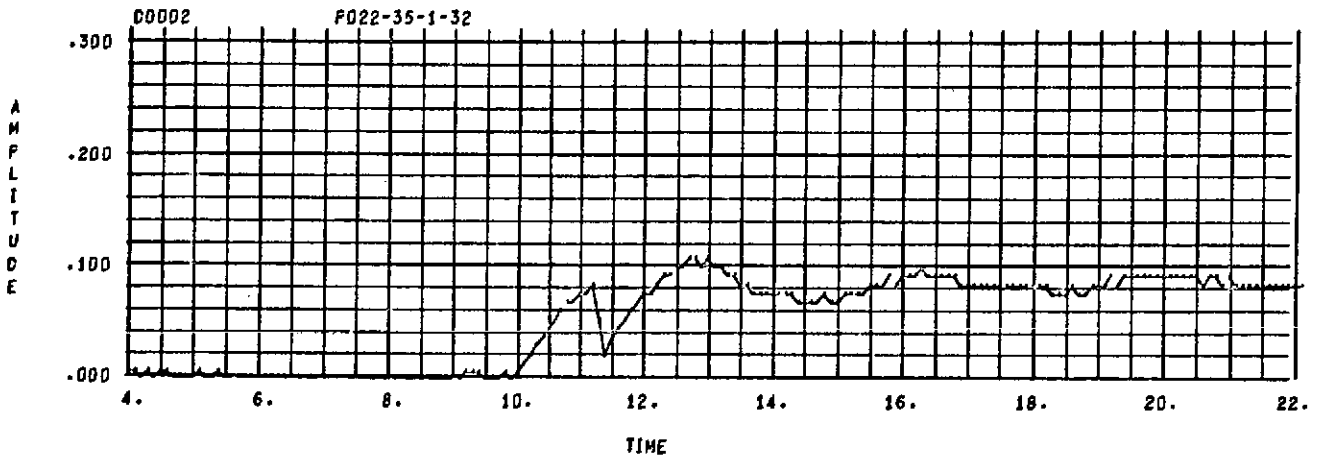

SEQ. = 0033

1

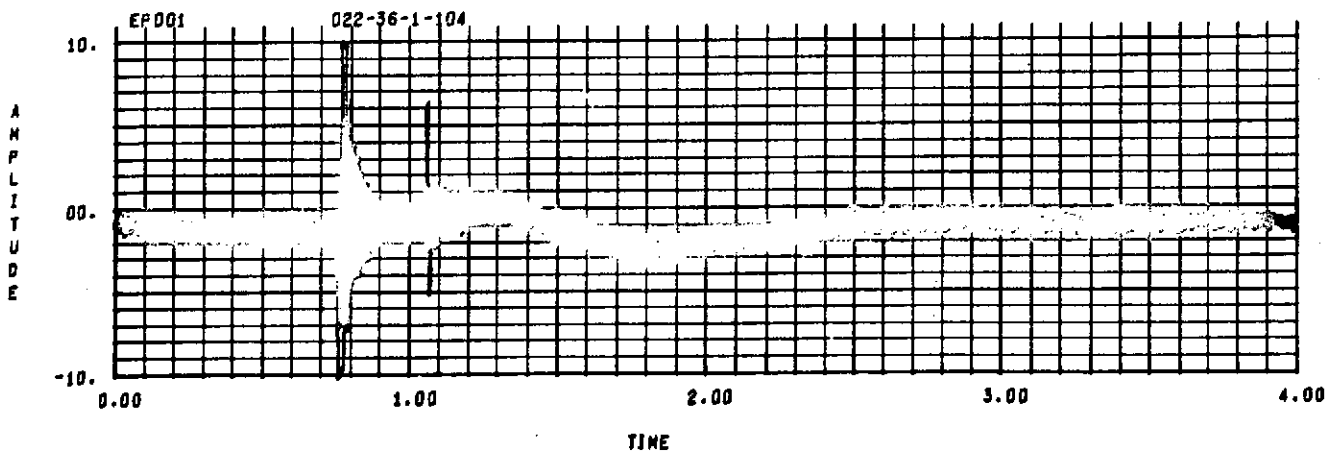
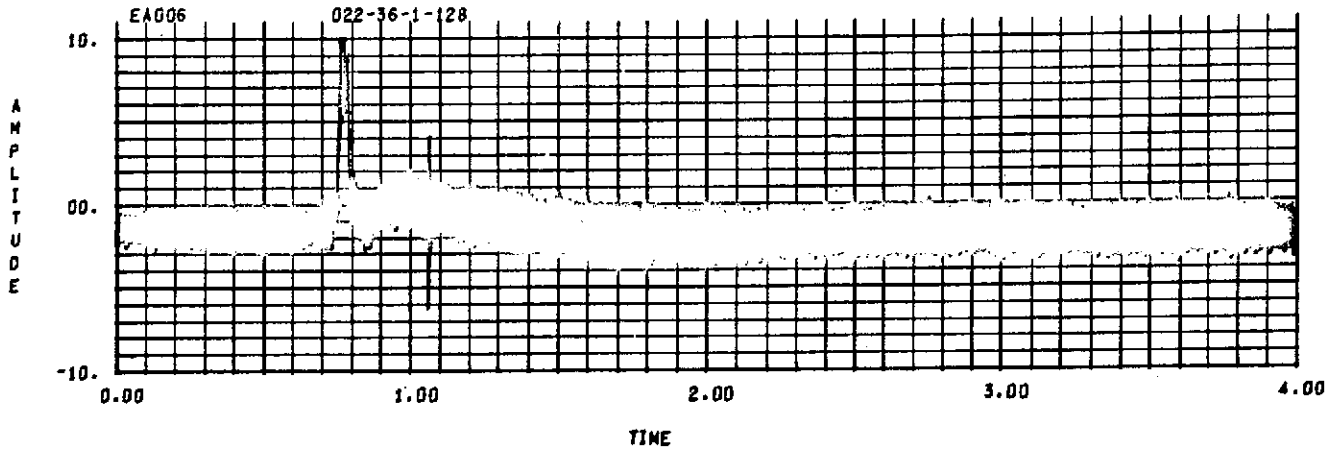
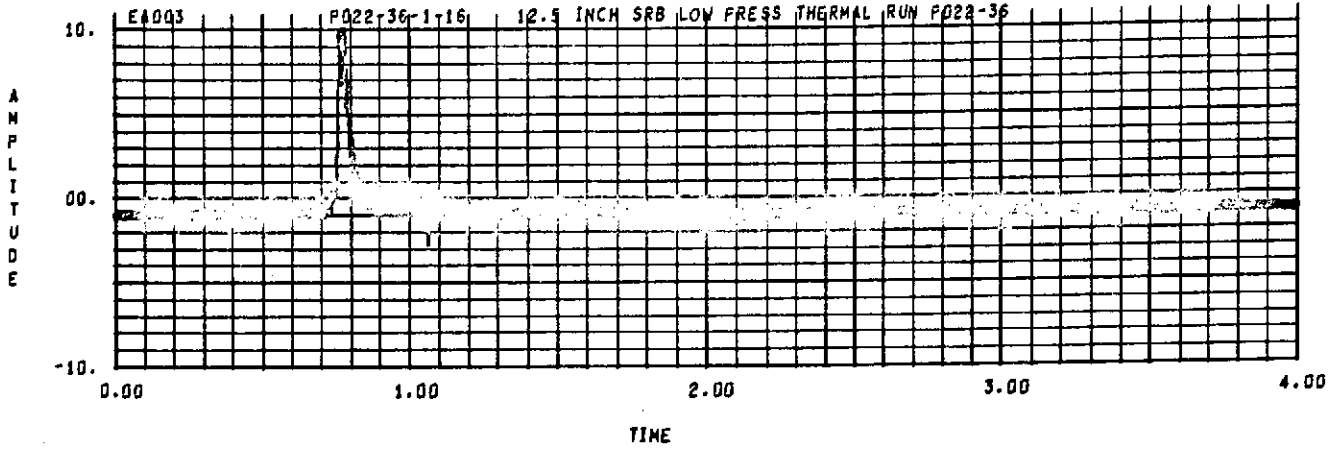

SEQ. = 0033

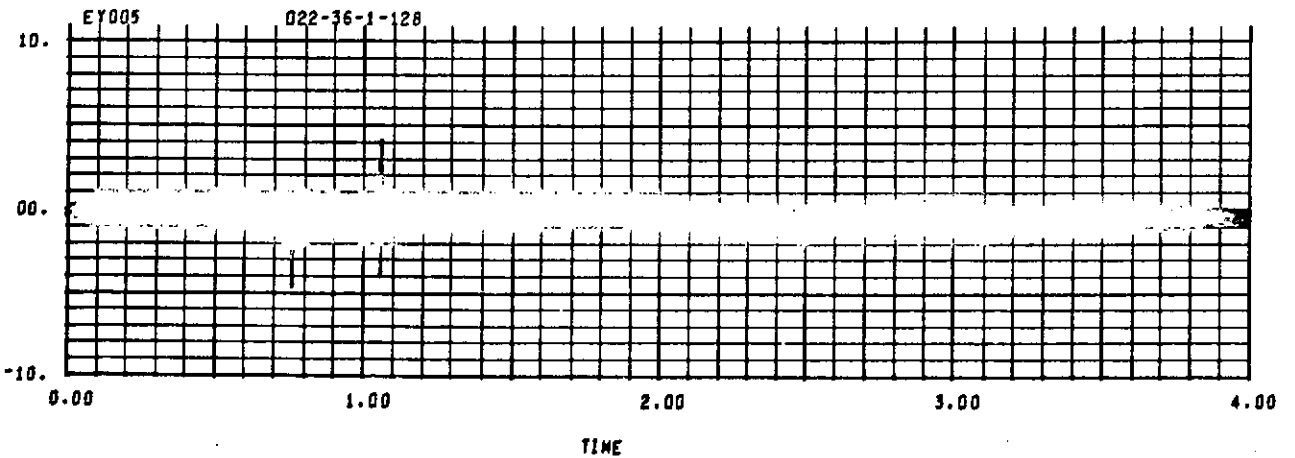
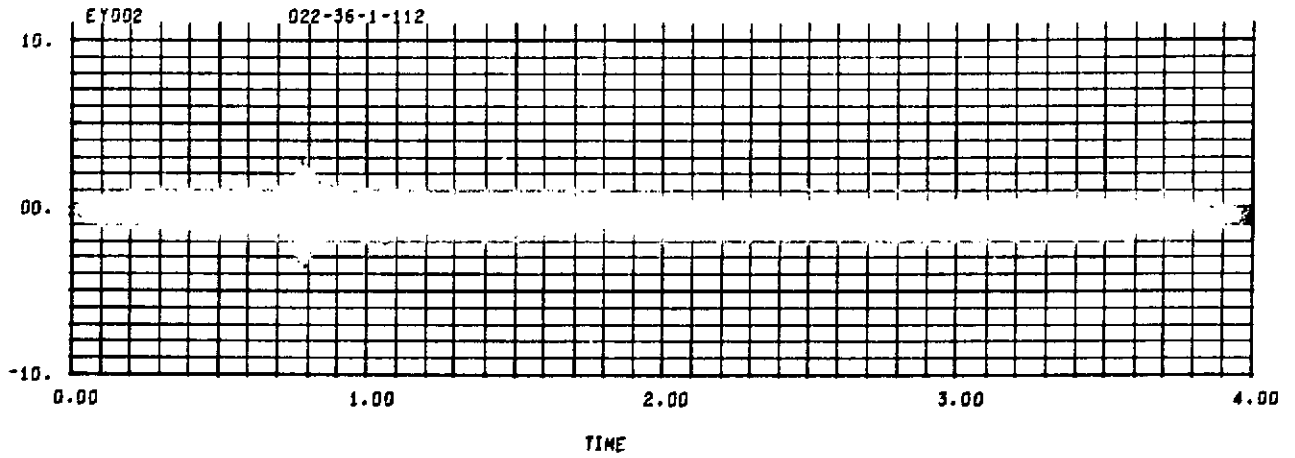
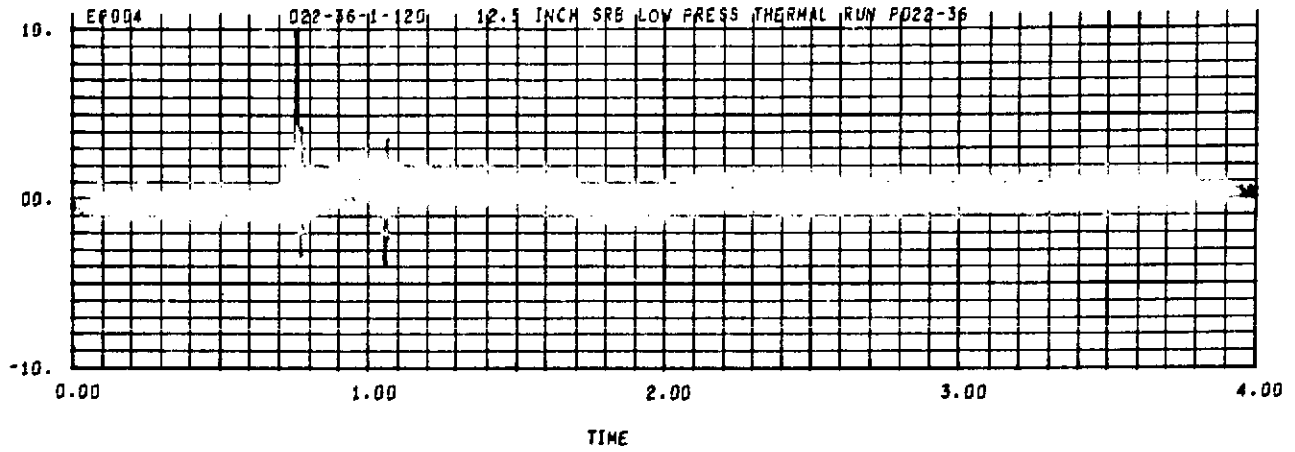



SEQ. = 0033

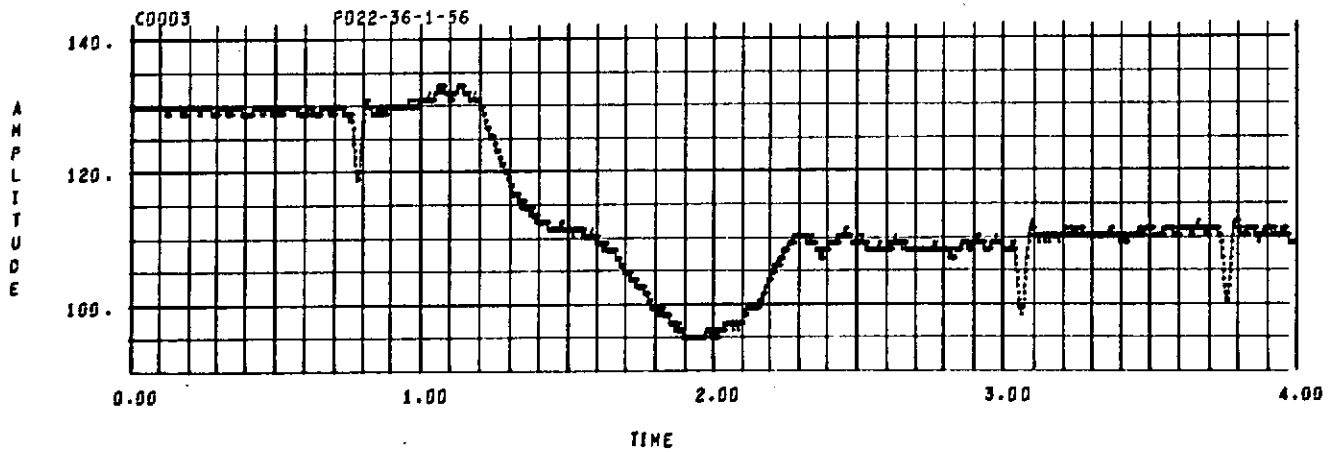
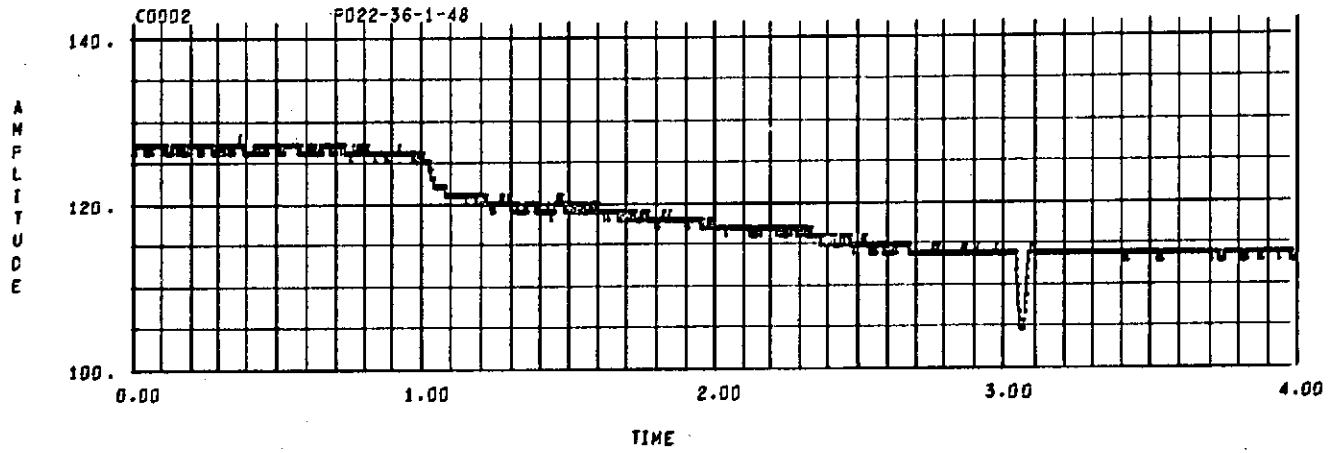
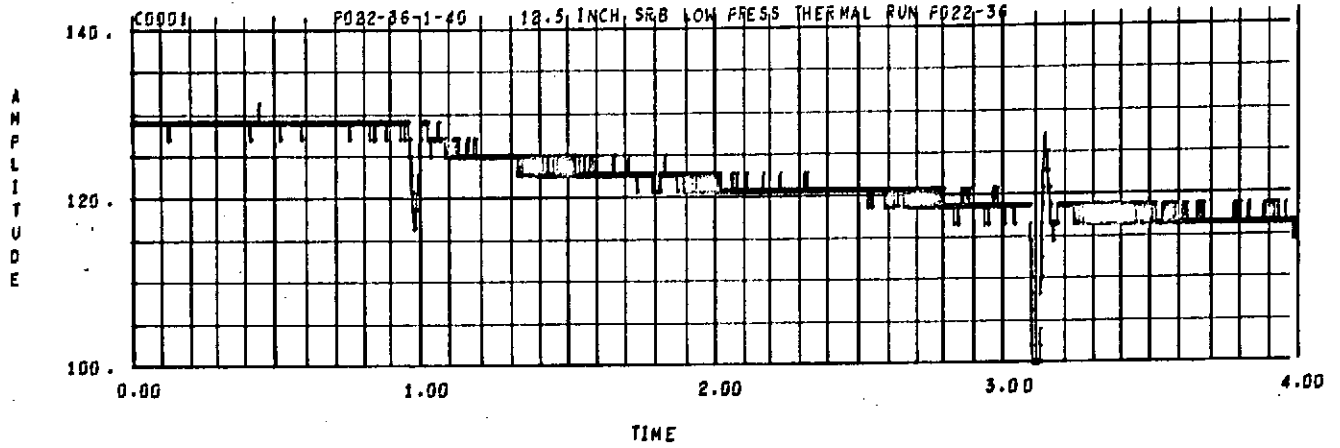

SER. = 0033

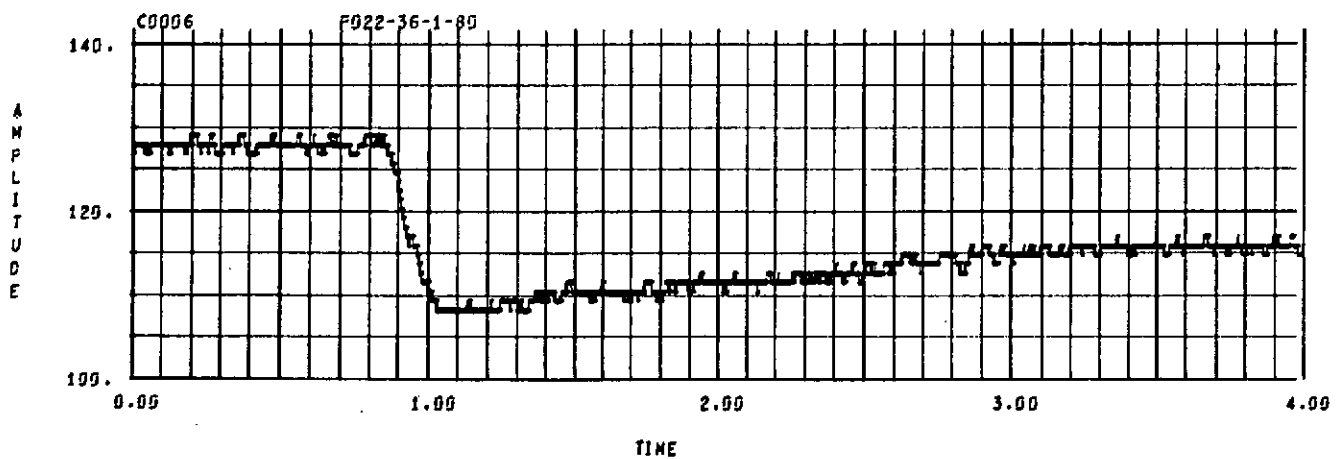
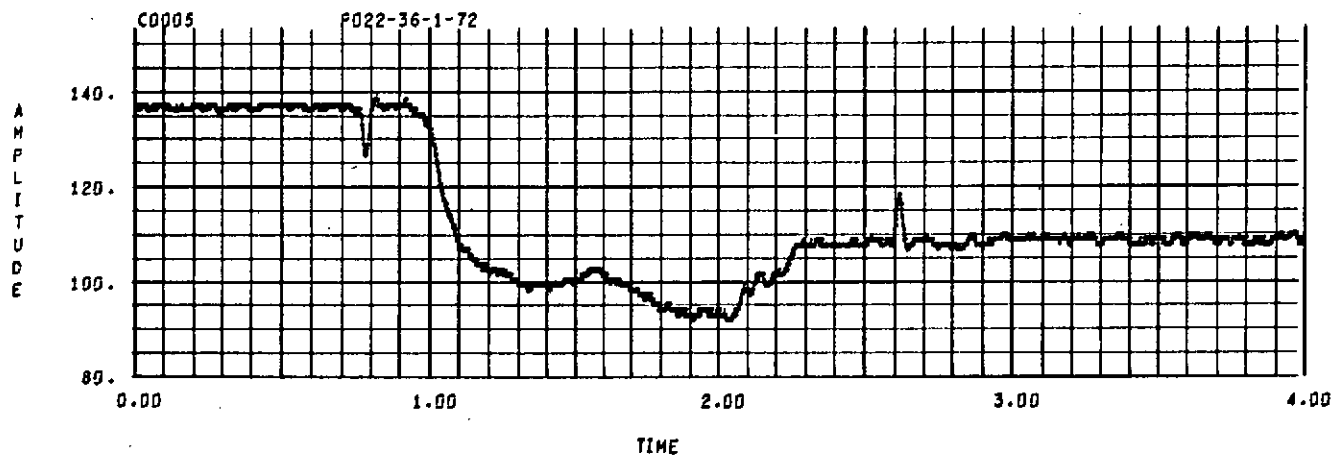
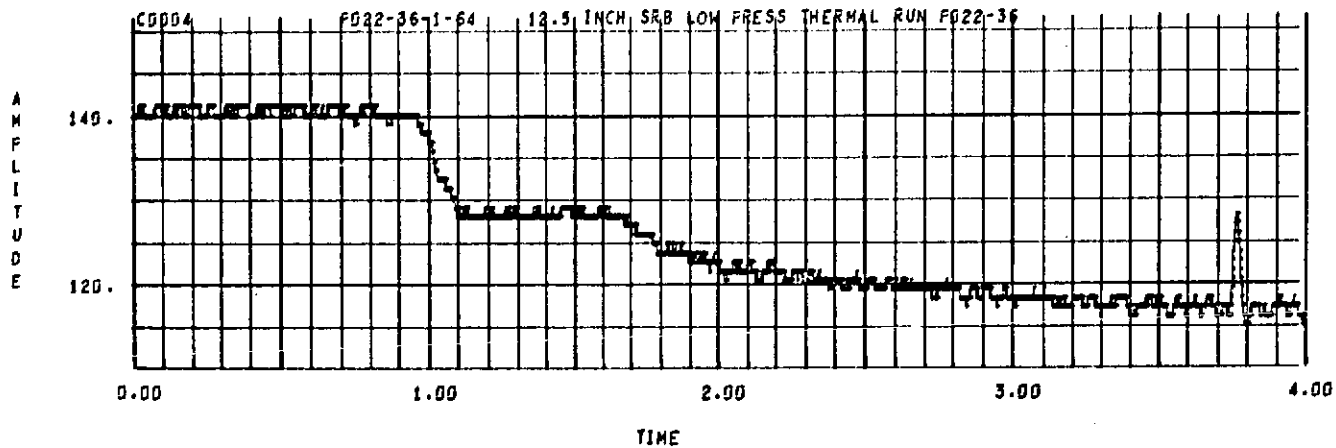



SEQ. = 0033

C0007 P022-36-1-88 12.5 INCH SRB LOW PRESS THERMAL RUN P022-36

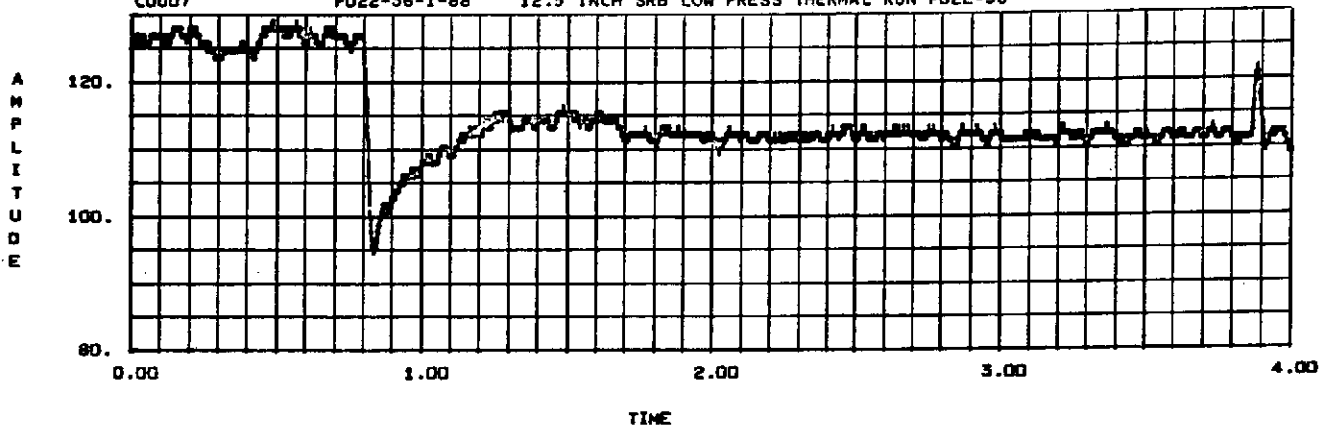

C0008 P022-36-1-96

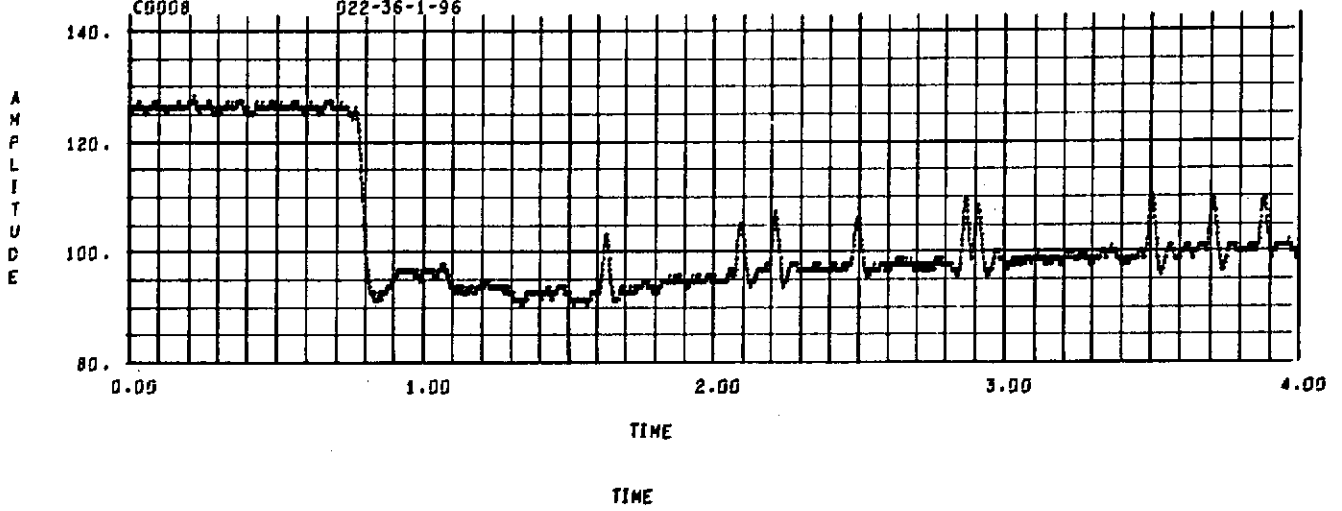

C0009 P022-36-1-24

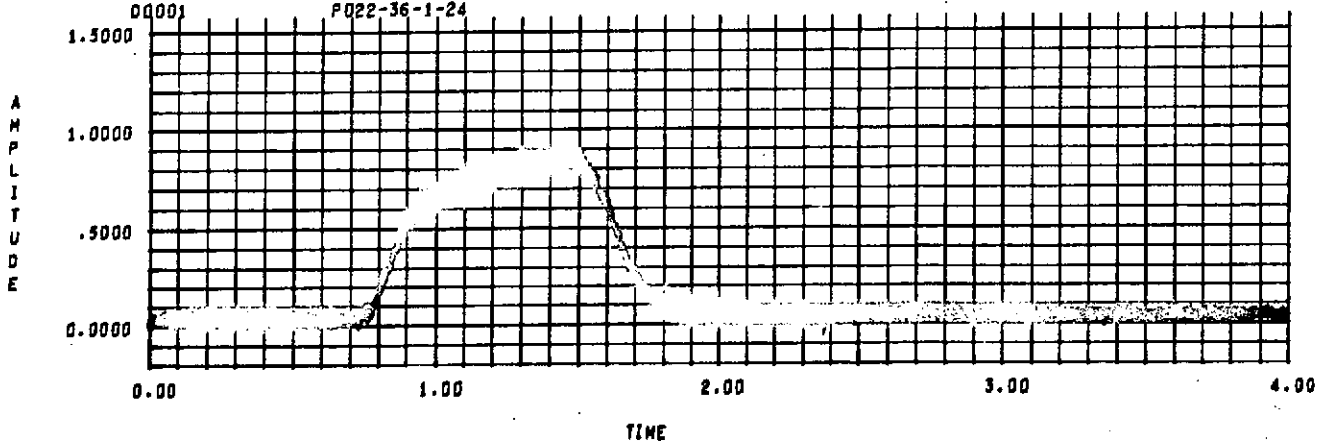

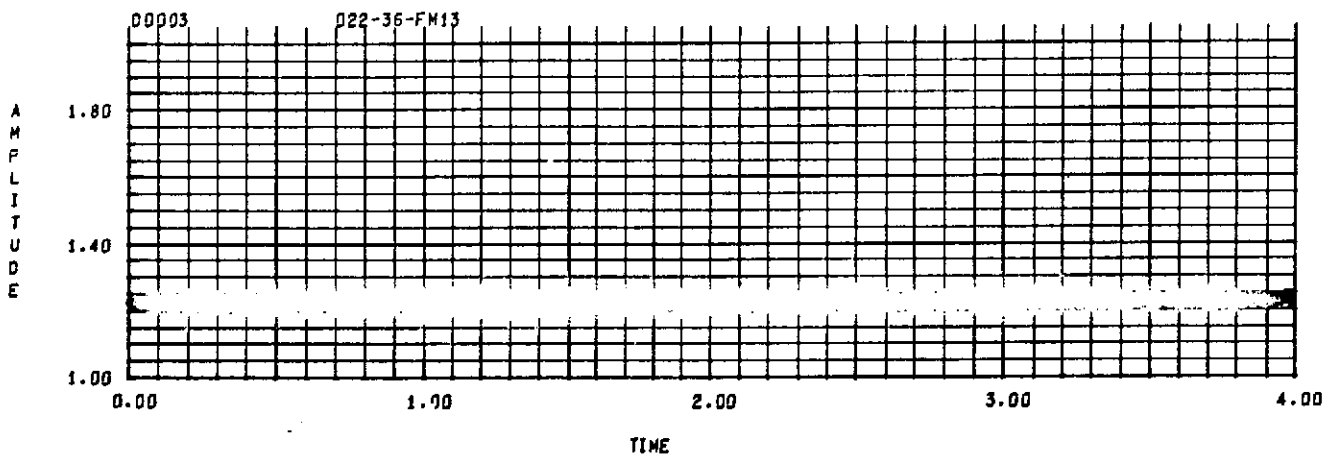
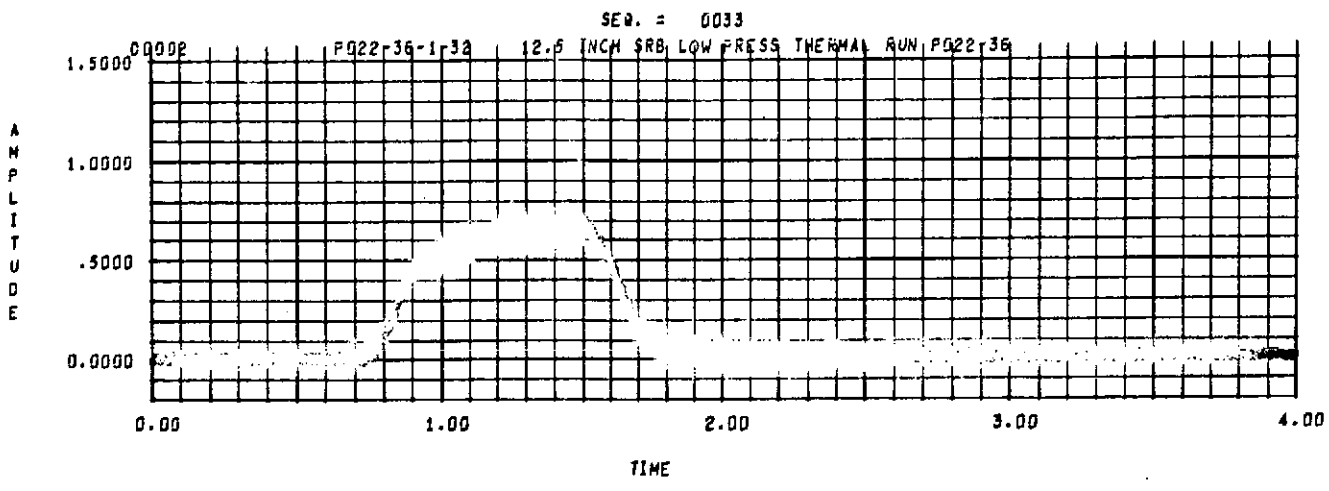

SEQ. = 0033

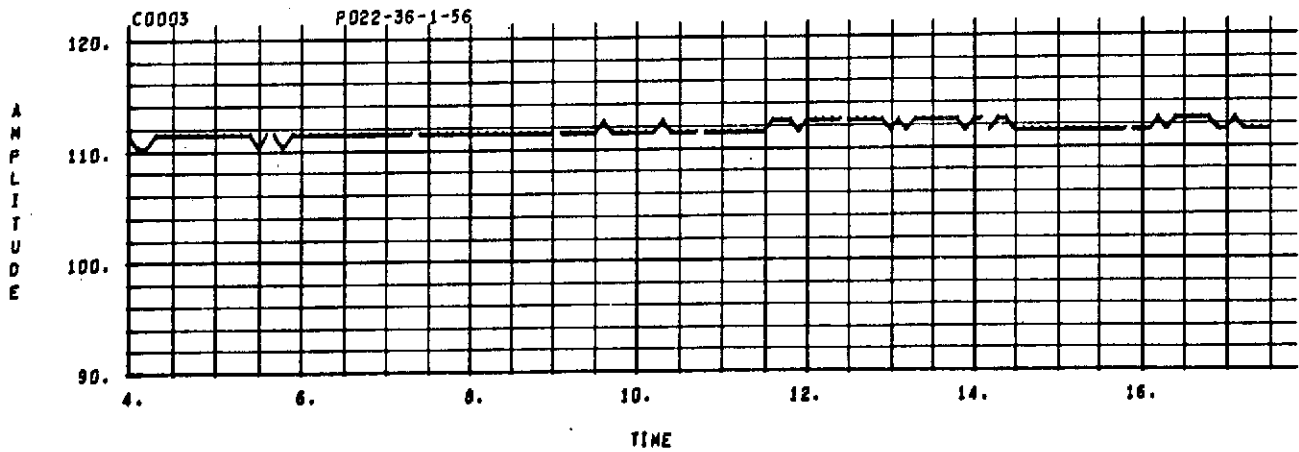
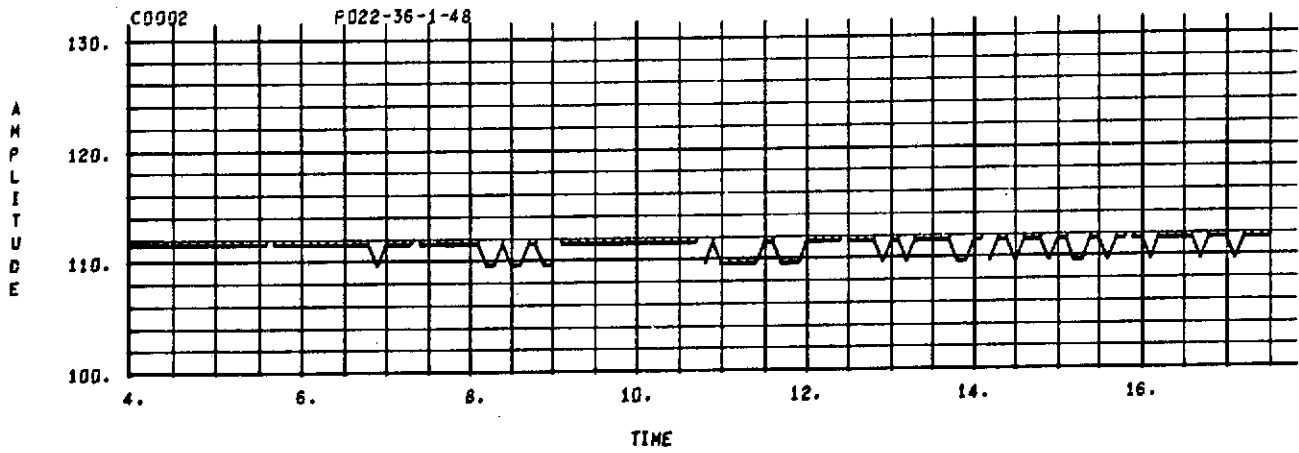
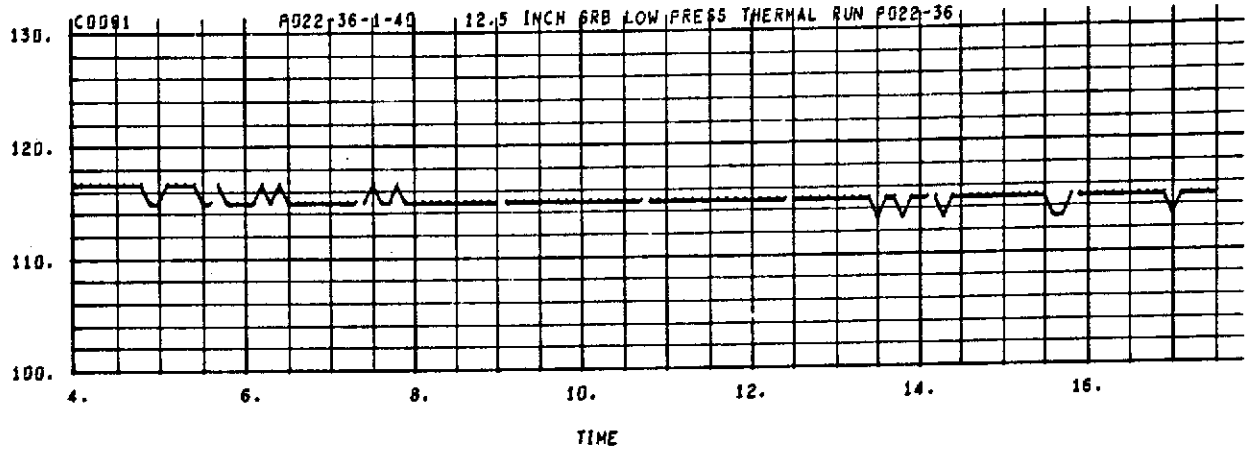

SEQ. = 0033

9

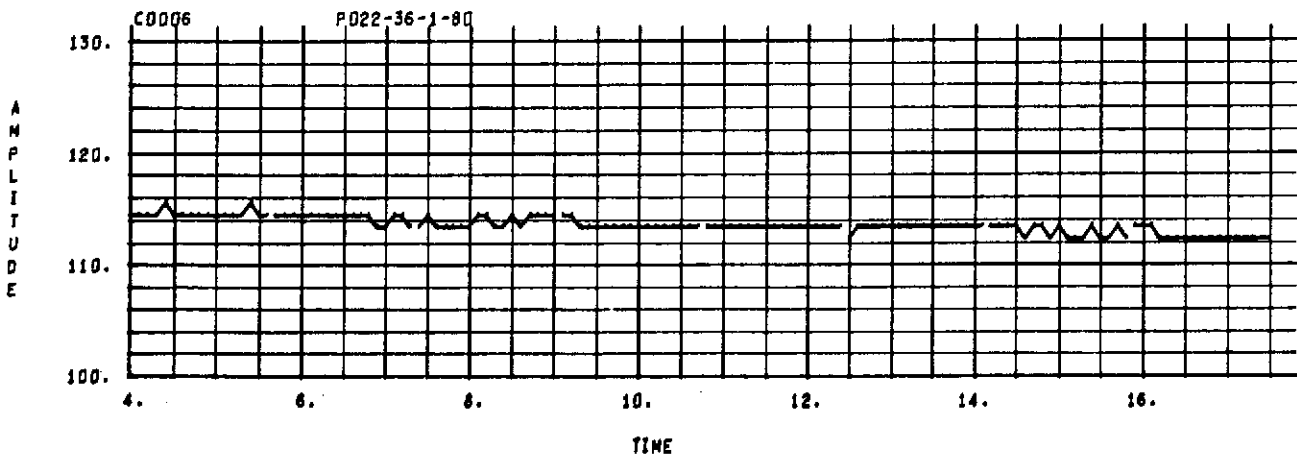
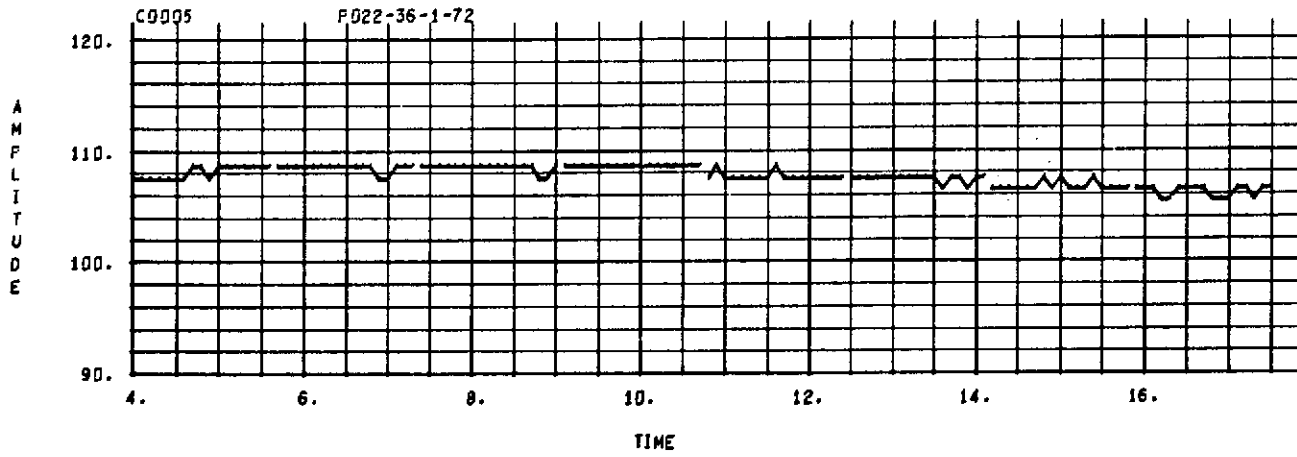
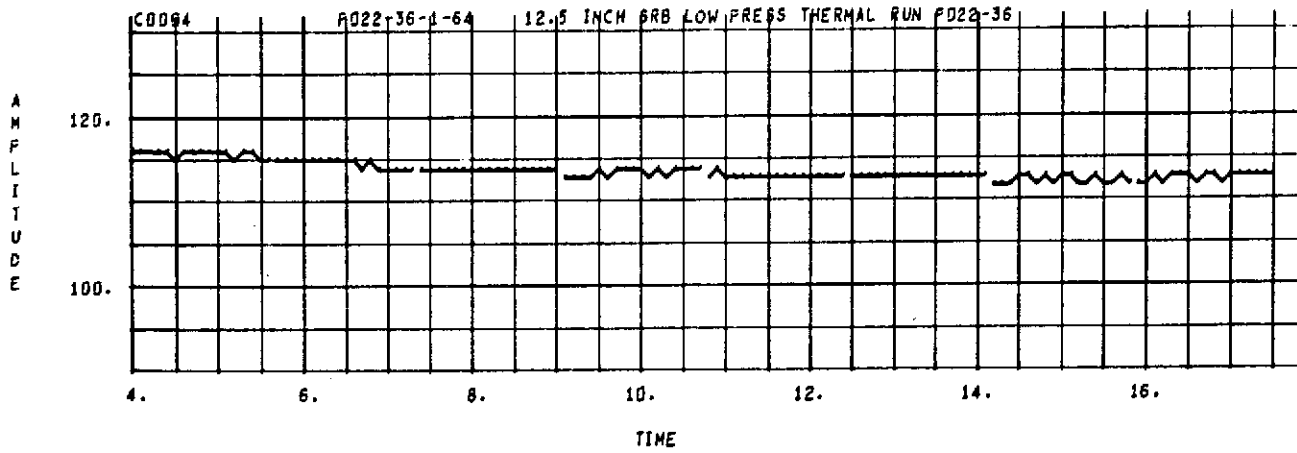

SEQ. = 0033

C0007 P022-36-1-00 12.5 INCH SRB LOW PRESS THERMAL RUN P020-36

A
M
P
L
I
T
U
D
E

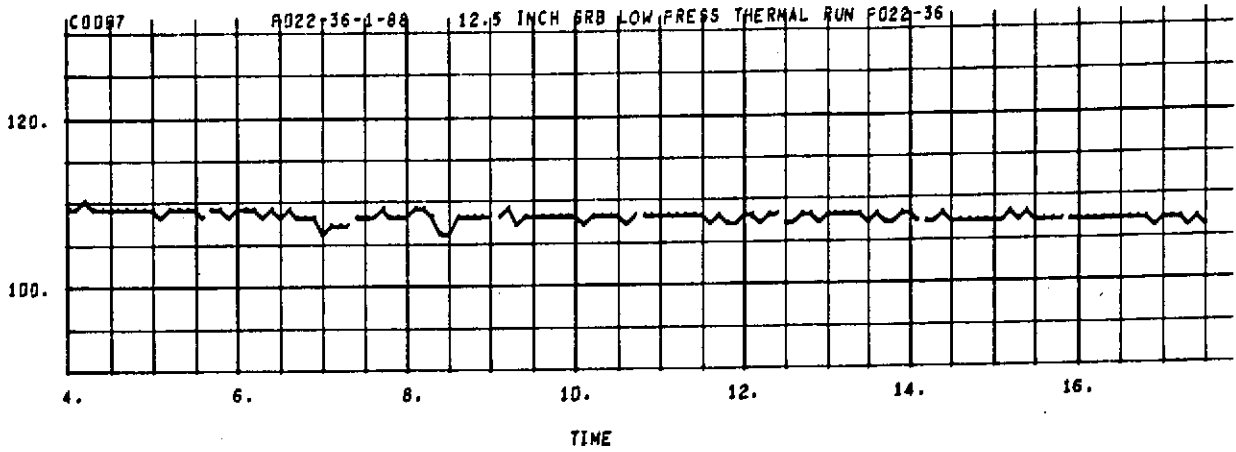

C0008 P022-36-1-96

A
M
P
L
I
T
U
D
E

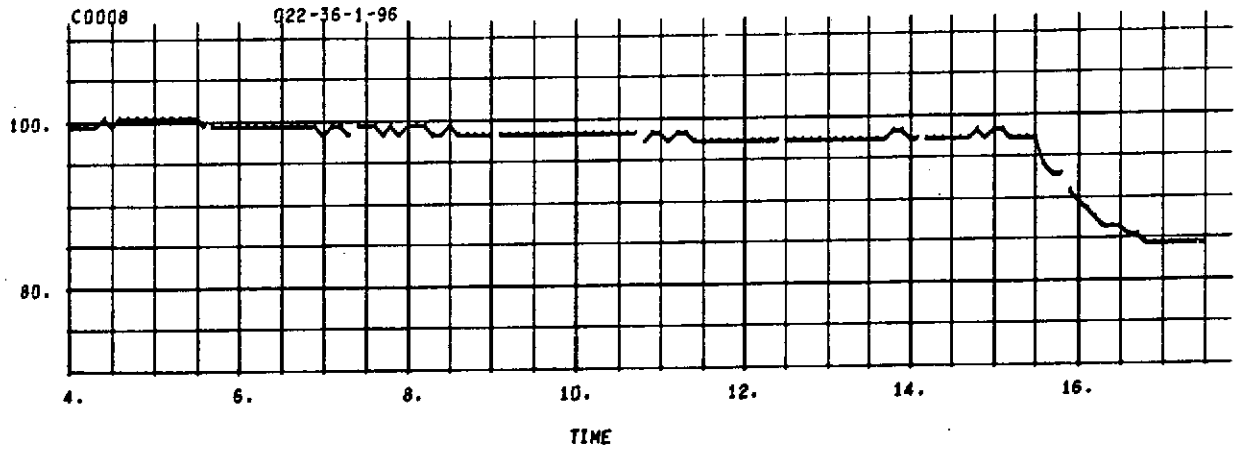

D0001 P022-36-1-24

A
M
P
L
I
T
U
D
E

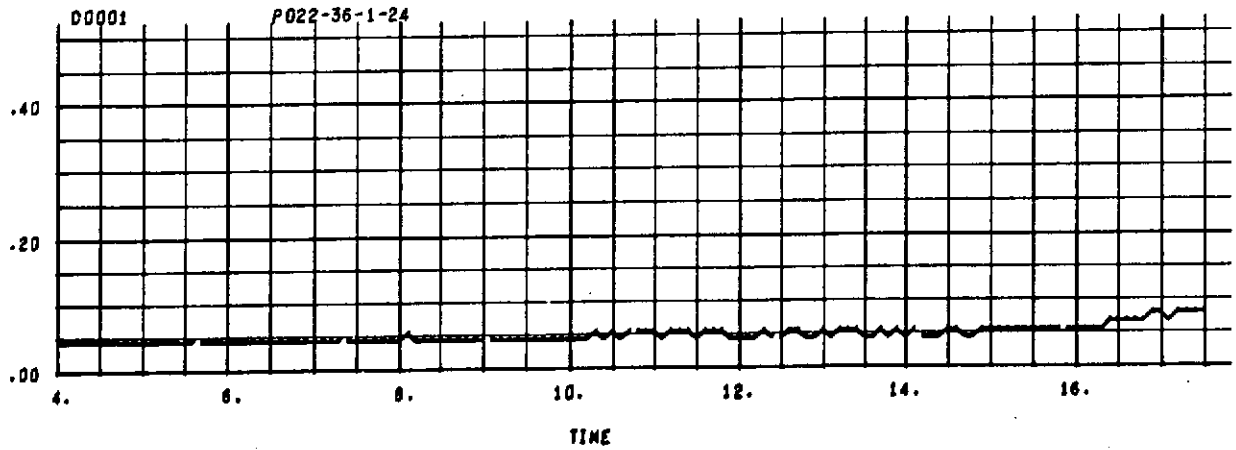



SER. # 0033

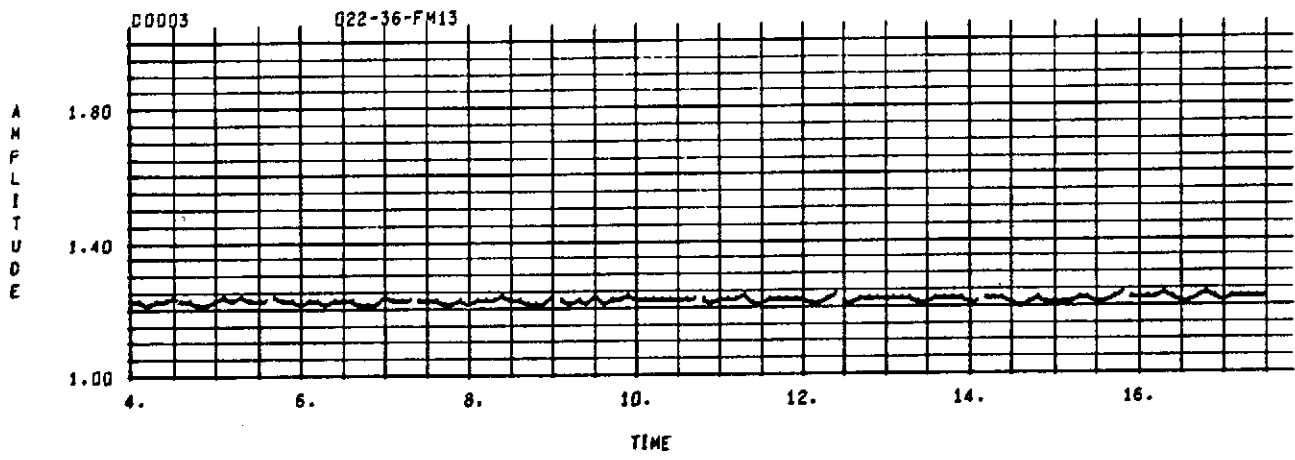
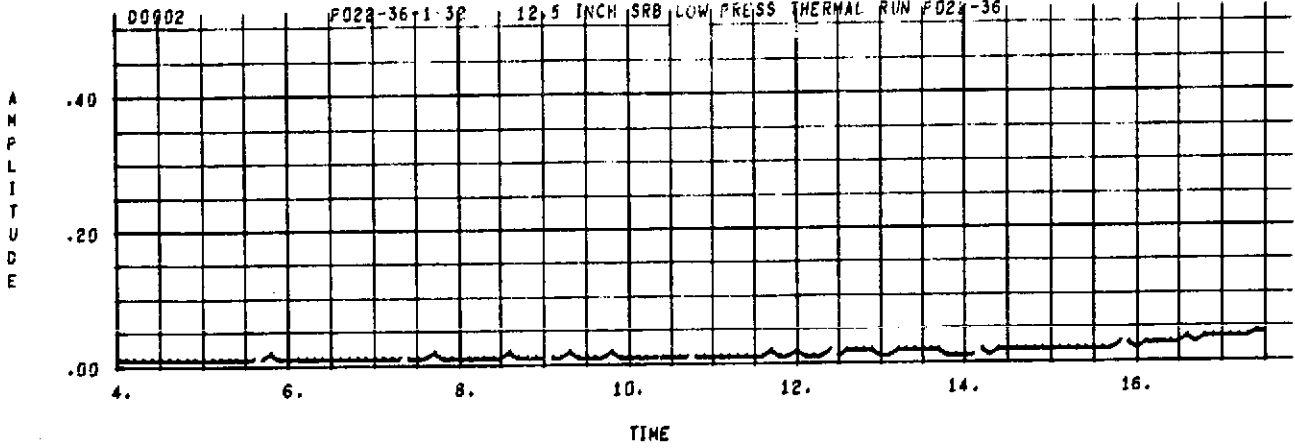

SEQ. = 0034

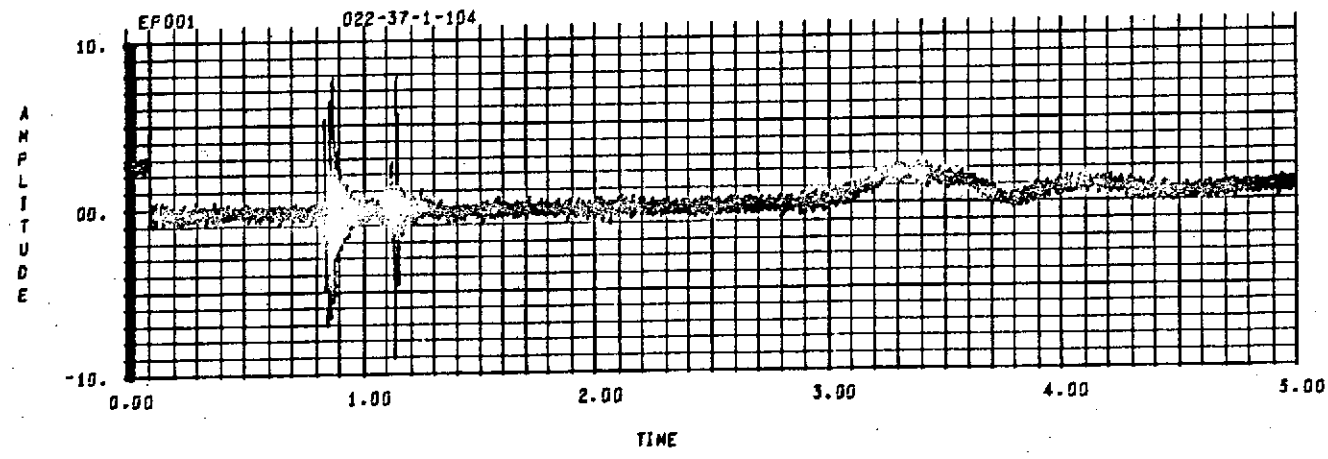
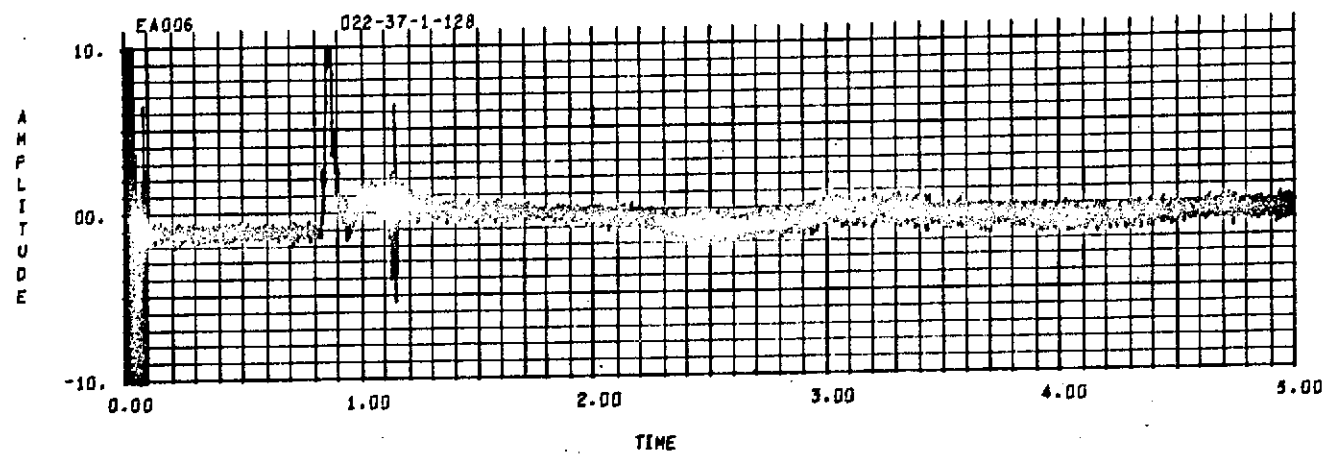
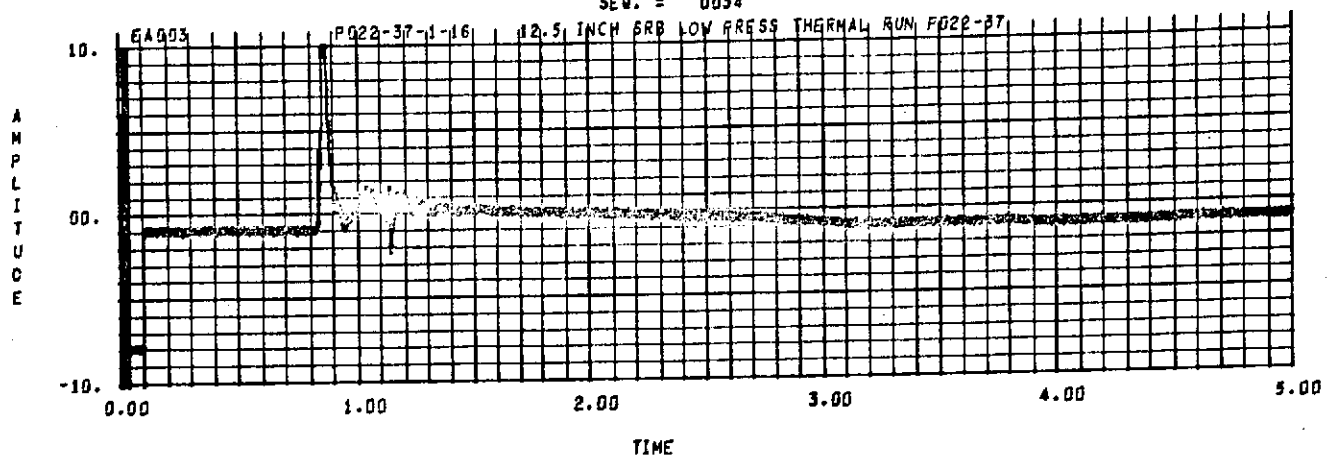



SEQ. = 0034

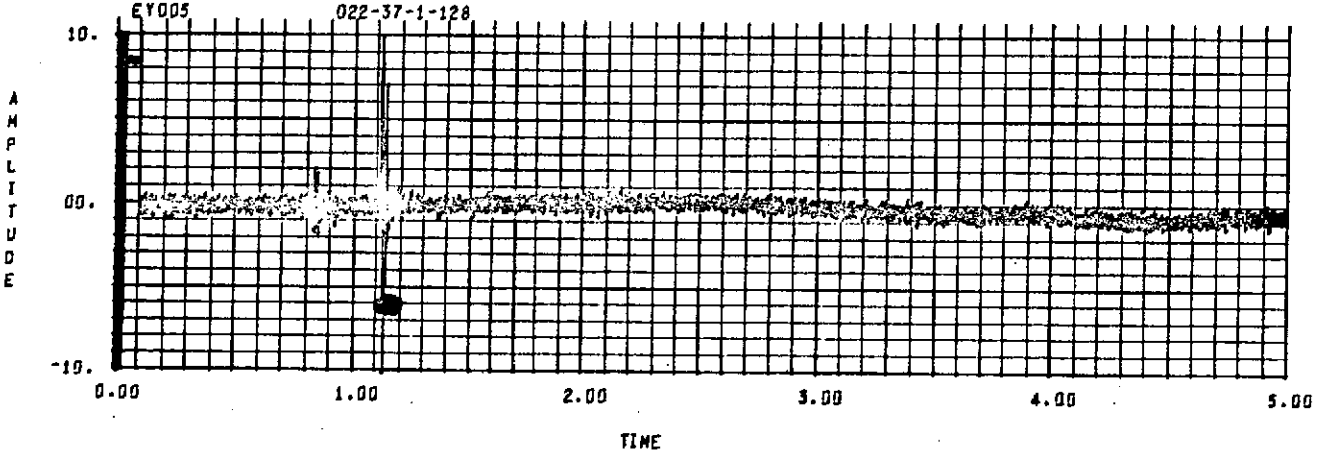
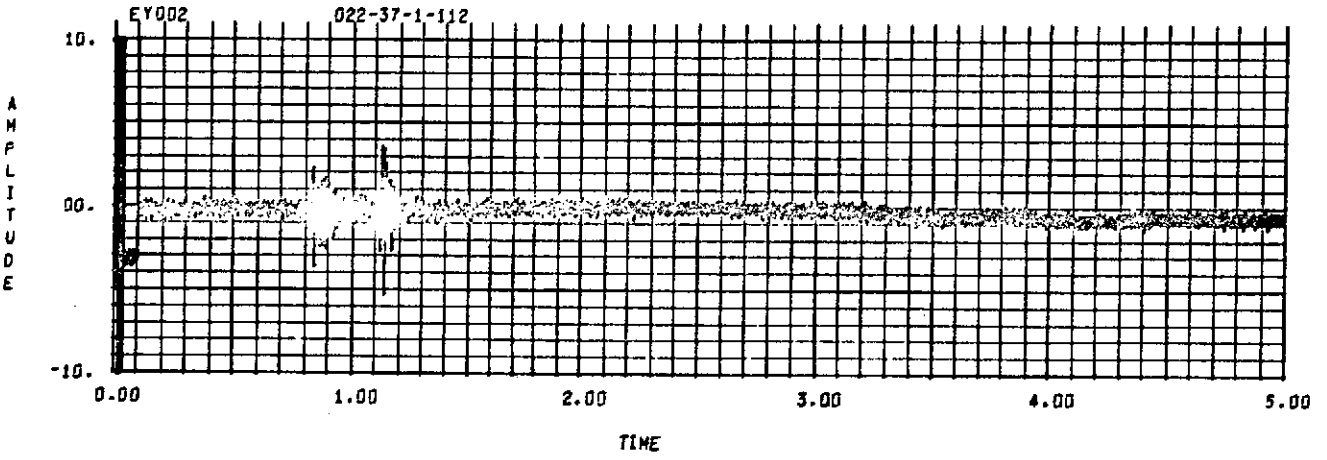
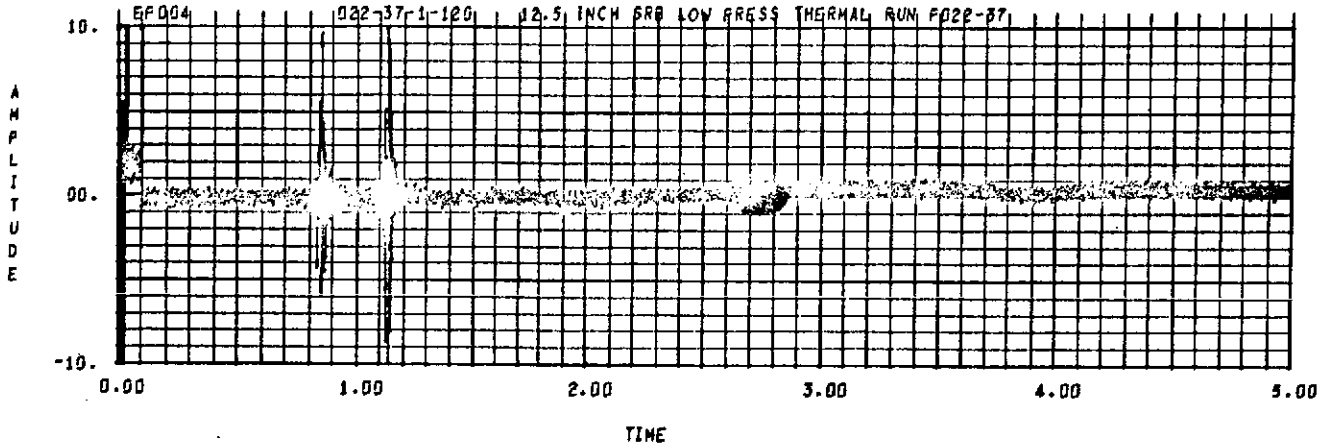

SEQ. = 0034

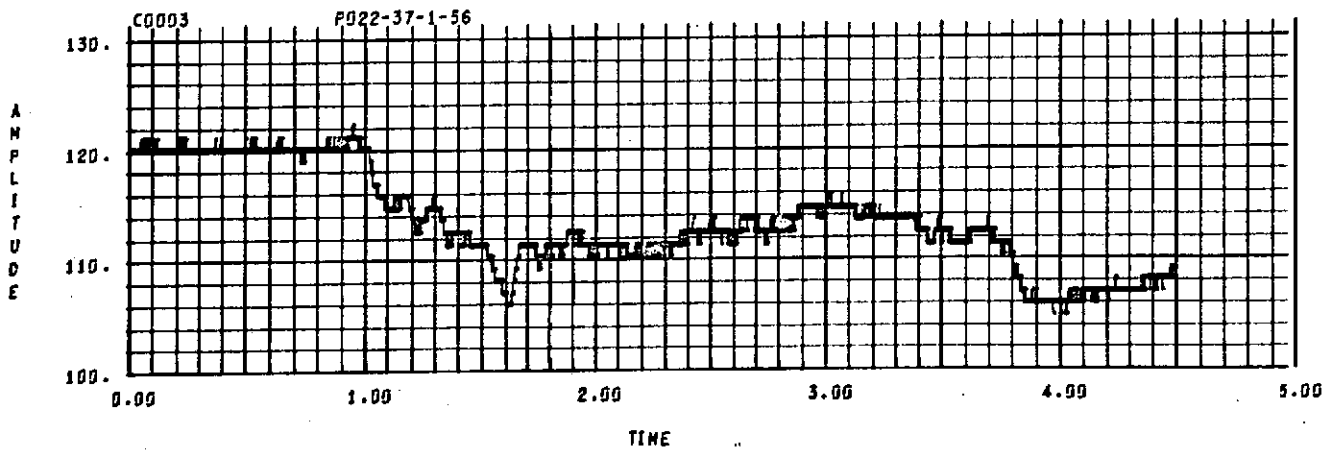
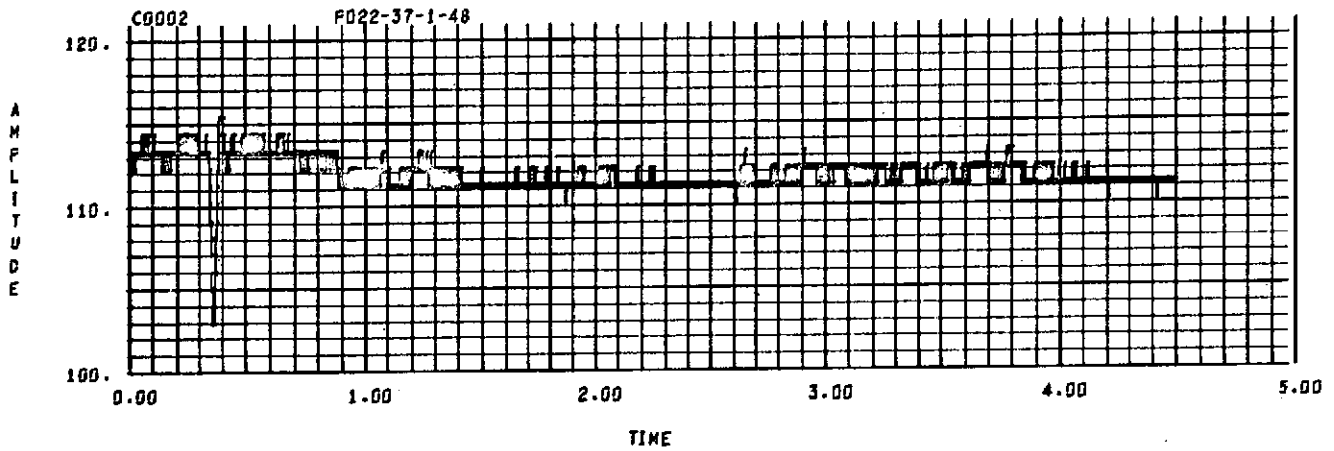
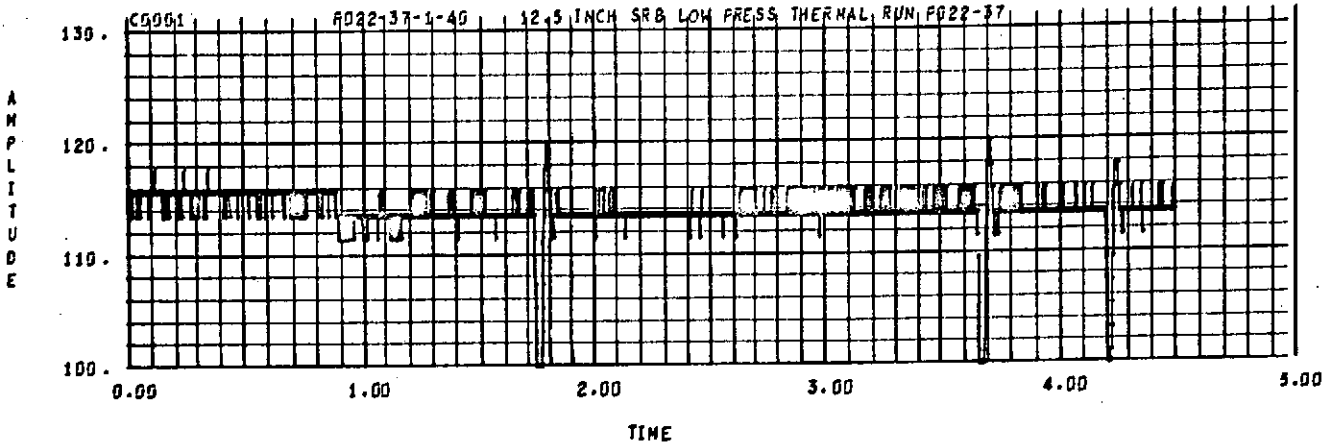



SEQ. = 0034

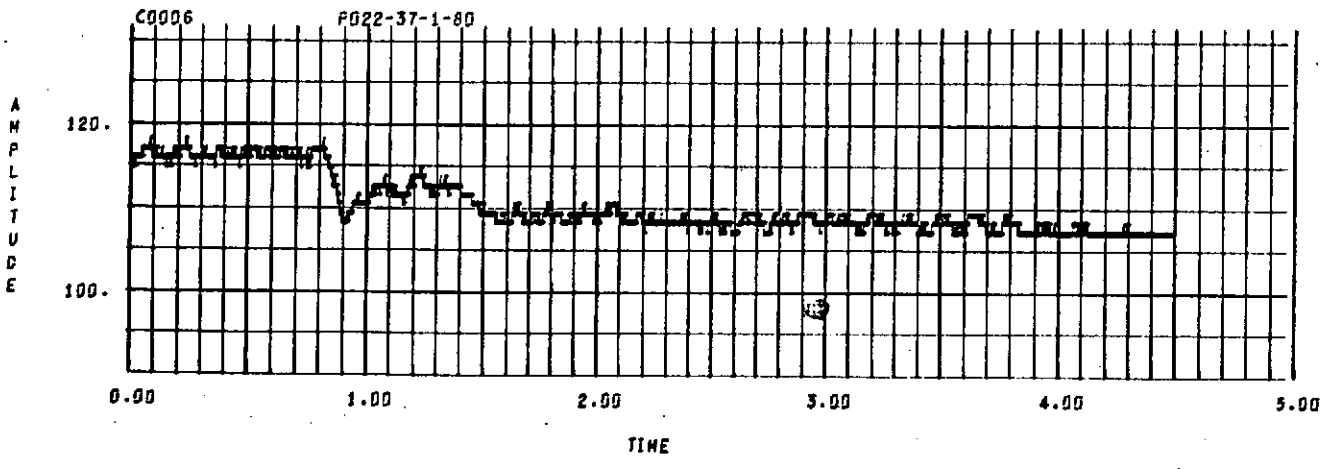
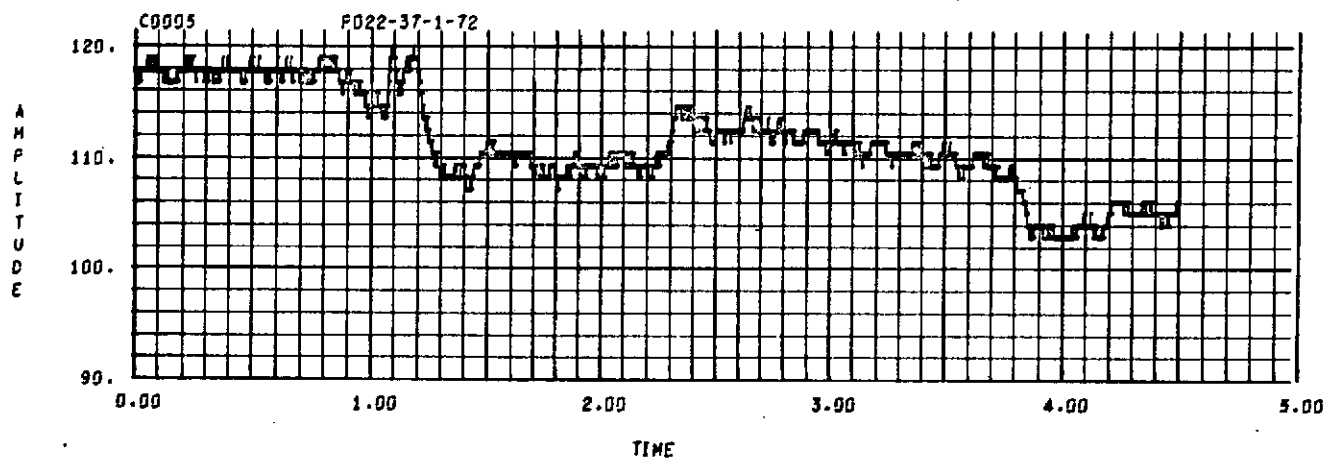
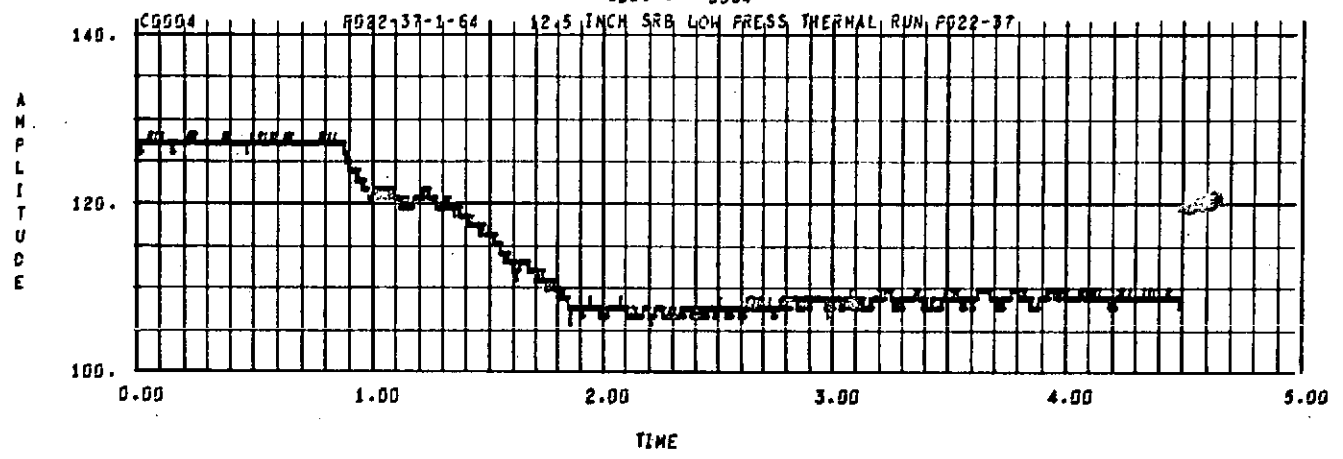

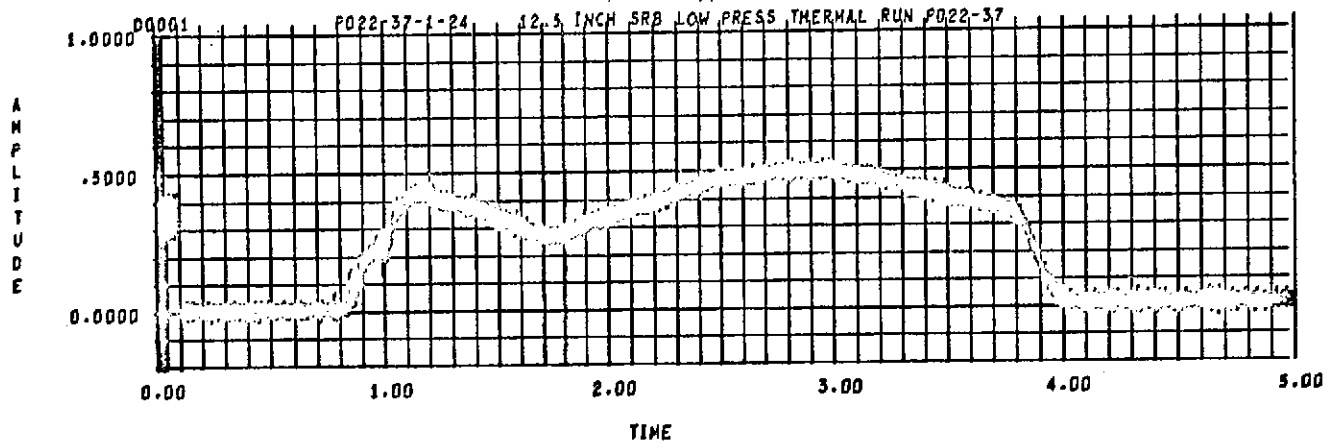
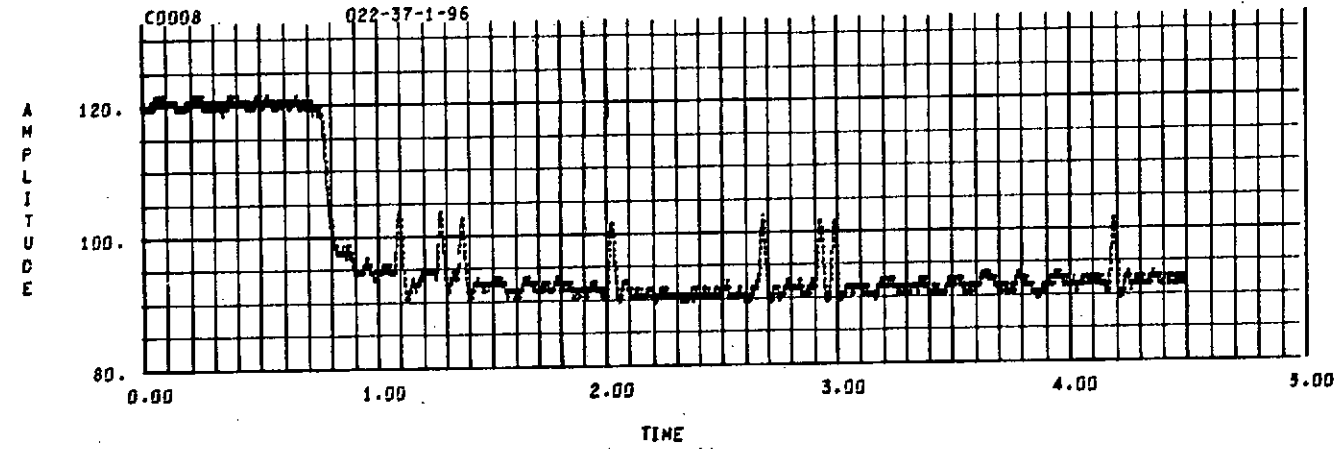
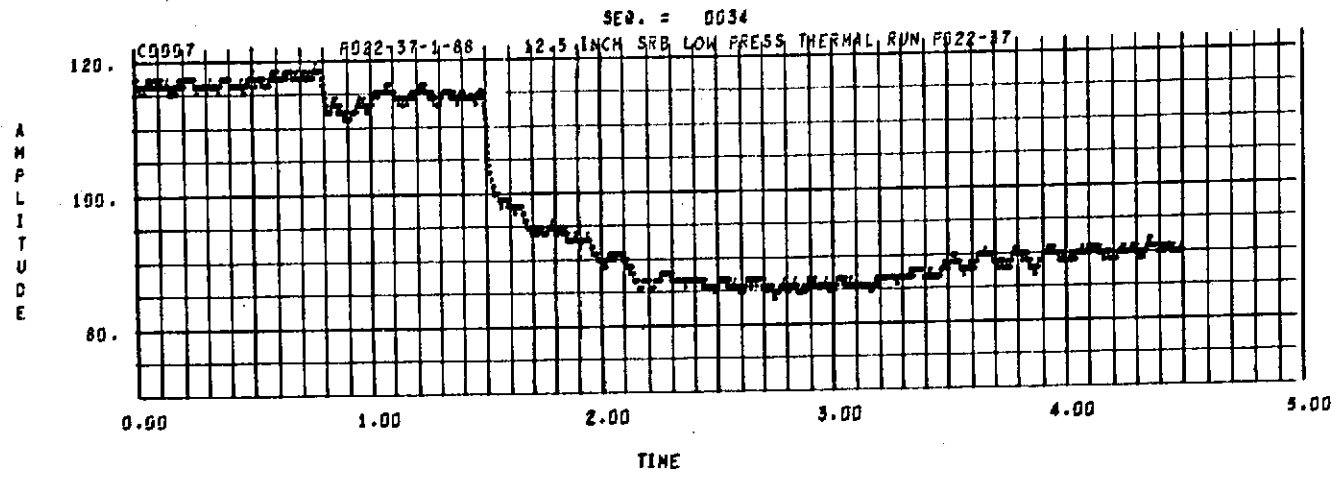

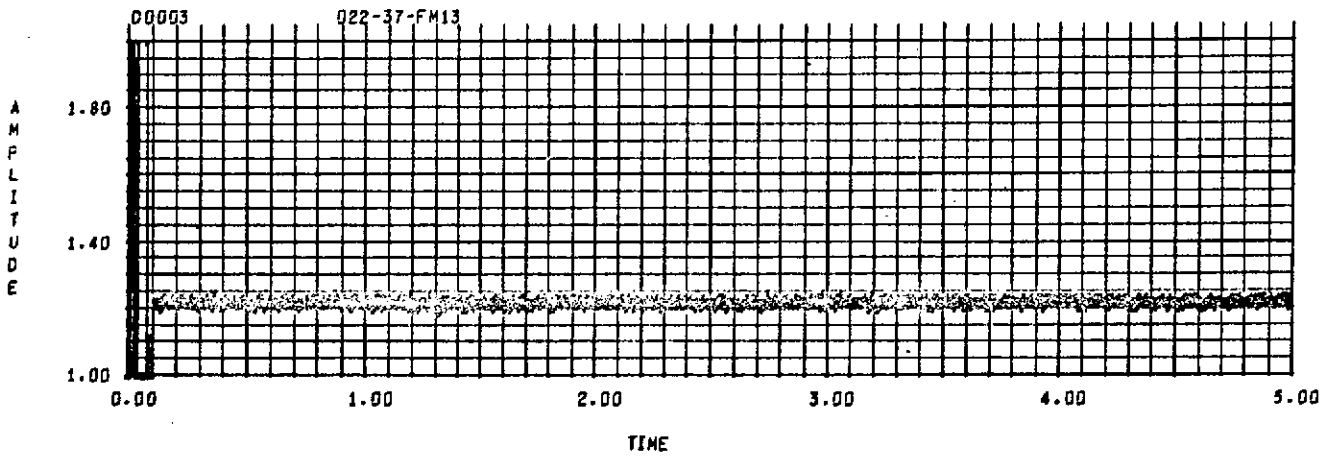
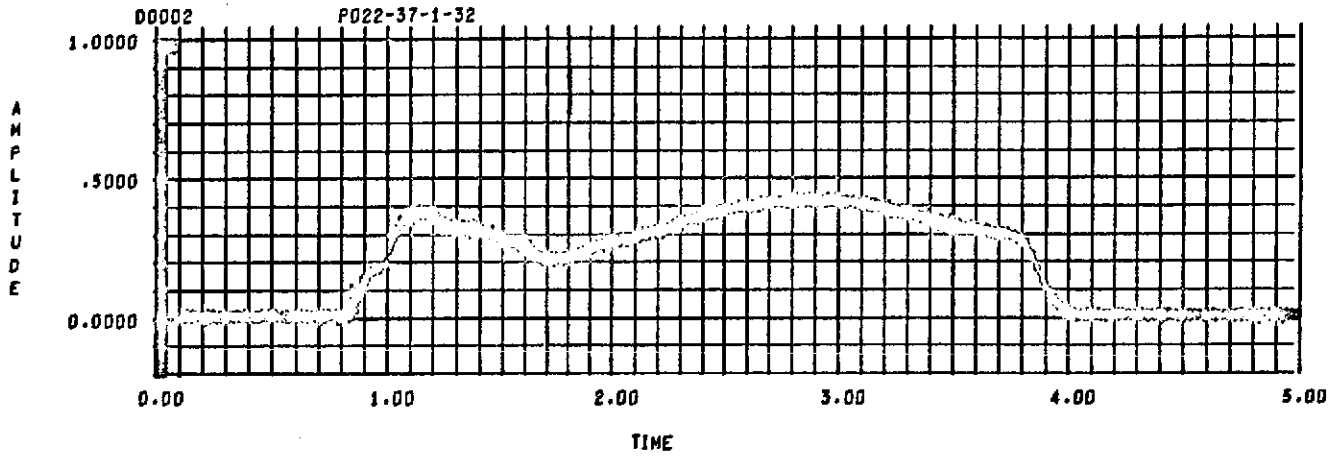



SEQ. = 0034

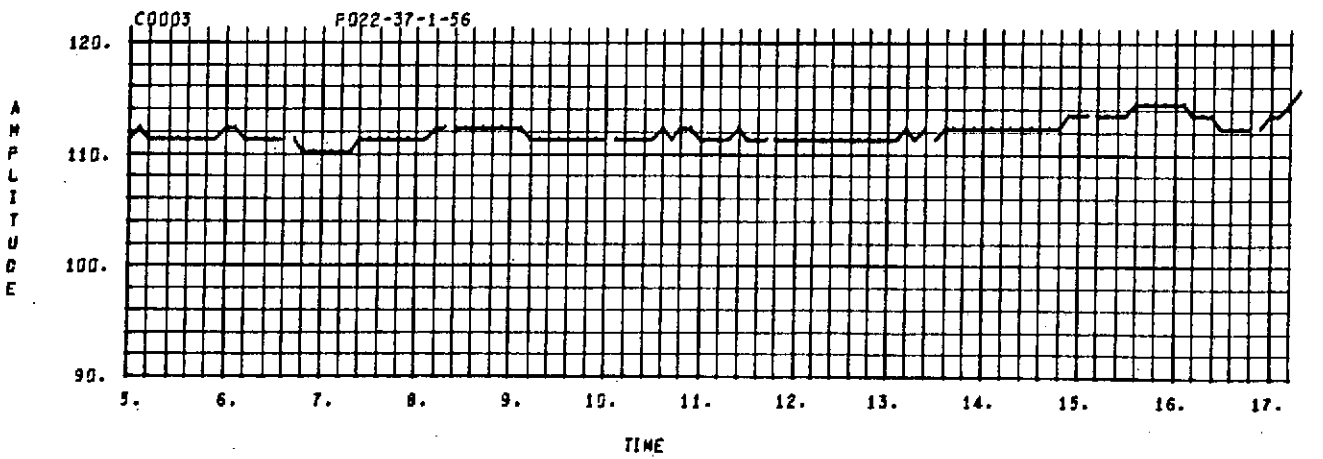
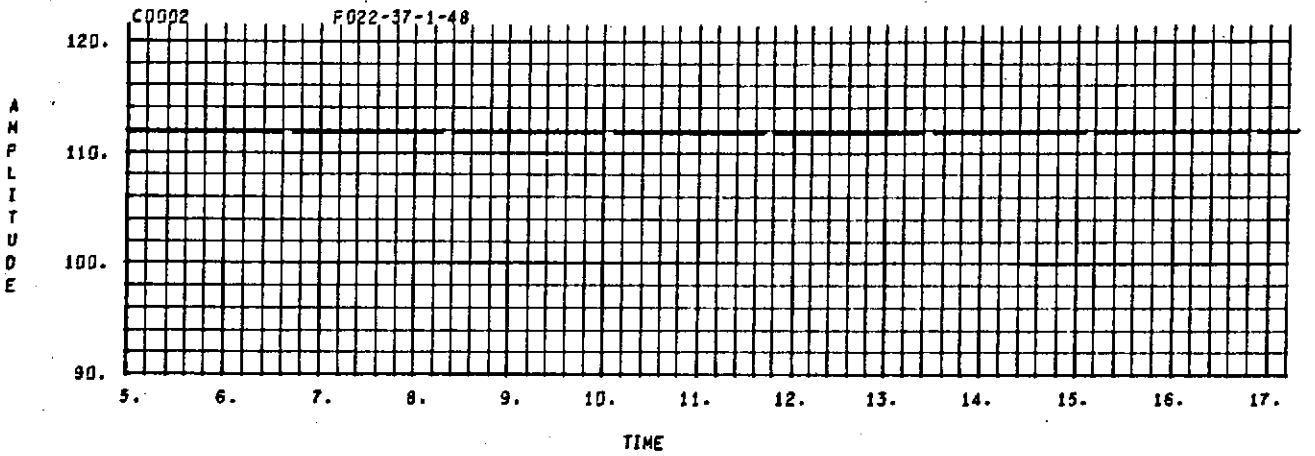
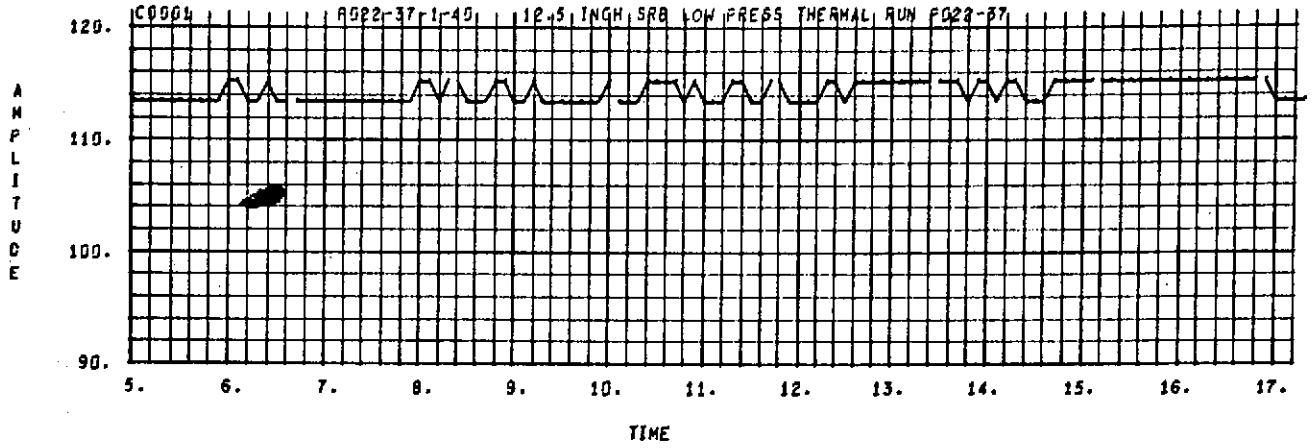

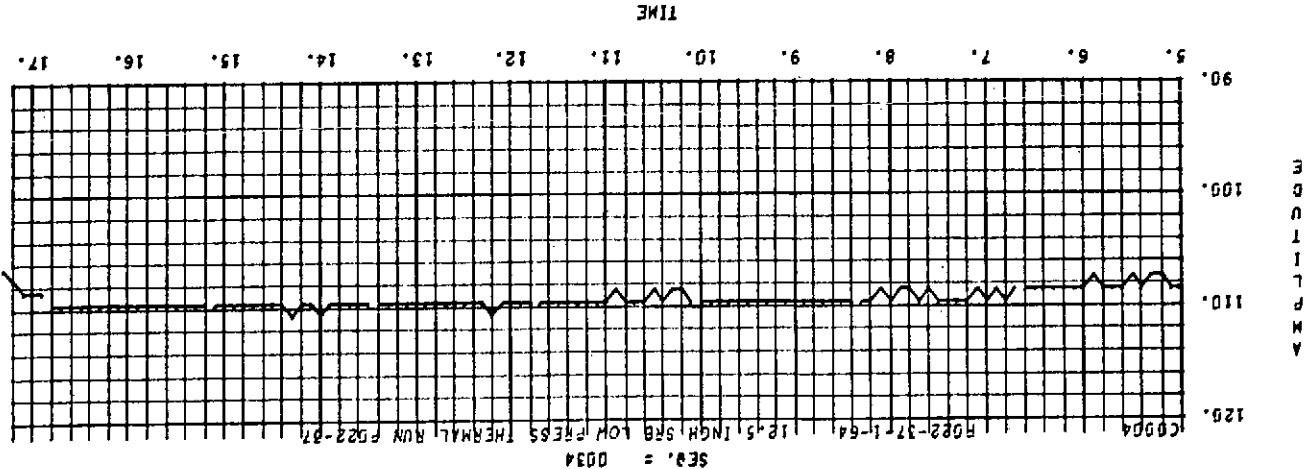
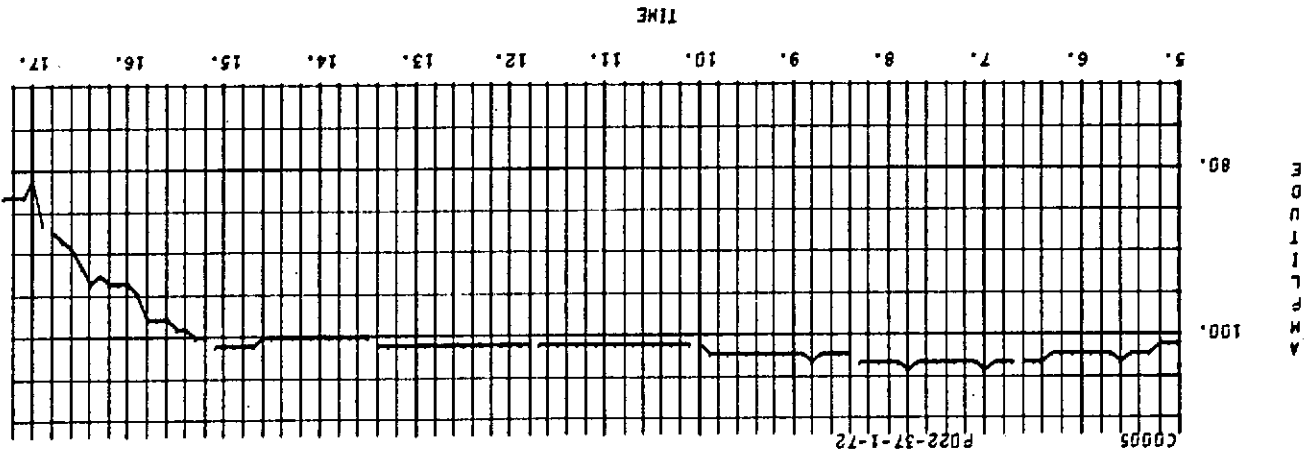
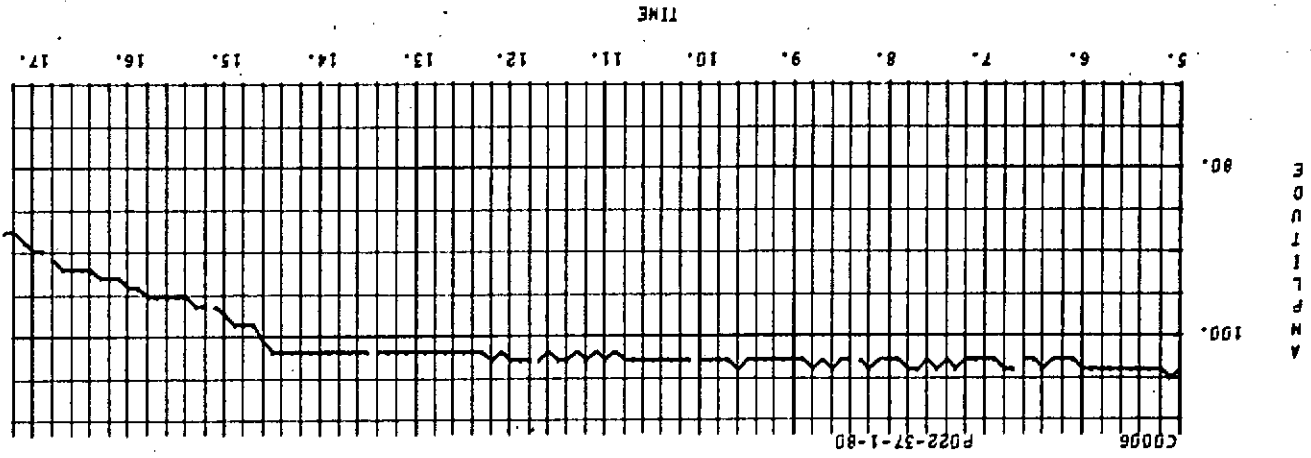

SEQ. = 0034
12.5 INGH, SRB LOW PRESS THERMAL RUN P522-07



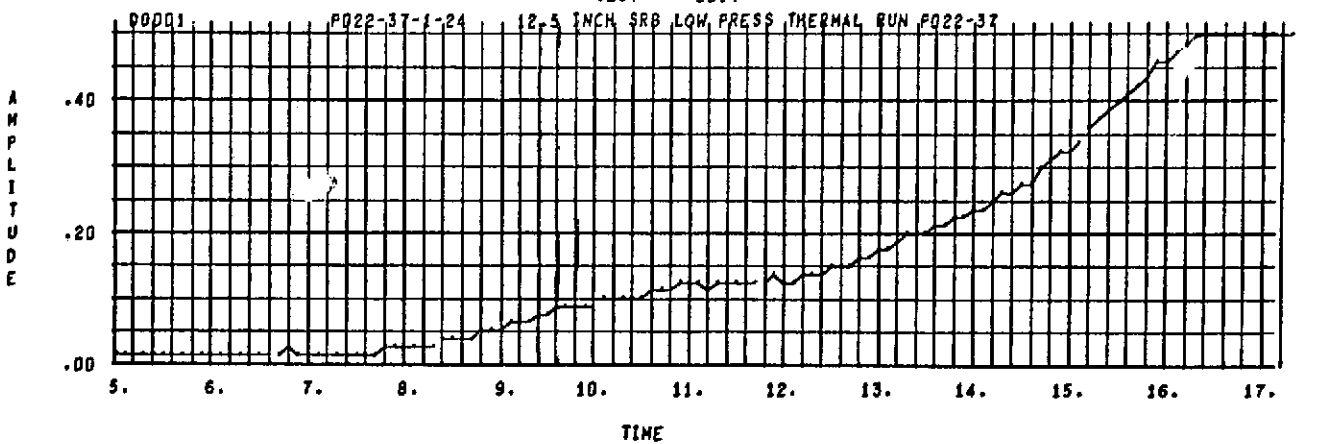
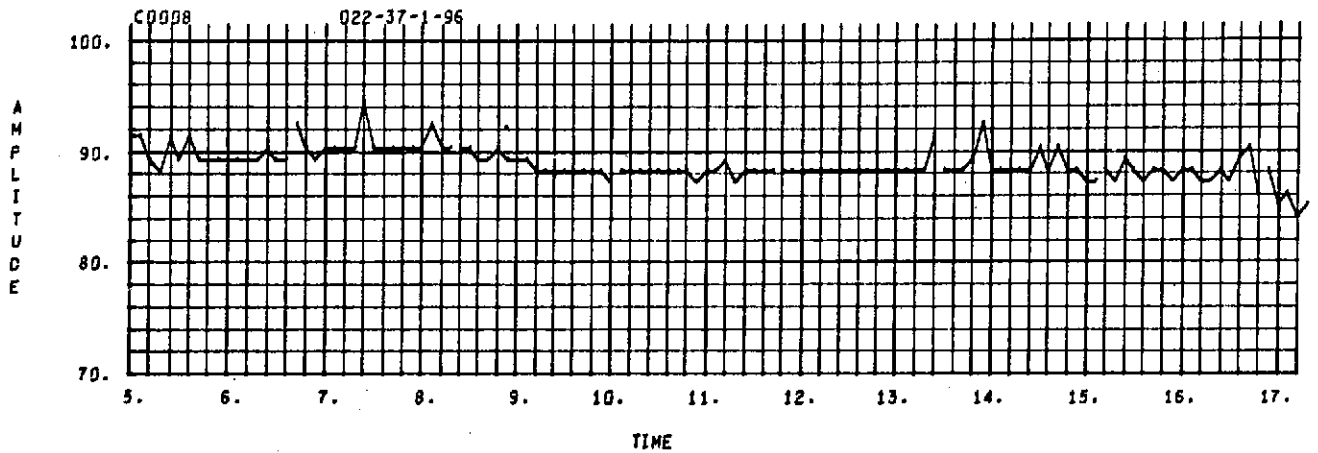
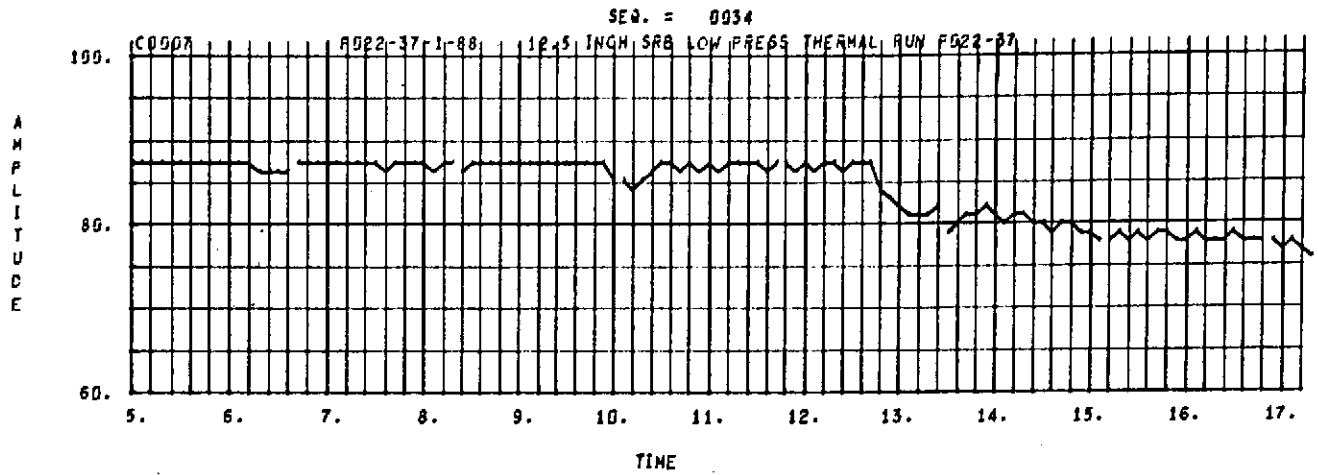

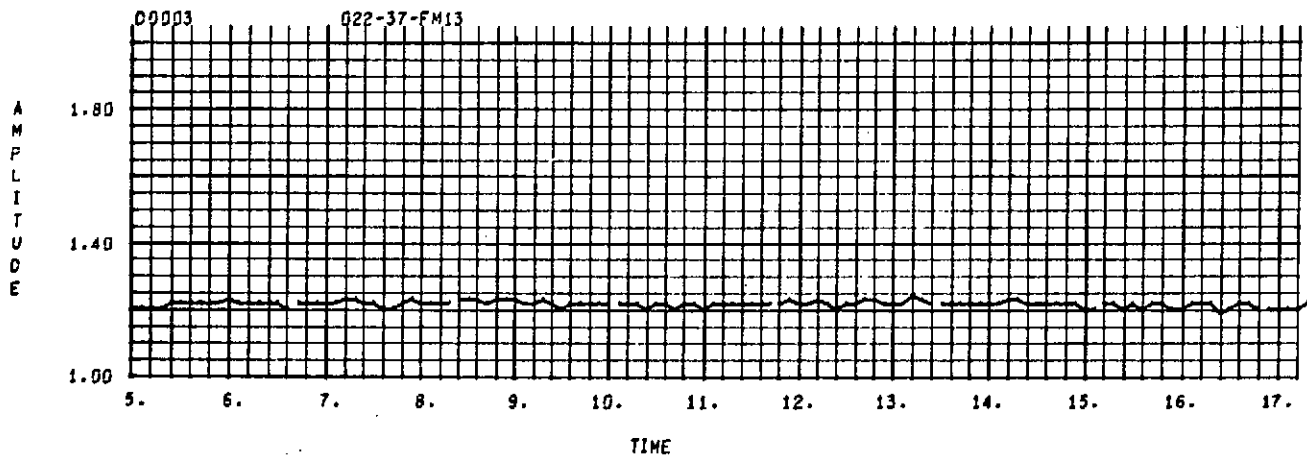
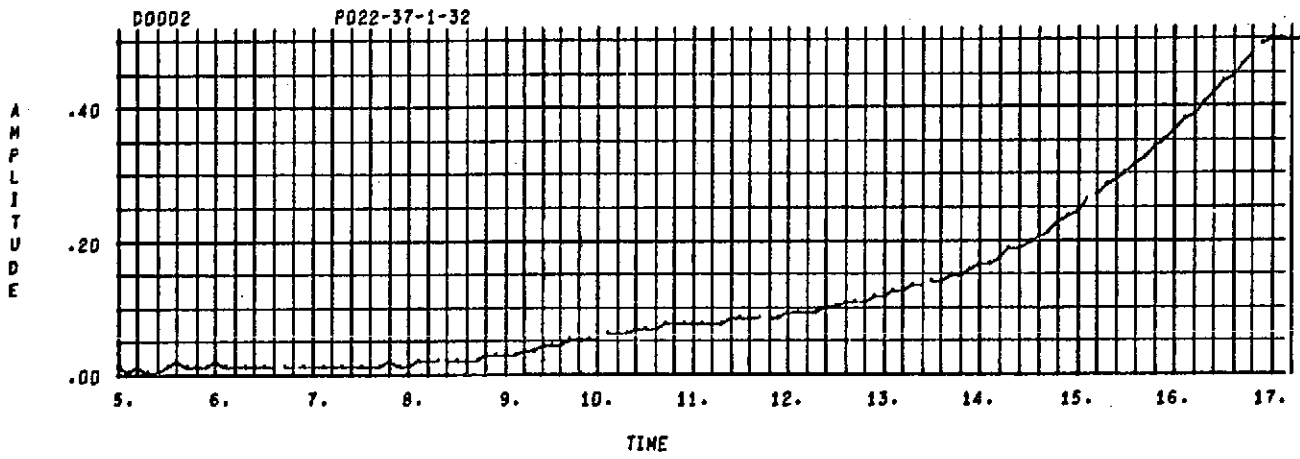

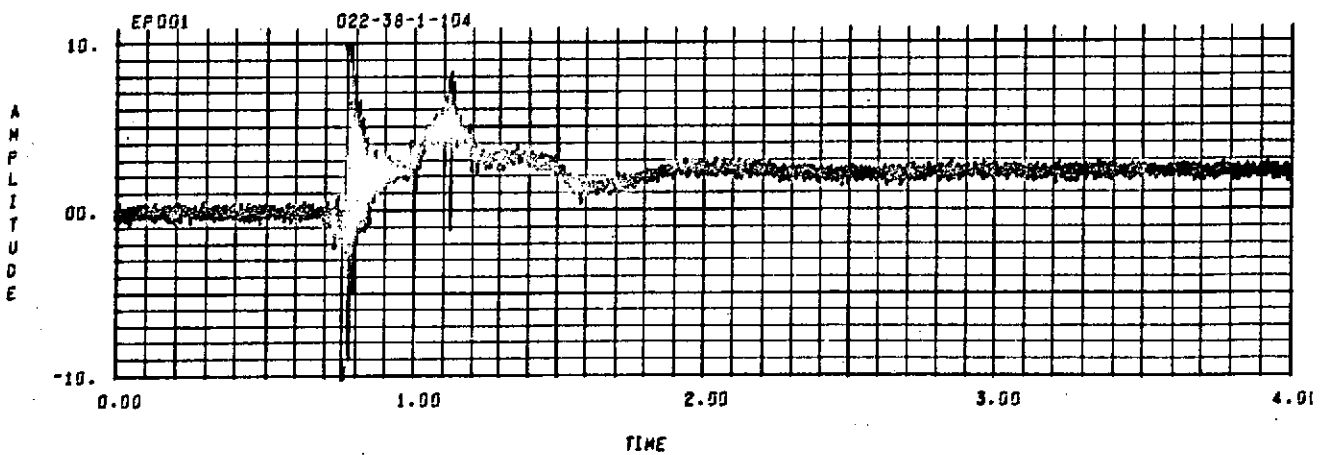
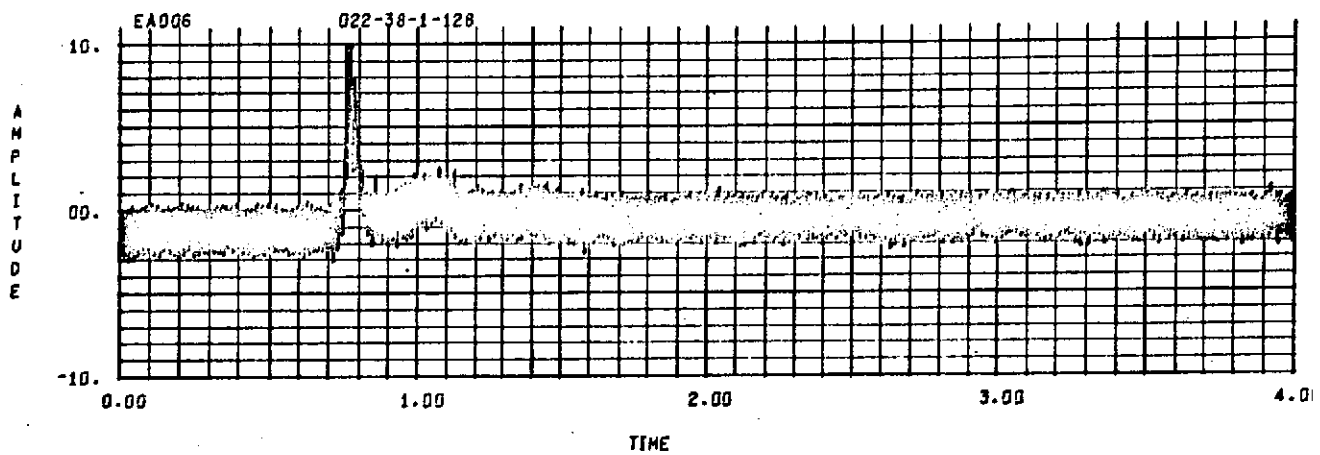
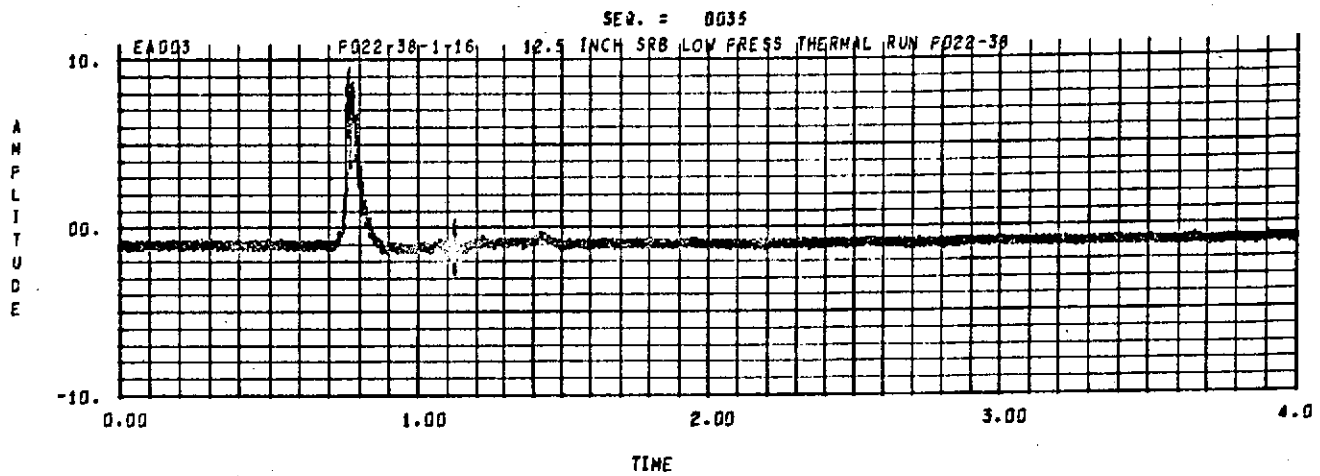



SEQ. = 0035

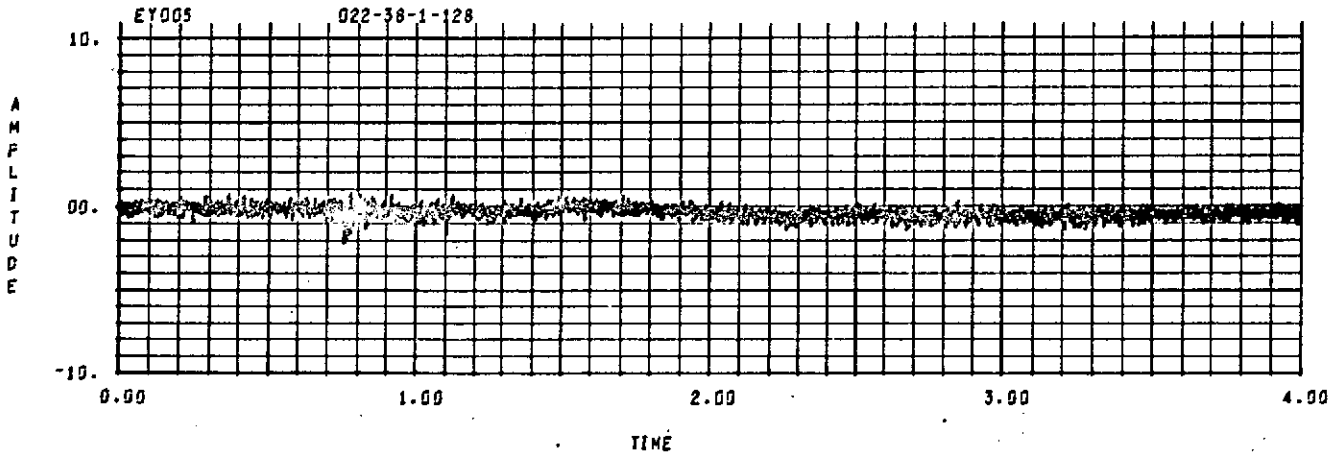
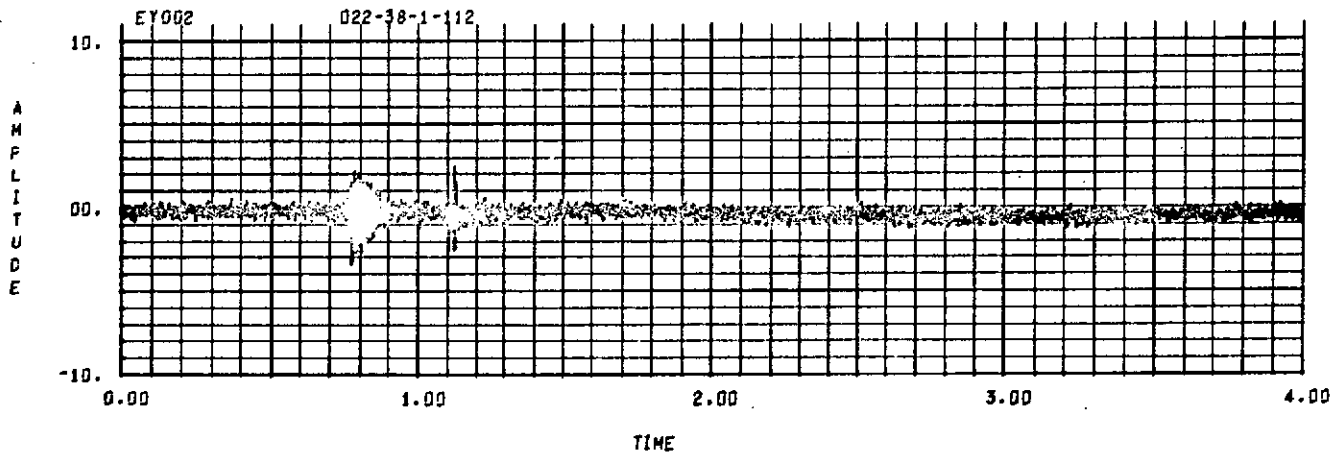
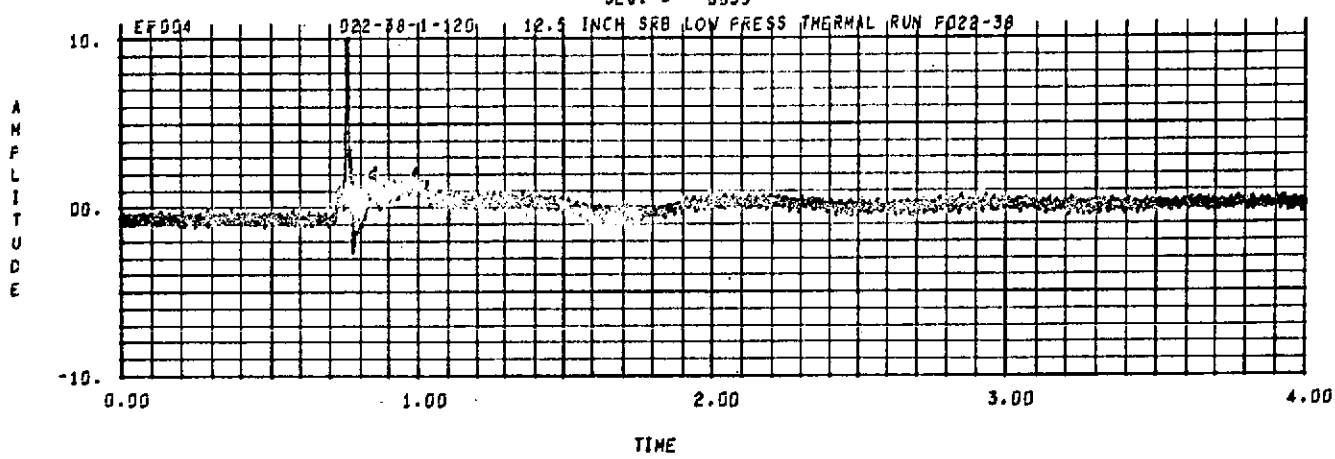



SEQ. = 0035

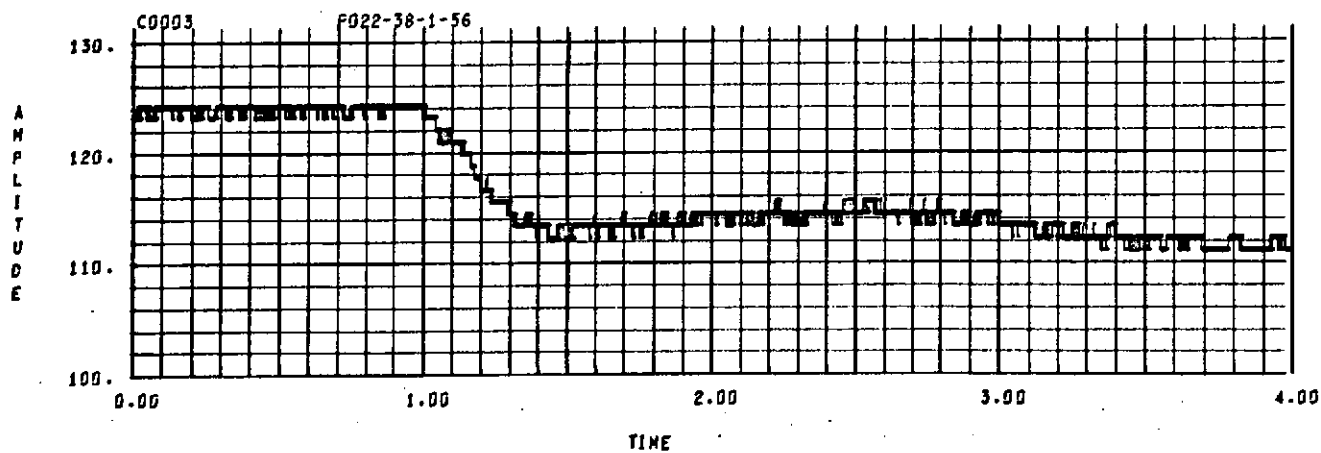
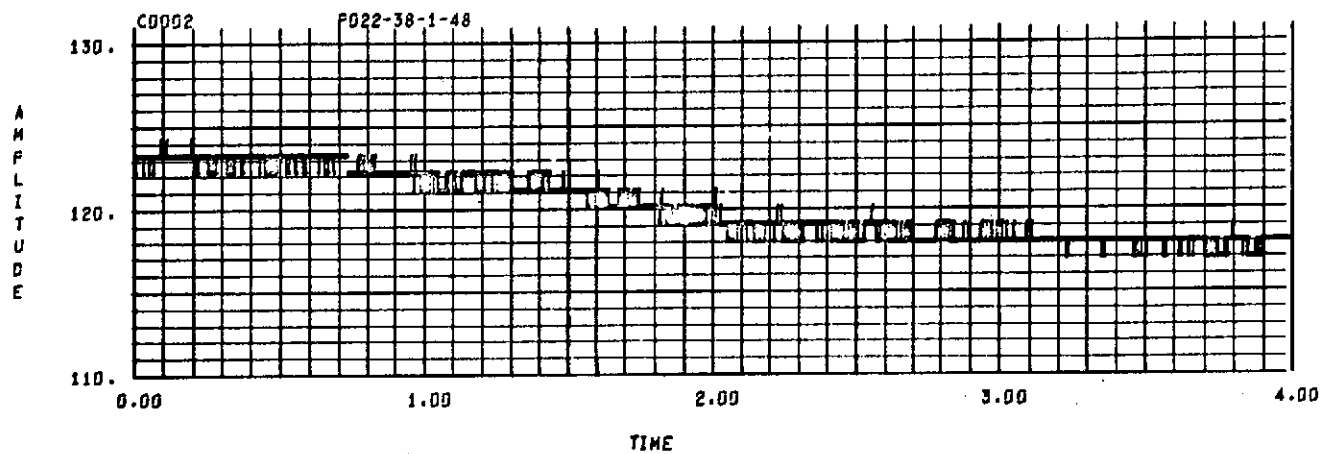
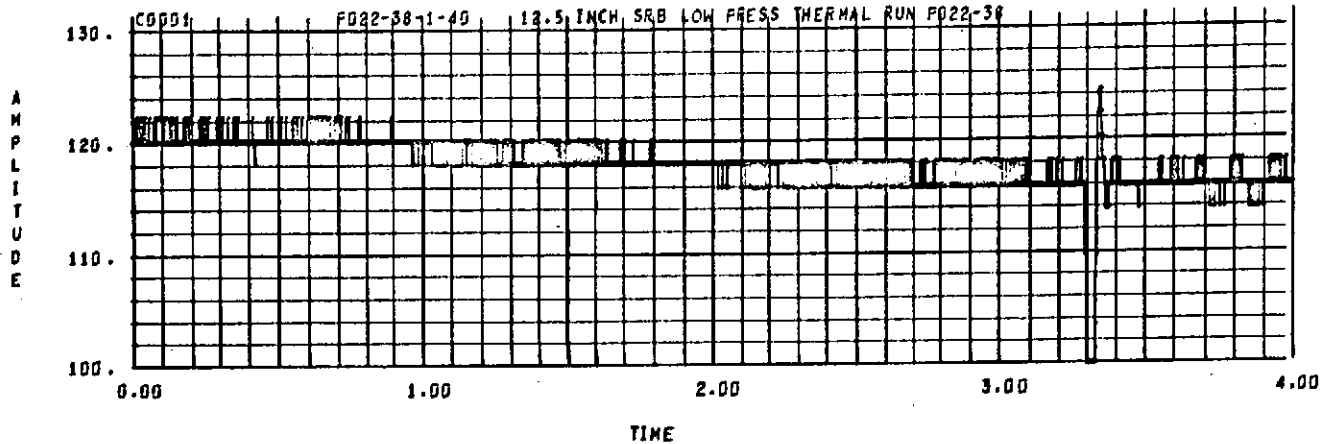

SEQ. = 0035

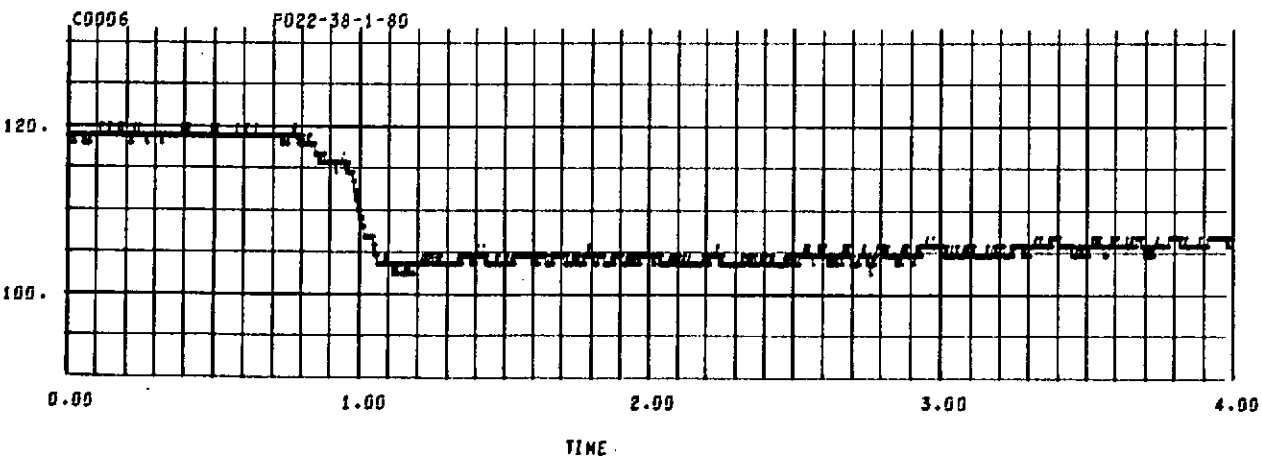
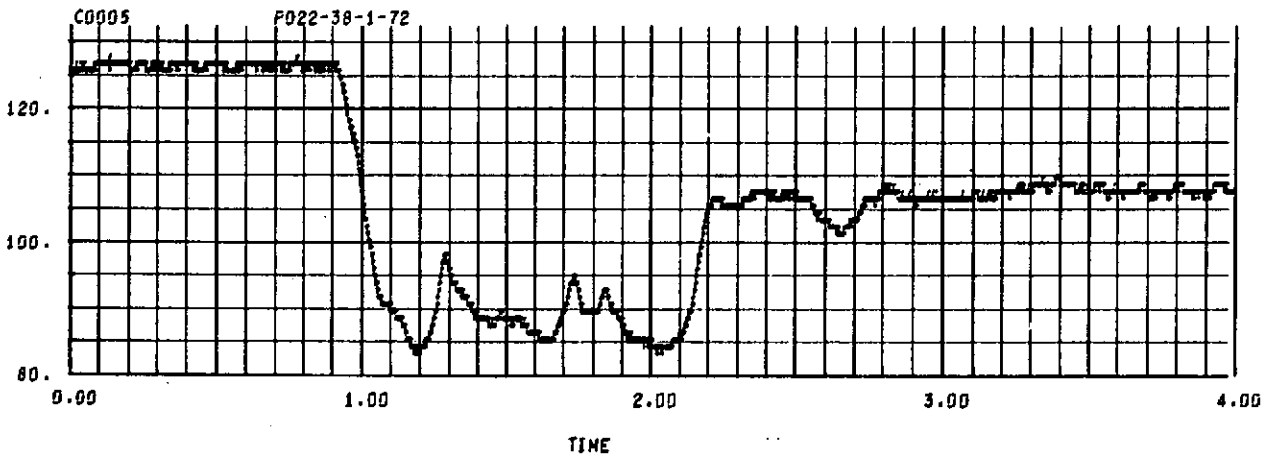
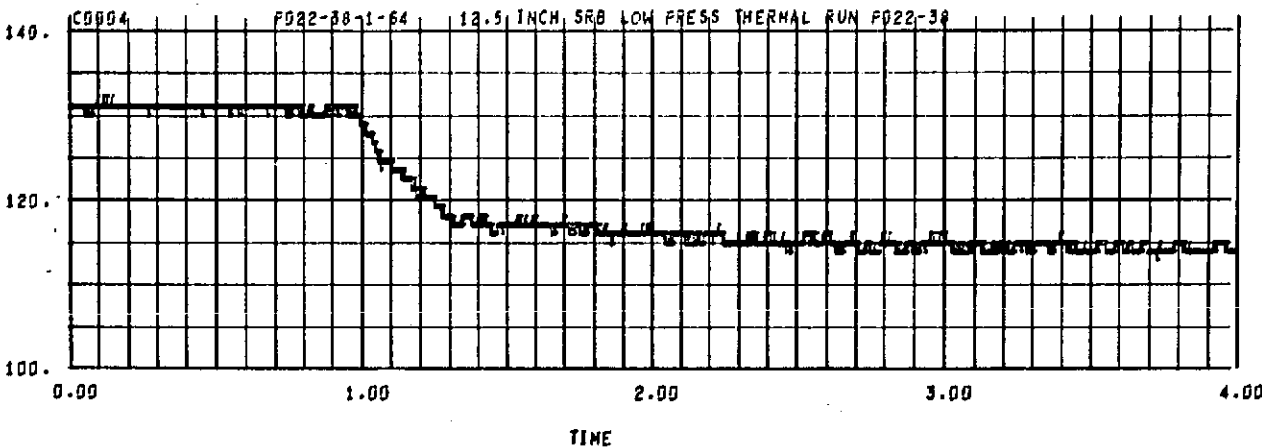



SEQ. = 0035

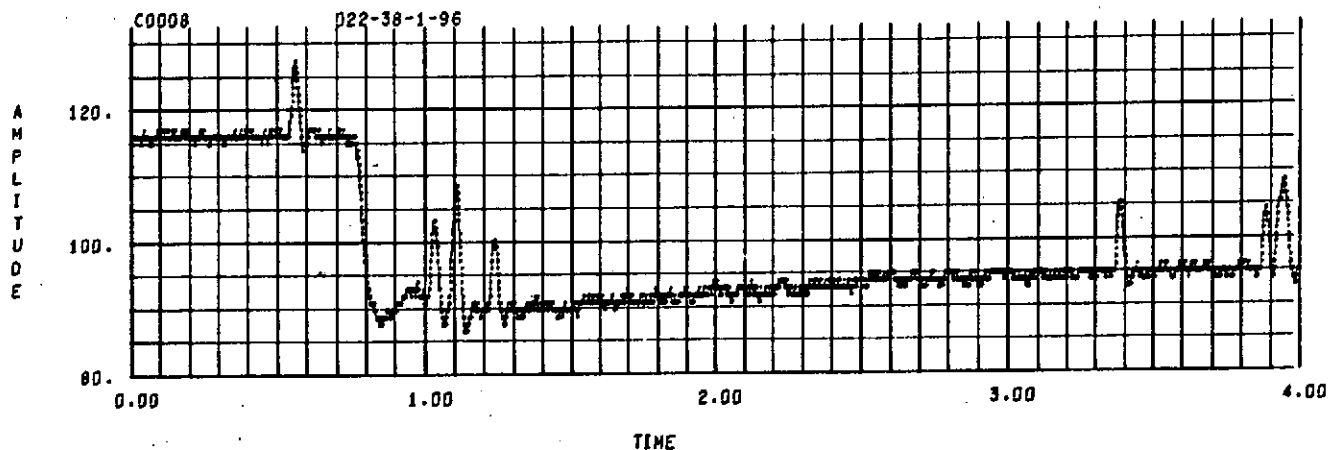
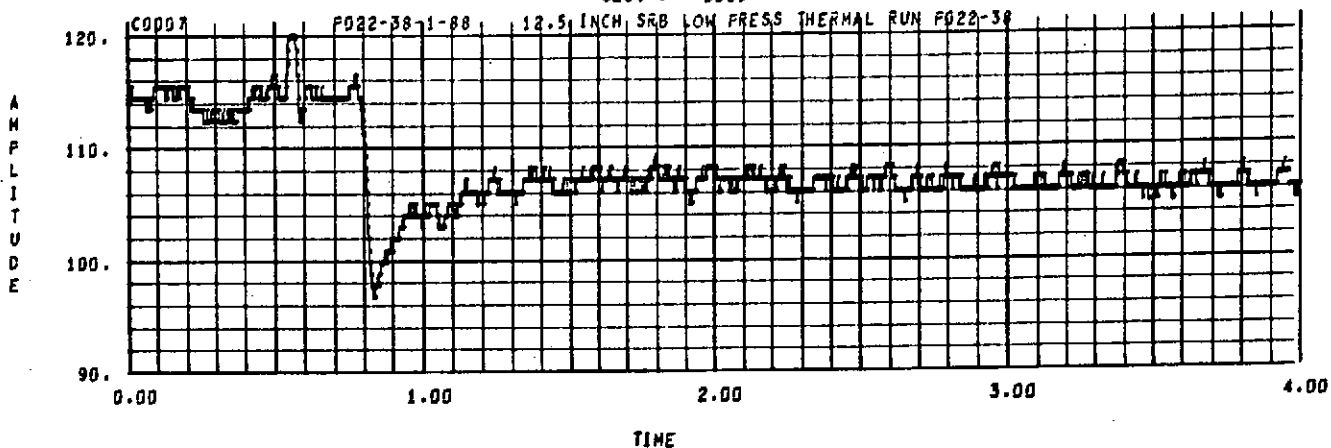

SEQ. = 0035

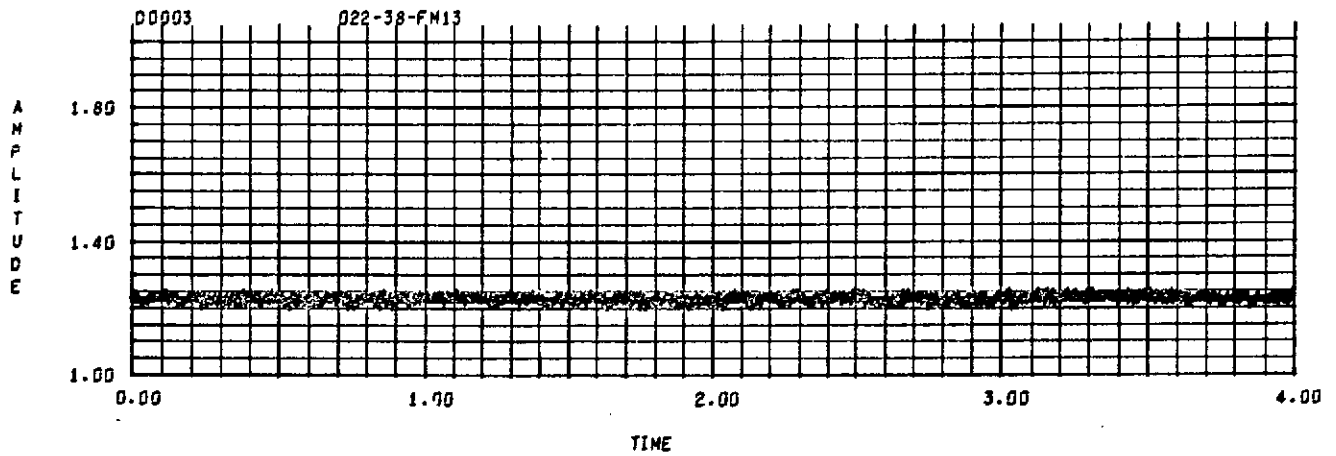
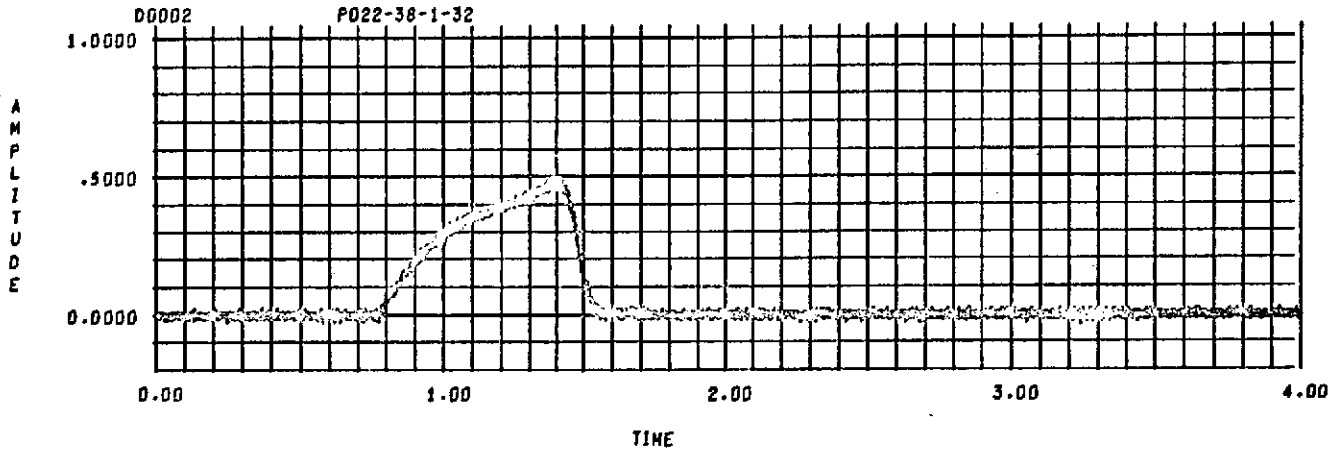
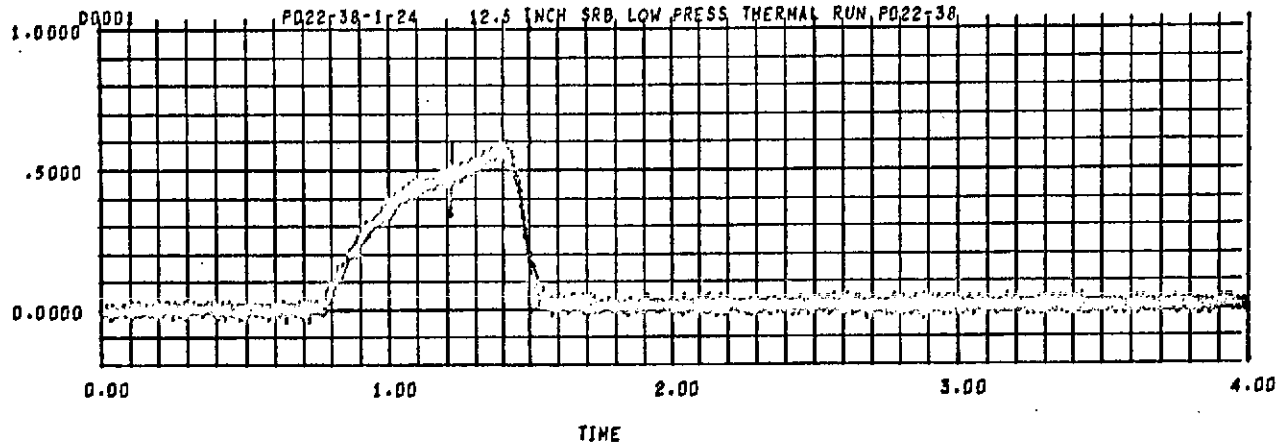



SEQ. = 0035

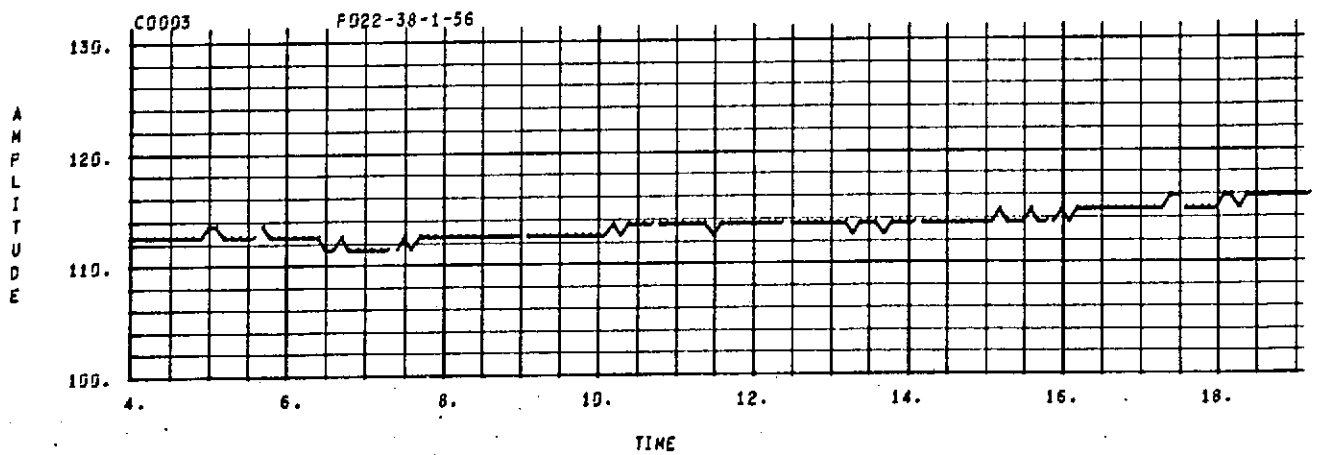
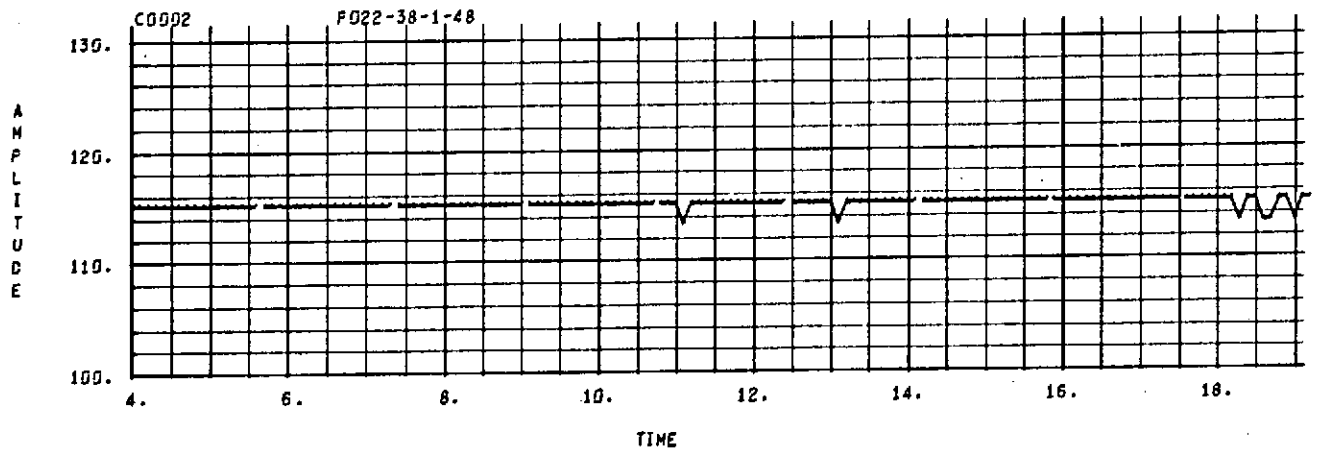
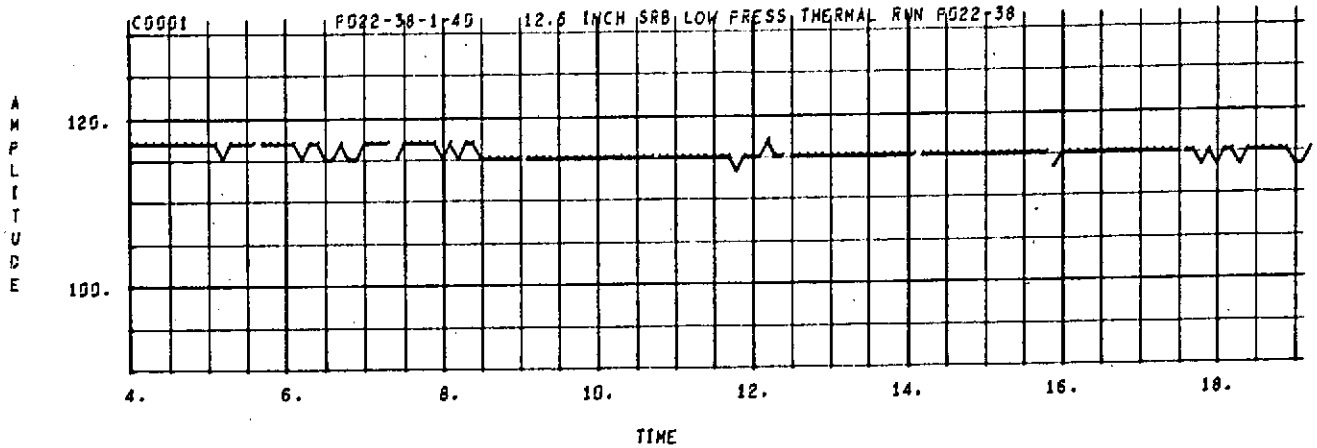



SEQ. = 0035

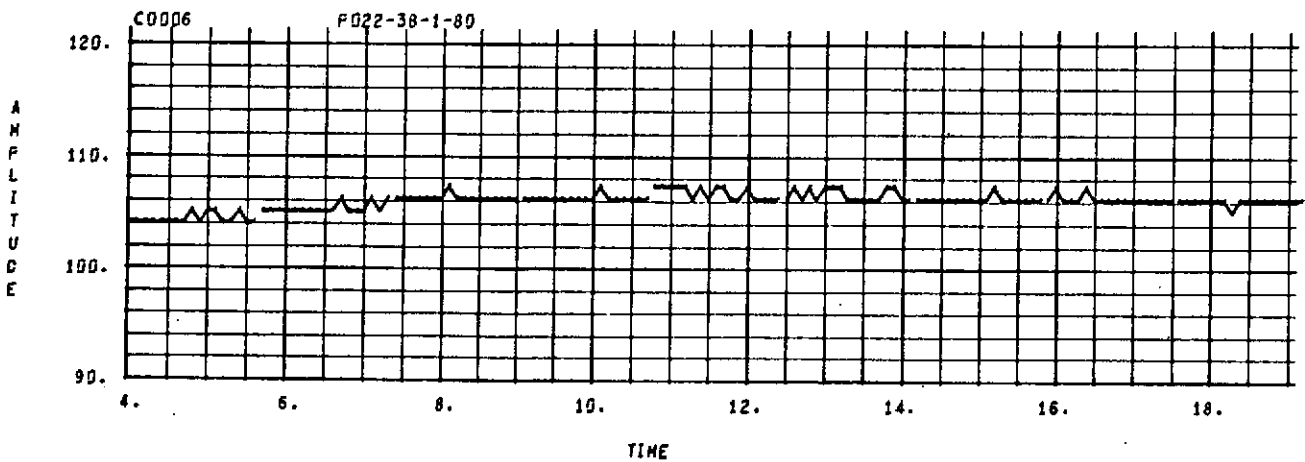
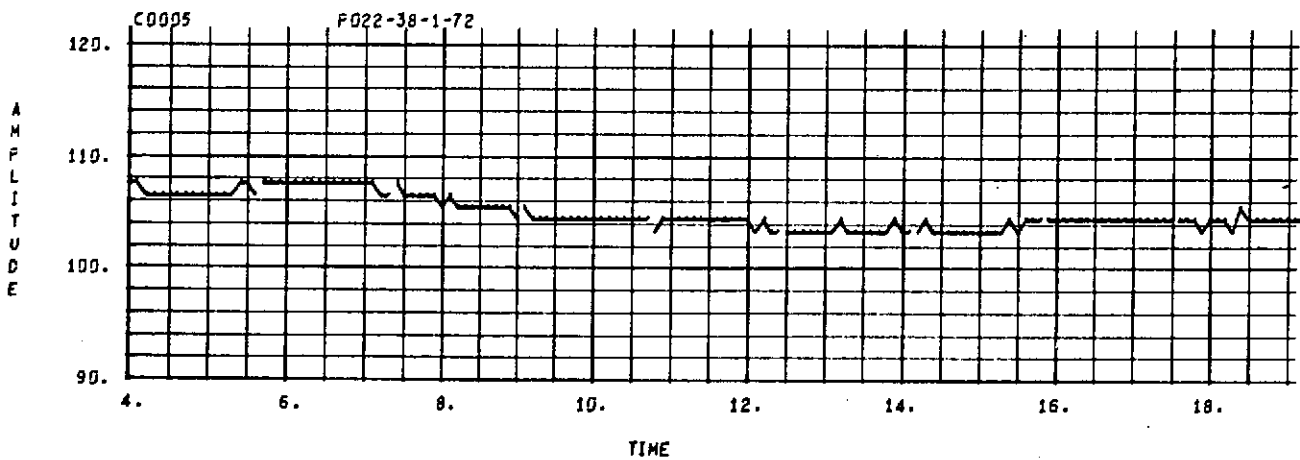
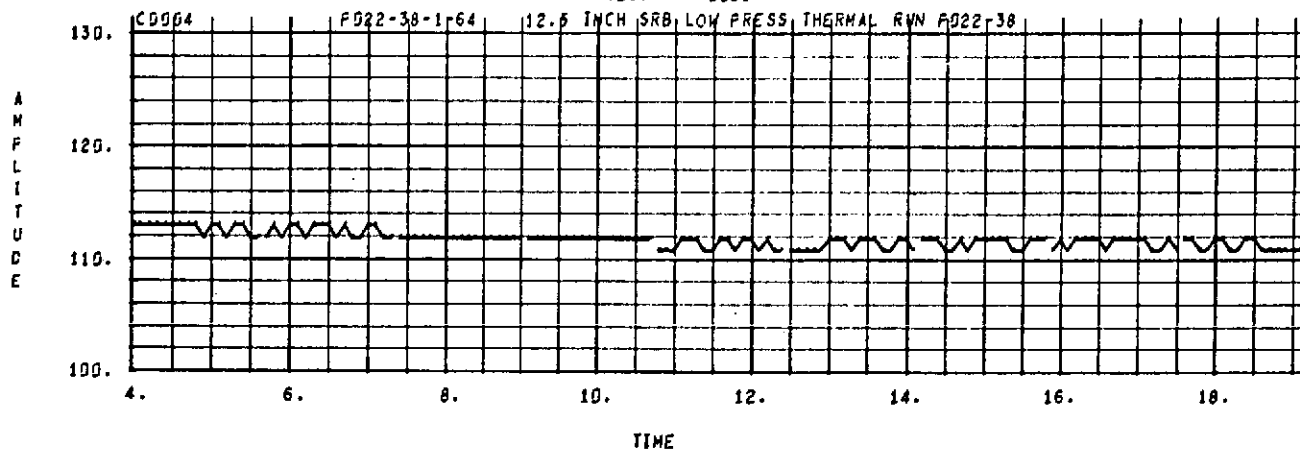

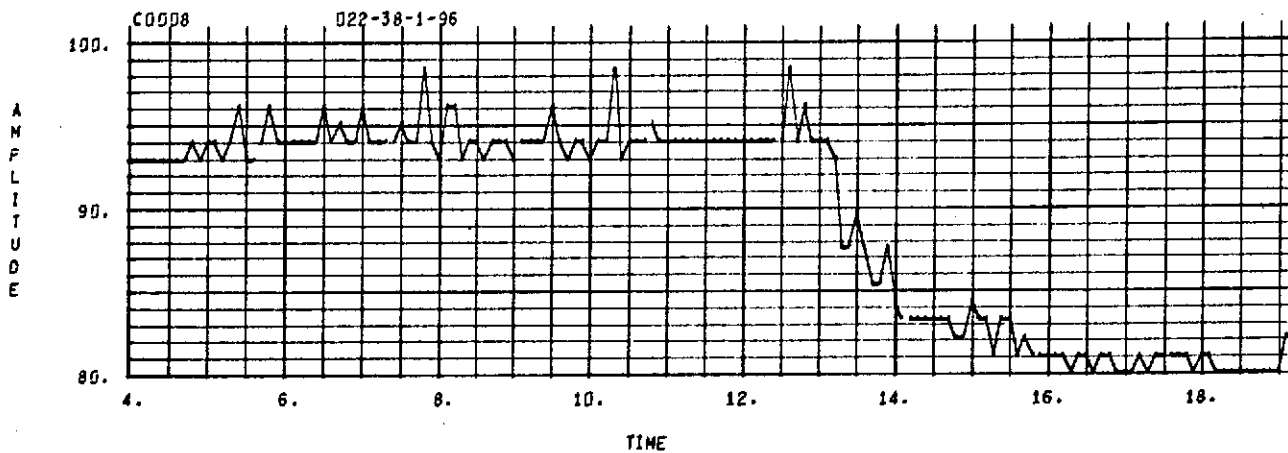
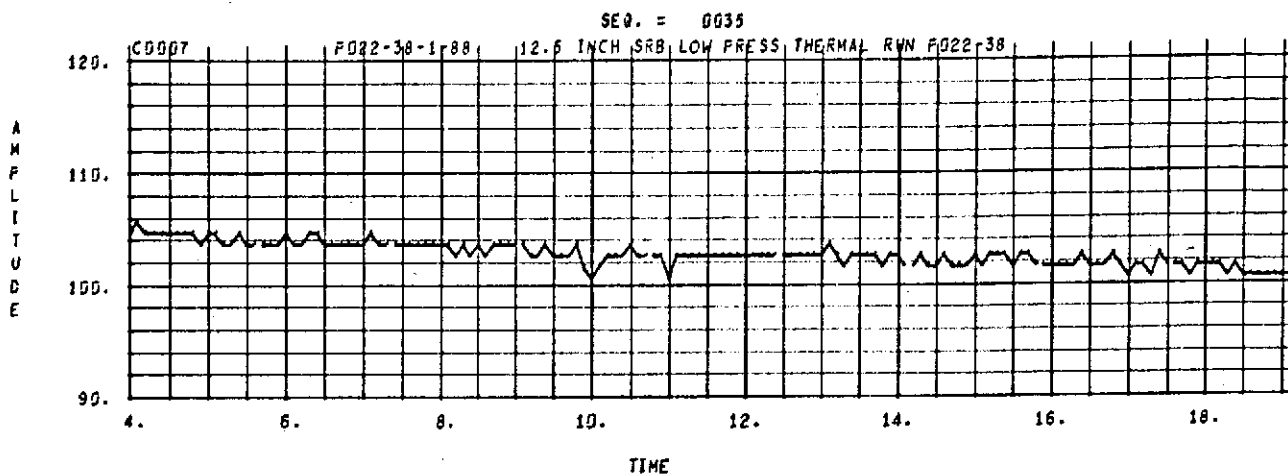

SEQ. = 0035

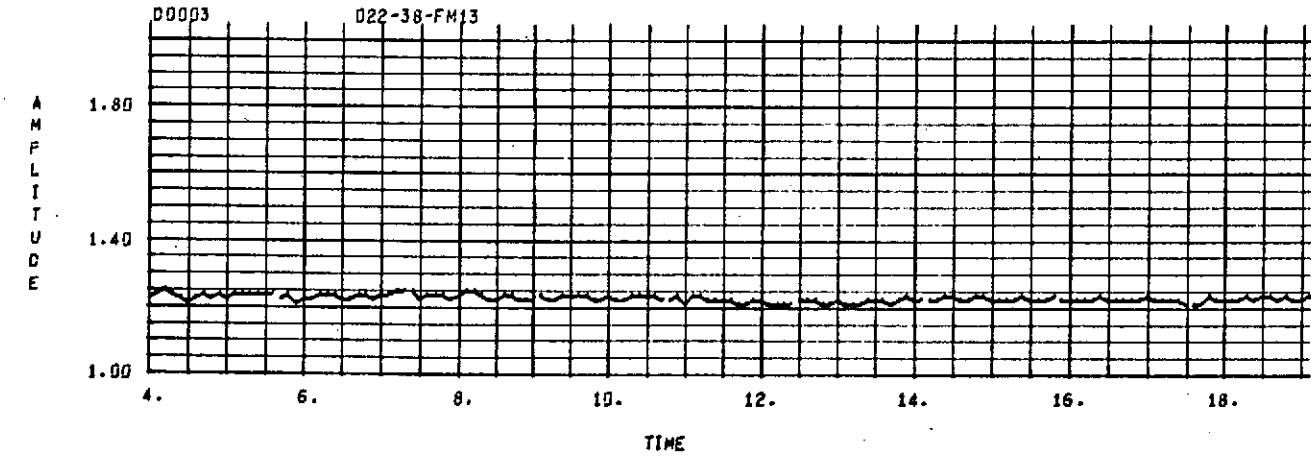
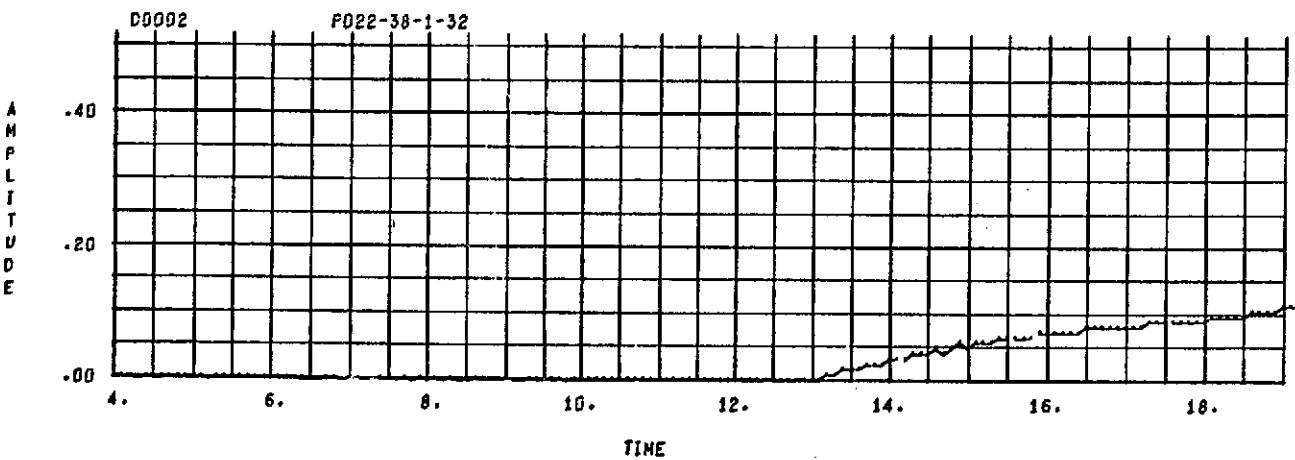
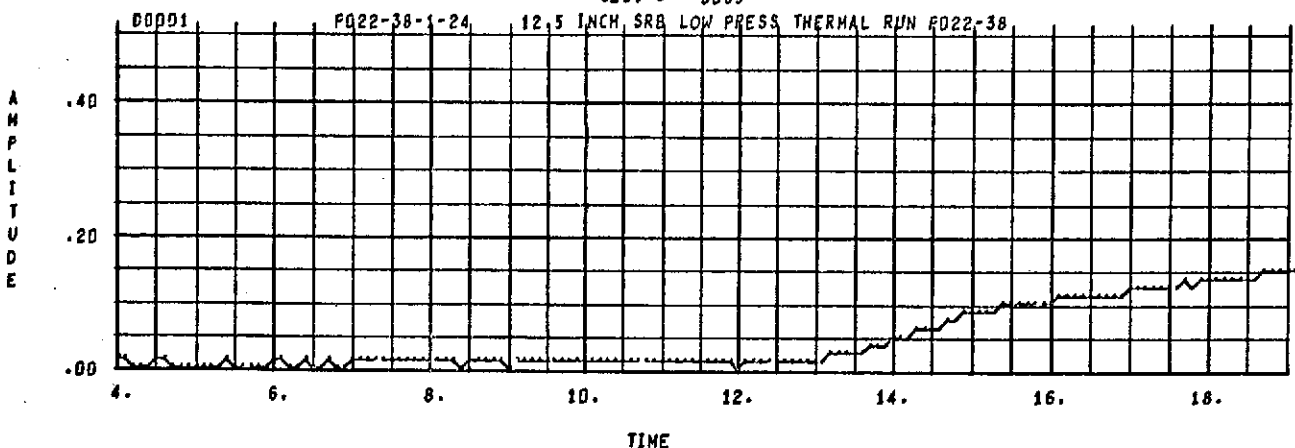

SEQ. = 0041

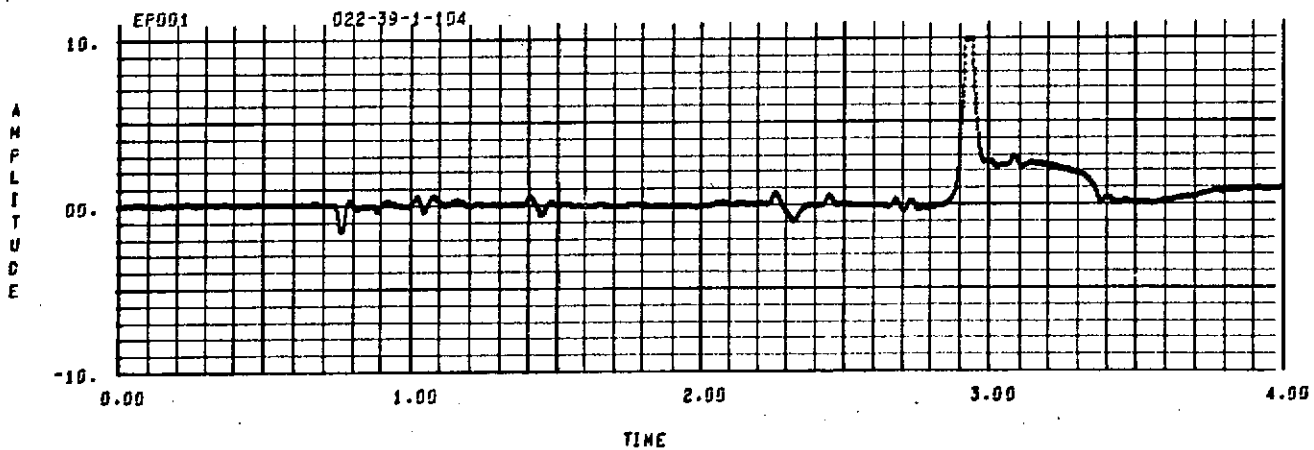
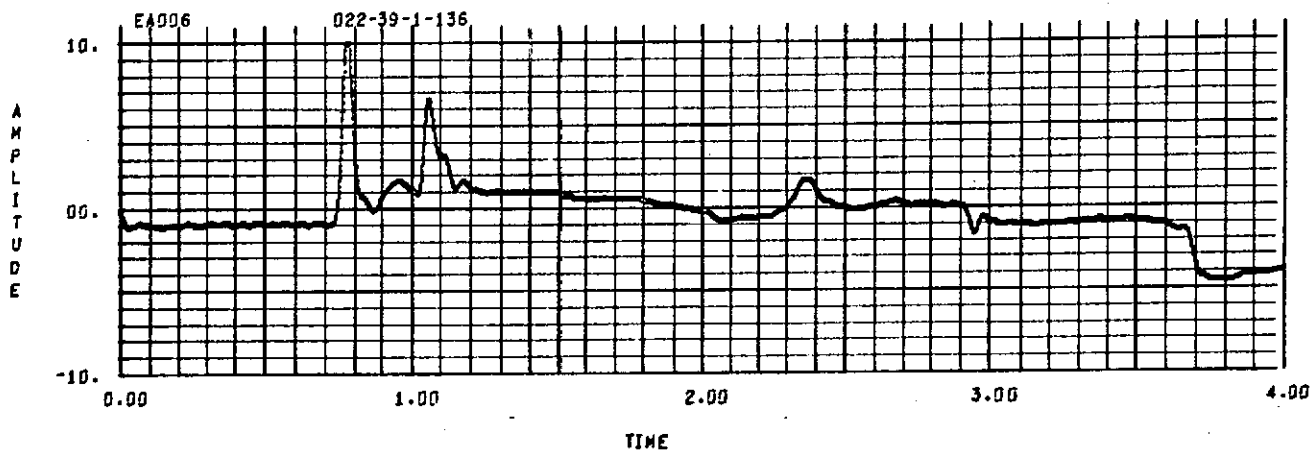
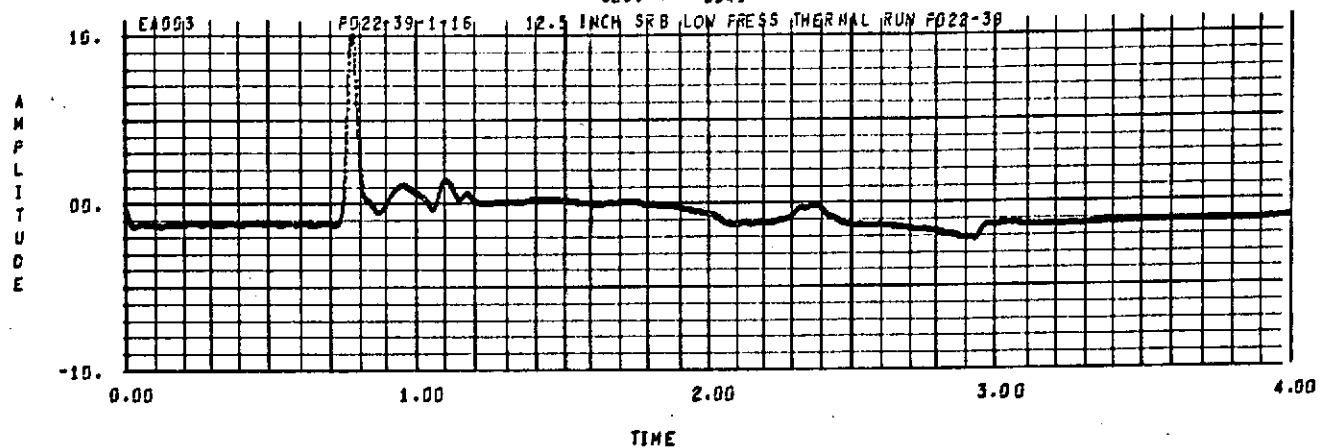

B-78

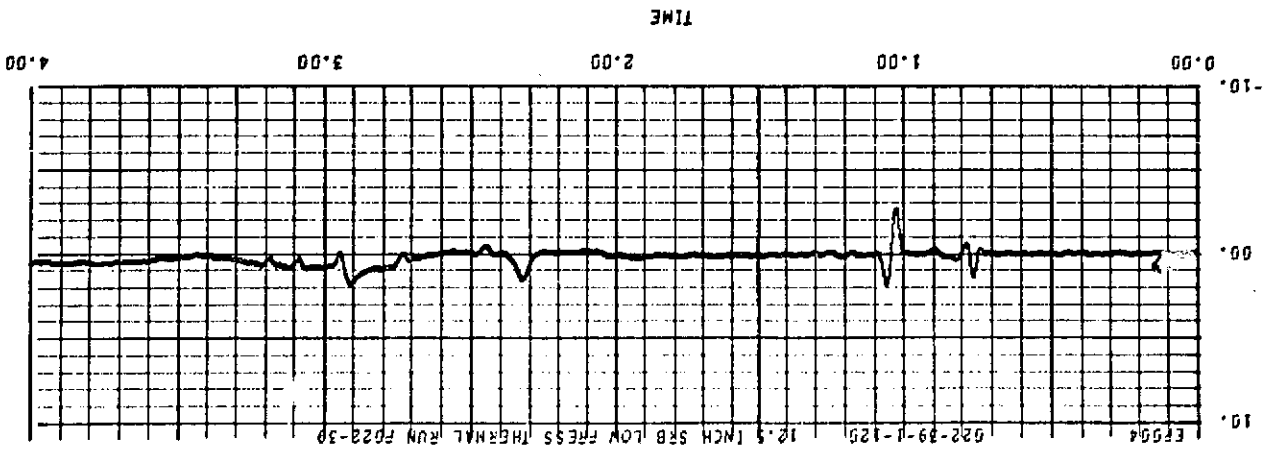
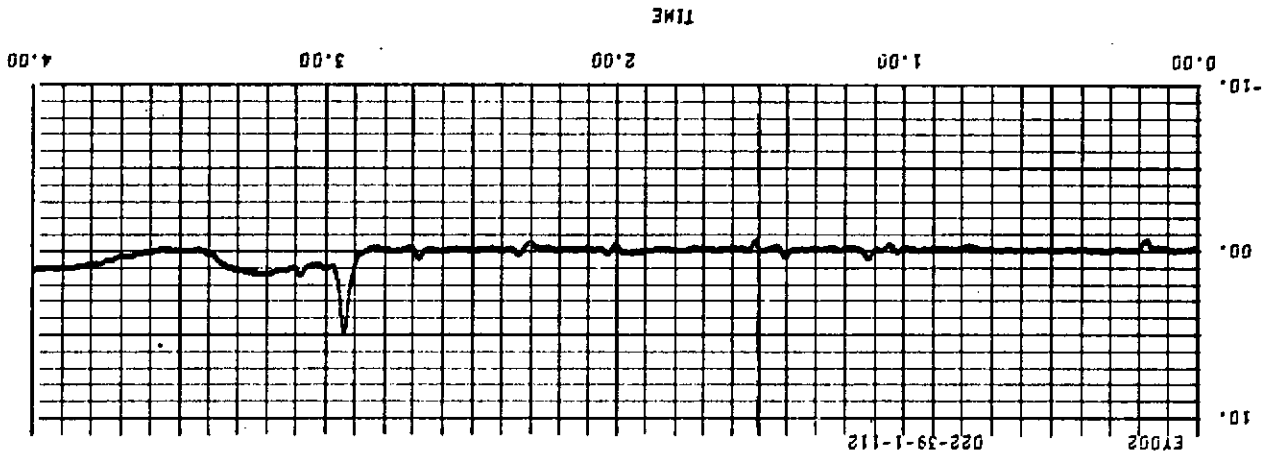
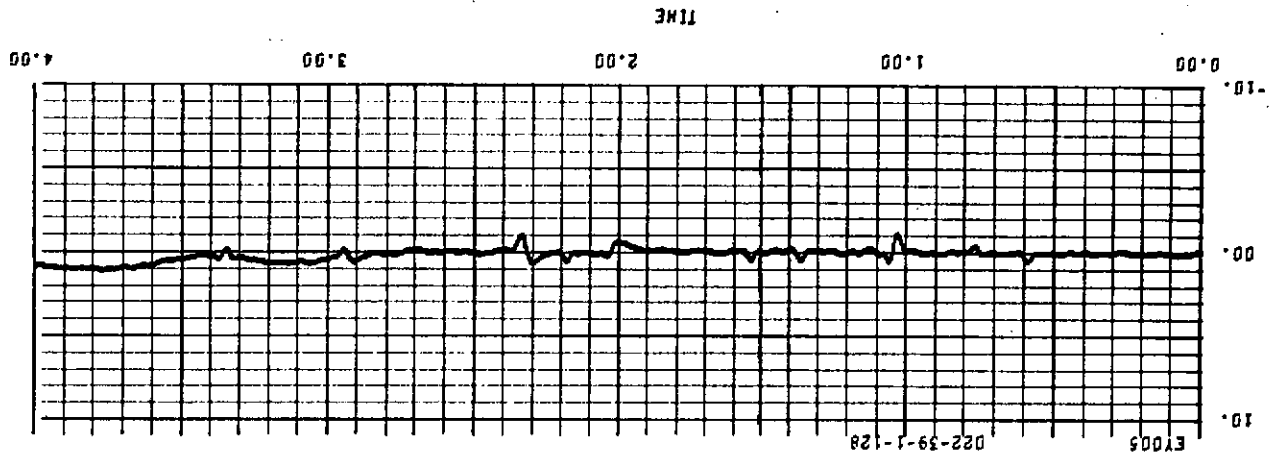

SEQ. = 0041

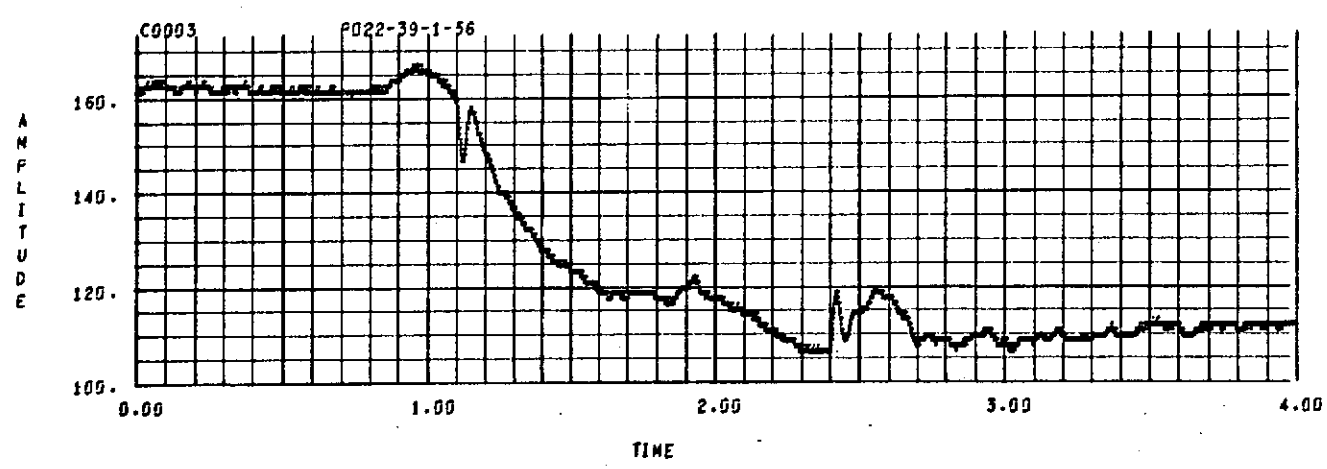
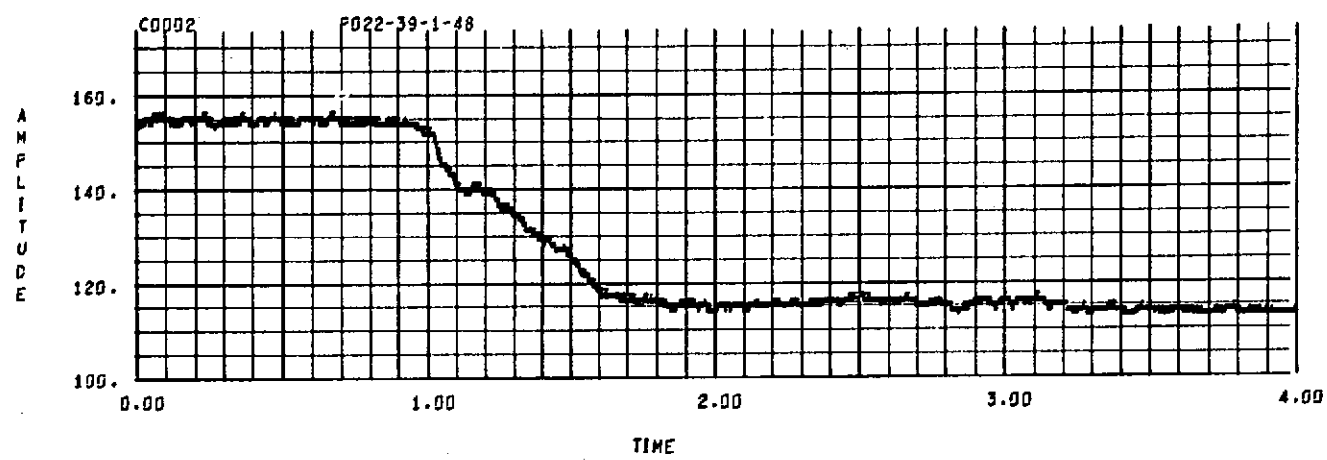
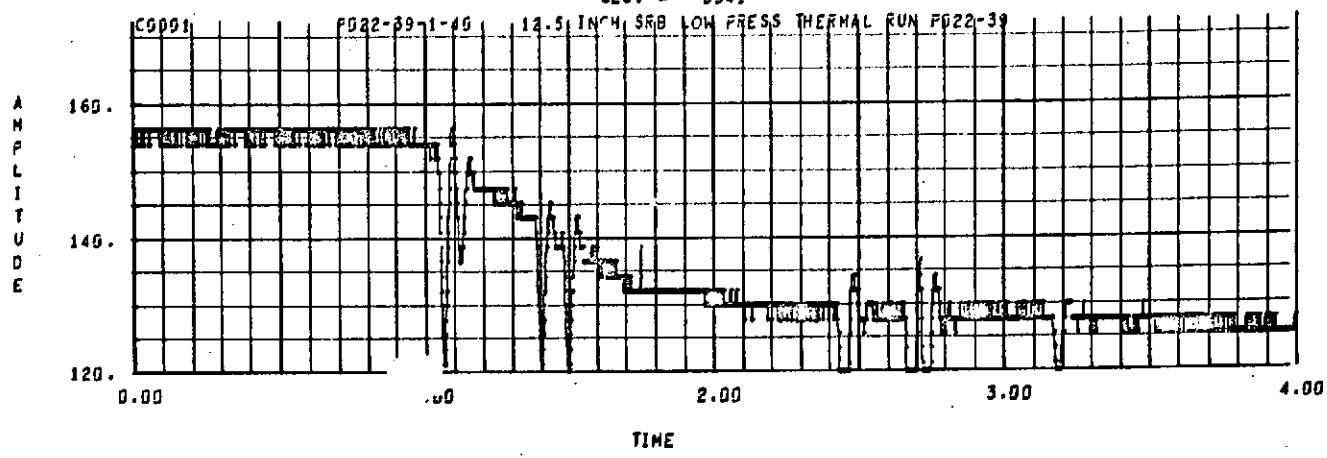

SEQ. = 0041

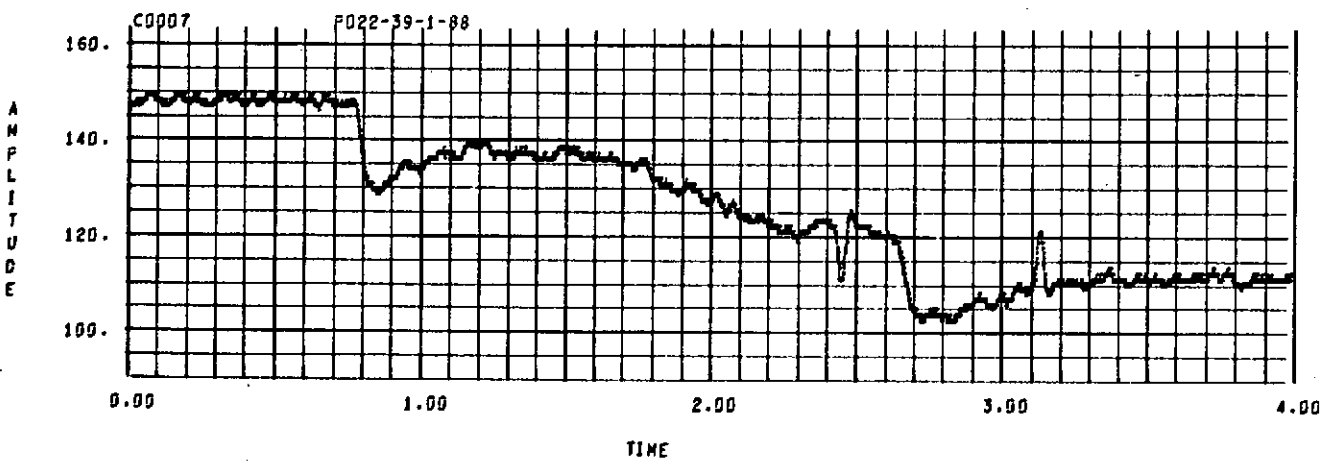
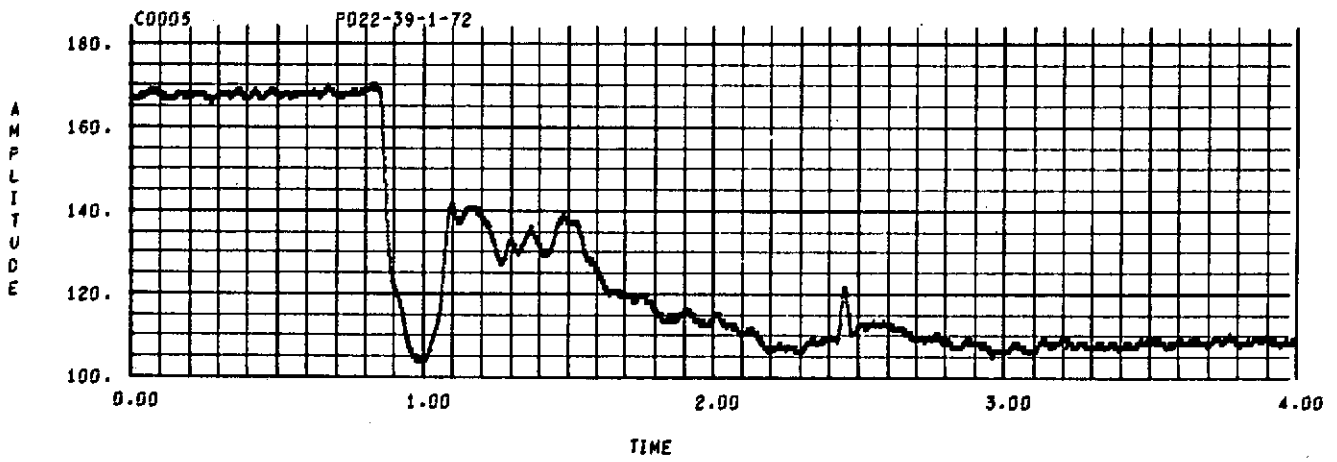
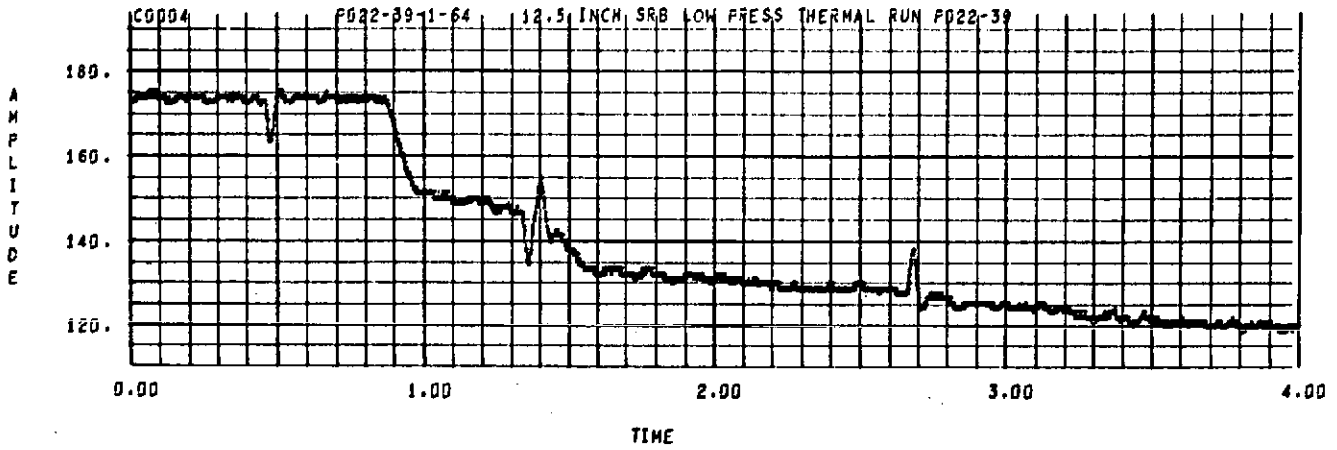

SEQ. = 0041

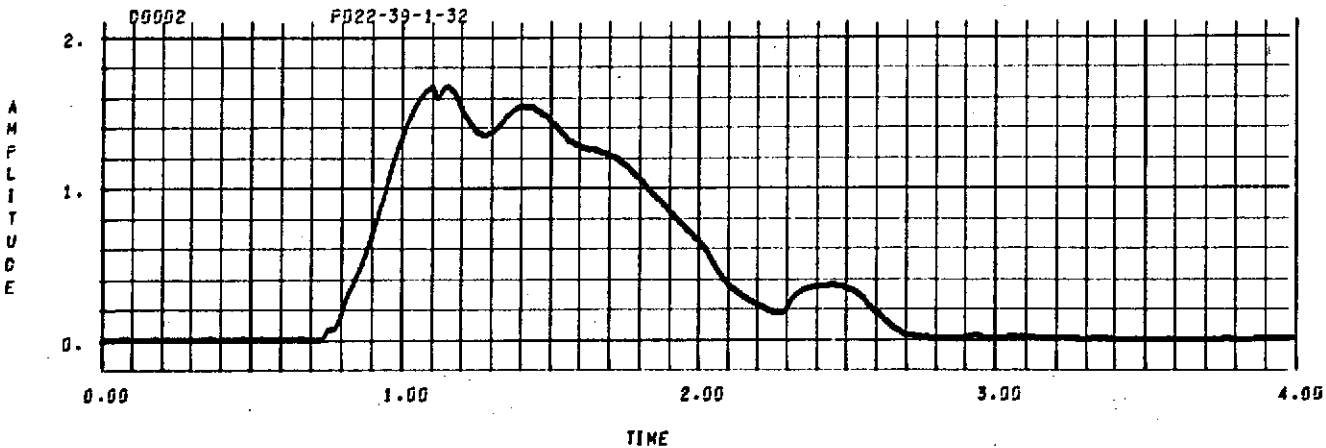
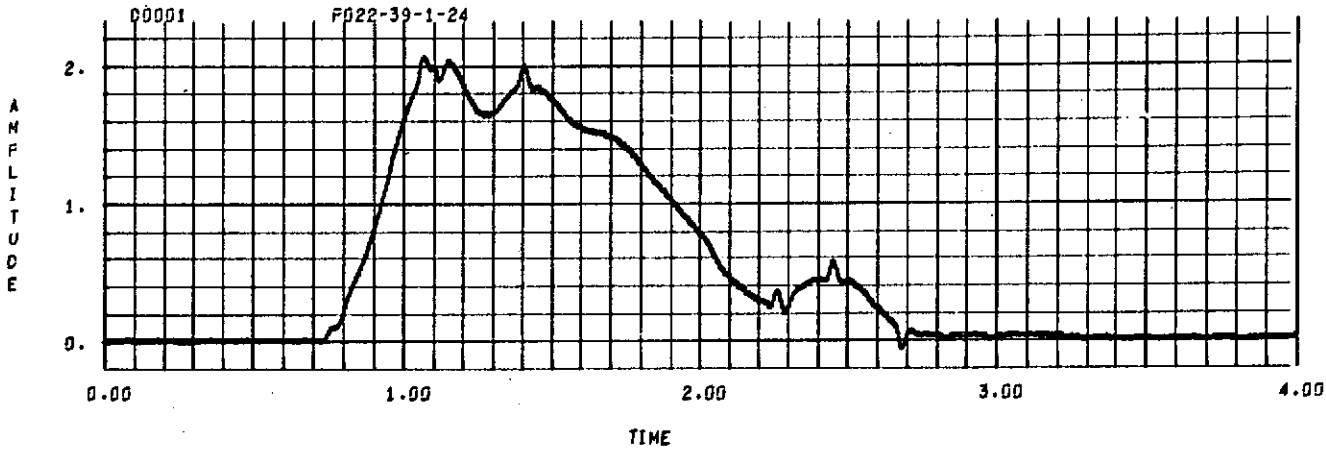
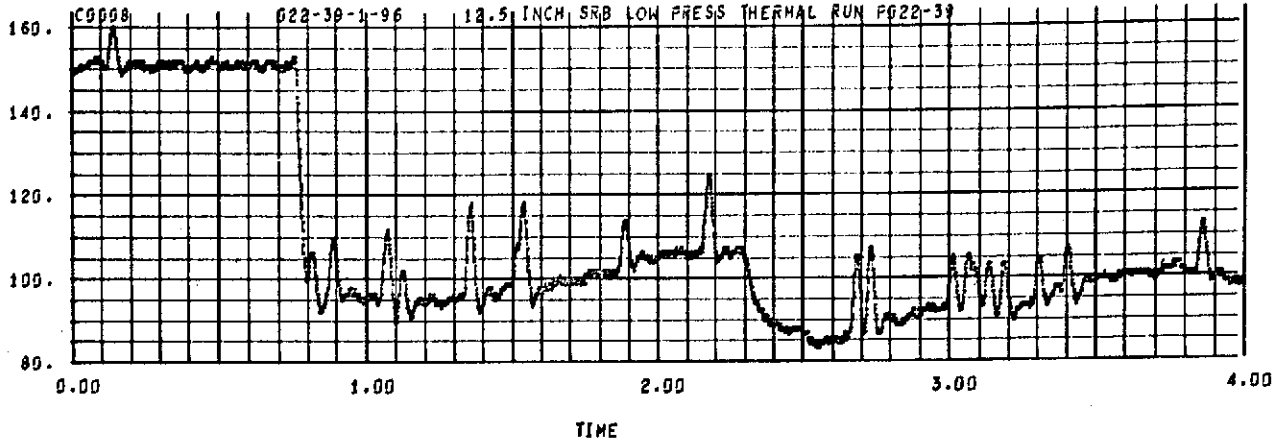

SEQ. = 0041

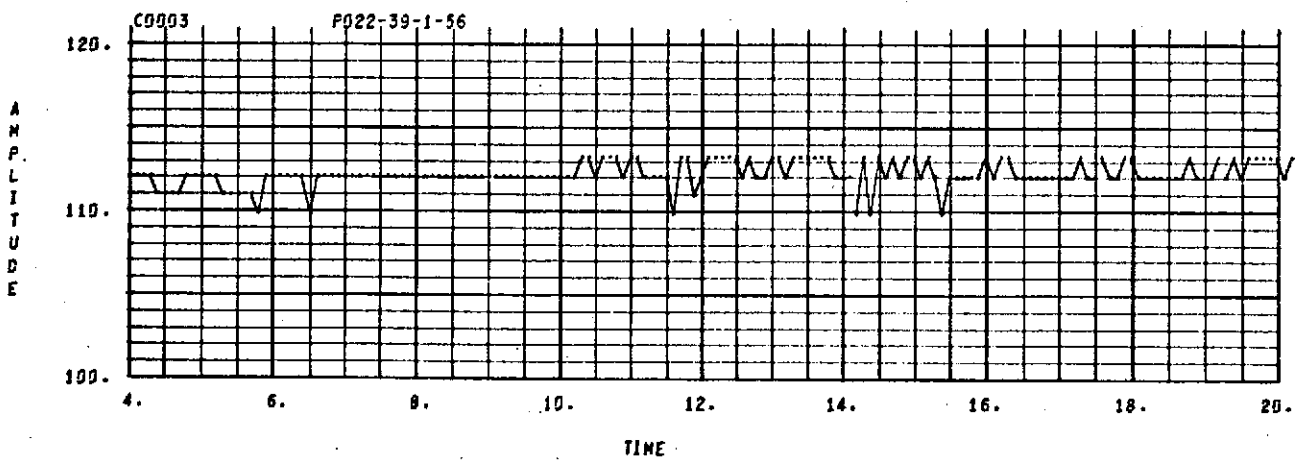
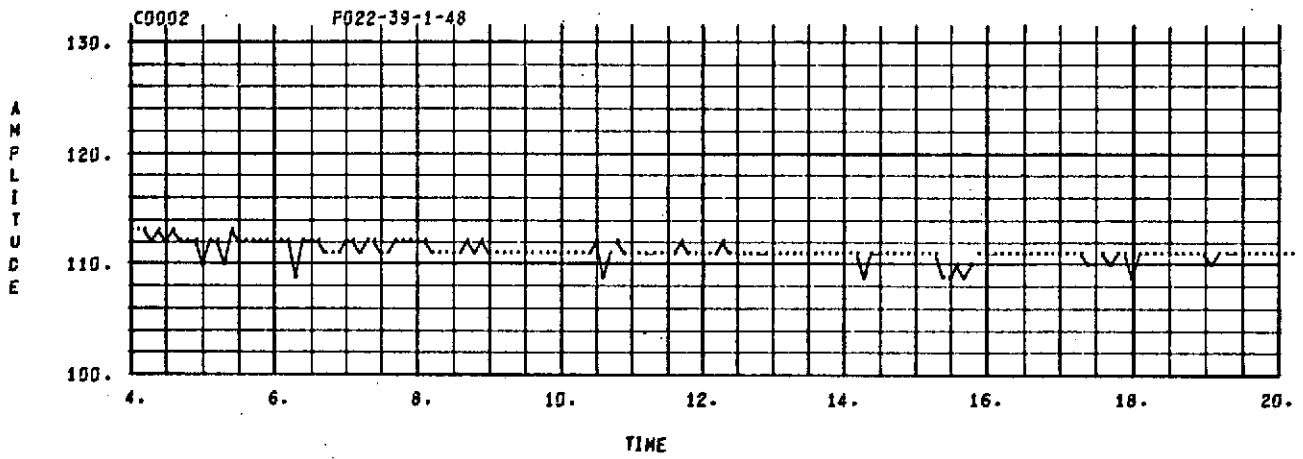
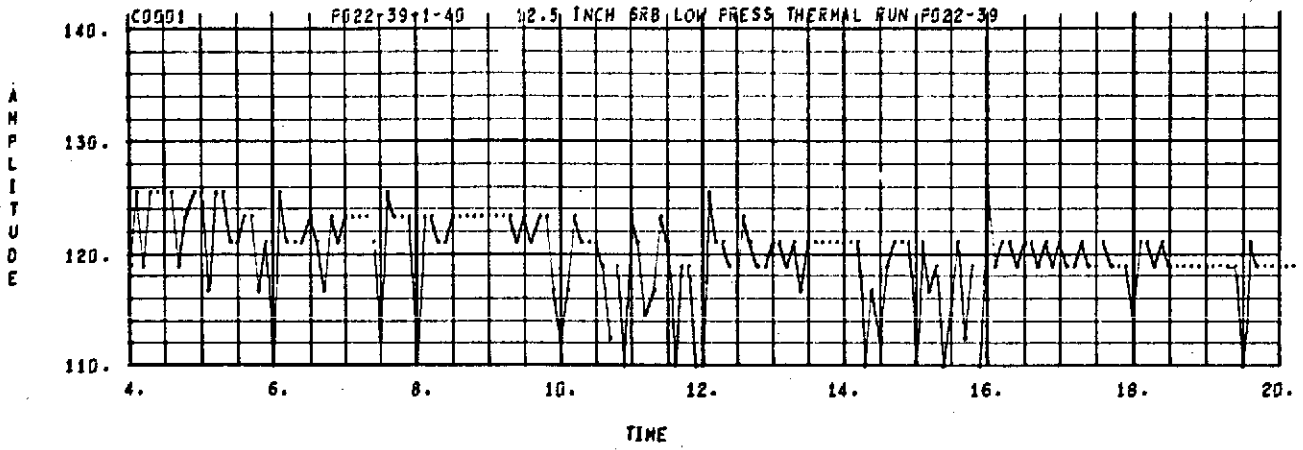

SEQ. = 0041

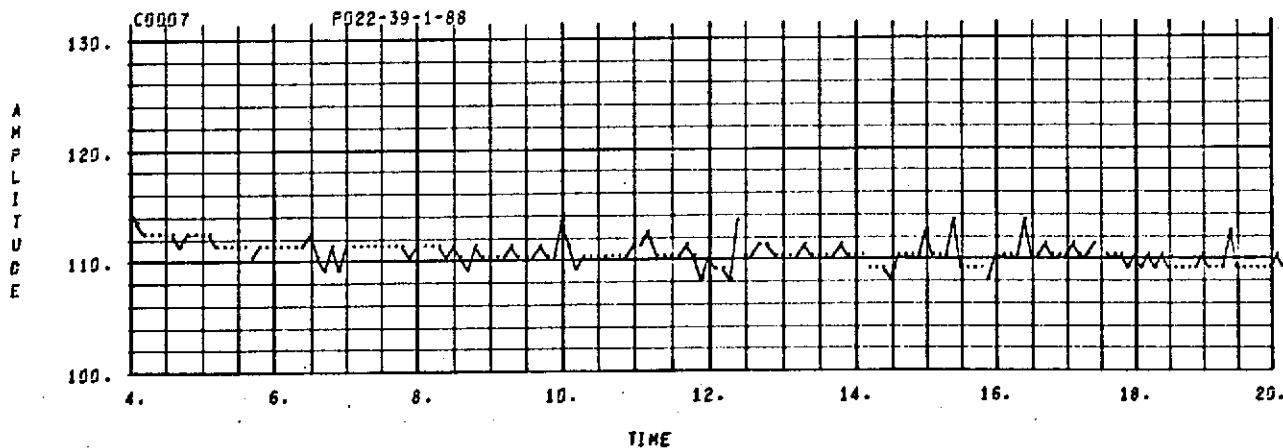
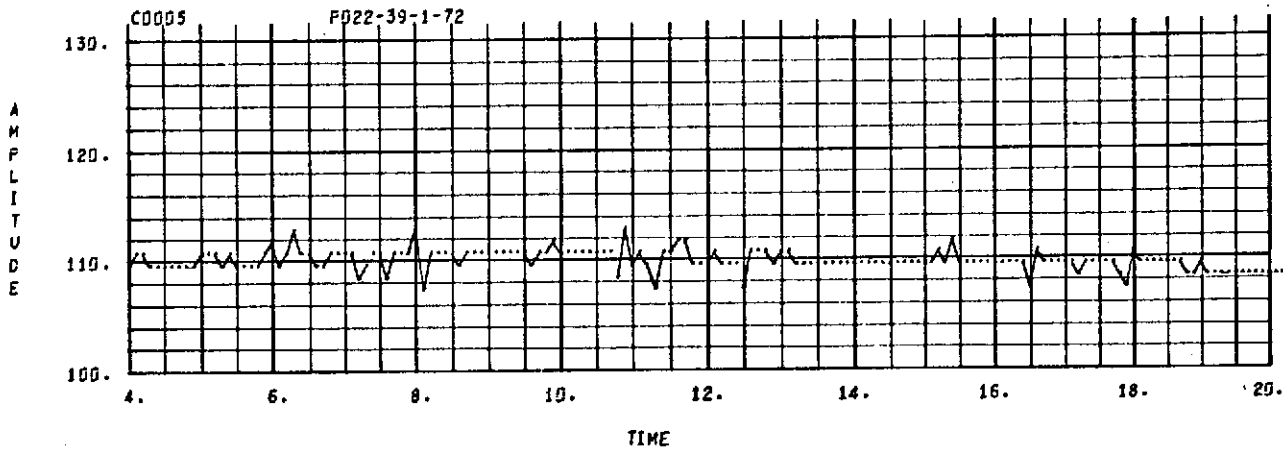
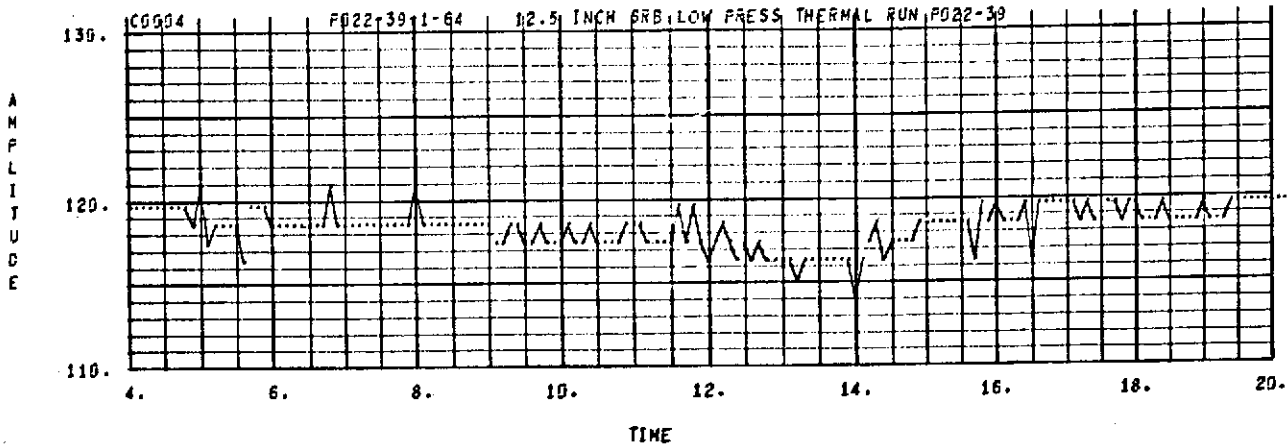

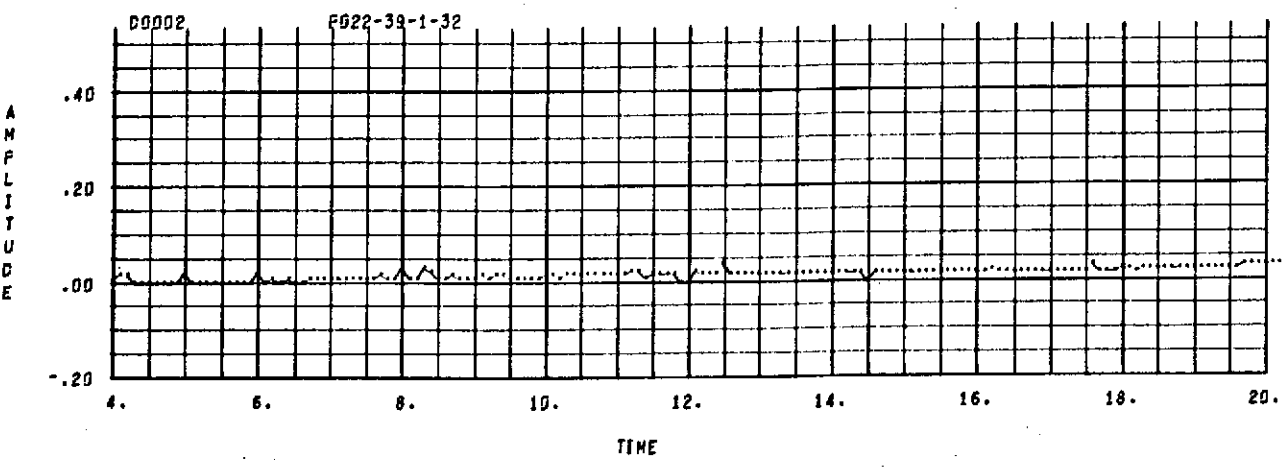
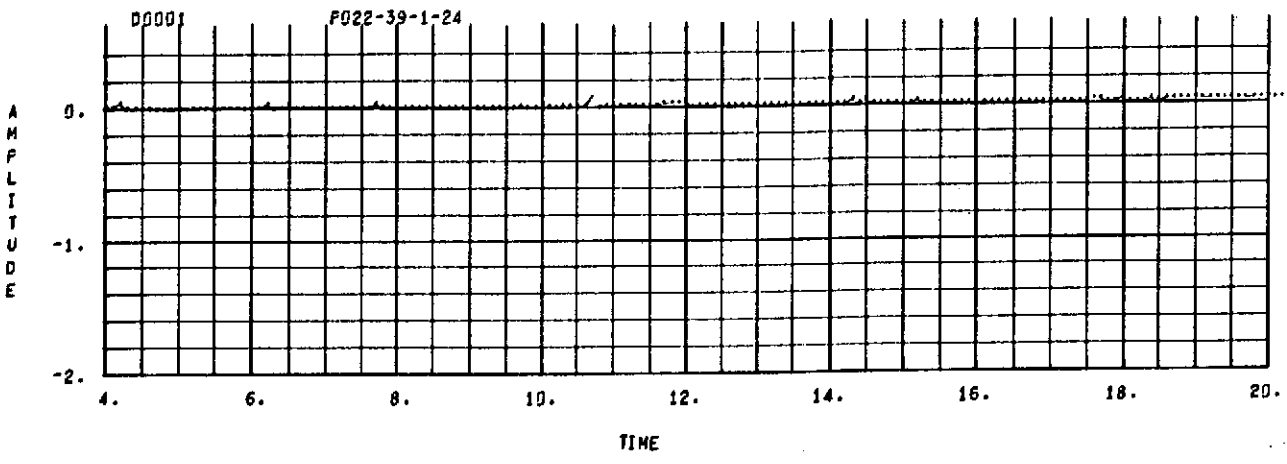
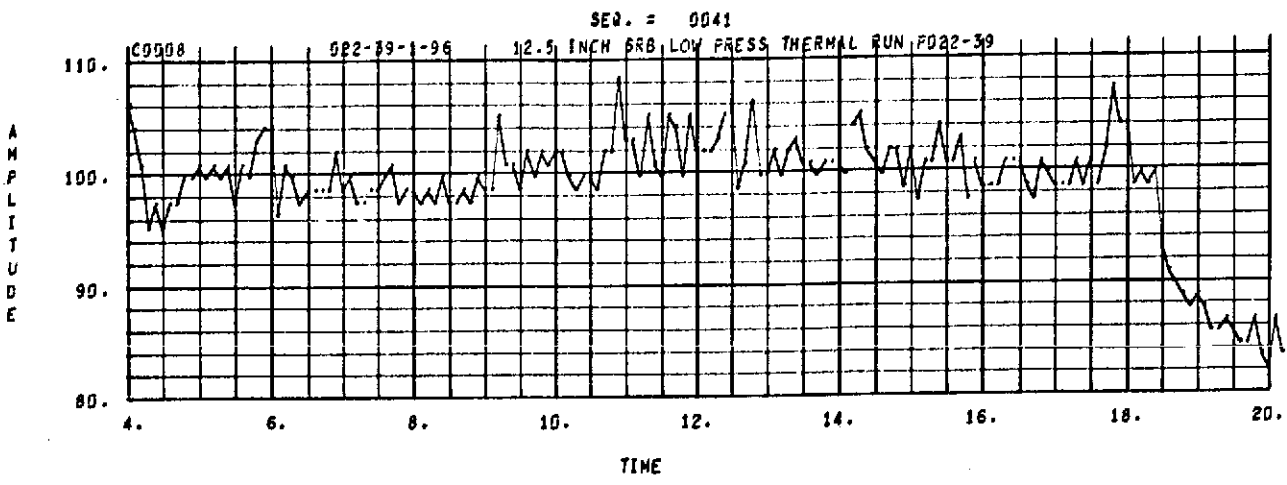

B-85

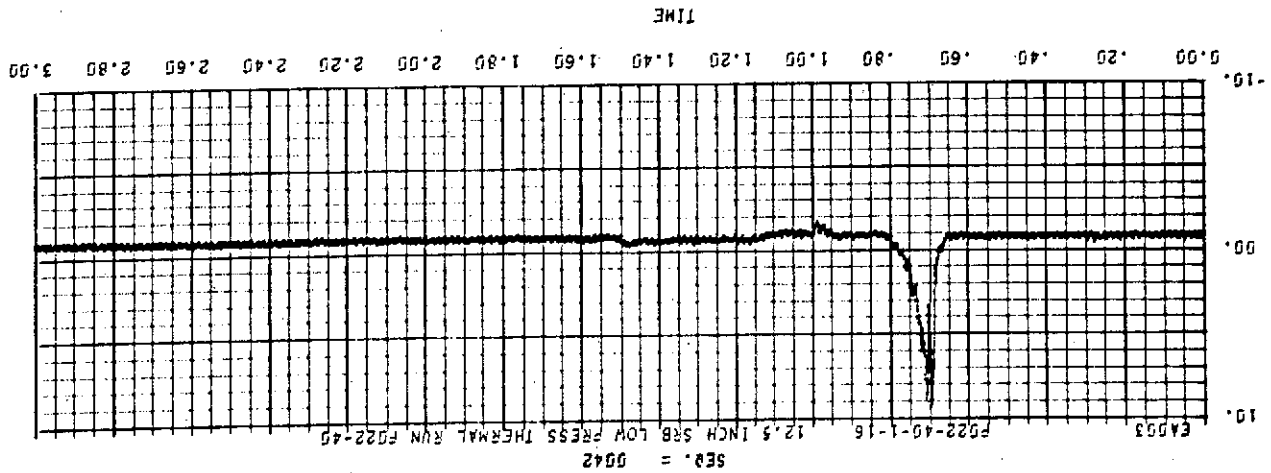
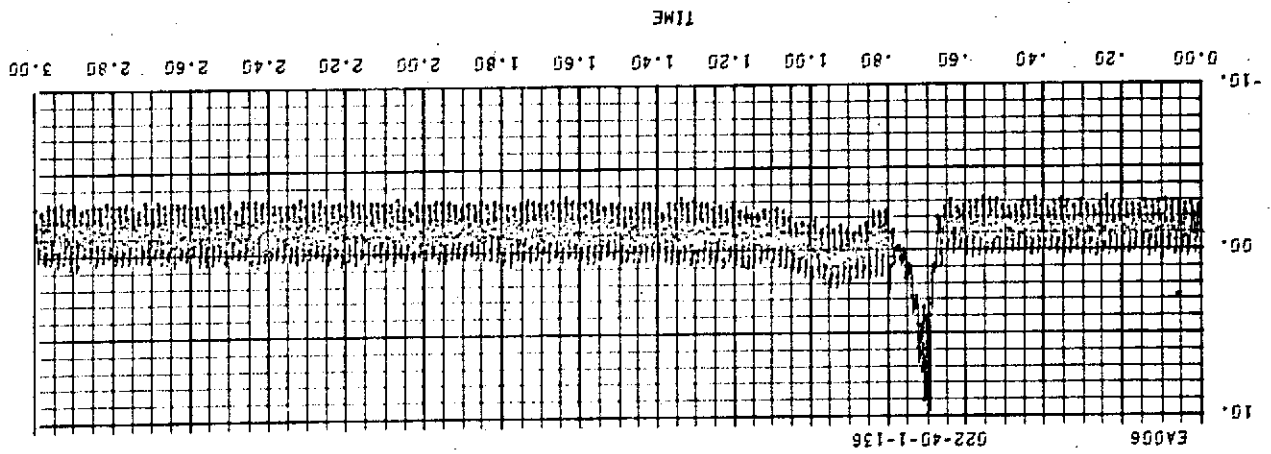
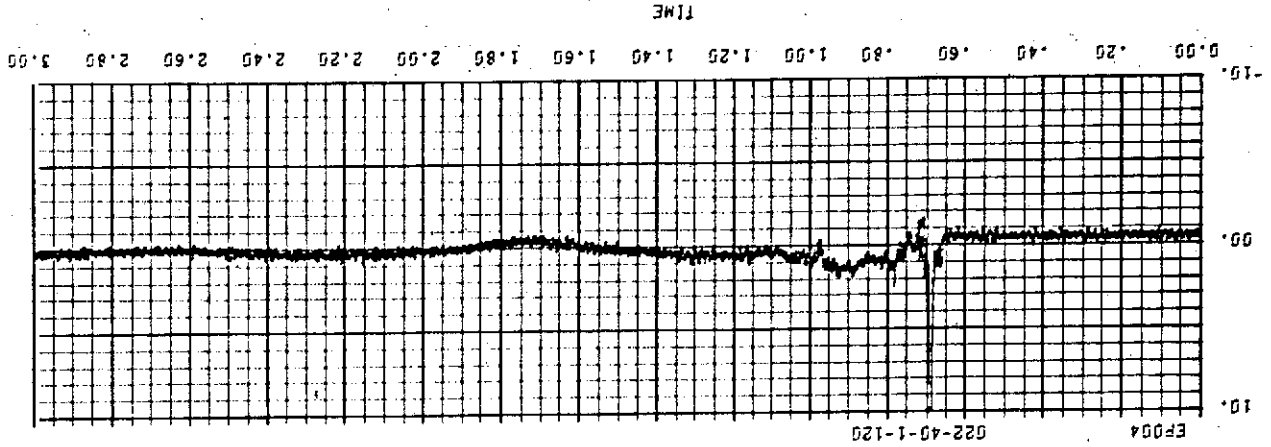

SEQ. = 0042

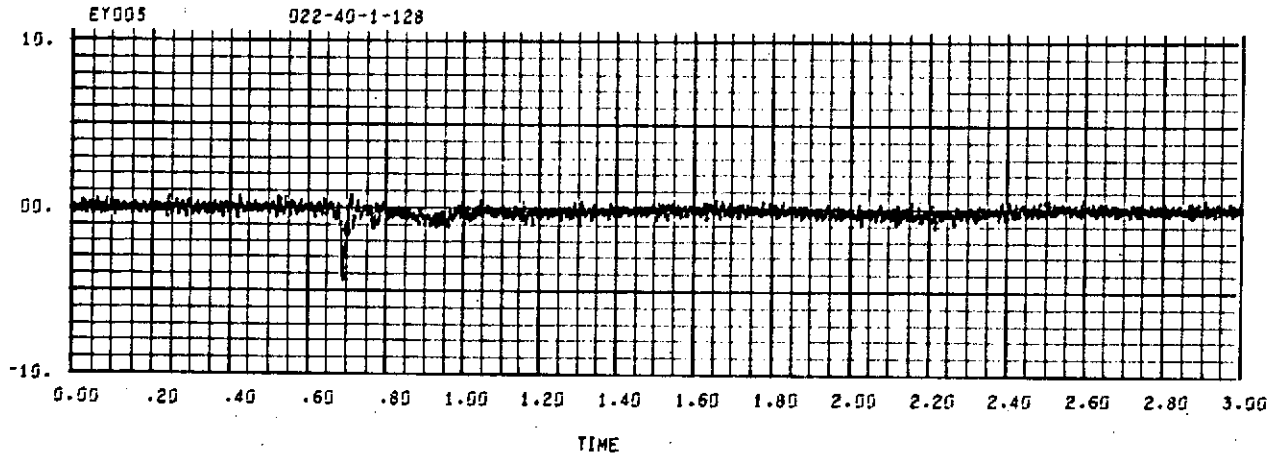
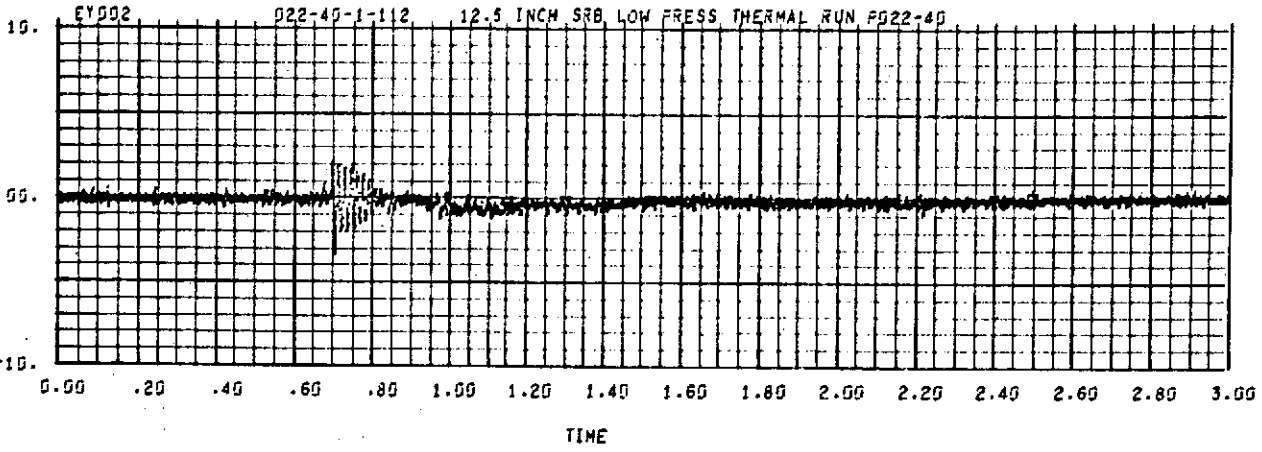

SEQ. = 0042

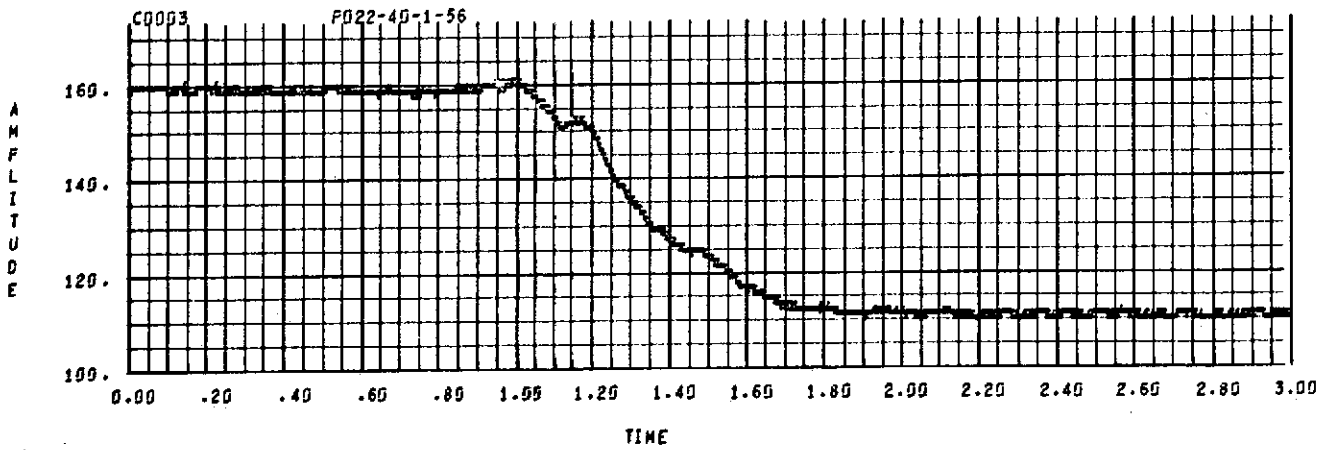
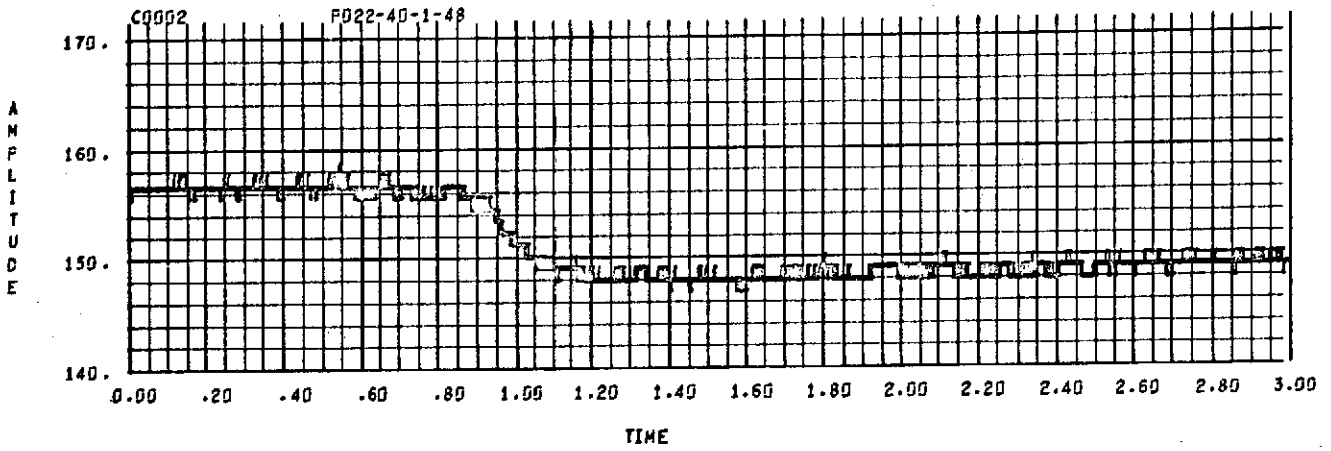
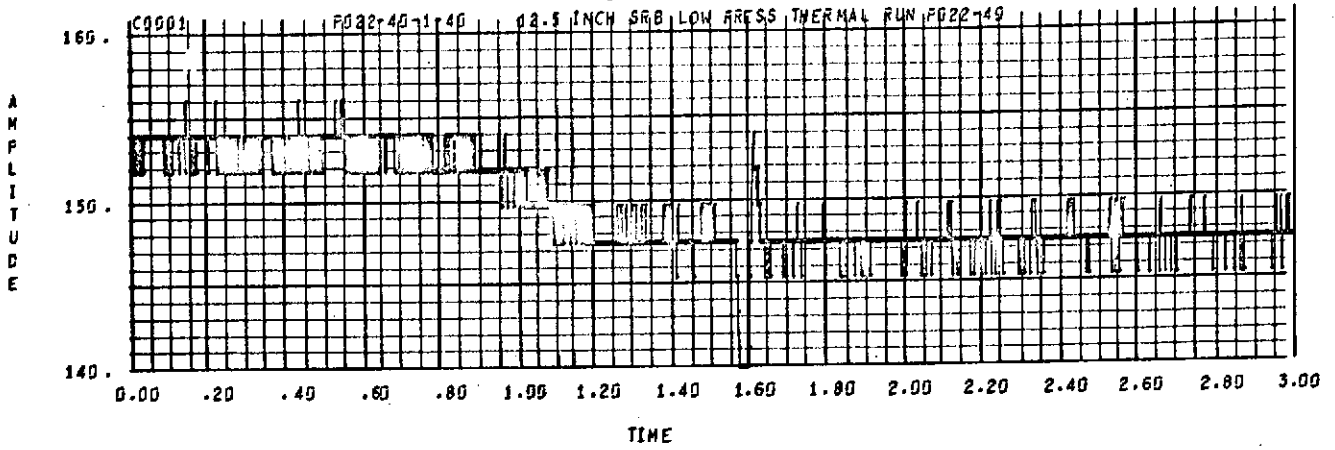

SEQ. = 0042

2

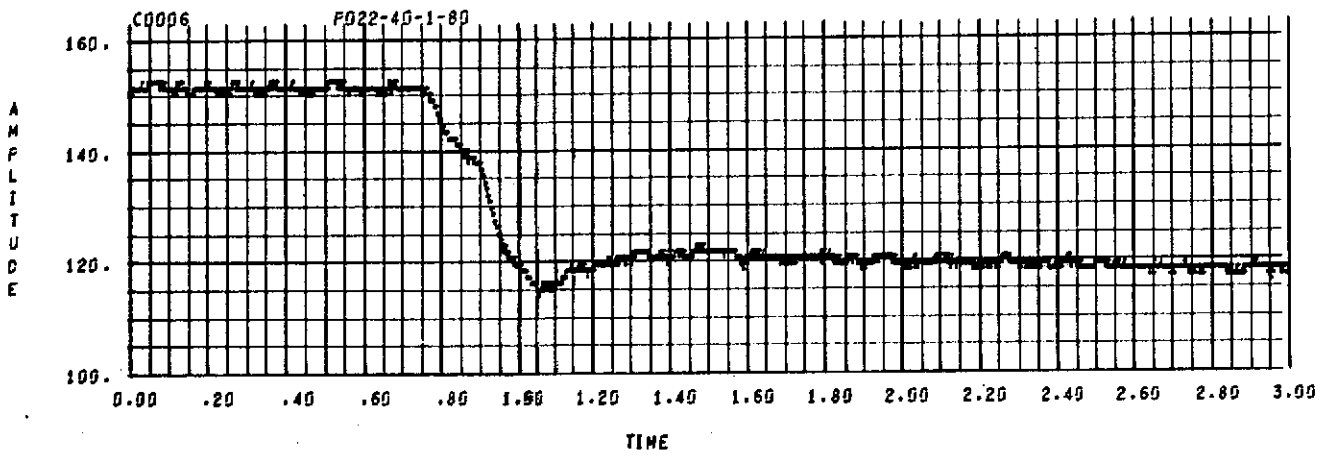
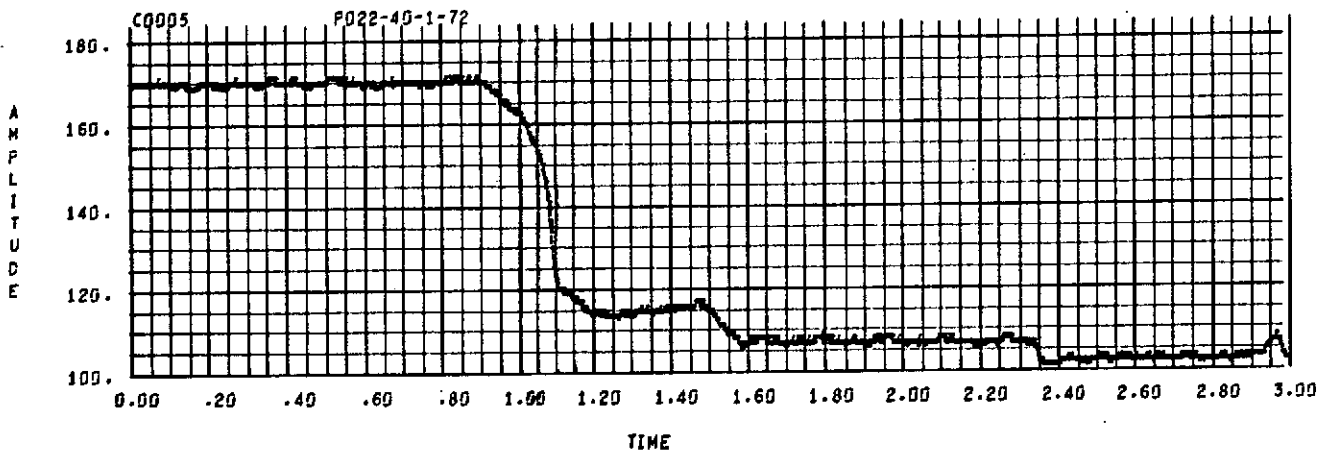
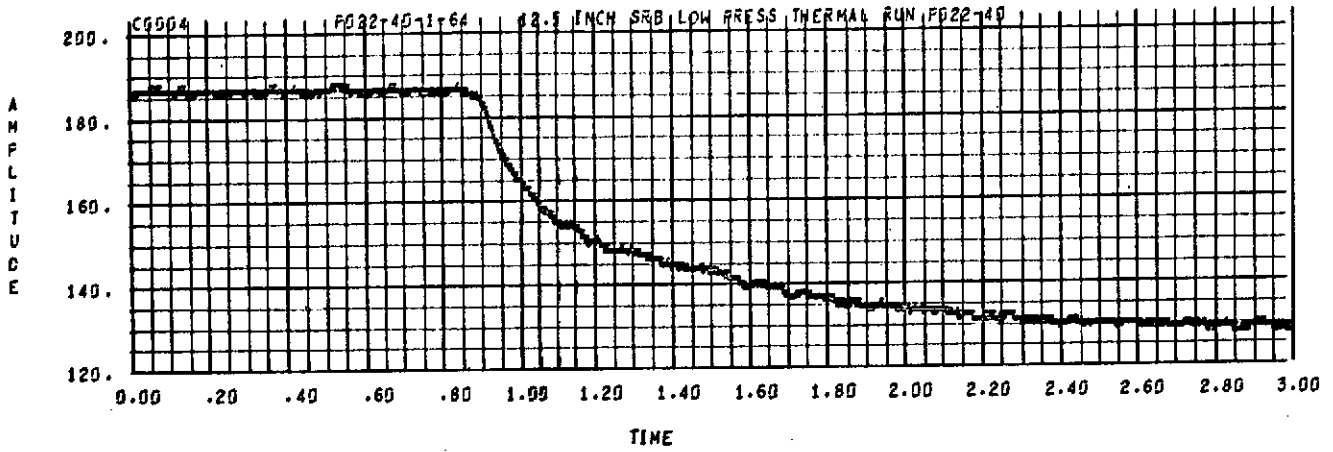

SEP. = 0042

3

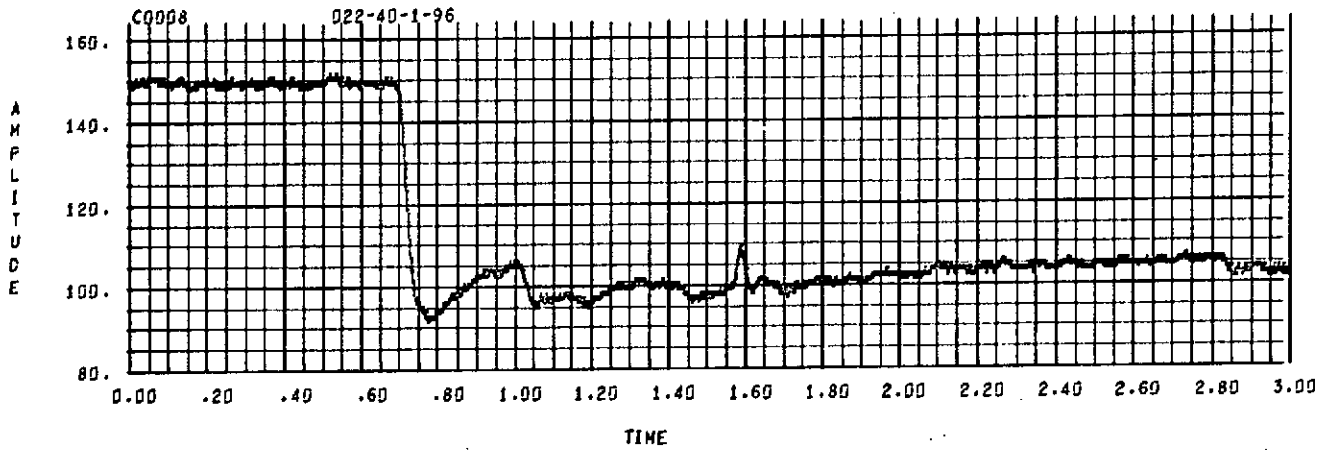
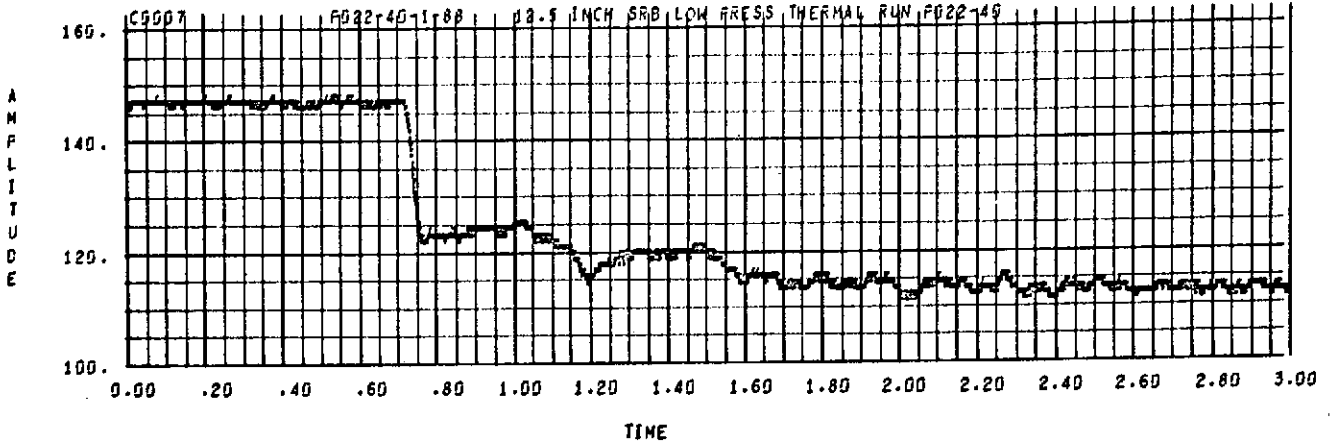

B-90

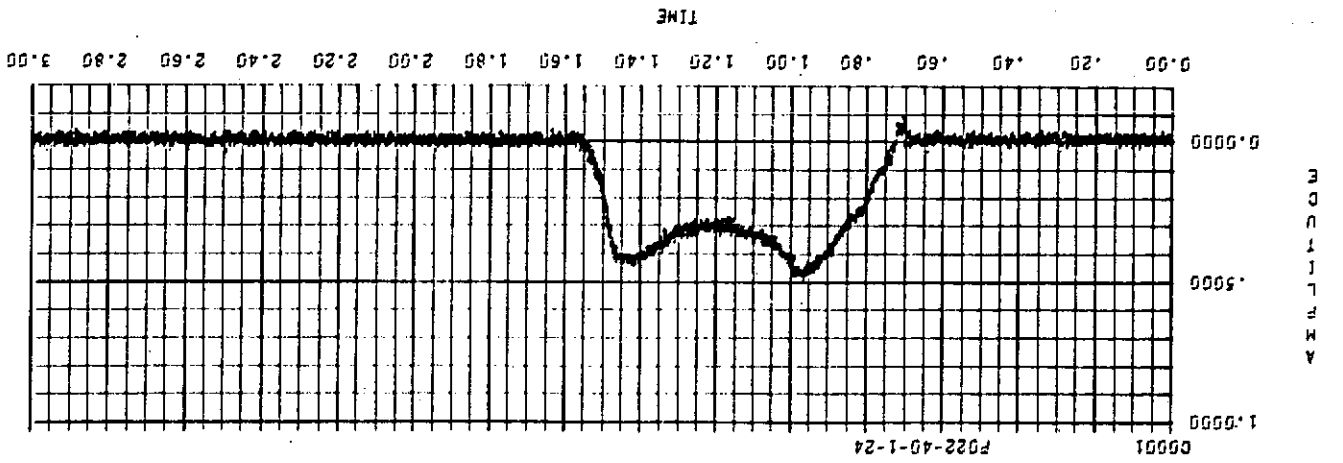
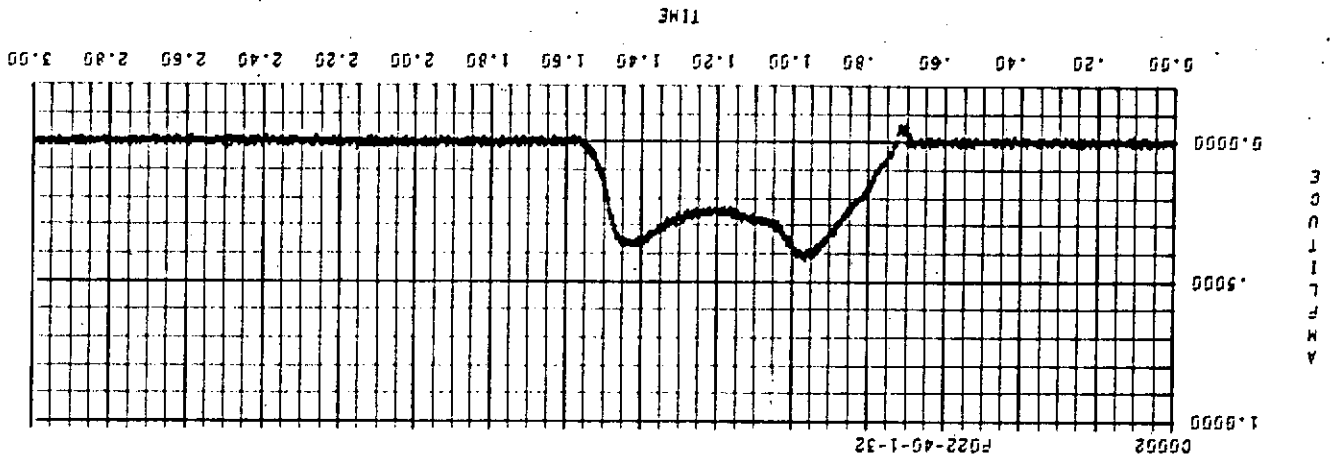

SEQ. = 0042

9

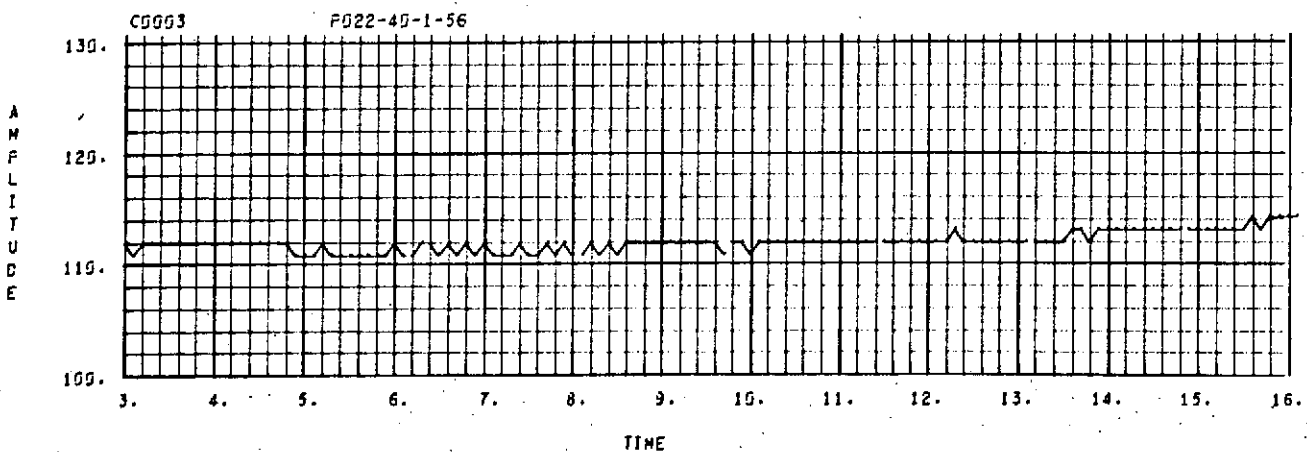
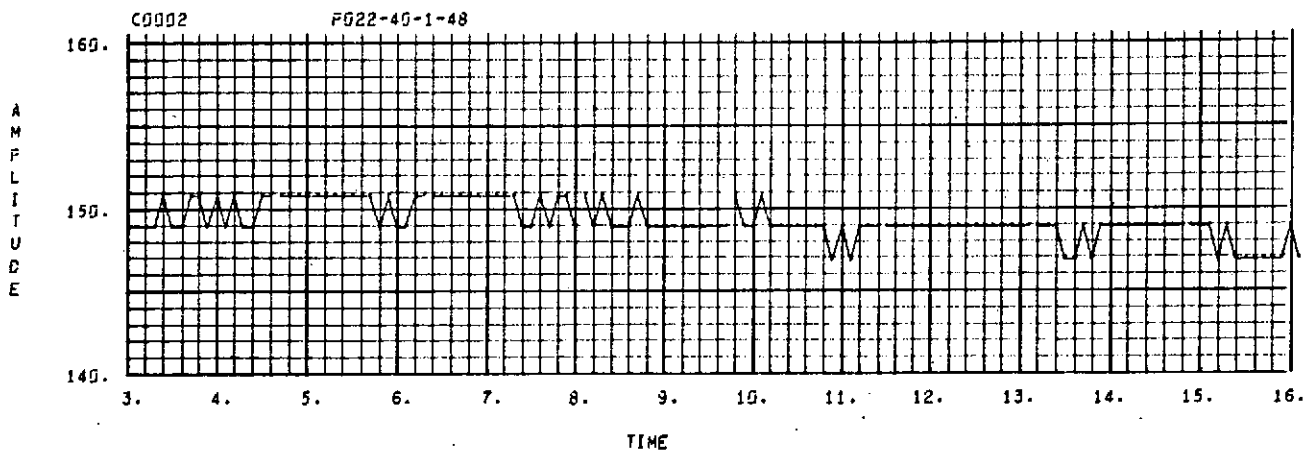
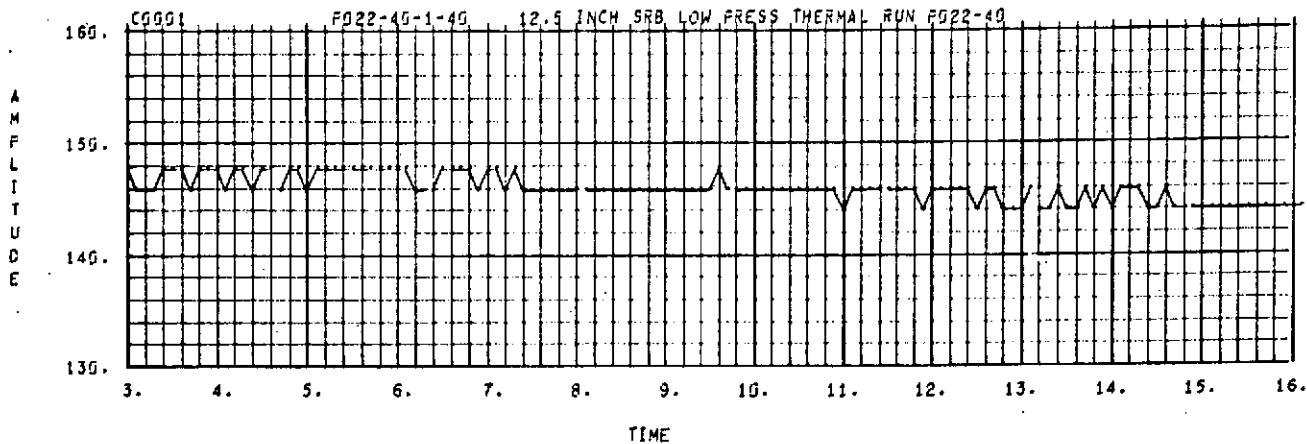

SEG. = 0042

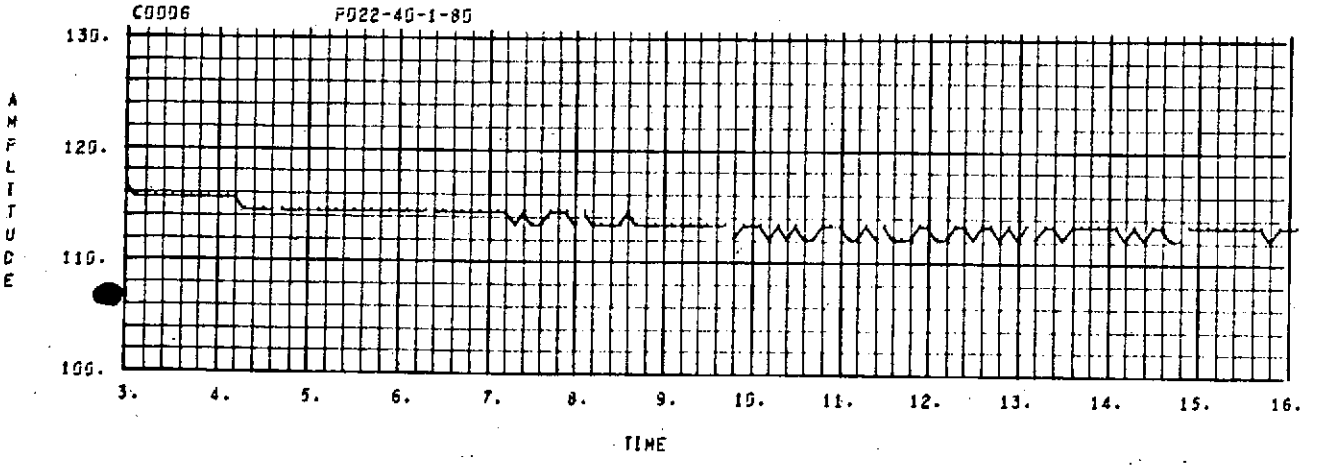
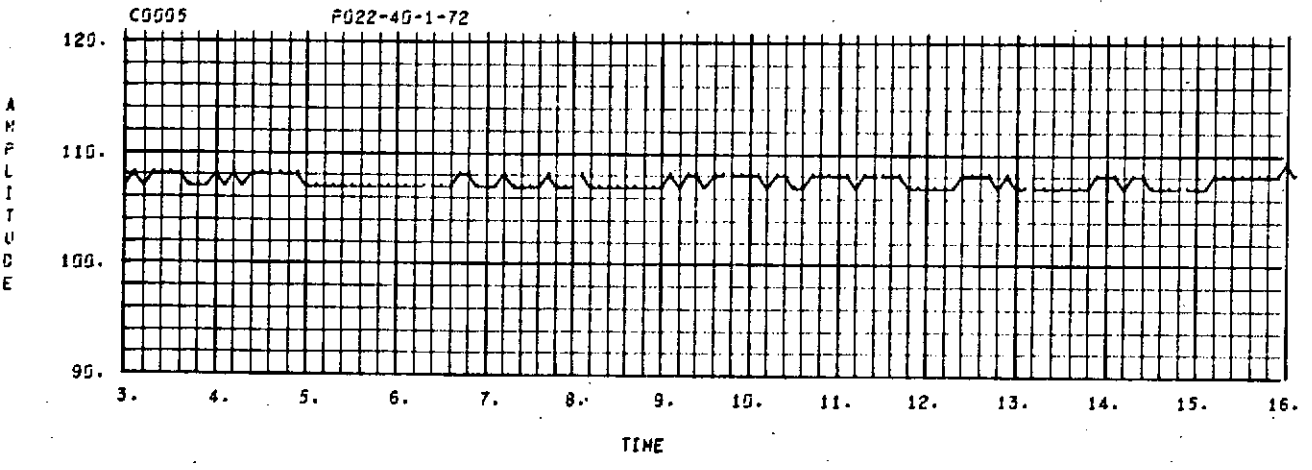
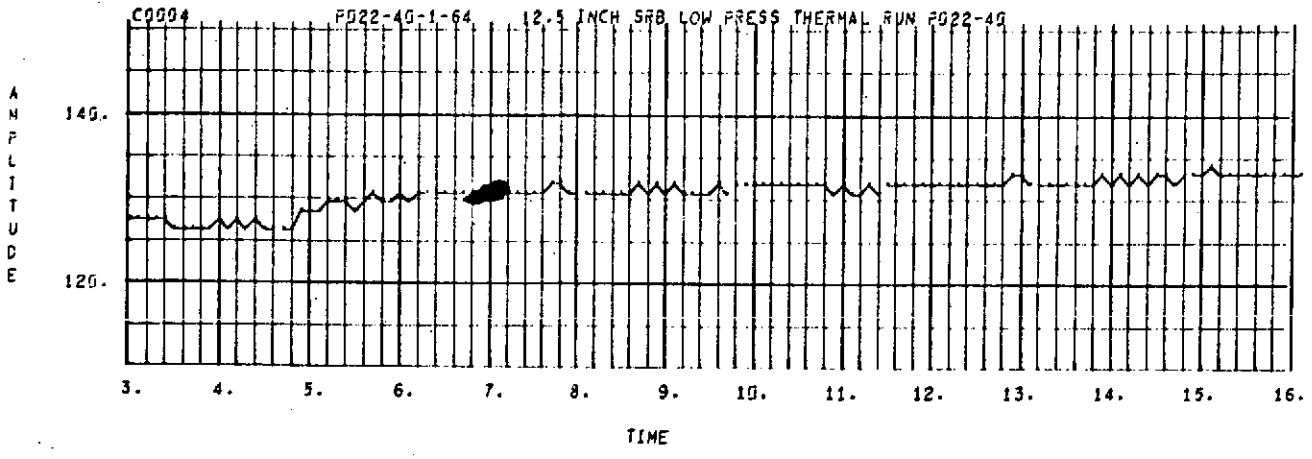

SER. = 0042

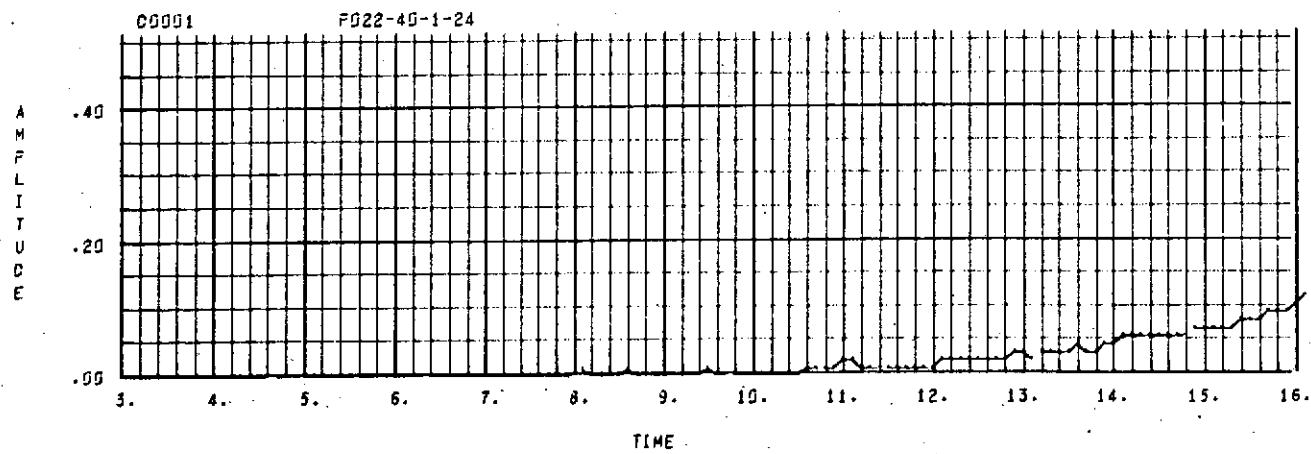
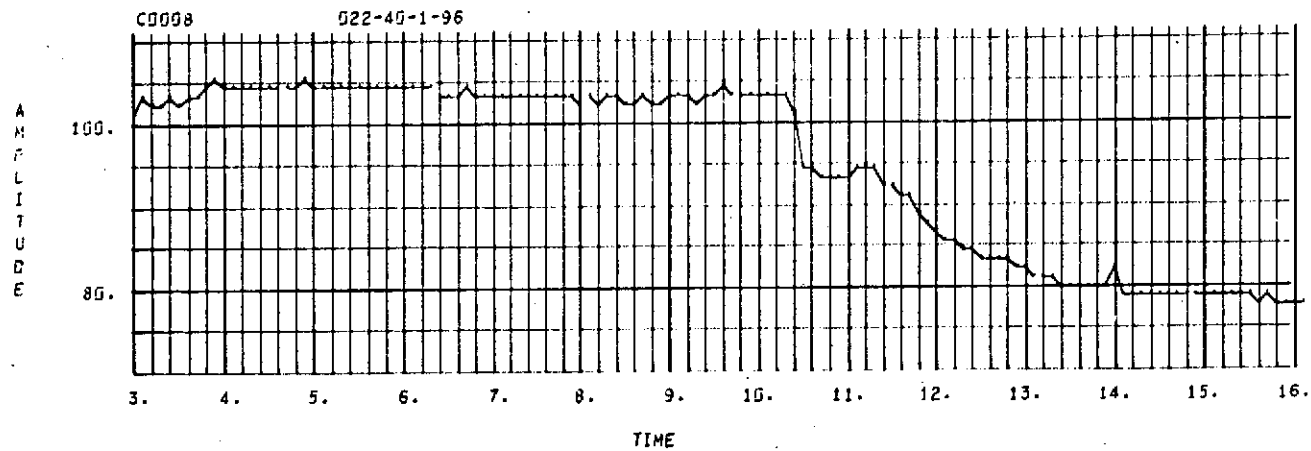
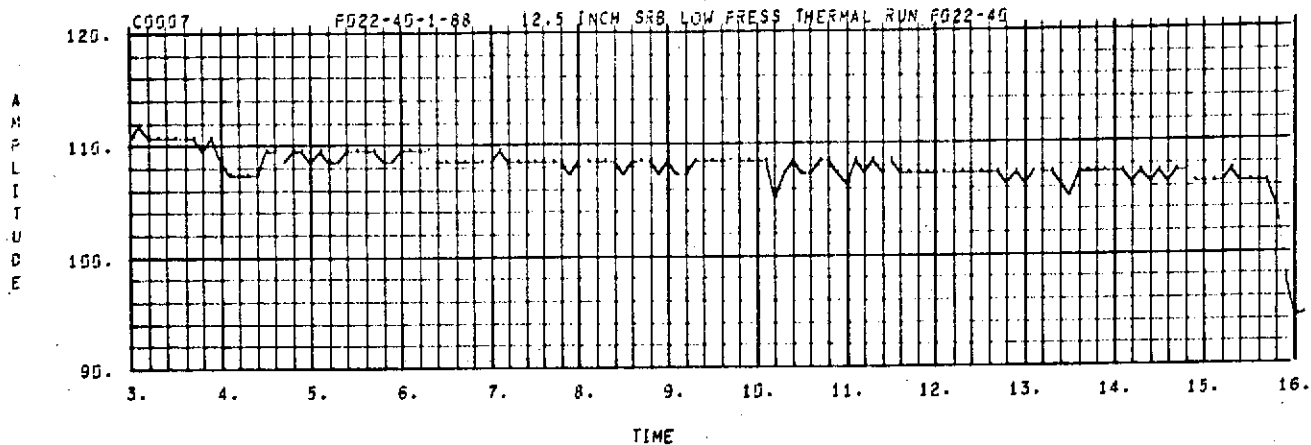

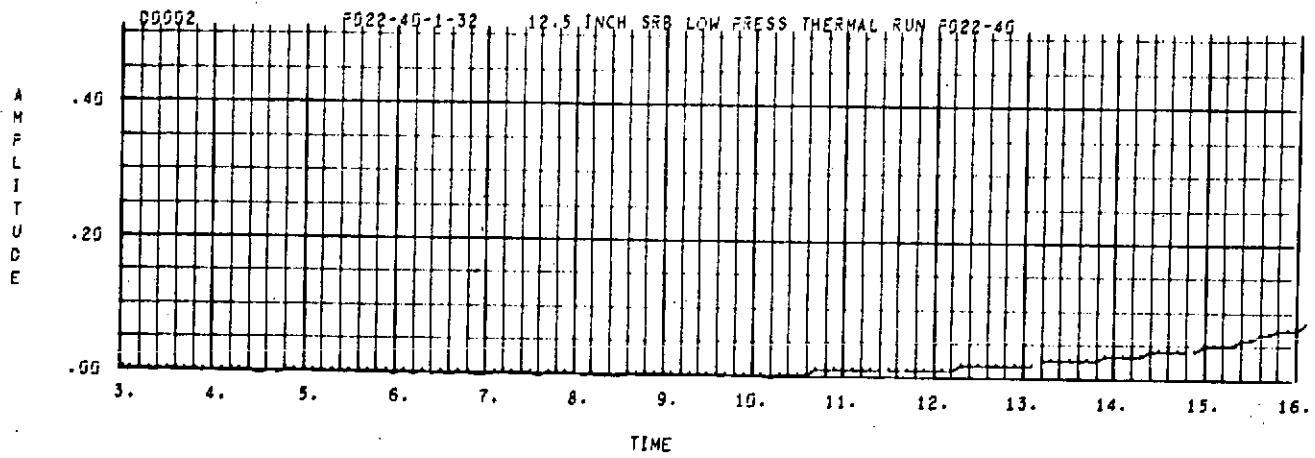

PAGES B-96 THROUGH B-113

LEFT BLANK

B-95

SEQ. = 0045

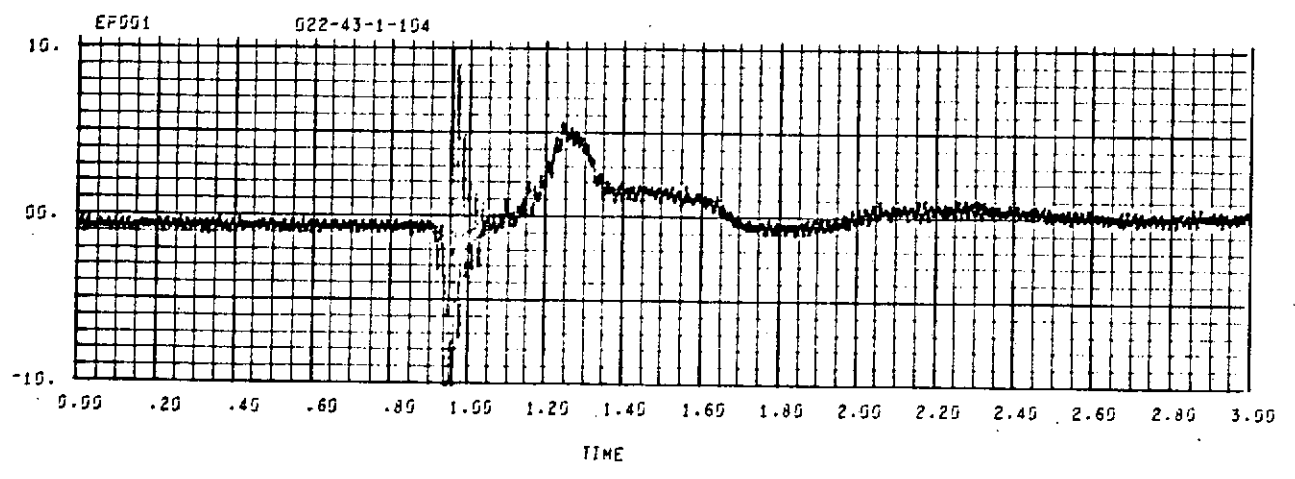
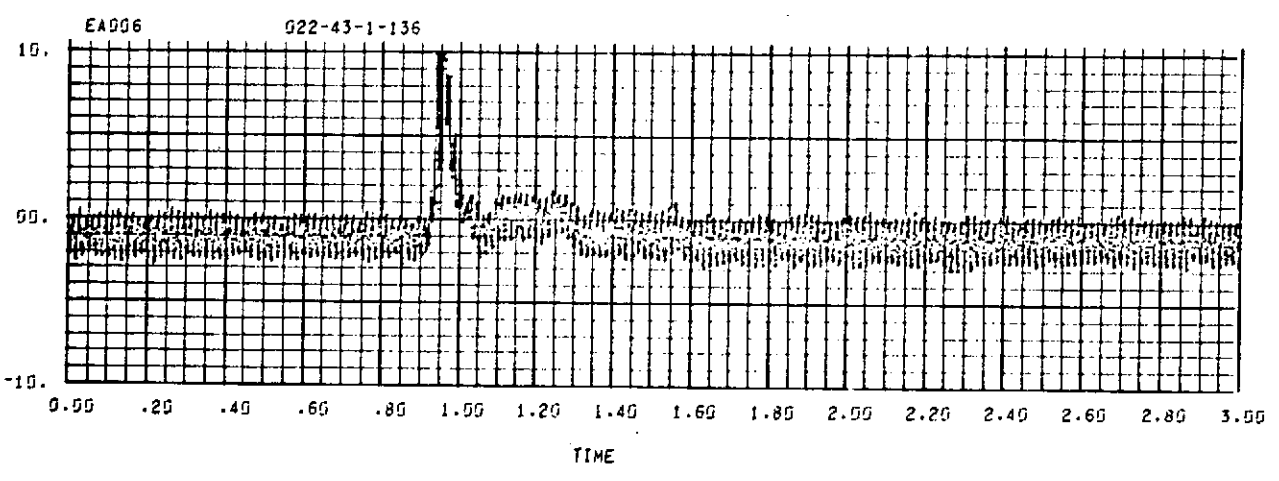
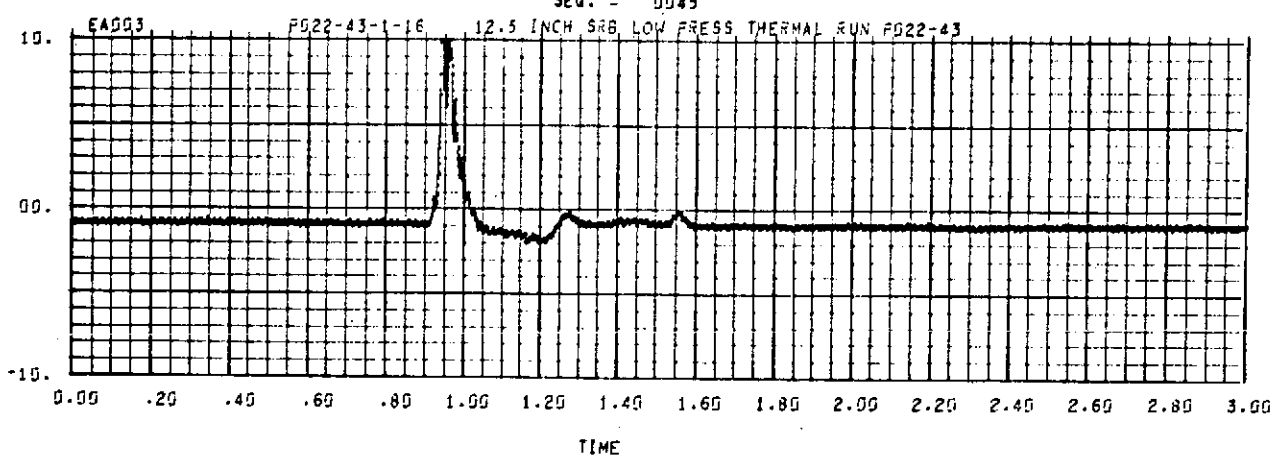



SEQ. = 0045

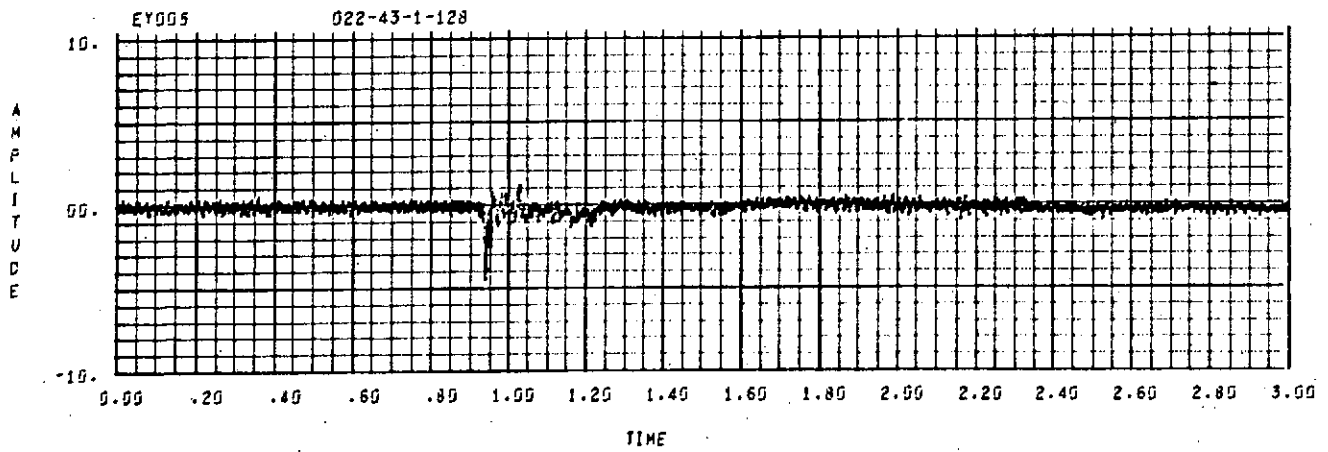
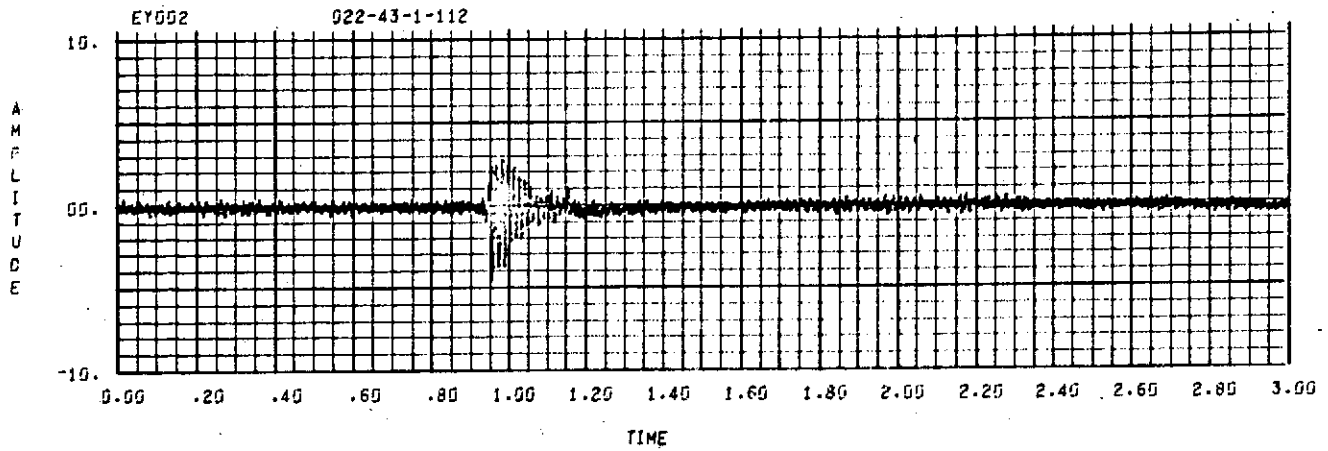
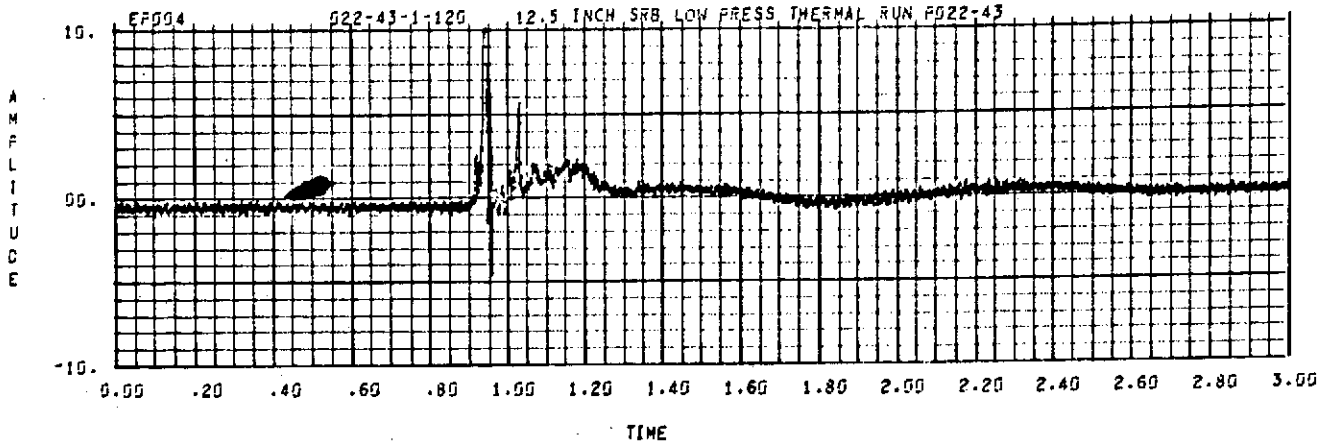

SER. = 0045

130. C0001 P022-43-1-40 12.5 INCH SRB LOW PRESS THERMAL RUN P022-43

A
M
P
L
I
T
U
D
E

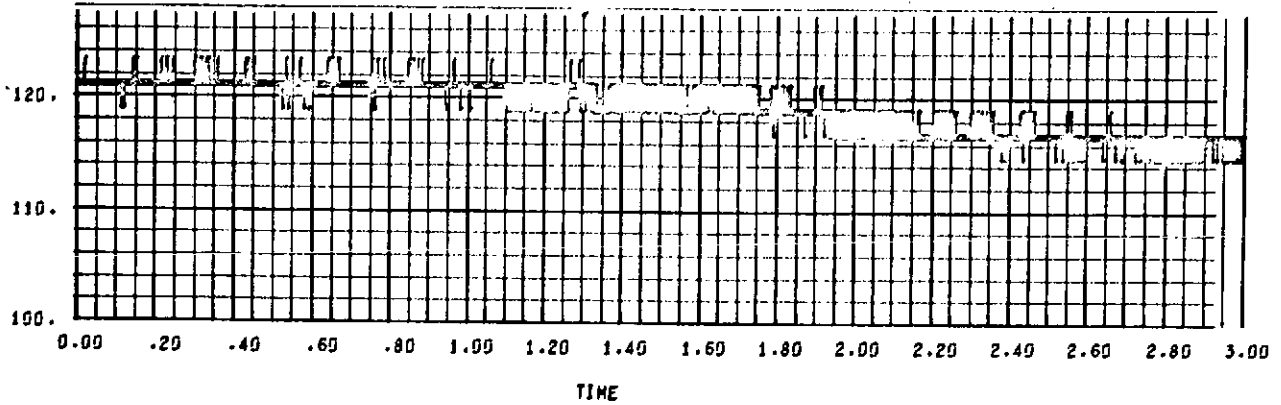

C0002 P022-43-1-48

A
M
P
L
I
T
U
D
E

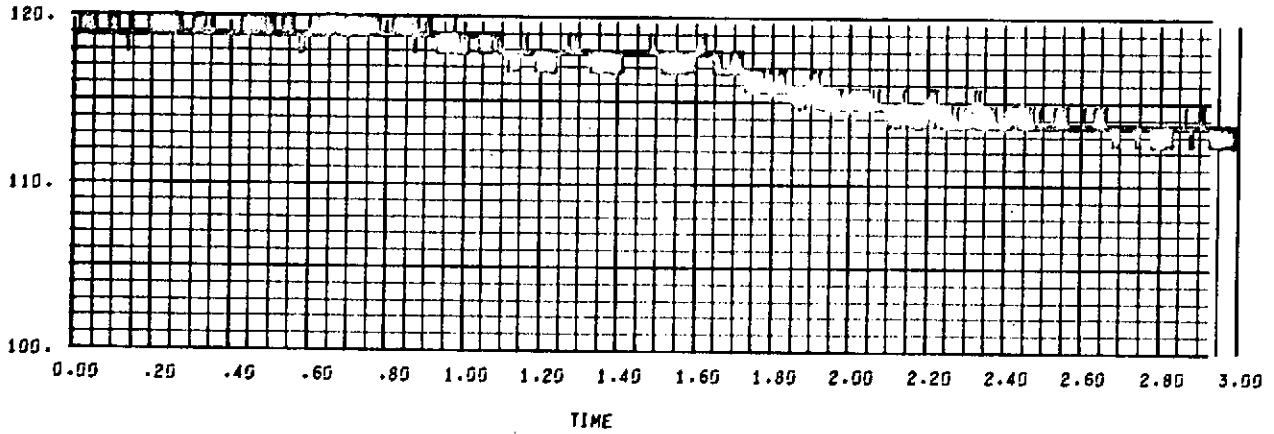

C0003 P022-43-1-56

A
M
P
L
I
T
U
D
E

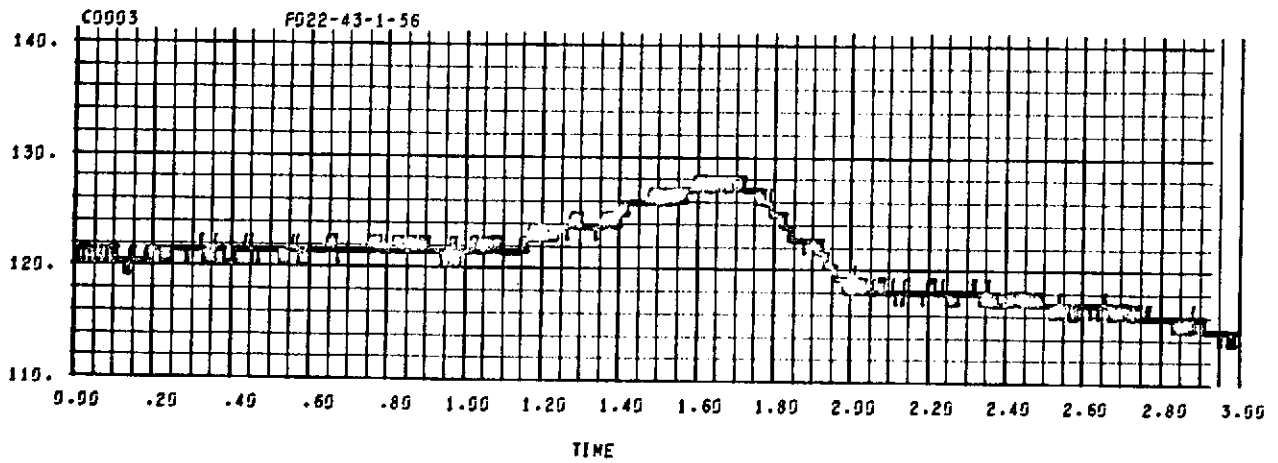

SEQ. = 0045

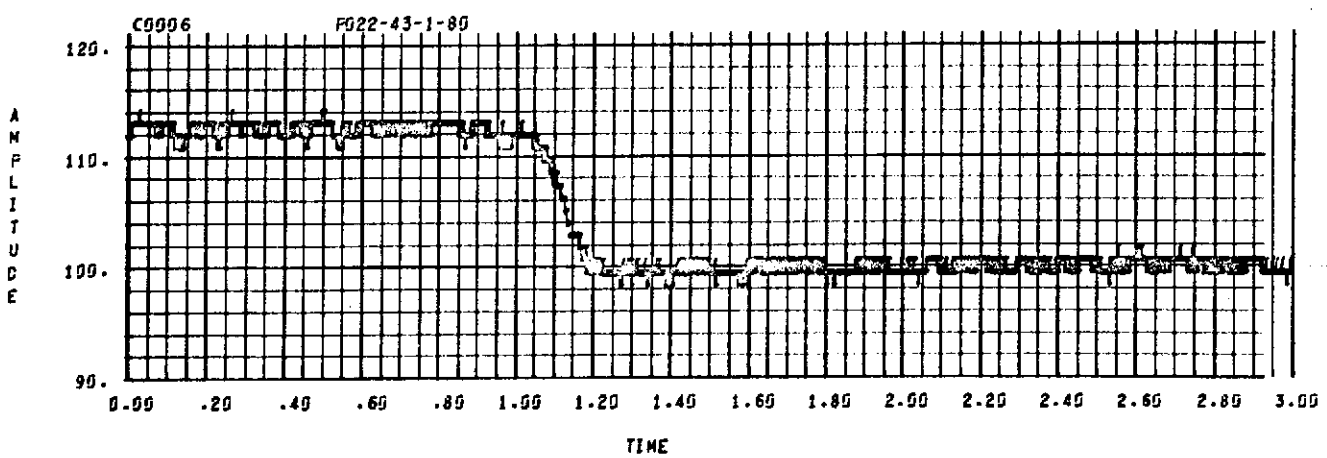
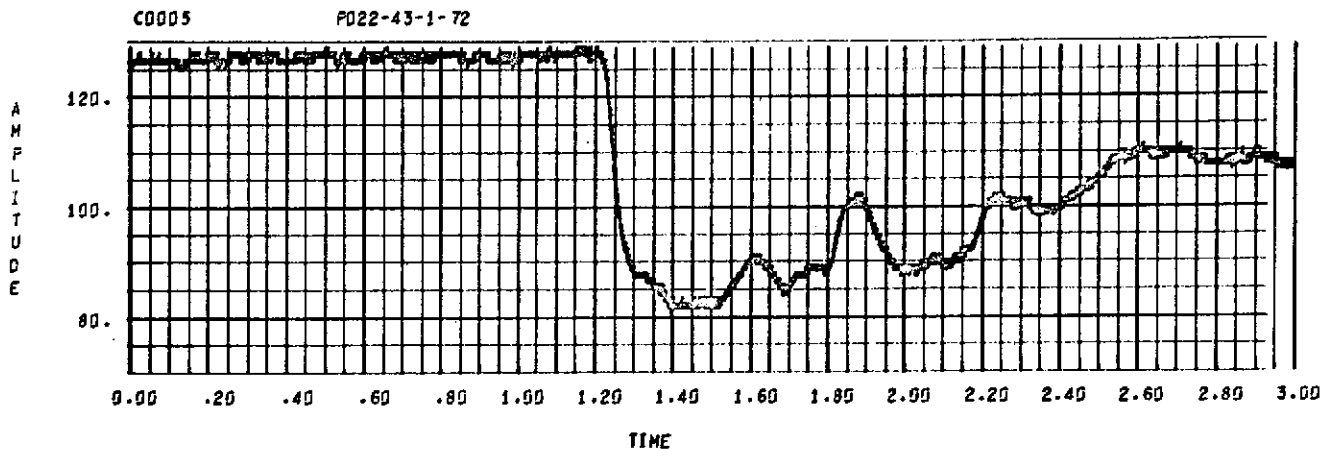
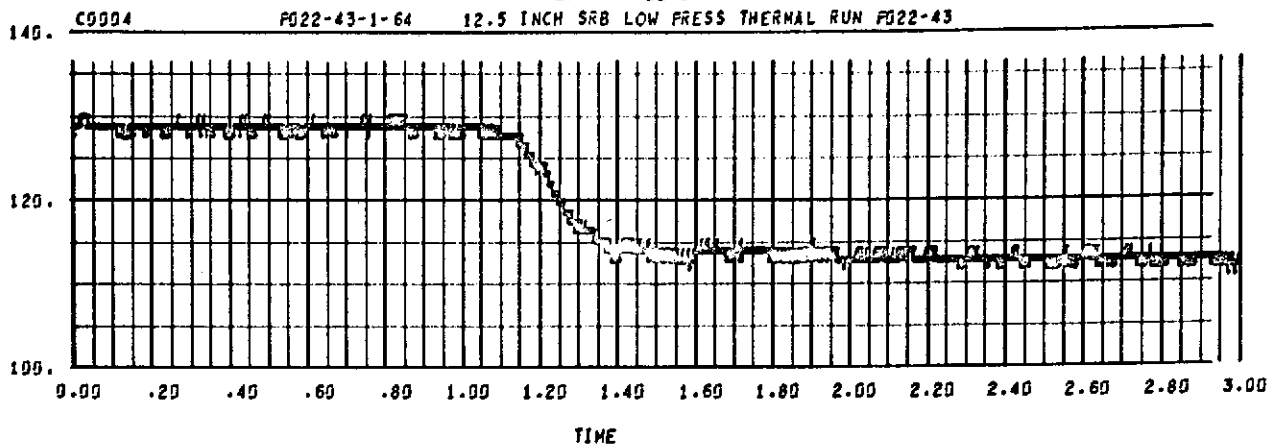

SEQ. = 0045
C0007 FG22-43-1-88 12.5 INCH SRB LOW PRESS THERMAL RUN PD22-43

3

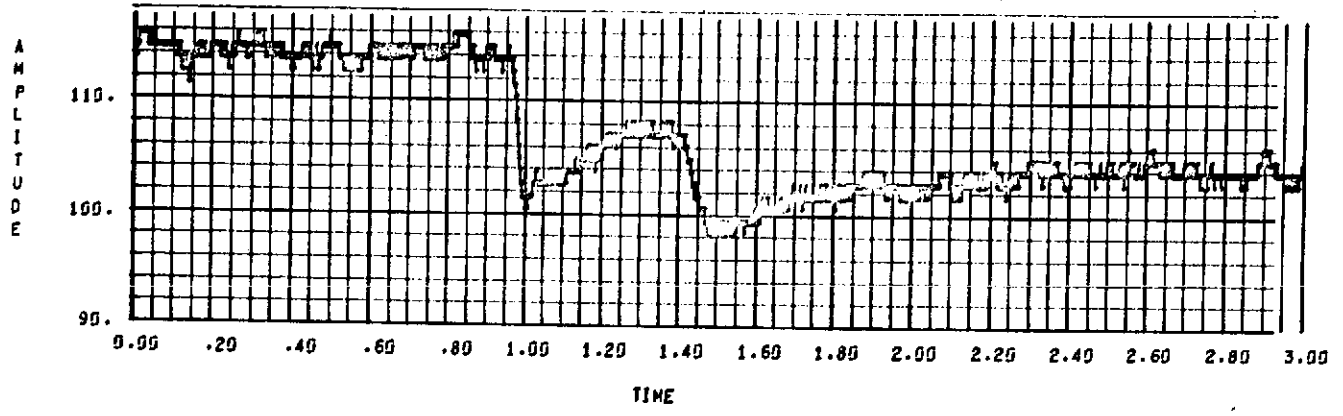

C0008 FG22-43-1-96

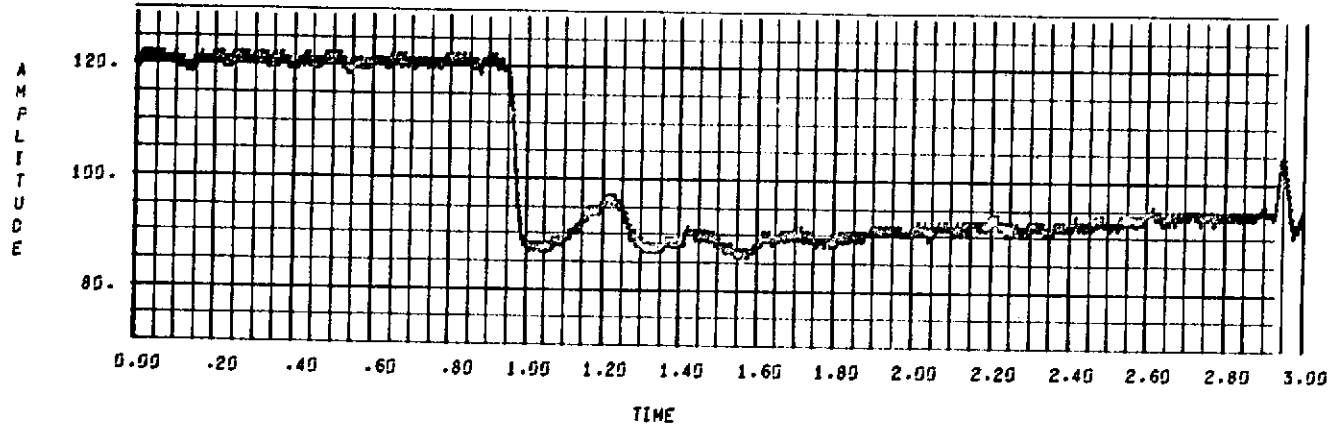

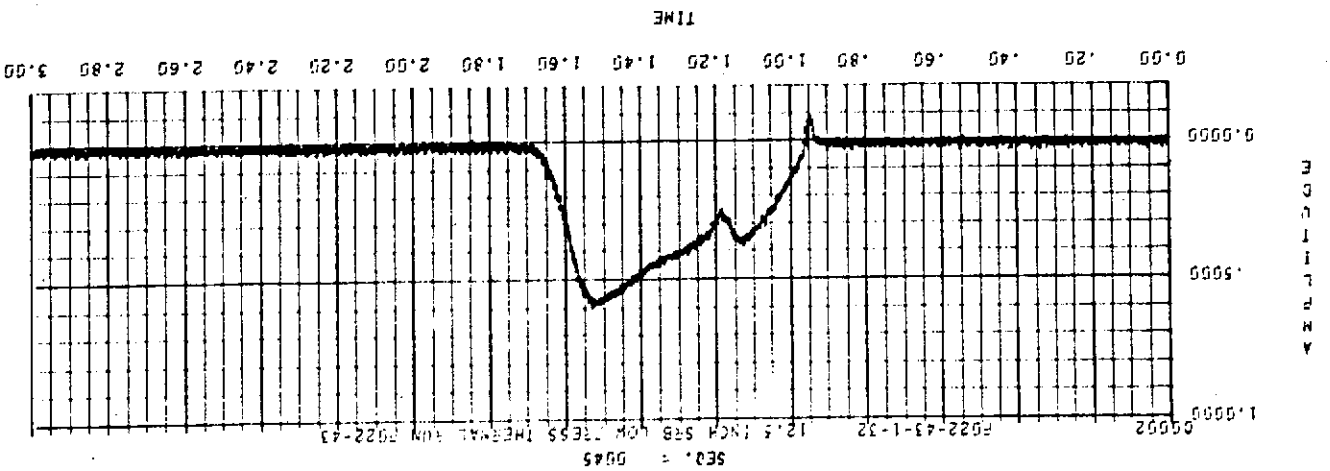

6

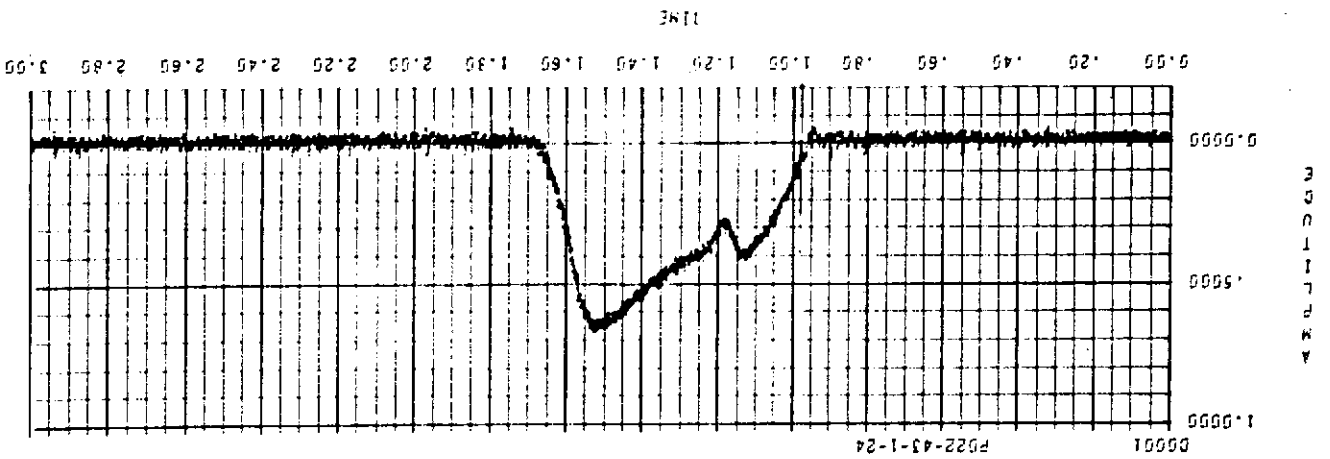

SEQ. = 0045

8

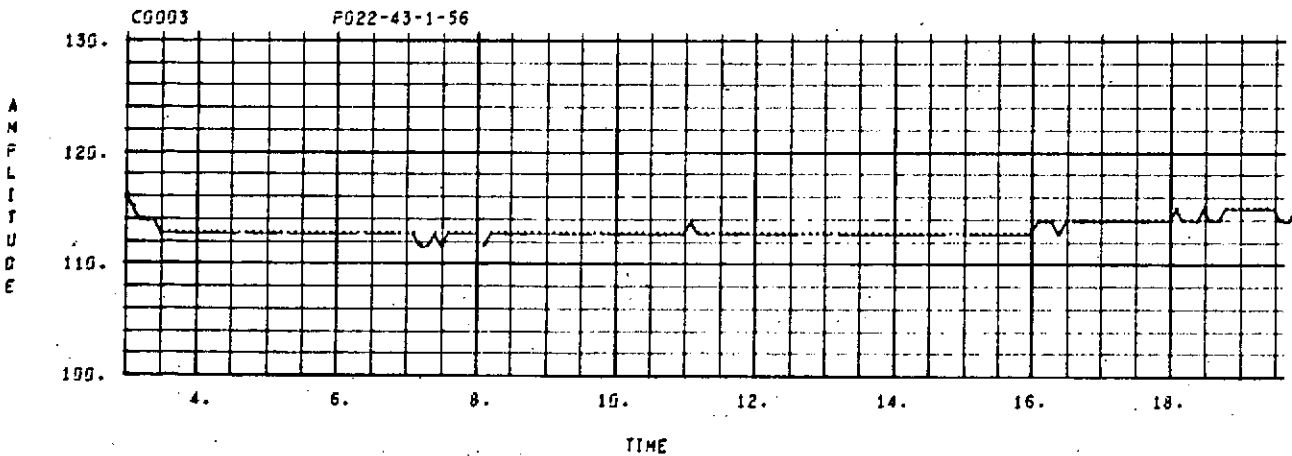
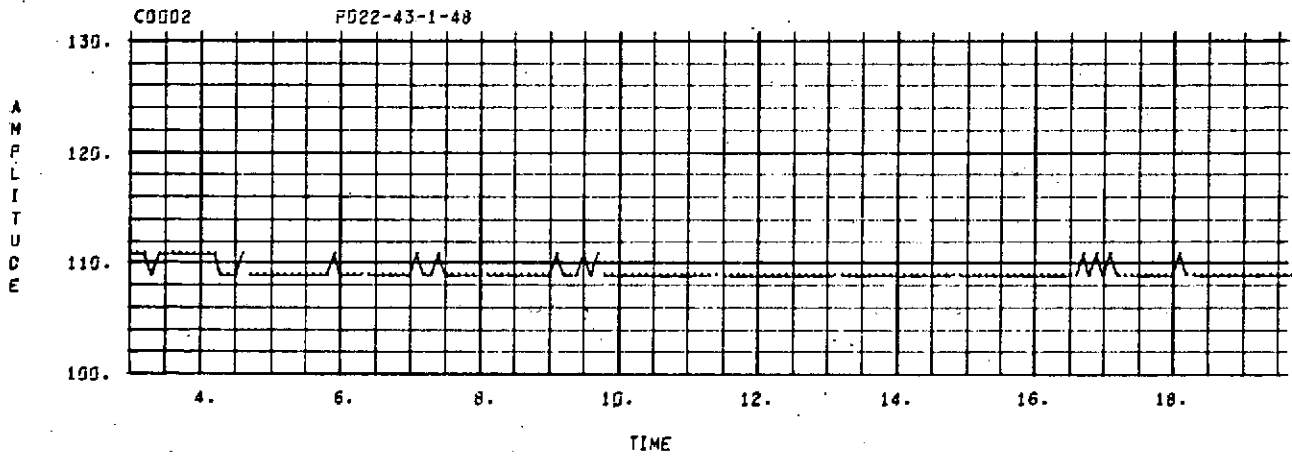
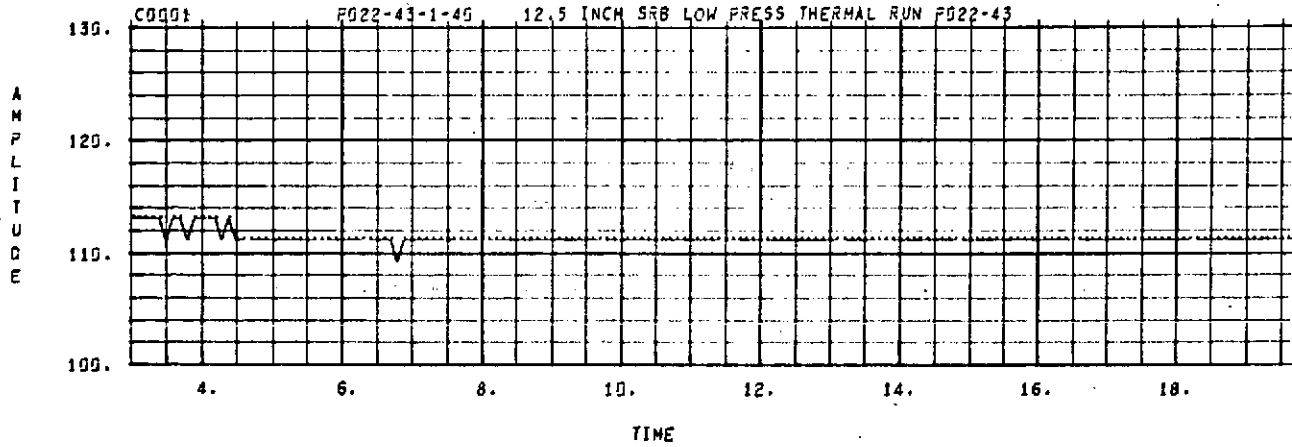

SEQ. = 5645

9

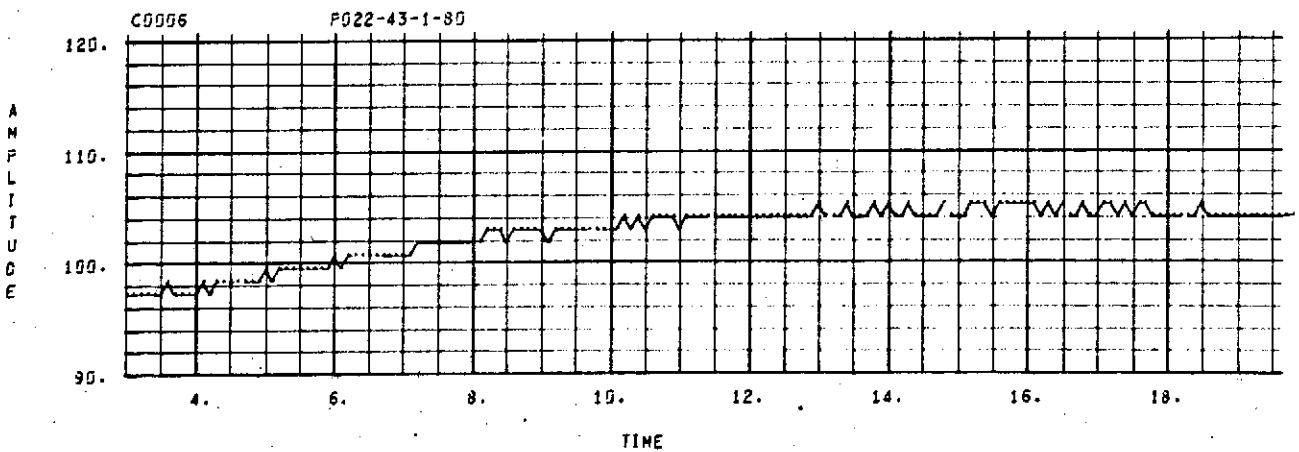
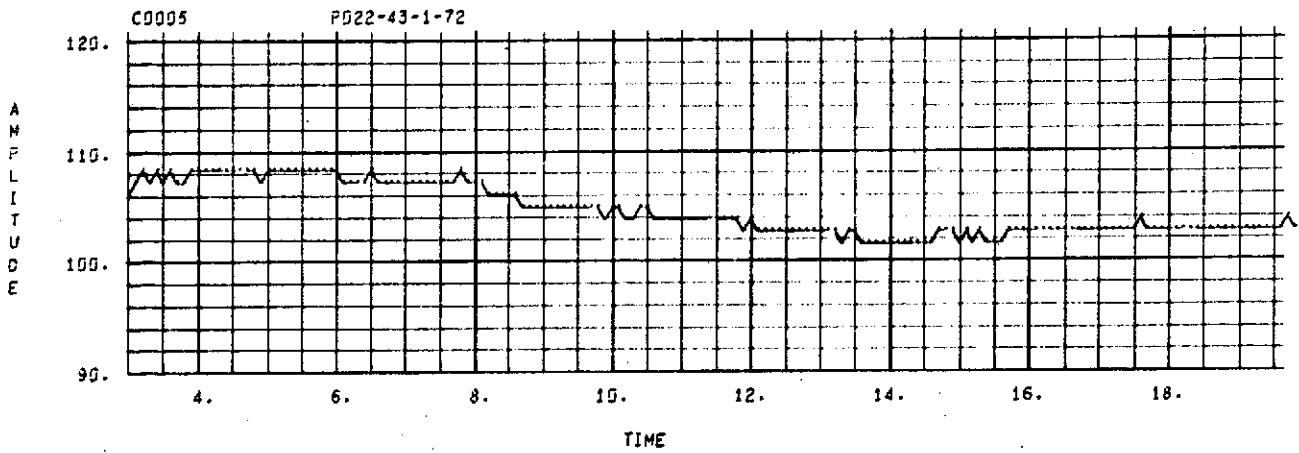
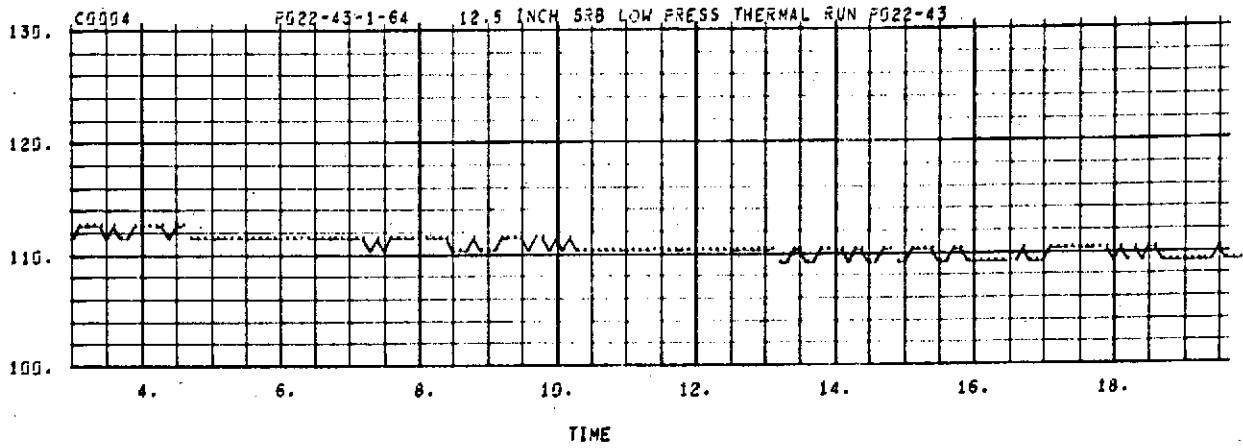

SEQ. = 0045

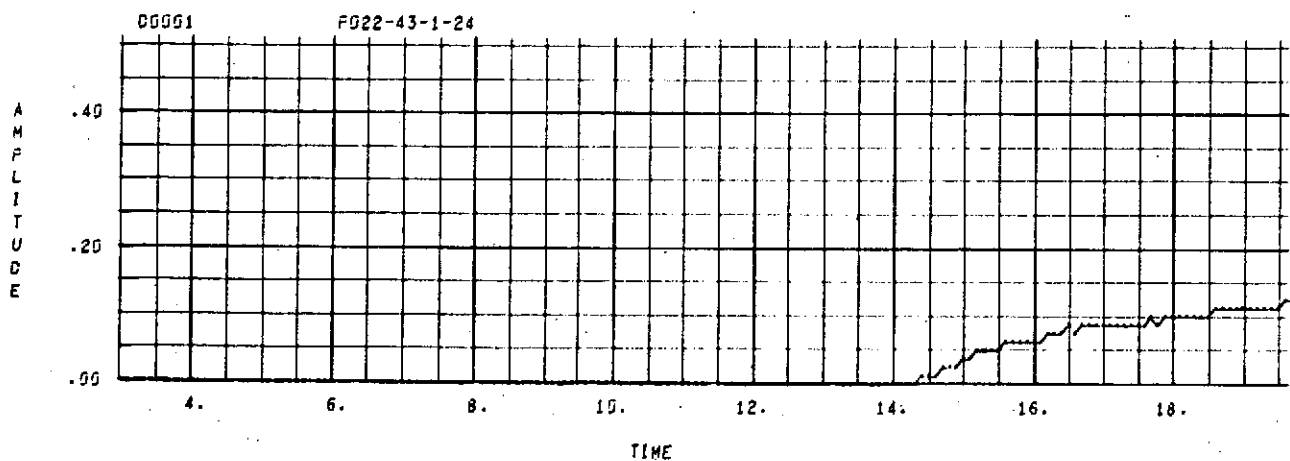
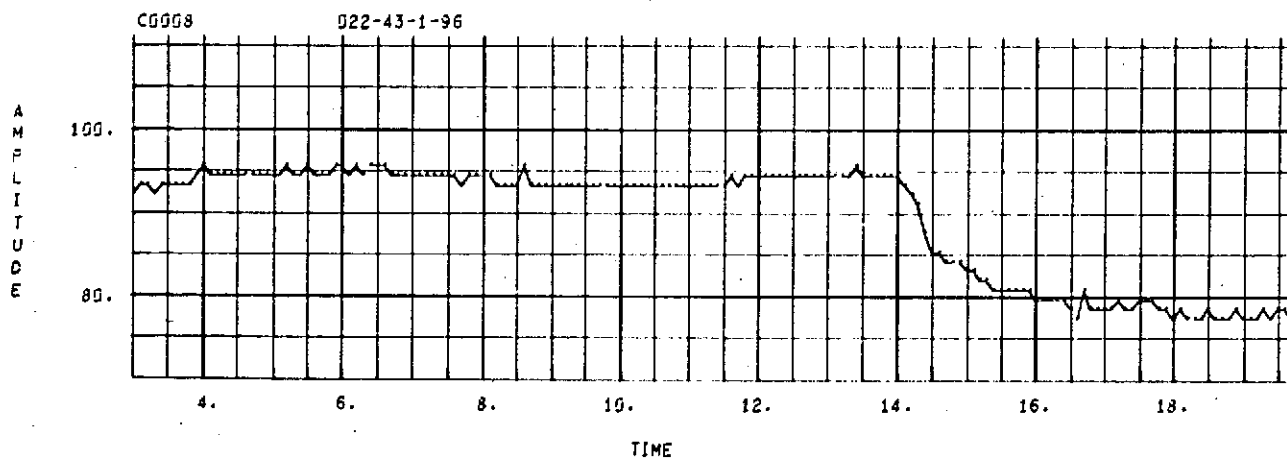
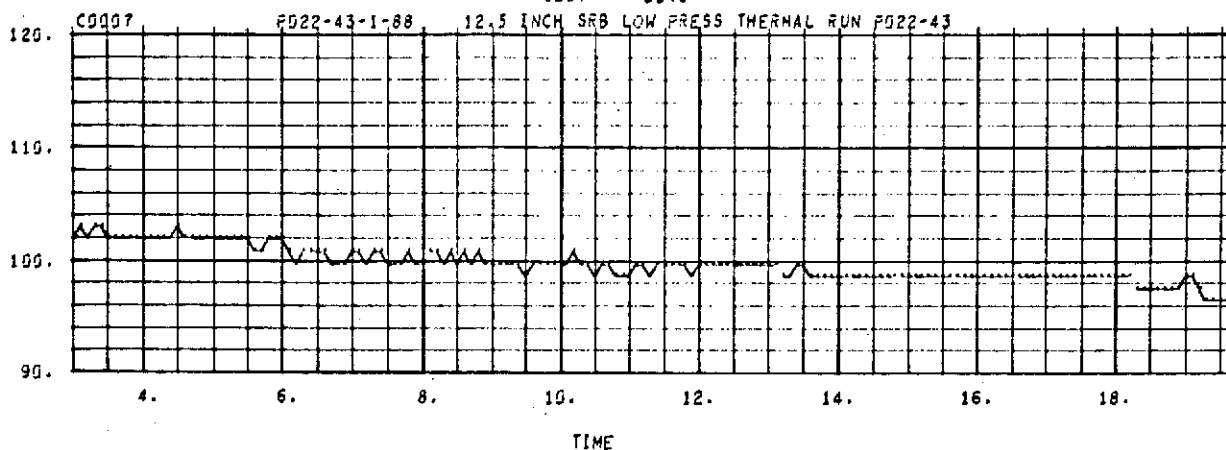

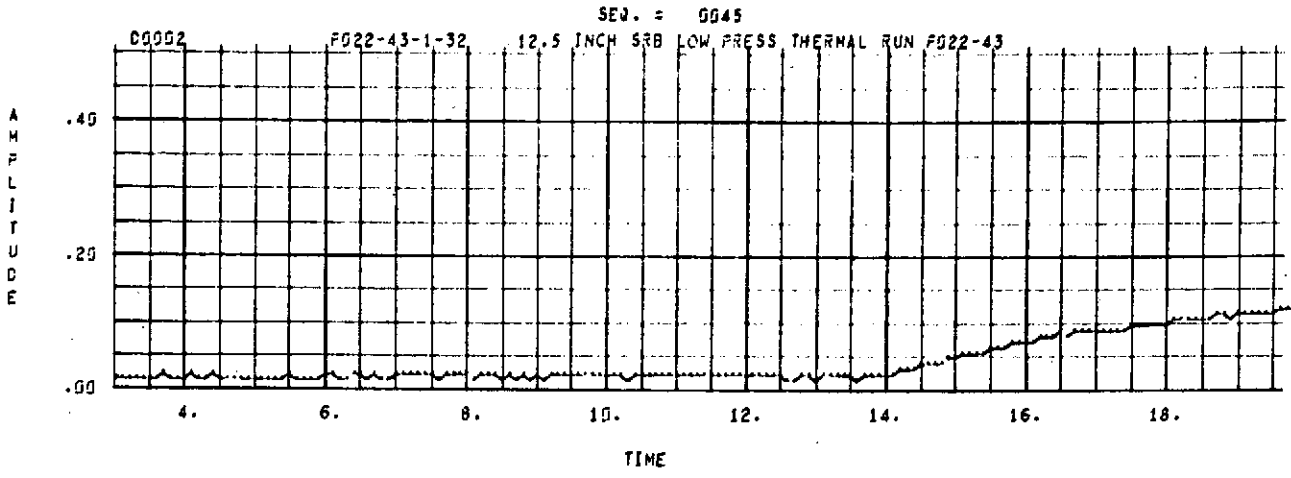

SEQ. = 0046

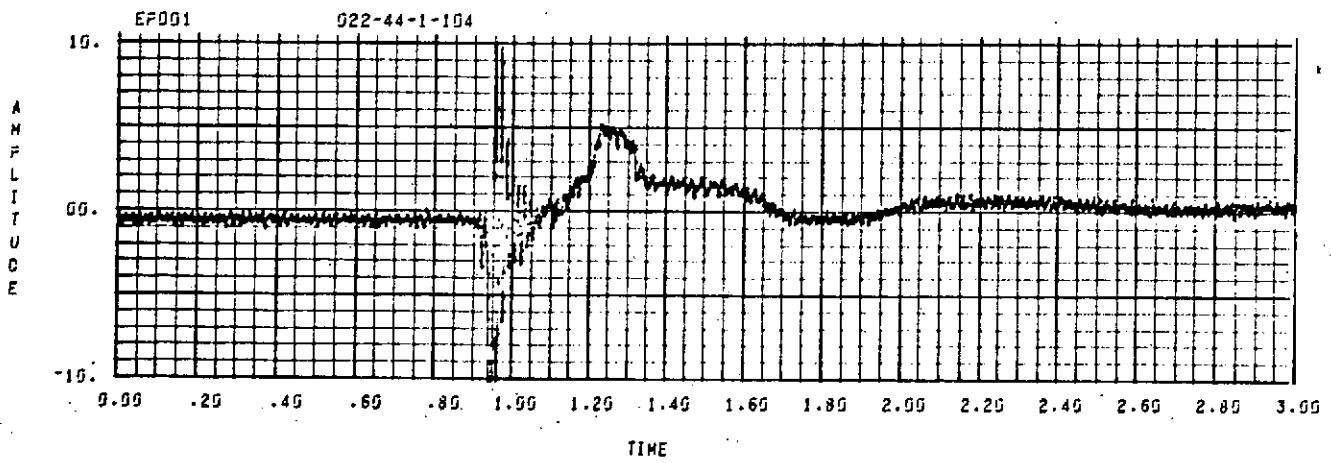
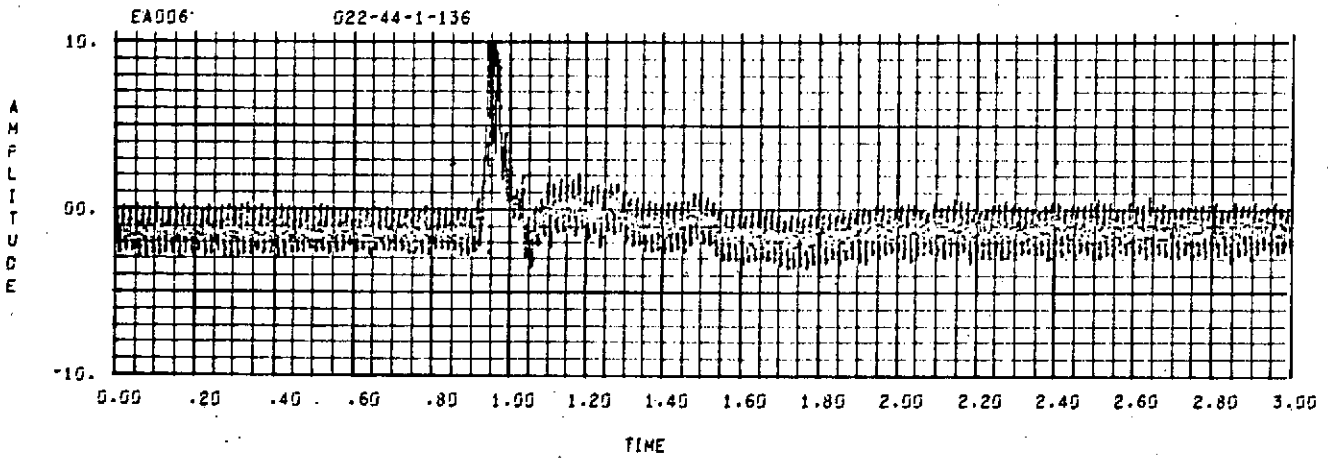
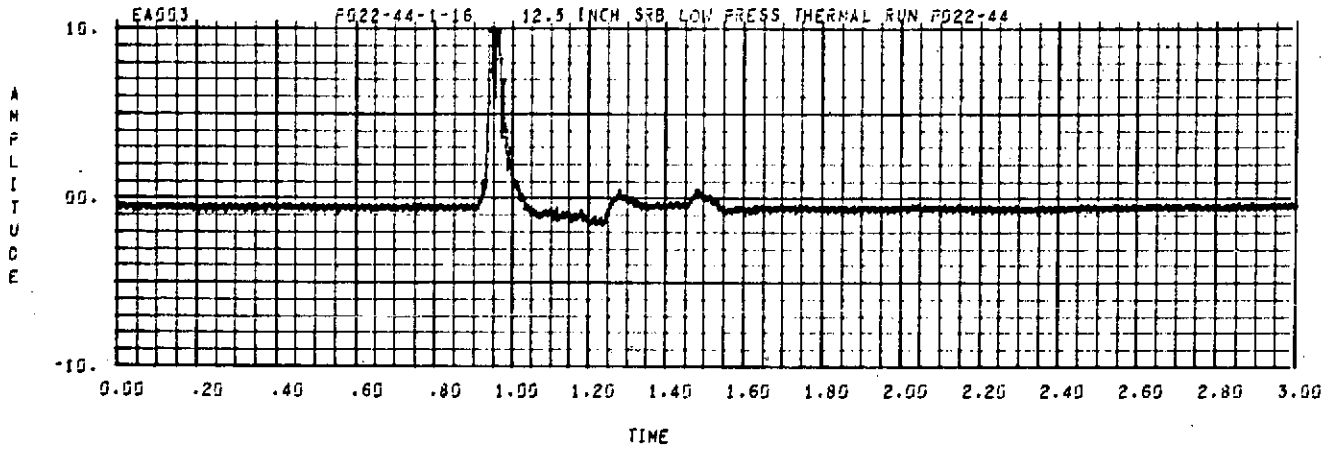

SEQ. = 0046

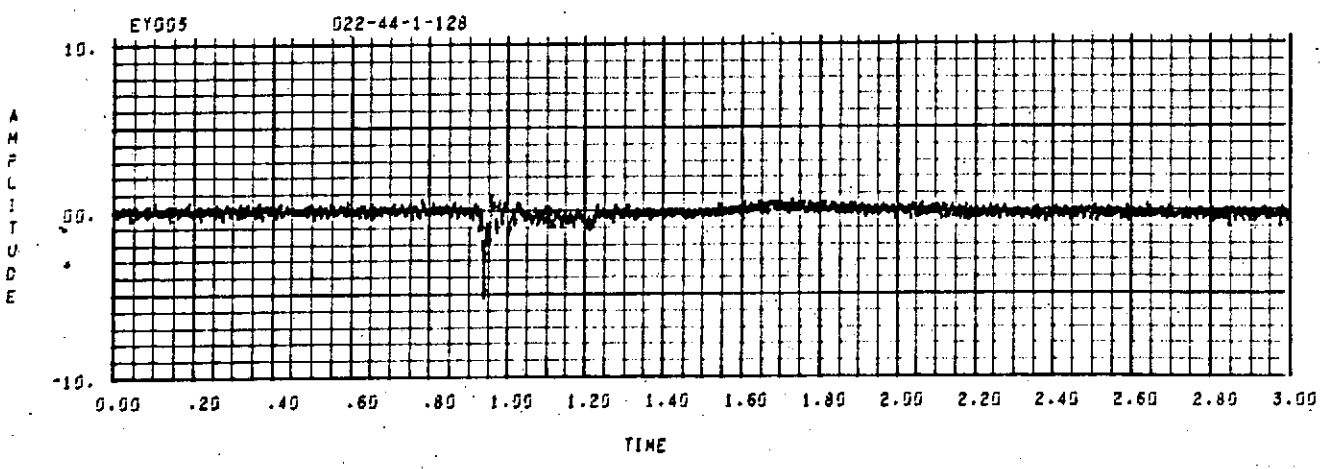
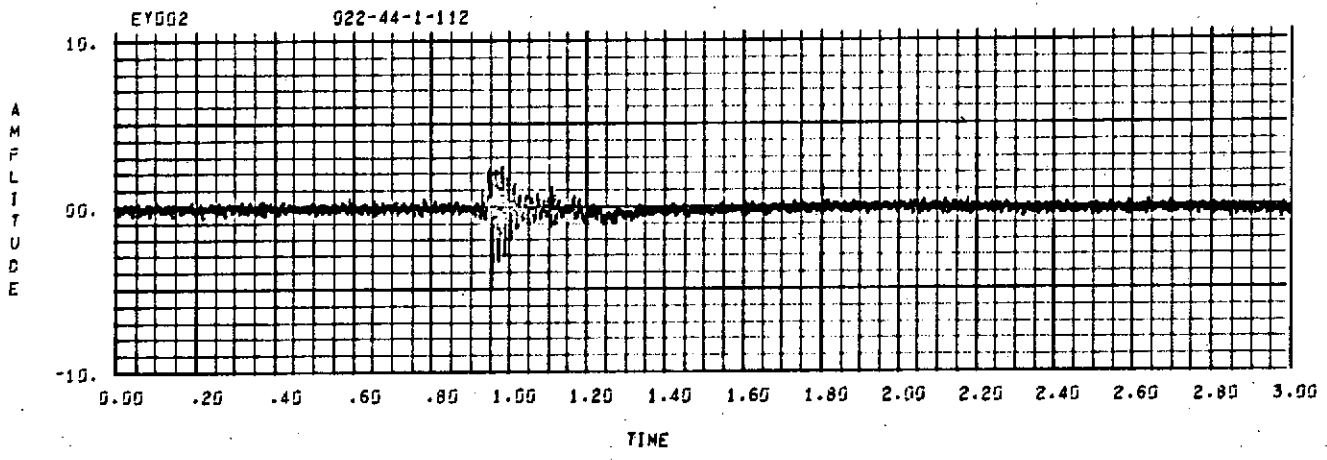
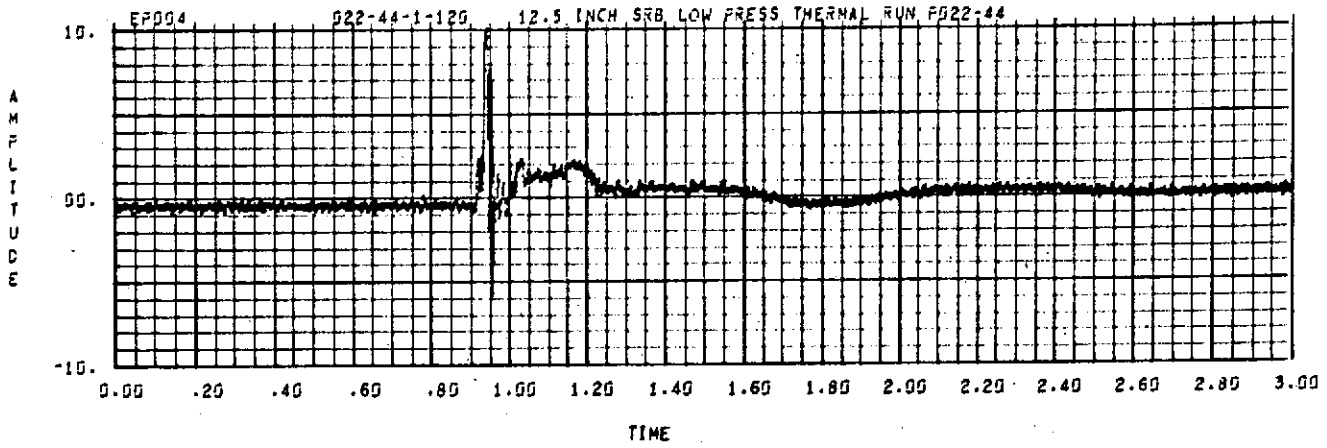



SEQ. = 0046

1

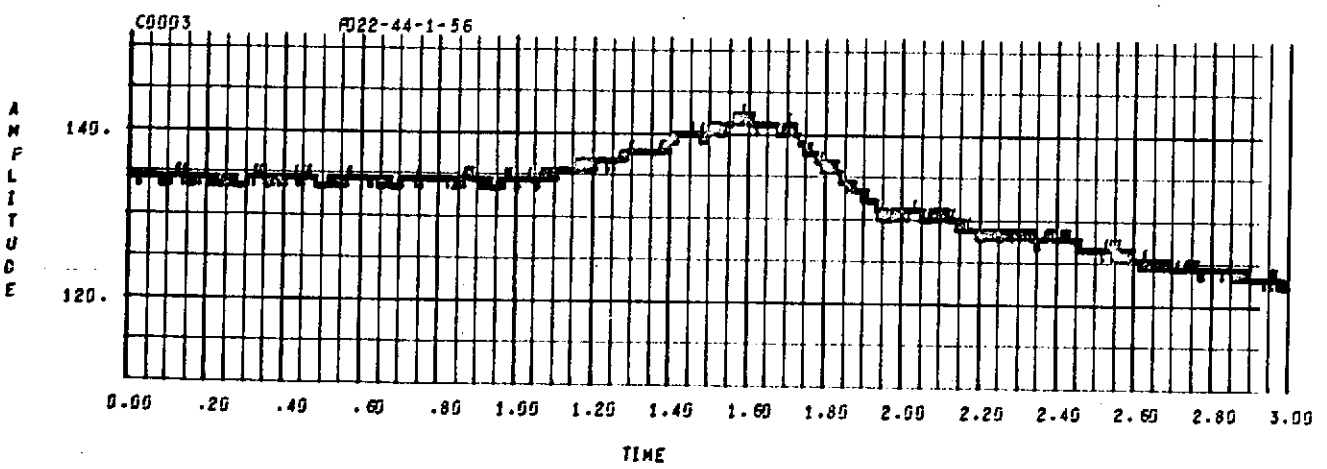
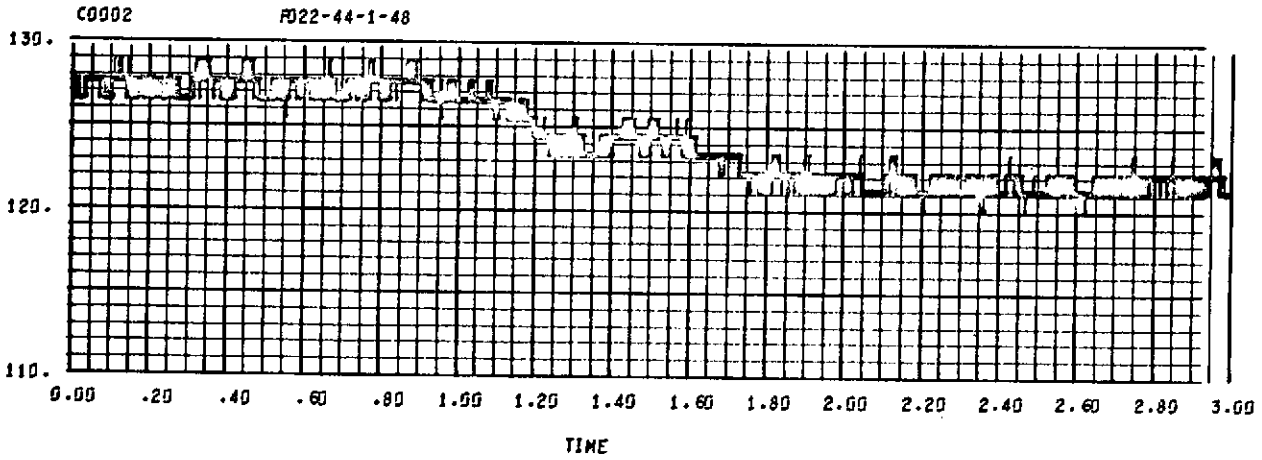
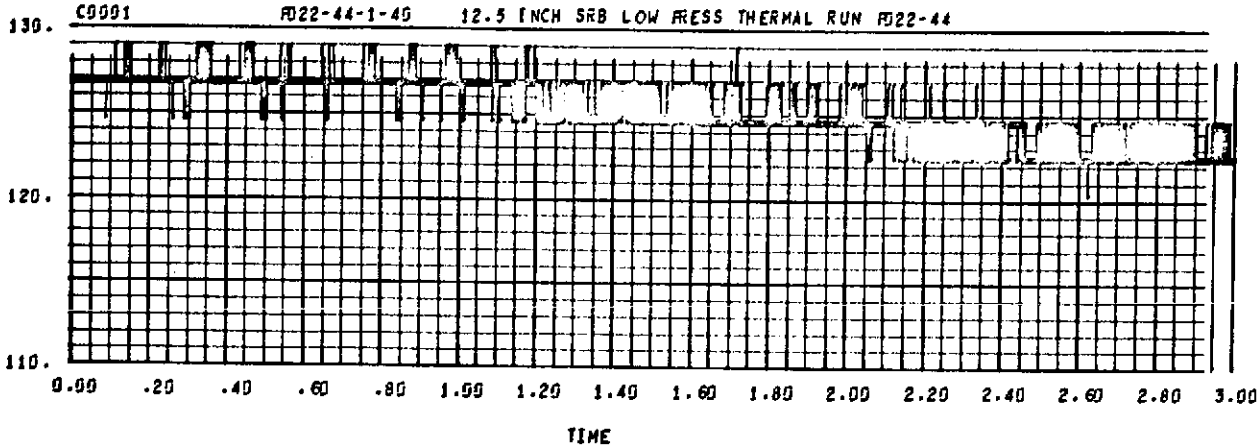



SEQ. = 0046

C0004 R022-44-1-64 12.5 INCH SRB LOW PRESS THERMAL RUN R022-44

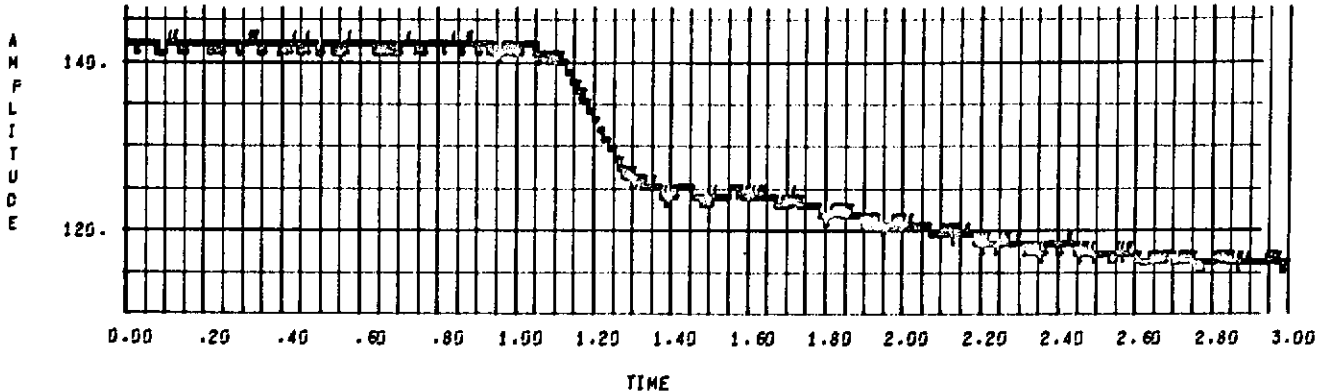

C0005 R022-44-1-72

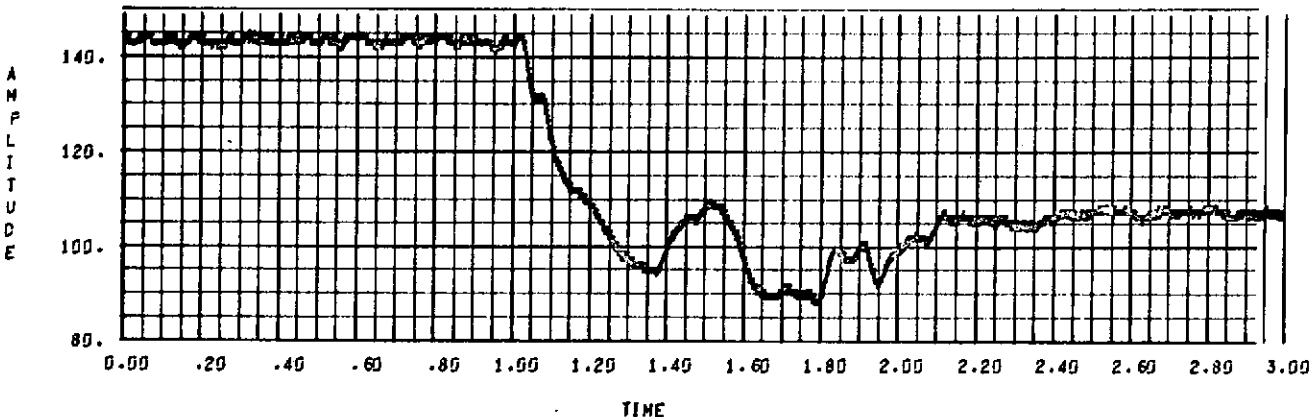

C0006 R022-44-1-80

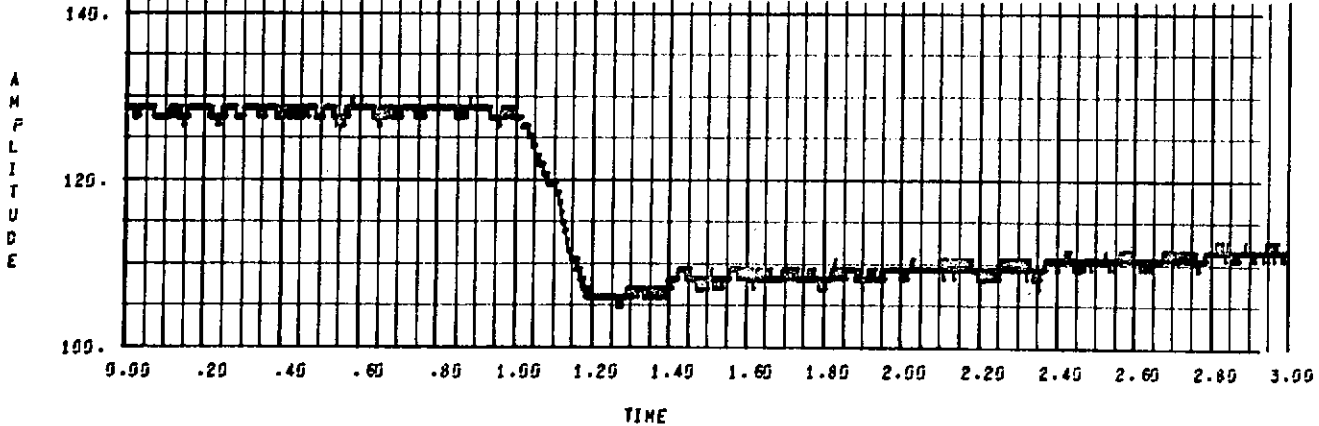

SEQ. = 0046

C0007 FD22-44-1-88 12.5 INCH SRB LOW PRESS THERMAL RUN FD22-44

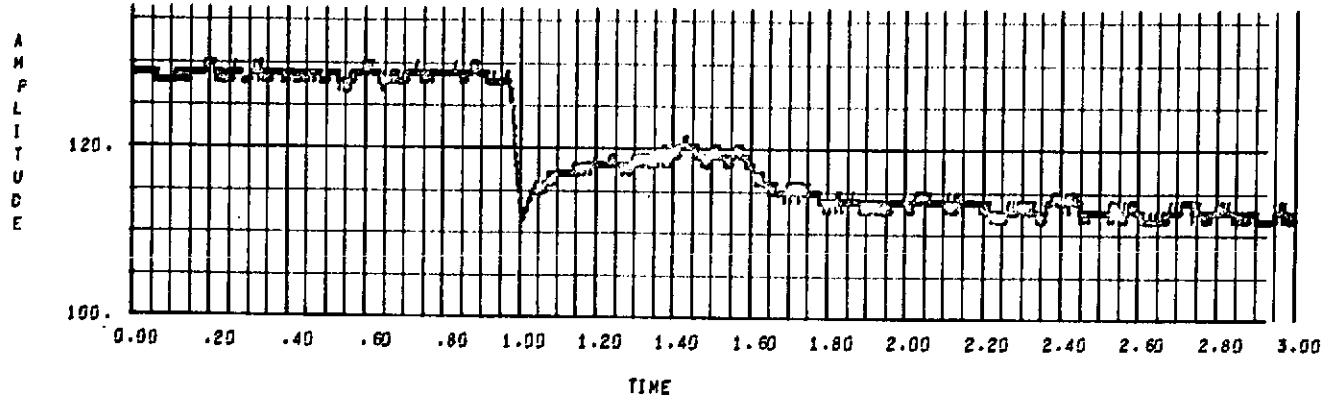

C0008 022-44-1-96

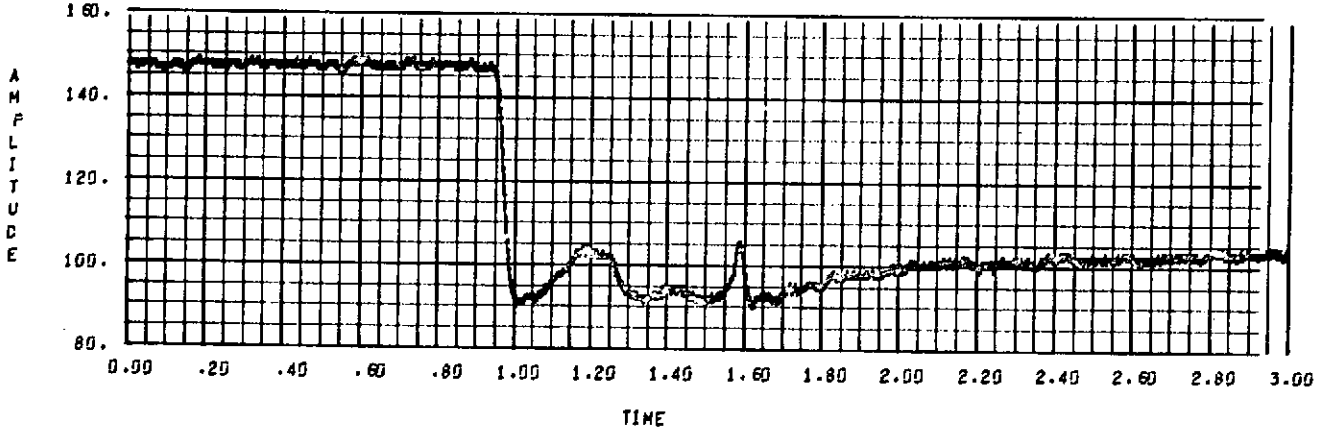

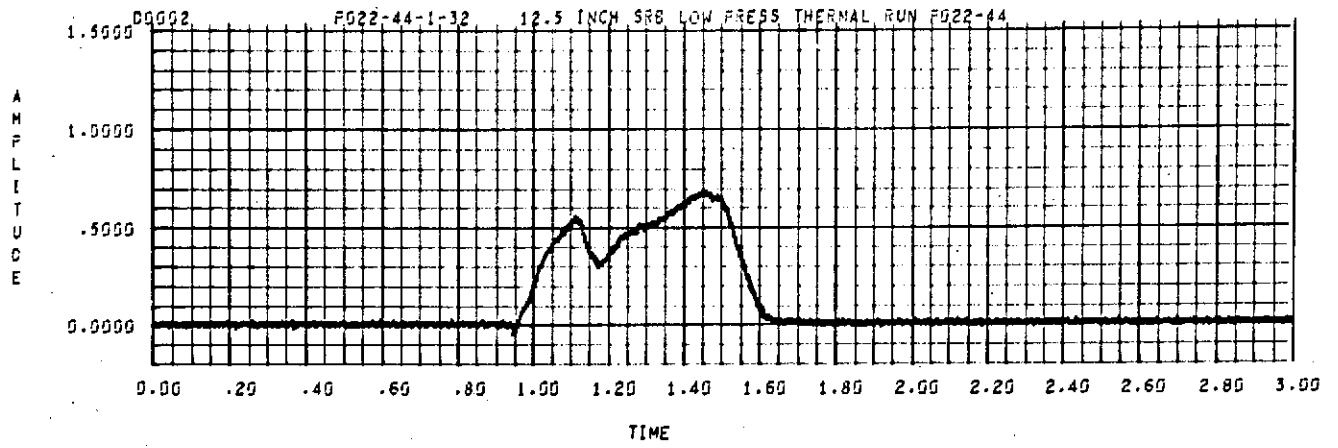
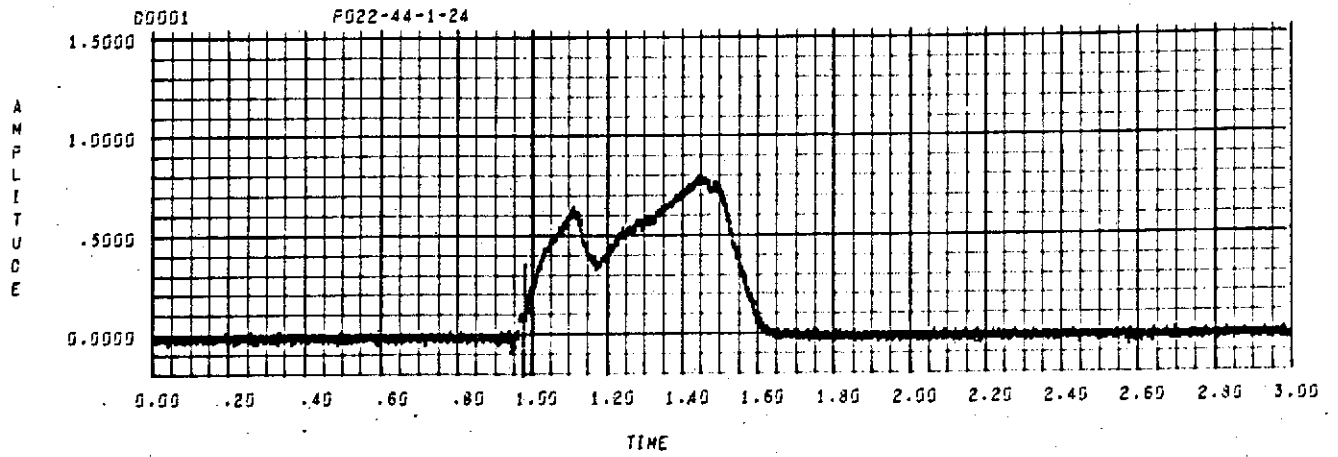

SEQ. = 0046

8

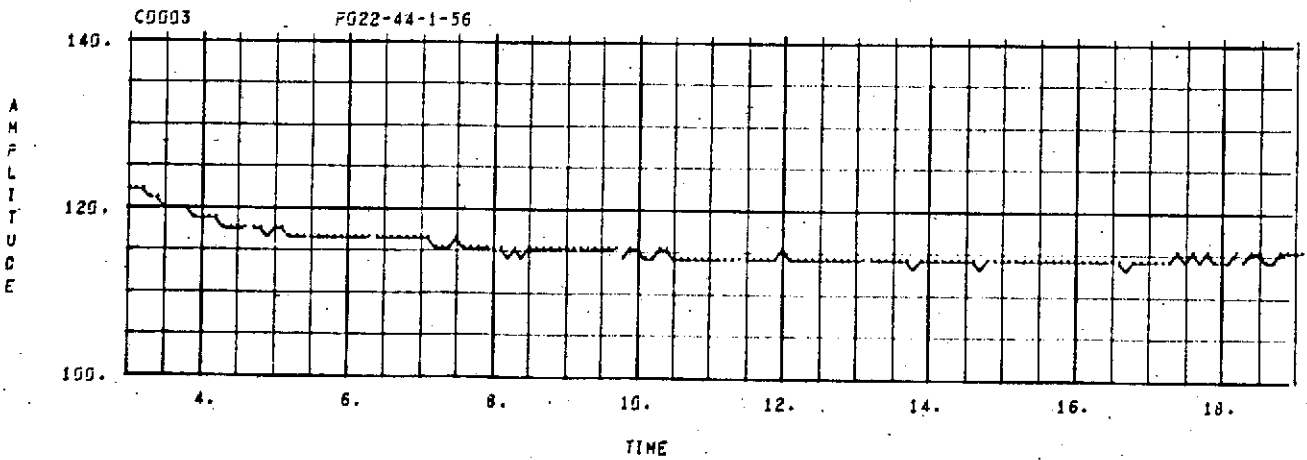
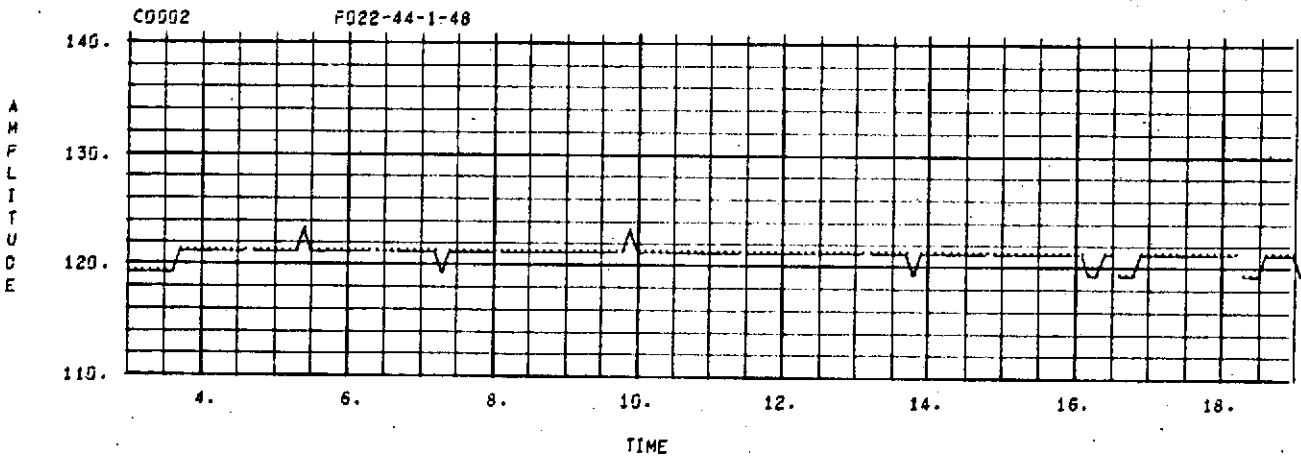
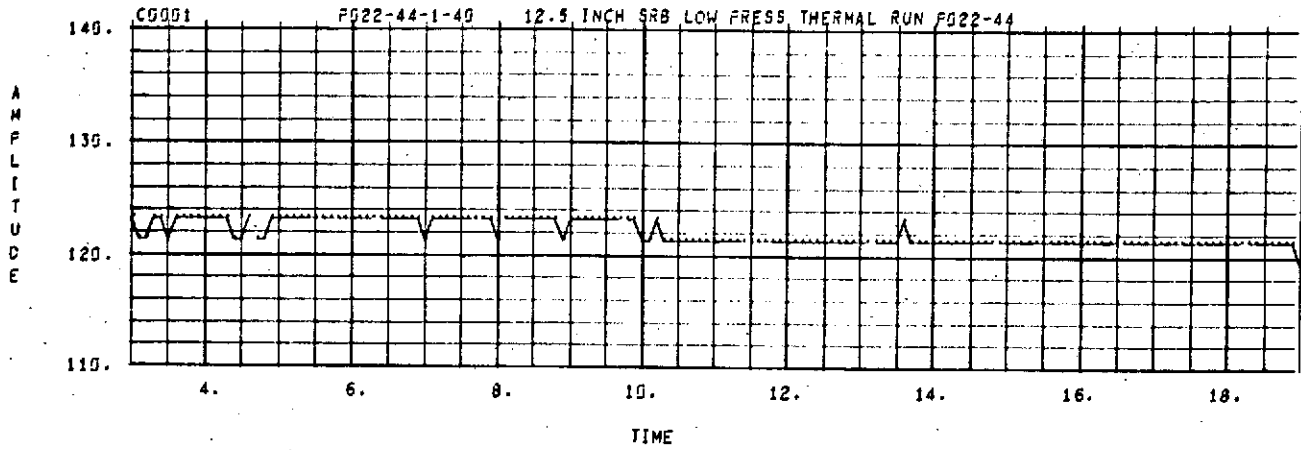

SEQ. = 0046

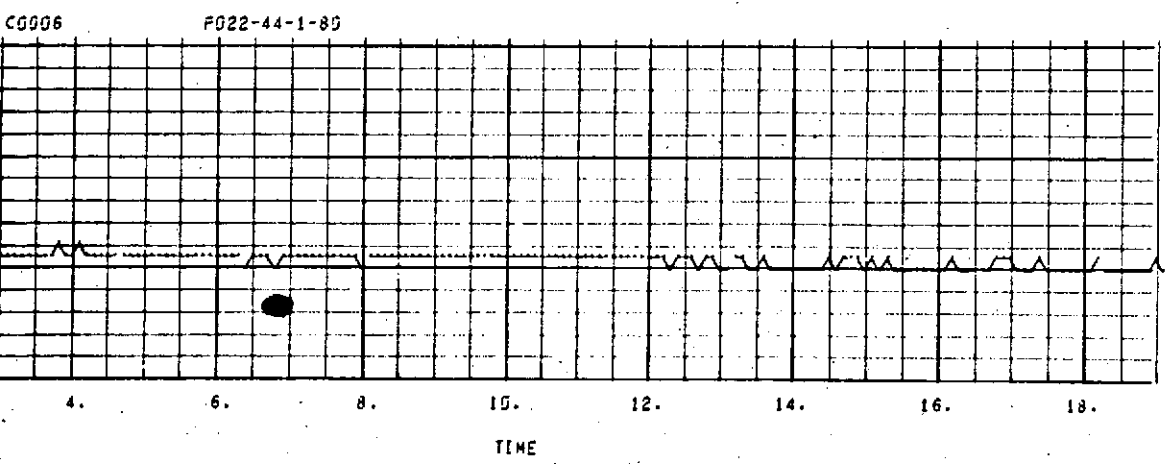
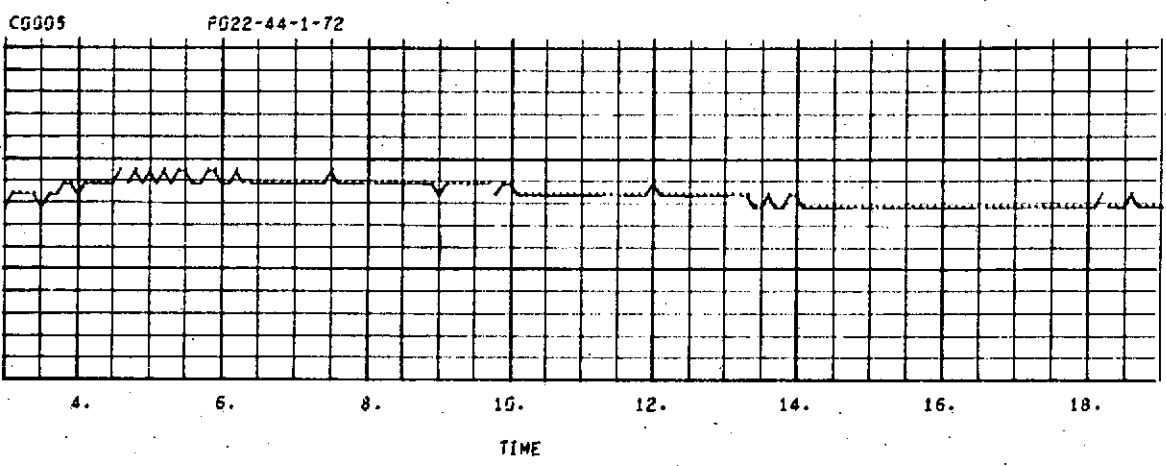
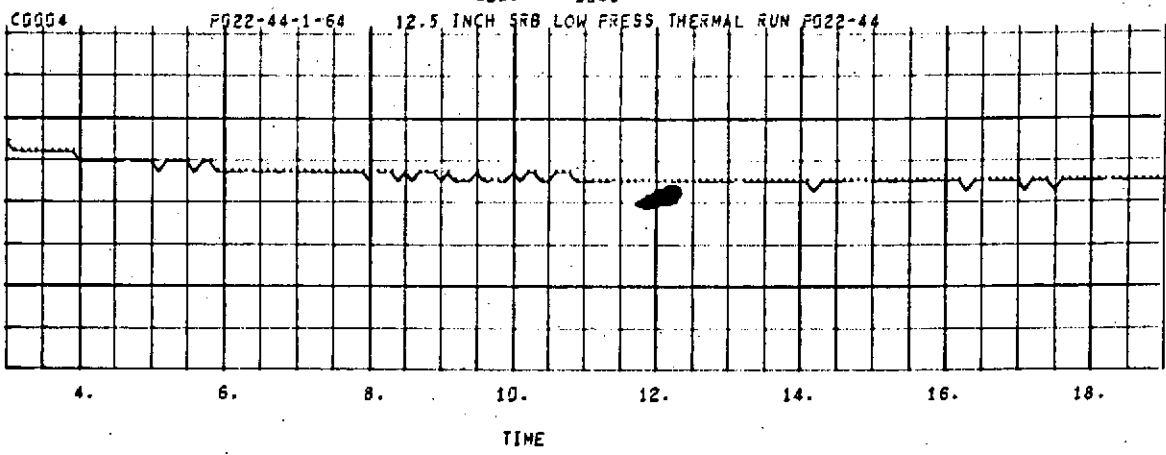

SEQ. = 0046

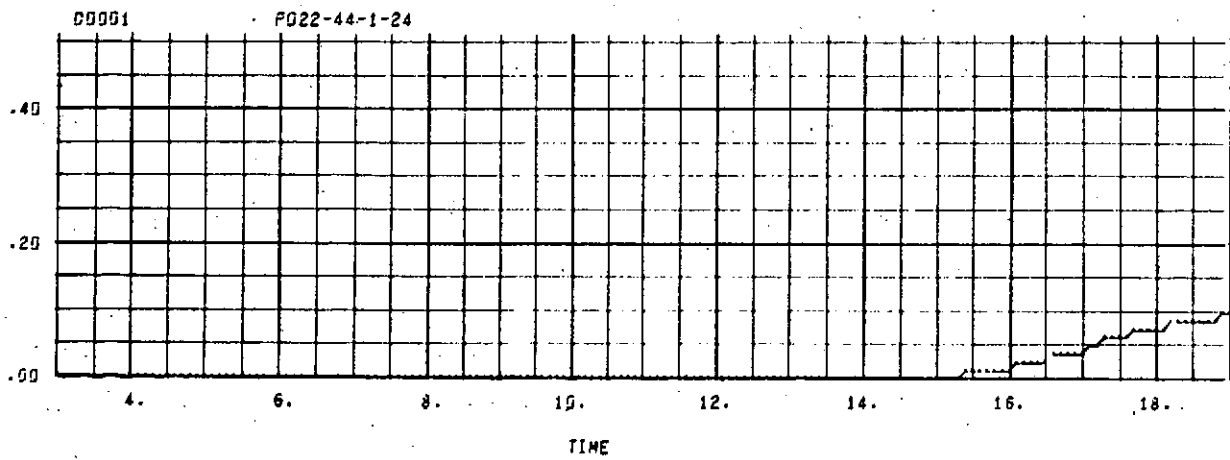
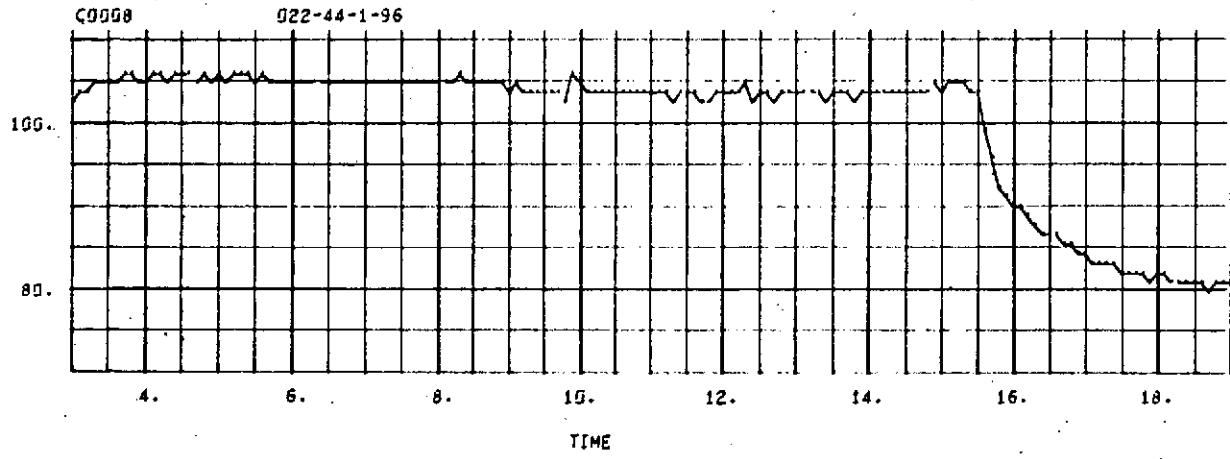
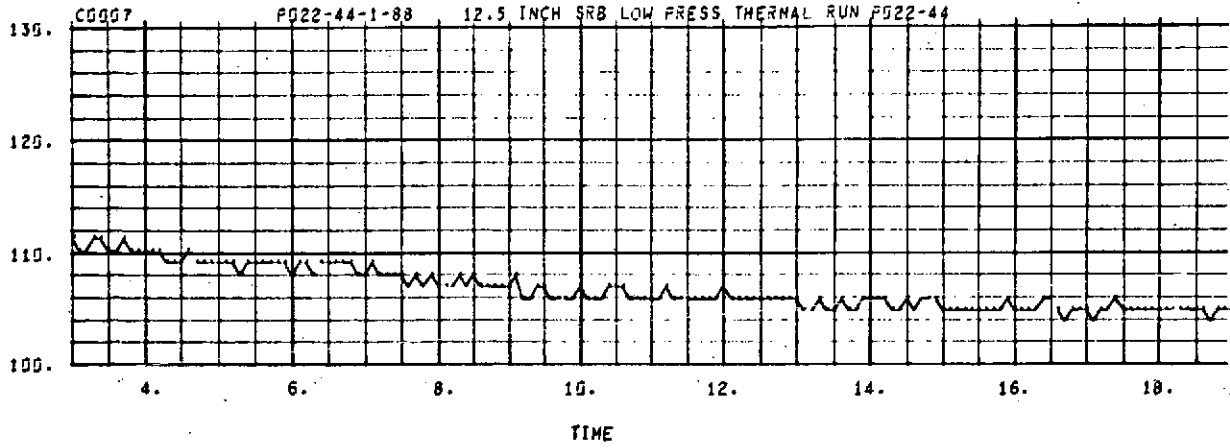

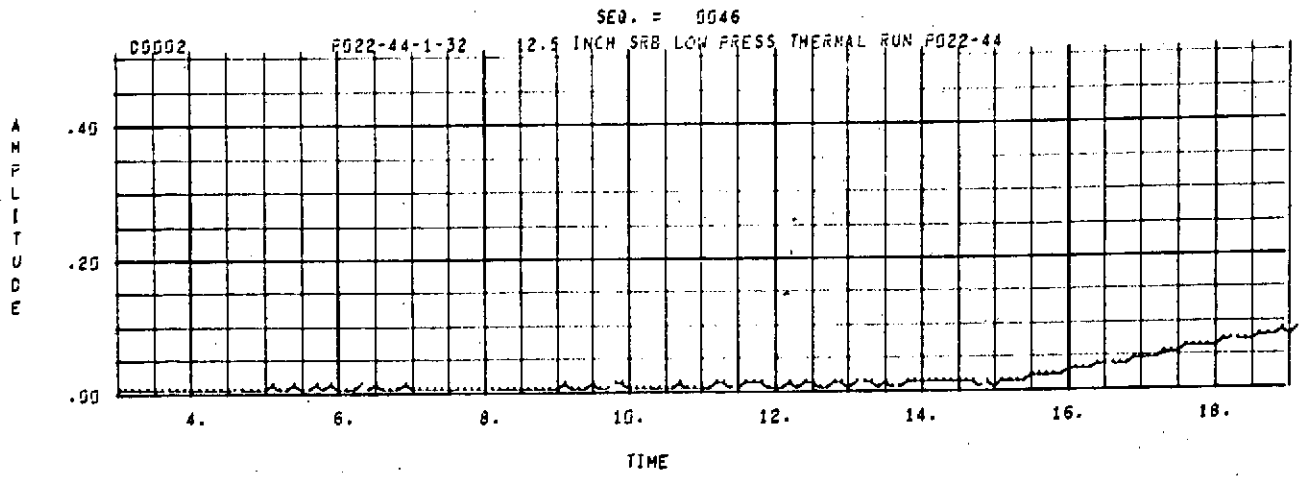

SEQ. = 0047

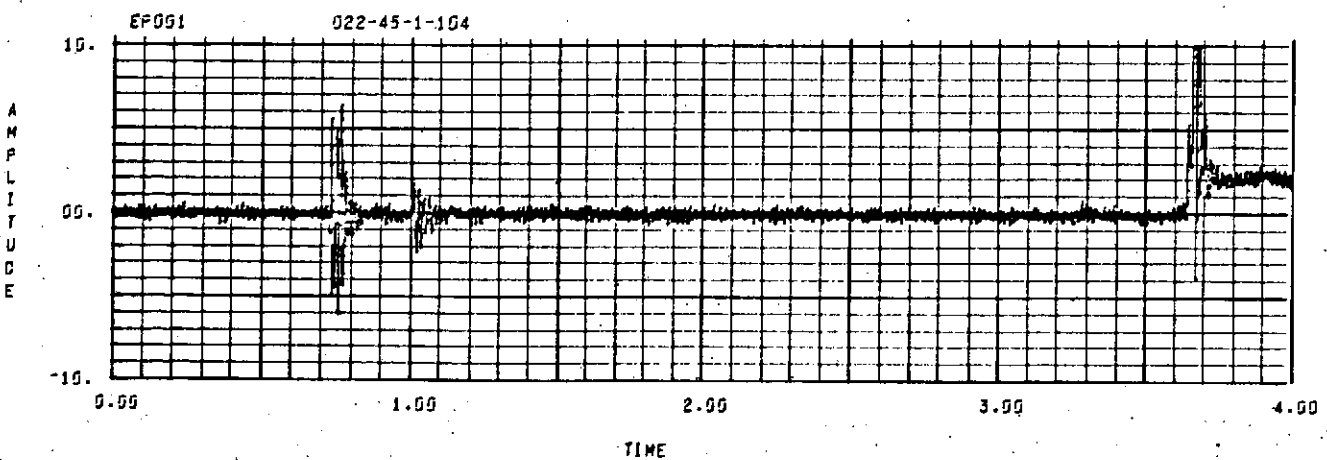
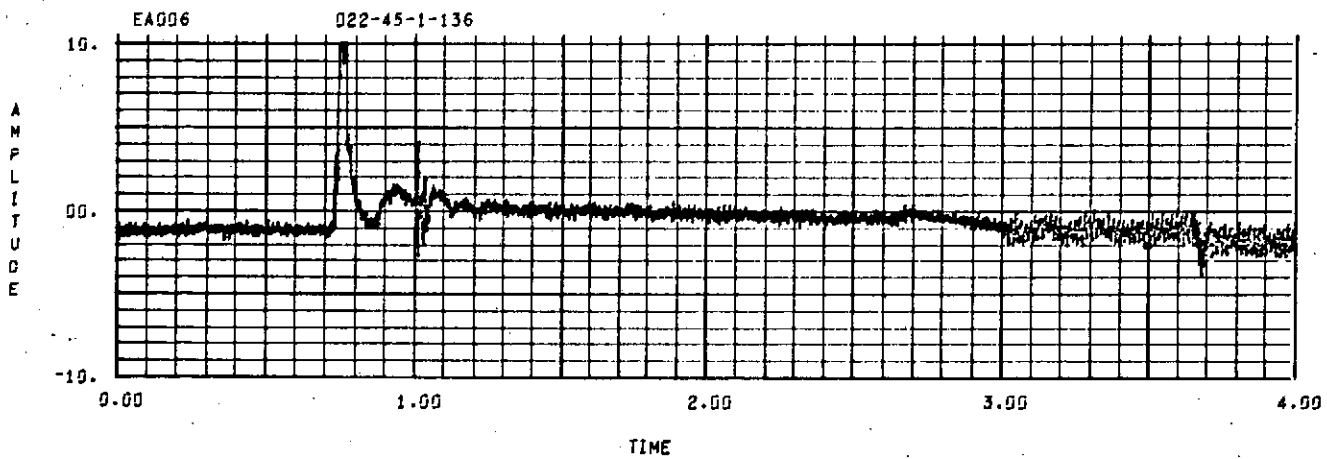
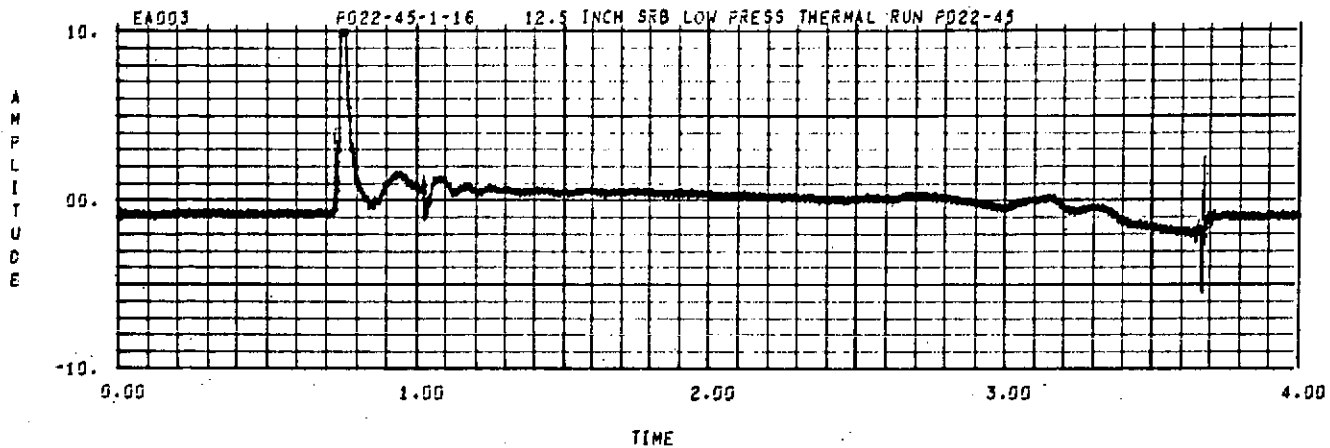

SEQ. = 0047

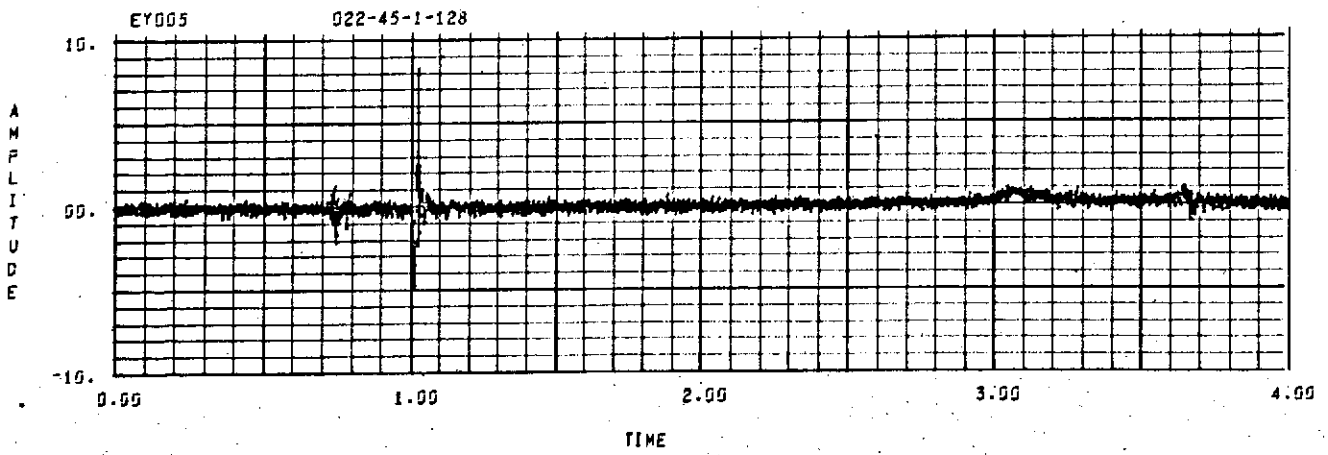
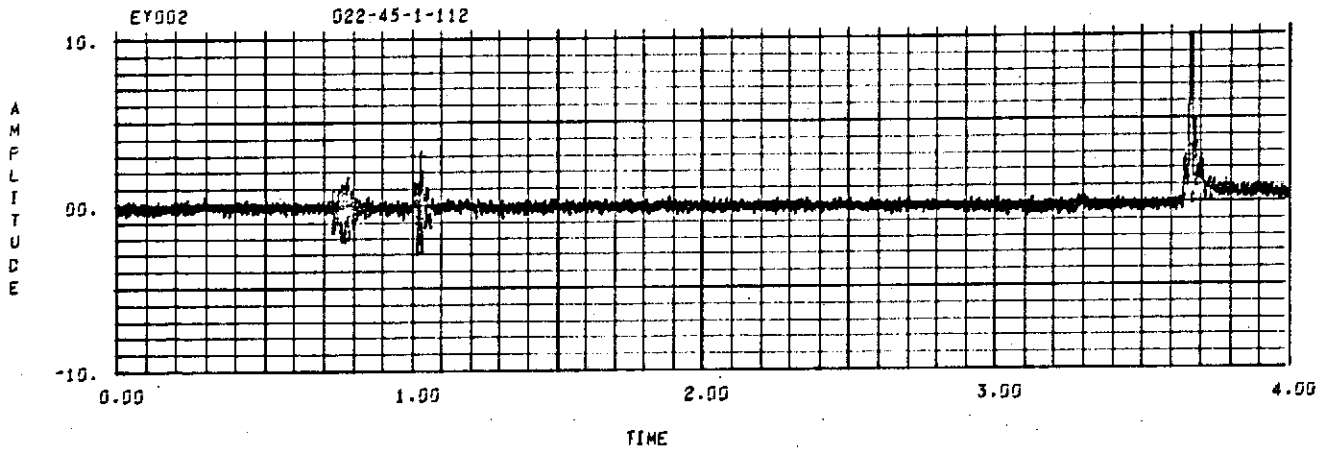
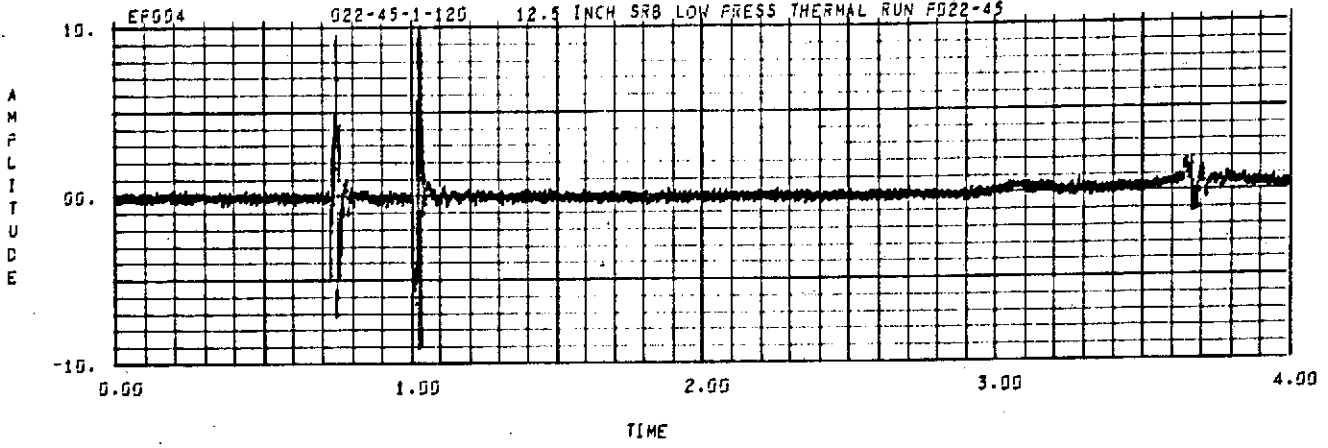



SEQ. = 0047

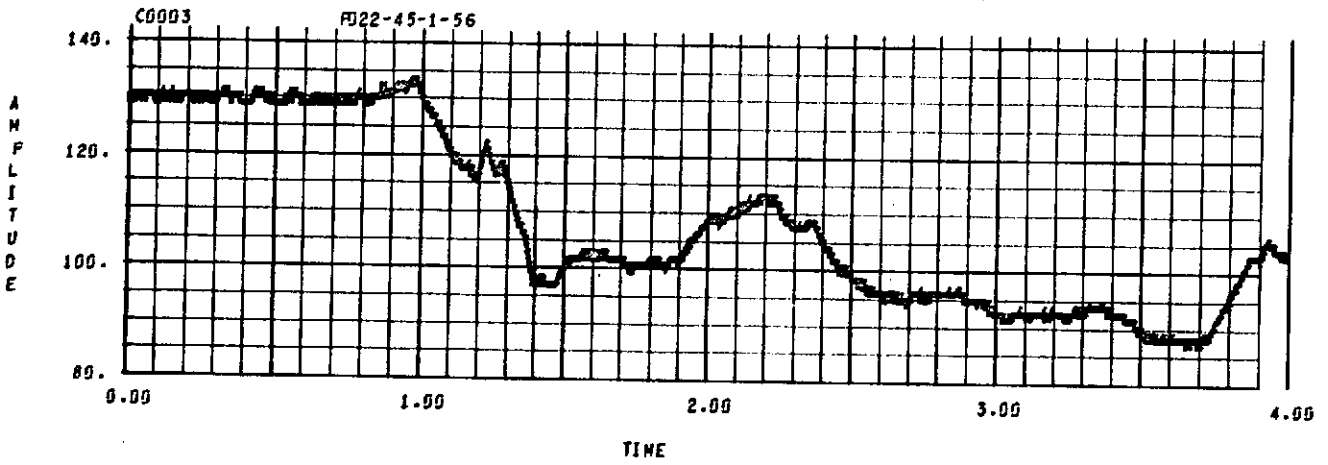
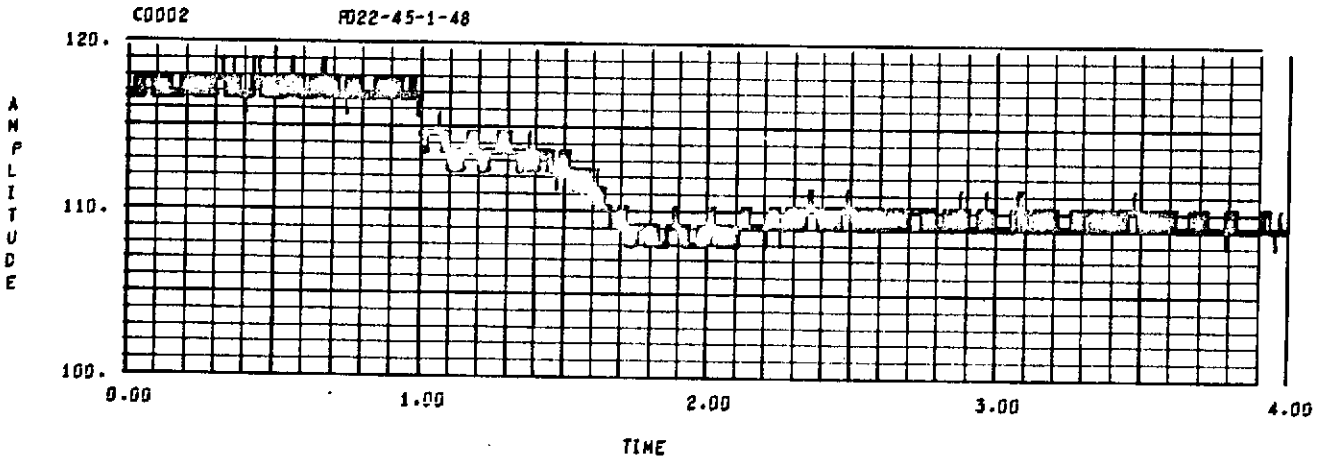
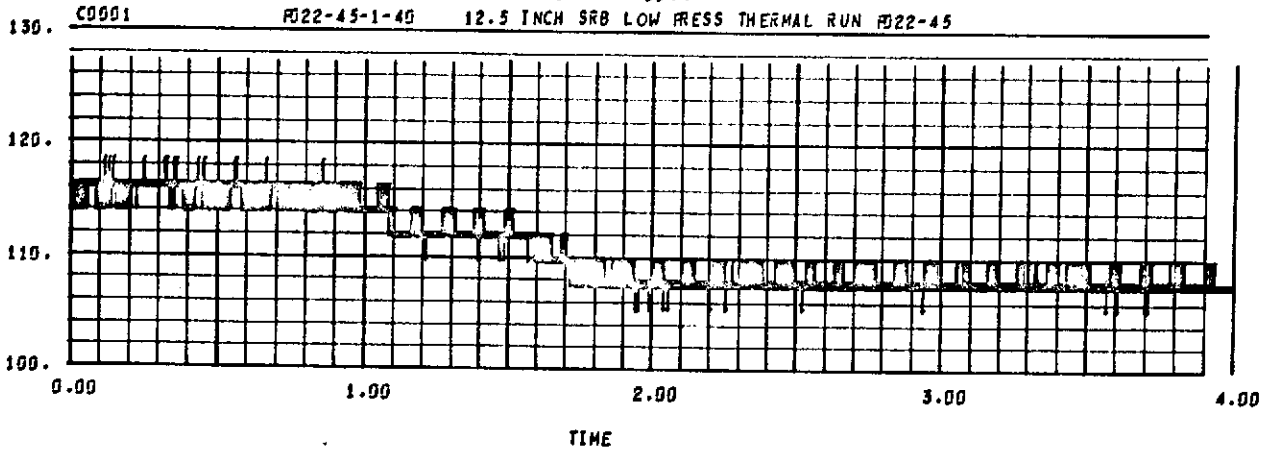



SEQ. = 0047

C0004 FD22-45-1-64 12.5 INCH SRB LOW PRESS THERMAL RUN FD22-45

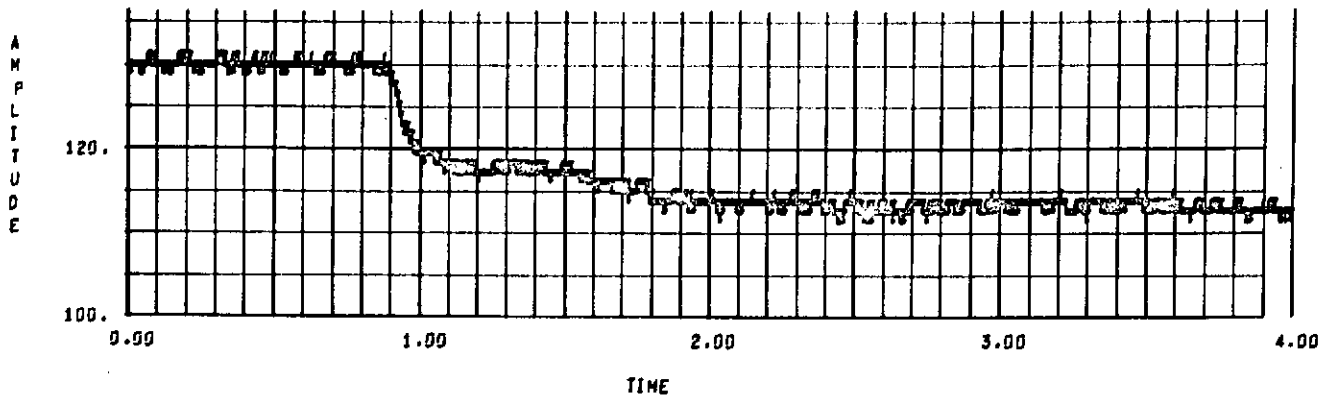

C0005 FD22-45-1-72

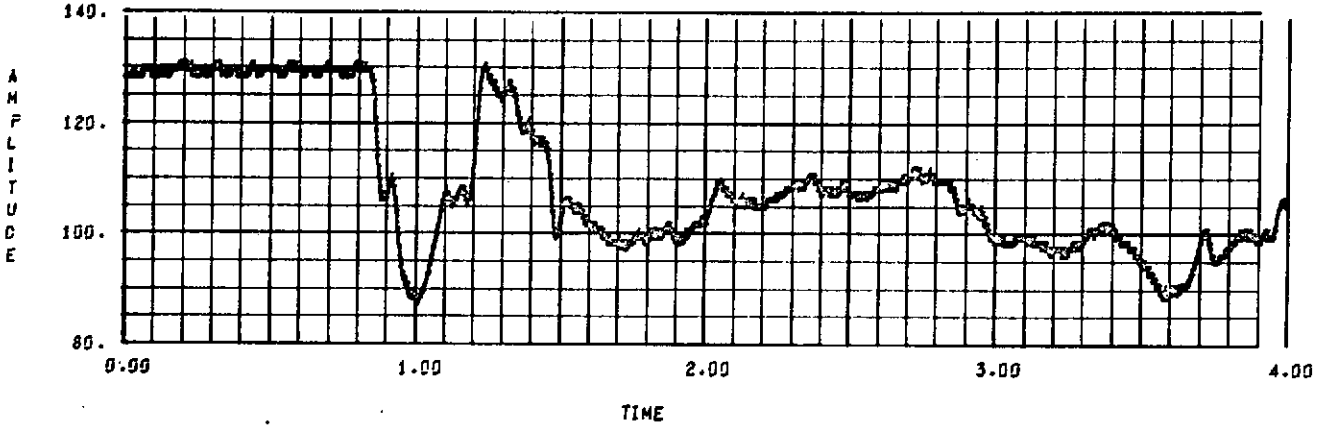

C0006 FD22-45-1-80

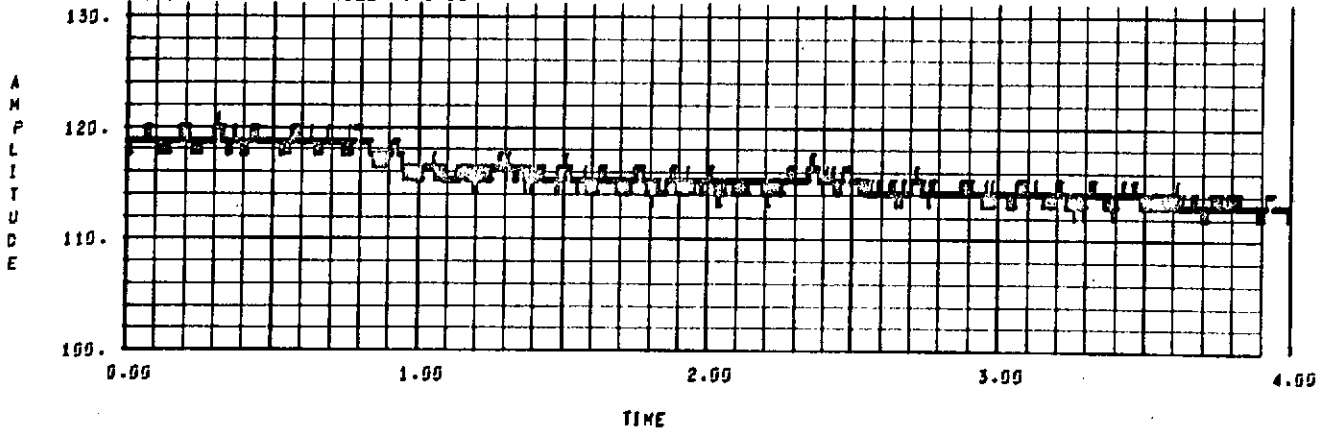

SEN. = 0047

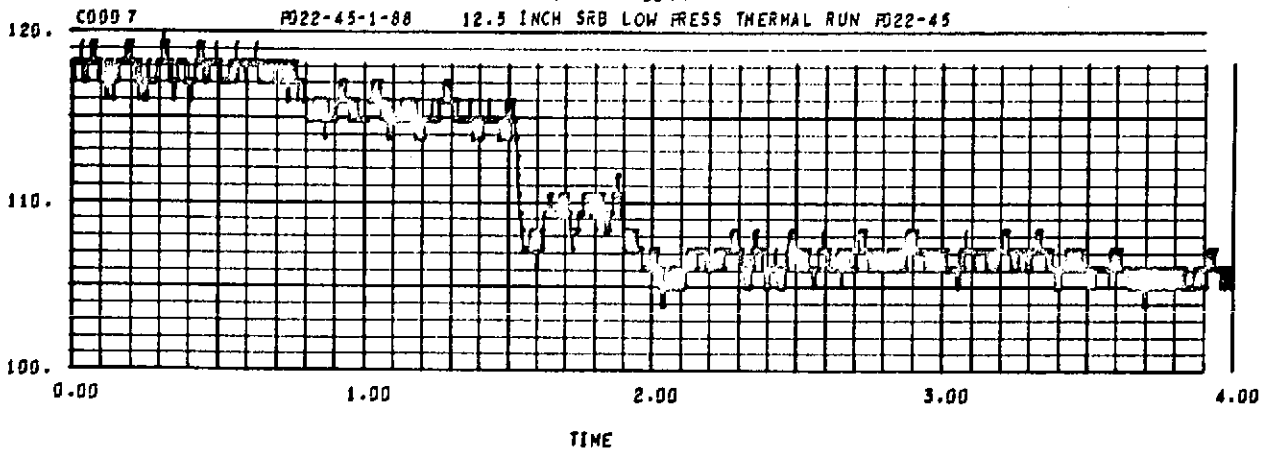

C0008 022-45-1-96

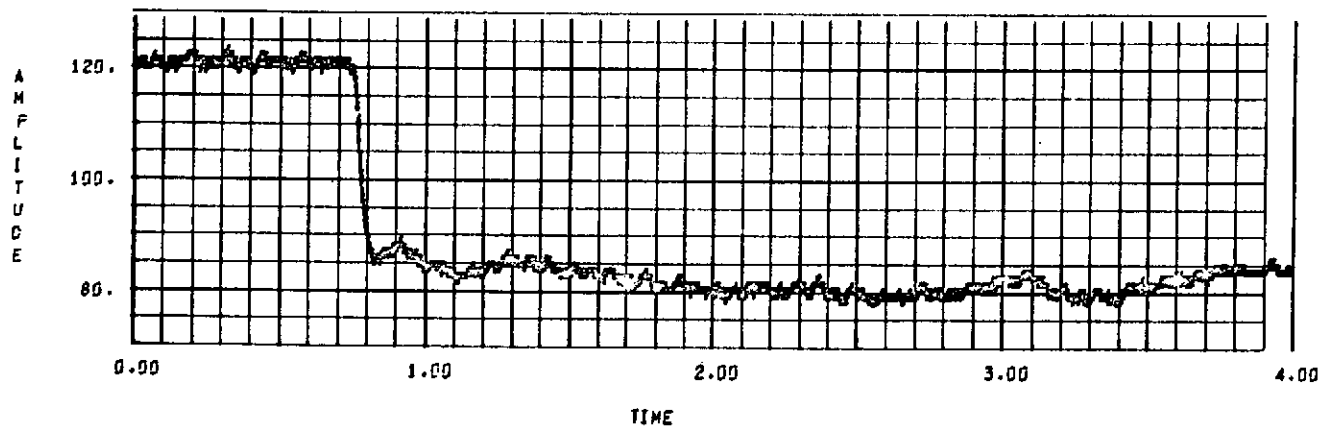

SEQ. = 0047

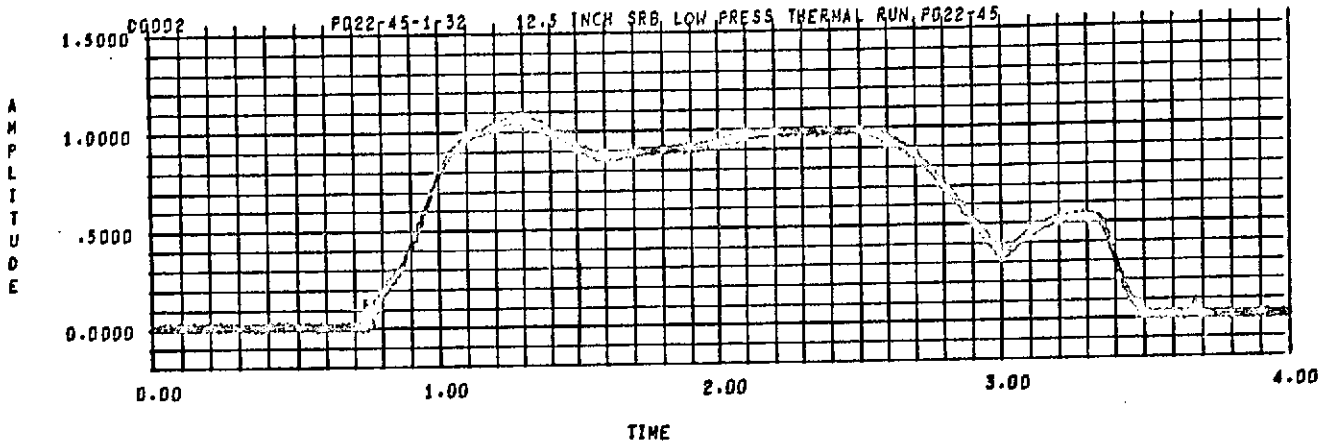
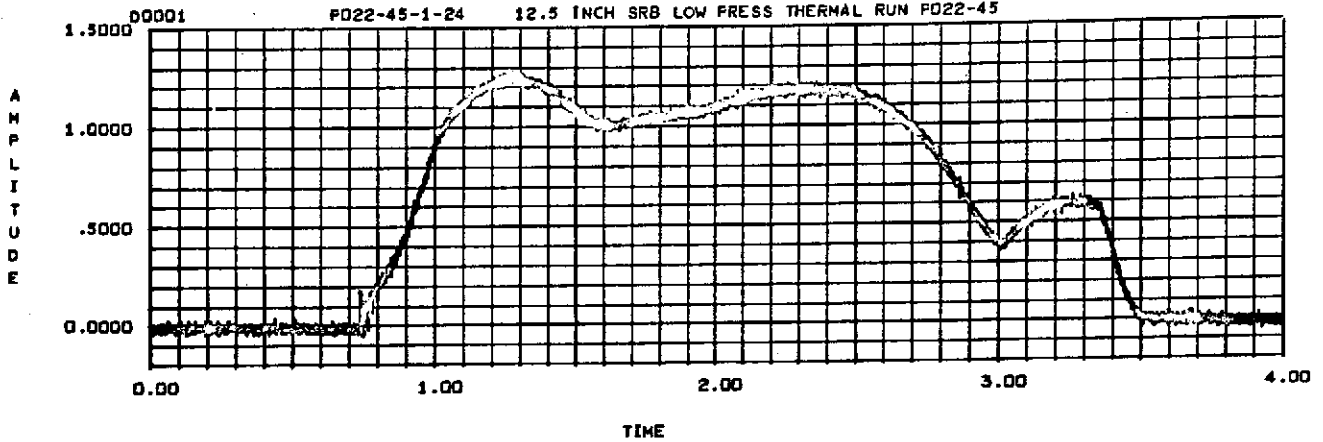

SEQ. = 0047

8

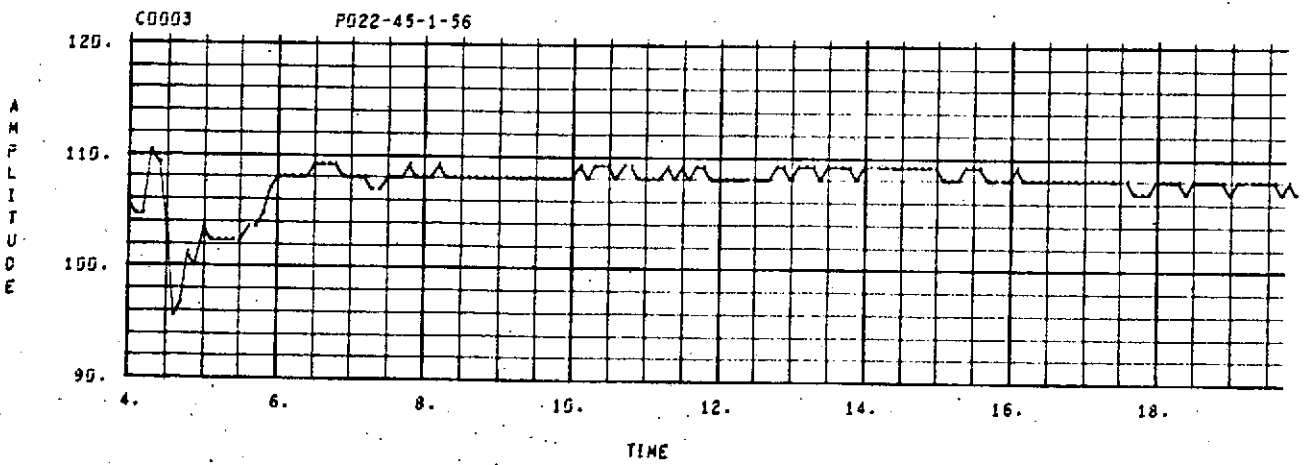
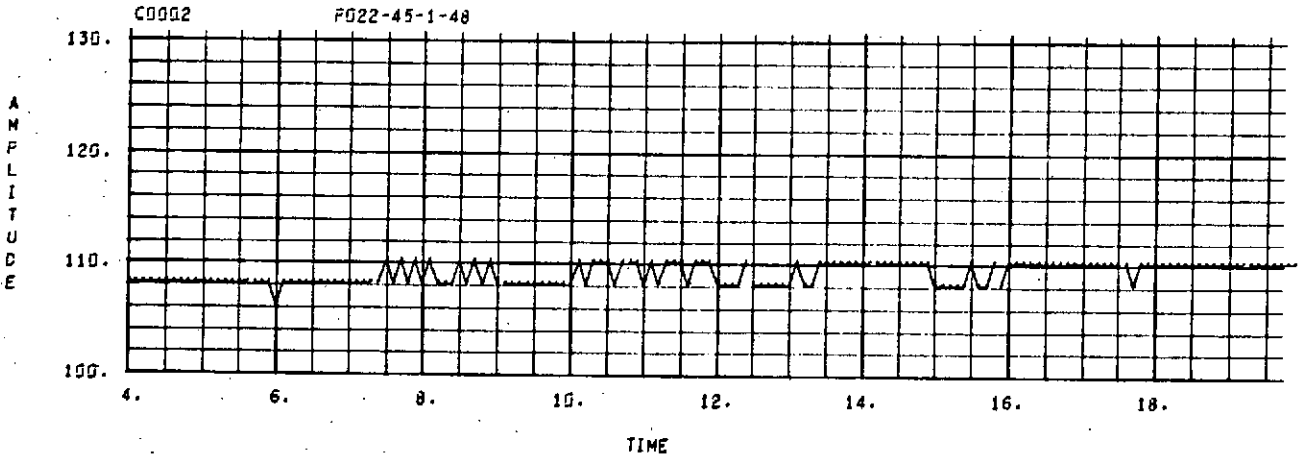
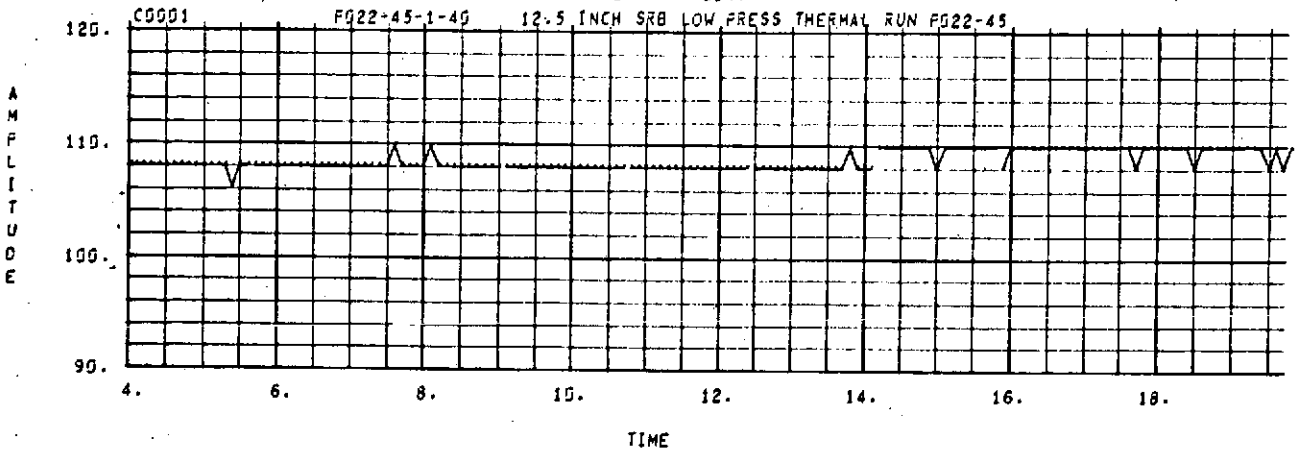

SEQ. = 0047

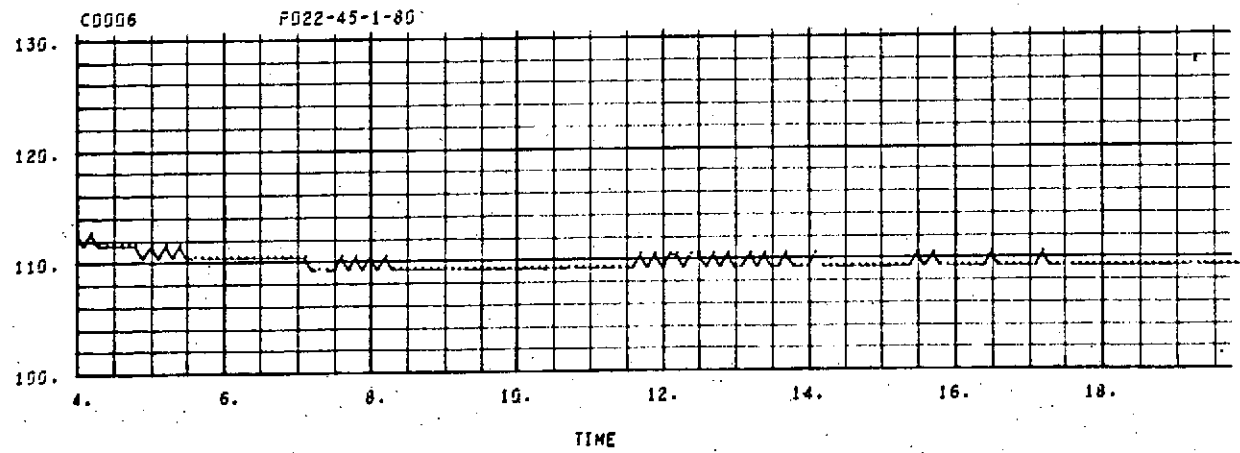
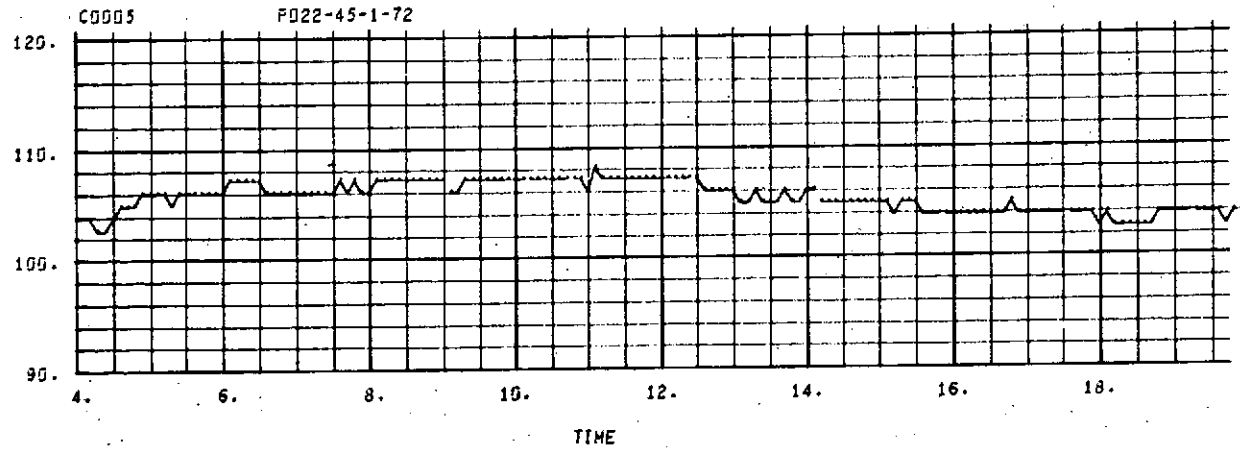
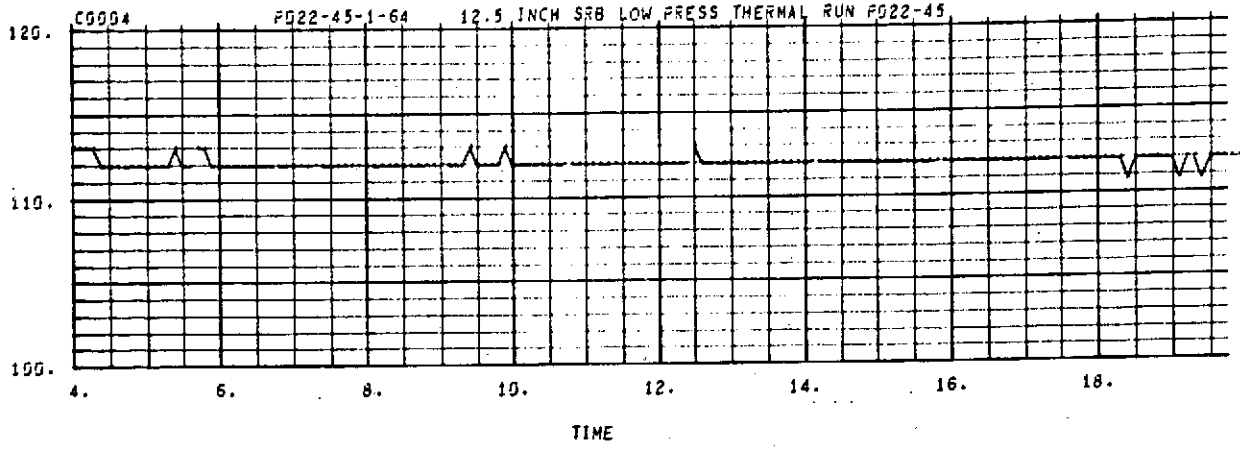

SEQ. = 0047

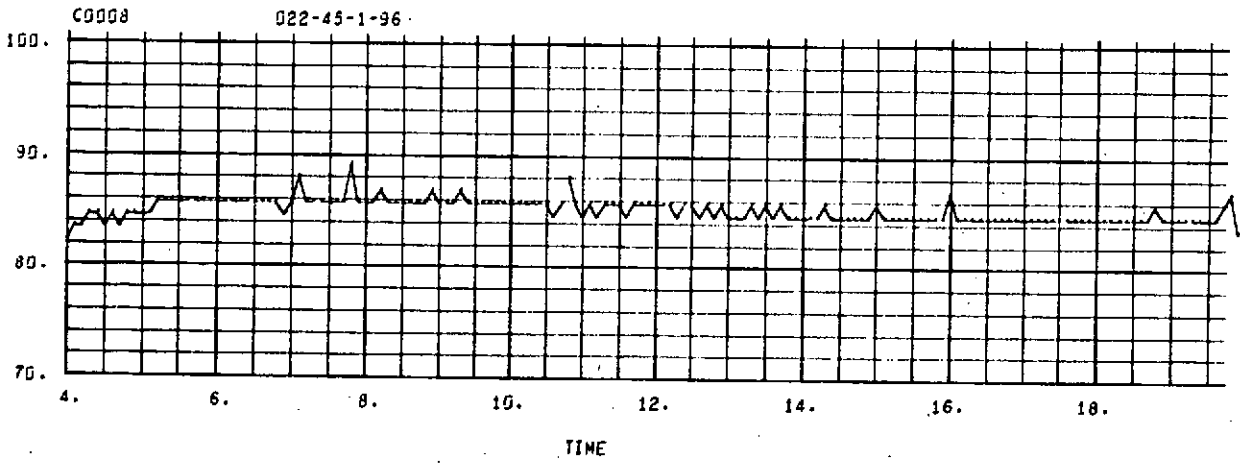
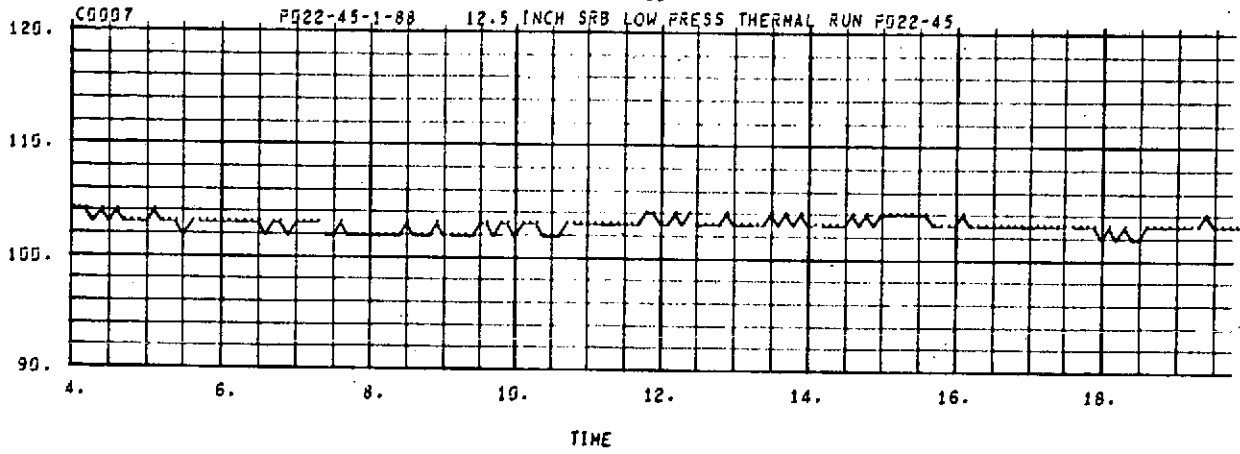



SEQ. = 0047

00001 P022-45-1-24 12.5 INCH SRB LOW PRESS THERMAL RUN P022-45

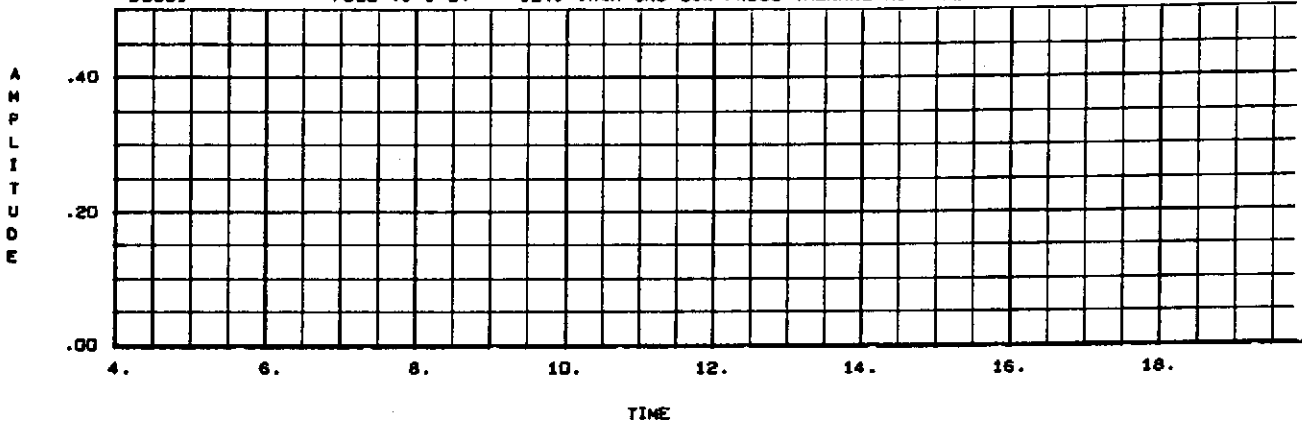

00002 P022-45-1-32 12.5 INCH SRB LOW PRESS THERMAL RUN P022-45

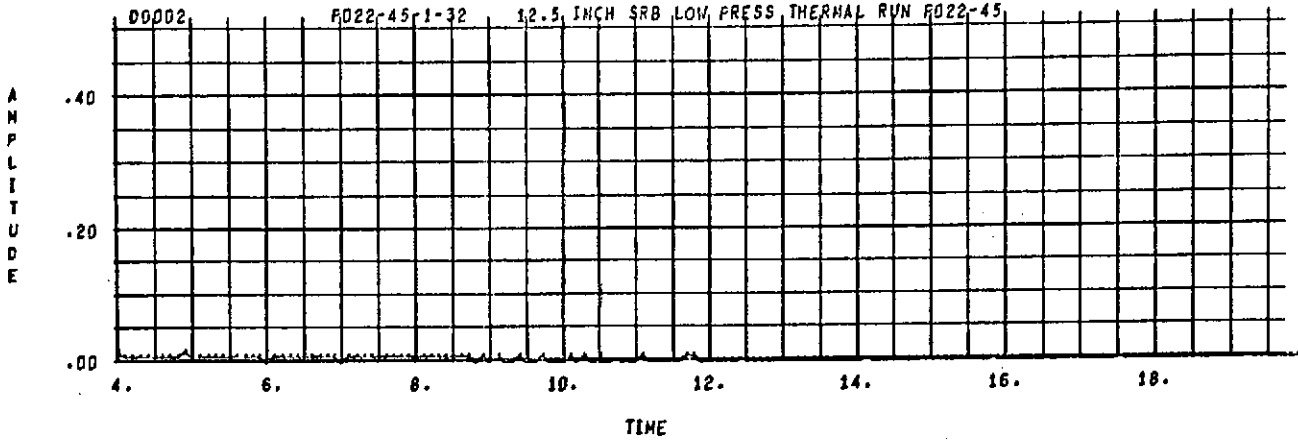

SEQ. = 0049

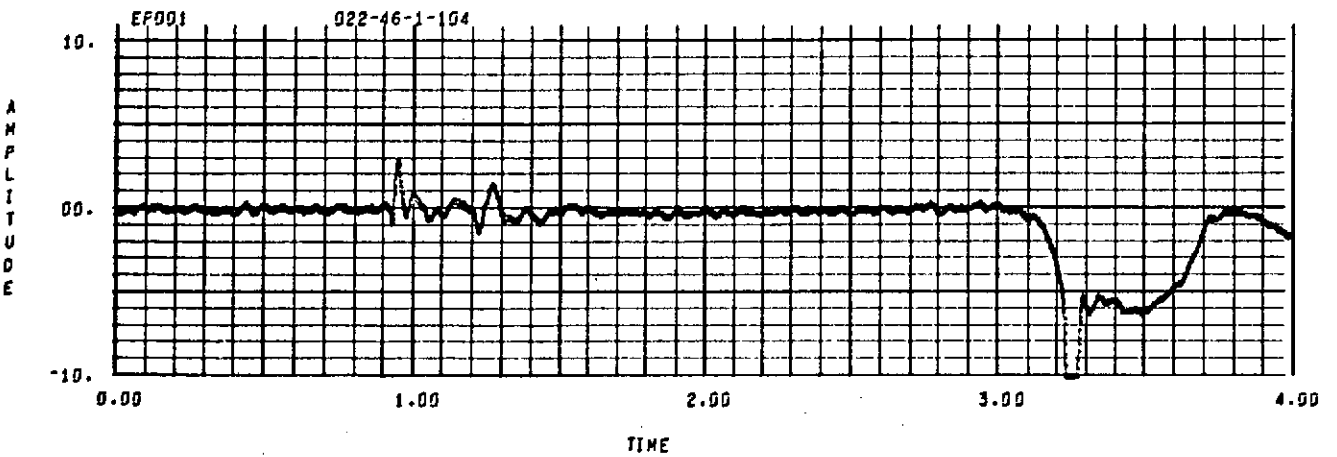
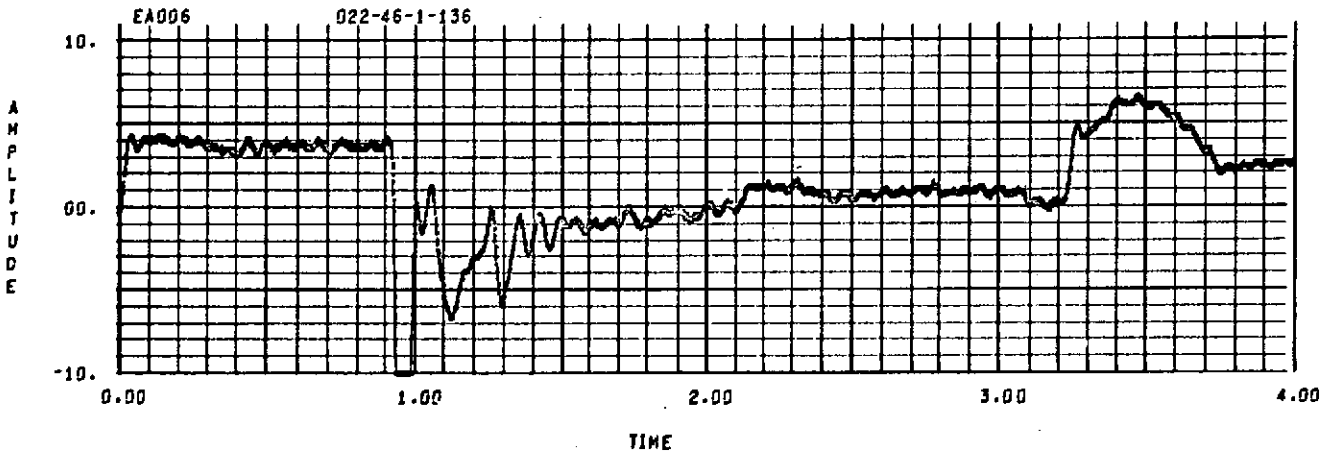
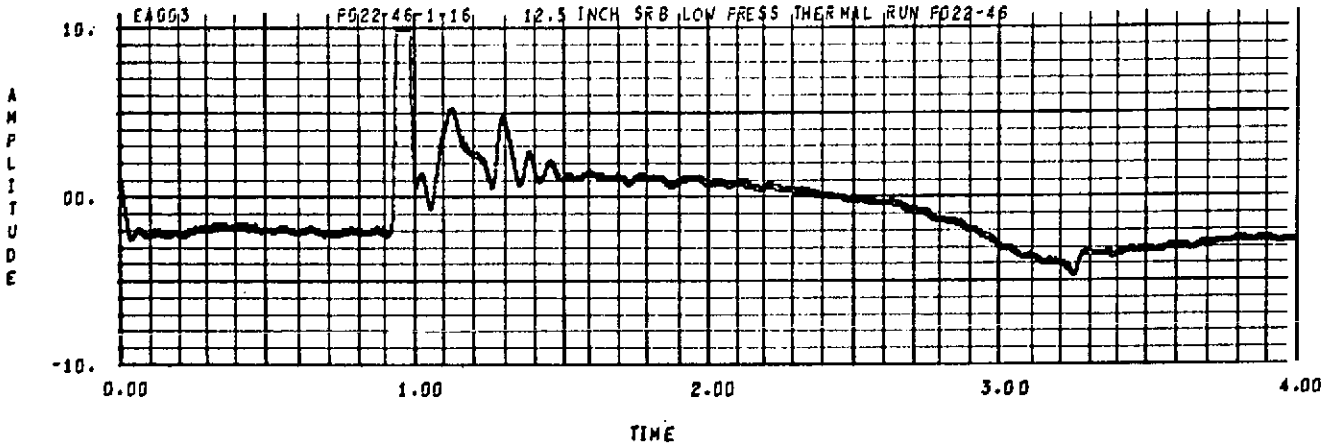

SEQ. = 0949

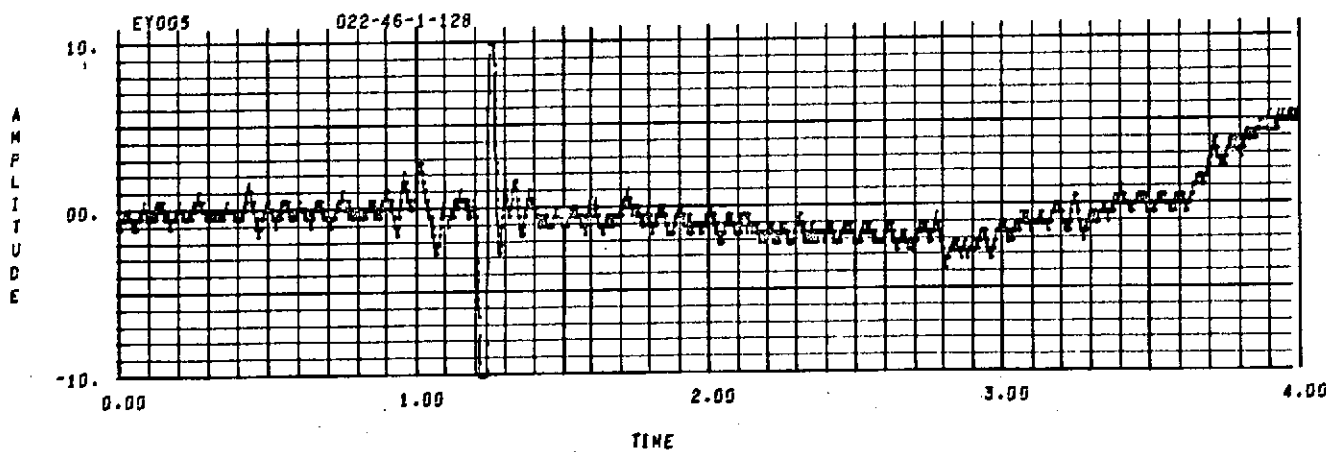
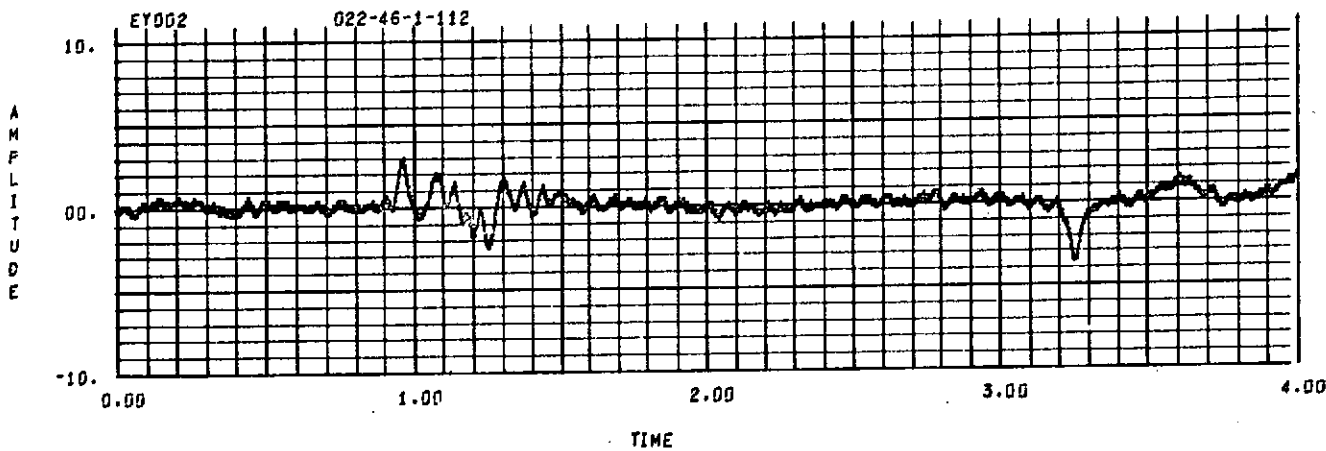
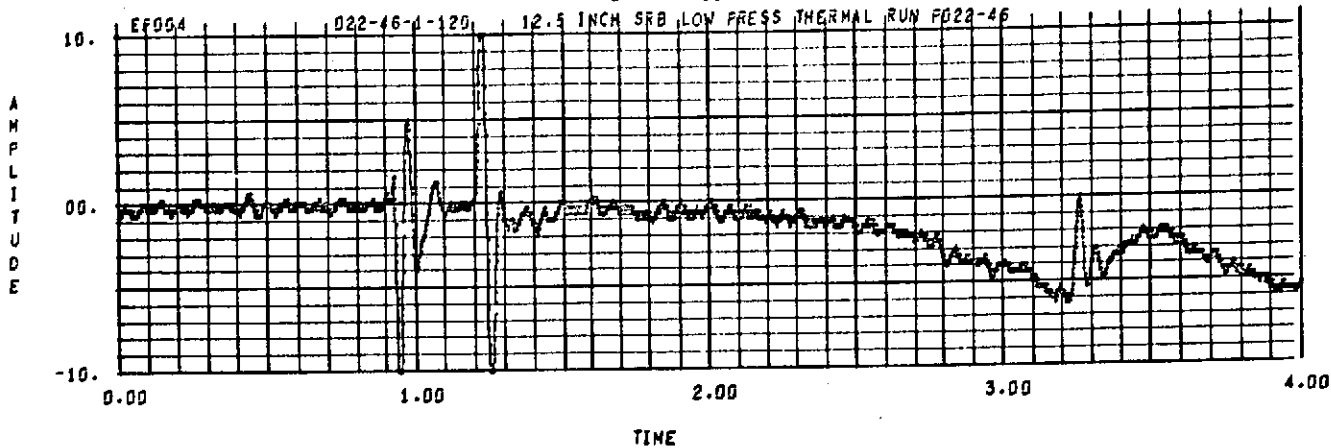

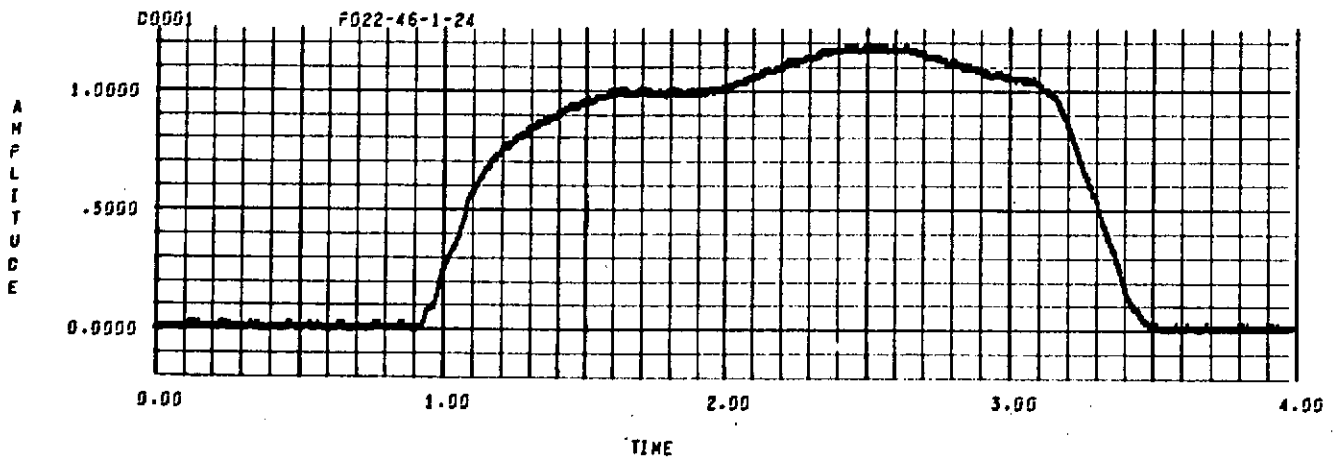
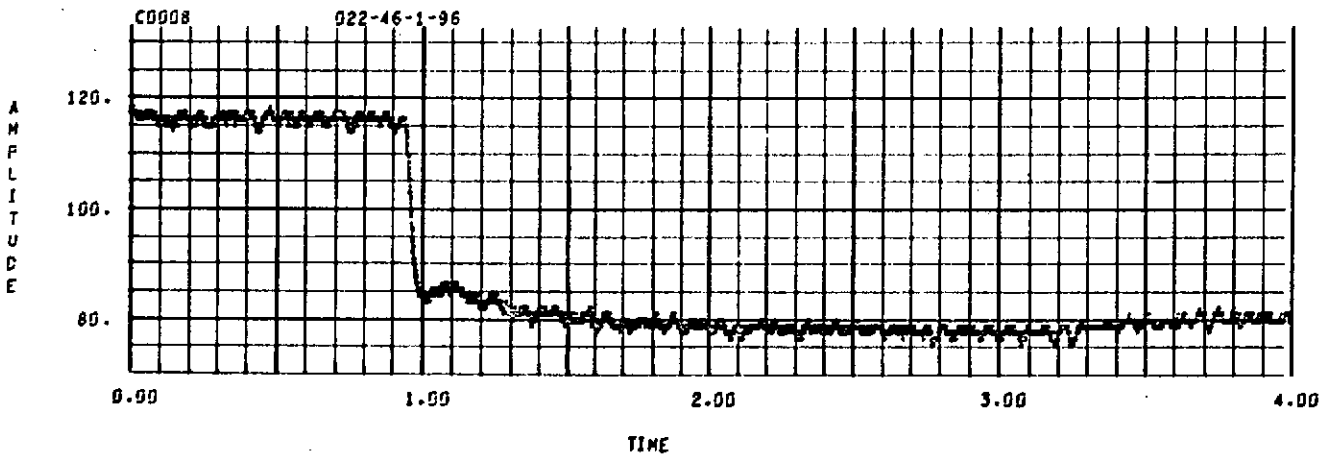
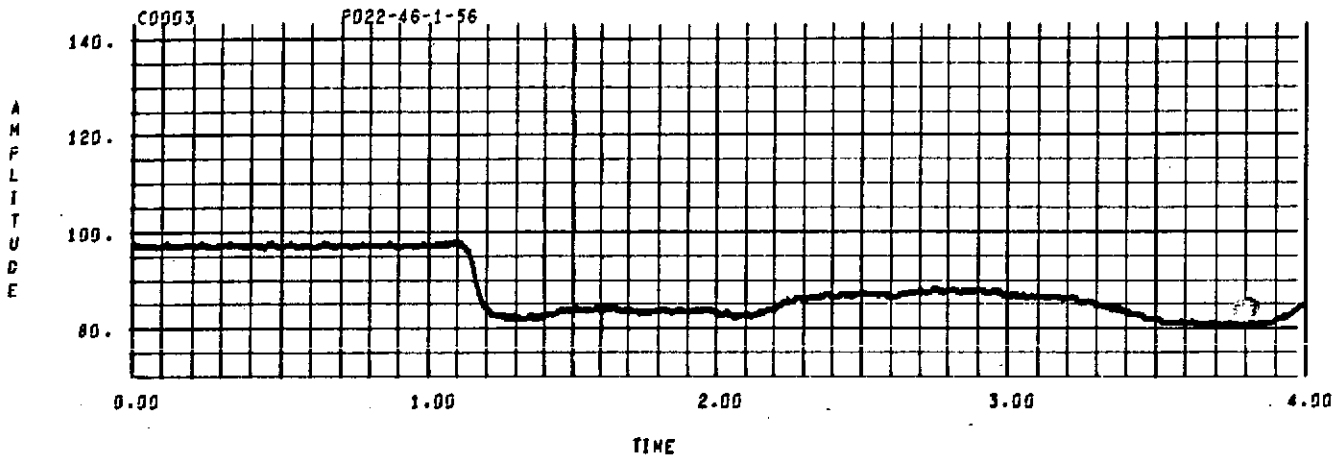

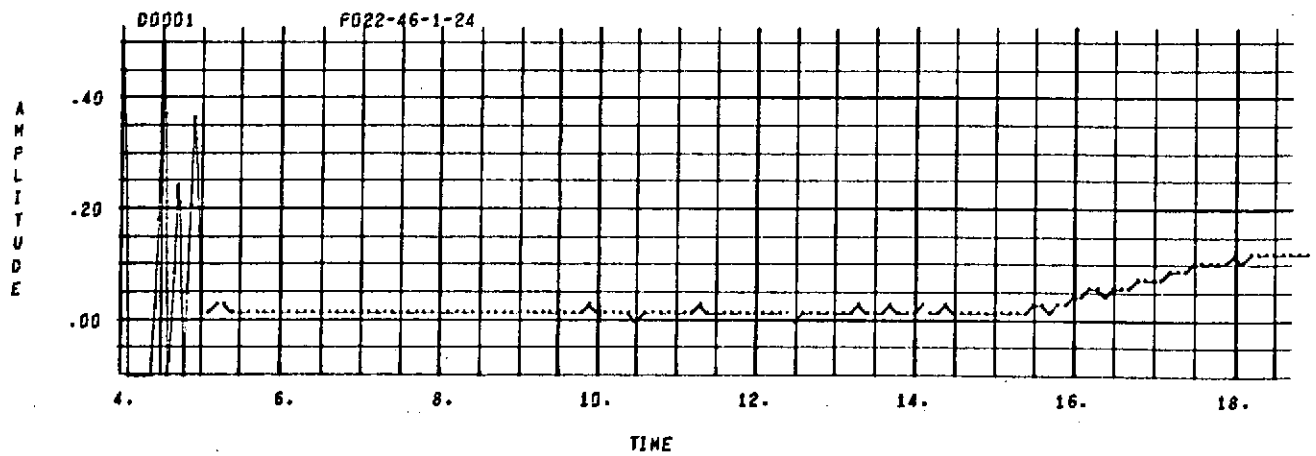
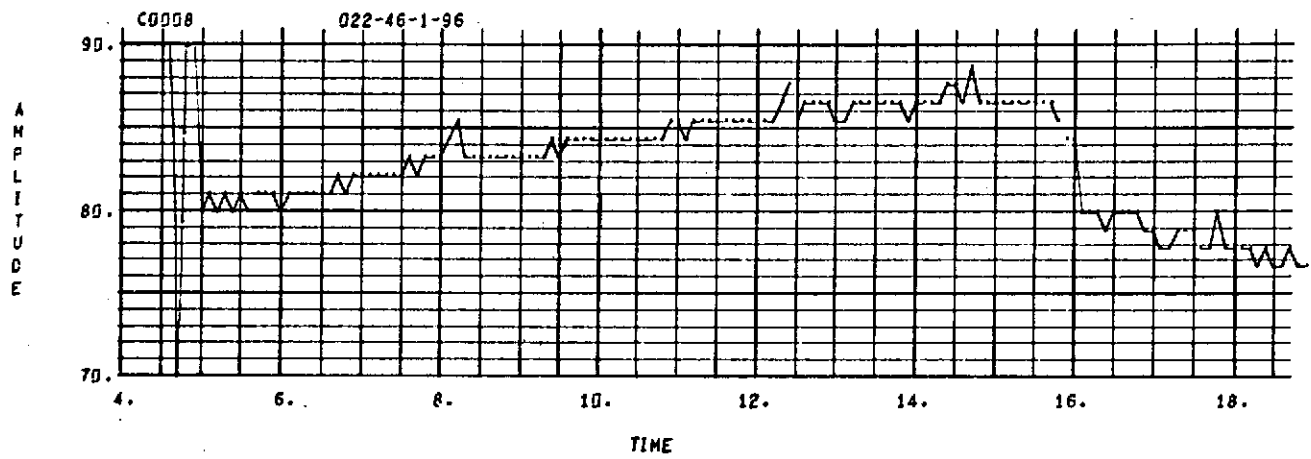
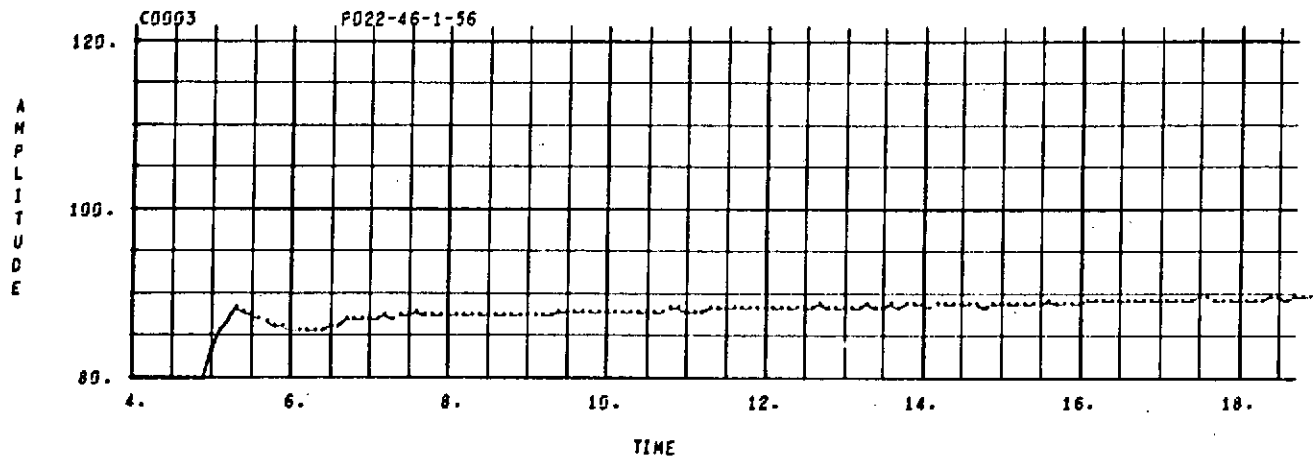

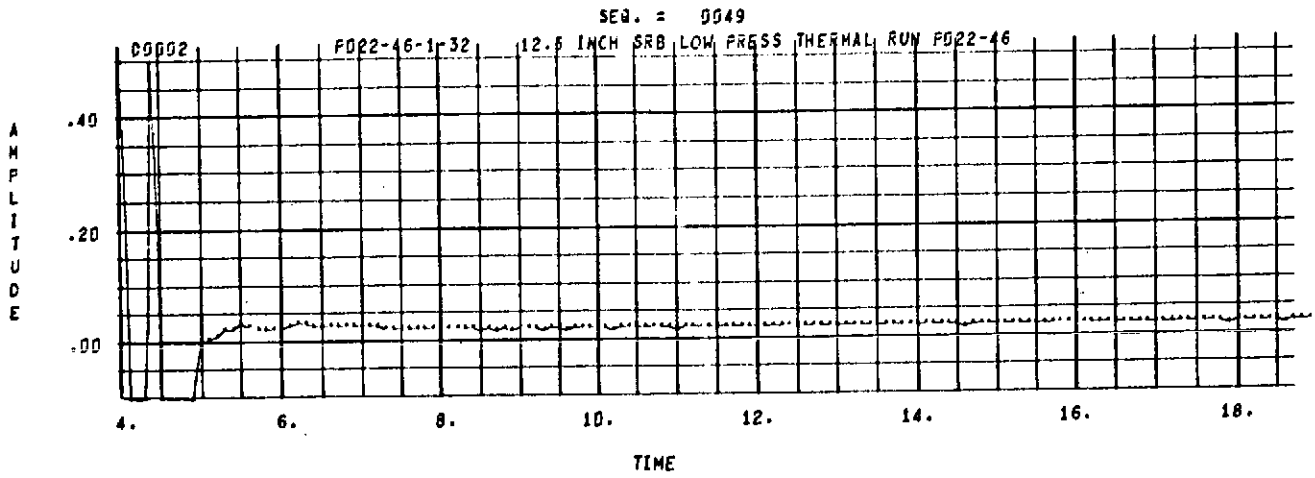



SEQ. = 0036

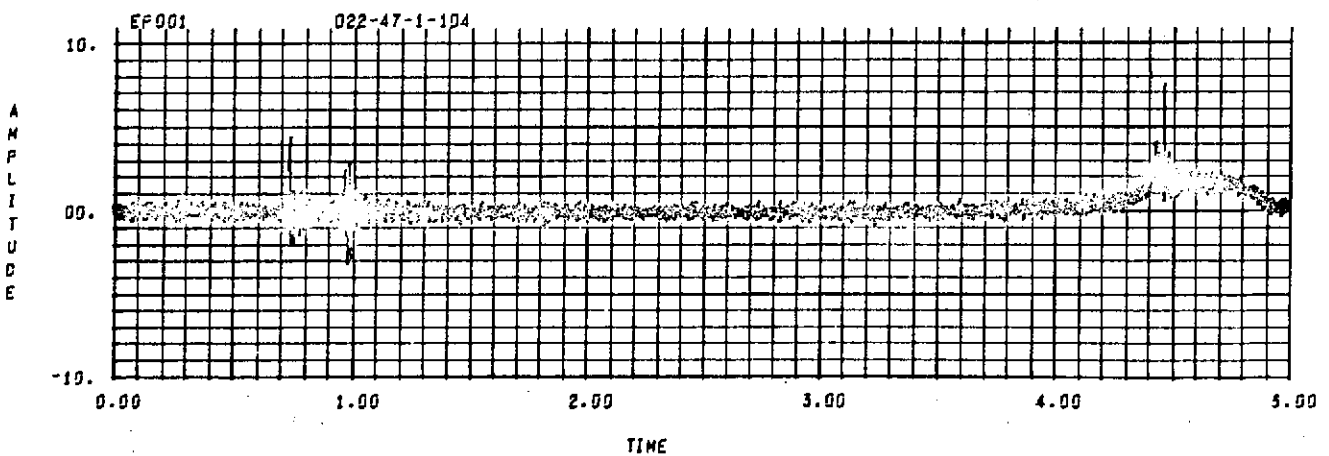
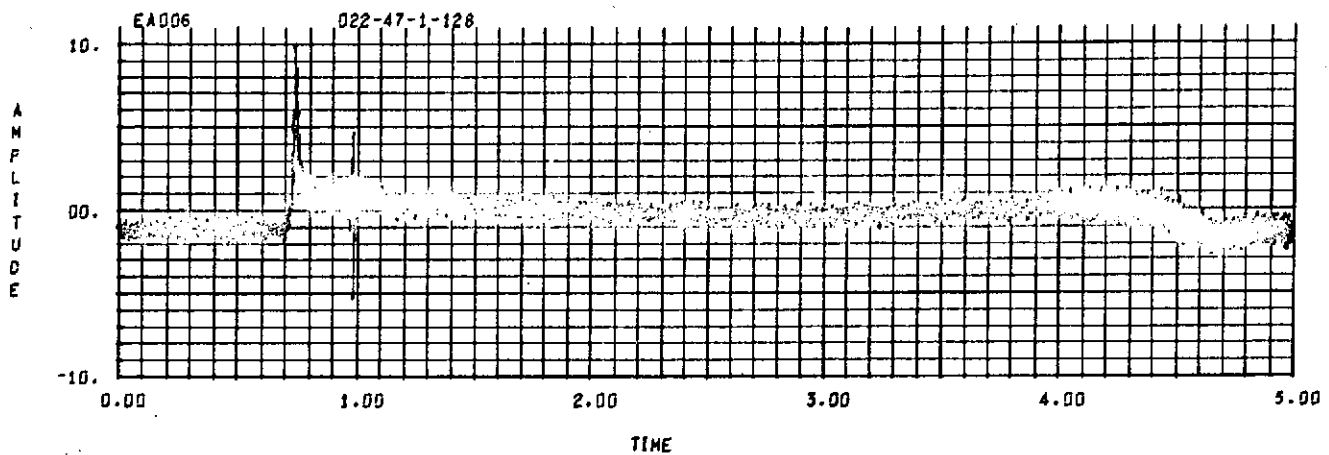
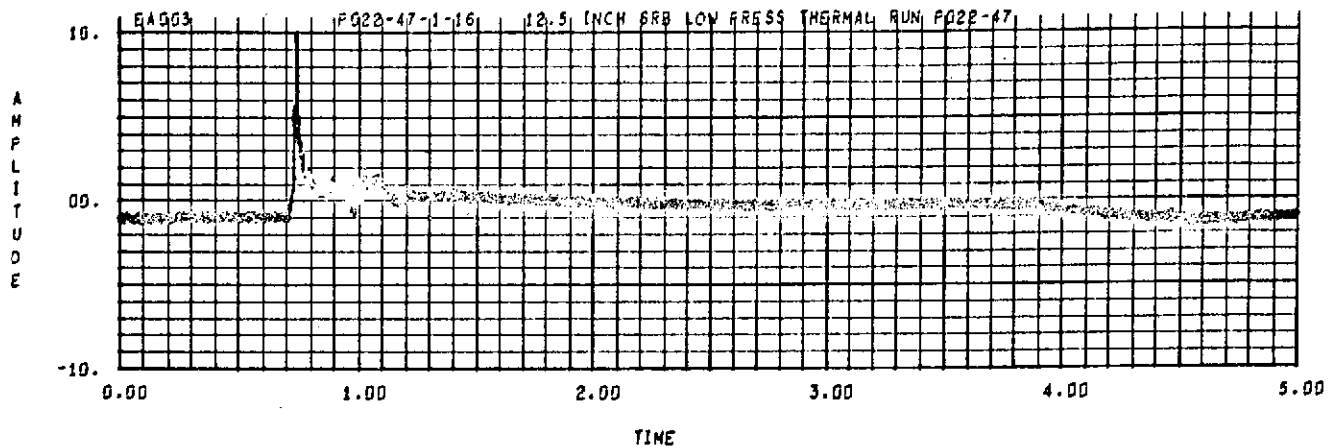



SEQ. = 0036

2

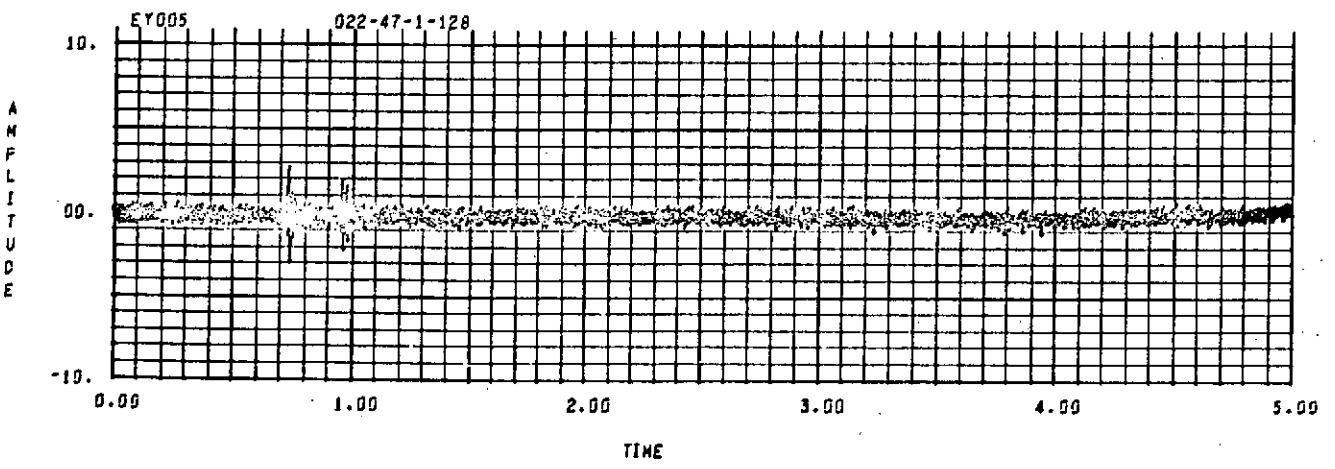
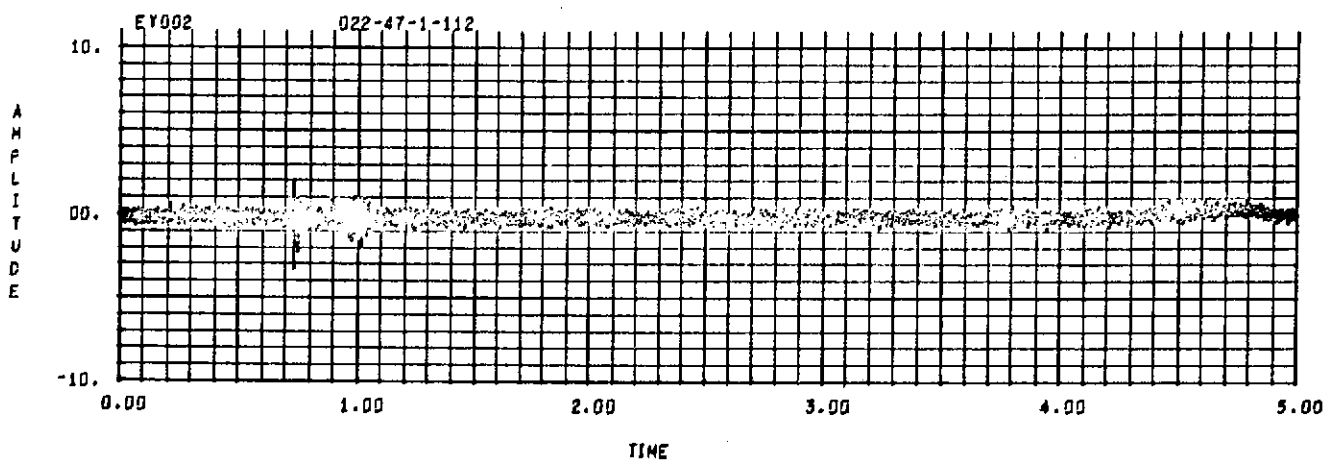
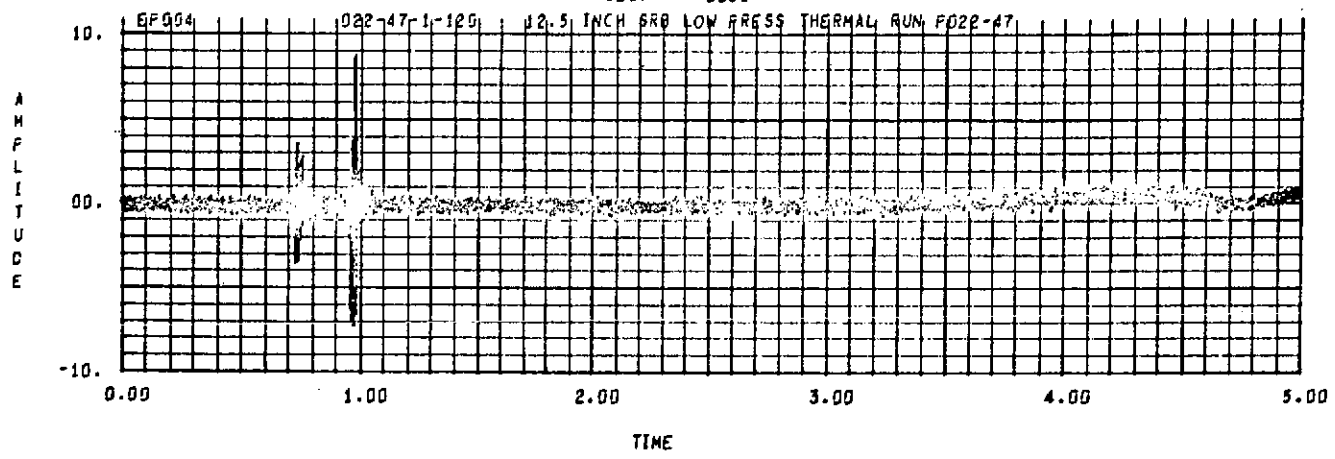



SEQ. = 0036

1

C0001 P022-47-1-40 12.5 INCH SRB LOW PRESS THERMAL RUN P022-47

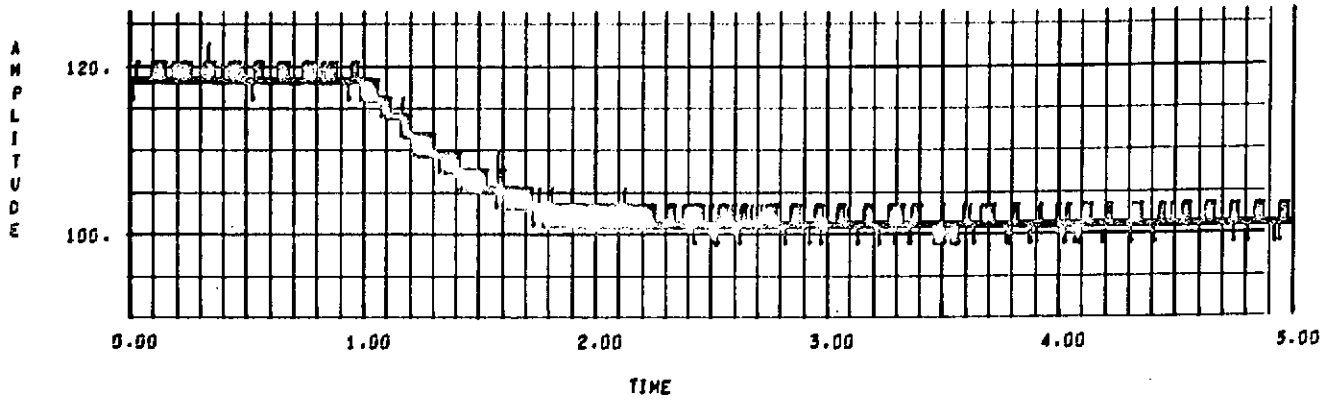

C0002 P022-47-1-48

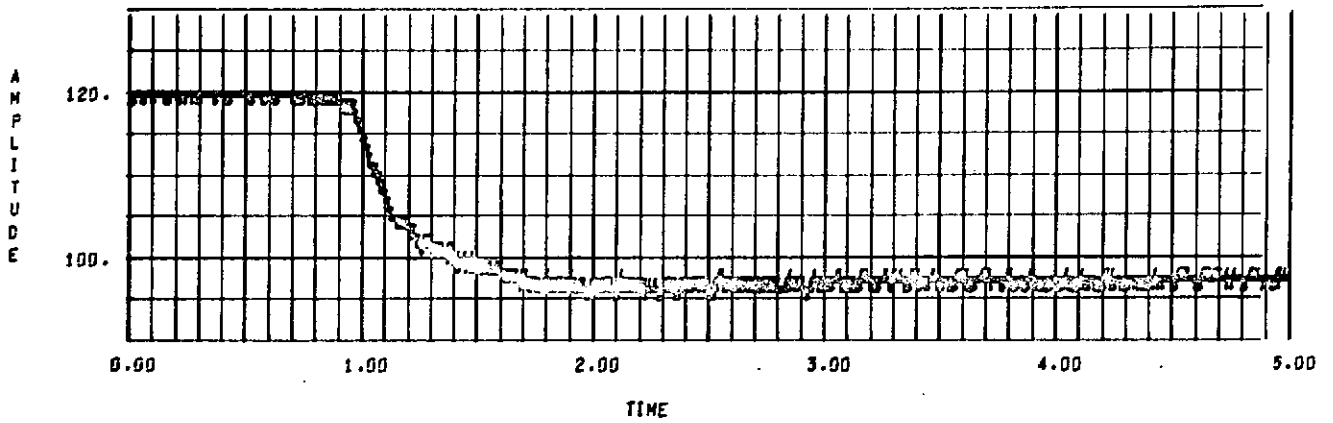

C0003 P022-47-1-56

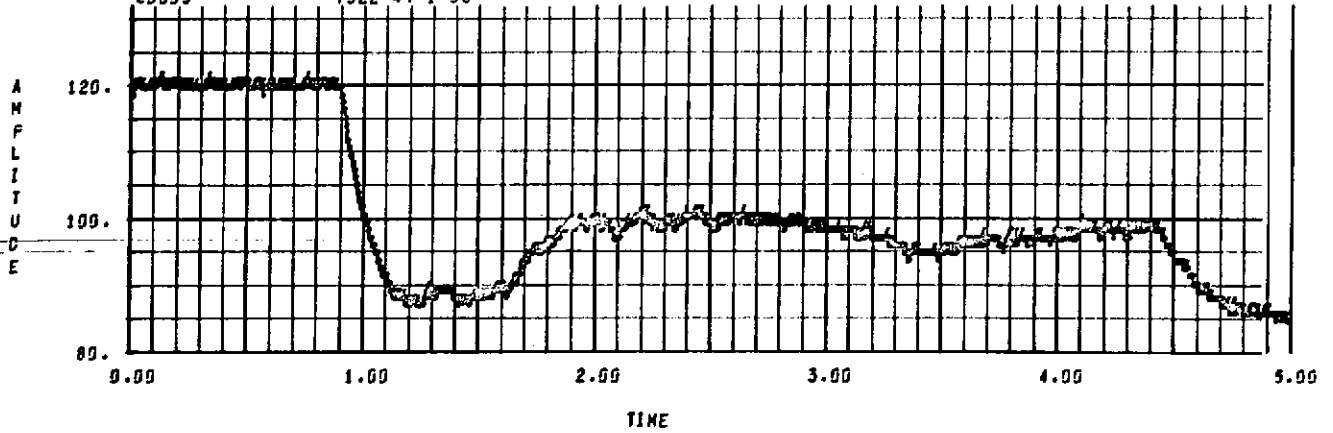

SEQ. = 0036

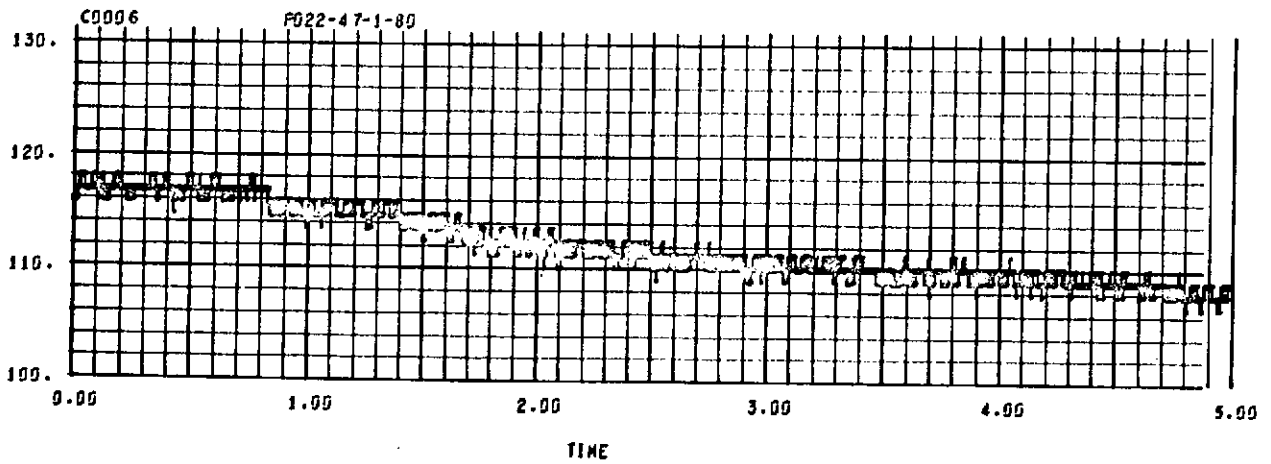
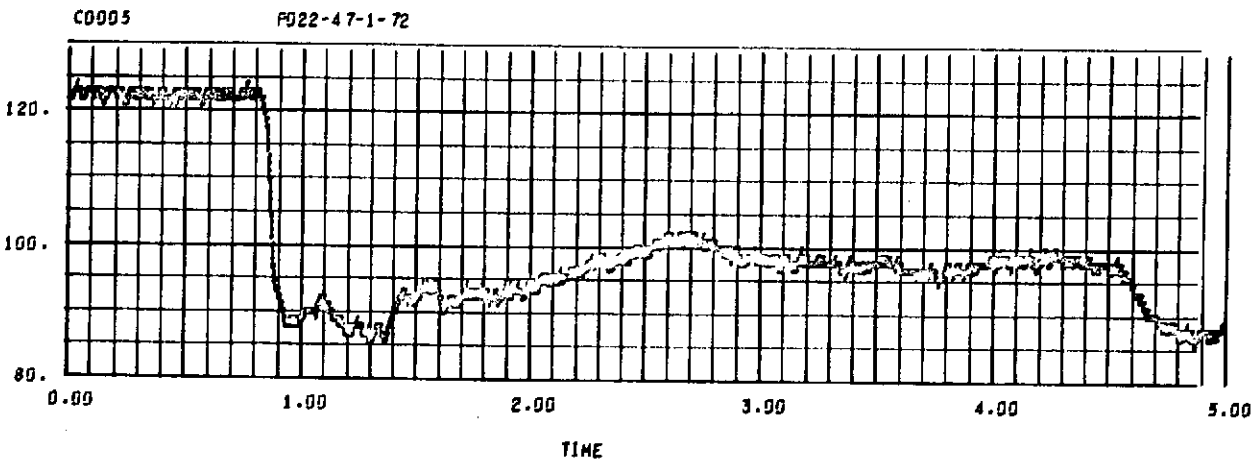
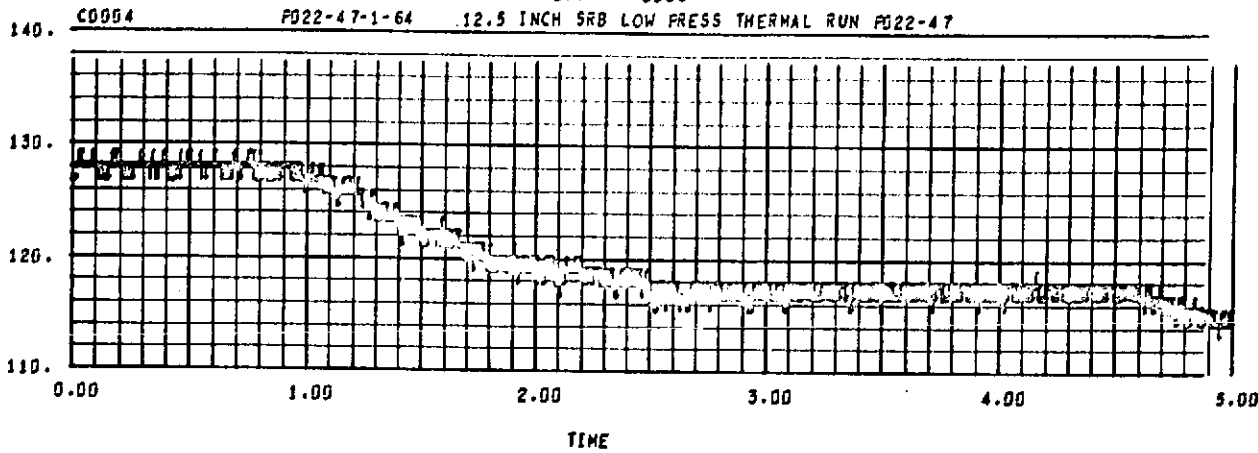



SEQ. = 0036

C0007 PG22-47-1-88 12.5 INCH SRB LOW PRESS THERMAL RUN PG22-47

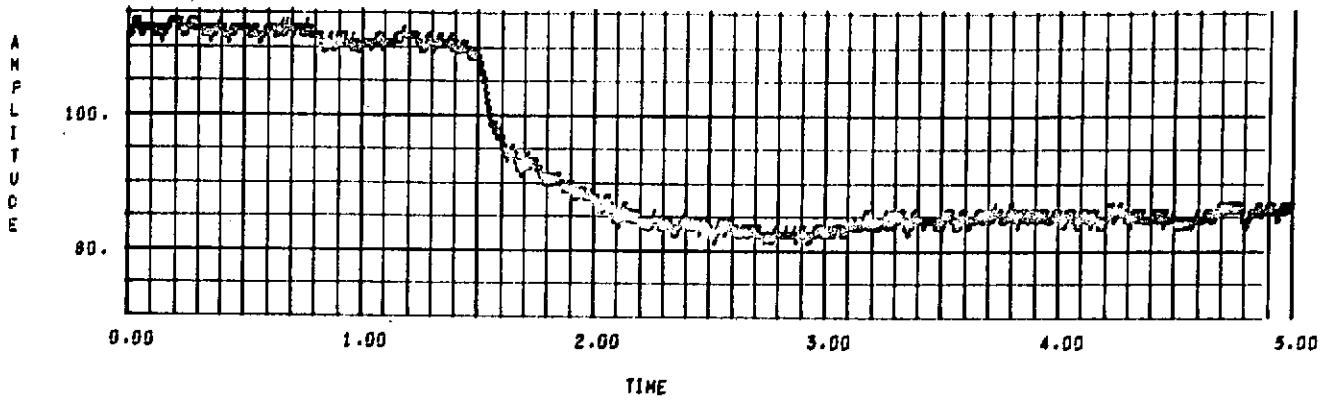

C0008 022-47-1-96

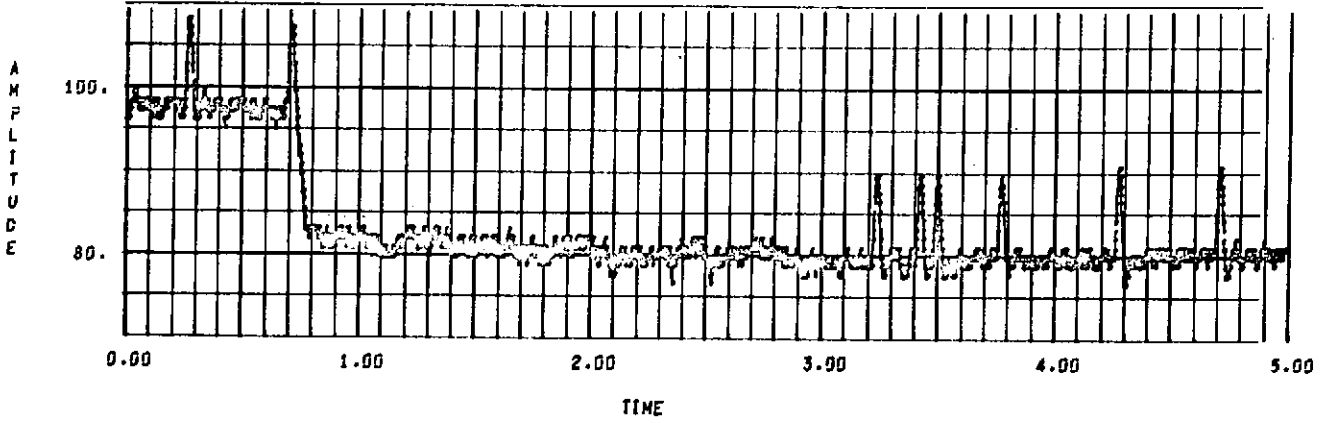

B-154

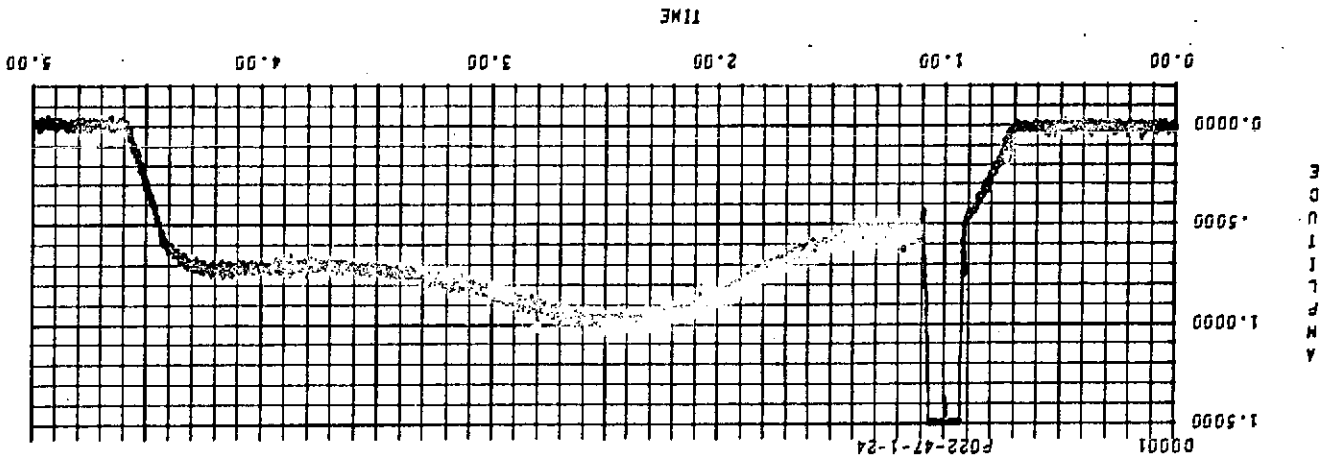
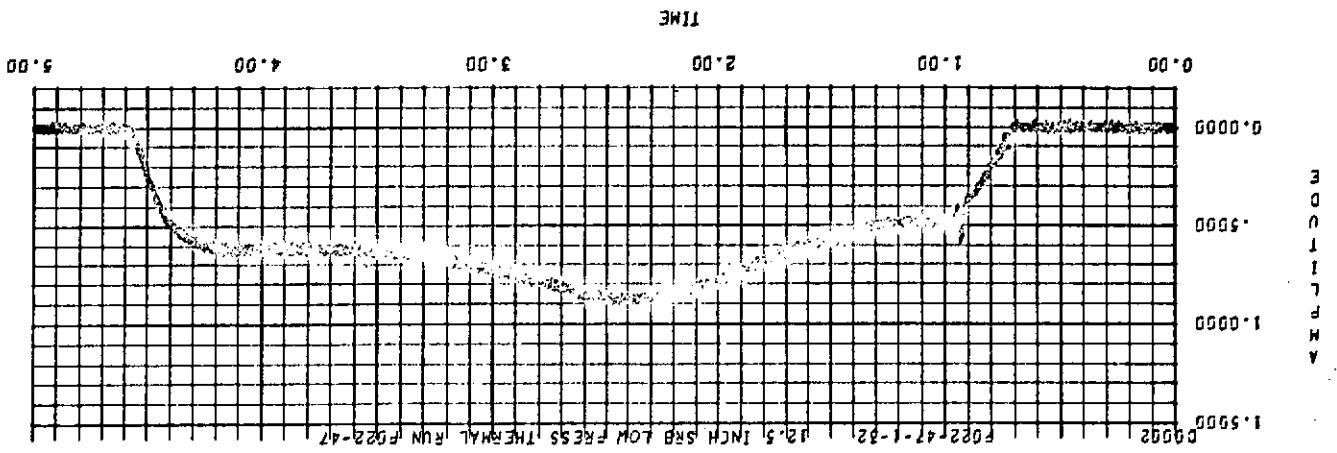
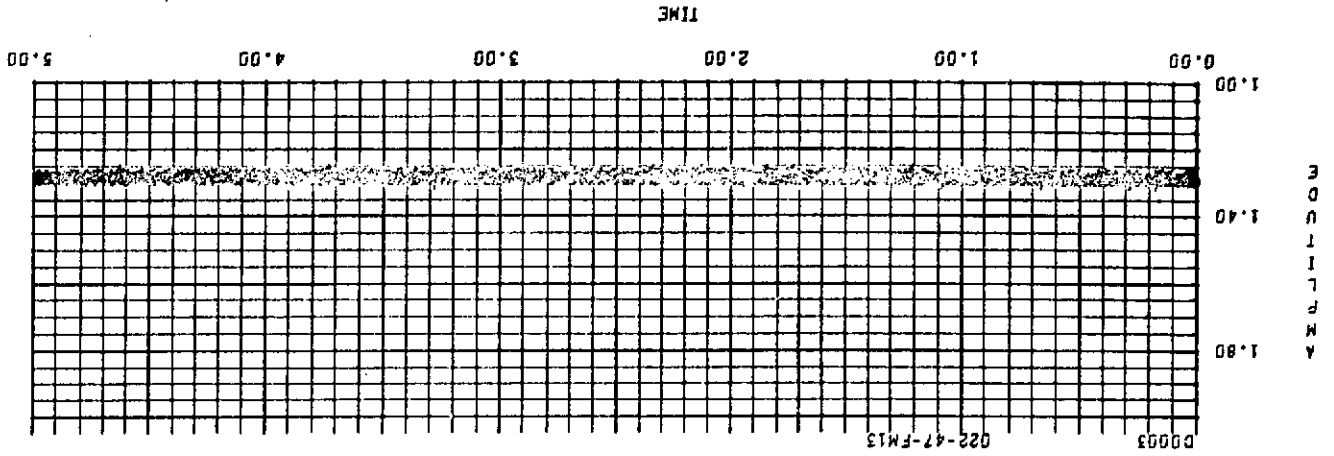

B-155

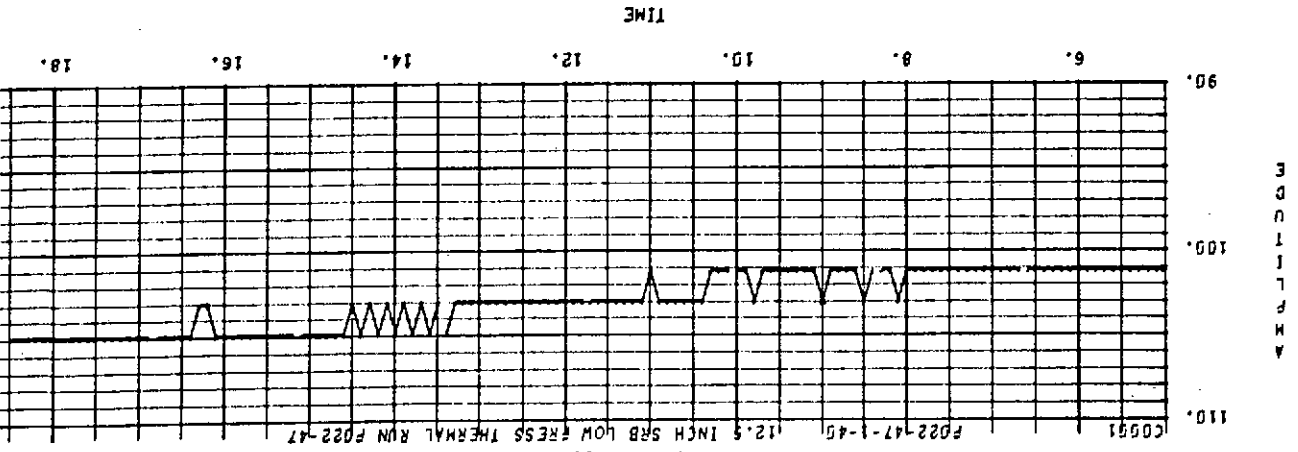
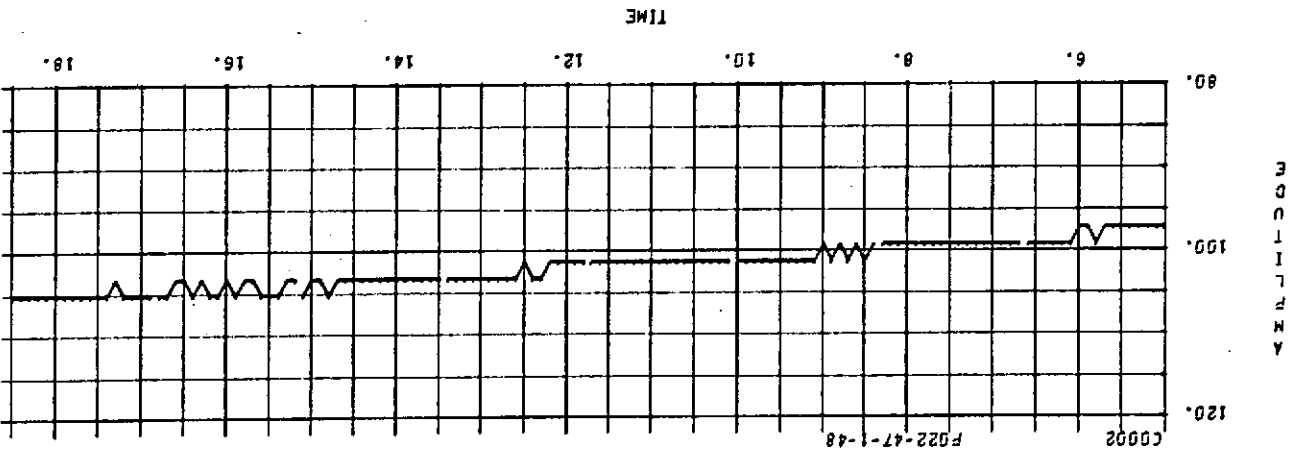
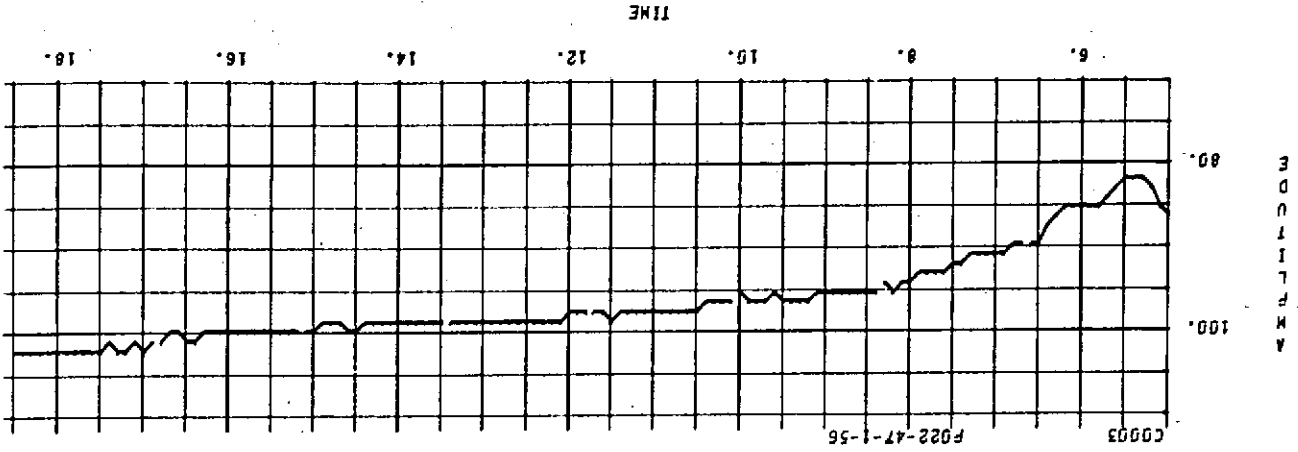



SEQ. = 0036

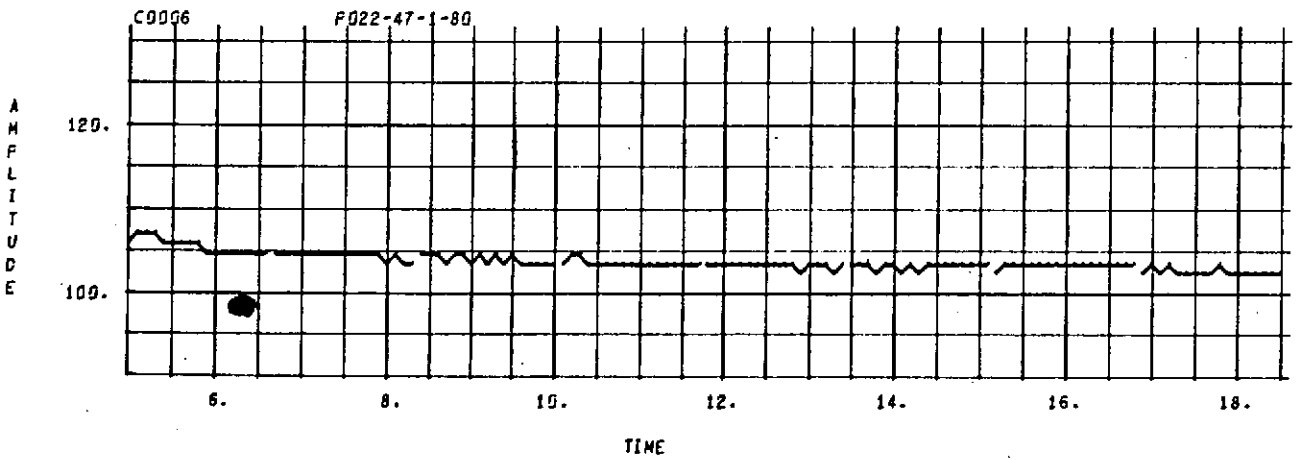
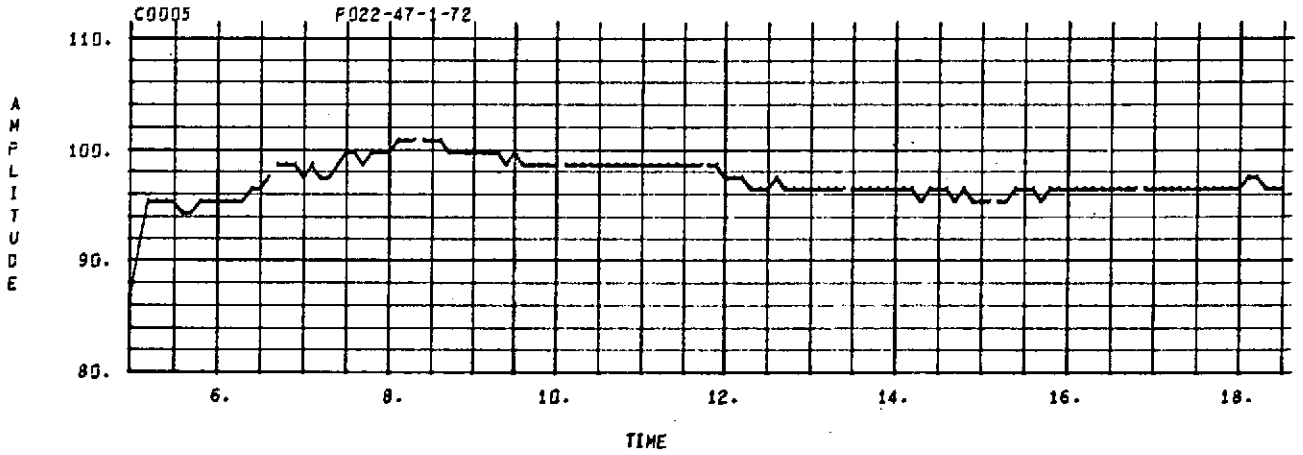
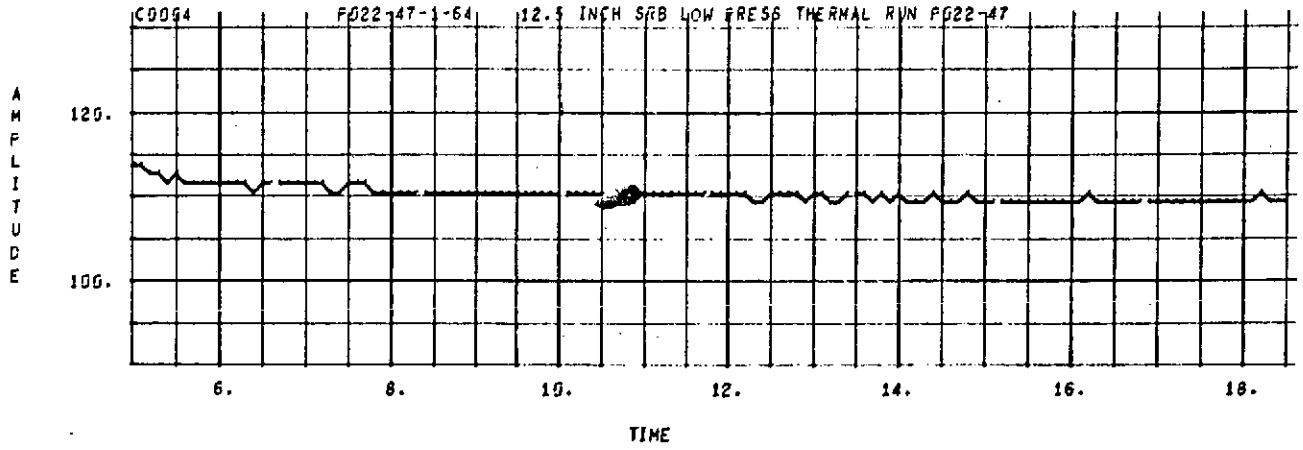

SEQ. = 0036

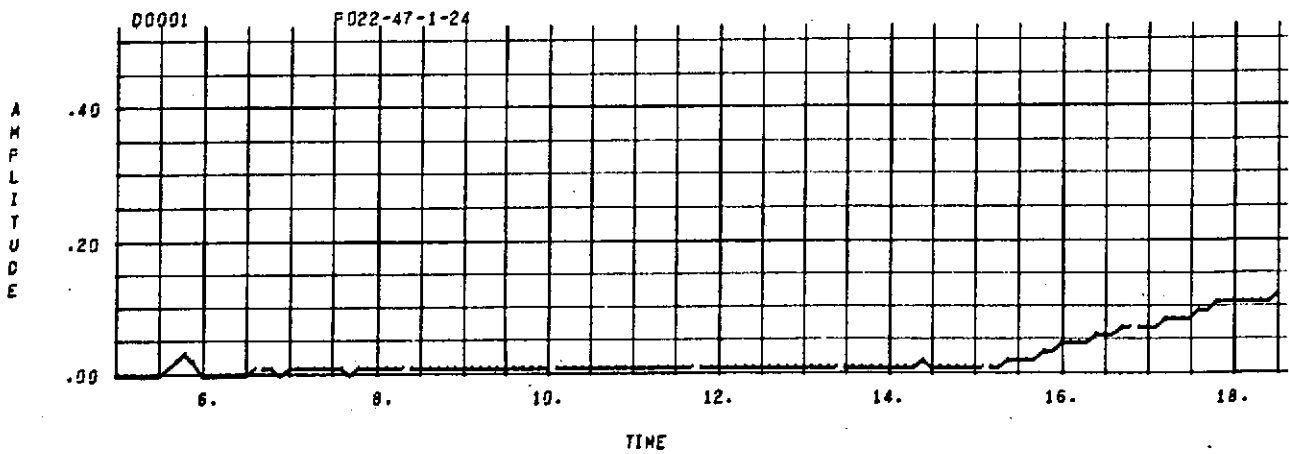
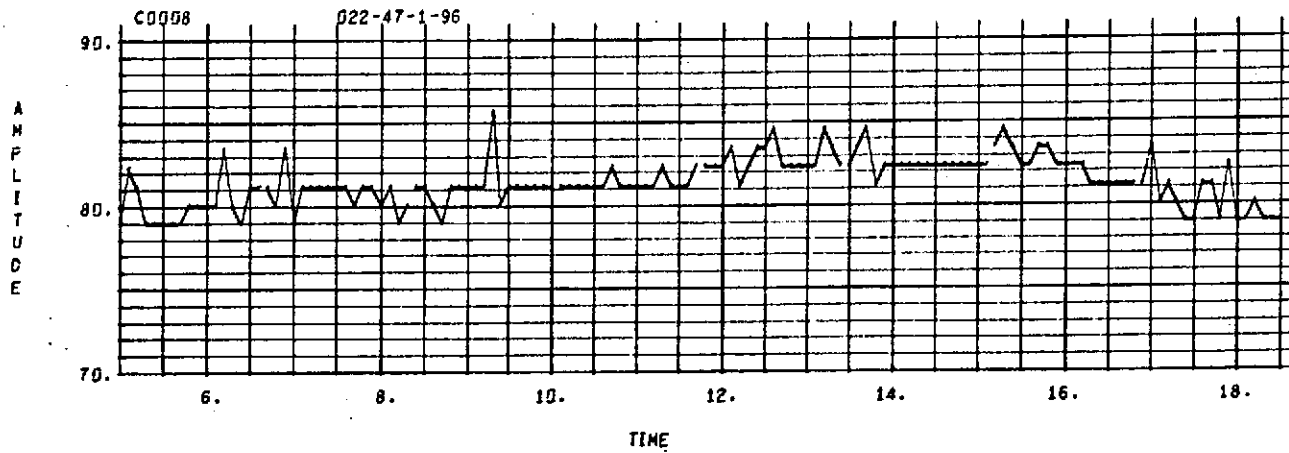
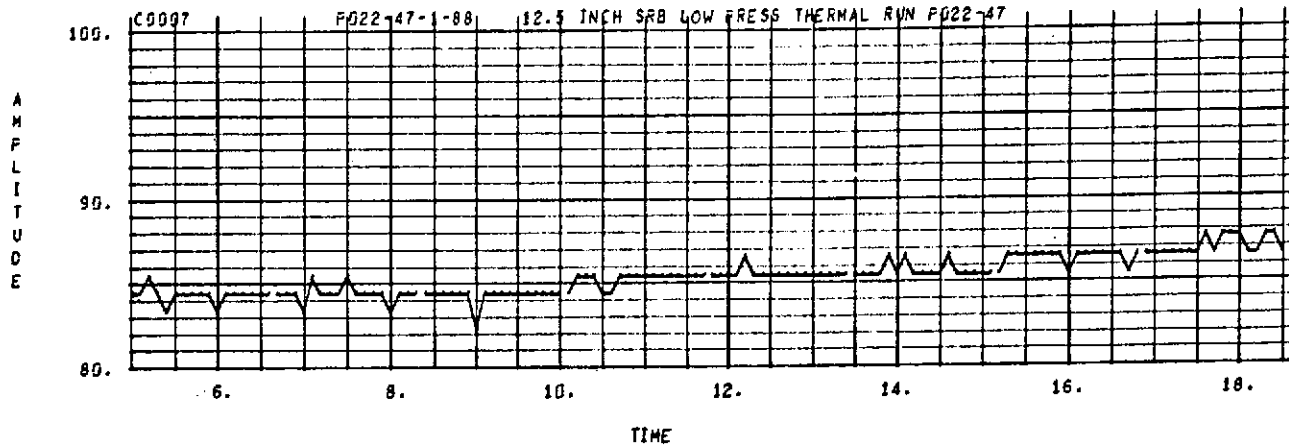

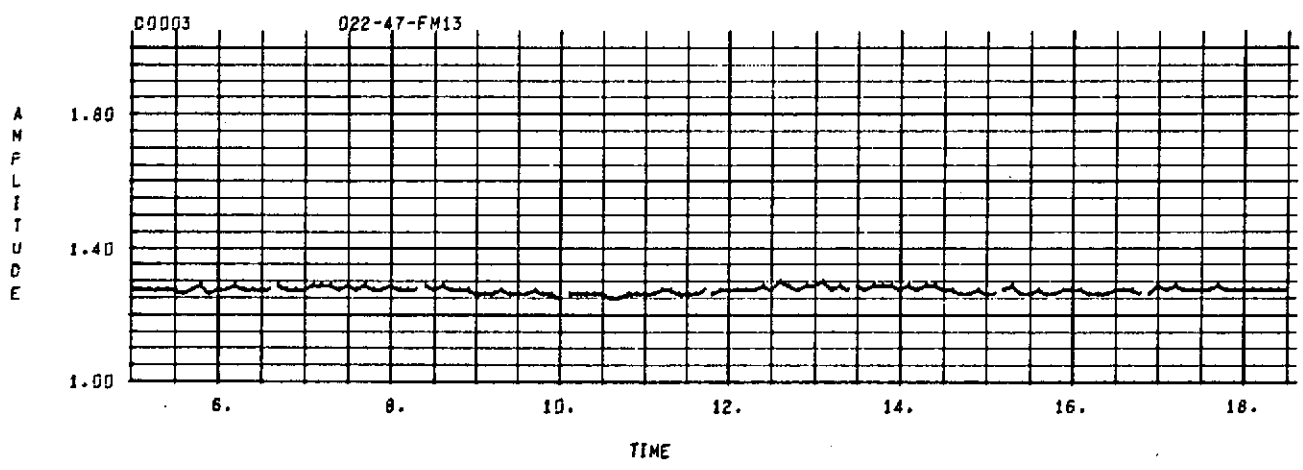
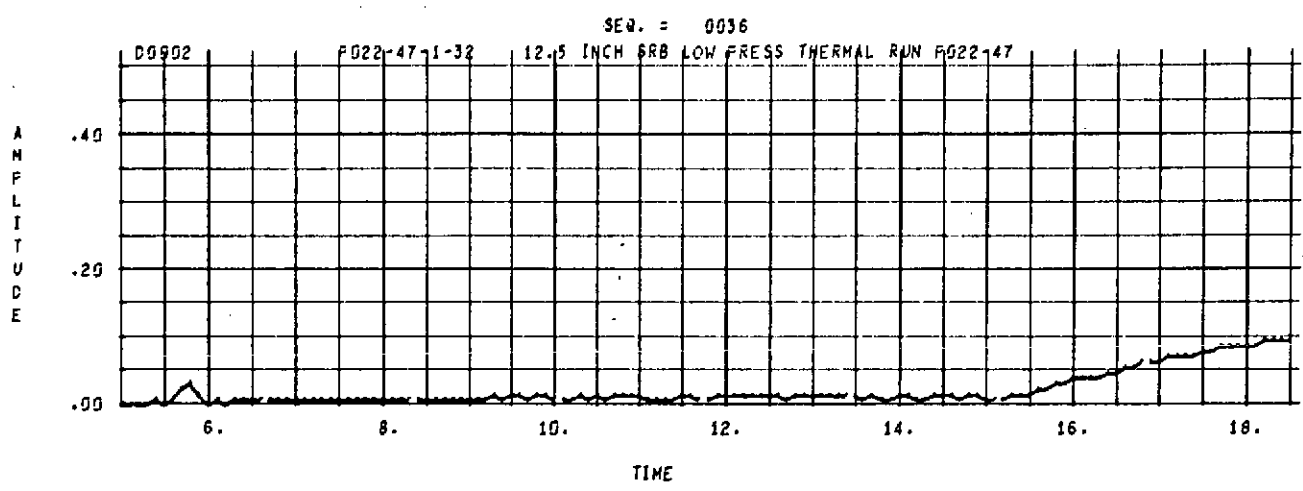



SEQ. = 0037

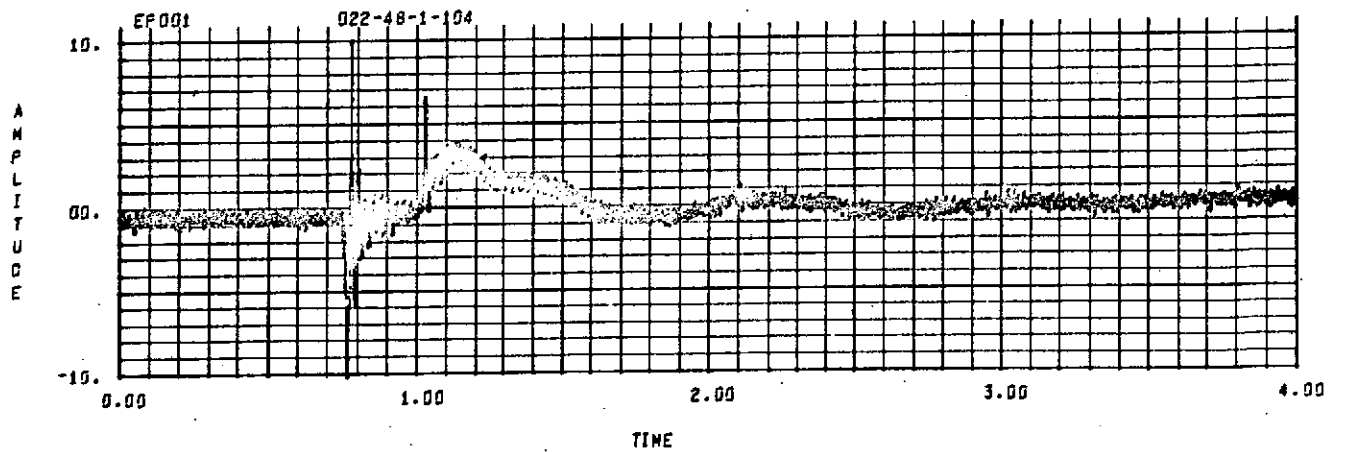
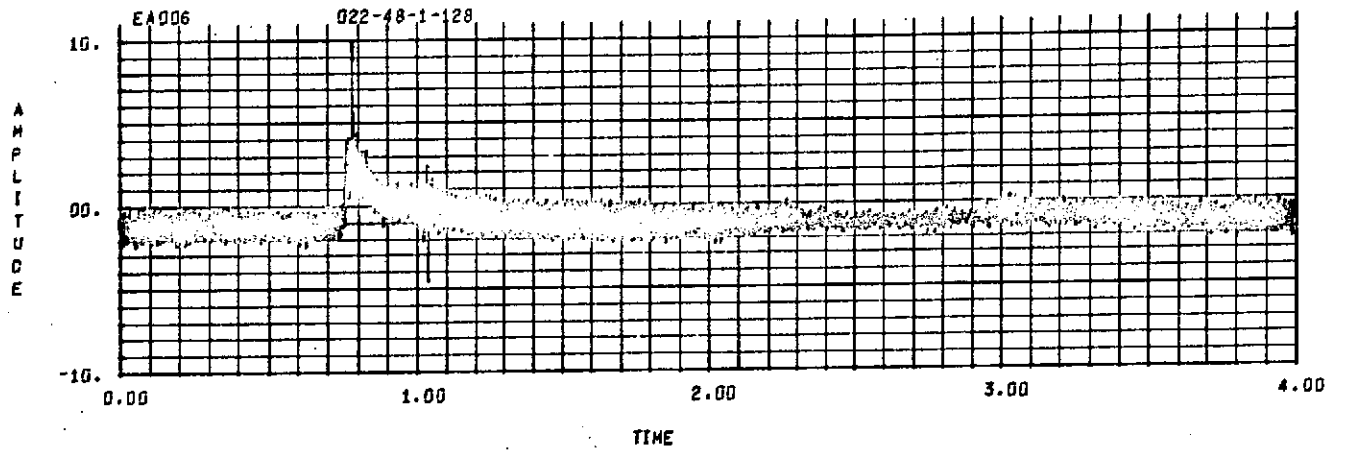
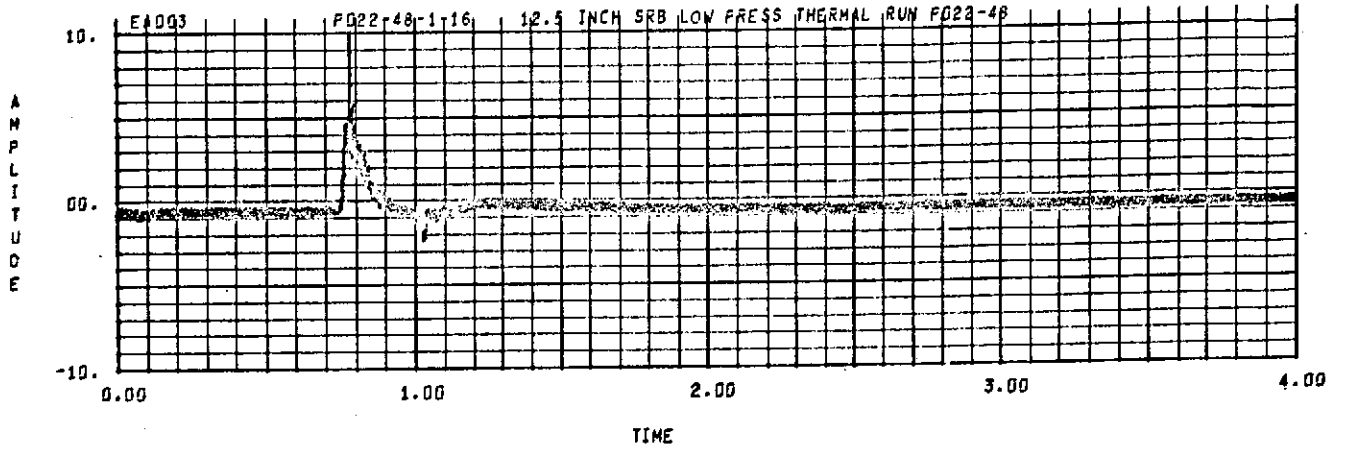



SEQ. = 0037

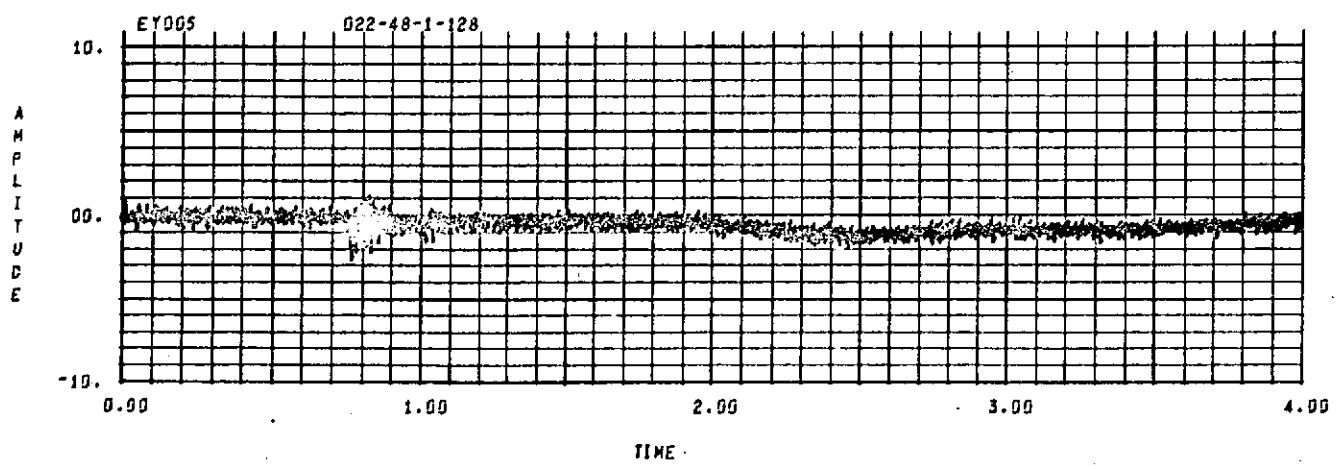
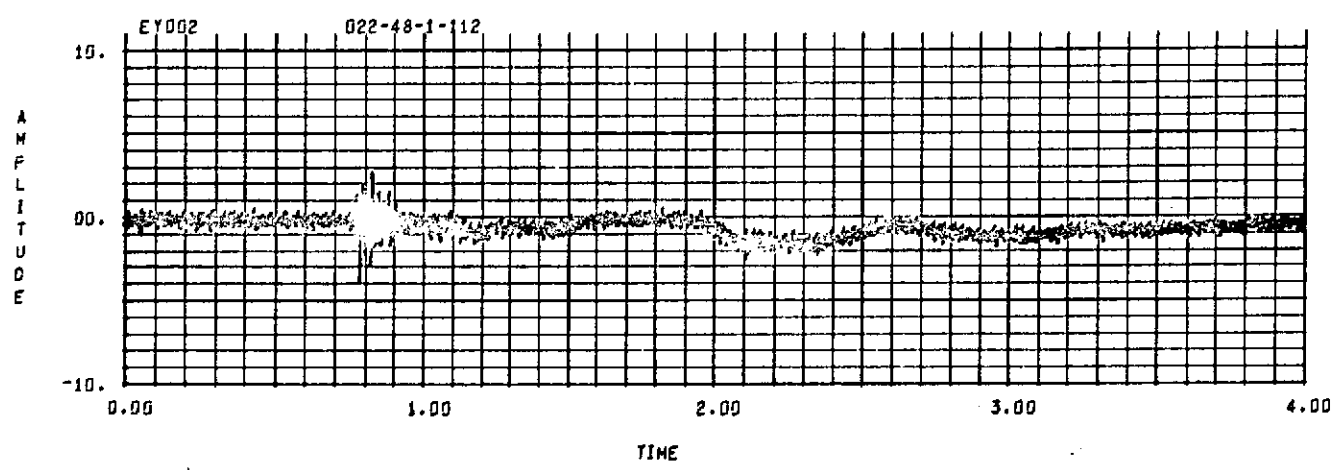
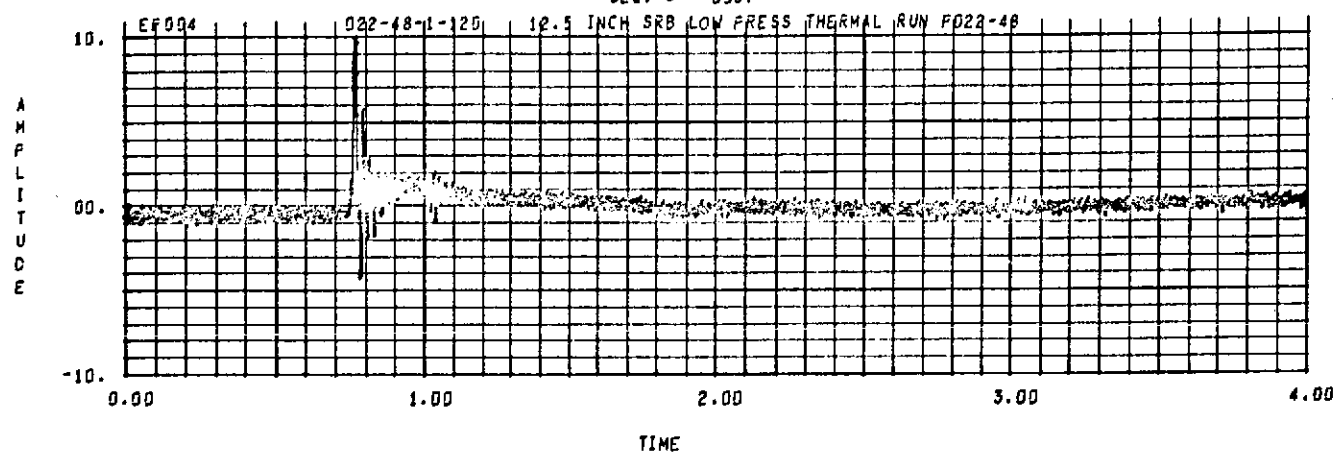

SEQ. = 0037

1

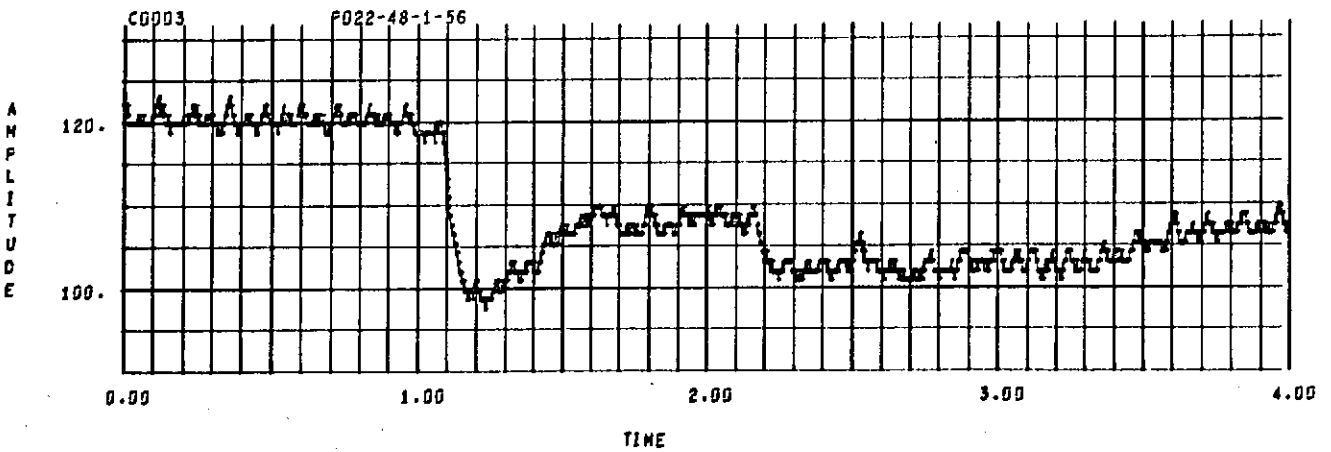
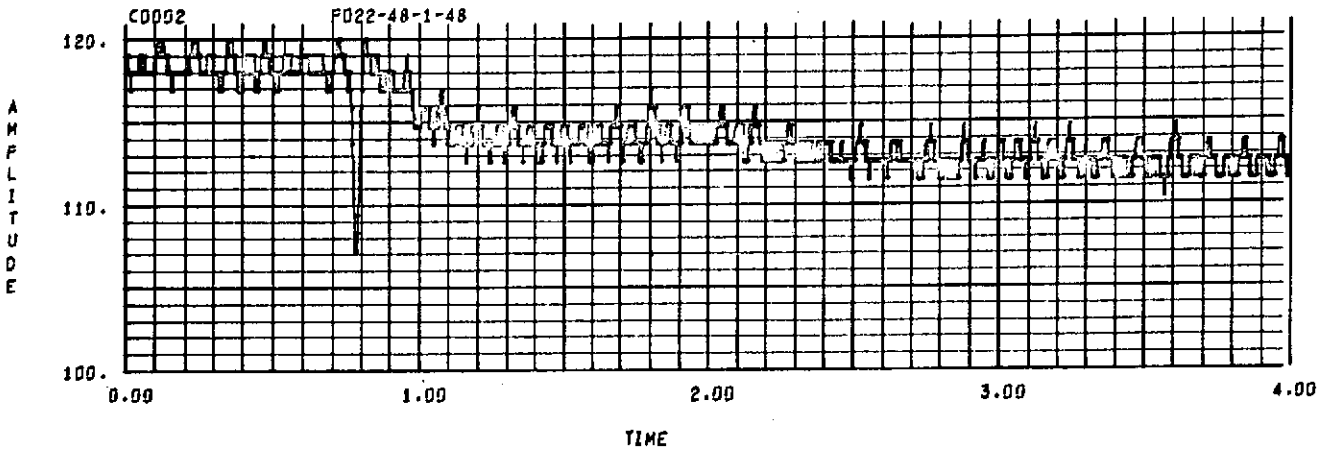
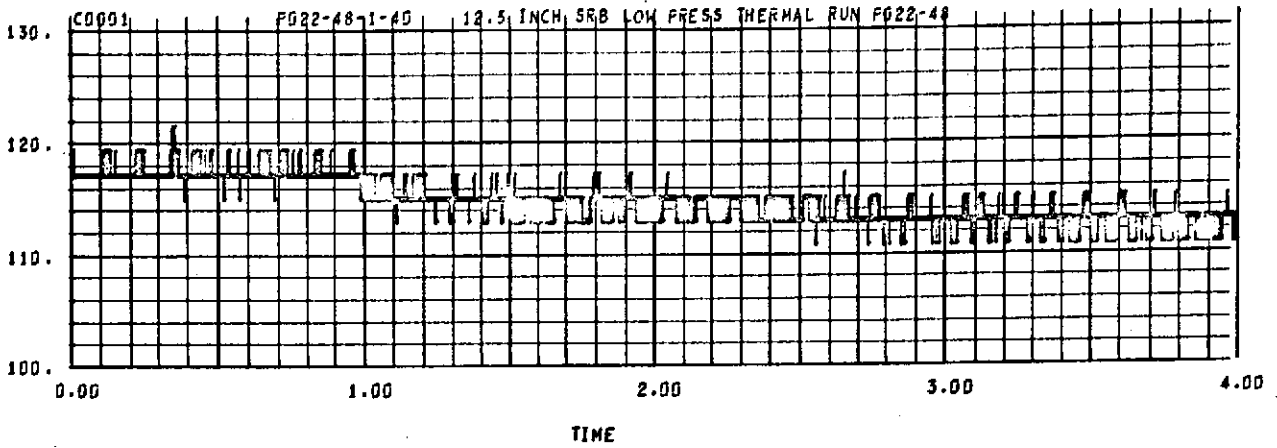

SEQ. = 0037

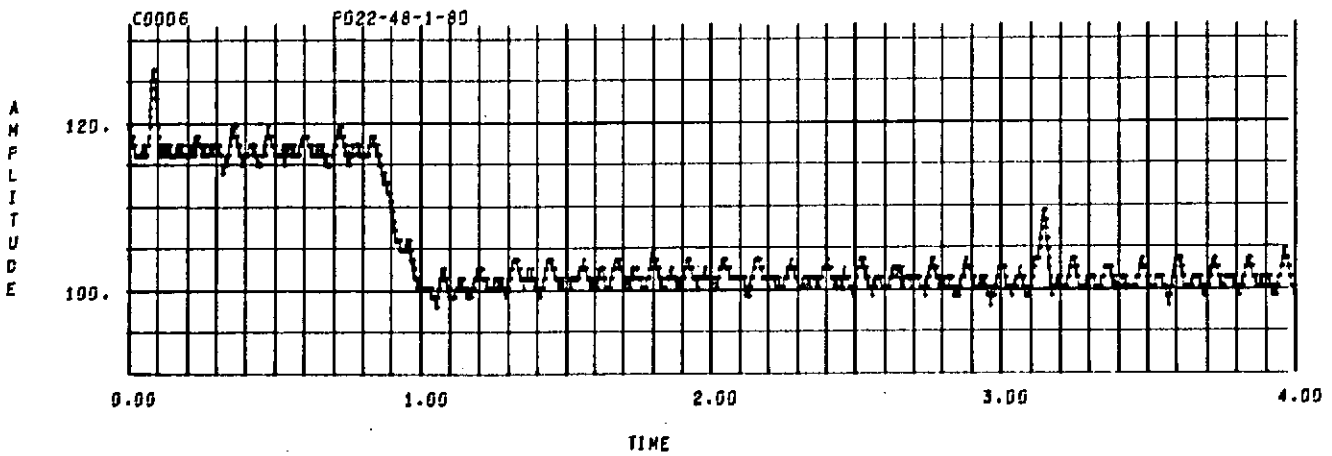
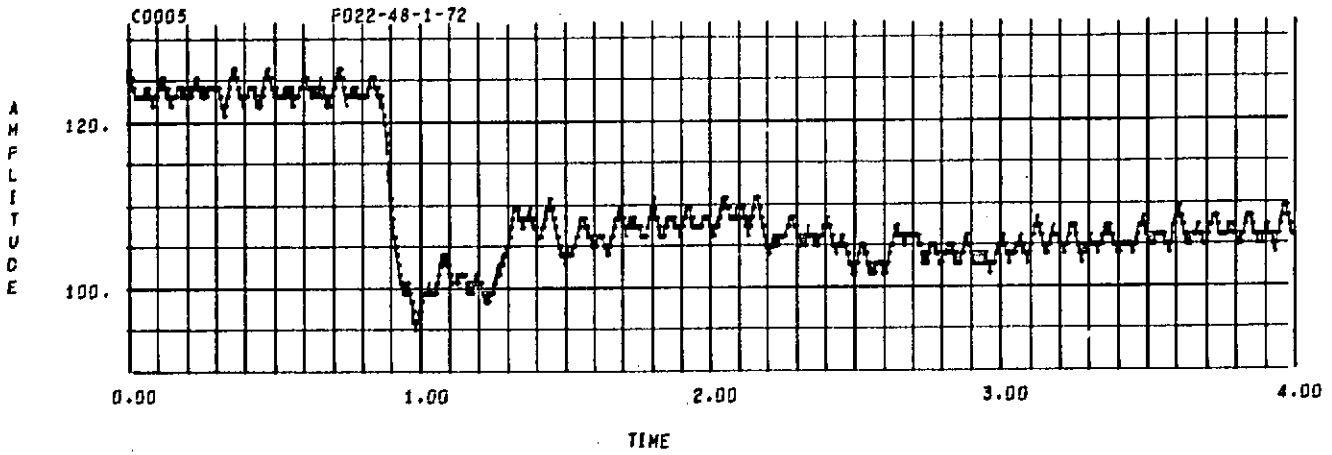
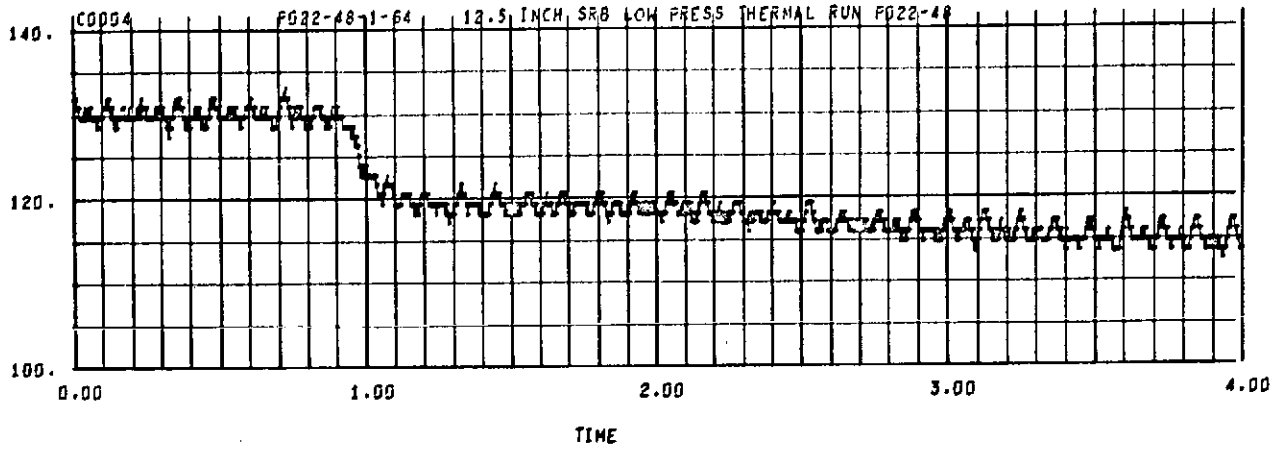

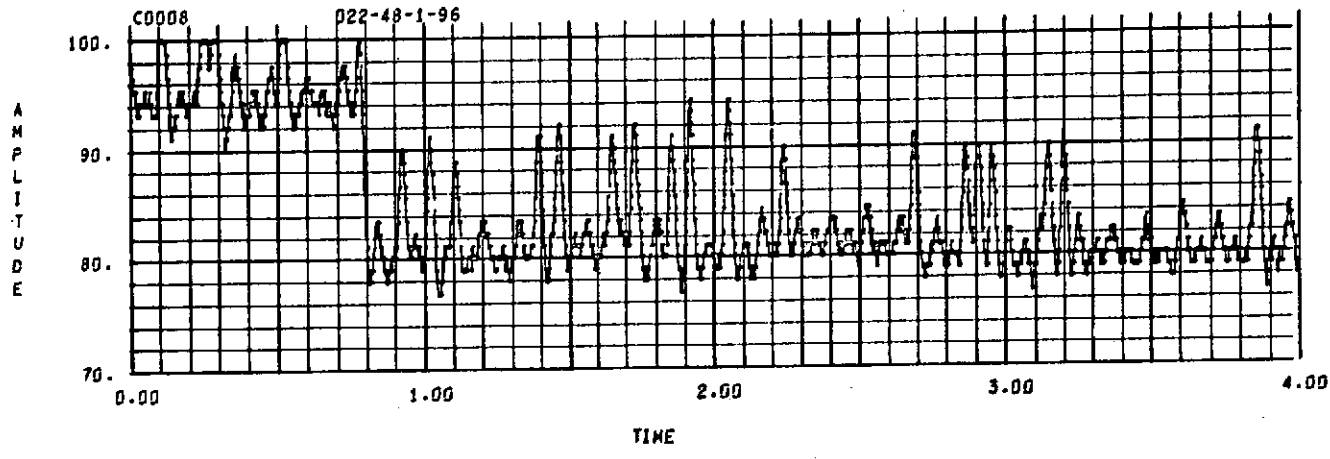
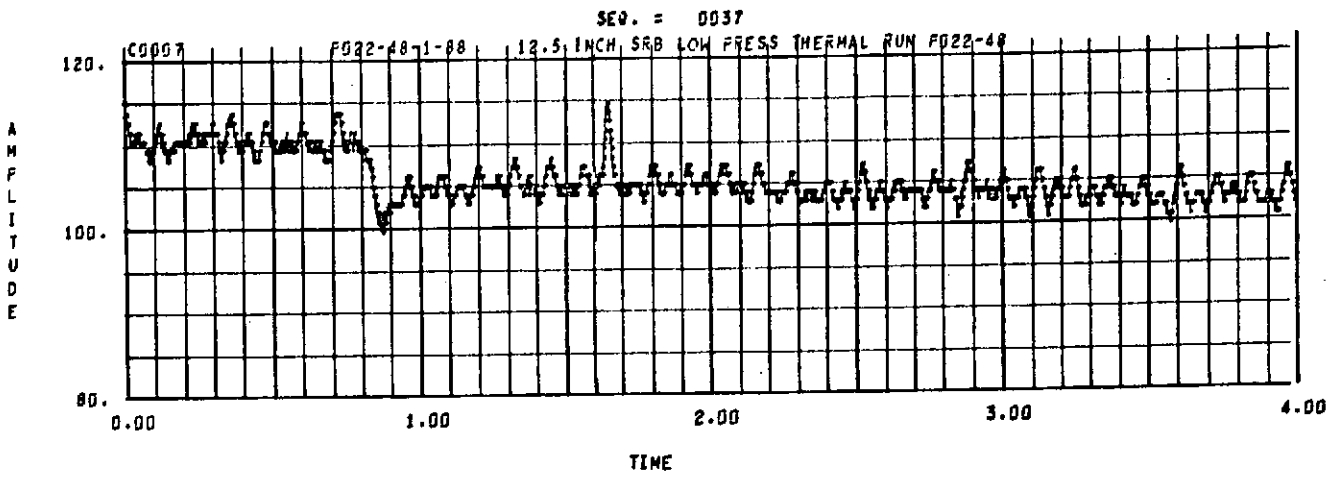

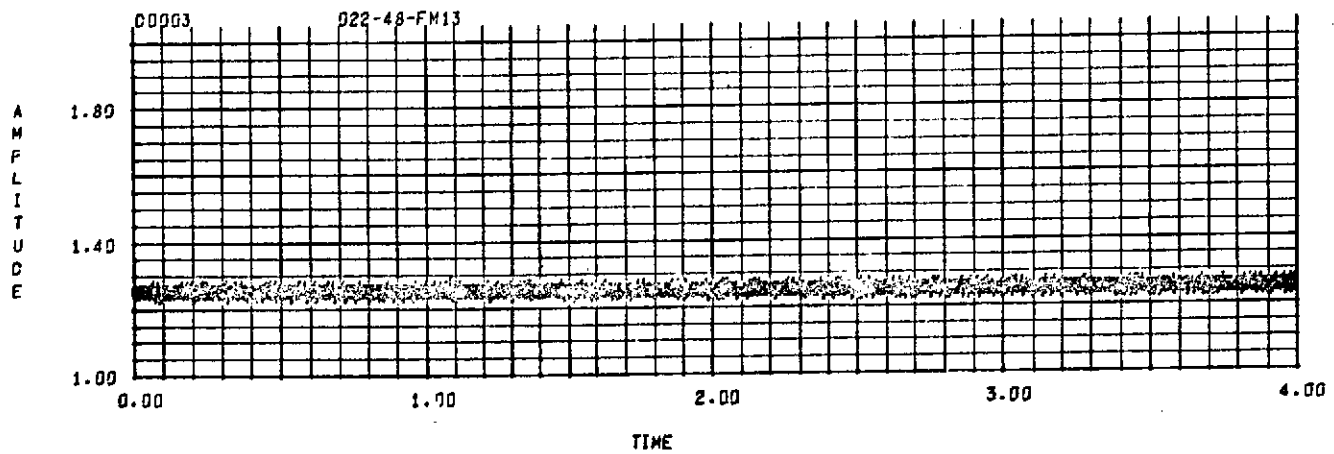
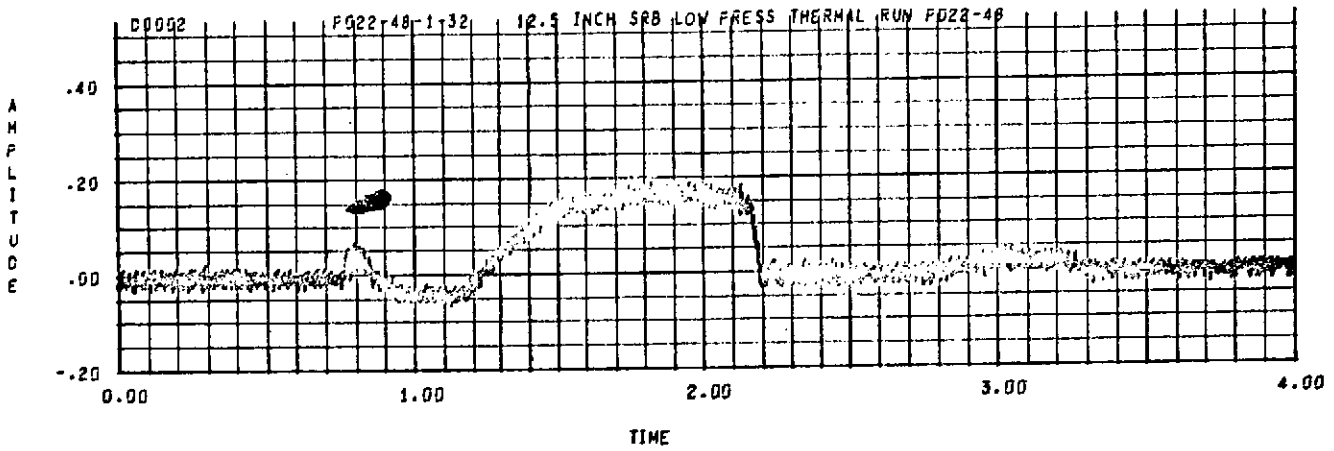
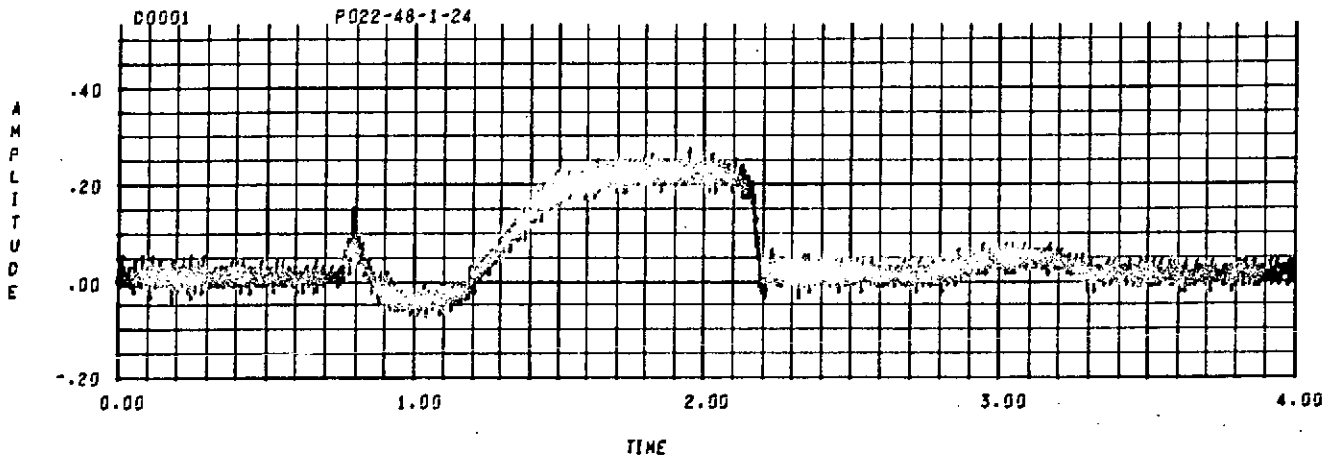



SEQ. = 0037

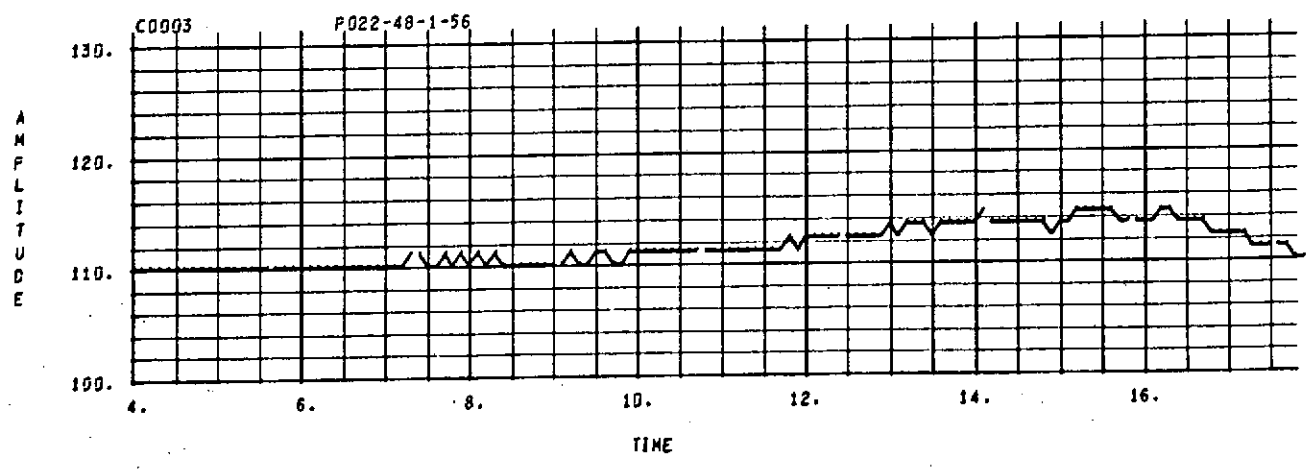
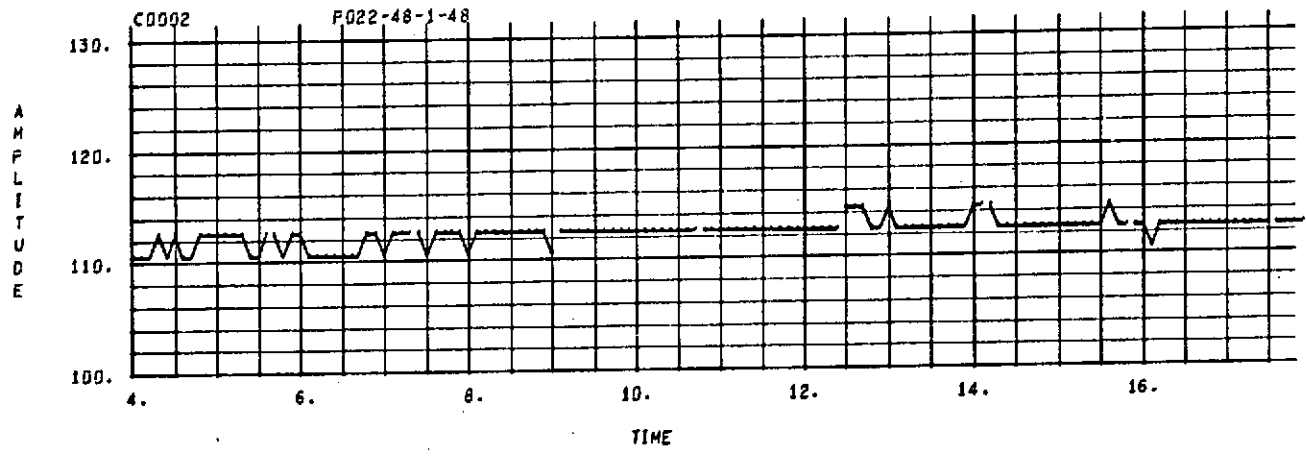
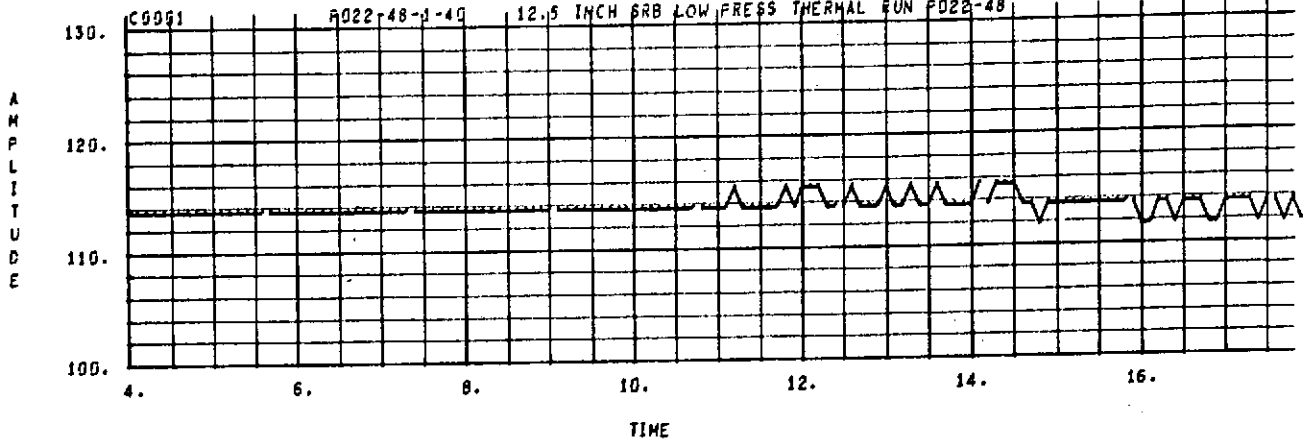



SEQ. = 0037

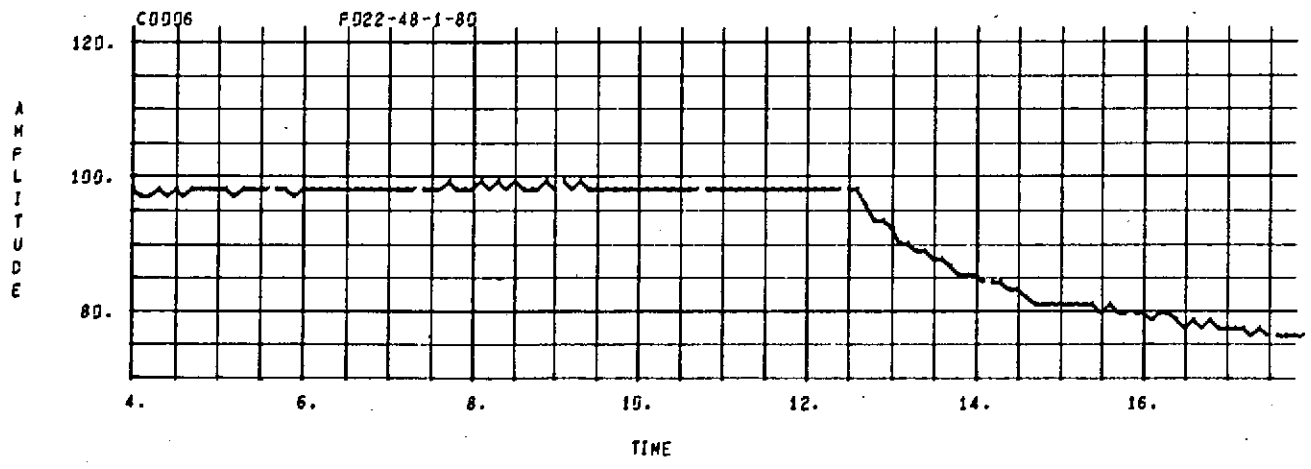
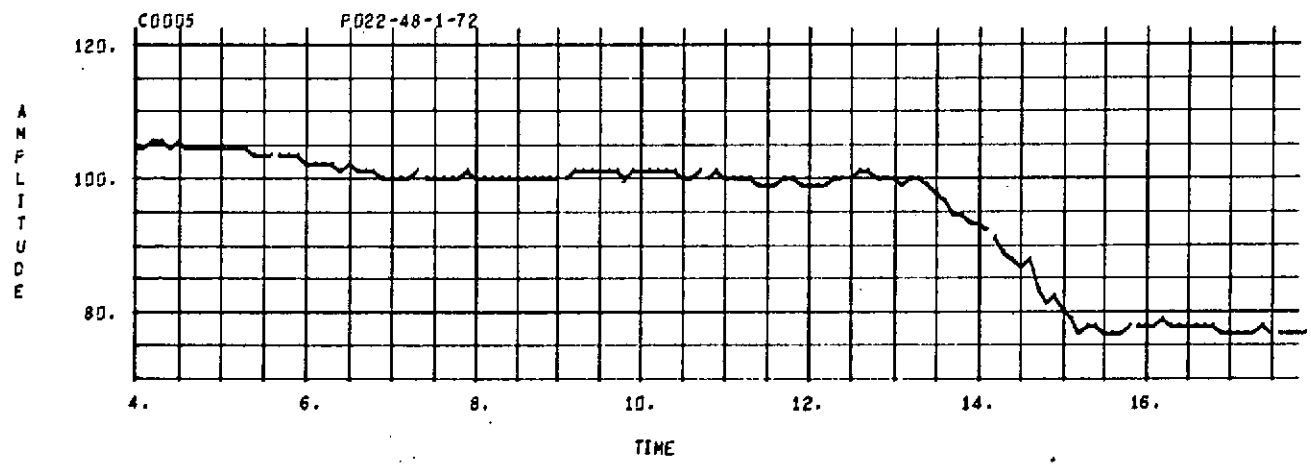
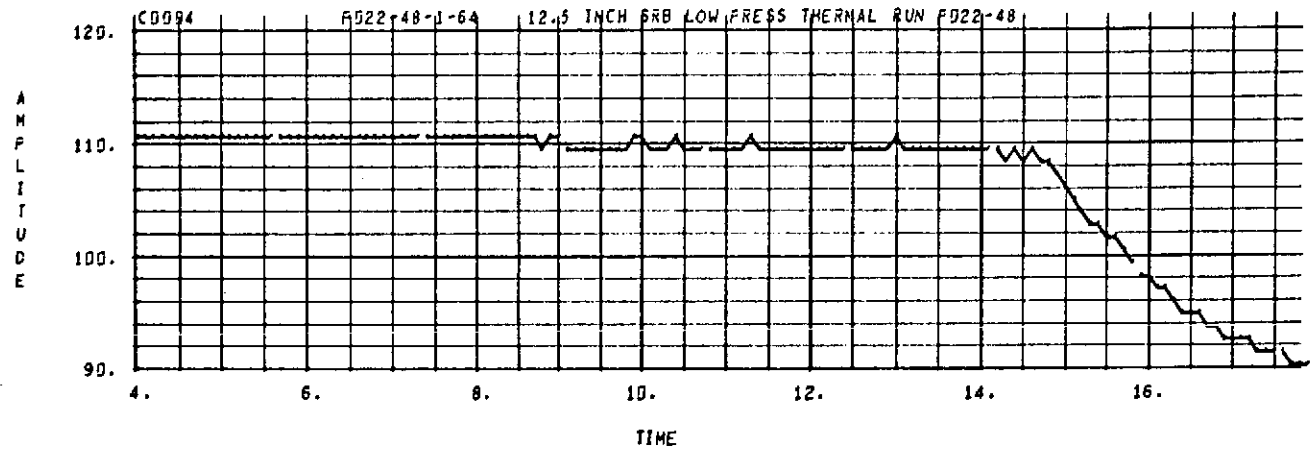



SEQ. = 0037

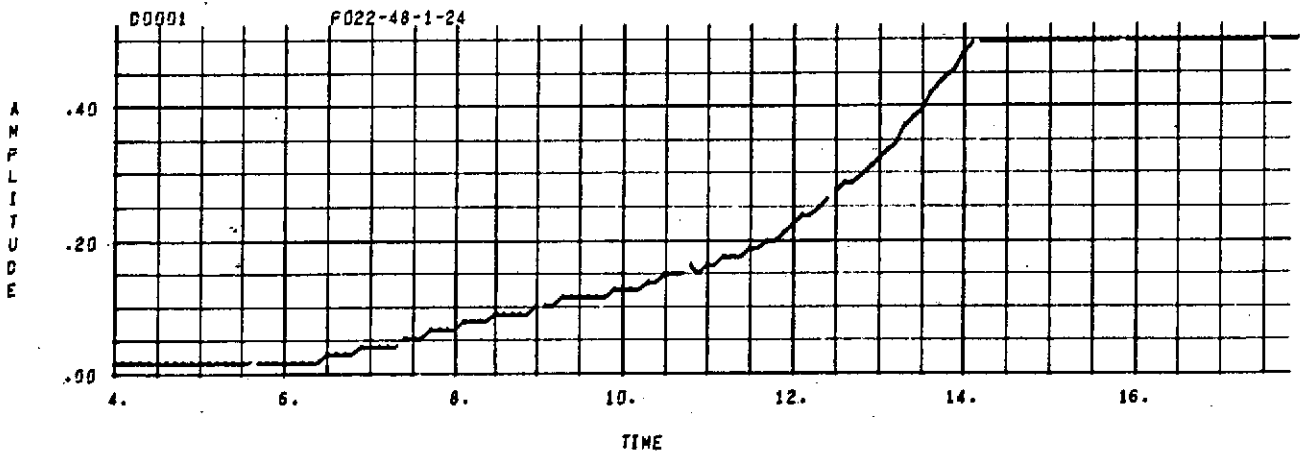
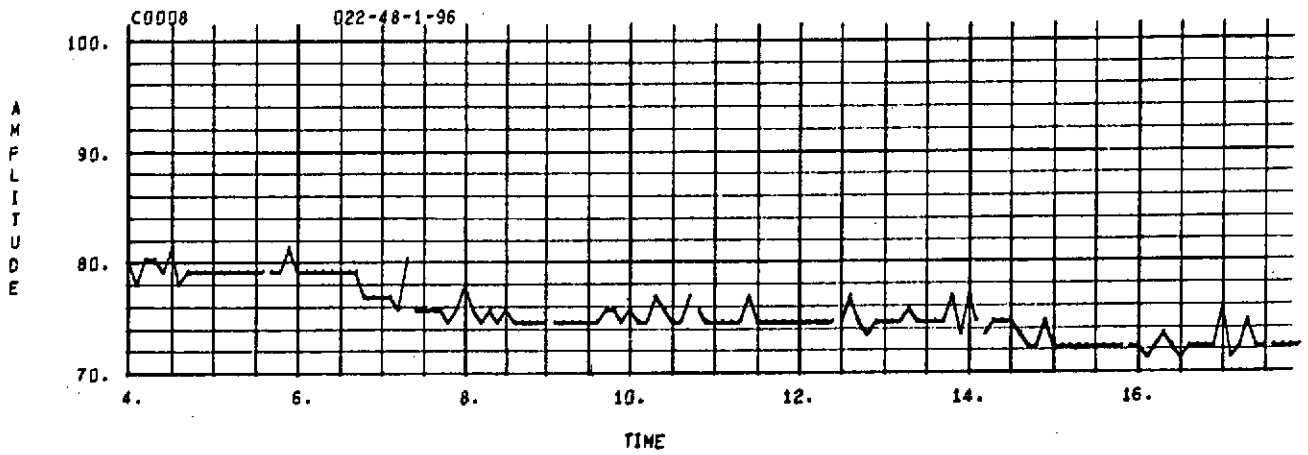
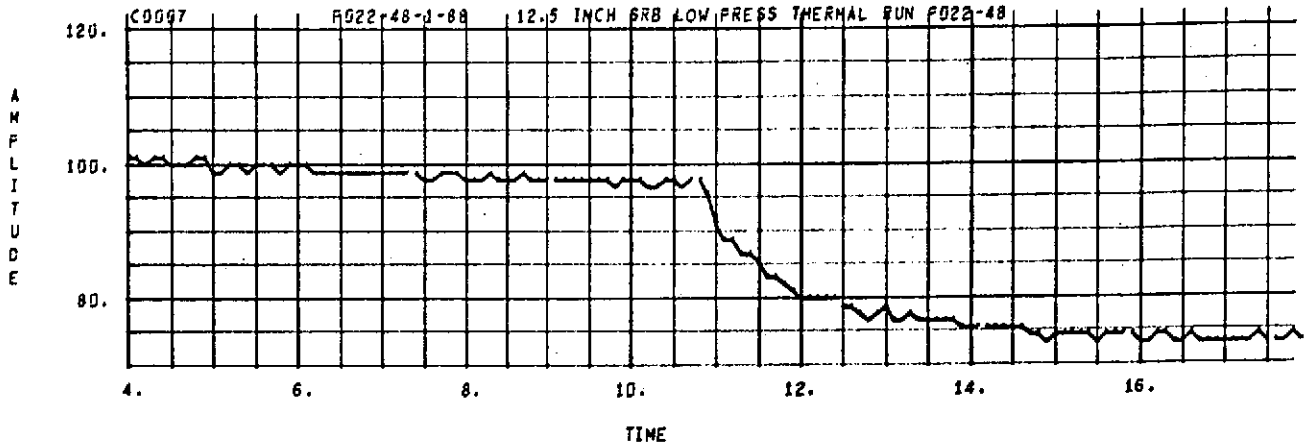



SEQ. = 0037

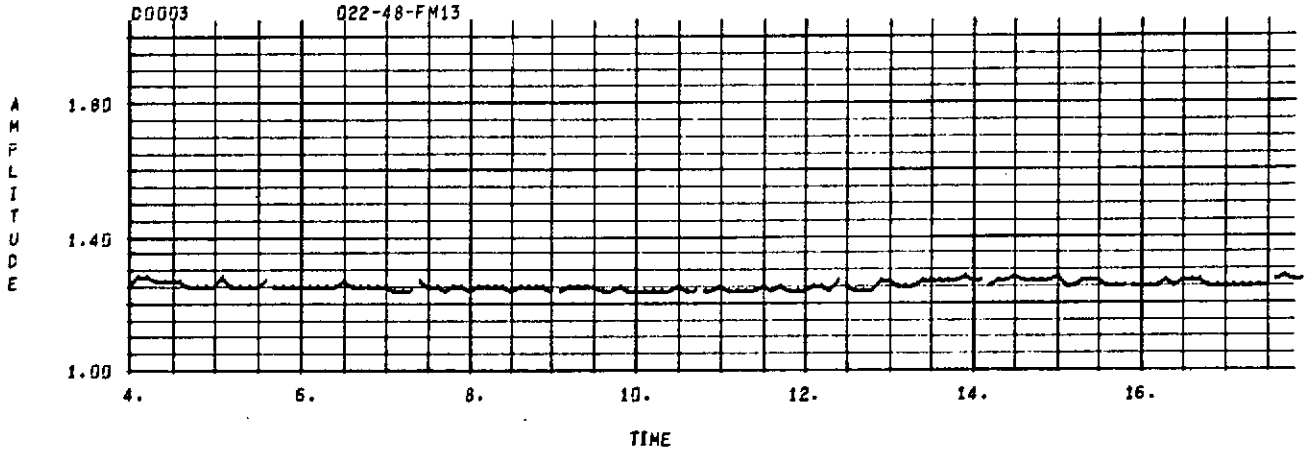
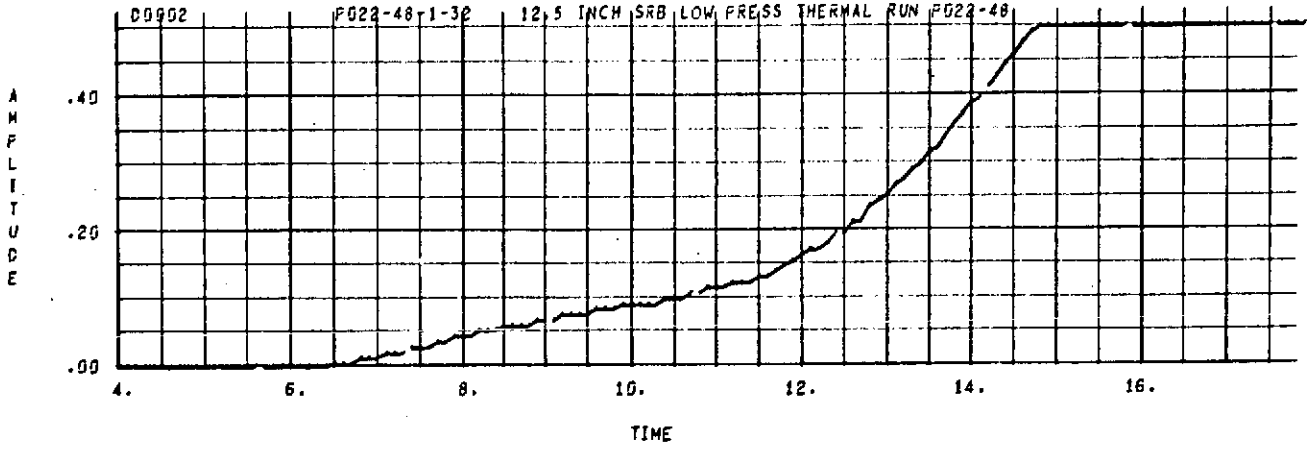

B-169

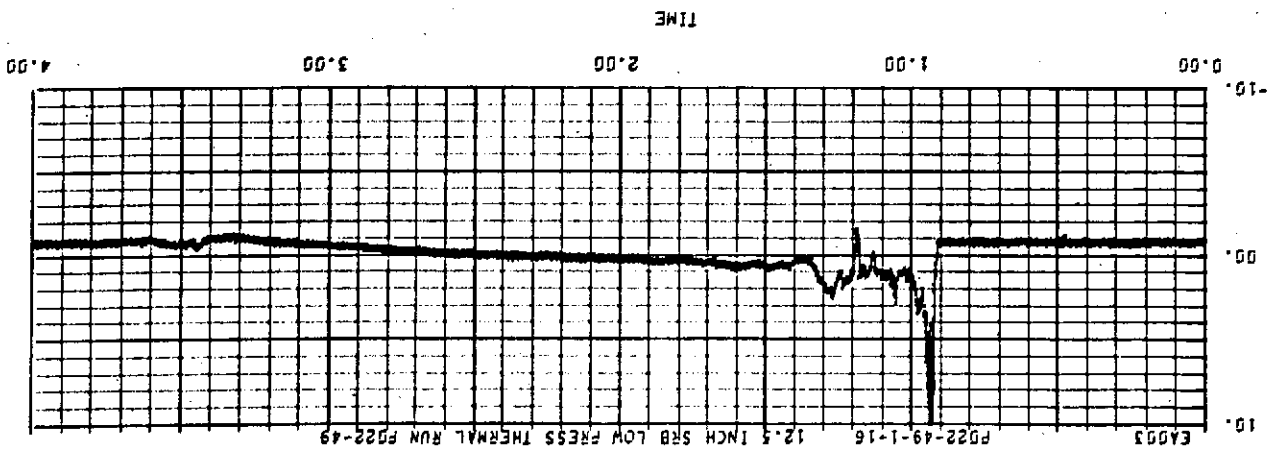
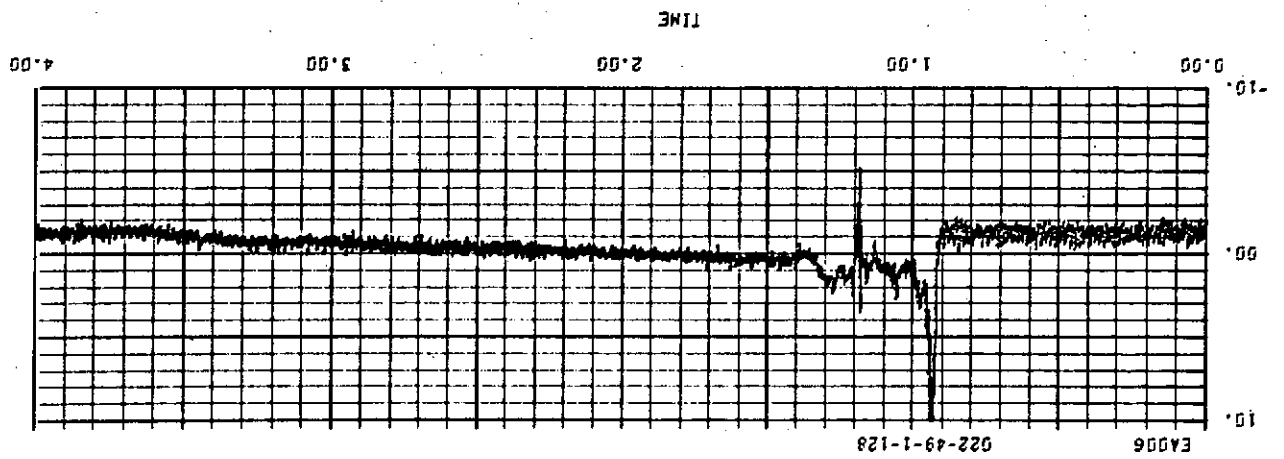
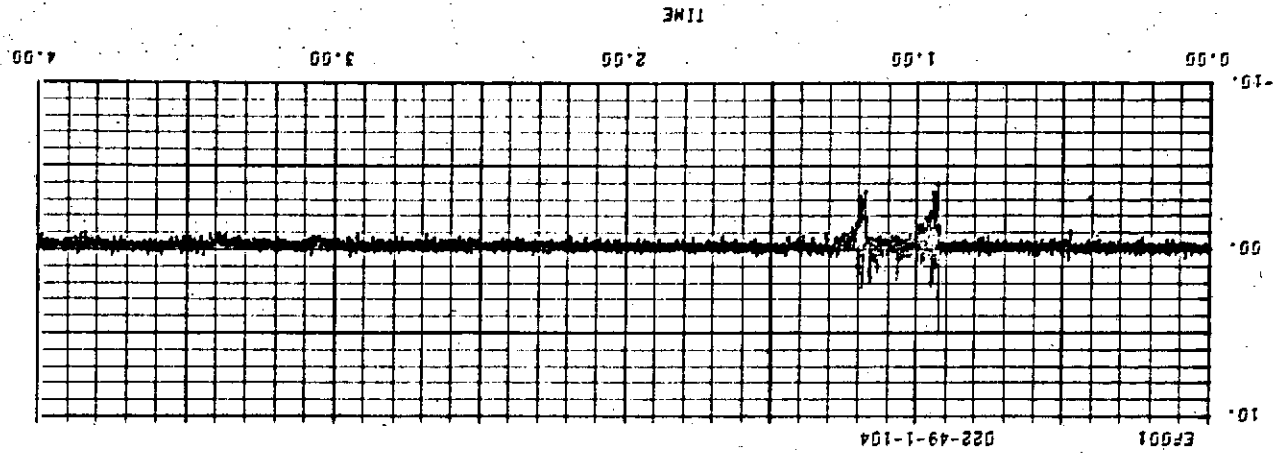

SEQ. = 0038
12.5 INCH SRB LOW PRESS THERMAL RUN P022-49

SEQ. = 0030

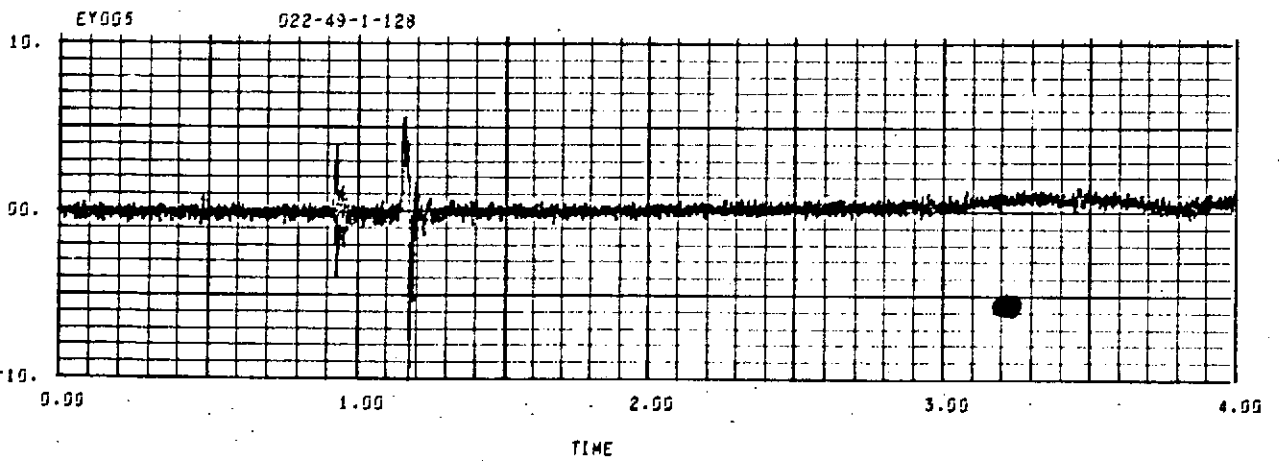
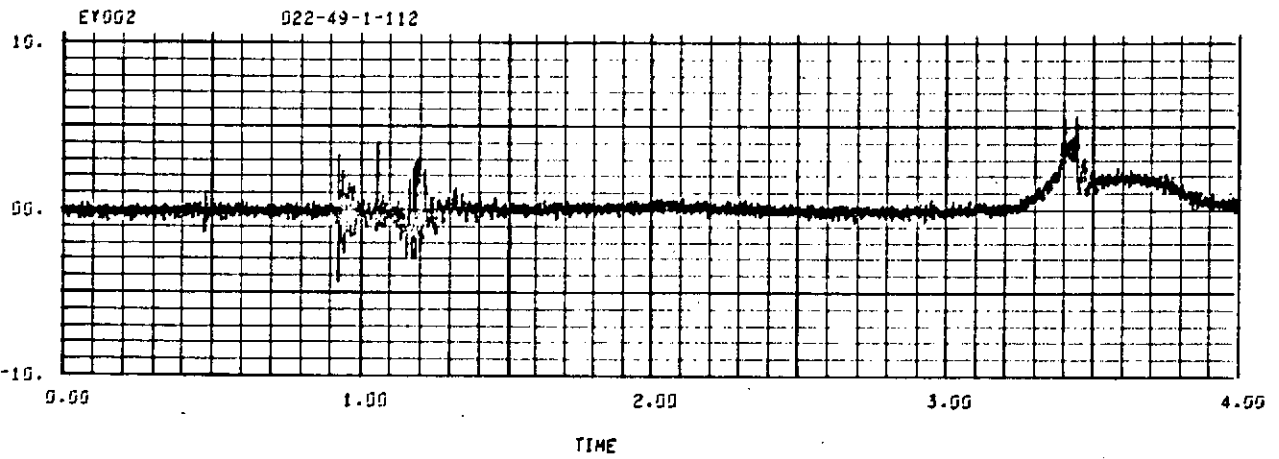
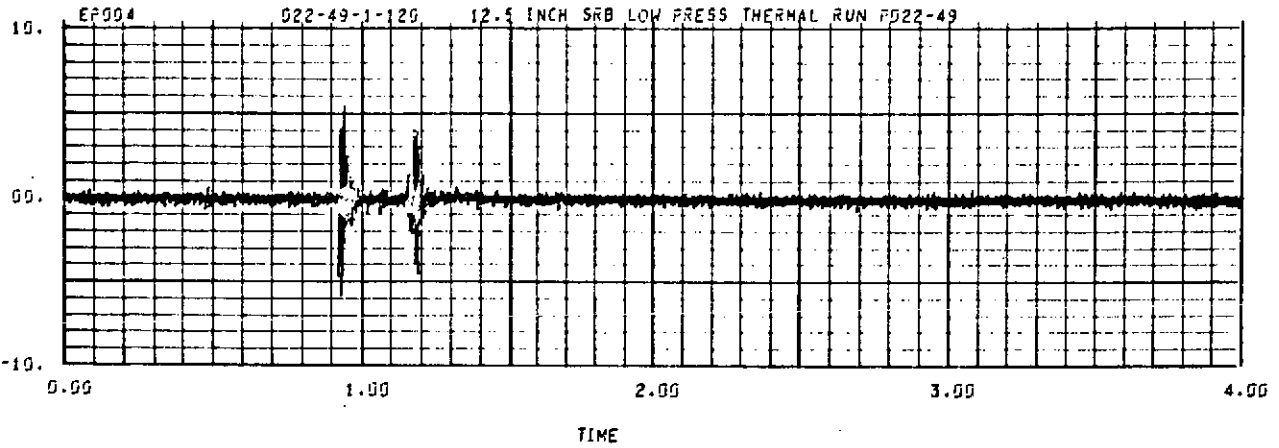

SEQ. = 0038

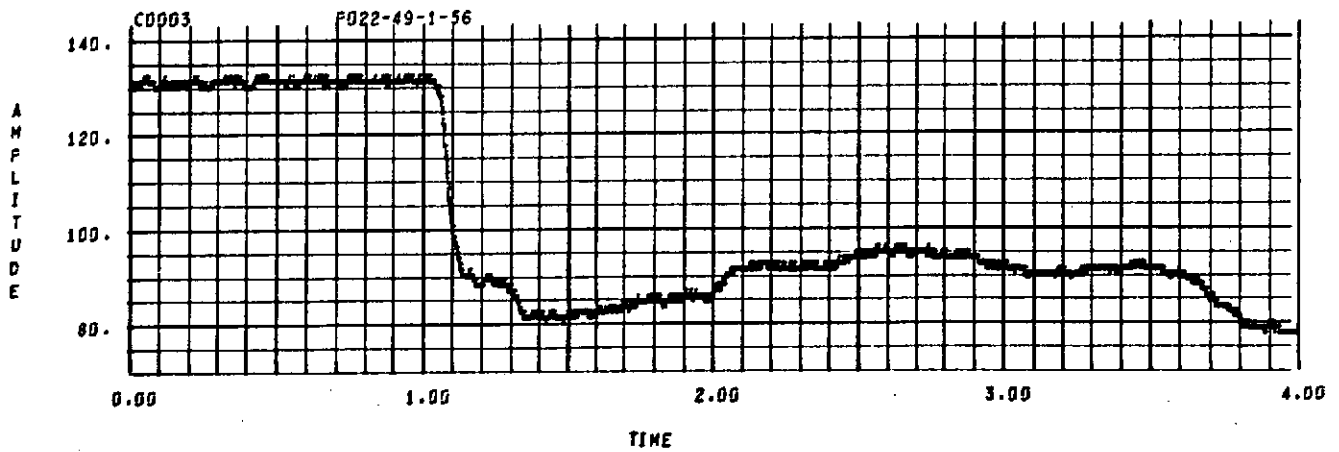
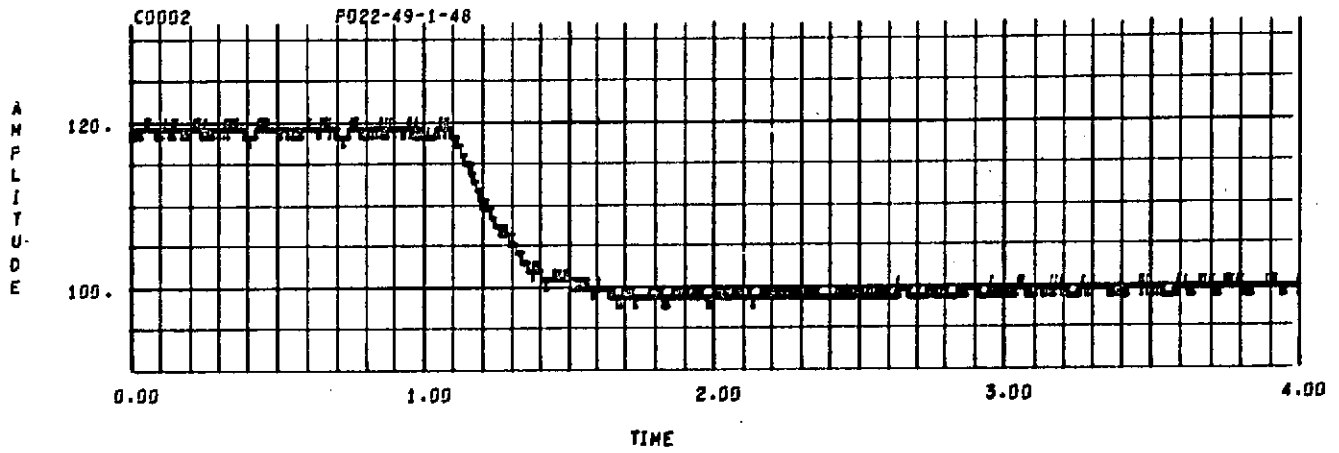
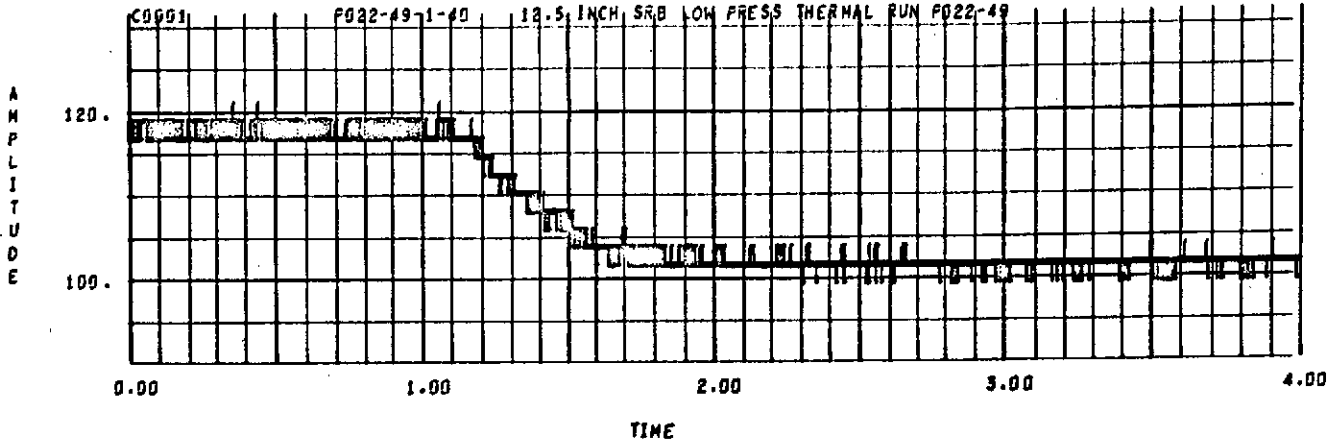

SEQ. = 0038

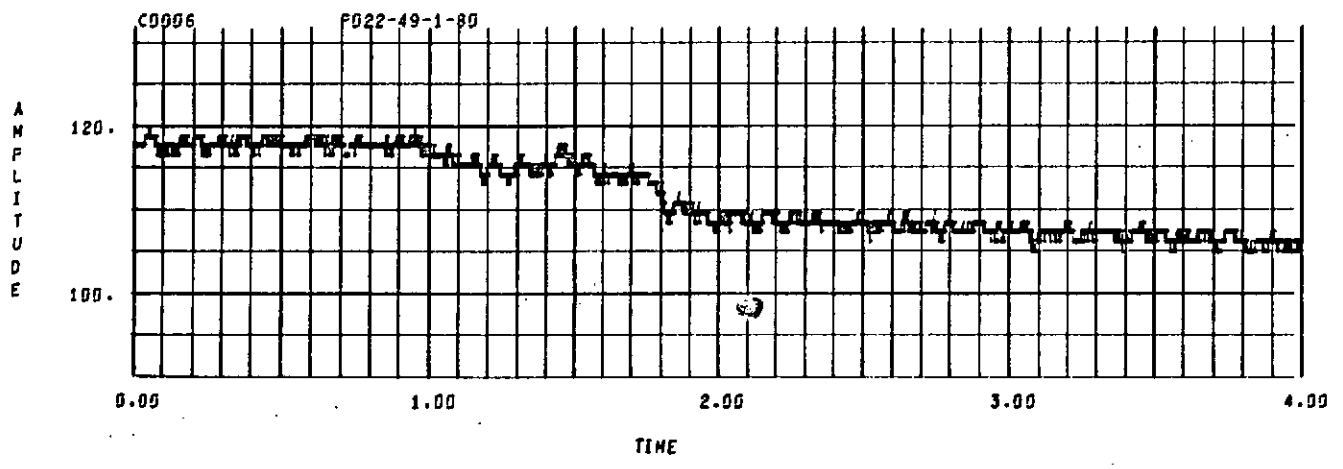
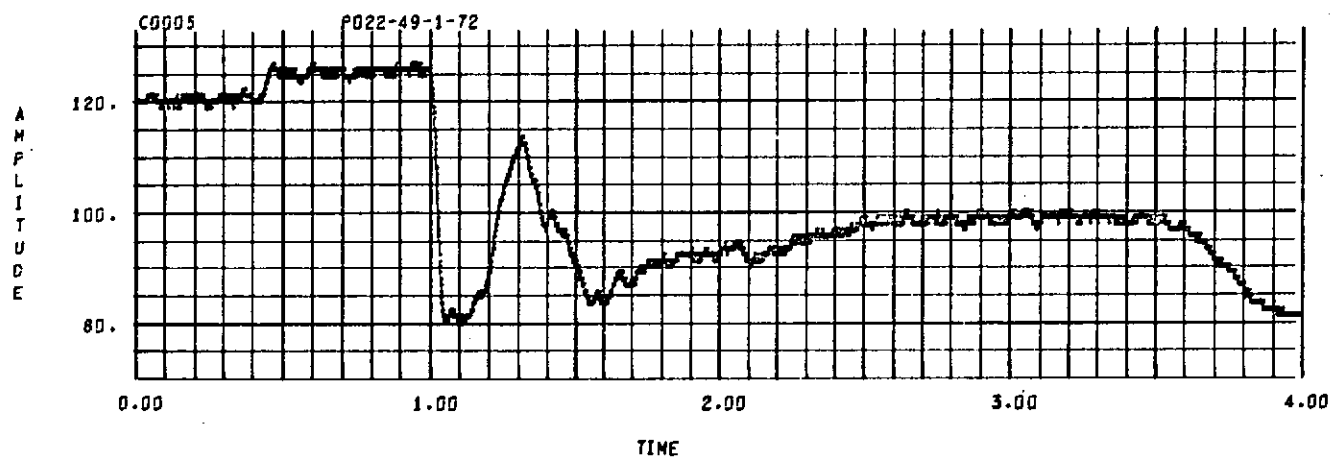
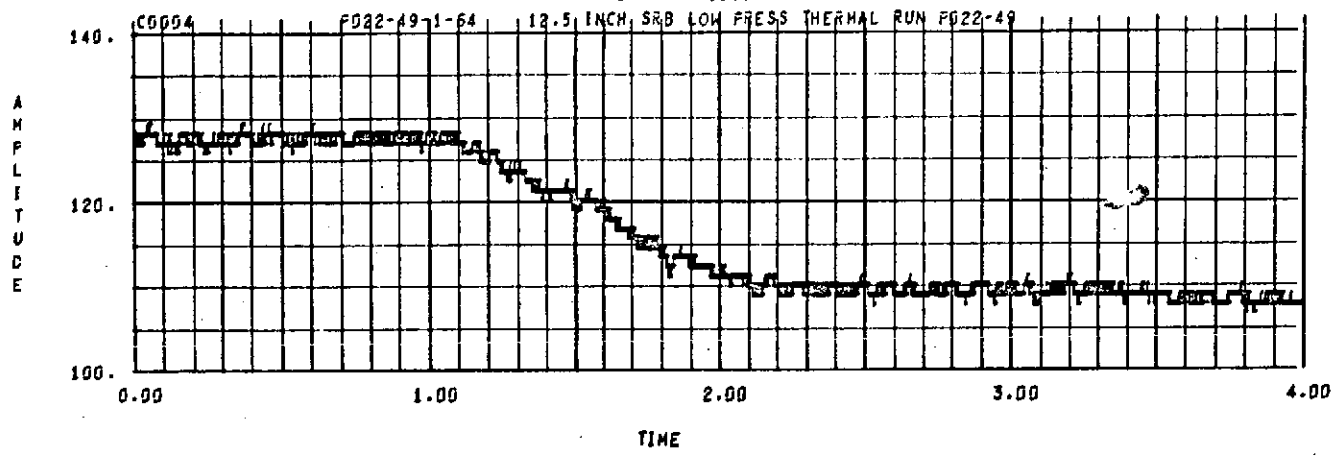

SER. = 0038

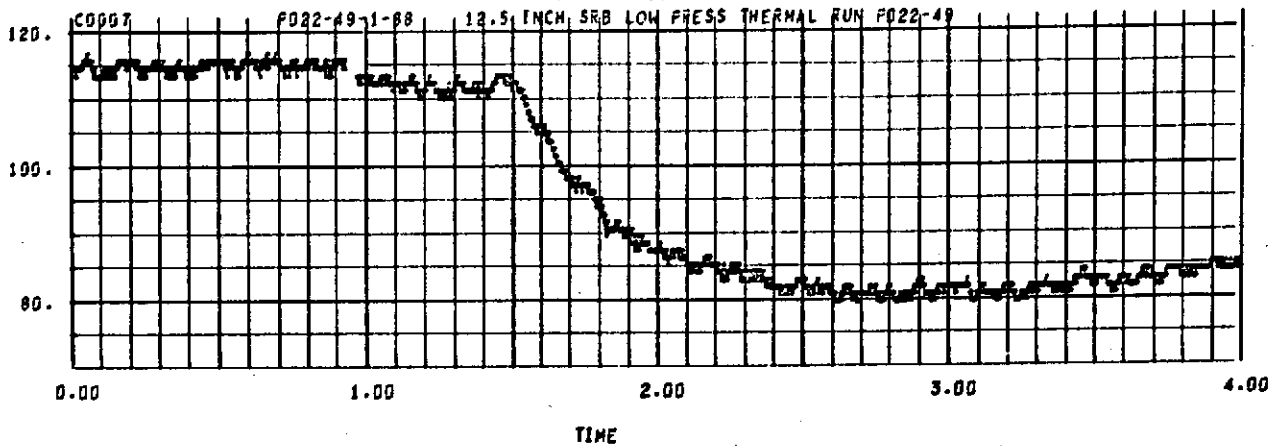

AMPLITUDE

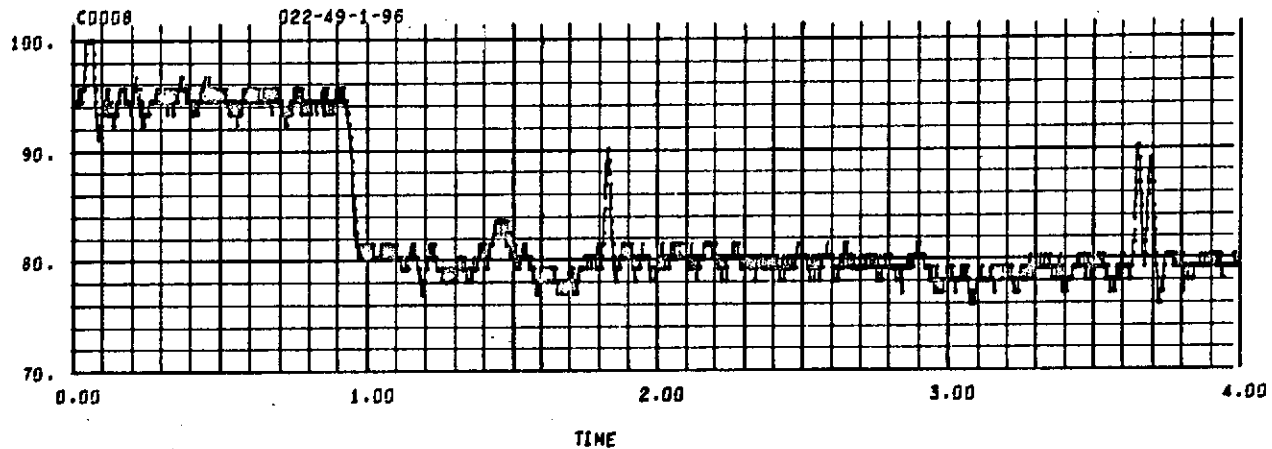

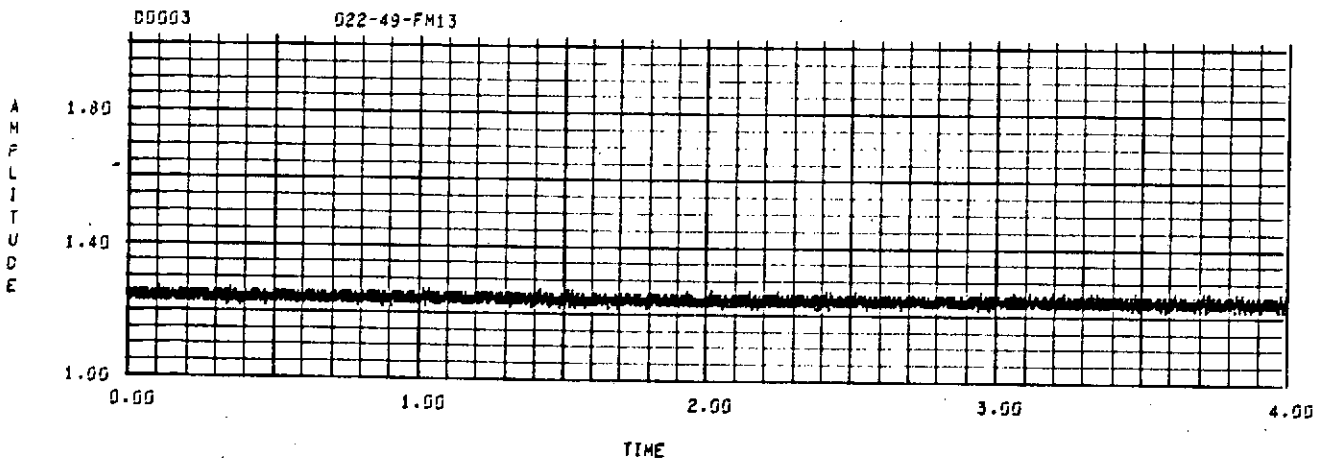
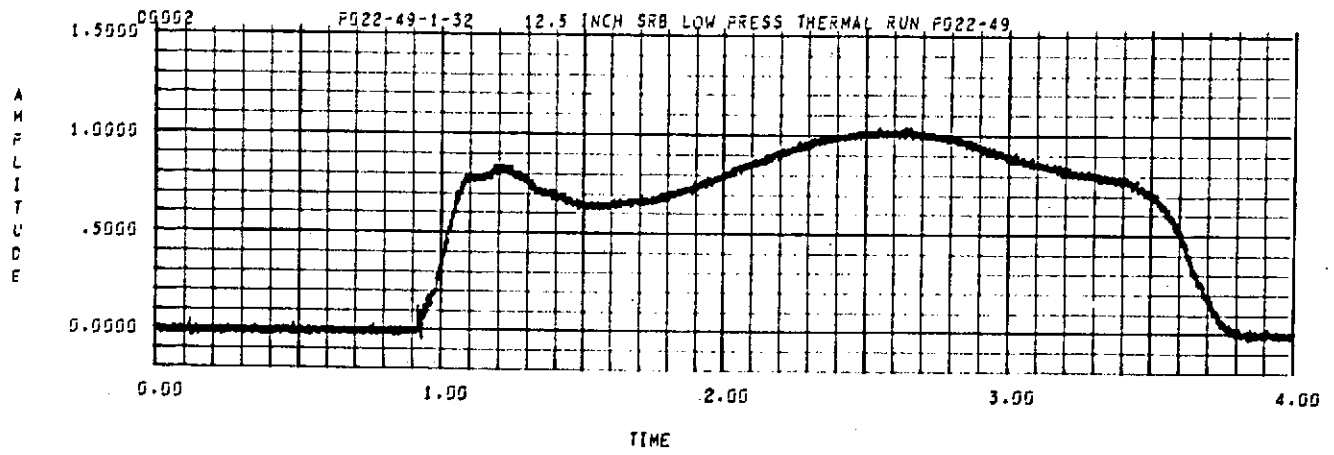
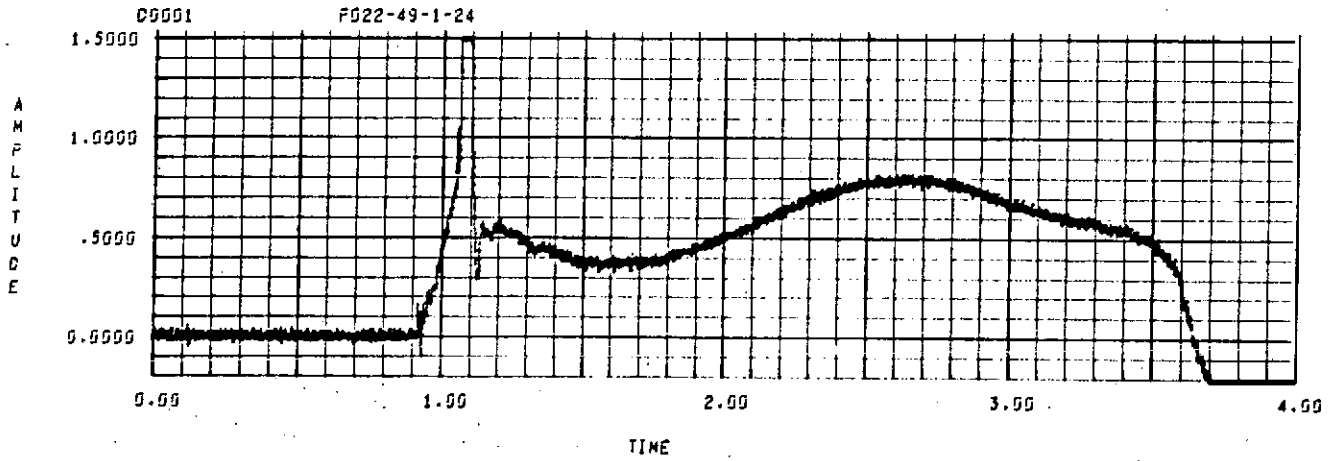

B-175

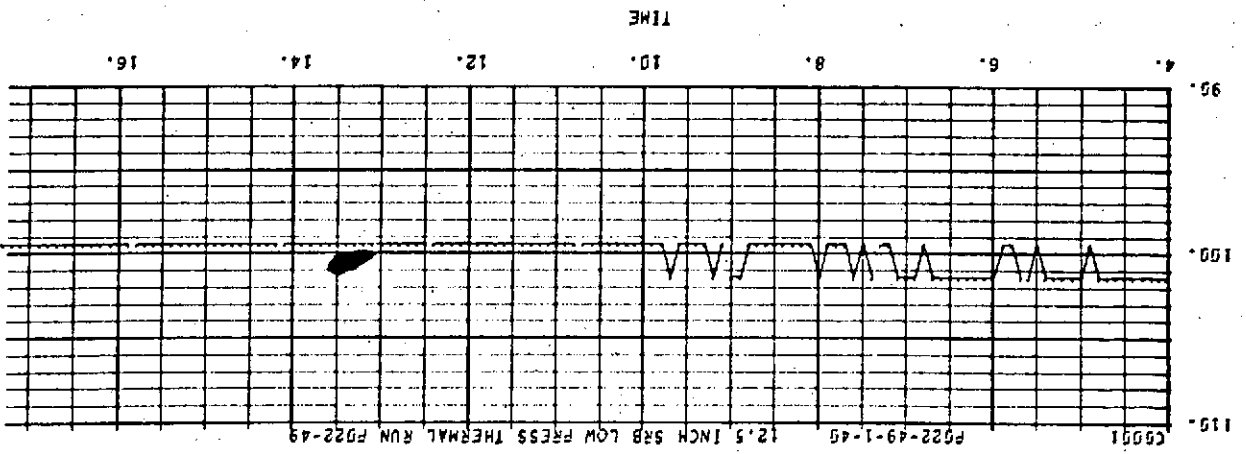
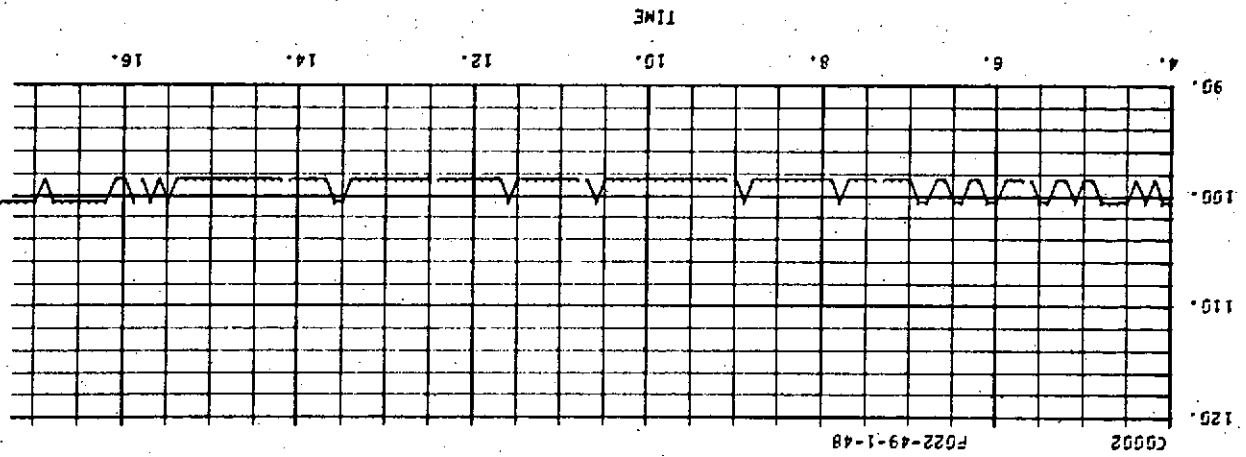
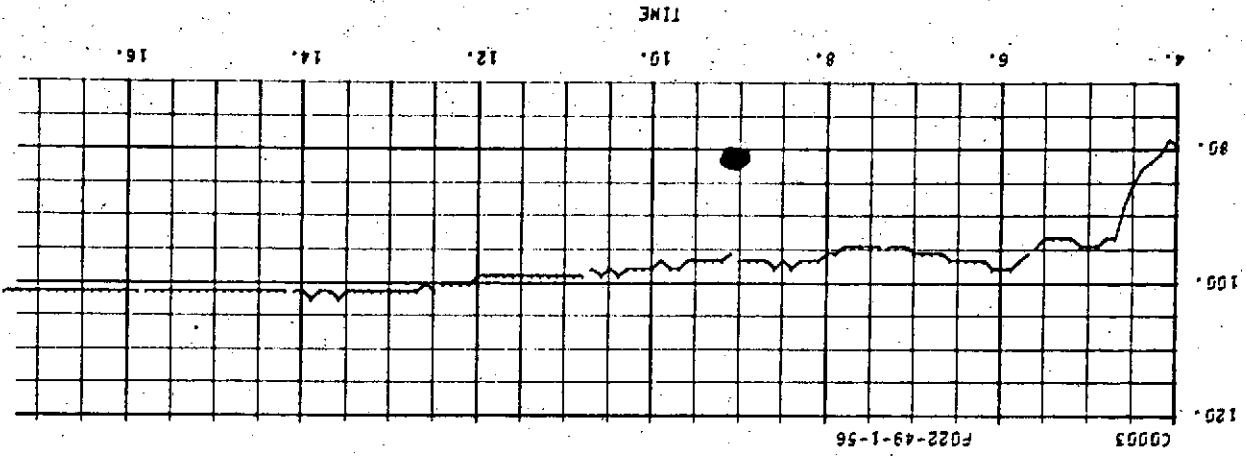

SEA. = 0038
12.5 INCH SRB LOW PRESS THERMAL RUN F022-49

SEQ. = 0038

9

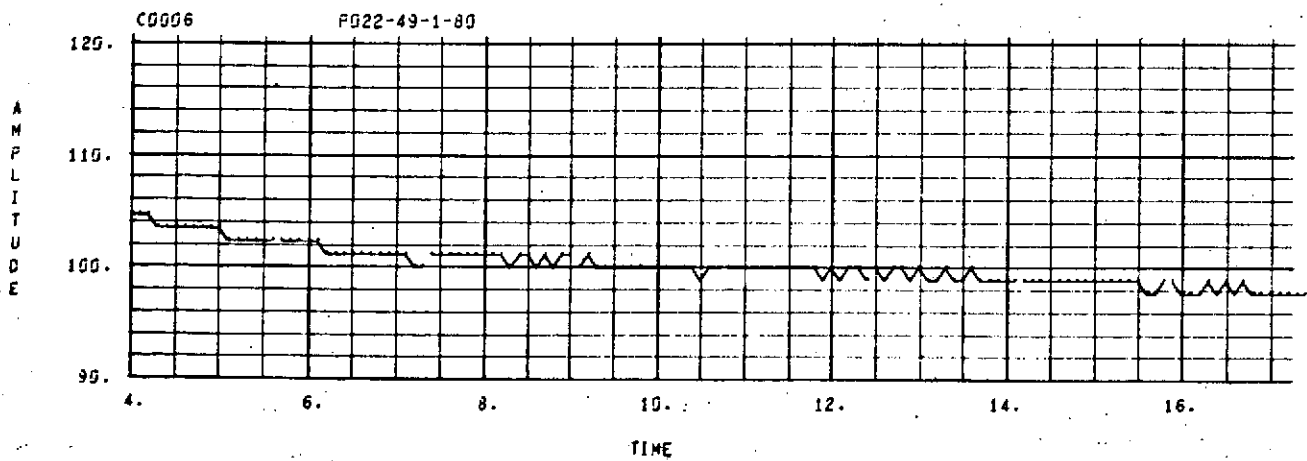
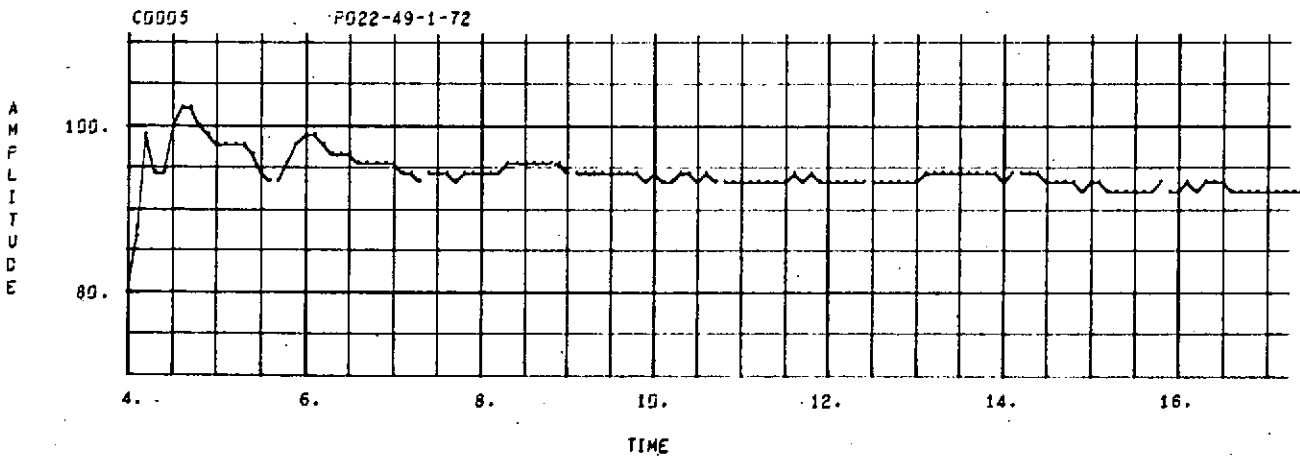
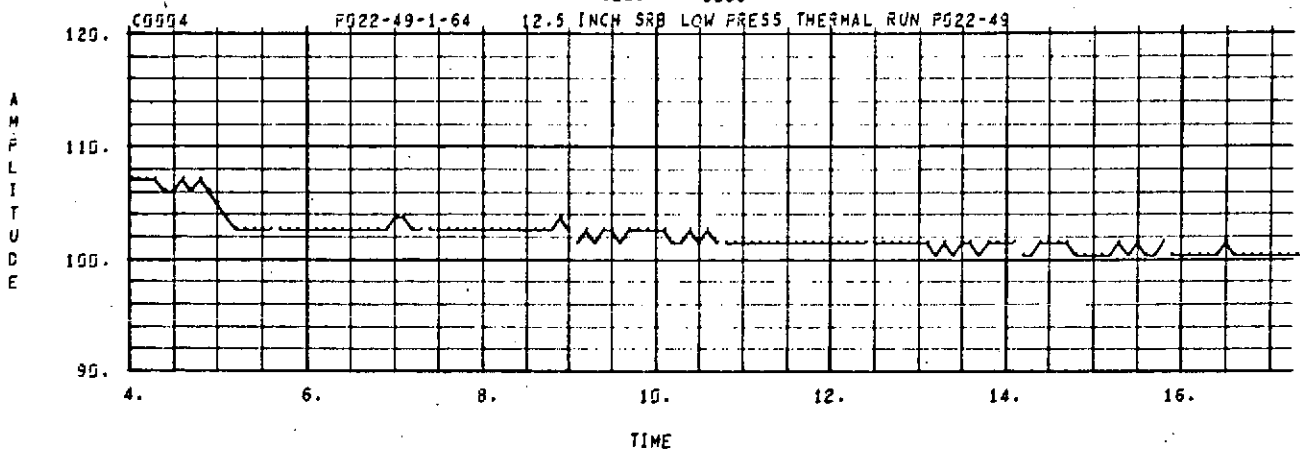

SEQ. = 0638

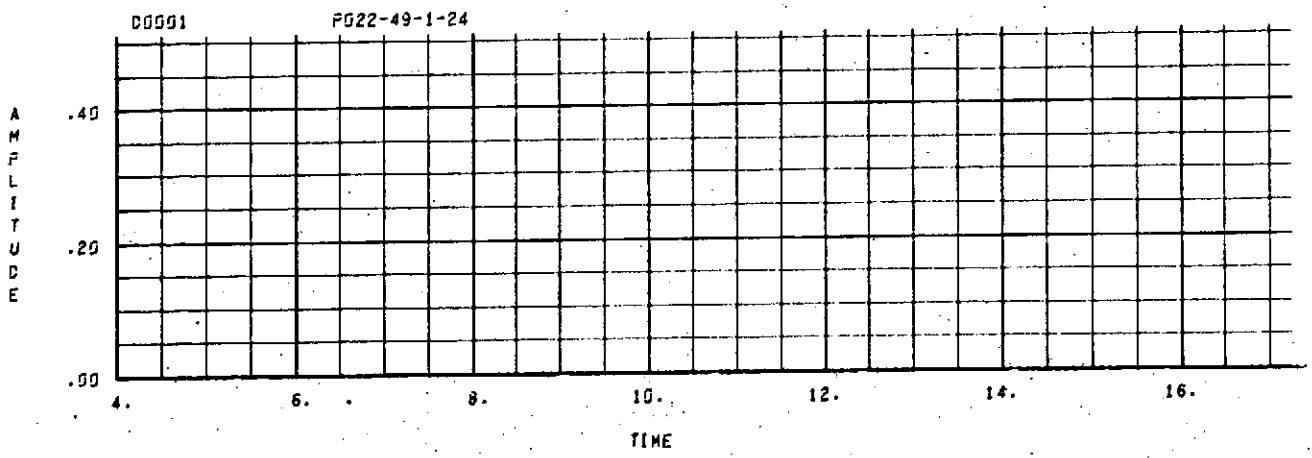
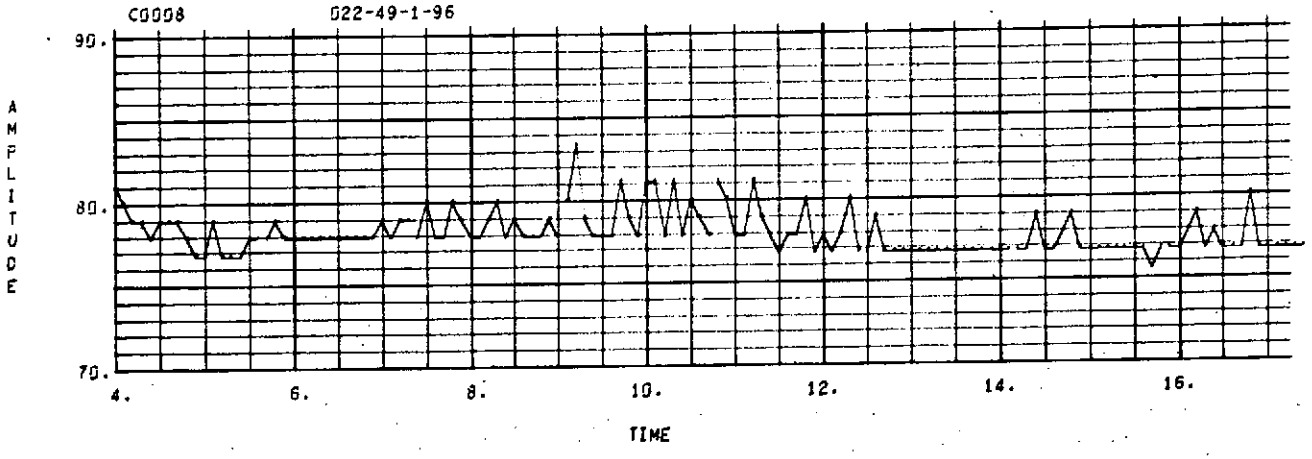
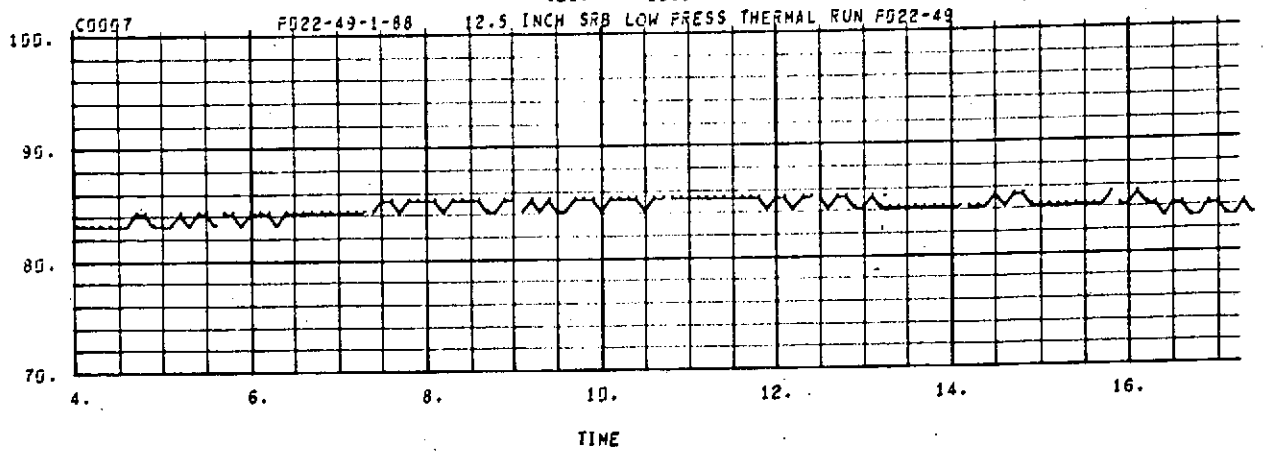

SEQ. = 0038

00002 022-49-1-32 12.5 INCH SRB LOW PRESS THERMAL RUN 022-49

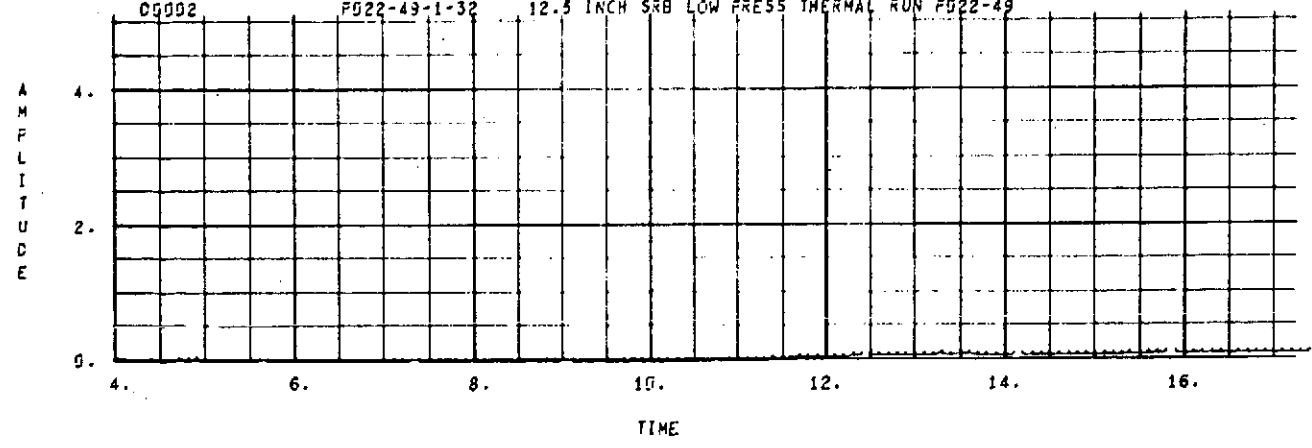

00003 022-49-FM13

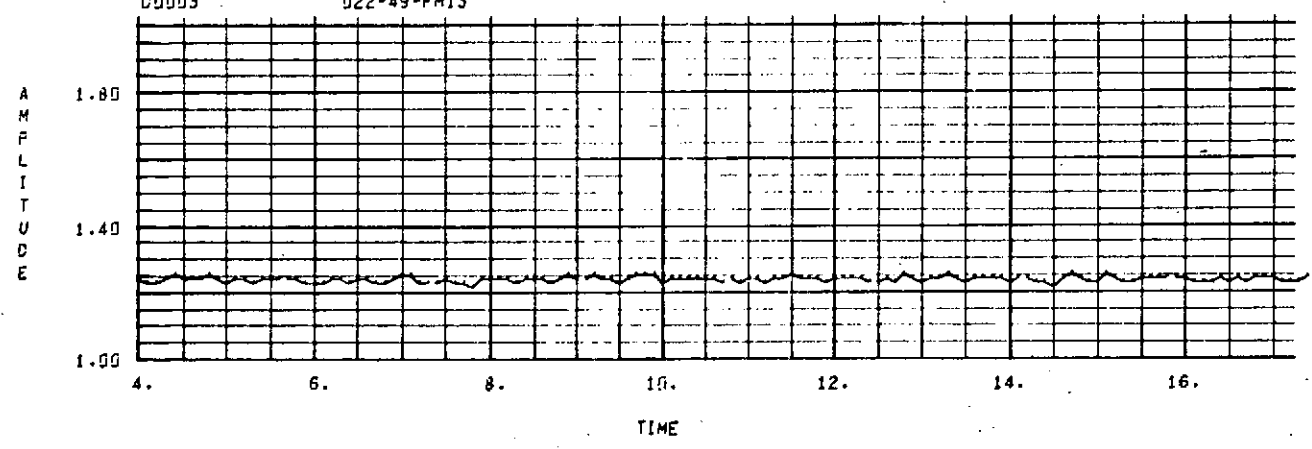

SEQ. = 0039

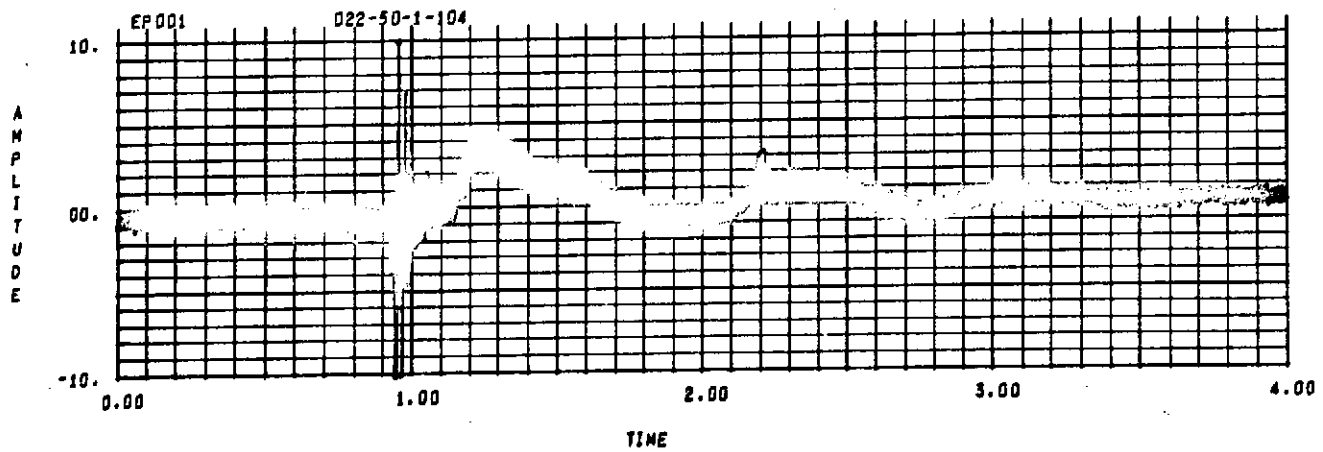
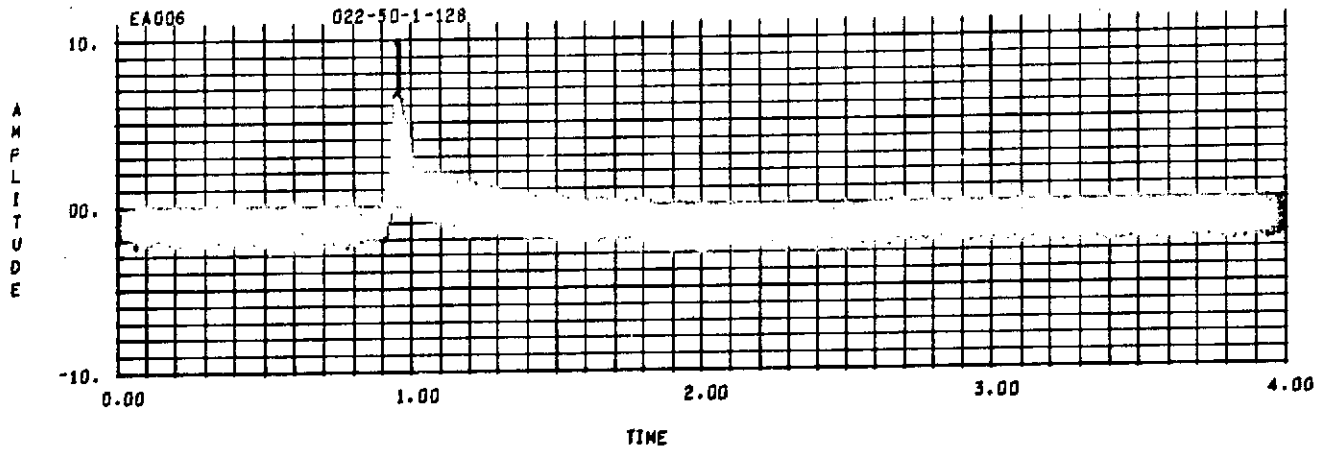
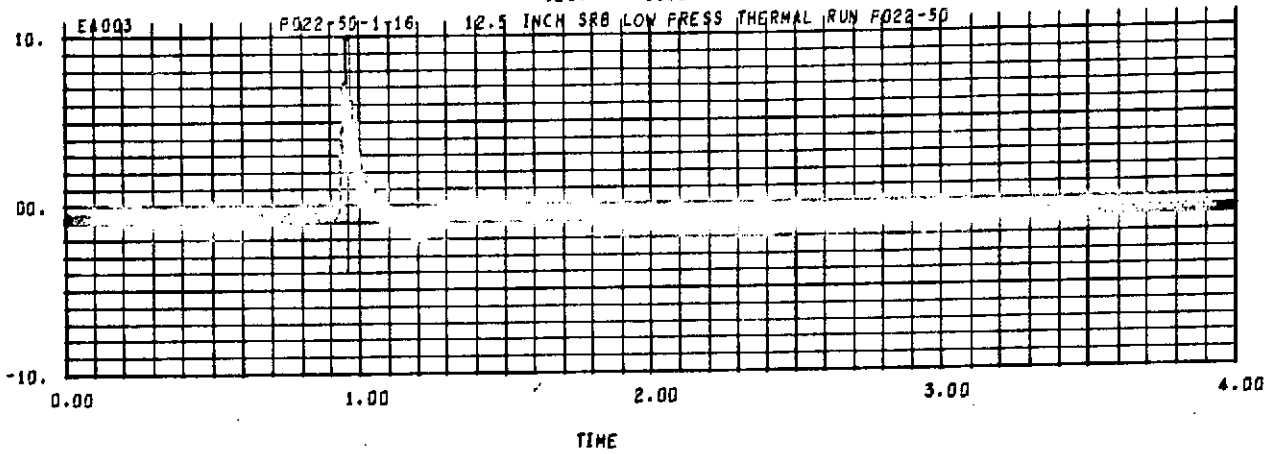

SEQ. = 0039

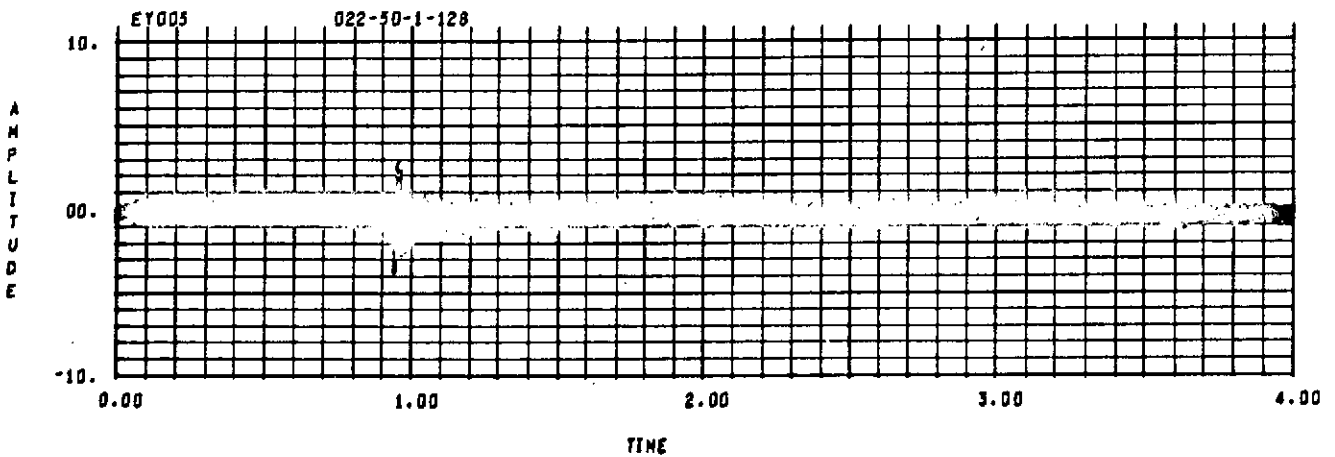
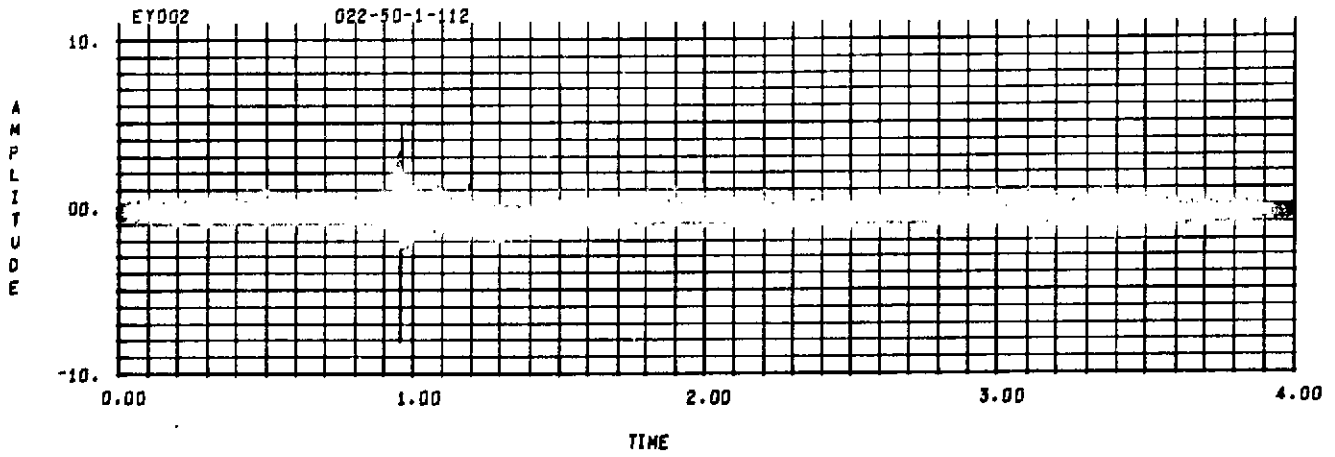
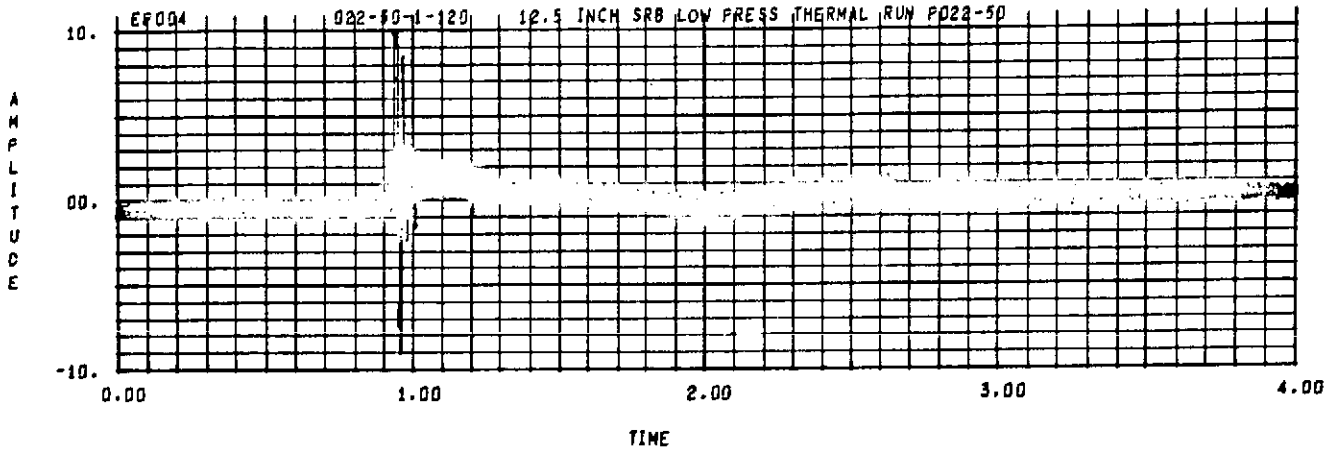

SEQ. = 0039

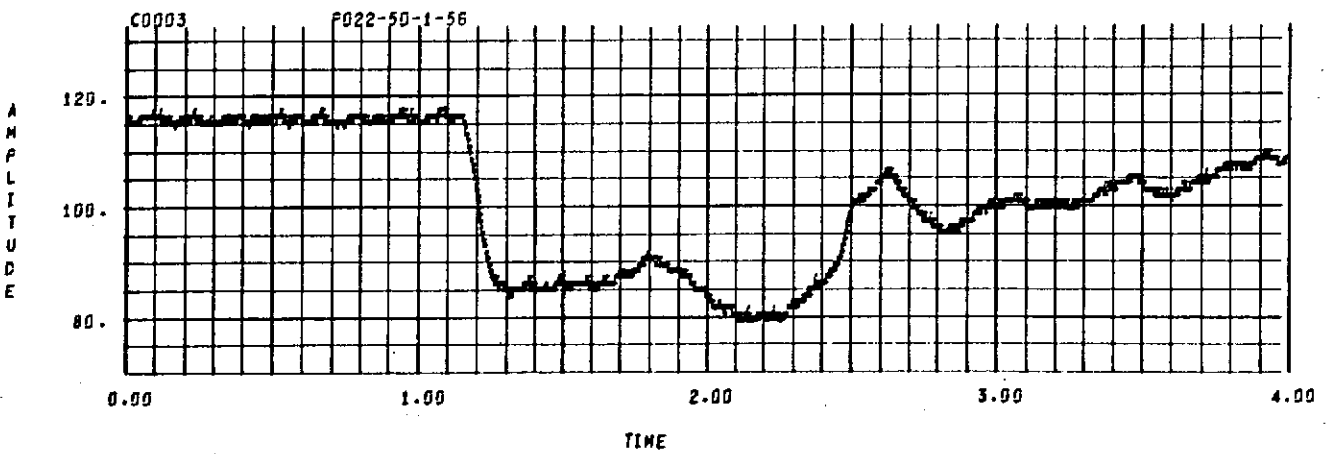
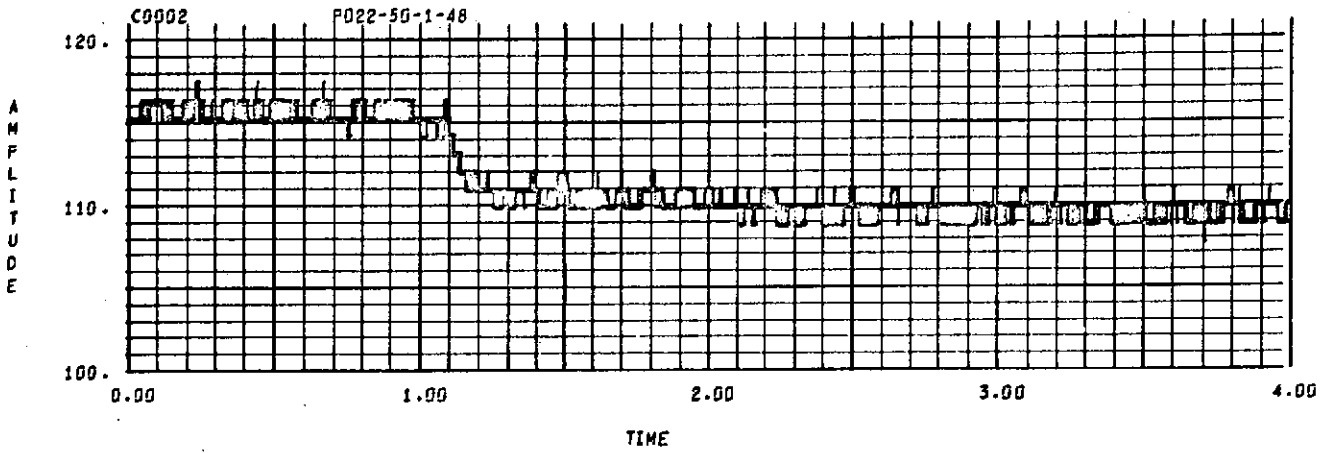
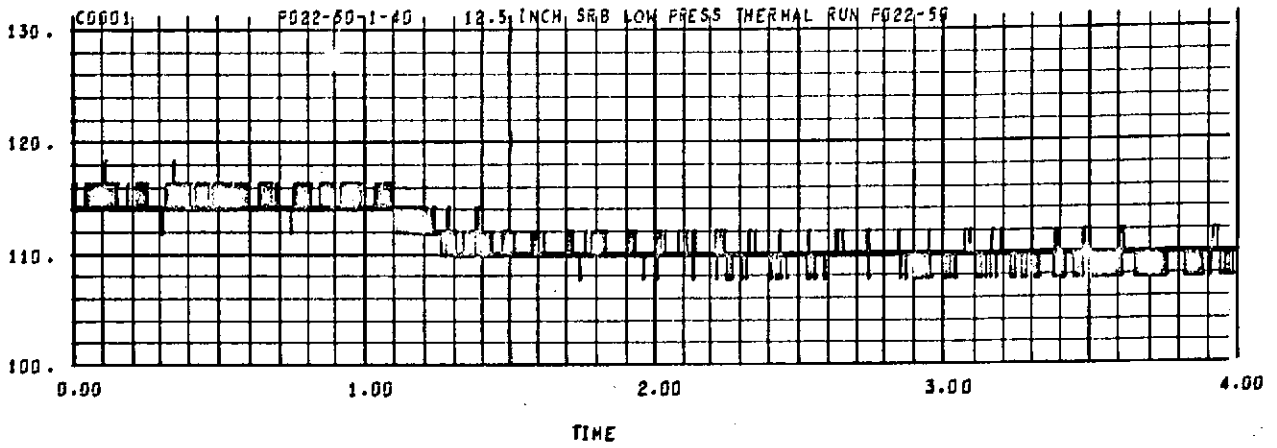

SEQ. = 0039

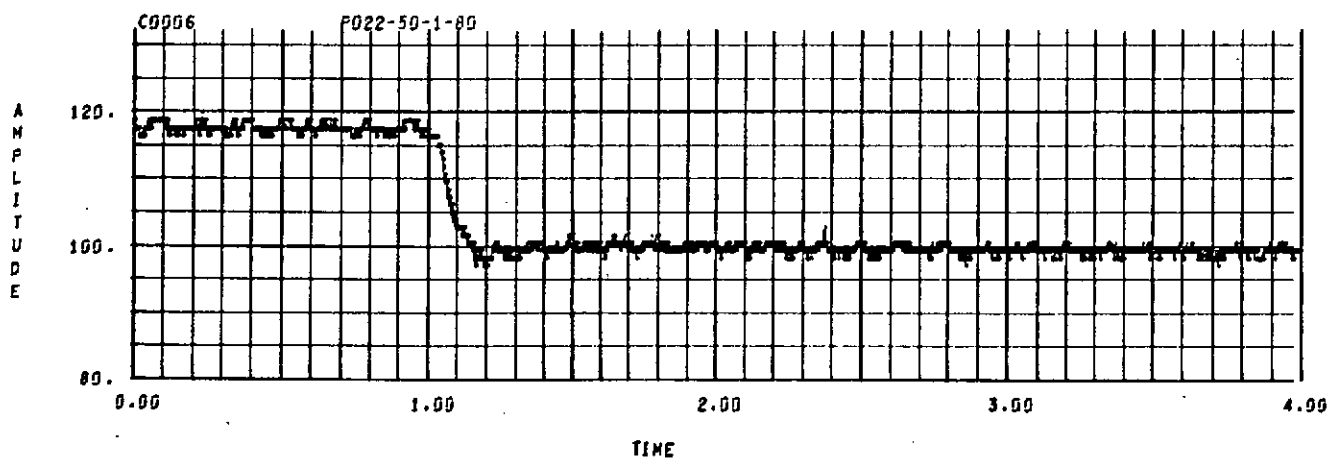
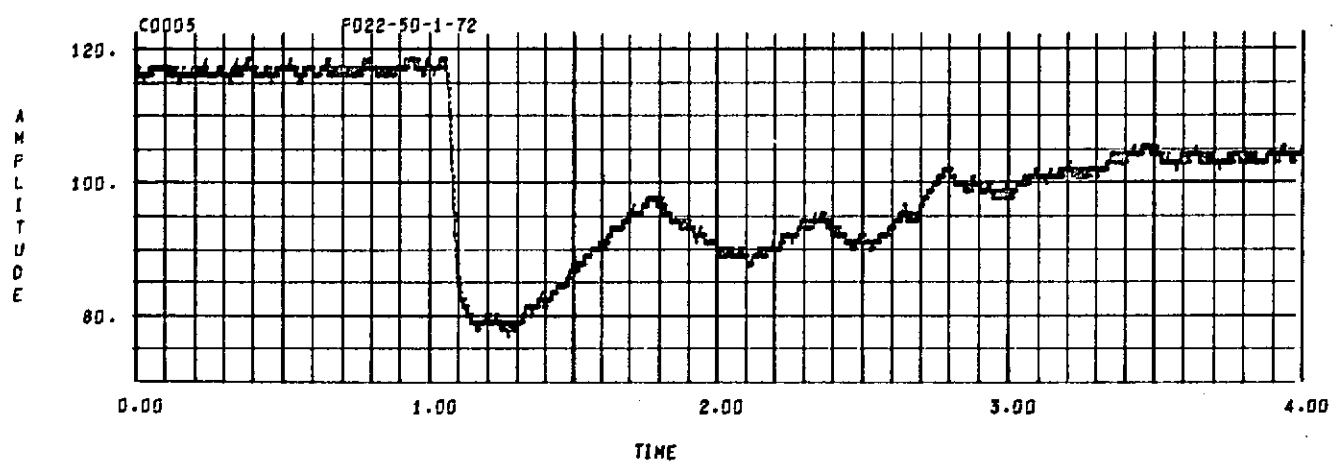
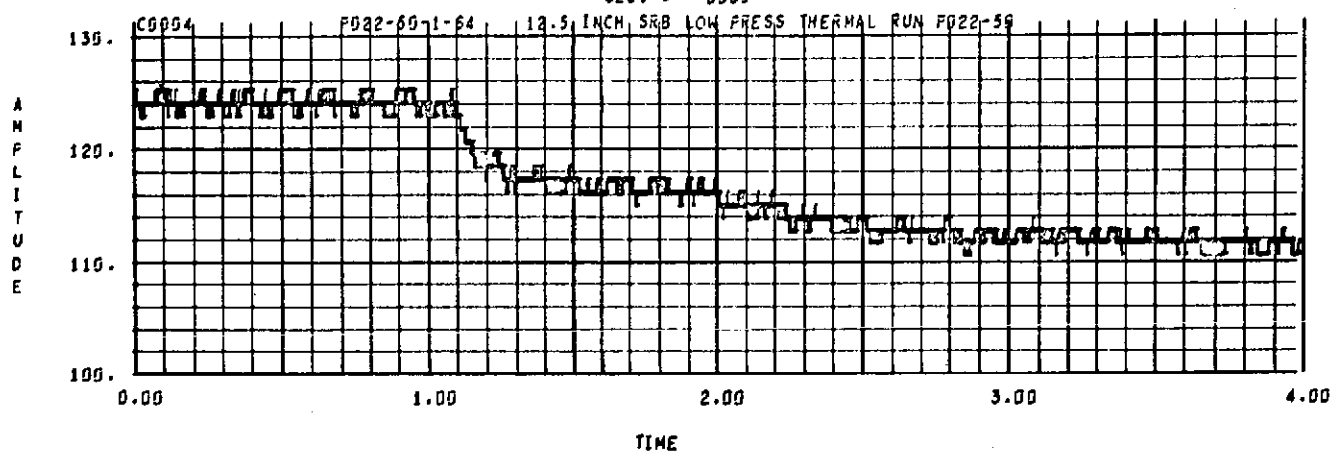



SEQ. = 0039

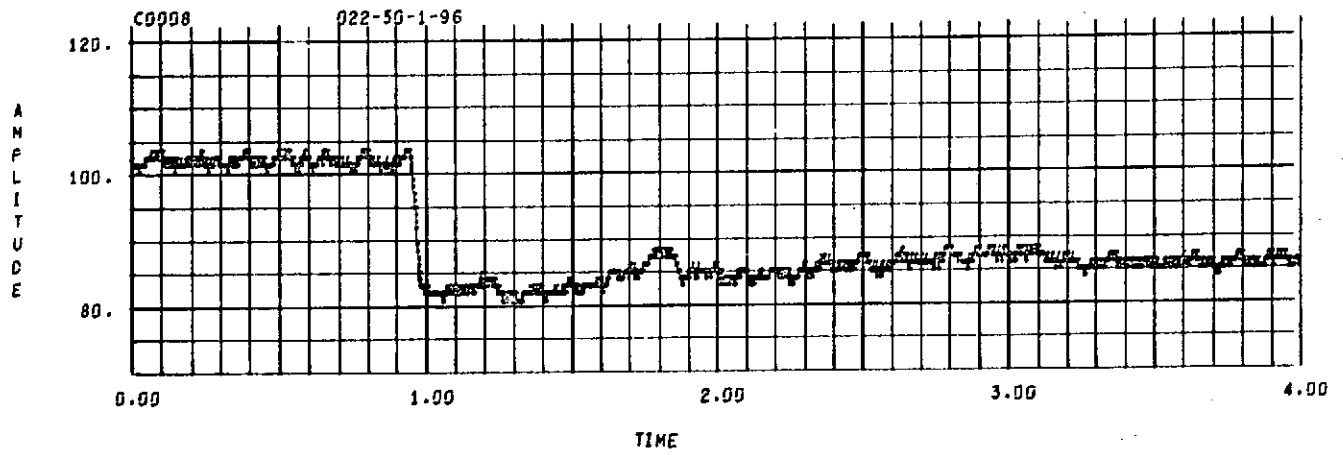
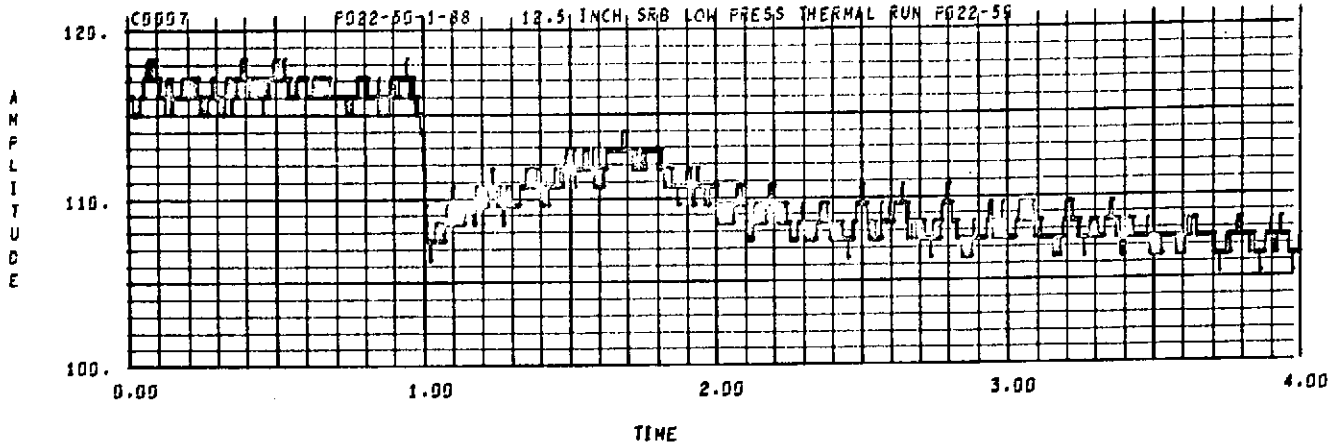

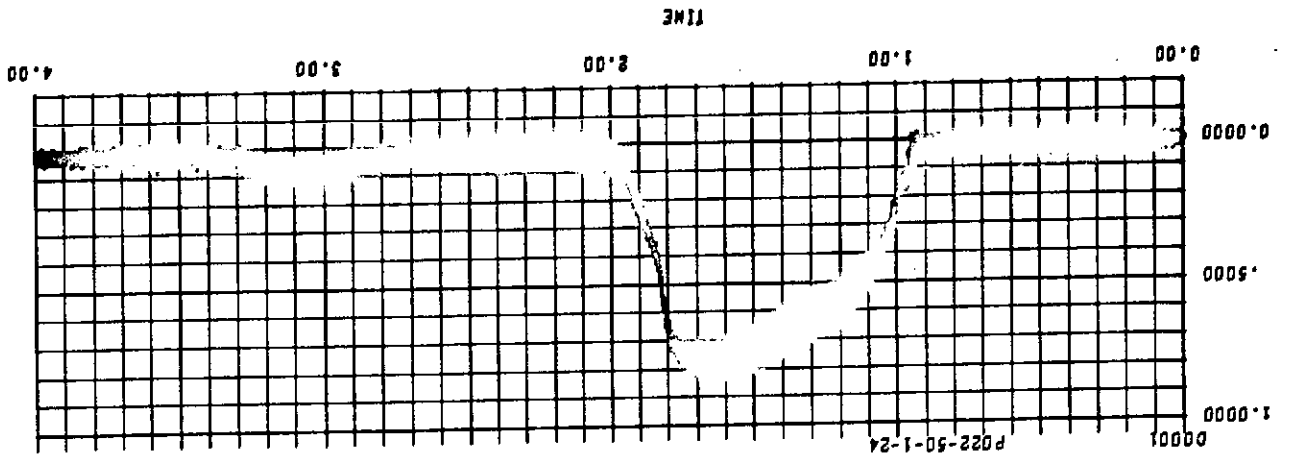
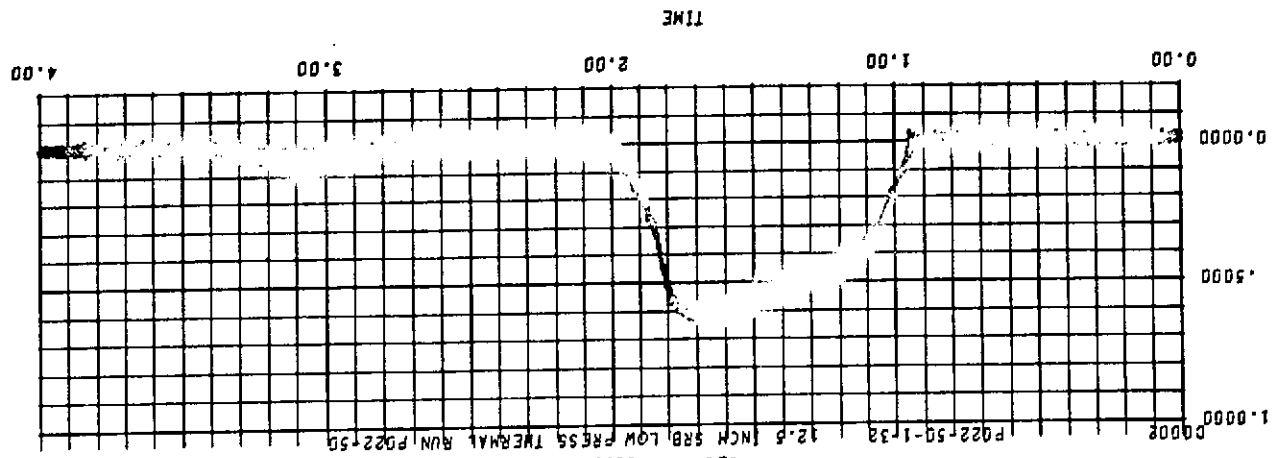
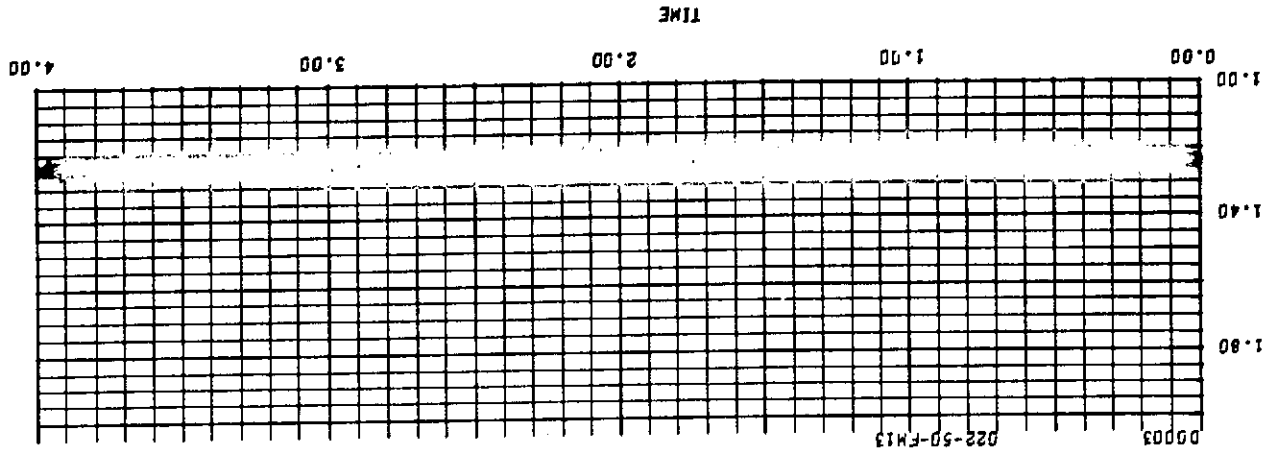

SEQ. = 0039

8

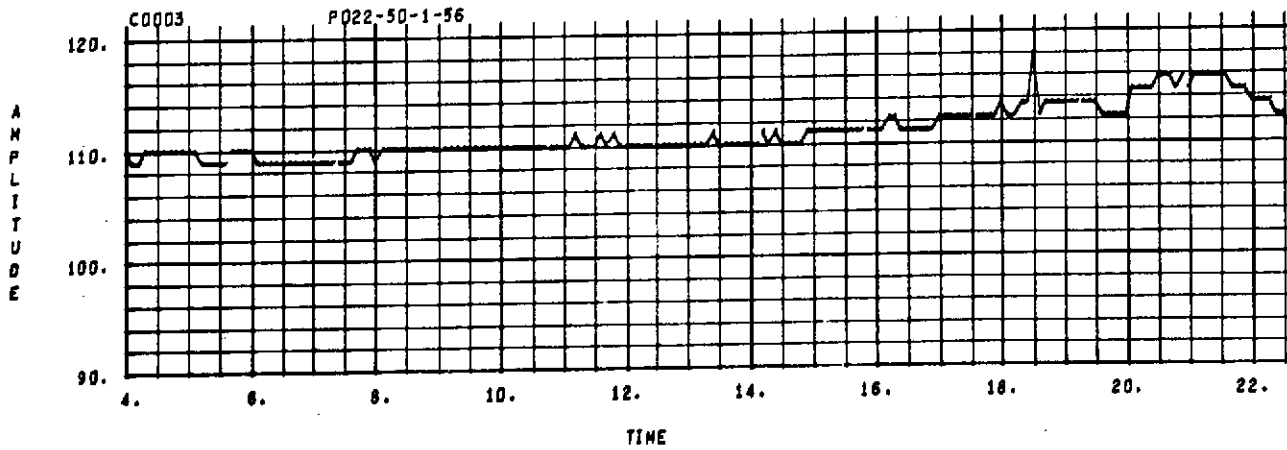
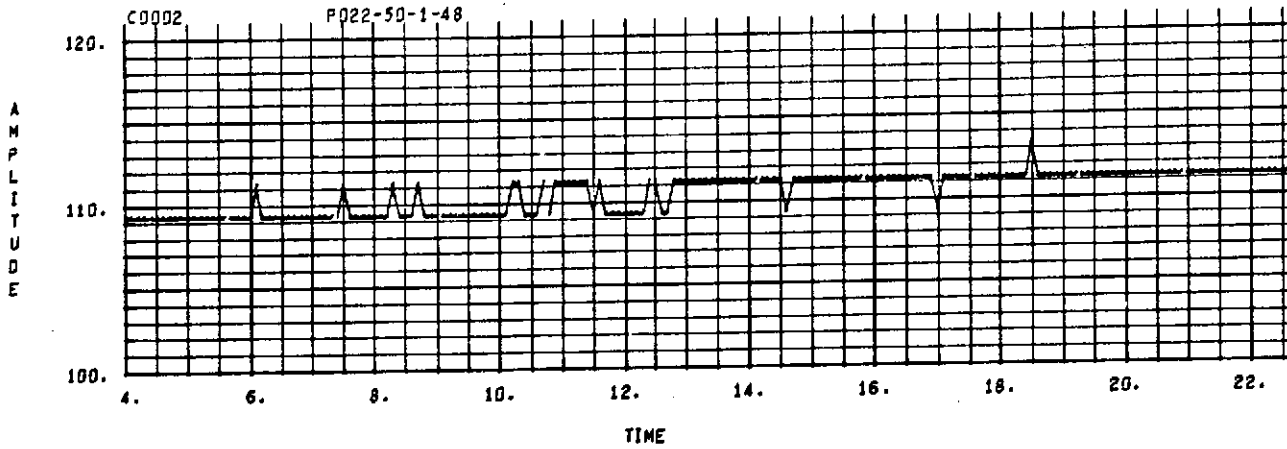
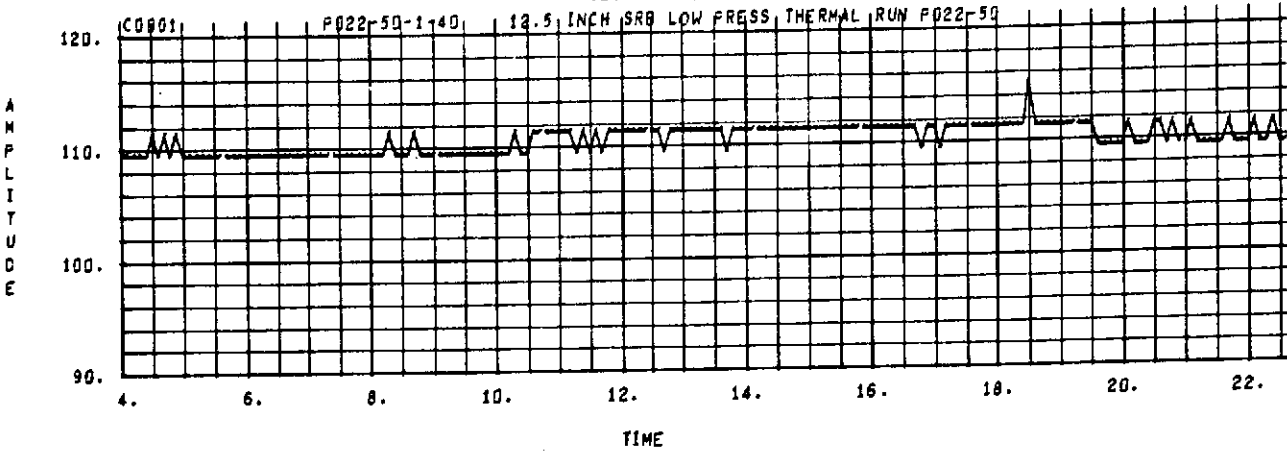



SEQ. = 0039

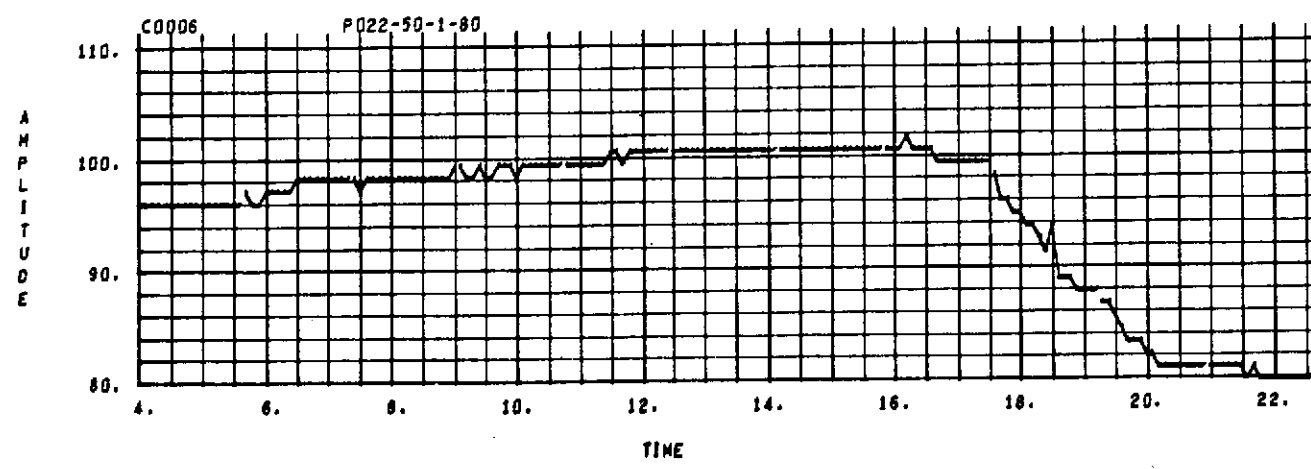
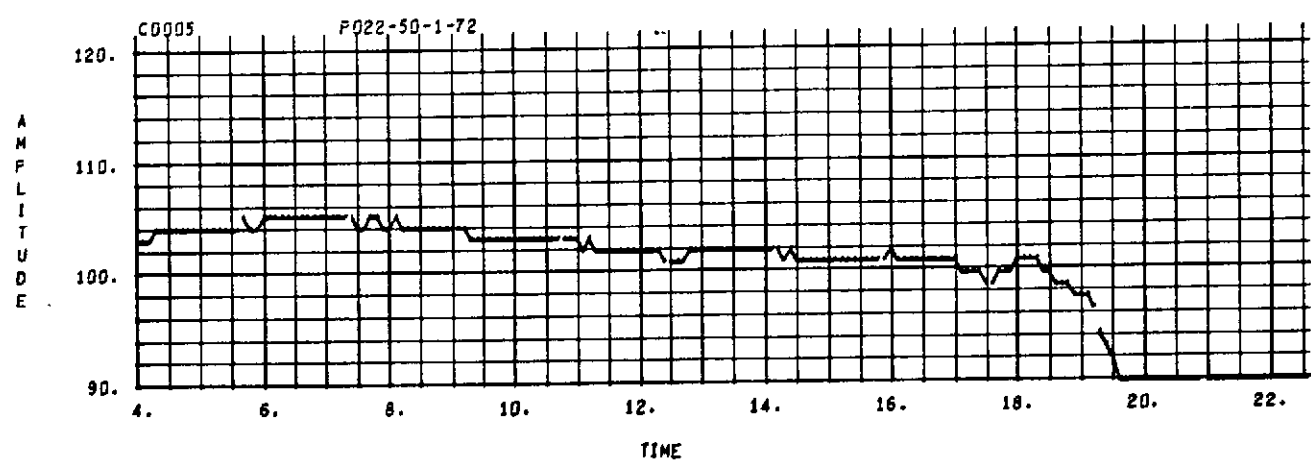
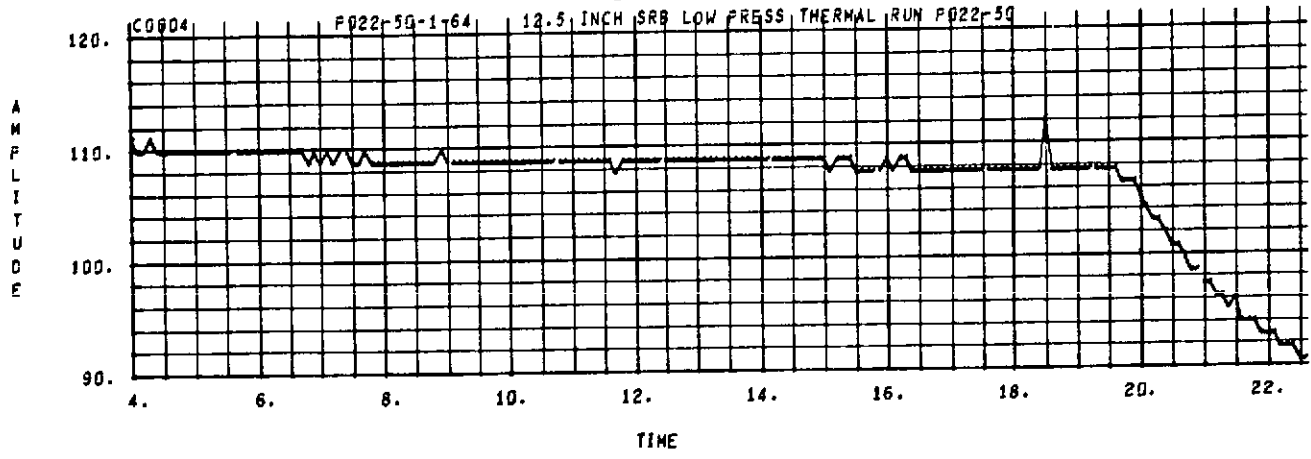

SEQ. = 0039

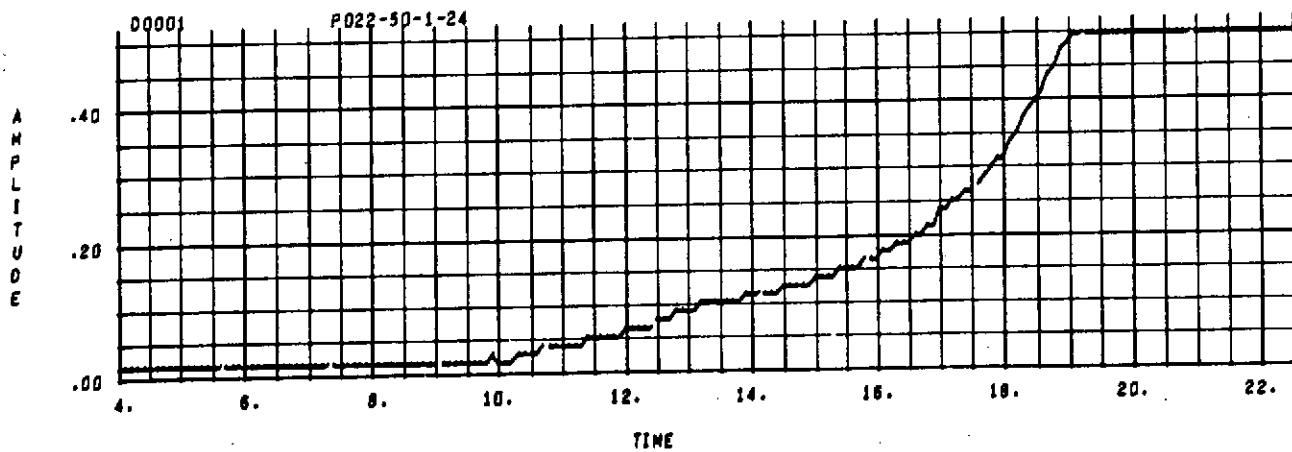
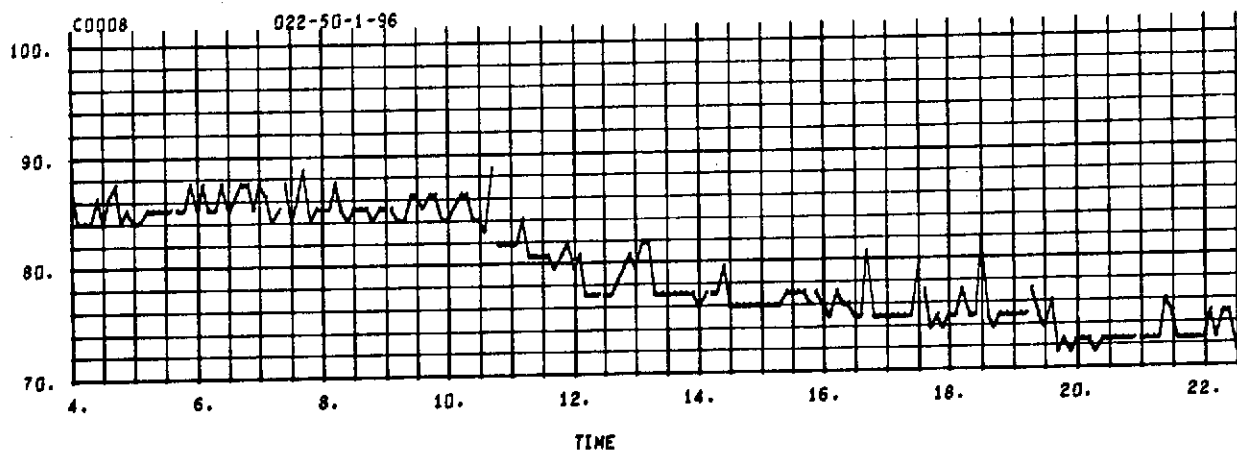
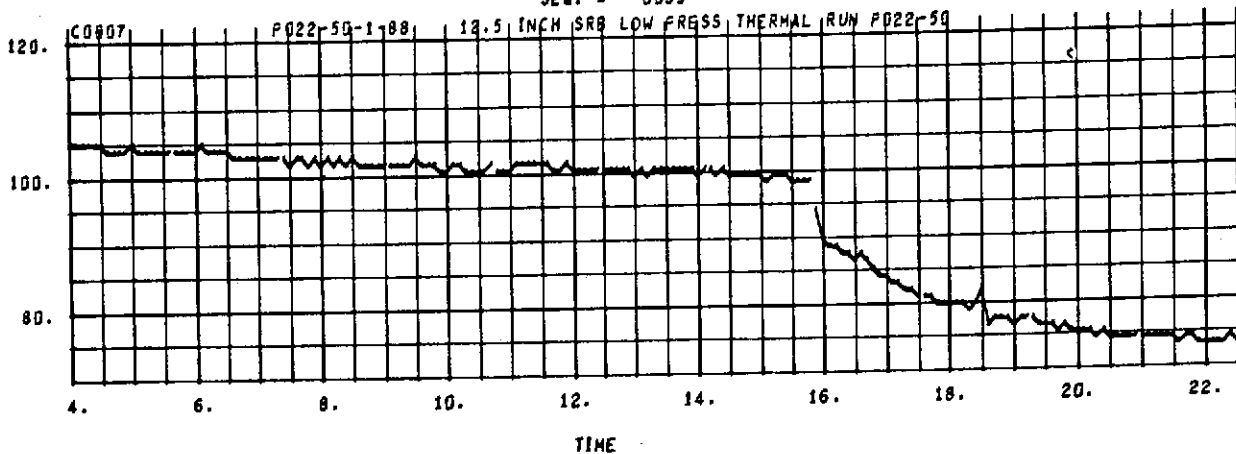

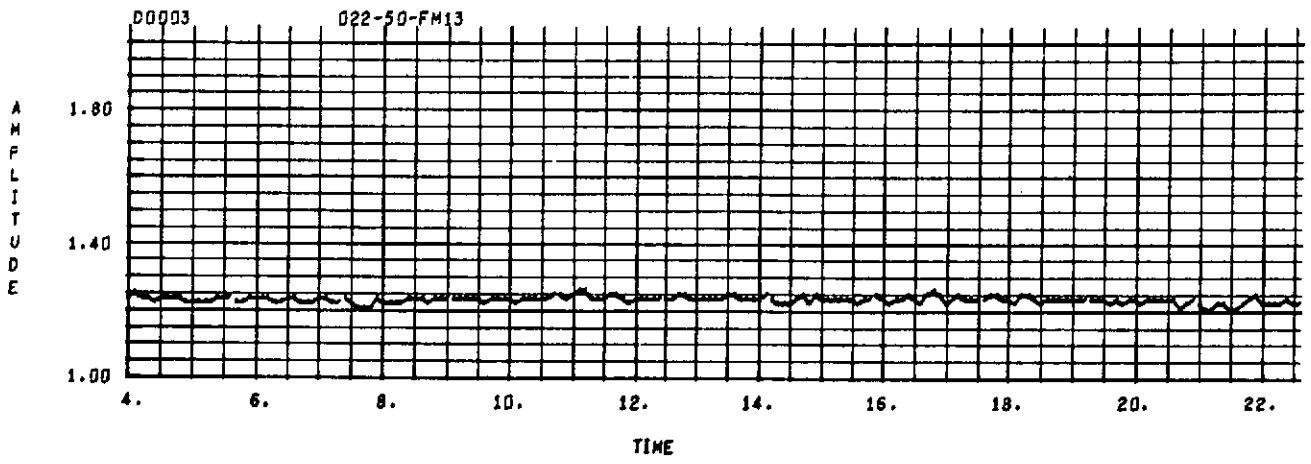
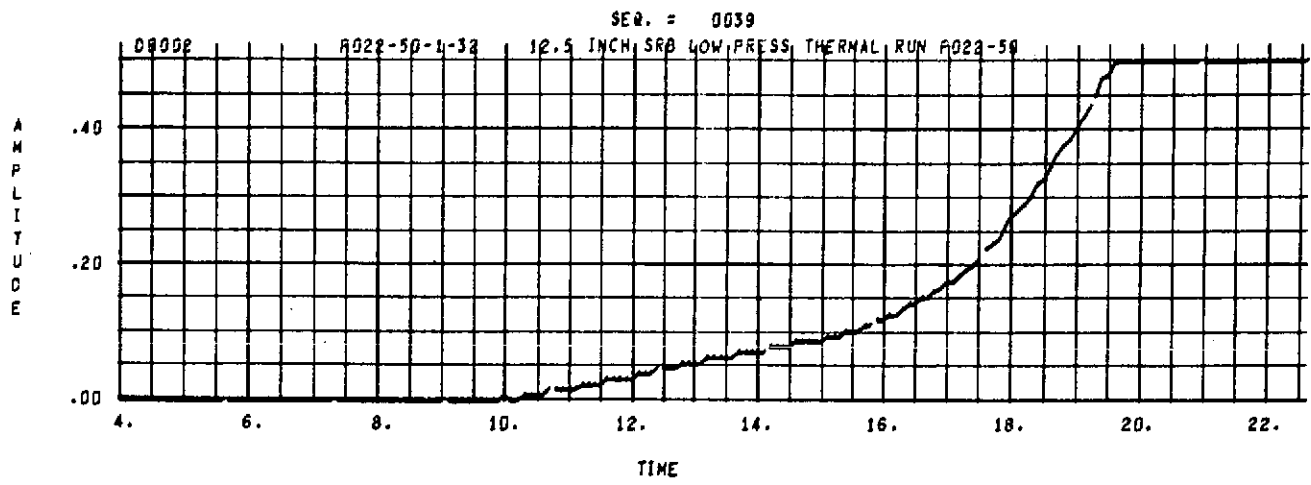

SEQ. = 0040

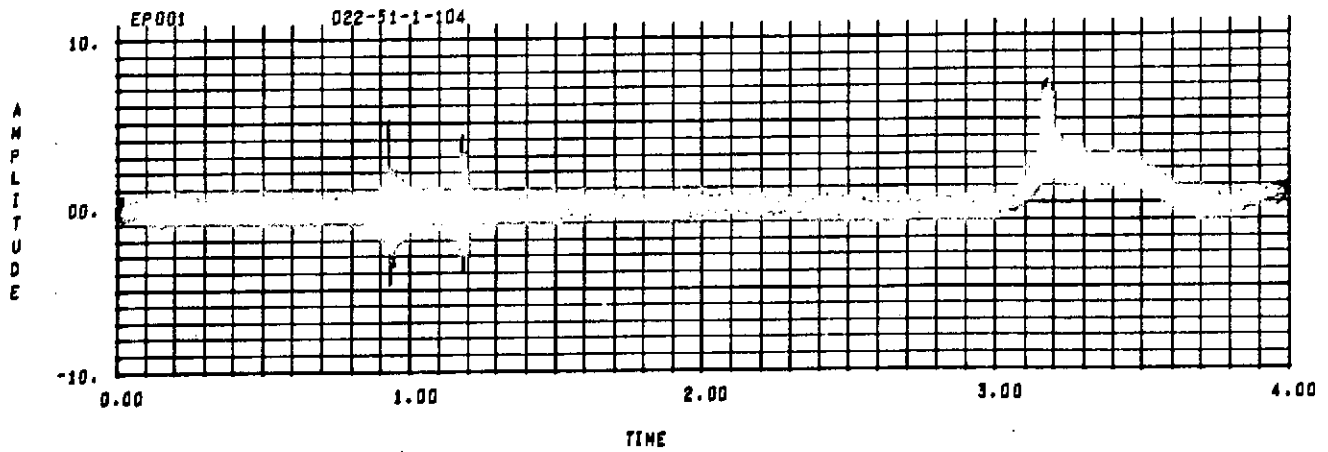
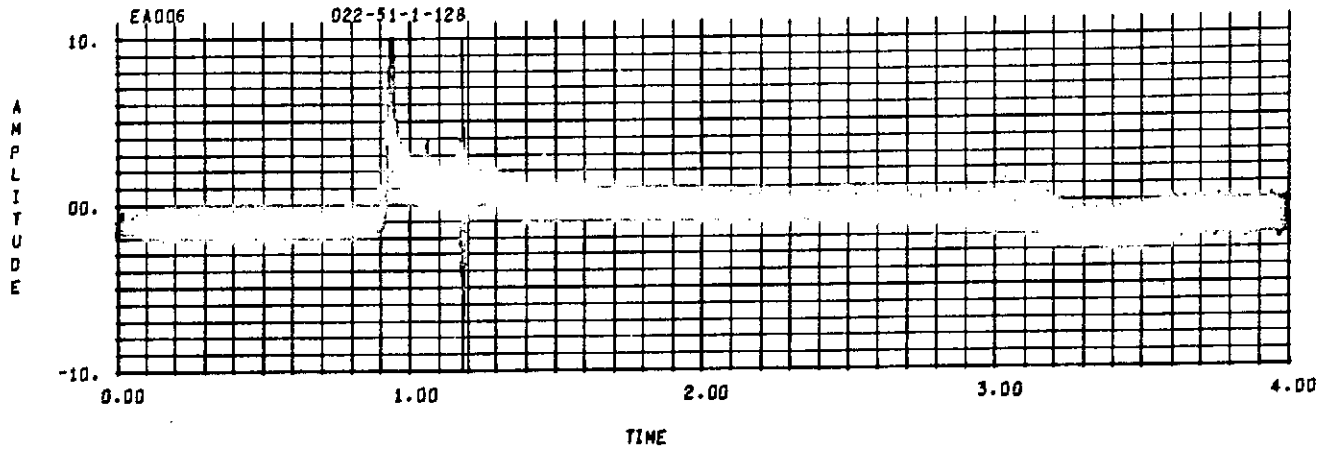
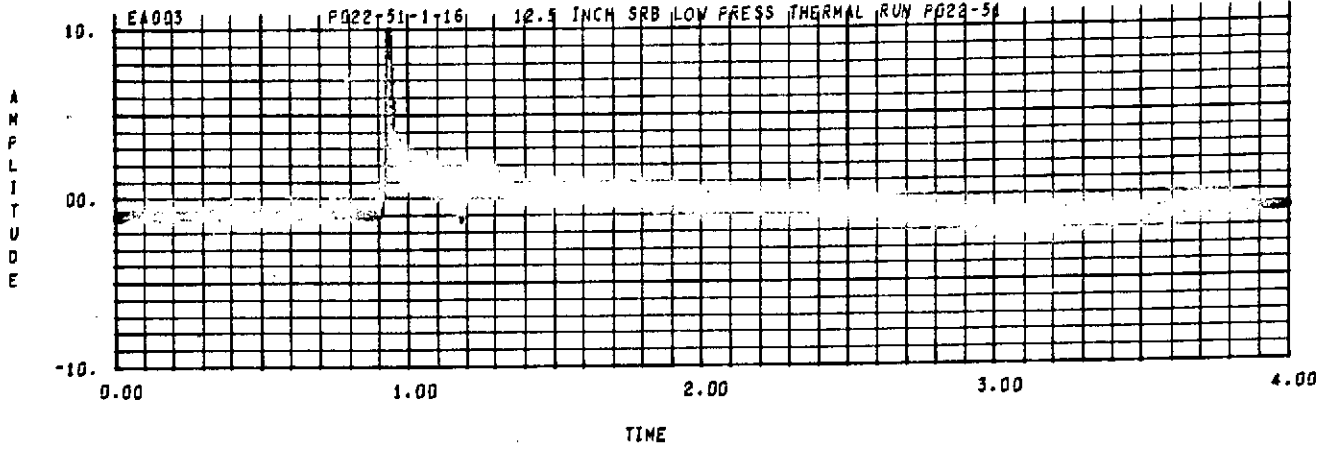

①-11

B-190

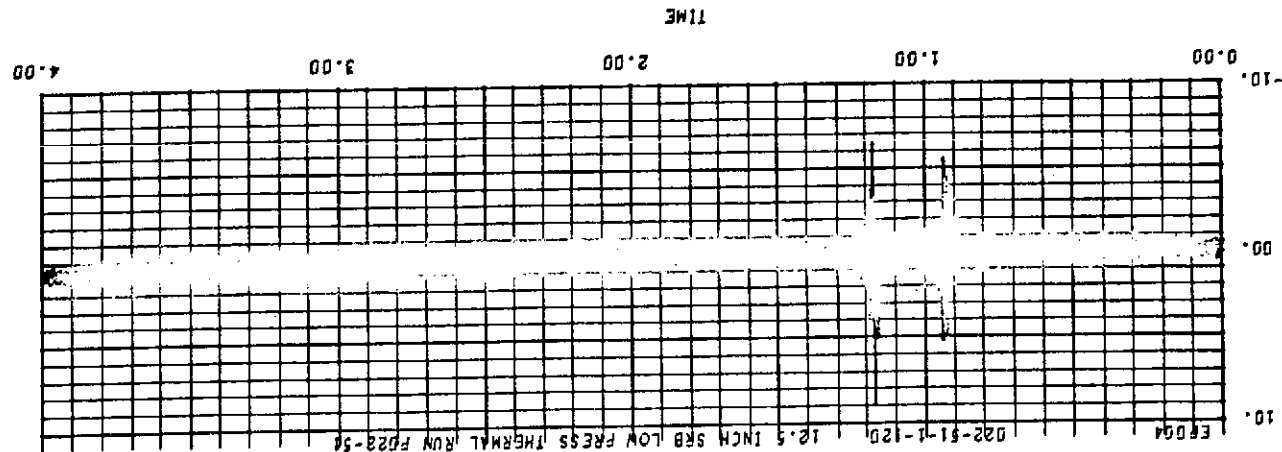
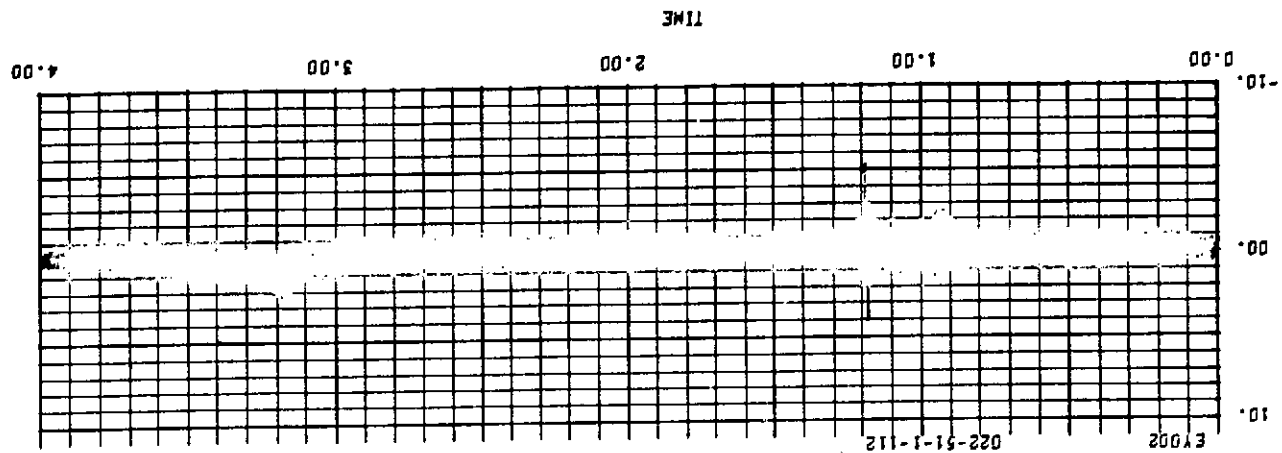
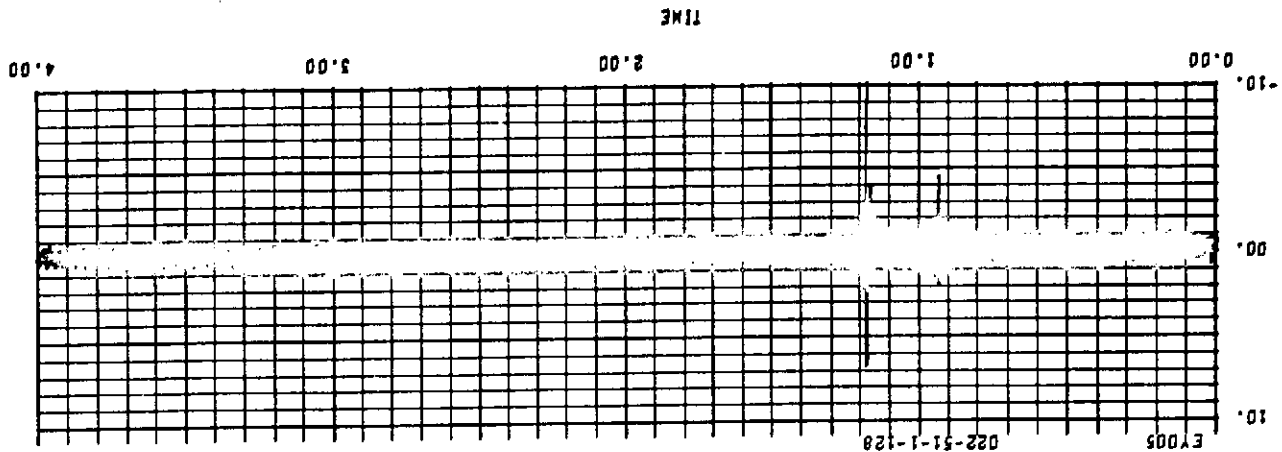

SEB. = 0040 022-51-1-120 12.5 INCH SRB LOW PRESS THERMAL RUN F022-51



SEQ. = 0040

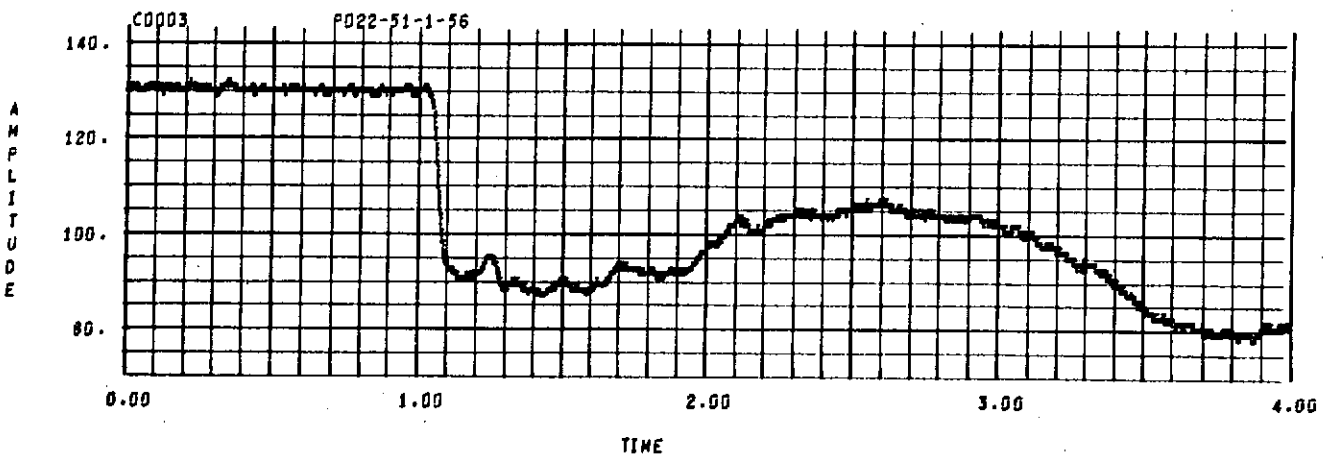
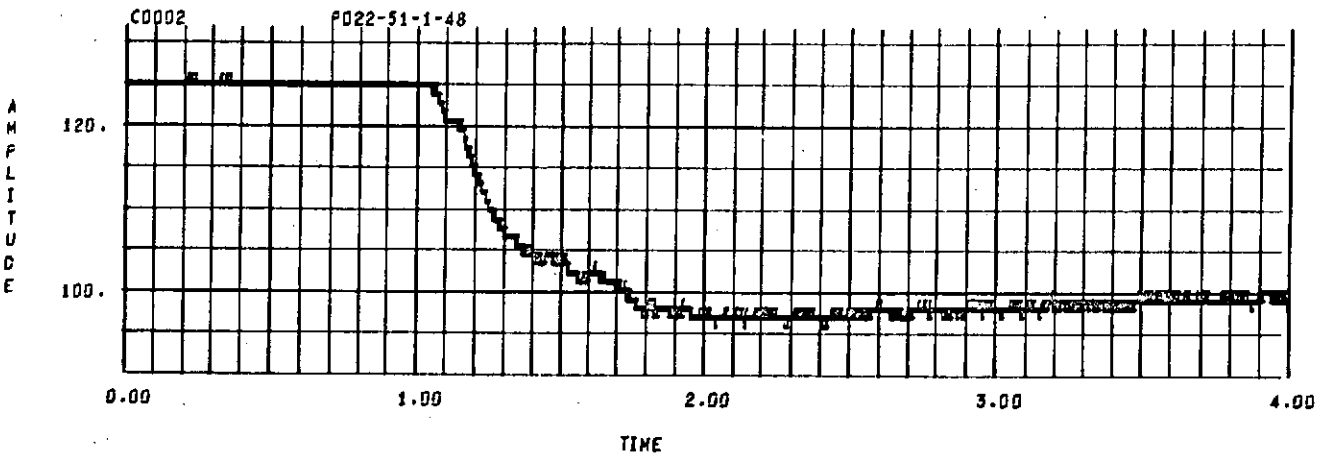
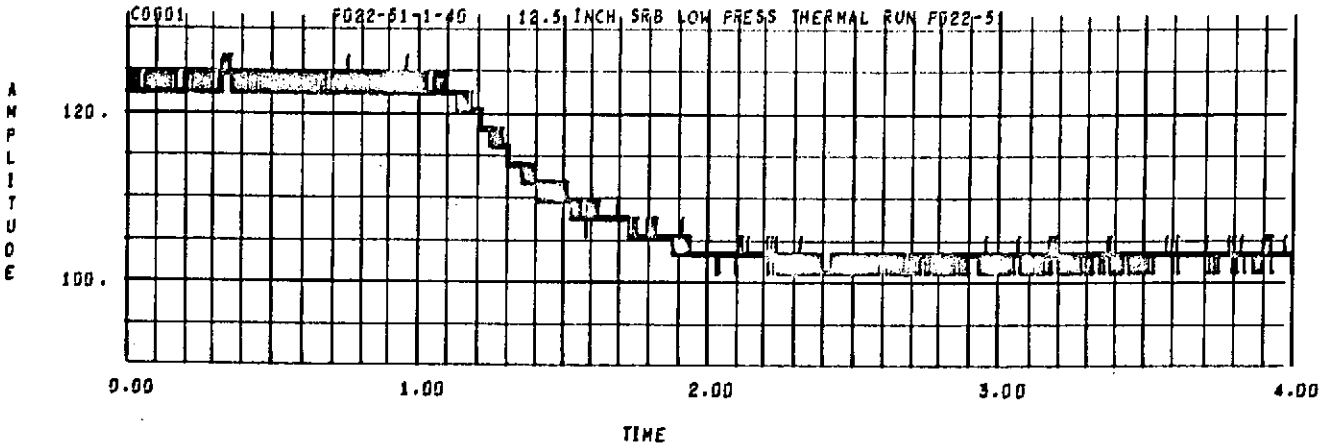

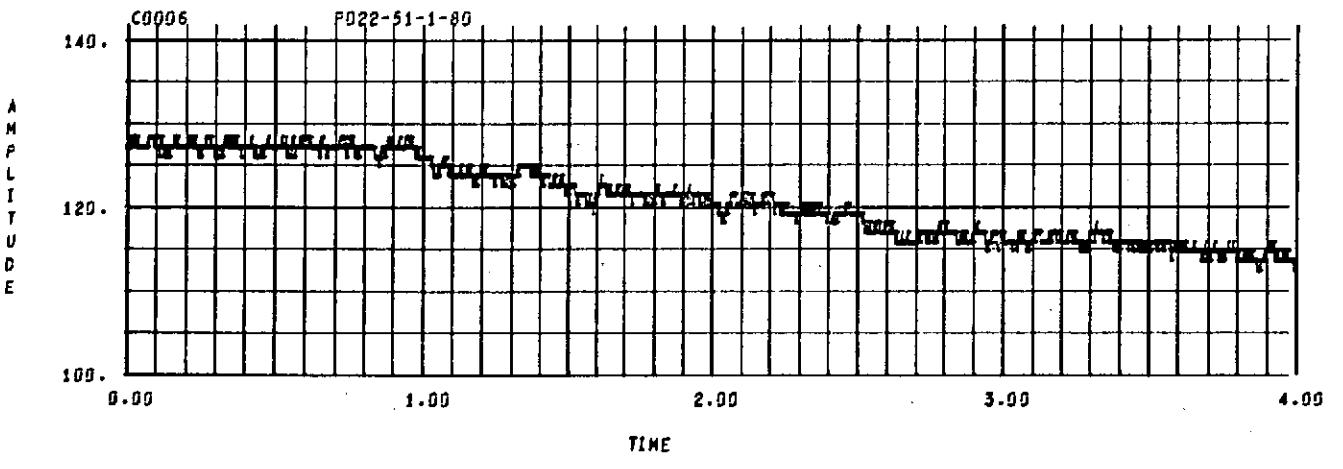
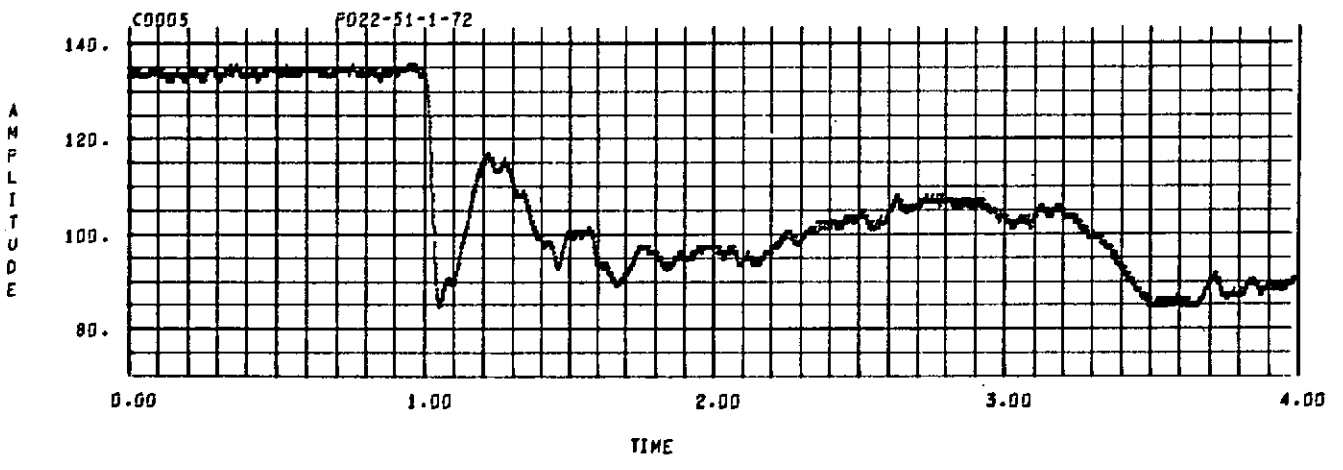
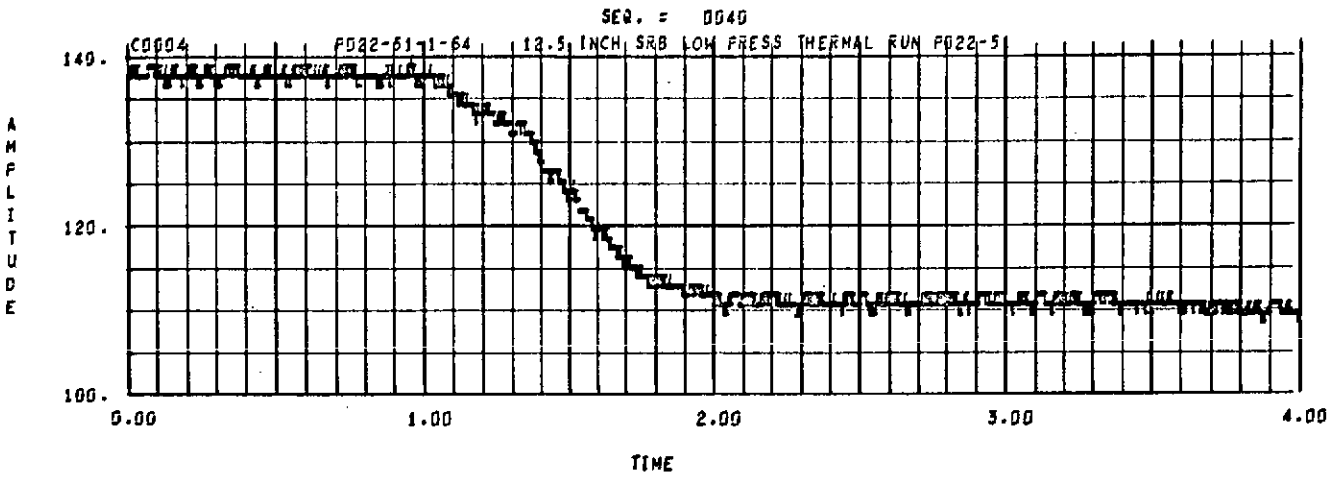

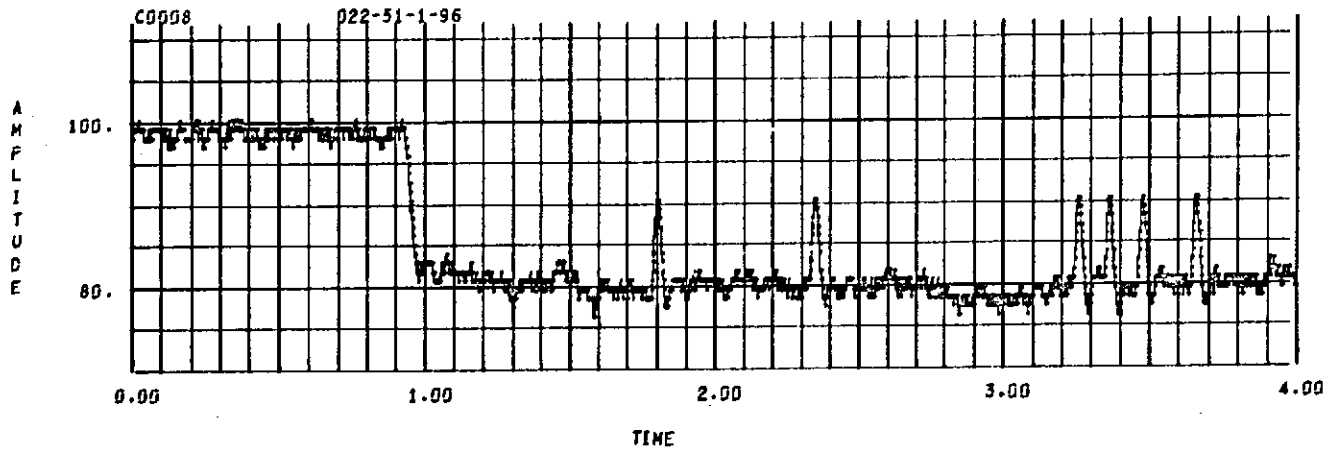
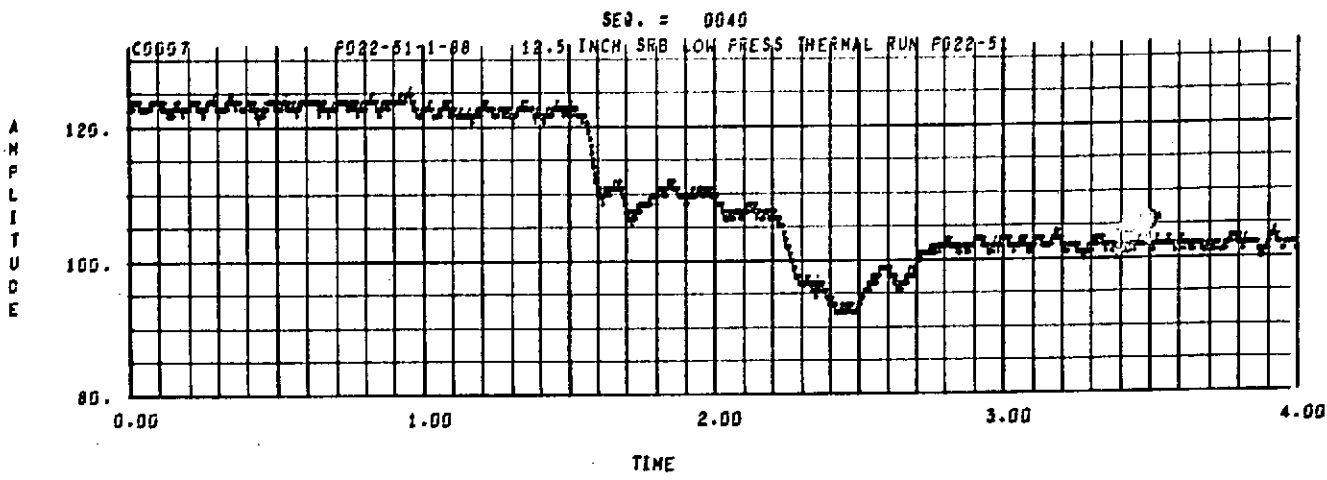

SEQ. = 0040

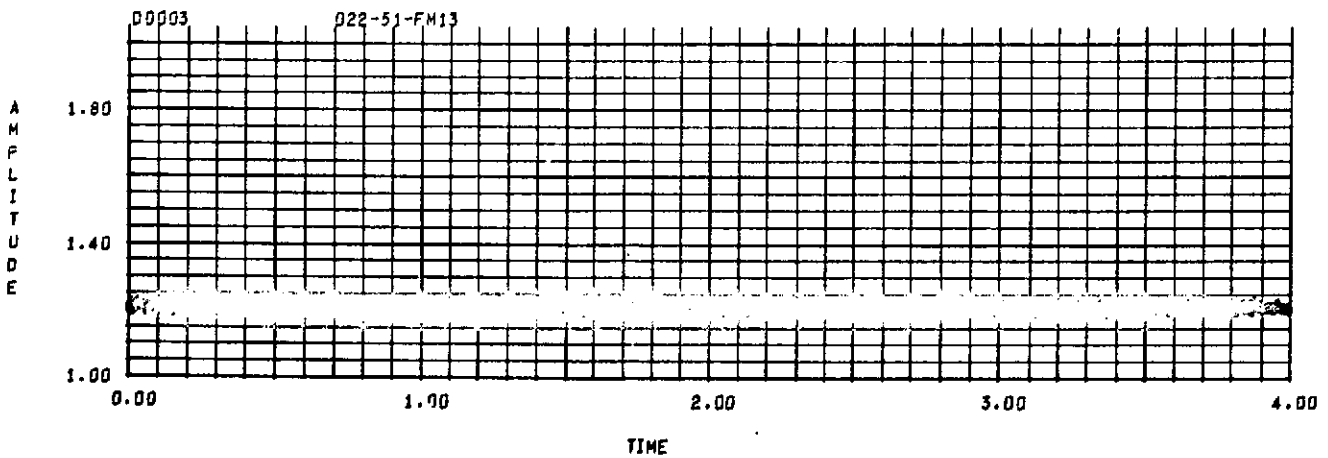
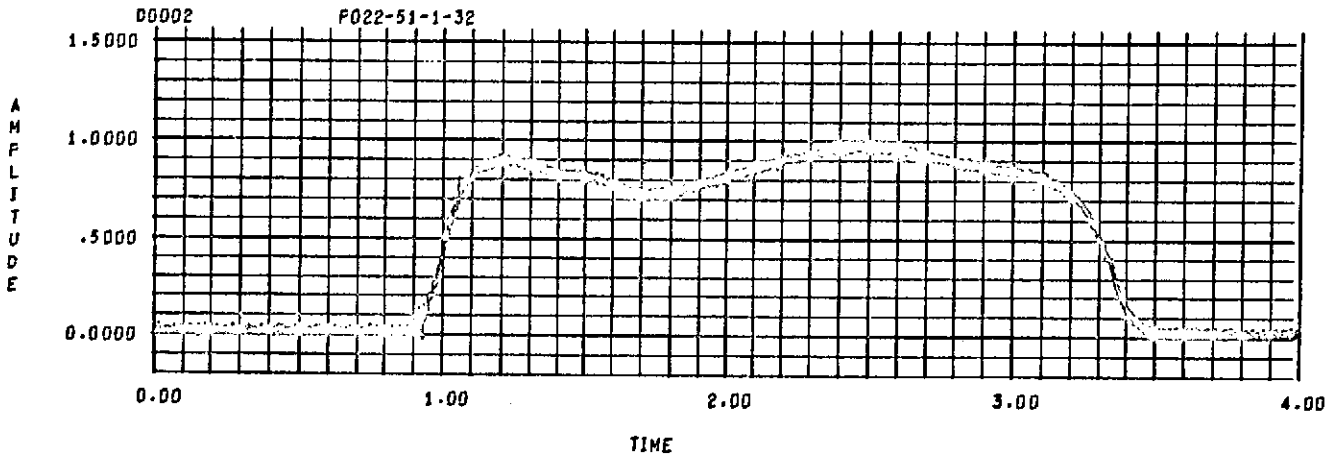
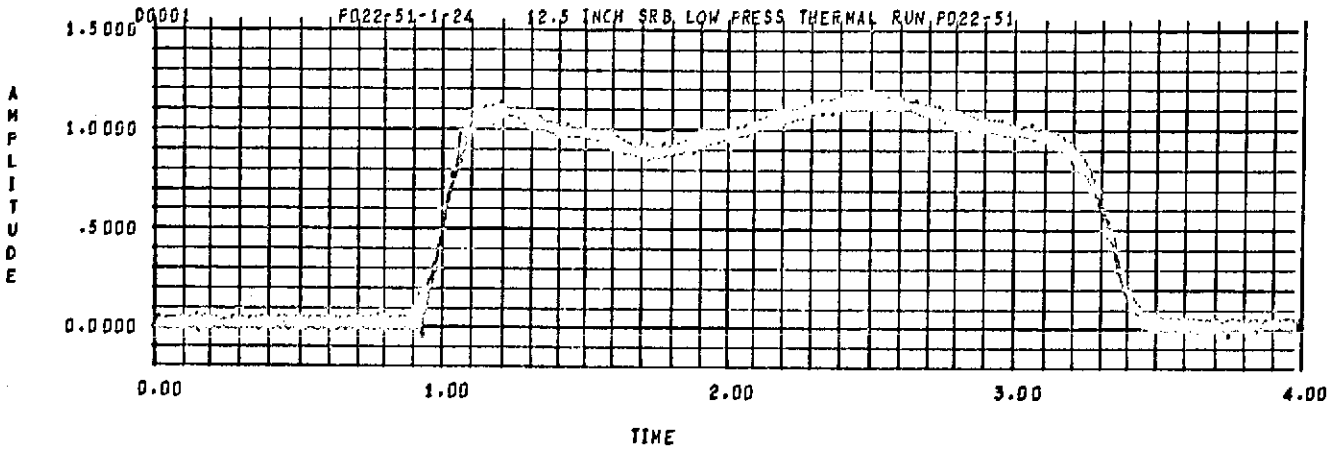

SEQ. = 0040

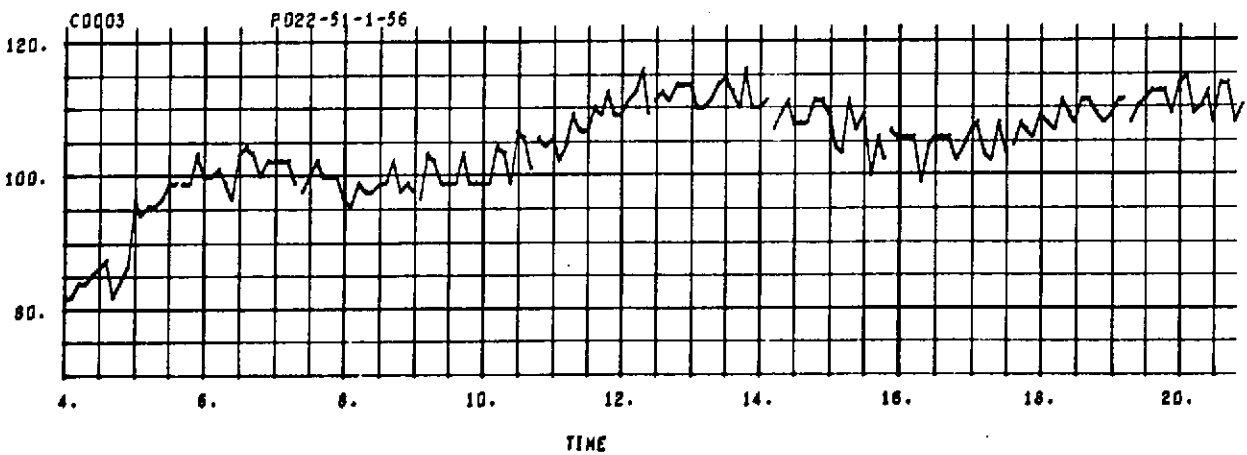
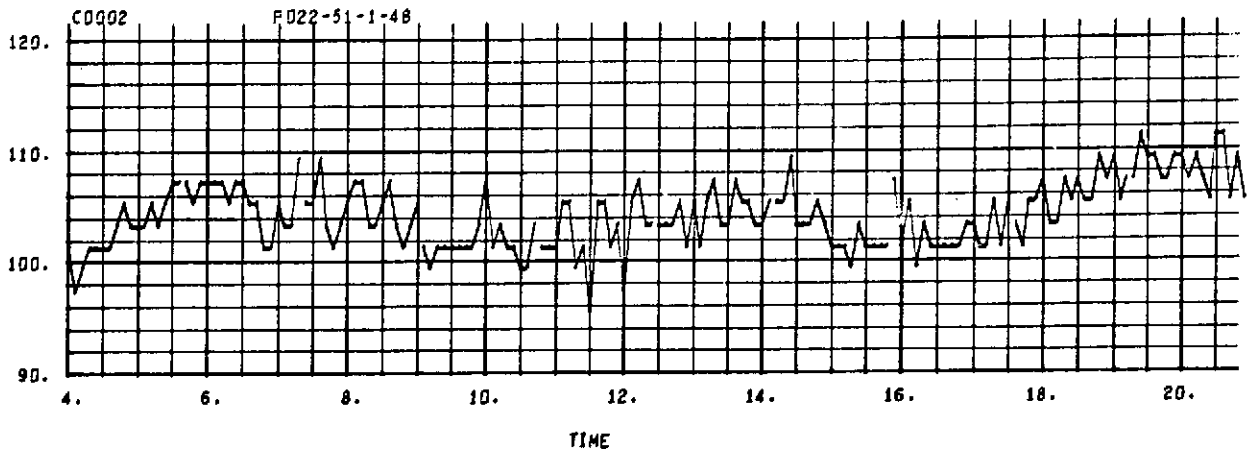
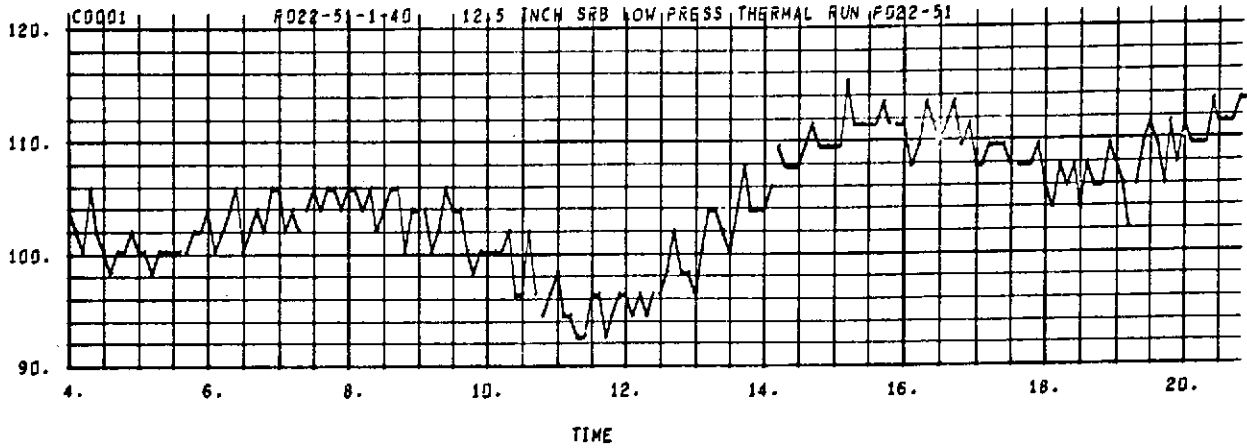

SEQ. = 0040

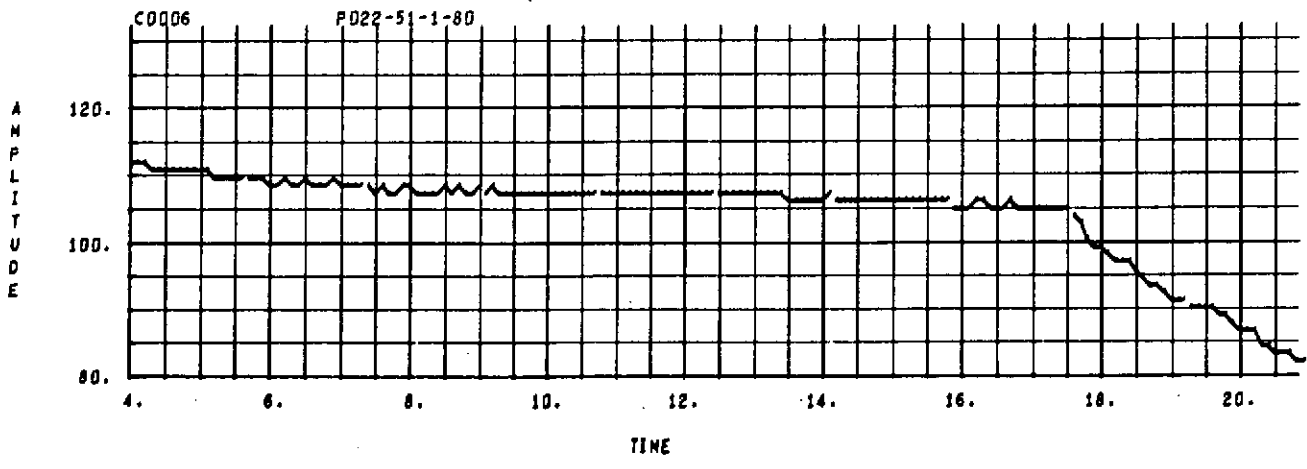
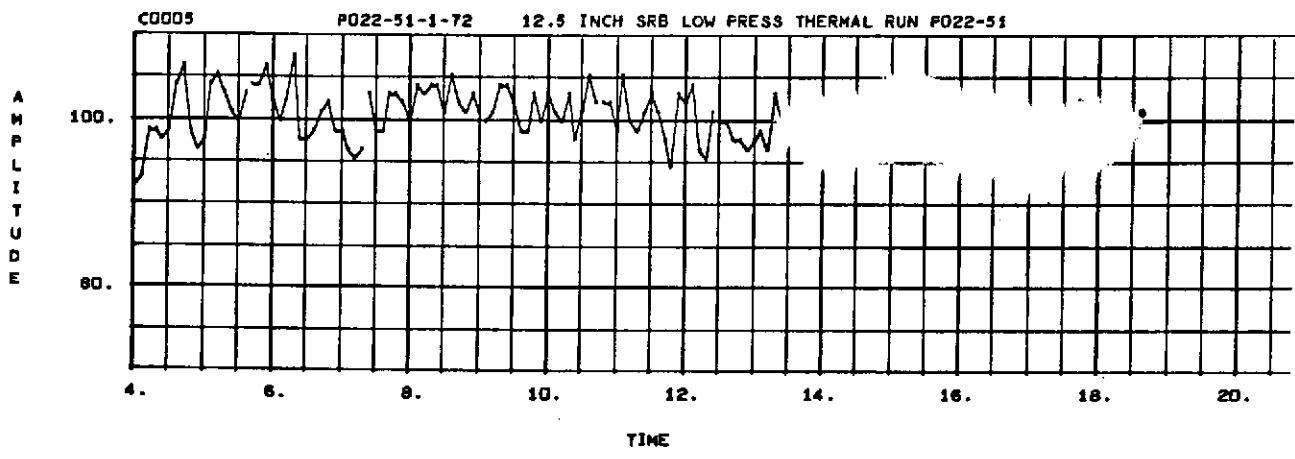
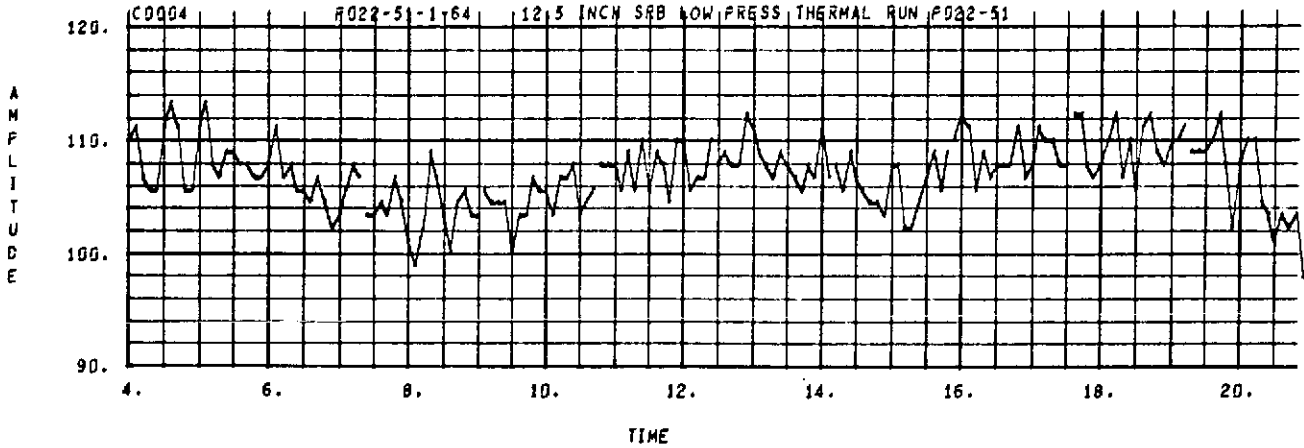

SEQ. = 0049

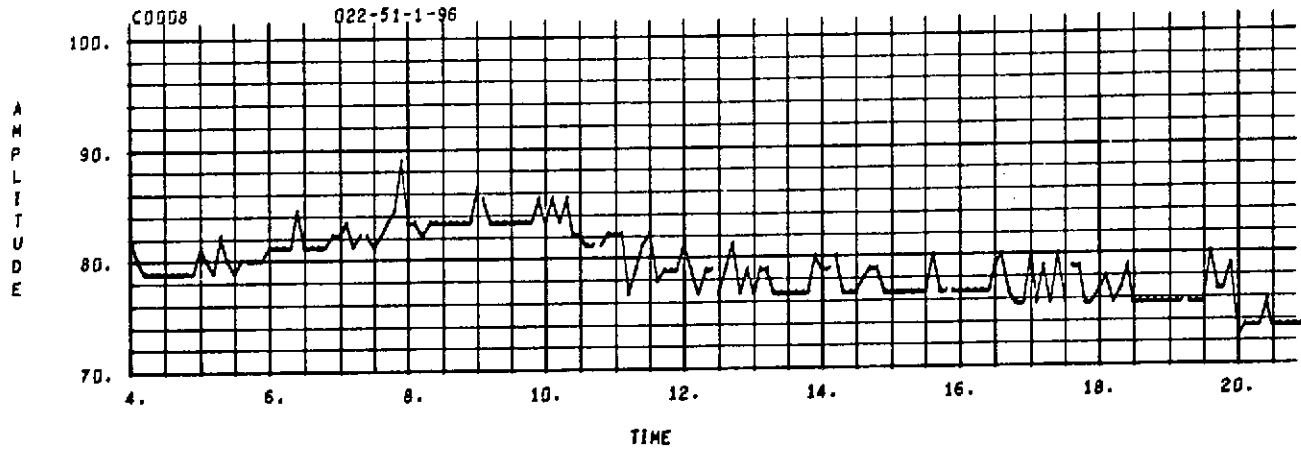
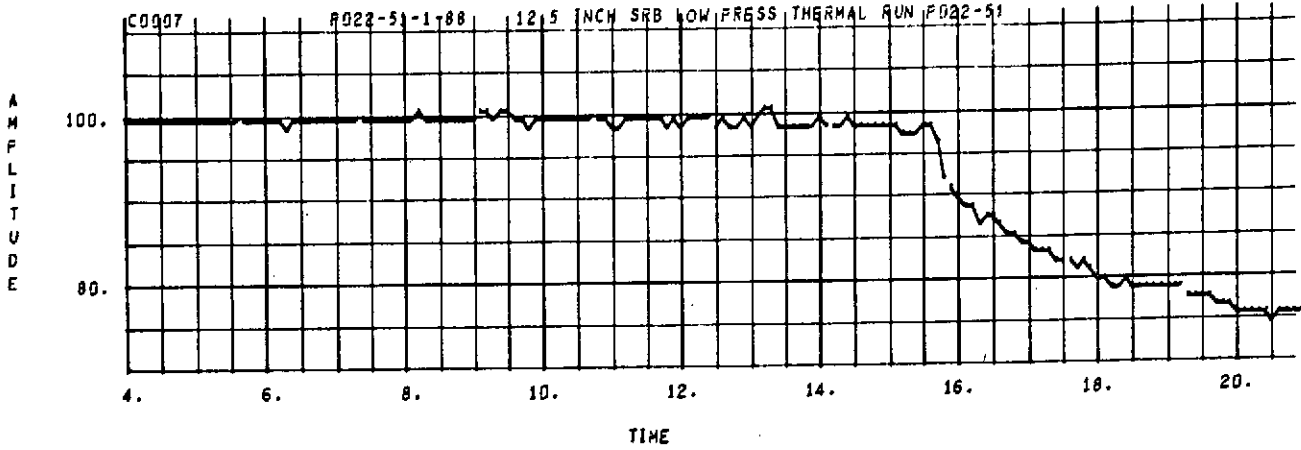

SEQ. = 0040

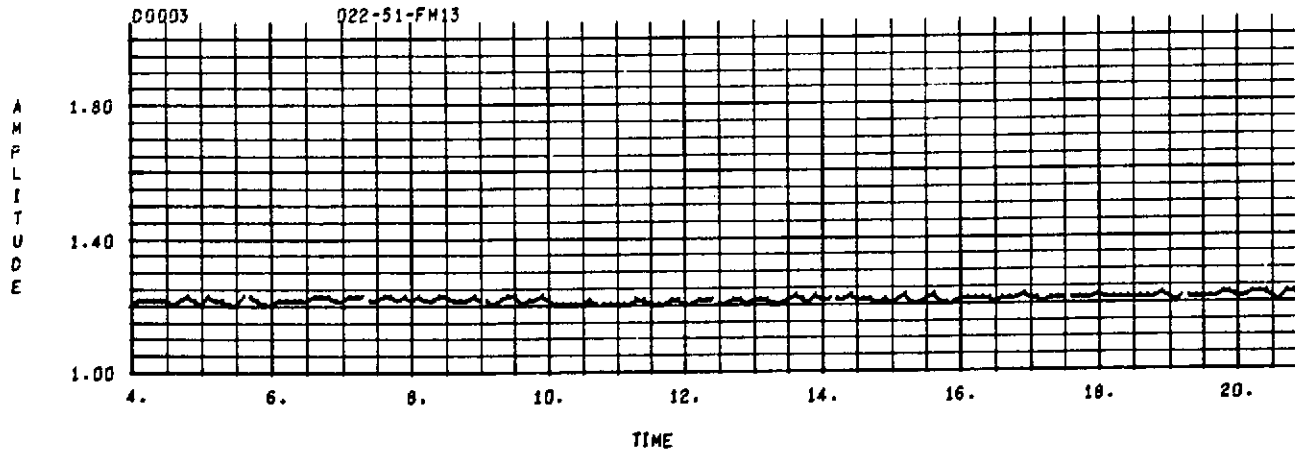
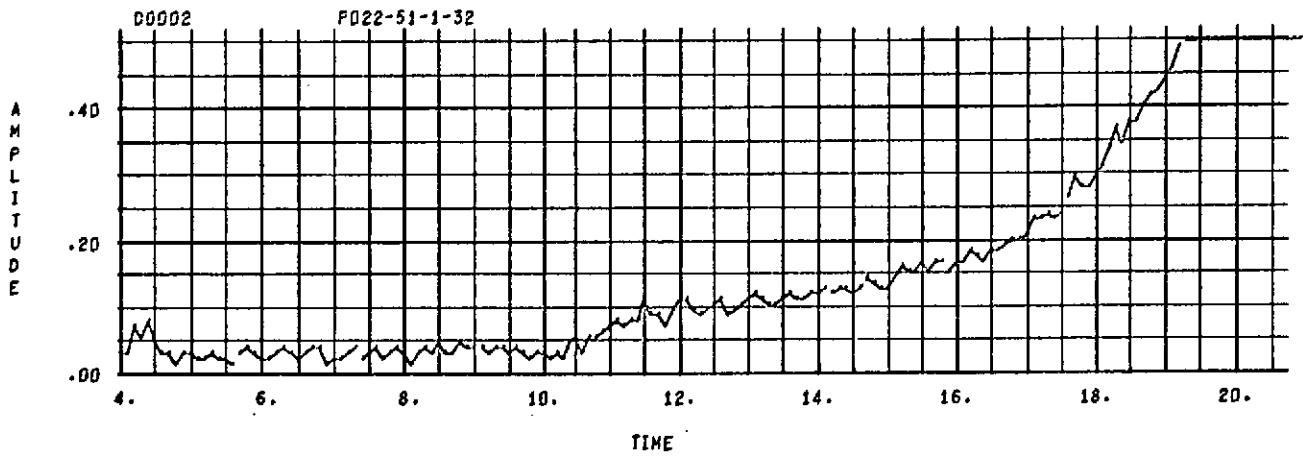
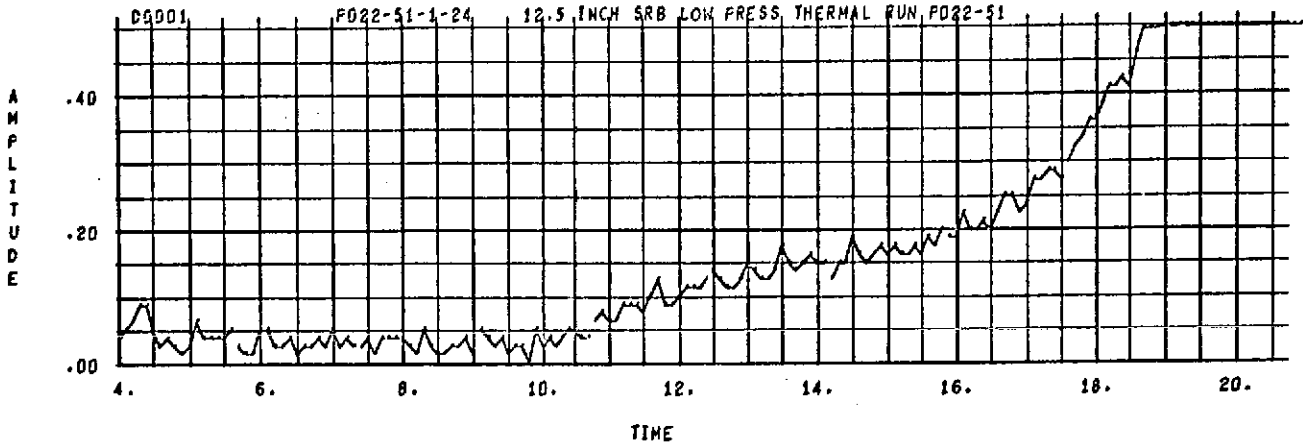

APPROVAL

DATA BOOK FOR 12.5-INCH DIAMETER
SRB THERMAL MODEL WATER FLOTATION TEST - 1.29 PSIA, SERIES P022

by
S. L. Allums

The information in this report has been reviewed and approved
for technical accuracy.



L. J. Hastings
Chief, Fluid Mechanics Section



A. L. Worlund
Chief, Fluid Mechanics & Dynamics Branch

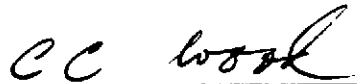

C. C. Wood
Acting Chief, Propulsion & Thermodynamics
Division