

-SPACE SHUTTLE-

**HIGH ANGLE OF ATTACK
TRANSITION AND LOW ANGLE OF
ATTACK LAUNCH PHASE
AERODYNAMIC STABILITY
AND CONTROL OF GD/C B-18E-2,
B-18E-3 DELTA WING BOOSTER,
AND LAUNCH CONFIGURATION
OF MSC-040A ORBITER AND
TWIN PRESSURE FED BOOSTERS**

by

JOHN M. De BEVOISE GD/C
ROBERT F. Mc GINNIS GD/C

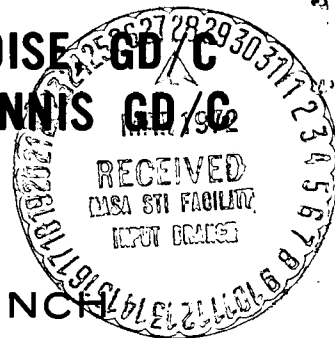

N72-19899

4-INCH
IND TUNNEL

Unclass
21144

(NASA-CR-120028) SPACE SHUTTLE: HIGH
ANGLE OF ATTACK TRANSITION AND LOW ANGLE OF
ATTACK LAUNCH PHASE AERODYNAMIC STABILITY
AND CONTROL OF GD/C J.M. DeBevoise, et al
(Chrysler Corp.) Feb. 1972 401 D CSCL 22B G3/31
FA (NASA CR OR TMX OR AD NUMBER) (CATEGORY)

Marshall Space Flight
Center

N A S A

SADSAC SPACE SHUTTLE
AEROTHERMODYNAMIC
DATA MANAGEMENT SYSTEM

CONTRACT NAS8-4016
MARSHALL SPACE FLIGHT CENTER

This document should be
referenced as NASA CR-120,028

NASA Series Number: S-0251

DMS-DR-1210
CR-120,028
February, 1972

SADSAC/SPACE SHUTTLE
WIND TUNNEL TEST DATA REPORT

CONFIGURATION: GD/C Convair B-18E-2 and B-18E-3 Delta Wing Boosters and a Launch Configuration Comprising the MSC 040A Orbiter and Twin Pressure Fed Boosters (.0035 and .003366 Scale)

TEST PURPOSE: High-Alpha Transition and Low-Alpha Launch Phase Stability and Control For Mach Number Range 0.9 to 4.96

TEST FACILITY: MSFC 14 x 14 Inch Trisonic Wind Tunnel

TESTING AGENCY: General Dynamics/Convair

TEST NO. & DATE: MSFC 514; December 13-17, 1971

FACILITY COORDINATOR: Mr. Jim Weaver - NASA/MSFC

PROJECT ENGINEER(S): Mr. John M. DeBevoise - GD/C
Mr. Robert F. McGinnis - GD/C

DATA MANAGEMENT SERVICES

LIAISON:

John E. Vaughn
John E. Vaughn

DATA OPERATIONS:

J. R. Ziller
J. R. Ziller

RELEASE APPROVAL:

N. D. Kemp
N. D. Kemp, Supervisor
Aero Thermo Data Group

CONTRACT NAS 8-4016

AMENDMENT 153

DRL 184-58

This report has been prepared by Chrysler Corporation Space Division under a Data Management Contract to the NASA. Chrysler assumes no responsibility for the data presented herein other than its display characteristics.

FACILITY COORDINATOR:

Mr. Jim Weaver
Marshall Space Flight Center
Mail Stop S&E - AERO - AAE
Huntsville, Alabama 35801

Phone: (205) 453-2512

PROJECT ENGINEERS:

Mr. John DeBevoise
Kearny Mesa Plant
GD/Convair Aerospace Division
Mail Zone 583-00, Bldg. 3
San Diego, California 92112

Phone: (714) 277-8900

Mr. Robert F. McGinnis
Kearny Mesa Plant
GD/Convair Aerospace Division
Mail Zone 583-00, Bldg. 3
San Diego, California 92112

Phone: (714) 277-8900

SADSAC LIAISON:

Mr. John E. Vaughn
Chrysler Corp. Huntsville Division
102 Wynn Drive
Department
Huntsville, Alabama 35805

Phone: (205) 895-1560

SADSAC OPERATIONS:

Mr. J. R. Ziler
Chrysler Corp. Space Division
P. O. Box 29200
Department 2780
New Orleans, Louisiana 70129

Phone: (504) 255-2304

TABLE OF CONTENTS

	PAGE
SUMMARY	2
NOMENCLATURE	4
ADDITIONS TO NOMENCLATURE	9
CONFIGURATIONS INVESTIGATED	10
TEST FACILITY DESCRIPTION	11
DATA REDUCTION	12
TABULAR DATA AVAILABILITY	15
TABLES	
I TEST CONDITIONS	16
II DATASET COLLATIONS	17
III MODEL COMPONENT DESCRIPTIONS	21
IV SUMMARY OF SADSAC NOMENCLATURE	34
V INDEX OF MODEL FIGURES	35
VI INDEX OF DATA FIGURES	36
MODEL FIGURES	37
DATA FIGURES	51

HIGH ANGLE OF ATTACK TRANSITION
AND LOW ANGLE OF ATTACK LAUNCH PHASE AERODYNAMIC
STABILITY AND CONTROL OF GD/C B-18E-2, B-18E-3 DELTA
WING BOOSTER, AND LAUNCH CONFIGURATION OF MSC-040A ORBITER
AND TWIN PRESSURE FED BOOSTERS

By John DeBevoise and Robert F. McGinnis

SUMMARY

The test was a conventional stability and control test except for two aspects. One was the very high angles of attack at which the delta wing configurations were tested (up to 60 degrees) at Mach numbers of 3 and 4.96. The other was the installation of the orbiter and twin boosters in a manner that caused the support system to induce normal forces and side forces on the aft portion of the boosters at all Mach numbers; i.e., the support and the booster bodies were close together, side by side.

In a previous test of similar delta-wing models, (MSFC 481) it was not possible to bring the angle of attack up to 60 degrees at Mach numbers of 3 and 5 because the bow shock from the model separated the tunnel boundary layer to the extent that the reflected shock obviously affected the model, and in some cases the flow broke down completely. In this test, the model was located in the tunnel somewhat higher (permitted by a shorter body) so that the separation of the boundary layer on the tunnel floor was delayed sufficiently that the reflected shock did not reach a position higher than illustrated below.

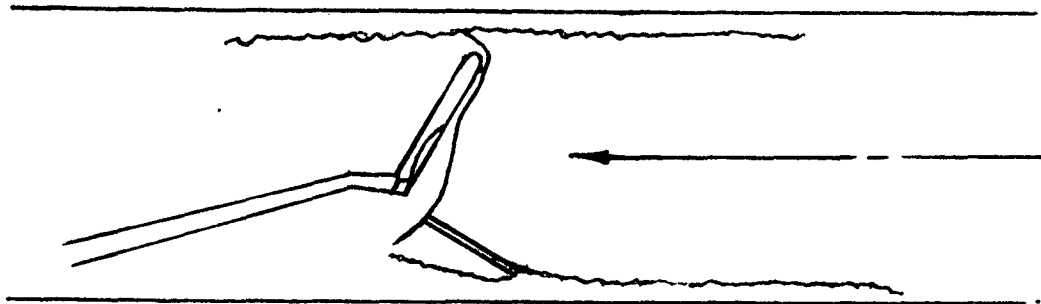

In a supersonic wind tunnel test, the forces on the model can be affected by downstream pressure disturbances propagating upstream through regions of subsonic flow. The usual pathway is the boundary layer on the sting. However, at the large angles of attack the velocity behind the bow shock becomes subsonic so that it is possible for downstream disturbances; e.g., the reflected shock, to produce upstream effects behind the bow shock. Thus, the measured forces and moments were affected when there was subsonic flow behind the bow shock at the point where the reflected shock intersected the bow shock. At Mach 3, the flow is subsonic behind the shock when the shock wave angle is steeper than 64 degrees. At Mach 5, the angle is 66 degrees. The Schlieren photographs must be examined to determine the angles of attack at which these conditions occur. There is also the possibility that the sting affected normal force and pitching moment measurements, but the probability of such interference is difficult to assess because the Schlieren photographs are difficult to interpret in that region.

Regarding the parallel cluster arrangement in the Twin Pressure Fed Booster: It was necessary to install a windshield over the rear half of the balance, which protruded from the central body of the cluster. The force on the windshield did not go through the balance. However, the windshield filled most of the space between the booster bodies. Since it was not downstream of the booster bodies it induced forces on them at all Mach numbers. Those forces were not evaluated in the test, and no corrections have been incorporated in the data.

NOMENCLATURE

(General)

<u>SYMBOL</u>	<u>SADSAC SYMBOL</u>	<u>DEFINITION</u>
α	ALPHA	angle of attack, angle between the projection of the wind X_w -axis on the body X, Z-plane and the body X-axis; degrees
β	BETA	sideslip angle, angle between the wind X_w -axis and the projection of this axis on the body X-Z-plane; degrees
ψ	PSI	yaw angle, angle of rotation about the body Z-axis, positive when the positive X-axis is rotated toward the positive Y-axis; degrees
ϕ	PHI	roll angle, angle of rotation about the body X-axis, positive when the positive Y-axis is rotated toward the positive Z-axis; degrees
ρ		air density; Kg/m^3 , slugs/ft ³
a		speed of sound; m/sec, ft/sec
V		speed of vehicle relative to surrounding atmosphere; m/sec, ft/sec
q	Q(PSI) Q(PSF)	dynamic pressure; $1/2\rho V^2$, psi, psf
M	MACH	Mach number; V/a
RN/L	RN/L	Reynolds number per unit length; million/ft
p		static pressure; psi
P		total pressure; psi
C_p	CP	pressure coefficient; $(p-p_\infty)/q$

NOMENCLATURE (Continued)

Reference & C. G. Definitions

<u>SYMBOL</u>	<u>SADSAC SYMBOL</u>	<u>DEFINITION</u>
S		wing area; m^2 , ft^2
S	SREF	reference area; m^2 , ft^2
\bar{c}		wing mean aerodynamic chord or reference chord; m, ft, in (see l_{ref} or LREF)
l_{ref}	LREF	reference length; m, ft, in.; (see \bar{c})
b_{ref}	BREF	wing span or reference span; m, ft, in
A_b		base area; m^2 , ft^2 , in^2
c. g.		center of gravity
MRP	MRP	abbreviation for moment reference point
	XMRP	abbreviation for moment reference point on X-axis
	YMRP	abbreviation for moment reference point on Y-axis
	ZMRP	abbreviation for moment reference point on Z-axis

NOMENCLATURE (Continued)

Axis System General

SYMBOL

F

force; F, lbs

M

moment; M, in-lb

DEFINITION

Subscript

N

normal force

A

axial force

L

lift force

D

drag force

Y

force or moment about the Y axis

Z

moment about the Z axis

X

moment about the X axis

s

stability axis system

w

wind axis system

ref

reference conditions

∞

free stream conditions

t

total conditions

b

base

NOMENCLATURE (Continued)
Body & Stability Axis System

<u>SYMBOL</u>	<u>SADSAC SYMBOL</u>	<u>DEFINITION</u>
<u>Body Axis System</u>		
C_N	CN	normal force coefficient; F_N/qS
C_A	CA	axial force coefficient; F_A/qS
C_{A_b}	CAB	base axial force coefficient; $\begin{bmatrix} -1 \\ \end{bmatrix} \begin{bmatrix} (p_b - p_\infty)/q \end{bmatrix} (A_b/S)$
C_{A_f}	CAF	forebody axial force coefficient; $C_A - C_{A_b}$
C_n	CYN	yawing moment coefficient; $M_Z/qS b_{ref}$
C_l	CBL	rolling moment coefficient; $M_X/qS b_{ref}$
<u>Common to Both Axis Systems</u>		
C_m	CIM	pitching moment coefficient; $M_Y/qS l_{ref}$
C_y	CY	side force coefficient; F_Y/qS
<u>Stability Axis System</u>		
C_L	CL	lift force coefficient; F_L/qS
C_D	CD	drag force coefficient; F_D/qS
C_{D_b}	CDB	base drag coefficient
C_{D_f}	CDF	forebody drag coefficient; $C_D - C_{D_b}$
C_n	CLN	yawing moment coefficient; $M_{Z,s}/qS b_{ref}$
C_l	CSL	rolling moment coefficient; $M_{X,s}/qS b_{ref}$
L/D	L/D	lift-to-drag ratio; C_L/C_D
L/D _f	L/DF	lift to forebody drag ratio; C_L/C_{D_f}

NOMENCLATURE (Continued)

Surface Definitions

<u>SYMBOL</u>	<u>SADSAC SYMBOL</u>	<u>DEFINITION</u>
1t	HORIZT	horizontal tail incidence; positive when trailing edge down; degrees
δ		symmetrical surface deflection angle; degrees; positive deflections are:
	AILRON	aileron - total aileron deflection; (left aileron - right aileron)/2
	CANARD	canard - trailing edge down
	ELEVON	elevon - trailing edge down
	ELEVTR	elevator - trailing edge down
	FLAP	flap - trailing edge down
	RUDDER	rudder - trailing edge to the left
	SPOILR	spoiler - trailing edge down
	TAB	tab - trailing edge down with respect to control surface
δ		antisymmetrical surface deflection angle, degrees; positive trailing edge down:
	AIL-L	left aileron - trailing edge down
	AIL-R	right aileron - trailing edge down
	ELVN-L	left elevon - trailing edge down
	ELVN-R	right elevon - trailing edge down
	SPLR-L	left spoiler - trailing edge down
	SPLR-R	right spoiler - trailing edge down

<u>SURFACE SUBSCRIPTS</u>	<u>DEFINITION</u>
a	aileron
b	base
c	canard
e	elevator or elevon
f	flap
r	rudder or ruddervator
s	spoiler
t	tail

ADDITIONS TO NOMENCLATURE

<u>SYMBOL</u>	<u>DESCRIPTION</u>
A_C	Balance cavity area
BDL	Body length
F_{AG}	Axial force with tunnel corrections for weight tare and balance interactions
F_{NG}	Normal force with tunnel corrections for weight tare and balance interactions
F_{YG}	Side force corrected for weight tare, balance interaction and tunnel effects
$M_{\ell G}$	Rolling moment at balance center corrected for tares and interaction
M_{PG}	Pitching moment at balance center corrected for weight tare, balance interaction and tunnel effects
MRC	Moment reference center
M_{YG}	Yawing moment at balance center corrected for tares and balance interaction
P_B	Base pressure, relative to P_∞
P_C	Cavity pressure, relative to P_∞
P_∞	Free stream static pressure
X_{Cp}	Location of center of normal force, measured from nose
X_{MRP}	Distance from body base to MRP, positive when MRP is ahead of base.

CONFIGURATIONS INVESTIGATED

The basic B-18E-3 configuration is denoted by $B_{30}W_{23}C_{10}V_{14}$

- B₃₀ Basic B-18E-3 booster body. This part designation includes the R₅ rocket engines (4 engines with center engine removed), the X₄ rocket engine shrouds, the canard flats, and canopy.
- B₃₁ Same as B₃₀ except with blunt nose
- B₃₂ Same as B₃₀ except with 8-ft (full scale) fuselage section removed, just aft of canards.
- W₂₃ Basic B-18E-3 wing, 8549 ft², AR = 2.436, TR = .2158, 53° LE sweep, located as shown in dwg.
- C₁₀ Basic delta canard, 485 ft² full scale planform area (two panels)
- V₁₄ Basic vertical tail, 1300 ft² fuel scale area, AR = 1.4, 40° LE sweep.

The basic B-18E-2 configuration is denoted by $B_{33}W_{25}V_{16}$

- B₃₃ Body of same length and diameter as B₃₀, but without canopy or flats for canard fairings, so nose is a body of revolution.
- W₂₅ Basic B-18E-2 wing, 11,175 ft² same AR and LE sweep as W₂₃
- V₁₆ Basic vertical tail, 2200 ft² full scale area, 40° LE sweep.

The launch-phase configuration comprising the twin pressure fed booster with the O40-A orbiter and tank is denoted by $B_{37}R_7T_{19}O_2T_4$ or $B_{37}R_7T_{19}O_5T_4$

- B₃₇ Twin pressure fed booster bodies, scaled down versions of the single booster body B₃₄, reduced in linear dimensions by the ratio .840
- R₇ Rocket engines (4 per booster)
- T₁₉ Wedge section tail fin (half angle 5°), blunt TE, rounded LE, full scale area 283 sq. ft exposed planform, scaled-down copy of T₁₀ tail fins, reduced in linear dimensions by the ratio .840.
- O₂ MSC orbiter O40-A, modified with large vertical tail
- T₄ Orbiter tank with conical nose plus small-diameter extension on nose.
- O₅ Same as O₂, in forward position

TEST FACILITY DESCRIPTION

The Marshall Space Flight Center 14" x 14" Transonic Wind Tunnel is an intermittent blowdown tunnel which operates by high pressure air flowing from storage to either vacuum or atmospheric conditions. A Mach number range from .2 to 5.85 is covered by utilizing two interchangeable test sections. The transonic section permits testing at Mach 0.20 through 2.50, and the supersonic section permits testing at Mach 2.74 through 5.85. Mach numbers between .2 and .9 are obtained by using a controllable diffuser. The range from .95 to 1.3 is achieved through the use of plenum suction and perforated walls. Mach numbers of 1.44, 1.93 and 2.50 are produced by interchangeable sets of fixed contour nozzle blocks. Above Mach 2.50 a set of fixed contour nozzle blocks are tilted and translated automatically to produce any desired Mach number in .25 increments.

Air is supplied to a 6000 cubic foot storage tank at approximately -40°F dew point and 500 psi. The compressor is a three-stage reciprocating unit driven by a 1500 hp motor.

The tunnel flow is established and controlled with a servo actuated gate valve. The controlled air flows through the valve diffuser into the stilling chamber and heat exchanger where the air temperature can be controlled from ambient to approximately 180°F . The air then passes through the test section which contains the nozzle blocks and test region.

Downstream of the test section is a hydraulically controlled pitch sector that provides a total angle of attack range of 20° ($\pm 10^{\circ}$). Sting offsets are available for obtaining various maximum angles of attack up to 25° .

DATA REDUCTION

The MSFC Trisonic Wind Tunnel Balance model 232 was used to obtain 6-component data. In addition, base pressures and balance cavity pressure were measured. Aerodynamic coefficients were calculated using the dimensional data and equations presented below.

The reference dimensions for the data reduction were as follows for the three basic models (all dimensions inches or square inches):

	SYMBOL IN EQS.	SADSAC SYMBOL	B-18 E-2	B-18 E-3	TPFB
Model scale			.0035	.0035	.003366
Reference area	S_{ref}	SREF	19.630 (Theor. wing)	15.03 (Theor. wing)	0.660 (Body cross section.)
Reference length	l_{ref}	LREF	3.240 (MAC)	2.830 (MAC)	5.323 (Body length)
Reference span	b_{ref}	BREF	6.930 (wing span)	6.062 (wing span)	0.917 (Body dia.)
Body length	BDL		7.271	7.271*	5.323
<p>*In calculating X/L, the center of pressure location, this length was used for both B₃₀ and B₃₁ (blunt) bodies, and the nose of B₃₀ was used as the origin of X. * The short-body version (B₃₂) had a length of 6.935. X was meas. from the nose.</p>					

For the twin pressure fed booster test, three base areas were defined and the axial forces on the three bases were found separately, the corresponding areas being:

	<u>Desig.</u>	<u>Area, sq. in.</u>
Two boosters	A_{b1}	2.532
Orbiter base	A_{b2}	0.423
Orbiter tank base	A_{b3}	0.660

The orbiter tank base area includes the balance cavity area. The physical setup, sketched below, made it impractical to measure the pressures on the annulus and in the cavity separately. Therefore, the two cavity pressure tubes (fore and aft) were manifolded together and the resultant pressure was assumed to act over the entire base A_{b3} .

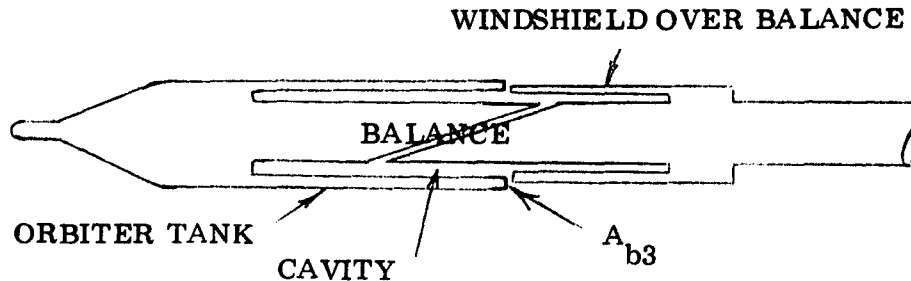

A single base pressure orifice was provided at the center of each base for the orbiter and the two boosters. The two booster pressure tubes were manifolded to obtain an average pressure assumed to act over area A_{b1} .

For the delta-wing boosters the bases were the same in all cases. The base was divided into cavity, upper half, and lower half, for which the pressures were obtained separately.

Upper half	A_{b1}	= 0.656 sq. in. outside of cavity
Lower half	A_{b2}	= 0.656 sq. in. outside of cavity
Cavity	A_c	= 0.786

The moment transfers from balance moment center (BMC) to moment reference point (MRP) were simple, since the MRP was located on the balance center line in all cases. The relationships between BMC and MRP are shown in Figure 2.

Base and forebody axial force coefficients were determined for the delta wing boosters and the pressure fed booster as follows:

Delta Wing Booster

$$CAF = CA - CAB$$

$$CAB = - (p_{b1} A_{b1} + p_{b2} A_{b2} + p_b A_c) / 2q_\infty SREF$$

Twin Pressure Fed Booster

$$CAF = CA - CAB_1 - CAB_2 - CAB_3$$

$$CAB_1 = - (p_{b1} A_{b1} / q_\infty SREF)$$

CAB₂ and CAB₃ calculated in same manner with appropriate pressure coefficients and base areas substituted into equation.

TABULATED DATA LISTING

A tabulated data listing, consisting of all aero data sets, both original and those created in arriving at the plotted material to be presented subsequently, is available as an addendum to this report. The tabular listing is made up in two sections:

- (a) a brief summary list of all data sets containing the identifier, the descriptor, and the resident dependent variables.
- (b) a full list of all data sets containing all resident or selected aerodynamic coefficients of the data sets as well as the above mentioned information.

The listing is currently sent on limited distribution to the following organizations:

NASA AMES	Mr. V. Stevens
NASA MSFC	Mr. J. Weaver
GD/C	Mr. J. DeBevoise

If copies of this listing are desired, please contact the above or the cognizant SADSAC personnel who, for this data, is:

Mr. J. Ziler
Department 2780
Chrysler Corporation Space Division
New Orleans, La. 70129

(504) 255-2304

TABLE I.
TEST CONDITIONS
TEST MSFC 514

MACH NUMBER	REYNOLDS NUMBER per unit length	DYNAMIC PRESSURE (pounds/sq. inch)	STAGNATION TEMPERATURE (degrees Fahrenheit)
0.9	6.3	7.4	99
1.1	6.7	8.75	98
1.2	6.7	9.15	100
1.5	7.5	10.8	98
1.95	7.6	11	100
3.0	5.3	6.1	100
4.96	5.5	3.1	100

BALANCE UTILIZED: TWT Model 232

CAPACITY:

NF _____
SF _____
AF _____
PM _____
YM _____
RM _____

ACCURACY:

COEFFICIENT
TOLERANCE:

COMMENTS:

TABLE II.
 TEST WSP-514 DATA SET/RUN NUMBER
 COLLATION SUMMARY

PRETEST
 POSTTEST

TWIN PRESSURE FWD BOOSTER

DATA SET IDENTIFIERS	CONFIGURATION	SCHD.		PARAMETERS/VALUES	NO. of RUNS	MACH NUMBERS (OR ALTERNATE INDEPENDENT VARIABLE)											
		A	B			.6	.9	1.0	1.1	1.2	1.5	2.0	2.7	3.0	4.0	5.0	
05000	0874	A	0		6		10		11	12	5	4					1
050	B37220874	A	0		6		9		8	7	6	3					2
040	✓	0	5		6		15		14	13	51	50					47
050	B37277190874	A	0		6		16		17	18	52	49					48
050	✓	0	3		6		22		23	24	38	39					46
050	B37277190874	0	3		6		21		20	19	37	40					45
050	B37277190874	A	0		5		31		33		35	42					43
050	✓	0	5		6		31		30	29	36	41					44
050	B37277190874	A	0		2		26		26	25							
058160	✓	0	5		2		27		27	28							

TEST RUN NUMBERS

1 7 13 19 25 31 37 43 49 55 61 67 7576

COEFFICIENTS: KA-10 TA 10 25.3 * SEE DATA IDENTIFICATION SECTION
 a or B RB-15 TA 10 25.3
 SCHEDULES

IPVAR(1) | IPVAR(2) | INDV

TABLE II. (CONTINUED)
 TEST MSR-574 DATA SET/RUN NUMBER
 COLLATION SUMMARY

B-105-3 P/BW RUNS

PRETEST
 POSTTEST

DATA SET IDENTIFIER	CONFIGURATION	SCHD.		PARAMETERS/VALUES	NO. OF RUNS	MACH NUMBERS (OR ALTERNATE INDEPENDENT VARIABLE)																																		
		a	B			6	7	8	9	10	11	12	13	14	15	16	17	18	19	20	21	22																		
258110	B30W232.0	A	0	0	0	0	6	77																																
120	B30W232.0	B	1	1	1	2																																		
139	✓			1	1	2																																		
140	B30W232.0	A	1	-20	-20	3		74																																
150	B30W232.0	B	1	1	1	2																																		
160	✓			1	1	2																																		
17	B30W232.0	A	1	-40	-40	2		73																																
186	✓			1	1	2																																		
196	B30W232.0	A	1	10	10	3		70																																
200	B30W232.0	A	1	0	0	3		65																																
210	B30W232.0	B	1	1	1	3																																		
220	✓			1	1	2																																		
230	B30W232.0	B	1	1	-60	2																																		
240	✓			1	1	2																																		
250	B31W232.0	A	1	0	0	2		66																																
260	B31W232.0	B	1	1	1	2																																		
270	✓			1	1	2																																		
280	B32W232.0	A	1	1	1	2		69																																
290	B32W232.0	B	1	1	1	2																																		
258291	B32W232.0	B	0	1	1	2																																		

TEST RUN NUMBERS

COEFFICIENTS: KA = 0.5 - 30 D.S.
AS = 30 TO 40 D.S.
Q10 = 40 TO 60 D.S.

1 7 13 19 25 31 37 43 49 55 61 67 75 76
 CLM VAL RBL QYM RA RAE RAB RAC RDC RDE RDF RGE

COEFFICIENTS:
 NO. OF SCHEDULES

IDENTIFIER(1) IDENTIFIER(2) INDY

TABLE II. (CONTINUED)
 TEST WSE-514 DATA SET/RUN NUMBER
 COLLATION SUMMARY

3-18E-3 YAW RUNS

PRETEST
 POSTTEST

DATA SET IDENTIFIER	CONFIGURATION	SCHD.		PARAMETERS/VALUES		NO. OF RUNS	MACH NUMBERS (OR ALTERNATE INDEPENDENT VARIABLE)																								
		A	B	1	2		3	4	5	6	7	8	9	10	11	12	13	14	15	16	17	18									
R51300	B30W23E10V14	15	D	0	0	0	2	6.9	7.8	7.9	8.0	8.1	8.2	8.3	8.4	8.5	8.6	8.7	8.8	8.9	9.0	9.1	9.2	9.3	9.4	9.5	9.6	9.7	9.8	9.9	10.0
1 310	B30W23E10V14	1	1	1	1	25	2																								
R3320	✓	30	1	1	1	0	3																								

1 7 13 19 25 31 37 43 49 55 61 67 75 76

Q114 Q11 Q12 Q13 Q14 Q15 Q16 Q17 Q18 Q19 Q20 Q21 Q22 Q23 Q24 Q25 Q26 Q27 Q28 Q29 Q30 Q31 Q32 Q33 Q34 Q35 Q36 Q37 Q38 Q39 Q40 Q41 Q42 Q43 Q44 Q45 Q46 Q47 Q48 Q49 Q50 Q51 Q52 Q53 Q54 Q55 Q56 Q57 Q58 Q59 Q60 Q61 Q62 Q63 Q64 Q65 Q66 Q67 Q68 Q69 Q70 Q71 Q72 Q73 Q74 Q75 Q76

COEFFICIENTS: 3D = -10, -8, -5, -4, -2, 0, 2, 4, 6, 8, 10

a or b SCHEDULES

TABLE II. (CONCLUDED)
 TEST MSFC-576 DATA SET/RUN NUMBER
 COLLATION SUMMARY

B-18E-2

PRETEST
 POSTTEST

DATA SET IDENTIFIER	CONFIGURATION	SCHD.		PARAMETERS/VALUES		NO. of RUNS	MATCH NUMBERS (OR ALTERNATE INDEPENDENT VARIABLE)													
		A	B	1st	2nd		1.6	1.9	1.10	1.1	1.2	1.5	2.0	2.7	3.0	4.0	5.0			
258330	B33W25	A	0	0	0	3	62													
340	B33W25	B	1	-	-	1														
350	—	C	1	-	-	2														
360	B33W25	A	1	-20	-20	3	61													
370	B33W25	B	1	-	-	2														
258380	B33W25	C	1	-	-	2														
	B33W25	A	1	10	10	3														
	B33W25	B	1	-	-	-2														
	—	C	0	-	-	-2														

TEST RUN NUMBERS

COEFFICIENTS:
 A 0 5 20 25
 B 30 40 50
 C 40 50 60 70
 7 13 19 25 31 37 43 49 55 61 67 7576
 IDPVAR(1) IDPVAR(2) INDV

TABLE III. MODEL COMPONENT DESCRIPTION

MODEL COMPONENT: BODY - Twin Pressure Fed Booster Bodies B37

GENERAL DESCRIPTION: Cone-cylinder-flare bodies, scaled down versions of the single booster body B34, reduced in linear dimensions by ratio 0.840, with cutout for clearance from adjacent sting.

DRAWING NUMBER: _____

<u>DIMENSIONS:</u>	<u>FULL-SCALE</u>	<u>MODEL SCALE</u>
Length	_____	<u>5.323</u>
Max. Width, flare	_____	<u>1.304</u>
Max. Depth	_____	<u>1.304</u>
Fineness Ratio	_____	_____
Area		
Max. Cross-Sectional	_____	<u>1.266</u>
Planform	_____	_____
Wetted	_____	_____
Base	_____	<u>1.266</u>

TABLE III. (con't)

MODEL COMPONENT: Tail Fin T₁₉

GENERAL DESCRIPTION: Wedge section (5° half angle stream-wise). Used on B₃₇ twin booster bodies. Four fins per booster body.

DRAWING NUMBER: WT-71-105240

<u>DIMENSIONS:</u>	<u>FULL-SCALE</u>	<u>MODEL SCALE</u>
Area, ft ²	<u>283</u>	<u>.460 in²</u>
Span (equivalent), inches	<u> </u>	<u>.640</u>
Inb'd equivalent chord, inches	<u> </u>	<u>1.069</u>
Outb'd equivalent chord, inches	<u> </u>	<u>.573</u>
Ratio Elevator chord/horizontal tail chord		
At Inb'd equiv. chord	<u> </u>	<u> </u>
At Outb'd equiv. chord	<u> </u>	<u> </u>
Sweep Back Angles, degrees		
Leading Edge	<u> </u>	<u>37°45'</u>
Tailing Edge	<u> </u>	<u>0</u>
Hingeline	<u> </u>	<u> </u>
Area Moment (Normal to hinge line) ft ³	<u> </u>	<u> </u>

TABLE III. (con't)

MODEL COMPONENT: Canard C10

GENERAL DESCRIPTION: Clipped delta planform, all-movable,
hinge line inclined fwd 11°28'

DRAWING NUMBER: WT-71-105250

<u>DIMENSIONS:</u>	<u>FULL-SCALE</u>	<u>MODEL SCALE</u>
Area (per panel)	<u>485 Ft²</u>	<u>.436 in²</u>
Span (equivalent) panel T.E.	<u>_____</u>	<u>.687</u>
Inb'd equivalent chord	<u>_____</u>	<u>1.05</u>
Outb'd equivalent chord	<u>_____</u>	<u>.13</u>
Ratio movable surface chord/ total surface chord		
At Inb'd equiv. chord	<u>_____</u>	<u>1</u>
At Outb'd equiv. chord	<u>_____</u>	<u>1</u>
Sweep Back Angles, degrees		
Leading Edge	<u>_____</u>	<u>45°</u>
Tailing Edge	<u>_____</u>	<u>0</u>
Hingeline	<u>_____</u>	<u>-11°28'</u>
Area Moment (Normal to hinge line)	<u>_____</u>	<u>_____</u>

TABLE III. (con't)

MODEL COMPONENT: BODY - B30

GENERAL DESCRIPTION: Basic B-18E-3 booster body including the R₅ rocket engines, the X₄ rocket engine shrouds, the canard flats, and the canopy.

DRAWING NUMBER: WT-71-105250

<u>DIMENSIONS:</u>	<u>FULL-SCALE</u>	<u>MODEL SCALE</u>
Length	_____	<u>7.271 in</u>
Max. Width at base	_____	<u>1.625</u>
Max. Depth at base	_____	<u>1.565</u>
Fineness Ratio	_____	_____
Area		
Max. Cross-Sectional	_____	<u>2.098 in²</u>
Planform	_____	_____
Wetted	_____	_____
Base	_____	<u>2.098 in²</u>

TABLE III. (con't)

MODEL COMPONENT: BODY - B31

GENERAL DESCRIPTION: Same as B30 except 0.185 inch shorter with blunt nose.

DRAWING NUMBER: WT-71-105250

<u>DIMENSIONS:</u>	<u>FULL-SCALE</u>	<u>MODEL SCALE</u>
Length		<u>7.086 in</u>
Max. Width		<u>1.625</u>
Max. Depth		<u>1.565</u>
Fineness Ratio		
Area		
Max. Cross-Sectional		<u>2.098 in²</u>
Planform		
Wetted		
Base		<u>2.098 in²</u>

TABLE III. (con't)

MODEL COMPONENT: BODY - B32

GENERAL DESCRIPTION: Same as B30 except with 8 ft. full scale (.336" model scale) section removed just aft of canards.

DRAWING NUMBER: WT-71-105250

<u>DIMENSIONS:</u>	<u>FULL-SCALE</u>	<u>MODEL SCALE</u>
Length	_____	<u>6.935 in</u>
Max. Width	_____	<u>1.625</u>
Max. Depth	_____	<u>1.565</u>
Fineness Ratio	_____	_____
Area		
Max. Cross-Sectional	_____	<u>2.098 in²</u>
Planform	_____	_____
Wetted	_____	_____
Base	_____	<u>2.098</u>

TABLE III. (con't)

MODEL COMPONENT: BODY - B33

GENERAL DESCRIPTION: Same as B30 except without canopy or canard flats

DRAWING NUMBER: WT-71-105250

<u>DIMENSIONS:</u>	<u>FULL-SCALE</u>	<u>MODEL SCALE</u>
Length	_____	<u>7.271 in</u>
Max. Width	_____	<u>1.625</u>
Max. Depth	_____	<u>1.565</u>
Fineness Ratio	_____	_____
Area		
Max. Cross-Sectional	_____	<u>2.098 in²</u>
Planform	_____	_____
Wetted	_____	_____
Base	_____	<u>2.098 in²</u>

TABLE III. (con't)

MODEL COMPONENT: Vertical Tail V₁₄

GENERAL DESCRIPTION: Basic Vertical Tail for B-18E-3,
1300 ft² full scale area. AR=1.4

DRAWING NUMBER: WT-71-105250

<u>DIMENSIONS:</u>	<u>FULL-SCALE</u>	<u>MODEL SCALE</u>
Area, ft ²	<u>1300</u>	<u>2.28 in²</u>
Span (equivalent), inches	<u> </u>	<u>1.792 in</u>
Inb'd equivalent chord, inches	<u> </u>	<u>1.828</u>
Outb'd equivalent chord, inches	<u> </u>	<u>0.731</u>
Ratio Elevator ^{Rudder} chord/horizontal tail chord	<u> </u>	<u> </u>
At Inb'd equiv. chord	<u> </u>	<u>0.35</u>
At Outb'd equiv. chord	<u> </u>	<u>0.35</u>
Sweep Back Angles, degrees	<u> </u>	<u> </u>
Leading Edge	<u> </u>	<u>40°</u>
Tailing Edge	<u> </u>	<u> </u>
Hingeline	<u> </u>	<u> </u>
Area Moment (Normal to hinge line) ft ³	<u> </u>	<u> </u>

TABLE III. (con't)

MODEL COMPONENT: Vertical Tail V16

GENERAL DESCRIPTION: Basic Vertical Tail for B-18E-2 configuration, 2200 ft² full scale area.

DRAWING NUMBER: WT-71-105250

<u>DIMENSIONS:</u>	<u>FULL-SCALE</u>	<u>MODEL SCALE</u>
Area, ft ²	<u>2200</u>	<u>3,898 in²</u>
Span (equivalent), inches	<u> </u>	<u>2.335 in</u>
Inb'd equivalent chord, inches	<u> </u>	<u>2.344</u>
Outb'd equivalent chord, inches	<u> </u>	<u>0.995</u>
Ratio ^{Rudder} Elevator chord/horizontal tail chord	<u> </u>	<u> </u>
At Inb'd equiv. chord	<u> </u>	<u>0.35</u>
At Outb'd equiv. chord	<u> </u>	<u>0.35</u>
Sweep Back Angles, degrees	<u> </u>	<u> </u>
Leading Edge	<u> </u>	<u>40°</u>
Tailing Edge	<u> </u>	<u> </u>
Hingeline	<u> </u>	<u> </u>
Area Moment (Normal to hinge line) ft ³	<u> </u>	<u> </u>

TABLE III. (con't)

MODEL COMPONENT: Wing. W23
 GENERAL DESCRIPTION: Basic wing for B-18E-3

DRAWING NUMBER: WT-71-105250

DIMENSIONS: FULL-SCALE MODEL SCALE

TOTAL DATA

	<u>FULL-SCALE</u>	<u>MODEL SCALE</u> (.0035')
Area, ft ²		
Planform	<u>8549 ft²</u>	<u>14,900 in²</u>
Wetted		
Span (equivalent), ft.		<u>6.062</u>
Aspect Ratio		<u>2.436</u>
Rate of Taper		
Taper Ratio		<u>0.2158</u>
Dihedral Angle, degrees		<u>4.0</u>
Incidence Angle, degrees		<u>2.0</u>
Aerodynamic Twist, degrees		<u>X</u>
Toe-In Angle		
Cant Angle		
Sweep Back Angles, degrees		
Leading Edge		<u>53° 30'</u>
Trailing Edge		<u>15° 15'</u>
0.25 Element Line		
Chords:		
Root (Wing Sta. 0.0), inches		<u>4.094</u>
Tip, (equivalent), inches		<u>0.832</u>
MAC, inches		<u>2.830</u>
Fus. Sta. of .25 MAC, inches		
W.P. of .25 MAC, inches		
Airfoil Section		
Root <u>AT BL 1.772 INCHES</u>		<u>0012-64*</u>
Tip		<u>0010-64*</u>

EXPOSED DATA

Area, ft ²		
Span, (equivalent), ft		
Aspect Ratio		
Taper Ratio		
Chords		
Root, inches		
Tip, inches		
MAC, inches		
Fus. Sta. of .25 MAC, inches		
W.P. of .25 MAC, inches		

* INBOARD OF 82% OF THE LOCAL (THEOR) SEMISPAN THE WING WAS UNTWISTED AND UNCAMBERED. THE OUTER 18% HAD CONICAL CAMBER WITH DESIGN $C_L = 0.35$. INBOARD OF BL 1.772 THE THICKNESS (NOT THICKNESS RATIO) WAS CONSTANT.

TABLE III. (con't)

MODEL COMPONENT: Wing . W₂₅
 GENERAL DESCRIPTION: Basic wing for B-18E-2

DRAWING NUMBER: WT-71-105250

<u>DIMENSIONS:</u>	<u>FULL-SCALE</u>	<u>MODEL SCALE</u> (.0035)
<u>TOTAL DATA</u>		
Area, ft ²		
Planform	<u>11,175</u>	<u>19.750 in²</u>
Wetted		
Span (equivalent), ft.		<u>6.911</u>
Aspect Ratio		<u>2.436</u>
Rate of Taper		
Taper Ratio		<u>0.2158</u>
Diehedral Angle, degrees		<u>4.0</u>
Incidence Angle, degrees		<u>2.0</u>
Aerodynamic Twist, degrees		<u>*</u>
Toe-In Angle		
Cant Angle		
Sweep Back Angles, degrees		
Leading Edge		<u>53° 30'</u>
Trailing Edge		<u>19° 15'</u>
0.25 Element Line		
Chords:		
Root (Wing Sta. 0.0), inches		<u>4.690</u>
Tip, (equivalent), inches		<u>1.025</u>
MAC, inches		<u>3.24</u>
Fus. Sta. of .25 MAC, inches		
W.P. of .25 MAC, inches		
Airfoil Section		
Root		<u>0010-64*</u>
Tip		<u>0010-64*</u>
<u>EXPOSED DATA</u>		
Area, ft ²		
Span, (equivalent), ft		
Aspect Ratio		
Taper Ratio		
Chords		
Root, inches		
Tip, inches		
MAC, inches		
Fus. Sta. of .25 MAC, inches		
W.P. of .25 MAC, inches		

* INBOARD OF 82% OF THE LOCAL SEMISPAN THE WING WAS UNTWISTED AND UNCAMBERED. THE OUTER 18% HAD CONICAL CAMBER WITH DESIGN $C_L = 0.35$. INBOARD OF BL 1.772 THE THICKNESS (NOT THICKNESS RATIO) WAS CONSTANT.

TABLE III. (con't)

MODEL COMPONENT: ORBITERS O2 and O5
 GENERAL DESCRIPTION: MODIFIED MSC 040-A ORBITER. OVERALL LENGTH SHORTENED BY REDUCING TRAILING EDGE ANGLE FROM A SWEEP FORWARD TO ZERO DEGREES. VERTICAL TAIL SIZE INCREASED.

DRAWING NUMBER: _____

DIMENSIONS: FULL-SCALE MODEL SCALE

TOTAL DATA

Area		
Planform	_____	_____
Wetted	_____	_____
Span (equivalent)	_____	_____
Aspect Ratio	_____	_____
Rate of Taper	_____	_____
Taper Ratio	_____	_____
Diehedral Angle, degrees	7.0	7.0
Incidence Angle, degrees	2.0	2.0
Aerodynamic Twist, degrees	_____	_____
Toe-In Angle	_____	_____
Cant Angle	_____	_____
Sweep Back Angles, degrees		
Leading Edge	60°	60°
Trailing Edge	0°	0°
0.25 Element Line	_____	_____
Chords:		
Root (Wing Sta. 0.0)	_____	_____
Tip, (equivalent)	_____	_____
MAC	_____	_____
Fus. Sta. of .25 MAC	_____	_____
W.P. of .25 MAC	_____	_____
B.L. of .25 MAC	_____	_____
Airfoil Section	_____	_____
Root	_____	_____
Tip	_____	_____

EXPOSED DATA

Area		
Span, (equivalent)	74.0	2.998
Aspect Ratio	_____	_____
Taper Ratio	0	0
Chords		
Root	58.3	2.357
Tip	0	_____
MAC	_____	_____
Fus. Sta. of .25 MAC	_____	_____
W.P. of .25 MAC	_____	_____
B.L. of .25 MAC	_____	_____

TABLE III. (concl'd)

MODEL COMPONENT: BODY - Tank Ty

GENERAL DESCRIPTION: Orbiter tank with conical nose
and small diameter extension on nose

DRAWING NUMBER: _____

.00366 SCALE

<u>DIMENSIONS:</u>	<u>FULL-SCALE</u>	<u>MODEL SCALE</u>
Length	_____	<u>5.086</u>
Max. Width	_____	<u>.916</u>
Max. Depth	_____	_____
Fineness Ratio	_____	_____
Area		
Max. Cross-Sectional	_____	<u>.66</u>
Planform	_____	_____
Wetted	_____	_____
Base	_____	<u>.66</u>

TABLE IV.

SUMMARY OF SADSAC NOMENCLATURE - AERODYNAMIC FORCE AND MOMENT COEFFICIENTS

COEFFICIENT	COEFFICIENT NAME	SADSAC NOMENCLATURE		
		BODY AXIS	STABILITY AXIS	WIND AXIS
CA	Total Axial Force	CA	-	-
CAB	Base Axial Force	CAB	--	-
CAF	Forebody Axial Force	CAF	-	-
CD	Total Drag Force	-	CD	CDTOTL
CDB	Base Drag Force	-	CDB	CDBASE
CDF	Forebody Drag Force	-	CDF	CDFORE
CL	Lift Force	-	CL	CL
CN	Normal Force	CN	-	-
CY	Side Force	CY	CY	CC
Cl	Rolling Moment	CBL	CSL	CWL
Cm	Pitching Moment	CLM	CLM	CPM
Cn	Yawing Moment	CYN	CLN	CLN
L/D	Lift-To-Drag Force Ratio	-	L/D	CL/CD
L/D	Lift-To-Forebody Drag Force Ratio	-	L/DF	CL/CDF
N/A	Normal-To-Axial Force Ratio	N/A	-	-
N/A	Normal-To-Forebody Axial Force Ratio	CN/CAF	-	-

TABLE V. INDEX OF MODEL FIGURES

<u>FIGURE</u>	<u>TITLE</u>	<u>PAGE</u>
1.	Axis Systems	38
2.	Positions of Moment Reference Points	39
3.	B-18E-2 and B-18E-3, 3-Views and Model Component Identification	40
4.	Launch Phase Configuration O4OA Orbiter and Twin Pressure Fed Boosters	41
5.	Installation of B-18E-2 and B-18E-3 Models On Offset at 10° Setting (15° Setting Used In Some Yaw Runs is Similar)	42
6.	Installation of B-18E-2 and B-18E-3 Models On Offset at 30° and 50° Settings	43
7.	Body B ₃₇ and Rockets R ₇	44
8.	Tail Fin T ₁₉	45
9.	Canard C ₁₀	46
10.	Bodies B ₃₀ , B ₃₁ , B ₃₂ and B ₃₃ ; Vertical Tails V ₁₄ and V ₁₆	47
11.	Wings W ₂₃ and W ₂₅	48
12.	Orbiter O ₂ and O ₅	49
13.	Tank T ₄	50

TABLE VI. INDEX OF DATA FIGURES

		<u>DATA</u> <u>PAGE</u>
Figure 1.	Longitudinal Characteristics of Twin Pressure Fed Booster Buildup	1
Figure 2.	Lateral Characteristics of Twin Pressure Fed Booster Buildup	67
Figure 3.	Elevator Effectiveness of B-18E-3 Configuration	91
Figure 4.	Canard Effectiveness of B-18E-3 Configuration	151
Figure 5.	Effect of Nose Shape Variation on B-18E-3 Configuration	211
Figure 6.	Effect of Reducing Body Length on B-18E-3 Configuration	271
Figure 7.	Rudder Effectiveness at ALPHA = 15 Degrees on B-18E-3 Configuration	331
Figure 8.	Lateral Characteristics at ALPHA = 30 Degrees of B-18E-3 Configuration	339
Figure 9.	Elevator Effectiveness of B-18E-2 Configuration	351

MODEL FIGURES

- Notes:
1. Positive directions of force coefficients moment coefficients, and angles are indicated by arrows.
 2. For clarity, origins of wind and stability axes have been displaced from the center of gravity.

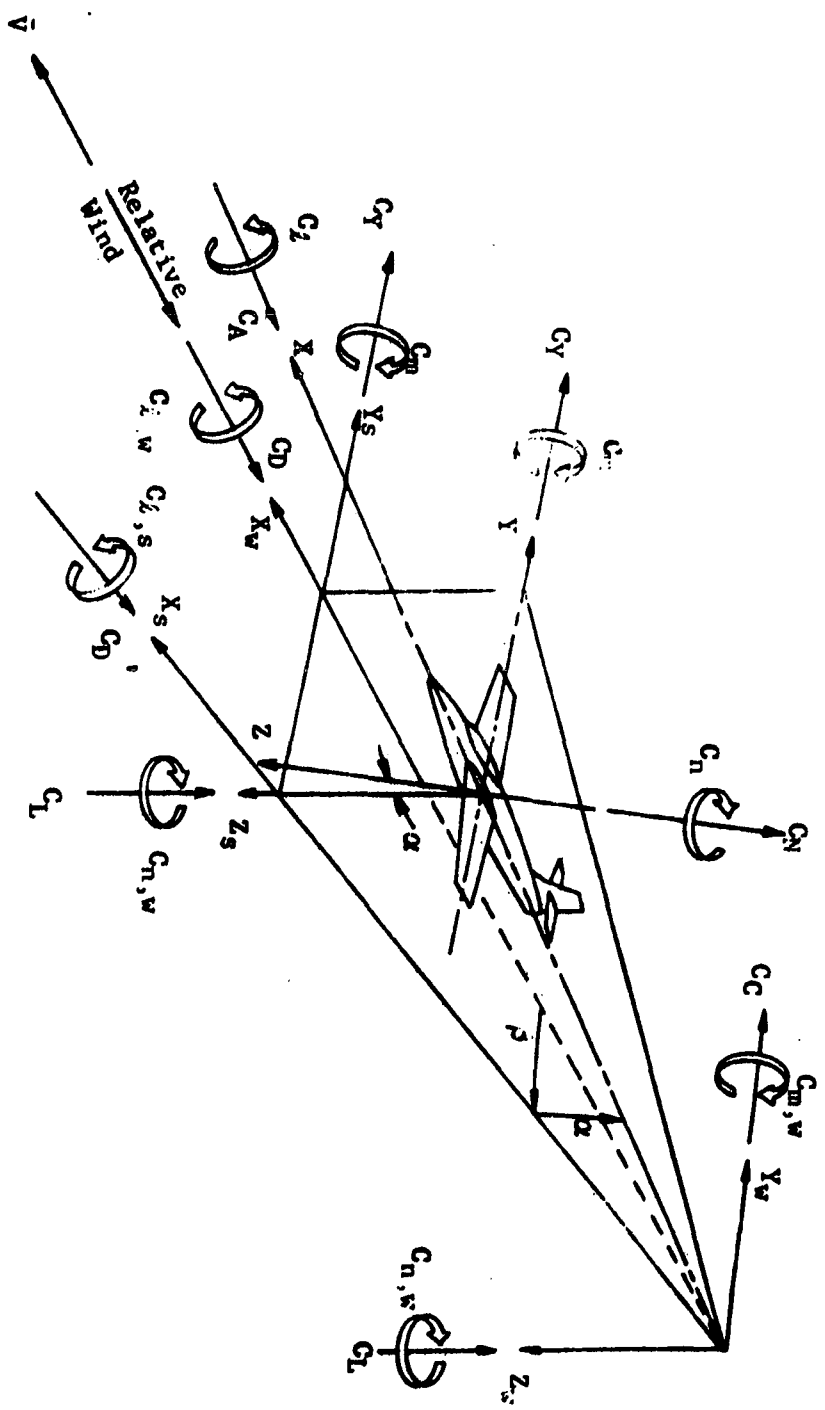

Figure 1. Axis systems, showing direction and sense of force and moment coefficients, angle of attack, and sideslip angle

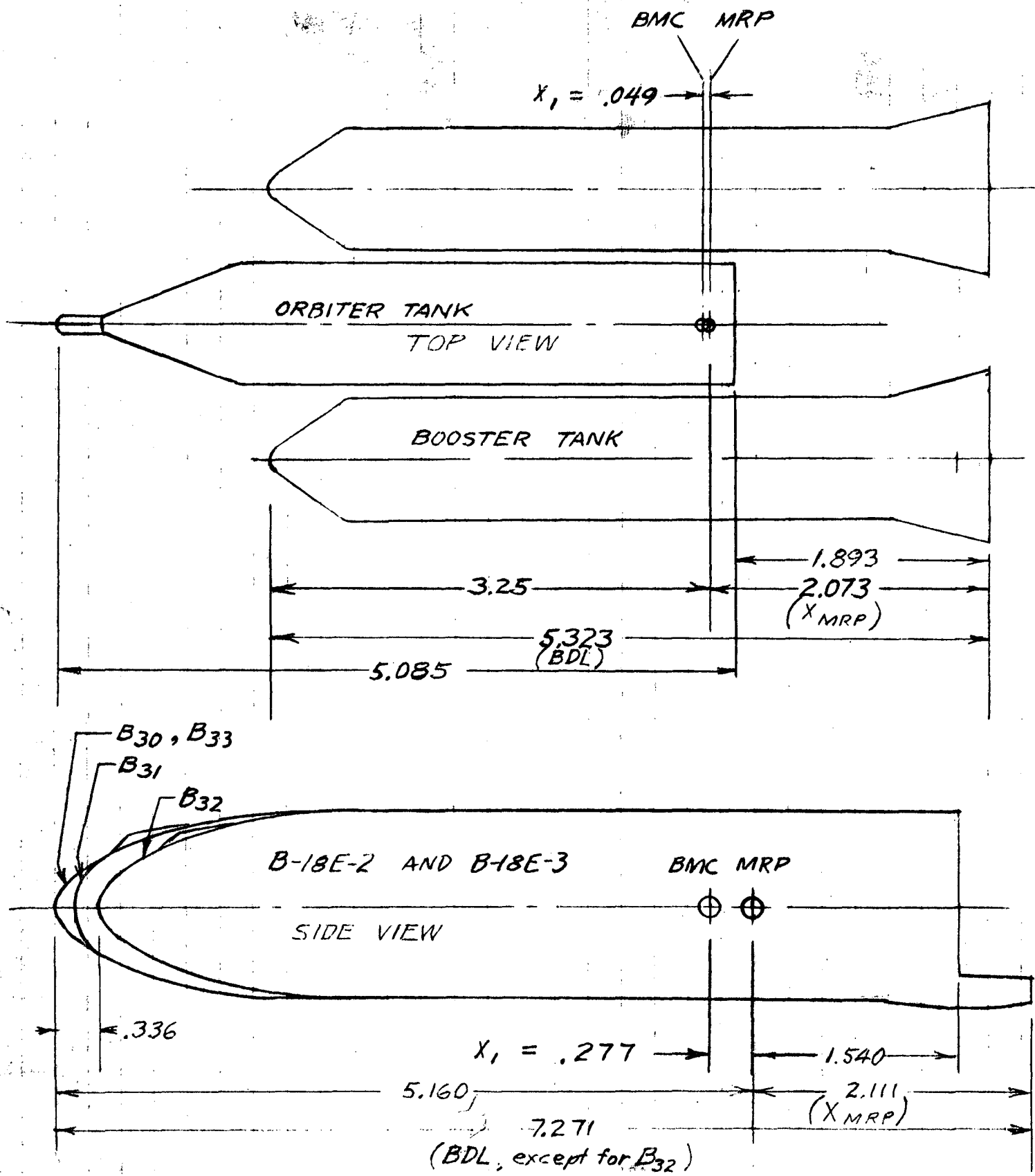
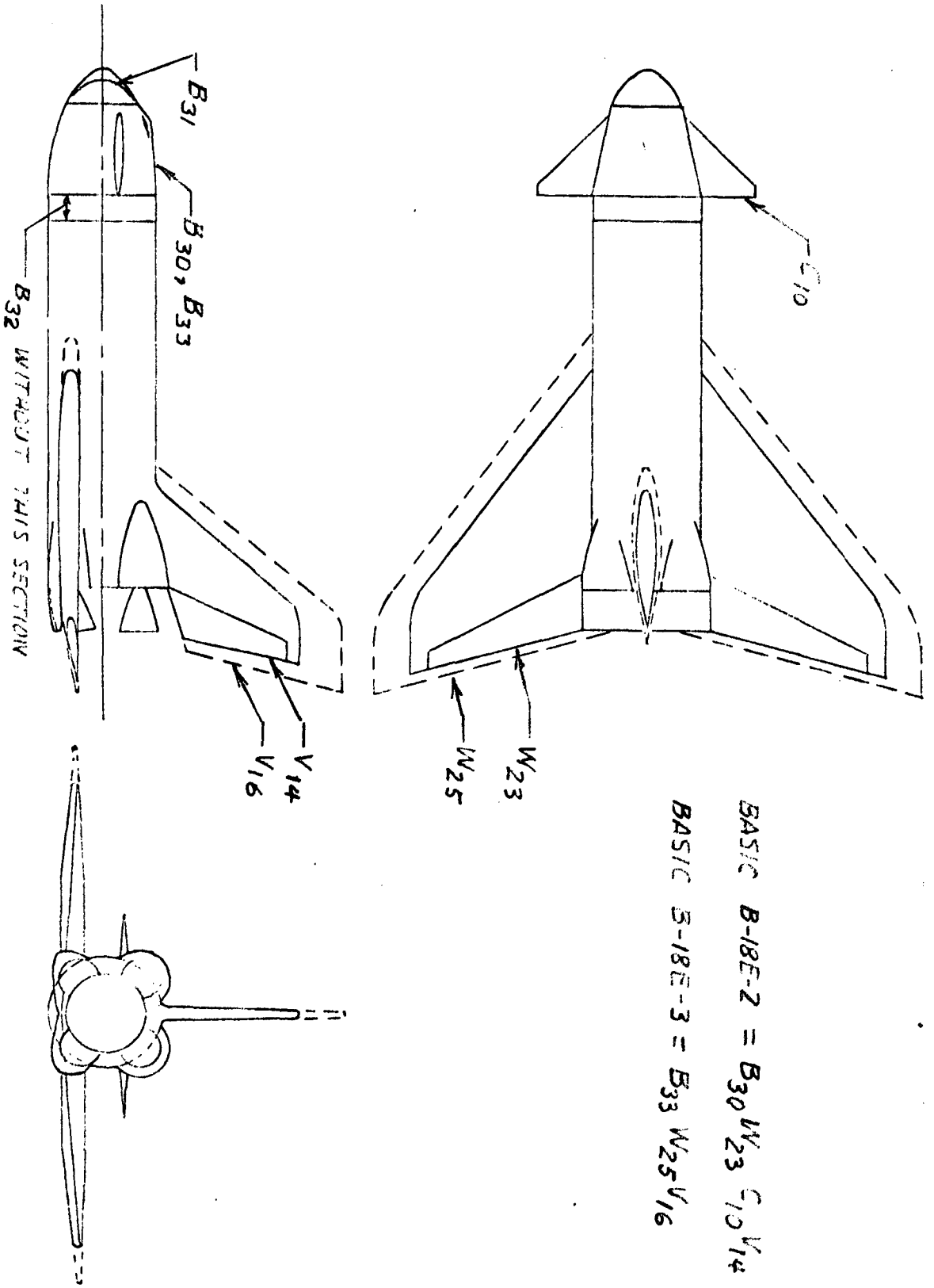
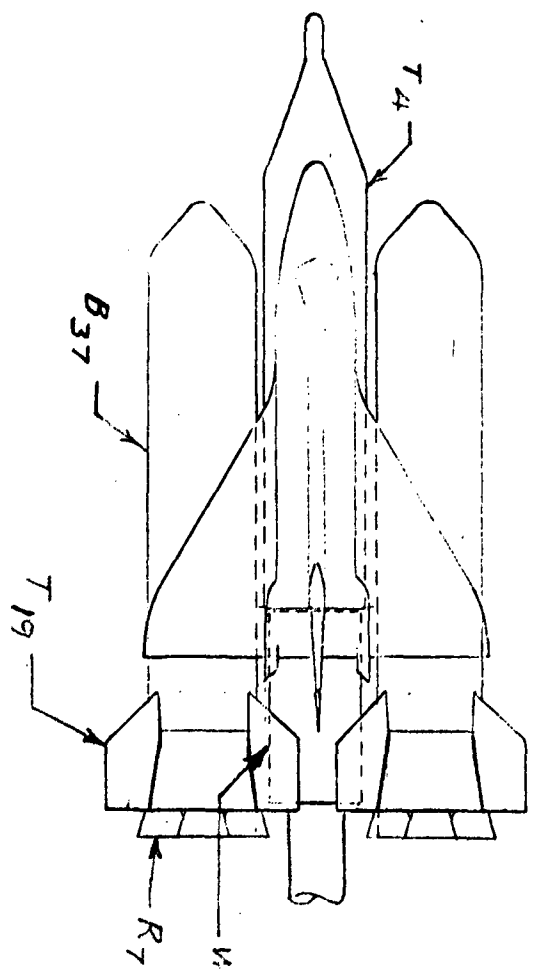

FIG 2. POSITIONS OF MOMENT REFERENCE POINTS

FIG 3. B-18E-2 AND B-18E-3, 3-VIEWS AND MODEL COMPONENT IDENTIFICATION





COMPLETE CONFIG = B₃₇ R₇ T₁₉ O₂ T₄

OR

B₃₇ R₇ T₁₉ O₅ T₄

WINDSHIELD AROUND BALANCE

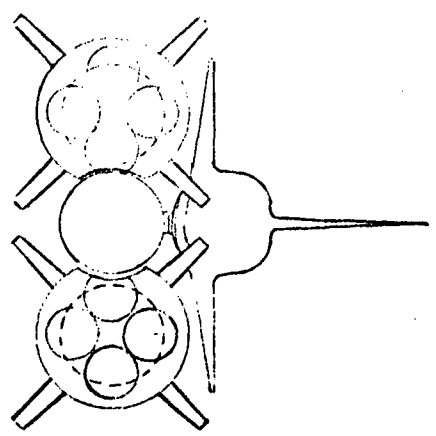
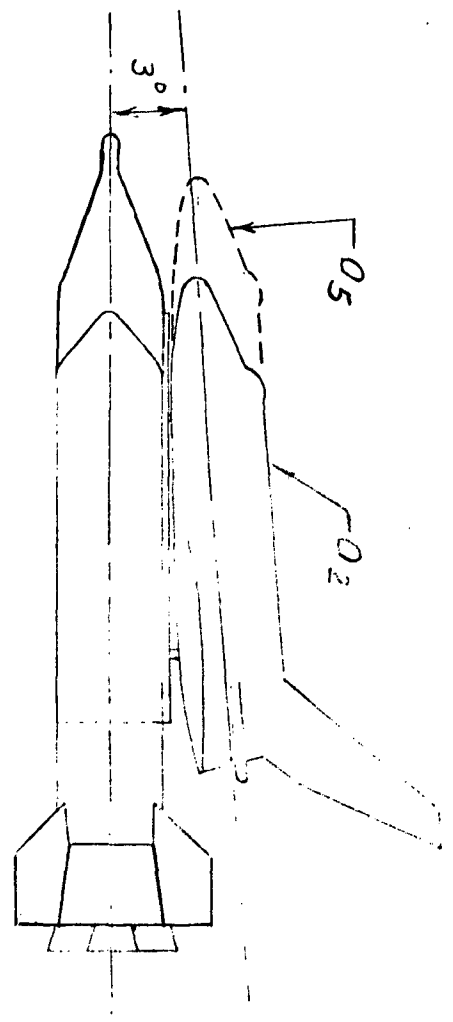

FIG 4. LAUNCH PHASE CONFIGURATION O404 ORBITER AND TWIN PRESSURE FED BOOSTERS

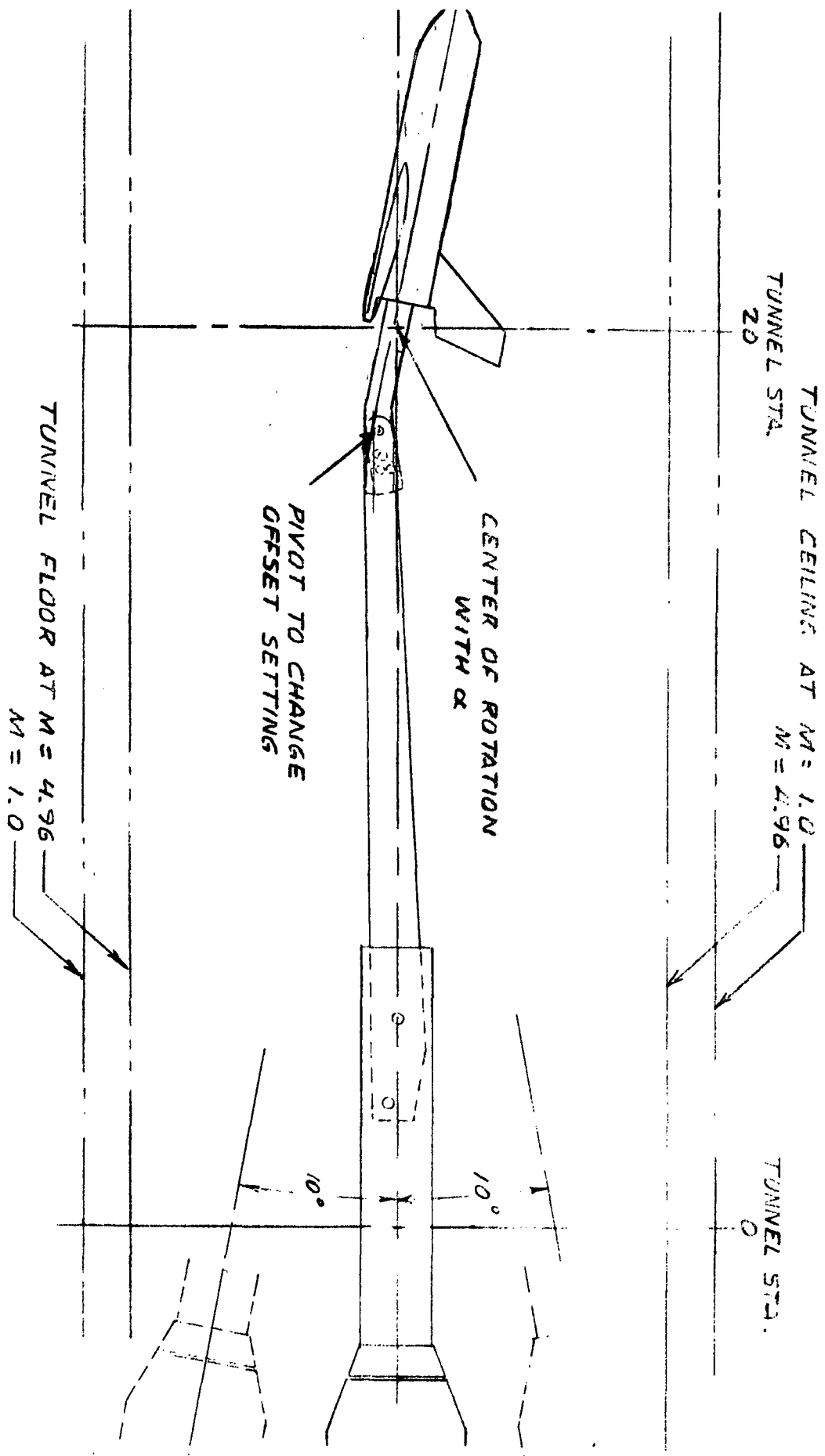

FIG. 5. INSTALLATION OF B-18E-2 AND B-18E-3 MODELS ON OFFSET AT 10° SETTING. (15° SETTING USED IN SOME YAW RUNS IS SIMILAR)

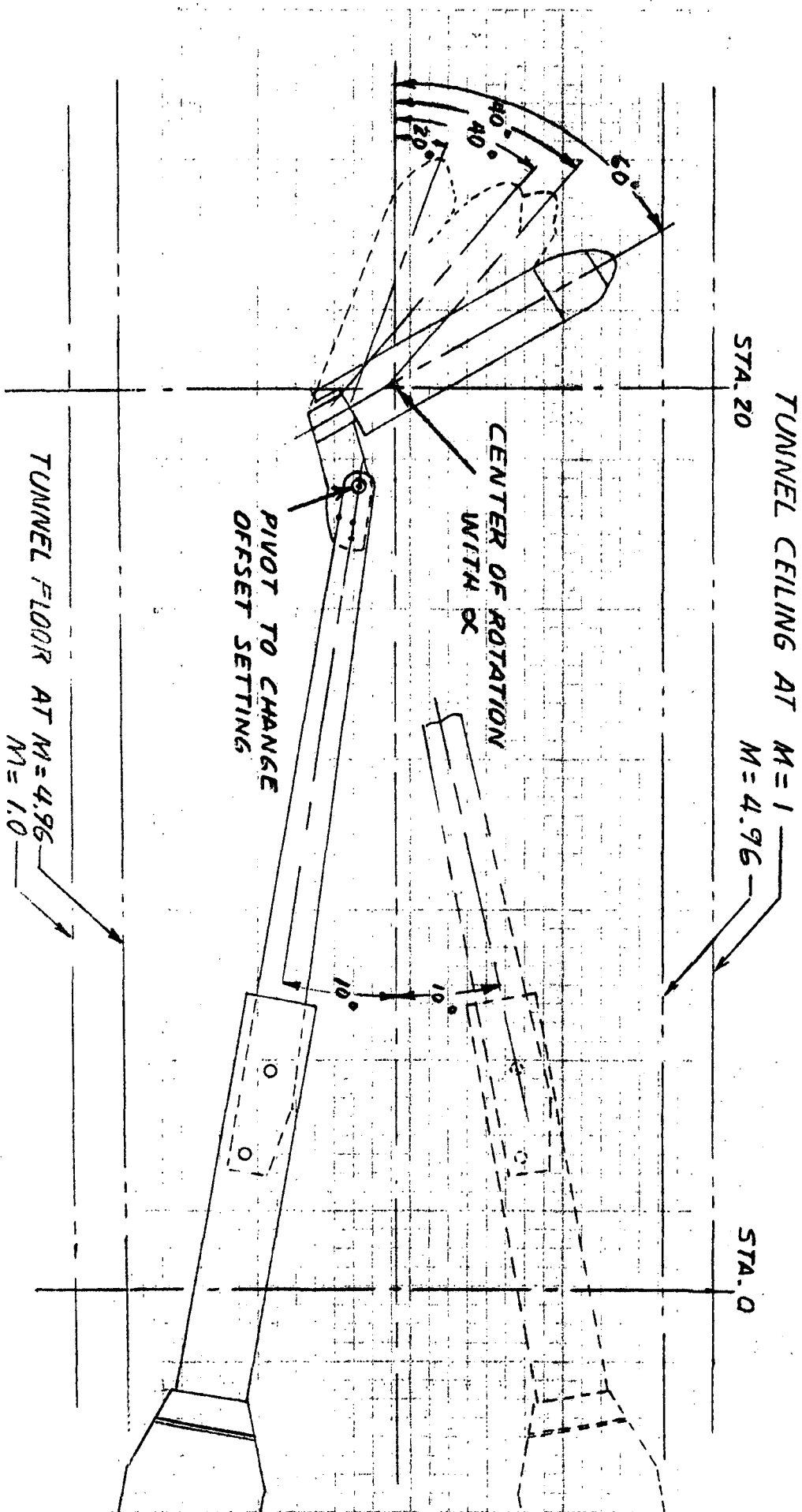

FIG. 6. INSTALLATION OF B-18E-2 AND B-18E-3 MODELS ON OFFSET AT 30° AND 50° SETTINGS

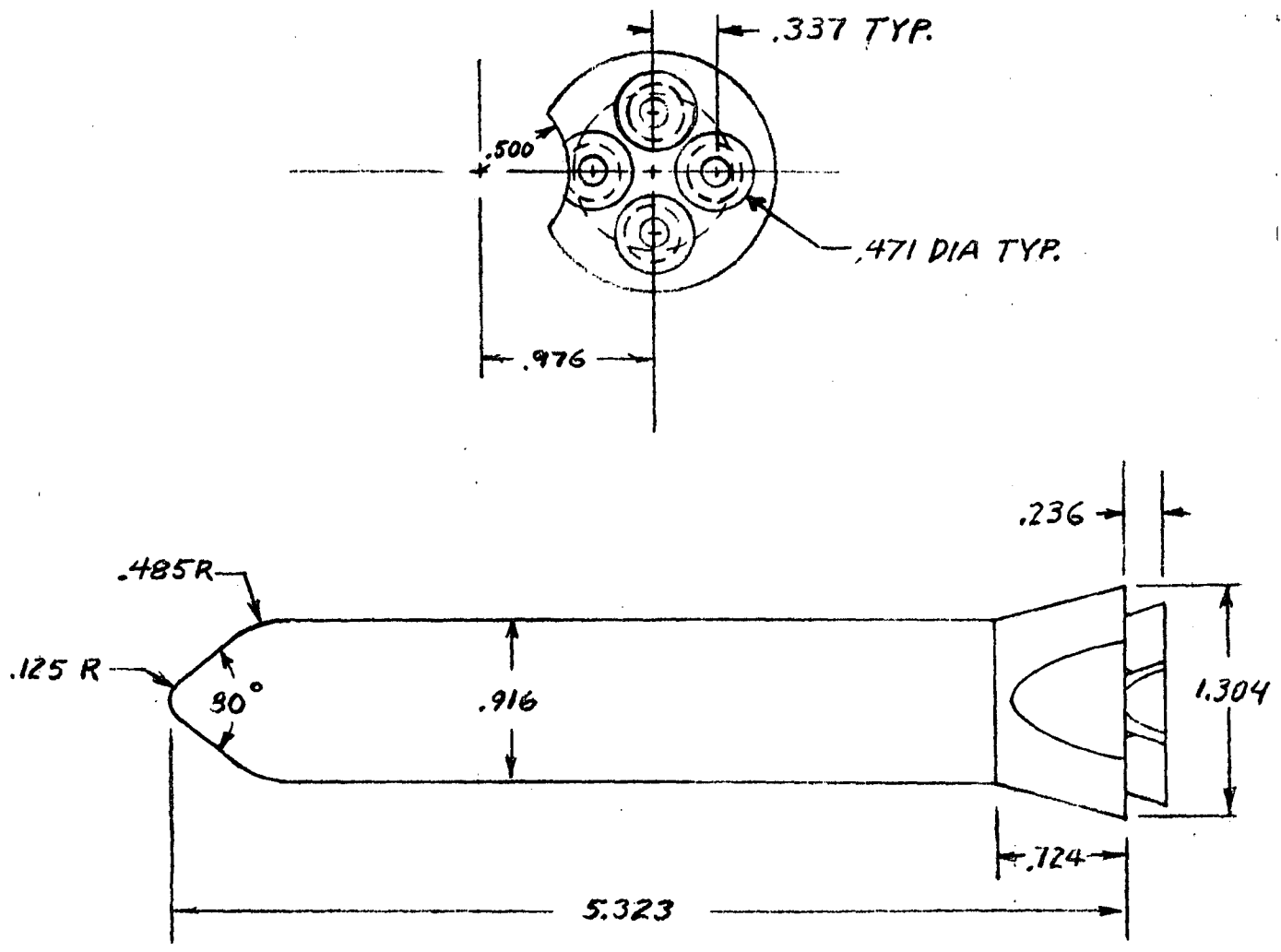

FIG 7. BODY B₃₇ AND ROCKETS R₇

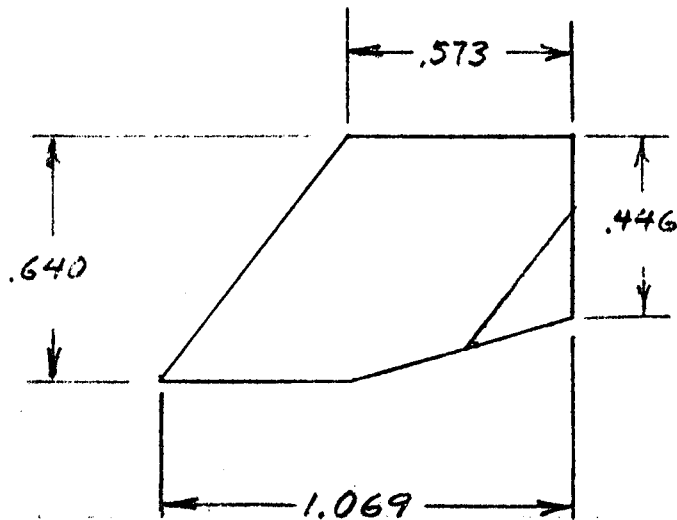
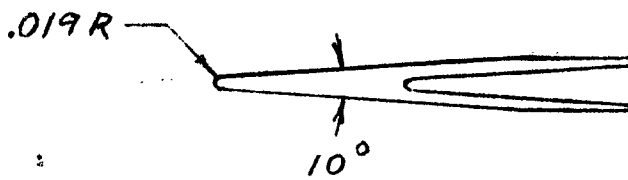

FIG 8. TAIL FIN TIP

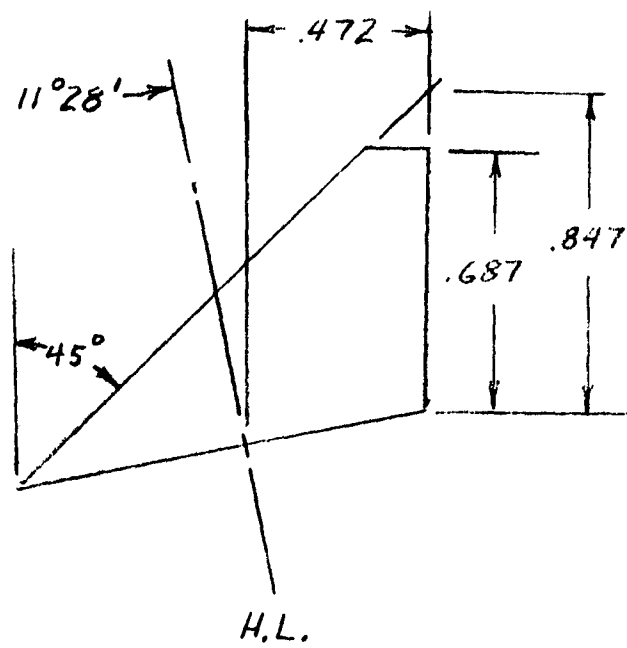
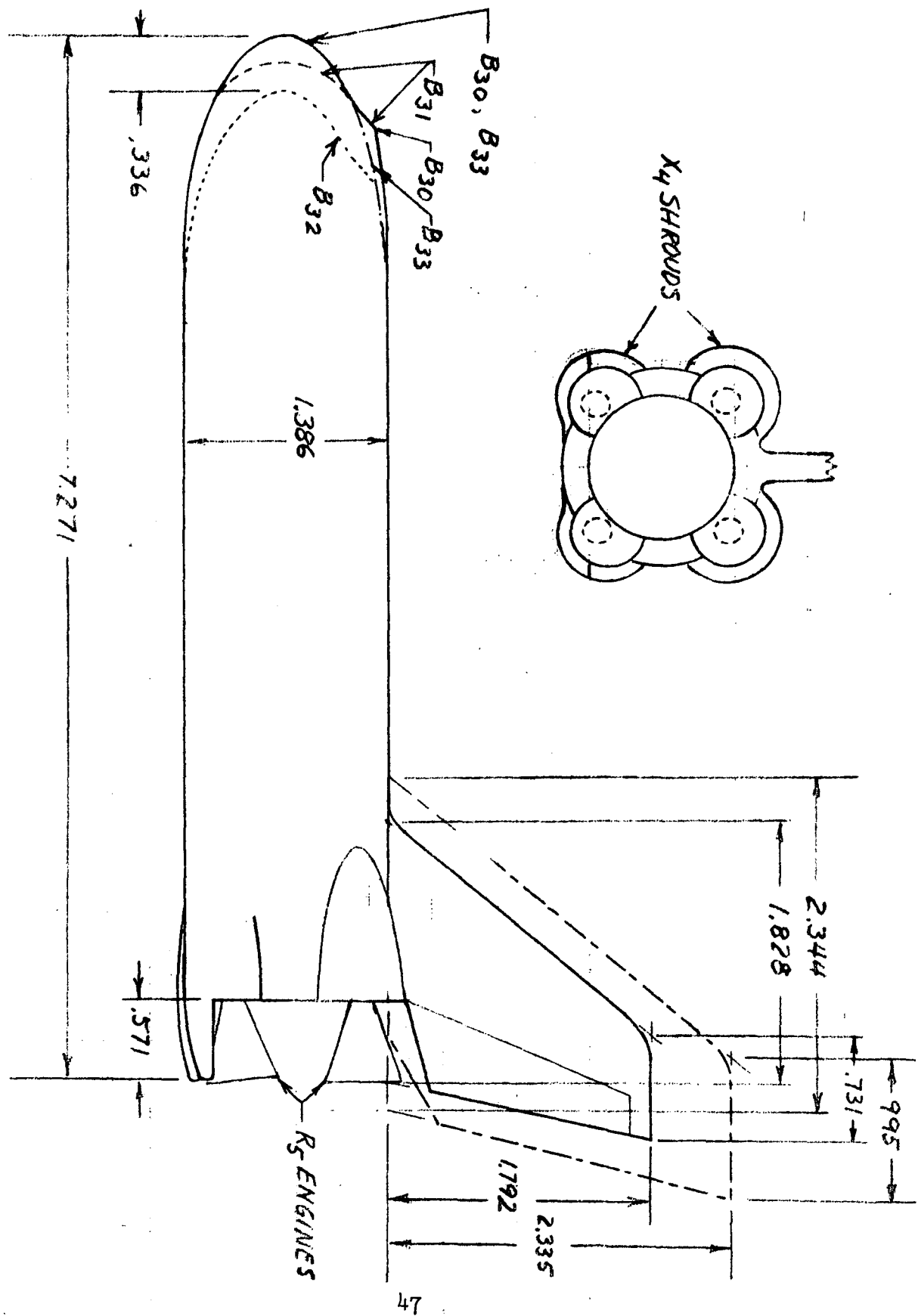

FIG 9. CANARD C10

FIG 10. BODIES B₃₀, B₃₁, B₃₂, AND B₃₃ ; VERTICAL TAILS V_{1/4} AND V_{1/6}



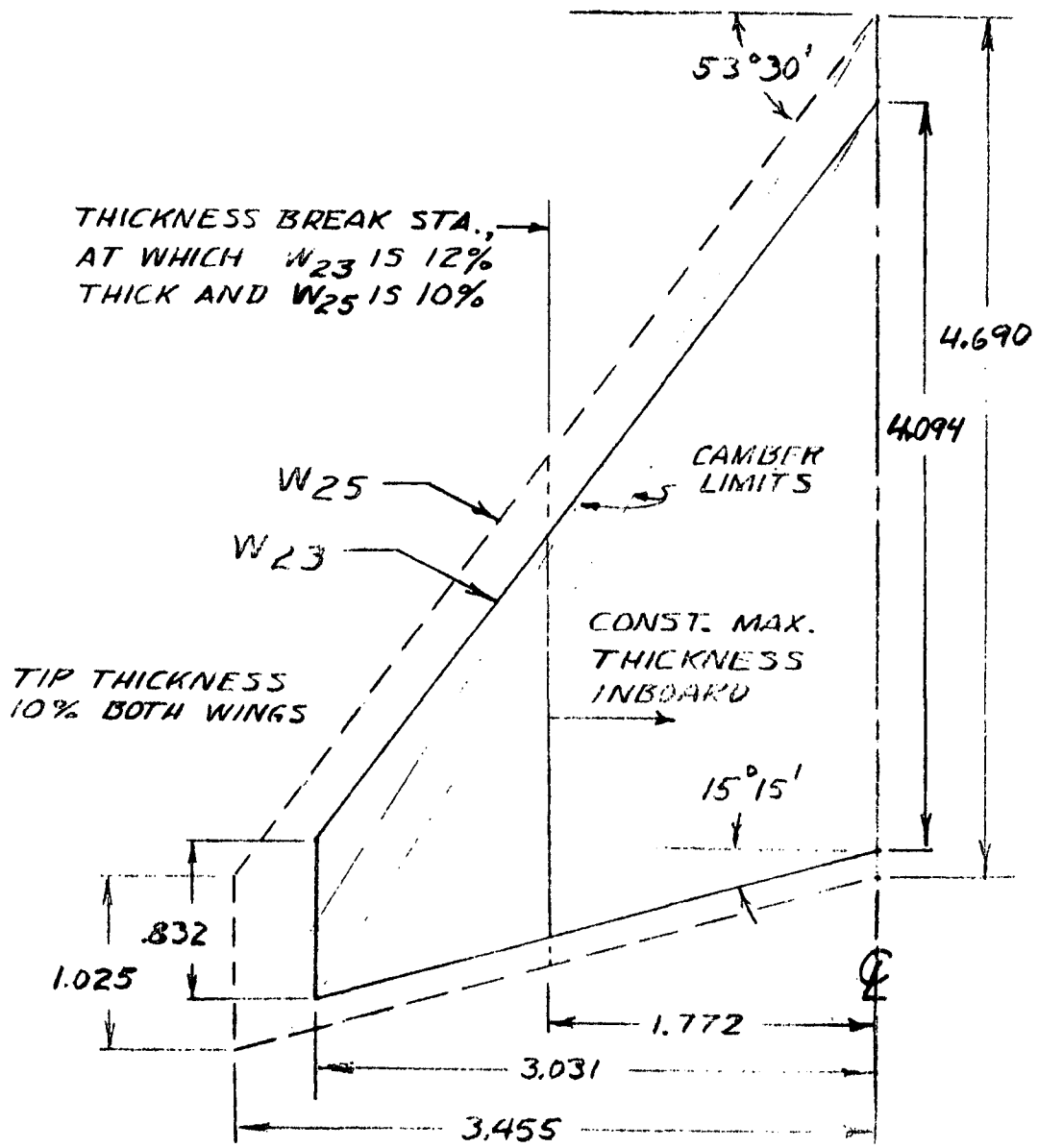
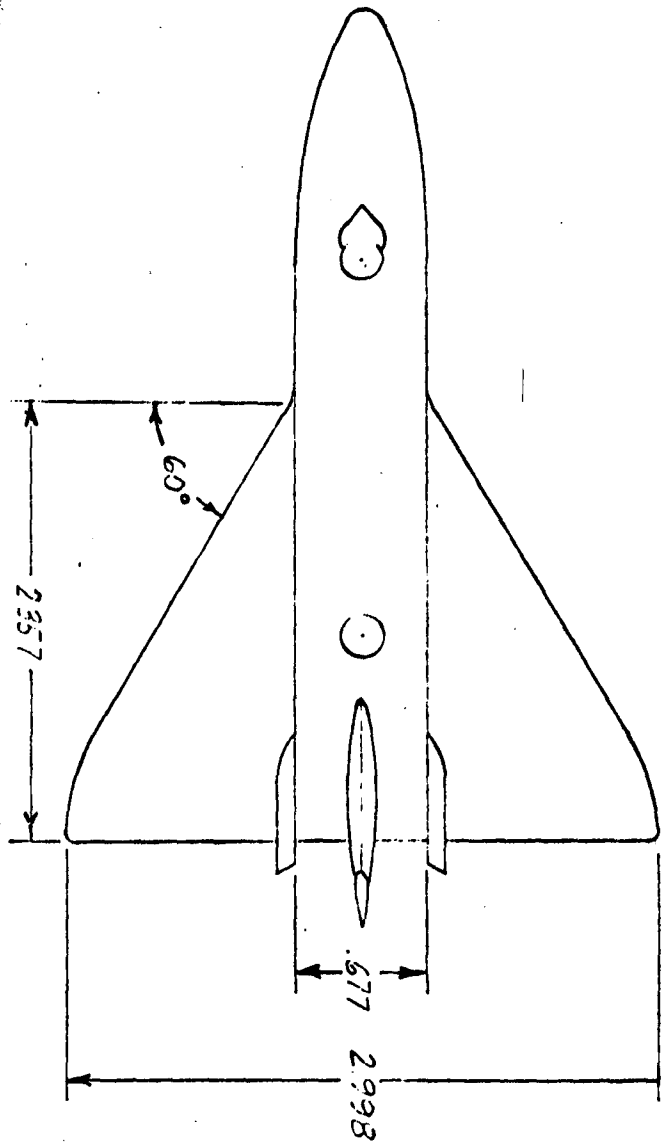

FIG 11. WINGS W_{23} AND W_{25}



ORBITER O5 15
ORBITER O2 MOVED
FORWARD 0.819 INCHES

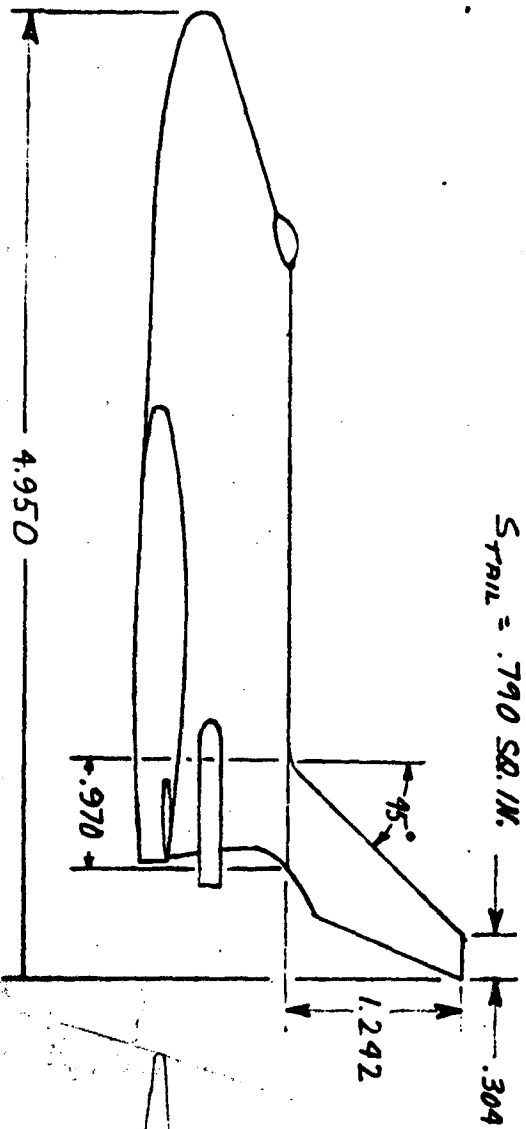
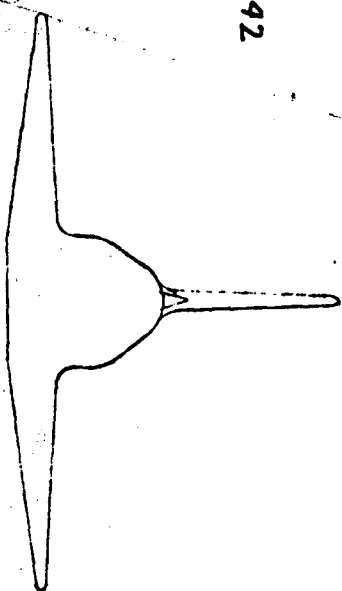

FIG. 12. ORBITER O2 AND O5



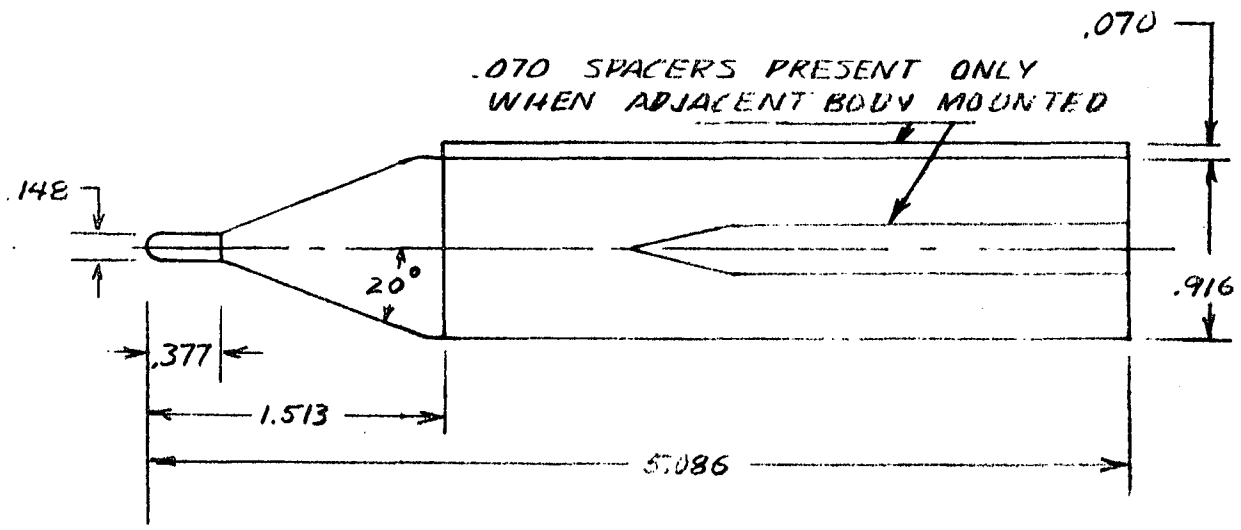
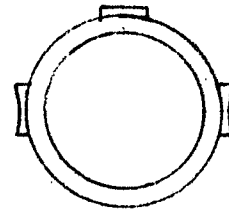
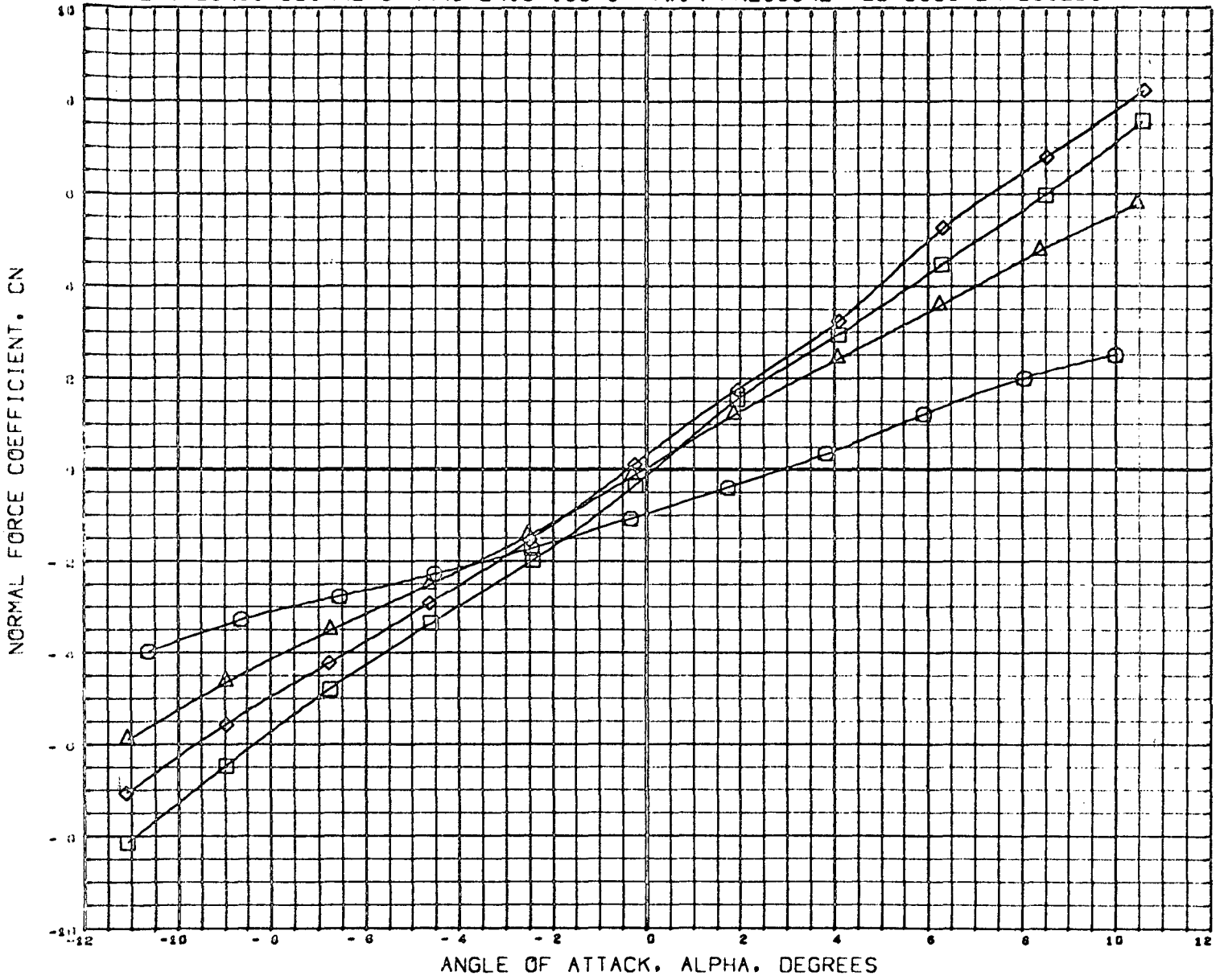

FIG. 13. TANK T₄

D A T A F I G U R E S

FIGURE-1 LONGITUDINAL CHARACTERISTICS OF TWIN PRESSURE FED BOOSTER BUILDUP



DATA SET SYMBOL	CONFIGURATION DESCRIPTION
(E80010)	MSFC TWT 514 TFFB Q2T4
(E80030)	MSFC TWT 514 TFFB B37R702T4
(E80050)	MSFC TWT 514 TFFB B37R7T1902T4
(E80070)	MSFC TWT 514 TFFB B37R7T19T4
(E80090)	DATA NOT AVAILABLE FOR ALL CONDITIONS

BETA
0.000
0.000
0.000
0.000
0.000

REFERENCE INFORMATION		
SREF	0.6600	89 IN
LREF	5.3230	INCHES
BREF	0.9170	INCHES
XM RP	2.0730	INCHES
YM RP	0.0000	INCHES
ZM RP	0.0000	INCHES
SCALE	0.0034	

MACH 0.099

FIGURE-1 LONGITUDINAL CHARACTERISTICS OF TWIN PRESSURE FED BOOSTER BUILDUP

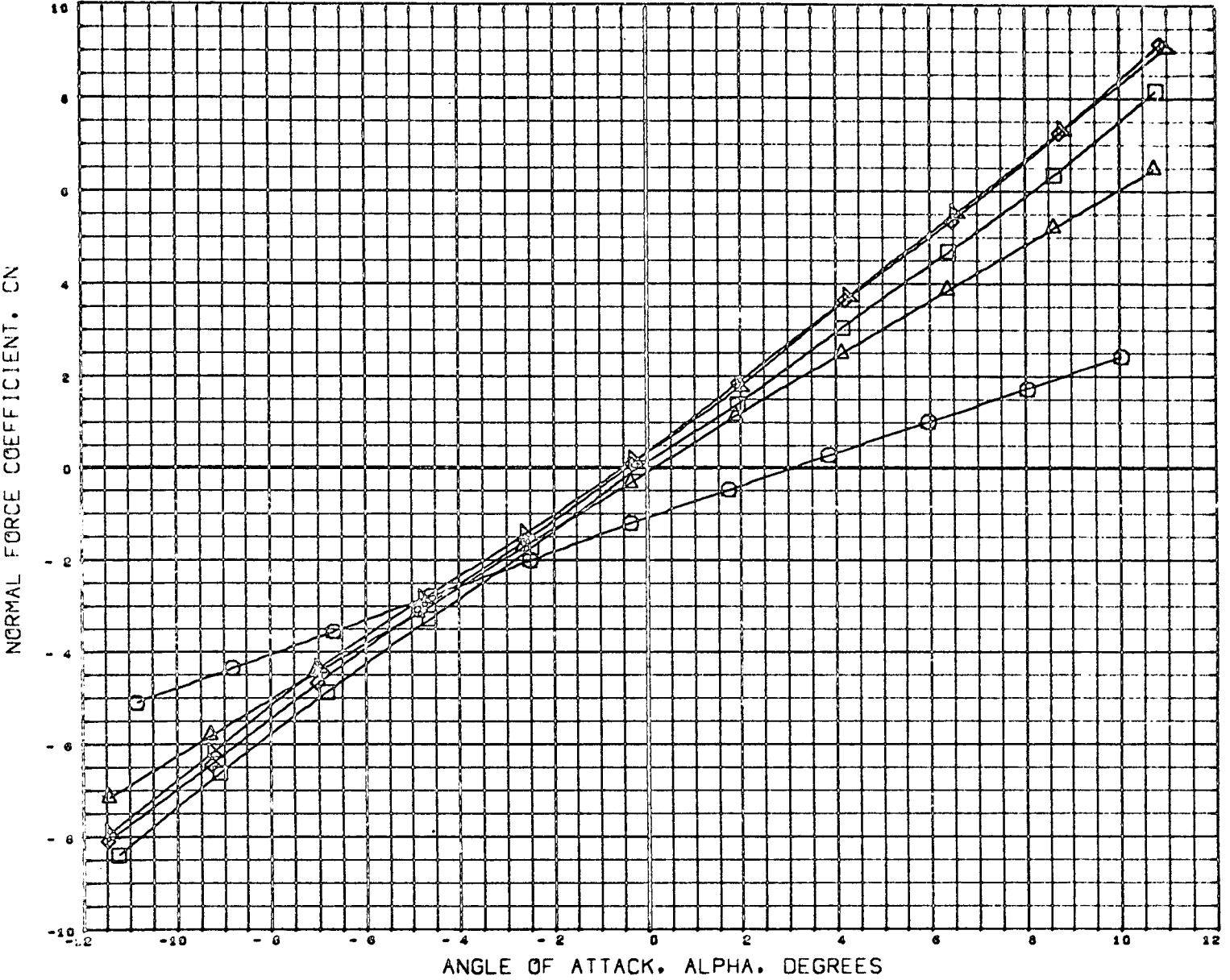

DATA SET SYMBOL	CONFIGURATION DESCRIPTION
(E9001)	MSFC TWT 514 TPF8 02T4
(E9003)	MSFC TWT 514 TPF8 837R702T4
(E9005)	MSFC TWT 514 TPF8 837R7T1902T4
(E9007)	MSFC TWT 514 TPF8 837R7T19T4
(E9009)	MSFC TWT 514 TPF8 837R7T1905T4

BETA
0.000
0.000
0.000
0.000
0.000

REFERENCE INFORMATION		
SREF	0.0600	SQ IN
LREF	5.3230	INCHES
BREF	0.9170	INCHES
XMRF	2.0730	INCHES
YMRF	0.0000	INCHES
ZMRF	0.0000	INCHES
SCALE	0.0034	

MACH 1.101

FIGURE-1 LONGITUDINAL CHARACTERISTICS OF TWIN PRESSURE FED BOOSTER BUILDUP

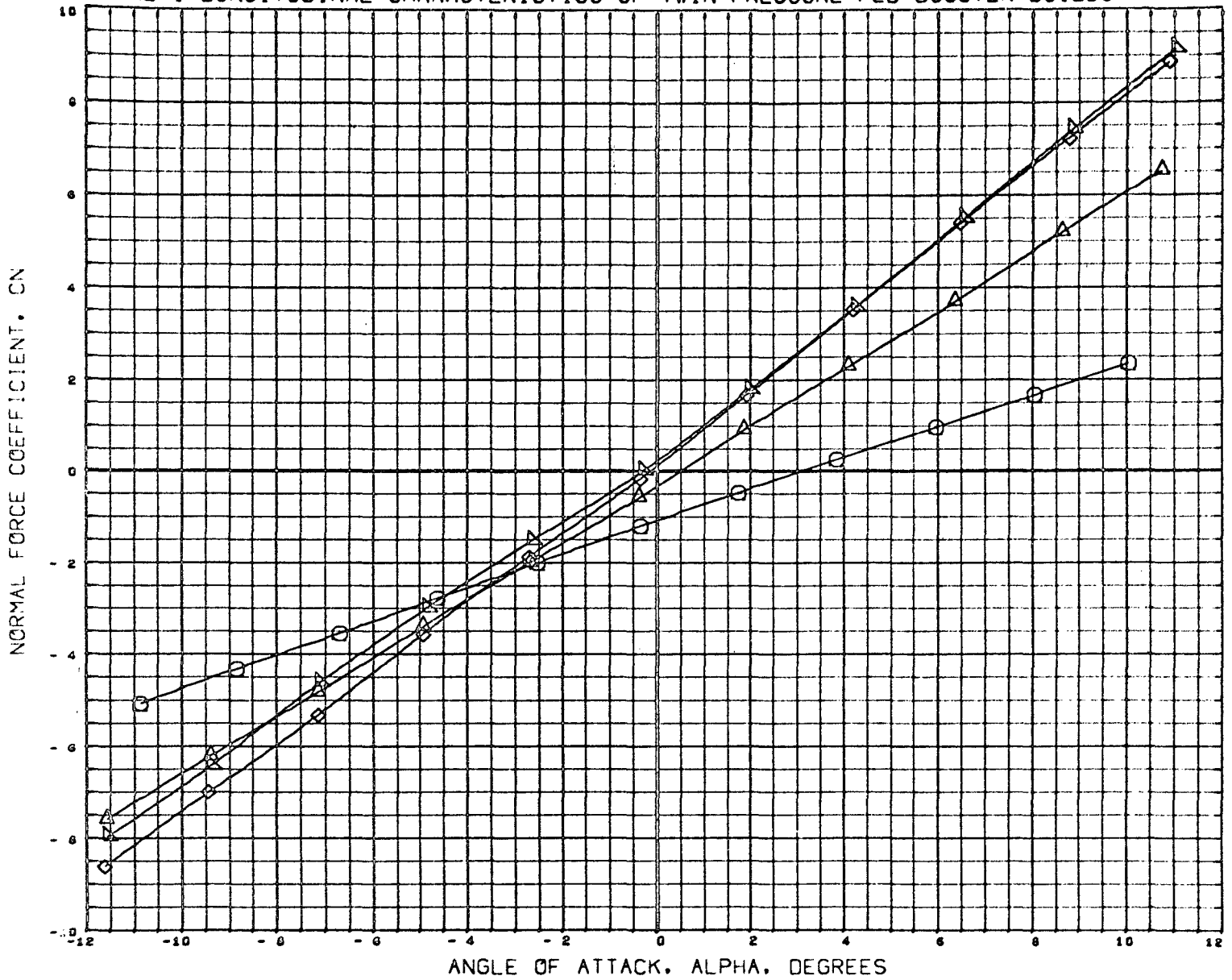

DATA SET SYMBOL	CONFIGURATION DESCRIPTION	BETA
(E98E10)	MSFC TWT 514 TPFB O2T4	0.000
(E98E30)	MSFC TWT 514 TPFB B37R702T4	0.000
(E98E50)	MSFC TWT 514 TPFB B37R7T1902T4	0.000
(E98E70)	DATA NOT AVAILABLE FOR ALL CONDITIONS	0.000
(E98E90)	MSFC TWT 514 TPFB B37R7T1905T4	0.000

REFERENCE INFORMATION	
SREF	0.6600 SQ IN
LREF	5.3230 INCHES
BREF	0.9170 INCHES
XMRP	2.0730 INCHES
YMRP	0.0000 INCHES
ZMRP	0.0000 INCHES
SCALE	0.0034

MACH 1.197

FIGURE-1 LONGITUDINAL CHARACTERISTICS OF TWIN PRESSURE FED BOOSTER BUILDUP

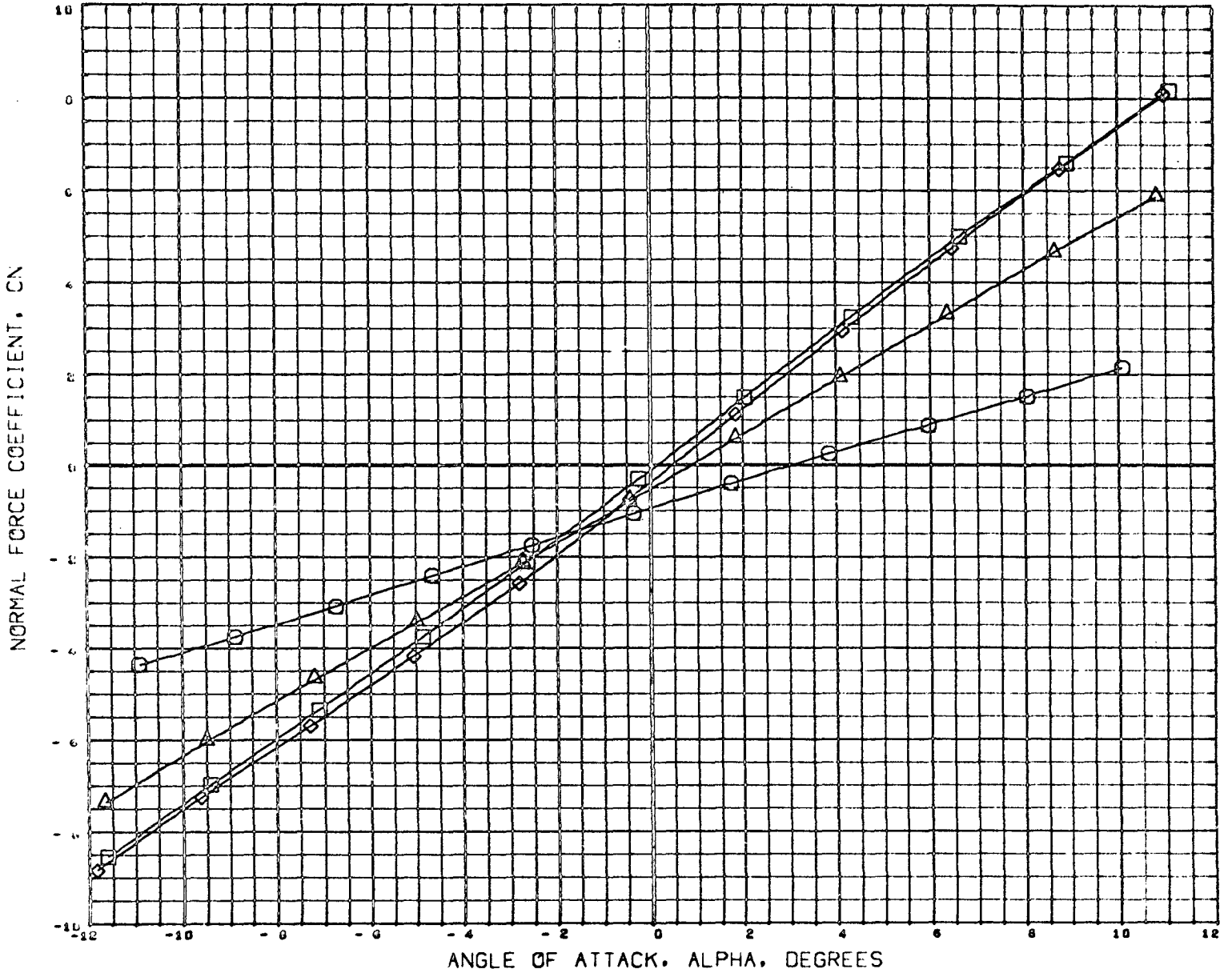

DATA SET SYMBOL	CONFIGURATION DESCRIPTION
(E90010)	MSFC TWT 514 TFPB 02T4
(E90033)	MSFC TWT 514 TFPB B37R702T4
(E90055)	MSFC TWT 514 TFPB B37R711902T4
(E90070)	MSFC TWT 514 TFPB B37R7119T4
(E90090)	DATA NOT AVAILABLE FOR ALL CONDITIONS

BETA
0.000
0.000
0.000
0.000
0.000

REFERENCE INFORMATION	
SREF	0.6600 SQ IN
LREF	5.3250 INCHES
BREF	0.9170 INCHES
XHRP	2.0730 INCHES
YHRP	0.0000 INCHES
ZHRP	0.0000 INCHES
SCALE	0.0034

MACH 1.450

FIGURE-1 LONGITUDINAL CHARACTERISTICS OF TWIN PRESSURE FED BOOSTER BUILDUP

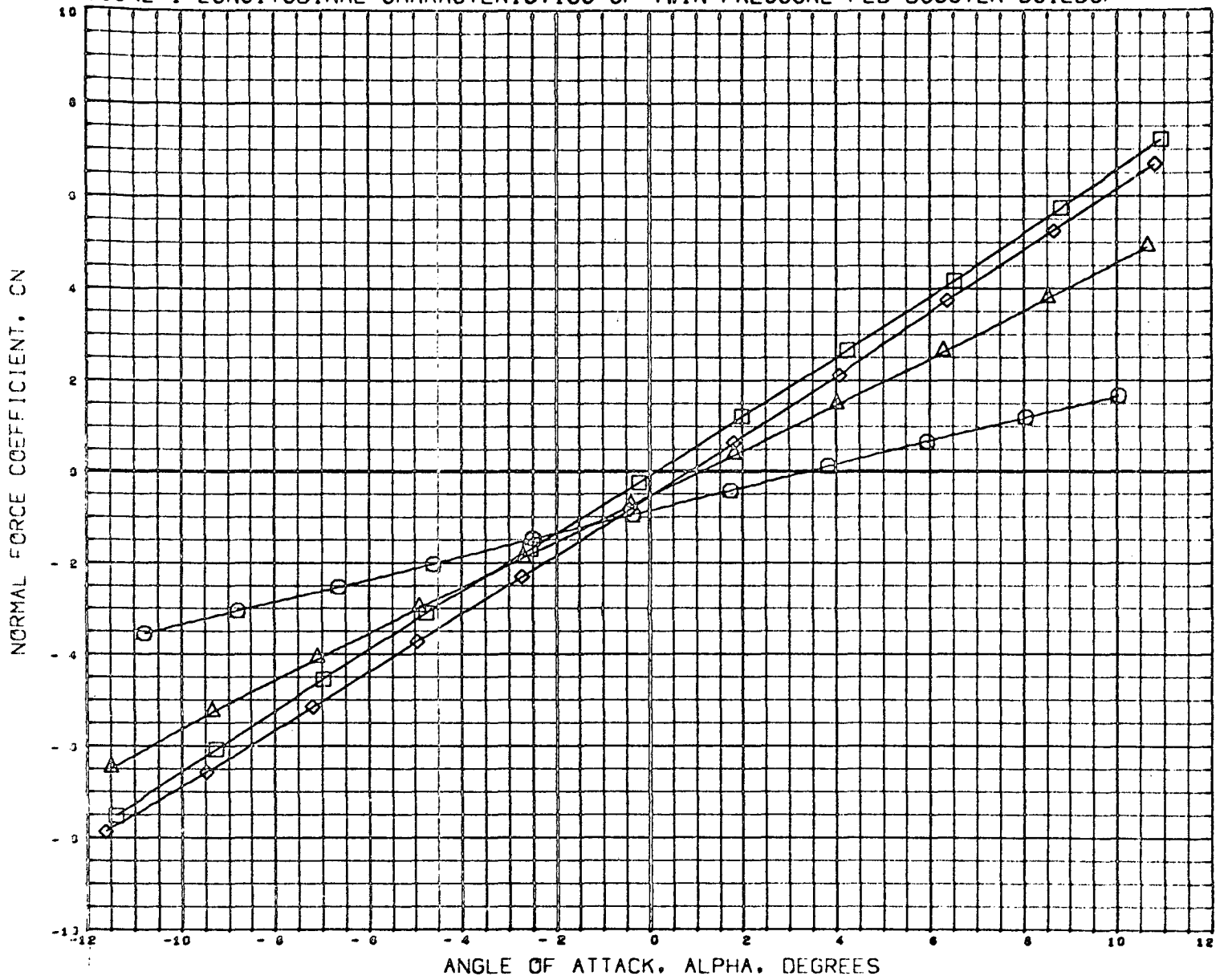

DATA SET SYMBOL	CONFIGURATION DESCRIPTION	BETA
(E500:0)	MSFC TWT 514 TPF8 02T4	0.000
(E500:0)	MSFC TWT 514 TPF8 B37R702T4	0.000
(E500:0)	MSFC TWT 514 TPF8 B37R711902T4	0.000
(E500:0)	MSFC TWT 514 TPF8 B37R7119T4	0.000
(E500:0)	DATA NOT AVAILABLE FOR ALL CONDITIONS	0.000

REFERENCE INFORMATION		
SREF	0.6600	50 IN
LREF	5.3230	INCHES
BREF	0.9170	INCHES
XMRP	2.0730	INCHES
YMRP	0.0000	INCHES
ZMRP	0.0000	INCHES
SCALE	0.0034	

MACH 1.961

N

FIGURE-1 LONGITUDINAL CHARACTERISTICS OF TWIN PRESSURE FED BOOSTER BUILDUP

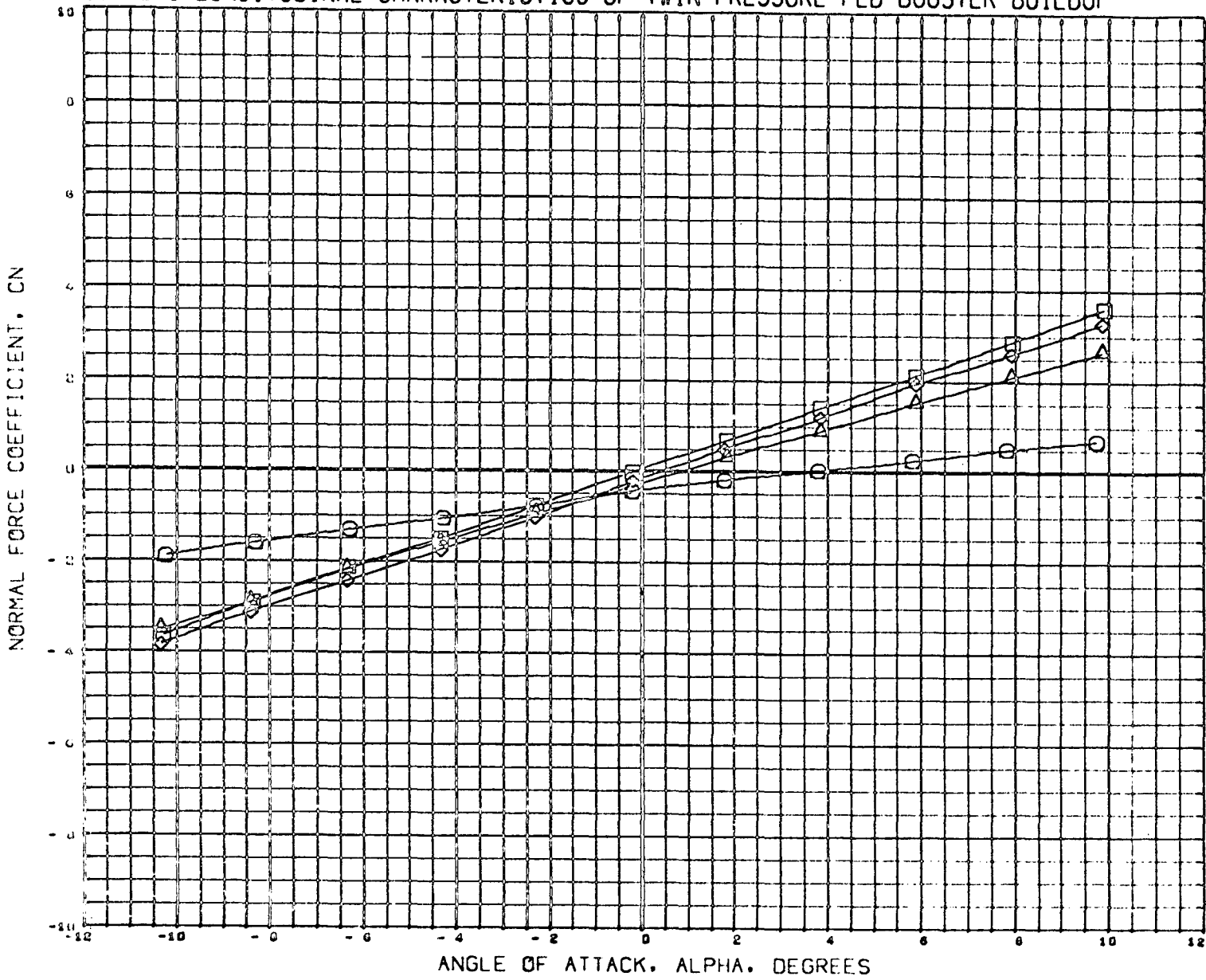

DATA SET SYMBOL	CONFIGURATION DESCRIPTION	BETA
(E50010)	MSFC TWT 514 TPF8 O2T4	0.000
(E50050)	MSFC TWT 514 TPF8 Q37R7O2T4	0.000
(E50050)	MSFC TWT 514 TPF8 Q37K/119O2T4	0.000
(E50070)	MSFC TWT 514 TPF8 Q37R7119T4	0.000
(E50090)	DATA NOT AVAILABLE FOR ALL CONDITIONS	0.000

REFERENCE INFORMATION		
SREF	0.6600	SQ IN
LREF	5.3230	INCHES
BREF	0.9170	INCHES
XMRP	2.0730	INCHES
YMRP	0.0000	INCHES
ZMRP	0.0000	INCHES
SCALE	0.0034	

MACH 4.959

FIGURE-1 LONGITUDINAL CHARACTERISTICS OF TWIN PRESSURE FED BOOSTER BUILDUP

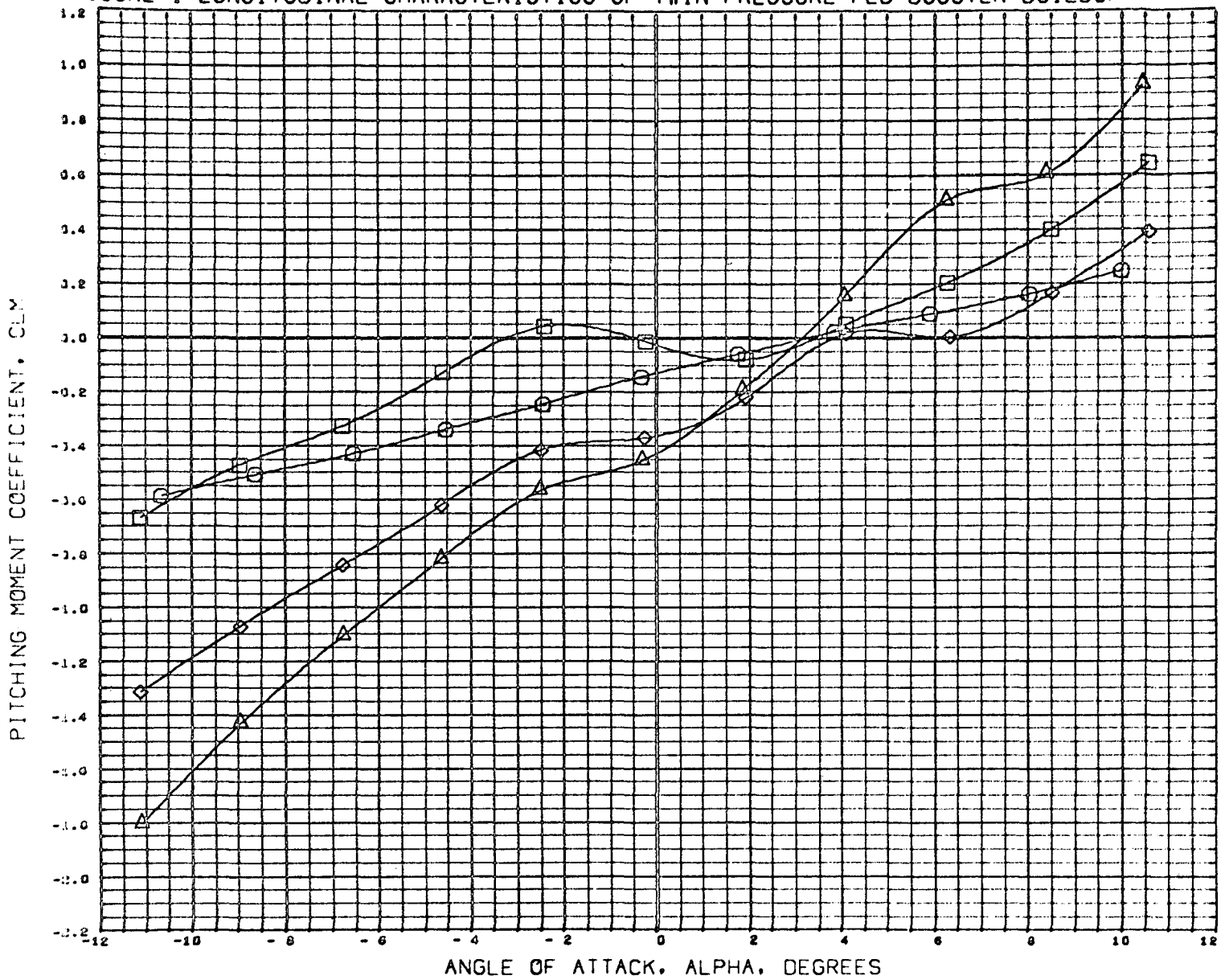

DATA SET SYMBOL	CONFIGURATION DESCRIPTION	BETA
(E58010)	MSFC TWT 514 TFFB O2T4	0.000
(E58030)	MSFC TWT 514 TFFB B37R702T4	0.000
(E58050)	MSFC TWT 514 TFFB B37R7T1902T4	0.000
(E58070)	MSFC TWT 514 TFFB B37R7T19T4	0.000
(E58090)	DATA NOT AVAILABLE FOR ALL CONDITIONS	0.000

REFERENCE INFORMATION		
SREF	0.6600	SQ IN
LREF	5.3230	INCHES
BREF	0.9170	INCHES
XMRP	2.0730	INCHES
YMRP	0.0000	INCHES
ZMRP	0.0000	INCHES
SCALE	0.0034	

MACH 0.899

FIGURE-1 LONGITUDINAL CHARACTERISTICS OF TWIN PRESSURE FED BOOSTER BUILDUP

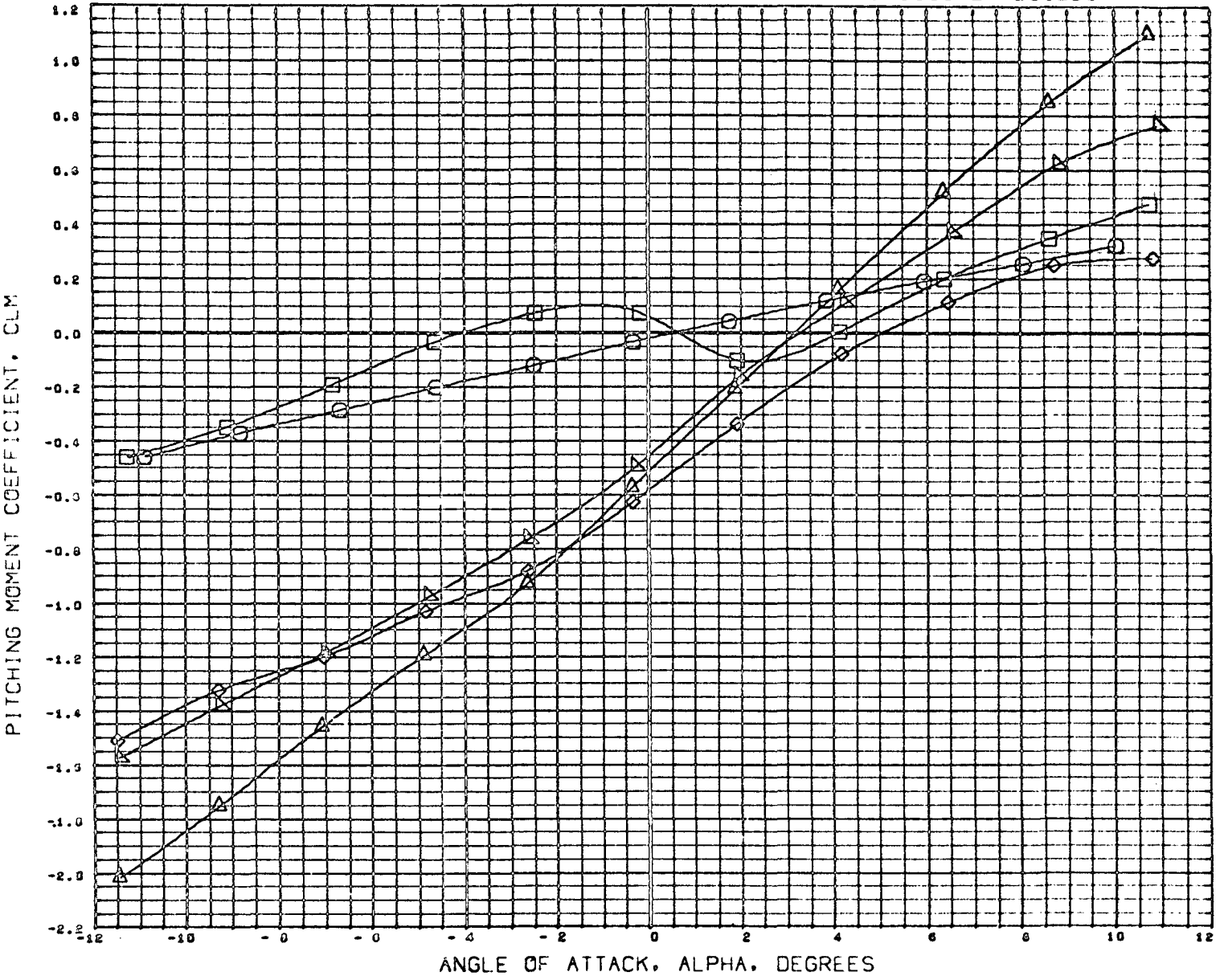

DATA SET SYMBOL	CONFIGURATION DESCRIPTION	BETA	REFERENCE INFORMATION
(E5001)	MSFC TWT 514 TPFB O2T4	0.000	SREF 0.6600 90 IN
(E5003)	MSFC TWT 514 TPFB Q37R7O2T4	0.000	LREF 5.3230 INCHES
(E5005)	MSFC TWT 514 TPFB Q37R7T19O2T4	0.000	BREF 0.9170 INCHES
(E5007)	MSFC TWT 514 TPFB Q37R7T19T4	0.000	XMRP 2.0730 INCHES
(E5009)	MSFC TWT 514 TPFB Q37R7T19O5T4	0.000	YMRP 0.0000 INCHES
			ZMRP 0.0000 INCHES
			SCALE 0.0034

MACH 1.101

FIGURE-1 LONGITUDINAL CHARACTERISTICS OF TWIN PRESSURE FED BOOSTER BUILDUP

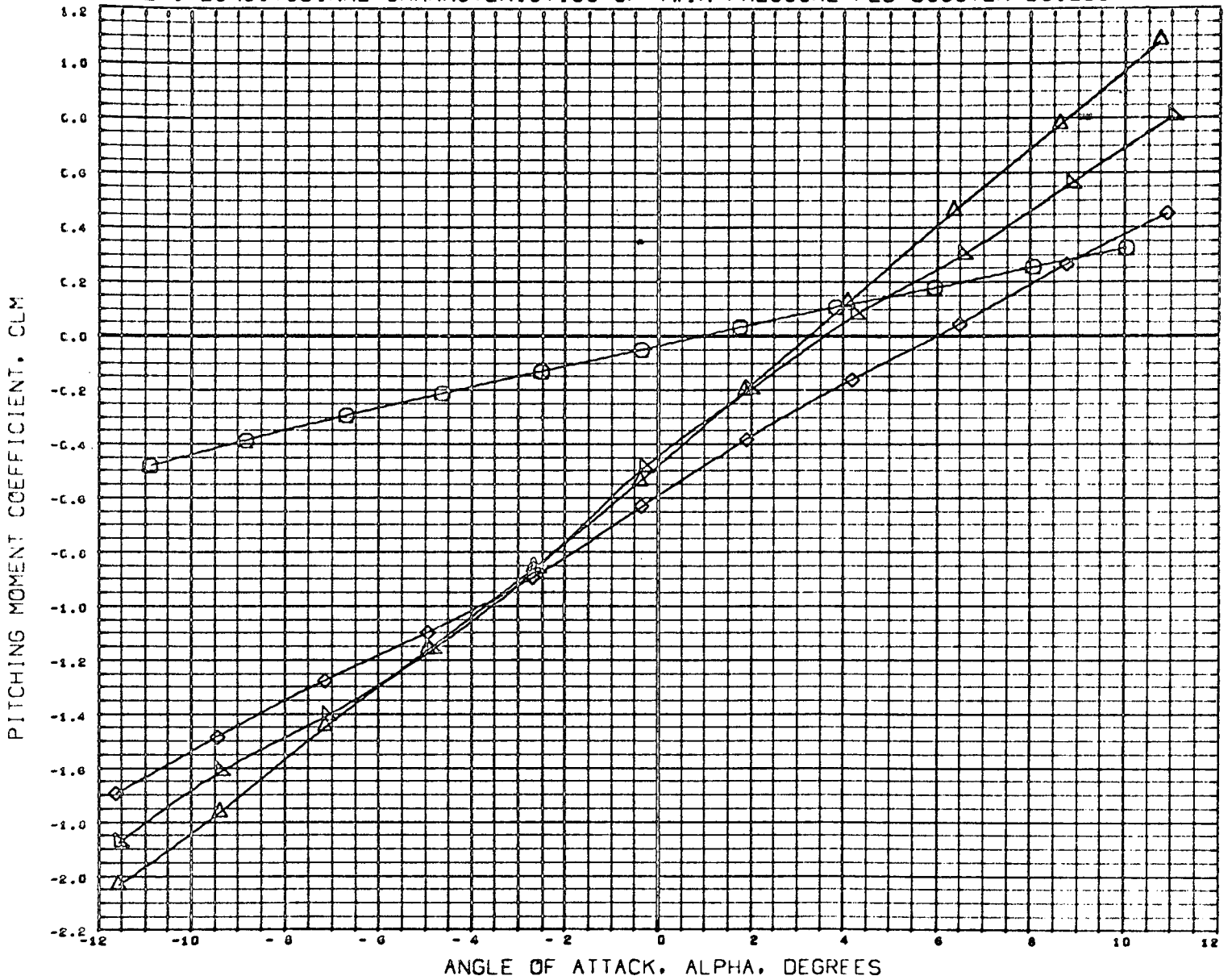

DATA SET SYMBOL	CONFIGURATION DESCRIPTION	BETA
(E380:0)	MSFC TWT 514 TPF8 O2T4	0.000
(E390:0)	MSFC TWT 514 TPF8 B37R702T4	0.000
(E300:0)	MSFC TWT 514 TPF8 B37R7T1902T4	0.000
(E300:0)	DATA NOT AVAILABLE FOR ALL CONDITIONS	0.000
(E300:0)	MSFC TWT 514 TPF8 B37R7T1905T4	0.000

REFERENCE INFORMATION	
SREF	0.6600 SQ IN
LREF	5.3230 INCHES
BREF	0.9170 INCHES
XMRP	2.0730 INCHES
YMRP	0.0000 INCHES
ZMRP	0.0000 INCHES
SCALE	0.0034

MACH 1.197

FIGURE-1 LONGITUDINAL CHARACTERISTICS OF TWIN PRESSURE FED BOOSTER BUILDUP

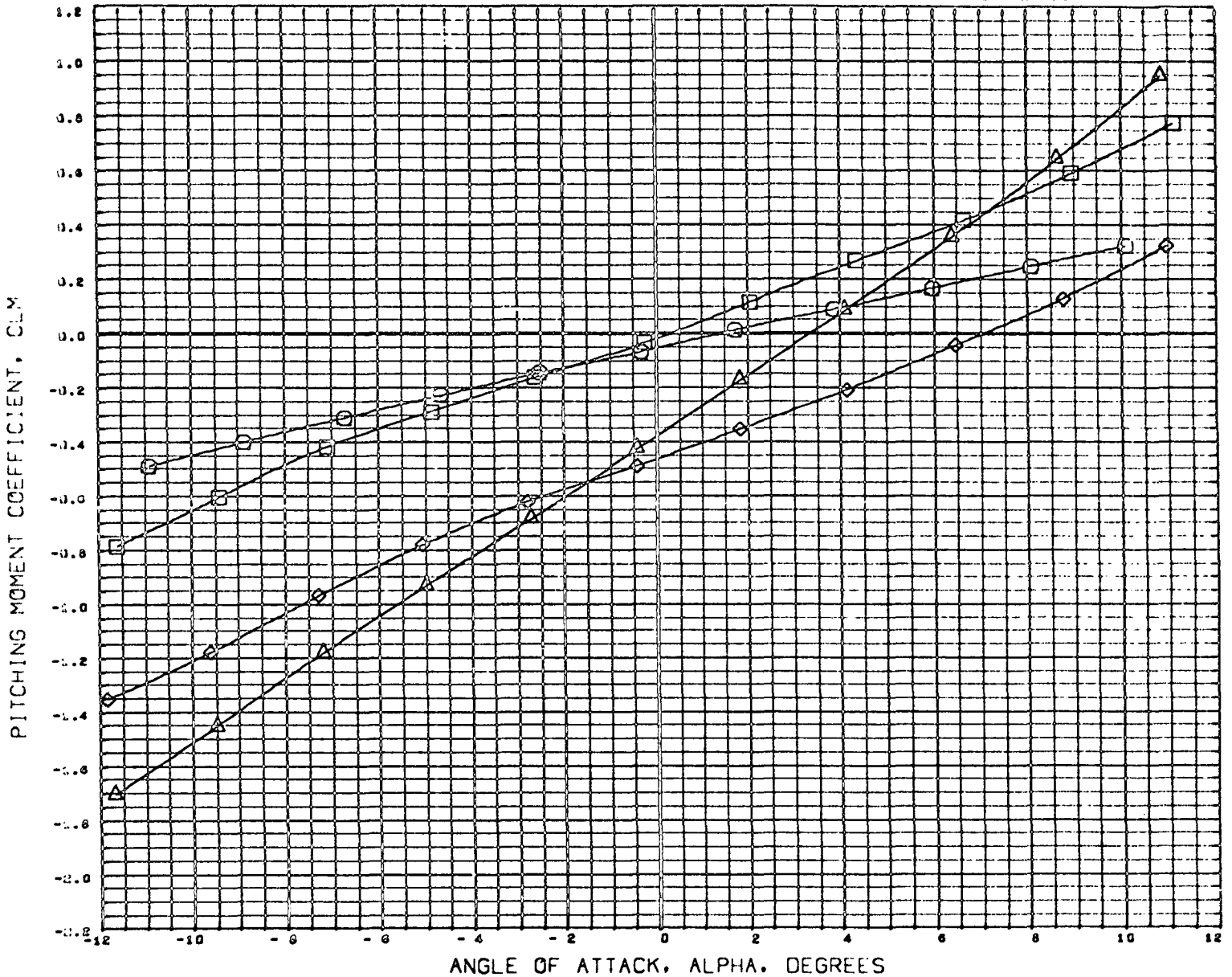

DATA SET SYMBOL	CONFIGURATION DESCRIPTION
(E90010)	MSFC TWT 914 TPF8 O2T4
(E90030)	MSFC TWT 914 TPF8 B37R7O2T4
(E90050)	MSFC TWT 914 TPF8 B37R7I19O2T4
(E90070)	MSFC TWT 914 TPF8 B37R7I19T4
(E90090)	DATA NOT AVAILABLE FOR ALL CONDITIONS

BETA
0.000
0.000
0.000
0.000
0.000

REFERENCE INFORMATION	
SREF	0.6600 60 IN
LREF	5.5230 INCHES
DREF	0.9170 INCHES
XMRP	2.0750 INCHES
YMRP	0.0000 INCHES
ZMRP	0.0000 INCHES
SCALE	0.0034

MACH 1.450

FIGURE-1 LONGITUDINAL CHARACTERISTICS OF TWIN PRESSURE FED BOOSTER BUILDUP

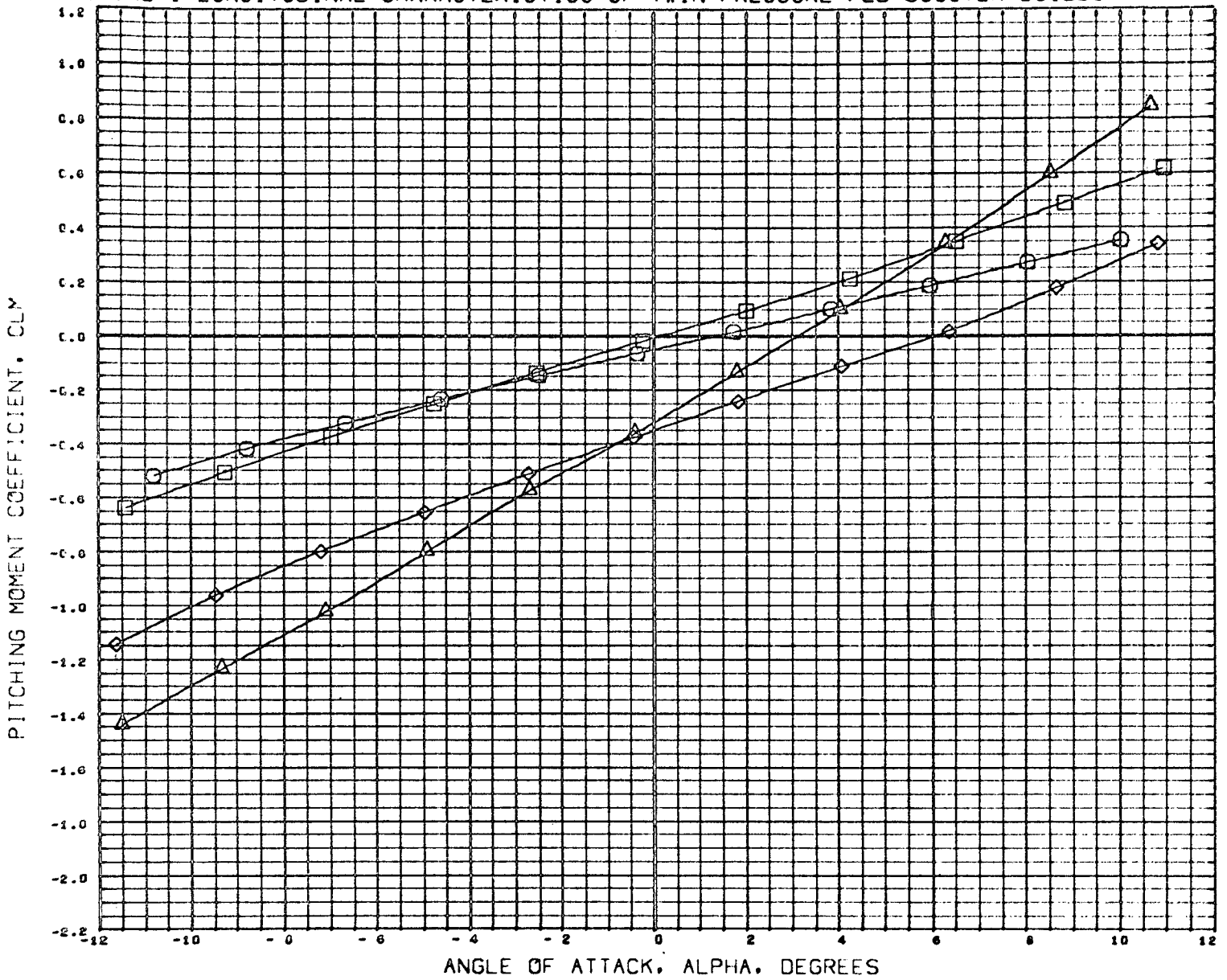

DATA SET SYMBOL	CONFIGURATION DESCRIPTION
(E580.0)	MSFC TWT 514 TPF8 O2T4
(E560.0)	MSFC TWT 514 TPF8 B37R7O2T4
(E580.0)	MSFC TWT 514 TPF8 B37R7I19O2T4
(E500.0)	MSFC TWT 514 TPF8 B37R7I19T4
(E58000)	DATA NOT AVAILABLE FOR ALL CONDITIONS

BETA
0.000
0.000
0.000
0.000
0.000

REFERENCE INFORMATION	
SREF	0.6600 50 IN
LREF	5.3250 INCHES
BREF	0.9170 INCHES
XMRP	2.0730 INCHES
YMRP	0.0000 INCHES
ZMRP	0.0000 INCHES
SCALE	0.0034

MACH 1.961

FIGURE-1 LONGITUDINAL CHARACTERISTICS OF TWIN PRESSURE FED BOOSTER BUILDUP

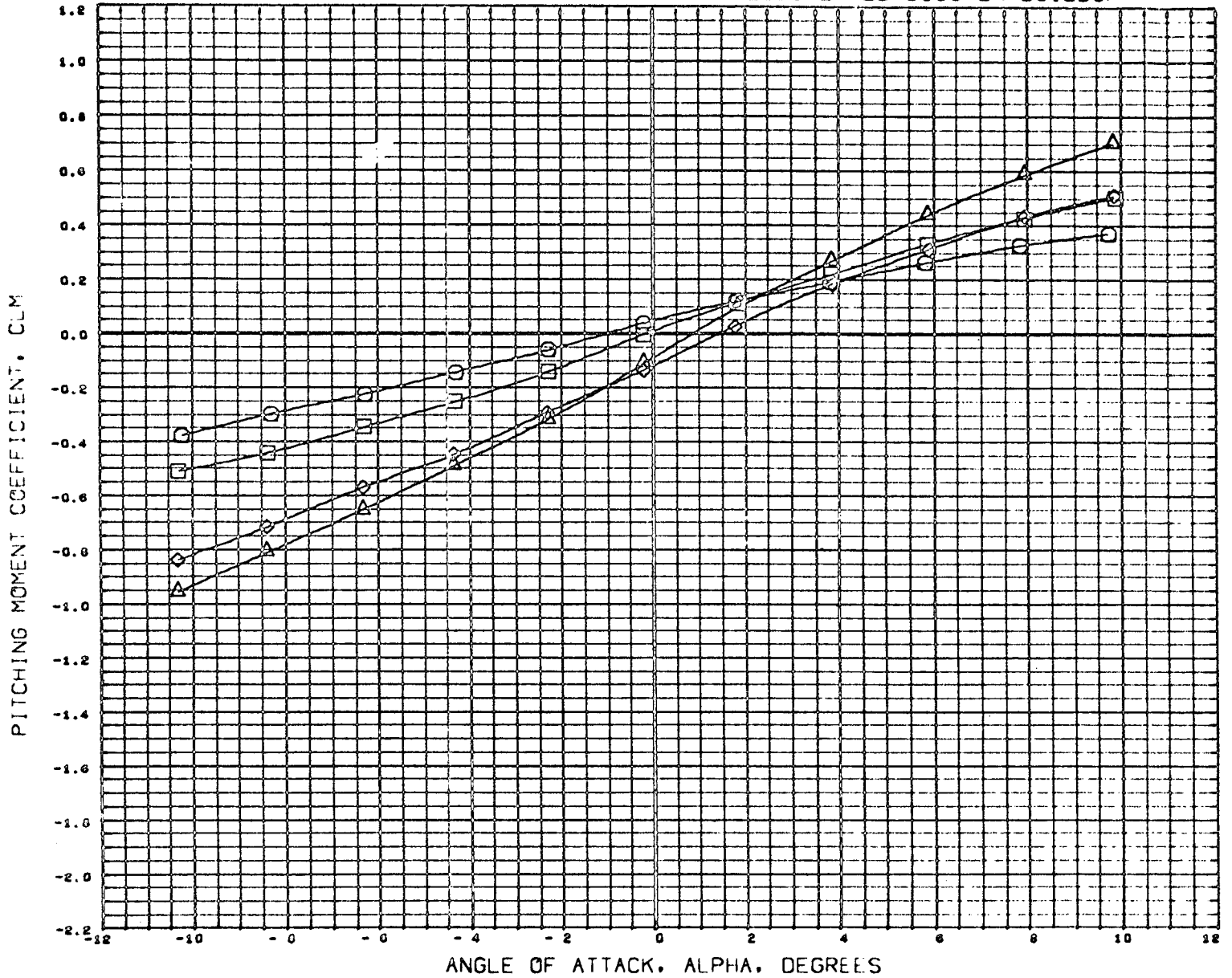

DATA SET	SYMBOL	CONFIGURATION DESCRIPTION	BETA
(E98019)	○	MSFC TWT 514 TPFB 02T4	0.000
(E98033)	□	MSFC TWT 514 TPFB B37R702T4	0.000
(E98057)	◇	MSFC TWT 514 TPFB B37R7T1902T4	0.000
(E98007)	△	MSFC TWT 514 TPFB B37R7T19T4	0.000
(E98009)	◻	DATA NOT AVAILABLE FOR ALL CONDITIONS	0.000

REFERENCE INFORMATION	
SREF	0.8600 SQ IN
LREF	5.3230 INCHES
BREF	0.9170 INCHES
XMRP	2.0730 INCHES
YMRP	0.0000 INCHES
ZMRP	0.0000 INCHES
SCALE	0.0034

MACH 4.959

FIGURE-1 LONGITUDINAL CHARACTERISTICS OF TWIN PRESSURE FED BOOSTER BUILDUP

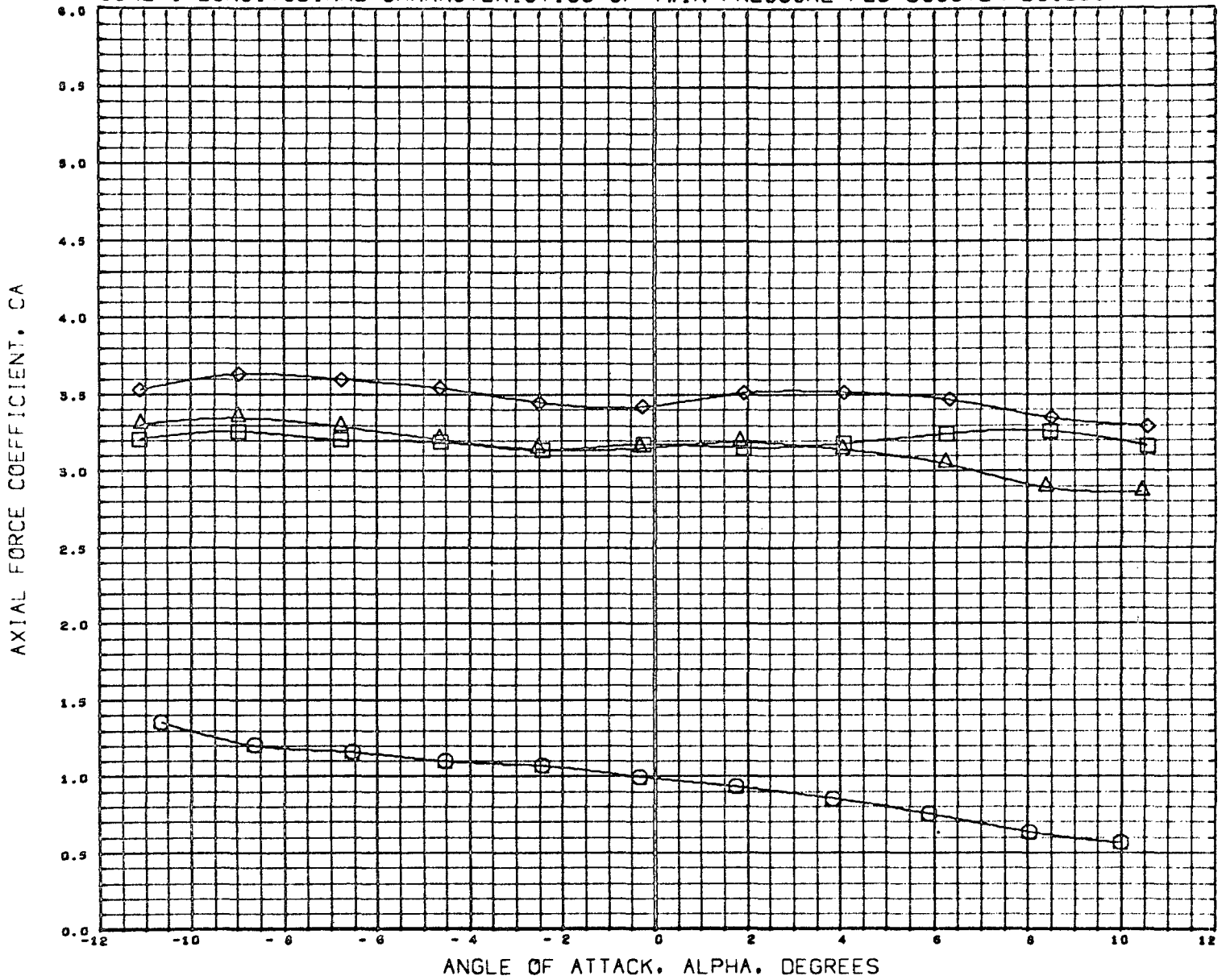

DATA SET SYMBOL	CONFIGURATION DESCRIPTION	BETA
(E58310)	MSFC TWT 514 TFFB O2T4	0.000
(E58330)	MSFC TWT 514 TFFB B37R7O2T4	0.000
(E58350)	MSFC TWT 514 TFFB B37R7T19O2T4	0.000
(E58370)	MSFC TWT 514 TFFB B37R7T19T4	0.000
(E58390)	DATA NOT AVAILABLE FOR ALL CONDITIONS	0.000

REFERENCE INFORMATION		
SREF	0.6600	SQ IN
LREF	5.3230	INCHES
BREF	0.9170	INCHES
XMRP	2.0730	INCHES
YMRP	0.0000	INCHES
ZMRP	0.0000	INCHES
SCALE	0.0034	

MACH 0.099

FIGURE-1 LONGITUDINAL CHARACTERISTICS OF TWIN PRESSURE FED BOOSTER BUILDUP

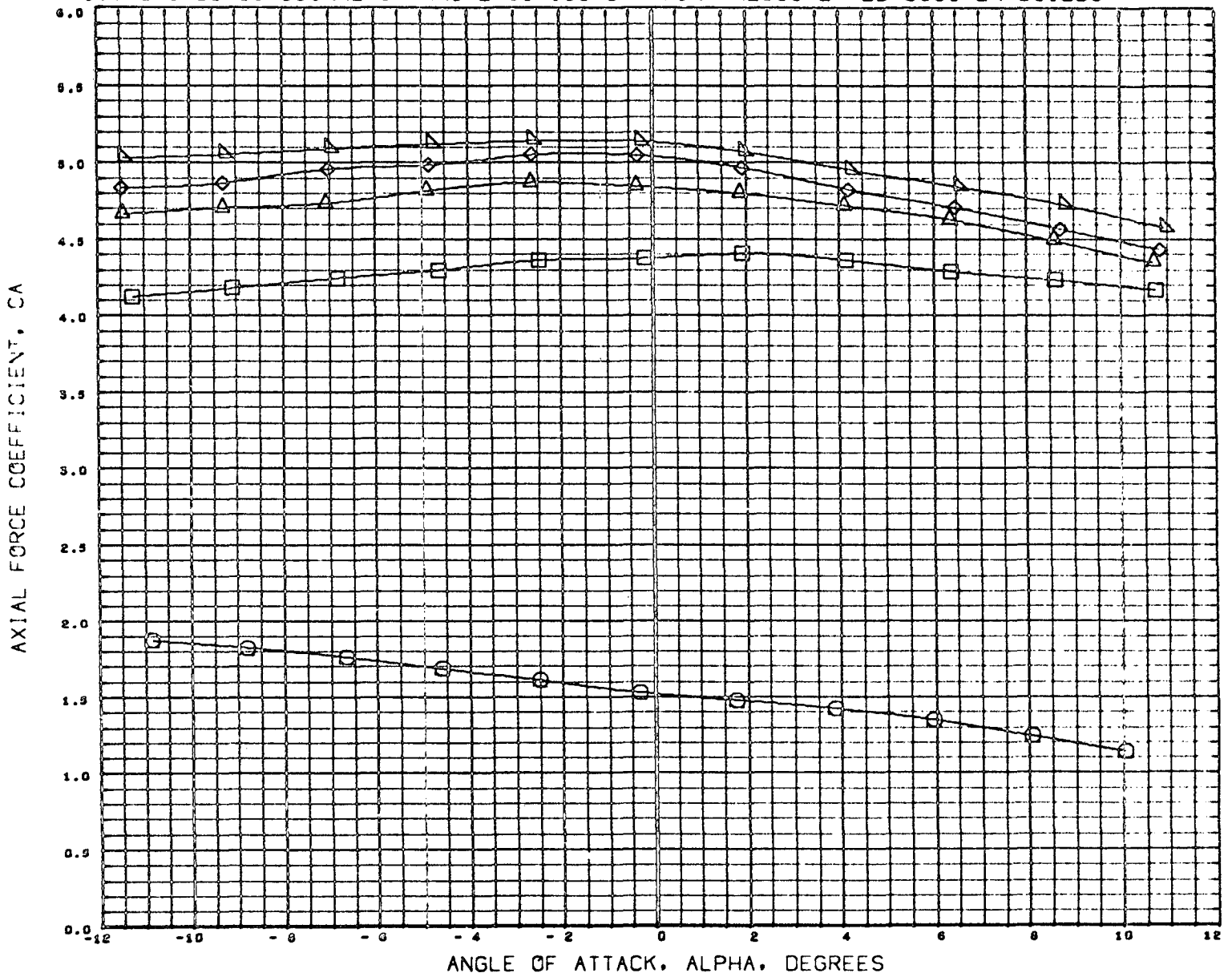

DATA SET SYMBOL	CONFIGURATION DESCRIPTION
(E96010)	MSFC TWT 514 TPFB O2T4
(E96030)	MSFC TWT 514 TPFB B37R702T4
(E96050)	MSFC TWT 514 TPFB B37R7T1902T4
(E96070)	MSFC TWT 514 TPFB B37R7T19T4
(E96090)	MSFC TWT 514 TPFB B37R7T1905T4

BETA
0.000
0.000
0.000
0.000
0.000

REFERENCE INFORMATION		
SREF	0.6600	SQ IN
LREF	9.3230	INCHES
BREF	0.9170	INCHES
XMRP	2.0730	INCHES
YMRP	0.0000	INCHES
ZMRP	0.0000	INCHES
SCALE	0.0034	

MACH 1.101

FIGURE-1 LONGITUDINAL CHARACTERISTICS OF TWIN PRESSURE FED BOOSTER BUILDUP

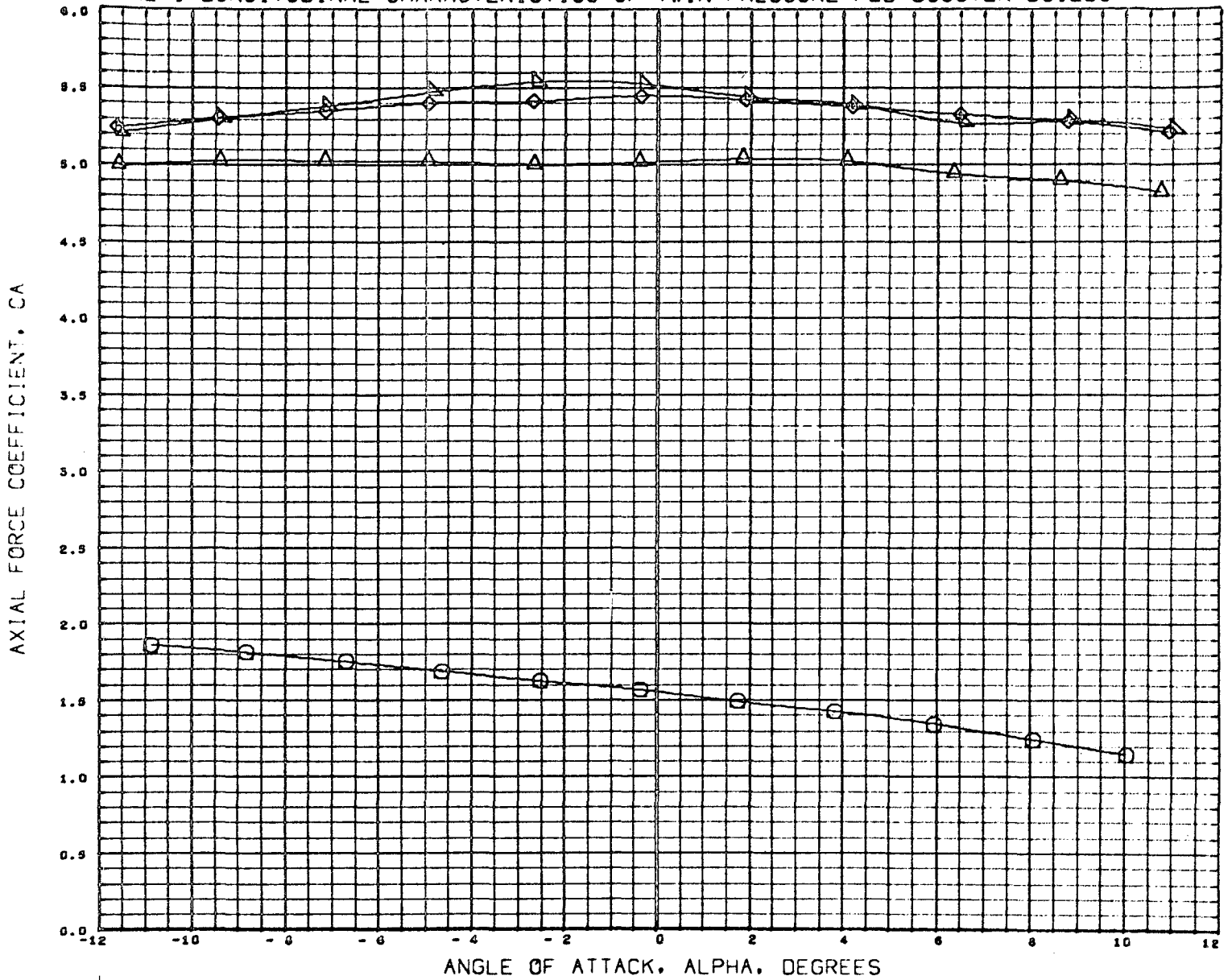

DATA SET	SYMBOL	CONFIGURATION DESCRIPTION
(E58110)	◇	MSFC TWT 514 TPFB Q2T4
(E58130)	◇	MSFC TWT 514 TPFB B37R702T4
(E58150)	◇	MSFC TWT 514 TPFB B37R7T1902T4
(E58170)	◇	DATA NOT AVAILABLE FOR ALL CONDITIONS
(E58190)	△	MSFC TWT 514 TPFB B37R7T1905T4

BETA
0.000
0.000
0.000
0.000
0.000

REFERENCE INFORMATION	
SREF	0.6600 SQ IN
LREF	5.3230 INCHES
BREF	0.9170 INCHES
XMRP	2.0730 INCHES
YMRP	0.0000 INCHES
ZMRP	0.0000 INCHES
SCALE	0.0034

MACH 1.197

FIGURE-1 LONGITUDINAL CHARACTERISTICS OF TWIN PRESSURE FED BOOSTER BUILDUP

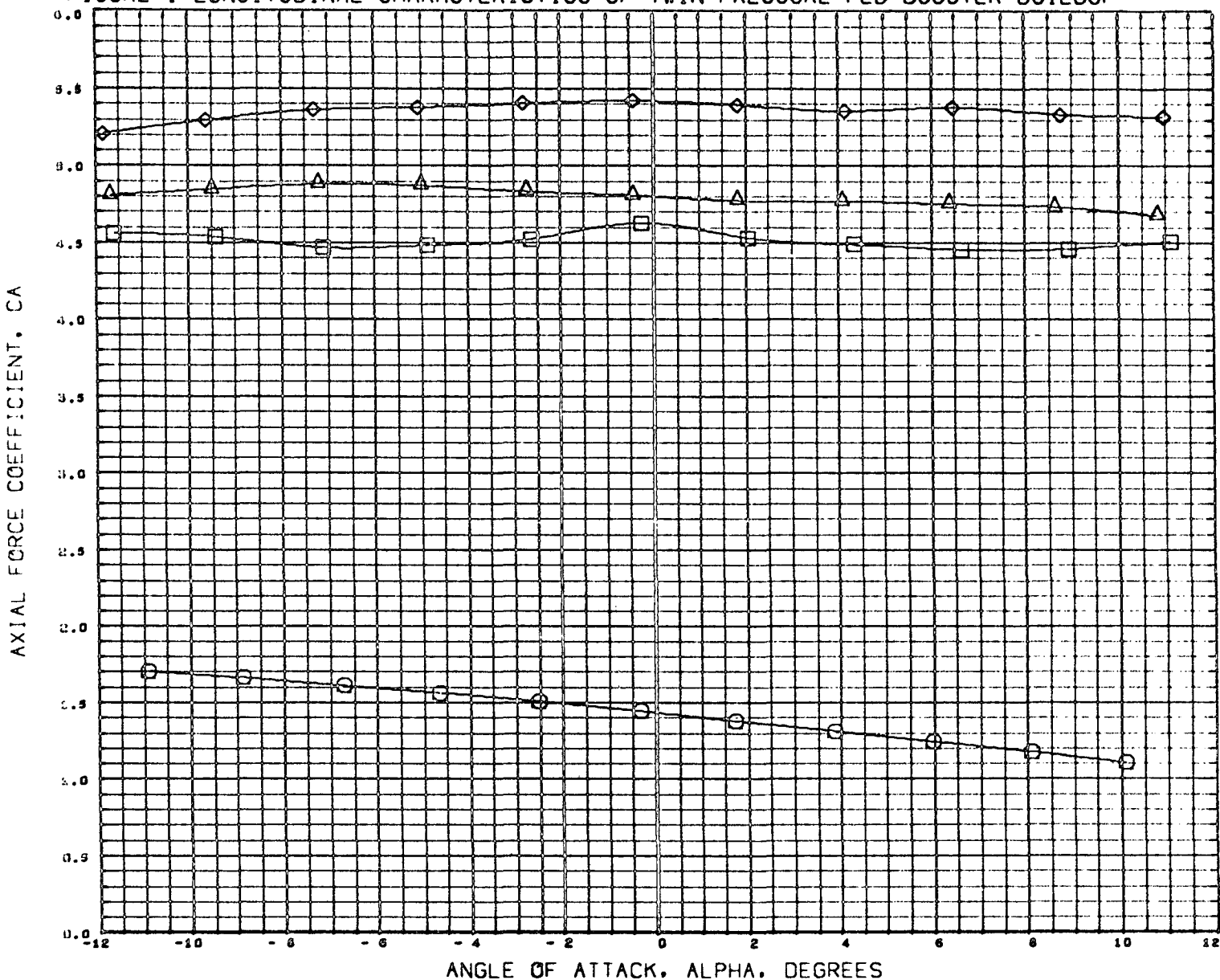

DATA SET SYMBOL	CONFIGURATION DESCRIPTION	BETA
(E90010)	MSFC TWT 514 TPF8 02T4	0.000
(E90030)	MSFC TWT 514 TPF8 B37R702T4	0.000
(E90050)	MSFC TWT 514 TPF8 B37R7T1902T4	0.000
(E90070)	MSFC TWT 514 TPF8 B37R7T19T4	0.000
(E90090)	DATA NOT AVAILABLE FOR ALL CONDITIONS	0.000

REFERENCE INFORMATION		
SREF	0.6600	sq IN
LREF	5.3230	INCHES
BREF	0.9170	INCHES
XMRP	2.0730	INCHES
YMRP	0.0000	INCHES
ZMRP	0.0000	INCHES
SCALE	0.0034	

MACH 1.450

FIGURE-1 LONGITUDINAL CHARACTERISTICS OF TWIN PRESSURE FED BOOSTER BUILDUP

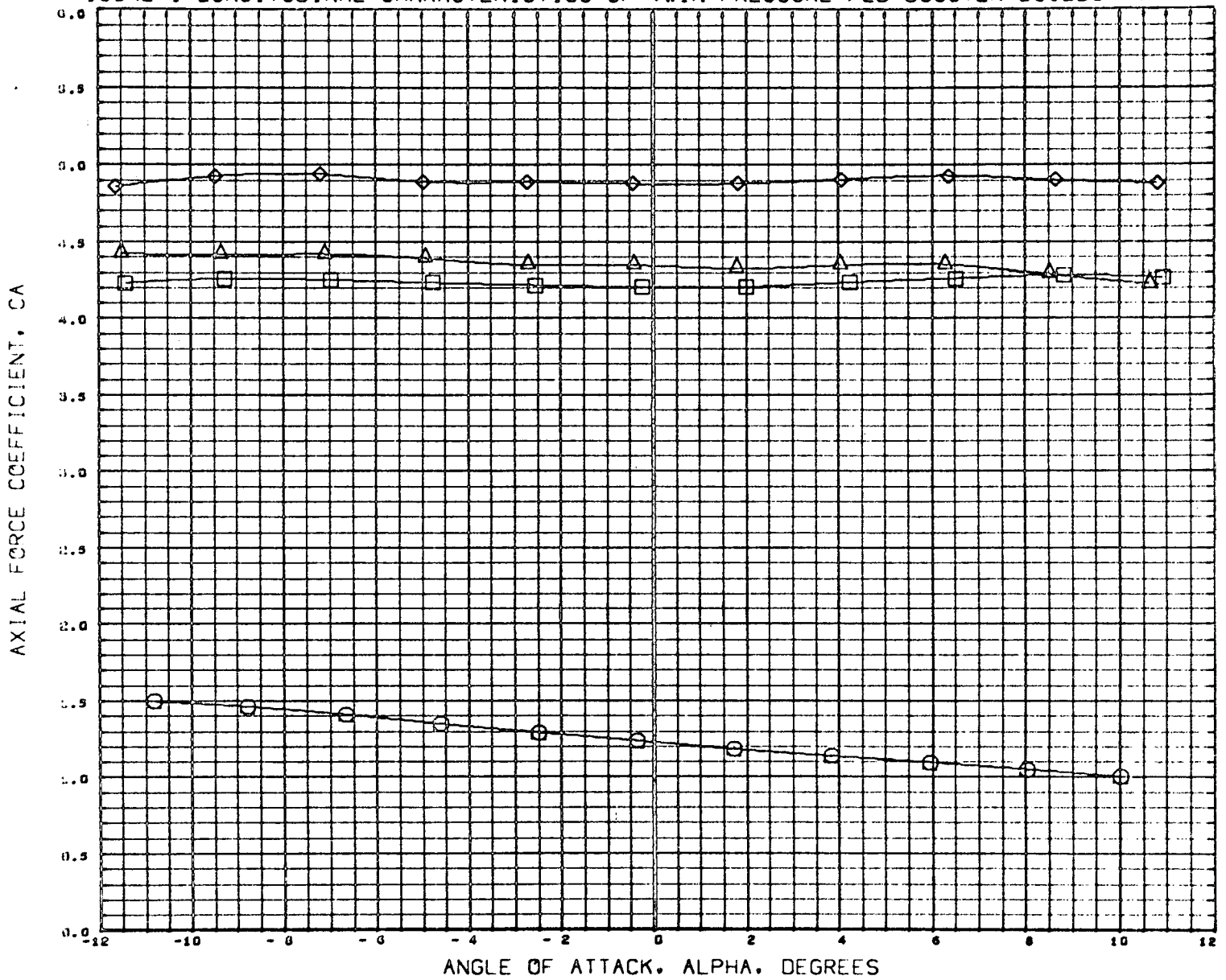

DATA SET SYMBOL	CONFIGURATION DESCRIPTION	BETA
(E50G10)	MSFC TWT 514 TFFB 02T4	0.000
(E50C30)	MSFC TWT 514 TFFB B37R702T4	0.000
(E50C50)	MSFC TWT 514 TFFB B37R7T19C2T4	0.000
(E50C70)	MSFC TWT 514 TFFB B37R7T19T4	0.000
(E50C90)	DATA NOT AVAILABLE FOR ALL CONDITIONS	0.000

REFERENCE INFORMATION	
SREF	0.6600 SQ IN
LREF	5.5230 INCHES
BREF	0.9170 INCHES
XMRP	2.0730 INCHES
YMRP	0.0000 INCHES
ZMRP	0.0000 INCHES
SCALE	0.0034

MACH 1.961

FIGURE-1 LONGITUDINAL CHARACTERISTICS OF TWIN PRESSURE FED BOOSTER BUILDUP

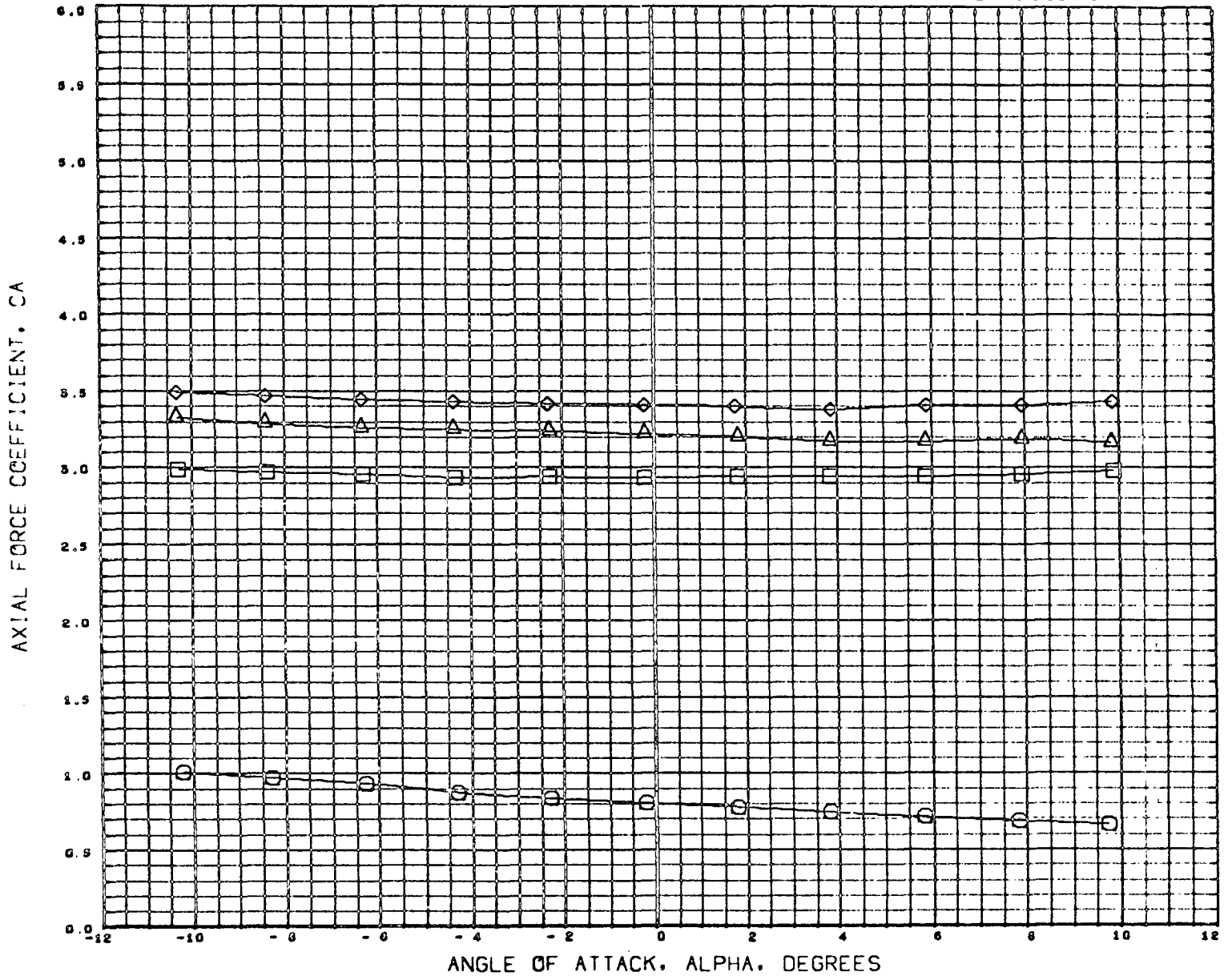

DATA SET SYMBOL	CONFIGURATION DESCRIPTION	BETA
(E50010)	MSFC TWT 514 TFFB 02T4	0.000
(E50030)	MSFC TWT 514 TFFB 037R702T4	0.000
(E50050)	MSFC TWT 514 TFFB 037R7T1902T4	0.000
(E50070)	MSFC TWT 514 TFFB 037R7T19T4	0.000
(E56000)	DATA NOT AVAILABLE FOR ALL CONDITIONS	0.000

REFERENCE INFORMATION		
SREF	0.6600	SQ IN
LREF	5.3230	INCHES
BREF	0.9170	INCHES
XMRRP	2.0730	INCHES
YMRRP	0.0000	INCHES
ZMRRP	0.0000	INCHES
SCALE	0.0034	

MACH 4.959

FIGURE-1 LONGITUDINAL CHARACTERISTICS OF TWIN PRESSURE FED BOOSTER BUILDUP

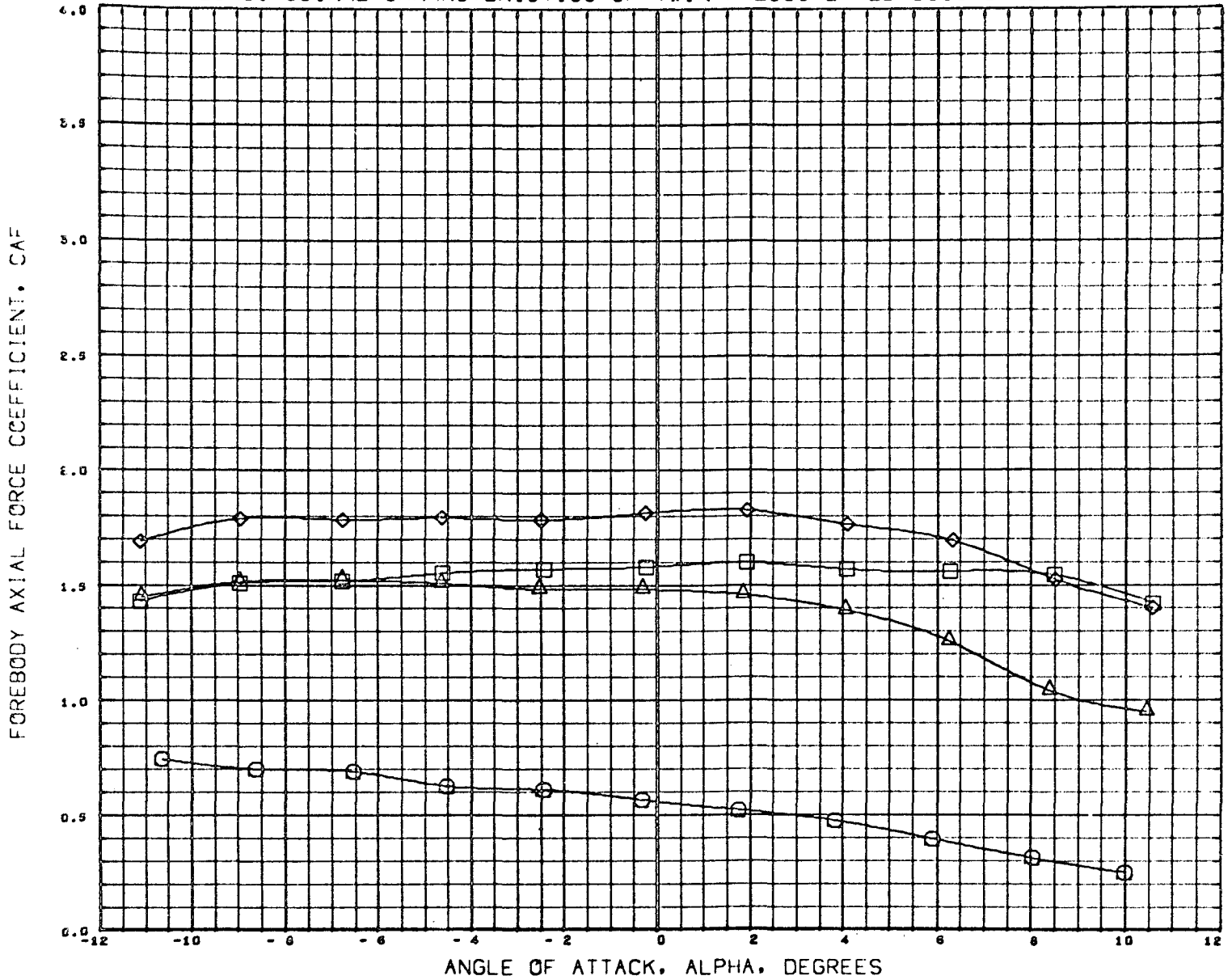

DATA SET SYMBOL	CONFIGURATION DESCRIPTION
(E58010)	MSFC TWT 514 TPF8 Q2T4
(E58020)	MSFC TWT 514 TPF8 B37R702T4
(E58030)	MSFC TWT 514 TPF8 B37R7T1902T4
(E58040)	MSFC TWT 514 TPF8 B37R7T19T4
(E58050)	DATA NOT AVAILABLE FOR ALL CONDITIONS

BETA
0.000
0.000
0.000
0.000
0.000

REFERENCE INFORMATION	
SREF	0.6600 SQ IN
LREF	5.3250 INCHES
BREF	0.9170 INCHES
XMRP	2.0730 INCHES
YMRP	0.0000 INCHES
ZMRP	0.0000 INCHES
SCALE	0.0034

MACH 0.899

FIGURE-1 LONGITUDINAL CHARACTERISTICS OF TWIN PRESSURE FED BOOSTER BUILDUP

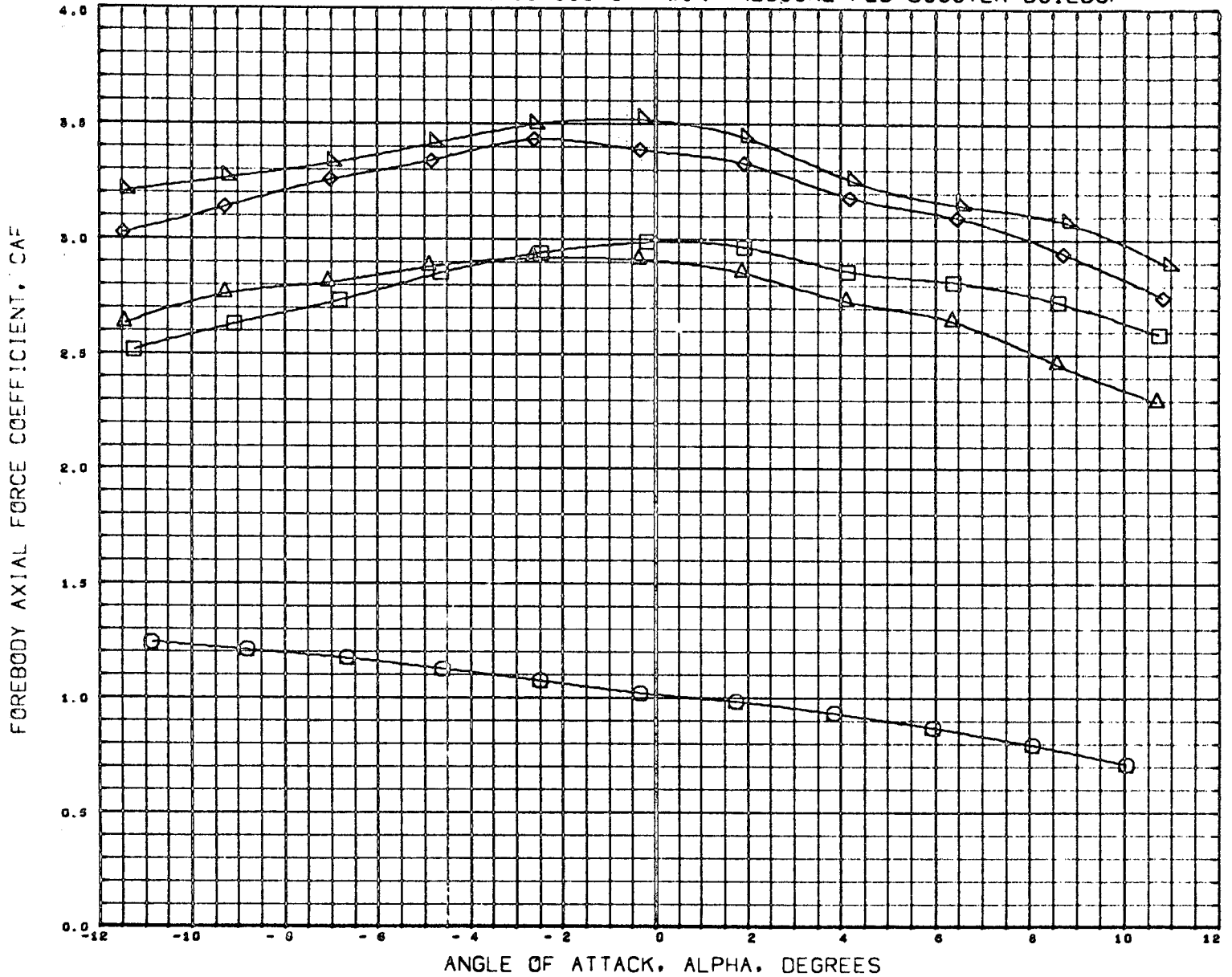

DATA SET SYMBOL	CONFIGURATION DESCRIPTION
(E90013)	MSFC TWT 514 TFFB O2T4
(E90033)	MSFC TWT 514 TFFB B37R7O2T4
(E90053)	MSFC TWT 514 TFFB B37R7I19O2T4
(E90073)	MSFC TWT 514 TFFB B37R7I19T4
(E90093)	MSFC TWT 514 TFFB B37R7I19O5T4

BETA
0.000
0.000
0.000
0.000
0.000

REFERENCE INFORMATION		
SREF	0.6600	SQ IN
LREF	5.3230	INCHES
BREF	0.9170	INCHES
XMRF	2.0730	INCHES
YMRF	0.0000	INCHES
ZMRF	0.0000	INCHES
SCALE	0.0034	

MACH 1.101

FIGURE-1 LONGITUDINAL CHARACTERISTICS OF TWIN PRESSURE FED BOOSTER BUILDUP

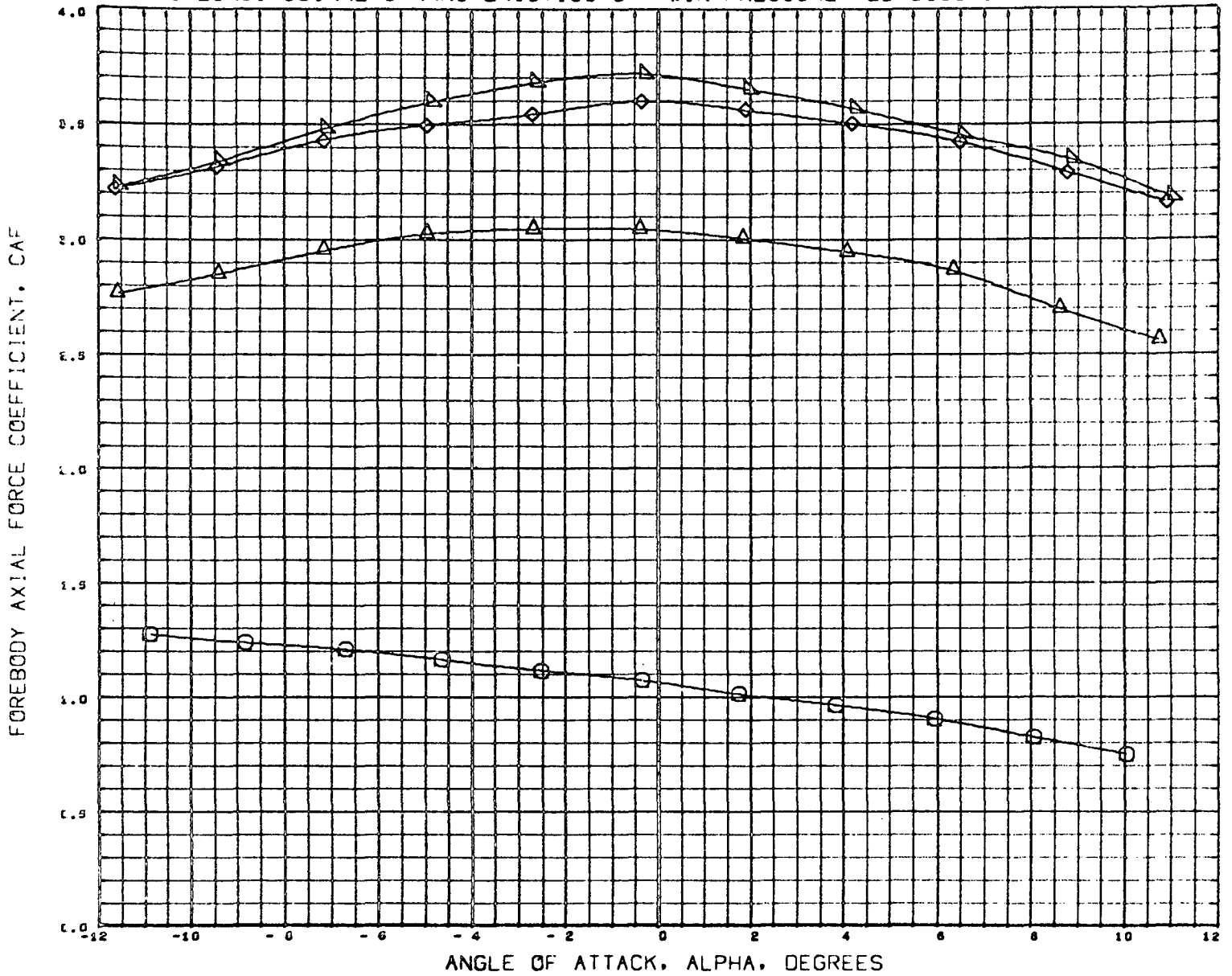

DATA SET SYMBOL	CONFIGURATION DESCRIPTION	BETA
(2500:0)	MSFC TWT 514 TFFB 02T4	0.000
(2500:10)	MSFC TWT 514 TFFB 837R702T4	0.000
(2500:0)	MSFC TWT 514 TFFB 837R7T1902T4	0.000
(2580:0)	DATA NOT AVAILABLE FOR ALL CONDITIONS	0.000
(2580:00)	MSFC TWT 514 TFFB 837R7T1903T4	0.000

REFERENCE INFORMATION	
SREF	0.6600 SQ IN
LREF	5.3230 INCHES
BREF	0.9170 INCHES
XMRP	2.0730 INCHES
YMRP	0.0000 INCHES
ZMRP	0.0000 INCHES
SCALE	0.0034

MACH 1.197

FIGURE-1 LONGITUDINAL CHARACTERISTICS OF TWIN PRESSURE FED BOOSTER BUILDUP

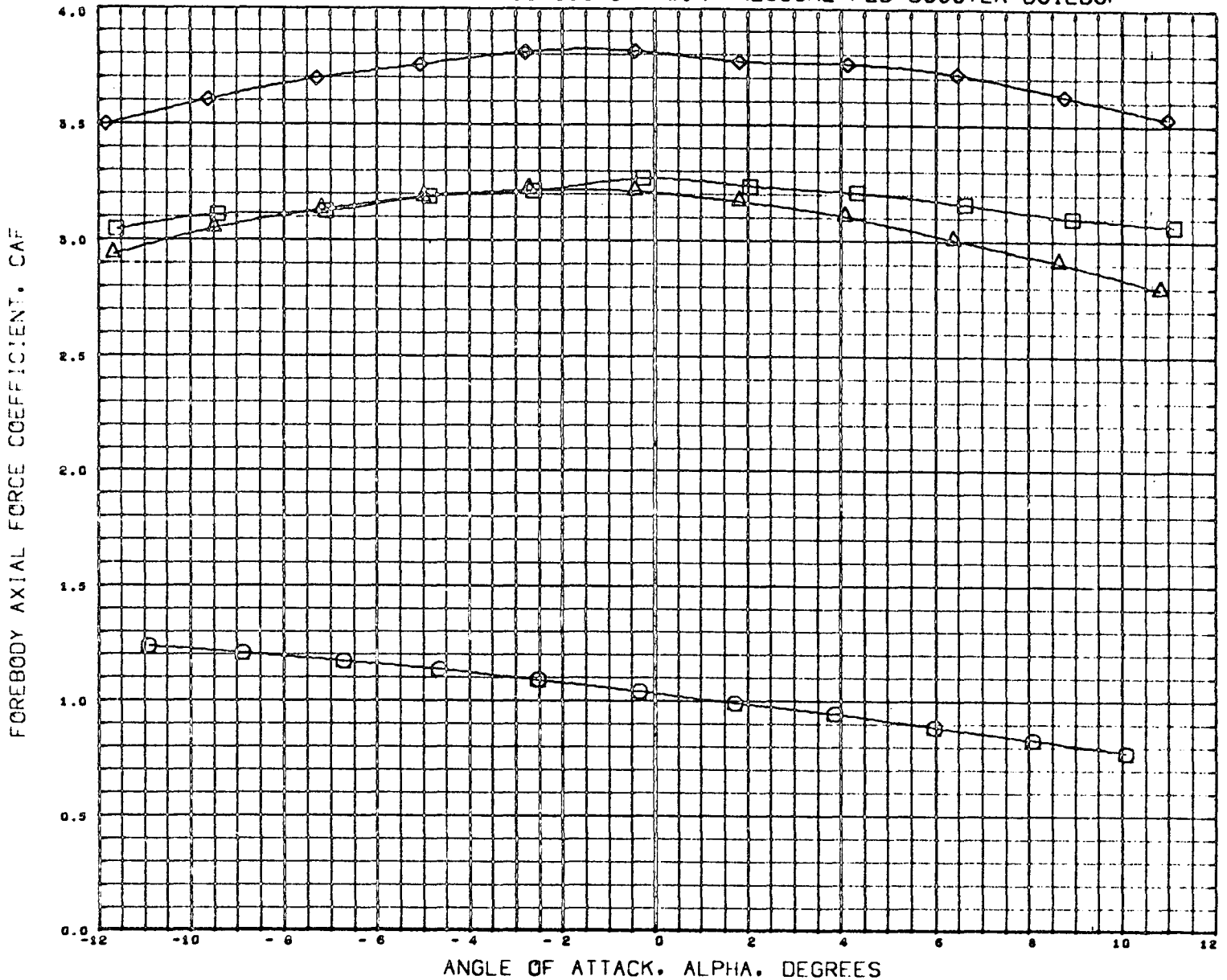

DATA SET SYMBOL	CONFIGURATION DESCRIPTION	BETA
(E90010)	MSFC TWT 514 TPF8 02T4	0.000
(E90030)	MSFC TWT 514 TPF8 B37R702T4	0.000
(E90050)	MSFC TWT 514 TPF8 B37R711902T4	0.000
(E90070)	MSFC TWT 514 TPF8 B37R7119T4	0.000
(E90090)	DATA NOT AVAILABLE FOR ALL CONDITIONS	0.000

REFERENCE INFORMATION		
SREF	0.6600	SQ IN
LREF	5.3230	INCHES
BREF	0.9170	INCHES
XMRP	2.0730	INCHES
YMRP	0.0000	INCHES
ZMRP	0.0000	INCHES
SCALE	0.0034	

MACH 1.456

FIGURE-1 LONGITUDINAL CHARACTERISTICS OF TWIN PRESSURE FED BOOSTER BUILDUP

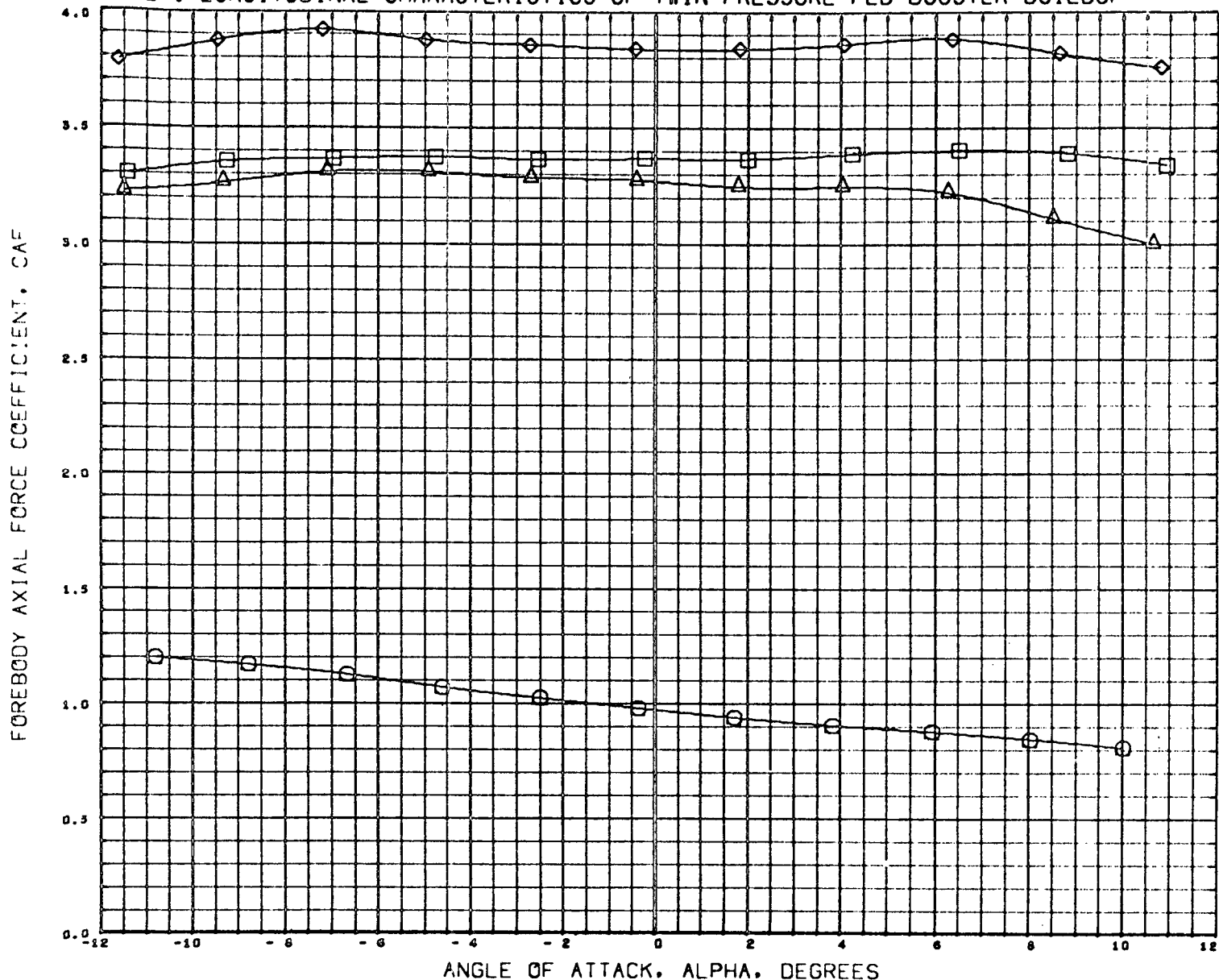

DATA SET SYMBOL	CONFIGURATION DESCRIPTION
(E50010)	MSFC TWT 514 TFFB 02T4
(E50030)	MSFC TWT 514 TFFB B37R702T4
(E50050)	MSFC TWT 514 TFFB B37R711902T4
(E50070)	MSFC TWT 514 TFFB B37R7119T4
(E50090)	DATA NOT AVAILABLE FOR ALL CONDITIONS

BETA
0.000
0.000
0.000
0.000
0.000

REFERENCE INFORMATION		
SREF	0.6600	sq IN
LREF	5.3230	INCHES
BREF	0.9170	INCHES
XMRP	2.0730	INCHES
YMRP	0.0000	INCHES
ZMRP	0.0000	INCHES
SCALE	0.0034	

MACH 1.981

FIGURE-1 LONGITUDINAL CHARACTERISTICS OF TWIN PRESSURE FED BOOSTER BUILDUP

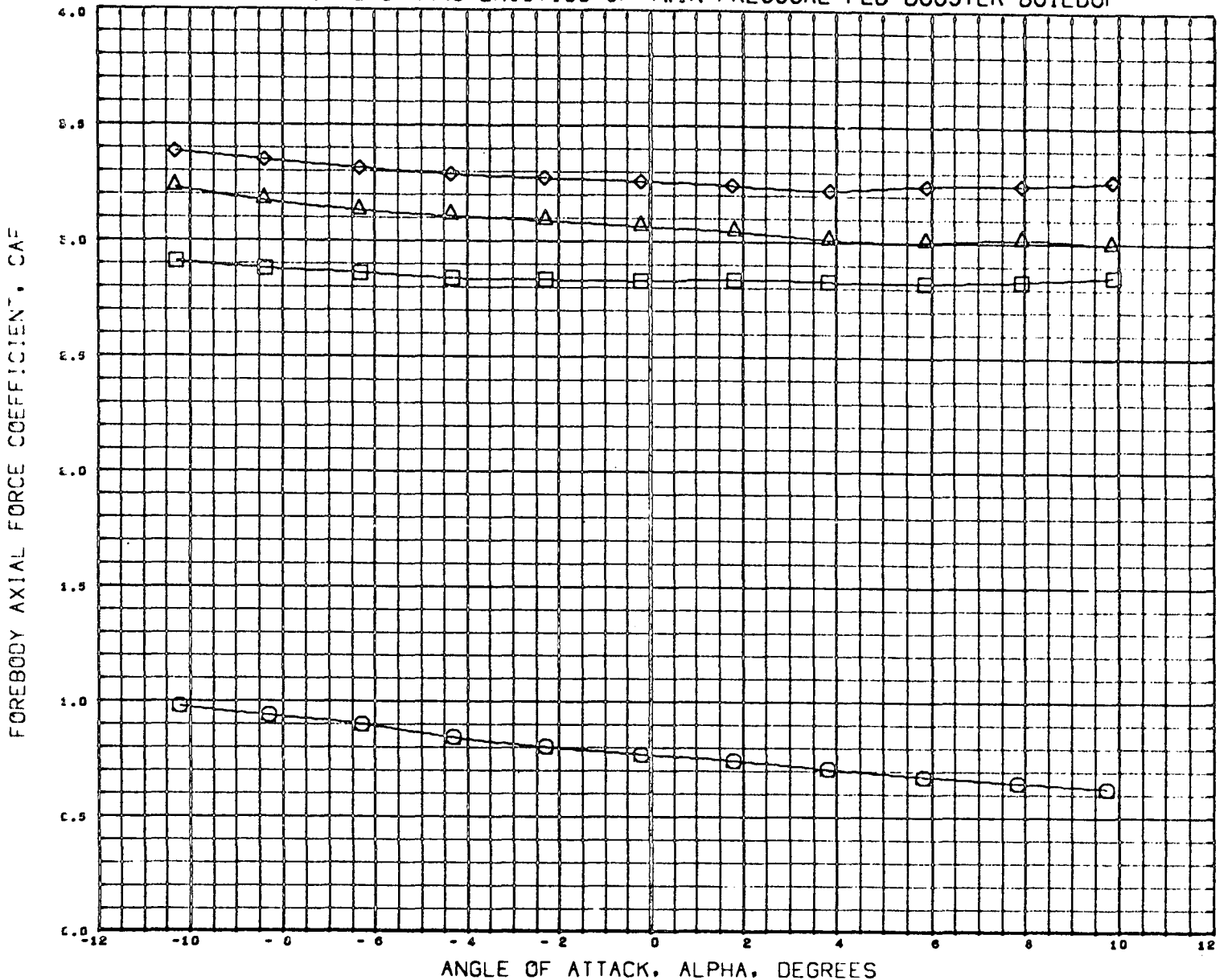

DATA SET SYMBOL	CONFIGURATION DESCRIPTION	BETA
(2980:0)	MSFC TWT 514 TPF8 02T4	0.000
(2980:0)	MSFC TWT 514 TPF8 037R702T4	0.000
(2980:0)	MSFC TWT 514 TPF8 037R7T1902T4	0.000
(2980:0)	MSFC TWT 514 TPF8 037R7T19T4	0.000
(2980:0)	DATA NOT AVAILABLE FOR ALL CONDITIONS	0.000

REFERENCE INFORMATION		
SREF	0.6600	90 IN
LREF	5.3250	INCHES
BREF	0.9170	INCHES
XMRP	2.0730	INCHES
YMRP	0.0000	INCHES
ZMRP	0.0000	INCHES
SCALE	0.0034	

MACH 4.059

FIGURE-1 LONGITUDINAL CHARACTERISTICS OF TWIN PRESSURE FED BOOSTER BUILDUP

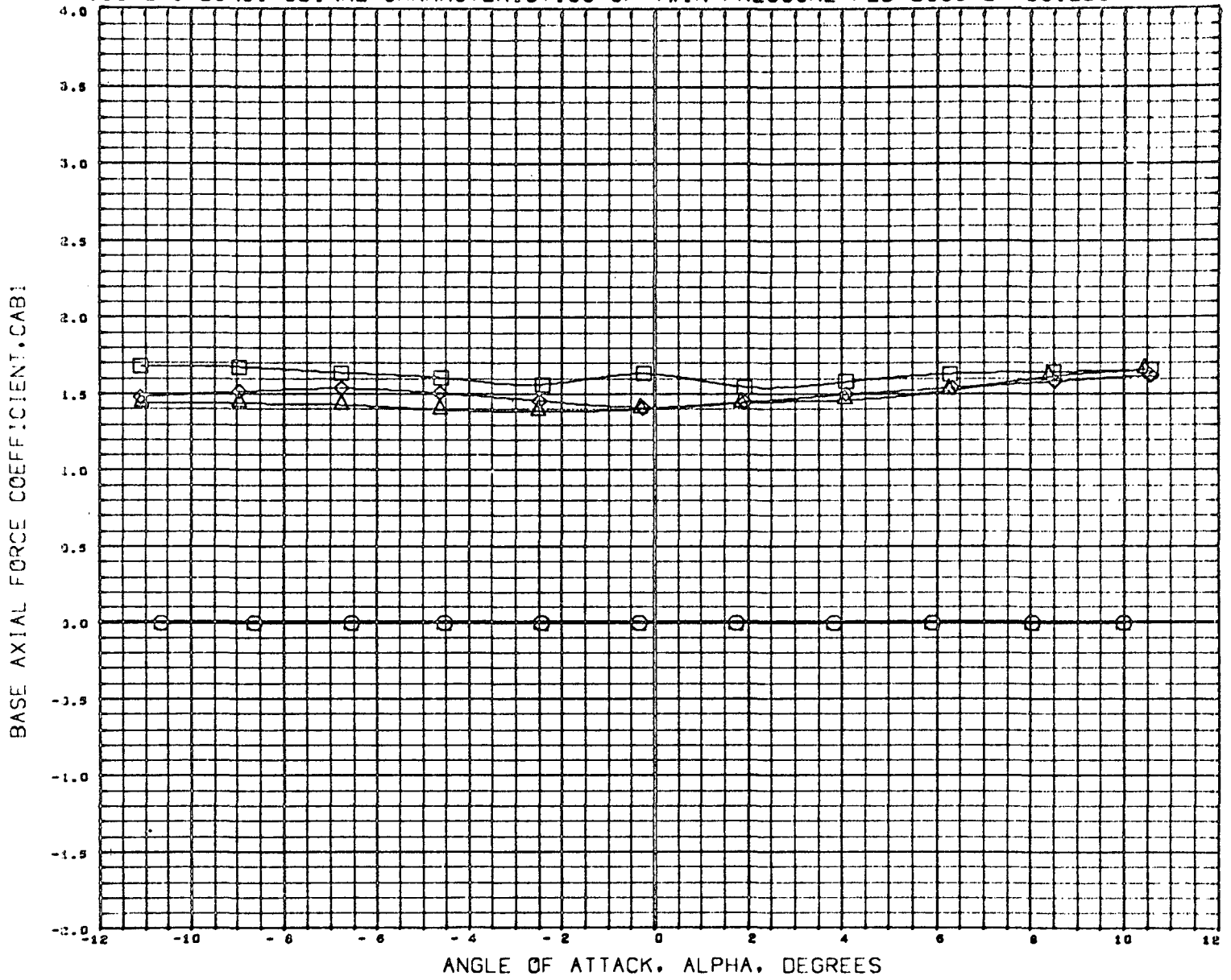

DATA SET SYMBOL	CONFIGURATION DESCRIPTION	BETA
(E90010)	MSFC TWT 514 TPF8 O2T4	0.000
(E90030)	MSFC TWT 514 TPF8 B37R7O2T4	0.000
(E90050)	MSFC TWT 514 TPF8 B37R7T19O2T4	0.000
(E90070)	MSFC TWT 514 TPF8 B37R7T19T4	0.000
(E90090)	DATA NOT AVAILABLE FOR ALL CONDITIONS	0.000

REFERENCE INFORMATION	
SREF	0.6600 50 IN
LREF	5.3230 INCHES
BREF	0.9170 INCHES
XMRP	2.0730 INCHES
YMRP	0.0000 INCHES
ZMRP	0.0000 INCHES
SCALE	0.0034

MACH 0.099

FIGURE-1 LONGITUDINAL CHARACTERISTICS OF TWIN PRESSURE FED BOOSTER BUILDUP

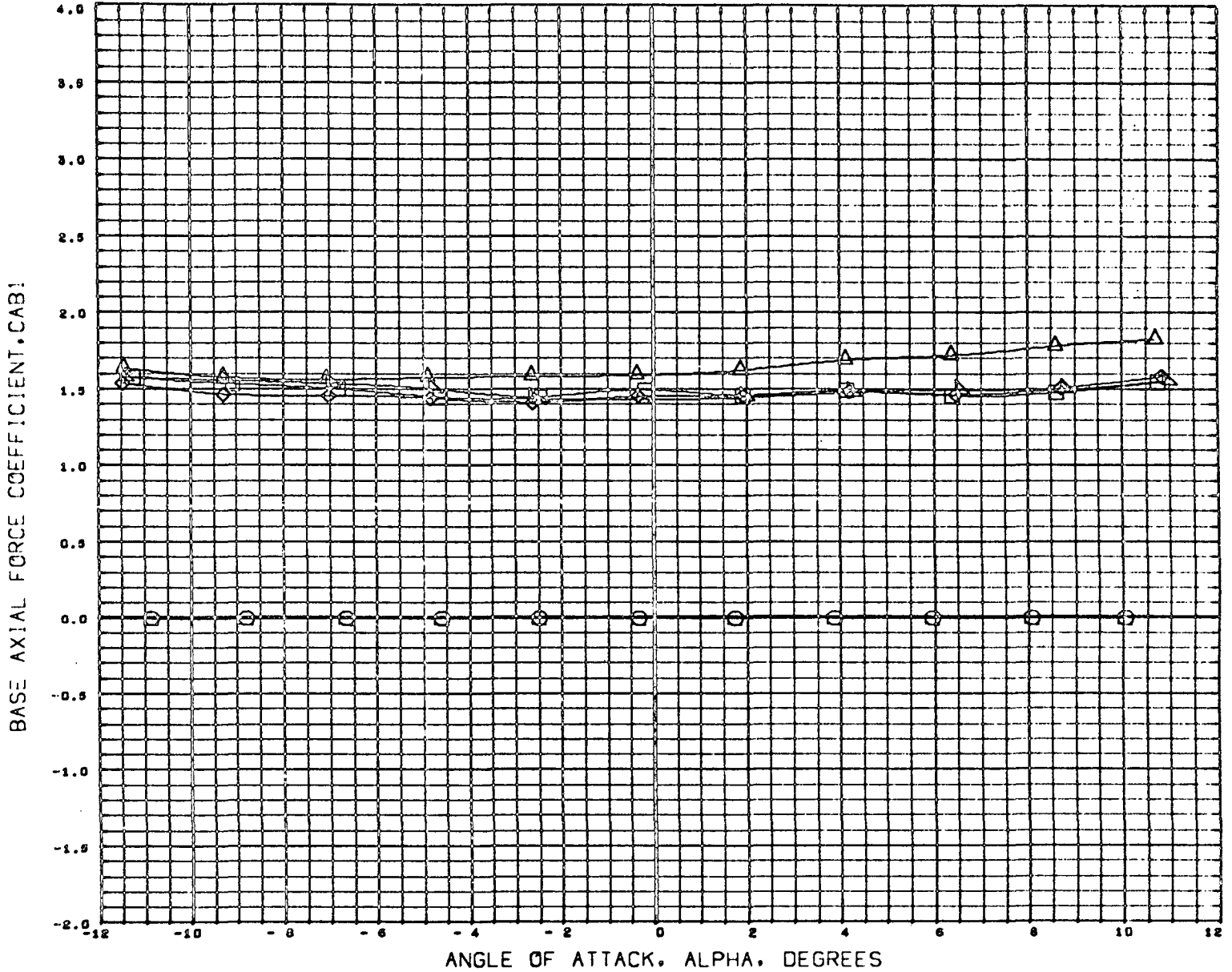

DATA SET SYMBOL	CONFIGURATION DESCRIPTION
(E50310)	MSFC TWT 514 TPF8 O2T4
(E50330)	MSFC TWT 514 TPF8 B37R702T4
(E50350)	MSFC TWT 514 TPF8 B37R7T1902T4
(E50370)	MSFC TWT 514 TPF8 B37R7T19T4
(E50390)	MSFC TWT 514 TPF8 B37R7T1905T4

BETA
0.000
0.000
0.000
0.000
0.000

REFERENCE INFORMATION		
SREF	0.6600	SQ IN
LREF	9.5230	INCHES
BREF	0.9170	INCHES
XMRP	2.0730	INCHES
YMRP	0.0000	INCHES
ZMRP	0.0000	INCHES
SCALE	0.0034	

MACH 1.101

FIGURE-1 LONGITUDINAL CHARACTERISTICS OF TWIN PRESSURE FED BOOSTER BUILDUP

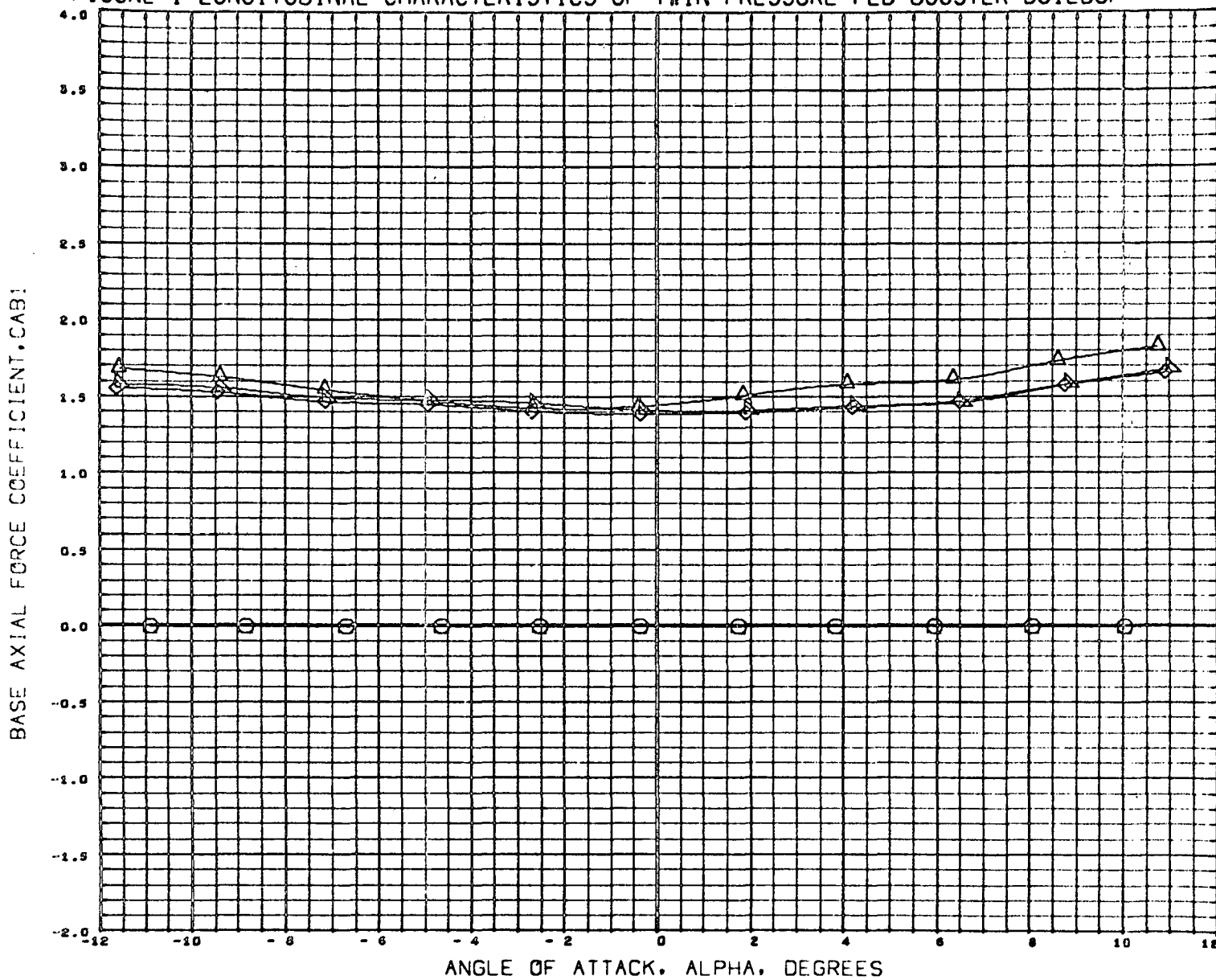

DATA SET SYMBOL	CONFIGURATION DESCRIPTION	BETA
(E50310)	MSFC TWT 514 TFFB 02T4	0.000
(E50330)	MSFC TWT 514 TFFB B37R7O2T4	0.000
(E50350)	MSFC TWT 514 TFFB B37R7T19O2T4	0.000
(E50370)	DATA NOT AVAILABLE FOR ALL CONDITIONS	0.000
(E50390)	MSFC TW: 514 TFFB B37R7T19O5T4	0.000

REFERENCE INFORMATION		
SREF	0.6600	SQ IN
LREF	9.3250	INCHES
BREF	0.9170	INCHES
XMRP	2.0730	INCHES
YMRP	0.0000	INCHES
ZMRP	0.0000	INCHES
SCALE	0.0034	

MACH 1.197

FIGURE-1 LONGITUDINAL CHARACTERISTICS OF TWIN PRESSURE FED BOOSTER BUILDUP

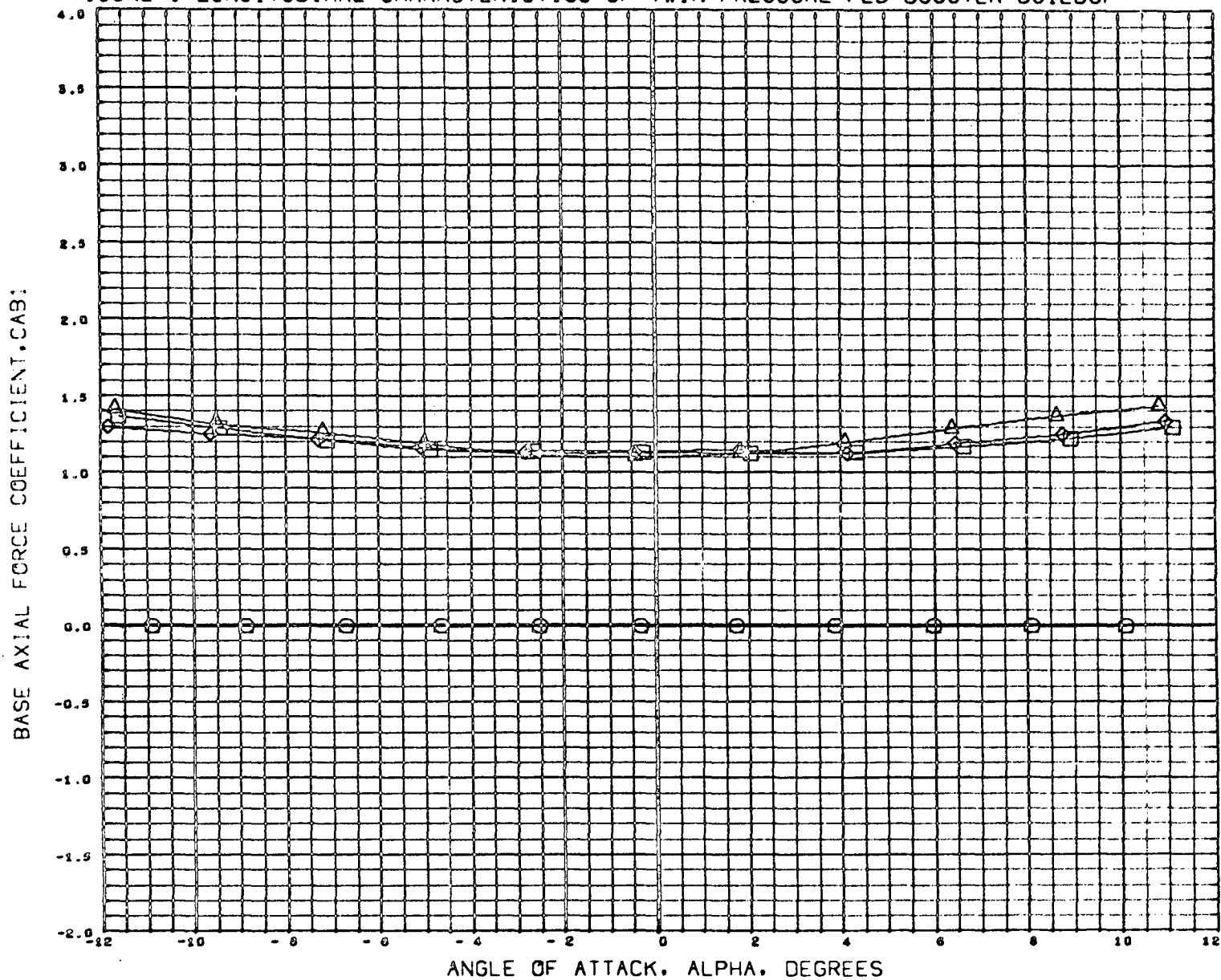

DATA SET SYMBOL	CONFIGURATION DESCRIPTION	BETA
(E58010)	MSFC TWT 914 TFFB O2T4	0.000
(E58050)	MSFC TWT 914 TFFB B37R7O2T4	0.000
(E58050)	MSFC TWT 914 TFFB B37R7T19O2T4	0.000
(E58070)	MSFC TWT 914 TFFB B37R7T19T4	0.000
(E58090)	DATA NOT AVAILABLE FOR ALL CONDITIONS	0.000

REFERENCE INFORMATION		
SREF	0.6600	SQ IN
LREF	5.3250	INCHES
BREF	0.9170	INCHES
XMRP	2.0730	INCHES
YMRP	0.0000	INCHES
ZMRP	0.0000	INCHES
SCALE	0.0034	

MACH 1.450

FIGURE-1 LONGITUDINAL CHARACTERISTICS OF TWIN PRESSURE FED BOOSTER BUILDUP

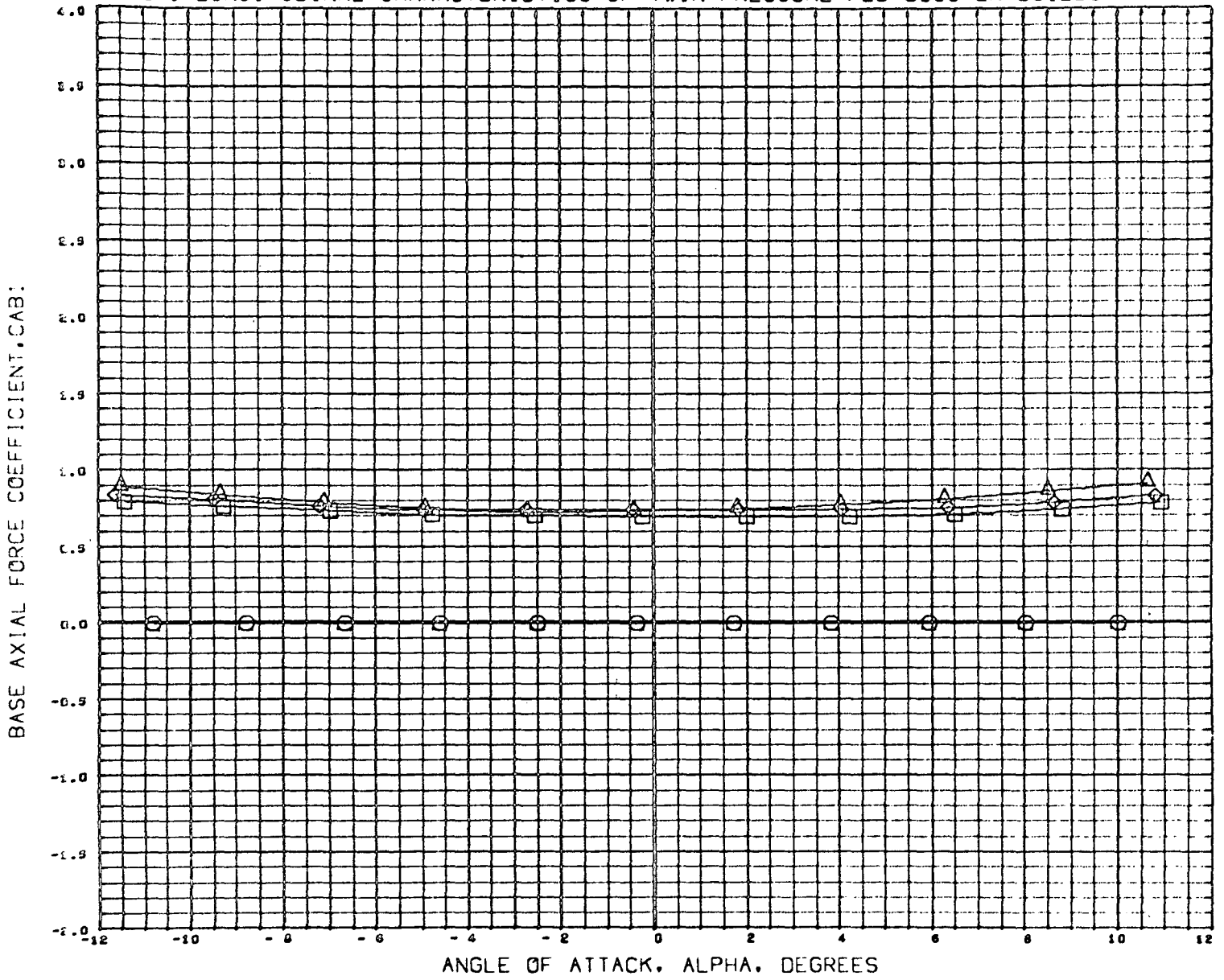

DATA SET SYMBOL	CONFIGURATION DESCRIPTION
(R50010)	MSFC TWT 514 TPF8 O2T4
(R50010)	MSFC TWT 514 TPF8 B37R7O2T4
(R50010)	MSFC TWT 514 TPF8 B37R7T19O2T4
(R50010)	MSFC TWT 514 TPF8 B37R7T19T4
(R50010)	DATA NOT AVAILABLE FOR ALL CONDITIONS

BETA
0.000
0.000
0.000
0.000
0.000

REFERENCE INFORMATION		
SREF	0.6600	sq IN
LREF	5.3230	INCHES
BREF	0.9170	INCHES
XMRP	2.0730	INCHES
YMRP	0.0000	INCHES
ZMRP	0.0000	INCHES
SCALE	0.0034	

MACH 1.961

FIGURE-1 LONGITUDINAL CHARACTERISTICS OF TWIN PRESSURE FED BOOSTER BUILDUP

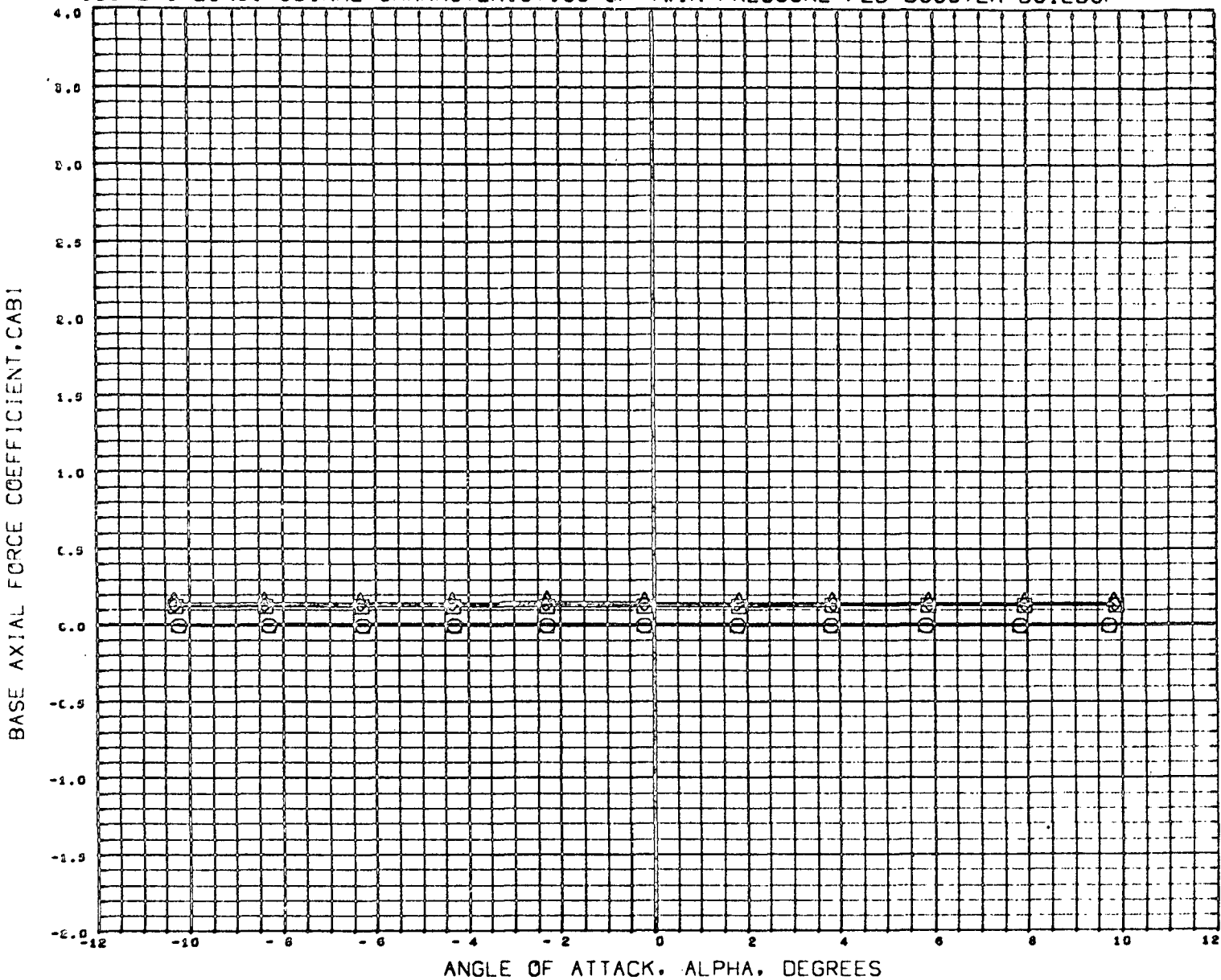

DATA SET SYMBOL	CONFIGURATION DESCRIPTION
(E900 0)	MSFC TWT 514 TPFB 02T4
(E900 0)	MSFC TWT 514 TPFB 037R702T4
(E900 0)	MSFC TWT 514 TPFB 037R7T1902T4
(E900 0)	MSFC TWT 514 TPFB 037R7T19T4
(E900 0)	DATA NOT AVAILABLE FOR ALL CONDITIONS

BETA
0.000
0.000
0.000
0.000
0.000

REFERENCE INFORMATION		
\$REF	0.6600	SQ IN
LREF	5.3230	INCHES
BREF	0.9170	INCHES
XMRP	2.0730	INCHES
YMRP	0.0000	INCHES
ZMRP	0.0000	INCHES
SCALE	0.0034	

MACH 4.959

FIGURE-1 LONGITUDINAL CHARACTERISTICS OF TWIN PRESSURE FED BOOSTER BUILDUP

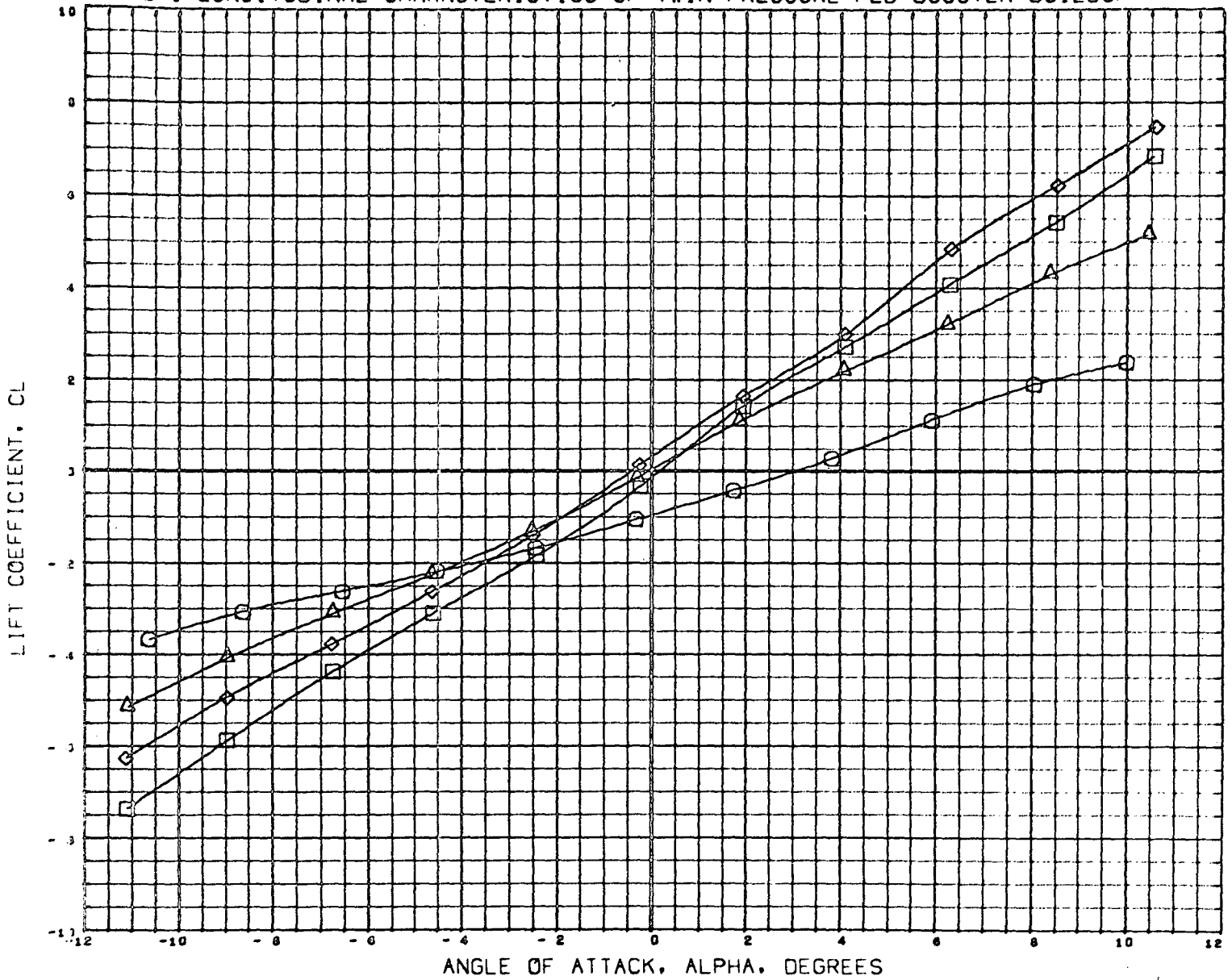

DATA SET SYMBOL	CONFIGURATION DESCRIPTION	BETA
(E90010)	MSFC TWT 514 TPF8 O2T4	0.000
(E90020)	MSFC TWT 514 TPF8 B37R7O2T4	0.000
(E90030)	MSFC TWT 514 TPF8 B37R7T19O2T4	0.000
(E90070)	MSFC TWT 514 TPF8 B37R7T19T4	0.000
(E90090)	DATA NOT AVAILABLE FOR ALL CONDITIONS	0.000

REFERENCE INFORMATION		
SREF	0.6600	SQ IN
LREF	5.3230	INCHES
BREF	0.9170	INCHES
XMRP	2.0730	INCHES
YMRP	0.0000	INCHES
ZMRP	0.0000	INCHES
SCALE	0.0034	

MACH 0.899

FIGURE-1 LONGITUDINAL CHARACTERISTICS OF TWIN PRESSURE FED BOOSTER BUILDUP

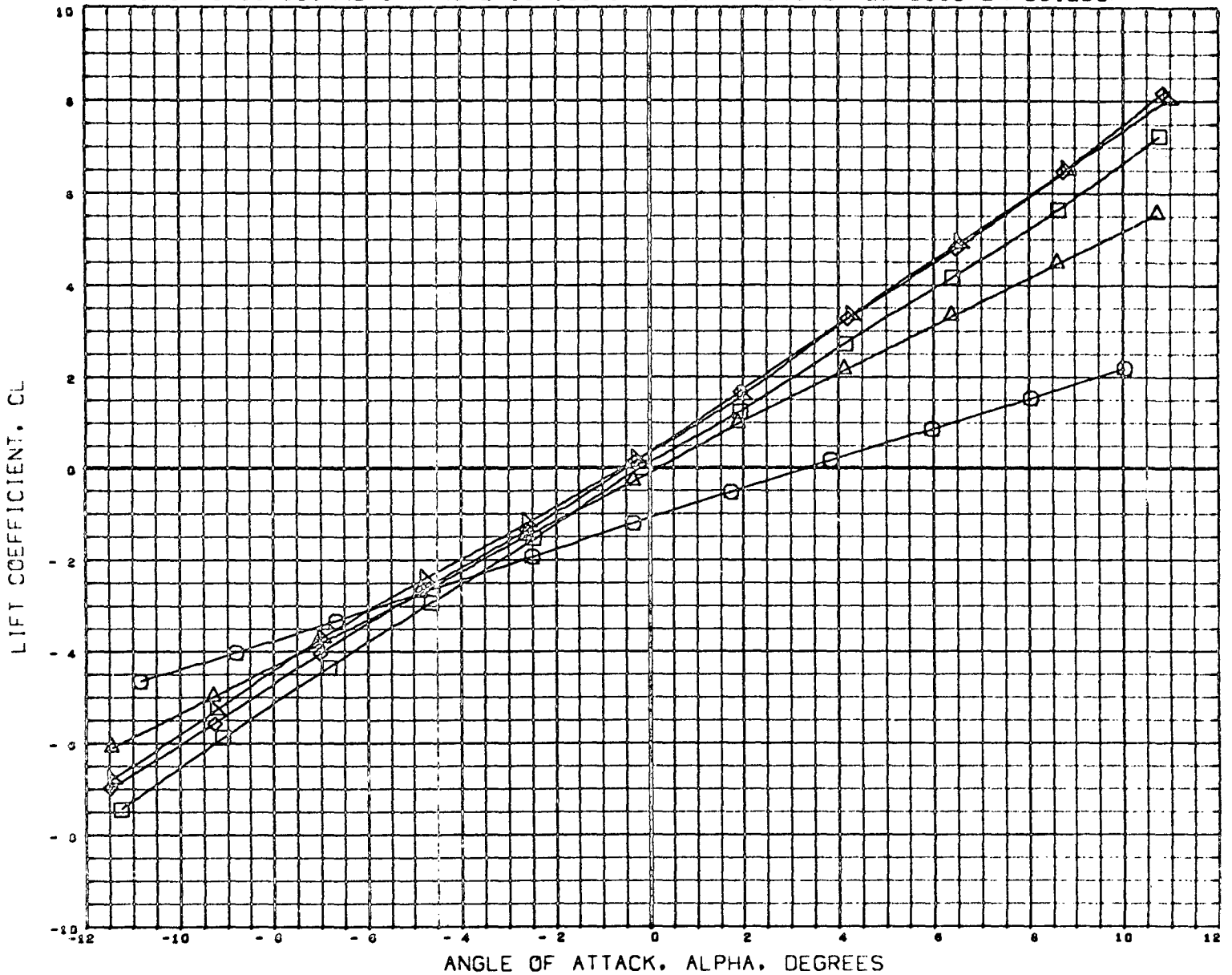

DATA SET SYMBOL	CONFIGURATION DESCRIPTION
(E500:0)	MSFC TWT 514 TPF8 02T4
(E500:0)	MSFC TWT 514 TPF8 037R702T4
(E500:0)	MSFC TWT 514 TPF8 037R7T1902T4
(E500:0)	MSFC TWT 514 TPF8 037R7T19T4
(E500:0)	MSFC TWT 514 TPF8 037R7T1905T4

BETA
0.000
0.000
0.000
0.000
0.000

REFERENCE INFORMATION	
SREF	0.6600 SQ IN
LREF	5.3230 INCHES
BREF	0.9170 INCHES
XMRP	2.0730 INCHES
YMRP	0.0000 INCHES
ZMRP	0.0000 INCHES
SCALE	0.0034

MACH 1.101

FIGURE-1 LONGITUDINAL CHARACTERISTICS OF TWIN PRESSURE FED BOOSTER BUILDUP

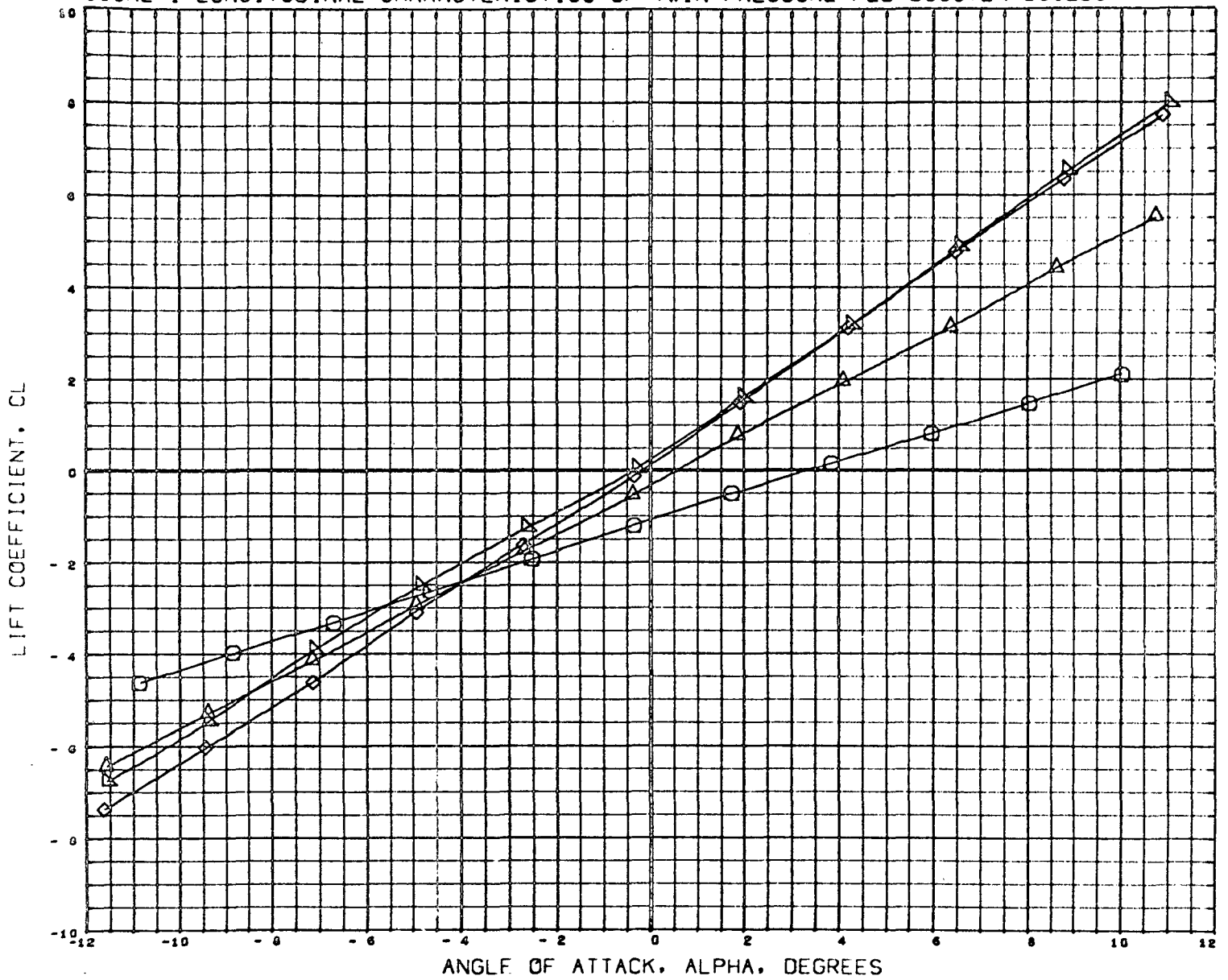

DATA SET SYMBOL	CONFIGURATION DESCRIPTION	BETA
(E58010)	MSFC TWT 514 TPFB 02T4	0.000
(E58010)	MSFC TWT 514 TPFB 837R702T4	0.000
(E58010)	MSFC TWT 514 TPFB 837R7T1902T4	0.000
(E58010)	DATA NOT AVAILABLE FOR ALL CONDITIONS	0.000
(E58000)	MSFC TWT 514 TPFB 837R7T1905T4	0.000

REFERENCE INFORMATION		
SREF	0.6600	SQ IN
LREF	5.3230	INCHES
BREF	0.9170	INCHES
XMRP	2.0730	INCHES
YMRP	0.0000	INCHES
ZMRP	0.0000	INCHES
SCALE	0.0034	

MACH 1.197

FIGURE-1 LONGITUDINAL CHARACTERISTICS OF TWIN PRESSURE FED BOOSTER BUILDUP

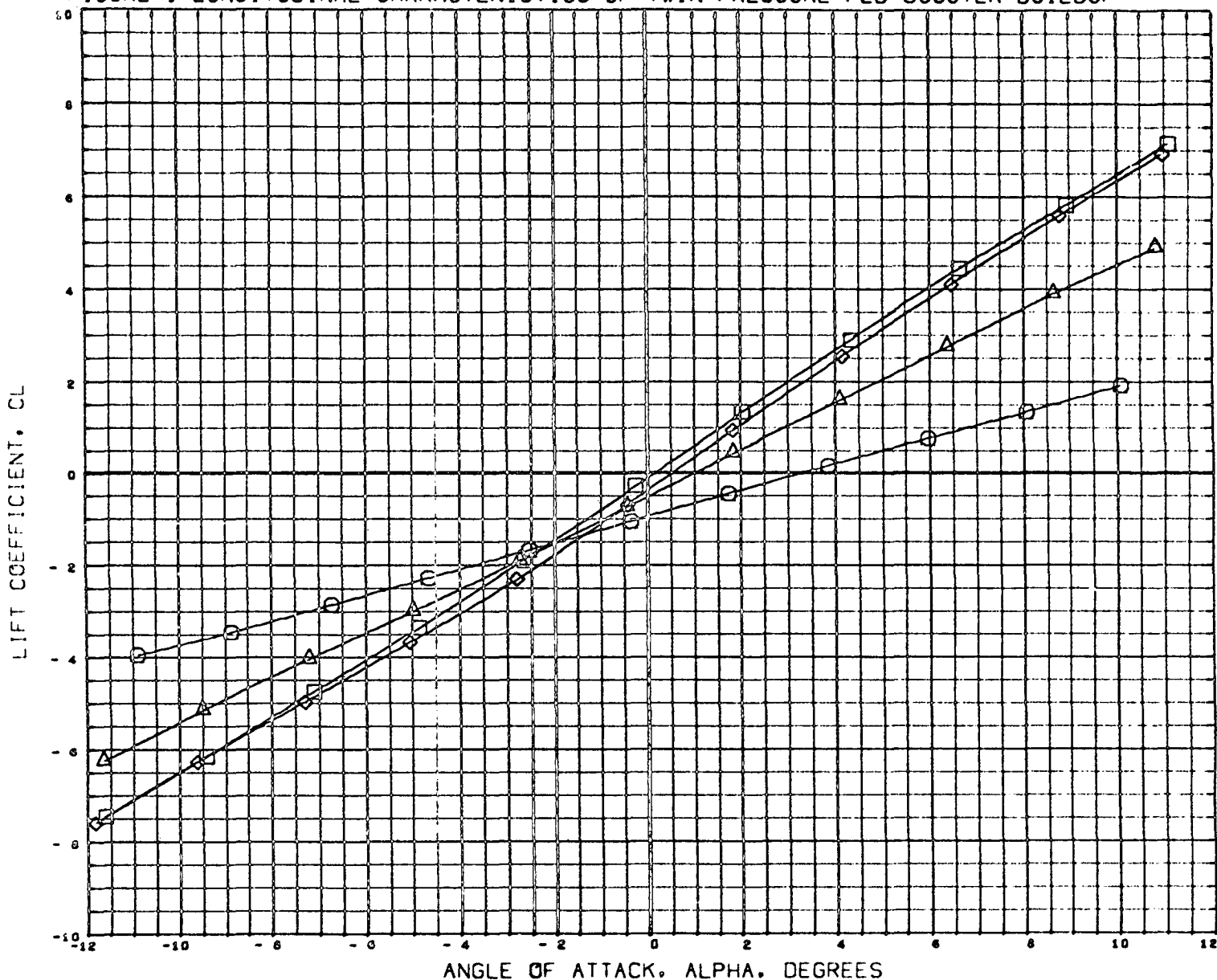

DATA SET SYMBOL	CONFIGURATION DESCRIPTION
(E500.0)	MSFC TWT 514 TPF8 O2T4
(E500.0)	MSFC TWT 514 TPF8 B37R7O2T4
(E500.0)	MSFC TWT 514 TPF8 B37R7I19O2T4
(E500.0)	MSFC TWT 514 TPF8 B37R7I19T4
(E500.0)	DATA NOT AVAILABLE FOR ALL CONDITIONS

BETA
0.000
0.000
0.000
0.000
0.000

REFERENCE INFORMATION		
SREF	0.6600	SQ IN
LREF	5.3230	INCHES
BREF	0.9170	INCHES
XMRF	2.0730	INCHES
YMRF	0.0000	INCHES
ZMRF	0.0000	INCHES
SCALE	0.0034	

MACH 1.450

FIGURE-1 LONGITUDINAL CHARACTERISTICS OF TWIN PRESSURE FED BOOSTER BUILDUP

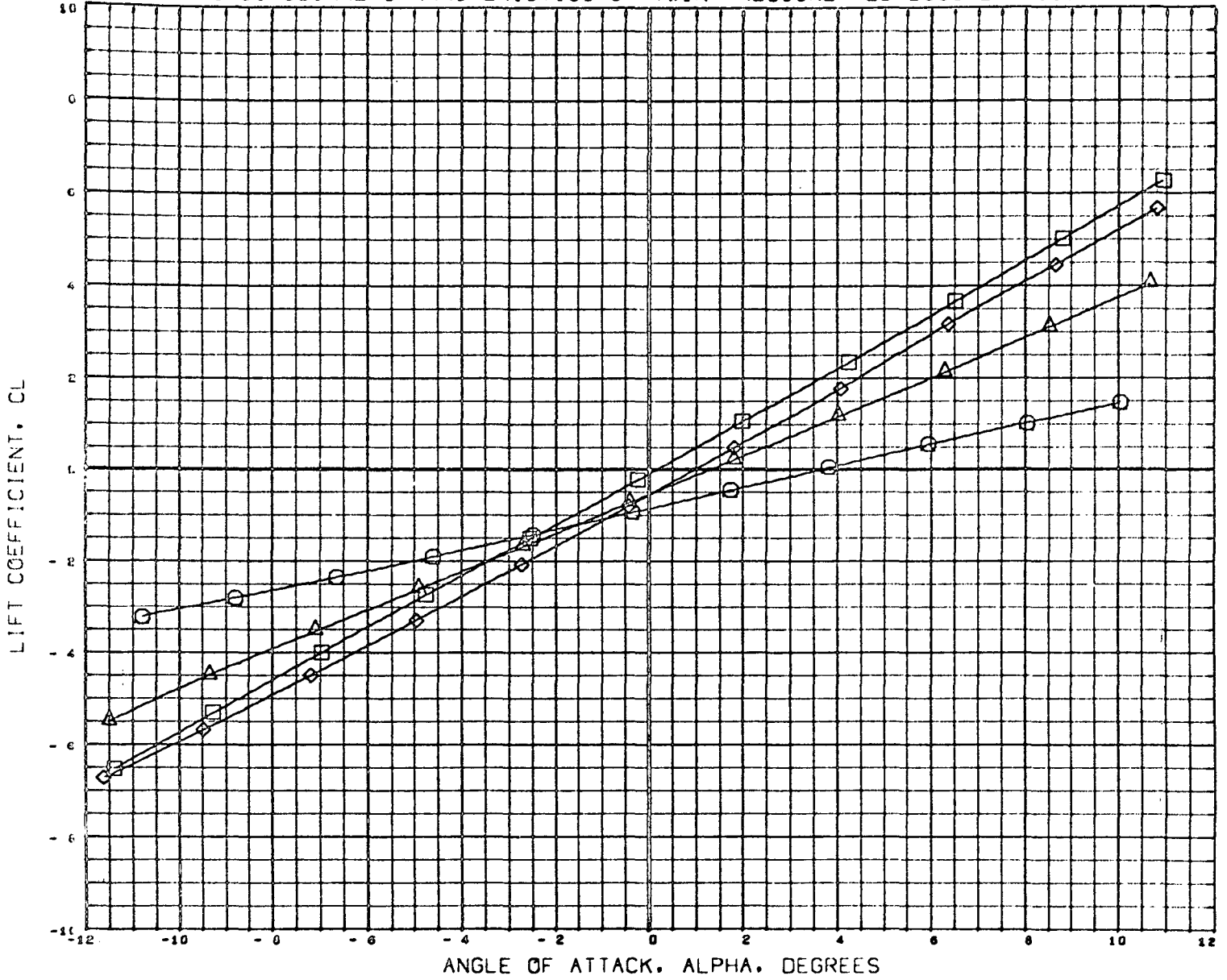

DATA SET SYMBOL	CONFIGURATION DESCRIPTION	BETA
(E5801)	MSFC TWT 514 TPFB Q2T4	0.000
(E5803)	MSFC TWT 514 TPFB B37R702T4	0.000
(E5805)	MSFC TWT 514 TPFB B37R7T1902T4	0.000
(E5807)	MSFC TWT 514 TPFB B37R7T19T4	0.000
(E5809)	DATA NOT AVAILABLE FOR ALL CONDITIONS	0.000

REFERENCE INFORMATION		
SREF	0.6600	SQ IN
LREF	5.3230	INCHES
BREF	0.9170	INCHES
XMRP	2.0730	INCHES
YMRP	0.0000	INCHES
ZMRP	0.0000	INCHES
SCALE	0.0034	

MACH 1.981

FIGURE-1 LONGITUDINAL CHARACTERISTICS OF TWIN PRESSURE FED BOOSTER BUILDUP

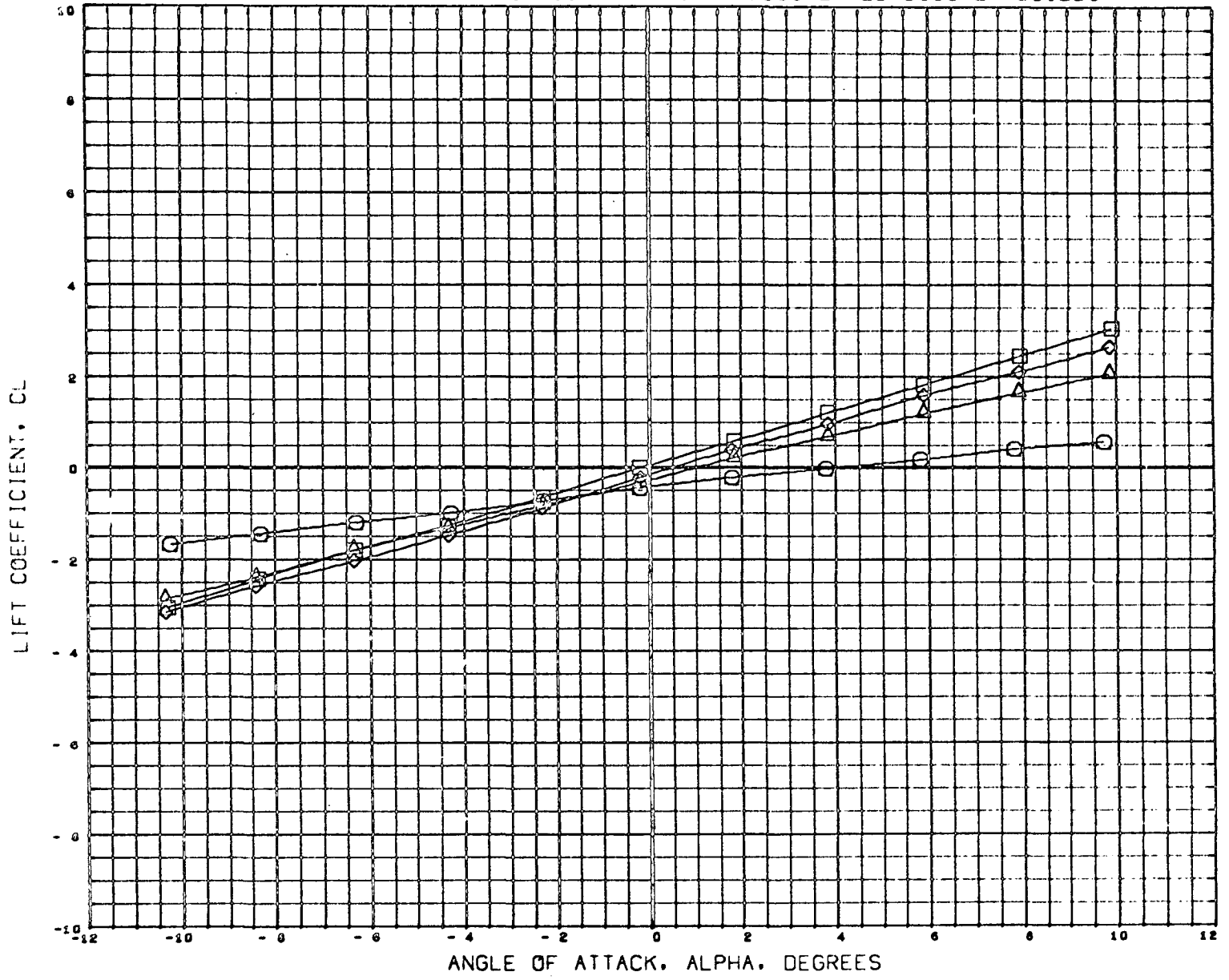

DATA SET SYMBOL	CONFIGURATION DESCRIPTION	BETA
(E90010)	MSFC TWT 514 TPF8 02T4	0.000
(E90010)	MSFC TWT 514 TPF8 B37R702T4	0.000
(E90010)	MSFC TWT 514 TPF8 B37R711902T4	0.000
(E90010)	MSFC TWT 514 TPF8 B37R7119T4	0.000
(E90010)	DATA NOT AVAILABLE FOR ALL CONDITIONS	0.000

REFERENCE INFORMATION		
SREF	0.6600	SQ IN
LREF	5.3230	INCHES
BREF	0.9170	INCHES
XMRP	2.0730	INCHES
YMRP	0.0000	INCHES
ZMRP	0.0000	INCHES
SCALE	0.0034	

MACH 4.959

FIGURE-1 LONGITUDINAL CHARACTERISTICS OF TWIN PRESSURE FED BOOSTER BUILDUP

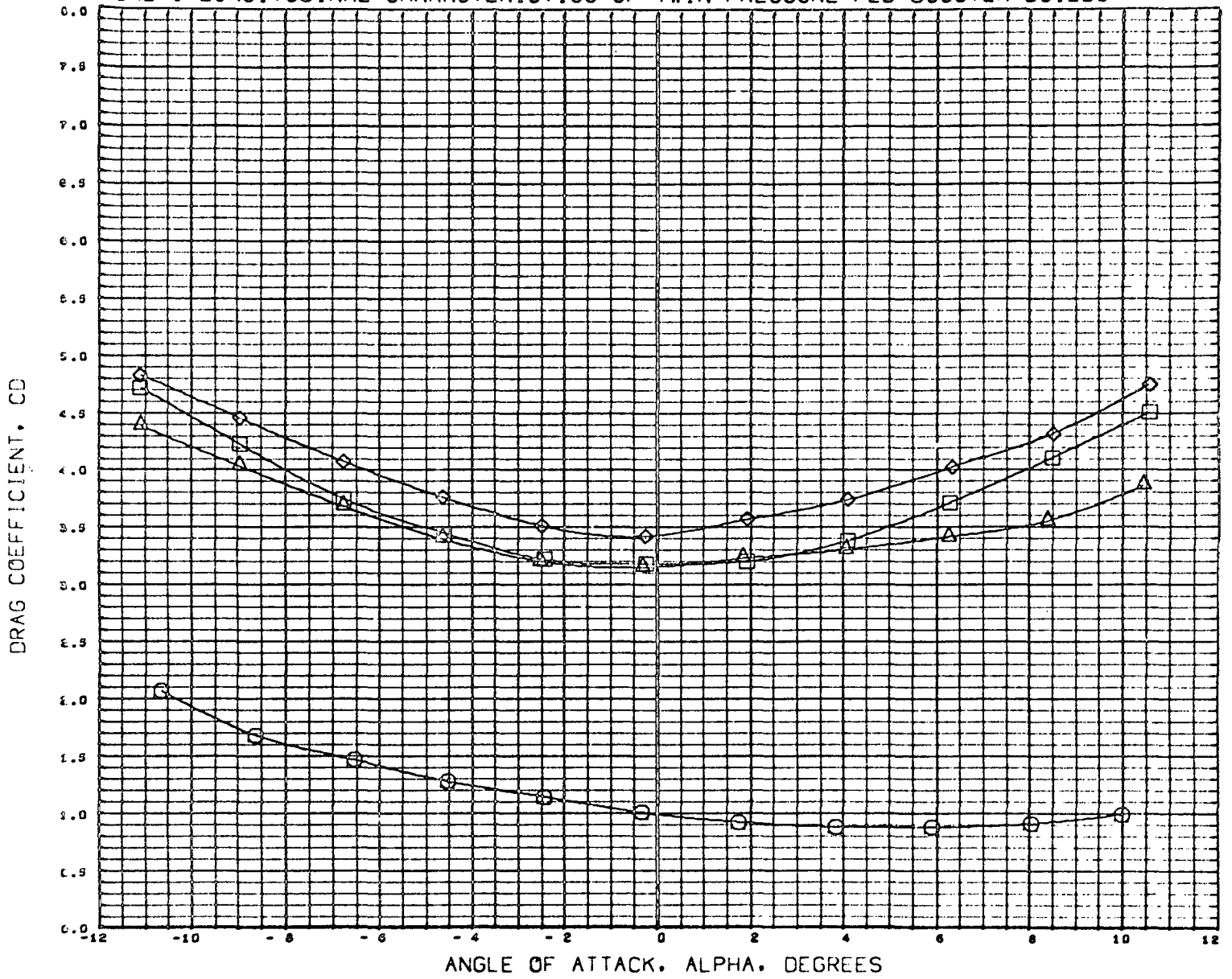

DATA SET SYMBOL	CONFIGURATION DESCRIPTION	BETA
(E500 0)	MSFC TWT 514 TPF8 O2T4	0.000
(E500 00)	MSFC TWT 514 TPF8 B37R7O2T4	0.000
(E500 0)	MSFC TWT 514 TPF8 B37R7I19O2T4	0.000
(E500 0)	MSFC TWT 514 TPF8 B37R7I19T4	0.000
(E500 00)	DATA NOT AVAILABLE FOR ALL CONDITIONS	0.000

REFERENCE INFORMATION		
SREF	0.6600	50 IN
LREF	5.3230	INCHES
BREF	0.9170	INCHES
XMRP	2.0730	INCHES
YMRP	0.0000	INCHES
ZMRP	0.0000	INCHES
SCALE	0.0034	

MACH 0.099

FIGURE-1 LONGITUDINAL CHARACTERISTICS OF TWIN PRESSURE FED BOOSTER BUILDUP

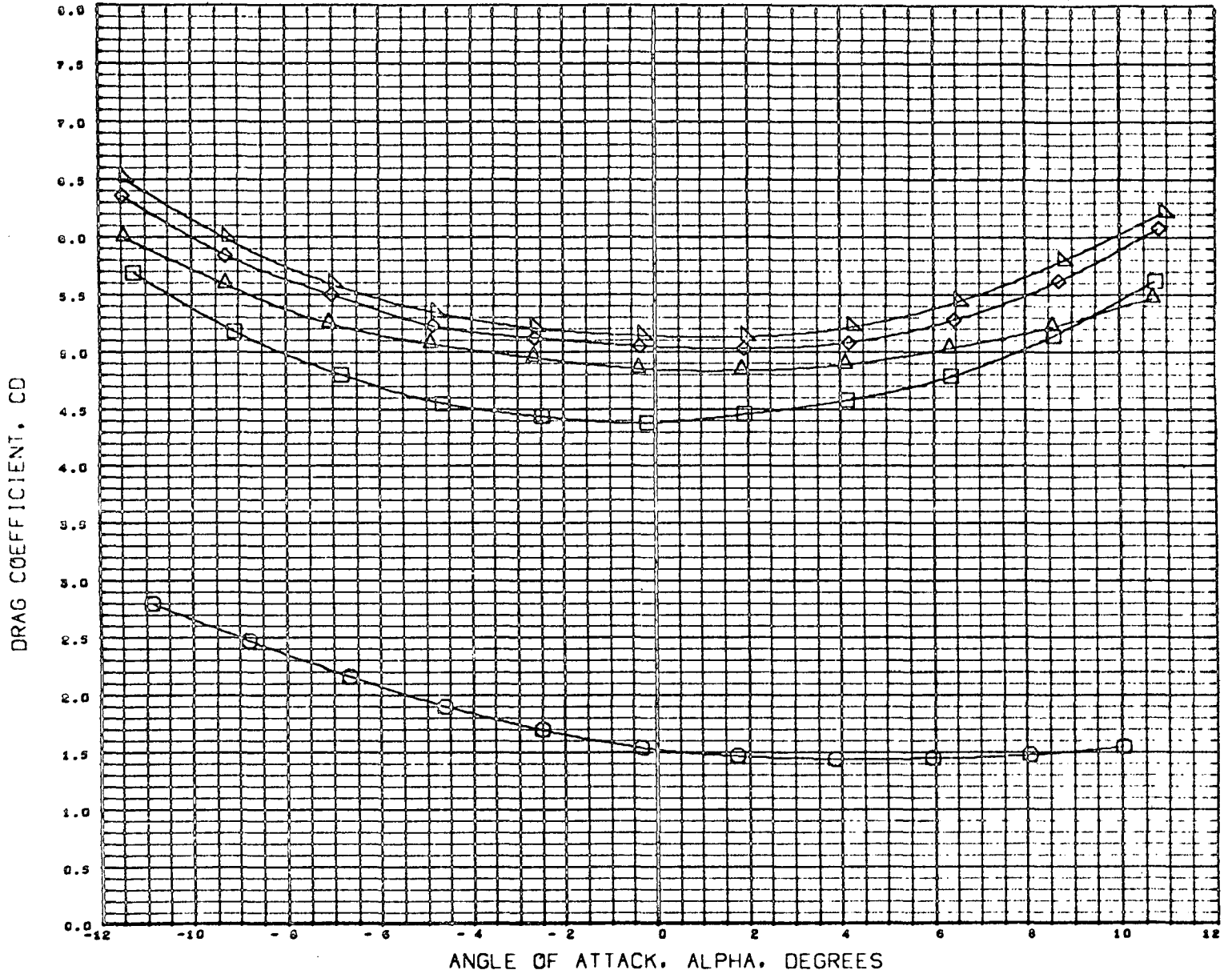

DATA SET SYMBOL	CONFIGURATION DESCRIPTION
(E500:0)	MSFC TWT 514 TFFB 02T4
(E500:0)	MSFC TWT 514 TFFB B37R702T4
(E500:0)	MSFC TWT 514 TFFB B37R7T1902T4
(E500:0)	MSFC TWT 514 TFFB B37R7T19T4
(E580:0)	MSFC TWT 514 TFFB B37R7T1909T4

BETA
0.000
0.000
0.000
0.000
0.000

REFERENCE INFORMATION		
SREF	0.6600	SQ IN
LREF	5.3230	INCHES
BREF	0.9170	INCHES
XMRP	2.0730	INCHES
YMRP	0.0000	INCHES
ZMRP	0.0000	INCHES
SCALE	0.0034	

MACH 1.101

FIGURE-1 LONGITUDINAL CHARACTERISTICS OF TWIN PRESSURE FED BOOSTER BUILDUP

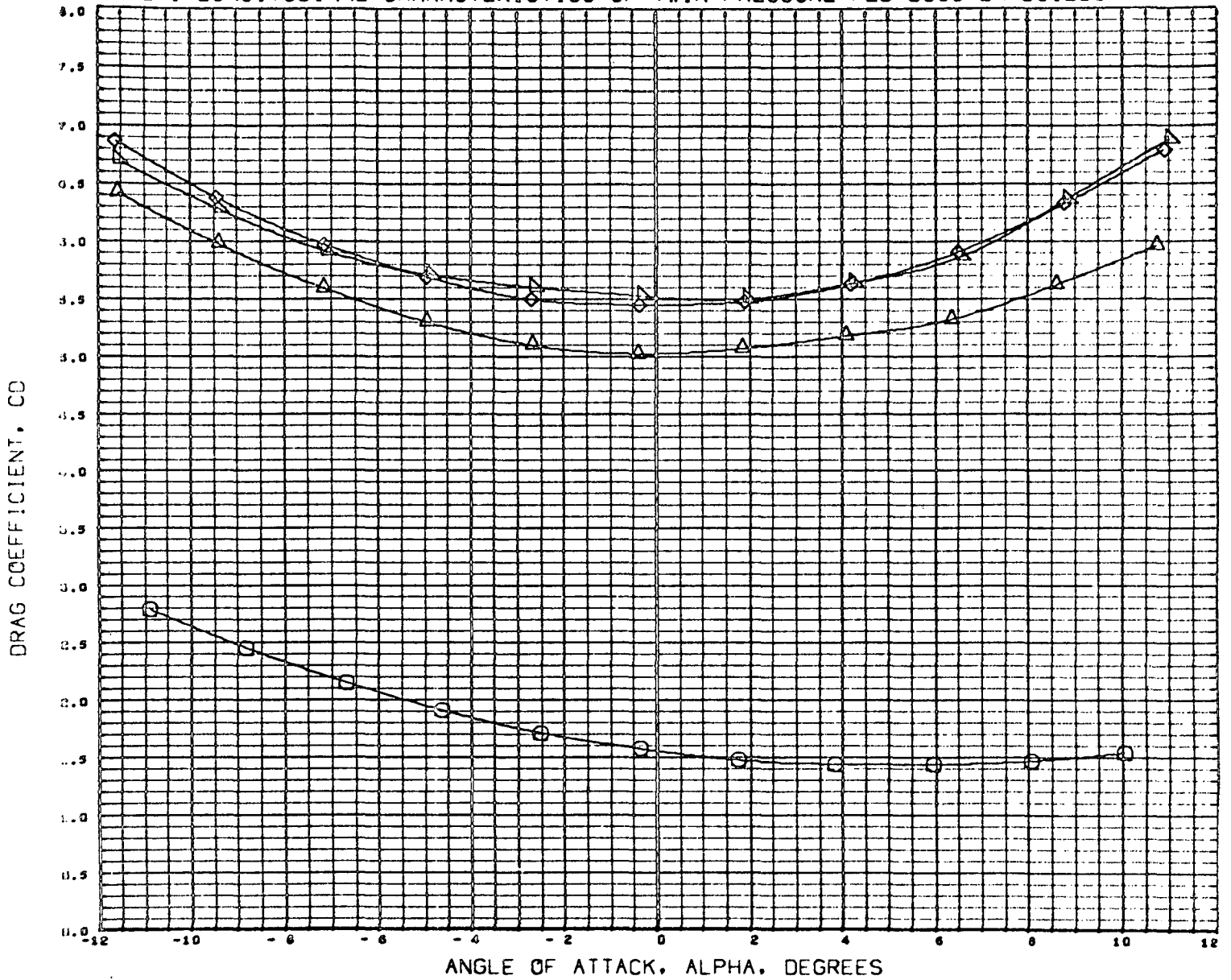

DATA SET SYMBOL	CONFIGURATION DESCRIPTION	BETA
(E58010)	MSFC TWT 314 TFFB O2T4	0.000
(E50010)	MSFC TWT 314 TFFB B37R7O2T4	0.000
(E50010)	MSFC TWT 314 TFFB B37R7T19O2T4	0.000
(E50010)	DATA NOT AVAILABLE FOR ALL CONDITIONS	0.000
(E58030)	MSFC TWT 314 TFFB B37R7T19O5T4	0.000

REFERENCE INFORMATION		
SREF	0.6600	SQ IN
LREF	5.3230	INCHES
BREF	0.9170	INCHES
XMRP	2.0730	INCHES
YMRP	0.0000	INCHES
ZMRP	0.0000	INCHES
SCALE	0.0034	

MACH 1.197

FIGURE-1 LONGITUDINAL CHARACTERISTICS OF TWIN PRESSURE FED BOOSTER BUILDUP

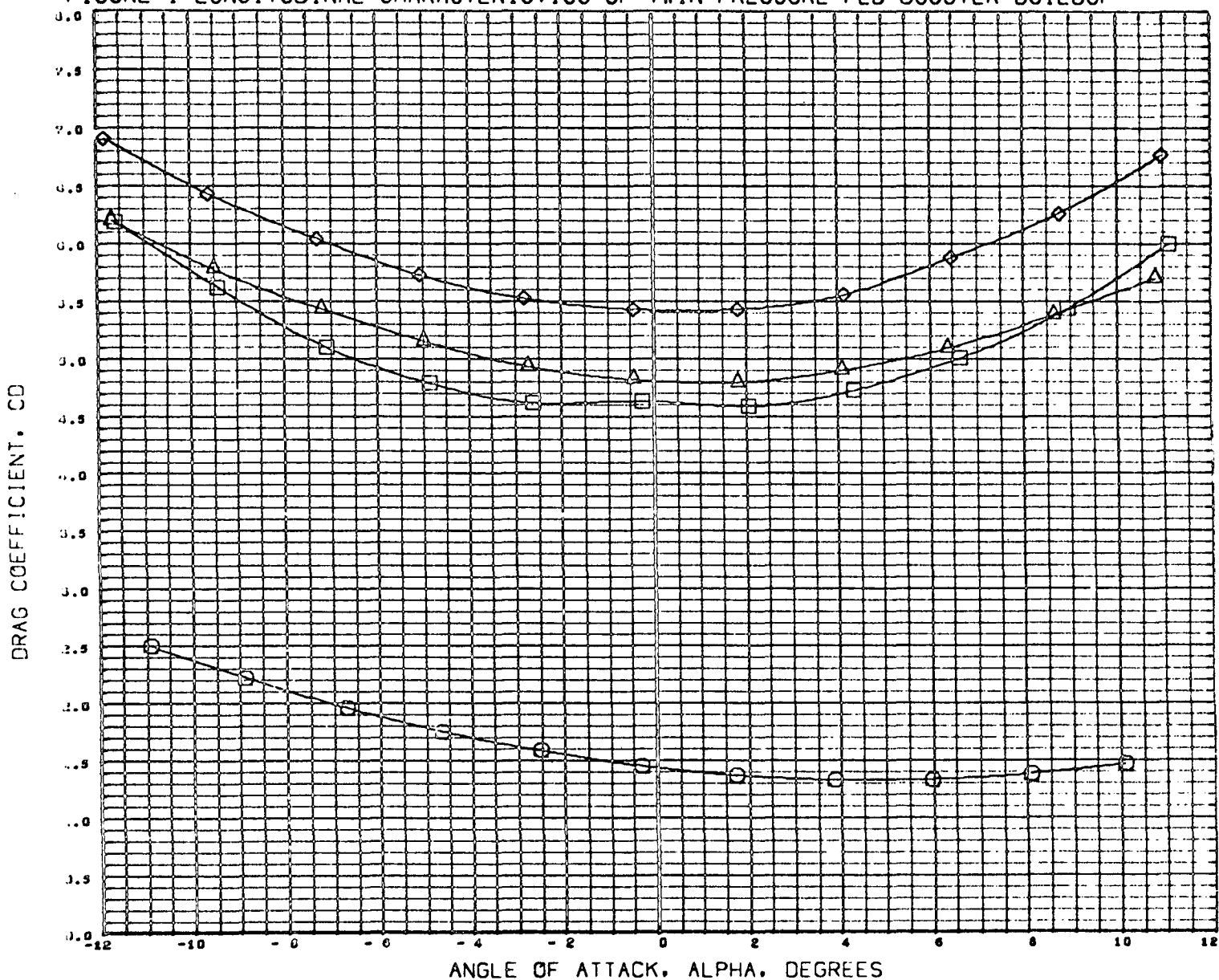

DATA SET SYMBOL	CONFIGURATION DESCRIPTION
(E90C10)	MSFC TWT 914 TFFB 02T4
(E90C30)	MSFC TWT 914 TFFB 037R702T4
(E90C50)	MSFC TWT 914 TFFB 037R7119G2T4
(E90C70)	MSFC TWT 914 TFFB 037R7119T4
(E90C90)	DATA NOT AVAILABLE FOR ALL CONDITIONS

BETA
0.000
0.000
0.000
0.000
0.000

REFERENCE INFORMATION		
SREF	0.6600	SQ IN
LREF	5.3230	INCHES
BREF	0.9170	INCHES
XMRP	2.0730	INCHES
YMRP	0.0000	INCHES
ZMRP	0.0000	INCHES
SCALE	0.0034	

MACH 1.450

FIGURE-1 LONGITUDINAL CHARACTERISTICS OF TWIN PRESSURE FED BOOSTER BUILDUP

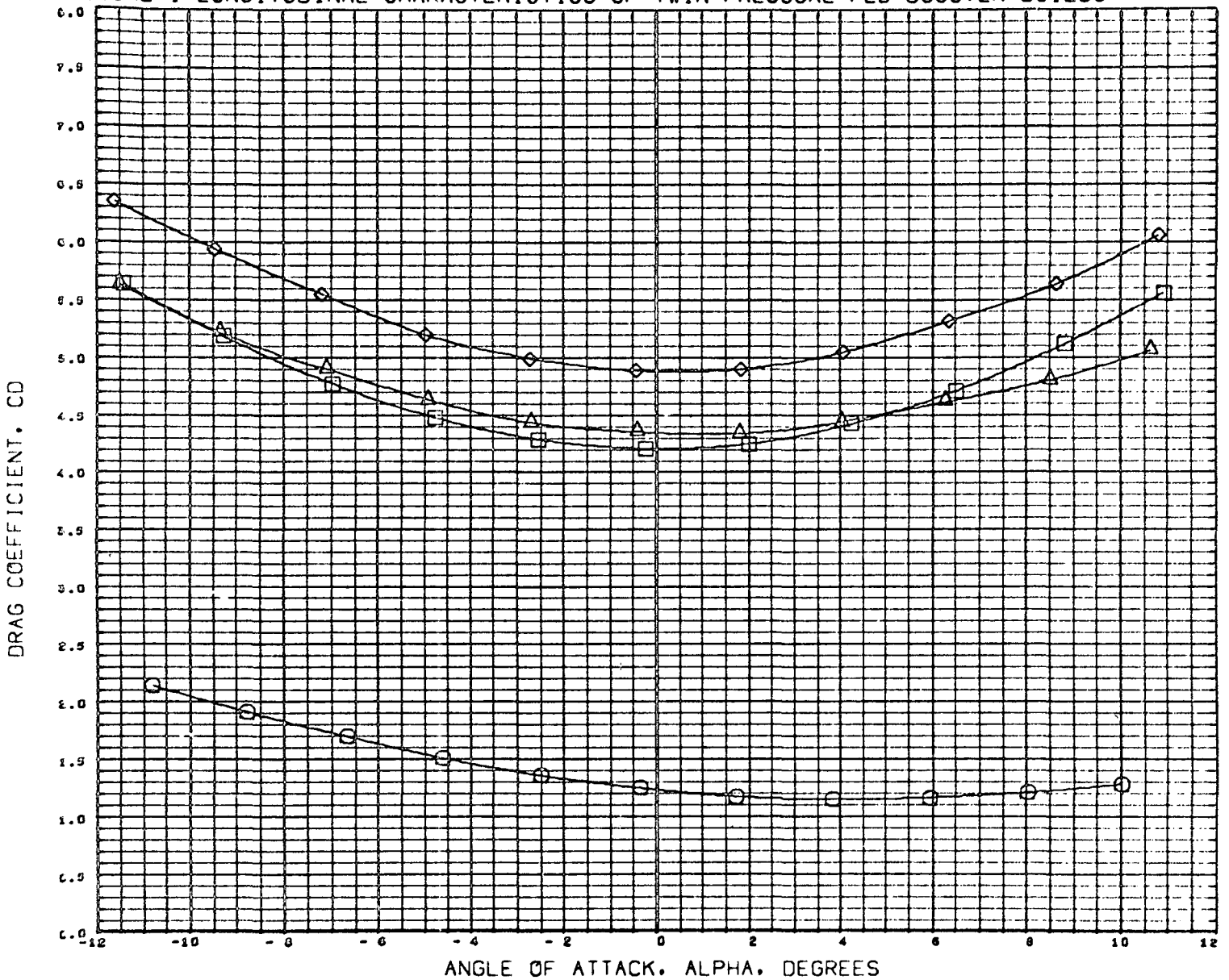

DATA SET SYMBOL	CONFIGURATION DESCRIPTION	BETA
(2500:0)	MSFC TWT 514 TFFB O2T4	0.000
(2500:0)	MSFC TWT 514 TFFB B37R7O2T4	0.000
(2500:0)	MSFC TWT 514 TFFB B37R7T19O2T4	0.000
(2500:0)	MSFC TWT 514 TFFB B37R7T19T4	0.000
(2500:0)	DATA NOT AVAILABLE FOR ALL CONDITIONS	0.000

REFERENCE INFORMATION		
SREF	0.6600	sq IN
LREF	5.3250	INCHES
BREF	0.9170	INCHES
XMRP	2.0750	INCHES
YMRP	0.0000	INCHES
ZMRP	0.0000	INCHES
SCALE	0.0034	

MACH 1.961

FIGURE-1 LONGITUDINAL CHARACTERISTICS OF TWIN PRESSURE FED BOOSTER BUILDUP

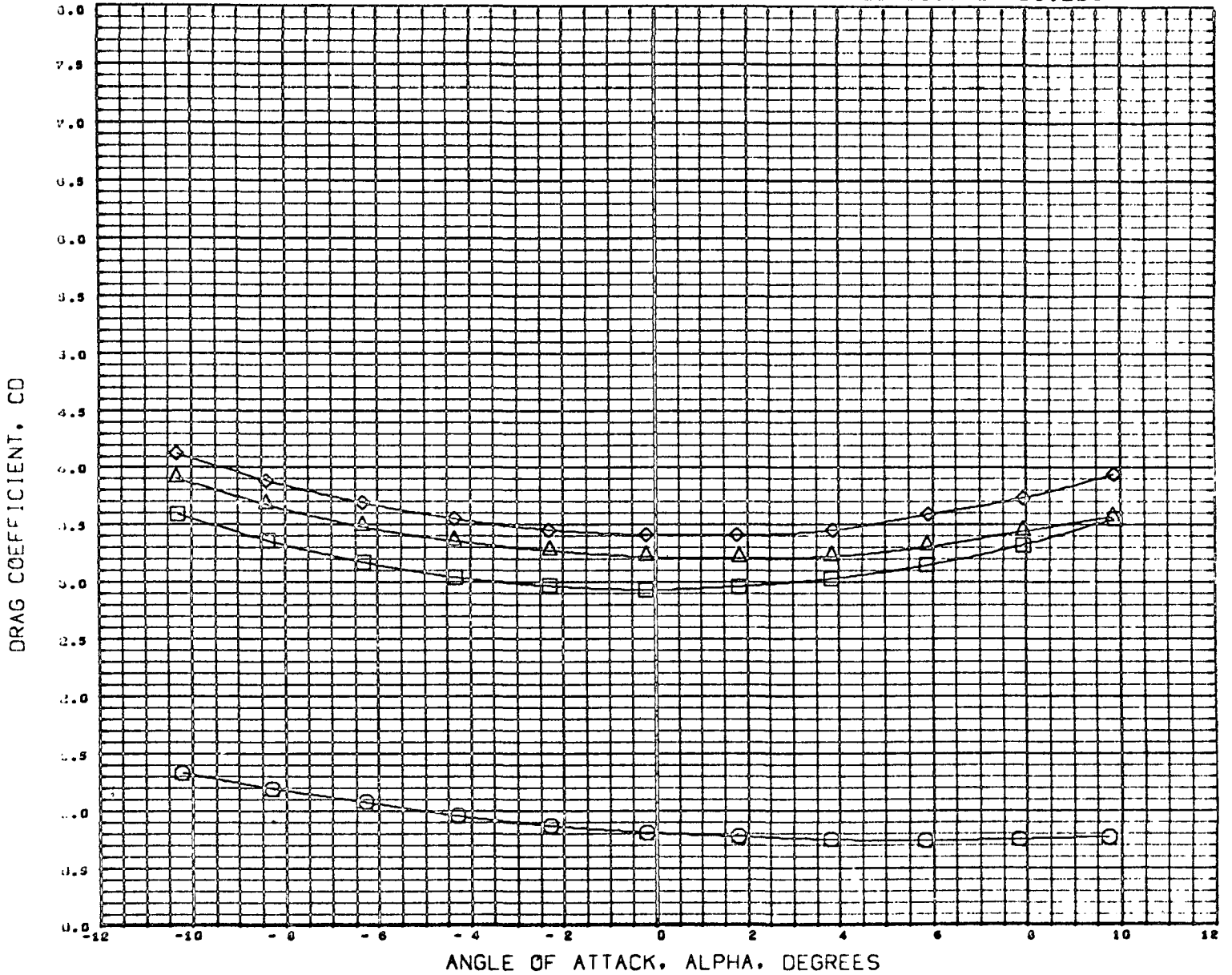

DATA SET SYMBOL	CONFIGURATION DESCRIPTION
(E98610)	MSFC TWT 514 TPF8 02T4
(E98630)	MSFC TWT 514 TPF8 037R702T4
(E98650)	MSFC TWT 514 TPF8 037R711902T4
(E98670)	MSFC TWT 514 TPF8 037R7119T4
(E98690)	DATA NOT AVAILABLE FOR ALL CONDITIONS

BETA
0.000
0.000
0.000
0.000
0.000

REFERENCE INFORMATION		
SREF	0.6600	50 IN
LREF	5.3250	INCHES
BREF	0.9170	INCHES
XMRP	2.0750	INCHES
YMRP	0.0000	INCHES
ZMRP	0.0000	INCHES
SCALE	0.0034	

MACH 4.059

FIGURE-1 LONGITUDINAL CHARACTERISTICS OF TWIN PRESSURE FED BOOSTER BUILDUP

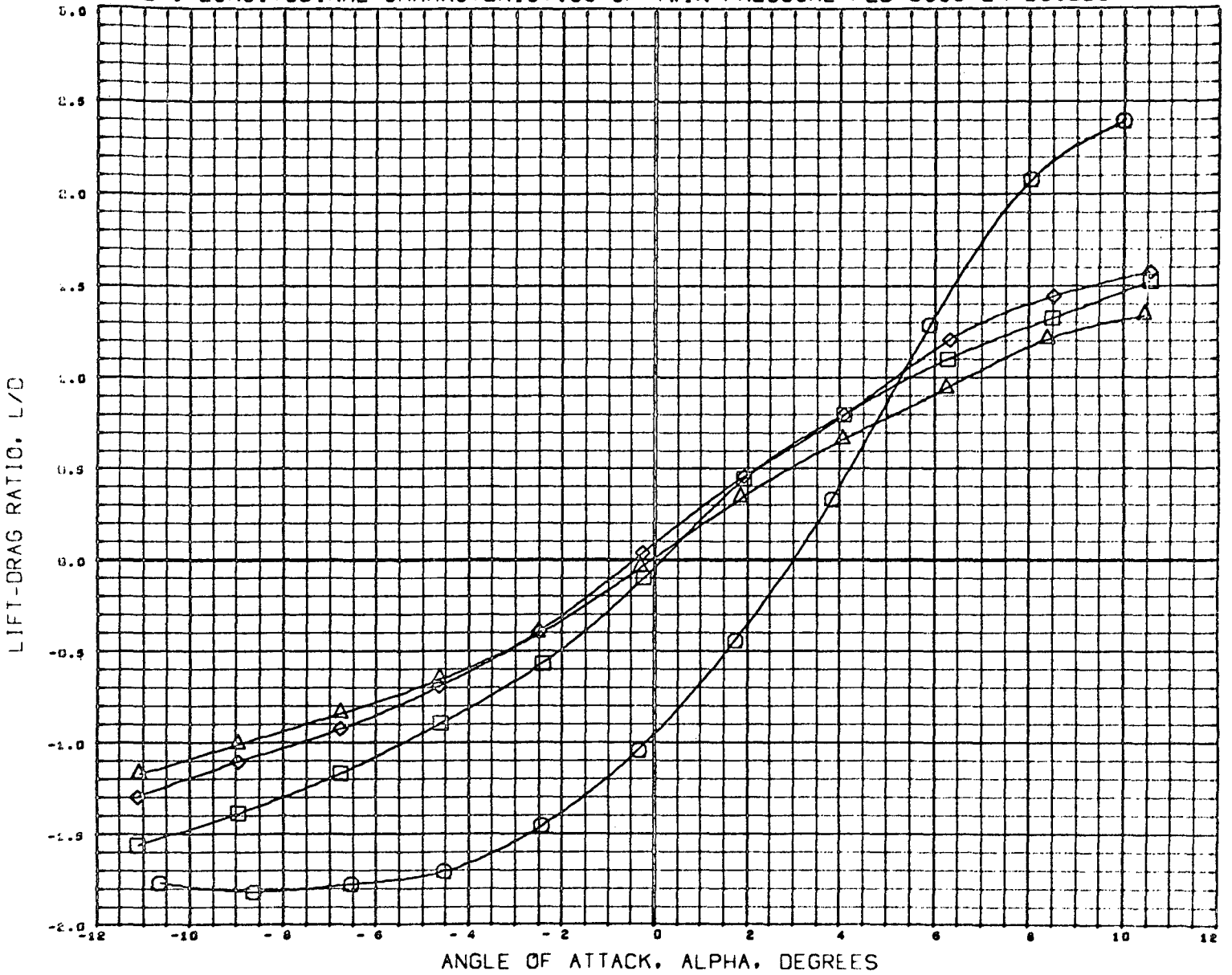

DATA SET SYMBOL	CONFIGURATION DESCRIPTION	BETA
(E900'0)	MSFC TWT 514 TPF8 Q2T4	0.000
(E900'10)	MSFC TWT 514 TPF8 B37R7C2T4	0.000
(E900'10)	MSFC TWT 514 TPF8 B37R7T.902T4	0.000
(E900'0)	MSFC TWT 514 TPF8 B37R7T19T4	0.000
(E900'10)	DATA NOT AVAILABLE FOR ALL CONDITIONS	0.000

REFERENCE INFORMATION		
SREF	0.6600	SQ IN
LREF	5.3230	INCHES
BREF	0.9170	INCHES
XMRP	2.0730	INCHES
YMRP	0.0000	INCHES
ZMRP	0.0000	INCHES
SCALE	0.0034	

MACH 0.899

FIGURE-1 LONGITUDINAL CHARACTERISTICS OF TWIN PRESSURE FED BOOSTER BUILDUP

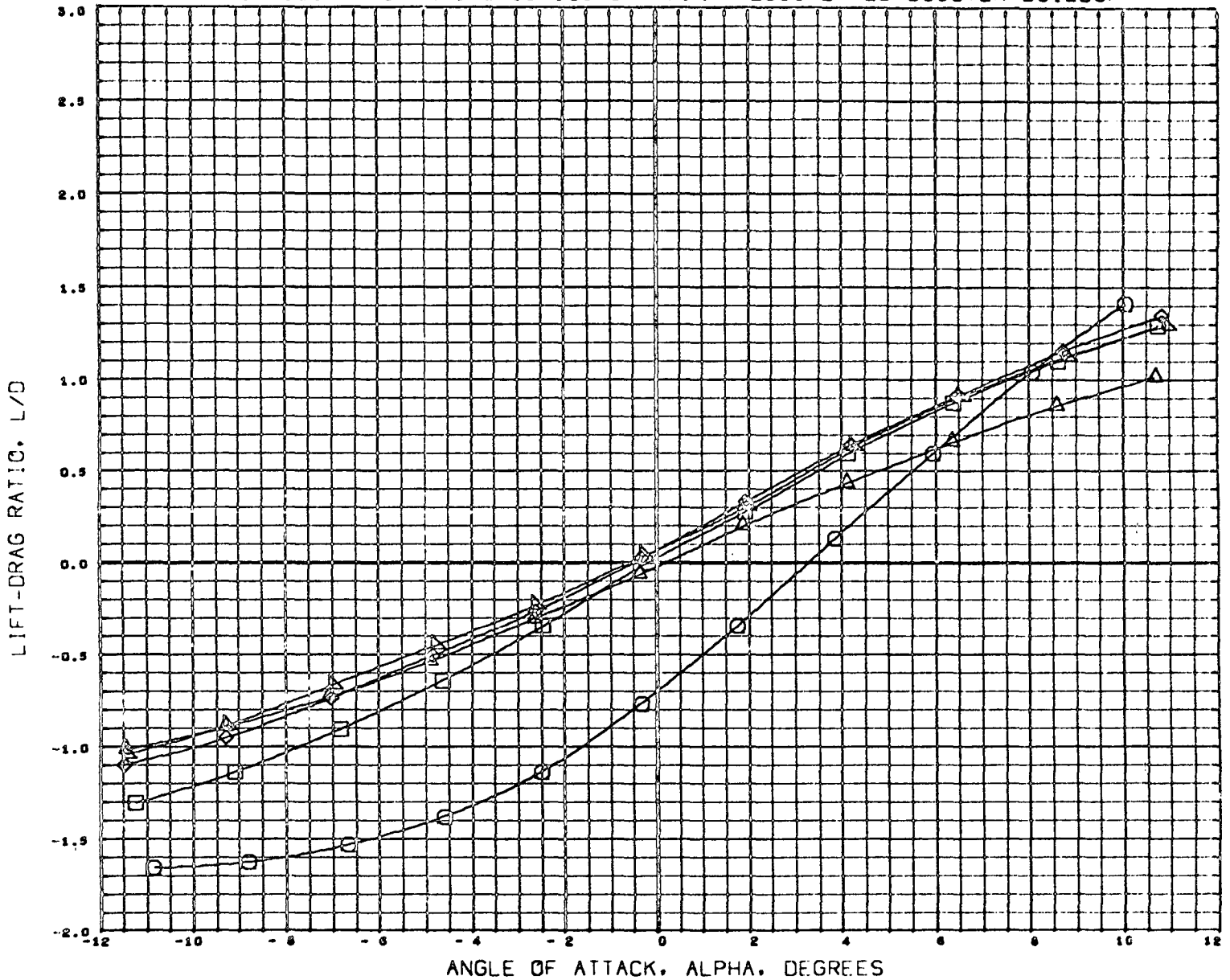

DATA SET SYMBOL	CONFIGURATION DESCRIPTION
(E50110)	MSFC TWT 514 TPF8 O2T4
(E50130)	MSFC TWT 514 TPF8 B37R702T4
(E50150)	MSFC TWT 514 TPF8 B37R7T1902T4
(E50170)	MSFC TWT 514 TPF8 B37R7T19T4
(E56190)	MSFC TWT 514 TPF8 B37R7T1905T4

BETA
0.000
0.000
0.000
0.000
0.000

REFERENCE INFORMATION		
SREF	0.6600	90 IN
LREF	5.3230	INCHES
BREF	0.9170	INCHES
XMRP	2.0730	INCHES
YMRP	0.0000	INCHES
ZMRP	0.0000	INCHES
SCALE	0.0034	

MACH 1.101

FIGURE-1 LONGITUDINAL CHARACTERISTICS OF TWIN PRESSURE FED BOOSTER BUILDUP

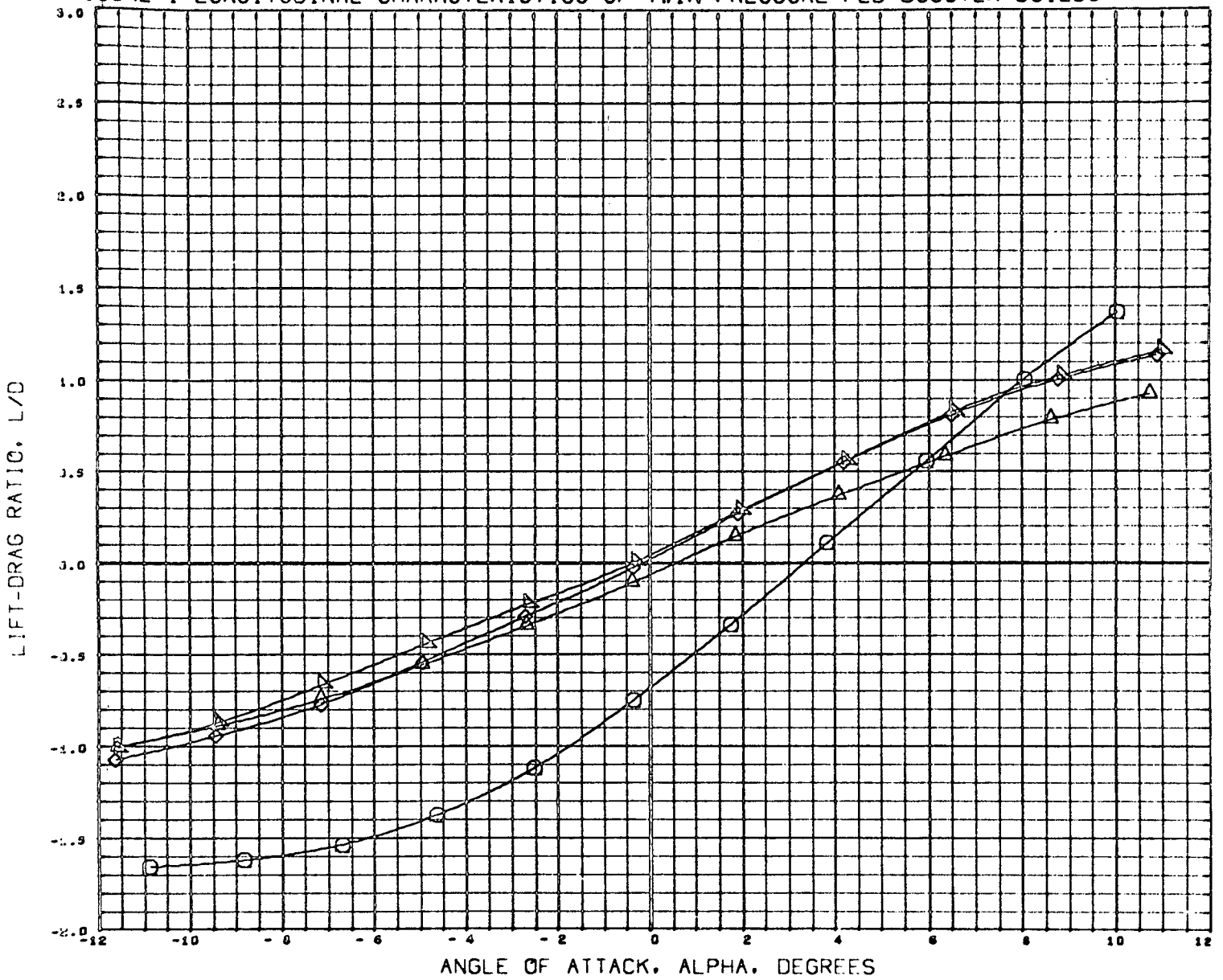

DATA SET SYMBOL	CONFIGURATION DESCRIPTION	BETA
(E90010)	MSFC TWT 514 TFFB Q2T4	0.000
(E90030)	MSFC TWT 514 TFFB B37R702T4	0.000
(E90050)	MSFC TWT 514 TFFB B37R7T19G2T4	0.000
(E90070)	DATA NOT AVAILABLE FOR ALL CONCDITIONS	0.000
(E90090)	MSFC TWT 514 TFFB B37R7T1905T4	0.000

MACH 1.197

REFERENCE INFORMATION	
SREF	0.6600 SQ IN
LREF	5.3230 INCHES
BREF	0.9170 INCHES
XMRP	2.0730 INCHES
YMRP	0.0000 INCHES
ZMRP	0.0000 INCHES
SCALE	0.0034

FIGURE-1 LONGITUDINAL CHARACTERISTICS OF TWIN PRESSURE FED BOOSTER BUILDUP

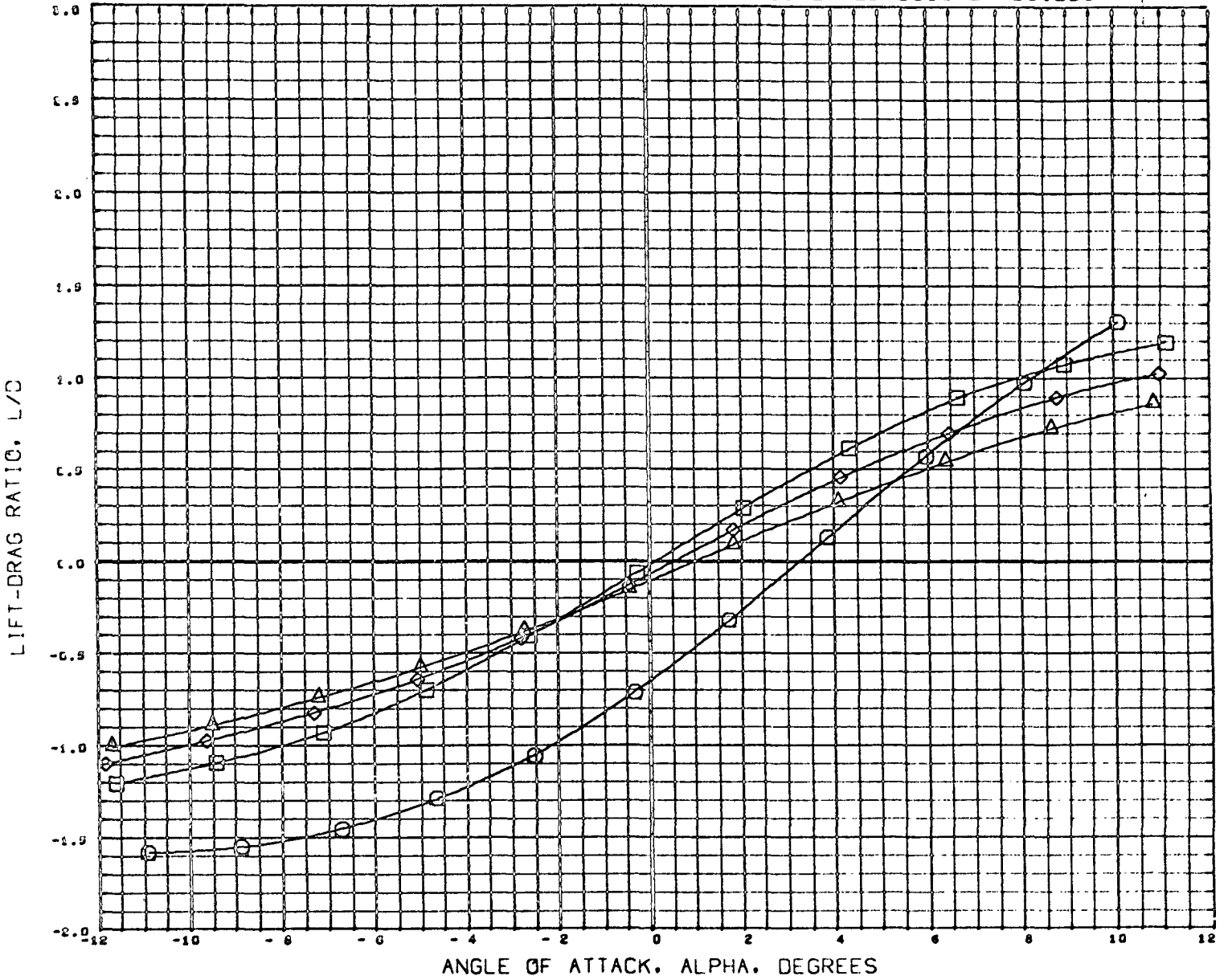

DATA SET SYMBOL	CONFIGURATION DESCRIPTION
(E900 0)	MSFC TWT 514 TPF8 O2T4
(E900.0)	MSFC TWT 514 TPF8 B37R702T4
(E900.0)	MSFC TWT 514 TPF8 B37R711902T4
(E900.0)	MSFC TWT 514 TPF8 B37R7119T3
(E900J0)	DATA NOT AVAILABLE FOR ALL CONDITIONS

BETA
0.000
0.000
0.000
0.000
0.000

REFERENCE INFORMATION		
SREF	0.6600	SQ IN.
LREF	5.3230	INCHES
BREF	0.9170	INCHES
XMRP	2.0730	INCHES
YMRP	0.0000	INCHES
ZMRP	0.0000	INCHES
SCALE	0.0034	

MACH 1.450

FIGURE-1 LONGITUDINAL CHARACTERISTICS OF TWIN PRESSURE FED BOOSTER BUILDUP

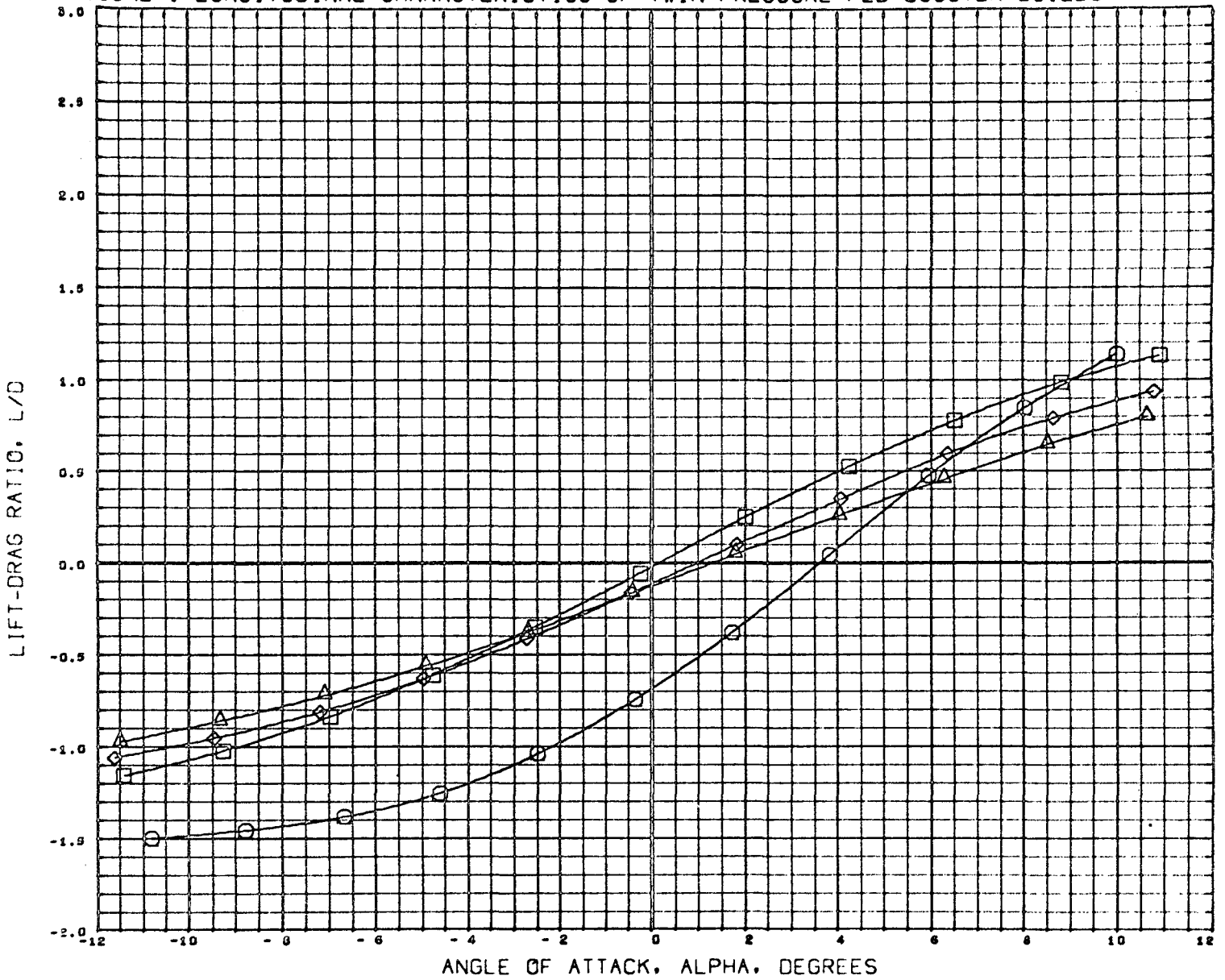

DATA SET SYMBOL	CONFIGURATION DESCRIPTION	BETA
(E50010)	MSFC TWT 514 TPF8 O2T4	0.000
(E50030)	MSFC TWT 514 TPF8 B37R7O2T4	0.000
(E50050)	MSFC TWT 514 TPF8 B37R7I19O2T4	0.000
(E50070)	MSFC TWT 514 TPF8 B37R7I19T4	0.000
(E50090)	DATA NOT AVAILABLE FOR ALL CONDITIONS	0.000

REFERENCE INFORMATION		
SREF	0.6600	sq IN
LREF	5.3230	INCHES
BREF	0.9170	INCHES
XMRP	2.0730	INCHES
YMRP	0.0000	INCHES
ZMRP	0.0000	INCHES
SCALE	0.0034	

MACH 1.961

FIGURE-1 LONGITUDINAL CHARACTERISTICS OF TWIN PRESSURE FED BOOSTER BUILDUP

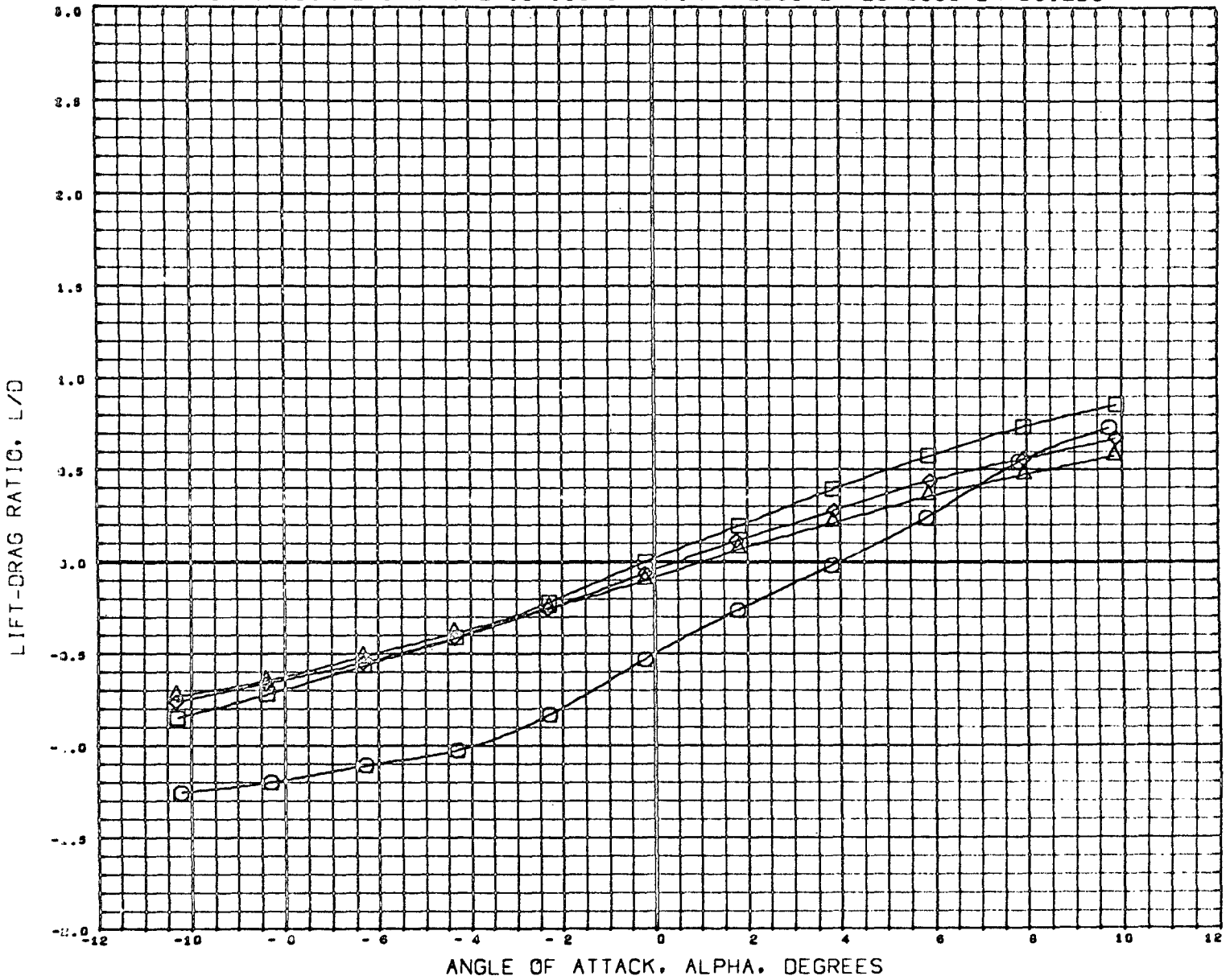

DATA SET SYMBOL	CONFIGURATION DESCRIPTION	BETA
(E90010)	MSFC TWT 514 TPF8 02T4	0.000
(E90030)	MSFC TWT 514 TPF8 837R702T4	0.000
(E90050)	MSFC TWT 514 TPF8 837R7T1902T4	0.000
(E90070)	MSFC TWT 514 TPF8 837R7T19T4	0.000
(E90090)	DATA NOT AVAILABLE FOR ALL CONDITIONS	0.000

REFERENCE INFORMATION		
SREF	0.6600	SQ IN
LREF	5.3230	INCHES
BREF	0.9170	INCHES
XMRP	2.0730	INCHES
YMRP	0.0000	INCHES
ZMRP	0.0000	INCHES
SCALE	0.0034	

MACH 4.959

FIGURE-1 LONGITUDINAL CHARACTERISTICS OF TWIN PRESSURE FED BOOSTER BUILDUP

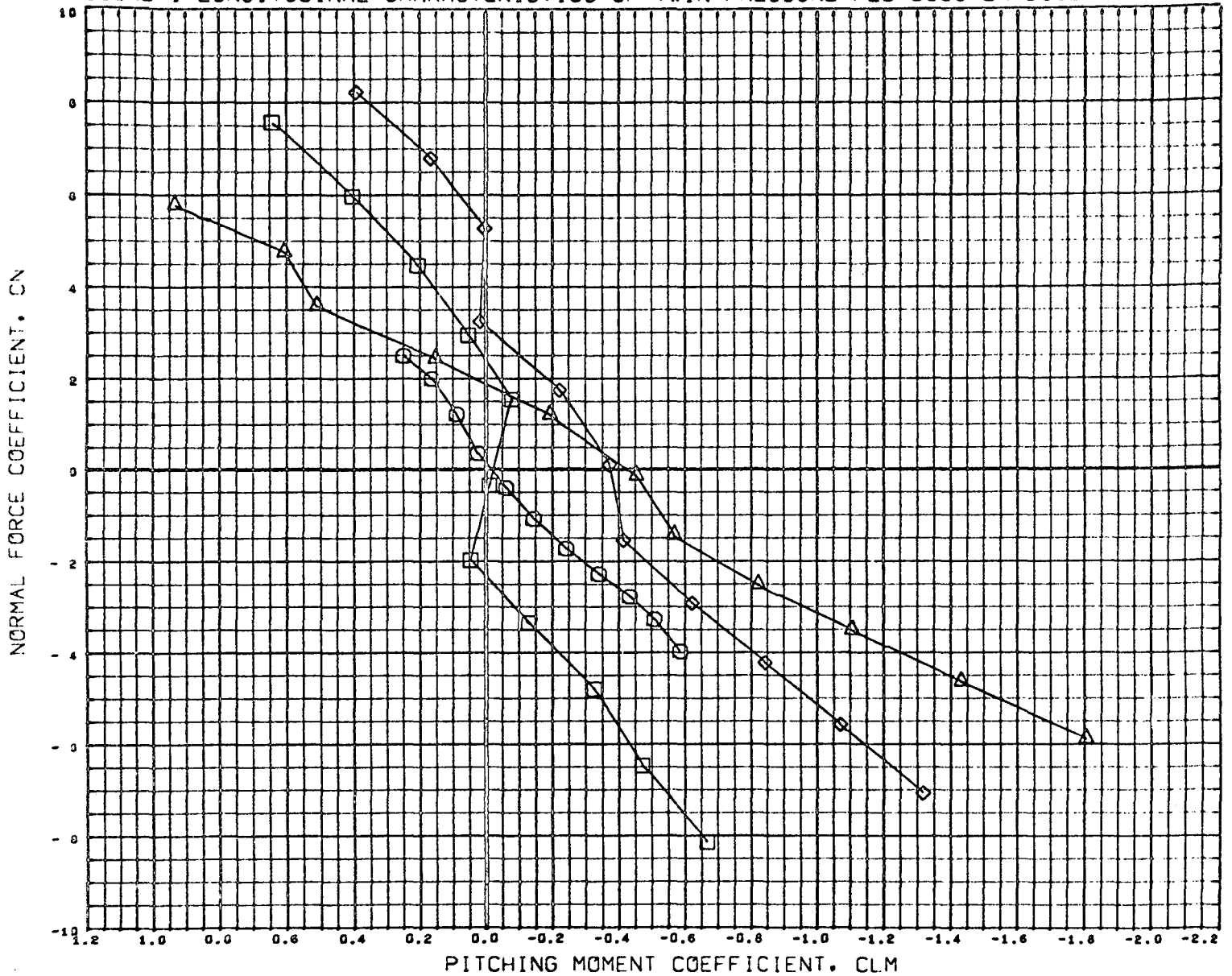

DATA SET SYMBOL	CONFIGURATION DESCRIPTION	BETA
(E500:0)	MSFC TWT 514 TFFB Q2T4	0.000
(E500:0)	MSFC TWT 514 TFFB B37R7O2T4	0.000
(E500:0)	MSFC TWT 514 TFFB B37R7T19O2T4	0.000
(E500:0)	MSFC TWT 514 TFFB B37R7T19T4	0.000
(E500:0)	DATA NOT AVAILABLE FOR ALL CONDITIONS	0.000

REFERENCE INFORMATION		
SREF	0.6600	SQ IN
LREF	9.3230	INCHES
BREF	0.9170	INCHES
XMRP	2.0730	INCHES
YMRP	0.0000	INCHES
ZMRP	0.0000	INCHES
SCALE	0.0034	

MACH 0.899

FIGURE-1 LONGITUDINAL CHARACTERISTICS OF TWIN PRESSURE FED BOOSTER BUILDUP

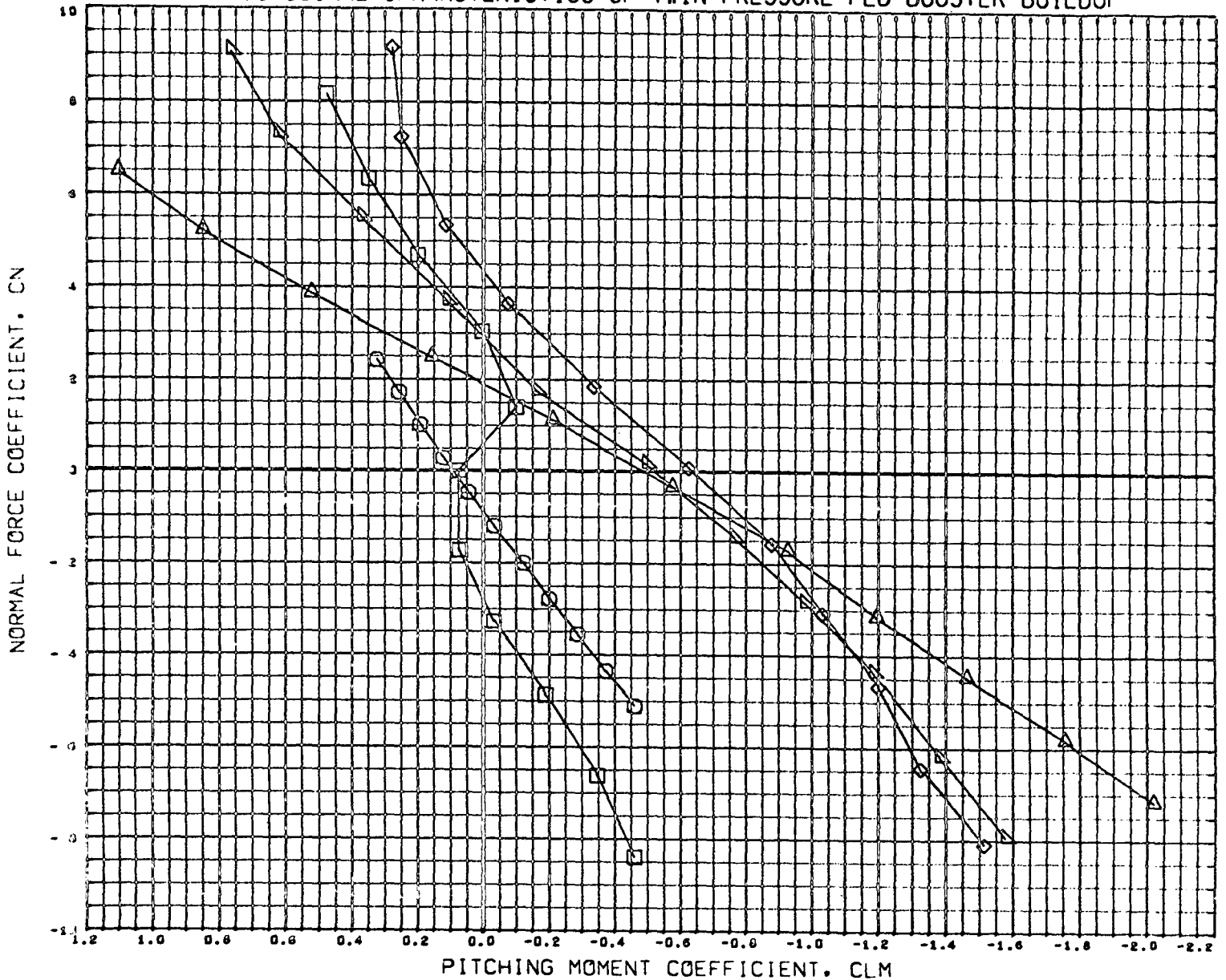

DATA SET SYMBOL	CONFIGURATION DESCRIPTION
(E90010)	MSFC TWT 514 TPF8 O2T4
(E90030)	MSFC TWT 514 TPF8 B37R7O2T4
(E90050)	MSFC TWT 514 TPF8 B37R7I19O2T4
(E90070)	MSFC TWT 514 TPF8 B37R7I19T4
(E90090)	MSFC TWT 514 TPF8 B37R7I19O5T4

BETA
0.000
0.000
0.000
0.000
0.000

REFERENCE INFORMATION		
SREF	0.6600	SQ IN
LREF	5.3250	INCHES
BREF	0.9170	INCHES
XMRP	2.0730	INCHES
YMRP	0.0000	INCHES
ZMRP	0.0000	INCHES
SCALE	0.0034	

MACH 1.101

FIGURE-1 LONGITUDINAL CHARACTERISTICS OF TWIN PRESSURE FED BOOSTER BUILDUP

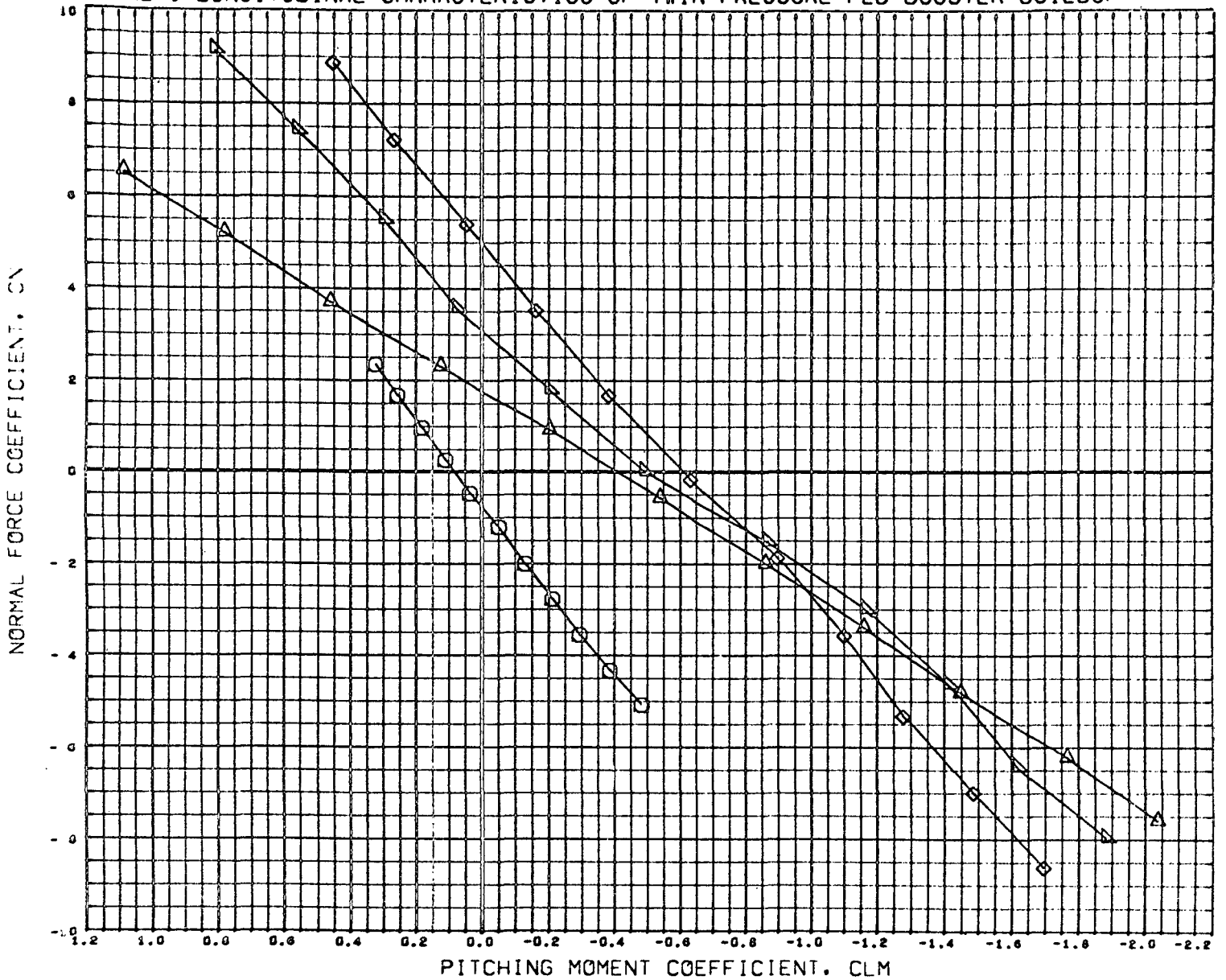

DATA SET SYMBOL	CONFIGURATION DESCRIPTION	BETA
(E90010)	MSFC TWT 514 TFFB O2T4	0.000
(E90030)	MSFC TWT 514 TFFB B37R702T4	0.000
(E90050)	MSFC TWT 514 TFFB B37R7T1902T4	0.000
(E90070)	DATA NOT AVAILABLE FOR ALL CONDITIONS	0.000
(E90090)	MSFC TWT 514 TFFB B37R7T1905T4	0.000

REFERENCE INFORMATION		
SREF	0.6600	SQ IN
LREF	5.3230	INCHES
BREF	0.9170	INCHES
XMRP	2.0730	INCHES
YMRP	0.0000	INCHES
ZMRP	0.0000	INCHES
SCALE	0.0034	

MACH 1.197

FIGURE-1 LONGITUDINAL CHARACTERISTICS OF TWIN PRESSURE FED BOOSTER BUILDUP

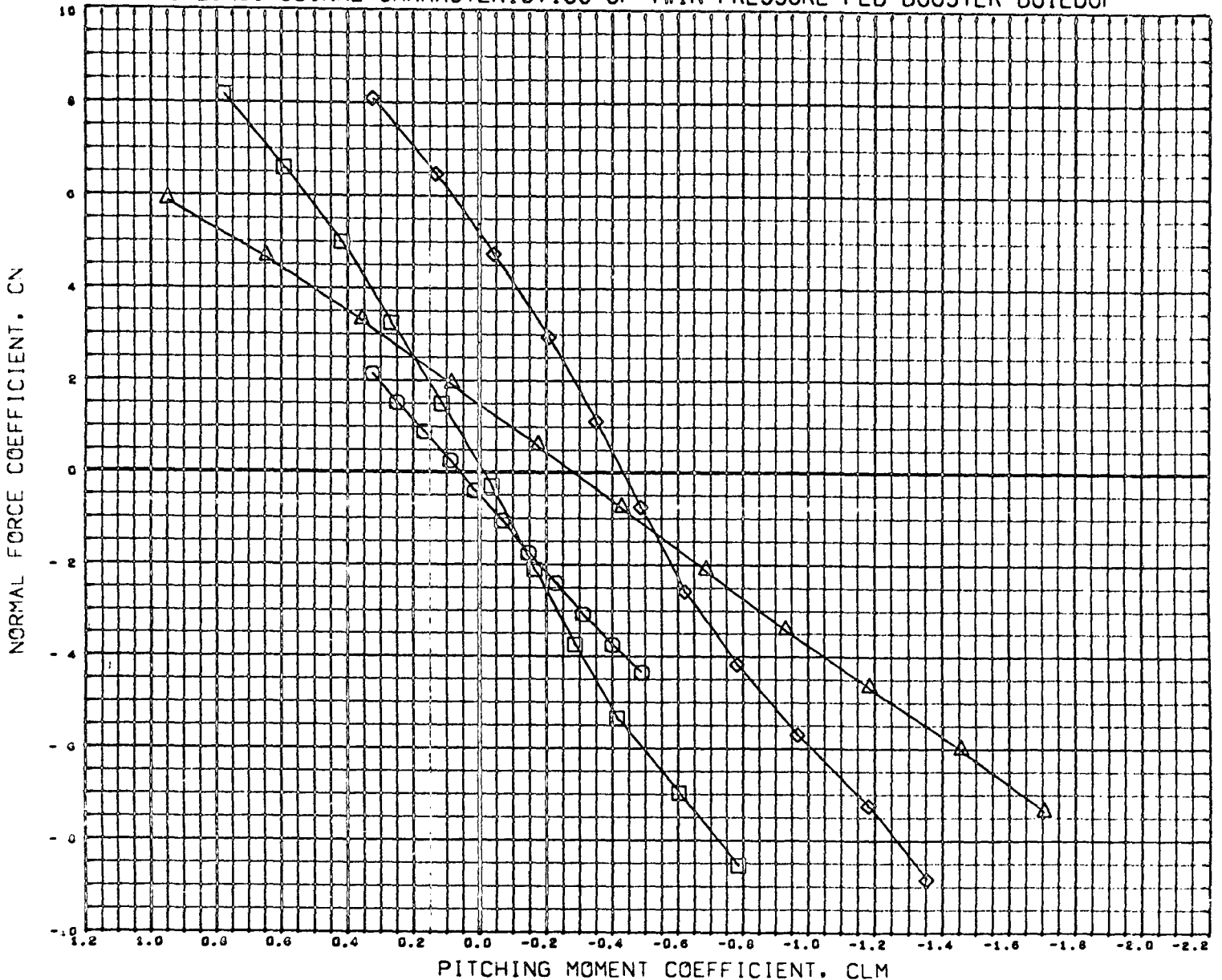

DATA SET SYMBOL	CONFIGURATION DESCRIPTION	BETA
(E50C10)	MSFC TWT 514 TPFB 02T4	0.000
(E50C30)	MSFC TWT 514 TPFB 037R702T4	0.000
(E50C50)	MSFC TWT 514 TPFB 037R7T1902T4	0.000
(E50C70)	MSFC TWT 514 TPFB 037R7T19T4	0.000
(E50C90)	DATA NOT AVAILABLE FOR ALL CONDITIONS	0.000

REFERENCE INFORMATION		
SREF	0.6600	SQ IN
LREF	5.3230	INCHES
BREF	0.9170	INCHES
XMRP	2.0730	INCHES
YMRP	0.0000	INCHES
ZMRP	0.0000	INCHES
SCALE	0.0034	

MACH 2.450

FIGURE-1 LONGITUDINAL CHARACTERISTICS OF TWIN PRESSURE FED BOOSTER BUILDUP

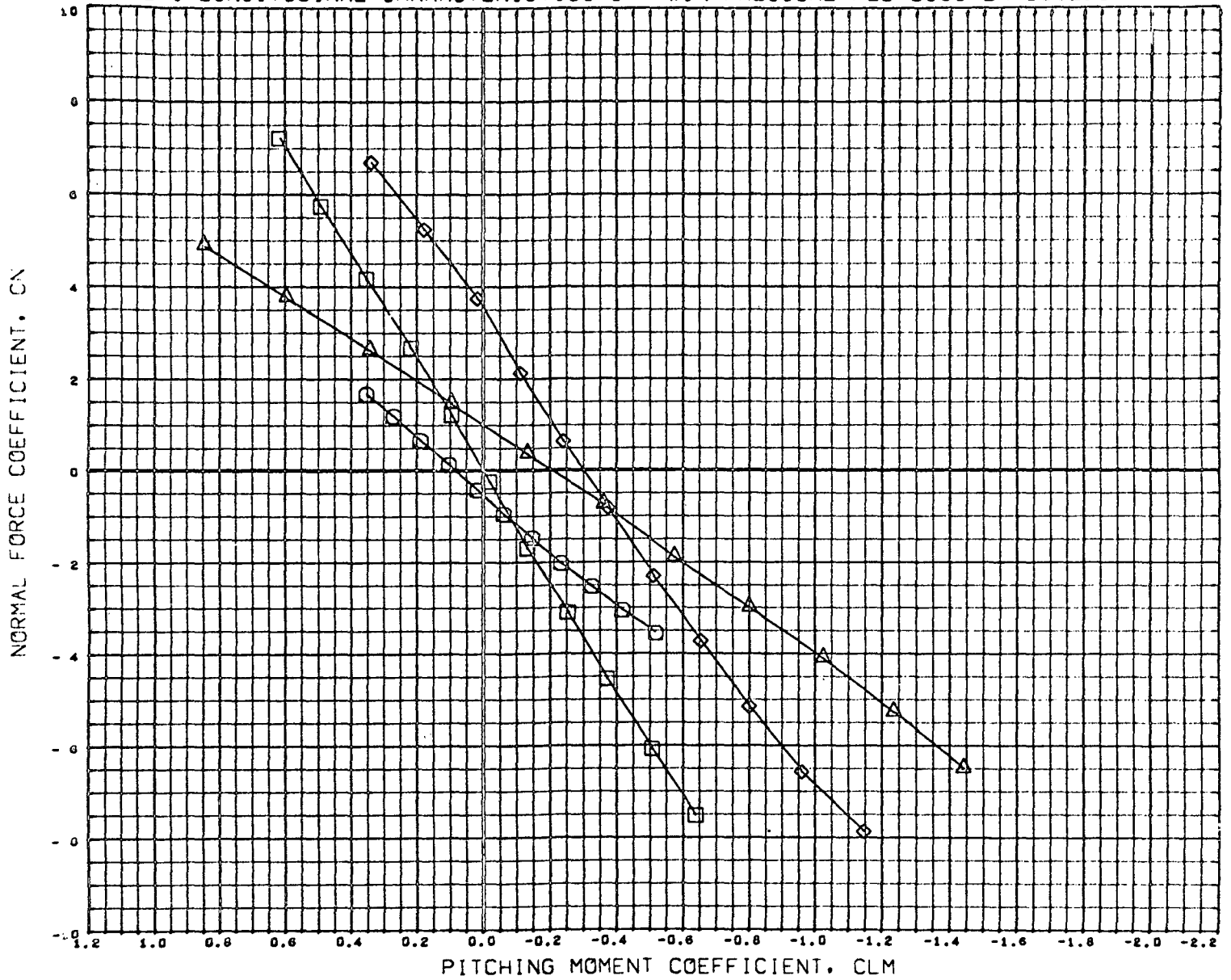

DATA SET SYMBOL	CONFIGURATION DESCRIPTION	BETA
(E90010)	MSFC TWT 514 TPF8 O2T4	0.000
(E90030)	MSFC TWT 514 TPF8 B37R7O2T4	0.000
(E90050)	MSFC TWT 514 TPF8 B37R7T19O2T4	0.000
(E90070)	MSFC TWT 514 TPF8 B37R7T19T4	0.000
(E90090)	DATA NOT AVAILABLE FOR ALL CONDITIONS	0.000

REFERENCE INFORMATION		
SREF	0.6600	SQ IN
LREF	5.3230	INCHES
BREF	0.9170	INCHES
XMRP	2.0730	INCHES
YMRP	0.0000	INCHES
ZMRP	0.0000	INCHES
SCALE	0.0034	

MACH 1.961

FIGURE-1 LONGITUDINAL CHARACTERISTICS OF TWIN PRESSURE FED BOOSTER BUILDUP

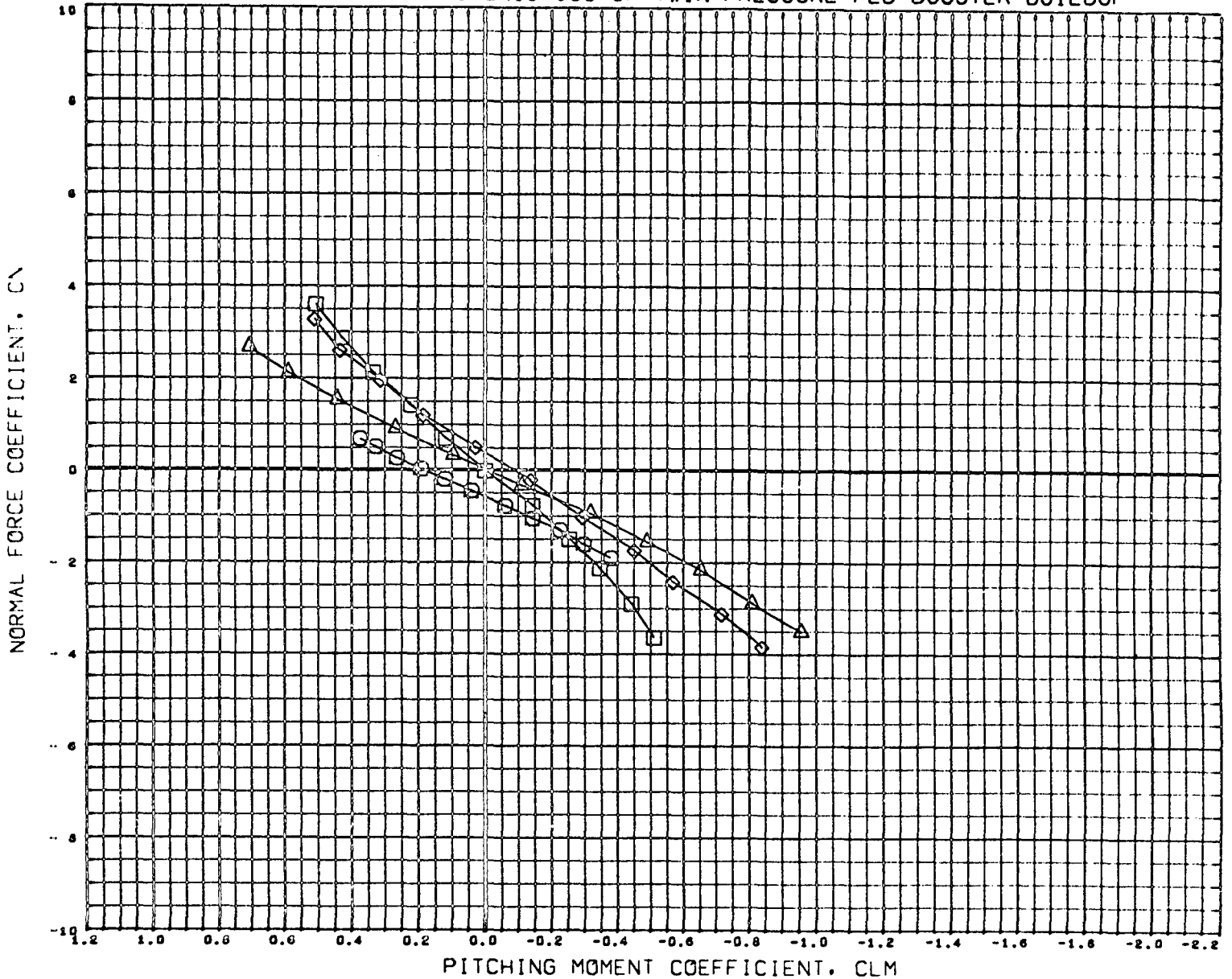

DATA SET SYMBOL	CONFIGURATION DESCRIPTION	BETA
(E50310)	MSFC TWT 514 TPF8 02T4	0.000
(E50330)	MSFC TWT 514 TPF8 037R702T4	0.000
(E50350)	MSFC TWT 514 TPF3 037R7T1902T4	0.000
(E50370)	MSFC TWT 514 TPF8 037R7T19T4	0.000
(E50390)	DATA NOT AVAILABLE FOR ALL CONDITIONS	0.000

REFERENCE INFORMATION	
SREF	0.6600 SQ IN
LREF	5.3230 INCHES
BREF	0.9170 INCHES
XMRP	2.0730 INCHES
YMRP	0.0000 INCHES
ZMRP	0.0000 INCHES
SCALE	0.0034

MACH 4.959

FIGURE-1 LONGITUDINAL CHARACTERISTICS OF TWIN PRESSURE FED BOOSTER BUILDUP

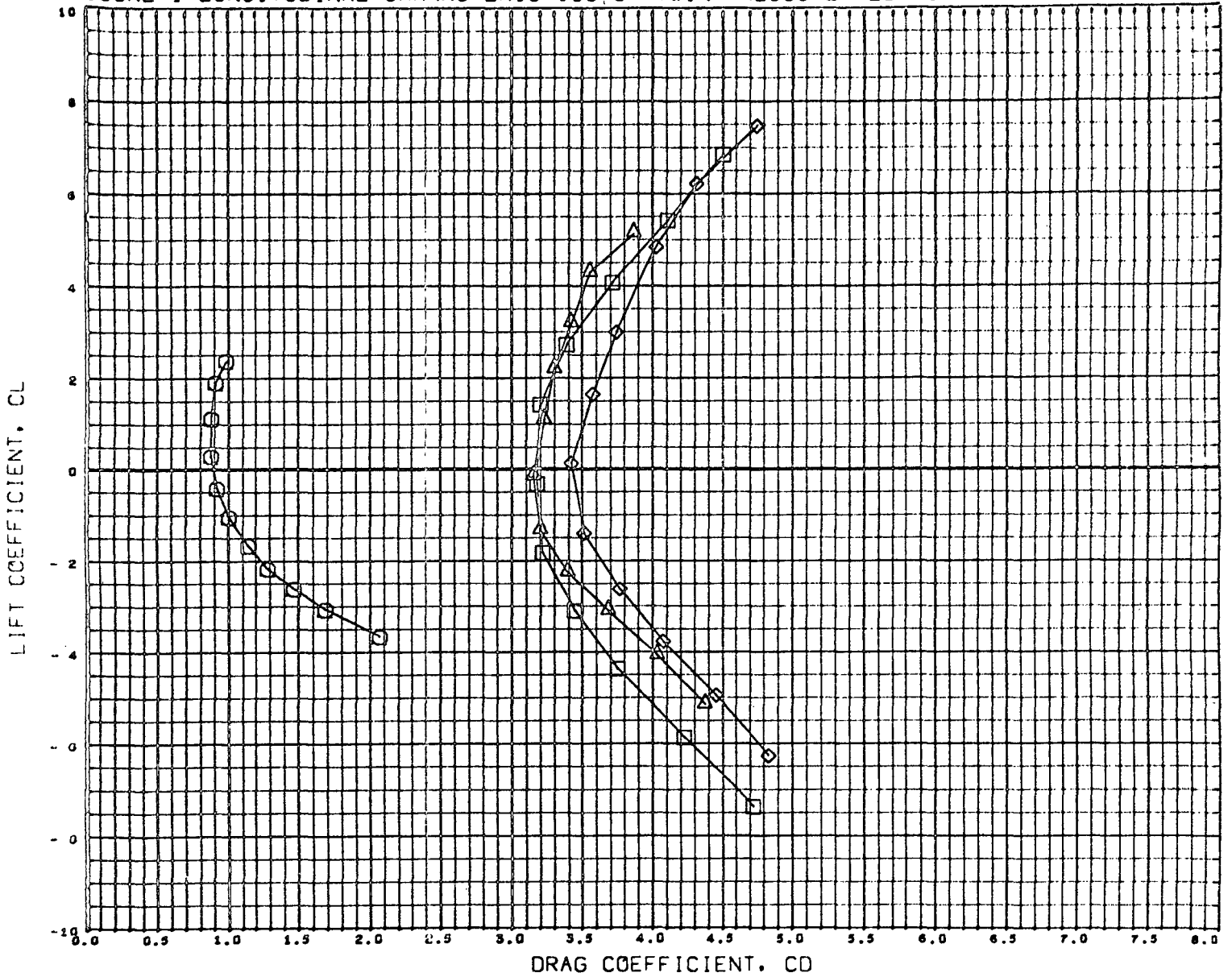

DATA SET SYMBOL	CONFIGURATION DESCRIPTION	BETA
(E50110)	MSFC TWT 514 TFFB Q2T4	0.000
(E50130)	MSFC TWT 514 TFFB B37R7Q2T4	0.000
(E50150)	MSFC TWT 514 TFFB B37R7T19Q2T4	0.000
(E50170)	MSFC TWT 514 TFFB B37R7T19T4	0.000
(E50190)	DATA NOT AVAILABLE FOR ALL CONDITIONS	0.000

REFERENCE INFORMATION		
SREF	0.6600	SQ IN
LREF	5.3230	INCHES
BREF	0.9170	INCHES
XMRP	2.0730	INCHES
YMRP	0.0000	INCHES
ZMRP	0.0000	INCHES
SCALE	0.0034	

MACH 0.899

FIGURE-1 LONGITUDINAL CHARACTERISTICS OF TWIN PRESSURE FED BOOSTER BUILDUP

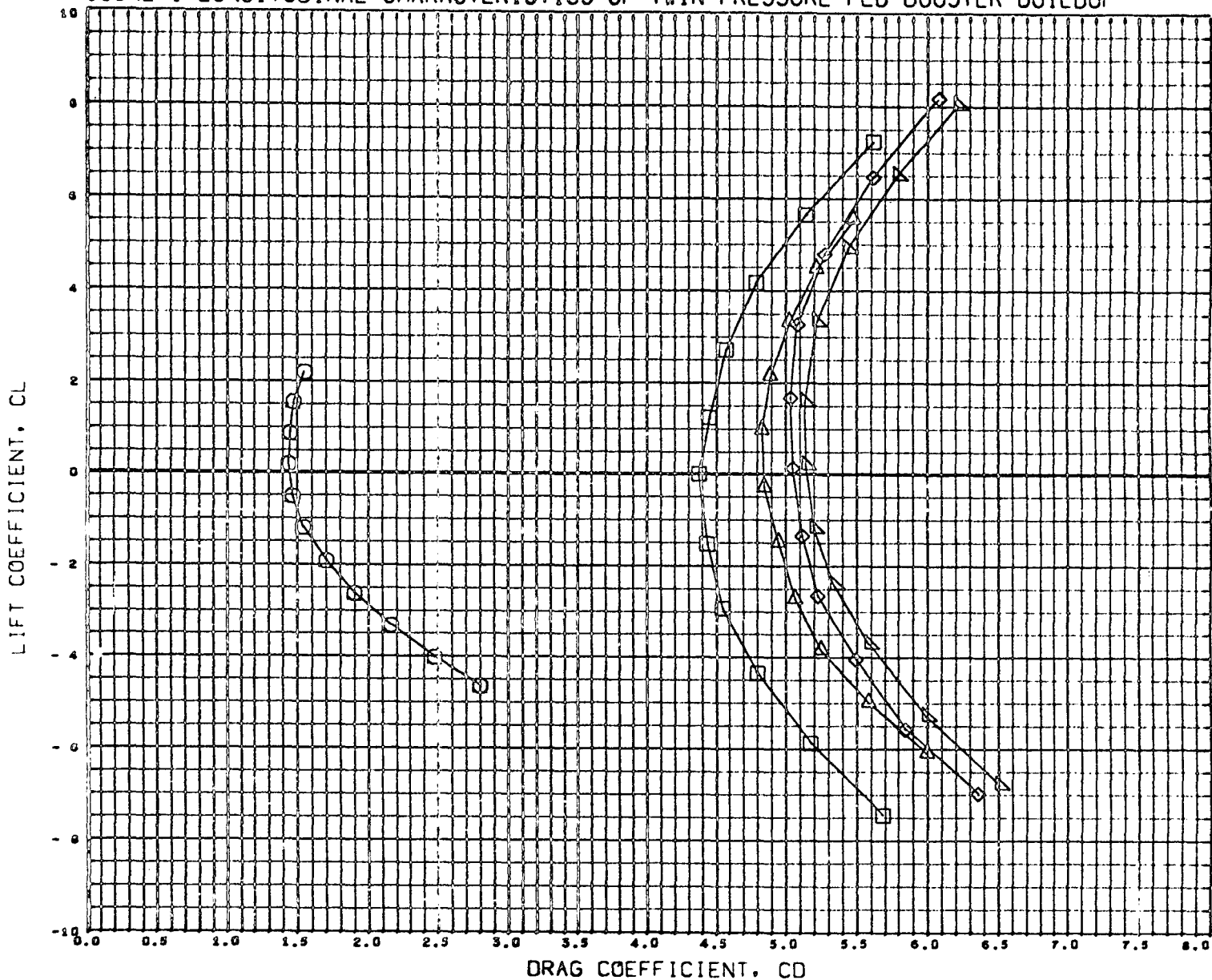

DATA SET SYMBOL	CONFIGURATION DESCRIPTION
(2900) O	MSFC TWT 514 TPF8 O2T4
(2900) O	MSFC TWT 514 TPF8 837R7O2T4
(2900) O	MSFC TWT 514 TPF8 837R7T19O2T4
(2900) O	MSFC TWT 514 TPF8 837R7T19T4
(2900) O	MSFC TWT 514 TPF8 837R7T19O5T4

BETA
0.000
0.000
0.000
0.000
0.000

REFERENCE INFORMATION	
SREF	0.6600 SQ IN
LREF	5.3250 INCHES
BREF	0.9170 INCHES
XHRP	2.0730 INCHES
YHRP	0.0000 INCHES
ZHRP	0.0000 INCHES
SCALE	0.0034

MACH 1.101

FIGURE-1 LONGITUDINAL CHARACTERISTICS OF TWIN PRESSURE FED BOOSTER BUILDUP

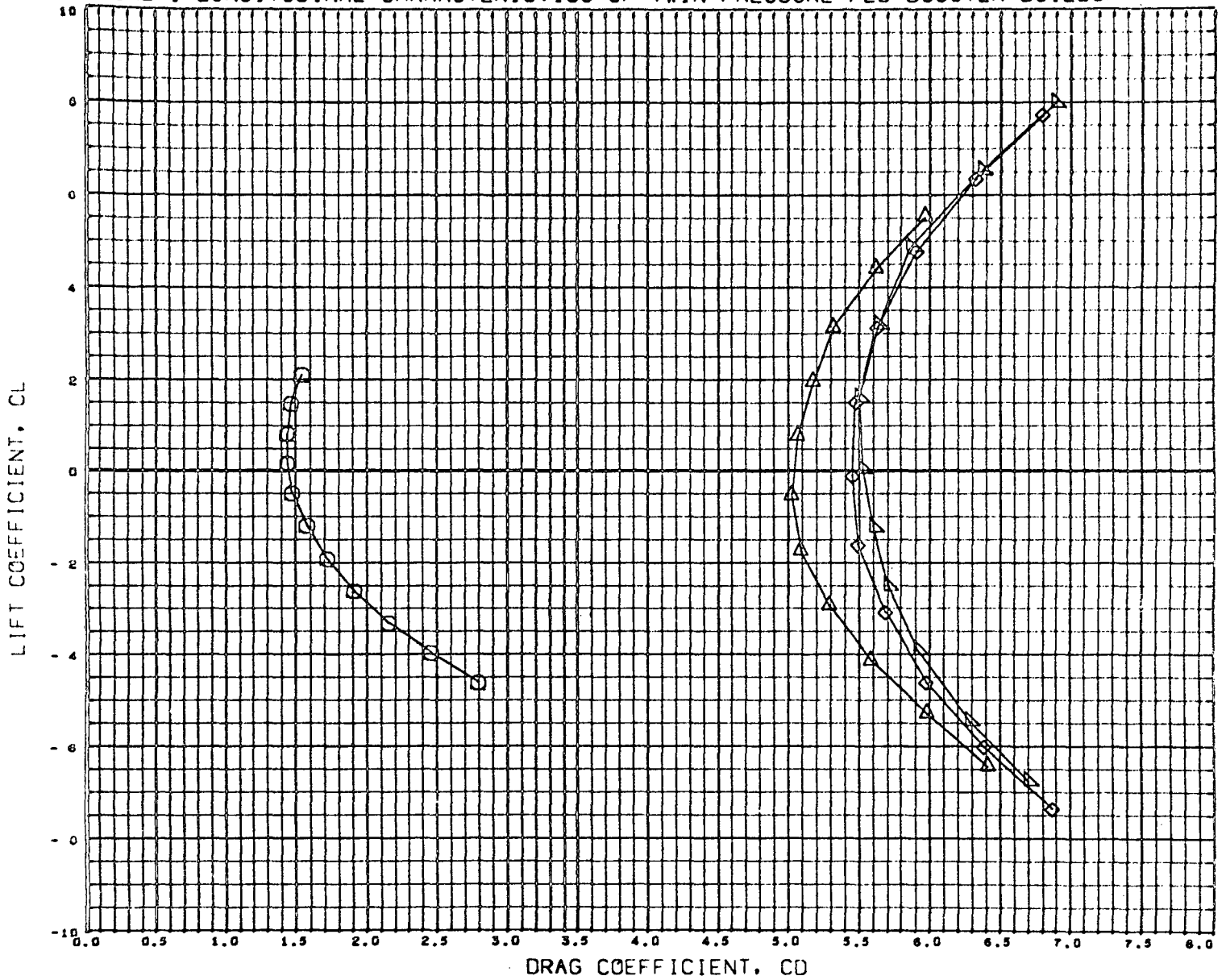

DATA SET SYMBOL	CONFIGURATION DESCRIPTION	BETA
(E50L10)	MSFC TWT 514 TFFB O2T4	0.000
(E50L30)	MSFC TWT 514 TFFB B37R7O2T4	0.000
(E50L50)	MSFC TWT 514 TFFB B37R7T19O2T4	0.000
(E50L70)	DATA NOT AVAILABLE FOR ALL CONDITIONS	0.000
(E50L90)	MSFC TWT 514 TFFB B37R7T19O5T4	0.000

MACH 1.197

REFERENCE INFORMATION		
SREF	0.6600	SQ IN
LREF	5.3230	INCHES
BREF	0.9170	INCHES
XMRP	2.0730	INCHES
YMRP	0.0000	INCHES
ZMRP	0.0000	INCHES
SCALE	0.0034	

FIGURE-1 LONGITUDINAL CHARACTERISTICS OF TWIN PRESSURE FED BOOSTER BUILDUP

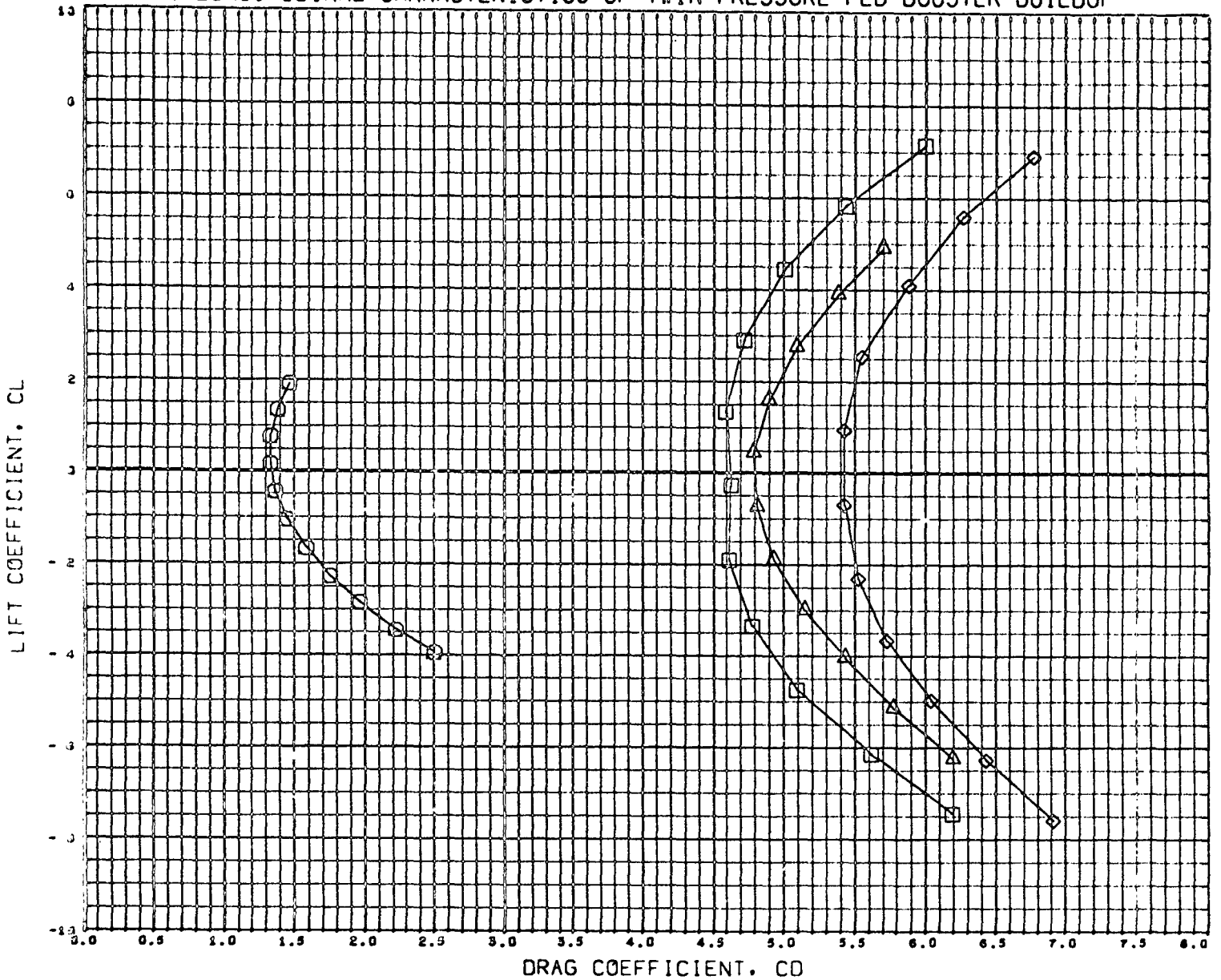

DATA SET SYMBOL	CONFIGURATION DESCRIPTION	BETA
(E90010)	MSFC TWT 514 TPF8 02T4	0.000
(E90020)	MSFC TWT 514 TPF8 837R702T4	0.000
(E98050)	MSFC TWT 514 TPF8 837R711902T4	0.000
(E90030)	MSFC TWT 514 TPF8 837R7119T4	0.000
(E98060)	DATA NOT AVAILABLE FOR ALL CONDITIONS	0.000

REFERENCE INFORMATION		
SREF	0.6600	SQ IN
LREF	5.3230	INCHES
BREF	0.9170	INCHES
XMRP	2.0730	INCHES
YMRP	0.0000	INCHES
ZMRP	0.0000	INCHES
SCALE	0.0034	

MACH 1.450

FIGURE-1 LONGITUDINAL CHARACTERISTICS OF TWIN PRESSURE FED BOOSTER BUILDUP

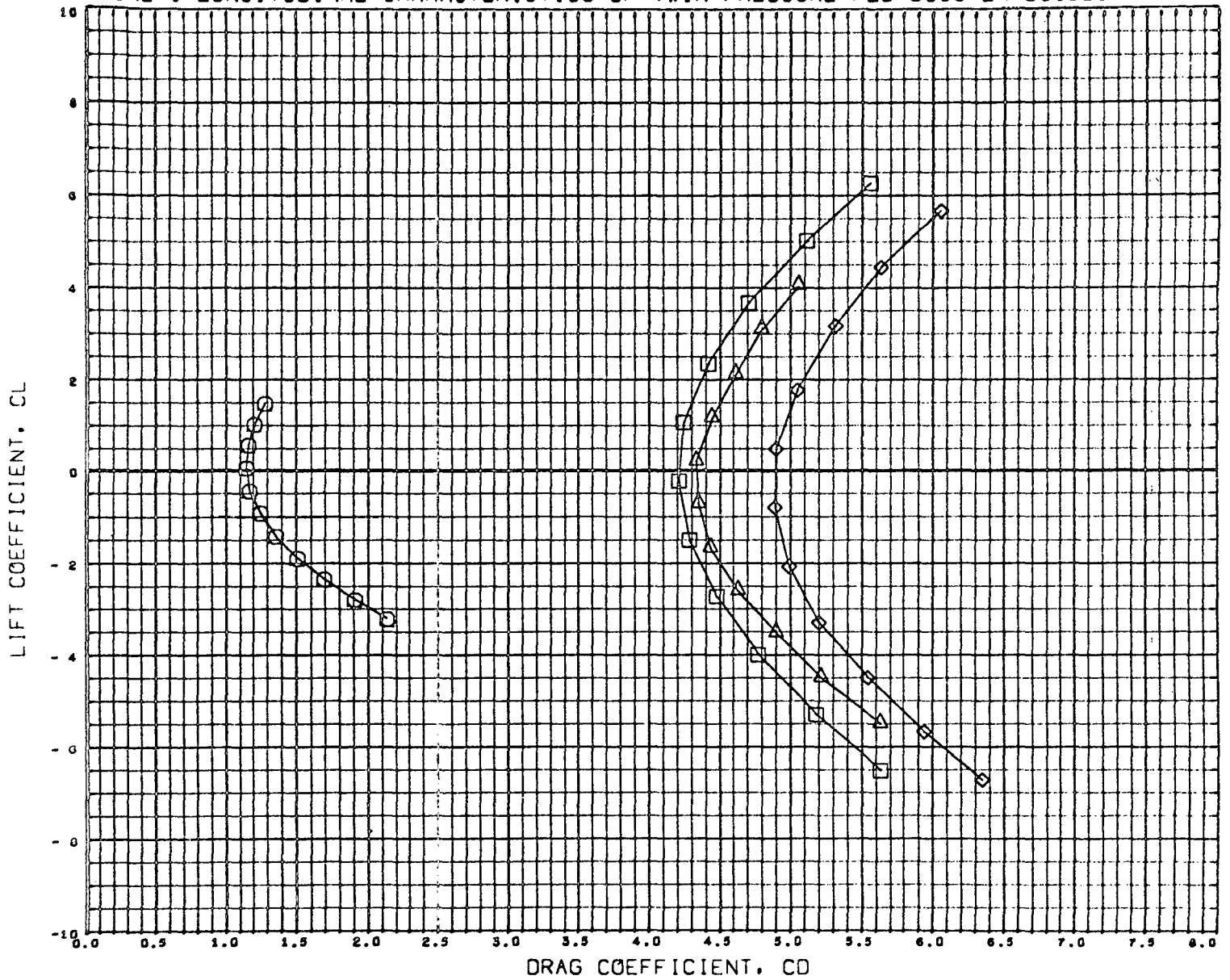

DATA SET	SYMBOL	CONFIGURATION DESCRIPTION	BETA
(E500:0)	○	MSFC TWT 514 TPF8 02T4	0.000
(E500:0)	□	MSFC TWT 514 TPF8 B37R702T4	0.000
(E500:0)	△	MSFC TWT 514 TPF8 B37R7T1902T4	0.000
(E500:0)	□	MSFC TWT 514 TPF8 B37R7T19T4	0.000
(E500:10)	□	DATA NOT AVAILABLE FOR ALL CONDITIONS	0.000

REFERENCE INFORMATION		
SREF	0.6600	SQ IN
LREF	5.3230	INCHES
BREF	0.9170	INCHES
XMRP	2.0730	INCHES
YMRP	0.0000	INCHES
ZMRP	0.0000	INCHES
SCALE	0.0034	

MACH 1.961

FIGURE-1 LONGITUDINAL CHARACTERISTICS OF TWIN PRESSURE FED BOOSTER BUILDUP

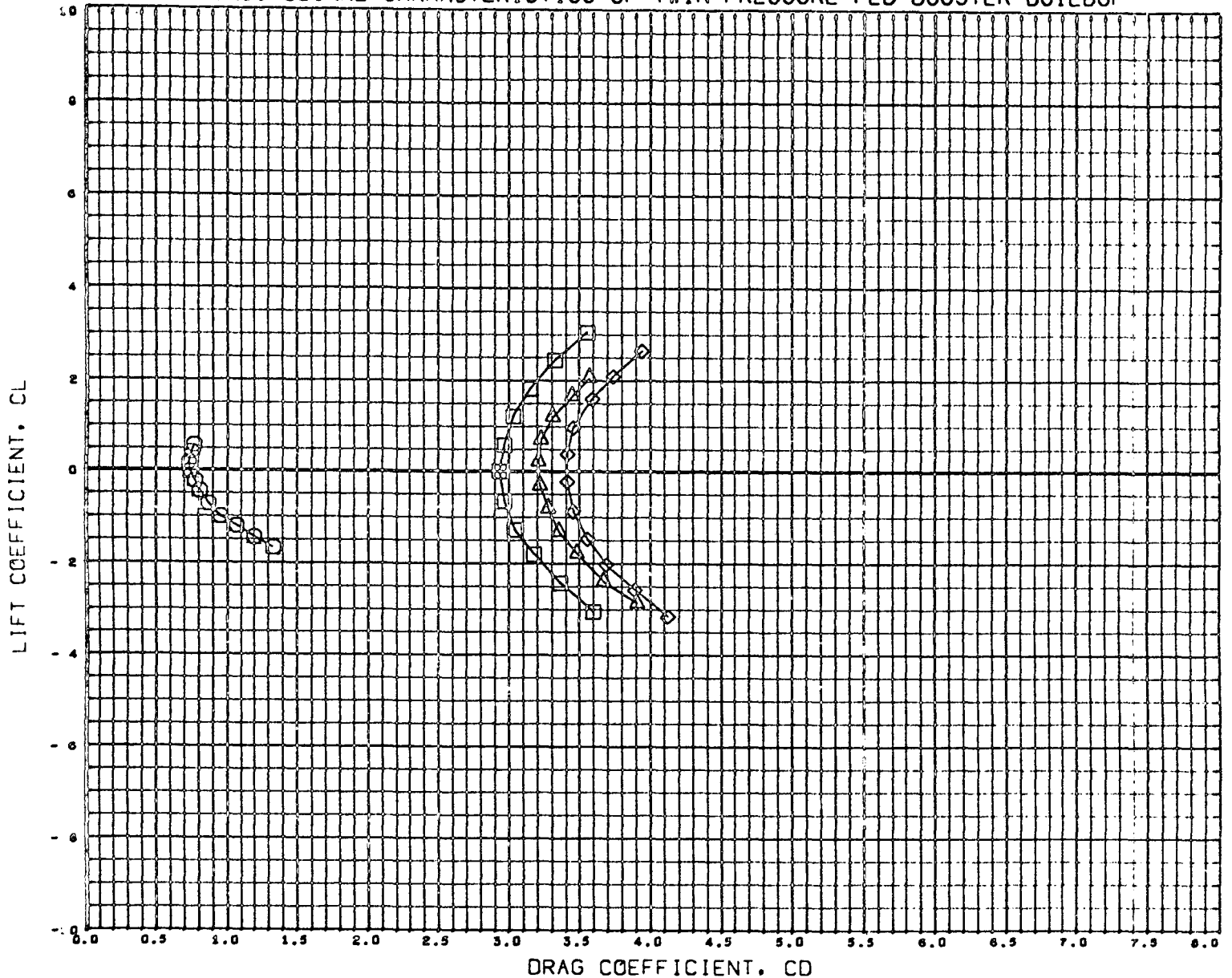

DATA SET SYMBOL	CONFIGURATION DESCRIPTION	BETA
(E50010)	MSFC TWT 514 TPF8 02T4	0.000
(E50030)	MSFC TWT 514 TPF8 B37R702T4	0.000
(E50016)	MSFC TWT 514 TPF8 B37R7T1902T4	0.000
(E50070)	MSFC TWT 514 TPF8 B37R7T19T4	0.000
(E58030)	DATA NOT AVAILABLE FOR ALL CONDITIONS	0.000

REFERENCE INFORMATION		
SREF	0.6600	99 IN
LREF	9.3230	INCHES
BREF	0.9170	INCHES
XMRP	2.0730	INCHES
YMRP	0.0000	INCHES
ZMRP	0.0000	INCHES
SCALE	0.0034	

MACH 4.959

FIGURE-1 LONGITUDINAL CHARACTERISTICS OF TWIN PRESSURE FED BOOSTER BUILDUP

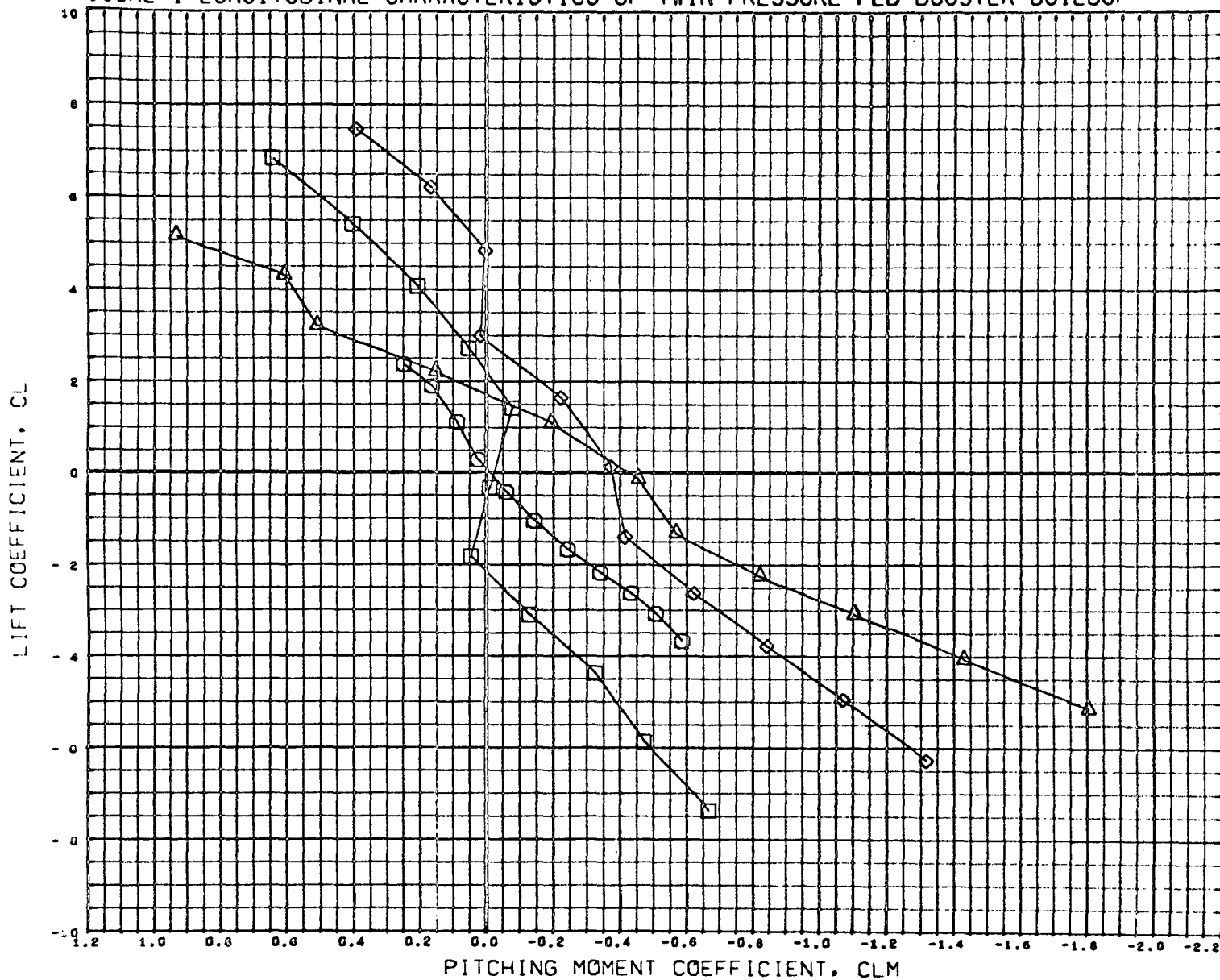

DATA SET SYMBOL	CONFIGURATION DESCRIPTION
(E58610)	MSFC TWT 514 TFFB 02T4
(E58630)	MSFC TWT 514 TFFB B37R702T4
(E58650)	MSFC TWT 514 TFFB B37R711902T4
(E58670)	MSFC TWT 514 TFFB B37R711914
(E58690)	DATA NOT AVAILABLE FOR ALL CONDITIONS

BETA
0.000
0.000
0.000
0.000
0.000
0.000

REFERENCE INFORMATION	
SREF	0.6600 SQ IN
LREF	5.3250 INCHES
BREF	0.9170 INCHES
XMRP	2.0730 INCHES
YMRP	0.0000 INCHES
ZMRP	0.0000 INCHES
SCALE	0.0034

MACH 0.899

FIGURE-1 LONGITUDINAL CHARACTERISTICS OF TWIN PRESSURE FED BOOSTER BUILDUP

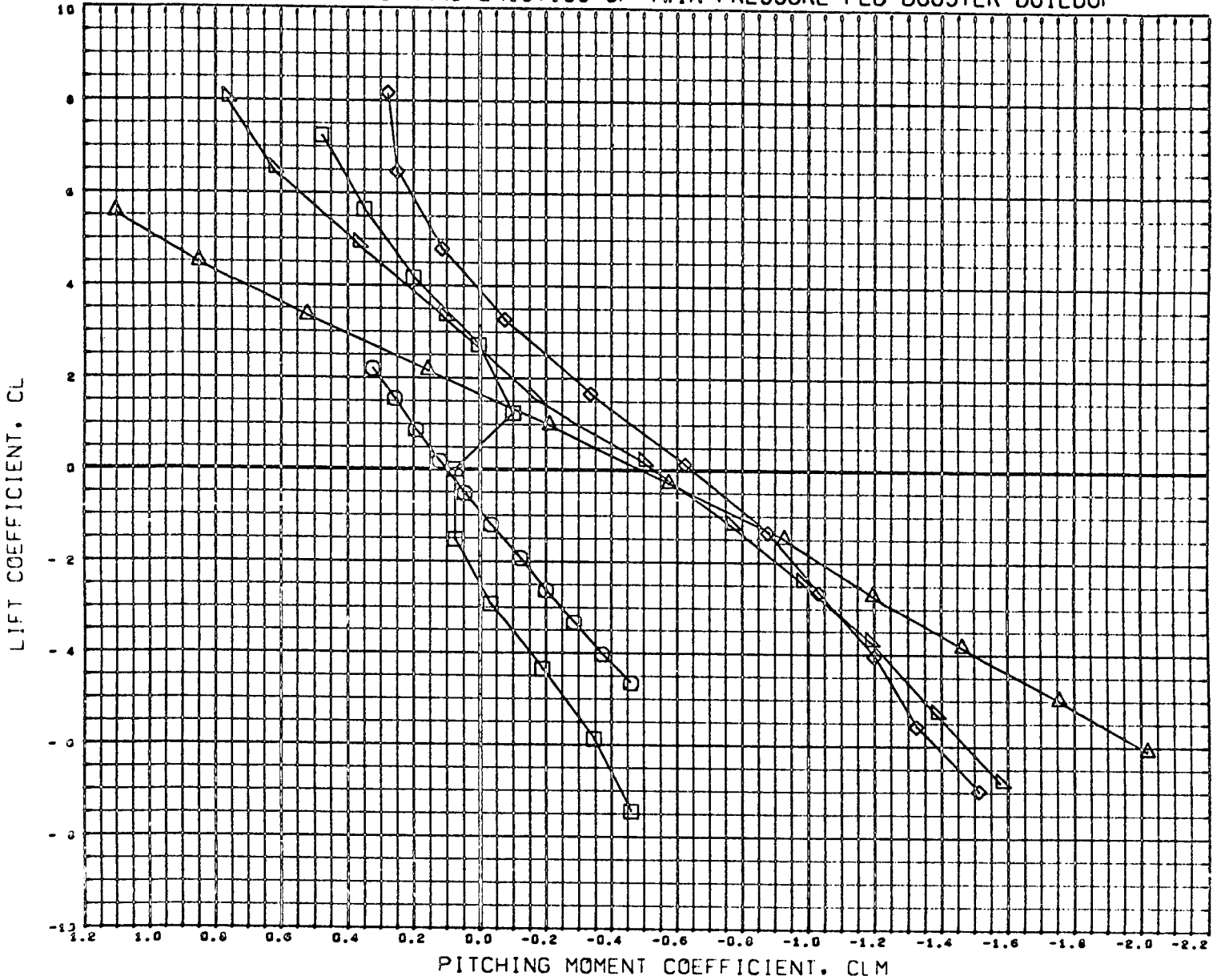

DATA SET SYMBOL	CONFIGURATION DESCRIPTION
(E90010)	MSFC TWT 514 TPF8 02T4
(E90020)	MSFC TWT 514 TPF8 037R702T4
(E90050)	MSFC TWT 514 TPF8 037R711902T4
(E90070)	MSFC TWT 514 TPF8 037R7119T4
(E90080)	MSFC TWT 514 TPF8 037R711905T4

BETA
 0.000
 0.000
 0.000
 0.000
 0.000

REFERENCE INFORMATION		
SREF	0.6600	90 IN
LREF	5.3230	INCHES
BREF	0.9170	INCHES
XMRP	2.0730	INCHES
YMRP	0.0000	INCHES
ZMRP	0.0000	INCHES
SCALE	0.0034	

MACH 1.101

FIGURE-1 LONGITUDINAL CHARACTERISTICS OF TWIN PRESSURE FED BOOSTER BUILDUP

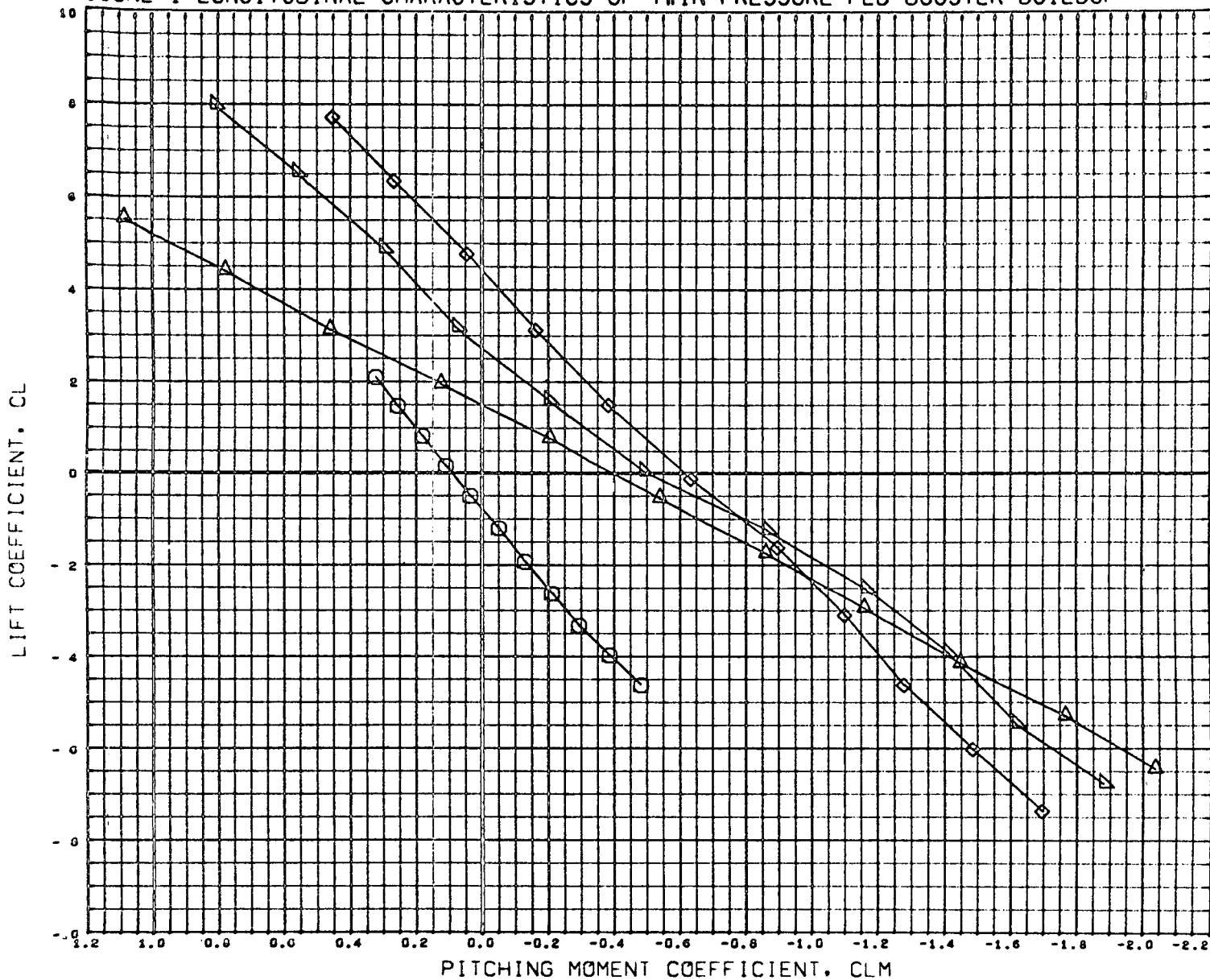

DATA SET SYMBOL	CONFIGURATION DESCRIPTION	BETA
(E90610)	MSFC TWT 514 TPF8 O2T4	0.000
(E90630)	MSFC TWT 514 TPF8 B37R7O2T4	0.000
(E90650)	MSFC TWT 514 TPF8 B37R7T19O2T4	0.000
(E90670)	DATA NOT AVAILABLE FOR ALL CONDITIONS	0.000
(E90690)	MSFC TWT 514 TPF8 B37R7T19O5T4	0.000

REFERENCE INFORMATION		
SREF	0.6600	98 IN
LREF	5.3230	INCHES
BREF	0.9170	INCHES
XMRP	2.0730	INCHES
YMRP	0.0000	INCHES
ZMRP	0.0000	INCHES
SCALE	0.0034	

MACH 1.197

FIGURE-1 LONGITUDINAL CHARACTERISTICS OF TWIN PRESSURE FED BOOSTER BUILDUP

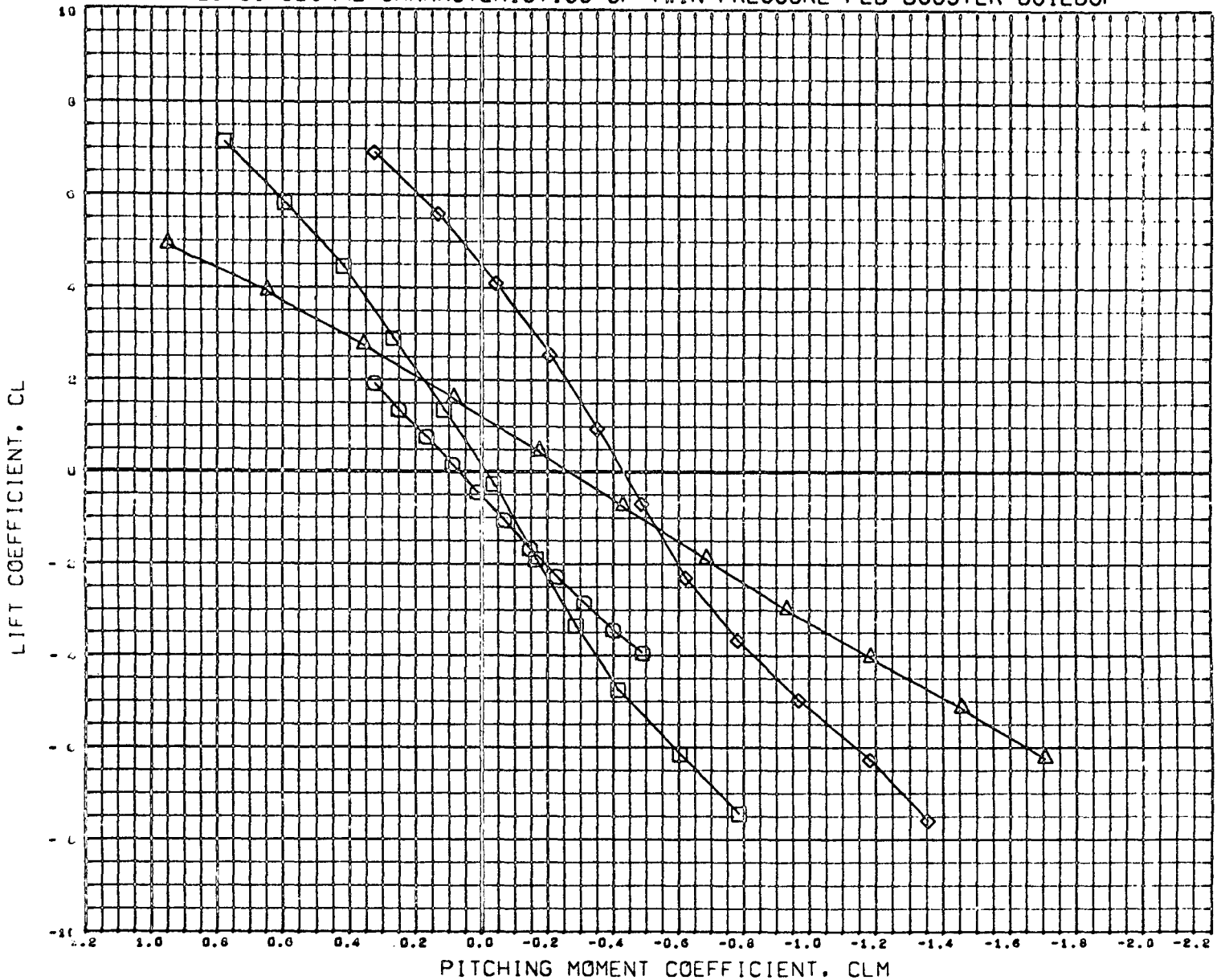

DATA SET	SYMBOL	CONFIGURATION DESCRIPTION	BETA
(E9001)	□	MSFC TWT 514 TFFB O2T4	0.000
(E9003)	○	MSFC TWT 514 TFFB D37R7O2T4	0.000
(E9005)	△	MSFC TWT 514 TFFB D37R7T19O2T4	0.000
(E9007)	◇	MSFC TWT 514 TFFB B37R7T18T4	0.000
(E9009)	▽	DATA NOT AVAILABLE FOR ALL CONDITIONS	0.000

REFERENCE INFORMATION		
SREF	0.6600	98 IN
LREF	5.3250	INCHES
QREF	0.9170	INCHES
XMRP	2.0730	INCHES
YMRP	0.0000	INCHES
ZMRP	0.0000	INCHES
SCALE	0.0034	

MACH 1.458

FIGURE-1 LONGITUDINAL CHARACTERISTICS OF TWIN PRESSURE FED BOOSTER BUILDUP

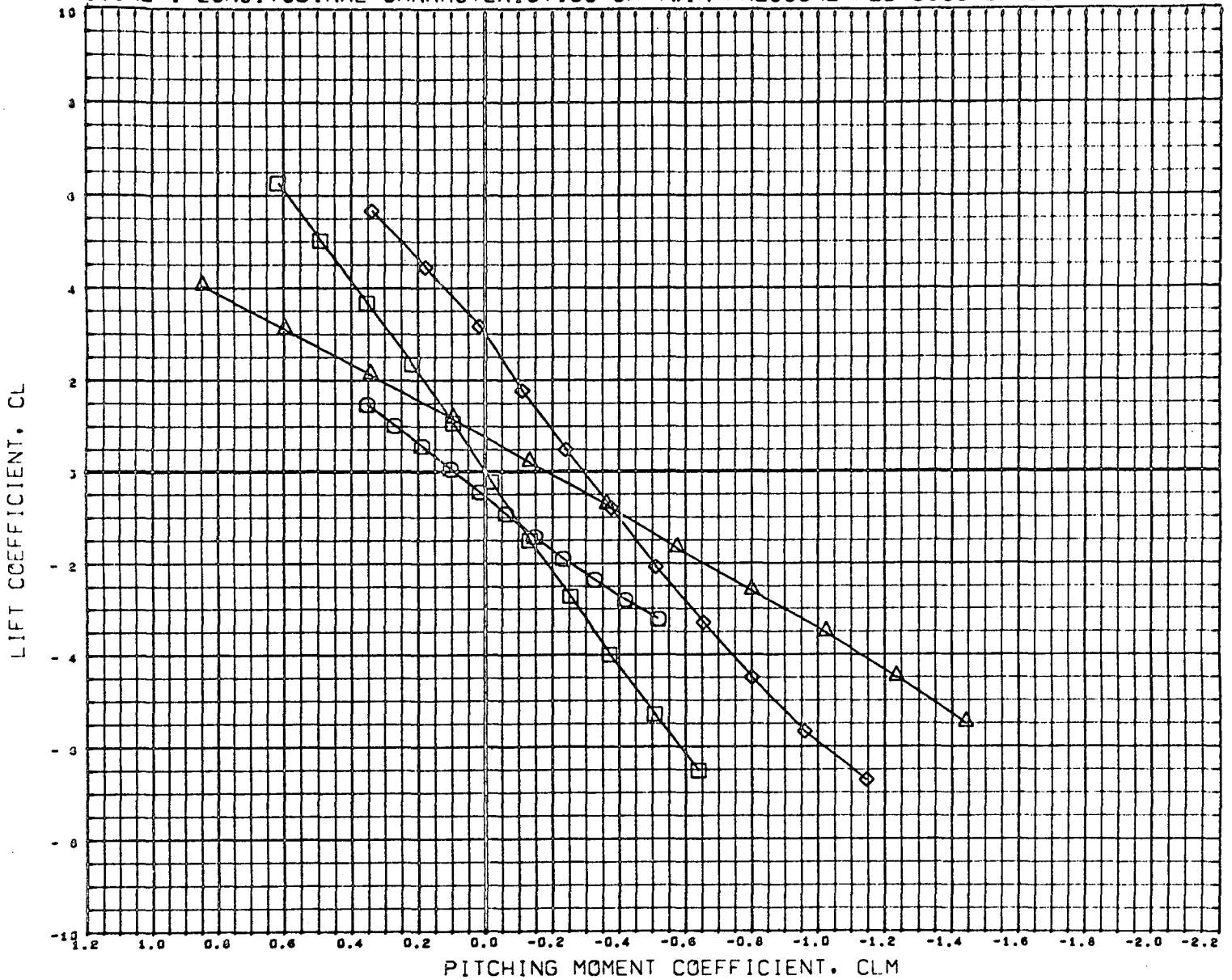

DATA SET SYMBOL	CONFIGURATION DESCRIPTION	BETA
(E500:0)	MSFC TWT 514 TPF8 O2T4	0.000
(E580:0)	MSFC TWT 514 TPF8 B37R7O2T4	0.000
(E500:0)	MSFC TWT 514 TPF8 B37R7T19O2T4	0.000
(E500:0)	MSFC TWT 514 TPF8 B37R7T19T4	0.000
(E500:0)	DATA NOT AVAILABLE FOR ALL CONDITIONS	0.000

REFERENCE INFORMATION		
SREF	0.6600	sq IN
LREF	5.3250	INCHES
BREF	0.9170	INCHES
XMRP	2.0730	INCHES
YMRP	0.0000	INCHES
ZMRP	0.0000	INCHES
SCALE	0.0034	

MACH 1.961

FIGURE-1 LONGITUDINAL CHARACTERISTICS OF TWIN PRESSURE FED BOOSTER BUILDUP

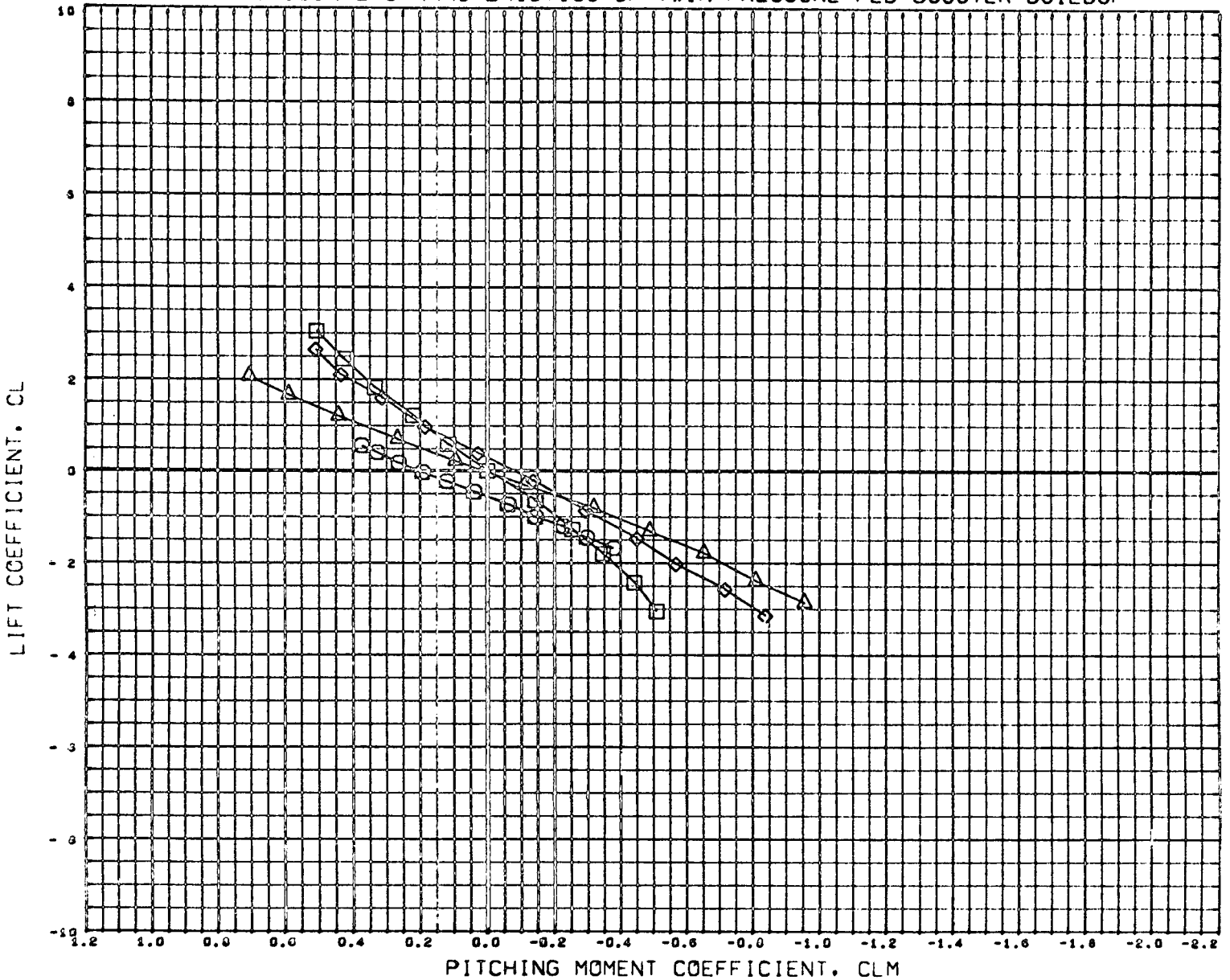

DATA SET SYMBOL	CONFIGURATION DESCRIPTION	BETA
(E900:0)	MSFC TWT 514 TPF8 O2T4	0.000
(E900:0)	MSFC TWT 514 TPF8 B37R7O2T4	0.000
(E900:0)	MSFC TWT 514 TPF8 B37R7T19O2T4	0.000
(E900:0)	MSFC TWT 514 TPF8 B37R7T19T4	0.000
(E900:0)	DATA NOT AVAILABLE FOR ALL CONDITIONS	0.000

REFERENCE INFORMATION	
SREP	0.6600 SQ IN
LREF	5.3230 INCHES
BREF	0.9170 INCHES
XMRP	2.0730 INCHES
YMRP	0.0000 INCHES
ZMRP	0.0000 INCHES
SCALE	0.0034

MACH 4.959

FIGURE-2 LATERAL CHARACTERISTICS OF TWIN PRESSURE FED BOOSTER BUILDUP

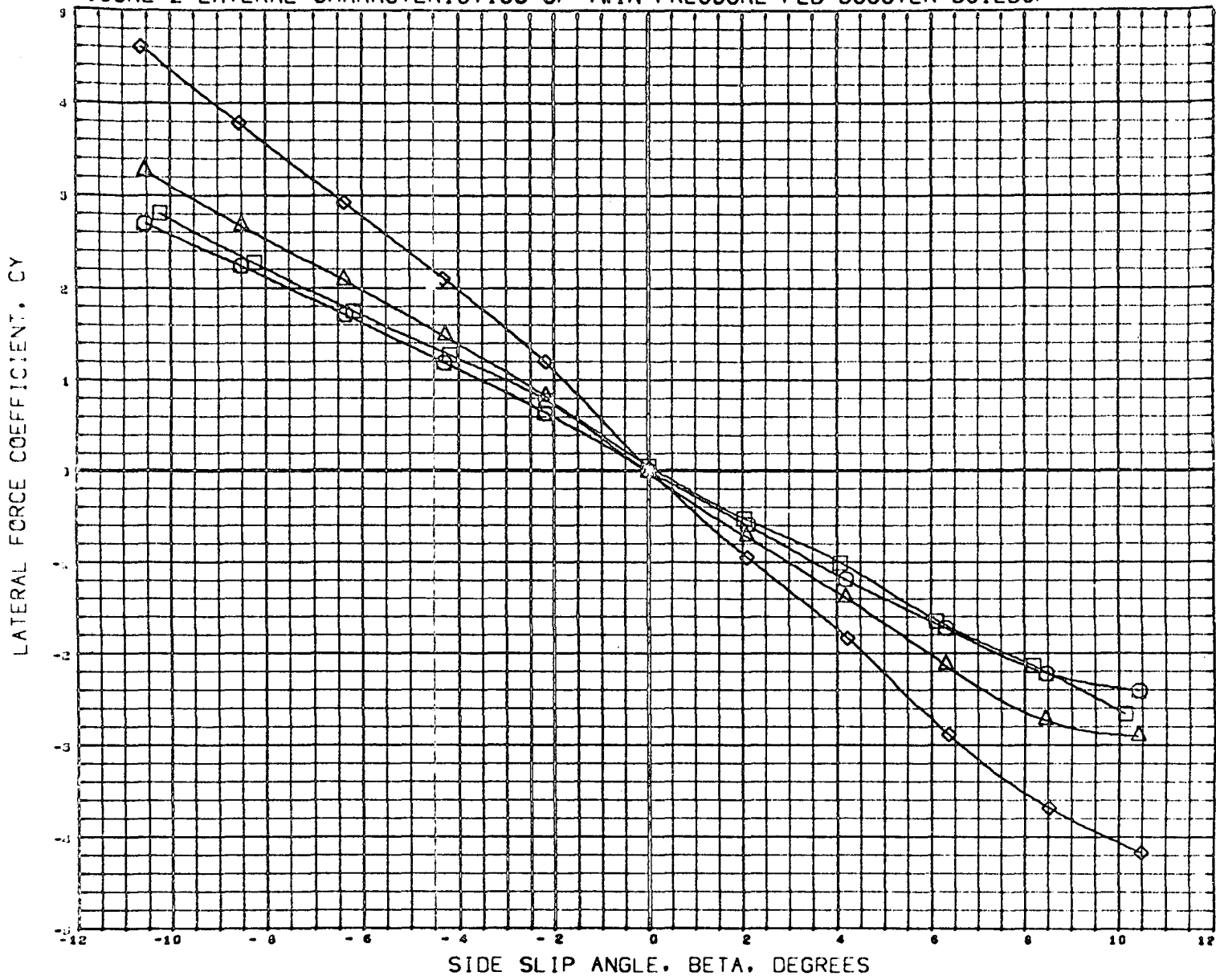

DATA SET SYMBOL	CONFIGURATION DESCRIPTION
(050020)	MSFC TWT 514 TFFB O2T4
(050030)	MSFC TWT 514 TFFB B37R7O2T4
(050040)	MSFC TWT 514 TFFB B37R7T19O2T4
(050080)	MSFC TWT 514 TFFB B37R7T19T4
(050100)	DATA NOT AVAILABLE FOR ALL CONDITIONS

ALPHA
0.000
0.000
0.000
0.000
0.000

REFERENCE INFORMATION	
SREF	0.8600 SQ IN
LREF	5.3230 INCHES
BREF	0.9170 INCHES
XMRP	2.0730 INCHES
YMRP	0.0000 INCHES
ZMRP	0.0000 INCHES
SCALE	0.0034

MACH 0.905

FIGURE-2 LATERAL CHARACTERISTICS OF TWIN PRESSURE FED BOOSTER BUILDUP

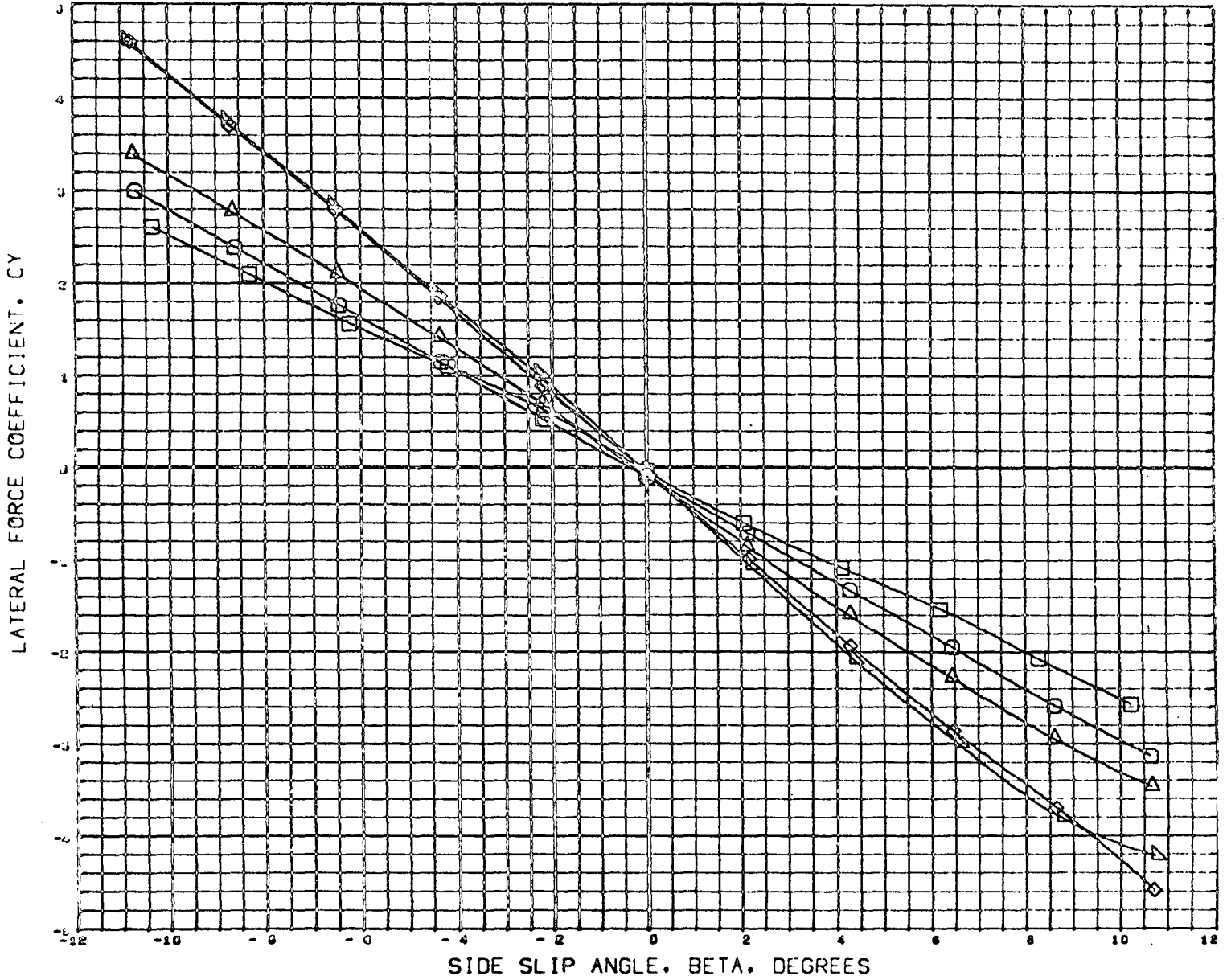

DATA SET SYMBOL	CONFIGURATION DESCRIPTION
(050020)	MSFC TWT 514 TPF8 O2T4
(050030)	MSFC TWT 514 TPF8 B37R7O2T4
(050050)	MSFC TWT 514 TPF8 B37R7T19O2T4
(050030)	MSFC TWT 514 TPF8 B37R7T19T4
(050100)	MSFC TWT 514 TPF8 B37R7T19O5T4

ALPHA
0.000
0.000
0.000
0.000
0.000

REFERENCE INFORMATION		
SREF	0.6600	SQ IN
LREF	5.3250	INCHES
BREF	0.9170	INCHES
XMRP	2.0730	INCHES
YMRP	0.0000	INCHES
ZMRP	0.0000	INCHES
SCALE	0.0034	

MACH 1.100

FIGURE-2 LATERAL CHARACTERISTICS OF TWIN PRESSURE FED BOOSTER BUILDUP

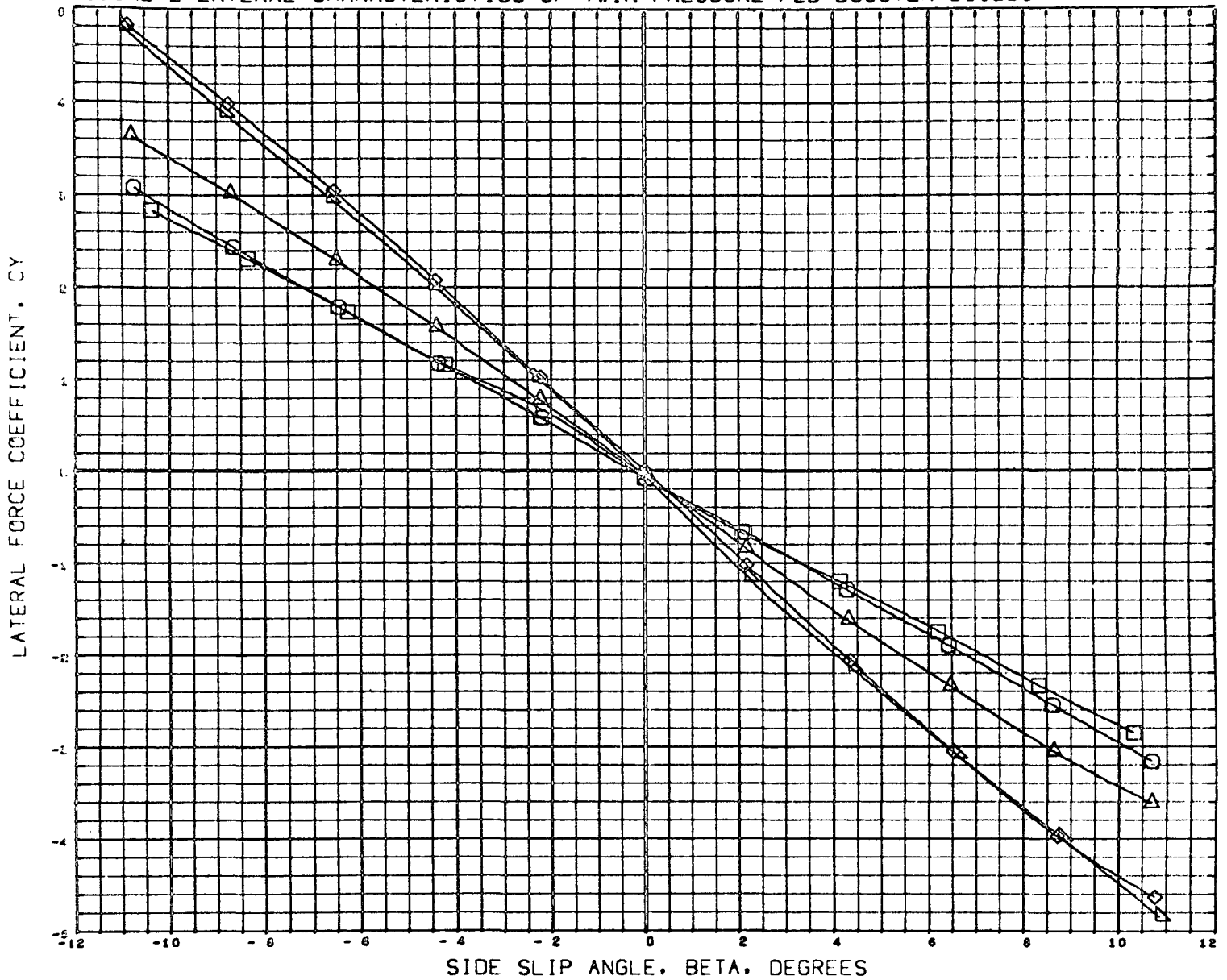

DATA SET	SYMBOL	CONFIGURATION DESCRIPTION
(0500:0)	○	MSFC TWT 514 TPF8 O2T4
(0500:0)	□	MSFC TWT 514 TPF8 B37R7O2T4
(0500:0)	△	MSFC TWT 514 TPF8 B37R7T19O2T4
(0500:0)	◇	MSFC TWT 514 TPF8 B37R7T19T4
(0501:0)	▽	MSFC TWT 514 TPF8 B37R7T19O3T4

ALPHA
0.000
0.000
0.000
0.000
0.000

REFERENCE INFORMATION		
SREF	0.6600	SQ IN
LREF	5.3230	INCHES
BREF	0.9170	INCHES
XMRP	2.0730	INCHES
YMRP	0.0000	INCHES
ZMRP	0.0000	INCHES
SCALE	0.0034	

MACH 1.199

FIGURE-2 LATERAL CHARACTERISTICS OF TWIN PRESSURE FED BOOSTER BUILDUP

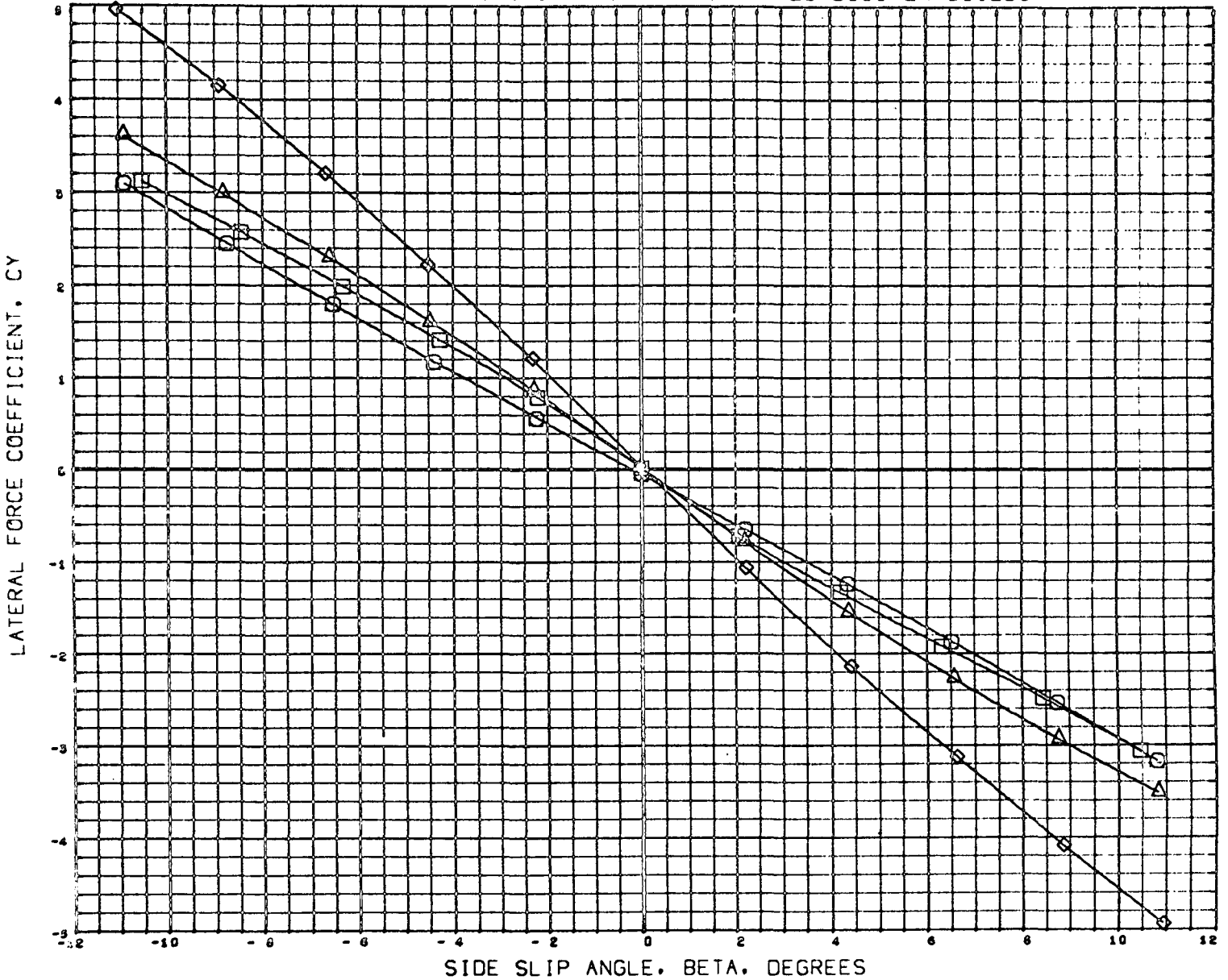

DATA SET SYMBOL	CONFIGURATION DESCRIPTION
(090020)	MSFC TWT 914 TPF8 02T4
(090040)	MSFC TWT 914 TPF8 B37R702T4
(090060)	MSFC TWT 914 TPF8 B37R711902T4
(090080)	MSFC TWT 914 TPF8 B37R7119T4
(098100)	DATA NOT AVAILABLE FOR ALL CONDITIONS

ALPHA
0.000
0.000
0.000
0.000
0.000

REFERENCE INFORMATION		
SREF	0.6600	SQ IN
LREF	5.3250	INCHES
BREF	0.9170	INCHES
XMRF	2.0730	INCHES
YMRF	0.0000	INCHES
ZMRF	0.0000	INCHES
SCALE	0.0034	

MACH 1.462

FIGURE-2 LATERAL CHARACTERISTICS OF TWIN PRESSURE FED BOOSTER BUILDUP

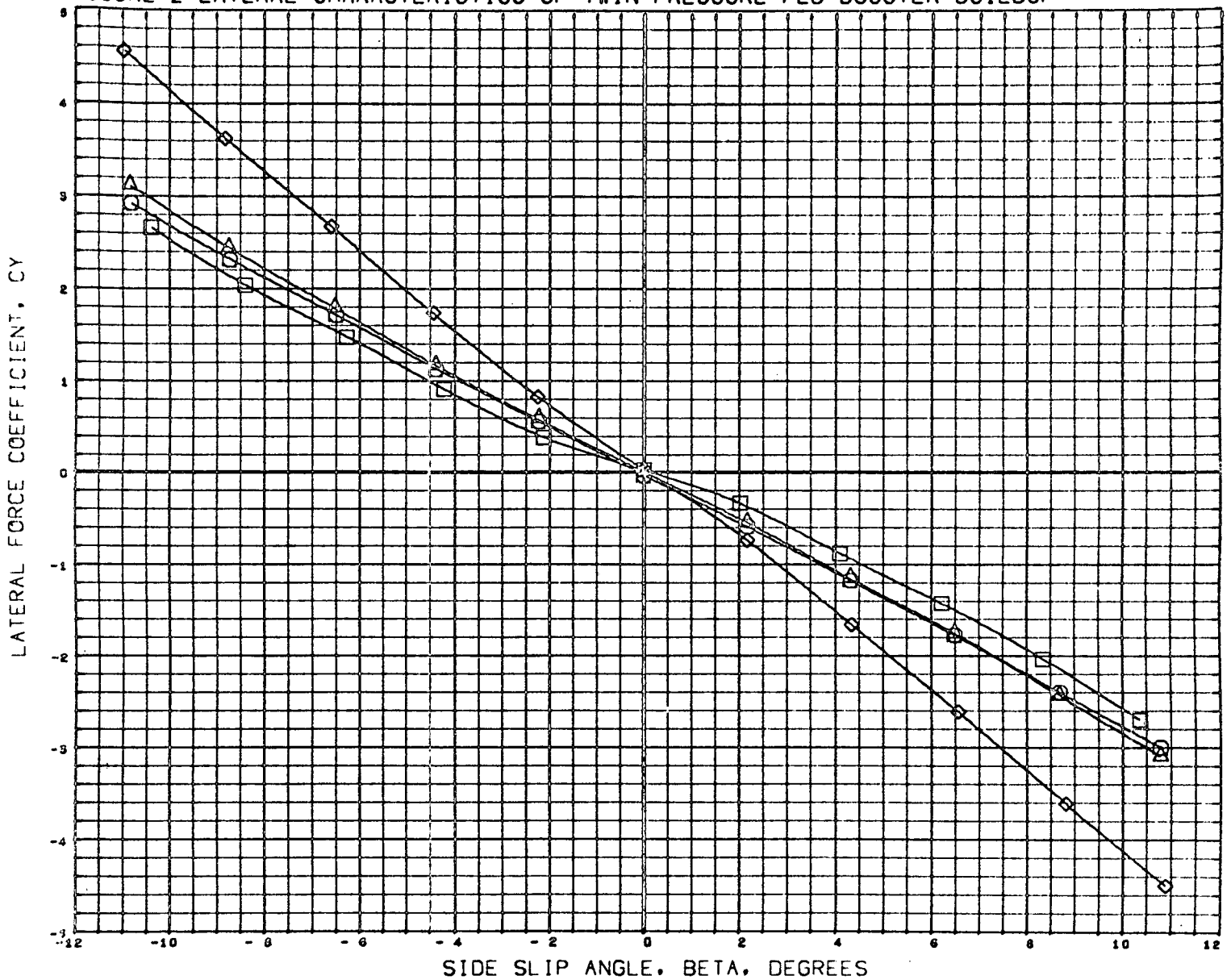

DATA SET SYMBOL	CONFIGURATION DESCRIPTION	ALPHA
(050:20)	MSFC TWT 514 TFFB O2T4	0.000
(050:40)	MSFC TWT 514 TFFB B37R7O2T4	0.000
(050:60)	MSFC TWT 514 TFFB B37R7T19O2T4	0.000
(050:80)	MSFC TWT 514 TFFB B37R7T19T4	0.000
(050:00)	DATA NOT AVAILABLE FOR ALL CONDITIONS	0.000

MACH 1.060

REFERENCE INFORMATION	
SREF	0.6400 SQ IN
LREF	5.3230 INCHES
BREF	0.9170 INCHES
XMRP	2.0730 INCHES
YMRP	0.0000 INCHES
ZMRP	0.0000 INCHES
SCALE	0.0034

FIGURE-2 LATERAL CHARACTERISTICS OF TWIN PRESSURE FED BOOSTER BUILDUP

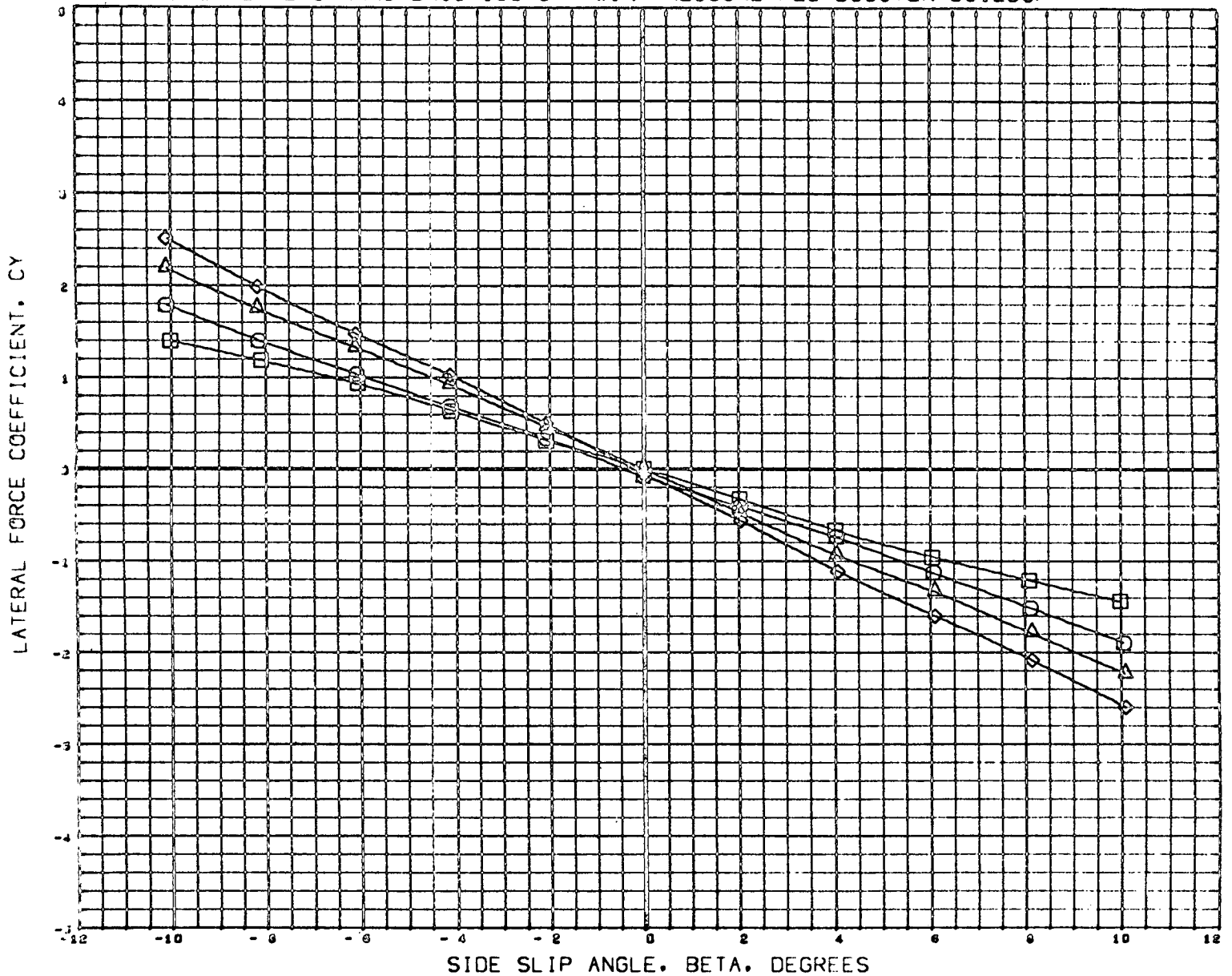

DATA SET SYMBOL	CONFIGURATION DESCRIPTION	ALPHA
(090C20)	MSFC TWT 914 TPFB 02T4	0.000
(090C40)	MSFC TWT 914 TPFB 037R702T4	0.000
(090C60)	MSFC TWT 914 TPFB 037R7T1902T4	0.000
(090C80)	MSFC TWT 914 TPFB 037R7T19T4	0.000
(090I00)	DATA NOT AVAILABLE FOR ALL CONDITIONS	0.000

REFERENCE INFORMATION		
SREF	0.0600	90 IN
LREF	9.3230	INCHES
BREF	0.0170	INCHES
XMRP	2.0730	INCHES
YMRP	0.0000	INCHES
ZMRP	0.0000	INCHES
SCALE	0.0034	

MACH 4.950

FIGURE-2 LATERAL CHARACTERISTICS OF TWIN PRESSURE FED BOOSTER BUILDUP

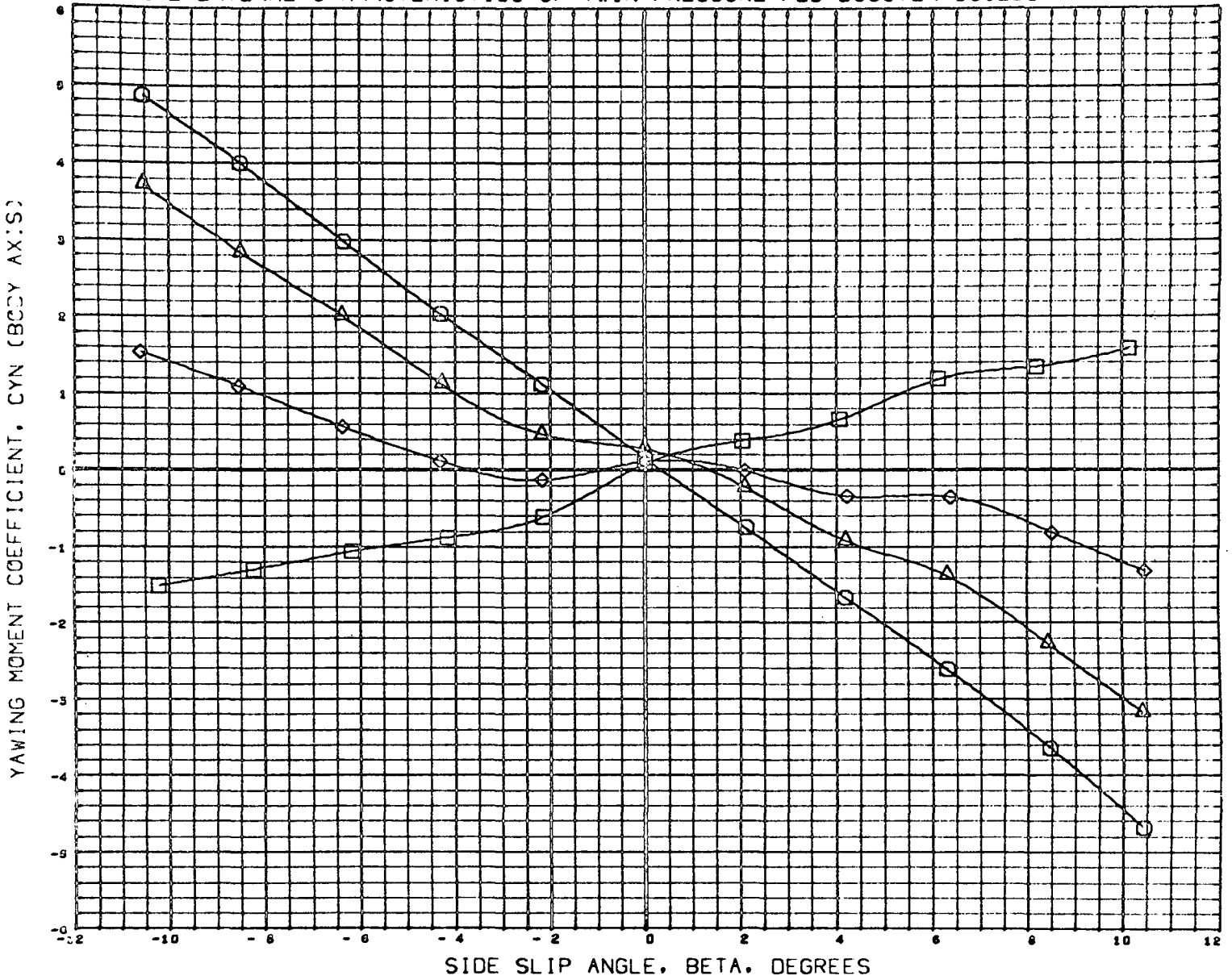

DATA SET SYMBOL	CONFIGURATION DESCRIPTION	ALPHA
(058020)	MSFC TWT 514 TPFB O2T4	0.000
(050040)	MSFC TWT 514 TPFB B37R702T4	0.000
(050000)	MSFC TWT 514 TPFB B37R7T1902T4	0.000
(050010)	MSFC TWT 514 TPFB B37R7T19T4	0.000
(058100)	DATA NOT AVAILABLE FOR ALL CONDITIONS	0.000

MACH 0.903

REFERENCE INFORMATION		
SREF	0.6600	80 IN
LREF	5.3230	INCHES
BREF	0.9170	INCHES
XMRP	2.0730	INCHES
YMRP	0.0000	INCHES
ZMRP	0.0000	INCHES
SCALE	0.0034	

FIGURE-2 LATERAL CHARACTERISTICS OF TWIN PRESSURE FED BOOSTER BUILDUP

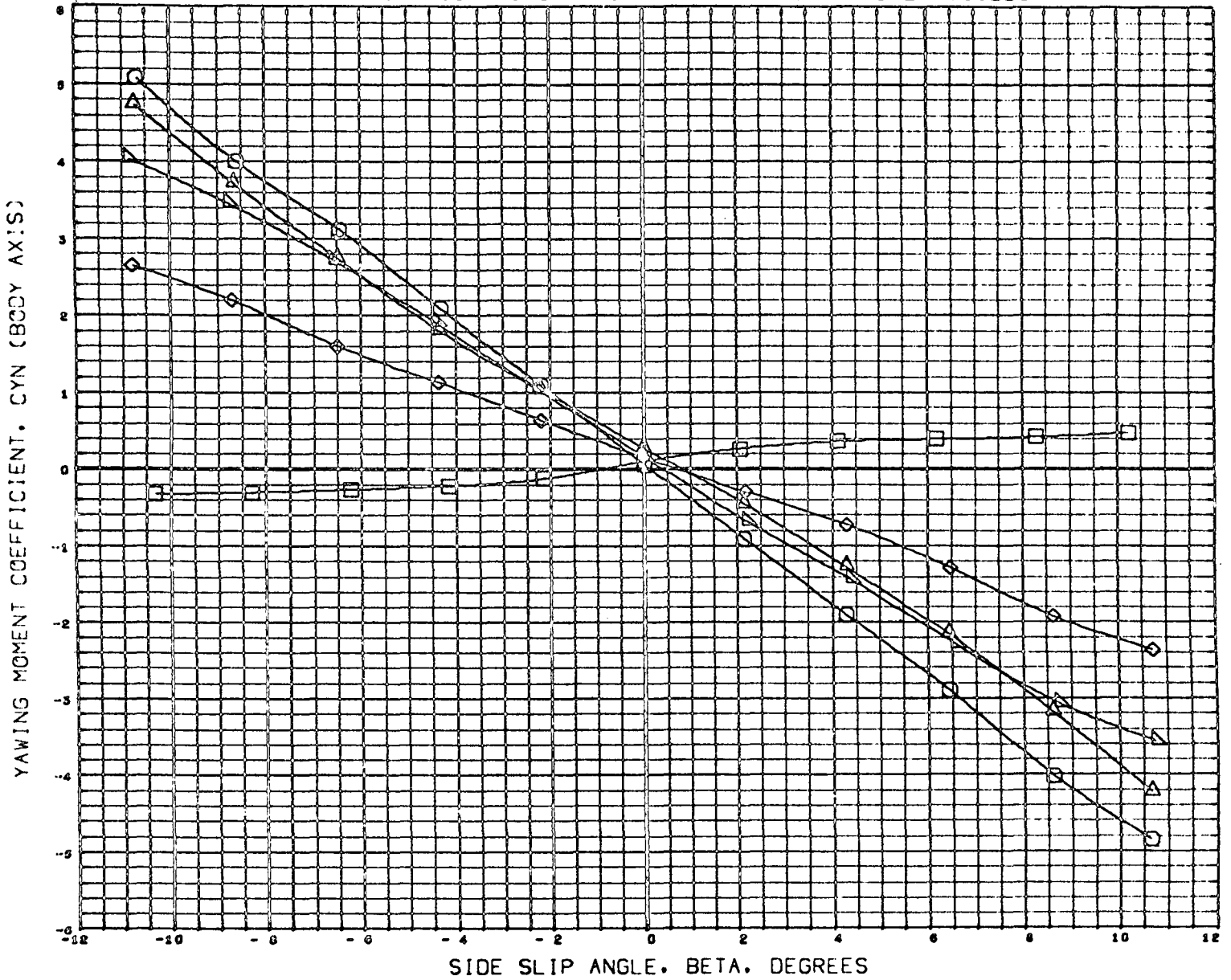

DATA SET SYMBOL	CONFIGURATION DESCRIPTION	ALPHA
(090320)	MSFC TWT 914 TFFB 02T4	0.000
(090040)	MSFC TWT 914 TFFB 037R702T4	0.000
(090060)	MSFC TWT 914 TFFB 037R71102T4	0.000
(090300)	MSFC TWT 914 TFFB 037R7110T4	0.000
(090100)	MSFC TWT 914 TFFB 037R71105T4	0.000

MACH 1.106

REFERENCE INFORMATION		
SREF	0.6600	58 IN
LREF	9.3230	INCHES
BREF	0.9170	INCHES
XMRP	2.0730	INCHES
YMRP	0.0000	INCHES
ZMRP	0.0000	INCHES
SCALE	0.0034	

FIGURE-2 LATERAL CHARACTERISTICS OF TWIN PRESSURE FED BOOSTER BUILDUP

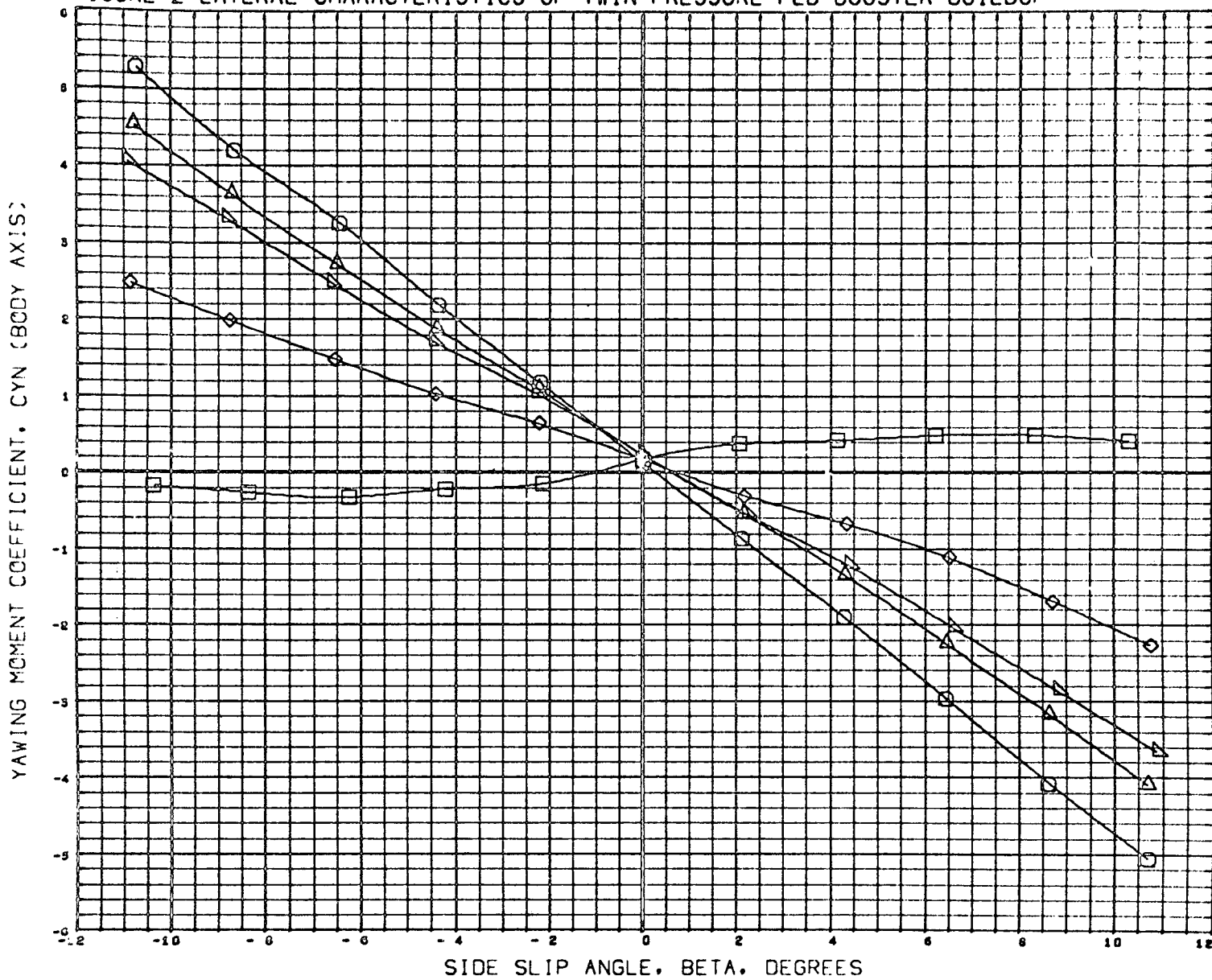

DATA SET SYMBOL	CONFIGURATION DESCRIPTION	ALPHA
(050020)	MSFC TWT 514 TPF8 02T4	0.000
(050040)	MSFC TWT 514 TPF8 B37R702T4	0.000
(050060)	MSFC TWT 514 TPF8 B37R7T1902T4	0.000
(050080)	MSFC TWT 514 TPF8 B37R7T19T4	0.000
(050100)	MSFC TWT 514 TPF8 B37R7T1905T4	0.000

REFERENCE INFORMATION		
SREF	0.6600	98 IN
LREF	5.3230	INCHES
BREF	0.9170	INCHES
XMRP	2.0730	INCHES
YMRP	0.0000	INCHES
ZMRP	0.0000	INCHES
SCALE	0.0034	

MACH 1.199

FIGURE-2 LATERAL CHARACTERISTICS OF TWIN PRESSURE FED BOOSTER BUILDUP

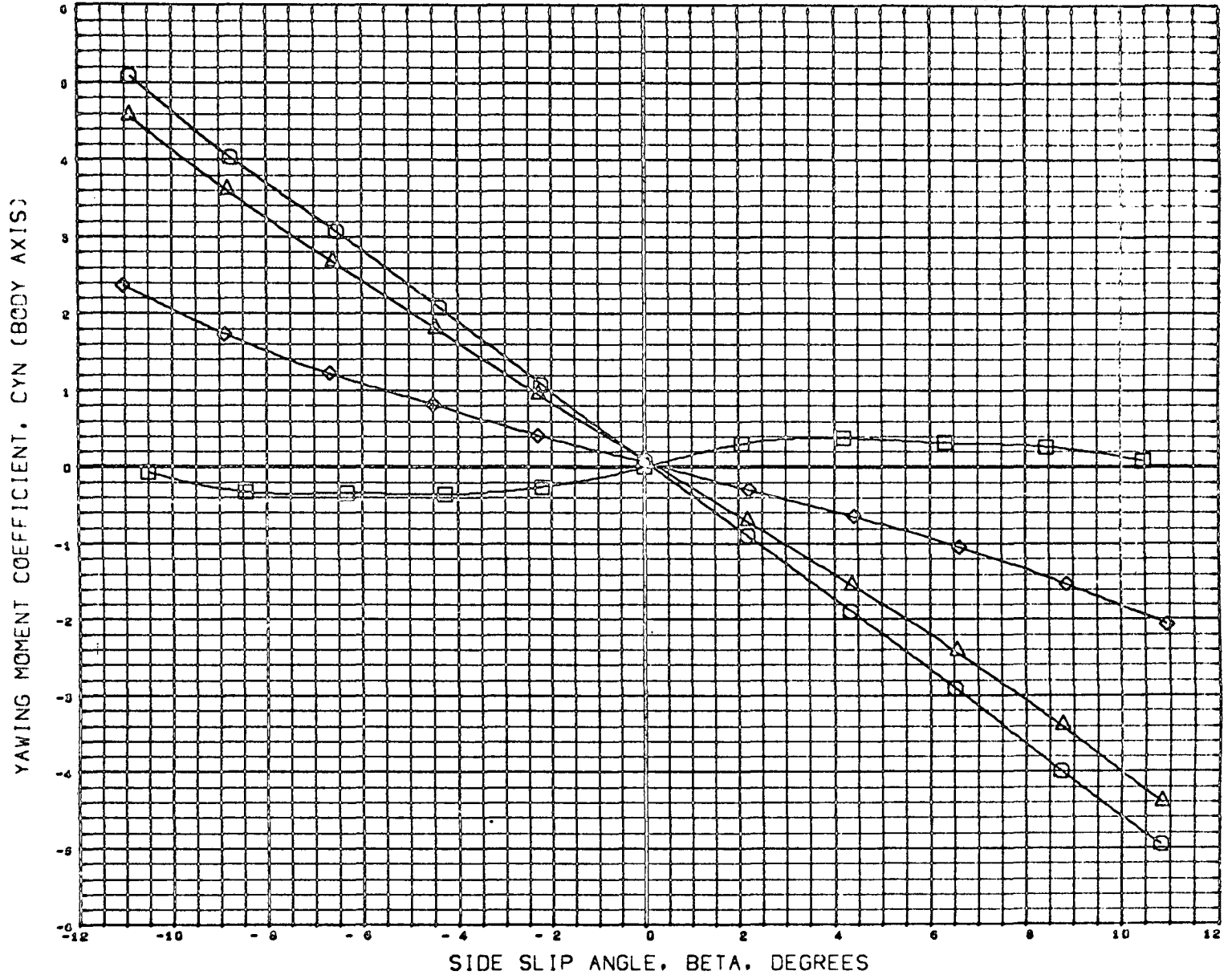

DATA SET SYMBOL	CONFIGURATION DESCRIPTION	ALPHA
(05.020)	MSFC TWT 914 TPF0 02T4	0.000
(05.040)	MSFC TWT 914 TPF0 037R702T4	0.000
(05.060)	MSFC TWT 914 TPF0 037R711902T4	0.000
(05.080)	MSFC TWT 914 TPF0 037R7113T4	0.000
(05.100)	DATA NOT AVAILABLE FOR ALL CONDITIONS	0.000

REFERENCE INFORMATION		
SREF	0.6600	89 IN
LREF	5.3230	INCHES
BREF	0.9170	INCHES
XMRF	2.0730	INCHES
YMRF	0.0000	INCHES
ZMRF	0.0000	INCHES
SCALE	0.0034	

MACH 1.402

FIGURE-2 LATERAL CHARACTERISTICS OF TWIN PRESSURE FED BOOSTER BUILDUP

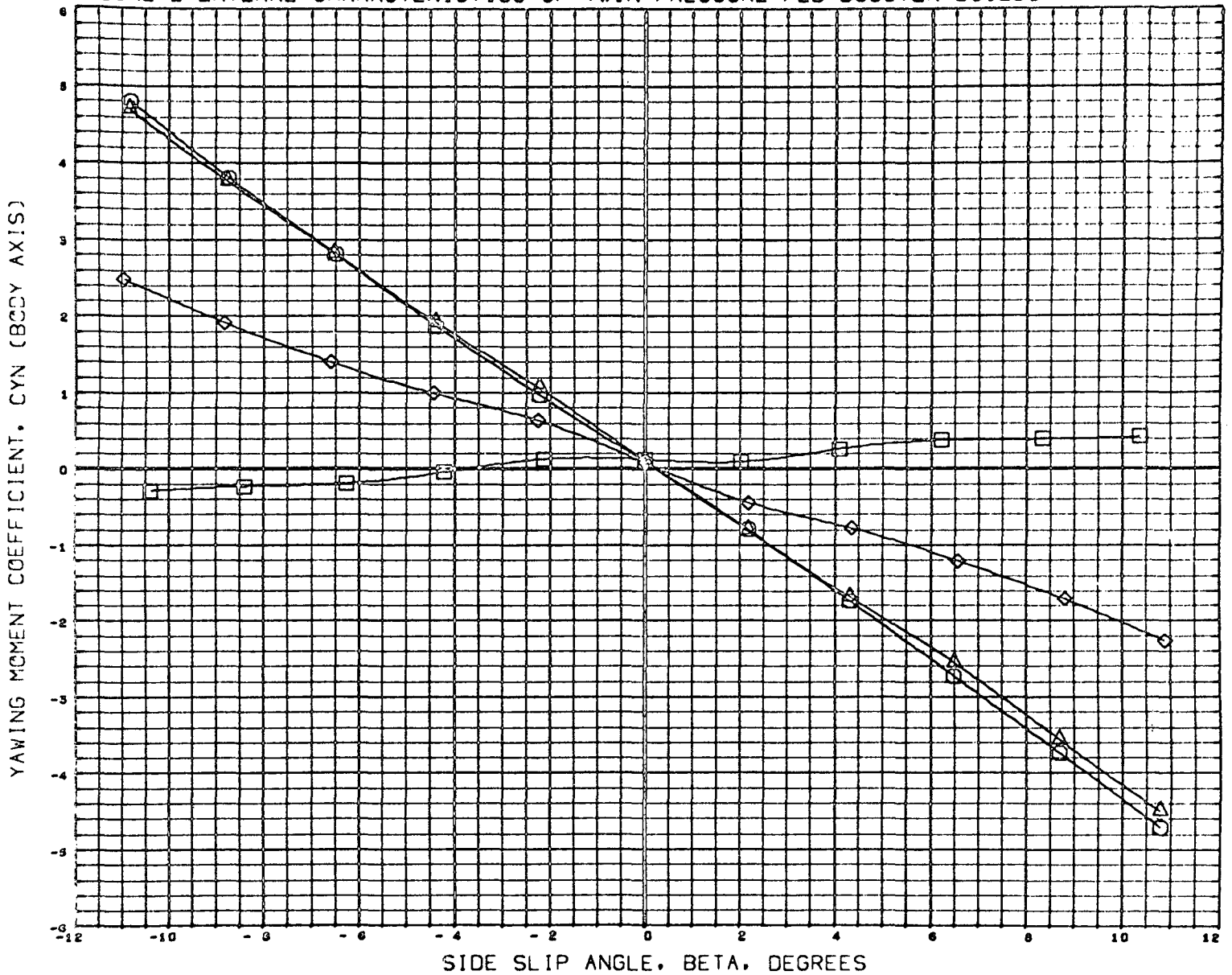

DATA SET	SYMBOL	CONFIGURATION DESCRIPTION	ALPHA
(09002)	○	MSFC TWT 514 TPF8 Q2T4	0.000
(09004)	◇	MSFC TWT 514 TPF8 B37R7G2T4	0.000
(09008)	□	MSFC TWT 514 TPF8 B37R7T1902T4	0.000
(09008)	△	MSFC TWT 514 TPF8 B37R7T19T4	0.000
(09010)		DATA NOT AVAILABLE FOR ALL CONDITIONS	0.000

REFERENCE INFORMATION		
SREF	0.6600	SQ IN
LREF	5.3230	INCHES
BREF	0.9170	INCHES
XMRP	2.0730	INCHES
YMRP	0.0000	INCHES
ZMRP	0.0000	INCHES
SCALE	0.0034	

MACH 1.960

FIGURE-2 LATERAL CHARACTERISTICS OF TWIN PRESSURE FED BOOSTER BUILDUP

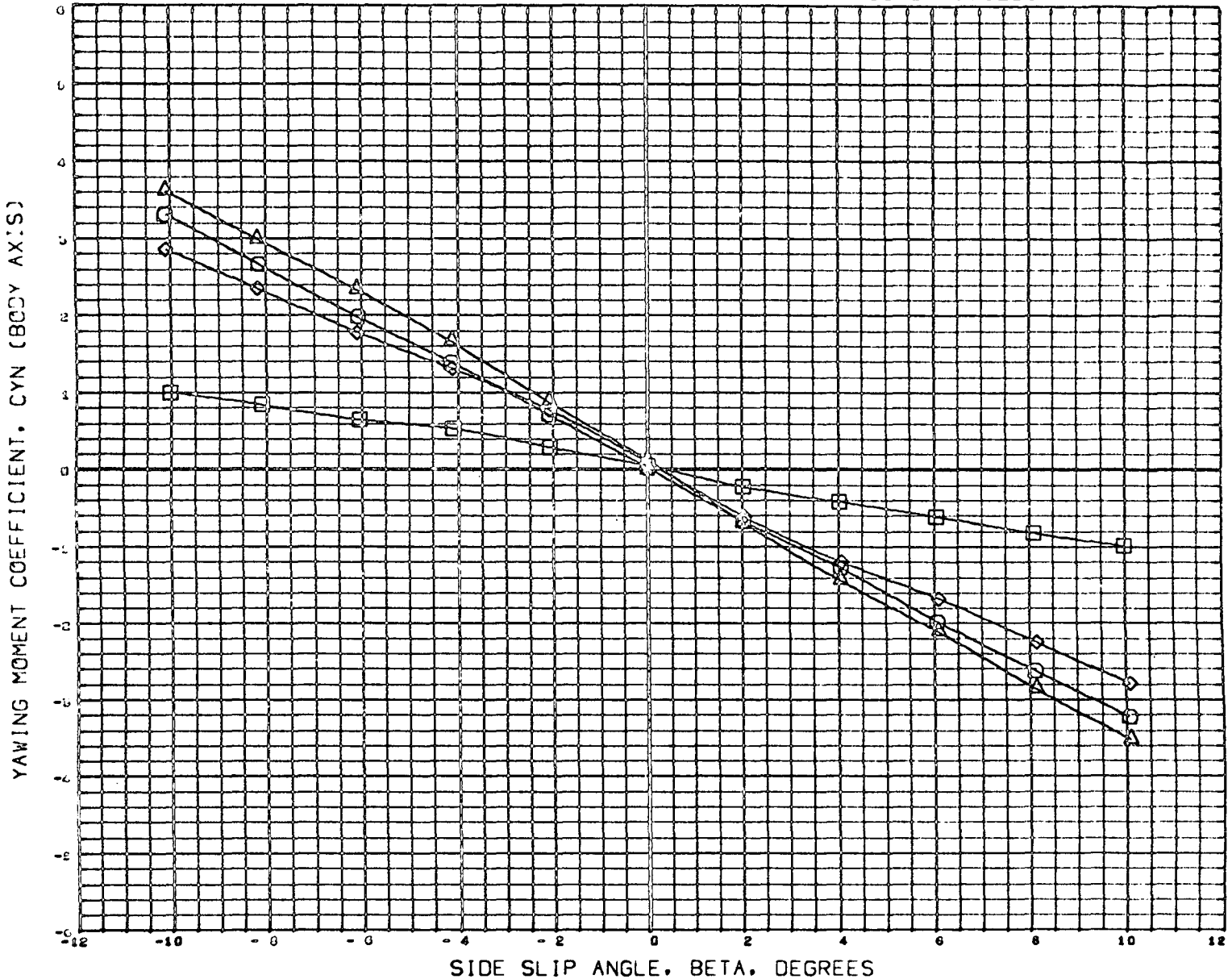

DATA SET SYMBOL	CONFIGURATION DESCRIPTION
(0500:0)	MSFC TWT 514 TPF8 02T4
(0500:0)	MSFC TWT 514 TPF8 037R702T4
(0500:0)	MSFC TWT 514 TPF8 037R7I1902T4
(0500:0)	MSFC TWT 514 TPF8 037R7I19T4
(0501:0)	DATA NOT AVAILABLE FOR ALL CONDITIONS

ALPHA
0.000
0.000
0.000
0.000
0.000

REFERENCE INFORMATION		
SREF	0.6600	SQ IN
LREF	9.3230	INCHES
BREF	0.9170	INCHES
XMRP	2.0730	INCHES
YMRP	0.0000	INCHES
ZMRP	0.0000	INCHES
SCALE	0.0034	

MACH 4.959

FIGURE-2 LATERAL CHARACTERISTICS OF TWIN PRESSURE FED BOOSTER BUILDUP

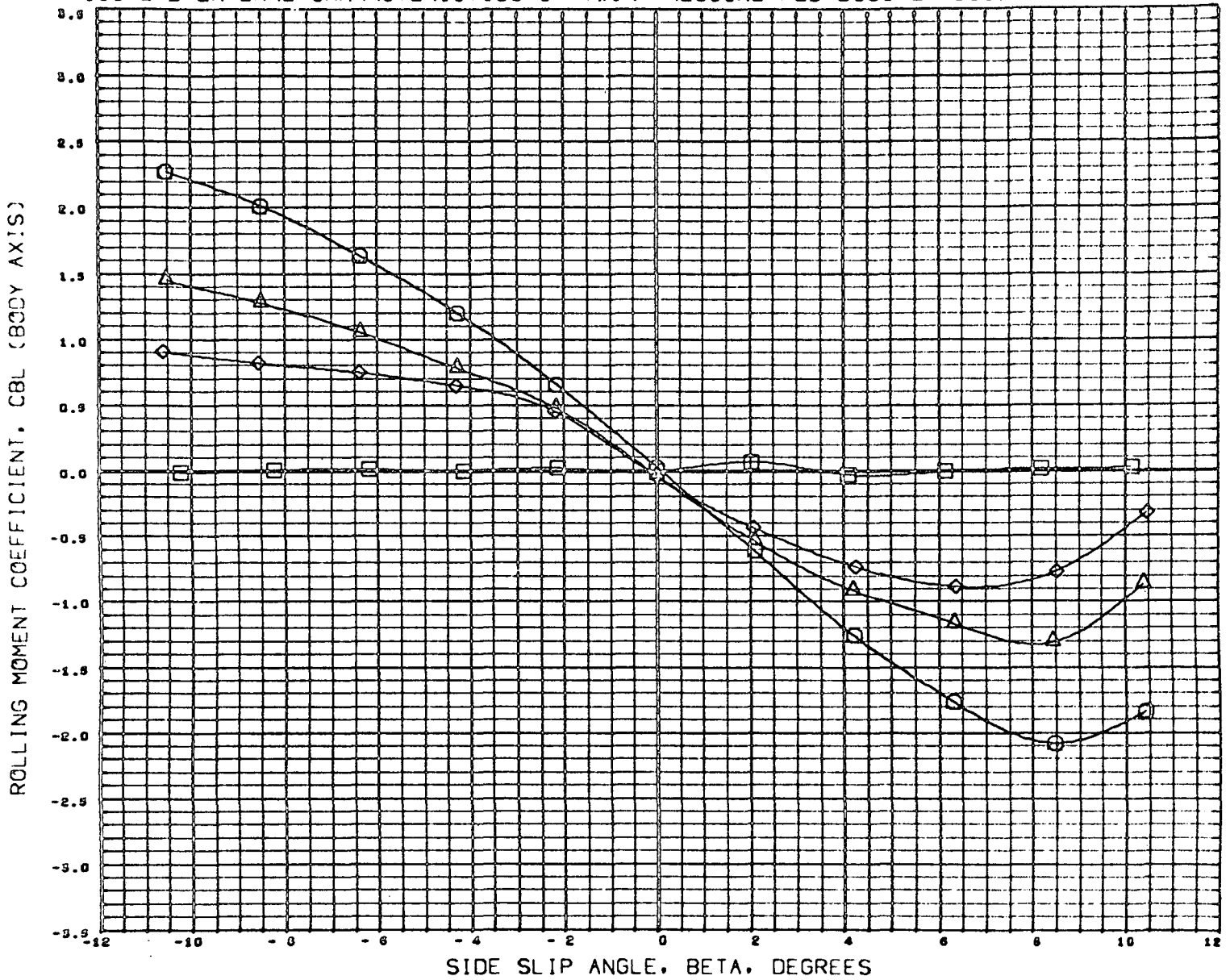

DATA SET SYMBOL	CONFIGURATION DESCRIPTION	ALPHA
(050020)	MSFC TWT 514 TFFB O2T4	0.000
(050040)	MSFC TWT 514 TFFB B37R702T4	0.000
(050060)	MSFC TWT 514 TFFB B37R7T1902T4	0.000
(050100)	MSFC TWT 514 TFFB B37R7T19T4	0.000
(050100)	DATA NOT AVAILABLE FOR ALL CONDITIONS	0.000

REFERENCE INFORMATION		
SREF	0.6600	SQ IN
LREF	5.3230	INCHES
BREF	0.9170	INCHES
XMRP	2.0730	INCHES
YMRP	0.0000	INCHES
ZMRP	0.0000	INCHES
SCALE	0.0034	

MACH 0.905

FIGURE-2 LATERAL CHARACTERISTICS OF TWIN PRESSURE FED BOOSTER BUILDUP

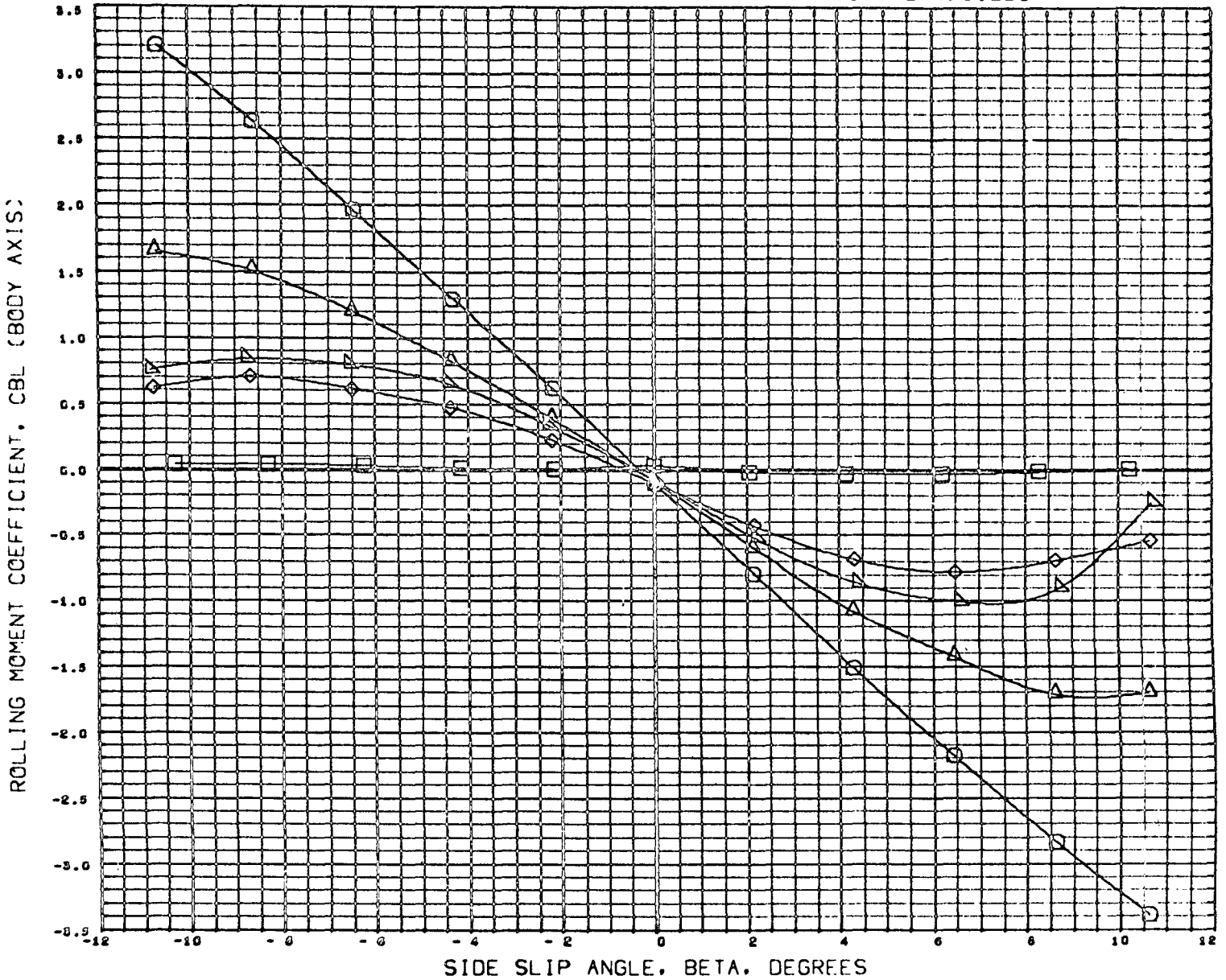

DATA SET SYMBOL	CONFIGURATION DESCRIPTION
(050020)	MSFC TWT 914 TPF0 Q2T4
(050040)	MSFC TWT 914 TPF0 Q37R702T4
(050060)	MSFC TWT 914 TPF0 Q37R7T1902T4
(050080)	MSFC TWT 914 TPF0 Q37R7T19T4
(050100)	MSFC TWT 914 TPF0 Q37R7T1905T4

ALPHA
0.000
0.000
0.000
0.000
0.000

REFERENCE INFORMATION		
SREF	0.6600	sq IN
LREF	5.3250	INCHES
DREF	0.9170	INCHES
XHRP	2.0750	INCHES
YHRP	0.0000	INCHES
ZHRP	0.0000	INCHES
SCALE	0.0034	

MACH 1.106

FIGURE-2 LATERAL CHARACTERISTICS OF TWIN PRESSURE FED BOOSTER BUILDUP

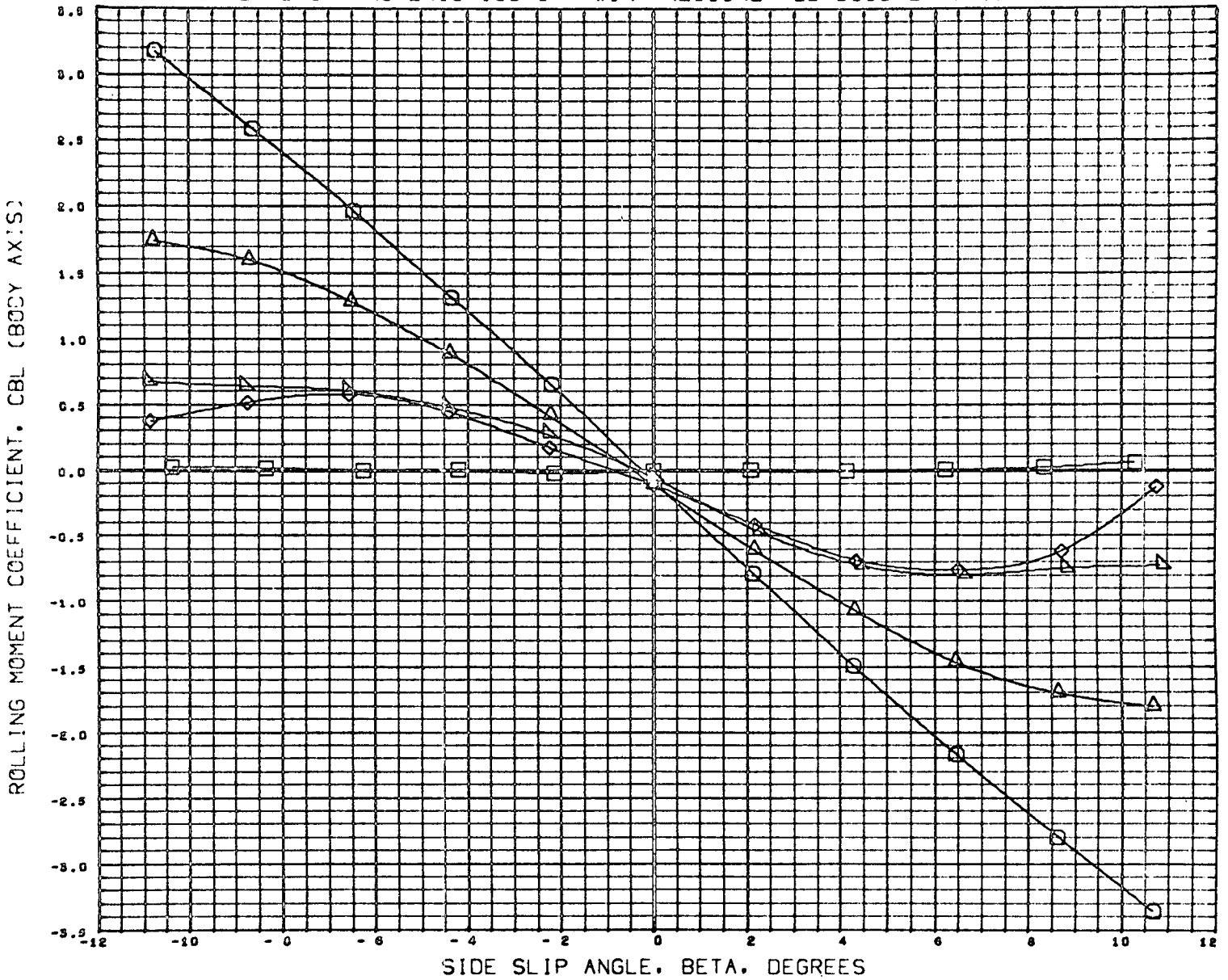

DATA SET SYMBOL	CONFIGURATION DESCRIPTION	ALPHA
(058020)	MSFC TWT 314 TPF8 O2T4	0.000
(058040)	MSFC TWT 314 TPF8 B37R7O2T4	0.000
(058060)	MSFC TWT 314 TPF8 B37R7T19O2T4	0.000
(058080)	MSFC TWT 314 TPF8 B37R7T19T4	0.000
(058100)	MSFC TWT 314 TPF8 B37R7T19O5T4	0.000

REFERENCE INFORMATION	
SREF	0.6600 50 IN
LREF	5.3230 INCHES
BREF	0.9170 INCHES
XMRP	2.0730 INCHES
YMRP	0.0000 INCHES
ZMRP	0.0000 INCHES
SCALE	0.0034

MACH 1.199

FIGURE-2 LATERAL CHARACTERISTICS OF TWIN PRESSURE FED BOOSTER BUILDUP

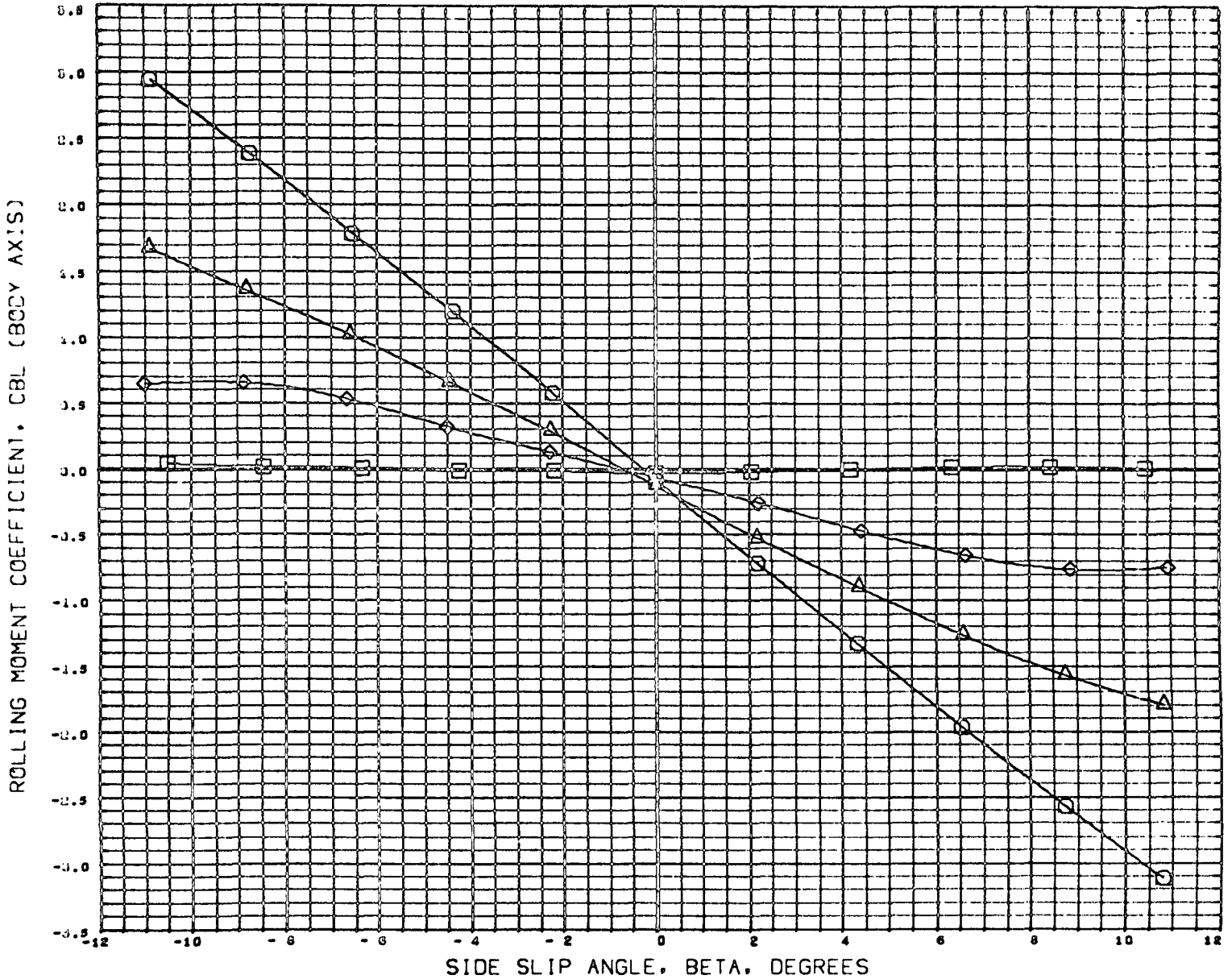

DATA SET SYMBOL	CONFIGURATION DESCRIPTION	ALPHA
(058030)	MSFC TWT 514 TPF8 02T4	0.000
(058040)	MSFC TWT 514 TPF8 037R702T4	0.000
(058050)	MSFC TWT 514 TPF8 037R7T1902T4	0.000
(058060)	MSFC TWT 514 TPF8 037R7T19T4	0.000
(058100)	DATA NOT AVAILABLE FOR ALL CONDITIONS	0.000

REFERENCE INFORMATION		
SREF	0.6600	sq IN
LREF	5.5230	INCHES
BREF	0.9170	INCHES
XMRP	2.0730	INCHES
YMRP	0.0000	INCHES
ZMRP	0.0000	INCHES
SCALE	0.0034	

MACH 1.402

FIGURE-2 LATERAL CHARACTERISTICS OF TWIN PRESSURE FED BOOSTER BUILDUP

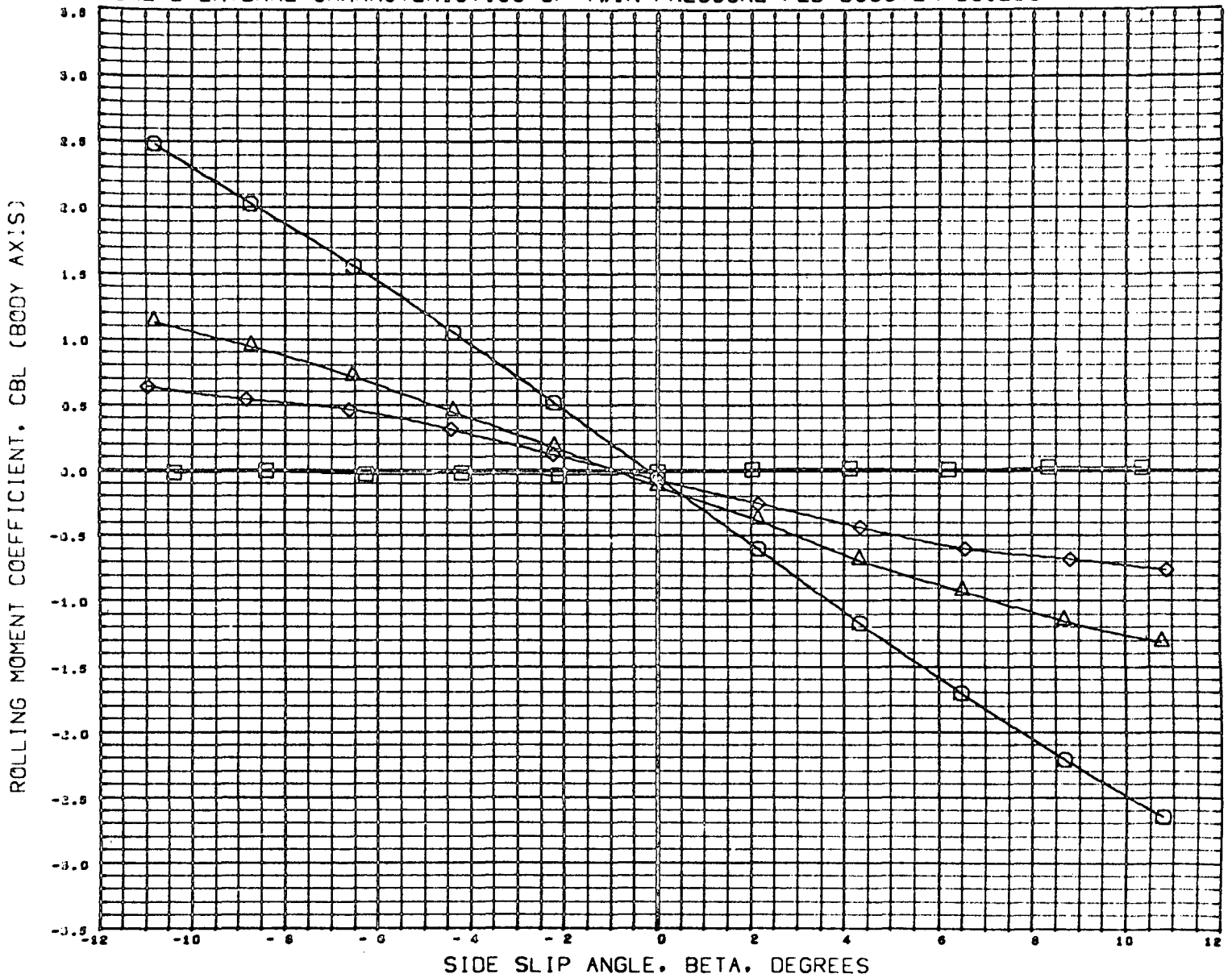

DATA SET SYMBOL	CONFIGURATION DESCRIPTION
(050020)	MSFC TWT 514 TPF8 O2T4
(050040)	MSFC TWT 514 TPF8 B37R702T4
(050060)	MSFC TWT 514 TPF8 B37R7119O2T4
(050080)	MSFC TWT 514 TPF8 B37R7119T4
(050100)	DATA NOT AVAILABLE FOR ALL CONDITIONS

ALPHA
0.000
0.000
0.000
0.000
0.000

REFERENCE INFORMATION		
SREF	0.6600	SQ IN
LREF	5.3230	INCHES
BREF	0.9170	INCHES
XMRP	2.0730	INCHES
YMRP	0.0000	INCHES
ZMRP	0.0000	INCHES
SCALE	0.0034	

MACH 1.960

FIGURE-2 LATERAL CHARACTERISTICS OF TWIN PRESSURE FED BOOSTER BUILDUP

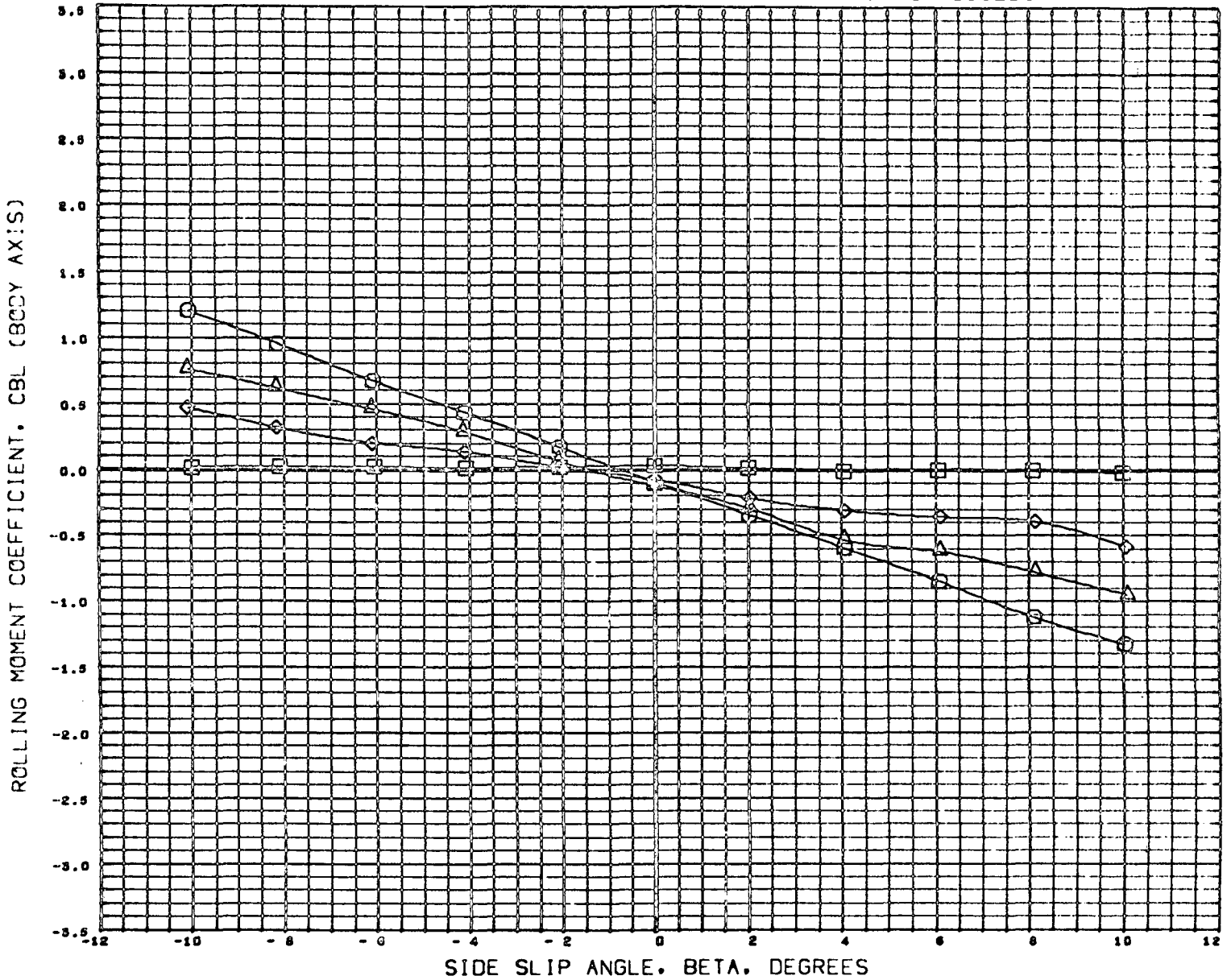

DATA SET SYMBOL	CONFIGURATION DESCRIPTION
(050120)	MSFC TWT 514 TPF8 02T4
(050140)	MSFC TWT 514 TPF8 B37R702T4
(050160)	MSFC TWT 514 TPF8 B37R711902T4
(050180)	MSFC TWT 514 TPF8 B37R7119T4
(050200)	DATA NOT AVAILABLE FOR ALL CONDITIONS

ALPHA
0.000
0.000
0.000
0.000
0.000

REFERENCE INFORMATION		
SREF	0.6600	sq IN
LREF	5.3230	INCHES
QREF	0.9170	INCHES
XMRP	2.0730	INCHES
YMRP	0.0000	INCHES
ZMRP	0.0000	INCHES
SCALE	0.0034	

MACH 4.950

FIGURE-2 LATERAL CHARACTERISTICS OF TWIN PRESSURE FED BOOSTER BUILDUP

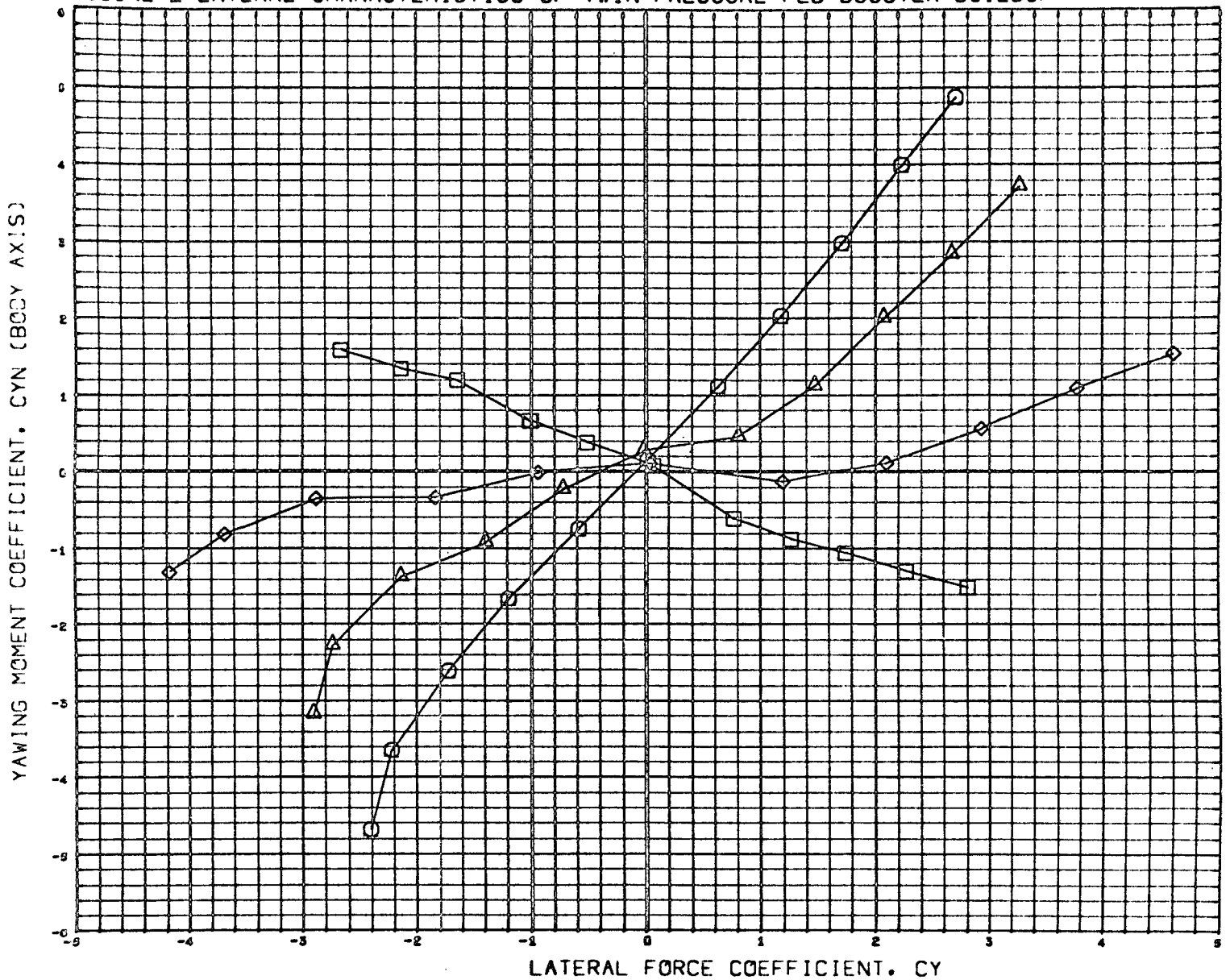

DATA SET	SYMBOL	CONFIGURATION DESCRIPTION
(058000)	○	MSFC TWT 514 TPF8 O2T4
(059000)	△	MSFC TWT 514 TPF8 B37R7O2T4
(058000)	□	MSFC TWT 514 TPF8 B37R7T19O2T4
(058000)	◇	MSFC TWT 514 TPF8 B37R7T19T4
(058100)	□	DATA NOT AVAILABLE FOR ALL CONDITIONS

ALPHA
0.000
0.000
0.000
0.000
0.000

REFERENCE INFORMATION	
SREF	0.6600 94 IN
LREF	5.3230 INCHES
BREF	0.9170 INCHES
XMRP	2.0730 INCHES
YMRP	0.0000 INCHES
ZMRP	0.0000 INCHES
SCALE	0.0034

MACH 0.905

FIGURE-2 LATERAL CHARACTERISTICS OF TWIN PRESSURE FED BOOSTER BUILDUP

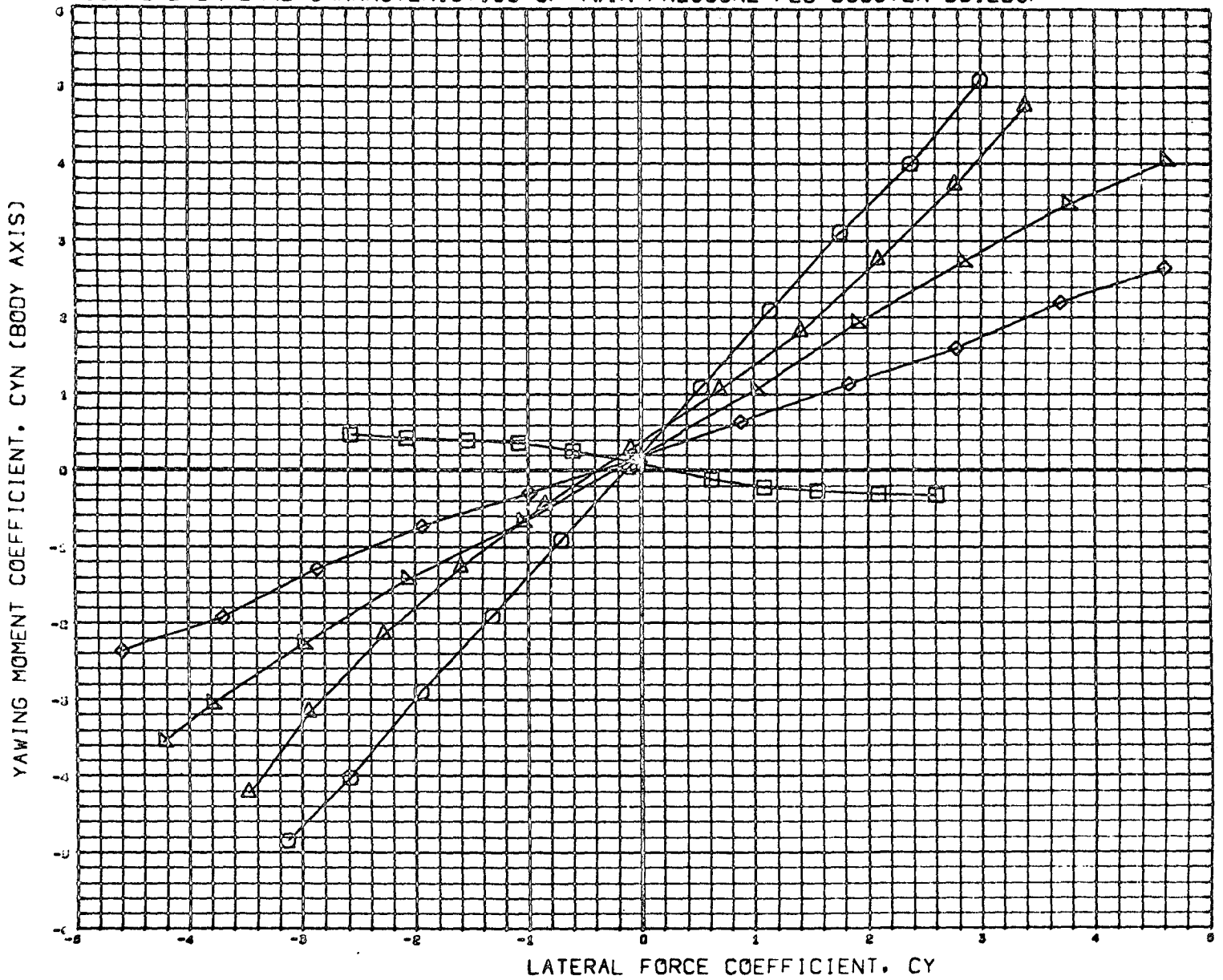

DATA SET SYMBOL	CONFIGURATION DESCRIPTION
(050020)	MSFC TWT 914 TPF8 02T4
(050040)	MSFC TWT 914 TPF8 G37R702T4
(050030)	MSFC TWT 914 TPF8 Q37R7T1902T4
(050000)	MSFC TWT 914 TPF8 Q37R7T19T4
(050100)	MSFC TWT 914 TPF8 G37R7T1905T4

ALPHA
0.000
0.000
0.000
0.000
0.000

REFERENCE INFORMATION		
SREF	0.6600	sq IN
LREF	5.3250	INCHES
QREF	0.0170	INCHES
XMRP	2.0750	INCHES
YMRP	0.0000	INCHES
ZMRP	0.0000	INCHES
SCALE	0.0034	

NACH 1.106

FIGURE-2 LATERAL CHARACTERISTICS OF TWIN PRESSURE FED BOOSTER BUILDUP

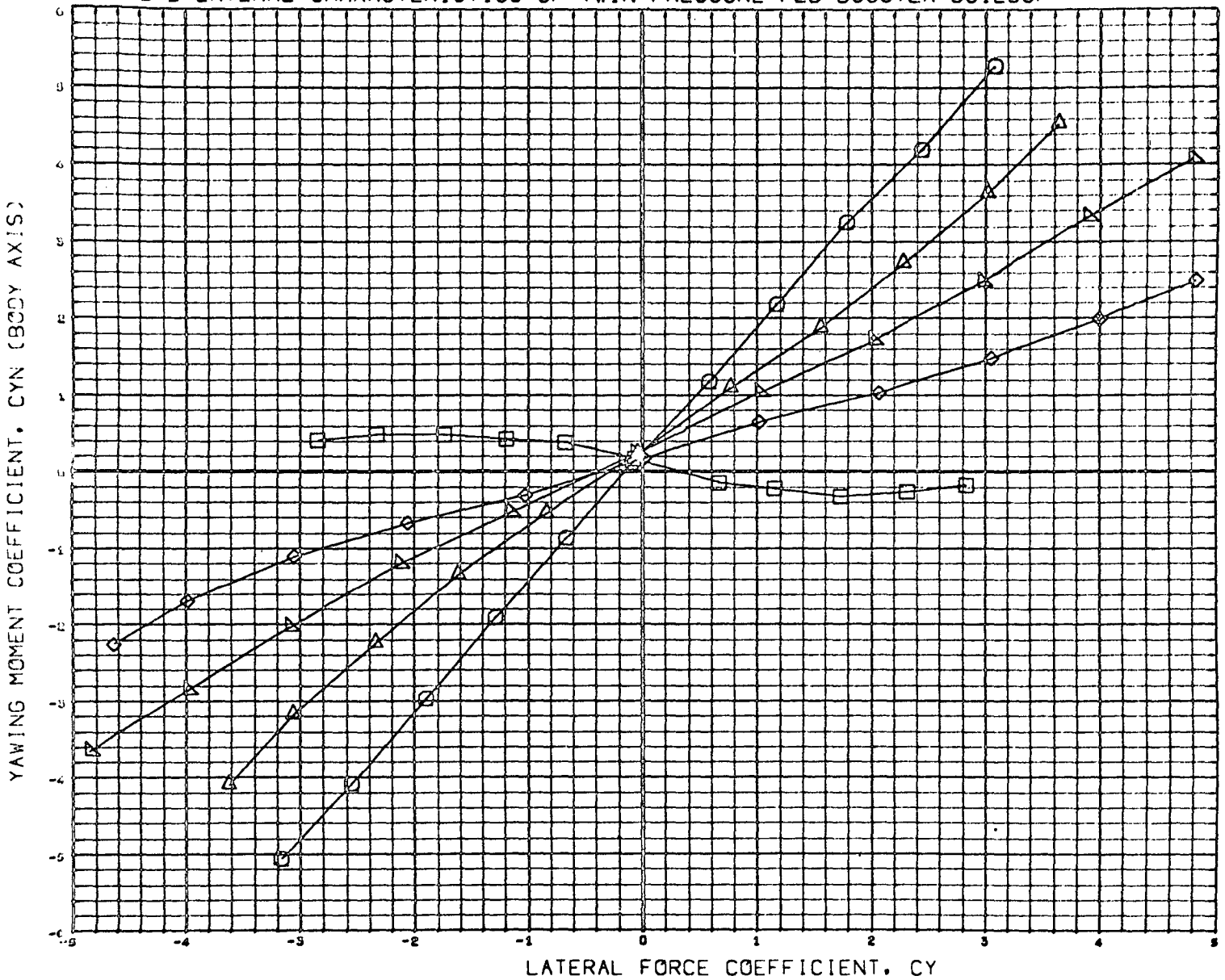

DATA SET SYMBOL	CONFIGURATION DESCRIPTION
(050020)	MSFC TWT 514 TPFB O2T4
(050010)	MSFC TWT 514 TPFB B37R702T4
(050030)	MSFC TWT 514 TPFB B37R7T1902T4
(050030)	MSFC TWT 514 TPFB B37R7T19T4
(050100)	MSFC TWT 514 TPFB B37R7T1903T4

ALPHA
0.000
0.000
0.000
0.000
0.000

REFERENCE INFORMATION	
SREF	0.6600 SQ IN
LREF	5.3230 INCHES
BREF	0.9170 INCHES
XMRP	2.0730 INCHES
YMRP	0.0000 INCHES
ZMRP	0.0000 INCHES
SCALE	0.0034

MACH 1.199

FIGURE-2 LATERAL CHARACTERISTICS OF TWIN PRESSURE FED BOOSTER BUILDUP

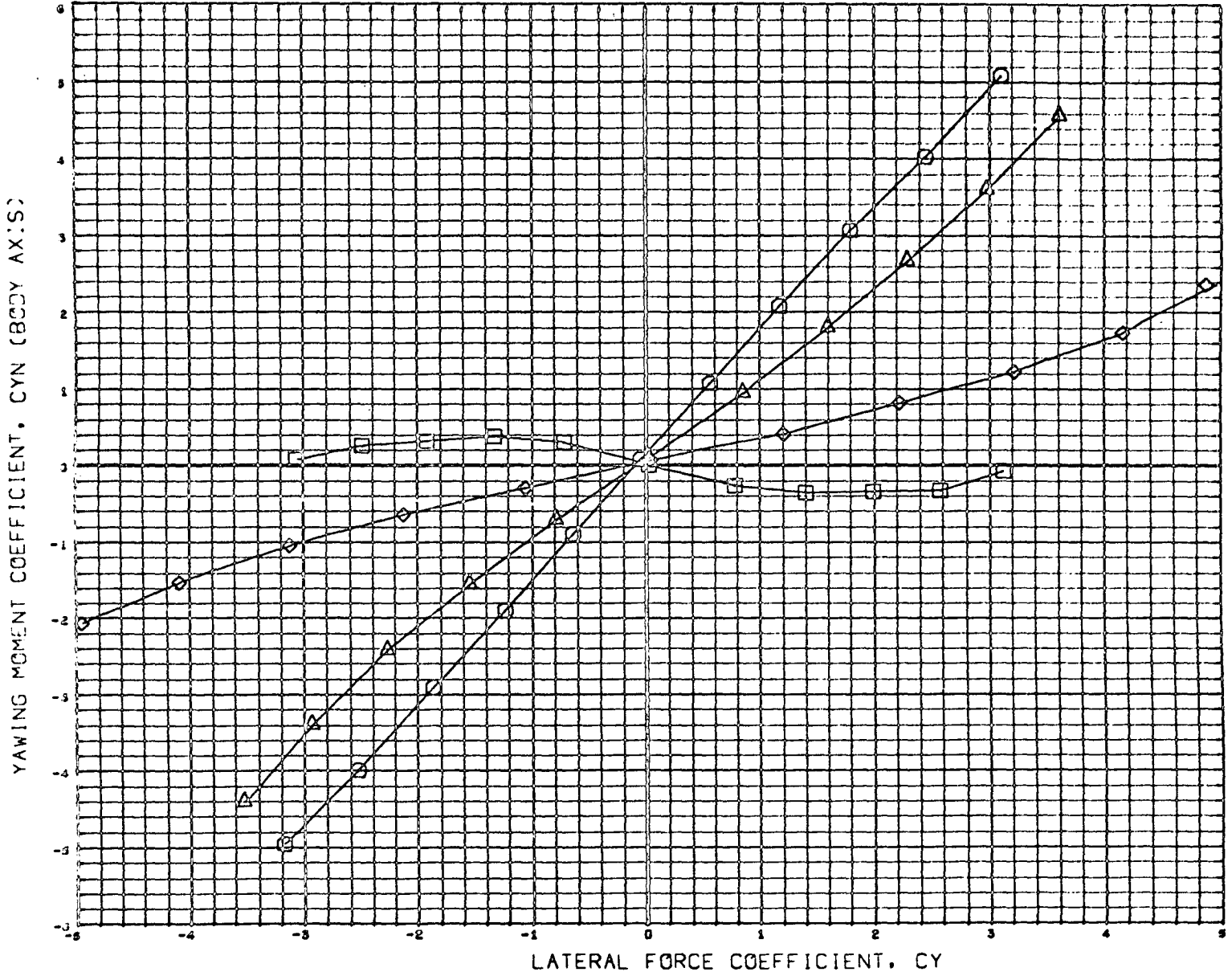

DATA SET SYMBOL	CONFIGURATION DESCRIPTION	ALPHA
(090120)	MSFC TWT 514 TFFB 02T4	0.000
(090140)	MSFC TWT 514 TFFB B37R702T4	0.000
(090160)	MSFC TWT 514 TFFB B37R711902T4	0.000
(090180)	MSFC TWT 514 TFFB B37R7119T4	0.000
(090200)	DATA NOT AVAILABLE FOR ALL CONDITIONS	0.000

REFERENCE INFORMATION		
SREF	0.6600	SQ IN
LREF	5.3250	INCHES
BREF	0.9170	INCHES
XMRF	2.0730	INCHES
YMRF	0.0000	INCHES
ZMRF	0.0000	INCHES
SCALE	0.0034	

MACH 1.402

FIGURE-2 LATERAL CHARACTERISTICS OF TWIN PRESSURE FED BOOSTER BUILDUP

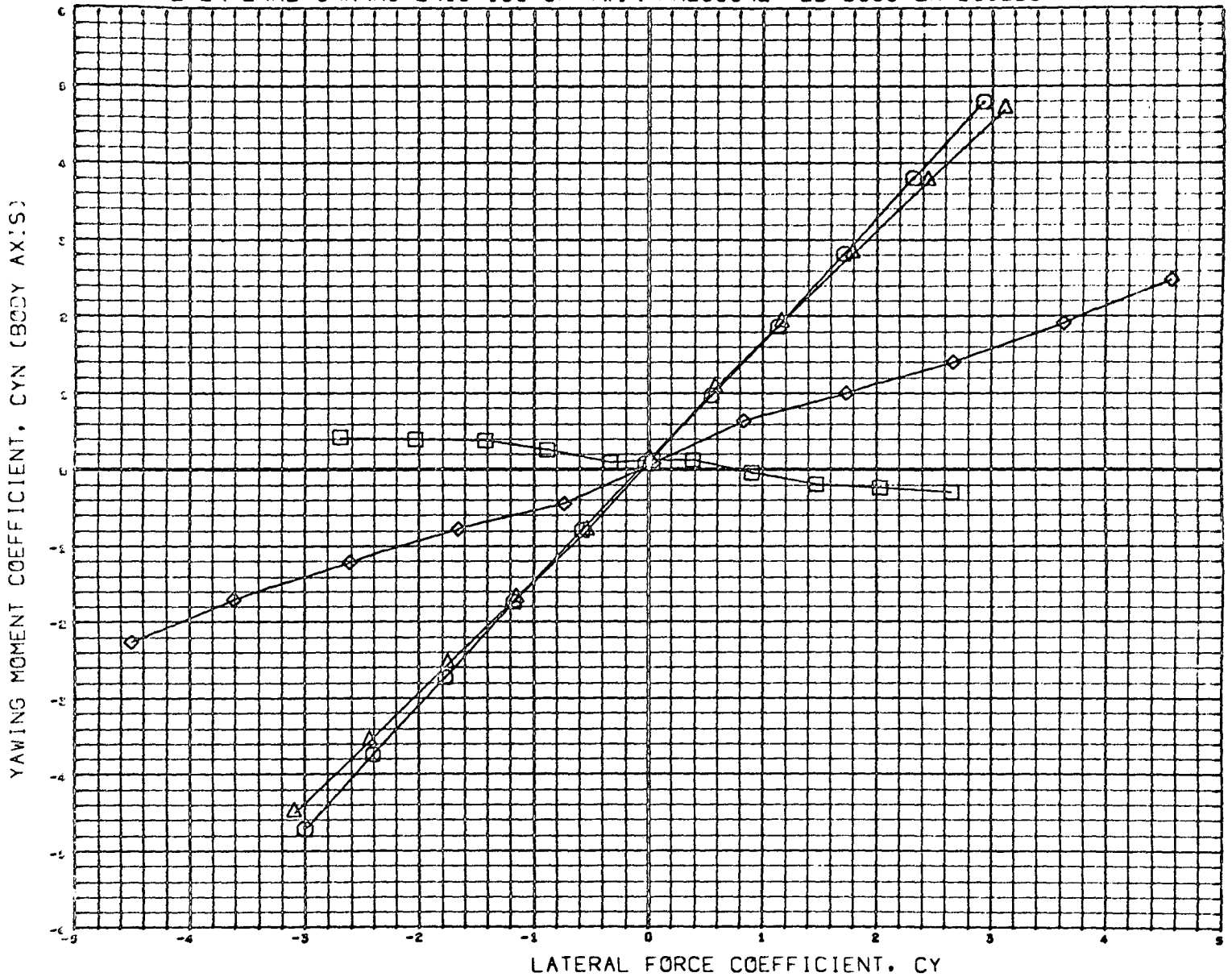

DATA SET SYMBOL	CONFIGURATION DESCRIPTION	ALPHA
(050010)	MSFC TWT 514 TPF8 O2T4	0.000
(050010)	MSFC TWT 514 TPF8 B37R702T4	0.000
(050010)	MSFC TWT 514 TPF8 B37R7T1902T4	0.000
(050010)	MSFC TWT 514 TPF8 B37R7T19T4	0.000
(050100)	DATA NOT AVAILABLE FOR ALL CONDITIONS	0.000

REFERENCE INFORMATION		
SREF	0.6600	sq IN
LREF	9.3250	INCHES
BREF	0.9170	INCHES
XMRP	2.0730	INCHES
YMRP	0.0000	INCHES
ZMRP	0.0000	INCHES
SCALE	0.0034	

MACH 1.960

FIGURE-2 LATERAL CHARACTERISTICS OF TWIN PRESSURE FED BOOSTER BUILDUP

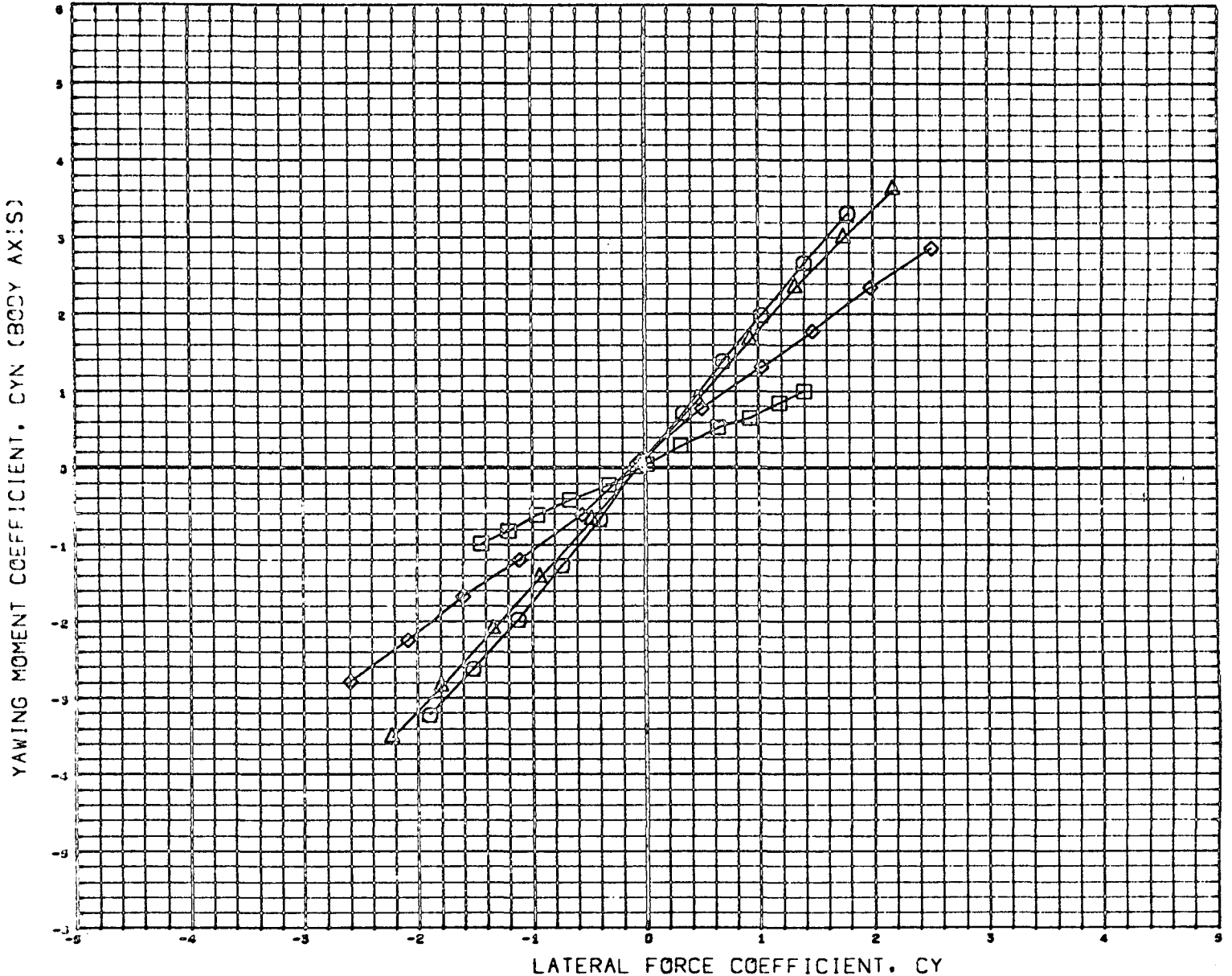

DATA SET SYMBOL	CONFIGURATION DESCRIPTION
(090:20)	MSFC TWT 514 TPF8 Q2T4
(090:40)	MSFC TWT 514 TPF8 B37R702T4
(090:60)	MSFC TWT 514 TPF8 B37R711902T4
(090:80)	MSFC TWT 514 TPF8 B37R7119T4
(090:00)	DATA NOT AVAILABLE FOR ALL CONDITIONS

ALPHA
0.000
0.000
0.000
0.000
0.000

REFERENCE INFORMATION		
SREF	0.6600	30 IN
LREF	5.5230	INCHES
BREF	0.9170	INCHES
XMRP	2.0730	INCHES
YMRP	0.0000	INCHES
ZMRP	0.0000	INCHES
SCALE	0.0034	

MACH 4.959

FIGURE-3 ELEVATOR EFFECTIVENESS OF B-18E-3 CONFIGURATION

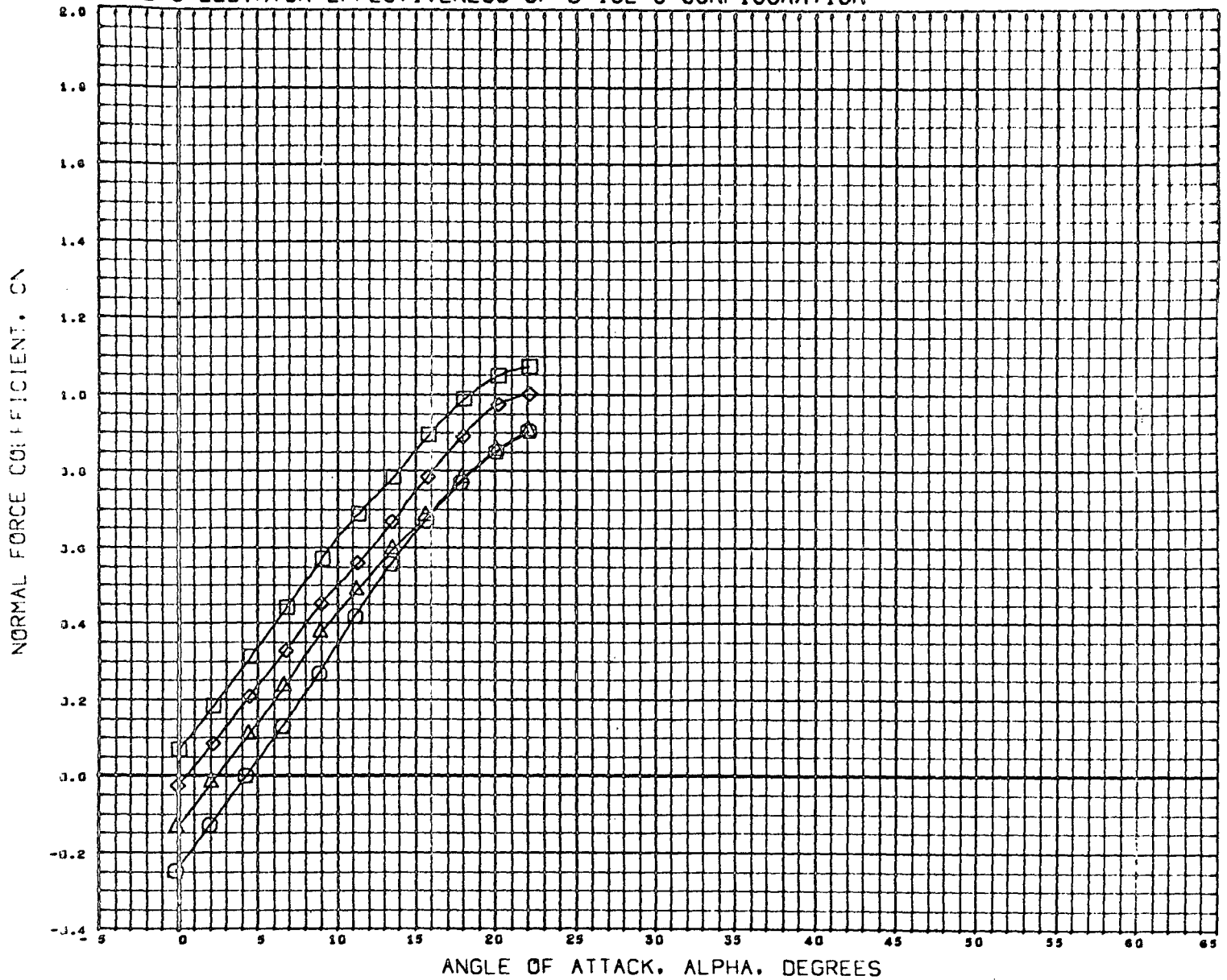

DATA SET SYMBOL	CONFIGURATION DESCRIPTION
(C50030)	MSFC TWT 514 E3 B30W23C10
(C50020)	MSFC TWT 514 E3 B30W23C10
(C50010)	MSFC TWT 514 E3 B30W23C10
(C50190)	MSFC TWT 514 E3 B30W23C10

BETA	ELEVTR	CANARD
0.000	-40.000	0.000
0.000	-20.000	0.000
0.000	0.000	0.000
0.000	10.000	0.000

REFERENCE INFORMATION		
SREF	15.0500	50 INC
LREF	2.8300	INCHES
OREF	0.0620	INCHES
XMRP	2.1110	INCHES
YMRP	0.0000	INCHES
ZMRP	0.0000	INCHES
SCALE	0.0035	

MACH 0.900

FIGURE-3 ELEVATOR EFFECTIVENESS OF B-18E-3 CONFIGURATION

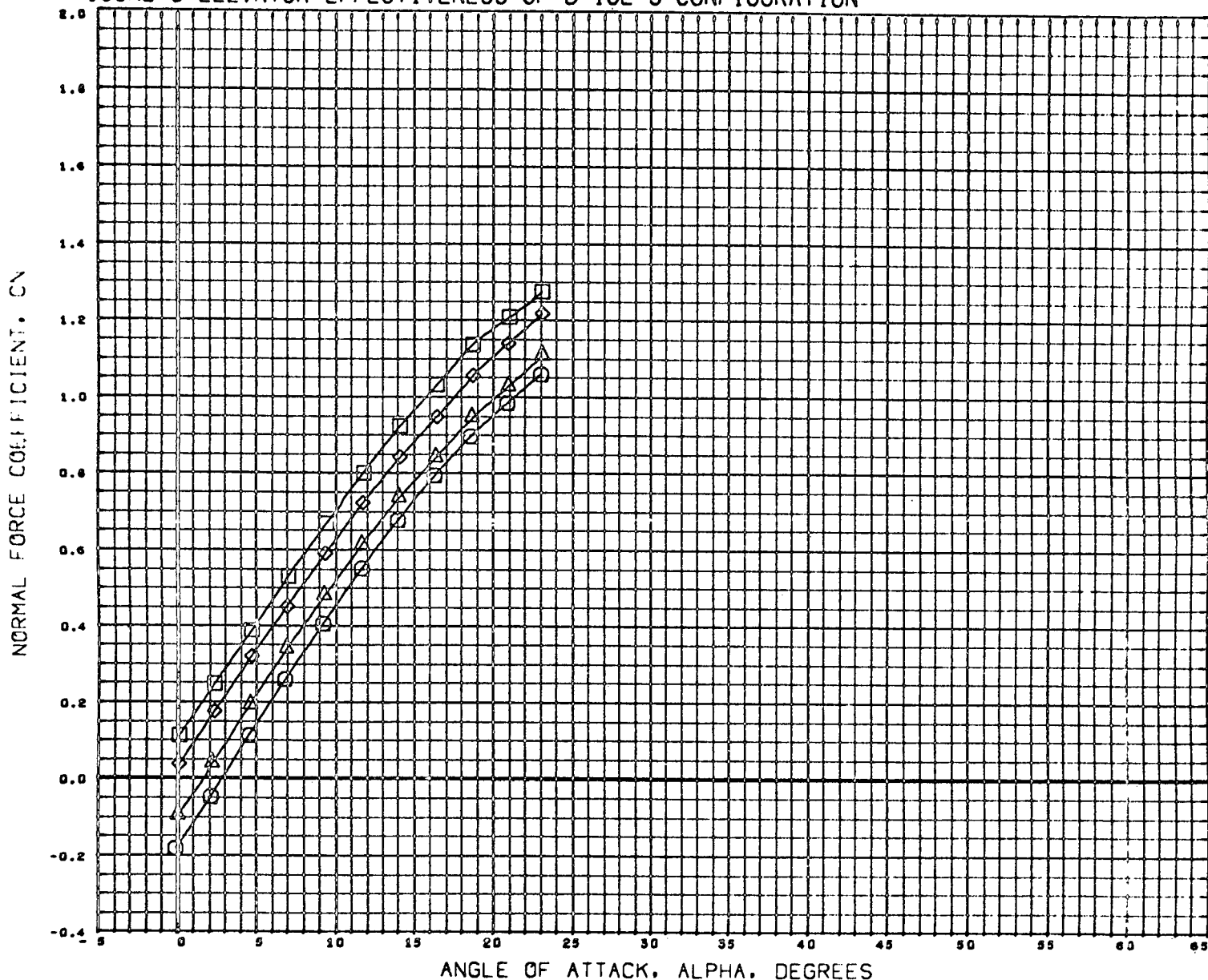

DATA SET SYMBOL	CONFIGURATION DESCRIPTION
(C58030)	MSFC TWT 514 E3 030W23C13
(C58020)	MSFC TWT 514 E3 030W23C13
(C58010)	MSFC TWT 514 E3 030W23C13
(058.90)	MSFC TWT 514 E3 030W23C13

BETA	ELEVTR	CANARD
0.000	-40.000	0.000
0.000	-20.000	0.000
0.000	0.000	0.000
0.000	10.000	0.000

REFERENCE INFORMATION		
SREF	15.0300	SQ INC
LREF	2.0300	INCHES
BREF	6.0620	INCHES
XMRP	2.1110	INCHES
YMRP	0.0000	INCHES
ZMRP	0.0000	INCHES
SCALE	0.0035	

MACH 1.100

FIGURE-3 ELEVATOR EFFECTIVENESS OF B-18E-3 CONFIGURATION

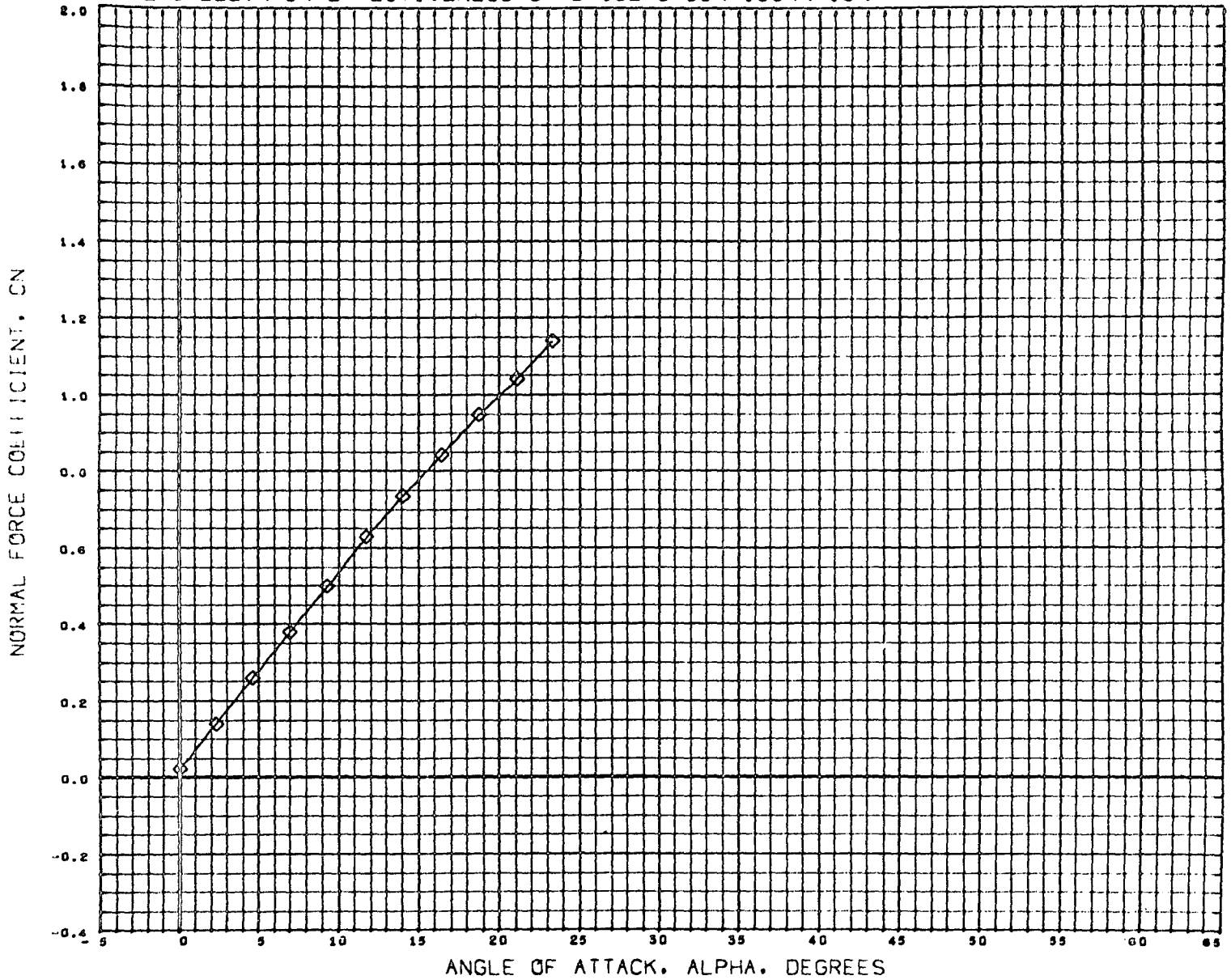

DATA SET SYMBOL	CONFIGURATION DESCRIPTION	BETA	ELEVTR	CANARD	REFERENCE INFORMATION
(C96030)	DATA NOT AVAILABLE FOR ALL CONDITIONS	0.000	-40.000	0.000	SREF 15.0300 SQ INC
(C98020)	DATA NOT AVAILABLE FOR ALL CONDITIONS	0.000	-20.000	0.000	LREF 2.8300 INCHES
(C96010)	MSFC TWT 514 E3 B30W23C10	0.000	0.000	0.000	BREF 6.0820 INCHES
(050190)	DATA NOT AVAILABLE FOR ALL CONDITIONS	0.000	10.000	0.000	XMRP 2.1110 INCHES
					YMRP 0.0000 INCHES
					ZMRP 0.0000 INCHES
					SCALE 0.0035

MACH 1.459

FIGURE-3 ELEVATOR EFFECTIVENESS OF B-18E-3 CONFIGURATION

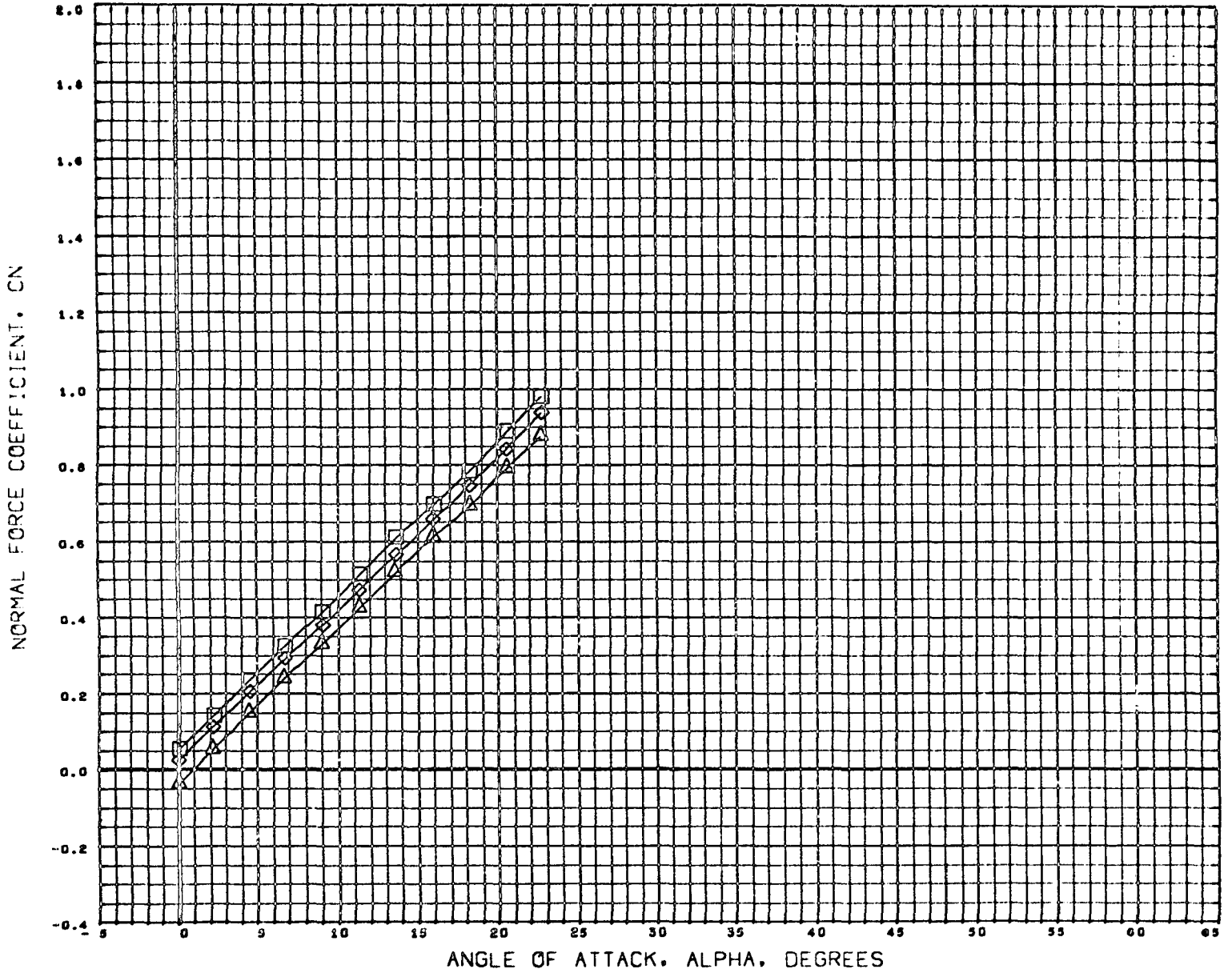

DATA SET	SYMBOL	CONFIGURATION DESCRIPTION
(C50030)		DATA NOT AVAILABLE FOR ALL CONDITIONS
(C50020)	○	MSFC TWT 514 E3 B30W23C10
(C50010)	△	MSFC TWT 514 E3 B30W23C10
(D56190)	□	MSFC TWT 514 E3 B30W23C10

BETA	ELEVTR	CANARD
0.000	-40.000	0.000
0.000	-20.000	0.000
0.000	0.000	0.000
0.000	10.000	0.000

REFERENCE INFORMATION		
SREF	15.0300	Sq INC
LREF	2.8300	INCHES
BREF	0.0620	INCHES
XMRP	2.1110	INCHES
YMRP	0.0000	INCHES
ZMRP	0.0000	INCHES
SCALE	0.0035	

MACH 1.955

FIGURE-3 ELEVATOR EFFECTIVENESS OF B-18E-3 CONFIGURATION

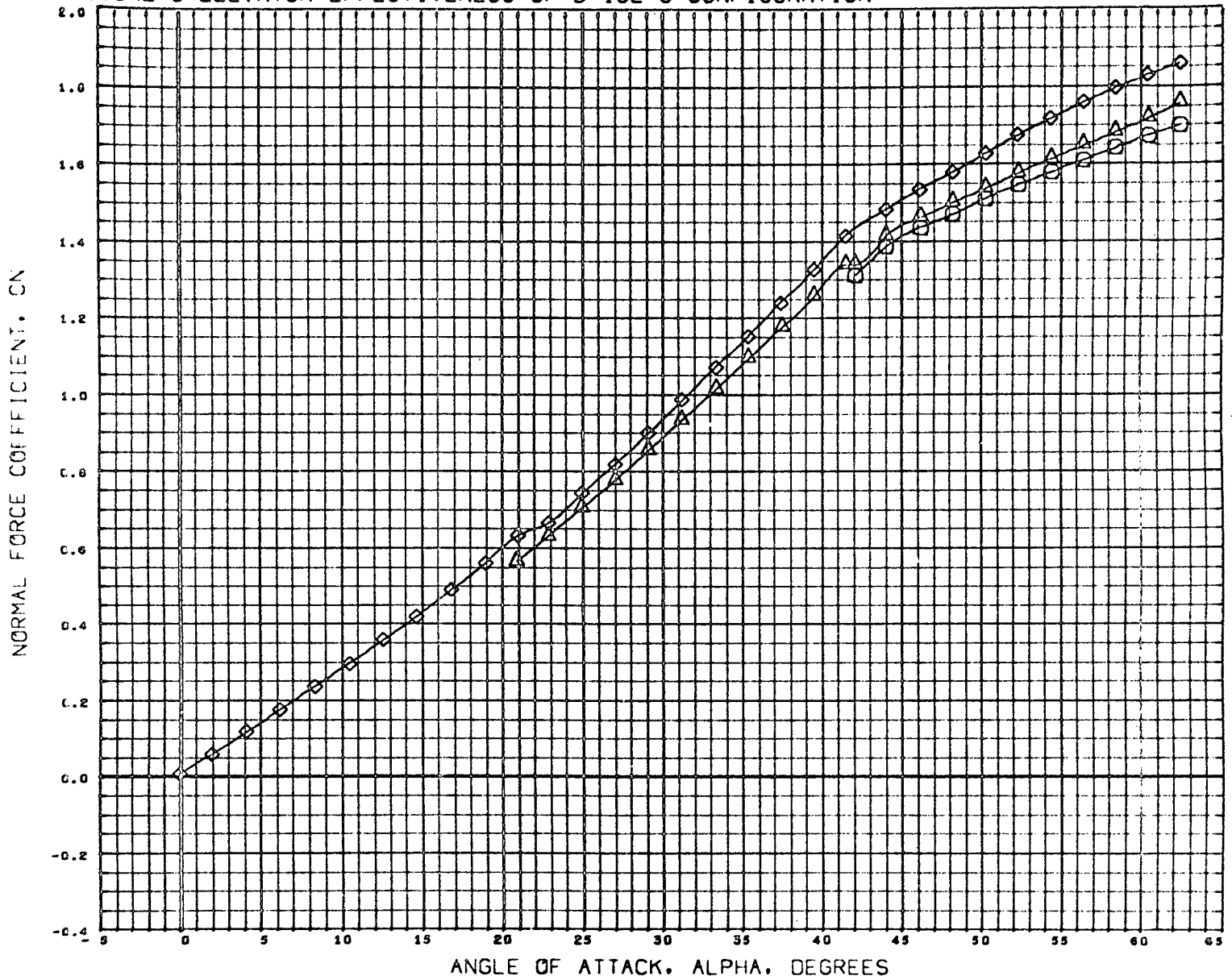

DATA SET	SYMBOL	CONFIGURATION DESCRIPTION
(C58030)	○	MSFC TWT 514 E3 B30W23C10
(C58020)	△	MSFC TWT 514 E3 B30W23C10
(C58010)	◇	MSFC TWT 514 E3 B30W23C10
(D58100)	□	DATA NOT AVAILABLE FOR ALL CONDITIONS

BETA	ELEVTR	CANARD
0.000	-40.000	0.000
0.000	-20.000	0.000
0.000	0.000	0.000
0.000	10.000	0.000

REFERENCE INFORMATION		
SREF	15.0300	50 INC
LREF	2.8300	INCHES
BREF	6.0620	INCHES
XHRP	2.1110	INCHES
YHRP	0.0000	INCHES
ZHRP	0.0000	INCHES
SCALE	0.0035	

MACH 2.990

FIGURE-3 ELEVATOR EFFECTIVENESS OF B-18E-3 CONFIGURATION

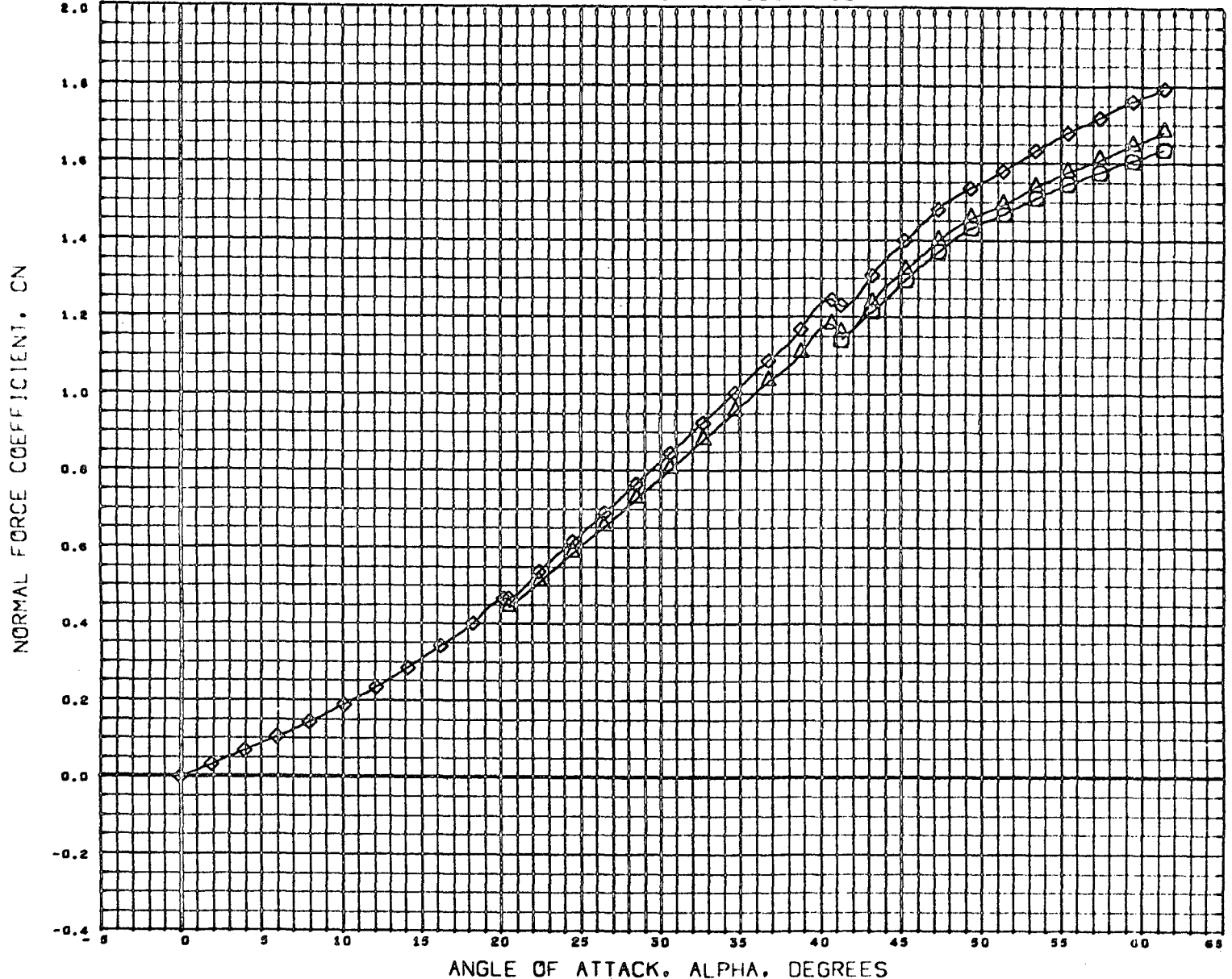

DATA SET SYMBOL	CONFIGURATION DESCRIPTION
(C50330)	MSFC TWT 514 E3 B30W23C10
(C50020)	MSFC TWT 514 E3 B30W23C10
(C50310)	MSFC TWT 514 E3 B30W23C10
(D50190)	DATA NOT AVAILABLE FOR ALL CONDITIONS

BETA	ELEVTR	CANARD
0.000	-40.000	0.000
0.000	-20.000	0.000
0.000	0.000	0.000
0.000	10.000	0.000

REFERENCE INFORMATION		
SREF	15.0300	50 INC
LREF	2.8300	INCHES
BREF	6.0620	INCHES
XMRP	2.1110	INCHES
YMRP	0.0000	INCHES
ZMRP	0.0000	INCHES
SCALE	0.0035	

MACH 4.959

FIGURE-3 ELEVATOR EFFECTIVENESS OF B-18E-3 CONFIGURATION

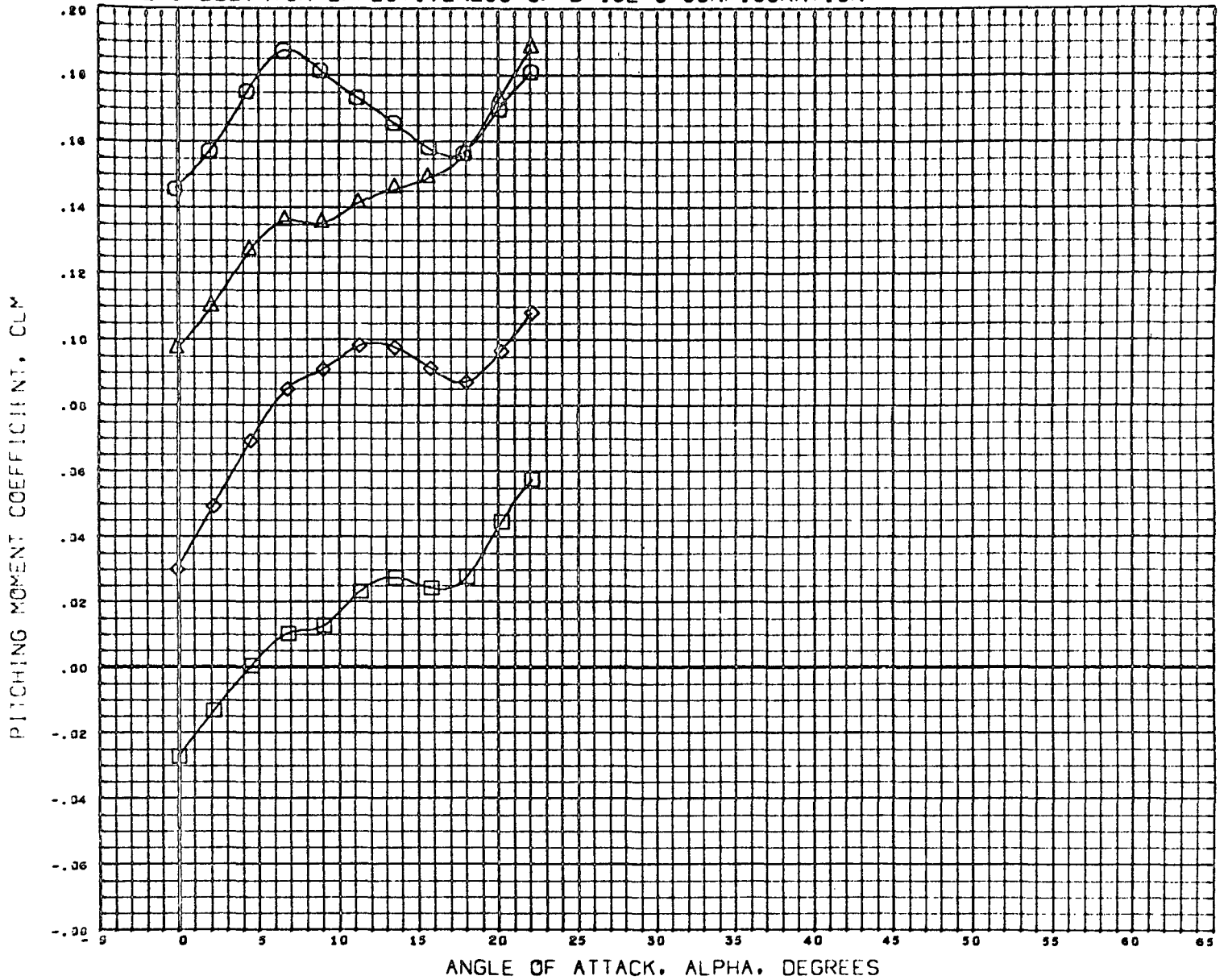

DATA SET	SYMBOL	CONFIGURATION	DESCRIPTION
(C50000)	○	MSFC TWT 514 E3	B30W23C10
(C50020)	△	MSFC TWT 514 E3	B30W23C10
(C50040)	◇	MSFC TWT 514 E3	B30W23C10
(C50100)	□	MSFC TWT 514 E3	B30W23C10

BETA	ELEVTR	CANARD
0.000	-40.000	0.000
0.000	-20.000	0.000
0.000	0.000	0.000
0.000	10.000	0.000

REFERENCE INFORMATION		
SREF	15.0300	80 INC
LREF	2.0300	INCHES
BREF	6.0620	INCHES
XMRP	2.1110	INCHES
YMRP	0.0000	INCHES
ZMRP	0.0000	INCHES
SCALE	0.0035	

MACH 0.900

FIGURE-3 ELEVATOR EFFECTIVENESS OF B-18E-3 CONFIGURATION

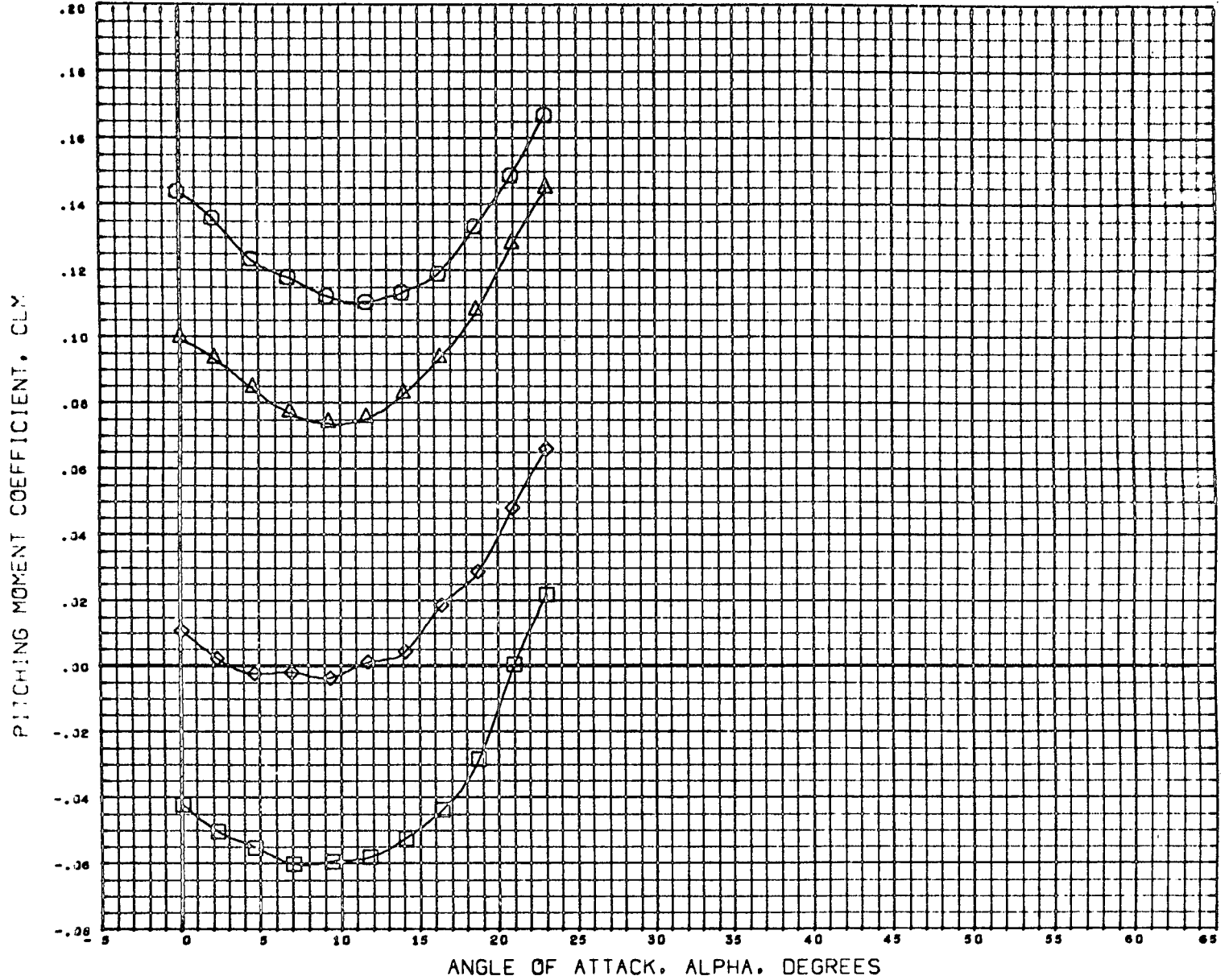

DATA SET SYMBOL	CONFIGURATION	DESCRIPTION
(C58030)	MSFC TWT 514 E3	830W23C10
(C58020)	MSFC TWT 514 E3	830W23C10
(C58010)	MSFC TWT 514 E3	830W23C10
(D58150)	MSFC TWT 514 E3	830W23C10

BETA	ELEVTR	CANARD
0.000	-40.000	0.000
0.000	-20.000	0.000
0.000	0.000	0.000
0.000	10.000	0.000

REFERENCE INFORMATION		
SREF	15.0300	SQ INC
LREF	2.8300	INCHES
BREF	6.0620	INCHES
XMRP	2.1110	INCHES
YMRP	0.0000	INCHES
ZMRP	0.0000	INCHES
SCALE	0.0035	

MACH 1.100

FIGURE-3 ELEVATOR EFFECTIVENESS OF B-18E-3 CONFIGURATION

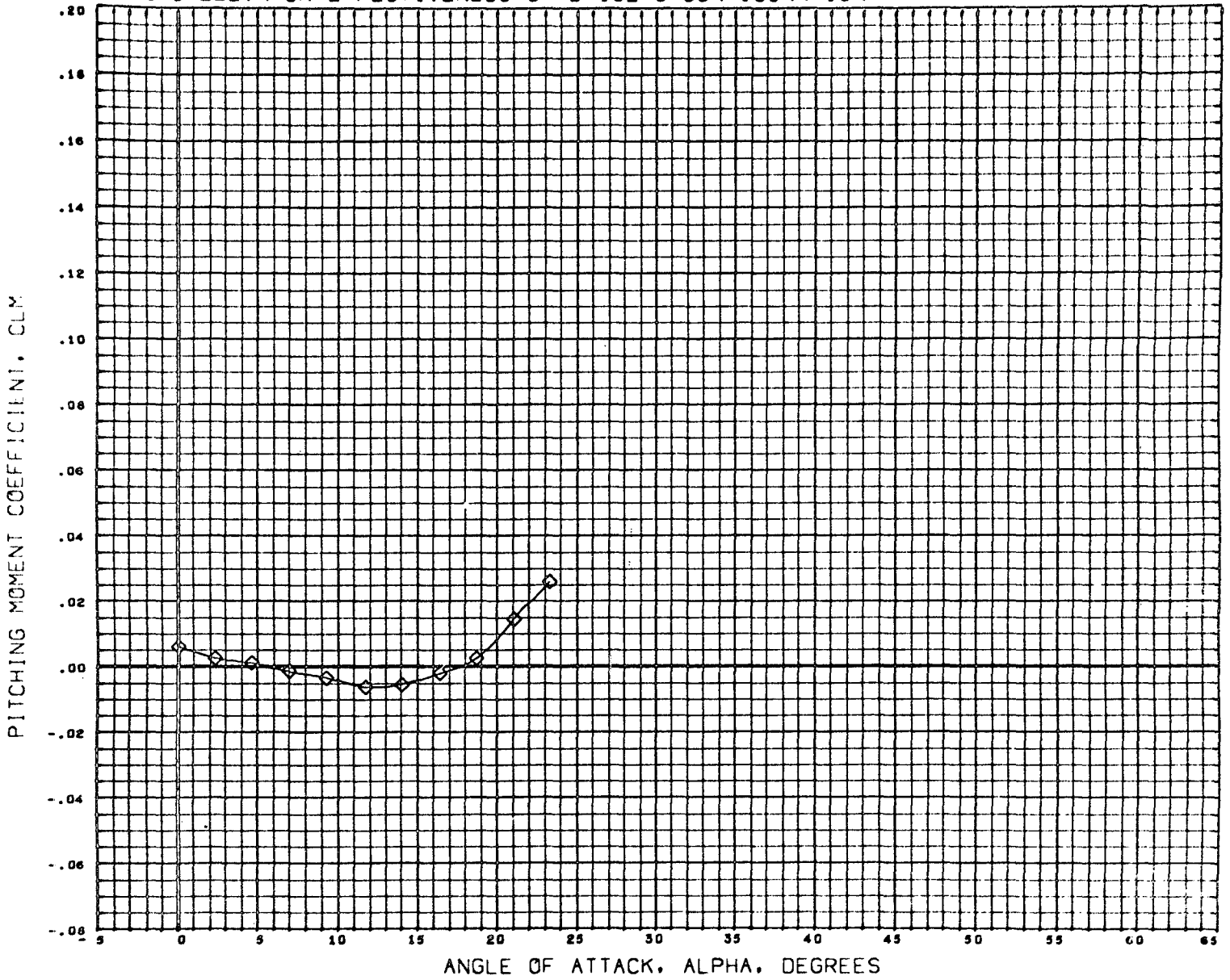

DATA SET SYMBOL	CONFIGURATION DESCRIPTION
(C50050)	DATA NOT AVAILABLE FOR ALL CONDITIONS
(C50020)	DATA NOT AVAILABLE FOR ALL CONDITIONS
(C50010)	MSFC TWT 514 E3 B30W23C10
(D50090)	DATA NOT AVAILABLE FOR ALL CONDITIONS

BETA	ELEVTR	CANARD
0.000	-40.000	0.000
0.000	-20.000	0.000
0.000	0.000	0.000
0.000	10.000	0.000

REFERENCE INFORMATION		
SREF	15.0300	SQ INC
LREF	2.8300	INCHES
BREF	6.0620	INCHES
XMRP	2.1110	INCHES
YMRP	0.0000	INCHES
ZMRP	0.0000	INCHES
SCALE	0.0035	

MACH 1.459

FIGURE-3 ELEVATOR EFFECTIVENESS OF B-18E-3 CONFIGURATION

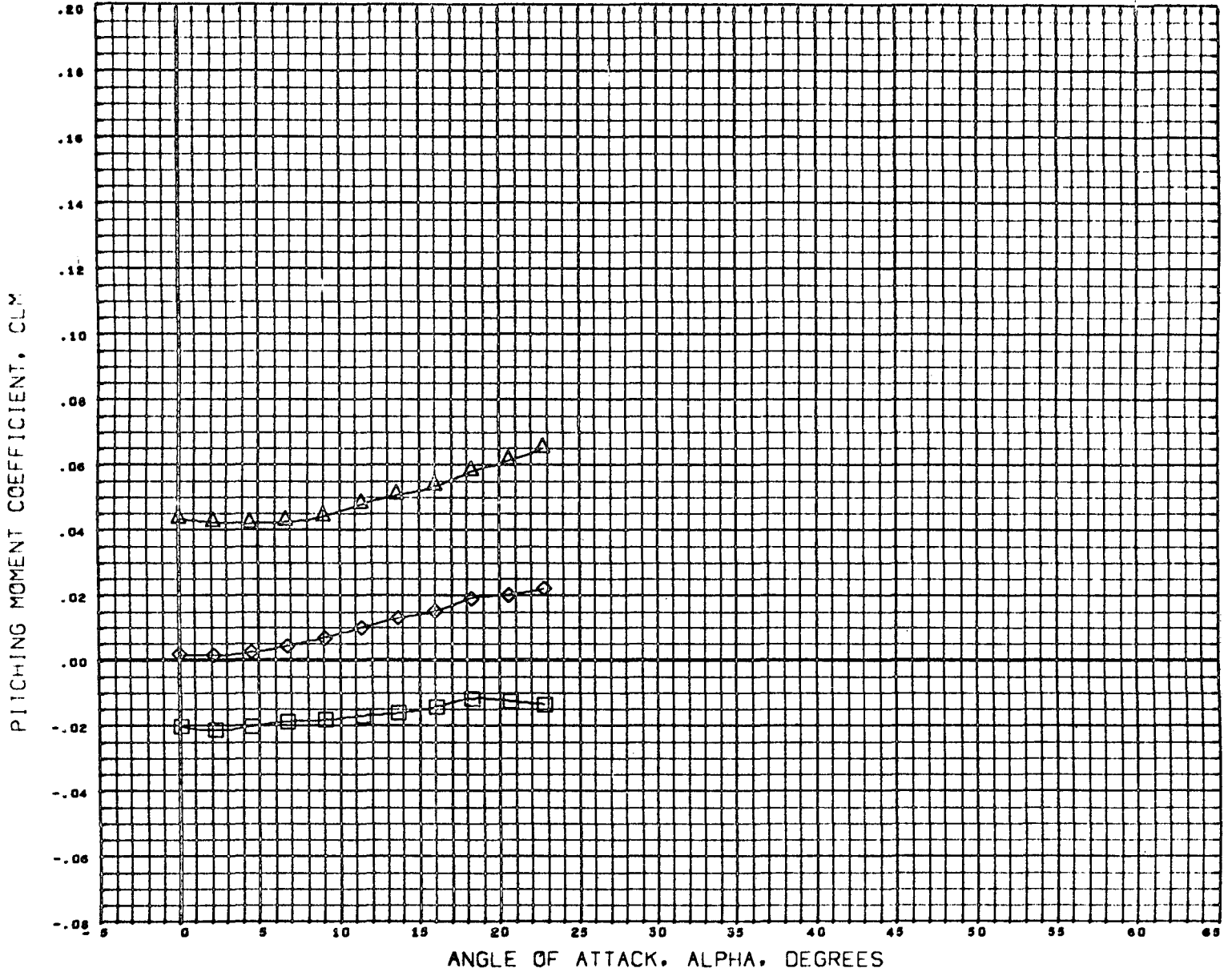

DATA SET SYMBOL	CONFIGURATION DESCRIPTION
(C58030)	DATA NOT AVAILABLE FOR ALL CONDITIONS
(C58020)	MSFC TWT 514 E3 B30W23C10
(C58010)	MSFC TWT 514 E3 B30W23C10
(058190)	MSFC TWT 514 E3 B30W23C10

BETA	ELEVTR	CANARD
0.000	-40.000	0.000
0.000	-20.000	0.000
0.000	0.000	0.000
0.000	10.000	0.000

REFERENCE INFORMATION		
SREF	15.0300	50 INC
LREF	2.8300	INCHES
BREF	6.0820	INCHES
XMRP	2.1110	INCHES
YMRP	0.0000	INCHES
ZMRP	0.0000	INCHES
SCALE	0.0035	

MACH 1.955

FIGURE-3 ELEVATOR EFFECTIVENESS OF B-18E-3 CONFIGURATION

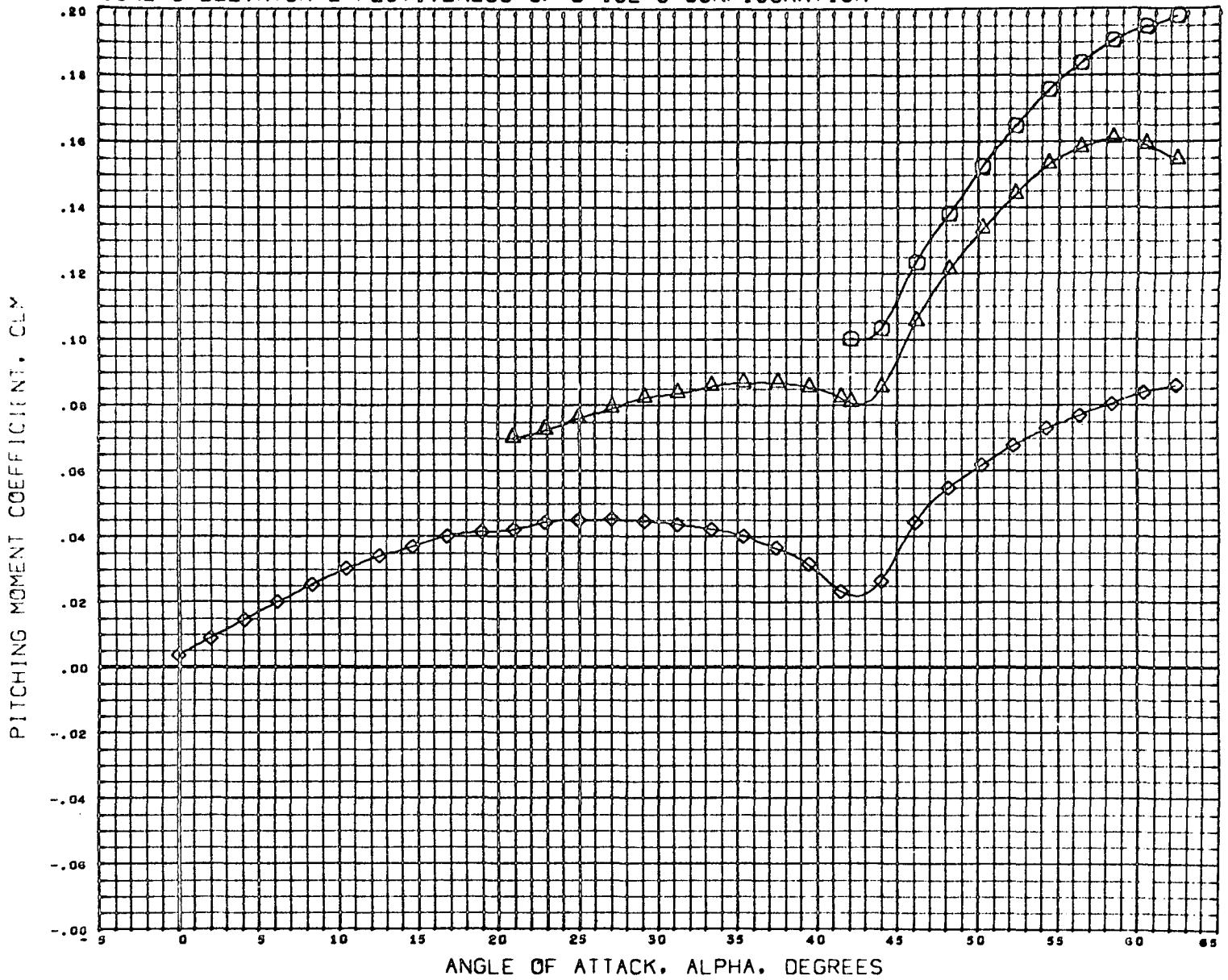

DATA SET SYMBOL	CONFIGURATION DESCRIPTION
(C50030)	MSFC TWT 514 E3 830W23C10
(C50020)	MSFC TWT 514 E3 830W23C10
(C50010)	MSFC TWT 514 E3 830W23C10
(C50190)	DATA NOT AVAILABLE FOR ALL CONDITIONS

BETA	ELEVTR	CANARD
0.000	-40.000	0.000
0.000	-20.000	0.000
0.000	0.000	0.000
0.000	10.000	0.000

REFERENCE INFORMATION		
SREF	15.0300	sq INC
LREF	2.8300	INCHES
BREF	6.0620	INCHES
XMRP	2.1110	INCHES
YMRP	0.0000	INCHES
ZMRP	0.0000	INCHES
SCALE	0.0035	

MACH 2.990

FIGURE-3 ELEVATOR EFFECTIVENESS OF B-18E-3 CONFIGURATION

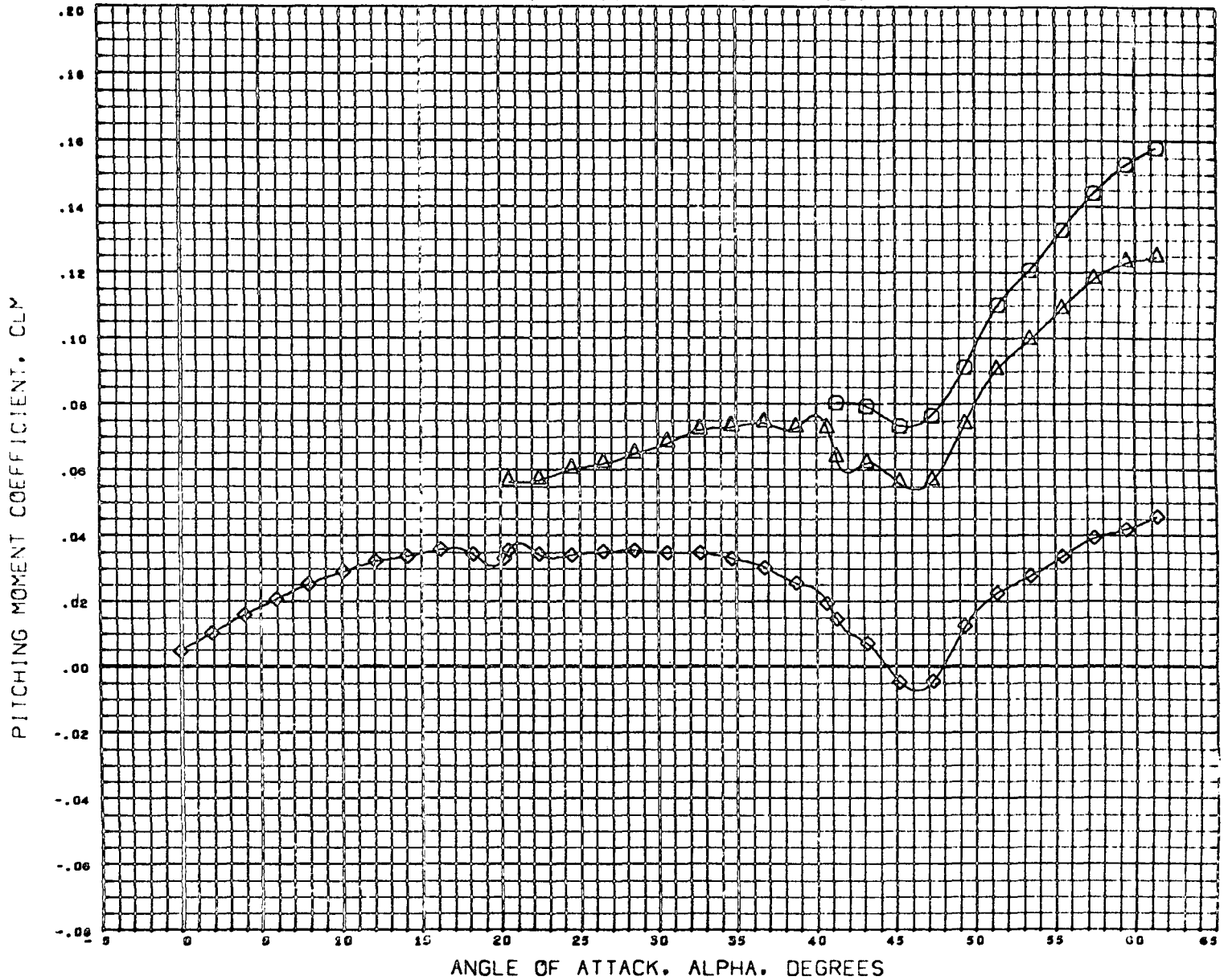

DATA SET SYMBOL	CONFIGURATION DESCRIPTION
(C5L030)	MSFC TWT 914 E3 030W23C10
(C5L020)	MSFC TWT 914 E3 030W23C10
(C5L010)	MSFC TWT 914 E3 030W23C10
(D5L190)	DATA NOT AVAILABLE FOR ALL CONDITIONS

BETA	ELEVTR	CANARD
0.000	-40.000	0.000
0.000	-20.000	0.000
0.000	0.000	0.000
0.000	10.000	0.000

REFERENCE INFORMATION		
SREF	15.0300	50 INC
LREF	2.0300	INCHES
BREF	6.0620	INCHES
XMRP	2.1110	INCHES
YMRP	0.0000	INCHES
ZMRP	0.0000	INCHES
SCALE	0.0035	

MACH 4.959

FIGURE-3 ELEVATOR EFFECTIVENESS OF B-18E-3 CONFIGURATION

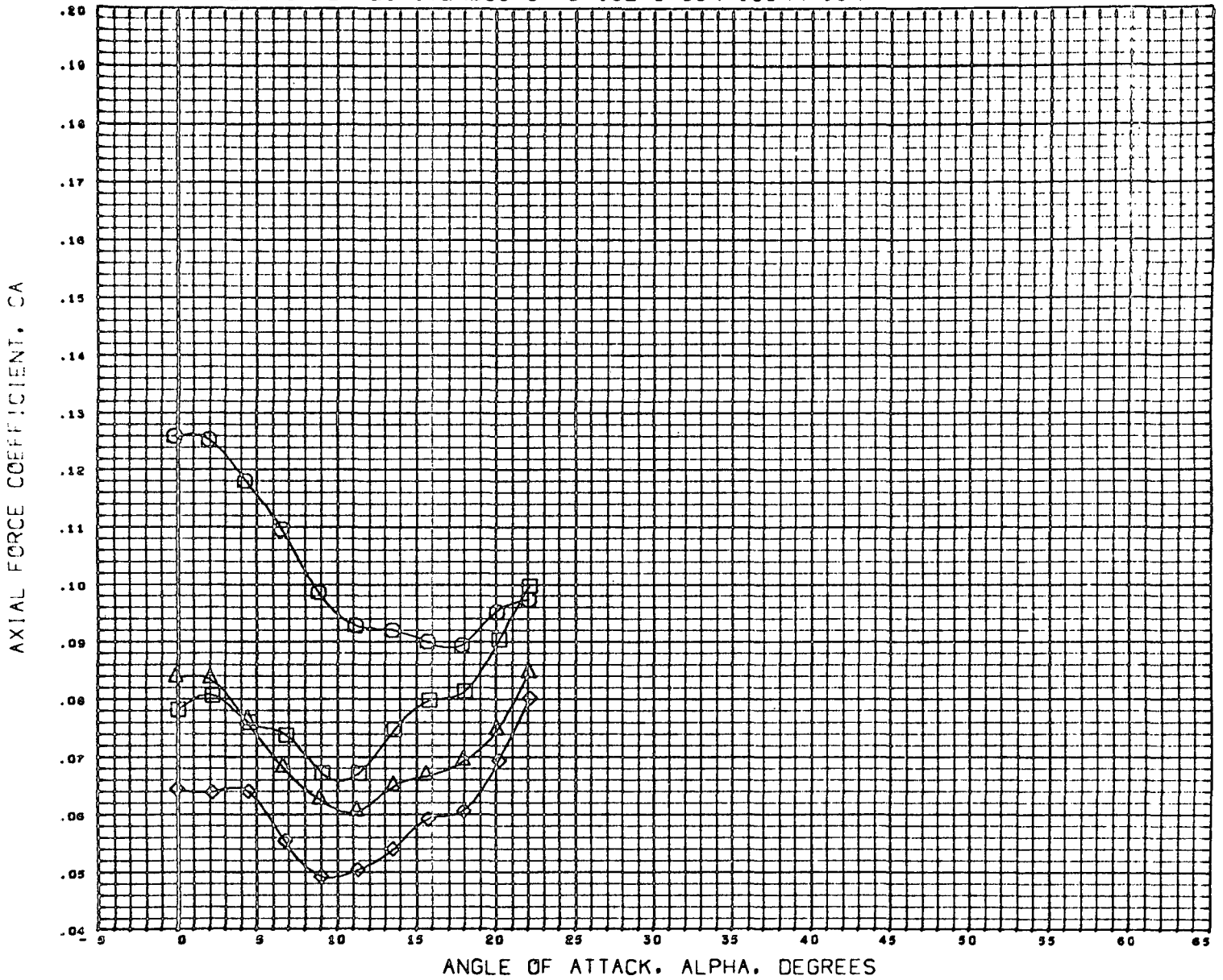

DATA SET SYMBOL	SYMBOL	CONFIGURATION DESCRIPTION
(C58030)	○	MSFC TWT 514 E3 830W23C1G
(C58120)	△	MSFC TWT 514 E3 830W23C1G
(C58010)	◇	MSFC TWT 514 E3 830W23C1G
(D58190)	□	MSFC TWT 514 E3 830W23C1G

BETA	ELEVTR	CANARD
0.000	-40.000	0.000
0.000	-20.000	0.000
0.000	0.000	0.000
0.000	10.000	0.000

REFERENCE INFORMATION		
SREF	15.0300	80 INC
LREF	2.8300	INCHES
BREF	6.0620	INCHES
XMRP	2.1110	INCHES
YMRP	0.0000	INCHES
ZMRP	0.0000	INCHES
SCALE	0.0039	

MACH 0.900

FIGURE-3 ELEVATOR EFFECTIVENESS OF B-18E-3 CONFIGURATION

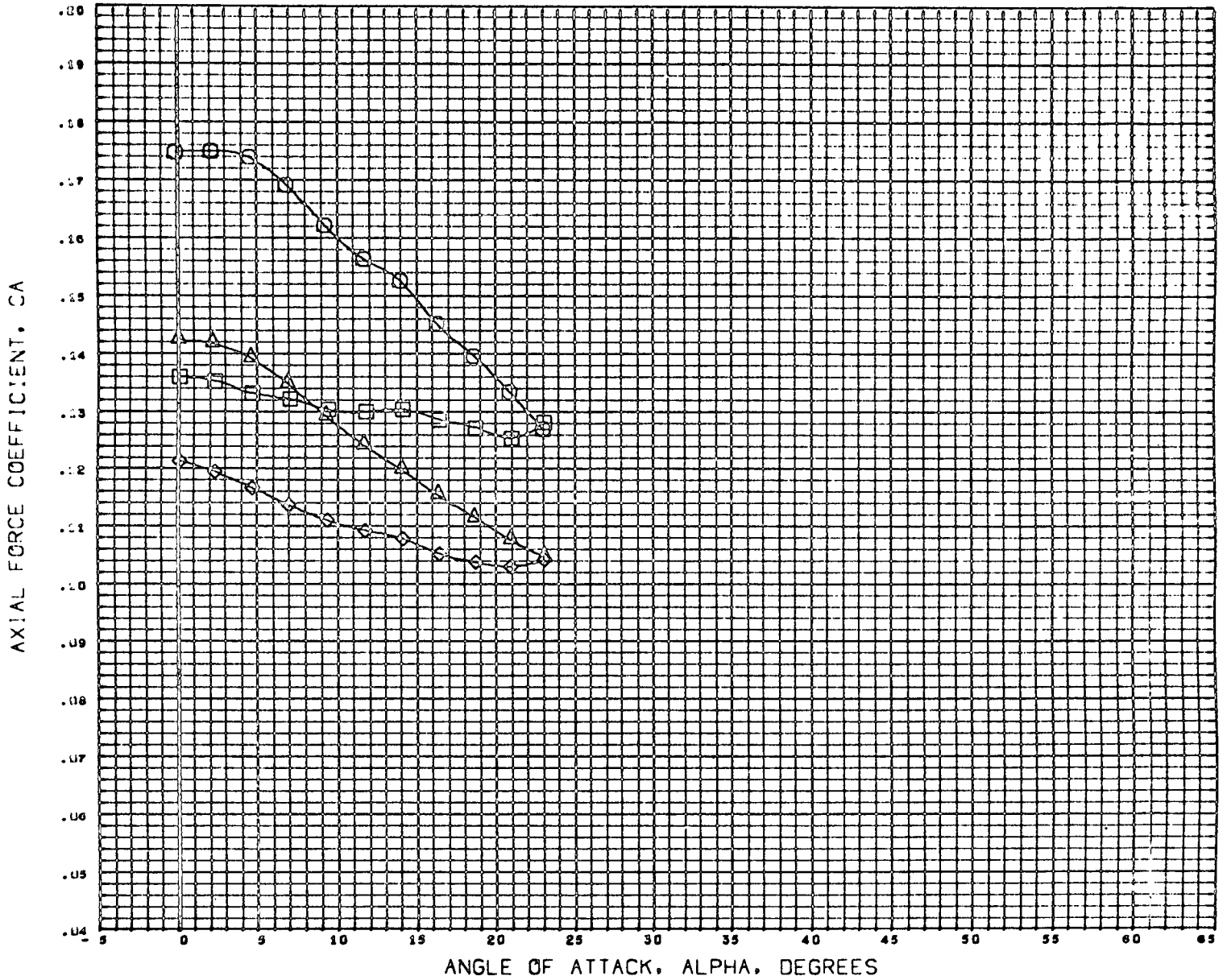

DATA SET	SYMBOL	CONFIGURATION DESCRIPTION
(C50030)	○	MSFC TWT 514 E3 030W23C10
(C50020)	△	MSFC TWT 514 E3 030W23C10
(C50010)	◇	MSFC TWT 514 E3 030W23C10
(050100)	□	MSFC TWT 514 E3 030W23C10

BETA	ELEVTR	CANARD
0.000	-40.000	0.000
0.000	-20.000	0.000
0.000	0.000	0.000
0.000	10.000	0.000

REFERENCE INFORMATION		
SREF	15.0300	90 INC
LREF	2.0300	INCHES
BREF	6.0620	INCHES
XMRP	2.1110	INCHES
YMRP	0.0000	INCHES
ZMRP	0.0000	INCHES
SCALE	0.0035	

MACH 1.198

FIGURE-3 ELEVATOR EFFECTIVENESS OF B-18E-3 CONFIGURATION

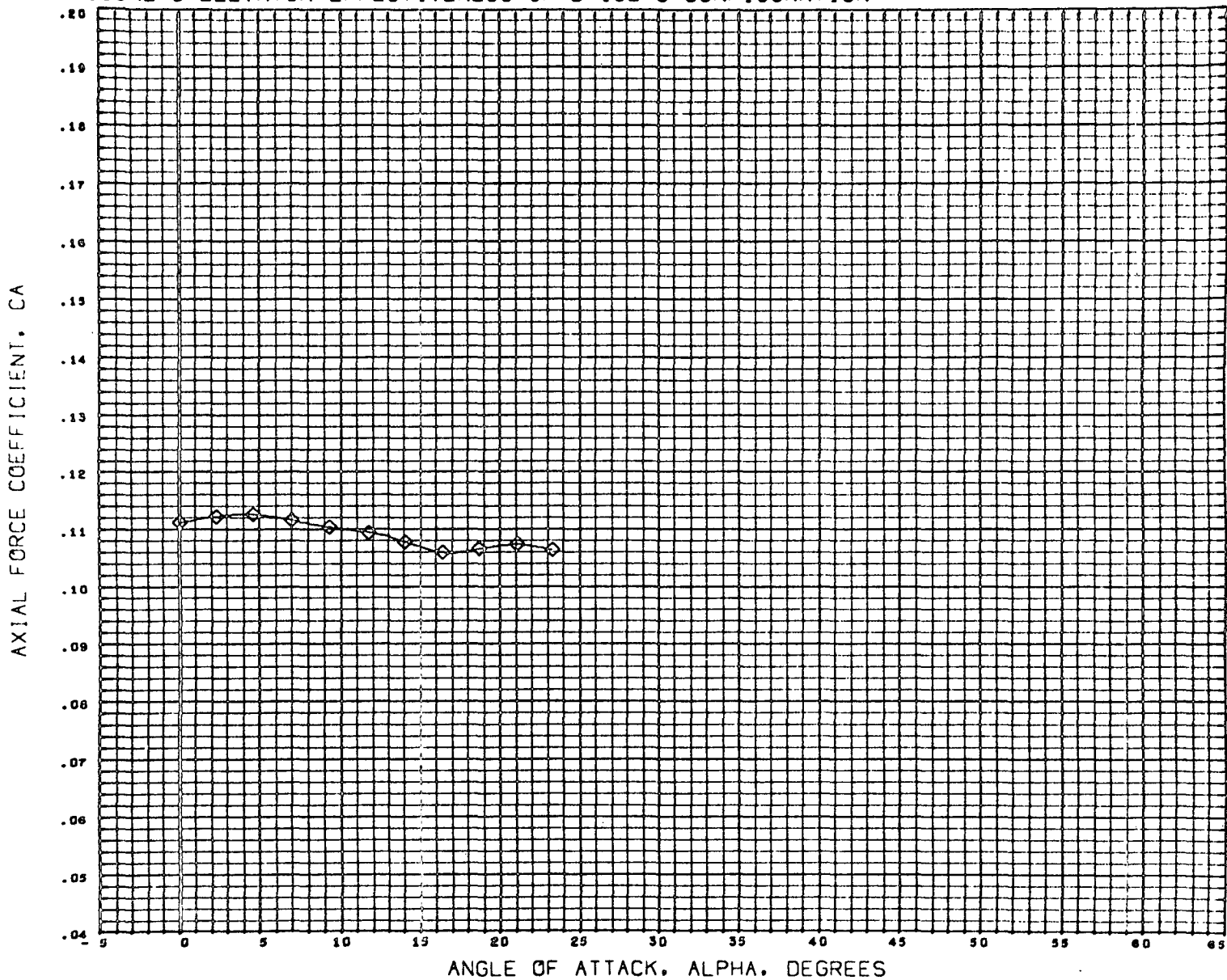

DATA SET SYMBOL	CONFIGURATION DESCRIPTION
(CS1030)	DATA NOT AVAILABLE FOR ALL CONDITIONS
(CS1020)	DATA NOT AVAILABLE FOR ALL CONDITIONS
(CS1010)	MSFC TWT 514 E3 B30W23C10
(CSJ190)	DATA NOT AVAILABLE FOR ALL CONDITIONS

BETA	ELEVTR	CANARD
0.000	-40.000	0.000
0.000	-20.000	0.000
0.000	0.000	0.000
0.000	10.000	0.000

REFERENCE INFORMATION		
SREF	15.0303	SQ INC
LREF	2.8303	INCHES
BREF	6.0623	INCHES
XMRP	2.1113	INCHES
YMRP	0.0000	INCHES
ZMRP	0.0000	INCHES
SCALE	0.0033	

MACH 1.450

FIGURE-3 ELEVATOR EFFECTIVENESS OF B-18E-3 CONFIGURATION

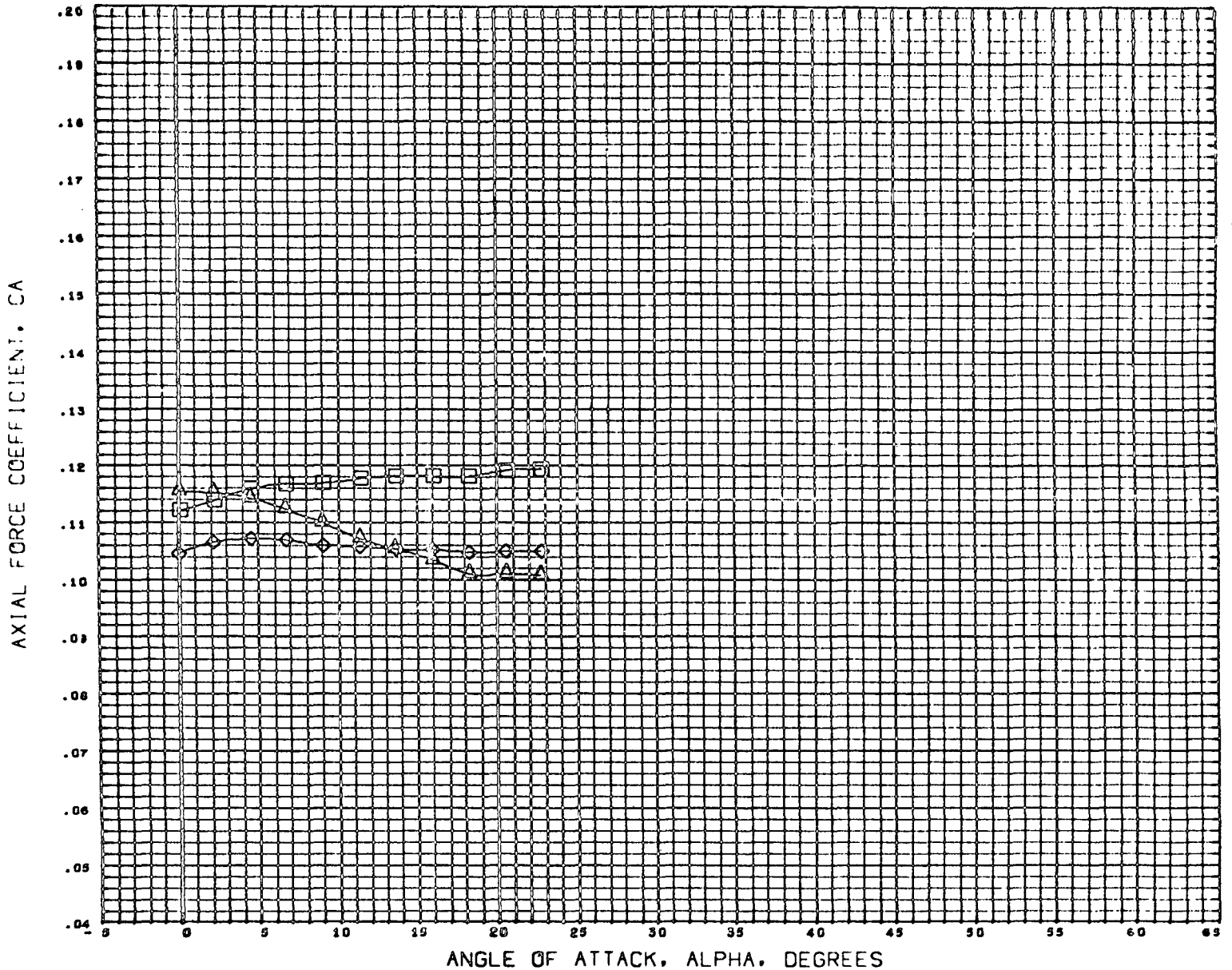

DATA SET SYMBOL	CONFIGURATION DESCRIPTION
(C59030)	DATA NOT AVAILABLE FOR ALL CONDITIONS
(C50C20)	MSFC TWT 514 E3 B30W23C10
(C58010)	MSFC TWT 514 E3 B30W23C10
(D58190)	MSFC TWT 514 E3 B30W23C10

BETA	ELEVTR	CANARD
0.000	-40.000	0.000
0.000	-20.000	0.000
0.000	0.000	0.000
0.000	10.000	0.000

REFERENCE INFORMATION		
SREF	15.0300	90 INC
LREF	2.8300	INCHE0
BREF	0.0620	INCHE0
XMRP	2.1110	INCHE0
YMRP	0.0000	INCHE0
ZMRP	0.0000	INCHE0
SCALE	0.0035	

MACH 1.995

FIGURE-3 ELEVATOR EFFECTIVENESS OF B-18E-3 CONFIGURATION

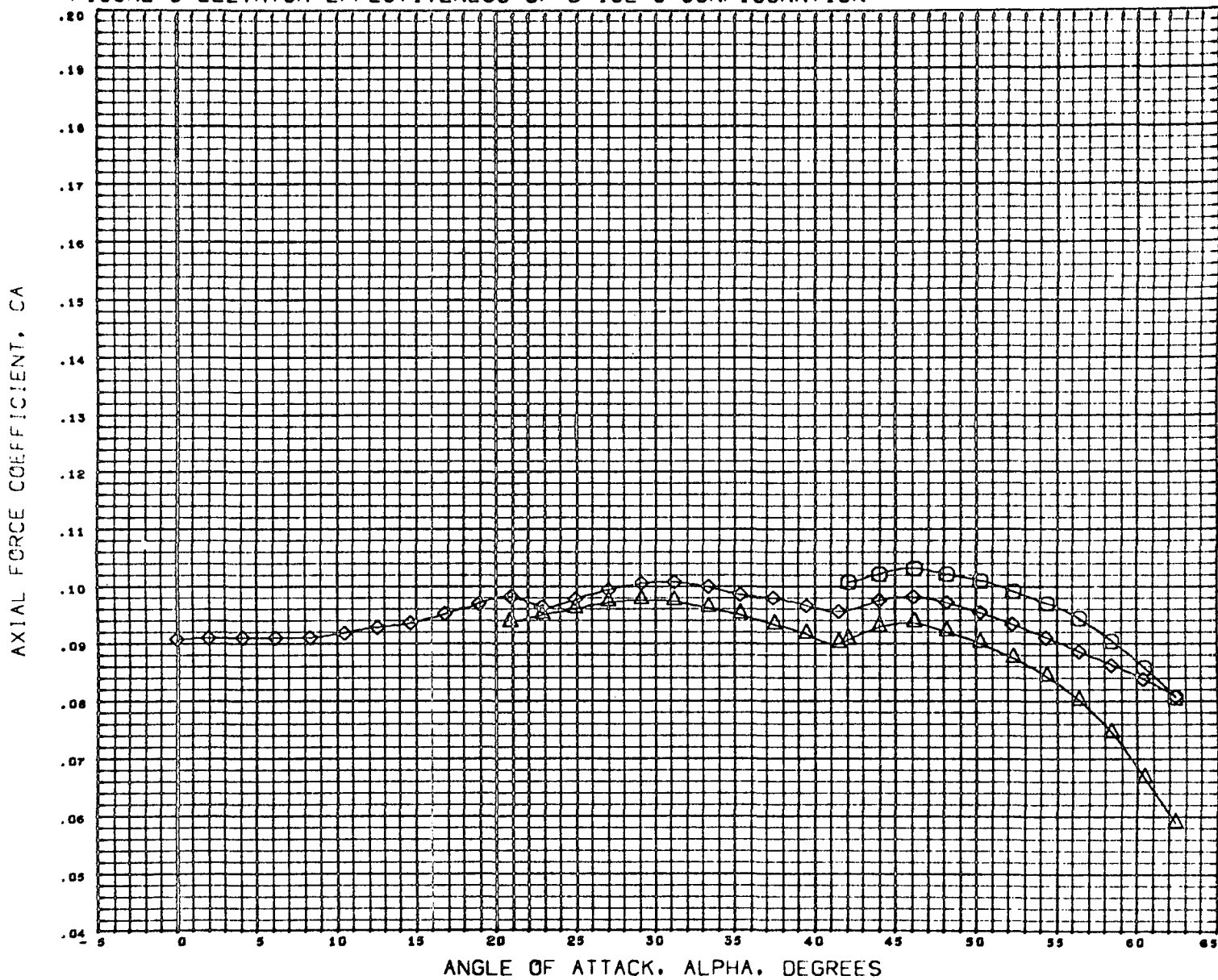

DATA SET SYMBOL	CONFIGURATION DESCRIPTION
(C50030)	MSFC TWT 514 E3 B30W23C10
(C58020)	MSFC TWT 514 E3 B30W23C10
(C58010)	MSFC TWT 514 E3 B30W23C10
(D58190)	DATA NOT AVAILABLE FOR ALL CONDITIONS

BETA	ELEVTR	CANARD
0.000	-40.000	0.000
0.000	-20.000	0.000
0.000	0.000	0.000
0.000	10.000	0.000

REFERENCE INFORMATION		
SREF	15.0300	90 INC
LREF	2.8300	INCHES
BREF	6.0620	INCHES
XMRP	2.1110	INCHES
YMRP	0.0000	INCHES
ZMRP	0.0000	INCHES
SCALE	0.0035	

MACH 2.990

FIGURE-3 ELEVATOR EFFECTIVENESS OF B-18E-3 CONFIGURATION

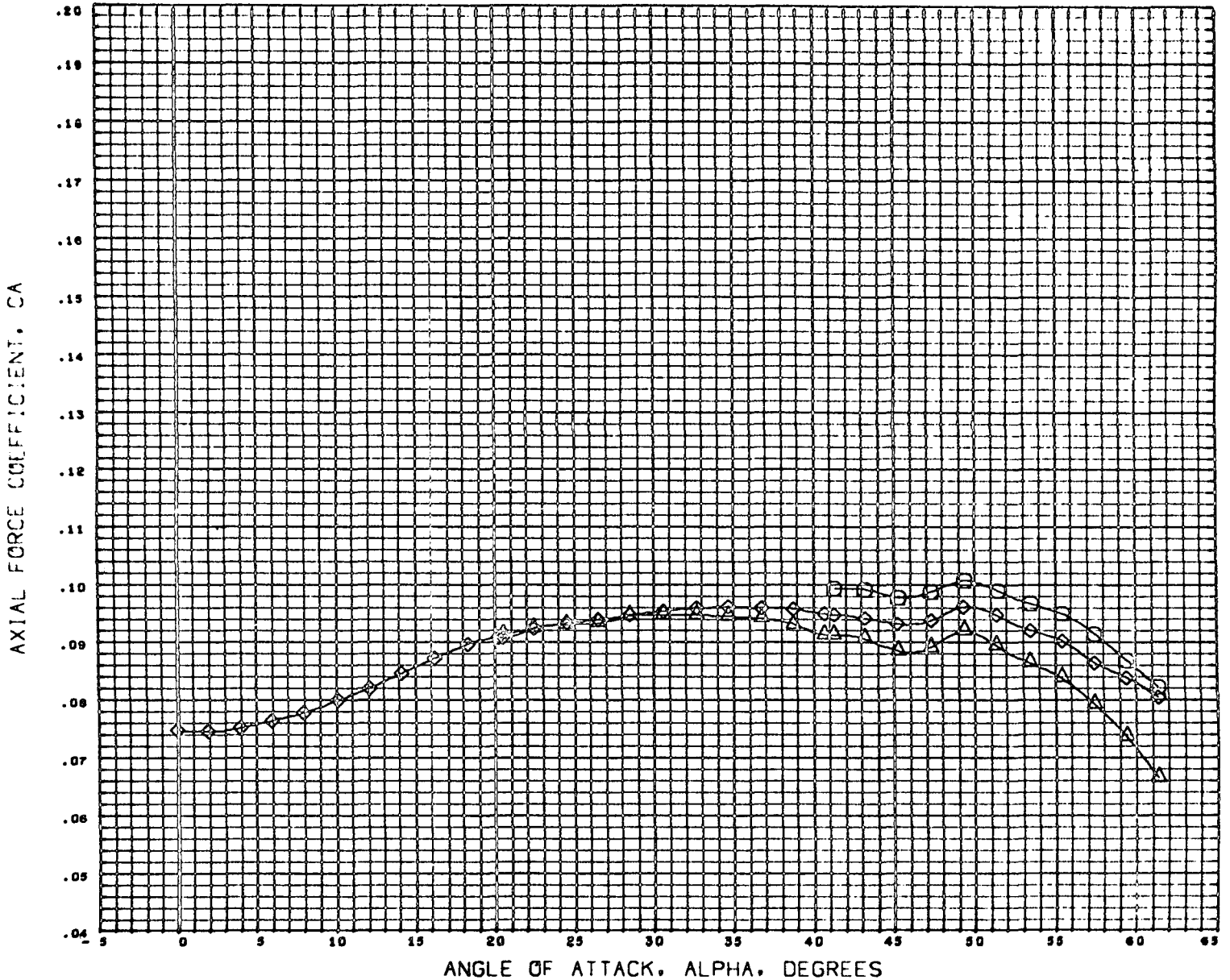

DATA SET SYMBOL	CONFIGURATION DESCRIPTION
(C58(30))	MSFC TWT 514 E3 B30W23C10
(C58(20))	MSFC TWT 514 E3 B30W23C10
(C58(10))	MSFC TWT 514 E3 B30W23C10
(D58190)	DATA NOT AVAILABLE FOR ALL CONDITIONS

BETA	ELEVTR	CANARD
0.000	-40.000	0.000
0.000	-20.000	0.000
0.000	0.000	0.000
0.000	10.000	0.000

REFERENCE INFORMATION		
SREF	15.0300	90 INC
LREF	2.8300	INCHES
BREF	6.0620	INCHES
XMRP	2.1110	INCHES
YMRP	0.0000	INCHES
ZMRP	0.0000	INCHES
SCALE	0.0035	

MACH 4.959

FIGURE-3 ELEVATOR EFFECTIVENESS OF B-18E-3 CONFIGURATION

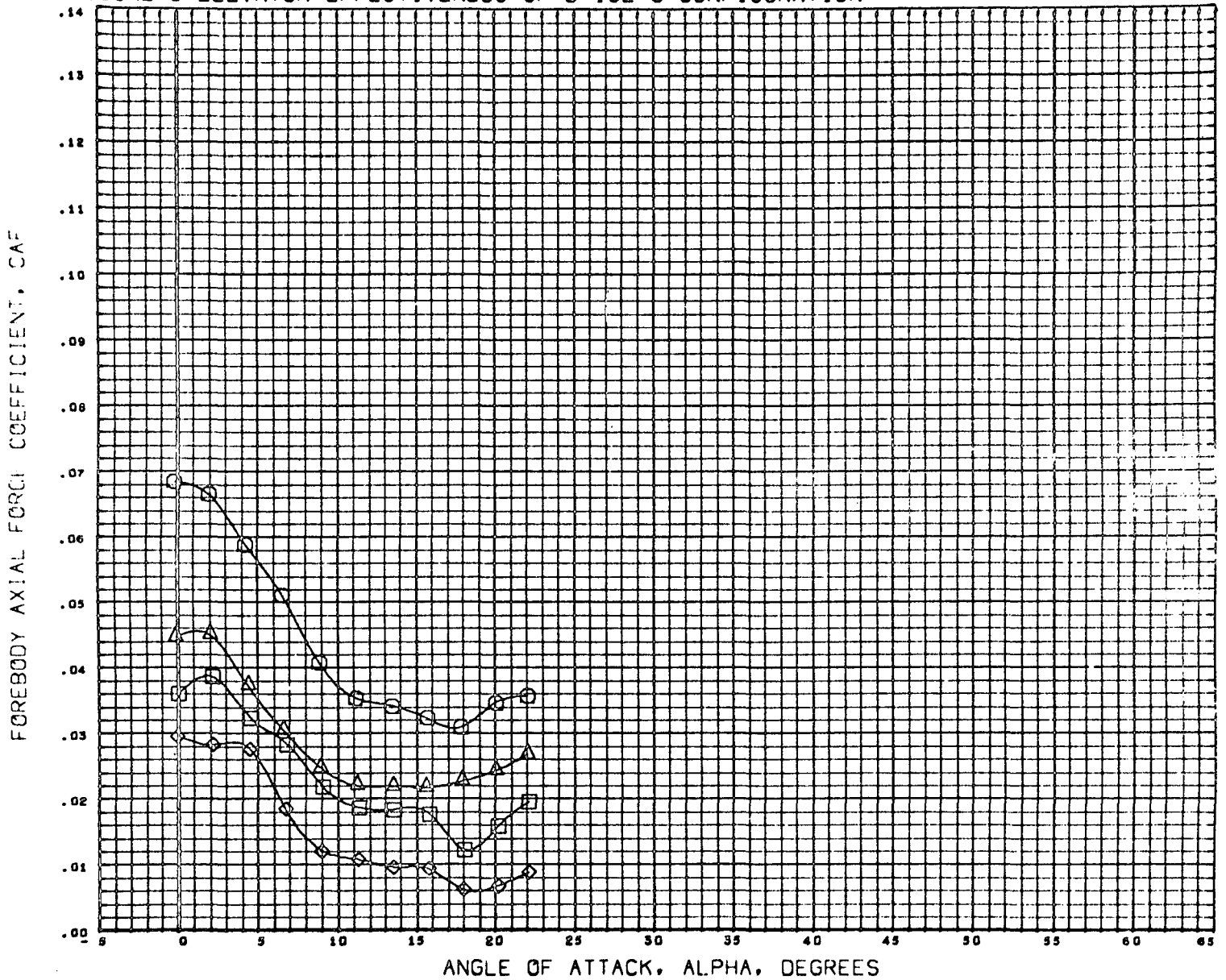

DATA SET	SYMBOL	CONFIGURATION DESCRIPTION
(C98050)	○	MSFC TWT 514 E3 B30W23C10
(C98020)	△	MSFC TWT 514 E3 B30W23C10
(C98010)	◇	MSFC TWT 514 E3 B30W23C10
(D98190)	□	MSFC TWT 514 E3 B30W23C10

BETA	ELEVTR	CANARD
0.000	-40.000	0.000
0.000	-20.000	0.000
0.000	0.000	0.000
0.000	10.000	0.000

REFERENCE INFORMATION		
SREF	15.0500	90 INC
LREF	2.8500	INCHES
BREF	6.0020	INCHES
XMRP	2.1110	INCHES
YMRP	0.0000	INCHES
ZMRP	0.0000	INCHES
SCALE	0.0035	

MACH 0.900

FIGURE-3 ELEVATOR EFFECTIVENESS OF B-18E-3 CONFIGURATION

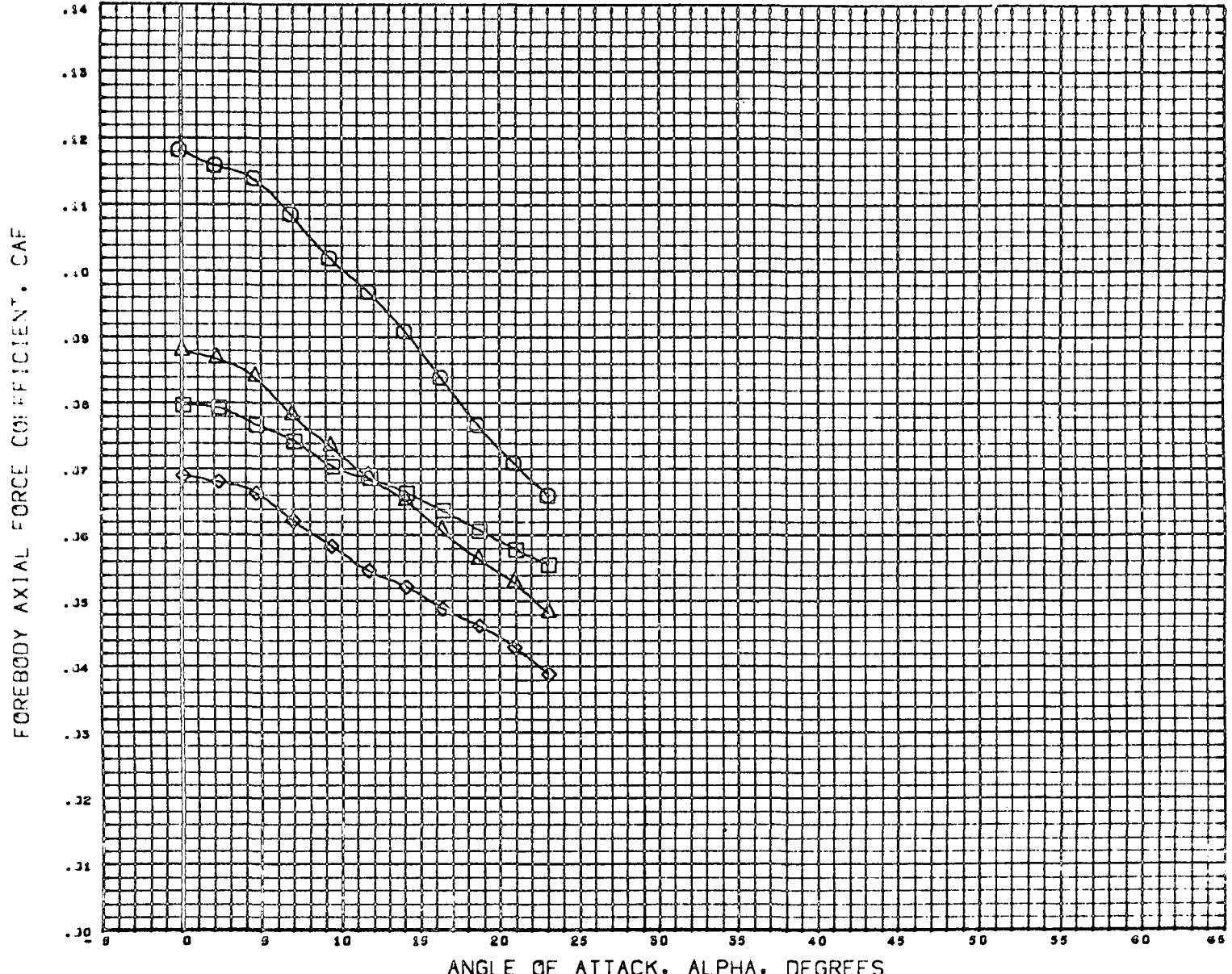

DATA SET	SYMBOL	CONFIGURATION DESCRIPTION
(C50030)	○	MSFC TWT 514 E3 030W23C10
(C50020)	△	MSFC TWT 514 E3 030W23C10
(C50010)	◇	MSFC TWT 514 E3 030W23C10
(058100)	□	MSFC TWT 514 E3 030W23C10

BETA	ELEVTR	CANARD
0.000	-40.000	0.000
0.000	-20.000	0.000
0.000	0.000	0.000
0.000	10.000	0.000

REFERENCE INFORMATION		
SREF	15.0300	50 INC
LREF	2.8300	INCHES
BREF	0.0620	INCHES
XMRP	2.1110	INCHES
YMRP	0.0000	INCHES
ZMRP	0.0000	INCHES
SCALE	0.0035	

MACH 1.198

FIGURE-3 ELEVATOR EFFECTIVENESS OF B-18E-3 CONFIGURATION

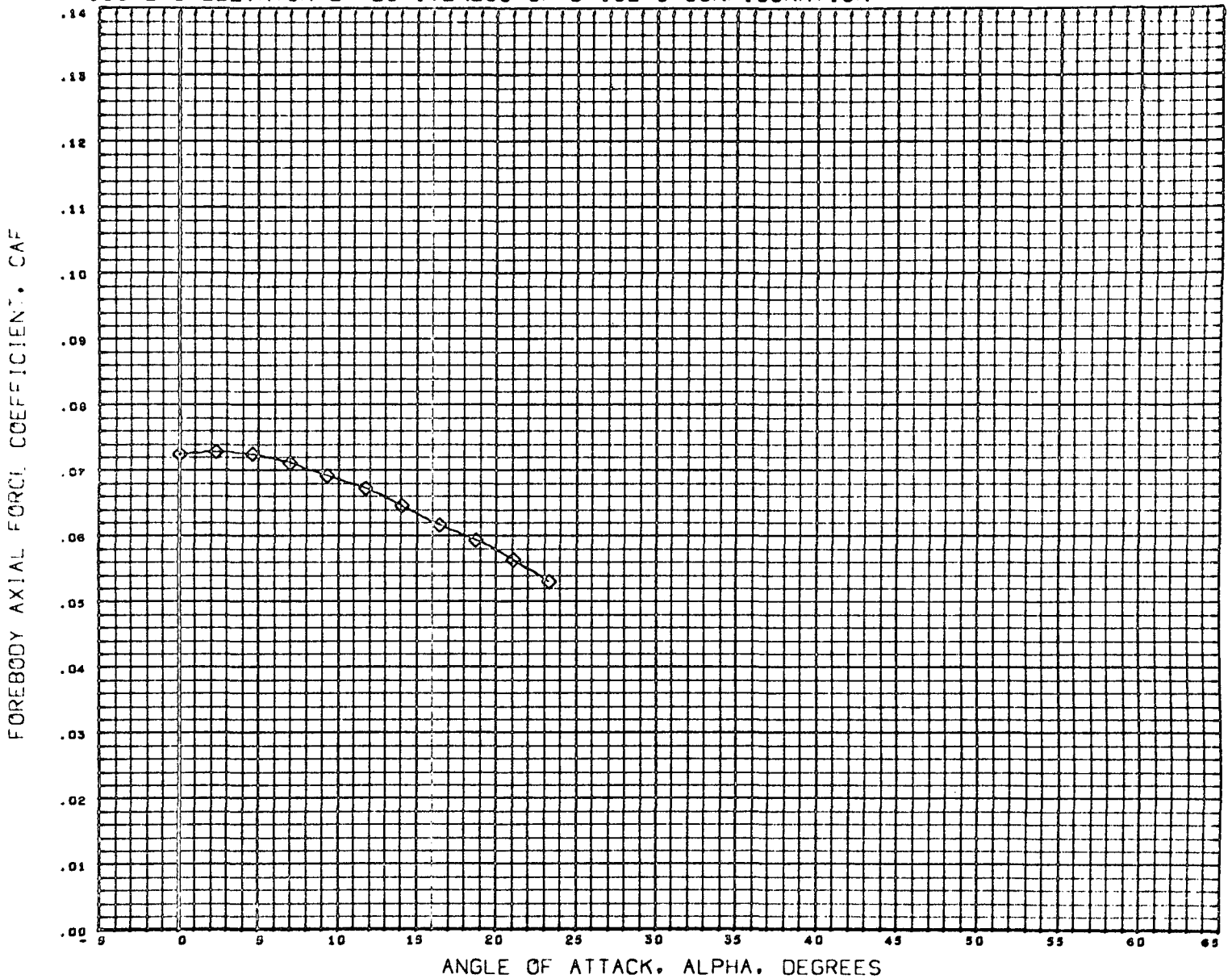

DATA SET SYMBOL	CONFIGURATION DESCRIPTION
(C50130)	DATA NOT AVAILABLE FOR ALL CONDITIONS
(C50120)	DATA NOT AVAILABLE FOR ALL CONDITIONS
(C50110)	M5FC TWI 514 E3 B30W23C10
(050190)	DATA NOT AVAILABLE FOR ALL CONDITIONS

BETA	ELEVTR	CANARD
0.000	-40.000	0.000
0.000	-20.000	0.000
0.000	0.000	0.000
0.000	10.000	0.000

REFERENCE INFORMATION		
SREF	15.0300	50 INC
LREF	2.8300	INCHES
BREF	6.0620	INCHES
XMRP	2.1110	INCHES
YNRP	0.0000	INCHES
ZMRP	0.0000	INCHES
SCALE	0.0035	

MACH 1.450

FIGURE-3 ELEVATOR EFFECTIVENESS OF B-18E-3 CONFIGURATION

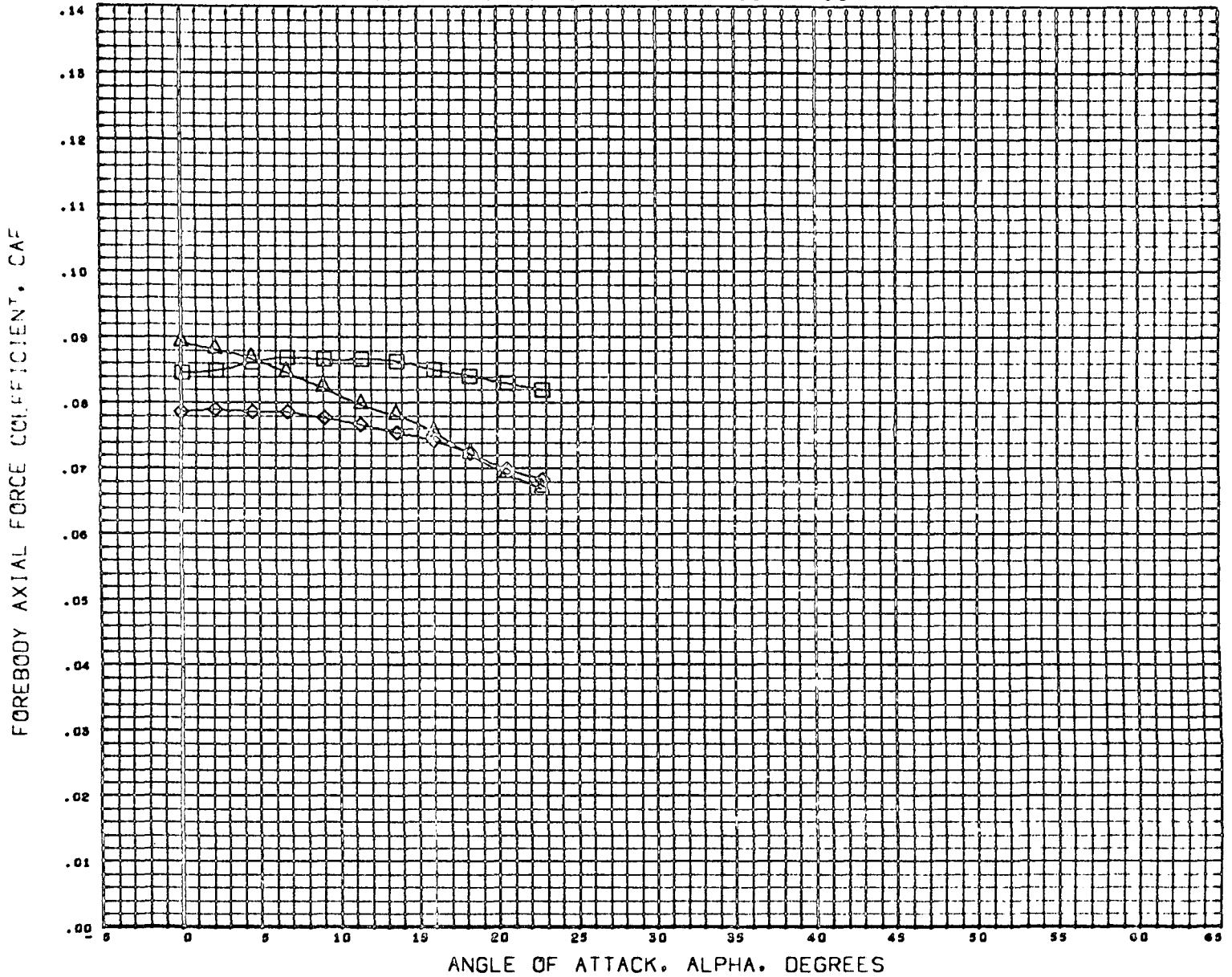

DATA SET	SYMBOL	CONFIGURATION DESCRIPTION
(C50030)	○	DATA NOT AVAILABLE FOR ALL CONDITIONS
(C50020)	△	MSFC TWT 514 E3 B30W23C10
(C50010)	◇	MSFC TWT 514 E3 B30W23C10
(D58190)	□	MSFC TWT 514 E3 B30W23C10

BETA	ELEVTR	CANARD
0.000	-40.000	0.000
0.000	-20.000	0.000
0.000	0.000	0.000
0.000	10.000	0.000

REFERENCE INFORMATION		
SREF	15.0300	50 INC
LREF	2.0300	INCHES
BREF	6.0620	INCHES
XMRP	2.1110	INCHES
YMRP	0.0000	INCHES
ZMRP	0.0000	INCHES
SCALE	0.0035	

MACH 1.055

FIGURE-3 ELEVATOR EFFECTIVENESS OF B-18E-3 CONFIGURATION

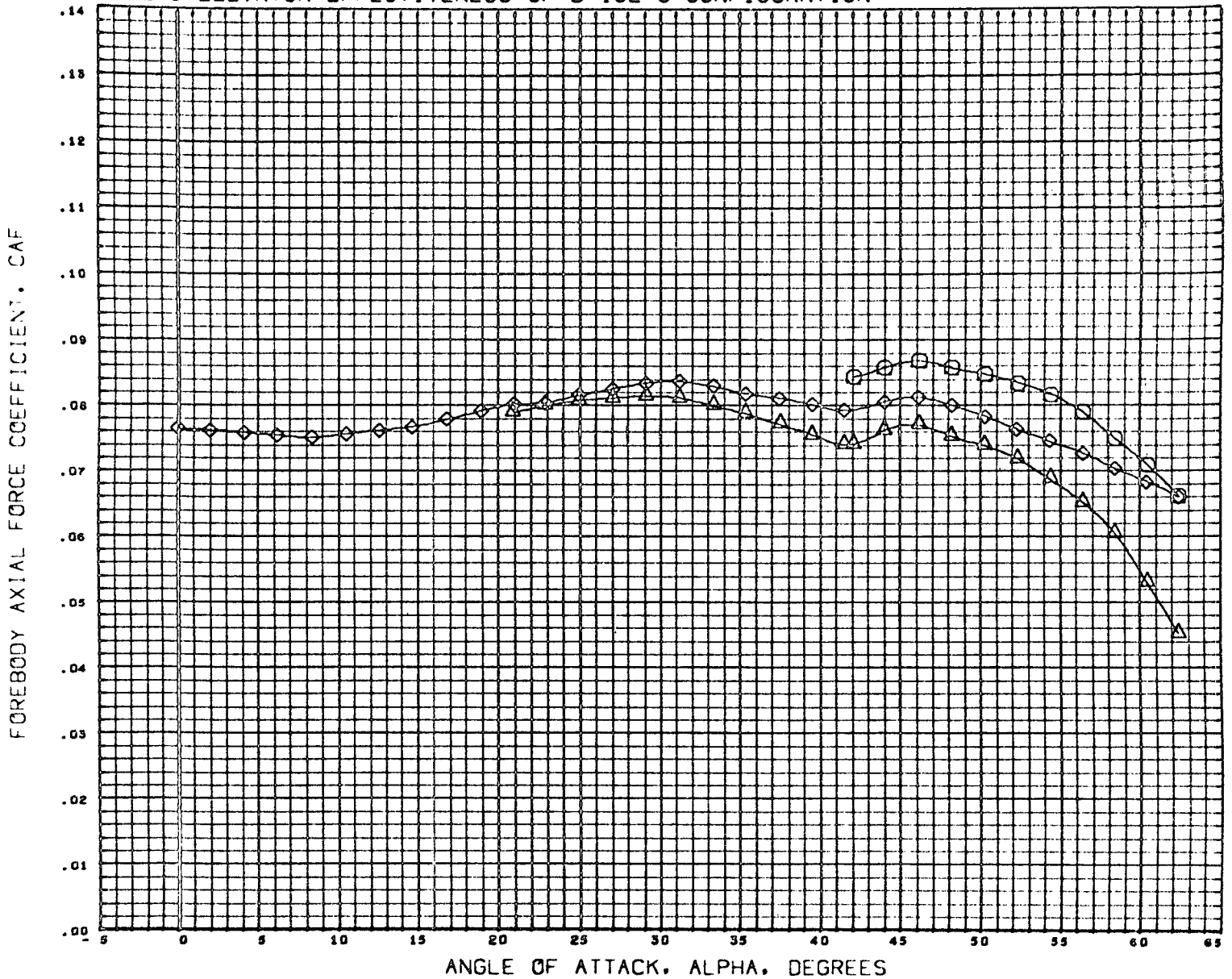

DATA SET SYMBOL	CONFIGURATION DESCRIPTION
(C58030)	MSFC TWT 514 E3 B30W23C10
(C58020)	MSFC TWT 514 E3 B30W23C10
(C58010)	MSFC TWT 514 E3 B30W23C10
(C58190)	DATA NOT AVAILABLE FOR ALL CONDITIONS

BETA	ELEVTR	CANARD
0.000	-40.000	0.000
0.000	-20.000	0.000
0.000	0.000	0.000
0.000	10.000	0.000

REFERENCE INFORMATION		
SREF	15.0300	SQ INC
LREF	2.8300	INCHES
BREF	6.0620	INCHES
XMRF	2.1110	INCHES
YMRF	0.0000	INCHES
ZMRF	0.0000	INCHES
SCALE	0.0035	

MACH 2.990

FIGURE-3 ELEVATOR EFFECTIVENESS OF B-18E-3 CONFIGURATION

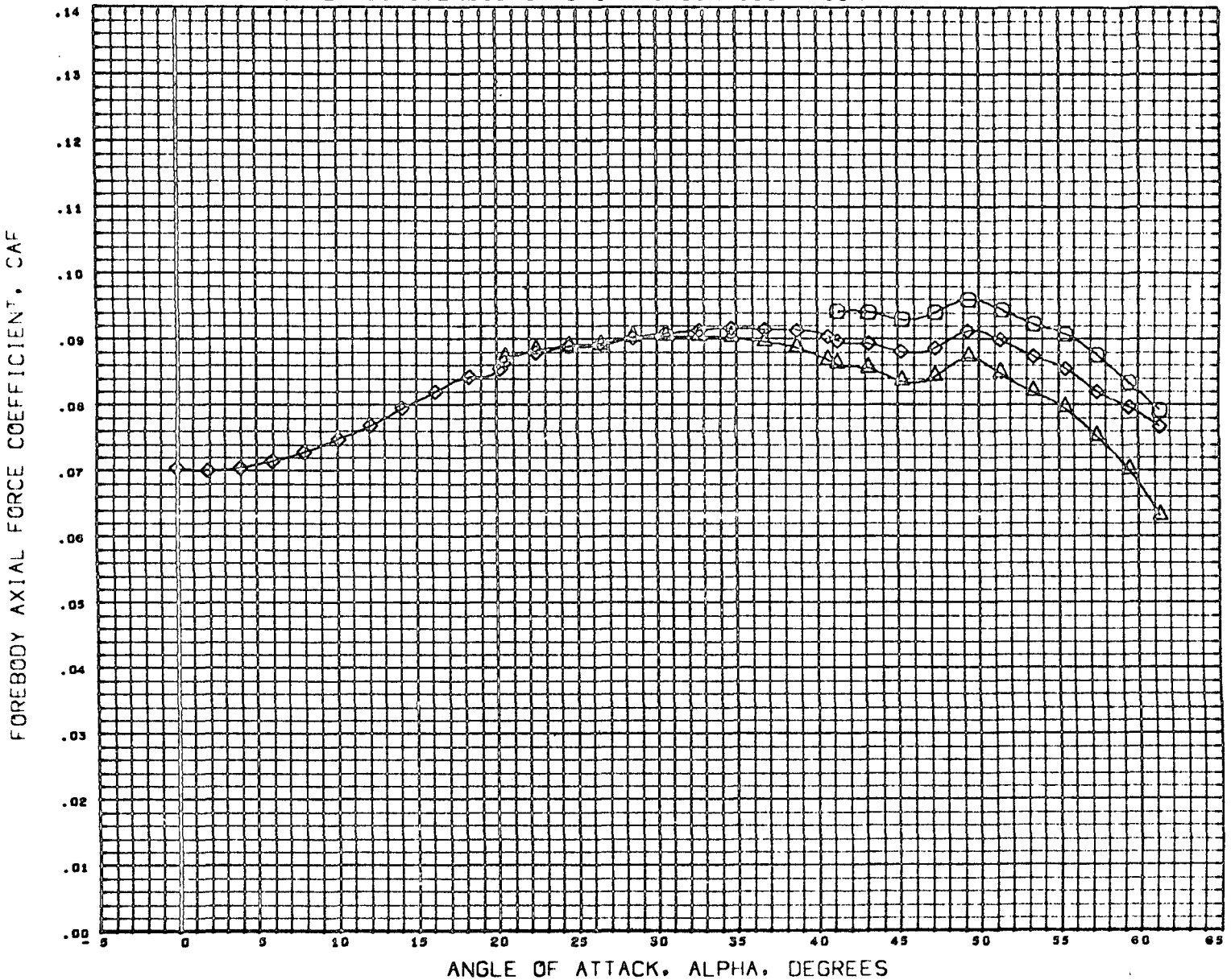

DATA SET SYMBOL	CONFIGURATION DESCRIPTION
(C:0030)	MSFC TWT 514 E3 B30W23C10
(C:0020)	MSFC TWT 514 E3 B30W23C10
(C:0010)	MSFC TWT 514 E3 B30W23C10
(D:0100)	DATA NOT AVAILABLE FOR ALL CONDITIONS

BETA	ELEVTR	CANARD
0.000	-40.000	0.000
0.000	-20.000	0.000
0.000	0.000	0.000
0.000	10.000	0.000

REFERENCE INFORMATION		
SREF	15.0300	50 INC
LREF	2.8300	INCHES
BREF	6.0620	INCHES
XMRP	2.1110	INCHES
YMRP	0.0000	INCHES
ZMRP	0.0000	INCHES
SCALE	0.0035	

MACH 4.959

FIGURE-3 ELEVATOR EFFECTIVENESS OF B-18E-3 CONFIGURATION

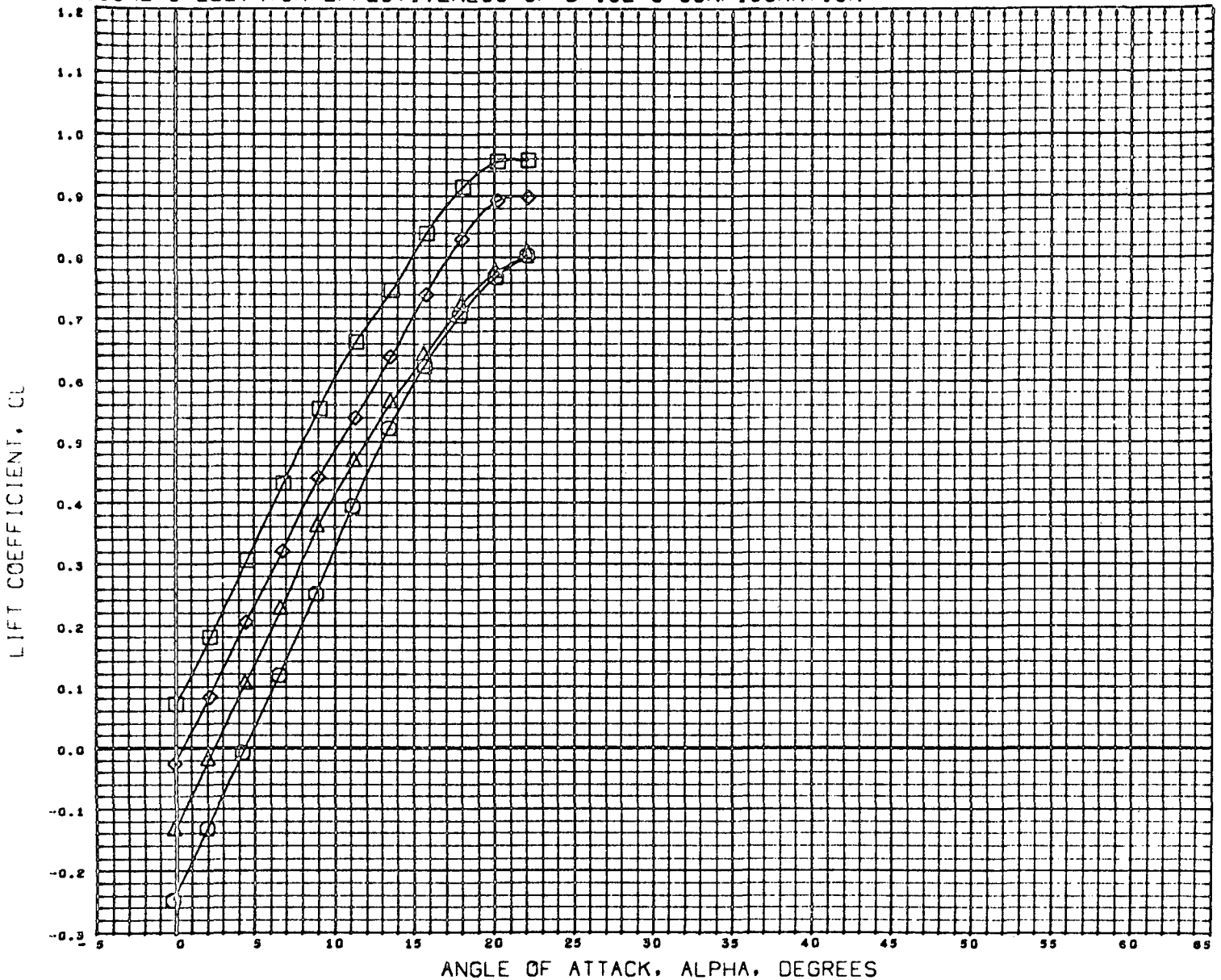

DATA SET	SYMBOL	CONFIGURATION	DESCRIPTION
(C58030)	○	MSFC TWT 514 E3	B30W23C10
(C58020)	△	MSFC TWT 514 E3	B30W23C10
(C58010)	◇	MSFC TWT 514 E3	B30W23C10
(D58190)	□	MSFC TWT 514 E3	B30W23C10

BETA	ELEVTR	CANARD
0.000	-40.000	0.000
0.000	-20.000	0.000
0.000	0.000	0.000
0.000	10.000	0.000

REFERENCE INFORMATION		
SREF	15.0300	sq INC
LREF	2.8300	INCHES
BREF	6.0620	INCHES
XMRP	2.1110	INCHES
YMRP	0.0000	INCHES
ZMRP	0.0000	INCHES
SCALE	0.0035	

MACH 0.900

FIGURE-3 ELEVATOR EFFECTIVENESS OF B-18E-3 CONFIGURATION

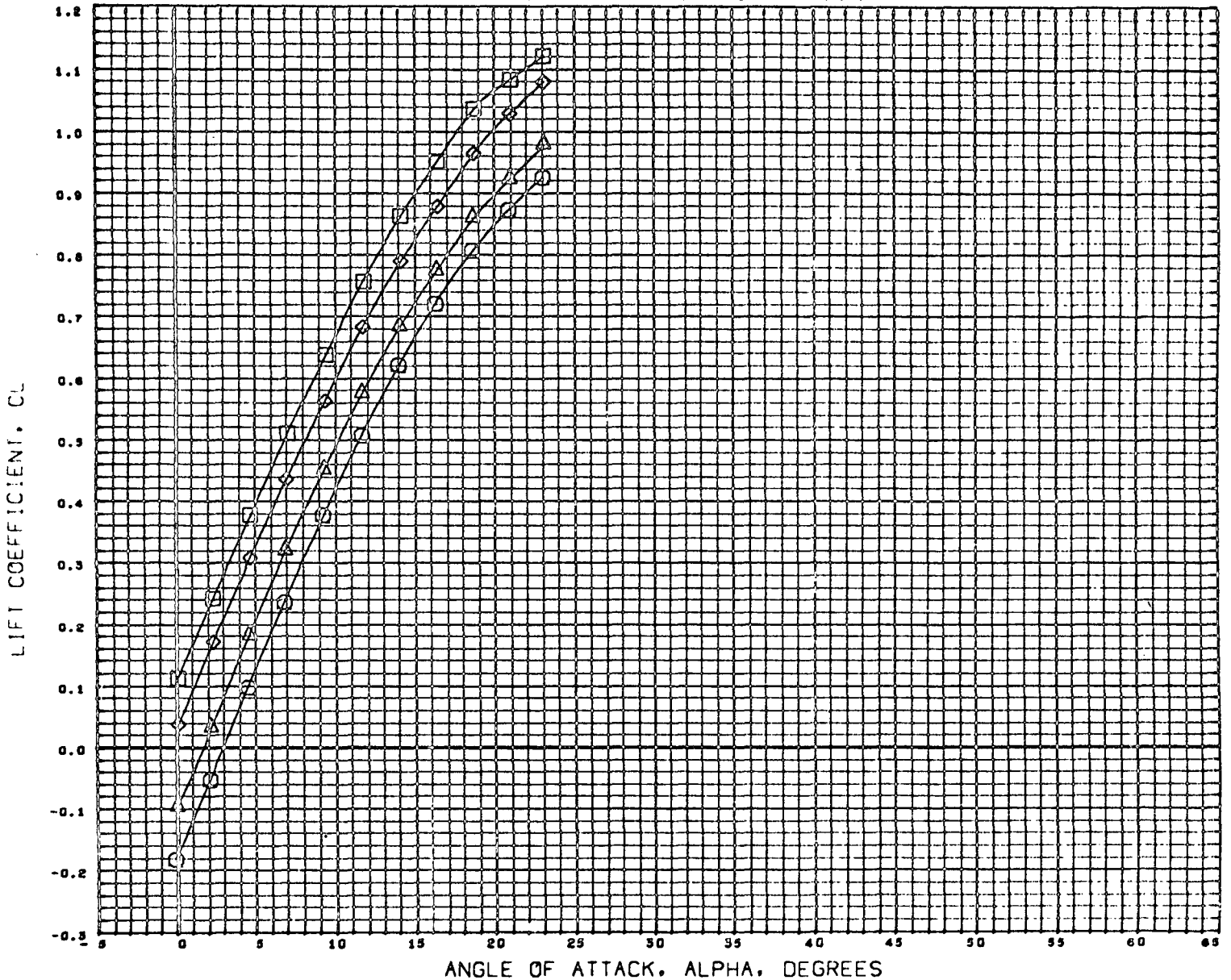

DATA SET SYMBOL	CONFIGURATION	DESCRIPTION
(C98130)	MSFC TWT 514 E3	030W23C10
(C98020)	MSFC TWT 514 E3	030W23C10
(C98010)	MSFC TWT 514 E3	030W23C10
(038190)	MSFC TWT 514 E3	030W23C10

BETA	ELEVTR	CANARD
0.000	-40.000	0.000
0.000	-20.000	0.000
0.000	0.000	0.000
0.000	10.000	0.000

REFERENCE INFORMATION		
SREF	15.0300	80 INC
LREF	2.8300	INCHES
BREF	6.0620	INCHES
XMRP	2.1110	INCHES
YMRP	0.0000	INCHES
ZMRP	0.0000	INCHES
SCALE	0.0035	

MACH 1.198

FIGURE-3 ELEVATOR EFFECTIVENESS OF B-18E-3 CONFIGURATION

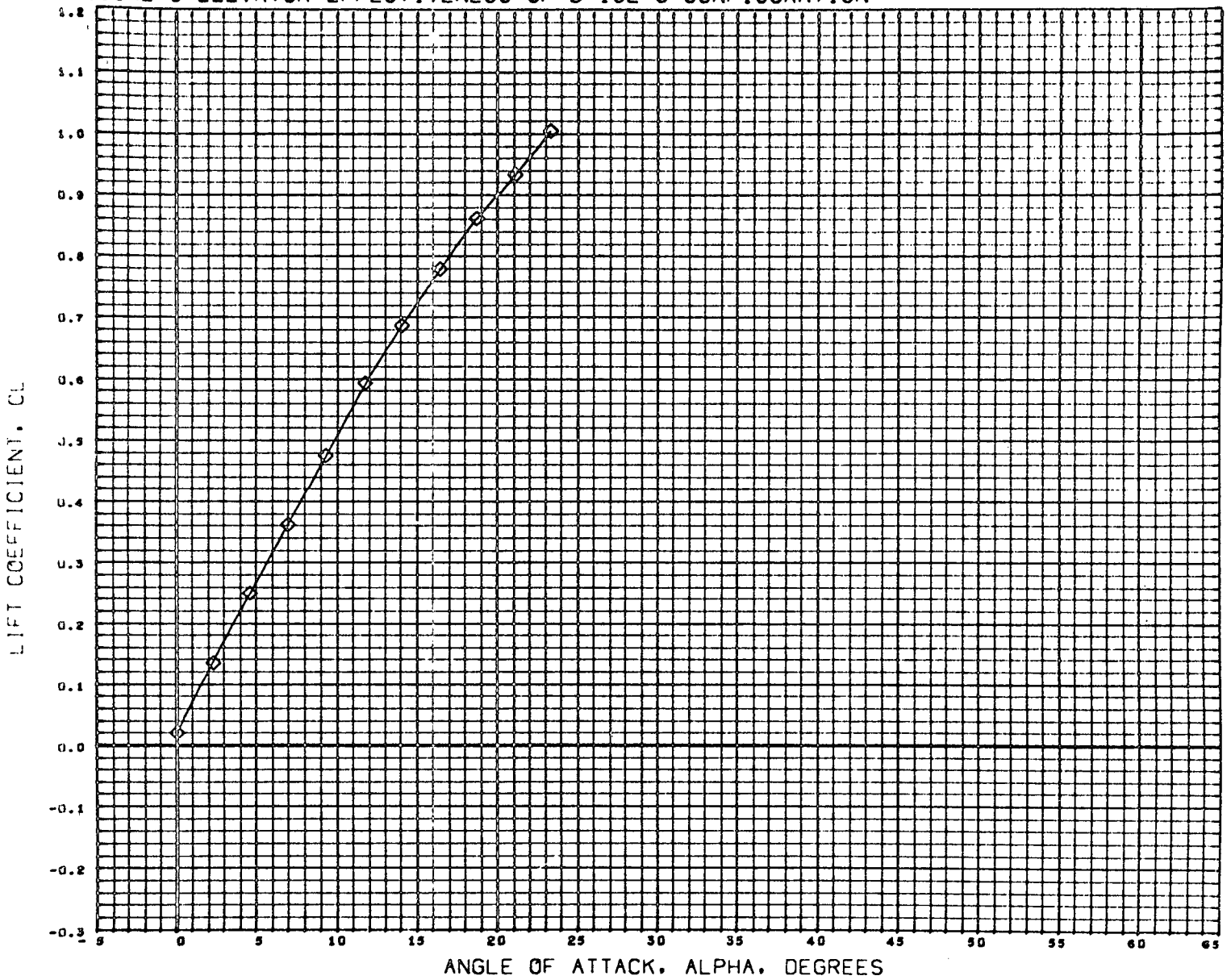

DATA SET SYMBOL	CONFIGURATION DESCRIPTION
(C58030)	DATA NOT AVAILABLE FOR ALL CONDITIONS
(C58020)	DATA NOT AVAILABLE FOR ALL CONDITIONS
(C58010)	MSFC TWT 514 E3 B30W23C10
(D58190)	DATA NOT AVAILABLE FOR ALL CONDITIONS

BETA	ELEVTR	CANARD
0.000	-40.000	0.000
0.000	-20.000	0.000
0.000	0.000	0.000
0.000	10.000	0.000

REFERENCE INFORMATION		
SREF	15.0300	SQ INC
LREF	2.8300	INCHES
BREF	6.0620	INCHES
XMRP	2.1110	INCHES
YMRP	0.0000	INCHES
ZMRP	0.0000	INCHES
SCALE	0.0039	

MACH 1.459

FIGURE-3 ELEVATOR EFFECTIVENESS OF B-18E-3 CONFIGURATION

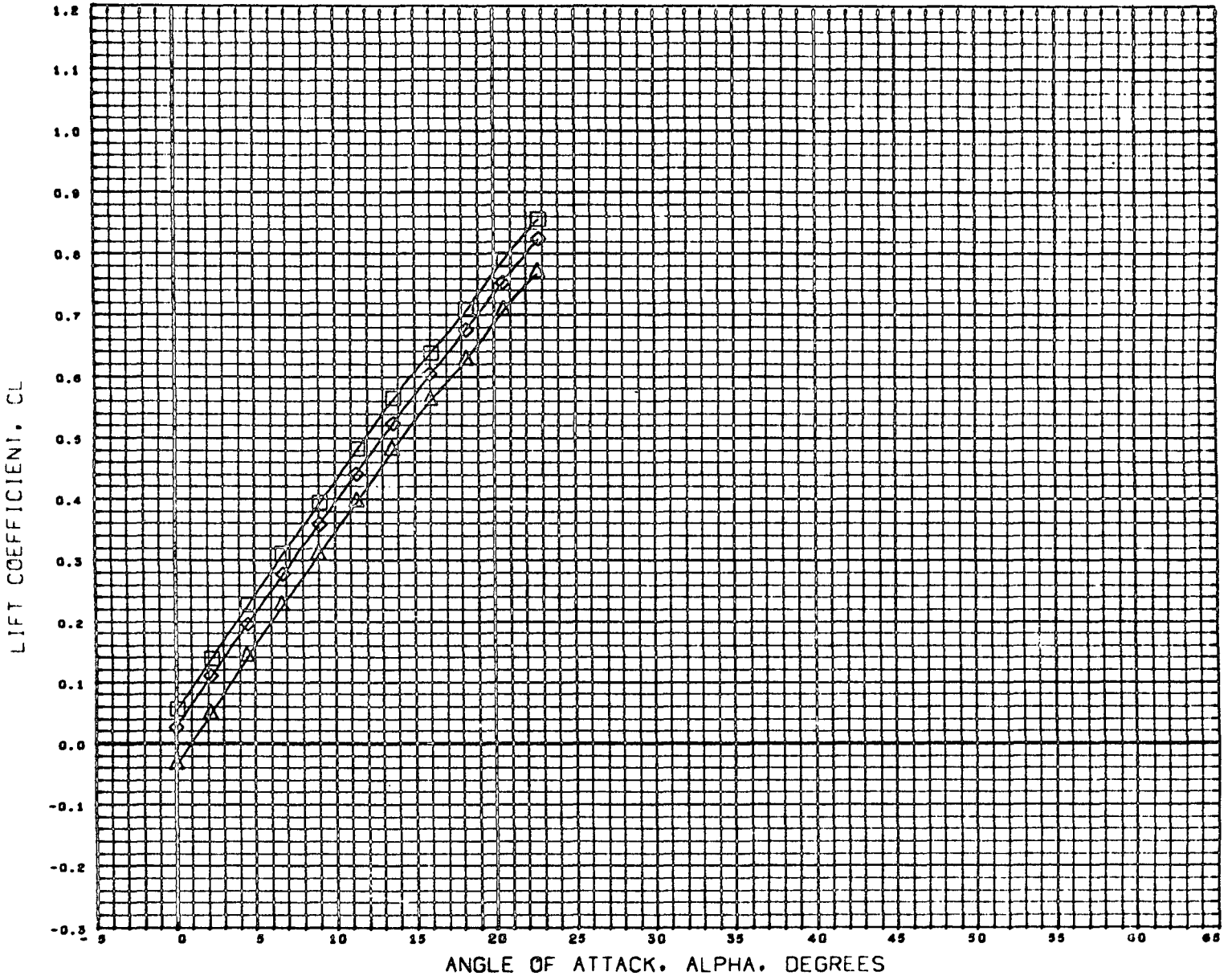

DATA SET SYMBOL	CONFIGURATION DESCRIPTION
(C56-130)	DATA NOT AVAILABLE FOR ALL CONDITIONS
(C56-120)	MSFC TWT 514 E3 030W23C10
(C56-110)	MSFC TWT 514 E3 030W23C10
(C56-90)	MSFC TWT 514 E3 030W23C10

BETA	ELEVTR	CANARD
0.000	-40.000	0.000
0.000	-20.000	0.000
0.000	0.000	0.000
0.000	10.000	0.000

REFERENCE INFORMATION		
SREF	15.0300	sq INC
LREF	2.6300	INCHES
BREF	6.0620	INCHES
XMRP	2.1110	INCHES
YMRP	0.0000	INCHES
ZMRP	0.0000	INCHES
SCALE	0.0035	

MACH 1.955

FIGURE-3 ELEVATOR EFFECTIVENESS OF B-18E-3 CONFIGURATION

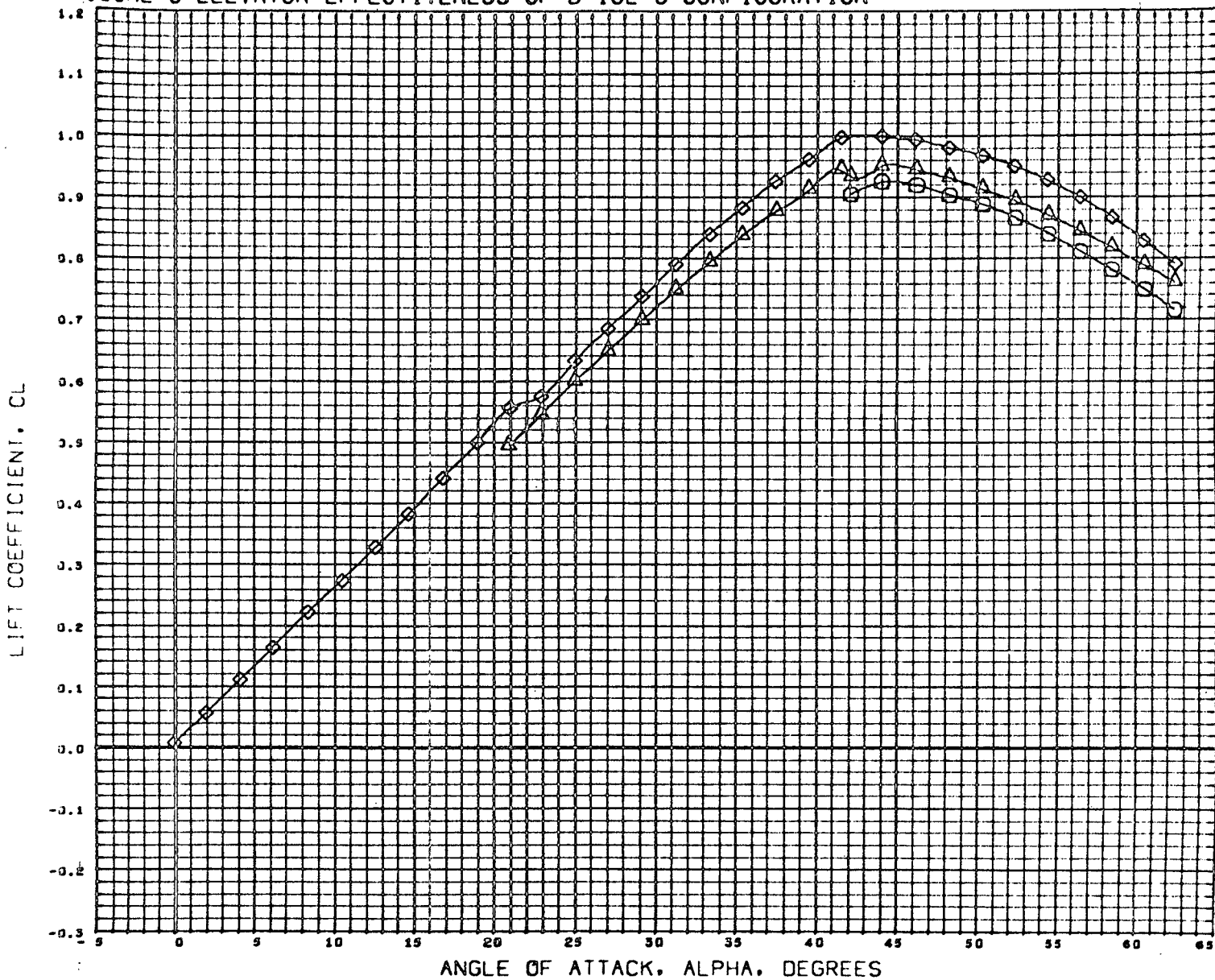

DATA SET SYMBOL	CONFIGURATION DESCRIPTION
(C50030)	MSFC TWT 514 E3 830W23C10
(C50020)	MSFC TWT 514 E3 830W23C10
(C50010)	MSFC TWT 514 E3 830W23C10
(058190)	DATA NOT AVAILABLE FOR ALL CONDITIONS

BETA	ELEVTR	CANARD
0.000	-40.000	0.000
0.000	-20.000	0.000
0.000	0.000	0.000
0.000	10.000	0.000

REFERENCE INFORMATION		
SREF	15.0300	50 INC
LREF	2.8300	INCHES
BREF	6.0620	INCHES
XMRP	2.1110	INCHES
YMRP	0.0000	INCHES
ZMRP	0.0000	INCHES
SCALE	0.0035	

MACH 2.990

FIGURE-3 ELEVATOR EFFECTIVENESS OF B-18E-3 CONFIGURATION

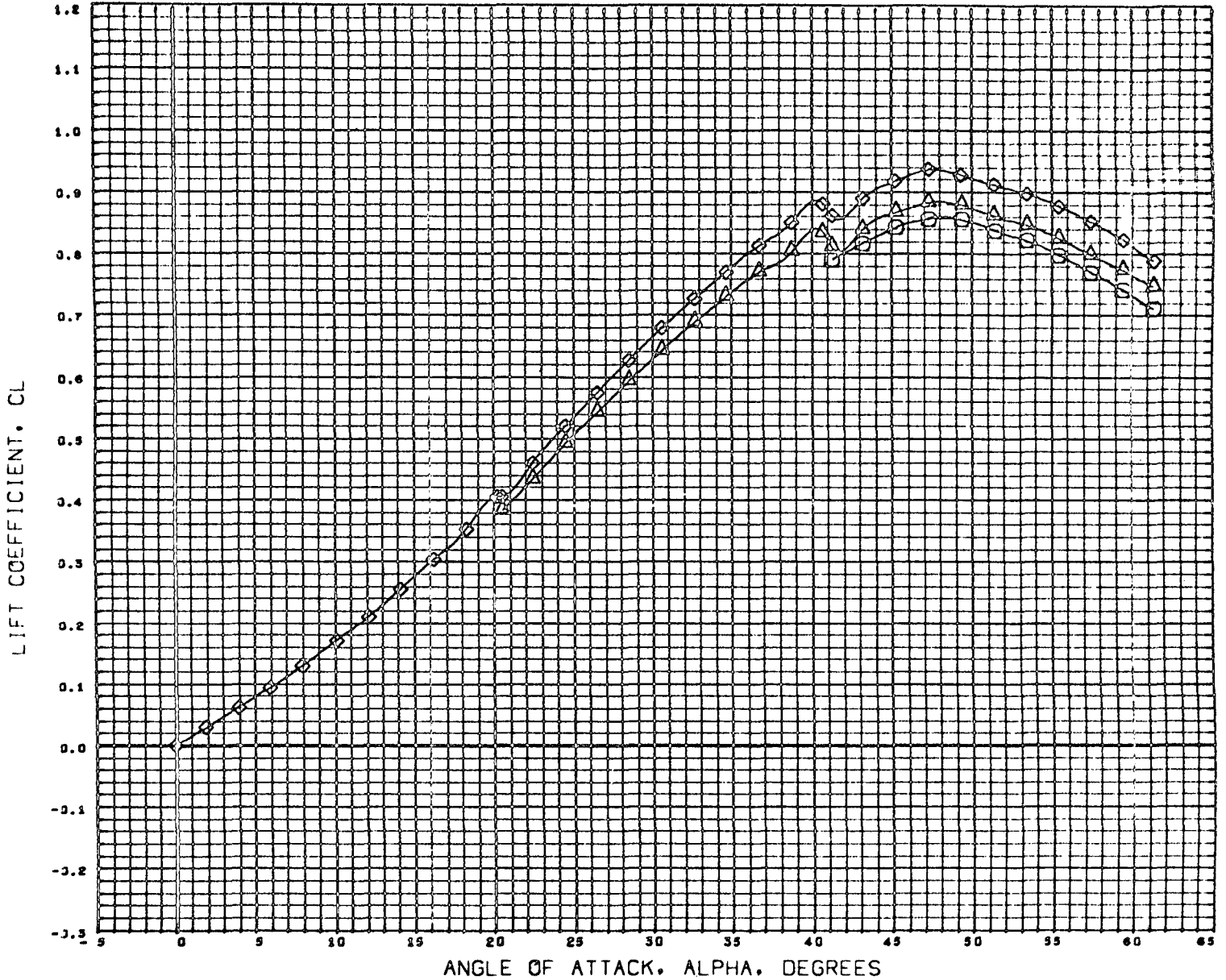

DATA SET SYMBOL	CONFIGURATION DESCRIPTION	BETA	ELEVTR	CANARD
(C50630)	MSFC TWT 514 E3 030W23C10	0.000	-40.000	0.000
(C50620)	MSFC TWT 514 E3 030W23C10	0.000	-20.000	0.000
(C50610)	MSFC TWT 514 E3 030W23C10	0.000	0.000	0.000
(058190)	DATA NOT AVAILABLE FOR ALL CONDITIONS	0.000	10.000	0.000

REFERENCE INFORMATION		
SREF	15.0300	SQ INC
LREF	2.8300	INCHES
BREF	6.0620	INCHES
XMRP	2.1110	INCHES
YMRP	0.0000	INCHES
ZMRP	0.0000	INCHES
SCALE	0.0035	

MACH 4.959

FIGURE-3 ELEVATOR EFFECTIVENESS OF B-18E-3 CONFIGURATION

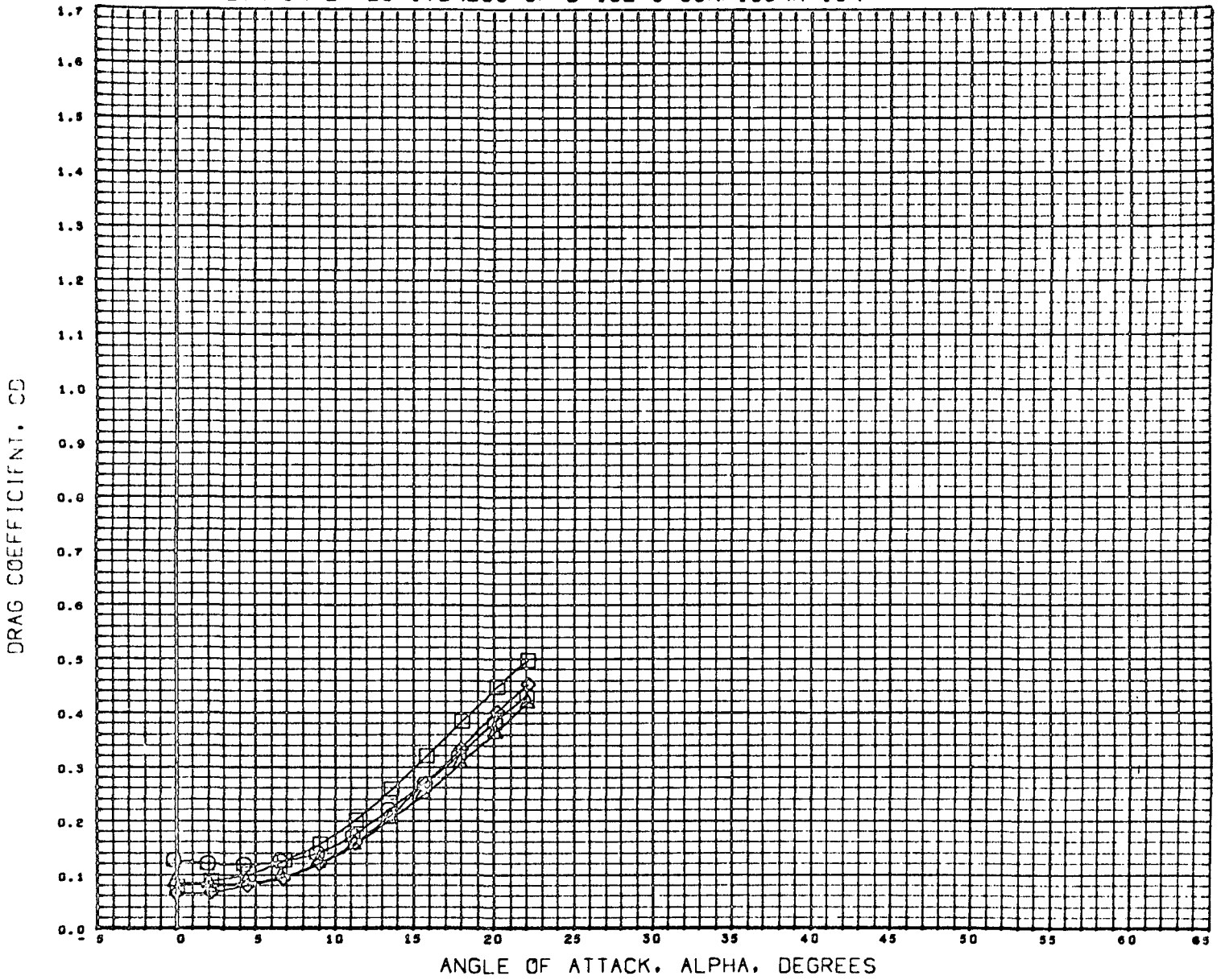

DATA SET SYMBOL	CONFIGURATION DESCRIPTION
(C50030)	MSFC TWT 514 E3 830W23C10
(C50020)	MSFC TWT 514 E3 830W23C10
(C50010)	MSFC TWT 514 E3 830W23C10
(C50190)	MSFC TWT 514 E3 830W23C10

BETA	ELEVTR	CANARD
0.000	-40.000	0.000
0.000	-20.000	0.000
0.000	0.000	0.000
0.000	10.000	0.000

REFERENCE INFORMATION		
SREF	15.0300	90 INC
LREF	2.8300	INCHES
BREF	6.0620	INCHES
XMRP	2.1110	INCHES
YMRP	0.0000	INCHES
ZMRP	0.0000	INCHES
SCALE	0.0035	

MACH 0.900

FIGURE-3 ELEVATOR EFFECTIVENESS OF B-18E-3 CONFIGURATION

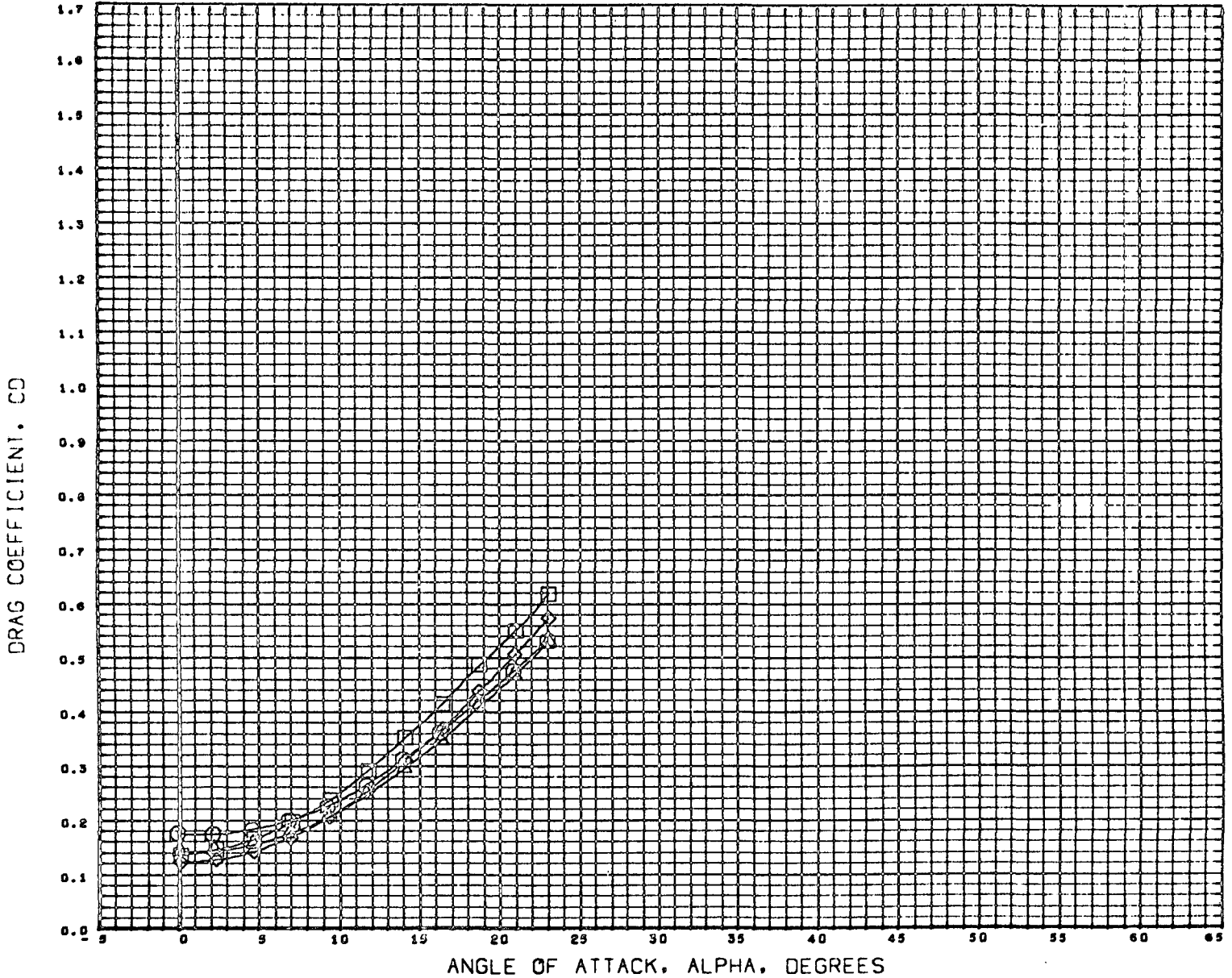

DATA SET SYMBOL	CONFIGURATION DESCRIPTION
(C90030)	MSFC TWT 514 E3 030W23C10
(C51020)	MSFC TWT 514 E3 030W23C10
(C51010)	MSFC TWT 514 E3 030W23C10
(D51190)	MSFC TWT 514 E3 030W23C10

BETA	ELEVTR	CANARD
0.000	-40.000	0.000
0.000	-20.000	0.000
0.000	0.000	0.000
0.000	10.000	0.000

REFERENCE INFORMATION		
SREF	15.0300	50 INC
LREF	2.0300	INCHES
BREF	0.0620	INCHES
XMRP	2.1110	INCHES
YMRP	0.0000	INCHES
ZMRP	0.0000	INCHES
SCALE	0.0030	

MACH 1.100

FIGURE-3 ELEVATOR EFFECTIVENESS OF B-18E-3 CONFIGURATION

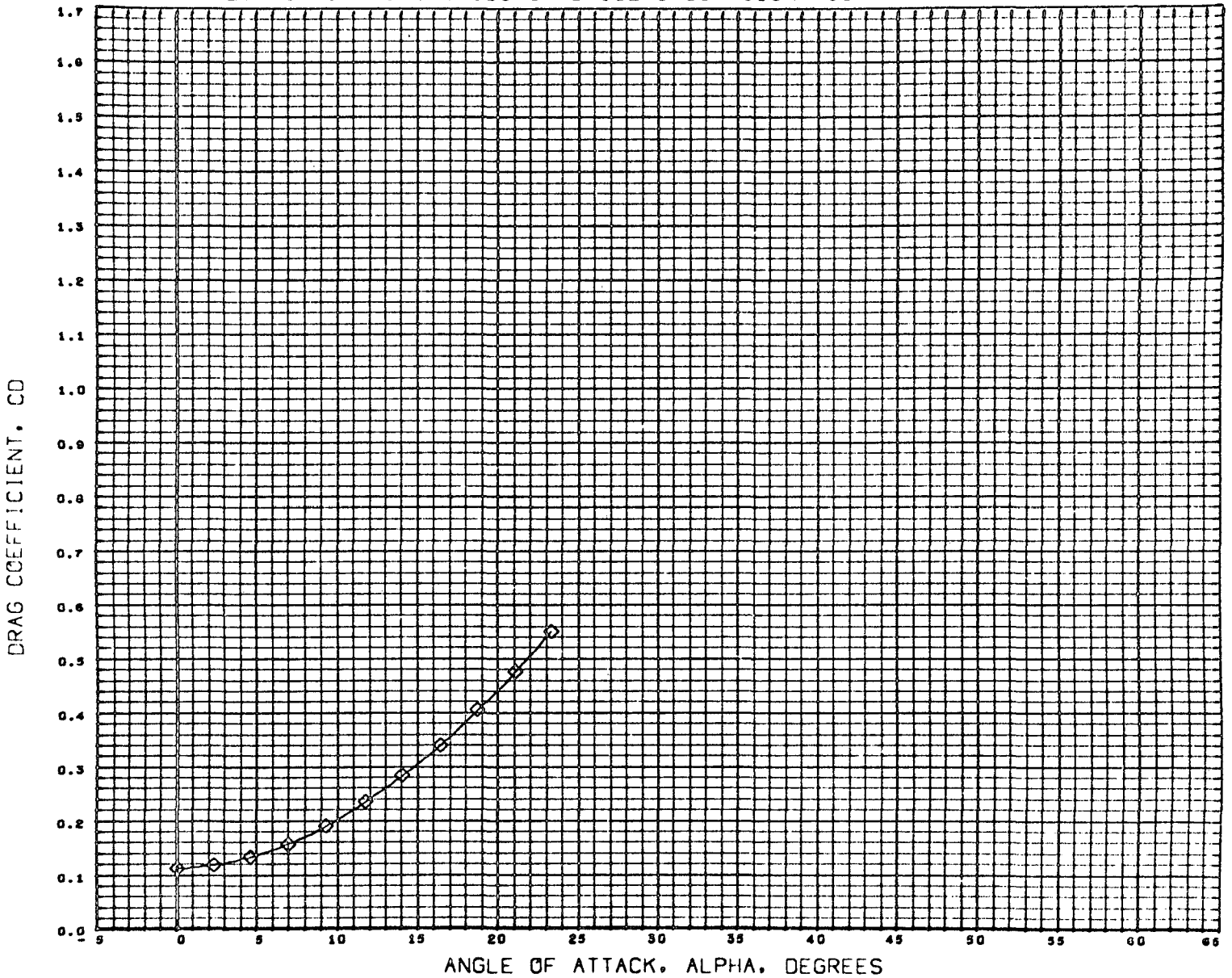

DATA SET SYMBOL	CONFIGURATION DESCRIPTION
(C58730)	DATA NOT AVAILABLE FOR ALL CONDITIONS
(C58920)	DATA NOT AVAILABLE FOR ALL CONDITIONS
(C58910)	MSFC TWT 514 E3 B30W23C10
(C58190)	DATA NOT AVAILABLE FOR ALL CONDITIONS

BETA	ELEVTR	CANARD
0.000	-40.000	0.000
0.000	-20.000	0.000
0.000	0.000	0.000
0.000	10.000	0.000

REFERENCE INFORMATION		
SREF	15.0300	30 INC
LREF	2.8300	INCHES
BREF	0.0620	INCHES
XMRP	2.1110	INCHES
YMRP	0.0000	INCHES
ZMRP	0.0000	INCHES
SCALE	0.0035	

MACH 1.459

FIGURE-3 ELEVATOR EFFECTIVENESS OF B-18E-3 CONFIGURATION

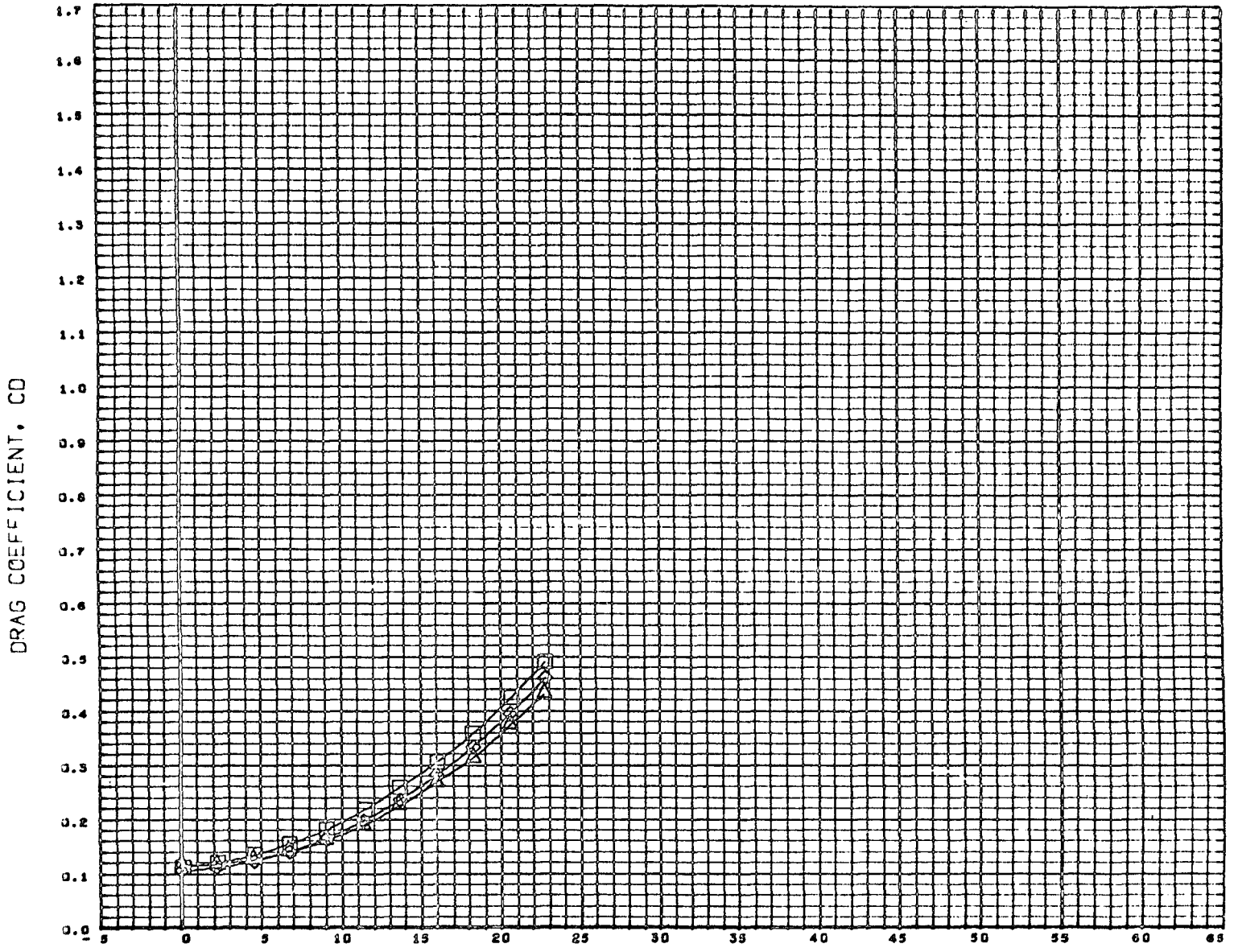

ANGLE OF ATTACK, ALPHA, DEGREES

DATA SET SYMBOL	CONFIGURATION DESCRIPTION
(C58C30)	DATA NOT AVAILABLE FOR ALL CONDITIONS
(C58C20)	MSFC TWT 514 E3 830W23C10
(C58G10)	MSFC TWT 514 E3 830W23C10
(058190)	MSFC TWT 514 E3 830W23C10

BETA	ELEVTR	CANARD
0.000	-40.000	0.000
0.000	-20.000	0.000
0.000	0.000	0.000
0.000	10.000	0.000

REFERENCE INFORMATION		
SREF	15.0300	SQ INC
LREF	2.8300	INCHES
BREF	0.0620	INCHES
XMRP	2.1110	INCHES
YMRP	0.0000	INCHES
ZMRP	0.0000	INCHES
SCALE	0.0035	

MACH 1.055

FIGURE-3 ELEVATOR EFFECTIVENESS OF B-18E-3 CONFIGURATION

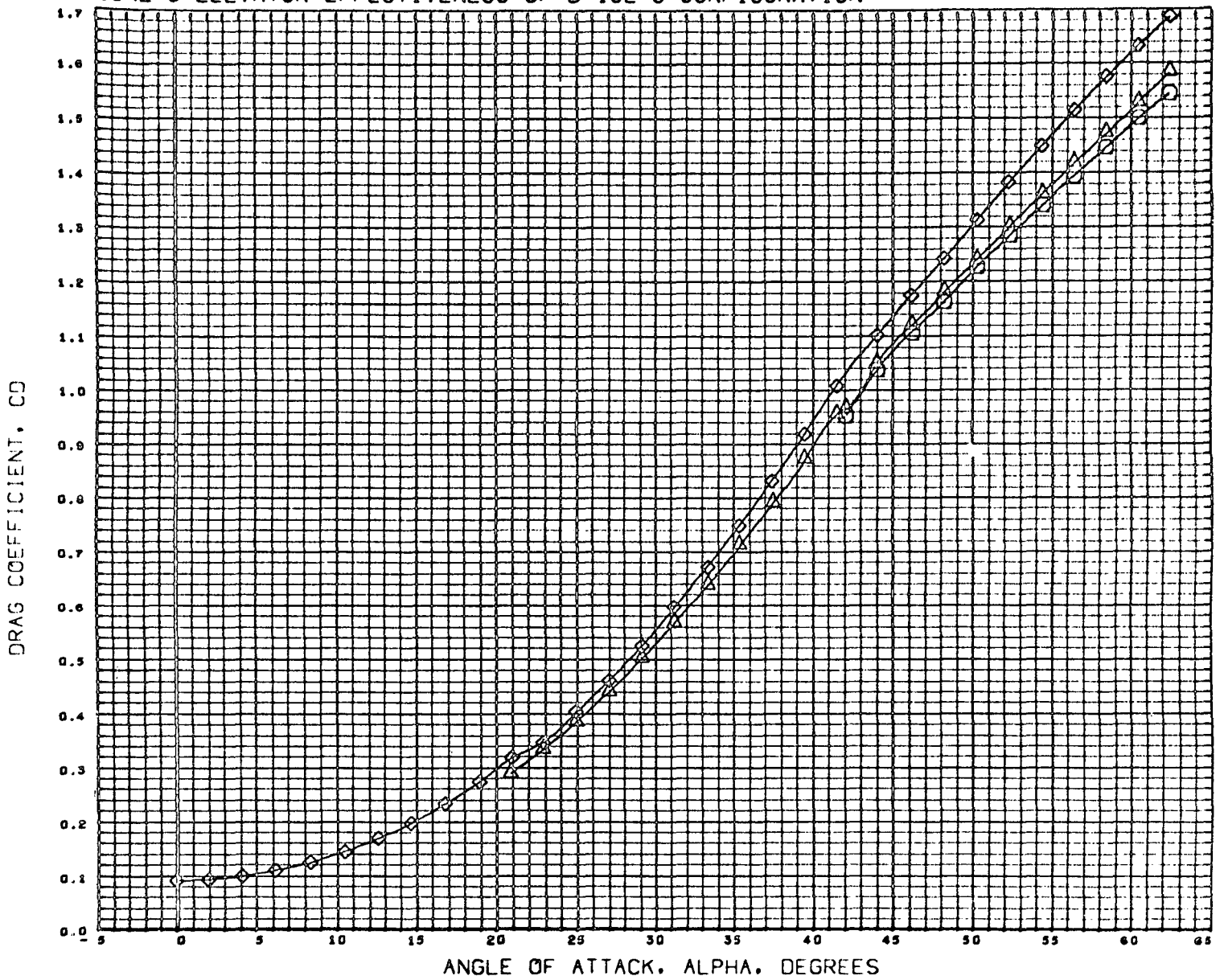

DATA SET	SYMBOL	CONFIGURATION DESCRIPTION
(C50030)	○	MSFC TWT 514 E3 830W23C10
(C50020)	△	MSFC TWT 514 E3 830W23C10
(C50010)	◇	MSFC TWT 514 E3 830W23C10
(D50160)	□	DATA NOT AVAILABLE FOR ALL CONDITIONS

BETA	ELEVTR	CANARD
0.000	-40.000	0.000
0.000	-20.000	0.000
0.000	0.000	0.000
0.000	10.000	0.000

REFERENCE INFORMATION		
SREF	15.0300	SQ INC
LREF	2.8300	INCHES
BREF	6.0620	INCHES
XMRP	2.1110	INCHES
YMRP	0.0000	INCHES
ZMRP	0.0000	INCHES
SCALE	0.0035	

MACH 2.990

FIGURE-3 ELEVATOR EFFECTIVENESS OF B-18E-3 CONFIGURATION

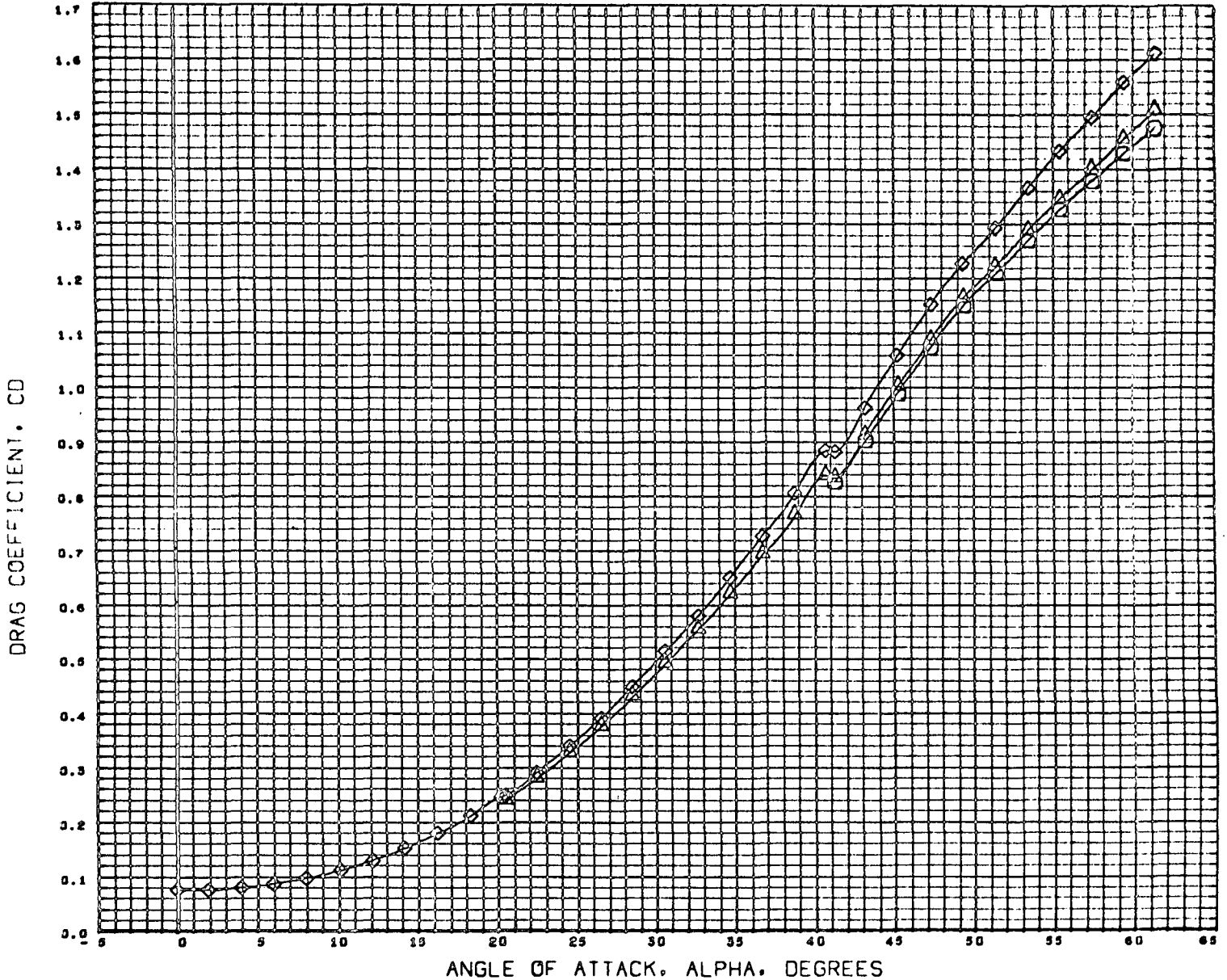

DATA SET	SYMBOL	CONFIGURATION DESCRIPTION
(C98030)	○	MSFC TWT 514 E3 030W23C10
(C98020)	△	MSFC TWT 514 E3 030W23C10
(C98010)	◇	MSFC TWT 514 E3 030W23C10
(D98190)	□	DATA NOT AVAILABLE FOR ALL CONDITIONS

BETA	ELEVTR	CANARD
0.000	-40.000	0.000
0.000	-20.000	0.000
0.000	0.000	0.000
0.000	10.000	0.000

REFERENCE INFORMATION	
SREF	15.0300 SQ INC
LREF	2.8300 INCHES
BREF	0.0620 INCHES
XMRP	2.1110 INCHES
YMRP	0.0000 INCHES
ZMRP	0.0000 INCHES
SCALE	0.0035

MACH 4.959

FIGURE-3 ELEVATOR EFFECTIVENESS OF B-18E-3 CONFIGURATION

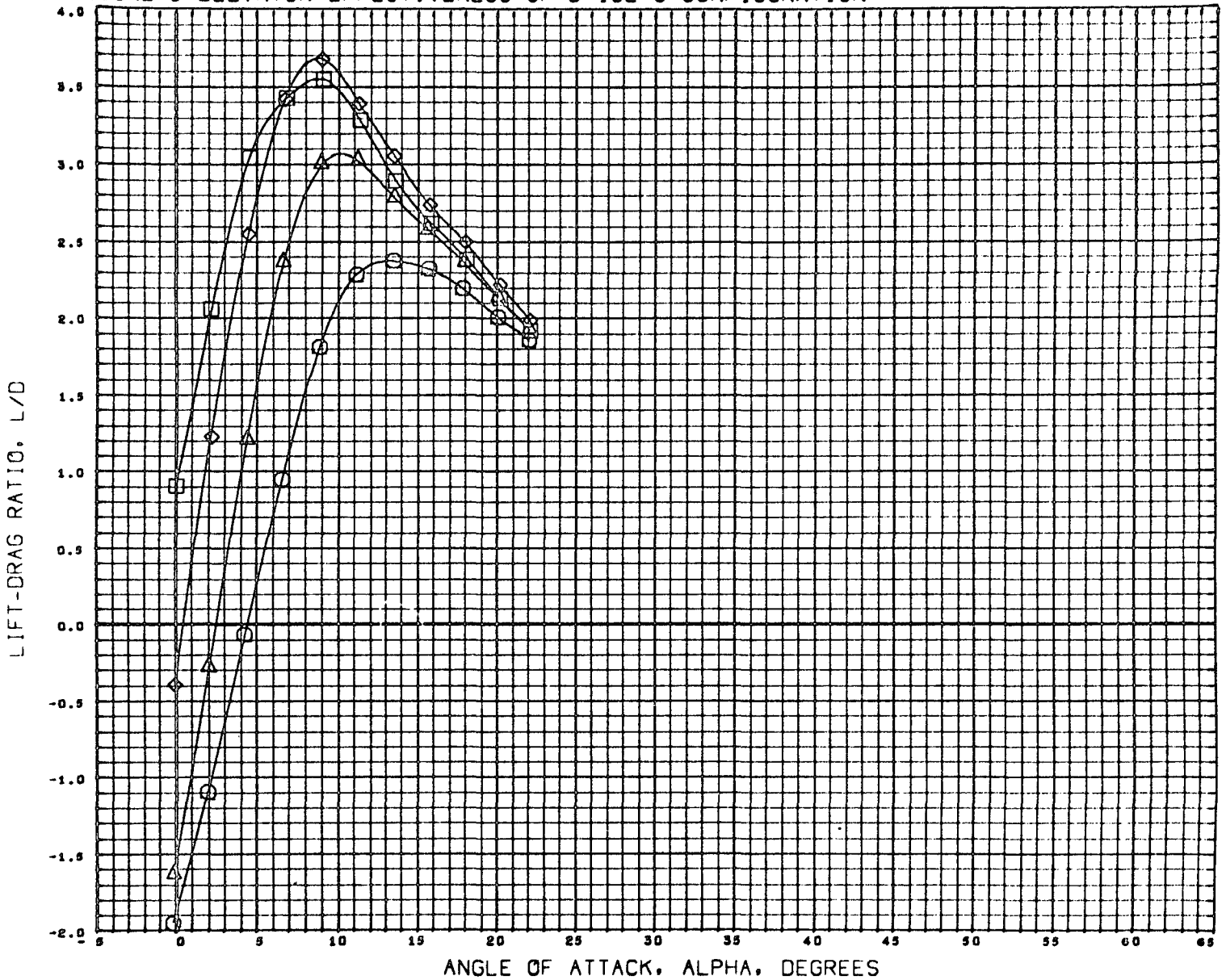

DATA SET SYMBOL	CONFIGURATION	DESCRIPTION
(C58030)	MSFC TWT 514 E3	B30W23C10
(C58020)	MSFC TWT 514 E3	B30W23C10
(C58010)	MSFC TWT 514 E3	B30W23C10
(D58190)	MSFC TWT 514 E3	B30W23C10

BETA	ELEVTR	CANARD
0.000	-40.000	0.000
0.000	-20.000	0.000
0.000	0.000	0.000
0.000	10.000	0.000

REFERENCE INFORMATION		
SREF	15.0300	SQ INC
LREF	2.8300	INCHES
BREF	8.0620	INCHES
XMRP	2.1110	INCHES
YMRP	0.0000	INCHES
ZMRP	0.0000	INCHES
SCALE	0.0035	

MACH 0.900

FIGURE-3 ELEVATOR EFFECTIVENESS OF B-18E-3 CONFIGURATION

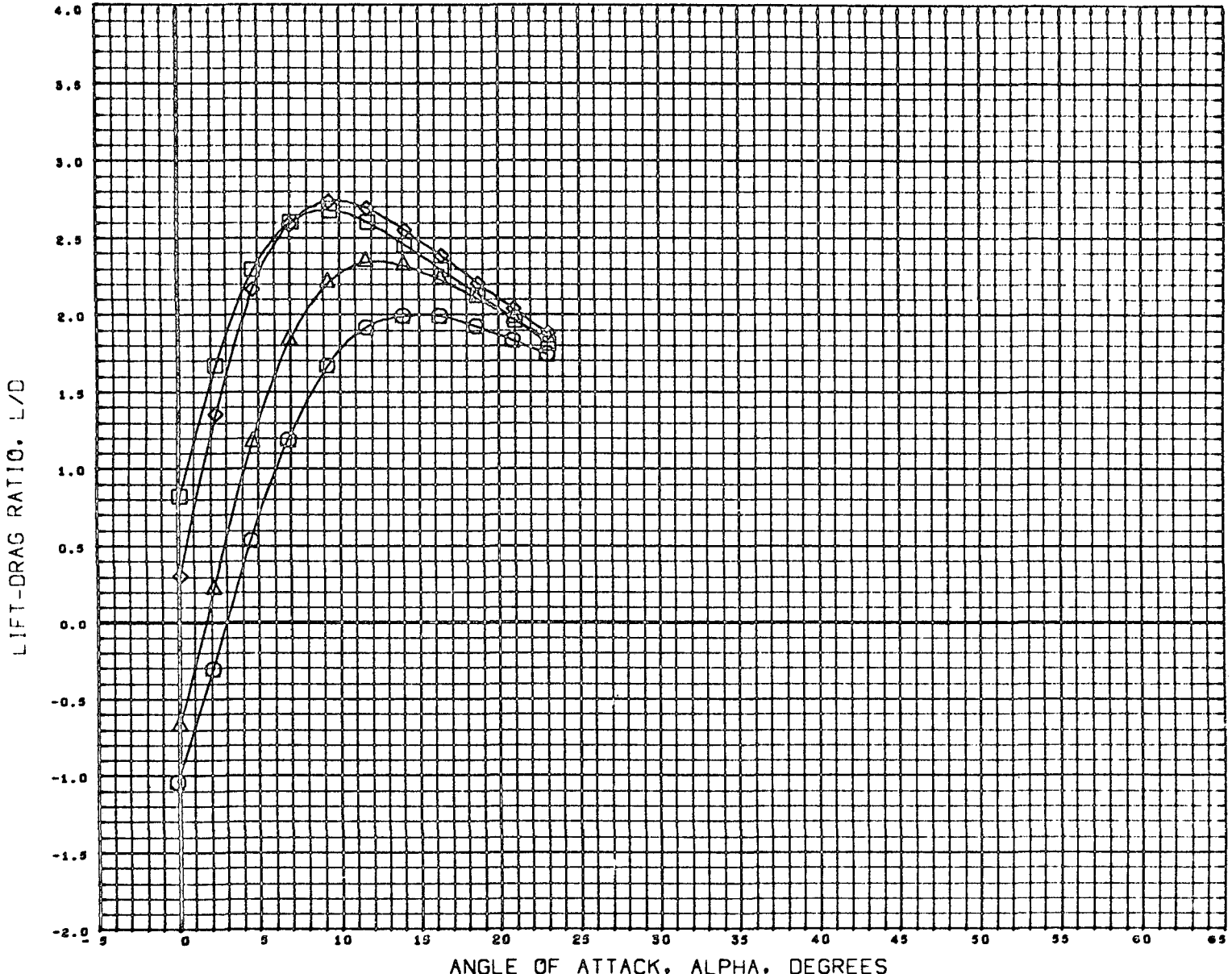

DATA SET SYMBOL	CONFIGURATION	DESCRIPTION
(C50:150)	MSFC TWT 514 E3	830W23C10
(C50:120)	MSFC TWT 514 E3	830W23C10
(C50:010)	MSFC TWT 514 E3	830W23C10
(058:90)	MSFC TWT 514 E3	830W23C10

BETA	ELEVTR	CANARD
0.000	-40.000	0.000
0.000	-20.000	0.000
0.000	0.000	0.000
0.000	10.000	0.000

REFERENCE INFORMATION		
SREF	15.0300	SQ INC
LREF	2.8300	INCHES
BREF	6.0620	INCHES
XMRP	2.1110	INCHES
YMRP	0.0000	INCHES
ZMRP	0.0000	INCHES
SCALE	0.0035	

MACH 1.198

FIGURE-3 ELEVATOR EFFECTIVENESS OF B-18E-3 CONFIGURATION

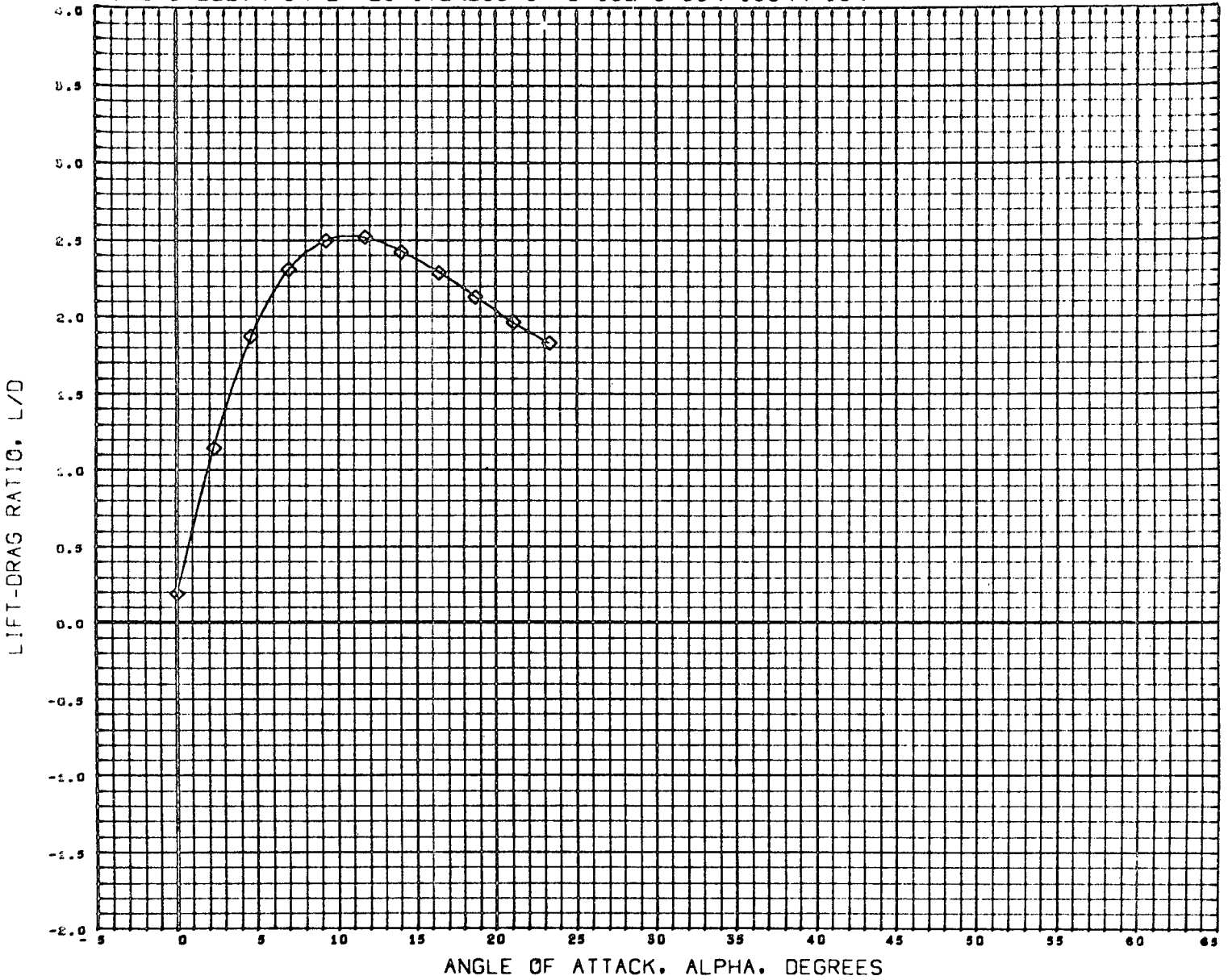

DATA SET SYMBOL	CONFIGURATION DESCRIPTION
(C58030)	DATA NOT AVAILABLE FOR ALL CONDITIONS
(C58020)	DATA NOT AVAILABLE FOR ALL CONDITIONS
(C58010)	MSFC TWT 514 E3 830W23C10
(C58190)	DATA NOT AVAILABLE FOR ALL CONDITIONS

BETA	ELEVTR	CANARD
0.000	-40.000	0.000
0.000	-20.000	0.000
0.000	0.000	0.000
0.000	10.000	0.000

REFERENCE INFORMATION		
SREF	15.0300	50 INC
LREF	2.8300	INCHES
BREF	6.0820	INCHES
XMRF	2.1110	INCHES
YMRF	0.0000	INCHES
ZMRF	0.0000	INCHES
SCALE	0.0035	

MACH 1.459

FIGURE-3 ELEVATOR EFFECTIVENESS OF B-18E-3 CONFIGURATION

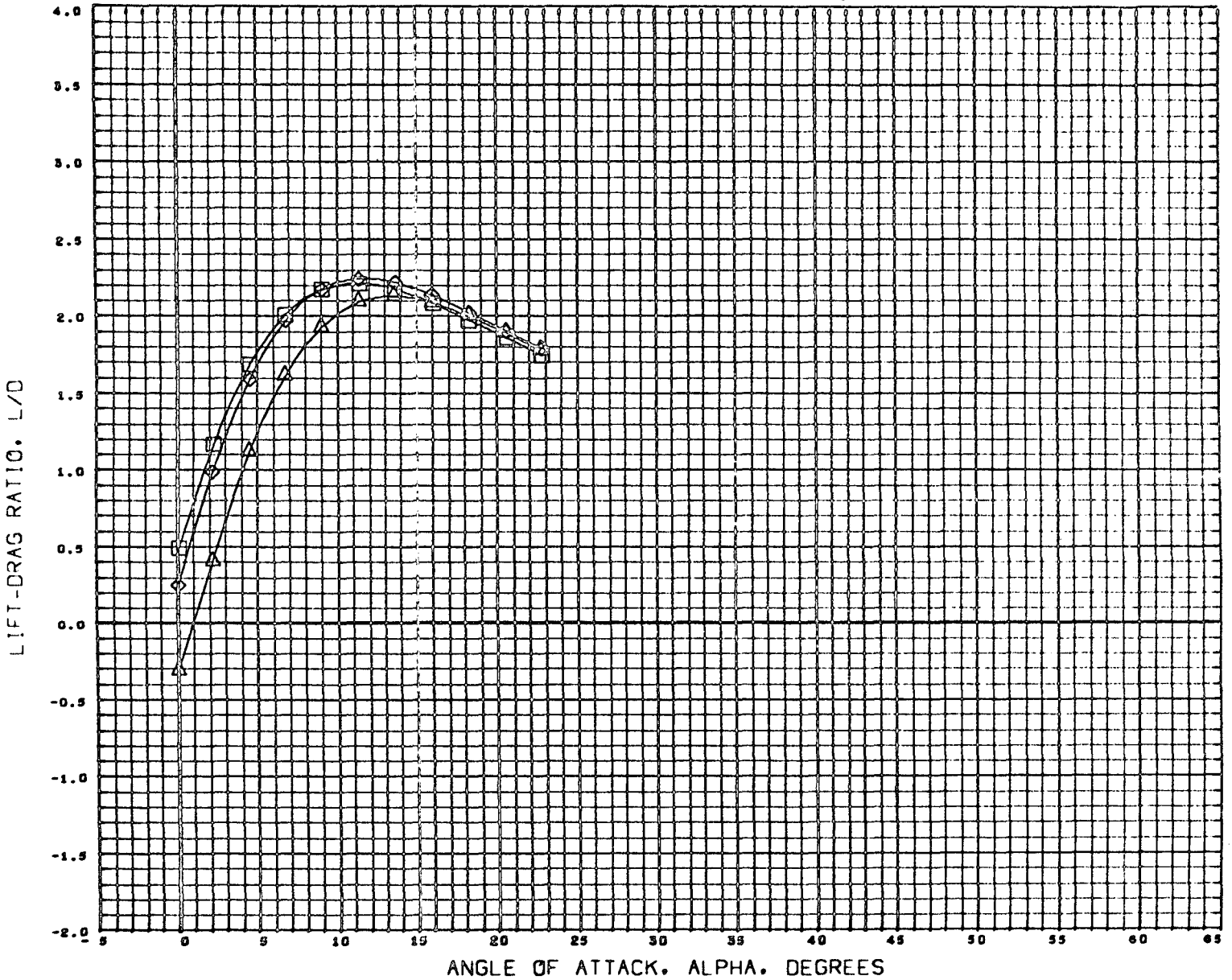

DATA SET SYMBOL	CONFIGURATION DESCRIPTION
(C56030)	DATA NOT AVAILABLE FOR ALL CONDITIONS
(C56020)	MSFC TWT 514 E3 030W23C10
(C56010)	MSFC TWT 514 E3 030W23C10
(D56190)	MSFC TWT 514 E3 030W23C10

BETA	ELEVTR	CANARD
0.000	-40.000	0.000
0.000	-20.000	0.000
0.000	0.000	0.000
0.000	10.000	0.000

REFERENCE INFORMATION		
SREF	15.0300	89 INC
LREF	2.8300	INCHES
BREF	6.0620	INCHES
XMRP	2.1110	INCHES
YMRP	0.0000	INCHES
ZMRP	0.0000	INCHES
SCALE	0.0035	

MACH 1.955

FIGURE-3 ELEVATOR EFFECTIVENESS OF B-18E-3 CONFIGURATION

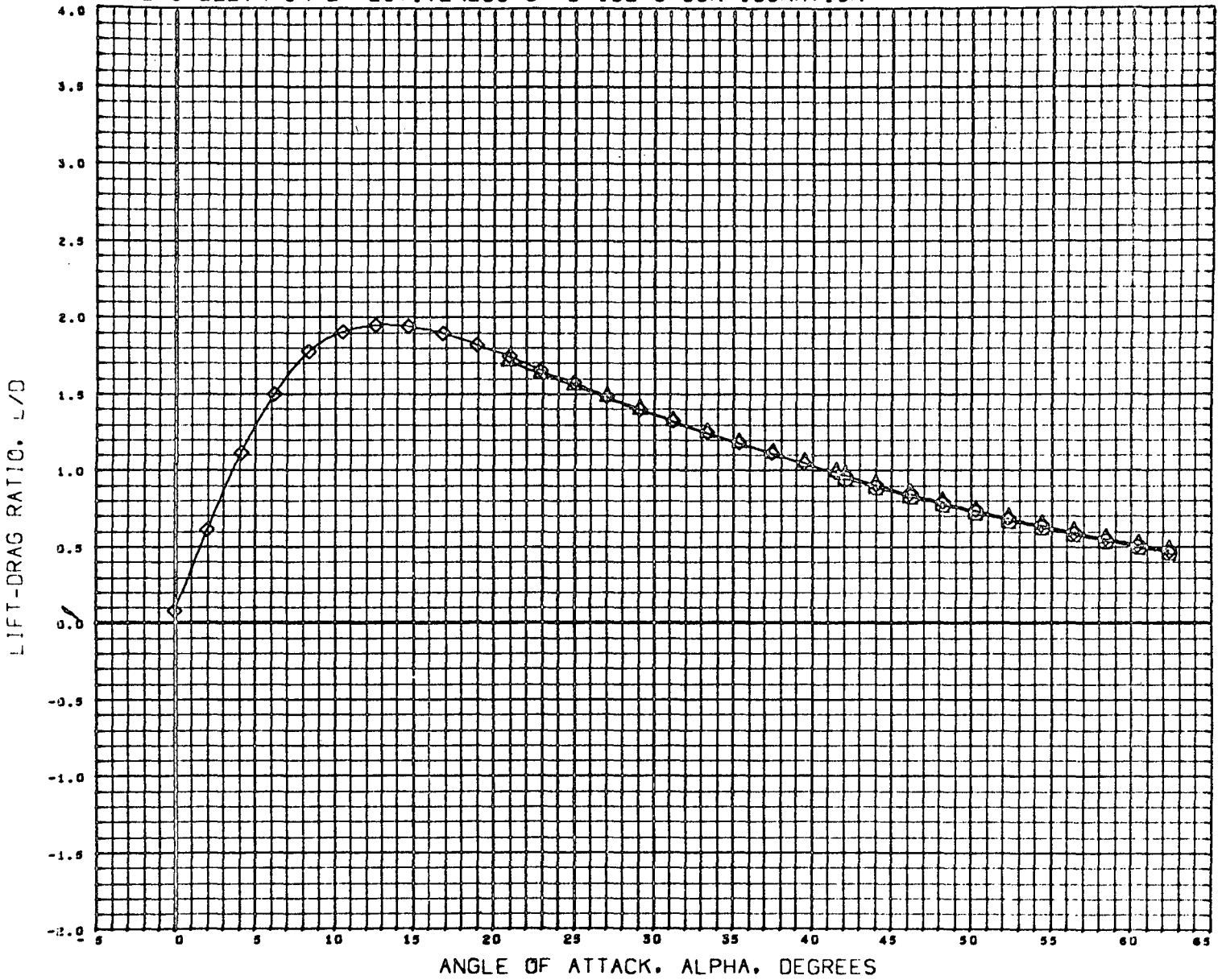

DATA SET SYMBOL	CONFIGURATION DESCRIPTION
(C50130)	MSFC TWT 514 E3 B30W23C10
(C50120)	MSFC TWT 514 E3 B30W23C10
(C50110)	MSFC TWT 514 E3 B30W23C10
(D56190)	DATA NOT AVAILABLE FOR ALL CONDITIONS

BETA	ELEVTR	CANARD
0.000	-40.000	0.000
0.000	-20.000	0.000
0.000	0.000	0.000
0.000	10.000	0.000

REFERENCE INFORMATION		
SREF	15.0500	SQ INC
LREF	2.8300	INCHES
BREF	6.0620	INCHES
XMRP	2.1110	INCHES
YMRP	0.0000	INCHES
ZMRP	0.0000	INCHES
SCALE	0.0035	

MACH 2.990

FIGURE-3 ELEVATOR EFFECTIVENESS OF B-18E-3 CONFIGURATION

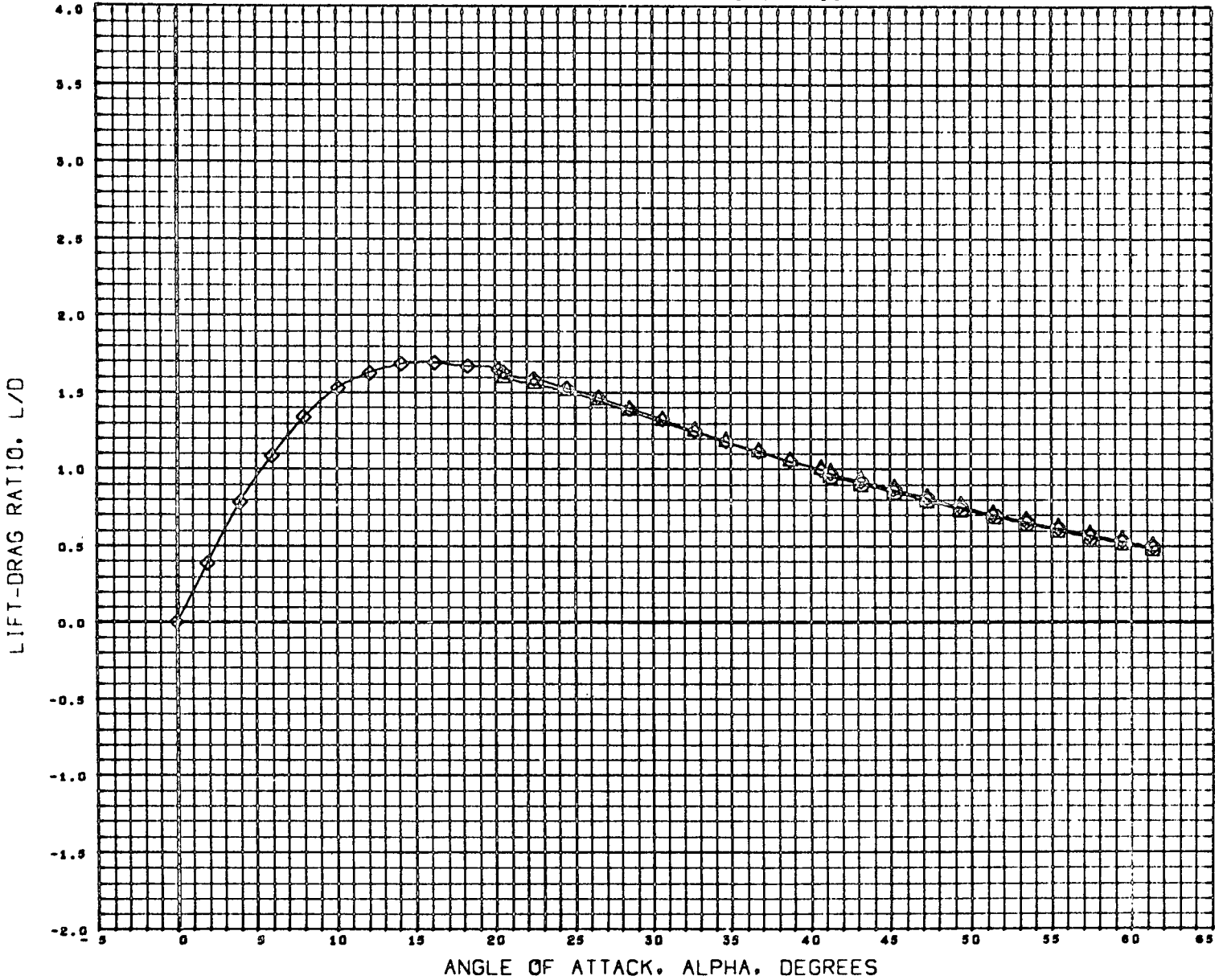

DATA SET	SYMBOL	CONFIGURATION DESCRIPTION
(C58030)	○	MSFC TWT 514 E3 B30W23C10
(C58020)	△	MSFC TWT 514 E3 B30W23C10
(C58010)	◇	MSFC TWT 514 E3 B30W23C10
(D58090)	□	DATA NOT AVAILABLE FOR ALL CONDITIONS

BETA	ELEVTR	CANARD
0.000	-40.000	0.000
0.000	-20.000	0.000
0.000	0.000	0.000
0.000	10.000	0.000

REFERENCE INFORMATION		
SREF	15.0300	30 INC
LREF	2.8300	INCHES
BREF	6.0620	INCHES
XMRP	2.1110	INCHES
YMRP	0.0000	INCHES
ZMRP	0.0000	INCHES
SCALE	0.0035	

MACH 4.959

FIGURE-3 ELEVATOR EFFECTIVENESS OF B-18E-3 CONFIGURATION

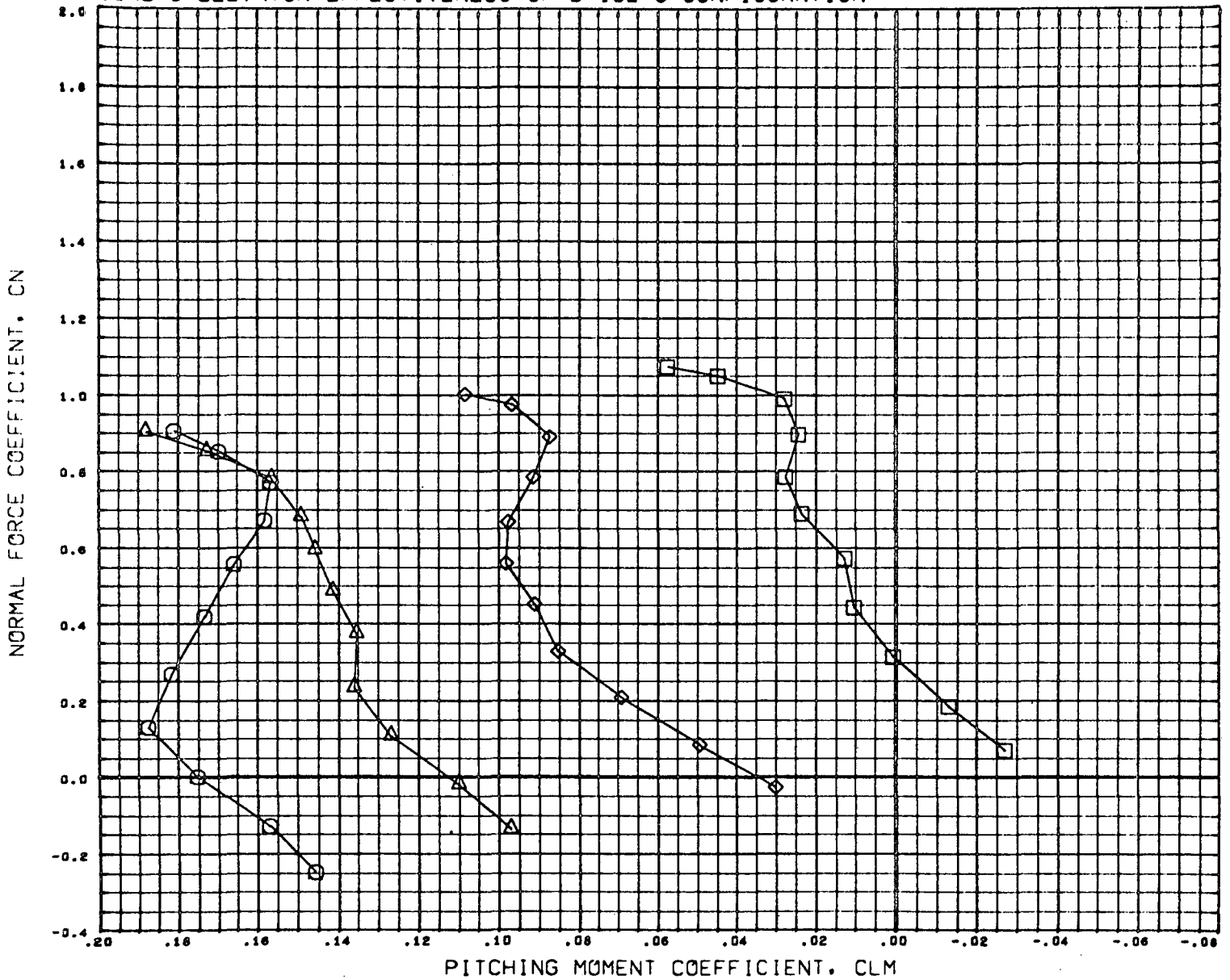

DATA SET SYMBOL	CONFIGURATION DESCRIPTION
(C58030)	MSFC TWT 514 E3 830W23C10
(C58020)	MSFC TWT 514 E3 830W23C10
(C58010)	MSFC TWT 514 E3 830W23C10
(D58190)	MSFC TWT 514 E3 830W23C10

BETA	ELEVTR	CANARD
0.000	-40.000	0.000
0.000	-20.000	0.000
0.000	0.000	0.000
0.000	10.000	0.000

REFERENCE INFORMATION		
SREF	15.0300	30 INC
LREF	2.8300	INCHES
BREF	6.0620	INCHES
XMRP	2.1110	INCHES
YMRP	0.0000	INCHES
ZMRP	0.0000	INCHES
SCALE	0.0035	

MACH 0.900

FIGURE-3 ELEVATOR EFFECTIVENESS OF B-18E-3 CONFIGURATION

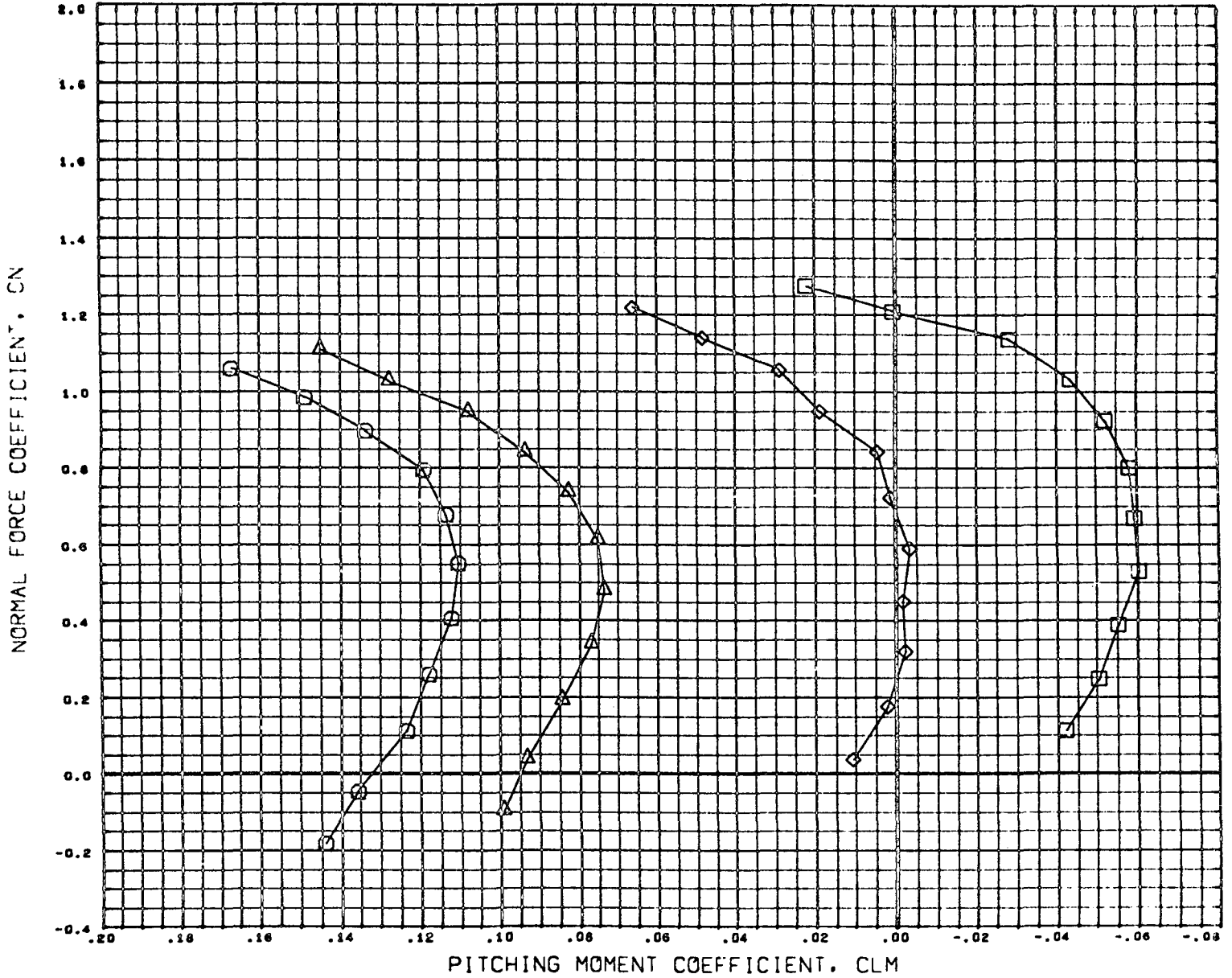

DATA SET	SYMBOL	CONFIGURATION DESCRIPTION
(C58330)	○	MSFC TWT 514 E3 830W23C10
(C50320)	△	MSFC TWT 514 E3 830W23C10
(C50310)	◇	MSFC TWT 514 E3 830W23C10
(C56190)	□	MSFC TWT 514 E3 830W23C10

BETA	ELEVTR	CANARD
0.000	-40.000	0.000
0.000	-20.000	0.000
0.000	0.000	0.000
0.000	10.000	0.000

REFERENCE INFORMATION		
SREF	15.0300	50 INC
LREF	2.8300	INCHES
BREF	0.0620	INCHES
XMRP	2.1110	INCHES
YMRP	0.0000	INCHES
ZMRP	0.0000	INCHES
SCALE	0.0035	

MACH 1.198

FIGURE-3 ELEVATOR EFFECTIVENESS OF B-18E-3 CONFIGURATION

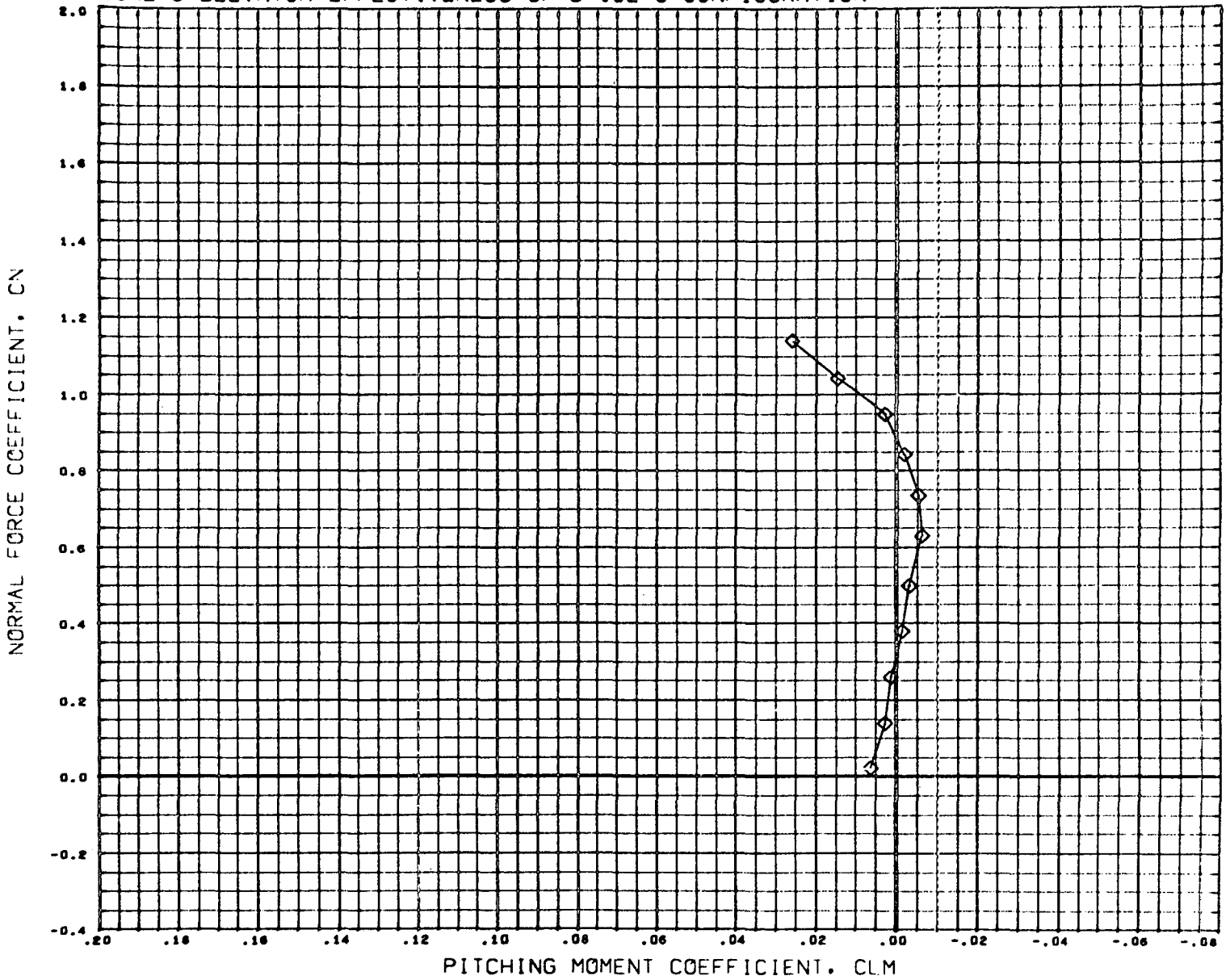

DATA SET SYMBOL	CONFIGURATION DESCRIPTION
(C59030)	DATA NOT AVAILABLE FOR ALL CONDITIONS
(C59020)	DATA NOT AVAILABLE FOR ALL CONDITIONS
(C59010)	MSFC TWT 514 E3 B30W23C10
(059190)	DATA NOT AVAILABLE FOR ALL CONDITIONS

BETA	ELEVTR	CANARD
0.000	-40.000	0.000
0.000	-20.000	0.000
0.000	0.000	0.000
0.000	10.000	0.000

REFERENCE INFORMATION		
SREF	15.0300	90 INC
LREF	2.8300	INCHES
BREF	6.0620	INCHES
XMRP	2.1110	INCHES
YMRP	0.0000	INCHES
ZMRP	0.0000	INCHES
SCALE	0.0035	

MACH 1.459

FIGURE-3 ELEVATOR EFFECTIVENESS OF B-18E-3 CONFIGURATION

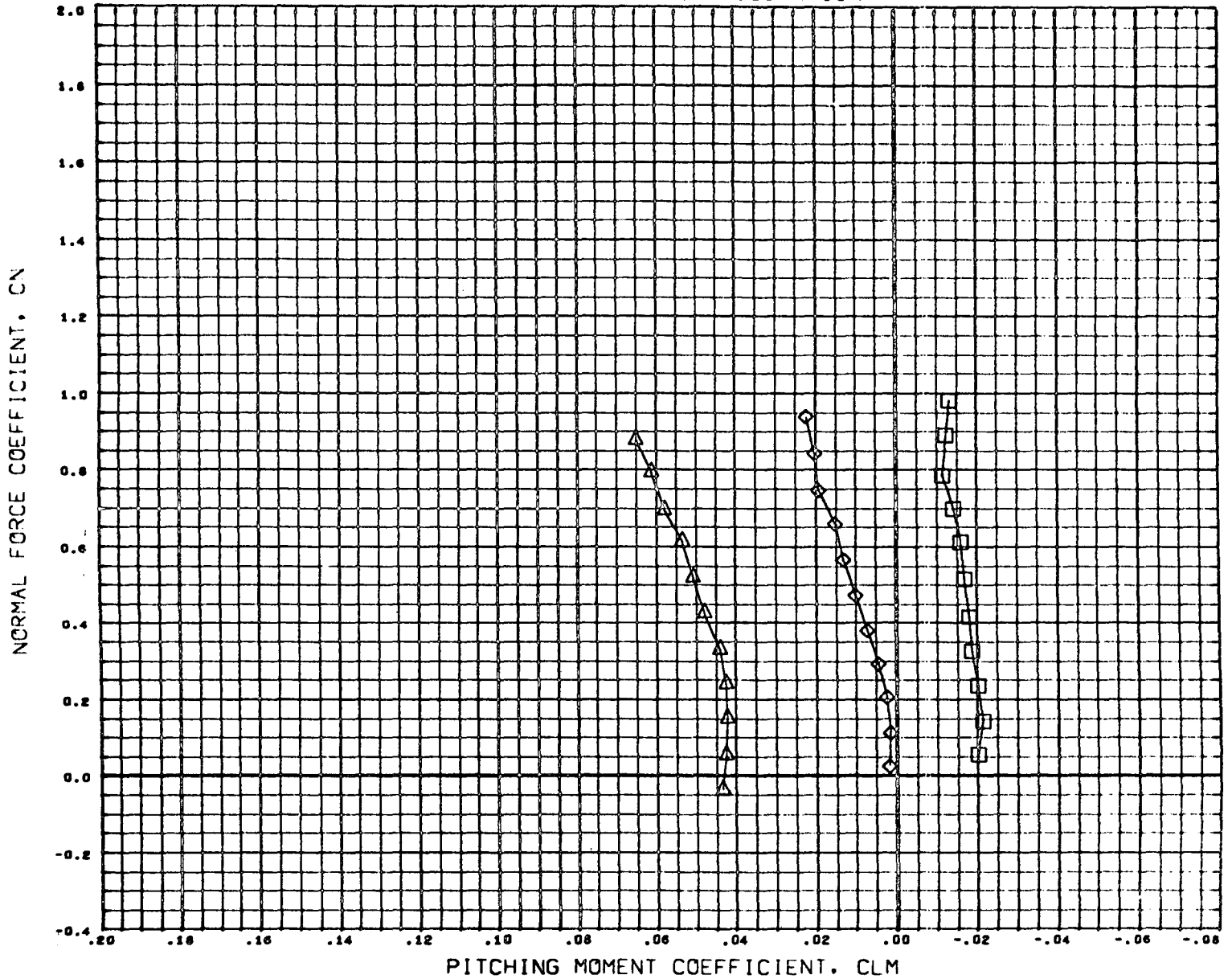

DATA SET SYMBOL	CONFIGURATION DESCRIPTION
(C34030)	DATA NOT AVAILABLE FOR ALL CONDITIONS
(C14020)	NSFC TWT 514 E3 B30W23C10
(C14010)	NSFC TWT 514 E3 B30W23C10
(034190)	NSFC TWT 514 E3 B30W23C10

BETA	ELEVTR	CANARD
0.000	-40.000	0.000
0.000	-20.000	0.000
0.000	0.000	0.000
0.000	10.000	0.000

REFERENCE INFORMATION		
SREF	15.0300	92 INC
LREF	2.8300	INCHES
BREF	6.0620	INCHES
XMRP	2.1100	INCHES
YMRP	6.0000	INCHES
ZMRP	0.0000	INCHES
SCALE	0.0039	

MACH 1.955

FIGURE-3 ELEVATOR EFFECTIVENESS OF B-18E-3 CONFIGURATION

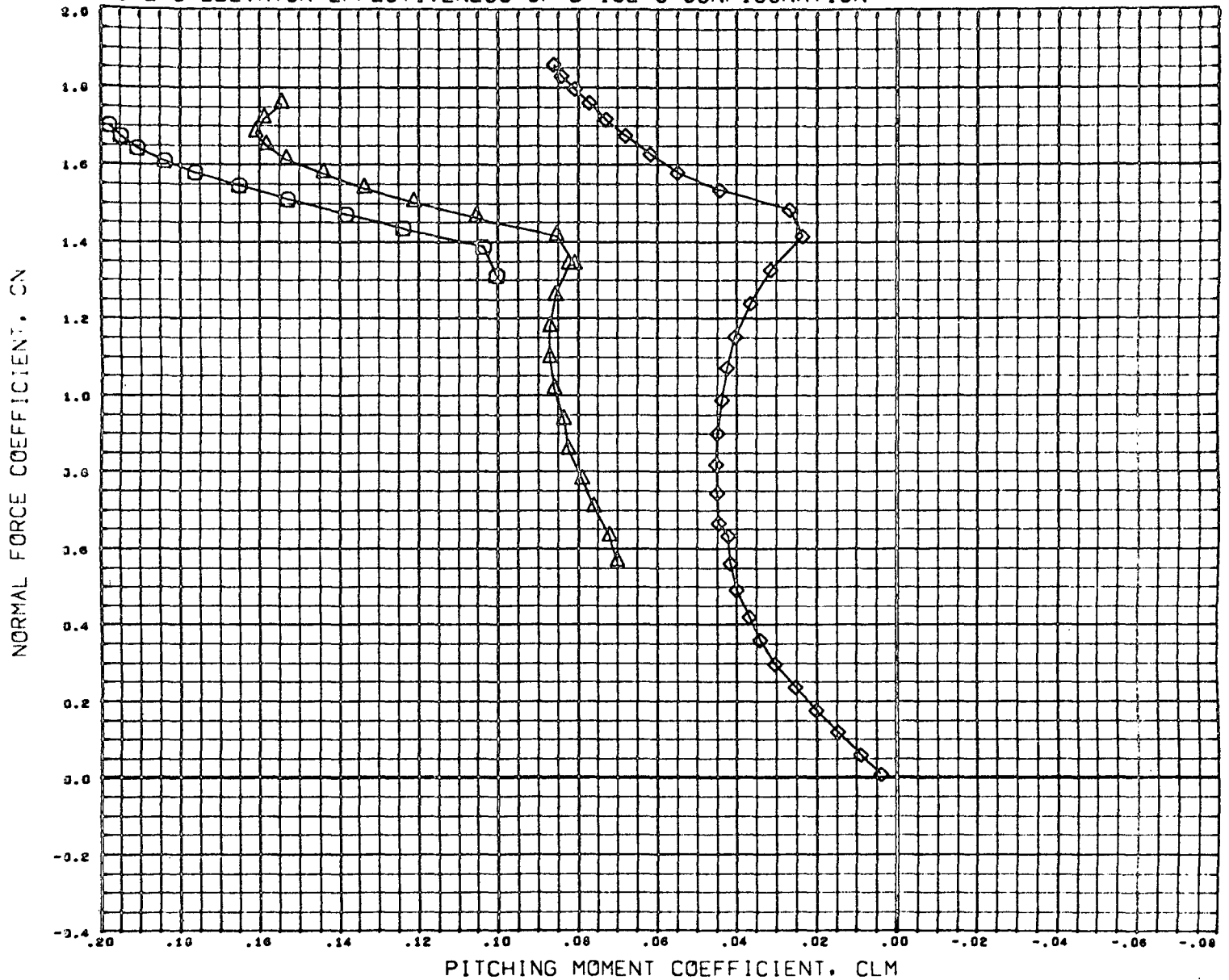

DATA SET SYMBOL	CONFIGURATION DESCRIPTION
(C50030)	MSFC TWT 514 E3 830W23C10
(C50020)	MSFC TWT 514 E3 830W23C10
(C58010)	MSFC TWT 514 E3 830W23C10
(058190)	DATA NOT AVAILABLE FOR ALL CONDITIONS

BETA	ELEVTR	CANARC
0.000	-40.000	0.000
0.000	-20.000	0.000
0.000	0.000	0.000
0.000	10.000	0.000

REFERENCE INFORMATION		
SREF	15.0300	SQ INC
LREF	2.8300	INCHES
BREF	6.0620	INCHES
XMRP	2.1110	INCHES
YMRP	0.0000	INCHES
ZMRP	0.0000	INCHES
SCALE	0.0035	

MACH 2.990

FIGURE-3 ELEVATOR EFFECTIVENESS OF B-18E-3 CONFIGURATION

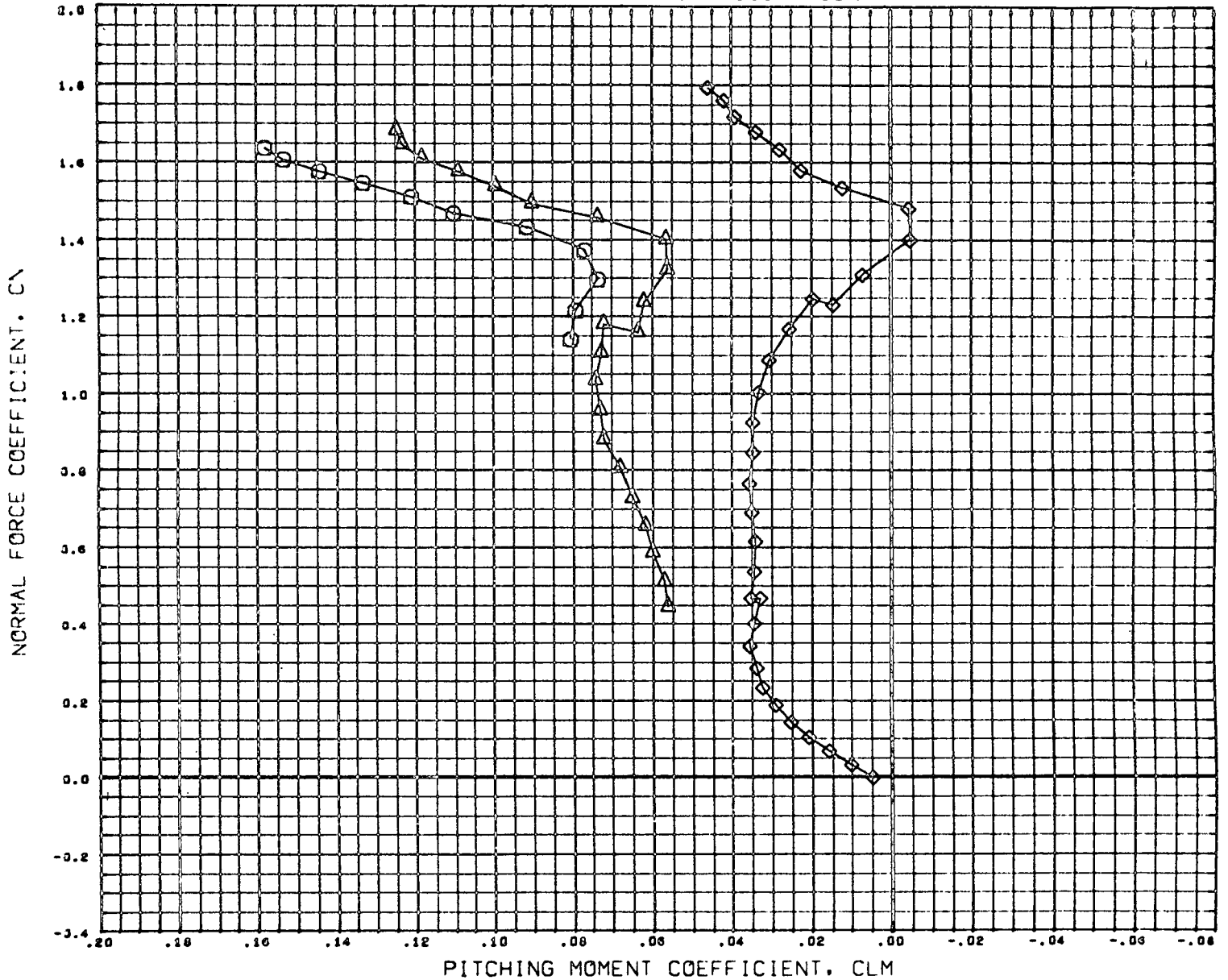

DATA SET SYMBOL	CONFIGURATION DESCRIPTION
(C50C30)	MSFC TWT 514 E3 030W23C10
(C50C20)	MSFC TWT 514 E3 030W23C10
(C50C10)	MSFC TWT 514 E3 030W23C10
(058190)	DATA NOT AVAILABLE FOR ALL CONDITIONS

BETA	ELEVTR	CANARD
0.000	-40.000	0.000
0.000	-20.000	0.000
0.000	0.000	0.000
0.000	10.000	0.000

REFERENCE INFORMATION		
SREF	15.0300	Sq INC
LREF	2.8300	INCHES
BREF	0.0620	INCHES
XMRP	2.1110	INCHES
YMRP	0.0000	INCHES
ZMRP	0.0000	INCHES
SCALE	0.0035	

MACH 4.959

FIGURE-3 ELEVATOR EFFECTIVENESS OF B-18E-3 CONFIGURATION

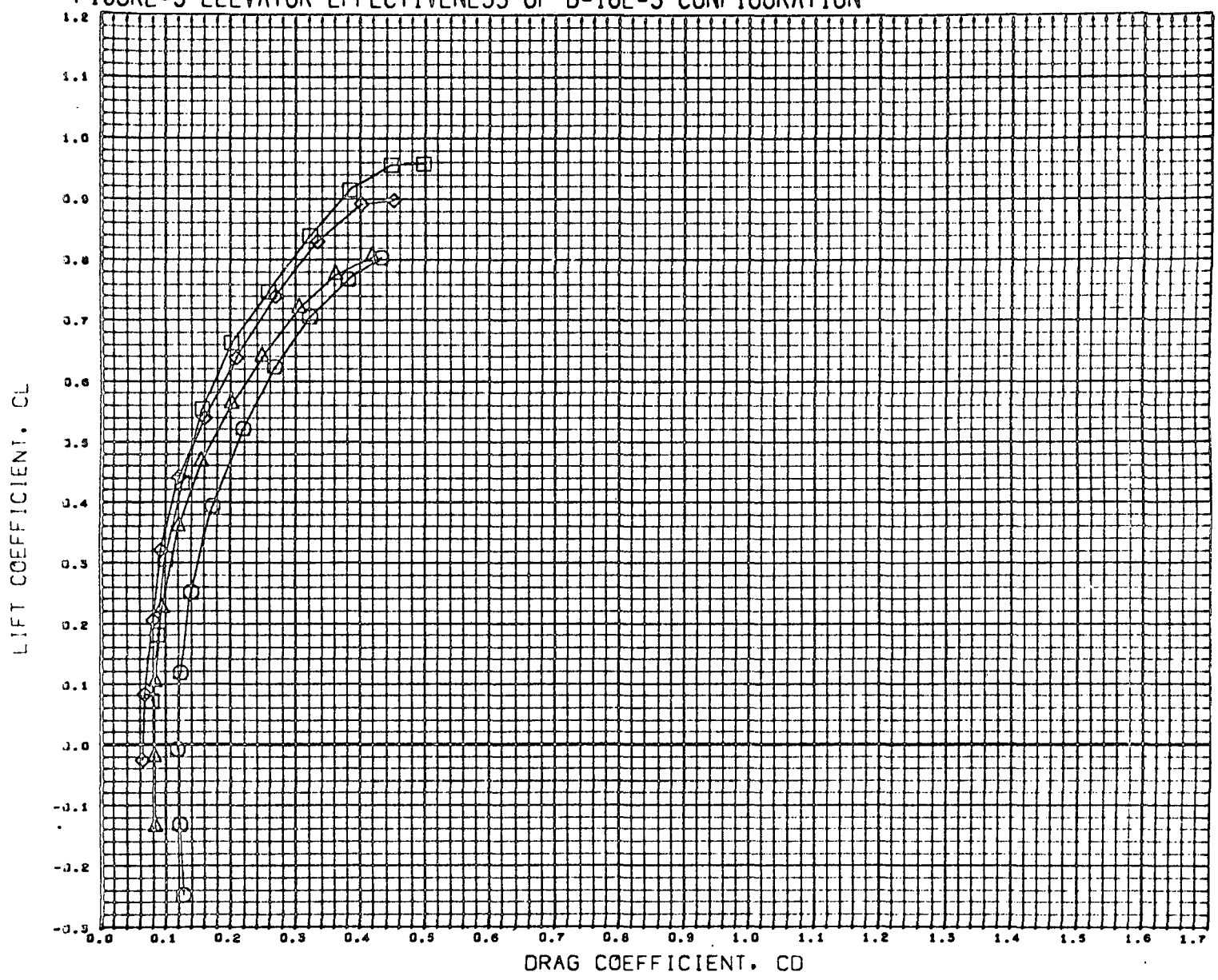

DATA SET	SYMBOL	CONFIGURATION	DESCRIPTION
(C50030)	○	MSFC TWT 514 E3	830W23C10
(C50020)	△	MSFC TWT 514 E3	830W23C10
(C50010)	◇	MSFC TWT 514 E3	830W23C10
(C50190)	□	MSFC TWT 514 E3	830W23C10

BETA	ELEVTR	CANARC
0.000	-40.000	0.000
0.000	-20.000	0.000
0.000	0.000	0.000
0.000	10.000	0.000

REFERENCE INFORMATION		
SREF	15.0300	90 INC
LREF	2.8300	INCHES
BREF	6.0820	INCHES
XMRP	2.1110	INCHES
YMRP	0.0000	INCHES
ZMRP	0.0000	INCHES
SCALE	0.0035	

MACH 0.900

FIGURE-3 ELEVATOR EFFECTIVENESS OF B-18E-3 CONFIGURATION

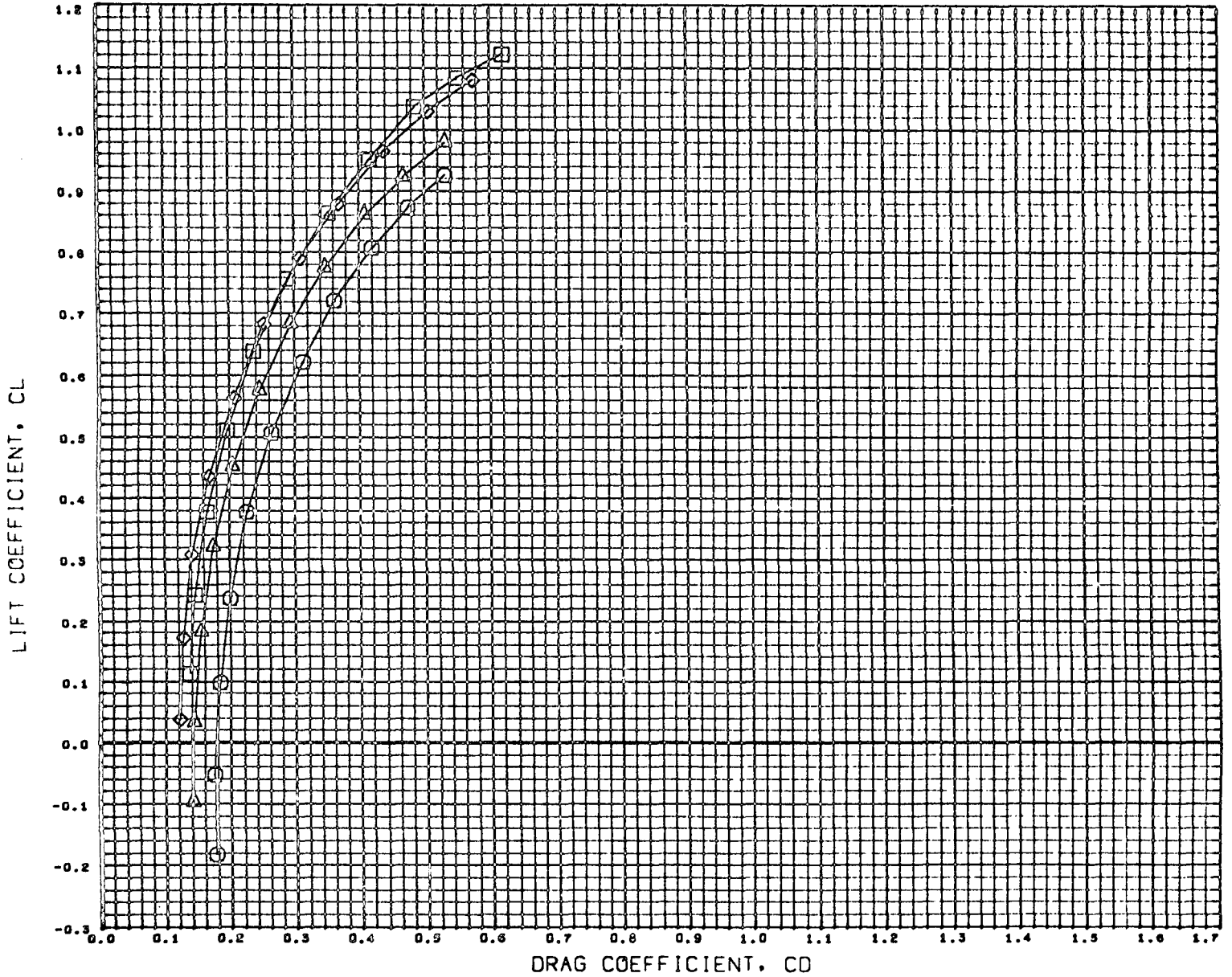

DATA SET SYMBOL	CONFIGURATION DESCRIPTION
(C50030)	MSFC TWT 914 E3 030W23C10
(C50020)	MSFC TWT 914 E3 030W23C10
(C50010)	MSFC TWT 914 E3 030W23C10
(050190)	MSFC TWT 914 E3 030W23C10

BETA	ELEVTR	CANARD
0.000	-40.000	0.000
0.000	-20.000	0.000
0.000	0.000	0.000
0.000	10.000	0.000

REFERENCE INFORMATION		
SREF	15.0300	Sq INC
LREF	2.8300	INCHES
BREF	6.0620	INCHES
XMRP	2.1110	INCHES
YMRP	0.0000	INCHES
ZMRP	0.0000	INCHES
SCALE	0.0035	

MACH 1.100

FIGURE-3 ELEVATOR EFFECTIVENESS OF B-18E-3 CONFIGURATION



DATA SET SYMBOL	CONFIGURATION DESCRIPTION
(C50330)	DATA NOT AVAILABLE FOR ALL CONDITIONS
(C50320)	DATA NOT AVAILABLE FOR ALL CONDITIONS
(C50310)	MSFC TWT 514 E3 B30W23C10
(C50190)	DATA NOT AVAILABLE FOR ALL CONDITIONS

BETA	ELEVTR	CANARC
0.000	-40.000	0.000
0.000	-20.000	0.000
0.000	0.000	0.000
0.000	10.000	0.000

REFERENCE INFORMATION	
SREF	15.0900 SQ INC
LREF	2.8300 INCHES
BREF	8.0520 INCHES
XMRP	2.1110 INCHES
YMRP	0.0000 INCHES
ZMRP	0.0000 INCHES
SCALE	0.0035

MACH 1.459

FIGURE-3 ELEVATOR EFFECTIVENESS OF B-18E-3 CONFIGURATION

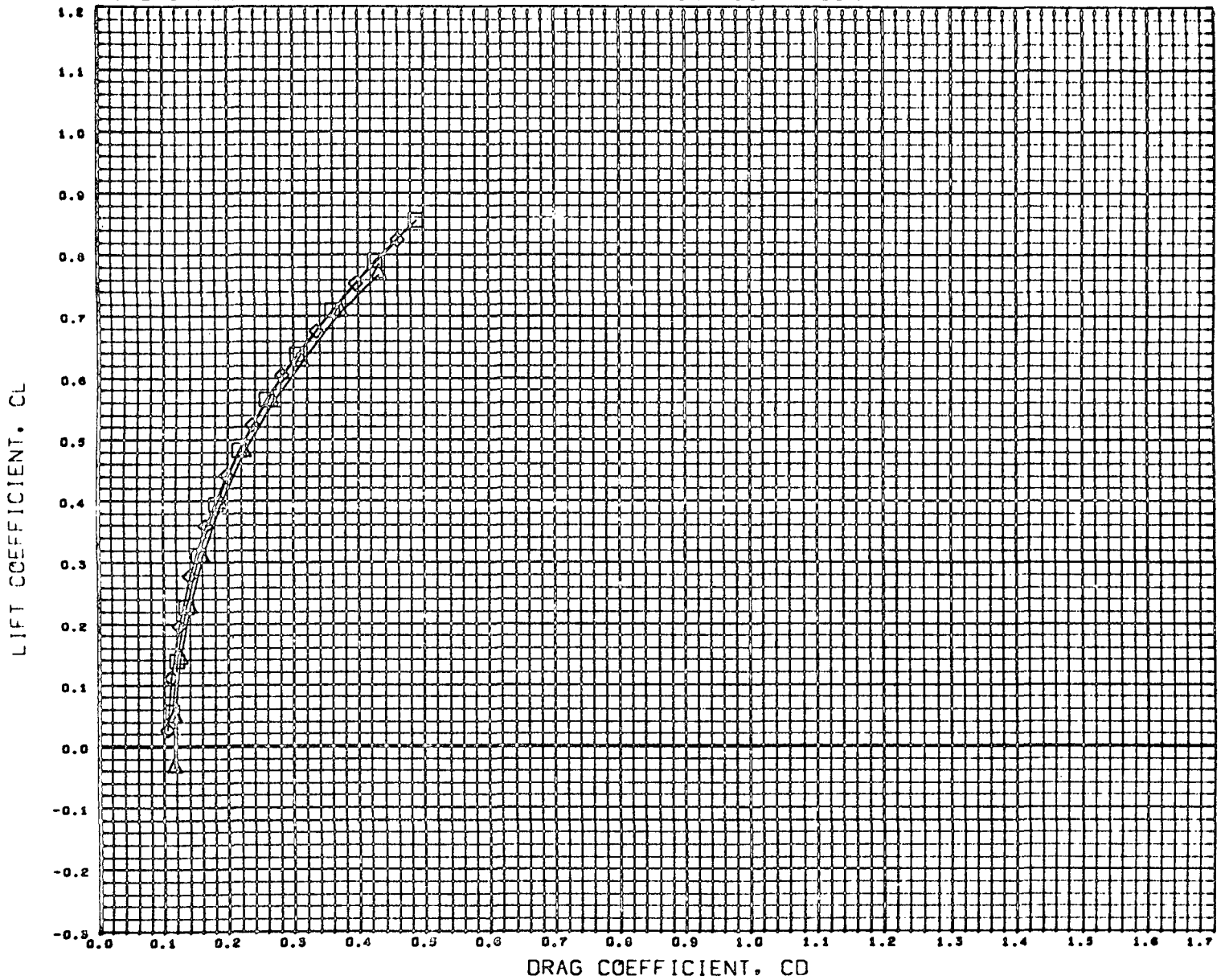

DATA SET SYMBOL	CONFIGURATION DESCRIPTION
(C98030)	DATA NOT AVAILABLE FOR ALL CONDITIONS
(C50020)	MSFC TWT 514 E3 030W23C10
(C50010)	MSFC TWT 514 E3 030W23C10
(D58:90)	MSFC TWT 514 E3 030W23C10

BETA	ELEVTR	CANARD
0.000	-40.000	0.000
0.000	-20.000	0.000
0.000	0.000	0.000
0.000	10.000	0.000

REFERENCE INFORMATION		
SREF	15.0300	SQ INC
LREF	2.8300	INCHE9
BREF	6.0620	INCHE9
XMRP	2.1110	INCHE9
YMRP	0.0000	INCHE9
ZMRP	0.0000	INCHE9
SCALE	0.0035	

MACH 1.059

FIGURE-3 ELEVATOR EFFECTIVENESS OF B-18E-3 CONFIGURATION

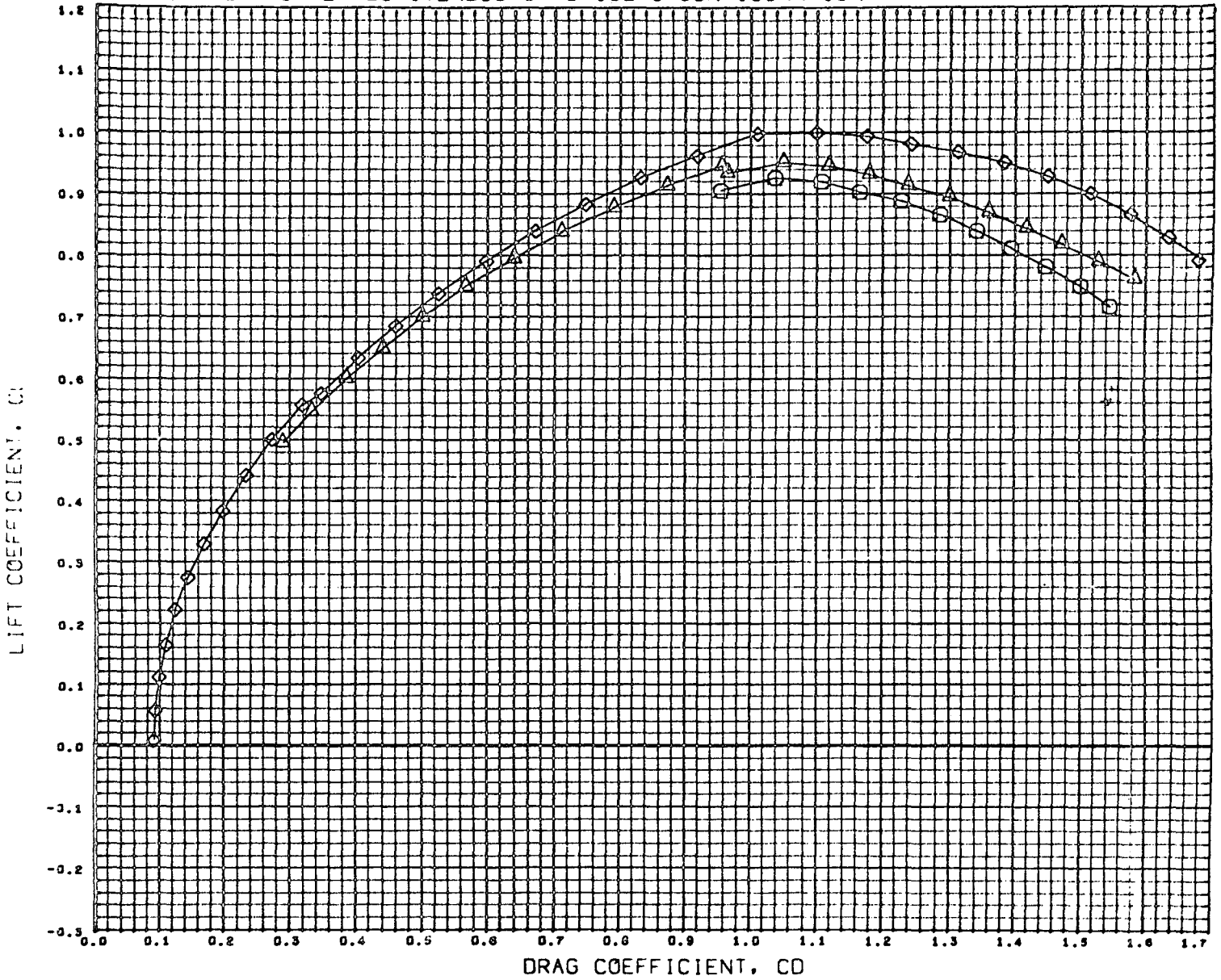

DATA SET	SYMBOL	CONFIGURATION DESCRIPTION
(C90030)	○	MSFC TWT 514 E3 B30W23C10
(C90020)	△	MSFC TWT 514 E3 B30W23C10
(C90010)	◇	MSFC TWT 514 E3 B30W23C10
(D90190)	□	DATA NOT AVAILABLE FOR ALL CONDITIONS

BETA	ELEVTR	CANARD
0.000	-40.000	0.000
0.000	-20.000	0.000
0.000	0.000	0.000
0.000	10.000	0.000

REFERENCE INFORMATION		
SREF	15.0300	50 INC
LREF	2.8300	INCHES
BREF	0.0620	INCHES
XMRP	2.1110	INCHES
YMRP	0.0000	INCHES
ZMRP	0.0000	INCHES
SCALE	0.0035	

MACH 2.990

FIGURE-3 ELEVATOR EFFECTIVENESS OF B-18E-3 CONFIGURATION

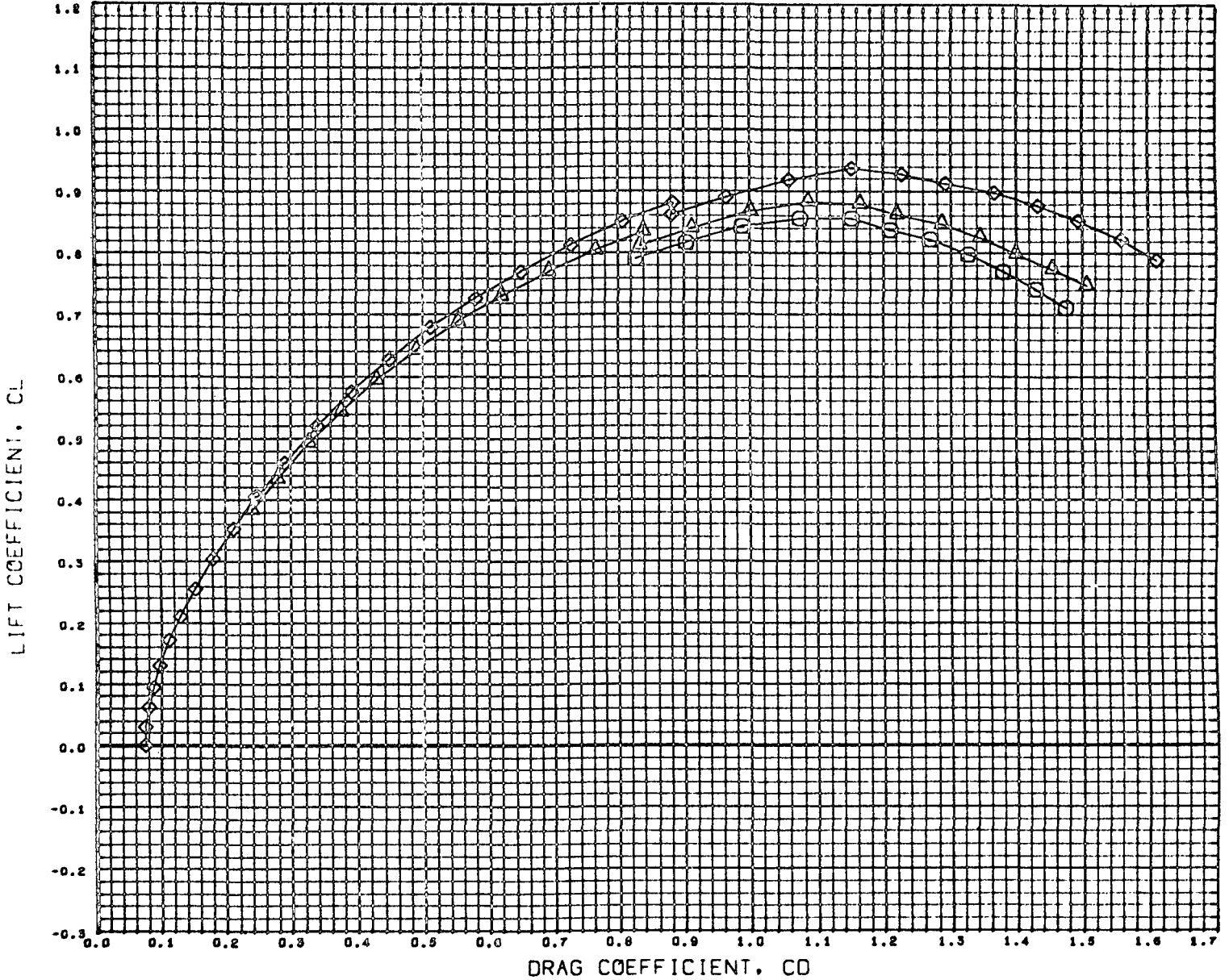

DATA SET SYMBOL	CONFIGURATION DESCRIPTION
(C91030)	MSFC TWT 514 E3 030W23C10
(C91020)	MSFC TWT 514 E3 030W23C10
(C91010)	MSFC TWT 514 E3 030W23C10
(D9L190)	DATA NOT AVAILABLE FOR ALL CONDITIONS

BETA	ELEVTR	CANARD
0.000	-40.000	0.000
0.000	-20.000	0.000
0.000	0.000	0.000
0.000	10.000	0.000

REFERENCE INFORMATION		
SREF	15.0300	SQ INC
LREF	2.0300	INCHES
BREF	6.0620	INCHES
XMRP	2.1110	INCHES
YMRP	0.0000	INCHES
ZMRP	0.0000	INCHES
SCALE	0.0035	

MACH 4.950

FIGURE-3 ELEVATOR EFFECTIVENESS OF B-18E-3 CONFIGURATION



DATA SET SYMBOL	CONFIGURATION DESCRIPTION
(C90C30)	MSFC TWT 514 E3 830W23C10
(C90C20)	MSFC TWT 514 E3 830W23C10
(C90C10)	MSFC TWT 514 E3 830W23C10
(D50190)	MSFC TWT 514 E3 830W23C10

BETA	ELEVTR	CANARD
0.000	-40.000	0.000
0.000	-20.000	0.000
0.000	0.000	0.000
0.000	10.000	0.000

REFERENCE INFORMATION		
SREF	15.0300	50 INC
LREF	2.8300	INCHES
BREF	0.0620	INCHES
XMRP	2.1110	INCHES
YMRP	0.0000	INCHES
ZMRP	0.0000	INCHES
SCALE	0.0035	

MACH 0.900

FIGURE-3 ELEVATOR EFFECTIVENESS OF B-18E-3 CONFIGURATION

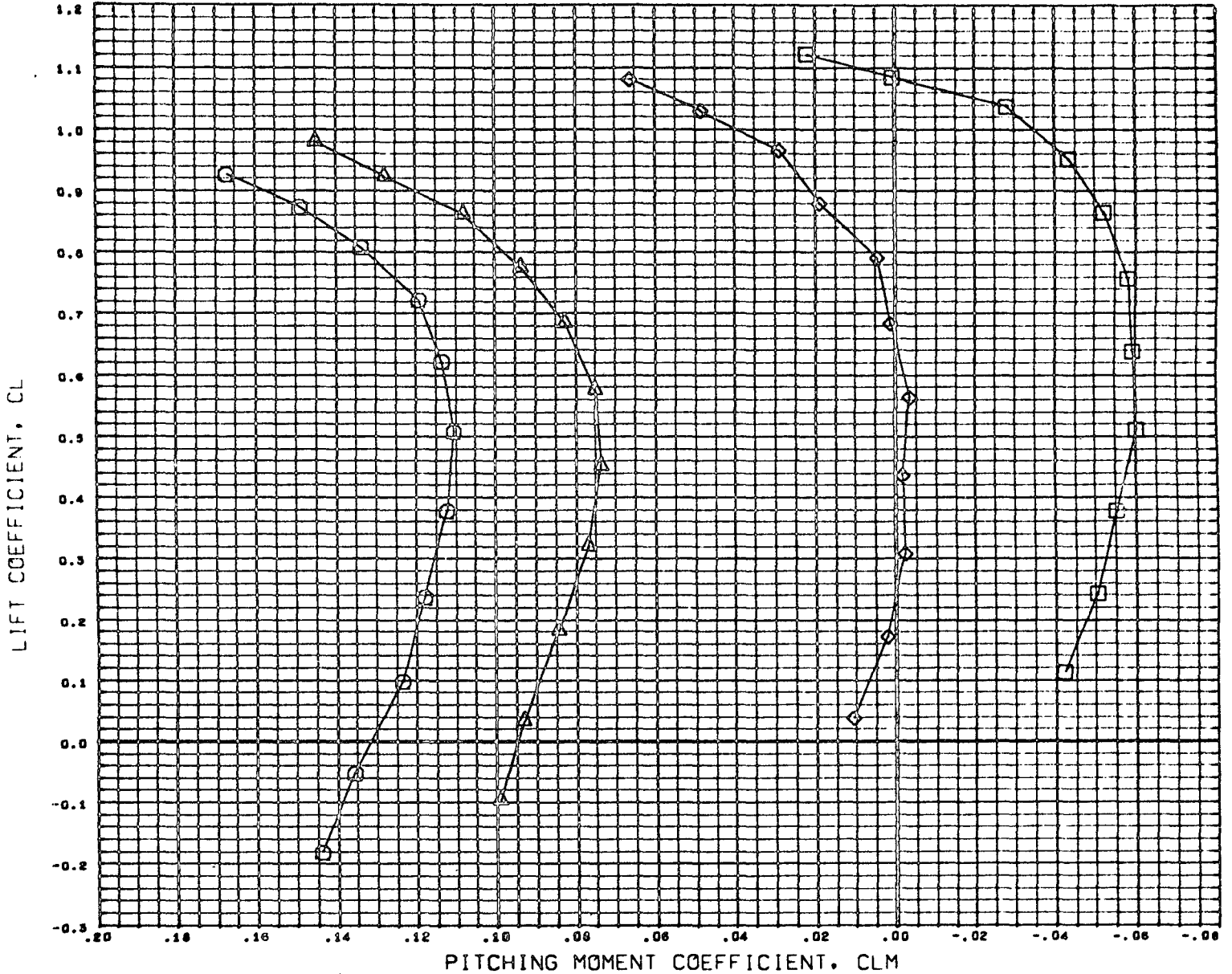

DATA SET SYMBOL	CONFIGURATION DESCRIPTION
(C56030)	MSFC TWT 514 E3 830W23C10
(C56020)	MSFC TWT 514 E3 830W23C10
(C56010)	MSFC TWT 514 E3 830W23C10
(056190)	MSFC TWT 514 E3 830W23C10

BETA	ELEVTR	CANARD
0.000	-40.000	0.000
0.000	-20.000	0.000
0.000	0.000	0.000
0.000	10.000	0.000

REFERENCE INFORMATION		
SREF	15.0300	50 INC
LREF	2.8300	INCHES
BREF	6.0620	INCHES
YMRF	2.1110	INCHES
ZMRF	0.0000	INCHES
SCALE	0.0035	

MACH 1.100

FIGURE-3 ELEVATOR EFFECTIVENESS OF B-18E-3 CONFIGURATION

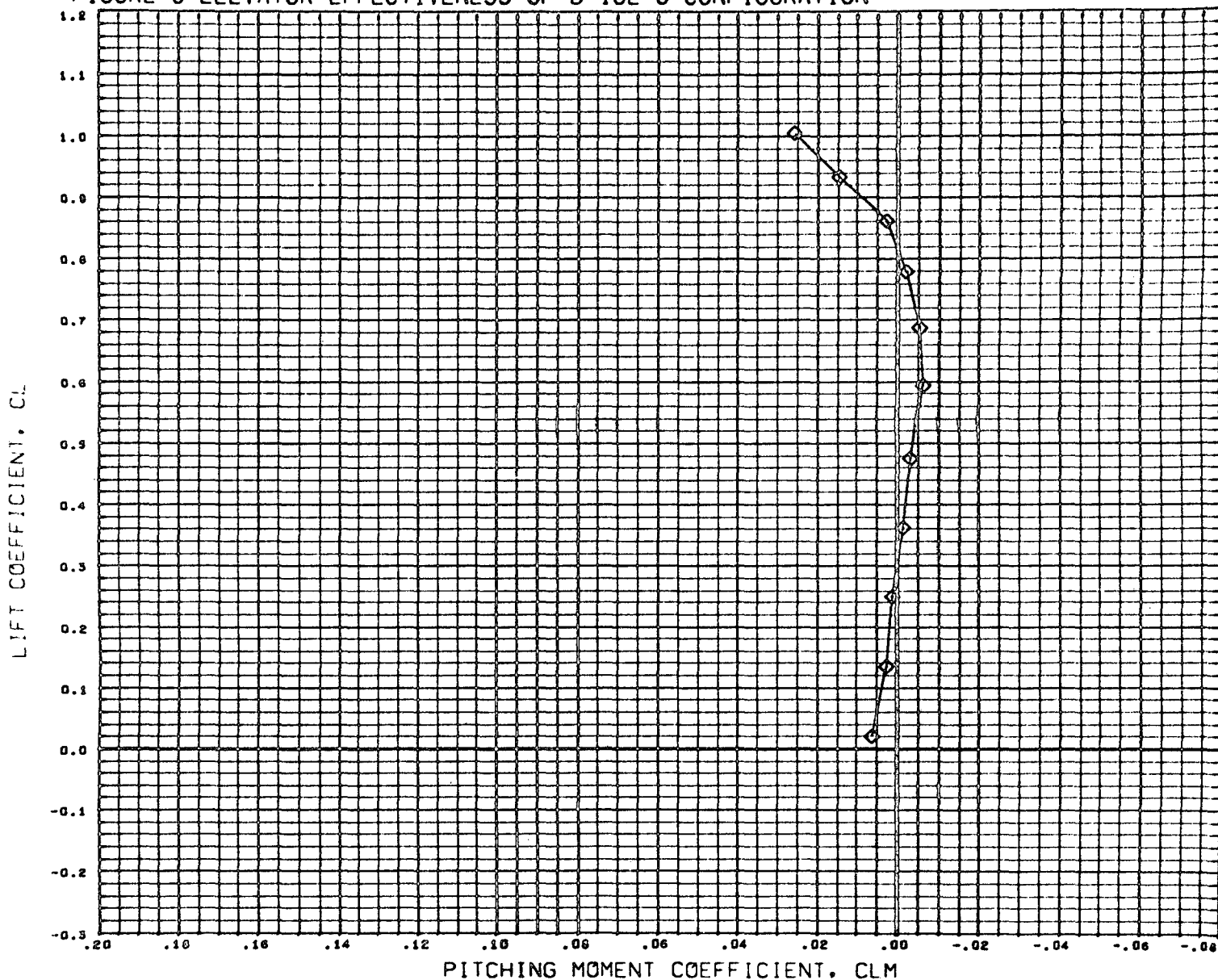

DATA SET	SYMBOL	CONFIGURATION DESCRIPTION
(C56030)	○	DATA NOT AVAILABLE FOR ALL CONDITIONS
(C58020)	△	DATA NOT AVAILABLE FOR ALL CONDITIONS
(C58010)	◇	MSFC TWT 514 E3 B30W23C10
(D58190)	□	DATA NOT AVAILABLE FOR ALL CONDITIONS

BETA	ELEVTR	CANARD
0.000	-40.000	0.000
0.000	-20.000	0.000
0.000	0.000	0.000
0.000	10.000	0.000

REFERENCE INFORMATION		
SREF	15.0300	50 INC
LREF	2.8300	INCHES
BREF	6.0620	INCHES
XMRP	2.1110	INCHES
YMRP	0.0000	INCHES
ZMRP	0.0000	INCHES
SCALE	0.0035	

MACH 1.459

FIGURE-3 ELEVATOR EFFECTIVENESS OF B-18E-3 CONFIGURATION

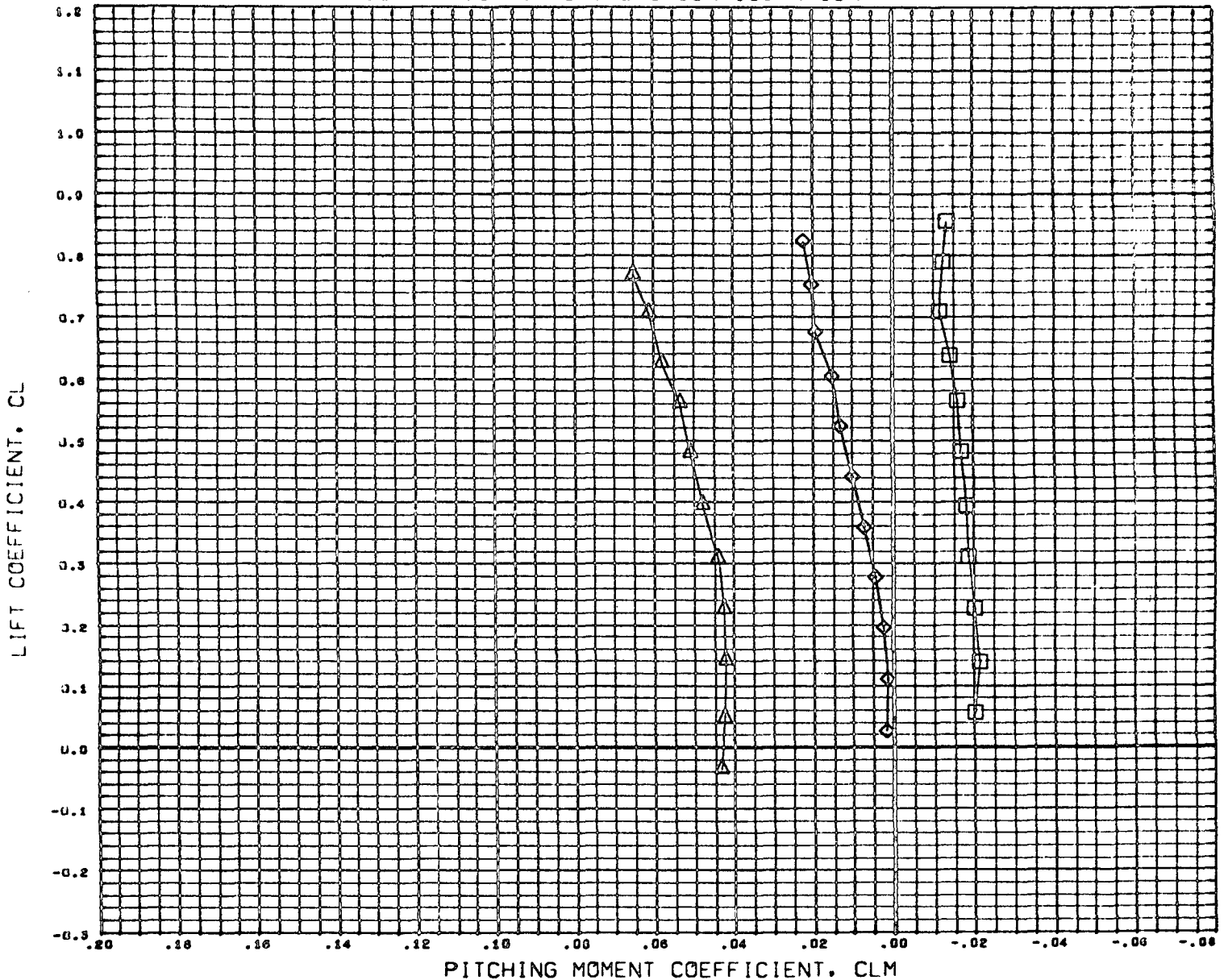

DATA SET SYMBOL	CONFIGURATION DESCRIPTION
(C50030)	DATA NOT AVAILABLE FOR ALL CONDITIONS
(C58020)	MSFC TWT 314 E3 830W23C10
(C58010)	MSFC TWT 314 E3 830W23C10
(058100)	MSFC TWT 314 E3 830W23C10

BETA	ELEVTR	CANARD
0.000	-40.000	0.000
0.000	-20.000	0.000
0.000	0.000	0.000
0.000	10.000	0.000

REFERENCE INFORMATION		
SREF	15.0300	SQ INC
LREF	2.8300	INCHES
BREF	6.0620	INCHES
XMRP	2.1110	INCHES
YMRP	0.0000	INCHES
ZMRP	0.0000	INCHES
SCALE	0.0035	

MACH 1.955

FIGURE-3 ELEVATOR EFFECTIVENESS OF B-18E-3 CONFIGURATION

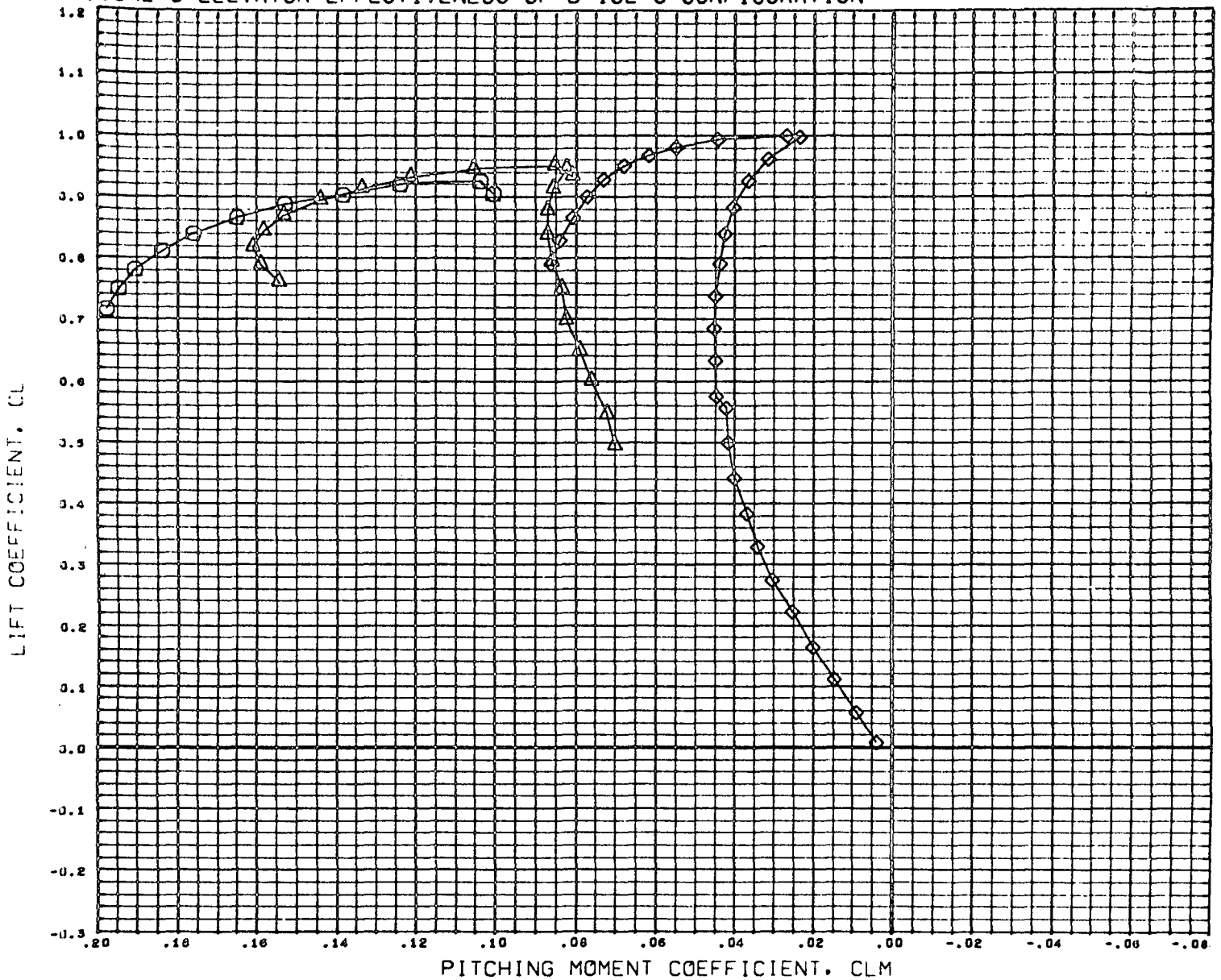

DATA SET SYMBOL	CONFIGURATION DESCRIPTION
(C58630)	MSFC TWT 514 E3 830W23C10
(C58620)	MSFC TWT 514 E3 830W23C10
(C58610)	MSFC TWT 514 E3 830W23C10
(058190)	DATA NOT AVAILABLE FOR ALL CONDITIONS

BETA	ELEVTR	CANARD
0.000	-40.000	0.000
0.000	-20.000	0.000
0.000	0.000	0.000
0.000	10.000	0.000

REFERENCE INFORMATION		
SREF	15.0500	SQ INC
LREF	2.8300	INCHES
BREF	6.0620	INCHES
XMRP	2.1110	INCHES
YMRP	0.0000	INCHES
ZMRP	0.0000	INCHES
SCALE	0.0035	

MACH 2.990

FIGURE-3 ELEVATOR EFFECTIVENESS OF B-18E-3 CONFIGURATION

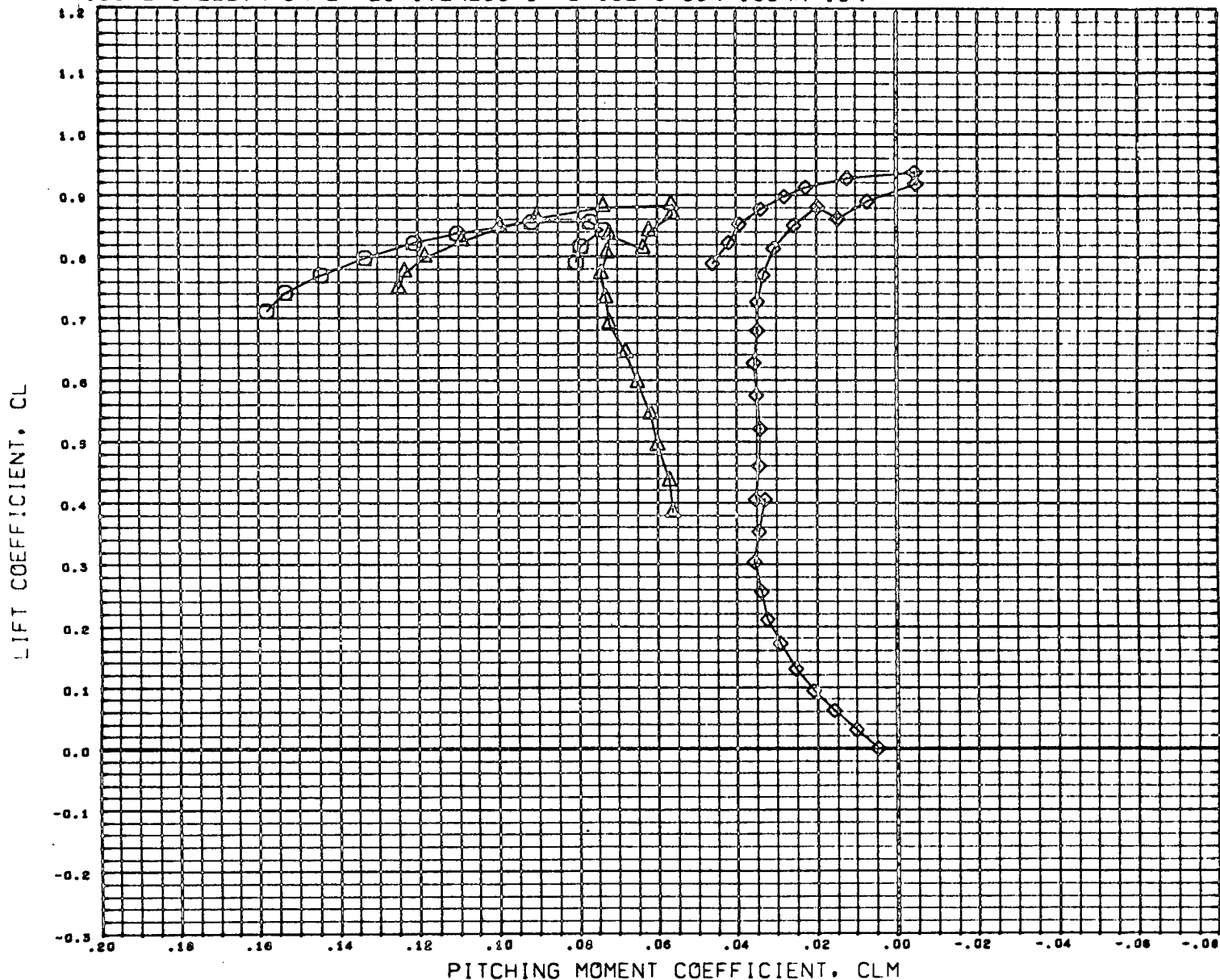

DATA SET SYMBOL	CONFIGURATION DESCRIPTION
(C98030)	MSFC TWT 514 E3 030W23C10
(C98020)	MSFC TWT 514 E3 030W23C10
(C98010)	MSFC TWT 514 E3 030W23C10
(098190)	DATA NOT AVAILABLE FOR ALL CONDITIONS

BETA	ELEVTR	CANARD
0.000	-40.000	0.000
0.000	-20.000	0.000
0.000	0.000	0.000
0.000	10.000	0.000

REFERENCE INFORMATION		
SREF	15.0300	80 INC
LREF	2.8300	INCHES
BREF	6.0620	INCHES
XMRP	2.1110	INCHES
YMRP	0.0000	INCHES
ZMRP	0.0000	INCHES
SCALE	0.0035	

MACH 4.099

FIGURE-4 CANARD EFFECTIVENESS OF B-18E-3 CONFIGURATION

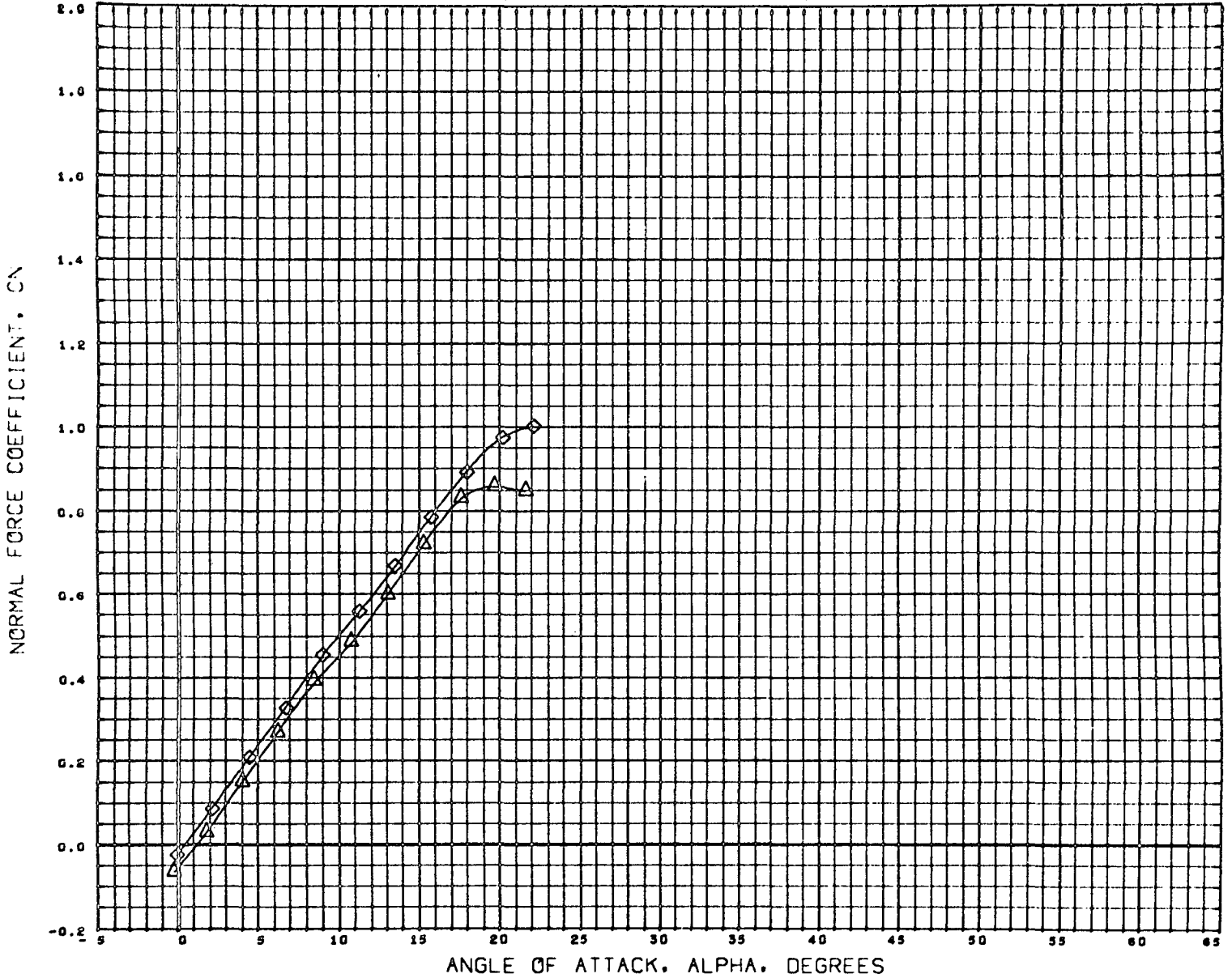

DATA SET SYMBOL	CONFIGURATION DESCRIPTION
(C50050)	DATA NOT AVAILABLE FOR ALL CONDITIONS
(C50040)	MSFC TWT 514 E3 B30W23C10
(C50010)	MSFC TWT 514 E3 B30W23C10

BETA	ELEVTR	CANARD
0.000	0.000	-60.000
0.000	0.000	-30.000
0.000	0.000	0.000

REFERENCE INFORMATION		
SREF	15.0300	SQ INC
LREF	2.8300	INCHES
BREF	6.0620	INCHES
XMRP	2.1110	INCHES
YMRP	0.0000	INCHES
ZMRP	0.0000	INCHES
SCALE	0.0035	

MACH 0.902

FIGURE-4 CANARD EFFECTIVENESS OF B-18E-3 CONFIGURATION

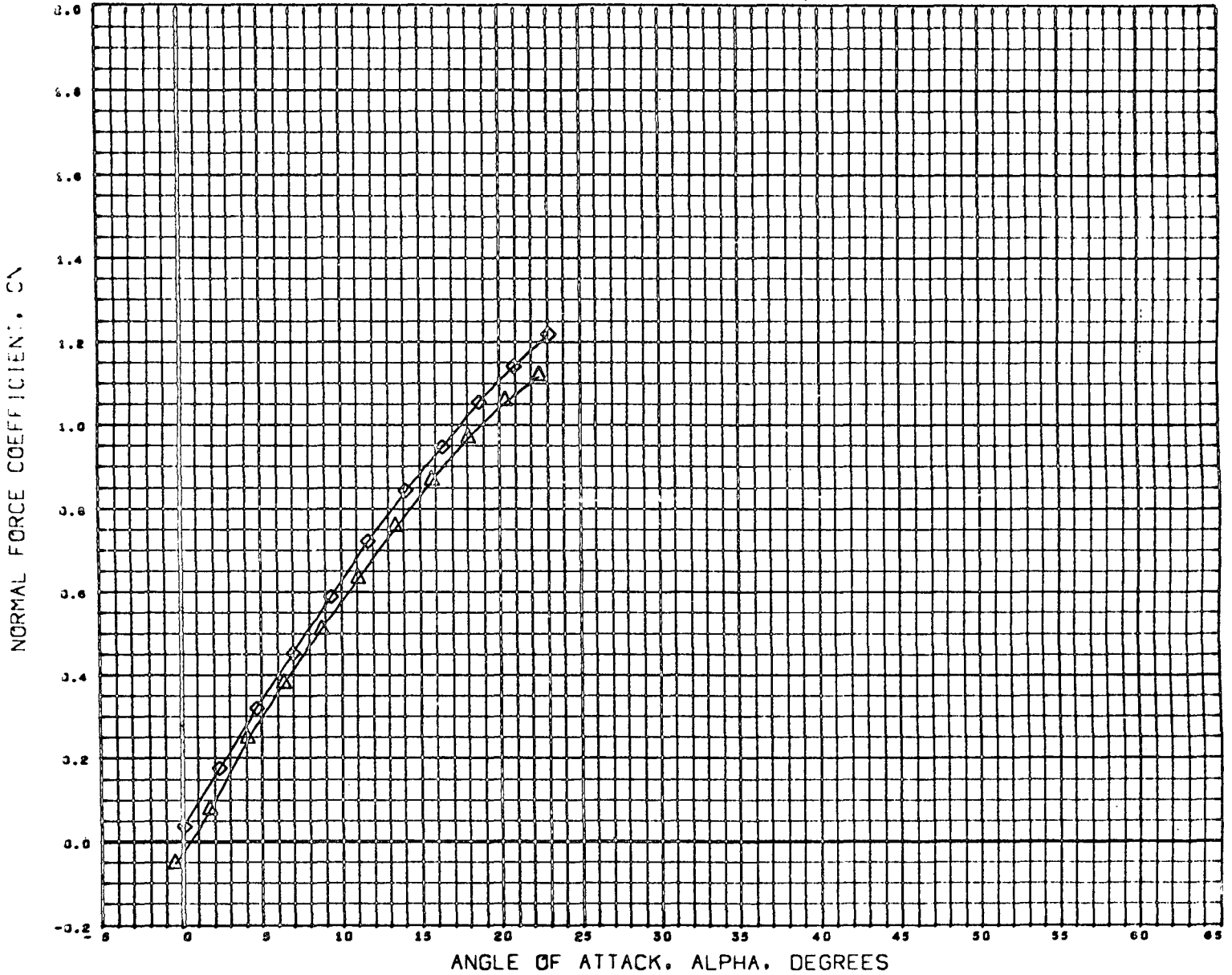

DATA SET	SYMBOL	CONFIGURATION DESCRIPTION
(C58050)	○	DATA NOT AVAILABLE FOR ALL CONDITIONS
(C58040)	△	HSFC TWT 514 E3 B3GW23C10
(C58010)	◇	HSFC TWT 514 E3 B30W23C10

BETA	ELEVTR	CANARD
0.000	0.000	-60.000
0.000	0.000	-30.000
0.000	0.000	0.000

REFERENCE INFORMATION		
SREF	15.0500	SQ INC
LREF	2.8300	INCHES
BREF	6.0620	INCHES
XMRP	2.1110	INCHES
YMRP	0.0000	INCHES
ZMRP	0.0000	INCHES
SCALE	0.0035	

NACM 1.106

FIGURE-4 CANARD EFFECTIVENESS OF B-18E-3 CONFIGURATION

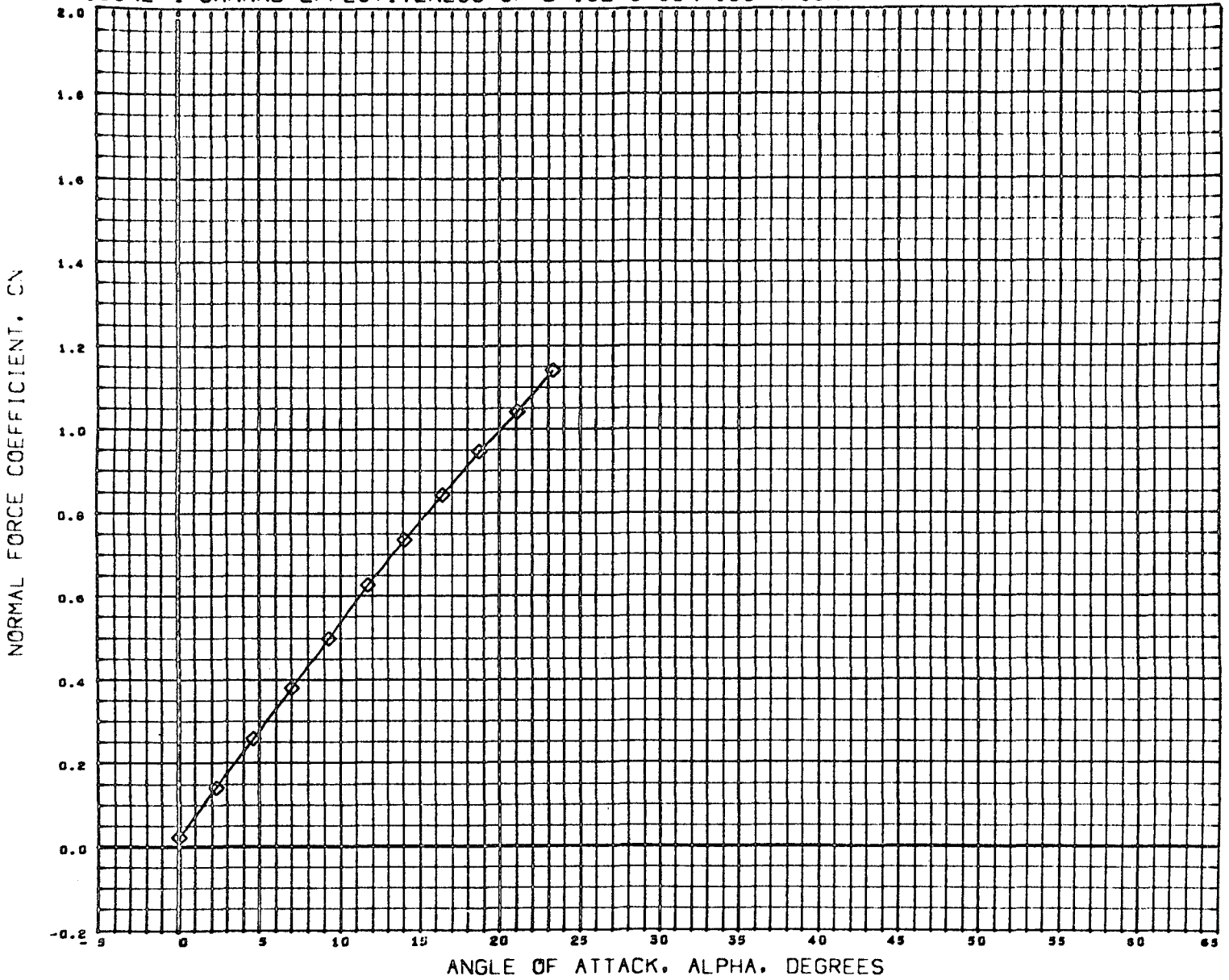

DATA SET SYMBOL	CONFIGURATION DESCRIPTION
(C50050)	DATA NOT AVAILABLE FOR ALL CONDITIONS
(C56040)	DATA NOT AVAILABLE FOR ALL CONDITIONS
(C56010)	MSFC TWT 514 E3 B30W23C10

BETA	ELEVTR	CANARD
0.000	0.000	-60.000
0.000	0.000	-30.000
0.000	0.000	0.000

REFERENCE INFORMATION		
SREF	15.0300	SQ INC
LREF	2.8300	INCHES
BREF	6.0620	INCHES
XMRP	2.1110	INCHES
YMRP	0.0000	INCHES
ZMRP	0.0000	INCHES
SCALE	0.0035	

MACH 1.459

FIGURE-4 CANARD EFFECTIVENESS OF B-18E-3 CONFIGURATION

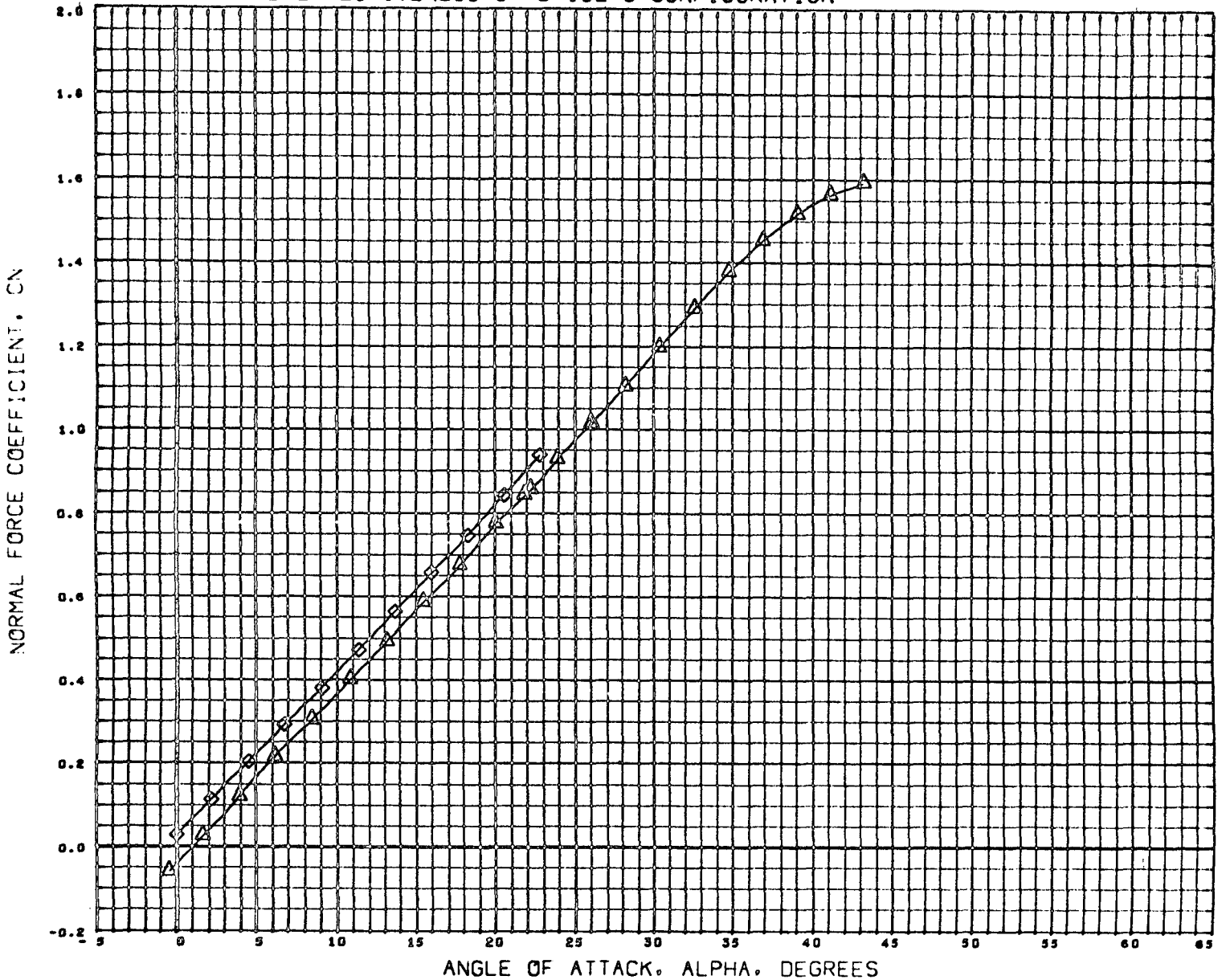

DATA SET SYMBOL	CONFIGURATION DESCRIPTION
(C90050)	DATA NOT AVAILABLE FOR ALL CONDITIONS
(C90040)	MSFC TWT 514 E3 B30W23C10
(C90010)	MSFC TWT 514 E3 B30W23C10

BETA	ELEVTR	CANARD
0.000	0.000	-60.000
0.000	0.000	-30.000
0.000	0.000	0.000

REFERENCE INFORMATION		
SREF	15.0300	SQ INC
LREF	2.8300	INCHES
BREF	6.0620	INCHES
XMRP	2.1110	INCHES
YMRP	0.0000	INCHES
ZMRP	0.0000	INCHES
SCALE	0.0035	

MACH 1.954

FIGURE-4 CANARD EFFECTIVENESS OF B-18E-3 CONFIGURATION

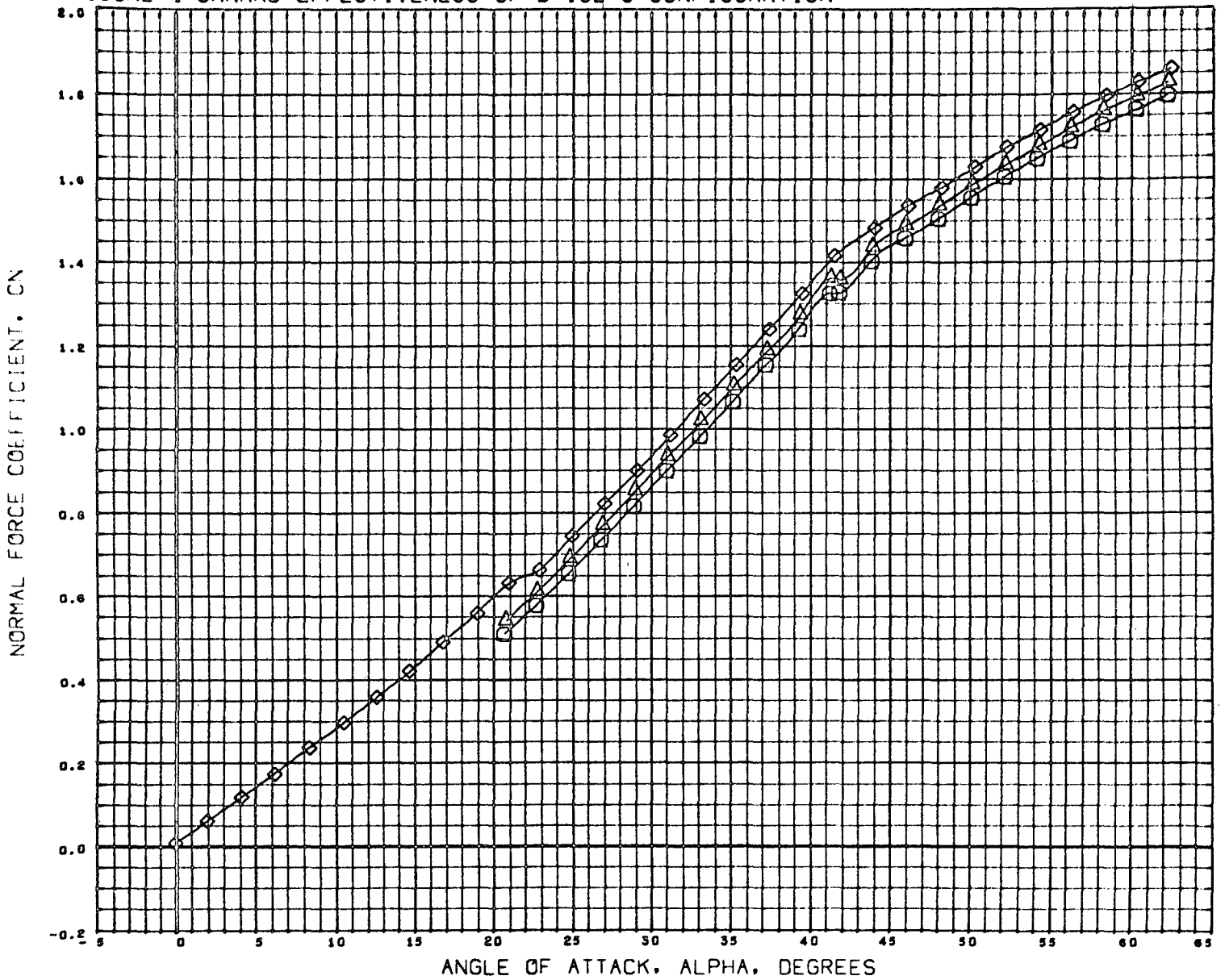

DATA SET SYMBOL	CONFIGURATION	DESCRIPTION
(C58050)	MSFC TWT 514 E3	B30W23C10
(C58040)	MSFC TWT 514 E3	B30W23C10
(C58010)	MSFC TWT 514 E3	B30W23C10

BETA	ELEVTR	CANARD
0.000	0.000	-60.000
0.000	0.000	-30.000
0.000	0.000	0.000

REFERENCE INFORMATION		
SREF	15.0300	94 INC
LREF	2.8300	INCHES
BREF	6.0620	INCHES
XMRP	2.1110	INCHES
YMRP	0.0000	INCHES
ZMRP	0.0000	INCHES
SCALE	0.0035	

MACH 2.990

FIGURE-4 CANARD EFFECTIVENESS OF B-18E-3 CONFIGURATION

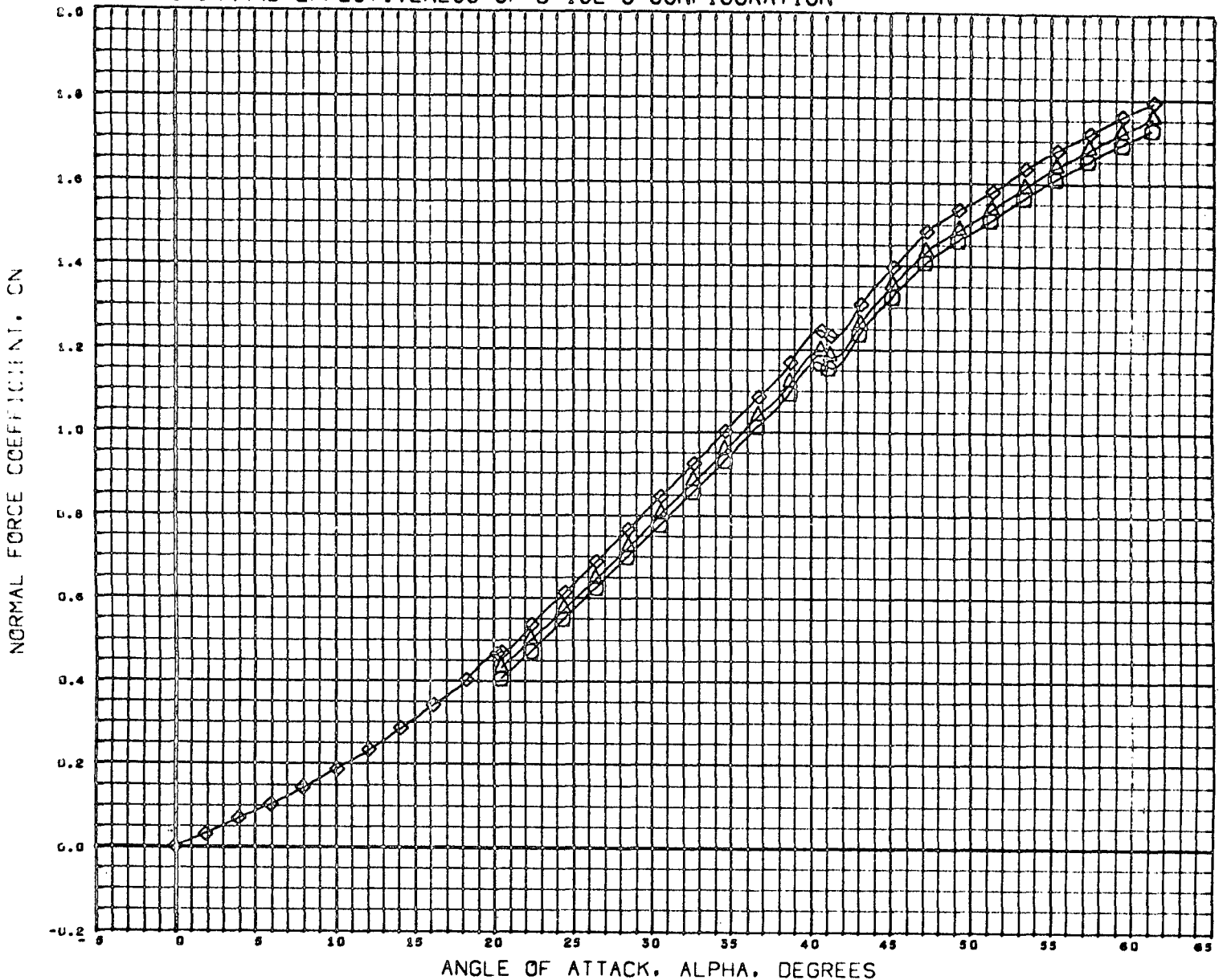

DATA SET SYMBOL	CONFIGURATION DESCRIPTION
(C90030) ○	MSFC TWT 514 E3 830W23C10
(C90040) △	MSFC TWT 514 E3 830W23C10
(C90010) ◇	MSFC TWT 514 E3 830W23C10

BETA	ELEVTR	CANARD
0.000	0.000	-60.000
0.000	0.000	-30.000
0.000	0.000	0.000

REFERENCE INFORMATION		
SREF	15.0300	SQ INC
LREF	2.8300	INCHES
BREF	6.0620	INCHES
XMRP	2.1110	INCHES
YMRP	0.0000	INCHES
ZMRP	0.0000	INCHES
SCALE	0.0035	

MACH 4.959

FIGURE-4 CANARD EFFECTIVENESS OF B-18E-3 CONFIGURATION

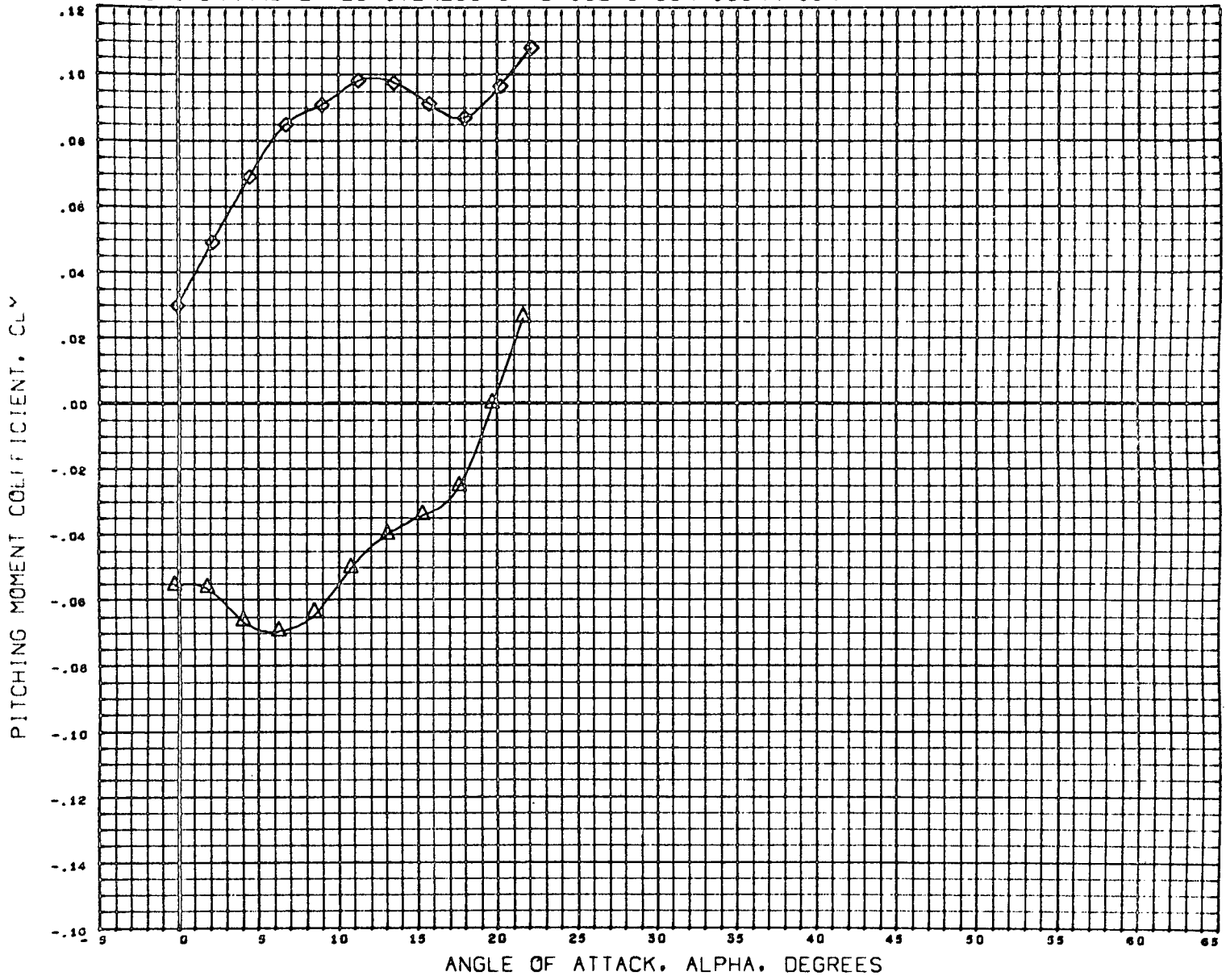

DATA SET SYMBOL	CONFIGURATION DESCRIPTION
(C58030)	DATA NOT AVAILABLE FOR ALL CONDITIONS
(C58040)	MSFC TWT 514 E3 B30W23C10
(C58010)	MSFC TWT 514 E3 B30W23C10

BETA	ELEVTR	CANARD
0.000	0.000	-60.000
0.000	0.000	-30.000
0.000	0.000	0.000

REFERENCE INFORMATION		
SREF	15.0300	SQ INC
LREF	2.8300	INCHES
BREF	6.0620	INCHES
XMRP	2.1110	INCHES
YMRP	0.0000	INCHES
ZMRP	0.0000	INCHES
SCALE	0.0035	

MACH 0.902

FIGURE-4 CANARD EFFECTIVENESS OF B-18E-3 CONFIGURATION

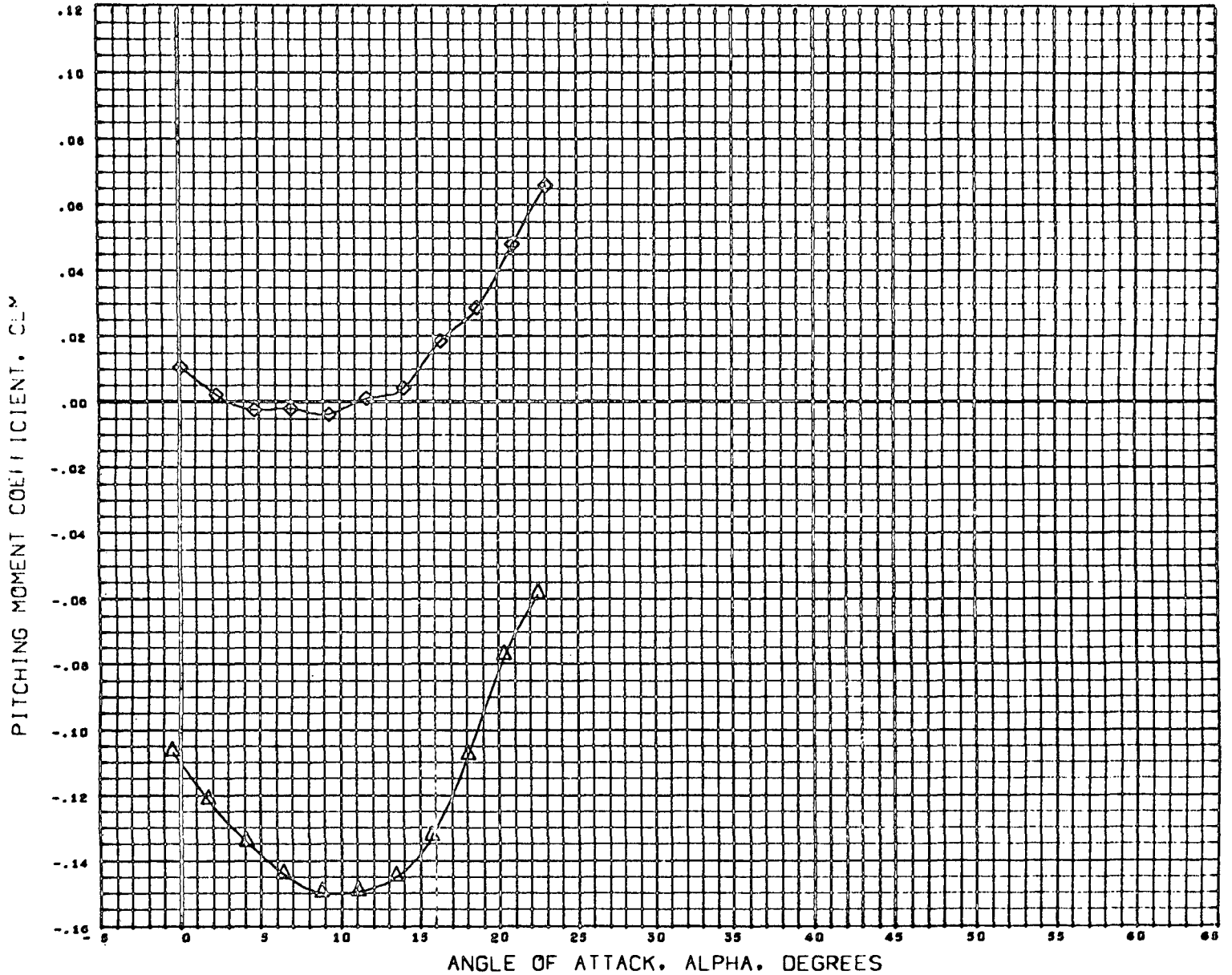

DATA SET SYMBOL	CONFIGURATION DESCRIPTION
(C58050)	DATA NOT AVAILABLE FOR ALL CONDITIONS
(C58040)	MSFC TWT 514 E3 B30W23C10
(C58010)	MSFC TWT 514 E3 B30W23C10

BETA	ELEVTR	CANARD
0.000	0.000	-60.000
0.000	0.000	-30.000
0.000	0.000	0.000

REFERENCE INFORMATION		
SREF	15.0300	80 INC
LREF	2.8300	INCHES
DREF	0.0620	INCHES
XWRP	2.1110	INCHES
YWRP	0.0000	INCHES
ZWRP	0.0000	INCHES
SCALE	0.0035	

MACH 1.196

FIGURE-4 CANARD EFFECTIVENESS OF B-18E-3 CONFIGURATION

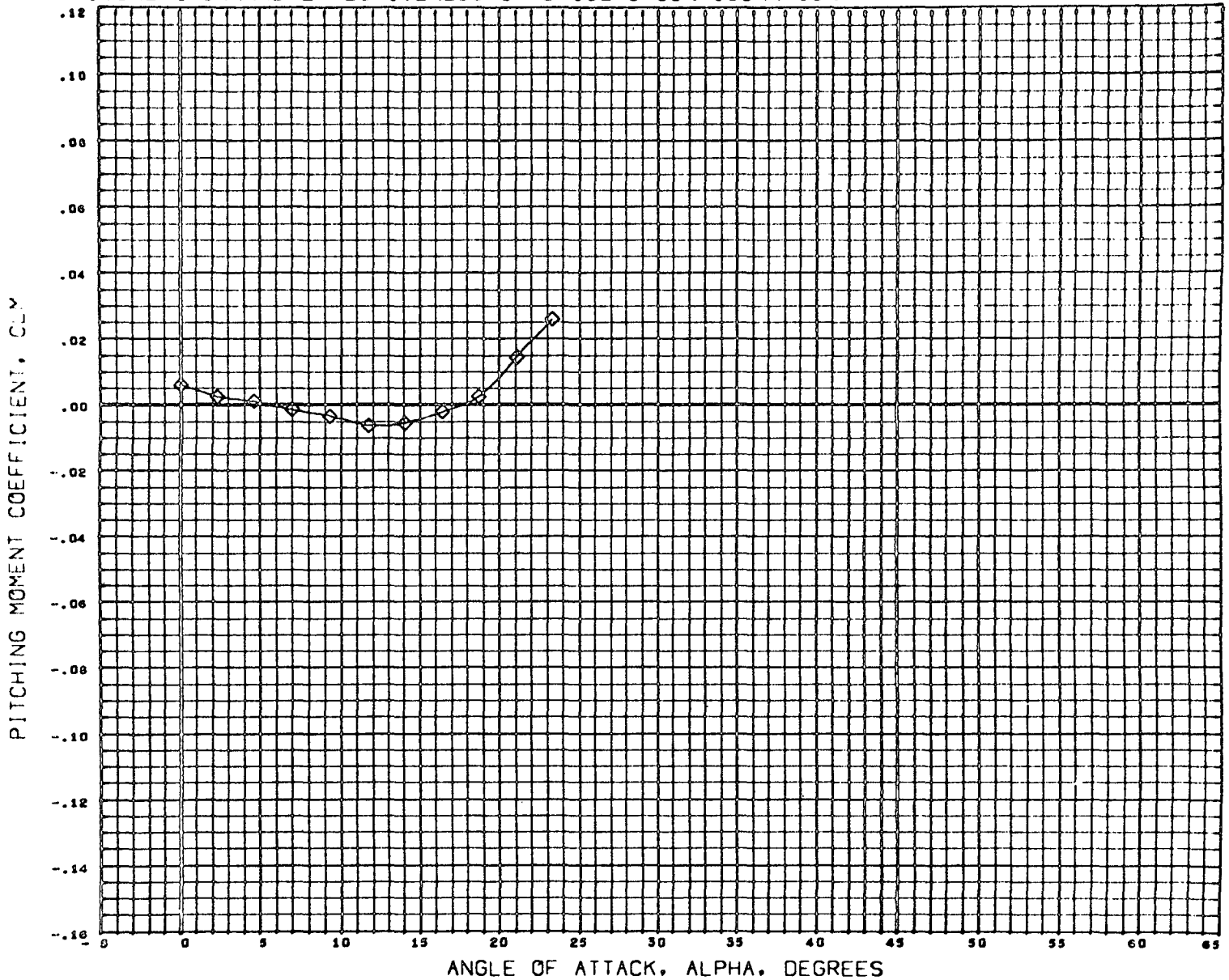

DATA SET SYMBOL	CONFIGURATION DESCRIPTION
(C58050)	DATA NOT AVAILABLE FOR ALL CONDITIONS
(C58040)	DATA NOT AVAILABLE FOR ALL CONDITIONS
(C58010)	MSFC TWT 514 E3 B30W23C10

BETA	ELEVTR	CANARD
0.000	0.000	-60.000
0.000	0.000	-30.000
0.000	0.000	0.000

REFERENCE INFORMATION		
SREF	15.0300	50 INC
LREF	2.8300	INCHES
BREF	6.0620	INCHES
XMRP	2.1110	INCHES
YMRF	0.0000	INCHES
ZMRF	0.0000	INCHES
SCALE	0.0039	

MACH 1.459

FIGURE-4 CANARD EFFECTIVENESS OF B-18E-3 CONFIGURATION

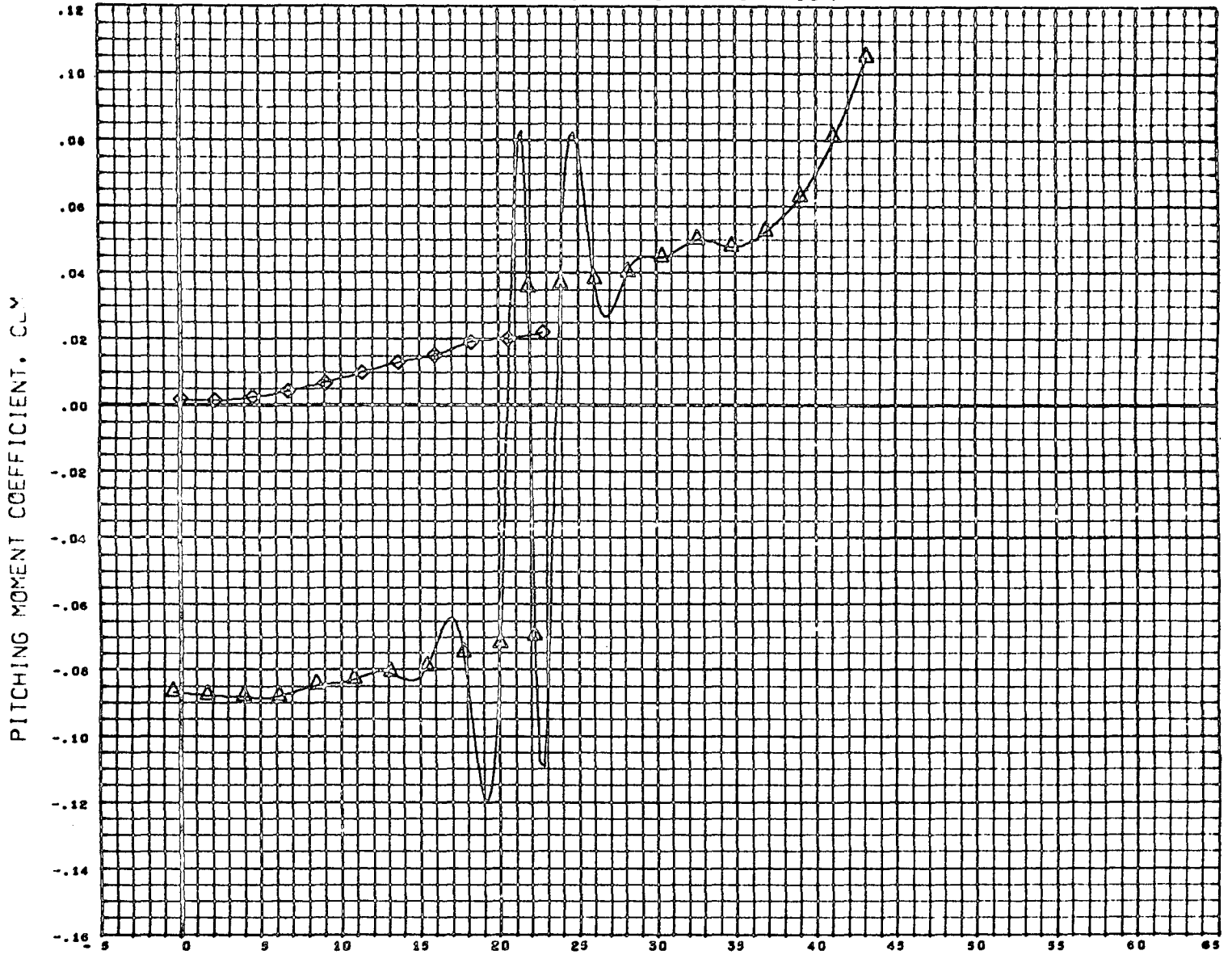

DATA SET SYMBOL	CONFIGURATION DESCRIPTION	BETA	ELEVTR	CANARD	REFERENCE INFORMATION
(C50050)	DATA NOT AVAILABLE FOR ALL CONDITIONS	0.000	0.000	-60.000	SREF 15.0300 SQ INC
(C90040)	MSFC TWT 514 E3 030W23C10	0.000	0.000	-30.000	LREF 2.8300 INCHES
(C90010)	MSFC TWT 514 E3 030W23C10	0.000	0.000	0.000	OREF 5.0620 INCHES
					XMRP 2.1110 INCHES
					YMRP 0.0000 INCHES
					ZMRP 0.0000 INCHES
					SCALE 0.0035

MACH 1.054

FIGURE-4 CANARD EFFECTIVENESS OF B-18E-3 CONFIGURATION

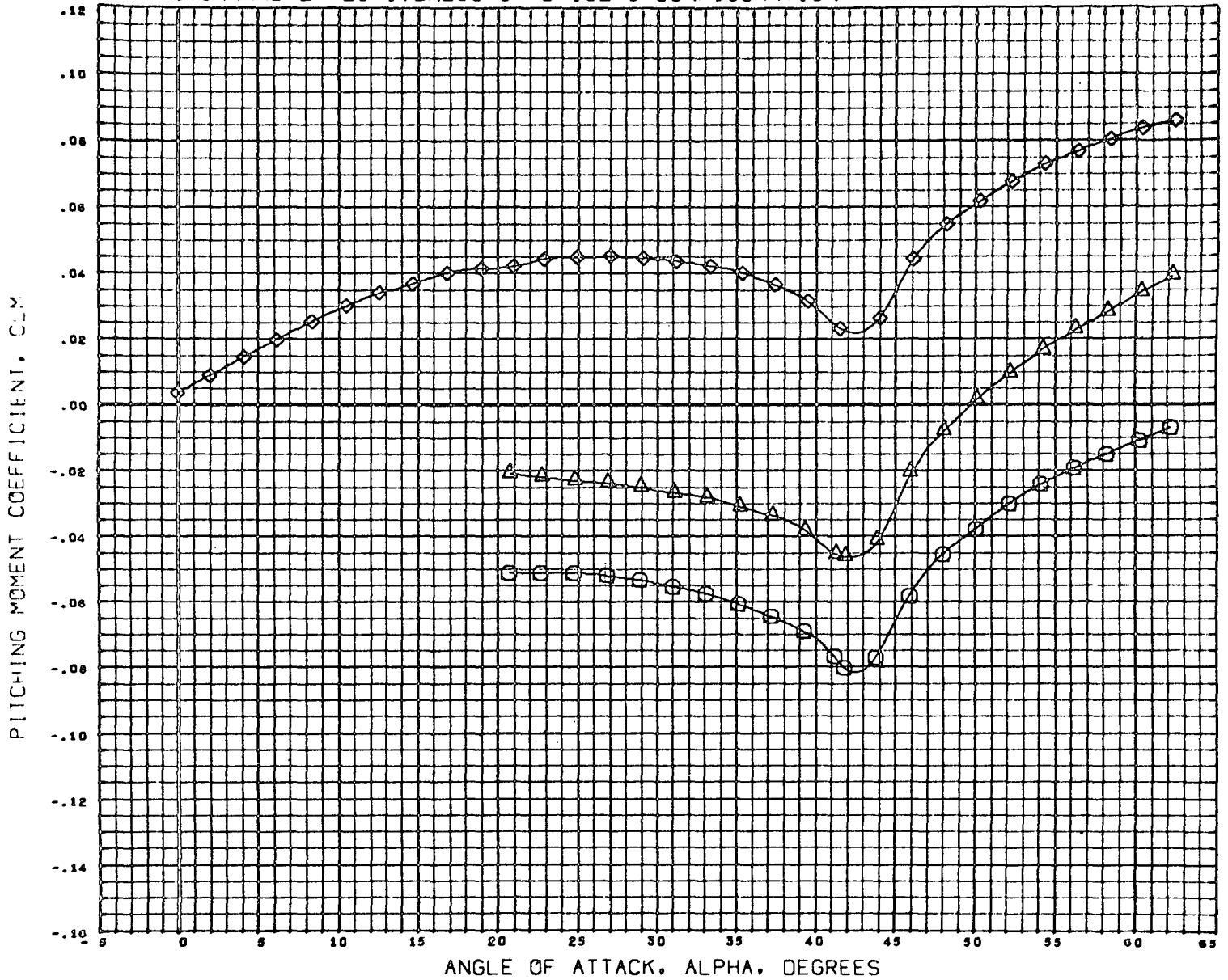

DATA SET SYMBOL	CONFIGURATION DESCRIPTION
(C50050)	MSFC TWT 514 E3 830W23C10
(C50040)	MSFC TWT 514 E3 830W23C10
(C50010)	MSFC TWT 514 E3 830W23C10

BETA	ELEVTR	CANARD
0.000	0.000	-60.000
0.000	0.000	-30.000
0.000	0.000	0.000

REFERENCE INFORMATION		
SREF	15.0300	00 INC
LREF	2.8300	INCHE8
BREF	6.0620	INCHE0
XMRP	2.1110	INCHE8
YMRP	0.0000	INCHE8
ZMRP	0.0000	INCHE8
SCALE	0.0035	

MACH 2.990

FIGURE-4 CANARD EFFECTIVENESS OF B-18E-3 CONFIGURATION

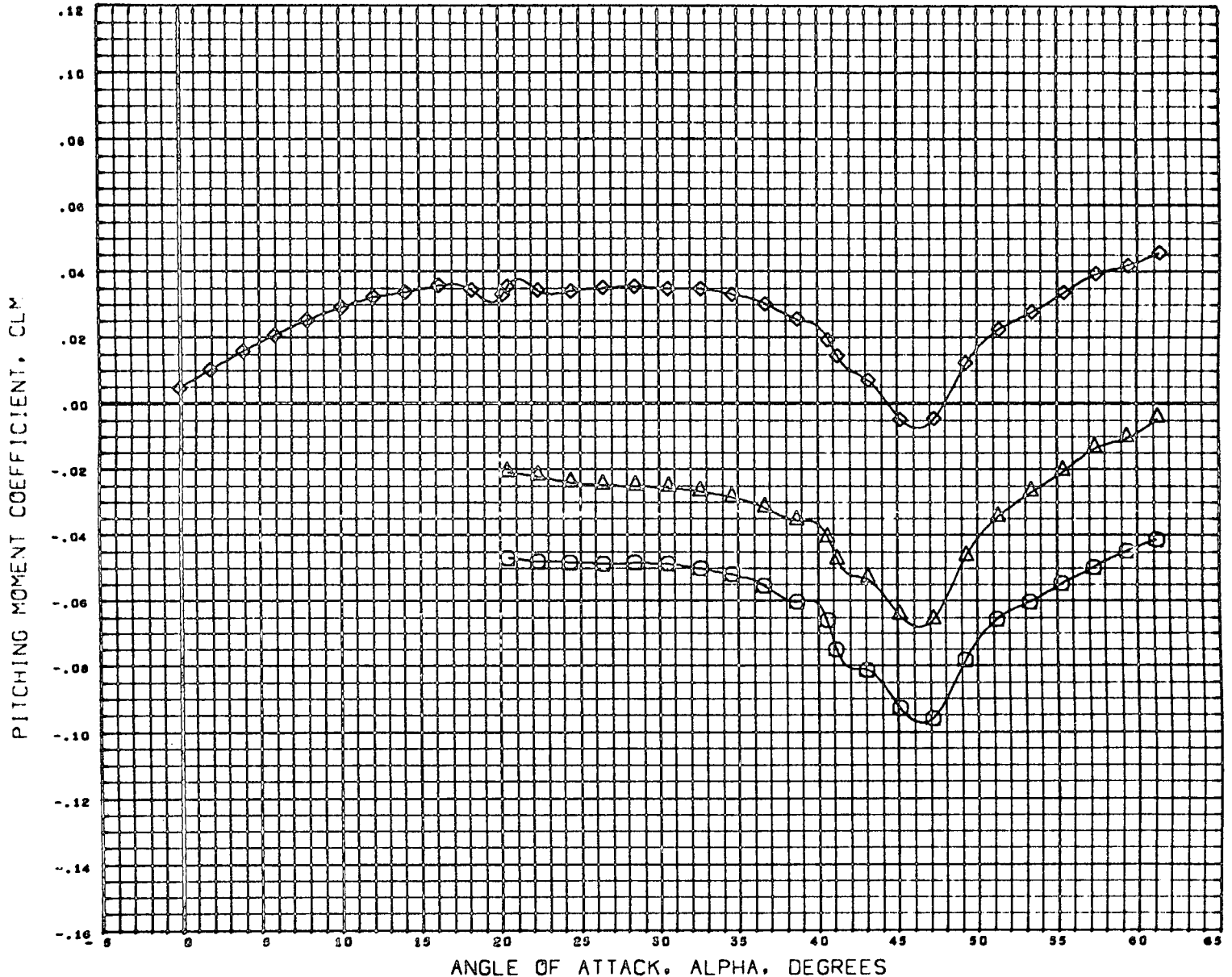

DATA SET	SYMBOL	CONFIGURATION	DESCRIPTION
(C58050)	○	MSFC TWT 514 E3	030W23C10
(C58040)	△	MSFC TWT 514 E3	030W23C10
(C58010)	◇	MSFC TWT 514 E3	030W23C10

BETA	ELEVTR	CANARD
0.000	0.000	-60.000
0.000	0.000	-30.000
0.000	0.000	0.000

REFERENCE INFORMATION		
SREF	15.0300	30 INC
LREF	2.6300	INCHES
BREF	6.0620	INCHES
XMRP	2.1110	INCHES
YMRP	0.0000	INCHES
ZMRP	0.0000	INCHES
SCALE	0.0039	

MACH 4.959

FIGURE-4 CANARD EFFECTIVENESS OF B-18E-3 CONFIGURATION

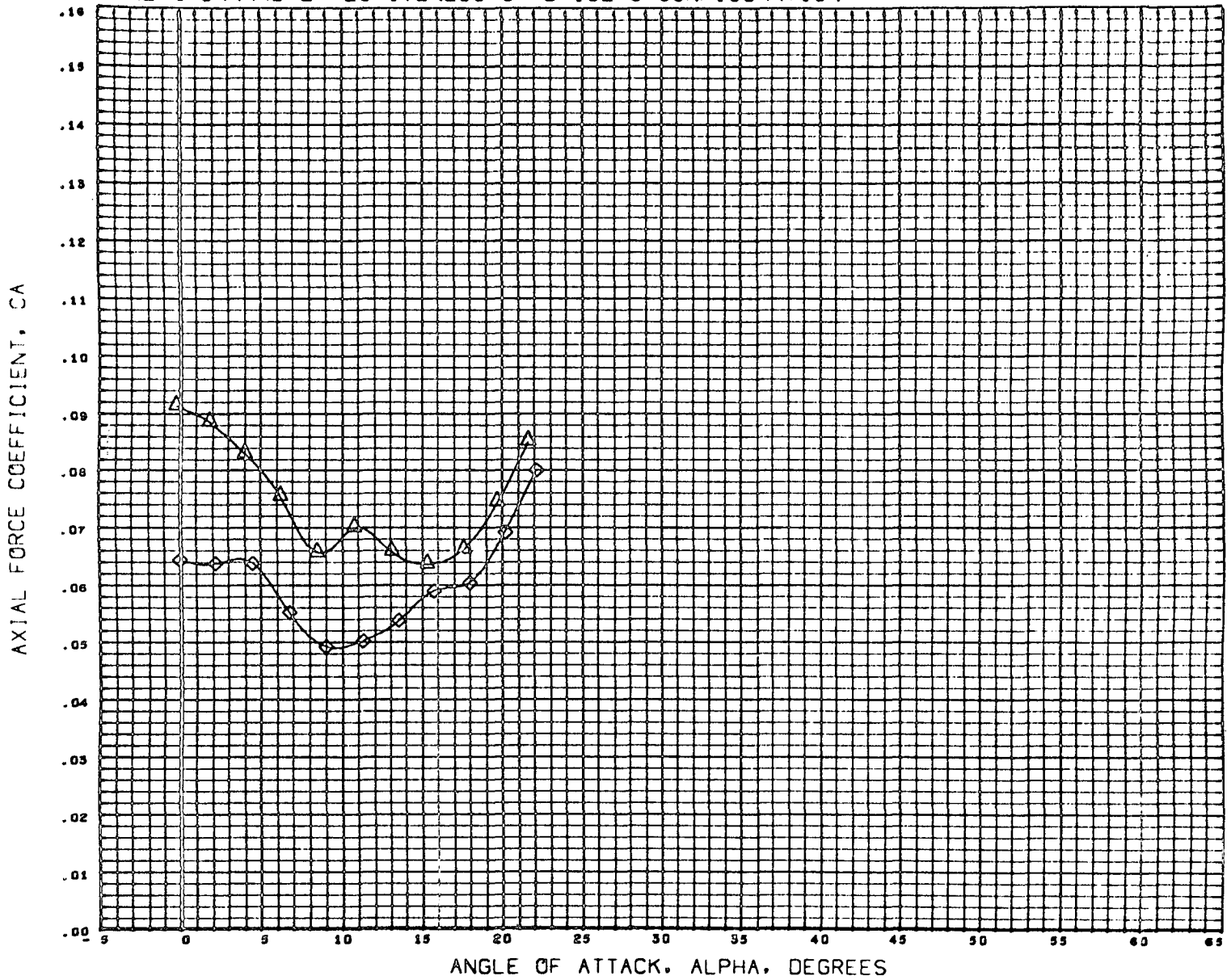

DATA SET SYMBOL	CONFIGURATION DESCRIPTION
(C58050)	DATA NOT AVAILABLE FOR ALL CONDITIONS
(C58040)	MSFC TWT 514 E3 830W23C10
(C58010)	MSFC TWT 514 E3 830W23C10

BETA	ELEVTR	CANARD
0.000	0.000	-60.000
0.000	0.000	-30.000
0.000	0.000	0.000

REFERENCE INFORMATION		
SREF	15.0500	89 INC
LREF	2.8300	INCHES
BREF	6.0620	INCHES
XMRP	2.1110	INCHES
YMRP	0.0000	INCHES
ZMRP	0.0000	INCHES
SCALE	0.0035	

MACH 0.902

FIGURE-4 CANARD EFFECTIVENESS OF B-18E-3 CONFIGURATION

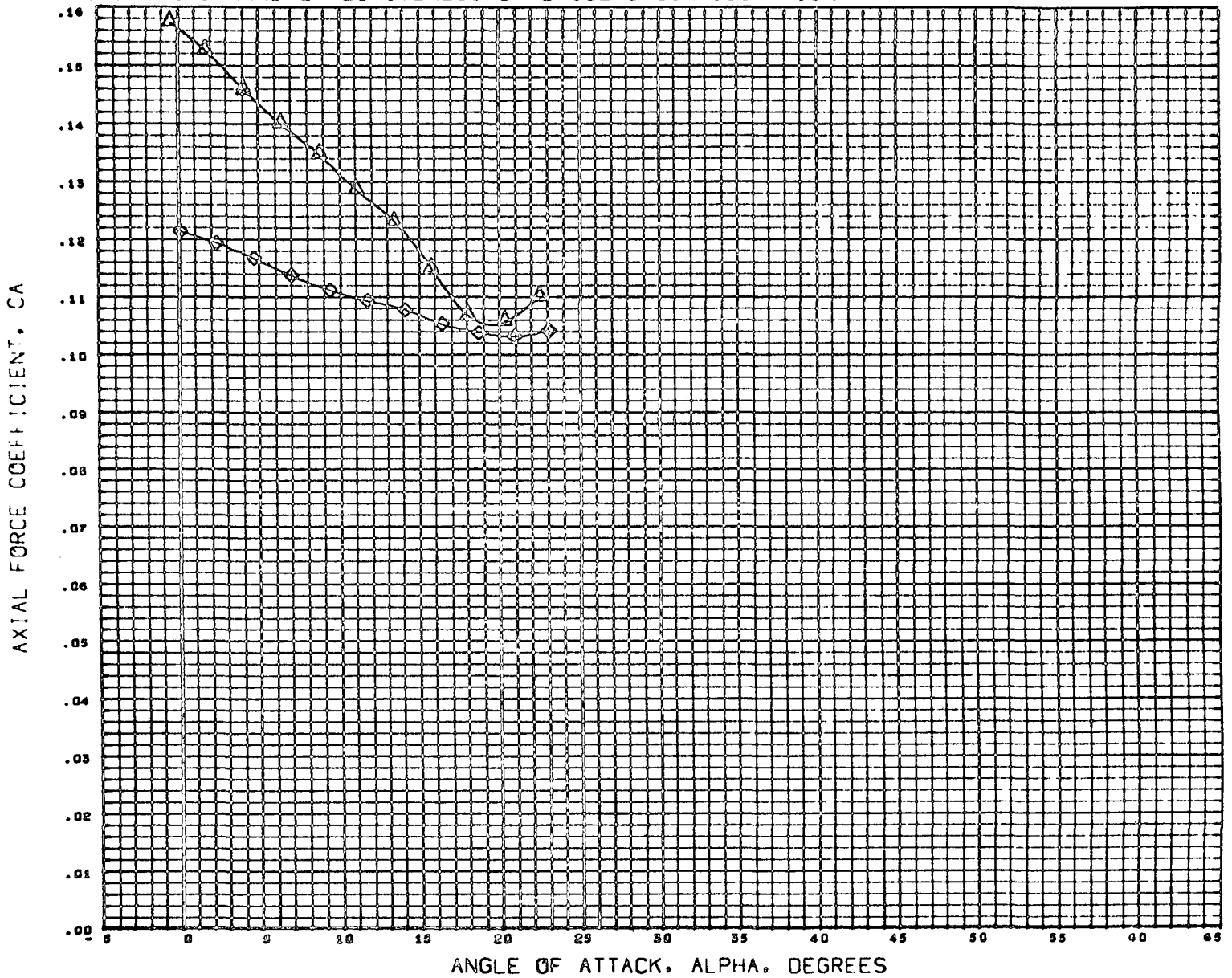

DATA SET SYMBOL	CONFIGURATION DESCRIPTION
(C50050)	DATA NOT AVAILABLE FOR ALL CONDITIONS
(C50040)	M8FC TWT 514 E3 B30W23C10
(C50010)	M8FC TWT 514 E3 B30W23C10

BETA	ELEVTR	CANARD
0.000	0.000	-60.000
0.000	0.000	-30.000
0.000	0.000	0.000

REFERENCE INFORMATION		
SREF	15.0300	SQ INC
LREF	2.8300	INCHES
BREF	6.0620	INCHES
XMRP	2.1110	INCHES
YMRP	0.0000	INCHES
ZMRP	0.0000	INCHES
SCALE	0.0035	

MACH 1.100

FIGURE-4 CANARD EFFECTIVENESS OF B-18E-3 CONFIGURATION

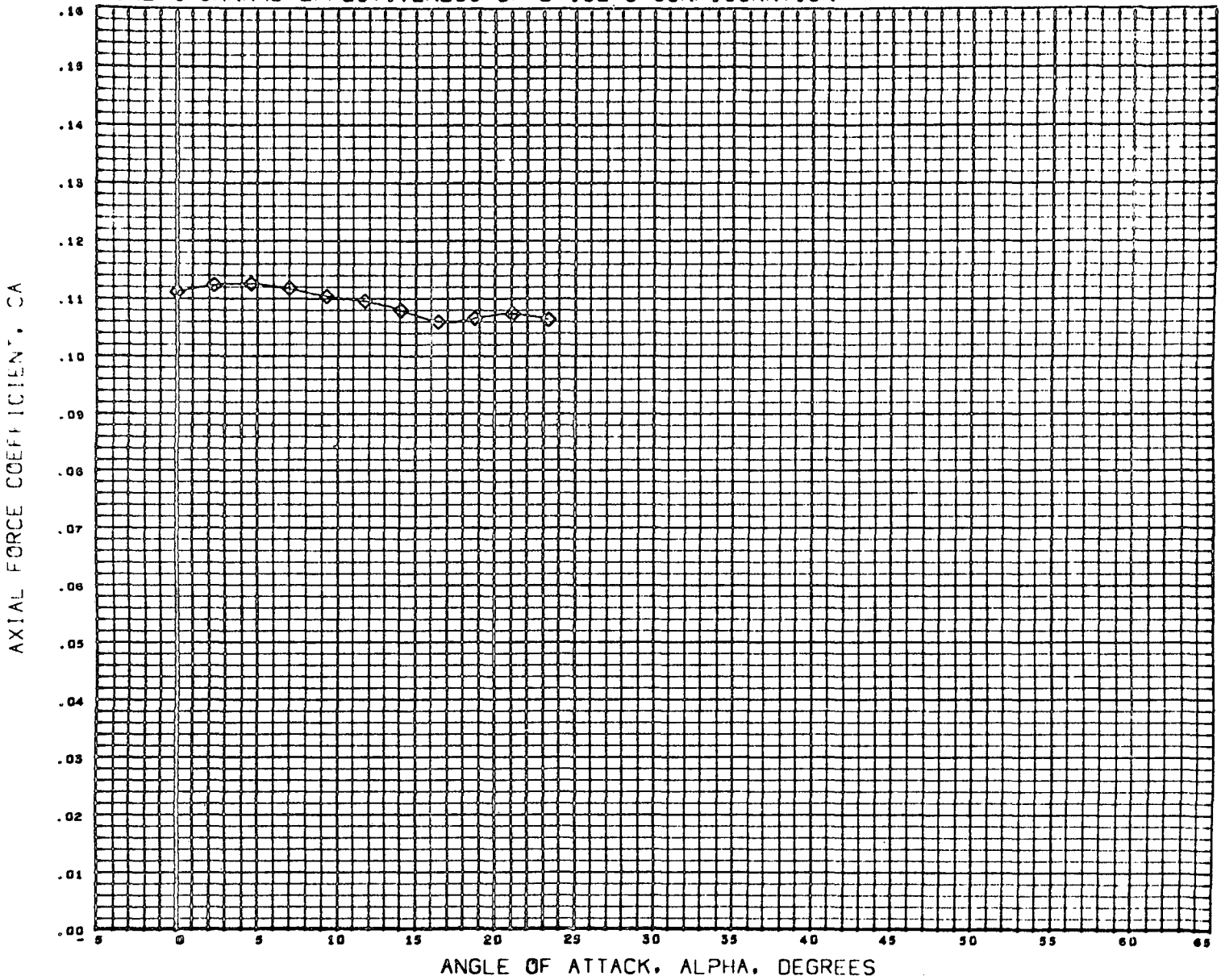

DATA SET SYMBOL	CONFIGURATION DESCRIPTION
(C58050)	○ DATA NOT AVAILABLE FOR ALL CONDITIONS
(C58040)	△ DATA NOT AVAILABLE FOR ALL CONDITIONS
(C58010)	◇ MSFC TWT 514 E3 B30W23C10

BETA	ELEVTR	CANARD
0.000	0.000	-60.000
0.000	0.000	-30.000
0.000	0.000	0.000

REFERENCE INFORMATION		
SREF	15.0300	SQ INC
LREF	2.8300	INCHES
BREF	0.0620	INCHES
XMRP	2.1110	INCHES
YMRP	0.0000	INCHES
ZMRP	0.0000	INCHES
SCALE	0.0035	

MACH 1.450

FIGURE-4 CANARD EFFECTIVENESS OF B-18E-3 CONFIGURATION

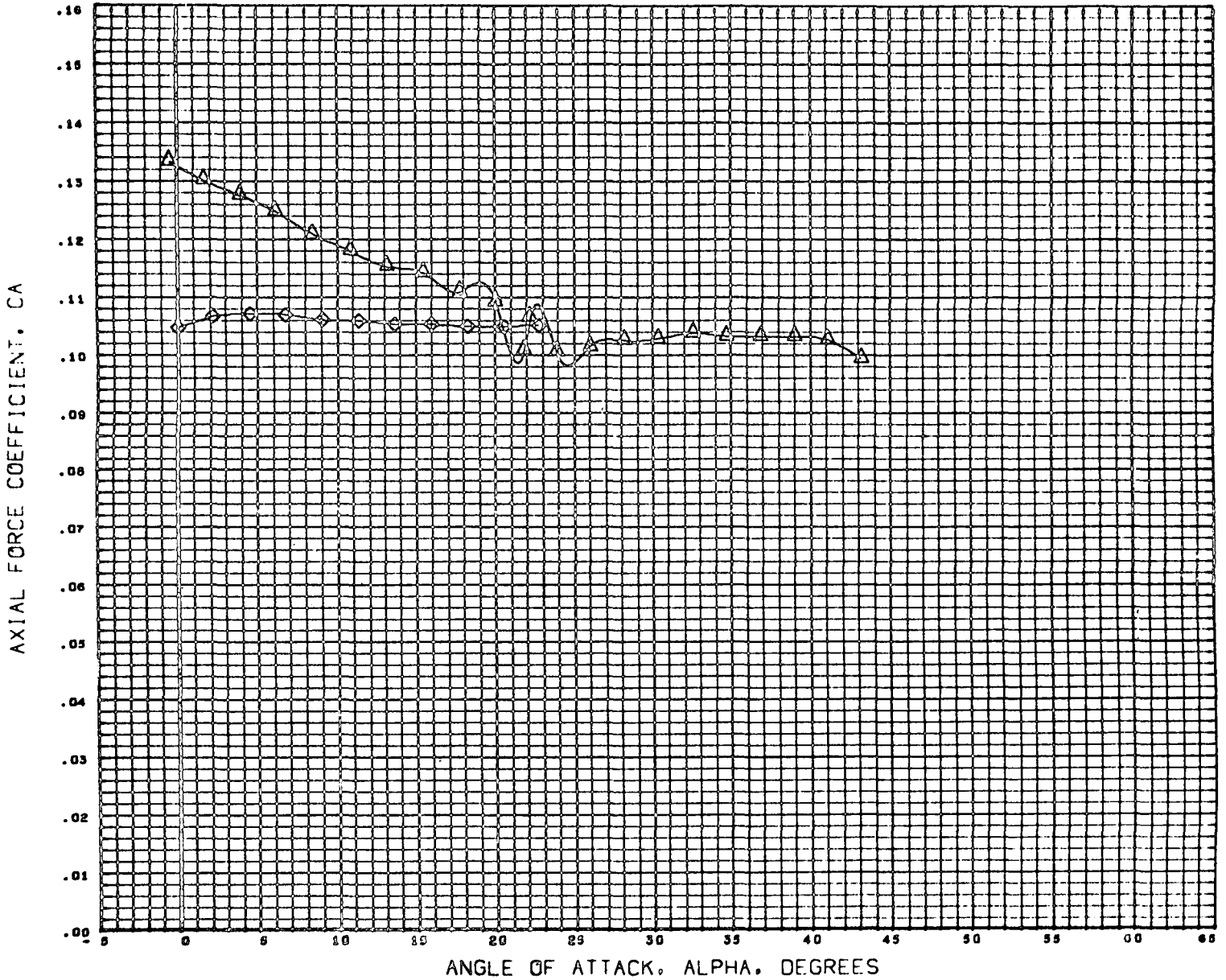

DATA SET	SYMBOL	CONFIGURATION DESCRIPTION
(C51050)	○	DATA NOT AVAILABLE FOR ALL CONDITIONS
(C51040)	△	MSFC TWT 514 E3 B30W23C10
(C51010)	◇	MSFC TWT 514 E3 B30W23C10

BETA	ELEVTR	CANARD
0.000	0.000	-60.000
0.000	0.000	-30.000
0.000	0.000	0.000

REFERENCE INFORMATION		
SREF	15.0300	50 INC
LREF	2.8300	INCHES
BREF	6.0620	INCHES
XMRP	2.1110	INCHES
YMRP	0.0000	INCHES
ZMRP	0.0000	INCHES
SCALE	0.0033	

MACH 1.994

FIGURE-4 CANARD EFFECTIVENESS OF B-18E-3 CONFIGURATION

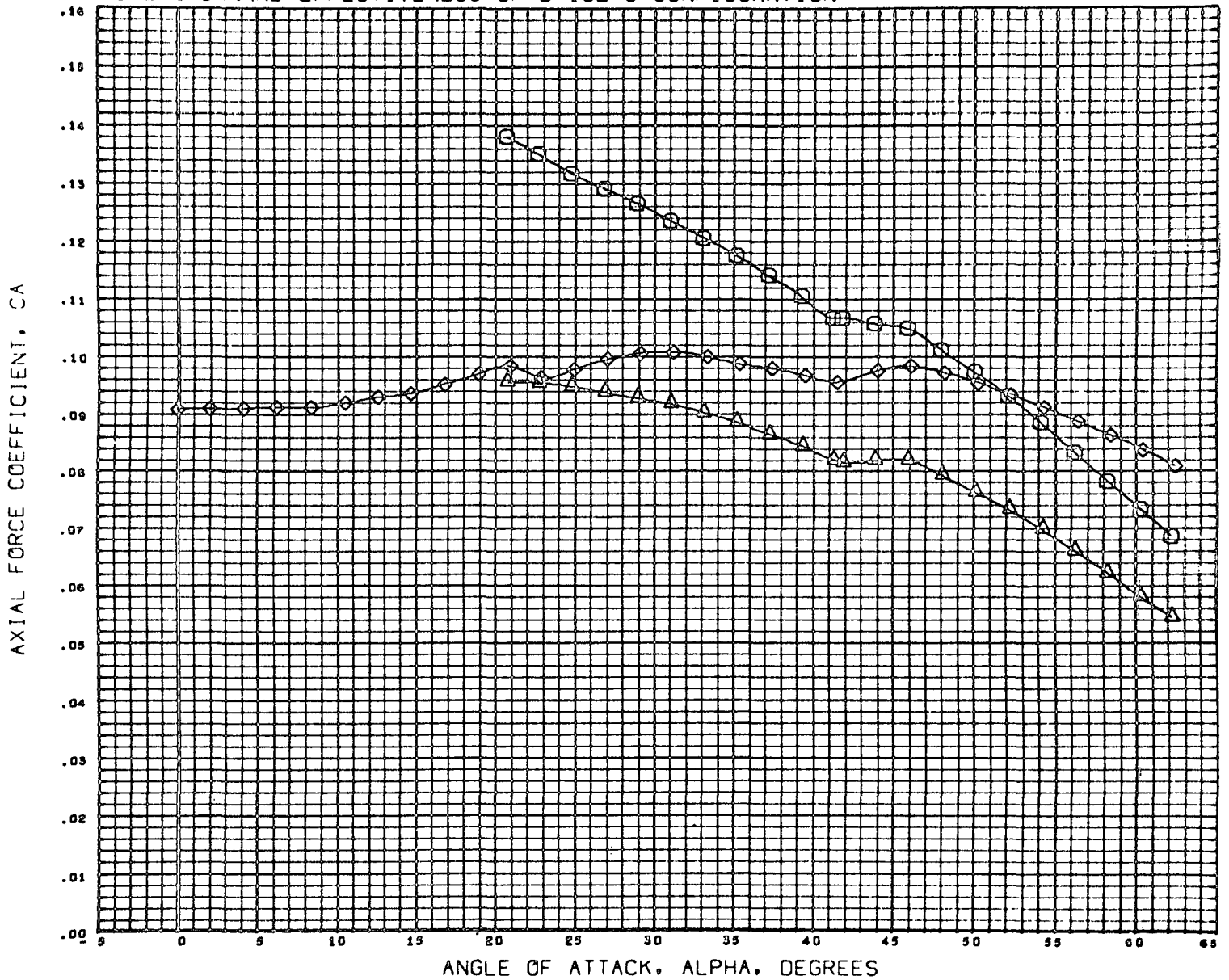

DATA SET SYMBOL	CONFIGURATION DESCRIPTION
(C58350)	MSFC TWT 514 E3 830W23C10
(C58340)	MSFC TWT 514 E3 830W23C10
(C58310)	MSFC TWT 514 E3 830W23C10

BETA	ELEVTR	CANARD
0.000	0.000	-60.000
0.000	0.000	-30.000
0.000	0.000	0.000

REFERENCE INFORMATION		
SREF	15.0300	90 INC
LREF	2.8300	INCHES
BREF	0.0620	INCHES
XMRP	2.1110	INCHES
YMRP	0.0000	INCHES
ZMRP	0.0000	INCHES
SCALE	0.0039	

MACH 2.990

FIGURE-4 CANARD EFFECTIVENESS OF B-18E-3 CONFIGURATION

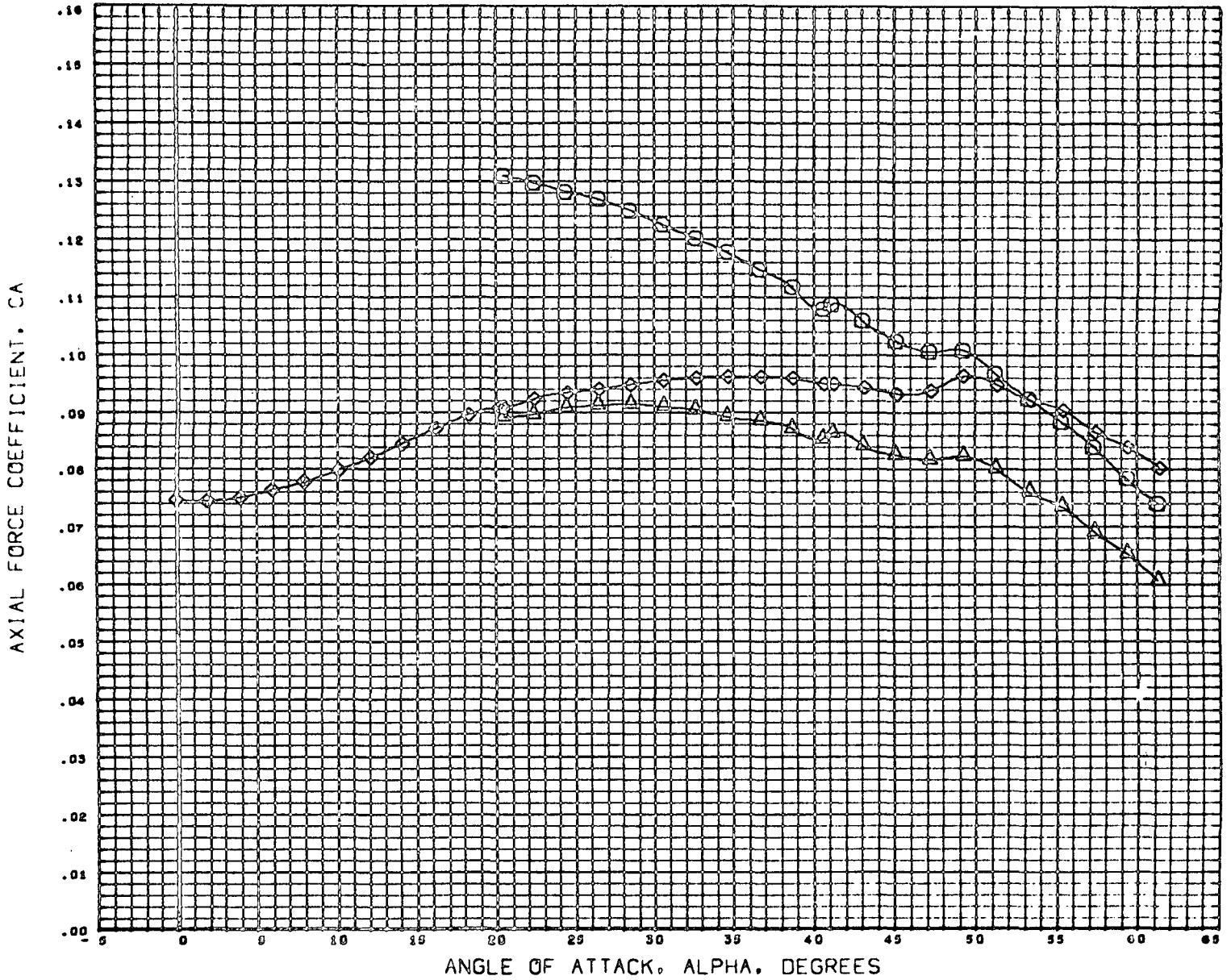

DATA SET	SYMBOL	CONFIGURATION	DESCRIPTION
(C50050)	○	MSFC TWT 514 E3	030W23C10
(C50040)	△	MSFC TWT 514 E3	030W23C10
(C50010)	◇	MSFC TWT 514 E3	030W23C10

BETA	ELEVTR	CANARD
0.000	0.000	-60.000
0.000	0.000	-30.000
0.000	0.000	0.000

REFERENCE INFORMATION		
SREF	15.0300	90 INC
LREF	2.8300	INCHES
BREF	6.0620	INCHES
XMRP	2.1110	INCHES
YMRP	0.0000	INCHES
ZMRP	0.0000	INCHES
SCALE	0.0035	

MACH 4.059

FIGURE-4 CANARD EFFECTIVENESS OF B-18E-3 CONFIGURATION

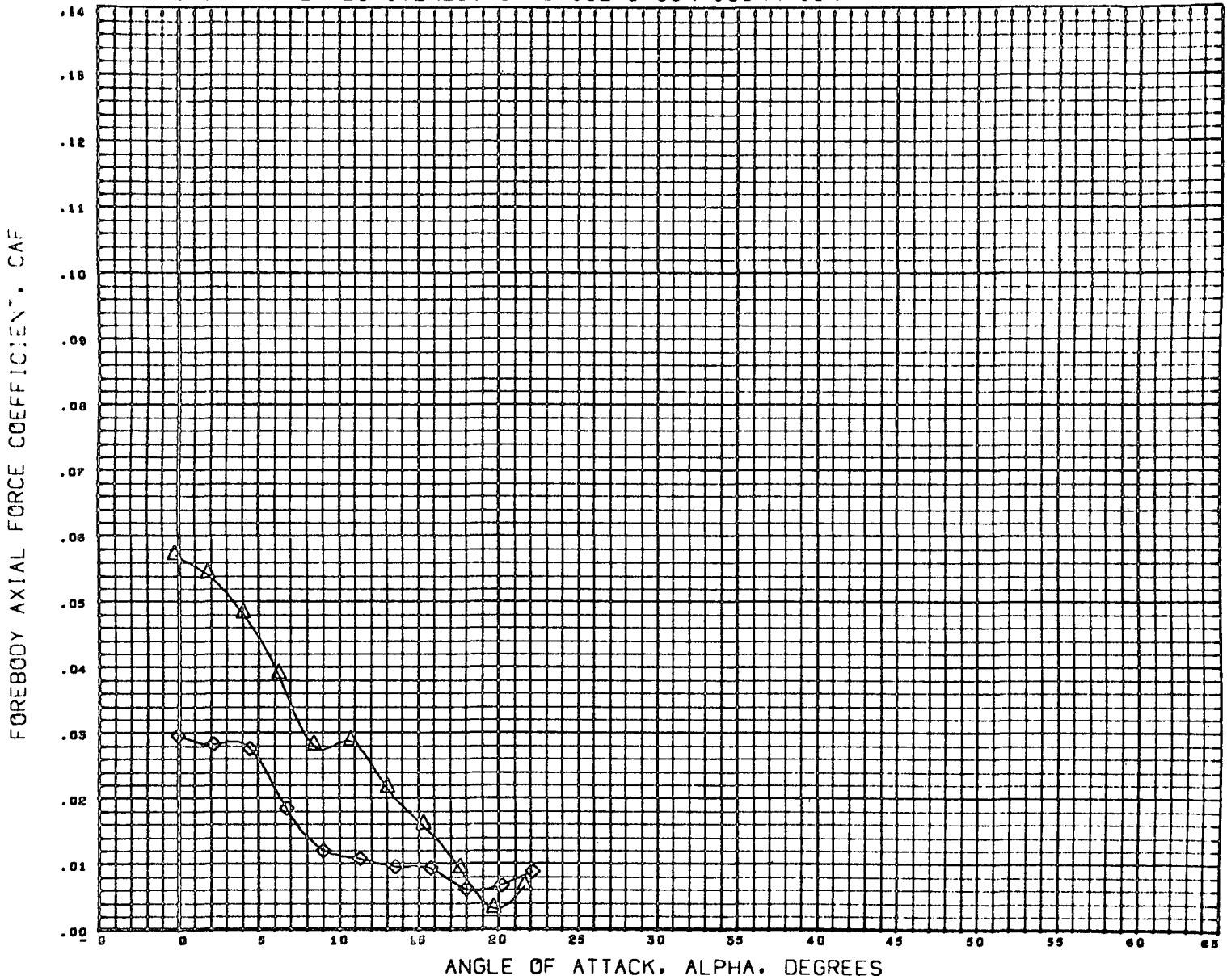

DATA SET SYMBOL	CONFIGURATION DESCRIPTION
(C50050)	DATA NOT AVAILABLE FOR ALL CONDITIONS
(C50040)	MSFC TWT 514 E3 B30W23C10
(C50010)	MSFC TWT 514 E3 B30W23C10

BETA	ELEVTR	CANARD
0.000	0.000	-60.000
0.000	0.000	-30.000
0.000	0.000	0.000

REFERENCE INFORMATION		
SREF	15.0300	58 INC
LREF	2.8300	INCHES
BREF	0.0620	INCHES
XMRP	2.1110	INCHES
YMRP	0.0000	INCHES
ZMRP	0.0000	INCHES
SCALE	0.0035	

MACH 0.902

FIGURE-4 CANARD EFFECTIVENESS OF B-18E-3 CONFIGURATION

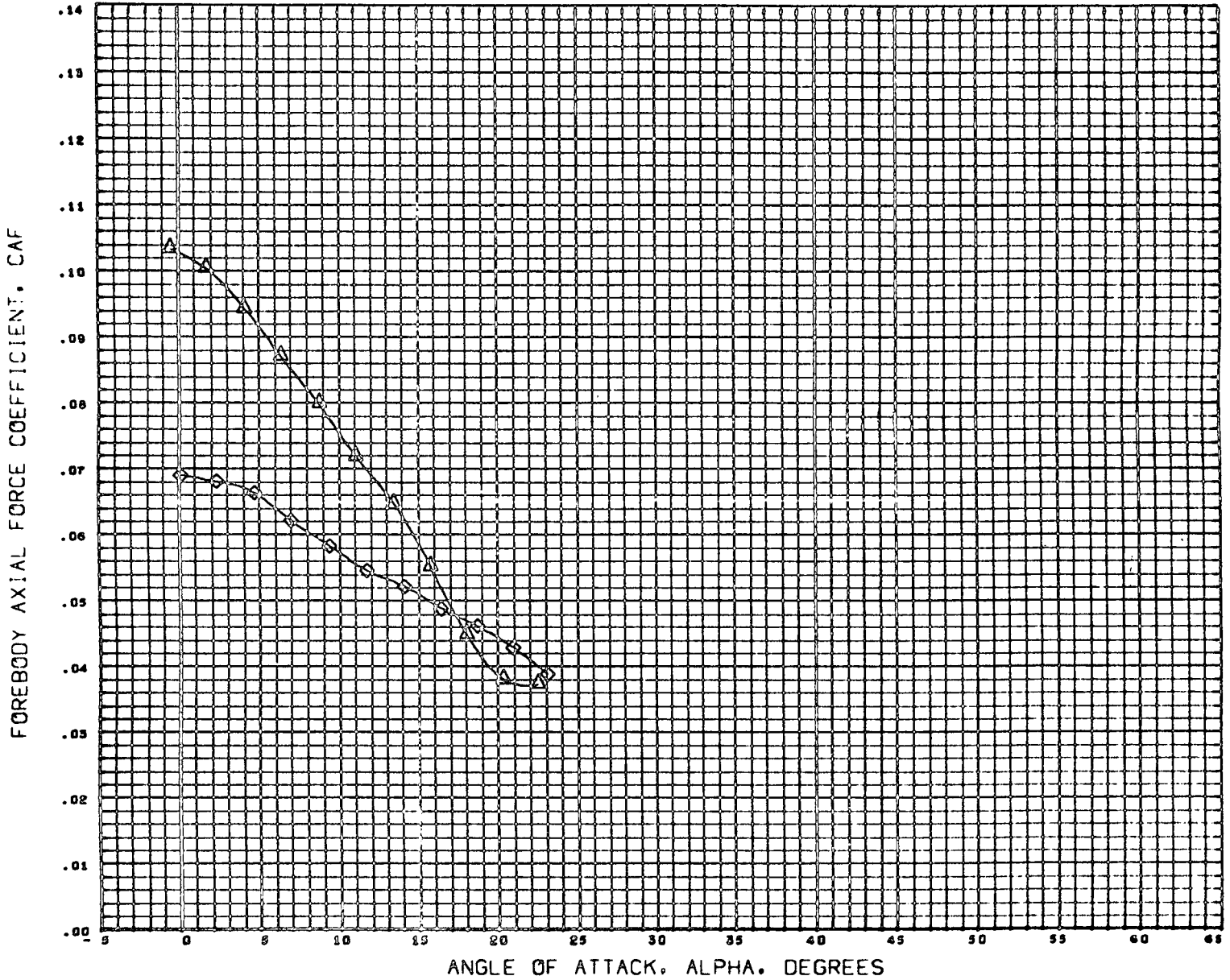

DATA SET SYMBOL	CONFIGURATION DESCRIPTION	BETA	ELEVTR	CANARD
(C58050)	DATA NOT AVAILABLE FOR ALL CONDITIONS	0.000	0.000	-60.000
(C58040)	MSFC TWT 514 E3 030W23C10	0.000	0.000	-30.000
(C58010)	MSFC TWT 514 E3 030W23C10	0.000	0.000	0.000

REFERENCE INFORMATION		
SREF	13.0360	50 INC
LREF	2.0360	INCHES
BREF	0.0620	INCHES
XMRP	2.1110	INCHES
YMRP	0.0000	INCHES
ZMRP	0.0000	INCHES
SCALE	0.0035	

MACH 1.100

FIGURE-4 CANARD EFFECTIVENESS OF B-18E-3 CONFIGURATION

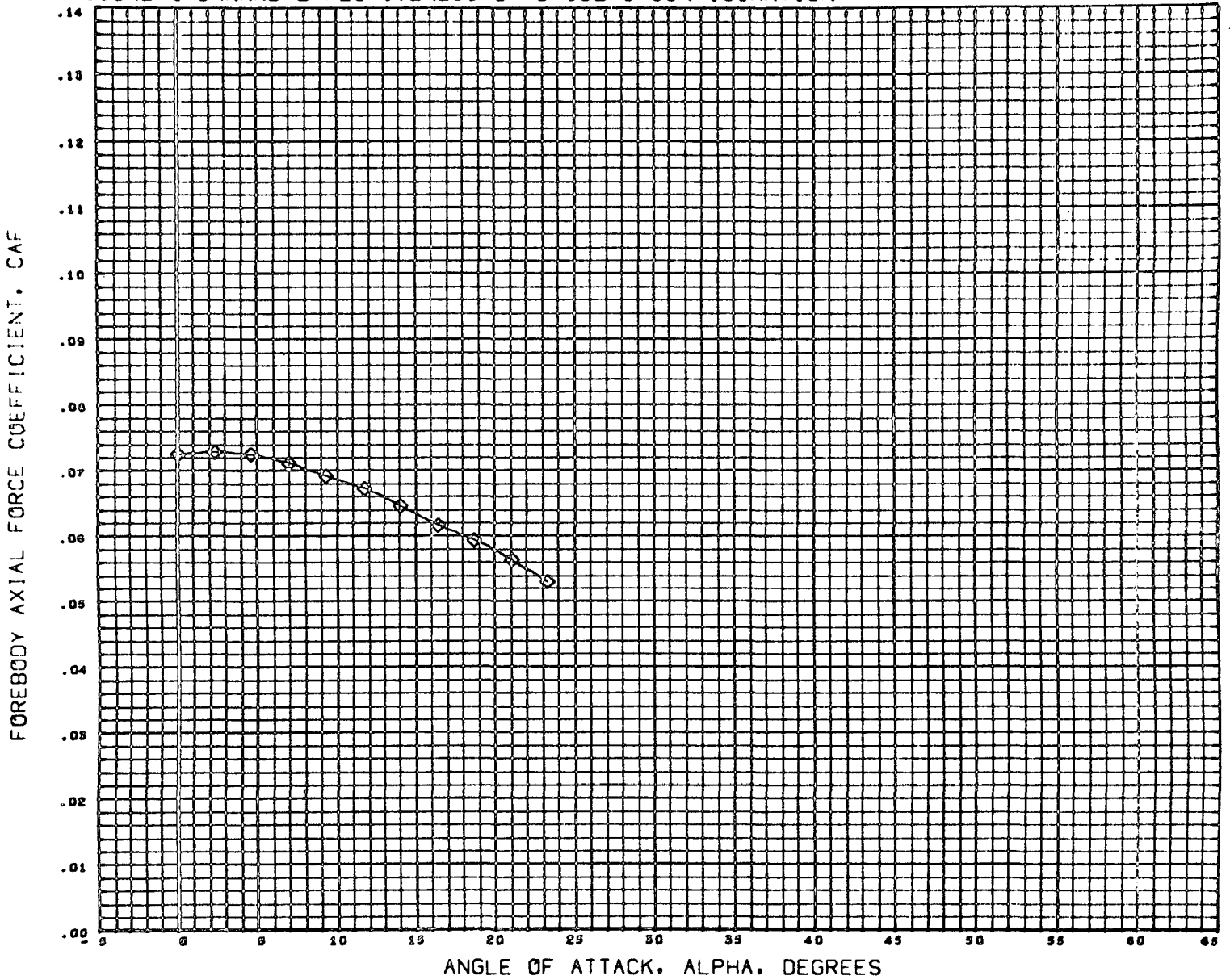

DATA SET SYMBOL	CONFIGURATION DESCRIPTION
(C50050)	DATA NOT AVAILABLE FOR ALL CONDITIONS
(C50040)	DATA NOT AVAILABLE FOR ALL CONDITIONS
(C50010)	HSFC TWT 514 E3 B30H23C10

BETA	ELEVTR	CANARD
0.000	0.000	-60.000
0.000	0.000	-30.000
0.000	0.000	0.000

REFERENCE INFORMATION		
SREF	19.0300	90 INC
LREF	2.0300	INCHES
BREF	6.0020	INCHES
XMRP	2.1110	INCHES
YMRP	0.0000	INCHES
ZMRP	0.0000	INCHES
SCALE	0.0035	

MACH 1.459

FIGURE-4 CANARD EFFECTIVENESS OF B-18E-3 CONFIGURATION

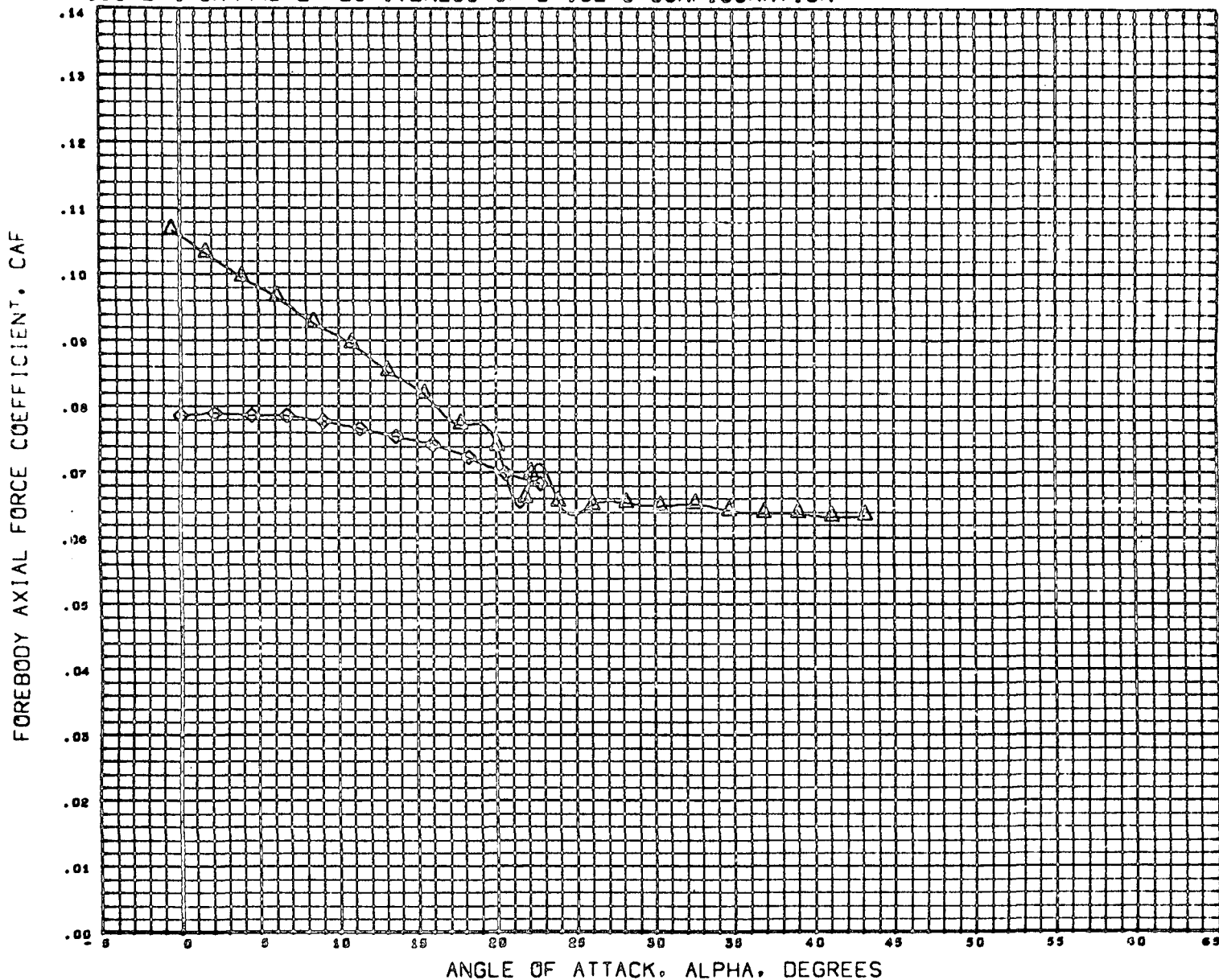

DATA SET SYMBOL	SYMBOL	CONFIGURATION DESCRIPTION
(C50050)	○	DATA NOT AVAILABLE FOR ALL CONDITIONS
(C50040)	△	WSFC TWT 914 E3 030W23C10
(C50010)	◇	WSFC TWT 914 E3 030W23C10

BETA	ELEVTR	CANARD
0.000	0.000	-60.000
0.000	0.000	-30.000
0.000	0.000	0.000

REFERENCE INFORMATION		
SREF	15.0300	80 INC
LREF	2.8300	INCHES
OREF	6.0620	INCHES
XMRP	2.1120	INCHES
YMRP	0.0000	INCHES
ZMRP	0.0000	INCHES
SCALE	0.0035	

MACH 1.054

FIGURE-4 CANARD EFFECTIVENESS OF B-18E-3 CONFIGURATION

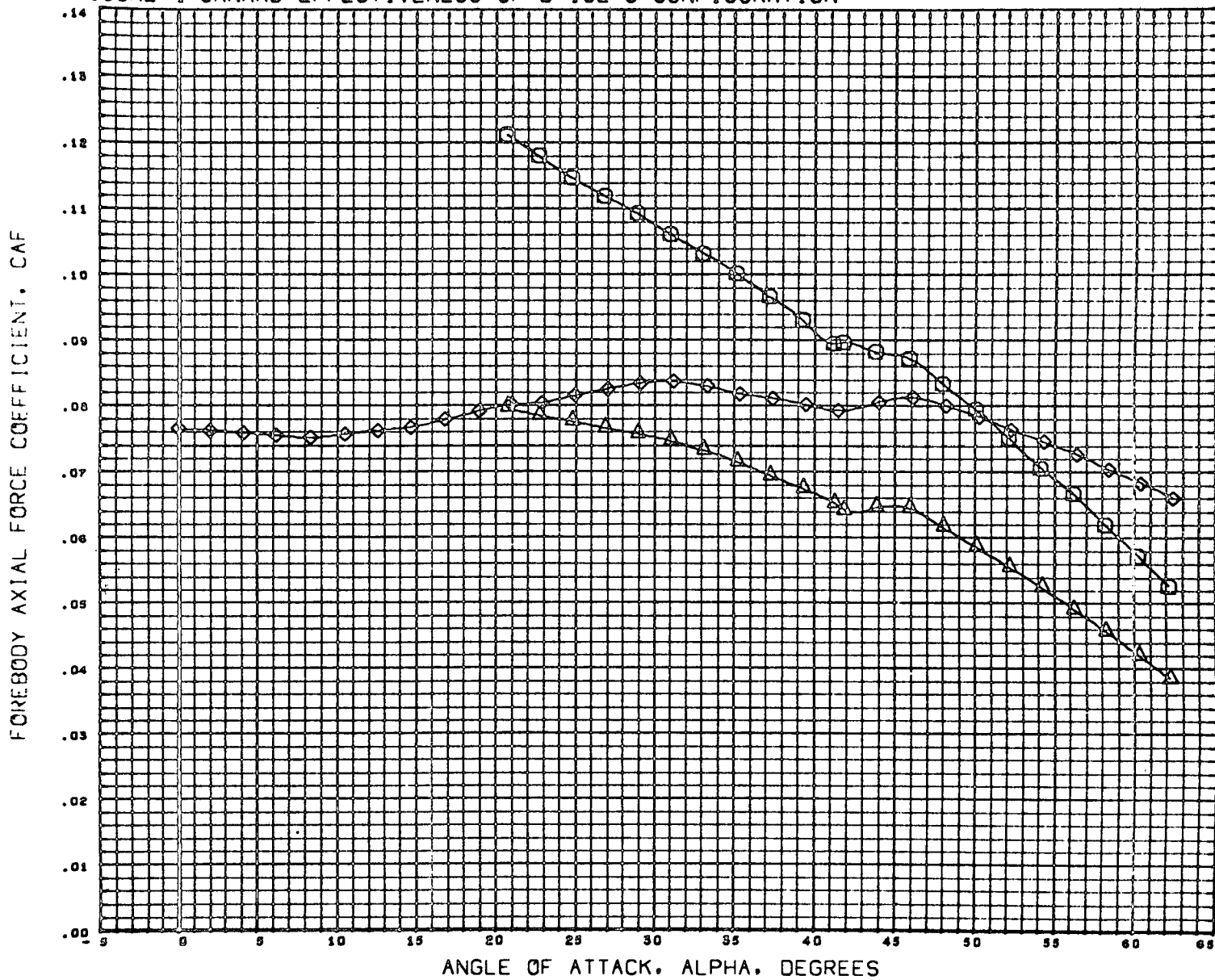

DATA SET	SYMBOL	CONFIGURATION	DESCRIPTION
(C38050)	○	MSFC TWT 514 E3	B30W23C10
(C38040)	◇	MSFC TWT 514 E3	B30W23C10
(C38010)	△	MSFC TWT 514 E3	B30W23C10

BETA	ELEVTR	CANARD
0.000	0.000	-60.000
0.000	0.000	-30.000
0.000	0.000	0.000

REFERENCE INFORMATION		
SREF	15.0300	80 INC
LREF	2.8300	INCHES
BREF	6.0620	INCHES
XMRP	2.1110	INCHES
YMRP	0.0000	INCHES
ZMRP	0.0000	INCHES
SCALE	0.0035	

MACH 2.990

FIGURE-4 CANARD EFFECTIVENESS OF B-18E-3 CONFIGURATION

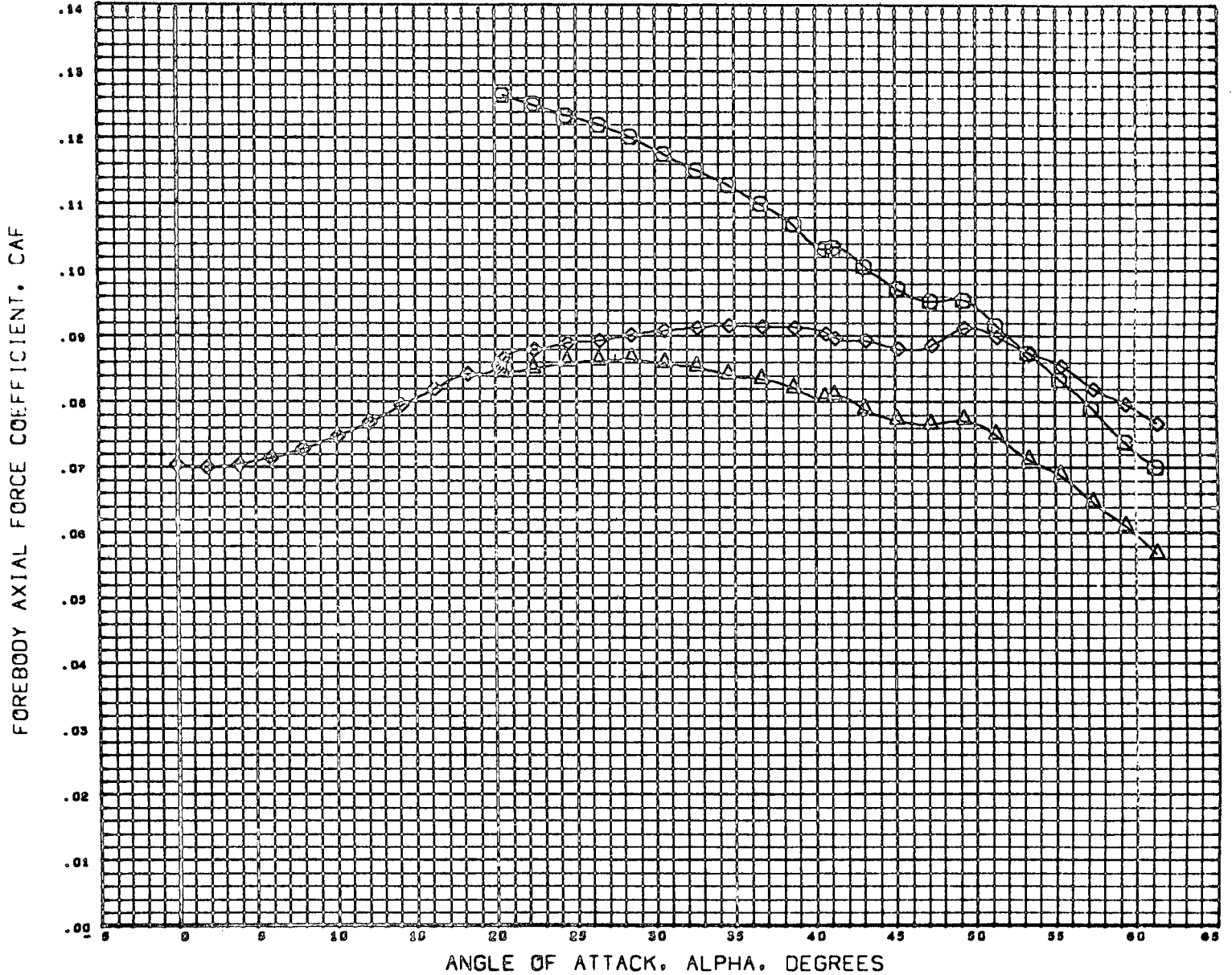

DATA SET SYMBOL	CONFIGURATION DESCRIPTION
(C98030)	MSFC TWT 914 (3) 030W23C10
(C98040)	MSFC TWT 914 (3) 030W23C10
(C98010)	MSFC TWT 914 (3) 030W23C10

BETA	ELEVTR	CANARD
0.000	0.000	-60.000
0.000	0.000	-30.000
0.000	0.000	0.000

REFERENCE INFORMATION		
SREF	15.0300	50 INC
LREF	2.8300	INCHES
BREF	0.0620	INCHES
XMRP	2.1110	INCHES
YMRP	0.0000	INCHES
ZMRP	0.0000	INCHES
SCALE	0.0035	

MACH 4.090

FIGURE-4 CANARD EFFECTIVENESS OF B-18E-3 CONFIGURATION

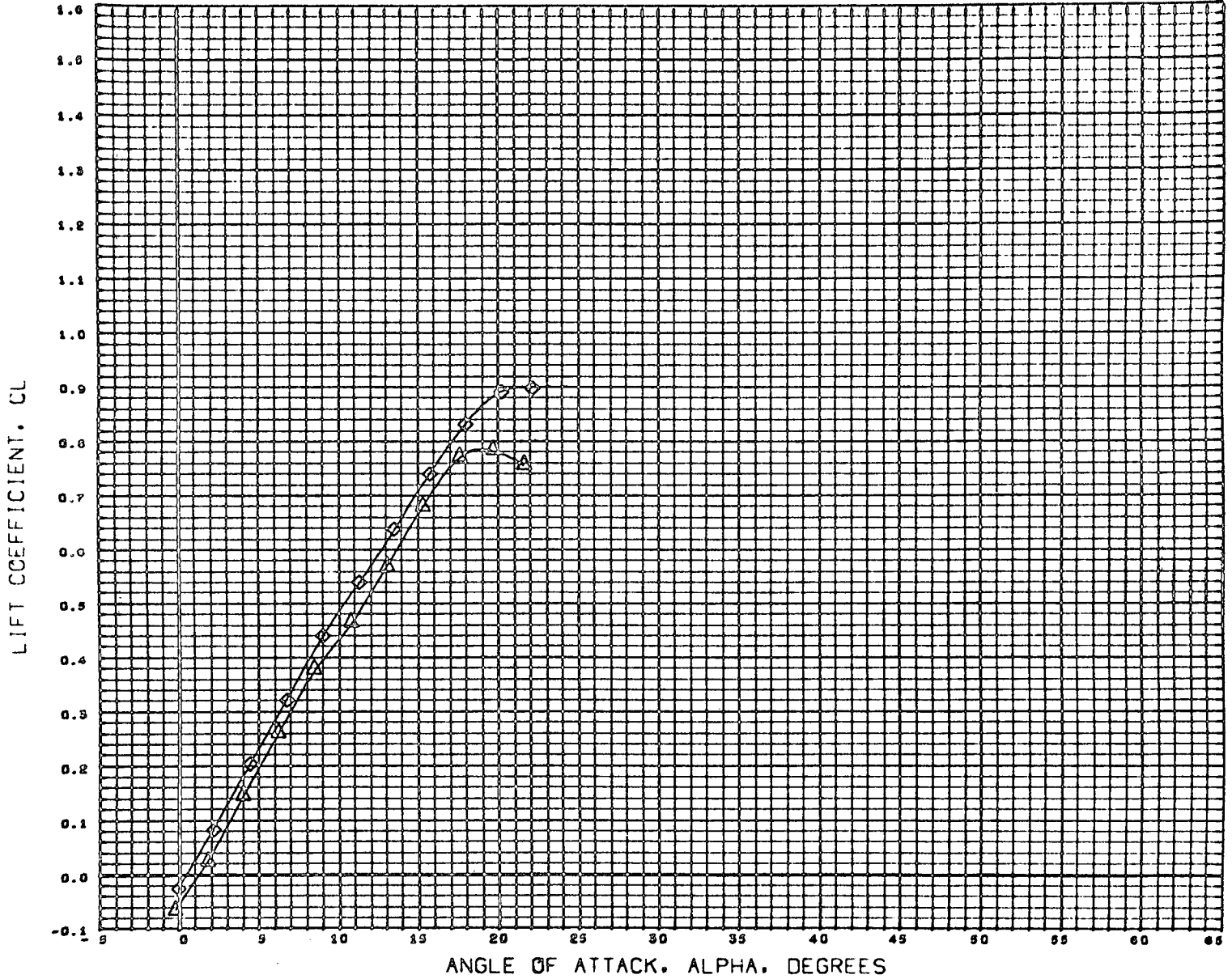

DATA SET SYMBOL	CONFIGURATION DESCRIPTION
(C50050)	DATA NOT AVAILABLE FOR ALL CONDITIONS
(C50040)	M8FC TWT 514 E3 830W23C10
(C50010)	M8FC TWT 514 E3 830W23C10

BETA	ELEVTR	CANARD
0.000	0.000	-60.000
0.000	0.000	-30.000
0.000	0.000	0.000

REFERENCE INFORMATION	
SREF	15.0300 88 INC
LREF	2.8300 INCHES
OREF	0.0620 INCHES
XMRP	2.1110 INCHES
YMRP	0.0000 INCHES
ZMRP	0.0000 INCHES
SCALE	0.0039

MACH 0.902

FIGURE-4 CANARD EFFECTIVENESS OF B-18E-3 CONFIGURATION

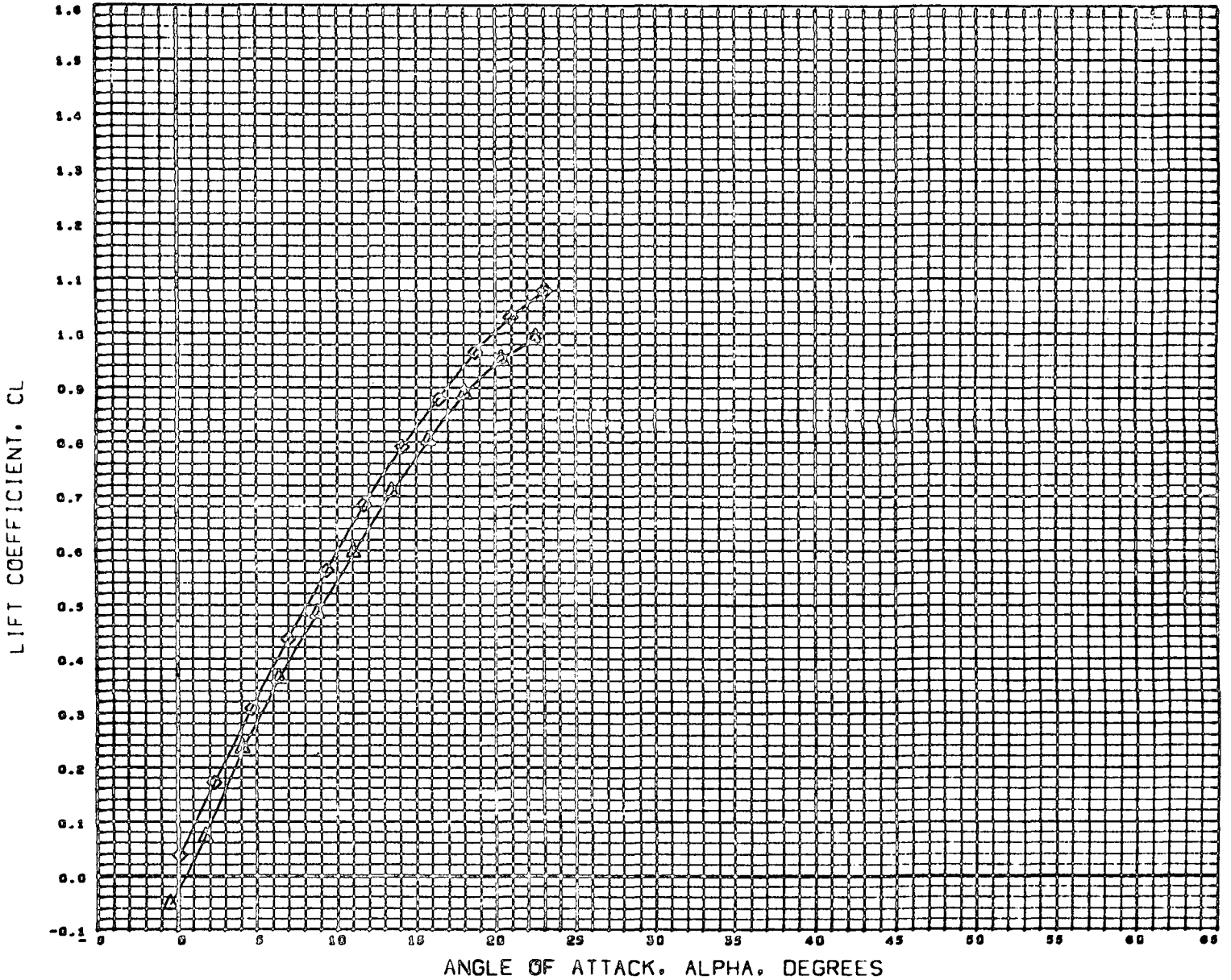

DATA SET	SYMBOL	CONFIGURATION DESCRIPTION
(C38020)	○	DATA NOT AVAILABLE FOR ALL CONDITIONS
(C38020)	△	MSFC TWT 514 E3 030W23C10
(C38010)	◇	MSFC TWT 514 E3 030W23C10

BETA	ELEVTR	CANARD
0.000	0.000	-60.000
0.000	0.000	-30.000
0.000	0.000	0.000

REFERENCE INFORMATION		
SREF	15.0300	00 INC
LREF	2.8300	INCHE3
BREF	0.0020	INCHE3
XMRP	2.1110	INCHE3
YMRP	0.0000	INCHE3
ZMRP	0.0000	INCHE3
SCALE	0.0035	

NACN 2.100

FIGURE-4 CANARD EFFECTIVENESS OF B-18E-3 CONFIGURATION

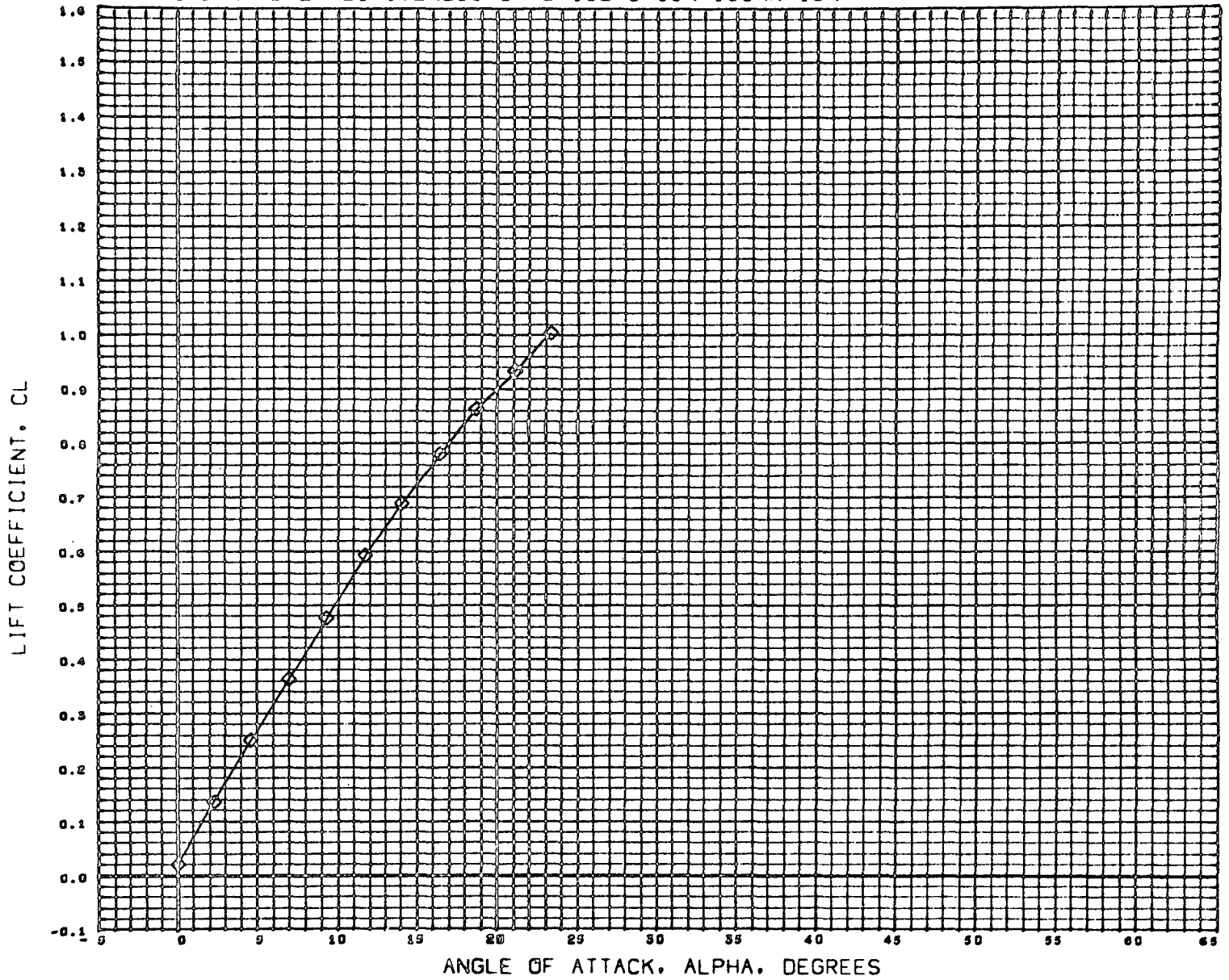

DATA SET SYMBOL	CONFIGURATION DESCRIPTION
(C30000)	DATA NOT AVAILABLE FOR ALL CONDITIONS
(C30040)	DATA NOT AVAILABLE FOR ALL CONDITIONS
(C30010)	MSFC TWT 514 ES 830W23C10

BETA	ELEVTR	CANARD
0.000	0.000	-60.000
0.000	0.000	-30.000
0.000	0.000	0.000

REFERENCE INFORMATION		
SREF	15.0300	80 INC
LREF	2.8300	INCHES
BREF	6.0620	INCHES
XMRP	2.1110	INCHES
YMRP	0.0000	INCHES
ZMRP	0.0000	INCHES
SCALE	0.0035	

MACH 1.459

FIGURE-4 CANARD EFFECTIVENESS OF B-18E-3 CONFIGURATION

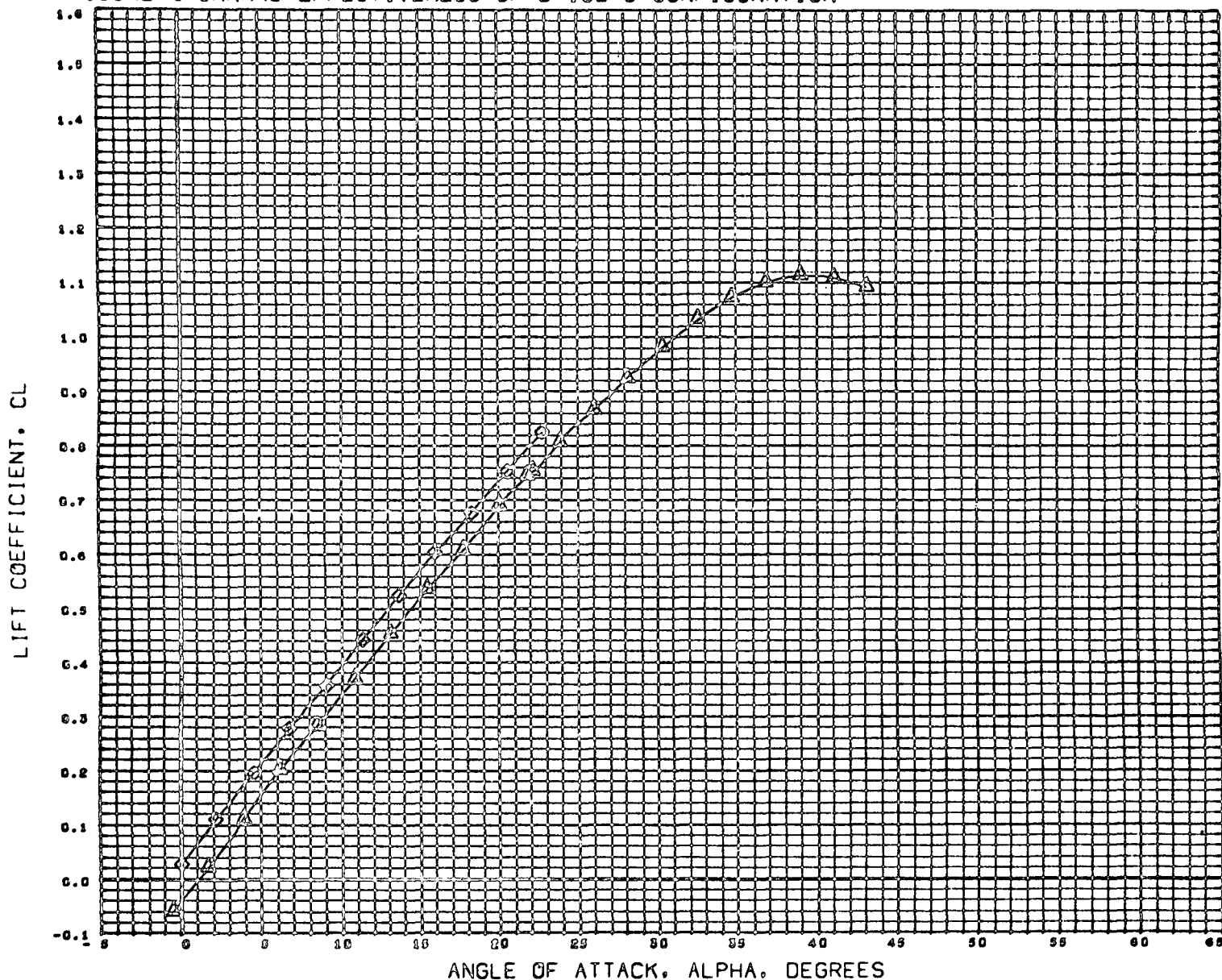

DATA SET SYMBOL	CONFIGURATION DESCRIPTION
(C98050)	DATA NOT AVAILABLE FOR ALL CONDITIONS
(C98060)	MSFC THT 914 E3 030W23C10
(C98070)	MSFC THT 914 E3 030W23C10

BETA	ELEVTR	CANARD
0.000	0.000	-60.000
0.000	0.000	-30.000
0.000	0.000	0.000

REFERENCE INFORMATION		
SREF	15.0900	30 INC
LREF	2.8300	INCHES
BREF	0.0620	INCHES
XMRP	2.1110	INCHES
YMRP	0.0000	INCHES
ZMRP	0.0000	INCHES
SCALE	0.0035	

MACH 1.054

FIGURE-4 CANARD EFFECTIVENESS OF B-18E-3 CONFIGURATION

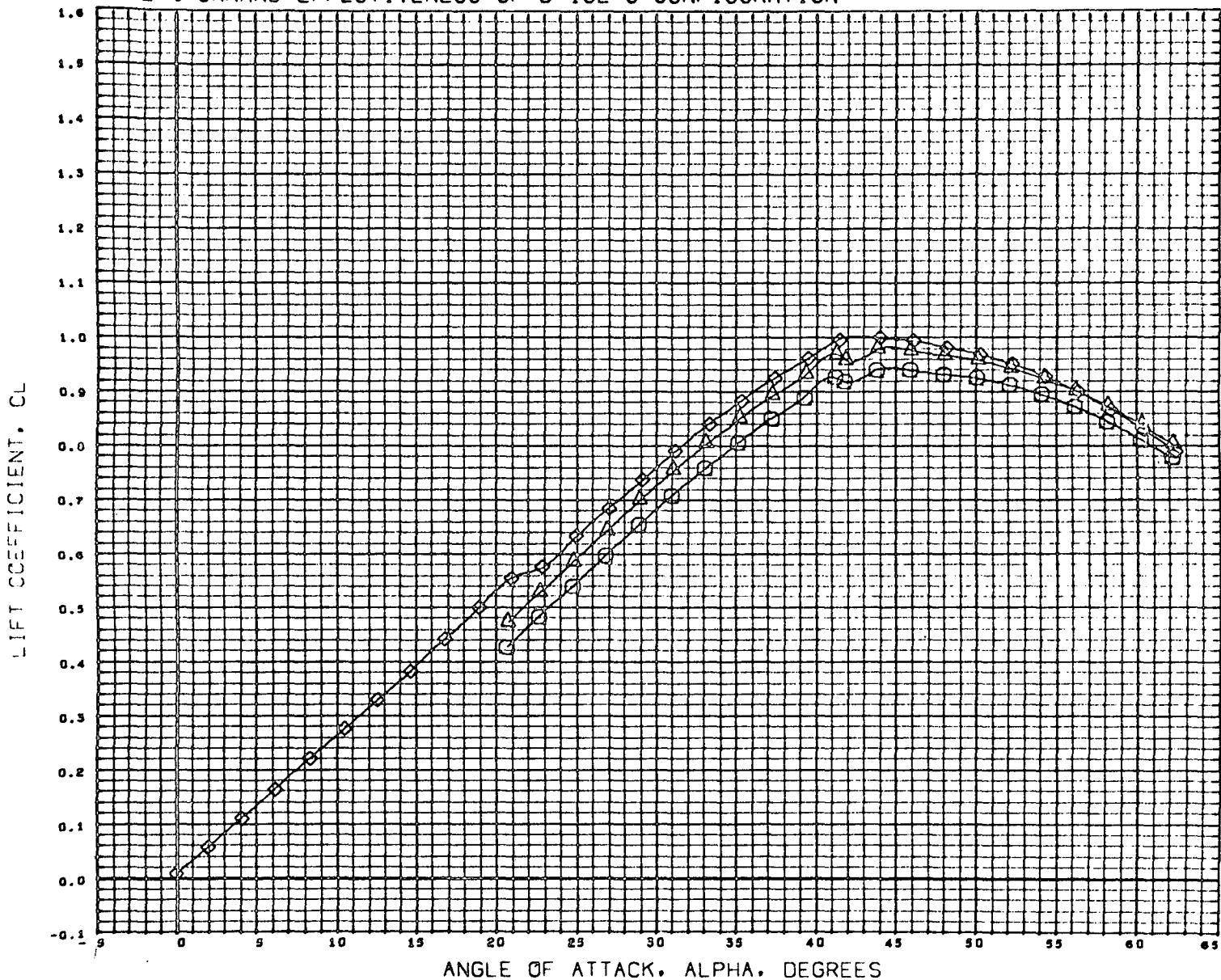

DATA SET	SYMBOL	CONFIGURATION DESCRIPTION
(C58050)	○	MSFC TWT 514 E3 830W23C10
(C58040)	△	MSFC TWT 514 E3 830W23C10
(C58010)	◇	MSFC TWT 514 E3 830W23C10

BETA	ELEVTR	CANARD
0.000	0.000	-60.000
0.000	0.000	-30.000
0.000	0.000	0.000

REFERENCE INFORMATION		
SREF	15.0300	SQ INC
LREF	2.8300	INCHES
BREF	6.0620	INCHES
XMRP	2.1110	INCHES
YMRP	0.0000	INCHES
ZMRP	0.0000	INCHES
SCALE	0.0035	

MACH 2.990

FIGURE-4 CANARD EFFECTIVENESS OF B-18E-3 CONFIGURATION

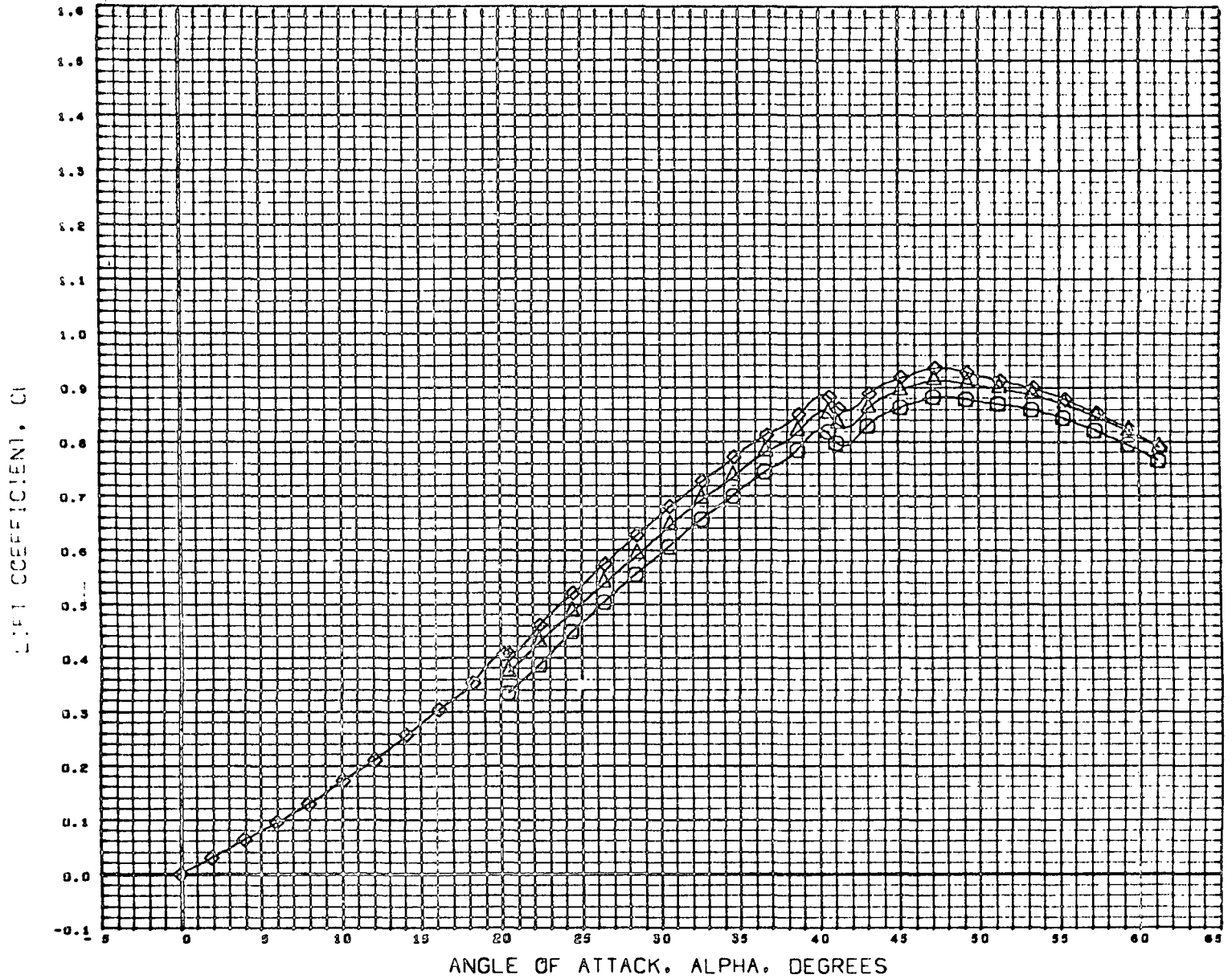

DATA SET SYMBOL	CONFIGURATION DESCRIPTION
(C58650) ○	MSFC TWT 914 E3 Q30W23C10
(C58640) △	MSFC TWT 914 E3 Q30W23C10
(C58610) ◇	MSFC TWT 914 E3 Q30W23C10

BETA	ELEVTR	CANARD
0.000	0.000	-60.000
0.000	0.000	-30.000
0.000	0.000	0.000

REFERENCE INFORMATION		
SREF	15.0300	SQ INC
LREF	2.8300	INCHES
BREF	6.0620	INCHES
XMRP	2.1110	INCHES
YMRP	0.0000	INCHES
ZMRP	0.0000	INCHES
SCALE	0.0035	

MACH 4.090

FIGURE-4 CANARD EFFECTIVENESS OF B-18E-3 CONFIGURATION

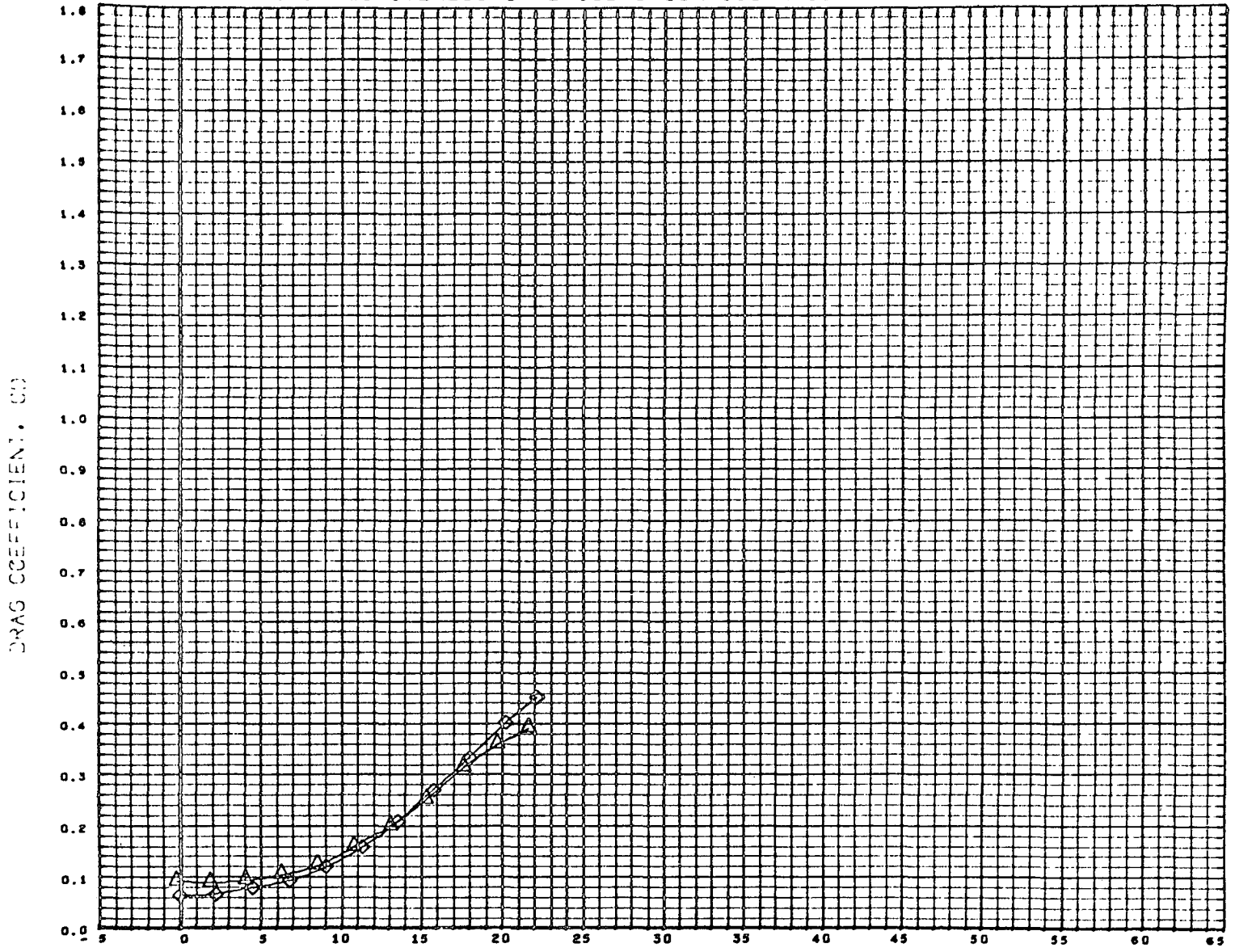

ANGLE OF ATTACK, ALPHA, DEGREES

DATA SET	SYMBOL	CONFIGURATION DESCRIPTION
(C58053)	○	DATA NOT AVAILABLE FOR ALL CONDITIONS
(C58040)	△	MSFC TWT 514 E3 830W23C10
(C58010)	◇	MSFC TWT 514 E3 830W23C10

BETA	ELEVTR	CANARD
0.000	0.000	-60.000
0.000	0.000	-30.000
0.000	0.000	0.000

REFERENCE INFORMATION		
SREF	15.0300	Sq INC
LREF	2.8300	INCHES
BREF	0.0620	INCHES
XMRP	2.1110	INCHES
YMRP	0.0000	INCHES
ZMRP	0.0000	INCHES
SCALE	0.0035	

MACH 0.902

FIGURE-4 CANARD EFFECTIVENESS OF B-18E-3 CONFIGURATION

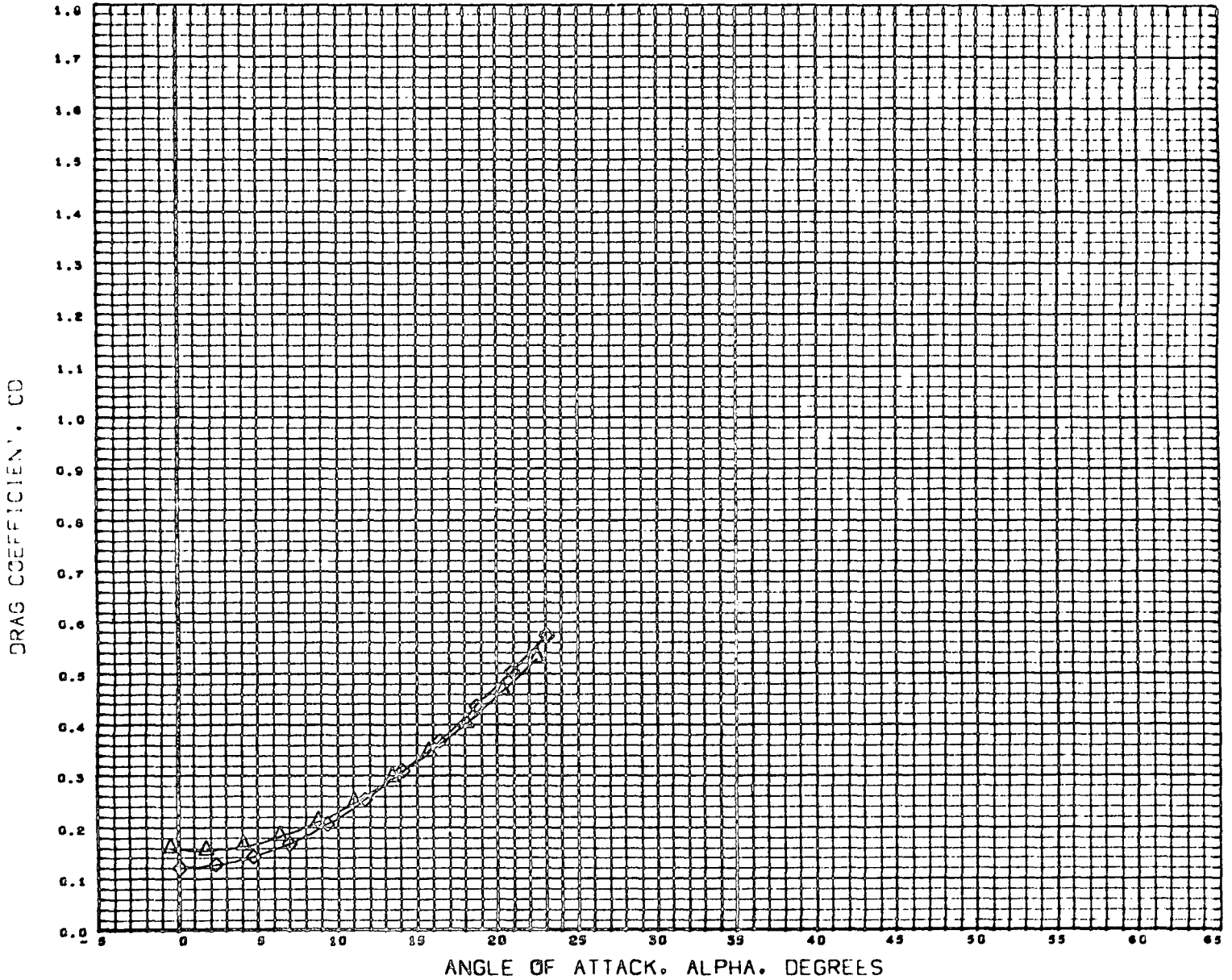

DATA SET	SYMBOL	CONFIGURATION DESCRIPTION
(C58050)	○	DATA NOT AVAILABLE FOR ALL CONDITIONS
(C58040)	△	MSFC TWT 514 E3 030H23C10
(C58010)	◇	MSFC TWT 514 E3 030H23C10

BETA	ELEVTR	CANARD
0.000	0.000	-60.000
0.000	0.000	-30.000
0.000	0.000	0.000

REFERENCE INFORMATION		
SREF	15.0300	SQ INC
LREF	2.8300	INCHES
BREF	6.0620	INCHES
XMRP	2.1110	INCHES
YMRP	0.0000	INCHES
ZMRP	0.0000	INCHES
SCALE	0.0035	

MACH 1.100

FIGURE-4 CANARD EFFECTIVENESS OF B-18E-3 CONFIGURATION

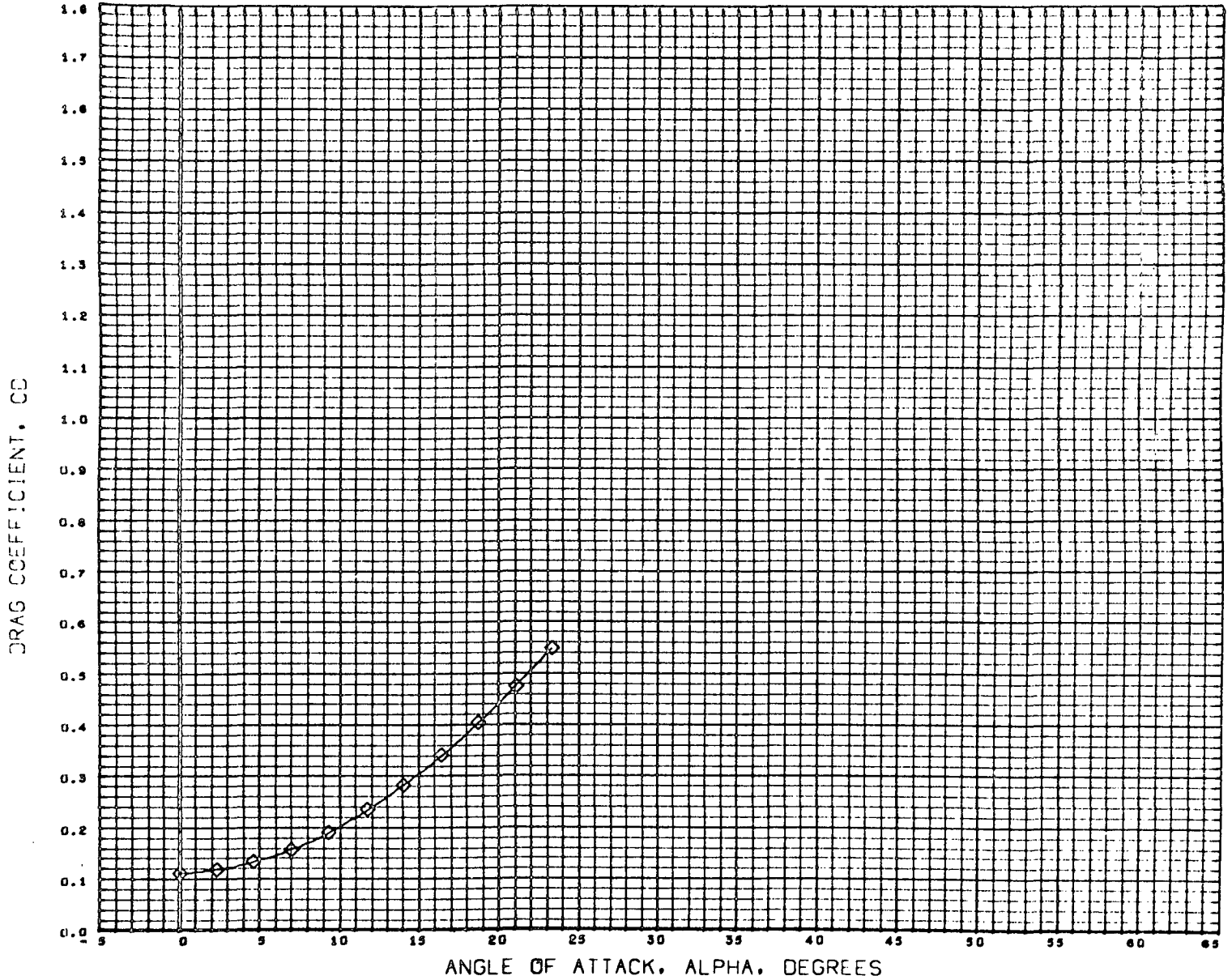

DATA SET SYMBOL	CONFIGURATION DESCRIPTION
(C58030)	DATA NOT AVAILABLE FOR ALL CONDITIONS
(C58040)	DATA NOT AVAILABLE FOR ALL CONDITIONS
(C58010)	MSFC TWT 514 E3 B30W23C10

BETA	ELEVTR	CANARD
0.000	0.000	-60.000
0.000	0.000	-30.000
0.000	0.000	0.000

REFERENCE INFORMATION		
SREF	15.0300	30 INC
LREF	2.8300	INCHES
BREF	6.0620	INCHES
XMRP	2.1110	INCHES
YMRP	0.0000	INCHES
ZMRP	0.0000	INCHES
SCALE	0.0035	

MACH 1.659

FIGURE-4 CANARD EFFECTIVENESS OF B-18E-3 CONFIGURATION

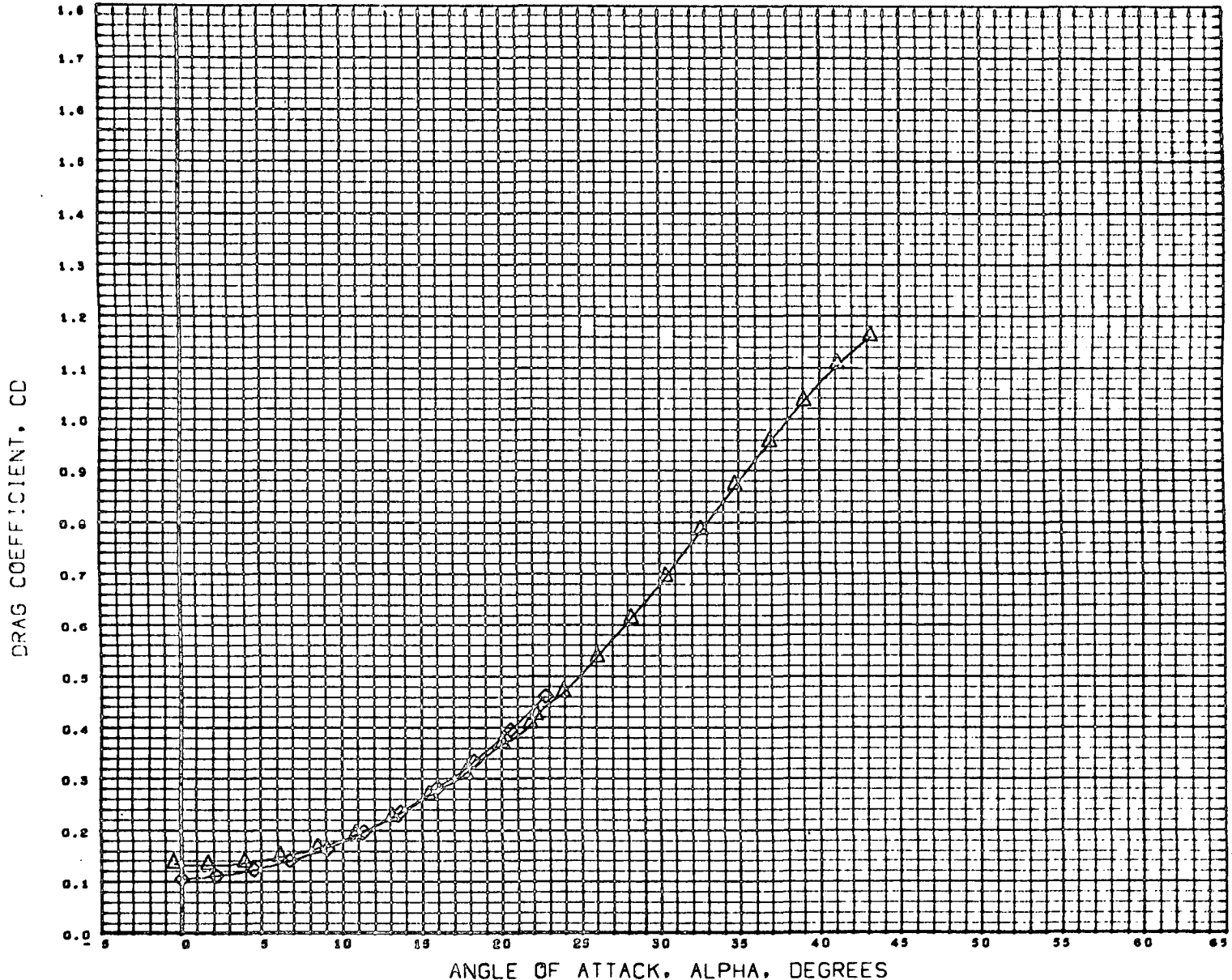

DATA SET SYMBOL	CONFIGURATION DESCRIPTION
(C58050)	DATA NOT AVAILABLE FOR ALL CONDITIONS
(C58040)	MSFC TWT 514 E3 B30W23C10
(C58010)	MSFC TWT 514 E3 B30W23C10

BETA	ELEVTR	CANARD
0.000	0.000	-60.000
0.000	0.000	-30.000
0.000	0.000	0.000

REFERENCE INFORMATION		
SREF	15.0300	SQ INC
LREF	2.8300	INCHES
BREF	6.0620	INCHES
XMRP	2.1110	INCHES
YMRP	0.0000	INCHES
ZMRP	0.0000	INCHES
SCALE	0.0035	

MACH 1.094

FIGURE-4 CANARD EFFECTIVENESS OF B-18E-3 CONFIGURATION

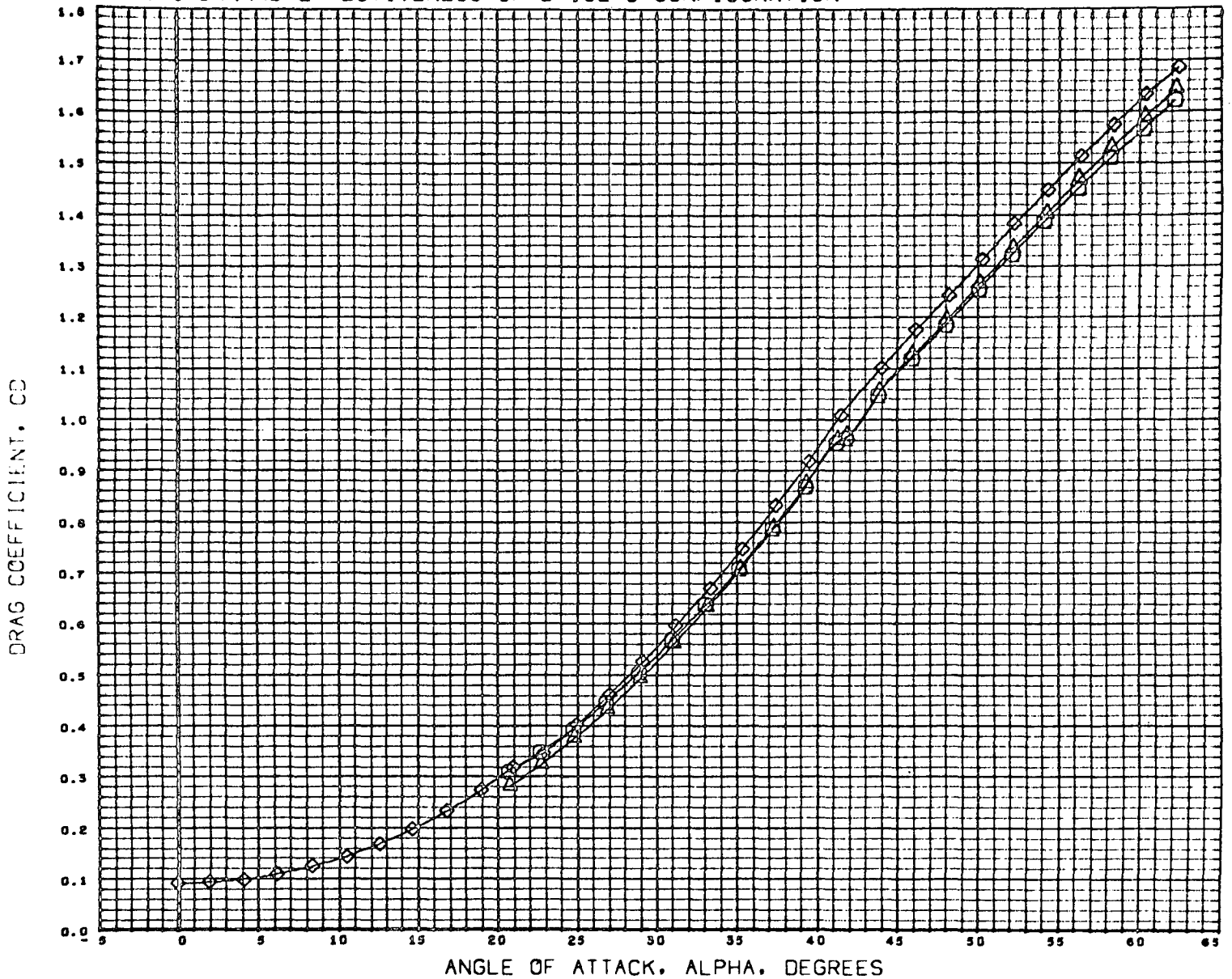

DATA SET SYMBOL	CONFIGURATION DESCRIPTION
(C98050)	MSFC TWT 514 E3 B30W23C10
(C98040)	MSFC TWT 514 E3 B30W23C10
(C98010)	MSFC TWT 514 E3 B30W23C10

BETA	ELEVTR	CANARD
0.000	0.000	-60.000
0.000	0.000	-30.000
0.000	0.000	0.000

REFERENCE INFORMATION		
SREF	15.0500	50 INC
LREF	2.8500	INCHES
BREF	6.0620	INCHES
XMRP	2.1110	INCHES
YMRP	0.0000	INCHES
ZMRP	0.0000	INCHES
SCALE	0.0035	

MACH 2.990

FIGURE-4 CANARD EFFECTIVENESS OF B-18E-3 CONFIGURATION

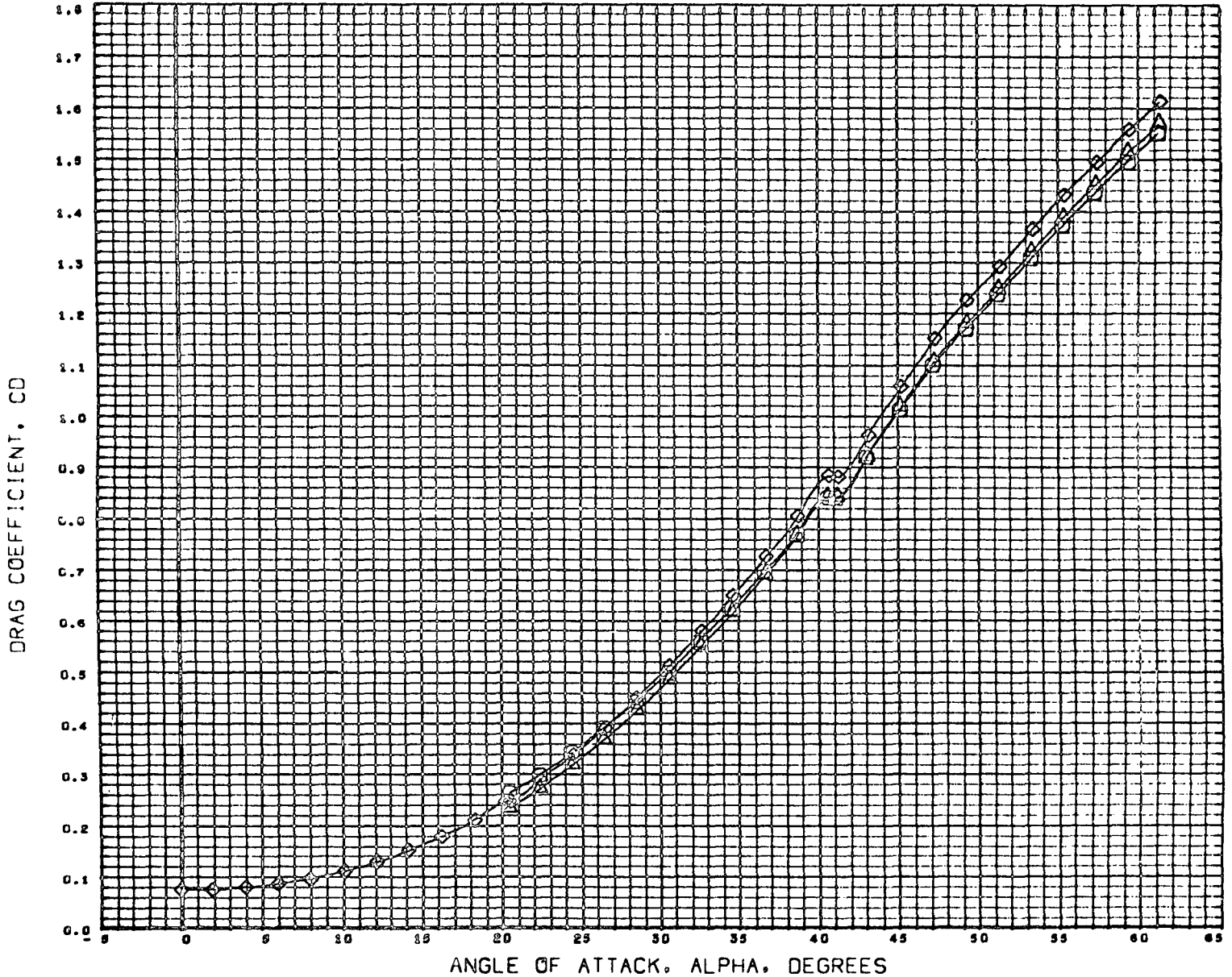

DATA SET SYMBOL	CONFIGURATION DESCRIPTION
(C58030)	MSFC TWT 514 E3 830W23C10
(C58040)	MSFC TWT 514 E3 830W23C10
(C58010)	MSFC TWT 514 E3 830W23C10

BETA	ELEVTR	CANARD
0.000	0.000	-60.000
0.000	0.000	-30.000
0.000	0.000	0.000

REFERENCE INFORMATION		
SREF	15.0300	50 INC
LREF	2.8300	INCHES
BREF	6.0620	INCHES
XMRP	2.1110	INCHES
YMRP	0.0000	INCHES
ZMRP	0.0000	INCHES
SCALE	0.0035	

MACH 4.959

FIGURE-4 CANARD EFFECTIVENESS OF B-18E-3 CONFIGURATION

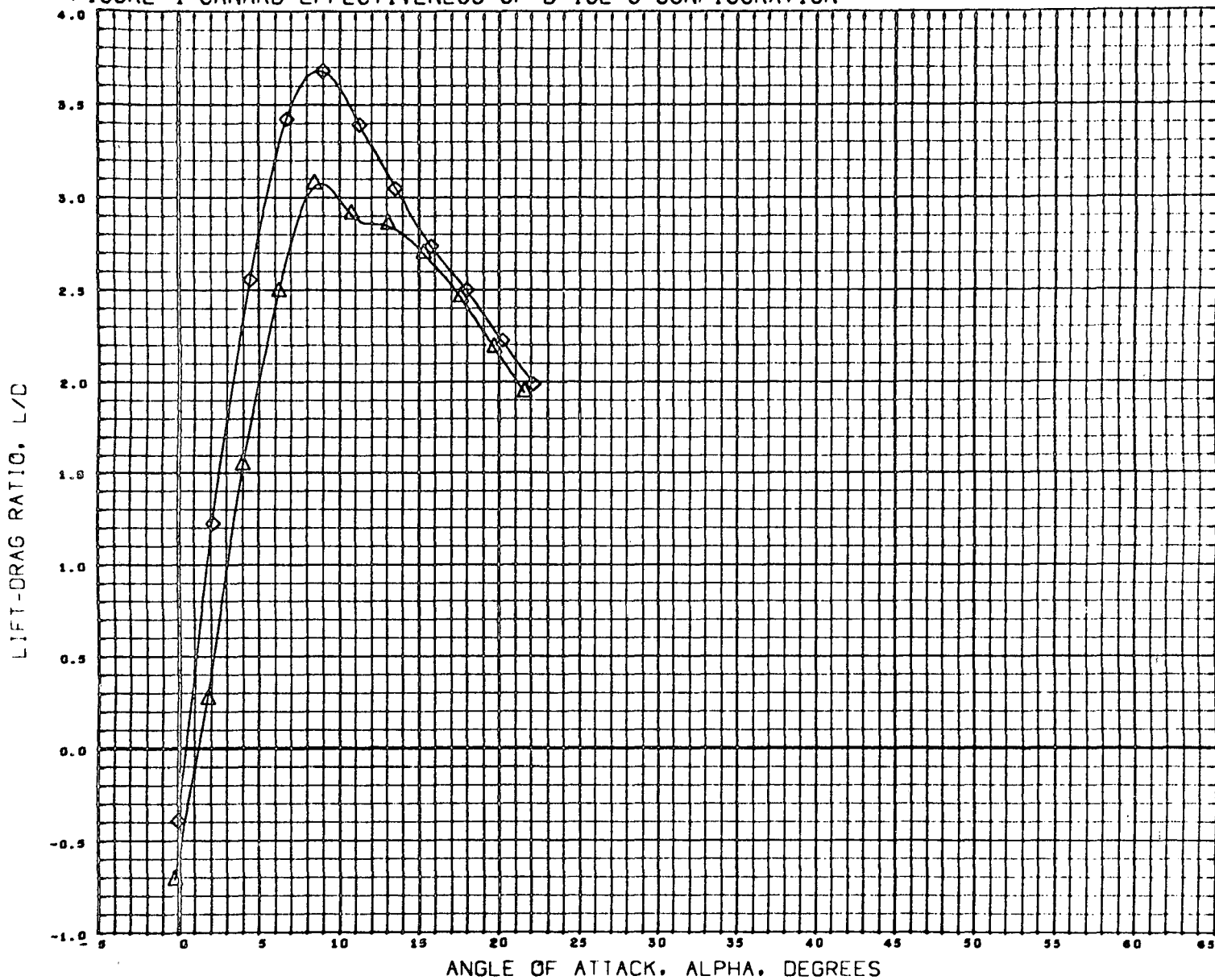

DATA SET	SYMBOL	CONFIGURATION DESCRIPTION
(C58053)	○	DATA NOT AVAILABLE FOR ALL CONDITIONS
(C58040)	△	MSFC TWT 314 E3 B30W23C10
(C58010)	◇	MSFC TWT 314 E3 B30W23C10

BETA	ELEVTR	CANARD
0.000	0.000	-60.000
0.000	0.000	-30.000
0.000	0.000	0.000

REFERENCE INFORMATION		
SREF	15.0300	SQ INC
LREF	2.8500	INCHES
BREF	6.0620	INCHES
XMRP	2.1110	INCHES
YMRP	0.0000	INCHES
ZMRP	0.0000	INCHES
SCALE	0.0035	

MACH 0.902

FIGURE-4 CANARD EFFECTIVENESS OF B-18E-3 CONFIGURATION

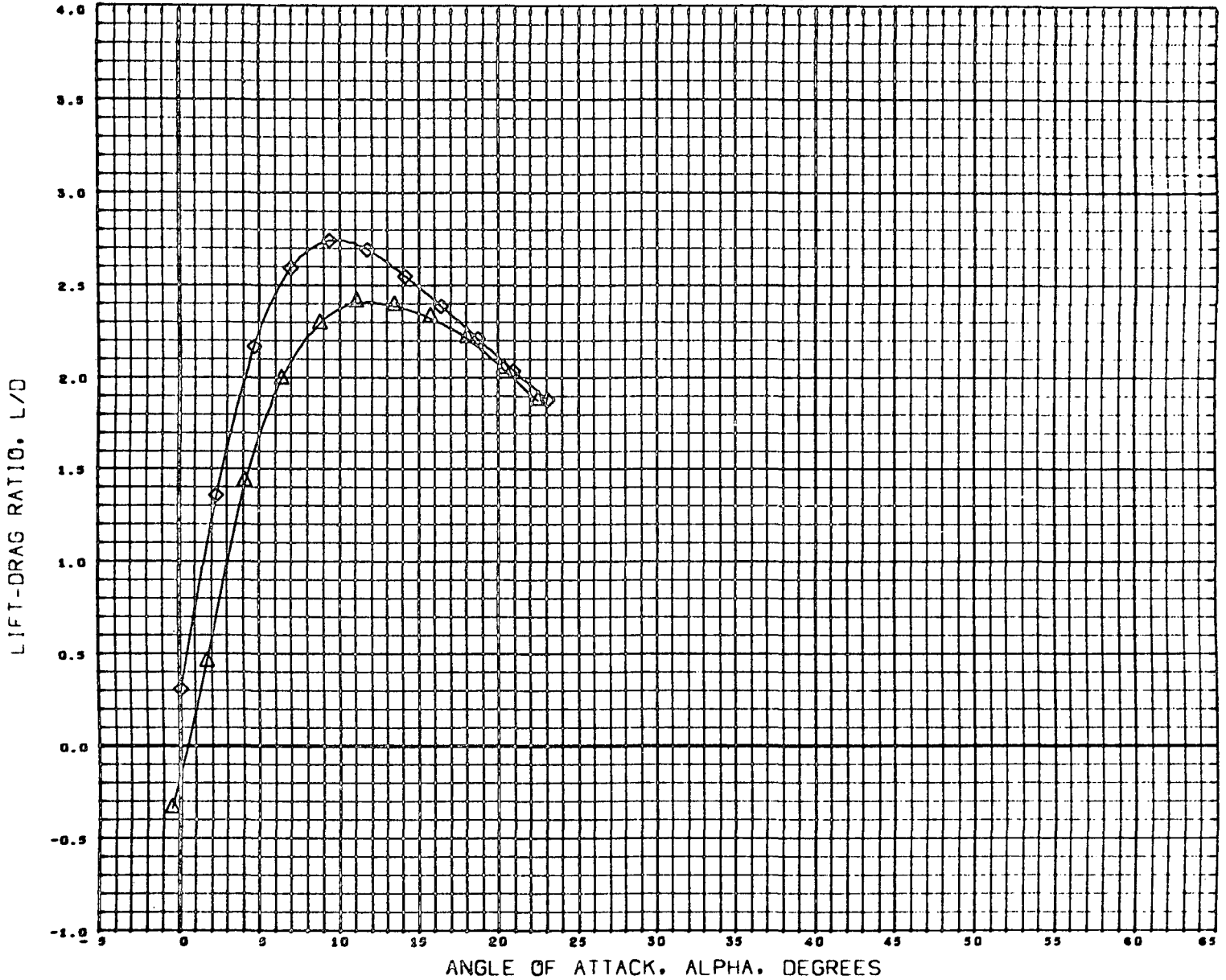

DATA SET SYMBOL	CONFIGURATION DESCRIPTION
(C58053)	DATA NOT AVAILABLE FOR ALL CONDITIONS
(C58043)	MSFC TWT 914 E3 @30W23C10
(C58013)	MSFC TWT 914 E3 @30W23C10

BETA	ELEVTR	CANARD
0.000	0.000	-60.000
0.000	0.000	-30.000
0.000	0.000	0.000

REFERENCE INFORMATION		
SREF	15.0300	SQ INC
LREF	2.8300	INCHES
BREF	6.0620	INCHES
XMRP	2.1110	INCHES
YMRP	0.0000	INCHES
ZMRP	0.0000	INCHES
SCALE	0.0035	

MACH 1.196

FIGURE-4 CANARD EFFECTIVENESS OF B-18E-3 CONFIGURATION

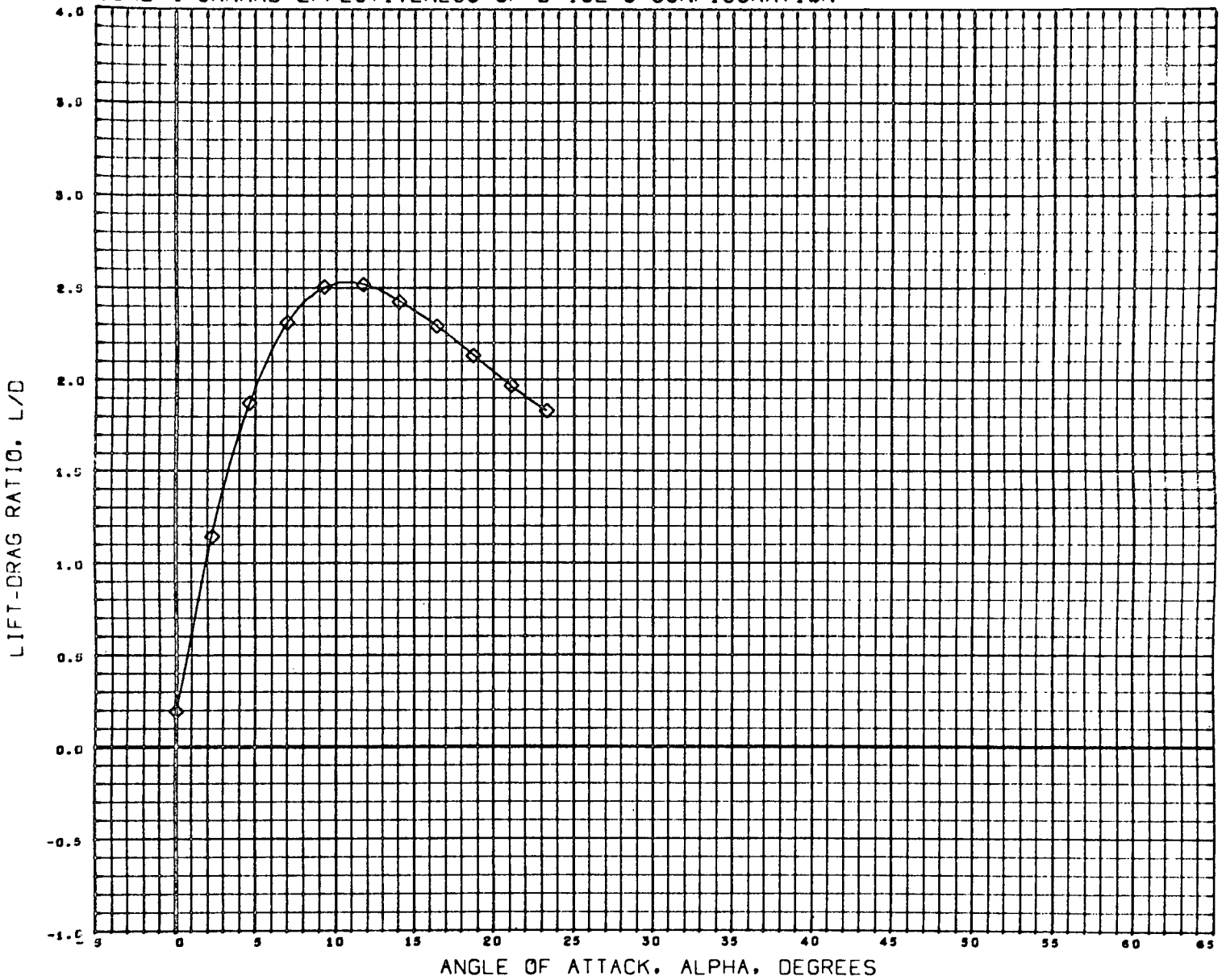

DATA SET SYMBOL	CONFIGURATION DESCRIPTION
(C98050)	DATA NOT AVAILABLE FOR ALL CONDITIONS
(C98040)	DATA NOT AVAILABLE FOR ALL CONDITIONS
(C98010)	MSFC TWT 514 E3 B30W23C10

BETA	ELEVTR	CANARD
0.000	0.000	-60.000
0.000	0.000	-30.000
0.000	0.000	0.000

REFERENCE INFORMATION		
SREF	15.0500	SQ INC
LREF	2.8300	INCHES
BREF	6.0620	INCHES
XMRP	2.1110	INCHES
YMRP	0.0000	INCHES
ZMRP	0.0000	INCHES
SCALE	0.0035	

MACH 1.459

FIGURE-4 CANARD EFFECTIVENESS OF B-18E-3 CONFIGURATION

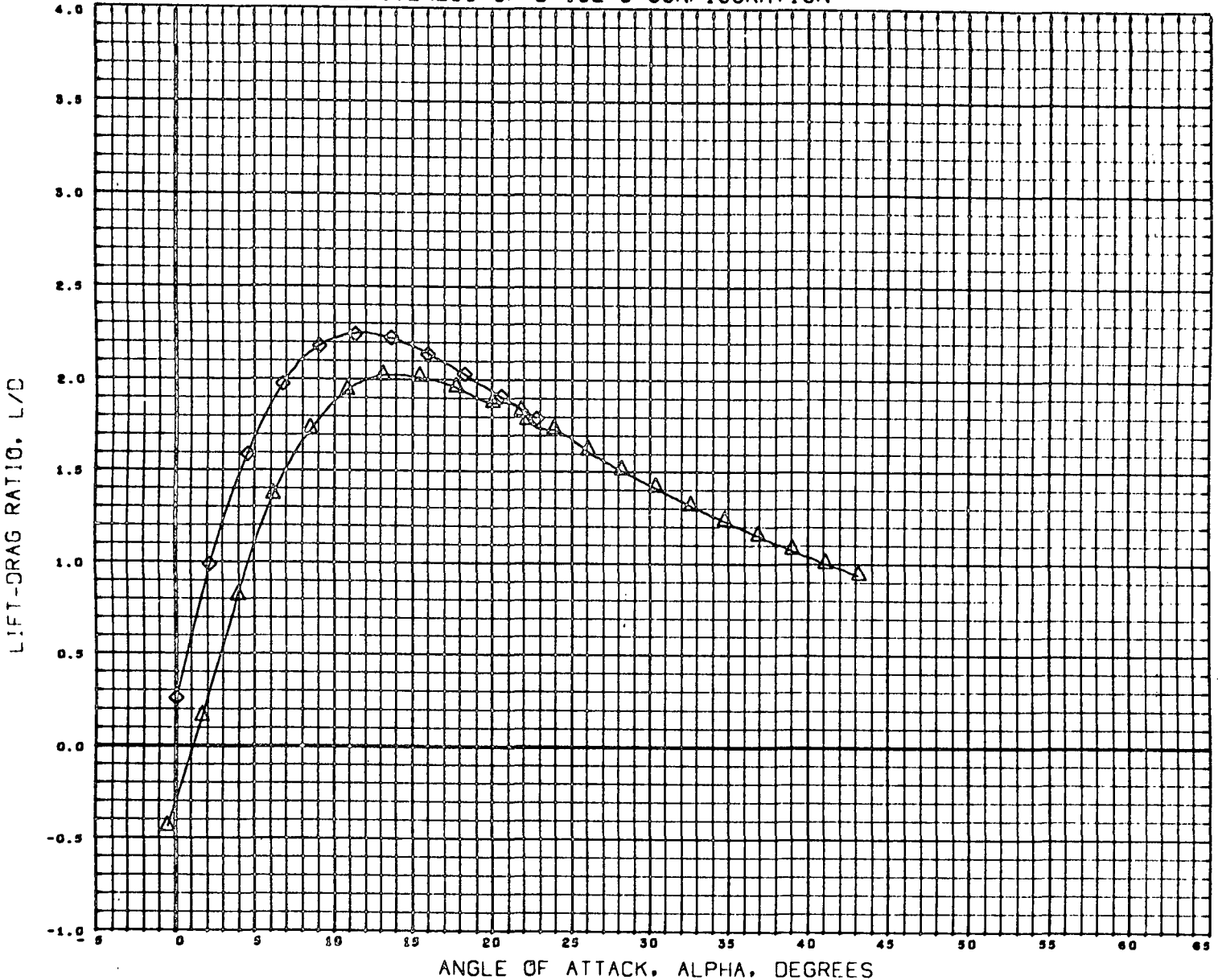

DATA SET SYMBOL	CONFIGURATION DESCRIPTION
(C98030)	DATA NOT AVAILABLE FOR ALL CONDITIONS
(C98040)	MSFC TWT 514 E3 030W23C10
(C98010)	MSFC TWT 514 E3 030W23C10

BETA	ELEVTR	CANARD
0.000	0.000	-60.000
0.000	0.000	-30.000
0.000	0.000	0.000

REFERENCE INFORMATION	
SREF	15.0300 50 INC
LREF	2.8300 INCHES
BREF	6.0620 INCHES
YMRP	2.1110 INCHES
ZMRP	0.0000 INCHES
SCALE	0.0035

MACH 1.954

FIGURE-4 CANARD EFFECTIVENESS OF B-18E-3 CONFIGURATION

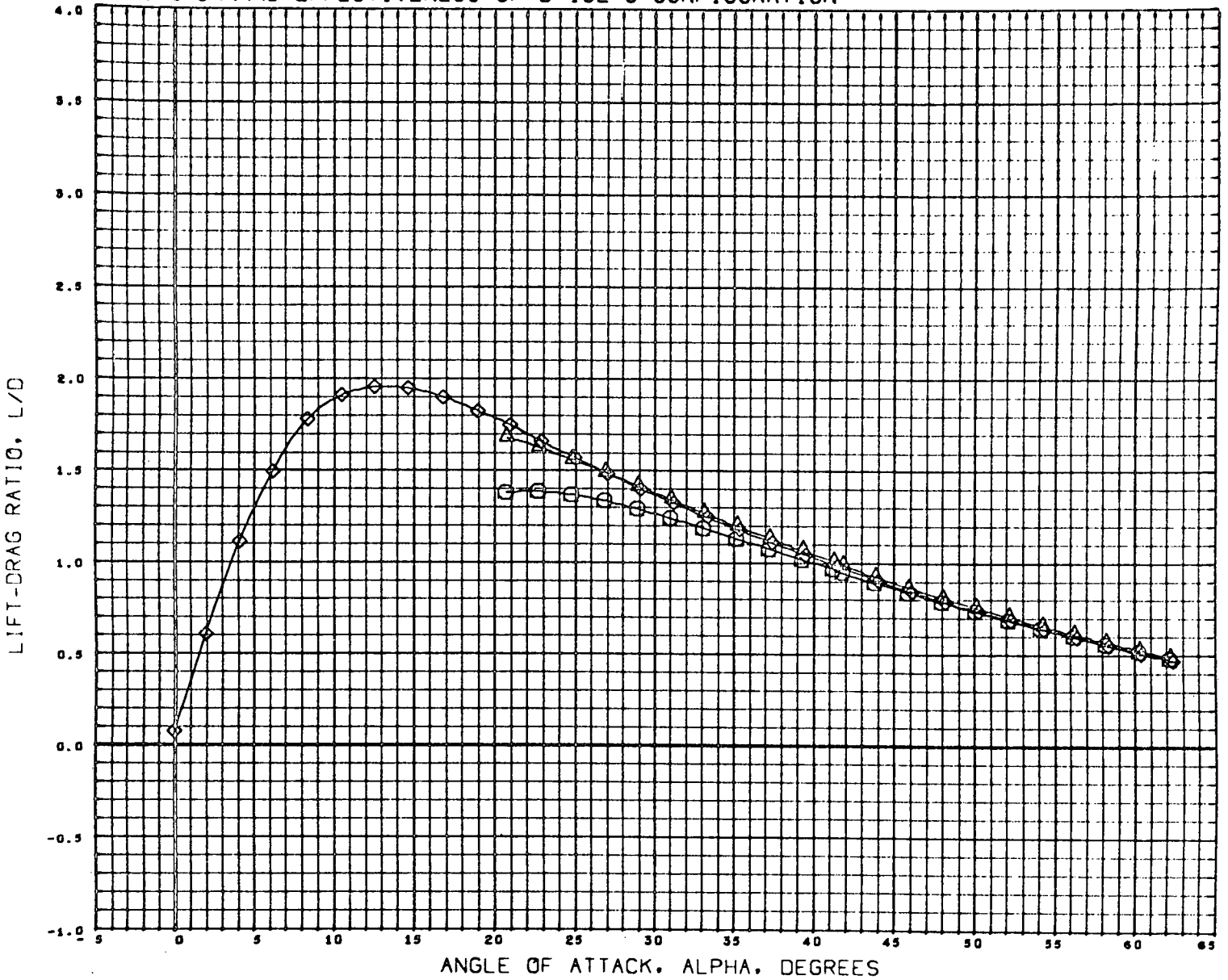

DATA SET SYMBOL	CONFIGURATION DESCRIPTION
(C58050)	MSFC TWT 514 E3 830W23C10
(C58040)	MSFC TWT 514 E3 830W23C10
(C58010)	MSFC TWT 514 E3 830W23C10

BETA	ELEVTR	CANARD
0.000	0.000	-60.000
0.000	0.000	-30.000
0.000	0.000	0.000

REFERENCE INFORMATION		
SREF	15.0300	94 INC
LREF	2.8300	INCHES
BREF	6.0620	INCHES
XMRP	2.1110	INCHES
YMRP	0.0000	INCHES
ZMRP	0.0000	INCHES
SCALE	0.0035	

MACH 2.990

FIGURE-4 CANARD EFFECTIVENESS OF B-18E-3 CONFIGURATION

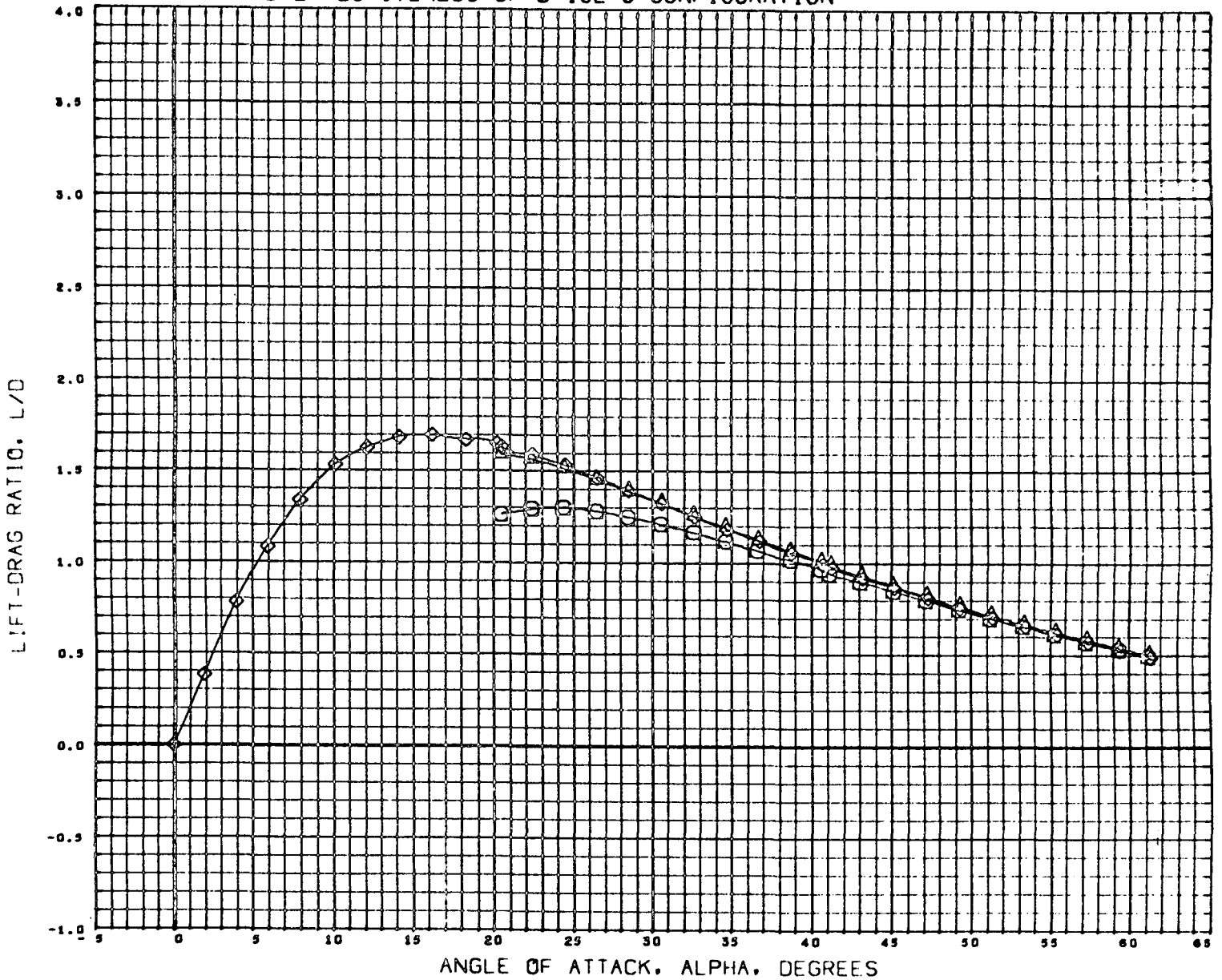

DATA SET	SYMBOL	CONFIGURATION	DESCRIPTION
(C5805J)	○	MSFC TWT 514 E3	030W23C10
(C5804J)	△	MSFC TWT 514 E3	030W23C10
(C5801U)	◇	MSFC TWT 514 E3	030W23C10

BETA	ELEVTR	CANARD
0.000	0.000	-60.000
0.000	0.000	-30.000
0.000	0.000	0.000

REFERENCE INFORMATION		
SREF	15.0300	30 INC
LREF	2.8300	INCHES
BREF	6.0620	INCHES
XMRP	2.1110	INCHES
YMRP	0.0000	INCHES
ZMRP	0.0000	INCHES
SCALE	0.0035	

MACH 4.059

FIGURE-4 CANARD EFFECTIVENESS OF B-18E-3 CONFIGURATION

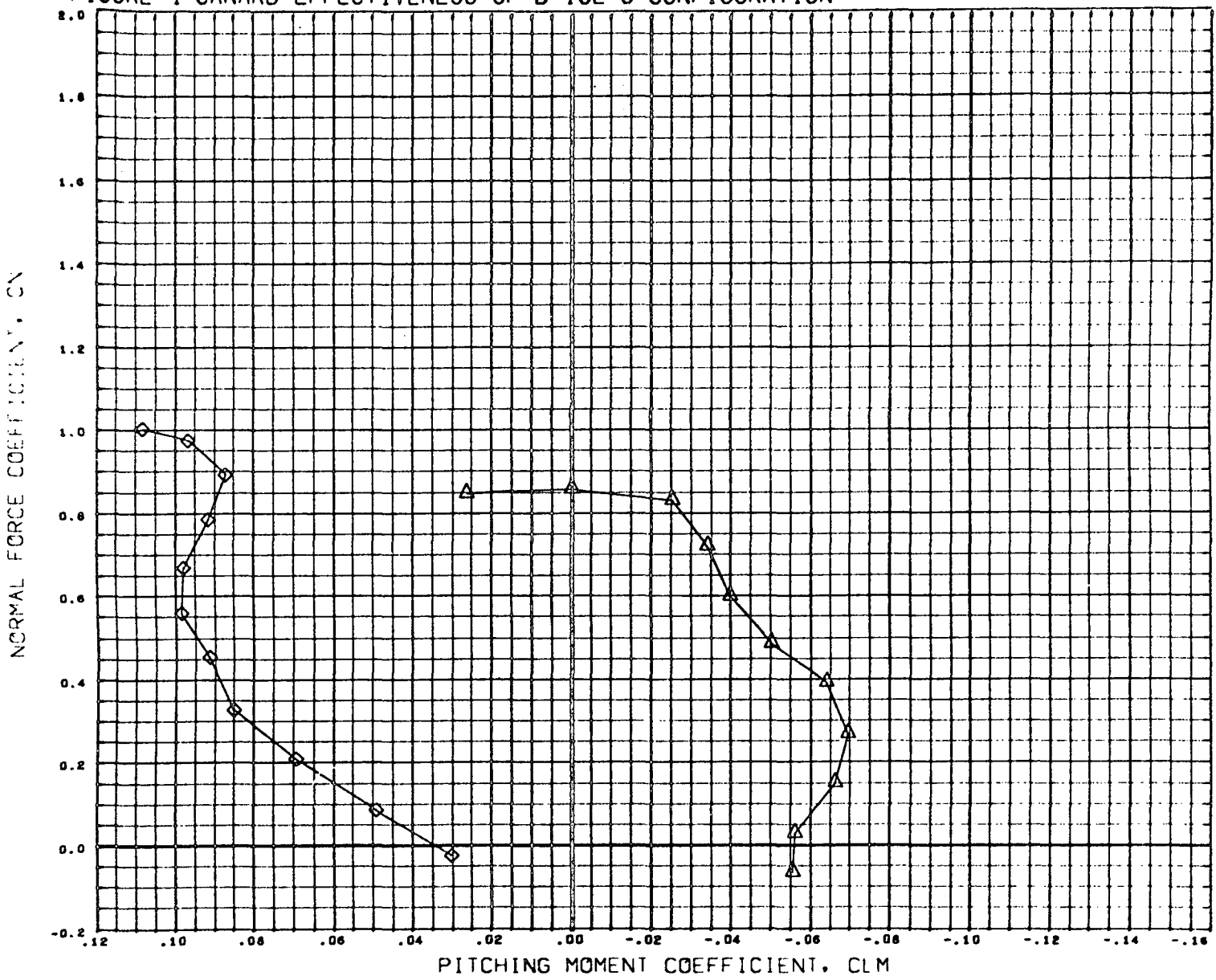

DATA SET SYMBOL CONFIGURATION DESCRIPTION
 (C5805) DATA NOT AVAILABLE FOR ALL CONDITIONS
 (C5804) MSFC TWT 514 E3 B30W23C10
 (C5801) MSFC TWT 514 E3 B30W23C10

BETA	ELEVTR	CANARD
0.000	0.000	-60.000
0.000	0.000	-30.000
0.000	0.000	0.000

REFERENCE INFORMATION	
SREF	15.0300 SQ INC
LREF	2.8300 INCHES
BREF	6.0620 INCHES
XWRP	2.1110 INCHES
YWRP	0.0000 INCHES
ZWRP	0.0000 INCHES
SCALE	0.0035

MACH 0.902

FIGURE-4 CANARD EFFECTIVENESS OF B-18E-3 CONFIGURATION

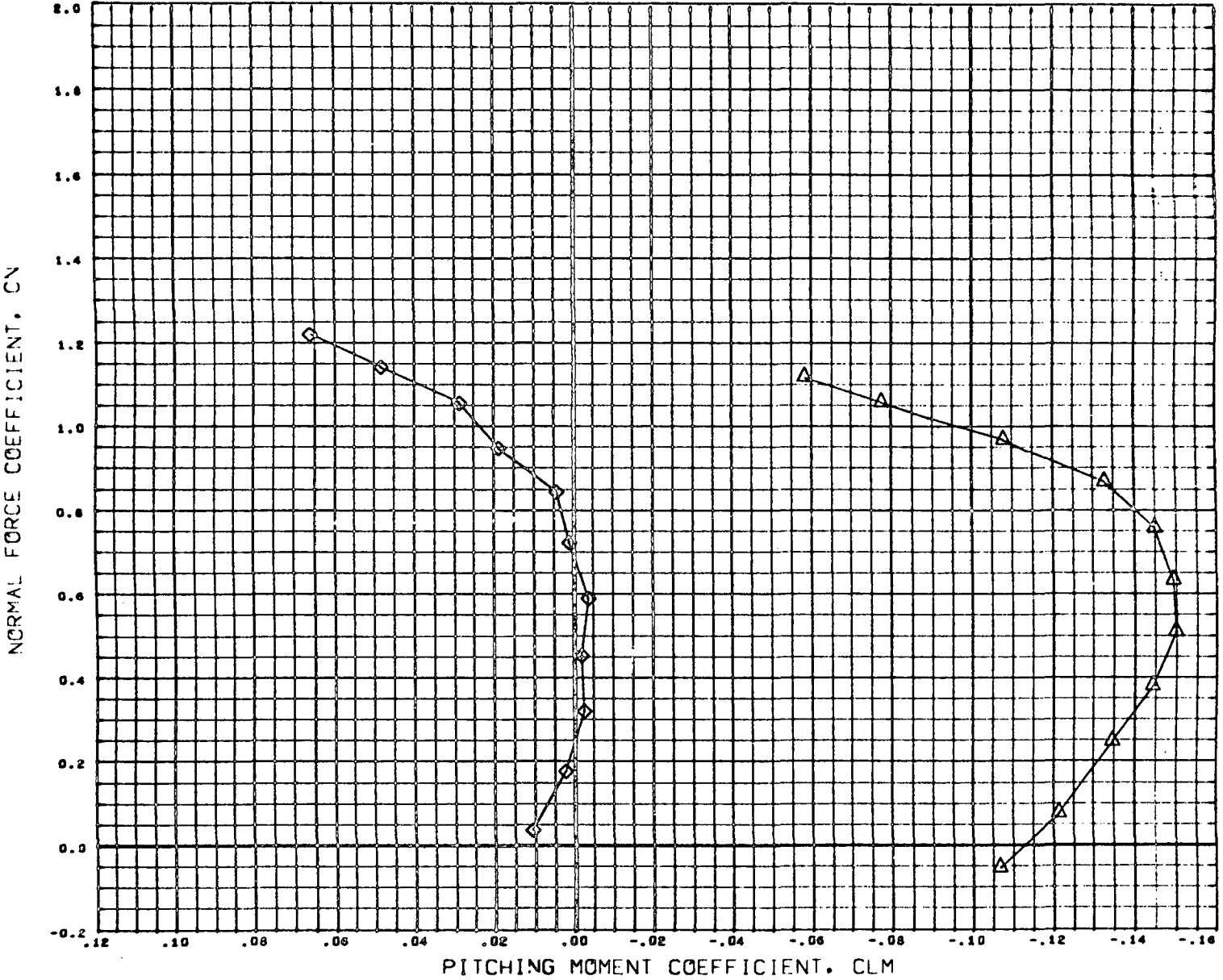

DATA SET SYMBOL	CONFIGURATION DESCRIPTION
(C58051)	DATA NOT AVAILABLE FOR ALL CONDITIONS
(C58041)	MSFC TWT 514 E3 B30W23C10
(C58010)	MSFC TWT 514 E3 B30W23C10

BETA	ELEVTR	CANARD
0.000	0.000	-60.000
0.000	0.000	-30.000
0.000	0.000	0.000

REFERENCE INFORMATION		
SREF	15.0300	30 INC
LREF	2.8300	INCHES
BREF	6.0620	INCHES
XMRP	2.1110	INCHES
YMRP	0.0000	INCHES
ZMRP	0.0000	INCHES
SCALE	0.0035	

MACH 1.196

FIGURE-4 CANARD EFFECTIVENESS OF B-18E-3 CONFIGURATION

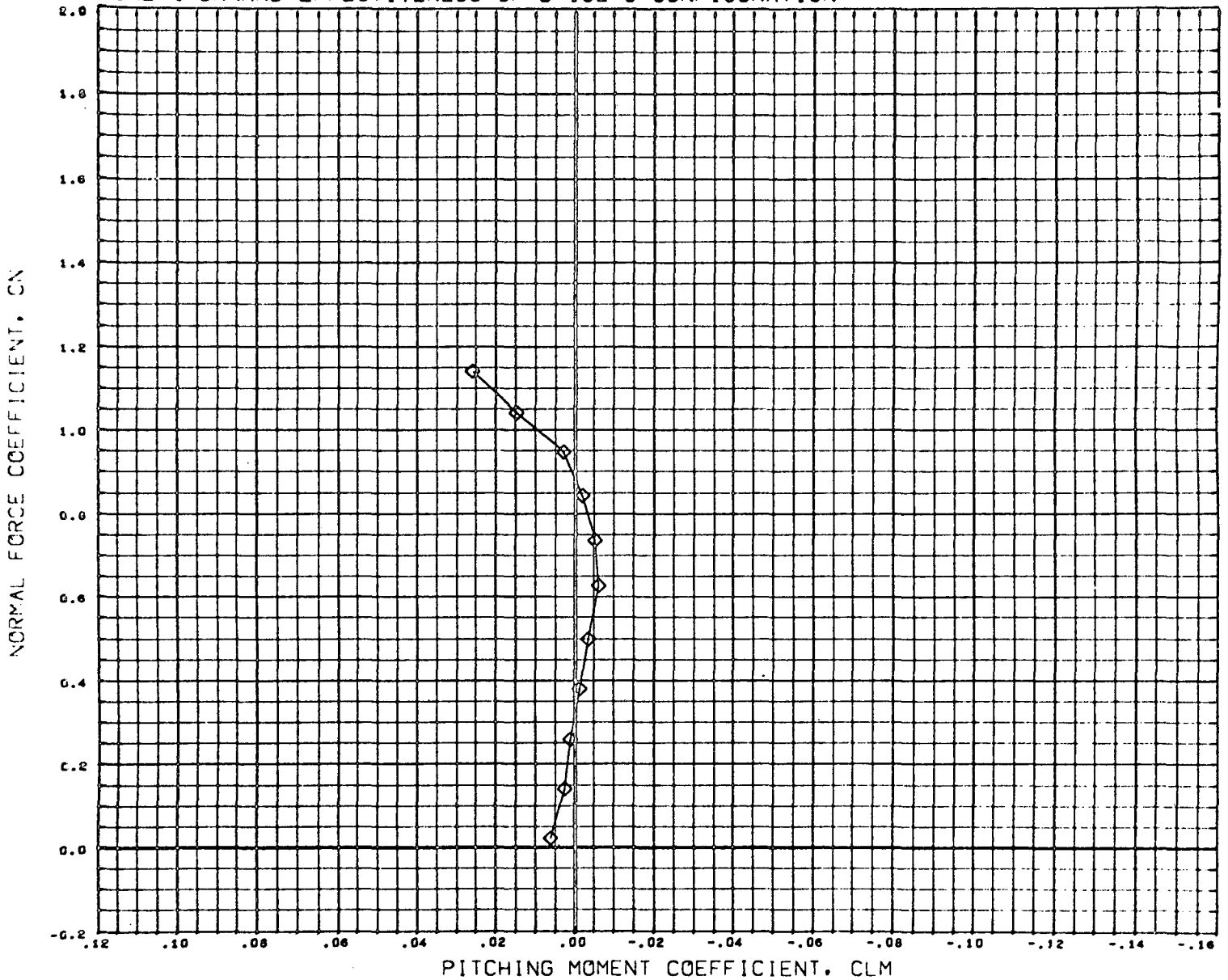

DATA SET SYMBOL	CONFIGURATION DESCRIPTION
(C380:0)	DATA NOT AVAILABLE FOR ALL CONDITIONS
(C380:0)	DATA NOT AVAILABLE FOR ALL CONDITIONS
(C380:0)	MSFC TWT 514 E3 B30W23C10

BETA	ELEVTR	CANARD
0.000	0.000	-60.000
0.000	0.000	-30.000
0.000	0.000	0.000

REFERENCE INFORMATION		
SREF	15.0500	sq INC
LREF	2.8300	INCHES
BREF	6.0620	INCHES
XMRP	2.1110	INCHES
YMRP	0.0000	INCHES
ZMRP	0.0000	INCHES
SCALE	0.0035	

MACH 1.459

FIGURE-4 CANARD EFFECTIVENESS OF B-18E-3 CONFIGURATION

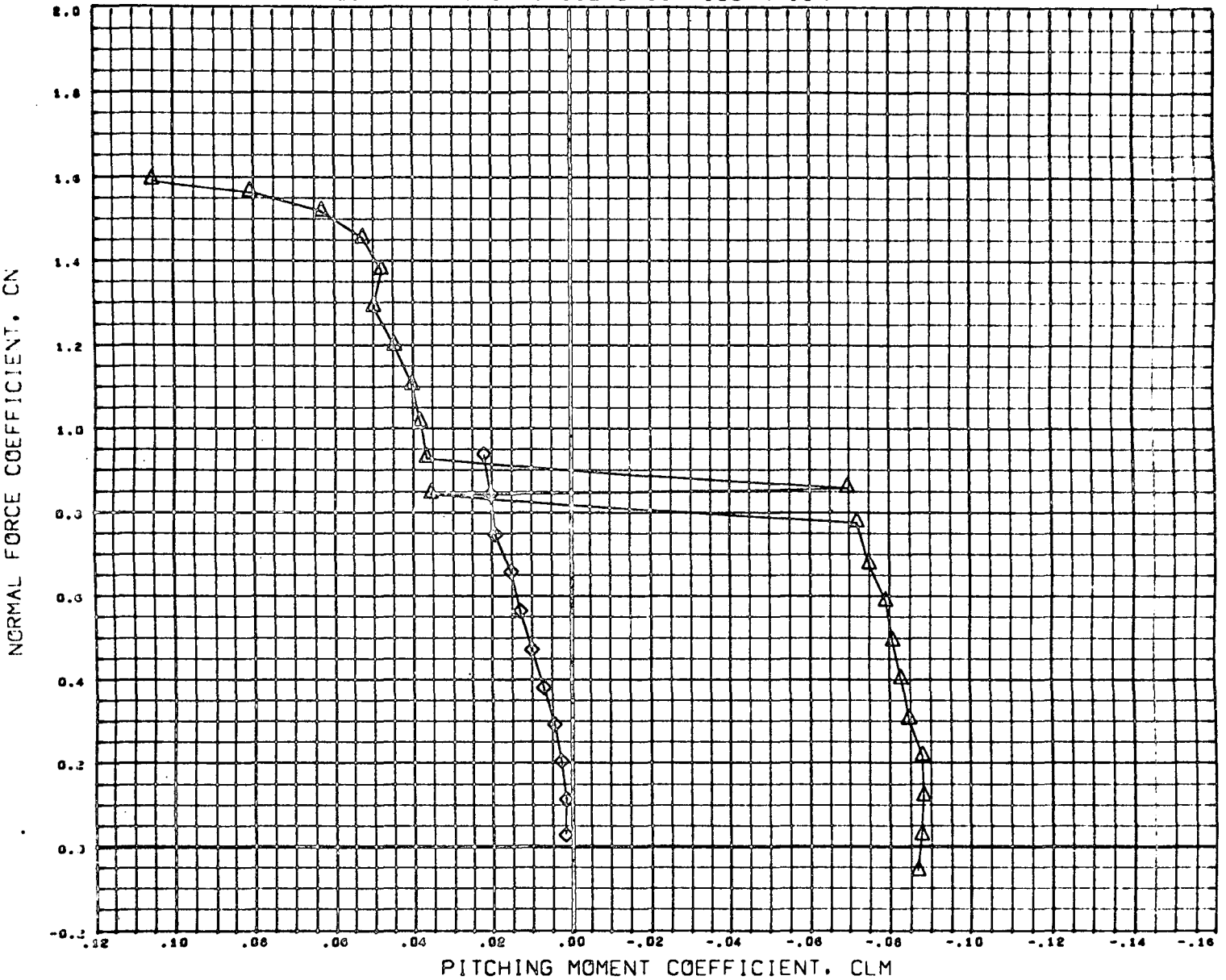

DATA SET	SYMBOL	CONFIGURATION DESCRIPTION
(C9005C)	○	DATA NOT AVAILABLE FOR ALL CONDITIONS
(C9004C)	△	MSFC TWT 514 E3 B30W29C10
(C9001C)	◇	MSFC TWT 514 E3 B30W29C10

BETA	ELEVTR	CANARD
0.000	0.000	-60.000
0.000	0.000	-50.000
0.000	0.000	0.000

REFERENCE INFORMATION		
SREF	15.0300	50 INC
LREF	2.8300	INCHES
BREF	6.0620	INCHES
XMRP	2.1110	INCHES
YMRP	0.0000	INCHES
ZMRP	0.0000	INCHES
SCALE	0.0035	

MACH 1.954

FIGURE-4 CANARD EFFECTIVENESS OF B-18E-3 CONFIGURATION

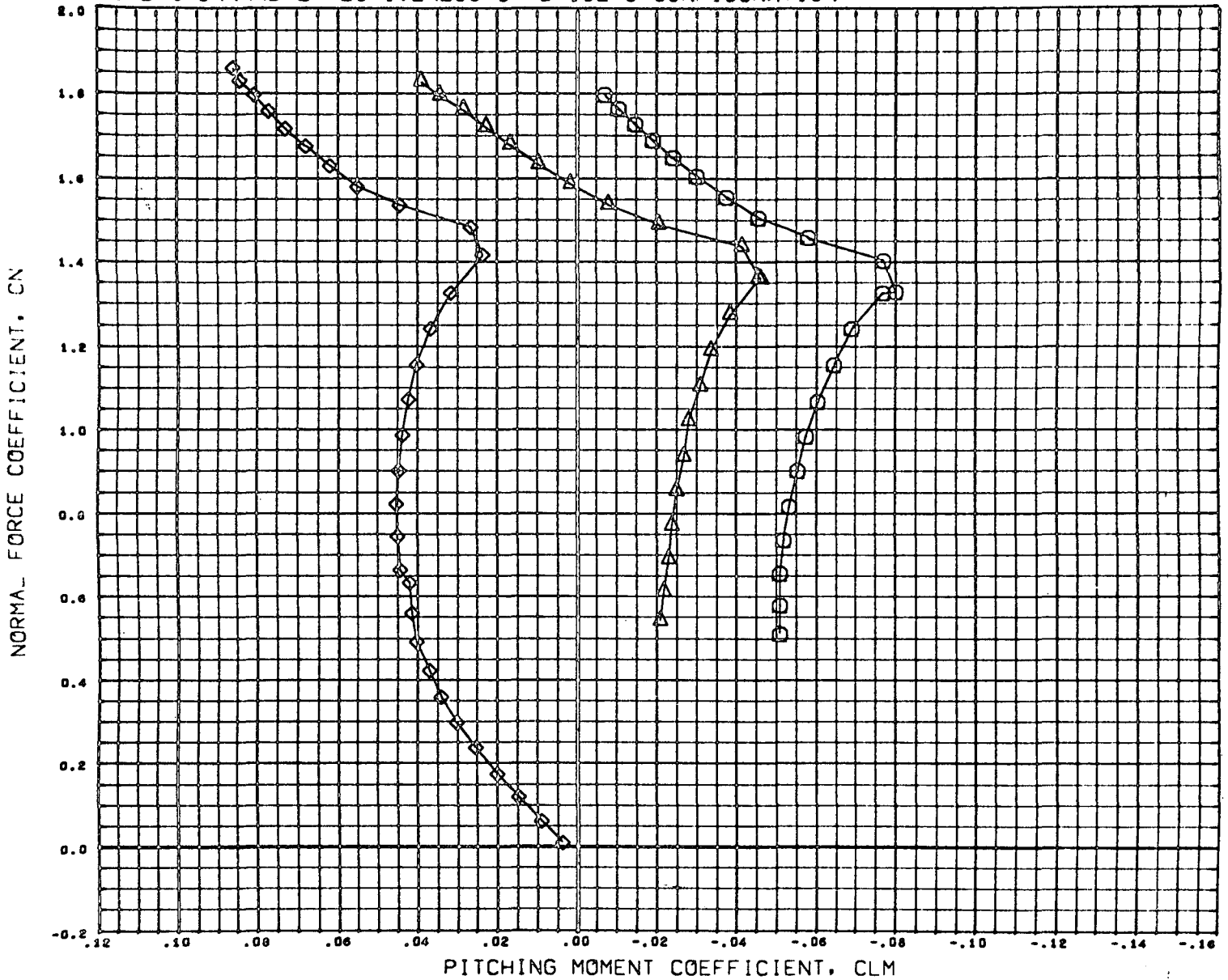

DATA SET SYMBOL	CONFIGURATION	DESCRIPTION
(C58051)	MSFC TWT 514 E3	B30W23C10
(C58041)	MSFC TWT 514 E3	B30W23C10
(C58010)	MSFC TWT 514 E3	B30W23C10

BETA	ELEVTR	CANARD
0.000	0.000	-60.000
0.000	0.000	-30.000
0.000	0.000	0.000

REFERENCE INFORMATION		
SREF	15.0300	sq INC
LREF	2.8300	INCHES
BREF	6.0620	INCHES
XMRP	2.1110	INCHES
YMRP	0.0000	INCHES
ZMRP	0.0000	INCHES
SCALE	0.0035	

MACH 2.990

FIGURE-4 CANARD EFFECTIVENESS OF B-18E-3 CONFIGURATION

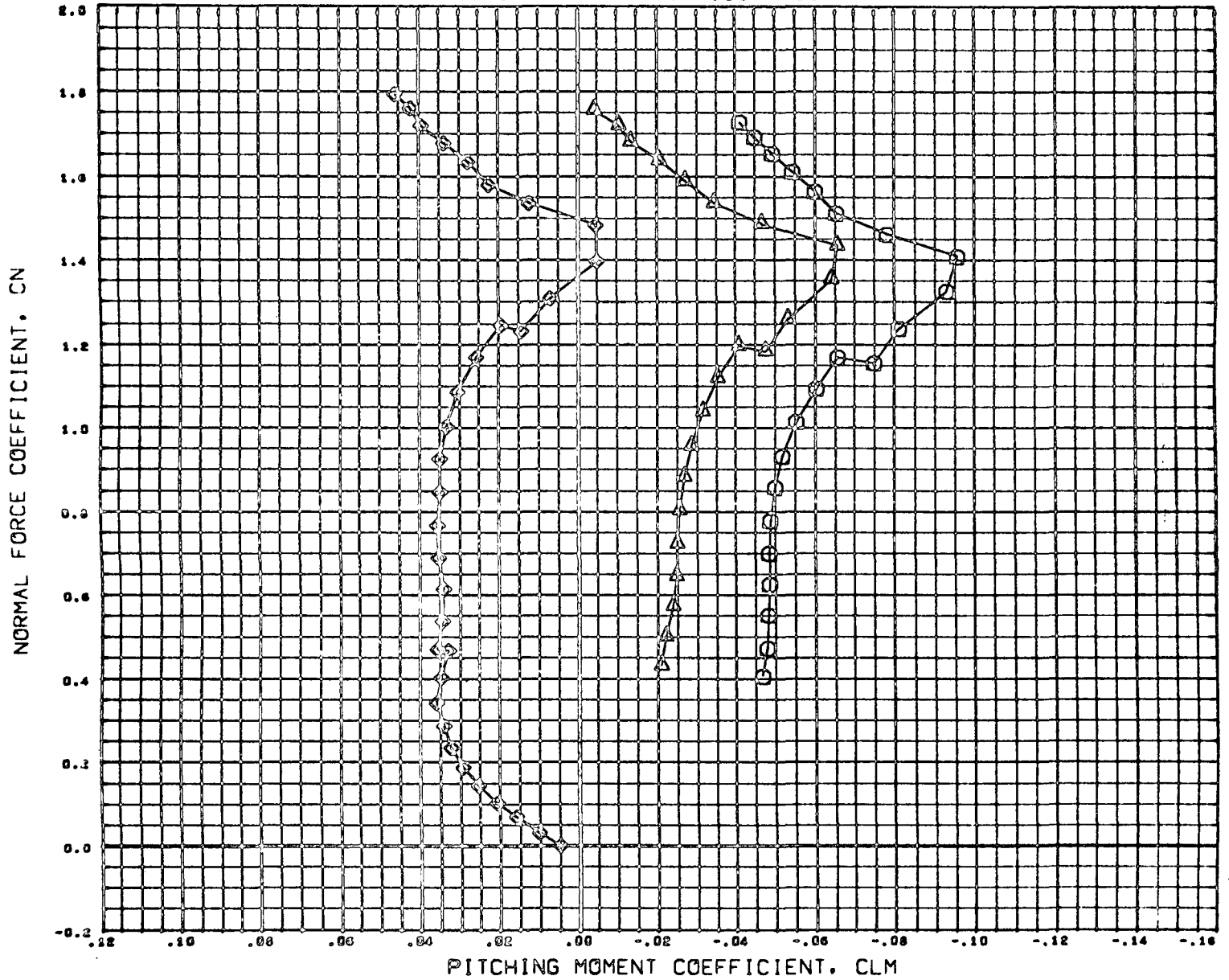

DATA SET SYMBOL	CONFIGURATION DESCRIPTION	BETA	LEVTR	CANARD	REFERENCE INFORMATION
(C5805C)	MSFC TWT 514 E3 030W23C10	0.000	0.000	-60.000	BREF 15.0500 SQ INC
(C5804C)	MSFC TWT 514 E3 030W23C10	0.000	0.000	-30.000	LREF 2.8300 INCHES
(C5801C)	MSFC TWT 514 E3 030W23C10	0.000	0.000	0.000	BREF 6.0620 INCHES
					XMRP 2.1110 INCHES
					YMRP 0.0000 INCHES
					ZMRP 0.0000 INCHES
					SCALE 0.0035

MACH 4.990

FIGURE-4 CANARD EFFECTIVENESS OF B-18E-3 CONFIGURATION

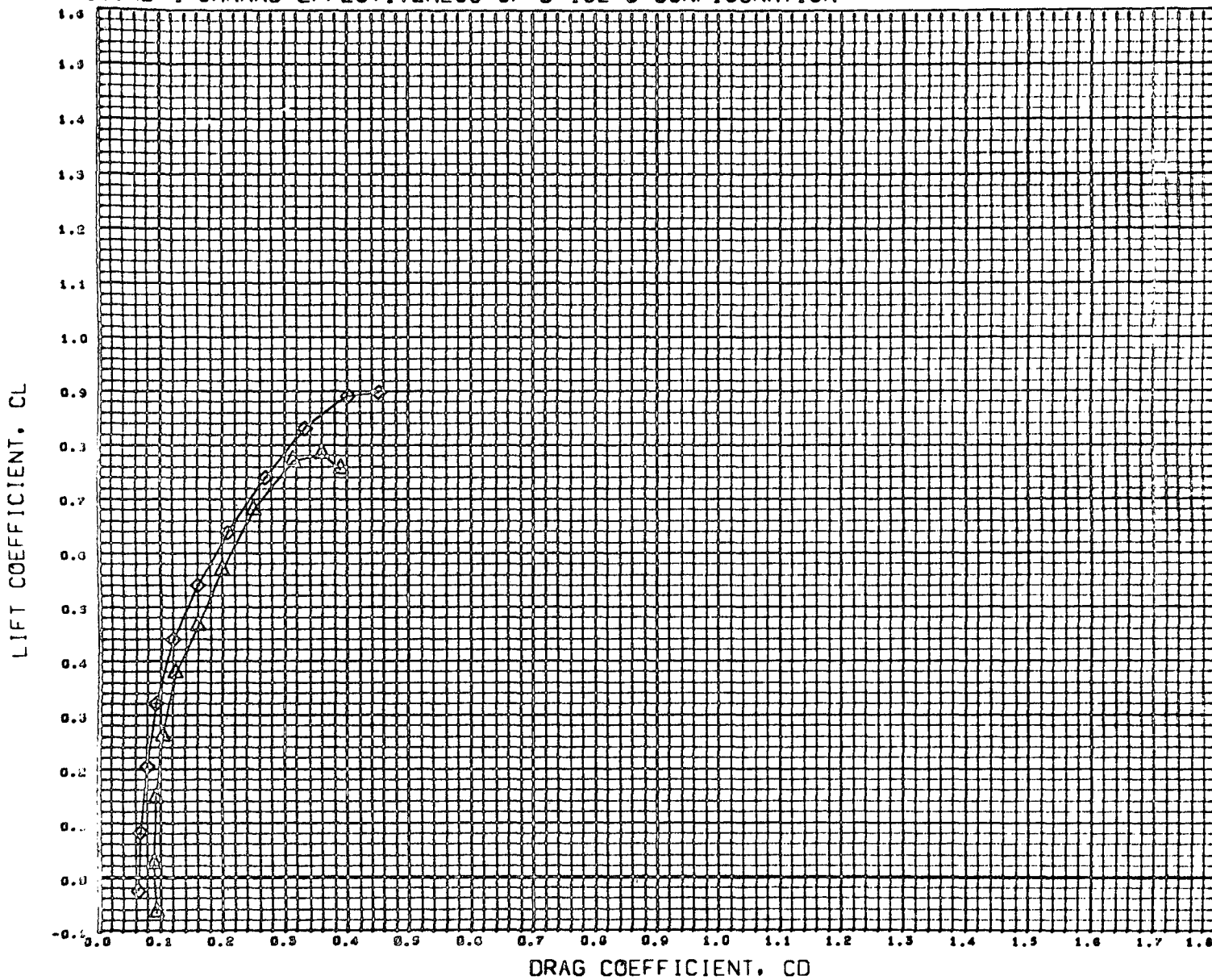

DATA SET SYMBOL	CONFIGURATION DESCRIPTION	BETA	ELEVTR	CANARD	REFERENCE INFORMATION
(C98050)	DATA NOT AVAILABLE FOR ALL CONDITIONS	0.000	0.000	-60.000	SREF 15.0300 SQ INC
(C90040)	HSFC TWT 514 E3 @30W23C10	0.000	0.000	-30.000	LREF 2.8300 INCHES
(C86010)	HSFC TWT 514 E3 @30W23C10	0.000	0.000	0.000	BREF 6.0620 INCHES
					XMRP 2.1110 INCHES
					YMRP 0.0000 INCHES
					ZMRP 0.0000 INCHES
					SCALE 0.0035

MACH 0.902

FIGURE-4 CANARD EFFECTIVENESS OF B-18E-3 CONFIGURATION

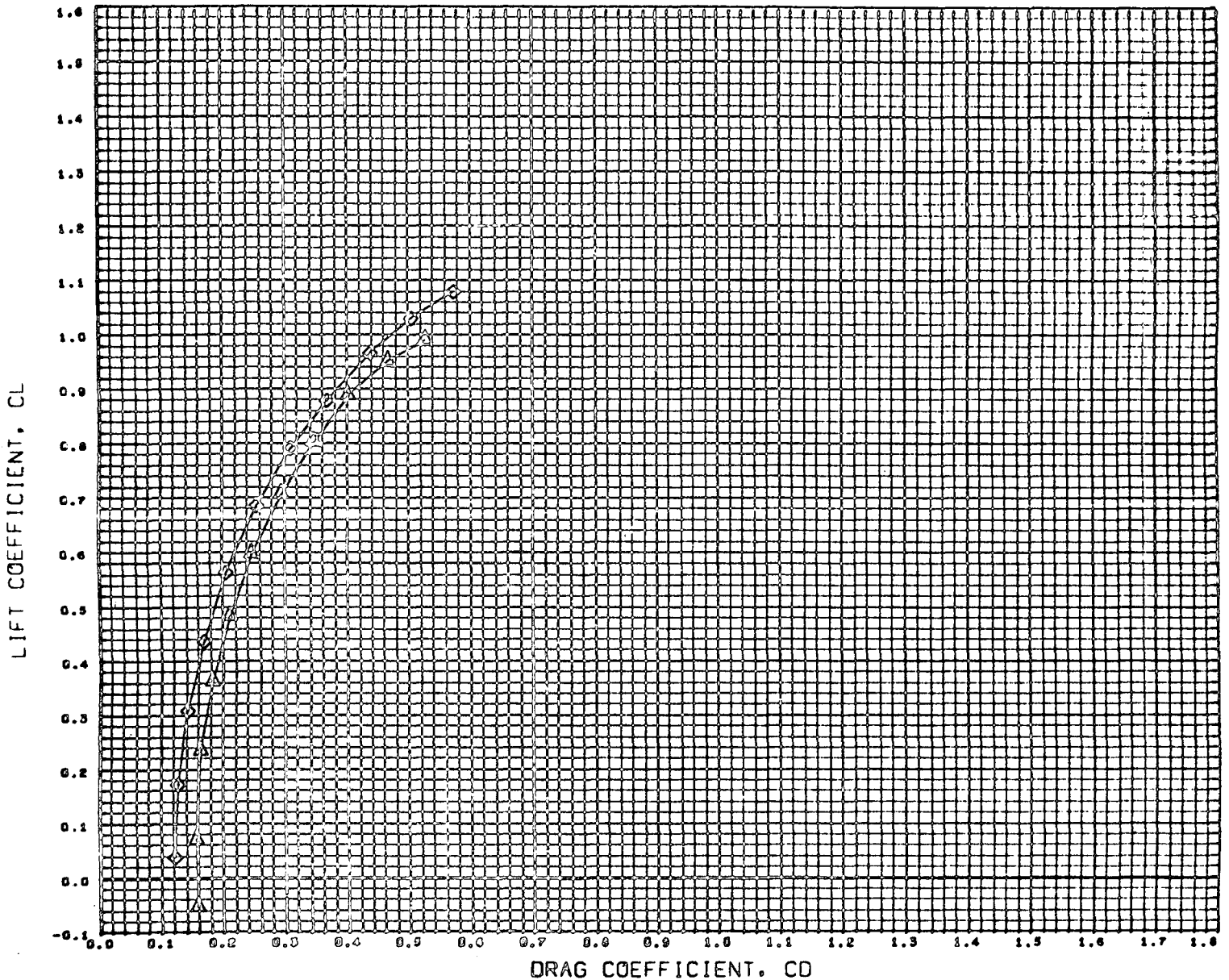

DATA SET SYMBOL	CONFIGURATION DESCRIPTION
(C98050)	DATA NOT AVAILABLE FOR ALL CONDITIONS
(C98040)	MSFC TWT 914 E3 030W25C10
(C98010)	MSFC TWT 914 E3 030W25C10

BETA	ELEVTR	CANARD
0.000	0.000	-60.000
0.000	0.000	-30.000
0.000	0.000	0.000

REFERENCE INFORMATION		
SREF	15.0300	SQ INC
LREF	2.6300	INCHES
BREF	0.0620	INCHES
XMRP	2.1110	INCHES
YMRP	0.0000	INCHES
ZMRP	0.0000	INCHES
SCALE	0.0035	

MACH 0.190

FIGURE-4 CANARD EFFECTIVENESS OF B-18E-3 CONFIGURATION

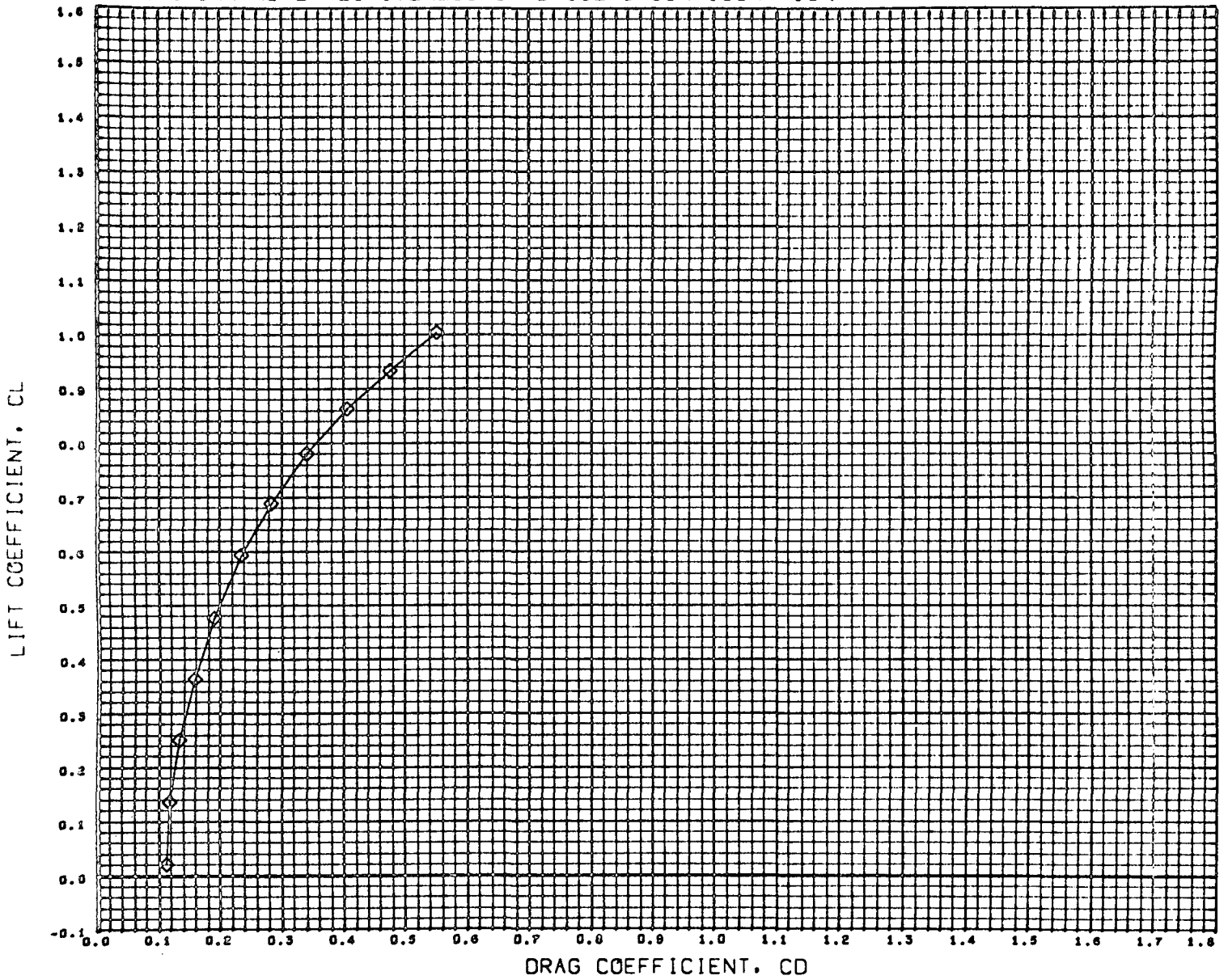

DATA SET SYMBOL	CONFIGURATION DESCRIPTION
(CS805)	○ DATA NOT AVAILABLE FOR ALL CONDITIONS
(CS004)	△ DATA NOT AVAILABLE FOR ALL CONDITIONS
(CS8010)	◇ MSFC TWT 314 E3 D30W23C10

BETA	ELEVTR	CANARD
0.000	0.000	-60.000
0.000	0.000	-30.000
0.000	0.000	0.000

REFERENCE INFORMATION		
SREF	15.0300	50 INC
LREF	2.8300	INCHES
BREF	6.0620	INCHES
XMRP	2.1110	INCHES
YMRP	0.0000	INCHES
ZMRP	0.0000	INCHES
SCALE	0.0035	

MACH 1.450

FIGURE-4 CANARD EFFECTIVENESS OF B-18E-3 CONFIGURATION

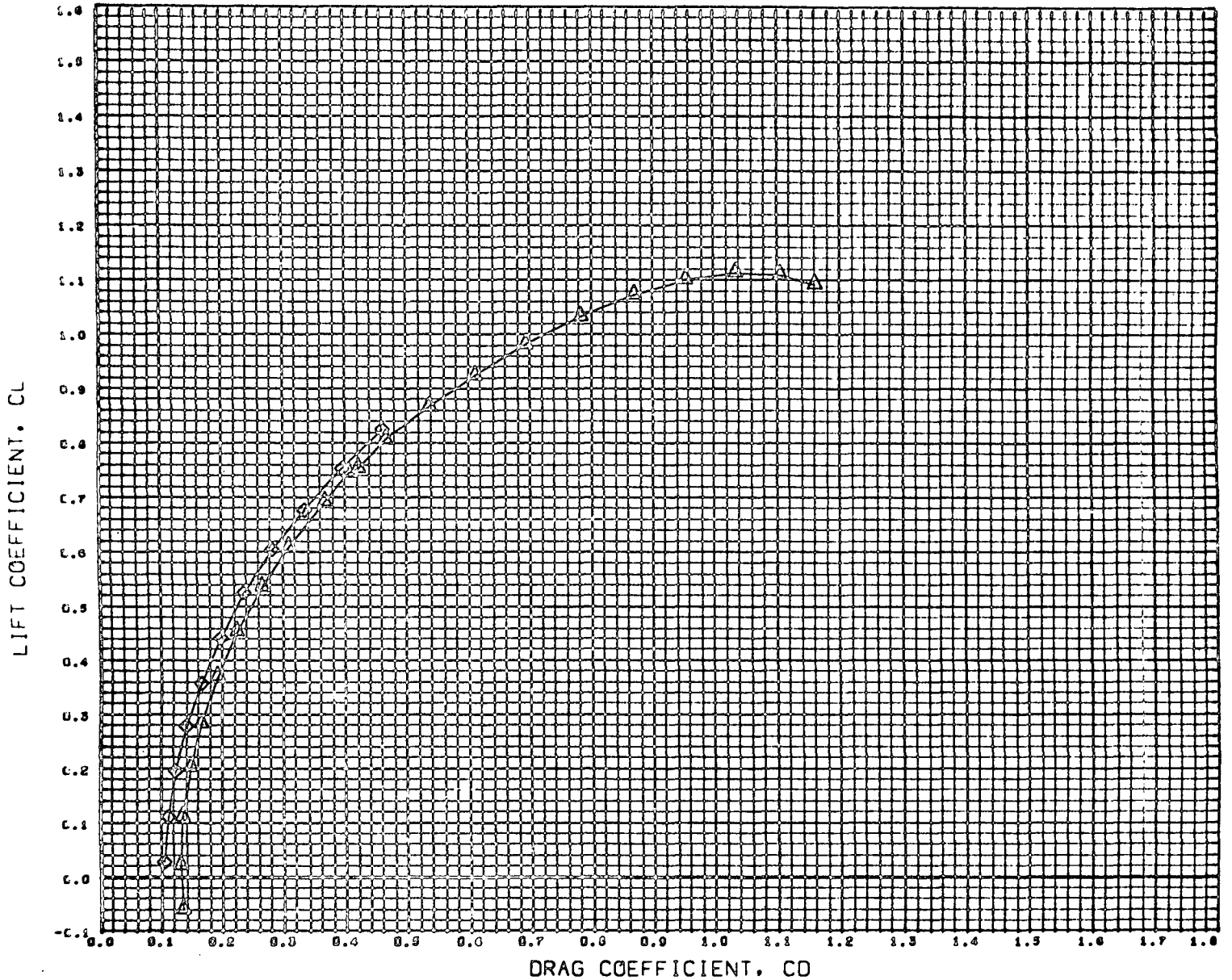

DATA SET	SYMBOL	CONFIGURATION DESCRIPTION
(C5803.0)	○	DATA NOT AVAILABLE FOR ALL CONDITIONS
(C5804.0)	△	MSFC TWT 914 E3 030W23C10
(C5801.0)	◇	MSFC TWT 914 E3 030W23C10

BETA	ELEVTR	CANARD
0.000	0.000	-60.000
0.000	0.000	-30.000
0.000	0.000	0.000

REFERENCE INFORMATION		
SREF	15.0300	89 INC
LREF	2.8300	INCHES
BREF	0.0620	INCHES
XMRP	2.1110	INCHES
YMRP	0.0000	INCHES
ZMRP	0.0000	INCHES
SCALE	0.0033	

MACH 8.094

FIGURE-4 CANARD EFFECTIVENESS OF B-18E-3 CONFIGURATION

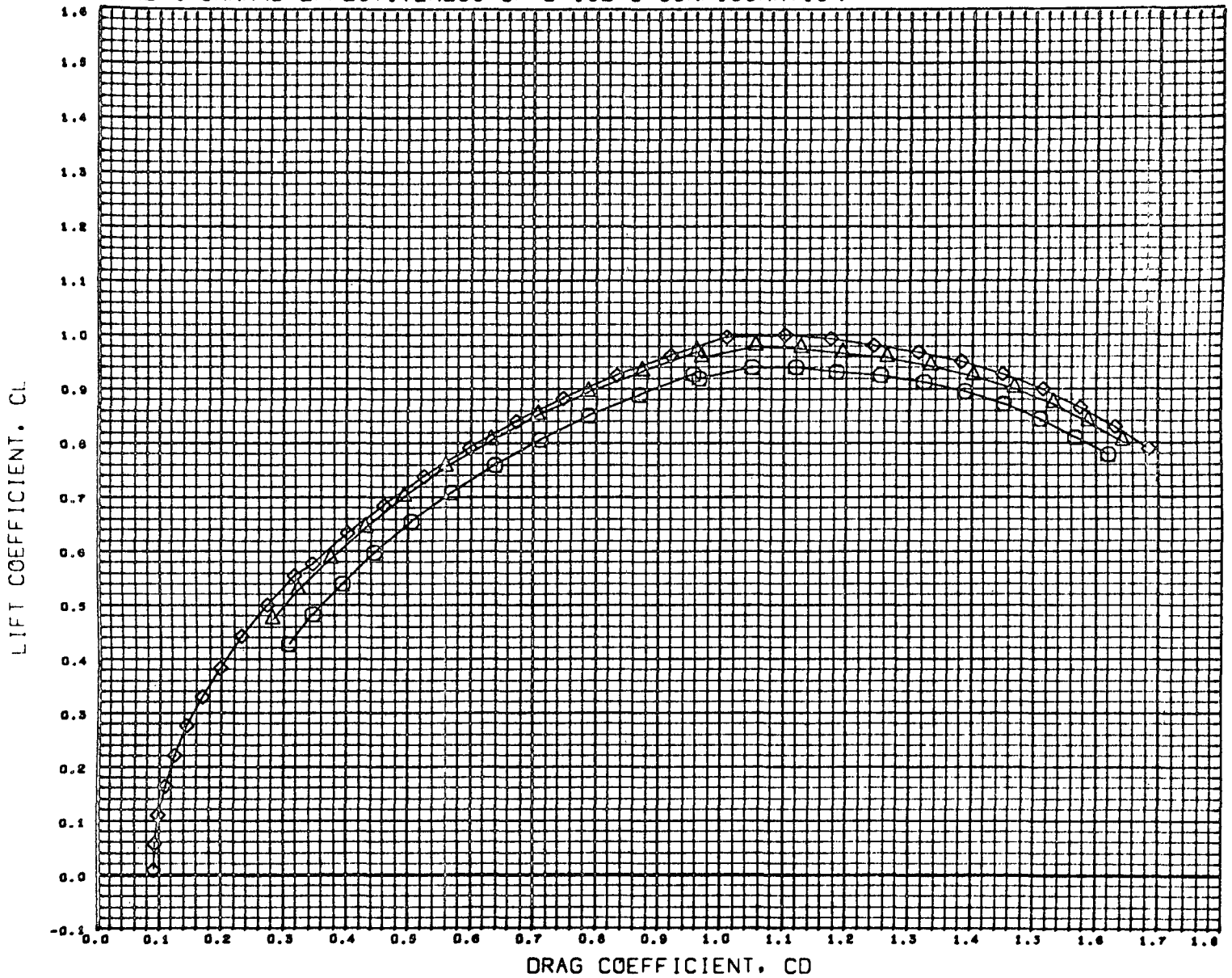

DATA SET SYMBOL	CONFIGURATION DESCRIPTION
(C58053)	MSFC TWT 514 E3 830W23C10
(C58043)	MSFC TWT 514 E3 830W23C10
(C58013)	MSFC TWT 514 E3 830W23C10

BETA	ELEVTR	CANARD
0.000	0.000	-60.000
0.000	0.000	-30.000
0.000	0.000	0.000

REFERENCE INFORMATION		
SREF	15.0300	90 INC
LREF	2.8300	INCHES
BREF	6.0620	INCHES
XMRP	2.1110	INCHES
YMRP	0.0000	INCHES
ZMRP	0.0000	INCHES
SCALE	0.0035	

MACH 2.990

FIGURE-4 CANARD EFFECTIVENESS OF B-18E-3 CONFIGURATION

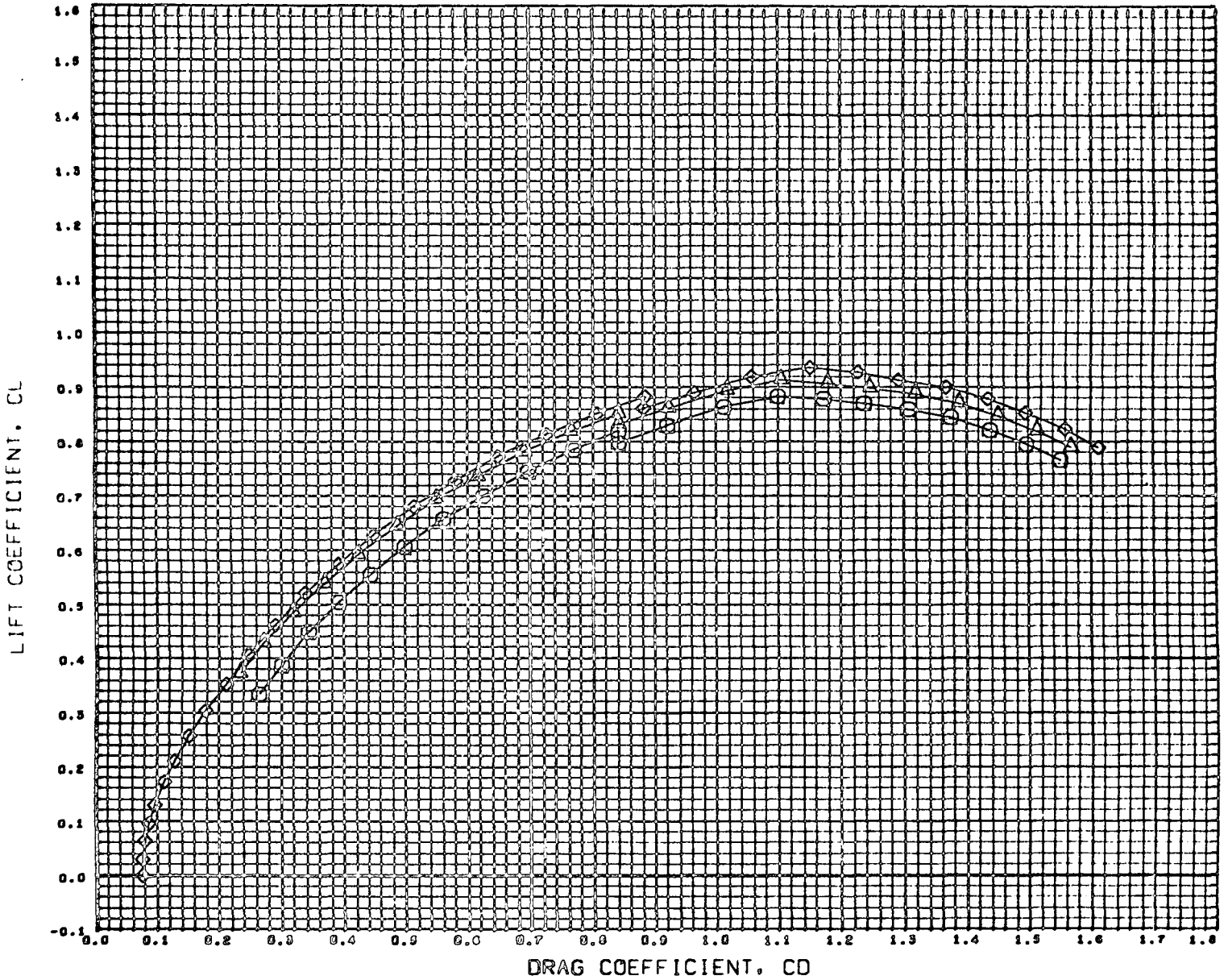

DATA SET	SYMBOL	CONFIGURATION	DESCRIPTION
(C58051)	○	MSFC TWT 914 E3	030W23C10
(C58041)	△	MSFC TWT 914 E3	030W23C10
(C58011)	◇	MSFC TWT 914 E3	030W23C10

BETA	ELEVTR	CANARD
0.000	0.000	-60.000
0.000	0.000	-30.000
0.000	0.000	0.000

REFERENCE INFORMATION		
SREF	19.0500	SQ INC
LREF	2.8300	INCHES
BREF	6.0820	INCHES
XMRP	2.1110	INCHES
YMRP	0.0000	INCHES
ZMRP	0.0000	INCHES
SCALE	0.0035	

MACH 4.990

FIGURE-4 CANARD EFFECTIVENESS OF B-18E-3 CONFIGURATION

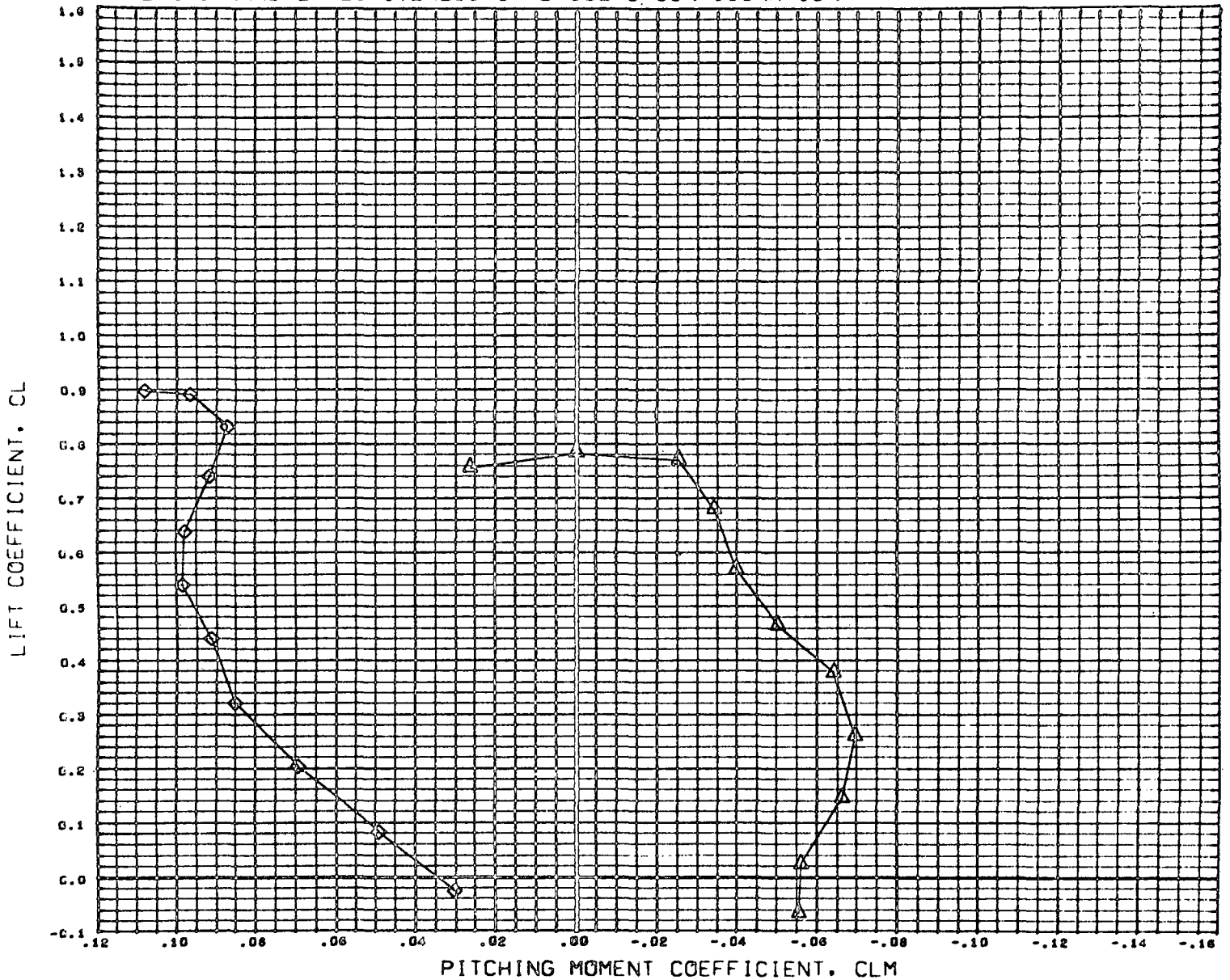

DATA SET SYMBOL	CONFIGURATION DESCRIPTION
(C500B0)	DATA NOT AVAILABLE FOR ALL CONDITIONS
(C500A0)	MSFC TWT 514 E3 830W23C10
(C500D0)	MSFC TWT 514 E3 830W23C10

BETA	ELEVTR	CANARD
0.000	0.000	-60.000
0.000	0.000	-30.000
0.000	0.000	0.000

REFERENCE INFORMATION		
SREF	15.0300	98 INC
LREF	2.8300	INCHES
BREF	6.0620	INCHES
XMRP	2.1110	INCHES
YMRP	0.0000	INCHES
ZMRP	0.0000	INCHES
SCALE	0.0035	

MACH 0.002

FIGURE-4 CANARD EFFECTIVENESS OF B-18E-3 CONFIGURATION

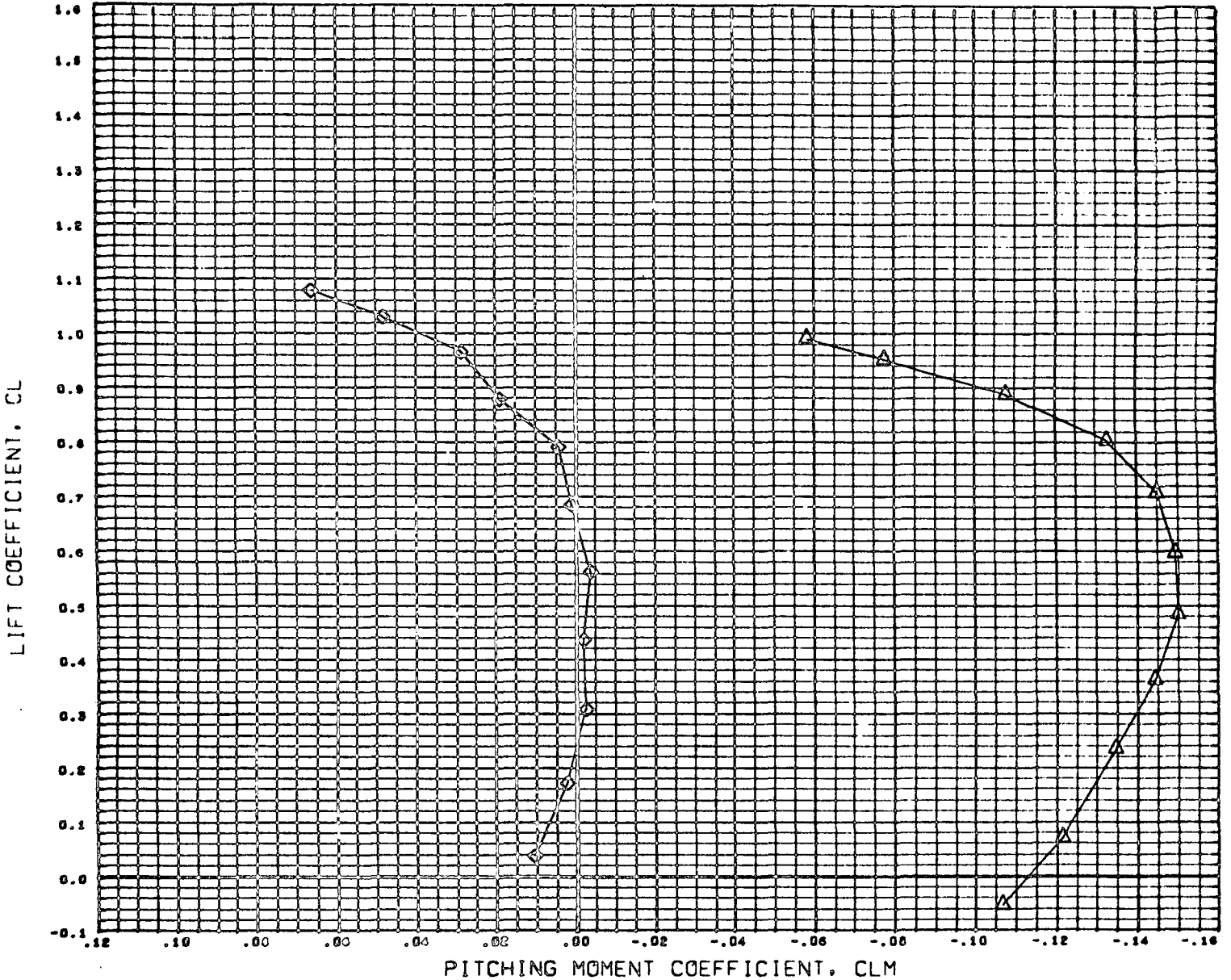

DATA SET SYMBOL	CONFIGURATION DESCRIPTION
(C98050)	DATA NOT AVAILABLE FOR ALL CONDITIONS
(C98040)	NSFC TWT 914 E3 090H29C10
(C98010)	NSFC TWT 914 E9 090H29C10

BETA	ELEVTR	CANARD
0.000	0.000	-80.000
0.000	0.000	-30.000
0.000	0.000	0.000

REFERENCE INFORMATION		
SREF	15.0300	50 INC
LREF	2.8300	INCHES
BREF	6.0620	INCHES
XMRP	2.1110	INCHES
YMRP	0.0000	INCHES
ZMRP	0.0000	INCHES
SCALE	0.0039	

MACH 8.196

FIGURE-4 CANARD EFFECTIVENESS OF B-18E-3 CONFIGURATION

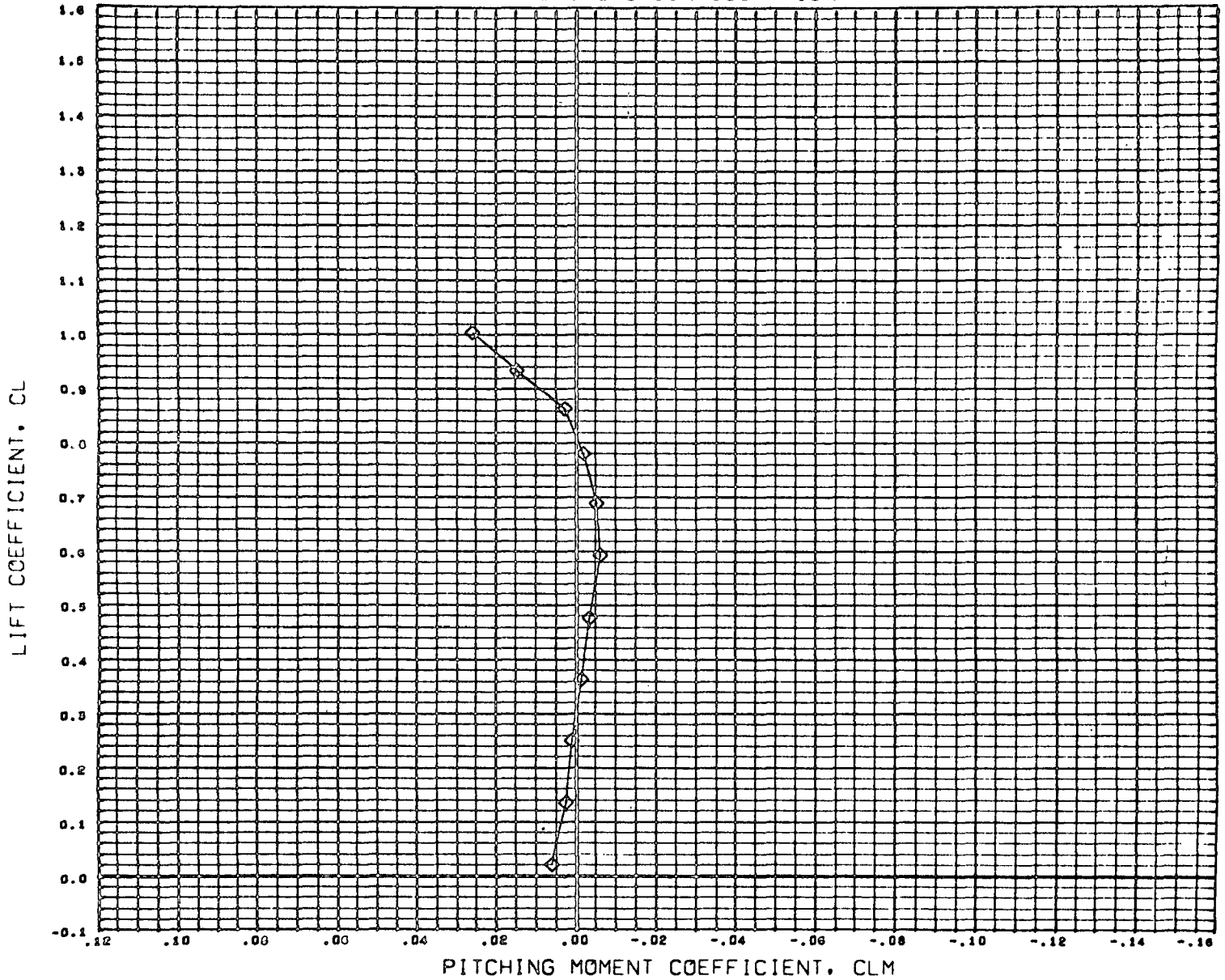

DATA SET SYMBOL	CONFIGURATION DESCRIPTION
(C58050)	DATA NOT AVAILABLE FOR ALL CONDITIONS
(C58040)	DATA NOT AVAILABLE FOR ALL CONDITIONS
(C58010)	MSFC YWT 914 E3 B30W23C10

BETA	ELEVTR	CANARD
0.000	0.000	-60.000
0.000	0.000	-30.000
0.000	0.000	0.000

REFERENCE INFORMATION		
SREF	15.0300	30 INC
LREF	2.8300	INCHES
BREF	6.0620	INCHES
XMRP	2.1110	INCHES
YMRP	0.0000	INCHES
ZMRP	0.0000	INCHES
SCALE	0.0035	

MACH 1.450

FIGURE-4 CANARD EFFECTIVENESS OF B-18E-3 CONFIGURATION

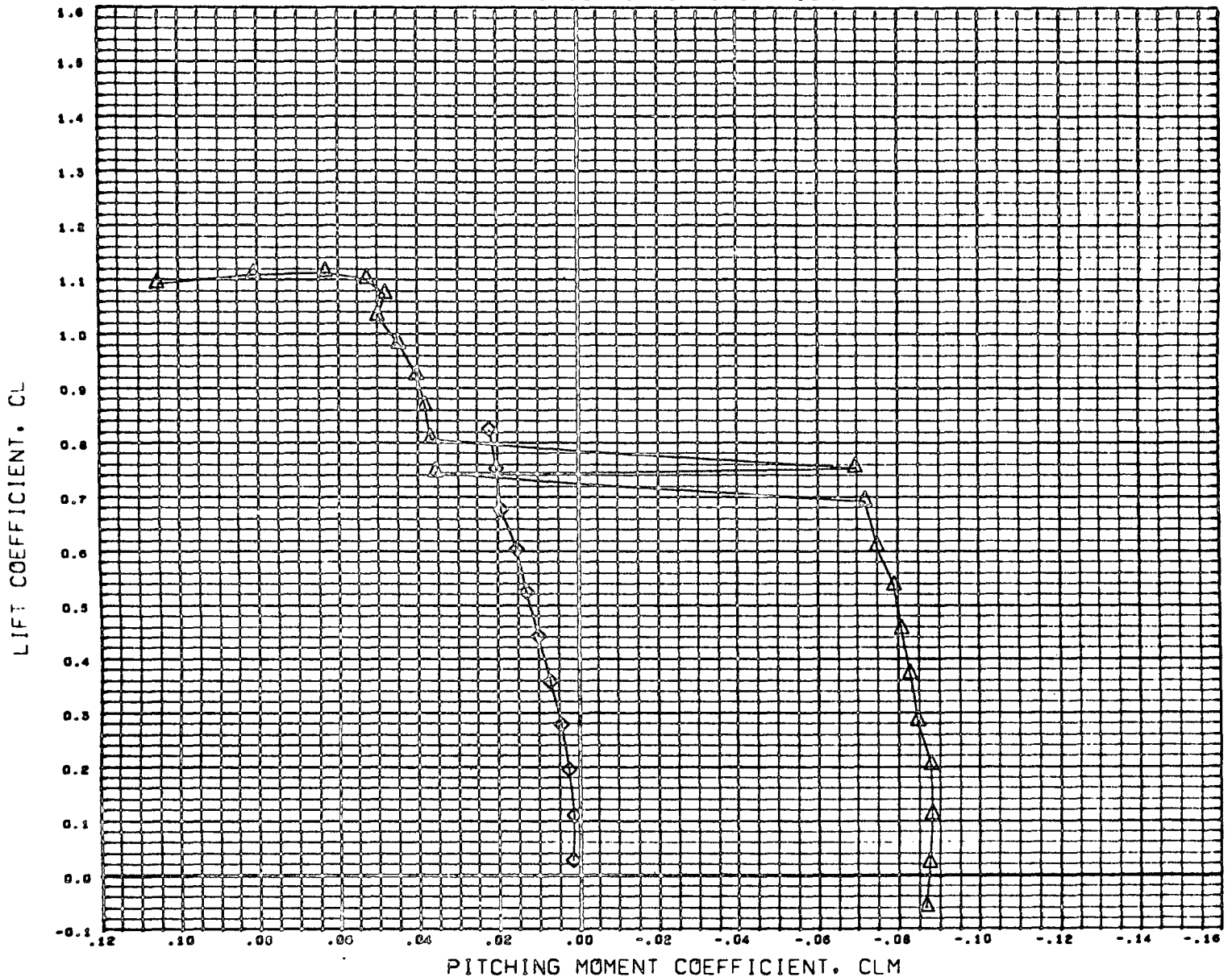

DATA SET SYMBOL	CONFIGURATION DESCRIPTION
(C58050)	DATA NOT AVAILABLE FOR ALL CONDITIONS
(C58040)	MSFC TWT 914 Q3 030W23C10
(C58010)	MSFC TWT 914 Q3 030W23C10

BETA	ELEVTR	CANARD
0.000	0.000	-60.000
0.000	0.000	-30.000
0.000	0.000	0.000

REFERENCE INFORMATION		
SREF	15.0300	90 INC
LREF	2.6300	INCHES
BREF	6.0620	INCHES
XMRP	2.1110	INCHES
YMRP	0.0000	INCHES
ZMRP	0.0000	INCHES
SCALE	0.0035	

MACH 1.954

FIGURE-4 CANARD EFFECTIVENESS OF B-18E-3 CONFIGURATION

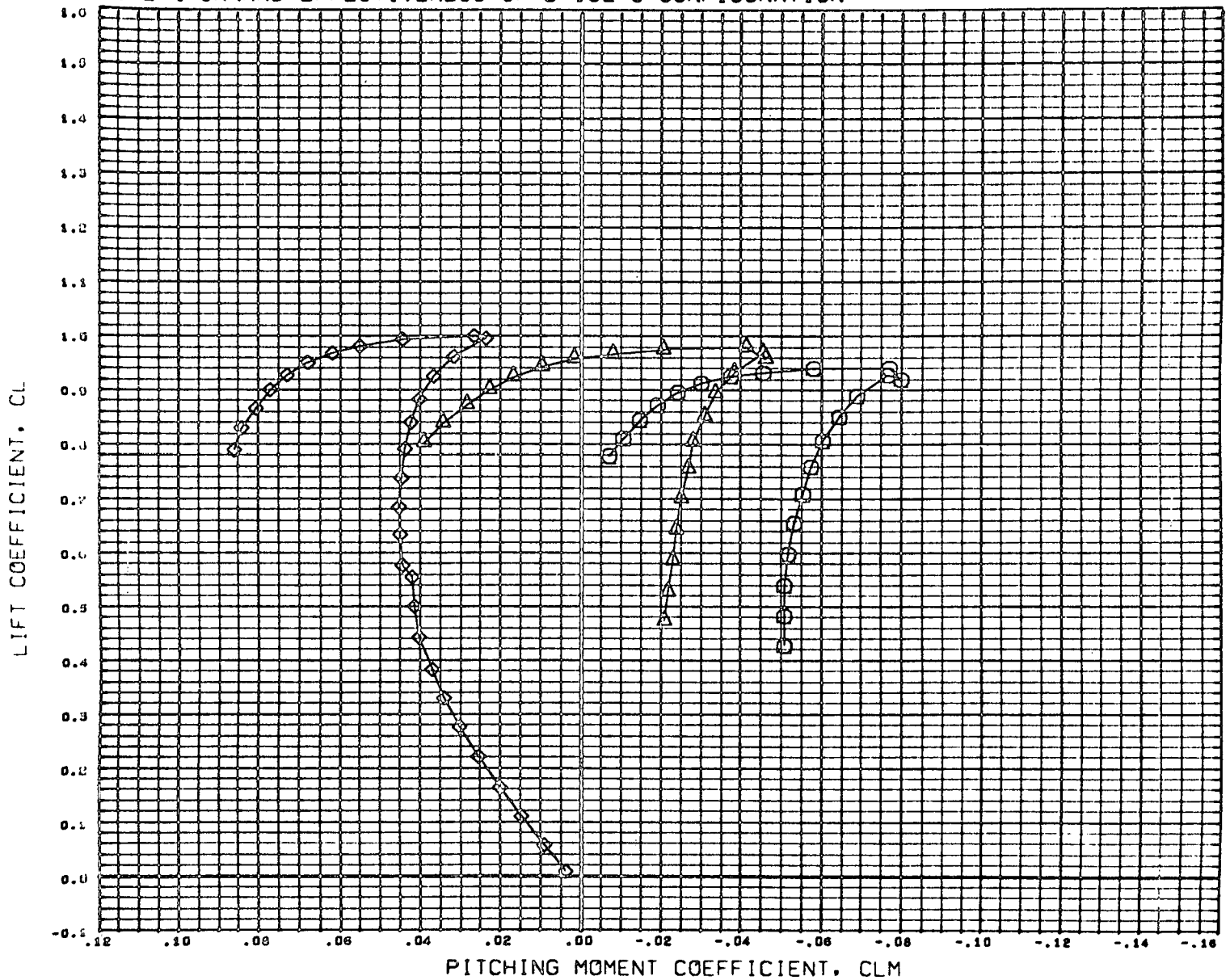

DATA SET SYMBOL	CONFIGURATION	DESCRIPTION
(C58050)	MSFC TWT 914 E3	B30W23C10
(C58040)	MSFC TWT 914 E3	B30W23C10
(C58010)	MSFC TWT 914 E3	B30W23C10

BETA	ELEVTR	CANARD
0.000	0.000	-60.000
0.000	0.000	-30.000
0.000	0.000	0.000

REFERENCE INFORMATION		
SREF	15.0300	38 INC
LREF	2.8300	INCHES
BREF	6.0620	INCHES
XMRP	2.1110	INCHES
YMRP	0.0000	INCHES
ZMRP	0.0000	INCHES
SCALE	0.0035	

MACH 2.090

FIGURE-4 CANARD EFFECTIVENESS OF B-18E-3 CONFIGURATION

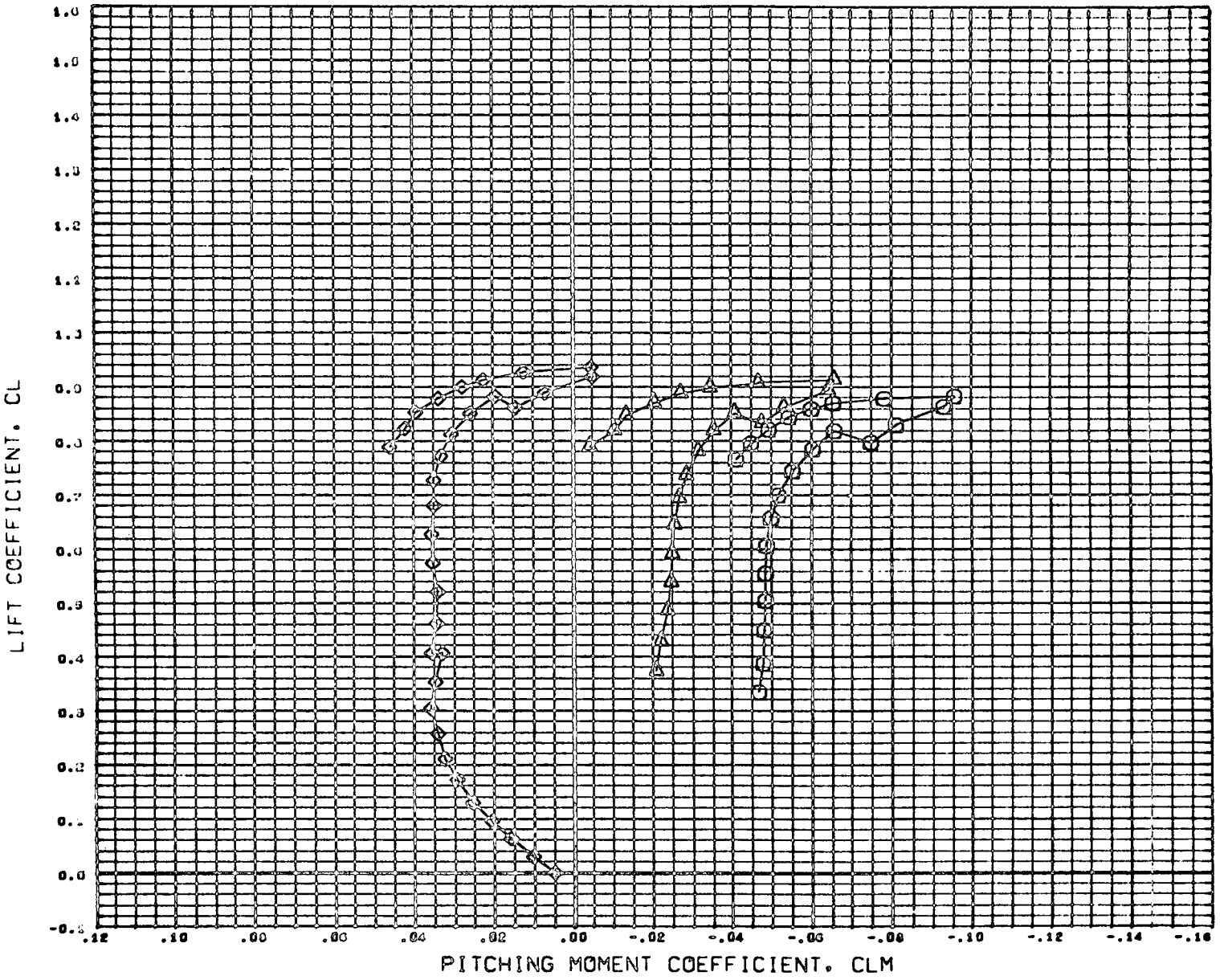

DATA SET SYMBOL	CONFIGURATION DESCRIPTION
(C58050)	MSFC TWT 914 E3 090W29C10
(C58040)	MSFC TWT 914 E3 090W29C10
(C58010)	MSFC TWT 914 E3 090W29C10

BETA	ZLEVTR	CANARD
0.000	0.000	-60.000
0.000	0.000	-30.000
0.000	0.000	0.000

REFERENCE INFORMATION		
SREF	15.0300	30 INC
LREF	2.8300	INCHES
BREF	6.0620	INCHES
XMRP	2.1110	INCHES
YMRP	0.0000	INCHES
ZMRP	0.0000	INCHES
SCALE	0.0035	

MACH 4.080

FIGURE-5 EFFECT OF NOSE SHAPE VARIATION ON B-18E-3 CONFIGURATION

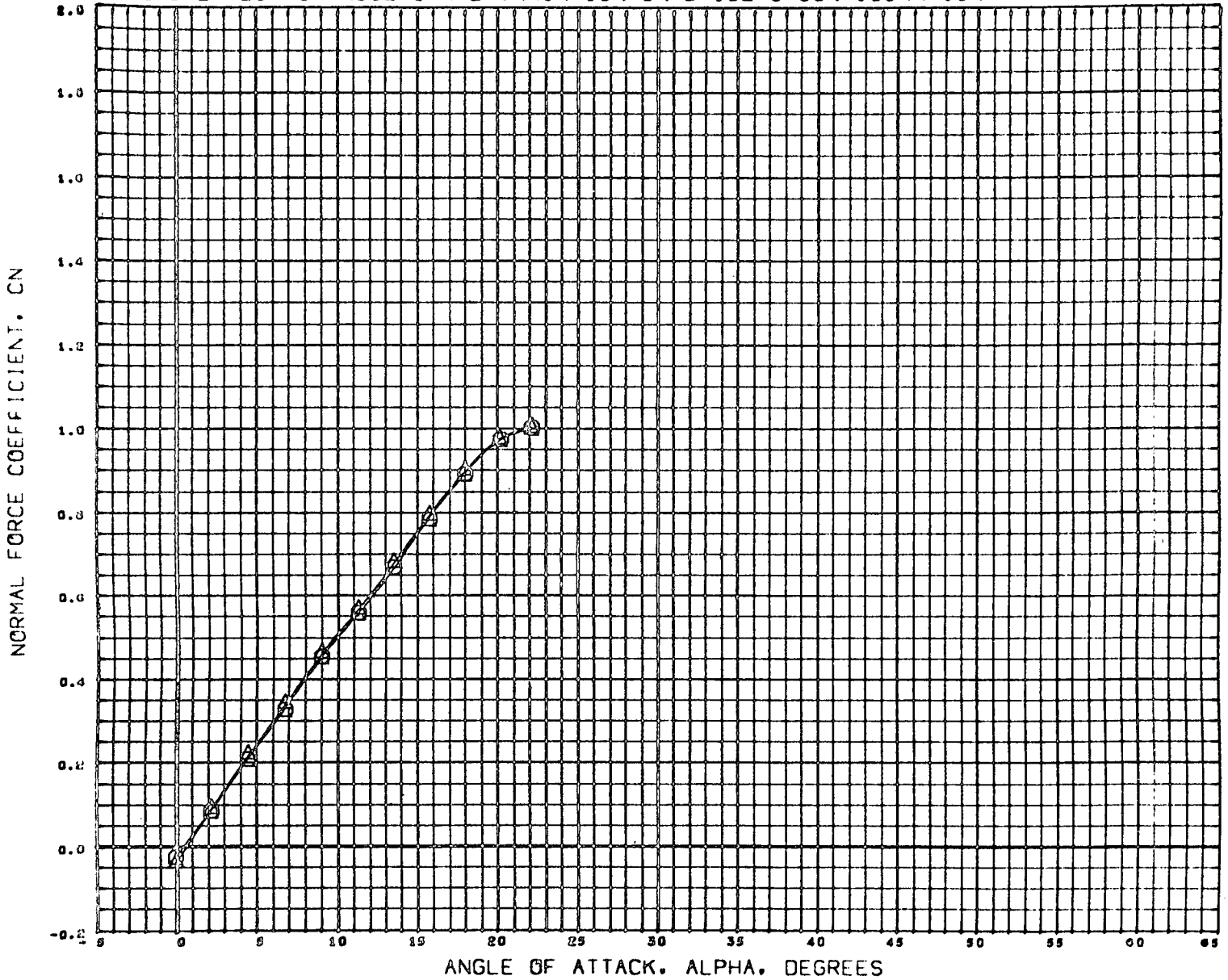

DATA SET SYMBOL	CONFIGURATION DESCRIPTION
(C98010)	MSFC TWT 514 E3 830W23C10
(C98060)	MSFC TWT 514 E3 831W23C10

BETA	ELEVTR	CANARD
0.000	0.000	0.000
0.000	0.000	0.000

REFERENCE INFORMATION		
SREF	15.0300	30 INC
LREF	2.8300	INCHES
BREF	6.0620	INCHES
XMRP	2.1110	INCHES
YMRP	0.0000	INCHES
ZMRP	0.0000	INCHES
SCALE	0.0035	

MACH 0.907

FIGURE-5 EFFECT OF NOSE SHAPE VARIATION ON B-18E-3 CONFIGURATION

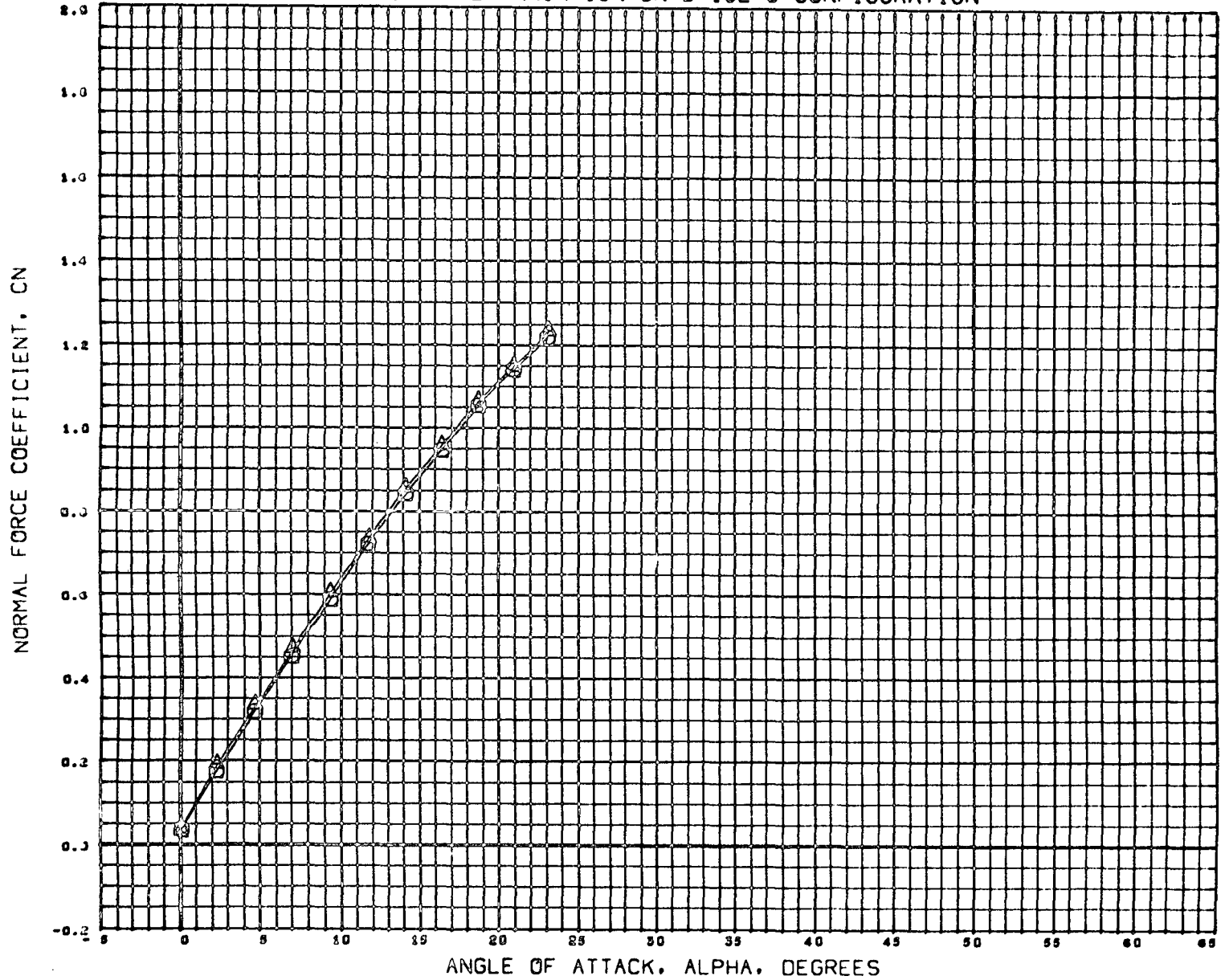

DATA SET SYMBOL	CONFIGURATION DESCRIPTION
(C58010)	MSFC TWT 914 E3 030W23C10
(C58066)	MSFC TWT 914 E3 031W23C10

BETA	ELEVTR	CANARD
0.000	0.000	0.000
0.000	0.000	0.000

REFERENCE INFORMATION		
SREF	15.0300	SQ INC
LREF	2.6300	INCHES
BREF	0.0620	INCHES
XMRP	2.1110	INCHES
YMRP	0.0000	INCHES
ZMRP	0.0000	INCHES
SCALE	0.0035	

MACH 0.201

FIGURE-5 EFFECT OF NOSE SHAPE VARIATION ON B-18E-3 CONFIGURATION

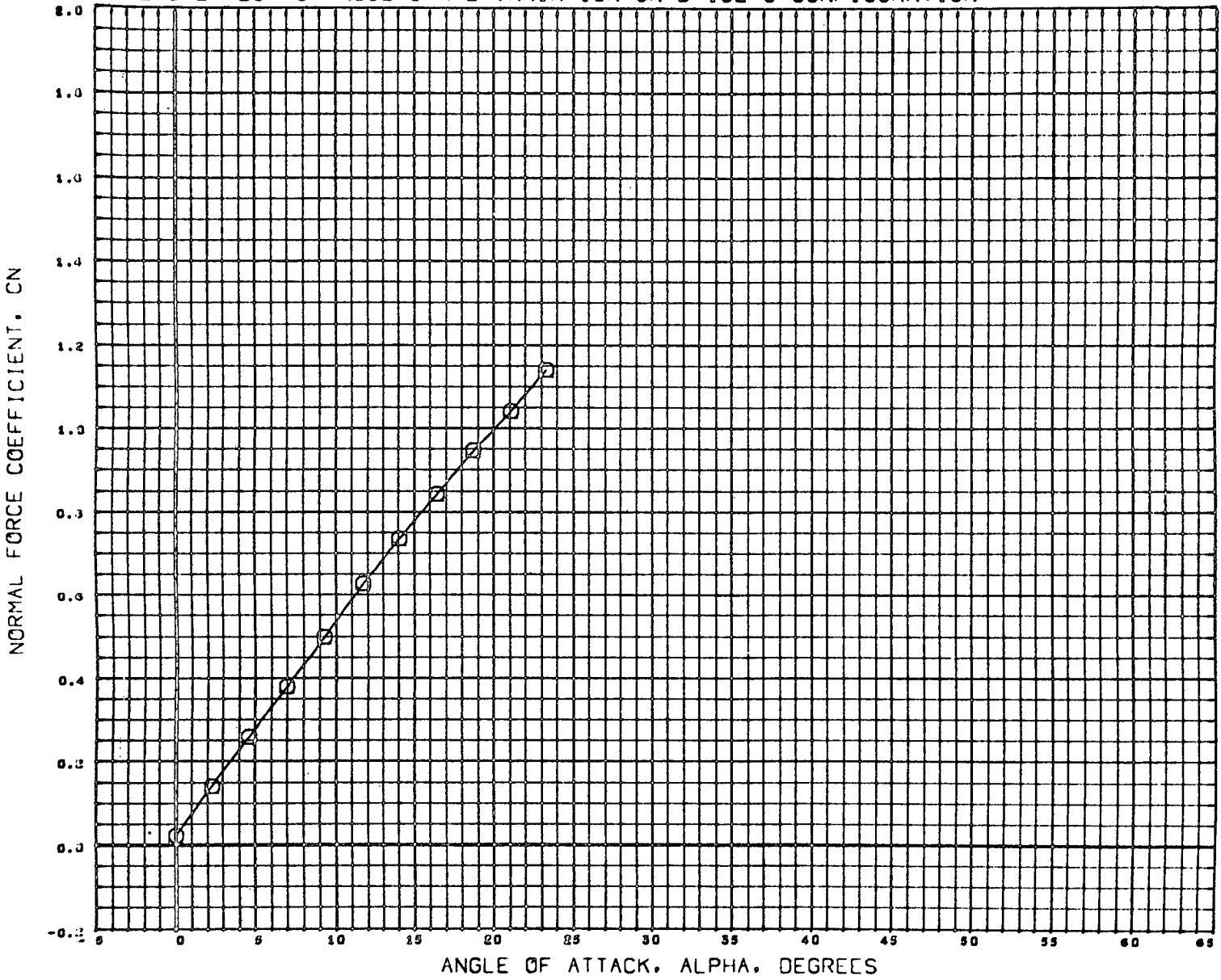

DATA SET SYMBOL CONFIGURATION DESCRIPTION
 (C58010) MSFC TWT 514 E3 B30W23C10
 (C58066) DATA NOT AVAILABLE FOR ALL CONDITIONS

BETA ELEVTR CANARD
 0.000 0.000 0.000
 0.000 0.000 0.000

REFERENCE INFORMATION
 SREF 15.0300 INCH
 LREF 2.8300 INCHES
 BRP 6.0620 INCHES
 XMRP 2.1110 INCHES
 YMRP 0.0000 INCHES
 ZMRP 0.0000 INCHES
 SCALE 0.0035

MACH 1.499

FIGURE-5 EFFECT OF NOSE SHAPE VARIATION ON B-18E-3 CONFIGURATION

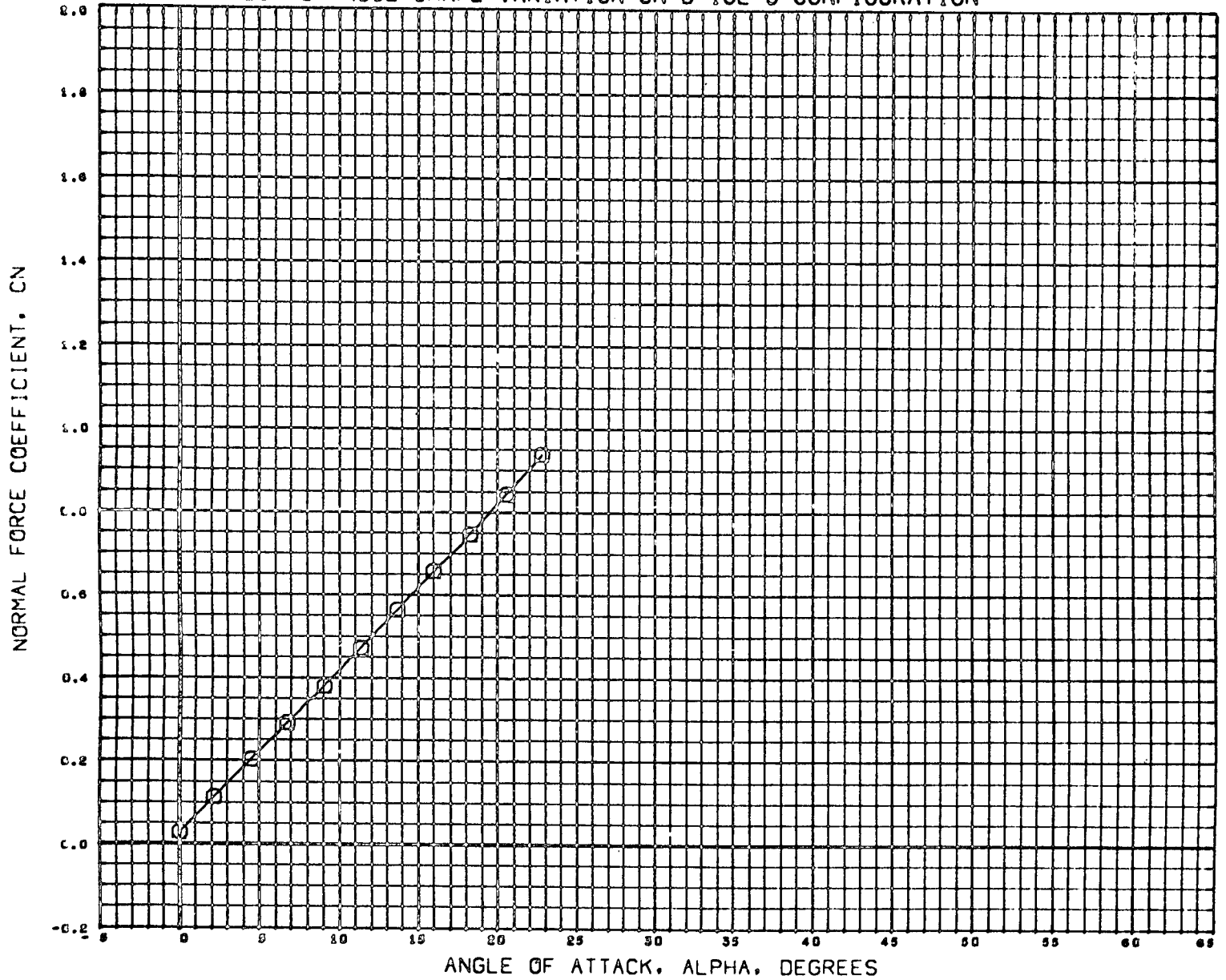

DATA SET SYMBOL CONFIGURATION DESCRIPTION
 (C98010) M8FC TWT 514 ES D30W23C10
 (C98000) DATA NOT AVAILABLE FOR ALL CONDITIONS

BETA ELEVTR CANARD
 0.000 0.000 0.000
 0.000 0.000 0.000

REFERENCE INFORMATION
 SREF 15.0300 90 INC
 LREF 2.8300 INCHES
 DREF 6.0620 INCHES
 XMRP 2.1110 INCHES
 YMRP 0.0000 INCHES
 ZMRP 0.0000 INCHES
 SCALE 0.0035

MACH 1.980

FIGURE-5 EFFECT OF NOSE SHAPE VARIATION ON B-18E-3 CONFIGURATION

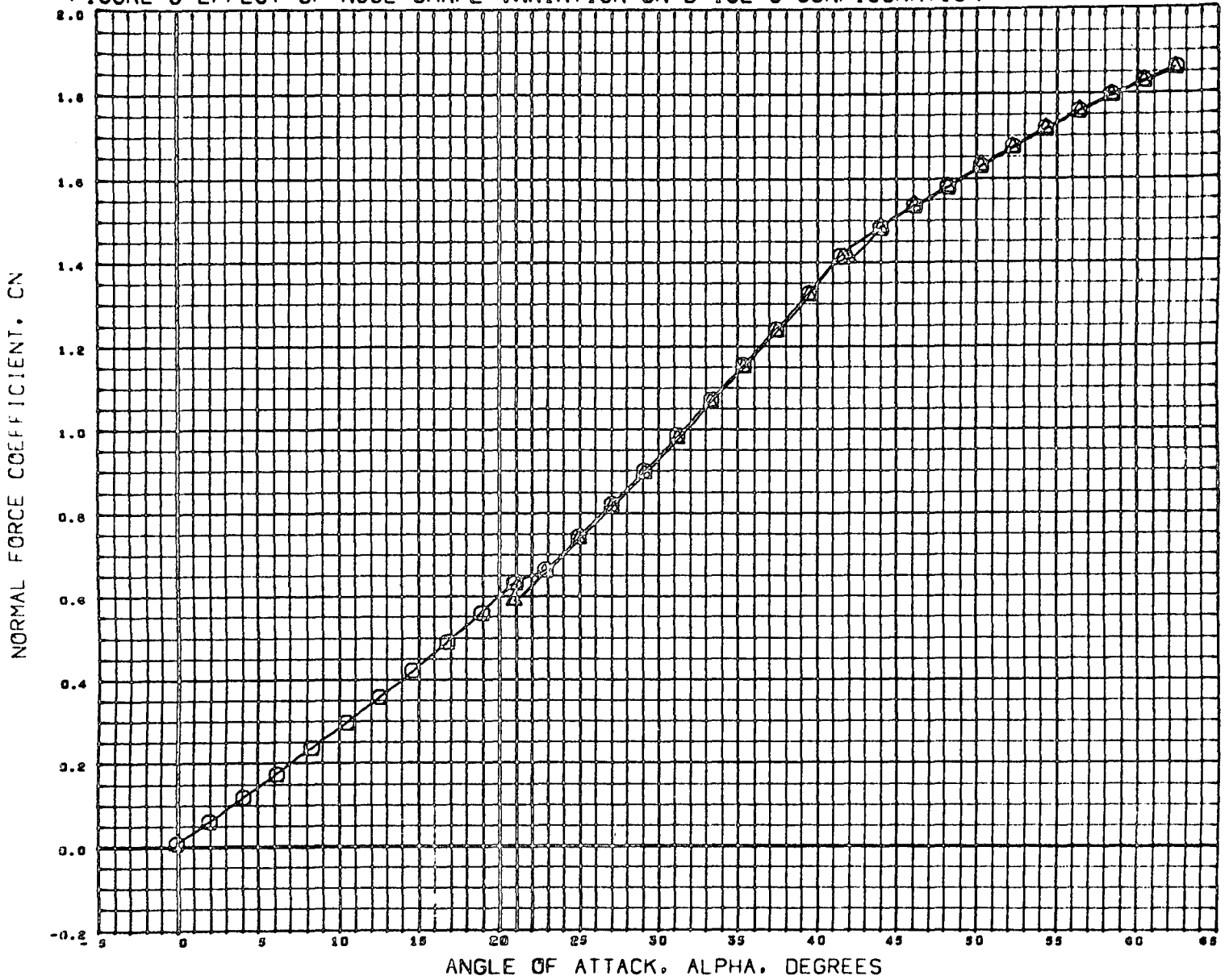

DATA SET SYMBOL	CONFIGURATION DESCRIPTION
(C96G10)	NSFC TWT 514 E3 B30W23C10
(C96G60)	NSFC TWT 514 E3 B31W23C10

BETA	ELEVTR	CANARD
0.000	0.000	0.000
0.000	0.000	0.000

REFERENCE INFORMATION		
SREF	15.0300	50 INC
LREF	2.8300	INCHES
BREF	6.0620	INCHES
XMRP	2.1110	INCHES
YMRP	0.0000	INCHES
ZMRP	0.0000	INCHES
SCALE	0.0035	

MACH 2.990

FIGURE-5 EFFECT OF NOSE SHAPE VARIATION ON B-18E-3 CONFIGURATION

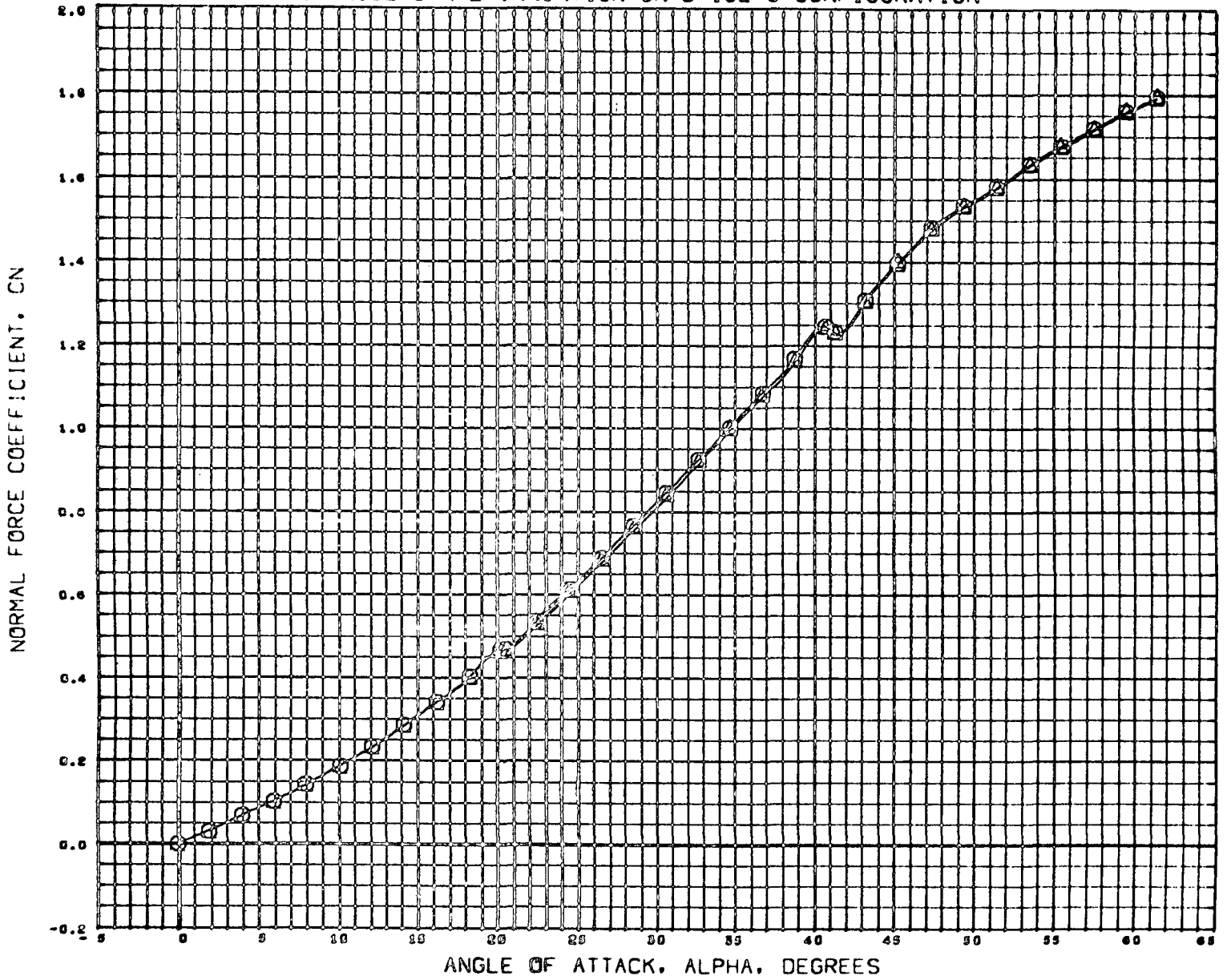

DATA SET SYMBOL	CONFIGURATION DESCRIPTION
(C98000)	MSFC TWT 914 23 030W29C10
(C98000)	MSFC TWT 914 23 031W29C10

DELTA	ELEVTR	CANARD
0.000	0.000	0.000
0.000	0.000	0.000

REFERENCE INFORMATION		
SREF	15.0300	50 INC
LREF	2.8300	INCHES
BREF	6.0620	INCHES
XMRP	2.1110	INCHES
YMRP	0.0000	INCHES
ZMRP	0.0000	INCHES
SCALE	0.0035	

MACH 4.950

FIGURE-5 EFFECT OF NOSE SHAPE VARIATION ON B-18E-3 CONFIGURATION

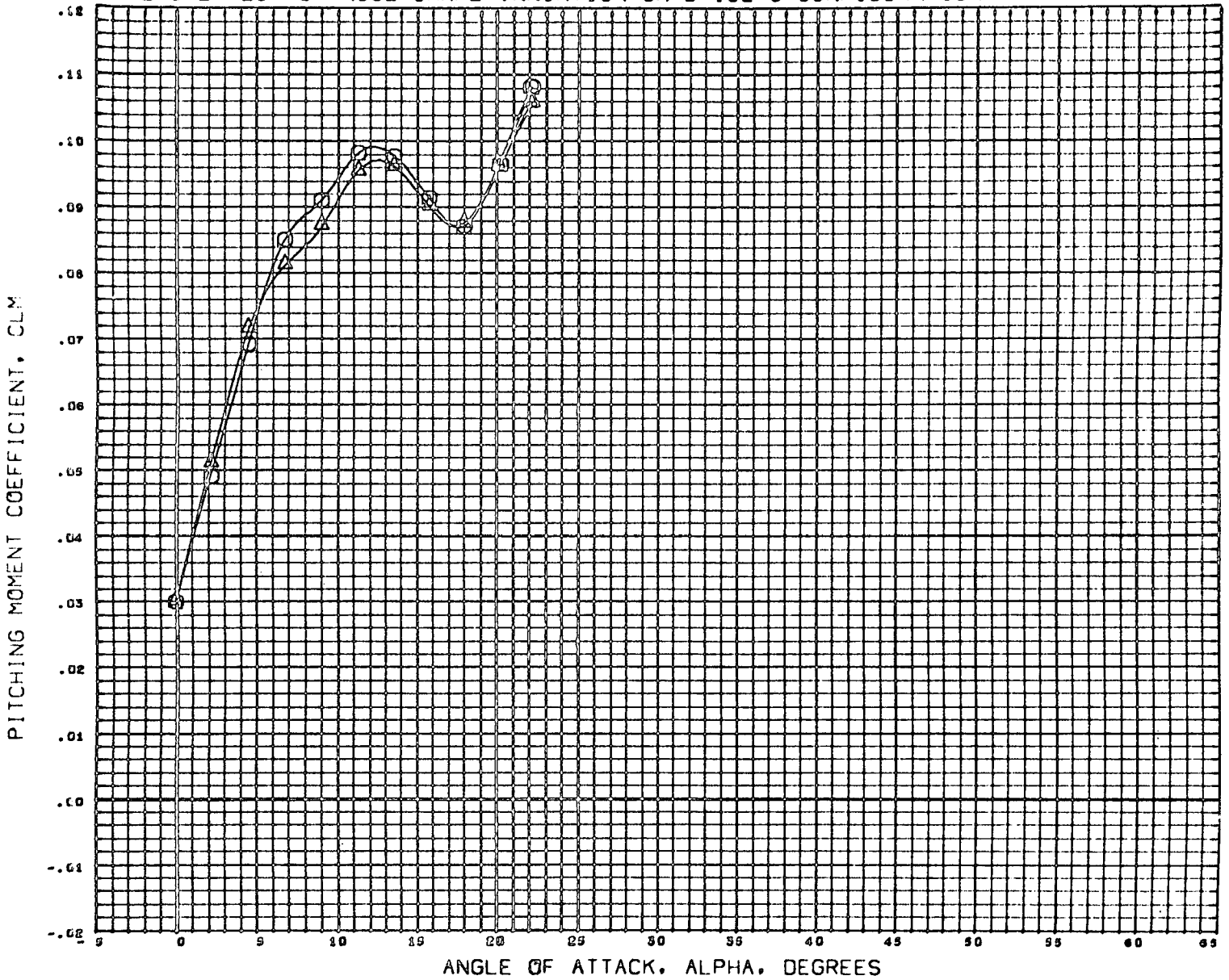

DATA SET SYMBOL	CONFIGURATION DESCRIPTION
(C5801)	MSFC TWT 514 E3 830W23C10
(C58060)	MSFC TWT 514 E3 851W23C10

BETA	ELEVTR	CANARD
0.000	0.000	0.000
0.000	0.000	0.000

REFERENCE INFORMATION		
SREF	15.0300	80 INC
LREF	2.8300	INCHES
BREF	6.0620	INCHES
XMRP	2.1110	INCHES
YMRP	0.0000	INCHES
ZMRP	0.0000	INCHES
SCALE	0.0035	

MACH 0.007

FIGURE-5 EFFECT OF NOSE SHAPE VARIATION ON B-18E-3 CONFIGURATION

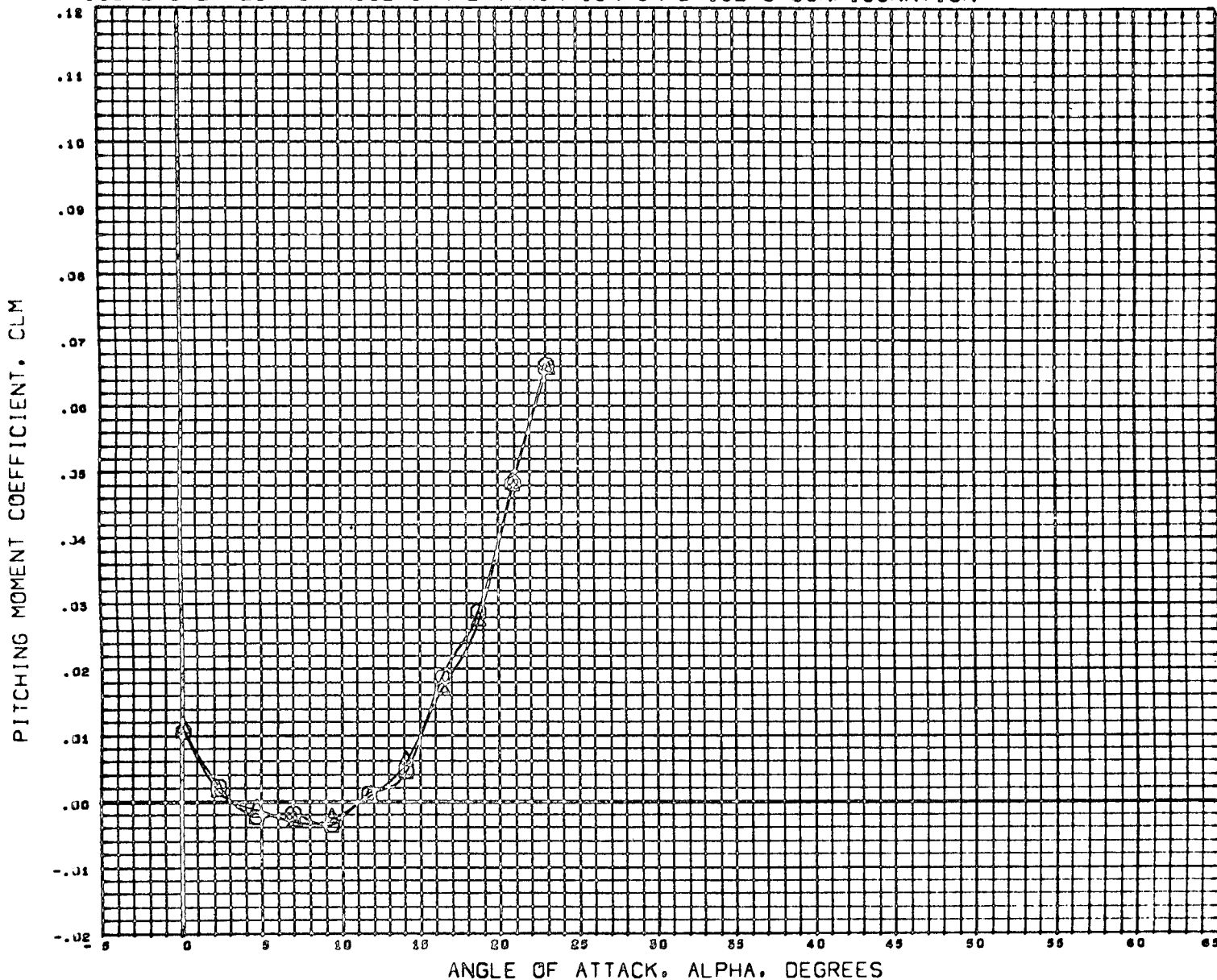

DATA SET SYMBOL	CONFIGURATION	DESCRIPTION
(C58010)	MSFC TWT 914 E3	D50W29C10
(C58060)	MSFC TWT 914 E3	D31W29C10

BETA	LEVTR	CANARD
0.000	0.000	0.000
0.000	0.000	0.000

REFERENCE INFORMATION		
SREF	19.0300	90 INC
LREF	2.8300	INCHES
BREF	6.0620	INCHES
XMRP	2.1110	INCHES
YMRP	0.0000	INCHES
ZMRP	0.0000	INCHES
SCALE	0.0035	

MACH 1.201

FIGURE-5 EFFECT OF NOSE SHAPE VARIATION ON B-18E-3 CONFIGURATION

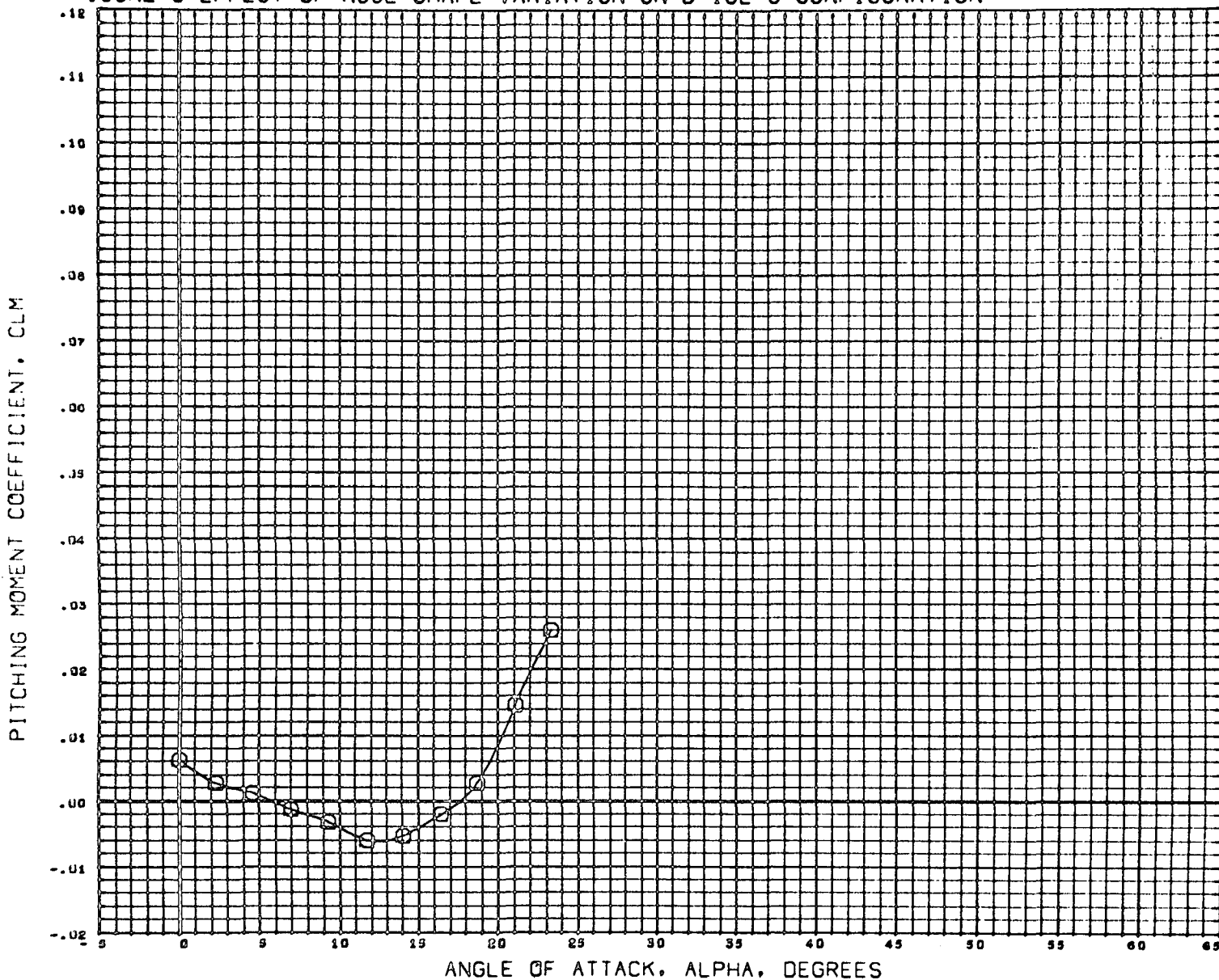

DATA SET SYMBOL	CONFIGURATION DESCRIPTION
(C58010)	MSFC TWT 514 E3 B30W23C10
(C58060)	DATA NOT AVAILABLE FOR ALL CONDITIONS

BETA	ELEVTR	CANARD
0.000	0.000	0.000
0.000	0.000	0.000

REFERENCE INFORMATION		
SREF	15.0300	90 INC
LREF	2.8300	INCHES
BREF	6.0620	INCHES
XMRP	2.1110	INCHES
YMRP	0.0000	INCHES
ZMRP	0.0000	INCHES
SCALE	0.0039	

MACH 1.059

FIGURE-5 EFFECT OF NOSE SHAPE VARIATION ON B-18E-3 CONFIGURATION

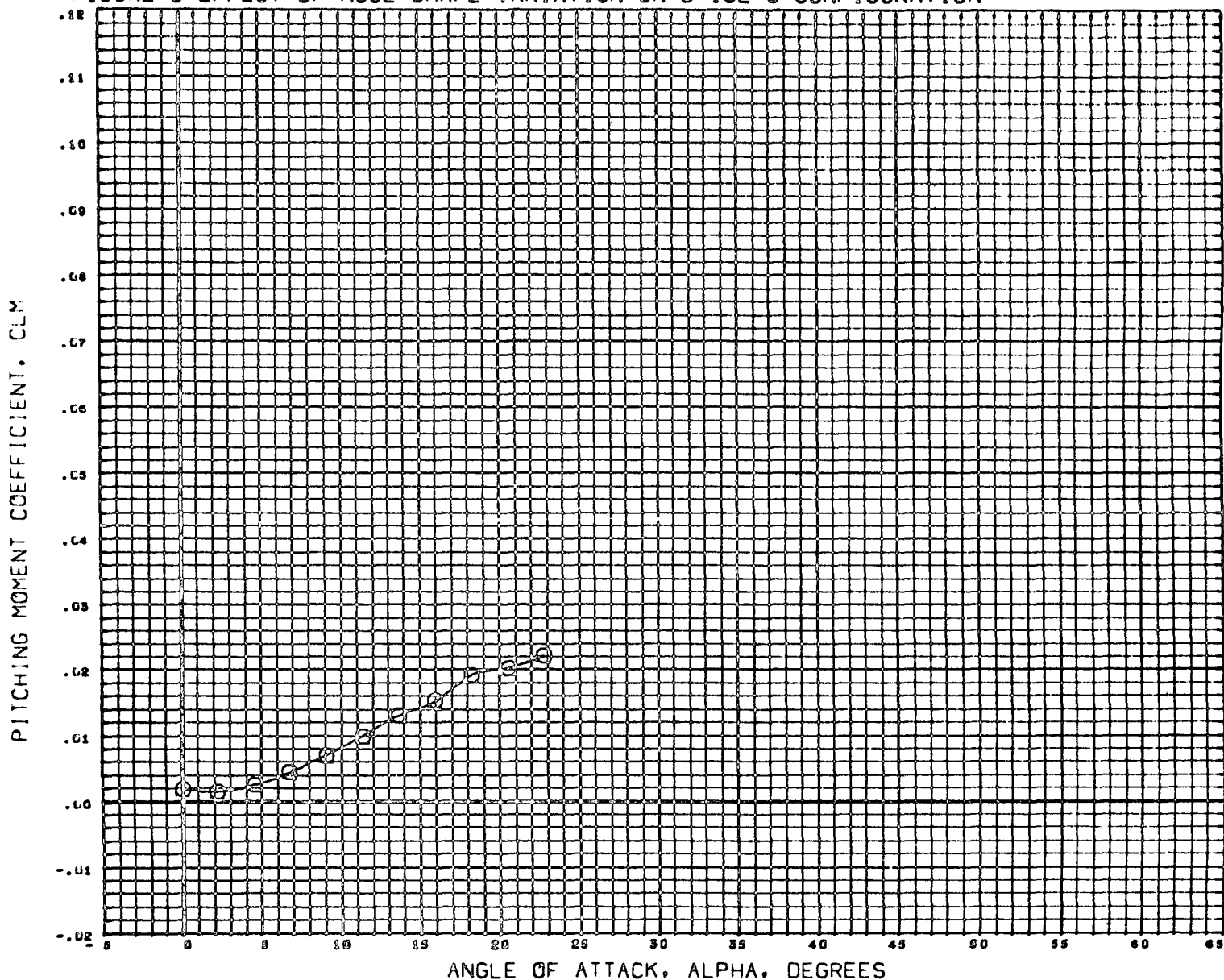

DATA SET SYMBOL	CONFIGURATION DESCRIPTION
(C38010) HBPC TWY 914 23	030W23C10
(C38060)	DATA NOT AVAILABLE FOR ALL CONDITIONS

BETA	ELEVTR	CANARD
0.000	0.000	0.000
0.000	0.000	0.000

REFERENCE INFORMATION		
SREF	15.0300	30 INC
LREF	2.6300	INCHES
BREF	6.0620	INCHES
XMRP	2.1110	INCHES
YMRP	0.0000	INCHES
ZMRP	0.0000	INCHES
SCALE	0.0035	

MACH 8.900

FIGURE-5 EFFECT OF NOSE SHAPE VARIATION ON B-18E-3 CONFIGURATION

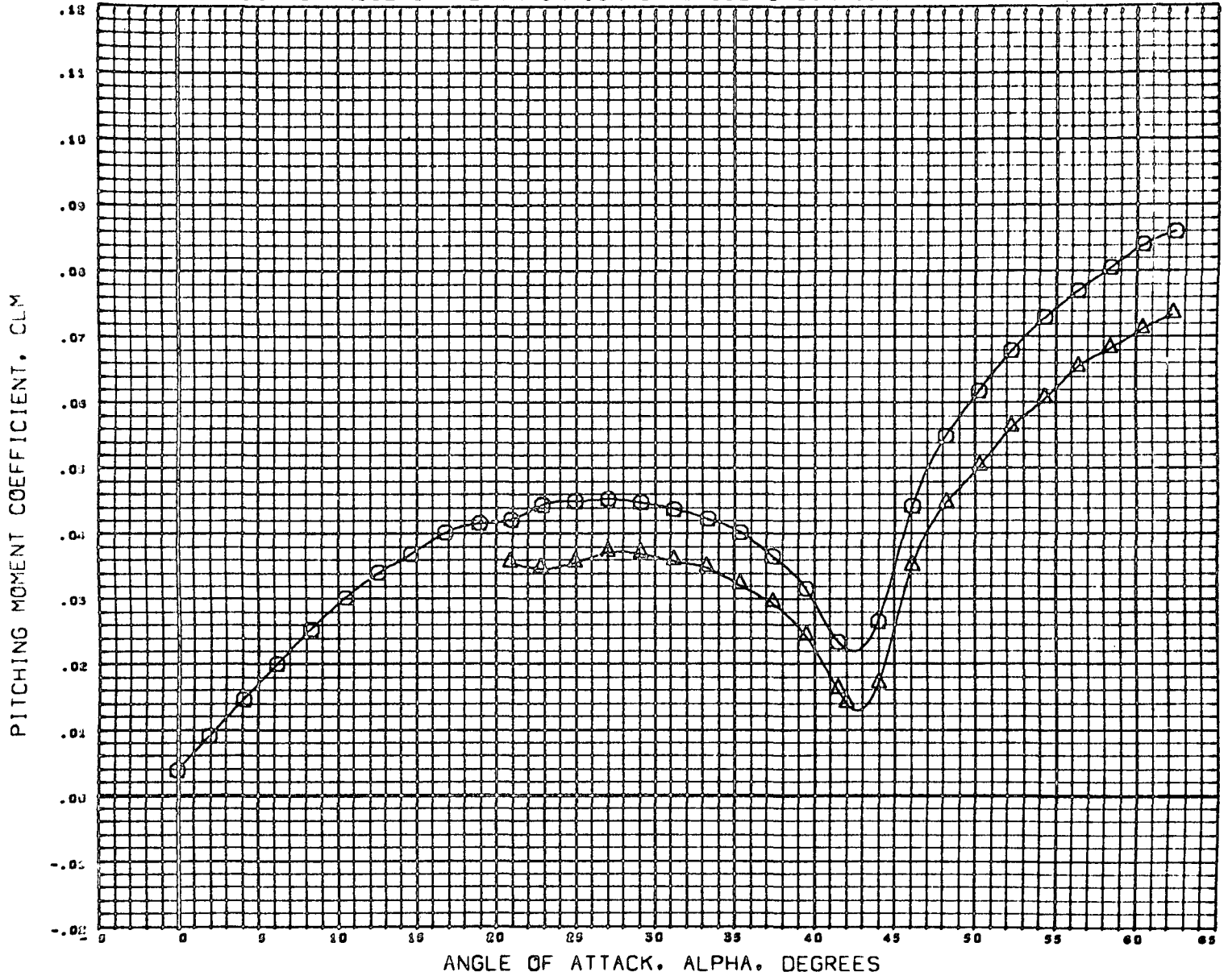

DATA SET SYMBOL	CONFIGURATION DESCRIPTION
(C58010) ○	MSFC TWT 514 E3 830W23C10
(C58060) △	MSFC TWT 514 E3 831W23C10

BETA	ELEVTR	CANARD
0.000	0.000	0.000
0.000	0.000	0.000

REFERENCE INFORMATION		
SREF	15.0300	50 INC
LREF	2.8300	INCHES
BREF	0.0620	INCHES
IMRP	2.1110	INCHES
YMRF	0.0000	INCHES
ZMRF	0.0000	INCHES
SCALE	0.0035	

MACH 2.000

FIGURE-5 EFFECT OF NOSE SHAPE VARIATION ON B-18E-3 CONFIGURATION

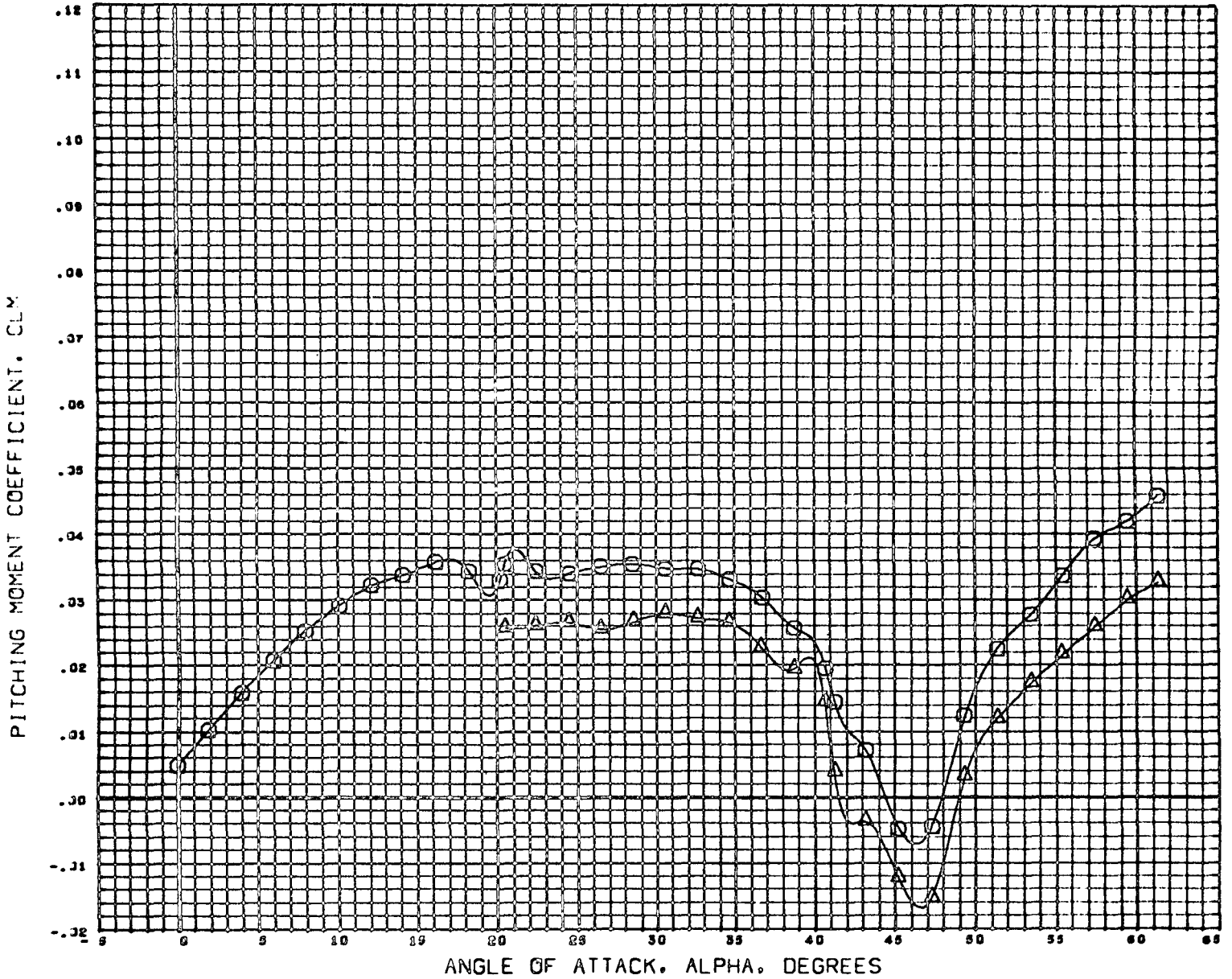

DATA SET SYMBOL	CONFIGURATION DESCRIPTION
(C98010)	MSFC TWT 914 Q3 030W29C10
(C98060)	MSFC TWT 914 Q3 091W23C10

BETA	ELEVTR	CANARD
0.000	0.000	0.000
0.000	0.000	0.000

REFERENCE INFORMATION		
SREF	15.0300	90 INC
LREF	2.8300	INCHES
BREF	0.0620	INCHES
XMRP	2.1110	INCHES
YMRP	0.0000	INCHES
ZMRP	0.0000	INCHES
SCALE	0.0035	

MACH 4.059

FIGURE-5 EFFECT OF NOSE SHAPE VARIATION ON B-18E-3 CONFIGURATION

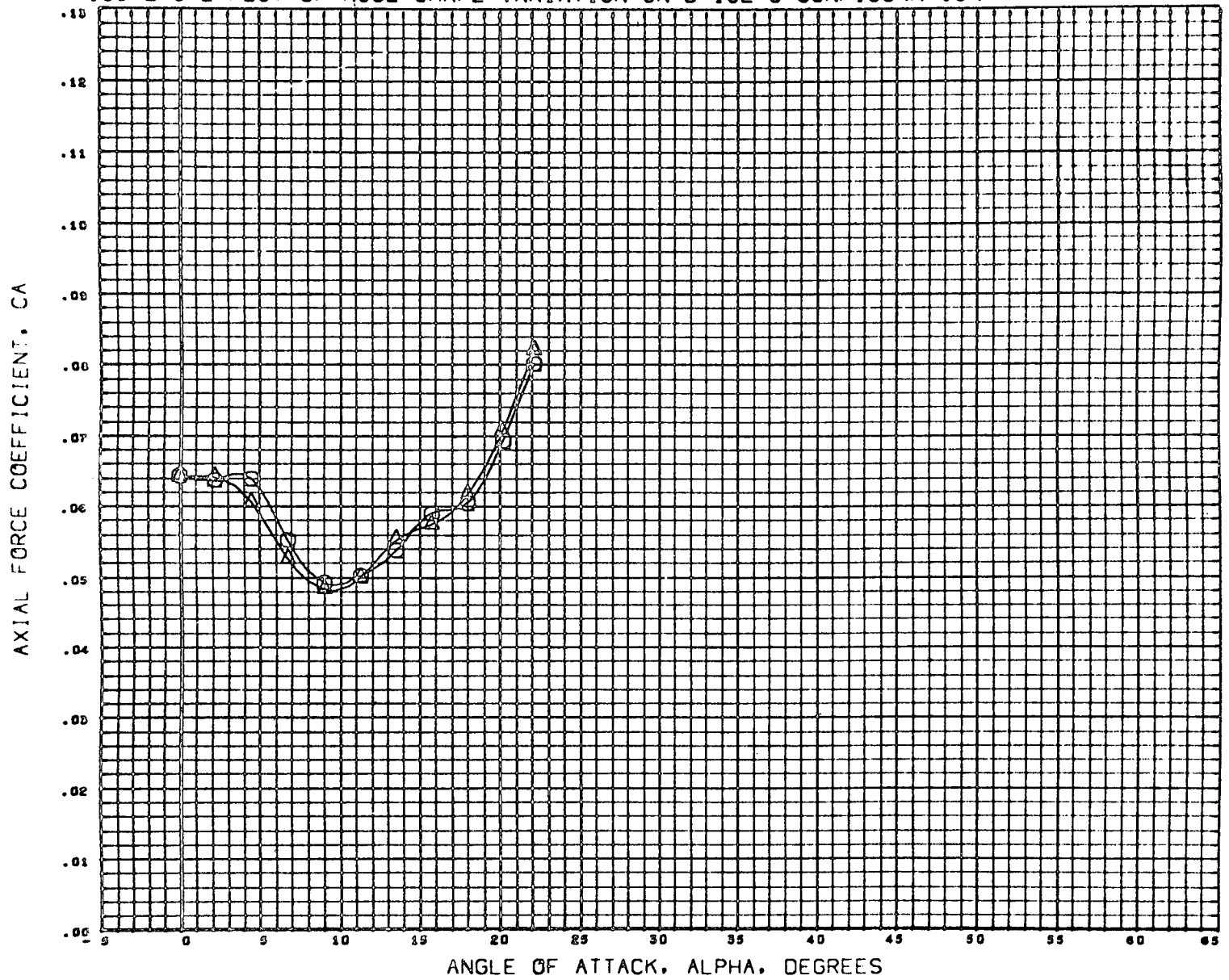

DATA SET SYMBOL	CONFIGURATION DESCRIPTION
(C58010)	H5FC TWT 514 E3 830W23C10
(C58060)	H5FC TWT 514 E3 831W23C10

BETA	ELEVTR	CANARD
0.000	0.000	0.000
0.000	0.000	0.000

REFERENCE INFORMATION		
SREF	15.0300	SQ INC
LREF	2.8300	INCHES
BREF	0.0620	INCHES
XMRP	2.1110	INCHES
YMRP	0.0000	INCHES
ZMRP	0.0000	INCHES
SCALE	0.0035	

MACH 0.007

FIGURE-5 EFFECT OF NOSE SHAPE VARIATION ON B-18E-3 CONFIGURATION

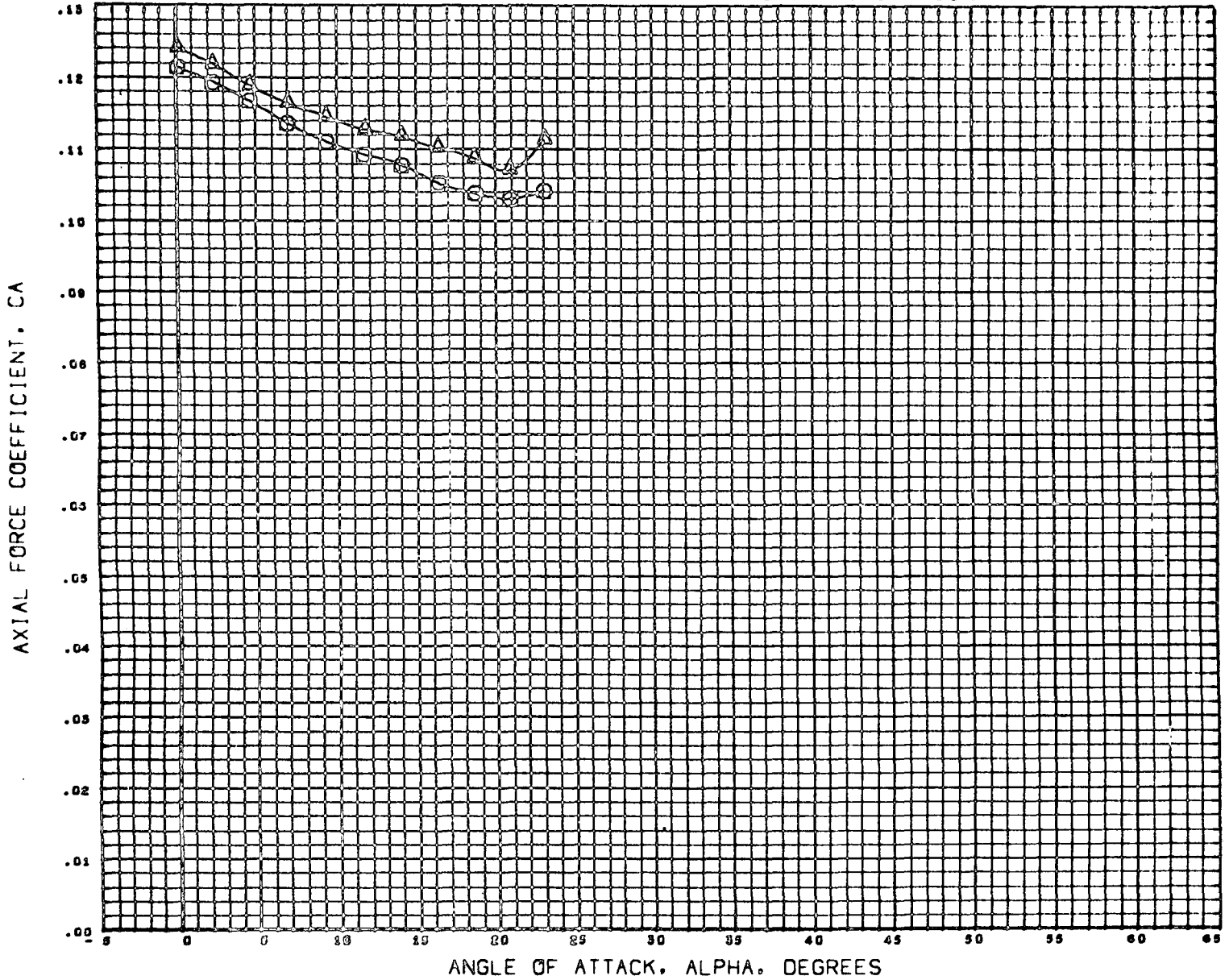

DATA SET SYMBOL	CONFIGURATION DESCRIPTION
(CS6010)	MSFC TWT 914 ES 030W23C10
(CS6060)	MSFC TWT 914 ES 031W23C10

BETA	ELEVTR	CANARD
0.000	0.000	0.000
0.000	0.000	0.000

REFERENCE INFORMATION		
SREF	15.0300	30 INC
LREF	2.8300	INCHES
BREF	6.0620	INCHES
XMRP	2.1110	INCHES
YMRP	0.0000	INCHES
ZMRP	0.0000	INCHES
SCALE	0.0035	

MACH 1.201

FIGURE-5 EFFECT OF NOSE SHAPE VARIATION ON B-18E-3 CONFIGURATION

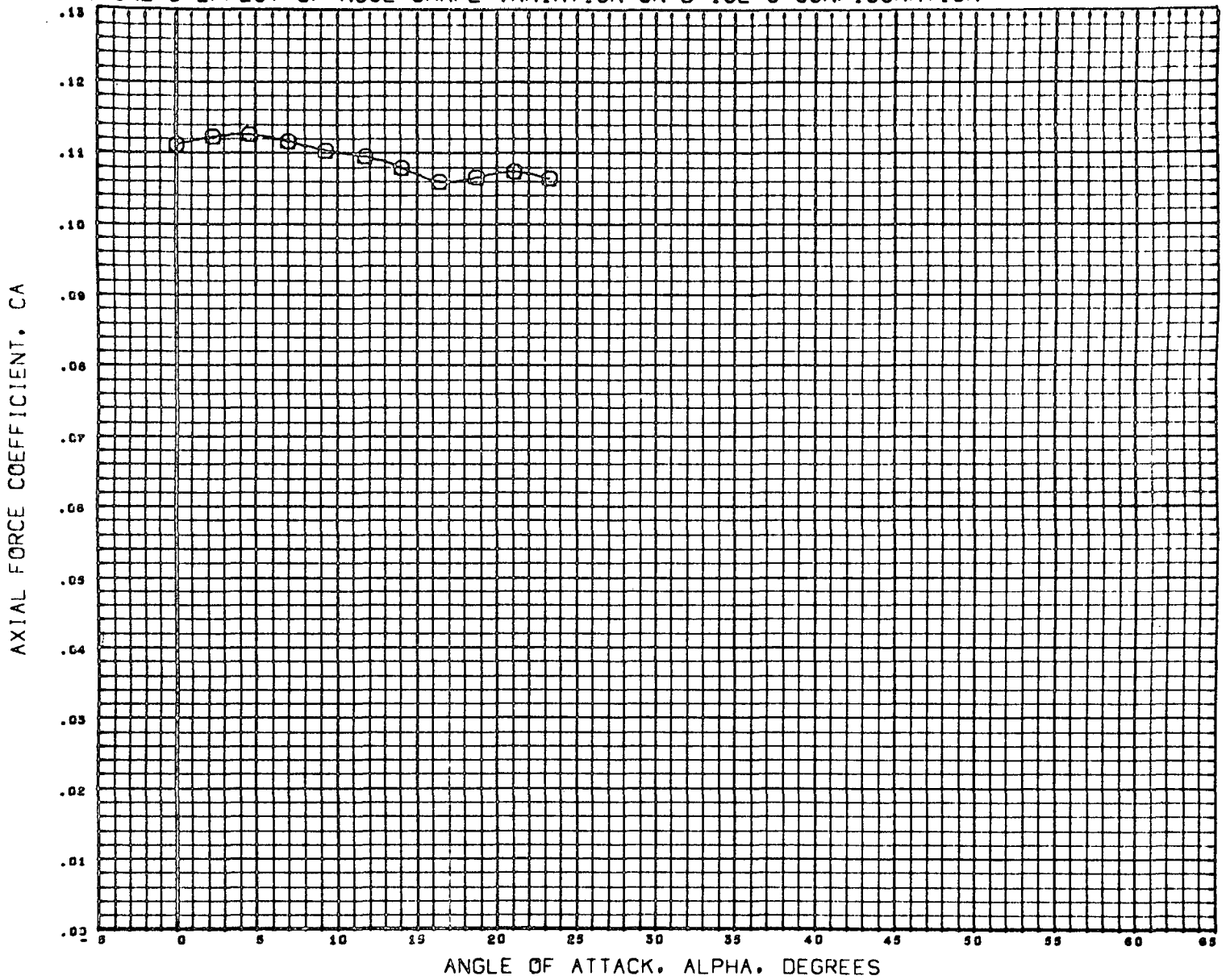

DATA SET SYMBOL	CONFIGURATION DESCRIPTION
(C50010)	MSFC TWT 314 E3 B30W23C10
(C50066)	DATA NOT AVAILABLE FOR ALL CONDITIONS

BETA	ELEVTR	CANARD
0.000	0.000	0.000
0.000	0.000	0.000

REFERENCE INFORMATION		
SREF	15.0300	30 INC
LREF	2.8300	INCHES
BREF	6.0620	INCHES
XMRP	2.1110	INCHES
YMRP	0.0000	INCHES
ZMRP	0.0000	INCHES
SCALE	0.0035	

MACH 1.499

FIGURE-5 EFFECT OF NOSE SHAPE VARIATION ON B-18E-3 CONFIGURATION

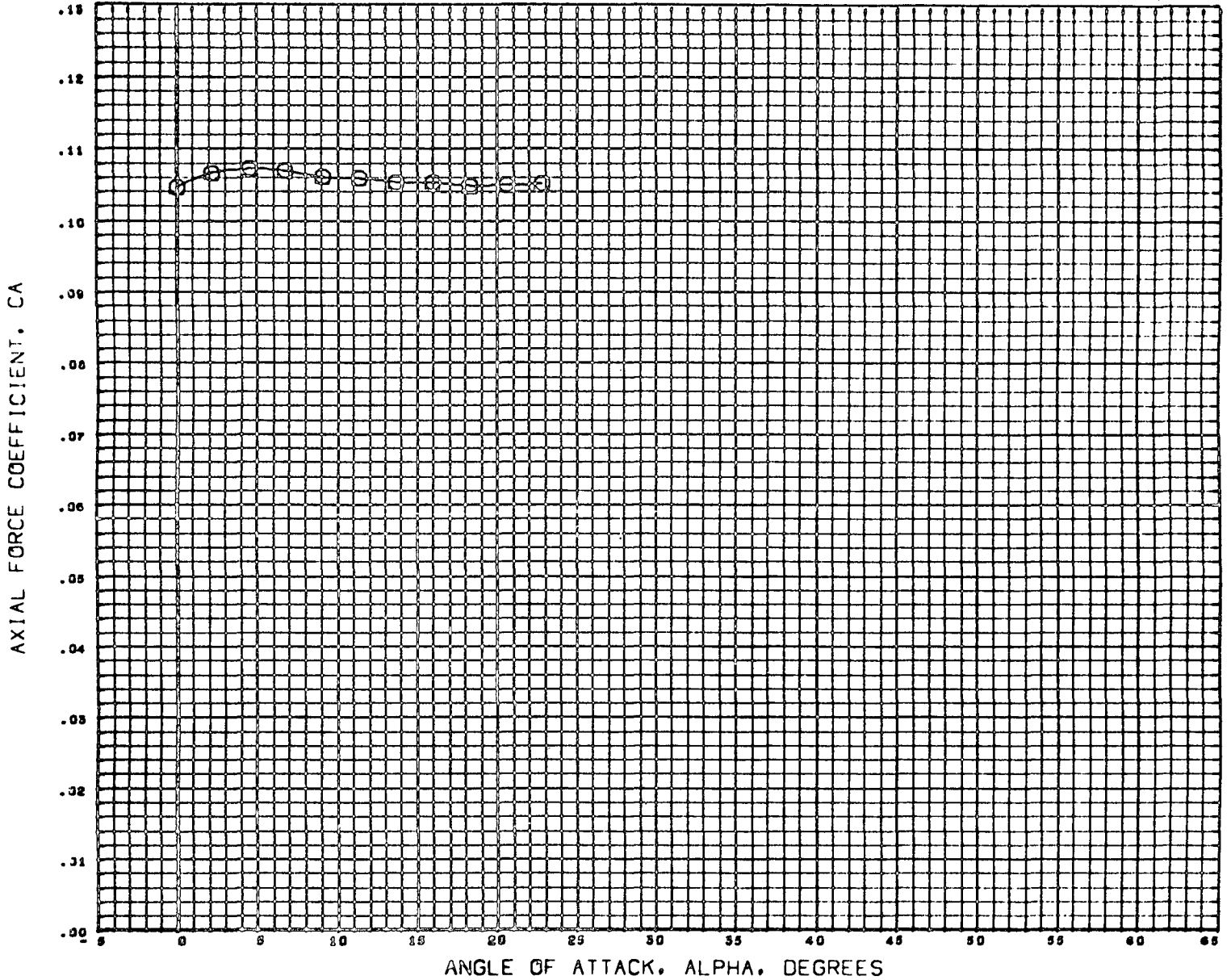

DATA SET SYMBOL	CONFIGURATION DESCRIPTION
(C56010) MSFC TWT 514 E3 030W23C10	
(C56060) DATA NOT AVAILABLE FOR ALL CONDITIONS	

BETA	ELEVTR	CANARD
0.000	0.000	0.000
0.000	0.000	0.000

REFERENCE INFORMATION		
SREF	15.0300	50 INC
LREF	2.8300	INCHES
BREF	6.0620	INCHES
XMRP	2.1110	INCHES
YMRP	0.0000	INCHES
ZMRP	0.0000	INCHES
SCALE	0.0033	

MACH 3.060

FIGURE-5 EFFECT OF NOSE SHAPE VARIATION ON B-18E-3 CONFIGURATION

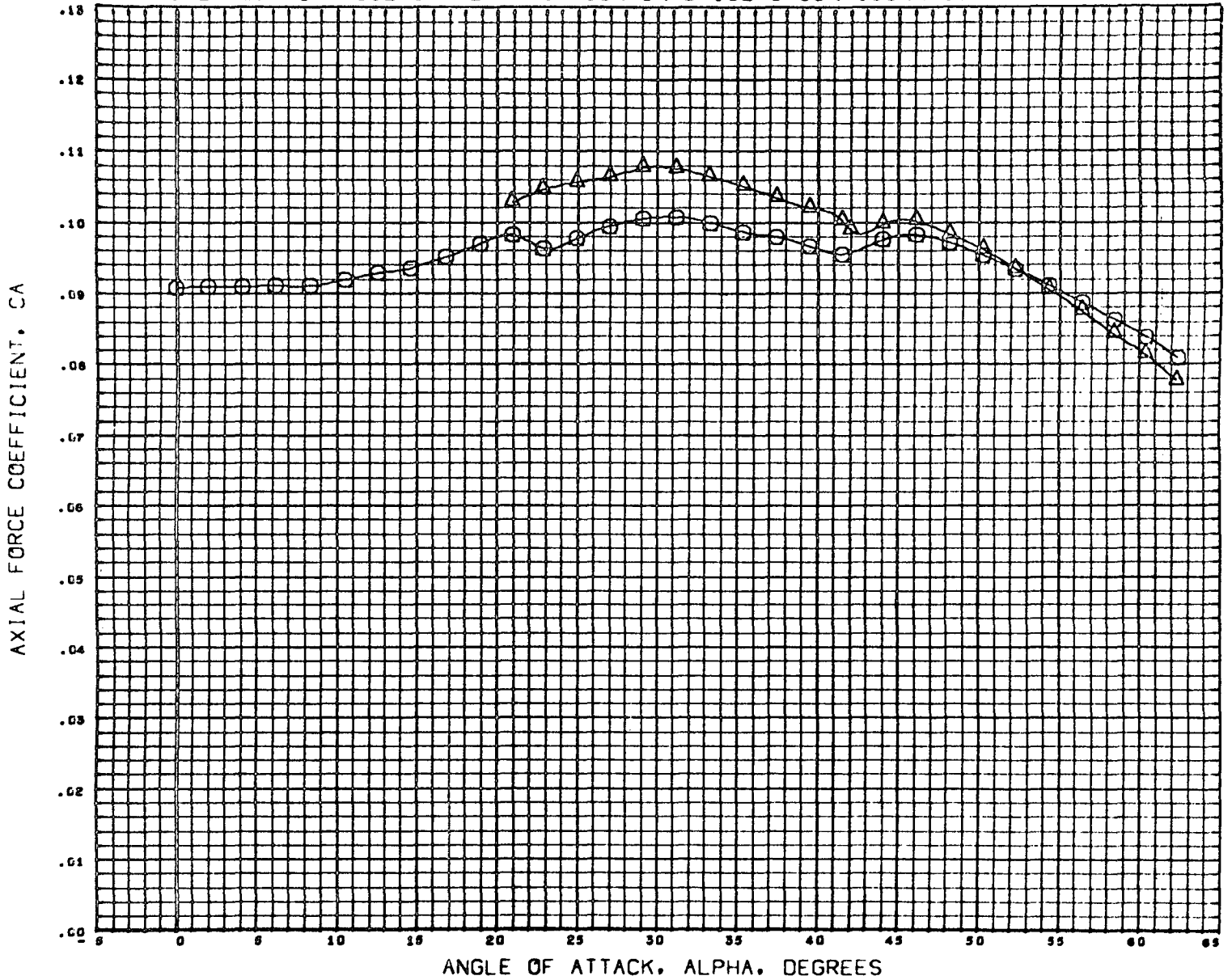

DATA SET SYMBOL	CONFIGURATION DESCRIPTION
(C58010)	MSFC TWT 514 E3 830W23C10
(C58060)	MSFC TWT 514 E3 831W23C10

BETA	ELEVTR	CANARD
0.000	0.000	0.000
0.000	0.000	0.000

REFERENCE INFORMATION		
SREF	15.0300	50 INC
LREF	2.8300	INCHES
BREF	6.0620	INCHES
XMRP	2.1110	INCHES
YMRP	0.0000	INCHES
ZMRP	0.0000	INCHES
SCALE	0.0035	

MACH 2.990

FIGURE-5 EFFECT OF NOSE SHAPE VARIATION ON B-18E-3 CONFIGURATION

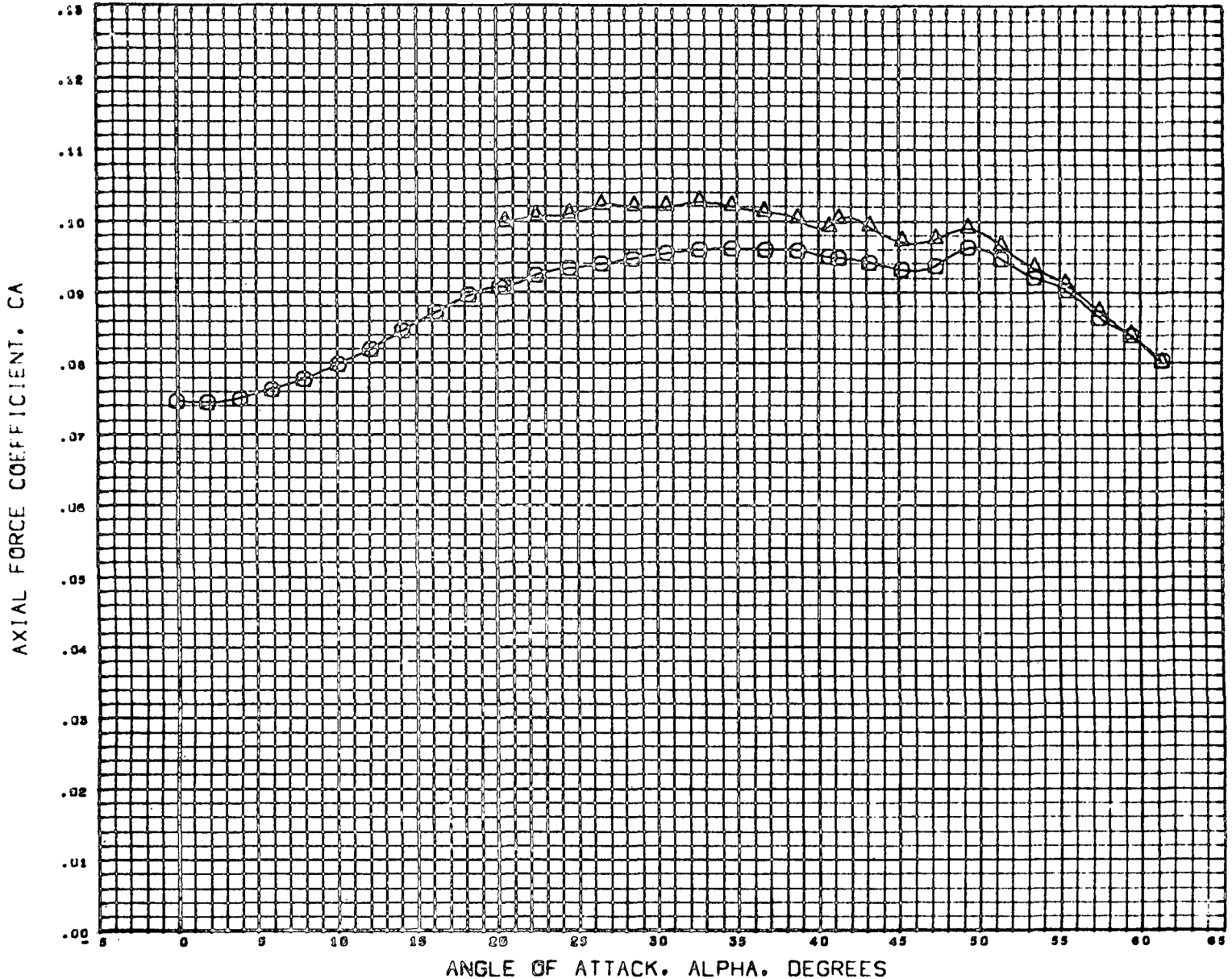

DATA SET	SYMBOL	CONFIGURATION DESCRIPTION
(C98010)	○	M8FC TWT 914 E3 090W23C10
(C98080)	△	M8FC TWT 914 E3 091W23C10

BETA	ELEVTR	CANARD
0.000	0.000	0.000
0.000	0.000	0.000

REFERENCE INFORMATION		
SREF	15.0300	Sq INC
LREF	2.8300	INCHES
BREF	6.0620	INCHES
XMRP	2.1110	INCHES
YMRP	0.0000	INCHES
ZMRP	0.0000	INCHES
SCALE	0.0035	

MACH 4.999

FIGURE-5 EFFECT OF NOSE SHAPE VARIATION ON B-18E-3 CONFIGURATION

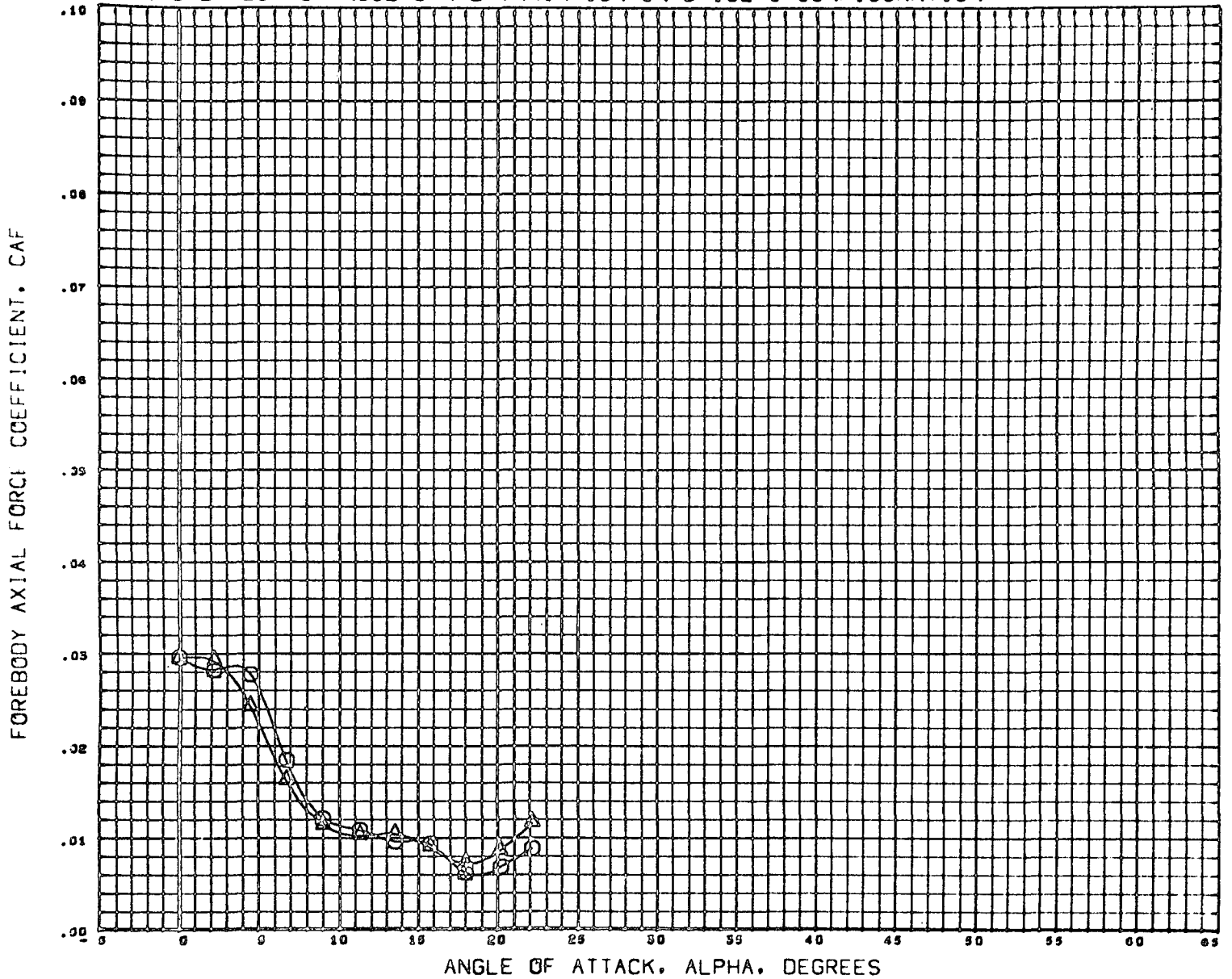

DATA SET SYMBOL	CONFIGURATION DESCRIPTION	DESCRIPTION
(C58010)	MSFC TWT 914 E3	850W23C10
(C58060)	MSFC TWT 914 E3	891W23C10

BETA	ELEVTR	CANARD
0.000	0.000	0.000
0.000	0.000	0.000

REFERENCE INFORMATION		
SREF	15.0300	90 INC
LREF	2.8300	INCHES
BREF	6.0620	INCHES
XMRP	2.1110	INCHES
YMRP	0.0000	INCHES
ZMRP	0.0000	INCHES
SCALE	0.0035	

MACH 0.007

FIGURE-5 EFFECT OF NOSE SHAPE VARIATION ON B-18E-3 CONFIGURATION

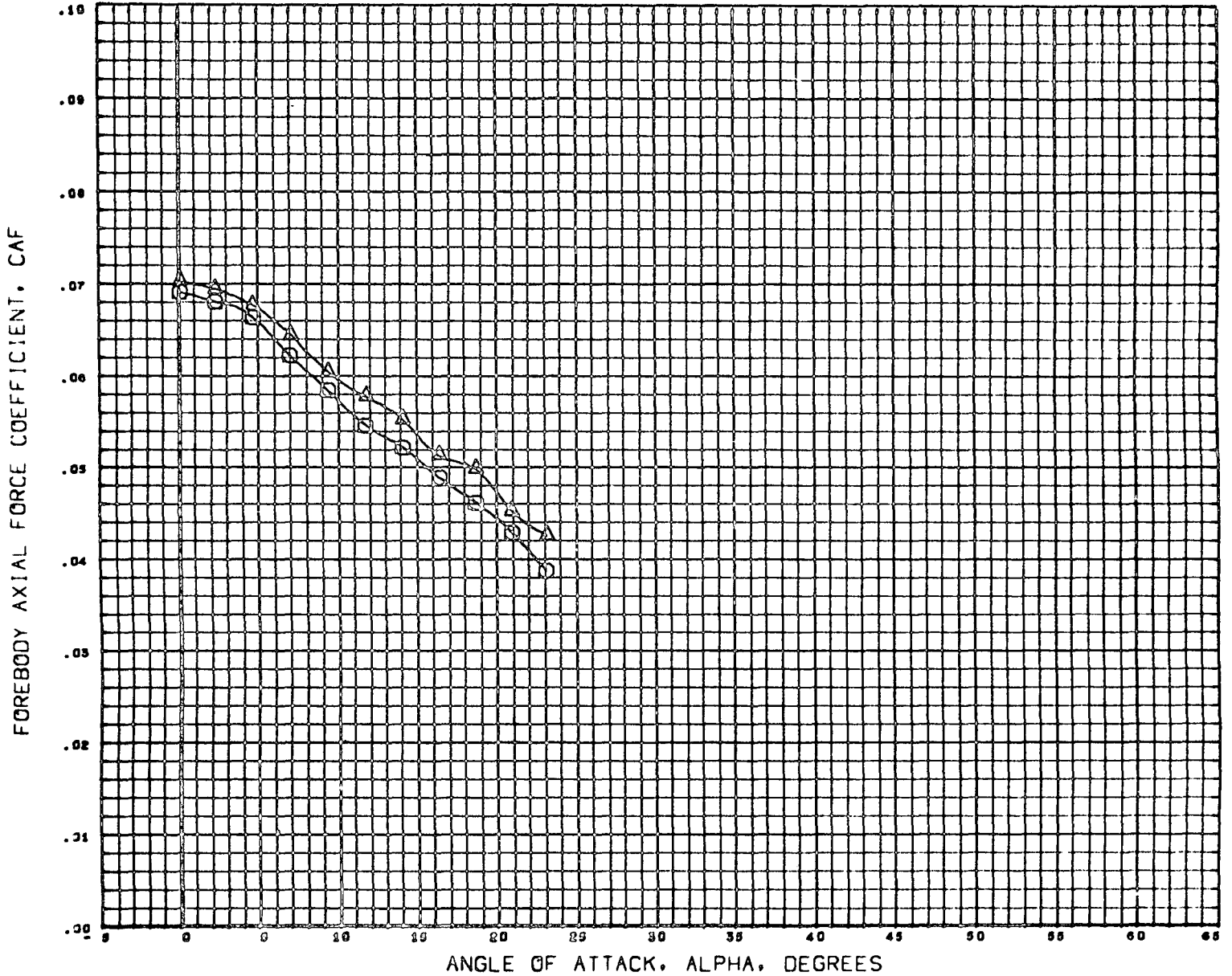

DATA DET	SYMBOL	CONFIGURATION	DESCRIPTION
(C58010)	○	MSFC-TWT 514 E3	090W23C10
(C58060)	△	MSFC-TWT 514 E3	091W23C10

BETA	ELEVTR	CANARD
0.000	0.000	0.000
0.000	0.000	0.000

REFERENCE INFORMATION		
SREF	13.0300	30 INC
LREF	2.8300	INCHES
BREF	6.0620	INCHES
XMRP	2.1110	INCHES
YMRP	0.0000	INCHES
ZMRP	0.0000	INCHES
SCALE	0.0035	

MACH 1.201

FIGURE-5 EFFECT OF NOSE SHAPE VARIATION ON B-18E-3 CONFIGURATION

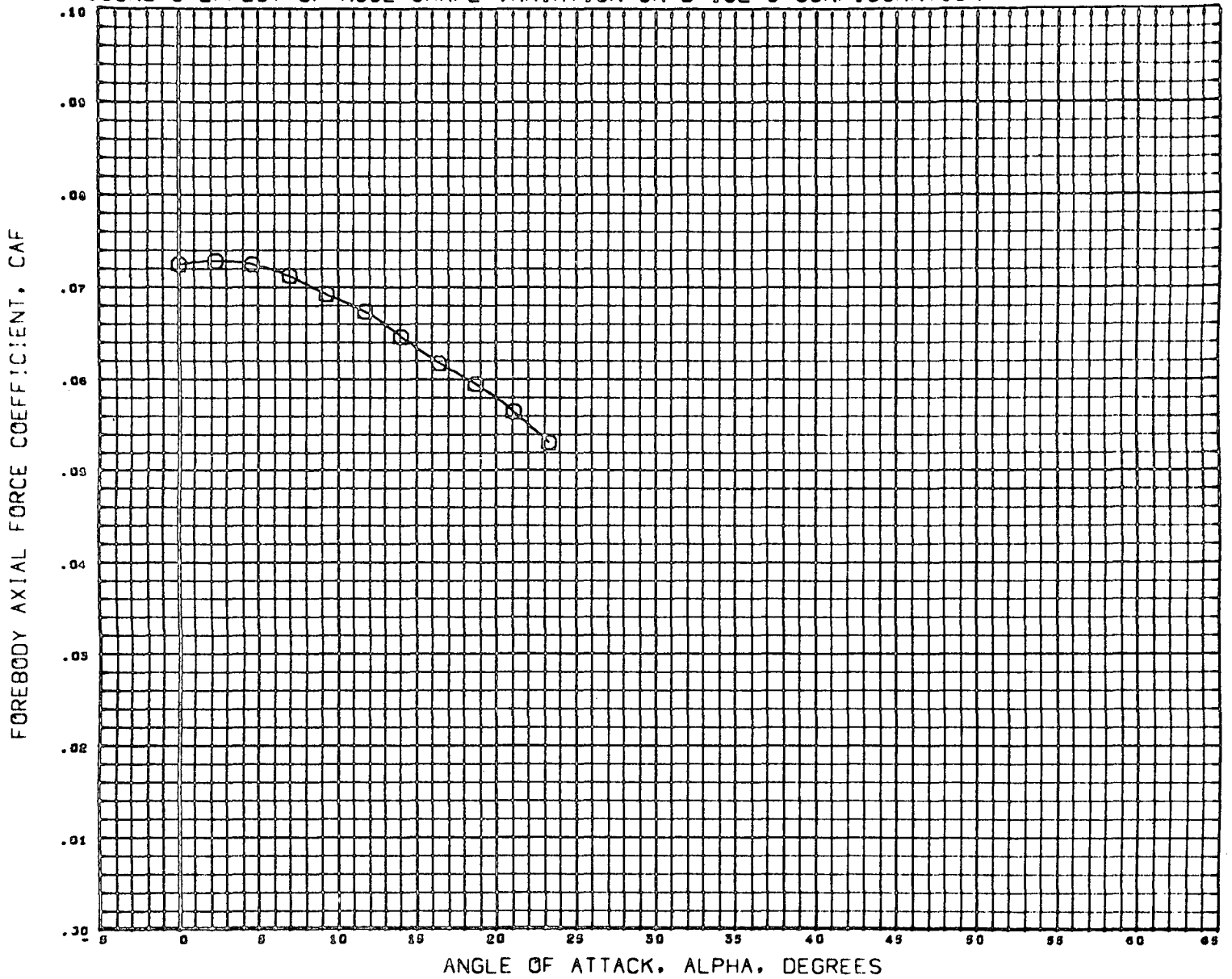

DATA SET SYMBOL	CONFIGURATION DESCRIPTION
(C50010)	MSPC INT 514 E3 030W23C10
(C50060)	DATA NOT AVAILABLE FOR ALL CONDITIONS

BETA	ELEVTR	CANARD
0.000	0.000	0.000
0.000	0.000	0.000

REFERENCE INFORMATION		
SREF	15.0300	80 INC
LREF	2.8300	INCHES
BREF	0.0020	INCHES
XMRP	2.1110	INCHES
YMRP	0.0000	INCHES
ZMRP	0.0000	INCHES
SCALE	0.0035	

MACH 1.490

FIGURE-5 EFFECT OF NOSE SHAPE VARIATION ON B-18E-3 CONFIGURATION

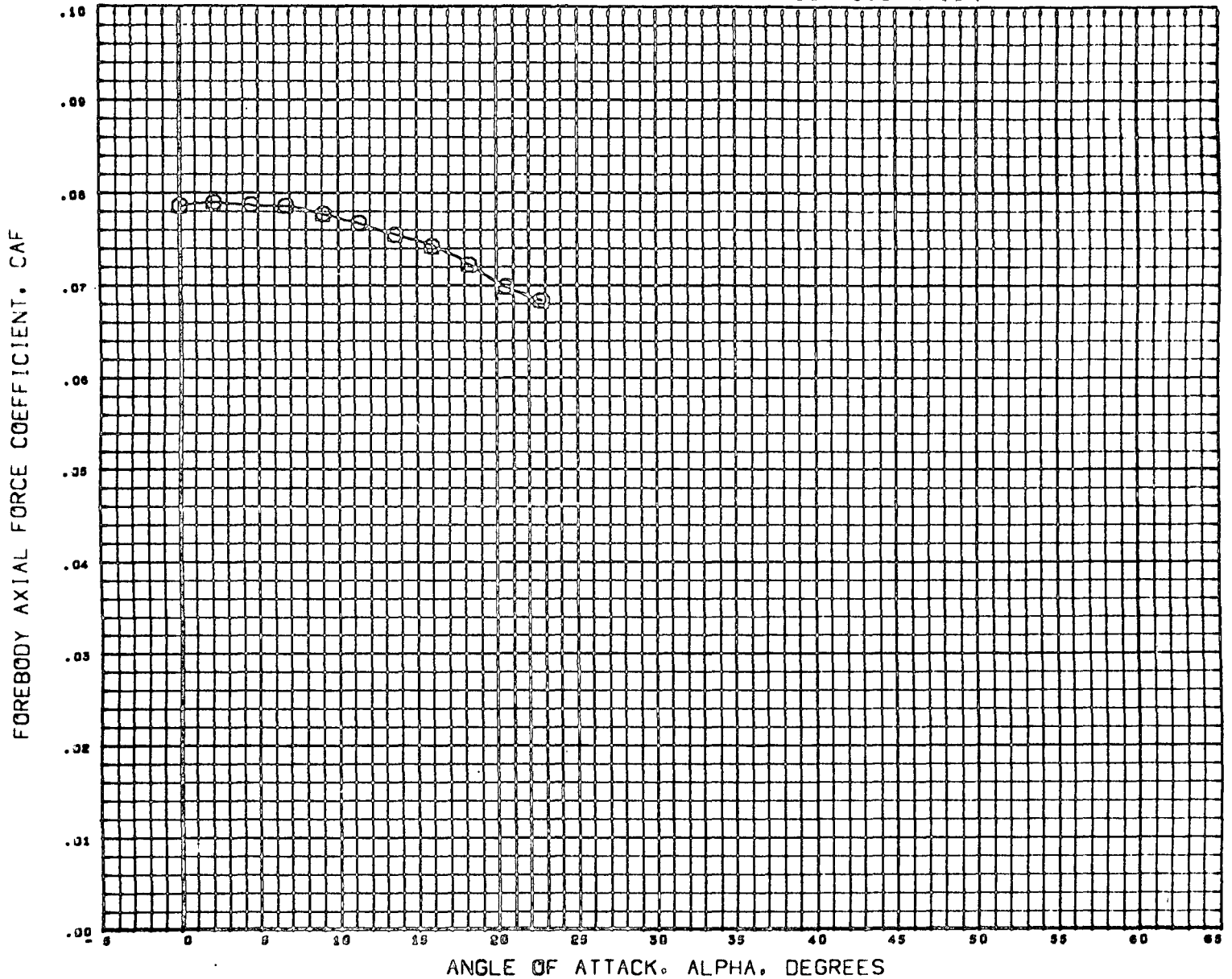

DATA SET SYMBOL CONFIGURATION DESCRIPTION
 (C58010) \odot MSFC TWY 914 ES B30W23C10
 (C58060) \triangle DATA NOT AVAILABLE FOR ALL CONDITIONS

BETA ELEVTR CANARD
 0.000 0.000 0.000
 0.000 0.000 0.000

REFERENCE INFORMATION
 SREF 15.0300 SQ INC
 LREF 2.8300 INCHES
 BREF 6.0620 INCHES
 XMRP 2.1110 INCHES
 YMRP 0.0000 INCHES
 ZMRP 0.0000 INCHES
 SCALE 0.0035

MACH 1.960

FIGURE-5 EFFECT OF NOSE SHAPE VARIATION ON B-18E-3 CONFIGURATION

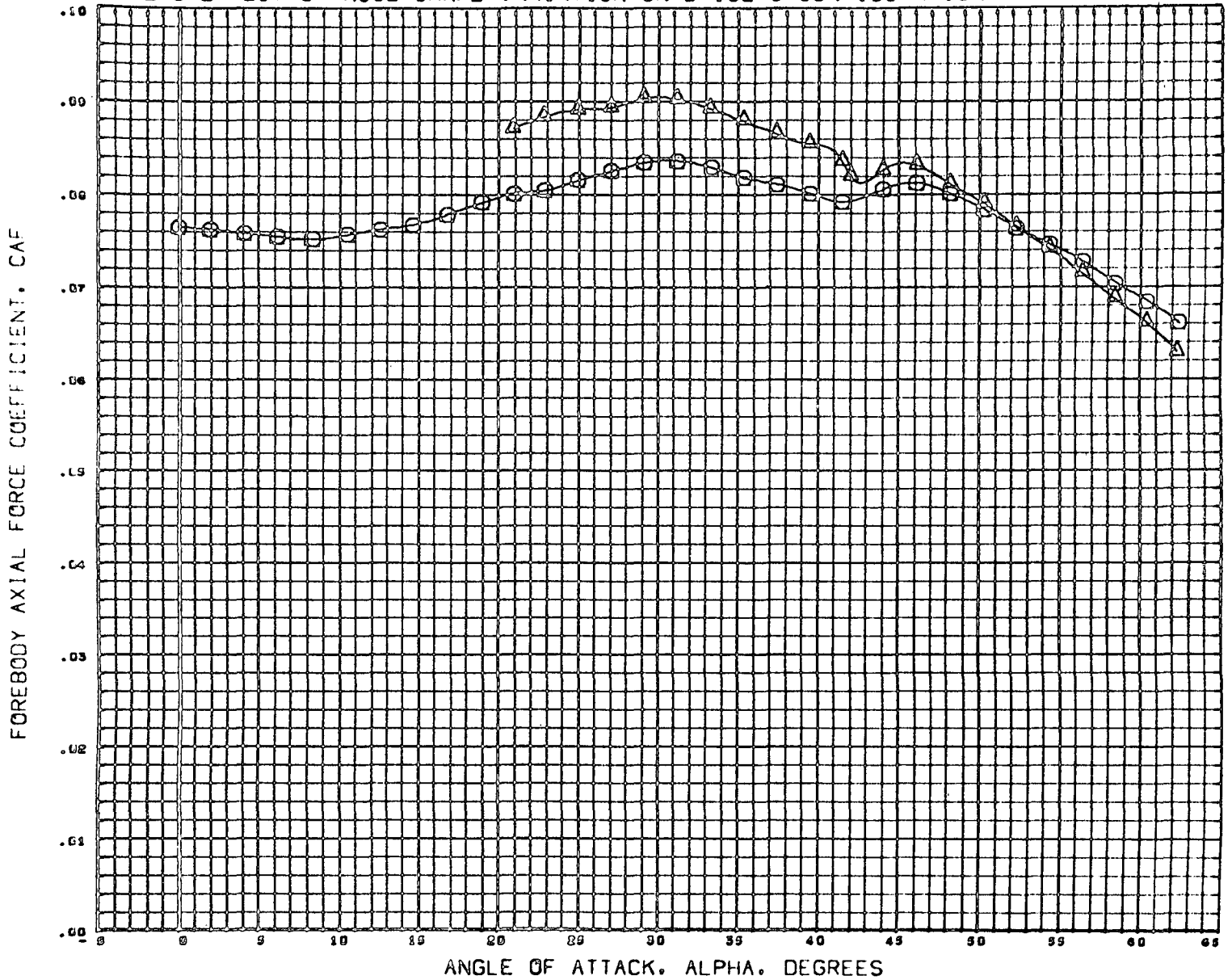

DATA SET SYMBOL	CONFIGURATION DESCRIPTION
(C50010)	MSFC TWT 914 E3 030W23C10
(C50060)	MSFC TWT 914 E3 031W23C10

DELTA	ELEVTR	CANARD
0.000	0.000	0.000
0.000	0.000	0.000

REFERENCE INFORMATION		
SREF	15.0300	80 INC
LREF	2.8300	INCHES
BREF	0.0620	INCHES
XMRP	2.1110	INCHES
YMRP	0.0000	INCHES
ZMRP	0.0000	INCHES
SCALE	0.0033	

MACH 2.090

FIGURE-5 EFFECT OF NOSE SHAPE VARIATION ON B-18E-3 CONFIGURATION

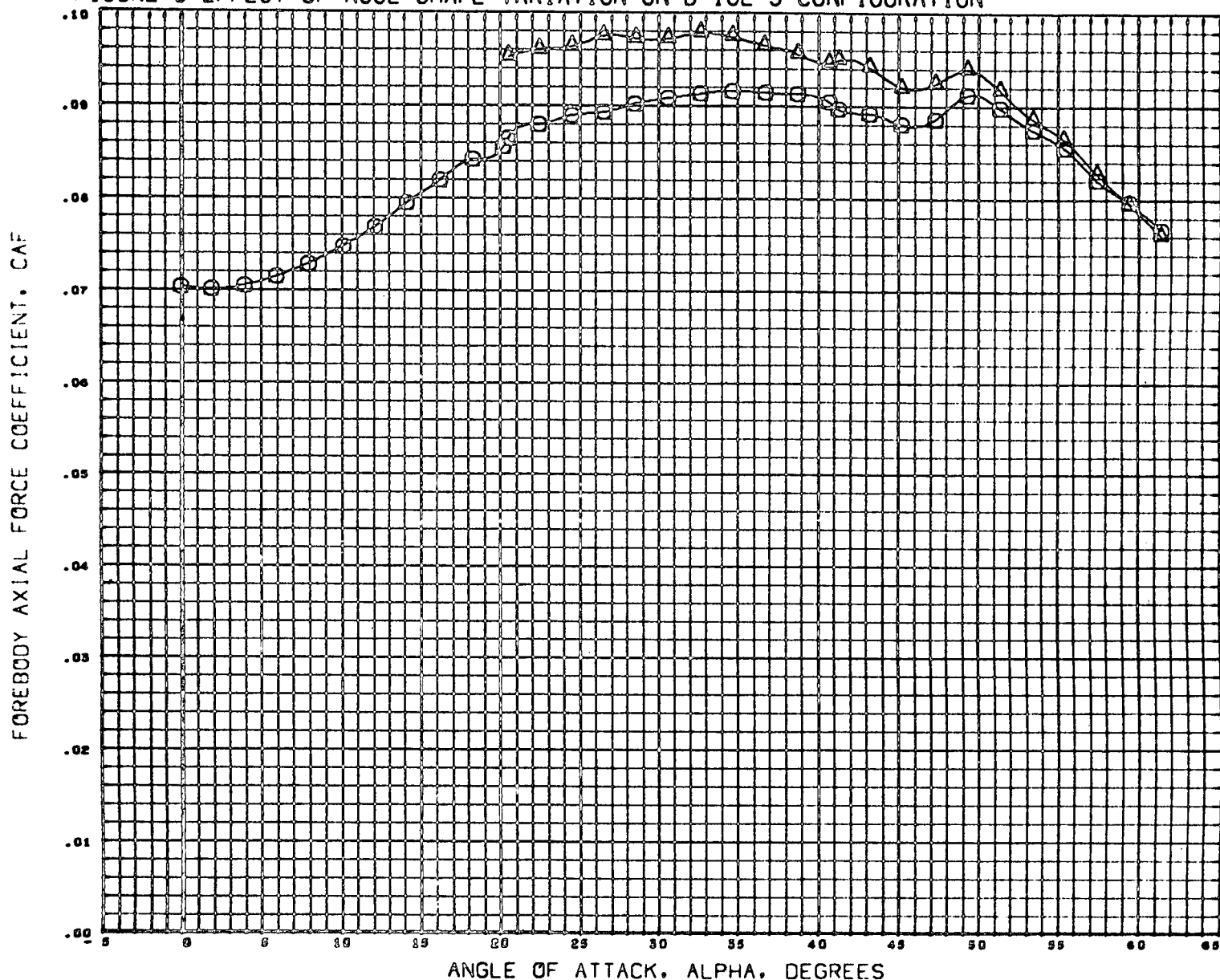

DATA SET SYMBOL	CONFIGURATION DESCRIPTION
(C58010)	NOSE TWT 914 23 030W23C10
(C58000)	NOSE TWT 914 23 031W23C10

BETA	ELEVTR	CANARD
0.000	0.000	0.000
0.000	0.000	0.000

REFERENCE INFORMATION		
SREF	15.0300	SQ INC
LREF	2.8300	INCHES
BREF	0.0620	INCHES
XMRP	2.1110	INCHES
YMRP	0.0000	INCHES
ZMRP	0.0000	INCHES
SCALE	0.0035	

MACH 4.950

FIGURE-5 EFFECT OF NOSE SHAPE VARIATION ON B-18E-3 CONFIGURATION

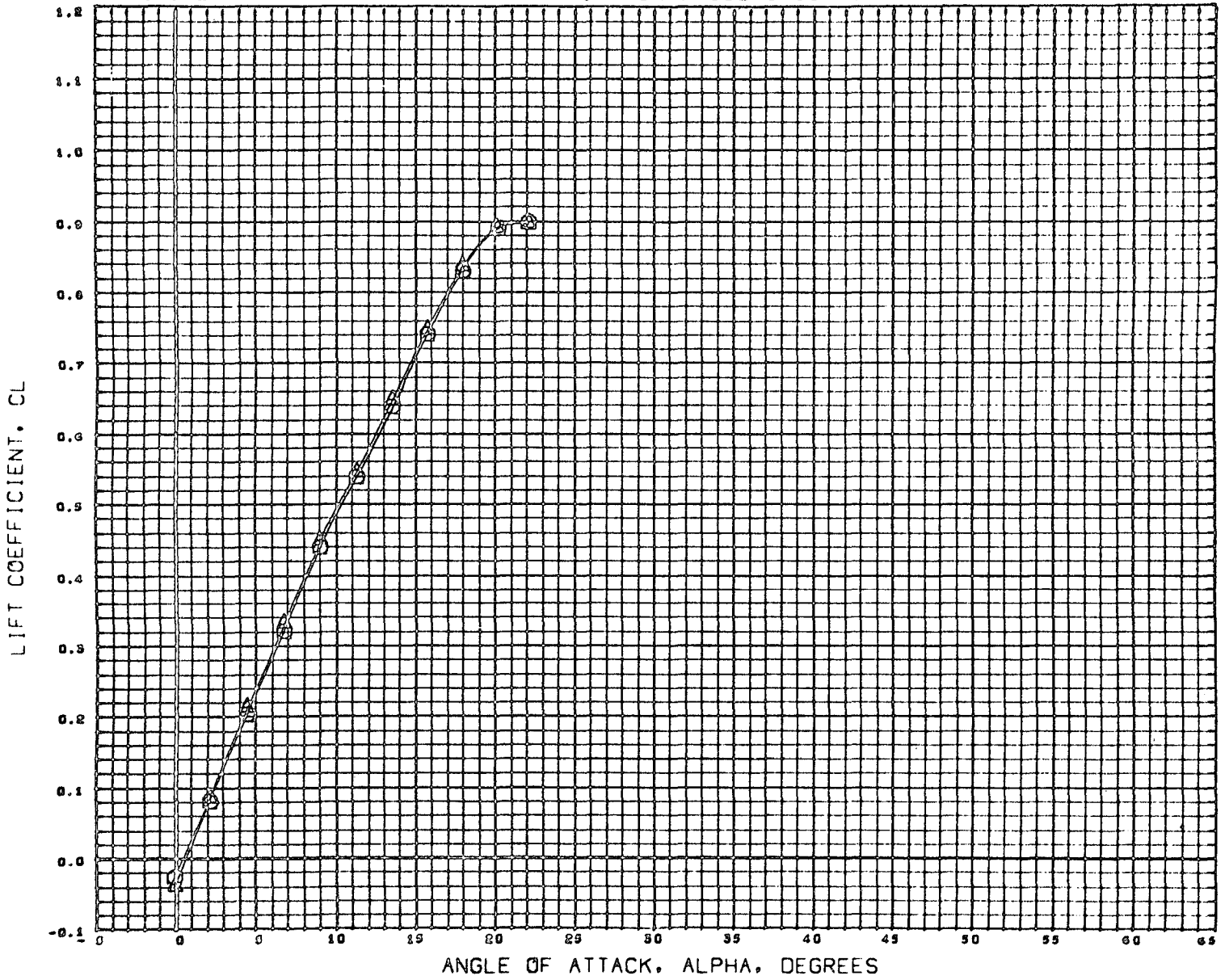

DATA SET SYMBOL	CONFIGURATION DESCRIPTION
(C96010)	MSFC TWT 514 E3 830W23C10
(C96060)	MSFC TWT 514 E3 831W23C10

BETA	ELEVTR	CANARD
0.000	0.000	0.000
0.000	0.000	0.000

REFERENCE INFORMATION		
SREF	15.0300	50 INC
LREF	2.8300	INCHES
BREF	0.0620	INCHES
XMRP	2.1110	INCHES
YMRP	0.0000	INCHES
ZMRP	0.0000	INCHES
SCALE	0.0035	

MACH 0.007

FIGURE-5 EFFECT OF NOSE SHAPE VARIATION ON B-18E-3 CONFIGURATION

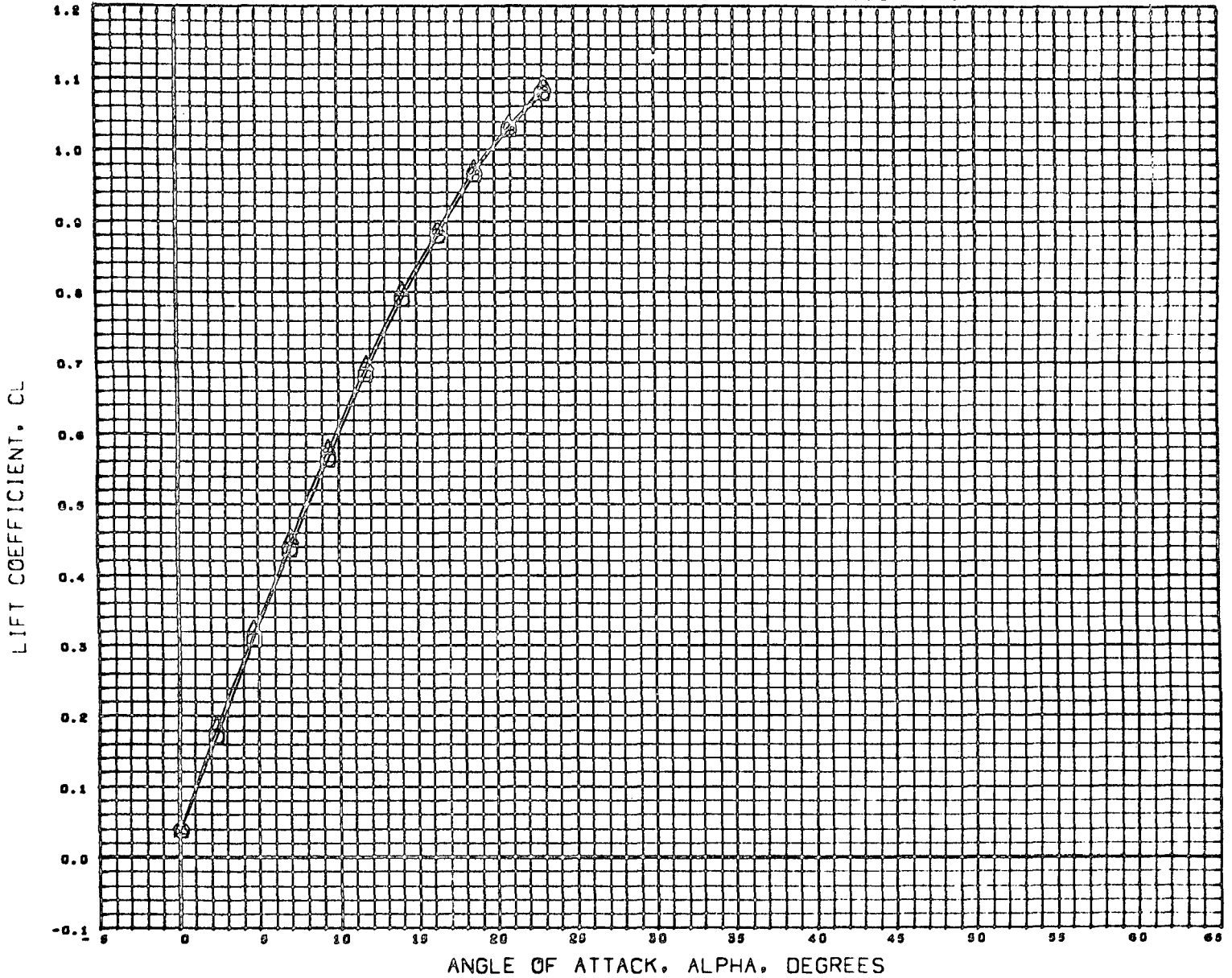

DATA SET SYMBOL	CONFIGURATION DESCRIPTION
(C98013)	MSFC TWT 314 E3 030W23C10
(C98060)	MSFC TWT 314 E3 031W23C10

BETA	ELEVTR	CANARD
0.000	0.000	0.000
0.000	0.000	0.000

REFERENCE INFORMATION		
SREF	15.0300	50 INC
LREF	2.8300	INCHES
BREF	0.0620	INCHES
XMRP	2.1110	INCHES
YMRP	0.0000	INCHES
ZMRP	0.0000	INCHES
SCALE	0.0035	

MACH 1.201

FIGURE-5 EFFECT OF NOSE SHAPE VARIATION ON B-18E-3 CONFIGURATION

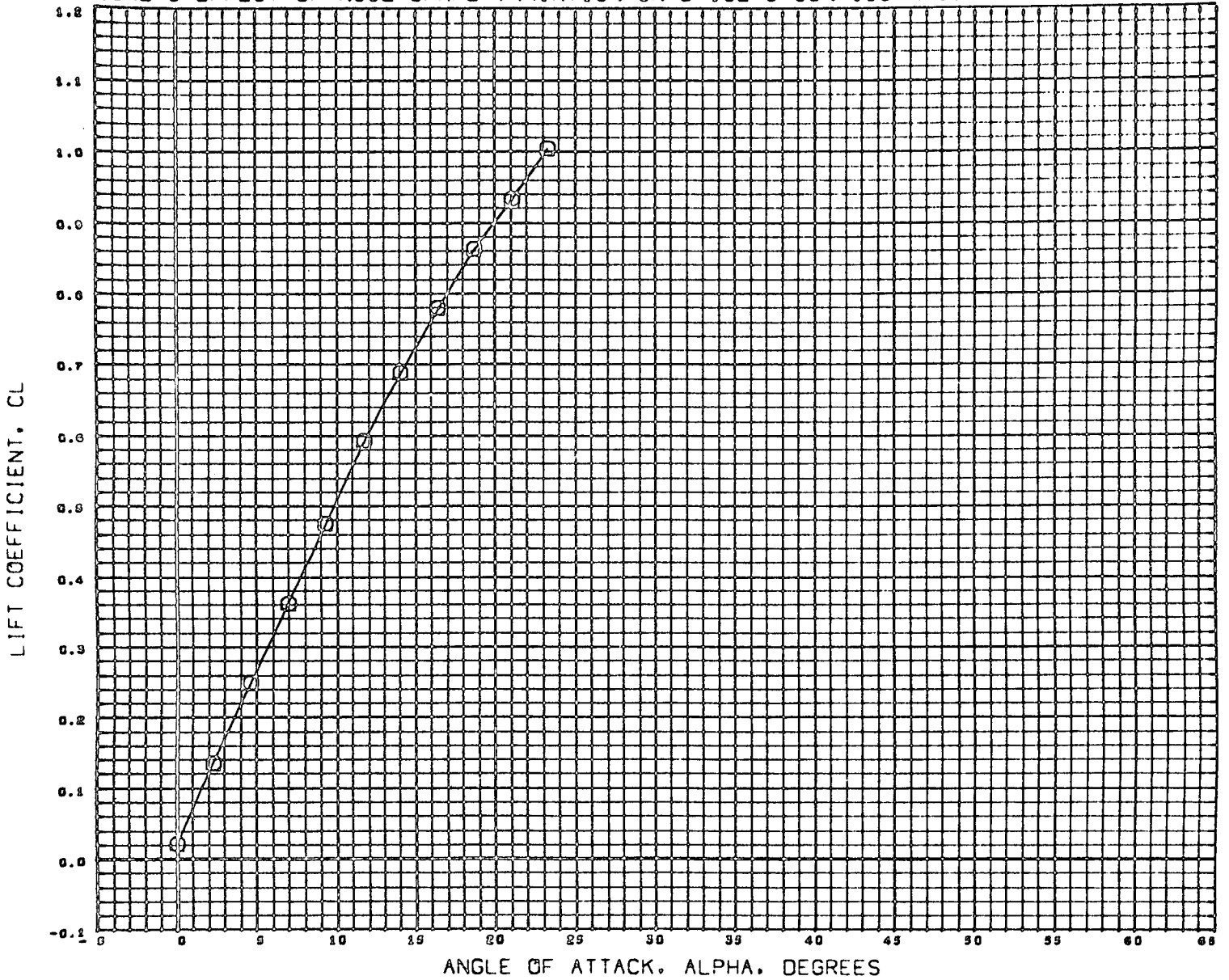

DATA SET SYMBOL	CONFIGURATION DESCRIPTION	BETA	ELEVTR	CANARD
(C58010)	MOFC THT 914 Q3 030W23C10	0.000	0.000	0.000
(C58060)	DATA NOT AVAILABLE FOR ALL CONDITIONS	0.000	0.000	0.000

REFERENCE INFORMATION		
SREF	15.0300	00 INC
LREF	2.0300	INCHES
BREF	6.0020	INCHES
XMRP	2.1110	INCHES
YMRP	0.0000	INCHES
ZMRP	0.0000	INCHES
SCALE	0.0035	

MACH 1.490

FIGURE-5 EFFECT OF NOSE SHAPE VARIATION ON B-18E-3 CONFIGURATION

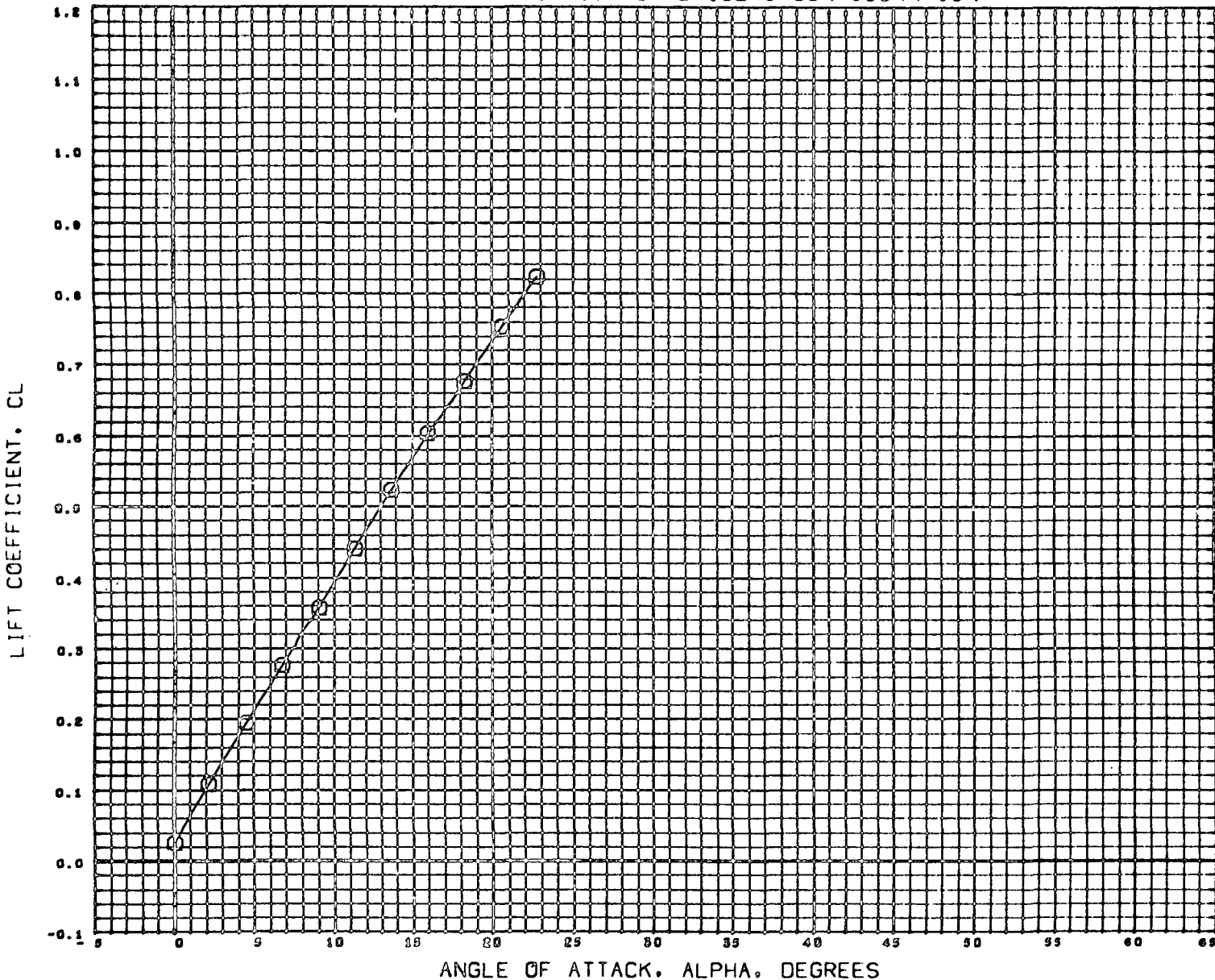

DATA SET SYMBOL CONFIGURATION DESCRIPTION
 (C58010) \odot NSFC TWT 514 29 D90W29C10
 (C58060) \triangle DATA NOT AVAILABLE FOR ALL CONDITIONS

BETA ELEVTR CANARD
 0.000 0.000 0.000
 0.000 0.000 0.000

REFERENCE INFORMATION
 SREF 15.0300 SQ INC
 LREF 2.8300 INCHES
 OREF 0.0620 INCHES
 XMRP 2.1150 INCHES
 YMRP 0.0000 INCHES
 ZMRP 0.0000 INCHES
 SCALE 0.0035

MACH 1.000

FIGURE-5 EFFECT OF NOSE SHAPE VARIATION ON B-18E-3 CONFIGURATION

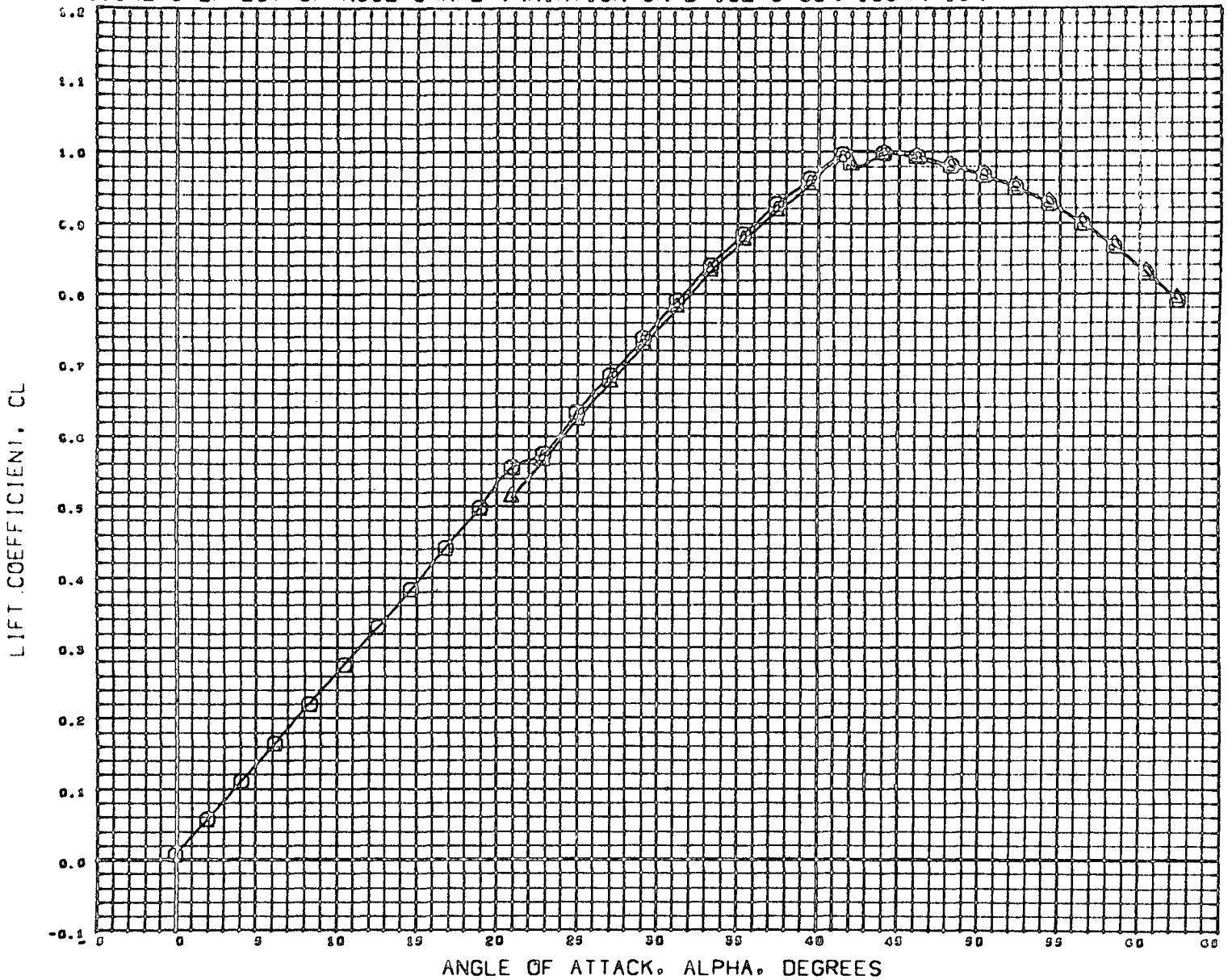

DATA SET	SYMBOL	CONFIGURATION DESCRIPTION
(C98015)	○	MSFC TWT 514 E3 B30W23C10
(C98080)	△	MSFC TWT 514 E3 B31W23C10

DELTA	ZLEVTR	CANARD
0.000	0.000	0.000
0.000	0.000	0.000

REFERENCE INFORMATION		
SREF	19.0300	90 INC
LREF	2.0300	INCHES
OREP	0.0620	INCHES
XMRP	2.1110	INCHES
YMRP	0.0000	INCHES
ZMRP	0.0000	INCHES
SCALE	0.0035	

MACH 2.000

FIGURE-5 EFFECT OF NOSE SHAPE VARIATION ON B-18E-3 CONFIGURATION

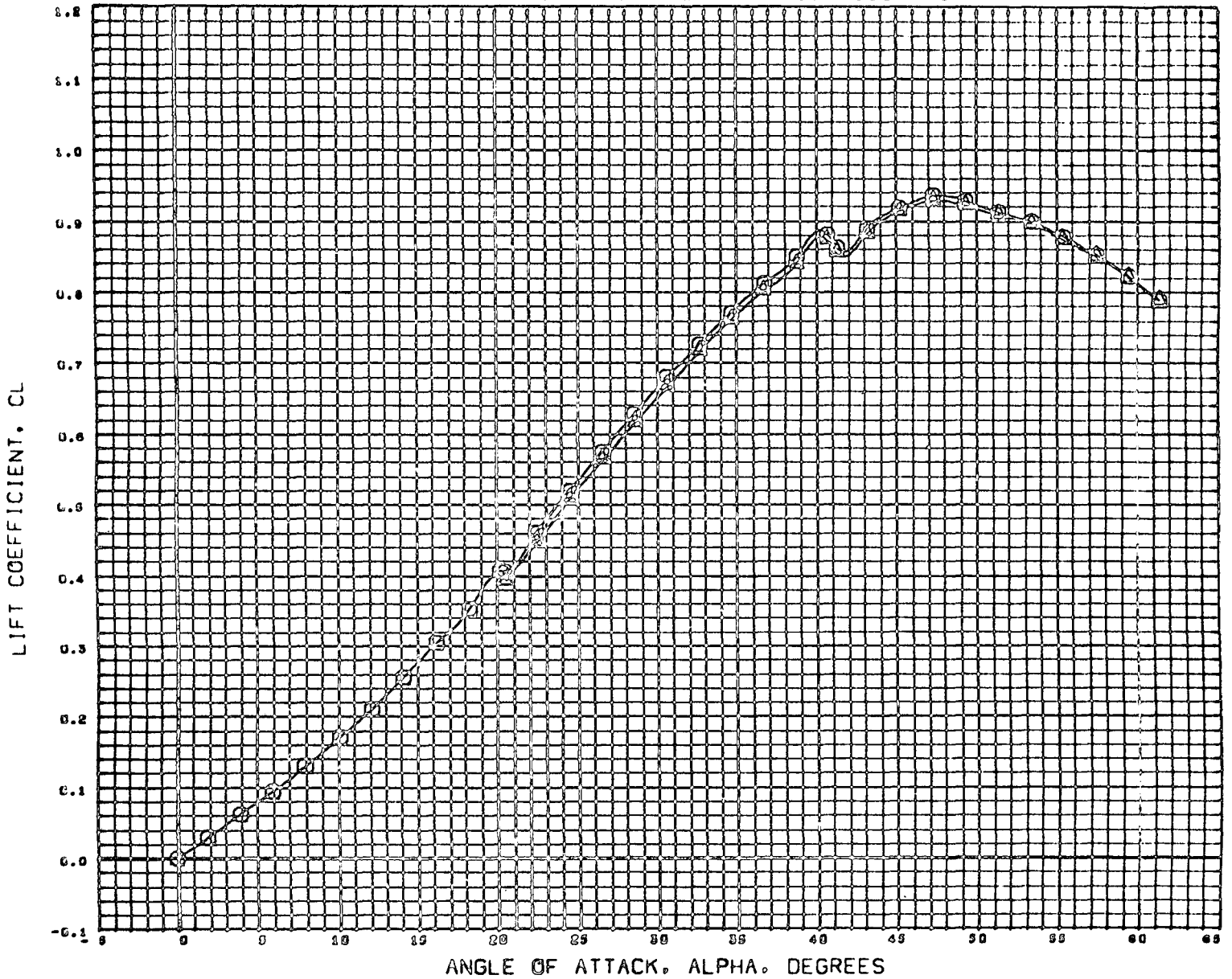

DATA SET SYMBOL	CONFIGURATION DESCRIPTION
(C38010)	MSFC TWT 514 E3 030H23C10
(C38030)	MSFC TWT 514 E3 031H23C10

BETA	ELEVTR	CANARD
0.000	0.000	0.000
0.000	0.000	0.000

REFERENCE INFORMATION		
SREF	13.0300	50 INC
LREF	2.0300	INCHES
DREF	0.0620	INCHES
XWRP	2.1110	INCHES
YWRP	0.0000	INCHES
ZWRP	0.0000	INCHES
SCALE	0.0035	

MACH 4.050

FIGURE-5 EFFECT OF NOSE SHAPE VARIATION ON B-18E-3 CONFIGURATION

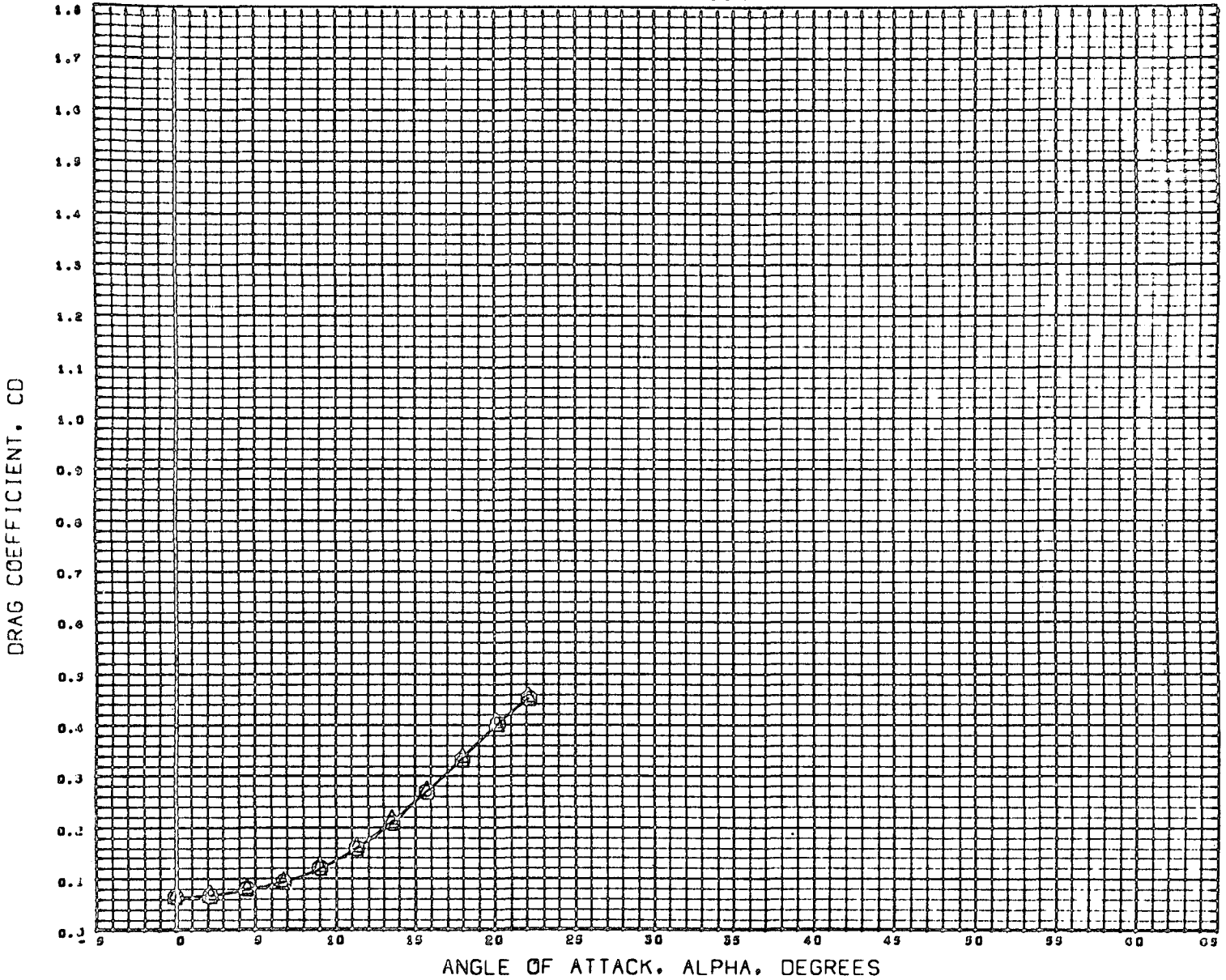

DATA SET SYMBOL	CONFIGURATION DESCRIPTION
(C9801C)	MSFC TWT 514 E3 030W23C10
(C9806C)	MSFC TWT 514 E3 031W23C10

BETA	ELEVTR	CANARD
0.000	0.000	0.000
0.000	0.000	0.000

REFERENCE INFORMATION		
SREF	19.0300	50 INC
LREF	2.0300	INCHES
QREF	0.0020	INCHES
XMRP	2.1110	INCHES
YMRP	0.0000	INCHES
ZMRP	0.0000	INCHES
SCALE	0.0039	

MACH 0.007

FIGURE-5 EFFECT OF NOSE SHAPE VARIATION ON B-18E-3 CONFIGURATION

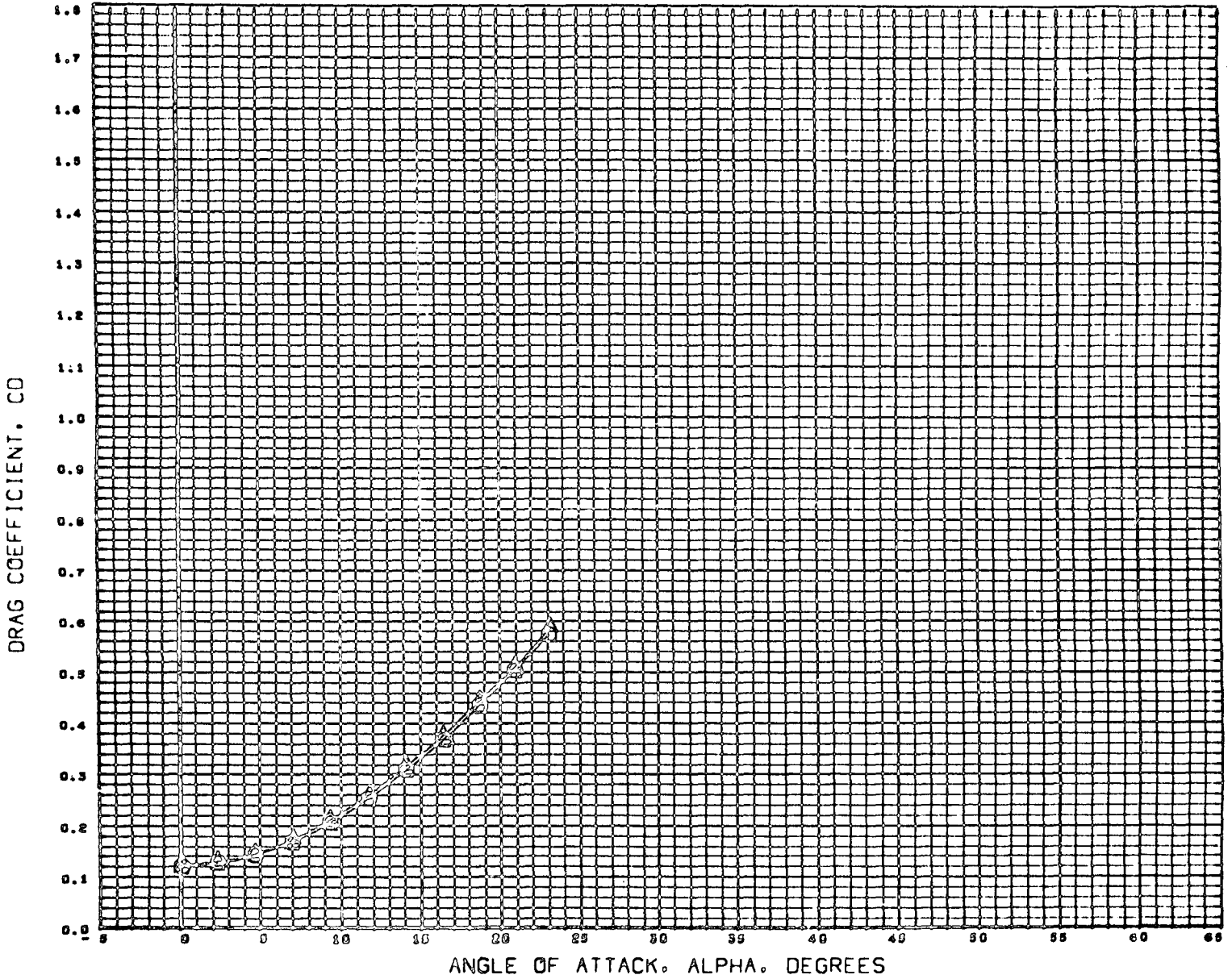

DATA SET SYMBOL	CONFIGURATION DESCRIPTION
(C96010) ○	HSFC TWT 914 (2) 030H23C10
(C96060) △	HSFC TWT 914 (2) 031H23C10

BETA	ELEVTR	CANARD
0.000	0.000	0.000
0.000	0.000	0.000

REFERENCE INFORMATION		
SREP	19.0300	90 INC
LREP	2.8300	INCHES
OREP	0.0620	INCHES
XMRP	2.1110	INCHES
YMRP	0.0000	INCHES
ZMRP	0.0000	INCHES
SCALE	0.0035	

MACH 1.201

FIGURE-5 EFFECT OF NOSE SHAPE VARIATION ON B-18E-3 CONFIGURATION

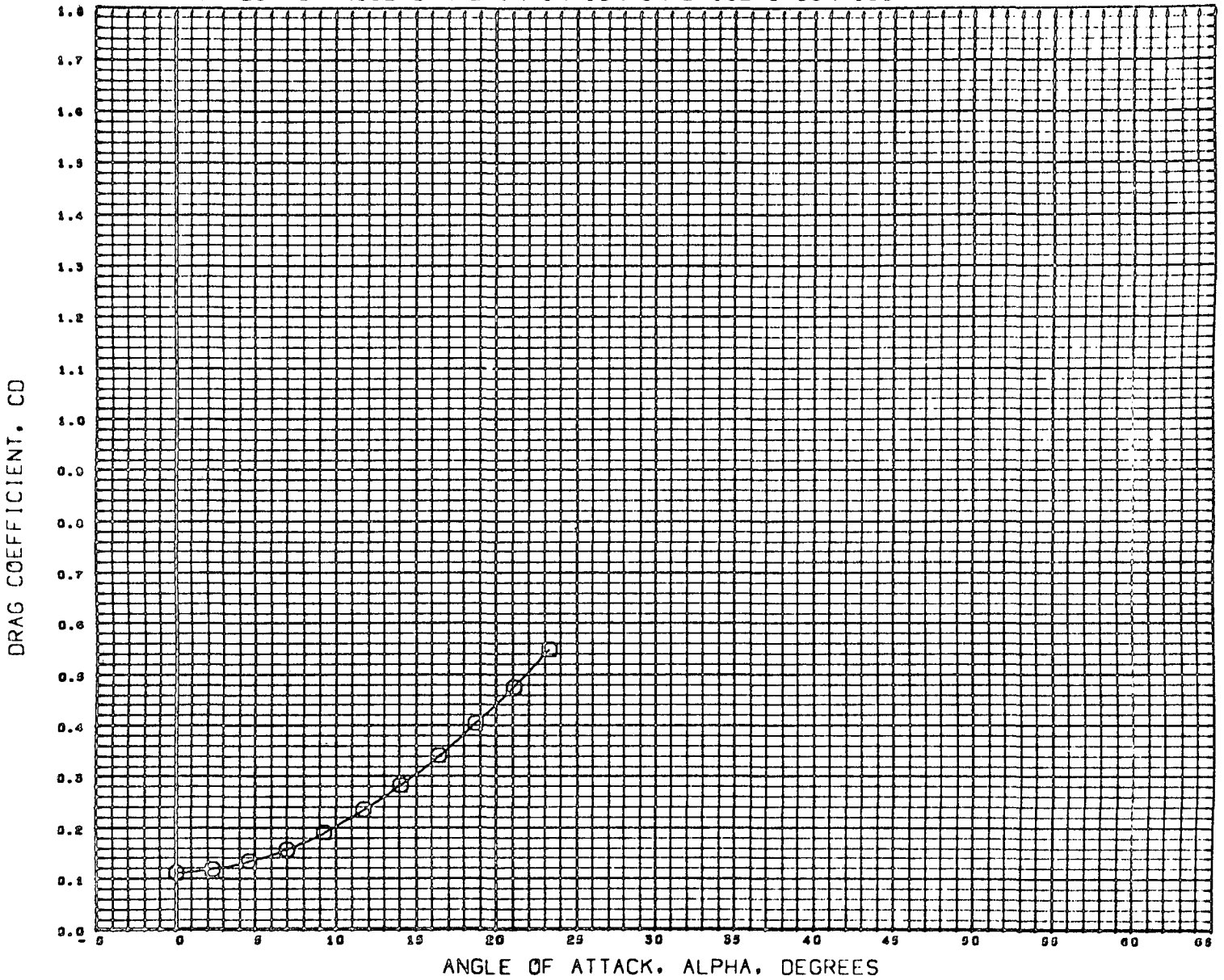

DATA SET SYMBOL	CONFIGURATION DESCRIPTION
(C90010)	HQFC TWT 914 E3 850W23C10
(C58060)	DATA NOT AVAILABLE FOR ALL CONDITIONS

BETA	ELEVTR	CANARD
0.000	0.000	0.000
0.000	0.000	0.000

REFERENCE INFORMATION		
SREF	15.0300	80 INC
LREF	2.0300	INCHES
BREF	0.0620	INCHES
XHRP	2.1110	INCHES
YHRP	0.0000	INCHES
ZHRP	0.0000	INCHES
SCALE	0.0039	

MACH 1.450

FIGURE-5 EFFECT OF NOSE SHAPE VARIATION ON B-18E-3 CONFIGURATION

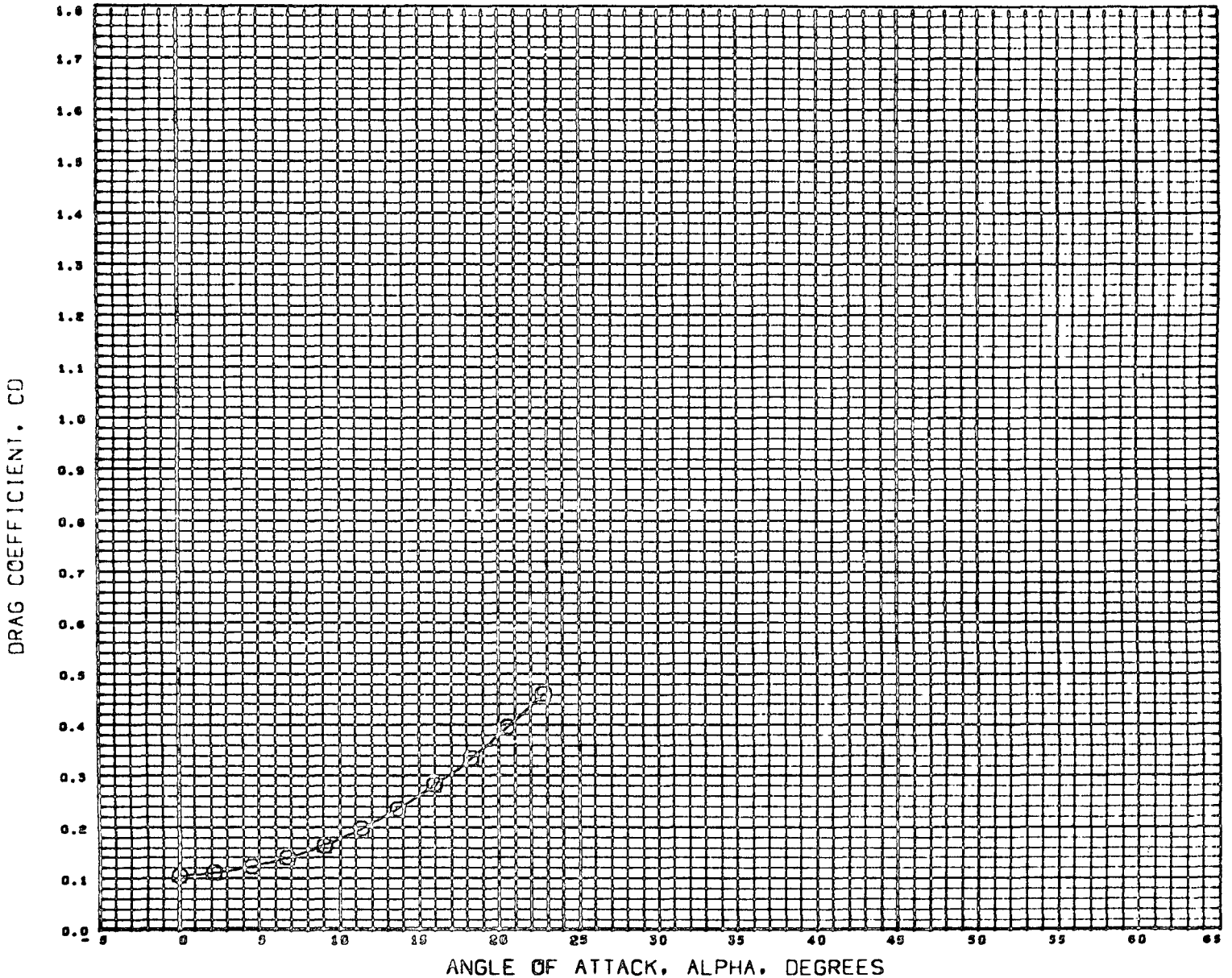

DATA SET SYMBOL CONFIGURATION DESCRIPTION
 (C98G10) ○ MSFC TWT 514 E3 030W23C10
 (C98G60) △ DATA NOT AVAILABLE FOR ALL CONDITIONS

BETA ELEVTR CANARD
 0.000 0.000 0.000
 0.000 0.000 0.000

REFERENCE INFORMATION
 SREF 15.0300 SQ INC
 LREF 2.8300 INCHES
 BREF 6.9620 INCHES
 XMRP 2.1110 INCHES
 YMRP 0.0000 INCHES
 ZMRP 0.0000 INCHES
 SCALE 0.0033

MACH 1.000

FIGURE-5 EFFECT OF NOSE SHAPE VARIATION ON B-18E-3 CONFIGURATION

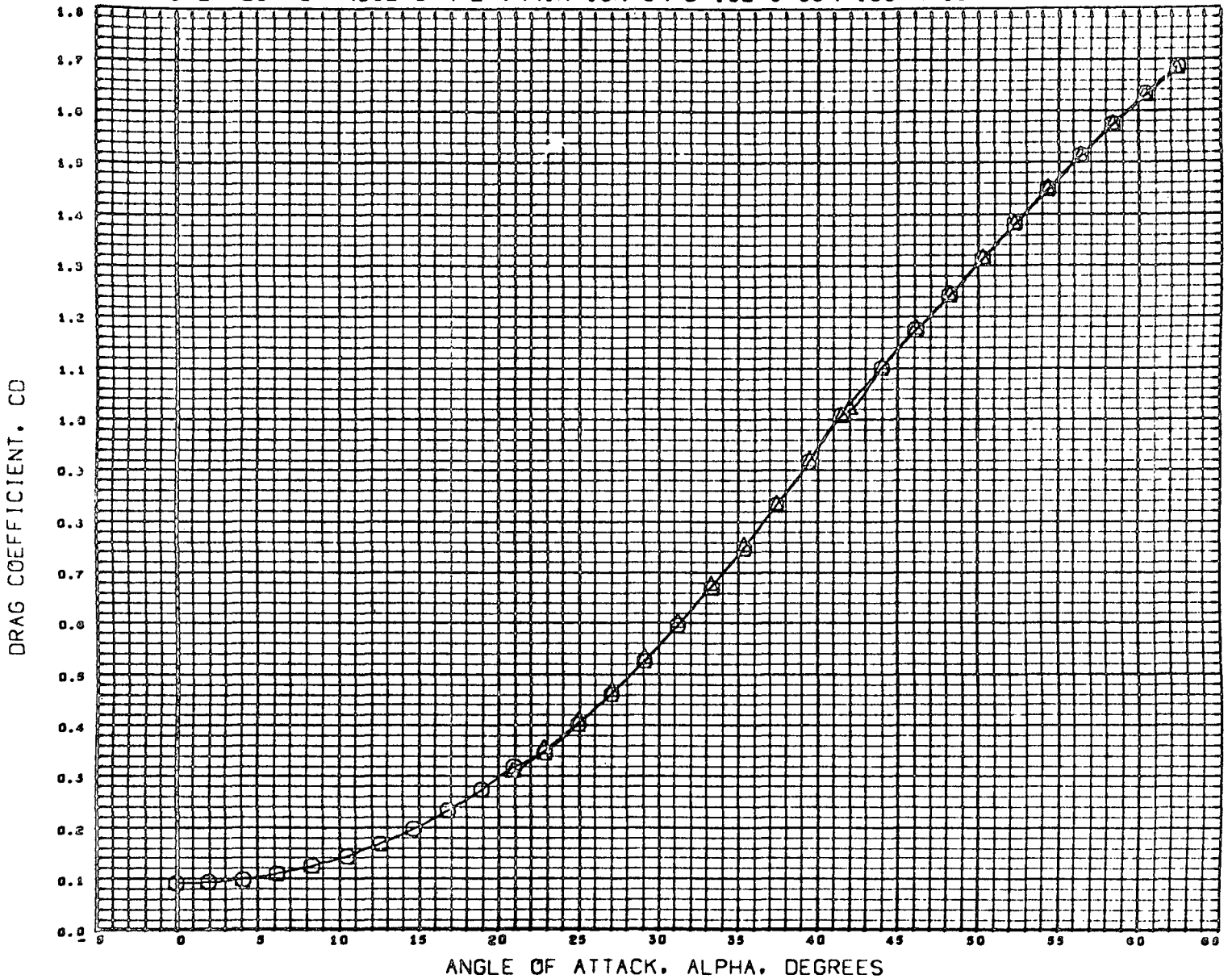

DATA SET SYMBOL	CONFIGURATION DESCRIPTION
(C50017)	MSFC TWT 514 E3 030W23C10
(C50060)	MSFC TWT 514 E3 031W23C10



BETA	ELEVTR	CANARD
0.000	0.000	0.000
0.000	0.000	0.000

REFERENCE INFORMATION		
SREF	15.0300	00 INC
LREF	2.0300	INCHES
OREF	0.0620	INCHES
XMRP	2.1110	INCHES
YMRP	0.0000	INCHES
ZMRP	0.0000	INCHES
SCALE	0.0035	

MACH 2.000

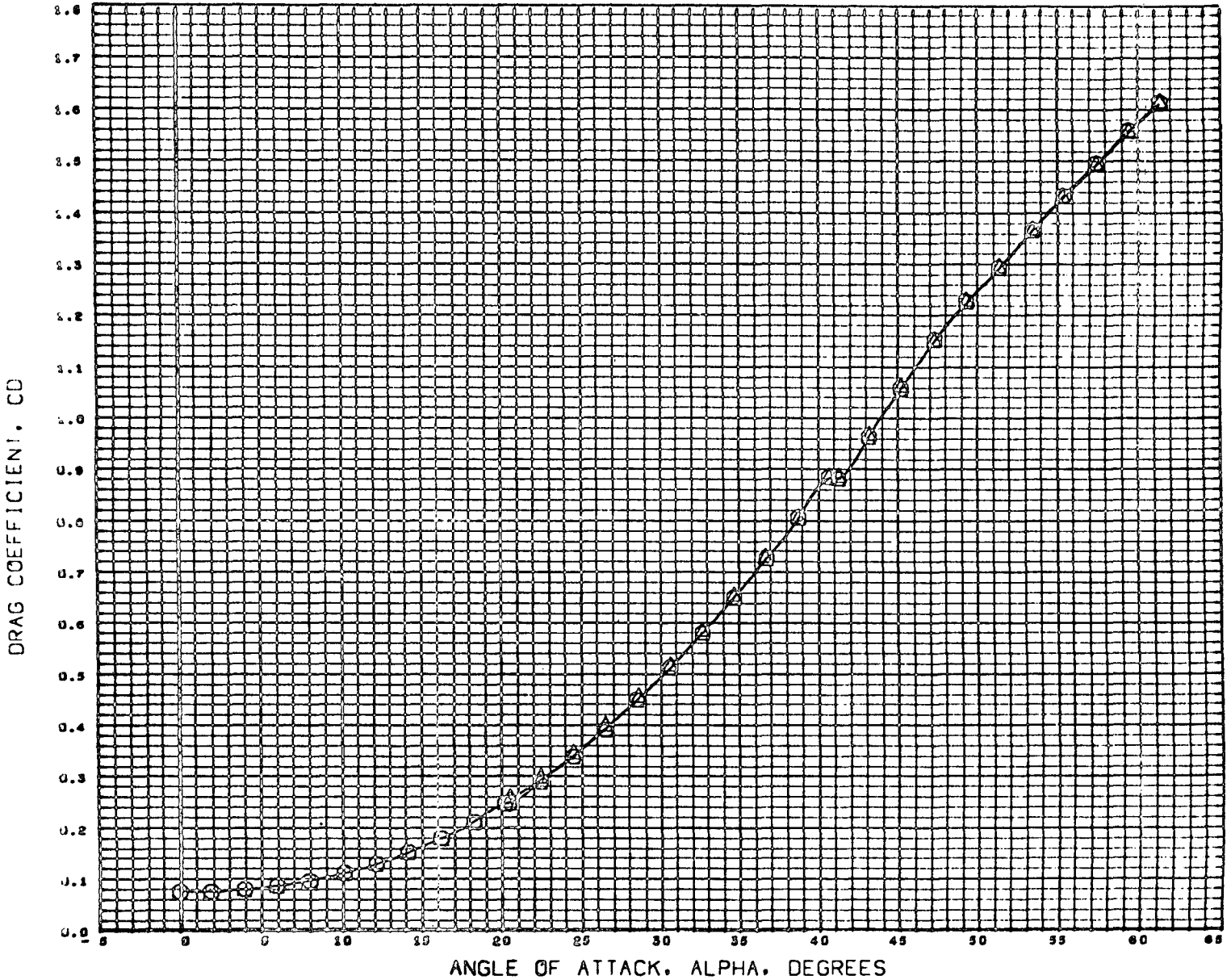
FIGURE-5 EFFECT OF NOSE SHAPE VARIATION ON B-18E-3 CONFIGURATION



DATA SET SYMBOL	CONFIGURATION DESCRIPTION
(C56010) 	MSFC TWT 514 E3 030W23C10
(C56060) 	MSFC TWT 514 E3 031W23C10

BETA	ELEVTR	CANARD
0.000	0.000	0.000
0.000	0.000	0.000

REFERENCE INFORMATION		
SREF	15.0300	SQ INC
LREF	2.8300	INCHES
BREF	6.0620	INCHES
XMRF	2.1110	INCHES
YMRF	0.0000	INCHES
ZMRF	0.0000	INCHES
SCALE	0.0035	

MACH 4.050

FIGURE-5 EFFECT OF NOSE SHAPE VARIATION ON B-18E-3 CONFIGURATION

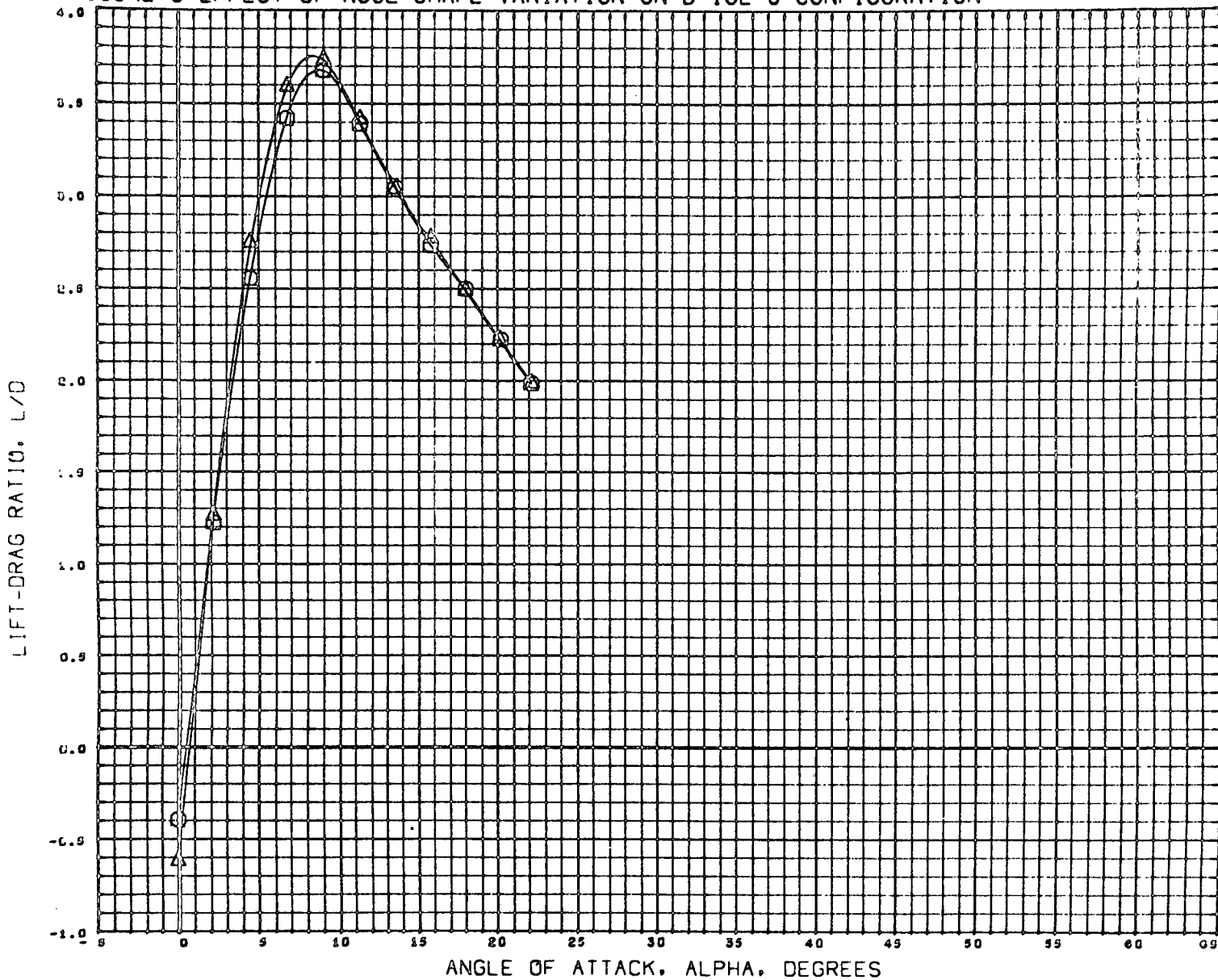

DATA SET SYMBOL	CONFIGURATION DESCRIPTION
(C50010)	MSFC TWT 514 E3 B30W23C10
(C50000)	MSFC TWT 514 E3 B31W23C10

BETA	ELEVTR	CANARD
0.000	0.000	0.000
0.000	0.000	0.000

REFERENCE INFORMATION		
SREF	15.0300	SQ INC
LREF	2.0300	INCHES
BREF	0.0620	INCHES
XMRP	2.1110	INCHES
YMRP	0.0000	INCHES
ZMRP	0.0000	INCHES
SCALE	0.0039	

MACH 0.907

FIGURE-5 EFFECT OF NOSE SHAPE VARIATION ON B-18E-3 CONFIGURATION

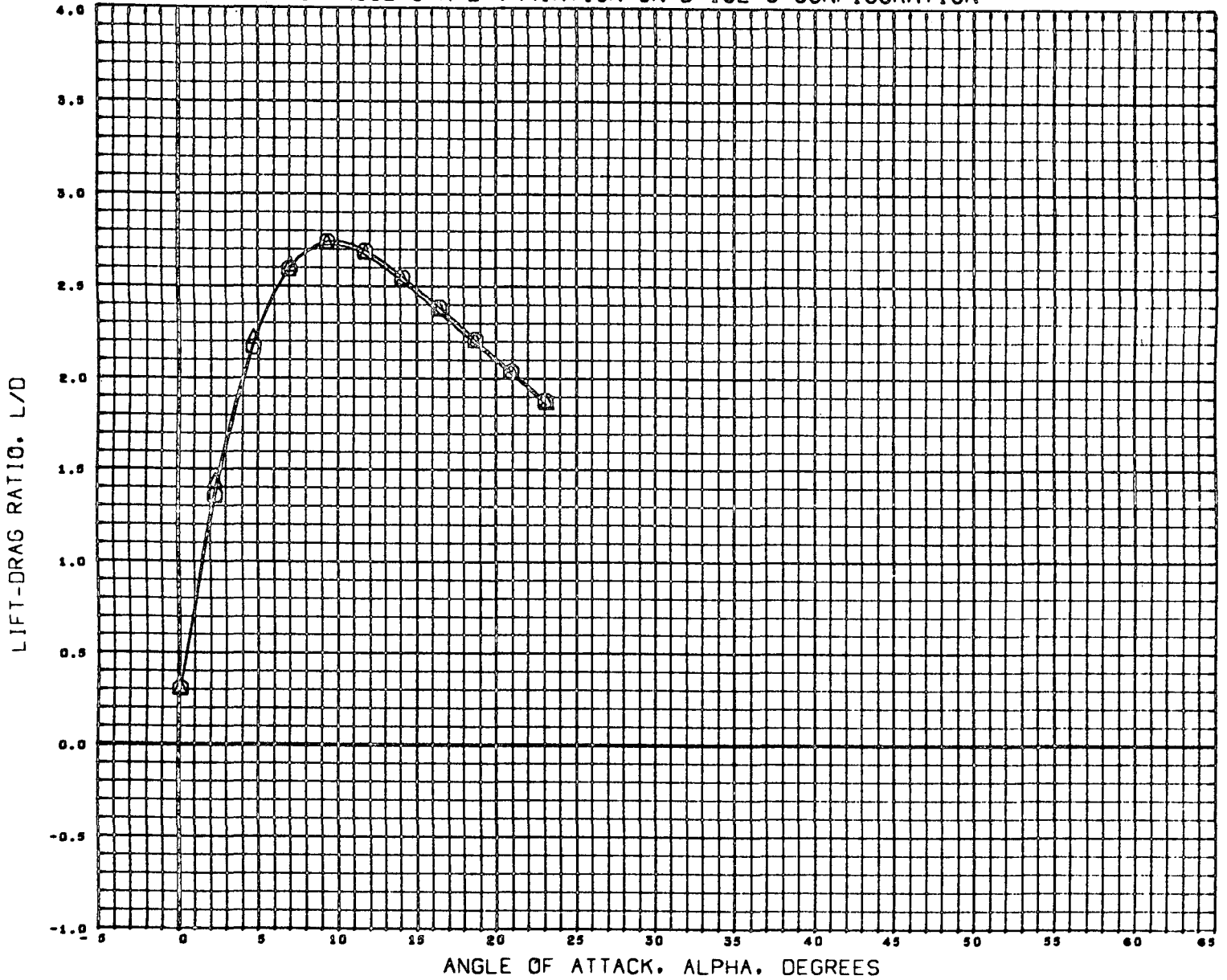

DATA SET SYMBOL	CONFIGURATION	DESCRIPTION
(C58010)	MSFC TWT 514 E3	830W23C10
(C58060)	MSFC TWT 514 E3	831W23C10

BETA	ELEVTR	CANARD
0.000	0.000	0.000
0.000	0.000	0.000

REFERENCE INFORMATION		
SREF	15.0300	90 INC
LREF	2.8300	INCHES
BREF	6.0620	INCHES
XMRP	2.1110	INCHES
YMRP	0.0000	INCHES
ZMRP	0.0000	INCHES
SCALE	0.0035	

MACH 1.208

FIGURE-5 EFFECT OF NOSE SHAPE VARIATION ON B-18E-3 CONFIGURATION

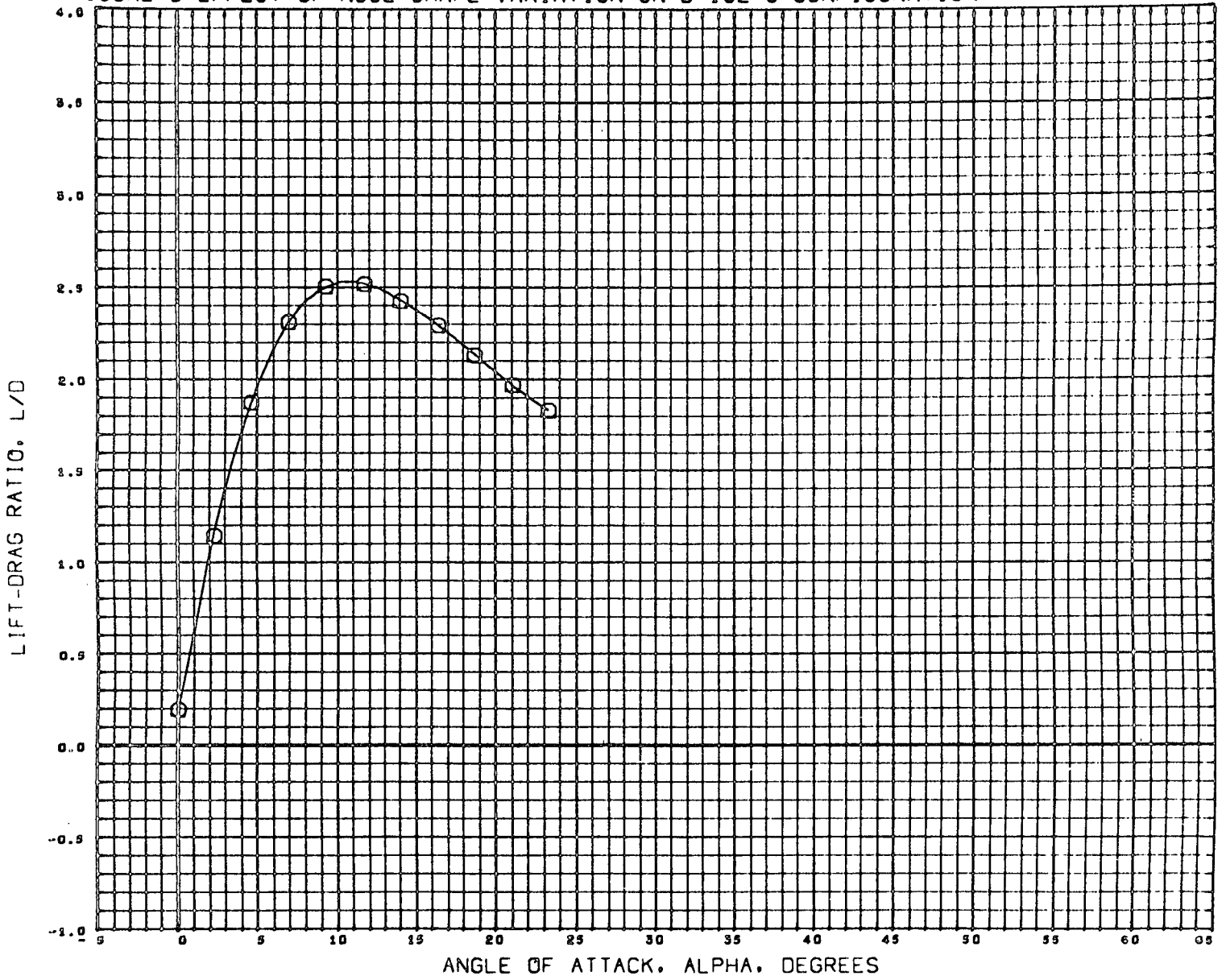

DATA SET SYMBOL CONFIGURATION DESCRIPTION
 (C56010) MSFC TWT 514 E3 B30W23C10
 (C56060) DATA NOT AVAILABLE FOR ALL CONDITIONS

BETA ELEVTR CANARD
 0.000 0.000 0.000
 0.000 0.000 0.000

REFERENCE INFORMATION
 SREF 19.0300 SQ INC
 LREF 2.8300 INCHES
 BREF 6.0020 INCHES
 XMRP 2.1110 INCHES
 YMRP 0.0000 INCHES
 ZMRP 0.0000 INCHES
 SCALE 0.0035

MACH 1.499

FIGURE-5 EFFECT OF NOSE SHAPE VARIATION ON B-18E-3 CONFIGURATION

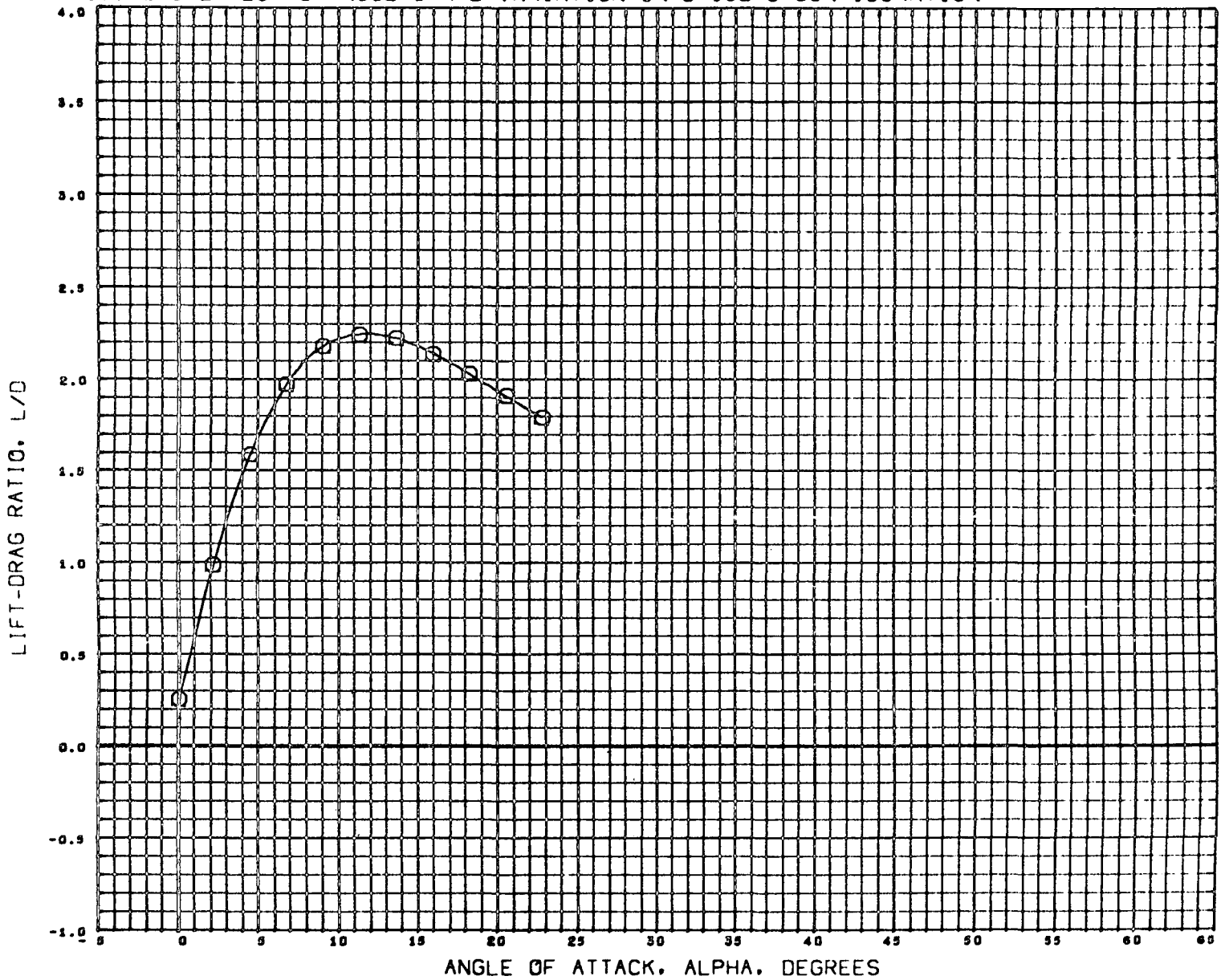

DATA SET SYMBOL	CONFIGURATION DESCRIPTION
(C58010)	MSFC TWT 514 E3 B30W23C10
(C58060)	DATA NOT AVAILABLE FOR ALL CONDITIONS

BETA	ELEVTR	CANARD
0.000	0.000	0.000
0.000	0.000	0.000

REFERENCE INFORMATION		
SREF	15.0300	SQ INC
LREF	2.6300	INCHES
BREF	6.0620	INCHES
XMRP	2.1110	INCHES
YMRP	0.0000	INCHES
ZMRP	0.0000	INCHES
SCALE	0.0035	

MACH 1.960

FIGURE-5 EFFECT OF NOSE SHAPE VARIATION ON B-18E-3 CONFIGURATION

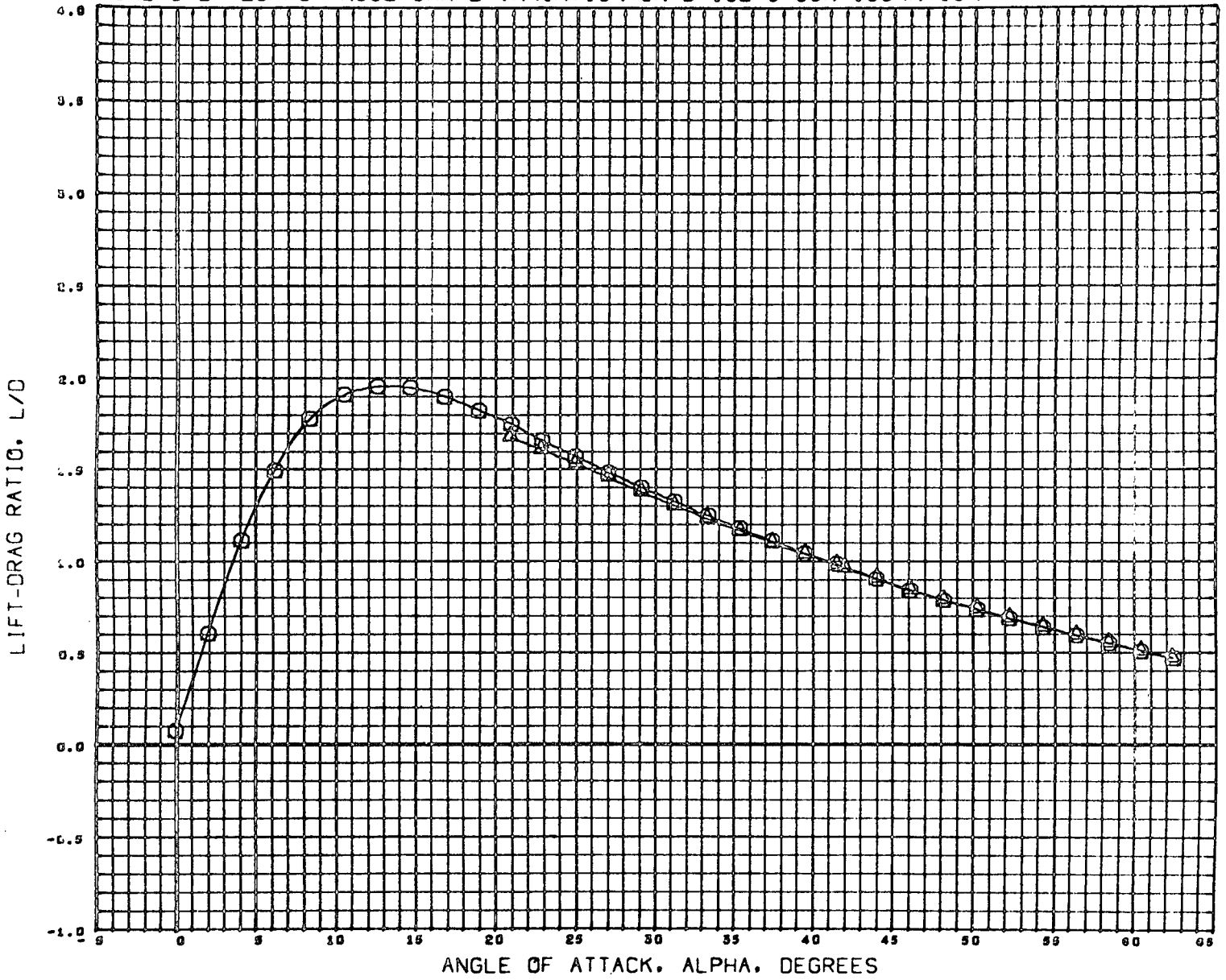

DATA SET SYMBOL	CONFIGURATION DESCRIPTION
(C90010) ○	MSFC TWT 514 E3 830W23C10
(C90030) △	MSFC TWT 514 E3 831W23C10

BETA	ELEVTR	CANARD
0.000	0.000	0.000
0.000	0.000	0.000

REFERENCE INFORMATION		
SREF	15.0300	50 INC
LREF	2.8300	INCHES
BREF	0.0620	INCHES
XMRP	2.1110	INCHES
YMRP	0.0000	INCHES
ZMRP	0.0000	INCHES
SCALE	0.0035	

MACH 2.900

FIGURE-5 EFFECT OF NOSE SHAPE VARIATION ON B-18E-3 CONFIGURATION

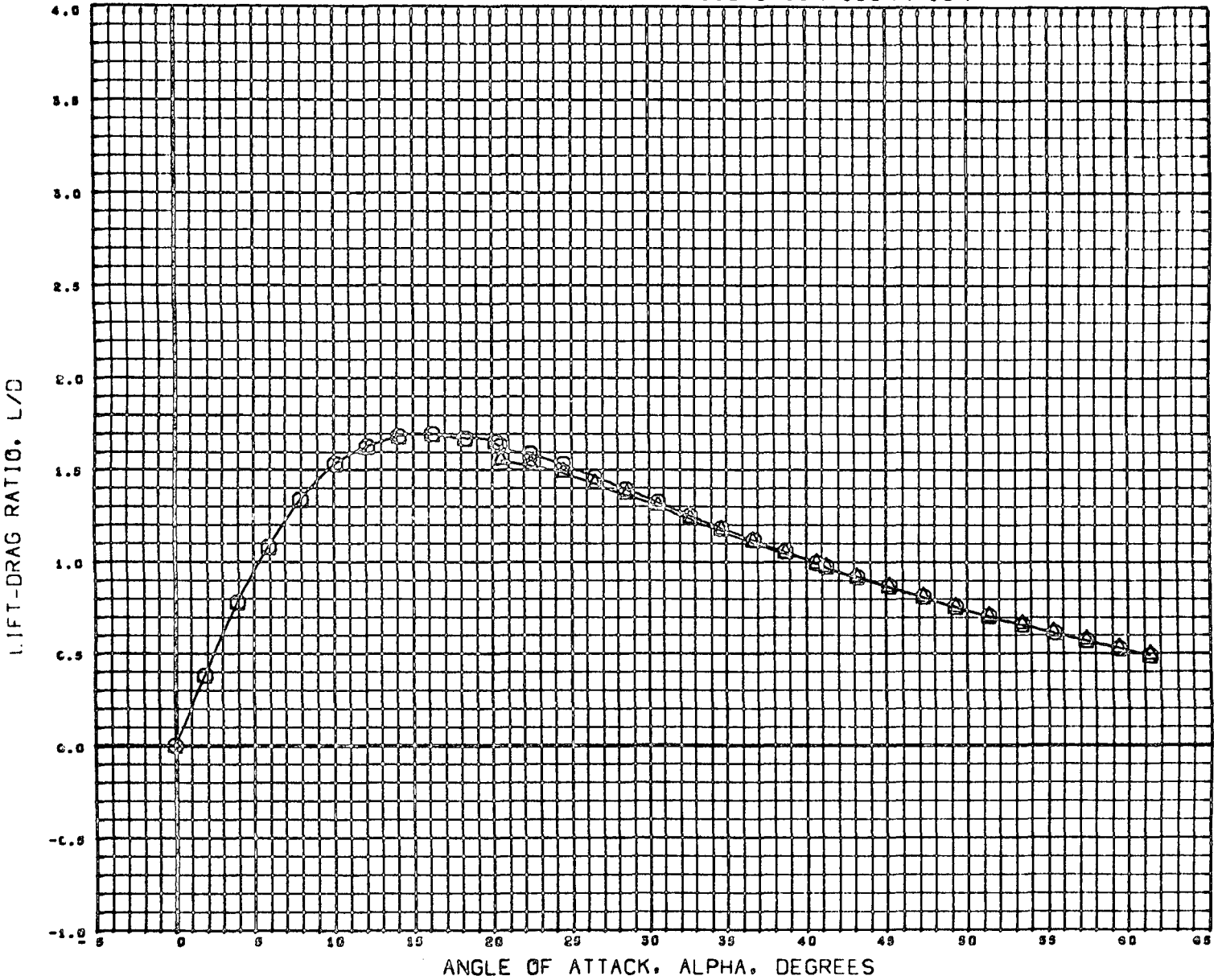

DATA SET SYMBOL	CONFIGURATION DESCRIPTION
(CS6010)	MSFC TWT 514 ES 030W23C10
(CS6000)	MSFC TWT 514 ES 031W23C10

BETA	ELEVTR	CANARD
0.000	0.000	0.000
0.000	0.000	0.000

REFERENCE INFORMATION		
SREF	19.0300	90 INC
LREF	2.8300	INCHES
BREF	0.0620	INCHES
XMRP	2.1110	INCHES
YMRP	0.0000	INCHES
ZMRP	0.0000	INCHES
SCALE	0.0035	

MACH 4.959

FIGURE-5 EFFECT OF NOSE SHAPE VARIATION ON B-18E-3 CONFIGURATION

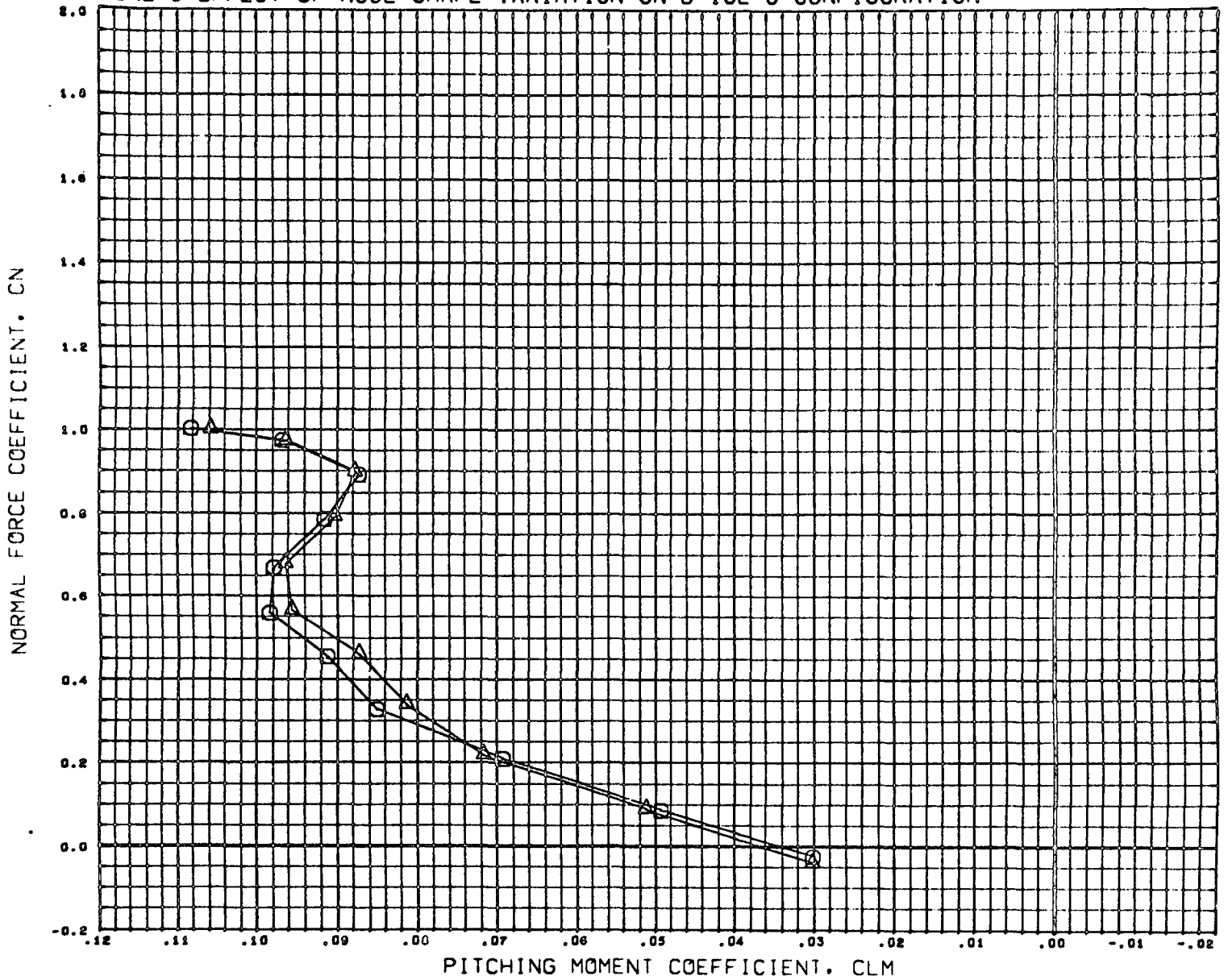

DATA SET SYMBOL	CONFIGURATION DESCRIPTION
(C58010)	MSFC TWT 514 E3 830W23C10
(C58060)	MSFC TWT 514 E3 831W23C10

BETA	ELEVTR	CANARD
0.000	0.000	0.000
0.000	0.000	0.000

REFERENCE INFORMATION		
SREF	15.0500	84 INC
LREF	2.8300	INCHES
BREF	0.0020	INCHES
XMRP	2.1110	INCHES
YMRP	0.0000	INCHES
ZMRP	0.0000	INCHES
SCALE	0.0035	

MACH 0.907

FIGURE-5 EFFECT OF NOSE SHAPE VARIATION ON B-18E-3 CONFIGURATION

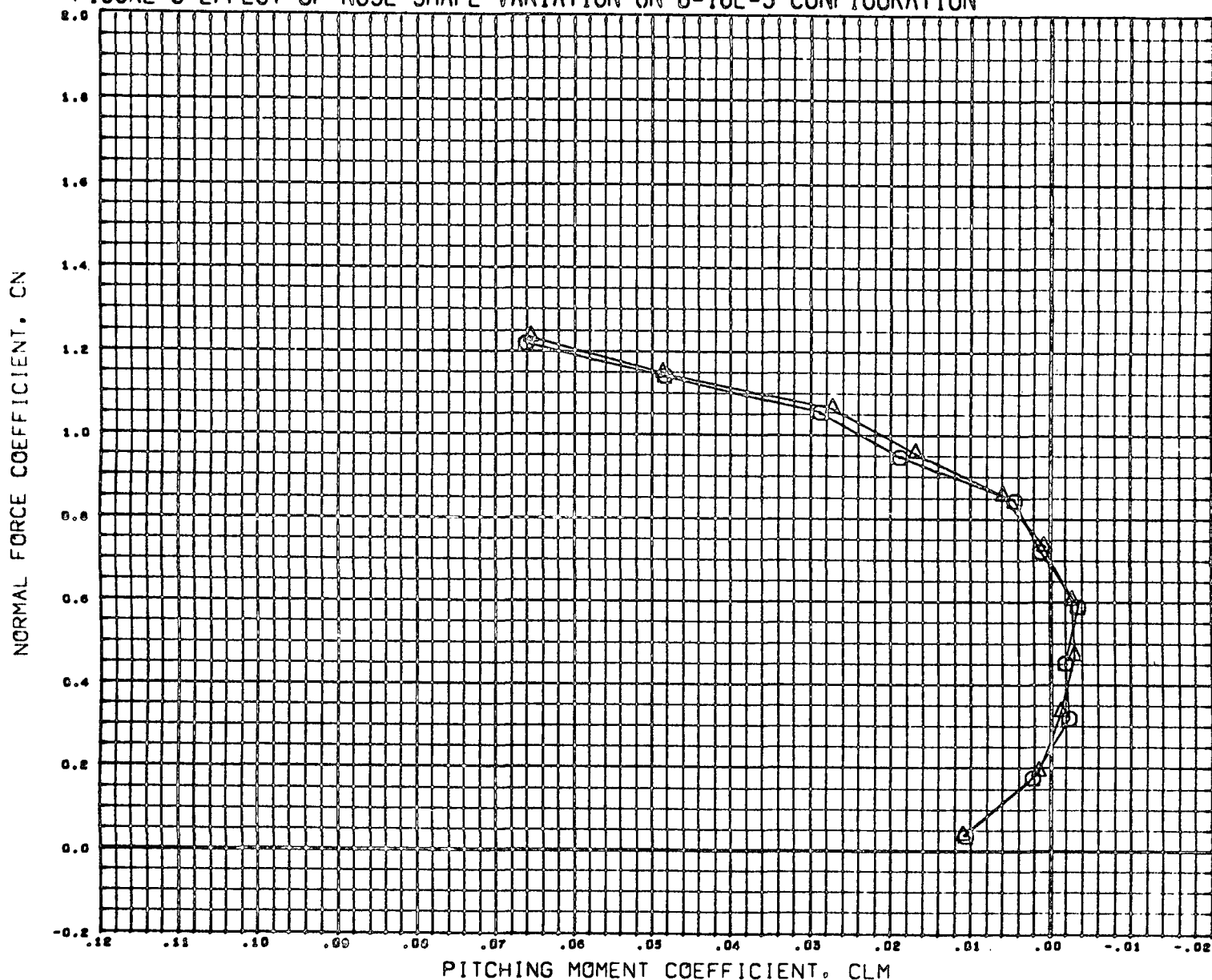

DATA SET SYMBOL	CONFIGURATION DESCRIPTION
(C56010)	MSFC TWT 914 E3 030W23C10
(C56060)	MSFC TWT 914 E3 031W23C10

BETA	ELEVTR	CANARD
0.000	0.000	0.000
0.000	0.000	0.000

REFERENCE INFORMATION		
SREF	19.0300	80 INC
LREF	2.8300	INCHES
BREF	6.0620	INCHES
XMRP	2.1110	INCHES
YMRP	0.0000	INCHES
ZMRP	0.0000	INCHES
SCALE	0.0039	

MACH 1.208

FIGURE-5 EFFECT OF NOSE SHAPE VARIATION ON B-18E-3 CONFIGURATION

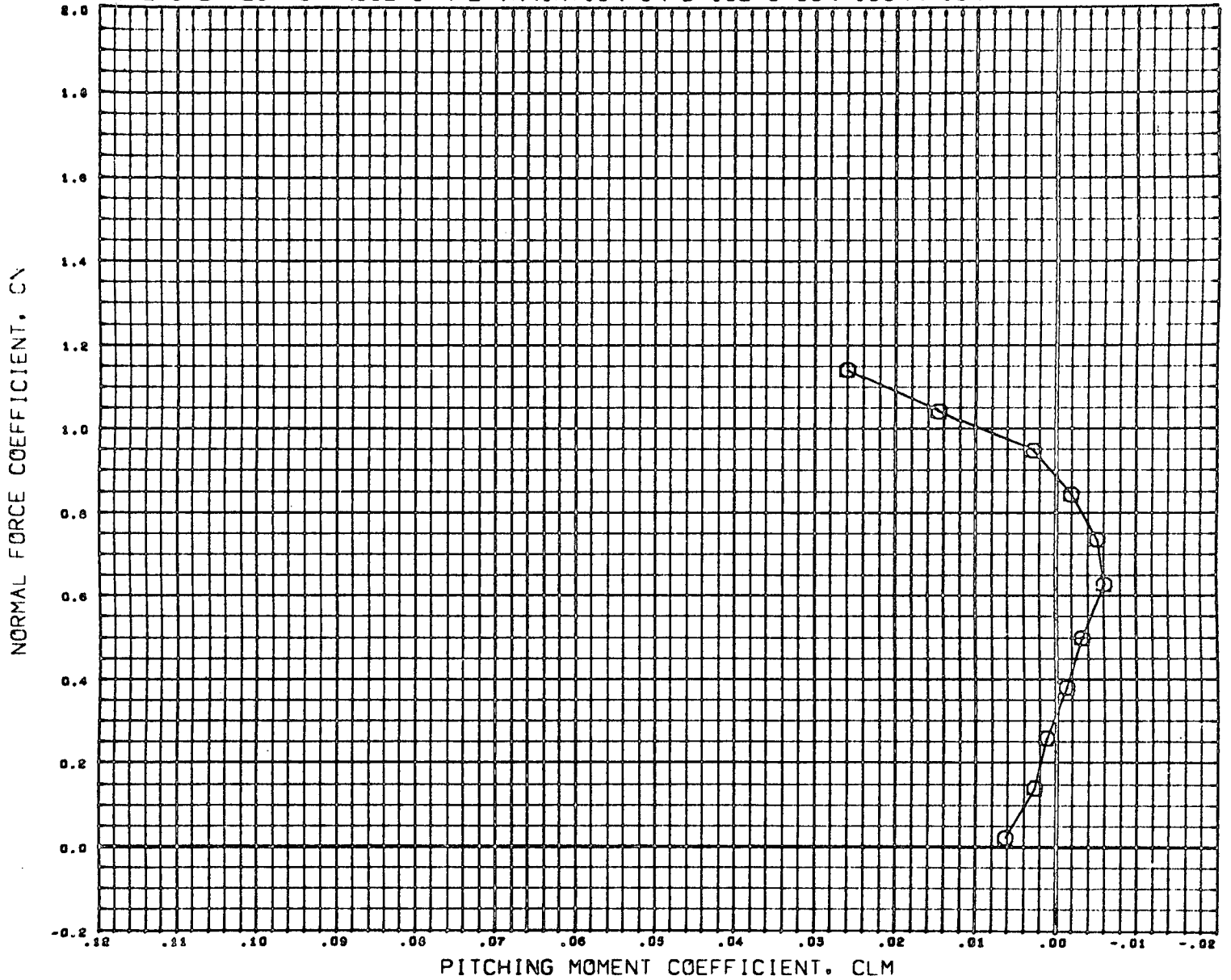

DATA SET SYMBOL CONFIGURATION DESCRIPTION
 (C58010) ○ MSFC TWT 514 E3 B30W23C10
 (C58060) △ DATA NOT AVAILABLE FOR ALL CONDITIONS

BETA ELEVTR CANARD
 0.000 0.000 0.000
 0.000 0.000 0.000

REFERENCE INFORMATION
 SREF 15.0300 50 INC
 LREF 2.8300 INCHES
 BREF 0.0020 INCHES
 XMRP 2.1110 INCHES
 YMRP 0.0000 INCHES
 ZMRP 0.0000 INCHES
 SCALE 0.0035

MACH 1.459

FIGURE-5 EFFECT OF NOSE SHAPE VARIATION ON B-18E-3 CONFIGURATION

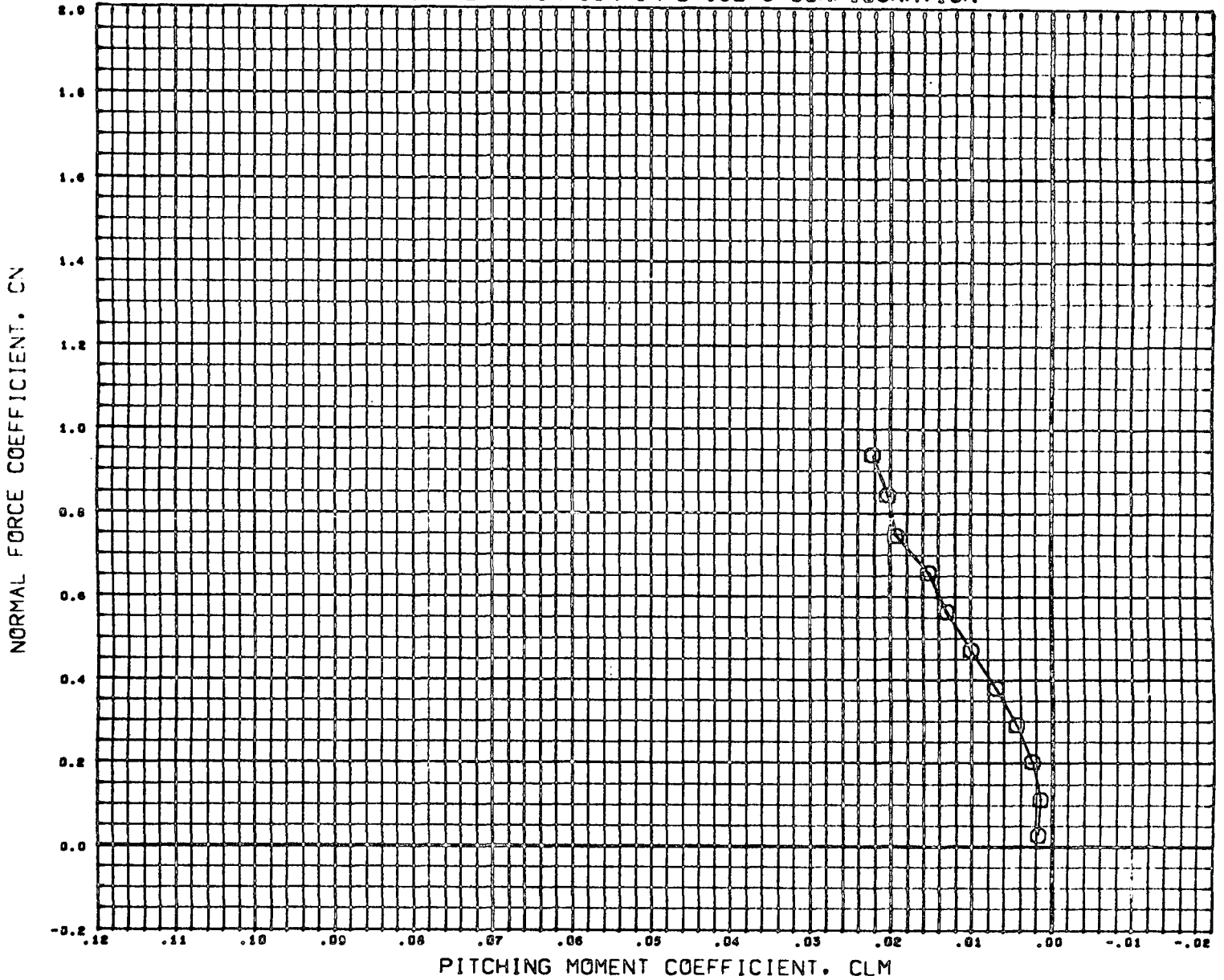

DATA SET SYMBOL CONFIGURATION DESCRIPTION
 (C58610) Ⓚ MSFC TWT 914 E3 030W23C10
 (C58660) Ⓛ DATA NOT AVAILABLE FOR ALL CONDITIONS

BETA ELEVTR CANARD
 0.000 0.000 0.000
 0.000 0.000 0.000

REFERENCE INFORMATION
 SREF 15.0300 80 INC
 LREF 2.8300 INCHES
 DREF 0.0620 INCHES
 XWRP 2.1110 INCHES
 YWRP 0.0000 INCHES
 ZWRP 0.0000 INCHES
 SCALE 0.0035

MACH 1.960

FIGURE-5 EFFECT OF NOSE SHAPE VARIATION ON B-18E-3 CONFIGURATION

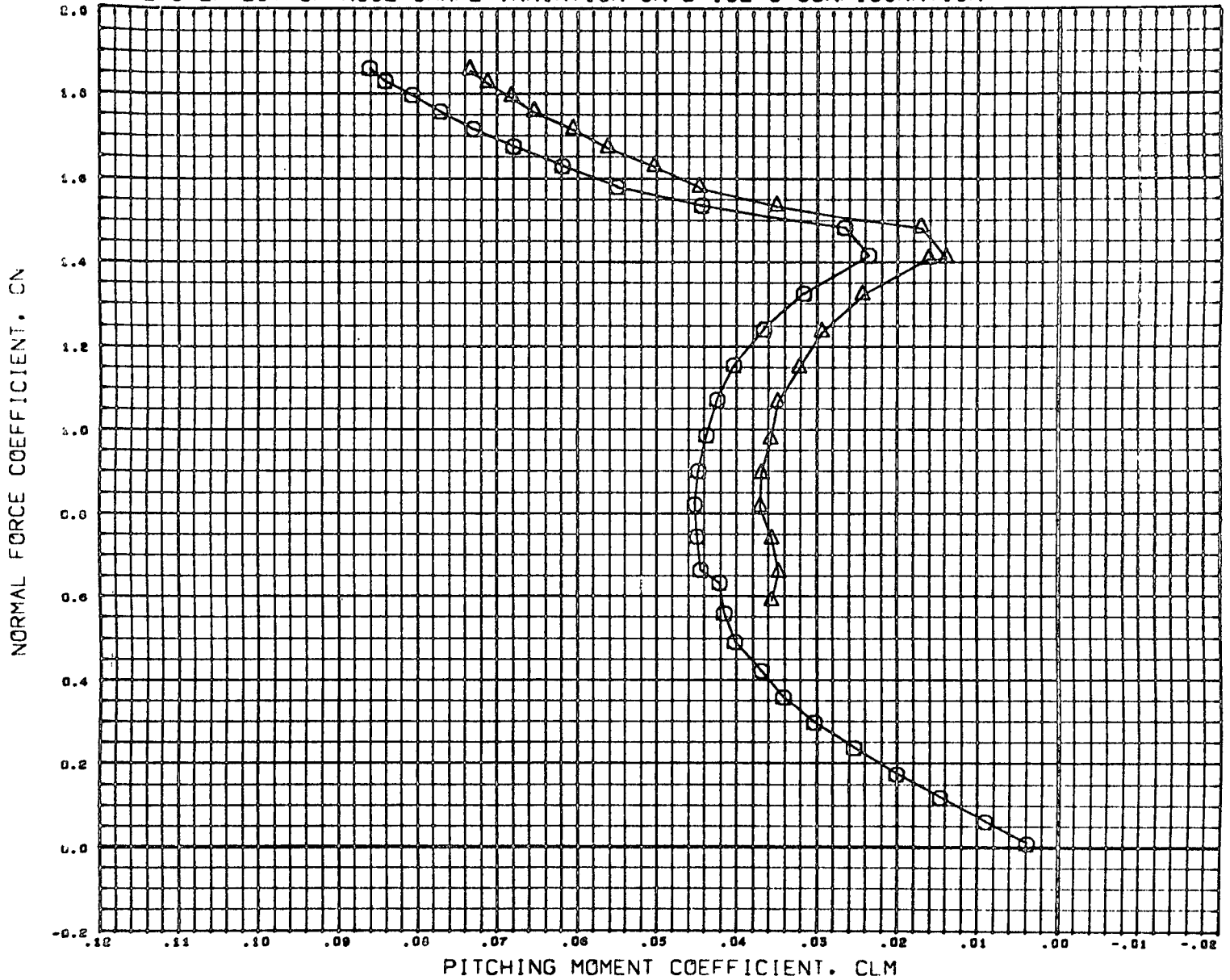

DATA SET SYMBOL	CONFIGURATION DESCRIPTION
(C98010)	MSFC TWT 514 E3 B30W23C10
(C98050)	MSFC TWT 514 E3 B31W23C10

BETA	ELEVTR	CANARD
0.000	0.000	0.000
0.000	0.000	0.000

REFERENCE INFORMATION		
SREF	15.0300	50 INC
LREF	2.0300	INCHES
BREF	6.0620	INCHES
XMRP	2.1110	INCHES
YMRP	0.0000	INCHES
ZMRP	0.0000	INCHES
SCALE	0.0055	

MACH 2.090

FIGURE-5 EFFECT OF NOSE SHAPE VARIATION ON B-18E-3 CONFIGURATION

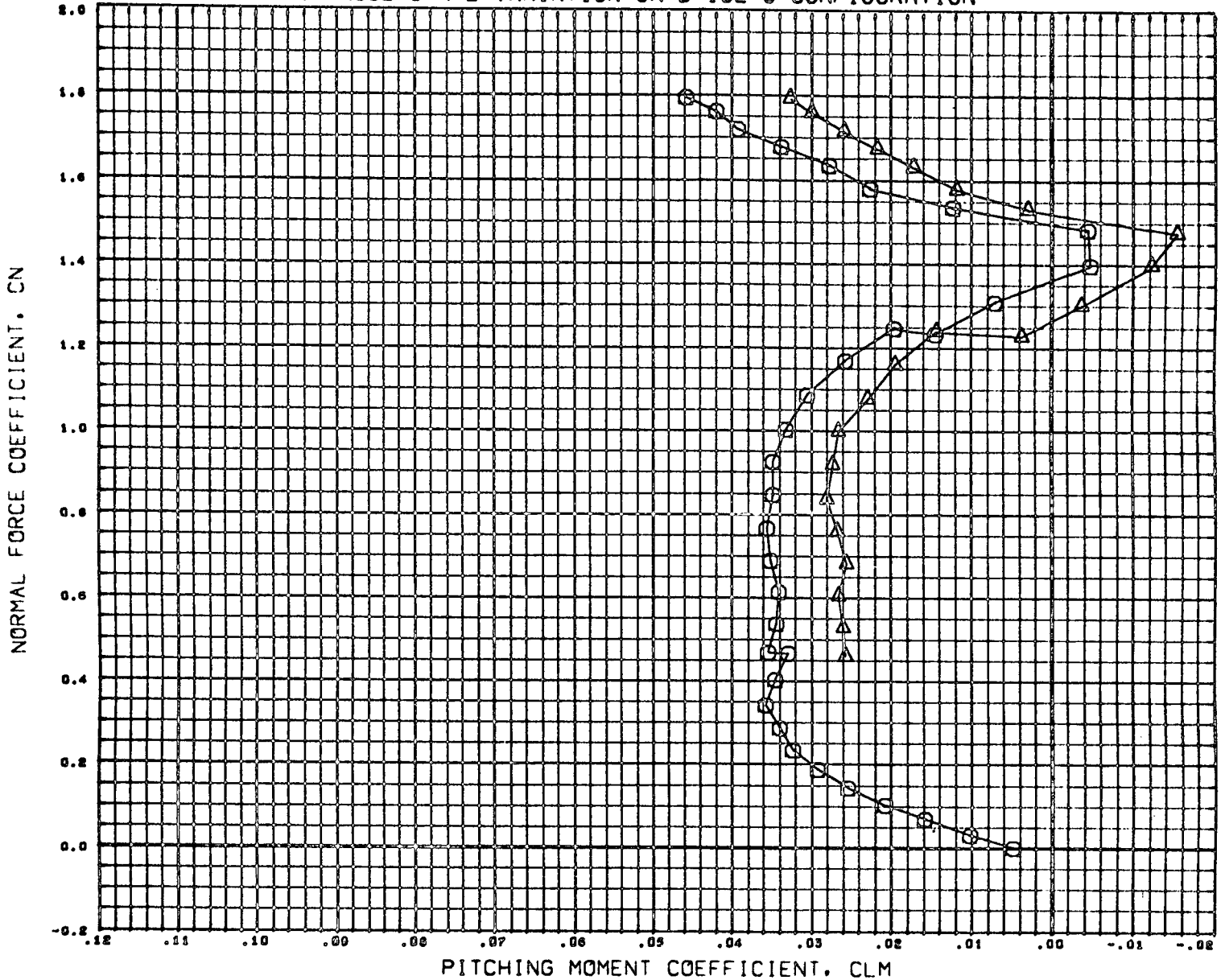

DATA SET SYMBOL	CONFIGURATION DESCRIPTION
(C98010)	MSFC TWT 914 E3 090W23C10
(C98060)	MSFC TWT 914 E3 091W23C10

BETA	ELEVTR	CANARD
0.000	0.000	0.000
0.000	0.000	0.000

REFERENCE INFORMATION		
SREF	19.0300	89 INC
LREF	2.8300	INCHES
BREF	6.0620	INCHES
XMRP	2.1110	INCHES
YMRP	0.0000	INCHES
ZMRP	0.0000	INCHES
SCALE	0.0039	

MACH 4.090

FIGURE-5 EFFECT OF NOSE SHAPE VARIATION ON B-18E-3 CONFIGURATION

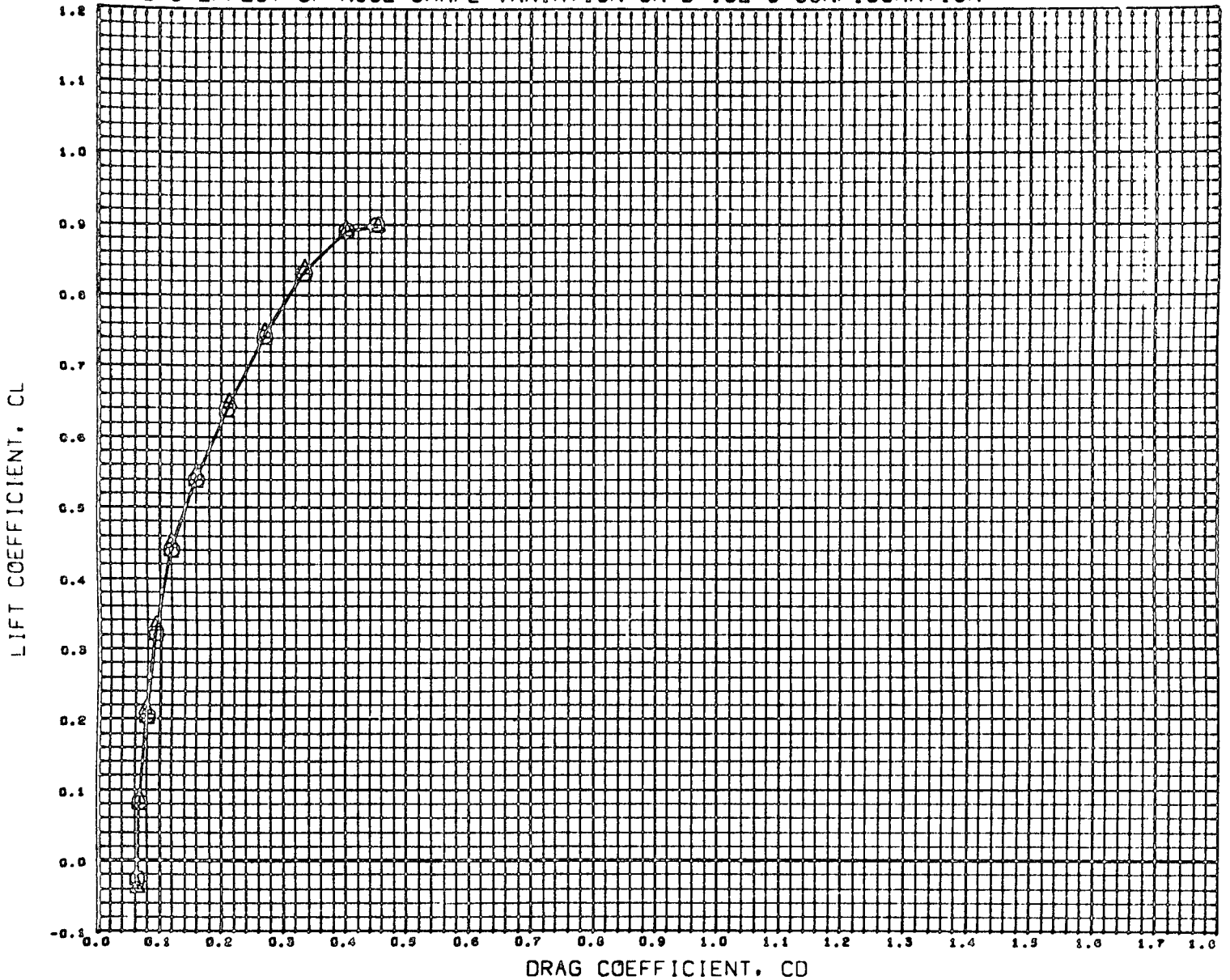

DATA SET SYMBOL	CONFIGURATION	DESCRIPTION
(C58010)	MSFC TWT 314 E3	830W23C10
(C58060)	MSFC TWT 314 E3	831W23C10

BETA	ELEVTR	CANARD
0.000	0.000	0.000
0.000	0.000	0.000

REFERENCE INFORMATION		
SREF	15.0300	50 INC
LREF	2.0300	INCHES
BREF	6.0620	INCHES
XMRP	2.1110	INCHES
YMRP	0.0000	INCHES
ZMRP	0.0000	INCHES
SCALE	0.0035	

MACH 0.907

FIGURE-5 EFFECT OF NOSE SHAPE VARIATION ON B-18E-3 CONFIGURATION

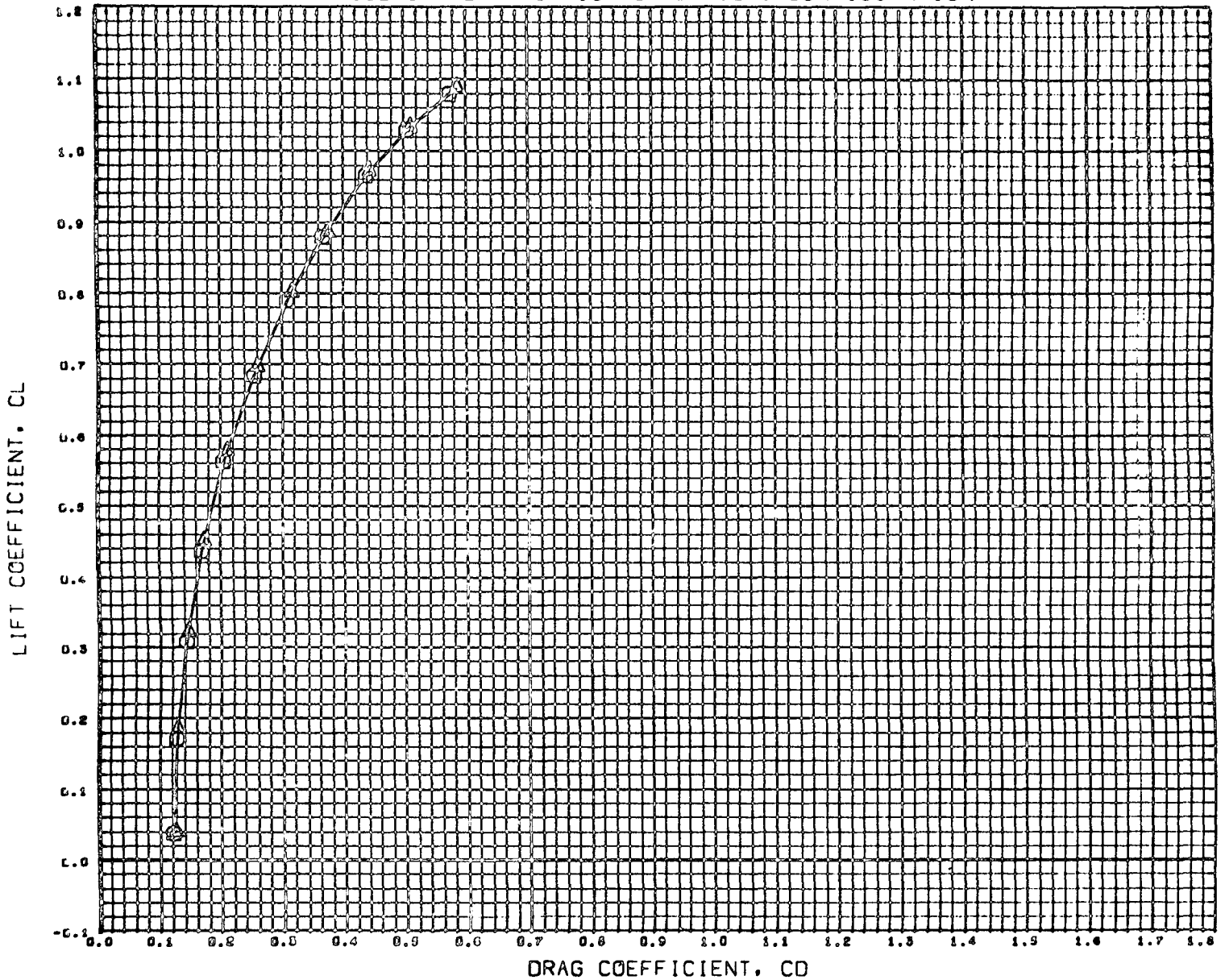

DATA SET SYMBOL	CONFIGURATION DESCRIPTION
(C98010)	MSFC TWT 914 E3 030H29C10
(C98000)	MSFC TWT 914 E3 031H29C10

BETA	ELEVTR	CANARD
0.000	0.000	0.000
0.000	0.000	0.000

REFERENCE INFORMATION		
SREF	15.0300	50 INC
LREF	2.0300	INCHES
BREF	6.0620	INCHES
XMRP	2.1110	INCHES
YMRP	0.0000	INCHES
ZMRP	0.0000	INCHES
SCALE	0.0035	

MACH 1.201

FIGURE-5 EFFECT OF NOSE SHAPE VARIATION ON B-18E-3 CONFIGURATION

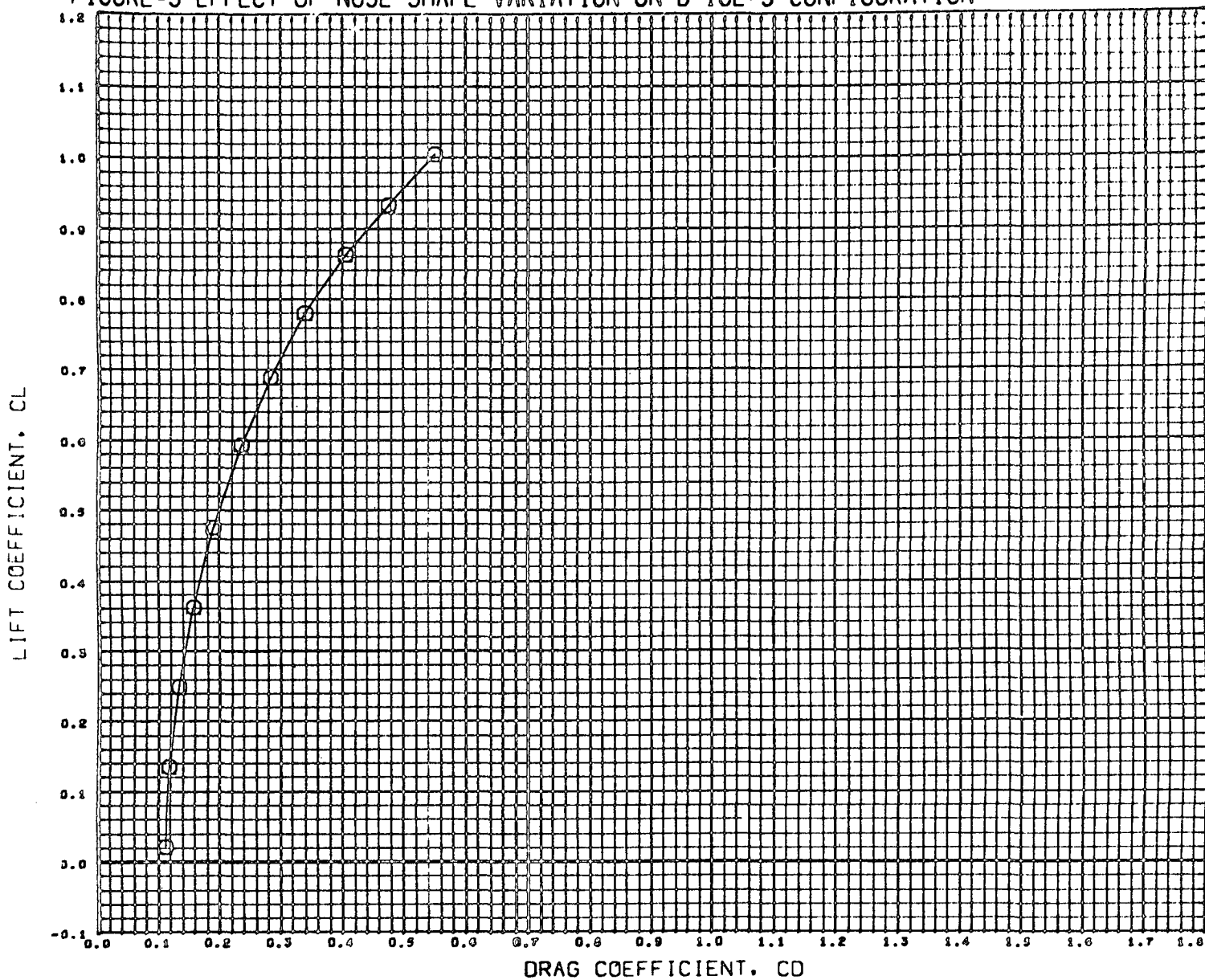

DATA SET SYMBOL CONFIGURATION DESCRIPTION
 (C98610) MSFC TWT 914 25 B30W23C10
 (C98600) DATA NOT AVAILABLE FOR ALL CONDITIONS

BETA ELEVTR CANARD
 0.000 0.000 0.000
 0.000 0.000 0.000

REFERENCE INFORMATION
 SREF 15.0500 94 INC
 LREF 2.6500 INCHES
 DREF 0.0020 INCHES
 XMRP 2.1110 INCHES
 YMRP 0.0000 INCHES
 ZMRP 0.0000 INCHES
 SCALE 0.0035

MACH 1.459

FIGURE-5 EFFECT OF NOSE SHAPE VARIATION ON B-18E-3 CONFIGURATION

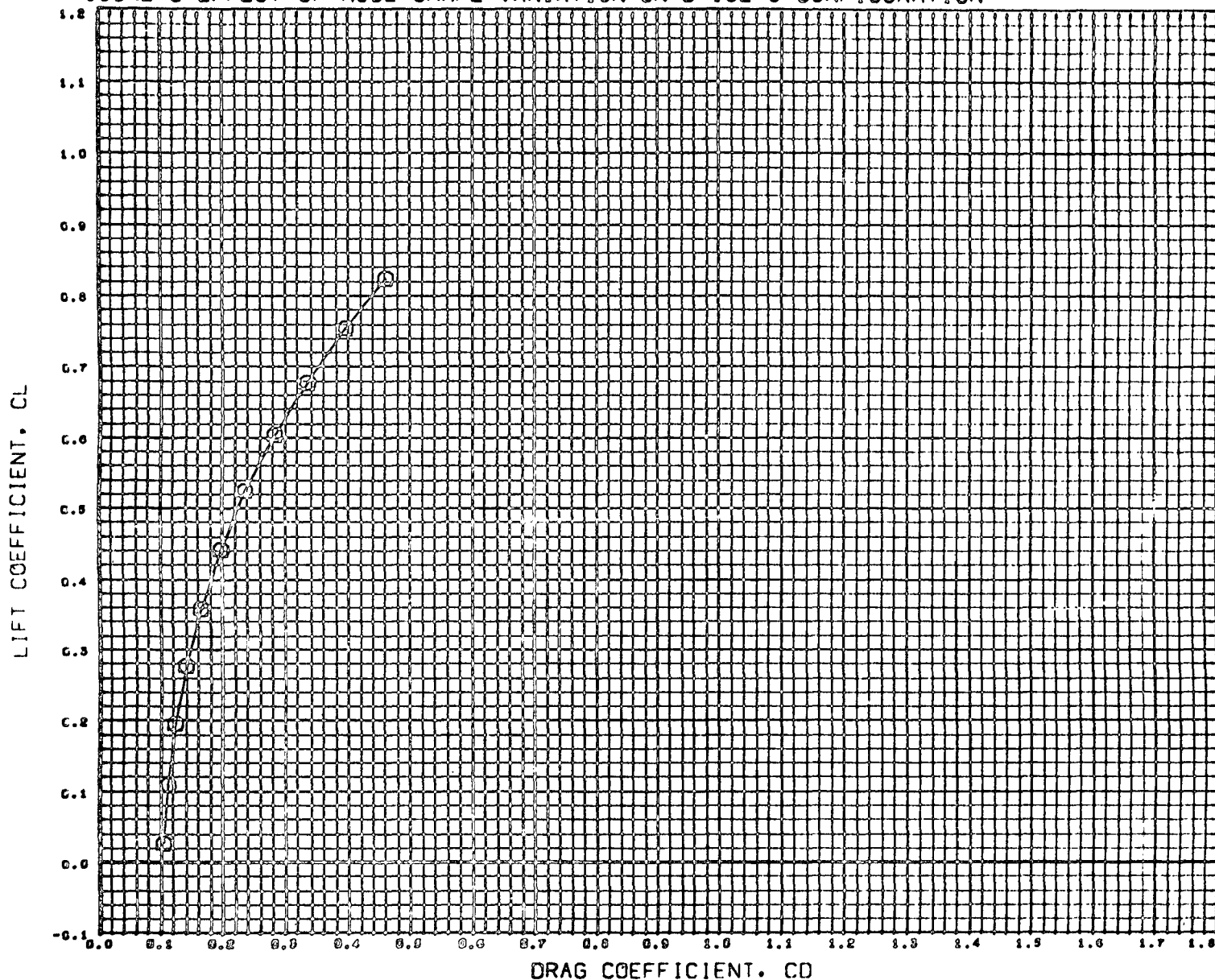

DATA SET SYMBOL CONFIGURATION DESCRIPTION
 (C580.0) Ⓚ NOFC TWT 514 CS 030W23C10
 (C58000) Ⓚ DATA NOT AVAILABLE FOR ALL CONDITIONS

BETA ELEVTR CANARD
 0.000 0.000 0.000
 0.000 0.000 0.000

REFERENCE INFORMATION
 SREF 15.0300 SQ INC
 LREF 2.8300 INCHES
 OREF 6.0620 INCHES
 XHRP 2.1110 INCHES
 YHRP 0.0000 INCHES
 ZHRP 0.0000 INCHES
 SCALE 0.0035

MACH 0.960

FIGURE-5 EFFECT OF NOSE SHAPE VARIATION ON B-18E-3 CONFIGURATION

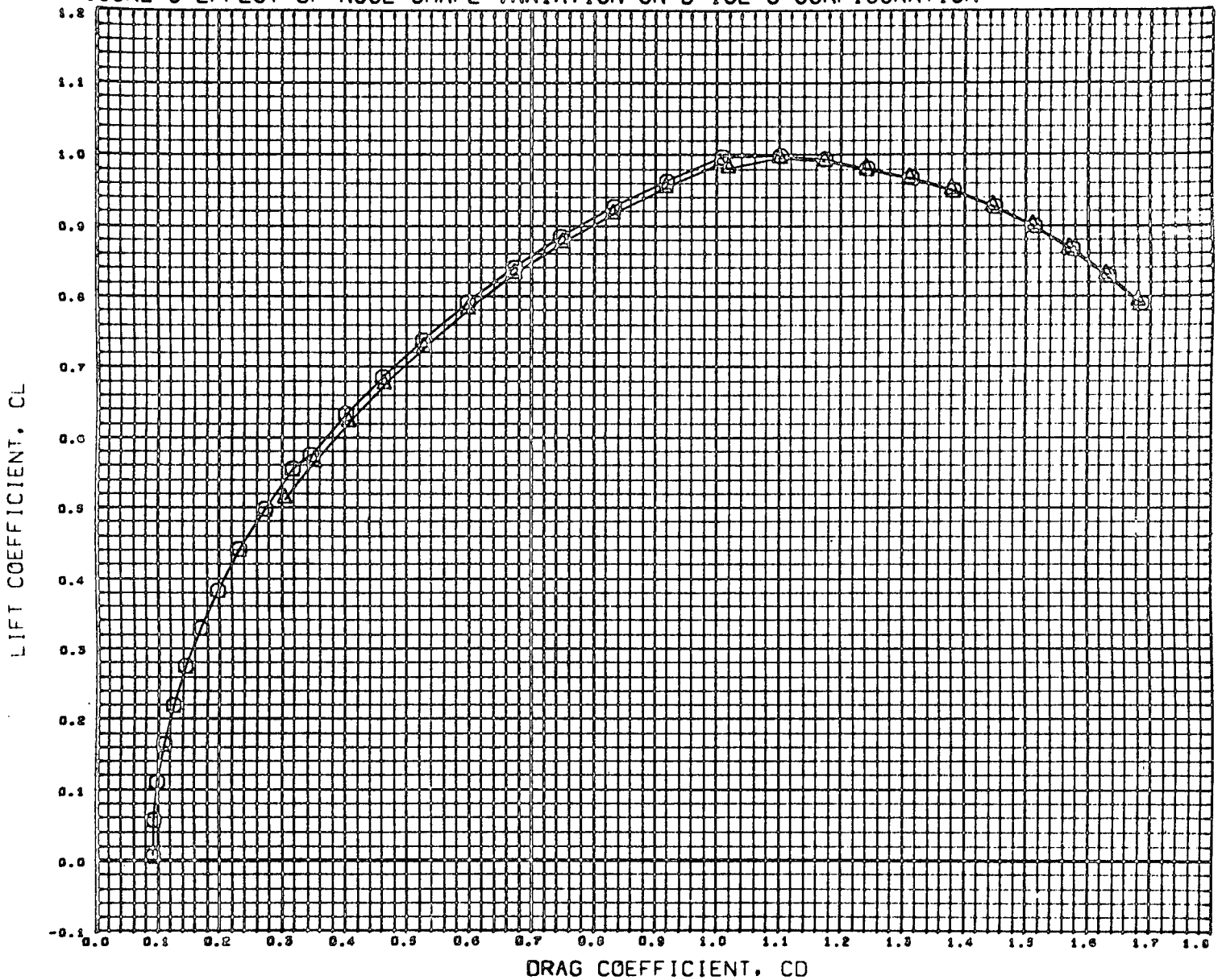

DATA SET SYMBOL	CONFIGURATION DESCRIPTION
(C58010)	M87C TWT 914 E3 B30W23C10
(C58060)	M87C TWT 914 E3 B31W23C10

BETA	ELEVTR	CANARD
0.000	0.000	0.000
0.000	0.000	0.000

REFERENCE INFORMATION		
SREF	15.0300	30 INC
LREF	2.0300	INCHES
OREF	0.0620	INCHES
XMRP	2.1110	INCHES
YMRP	0.0000	INCHES
ZMRP	0.0000	INCHES
SCALE	0.0035	

MACH 2.990

FIGURE-5 EFFECT OF NOSE SHAPE VARIATION ON B-18E-3 CONFIGURATION

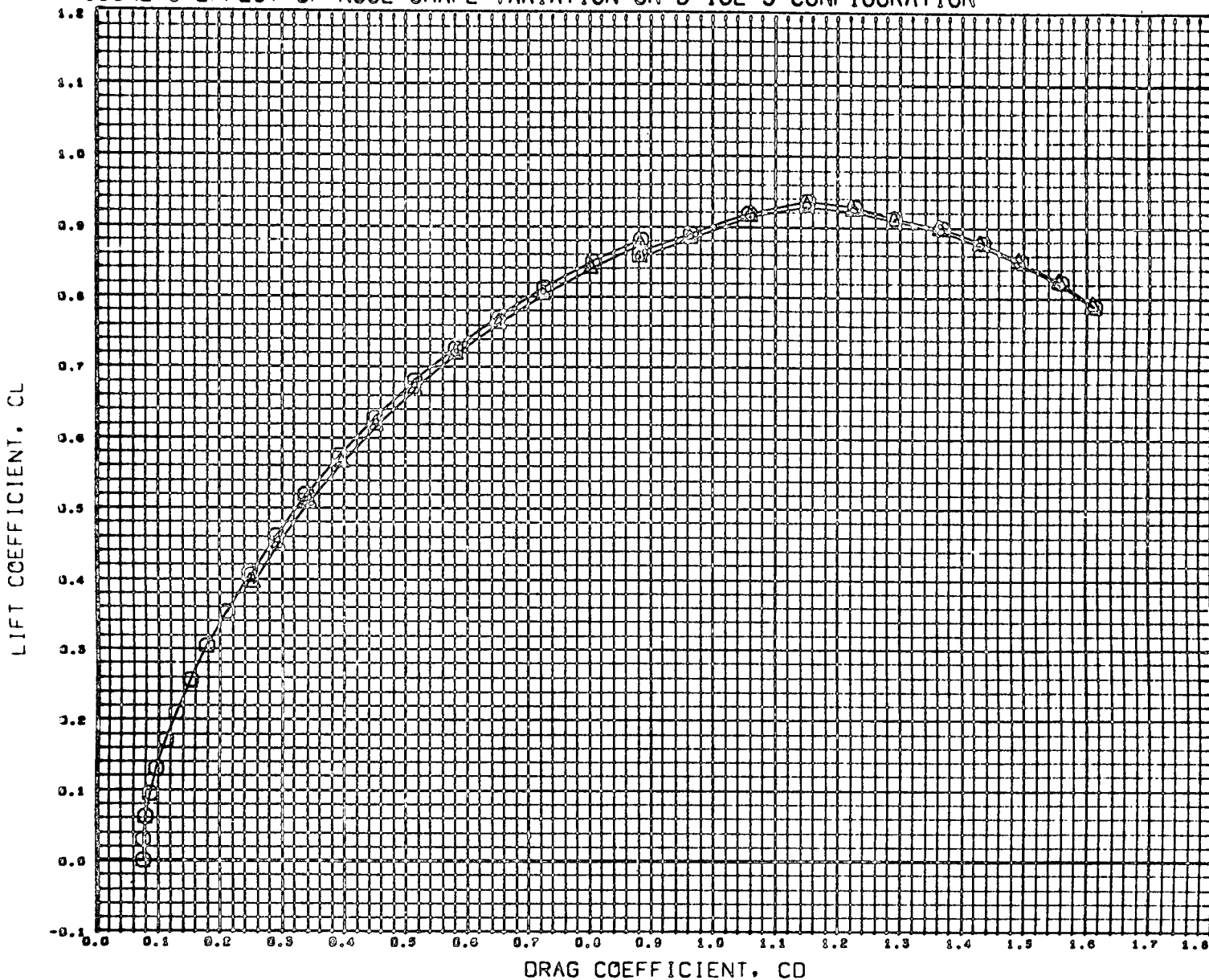

DATA SET SYMBOL	CONFIGURATION	DESCRIPTION
(C38010)	MSFC TWT S14 E3	D30W23C10
(C38060)	MSFC TWT S14 E3	D31W23C10

BETA	ELEVTR	CANARD
0.000	0.000	0.000
0.000	0.000	0.000

REFERENCE INFORMATION		
SREF	15.0300	80 INC
LREF	2.8300	INCHES
OREF	6.0620	INCHES
XMRP	2.1110	INCHES
YMRP	0.0000	INCHES
ZMRP	0.0000	INCHES
SCALE	0.0035	

MACH 0.999

FIGURE-5 EFFECT OF NOSE SHAPE VARIATION ON B-18E-3 CONFIGURATION

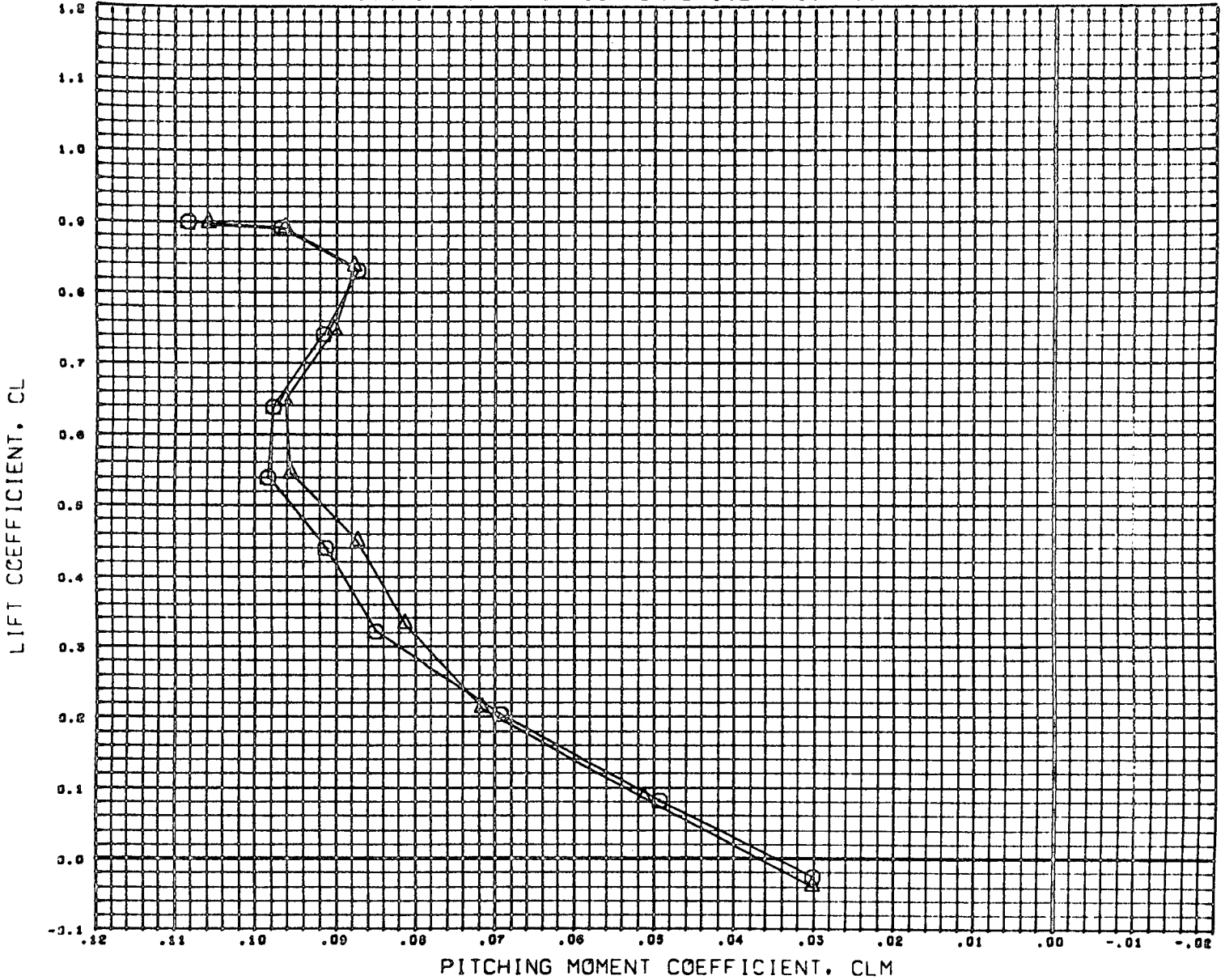

DATA SET SYMBOL	CONFIGURATION DESCRIPTION
(C586G10)	MSFC TWT 514 E3 830W23C10
(C586G60)	MSFC TWT 514 E3 831W23C10

BETA	ELEVTR	CANARD
0.000	0.000	0.000
0.000	0.000	0.000

REFERENCE INFORMATION		
SREF	15.0300	80 INC
LREF	2.0300	INCHES
BREF	6.0620	INCHES
XMRP	2.1110	INCHES
YMRP	0.0000	INCHES
ZMRP	0.0000	INCHES
SCALE	0.0033	

MACH 0.007

FIGURE-5 EFFECT OF NOSE SHAPE VARIATION ON B-18E-3 CONFIGURATION

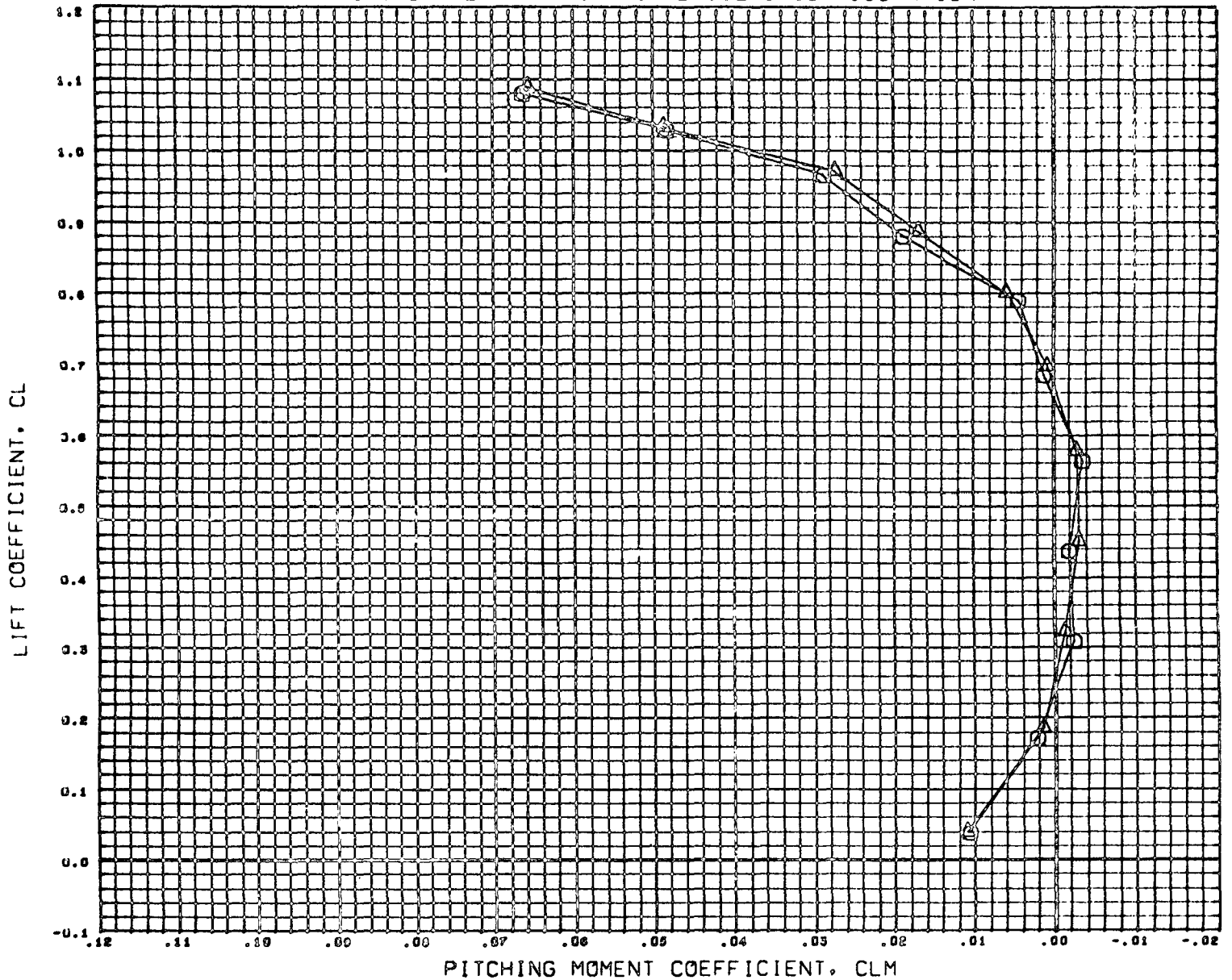

DATA SET SYMBOL	CONFIGURATION DESCRIPTION
(C58010)	NSFC TWT 914 E3 03GW23C10
(C58000)	NSFC TWT 914 E3 031W23C10

BETA	ELEVTR	CANARD
0.000	0.000	0.000
0.000	0.000	0.000

REFERENCE INFORMATION		
SREF	15.0300	99 INC
LREF	2.8300	INCHE8
BREF	6.0620	INCHE8
XHRP	2.1110	INCHE8
YHRP	0.0000	INCHE8
ZHRP	0.0000	INCHE8
SCALE	0.0039	

MACH 1.201

FIGURE-5 EFFECT OF NOSE SHAPE VARIATION ON B-18E-3 CONFIGURATION

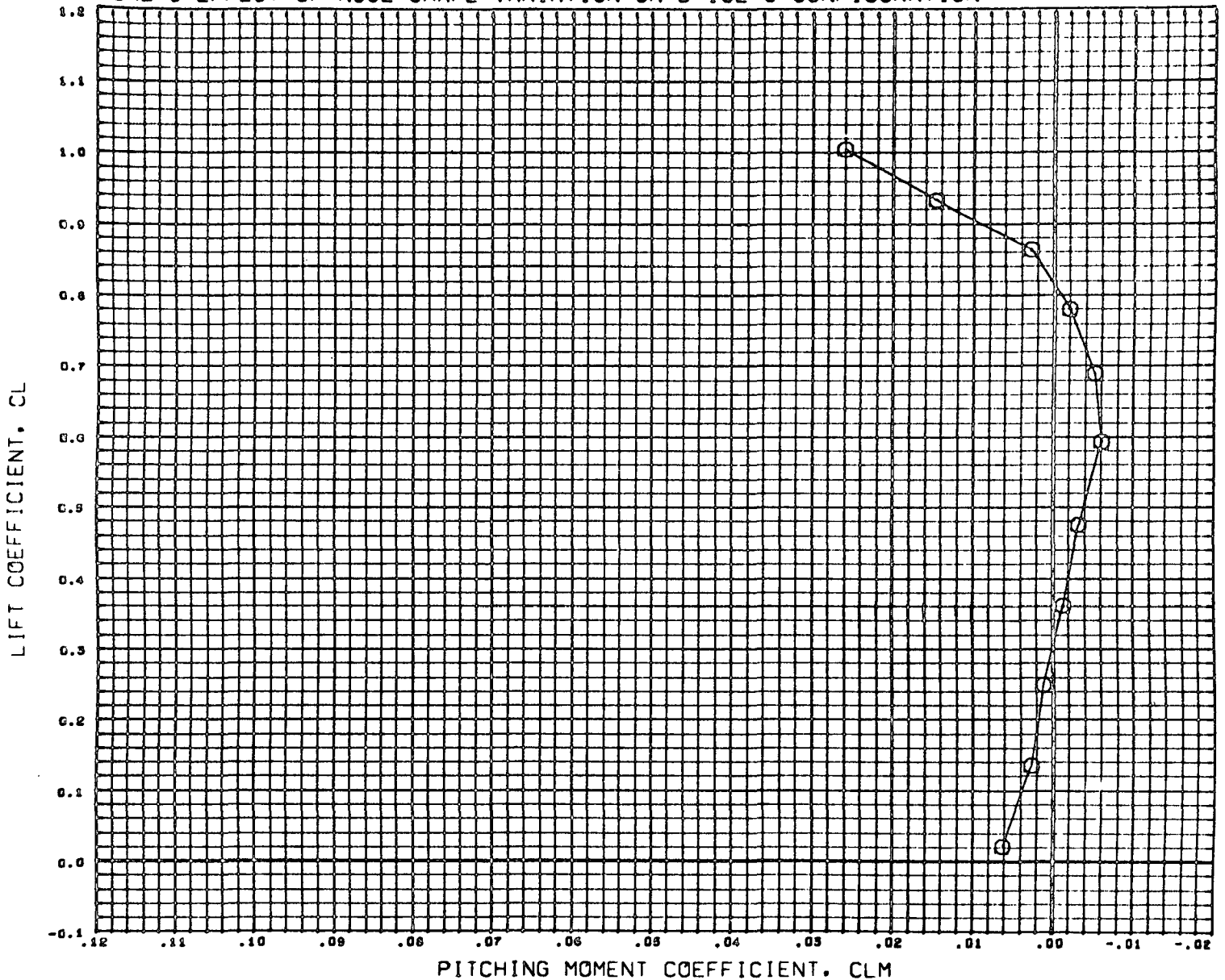

DATA SET SYMBOL	CONFIGURATION DESCRIPTION
(CS00:0) \odot	MSFC TWT 514 E3 030W23C10
(CS8060) \triangle	DATA NOT AVAILABLE FOR ALL CONDITIONS

BETA	ELEVTR	CANARD
0.000	0.000	0.000
0.000	0.000	0.000

REFERENCE INFORMATION		
SREF	15.0300	80 INC
LREF	2.8300	INCHES
BREF	0.0620	INCHES
XMRP	2.1110	INCHES
YMRP	0.0000	INCHES
ZMRP	0.0000	INCHES
SCALE	0.0035	

MACH 1.490

FIGURE-5 EFFECT OF NOSE SHAPE VARIATION ON B-18E-3 CONFIGURATION

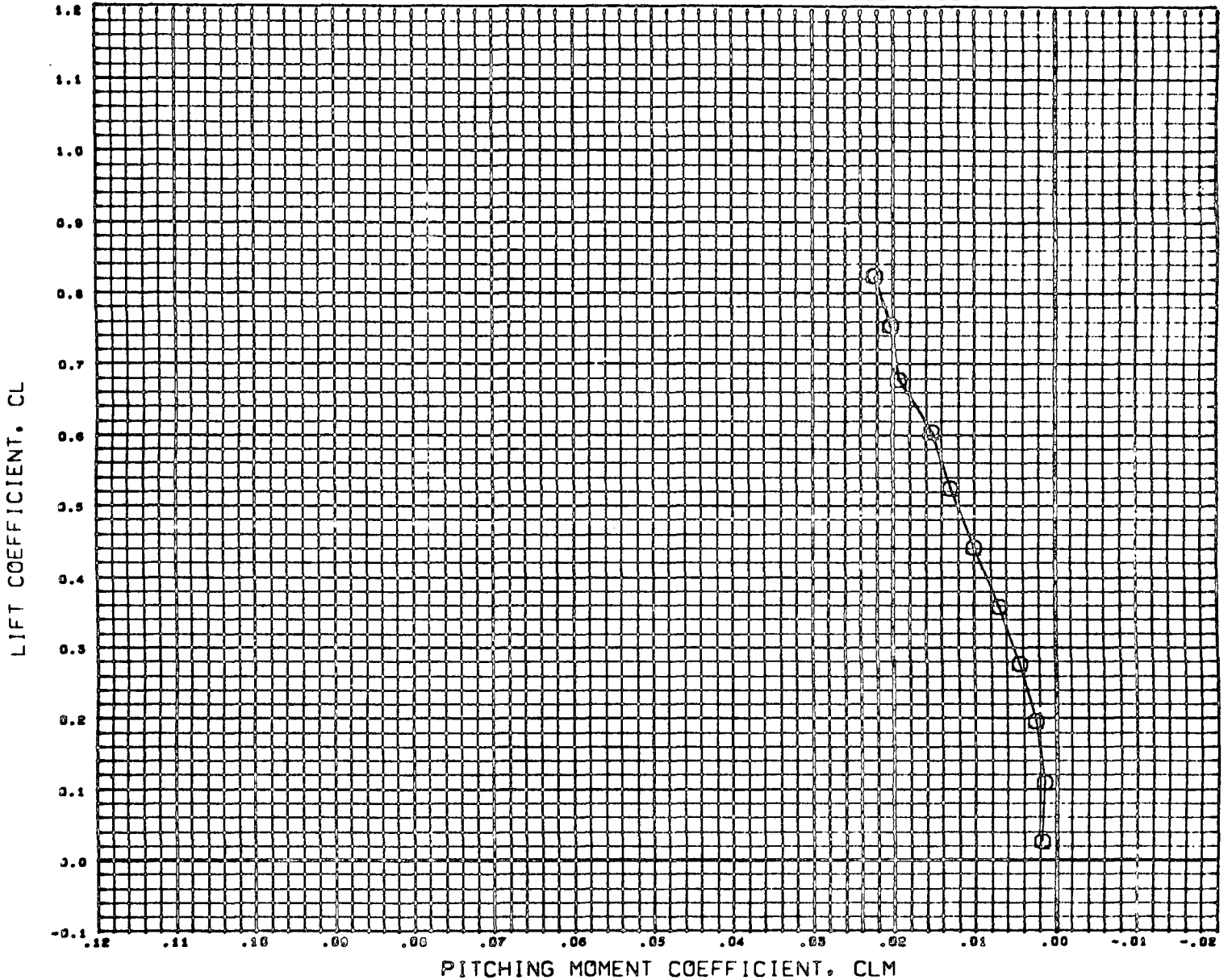

DATA SET SYMBOL CONFIGURATION DESCRIPTION
 (C58010) MSFC TWT 514 E3 050W23C10
 (C58060) DATA NOT AVAILABLE FOR ALL CONDITIONS

BETA ELEVTR CANARD
 0.000 0.000 0.000
 0.000 0.000 0.000

REFERENCE INFORMATION
 SREF 15.0300 50 INC
 LREF 2.0300 INCHES
 ØREF 6.0620 INCHES
 XMRP 2.1110 INCHES
 YMRP 0.0000 INCHES
 ZMRP 0.0000 INCHES
 SCALE 0.0035

MACH 1.960

FIGURE-5 EFFECT OF NOSE SHAPE VARIATION ON B-18E-3 CONFIGURATION

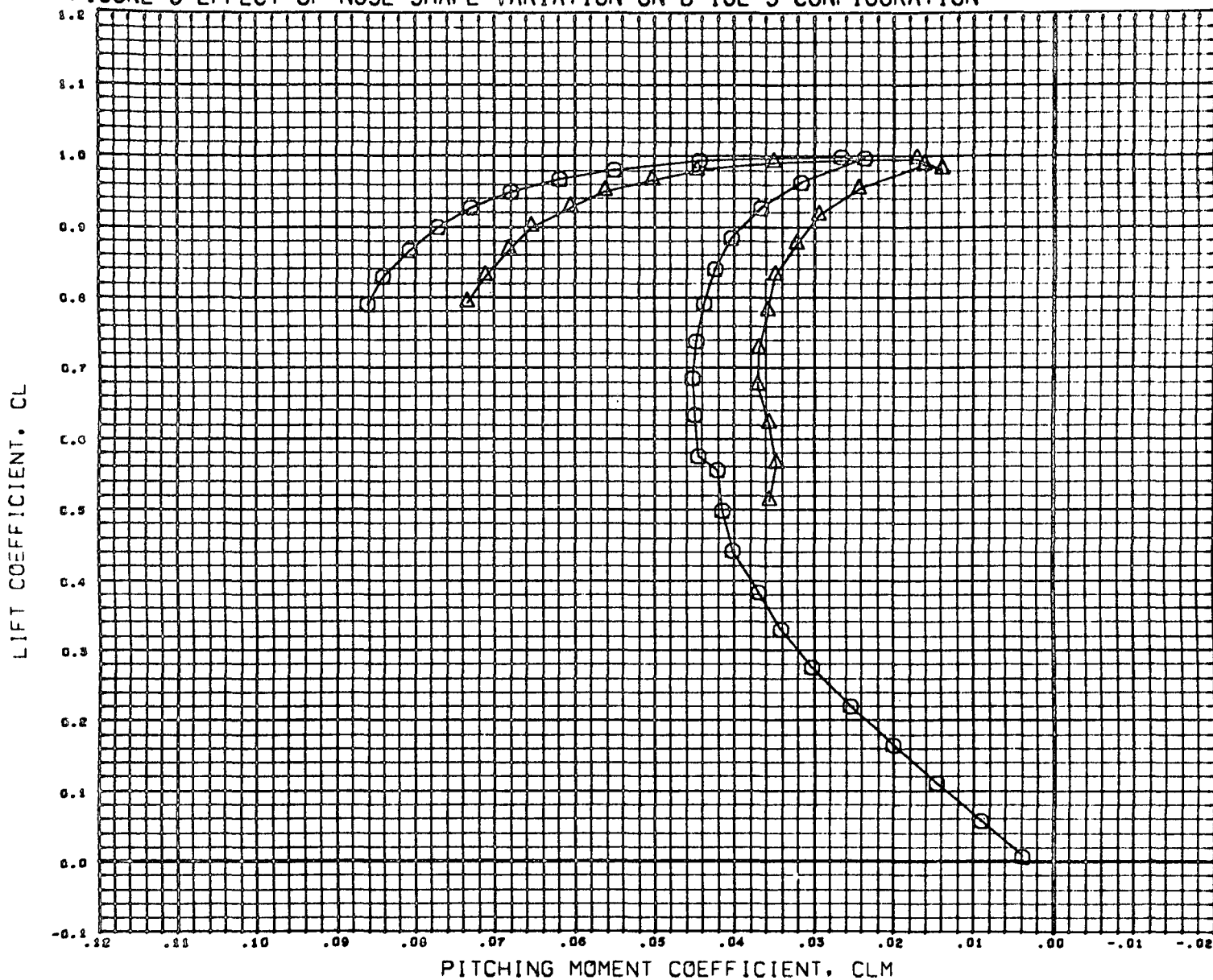

DATA SET SYMBOL	CONFIGURATION DESCRIPTION
(CS00.0)	MSFC TWT 514 E3 030W23C10
(CS8000)	MSFC TWT 514 E3 031W23C10

BETA	ELEVTR	CANARD
0.000	0.000	0.000
0.000	0.000	0.000

REFERENCE INFORMATION		
SREF	15.0300	SQ INC
LREF	2.8300	INCHES
BREF	6.0620	INCHES
XMRP	2.1110	INCHES
YMRP	0.0000	INCHES
ZMRP	0.0000	INCHES
SCALE	0.0035	

MACH 2.900

FIGURE-5 EFFECT OF NOSE SHAPE VARIATION ON B-18E-3 CONFIGURATION

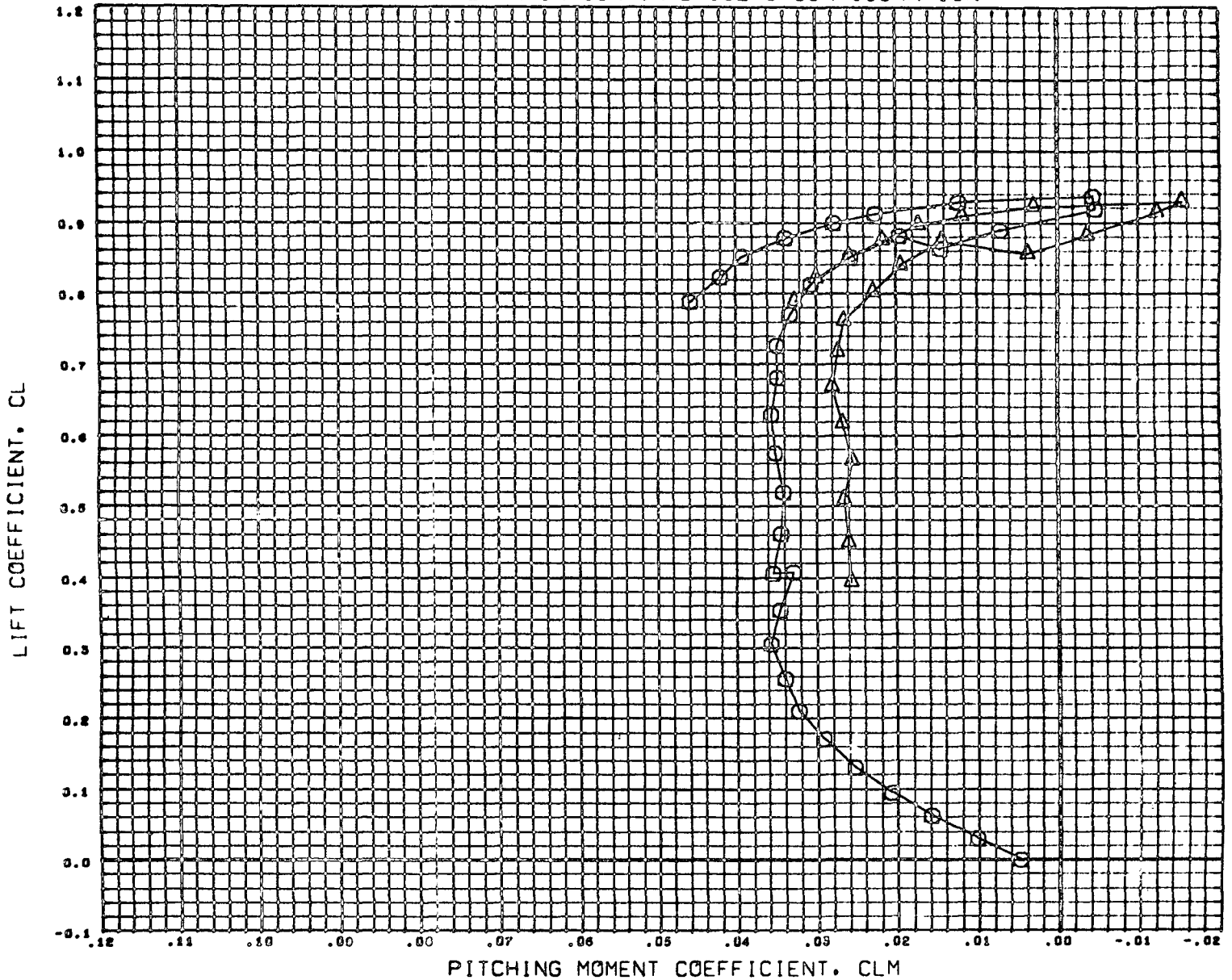

DATA SET SYMBOL	CONFIGURATION DESCRIPTION
(C50010)	MBFC TWT 514 ES 030W23C10
(C50060)	MBFC TWT 514 ES 031W23C10

BETA	ELEVTR	CANARD
0.000	0.000	0.000
0.000	0.000	0.000

REFERENCE INFORMATION		
SREF	15.0300	80 INC
LREF	2.8300	INCHES
BREF	6.0620	INCHES
XMRP	2.1110	INCHES
YMRP	0.0000	INCHES
ZMRP	0.0000	INCHES
SCALE	0.0035	

MACH 4.990

FIGURE-6 EFFECT OF REDUCING BODY LENGTH ON B-18E-3 CONFIGURATION

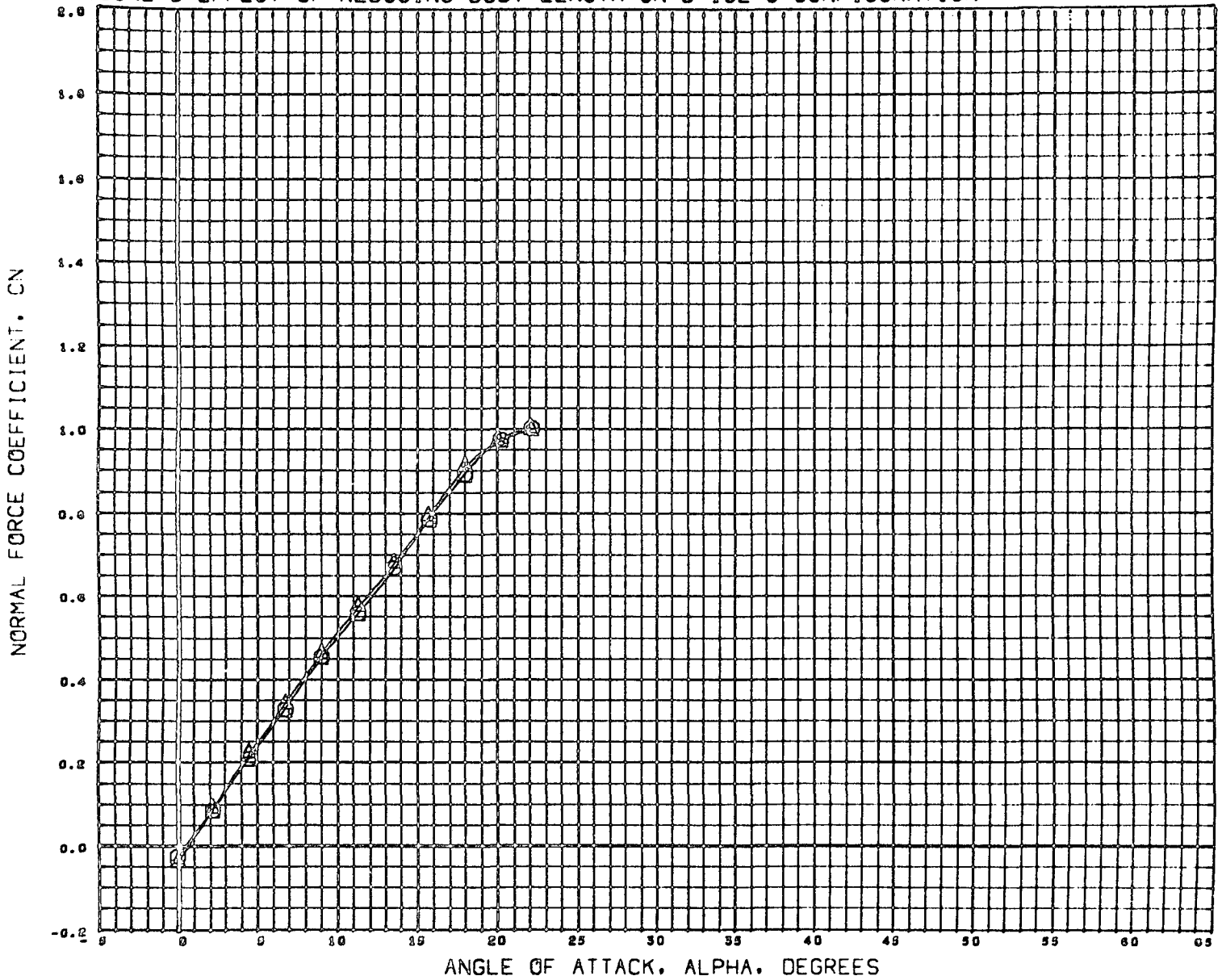

DATA SET SYMBOL	CONFIGURATION DESCRIPTION
(C96019)	HSPC TWT 914 E3 030W23C10
(D50200)	HSPC TWT 914 E3 032W23C10
(D56290)	DATA NOT AVAILABLE FOR ALL CONDITIONS

BETA	ELEVTR	CANARD
0.000	0.000	0.000
0.000	0.000	0.000
0.000	0.000	0.000

REFERENCE INFORMATION		
SREF	15.0300	sq INC
LREF	2.8300	INCHES
BREF	6.0620	INCHES
XMRP	2.1110	INCHES
YMRP	0.0000	INCHES
ZMRP	0.0000	INCHES
SCALE	0.0035	

MACH 0.007

FIGURE-6 EFFECT OF REDUCING BODY LENGTH ON B-18E-3 CONFIGURATION

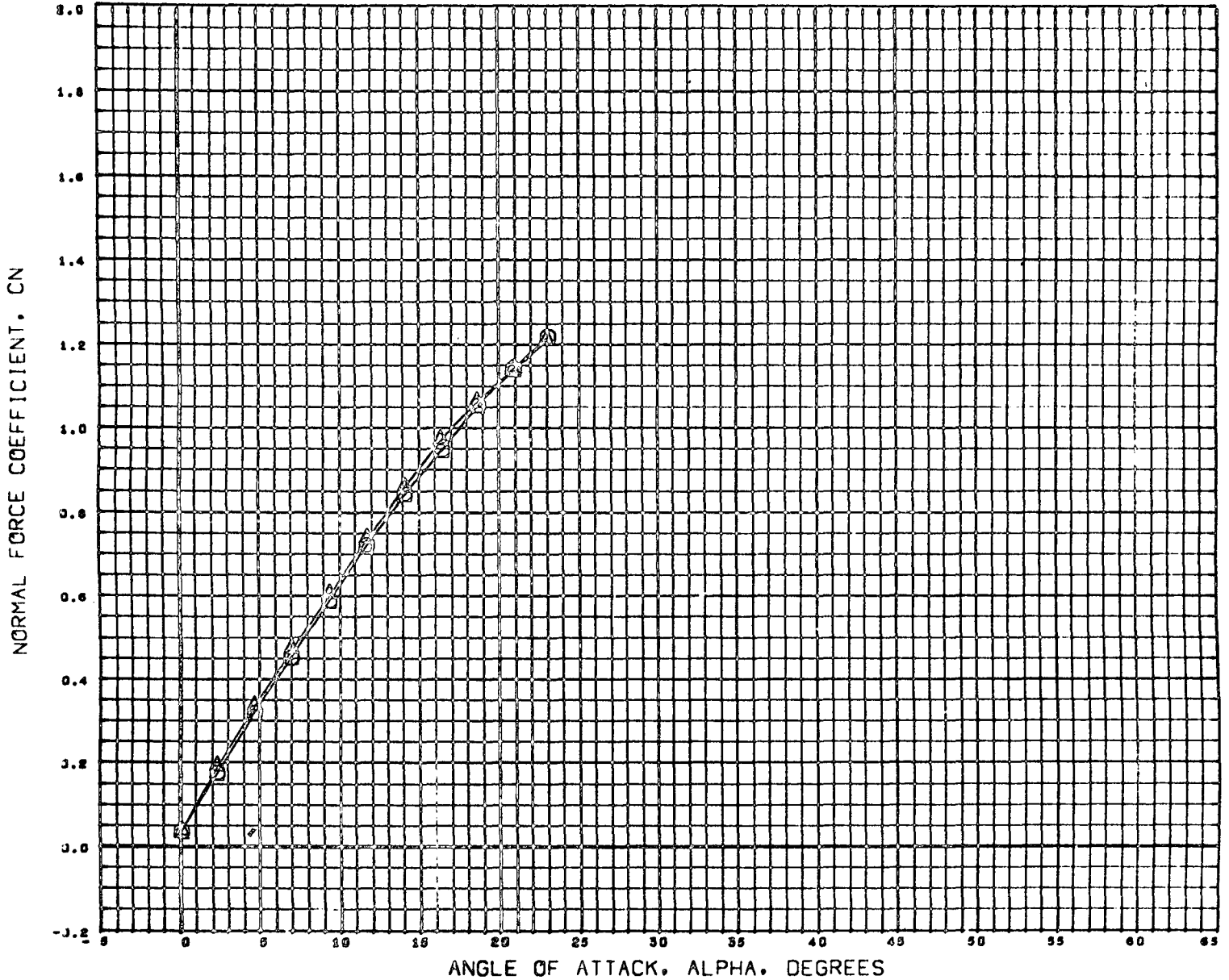

DATA SET SYMBOL	CONFIGURATION DESCRIPTION
(C58C10)	MOFC TWT 514 03 030W23C10
(D58280)	MOFC TWT 514 03 032W23C10
(D58290)	DATA NOT AVAILABLE FOR ALL CONDITIONS

BETA	ELEVTR	CANARD
0.000	0.000	0.000
0.000	0.000	0.000
0.000	0.000	0.000

REFERENCE INFORMATION		
SREF	19.0300	30 INC
LREF	2.8300	INCHES
BREF	6.0620	INCHES
XMRP	2.1110	INCHES
YMRP	0.0000	INCHES
ZMRP	0.0000	INCHES
SCALE	0.0035	

MACH 1.200

FIGURE-6 EFFECT OF REDUCING BODY LENGTH ON B-18E-3 CONFIGURATION

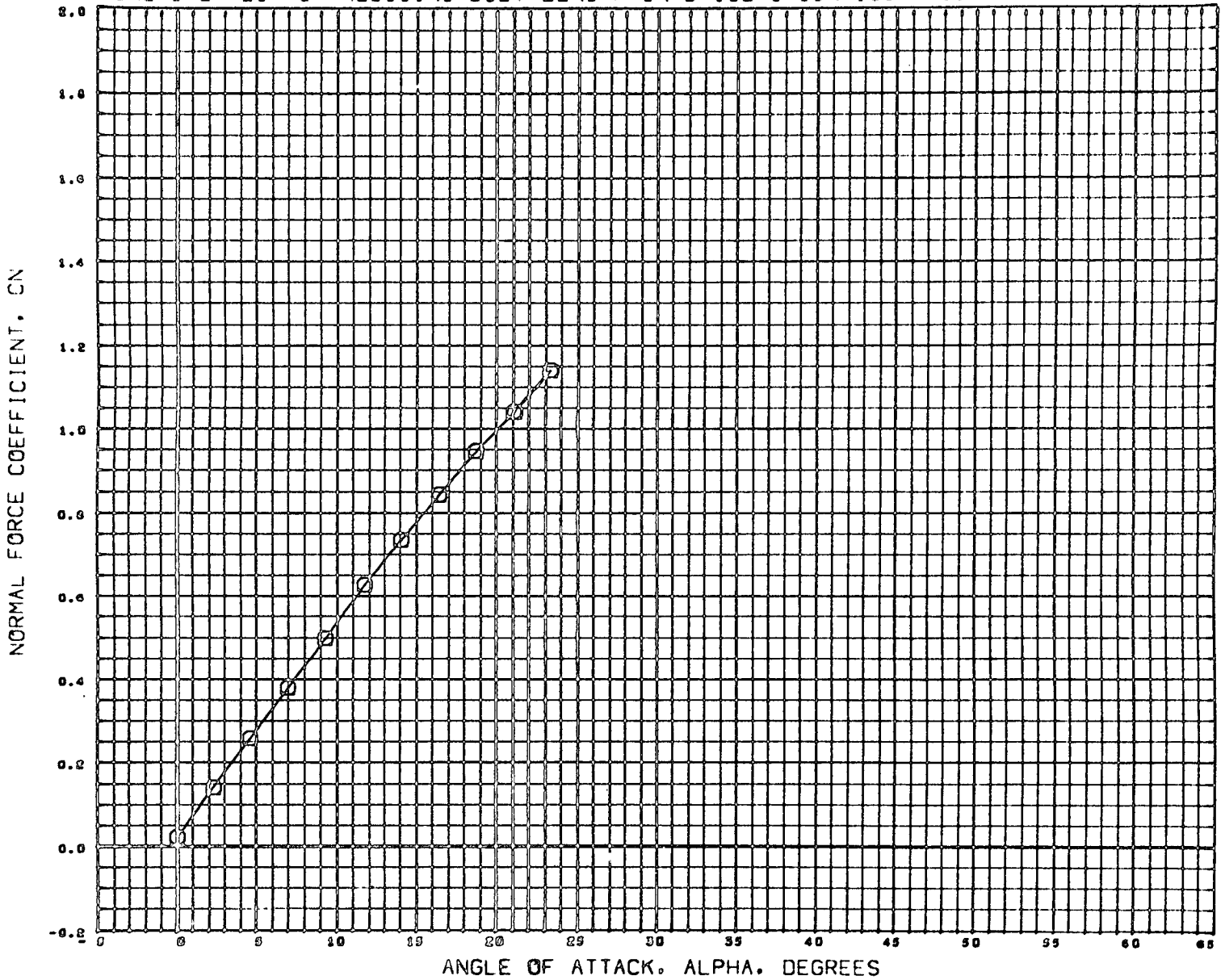

DATA SET SYMBOL	CONFIGURATION DESCRIPTION
(C50110)	Q MOPC TWT 914 ES 030W23C10
(050200)	△ DATA NOT AVAILABLE FOR ALL CONDITIONS
(050290)	◇ DATA NOT AVAILABLE FOR ALL CONDITIONS

BETA	ELEVTR	CANARD
0.000	0.000	0.000
0.000	0.000	0.000
0.000	0.000	0.000

REFERENCE INFORMATION		
SREF	15.0300	50 INC
LREF	2.8300	INCHES
BREF	6.0620	INCHES
XMRP	2.1110	INCHES
YMRP	0.0000	INCHES
ZMRP	0.0000	INCHES
SCALE	0.0035	

MACH 1.490

FIGURE-6 EFFECT OF REDUCING BODY LENGTH ON B-18E-3 CONFIGURATION

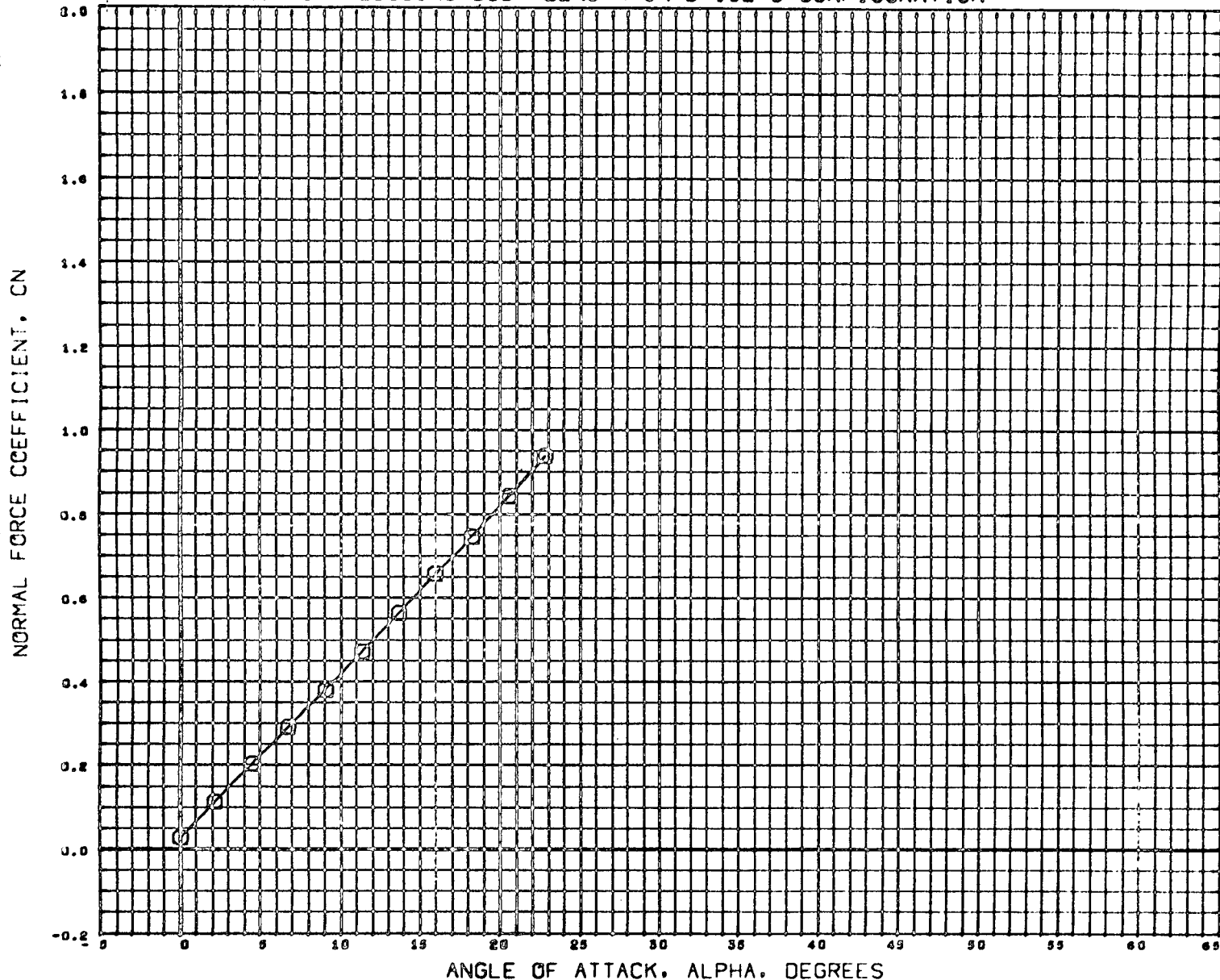

DATA SET SYMBOL	CONFIGURATION DESCRIPTION
(C58610)	MOFC TWT 514 EB 030W23C10
(D58280)	DATA NOT AVAILABLE FOR ALL CONDITIONS
(D58290)	DATA NOT AVAILABLE FOR ALL CONDITIONS

BETA	ELEVTR	CANARD
0.000	0.000	0.000
0.000	0.000	0.000
0.000	0.000	0.000

REFERENCE INFORMATION		
SREF	15.0300	sq INC
LREF	2.8300	INCHES
BREF	6.0620	INCHES
XMRP	2.1110	INCHES
YMRP	0.0000	INCHES
ZMRP	0.0000	INCHES
SCALE	0.0035	

MACH 1.000

FIGURE-6 EFFECT OF REDUCING BODY LENGTH ON B-18E-3 CONFIGURATION

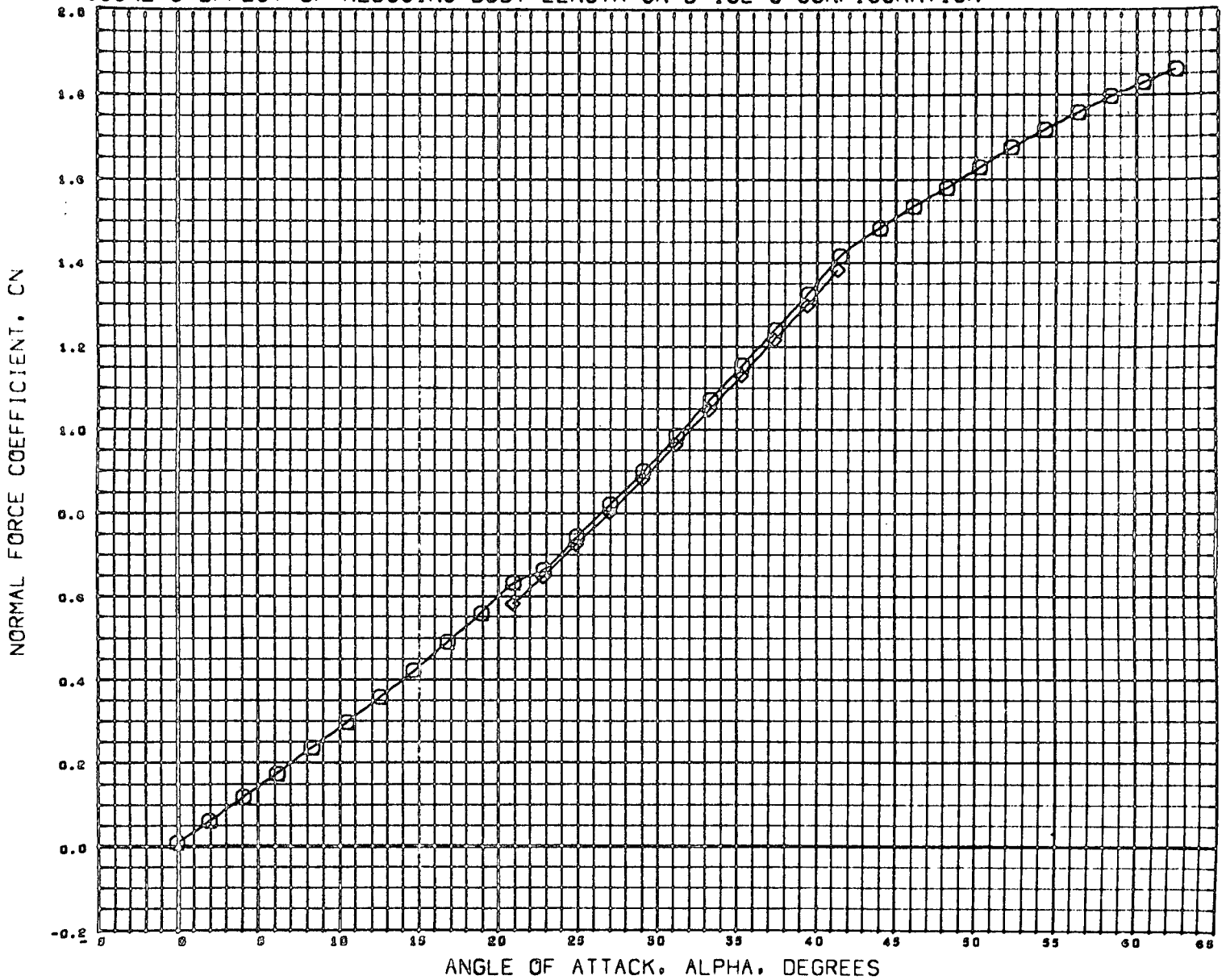

DATA SET SYMBOL	CONFIGURATION DESCRIPTION
(C50010)	MSFC TWT 514 E3 B30W23C10
(050200)	DATA NOT AVAILABLE FOR ALL CONDITIONS
(050290)	MSFC TWT 514 E3 B32W23C10

BETA	ELEVTR	CANARD
0.000	0.000	0.000
0.000	0.000	0.000
0.000	0.000	0.000

REFERENCE INFORMATION		
SREF	15.0300	50 INC
LREF	2.8300	INCHES
BREF	6.0620	INCHES
XMRP	2.1110	INCHES
YMRP	0.0000	INCHES
ZMRP	0.0000	INCHES
SCALE	0.0035	

MACH 2.900

FIGURE-6 EFFECT OF REDUCING BODY LENGTH ON B-18E-3 CONFIGURATION

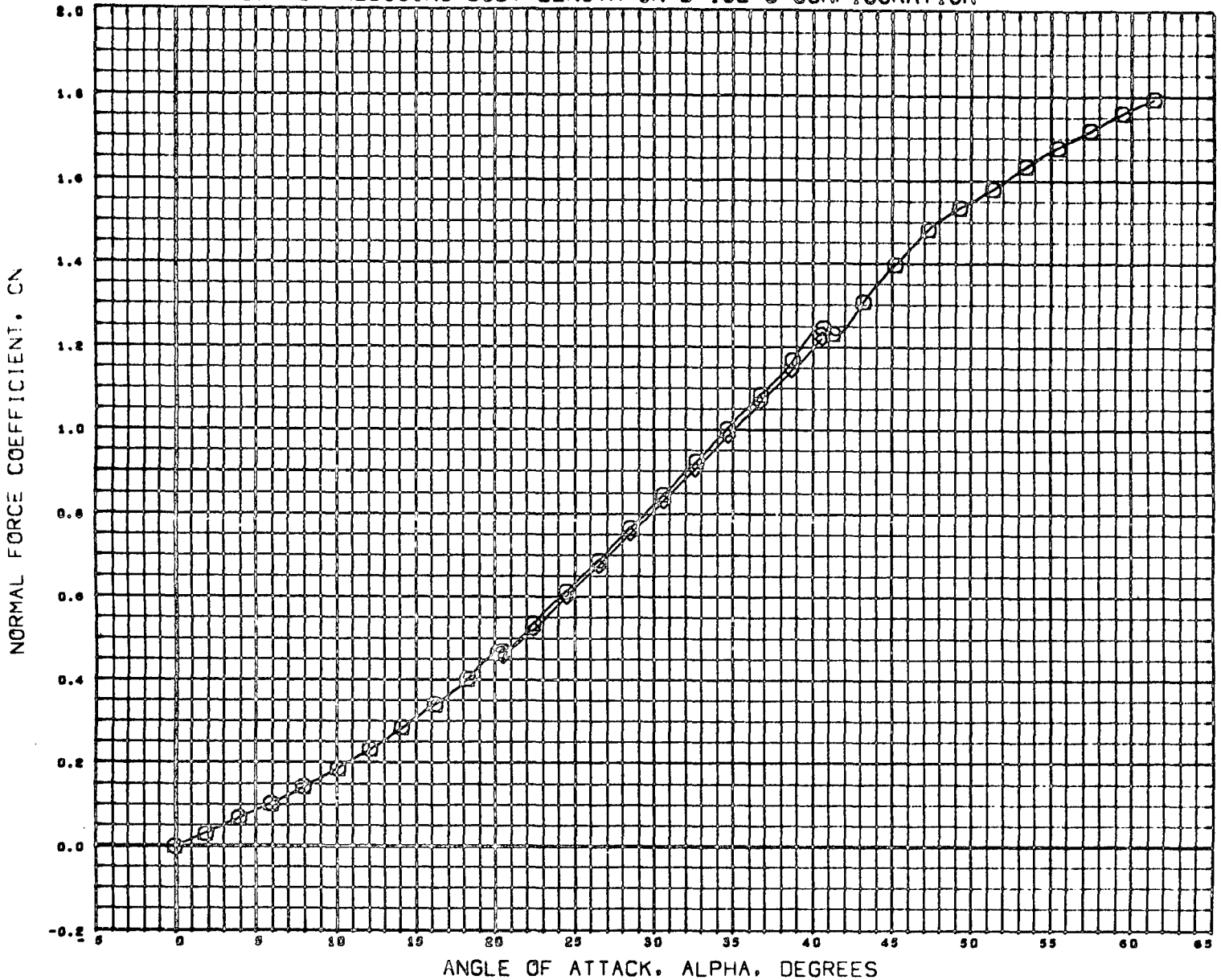

DATA SET SYMBOL	CONFIGURATION DESCRIPTION
(C58010)	MSFC TWT 914 Z3 030W23C10
(D58280)	DATA NOT AVAILABLE FOR ALL CONDITIONS
(D58290)	MSFC TWT 914 Z3 032W23C10

BETA	ELEVTR	CANARD
0.000	0.000	0.000
0.000	0.000	0.000
0.000	0.000	0.000

REFERENCE INFORMATION		
SREF	15.0300	59 INC
LREF	2.8300	INCHES
BREF	6.0620	INCHES
XMRP	2.1110	INCHES
YMRP	0.0000	INCHES
ZMRP	0.0000	INCHES
SCALE	0.0035	

MACH 4.999

FIGURE-6 EFFECT OF REDUCING BODY LENGTH ON B-18E-3 CONFIGURATION

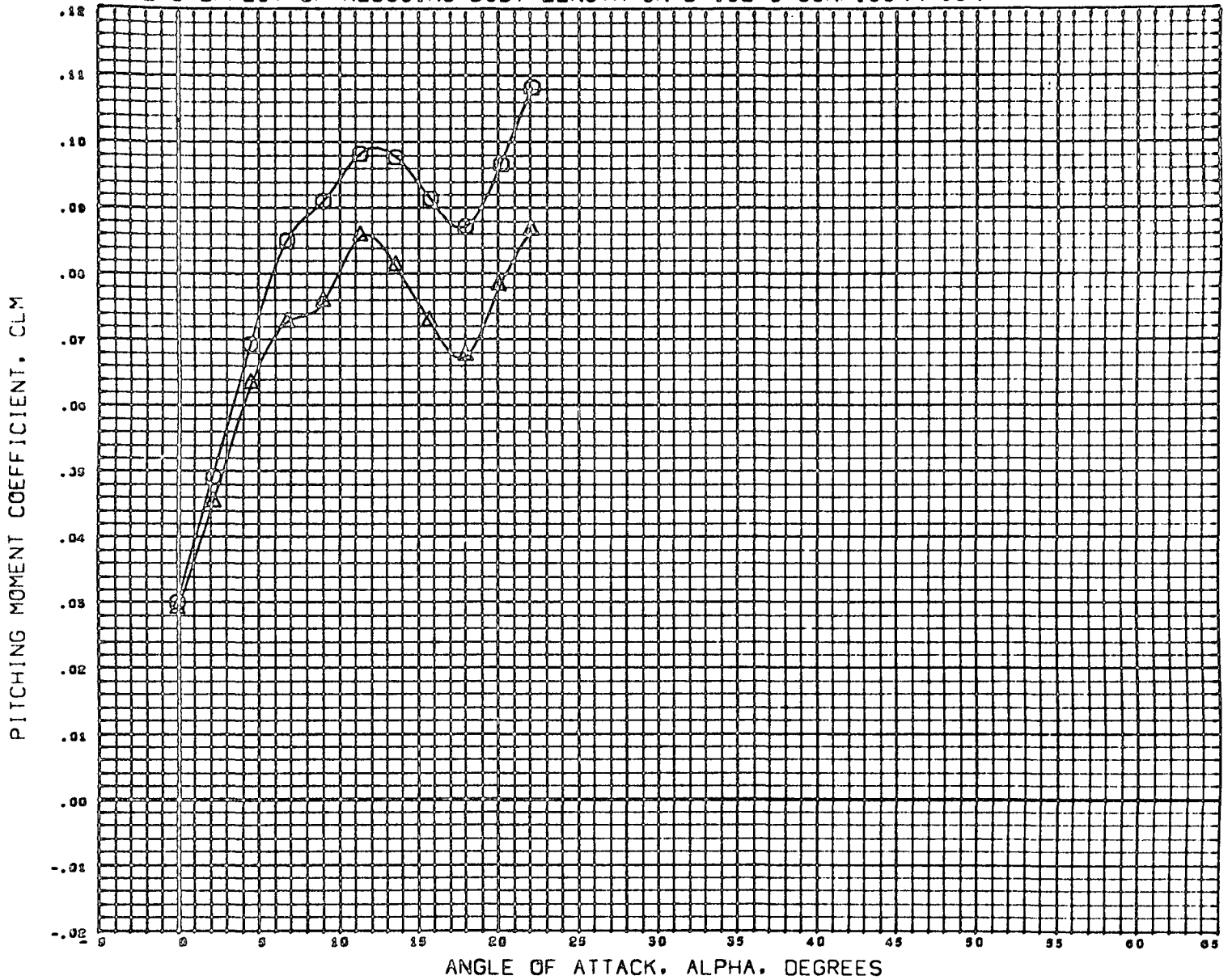

DATA SET SYMBOL	CONFIGURATION DESCRIPTION
(C50010)	MDPC TWT 514 63 030W23C10
(D50260)	MDPC TWT 514 63 032W23C10
(D56260)	DATA NOT AVAILABLE FOR ALL CONDITIONS

BETA	ELEVTR	CANARD
0.000	0.000	0.000
0.000	0.000	0.000
0.000	0.000	0.000

REFERENCE INFORMATION		
SREF	15.0300	33 INC
LREF	2.8300	INCHES
BREF	6.0620	INCHES
XMRP	2.1110	INCHES
YMRP	0.0000	INCHES
ZMRP	0.0000	INCHES
SCALE	0.0033	

MACH 0.007

FIGURE-6 EFFECT OF REDUCING BODY LENGTH ON B-18E-3 CONFIGURATION

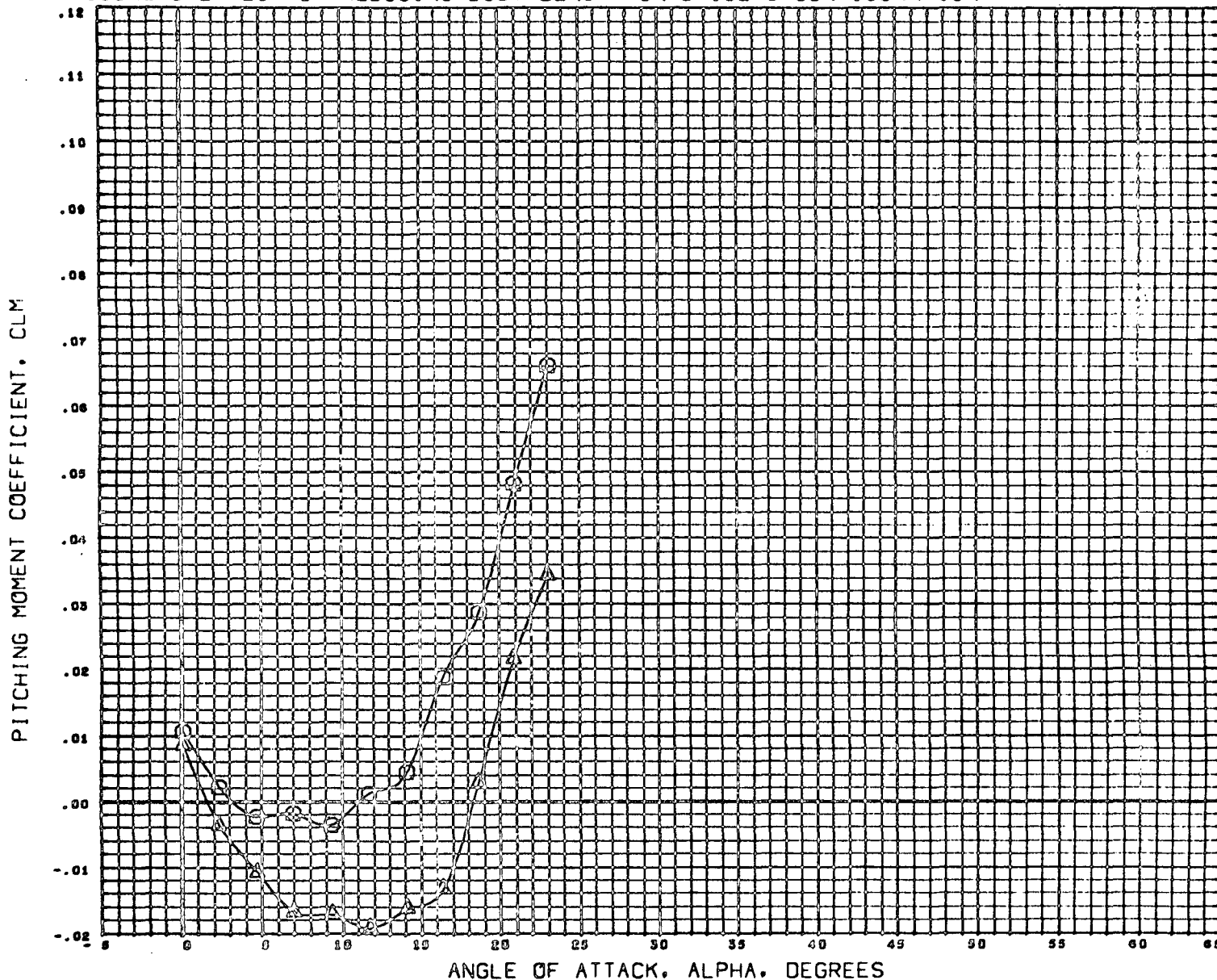

DATA SET SYMBOL	CONFIGURATION DESCRIPTION
(C50010)	MOPC TWT 514 E3 B30W23C10
(D50200)	MOPC TWT 514 E3 B32W29C10
(D50200)	DATA NOT AVAILABLE FOR ALL CONDITIONS

BETA	ELEVTR	CANARD
0.000	0.000	0.000
0.000	0.000	0.000
0.000	0.000	0.000

REFERENCE INFORMATION		
SREF	15.0300	90 INC
LREF	2.8300	INCHES
BREF	6.0620	INCHES
XMRP	2.1110	INCHES
YMRP	0.0000	INCHES
ZMRP	0.0000	INCHES
SCALE	0.0033	

MACH 1.201

FIGURE-6 EFFECT OF REDUCING BODY LENGTH ON B-18E-3 CONFIGURATION

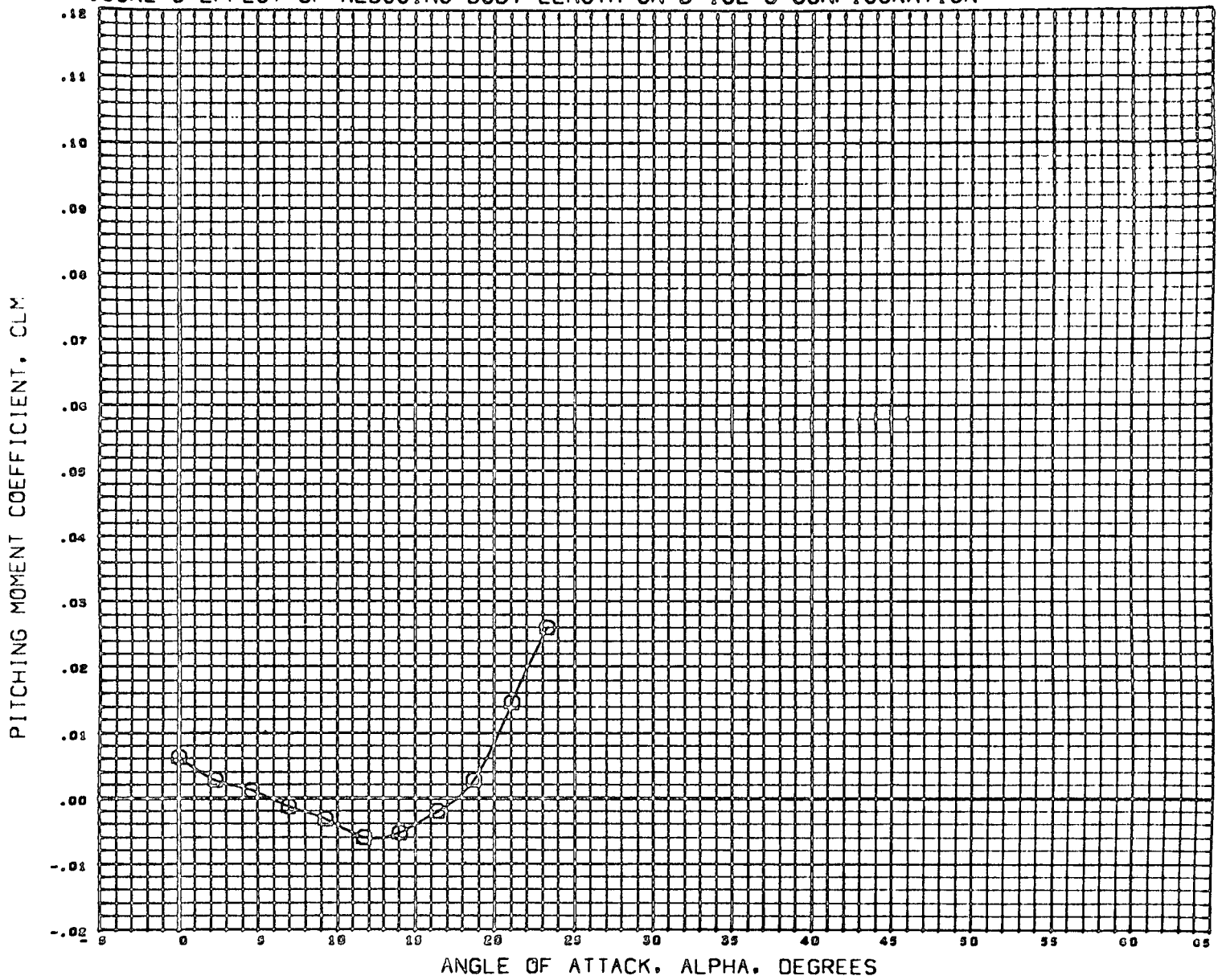

DATA SET	SYMBOL	CONFIGURATION DESCRIPTION
(C58910)	○	MSFC TWT 514 ES 030W23C10
(050280)	△	DATA NOT AVAILABLE FOR ALL CONDITIONS
(050290)	◇	DATA NOT AVAILABLE FOR ALL CONDITIONS

BETA	ELEVTR	CANARD
0.000	0.000	0.000
0.000	0.000	0.000
0.000	0.000	0.000

REFERENCE INFORMATION		
SREF	15.0300	90 INC
LREF	2.8300	INCHES
BREF	6.0620	INCHES
XMRP	2.1110	INCHES
YMRP	0.0000	INCHES
ZMRP	0.0000	INCHES
SCALE	0.0035	

MACH 1.450

FIGURE-6 EFFECT OF REDUCING BODY LENGTH ON B-18E-3 CONFIGURATION

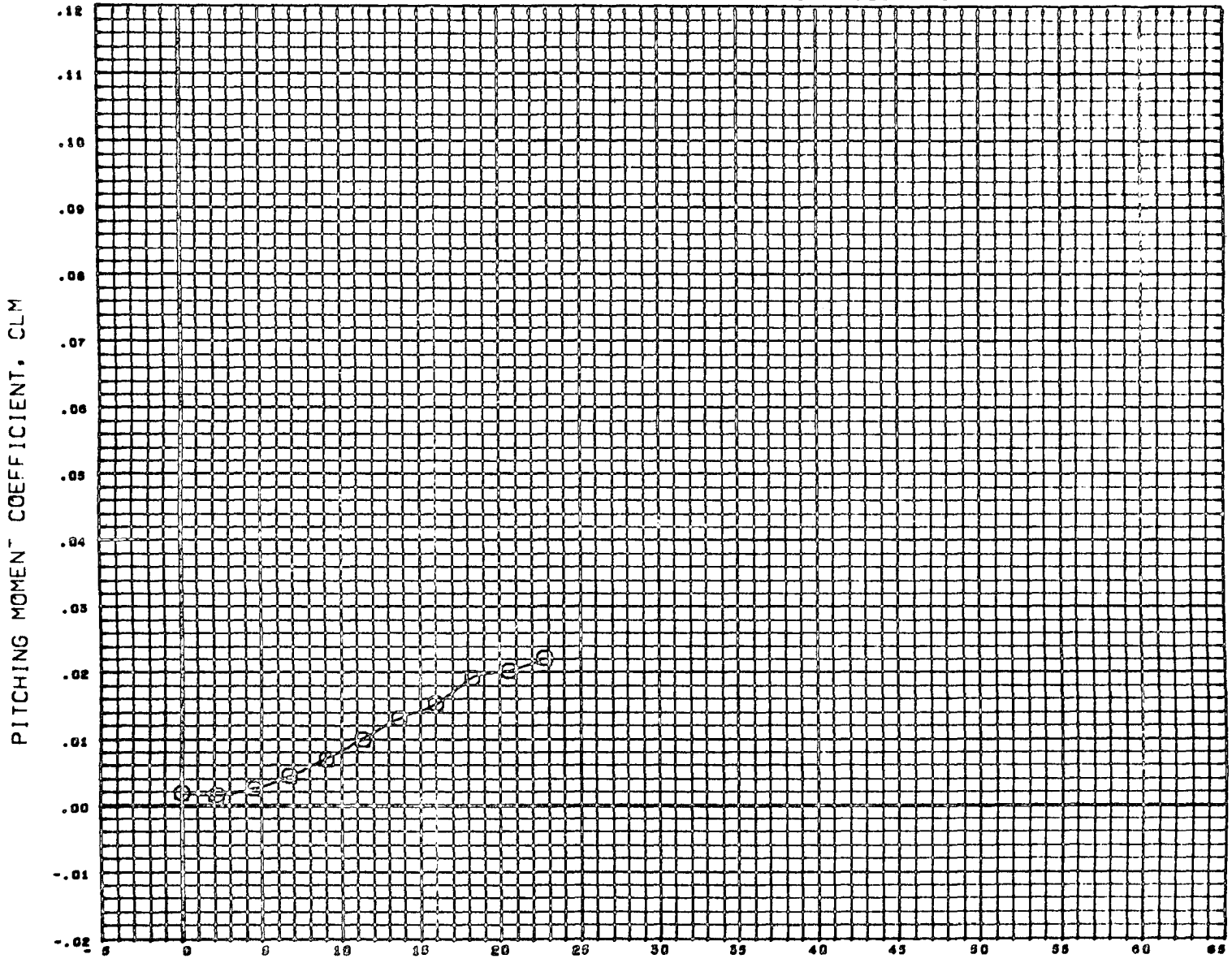

DATA SET	SYMBOL	CONFIGURATION DESCRIPTION
(C58010)	○	NSFC TWT 914 03 030W23C10
(058280)	△	DATA NOT AVAILABLE FOR ALL CONDITIONS
(058290)	◇	DATA NOT AVAILABLE FOR ALL CONDITIONS

BETA	ELEVTR	CANARD
0.000	0.000	0.000
0.000	0.000	0.000
0.000	0.000	0.000

REFERENCE INFORMATION		
SRF	15.0300	SQ INC
LREF	2.6300	INCHES
SRF	6.0620	INCHES
XMRP	2.1110	INCHES
YMRP	0.0000	INCHES
ZMRP	0.0000	INCHES
SCALE	0.0039	

MACH 1.068

FIGURE-6 EFFECT OF REDUCING BODY LENGTH ON B-18E-3 CONFIGURATION

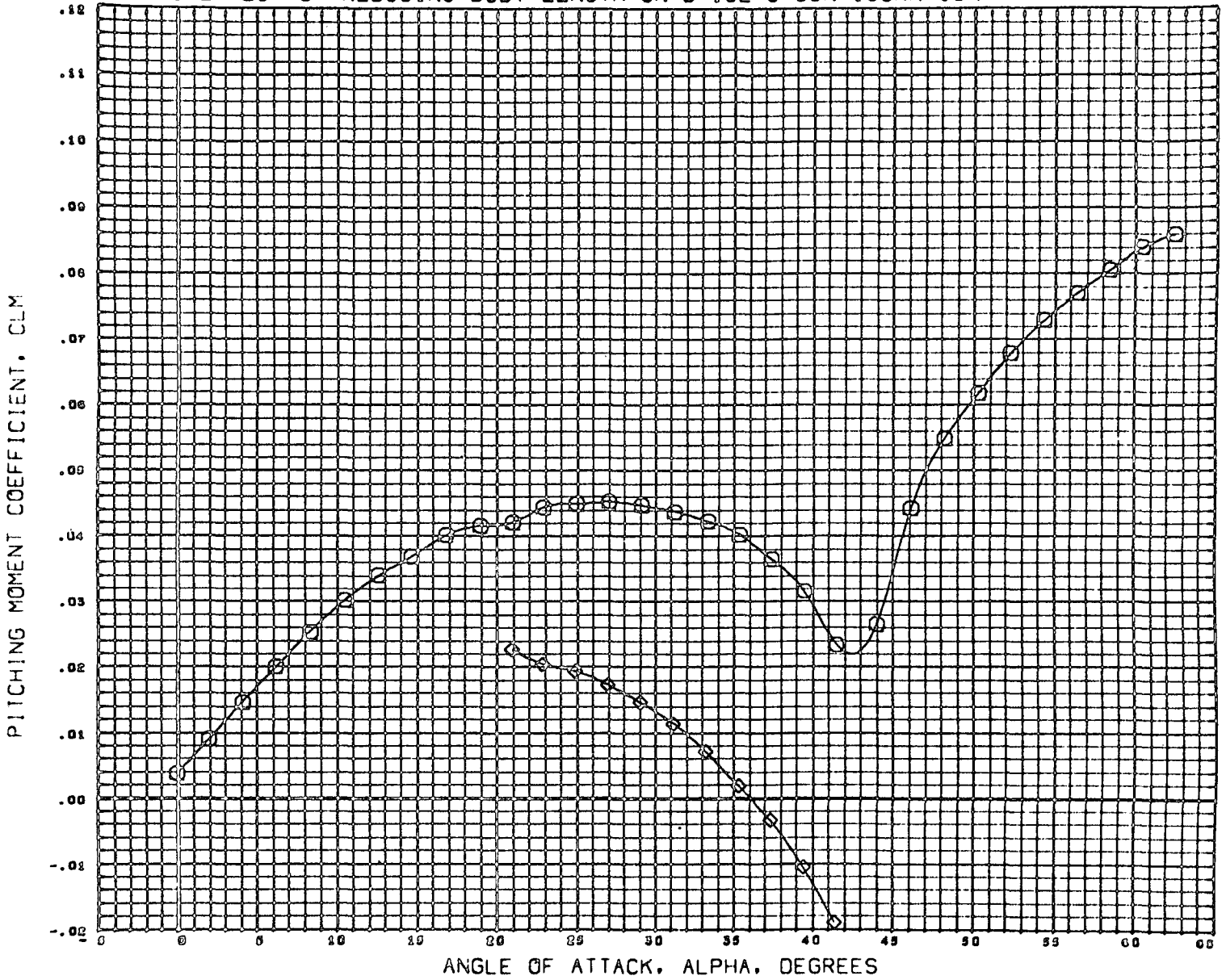

DATA SET	SYMBOL	CONFIGURATION DESCRIPTION
(C90010)	○	HSFC TWT 914 E9 030W23C10
(C90200)	△	DATA NOT AVAILABLE FOR ALL CONDITIONS
(C90290)	◇	HSFC TWT 914 E9 032W23C10

BETA	ELEVTR	CANARD
0.000	0.000	0.000
0.000	0.000	0.000
0.000	0.000	0.000

REFERENCE INFORMATION		
SREF	19.0300	80 INC
LREF	2.8300	INCHES
BREF	6.0620	INCHES
XMRP	2.1110	INCHES
YMRP	0.0000	INCHES
ZMRP	0.0000	INCHES
SCALE	0.0035	

MACH 2.990

FIGURE-6 EFFECT OF REDUCING BODY LENGTH ON B-18E-3 CONFIGURATION

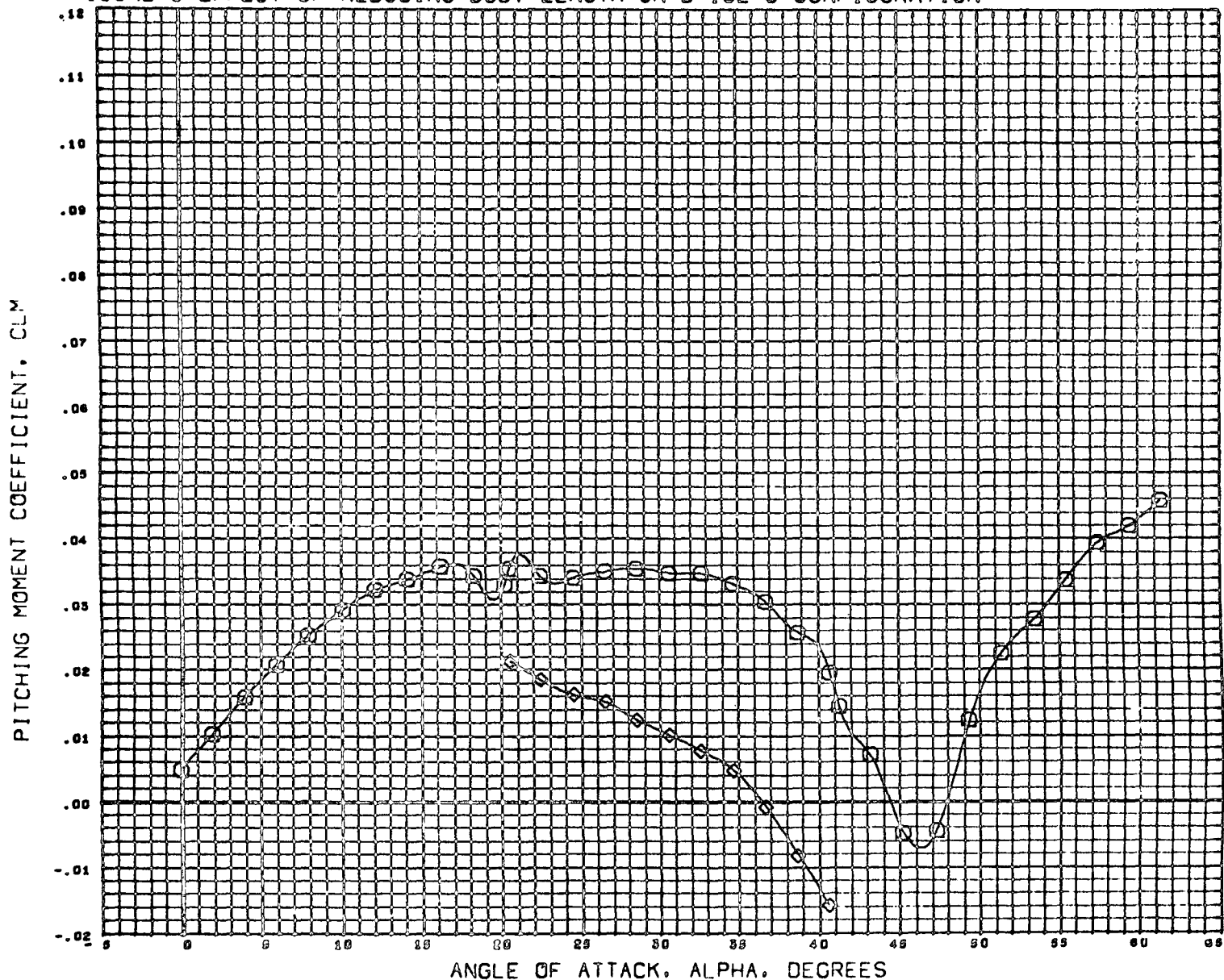

DATA SET SYMBOL	CONFIGURATION DESCRIPTION
(C58010)	MSFC TWT 214 E3 030W23C10
(058280)	DATA NOT AVAILABLE FOR ALL CONDITIONS
(058290)	MSFC TWT 214 E3 032W23C10

BETA	ELEVTR	CANARD
0.000	0.000	0.000
0.000	0.000	0.000
0.000	0.000	0.000

REFERENCE INFORMATION		
SREF	15.0300	90 INC
LREF	2.0300	INCHES
BREF	6.0620	INCHES
XMRP	2.1110	INCHES
YMRP	0.0000	INCHES
ZMRP	0.0000	INCHES
SCALE	0.0039	

MACH 4.980

FIGURE-6 EFFECT OF REDUCING BODY LENGTH ON B-18E-3 CONFIGURATION

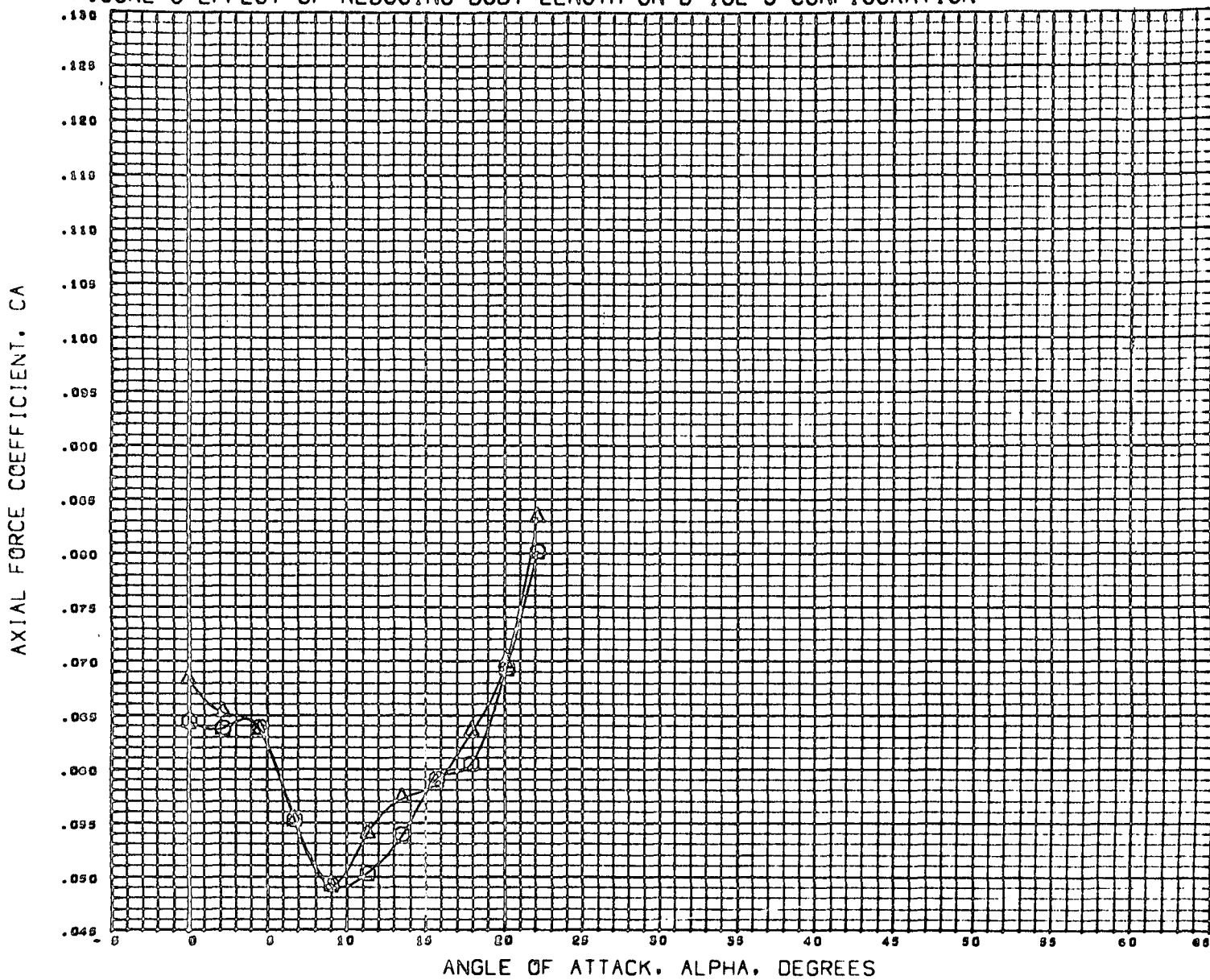

DATA SET SYMBOL	CONFIGURATION DESCRIPTION	BETA	ELEVTR	CANARD
(C90010)	HSPC TWT 914 E3 030W23C10	0.000	0.000	0.000
(030200)	HSPC TWT 914 E3 032W23C10	0.000	0.000	0.000
(050290)	DATA NOT AVAILABLE FOR ALL CONDITIONS	0.000	0.000	0.000

REFERENCE INFORMATION		
SREF	15.0300	90 INC
LREF	2.8300	INCHES
BREF	6.0620	INCHES
XMRP	2.1110	INCHES
YMRP	0.0000	INCHES
ZMRP	0.0000	INCHES
SCALE	0.0035	

MACH 0.007

FIGURE-6 EFFECT OF REDUCING BODY LENGTH ON B-18E-3 CONFIGURATION

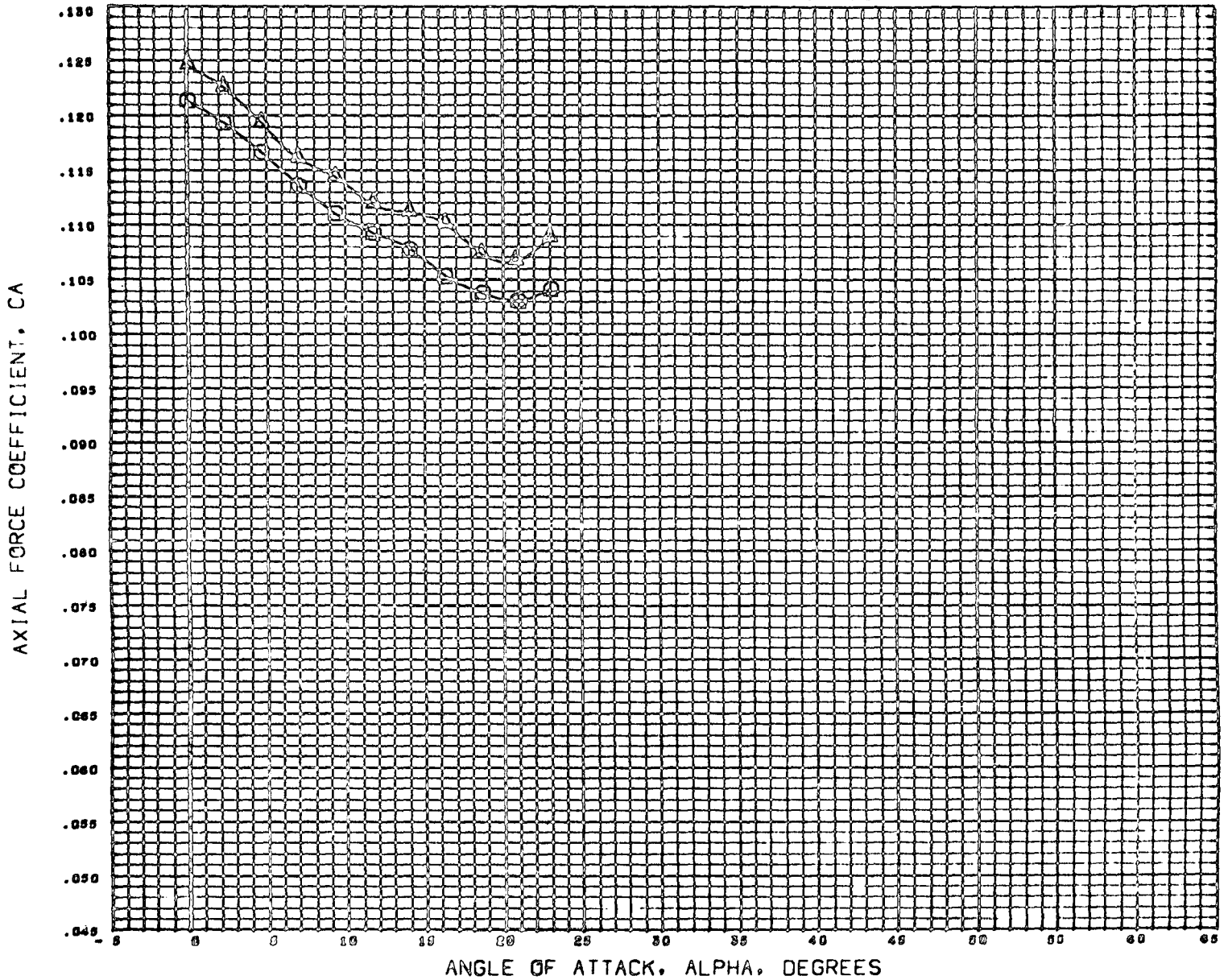

DATA SET SYMBOL	CONFIGURATION DESCRIPTION
(C56610)	MSFC TWT 514 E3 Q30W23C10
(D56280)	MSFC TWT 514 E3 Q32W23C10
(D56290)	DATA NOT AVAILABLE FOR ALL CONDITIONS

DELTA	ELEVTR	CANARD
0.000	0.000	0.000
0.000	0.000	0.000
0.000	0.000	0.000

REFERENCE INFORMATION		
SREF	19.0300	50 INC
LREF	2.8300	INCHES
OREP	0.0620	INCHES
YMRP	2.1110	INCHES
ZMRP	0.0000	INCHES
SCALE	0.0033	

MACH 1.201

FIGURE-6 EFFECT OF REDUCING BODY LENGTH ON B-18E-3 CONFIGURATION

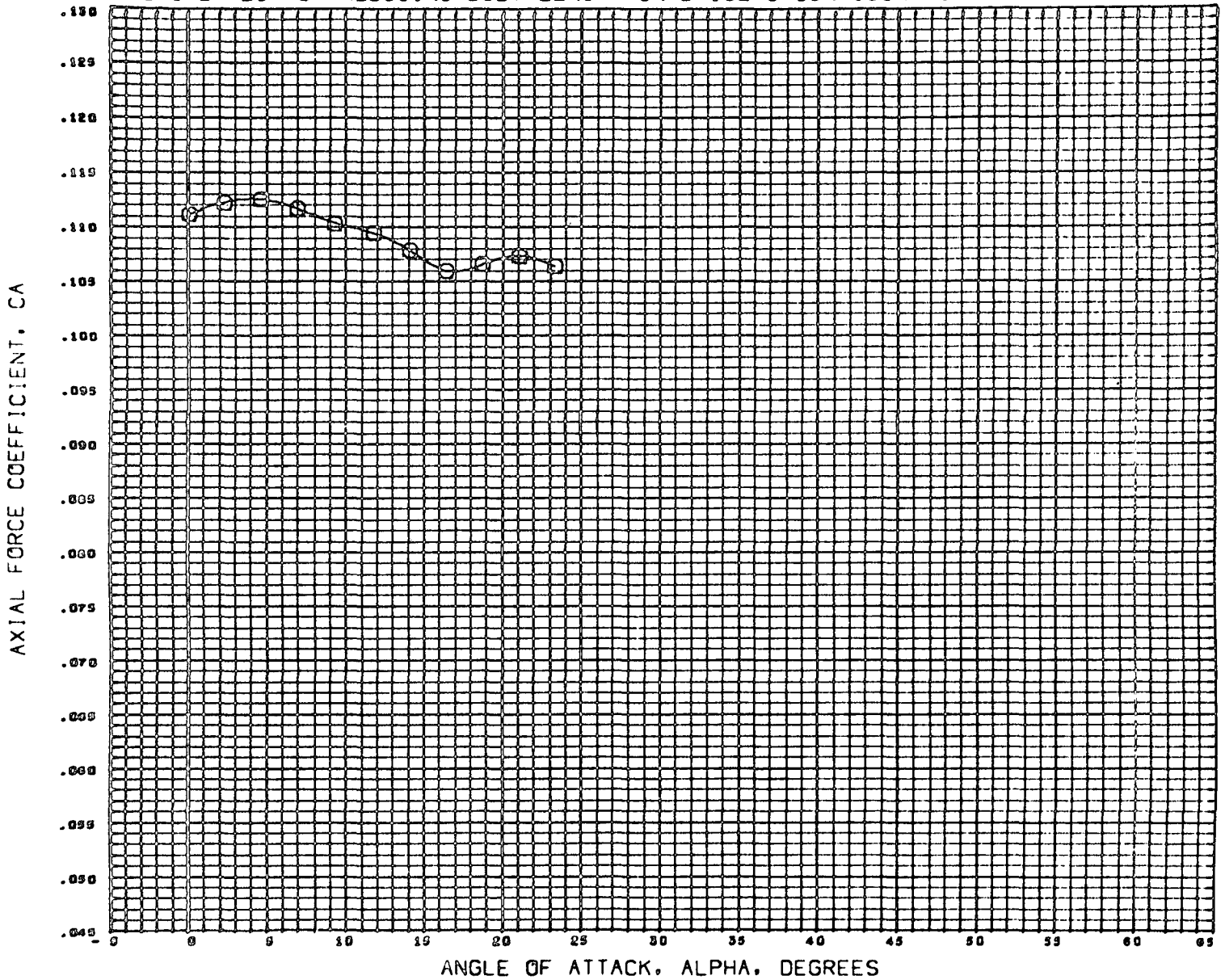

DATA SET SYMBOL	CONFIGURATION DESCRIPTION
(C56010)	MSFC TWT 514 E3 030W23C10
(D56200)	DATA NOT AVAILABLE FOR ALL CONDITIONS
(D56290)	DATA NOT AVAILABLE FOR ALL CONDITIONS

BETA	ELEVTR	CANARD
0.000	0.000	0.000
0.000	0.000	0.000
0.000	0.000	0.000

REFERENCE INFORMATION	
SREF	15.0300 SQ INC
LREF	2.8300 INCHES
BREF	6.0620 INCHES
XHRP	2.1110 INCHES
YHRP	0.0000 INCHES
ZHRP	0.0000 INCHES
SCALE	0.0035 INCHES

MACH 1.450

FIGURE-6 EFFECT OF REDUCING BODY LENGTH ON B-18E-3 CONFIGURATION

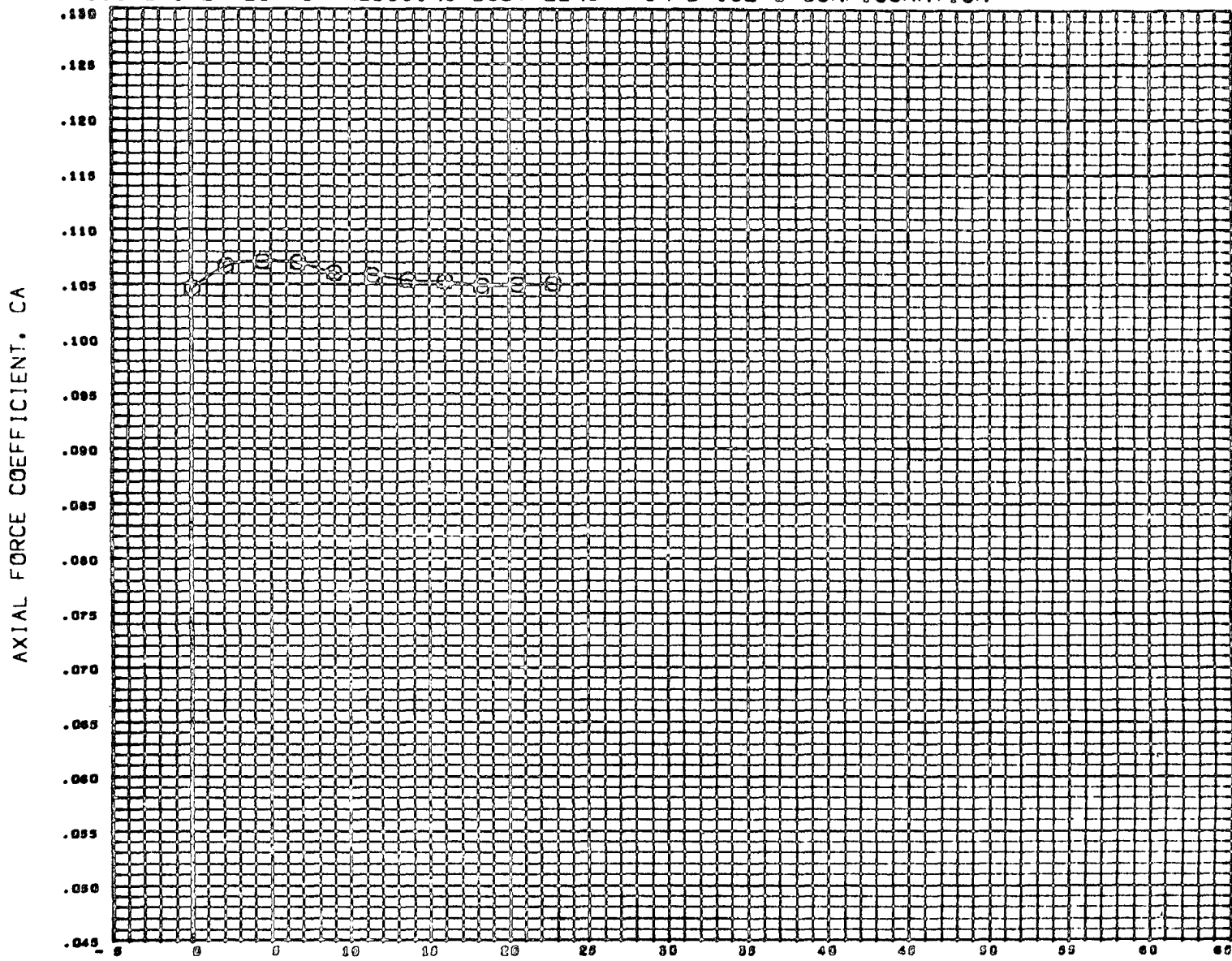

ANGLE OF ATTACK, ALPHA, DEGREES

DATA SET SYMBOL	CONFIGURATION DESCRIPTION
(C58610)	MBFC TWT 914 CS 030W29C10
(038280)	DATA NOT AVAILABLE FOR ALL CONDITIONS
(038290)	DATA NOT AVAILABLE FOR ALL CONDITIONS

BETA	ELEVTR	CANARD
0.000	0.000	0.000
0.000	0.000	0.000
0.000	0.000	0.000

REFERENCE INFORMATION		
SREF	15.0300	94 INC
LREF	2.8300	INCHES
BREF	6.0020	INCHES
XMRP	2.1110	INCHES
YMRP	0.0000	INCHES
ZMRP	0.0000	INCHES
SCALE	0.0039	

MACH 1.968

FIGURE-6 EFFECT OF REDUCING BODY LENGTH ON B-18E-3 CONFIGURATION

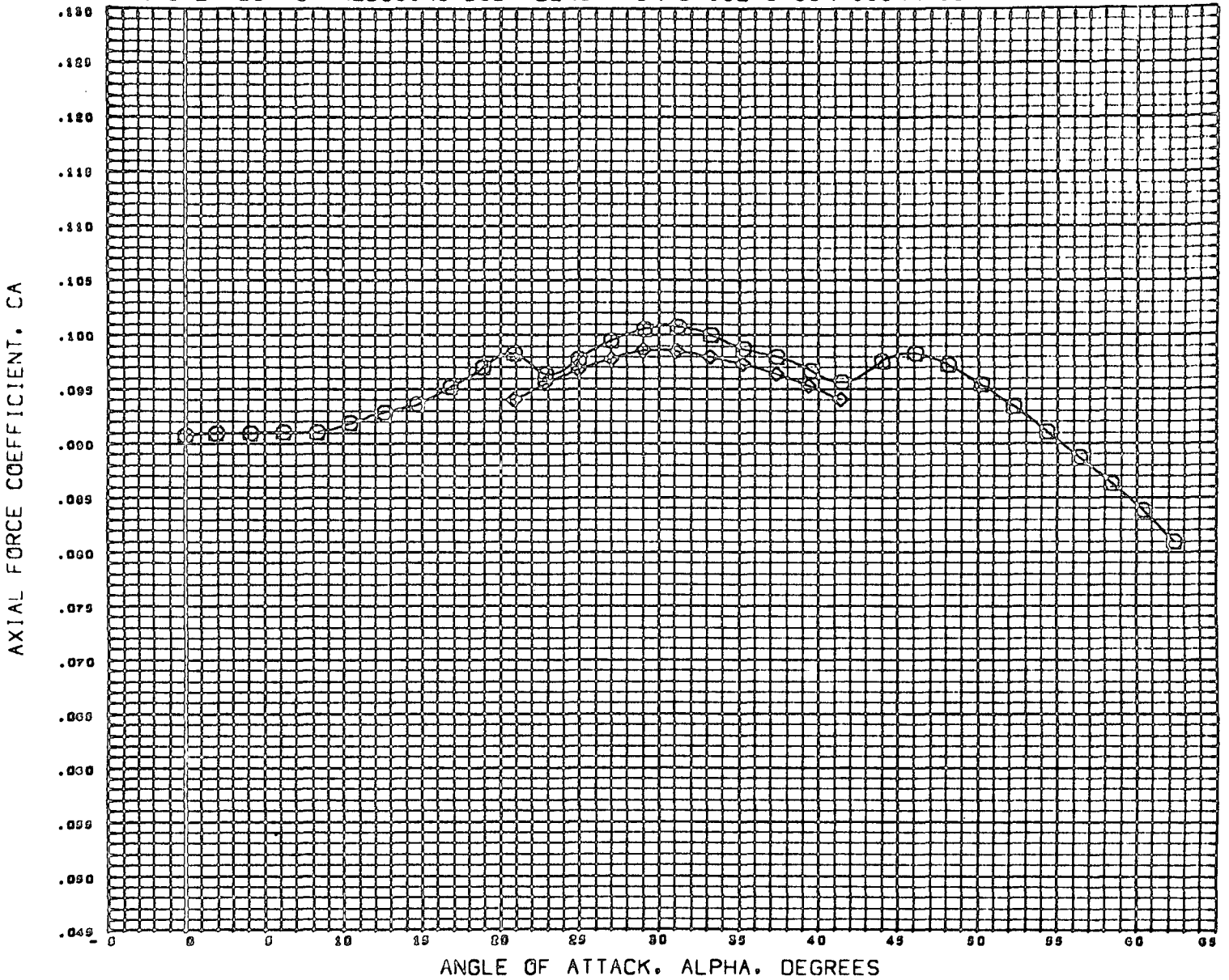

DATA SET SYMBOL	CONFIGURATION DESCRIPTION
(C98010)	MSFC THT 914 E3 030W23C10
(D58200)	DATA NOT AVAILABLE FOR ALL CONDITIONS
(D58200)	MSFC THT 914 E3 032W23C10

BETA	ELEVTR	CANARD
0.000	0.000	0.000
0.000	0.000	0.000
0.000	0.000	0.000

REFERENCE INFORMATION		
SREF	15.0300	90 INC
LREF	2.0300	INCHES
BREF	0.0020	INCHES
XMRP	2.1110	INCHES
YMRP	0.0000	INCHES
ZMRP	0.0000	INCHES
SCALE	0.0035	

MACH 2.000

FIGURE-6 EFFECT OF REDUCING BODY LENGTH ON B-18E-3 CONFIGURATION

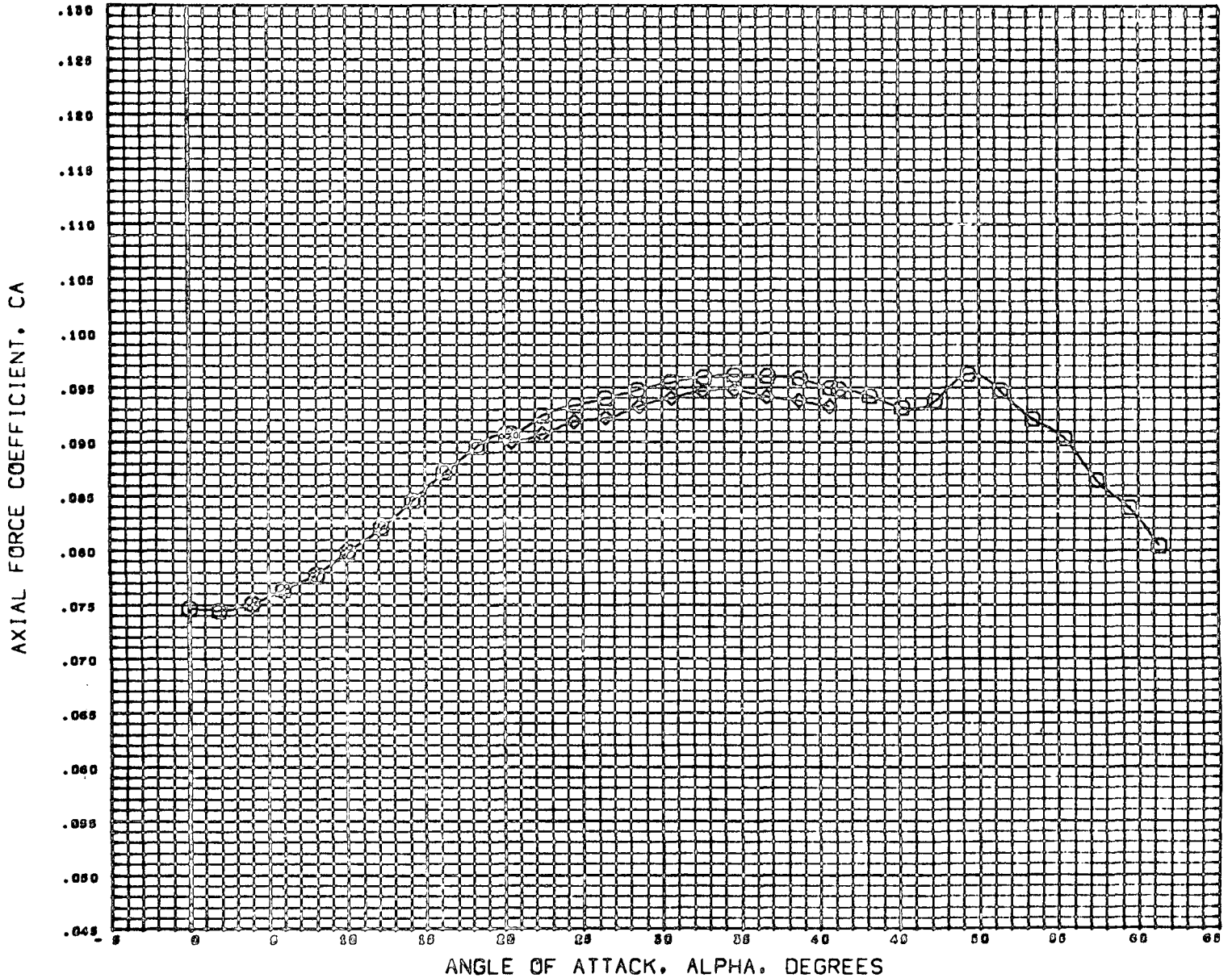

DATA SET SYMBOL	CONFIGURATION DESCRIPTION	BETA	ELEVTR	CANARD
(CS8030)	NOFC TWT 914 E3 092W23C10	0.000	0.000	0.000
(DS8200)	DATA NOT AVAILABLE FOR ALL CONDITIONS	0.000	0.000	0.000
(DS8200)	MSFC TWT 914 E3 092W23C10	0.000	0.000	0.000

REFERENCE INFORMATION		
SREP	15.0300	80 INC
LREP	2.8300	INCHES
OREP	0.0620	INCHES
XMRP	0.1150	INCHES
YMRP	0.0000	INCHES
ZMRP	0.0000	INCHES
SCALE	0.0033	

MACH 4.050

FIGURE-6 EFFECT OF REDUCING BODY LENGTH ON B-18E-3 CONFIGURATION

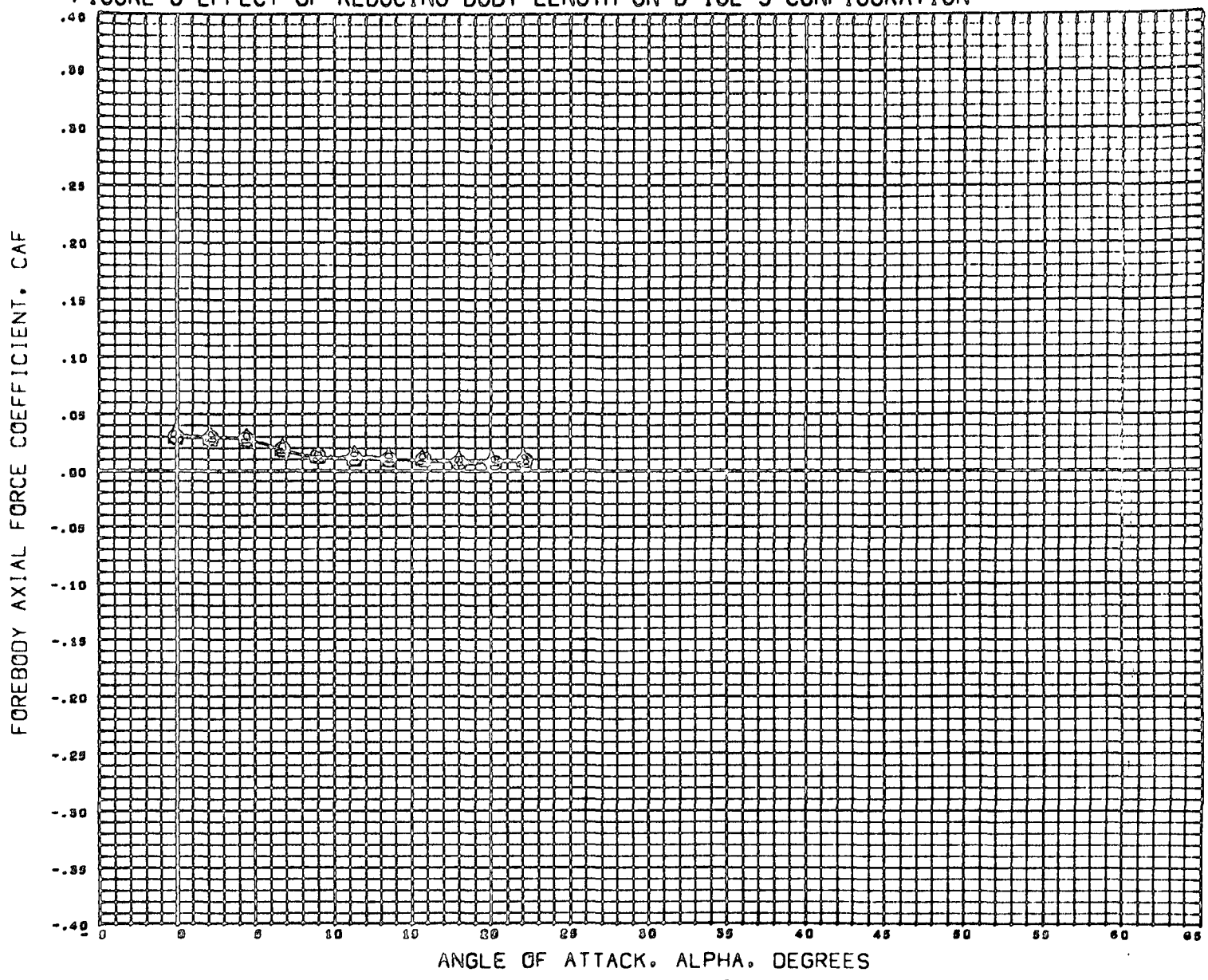

DATA SET	SYMBOL	CONFIGURATION DESCRIPTION
(C90010)	○	HSFC TWT 914 E3 030W23C10
(090200)	△	HSFC TWT 914 E3 032W23C10
(090290)	◇	DATA NOT AVAILABLE FOR ALL CONDITIONS

BETA	ELEVTR	CANARD
0.000	0.000	0.000
0.000	0.000	0.000
0.000	0.000	0.000

REFERENCE INFORMATION		
SREF	15.0300	90 INC
LREF	2.8300	INCHES
BREF	6.0620	INCHES
XMRP	2.1110	INCHES
YMRP	0.0000	INCHES
ZMRP	0.0000	INCHES
SCALE	0.0035	

MACH 0.007

FIGURE-6 EFFECT OF REDUCING BODY LENGTH ON B-18E-3 CONFIGURATION

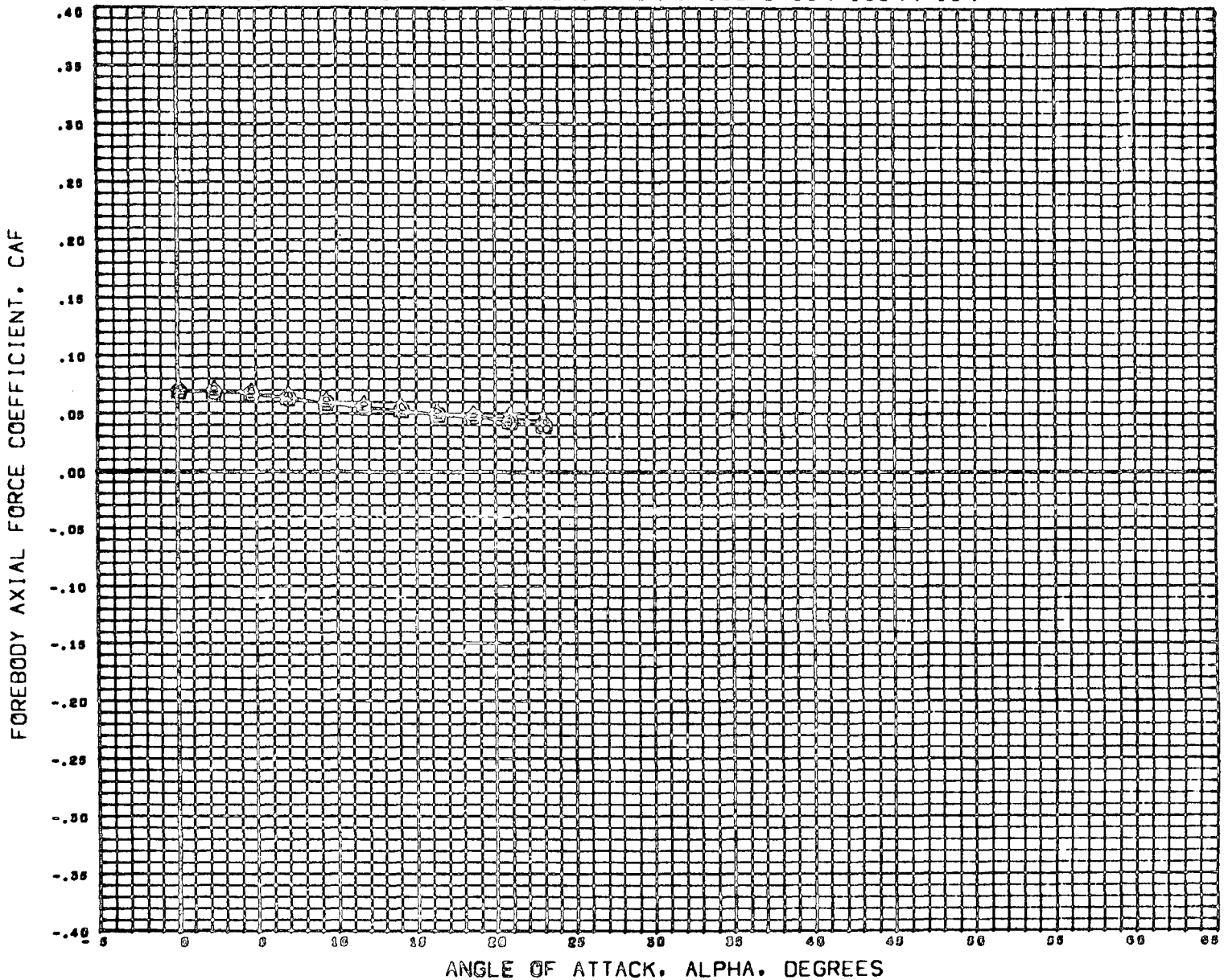

DATA SET SYMBOL	CONFIGURATION DESCRIPTION
(C58010)	MOFC TWY 914 03 030W23C10
(058280)	MOFC TWY 914 03 032W23C10
(058290)	DATA NOT AVAILABLE FOR ALL CONDITIONS

BETA	ELEVTR	CANARD
0.000	0.000	0.000
0.000	0.000	0.000
0.000	0.000	0.000

REFERENCE INFORMATION		
SREF	19.0300	50 INC
LREF	2.6300	INCHES
BREF	6.0620	INCHES
XMRP	2.1110	INCHES
YMRP	0.0000	INCHES
ZMRP	0.0000	INCHES
SCALE	0.0033	

MACH 1.201

FIGURE-6 EFFECT OF REDUCING BODY LENGTH ON B-18E-3 CONFIGURATION

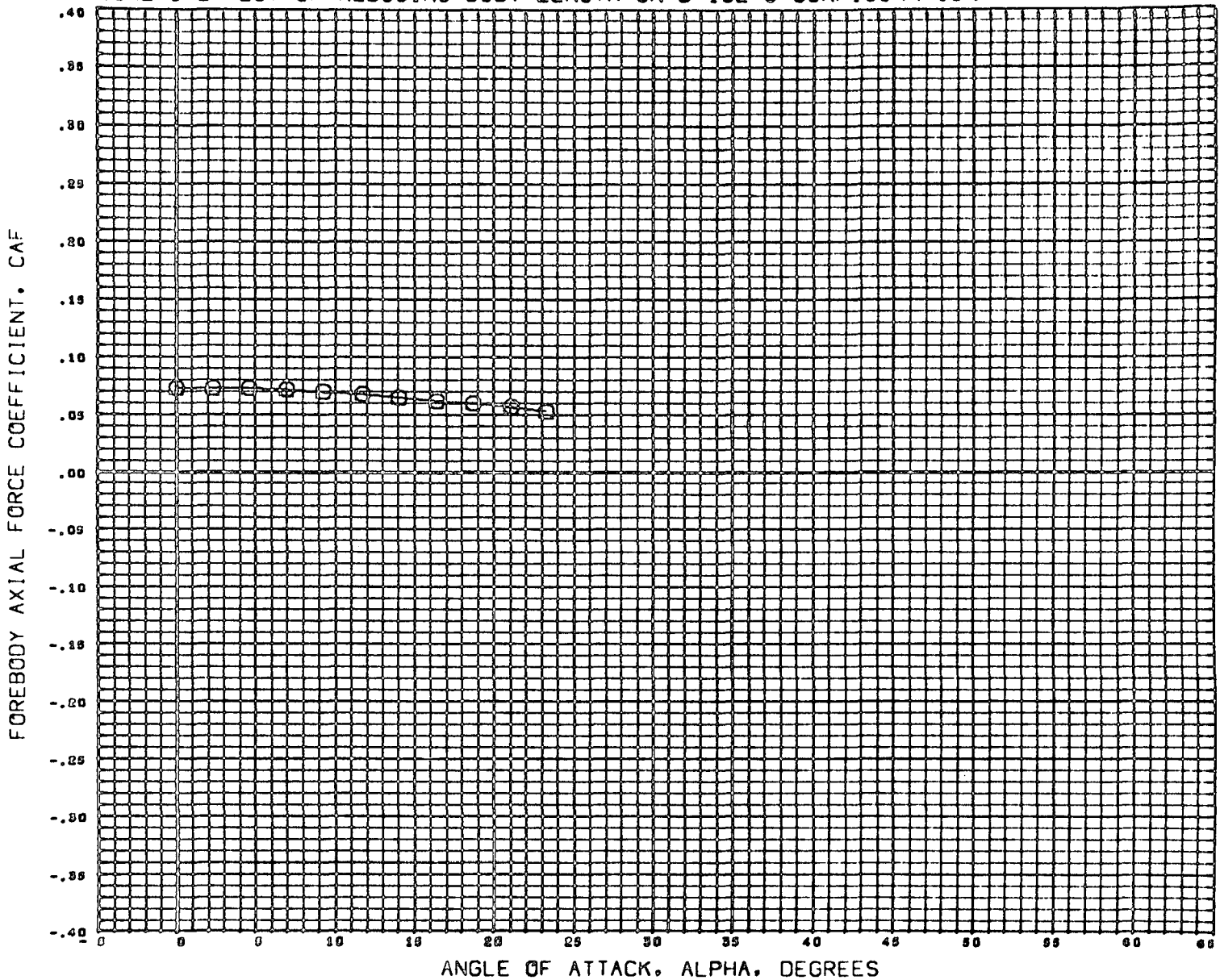

DATA SET SYMBOL	CONFIGURATION DESCRIPTION
(C50010)	HSFC TWT 514 E3 B30W23C10
(050200)	DATA NOT AVAILABLE FOR ALL CONDITIONS
(050290)	DATA NOT AVAILABLE FOR ALL CONDITIONS

BETA	ELEVTR	CANARD
0.000	0.000	0.000
0.000	0.000	0.000
0.000	0.000	0.000

REFERENCE INFORMATION		
SREF	15.0500	50 INC
LREF	2.8300	INCHES
BREF	6.0620	INCHES
XMRP	2.1110	INCHES
YMRP	0.0000	INCHES
ZMRP	0.0000	INCHES
SCALE	0.0035	

MACH 1.450

FIGURE-6 EFFECT OF REDUCING BODY LENGTH ON B-18E-3 CONFIGURATION

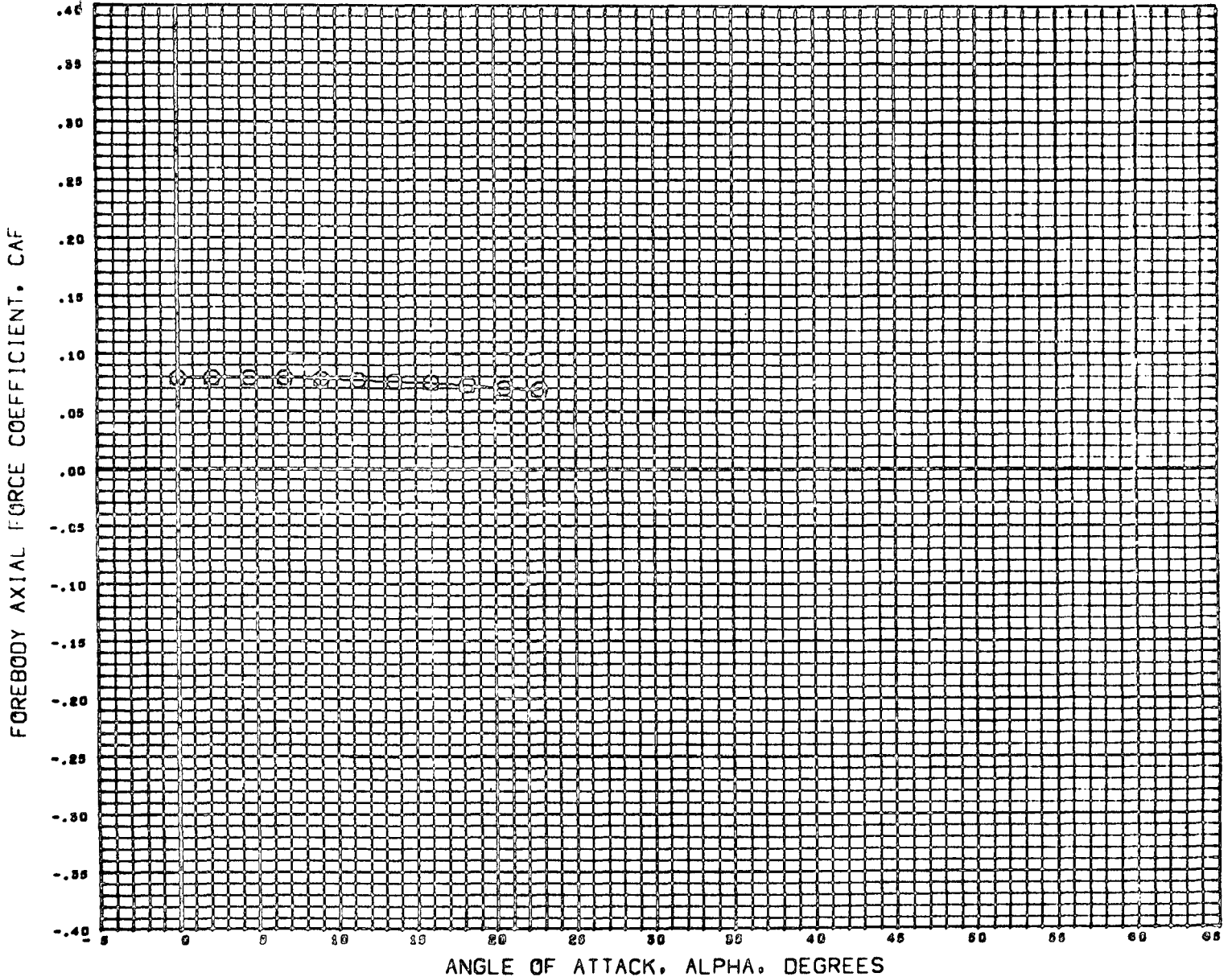

DATA SET SYMBOL	CONFIGURATION DESCRIPTION
(C88010)	MDPC TNT 914 ES 090W29C10
(D56280)	DATA NOT AVAILABLE FOR ALL CONDITIONS
(D56290)	DATA NOT AVAILABLE FOR ALL CONDITIONS

DETA	ELEVTR	CANARD
0.000	0.000	0.000
0.000	0.000	0.000
0.000	0.000	0.000

REFERENCE INFORMATION	
BREF	15.0300 80 INC
LREF	2.8300 INCHES
SREF	6.0620 INCHES
XWOP	2.1110 INCHES
YWRP	0.0000 INCHES
ZWRP	0.0000 INCHES
SCALE	0.0039

MACH 1.000

FIGURE-6 EFFECT OF REDUCING BODY LENGTH ON B-18E-3 CONFIGURATION

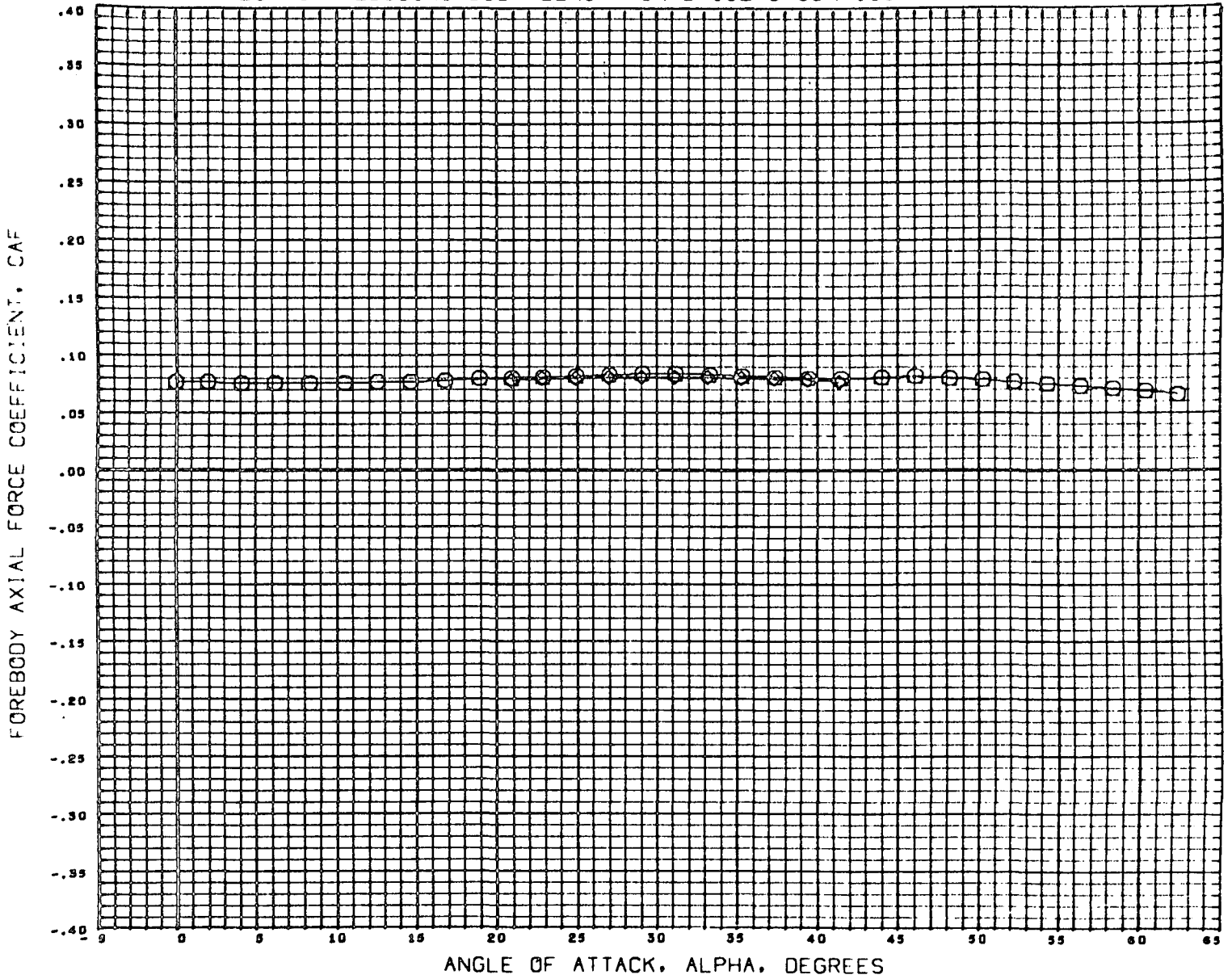

DATA SET SYMBOL	CONFIGURATION DESCRIPTION
(C56010)	HSFC TWT 514 E3 B50W23C10
(D56280)	DATA NOT AVAILABLE FOR ALL CONDITIONS
(D56290)	HSFC TWT 514 E3 B52W23C10

BETA	ELEVTR	CANARD
0.000	0.000	0.000
0.000	0.000	0.000
0.000	0.000	0.000

REFERENCE INFORMATION		
SREF	15.0300	80 INC
LREF	2.8300	INCHES
BREF	6.0620	INCHES
XMRP	2.1110	INCHES
YMRP	0.0000	INCHES
ZMRP	0.0000	INCHES
SCALE	0.0035	

MACH 2.090

FIGURE-6 EFFECT OF REDUCING BODY LENGTH ON B-18E-3 CONFIGURATION

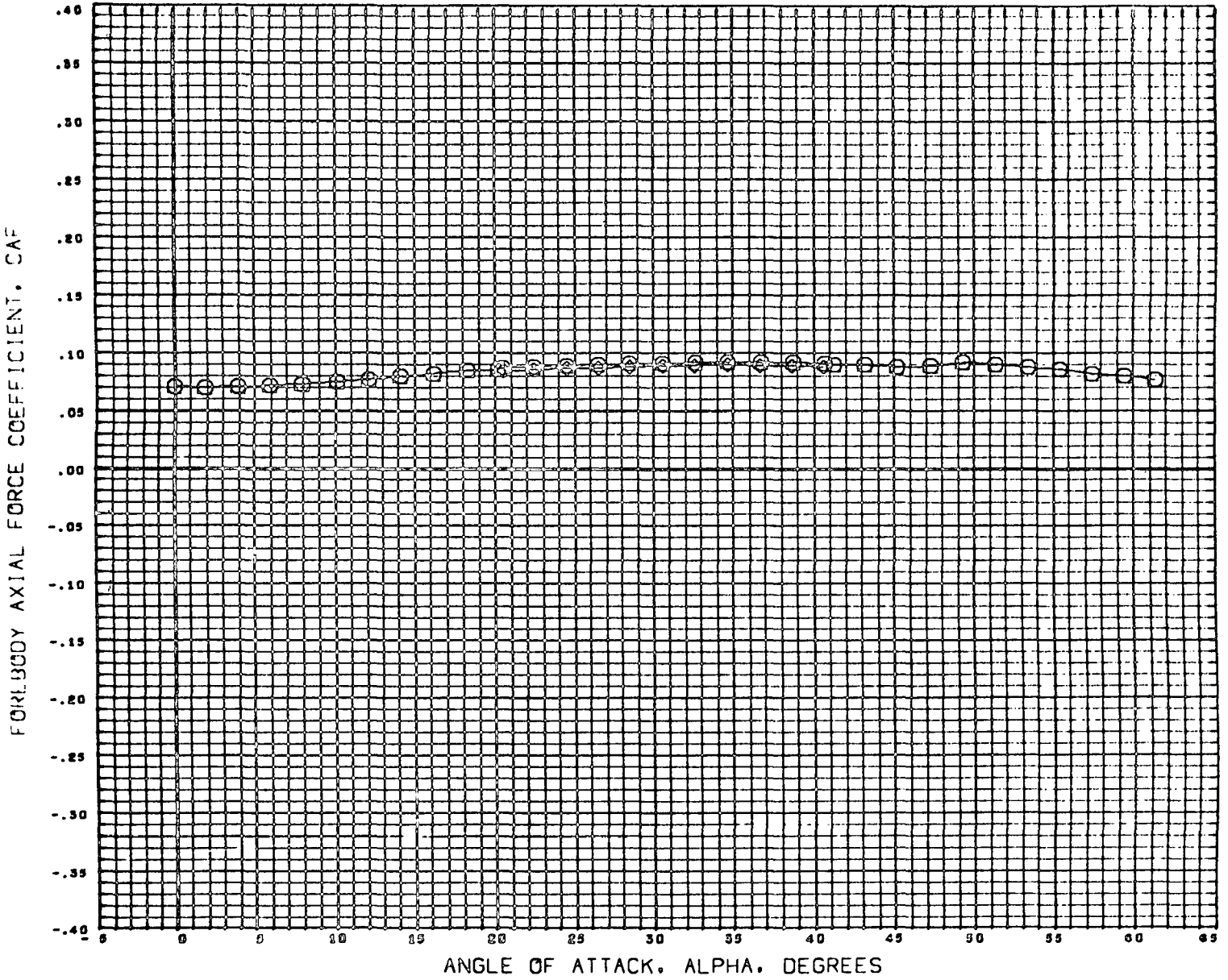

DATA SET SYMBOL	CONFIGURATION DESCRIPTION
(C50010)	MSFC TWT 914 E3 Q30W23C10
(D50280)	DATA NOT AVAILABLE FOR ALL CONDITIONS
(D50290)	MSFC TWT 914 E3 Q32W23C10

BETA	ELEVTR	CANARD
0.000	0.000	0.000
0.000	0.000	0.000
0.000	0.000	0.000

REFERENCE INFORMATION		
SREF	19.0300	SQ INC
LREF	2.8300	INCHES
BREF	6.0620	INCHES
XMRP	2.1110	INCHES
YMRP	0.0000	INCHES
ZMRP	0.0000	INCHES
SCALE	0.0035	

MACH 4.090

FIGURE-6 EFFECT OF REDUCING BODY LENGTH ON B-18E-3 CONFIGURATION

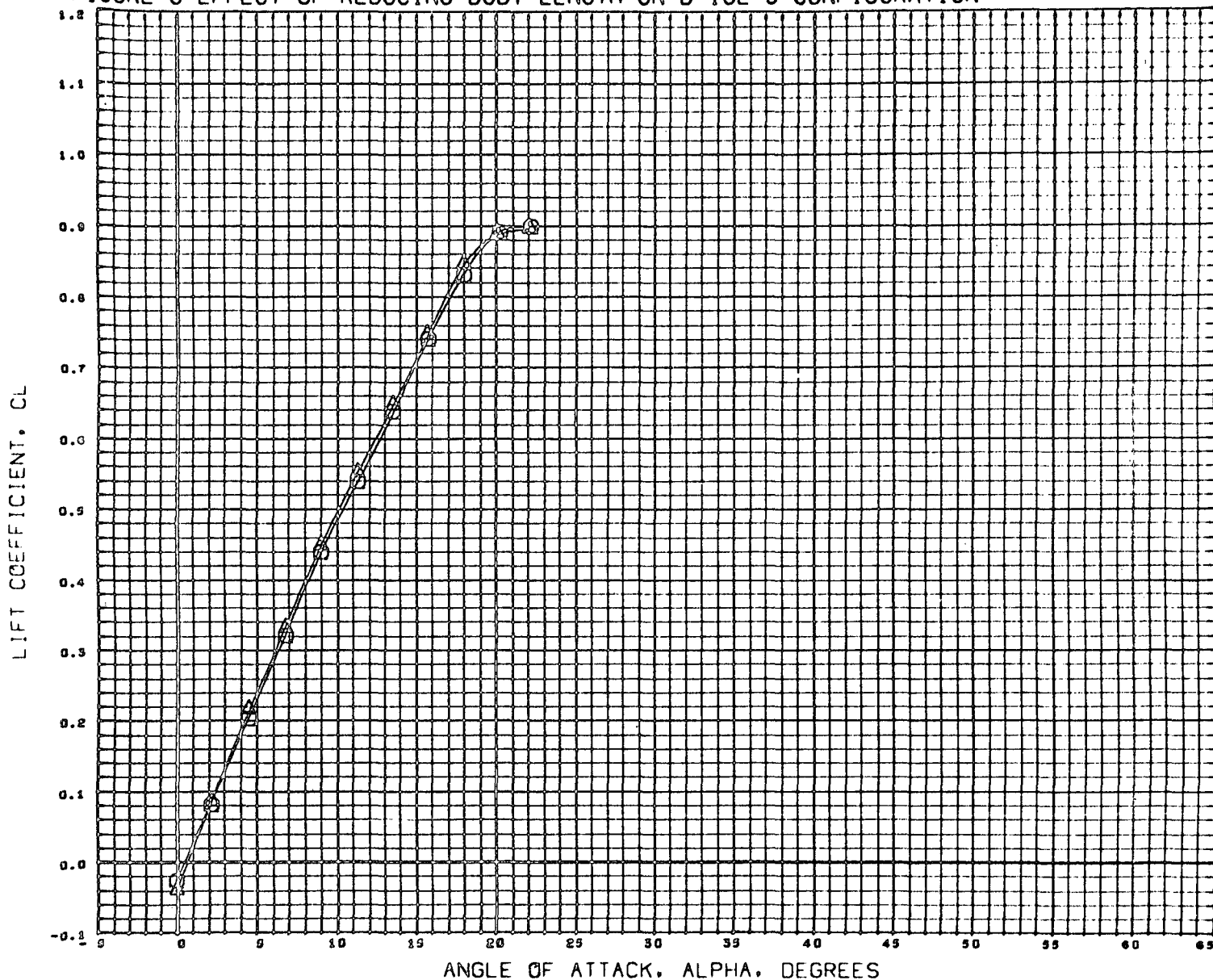

DATA SET SYMBOL	CONFIGURATION DESCRIPTION
(C58010)	MSFC TWT 514 E3 B30W23C10
(D58200)	MSFC TWT 514 E3 B32W23C10
(D58290)	DATA NOT AVAILABLE FOR ALL CONDITIONS

BETA	ELEVTR	CANARD
0.000	0.000	0.000
0.000	0.000	0.000
0.000	0.000	0.000

REFERENCE INFORMATION		
SREF	15.0300	Sq INC
LREF	2.8300	INCHES
BREF	6.0620	INCHES
XMRP	2.1110	INCHES
YMRP	0.0000	INCHES
ZMRP	0.0000	INCHES
SCALE	0.0035	

MACH 0.007

FIGURE-6 EFFECT OF REDUCING BODY LENGTH ON B-18E-3 CONFIGURATION

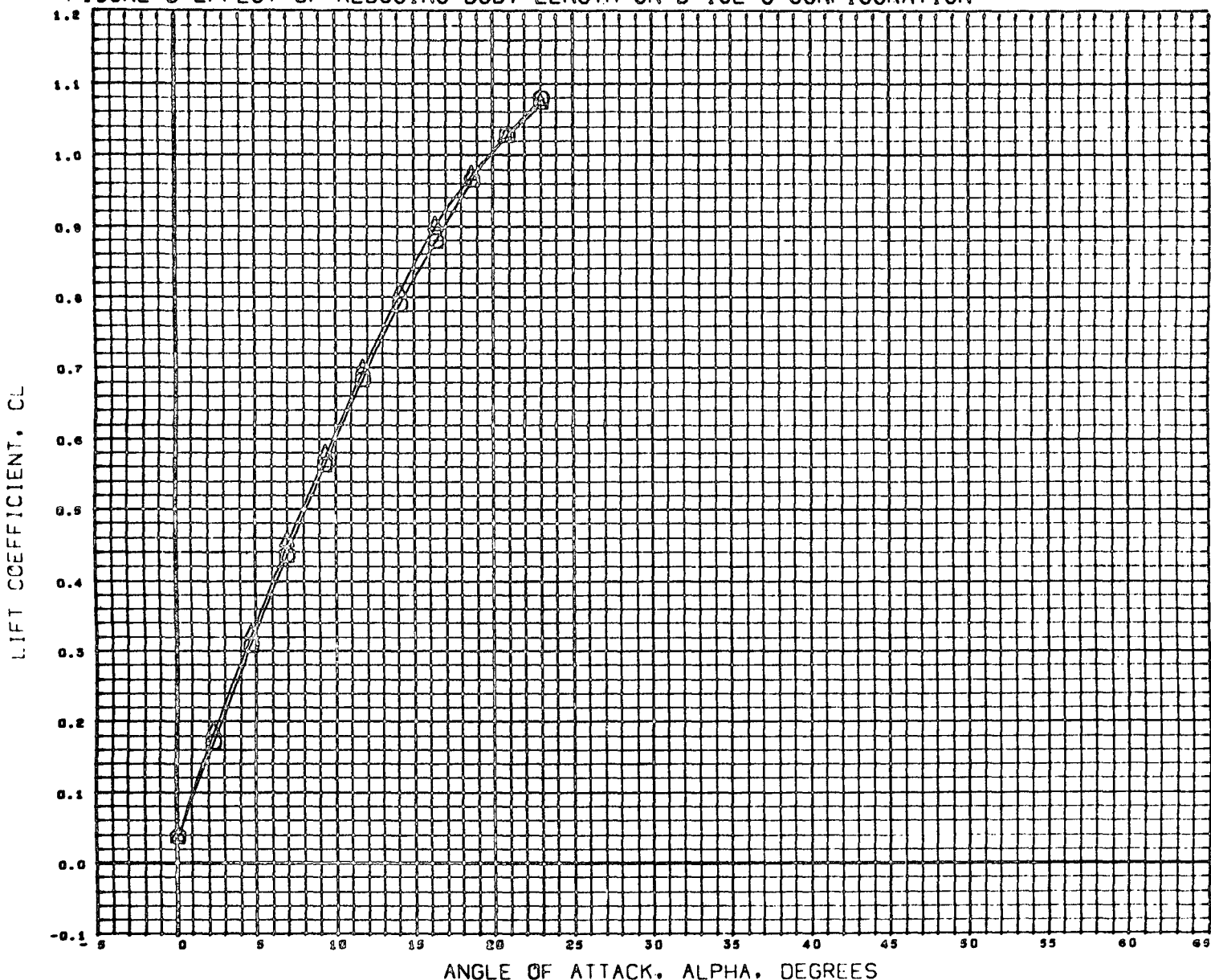

DATA SET SYMBOL	CONFIGURATION DESCRIPTION
(C58010)	MSFC TWT 514 E3 050W23C10
(D58280)	MSFC TWT 514 E3 092W23C10
(058290)	DATA NOT AVAILABLE FOR ALL CONDITIONS

BETA	ELEVTR	CANARD
0.000	0.000	0.000
0.000	0.000	0.000
0.000	0.000	0.000

REFERENCE INFORMATION		
SREF	15.0300	sq INC
LREF	2.8300	INCHES
BREF	6.0620	INCHES
XMRP	2.1110	INCHES
YMRP	0.0000	INCHES
ZMRP	0.0000	INCHES
SCALE	0.0035	

MACH 1.201

FIGURE-6 EFFECT OF REDUCING BODY LENGTH ON B-18E-3 CONFIGURATION

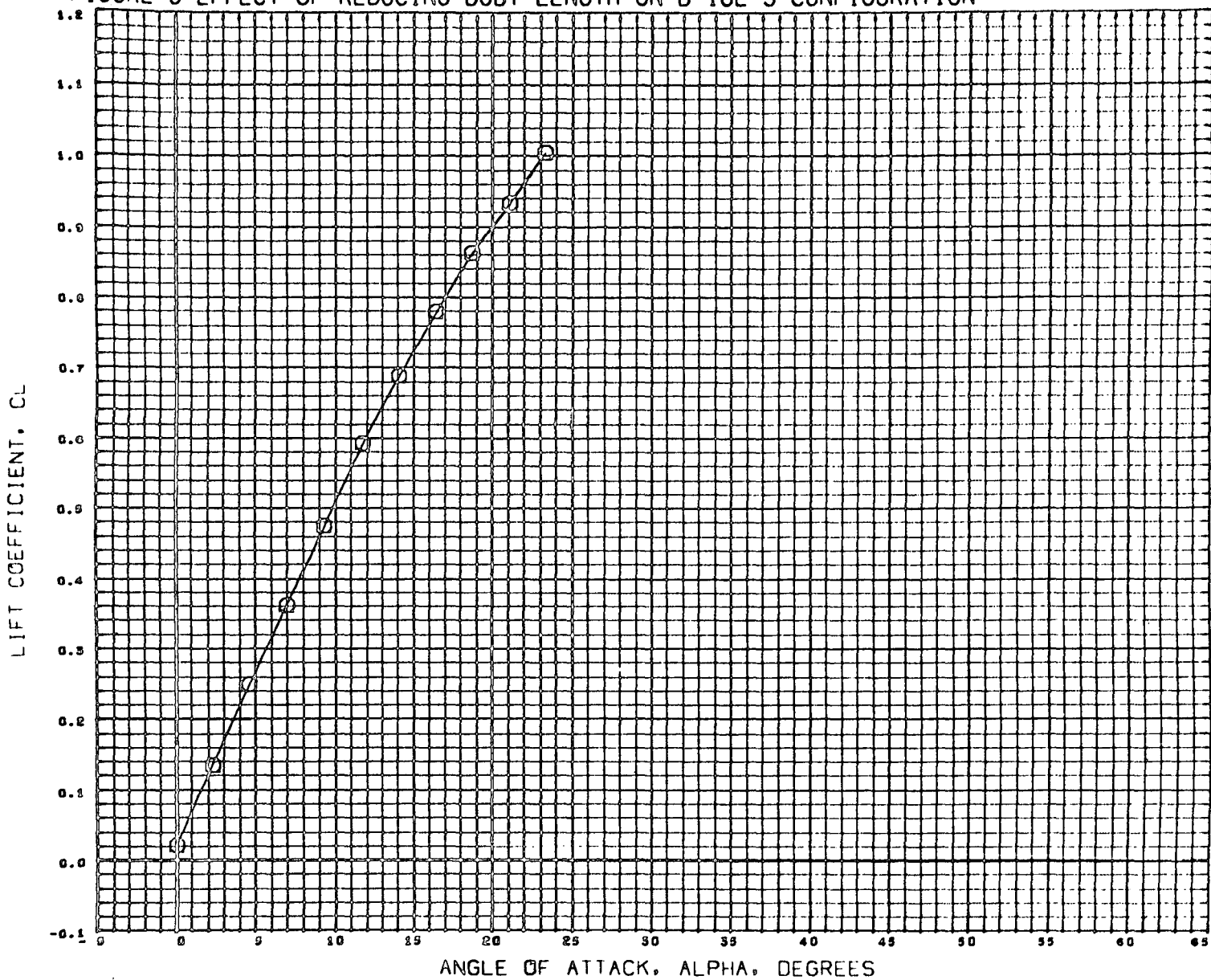

DATA SET SYMBOL	CONFIGURATION DESCRIPTION
(C58010)	MSFC TWT 514 E3 Q30W23C10
(058280)	DATA NOT AVAILABLE FOR ALL CONDITIONS
(058290)	DATA NOT AVAILABLE FOR ALL CONDITIONS

BETA	ELEVTR	CANARD
0.000	0.000	0.000
0.000	0.000	0.000
0.000	0.000	0.000

REFERENCE INFORMATION		
SREF	15.0300	50 INC
LREF	2.8500	INCHES
BREF	6.0820	INCHES
XMRP	2.1110	INCHES
YMRP	0.0000	INCHES
ZMRP	0.0000	INCHES
SCALE	0.0035	

MACH 1.450

FIGURE-6 EFFECT OF REDUCING BODY LENGTH ON B-18E-3 CONFIGURATION

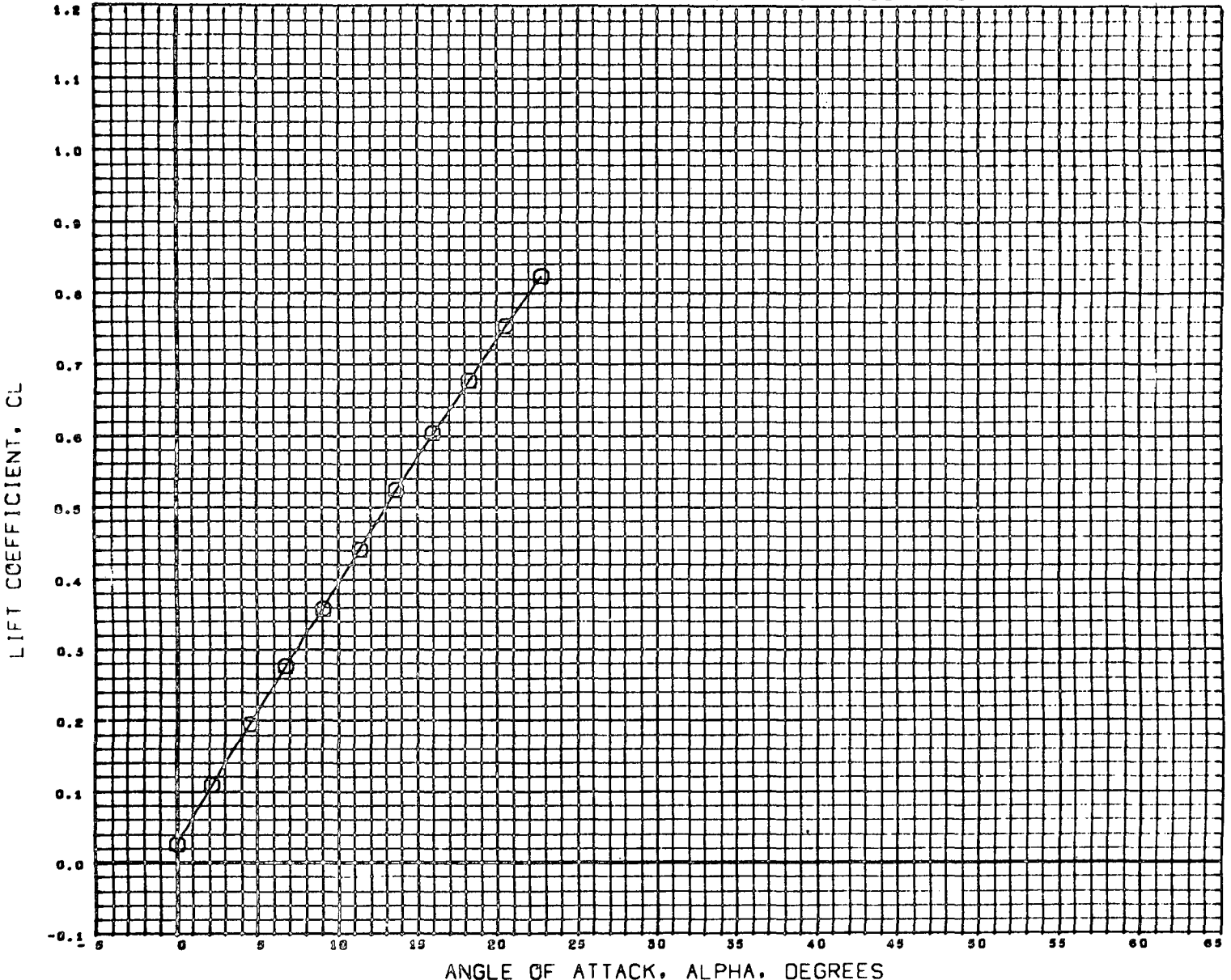

DATA SET SYMBOL	CONFIGURATION DESCRIPTION
(C58010)	MSFC TWT 514 E3 OS0W25C10
(058280)	DATA NOT AVAILABLE FOR ALL CONDITIONS
(058290)	DATA NOT AVAILABLE FOR ALL CONDITIONS

BETA	ELEVTR	CANARD
0.000	0.000	0.000
0.000	0.000	0.000
0.000	0.000	0.000

REFERENCE INFORMATION		
SREF	15.0300	SQ INC
LREF	2.8300	INCHES
QREF	6.0620	INCHES
XMRP	2.1110	INCHES
YMRP	0.0000	INCHES
ZMRP	0.0000	INCHES
SCALE	0.0035	

MACH 8.000

FIGURE-6 EFFECT OF REDUCING BODY LENGTH ON B-18E-3 CONFIGURATION

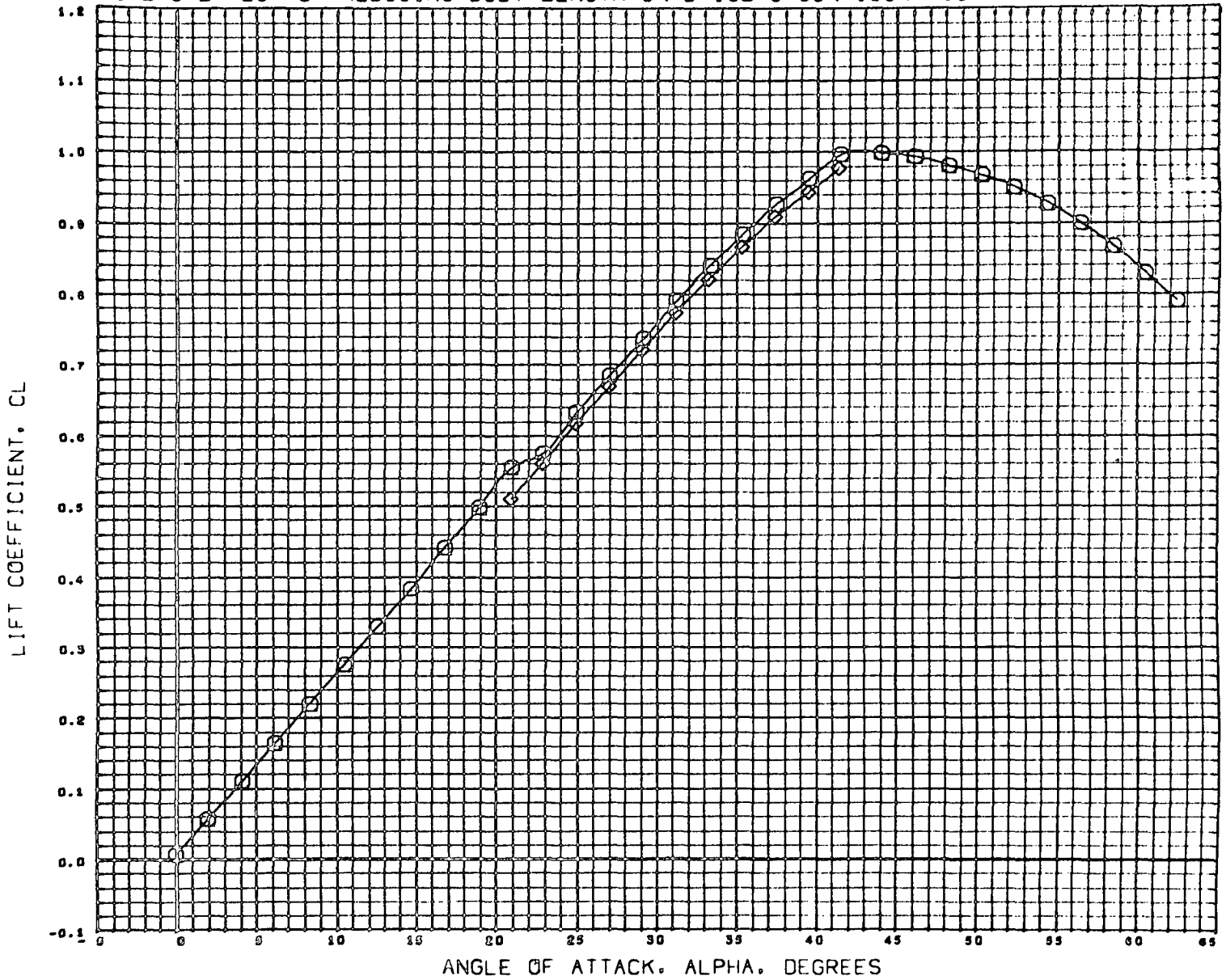

DATA SET SYMBOL	CONFIGURATION DESCRIPTION
(C50010)	HSFC TWT 914 E3 030W23C10
(D96200)	DATA NOT AVAILABLE FOR ALL CONDITIONS
(D50290)	HSFC TWT 914 E3 032W23C10

BETA	ELEVTR	CANARD
0.000	0.000	0.000
0.000	0.000	0.000
0.000	0.000	0.000

REFERENCE INFORMATION	
SREF	19.0300 SQ INC
LREF	2.8300 INCHES
BREF	6.0620 INCHES
XMRP	2.1110 INCHES
YMRP	0.0000 INCHES
ZMRP	0.0000 INCHES
SCALE	0.0035 INCHES

MACH 2.000

FIGURE-6 EFFECT OF REDUCING BODY LENGTH ON B-18E-3 CONFIGURATION

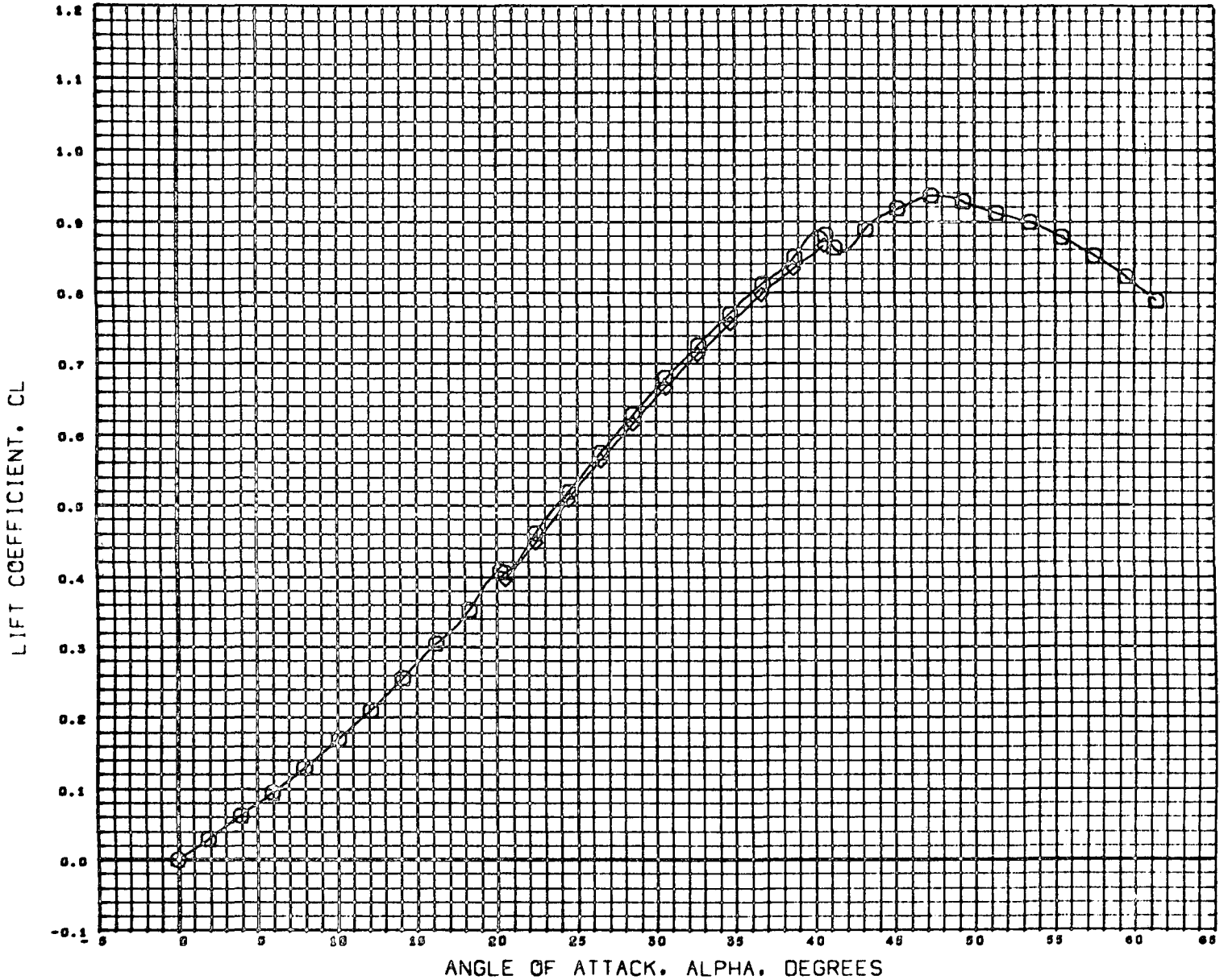

DATA SET SYMBOL	CONFIGURATION DESCRIPTION
(C58010)	M8FC TWT 914 C3 050W23C10
(058280)	DATA NOT AVAILABLE FOR ALL CONDITIONS
(068290)	M8FC TWT 914 C3 032W23C10

BETA	ELEVTR	CANARD
0.000	0.000	0.000
0.000	0.000	0.000
0.000	0.000	0.000

REFERENCE INFORMATION	
QREF	15.0300 SQ INC
LREF	2.8300 INCHES
QREF	6.0620 INCHES
XMRP	2.1110 INCHES
YMRP	0.0000 INCHES
ZMRP	0.0000 INCHES
SCALE	0.0035

MACH 4.999

7

FIGURE-6 EFFECT OF REDUCING BODY LENGTH ON B-18E-3 CONFIGURATION

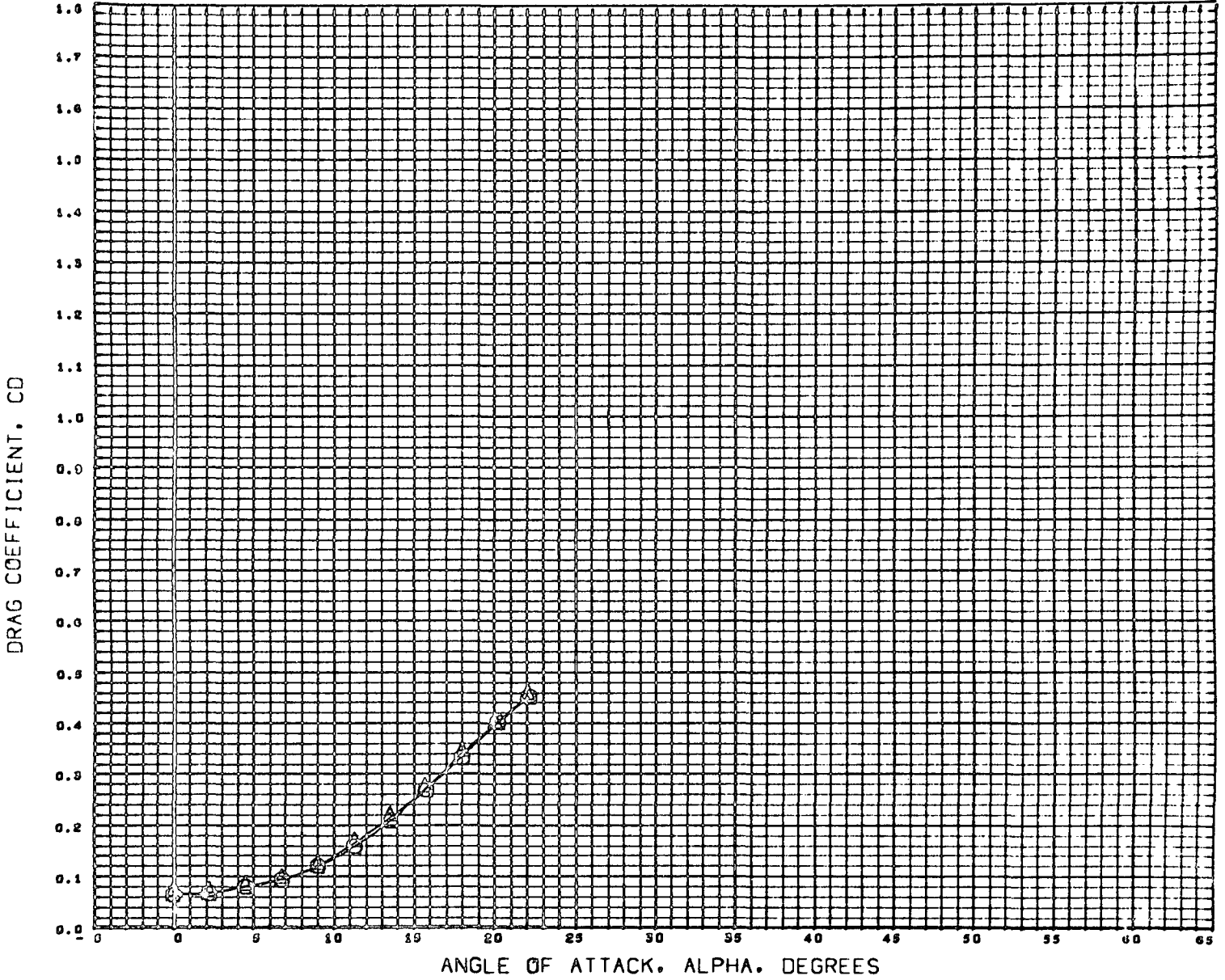

DATA SET SYMBOL	CONFIGURATION DESCRIPTION	BETA	ELEVTR	CANARD	REFERENCE INFORMATION
(C58010)	MBFC TWT 914 E3 030W23C10	0.000	0.000	0.000	SREF 15.0300 SQ INC
(D58280)	MBFC TWT 914 E3 032W23C10	0.000	0.000	0.000	LREF 2.8300 INCHES
(D58290)	DATA NOT AVAILABLE FOR ALL CONDITIONS	0.000	0.000	0.000	BREF 6.0620 INCHES
					XMRP 2.1110 INCHES
					YMRP 0.0000 INCHES
					ZMRP 0.0000 INCHES
					SCALE 0.0039

MACH 0.007

FIGURE-6 EFFECT OF REDUCING BODY LENGTH ON B-18E-3 CONFIGURATION

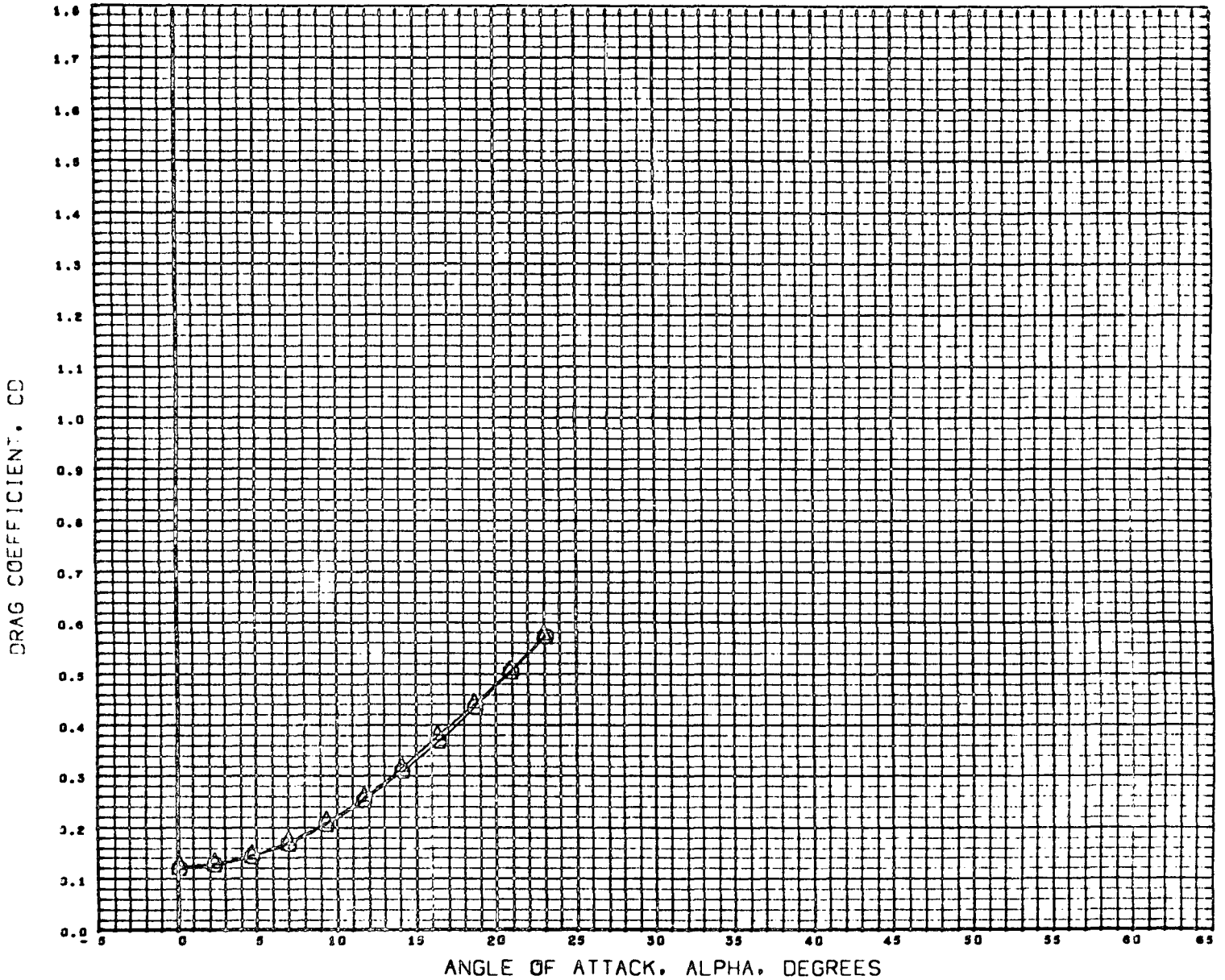

DATA SET SYMBOL	CONFIGURATION DESCRIPTION
(C98610)	MSFC TWT 914 E3 830W23C1G
(D58780)	MSFC TWT 914 E3 832W23C1G
(D58290)	DATA NOT AVAILABLE FOR ALL CONDITIONS

BETA	ELEVTR	CANARD
0.000	0.000	0.000
0.000	0.000	0.000
0.000	0.000	0.000

REFERENCE INFORMATION		
SREF	15.0300	SQ INC
LREF	2.8300	INCHES
BREF	6.0620	INCHES
XMRP	2.1110	INCHES
YMRP	0.0000	INCHES
ZMRP	0.0000	INCHES
SCALE	0.0035	

MACH 1.201

FIGURE-6 EFFECT OF REDUCING BODY LENGTH ON B-18E-3 CONFIGURATION

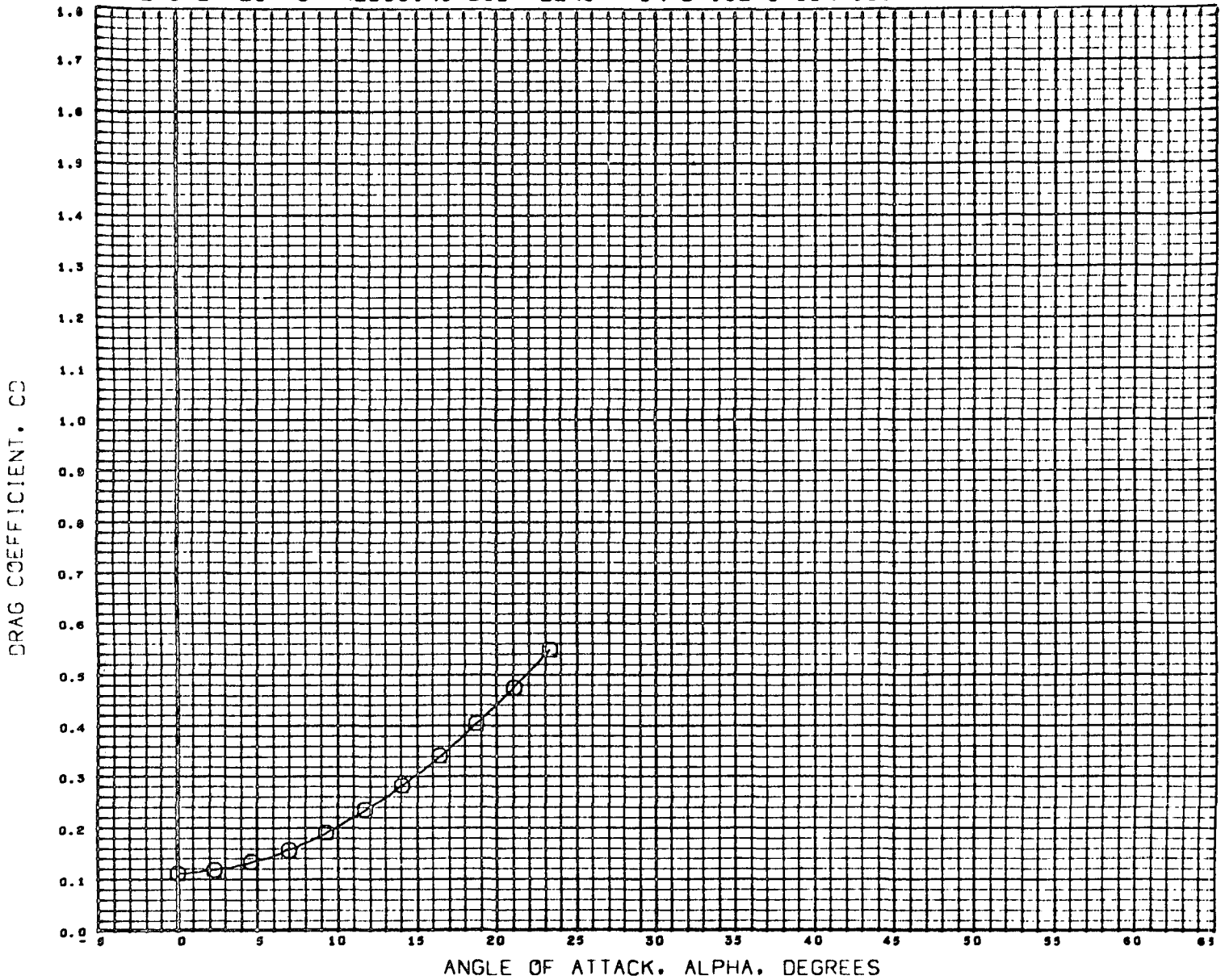

DATA SET	SYMBOL	CONFIGURATION DESCRIPTION
(058010)	○	MSFC TWT 514 E3 B30W23C13
(058280)	×	DATA NOT AVAILABLE FOR ALL CONDITIONS
(058290)	◇	DATA NOT AVAILABLE FOR ALL CONDITIONS

BETA	ELEVTR	CANARD
0.000	0.000	0.000
0.000	0.000	0.000
0.000	0.000	0.000

REFERENCE INFORMATION	
SREF	15.0300 SQ INC
LREF	2.8300 INCHES
BREF	6.0620 INCHES
XMRP	2.1110 INCHES
YMRP	0.0000 INCHES
ZMRP	0.0000 INCHES
SCALE	0.0035

MACH 1.459

FIGURE-6 EFFECT OF REDUCING BODY LENGTH ON B-18E-3 CONFIGURATION

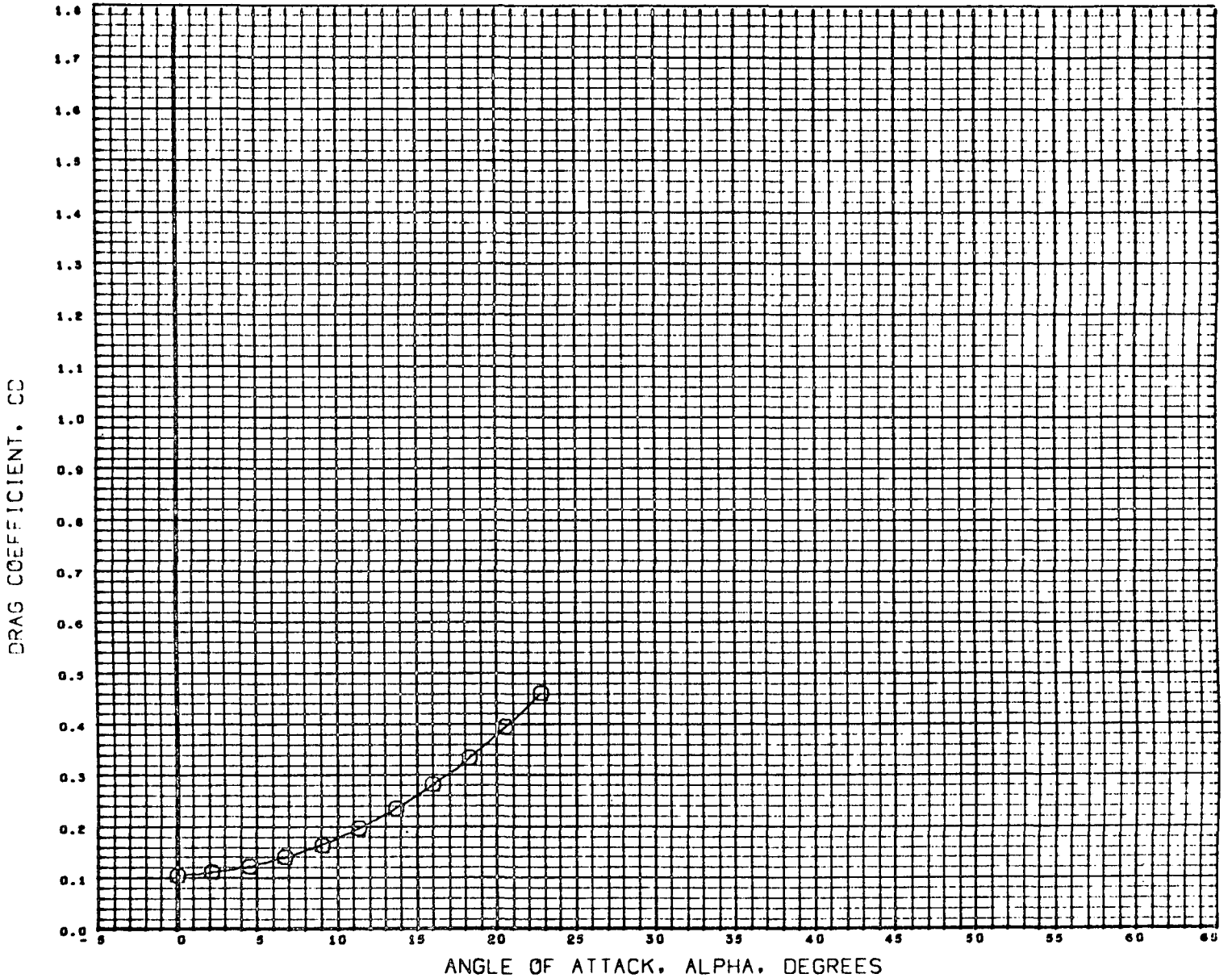

DATA SET SYMBOL	CONFIGURATION DESCRIPTION
(C58010)	MSFC TWT 514 E3 B30N23C10
(C58280)	DATA NOT AVAILABLE FOR ALL CONDITIONS
(C58290)	DATA NOT AVAILABLE FOR ALL CONDITIONS

BETA	ELEVTR	CANARD
0.000	0.000	0.000
0.000	0.000	0.000
0.000	0.000	0.000

REFERENCE INFORMATION		
SREF	15.0300	59 INC
LREF	2.8300	INCHES
BREF	6.0620	INCHES
XMRP	2.1110	INCHES
YMRP	0.0000	INCHES
ZMRP	0.0000	INCHES
SCALE	0.0039	

MACH 1.060

FIGURE-6 EFFECT OF REDUCING BODY LENGTH ON B-18E-3 CONFIGURATION

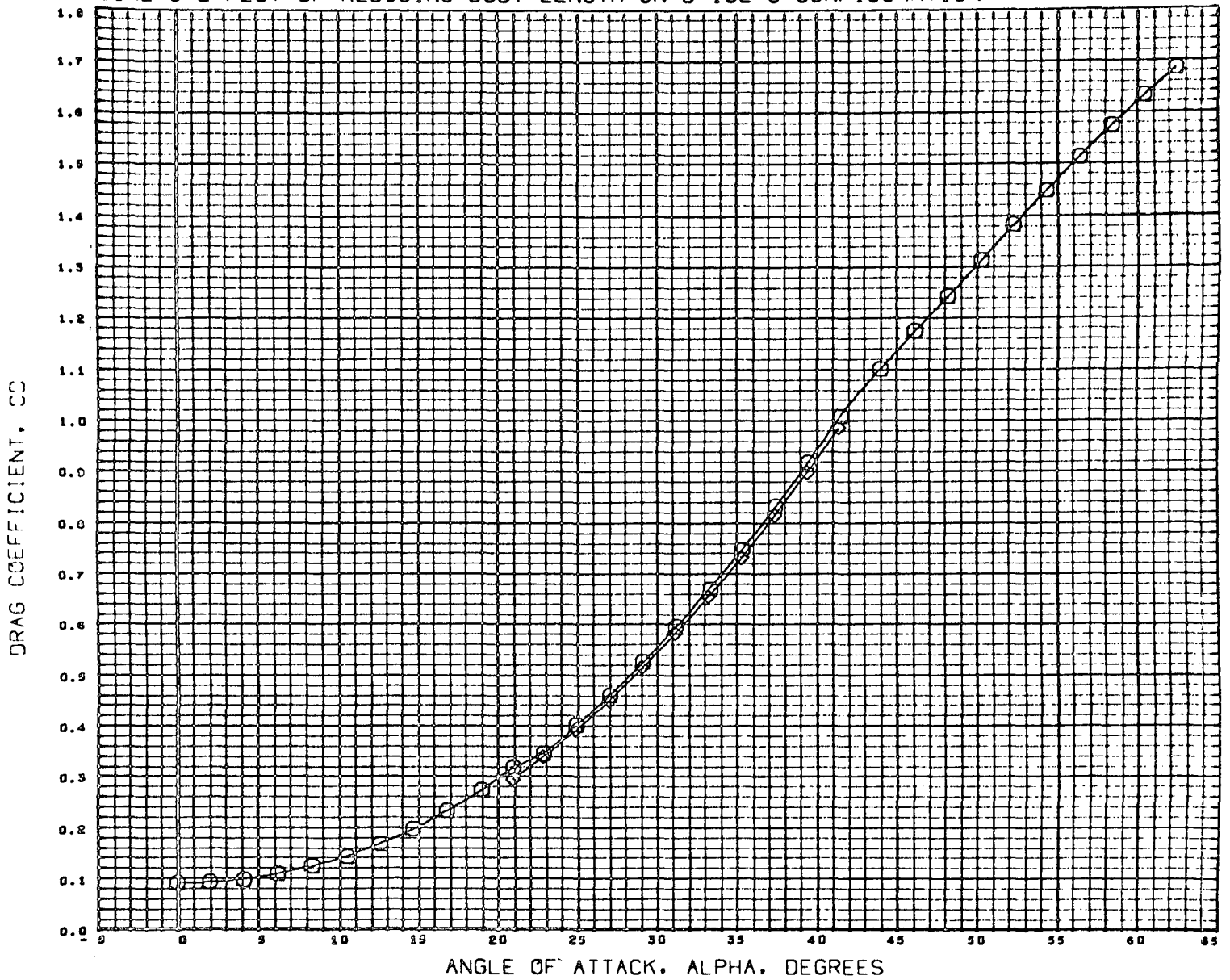

DATA SET SYMBOL	CONFIGURATION DESCRIPTION
(C53010)	MSFC TWT 514 E3 B3GW23C10
(D53200)	DATA NOT AVAILABLE FOR ALL CONDITIONS
(D53290)	MSFC TWT 514 E3 B32W23C10

BETA	ELEVTR	CANARD
0.000	0.000	0.000
0.000	0.000	0.000
0.000	0.000	0.000

REFERENCE INFORMATION		
SREF	15.0300	90 INC
LREF	2.8300	INCHES
BREF	6.0620	INCHES
XMRP	2.1110	INCHES
YMRP	0.0000	INCHES
ZMRP	0.0000	INCHES
SCALE	0.0035	

MACH 2.990

FIGURE-6 EFFECT OF REDUCING BODY LENGTH ON B-18E-3 CONFIGURATION

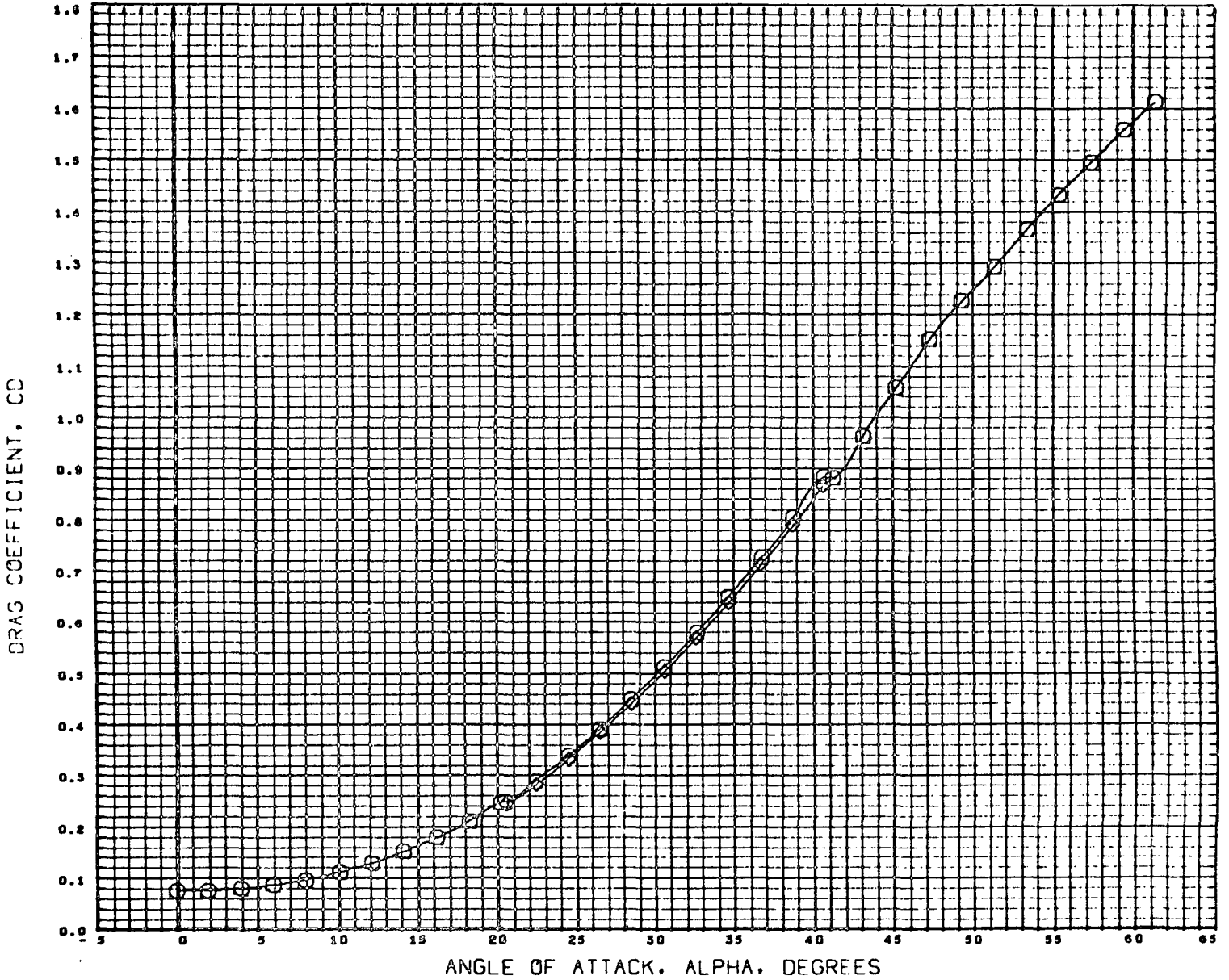

DATA SET SYMBOL	CONFIGURATION DESCRIPTION
(C56310)	MSFC TWT 514 E3 030W23C10
(C56280)	DATA NOT AVAILABLE FOR ALL CONDITIONS
(D56290)	MSFC TWT 514 E3 032W23C10

BETA	ELEVTR	CANARD
0.000	0.000	0.000
0.000	0.000	0.000
0.000	0.000	0.000

REFERENCE INFORMATION		
SREF	15.0300	SQ INC
LREF	2.8300	INCHES
BREF	6.0820	INCHES
XMRP	2.1110	INCHES
YMRP	0.0000	INCHES
ZMRP	0.0000	INCHES
SCALE	0.0035	

MACH 4.059

FIGURE-6 EFFECT OF REDUCING BODY LENGTH ON B-18E-3 CONFIGURATION

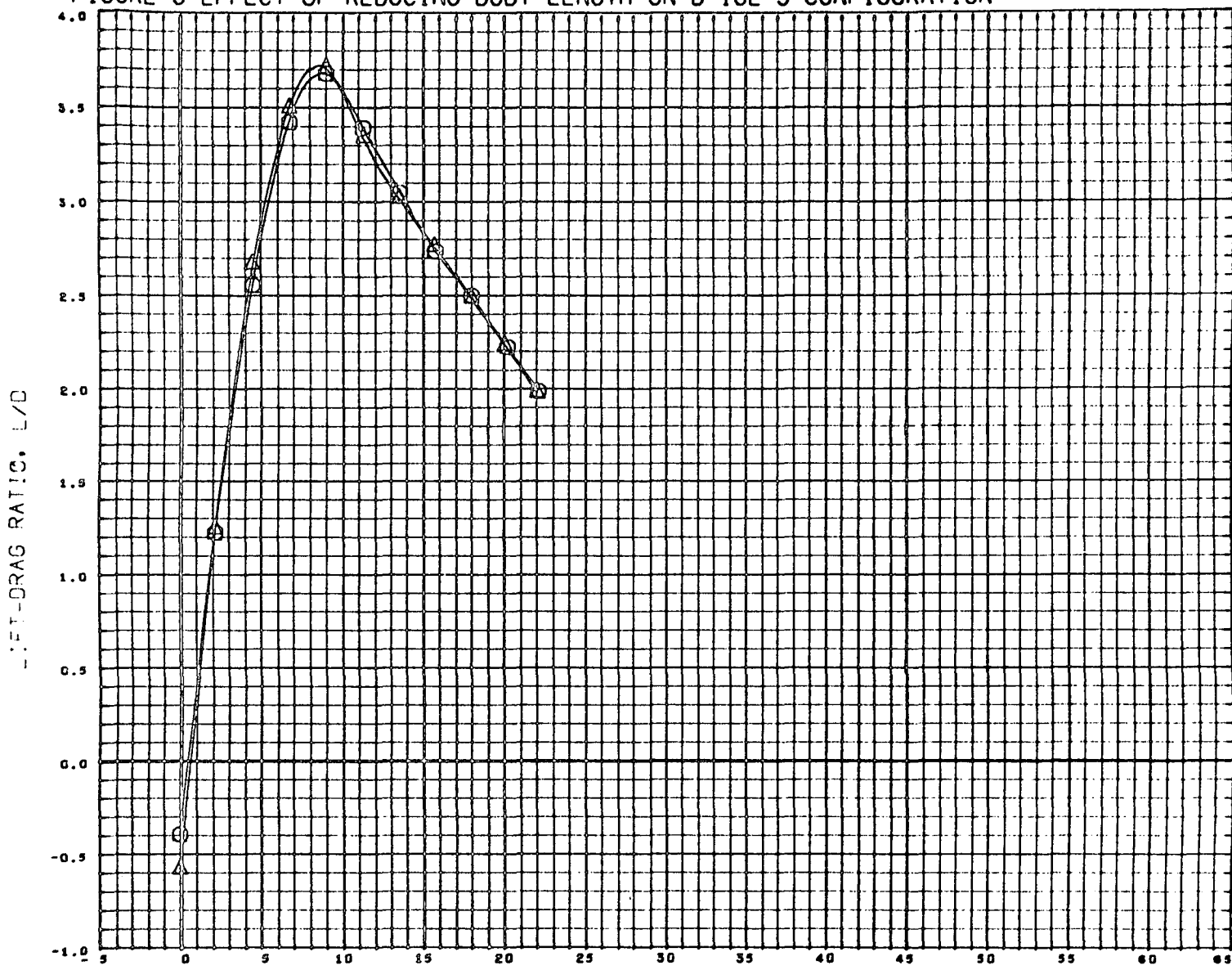

DATA SET SYMBOL	CONFIGURATION DESCRIPTION	BETA	ELEVTR	CANARD	REFERENCE INFORMATION	
(C58010)	MSFC TWT 514 E3 830W23C10	0.000	0.000	0.000	SREF	15.0300 SQ INC
(C58210)	MSFC TWT 514 E3 832W23C10	0.000	0.000	0.000	LREF	2.8300 INCHES
(C58250)	DATA NOT AVAILABLE FOR ALL CONDITIONS	0.000	0.000	0.000	BREF	6.0620 INCHES
					XMRP	2.1110 INCHES
					YMRF	0.0000 INCHES
					ZMRF	0.0000 INCHES
					SCALE	0.0035

MACH 0.907

FIGURE-6 EFFECT OF REDUCING BODY LENGTH ON B-18E-3 CONFIGURATION

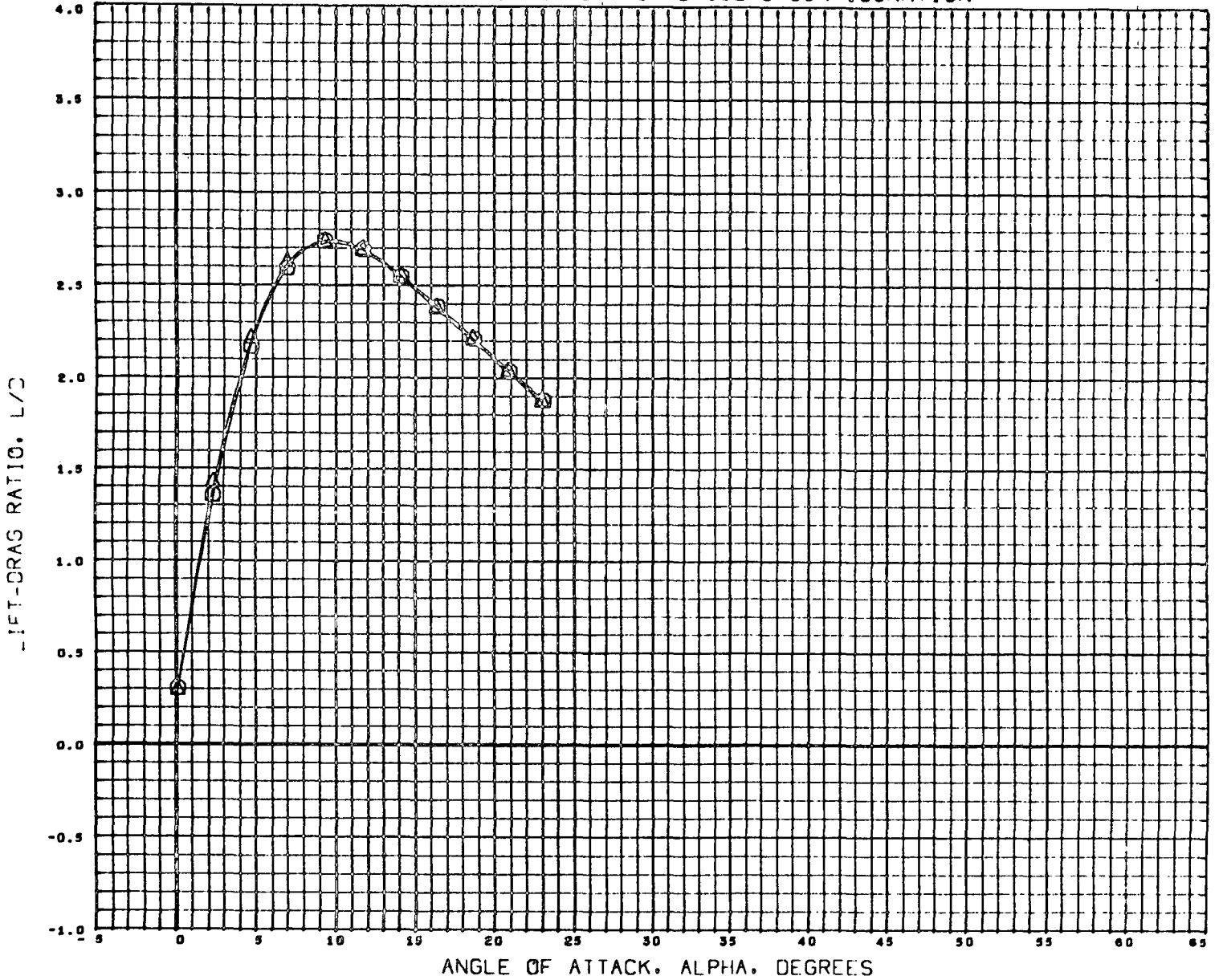

DATA SET SYMBOL	CONFIGURATION DESCRIPTION
(C56010)	MSFC TWT 514 E3 030W23C10
(C56280)	MSFC TWT 514 E3 032W23C10
(C56290)	DATA NOT AVAILABLE FOR ALL CONDTIONS

BETA	ELEVTR	CANARD
0.000	0.000	0.000
0.000	0.000	0.000
0.000	0.000	0.000

REFERENCE INFORMATION		
SREF	15.0300	SQ INC
LREF	2.8300	INCHES
BREF	6.0620	INCHES
XMRP	2.1110	INCHES
YMRP	0.0000	INCHES
ZMRP	0.0000	INCHES
SCALE	0.0035	

MACH 1.201

FIGURE-6 EFFECT OF REDUCING BODY LENGTH ON B-18E-3 CONFIGURATION

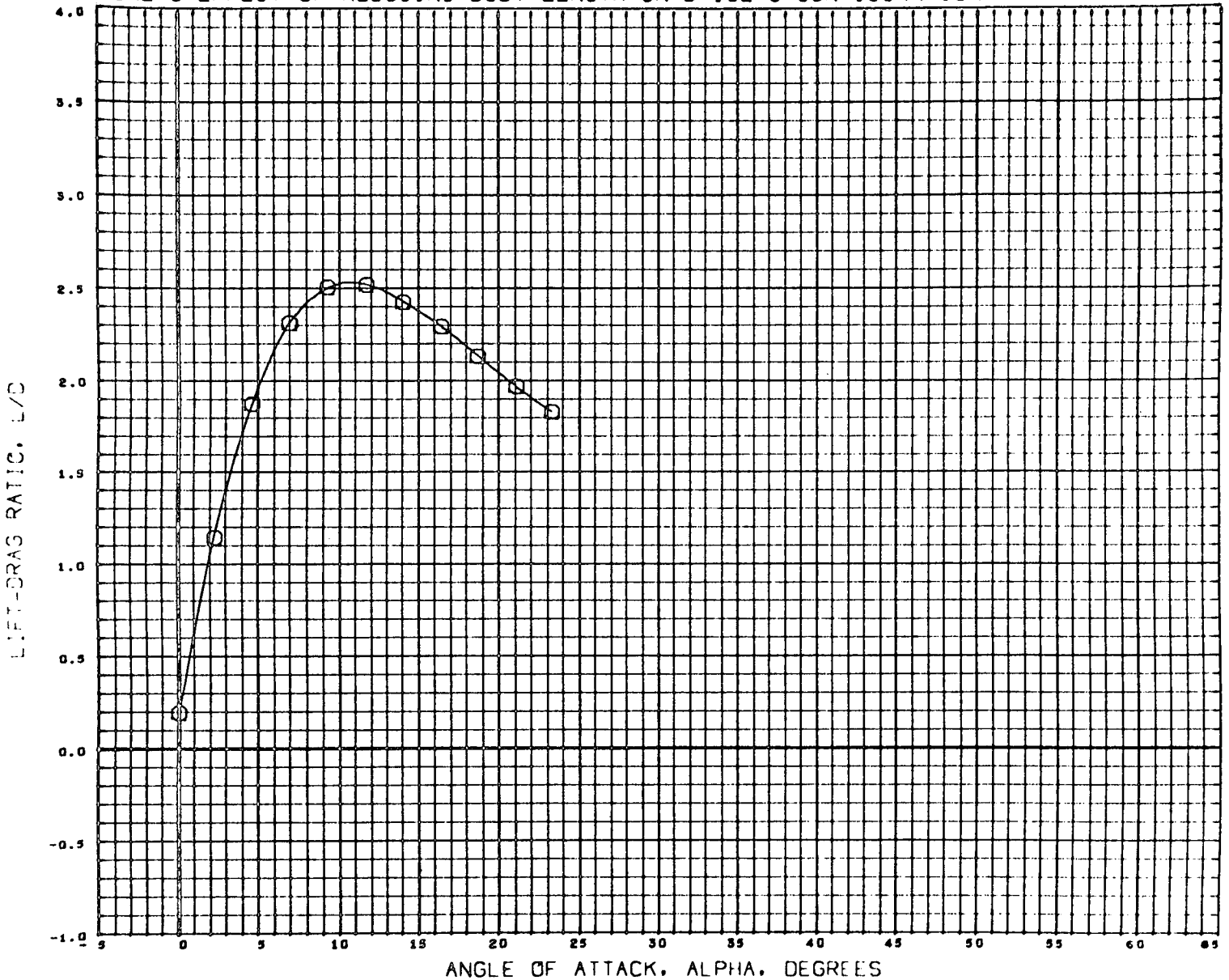

DATA SET SYMBOL	CONFIGURATION DESCRIPTION
(C58010)	MSFC TWT 514 E3 B30W23C10
(C58280)	DATA NOT AVAILABLE FOR ALL CONDITIONS
(C58290)	DATA NOT AVAILABLE FOR ALL CONDITIONS

BETA	ELEVTR	CANARD
0.000	0.000	0.000
0.000	0.000	0.000
0.000	0.000	0.000

REFERENCE INFORMATION	
SREF	15.0355 SQ INC
LREF	2.8355 INCHES
BREF	6.0625 INCHES
XMRP	2.1110 INCHES
YMRP	0.0000 INCHES
ZMRP	0.0000 INCHES
SCALE	0.0035

MACH 1.459

FIGURE-6 EFFECT OF REDUCING BODY LENGTH ON B-18E-3 CONFIGURATION

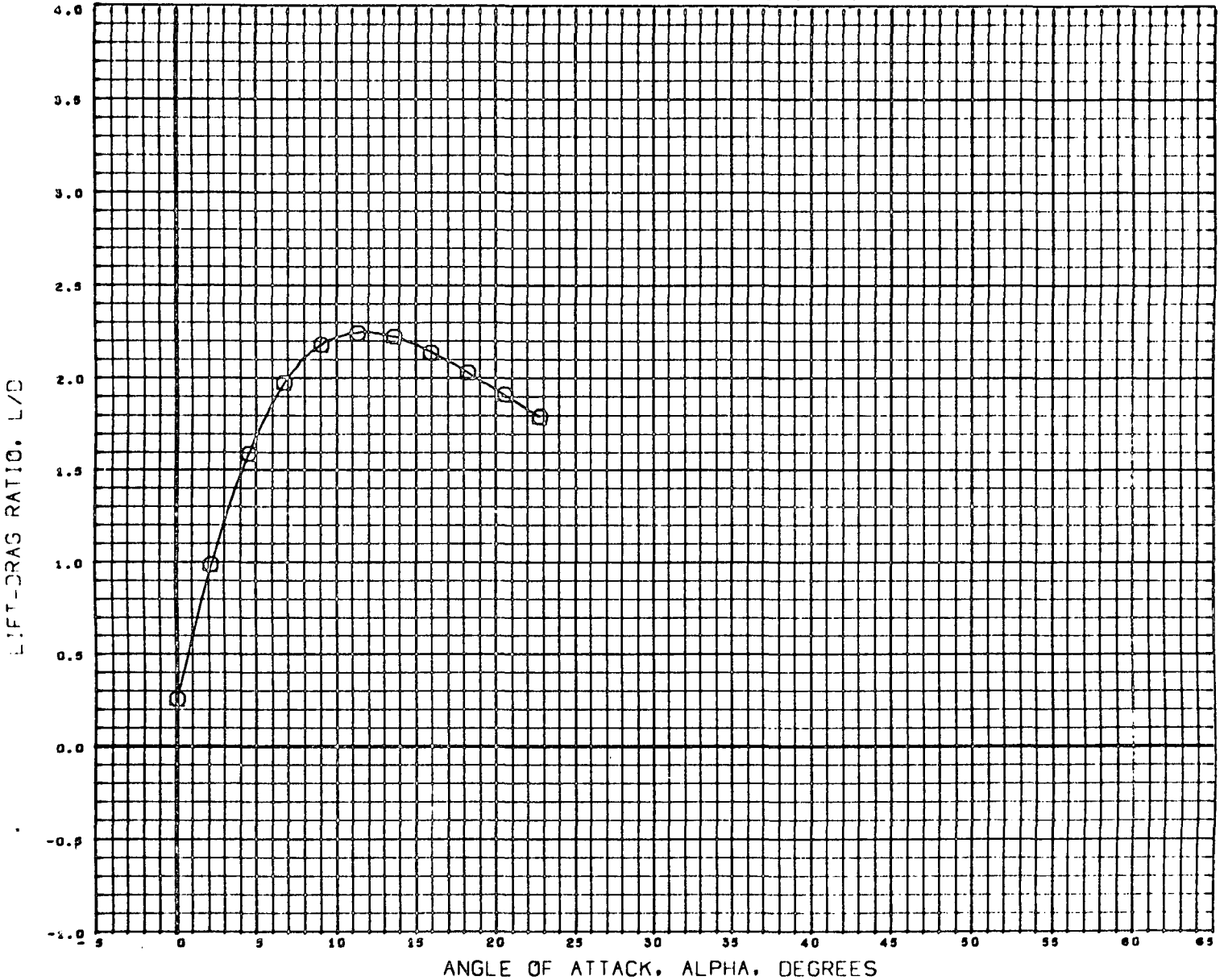

DATA SET	SYMBOL	CONFIGURATION DESCRIPTION
(C98610)	○	MSFC TWT 514 E3 B30W25C1G
(058280)	△	DATA NOT AVAILABLE FOR ALL CONDITIONS
(058290)	◇	DATA NOT AVAILABLE FOR ALL CONDITIONS

BETA	ELEVTR	CANARD
0.000	0.000	0.000
0.000	0.000	0.000
0.000	0.000	0.000

REFERENCE INFORMATION		
SREF	15.0500	99 INC
LREF	2.8300	INCHES
BREF	6.0620	INCHES
XMRP	2.1110	INCHES
YMRP	0.0000	INCHES
ZMRP	0.0000	INCHES
SCALE	0.0035	

MACH 1.060

FIGURE-6 EFFECT OF REDUCING BODY LENGTH ON B-18E-3 CONFIGURATION

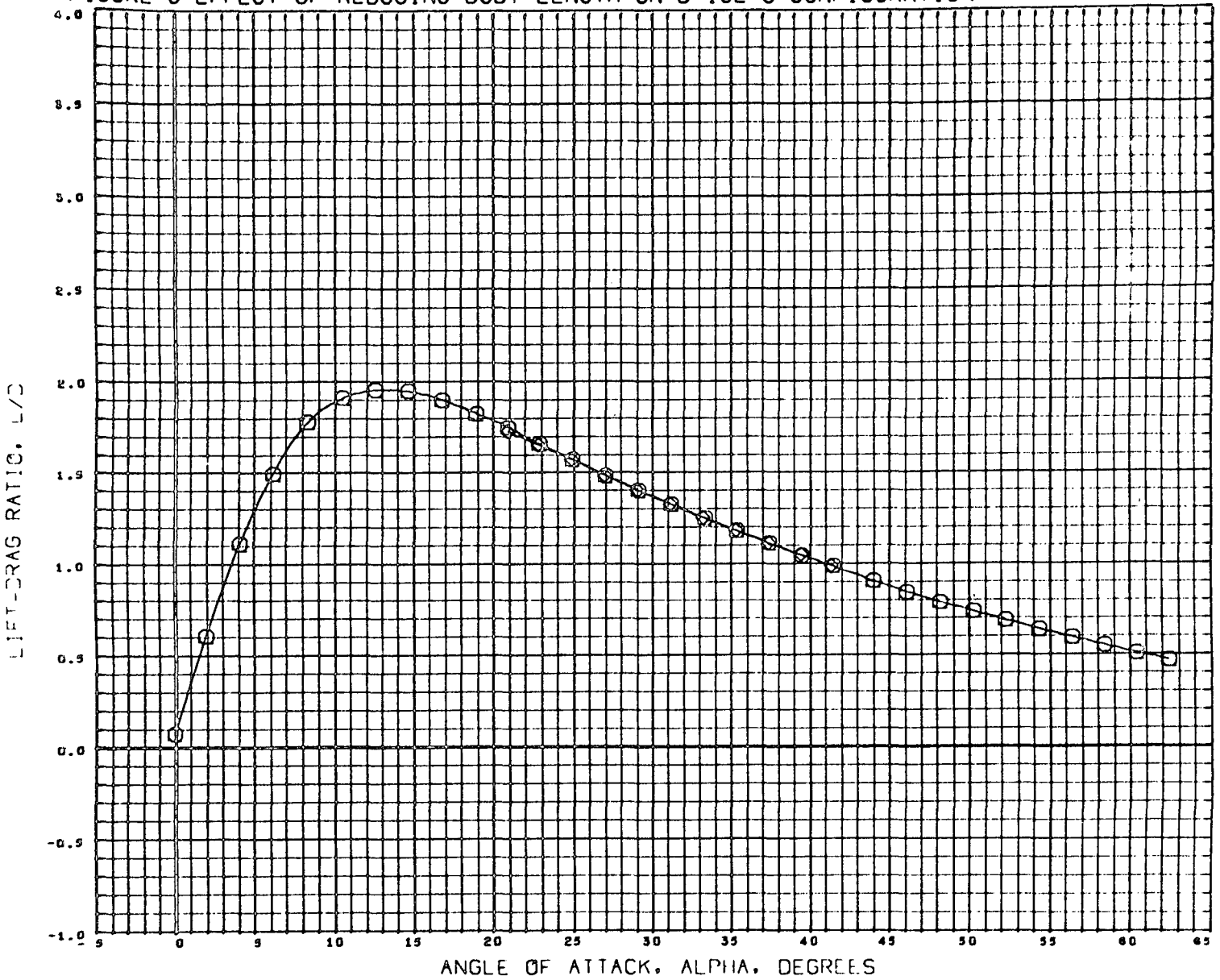

DATA SET SYMBOL	CONFIGURATION DESCRIPTION
(C58010)	MSFC TWT 514 E3 B30W23C10
(C58200)	DATA NOT AVAILABLE FOR ALL CONDITIONS
(C58290)	MSFC TWT 514 E3 B32W23C10

BETA	ELEVTR	CANARC
0.000	0.000	0.000
0.000	0.000	0.000
0.000	0.000	0.000

REFERENCE INFORMATION		
SREF	15.0300	SQ INC
LREF	2.8500	INCHES
BREF	6.0620	INCHES
XMRP	2.1110	INCHES
YMRP	0.0000	INCHES
ZMRP	0.0000	INCHES
SCALE	0.0035	

MACH 2.990

FIGURE-6 EFFECT OF REDUCING BODY LENGTH ON B-18E-3 CONFIGURATION

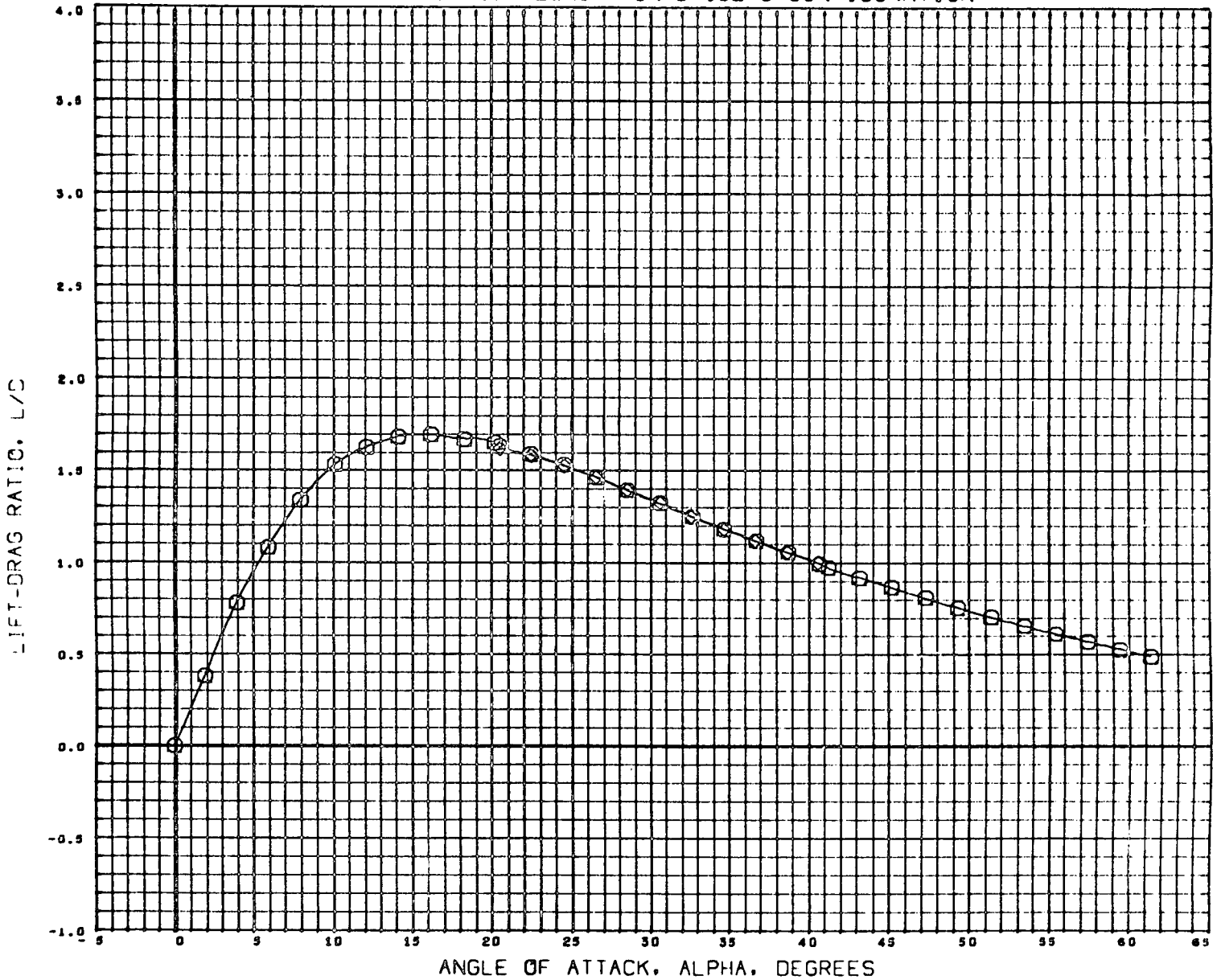

DATA SET SYMBOL	CONFIGURATION DESCRIPTION
(C98010)	MSFC TWT 514 E3 B30W23C10
(D58280)	DATA NOT AVAILABLE FOR ALL CONDITIONS
(D58290)	MSFC TWT 514 E3 B32W23C10

BETA	ELEVTR	CANARD
0.000	0.000	0.000
0.000	0.000	0.000
0.000	0.000	0.000

REFERENCE INFORMATION		
SREF	15.0300	SQ INC
LREF	2.8300	INCHES
BREF	6.0620	INCHES
XMRP	2.1110	INCHES
YMRP	0.0000	INCHES
ZMRP	0.0000	INCHES
SCALE	0.0035	

MACH 4.059

FIGURE-6 EFFECT OF REDUCING BODY LENGTH ON B-18E-3 CONFIGURATION

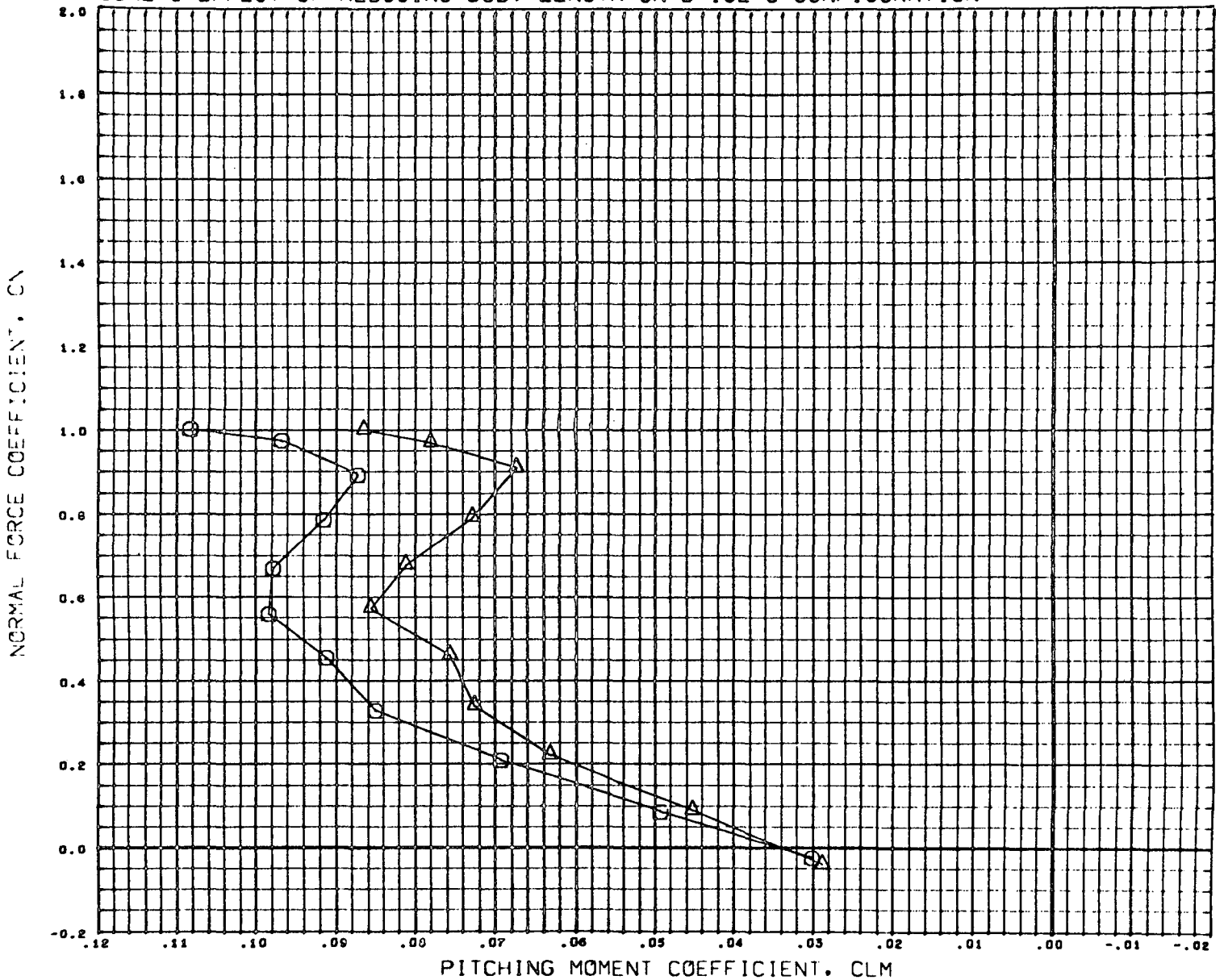

DATA SET SYMBOL	CONFIGURATION DESCRIPTION
(DS0010)	MSFC TWT 314 E3 B30W23C10
(DS0260)	MSFC TWT 314 E3 B32W23C10
(DS0290)	DATA NOT AVAILABLE FOR ALL CONDITIONS

BETA	ELEVTR	CANARD
0.000	0.000	0.000
0.000	0.000	0.000
0.000	0.000	0.000

REFERENCE INFORMATION		
SREF	15.0300	SQ INC
LREF	2.8300	INCHES
BREF	6.0620	INCHES
XMRP	2.1110	INCHES
YMRP	0.0000	INCHES
ZMRP	0.0000	INCHES
SCALE	0.0035	

MACH 0.907

FIGURE-6 EFFECT OF REDUCING BODY LENGTH ON B-18E-3 CONFIGURATION

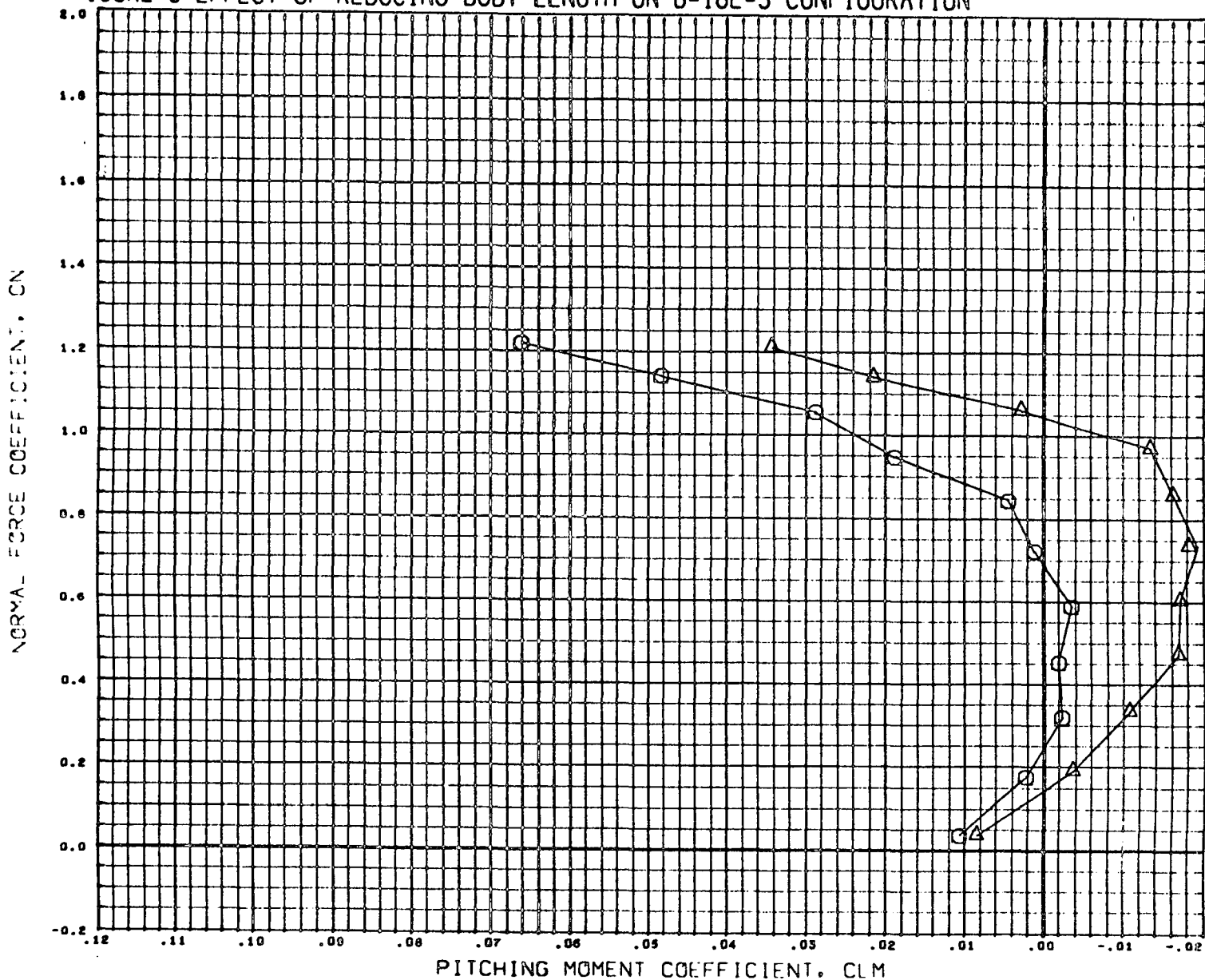

DATA SET SYMBOL	CONFIGURATION DESCRIPTION
(C58010)	MSFC TWT 514 E3 B30W23C10
(C58080)	MSFC TWT 514 E3 B32W23C10
(C58290)	DATA NOT AVAILABLE FOR ALL CONDITIONS

BETA	ELEVTR	CANARD
0.000	0.000	0.000
0.000	0.000	0.000
0.000	0.000	0.000

REFERENCE INFORMATION		
SREF	15.0300	SQ INC
LREF	2.8300	INCHES
BREF	6.0620	INCHES
XMRP	2.1110	INCHES
YMRP	0.0000	INCHES
ZMRP	0.0000	INCHES
SCALE	0.0033	

MACH 1.201

FIGURE-6 EFFECT OF REDUCING BODY LENGTH ON B-18E-3 CONFIGURATION

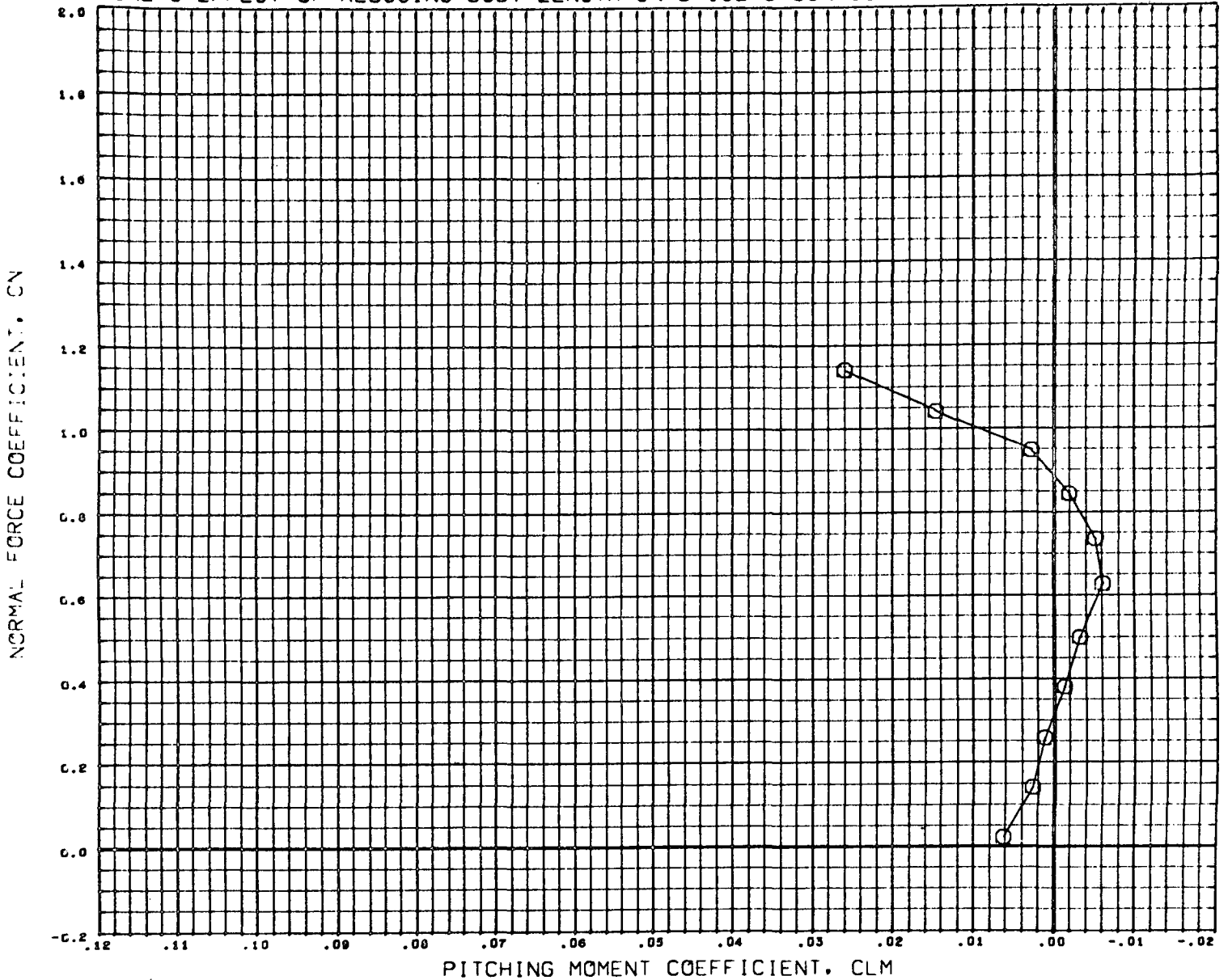

DATA SET SYMBOL	CONFIGURATION DESCRIPTION
(C58000)	MSFC TWT 514 E3 B30W23C10
(C58200)	DATA NOT AVAILABLE FOR ALL CONDITIONS
(C58290)	DATA NOT AVAILABLE FOR ALL CONDITIONS

BETA	ELEVTR	CANARD
0.000	0.000	0.000
0.000	0.000	0.000
0.000	0.000	0.000

REFERENCE INFORMATION		
SREF	15.0300	90 INC
LREF	2.8300	INCHES
BREF	6.0620	INCHES
XMRP	2.1110	INCHES
YMRP	0.0000	INCHES
ZMRP	0.0000	INCHES
SCALE	0.0035	

MACH 1.459

FIGURE-6 EFFECT OF REDUCING BODY LENGTH ON B-18E-3 CONFIGURATION

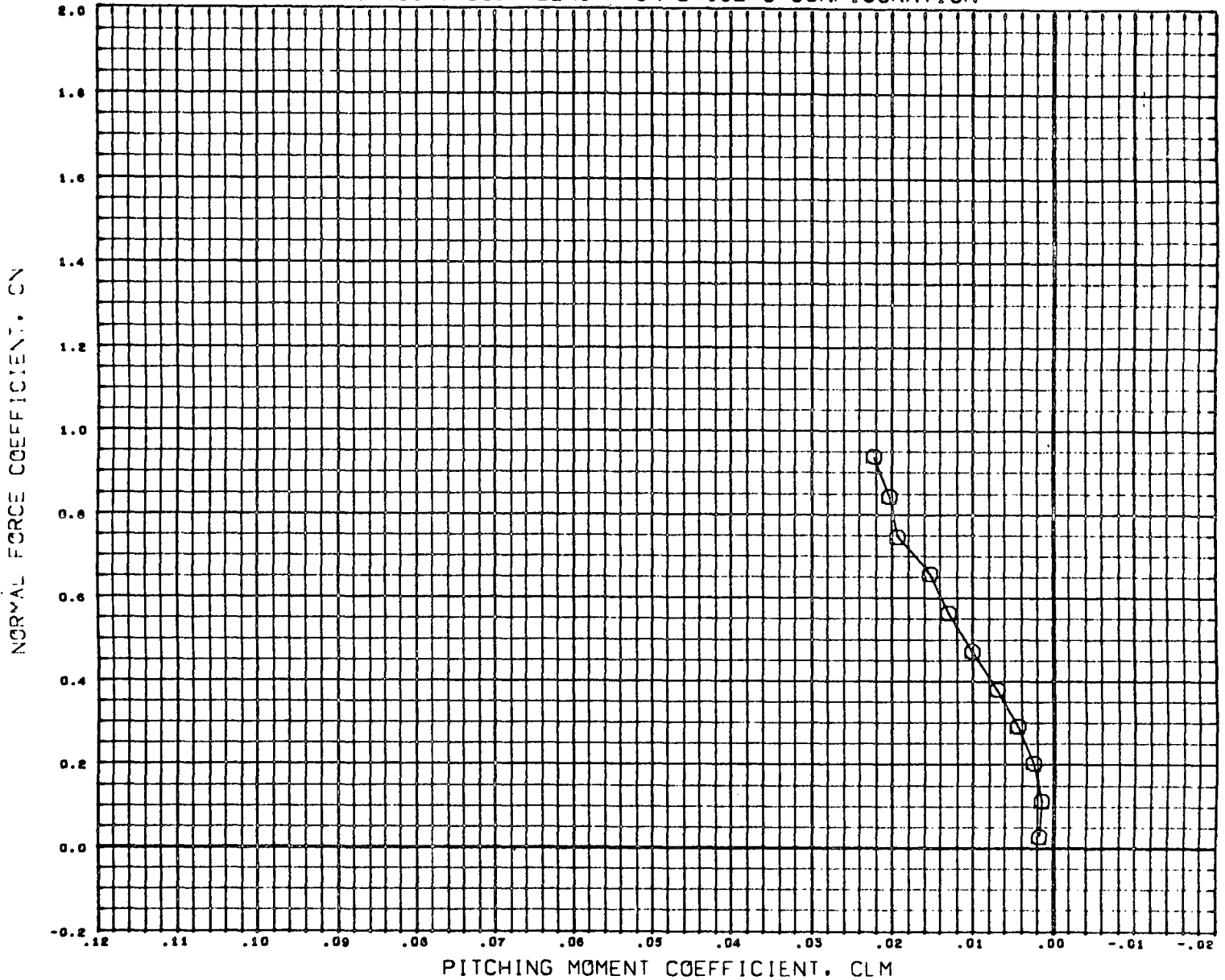

DATA SET SYMBOL	CONFIGURATION DESCRIPTION
(C98010)	MSFC TWT 514 E3 B30W23C10
(D56280)	DATA NOT AVAILABLE FOR ALL CONDITIONS
(D56290)	DATA NOT AVAILABLE FOR ALL CONDITIONS

BETA	ELEVTR	CANARD
0.000	0.000	0.000
0.000	0.000	0.000
0.000	0.000	0.000

REFERENCE INFORMATION		
SREF	15.0300	sq INC
LREF	2.6300	INCHES
BREF	6.0620	INCHES
XMRP	2.1110	INCHES
YMRP	0.0000	INCHES
ZMRP	0.0000	INCHES
SCALE	0.0035	

MACH 1.960

FIGURE-6 EFFECT OF REDUCING BODY LENGTH ON B-18E-3 CONFIGURATION

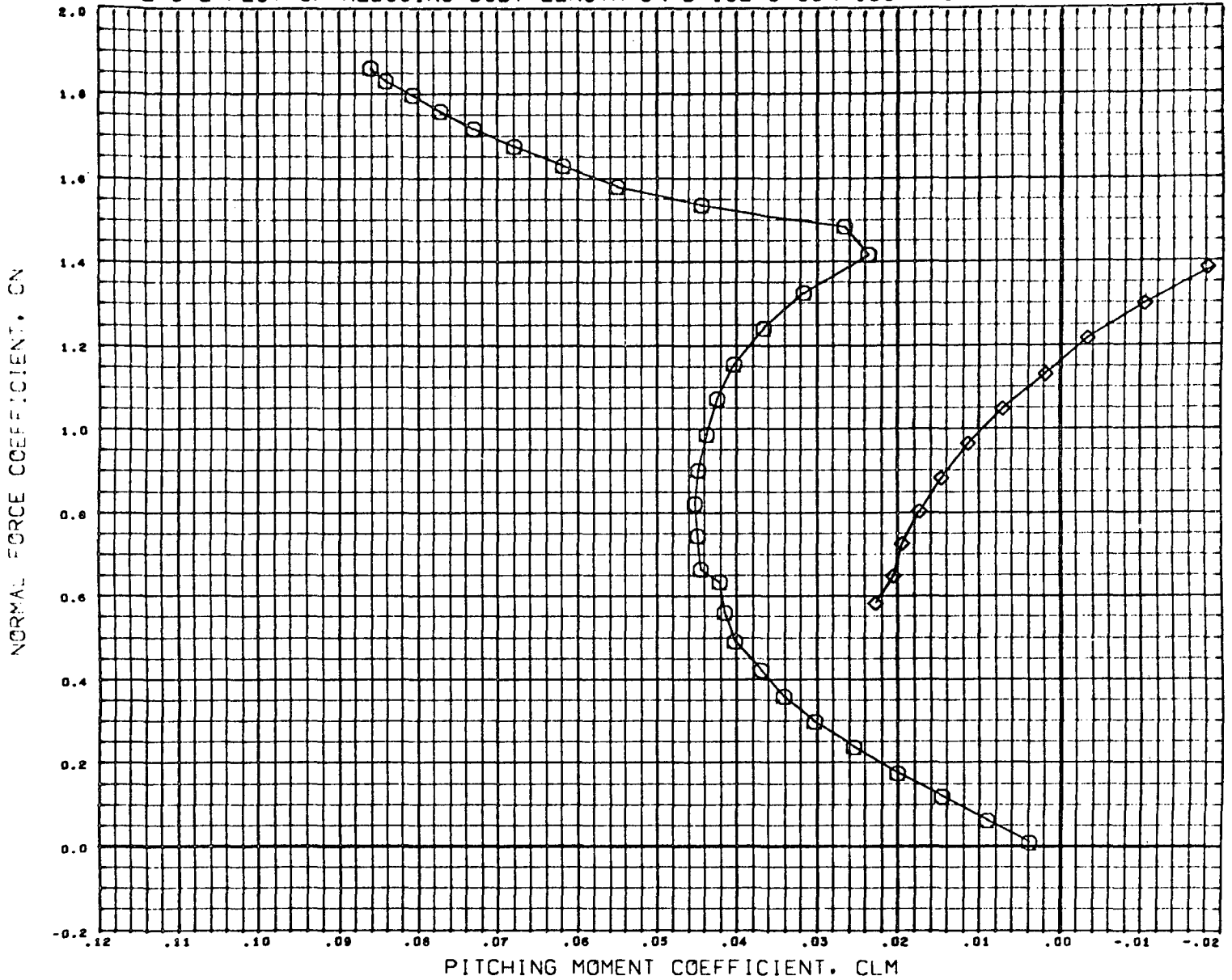

DATA SET SYMBOL	CONFIGURATION DESCRIPTION
(C58010)	MSFC TWT 514 E3 B30W23C10
(C58280)	DATA NOT AVAILABLE FOR ALL CONDITIONS
(C58290)	MSFC TWT 514 E3 B32W23C10

BETA	ELEVTR	CANARD
0.000	0.000	0.000
0.000	0.000	0.000
0.000	0.000	0.000

REFERENCE INFORMATION		
SREF	15.0300	sq INC
LREF	2.8300	INCHES
BREF	6.0620	INCHES
XMRP	2.1110	INCHES
YMRP	0.0000	INCHES
ZMRP	0.0000	INCHES
SCALE	0.0035	

MACH 2.990

FIGURE-6 EFFECT OF REDUCING BODY LENGTH ON B-18E-3 CONFIGURATION



DATA SET SYMBOL	CONFIGURATION DESCRIPTION
(C580:0)	MSFC TWT 514 E3 B30W23C10
(D582:0)	DATA NOT AVAILABLE FOR ALL CONDITIONS
(D582:50)	MSFC TWT 514 E3 B32W23C10

BETA	ELEVTR	CANARD
0.000	0.000	0.000
0.000	0.000	0.000
0.000	0.000	0.000

REFERENCE INFORMATION		
SREF	15.0300	50 INC
LREF	2.0300	INCHES
BREF	6.0620	INCHES
XMRP	2.1110	INCHES
YMRP	0.0000	INCHES
ZMRP	0.0000	INCHES
SCALE	0.0035	

MACH 4.959

FIGURE-6 EFFECT OF REDUCING BODY LENGTH ON B-18E-3 CONFIGURATION

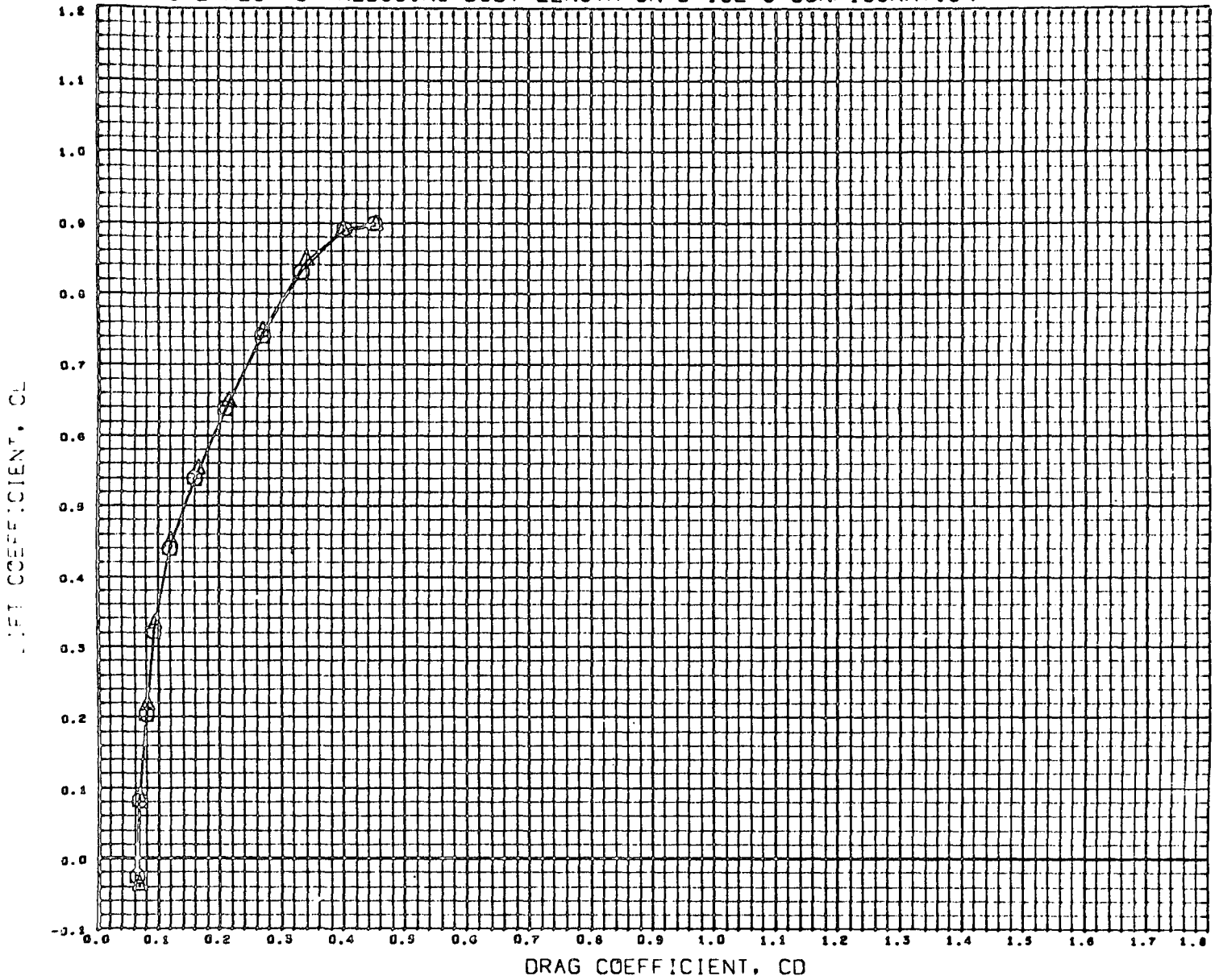

DATA SET SYMBOL	CONFIGURATION DESCRIPTION
(C58610)	MSFC TWT 514 E3 830W23C10
(C58280)	MSFC TWT 514 E3 832W23C10
(C58290)	DATA NOT AVAILABLE FOR ALL CONDITIONS

BETA	ELEVTR	CANARD
0.000	0.000	0.000
0.000	0.000	0.000
0.000	0.000	0.000

REFERENCE INFORMATION		
SREF	15.0300	90 INC
LREF	2.8300	INCHES
BREF	6.0620	INCHES
XMRP	2.1110	INCHES
YMRP	0.0000	INCHES
ZMRP	0.0000	INCHES
SCALE	0.0035	

MACH 0.007

FIGURE-6 EFFECT OF REDUCING BODY LENGTH ON B-18E-3 CONFIGURATION

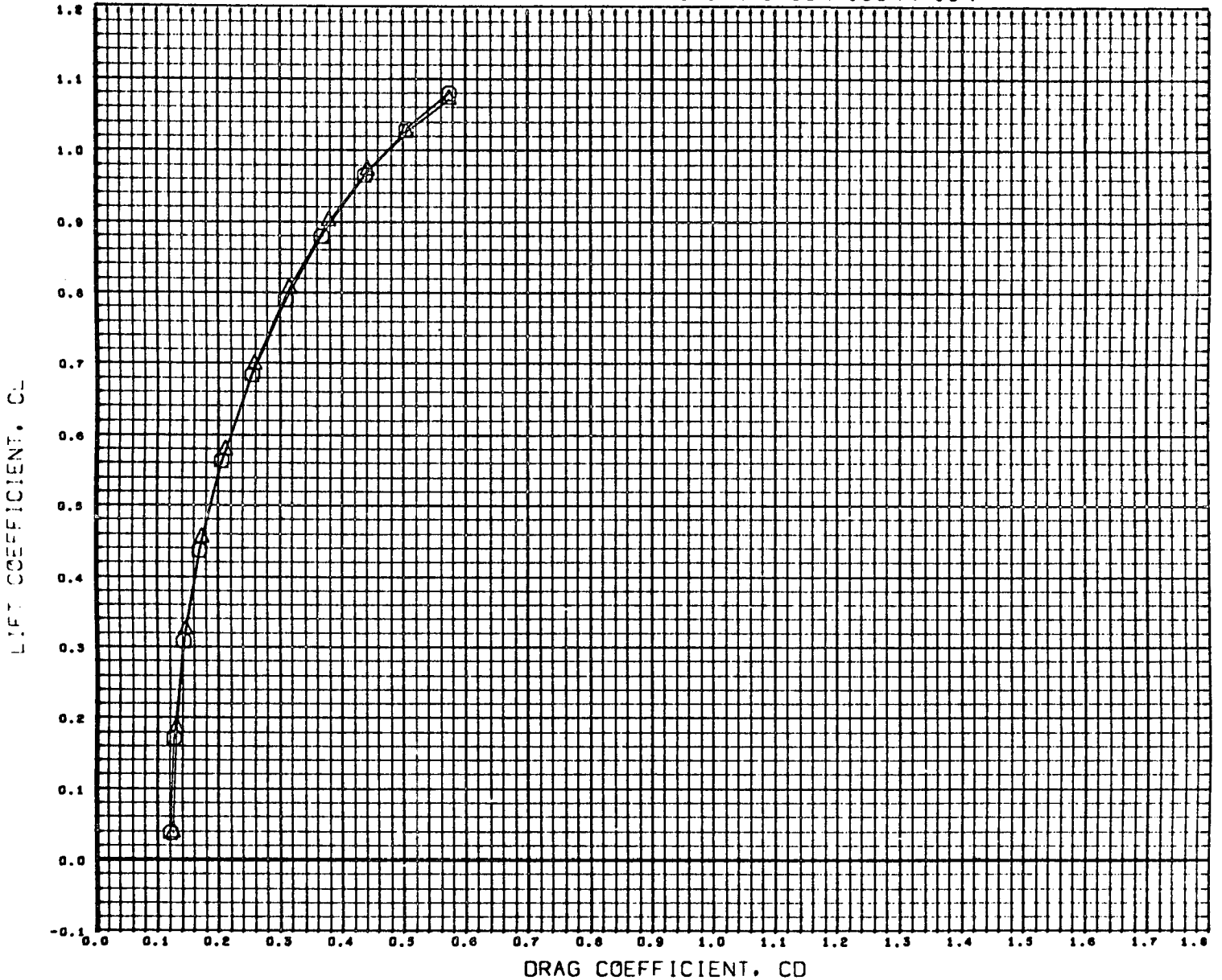

DATA SET SYMBOL	CONFIGURATION DESCRIPTION
(C9J010)	MSFC TWT 514 E3 B30W23C10
(D9J280)	MSFC TWT 514 E3 B32W23C10
(D9J290)	DATA NOT AVAILABLE FOR ALL CONDITIONS

BETA	ELEVTR	CANARD
0.000	0.000	0.000
0.000	0.000	0.000
0.000	0.000	0.000

REFERENCE INFORMATION		
SREF	15.0300	30 INCHES
LREF	2.8300	INCHES
BREF	6.0620	INCHES
XMRP	2.1110	INCHES
YMRP	0.0000	INCHES
ZMRP	0.0000	INCHES
SCALE	0.0035	

MACH 1.201

FIGURE-6 EFFECT OF REDUCING BODY LENGTH ON B-18E-3 CONFIGURATION

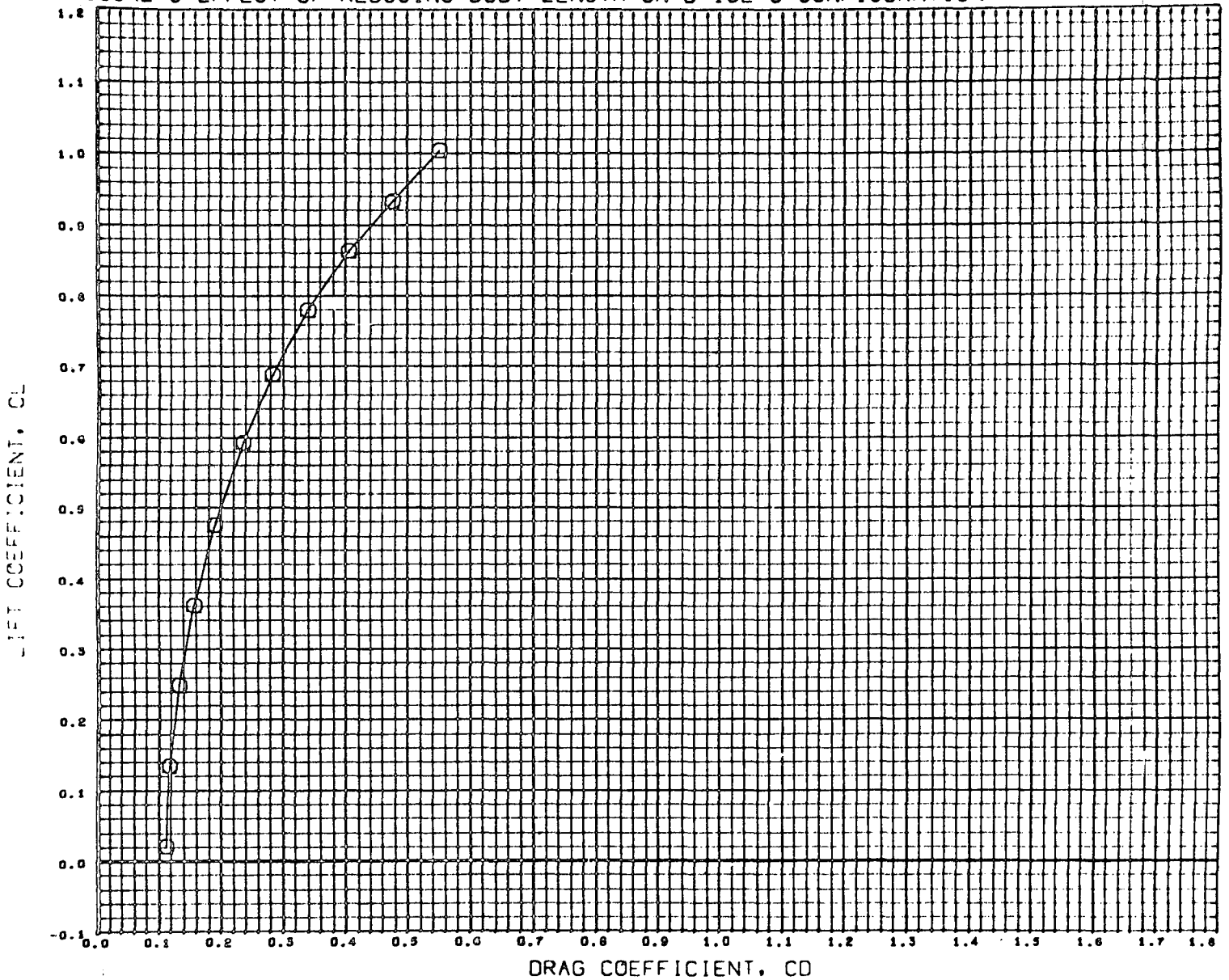

DATA SET SYMBOL	CONFIGURATION DESCRIPTION
(C56010)	MSFC TWT 514 E3 830W23C10
(D56080)	DATA NOT AVAILABLE FOR ALL CONDITIONS
(D56090)	DATA NOT AVAILABLE FOR ALL CONDITIONS

BETA	ELEVTR	CANARD
0.000	0.000	0.000
0.000	0.000	0.000
0.000	0.000	0.000

REFERENCE INFORMATION		
SREF	15.0300	SQ INC
LREF	2.8300	INCHES
BREF	6.0620	INCHES
XMRP	2.1110	INCHES
YMRP	0.0000	INCHES
ZMRP	0.0000	INCHES
SCALE	0.0035	

MACH 1.459

FIGURE-6 EFFECT OF REDUCING BODY LENGTH ON B-18E-3 CONFIGURATION

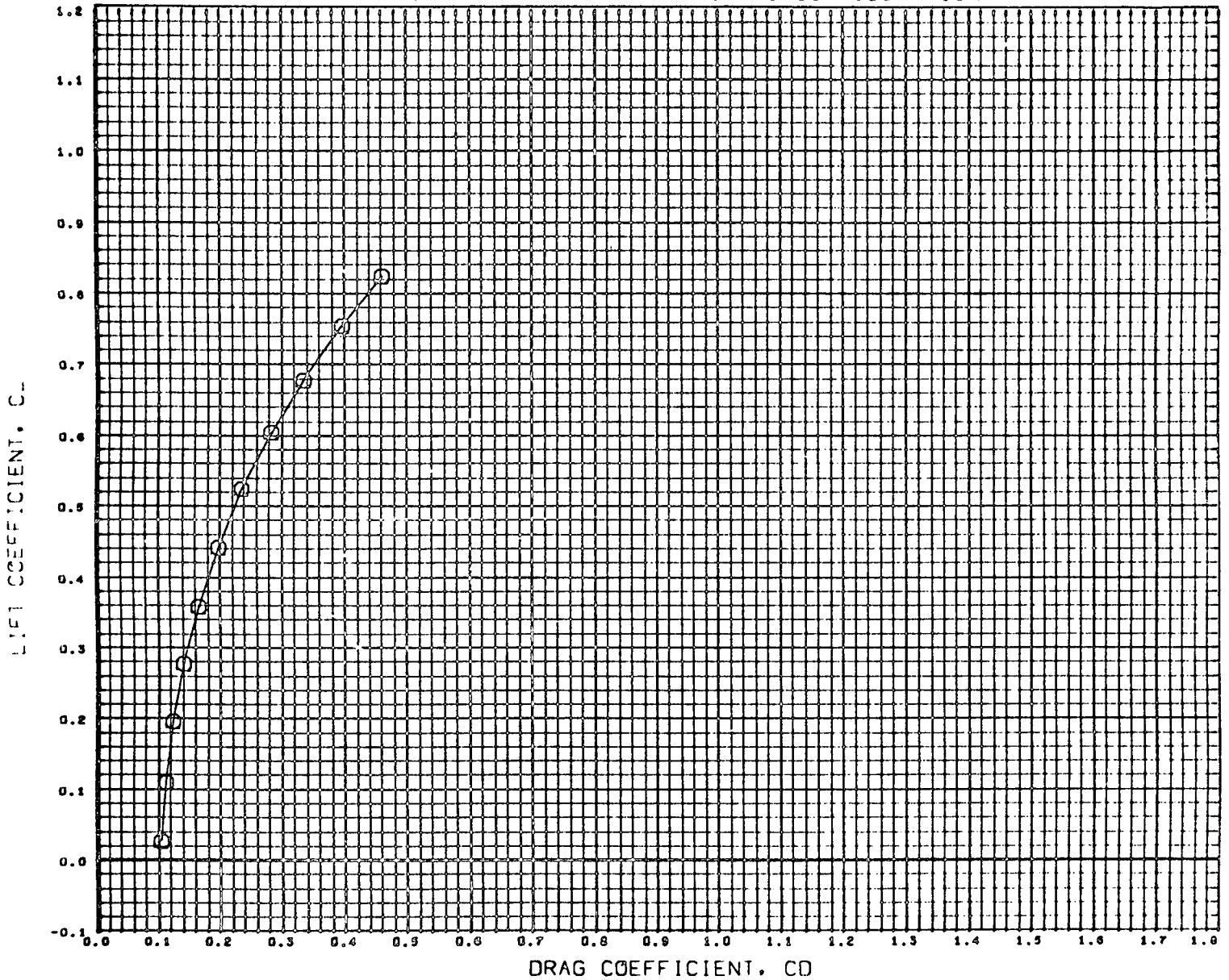

DATA SET SYMBOL	CONFIGURATION DESCRIPTION
(C58010)	MSFC TWT 314 E3 030W23C1G
(058280)	DATA NOT AVAILABLE FOR ALL CONDITIONS
(058290)	DATA NOT AVAILABLE FOR ALL CONDITIONS

BETA	ELEVTR	CANARD
0.000	0.000	0.000
0.000	0.000	0.000
0.000	0.000	0.000

REFERENCE INFORMATION		
SREF	15.0300	30 INC
LREF	2.8300	INCHES
BREF	6.0620	INCHES
XMRP	2.1110	INCHES
YMRP	0.0000	INCHES
ZMRP	0.0000	INCHES
SCALE	0.0035	

MACH 1.000

FIGURE-6 EFFECT OF REDUCING BODY LENGTH ON B-18E-3 CONFIGURATION

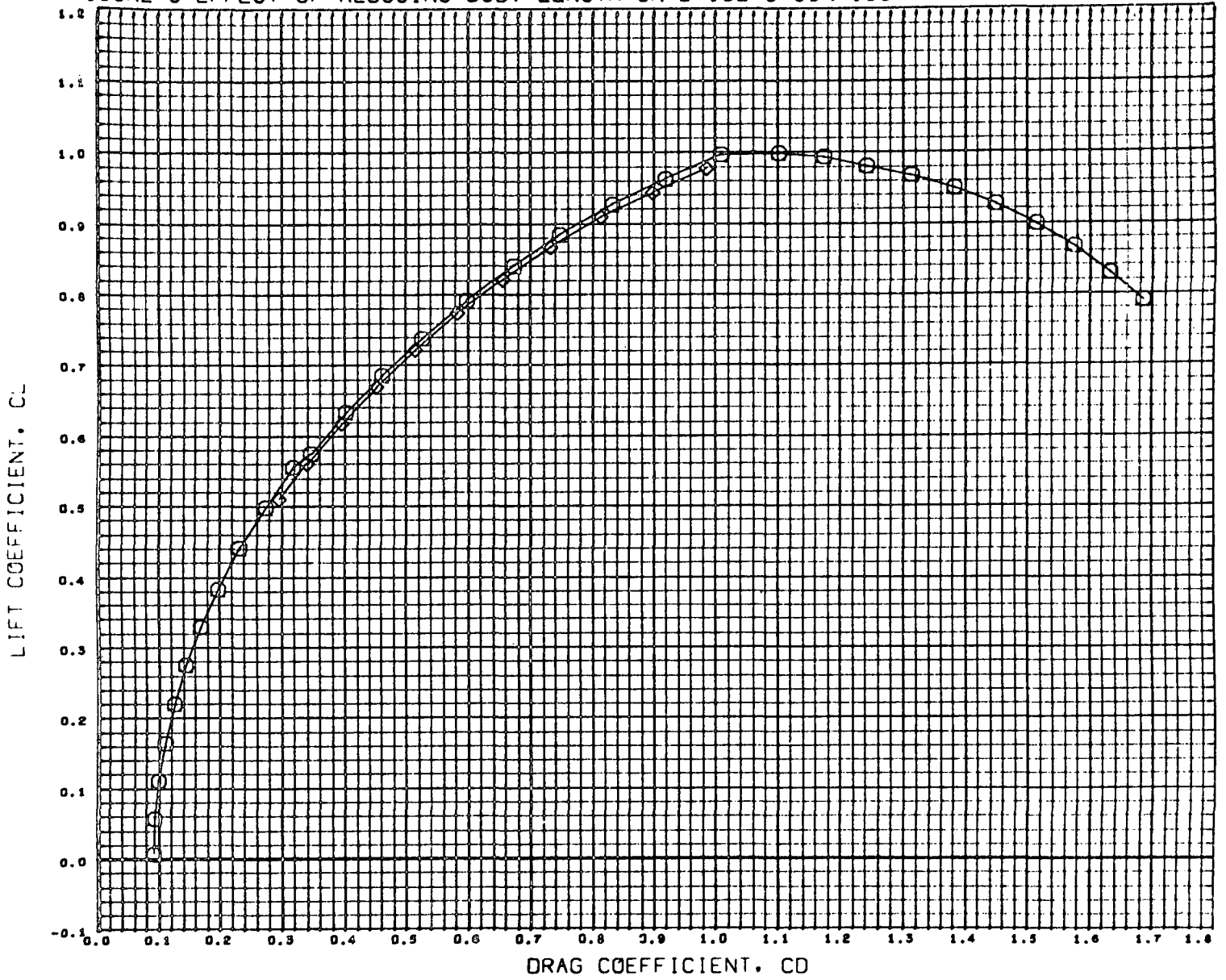

DATA SET SYMBOL	CONFIGURATION DESCRIPTION
(C58010)	MSFC TWT 514 E3 B30W23C10
(C58280)	DATA NOT AVAILABLE FOR ALL CONDITIONS
(C58290)	MSFC TWT 514 E3 B32W23C10

BETA	ELEVTR	CANARD
0.000	0.000	0.000
0.000	0.000	0.000
0.000	0.000	0.000

REFERENCE INFORMATION		
SREF	15.0300	50 INC
LREF	2.8300	INCHES
BREF	6.0620	INCHES
XMRP	2.1110	INCHES
YMRP	0.0000	INCHES
ZMRP	0.0000	INCHES
SCALE	0.0035	

MACH 2.990

FIGURE-6 EFFECT OF REDUCING BODY LENGTH ON B-18E-3 CONFIGURATION

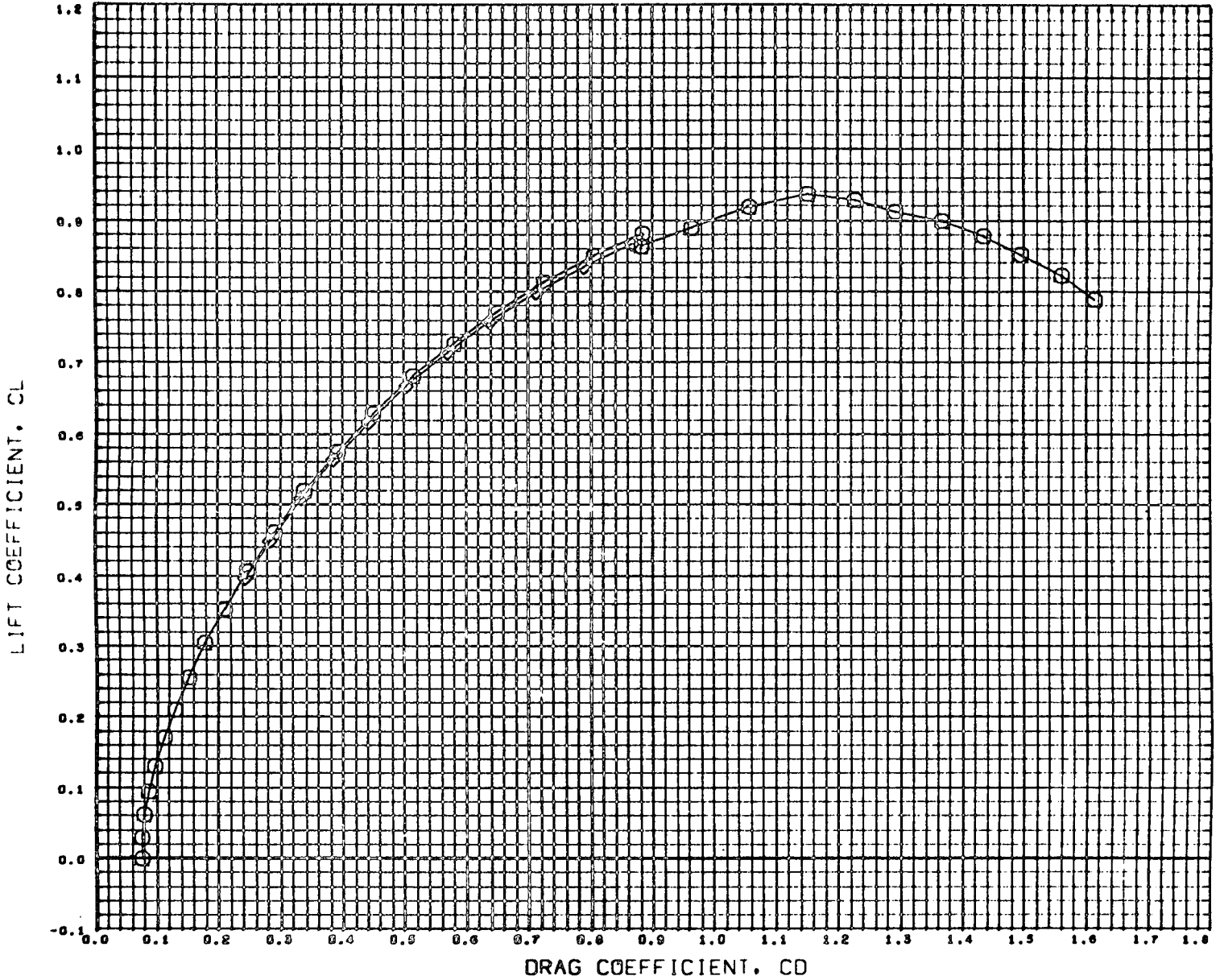

DATA SET SYMBOL	CONFIGURATION DESCRIPTION
(C56010)	MSFC THT 914 E3 030W23C10
(056280)	DATA NOT AVAILABLE FOR ALL CONDITIONS
(056290)	MSFC THT 914 E9 032W23C10

BETA	ELEVTR	CANARD
0.000	0.000	0.000
0.000	0.000	0.000
0.000	0.000	0.000

REFERENCE INFORMATION		
SREF	15.0300	90 INC
LREF	2.8300	INCHES
BREF	6.0620	INCHES
XMRP	2.1110	INCHES
YMRP	0.0000	INCHES
ZMRP	0.0000	INCHES
SCALE	0.0035	

MACH 4.059

FIGURE-6 EFFECT OF REDUCING BODY LENGTH ON B-18E-3 CONFIGURATION

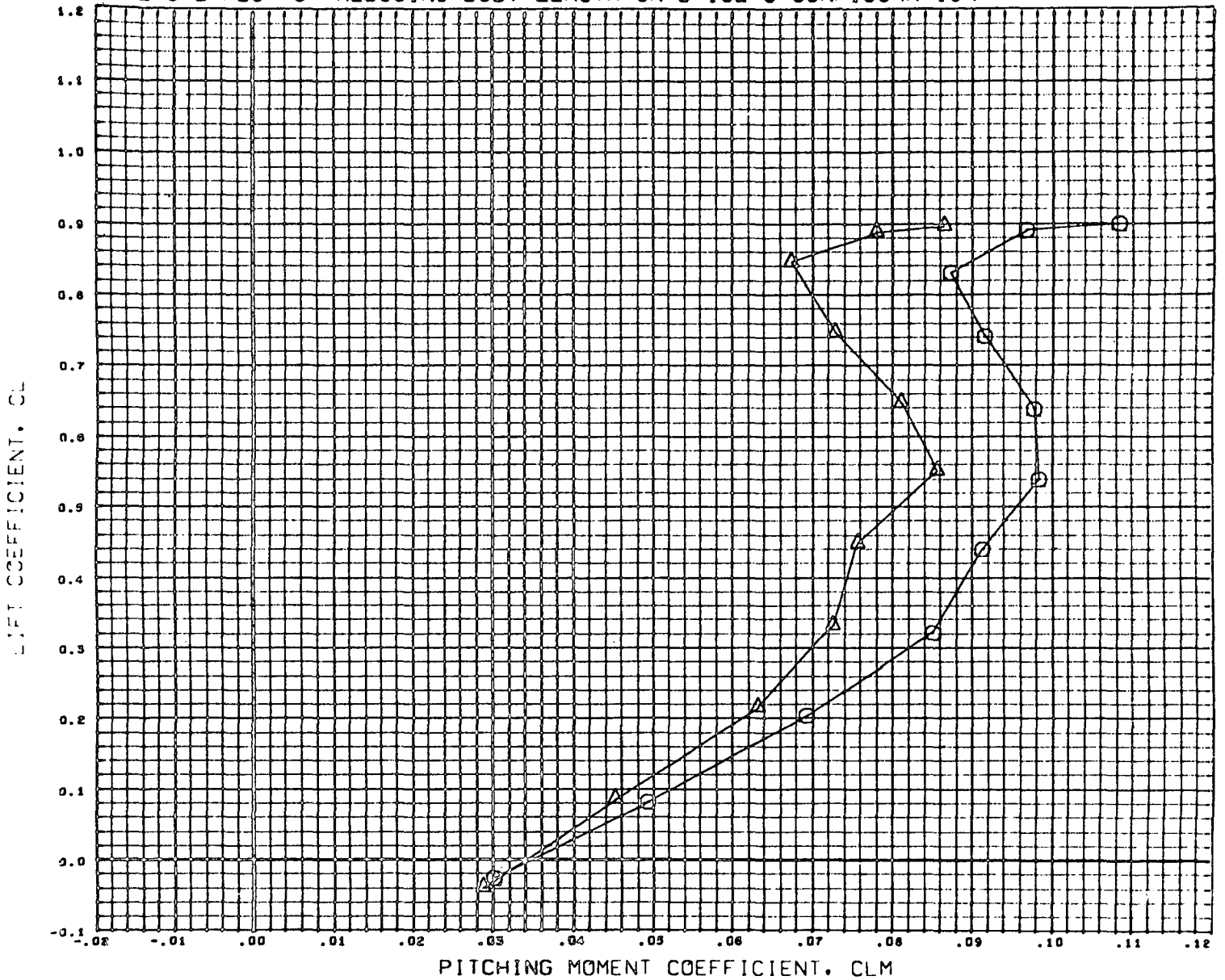

DATA SET	SYMBOL	CONFIGURATION DESCRIPTION
(C58010)	○	MSFC TWT 914 E3 830W23C10
(C58020)	△	MSFC TWT 914 E3 832W23C12
(C580290)	◇	DATA NOT AVAILABLE FOR ALL CONDITIONS

BETA	ELEVTR	CANARD
0.000	0.000	0.000
0.000	0.000	0.000
0.000	0.000	0.000

REFERENCE INFORMATION		
SREF	15.0300	50 INC
LREF	2.8300	INCHES
BREF	6.0620	INCHES
XMRP	2.1110	INCHES
YMRP	0.0000	INCHES
ZMRP	0.0000	INCHES
SCALE	0.0035	

MACH 0.907

FIGURE-6 EFFECT OF REDUCING BODY LENGTH ON B-18E-3 CONFIGURATION

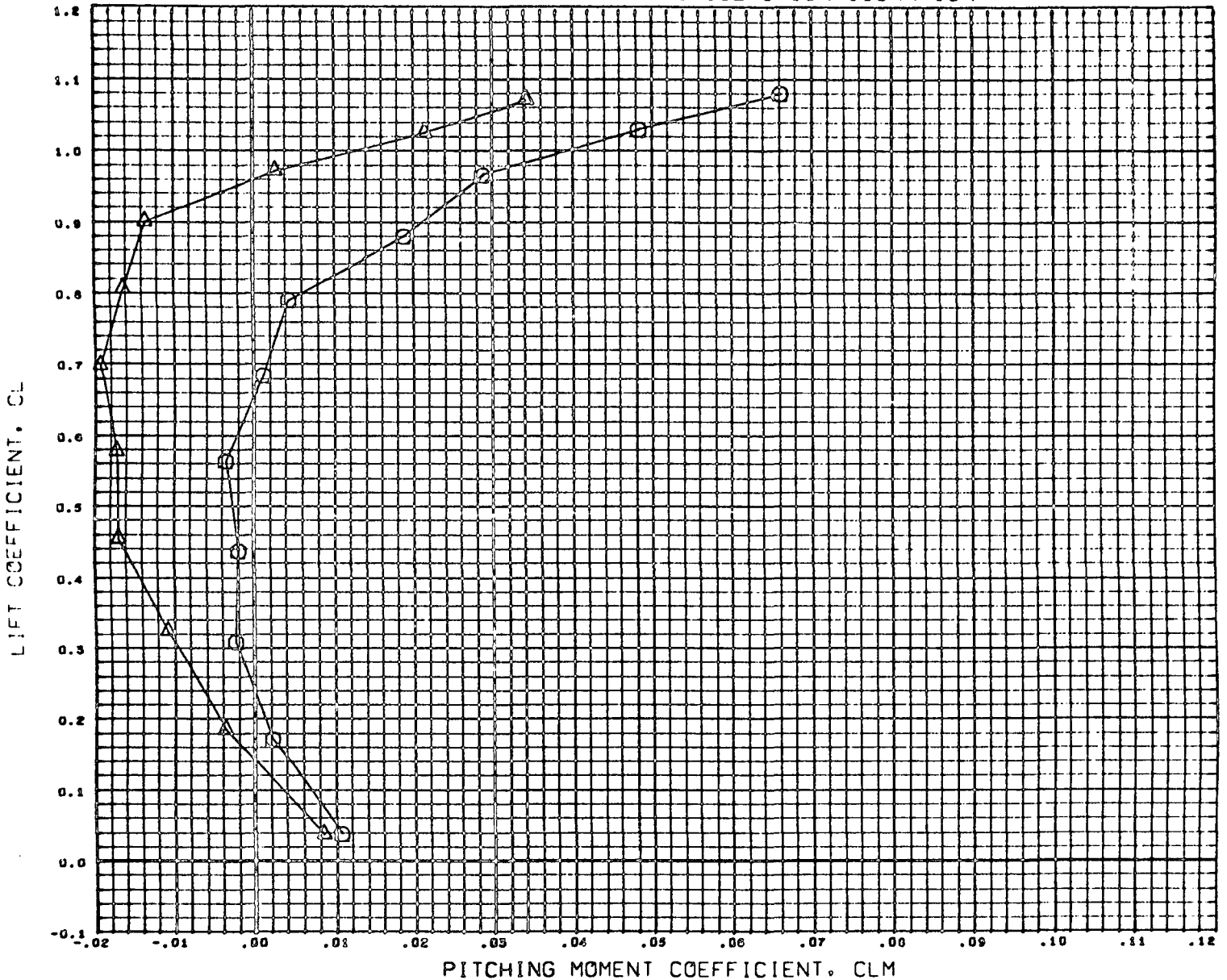

DATA SET SYMBOL	CONFIGURATION DESCRIPTION
(C58010)	MSFC TWT 914 E3 Q30W23C10
(D58290)	MSFC TWT 914 E3 Q32W23C10
(D58290)	DATA NOT AVAILABLE FOR ALL CONDITIONS

BETA	ELEVTR	CANARD
0.000	0.000	0.000
0.000	0.000	0.000
0.000	0.000	0.000

REFERENCE INFORMATION		
SREF	15.0300	50 INC
LREF	2.8300	INCHES
BREF	6.0620	INCHES
XMRP	2.1110	INCHES
YMRP	0.0000	INCHES
ZMRP	0.0000	INCHES
SCALE	0.0035	

MACH 8.201

FIGURE-6 EFFECT OF REDUCING BODY LENGTH ON B-18E-3 CONFIGURATION

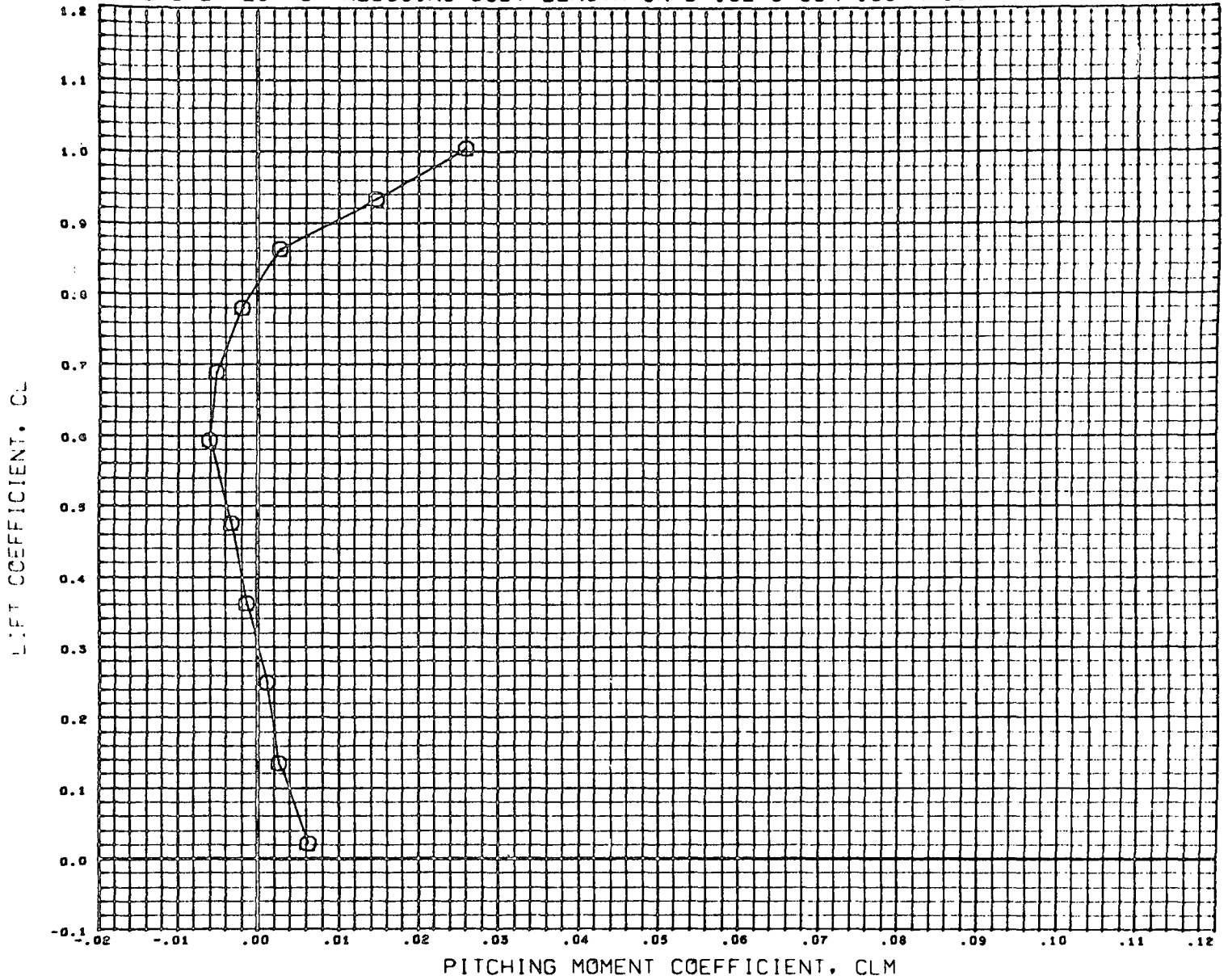

DATA SET SYMBOL	CONFIGURATION DESCRIPTION
(C58010)	MSFC TWT 514 E3 B30W23C10
(C58280)	DATA NOT AVAILABLE FOR ALL CONDITIONS
(D58290)	DATA NOT AVAILABLE FOR ALL CONDITIONS

BETA	ELEVTR	CANARD
0.000	0.000	0.000
0.000	0.000	0.000
0.000	0.000	0.000

REFERENCE INFORMATION		
SREF	15.0300	90 INC
LREF	2.8300	INCHES
BREF	6.0620	INCHES
XMRP	2.1110	INCHES
YMRP	0.0000	INCHES
ZMRP	0.0000	INCHES
SCALE	0.0033	

MACH 1.459

FIGURE-6 EFFECT OF REDUCING BODY LENGTH ON B-18E-3 CONFIGURATION

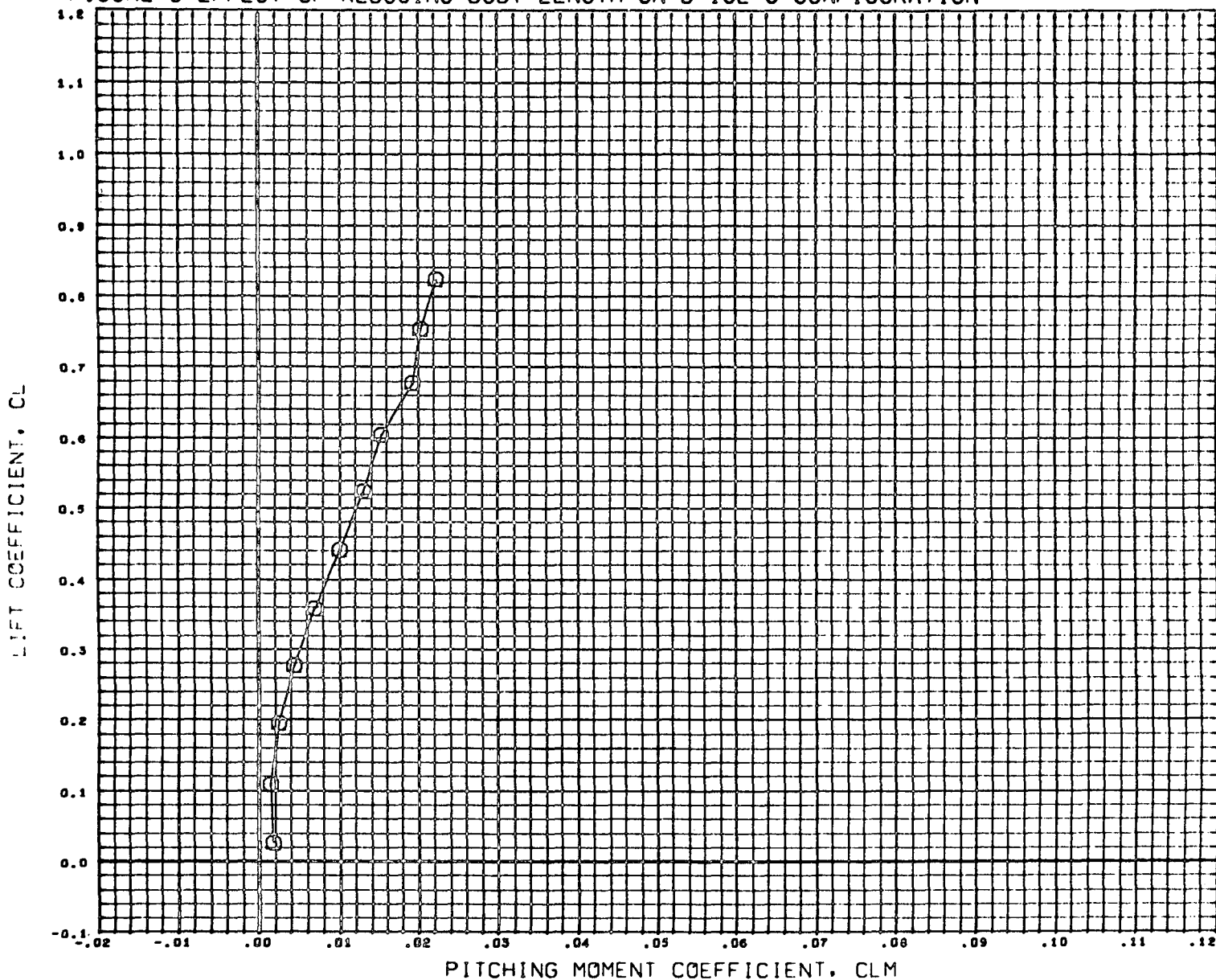

DATA SET SYMBOL	CONFIGURATION DESCRIPTION
(C58010)	MSFC TWT 514 E3 B30W23C10
(D58280)	DATA NOT AVAILABLE FOR ALL CONDITIONS
(D58290)	DATA NOT AVAILABLE FOR ALL CONDITIONS

BETA	ELEVTR	CANARD
0.000	0.000	0.000
0.000	0.000	0.000
0.000	0.000	0.000

REFERENCE INFORMATION		
SREF	15.0300	sq INC
LREF	2.8300	INCHES
BREF	6.0620	INCHES
XMRP	2.1110	INCHES
YMRP	0.0000	INCHES
ZMRP	0.0000	INCHES
SCALE	0.0035	

MACH 1.960

FIGURE-6 EFFECT OF REDUCING BODY LENGTH ON B-18E-3 CONFIGURATION



DATA SET SYMBOL	CONFIGURATION DESCRIPTION
(C58010)	HSFC TWT 514 E3 B30W23C10
(C58280)	DATA NOT AVAILABLE FOR ALL CONDITIONS
(C58290)	HSFC TWT 514 E3 B32W23C10

BETA	ELEVTR	CANARD
0.000	0.000	0.000
0.000	0.000	0.000
0.000	0.000	0.000

REFERENCE INFORMATION	
SREF	15.0300 SQ INC
LREF	2.8300 INCHES
BREF	6.0620 INCHES
XHRP	2.1110 INCHES
YHRP	0.0000 INCHES
ZHRP	0.0000 INCHES
SCALE	0.0035

MACH 2.000

FIGURE-6 EFFECT OF REDUCING BODY LENGTH ON B-18E-3 CONFIGURATION

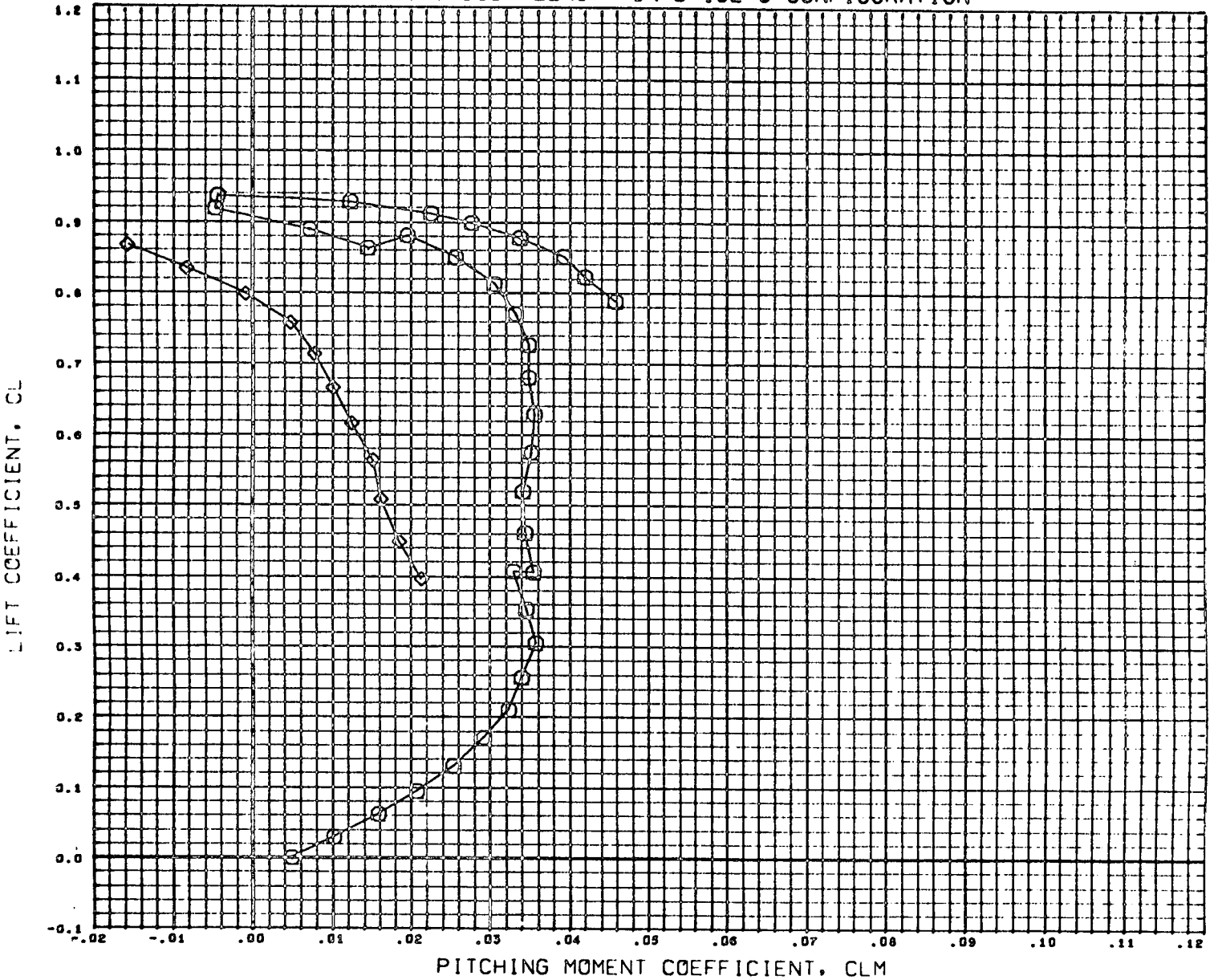

DATA SET SYMBOL	CONFIGURATION DESCRIPTION
(C58010)	MSFC TWT 514 E3 B30W23C10
(C58280)	DATA NOT AVAILABLE FOR ALL CONDITIONS
(C58290)	MSFC TWT 514 E3 B32W23C10

BETA	ELEVTR	CANARD
0.000	0.000	0.000
0.000	0.000	0.000
0.000	0.000	0.000

REFERENCE INFORMATION		
SREF	15.0300	SQ INC
LREF	2.8300	INCHES
BREF	6.0620	INCHES
XMRP	2.1110	INCHES
YMRP	0.0000	INCHES
ZMRP	0.0000	INCHES
SCALE	0.0035	

MACH 4.899

FIGURE-7 RUDDER EFFECTIVENESS AT ALPHA=15 DEGREES ON B-18E-3 CONFIGURATION

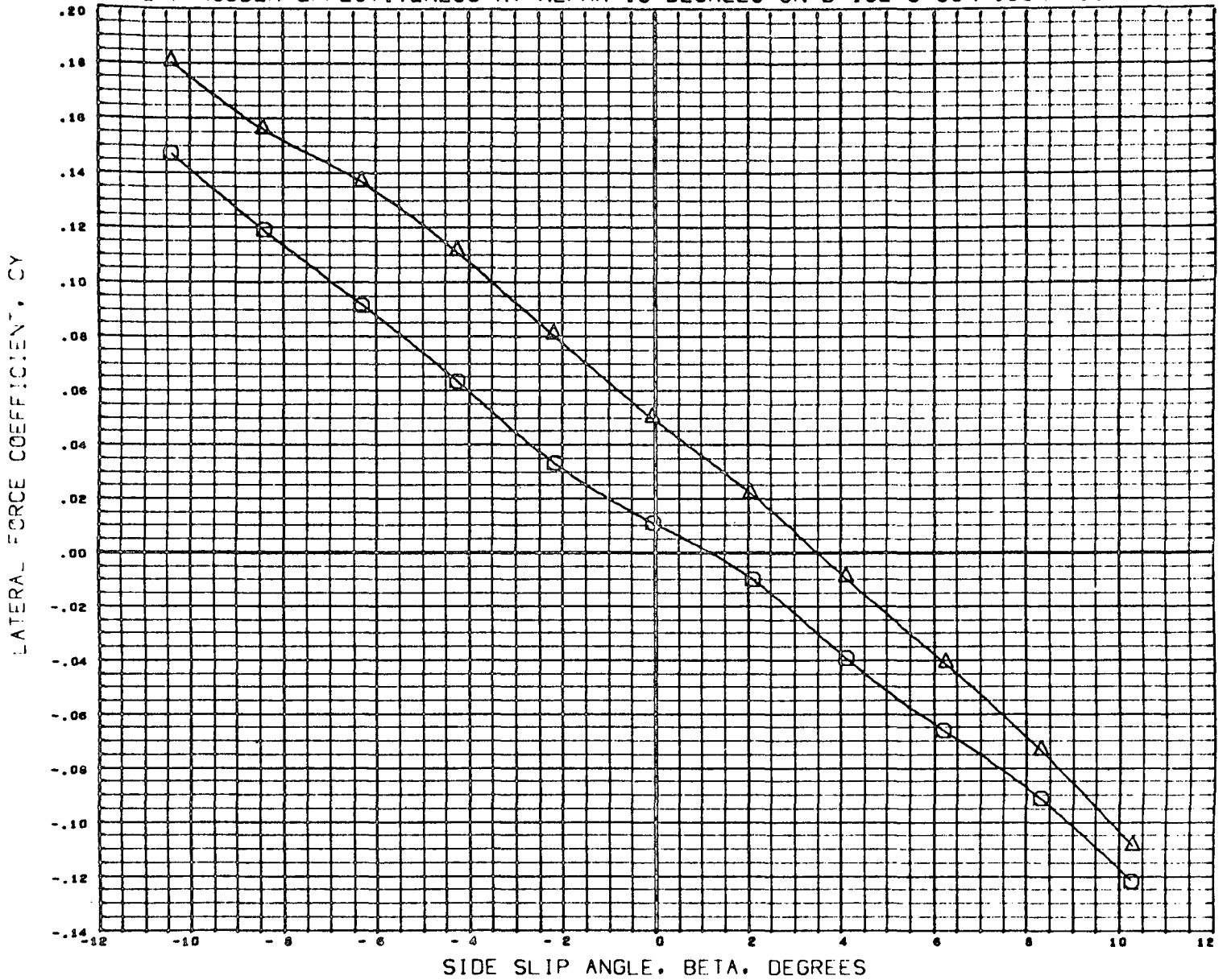

DATA SET SYMBOL	CONFIGURATION DESCRIPTION
(058300)	MSFC TWT 514 E3 830W23C10V14
(058310)	MSFC TWT 514 E3 830W23C10V14

ALPHA	ELEVTR	CANARD	RUDDER	REFERENCE INFORMATION
15.000	0.000	0.000	0.000	SREF 15.0300 SQ INC
15.000	0.000	0.000	25.000	LREF 2.8300 INCHES
				BREF 6.0620 INCHES
				XMRP 2.1110 INCHES
				YMRP 0.0000 INCHES
				ZMRP 0.0000 INCHES
				SCALE 0.0035

MACH 0.905

FIGURE-7 RUDDER EFFECTIVENESS AT ALPHA=15 DEGREES ON B-18E-3 CONFIGURATION

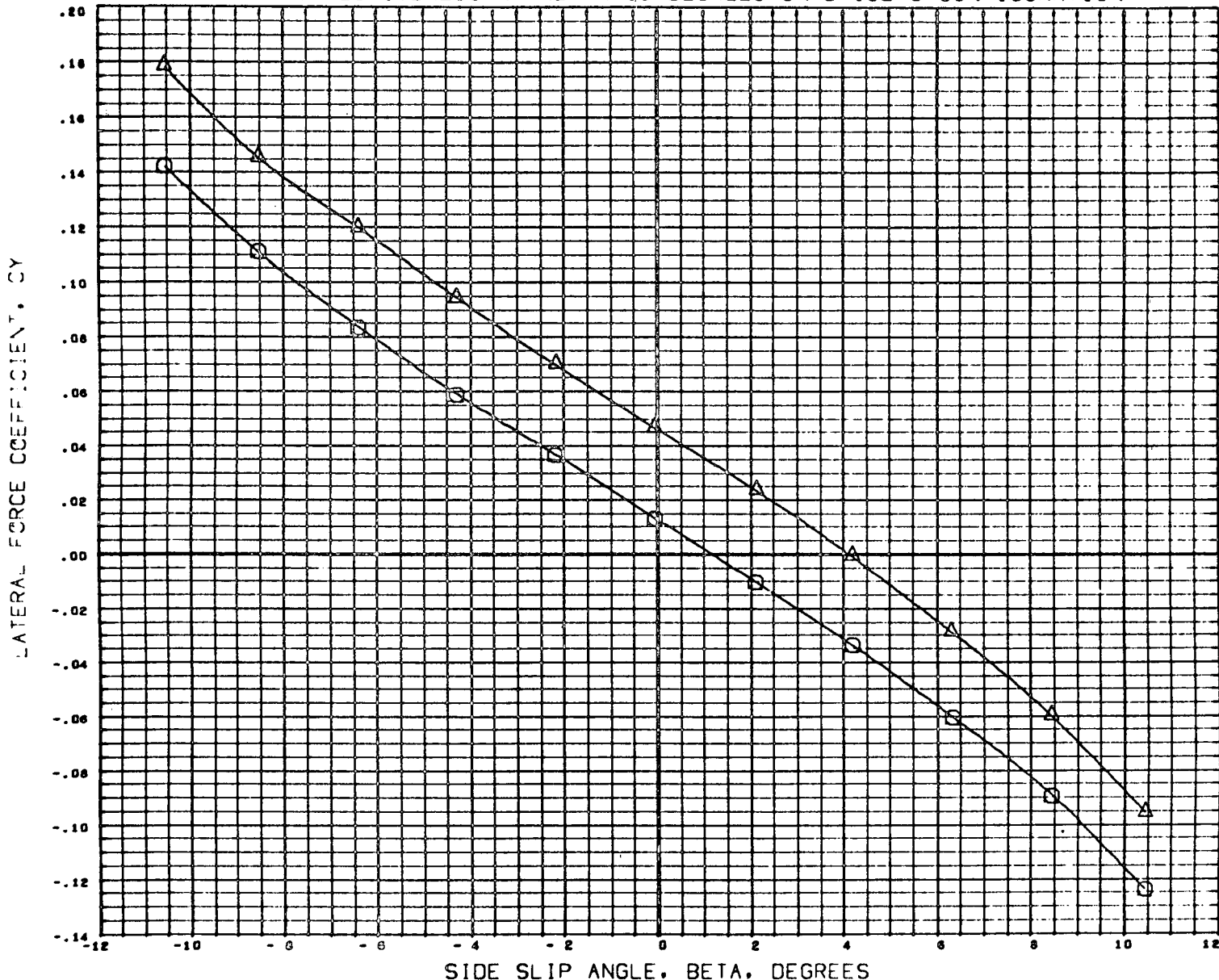

DATA SET SYMBOL	CONFIGURATION DESCRIPTION	ALPHA	ELEVTR	CANARD	RUDDER	REFERENCE INFORMATION	
(058300)	MSFC TWT 514 E3 030W23C10V14	15.000	0.000	0.000	0.000	SREF	15.0300 SQ INC
(058310)	MSFC TWT 514 E3 030W23C10V14	15.000	0.000	0.000	25.000	LREF	2.8300 INCHES
						BREF	6.0620 INCHES
						XMRP	2.1110 INCHES
						YMRP	0.0000 INCHES
						ZMRP	0.0000 INCHES
						SCALE	0.0035

MACH 1.200

FIGURE-7 RUDDER EFFECTIVENESS AT ALPHA=15 DEGREES ON B-18E-3 CONFIGURATION

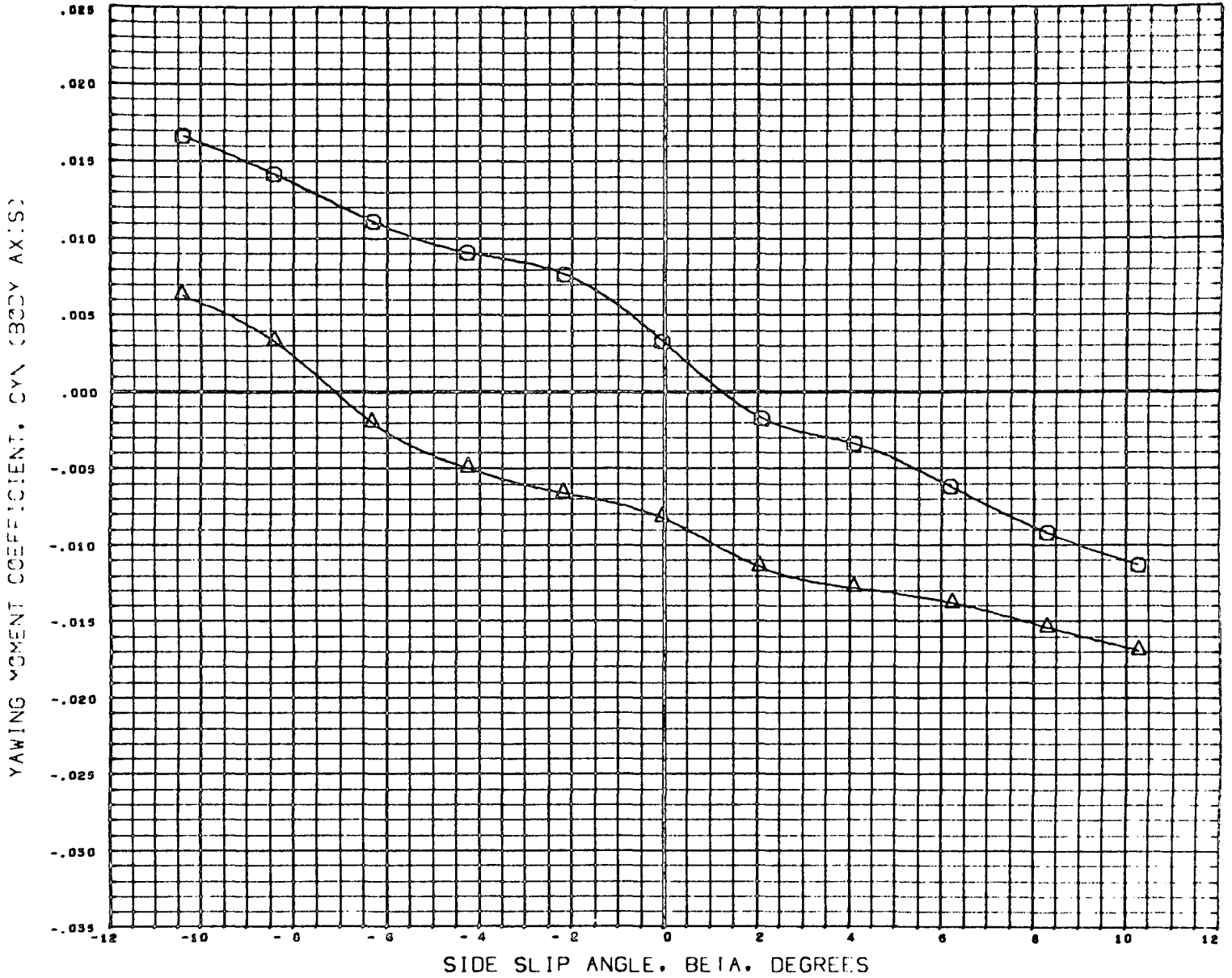

DATA SET SYMBOL	CONFIGURATION DESCRIPTION
(058300) MSFC TWT 514 E3	B30W23C10V14
(058310) MSFC TWT 514 E3	B30W23C10V14

ALPHA	ELEVTR	CANARD	RUDDER	REFERENCE INFORMATION
15.000	0.000	0.000	0.000	SREF 15.0300 SQ INC
15.000	0.000	0.000	25.000	LREF 2.8300 INCHES
				BREF 6.0620 INCHES
				XMRP 2.1110 INCHES
				YMRP 0.0000 INCHES
				ZMRP 0.0000 INCHES
				SCALE 0.0035

MACH 0.905

FIGURE-7 RUDDER EFFECTIVENESS AT ALPHA=15 DEGREES ON B-18E-3 CONFIGURATION

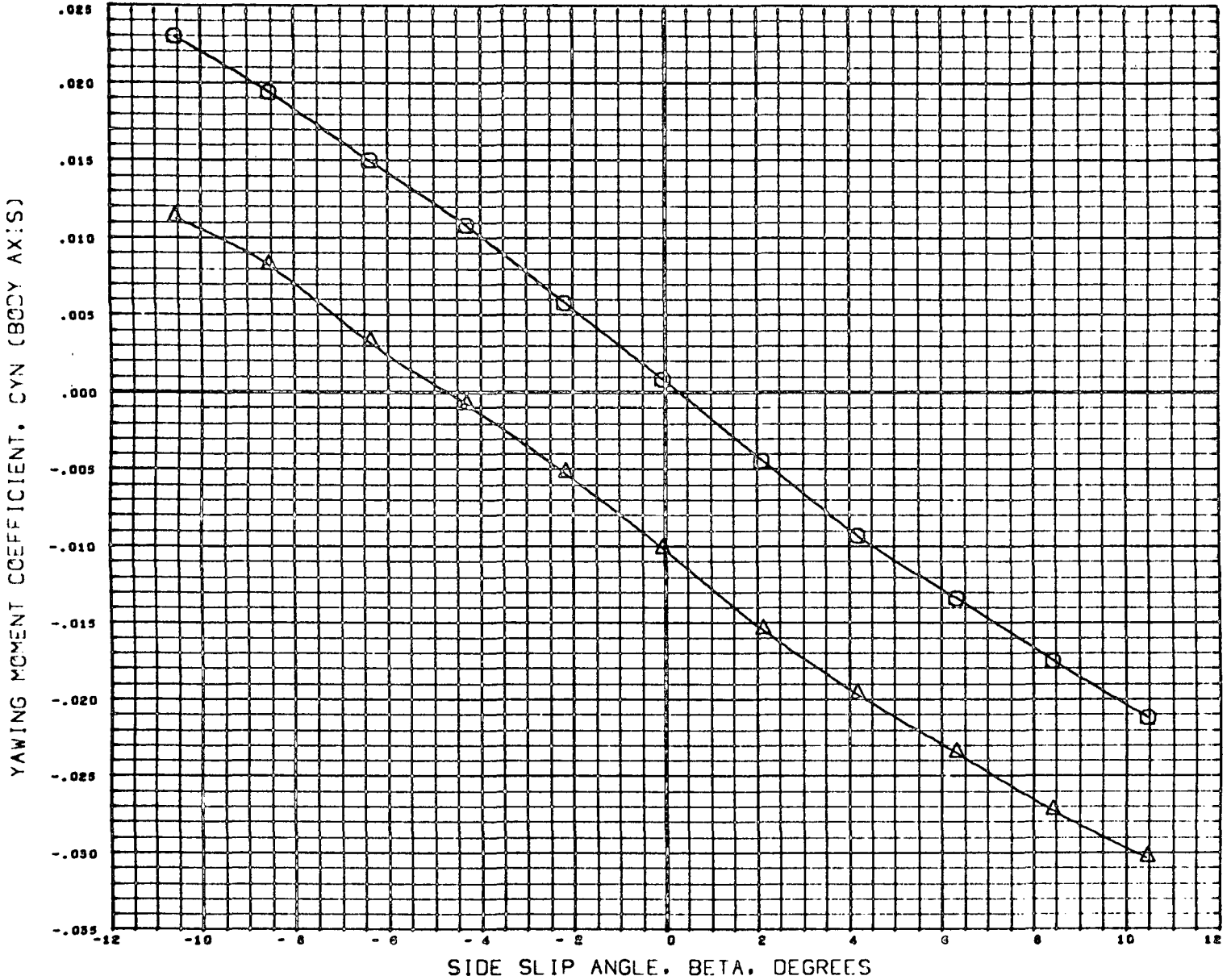

DATA SET SYMBOL	CONFIGURATION DESCRIPTION	ALPHA	ELEVTR	CANARD	RUDDER	REFERENCE INFORMATION	
(050300)	MSFC TWT 914 E3 030W23C10V14	15.000	0.000	0.000	0.000	SREF	15.0300 SQ INC
(050310)	MSFC TWT 914 E3 030W23C10V14	15.000	0.000	0.000	25.000	LREF	2.8300 INCHES
						BREF	6.0620 INCHES
						XMRP	2.1110 INCHES
						YMRP	0.0000 INCHES
						ZMRP	0.0000 INCHES
						SCALE	0.0035

MACH 1.200

FIGURE-7 RUDDER EFFECTIVENESS AT ALPHA=15 DEGREES ON B-18E-3 CONFIGURATION

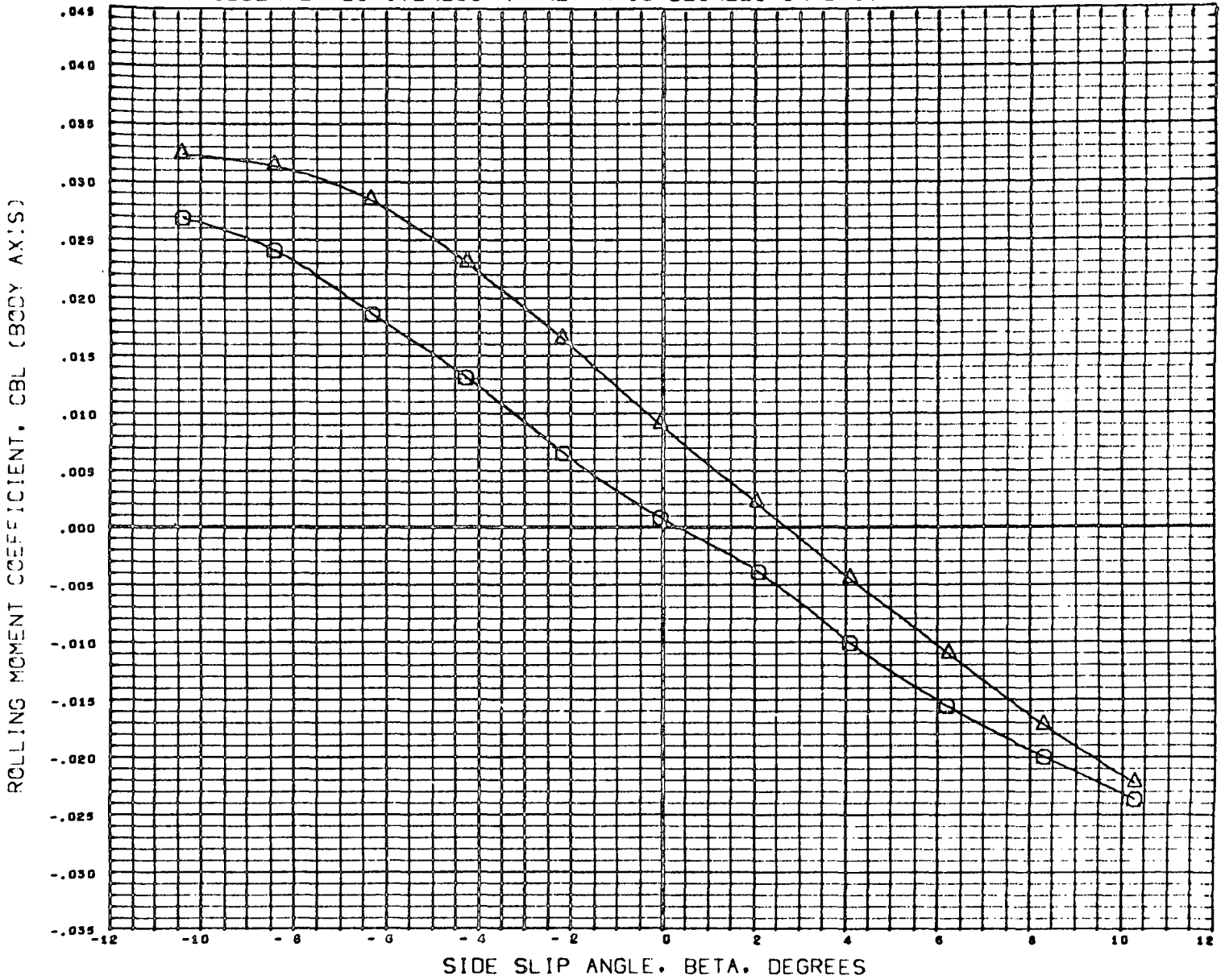

DATA SET SYMBOL	CONFIGURATION DESCRIPTION	ALPHA	ELEVTR	CANARD	RUDDER	REFERENCE INFORMATION
(05800)	MSFC TWT 514 E3 830W23C10V14	15.000	0.000	0.000	0.000	SREF 15.0300 SQ INC
(058510)	MSFC TWT 514 E3 830W23C10V14	15.000	0.000	0.000	25.000	LREF 2.8300 INCHES
						BREF 6.0820 INCHES
						XHRP 2.1110 INCHES
						YHRP 0.0000 INCHES
						ZHRP 0.0000 INCHES
						SCALE 0.0035

MACH 0.005

FIGURE-7 RUDDER EFFECTIVENESS AT ALPHA=15 DEGREES ON B-18E-3 CONFIGURATION

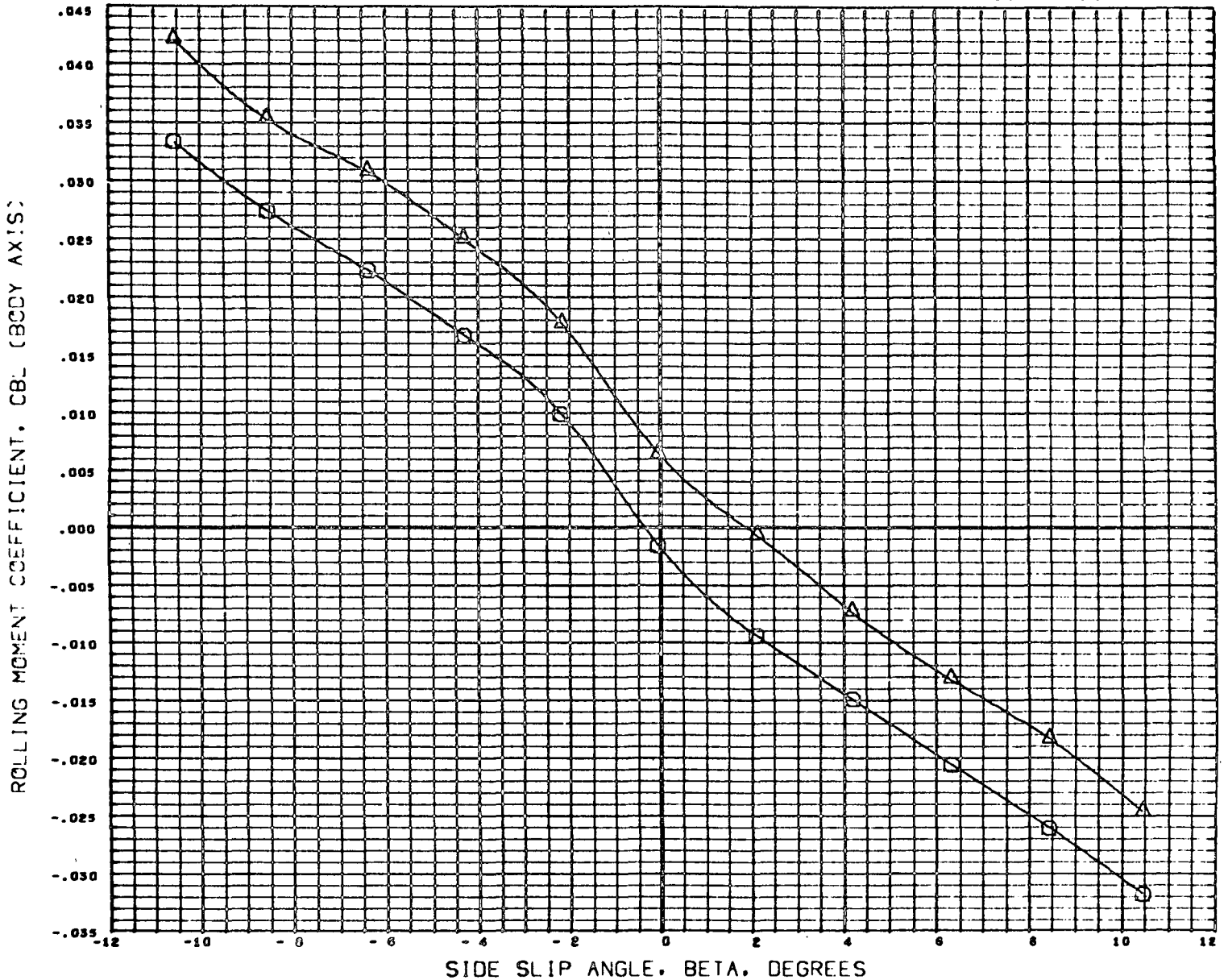

DATA SET SYMBOL	CONFIGURATION DESCRIPTION
(098500) MSFC TWT 514 E3	030W23C10V14
(098510) MSFC TWT 514 E3	030W23C10V14

ALPHA	ELEVTR	CANARD	RUDDER
15.000	0.000	0.000	0.000
15.000	0.000	0.000	29.000

REFERENCE INFORMATION		
SREF	15.0300	SQ INC
LREF	2.8300	INCHES
BREF	6.0620	INCHES
XMRP	2.1110	INCHES
YMRP	0.0000	INCHES
ZMRP	0.0000	INCHES
SCALE	0.0035	

MACH 1.200

FIGURE-7 RUDDER EFFECTIVENESS AT ALPHA=15 DEGREES ON B-18E-3 CONFIGURATION

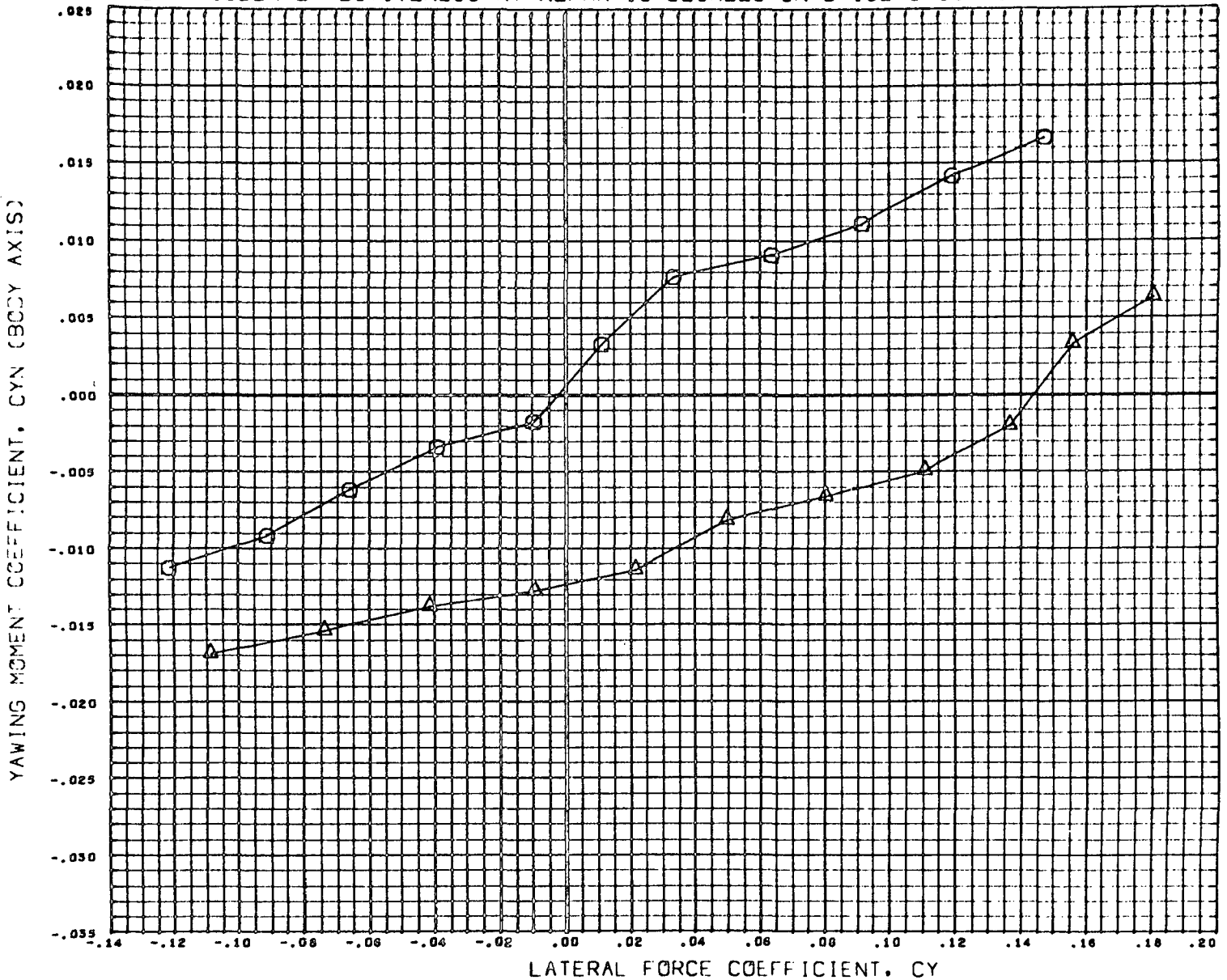

DATA SET SYMBOL CONFIGURATION DESCRIPTION
 (058300) ○ MSFC TWT 514 E3 B30W23C10V14
 (058310) △ MSFC TWT 914 E3 B30W23C10V14

ALPHA ELEVTR CANARC RUDDER
 15.000 0.000 0.000 0.000
 15.000 0.000 0.000 25.000

REFERENCE INFORMATION
 SREF 15.0300 SQ INC
 LREF 2.8300 INCHES
 BREF 6.0620 INCHES
 XMRP 2.1110 INCHES
 YMRP 0.0000 INCHES
 ZMRP 0.0000 INCHES
 SCALE 0.0035

MACH 0.903

FIGURE-7 RUDDER EFFECTIVENESS AT ALPHA=15 DEGREES ON B-18E-3 CONFIGURATION

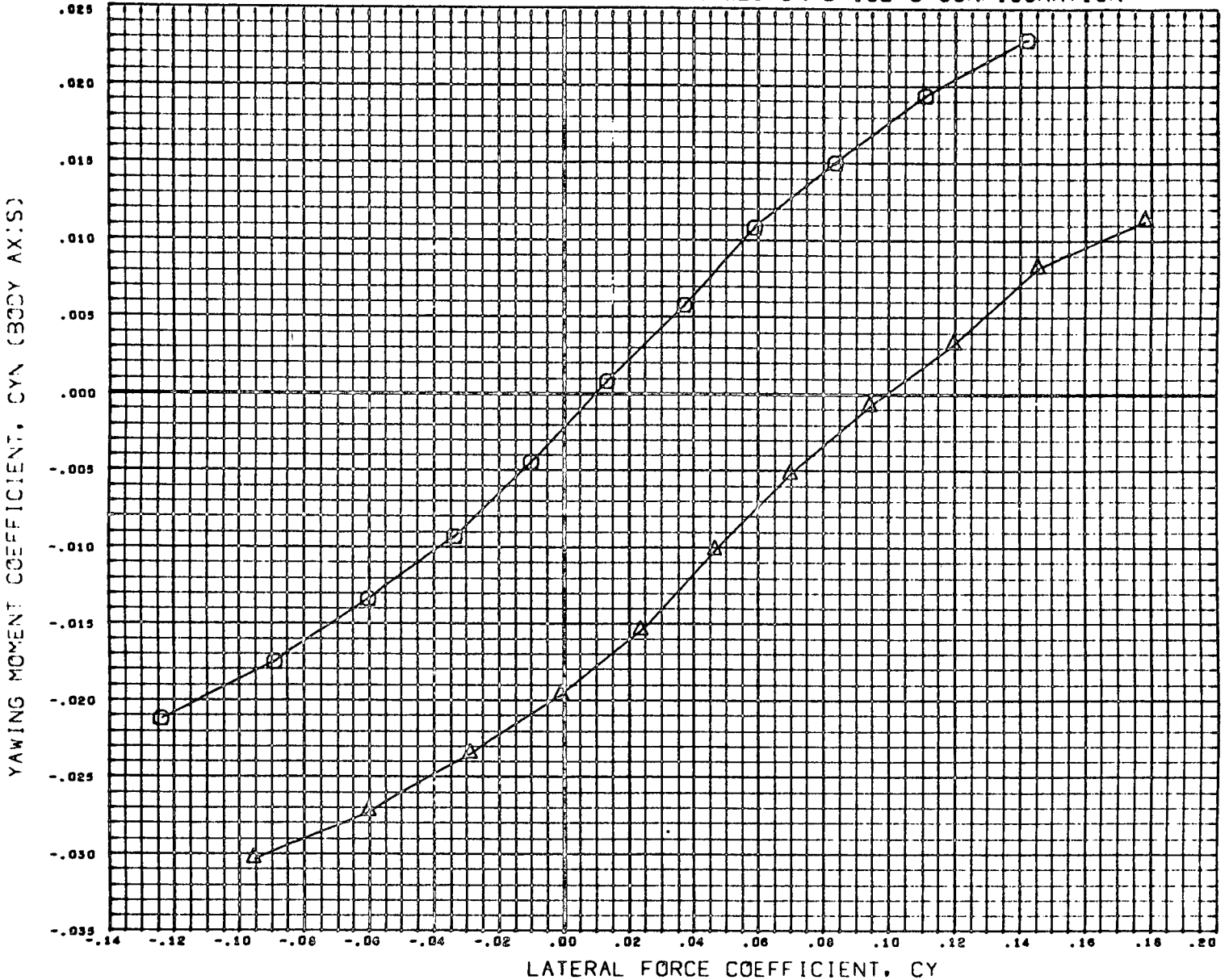

DATA SET SYMBOL	CONFIGURATION DESCRIPTION
(058300)	MSFC TWT 914 E3 030W23C10V14
(058510)	MSFC TWT 914 E3 030W23C10V14

ALPHA	ELEVTR	CANARD	RUDDER
15.000	0.000	0.000	0.000
15.000	0.000	0.000	25.000

REFERENCE INFORMATION		
SREF	15.0300	50 INC
LREF	2.8300	INCHES
BREF	6.0620	INCHES
XMRP	2.1110	INCHES
YMRP	0.0000	INCHES
ZMRP	0.0000	INCHES
SCALE	0.0035	

MACH 1.200

FIGURE-8 LATERAL CHARACTERISTICS AT ALPHA=30 DEGREES OF B-18E-3 CONFIGURATION

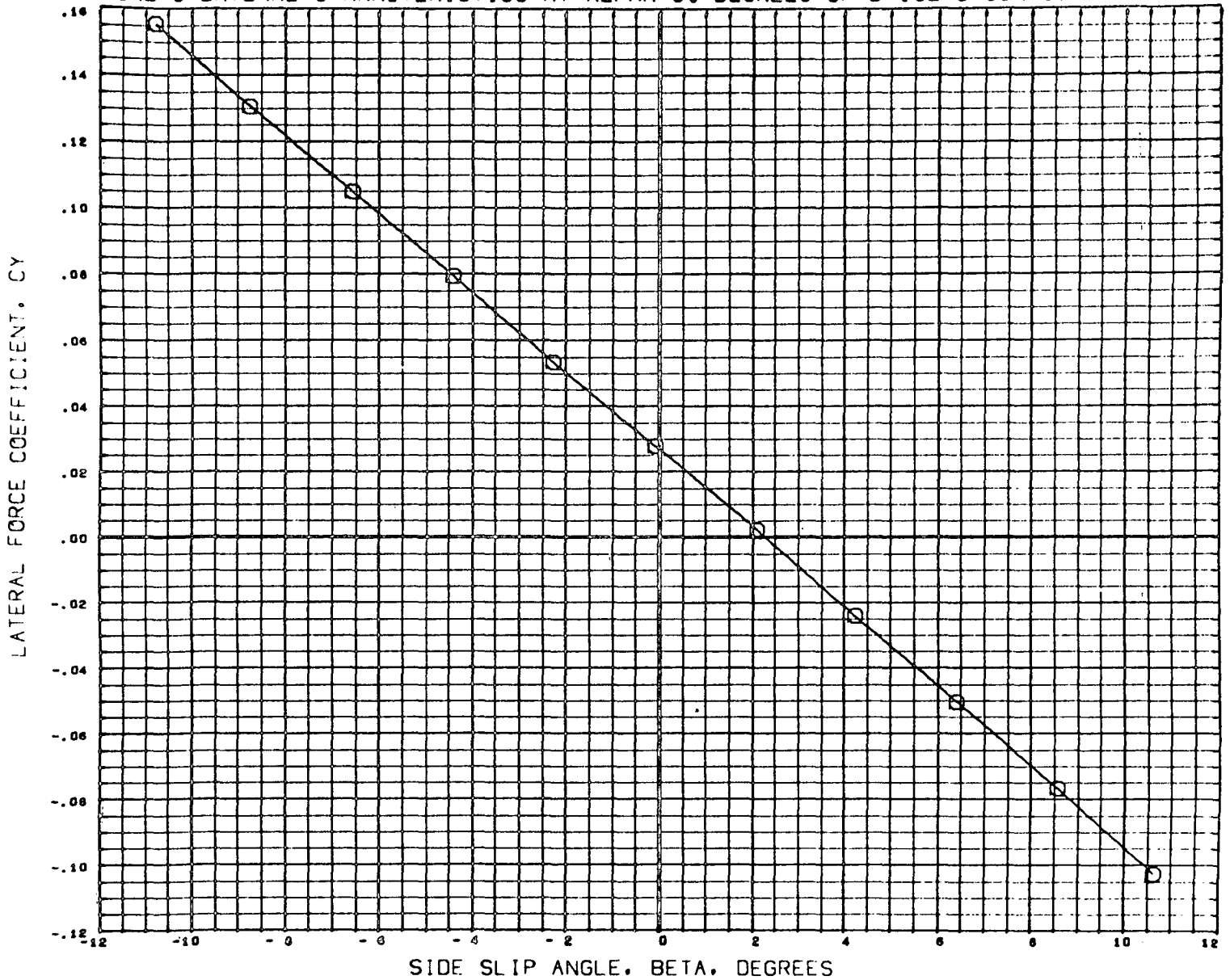

SYMBOL	MACH	PARAMETRIC VALUES			
○	1.062	ALPHA	30.000	ELEVTR	0.000
		CANARD	0.000	RUDDER	0.000

REFERENCE INFORMATION		
SREF	15.0300	sq INC
LREF	2.8300	INCHES
BREF	6.0620	INCHES
XHRP	2.1110	INCHES
YHRP	0.0000	INCHES
ZHRP	0.0000	INCHES
SCALE	0.0035	

DATA HIST. CODE #EV

MSFC TWT 514 E3

B30W23C10

(D58320)

06 FEB 72

PAGE

339

FIGURE-8 LATERAL CHARACTERISTICS AT ALPHA=30 DEGREES OF B-18E-3 CONFIGURATION

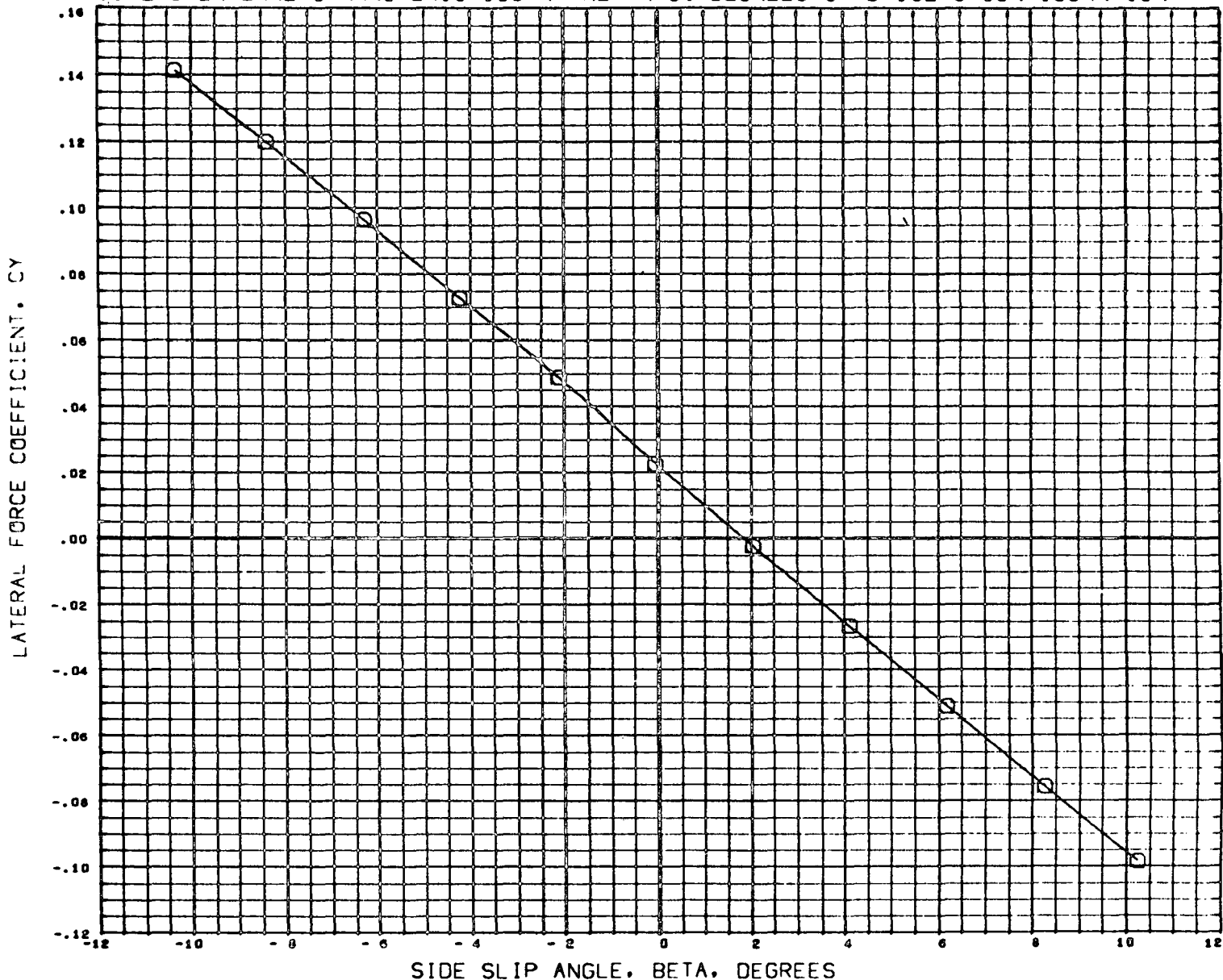

SYMBOL	MACH	PARAMETRIC VALUES			
○	2.990	ALPHA	30.000	ELEVTR	0.000
		CANARD	0.000	RUDDER	0.000

REFERENCE INFORMATION		
SREF	15.0300	30 INC
LREF	2.8300	INCHES
BREF	6.0620	INCHES
XMRP	2.1110	INCHES
YMRP	0.0000	INCHES
ZMRP	0.0000	INCHES
SCALE	0.0035	

DATA HIST. CODE 9EV

MSFC TWT 514 E3 B30W23C10

(D58320) 06 FEB 72 PAGE 340

FIGURE-8 LATERAL CHARACTERISTICS AT ALPHA=30 DEGREES OF B-18E-3 CONFIGURATION

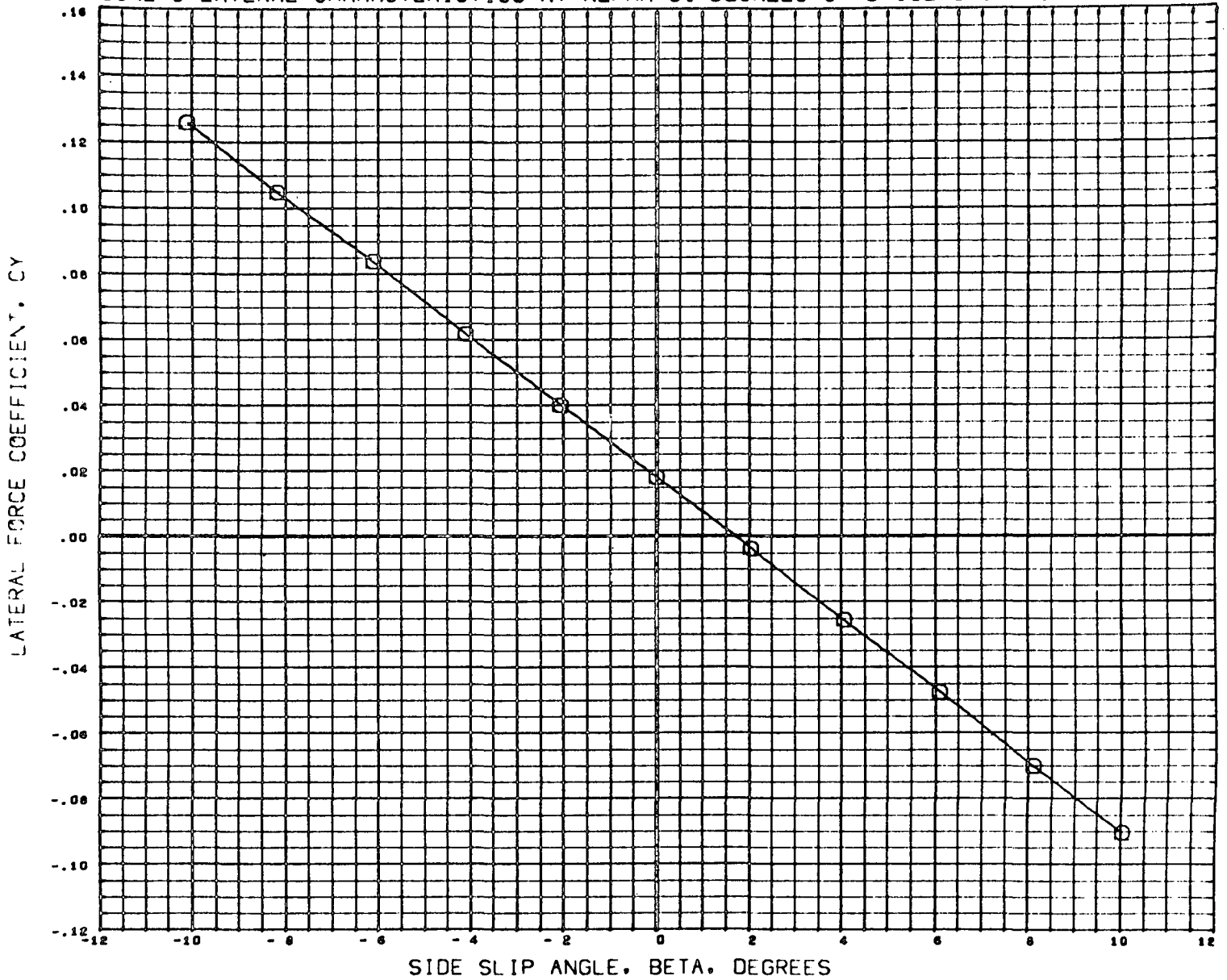

SYMBOL	MACH	PARAMETRIC VALUES			
○	4.959	ALPHA	50.000	ELEVTR	0.000
		CANARD	0.000	RUDDER	0.000

REFERENCE INFORMATION		
SREF	15.0300	90 INC
LREF	2.8300	INCHES
BREF	6.0620	INCHES
XMRP	2.1110	INCHES
YMRP	0.0000	INCHES
ZMRP	0.0000	INCHES
SCALE	0.0035	

DATA HIST. CODE *EV

MSFC TWT 514 E3

B30W23C10

(058320)

06 FEB 72

PAGE

341

FIGURE-8 LATERAL CHARACTERISTICS AT ALPHA=30 DEGREES OF B-18E-3 CONFIGURATION

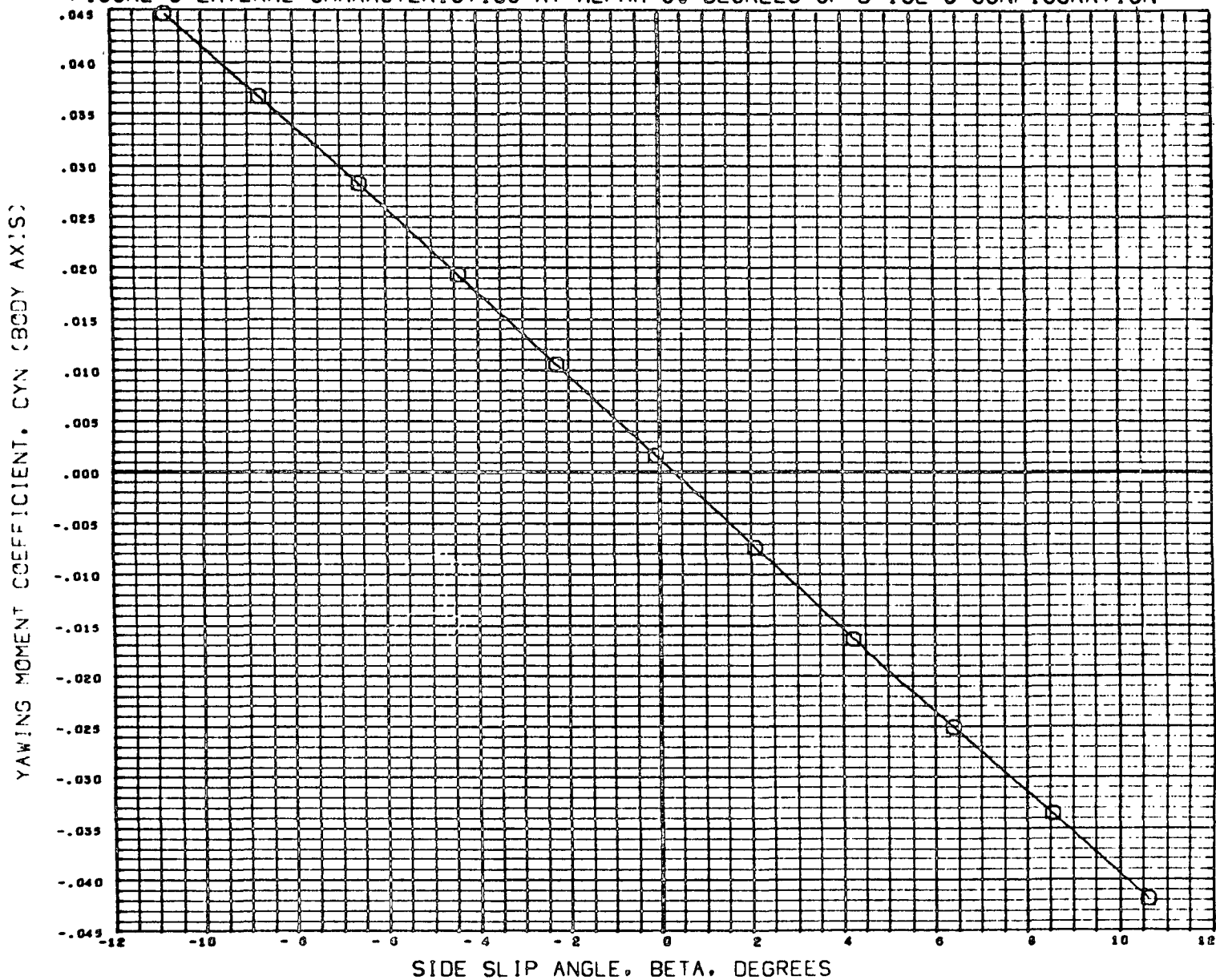

SYMBOL	MACH	PARAMETRIC VALUES			
○	1.962	ALPHA	30.000	ELEVTR	0.000
		CANARD	0.000	RUDDER	0.000

REFERENCE INFORMATION		
SREF	15.0300	80 INC
LREF	2.8300	INCHES
BREF	6.0620	INCHES
XMRP	2.1110	INCHES
YMRP	0.0000	INCHES
ZMRP	0.0000	INCHES
SCALE	0.0035	

DATA INST. CODE 9EV

FIGURE-8 LATERAL CHARACTERISTICS AT ALPHA=30 DEGREES OF B-18E-3 CONFIGURATION

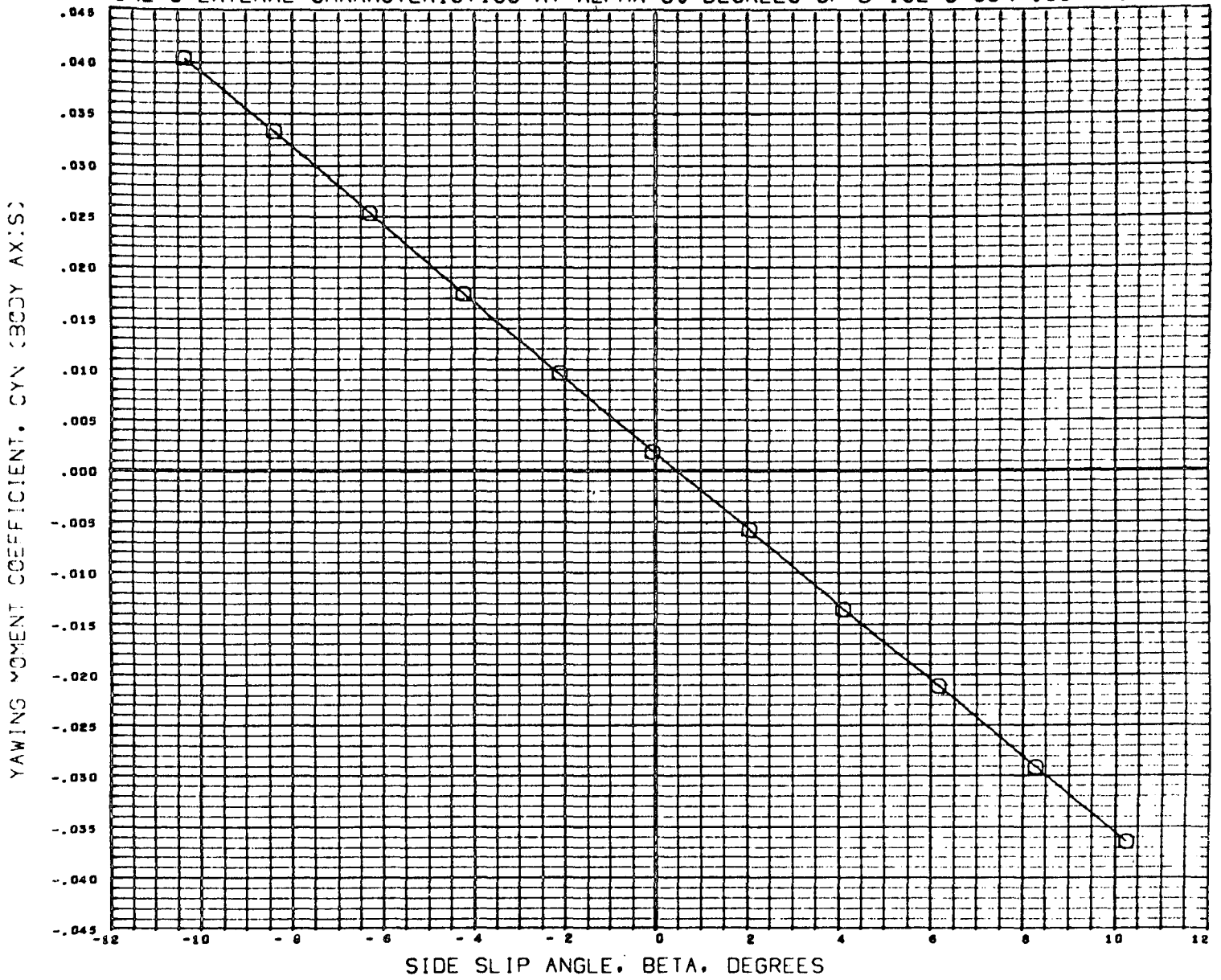

SYMBOL	MACH	PARAMETRIC VALUES			
○	2.990	ALPHA	30.000	ELEVTR	0.000
		CANARD	0.000	RUDDER	0.000

REFERENCE INFORMATION		
SREF	15.0300	SQ INC
LREF	2.8300	INCHES
BREF	6.0620	INCHES
XMRP	2.1110	INCHES
YMRP	0.0000	INCHES
ZMRP	0.0000	INCHES
SCALE	0.0035	

DATA HIST. CODE #EV

FIGURE-8 LATERAL CHARACTERISTICS AT ALPHA=30 DEGREES OF B-18E-3 CONFIGURATION

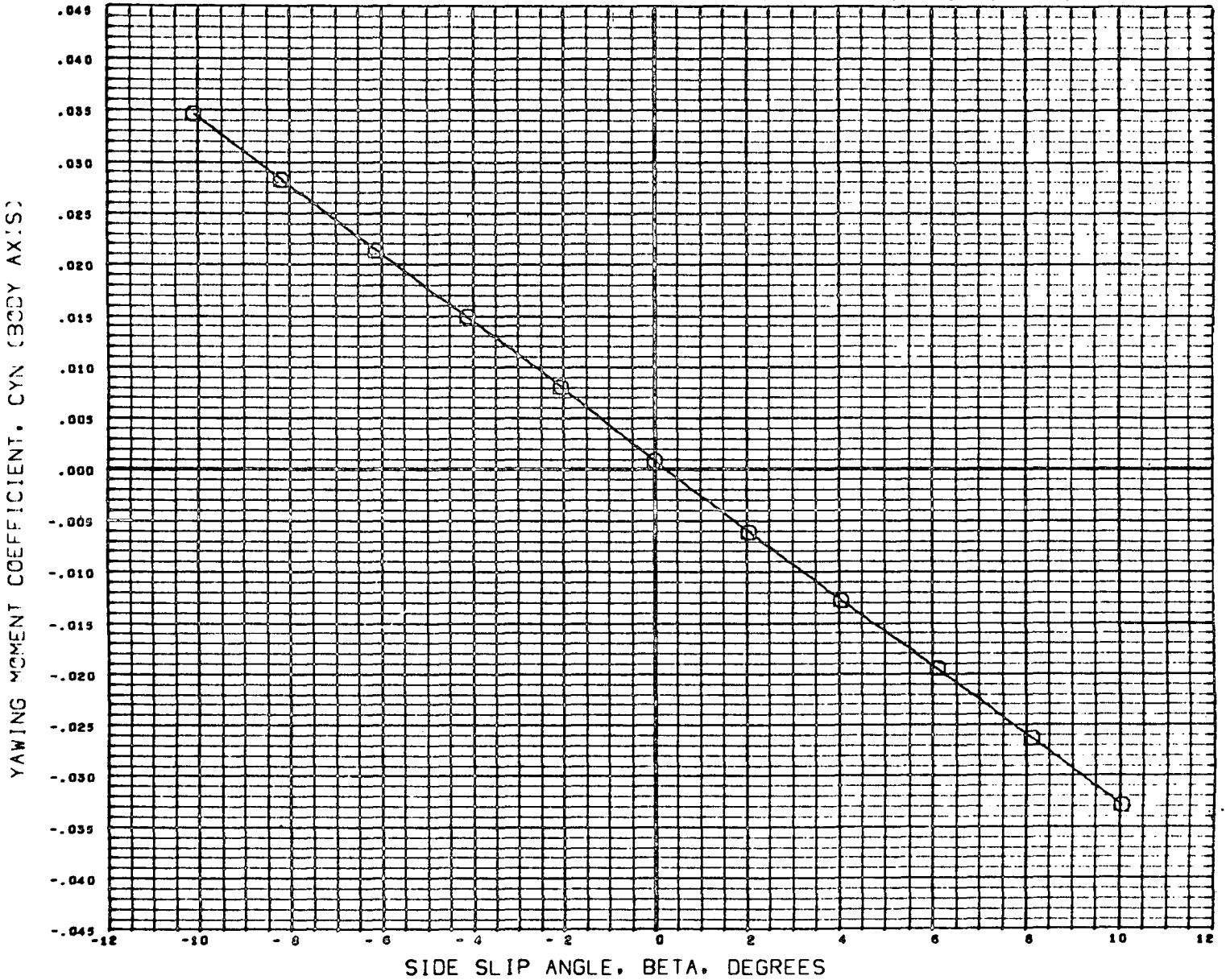

SYMBOL	MACH	PARAMETRIC VALUES			
○	4.959	ALPHA	30.000	ELEVTR	0.000
		CANARD	0.000	RUDDER	0.000

REFERENCE INFORMATION		
QREF	15.0300	90 INC
LREF	2.8300	INCHES
BREF	6.0620	INCHES
XMRP	2.1110	INCHES
YMRP	0.0000	INCHES
ZMRP	0.0000	INCHES
SCALE	0.0035	

DATA HIST. CODE 02V

FIGURE-8 LATERAL CHARACTERISTICS AT ALPHA=30 DEGREES OF B-18E-3 CONFIGURATION

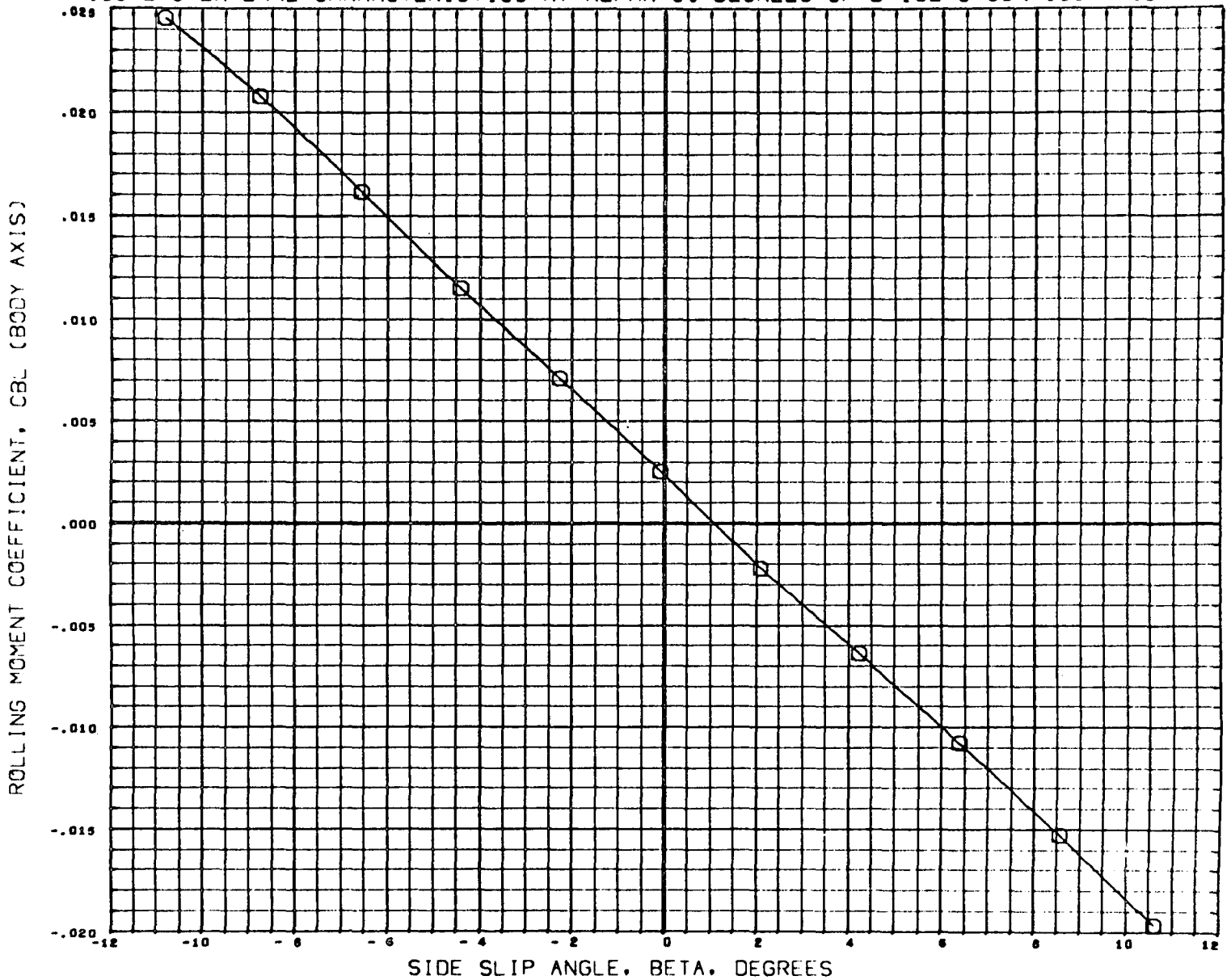

SYMBOL	MACH	PARAMETRIC VALUES			
○	1.962	ALPHA	30.000	ELEVTR	0.000
		CANARD	0.000	RUDDER	0.000

REFERENCE INFORMATION		
SREF	15.0300	SQ INC
LREF	2.6300	INCHES
BREF	6.0620	INCHES
XMRP	2.1110	INCHES
YMRP	0.0000	INCHES
ZMRP	0.0000	INCHES
SCALE	0.0035	

DATA HIST. CODE *EV

MSFC TWT 514 E3

B30W23C10

(058320)

06 FEB 72

PAGE

345

FIGURE-8 LATERAL CHARACTERISTICS AT ALPHA=30 DEGREES OF B-18E-3 CONFIGURATION

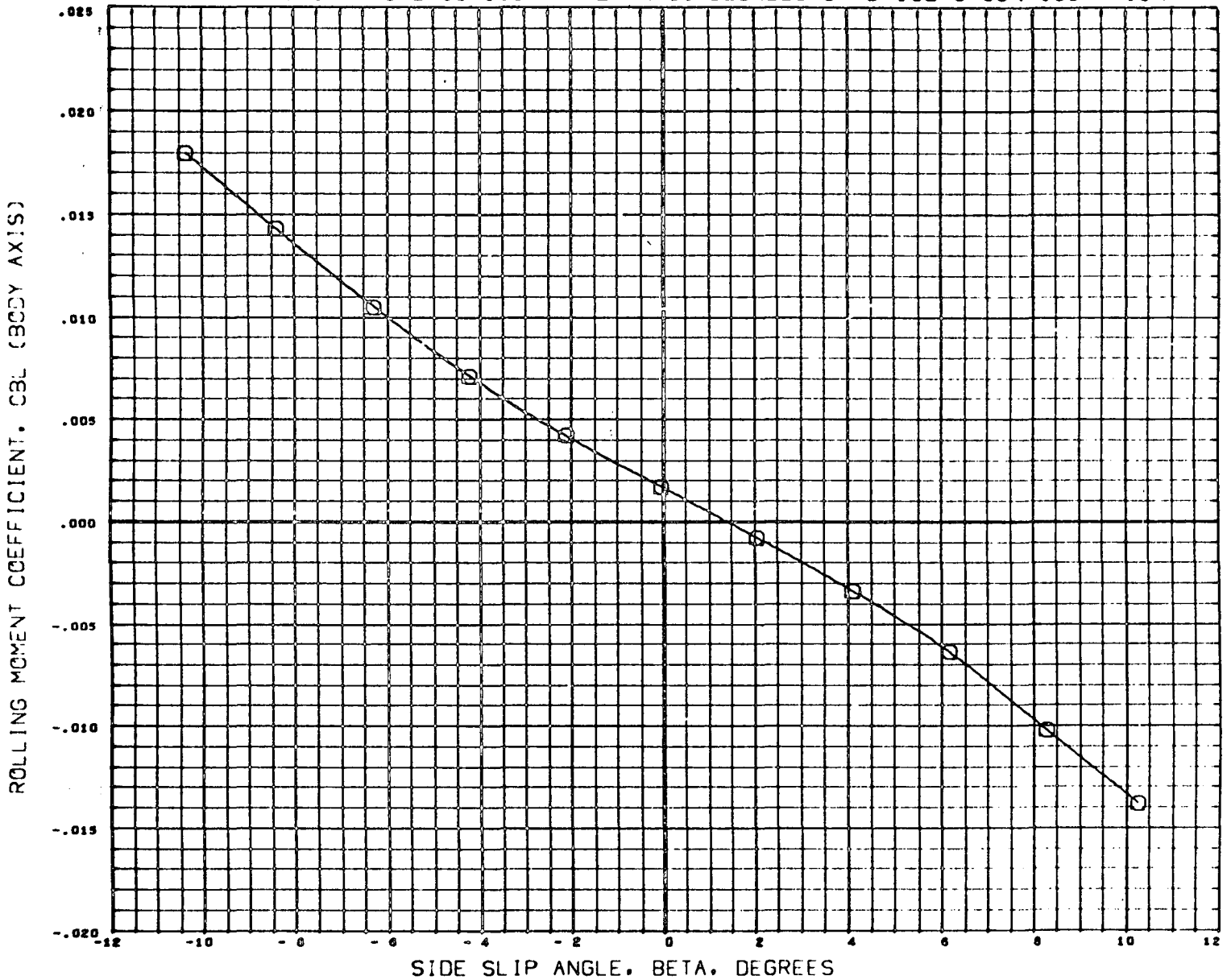

SYMBOL	MACH	PARAMETRIC VALUES			
○	2.990	ALPHA	30.000	ELEVTR	0.000
		CANARD	0.000	RUDDER	0.000

REFERENCE INFORMATION		
SREF	15.0300	SQ INC
LREF	2.8300	INCHES
BREF	6.0620	INCHES
XMRP	2.1110	INCHES
YMRP	0.0000	INCHES
ZMRP	0.0000	INCHES
SCALE	0.0035	

DATA HIST. CODE *EV

FIGURE-8 LATERAL CHARACTERISTICS AT ALPHA=30 DEGREES OF B-18E-3 CONFIGURATION

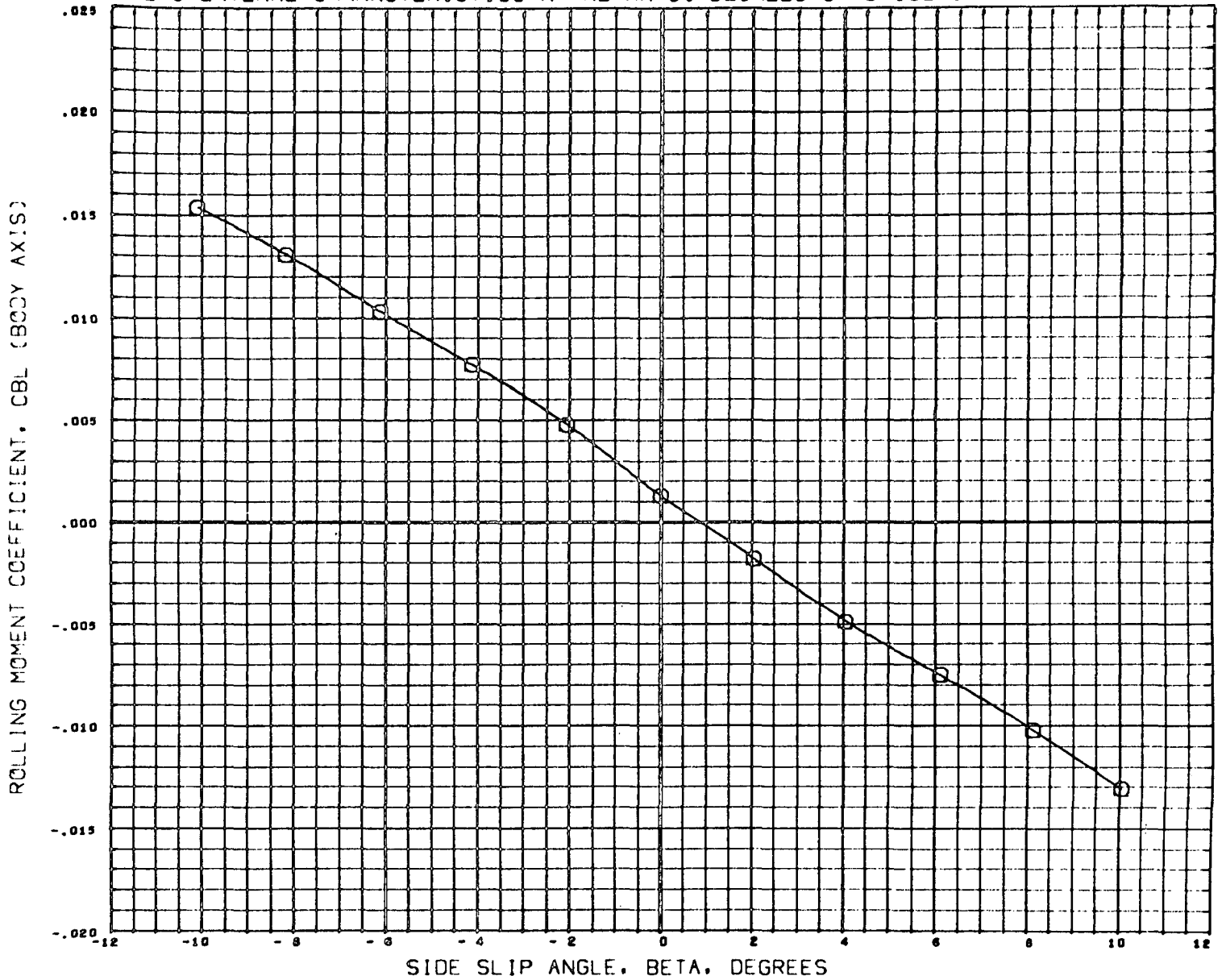

SYMBOL	MACH	PARAMETRIC VALUES			
○	4.950	ALPHA	30.000	ELEVTR	0.000
		CANARD	0.000	RUDDER	0.000

REFERENCE INFORMATION		
SREF	15.0500	50 INC
LREF	2.0300	INCHES
BREF	6.0620	INCHES
XMRP	2.1110	INCHES
YMRP	0.0000	INCHES
ZMRP	0.0000	INCHES
SCALE	0.0035	INCHES

DATA HIST. CODE #EV

MSFC TWT 514 E3 B30W23C10

(D58320) 06 FEB 72 PAGE 347

FIGURE-8 LATERAL CHARACTERISTICS AT ALPHA=30 DEGREES OF B-18E-3 CONFIGURATION

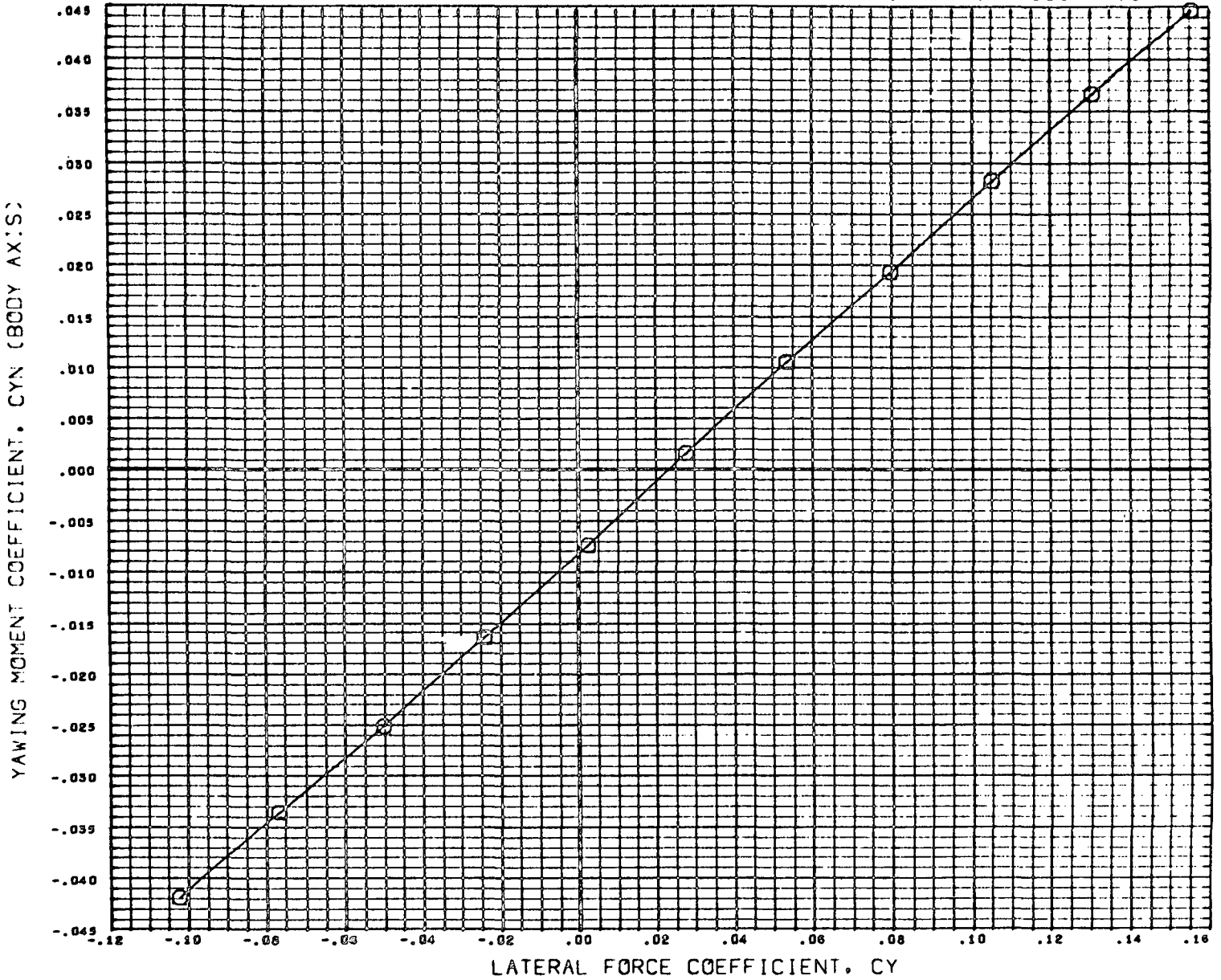

SYMBOL	MACH	PARAMETRIC VALUES			
○	1.962	ALPHA	30.000	ELEVTR	0.000
		CANARD	0.000	RUDDER	0.000

REFERENCE INFORMATION		
SREF	15.0300	50 INC
LREF	2.8300	INCHES
BREF	0.0620	INCHES
XMRP	2.1110	INCHES
YMRP	0.0000	INCHES
ZMRP	0.0000	INCHES
SCALE	0.0035	

DATA HIST. CODE 0EV

MSC TWT 514 E3

B30W23C10

(058320) 06 FEB 72

PAGE 348

FIGURE-8 LATERAL CHARACTERISTICS AT ALPHA=30 DEGREES OF B-18E-3 CONFIGURATION

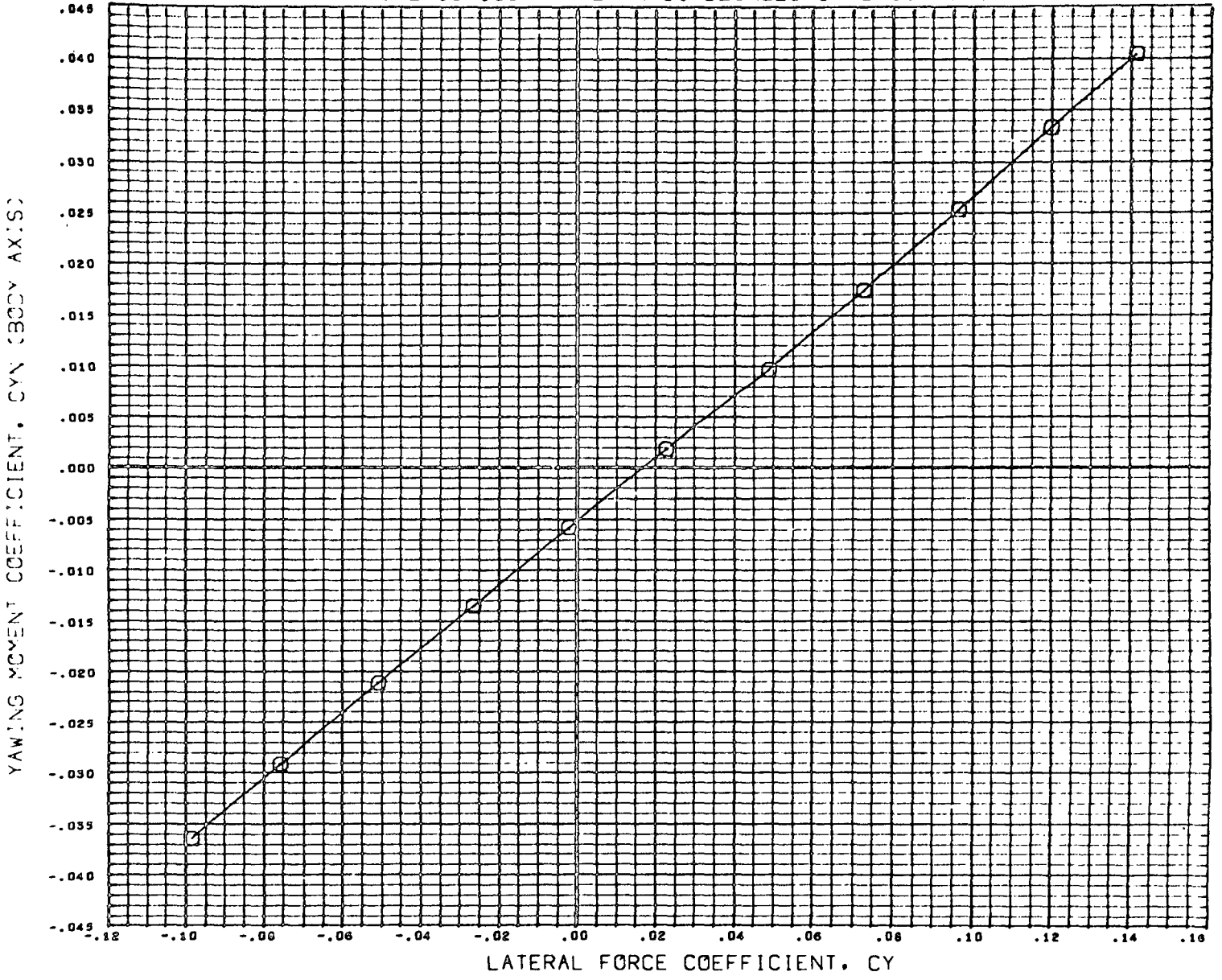

SYMBOL	MACH	PARAMETRIC VALUES			
○	2.990	ALPHA	30.000	ELEVTR	0.000
		CANARD	0.000	RUDDER	0.000

REFERENCE INFORMATION		
SREF	15.0300	30 INC
LREF	2.8300	INCHES
BREF	6.0620	INCHES
XMRP	2.1110	INCHES
YMRP	0.0000	INCHES
ZMRP	0.0000	INCHES
SCALE	0.0035	

DATA HIST. CODE *EV

FIGURE-8 LATERAL CHARACTERISTICS AT ALPHA=30 DEGREES OF B-18E-3 CONFIGURATION

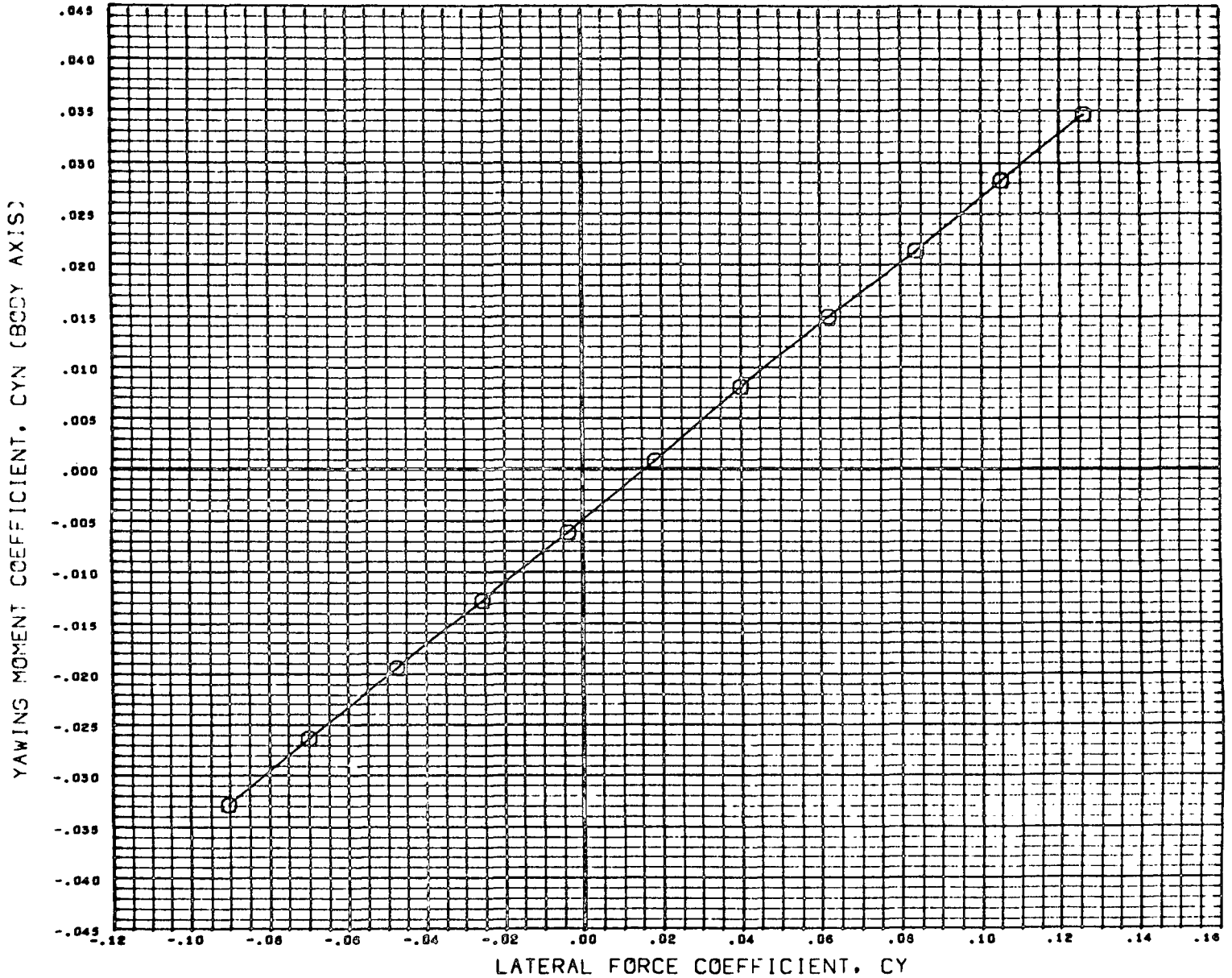

SYMBOL	MACH	PARAMETRIC VALUES			
○	4.959	ALPHA	30.000	ELEVTR	0.000
		CANARD	0.000	RUDDER	0.000

REFERENCE INFORMATION		
SREF	15.0300	90 INC
LREF	2.8300	INCHES
BREF	6.0620	INCHES
XHRP	2.1110	INCHES
YMRP	0.0000	INCHES
ZMRP	0.0000	INCHES
SCALE	0.0035	

DATA MIST. CODE 0EV

FIGURE-9 ELEVATOR EFFECTIVENESS OF B-18E-2 CONFIGURATION

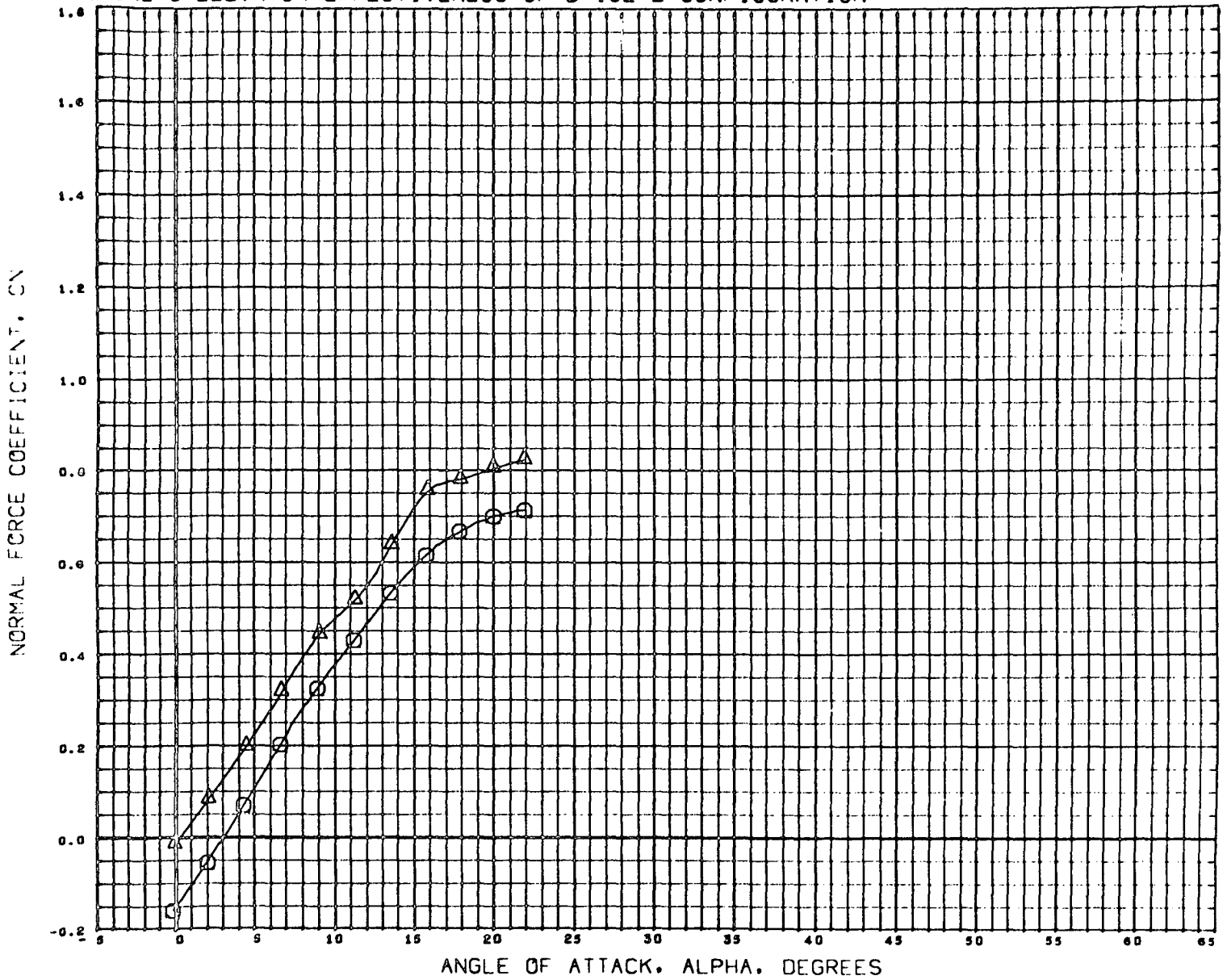

DATA SET SYMBOL	CONFIGURATION DESCRIPTION
(C56080)	MSFC TWT 514 E2 B33W25
(C56070)	MSFC TWT 514 E2 B33W25

BETA	ELEVTR
0.000	-20.000
0.000	0.000

REFERENCE INFORMATION		
SREF	19.6300	30 INC
LREF	3.2400	INCHES
BREF	6.9300	INCHES
XMRP	2.1110	INCHES
YMRP	0.0000	INCHES
ZMRP	0.0000	INCHES
SCALE	0.0035	

MACH 0.902

FIGURE-9 ELEVATOR EFFECTIVENESS OF B-18E-2 CONFIGURATION

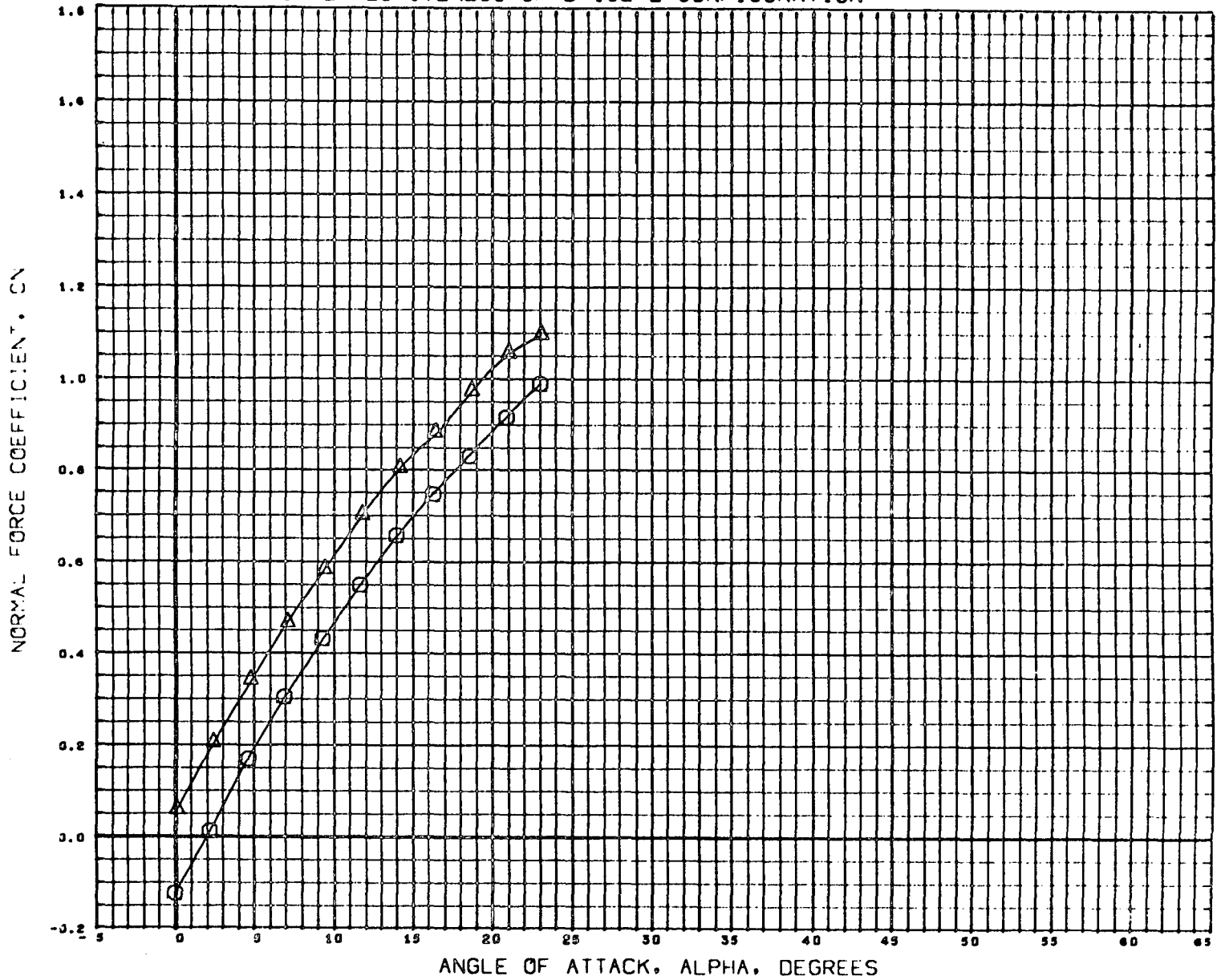

DATA SET SYMBOL	CONFIGURATION DESCRIPTION
(C58080)	MSFC TWT 914 E2 833W25
(C58070)	MSFC TWT 514 E2 833W25

BETA	ELEVTR
0.000	-20.000
0.000	0.000

REFERENCE INFORMATION		
SREF	19.6300	SQ INC
LREF	3.2400	INCHES
BREF	6.9300	INCHES
XMRP	2.1110	INCHES
YMRP	0.0000	INCHES
ZMRP	0.0000	INCHES
SCALE	0.0035	

MACH 1.201

FIGURE-9 ELEVATOR EFFECTIVENESS OF B-18E-2 CONFIGURATION

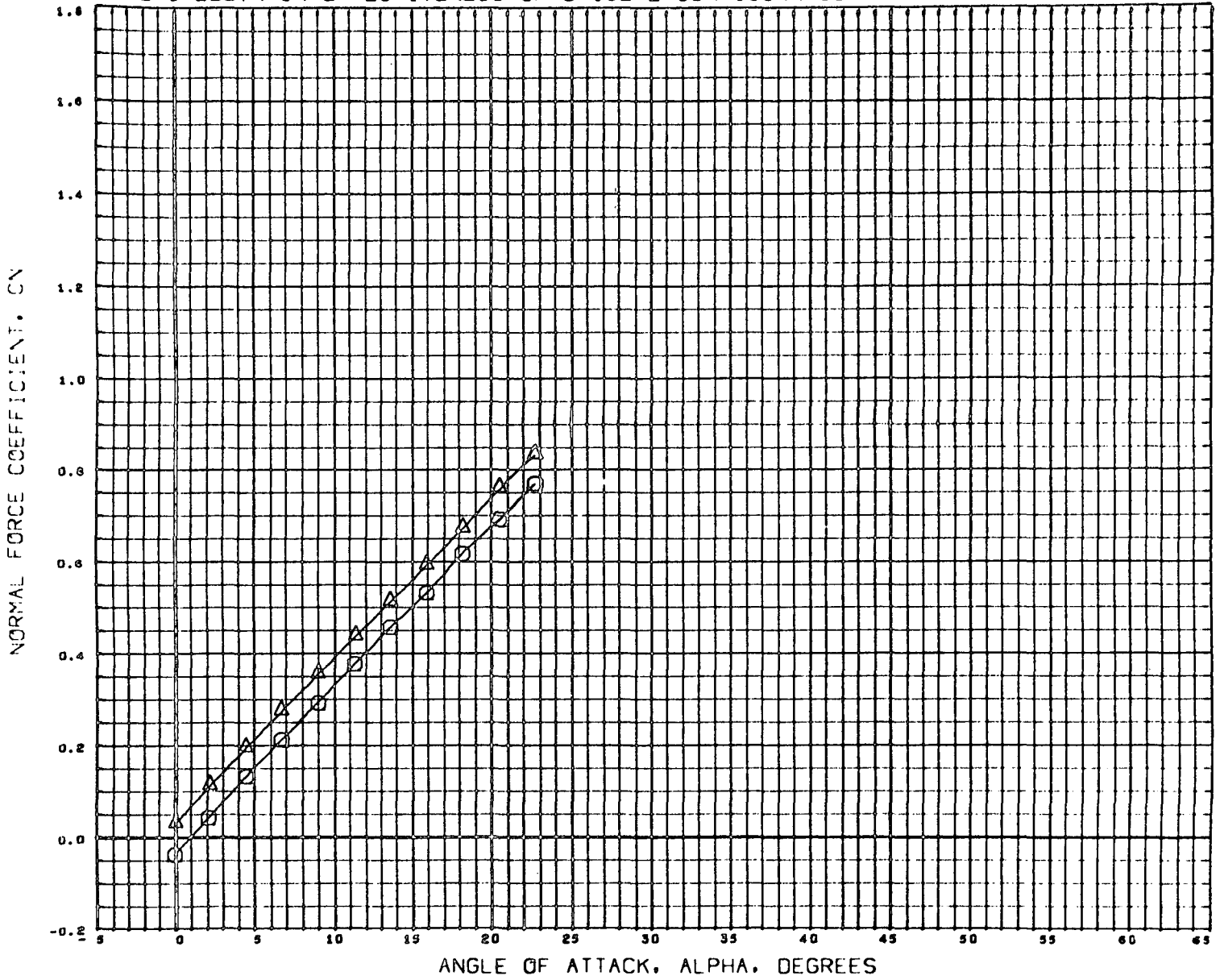

DATA SET SYMBOL	CONFIGURATION DESCRIPTION
(C58680) ○	HSFC TWT 514 E2 833W25
(C58670) △	HSFC TWT 514 E2 833W25

BETA	ELEVTR
0.000	-20.000
0.000	0.000

REFERENCE INFORMATION	
SREF	19.6500 SQ INC
LREF	3.2400 INCHES
BREF	6.9300 INCHES
XMRP	2.1110 INCHES
YMRP	0.0000 INCHES
ZMRP	0.0000 INCHES
SCALE	0.0035

MACH 1.961

FIGURE-9 ELEVATOR EFFECTIVENESS OF B-18E-2 CONFIGURATION

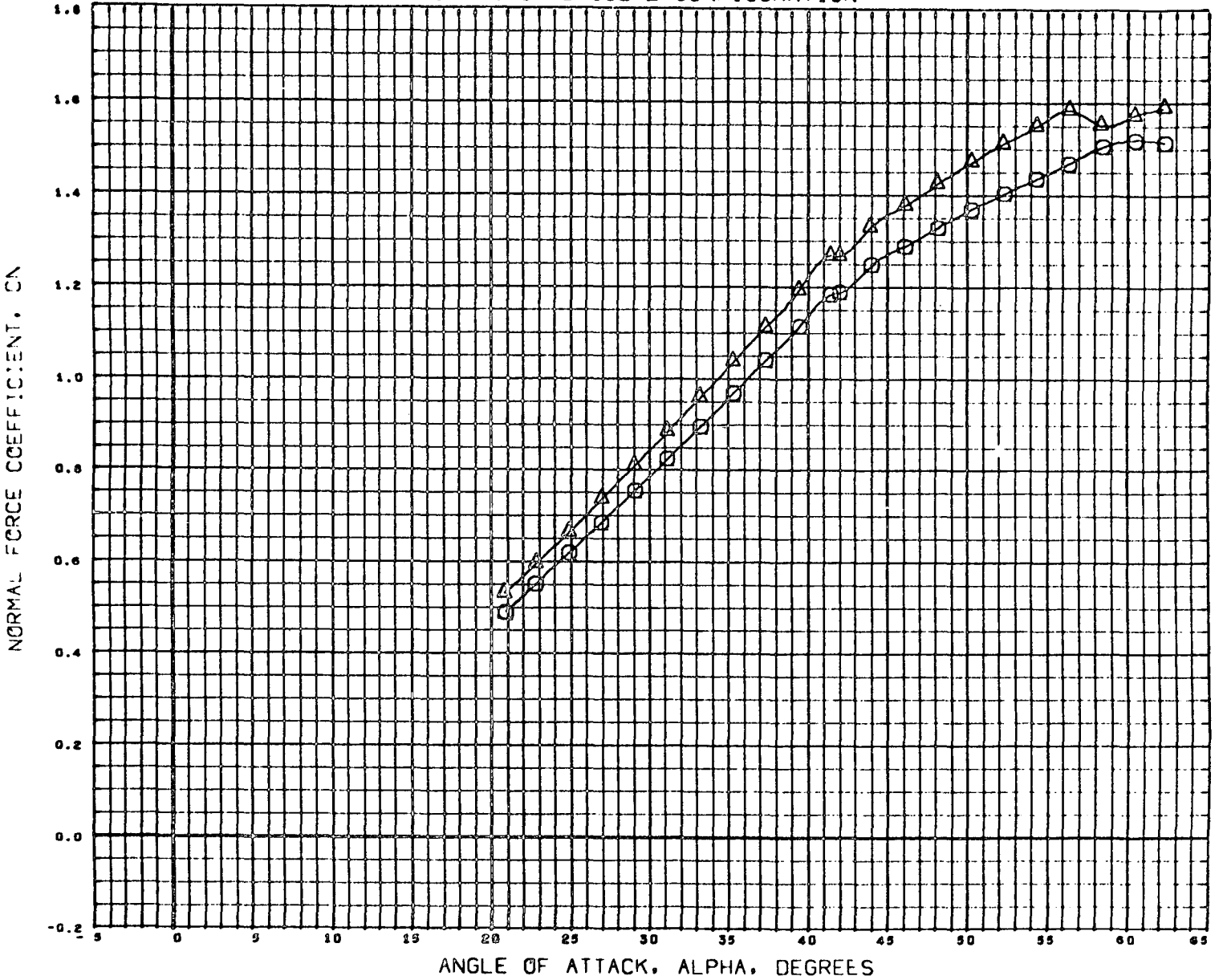

DATA SET SYMBOL	CONFIGURATION DESCRIPTION
(C58080)	MSFC TWT 514 E2 833W25
(C58070)	MSFC TWT 514 E2 833W25

BETA	ELEVTR
0.000	-20.000
0.000	0.000

REFERENCE INFORMATION		
SREF	19.6300	90 INC
LREF	3.2400	INCHES
BREF	6.9300	INCHES
XMRP	2.1110	INCHES
YMRP	0.0000	INCHES
ZMRP	0.0000	INCHES
SCALE	0.0035	

MACH 2.990

FIGURE-9 ELEVATOR EFFECTIVENESS OF B-18E-2 CONFIGURATION

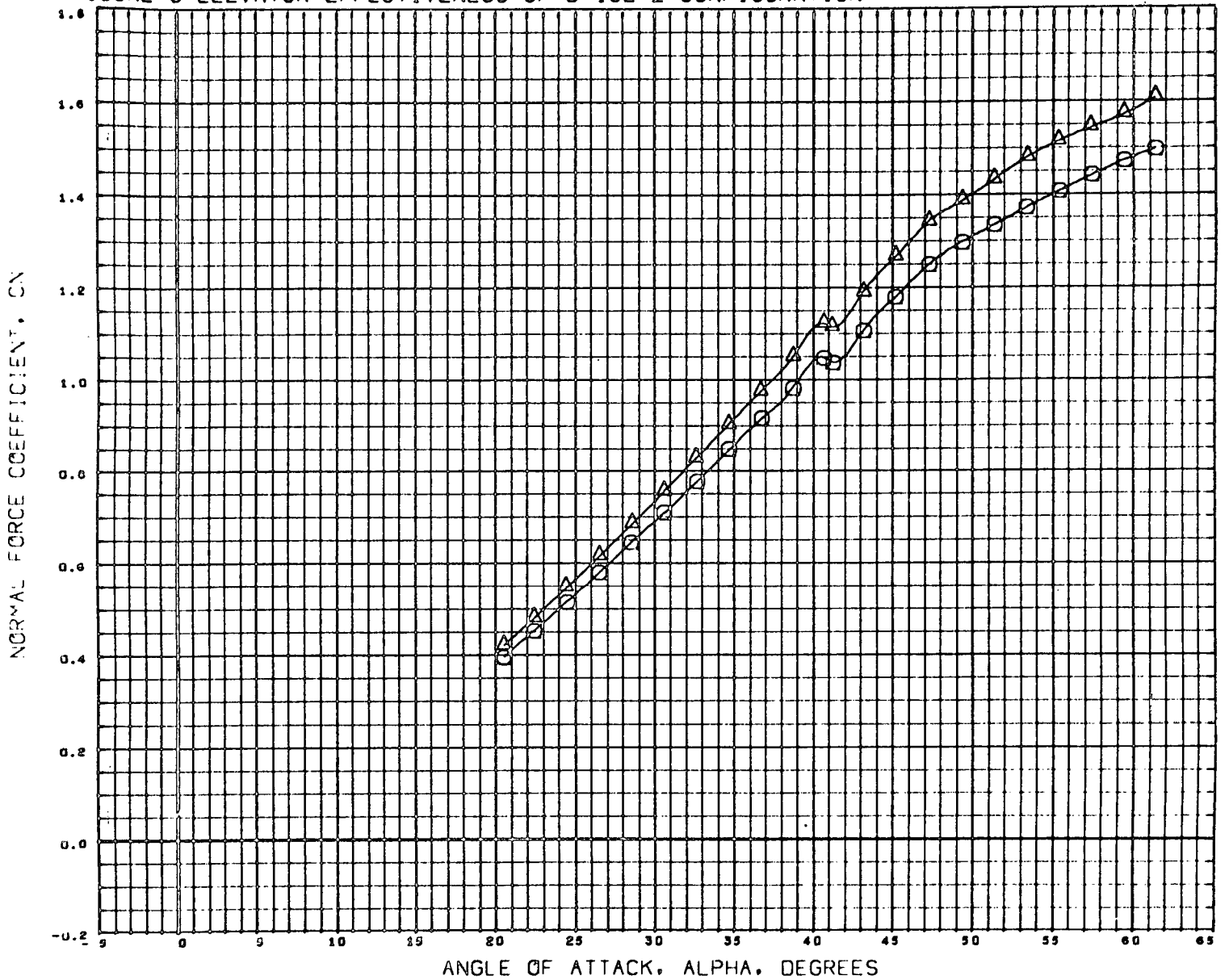

DATA SET SYMBOL	CONFIGURATION DESCRIPTION
(C590080)	MSFC TWT 514 E2 833W25
(C590070)	MSFC TWT 514 E2 833W25

BETA	ELEVTR
0.000	-20.000
0.000	0.000

REFERENCE INFORMATION		
SREF	19.6300	50 INC
LREF	3.2400	INCHES
BREF	6.9300	INCHES
XMRP	2.1110	INCHES
YMRP	0.0000	INCHES
ZMRP	0.0000	INCHES
SCALE	0.0035	

MACH 4.959

FIGURE-9 ELEVATOR EFFECTIVENESS OF B-18E-2 CONFIGURATION

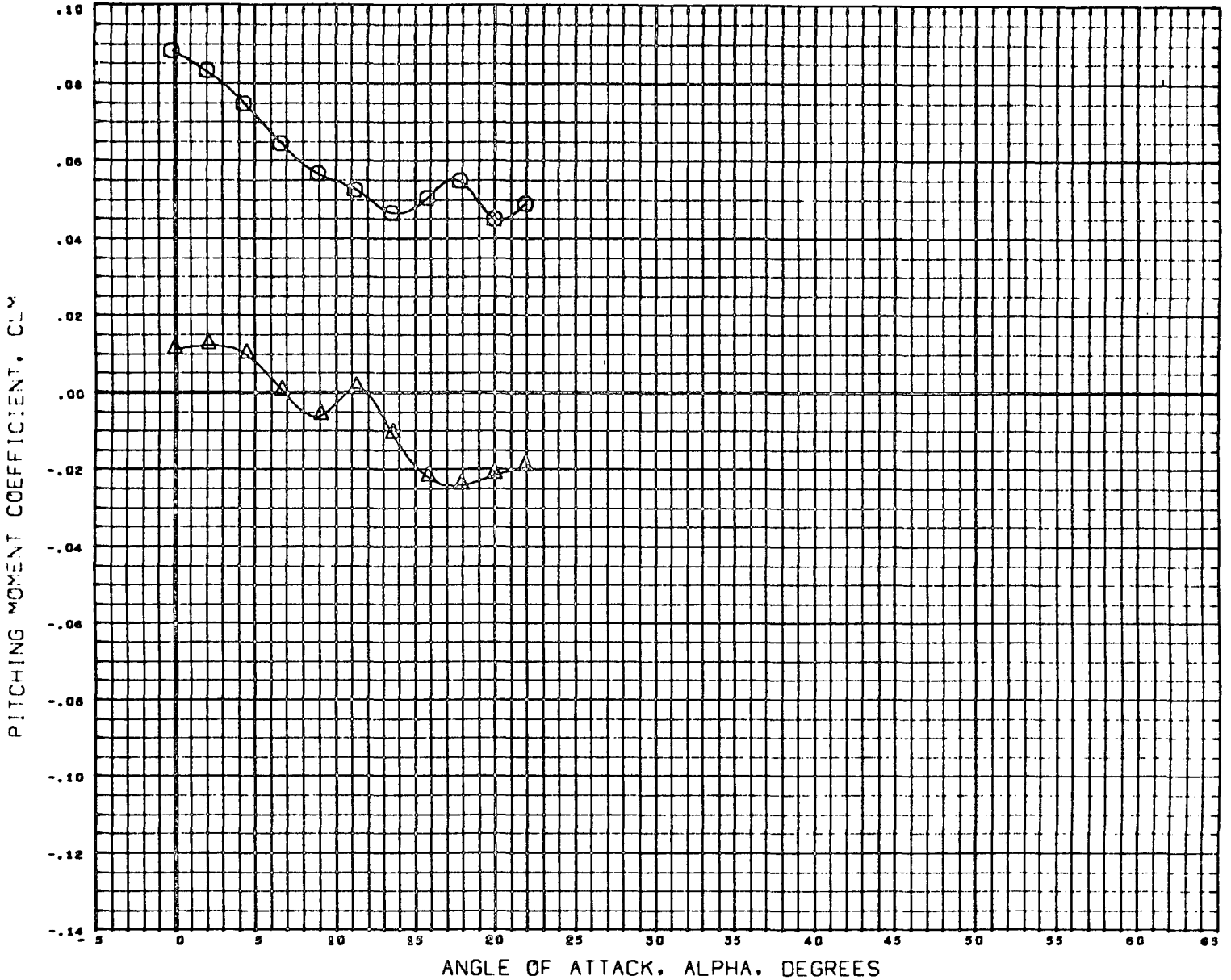

DATA SET SYMBOL	CONFIGURATION DESCRIPTION
(C58080) ○	MSFC TWT 514 E2 B33W25
(C58070) △	MSFC TWT 514 E2 B33W25

BETA	ELEVTR
0.000	-20.000
0.000	0.000

REFERENCE INFORMATION		
SREF	19.6300	SQ INC
LREF	3.2400	INCHES
BREF	6.9300	INCHES
XMRP	2.1110	INCHES
YMRP	0.0000	INCHES
ZMRP	0.0000	INCHES
SCALE	0.0033	

MACH 0.002

FIGURE-9 ELEVATOR EFFECTIVENESS OF B-18E-2 CONFIGURATION

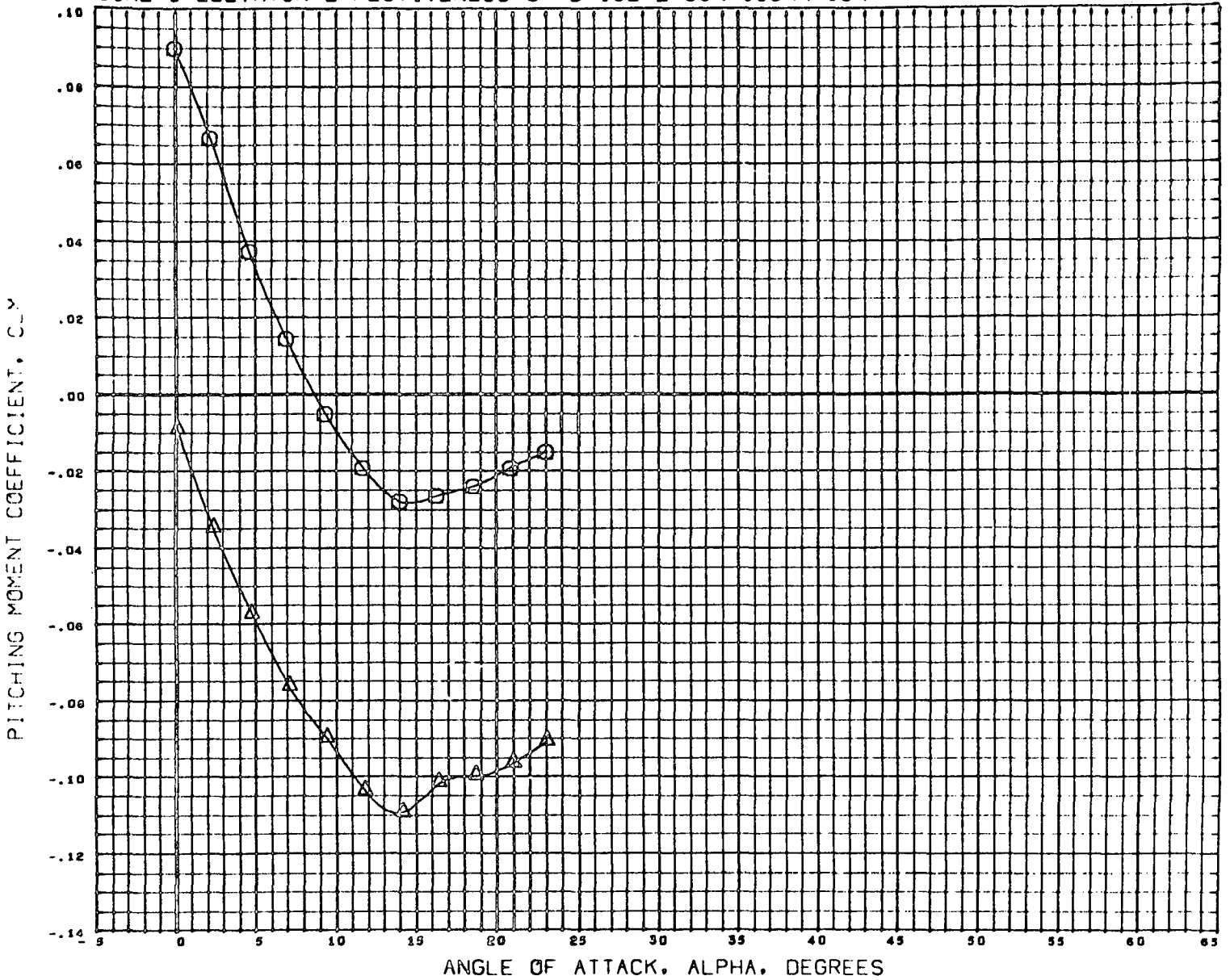

DATA SET SYMBOL	CONFIGURATION DESCRIPTION
(C98080) ○	MSFC TWT 914 E2 B33W25
(C98070) △	MSFC TWT 914 E2 B33W25

BETA	ELEVTR
0.000	-20.000
0.000	0.000

REFERENCE INFORMATION		
SREF	19.6300	50 INC
LREF	3.2400	INCHES
BREF	6.9300	INCHES
XMRP	2.1110	INCHES
YMRP	0.0000	INCHES
ZMRP	0.0000	INCHES
SCALE	0.0035	

MACH 1.201

FIGURE-9 ELEVATOR EFFECTIVENESS OF B-18E-2 CONFIGURATION

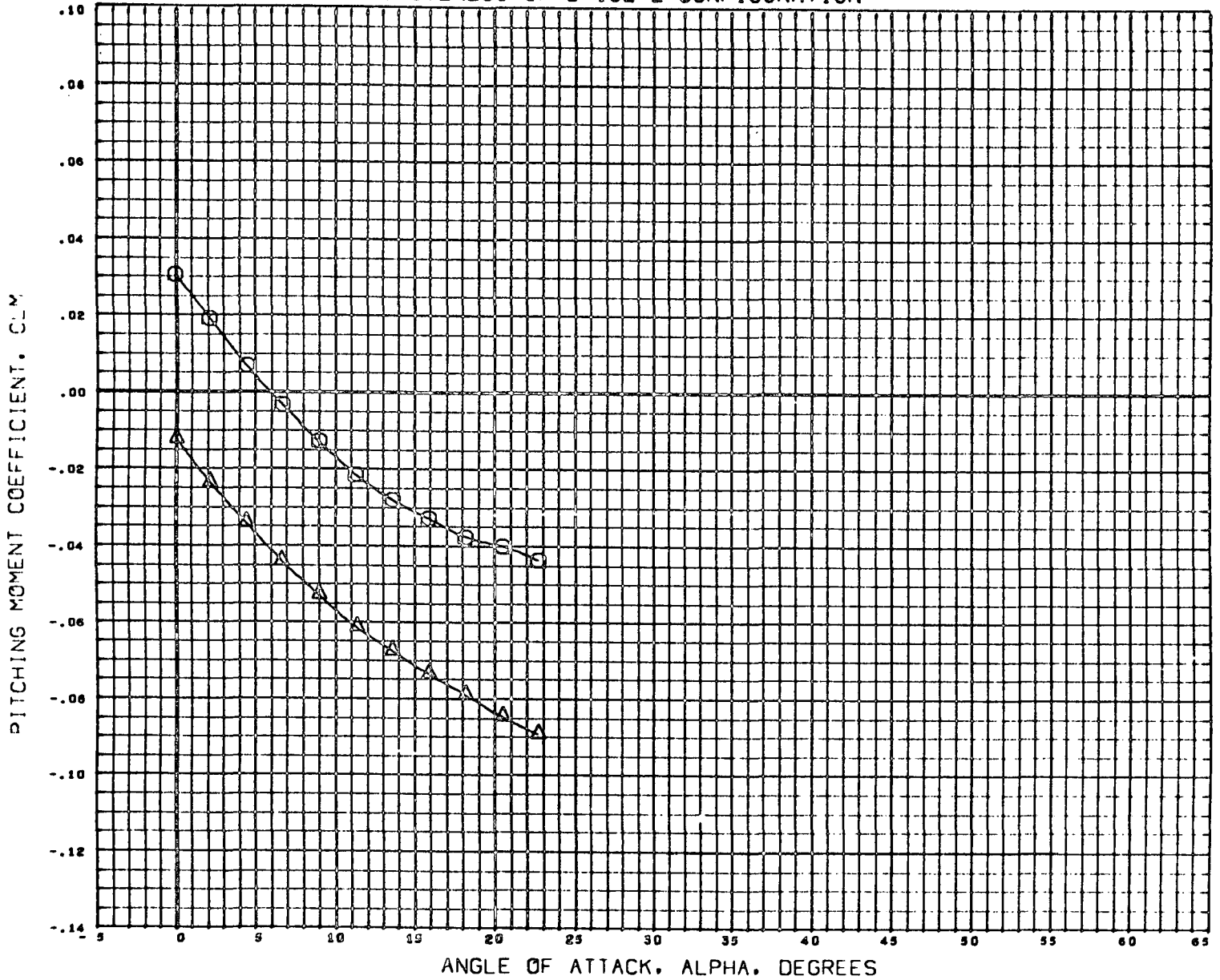

DATA SET SYMBOL	CONFIGURATION DESCRIPTION
(C58080)	MSFC TWT 514 E2 033W25
(C58070)	MSFC TWT 514 E2 033W25

BETA	ELEVTR
0.000	-20.000
0.000	0.000

REFERENCE INFORMATION	
SREF	19.6300 50 INC
LREF	3.2400 INCHES
OREF	6.9300 INCHES
XWRP	2.1110 INCHES
YWRP	0.0000 INCHES
ZWRP	0.0000 INCHES
SCALE	0.0035

MACH 1.061

FIGURE-9 ELEVATOR EFFECTIVENESS OF B-18E-2 CONFIGURATION

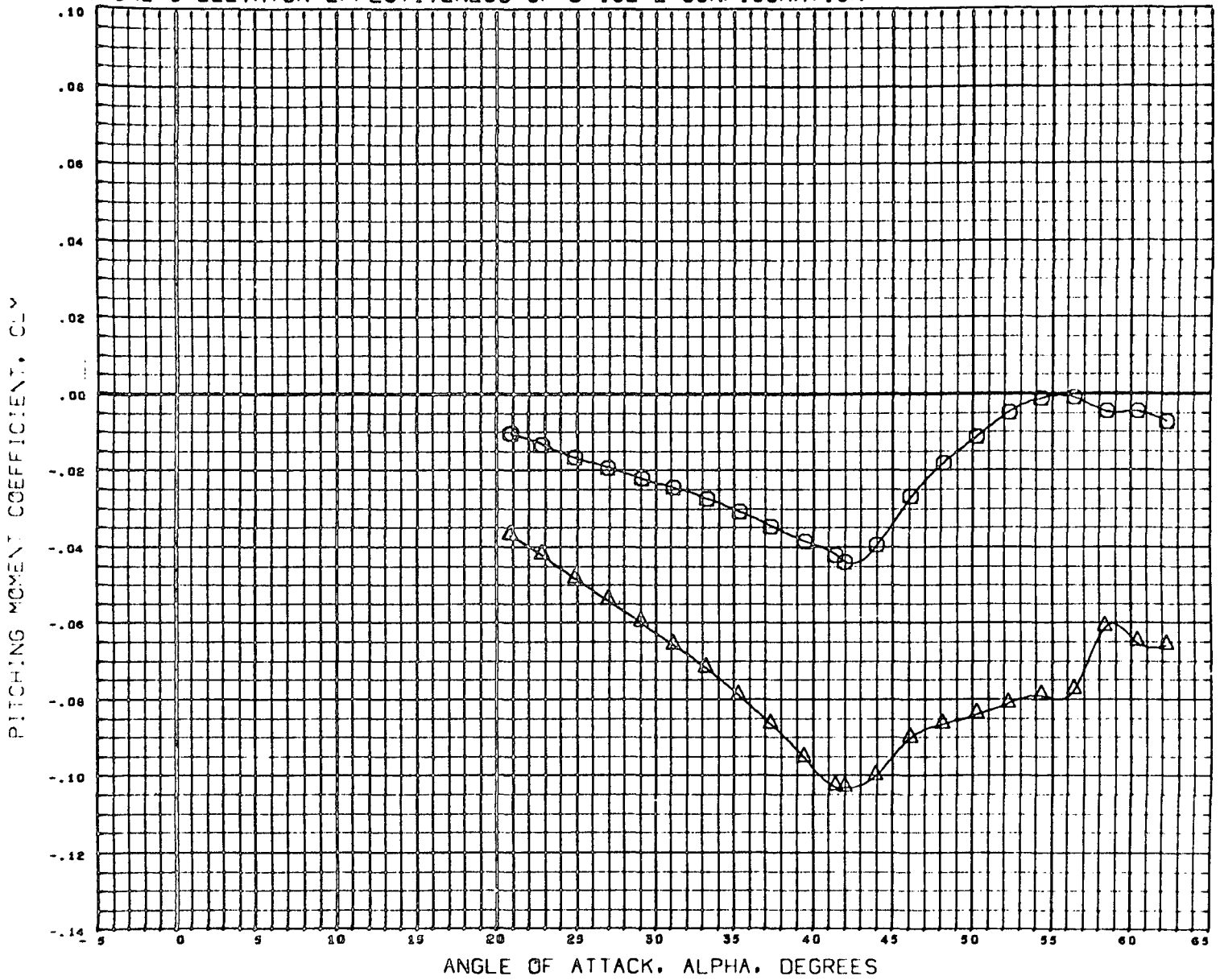

DATA SET SYMBOL	CONFIGURATION DESCRIPTION
(C58060)	MSFC TWT 914 E2 B33W25
(C58070)	MSFC TWT 914 E2 B33W25

BETA	ELEVTR
0.000	-20.000
0.000	0.000

REFERENCE INFORMATION		
SREF	19.6300	90 INC
LREF	3.2400	INCHES
BREF	6.9300	INCHES
XMRR	2.1110	INCHES
YMRR	0.0000	INCHES
ZMRR	0.0000	INCHES
SCALE	0.0055	

MACH 2.090

FIGURE-9 ELEVATOR EFFECTIVENESS OF B-18E-2 CONFIGURATION

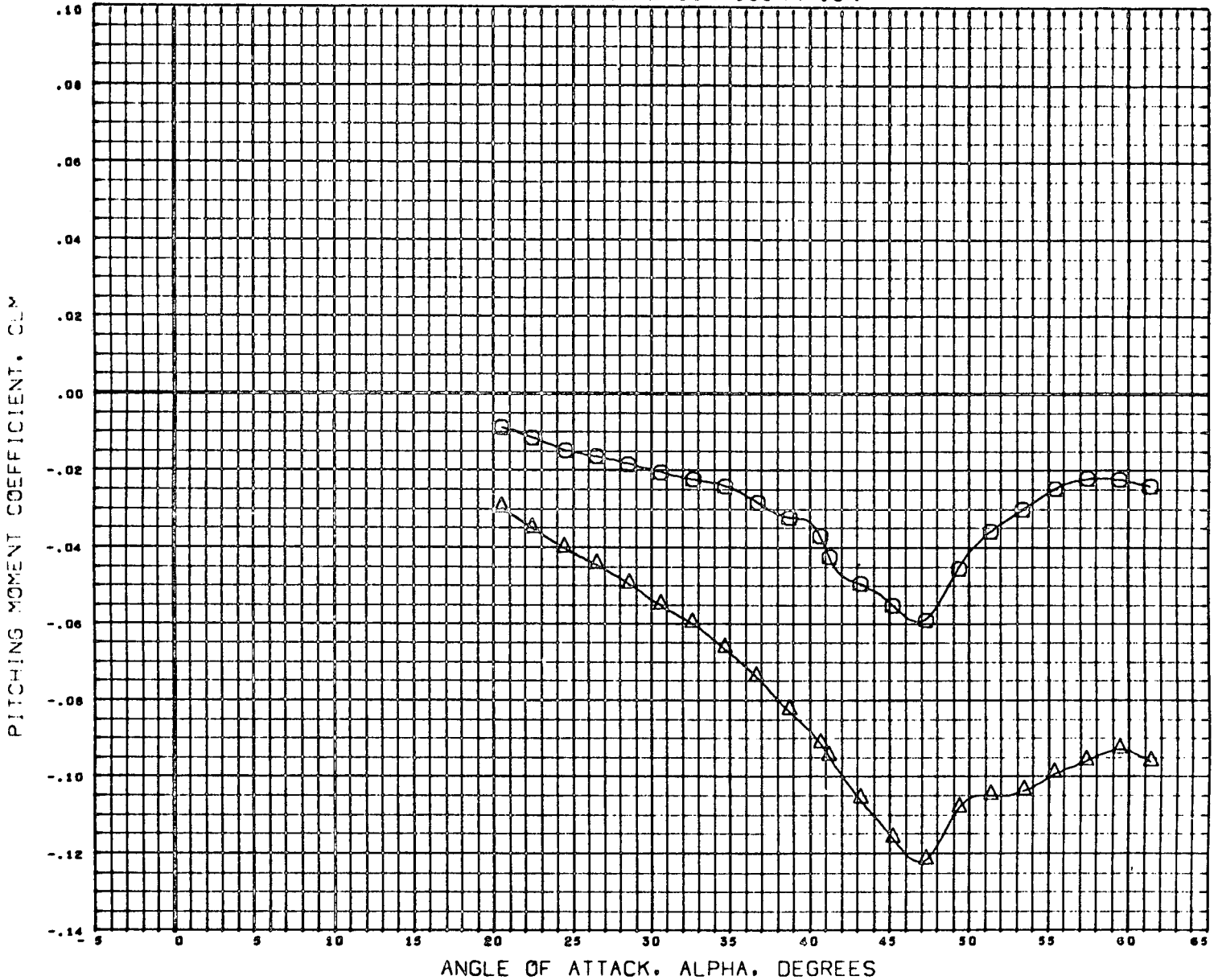

DATA SET SYMBOL	CONFIGURATION DESCRIPTION
(C56080)	MSFC TWT 514 E2 833W25
(C58070)	MSFC TWT 514 E2 833W25

BETA	ELEVTR
0.000	-20.000
0.000	0.000

REFERENCE INFORMATION		
SREF	19.6300	50 INC
LREF	3.2400	INCHES
BREF	6.9300	INCHES
XMRP	2.1110	INCHES
YMRP	0.0000	INCHES
ZMRP	0.0000	INCHES
SCALE	0.0035	

MACH 4.959

FIGURE-9 ELEVATOR EFFECTIVENESS OF B-18E-2 CONFIGURATION

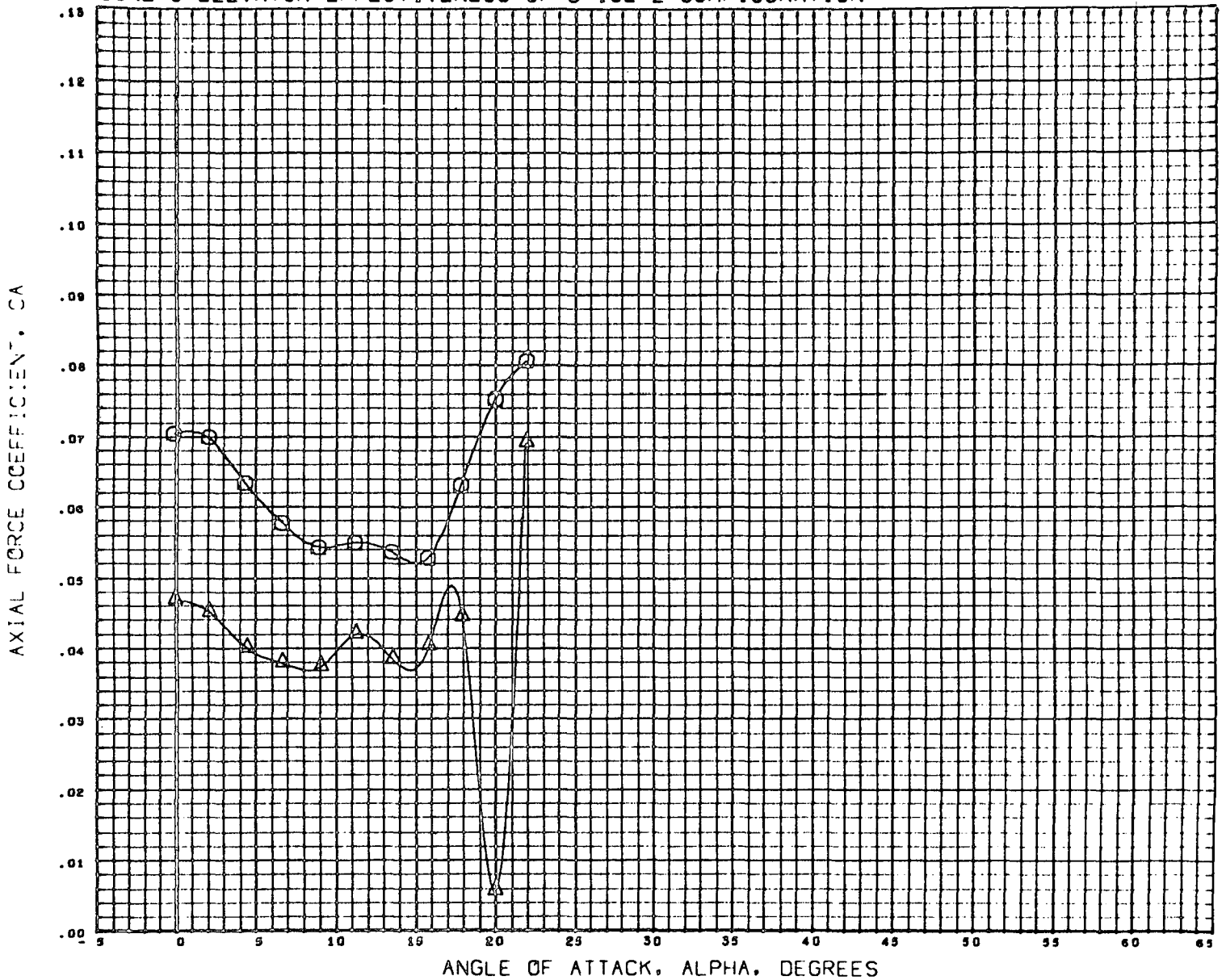

DATA SET SYMBOL	CONFIGURATION DESCRIPTION
(C96080)	MSFC TWT 914 E2 833W25
(C96070)	MSFC TWT 914 E2 833W25

BETA	ELEVTR
0.000	-20.000
0.000	0.000

REFERENCE INFORMATION		
SREF	19.6300	SQ INC
LREF	3.2400	INCHES
BREF	6.9300	INCHES
XMRP	2.1110	INCHES
YMRP	0.0000	INCHES
ZMRP	0.0000	INCHES
SCALE	0.0035	

MACH 0.902

FIGURE-9 ELEVATOR EFFECTIVENESS OF B-18E-2 CONFIGURATION

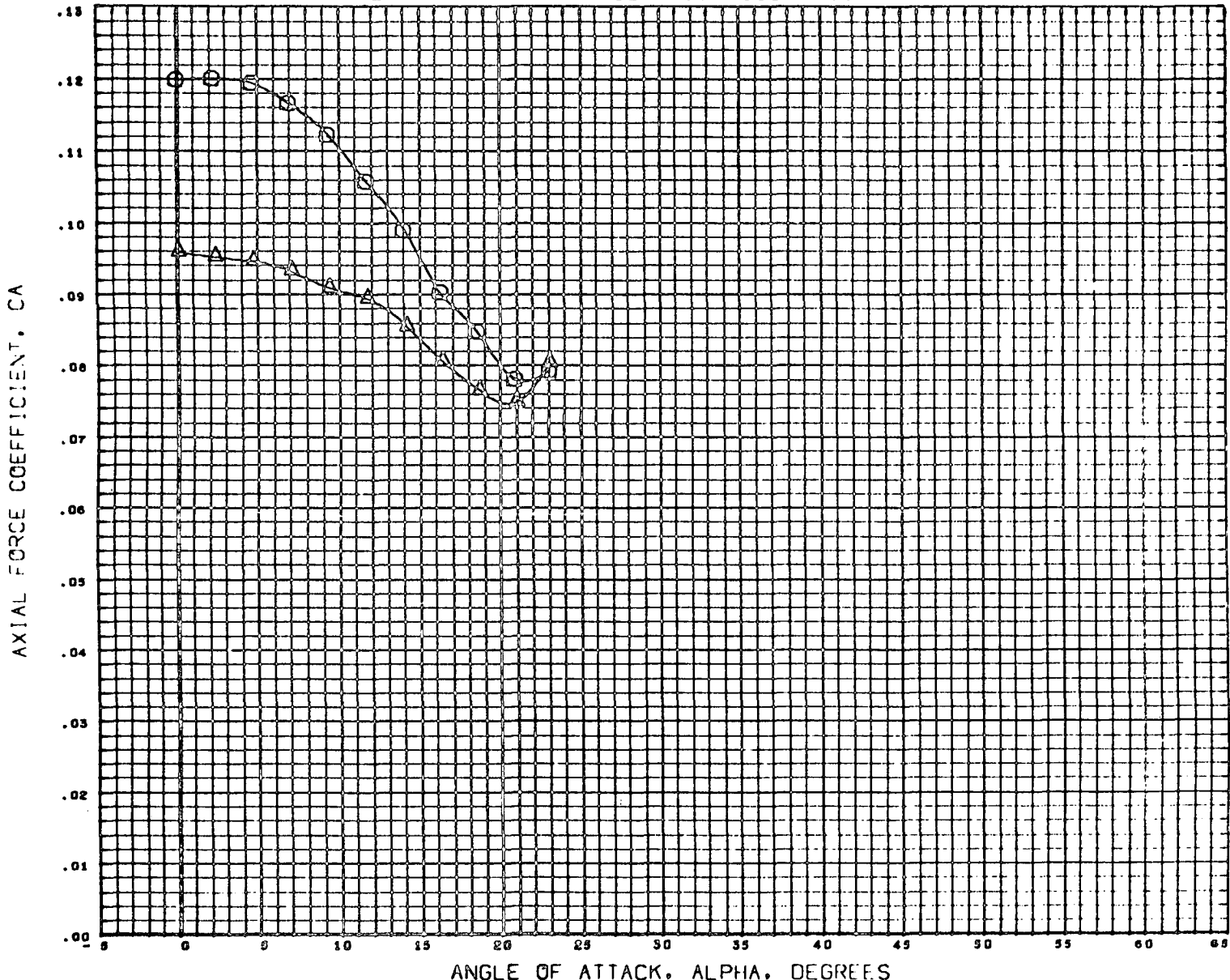

DATA SET SYMBOL	CONFIGURATION DESCRIPTION
(C58040)	MSFC TWT 514 E2 033W29
(C58070)	MSFC TWT 514 E2 033W29

BETA	ELEVTR
0.000	-20.000
0.000	0.000

REFERENCE INFORMATION		
SREF	19.6300	SQ INC
LREF	3.2400	INCHES
BREF	6.9300	INCHES
XMRP	2.1110	INCHES
YMRP	0.0000	INCHES
ZMRP	0.0000	INCHES
SCALE	0.0035	

MACH 1.201

FIGURE-9 ELEVATOR EFFECTIVENESS OF B-18E-2 CONFIGURATION

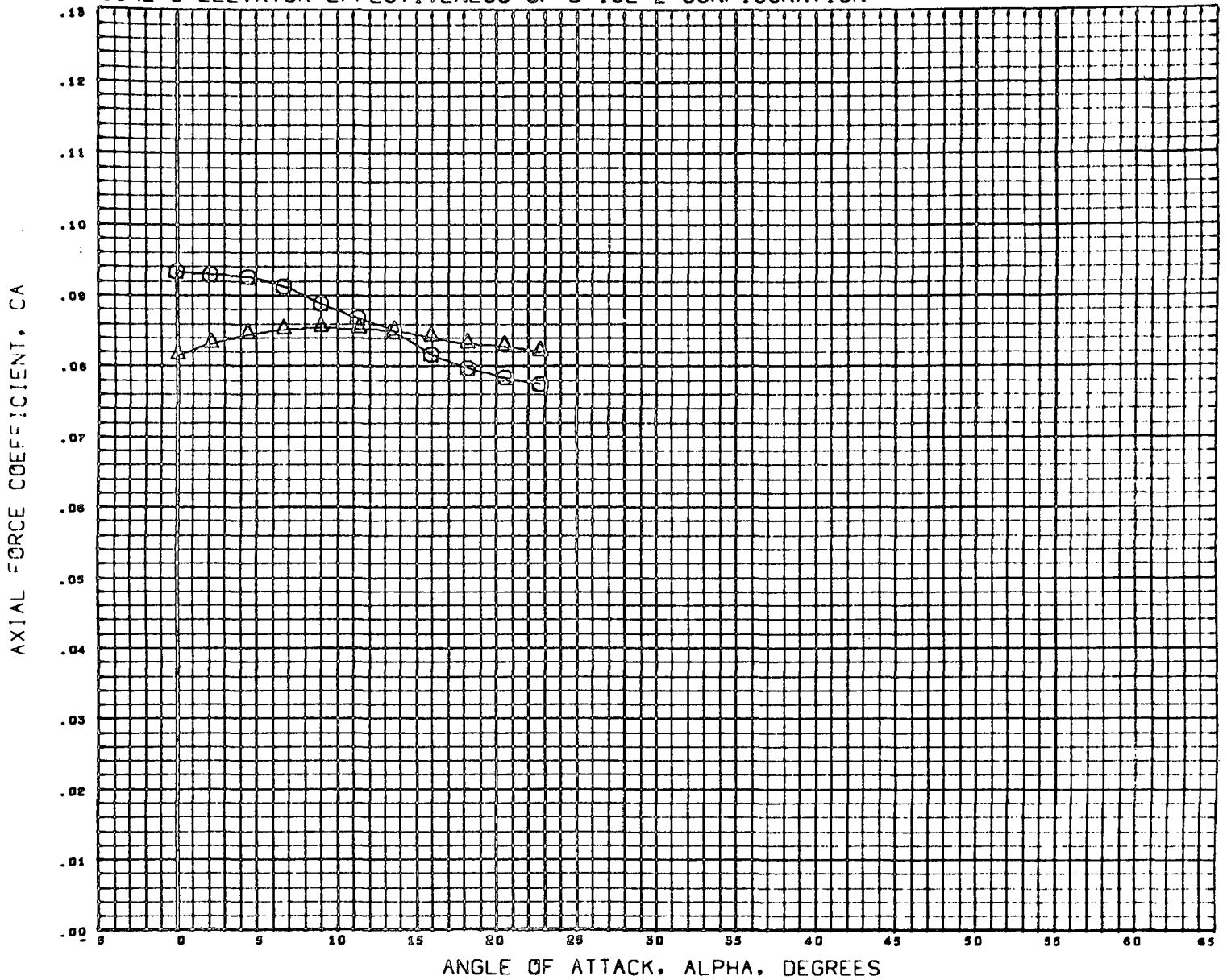

DATA SET SYMBOL	CONFIGURATION DESCRIPTION
(C58080)	MSFC TWT 514 E2 833W25
(C58070)	MSFC TWT 514 E2 833W25

BETA	ELEVTR
0.000	-20.000
0.000	0.000

REFERENCE INFORMATION		
SREF	19.6500	SQ INC
LREF	3.2400	INCHES
BREF	6.9300	INCHES
XMRP	2.1110	INCHES
YMRP	0.0000	INCHES
ZMRP	0.0000	INCHES
SCALE	0.0035	

MACH 1.061

FIGURE-9 ELEVATOR EFFECTIVENESS OF B-18E-2 CONFIGURATION

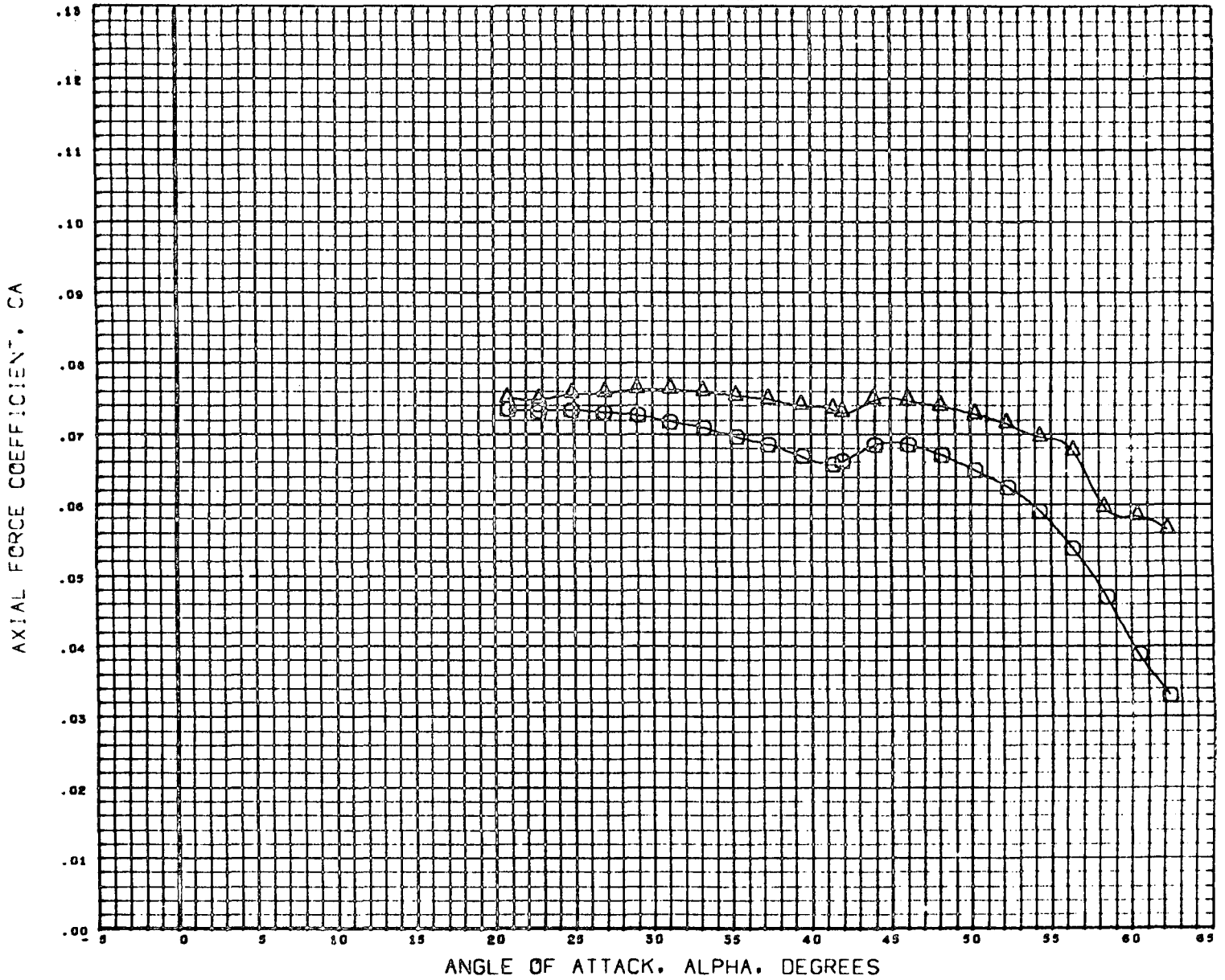

DATA SET SYMBOL	CONFIGURATION DESCRIPTION
(C58680)	MSFC TWT 514 E2 833W25
(C58670)	MSFC TWT 514 E2 833W25

BETA	ELEVTR
0.000	-20.000
0.000	0.000

REFERENCE INFORMATION	
SREF	19.6300 SQ INC
LREF	3.2400 INCHES
BREF	6.9300 INCHES
XMRP	2.1110 INCHES
YMRP	0.0000 INCHES
ZMRP	0.0000 INCHES
SCALE	0.0035

MACH 2.890

FIGURE-9 ELEVATOR EFFECTIVENESS OF B-18E-2 CONFIGURATION

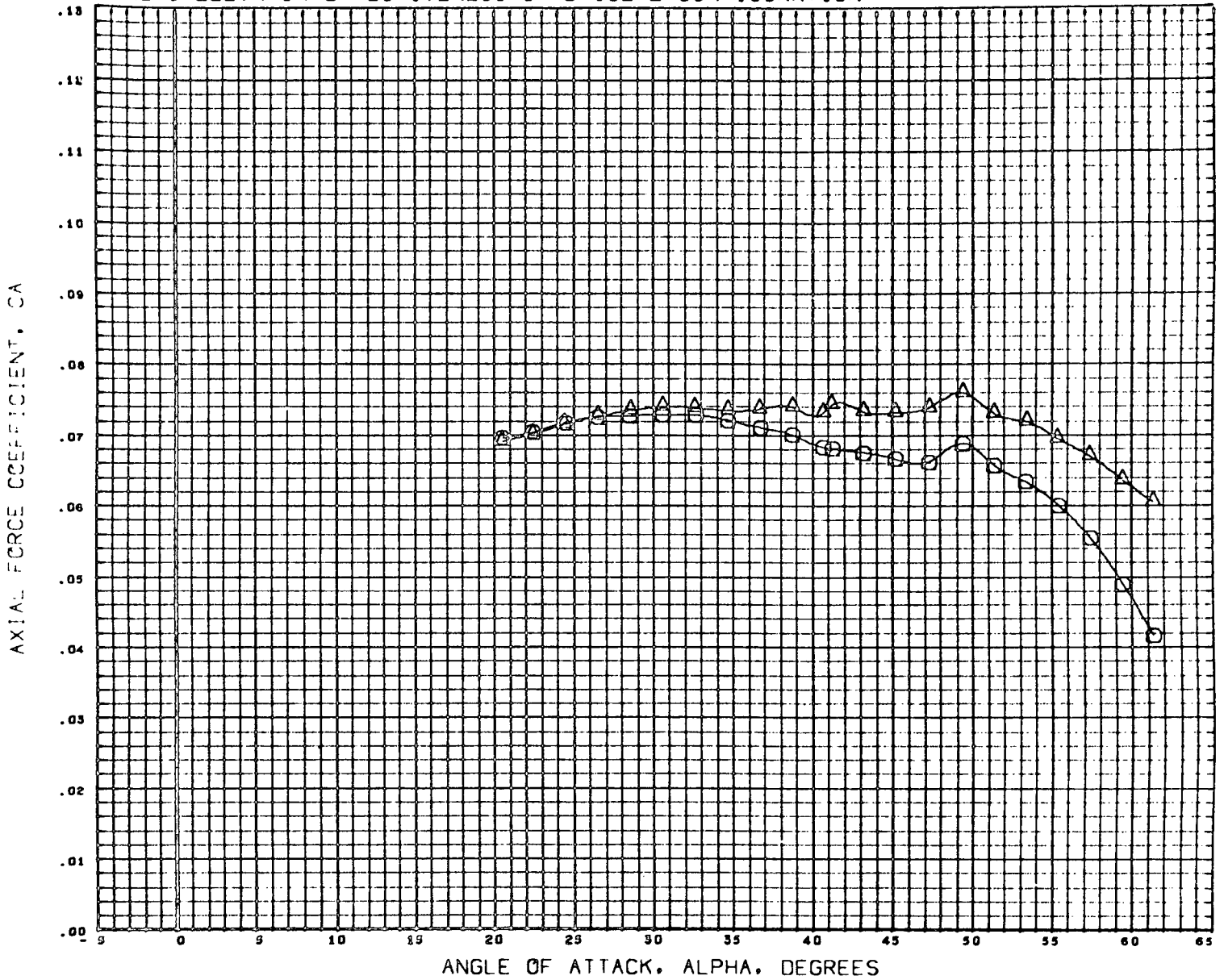

DATA SET SYMBOL	CONFIGURATION DESCRIPTION
(C58060)	MSFC TWT 514 E2 B53W25
(C58070)	MSFC TWT 514 E2 B53W25

BETA	ELEVTR
0.000	-20.000
0.000	0.000

REFERENCE INFORMATION		
SREF	19.6300	SQ INC
LREF	3.2400	INCHES
BREF	6.9300	INCHES
XMRP	2.1110	INCHES
YMRP	0.0000	INCHES
ZMRP	0.0000	INCHES
SCALE	0.0035	

MACM 4.099

FIGURE-9 ELEVATOR EFFECTIVENESS OF B-18E-2 CONFIGURATION

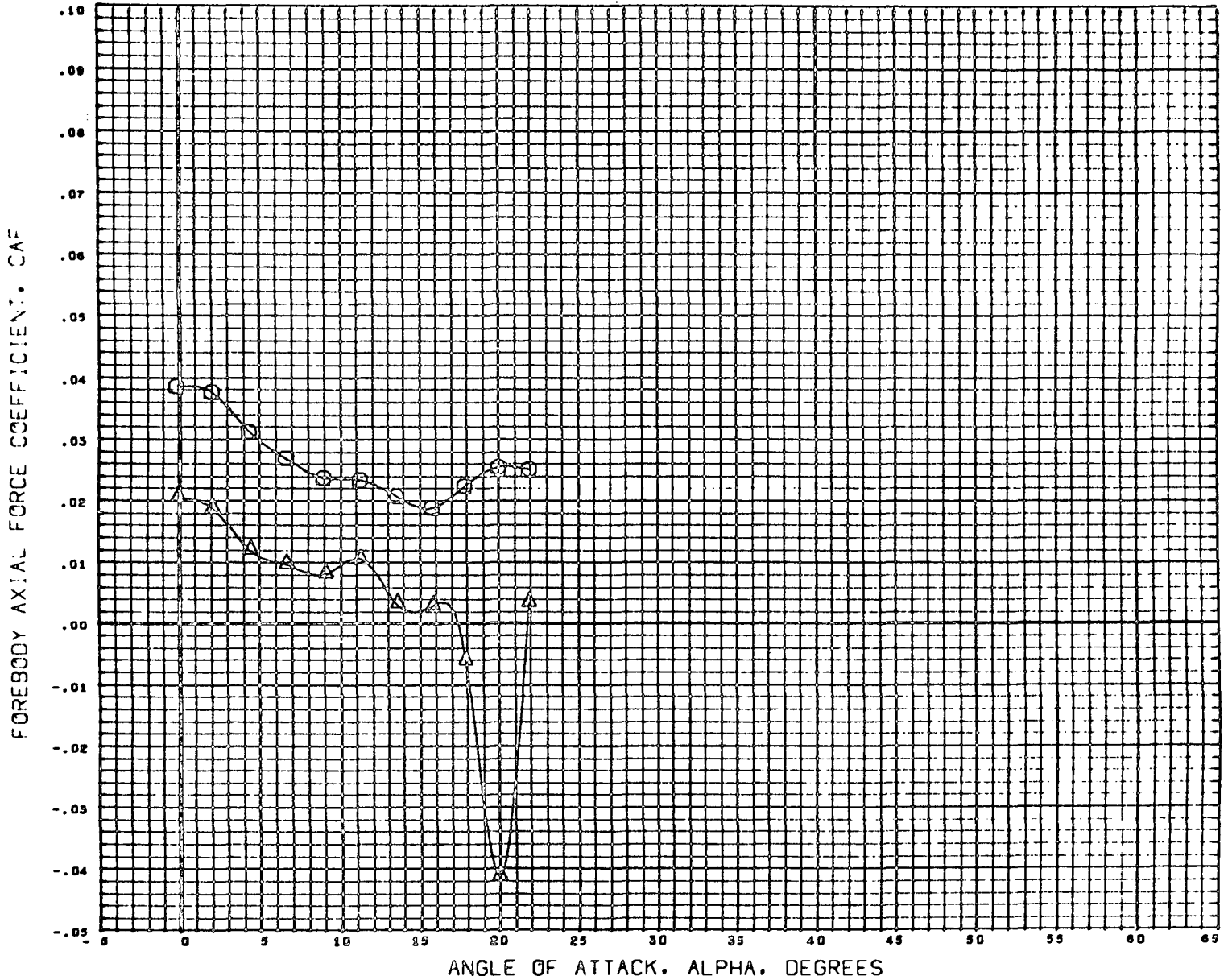

DATA SET SYMBOL	CONFIGURATION DESCRIPTION
(C58080) MSFC TWT 914 E2 033W25	
(C58070) MSFC TWT 914 E2 033W25	

BETA	ELEVTR
0.000	-20.000
0.000	0.000

REFERENCE INFORMATION		
SREF	19.6300	SW INC
LREF	3.2400	INCHES
BREF	6.9300	INCHES
XMRP	2.1117	INCHES
YMRP	0.0000	INCHES
ZMRP	0.0000	INCHES
SCALE	0.0039	

MACH 0.002

FIGURE-9 ELEVATOR EFFECTIVENESS OF B-18E-2 CONFIGURATION

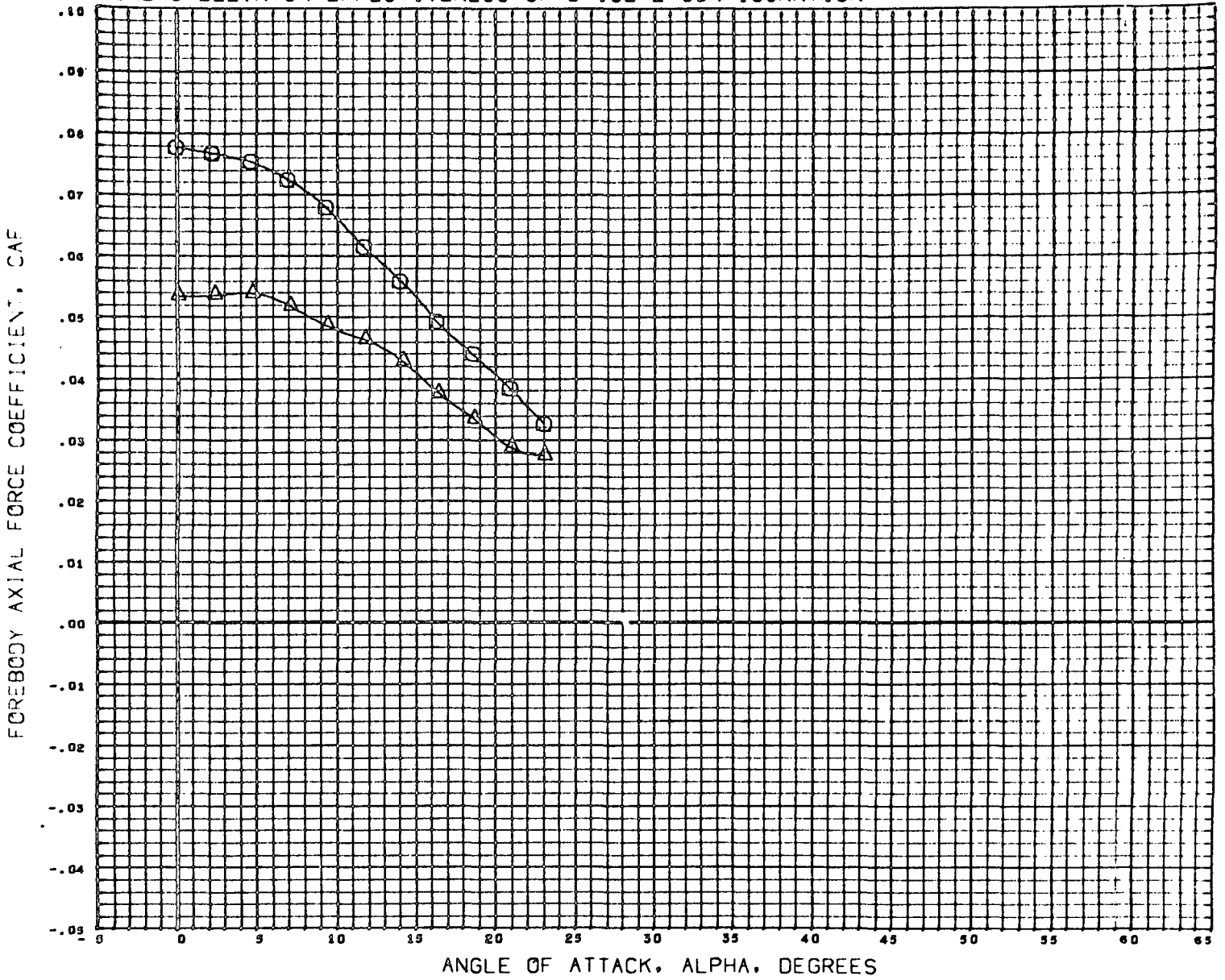

DATA SET SYMBOL	CONFIGURATION DESCRIPTION
(C58080)	MSFC TWT 914 E2 833W25
(C58070)	MSFC TWT 914 E2 833W25

BETA	ELEVTR
0.000	-20.000
0.000	0.000

REFERENCE INFORMATION		
SREF	19.6300	50 INC
LREF	3.2400	INCHES
BREF	6.9300	INCHES
XMRP	2.1111	INCHES
YMRP	0.0000	INCHES
ZMRP	0.0000	INCHES
SCALE	0.0035	

MACH 1.201

FIGURE-9 ELEVATOR EFFECTIVENESS OF B-18E-2 CONFIGURATION

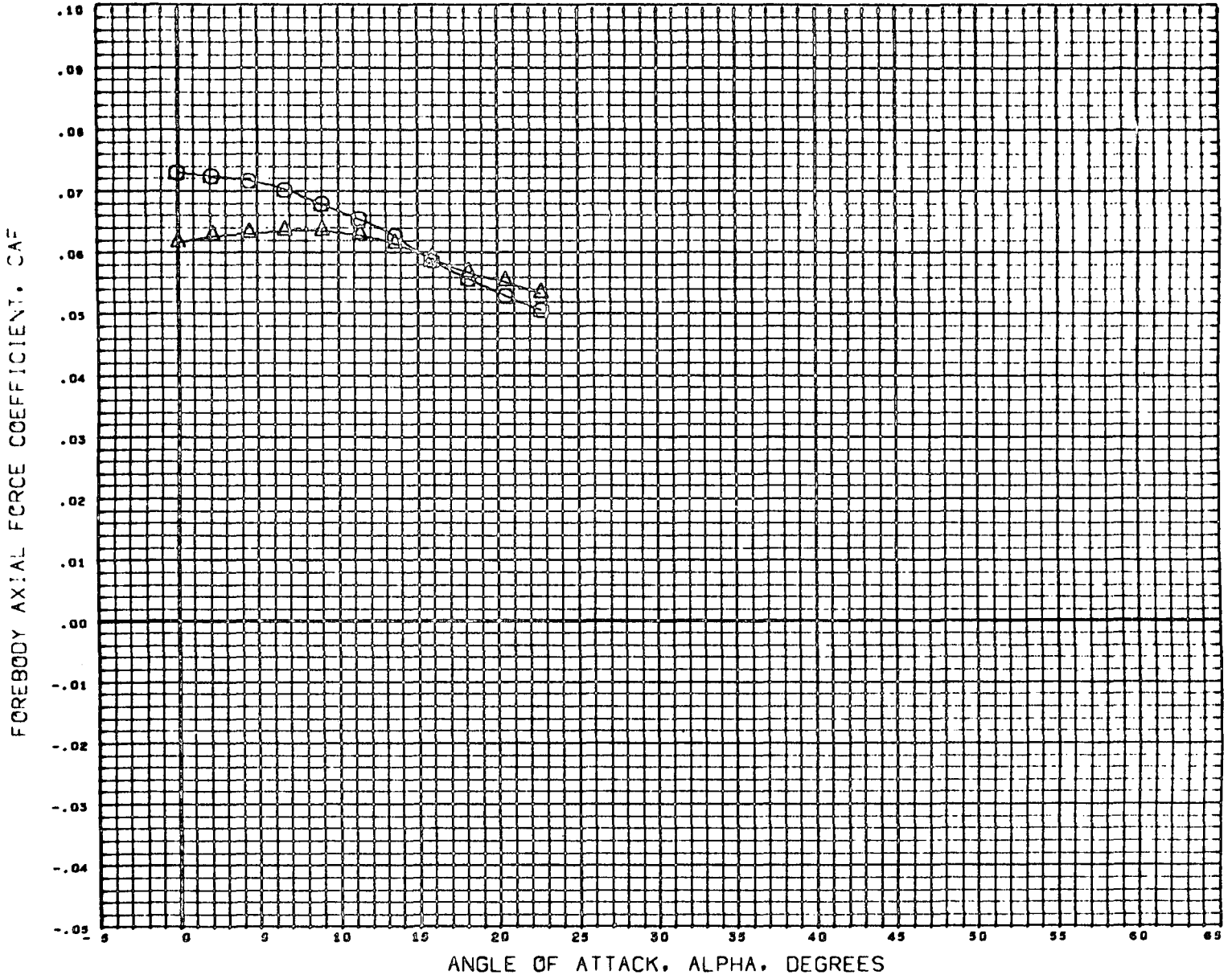

DATA SET SYMBOL	CONFIGURATION DESCRIPTION
(C58C80) \bigcirc	MSFC TWT 914 E2 B35W25
(C58C7D) \triangle	MSFC TWT 914 E2 B35W25

BETA	ELEVTR
0.000	-20.000
0.000	0.000

REFERENCE INFORMATION		
SREF	19.6300	SQ INC
LREF	3.2400	INCHES
BREF	6.9300	INCHES
XMRP	2.1110	INCHES
YMRP	0.0000	INCHES
ZMRP	0.0000	INCHES
SCALE	0.0035	

MACH 1.961

FIGURE-9 ELEVATOR EFFECTIVENESS OF B-18E-2 CONFIGURATION

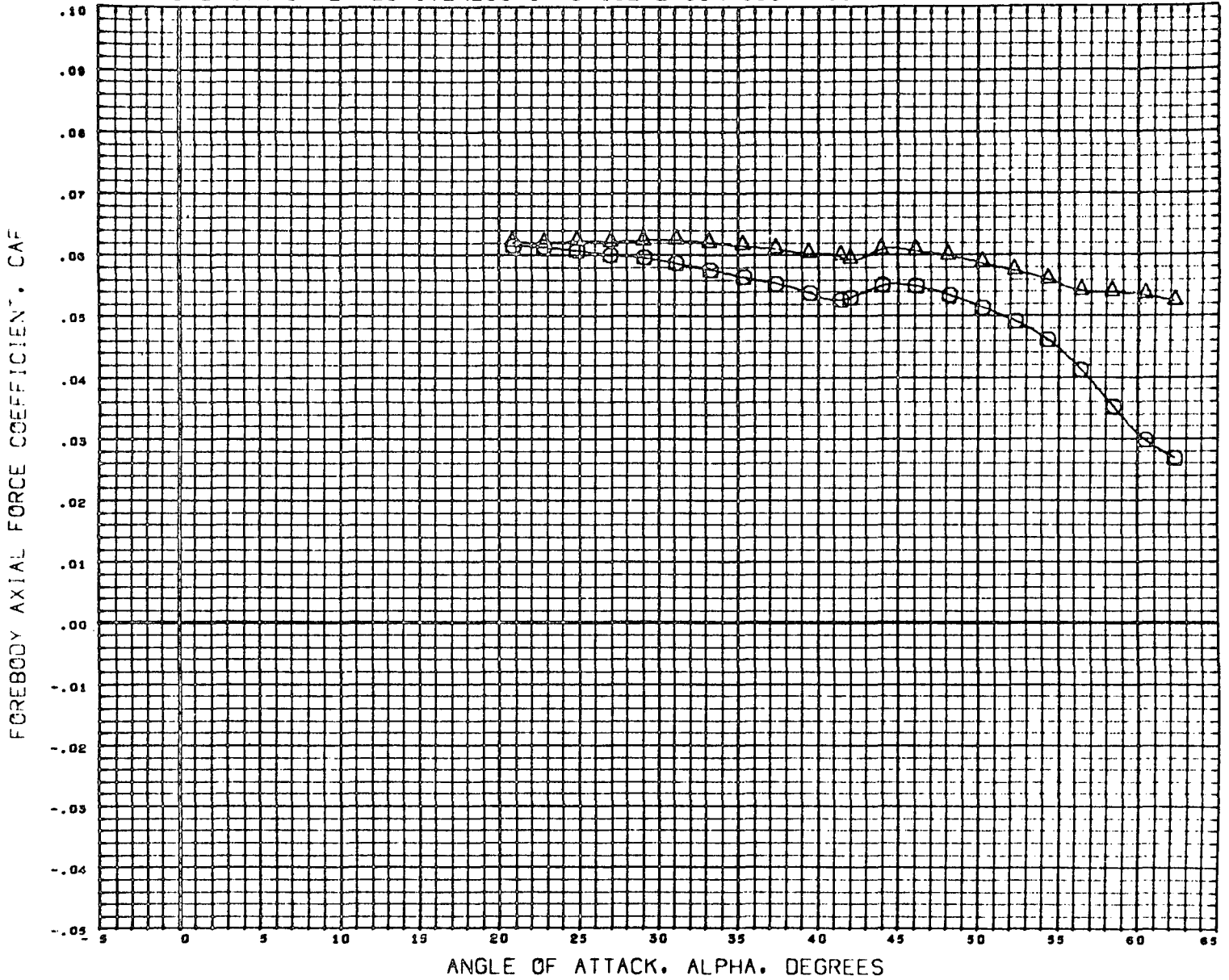

DATA SET SYMBOL	CONFIGURATION DESCRIPTION
(C58080)	MSFC TWT 914 E2 B33W25
(C58070)	MSFC TWT 914 E2 B33W25

BETA	ELEVTR
0.000	-20.000
0.000	0.000

REFERENCE INFORMATION	
SREF	19.6300 SQ INC
LREF	3.2400 INCHES
BREF	6.9300 INCHES
XMRP	2.1110 INCHES
YMRP	0.0000 INCHES
ZMRP	0.0000 INCHES
SCALE	0.0035

MACH 2.990

FIGURE-9 ELEVATOR EFFECTIVENESS OF B-18E-2 CONFIGURATION

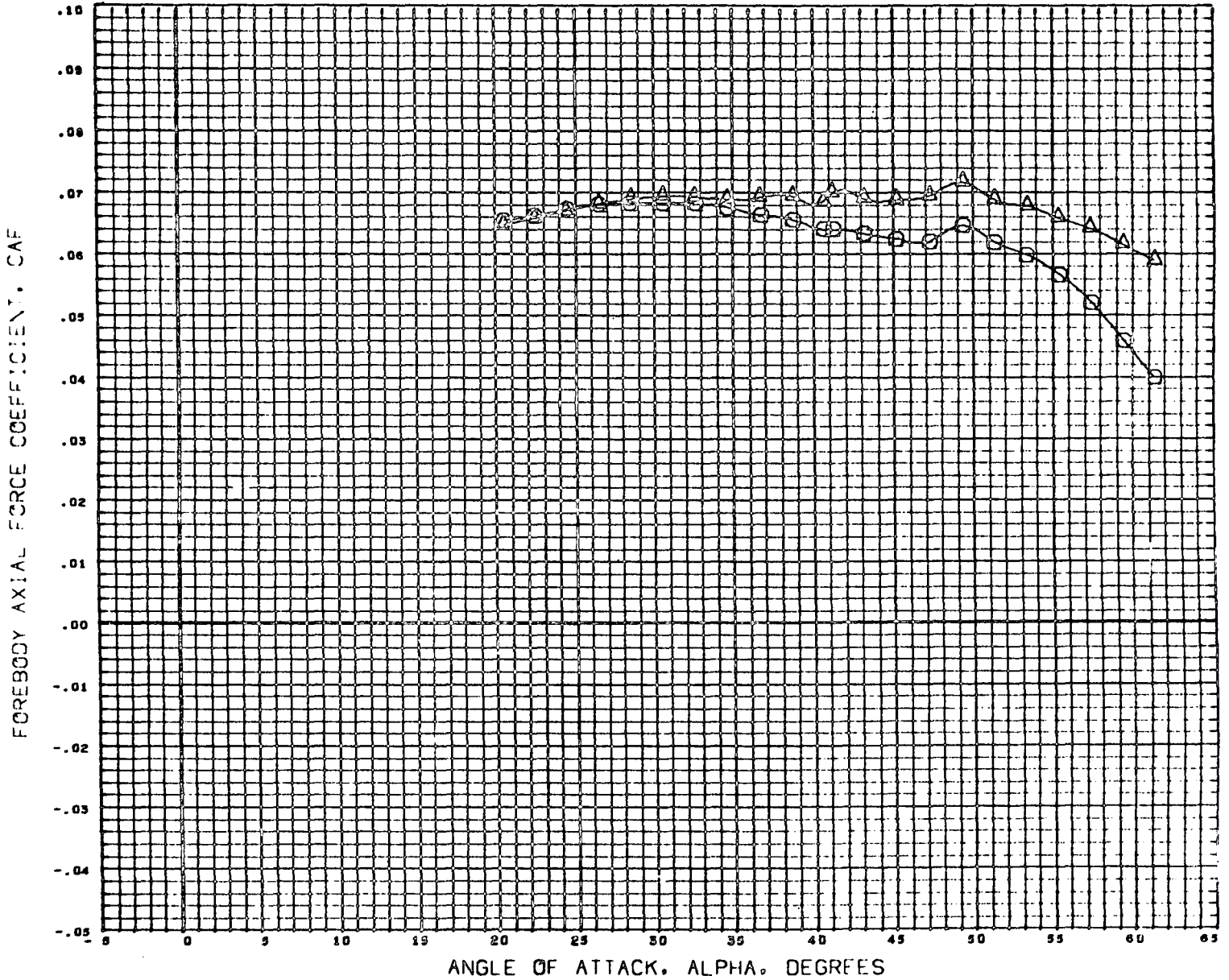

DATA SET SYMBOL	CONFIGURATION DESCRIPTION
(C58680) ○	MSFC TWT 314 E2 033W25
(C58670) △	MSFC TWT 314 E2 033W25

BETA	ELEVTR
0.000	-20.000
0.000	0.000

REFERENCE INFORMATION		
SREF	19.6300	SQ INC
LREF	3.2400	INCHES
BREF	6.9300	INCHES
XMRP	2.1110	INCHES
YMRP	0.0000	INCHES
ZMRP	0.0000	INCHES
SCALE	0.0035	

MACH 4.959

FIGURE-9 ELEVATOR EFFECTIVENESS OF B-18E-2 CONFIGURATION

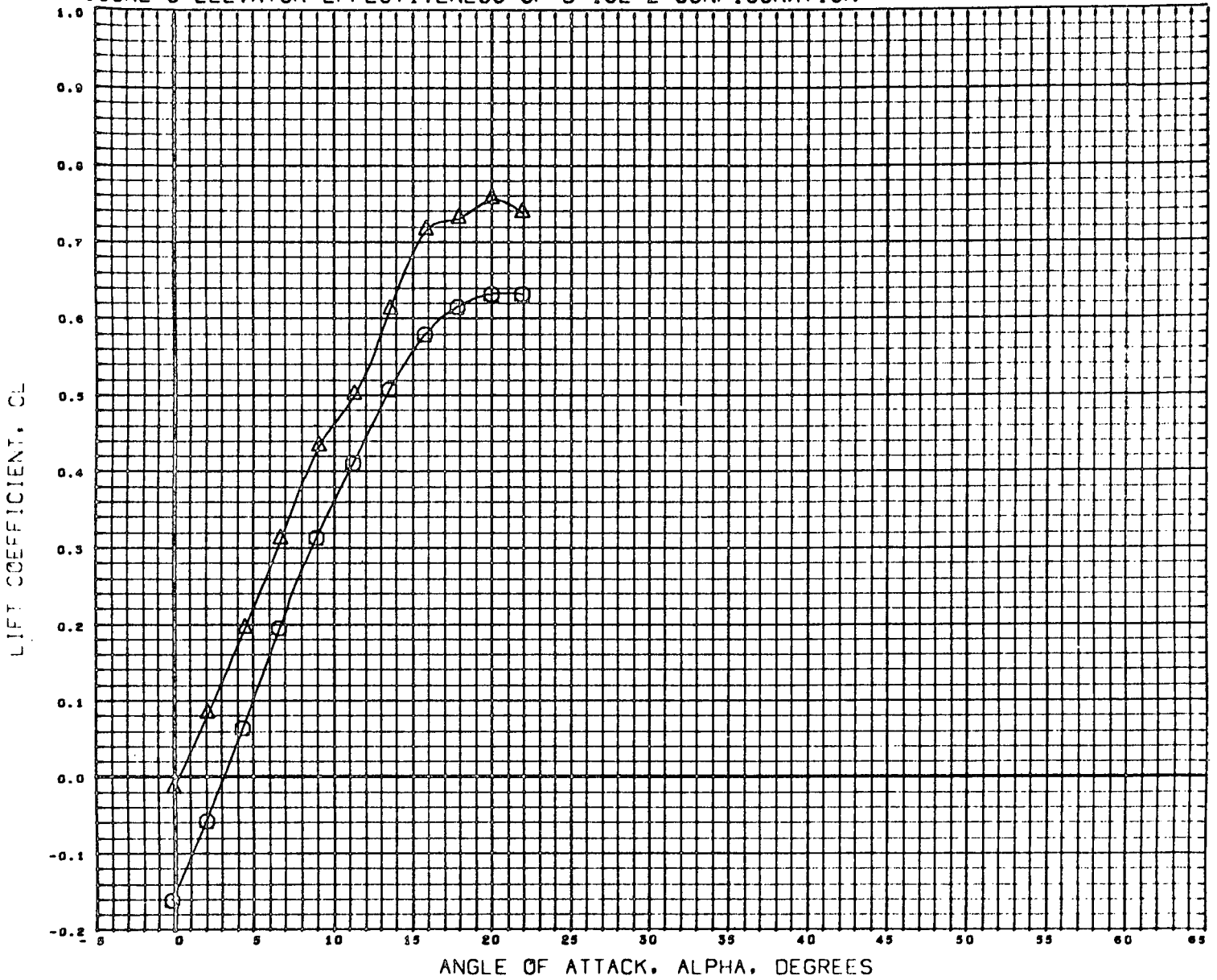

DATA SET SYMBOL	CONFIGURATION DESCRIPTION
(C58080)	MSFC TWT 514 E2 B33W25
(C58070)	MSFC TWT 514 E2 B33W25

BETA	ELEVTR
0.000	-20.000
0.000	0.000

REFERENCE INFORMATION		
SREF	19.6300	30 INC
LREF	3.2400	INCHES
BREF	4.9300	INCHES
XMRP	2.1110	INCHES
YMRP	0.0000	INCHES
ZMRP	0.0000	INCHES
SCALE	0.0035	

HACH 0.902

FIGURE-9 ELEVATOR EFFECTIVENESS OF B-18E-2 CONFIGURATION

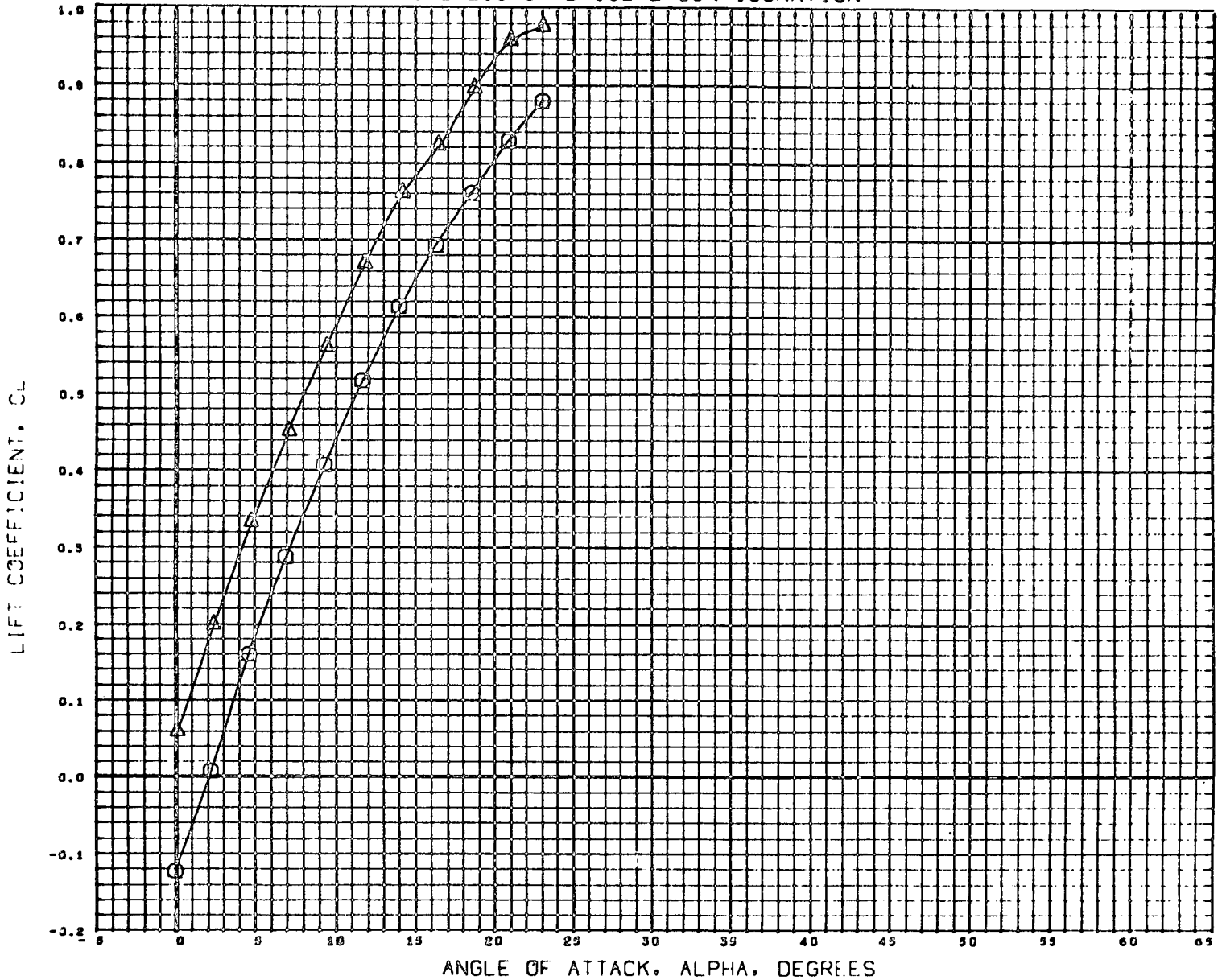

DATA SET SYMBOL	CONFIGURATION DESCRIPTION
(C56060)	MSFC TWT 914 E2 033W25
(C56070)	MSFC TWT 914 E2 033W29

BETA	ELEVTR
0.000	-20.000
0.000	0.000

REFERENCE INFORMATION		
SREF	19.6300	sq INC
LREF	3.2400	INCHES
BREF	0.9500	INCHES
XHRP	2.1110	INCHES
YHRP	0.0000	INCHES
ZHRP	0.0000	INCHES
SCALE	0.0033	

MACH 1.201

FIGURE-9 ELEVATOR EFFECTIVENESS OF B-18E-2 CONFIGURATION

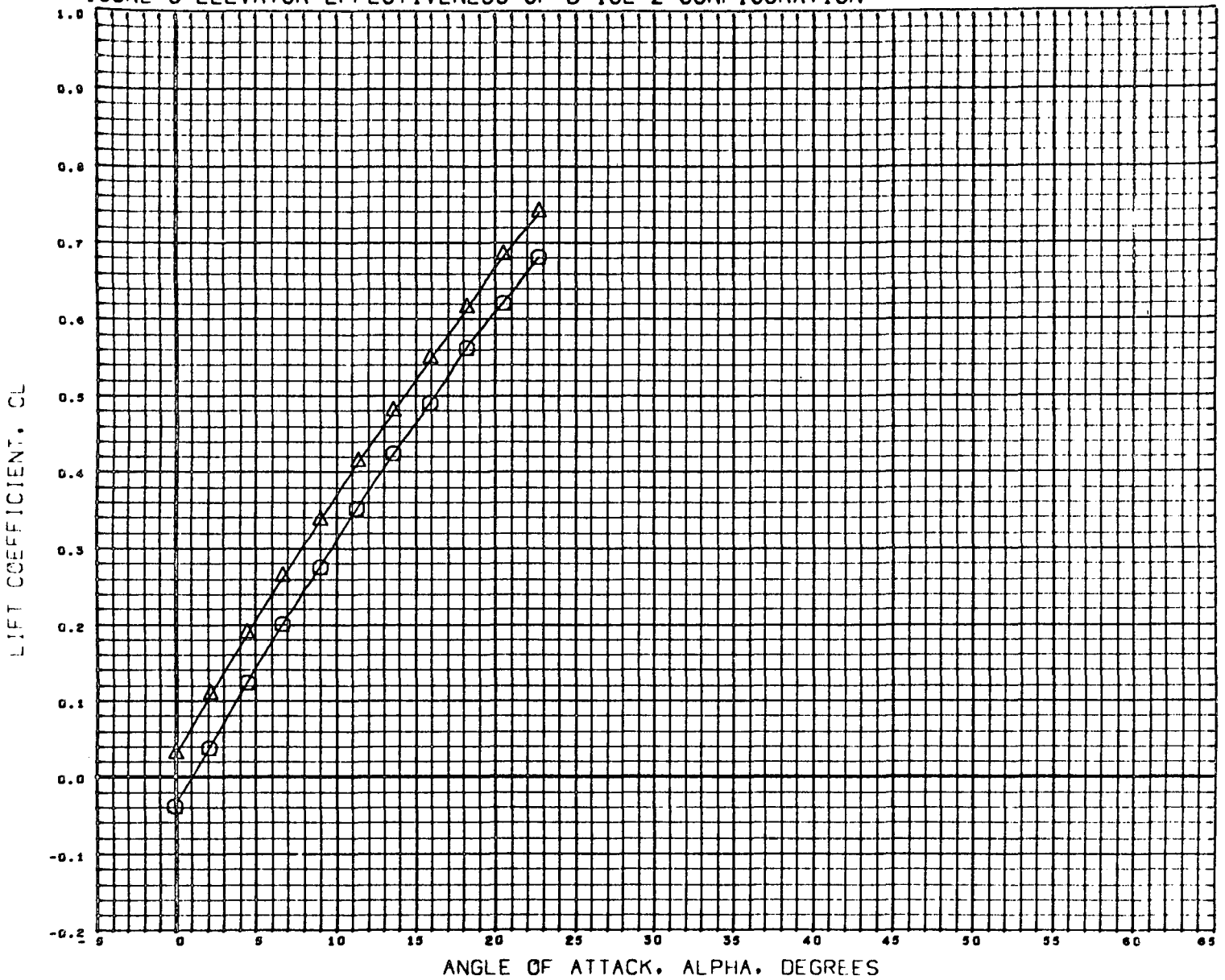

DATA SET SYMBOL	CONFIGURATION DESCRIPTION
(C58080) ○	MSFC TWT 514 E2 B33W25
(C58070) △	MSFC TWT 514 E2 B33W25

BETA	ELEVTR
0.000	-20.000
0.000	0.000

REFERENCE INFORMATION		
SREF	19.6300	SQ INC
LREF	3.2400	INCHES
BREF	0.9300	INCHES
XMRP	2.1110	INCHES
YMRP	0.0000	INCHES
ZMRP	0.0000	INCHES
SCALE	0.0035	

MACH 1.961

FIGURE-9 ELEVATOR EFFECTIVENESS OF B-18E-2 CONFIGURATION

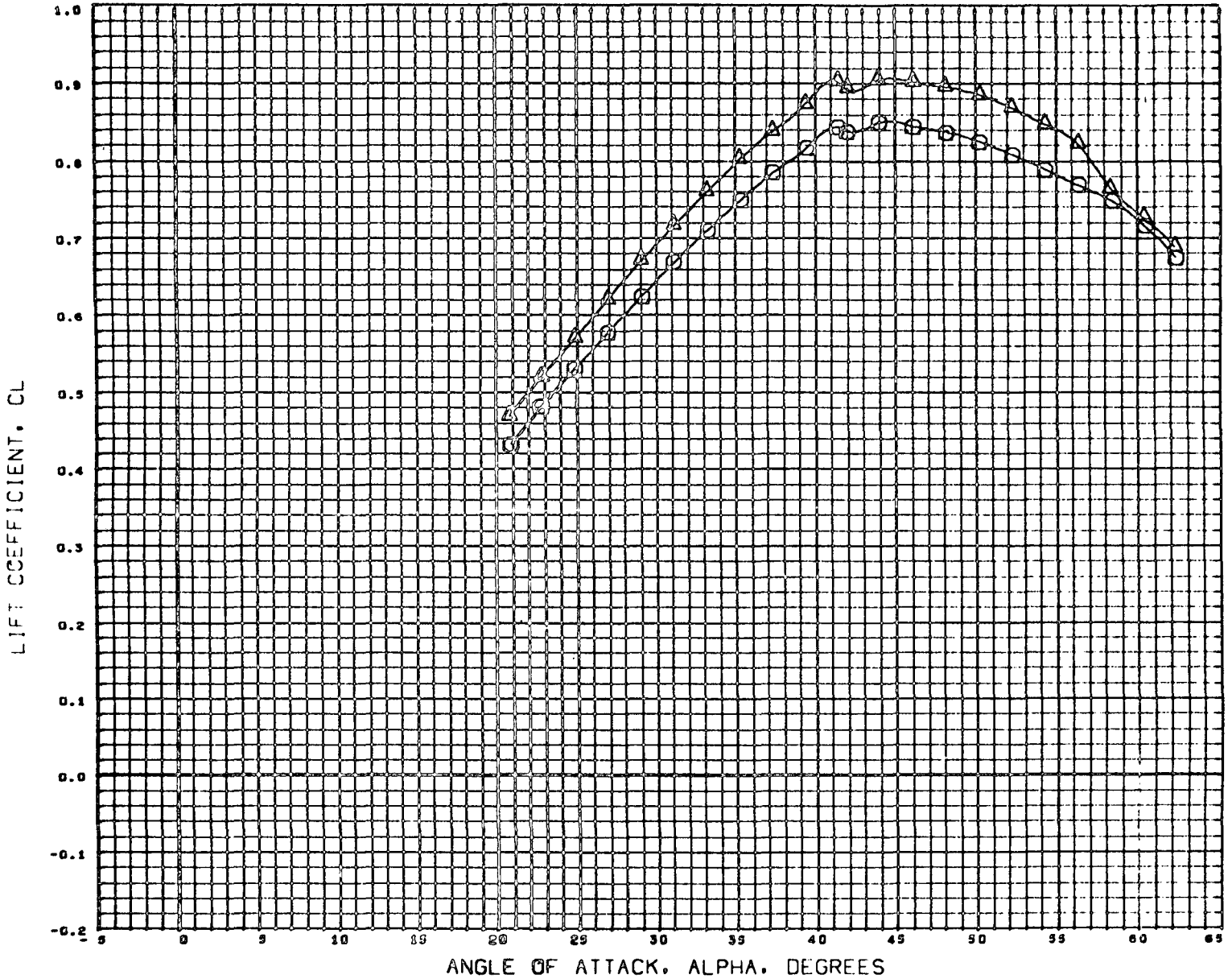

DATA SET SYMBOL	CONFIGURATION	DESCRIPTION
(C58036)	M8FC TWT 914 E2	Q35W25
(C58070)	M8FC TWT 914 E2	B35W25

DELTA	ELEVTR
0.000	-20.000
0.000	0.000

REFERENCE INFORMATION		
SREF	19.6300	80 INC
LREF	3.2400	INCHES
BREF	0.9300	INCHES
XMRP	2.1110	INCHES
VMRP	0.0000	INCHES
ZMRP	0.0000	INCHES
SCALE	0.0033	

MACH 2.090

FIGURE-9 ELEVATOR EFFECTIVENESS OF B-18E-2 CONFIGURATION

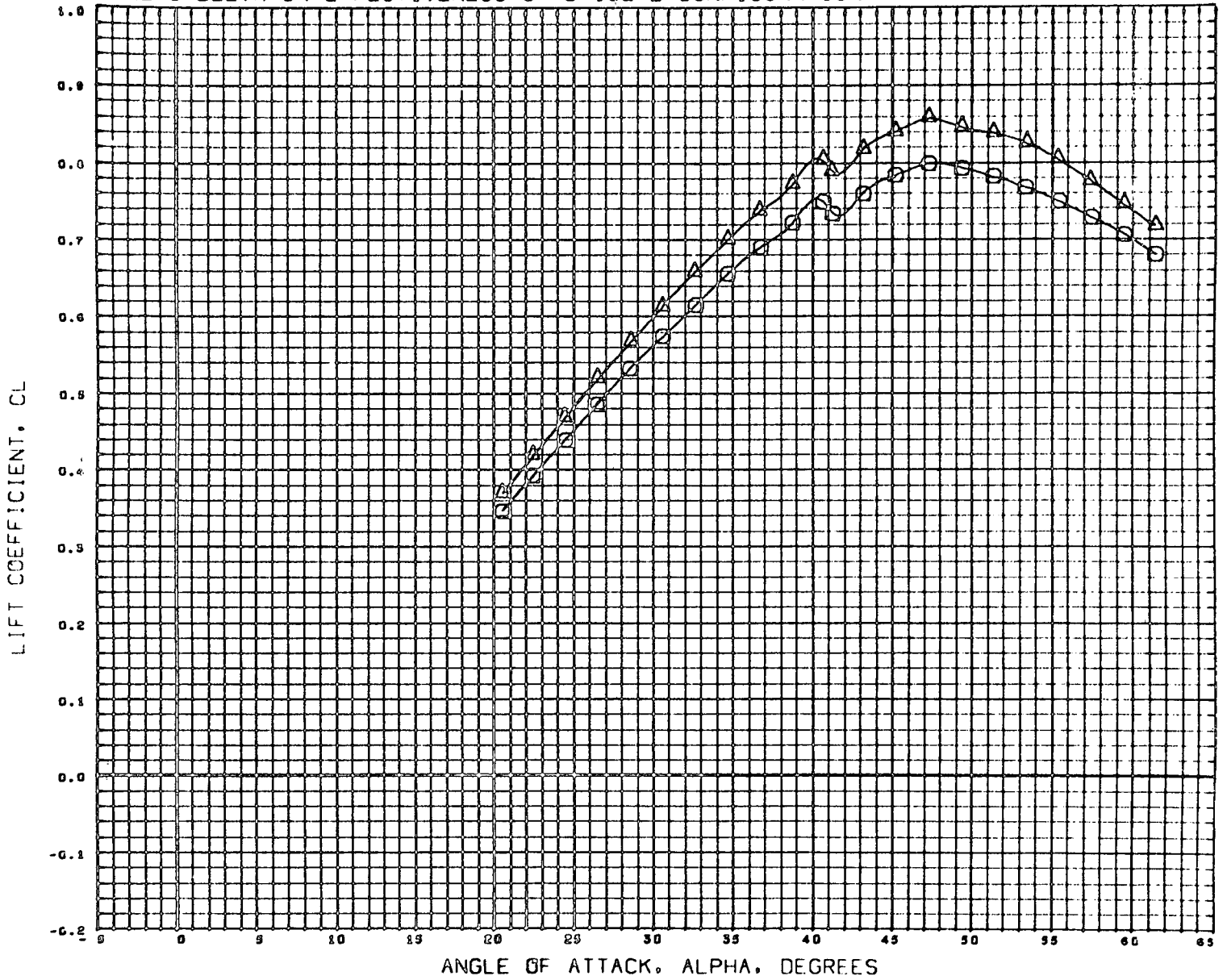

DATA SET SYMBOL	CONFIGURATION DESCRIPTION
(C58040)	MSFC TWT 514 E2 833W25
(C58070)	MSFC TWT 514 E2 833W29

BETA	ELEVTR
0.000	-20.000
0.000	0.000

REFERENCE INFORMATION		
SREF	19.6300	SQ INC
LREF	3.2400	INCHES
OREF	6.9300	INCHES
XMRP	2.1110	INCHES
YMRP	0.0000	INCHES
ZMRP	0.0000	INCHES
SCALE	0.0035	

HACH 4.950

FIGURE-9 ELEVATOR EFFECTIVENESS OF B-18E-2 CONFIGURATION

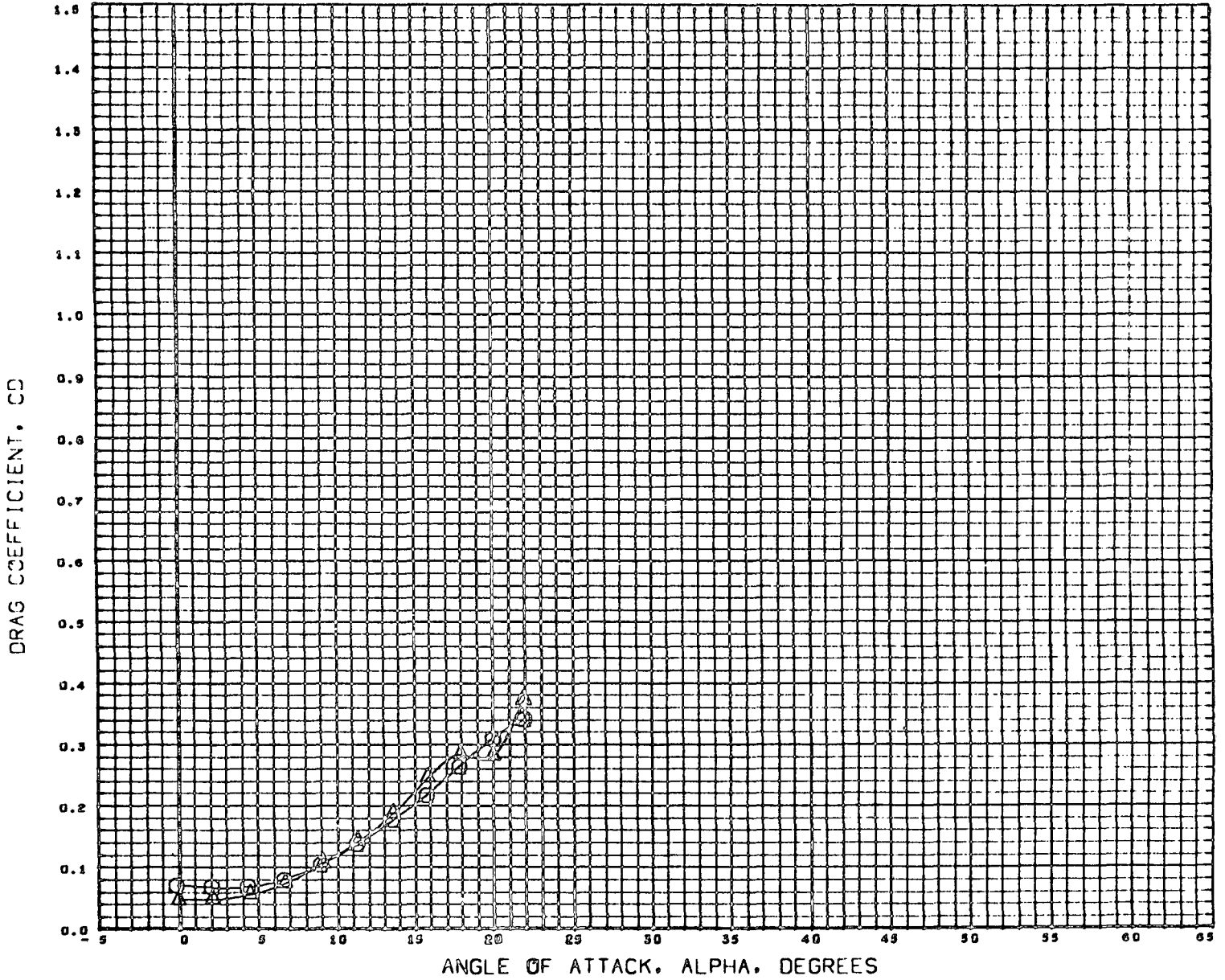

DATA SET	SYMBOL	CONFIGURATION	DESCRIPTION
(C58080)	Q	MSFC TWT 514 E2	B33W25
(C58070)	Q	MSFC TWT 514 E2	B33W29

BETA	ELEVTR
0.000	-20.000
0.000	0.000

REFERENCE INFORMATION		
SREF	19.8300	88 INC
LREF	3.2400	INCHES
BREF	6.9300	INCHES
HMRP	2.1110	INCHES
YMRP	0.0000	INCHES
ZMRP	0.0000	INCHES
SCALE	0.0035	

MACH 0.002

FIGURE-9 ELEVATOR EFFECTIVENESS OF B-18E-2 CONFIGURATION

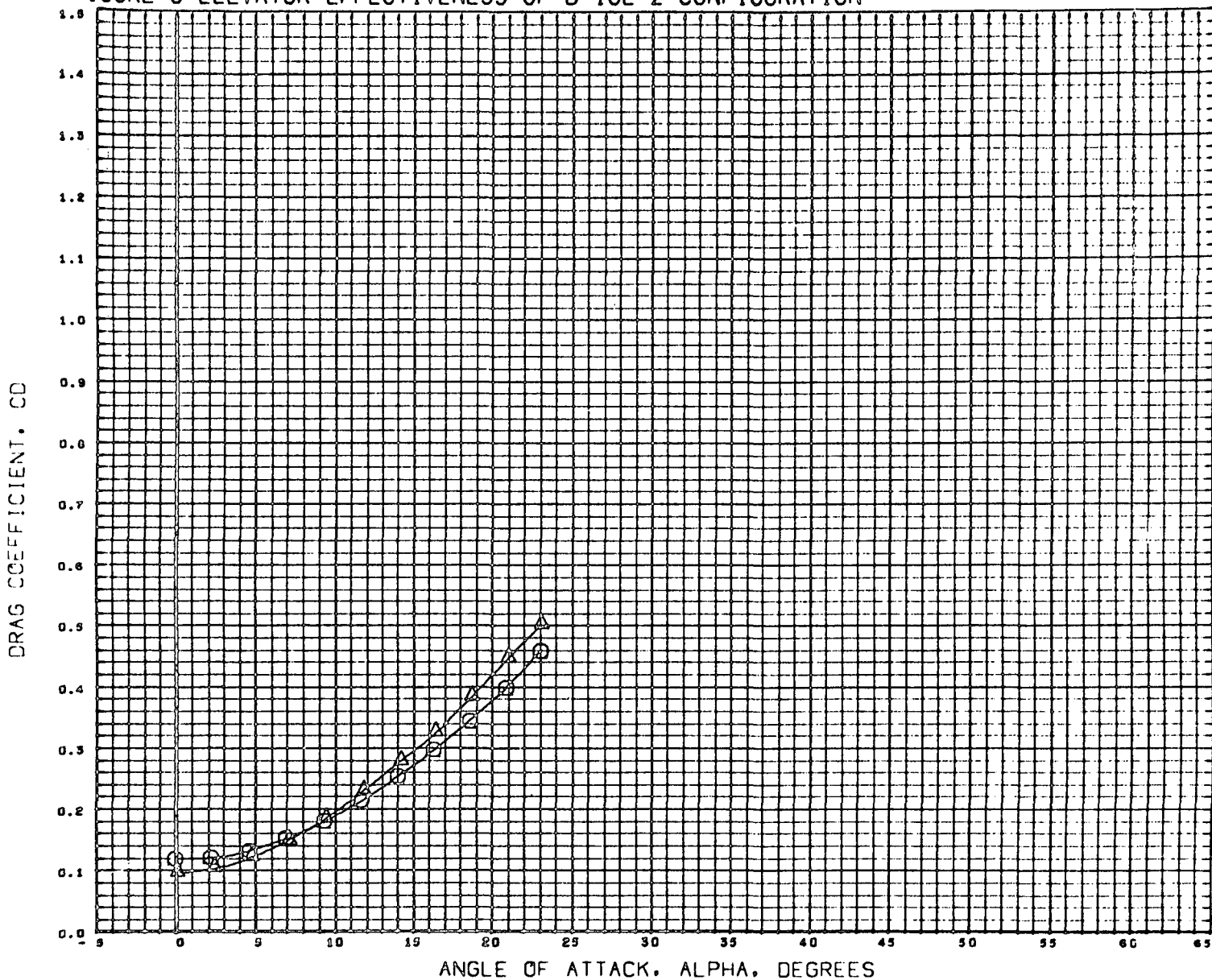

DATA SET SYMBOL	CONFIGURATION DESCRIPTION
(C58080)	MSFC TWT 514 E2 833W25
(C58070)	MSFC TWT 514 E2 833W25

BETA	ELEVTR
0.000	-20.000
0.000	0.000

REFERENCE INFORMATION		
SREF	19.6300	SQ INC
LREF	3.2400	INCHES
BREF	6.9300	INCHES
XMRP	2.1110	INCHES
YMRP	0.0000	INCHES
ZMRP	0.0000	INCHES
SCALE	0.0035	

MACH 1.201

FIGURE-9 ELEVATOR EFFECTIVENESS OF B-18E-2 CONFIGURATION

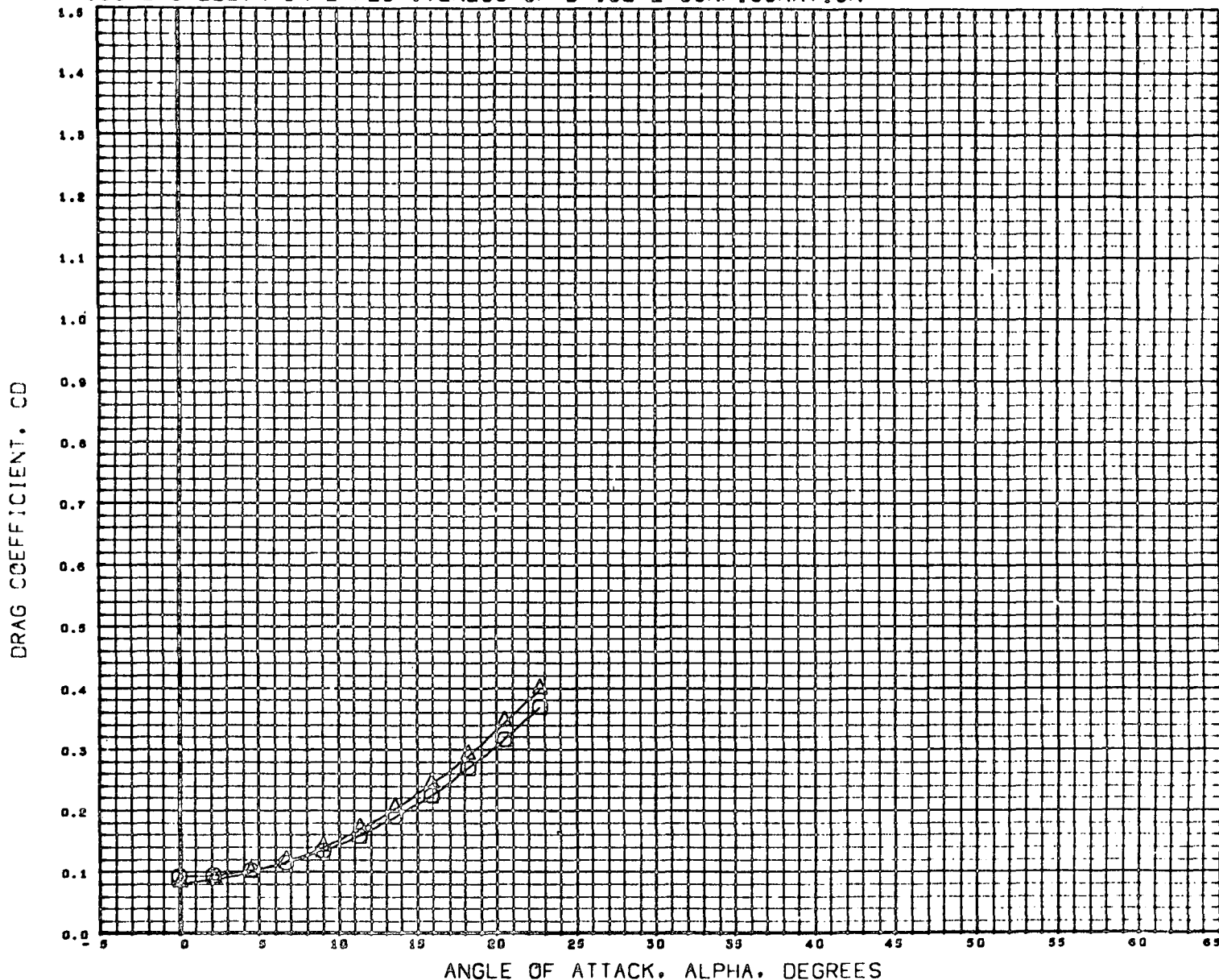

DATA SET SYMBOL	CONFIGURATION	DESCRIPTION
(C58080)	MSFC TWT 914 E2	033W25
(C58070)	MSFC TWT 914 E2	033W25

BETA	ELEVTR
0.000	-20.000
0.000	0.000

REFERENCE INFORMATION		
SREF	19.6300	S0 INC
LREF	3.2400	INCHES
BREF	6.9300	INCHES
XMRP	2.1110	INCHES
YMRP	0.0000	INCHES
ZMRP	0.0000	INCHES
SCALE	0.0035	

MACH 1.901

FIGURE-9 ELEVATOR EFFECTIVENESS OF B-18E-2 CONFIGURATION

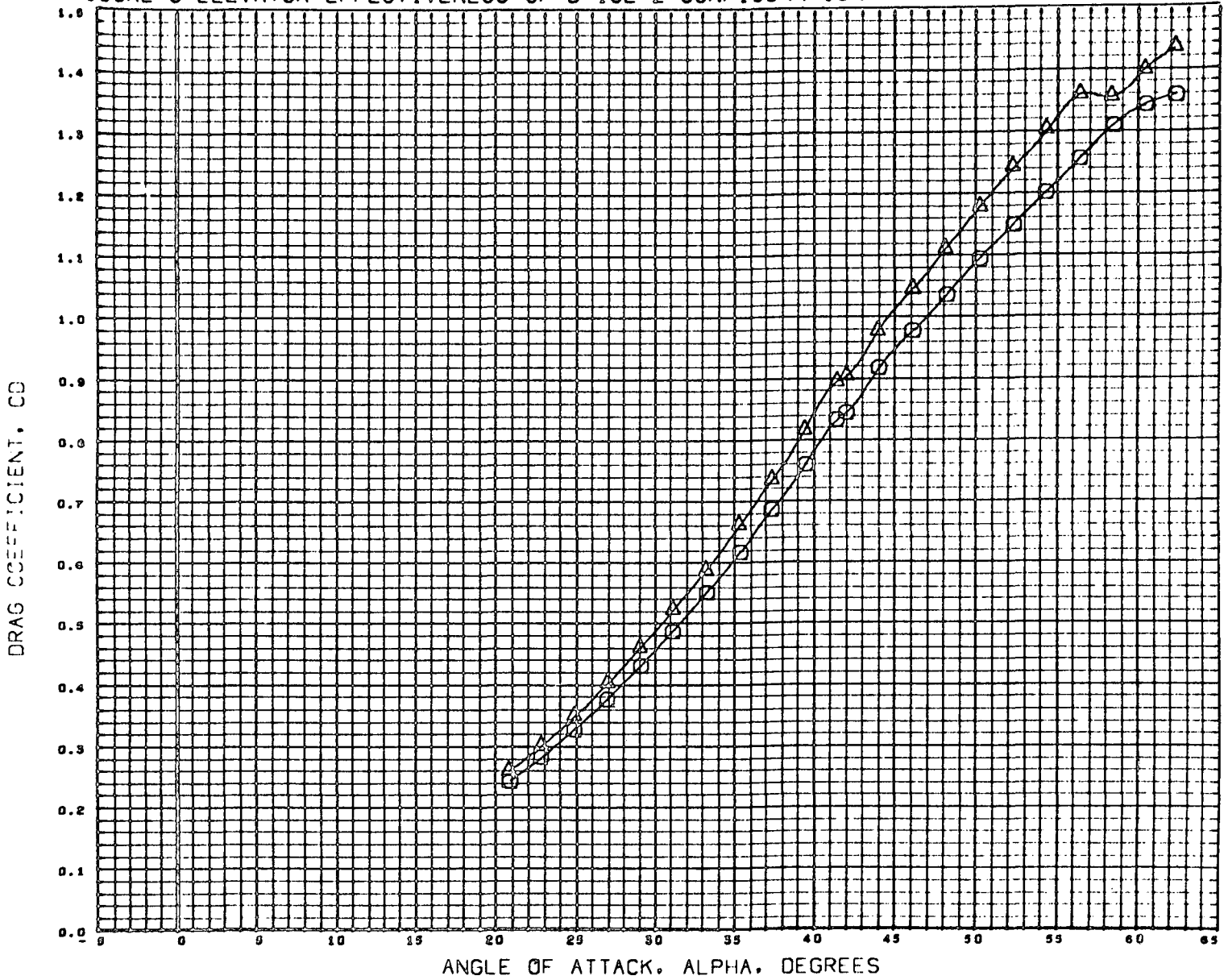

DATA SET SYMBOL	CONFIGURATION DESCRIPTION
(C98080)	MSFC TWT 914 E2 853W25
(C98070)	MSFC TWT 914 E2 853W25

BETA	ELEVTR
0.000	-20.000
0.000	0.000

REFERENCE INFORMATION		
SREF	19.6500	SQ INC
LREF	3.2400	INCHES
BREF	0.9300	INCHES
XMRP	2.1110	INCHES
YMRP	0.0000	INCHES
ZMRP	0.0000	INCHES
SCALE	0.0035	

MACH 2.900

FIGURE-9 ELEVATOR EFFECTIVENESS OF B-18E-2 CONFIGURATION

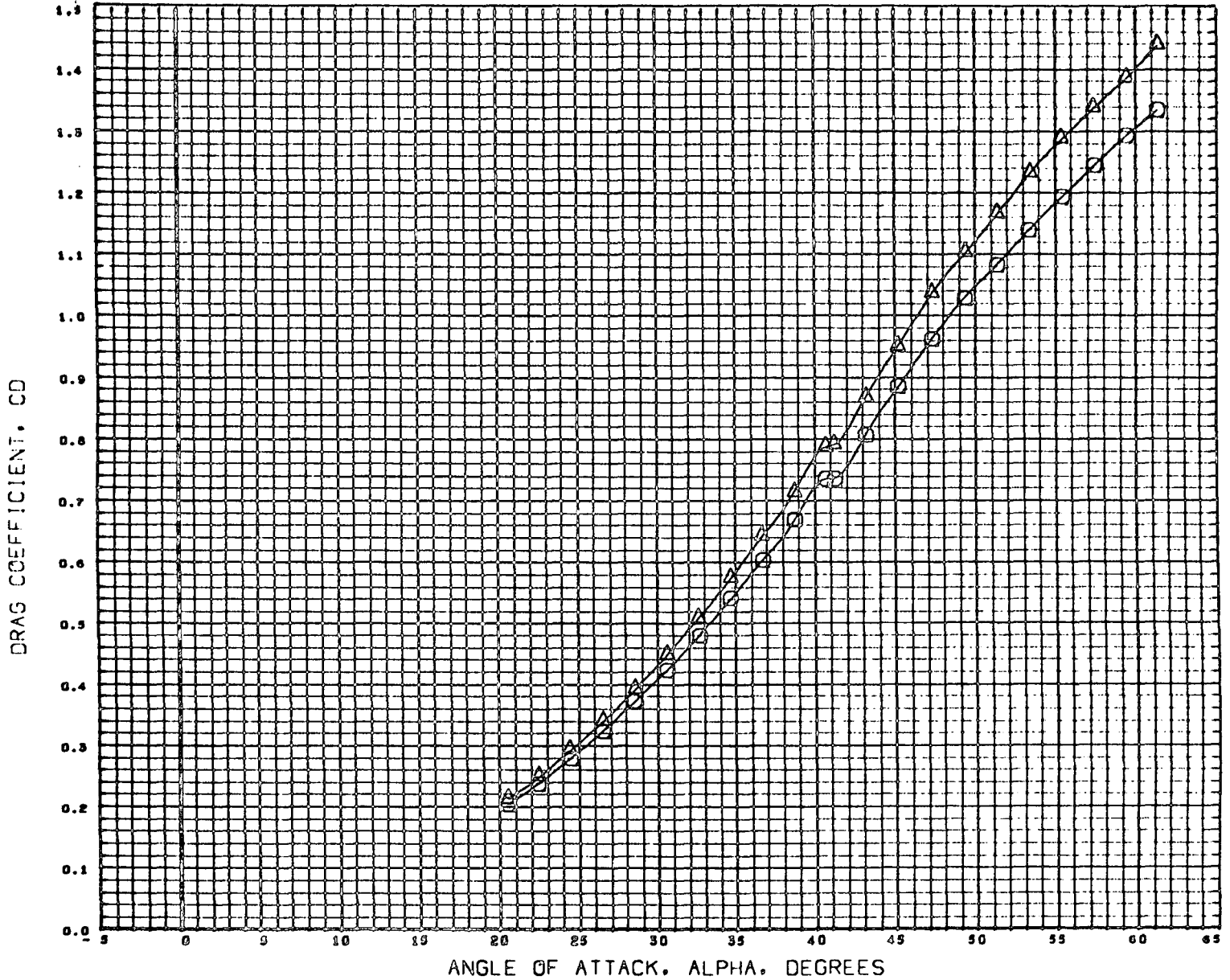

DATA SET SYMBOL	CONFIGURATION DESCRIPTION
(C56080)	MBFC TWT 914 E2 033W25
(C56070)	MBFC TWT 914 E2 033W25

BETA	ELEVTR
0.000	-20.000
0.000	0.000

REFERENCE INFORMATION		
SREF	19.6300	58 INC
LREF	3.2400	INCHES
BREF	6.9300	INCHES
XMRP	2.1110	INCHES
YMRP	0.0000	INCHES
ZMRP	0.0000	INCHES
SCALE	0.0035	

MACH 4.050

FIGURE-9 ELEVATOR EFFECTIVENESS OF B-18E-2 CONFIGURATION

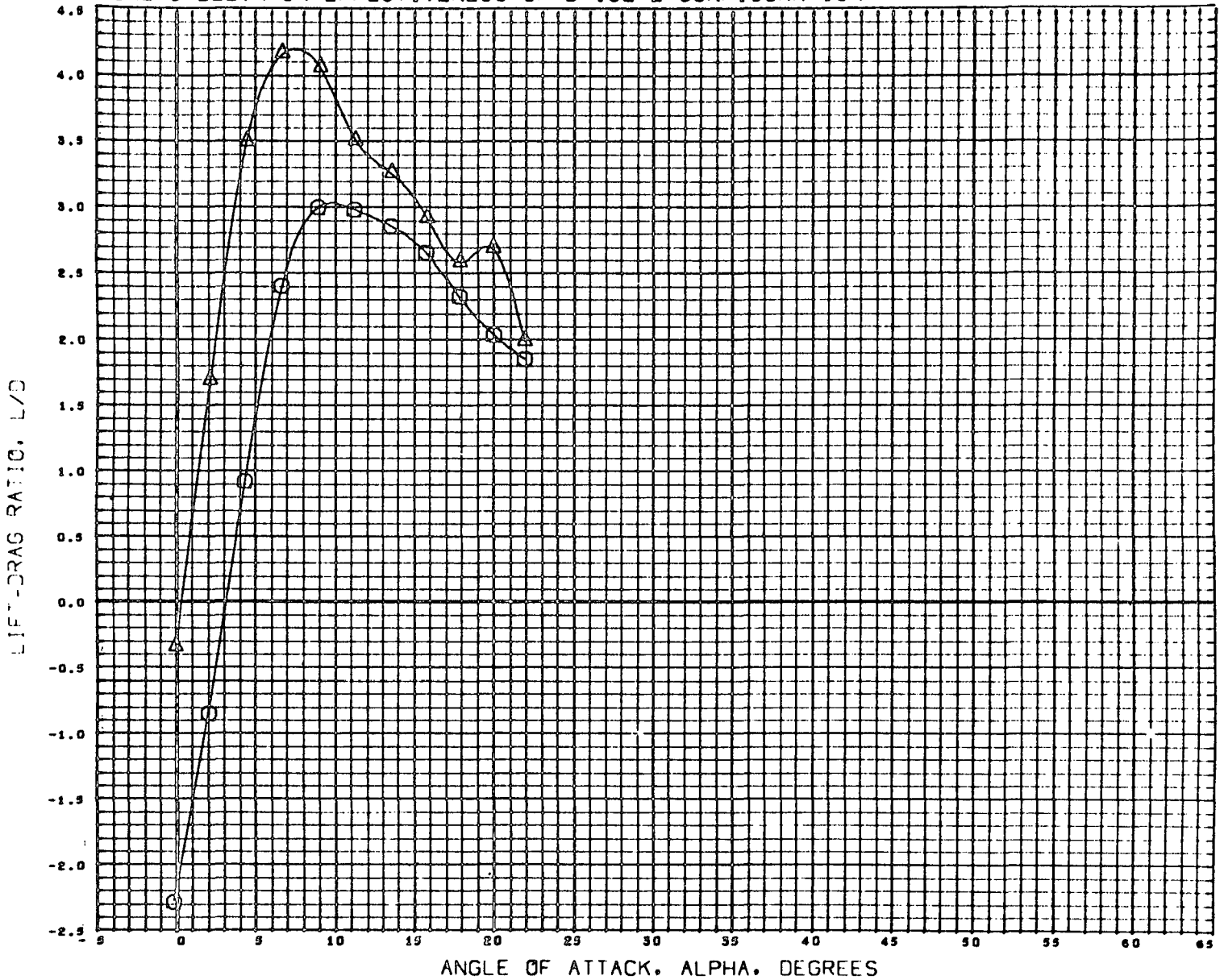

DATA SET SYMBOL	CONFIGURATION DESCRIPTION
(C98080)	MSFC TWT 914 E2 833W25
(C98070)	MSFC TWT 914 E2 833W25

BETA	ELEVTR
0.000	-20.000
0.000	0.000

REFERENCE INFORMATION		
SREF	19.6500	50 INC
LREF	3.2400	INCHES
BREF	6.9300	INCHES
XMRP	2.1110	INCHES
YMRP	0.0000	INCHES
ZMRP	0.0000	INCHES
SCALE	0.0035	

MACH 0.002

FIGURE-9 ELEVATOR EFFECTIVENESS OF B-18E-2 CONFIGURATION

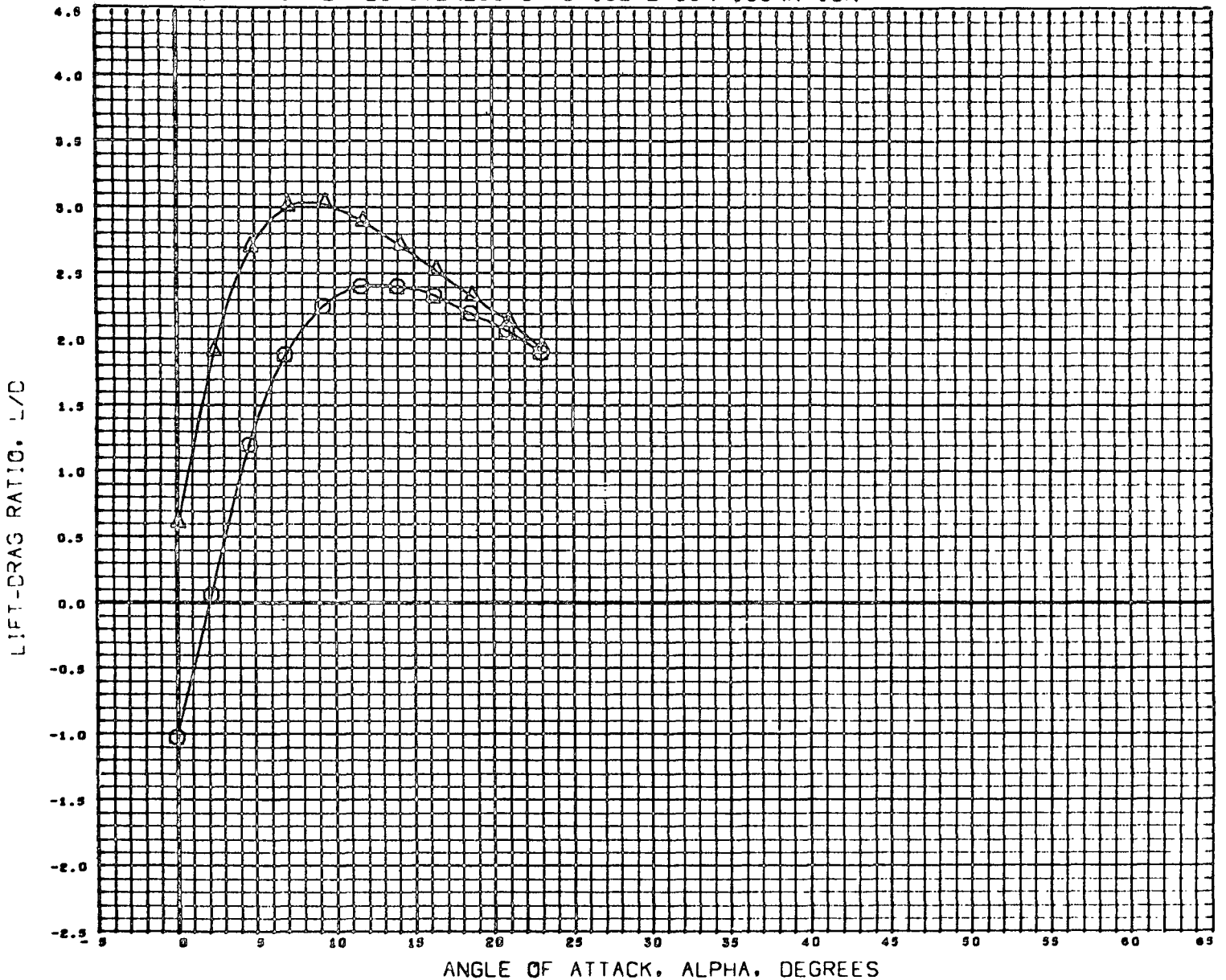

DATA SET SYMBOL	CONFIGURATION DESCRIPTION
(C58080)	MSFC TWT 514 E2 033H25
(C58070)	MSFC TWT 514 E2 033H25

BETA	ELEVTR
0.000	-20.000
0.000	0.000

REFERENCE INFORMATION		
SREF	19.6500	50 INC
LREF	3.2400	INCHES
BREF	6.9300	INCHES
XHRP	2.1110	INCHES
YHRP	0.0000	INCHES
ZHRP	0.0000	INCHES
SCALE	0.0035	

MACH 1.201

FIGURE-9 ELEVATOR EFFECTIVENESS OF B-18E-2 CONFIGURATION

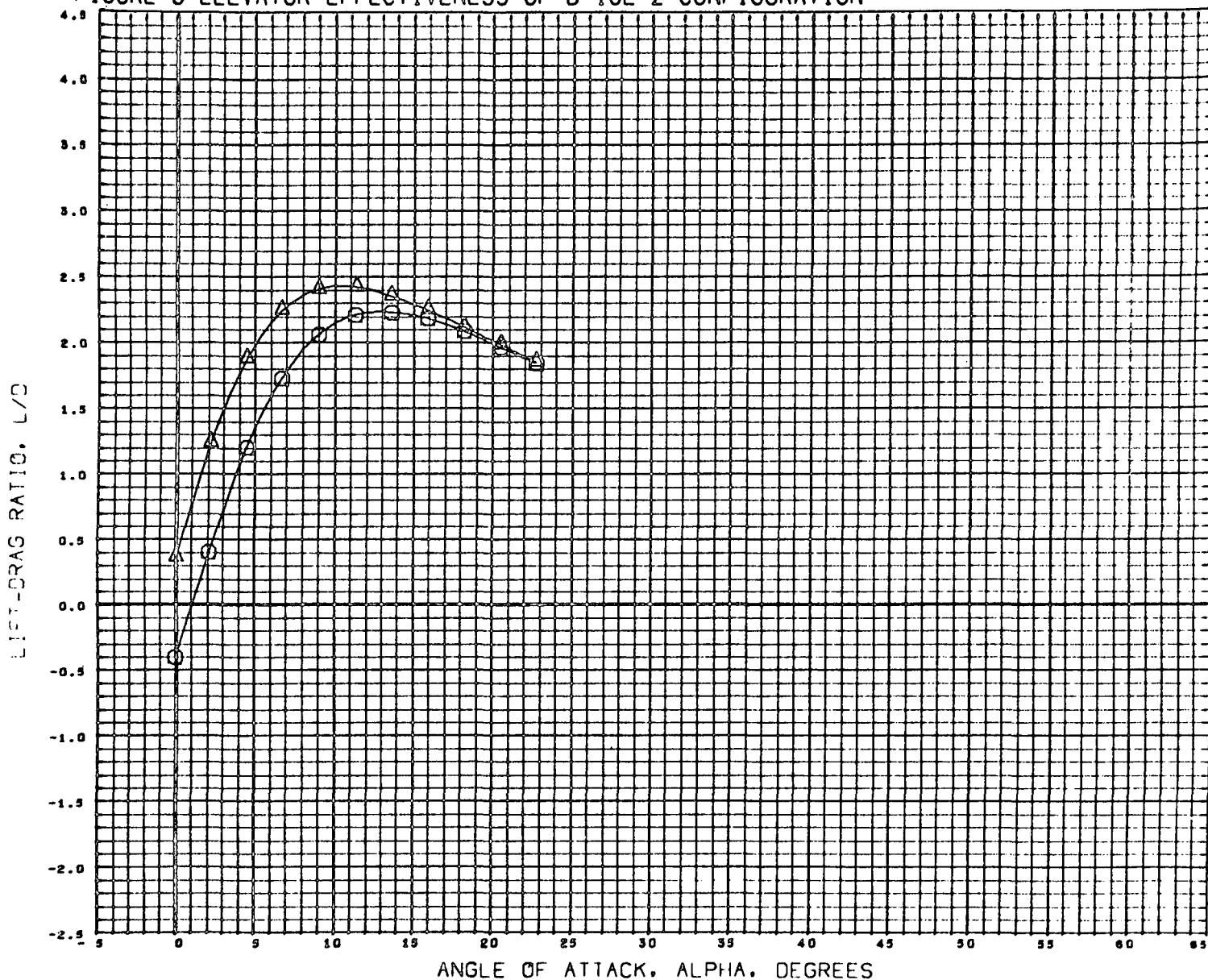

DATA SET SYMBOL	CONFIGURATION DESCRIPTION
(C58680)	MSFC TWT 914 E2 833W29
(C58670)	MSFC TWT 914 E2 833W25

BETA	ELEVTR
0.000	-20.000
0.000	0.000

REFERENCE INFORMATION		
SREF	19.6300	90 INC
LREF	3.2400	INCHES
BREF	6.9300	INCHES
XMRP	2.1110	INCHES
YMRP	0.0000	INCHES
ZMRP	0.0000	INCHES
SCALE	0.0035	

MACH 1.061

FIGURE-9 ELEVATOR EFFECTIVENESS OF B-18E-2 CONFIGURATION

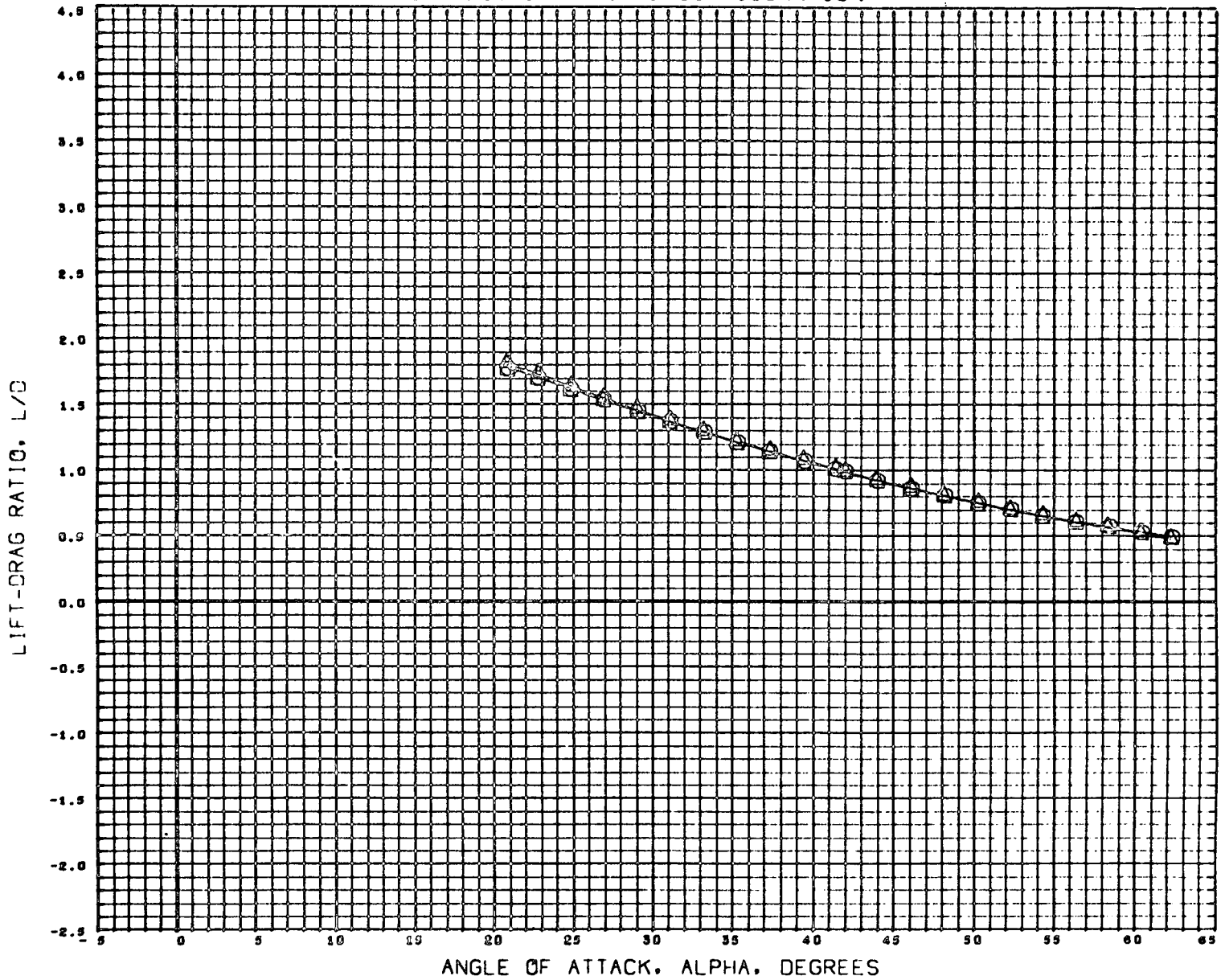

DATA SET SYMBOL	CONFIGURATION DESCRIPTION
(C98060)	HSFC TWT 514 E2 033W25
(C98070)	HSFC TWT 514 E2 033W25

BETA	ELEVTR
0.000	-20.000
0.000	0.000

REFERENCE INFORMATION		
SREF	19.6300	50 INC
LREF	3.2400	INCHES
BREF	6.9300	INCHES
XMRP	2.1110	INCHES
YMRP	0.0000	INCHES
ZMRP	0.0000	INCHES
SCALE	0.0035	

MACH 2.990

FIGURE-9 ELEVATOR EFFECTIVENESS OF B-18E-2 CONFIGURATION

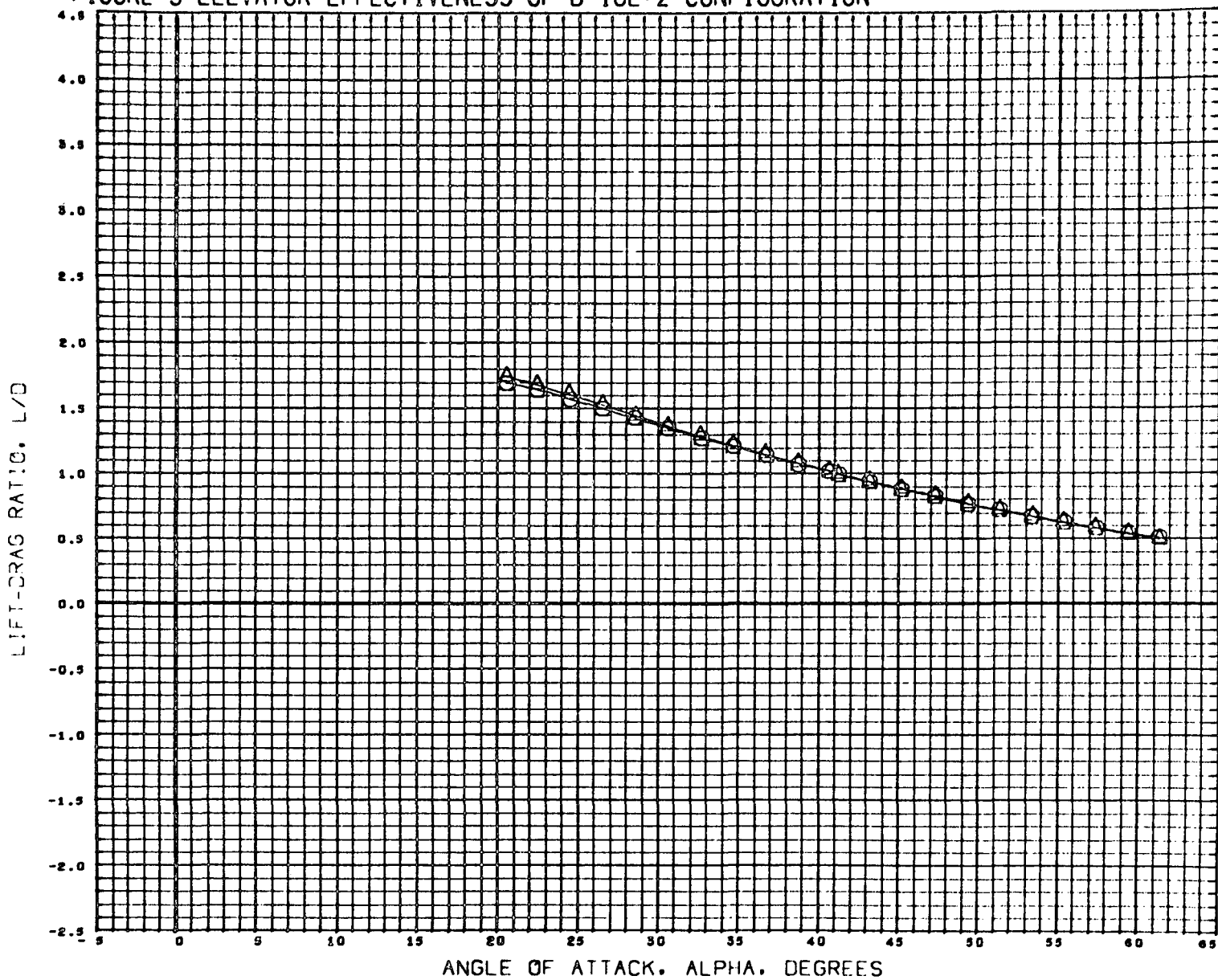

DATA SET SYMBOL	CONFIGURATION DESCRIPTION
(C58060)	MSFC TWT 514 E2 B33W25
(C58070)	MSFC TWT 514 E2 B33W25

BETA	ELEVTR
0.000	-20.000
0.000	0.000

REFERENCE INFORMATION		
SREF	19.6300	SQ INC
LREF	3.2400	INCHES
BREF	6.9300	INCHES
XMRP	2.1110	INCHES
YMRP	0.0000	INCHES
ZMRP	0.0000	INCHES
SCALE	0.0055	

MACH 4.959

FIGURE-9 ELEVATOR EFFECTIVENESS OF B-18E-2 CONFIGURATION



DATA SET SYMBOL	CONFIGURATION DESCRIPTION
(C58080)	MSFC TWT 514 E2 B33W25
(C58070)	MSFC TWT 514 E2 B33W25

BETA	ELEVTR
0.000	-20.000
0.000	0.000

REFERENCE INFORMATION		
SREF	19.6300	sq INC
LREF	3.2400	INCHES
BREF	6.9300	INCHES
XMRP	2.1110	INCHES
YMRP	0.0000	INCHES
ZMRP	0.0000	INCHES
SCALE	0.0035	

MACH 0.902

FIGURE-9 ELEVATOR EFFECTIVENESS OF B-18E-2 CONFIGURATION

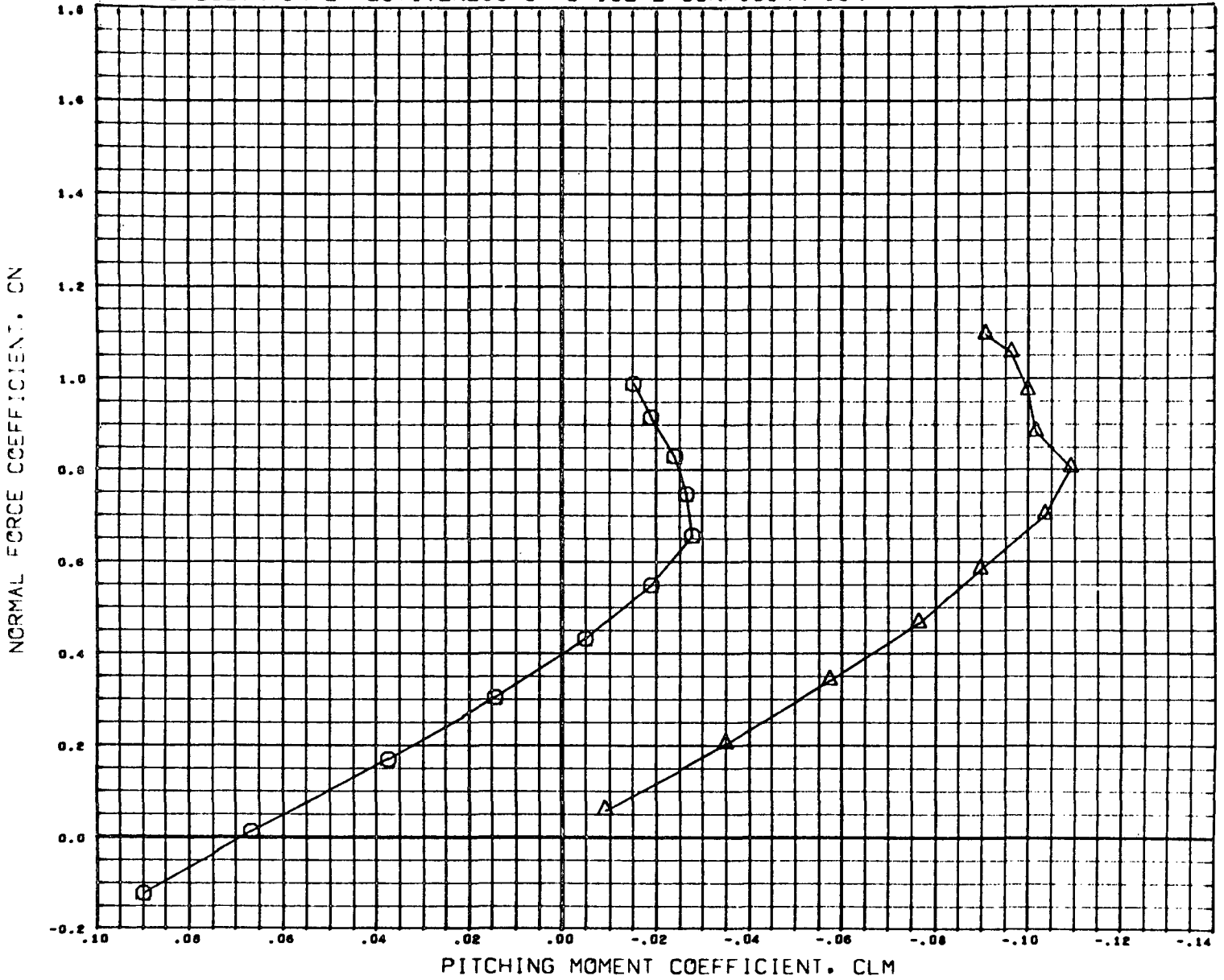

DATA SET SYMBOL	CONFIGURATION DESCRIPTION
(C58080)	MSFC TWT 514 E2 B33W25
(C58070)	MSFC TWT 514 E2 B33W25

BETA	ELEVTR
0.000	-20.000
0.000	0.000

REFERENCE INFORMATION		
SREF	19.6300	50 INC
LREF	3.2400	INCHES
BREF	6.9300	INCHES
XMRP	2.1110	INCHES
YMRP	0.0000	INCHES
ZMRP	0.0000	INCHES
SCALE	0.0035	

HACH 1.201

FIGURE-9 ELEVATOR EFFECTIVENESS OF B-18E-2 CONFIGURATION

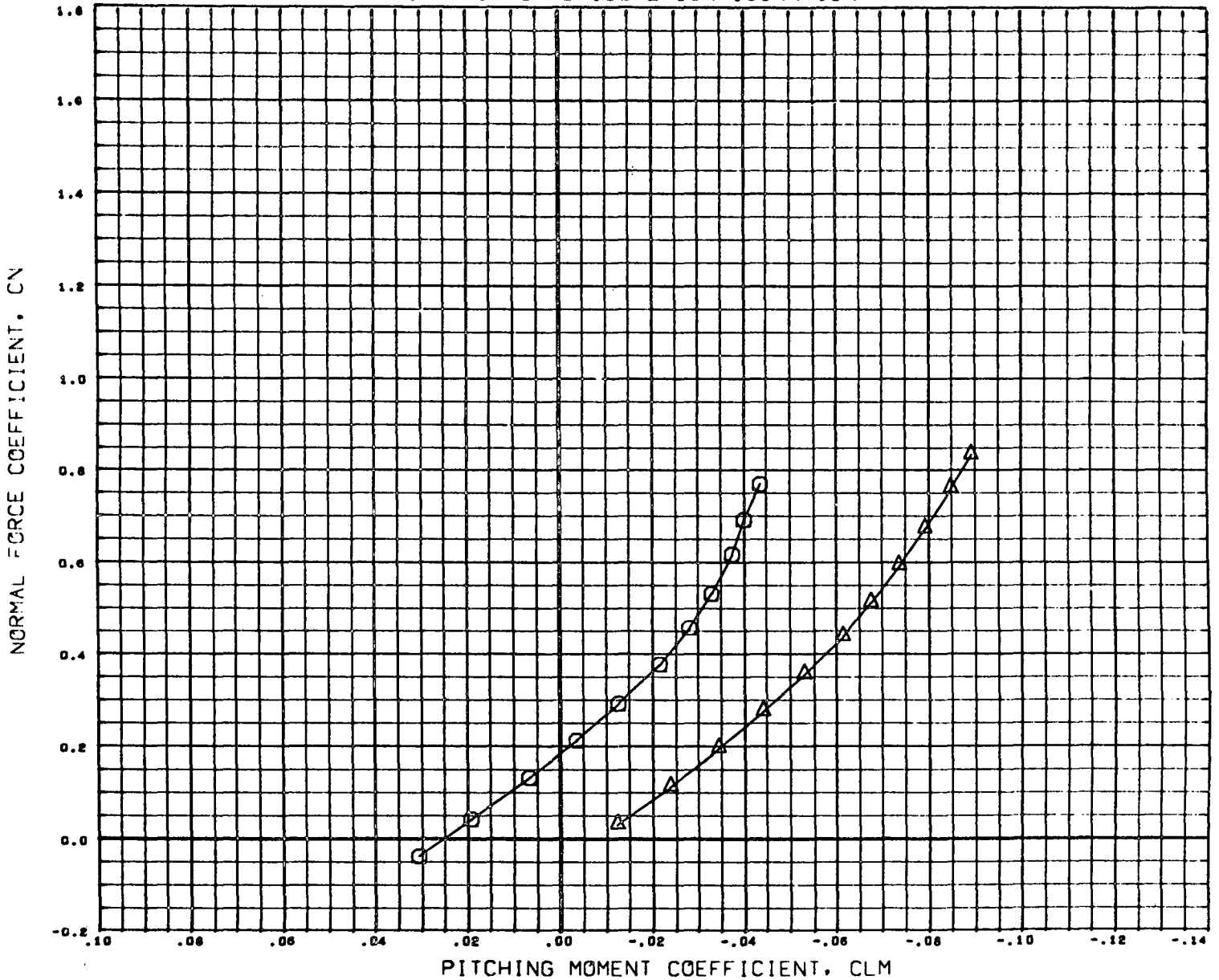

DATA SET SYMBOL	CONFIGURATION DESCRIPTION
(C98080) ○	MSFC TWT 514 E2 B33W25
(C98070) △	MSFC TWT 514 E2 B33W25

BETA	ELEVTR
0.000	-20.000
0.000	0.000

REFERENCE INFORMATION	
SREF	19.6300 SQ INC
LREF	3.2400 INCHES
BREF	6.9300 INCHES
XMRP	2.1110 INCHES
YMRP	0.0000 INCHES
ZMRP	0.0000 INCHES
SCALE	0.0035

MACH 1.961

FIGURE-9 ELEVATOR EFFECTIVENESS OF B-18E-2 CONFIGURATION

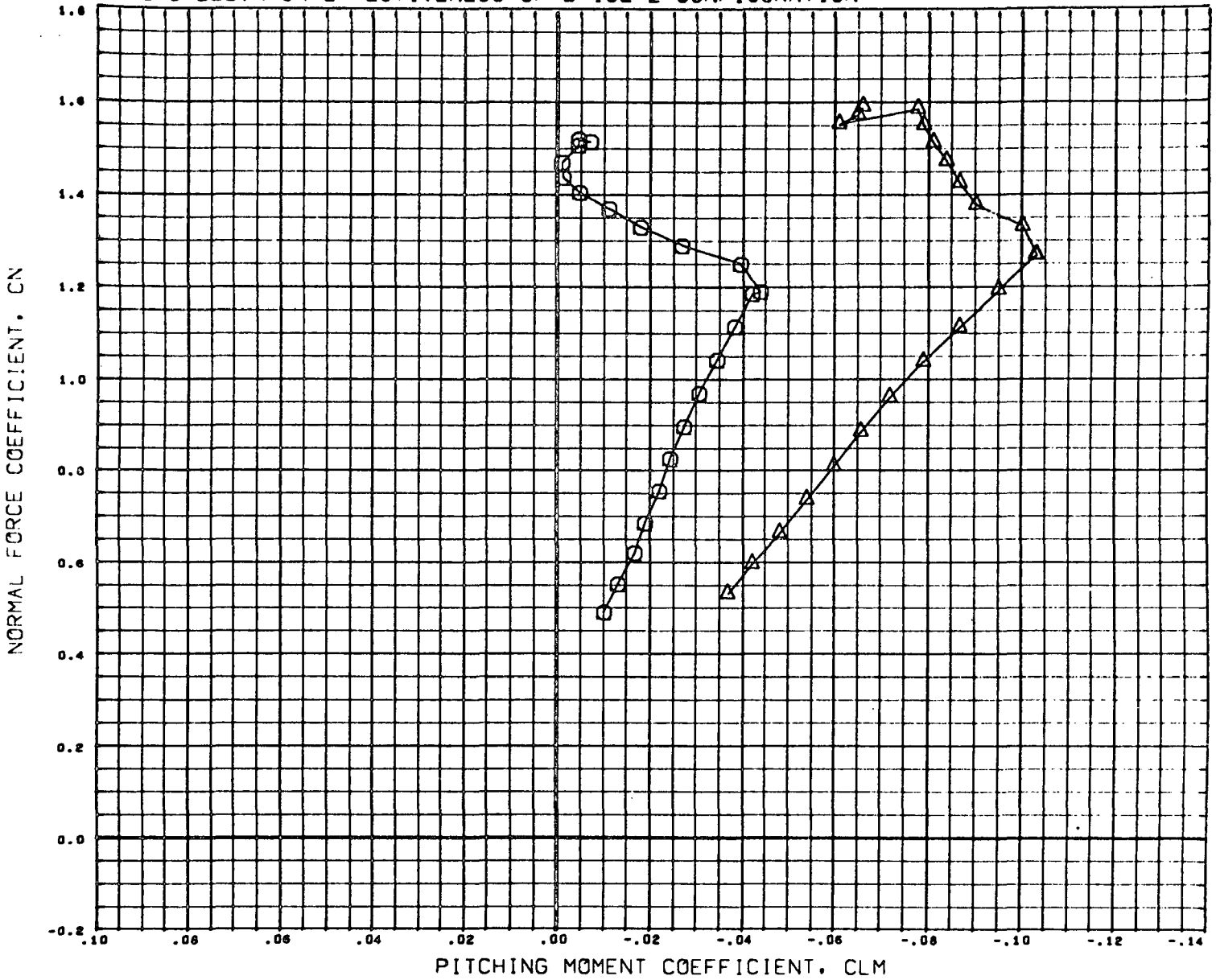

DATA SET SYMBOL	CONFIGURATION DESCRIPTION
(C58080)	MSFC TWT 514 E2 B33W25
(C58070)	MSFC TWT 514 E2 B33W25

BETA	ELEVTR
0.000	-20.000
0.000	0.000

REFERENCE INFORMATION		
SREF	19.6300	\$Q INC
LREF	3.2400	INCHES
BREF	6.9300	INCHES
XMRP	2.1110	INCHES
YMRP	0.0000	INCHES
ZMRP	0.0000	INCHES
SCALE	0.0035	

MACH 2.990

FIGURE-9 ELEVATOR EFFECTIVENESS OF B-18E-2 CONFIGURATION

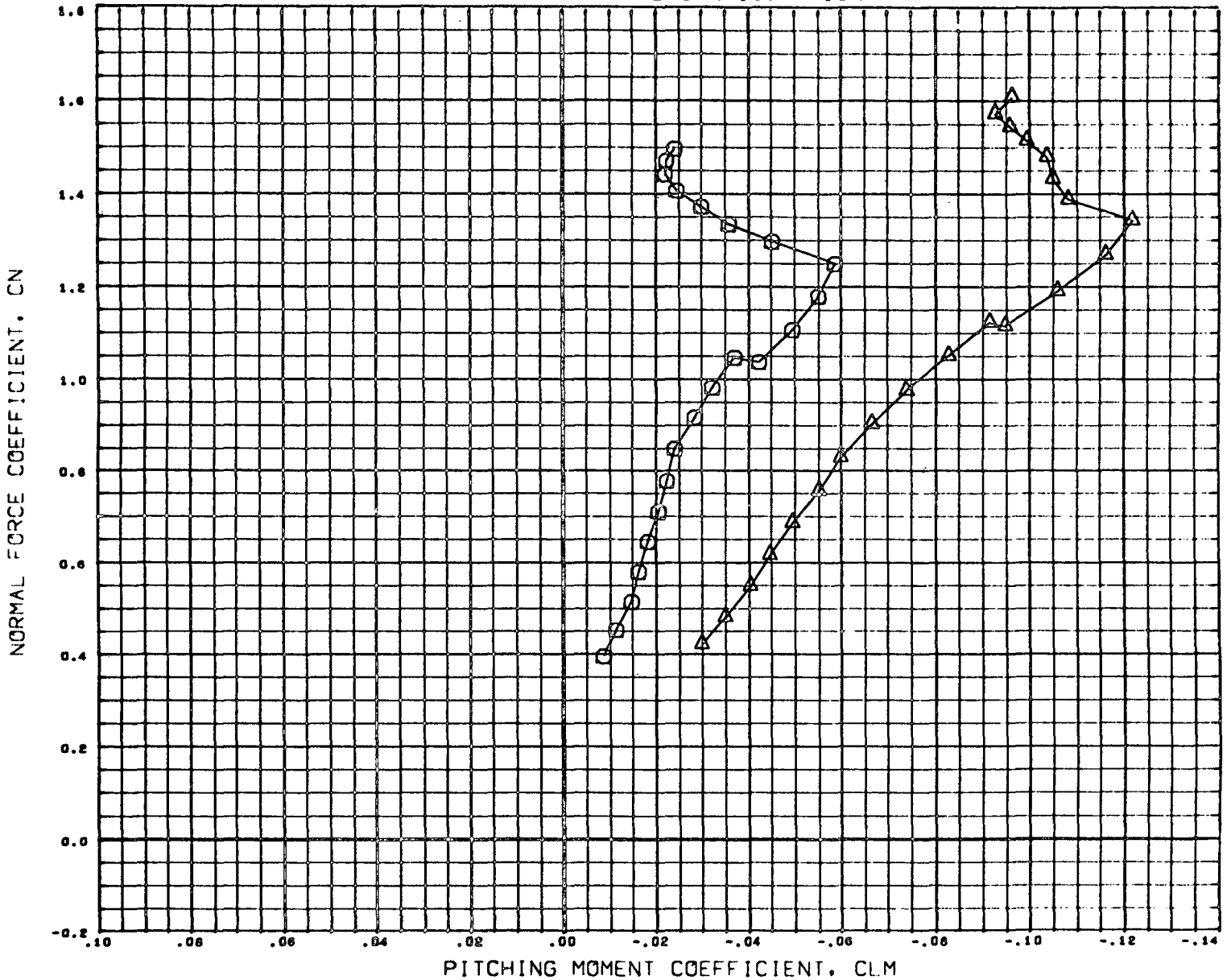

DATA SET SYMBOL	CONFIGURATION	DESCRIPTION
(C58080)	MSFC TWT 514 E2	833W25
(C58070)	MSFC TWT 514 E2	833W25

BETA	ELEVTR
0.000	-20.000
0.000	0.000

REFERENCE INFORMATION		
SREF	19.6300	50 INC
LREF	3.2400	INCHES
BREF	6.9500	INCHES
XMRP	2.1110	INCHES
YMRP	0.0000	INCHES
ZMRP	0.0000	INCHES
SCALE	0.0035	

MACH 4.959

FIGURE-9 ELEVATOR EFFECTIVENESS OF B-18E-2 CONFIGURATION

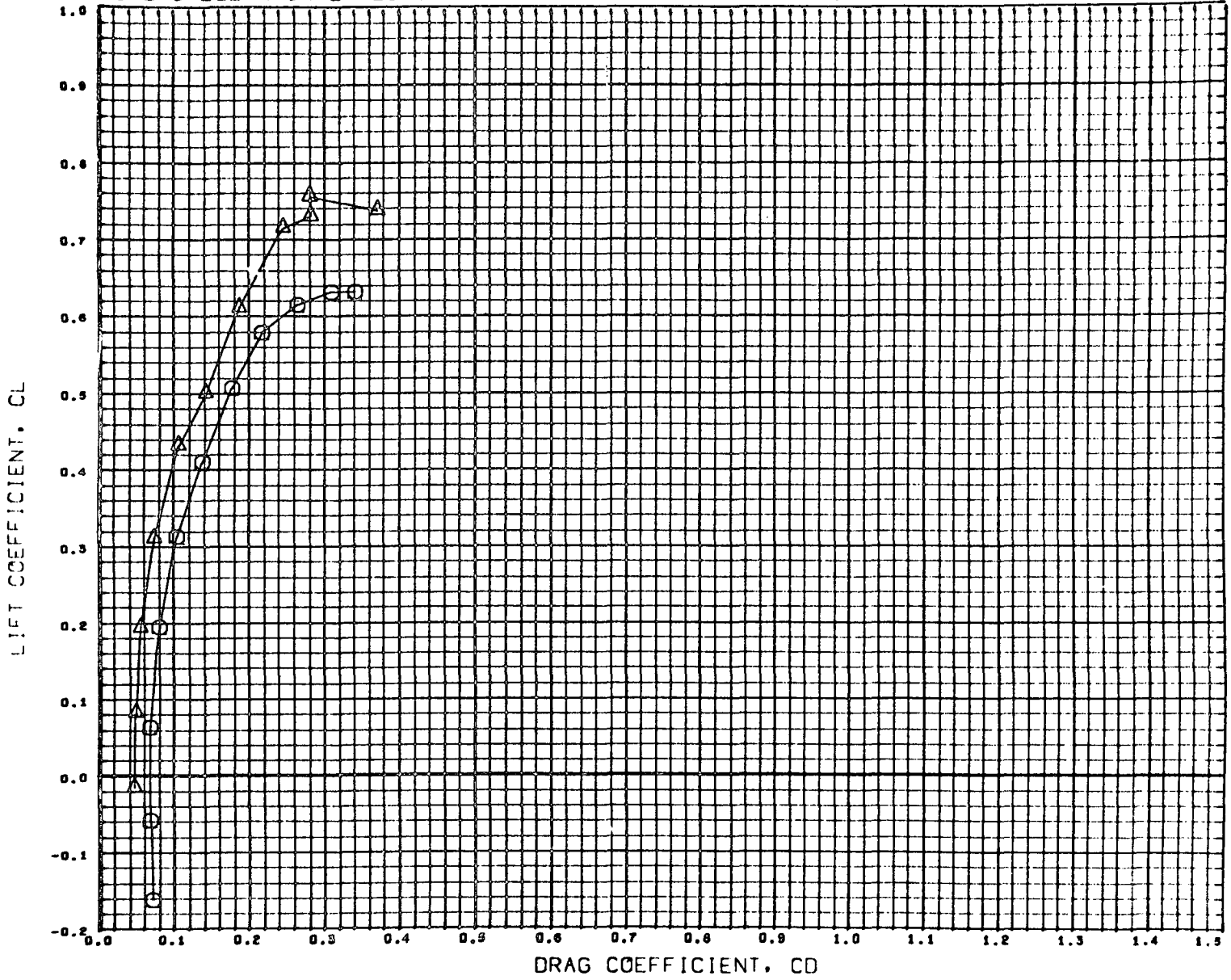

DATA SET SYMBOL	CONFIGURATION	DESCRIPTION
(C58980)	○	HDPC TWT 314 E2 B33W25
(C58970)	△	HDPC TWT 314 E2 B33W25

BETA	ELEVTR
0.000	-20.000
0.000	0.000

REFERENCE INFORMATION		
SREF	19.6300	50 INC
LREF	3.2400	INCHES
BREF	6.9300	INCHES
XMRP	2.1110	INCHES
YMRP	0.0000	INCHES
ZMRP	0.0000	INCHES
SCALE	0.0035	

MACH 0.002

FIGURE-9 ELEVATOR EFFECTIVENESS OF B-18E-2 CONFIGURATION

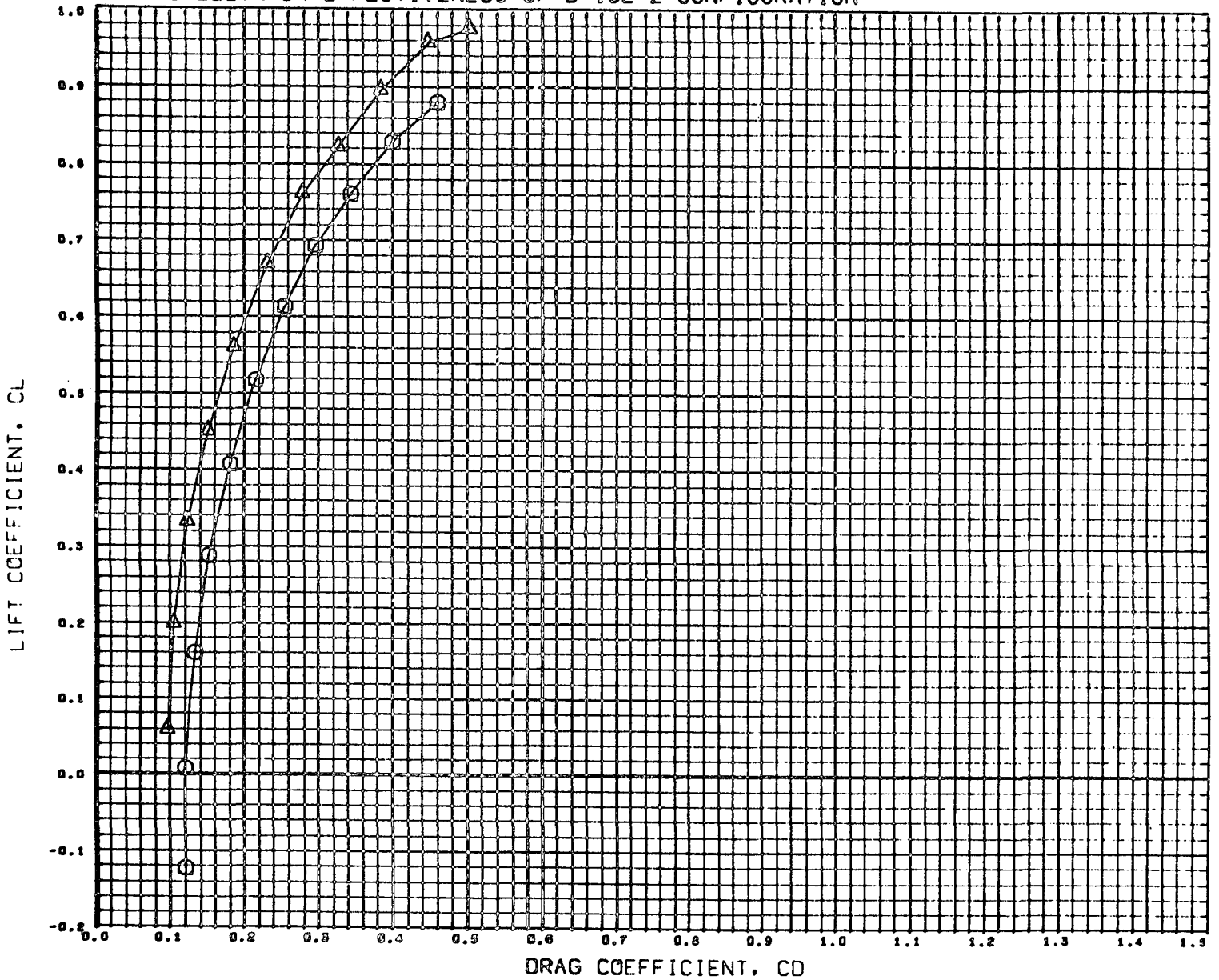

DATA SET SYMBOL	CONFIGURATION DESCRIPTION
(C98080)	MSFC TWT 914 E2 033W25
(C98090)	MSFC TWT 914 E2 033W25

BETA	ELEVTR
0.000	-20.000
0.000	0.000

REFERENCE INFORMATION		
SREF	19.6300	38 INC
LREF	3.2400	INCHES
BREF	6.9300	INCHES
XMRP	2.1110	INCHES
YMRP	0.0000	INCHES
ZMRP	0.0000	INCHES
SCALE	0.0035	

MACH 1.201

FIGURE-9 ELEVATOR EFFECTIVENESS OF B-18E-2 CONFIGURATION

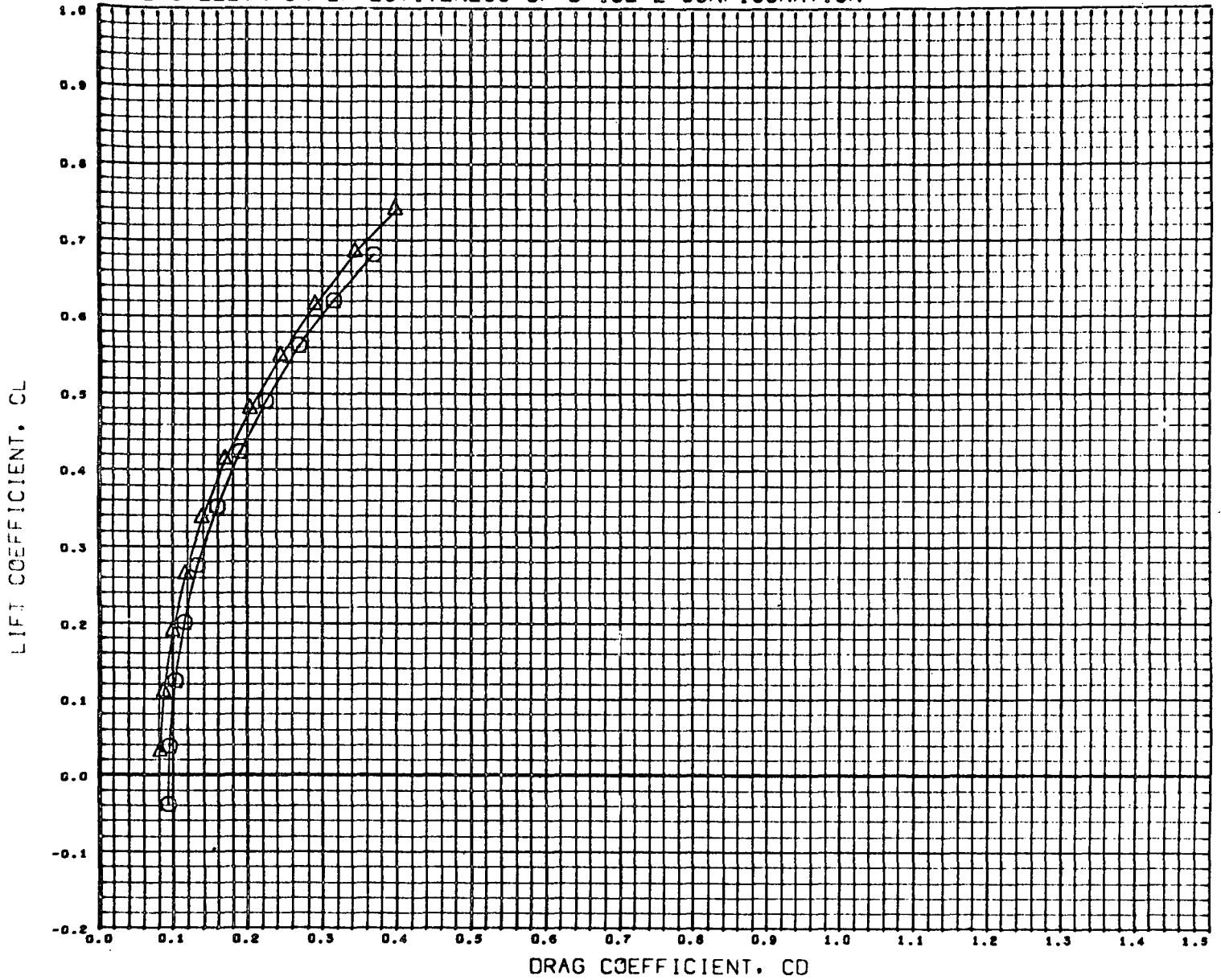

DATA SET SYMBOL	CONFIGURATION DESCRIPTION
(C58080) MSFC TWT 314 E2	B33W25
(C58070) MSFC TWT 314 E2	B33W25

BETA	ELEVTR
0.000	-20.000
0.000	0.000

REFERENCE INFORMATION		
SREF	19.8360	30 INC
LREF	3.2400	INCHES
BREF	6.9300	INCHES
XMRP	2.1110	INCHES
YMRP	0.0000	INCHES
ZMRP	0.0000	INCHES
SCALE	0.0035	

MACH 2.961

FIGURE-9 ELEVATOR EFFECTIVENESS OF B-18E-2 CONFIGURATION

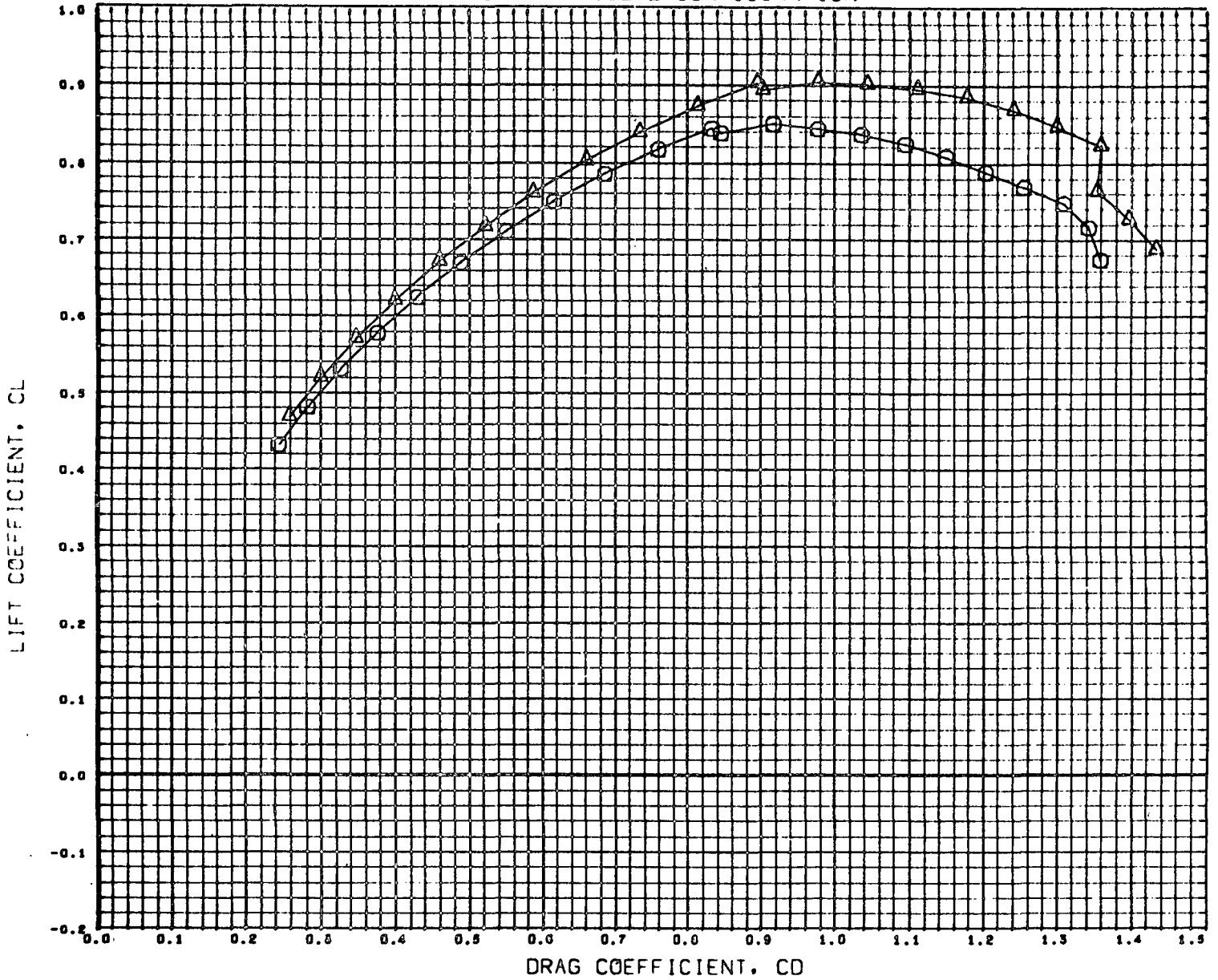

DATA SET SYMBOL	CONFIGURATION DESCRIPTION
(C58060)	MSFC TWT 514 E2 033W25
(C58070)	MSFC TWT 514 E2 033W25

BETA	ELEVTR
0.000	-20.000
0.000	0.000

REFERENCE INFORMATION		
SREF	19.6300	Sq INC
LREF	3.2400	INCHES
BREF	6.9300	INCHES
XMRP	2.1110	INCHES
YMRP	0.0000	INCHES
ZMRP	0.0000	INCHES
SCALE	0.0035	

MACH 2.990

FIGURE-9 ELEVATOR EFFECTIVENESS OF B-18E-2 CONFIGURATION

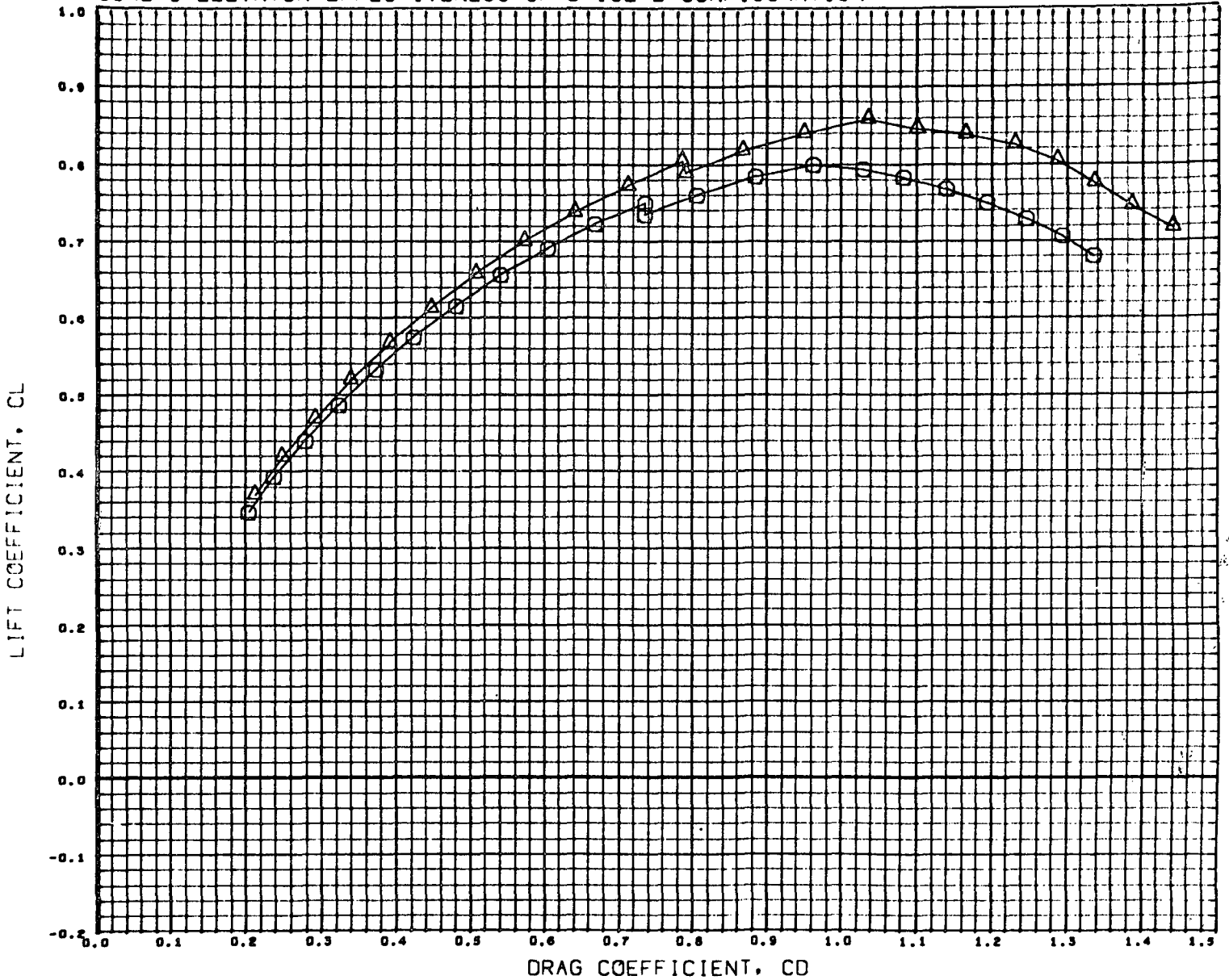

DATA SET SYMBOL	CONFIGURATION	DESCRIPTION
(C56080)	MSFC TWT 914 E2	B33W25
(C56070)	MSFC TWT 914 E2	B33W29

BETA	ELEVTR
0.000	-20.000
0.000	0.000

REFERENCE INFORMATION		
SREF	19.6300	30 INC
LREF	3.2400	INCHES
BREF	6.9300	INCHES
XMRP	2.1110	INCHES
YMRP	0.0000	INCHES
ZMRP	0.0000	INCHES
SCALE	0.0035	

MACH 4.959

FIGURE-9 ELEVATOR EFFECTIVENESS OF B-18E-2 CONFIGURATION

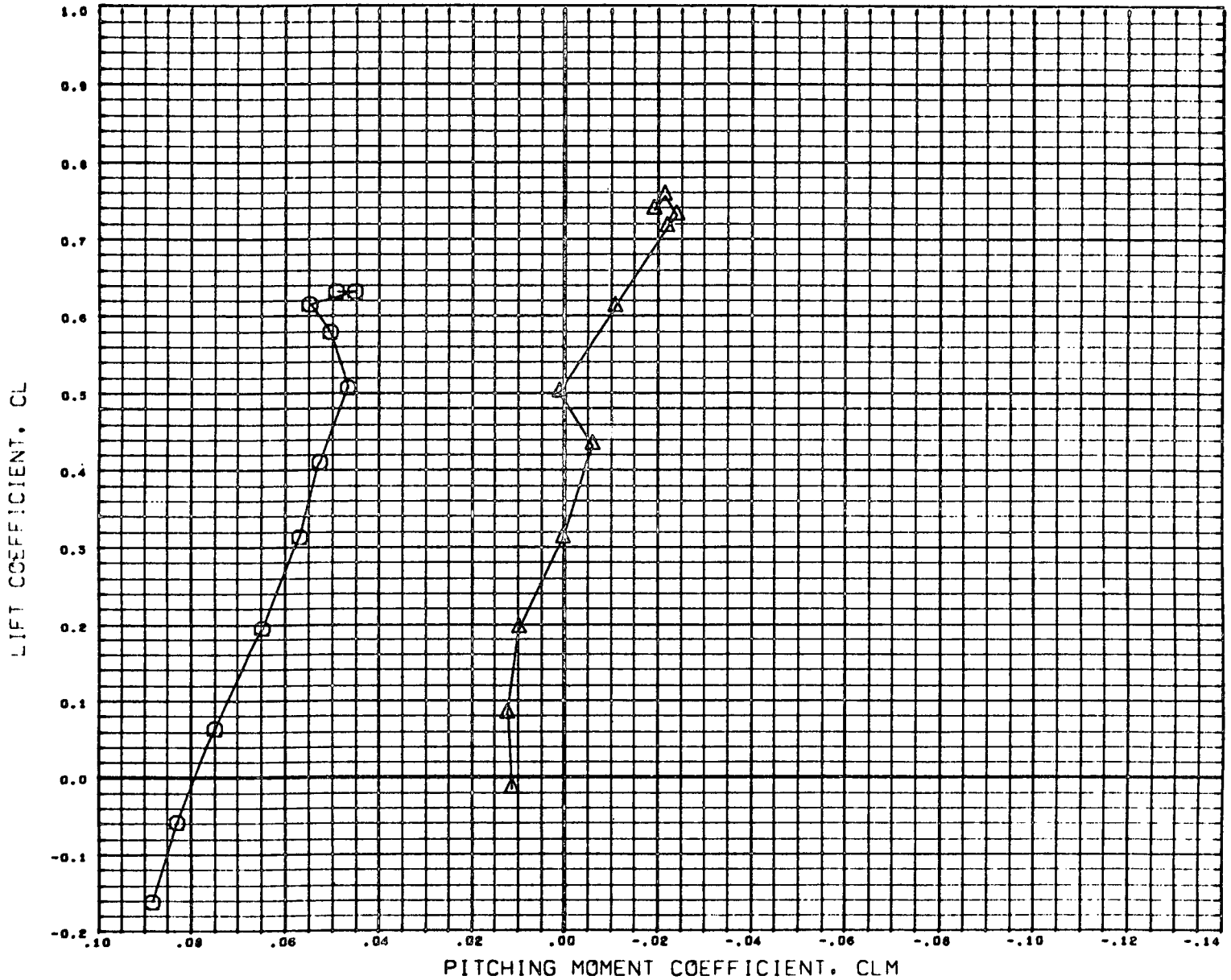

DATA SET SYMBOL	CONFIGURATION DESCRIPTION
(C98080)	MSFC TWT 514 E2 033W25
(C98070)	MSFC TWT 514 E2 033W25

BETA	ELEVTR
0.000	-20.000
0.000	0.000

REFERENCE INFORMATION		
SREF	19.6300	50 INC
LREF	3.2400	INCHES
BREF	6.9300	INCHES
XMRP	2.1110	INCHES
YMRP	0.0000	INCHES
ZMRP	0.0000	INCHES
SCALE	0.0035	

MACH 0.902

FIGURE-9 ELEVATOR EFFECTIVENESS OF B-18E-2 CONFIGURATION

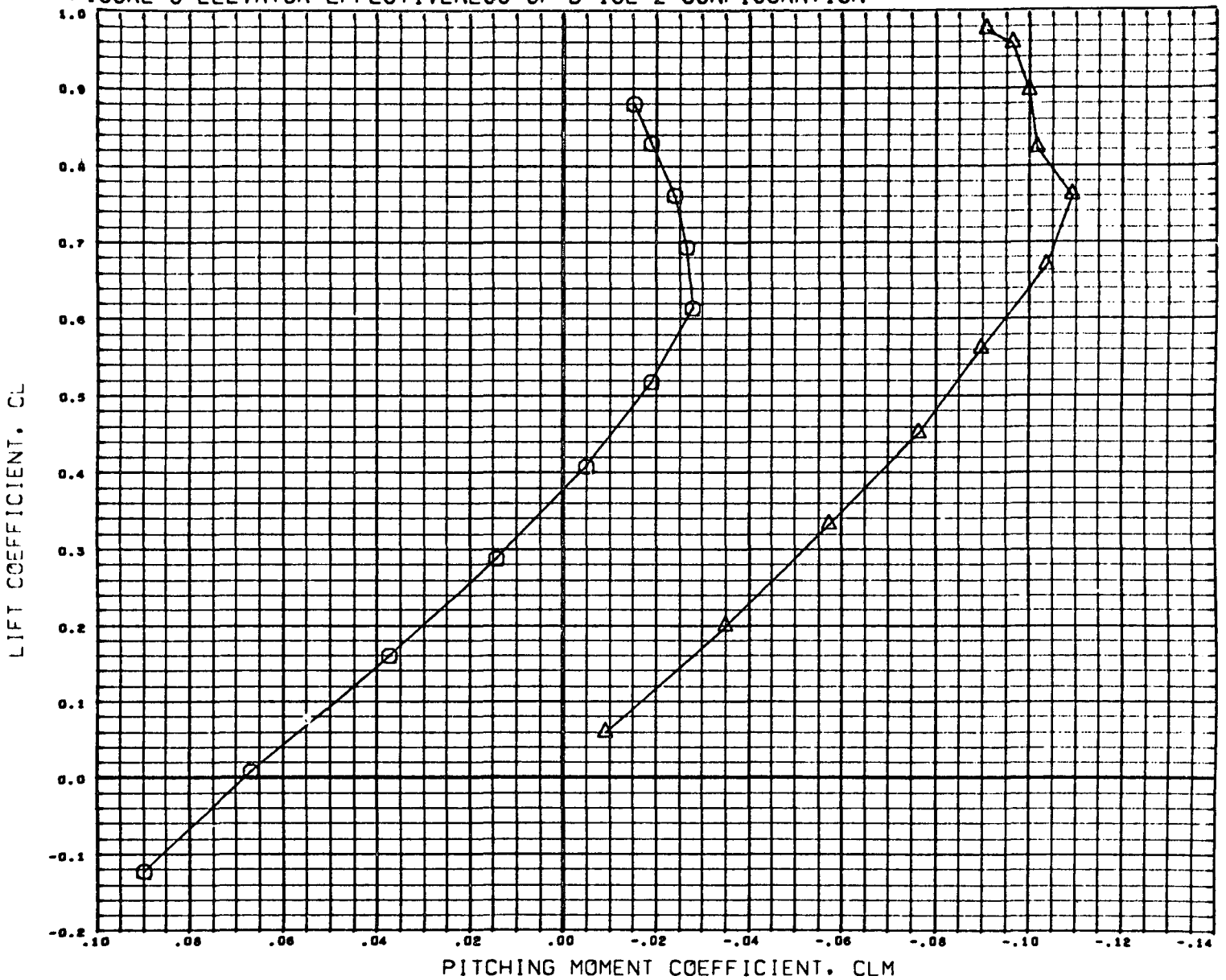

DATA SET SYMBOL	CONFIGURATION DESCRIPTION
(C56080)	MSFC TWT 514 E2 833W25
(C56070)	MSFC TWT 514 E2 833W25

BETA	ELEVTR
0.000	-20.000
0.000	0.000

REFERENCE INFORMATION		
SREF	19.6300	50 INC
LREF	3.2400	INCHES
BREF	6.9300	INCHES
XMRP	2.1110	INCHES
YMRP	0.0000	INCHES
ZMRP	0.0000	INCHES
SCALE	0.0039	

MACH 1.201

FIGURE-9 ELEVATOR EFFECTIVENESS OF B-18E-2 CONFIGURATION

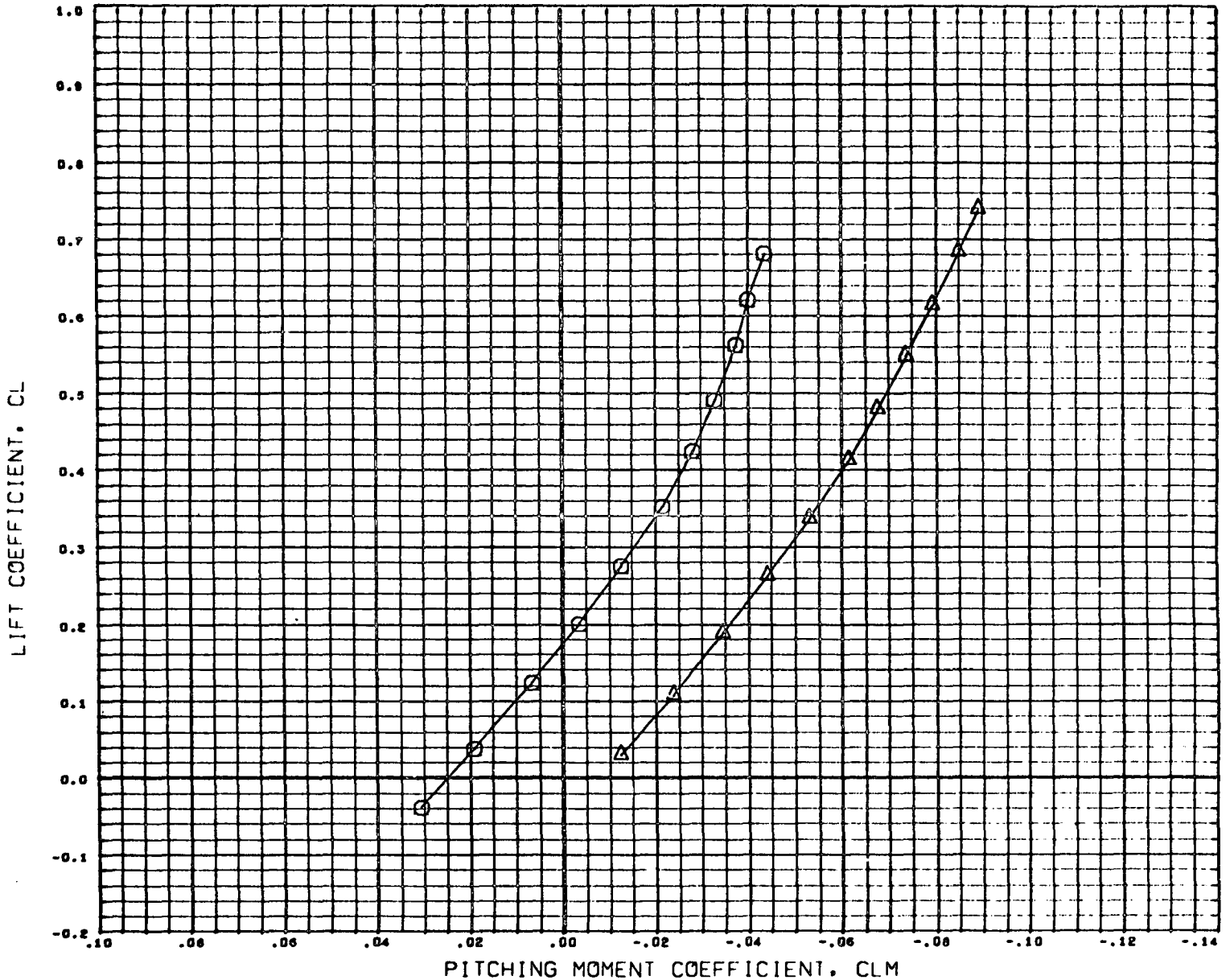

DATA SET SYMBOL	CONFIGURATION DESCRIPTION
(C98080)	MSFC TWT 514 E2 833W23
(C98070)	MSFC TWT 514 E2 833W23

BETA	ELEVTR
0.000	-20.000
0.000	0.000

REFERENCE INFORMATION		
SREF	19.6300	80 INC
LREF	3.2400	INCHES
BREF	6.9300	INCHES
XMRP	2.1110	INCHES
YMRP	0.0000	INCHES
ZMRP	0.0000	INCHES
SCALE	0.0055	

MACH 1.961

FIGURE-9 ELEVATOR EFFECTIVENESS OF B-18E-2 CONFIGURATION

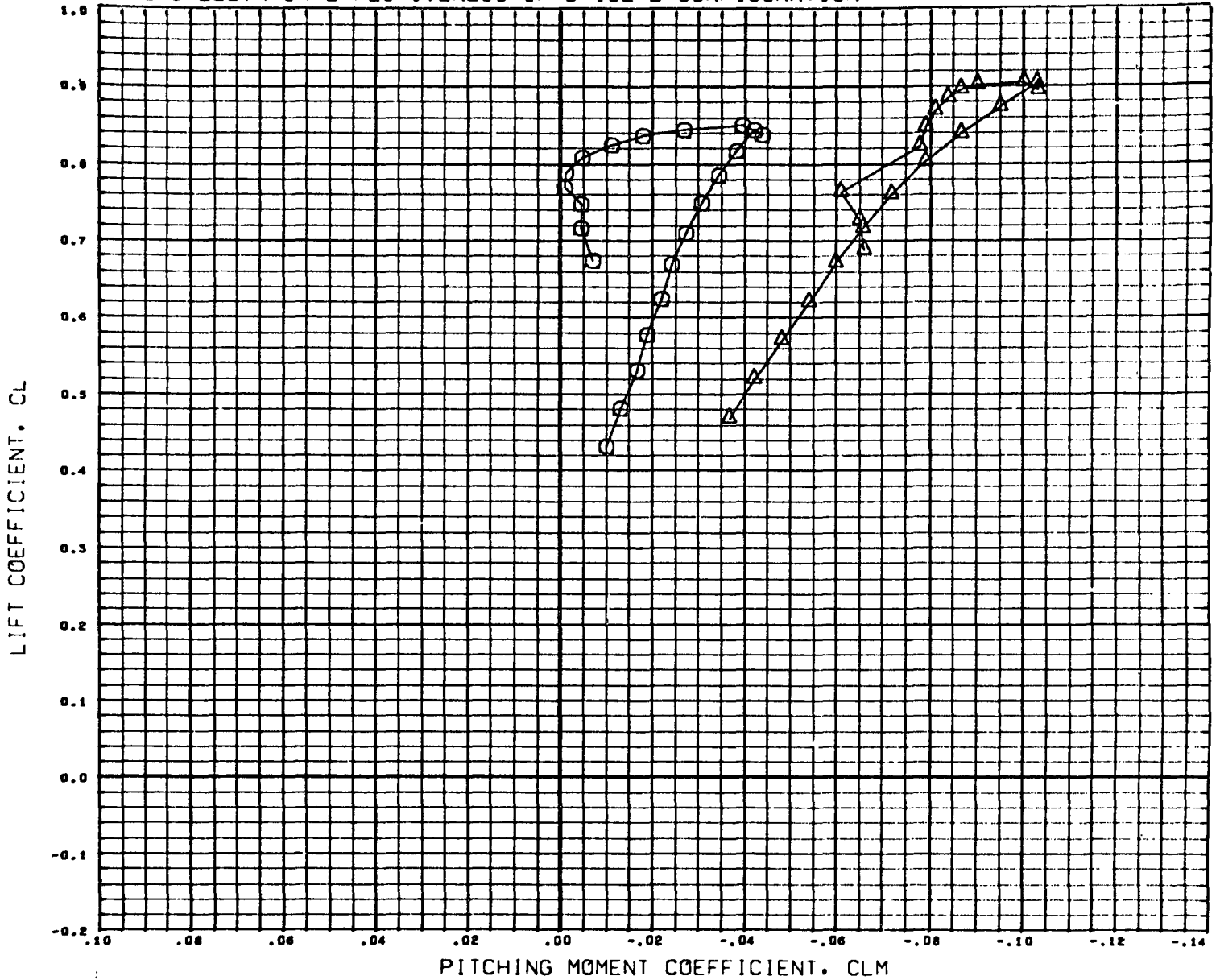

DATA SET	SYMBOL	CONFIGURATION	DESCRIPTION
(C56080)	○	HSFC TWT 514 E2	B33W25
(C98070)	△	HSFC TWT 514 E2	B33W25

BETA	ELEVTR
0.000	-20.000
0.000	0.000

REFERENCE INFORMATION		
SREF	19.6300	30 INC
LREF	3.2400	INCHES
BREF	6.9300	INCHES
XMRF	2.1110	INCHES
YMRF	0.0000	INCHES
ZMRF	0.0000	INCHES
SCALE	0.0035	

MACH 2.990

FIGURE-9 ELEVATOR EFFECTIVENESS OF B-18E-2 CONFIGURATION

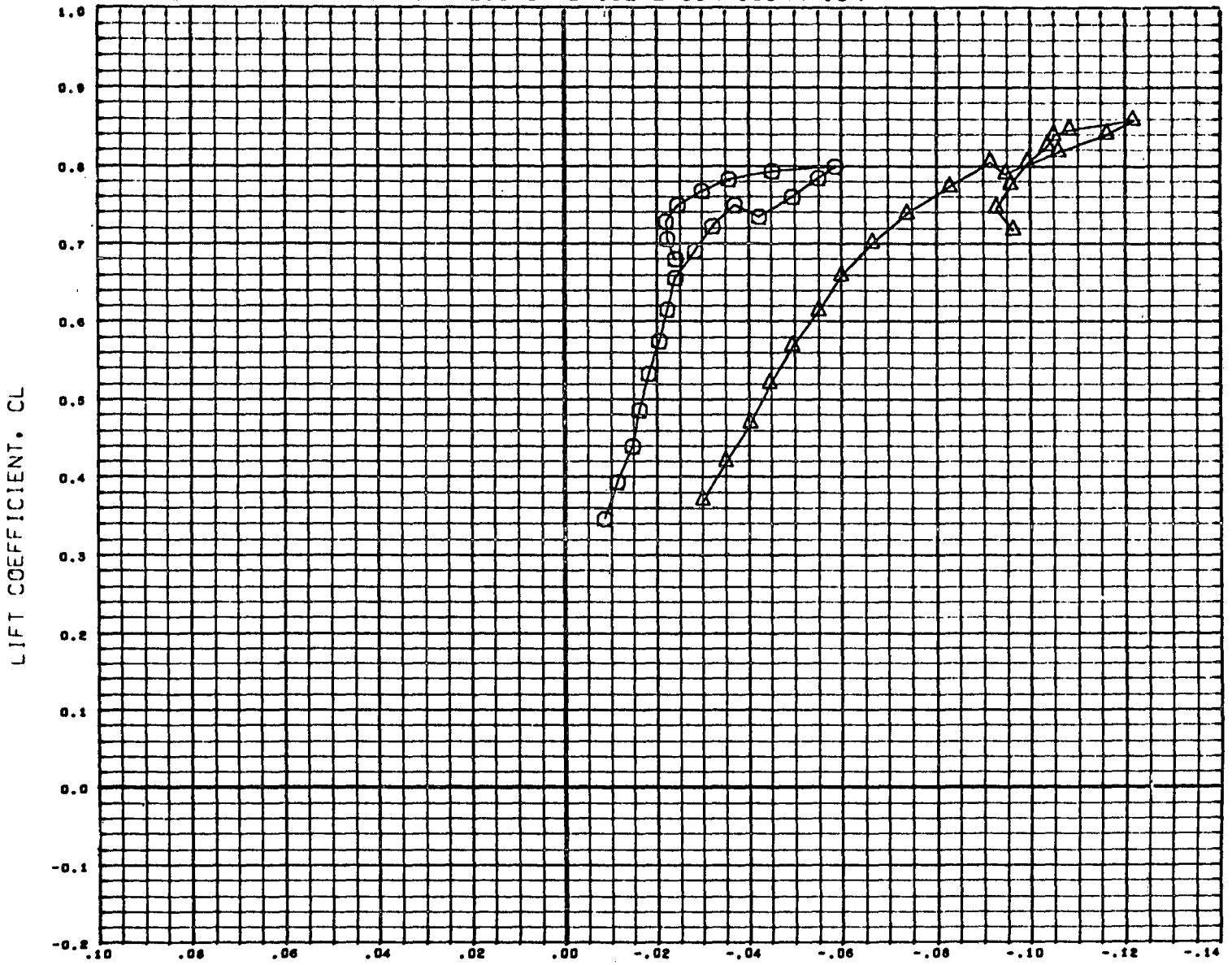

DATA SET SYMBOL	CONFIGURATION DESCRIPTION
(C58080)	MSFC TWT 514 E2 833W25
(C58070)	MSFC TWT 514 E2 833W25

BETA	ELEVTR
0.000	-20.000
0.000	0.000

REFERENCE INFORMATION		
SREF	19.6300	80 INC
LREF	3.2400	INCHES
BREF	6.9300	INCHES
XMRP	2.1110	INCHES
YMRP	0.0000	INCHES
ZMRP	0.0000	INCHES
SCALE	0.0033	

MACH 4.939