

**-SPACE SHUTTLE-**

**GENERAL DYNAMICS/CONVAIR  
SPACE SHUTTLE BOOSTER**

**INVESTIGATION OF  
SUBSONIC STABILITY AND  
CONTROL EFFECTIVENESS**

GENERAL DYNAMICS/CONVAIR  
LOW SPEED WIND TUNNEL

**WIND TUNNEL TEST RESULTS  
DATA REPORT**

NOVEMBER 1970

CONTRACT NAS8-4016

SCHEDULE II

DRL 184-58

AMENDMENT 130

MARSHALL

SPACE FLIGHT CENTER



FACILITY FORM 602	<u>N71-37499</u> (ACCESSION NUMBER)	_____ (THRU)
	<u>548</u> (PAGES)	<u>G3</u> (CODE)
	<u>CR-119963</u> (NASA CR OR TMX OR AD NUMBER)	<u>31</u> (CATEGORY)

**SADSAC SPACE SHUTTLE  
AEROTHERMODYNAMIC  
DATA MANAGEMENT SYSTEM**



Reproduced by  
**NATIONAL TECHNICAL  
INFORMATION SERVICE**  
Springfield, Va. 22151

DMS-DR-1030  
NOVEMBER 1970

SADSAC/SPACE SHUTTLE  
WIND TUNNEL TEST DATA REPORT

CONFIGURATION: General Dynamics/Convair Space Shuttle Booster  
TEST PURPOSE: Investigation of Subsonic Stability and Control Effectiveness  
  
  
TEST FACILITY: General Dynamics/Convair Low Speed Wind Tunnel  
TESTING AGENCY: General Dynamics/Convair  
TEST NO. & DATE: Test No. 579-0/20-28 July 1970  
TEST CONDUCTOR(S): W. Zombek

DATA MANAGEMENT SERVICES

LIAISON: N/A DATA OPERATIONS: J. L. Glynn, Jr.  
J. L. Glynn, Jr.  
Aero Thermo Data Group  
RELEASE APPROVAL: N. D. Kemp  
N. D. Kemp, Supervisor  
Aero Thermo Data Group

This report has been prepared by Chrysler Corporation Space Division under a Data Management Contract to the NASA. Chrysler assumes no responsibility for the data presented herein other than its display characteristics.

## TABLE OF CONTENTS

	<u>PAGE</u>
LIST OF FIGURES	iii
ABSTRACT	1
TEST CONDITIONS	2
DATA REDUCTION	3
CONFIGURATIONS INVESTIGATED	5
CONFIGURATION PARTS NOMENCLATURE	6
DIMENSIONAL DATA	8
DATA SET COLLATIONS	24
TEST FACILITY DESCRIPTION	52
TEST NOMENCLATURE	53
FIGURES	61
DATA DISPLAY INDEX	67
DATA	115
APPENDIX A - LONGITUDINAL TRIM DATA	

LIST OF FIGURES

<u>FIGURE NUMBER</u>	<u>TITLE</u>	<u>PAGE NUMBER</u>
1	Axis systems, showing direction and sense of force and moment coefficients, angle of attack, and sideslip angle	62
2	GD/Convair Straight Wing Space Shuttle Booster	63
3	GD/Convair Delta Wing Space Shuttle Booster	64
4	Photograph of Configuration B1W1-15T1-45	65
5	Photograph of Configuration B7W5V1G2	66



## ABSTRACT

Wind tunnel models (0.0175 scale) of the General Dynamics/Convair straight wing configuration and delta wing configuration Space Shuttle Booster were tested in the General Dynamics/Convair Low Speed Wind Tunnel (Test 579-0) during July 1970 to determine the subsonic stability and control effectiveness. The tests were conducted over a range of dynamic pressures from 50 to 150 lb/ft<sup>2</sup>, Mach numbers from 0.184 to 0.318, and Reynolds numbers from  $1.24 \times 10^6$  to  $2.15 \times 10^6$  per foot. Parameters investigated included wing position, boattail shape, control effectiveness, flap effectiveness, spoiler effectiveness, engine nacelle effect, and comparison of the delta wing and conventional wing.

**TEST CONDITIONS**  
**TEST CV LSWT 579-0**

MACH NUMBER	REYNOLDS NUMBER per unit length	DYNAMIC PRESSURE (pounds/sq. inch)	STAGNATION TEMPERATURE (degrees Fahrenheit)
0.184	$1.24 \times 10^6$	0.347	80 (Nominal)
0.225	$1.52 \times 10^6$	0.521	80 (Nominal)
0.259	$1.75 \times 10^6$	0.694	80 (Nominal)
0.318	$2.15 \times 10^6$	1.042	80 (Nominal)

BALANCE UTILIZED: GD Convair No. C-5-1.50

<b>CAPACITY:</b>	<b>ACCURACY:</b>	<b>COEFFICIENT TOLERANCE:</b>
NF <u>500 lb</u>	<u>                    </u>	<u>                    </u>
SF <u>500 lb</u>	<u>                    </u>	<u>                    </u>
AF <u>140 lb</u>	<u>                    </u>	<u>                    </u>
PM <u>3200 in-lb</u>	<u>                    </u>	<u>                    </u>
YM <u>1200 in-lb</u>	<u>                    </u>	<u>                    </u>
RM <u>1000 in-lb</u>	<u>                    </u>	<u>                    </u>

COMMENTS:

## DATA REDUCTION

Although two basic configurations were tested (conventional wing and delta wing configurations), only one set of reference dimensions were used in the reduction of the wind tunnel data. However, different model moment reference points were used for the conventional wing configuration and the delta wing configuration. The dimensional data are listed below:

$$\begin{aligned} S_{\text{ref}} &= \text{Bl body planform area} = 316.23 \text{ in}^2 \\ l_{\text{ref}} &= \text{Bl body length} = 50.19 \\ b_{\text{ref}} &= \text{Bl body width} = 7.35 \text{ in.} \end{aligned}$$

The moment reference points (see Figures 2 and 3) applicable to the test data are listed below:

<u>Configuration</u>	<u>XMRP(inches aft of station zero)</u>	<u>YMRP(inches away from B.L.zero)</u>	<u>ZMRP(inches away from W.L. =21.0)</u>
Straight Wing	29.392	0.0	0.0
Delta Wing W5 and Body B7	33.909	0.0	0.0

The relationship between the balance moment center and the moment reference point for each configuration is shown in the following sketches:

Conventional wing configuration

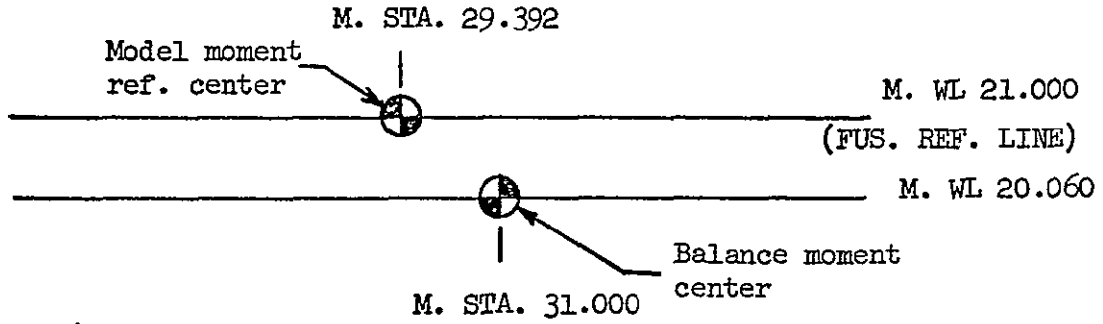

Delta wing configuration

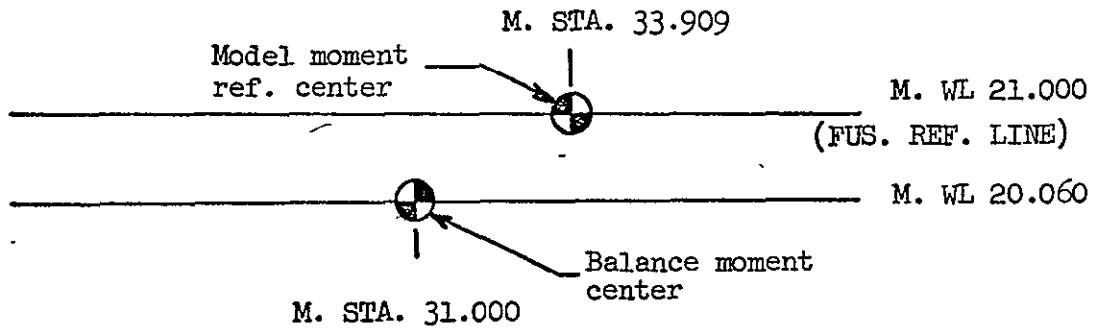

Axial force data were corrected for differences in balance cavity and base pressures.

## CONFIGURATIONS INVESTIGATED

Two basic booster configurations were tested. These are a straight wing configuration, as shown in the three view sketch in Figure 2, and a delta wing configuration shown in Figure 3.

The straight wing configuration was tested with and without landing gear and cruise engines. Runs were made with several afterbody shapes. The effect of wing longitudinal position and wing incidence were investigated as was the effect of Vee-tail roll out angle. A conventional horizontal and vertical tail was also tested. Flap deflections of 25, 35 and 45 degrees and spoiler deflections of 30 and 60 degrees were used. Elevator angles of +10, 0, -10, -20 and -30 degrees and rudder angle of 0, +10, and +20 degrees were tested to determine control effectiveness.

The delta wing configuration was tested with and without cruise engines and landing gear. Directional control effectiveness runs were made for rudder angles of 0, +19 and +20 degrees. The elevons were deflected at angles of +25, 0, -10 and -25 degrees for longitudinal control effectiveness and at angles of 0, +10 and +25 degrees for lateral control effectiveness.

## CONFIGURATION PARTS NOMENCLATURE

### Fuselage

B <sub>1</sub>	Basic body (nose at model sta. - 2.73)
B <sub>4</sub>	Basic body with -13°/-10° contraction boattail
B <sub>5</sub>	Basic body with -17°/+9°/-7° flare boattail
B <sub>6</sub>	Basic body with -17°/+9°/+5° flare boattail
B <sub>7</sub>	Basic body with centerbody removed (Delta wing config.)

### Wings

W <sub>1</sub> <sup>15</sup>	Conventional wing at 15°50' L.E. sweep at basic longitudinal position, with wing fillet.
W <sub>1A</sub> <sup>15</sup>	Conventional wing at 15°50' L.E. sweep at basic longitudinal position, without wing fillets.
W <sub>3A</sub>	Conventional wing at 15°50' L.E. sweep located 4.74% <sub>ref</sub> aft of basic longitudinal position without wing fillet.
W <sub>5</sub>	Delta wing

### Tails

T <sub>1</sub> <sup>55</sup>	— Cambered Vee-tail at 55 degree roll out angle
T <sub>1</sub> <sup>45</sup>	Cambered Vee-tail at 45 degree roll out angle
T <sub>1</sub> <sup>35</sup>	Cambered Vee-tail at 35 degree roll out angle
T <sub>2</sub> <sup>55</sup>	Reverse camber Vee-tail at 55 degrees roll out angle
T <sub>3</sub> <sup>55</sup>	Symmetric airfoil Vee-tail at 55 degrees roll out angle
T <sub>1</sub> <sup>90</sup>	Conventional cambered horizontal tail (roll out angle = 90°)
V <sub>1</sub>	Vertical tail (one panel of T <sub>3</sub> <sup>55</sup> )
V <sub>2</sub>	Vertical tail (aspect ratio = 1.521)

### Cruise Engine Nacelles

E <sub>1</sub>	Flow through nacelles used with conventional wing configuration, engine length = 4.50 in. model scale (4 each)
E <sub>2</sub>	Podded nacelles used with delta wing configuration (2 each)
E <sub>3</sub>	Same as E <sub>1</sub> but with inlets plugged. (4 each)
E <sub>4</sub>	Same as E <sub>1</sub> but with aft portion of engine cut off, engine length = 2.94 in. model scale (4 each)

Cruise Engine Nacelles (continued)

E<sub>5</sub> Same as E<sub>4</sub> but with inlets plugged (4 each)  
E<sub>6</sub> Same as E<sub>4</sub> but upper two engines only.

Flaps

F<sub>1</sub><sup>25</sup> Conventional wing flaps at 25 degree deflection  
F<sub>1</sub><sup>35</sup> Conventional wing flaps at 35 degree deflection  
F<sub>1</sub><sup>45</sup> Conventional wing flaps at 45 degree deflection

Spoiler

S<sub>1</sub><sup>30</sup> Conventional wing spoiler at 30 degrees deflection  
(one side only)  
S<sub>1</sub><sup>60</sup> Conventional wing spoiler at 60 degrees deflection  
(one side only)

Landing Gear

G<sub>1</sub> Main and nose wheel landing gear extended  
G<sub>2</sub> Main and nose wheel landing gear extended  
(delta wing configuration)

Miscellaneous

K<sub>1</sub> Delta wing L.E. strake.

DIMENSIONAL DATA

MODEL COMPONENT: BODY - (B<sub>1</sub>)

---

GENERAL DESCRIPTION: Basic body (nose at model station - 2.73 inches)

---



---



---

DRAWING NUMBER: WT 70-105103 (Sheet 1)

<u>DIMENSIONS:</u>	<u>FULL-SCALE</u>	<u>MODEL SCALE</u>
Length	<u>239.0 ft</u>	<u>50.19 in</u>
Max. Width	<u>35.0 ft</u>	<u>7.35 in</u>
Max. Depth	<u>37.1 ft</u>	<u>7.80 in</u>
Fineness Ratio	<u>6.82</u>	<u>6.82</u>
Area		
Max. Cross-Sectional	<u>                    </u>	<u>                    </u>
Planform	<u>7147.0 sq. ft</u>	<u>316.23 sq. in.</u>
Wetted	<u>                    </u>	<u>                    </u>
Base	<u>913.0 sq. ft</u>	<u>40.276 sq. in.</u>



MODEL COMPONENT: BODY - (B<sub>4</sub>)

GENERAL DESCRIPTION: Basic body with -13°/10° contraction boattail.

---

---

---

DRAWING NUMBER: WT 70-105103 (Sheets 1 and 4)

<u>DIMENSIONS:</u>	<u>FULL-SCALE</u>	<u>MODEL SCALE</u>
Length	<u>239.0 ft</u>	<u>50.19 in</u>
Max. Width	<u>35.0 ft</u>	<u>7.35 in</u>
Max. Depth	<u>36.80 ft</u>	<u>7.80 in</u>
Fineness Ratio	<u>6.82</u>	<u>6.82</u>
Area		
Max. Cross-Sectional	<u>                    </u>	<u>                    </u>
Planform	<u>7079.0 sq. ft</u>	<u>313.206 sq. in.</u>
Wetted	<u>                    </u>	<u>                    </u>
Base	<u>693.0 sq. ft</u>	<u>30.563 sq. in</u>

MODEL COMPONENT: BODY - (B<sub>5</sub>)

GENERAL DESCRIPTION: Basic body with -17°/+9°/-7° flare

---

---

---

DRAWING NUMBER: WT 70-105103 (Sheets 1 and 3)

<u>DIMENSIONS:</u>	<u>FULL-SCALE</u>	<u>MODEL SCALE</u>
Length	<u>239.0 ft</u>	<u>50.19 in</u>
Max. Width	<u>35.0 ft</u>	<u>7.35 in</u>
Max. Depth	<u>36.8 ft</u>	<u>7.80 in</u>
Fineness Ratio	<u>6.82</u>	<u>6.82</u>
Area		
Max. Cross-Sectional	<u>                    </u>	<u>                    </u>
Planform	<u>7232.0 sq. ft.</u>	<u>319.94 sq. in.</u>
Wetted	<u>                    </u>	<u>                    </u>
Base	<u>904.8 sq.ft</u>	<u>39.90 sq. in</u>

MODEL COMPONENT: BODY - (B<sub>6</sub>)

GENERAL DESCRIPTION: Basic body with -17°/+9°/+5°

DRAWING NUMBER: WT 70-105103 (Sheets 1 and 3)

<u>DIMENSIONS:</u>	<u>FULL-SCALE</u>	<u>MODEL SCALE</u>
Length	<u>239.0 ft</u>	<u>50.19 in</u>
Max. Width	<u>35.0 ft</u>	<u>7.35 in</u>
Max. Depth	<u>36.8 ft</u>	<u>7.80 in</u>
Fineness Ratio	<u>6.82</u>	<u>6.82</u>
Area		
Max. Cross-Sectional	<u>                                </u>	<u>                                </u>
Planform	<u>7232.0 sq. ft</u>	<u>319.94 sq. in.</u>
Wetted	<u>                                </u>	<u>                                </u>
Base	<u>1054.4 sq. ft</u>	<u>46.503 sq. in</u>

MODEL COMPONENT: BODY - (B<sub>7</sub>)

GENERAL DESCRIPTION: Basic body with centerbody removed. (Delta wing  
configuration body)

DRAWING NUMBER: WT 70-105103 (Sheets 1 and 5)

<u>DIMENSIONS:</u>	<u>FULL-SCALE</u>	<u>MODEL SCALE</u>
Length	<u>224.0 ft</u>	<u>47.04 in</u>
Max. Width—	<u>35.0 ft</u>	<u>7.35 in</u>
Max. Depth	<u>37.14 ft</u>	<u>7.80 in</u>
Fineness Ratio	<u>6.4</u>	<u>6.4</u>
Area		
Max. Cross-Sectional	<u>                    </u>	<u>                    </u>
Planform	<u>6622.0 sq.ft</u>	<u>292.03 sq. in</u>
Wetted	<u>                    </u>	<u>                    </u>
Base	<u>913.3 sq. ft</u>	<u>42.243 sq.in</u>

MODEL COMPONENT: Wing - ( $W_1^{15}$ ), ( $W_{2A}^{15}$ ), ( $W_3$ ), ( $W_{3A}$ )

GENERAL DESCRIPTION: Conventional straight wing at sweep angles of  $15^{\circ}50'$

DRAWING NUMBER: WF 70-105104

<u>DIMENSIONS:</u>	<u>FULL-SCALE</u>	<u>MODEL SCALE</u>
<u>TOTAL DATA-</u>		
Area		
Planform	<u>2907.0 sq.ft.</u>	<u>128.187 sq. in</u>
Wetted		
Span (equivalent)	<u>142.0 ft</u>	<u>29.82 in</u>
Aspect Ratio	<u>6.937</u>	<u>6.937</u>
Rate of Taper	<u>0.284</u>	<u>0.284</u>
Taper Ratio	<u>0.3405</u>	<u>0.3405</u>
Dihedral Angle, degrees	<u>0°</u>	<u>0°</u>
Incidence Angle, degrees	<u>0°, 3°, 6°</u>	<u>0°, 3°, 6°</u>
Aerodynamic Twist, degrees	<u>0°</u>	<u>0°</u>
Toe-In Angle		
Cant Angle		
Sweep Back Angles, degrees		
Leading Edge	<u>15°50'</u>	<u>15°50'</u>
Trailing Edge		
0.25 Element Line		
Chords:		
Root (Wing Sta. 0.0)	<u>30.538 ft</u>	<u>6.413 in</u>
Tip, (equivalent)	<u>10.40 ft</u>	<u>2.184 in</u>
MAC	<u>22.121 ft</u>	<u>4.646 in</u>
Fus. Sta. of .25 MAC		
W.P. of .25 MAC		
B.L. of .25 MAC		
Airfoil Section		
Root	<u>4416 (mod)</u>	<u>4416 (mod)</u>
Tip	<u>4414 (mod)</u>	<u>4414 (mod)</u>
<u>EXPOSED DATA</u>		
Area	<u>2002.0 sq.ft</u>	<u>88.288 sq.in</u>
Span, (equivalent)	<u>110.0 ft</u>	<u>23.10 in</u>
Aspect Ratio	<u>6.044</u>	<u>6.044</u>
Taper Ratio	<u>0.400</u>	<u>0.400</u>
Chords		
Root	<u>26.0 ft</u>	<u>5.46 in</u>
Tip	<u>10.4 ft</u>	<u>2.184 in</u>
MAC	<u>19.314 ft</u>	<u>4.056 in</u>
Fus. Sta. of .25 MAC		
W.P. of .25 MAC		
B.L. of .25 MAC		

MODEL COMPONENT: Wing - (W<sub>5</sub>)

GENERAL DESCRIPTION: Delta Wing

DRAWING NUMBER: WT 70-105105

<u>DIMENSIONS:</u>	<u>FULL-SCALE</u>	<u>MODEL SCALE</u>
<u>TOTAL DATA</u>		
Area		
Planform	<u>8640 sq. ft</u>	<u>379.842 sq.in</u>
Wetted		
Span (equivalent)	<u>138.0 ft</u>	<u>28.98 in</u>
Aspect Ratio	<u>2.211</u>	<u>2.211</u>
Rate of Taper	<u>1.319</u>	<u>1.319</u>
Taper Ratio	<u>0.1651</u>	<u>0.1651</u>
Diehedral Angle, degrees	<u>5.5°</u>	<u>5.5°</u>
Incidence Angle, degrees	<u>3°</u>	<u>2°</u>
Aerodynamic Twist, degrees	<u>0°</u>	<u>0°</u>
Toe-In Angle		
Cant Angle		
Sweep Back Angles, degrees		
Leading Edge	<u>53°</u>	<u>53°</u>
Trailing Edge	<u>0°</u>	<u>0°</u>
0.25 Element Line		
Chords:		
Root (Wing Sta. 0.0)	<u>109.0 ft</u>	<u>22.890 in</u>
Tip, (equivalent)	<u>18.0 ft</u>	<u>3.78 in</u>
MAC	<u>74.3 ft</u>	<u>15.60 in</u>
Fus. Sta. of .25 MAC		
W.P. of .25 MAC		
B.L. of .25 MAC		
Airfoil Section		
Root	<u>4408</u>	<u>4408</u>
Tip	<u>4408</u>	<u>4408</u>
<u>EXPOSED DATA</u>		
Area	<u>5500 sq.ft</u>	<u>241.442 sq.in</u>
Span, (equivalent)	<u>105.85 ft</u>	<u>22.228 in</u>
Aspect Ratio	<u>2.046</u>	<u>2.046</u>
Taper Ratio	<u>0.207</u>	<u>0.207</u>
Chords		
Root	<u>87.0 ft</u>	<u>18.27 in</u>
Tip	<u>18.0 ft</u>	<u>3.78 in</u>
MAC	<u>60.0 ft</u>	<u>12.61 in</u>
Fus. Sta. of .25 MAC		
W.P. of .25 MAC		
B.L. of .25 MAC		

MODEL COMPONENT: V-Tail-(T<sub>1</sub><sup>90</sup>), (T<sub>1</sub><sup>55</sup>), (T<sub>1</sub><sup>35</sup>)

GENERAL DESCRIPTION: Cambered section Vee tail rolled out at angles of 90°, 55°, 45° and 35° (from vertical plane)

DRAWING NUMBER: WT 70-105106 (Sheet 1)

DIMENSIONS: (Per Panel)

	<u>FULL-SCALE</u>	<u>MODEL SCALE</u>
<u>TOTAL DATA</u>		
Area		
Planform		
Wetted		
Span (equivalent)		
Aspect Ratio		
Rate of Taper		
Taper Ratio		
Diehedral Angle, degrees		
Incidence Angle, degrees		
Aerodynamic Twist, degrees		
Toe-In Angle		
Cant Angle		
Sweep Back Angles, degrees		
Leading Edge		
Trailing Edge		
0.25 Element Line		
Chords:		
Root (Wing Sta. 0.0)		
Tip, (equivalent)		
MAC		
Fus. Sta. of .25 MAC		
W.P. of .25 MAC		
B.L. of .25 MAC		
Airfoil Section		
Root	4416 (Mod)	4416 (Mod)
Tip	4414 (Mod)	4414 (Mod)
<u>EXPOSED DATA</u>		
Area	1179 sq.ft	52.04 sq. in
Span, (equivalent)	42.3 ft	8.883 in
Aspect Ratio	1.58	1.58
Taper Ratio	0.559	0.559
Chords		
Root	35.8 ft	7.518 in
Tip	20.0 ft	4.2 in
MAC	28.6 ft	6.010 in
Fus. Sta. of .25 MAC		
W.P. of .25 MAC		
B.L. of .25 MAC		

MODEL COMPONENT: V-Tail-(T<sub>2</sub><sup>55</sup>)

GENERAL DESCRIPTION: Reverse camber Vee tail rolled out at 55° (from vertical plane)

DRAWING NUMBER: WT 70-105106 (Sheet 1)

DIMENSIONS: (Per Panel) FULL-SCALE      MODEL SCALE

TOTAL DATA

Area		
Planform		
Wetted		
Span (equivalent)		
Aspect Ratio		
Rate of Taper		
Taper Ratio		
Dihedral Angle, degrees		
Incidence Angle, degrees		
Aerodynamic Twist, degrees		
Toe-In Angle		
Cant Angle		
Sweep Back Angles, degrees		
Leading Edge		
Trailing Edge		
0.25 Element Line		
Chords:		
Root (Wing Sta. 0.0)		
Tip, (equivalent)		
MAC		
Fus. Sta. of .25 MAC		
W.P. of .25 MAC		
B.L. of .25 MAC		
Airfoil Section		
Root	4416 (Mod)	4416 (Mod)
Tip	4414 (Mod)	4414 (Mod)

EXPOSED DATA

Area	1179.0 sq. ft	52.04 sq. in
Span, (equivalent)	42.3 ft	8.883 in
Aspect Ratio	1.57	1.57
Taper Ratio	0.559	0.559
Chords		
Root	35.8 ft	7.518 in
Tip	20.0 ft	4.20 in
MAC	28.6 ft	6.016 in
Fus. Sta. of .25 MAC		
W.P. of .25 MAC		
B.L. of .25 MAC		



MODEL COMPONENT: V-Tail - (T<sub>3</sub><sup>55</sup>)

GENERAL DESCRIPTION: Symmetric section Vee tail rolled out at 55° (from vertical plane)

DRAWING NUMBER: WT 70-105106 (Sheet 1)

DIMENSIONS: FULL-SCALE MODEL SCALE

TOTAL DATA

Area		
Planform		
Wetted		
Span (equivalent)		
Aspect Ratio		
Rate of Taper		
Taper Ratio		
Dihedral Angle, degrees		
Incidence Angle, degrees		
Aerodynamic Twist, degrees		
Toe-In Angle		
Cant Angle		
Sweep Back Angles, degrees		
Leading Edge		
Trailing Edge		
0.25 Element Line		
Chords:		
Root (Wing Sta. 0.0)		
Tip, (equivalent)		
MAC		
Fus. Sta. of .25 MAC		
W.P. of .25 MAC		
B.L. of .25 MAC		
Airfoil Section		
Root	0016 (Mod)	0016 (Mod)
Tip	0014 (Mod)	0014 (Mod)

EXPOSED DATA

Area	1179 sq.ft	52.04 sq.in
Span, (equivalent)	42.3 ft	8.803 in
Aspect Ratio	1.57	1.57
Taper Ratio	0.559	0.559
Chords		
Root	35.8 ft	7.518 in
Tip	20.0 ft	2.20 in
MAC	28.0 ft	6.016 in
Fus. Sta. of .25 MAC		
W.P. of .25 MAC		
B.L. of .25 MAC		

MODEL COMPONENT: Vertical Tail - (V<sub>1</sub>)

GENERAL DESCRIPTION: Symmetric section vertical tail

DRAWING NUMBER: WT 70-105106 (Sheet 1)

DIMENSIONS: FULL-SCALE MODEL SCALE

TOTAL DATA

Area		
Planform		
Wetted		
Span (equivalent)		
Aspect Ratio		
Rate of Taper		
Taper Ratio		
Dihedral Angle, degrees		
Incidence Angle, degrees		
Aerodynamic Twist, degrees		
Toe-In Angle		
Cant Angle		
Sweep Back Angles, degrees		
Leading Edge		
Trailing Edge		
0.25 Element Line		
Chords:		
Root (Wing Sta. 0.0)		
Tip, (equivalent)		
MAC		
Fus. Sta. of .25 MAC		
W.P. of .25 MAC		
B.L. of .25 MAC		
Airfoil Section		
Root	0016 (Mod)	0016 (Mod)
Tip	0014 (Mod)	0014 (Mod)

EXPOSED DATA

Area	1179 sq ft	52.04 sq. in
Span, (equivalent)	42.3 ft	8.883 in
Aspect Ratio	1.57	1.57
Taper Ratio	0.559	0.559
Chords		
Root	35.80 ft	7.518 in
Tip	200 ft	4.200 in
MAC	280 ft	6.010 in
Fus. Sta. of .25 MAC		
W.P. of .25 MAC		
B.L. of .25 MAC		

MODEL COMPONENT: Vertical Tail - (V<sub>2</sub>)

GENERAL DESCRIPTION: Sheet metal tail

DRAWING NUMBER: \_\_\_\_\_

DIMENSIONS: FULL-SCALE MODEL SCALE

TOTAL DATA

Area		
Planform	_____	_____
Wetted	_____	_____
Span (equivalent)	_____	_____
Aspect Ratio	_____	_____
Rate of Taper	_____	_____
Taper Ratio	_____	_____
Dihedral Angle, degrees	_____	_____
Incidence Angle, degrees	_____	_____
Aerodynamic Twist, degrees	_____	_____
Toe-In Angle	_____	_____
Cant Angle	_____	_____
Sweep Back Angles, degrees	_____	_____
Leading Edge	_____	_____
Trailing Edge	_____	_____
0.25 Element Line	_____	_____
Chords:		
Root (Wing Sta. 0.0)	_____	_____
Tip, (equivalent)	_____	_____
MAC	_____	_____
Fus. Sta. of .25 MAC	_____	_____
W.P. of .25 MAC	_____	_____
B.L. of .25 MAC	_____	_____
Airfoil Section	_____	_____
Root	_____	_____
Tip	_____	_____

EXPOSED DATA

Area	<u>1141 sq. ft</u>	<u>50.313 sq. in</u>
Span, (equivalent)	<u>41.6 ft</u>	<u>8.75 in</u>
Aspect Ratio	<u>1.521</u>	<u>1.521</u>
Taper Ratio	<u>0.1892</u>	<u>0.1892</u>
Chords		
Root	<u>460 ft</u>	<u>9.67 in</u>
Tip	<u>8.71 ft</u>	<u>1.83 in</u>
MAC	<u>31.05 ft</u>	<u>6.05 in</u>
Fus. Sta. of .25 MAC	_____	_____
W.P. of .25 MAC	_____	_____
B.L. of .25 MAC	_____	_____

MODEL COMPONENT: Elevon

GENERAL DESCRIPTION: Elevon fan delta wing

DRAWING NUMBER: WT 70-105105

<u>DIMENSIONS:</u> (Per Paral)	<u>FULL-SCALE</u>	<u>MODEL SCALE</u>
Area	<u>765 sq.ft</u>	<u>33.65 sq.in</u>
Span (equivalent)	<u>51.76 ft</u>	<u>10.87 in</u>
Inb'd equivalent chord	<u>18.51 ft</u>	<u>3.888 in</u>
Outb'd equivalent chord	<u>11.00 ft</u>	<u>2.310 in</u>
Ratio Elevon chord/wing chord		
At Inb'd equiv. chord	<u>0.668</u>	<u>0.668</u>
At Outb'd equiv. chord	<u>0.215</u>	<u>0.215</u>
Sweep Back Angles, degrees		
Leading Edge	<u>9.3°</u>	<u>9.3°</u>
Tailing Edge	<u>0°</u>	<u>0°</u>
Hingeline	<u>8.26°</u>	<u>8.26°</u>
Area Moment (Normal to hinge line)	<u>                    </u>	<u>                    </u>

MODEL COMPONENT: Rudder or ruddervator

GENERAL DESCRIPTION: Used as rudder for V<sub>1</sub> and as ruddervator for Vee-tail

DRAWING NUMBER: WT 70-105106 (Sheet 1)

<u>DIMENSIONS:</u> (Per Panel)	<u>FULL-SCALE</u>	<u>MODEL SCALE</u>
Area	<u>372.1 sq.ft</u>	<u>16.41 sq.in</u>
Span (equivalent)	<u>42.3 ft</u>	<u>8.883 in</u>
Inb'd equivalent chord	<u>12.09 ft</u>	<u>2.539 in</u>
Outb'd equivalent chord	<u>6.76 ft</u>	<u>1.419 in</u>
Ratio Ruddervator chord/Vee-tail chord		
At Inb'd equiv. chord	<u>0.35</u>	<u>0.35</u>
At Outb'd equiv. chord	<u>0.35</u>	<u>0.35</u>
Sweep Back Angles, degrees		
Leading Edge	<u>38.0°</u>	<u>38.0°</u>
Tailing Edge	<u>32.5°</u>	<u>32.5°</u>
Hingeline	<u>37.13°</u>	<u>37.13°</u>
Area Moment (Normal to hinge line)	<u>          </u>	<u>          </u>

MODEL COMPONENT: Flaps - ( $F_1^{25}$ ), ( $F_1^{35}$ ), ( $F_1^{45}$ )

GENERAL DESCRIPTION: Conventional wing flaps at 28°, 37°, and 48°  
settings.

DRAWING NUMBER: WT 70-105104

<u>DIMENSIONS:</u> (Total)	<u>FULL-SCALE</u>	<u>MODEL SCALE</u>
Area	<u>513.3 sq. ft</u>	<u>22.64 sq. in</u>
Span (equivalent)	<u>104.75 ft</u>	<u>21.998 in</u>
Inb'd equivalent chord	<u>6.95 ft</u>	<u>1.457 in</u>
Outb'd equivalent chord	<u>2.86 ft</u>	<u>0.601 in</u>
Ratio Flap chord/wing chord		
At Inb'd equiv. chord	<u>0.109</u>	<u>0.109</u>
At Outb'd equiv. chord	<u>0.660</u>	<u>0.660</u>
Sweep Back Angles, degrees		
Leading Edge	<u>0°</u>	<u>0°</u>
Tailing Edge	<u>0°</u>	<u>0°</u>
Hingeline	<u>0°</u>	<u>0°</u>
Area Moment (Normal to hinge line)	<u>                    </u>	<u>                    </u>

MODEL COMPONENT: Spoiler - (S<sub>1</sub><sup>30</sup>), (S<sub>1</sub><sup>60</sup>)

GENERAL DESCRIPTION: Conventional wing spoiler (one side only) at 30° and  
60° deflection.

DRAWING NUMBER: WT 70-105104

<u>DIMENSIONS:</u>	<u>FULL-SCALE</u>	<u>MODEL SCALE</u>
Area	<u>35.8 sq.ft</u>	<u>1.572 sq.in</u>
Span (equivalent)	<u>16.57 ft</u>	<u>3.48 in</u>
Inb'd equivalent chord	<u>2.83 ft</u>	<u>0.594 in</u>
Outb'd equivalent chord	<u>1.95 ft</u>	<u>0.410 in</u>
Ratio Elevator chord/horizontal tail chord		
At Inb'd equiv. chord	<u>                    </u>	<u>                    </u>
At Outb'd equiv. chord	<u>                    </u>	<u>                    </u>
Sweep Back Angles, degrees		
Leading Edge	<u>                    </u>	<u>                    </u>
Trailing Edge	<u>2°</u>	<u>2°</u>
Hingeline	<u>5.4°</u>	<u>5.4°</u>
Area Moment (Normal to hinge line)	<u>                    </u>	<u>                    </u>

TEST CV LSWT 579-0 DATA SET COLLATION SHEET

PRETEST  
 POSTTEST

DATA SET IDENTIFIER	CONFIGURATION	SCHD.		CONTROL DEFLECTION			NO. of RUNS	MACH NUMBERS									
		$\alpha$	$\beta$	$\delta_{er}$	$\delta_{rr}$				.184	.225	.259	.318					
RC7001	B, W, <sup>15</sup> T, <sup>55</sup>	A	0	0	0		3	5		7	6						
RC7002	↓	B	-8	0	0		1			9							
RC7003	↓	B	-4	0	0		1			8							
RC7004	B, W, <sup>15</sup> T, <sup>55</sup> F, <sup>35</sup> G,	A	0	0	0		1			10							
RC7005	B, W, <sup>15</sup> T, <sup>55</sup> F, <sup>15</sup> S, <sup>30</sup> G,	A	0	0	0		2	11	12								
RC7006	↓	B	-4	0	0		1			13							
RC7007	B, W, <sup>15</sup> T, <sup>55</sup> S, <sup>30</sup> G,	A	0	0	0		1			14							
RC7008	B, W, <sup>15</sup> T, <sup>55</sup> S, <sup>60</sup> G,	A	0	0	0		1			15							
RC7009	↓	B	-4	0	0		1			16							
RC7010	B, W, <sup>15</sup> T, <sup>55</sup> F, <sup>25</sup> G,	A	0	0	0		1			17							42
RC7011	B, W, <sup>15</sup> T, <sup>55</sup> F, <sup>45</sup> G,	A	0	0	0		1	18									
RC7012	↓	B	-8	0	0		1	20									
RC7013	↓	B	-4	0	0		1	21									
RC7014	↓	A	0	-10	0		1	22									
RC7015	↓	A	0	0	+10		1	23									
RC7016	↓	B	-8	0	+10		1	24									
RC7017	↓	B	-4	0	+10		1	25									
RC7018	↓	A	0	-20	0		1	26									
RC7019	↓	A	0	0	+20		1	27									
RC7020	↓	B	-8	0	+20		1	28									

1	1	13	19	25	31	37	43	49	55	61	67	75	76
C.L.M.	IC.N.	IC.L.N.	IC.Y.	IC.S.L.	IC.A.	IC.B.	IC.L.	IC.D.	L/D	MACH	ALPHA	10	
COLFFIC ILNTS;										IDPVAR(1) IDPVAR(2) NDV			
" or $\beta$										A $\alpha = -6$ TO $+18$ DEG $\Delta\alpha = 2$ DEG			
SCHEDULES										B $\alpha = 0$ TO $+16$ DEG $\Delta\alpha = 4$ DEG			
										C $\alpha = 0$ TO $+24$ DEG $\Delta\alpha = 4$ DEG			



TEST CV LSWT 579-0 DATA-SET COLLATION SHEET

PRETEST  
 POSTTEST

DATA SET IDENTIFIER	CONFIGURATION	SCHD.		CONTROL DEFLECTION				NO. of RUNS	MACH NUMBERS										
		$\alpha$	$\beta$	$\delta_{er}$	$\delta_{rr}$														
RC7021	B, W, <sup>15</sup> T, <sup>55</sup> F, <sup>45</sup> G,	B	-4	0	+20			1	.184	.225	.259	.318							
RC7022	↓	A	0	-30	0			1	29										
RC7023	↓	A	0	+10	0			1	30										
RC7024	B, W, <sup>15</sup> T, <sup>55</sup>	A	0	+10	0			1	31										
RC7025	↓	A	0	-10	0			1			32								
RC7026	↓	A	0	0	+10			1			33								
RC7027	↓	B	-8	0	+10			1			34								
RC7028	↓	B	-4	0	+10			1			35								
RC7029	↓	A	0	-20	0			1			36								
RC7030	↓	A	0	0	+20			1			37								
RC7031	↓	B	-8	0	+20			1			38								25
RC7032	↓	B	-4	0	+20			1			39								
RC7033	↓	A	0	-30	0			1			40								
RC7034	B, W, <sup>15</sup> T, <sup>55</sup> F, <sup>45</sup>	A	0	0	0			1			41								
RC7035	↓	B	-4	0	0			1	42										
RC7036	B, W, <sup>15</sup> T, <sup>55</sup> F, <sup>45</sup> E,	A	0	0	0			1	43										
RC7037	↓	B	-4	0	0			1	44										
RC7038	B, W, <sup>15</sup> T, <sup>55</sup> E,	A	0	0	0			1	45										
RC7039	↓	B	-4	0	0			1			46								
RC7040	B, W, <sup>15</sup>	A	0					1			47								
								1			48								

1 1 13 19 25 31 37 43 49 55 61 67 75 76  
 C.L.M. IC.N. IC.LN. IC.Y. IC.SL. IC.A. IC.AB. IC.L. IC.D. L/D MACH. ALPHA 10

COEFFICIENTS:  $A\alpha = -6$  TO  $+18$  DEG  $\Delta\alpha = 2$  DEG  $\rightarrow$  IDPVAR(1) | IDPVAR(2) | NDV  
 u or  $\beta$   $B\alpha = 0$  TO  $+16$  DEG  $\Delta\alpha = 4$  DEG  
 SCHEDULES  $C\alpha = 0$  TO  $+24$  DEG  $\Delta\alpha = 4$  DEG

TEST CV LSMT 579-0 DATA SET COLLATION SHEET

PRETEST  
 POSTTEST

DATA SET IDENTIFIER	CONFIGURATION	SCHD.		CONTROL DEFLECTION			NO. of RUNS	MACH NUMBERS										
		u	β	δ <sub>er</sub>	δ <sub>rr</sub>	δ <sub>α</sub>		.184	.225	.259	.318							
RC7041	B, W, <sup>15</sup>	B	-8				1											
RC7042	↓	B	-4				1											
RC7043	B, W, <sup>15</sup> F, <sup>45</sup>	A	0				1											
RC7044	↓	B	-4				1	51										
RC7045	B, W, <sup>15</sup> T, <sup>45</sup>	A	0	0	0		1											
RC7046	↓	B	-4	0	0		1											
RC7047	B, W, <sup>15</sup> T, <sup>35</sup>	A	0	0	0		1											
RC7048	↓	B	-4	0	0		1											
RC7049	B, W, <sup>15</sup> T, <sup>90</sup> V, <sup>1</sup>	A	0	0		0	1											
RC7050	↓	B	-4	C		0	1											26
RC7051	↓	A	0	10		0	1											
RC7052	↓	A	0	10		0	1											
RC7053	B, W, <sup>15</sup> T, <sup>90</sup> V, F, <sup>45</sup>	A	0	110		0	1	61										
RC7054	↓	A	0	-10		0	1	62										
RC7055	↓	A	0	0		0	1	63										
RC7056	↓	B	-4	0		0	1	64										
RC7057	B, W, <sup>15</sup> T, <sup>90</sup>	A	0	C			1											
RC7058	↓	B	-4	0			1											
RC7059	B, W, <sup>15</sup> E, <sup>1</sup>	A	0															
RC7060	B, W, <sup>15</sup> E, <sup>3</sup>	A	0															

C, L, M	16N	17N	18N	19N	20N	21N	22N	23N	24N	25N	26N	27N	28N	29N	30N	31N	32N	33N	34N
C, L, M	16N	17N	18N	19N	20N	21N	22N	23N	24N	25N	26N	27N	28N	29N	30N	31N	32N	33N	34N
COEFFICIENTS: $\alpha = -6$ TO $+18$ DEG $\Delta\alpha = 2$ DEG																			
" or β SCH DUALS $\alpha = 0$ TO $+16$ DEG $\Delta\alpha = 4$ DEG																			
$\alpha = 0$ TO $+24$ DEG $\Delta\alpha = 4$ DEG																			

TEST CV LSWT 579-0 DATA SET COLLATION SHEET

PRETEST  
 POSTTEST

DATA SET IDENTIFIER	CONFIGURATION	SCHD.		CONTROL DEFLECTION				NO. of RUNS	MACH NUMBERS													
		α	β	δ <sub>cr</sub>	δ <sub>rr</sub>					.184	.225	.259	.318									
RC7061	B, W <sub>1</sub> , T <sub>1</sub> <sup>55</sup> , E <sub>2</sub>	A	0	0	0			1				69										
RC7062	B, W <sub>1</sub> , T <sub>1</sub> <sup>55</sup>	A	0	0	0			1				70										
RC7063	B, W <sub>1A</sub> , T <sub>1</sub> <sup>55</sup>	A	0	0	0			1				71										
RC7064	B, W <sub>2A</sub> , T <sub>1</sub> <sup>55</sup>	A	0	0	0			1				72										
RC7065	B, W <sub>3A</sub>	A	0					1				73										
RC7066	↓	A	0					1				74										
RC7067	B, W <sub>2A</sub> , T <sub>1</sub> <sup>55</sup>	A	0	0	0			1				75										
RC7068	↓	A	0	0	0			1				76										
RC7069	↓	B	-4	0	0			1				77										
RC7070	B, W <sub>3A</sub> , T <sub>1</sub> <sup>55</sup> , E <sub>2</sub>	A	0	0	0			1				78										
RC7071	B, W <sub>3A</sub> , T <sub>1</sub> <sup>55</sup> , E <sub>1</sub>	A	0	0	0			1				79										27
RC7072	B, W <sub>3A</sub> , E <sub>1</sub>	A	0					1				80										
RC7073	B, W <sub>3A</sub> , E <sub>2</sub>	A	0					1				81										
RC7074	B, W <sub>3A</sub> , E <sub>3</sub>	A	0					1				82										
RC7075	B, W <sub>3A</sub> , E <sub>4</sub>	A	0					1				83										
RC7076	B, W <sub>3A</sub>	A	0					1				84										
RC7077	B, T <sub>1</sub> <sup>55</sup>	A	0	0	0			1				85										
RC7078	↓	B	-4	0	0			1				86										
RC7079	B,	A	0					1				87										
RC7080	↓	B	-4					1				88										

1	1	13	19	25	31	37	43	49	55	61	67	75	76
CLM	ICN	ICLN	ICY	ICSL	CA	CAB	ICL	ICD	L/D	MACH	ALPHA	10	

COEFFICIENTS:

α or β  
 SCHEDULES

Aα = -6 TO +18 DEG	Δα = 2 DEG
Bα = 0 TO +16 DEG	Δα = 4 DEG
Cα = 0 TO +24 DEG	Δα = 4 DEG

⇒ IDPVAR(1) | IDPVAR(2) | NDV

TEST CVLSWT 579-0 DATA SET COLLATION SHEET

PRETEST  
 POSTTEST

DATA SET IDENTIFIER	CONFIGURATION	SCHD.		CONTROL DEFLECTION				NO. of RUNS	MACH NUMBERS								
		$\alpha$	$\beta$	$\delta_{ee}$	$\delta_{ae}$	$\delta_r$				.184	.225	.259	.318				
RC7081	$B_1 W_5 V, E_4$	A	0	0	0	0		1			89						
RC7082	↓	B	-8	0	0	0		1			90						
RC7083	$B_7 W_5 V,$	C	0	0	0	0		1			91						
RC7084		B	-8	0	0	0		1			92						
RC7085		B	-4	0	0	0		1			93						
RC7086		C	0	0	0	+10		1			94						
RC7087		B	-4	0	0	+10		1			95						
RC7088		C	0	0	0	+20		1			96						
RC7089		B	-4	0	0	+20		1			97						
RC7090		C	0	-10	0	0		1			98						28
RC7091		C	0	0	+10	0		1			99						
RC7092		B	-4	0	+10	0		1			100						
RC7093		C	0	-25	0	0		1			101						
RC7094		C	0	0	+25	0		1			102						
RC7095		B	-4	0	+25	0		1			103						
RC7096	↓	C	0	+25	0	0		1			104						
RC7097	$B_7 W_5 V, K_1$	C	0	0	0	0		1			105						
RC7098	$B_7 W_5 V, G_2$	C	0	0	0	0		1			106						
RC7099	↓	B	-4	0	0	0		1			107						
RC7100	$B_7 W_5 V, E_2 G_2$	C	0	0	0	0		1			108						

1	1	11	19	25	31	37	43	49	55	61	67	75	76
CLM	ICN	ICLN	ICY	ICSL	CA	CAB	ICL	CD	L/D	MACH	ALPHA	10	

COEFFICIENTS:

" or  $\beta$

SCHEDULES

$A \alpha = -6$ TO $+18$ DEG	$\Delta \alpha = 2$ DEG	IDPVAR(1) IDPVAR(2) INDV
$B \alpha = 0$ TO $+16$ DEG	$\Delta \alpha = 4$ DEG	
$C \alpha = 0$ TO $+24$ DEG	$\Delta \alpha = 4$ DEG	

TEST CV LSWT 579-0 DATA SET COLLATION SHEET

PRETEST

POSTTEST

DATA SET IDENTIFIER	CONFIGURATION	SCHD.		CONTROL DEFLECTION			NO. OF RUNS	MACH NUMBERS										
		$\alpha$	$\beta$	$\delta_{cc}$	$\delta_{ac}$	$\delta_r$		.184	.225	.259	.318							
RC7101	B <sub>7</sub> W <sub>5</sub> V <sub>1</sub> E <sub>2</sub> G <sub>2</sub>	B	-4	0	0	0	1				109							
RC7102	B <sub>7</sub> W <sub>5</sub> V <sub>1</sub> E <sub>2</sub>	C	0	0	0	0	1				110							
RC7103	↓	B	-4	0	0	0	1				111							
RC7104	B <sub>7</sub> W <sub>5</sub> V <sub>1</sub> E <sub>4</sub>	C	0	0	0	0	1				112							
RC7105	↓	B	-4	0	0	0	1				113							
RC7106	B <sub>7</sub> W <sub>5</sub> V <sub>1</sub> E <sub>6</sub>	C	0	0	0	0	1				114							
RC7107	↓	B	-4	0	0	0	1				115							
RC7108	B <sub>7</sub> W <sub>5</sub>	B	-4	0	0		1				116							
RC7109	↓	C	0	0	0		1				117							
RC7110	B <sub>7</sub> W <sub>5</sub> V <sub>2</sub>	C	0	0	0	0	1				118							62
RC7111	↓	B	-8	0	0	0	1				119							
RC7112	↓	B	-4	0	0	0	1				120							
RC7113	B <sub>7</sub>	A	0				1				121							
RC7114	↓	B	-8				1				122							
RC7115	↓	B	-4				1				123							

1	1	13	19	25	31	37	43	49	55	61	67	75	76
C.L.M.	ICN	ICLN	ICY	ICSL	ICA	CAB	CL	CD	L/D	MACH	ALPHA	10	

COEFFICIENTS:

$\alpha$  or  $\beta$

SCHEDULES

A $\alpha$ = -6 TO +18 DEG	$\Delta\alpha$ = 2 DEG
B $\alpha$ = 0 TO +16 DEG	$\Delta\alpha$ = 4 DEG
C $\alpha$ = 0 TO +24 DEG	$\Delta\alpha$ = 4 DEG

⇒ IDPVAR(1) | IDPVAR(2) | NDV

TEST CV LSWT 579-0 DATA SET COLLATION SHEET

PRETEST

POSTTEST

DATA SET IDENTIFIER	CONFIGURATION	SCHD.		CONTROL DEFLECTION			NO. of RUNS	MACH NUMBERS												
		u	β	δ <sub>er</sub>	δ <sub>αα</sub>	δ <sub>α</sub>		.184	.225	.259	.318									
RC7116	B <sub>1</sub> W <sub>3A</sub> T <sub>2</sub> <sup>55</sup>	A	0	0	0		1				124									
RC7117	↓	B	-4	0	0		1				125									
RC7118	B <sub>1</sub> W <sub>3A</sub> T <sub>3</sub> <sup>55</sup>	A	0	0	0		1				126									
RC7119	↓	B	-4	0	0		1				127									
RC7120	B <sub>4</sub> W <sub>3A</sub>	A	0				1				128									
RC7121	↓	B	-4				1				129									
RC7122	B <sub>4</sub> W <sub>3A</sub> T <sub>1</sub> <sup>55</sup>	A	0	0	0		1				130									
RC7123	↓	B	-4	0	0		1				131									
RC7124	B <sub>5</sub> W <sub>3A</sub> T <sub>1</sub> <sup>55</sup>	A	0	0	0		1				132									
RC7125	↓	B	-4	0	0		1				133									30
RC7126	B <sub>5</sub> W <sub>3A</sub>	A	0				1				134									
RC7127	↓	B	-4				1				135									
RC7128	B <sub>6</sub> W <sub>3A</sub>	A	0				1				136									
RC7129	↓	B	-4				1				137									
RC7130	B <sub>6</sub> W <sub>3A</sub> T <sub>1</sub> <sup>55</sup>	A	0	0	0		1				138									
RC7131	↓	B	-4	0	0		1				139									
RC7132	B <sub>1</sub> W <sub>3A</sub> T <sub>1</sub> <sup>55</sup>	A	0	-10	0		1				140									
RC7133	B <sub>1</sub> W <sub>3A</sub> T <sub>1</sub> <sup>55</sup> F <sub>1</sub> <sup>35</sup>	A	0	-10	0		1	141												
RC7134	B <sub>1</sub> W <sub>3A</sub> T <sub>1</sub> <sup>90</sup> V <sub>1</sub> <sup>35</sup>	A	0	-10	0		1	142												

1	1	11	19	25	31	37	43	49	55	61	67	75,76
CLM	ICN	ICLN	ICY	ICSL	CA	CAB	CL	CD	L/D	MACH	ALPHA	10

COEFFICIENTS:

u or β  
SCHDULLS

Aα = -6 TO +18 DEG	Δα = 2 DEG	=>  IDPVAR(1)   IDPVAR(2)   NDV
Bα = 0 TO +16 DEG	Δα = 4 DEG	
Cα = 0 TO +14 DEG	Δα = 7 DEG	

TEST CV LSWT 579-0 DATA SET DESCRIPTOR SHEET

DATA SET IDENTIFIER	DATA SET DESCRIPTOR				Node Type	CURVE SLOPE RANGE		
	11	21	31	41		51 LOWER LIMIT	61 UPPER LIMIT	
RC7001	C.V.L.S.W.T.	T.E.S.I.T.	579-0	B.I.W.I.-1.5	T.I.-5.5	1,1	-2.5	2.5
RC7002						1,1	0.0	5.0
RC7003						1,1	0.0	5.0
RC7004	C.V.L.S.W.T.	T.E.S.I.T.	579-0	B.I.W.I.-1.5	T.I.-5.5	F.I.-3.5	G.I.	3.5
RC7005	C.V.L.S.W.T.	T.E.S.I.T.	579-0	B.I.W.I.-1.5	T.I.-5.5	F.I.-4.5	S.I.-3.0	G.I.
RC7006						1,1	0.0	5.0
RC7007	C.V.L.S.W.T.	T.E.S.I.T.	579-0	B.I.W.I.-1.5	T.I.-5.5	S.I.-3.0	G.I.	2.5
RC7008	C.V.L.S.W.T.	T.E.S.I.T.	579-0	B.I.W.I.-1.5	T.I.-5.5	S.I.-6.0	G.I.	2.5
RC7009						1,1	0.0	5.0
RC7010	C.V.L.S.W.T.	T.E.S.I.T.	579-0	B.I.W.I.-1.5	T.I.-5.5	F.I.-2.5	G.I.	3.0
RC7011	C.V.L.S.W.T.	T.E.S.I.T.	579-0	B.I.W.I.-1.5	T.I.-5.5	F.I.-4.5	G.I.	3.0
RC7012						1,1	0.0	5.0
RC7013						1,1	0.0	5.0
RC7014						1,1	-2.5	3.0
RC7015						1,1	-2.5	3.0
RC7016						1,1	0.0	5.0
RC7017						1,1	0.0	5.0
RC7018						1,1	-2.5	3.0
RC7019						1,1	-2.5	3.0
RC7020						1,1	0.0	5.0

31

1	SREF(1)	11	SRLF(2)	21	LREF(1)	31	LREF(2)	41	BREF(1)	51	BREF(2)	61	XMRP(1)	71	XMRP(2)
	3.16	.23	1.50	1.19	1.1	1.1	1.1	1.1	1.1	1.1	1.1	1.1	2.9	3.92	1.1
	0.0	1.1	1.1	1.1	1.1	1.1	1.1	1.1	1.1	1.1	1.1	1.1	1.1	1.1	1.1
	YMRP(1)	YMRP(2)	ZMRP(1)	ZMRP(2)	SCALE(1)	SCALE(2)	EOMVAIR TN70-AE-12								
							FILREF								

TEST CVLSWT 579-0 DATA SET DESCRIPTOR SHEET

DATA SET IDENTIFIER	DATA SET DESCRIPTOR				Code Type	CURVE SLOPE RANGE				
	11	21	31	41		51 LOWER LIMIT	61 UPPER LIMIT			
RC7021	C.V.L.S.W.T.	T.E.S.T.	579-0	B.I.W.I.-1.5	T.I.-55	F.I.-4.5	G.I.	1,1	0.0	5.0
RC7022								1,1	-2.5	3.0
RC7023								1,1	-2.5	3.0
RC7024	C.V.L.S.W.T.	T.E.S.T.	579-0	B.I.W.I.-1.5	T.I.-55			1,1	-2.5	2.5
RC7025								1,1	-2.5	3.0
RC7026								1,1	-2.5	3.0
RC7027								1,1	0.0	5.0
RC7028								1,1	0.0	5.0
RC7029								1,1	-2.5	3.0
RC7030								1,1	-2.5	3.0
RC7031								1,1	0.0	5.0
RC7032								1,1	0.0	5.0
RC7033								1,1	-2.5	3.0
RC7034	C.V.L.S.W.T.	T.E.S.T.	579-0	B.I.W.I.-1.5	T.I.-55	F.I.-4.5		1,1	-2.5	3.0
RC7035								1,1	0.0	5.0
RC7036	C.V.L.S.W.T.	T.E.S.T.	579-0	B.I.W.I.-1.5	T.I.-55	F.I.-4.5	E.I.	1,1	-2.5	3.0
RC7037								1,1	0.0	5.0
RC7038	C.V.L.S.W.T.	T.E.S.T.	579-0	B.I.W.I.-1.5	T.I.-55	E.I.		1,1	-2.5	3.0
RC7039								1,1	0.0	5.0
RC7040	C.V.L.S.W.T.	T.E.S.T.	579-0	B.I.W.I.-1.5				1,1	-2.5	3.0

32

1	SRLF(1)	11	SRLF(2)	21	LREF(1)	31	LREF(2)	41	BREF(1)	51	BREF(2)	61	XMRP(1)	71	XMRP(2)
	316.23		1.50		1.14		1.14		17.35		1.14		29.392		1.14
	0.0		1.14		10.0		1.14		10.0		1.14		CONVAIR		T.M.P.-AE-12
	Y.MRP(1)		Y.MRP(2)		Z.MRP(1)		Z.MRP(2)		SCALE(1)		SCALE(2)		FILE REF		



TEST CV LSWT 579-0 DATA SET DESCRIPTOR SHEET

DATA SET IDENTIFIER	DATA SET DESCRIPTOR				Slope Type	CURVE SLOPE RANGE	
	11	21	31	41		51 LOWER LIMIT	61 UPPER LIMIT
RC7041	C.V.L.S.W.T.	T.E.S.I.T. 5.791-0	B.I.W.I.-1.5		1.1	0.0	5.0
RC7042		↓			1.1	0.0	5.0
RC7043	C.V.L.S.W.T.	T.E.S.I.T. 5.791-0	B.I.		1.1	-2.5	3.0
RC7044		↓			1.1	0.0	5.0
RC7045	C.V.L.S.W.T.	T.E.S.I.T. 5.791-0	B.I.W.I.-1.5	T.I.-4.5	1.1	-2.5	2.5
RC7046		↓			1.1	0.0	5.0
RC7047	C.V.L.S.W.T.	T.E.S.I.T. 5.791-0	B.I.W.I.-1.5	T.I.-3.5	1.1	-2.5	3.0
RC7048		↓			1.1	0.0	5.0
RC7049	C.V.L.S.W.T.	T.E.S.I.T. 5.791-0	B.I.W.I.-1.5	T.I.-9.0	V.I.	-2.5	3.0
RC7050		↓			1.1	0.0	5.0
RC7051		↓			1.1	-2.5	3.0
RC7052		↓			1.1	-2.5	2.5
RC7053	C.V.L.S.W.T.	T.E.S.I.T. 5.791-0	B.I.W.I.-1.5	T.I.-9.0	V.I.E.I.-1.5	-2.5	3.0
RC7054		↓			1.1	-2.5	3.0
RC7055		↓			1.1	-2.5	3.0
RC7056		↓			1.1	0.0	5.0
RC7057	C.V.L.S.W.T.	T.E.S.I.T. 5.791-0	B.I.W.I.-1.5	T.I.-9.0		-2.5	2.5
RC7058		↓			1.1	0.0	5.0
RC7059	C.V.L.S.W.T.	T.E.S.I.T. 5.791-0	B.I.W.I.-1.5	E.I.	1.1	-2.5	3.0
RC7060	C.V.L.S.W.T.	T.E.S.I.T. 5.791-0	B.I.W.I.-1.5	E.3	1.1	-2.5	3.0

33

1	SKRF(1)	11	SKRF(2)	21	LREF(1)	31	LREF(2)	41	BREF(1)	51	BREF(2)	61	XMRP(1)	71	XMRP(2)
	316.23		150.1N		50.19		1N		17.35		1N		29.392		1N
	0.0		1N		0.0		1N		0.0175		SCALE(2)		CONVAIR TX70-RE-12		
	Y.MRP(1)		YMRP(2)		ZMRP(1)		ZMRP(2)		SCALE(1)		SCALE(2)		FILREF		

TEST CV LSWT 579-0 DATA SET DESCRIPTOR SHEET

DATA SET IDENTIFIER	DATA SET DESCRIPTOR				Node Type	CURVE SLOPE RANGE	
	11	21	31	41		61 LOWER LIMIT	71 UPPER LIMIT
RC7061	C.V.L.S.W.T.	T.E.S.T.	579-0	B1W1-15T1-55E3	11	-2.5	3.5
RC7062	C.V.L.S.W.T.	T.E.S.T.	579-0	B1W1-15T1-55	11	-2.5	3.5
RC7063	C.V.L.S.W.T.	T.E.S.T.	579-0	B1W1A-15T1-55	11	-2.5	3.5
RC7064	C.V.L.S.W.T.	T.E.S.T.	579-0	B1W3AT1-55	11	-2.5	3.5
RC7065	C.V.L.S.W.T.	T.E.S.T.	579-0	B1W3A	11	-2.5	3.5
RC7066					11	-2.5	3.5
RC7067	C.V.L.S.W.T.	T.E.S.T.	579-0	B1W3AT1-55	11	-2.5	3.5
RC7068					11	-2.5	3.5
RC7069					11	0.0	5.0
RC7070	C.V.L.S.W.T.	T.E.S.T.	579-0	B1W3AT1-55E3	11	-2.5	3.5
RC7071	C.V.L.S.W.T.	T.E.S.T.	579-0	B1W3AT1-55E1	11	-2.5	3.5
RC7072	C.V.L.S.W.T.	T.E.S.T.	579-0	B1W3AE1	11	-2.5	3.5
RC7073	C.V.L.S.W.T.	T.E.S.T.	579-0	B1W3AE3	11	-2.5	3.5
RC7074	C.V.L.S.W.T.	T.E.S.T.	579-0	B1W3AE4	11	-2.5	3.5
RC7075	C.V.L.S.W.T.	T.E.S.T.	579-0	B1W3AE5	11	-2.5	3.5
RC7076	C.V.L.S.W.T.	T.E.S.T.	579-0	B1W3A	11	-2.5	3.5
RC7077	C.V.L.S.W.T.	T.E.S.T.	579-0	B1T1-55	11	-2.5	3.5
RC7078					11	-0.5	5.0
RC7079	C.V.L.S.W.T.	T.E.S.T.	579-0	B1	11	-2.5	3.5
RC7080					11	0.0	5.0

34

1	SREF(1)	11	SREF(2)	21	LREF(1)	31	LREF(2)	41	BREF(1)	51	BREF(2)	61	XMRP(1)	71	XMRP(2)
	316.23		150.1N		150.19		11N		17.35		11N		129.392		11N
	0.0		11N		0.0		11N		0.0175				CONV AIR TN70-AE-1.2		
	YMRP(1)		YMRP(2)		ZMRP(1)		ZMRP(2)		SCALE(1)		SCALE(2)		FILREF		

TEST CV LSWT 579-0 DATA SET DESCRIPTOR SHEET

DATA SET IDENTIFIER	DATA SET DESCRIPTOR				Node No	CURVE SLOPE RANGE	
	11	21	31	41		51 LOWER LIMIT	61 UPPER LIMIT
RC7081	C.V.L.S.W.T.	T.E.S.I.T.	5.7.91-0	B.11W.5.V.I.E.4	1.1	-2.5	2.5
RC7082					1.1	0.0	5.0
RC7083	C.V.L.S.W.T.	T.E.S.I.T.	5.7.91-0	B.71W.5.V.I.	1.1	0.0	5.0
RC7084					1.1	-0.5	5.0
RC7085					1.1	0.0	5.0
RC7086					1.1	0.0	5.0
RC7087					1.1	0.0	5.0
RC7088					1.1	0.0	5.0
RC7089					1.1	0.0	5.0
RC7090					1.1	0.0	5.0
RC7091					1.1	0.0	5.0
RC7092					1.1	0.0	5.0
RC7093					1.1	0.0	5.0
RC7094					1.1	0.0	5.0
RC7095					1.1	0.0	5.0
RC7096					1.1	-0.5	5.0
RC7097	C.V.L.S.W.T.	T.E.S.I.T.	5.7.91-0	B.71W.5.V.I.K.1	1.1	0.0	5.0
RC7098	C.V.L.S.W.T.	T.E.S.I.T.	5.7.91-0	B.71W.5.V.I.G.2	1.1	0.0	5.0
RC7099					1.1	0.0	5.0
RC7100	C.V.L.S.W.T.	T.E.S.I.T.	5.7.91-0	B.71W.5.V.I.E.2.G.2	1.1	0.0	5.0

35

1	SREF(1)	11	SREF(2)	21	LREF(1)	31	LREF(2)	41	BREF(1)	51	BREF(2)	61	XMRP(1)	71	XMRP(2)
	31.6	23	150	1.1	150	1.9	1.1	17.35	1.1	133	909	1.1			
	0.0	1.1	0.0	1.1	0.0175					CONVAIR T710-AE-1.2					
	YMRP(1)	YMRP(2)	ZMRP(1)	ZMRP(2)	SCALE(1)	SCALE(2)	FILREF								

TEST CV LSWT 579-0 DAT. SET DESCRIPTOR SHEET

DATA SET IDENTIFIER	DATA SET DESCRIPTOR				Mode type	CURVE SLOPE RANGE	
	11	21	31	41		51 LOWER LIMIT	61 UPPER LIMIT
RC7101	C.V.L.S.W.T. TEST	579-0	B71W5V1E2G2		11	0.0	5.0
RC7102	C.V.L.S.W.T. TEST	579-0	B71W5V1E2		11	0.0	5.0
RC7103		↓			11	0.0	5.0
RC7104	C.V.L.S.W.T. TEST	579-0	B71W5V1E4		11	0.0	5.0
RC7105		↓			11	0.0	5.0
RC7106	C.V.L.S.W.T. TEST	579-0	B71W5V1E6		11	0.0	5.0
RC7107		↓			11	0.0	5.0
RC7108	C.V.L.S.W.T. TEST	579-0	B71W5		11	0.0	5.0
RC7109		↓			11	0.0	5.0
RC7110	C.V.L.S.W.T. TEST	579-0	B71W5V2		11	0.0	5.0
RC7111		↓			11	0.0	5.0
RC7112		↓			11	0.0	5.0
RC7113	C.V.L.S.W.T. TEST	579-0	B71		11	-2.5	2.5
RC7114		↓			11	0.0	5.0
RC7115		↓			11	0.0	5.0

36

1	SREF(1)	11	SREF(2)	21	LREF(1)	31	LREF(2)	41	BREF(1)	51	BREF(2)	61	XMRP(1)	71	XMRP(2)
	316.23		150.1N		150.19		11N		17.35		1N		133.909		1N
	0.0		1N		0.0		1N		0.0175				CΦMVAIR TX70-AE-12		
	YMRP(1)		YMRP(2)		ZMRP(1)		ZMRP(2)		SCALE(1)		SCALE(2)		FILREF		

TEST CV LSWT 579-0 DATA SET DESCRIPTOR SHEET

DATA SET IDENTIFIER	DATA SET DESCRIPTOR					Slope Type	CURVE SLOPE RANGE	
	1	11	21	31	41		51 LOWER LIMIT	61 UPPER LIMIT
RC7116	C.V.L.S.W.T.	T.E.S.I.T.	579-0	B1W3A.T2	-5.5	1.1	-2.5	3.0
RC7117						1.1	0.0	5.0
RC7118	C.V.L.S.W.T.	T.E.S.I.T.	579-0	B1W3A.T3	-5.5	1.1	-2.5	2.5
RC7119						1.1	0.0	5.0
RC7120	C.V.L.S.W.T.	T.E.S.I.T.	579-0	B4W3A		1.1	-2.5	2.5
RC7121						1.1	0.0	5.0
RC7122	C.V.L.S.W.T.	T.E.S.I.T.	579-0	B4W3A.T1	-5.5	1.1	-2.5	2.5
RC7123						1.1	0.0	5.0
RC7124	C.V.L.S.W.T.	T.E.S.I.T.	579-0	B5W3A.T1	-5.5	1.1	-2.5	2.5
RC7125						1.1	0.0	5.0
RC7126	C.V.L.S.W.T.	T.E.S.I.T.	579-0	B5W3A		1.1	-2.5	2.5
RC7127						1.1	0.0	5.0
RC7128	C.V.L.S.W.T.	T.E.S.I.T.	579-0	B6W3A		1.1	-2.5	2.5
RC7129						1.1	0.0	5.0
RC7130	C.V.L.S.W.T.	T.E.S.I.T.	579-0	B6W3A.T1	-5.5	1.1	-2.5	2.5
RC7131						1.1	0.0	5.0
RC7132	C.V.L.S.W.T.	T.E.S.I.T.	579-0	B1W3A.T1	-5.5	1.1	-2.5	2.5
RC7133	C.V.L.S.W.T.	T.E.S.I.T.	579-0	B1W3A.T1	-5.5	1.1	-2.5	3.0
RC7134	C.V.L.S.W.T.	T.E.S.I.T.	579-0	B1W3A.T1	-9.0	1.1	-2.5	3.0

35

1	SREF(1)	11	SREF(2)	21	LREF(1)	31	LREF(2)	41	BREF(1)	51	BREF(2)	61	XMRP(1)	71	XMRP(2)
	316.23		150.1N		150.19		1.1N		17.35		1.1N		129.392		1.1N
	0.0		1.1N		0.0		1.1N		0.0175				CONVAIR T.N.70-A.F.-12		
	YMRP(1)		YMRP(2)		ZMRP(1)		ZMRP(2)		SCALE(1)		SCALE(2)		FILREF		



DATA SET PARAMETER NAME SHEET

TEST: CV LSWT 579-0

DATA SET IDENTIFIER	PARAMETER NAMES (Format 10A6)										NPJA
	1	7	13	19	25	31	37	43	49	55	61
RC7021	B,E,T,A, ,E,L,E,V,T,R,R,U,D,V,T,R,F,L,A,P,S, ,S,P,Ø,I,L,R										
RC7022											
RC7023											
RC7024											
RC7025											
RC7026											
RC7027											
RC7028											
RC7029											
RC7030											
RC7031											
RC7032											
RC7033											
RC7034											
RC7035											
RC7036											
RC7037											
RC7038											
RC7039											
RC7040	B,E,T,A, ,F,L,A,P,S, ,S,P,Ø,I,L,R										

39













DATA SET PARAMETER VALUE SHEET

TEST: CV LSWT 579-0

DATA SET IDENTIFIER	PARAMETER VALUE (Format 10F8.3)									
	1	9	17	25	33	41	49	51	65	73
RC7001	0.0	0.0	0.0	0.0	0.0					
RC7002	-8.0	0.0	0.0	0.0	0.0					
RC7003	-4.0	0.0	0.0	0.0	0.0					
RC7004	0.0	0.0	0.0	35.0	0.0					
RC7005	0.0	0.0	0.0	15.0	30.0					
RC7006	-4.0	0.0	0.0	45.0	30.0					
RC7007	0.0	0.0	0.0	0.0	30.0					
RC7008	0.0	0.0	0.0	0.0	60.0					
RC7009	-4.0	0.0	0.0	0.0	60.0					
RC7010	0.0	0.0	0.0	25.0	0.0					45
RC7011	0.0	0.0	0.0	45.0	0.0					
RC7012	-8.0	0.0	0.0	45.0	0.0					
RC7013	-4.0	0.0	0.0	45.0	0.0					
RC7014	0.0	-1.0	0.0	45.0	0.0					
RC7015	0.0	0.0	1.0	45.0	0.0					
RC7016	-8.0	0.0	1.0	45.0	0.0					
RC7017	-4.0	0.0	1.0	45.0	0.0					
RC7018	0.0	-20.0	0.0	45.0	0.0					
RC7019	0.0	0.0	12.0	45.0	0.0					
RC7020	-8.0	0.0	12.0	45.0	0.0					

DATA SET PARAMETER VALUE SHEET

TEST: CV LSWT 579-0

DATA SET IDENTIFIER	PARAMETER VALUE (Format 10F8.3)									
	1	9	17	25	33	41	49	51	65	73
RC7021	-4.0	0.0	20.0	45.0	0.0					
RC7022	0.0	-30.0	0.0	45.0	0.0					
RC7023	0.0	10.0	0.0	45.0	0.0					
RC7024	0.0	10.0	0.0	0.0	0.0					
RC7025	0.0	-10.0	0.0	0.0	0.0					
RC7026	0.0	0.0	10.0	0.0	0.0					
RC7027	-8.0	0.0	10.0	0.0	0.0					
RC7028	-4.0	0.0	10.0	0.0	0.0					
RC7029	0.0	-20.0	0.0	0.0	0.0					
RC7030	0.0	0.0	20.0	0.0	0.0					46
RC7031	-8.0	0.0	20.0	0.0	0.0					
RC7032	-4.0	0.0	20.0	0.0	0.0					
RC7033	0.0	-30.0	0.0	0.0	0.0					
RC7034	0.0	0.0	0.0	45.0	0.0					
RC7035	-4.0	0.0	0.0	45.0	0.0					
RC7036	0.0	0.0	0.0	45.0	0.0					
RC7037	-4.0	0.0	0.0	45.0	0.0					
RC7038	0.0	0.0	0.0	0.0	0.0					
RC7039	-4.0	0.0	0.0	0.0	0.0					
RC7040	0.0	0.0	0.0							

DATA SET PARAMETER VALUE SHEET

TEST CV LSWT 579-0

DATA SET IDENTIFIER	PARAMETER VALUE (Format 10F8.3)									
	1	9	17	25	33	41	49	51	65	73
RC7041	-8.0	0.0	0.0	0.0						
RC7042	-4.0	0.0	0.0	0.0						
RC7043	0.0	45.0	0.0	0.0						
RC7044	-4.0	45.0	0.0	0.0						
RC7045	0.0	0.0	0.0	0.0	0.0					
RC7046	-4.0	0.0	0.0	0.0	0.0	0.0				
RC7047	0.0	0.0	0.0	0.0	0.0	0.0				
RC7048	-4.0	0.0	0.0	0.0	0.0	0.0				
RC7049	0.0	0.0	0.0	0.0	0.0	0.0				
RC7050	-4.0	0.0	0.0	0.0	0.0	0.0				47
RC7051	0.0	-19.0	0.0	0.0	0.0	0.0				
RC7052	0.0	10.0	0.0	0.0	0.0	0.0				
RC7053	0.0	10.0	0.0	0.0	45.0	0.0				
RC7054	0.0	-1.0	0.0	0.0	45.0	0.0				
RC7055	0.0	0.0	0.0	0.0	45.0	0.0				
RC7056	-4.0	0.0	0.0	0.0	45.0	0.0				
RC7057	0.0	0.0	0.0	0.0	0.0	0.0				
RC7058	-4.0	0.0	0.0	0.0	0.0	0.0				
RC7059	0.0	0.0	0.0	0.0						
RC7060	0.0	0.0	0.0	0.0						





DATA SET PARAMETER VALUE SHEET

TEST: CV LSWT 579-0

DATA SET IDENTIFIER	PARAMETER VALUE (Format 10F8.3)									
	1	9	17	25	33	41	49	51	65	73
RC7081	0.0	0.0	0.0	0.0						
RC7082	-8.0	0.0	0.0	0.0						
RC7083	0.0	0.0	0.0	0.0						
RC7084	-8.0	0.0	0.0	0.0						
RC7085	-4.0	0.0	0.0	0.0						
RC7086	0.0	0.0	0.0	0.0						
RC7087	-4.0	0.0	0.0	0.0						
RC7088	0.0	0.0	0.0	20.0						
RC7089	-4.0	0.0	0.0	20.0						
RC7090	0.0	-10.0	0.0	0.0						64
RC7091	0.0	0.0	0.0	0.0						
RC7092	-4.0	0.0	0.0	0.0						
RC7093	0.0	-25.0	0.0	0.0						
RC7094	0.0	0.0	25.0	0.0						
RC7095	-4.0	0.0	25.0	0.0						
RC7096	0.0	25.0	0.0	0.0						
RC7097	0.0	0.0	0.0	0.0						
RC7098	0.0	0.0	0.0	0.0						
RC7099	-4.0	0.0	0.0	0.0						
RC7100	0.0	0.0	0.0	0.0						

DATA SET PARAMETER VALUE SHEET

TEST: CV LSWT 579-0

DATA SET IDENTIFIER	PARAMETER VALUE (Format 10F8.3)									
	1	9	17	25	33	41	49	51	65	73
RC7101	-4.0	0.0	0.0	0.0	0.0					
RC7102	0.0	0.0	0.0	0.0						
RC7103	-4.0	0.0	0.0	0.0						
RC7104	0.0	0.0	0.0	0.0						
RC7105	-4.0	0.0	0.0	0.0						
RC7106	0.0	0.0	0.0	0.0						
RC7107	-4.0	0.0	0.0	0.0						
RC7108	-4.0	0.0	0.0	0.0						
RC7109	0.0	0.0	0.0	0.0						
RC7110	0.0	0.0	0.0	0.0						50
RC7111	-8.0	0.0	0.0	0.0						
RC7112	-4.0	0.0	0.0	0.0						
RC7113	0.0									
RC7114	-8.0									
RC7115	-4.0									
RC7116	0.0	0.0	0.0	0.0	0.0					
RC7117	-4.0	0.0	0.0	0.0	0.0	0.0				
RC7118	0.0	0.0	0.0	0.0	0.0	0.0				
RC7119	-4.0	0.0	0.0	0.0	0.0	0.0				
RC7120	0.0	0.0	0.0	0.0						

DATA SET PARAMETER VALUE SHEET

TEST: CV LSWT 579-0

DATA SET IDENTIFIER	PARAMETER VALUE (Format 10F8.3)									
	1	9	17	25	33	41	49	51	65	73
RC7121	-4.0	0.0	0.0	0.0	0.0	0.0	0.0	0.0	0.0	0.0
RC7122	0.0	0.0	0.0	0.0	0.0	0.0	0.0	0.0	0.0	0.0
RC7123	-4.0	0.0	0.0	0.0	0.0	0.0	0.0	0.0	0.0	0.0
RC7124	0.0	0.0	0.0	0.0	0.0	0.0	0.0	0.0	0.0	0.0
RC7125	-4.0	0.0	0.0	0.0	0.0	0.0	0.0	0.0	0.0	0.0
RC7126	0.0	0.0	0.0	0.0	0.0	0.0	0.0	0.0	0.0	0.0
RC7127	-4.0	0.0	0.0	0.0	0.0	0.0	0.0	0.0	0.0	0.0
RC7128	0.0	0.0	0.0	0.0	0.0	0.0	0.0	0.0	0.0	0.0
RC7129	-4.0	0.0	0.0	0.0	0.0	0.0	0.0	0.0	0.0	0.0
RC7130	0.0	0.0	0.0	0.0	0.0	0.0	0.0	0.0	0.0	0.0
RC7131	-4.0	0.0	0.0	0.0	0.0	0.0	0.0	0.0	0.0	0.0
RC7132	0.0	-1.0	0.0	0.0	0.0	0.0	0.0	0.0	0.0	0.0
RC7133	0.0	-1.0	0.0	0.0	135.0	0.0	0.0	0.0	0.0	0.0
RC7134	0.0	-1.0	0.0	0.0	135.0	0.0	0.0	0.0	0.0	0.0

51

## TEST FACILITY DESCRIPTION

The General Dynamics/Convair low speed wind tunnel is a close-return atmospheric tunnel, constructed of reinforced concrete. Airflow is created by a 6-bladed propeller, 20 feet in diameter, powered by a 2250-horsepower synchronous motor.

The tunnel has a primary test section 8 feet high, 12 feet wide and 25 feet long. A model or component can be tested in this section at airspeeds up to 300 mph. The sides and ceiling of the test section are large glass windows. These windows and fluorescent lights, housed in corner fillets in the test section, provide excellent model observation and model photography. Personnel access doors open directly into the test section from the control room and the model service area.

A variety of support systems are available for mounting a model or component. These support systems include single, bicycle, and three-strut supports, sting supports and supports for two dimensional installations.

Digital computer and plotting facilities are available so that the results of a test run can be processed, tabulated, and plotted within 10 minutes of the test run.

## TEST NOMENCLATURE

<u>SYMBOL</u>	<u>SADSAC SYMBOL</u>	<u>DEFINITION</u>
$A_b$		base area; $m^2$ , $ft^2$ , $in^2$
a		speed of sound; m/sec, ft/sec
AR	ASPECT	aspect ratio, $b^2/S$
b	REFB	wing span or reference span; m, ft, in
c		wing chord; m, ft, in
$\bar{c}$		wing mean aerodynamic chord or reference chord; m, ft, in (see $l_{ref}$ or refl)
c. g.		center of gravity
C. P.		center of pressure
$C_A$	CA	axial force coefficient, $F_A/qS_{ref}$
$C_{A_b}$	CAB	base axial force coefficient, $[(p_\infty - p_b)/q] (A_b/S_{ref})$
$C_{A_f}$	CAF	forebody axial force coefficient, $C_A - C_{A_b}$
$C_D$	CDTOTL	drag force coefficient in the wind axis system, $F_D/q S_{ref}$

NOMENCLATURE (continued)

<u>SYMBOL</u>	<u>SADSAC SYMBOL</u>	<u>DEFINITION</u>
$C_D$	CD	drag force coefficient in the stability axis system, $F'_D/q S_{ref}$
$C_L$	CL	lift force coefficient (stability or wind axis) $F'_L/q S_{ref}$
$C_l$	CBL	rolling moment coefficient in body axis system, $M_x/q S_{ref} b$
$C_{l,s}$	CSL	rolling moment coefficient in the stability axis system, $M_{x,s}/q S_{ref} b$
$C_{l,w}$	CWL	rolling moment coefficient in the wind axis system, $M_{x,w}/q S_{ref} b$
$C_m$	CLM	pitching moment coefficient in the body axis system, $M_y/q S_{ref} l_{ref}$
$C_{m,s}$	CLM	pitching moment coefficient in the stability axis system, $C_{m,s} = C_m$
$C_{m,w}$	CPM	pitching moment coefficient in the wind axis system, $M_{y,w}/q S_{ref} l_{ref}$
$C_N$	CN	normal force coefficient in the body axis system, $F'_N/q S_{ref}$

NOMENCLATURE (continued)

<u>SYMBOL</u>	<u>SADSAC SYMBOL</u>	<u>DEFINITION</u>
$C_n$	CYN	yawing moment coefficient in the body axis system, $M_z/q S_{ref} b$
$C_{n,s}$	CLN	yawing moment coefficient in the stability axis system, $C_{n,s} = C_n$
$C_{n,w}$	CLN	yawing moment coefficient in the wind axis system, $M_{z,w}/q S_{ref} b$
$C_p$	CP	pressure coefficient, $(p-p_\infty)/q$
$C_y$	CY	side force coefficient (body or stability axis system), $F_y/q S_{ref}$
$C_c$	CC	side force coefficient (wind axis system); $F_y/q S_{ref}$
$F_A$		axial force; N, lb
$F_D$		drag force in wind axis system; N, lb
$F'_D$		drag force in the stability axis system; N, lb
$F_L$		lift force (stability or wind axis system); N, lb
$F_N$		normal force; N, lb

NOMENCLATURE (continued)

<u>SYMBOL</u>	<u>SADSAC SYMBOL</u>	<u>DEFINITION</u>
$F_Y$		side force; N, lb
	N/A	normal to axial force ratio
$l_{ref}$	REFL	reference length; m, ft, in (see $\bar{c}$ )
L/D	L/D	lift-to-drag ratio, $C_L/C_D$ (stability axis system)
L/D	CL/CD	lift-to-drag ratio, $C_L/C_D$ (wind axis system)
M	MACH	Mach number
MRP	MRP	abbreviation for moment reference point
	XMRP	abbreviation for moment reference point on x-axis
	YMRP	abbreviation for moment reference point on y-axis
	ZMRP	abbreviation for moment reference point on z-axis
$M_x$		rolling moment in the body axis system; N-m, ft-lb
$M_{x,s}$		rolling moment in the stability axis system; N-m, ft-lb



NOMENCLATURE- (continued)

<u>SYMBOL</u>	<u>SADSAC SYMBOL</u>	<u>DEFINITION</u>
$M_{x,w}$		rolling moment in the wind axis system; N-m, ft-lb
$M_y$		pitching moment in the body (or stability) axis system; N-m, ft-lb
$M_{y,w}$		pitching moment in the wind axis system; N-m, ft-lb
$M_z$		yawing moment in the body axis system; N-m, ft-lb
$M_{z,w}$		yawing moment in the wind axis system; N-m, ft-lb
p		static pressure; N/m <sup>2</sup> ; psi
P		total pressure; N/m <sup>2</sup> ; psi
q	Q(PSI) Q(PSF)	dynamic pressure; N/m <sup>2</sup> , psi, psf
RN/L	RN/L	Reynold's number per unit length; million/ft.
S		wing area; m <sup>2</sup> , ft <sup>2</sup>
$S_{ref}$	REFS	reference area; m <sup>2</sup> , ft <sup>2</sup>
T		temperature; °K, °C, °R, °F
V		speed of vehicle relative to surrounding atmosphere; m/sec, ft/sec

NOMENCLATURE (continued)

<u>SYMBOL</u>	<u>SADSAC SYMBOL</u>	<u>DEFINITION</u>
$i_T$		tail incidence positive when trailing edge down, deg
$\bar{V}$		velocity of vehicle relative to surrounding atmosphere; m/sec, ft/sec
$\alpha$	ALPHA	angle of attack, angle between the projection of the wind $X_W$ -axis on the body X, Z-plane and the body X-axis; deg
$\beta$	BETA	sideslip angle, angle between the wind $X_W$ -axis and the projection of this axis on the body X-Z-plane; deg
$\gamma$		ratio of specific heats
$\Gamma$	DIHDRL	wing dihedral angle; deg
$\rho$		air density; $K_g/m^3$ , slugs/ft <sup>3</sup> .

NOMENCLATURE (continued)

<u>SYMBOL</u>	<u>SADSAC SYMBOL</u>	<u>DEFINITION</u>
$\theta$		pitch angle, angle of rotation about the body Y-axis, positive when the positive Z-axis is rotated toward the positive X-axis; deg
$\phi$	PHI	roll angle, angle of rotation about the body X-axis, positive when the positive Y-axis is rotated toward the positive Z-axis; deg
$\psi$	PSI	yaw angle, angle of rotation about the body Z-axis, positive when the positive X-axis is rotated toward the positive Y-axis; deg
$\delta_F$	FLAPS	Wing flap deflection deg
$\delta_S$	SPOILR	Wing spoiler deflection deg
$\delta_r$	RUDDER	Rudder deflection, positive trailing edge left deg
$\delta_{er}$	ELEVTR	Vee-tail ruddervator deflection, pitch control, positive both trailing edges down $(\delta_{R_r} + \delta_{L_r})/2$ deg
$\delta_{rr}$	RUDVTR	Vee-tail ruddervator deflection, directional control, positive both trailing edges right $(\delta_{L_r} - \delta_{R_r})/2$ deg
$\delta_{ee}$	ELEVON	Elevon deflection, positive both trailing edges down, $(\delta_{R_e} + \delta_{L_e})/2$ deg
$\delta_{ae}$	AILRON	Aileron deflection, positive left side down, right side up $(\delta_{L_e} - \delta_{R_e})/2$ deg

NOMENCLATURE (continued)

SUBSCRIPTS

DEFINITION

a	aileron
b	base
c	canard
e	elevator or elevon
f	flap
r	rudder or ruddervator
s	stability axis system
t	tail, or total conditions
w	wind axis system
ref	reference conditions
$\infty$	freestream condition

FIGURES

Notes:

1. Positive directions of force coefficients, moment coefficients, and angles are indicated by arrows.
2. For clarity, origins of wind and stability axes have been displaced from the center of gravity.

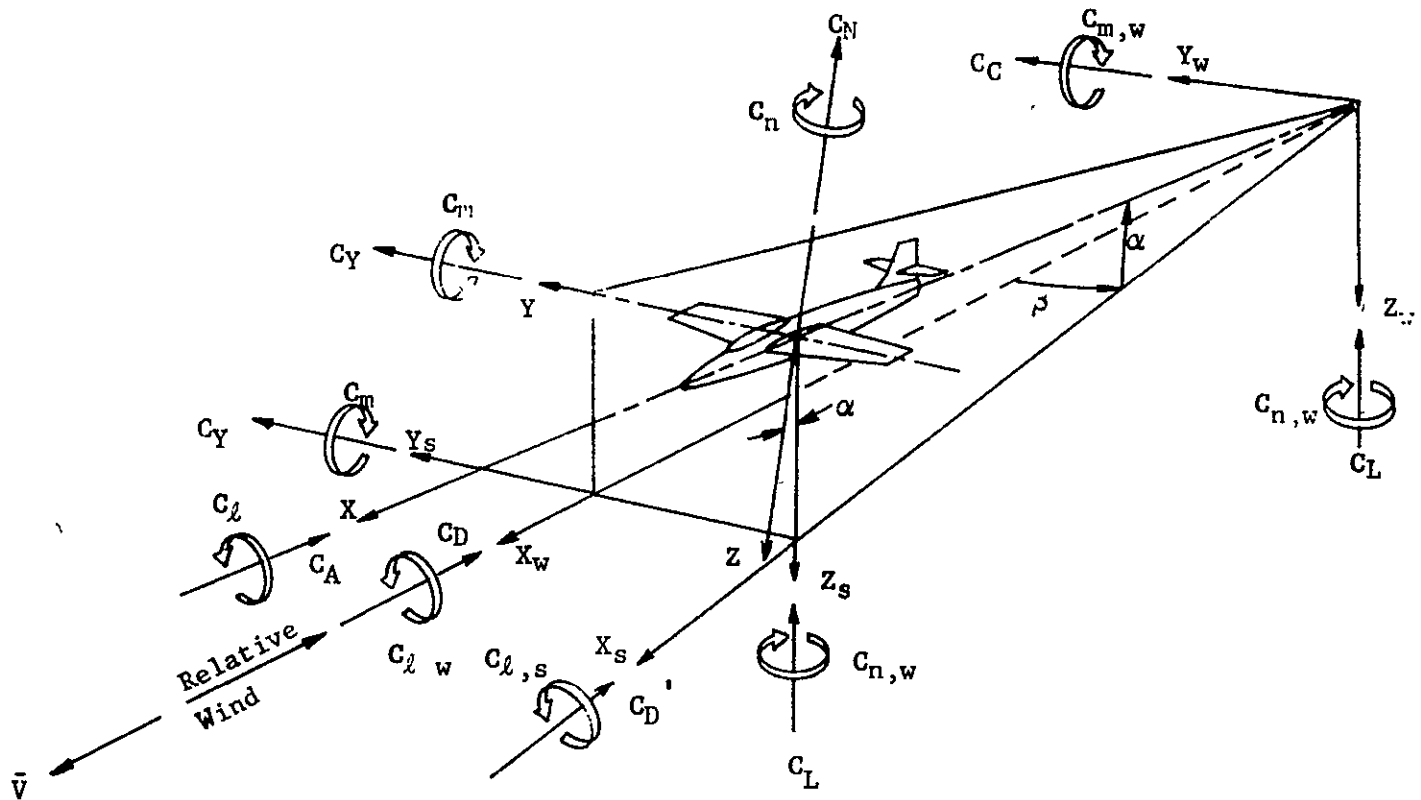
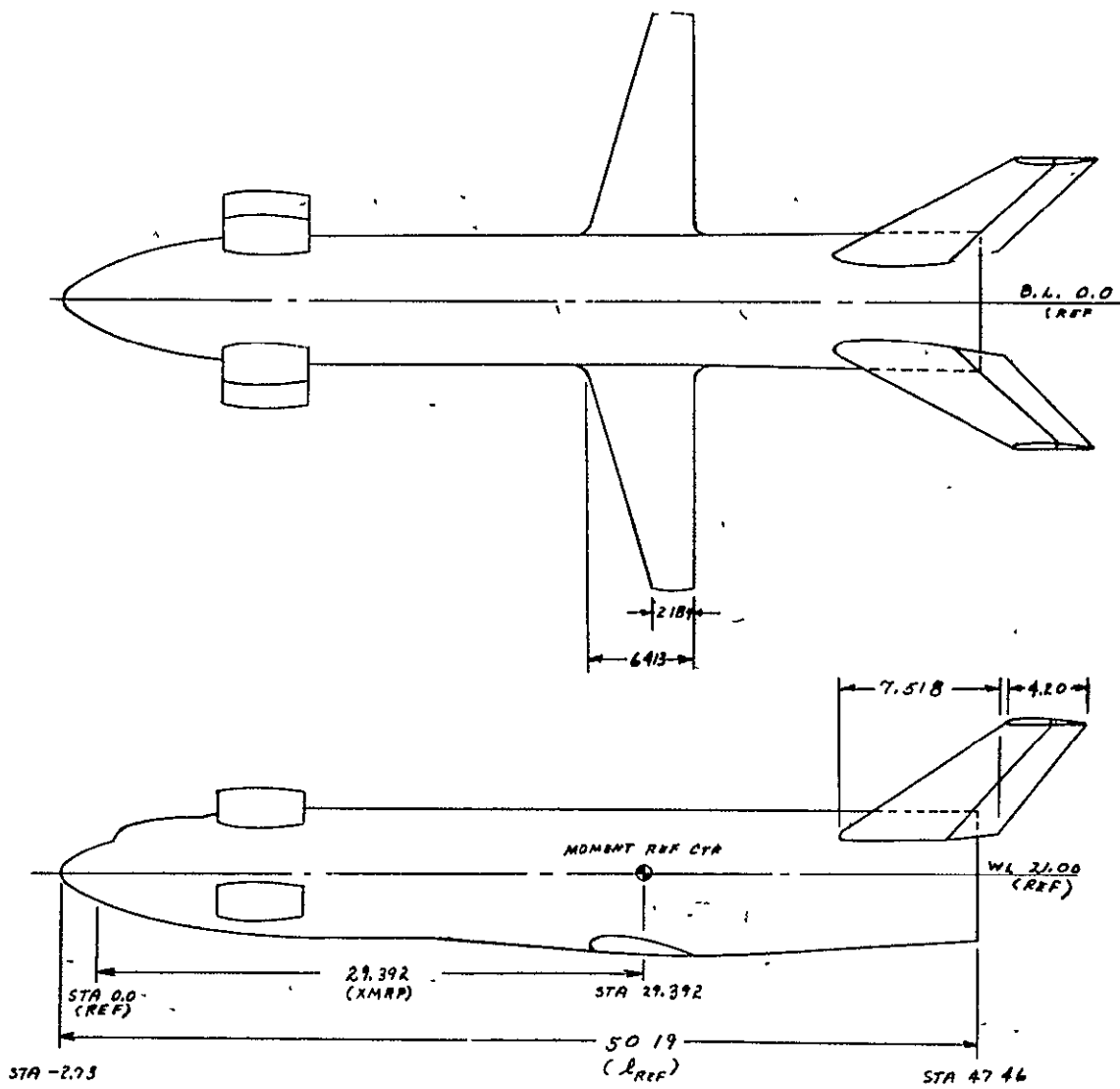

Figure 1. Axis systems, showing direction and sense of force and moment coefficients, angle of attack, and sideslip angle



CONFIGURATION. B, W, T, E.

NOTE: ALL DIMENSIONS, STATIONS, BUTT LINES, AND WATER LINES ARE MODEL SCALE IN INCHES

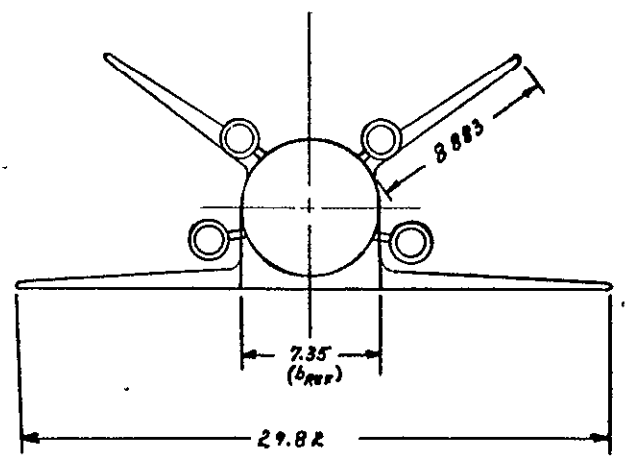
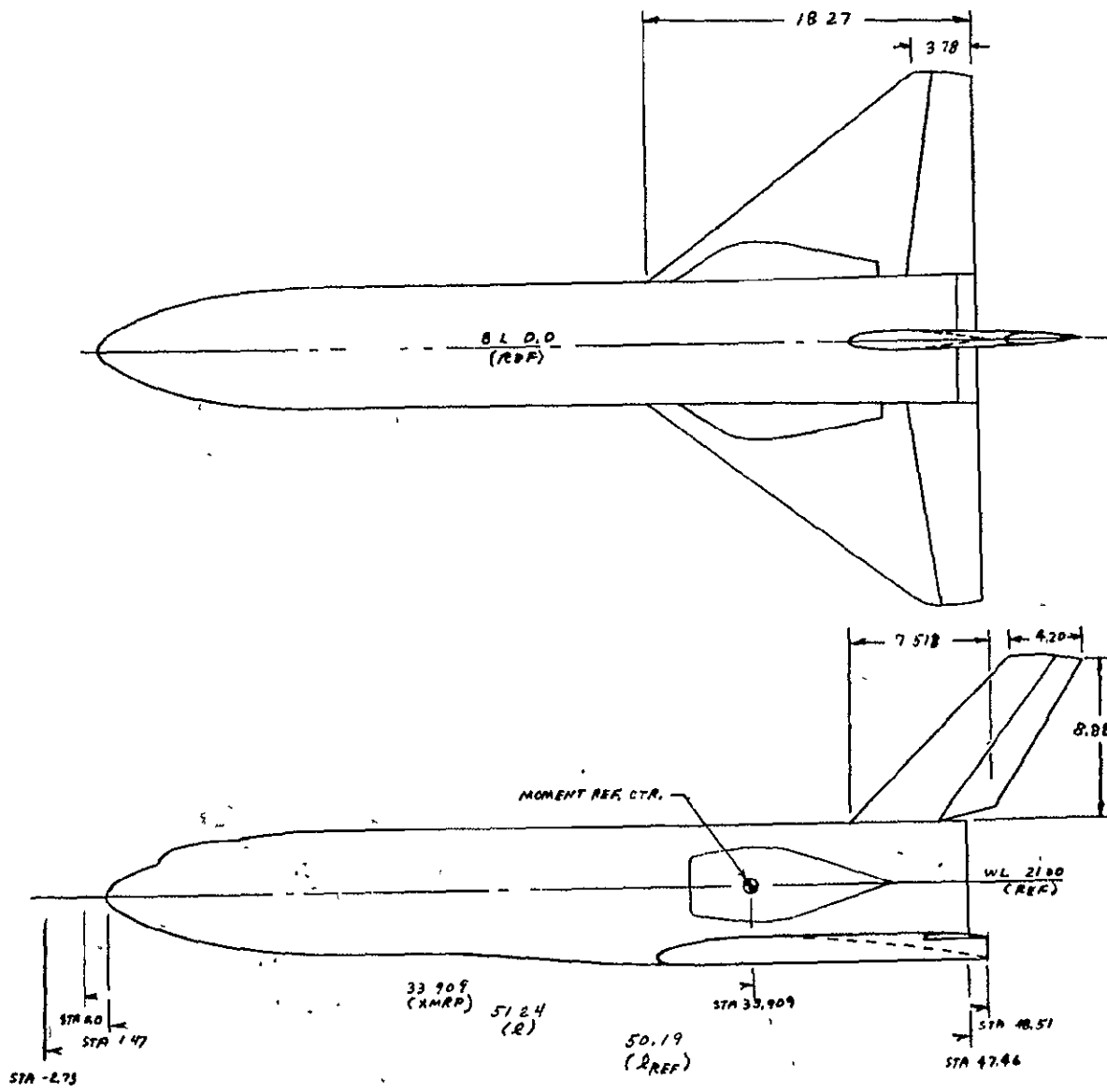
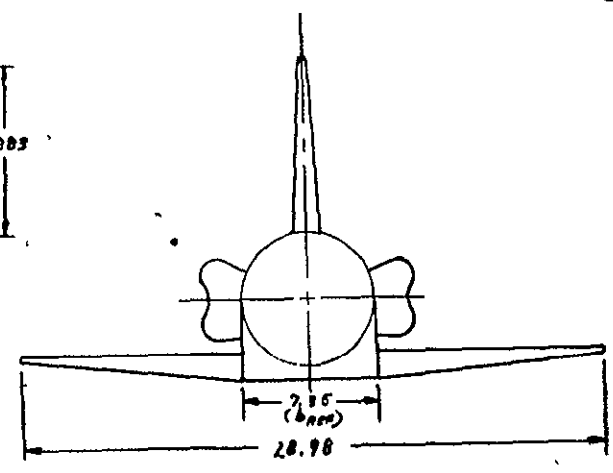

Figure 2 GD/Convair Straight Wing Space Shuttle Booster.



CONFIGURATION  $B_7, W_5, V, E_L$

NOTE: ALL DIMENSIONS, STATIONS,  
 BUTT LINES AND WATER LINES  
 ARE MODEL SCALE IN INCHES



64

Figure 3 GD/Convair Delta Wing Space Shuttle Booster.



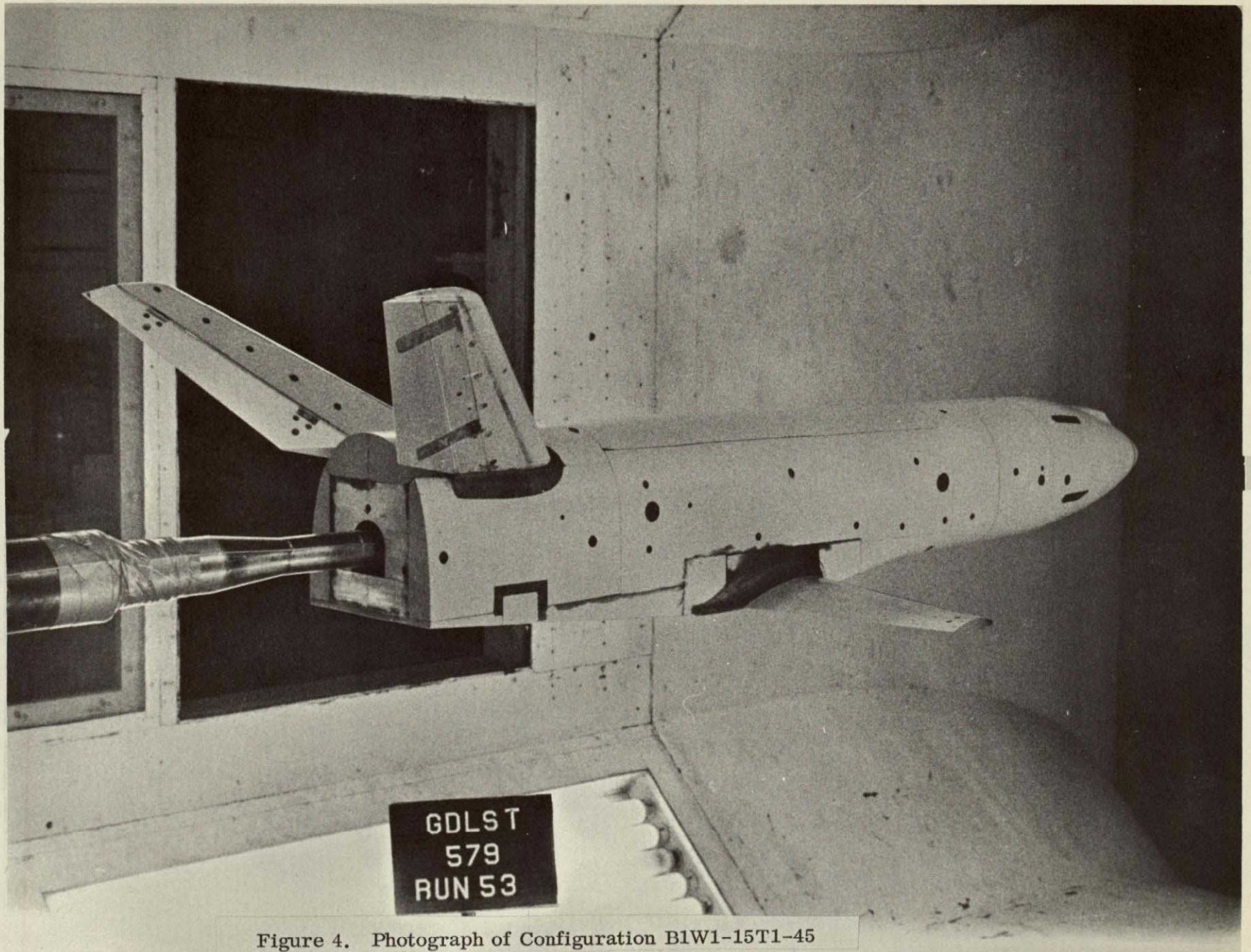

Figure 4. Photograph of Configuration B1W1-15T1-45



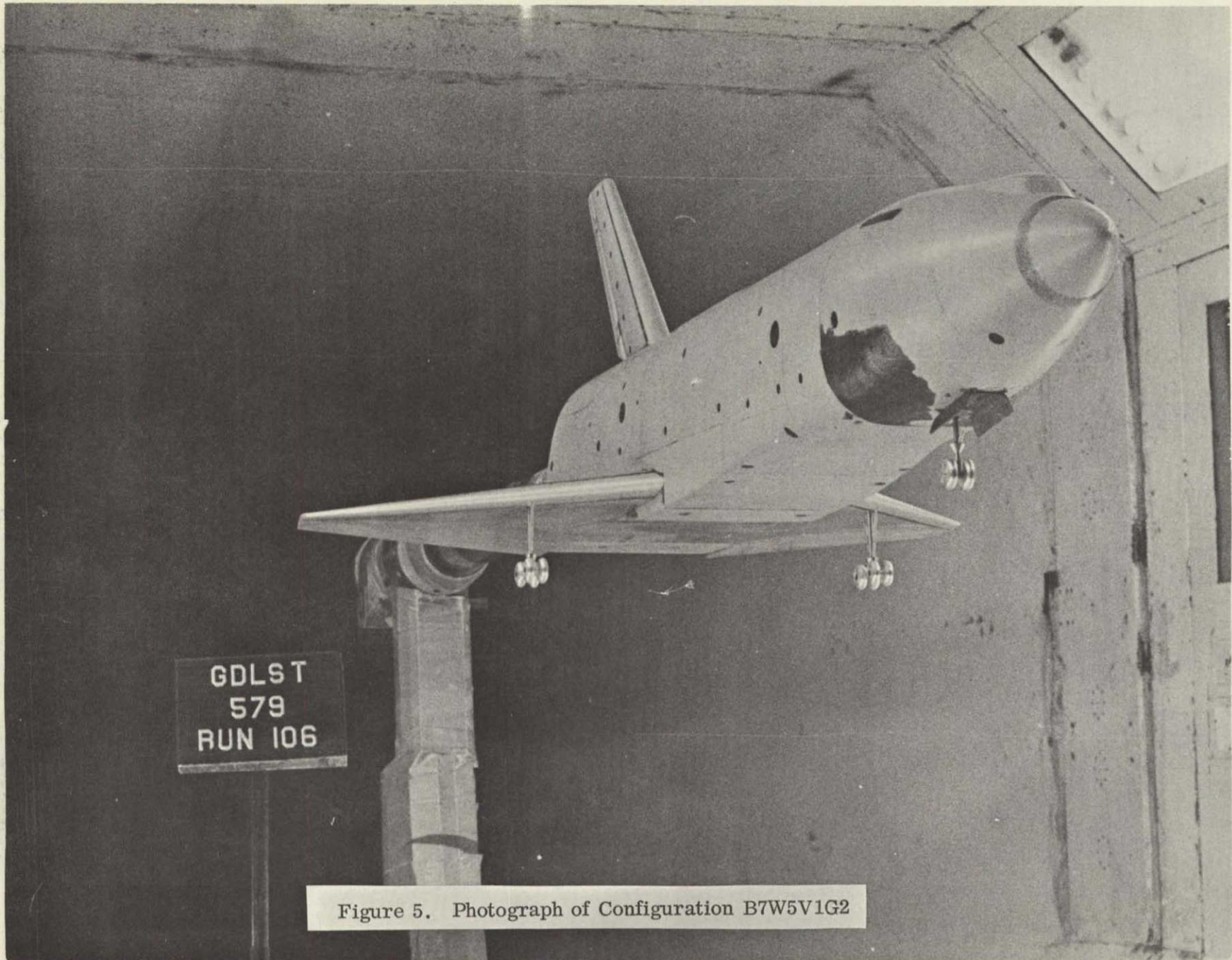

Figure 5. Photograph of Configuration B7W5V1G2

DATA DISPLAY INDEX

CONFIG. BUILDUP - LONGITUDINAL CHAR. - STRAIGHT WING BASIC POS. - V-TAIL=55DEG

DEPENDENT VARIABLE VS INDEPENDENT VARIABLE, MULTIPLE DATASETS

DATASETS PLOTTED:

RC7079 RC7040 SC7001 RC7038

DEPENDENT VARIABLE	INDEPENDENT VARIABLE	PLOT PAGE	
		BEGINNING	ENDING
CL	ALPHA	1	1
L/D	ALPHA	2	2
CAB	ALPHA	3	3

CONFIG. BUILDUP - LONGITUDINAL CHAR. - STRAIGHT WING BASIC POS. - V-TAIL=55DEG

DEPENDENT VARIABLE VS DEPENDENT VARIABLE, MULTIPLE DATASETS

DATASETS PLOTTED:

RC7079 RC7040 SC7001 RC7038

DEPENDENT VARIABLE	DEPENDENT VARIABLE	PLOT PAGE	
		BEGINNING	ENDING
CL	CD	4	4
CL	CLM	5	5

CONFIG. BUILDUP - LATERAL CHAR. - ST. WING BASIC POS. - V-TAIL=55DEG - BETA=0

DEPENDENT VARIABLE VS INDEPENDENT VARIABLE, MULTIPLE DATASETS

DATASETS PLOTTED:

RC7079 RC7040 SC7001 RC7038

DEPENDENT VARIABLE	INDEPENDENT VARIABLE	PLOT PAGE	
		BEGINNING	ENDING
CY	ALPHA	6	6
CLN	ALPHA	7	7
CSL	ALPHA	8	8

CONFIG. BUILDUP - LATERAL CHAR. - ST. WING BASIC POS. - V-TAIL=55DEG - BETA=-4

DEPENDENT VARIABLE VS INDEPENDENT VARIABLE, MULTIPLE DATASETS

DATASETS PLOTTED:

RC7080 RC7042 RC7003 ~~RC7039~~

DEPENDENT VARIABLE	INDEPENDENT VARIABLE	PLOT PAGE BEGINNING / ENDING	
CY	ALPHA	9	9
CLN	ALPHA	10	10
CSL	ALPHA	11	11

LATERAL CHAR. AT BETA = 0 AND -4 DEG. - CONFIG. B1

DEPENDENT VARIABLE VS INDEPENDENT VARIABLE, PARAMETRIC STUDY

DATASETS PLOTTED:

RC7080 RC7079

DEPENDENT VARIABLE	INDEPENDENT VARIABLE	PLOT PAGE BEGINNING / ENDING	
CY	ALPHA	12	12
CLN	ALPHA	13	13
CSL	ALPHA	14	14

LATERAL CHAR. AT BETA = 0 AND -4 DEG. - CONFIG. B1W1-15

DEPENDENT VARIABLE VS INDEPENDENT VARIABLE, PARAMETRIC STUDY

DATASETS PLOTTED:

RC7042 RC7040

DEPENDENT VARIABLE	INDEPENDENT VARIABLE	PLOT PAGE BEGINNING / ENDING	
CY	ALPHA	15	15
CLN	ALPHA	16	16
CSL	ALPHA	17	17

LATERAL CHAR. AT BETA = 0 AND -4 DEG. - CONFIG. BIWI-15TI-55

DEPENDENT VARIABLE VS INDEPENDENT VARIABLE, PARAMETRIC STUDY

DATASETS PLOTTED:  
RC7003 SC7001

DEPENDENT VARIABLE	INDEPENDENT VARIABLE	PLOT PAGE BEGINNING / ENDING	
CY	ALPHA	18	18
CLN	ALPHA	19	19
CSL	ALPHA	20	20

LATERAL CHAR. AT BETA = 0 AND -4 DEG. - CONFIG. BIWI-15TI-55E1

DEPENDENT VARIABLE VS INDEPENDENT VARIABLE, PARAMETRIC STUDY

DATASETS PLOTTED:  
RC7039 RC7038

DEPENDENT VARIABLE	INDEPENDENT VARIABLE	PLOT PAGE BEGINNING / ENDING	
CY	ALPHA	21	21
CLN	ALPHA	22	22
CSL	ALPHA	23	23

CONFIG. BUILDUP - SIDESLIP DERIVATIVES - STRAIGHT WING BASIC POS. - V-TAIL=55DEG

DEPENDENT VARIABLE VS INDEPENDENT VARIABLE, MULTIPLE DATASETS

DATASETS PLOTTED:  
DB7079 DB7040 DB7001 DB7038

DEPENDENT VARIABLE	INDEPENDENT VARIABLE	PLOT PAGE BEGINNING / ENDING	
CYBETA	ALPHA	24	24
DCLNDB	ALPHA	25	25
DCSLDB	ALPHA	26	26

CONFIG. BUILDUP - LONGITUDINAL CHAR. - STRAIGHT WING AFT - V-TAIL=55DEG

DEPENDENT VARIABLE VS INDEPENDENT VARIABLE, MULTIPLE DATASETS

DATASETS PLOTTED:

RC7079 RC7076 ~~RC7068~~ ~~RC7071~~

DEPENDENT VARIABLE	INDEPENDENT VARIABLE	PLOT PAGE BEGINNING / ENDING	
CL	ALPHA	27	27
L/D	ALPHA	28	28
CAB	ALPHA	29	29

CONFIG. BUILDUP - LONGITUDINAL CHAR. - STRAIGHT WING AFT - V-TAIL=55DEG

DEPENDENT VARIABLE VS DEPENDENT VARIABLE, MULTIPLE DATASETS

DATASETS PLOTTED:

RC7079 RC7076 ~~RC7068~~ ~~RC7071~~

DEPENDENT VARIABLE	DEPENDENT VARIABLE	PLOT PAGE BEGINNING / ENDING	
CL	CD	30	30
CL	CLM	31	31

LONG. CHAR. - ELEVATOR EFFECTIVENESS - STRAIGHT WING BASIC POS. - V-TAIL=55DEG

DEPENDENT VARIABLE VS INDEPENDENT VARIABLE, PARAMETRIC STUDY

DATASETS PLOTTED:

RC7033 RC7029 ~~RC7025~~ ~~SC7001~~ ~~RC7024~~

DEPENDENT VARIABLE	INDEPENDENT VARIABLE	PLOT PAGE BEGINNING / ENDING	
CL	ALPHA	32	32
L/D	ALPHA	33	33
CAB	ALPHA	34	34

LONG. CHAR. - ELEVATOR EFFECTIVENESS - STRAIGHT WING BASIC POS. - V-TAIL=55DEG

DEPENDENT VARIABLE VS DEPENDENT VARIABLE, PARAMETRIC STUDY

DATASETS PLOTTED:

RC7033 RC7029 RC7025 SC7001 RC7024

DEPENDENT VARIABLE	DEPENDENT VARIABLE	PLOT PAGE BEGINNING / ENDING	
CL	CD	35	35
CL	CLM	36	36

LATERAL DIRECTIONAL CHAR. - STRAIGHT WING BASIC POSITION - V-TAIL=55DEG

DEPENDENT VARIABLE VS PARAMETRIC VARIABLE, PARAMETRIC STUDY

DATASETS PLOTTED:

N37002 N37003 N37001  
 N37027 N37028 N37026  
 N37031 N37032 N37030

DEPENDENT VARIABLE	PARAMETRIC VARIABLE	PLOT PAGE BEGINNING / ENDING	
CY	BETA	37	39
CLN	BETA	40	42
CSL	BETA	43	45

DIRECTIONAL CONTROL DERIVATIVES - STRAIGHT WING BASIC POSITION - V-TAIL=55DEG

DEPENDENT VARIABLE VS INDEPENDENT VARIABLE, PARAMETRIC STUDY

DATASETS PLOTTED:

DR7002 DR7003 DR7001

DEPENDENT VARIABLE	INDEPENDENT VARIABLE	PLOT PAGE BEGINNING / ENDING	
DCY/DR	ALPHA	46	46
DCLNDR	ALPHA	47	47
DCSLDR	ALPHA	48	48



LONGITUDINAL CONTROL - STRAIGHT WING BASIC POSITION - V-TAIL=55DEG

DEPENDENT VARIABLE VS PARAMETRIC VARIABLE, PARAMETRIC STUDY

DATASETS PLOTTED:

~~N37033~~    ~~N37029~~    ~~N37025~~    ~~N37001~~    ~~N37024~~

DEPENDENT VARIABLE	PARAMETRIC VARIABLE	PLOT PAGE BEGINNING / ENDING	
CL	ELEVTR	49	49
CLM	ELEVTR	50	50
CD	ELEVTR	51	51

LONGITUDINAL CONTROL DERIVATIVES - STRAIGHT WING BASIC POSITION - V-TAIL=55DEG

DEPENDENT VARIABLE VS INDEPENDENT VARIABLE,

DATASETS PLOTTED	DEPENDENT VARIABLE	INDEPENDENT VARIABLE	PLOT PAGE BEGINNING / ENDING	
DE7033	DCL/DE	ALPHA	52	52
DE7033	DCD/DE	ALPHA	53	53
DE7033	DCLMDE	ALPHA	54	54

LONGITUDINAL CHAR. - ELEVTR EFFECTIVENESS - STRAIGHT WING AFT - V-TAIL=55DEG

DEPENDENT VARIABLE VS INDEPENDENT VARIABLE, PARAMETRIC STUDY

DATASETS PLOTTED:

RC7132    RC7068

DEPENDENT VARIABLE	INDEPENDENT VARIABLE	PLOT PAGE BEGINNING / ENDING	
CL	ALPHA	55	55
L/D	ALPHA	56	56
CAB	ALPHA	57	57

LONGITUDINAL CHAR. - ELEVTR EFFECTIVENESS - STRAIGHT WING AFT - V-TAIL=55DEG

DEPENDENT VARIABLE VS DEPENDENT VARIABLE, PARAMETRIC STUDY

DATASETS PLOTTED:  
RC7132 RC7068

DEPENDENT VARIABLE	DEPENDENT VARIABLE	PLOT PAGE	
		BEGINNING	ENDING
CL	CD	58	58
CL	CLM	59	59

LONGITUDINAL CONTROL - STRAIGHT WING AFT - V-TAIL=55DEG

DEPENDENT VARIABLE VS PARAMETRIC VARIABLE, PARAMETRIC STUDY

DATASETS PLOTTED:  
N37132 N37068

DEPENDENT VARIABLE	PARAMETRIC VARIABLE	PLOT PAGE	
		BEGINNING	ENDING
CL	ELEVTR	60	60
CLM	ELEVTR	61	61
CD	ELEVTR	62	62

LONGITUDINAL CONTROL DERIVATIVES - STRAIGHT WING AFT - V-TAIL=55DEG

DEPENDENT VARIABLE VS INDEPENDENT VARIABLE,

DATASETS PLOTTED	DEPENDENT VARIABLE	INDEPENDENT VARIABLE	PLOT PAGE	
			BEGINNING	ENDING
DE7132	DCL/DE	ALPHA	63	63
DE7132	DCD/DE	ALPHA	64	64
DE7132	DCLMDE	ALPHA	65	65

LONG. CHAR. - ELEVATOR EFF. - ST. WING BASIC POS. - FLAPS AND GEAR - V-TAIL=55DEG

DEPENDENT VARIABLE VS INDEPENDENT VARIABLE, PARAMETRIC STUDY

DATASETS PLOTTED:

RC7022 RC7018 RC7014 RC7011 RC7023

DEPENDENT VARIABLE	INDEPENDENT VARIABLE	PLOT PAGE BEGINNING / ENDING	
CL	ALPHA	66	66
L/D	ALPHA	67	67
CAB	ALPHA	68	68

LONG. CHAR. - ELEVATOR EFF. - ST. WING BASIC POS. - FLAPS AND GEAR - V-TAIL=55DEG

DEPENDENT VARIABLE VS DEPENDENT VARIABLE, PARAMETRIC STUDY

DATASETS PLOTTED:

RC7022 RC7018 RC7014 RC7011 RC7023

DEPENDENT VARIABLE	DEPENDENT VARIABLE	PLOT PAGE BEGINNING / ENDING	
CL	CD	69	69
CL	CLM	70	70

LONGITUDINAL CONTROL - STRAIGHT WING BASIC POS. - FLAPS AND GEAR - V-TAIL=55DEG

DEPENDENT VARIABLE VS PARAMETRIC VARIABLE, PARAMETRIC STUDY

DATASETS PLOTTED:

N37022 N37018 N37014 N37011 N37023

DEPENDENT VARIABLE	PARAMETRIC VARIABLE	PLOT PAGE BEGINNING / ENDING	
CL	ELEVTR	71	71
CLM	ELEVTR	72	72
CD	ELEVTR	73	73

LONG. CONTROL DERIVATIVES- STRAIGHT WING BASIC POS- FLAPS AND GEAR- V-TAIL=55DEG

DEPENDENT VARIABLE VS INDEPENDENT VARIABLE,

DATASETS PLOTTED	DEPENDENT VARIABLE	INDEPENDENT VARIABLE	PLOT PAGE	
			BEGINNING	ENDING
DE7022	DCL/DE	ALPHA	74	74
DE7022	DCD/DE	ALPHA	75	75
DE7022	DCLMDE	ALPHA	76	76

LAT.-DIR. CHAR. - STRAIGHT WING BASIC POSITION - FLAPS AND GEAR - V-TAIL=55DEG

DEPENDENT VARIABLE VS PARAMETRIC VARIABLE, PARAMETRIC STUDY

DATASETS PLOTTED:

N37012	N37013	N37011
N37016	N37017	N37015
N37020	N37021	N37019

DEPENDENT VARIABLE	PARAMETRIC VARIABLE	PLOT PAGE	
		BEGINNING	ENDING
CY	BETA	77	79
CLN	BETA	80	82
CSL	BETA	83	85

DIR. CONTROL DERIVATIVES- STRAIGHT WING BASIC POS.- FLAPS AND GEAR- V-TAIL=55DEG

DEPENDENT VARIABLE VS INDEPENDENT VARIABLE, PARAMETRIC STUDY

DATASETS PLOTTED:

DR7012	DR7013	DR7011
--------	--------	--------

DEPENDENT VARIABLE	INDEPENDENT VARIABLE	PLOT PAGE	
		BEGINNING	ENDING
DCY/DR	ALPHA	86	86
DCLNDR	ALPHA	87	87
DCSLDR	ALPHA	88	88

LONG. CHAR. - FLAP EFFECTIVENESS - ST. WING BASIC POS. - GEAR DOWN- V-TAIL=55DEG

DEPENDENT VARIABLE VS INDEPENDENT VARIABLE, MULTIPLE DATASETS

DATASETS PLOTTED:

TC7010 TC7004 TC7011

DEPENDENT VARIABLE	INDEPENDENT VARIABLE	PLOT PAGE BEGINNING / ENDING	
CL	ALPHA	89	89
L/D	ALPHA	90	90
CAB	ALPHA	91	91

LUNG. CHAR. - FLAP EFFECTIVENESS - ST. WING BASIC POS. - GEAR DOWN- V-TAIL=55DEG

DEPENDENT VARIABLE VS DEPENDENT VARIABLE, MULTIPLE DATASETS

DATASETS PLOTTED:

RC7010 RC7004 RC7011

DEPENDENT VARIABLE	DEPENDENT VARIABLE	PLOT PAGE BEGINNING / ENDING	
CL	CD	92	92
CL	CLM	93	93

LONG. CHAR. - FLAP EFFECTIVENESS - STRAIGHT WING AFT - V-TAIL=55DEG

DEPENDENT VARIABLE VS INDEPENDENT VARIABLE, MULTIPLE DATASETS

DATASETS PLOTTED:

TC7132 TC7133

DEPENDENT VARIABLE	INDEPENDENT VARIABLE	PLOT PAGE BEGINNING / ENDING	
CL	ALPHA	94	94
L/D	ALPHA	95	95
CAB	ALPHA	96	96

LONG. CHAR. - FLAP EFFECTIVENESS - STRAIGHT WING AFT - V-TAIL=55DEG

DEPENDENT VARIABLE VS DEPENDENT VARIABLE, MULTIPLE DATASETS

DATASETS PLOTTED:

RC7132 RC7133

DEPENDENT VARIABLE	DEPENDENT VARIABLE	PLOT PAGE	
		BEGINNING / ENDING	
CL	CD	97	97
CL	CLM	98	98

LONG. CHAR.- SPOILER EFFECTIVENESS- ST. WING BASIC POS.- GEAR DOWN- V-TAIL=55DEG

DEPENDENT VARIABLE VS INDEPENDENT VARIABLE, PARAMETRIC STUDY

DATASETS PLOTTED:

RC7007 RC7008

DEPENDENT VARIABLE	INDEPENDENT VARIABLE	PLOT PAGE	
		BEGINNING / ENDING	
CL	ALPHA	99	99

LONG. CHAR.- SPOILER EFFECTIVENESS- ST. WING BASIC POS.- GEAR DOWN- V-TAIL=55DEG

DEPENDENT VARIABLE VS DEPENDENT VARIABLE, PARAMETRIC STUDY

DATASETS PLOTTED:

RC7007 RC7008

DEPENDENT VARIABLE	DEPENDENT VARIABLE	PLOT PAGE	
		BEGINNING / ENDING	
CL	CD	100	100
CL	CLM	101	101

LAT. CHAR. - SPOILER EFFECTIVENESS - ST. WING BASIC POS. - GEAR DOWN - V-TAIL=55DEG

DEPENDENT VARIABLE VS PARAMETRIC VARIABLE, PARAMETRIC STUDY

DATASETS PLOTTED:

N37007 N37008

DEPENDENT VARIABLE	PARAMETRIC VARIABLE	PLOT PAGE BEGINNING / ENDING	
CY	SPOILR	102	102
CLN	SPOILR	103	103
CSL	SPOILR	104	104

LONG. CHAR. - SPOILER EFF. - ST. WING BASIC POS. - FLAPS AND GEAR - V-TAIL=55DEG

DEPENDENT VARIABLE VS INDEPENDENT VARIABLE, PARAMETRIC STUDY

DATASETS PLOTTED:

RC7011 SC7005

DEPENDENT VARIABLE	INDEPENDENT VARIABLE	PLOT PAGE BEGINNING / ENDING	
CL	ALPHA	105	105

LONG. CHAR. - SPOILER EFF. - ST. WING BASIC POS. - FLAPS AND GEAR - V-TAIL=55DEG

DEPENDENT VARIABLE VS DEPENDENT VARIABLE, PARAMETRIC STUDY

DATASETS PLOTTED:

RC7011 SC7005

DEPENDENT VARIABLE	DEPENDENT VARIABLE	PLOT PAGE BEGINNING / ENDING	
CL	CD	106	106
CL	CEM	107	107

LATERAL CHAR.- SPOILER EFF.- ST. WING BASIC POS. - FLAPS AND GEAR - V-TAIL=55DEG

DEPENDENT VARIABLE VS PARAMETRIC VARIABLE, PARAMETRIC STUDY

DATASETS PLOTTED:

N37011 N37005

DEPENDENT VARIABLE	PARAMETRIC VARIABLE	PLOT PAGE	
		BEGINNING	ENDING
CY	SPOILR	108	108
CLN	SPOILR	109	109
CSL	SPOILR	110	110

LONG. CHAR.- LANDING GEAR EFF. - ST. WING BASIC POS. - WITH FLAPS - V-TAIL=55DEG

DEPENDENT VARIABLE VS INDEPENDENT VARIABLE, MULTIPLE DATASETS

DATASETS PLOTTED:

RC7034 RC7011

DEPENDENT VARIABLE	INDEPENDENT VARIABLE	PLOT PAGE	
		BEGINNING	ENDING
CL	ALPHA	111	111
L/D	ALPHA	112	112
CAB	ALPHA	113	113

LONG. CHAR.- LANDING GEAR EFF. - ST. WING BASIC POS. - WITH FLAPS - V-TAIL=55DEG

DEPENDENT VARIABLE VS DEPENDENT VARIABLE, MULTIPLE DATASETS

DATASETS PLOTTED:

RC7034 RC7011

DEPENDENT VARIABLE	DEPENDENT VARIABLE	PLOT PAGE	
		BEGINNING	ENDING
CL	CD	114	114
CL	CLM	115	115



LANDING GEAR EFF.- SIDESLIP DERIV.- ST. WING BASIC POS.-WITH FLAPS- V-TAIL=55DEG

DEPENDENT VARIABLE VS INDEPENDENT VARIABLE, MULTIPLE DATASETS

DATASETS PLOTTED:  
DB7034 DB7011

DEPENDENT VARIABLE	INDEPENDENT VARIABLE	"PLOT PAGE" BEGINNING / ENDING	
CYBETA	ALPHA	116	116
DCLNDB	ALPHA	117	117
UCSLUB	ALPHA	118	118

LONG. CHAR. - WING FILLET EFFECT - STRAIGHT WING BASIC POSITION - V-TAIL=55DEG

DEPENDENT VARIABLE VS INDEPENDENT VARIABLE, MULTIPLE DATASETS

DATASETS PLOTTED:  
SC7001 RC7063

DEPENDENT VARIABLE	INDEPENDENT VARIABLE	"PLOT PAGE" BEGINNING / ENDING	
CL	ALPHA	119	119

LONG. CHAR. - WING FILLET EFFECT - STRAIGHT WING BASIC POSITION - V-TAIL=55DEG

DEPENDENT VARIABLE VS DEPENDENT VARIABLE, MULTIPLE DATASETS

DATASETS PLOTTED:  
SC7001 RC7063

DEPENDENT VARIABLE	DEPENDENT VARIABLE	"PLOT PAGE" BEGINNING / ENDING	
CL	CD	120	120
CL	CLM	121	121

LONGITUDINAL CHARACTERISTICS - V-TAIL ROLLOUT EFFECT - STRAIGHT WING BASIC POS.

DEPENDENT VARIABLE VS INDEPENDENT VARIABLE, MULTIPLE DATASETS

DATASETS PLOTTED:

RC7047 RC7045 SC7001

DEPENDENT VARIABLE	INDEPENDENT VARIABLE	PLOT PAGE BEGINNING / ENDING	
CL	ALPHA	122	122
L/D	ALPHA	123	123
CAB	ALPHA	124	124

LONGITUDINAL CHARACTERISTICS - V-TAIL ROLLOUT EFFECT - STRAIGHT WING BASIC POS.

DEPENDENT VARIABLE VS DEPENDENT VARIABLE, MULTIPLE DATASETS

DATASETS PLOTTED:

RC7047 RC7045 SC7001

DEPENDENT VARIABLE	DEPENDENT VARIABLE	PLOT PAGE BEGINNING / ENDING	
CL	CU	125	125
CL	CLM	126	126

V-TAIL ROLLOUT EFFECT - SIDESLIP DERIVATIVES - STRAIGHT WING BASIC POSITION

DEPENDENT VARIABLE VS INDEPENDENT VARIABLE, MULTIPLE DATASETS

DATASETS PLOTTED:

DB7047 DB7045 DB7001

DEPENDENT VARIABLE	INDEPENDENT VARIABLE	PLOT PAGE BEGINNING / ENDING	
CYBETA	ALPHA	127	127
DCLNDB	ALPHA	128	128
DCSLUB	ALPHA	129	129

LONG. CHAR. - V-TAIL SECTION CAMBER EFFECT - STRAIGHT WING AFT - V-TAIL=55DEG

DEPENDENT VARIABLE VS INDEPENDENT VARIABLE, MULTIPLE DATASETS

DATASETS PLOTTED:

RC7068 RC7116 RC7118

DEPENDENT VARIABLE	INDEPENDENT VARIABLE	PLOT PAGE BEGINNING / ENDING	
CL	ALPHA	130	130
L/D	ALPHA	<del>131</del>	<del>131</del>
CAB	ALPHA	132	132

LONG. CHAR. - V-TAIL SECTION CAMBER EFFECT - STRAIGHT WING AFT - V-TAIL=55DEG

DEPENDENT VARIABLE VS DEPENDENT VARIABLE, MULTIPLE DATASETS

DATASETS PLOTTED:

RC7068 RC7116 RC7118

DEPENDENT VARIABLE	DEPENDENT VARIABLE	PLOT PAGE BEGINNING / ENDING	
CL	CD	133	133
CL	CLM	<del>134</del>	<del>134</del>

V-TAIL SECTION CAMBER EFFECT - SIDESLIP DERIV. - STRAIGHT WING AFT - V-TAIL=55DEG

DEPENDENT VARIABLE VS INDEPENDENT VARIABLE, MULTIPLE DATASETS

DATASETS PLOTTED:

DB7068 DB7116 DB7118

DEPENDENT VARIABLE	INDEPENDENT VARIABLE	PLOT PAGE BEGINNING / ENDING	
CYBETA	ALPHA	135	135
DCLNDB	ALPHA	<del>136</del>	<del>136</del>
UCSLDB	ALPHA	137	137

COMPARISON OF V-TAIL=55DEG WITH HORIZ.-VERT. TAIL CONFIG. - ST. WING BASIC POS.

DEPENDENT VARIABLE VS INDEPENDENT VARIABLE, MULTIPLE DATASETS

DATASETS PLOTTED:  
SC7001 RC7049

DEPENDENT VARIABLE	INDEPENDENT VARIABLE	PLOT PAGE BEGINNING / ENDING	
CL	ALPHA	138	138
L/D	ALPHA	<del>139</del>	<del>139</del>
CAB	ALPHA	140	140

COMPARISON OF V-TAIL=55DEG WITH HORIZ.-VERT. TAIL CONFIG. - ST. WING BASIC POS.

DEPENDENT VARIABLE VS DEPENDENT VARIABLE, MULTIPLE DATASETS

DATASETS PLOTTED:  
SC7001 RC7049

DEPENDENT VARIABLE	DEPENDENT VARIABLE	PLOT PAGE BEGINNING / ENDING	
CL	CD	141	141
CL	CLM	<del>142</del>	<del>142</del>

COMPARISON OF V-TAIL=55DEG WITH HORIZ.-VERT. TAIL CONFIG. - ST. WING BASIC POS.

DEPENDENT VARIABLE VS INDEPENDENT VARIABLE, MULTIPLE DATASETS

DATASETS PLOTTED:  
DB7001 DB7049

DEPENDENT VARIABLE	INDEPENDENT VARIABLE	PLOT PAGE BEGINNING / ENDING	
CYBETA	ALPHA	143	143
DCLNDB	ALPHA	<del>144</del>	<del>144</del>
DCSLDB	ALPHA	145	145

LONG. CHAR.- ELEVATOR EFF.- STRAIGHT WING BASIC POS. - HORIZ.-VERT. TAIL CONFIG.

DEPENDENT VARIABLE VS INDEPENDENT VARIABLE, PARAMETRIC STUDY

DATASETS PLOTTED:

RC7051 RC7049 RC7052

DEPENDENT VARIABLE	INDEPENDENT VARIABLE	PLOT PAGE	
		BEGINNING	ENDING
CL	ALPHA	146	146
L/D	ALPHA	147	147
CAB	ALPHA	148	148

LONG. CHAR.- ELEVATOR EFF.- STRAIGHT WING BASIC POS. - HORIZ.-VERT. TAIL CONFIG.

DEPENDENT VARIABLE VS DEPENDENT VARIABLE, PARAMETRIC STUDY

DATASETS PLOTTED:

RC7051 RC7049 RC7052

DEPENDENT VARIABLE	DEPENDENT VARIABLE	PLOT PAGE	
		BEGINNING	ENDING
CL	CD	149	149
CL	CLM	150	150

LONGITUDINAL CONTROL - STRAIGHT WING BASIC POS. - HORIZ.-VERT. TAIL CONFIG.

DEPENDENT VARIABLE VS PARAMETRIC VARIABLE, PARAMETRIC STUDY

DATASETS PLOTTED:

N37051 N37049 N37052

DEPENDENT VARIABLE	PARAMETRIC VARIABLE	PLOT PAGE	
		BEGINNING	ENDING
CL	ELEVTR	151	151
CLM	ELEVTR	152	152
CD	ELEVTR	153	153

LONG. CONTROL DERIVATIVES - STRAIGHT WING BASIC POS. - HORIZ.-VERT. TAIL CONFIG.

DEPENDENT VARIABLE VS INDEPENDENT VARIABLE,

DATASETS PLOTTED	DEPENDENT VARIABLE	INDEPENDENT VARIABLE	PLOT PAGE	
			BEGINNING	ENDING
DE7051	DCL/DE	ALPHA	154	154
DE7051	DCD/DE	ALPHA	155	155
DE7051	DCLMDE	ALPHA	156	158

LONG. CHAR. - STRAIGHT WING BASIC POS. - FLAPS DOWN - HORIZ.-VERT. TAIL CONFIG.

DEPENDENT VARIABLE VS INDEPENDENT VARIABLE, PARAMETRIC STUDY

DATASETS PLOTTED:

RC7054 RC7055 RC7053

DEPENDENT VARIABLE	INDEPENDENT VARIABLE	PLOT PAGE	
		BEGINNING	ENDING
CL	ALPHA	157	157
L/D	ALPHA	158	158
CAB	ALPHA	159	159

LONG. CHAR. - STRAIGHT WING BASIC POS. - FLAPS DOWN - HORIZ.-VERT. TAIL CONFIG.

DEPENDENT VARIABLE VS DEPENDENT VARIABLE, PARAMETRIC STUDY

DATASETS PLOTTED:

RC7054 RC7055 RC7053

DEPENDENT VARIABLE	DEPENDENT VARIABLE	PLOT PAGE	
		BEGINNING	ENDING
CL	CJ	160	160
CL	CLM	161	161

LUNG. CONTROL - STRAIGHT WING BASIC POS.- FLAPS DOWN - HORIZ.-VERT. TAIL CONFIG.

DEPENDENT VARIABLE VS PARAMETRIC VARIABLE, PARAMETRIC STUDY

DATASETS PLOTTED:

N37054 N37055 N37053

DEPENDENT VARIABLE	PARAMETRIC VARIABLE	PLOT PAGE	
		BEGINNING	ENDING
CL	ELEVTR	162	162
CLM	ELEVTR	163	163
CD	ELEVTR	164	164

LUNG. CONTROL DERIV.- ST. WING BASIC POS.- FLAPS DOWN- HORIZ.-VERT. TAIL CONFIG.

DEPENDENT VARIABLE VS INDEPENDENT VARIABLE,

DATASETS PLOTTED	DEPENDENT VARIABLE	INDEPENDENT VARIABLE	PLOT PAGE	
			BEGINNING	ENDING
DE7054	DCL/DE	ALPHA	165	165
DE7054	DCD/DE	ALPHA	166	166
DE7054	DCLMDE	ALPHA	167	167

LONGITUDINAL CHAR. - EFFECT OF WING INCIDENCE - STRAIGHT WING AFT - V-TAIL=65DEG

DEPENDENT VARIABLE VS INDEPENDENT VARIABLE, PARAMETRIC STUDY

DATASETS PLOTTED:

I#7064 I#7067 I#7068

DEPENDENT VARIABLE	INDEPENDENT VARIABLE	PLOT PAGE	
		BEGINNING	ENDING
CL	ALPHA	168	168

LONGITUDINAL CHAR. - EFFECT OF WING INCIDENCE - STRAIGHT WING AFT - V-TAIL=55DEG

DEPENDENT VARIABLE VS DEPENDENT VARIABLE, PARAMETRIC STUDY

DATASETS PLOTTED:

IW7064 IW7067 IW7068

DEPENDENT VARIABLE	DEPENDENT VARIABLE	PLOT PAGE BEGINNING / ENDING	
CL	CD	169	169
CL	CLM	170	170

LONGITUDINAL CHAR. - EFFECT OF WING INCIDENCE - STRAIGHT WING AFT - TAIL OFF

DEPENDENT VARIABLE VS INDEPENDENT VARIABLE, PARAMETRIC STUDY

DATASETS PLOTTED:

IW7065 IW7066 IW7076

DEPENDENT VARIABLE	INDEPENDENT VARIABLE	PLOT PAGE BEGINNING / ENDING	
CL	ALPHA	171	171

LONGITUDINAL CHAR. - EFFECT OF WING INCIDENCE - STRAIGHT WING AFT - TAIL OFF

DEPENDENT VARIABLE VS DEPENDENT VARIABLE, PARAMETRIC STUDY

DATASETS PLOTTED:

IW7065 IW7066 IW7076

DEPENDENT VARIABLE	DEPENDENT VARIABLE	PLOT PAGE BEGINNING / ENDING	
CL	CD	172	172
CL	CLM	173	173



LONG. CHAR. - EFFECT OF AFTERBODY SHAPE - STRAIGHT WING AFT - V-TAIL=55DEG

DEPENDENT VARIABLE VS INDEPENDENT VARIABLE, MULTIPLE DATASETS

DATASETS PLOTTED:

RC7068 RC7122 RC7124 RC7130

DEPENDENT VARIABLE	INDEPENDENT VARIABLE	PLOT PAGE BEGINNING / ENDING	
CL	ALPHA	174	174
L/D	ALPHA	175	175
CAB	ALPHA	176	176

LONG. CHAR. - EFFECT OF AFTERBODY SHAPE - STRAIGHT WING AFT - V-TAIL=55DEG

DEPENDENT VARIABLE VS DEPENDENT VARIABLE, MULTIPLE DATASETS

DATASETS PLOTTED:

RC7068 RC7122 RC7124 RC7130

DEPENDENT VARIABLE	DEPENDENT VARIABLE	PLOT PAGE BEGINNING / ENDING	
CL	CD	177	177
CL	CLM	178	178

EFFECT OF AFTERBODY SHAPE - SIDESLIP DERIV. - STRAIGHT WING AFT - V-TAIL=55DEG

DEPENDENT VARIABLE VS INDEPENDENT VARIABLE, MULTIPLE DATASETS

DATASETS PLOTTED:

DB7068 DB7122 DB7124 DB7130

DEPENDENT VARIABLE	INDEPENDENT VARIABLE	PLOT PAGE BEGINNING / ENDING	
CYBETA	ALPHA	179	179
DCLNDB	ALPHA	180	180
DCSLUB	ALPHA	181	181

LONGITUDINAL CHAR. - EFFECT OF AFTERBODY SHAPE - STRAIGHT WING AFT - TAIL OFF

DEPENDENT VARIABLE VS INDEPENDENT VARIABLE, MULTIPLE DATASETS

DATASETS PLOTTED:

RC7076 RC7120 RC7126 RC7128

DEPENDENT VARIABLE	INDEPENDENT VARIABLE	PLOT PAGE BEGINNING / ENDING	
CL	ALPHA	182	182
L/D	ALPHA	183	183
CAB	ALPHA	184	184

LONGITUDINAL CHAR. - EFFECT OF AFTERBODY SHAPE - STRAIGHT WING AFT - TAIL OFF

DEPENDENT VARIABLE VS DEPENDENT VARIABLE, MULTIPLE DATASETS

DATASETS PLOTTED:

RC7076 RC7120 RC7126 RC7128

DEPENDENT VARIABLE	DEPENDENT VARIABLE	PLOT PAGE BEGINNING / ENDING	
CL	CD	185	185
CL	CLM	186	186

EFFECT OF AFTERBODY SHAPE - SIDESLIP DERIVATIVES - STRAIGHT WING AFT - TAIL OFF

DEPENDENT VARIABLE VS INDEPENDENT VARIABLE, MULTIPLE DATASETS

DATASETS PLOTTED:

DB7120 DB7126 DB7128

DEPENDENT VARIABLE	INDEPENDENT VARIABLE	PLOT PAGE BEGINNING / ENDING	
CYBETA	ALPHA	187	187
UCLNDB	ALPHA	188	188
DCSLDB	ALPHA	189	189

EFFECT OF RN NO.- ST. WING BASIC - V-TAIL=55DEG - MACH NOS 0.184,0.259,AND 0.318

DEPENDENT VARIABLE VS INDEPENDENT VARIABLE,

DATASETS PLOTTED	DEPENDENT VARIABLE	INDEPENDENT VARIABLE	PLOT PAGE	
			BEGINNING	ENDING
RN7001	CL	ALPHA	190	190
RN7001	L/D	ALPHA	191	191
RN7001	CAB	ALPHA	192	192

EFFECT OF RN NO.- ST. WING BASIC - V-TAIL=55DEG - MACH NOS 0.184,0.259,AND 0.318

DEPENDENT VARIABLE VS DEPENDENT VARIABLE,

DATASETS PLOTTED	DEPENDENT VARIABLE	DEPENDENT VARIABLE	PLOT PAGE	
			BEGINNING	ENDING
RN7001	CL	CD	193	193
RN7001	CL	CLM	194	194

LONG. CHAR. - CRUISE ENGINE EFFECT - STRAIGHT WING BASIC POS. - V-TAIL=55DEG

DEPENDENT VARIABLE VS INDEPENDENT VARIABLE, MULTIPLE DATASETS

DATASETS PLOTTED:

SC7001 RC7038 RC7061

DEPENDENT VARIABLE	INDEPENDENT VARIABLE	PLOT PAGE	
		BEGINNING	ENDING
CL	ALPHA	195	195
L/D	ALPHA	196	196
CAB	ALPHA	197	197

LONG. CHAR. - CRUISE ENGINE EFFECT - STRAIGHT WING BASIC POS. - V-TAIL=55DEG

DEPENDENT VARIABLE VS INDEPENDENT VARIABLE, MULTIPLE DATASETS

DATASETS PLOTTED:

SC7001 RC7038 RC7061

DEPENDENT VARIABLE	INDEPENDENT VARIABLE	PLOT PAGE BEGINNING / ENDING	
CL	CD	198	198
CL	CLM	199	199

CRUISE ENGINE EFFECT - SIDESLIP DERIVATIVES - ST. WING BASIC POS. - V-TAIL=55DEG

DEPENDENT VARIABLE VS INDEPENDENT VARIABLE, MULTIPLE DATASETS

DATASETS PLOTTED:

DB7001 DB7038

DEPENDENT VARIABLE	INDEPENDENT VARIABLE	PLOT PAGE BEGINNING / ENDING	
CYBETA	ALPHA	200	200
DCLNDS	ALPHA	201	201
DCSLDB	ALPHA	202	202

LONG. CHAR. - CRUISE ENGINE EFF. - FLAPS DOWN - ST. WING BASIC POS. - V-TAIL=55DEG

DEPENDENT VARIABLE VS INDEPENDENT VARIABLE, MULTIPLE DATASETS

DATASETS PLOTTED:

RC7034 RC7036

DEPENDENT VARIABLE	INDEPENDENT VARIABLE	PLOT PAGE BEGINNING / ENDING	
CL	ALPHA	203	203
L/D	ALPHA	204	204
CAB	ALPHA	205	205

LONG. CHAR. - CRUISE ENGINE EFF. - FLAPS DOWN - ST. WING BASIC POS. - V-TAIL=55DEG

DEPENDENT VARIABLE VS DEPENDENT VARIABLE, MULTIPLE DATASETS

DATASETS PLOTTED:

RC7034 RC7036

DEPENDENT VARIABLE	DEPENDENT VARIABLE	PLOT PAGE BEGINNING / ENDING	
CL	CD	206	206
CL	CLM	207	207

CRUISE ENGINE EFF. - SIDESLIP DERIV. - FLAPS DOWN - ST. WING BASIC - V-TAIL=55DEG

DEPENDENT VARIABLE VS INDEPENDENT VARIABLE, MULTIPLE DATASETS

DATASETS PLOTTED:

DB7034 DB7036

DEPENDENT VARIABLE	INDEPENDENT VARIABLE	PLOT PAGE BEGINNING / ENDING	
CYBETA	ALPHA	208	208
DCLNDB	ALPHA	209	209
DCSLDB	ALPHA	210	210

LONGITUDINAL CHAR. - CRUISE ENGINE EFFECT - STRAIGHT WING AFT - V-TAIL=55DEG

DEPENDENT VARIABLE VS INDEPENDENT VARIABLE, MULTIPLE DATASETS

DATASETS PLOTTED:

RC7068 RC7071 RC7070

DEPENDENT VARIABLE	INDEPENDENT VARIABLE	PLOT PAGE BEGINNING / ENDING	
CL	ALPHA	211	211
L/D	ALPHA	212	212
CAB	ALPHA	213	213

LONGITUDINAL CHAR. - CRUISE ENGINE EFFECT - STRAIGHT WING AFT - V-TAIL=55DEG

DEPENDENT VARIABLE VS DEPENDENT VARIABLE, MULTIPLE DATASETS

DATASETS PLOTTED:

RC7068 RC7071 RC7070 - - -

DEPENDENT VARIABLE	DEPENDENT VARIABLE	PLOT PAGE BEGINNING / ENDING	
CL	CU	214	214
CL	CLM	215	215

LONGITUDINAL CHAR. - CRUISE ENGINE EFFECT - STRAIGHT WING AFT - TAIL OFF

DEPENDENT VARIABLE VS INDEPENDENT VARIABLE, MULTIPLE DATASETS

DATASETS PLOTTED:

RC7076 RC7072 RC7073 RC7074 RC7075

DEPENDENT VARIABLE	INDEPENDENT VARIABLE	PLOT PAGE BEGINNING / ENDING	
CL	ALPHA	216	216
L/D	ALPHA	217	217
CAB	ALPHA	218	218

LONGITUDINAL CHAR. - CRUISE ENGINE EFFECT - STRAIGHT WING AFT - TAIL OFF

DEPENDENT VARIABLE VS DEPENDENT VARIABLE, MULTIPLE DATASETS

DATASETS PLOTTED:

RC7076 RC7072 RC7073 RC7074 RC7075

DEPENDENT VARIABLE	DEPENDENT VARIABLE	PLOT PAGE BEGINNING / ENDING	
CL	CU	219	219
CL	CLM	220	220

VERTICAL TAIL EFFECTIVENESS - SIDESLIP DERIVATIVES - STRAIGHT WING BASIC POS.

DEPENDENT VARIABLE VS INDEPENDENT VARIABLE, MULTIPLE DATASETS

DATASETS PLOTTED:  
DB7049 DB7057

DEPENDENT VARIABLE	INDEPENDENT VARIABLE	PLOT PAGE BEGINNING / ENDING	
CYBETA	ALPHA	221	221
DCLNDB	ALPHA	222	222
DCSLDB	ALPHA	223	223

LATERAL CHARACTERISTICS - WING-BODY DATA - STRAIGHT WING BASIC POSITION

DEPENDENT VARIABLE VS PARAMETRIC VARIABLE, PARAMETRIC STUDY

DATASETS PLOTTED:  
N37041 N37042 N37040

DEPENDENT VARIABLE	PARAMETRIC VARIABLE	PLOT PAGE BEGINNING / ENDING	
CY	BETA	224	224
CLN	BETA	225	225
CSL	BETA	226	226

LONGITUDINAL CHARACTERISTICS - BODY TAIL DATA - V-TAIL=55DEG

DEPENDENT VARIABLE VS INDEPENDENT VARIABLE, PARAMETRIC STUDY

DATASETS PLOTTED:  
RC7078 RC7077

DEPENDENT VARIABLE	INDEPENDENT VARIABLE	PLOT PAGE BEGINNING / ENDING	
CL	ALPHA	227	227

LONGITUDINAL CHARACTERISTICS - BODY TAIL DATA - V-TAIL=55DEG

DEPENDENT VARIABLE VS DEPENDENT VARIABLE, PARAMETRIC STUDY

DATASETS PLOTTED:

RC7078 RC7077

DEPENDENT VARIABLE	DEPENDENT VARIABLE	PLOT PAGE BEGINNING / ENDING	
CL	CD	228	228
CL	CLM	229	229

BODY-TAIL DATA - SIDESLIP DERIVATIVES - V-TAIL=55DEG

DEPENDENT VARIABLE VS INDEPENDENT VARIABLE,

DATASETS PLOTTED	DEPENDENT VARIABLE	INDEPENDENT VARIABLE	PLOT PAGE BEGINNING / ENDING	
DB7077	CYBETA	ALPHA	230	230
DB7077	DCLNDB	ALPHA	231	231
DB7077	DCSLDB	ALPHA	232	232

CONFIGURATION BUILDUP - LONGITUDINAL CHARACTERISTICS - DELTA WING

DEPENDENT VARIABLE VS INDEPENDENT VARIABLE, MULTIPLE DATASETS

DATASETS PLOTTED:

RC7113 RC7109 RC7083 RC7102 RC7100

DEPENDENT VARIABLE	INDEPENDENT VARIABLE	PLOT PAGE BEGINNING / ENDING	
CL	ALPHA	233	233
L/D	ALPHA	234	234
CAB	ALPHA	235	235



CONFIGURATION BUILDUP - LONGITUDINAL CHARACTERISTICS - DELTA WING

DEPENDENT VARIABLE VS INDEPENDENT VARIABLE, MULTIPLE DATASETS

DATASETS PLOTTED:

RC7113      RC7109      RC7083      RC7102      RC7100

DEPENDENT VARIABLE	DEPENDENT VARIABLE	PLOT PAGE BEGINNING / ENDING	
CL	CD	236	236
CL	CLM	237	237

CONFIGURATION BUILDUP - LATERAL CHARACTERISTICS - DELTA WING - BETA=-8 DEG

DEPENDENT VARIABLE VS INDEPENDENT VARIABLE, MULTIPLE DATASETS

DATASETS PLOTTED:

RC7114      RC7064

DEPENDENT VARIABLE	INDEPENDENT VARIABLE	PLOT PAGE BEGINNING / ENDING	
CY	ALPHA	238	238
CLN	ALPHA	239	239
CSL	ALPHA	240	240

CONFIGURATION BUILDUP - LATERAL CHARACTERISTICS - DELTA WING - BETA=-4 DEG

DEPENDENT VARIABLE VS INDEPENDENT VARIABLE, MULTIPLE DATASETS

DATASETS PLOTTED:

RC7115      RC7108      RC7065      RC7103      RC7101

DEPENDENT VARIABLE	INDEPENDENT VARIABLE	PLOT PAGE BEGINNING / ENDING	
CY	ALPHA	241	241
CLN	ALPHA	242	242
CSL	ALPHA	243	243

CONFIGURATION BUILDUP - LATERAL CHARACTERISTICS - DELTA WING - BETA=0 DEG

DEPENDENT VARIABLE VS INDEPENDENT VARIABLE, MULTIPLE DATASETS

DATASETS PLOTTED:

RC7113 RC7109 RC7083 RC7102 RC7100

DEPENDENT VARIABLE	INDEPENDENT VARIABLE	PLOT PAGE	
		BEGINNING	ENDING
CY	ALPHA	244	244
CLN	ALPHA	245	245
CSL	ALPHA	246	246

LATERAL CHARACTERISTICS - DELTA WING CONFIGURATIONS

DEPENDENT VARIABLE VS INDEPENDENT VARIABLE, PARAMETRIC STUDY

DATASETS PLOTTED:

RC7114 RC7115 RC7113

DEPENDENT VARIABLE	INDEPENDENT VARIABLE	PLOT PAGE	
		BEGINNING	ENDING
CY	ALPHA	247	247
CLN	ALPHA	248	248
CSL	ALPHA	249	249

DATASETS PLOTTED:

RC7108 RC7109

DEPENDENT VARIABLE	INDEPENDENT VARIABLE	PLOT PAGE	
		BEGINNING	ENDING
CY	ALPHA	250	250
CLN	ALPHA	251	251
CSL	ALPHA	252	252

DATASETS PLOTTED:

RC7084 RC7085 RC7083

DEPENDENT VARIABLE	INDEPENDENT VARIABLE	PLOT PAGE	
		BEGINNING	ENDING
CY	ALPHA	253	253
CLN	ALPHA	254	254
CSL	ALPHA	255	255

LATERAL CHARACTERISTICS - DELTA WING CONFIGURATIONS

DEPENDENT VARIABLE VS INDEPENDENT VARIABLE, PARAMETRIC STUDY

DATASETS PLOTTED:  
RC7103 RC7102

DEPENDENT VARIABLE	INDEPENDENT VARIABLE	PLOT PAGE BEGINNING / ENDING	
CY	ALPHA	256	256
CLN	ALPHA	257	257
CSL	ALPHA	258	258

DATASETS PLOTTED:  
RC7101 RC7100

DEPENDENT VARIABLE	INDEPENDENT VARIABLE	PLOT PAGE BEGINNING / ENDING	
CY	ALPHA	259	259

DATASETS PLOTTED:  
RC7101 RC7100

DEPENDENT VARIABLE	INDEPENDENT VARIABLE	PLOT PAGE BEGINNING / ENDING	
CLN	ALPHA	260	260
CSL	ALPHA	261	261

CONFIGURATION BUILDUP - SIDESLIP DERIVATIVES - DELTA WING

DEPENDENT VARIABLE VS INDEPENDENT VARIABLE, MULTIPLE DATASETS

DATASETS PLOTTED:  
DB7113 DB7109 DB7083 DB7100

DEPENDENT VARIABLE	INDEPENDENT VARIABLE	PLOT PAGE BEGINNING / ENDING	
CYBETA	ALPHA	262	262
DCLNDB	ALPHA	263	263
DCSLDB	ALPHA	264	264

LONGITUDINAL CHARACTERISTICS - ELEVON EFFECTIVENESS - DELTA WING

DEPENDENT VARIABLE VS INDEPENDENT VARIABLE, PARAMETRIC STUDY

DATASETS PLOTTED:

RC7093      RC7090      RC7083      RC7096

DEPENDENT VARIABLE	INDEPENDENT VARIABLE	PLOT PAGE	
		BEGINNING	ENDING
CL	ALPHA	265	265
L/D	ALPHA	266	266
CAB	ALPHA	267	267

LONGITUDINAL CHARACTERISTICS - ELEVON EFFECTIVENESS - DELTA WING

DEPENDENT VARIABLE VS DEPENDENT VARIABLE, PARAMETRIC STUDY

DATASETS PLOTTED:

RC7093      RC7090      RC7083      RC7096

DEPENDENT VARIABLE	DEPENDENT VARIABLE	PLOT PAGE	
		BEGINNING	ENDING
CL	CD	268	268
CL	CLM	269	269

LONGITUDINAL CONTROL - DELTA WING

DEPENDENT VARIABLE VS PARAMETRIC VARIABLE, PARAMETRIC STUDY

DATASETS PLOTTED:

N47093      N47090      N47083      N47096

DEPENDENT VARIABLE	PARAMETRIC VARIABLE	PLOT PAGE	
		BEGINNING	ENDING
CL	ELEVON	270	270
CLM	ELEVON	271	271
CD	ELEVON	272	272

LONGITUDINAL CONTROL DERIVATIVES - DELTA WING . . . . .

DEPENDENT VARIABLE VS. INDEPENDENT VARIABLE, . . . . .

DATASETS PLOTTED	DEPENDENT VARIABLE	INDEPENDENT VARIABLE	PLOT PAGE	
			BEGINNING /	ENDING
DE7093	DCL/DE	ALPHA	273	273
DE7093	DCD/DE	ALPHA	274	274
DE7093	DCLMDE	ALPHA	275	275

LATERAL CHARACTERISTICS - AILERON EFFECTIVENESS - DELTA WING CONFIGURATION

DEPENDENT VARIABLE VS PARAMETRIC VARIABLE, PARAMETRIC STUDY

DATASETS PLOTTED:

N47085	N47083
N47092	N47091
N47095	N47094

DEPENDENT VARIABLE	PARAMETRIC VARIABLE	PLOT PAGE	
		BEGINNING /	ENDING
CY	BETA	276	279
CLN	BETA	280	283
CSL	BETA	284	287

LATERAL CONTROL DERIVATIVES - DELTA WING CONFIGURATIONS

DEPENDENT VARIABLE VS INDEPENDENT VARIABLE, PARAMETRIC STUDY

DATASETS PLOTTED:

DA7085	DA7083
--------	--------

DEPENDENT VARIABLE	INDEPENDENT VARIABLE	PLOT PAGE	
		BEGINNING /	ENDING
DCY/DA	ALPHA	288	288
DCLNDA	ALPHA	289	289
DCSLDA	ALPHA	290	290

LATERAL CHARACTERISTICS - AILERON EFFECTIVENESS - DELTA WING CONFIG. - BETA=0DEG  
 DEPENDENT VARIABLE VS PARAMETRIC VARIABLE, PARAMETRIC STUDY

DATASETS PLOTTED:  
 N47083      N47091      N47094

DEPENDENT VARIABLE	PARAMETRIC VARIABLE	PLOT PAGE	
		BEGINNING	ENDING
CY	AILRON	291	291
CLN	AILRON	292	292
CSL	AILRON	293	293

LATERAL CHARACTERISTICS - AILERON EFFECTIVENESS - DELTA WING CONFIG. - BETA=4DEG  
 DEPENDENT VARIABLE VS PARAMETRIC VARIABLE, PARAMETRIC STUDY

DATASETS PLOTTED:  
 N47085      N47092      N47095

DEPENDENT VARIABLE	PARAMETRIC VARIABLE	PLOT PAGE	
		BEGINNING	ENDING
CY	AILRON	294	294
CLN	AILRON	295	295
CSL	AILRON	296	296

DIRECTIONAL CHARACTERISTICS - RUDDER EFFECTIVENESS - DELTA WING CONFIGURATION  
 DEPENDENT VARIABLE VS PARAMETRIC VARIABLE, PARAMETRIC STUDY

DATASETS PLOTTED:  
 N47085      N47083  
 N47087      N47086  
 N47089      N47088

DEPENDENT VARIABLE	PARAMETRIC VARIABLE	PLOT PAGE	
		BEGINNING	ENDING
CY	BETA	297	300
CLN	BETA	301	304
CSL	BETA	305	308

DIRECTIONAL CONTROL DERIVATIVES = DELTA WING CONFIGURATION . . .

DEPENDENT VARIABLE VS INDEPENDENT VARIABLE, PARAMETRIC STUDY

DATASETS PLOTTED:  
DR7085 DR7083

DEPENDENT VARIABLE	INDEPENDENT VARIABLE	PLOT PAGE	
		BEGINNING	ENDING
DCY/DR	ALPHA	309	309
DCLNDR	ALPHA	310	310
DCSLDR	ALPHA	311	311

LATERAL CHARACTERISTICS - RUDDER EFFECTIVENESS = DELTA WING CONFIG. = BETA=0DEG

DEPENDENT VARIABLE VS PARAMETRIC VARIABLE, PARAMETRIC STUDY

DATASETS PLOTTED:  
N47083 N47086 N47088

DEPENDENT VARIABLE	PARAMETRIC VARIABLE	PLOT PAGE	
		BEGINNING	ENDING
CY	RUDDER	312	312
CLN	RUDDER	313	313
CSL	RUDDER	314	314

LATERAL CHARACTERISTICS - RUDDER EFFECTIVENESS = DELTA WING CONFIG. = BETA=-40DEG

DEPENDENT VARIABLE VS PARAMETRIC VARIABLE, PARAMETRIC STUDY

DATASETS PLOTTED:  
N47085 N47087 N47089

DEPENDENT VARIABLE	PARAMETRIC VARIABLE	PLOT PAGE	
		BEGINNING	ENDING
CY	RUDDER	315	315
CLN	RUDDER	316	316
CSL	RUDDER	317	317

LONGITUDINAL CHARACTERISTICS - EFFECT OF LANDING GEAR - DELTA WING CONFIGURATION

DEPENDENT VARIABLE VS INDEPENDENT VARIABLE, ~~MULTIPLE DATASETS~~

DATASETS PLOTTED:  
RC7083 RC7098

DEPENDENT VARIABLE	INDEPENDENT VARIABLE	PLOT PAGE	
		BEGINNING	ENDING
CL	ALPHA	318	318
L/D	ALPHA	319	319
CAB	ALPHA	320	320

LONGITUDINAL CHARACTERISTICS - EFFECT OF LANDING GEAR - DELTA WING CONFIGURATION

DEPENDENT VARIABLE VS DEPENDENT VARIABLE, ~~MULTIPLE DATASETS~~

DATASETS PLOTTED:  
RC7083 RC7098

DEPENDENT VARIABLE	DEPENDENT VARIABLE	PLOT PAGE	
		BEGINNING	ENDING
CL	CD	321	321
CL	CLM	322	322

EFFECT OF LANDING GEAR - SIDESLIP DERIVATIVES - DELTA WING CONFIGURATION

DEPENDENT VARIABLE VS INDEPENDENT VARIABLE, ~~MULTIPLE DATASETS~~

DATASETS PLOTTED:  
DB7083 DB7098

DEPENDENT VARIABLE	INDEPENDENT VARIABLE	PLOT PAGE	
		BEGINNING	ENDING
CYBETA	ALPHA	323	323
DCLNDB	ALPHA	324	324
DCSLDB	ALPHA	325	325



LONG. CHAR. - EFFECT OF LANDING GEAR WITH ENGINES ON. - DELTA WING - BETA=0DEG

DEPENDENT VARIABLE VS INDEPENDENT VARIABLE, MULTIPLE DATASETS

DATASETS PLOTTED:  
RC7083 RC7100

DEPENDENT VARIABLE	INDEPENDENT VARIABLE	PLOT PAGE	
		BEGINNING	ENDING
CL	ALPHA	326	326
L/D	ALPHA	327	327
CAB	ALPHA	328	328

LONG. CHAR. - EFFECT OF LANDING GEAR WITH ENGINES ON - DELTA WING - BETA=UDEG

DEPENDENT VARIABLE VS DEPENDENT VARIABLE, MULTIPLE DATASETS

DATASETS PLOTTED:  
RC7083 RC7100

DEPENDENT VARIABLE	DEPENDENT VARIABLE	PLOT PAGE	
		BEGINNING	ENDING
CL	CD	329	329
CL	CLM	330	330

LONG. CHAR. - EFFECT OF LANDING GEAR WITH ENGINES ON - DELTA WING - BETA==4DEG

DEPENDENT VARIABLE VS INDEPENDENT VARIABLE, MULTIPLE DATASETS

DATASETS PLOTTED:  
RC7085 RC7101

DEPENDENT VARIABLE	INDEPENDENT VARIABLE	PLOT PAGE	
		BEGINNING	ENDING
CL	ALPHA	331	331
L/D	ALPHA	332	332
CAB	ALPHA	333	333

LONG. CHAR. - EFFECT OF LANDING GEAR WITH ENGINES.ON - DELTA WING - BETA=-4DEG

DEPENDENT VARIABLE VS DEPENDENT VARIABLE, ~~MULTIPLE DATASETS~~

DATASETS PLOTTED:  
RC7085 RC7101

DEPENDENT VARIABLE	DEPENDENT VARIABLE	PLOT PAGE	
		BEGINNING	ENDING
CL	CD	334	334
CL	CLM	335	335

EFFECT OF LANDING GEAR WITH ENGINES ON - SIDESLIP DERIVATIVES - DELTA WING

DEPENDENT VARIABLE VS INDEPENDENT VARIABLE, ~~MULTIPLE DATASETS~~

DATASETS PLOTTED:  
DB7083 DB7100

DEPENDENT VARIABLE	INDEPENDENT VARIABLE	PLOT PAGE	
		BEGINNING	ENDING
CYBETA	ALPHA	336	336
DCLNDB	ALPHA	337	337
DCSLDB	ALPHA	338	338

LONGITUDINAL CHARACTERISTICS - EFFECT OF CRUISE ENGINE CONFIG. - DELTA WING

DEPENDENT VARIABLE VS INDEPENDENT VARIABLE, ~~MULTIPLE DATASETS~~

DATASETS PLOTTED:  
RC7083 RC7102 RC7104 RC7106

DEPENDENT VARIABLE	INDEPENDENT VARIABLE	PLOT PAGE	
		BEGINNING	ENDING
CL	ALPHA	339	339
L/D	ALPHA	340	340
CAB	ALPHA	341	341

LONGITUDINAL CHARACTERISTICS - EFFECT OF CRUISE ENGINE CONFIG. - DELTA WING

DEPENDENT VARIABLE VS DEPENDENT VARIABLE, MULTIPLE DATASETS

DATASETS PLOTTED:

RC7083      RC7102      RC7104      RC7106

DEPENDENT VARIABLE	DEPENDENT VARIABLE	PLOT PAGE BEGINNING / ENDING	
CL	CD	342	342
CL	CLM	343	343

EFFECT OF CRUISE ENGINE CONFIGURATION - SIDESLIP DERIVATIVES - DELTA WING

DEPENDENT VARIABLE VS INDEPENDENT VARIABLE, MULTIPLE DATASETS

DATASETS PLOTTED:

DB7083      DB7102      DB7104      DB7106

DEPENDENT VARIABLE	INDEPENDENT VARIABLE	PLOT PAGE BEGINNING / ENDING	
CYBETA	ALPHA	344	344
DCLNDB	ALPHA	345	345
DCSLDB	ALPHA	346	346

COMPARISON OF CONFIG. - B7W5 (CONFIG 1.) B7W5V1 (CONFIG 2.) AND B7W5V2 (CONFIG 3.)

DEPENDENT VARIABLE VS PARAMETRIC VARIABLE, PARAMETRIC STUDY

DATASETS PLOTTED:

P47108      P47109  
P47084      P47085      P47083  
P47111      P47112      P47110

DEPENDENT VARIABLE	PARAMETRIC VARIABLE	PLOT PAGE BEGINNING / ENDING	
CY	BETA	347	350
CLN	BETA	351	354
CSL	BETA	355	358

LONGITUDINAL CHARACTERISTICS - EFFECT OF BODY LENGTH WITH ENGINES - DELTA WING

DEPENDENT VARIABLE VS INDEPENDENT VARIABLE, ~~MULTIPLE DATASETS~~

DATASETS PLOTTED:  
RC7102 RC7081

DEPENDENT VARIABLE	INDEPENDENT VARIABLE	PLOT PAGE	
		BEGINNING /	ENDING
CL	ALPHA	359	359
L/D	ALPHA	360	360
CAB	ALPHA	361	361

LONGITUDINAL CHARACTERISTICS - EFFECT OF BODY LENGTH WITH ENGINES - DELTA WING

DEPENDENT VARIABLE VS DEPENDENT VARIABLE, ~~MULTIPLE DATASETS~~

DATASETS PLOTTED:  
RC7102 RC7081

DEPENDENT VARIABLE	DEPENDENT VARIABLE	PLOT PAGE	
		BEGINNING /	ENDING
CL	CD	362	362
CL	CLM	363	363

EFFECT OF BODY LENGTH WITH ENGINES - SIDESLIP DERIVATIVES - DELTA WING

DEPENDENT VARIABLE VS INDEPENDENT VARIABLE, ~~MULTIPLE DATASETS~~

DATASETS PLOTTED:  
DB7102 DB7081

DEPENDENT VARIABLE	INDEPENDENT VARIABLE	PLOT PAGE	
		BEGINNING /	ENDING
CYBETA	ALPHA	364	364
DCLNDB	ALPHA	365	365
DCSLDB	ALPHA	366	366

LONGITUDINAL TRIM CHARACTERISTICS - DELTA WING = X/L = 0.68

DEPENDENT VARIABLE VS PARAMETRIC VARIABLE, PARAMETRIC STUDY

DATASETS PLOTTED:

4X7093 4X7090 4X7083 4X7096

DEPENDENT VARIABLE	PARAMETRIC VARIABLE	PLOT PAGE	
		BEGINNING	ENDING
CLM	ELEVON	367	368
CL	ELEVON	369	370
CD	ELEVON	371	372

LONGITUDINAL TRIM CHARACTERISTICS - DELTA WING = X/L = 0.73

DEPENDENT VARIABLE VS PARAMETRIC VARIABLE, PARAMETRIC STUDY

DATASETS PLOTTED:

5X7093 5X7090 5X7083 5X7096

DEPENDENT VARIABLE	PARAMETRIC VARIABLE	PLOT PAGE	
		BEGINNING	ENDING
CLM	ELEVON	373	374
CL	ELEVON	375	376
CD	ELEVON	377	378

LONGITUDINAL TRIM CHARACTERISTICS - DELTA WING = X/L = 0.78

DEPENDENT VARIABLE VS PARAMETRIC VARIABLE, PARAMETRIC STUDY

DATASETS PLOTTED:

6X7093 6X7090 6X7083 6X7096

DEPENDENT VARIABLE	PARAMETRIC VARIABLE	PLOT PAGE	
		BEGINNING	ENDING
CLM	ELEVON	379	380
CL	ELEVON	381	382
CD	ELEVON	383	384

FLAP EFFECTIVENESS - STRAIGHT WING BASIC POSITION - GEARS DOWN - V=TAIL=55DEG

DEPENDENT VARIABLE VS PARAMETRIC VARIABLE, ~~PARAMETRIC STUDY~~

DATASETS PLOTTED:  
N37010      N37004      M37011

DEPENDENT VARIABLE	PARAMETRIC VARIABLE	PLOT PAGE	
		BEGINNING	ENDING
CL	FLAPS	385	385
CLM	FLAPS	386	386
CD	FLAPS	387	387

FLAP EFFECTIVENESS - STRAIGHT WING BASIC POSITION - V=TAIL=55DEG

DEPENDENT VARIABLE VS INDEPENDENT VARIABLE, ~~PARAMETRIC STUDY~~

DATASETS PLOTTED	DEPENDENT VARIABLE	INDEPENDENT VARIABLE	PLOT PAGE	
			BEGINNING	ENDING
FD7133	DCL	ALPHA	388	388
FD7133	DCLM	ALPHA	389	389
FD7133	DCD	ALPHA	390	390

LONGITUDINAL TRIM CHAR. - STRAIGHT WING BASIC POS. - V=TAIL=55DEG - X/L = 0.56

DEPENDENT VARIABLE VS PARAMETRIC VARIABLE, ~~PARAMETRIC STUDY~~

DATASETS PLOTTED:  
IX7033      IX7029      IX7025      IX7001      IX7024

DEPENDENT VARIABLE	PARAMETRIC VARIABLE	PLOT PAGE	
		BEGINNING	ENDING
CLM	ELEVTR	391	391
CL	ELEVTR	392	392
CD	ELEVTR	393	393

LONGITUDINAL TRIM CHAR. - STRAIGHT WING BASIC POS. - V-TAIL=55DEG - X/L = 0.60

DEPENDENT VARIABLE VS PARAMETRIC VARIABLE, PARAMETRIC STUDY.

DATASETS PLOTTED:

2X7033 2X7029 2X7025 2X7001 2X7024

DEPENDENT VARIABLE	PARAMETRIC VARIABLE	PLOT PAGE	
		BEGINNING	ENDING
CLM	ELEVTR	394	394
CL	ELEVTR	395	395
CD	ELEVTR	396	396

LONGITUDINAL TRIM CHAR. - STRAIGHT WING BASIC POS. - V-TAIL=55DEG - X/L = 0.64

DEPENDENT VARIABLE VS PARAMETRIC VARIABLE, PARAMETRIC STUDY

DATASETS PLOTTED:

3X7033 3X7029 3X7025 3X7001 3X7024

DEPENDENT VARIABLE	PARAMETRIC VARIABLE	PLOT PAGE	
		BEGINNING	ENDING
CLM	ELEVTR	397	397
CL	ELEVTR	398	398
CD	ELEVTR	399	399

LONGITUDINAL TRIM CHAR. - STRAIGHT WING BASIC POS. - V-TAIL=55DEG - X/L = 0.68

DEPENDENT VARIABLE VS PARAMETRIC VARIABLE, PARAMETRIC STUDY.

DATASETS PLOTTED:

4X7033 4X7029 4X7025 4X7001 4X7024

DEPENDENT VARIABLE	PARAMETRIC VARIABLE	PLOT PAGE	
		BEGINNING	ENDING
CLM	ELEVTR	400	400
CL	ELEVTR	401	401
CD	ELEVTR	402	402

LONG. TRIM CHAR.- ST. WING BASIC POS.- FLAPS AND GEAR - V=TAIL=55DEG- X/L = 0.56

DEPENDENT VARIABLE VS PARAMETRIC VARIABLE, PARAMETRIC STUDY

DATASETS PLOTTED:

1X7022 1X7018 1X7014 1X7011 1X7023

DEPENDENT VARIABLE	PARAMETRIC VARIABLE	PLOT PAGE	
		<u>BEGINNING</u>	<u>ENDING</u>
CLM	ELEVTR	403	403
CL	ELEVTR	404	404
CD	ELEVTR	405	405

LONG. TRIM CHAR.- ST. WING BASIC POS.- FLAPS AND GEAR - V=TAIL=55DEG- X/L = 0.60

DEPENDENT VARIABLE VS PARAMETRIC VARIABLE, PARAMETRIC STUDY

DATASETS PLOTTED:

2X7022 2X7018 2X7014 2X7011 2X7023

DEPENDENT VARIABLE	PARAMETRIC VARIABLE	PLOT PAGE	
		<u>BEGINNING</u>	<u>ENDING</u>
CLM	ELEVTR	406	406
CL	ELEVTR	407	407
CD	ELEVTR	408	408

LONG. TRIM CHAR.- ST. WING BASIC POS.- FLAPS AND GEAR - V=TAIL=55DEG- X/L = 0.64

DEPENDENT VARIABLE VS PARAMETRIC VARIABLE, PARAMETRIC STUDY

DATASETS PLOTTED:

3X7022 3X7018 3X7014 3X7011 3X7023

DEPENDENT VARIABLE	PARAMETRIC VARIABLE	PLOT PAGE	
		<u>BEGINNING</u>	<u>ENDING</u>
CLM	ELEVTR	409	409
CL	ELEVTR	410	410
CD	ELEVTR	411	411



LONG. TRIM CHAR.- ST. WING BASIC POS.- FLAPS AND GEAR - V=TAIL=55DEG- X/L = 0.68

DEPENDENT VARIABLE VS PARAMETRIC VARIABLE, PARAMETRIC STUDY

DATASETS PLOTTED:

4X7022      4X7018      4X7014      4X7011      4X7023

DEPENDENT VARIABLE	PARAMETRIC VARIABLE	PLOT PAGE	
		BEGINNING	ENDING
CLM	ELEVTR	412	412
CL	ELEVTR	413	413
CD	ELEVTR	414	414

LONG. TRIM CHAR.- ST. WING BASIC- CONVENT. HORIZ=VERT TAIL WITH FLAPS- X/L=0.56

DEPENDENT VARIABLE VS PARAMETRIC VARIABLE, PARAMETRIC STUDY

DATASETS PLOTTED:

1X7054      1X7055      1X7053

DEPENDENT VARIABLE	PARAMETRIC VARIABLE	PLOT PAGE	
		BEGINNING	ENDING
CLM	ELEVTR	415	415
CL	ELEVTR	416	416
CD	ELEVTR	417	417

LONG. TRIM CHAR.- ST. WING BASIC- CONVENT. HORIZ=VERT TAIL WITH FLAPS- X/L=0.60

DEPENDENT VARIABLE VS PARAMETRIC VARIABLE, PARAMETRIC STUDY

DATASETS PLOTTED:

2X7054      2X7055      2X7053

DEPENDENT VARIABLE	PARAMETRIC VARIABLE	PLOT PAGE	
		BEGINNING	ENDING
CLM	ELEVTR	418	418
CL	ELEVTR	419	419
CD	ELEVTR	420	420

LONG. TRIM CHAR.- ST. WING BASIC- CONVENT. HORIZ-VERT TAIL WITH FLAPS- X/L=0.64

DEPENDENT VARIABLE VS PARAMETRIC VARIABLE, PARAMETRIC STUDY

DATASETS PLOTTED:

3X7054 3X7055 3X7053

DEPENDENT VARIABLE	PARAMETRIC VARIABLE	PLOT PAGE	
		BEGINNING	ENDING
CLM	ELEVTR	421	421
CL	ELEVTR	422	422
CD	ELEVTR	423	423

LONG. TRIM CHAR.- ST. WING BASIC- CONVENT. HORIZ-VERT TAIL WITH FLAPS- X/L=0.68

DEPENDENT VARIABLE VS PARAMETRIC VARIABLE, PARAMETRIC STUDY

DATASETS PLOTTED:

4X7054 4X7055 4X7053

DEPENDENT VARIABLE	PARAMETRIC VARIABLE	PLOT PAGE	
		BEGINNING	ENDING
CLM	ELEVTR	424	424
CL	ELEVTR	425	425
CD	ELEVTR	426	426

DATA

CONFIG. BUILDUP - LONGITUDINAL CHAR. - STRAIGHT WING BASIC POS. - V-TAIL=55DEG

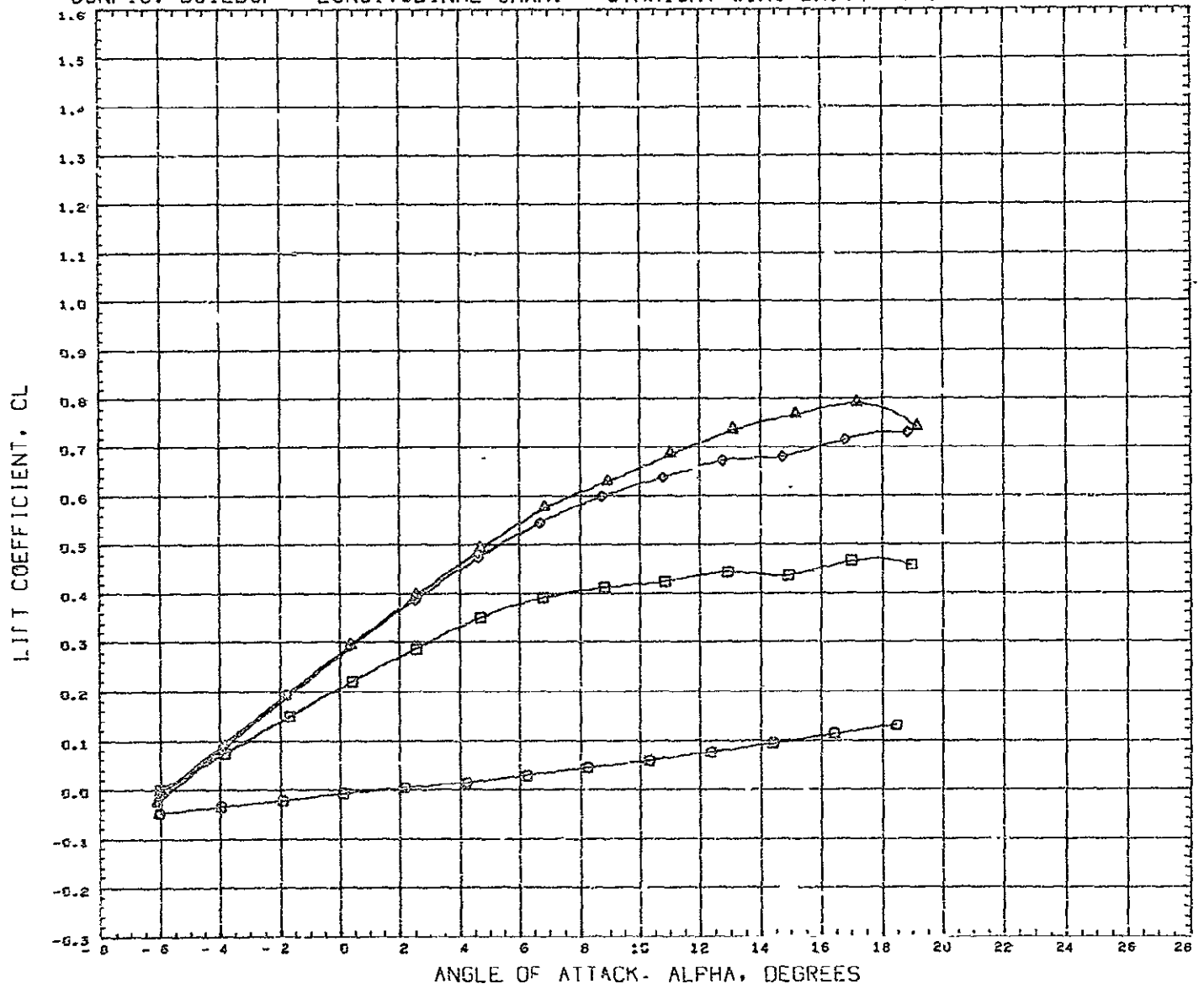

DATA SET SYMBOL	CONFIGURATION DESCRIPTION	PARAMETRIC VALUES	REFERENCE INFORMATION
(RC7079)	CVLSWT TEST 579-0 B1	BFTA 0.000	REFS 316 2304 SQ IN
(RC7040)	CVLSWT TEST 579-0 B1W1-15		REFL 50.1900 IN
(SC7001)	CVLSWT TEST 579-0 B1W1-15T1-55		REFB 7.3500 IN
(RC7038)	CVLSWT TEST 579-0 B1W1-15T1-55E1		XMRP 29.3920 IN
			IMRP 0.0000 IN
			ZMRP 0.0000 IN
			SCALE 0 0175

MACH 0.359

CONFIG. BUILDUP - LONGITUDINAL CHAR. - STRAIGHT WING BASIC POS. - V-TAIL=55DEG

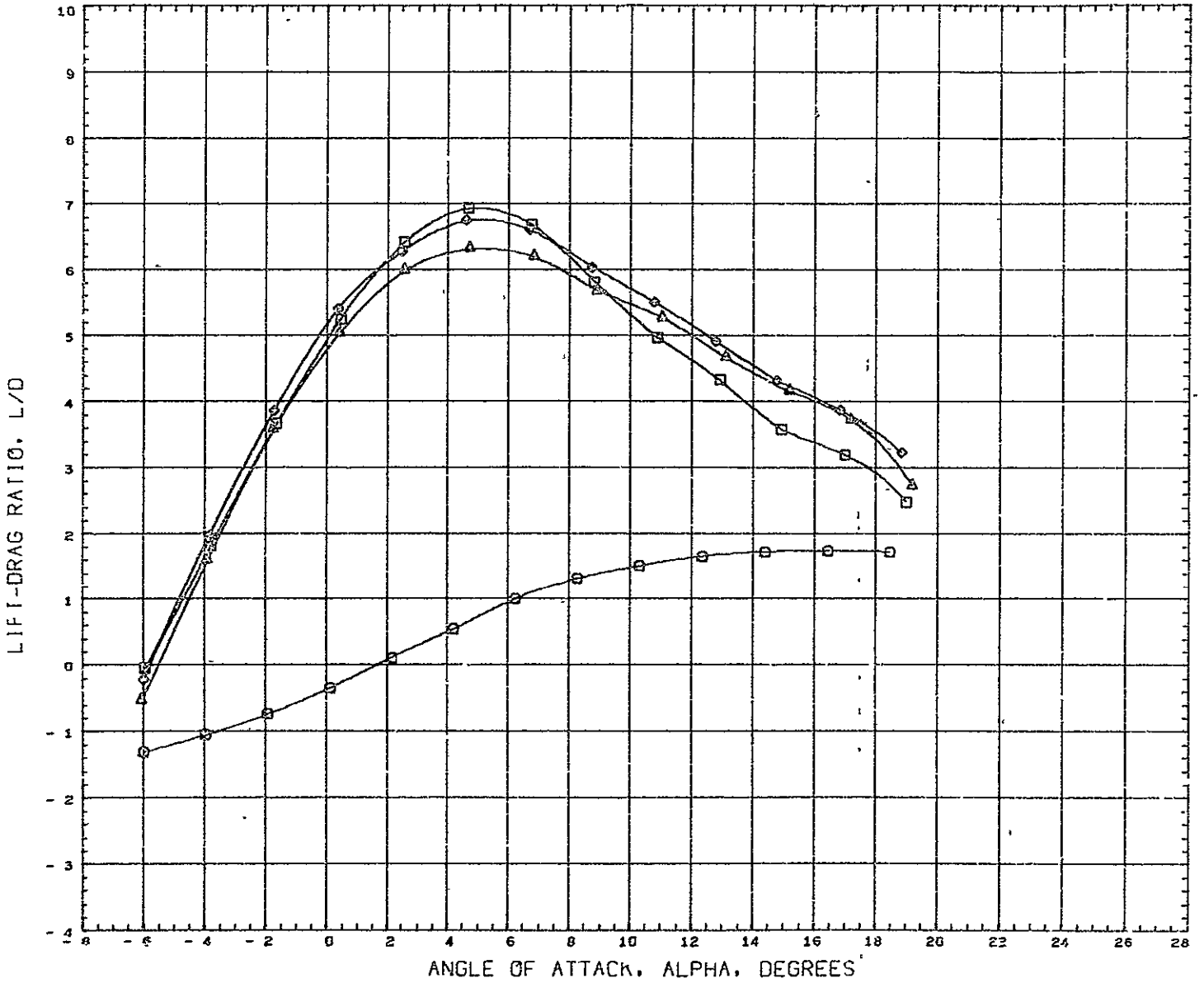

DATA SET SYMBOL	CONFIGURATION DESCRIPTION
(RC7079)	○ CVLSWT TEST 579-D B1
(RC7046)	□ CVLSWT TEST 579-D B1W1-15
(SC7001)	◇ CVLSWT TEST 579-U B1W1-15T1-55
(RC7038)	△ CVLSWT TEST 579-D B1W1-15T1-55E1

PARAMETRIC VALUES  
 BETA 0.000

REFERENCE INFORMATION		
REFS	316.2304	SQ IN
REFL	50.1900	IN
REFB	7.3300	IN
ARRP	29.3920	IN
YMFF	0.0000	IN
ZMRF	0.0000	IN
SCALE	0.0175	

MACH 0.259

CONFIG. BUILDUP - LONGITUDINAL CHAR. - STRAIGHT WING BASIC POS. - V-TAIL=55DEG

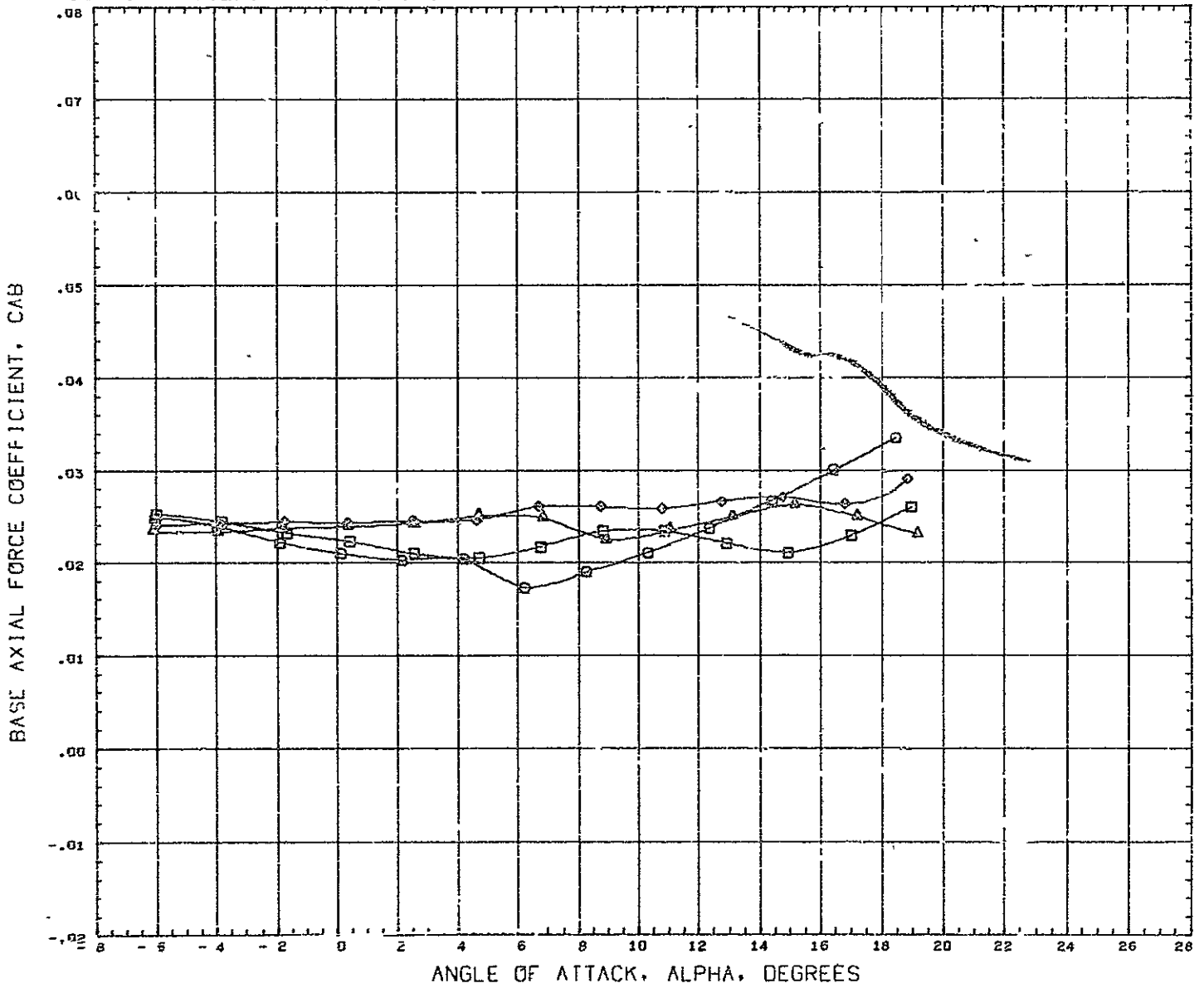

DATA SET SYMBOL	CONFIGURATION DESCRIPTION	PARAMETRIC VALUES	REFERENCE INFORMATION
(RC7079)	CVLSWT TEST 579-D B1	BETA 0.000	PEFS 316.2304 SQ IN
(RC7040)	CVLSWT TEST 579-D B1W1-15		REFL 50.1900 IN
(SC7001)	CVLSWT TEST 579-D B1W1-15T1-55		REFB 7.3500 IN
(RC7038)	CVLSWT TEST 579-D B1W1-15T1-55E1		XMRP 29.3920 IN
			YMPF 0.0000 IN
			ZMPF 0.0000 IN
			SCALE 0.0175

MACH 0.259

CONFIG. BUILDUP - LONGITUDINAL CHAR. - STRAIGHT WING BASIC PGS. - V-TAIL=55DEG

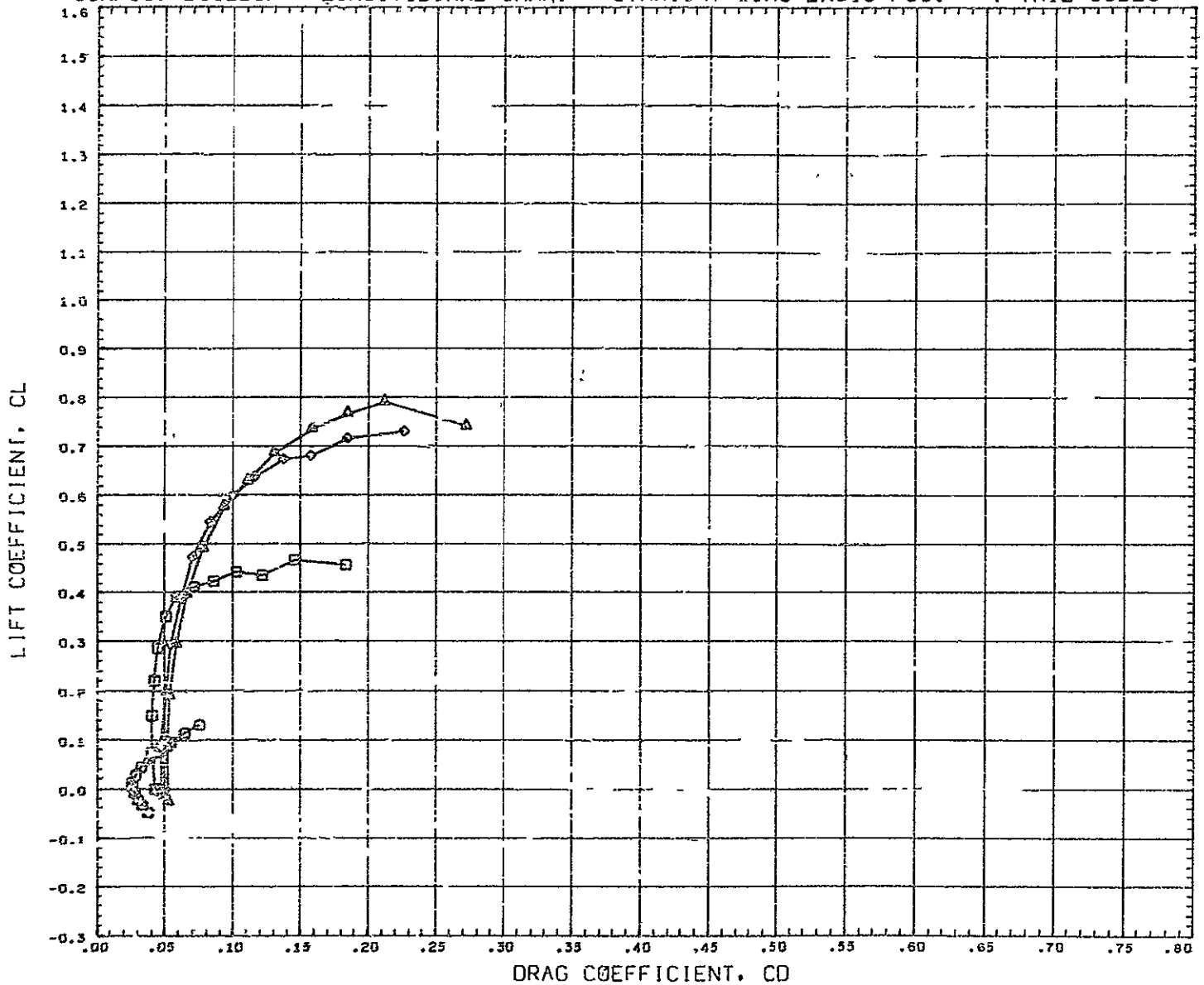

DATA SET SYMBOL	CONFIGURATION DESCRIPTION
(RC7079)	CVLSWT TEST 579-D B1
(RC7040)	CVLSWT TEST 579-D B1W1-15
(SC7003)	CVLSWT TEST 579-D B1W1-15T1-55
(RC7038)	CVLSWT TEST 579-D B1W1-15T1-55E1

PARAMETRIC VALUES  
BETA 0.000

REFERENCE INFORMATION	
REFS	316.2304 SQ IN
REFL	50.1900 IN
REFB	7.3500 IN
XMRP	29.3920 IN
YMRP	0.0000 IN
ZMRP	0.0000 IN
SCALE	0.0175

MACH 0.259

CONFIG. BUILDUP - LONGITUDINAL CHAR. - STRAIGHT WING BASIC POS. - V-TAIL=55DEG

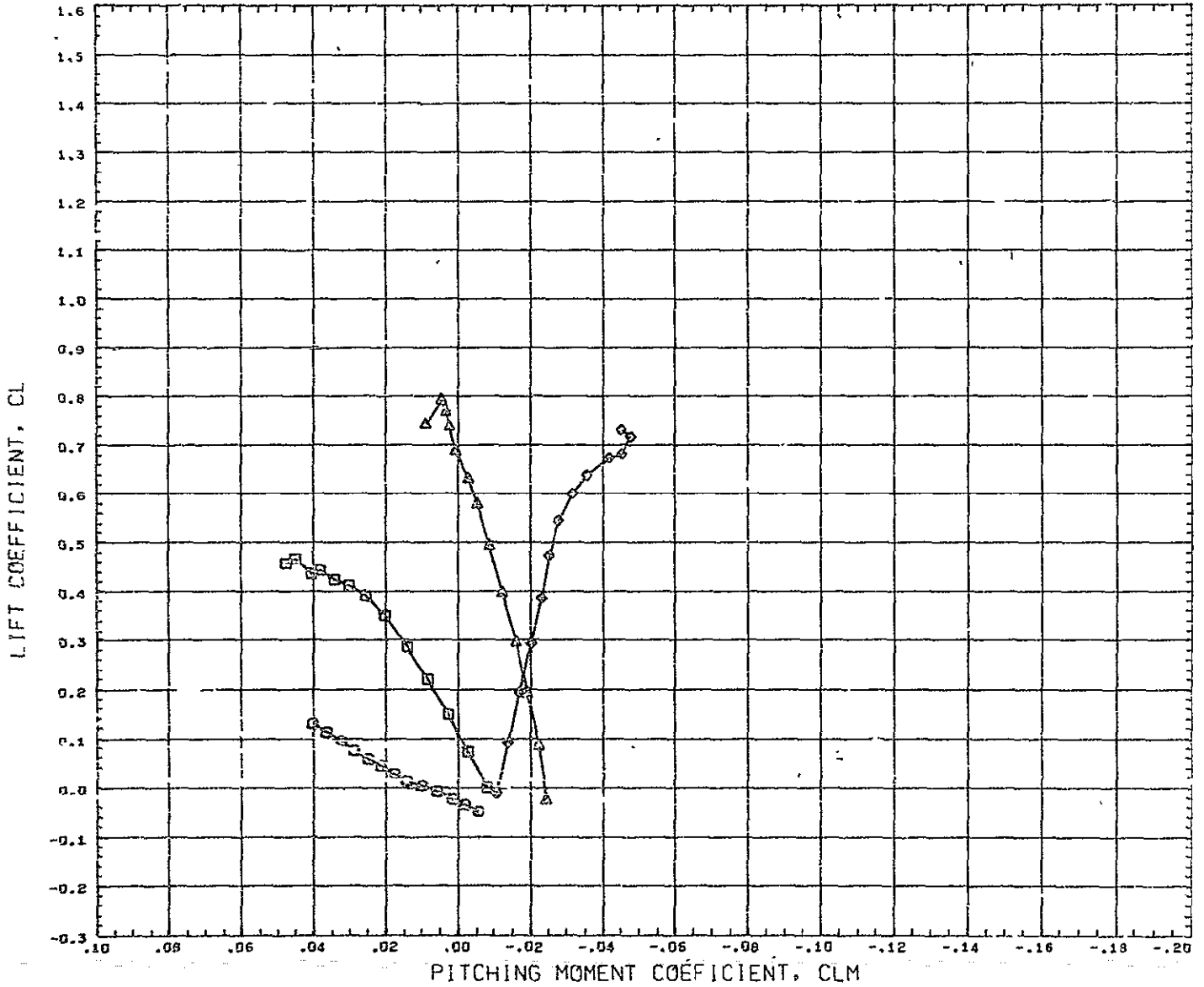

DATA SET SYMBOL	CONFIGURATION DESCRIPTION	PARAMETRIC VALUES		REFERENCE INFORMATION	
		BETA	CLM	REFS	SCALE
(RCT079)	CVLSWT TEST 579-0 B1	0.000		316,2304	SQ IN
(RCT040)	CVLSWT TEST 579-0 B1W1-15			50,1900	IN
(SCT001)	CVLSWT TEST 579-0 B1W1-15T1-55			7,3500	IN
(RCT032)	CVLSWT TEST 579-0 B1W1-15T1-55E1			29,3920	IN
				0,0000	IN
				0,0000	IN
				0,6175	

MACH 0.259



CONFIG. BUILDUP - LATERAL CHAR. - ST. WING BASIC POS. - V-TAIL=55DEG - BETA=0

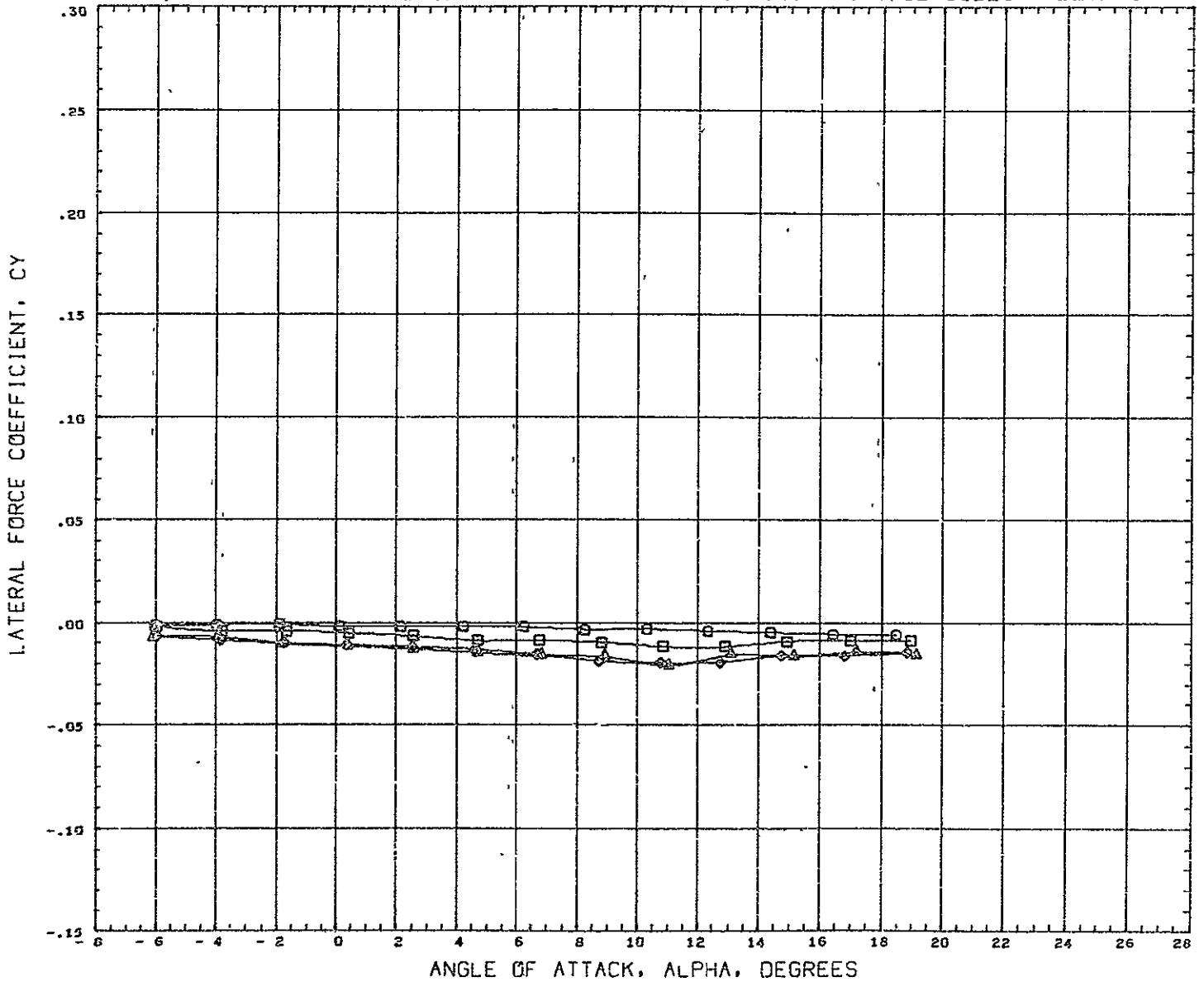

DATA SET SYMBOL	CONFIGURATION DESCRIPTION	PARAMETRIC VALUES	REFERENCE INFORMATION
(RC7079)	CVLSWT TEST 579-G B1	BETA 0.000	REFS 316.2304 SQ IN
(RC7040)	CVLSWT TEST 579-G B1W1-15		REFL 50.1900 IN
(SC7091)	CVLSWT TEST 579-G B1W1-15T1-55		REFB 7.3500 IN
(RC7038)	CVLSWT TEST 579-G B1W1-15T1->5E1		XMRP 29.3920 IN
			YMRP 0.0000 IN
			ZMRP 0.0000 IN
			SCALE 0.0175
MACH	0.259		

CONFIG. BUILDUP - LATERAL CHAR. - ST. WING BASIC POS. - V-TAIL=55DEG - BETA=0

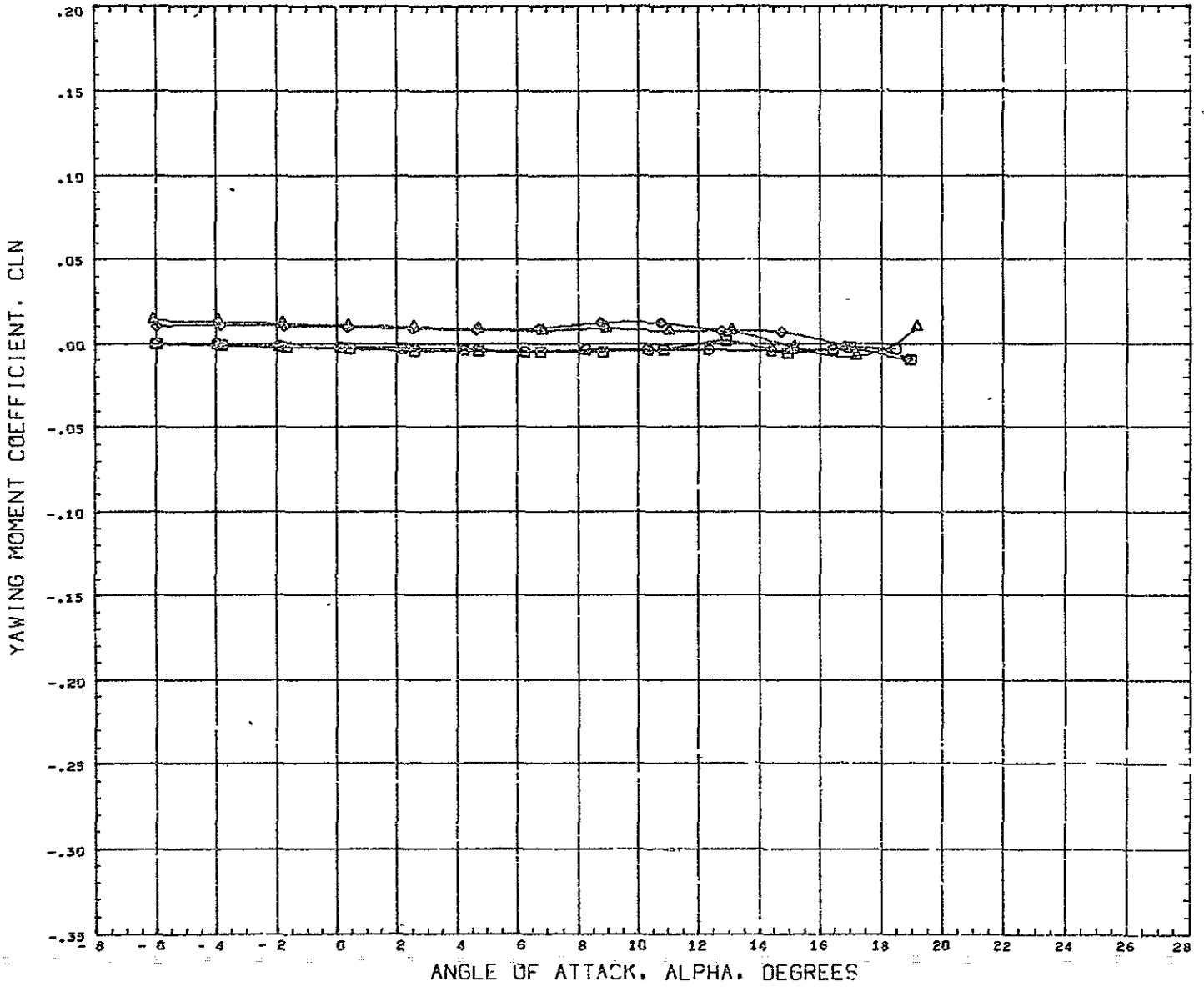

DATA SET SYMBOL	CONFIGURATION DESCRIPTION	PARAMETRIC VALUES	REFERENCE INFORMATION
(RC7079)	CVLSWT TEST 579-D B1	BETA 0.000	REFS 316.2304 SQ IN
(RC7040)	CVLSWT TEST 579-D B1W1-15		REFL 50.1900 IN
(SC7001)	CVLSWT TEST 579-D B1W1-15T1-55		REFB 7.3500 IN
(RC7038)	CVLSWT TEST 579-D B1W1-15T1-55E1		XMPF 9.3920 IN
			VMRF 0.0000 IN
			ZMRF 0.0000 IN
			SCALE 0.0175

MACH 0.259

CONFIG. BUILDUP - LATERAL CHAR. - ST. WING BASIC POS. - V-TAIL=55DEG - BETA=0

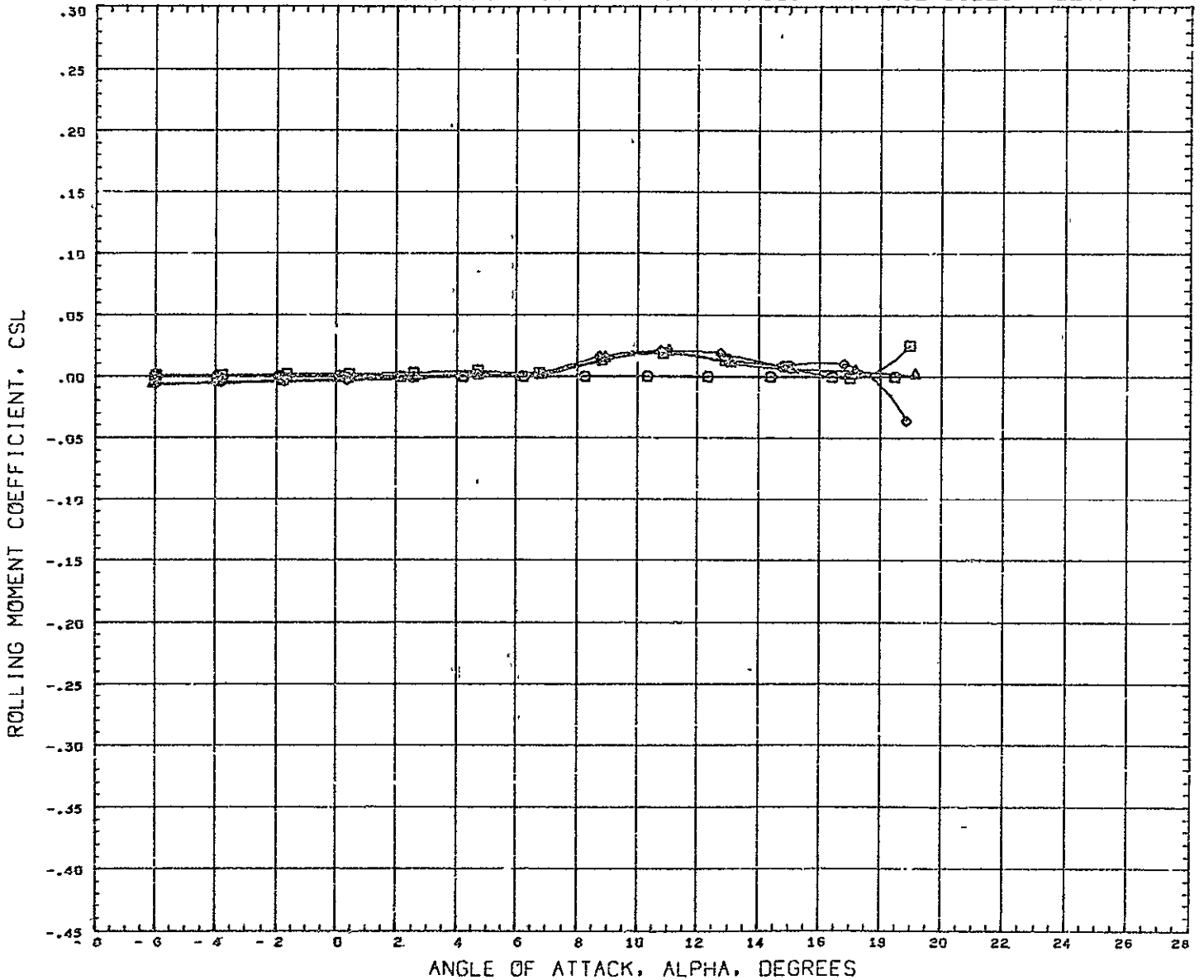

DATA SET SYMBOL	CONFIGURATION DESCRIPTION	PARAMETRIC VALUES	REFERENCE INFORMATION
(RC7079)	CVLSWT TEST 579-0 B1	BETA 0.000	REFS 316.2304 SQ IN
(RC7040)	CVLSWT TEST 579-0 B1W1-15		REFL 50 1900 IN
(SC7001)	CVLSWT TEST 579-0 B1W1-15T1-55		REFB 7 3500 IN
(RC7038)	CVLSWT TEST 579-0 B1 '1-15T1-55E1		XMRP 29.3920 IN
			YMRP 0.0000 IN
			ZMRP 0.0000 IN
			SCALE 0.0175

MACH 0.259

CONFIG. BUILDUP - LATERAL CHAR. - ST. WING BASIC POS. - V-TAIL=55DEG - BETA=-4

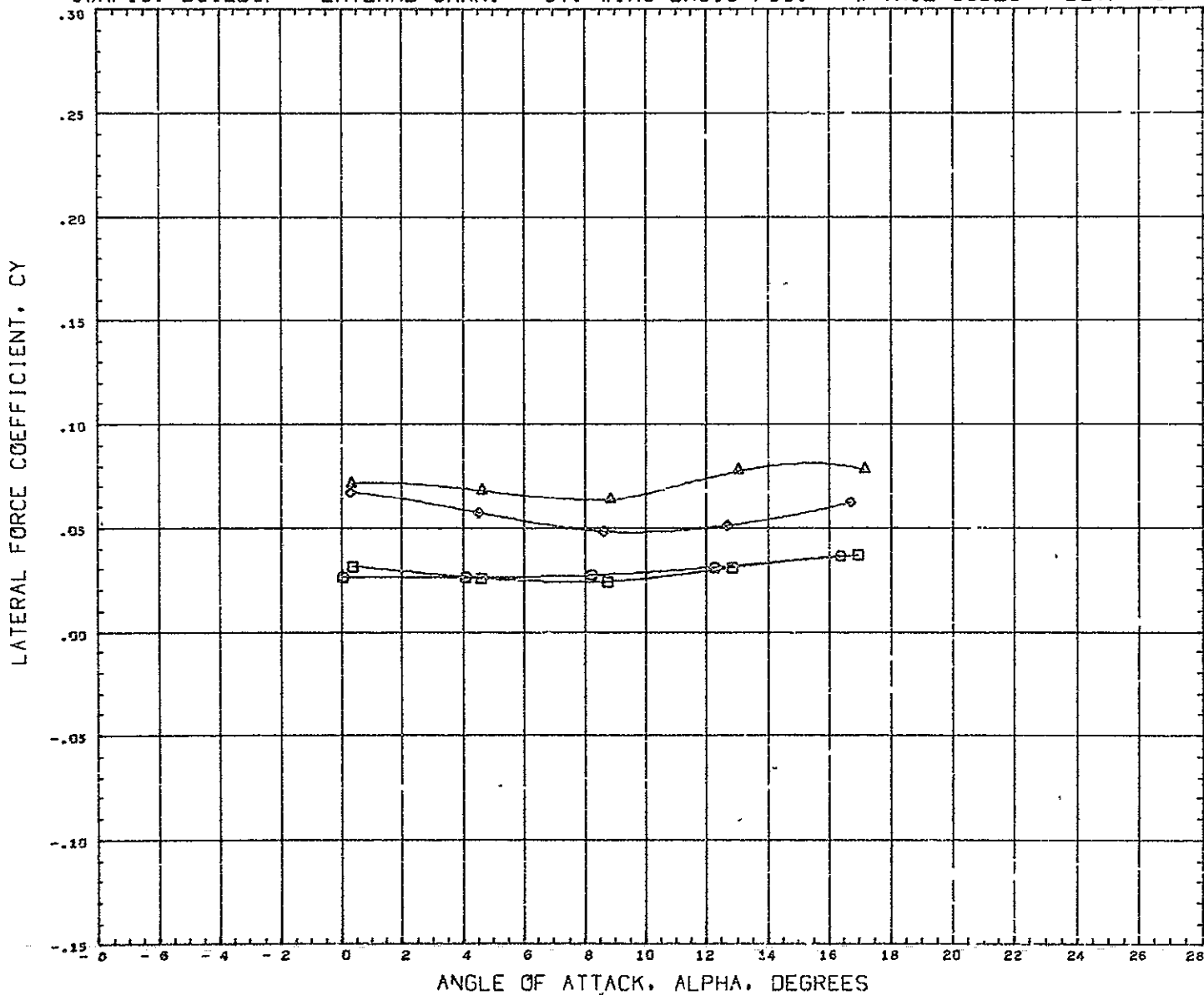

DATA SET SYMBOL	CONFIGURATION DESCRIPTION
(RC7080)	□ CVLSWT TEST 579-0 B1
(RC7042)	□ CVLSWT TEST 579-0 B1W1-15
(RC7083)	◇ CVLSWT TEST 579-0 B1W1-15T1-55
(RC7039)	△ CVLSWT TEST 579-0 B1W1-15T1-55E1

FAPAMETRIC VALUES  
BETA - 4.000

REFERENCE INFORMATION		
REFS	316 2384	SQ IN
REFL	50.1900	IN
REFB	7 3500	IN
XHRF	29 3920	IN
YHRF	0 0000	IN
ZHRF	0 0000	IN
SCALE	0 0175	

MACH 0.299

CONFIG. BUILDUP - LATERAL CHAR. - ST. WING BASIC POS. - V-TAIL=55DEG - BETA=-4

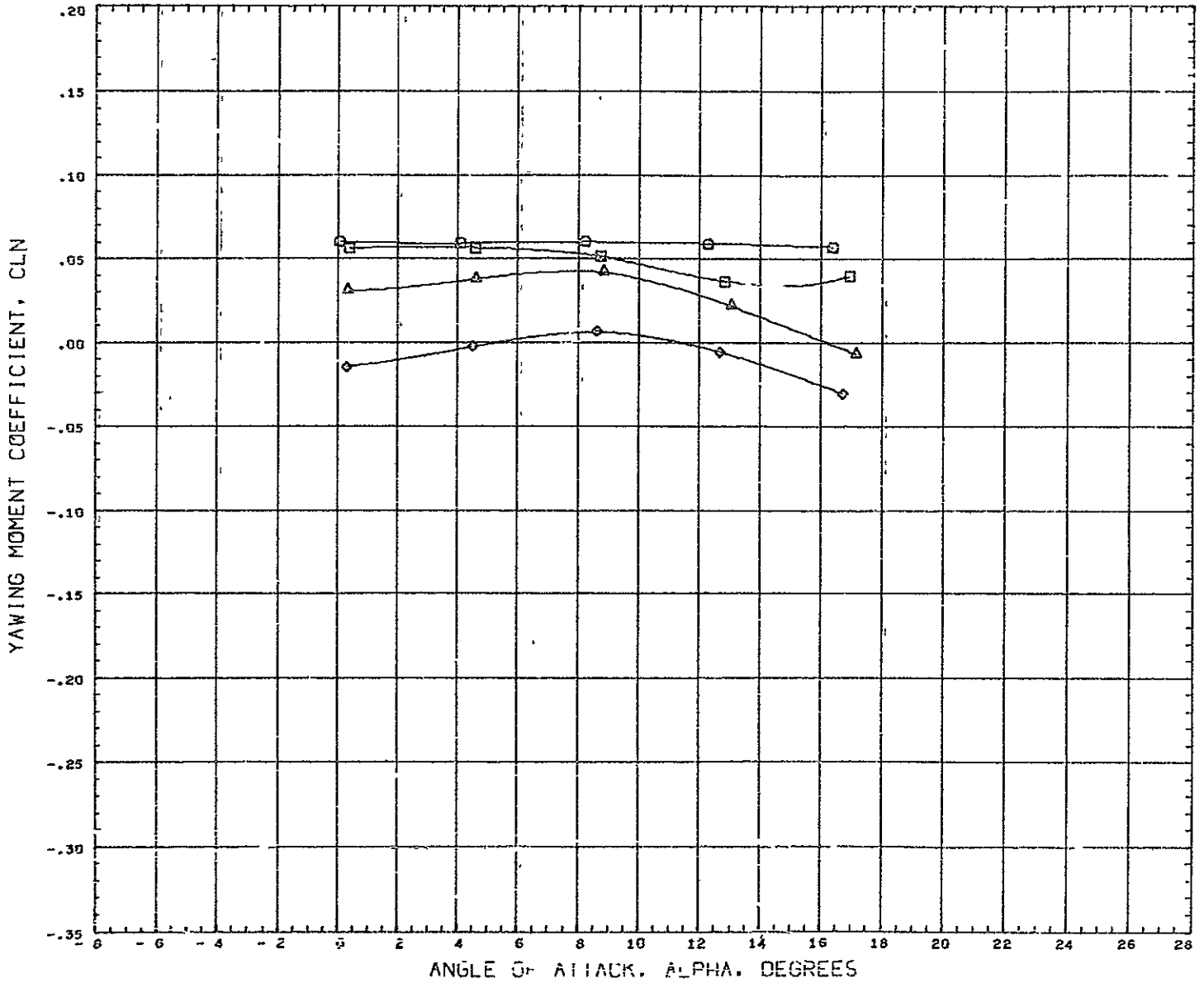

DATA SET SYMBOL	CONFIGURATION DESCRIPTION	PARAMETRIC VALUES	REFERENCE INFORMATION
(RC7080)	CVLSWT TEST 579-D B1	BETA - 4.000	PEFS 516 2304 SQ IN
(RC7042)	CVLSWT TEST 579-D B1W1-15		REFL 50 1350 IN
(RC7003)	CVLSWT TEST 579-D B1W1-15T1-55		REFB 7 3500 IN
(RC7039)	CVLSWT TEST 579-D B1W1-15T1-55E1		XMRP 29.3920 IN
			YMRP 0.0000 IN
			ZMRP 0.0000 IN
			SCALE 0.0175
MACH	0.259		

CONFIG. BUILDUP - LATERAL CHAR. - ST. WING BASIC POS. - V-TAIL=55DEG - BETA=-4

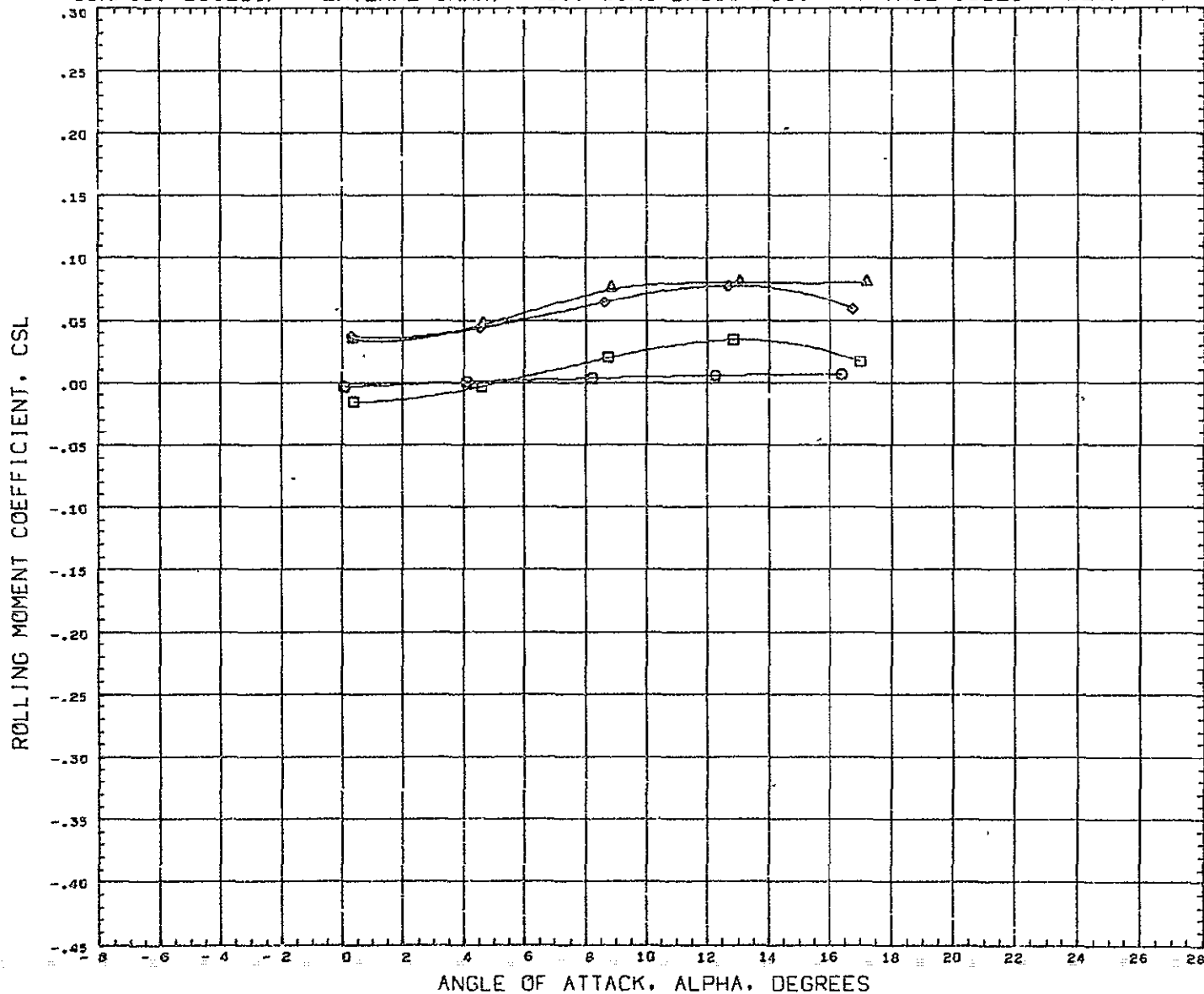

DATA SET SYMBOL	CONFIGURATION DESCRIPTION	PARAMETRIC VALUES	REFERENCE INFORMATION
(RC7080)	Q CVLSWT TEST 579-D B1	BETA - 4.000	REFS 316.2304 SQ IN
(RC7042)	L CVLSWT TEST 579-D B1W1-15		REFL 50.1900 IN
(RC7003)	O CVLSWT TEST 579-D B1W1-15T1-55		REFB 7.3500 IN
(RC7039)	A CVLSWT TEST 579-D B1W1-15T1-55E1		XMRP 29.3920 IN
			YMRP 0.0000 IN
			ZMRP 0.0000 IN
			SCALE 0.0175

MACH 0.259

LATERAL CHAR. AT BETA = 0 AND -4 DEG. - CONFIG. B1

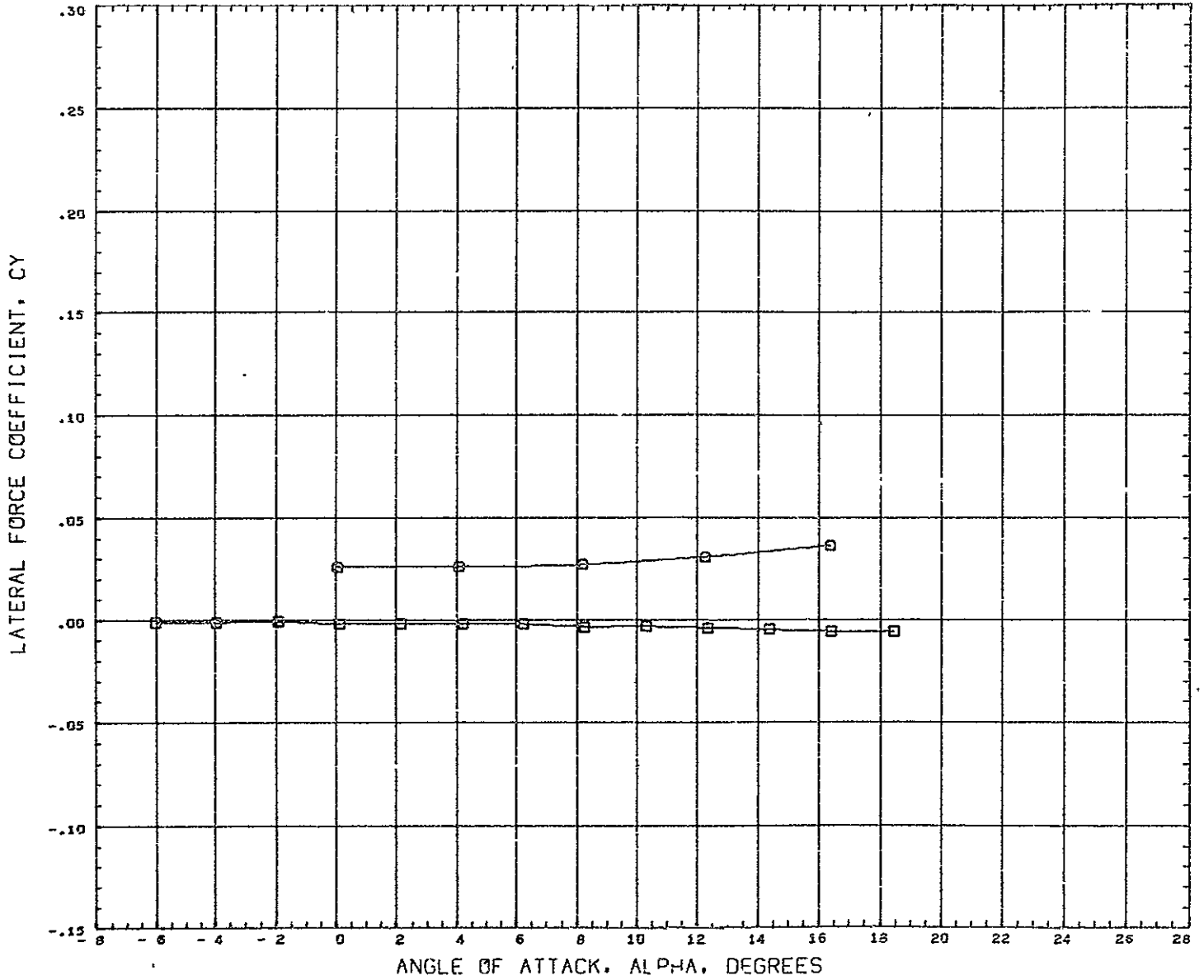

SYMBOL BETA PARAMETRIC VALUES  
 O - 4.000 MACH 0.259  
 □ 0.000

REFERENCE INFORMATION  
 REF 316 2304 SQ IN  
 REFL 50.1900 IN  
 REFB 7 3500 IN  
 XHRF 2 3920 IN  
 YHRF 0.0000 IN  
 ZHRF 0 0000 IN  
 SCALE 0 0175

REFERENCE FILE CONVAIR T47D-WE 12

LATERAL CHAR. AT BETA = 0 AND -4 DEG. - CONFIG. B1

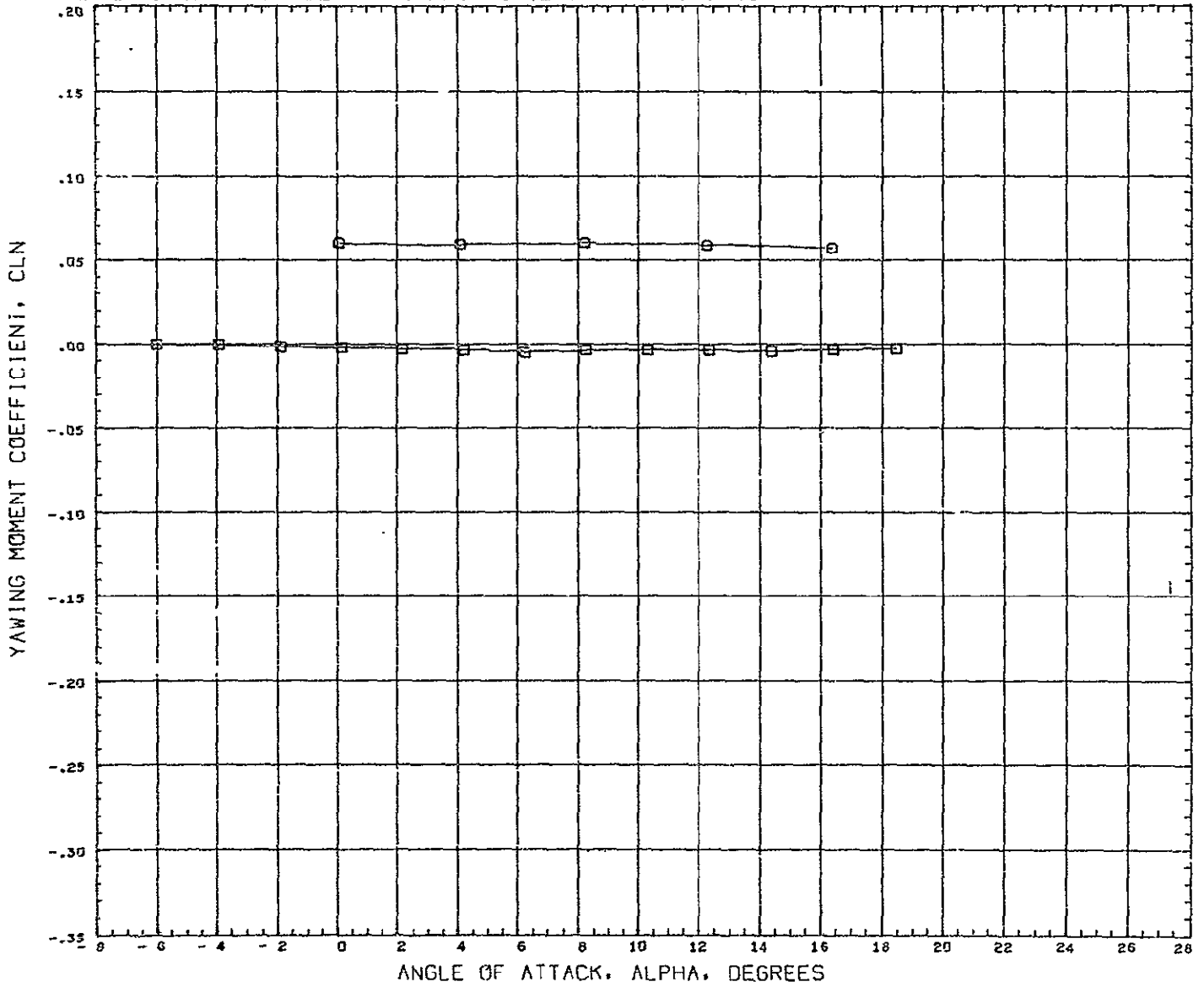

SYMBOL	BETA	PARAMETRIC VALUES	REFERENCE INFORMATION
U	4.000	MACH	REFS 316.2304 SQ IN
U	0.000	alpha 259	REFL 50.1900 IN
			REFB 7.3500 IN
			XMRP 29.3920 IN
			YMRP 0.0000 IN
			ZMRP 0.0000 IN
			SCALE 0.0175

REFERENCE FILE CONVAIR TN70-AE-12



LATERAL CHAR. AT BETA = 0 AND -4 DEG. - CONFIG. B1

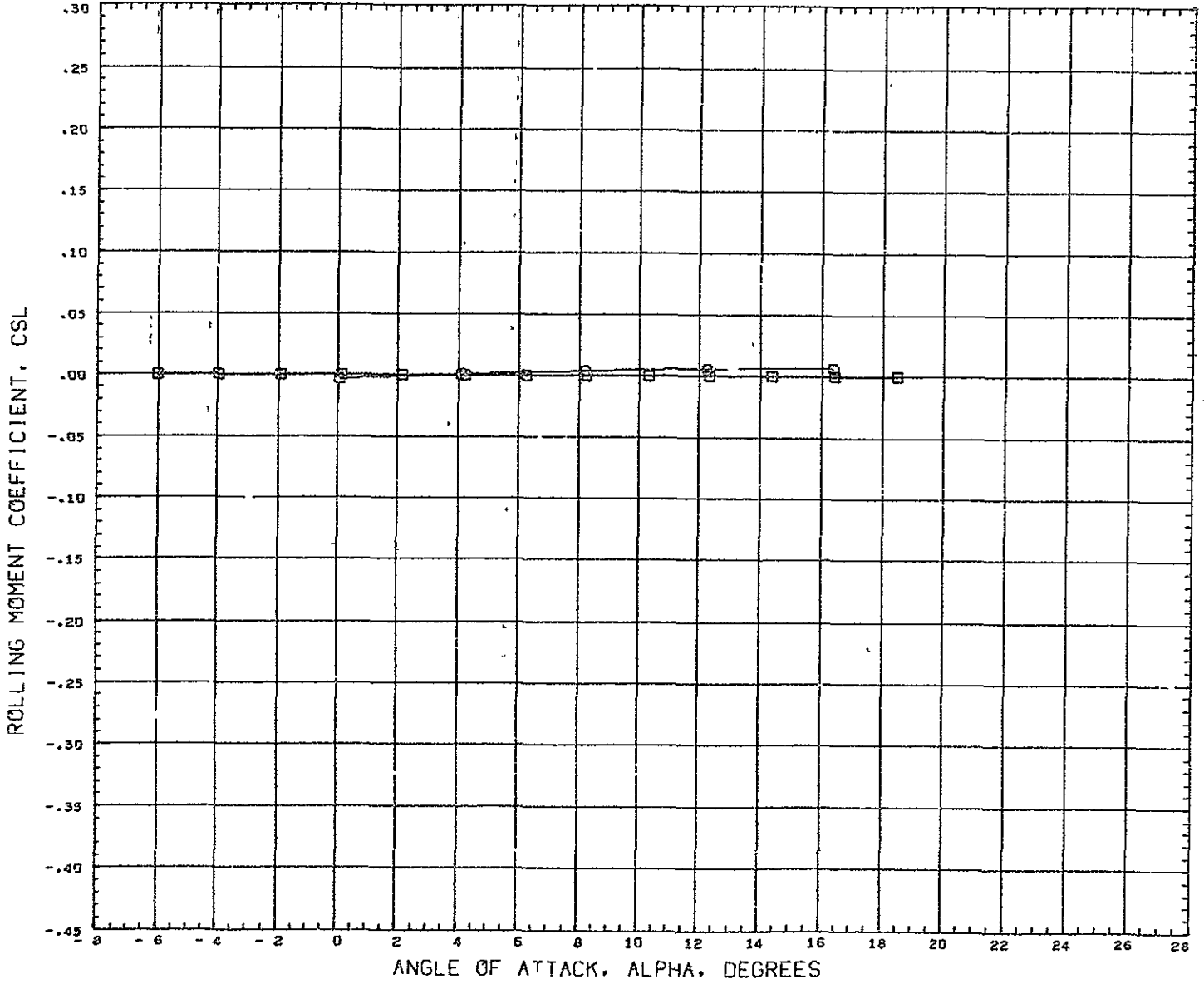

SYMBOL	BETA	PARAMETRIC VALUES
○	- 4.000	MACH 0.250
□	0.000	

REFERENCE INFORMATION		
REFS	316 2304	SQ IN
REFL	50 1900	IN
REFB	7.3500	-N
XNRP	29 3920	IN
YNRP	0.0000	IN
ZNRP	0.0000	IN
SCALE	0 0 P75	

REFERENCE FILE CONVAIR T170-AE-12

LATERAL CHAR. AT BETA = 0 AND -4 DEG. - CONFIG. B1W1-15

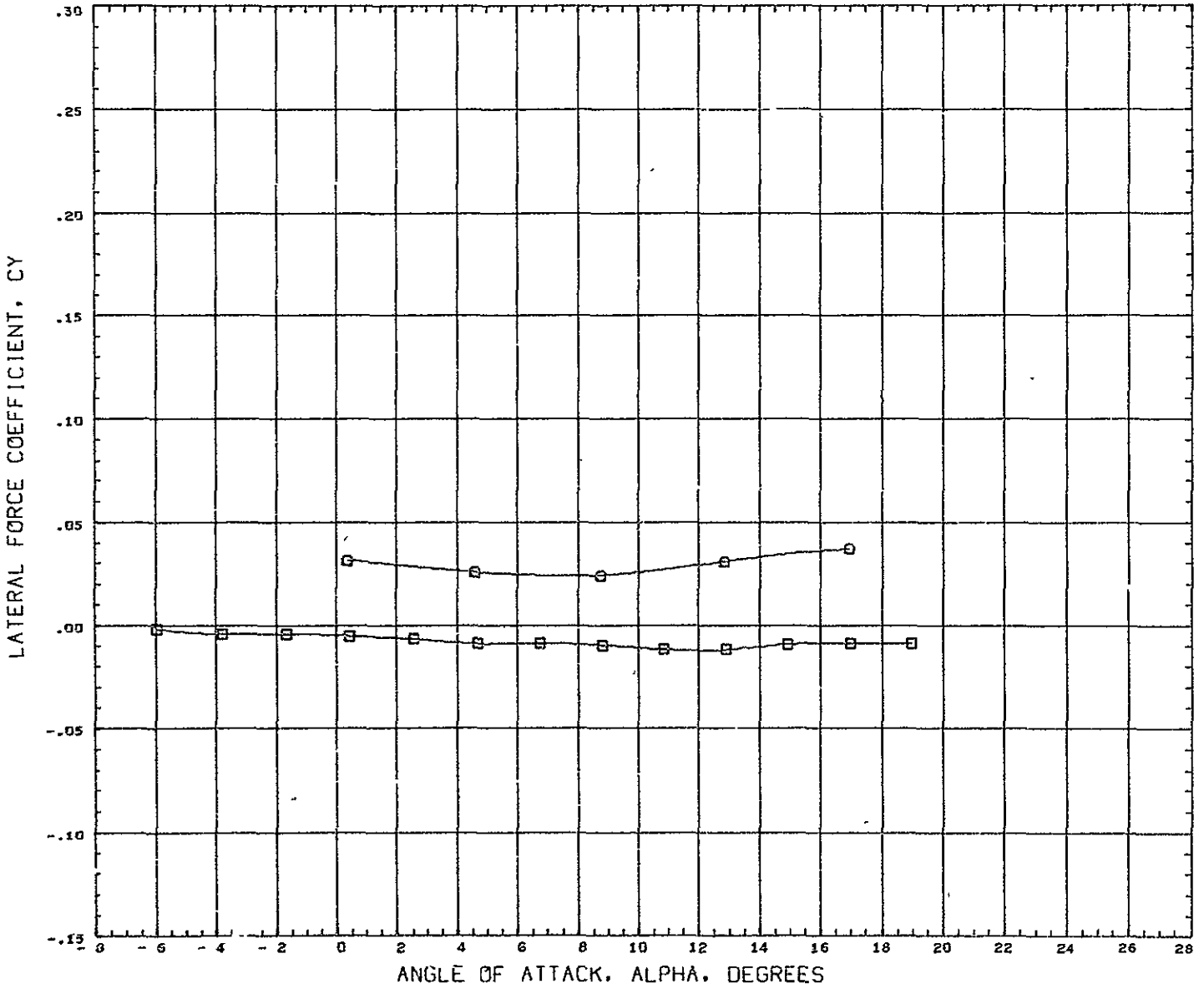

SYMBOL	BETA	PARAMETRIC VALUES			
○	-4.000	HACH	0.259	FLAPS	0.000
□	0.000	SPOILR	0.000		

REFERENCE INFORMATION		
REFS	316.2304	SQ IN
REFL	50.1900	IN
REFB	7.3500	IN
XMRP	29.3920	IN
YMRP	0.0000	IN
ZMRP	0.0000	IN
SCALE	0.0175	

REFERENCE FILE CONVAIR T17D-AE-12

LATERAL CHAR. AT BETA = 0 AND -4 DEG. - CONFIG. B1W1-15

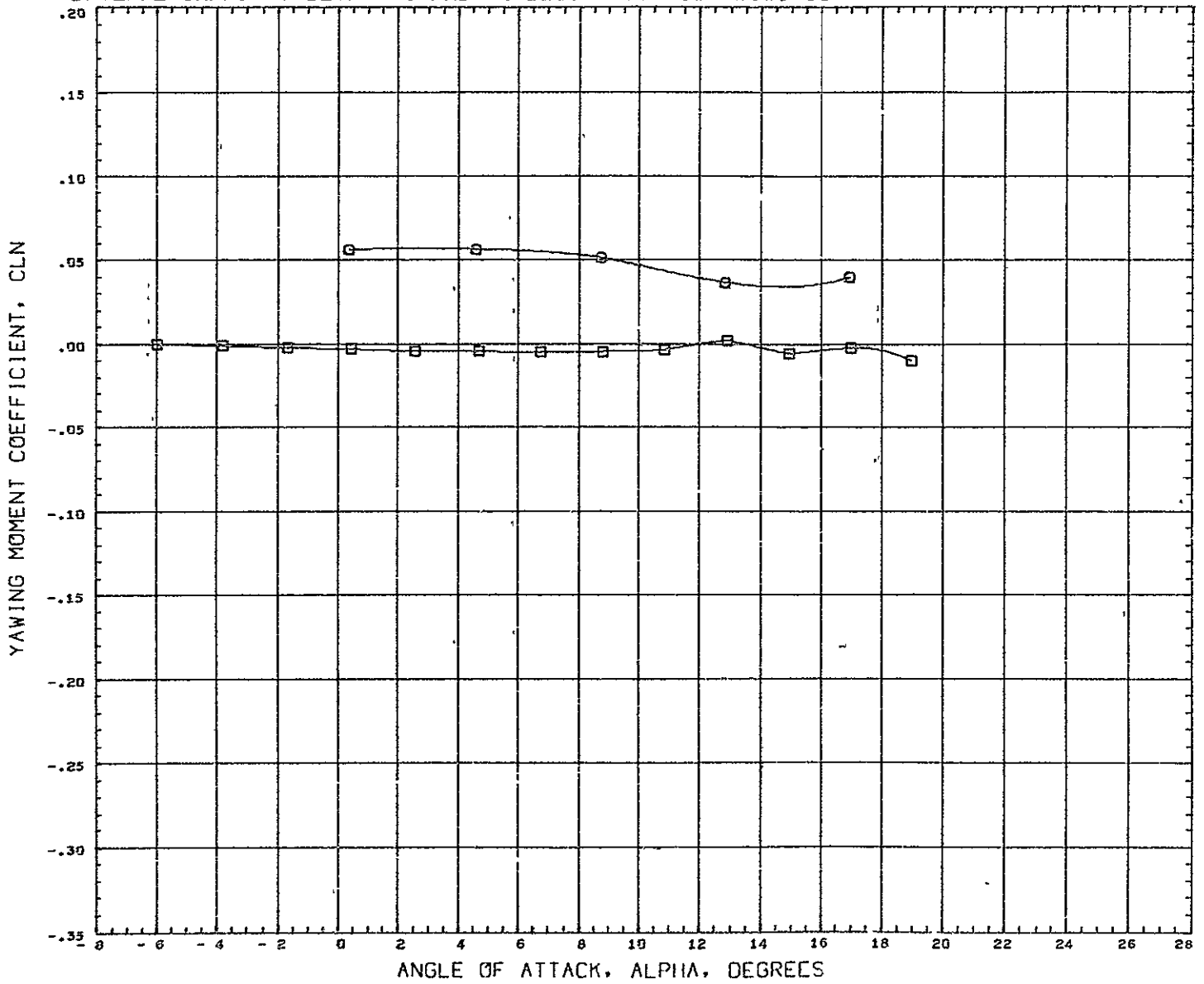

SYMBOL	BETA	MACH	PARAMETRIC VALUES	FLAPS	0.000
○	-4.000		0.259		
□	0.000	SFOILR	0.000		

REFERENCE INFORMATION		
REFS	316 2304	SQ IN
REFL	50.1900	IN
REFB	7.3500	IN
XMRP	29.3920	IN
YMRP	0.0000	IN
ZMRP	0.0000	IN
SCALE	0 0175	

REFERENCE FILE CONVAIR TN70-AE-12

LATERAL CHAR. AT BETA = 0 AND -4 DEG. - CONFIG. B1W1-15

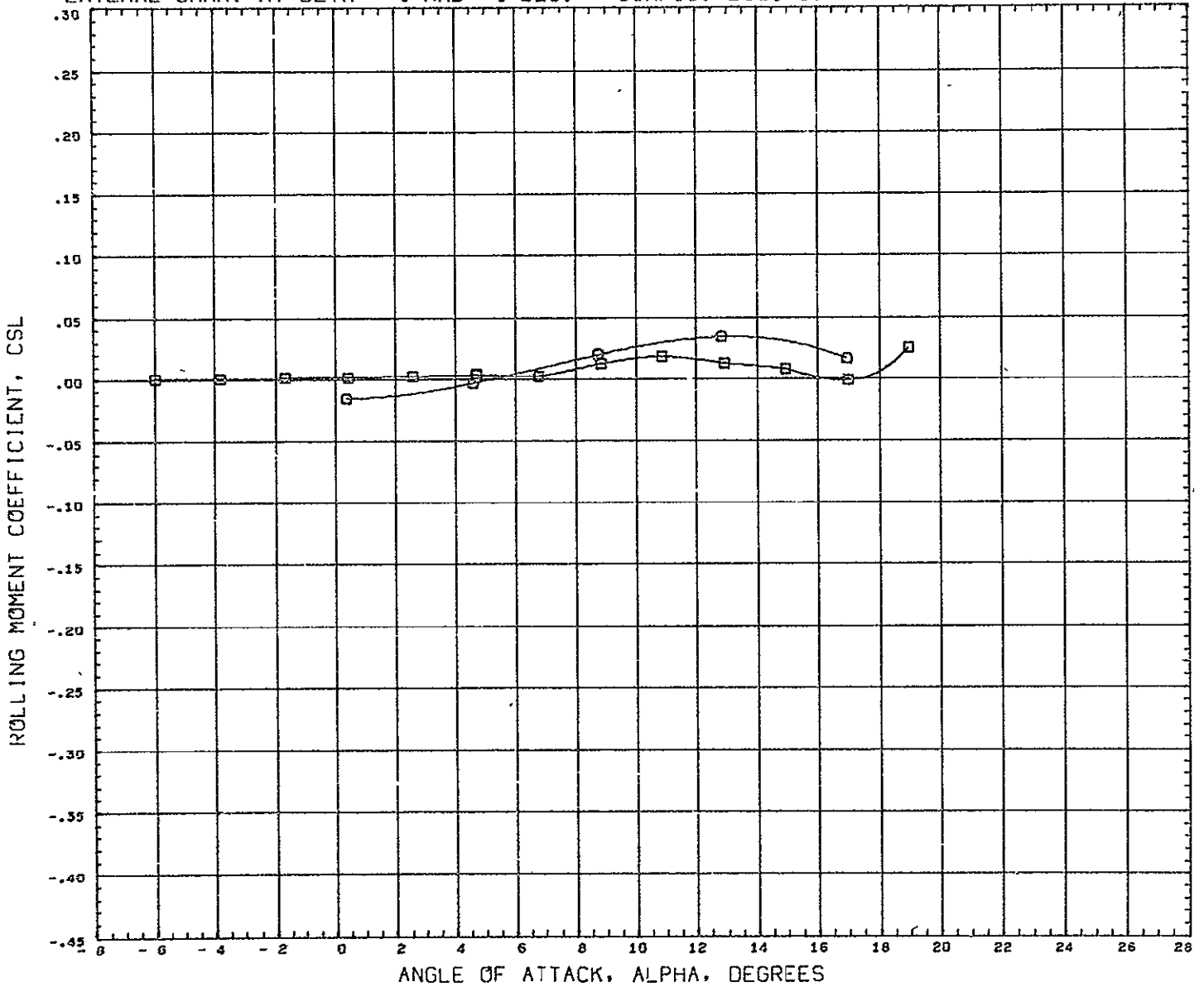

SYMBOL	BETA	PARAMETRIC VALUES			
○	- 4.000	HACH	0.259	FLAPS	0.000
□	0.000	SFOILR	0.000		

REFERENCE INFORMATION		
REFS	316.2304	SQ IN
REFL	50.1500	IN
REFB	7.3500	IN
XHRF	29.3920	IN
YHRF	0.0000	IN
ZHRF	0.0000	IN
SCALE	0.0175	

REFERENCE FILE    CONVAIR T170-AE-12

LATERAL CHAR. AT BETA = 0 AND -4 DEG. - CONFIG. B1W1-15T1-55

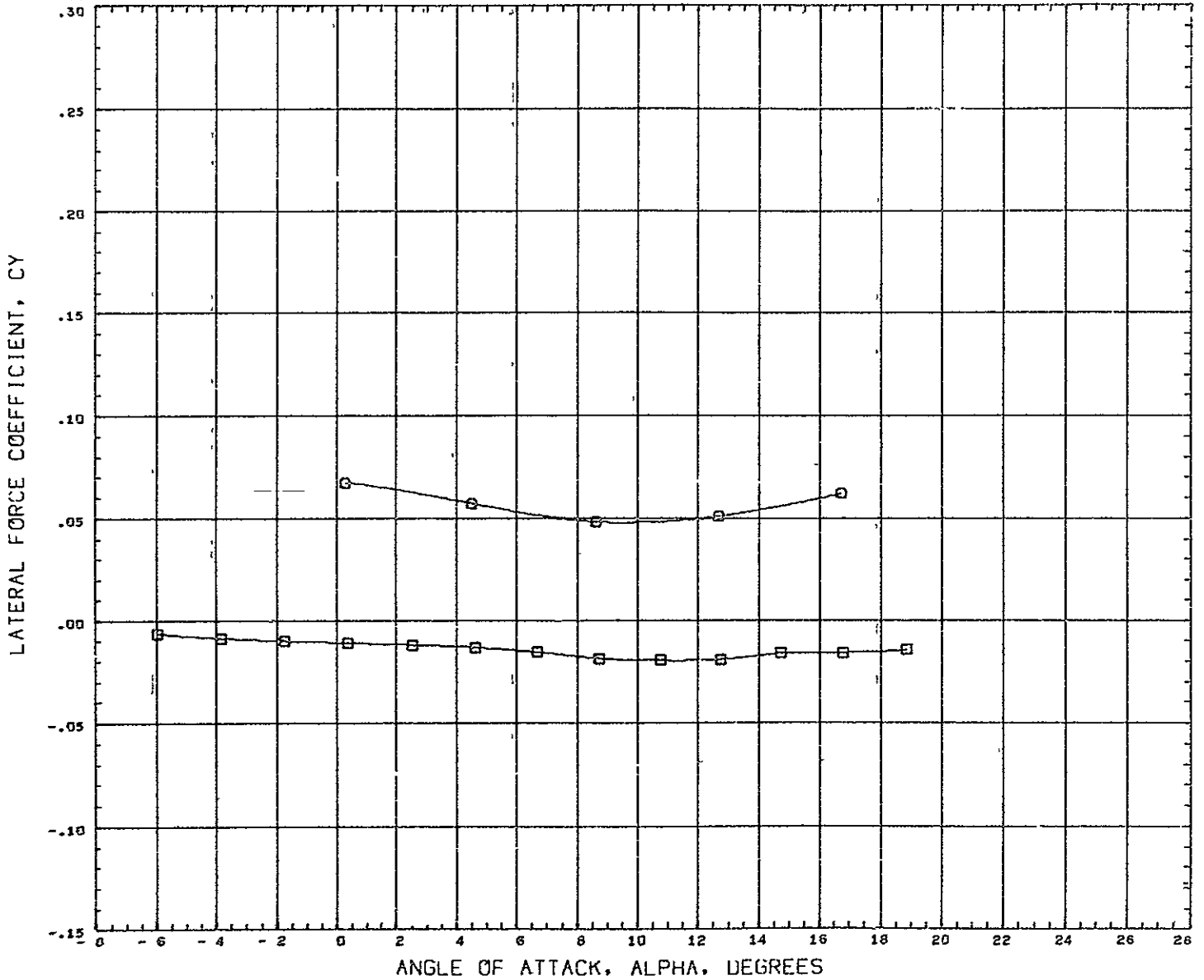

SYMBOL	BETA	PARAMETRIC VALUES			
O	- 4.000	MACH	0.259	ELEVTR	0.000
D	0.000	RUDYTR	0.000	FLAPS	0.000
		SPOILER	0.000		

REFERENCE INFORMATION		
REFS	316.2304	50 IN
REFL	50.1900	IN
REFB	7.3500	IN
XHRP	29.3920	IN
YHRP	0.0000	IN
ZHRP	0.0000	IN
SCALE	0.0175	

REFERENCE FILE CONVAIR TN70-AE-12

LATERAL CHAR. AT BETA = 0 AND -4 DEG. - CONFIG. B1W1-15T1-55

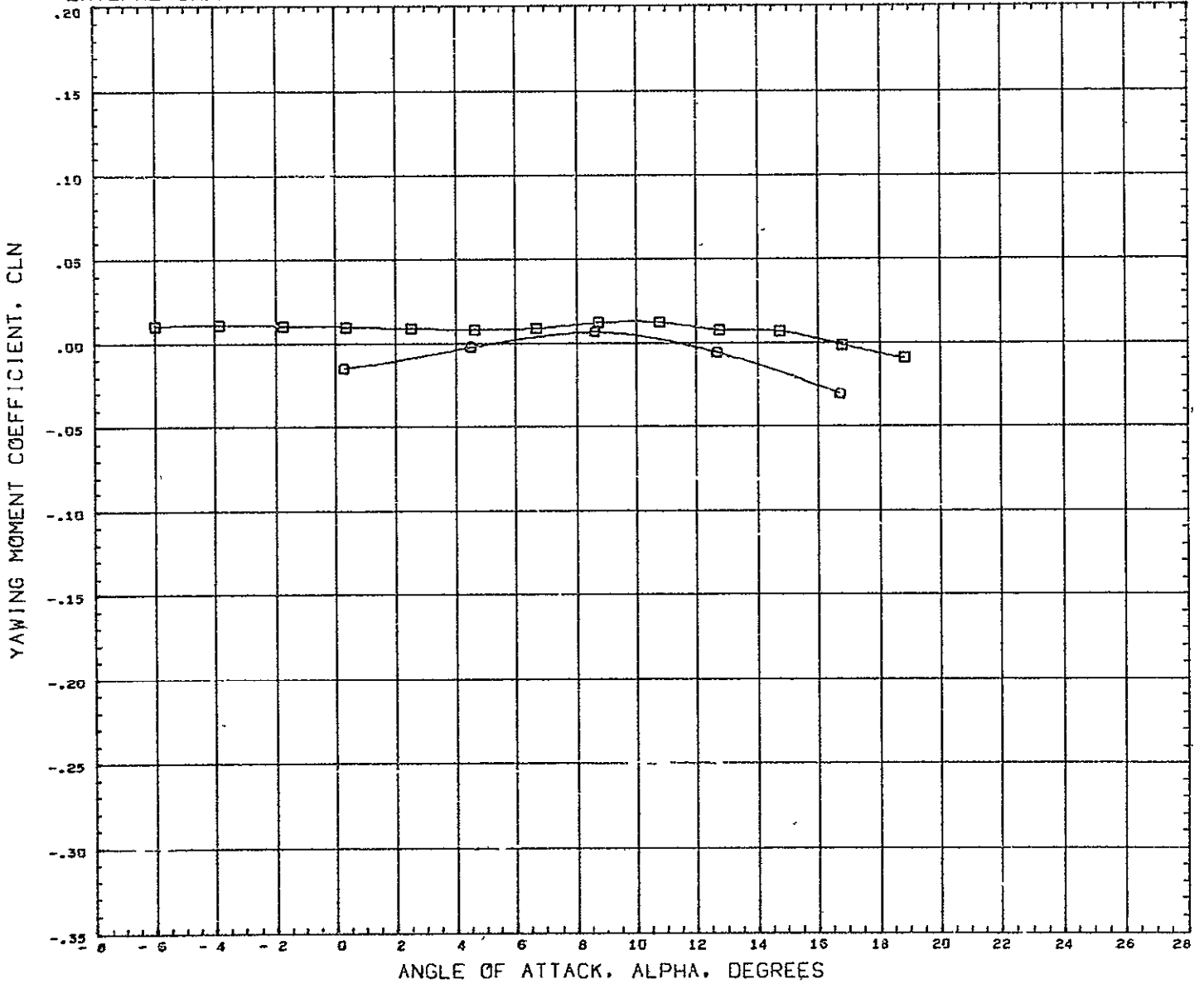

SYMBOL	BETA	PARAMETRIC VALUES			
○	-4.000	MACH	0.259	ELEVTR	0.000
□	0.000	RUDVTR	0.000	FLAPS	0.000
		SFOILR	0.000		

REFERENCE INFORMATION		
REFS	316 2304	SQ IN
REFL	50.1900	IN
REFB	7 3500	IN
XNRF	29.3920	IN
YNRF	0.0000	IN
ZNRF	0.0000	IN
SCALE	0 0175	

REFERENCE FILE CONVAIR T170-AE-12

LATERAL CHAR. AT BETA = 0 AND -4 DEG. - CONFIG. BIW1-15T1-55

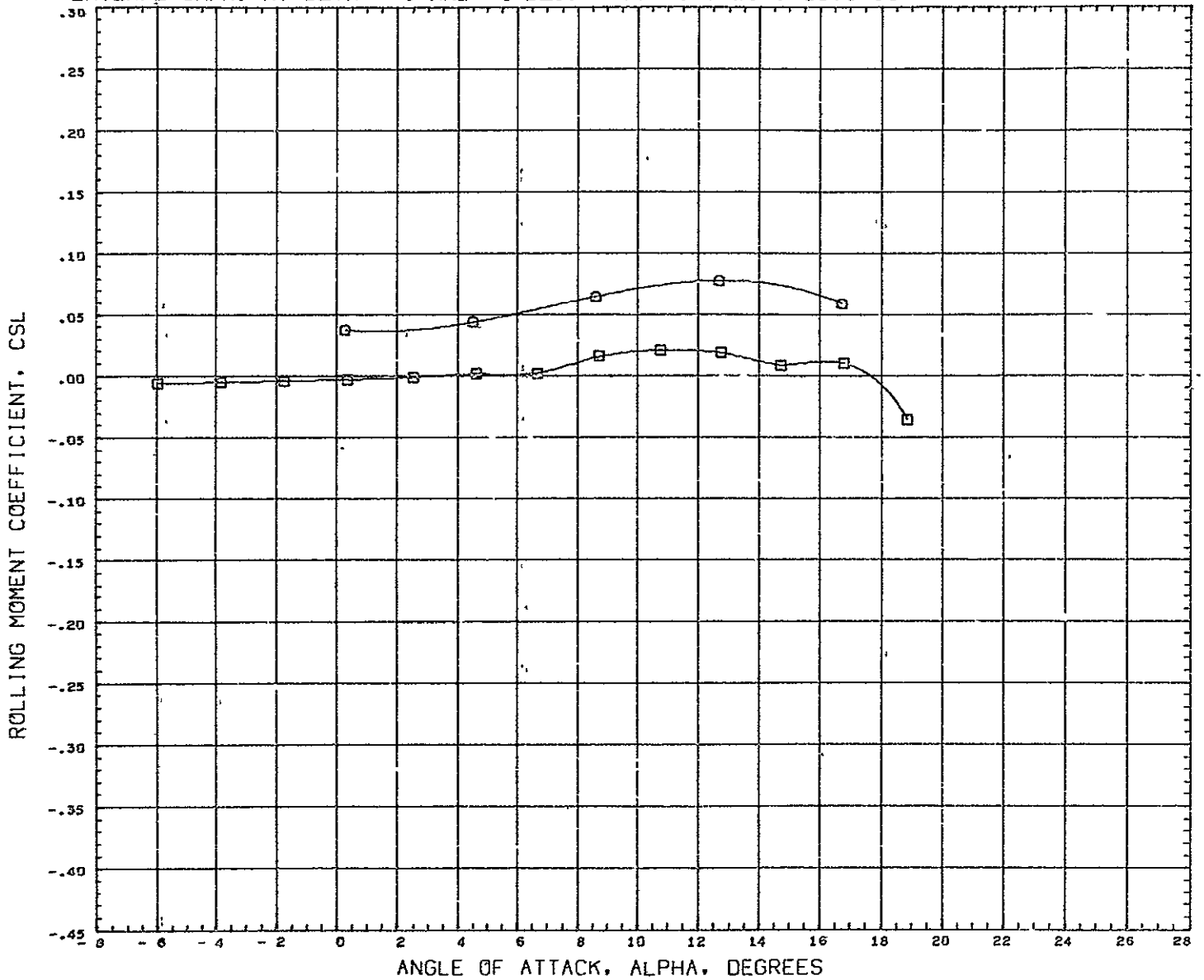

SYMBOL	BETA	PARAMETRIC VALUES			
○	- 4.000	MACH	0.259	ELEVTR	0.000
□	0.000	RUDYTR	0.000	FLAPS	0.000
		SPOILR	0.000		

REFERENCE INFORMATION		
REFS	315.2304	SQ IN
REFL	50.1900	IN
REFB	7.3500	IN
XMRP	29.3920	IN
YMRP	0.0000	IN
ZMRP	0.0000	IN
SCALE	0.0175	

REFERENCE FILE CONVAIR IN70-AE-12

LATERAL CHAR. AT BETA = 0 AND -4 DEG. - CONFIG. B1W1-15T1-55E1

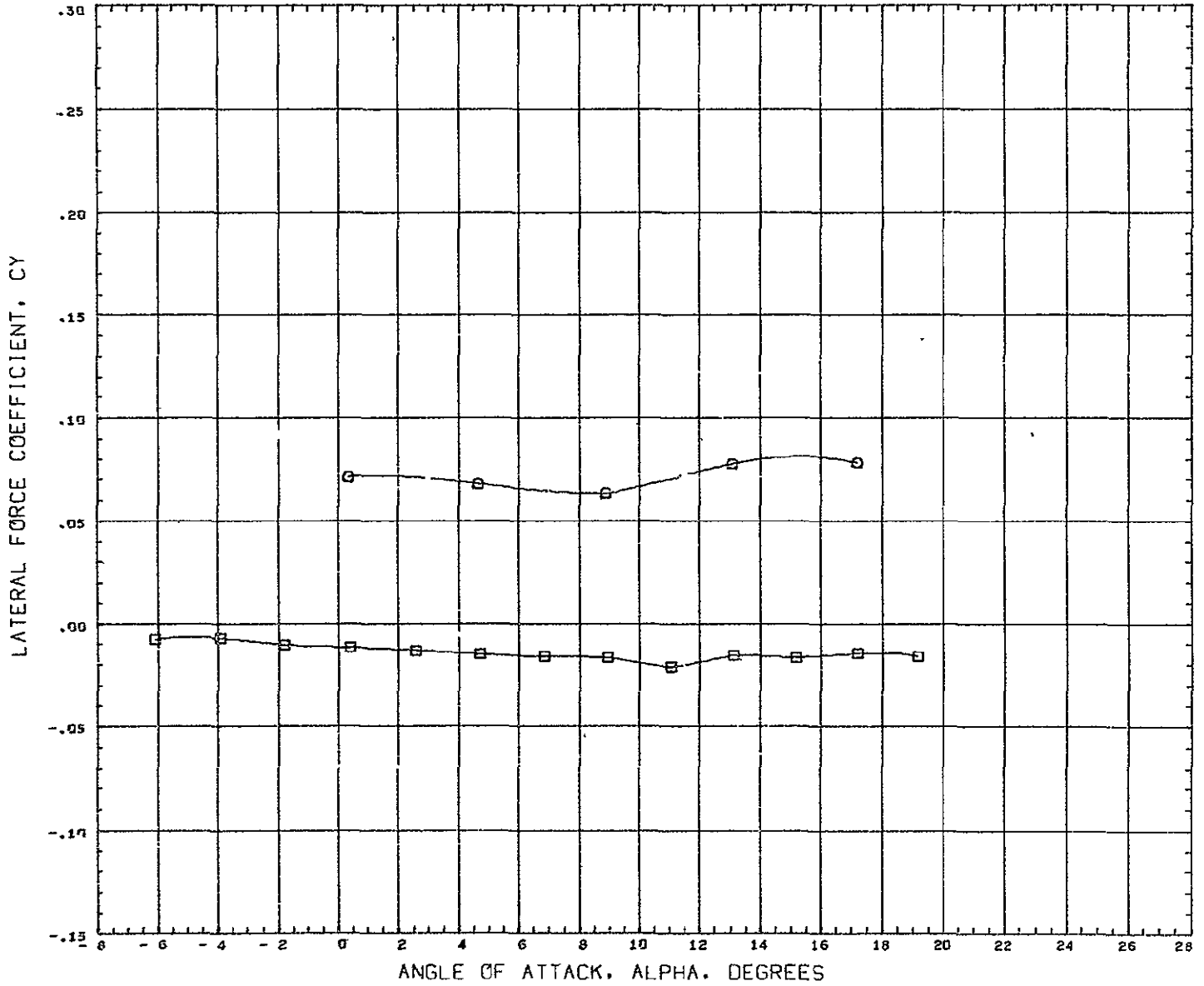

SYMBOL		BETA	PARAMETRIC VALUES			REFERENCE INFORMATION			
○	-	4.000	MACH	0.259	ELEVTR	0.000	REFS	316.2304	SQ IN
□		0.000	RUDVTR	0.000	FLAPS	0.000	REFL	50.1900	IN
			SFCILE	0.000			REFB	7.3300	IN
							XMRP	29.3920	IN
							YMRP	0.0000	IN
							ZMRP	0.0000	IN
							SCALE	0.0175	

REFERENCE FILE CONVAIR INT9-AE-12



LATERAL CHAR. AT BETA = 0 AND -4 DEG. - CONFIG. B1W1-15T1-55E1

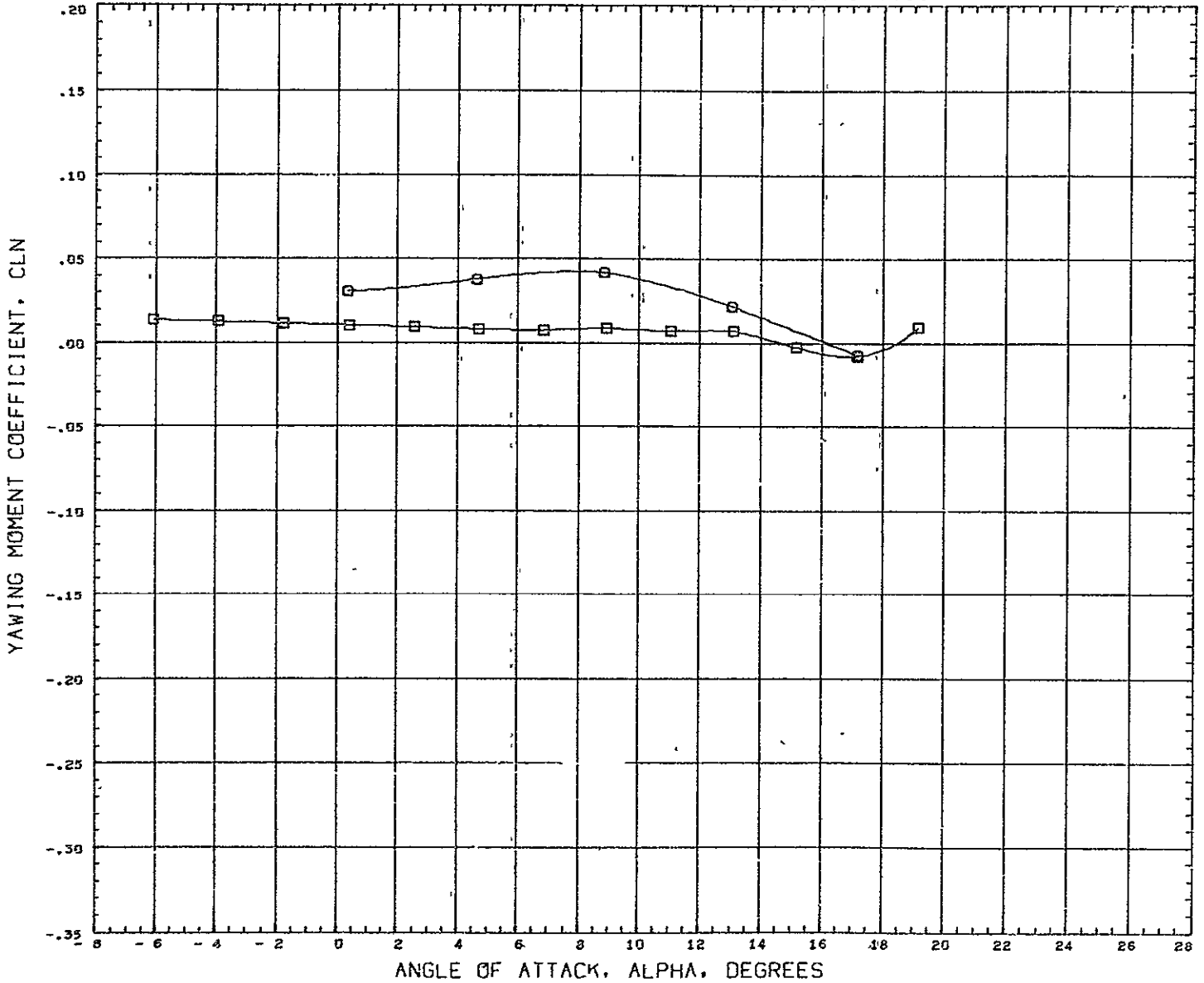

SYMBOL	BETA	PARAMETRIC VALUES			
○	- 4.000	MACH	0.259	ELEVTR	0.000
□	0.000	RUDYTR	0.000	FLAPS	0.000
		SFOILR	0.000		

REFERENCE INFORMATION		
REFS	316 2304	SQ IN
REFL	50.1900	IN
REFB	7.3500	IN
XMRP	29.3920	IN
YMRP	0.0000	IN
ZMRP	0.0000	IN
SCALE	0 0175	

REFERENCE FILE CONVAIR TN70-AE-12

LATERAL CHAR. AT BETA = 0 AND -4 DEG. - CONFIG. B1W1-15T1-55E1

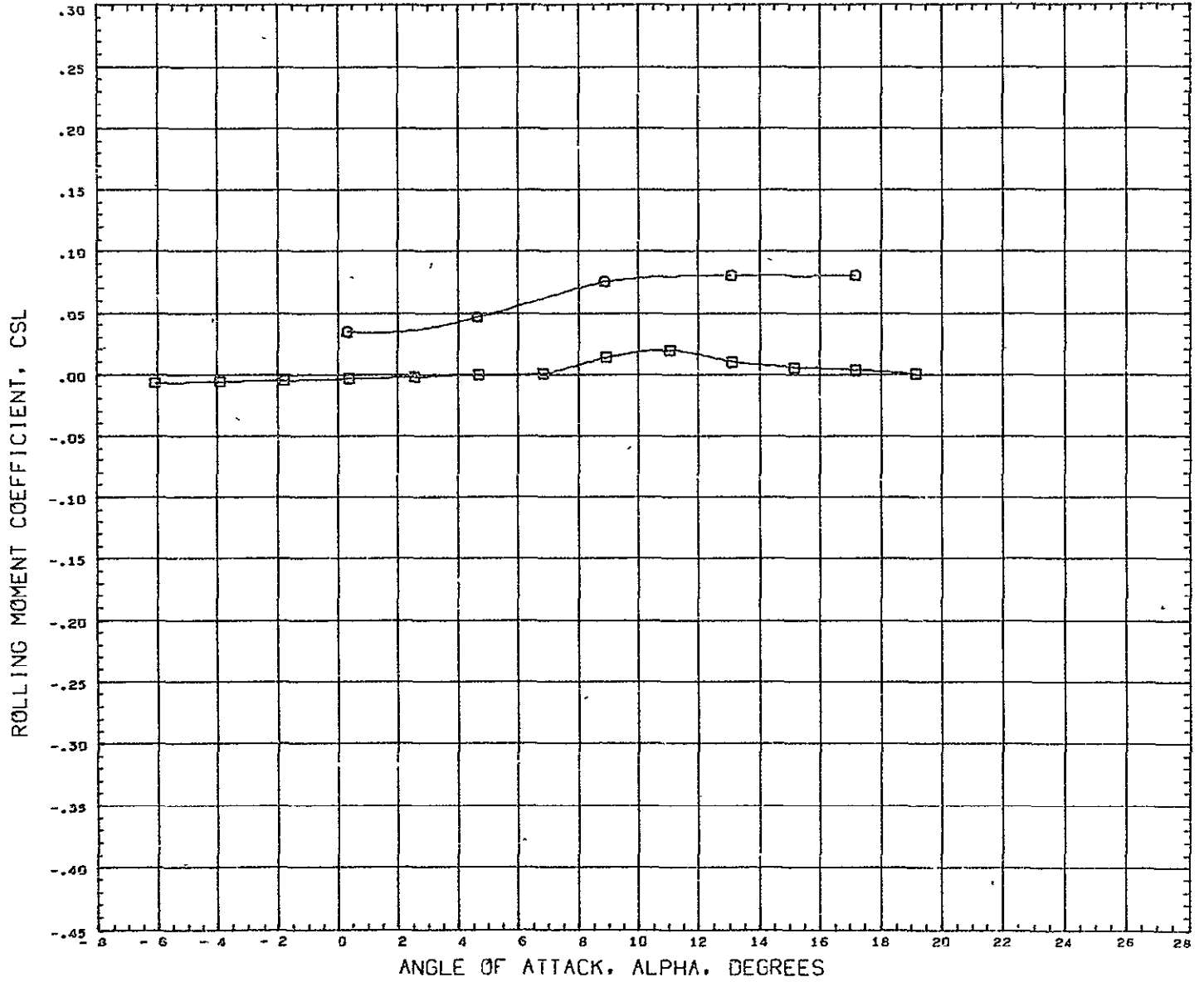

SYMBOL	BETA	PARAMETRIC VALUES				REFERENCE INFORMATION		
○	- 4.000	MACH	0.259	ELEVTF	0.000	REFS	316 2354	50 IN
□	0.000	RUDVTR	0.000	FLAPS	0.000	REFL	50.1900	IN
		SPOILR	0.000			REFB	7.3500	IN
						XHRP	29 3920	IN
						YHRP	0.0000	IN
						ZHRP	0.0000	IN
						SCALE	0 0175	

REFERENCE FILE CONVAIR T175-AE-12

CONFIG. BUILDUP - SIDESLIP DERIVATIVES - STRAIGHT WING BASIC POS. - V-TAIL=55DEG

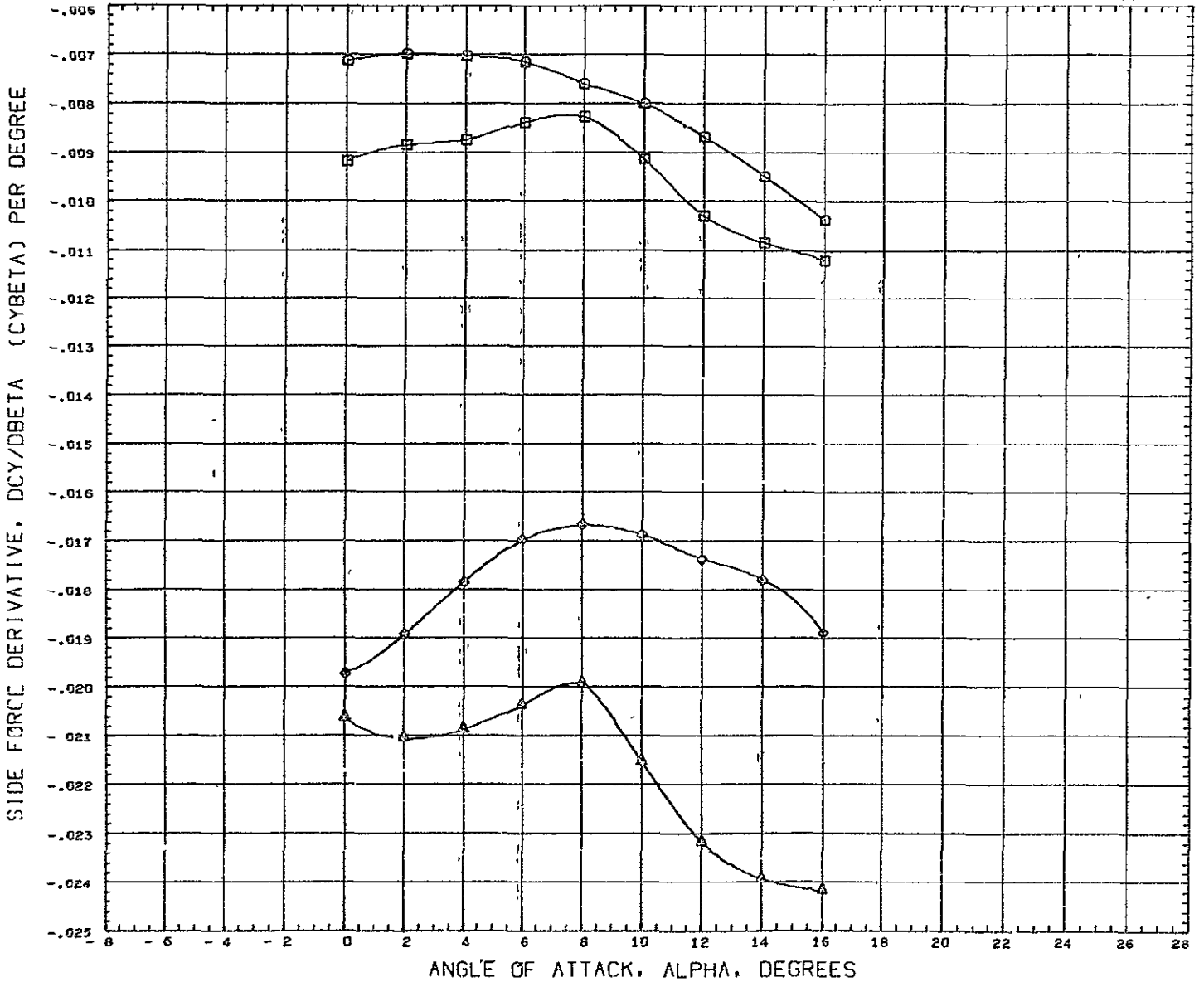

DATA SET SYMBOL    CONFIGURATION DESCRIPTION  
 (DB7579)    □    CVLSWT TEST 579-G B1  
 (L37245)    □    CVLSWT TEST 579-G B1W1-15  
 (DB7581)    ◊    CVLSWT TEST 579-G B1W1-15T1-55  
 (DB7552)    △    CVLSWT TEST 579-G B1W1-15T1-55E1

PARAMETRIC VALUES  
 BETA    0.500

REFERENCE INFORMATION  
 REFS    316.2304    SQ IN  
 REFL    50.1900    IN  
 REFB    7.3500    IN  
 XMRP    29.3920    IN  
 YMRP    0.0000    IN  
 ZMRP    0.0000    IN  
 SCALE    0.0175

MACH    0.259

CONFIG. BUILDUP - SIDESLIP DERIVATIVES - STRAIGHT WING BASIC POS. - V-TAIL=55DEG

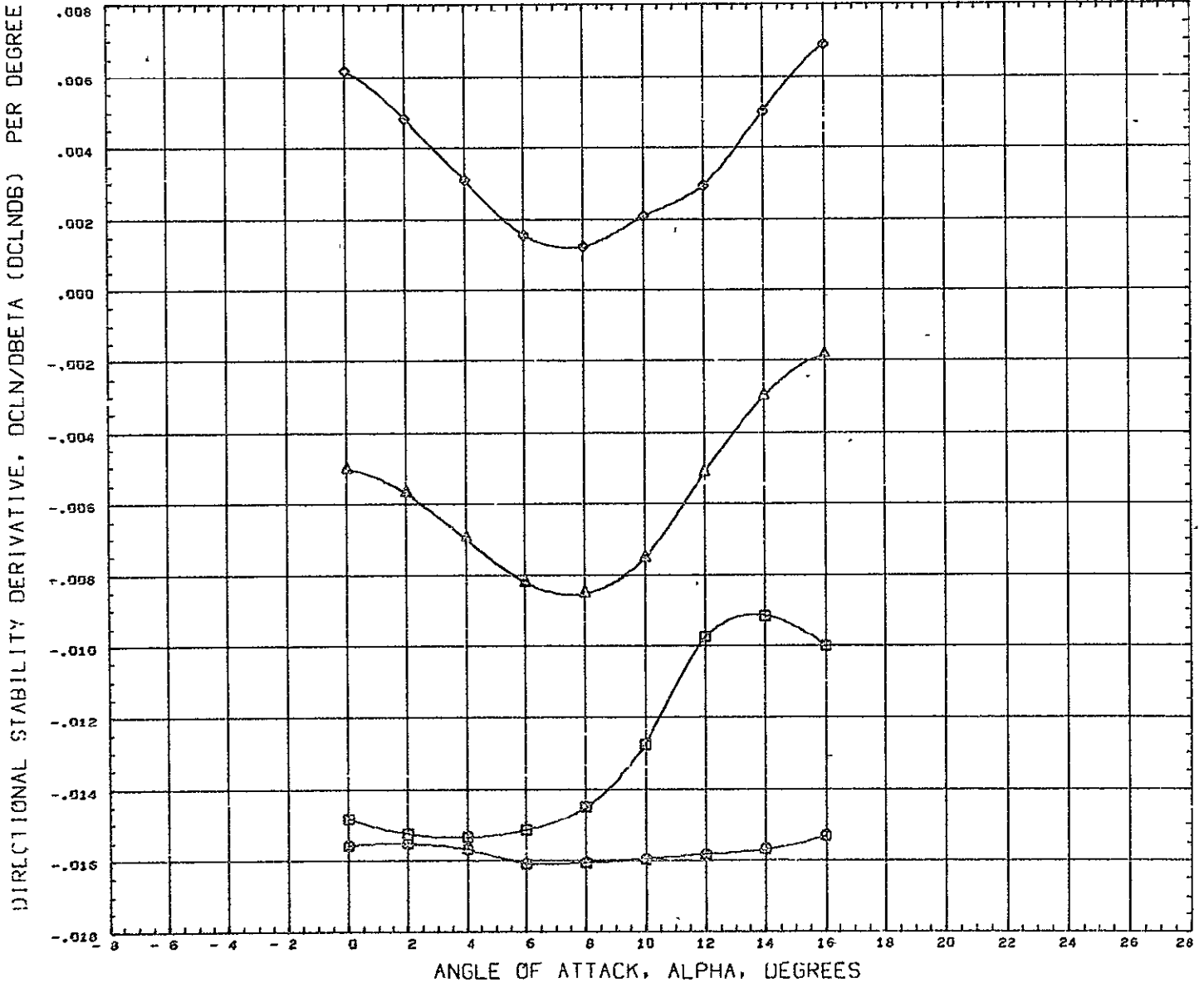

DATA SET SYMBOL	CONFIGURATION DESCRIPTION	PARAMETRIC VALUES	REFERENCE INFORMATION
(057079)	CVLSWT TEST 579-D S1	BETA 0.000	REFS 316 2304 SQ IN
(087645)	CVLSWT TEST 579-D B1W1-15		REFL 50.1900 IN
(087601)	CVLSWT TEST 579-D B1W1-15T1-55		REFB 7.3500 IN
(087238)	CVLSWT TEST 579-D B1W1-15T1-55E1		XMRP 29.3920 IN
			YMRP 0.0000 IN
			ZMRP 0.0000 IN
			SCALE 0.0175

MACH 0.259

CONFIG. BUILDUP - SIDESLIP DERIVATIVES - STRAIGHT WING BASIC POS. - V-TAIL=55DEG

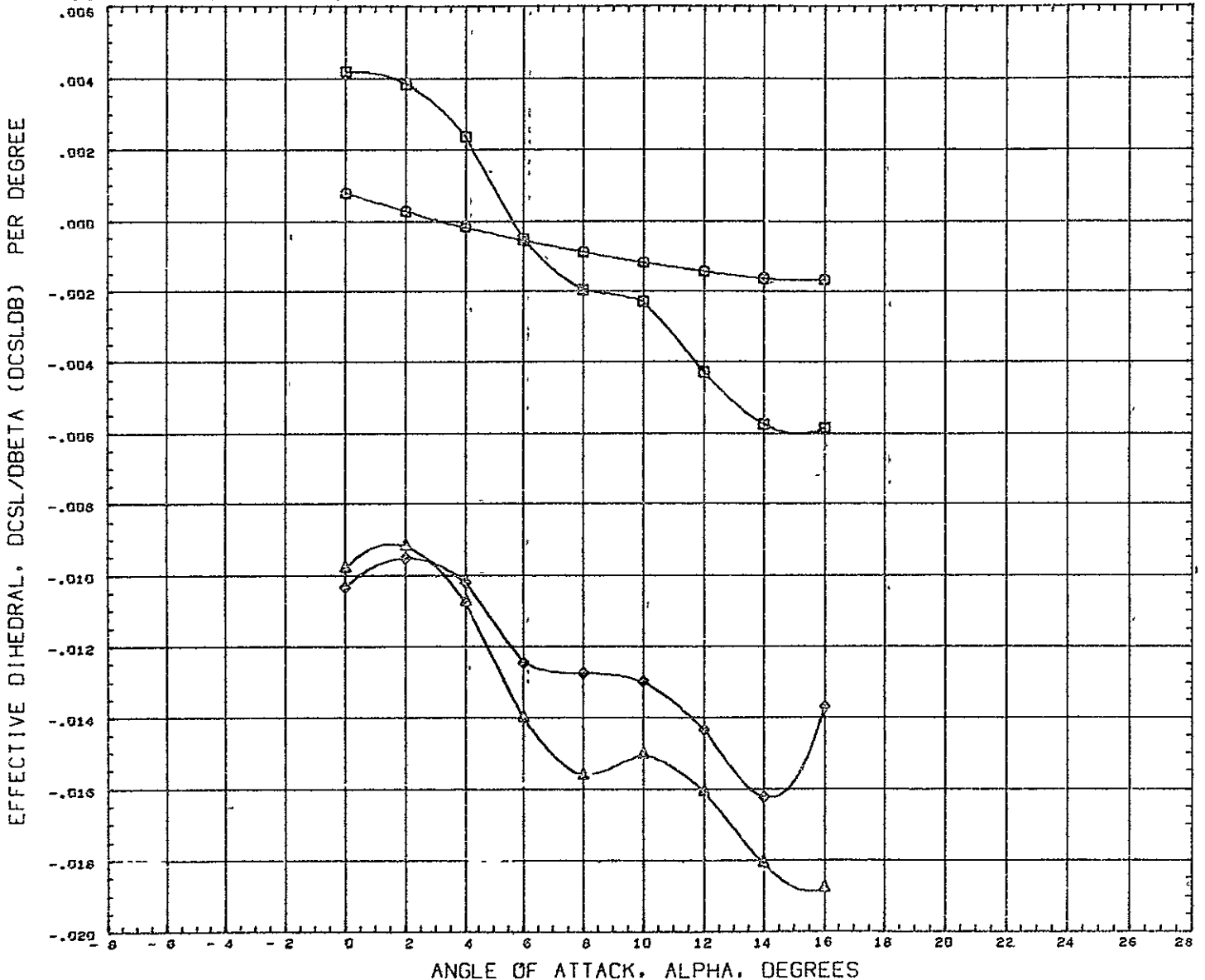

DATA SET SYMBOL	CONFIGURATION DESCRIPTION	PARAMETRIC VALUES	REFERENCE INFORMATION
(DB7079)	CVLSWT TEST 579-D 81	BETA 0.000	REFS 316.2304 SQ IN
(DB7040)	CVLSWT TEST 579-D 81W1-15		REFL 50.1900 IN
(DB7001)	CVLSWT TEST 579-D 81W1-1571-55		REFB 7.3500 IN
(DB7036)	CVLSWT TEST 579-D 81W1-1571-55E1		XMRP 29.3920 IN
			YMRF 0.0000 IN
			ZMRF 5.0000 IN
			SCALE 0.0175

MACH 0.259

CONFIG. BUILDUP - LONGITUDINAL CHAR. - STRAIGHT WING AFT - V-TAIL=55DEG

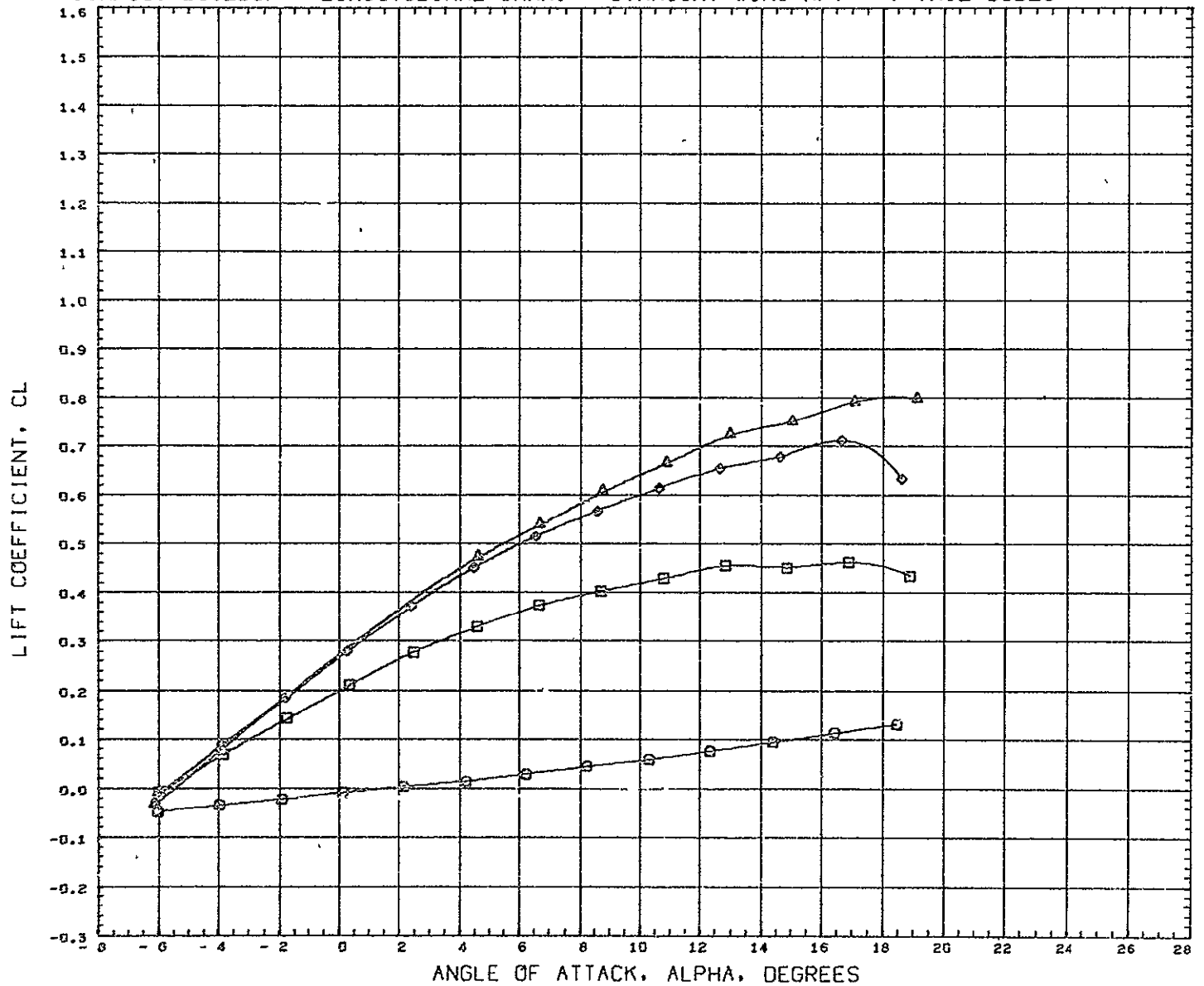

DATA SET SYMBOL	CONFIGURATION DESCRIPTION	PARAMETRIC VALUES	REFERENCE INFORMATION
(RC7079)	CVLSWT TEST 579-D B1	DELTA 0.000	REFS 316 2304 SQ IN
(RC7076)	CVLSWT TEST 579-D B1W3A		REFL 50.1900 IN
(RC7068)	CVLSWT TEST 579-D B1W3A11-55		REFB 7 3500 IN
(RC7071)	CVLSWT TEST 579-D B1W3A11-55E1		XMRP 29.3920 IN
			YHRP 0.0000 IN
			ZHRP 0.0000 IN
			SCALE 0 0175

MACH 0.259

CONFIG. BUILDUP - LONGITUDINAL CHAR. - STRAIGHT WING AFT - V-TAIL=55DEG

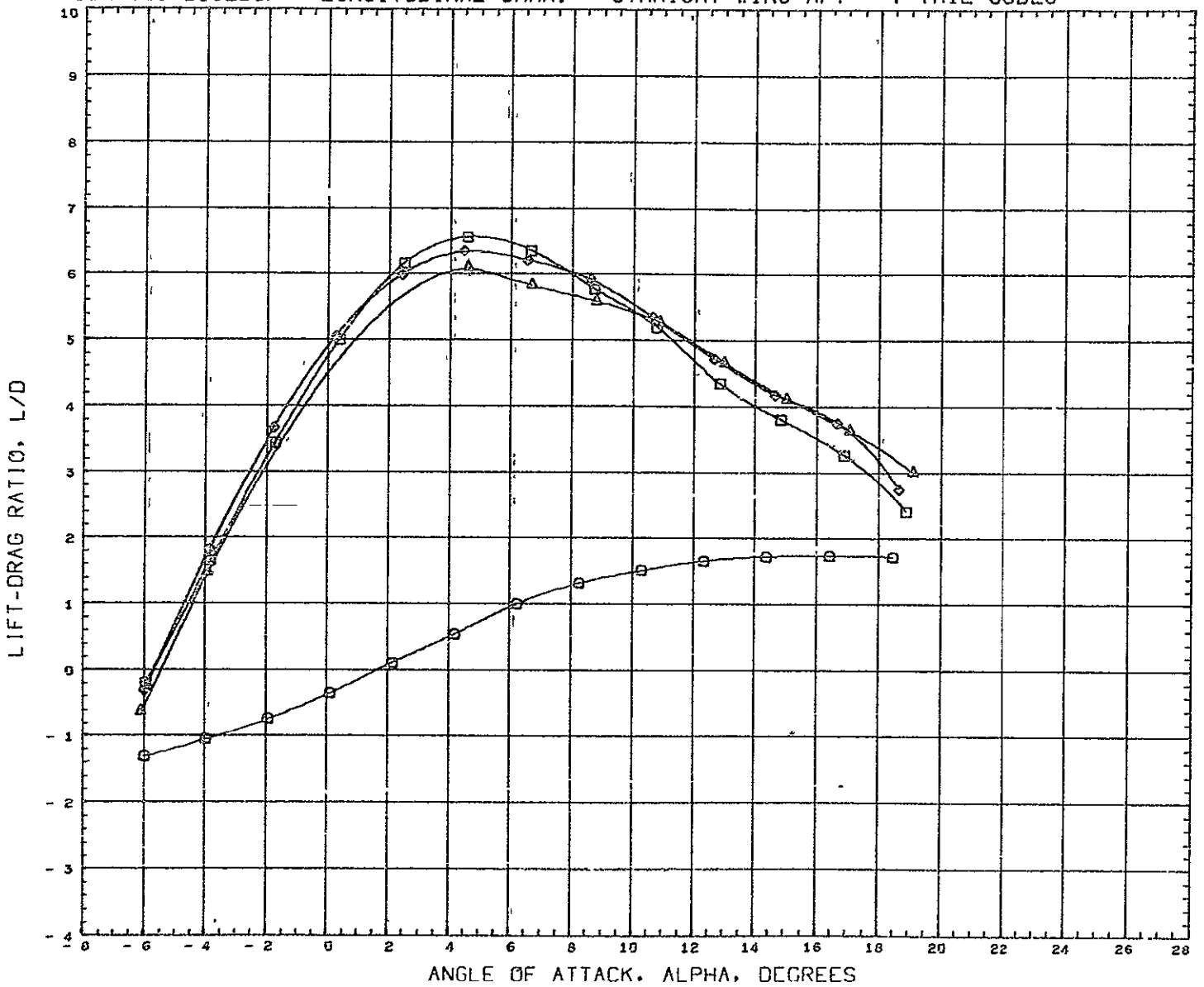

DATA SET SYMBOL	CONFIGURATION DESCRIPTION	PARAMETRIC VALUES	REFERENCE INFORMATION
(RC7079)	CVLSWT TEST 579-D B1	BETA 0.000	REFS 316.2304 SQ IN
(RC7076)	CVLSWT TEST 579-D B1W3A		REFL 50.1900 IN
(FC7068)	CVLSWT TEST 579-D B1W3AT1-35		REFB 7.3500 IN
(RC7071)	CVLSWT TEST 579-D B1W3AT1-55E1		XHRF 29.3920 IN
			YHRF 0.0000 IN
			ZHRF 0.0000 IN
			SCALE 0.0175

MACH 0.259

CONFIG. BUILDUP - LONGITUDINAL CHAR. - STRAIGHT WING AFT - V-TAIL=55DEG

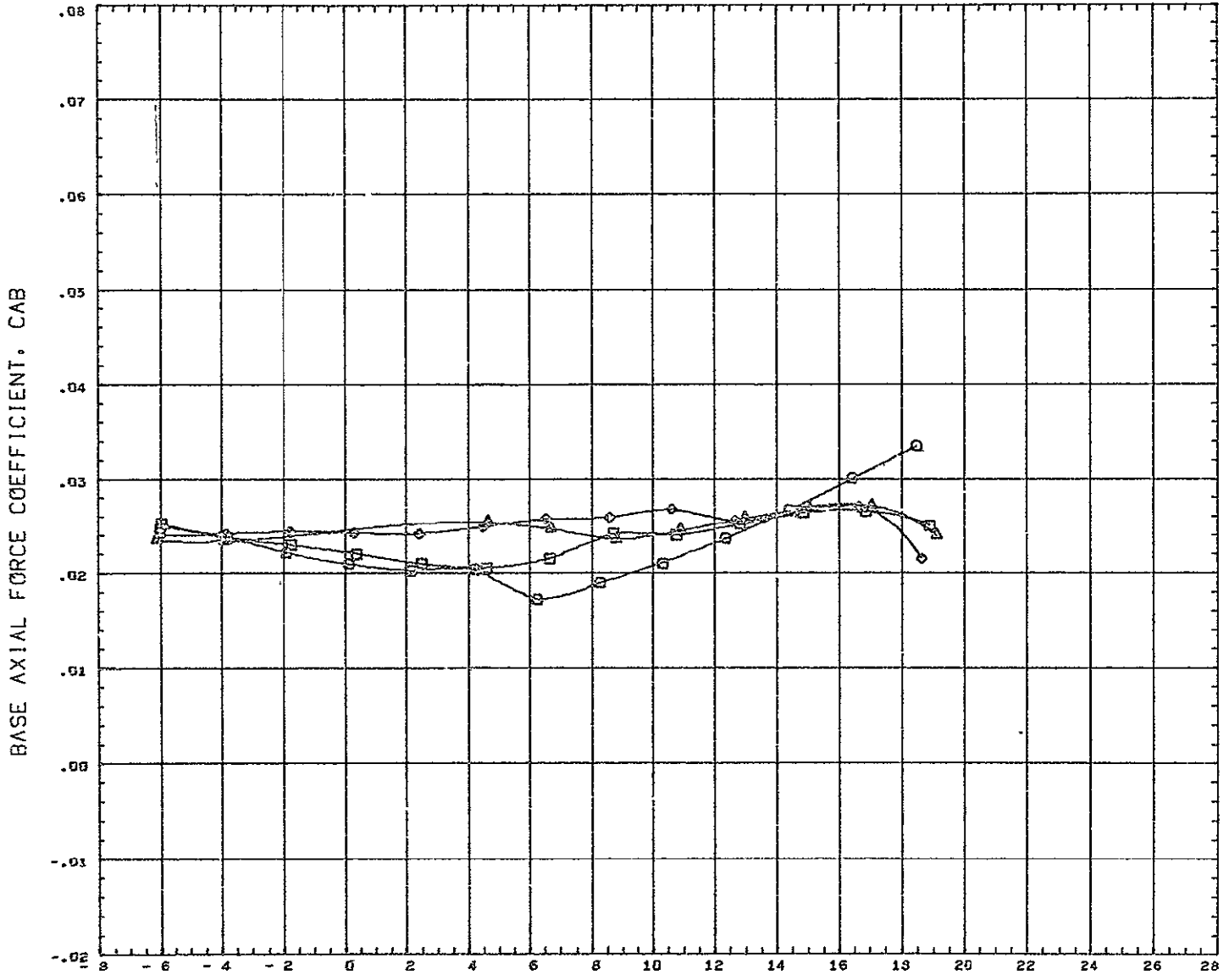

DATA SET SYMBOL	CONFIGURATION DESCRIPTION	PARAMETRIC VALUES	REFERENCE INFORMATION
(RC7079)	CVLSWT TEST 579-D B1	BETA 0.000	REFS 316.2304 SQ IN
(RC7076)	CVLSWT TEST 579-D B1W3A		REFL 50 1900 IN
(RC7068)	CVLSWT TEST 579-D B1W3AT1-55		REFB 7 3500 IN
(RC7071)	CVLSWT TEST 579-D B1W3AT1-55E1		XMRP 29 3920 IN
			YMRP 0 0000 IN
			ZMRP 0.0000 IN
			SCALE 0.0175

MACH 0 259



CONFIG. BUILDUP - LONGITUDINAL CHAR. - STRAIGHT WING AFT - V-TAIL=55DEG

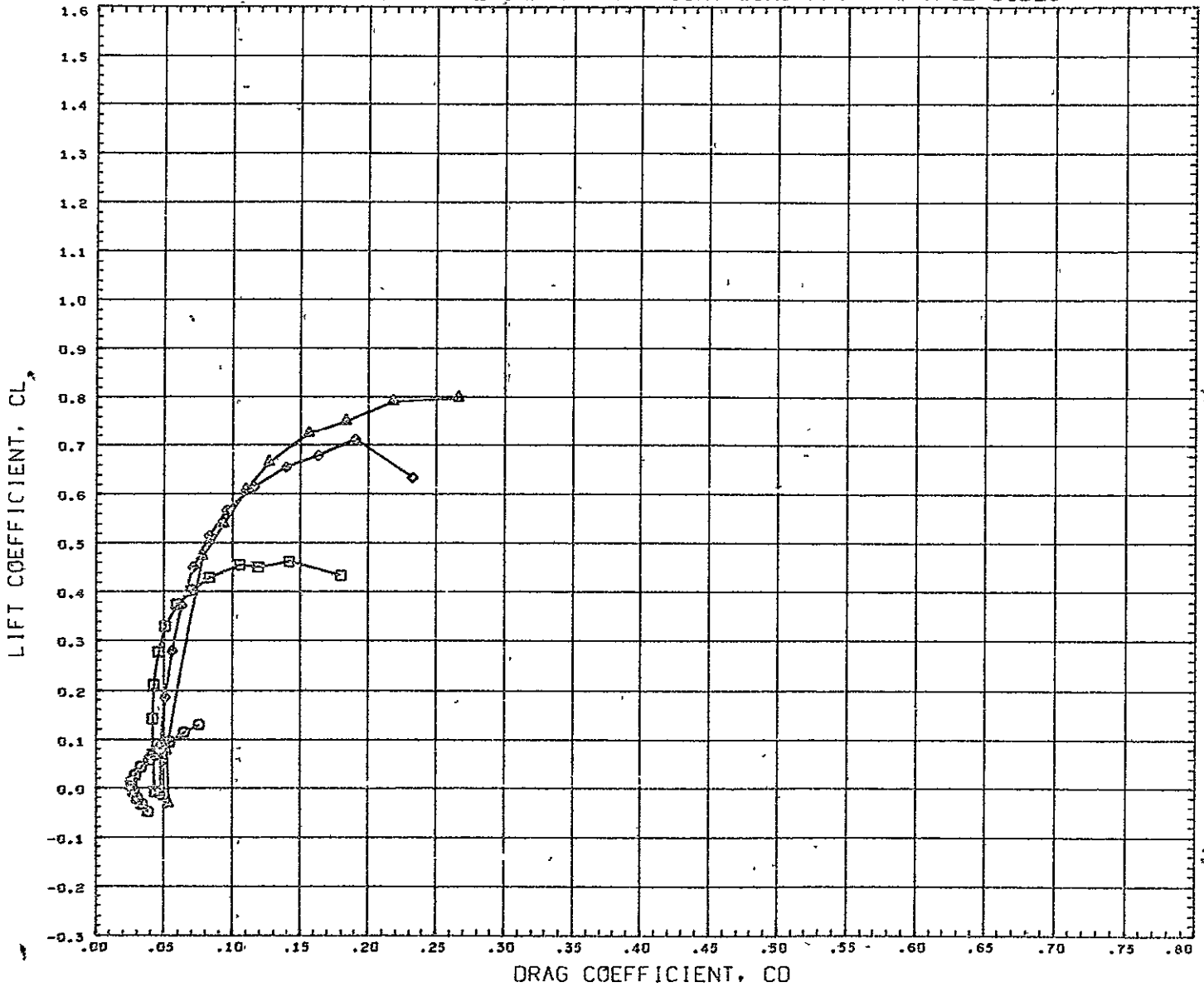

DATA SET SYMBOL	SYMBOL	CONFIGURATION DESCRIPTION
(RC7079)	□	C+SWT TEST 579-D B1
(RC7076)	◇	CVLSWT TEST 579-D B1W3A
(RC7068)	○	CVLSWT TEST 579-D B1W3AT1-55
(RC7071)	△	CVLSWT TEST 579-D B1W3AT1-55E1

BETA 0.000

REFERENCE INFORMATION		
REFS	316.2504	SQ IN
REFL	50 1900	IN
REFB	7 3500	*N
XMRP	29 3920	IN
YMRP	0 0000	IN
ZMRP	0 0000	IN
SCALE	0 0175	

MACH 0.259

CONFIG. BUILDUP - LONGITUDINAL CHAR. - STRAIGHT WING AFT - V-TAIL=55DEG

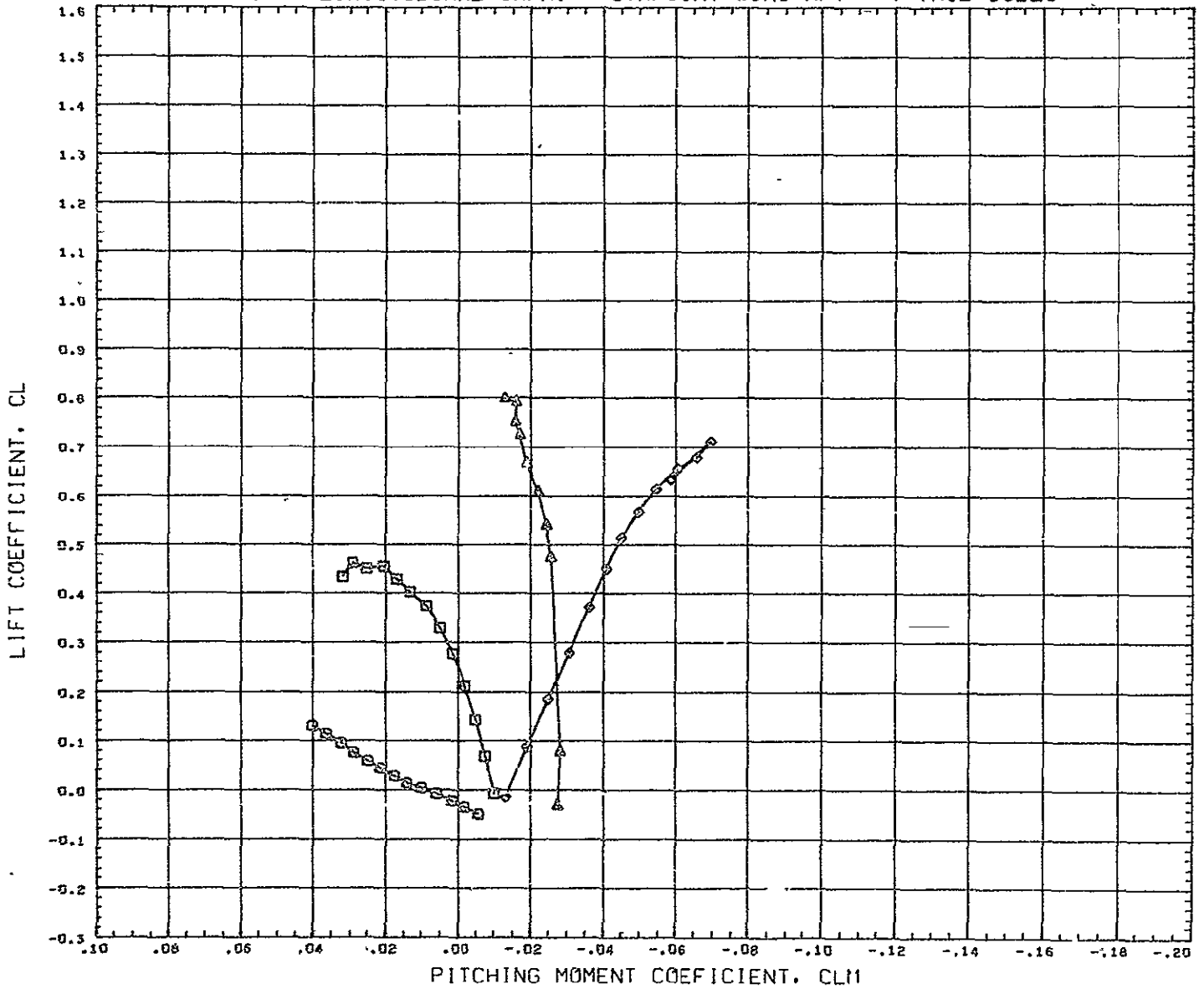

DATA SET SYMBOL	CONFIGURATION DESCRIPTION	PARAMETRIC VALUES	REFERENCE INFORMATION
(RC7079)	□ CVLSWT TEST 579-G B1	BETA 0.000	REFS 316.2304 SQ IN
(RC7076)	□ CVLSWT TEST 579-G B1W3A		REFL 50 1900 IN
(RC7068)	◇ CVLSWT TEST 579-G B1W3AT1-55		REFB 7 3500 IN
(RC7071)	△ CVLSWT TEST 579-G B1W3AT1-55E1		XMRP 29 3920 IN
			YMRP 0 0000 IN
			ZMRP 0 0000 IN
			SCALE 0 0175

MACH 0 259

LONG. CHAR. - ELEVATOR EFFECTIVENESS - STRAIGHT WING BASIC POS. - V-TAIL=55DEG

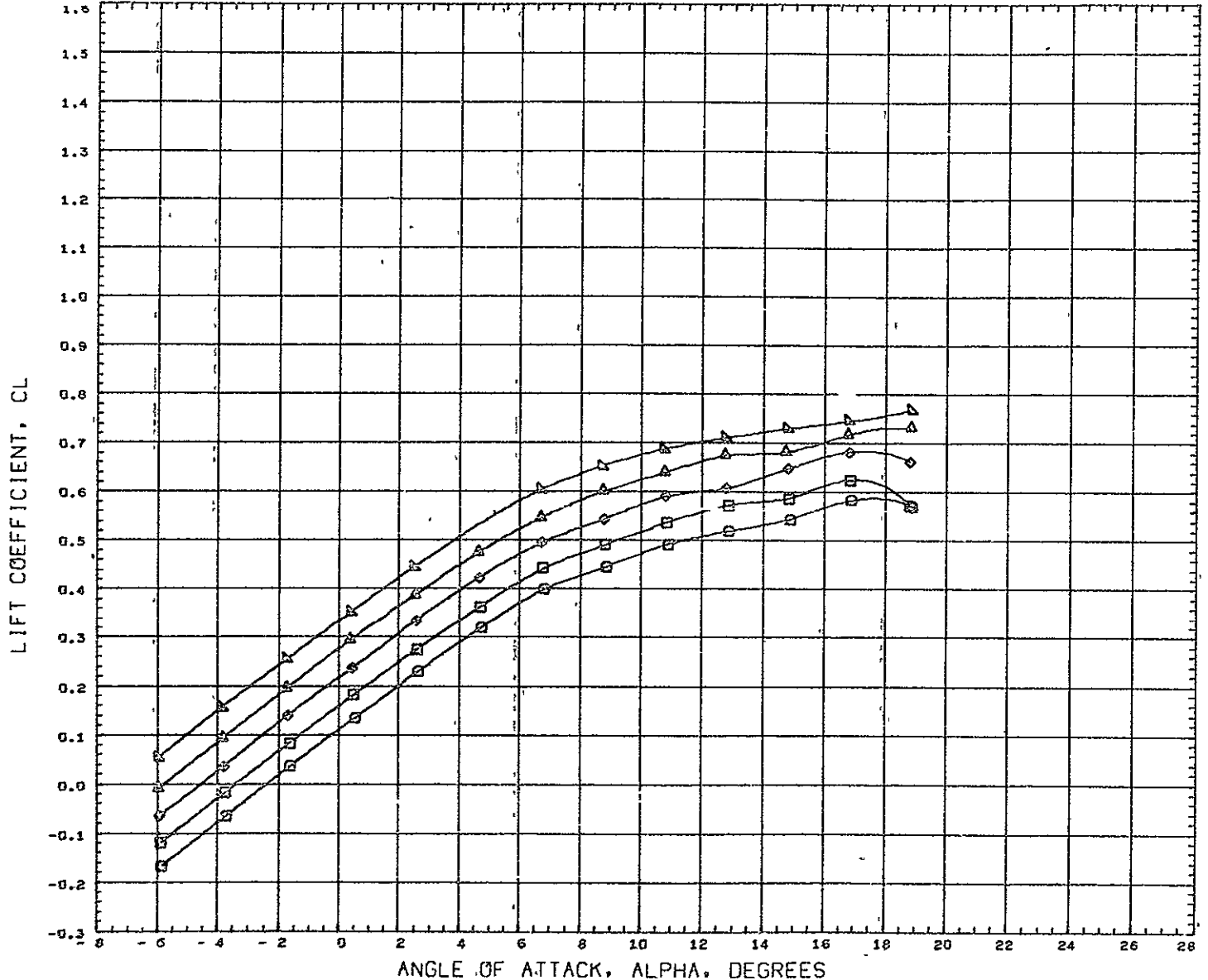

SYMBOL	ELEVTR	PARAMETRIC VALUES				REFERENCE INFORMATION		
○	-30.000	MACH	0.259	BETA	0.000	REFS	316.2304	sq IN
◻	-20.000	RUDYTR	0.000	FLAPS	0.000	REFL	50.1900	IN
◇	-10.000	SFOILR	0.000			REFB	7.3500	IN
△	0.000					XNRF	29.3926	IN
▽	10.000					YNRF	0.0000	IN
						ZNRF	0.0000	IN
						SCALE	0.0175	

REFERENCE FILE      CONVAIR IN70-AE-12

LONG. CHAR. - ELEVATOR EFFECTIVENESS - STRAIGHT WING BASIC POS. - V-TAIL=55DEG

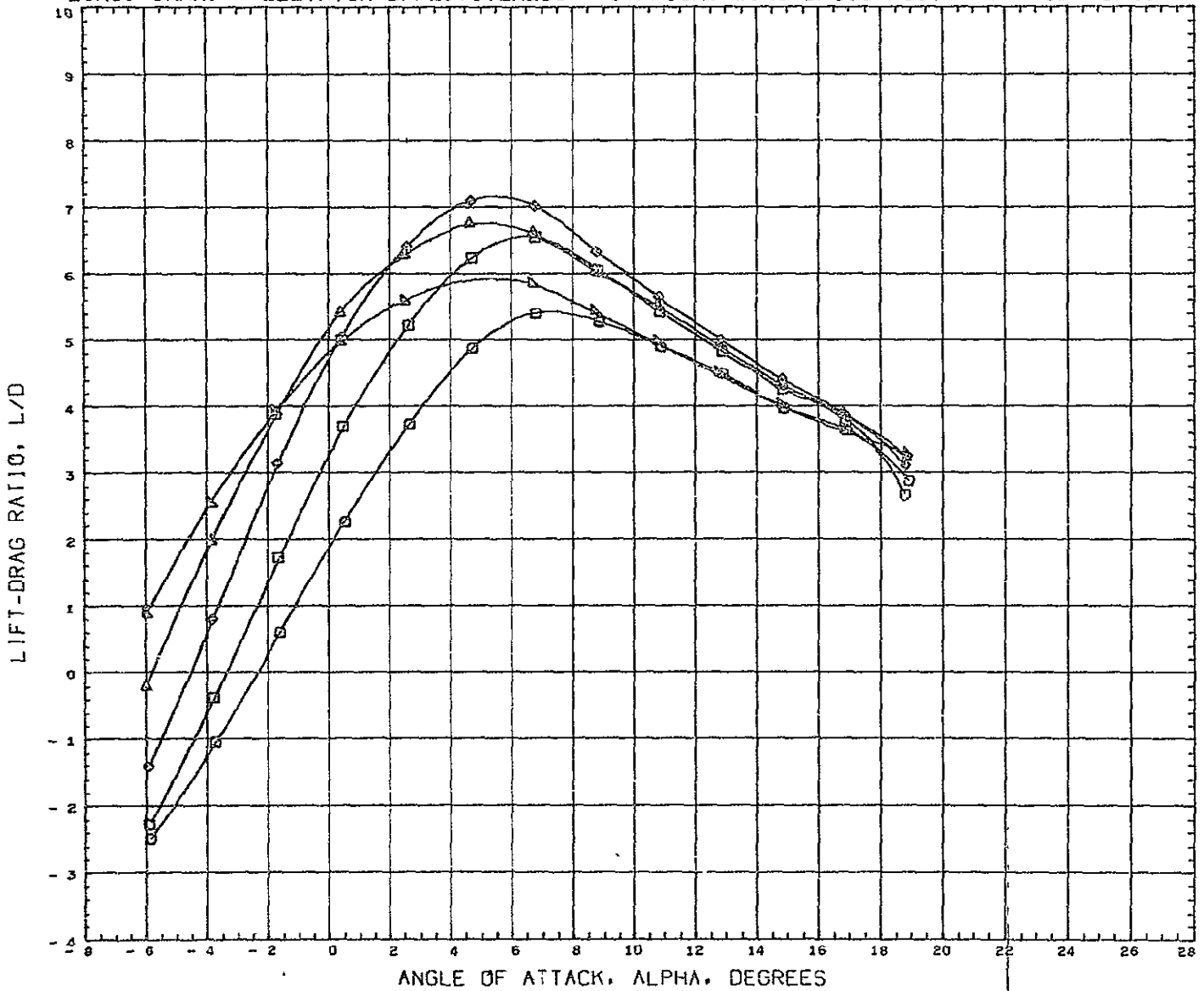

SYMBOL	ELEVTR	PARAMETRIC VALUES
□	- 30.000	MACH 0.259 BETA 0.000
□	- 20.000	RUDVTR 0.000 FLAPS 0.000
○	- 10.000	SPOILR 0.000
△	0.000	
▽	10.000	

REFERENCE FILE CONVAIR TN70-AE-12

REFERENCE INFORMATION

REFS	316 2304	SQ IN
REFL	50 1200	IN
REFB	7.3500	IN
XMRP	29.3920	IN
YMFP	0.0000	IN
ZMRF	0.0000	IN
SCALE	0.0175	

LONG. CHAR. - ELEVATOR EFFECTIVENESS - STRAIGHT WING BASIC POS. - V-TAIL=55DEG

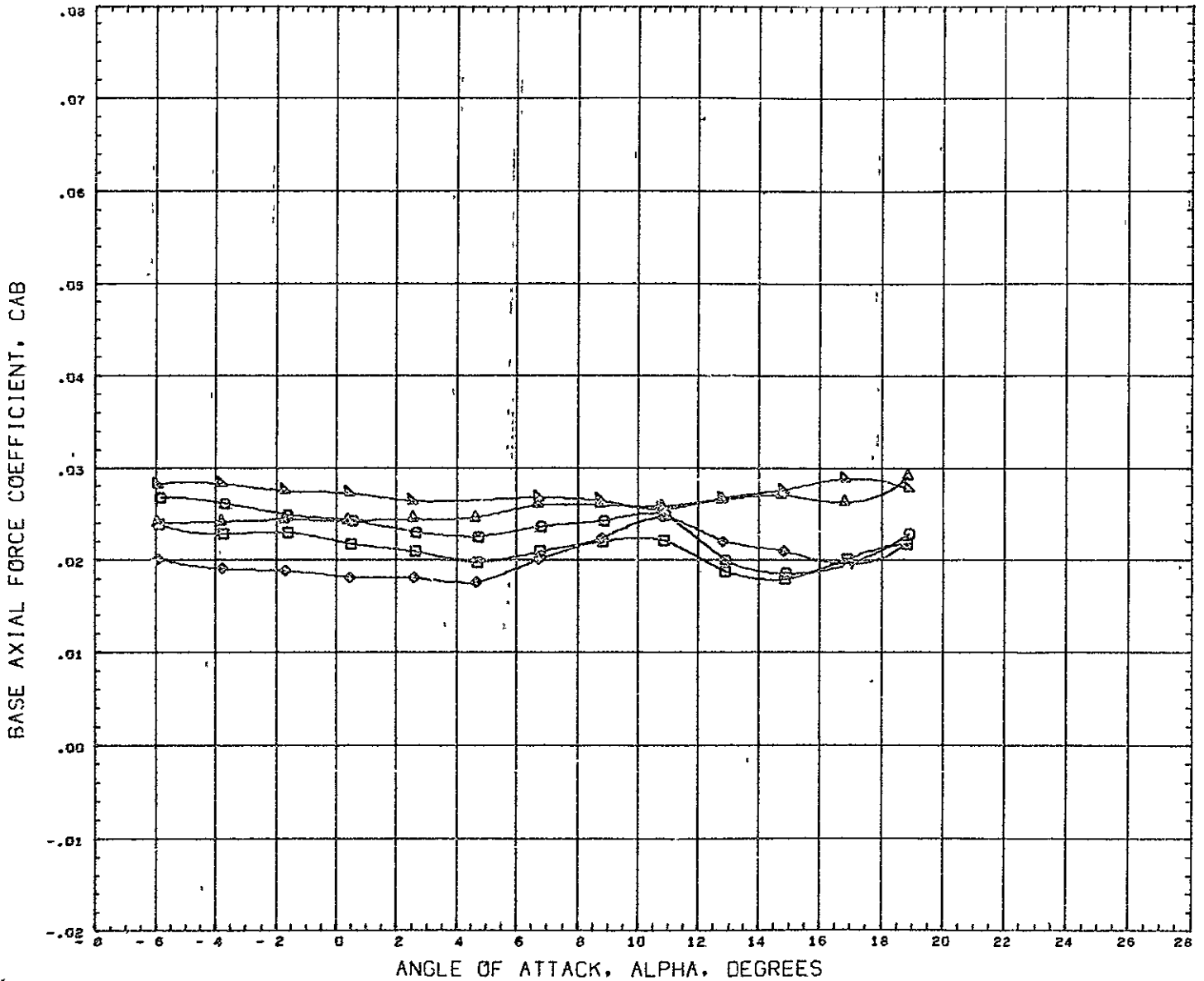

SYMBOL	ELEVTR	PARAMETRIC VALUES				REFERENCE INFORMATION		
○	- 30.000	MACH	0.259	BETA	0.000	REFS	316 2304	50 IN
□	- 20.000	RUDYTR	0.000	FLAPS	0.000	REFL	50.1900	IN
◇	- 10.000	SFCILR	0.000			REFB	7.3500	IN
△	0.000					XMRP	29.3920	IN
▽	10.000					YMRP	0.0000	IN
						ZMRP	0.0000	IN
						SCALE	0.0175	

REFERENCE FILE    COVVAIR IN70-AE-12

LONG. CHAR. - ELEVATOR EFFECTIVENESS - STRAIGHT WING BASIC POS. - V-TAIL=55DEG

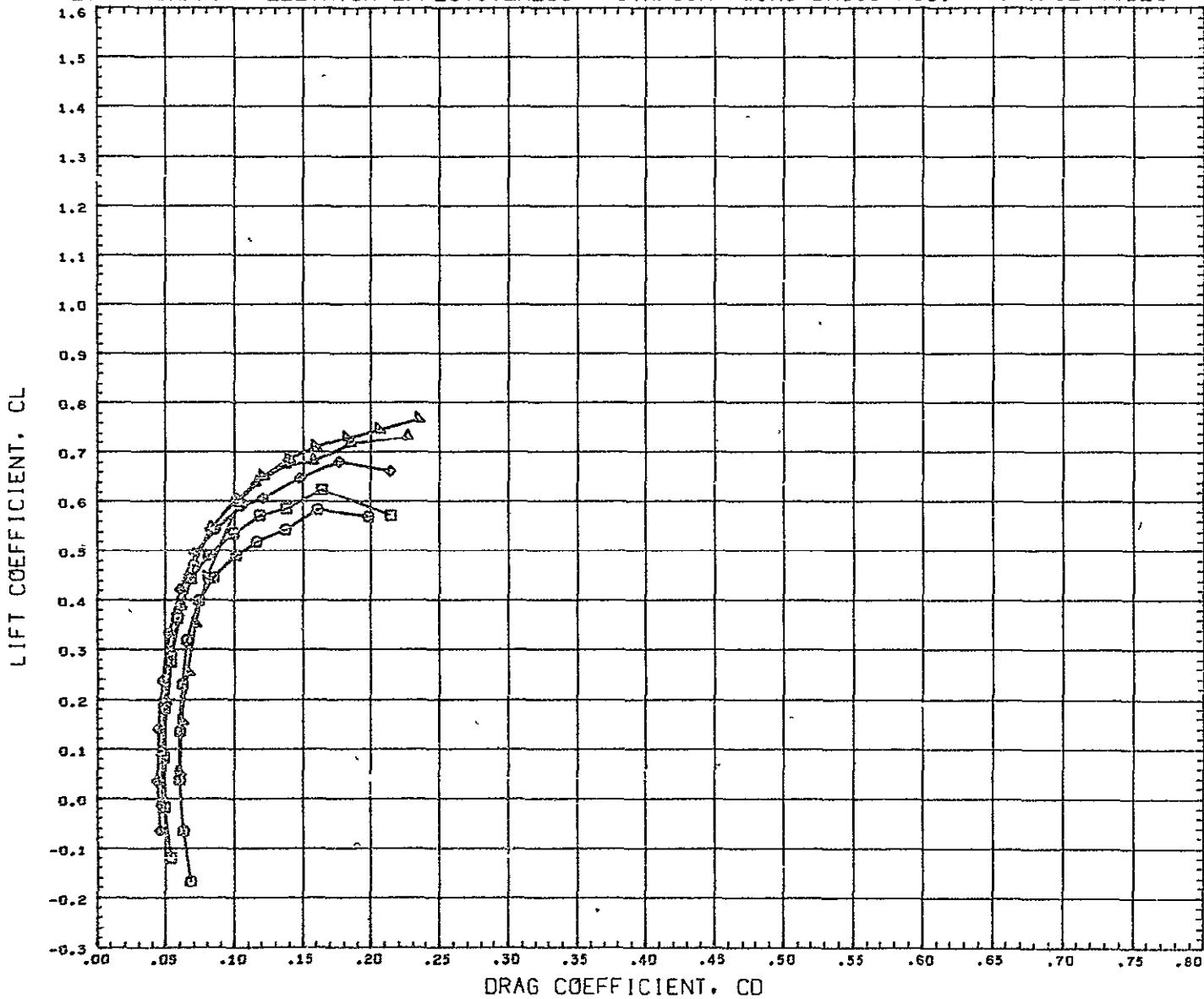

SYMBOL	ELEVTR	PARAMETRIC VALUES			
○	- 30.000	MACH	0.259	BETA	0.000
□	- 20.000	RUDVTR	0.000	FLAPS	0.000
◇	- 10.000	SFOILR	0.000		
△	0.000				
▽	10.000				

REFERENCE FILE    CONVAIR TN70-AE-12

REFERENCE INFORMATION		
REFS	316 2304	SQ IN
REFL	50.1900	IN
REFB	7.3500	IN
XNRP	29.3920	IN
YNRP	0.0000	IN
ZNRP	0.0000	IN
SCALE	0 0175	

LONG. CHAR. - ELEVATOR EFFECTIVENESS - STRAIGHT WING BASIC POS. - V-TAIL=55DEG

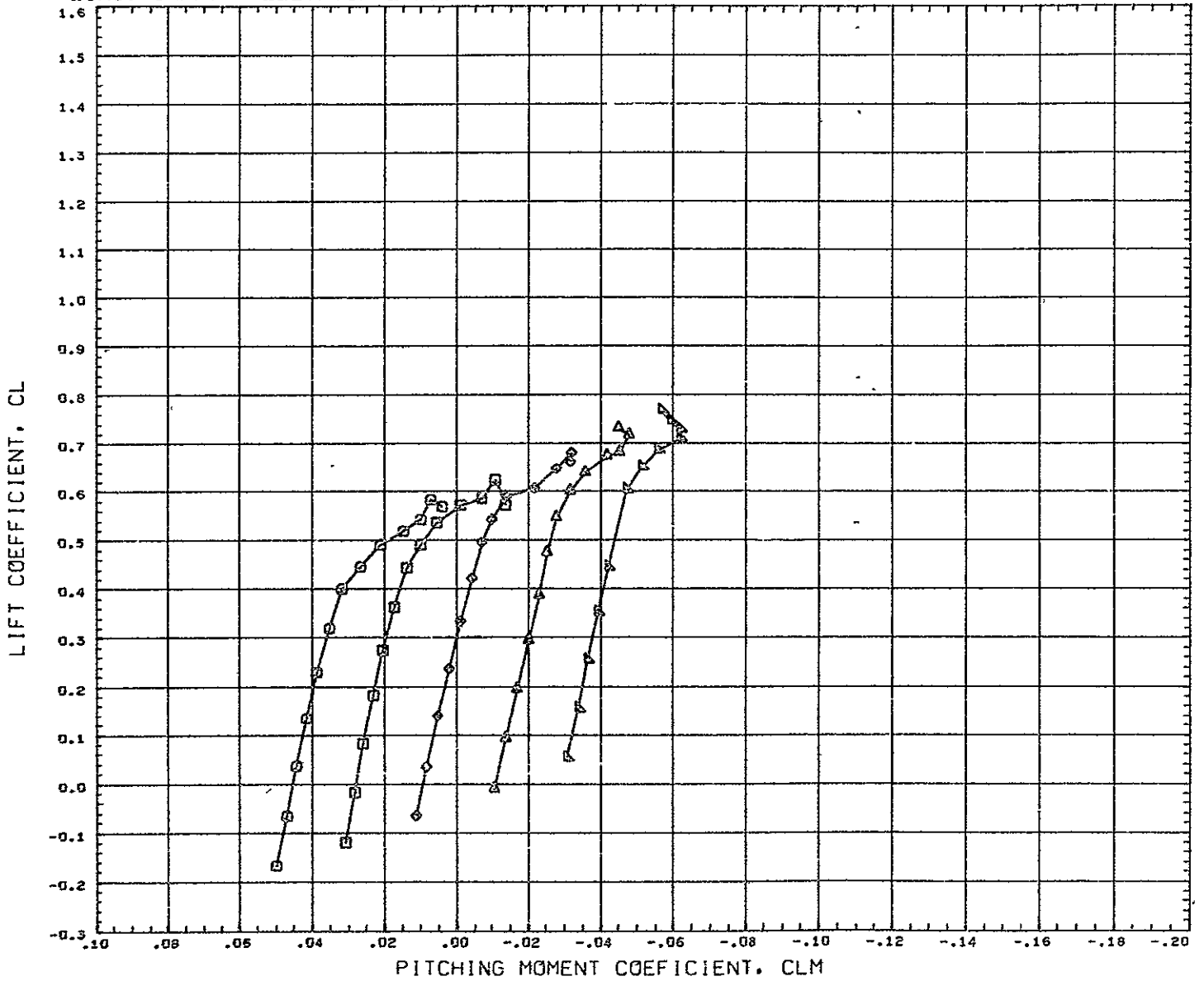

SYMBOL	ELEVTR	PARAMETRIC VALUES			
○	30.000	MACH	0.259	BETA	0.000
□	20.000	FUDVTR	0.000	FLAPS	0.000
◇	10.000	SPOILR	0.000		
△	0.000				
▽	10.000				

REFERENCE FILE      COVAIR TN70-AE-12

REFERENCE INFORMATION		
REFS	316.2304	SQ IN
REFL	50.1900	IN
REFB	7.3500	IN
XHRF	29.3920	IN
YHRF	0.0000	IN
ZHRF	0.0000	IN
SCALE	0.0175	

LATERAL DIRECTIONAL CHAR. - STRAIGHT WING BASIC POSITION - V-TAIL=55DEG

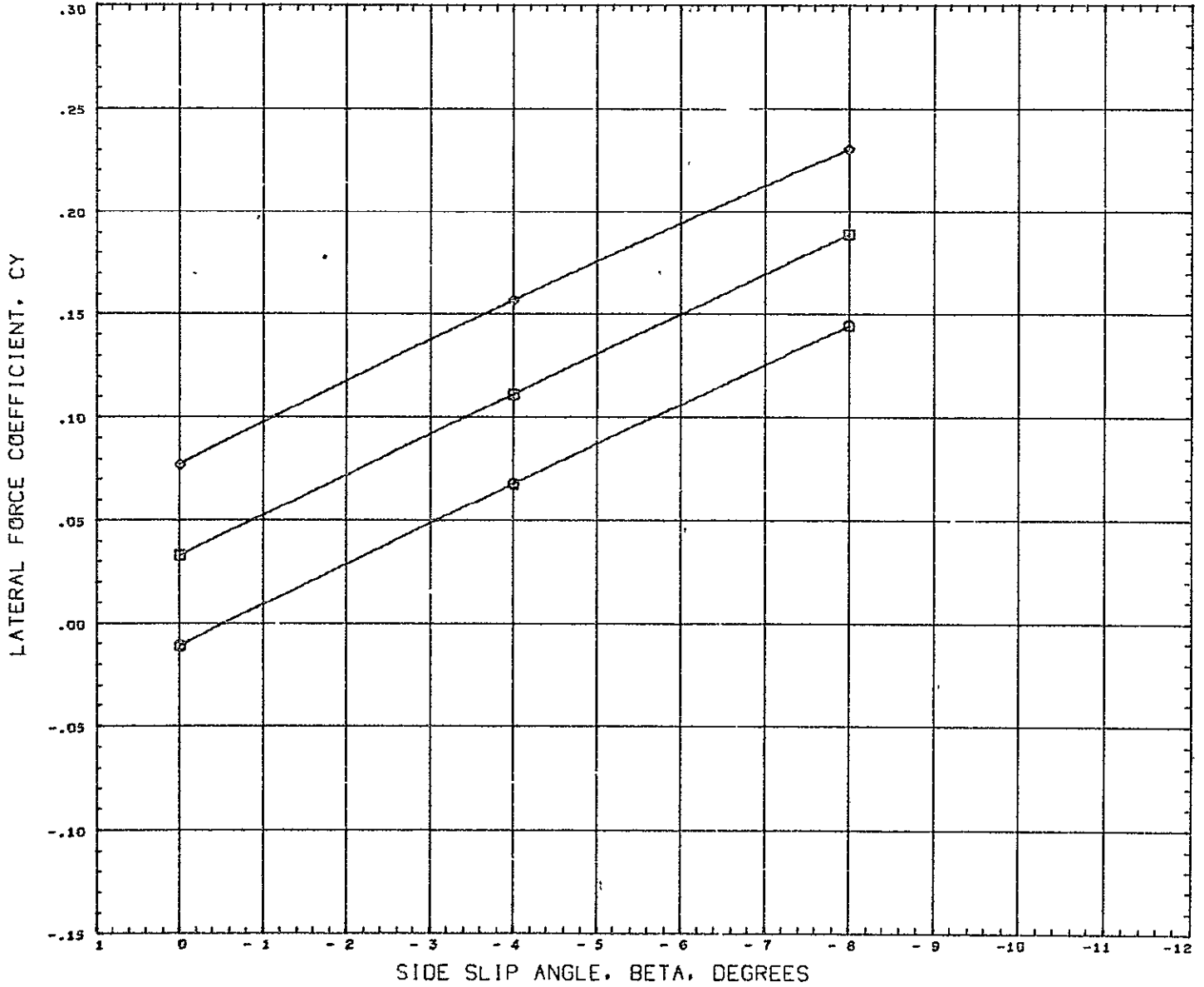

SYMBOL		PARAMETRIC VALUES				REFERENCE INFORMATION		
○	0.000	MACH	0.259	ALPHA	0.000	REFS	316.2304	SQ IN
□	10.000	ELEVTR	0.000	FLAPS	0.000	REFL	50.1900	IN
◇	20.000	SPOILR	0.000			REFB	7.3500	IN
						XHRF	29.3920	IN
						YNSP	0.0000	IN
						ZHRP	0.0000	IN
						SCALE	0.0175	

DATA HIST. CODE I



LATERAL DIRECTIONAL CHAR. - STRAIGHT WING BASIC POSITION - V-TAIL=55DEG

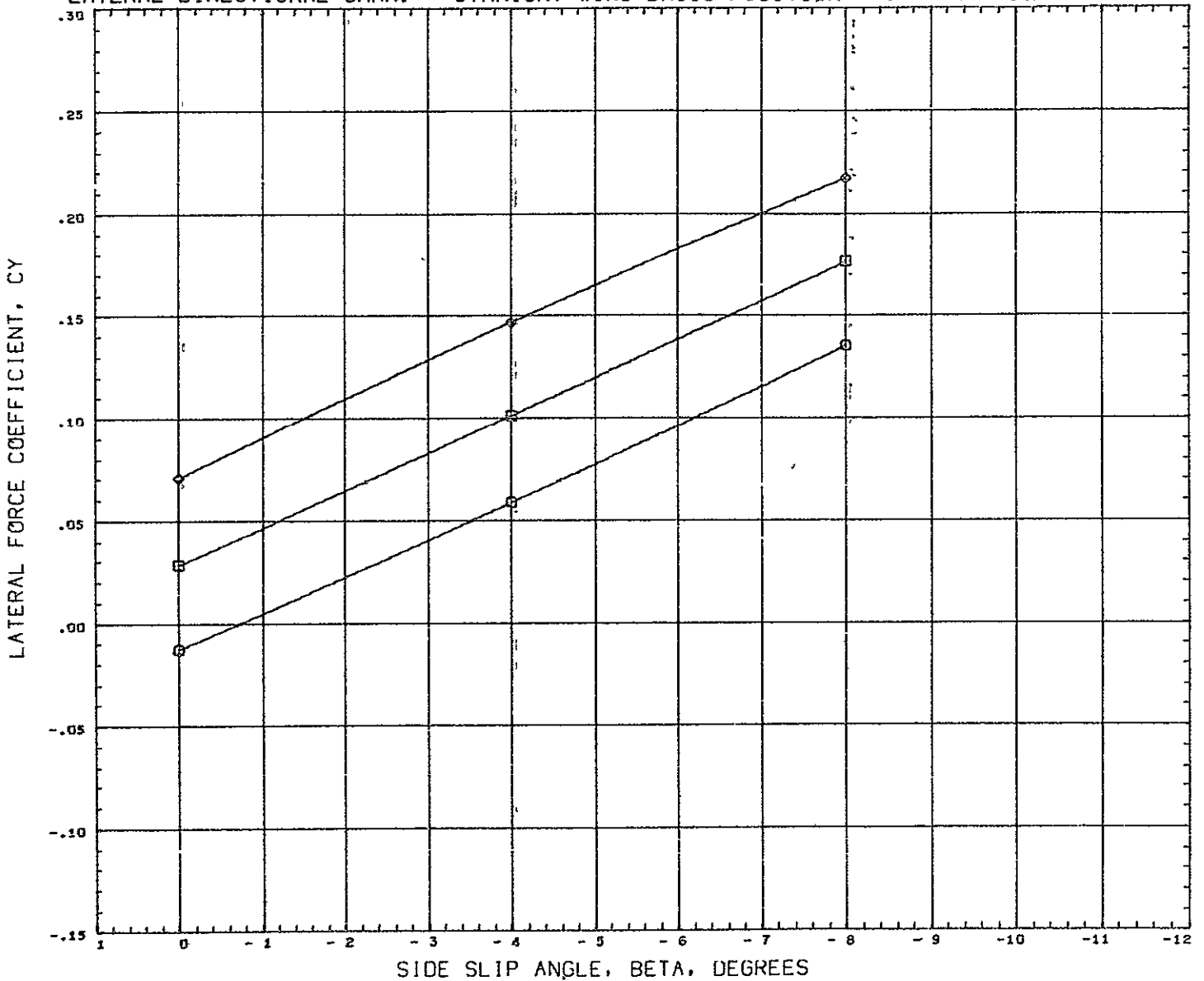

SYMBOL	RUDVTR	PARAMETRIC VALUES			
◇	0.000	MACH	0.259	ALPHA	4.000
□	10.000	ELEVTR	0.000	FLAPS	0.000
○	20.000	SFOILR	0.000		

REFERENCE INFORMATION		
REFS	316.2304	SQ IN
REFL	50.1900	IN
REFB	7.3500	IN
XMRP	29.3920	IN
YMRP	0.0000	IN
ZMRP	0.0000	IN
SCALE	0.0175	

DATA HIST. CODE 1

LATERAL DIRECTIONAL CHAR. - STRAIGHT WING BASIC POSITION - V-TAIL=55DEG.

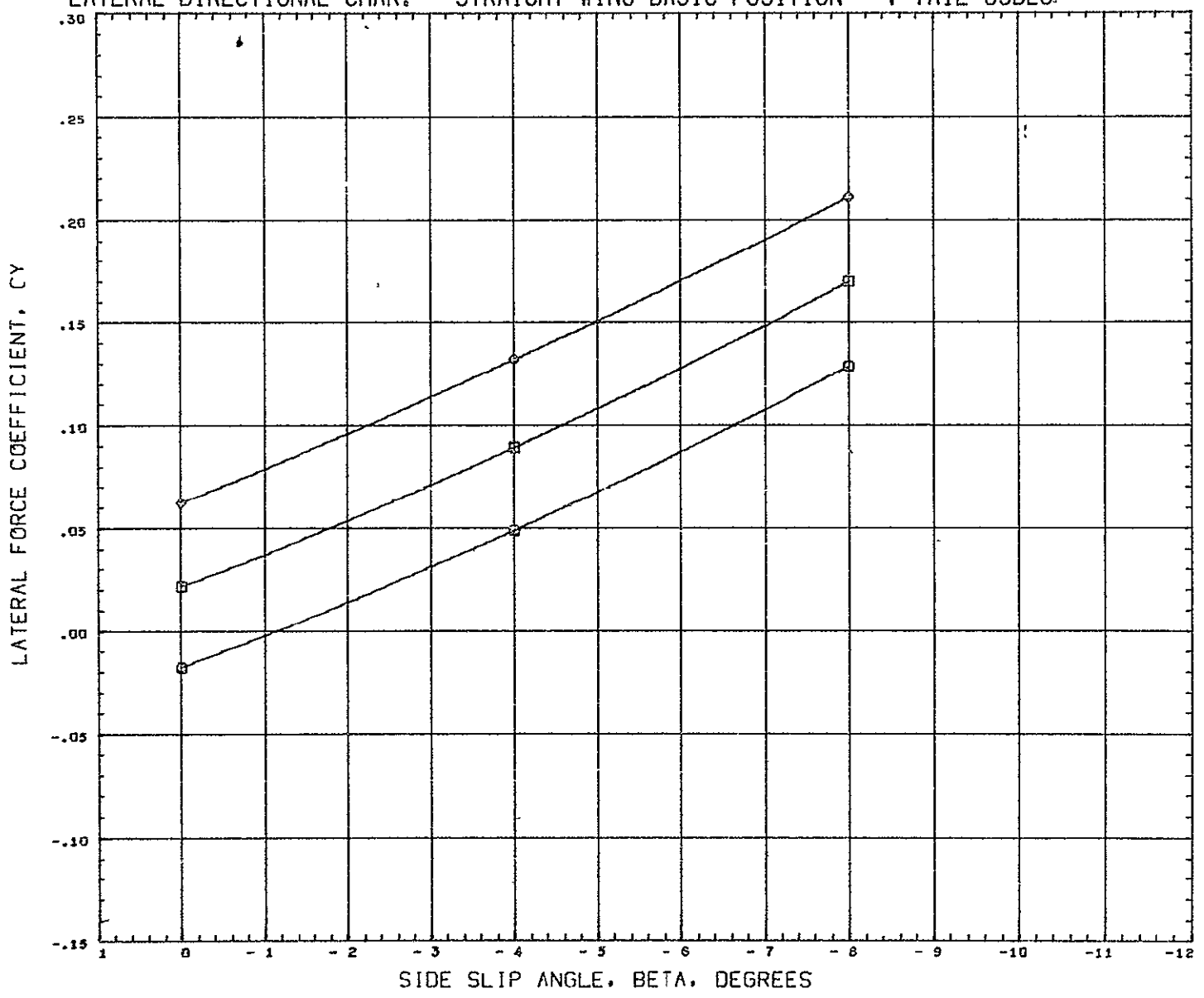

SYMBOL	RUDVTR	PARAMETRIC VALUES			
□	0.000	MACH	0.250	ALPHA	8.000
□	10.000	ELEVTR	0.000	FLAPS	0.000
○	20.000	SPOILF	0.000		

REFERENCE INFORMATION		
PEFS	316 2304	SQ IN
REFL	50.1900	IN
REFB	7.3500	IN
XHRF	29.3920	IN
YHRF	0 0000	IN
ZHRF	0 0000	IN
SCALE	0 0175	

DATA HIST. CODE 1

LATERAL DIRECTIONAL CHAR. - STRAIGHT WING BASIC POSITION<sup>1</sup> - V-TAIL=55DEG

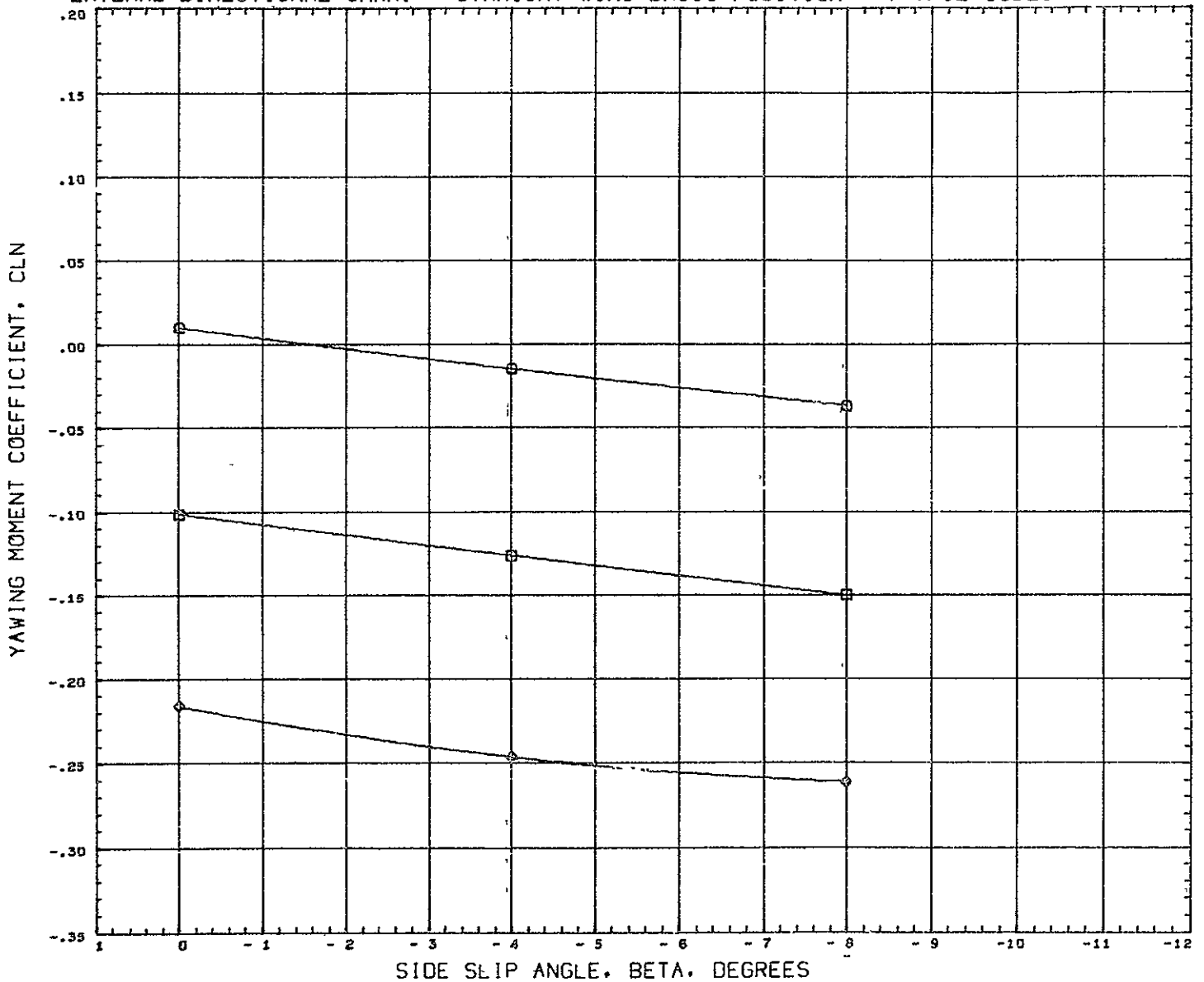

SYMBOL	RUDVTR	PARAMETRIC VALUES			
□	0.000	NACH	0.259	ALPHA	0.000
◇	10.000	ELEVTR	0.000	FLAPS	0.000
○	20.000	S <sup>2</sup> OILR	0.000		

REFERENCE INFORMATION		
REFS	316 2304	Sq IN
REFL	50.1900	IN
REFB	7.3500	IN
XMRP	29.3920	IN
YMRP	0.0000	IN
ZMRP	0.0000	IN
SCALE	0.0175	

DATA HIST. CODE 1

LATERAL DIRECTIONAL CHAR. - STRAIGHT WING BASIC POSITION - V-TAIL=55DEG

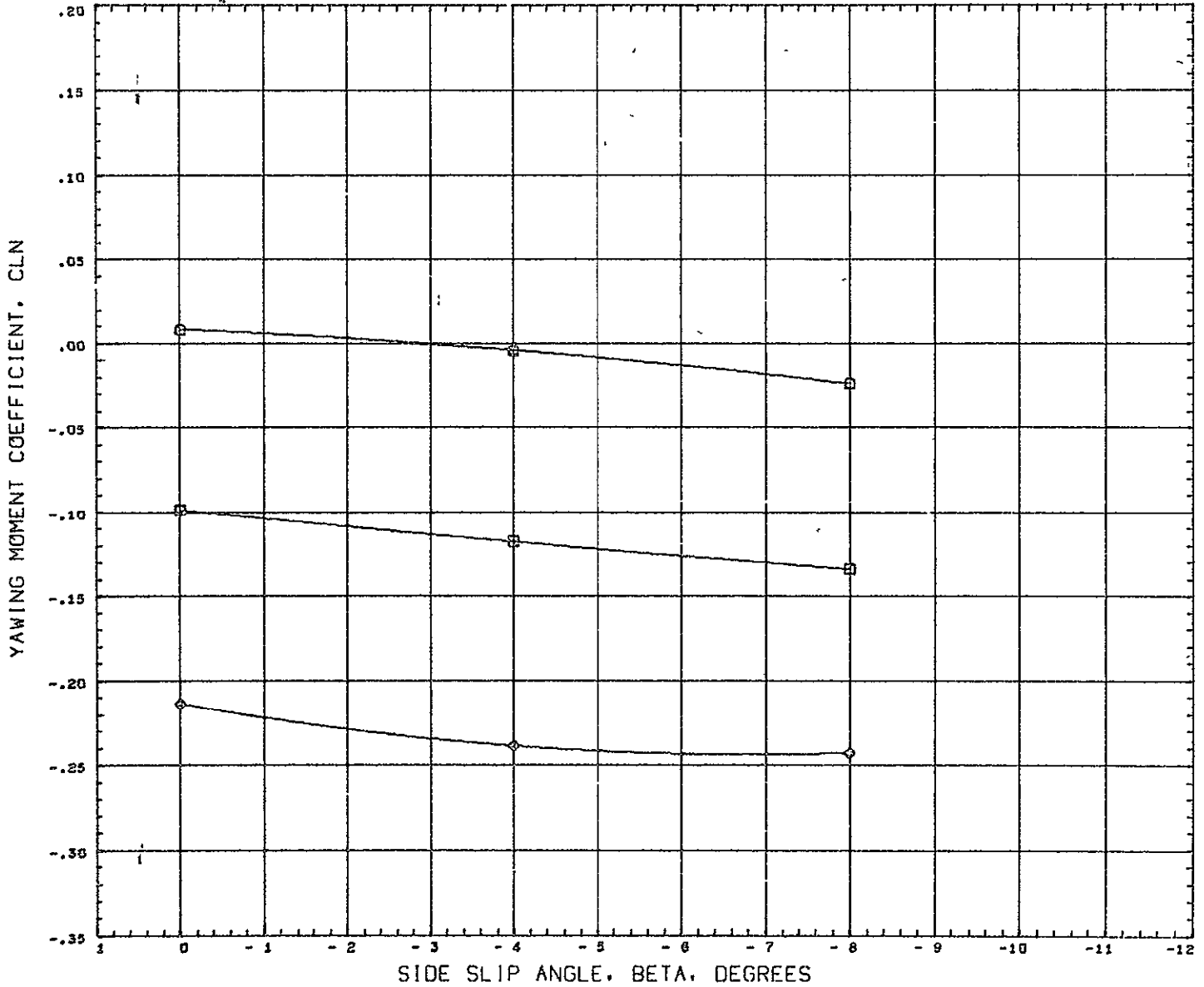

SYMBOL	RUDVTR	PARAMETRIC VALUES			
		MACH	ALPHA	FLAPS	
□	0.000	0.259	4.000		
◇	10.000	0.000	0.000		
○	20.000	0.000			

REFERENCE INFORMATION		
REFS	316.2304	SQ IN
REFL	50.1900	IN
REFB	7.3500	IN
XMRP	29.3920	IN
YMRP	0.0000	IN
ZMRP	0.0000	IN
SCALE	0.0175	

DATA HIST. CODE 1

LATERAL DIRECTIONAL CHAR. - STRAIGHT WING BASIC POSITION - V-TAIL=55DEG

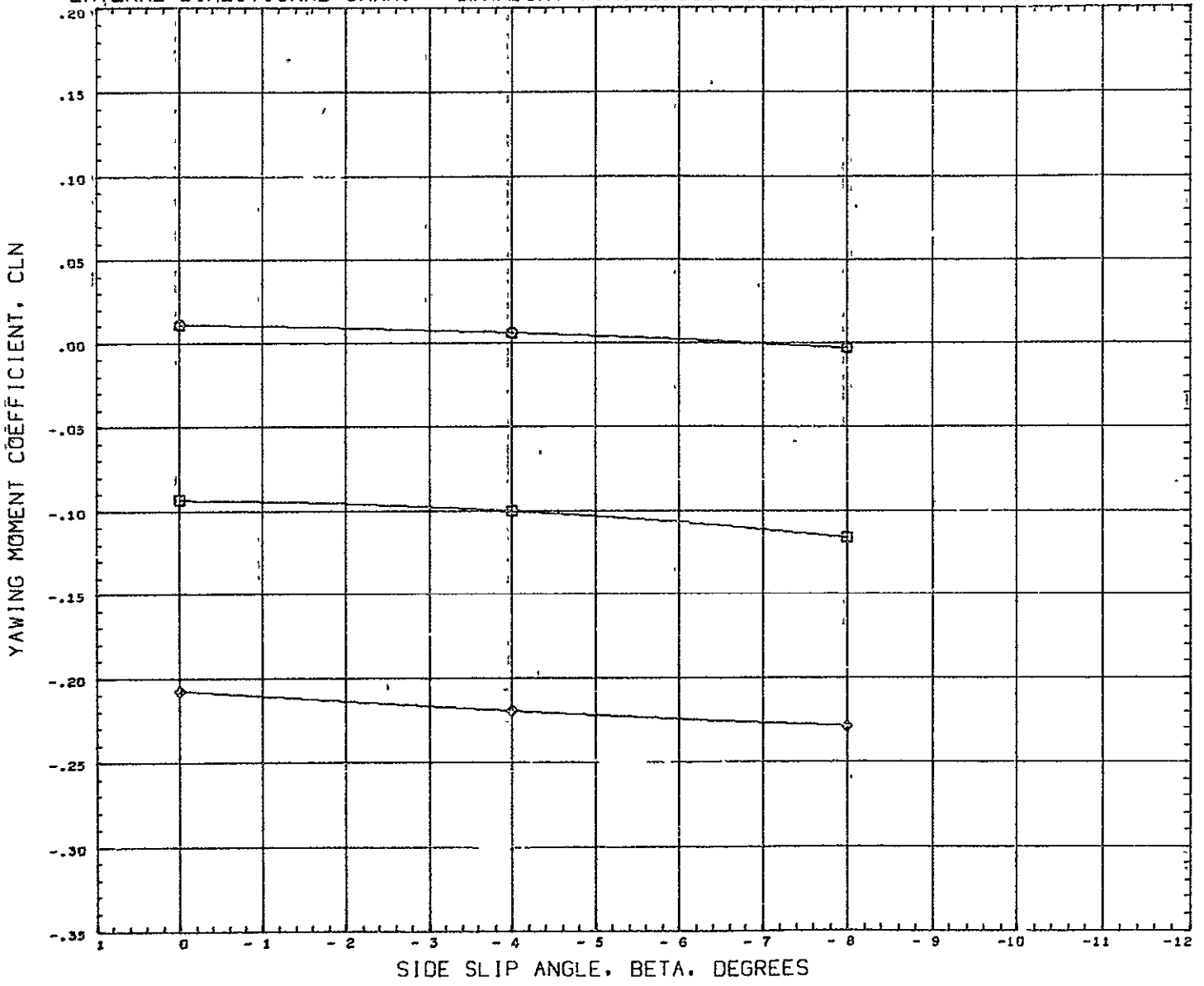

SYMBOL	RUDVTR	PARAMETRIC VALUES			
○	0.000	MACH	0.259	ALPHA	8.500
□	10.000	ELEVTR	0.000	FLAPS	0.000
◇	20.000	SPOILR	0.000		

REFERENCE INFORMATION		
REFS	316 2304	80 IN
REFL	50.1900	IN
REFB	7.3500	IN
XHRF	29 3920	IN
YHFP	0.0000	IN
ZHFP	0.0000	IN
SCALE	0.0175	

DATA HIST. CODE 1

LATERAL DIRECTIONAL CHAR. - STRAIGHT WING BASIC POSITION - V-TAIL=55DEG

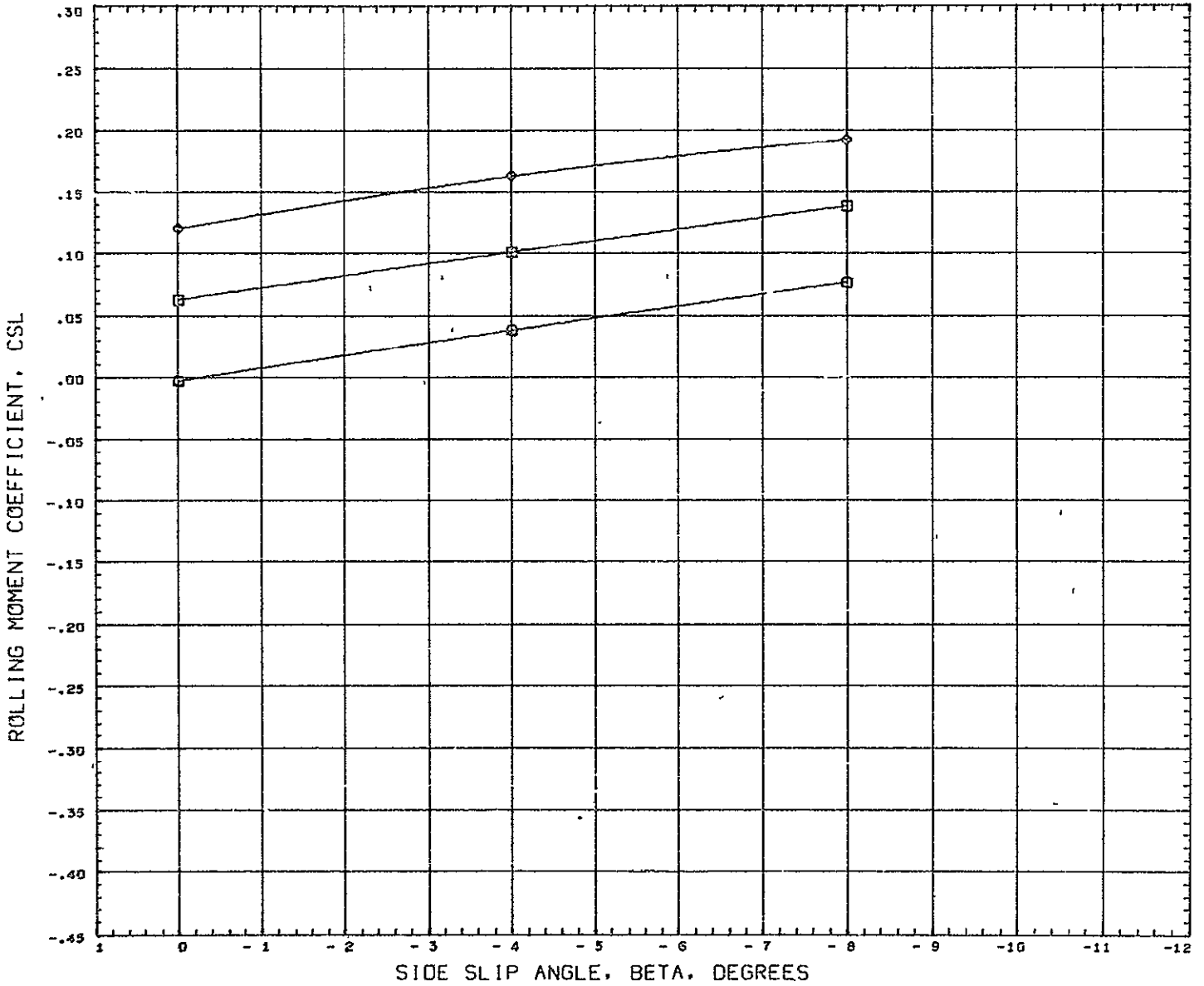

S <sup>W</sup> BCL	90DVTR	PARAMETRIC VALUES			
□	0.000	MACH	0.259	ALPHA	0.000
□	10.000	ELEVTR	0.000	FLAPS	0.000
○	20.000	SFOILF	0.000		

REFERENCE INFORMATION		
REFS	316 2304	SQ IN
REFL	50.1900	IN
REFB	7.3500	IN
XMRP	- 29.3920	IN
YMRP	0.0000	IN
ZMRP	0.0000	IN
SCALE	0.0175	

DATA HIST. CODE I

LATERAL DIRECTIONAL CHAR. - STRAIGHT WING BASIC POSITION - V-TAIL=55DEG

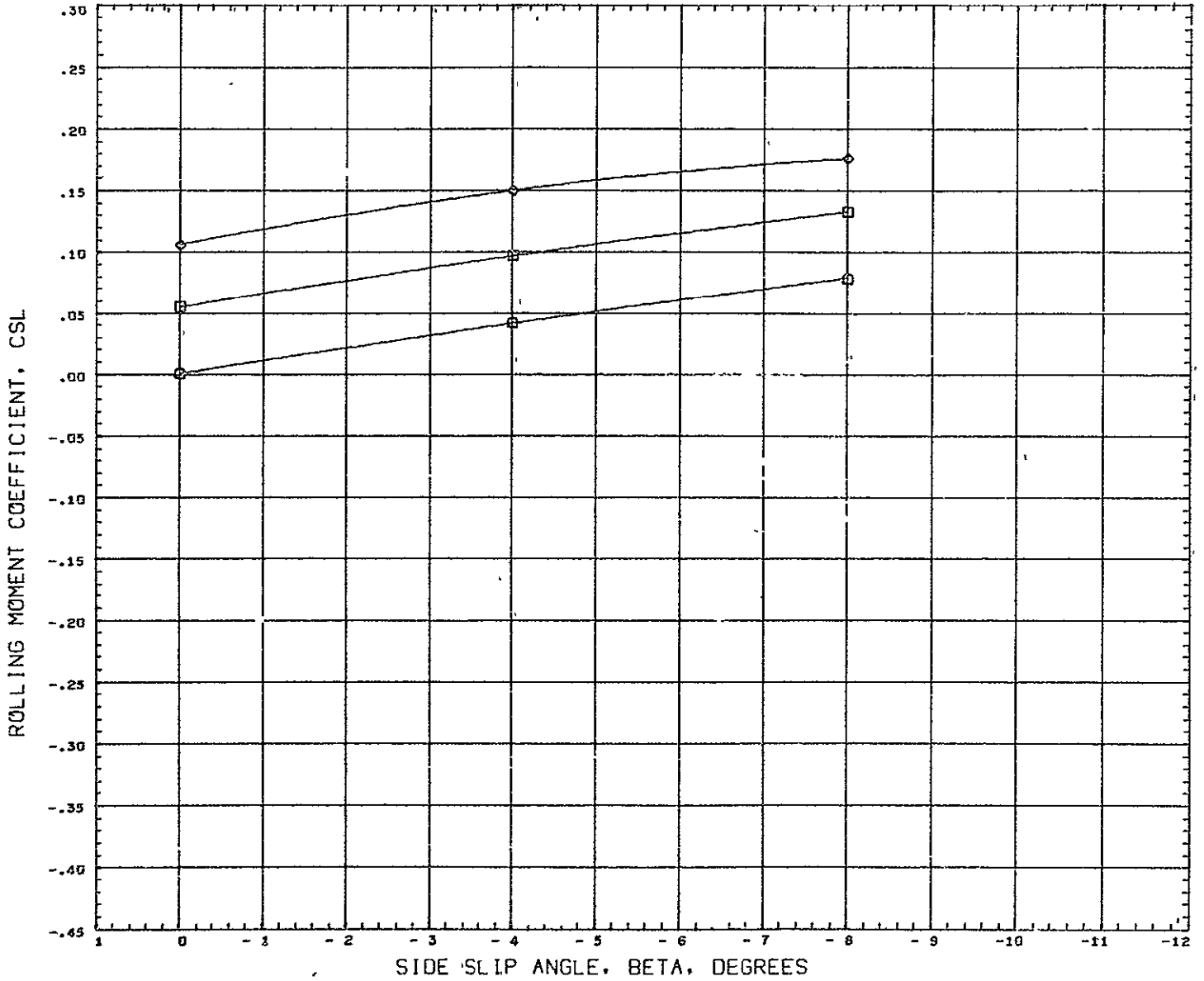

SYMBOL		PARAMETRIC VALUES				REFERENCE INFORMATION	
○	RUDVTR	HACH	0.259	ALPHA	4.000	REFS	316.2304 SQ IN
□	10.000	ELEVTR	0.000	FLAPS	0.000	REFL	50.1900 IN
○	20.000	SFOILR	0.000			REFB	7.3500 IN
						XMRP	29.3920 IN
						YMRP	0.0000 IN
						ZMRP	0.0000 IN
						SCALE	0.0175

DATA HIST. CODE 1

LATERAL DIRECTIONAL CHAR. - STRAIGHT WING BASIC POSITION - V-TAIL=55DEG

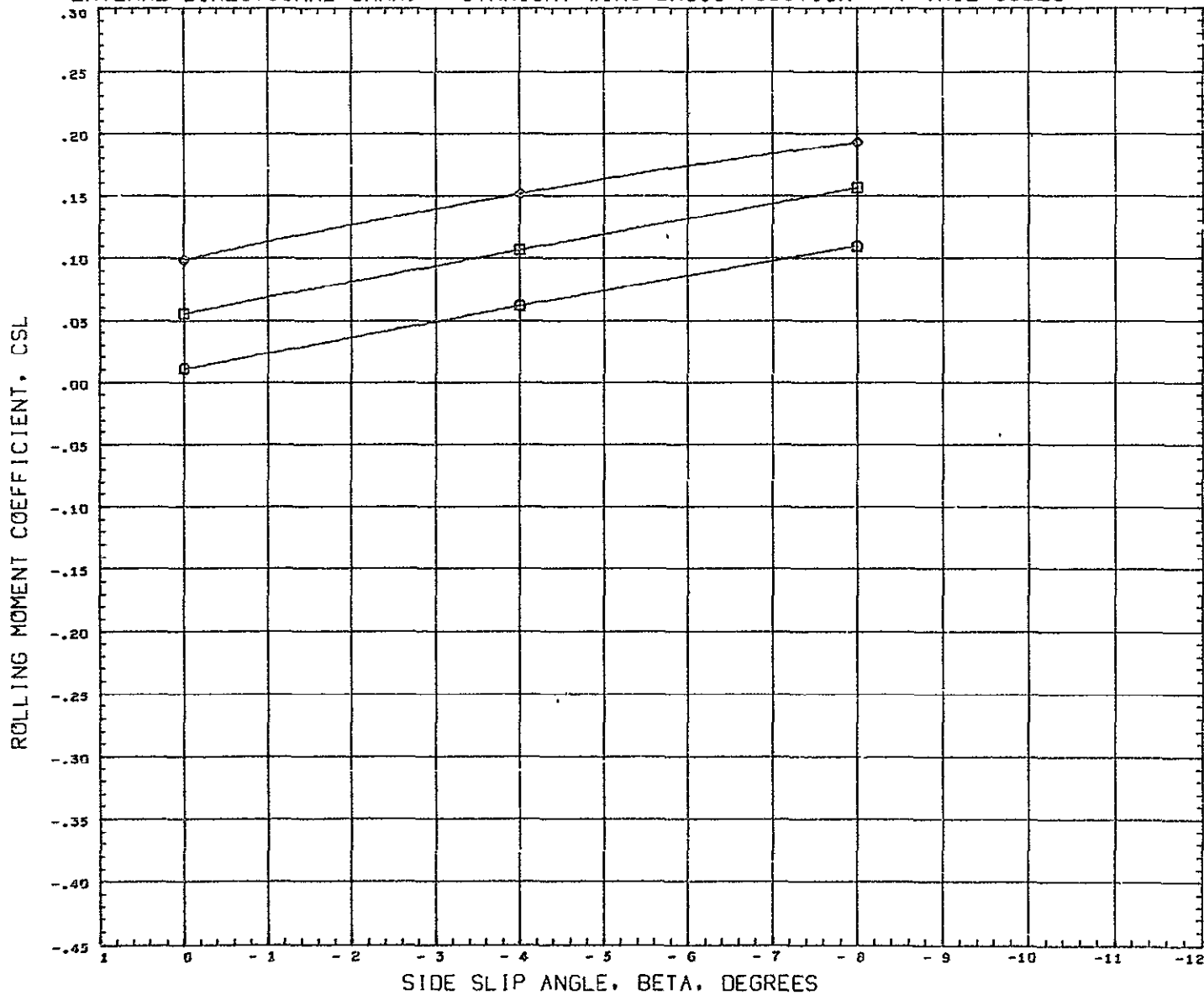

SYMBOL	RUDYTR	PARAMETRIC VALUES			
○	0.000	MACH	0.259	ALPHA	8.000
□	10.000	ELEVTR	0.000	FLAPS	0.000
◇	20.000	SFOILR	0.000		

REFERENCE INFORMATION		
REFS	316 2304	SQ IN
REFL	50.1900	IN
REFB	7.3500	IN
XMRP	29 3920	IN
YMRP	0.0000	IN
ZMRP	0.0000	IN
SCALE	0 0175	

DATA HIST. CODE 1



DIRECTIONAL CONTROL DERIVATIVES - STRAIGHT WING BASIC POSITION - V-TAIL=55DEG

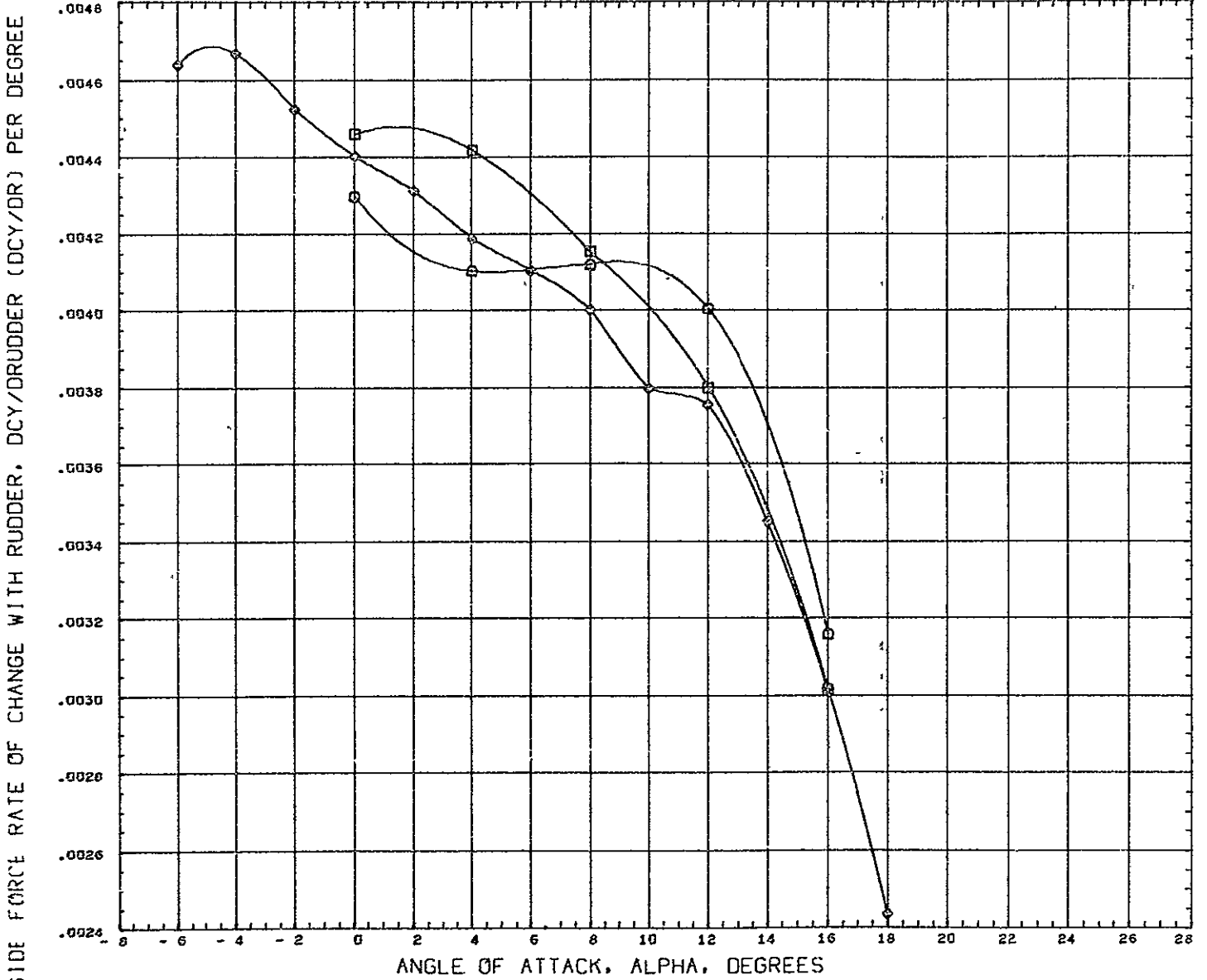

SYMBOL	BETA	PARAMETRIC VALUES				REFERENCE INFORMATION		
	○ - 8.000	MACH	0.259	ELEVTR	0.000	REFS	316.2304	SQ IN
	◻ - 4.000	RUDYTR	0.000	FLAPS	0.000	REFL	50.1900	IN
◇	0.000	SPOILR	0.000			REFB	7.3500	IN
						XHRF	29.3920	IN
						YHRF	0.0000	IN
						ZHRF	0.0000	IN
						SCALE	0.0175	

DATA HIST. CODE \*F

DIRECTIONAL CONTROL DERIVATIVES - STRAIGHT WING BASIC POSITION - V-TAIL=55DEG

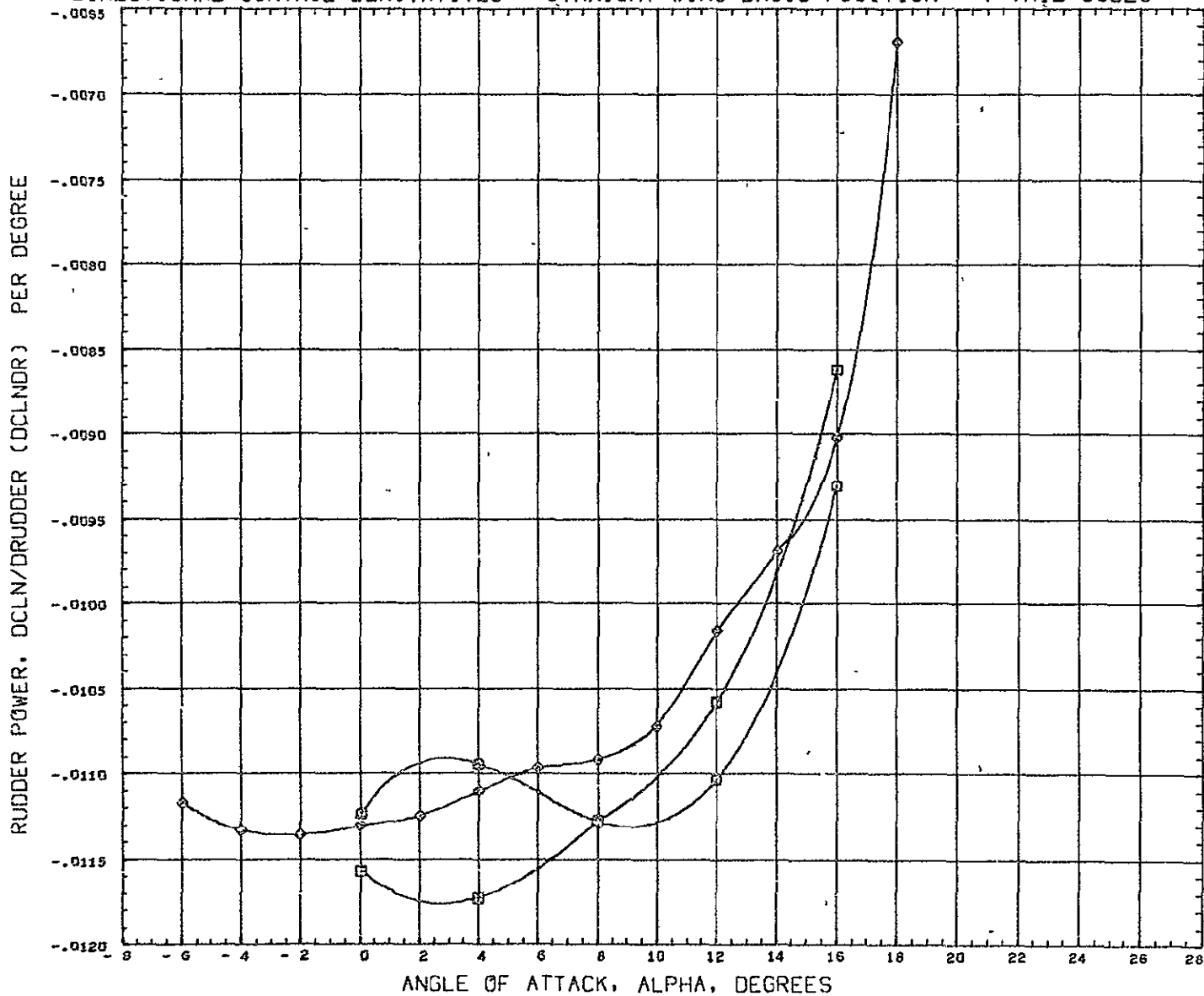

SYMBOL		BETA		PARAMETRIC VALUES			
□	-	8.000	MACH	0.259	ELEVTR	0.000	
□	-	4.000	RUDYTR	0.000	FLAPS	3.000	
◇	-	0.000	SFOILR	0.000			

REFERENCE INFORMATION		
REFS	316.2304	SQ IN
REFL	50.1900	IN
REFB	7.3500	IN
XMRP	29.3920	IN
YMRP	0.0000	IN
ZMRP	0.0000	IN
SCALE	0.0175	

DATA HIST. CODE \*F

DIRECTIONAL CONTROL DERIVATIVES - STRAIGHT WING BASIC POSITION - V-TAIL=55DEG

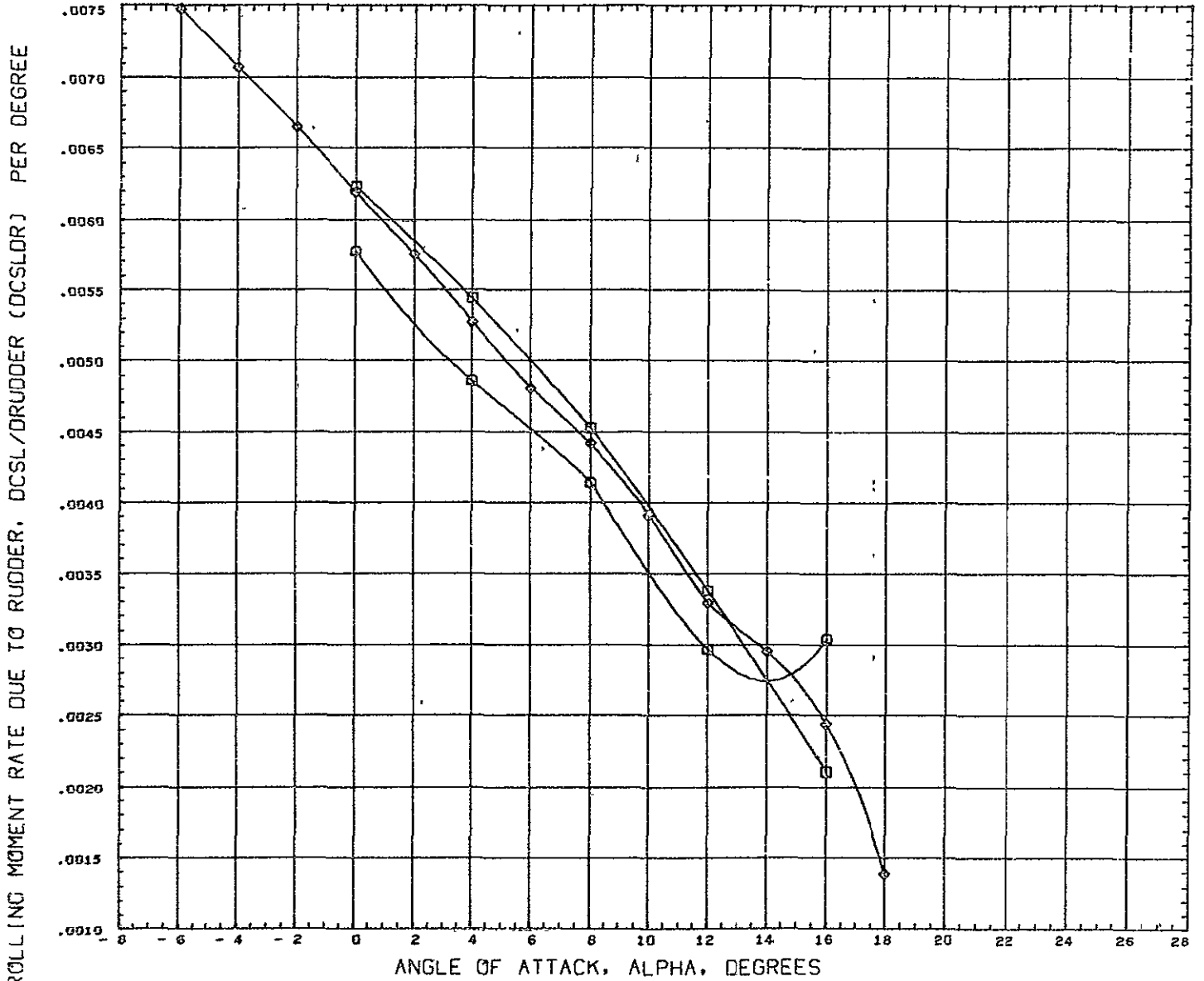

SYMBOL	BETA	PARAMETRIC VALUES
○	8.000	HACH 0.259 ELEVTR 0.000
□	4.000	RUDYTR 0.000 FLAPS 0.000
◇	0.000	SPOILR 0.000

REFERENCE INFORMATION		
REFS	316 2304	'SQ IN
REFL	50 1900	'IN
REFB	7.3500	IN
XHRF	29.3920	IN
YHRF	0.0000	IN
ZHRF	0.0000	IN
SCALE	0.0175	

DATA HIST. CODE #F

LONGITUDINAL CONTROL -- STRAIGHT WING BASIC POSITION - V-TAIL=55DEG

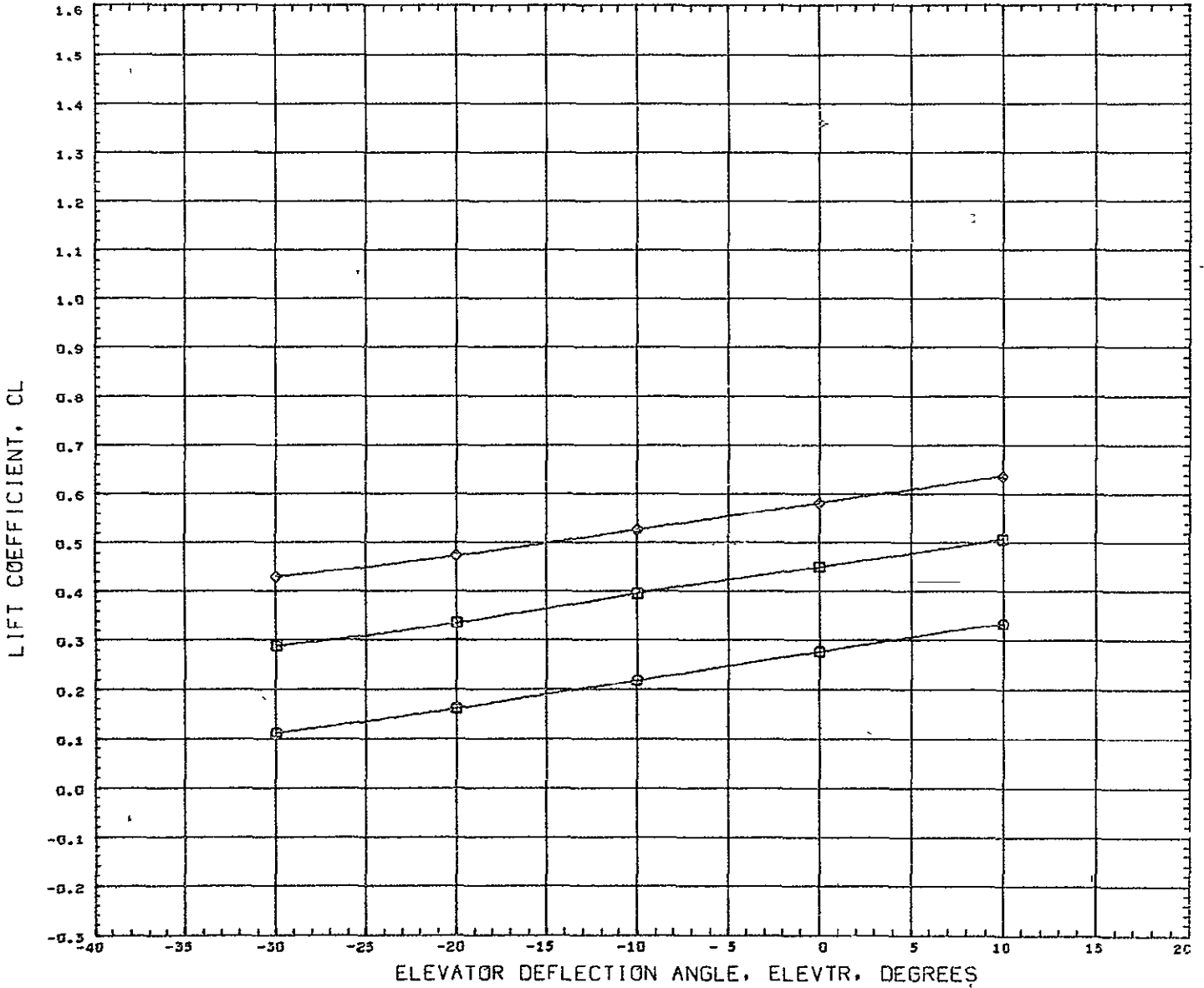

SYMBOL	ALPHA	PARAMETRIC VALUES			
○	0.000	HACH	0.259	BETA	0.000
□	4.000	RUDVTR	0.000	FLAPS	0.000
◇	6.000	SFOILR	0.000		

REFERENCE INFORMATION		
REFS	316.2304	SQ IN
REFL	50.1300	IN
REFB	7.3500	IN
XMRP	29.3920	IN
YMRP	0.0000	IN
ZMRP	0.0000	IN
SCALE	0.0175	

DATA HIST. CODE I

LONGITUDINAL CONTROL - STRAIGHT WING BASIC POSITION - V-TAIL=55DEG

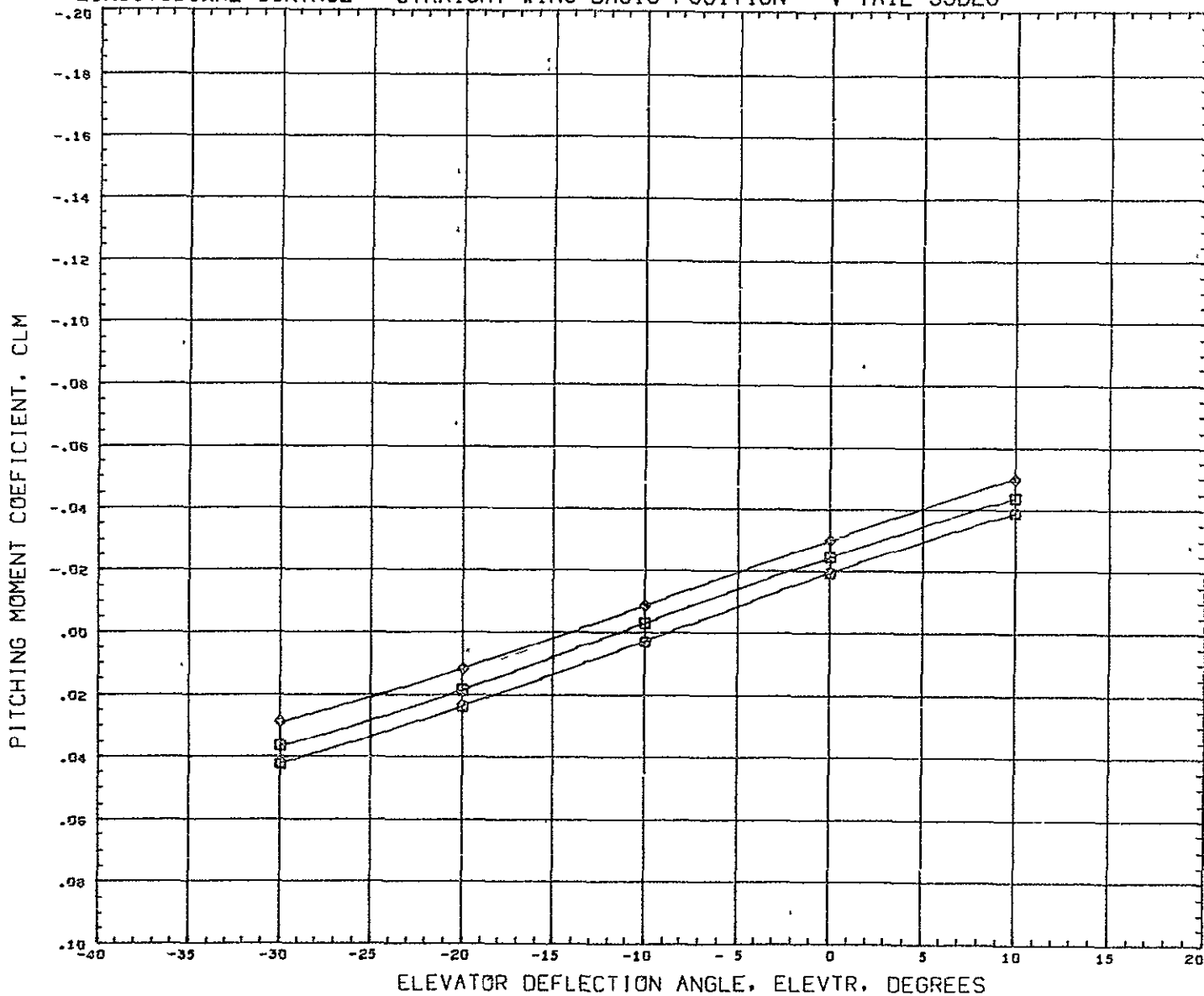

SYMBOL	ALPHA	PARAMETRIC VALUES			
○	0.000	MACH	0.259	BETA	0.000
□	4.000	RUCVTE	0.000	FLAPS	0.000
◇	8.000	SFOILR	0.000		

REFERENCE INFORMATION		
REFS	316.2304	SQ IN
REFL	50.1900	IN
REFB	7.3500	IN
XMRP	29.3920	IN
YMRP	0.0000	IN
ZMRP	0.0000	IN
SCALE	0.0175	

DATA HIST CODE I

LONGITUDINAL CONTROL - STRAIGHT WING BASIC POSITION - V-TAIL=55DEG

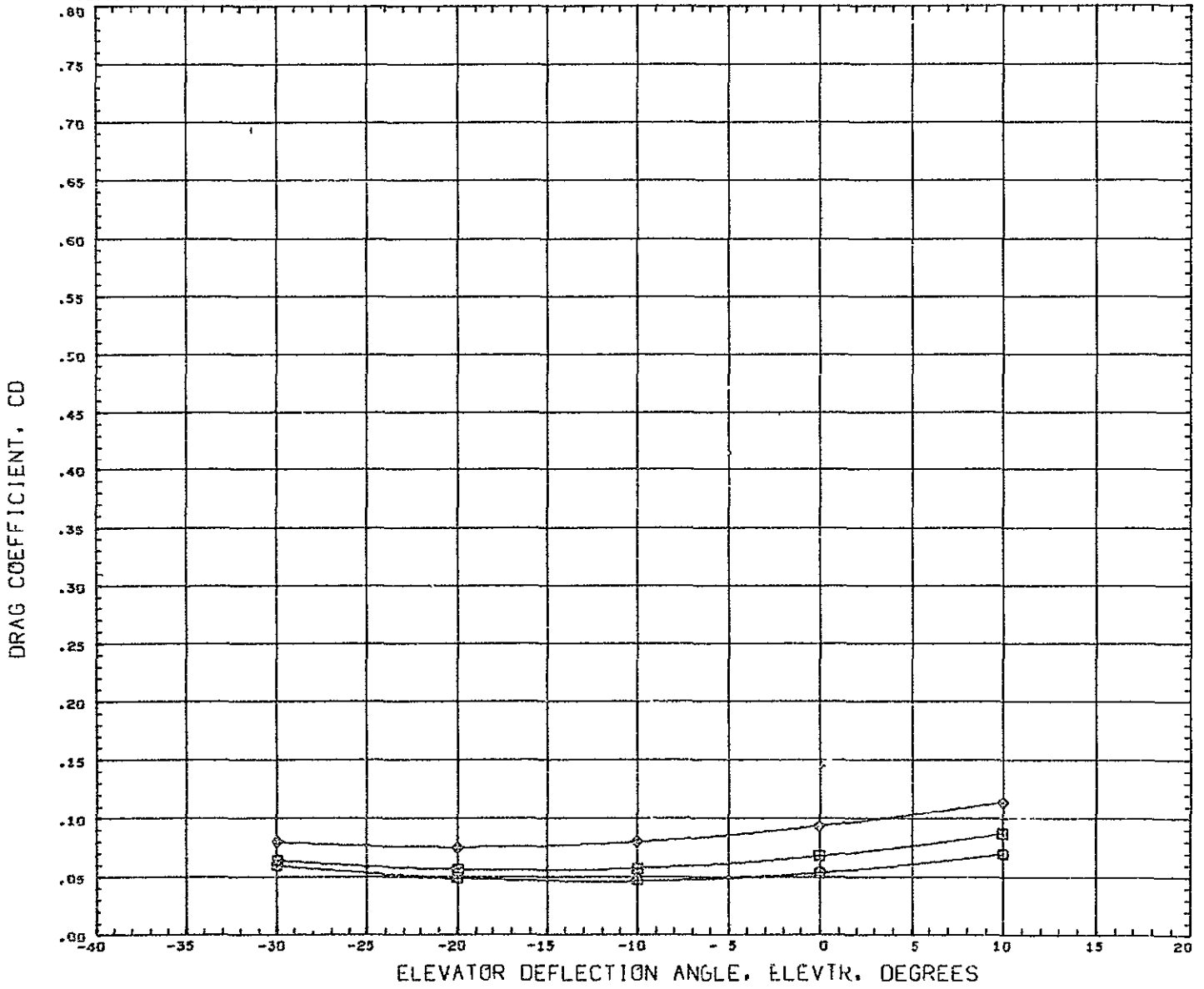

SYMBOL	ALPHA	PARAMETRIC VALUES				REFERENCE INFORMATION		
○	0.000	MACH	0.259	BETA	0.000	REFS	316 2304	SQ IN
□	4.000	RUDVTR	0.000	FLAPS	0.000	REFL	50 1900	IN
◇	8.000	SFOILR	0.000			REFB	7.3500	IN
						XMRP	29 3920	IN
						YMRP	0.0000	IN
						ZMRP	0.0000	IN
						SCALE	0.0175	

DATA HIST CODE 1

## LONGITUDINAL CONTROL DERIVATIVES - STRAIGHT WING BASIC POSITION - V-TAIL=55DEG

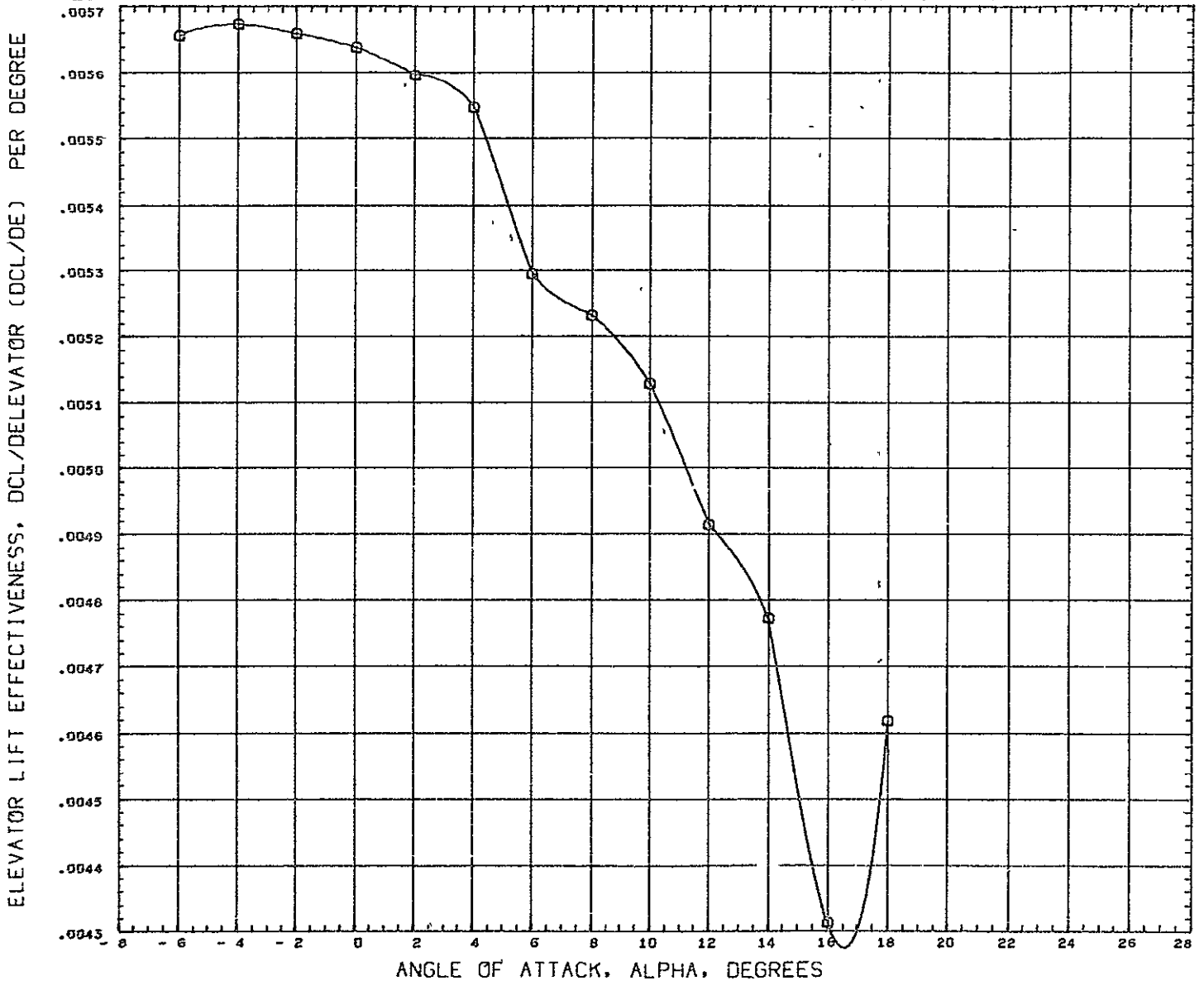

<b>SYMBOL</b>	<b>MACH</b>	<b>PARAMETRIC VALUES</b>			
Q	0.259	BETA	0.000	ELEVTR	-30.000
		RJDYTR	0.000	FLAPS	0.000
		SFOILR	0.000		

DATA HIST. CODE #F

<b>REFERENCE INFORMATION</b>	
REFS	316.2304 SQ IN
REFL	50.1900 IN
REFB	7.3500 IN
XHRF	29.3920 IN
YHRF	0.0000 IN
ZHRF	0.0000 IN
SCALE	0.0175

LONGITUDINAL CONTROL DERIVATIVES - STRAIGHT WING BASIC POSITION - V-TAIL=55DEG

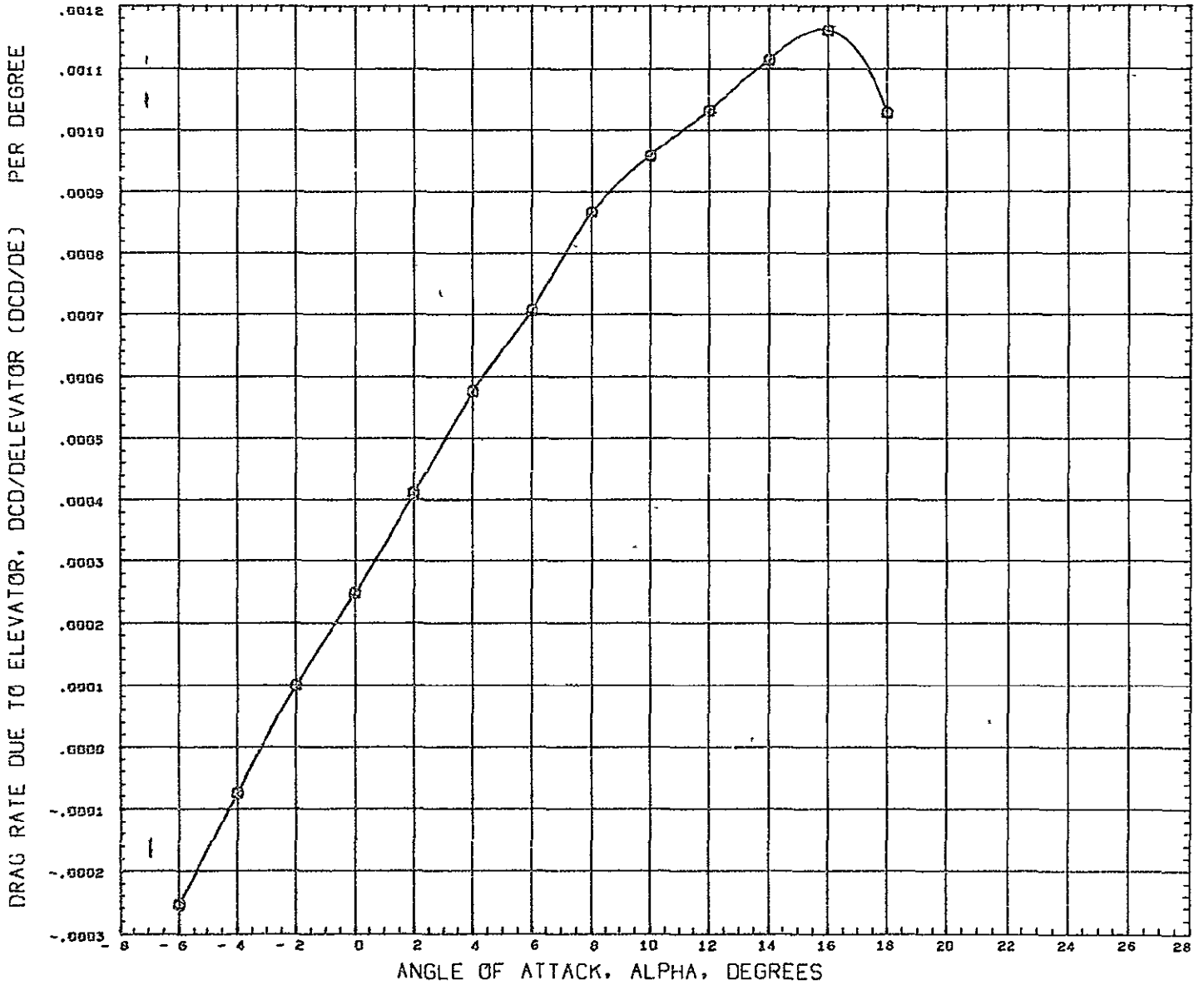

SYMBOL MACH PARAMETRIC VALUES  
 D 0.259 BETA 0.000 ELEVTR - 30.000  
 RUDVTR 0.000 FLAPS 0.000  
 SFOILR 0.000

REFERENCE INFORMATION  
 REFS 316.2304 SQ IN  
 REFL 50.1900 IN  
 REFB 7.3500 IN  
 XMRP 29.3920 IN  
 YMRP 0.0000 IN  
 ZMRP 0.0000 IN  
 SCALE 0.0175

DATA HIST. CODE #F



LONGITUDINAL CONTROL DERIVATIVES - STRAIGHT WING BASIC POSITION - V-TAIL=55DEG

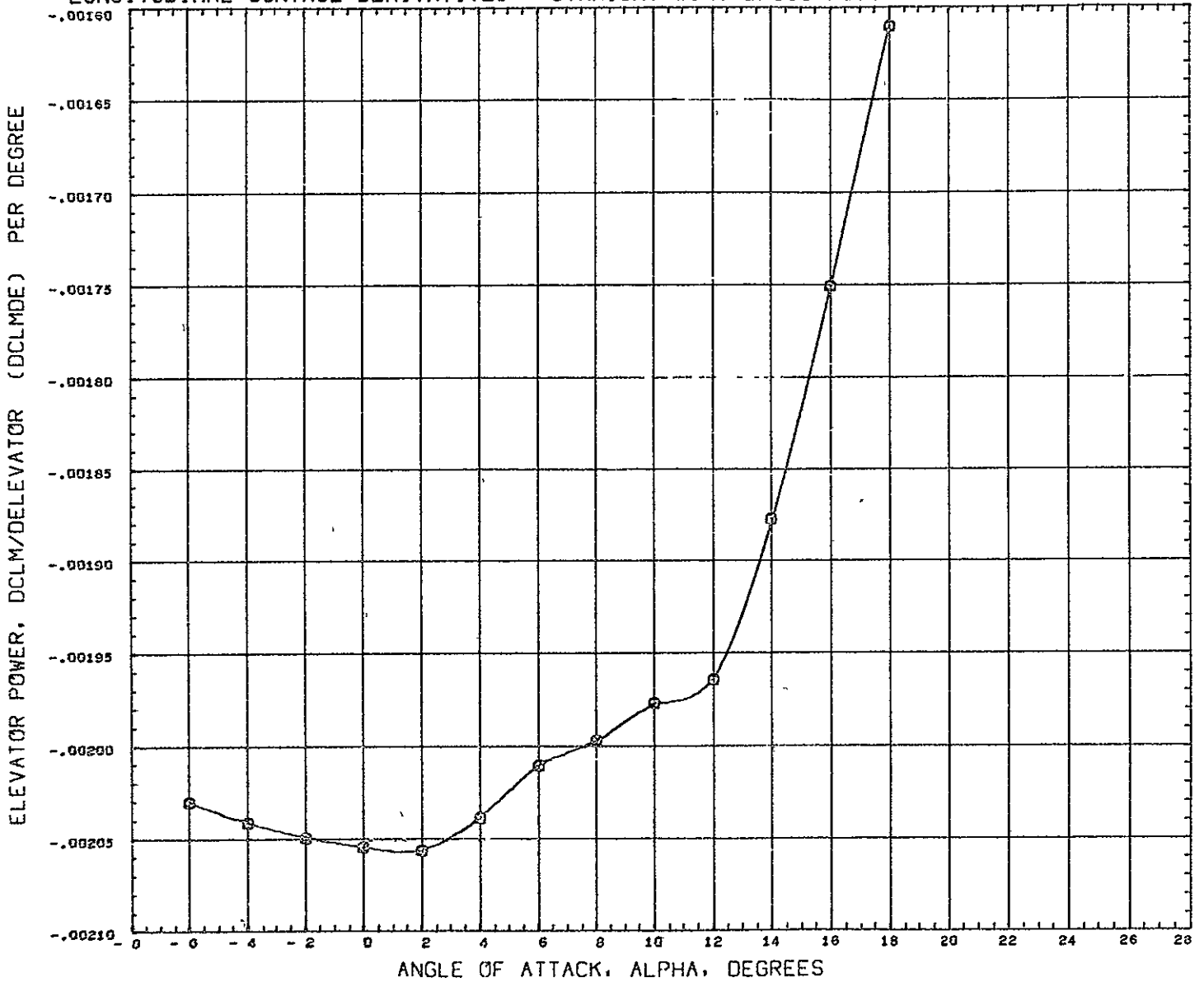

SYMBOL		MACH		PARAMETRIC VALUES				REFERENCE INFORMATION		
0	0	259		BETA	0.000	ELEVTR	- 30.000	REFS	316.2304	SQ IN
				RUDVTR	0.000	FLAPS	0.000	REFL	50.1900	IN
				SFOILR	0.000			REFB	7.3500	IN
								XMRP	29.3920	IN
								YMRP	0.0000	IN
								ZMRP	0.0000	IN
								SCALE	0.0175	
DATA HIST. CODE #F										

LONGITUDINAL CHAR. - ELEVTR EFFECTIVENESS - STRAIGHT WING AFT - V-TAIL=55DEG

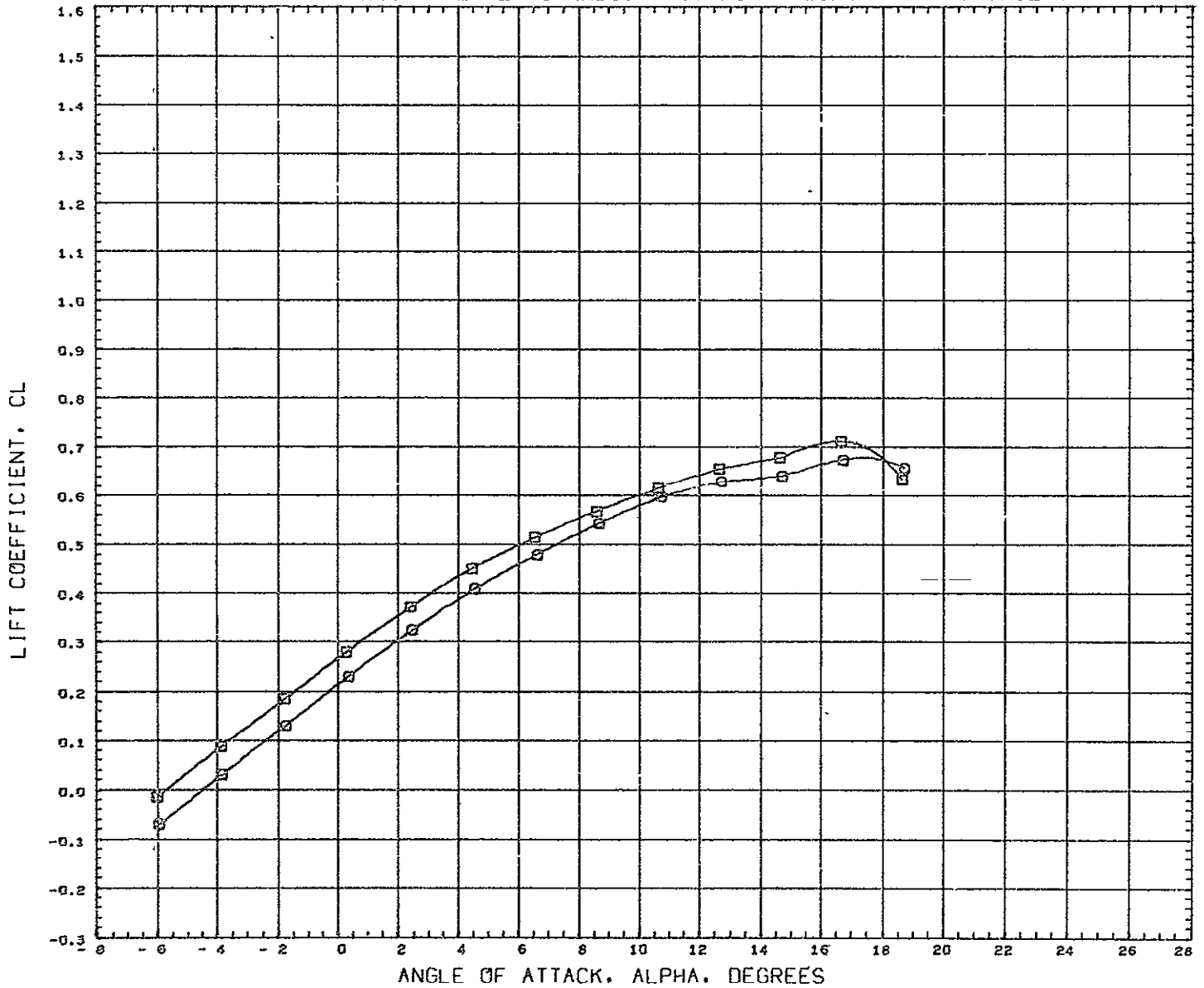

SYMBOL	ELEVTR	PARAMETRIC VALUES				REFERENCE INFORMATION		
○	15.000	WACH	0.259	BETA	0.000	REFS	316 2304	SQ IN
□	5.000	RUBVTR	0.000	FLAPS	0.000	REFL	50.1900	IN
		SFOILE	0.000			REFB	7.3500	IN
						XNRF	29.3920	IN
						YNRF	0.0000	IN
						ZNRF	0.0000	IN
						SCALE	0.0175	

REFERENCE FILE CONVAIR TN70-AE-12

LONGITUDINAL CHAR. - ELEVTR EFFECTIVENESS - STRAIGHT WING AFT - V-TAIL=55DEG

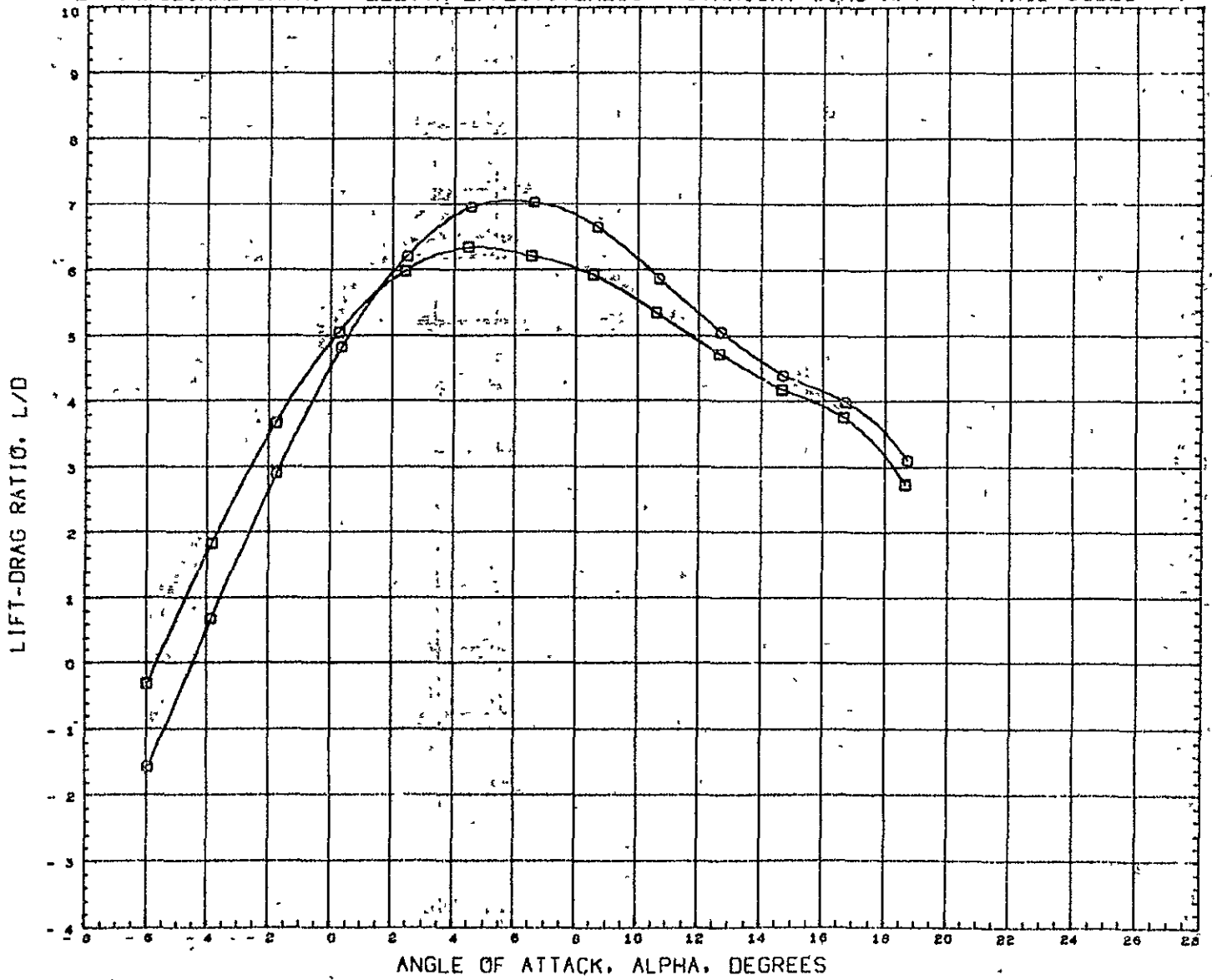

SYMBOL	ELEVTR	MACH	PARAMETRIC VALUES	BETA	FLAPS
O	-10.000	0.250		0.000	
D	0.000	0.000		0.000	

REFERENCE INFORMATION		
REFS	316.2304	SQ IN
REFL	50.1900	IN
REFB	7.3500	IN
XHRP	29.3920	IN
YHRP	0.0000	IN
ZHRP	0.0000	IN
SCALE	0.0175	

REFERENCE FILE CONVAIN TH70-AE-12

LONGITUDINAL CHAR. - ELEVTR EFFECTIVENESS - STRAIGHT WING AFI - V-TAIL=55DEG

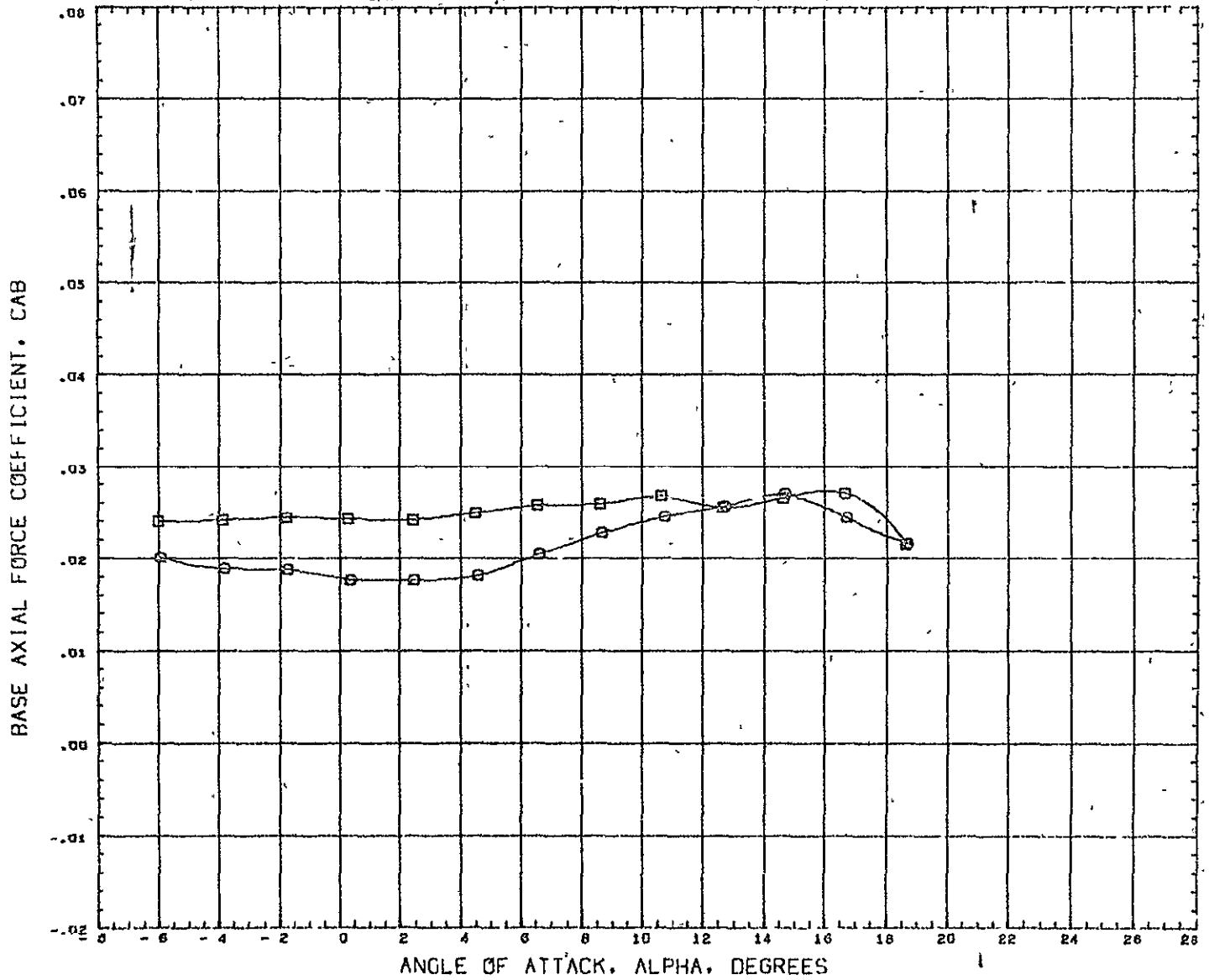

SYMBOL	ELEVTR	PARAMETRIC VALUES			
○	10.000	MACH	0.259	BETA	0.000
□	0.000	RUDYTR	0.000	FLAPS	0.000
		SPOILR	0.000		

REFERENCE INFORMATION		
REFS	316.P304	SQ IN
REFL	50.1900	IN
REFB	7.3500	IN
XMRP	29.3920	IN
YHRP	0.0000	IN
ZHRP	0.0000	IN
SCALE	0.0175	

REFERENCE FILE CONVAIR TN70-AE-12

LONGITUDINAL CHAR. - ELEVTR EFFECTIVENESS - STRAIGHT WING AFT - V-TAIL=55DEG

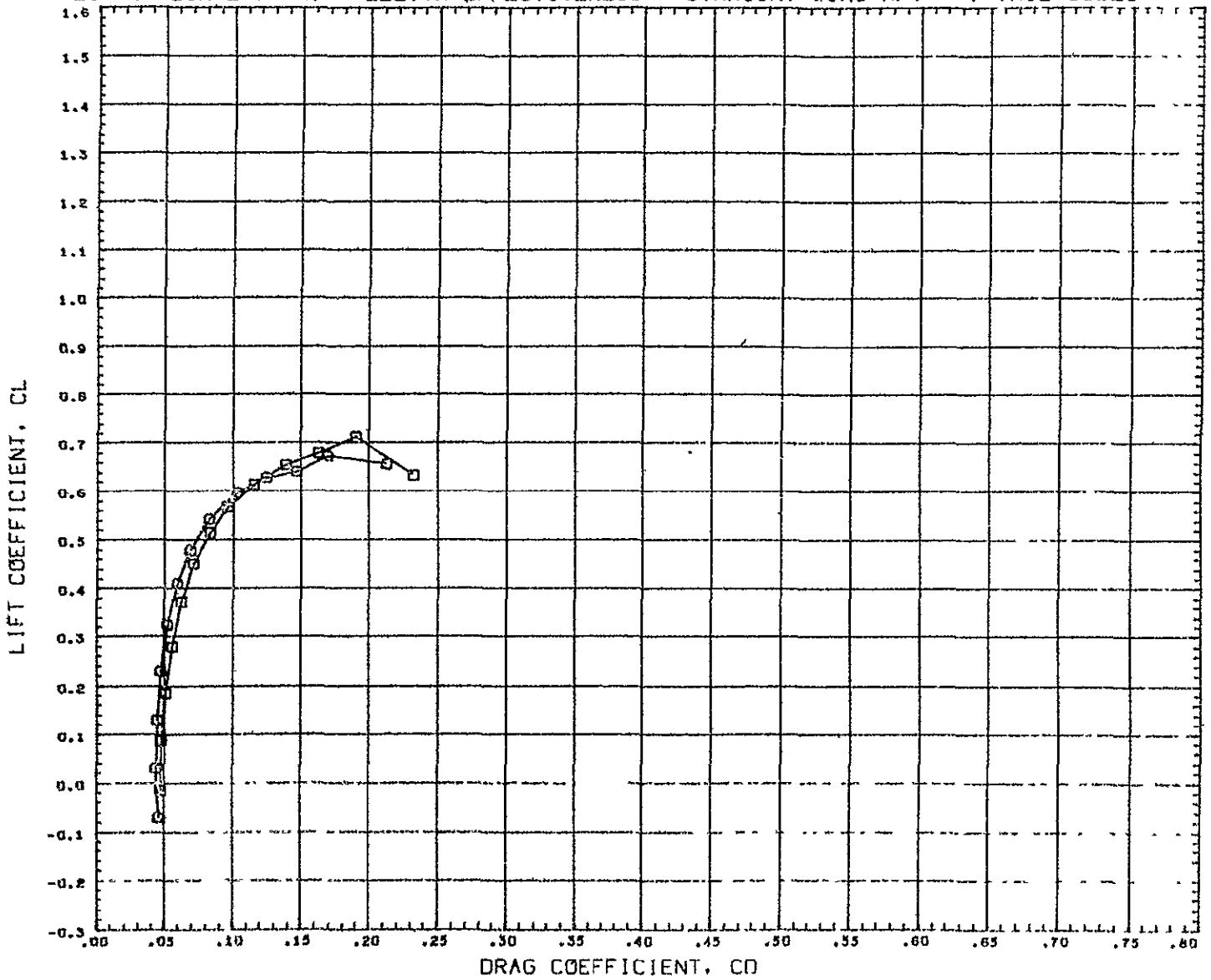

SYMBOL	ELEVTR	PARAMETRIC VALUES			
○	-10.000	HACH	0.250	BETA	0.000
□	0.000	RUDVTR	0.000	FLAF5	0.000
		SFOILR	0.000		

REFERENCE INFORMATION		
REFS	316.2304	SQ IN
REFL	50.1900	IN
REFB	7.3500	IN
XHRP	23.3920	IN
YHRP	0.0000	IN
ZHRP	0.0000	IN
SCALE	0.0175	

REFERENCE FILE CONVAIR T710-AE-12

LONGITUDINAL CHAR. - ELEVTR EFFECTIVENESS - STRAIGHT WING AFT - V-TAIL=55DEG

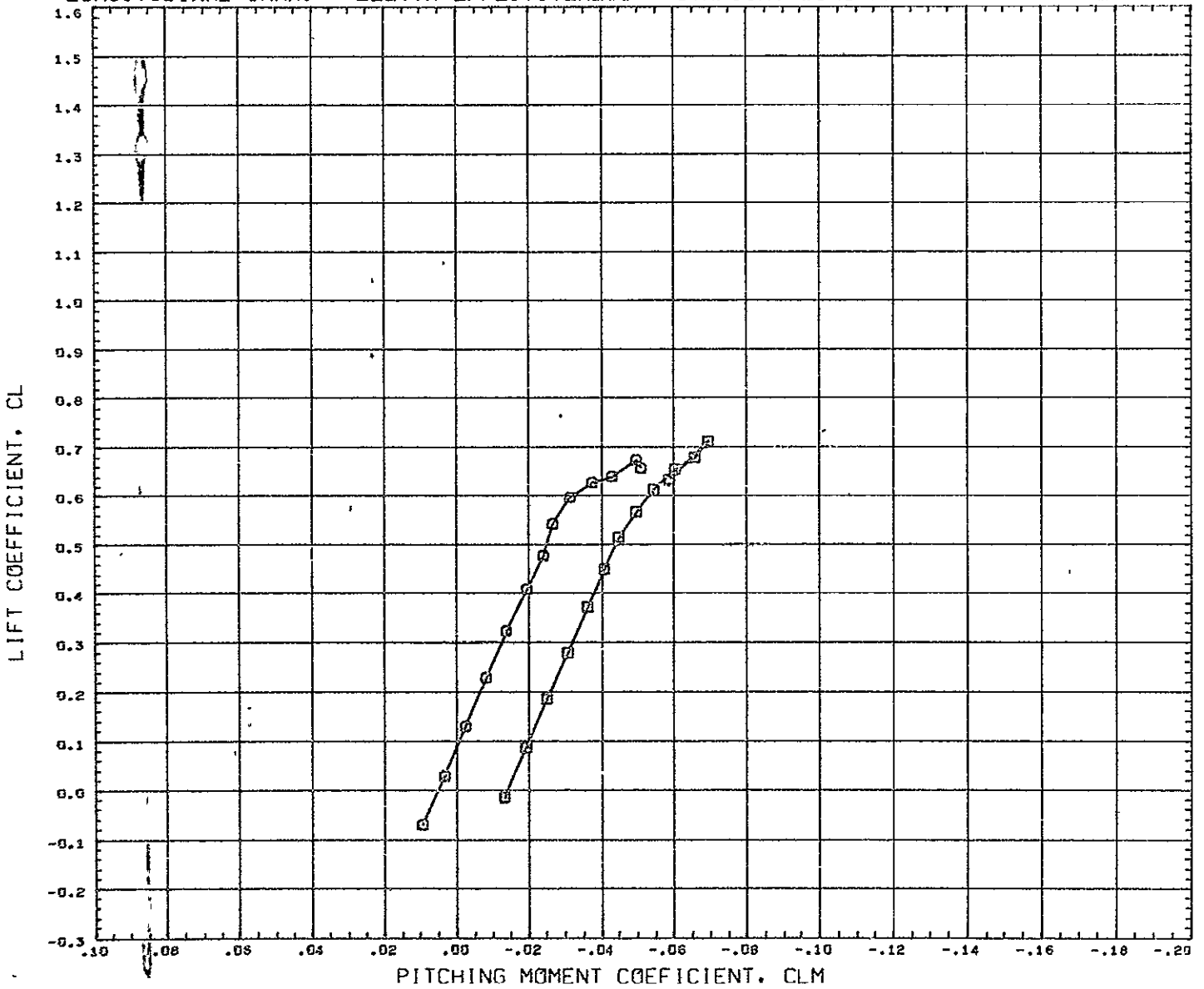

SYMBOL	ELEVTR	PARAMETRIC VALUES			
○	10.000	MACH	0.259	BETA	0.000
□	0.000	RUDVTR	0.000	FLAF5	0.000
		SFOILR	0.000		

REFERENCE INFORMATION		
REFS	316.2304	SQ IN
REFL	50 1900	IN
REFB	7.3500	IN
XMRP	29 3920	IN
YMRP	0.0000	IN
ZMRP	0 0000	IN
SCALE	0.0175	

REFERENCE FILE CONVAIR T170-AE-12

LONGITUDINAL CONTROL - STRAIGHT WING AFT - V-TAIL=55DEG

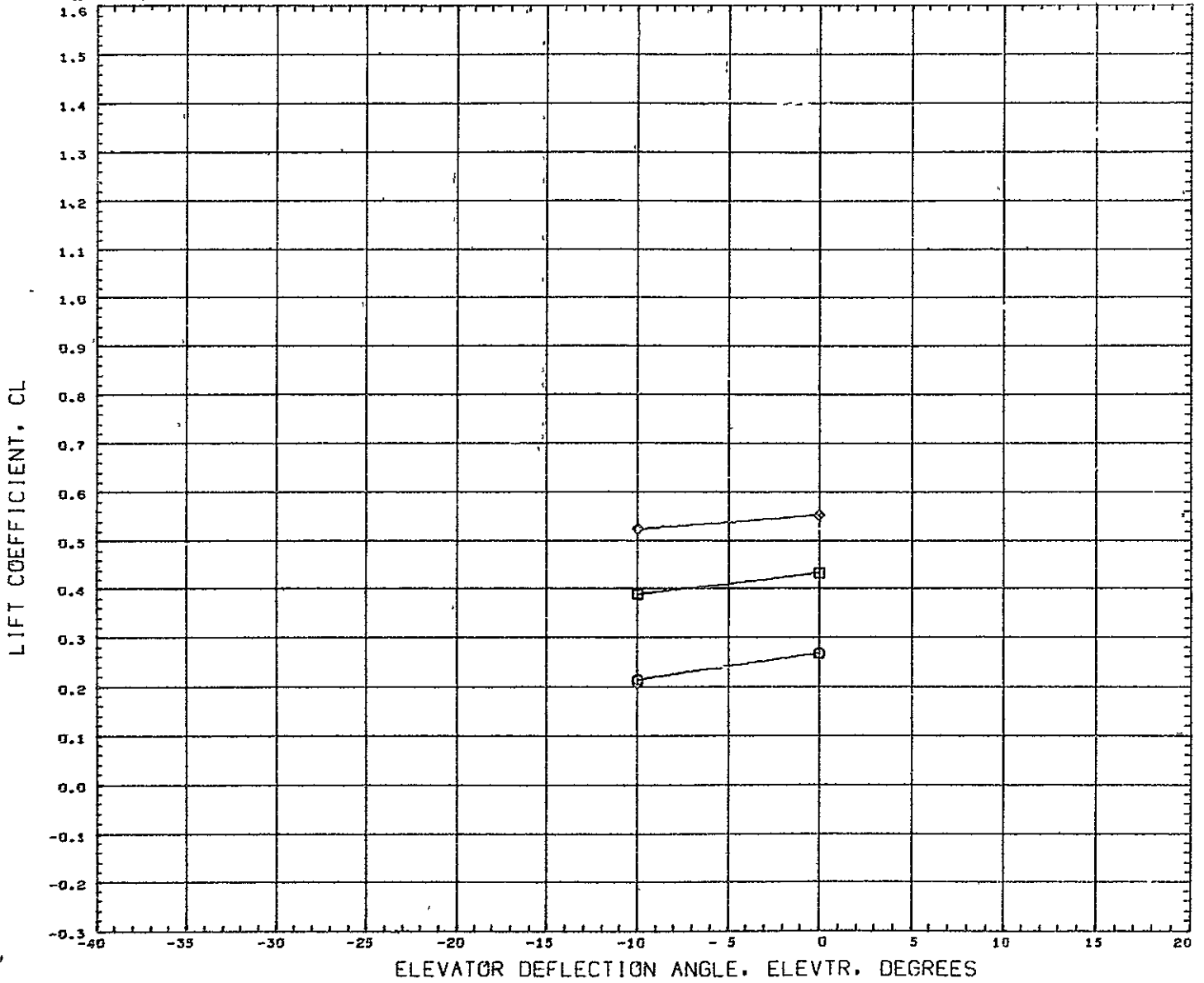

SYMBOL	ALPHA	PARAMETRIC VALUES			
○	0.000	MACH	0.259	BETA	0.000
□	4.000	RUDVTR	0.000	FLAPS	0.000
◇	8.000	SFOILR	0.000		

REFERENCE INFORMATION		
REFS	316 2304	SQ IN
REFL	50 1900	IN
REFB	7.3500	IN
XMRP	29.3920	IN
YMRP	0.0000	IN
ZMRP	0.0000	IN
SCALE	0.0175	

DATA HIST. CODE I

LONGITUDINAL CONTROL - STRAIGHT WING AFT - V-TAIL=55DEG

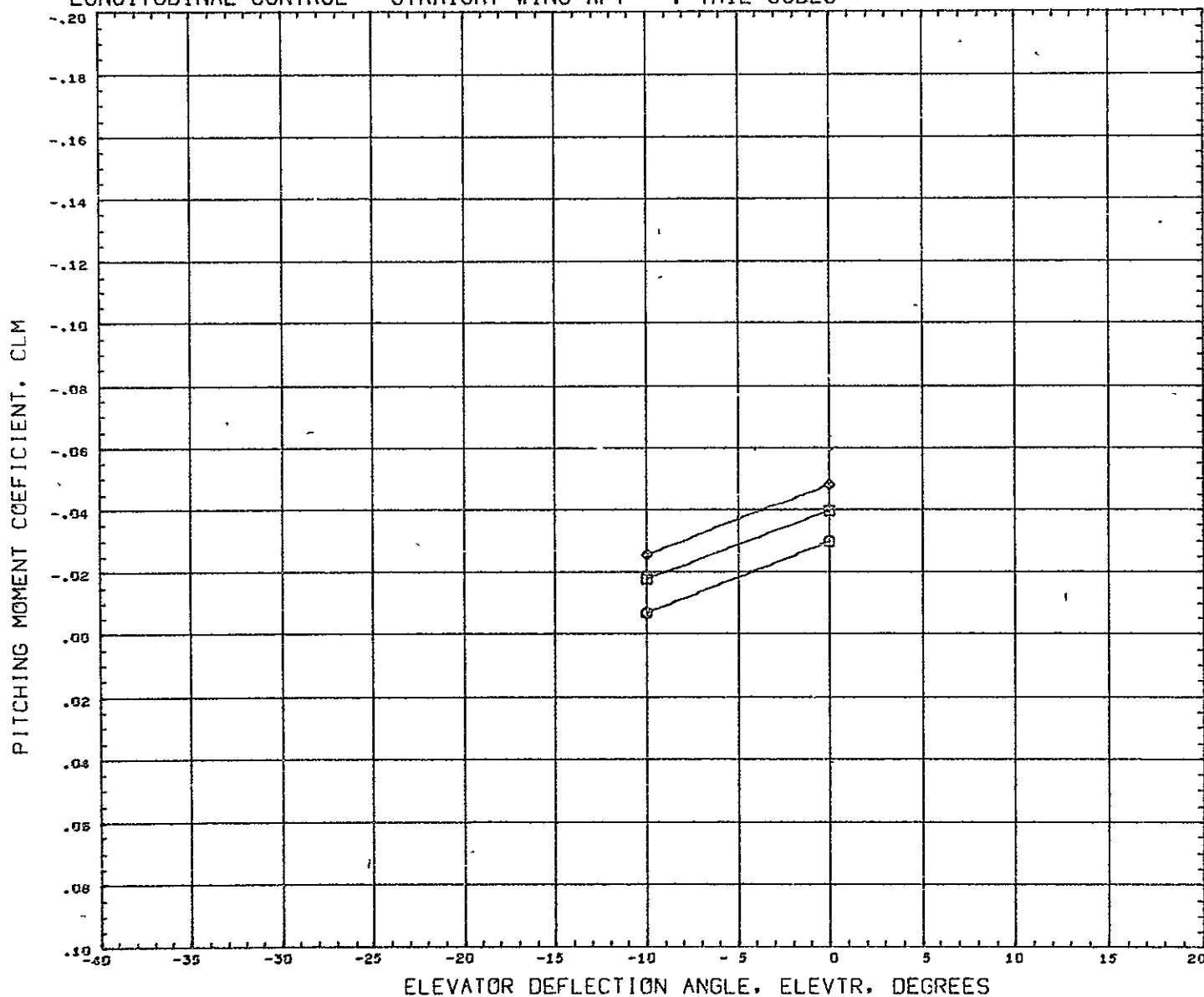

SYMBOL	ALPHA	PARAMETRIC VALUES				REFERENCE INFORMATION		
◇	0.000	MACH	0.259	BETA	0.000	REFS	316 2304	SQ IN
□	4.000	RUD/TR	0.000	FLAPS	0.000	REFL	50 1900	IN
○	8.000	SPOILER	0.000			REFB	7.3500	IN
						XMRP	29.3920	IN
						YMRP	0.0000	IN
						ZMRP	0.0000	IN
						SCALE	0.0175	

DATA HIST. CODE I



LONGITUDINAL CONTROL - STRAIGHT WING AFT - V-TAIL=55DEG

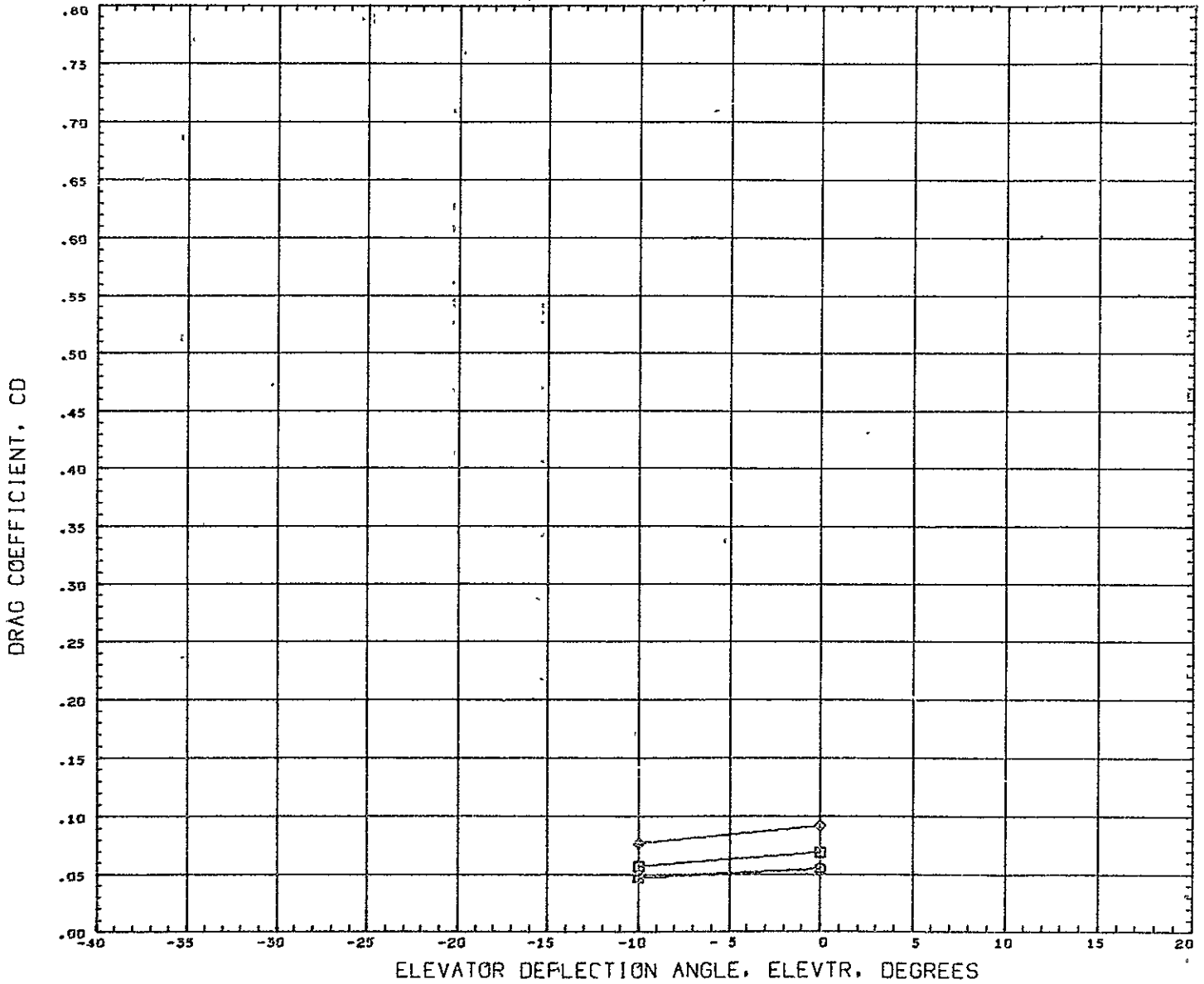

SYMBOL	ALPHA	PARAMETRIC VALUES				REFERENCE INFORMATION		
○	0.000	MACH	0.259	BETA	0.000	REFS	316.2304	SQ IN
□	4.000	RUDYTR	0.000	FLAPS	0.000	REFL	50.1900	IN
◇	8.000	SFOILR	0.000			REFB	7.3500	IN
						XHRF	29.3920	IN
						YHRF	0.0000	IN
						ZHRF	0.0000	IN
						SCALE	0.0175	

DATA HIST. CODE I

LONGITUDINAL CONTROL DERIVATIVES - STRAIGHT WING AFT - V-TAIL=55DEG

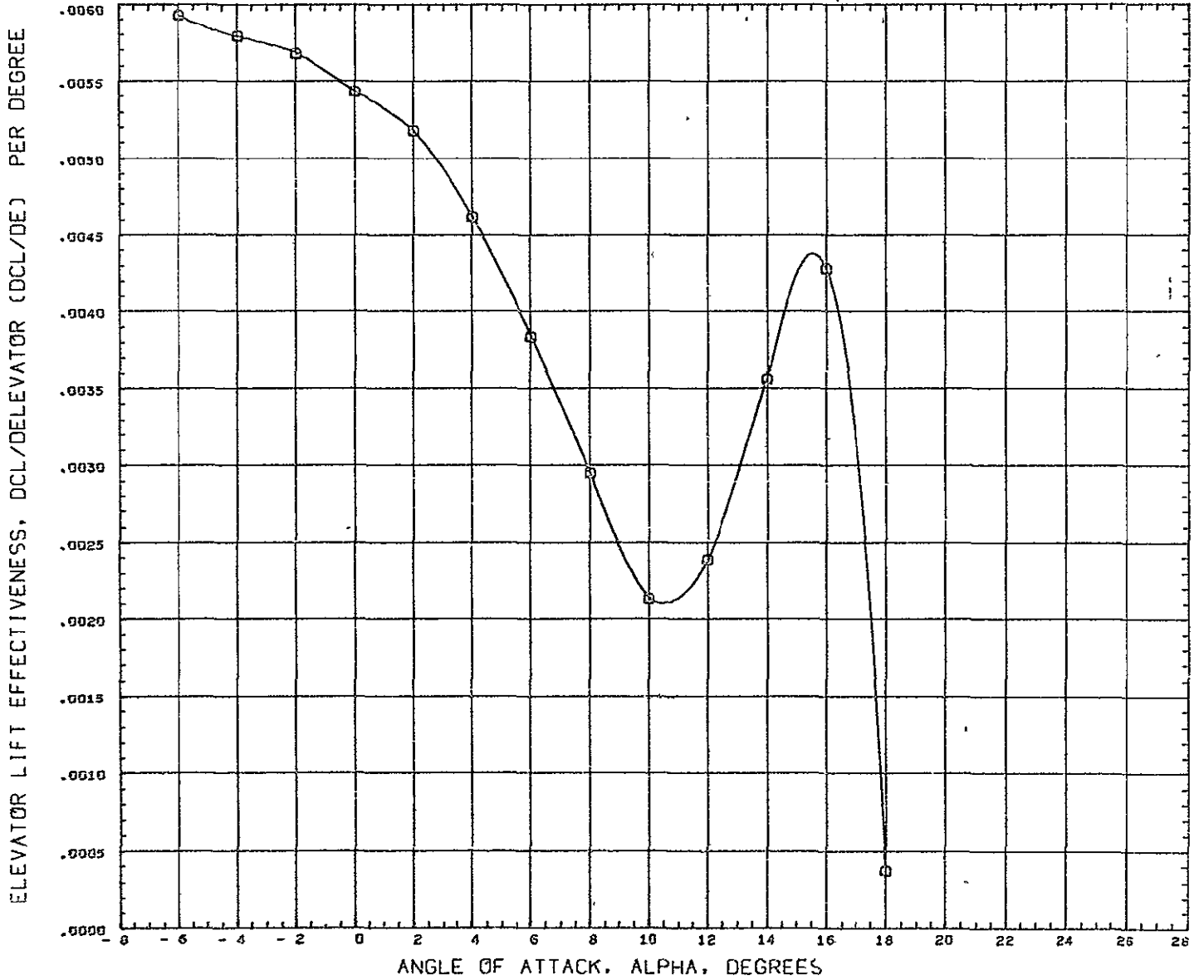

SYMBOL	MACH	PARAMETRIC VALUES				REFERENCE INFORMATION		
0	0.259	BETA	0.000	ELEVTR	- 10.000	REFS	316.2304	SQ IN
		RUDYTR	0.000	FLAPS	0.000	REFL	50.1900	IN
		SPOILF	0.000			REFB	7.3500	IN
						XMRP	29.3920	IN
						YMRP	0.0000	IN
						ZMRP	0.0000	IN
						SCALE	0.0175	
		DATA HIST. CODE	*F					

LONGITUDINAL CONTROL DERIVATIVES - STRAIGHT WING AFT - V-TAIL=55DEG

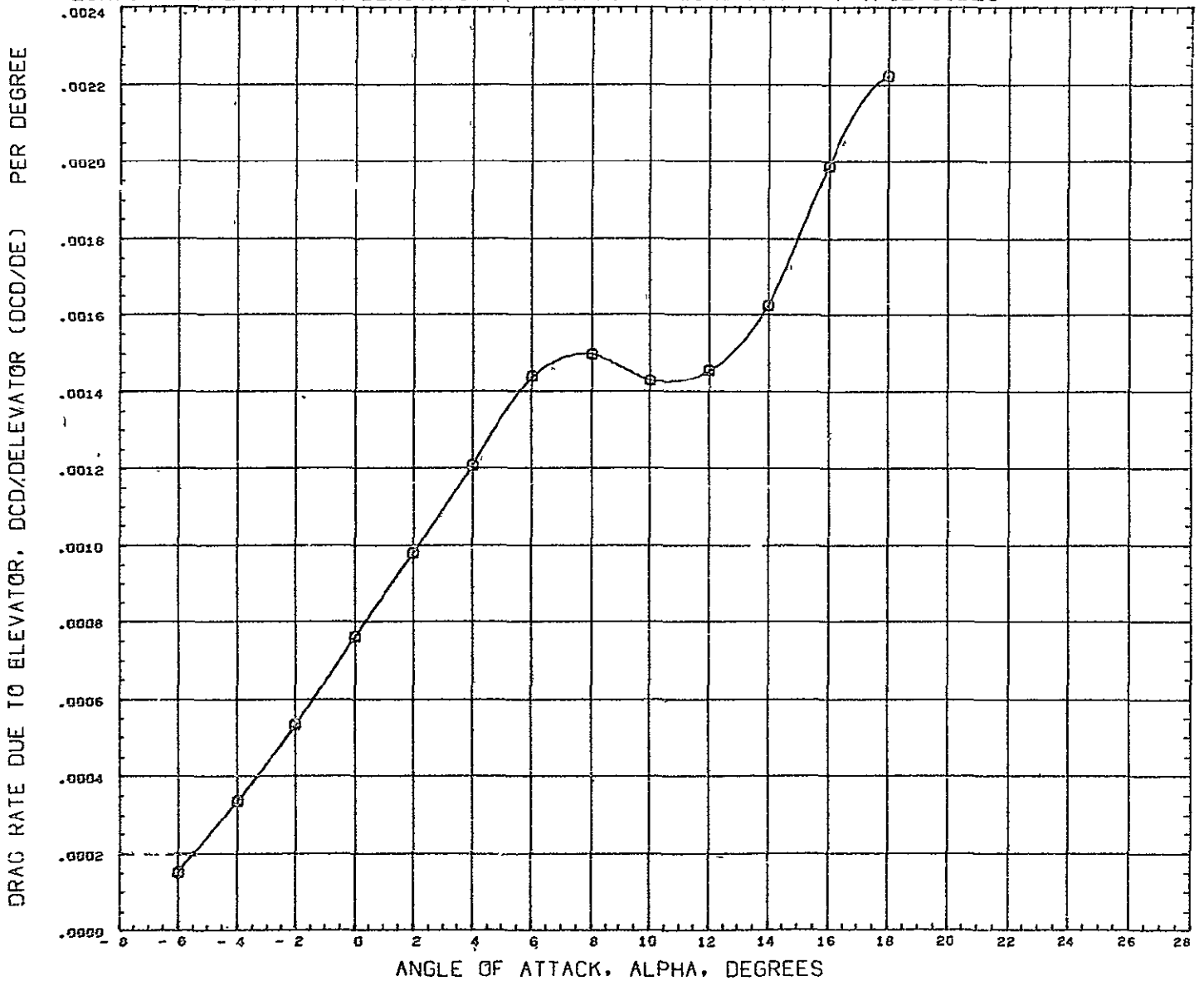

SYMBOL	MACH	PARAMETRIC VALUES		
0	0.259	BETA	0.000	ELEVTR - 10.000
		RUDVTR	0.000	FLAPS 0.000
		SPOILR	0.000	

REFERENCE INFORMATION		
REFS	316 2304	SQ IN
REFL	50 1900	IN
REFB	7 3500	IN
XMRP	29 3920	IN
YMRP	0 0000	DN
ZMRP	0.0000	IN
SCALE	0 0175	

DATA HIST. CODE \*P

LONGITUDINAL CONTROL DERIVATIVES - STRAIGHT WING AFT - V-TAIL=55DEG

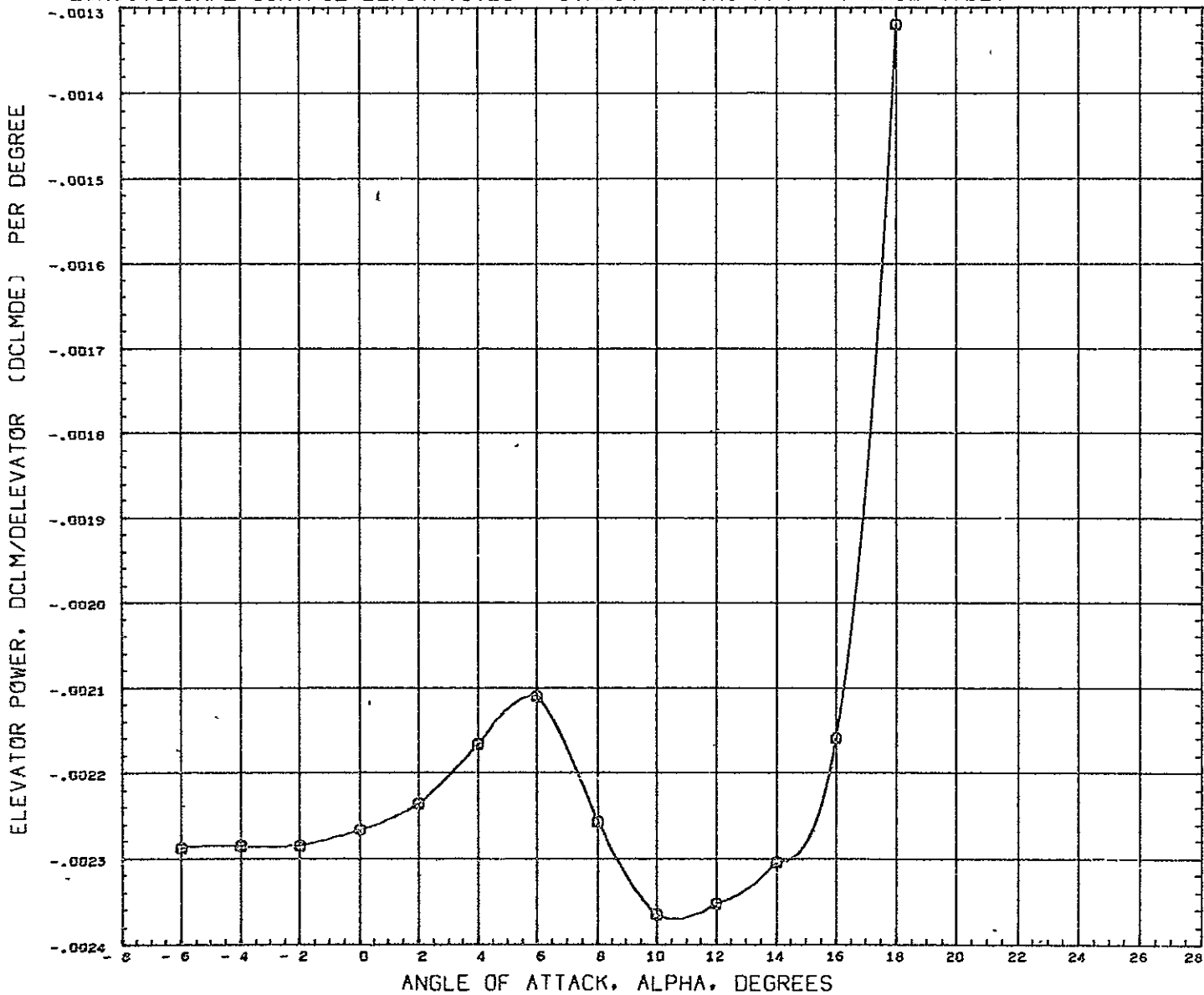

SYMBOL	MACH	PARAMETRIC VALUES			
O	0.259	BETA	0.000	ELEVTR	-10.000
		RUDVTR	0.000	FLAPS	0.000
		SPOILR	0.000		

REFERENCE INFORMATION		
REFS	316 2304	SQ IN
REFL	50 1900	IN
REFB	7.3500	IN
XNRF	29.3920	IN
YNRF	0.0000	IN
ZNRF	0.0000	IN
SCALE	0.0175	

DATA HIST. CODE =F

LONG. CHAR. - ELEVATOR EFF. - ST. WING BASIC POS. - FLAPS AND GEAR- V-TAIL=55DEG

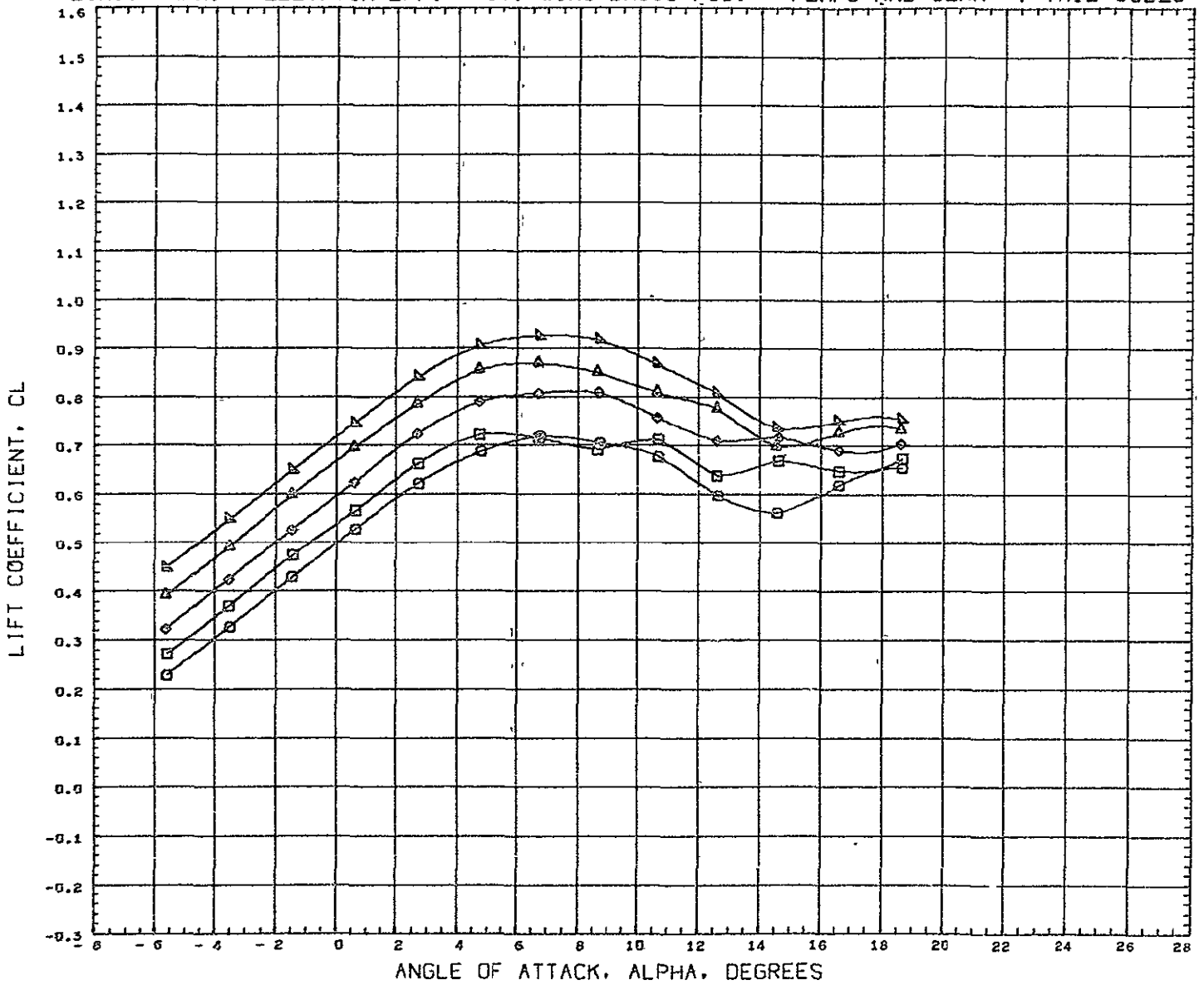

SYMBOL		ELEVTR		PARAMETRIC VALUES				REFERENCE INFORMATION		
○	-	30.000	MACH	0.184	BETA	0.000	REFS	316 2304	50 IN	
□	-	20.000	RUDVTR	0.000	FLAPS	45.000	REFL	50.1900	IN	
◇	-	10.000	SPOILR	0.000			REFB	7.3500	IN	
△		0.000					XHRF	29.3920	IN	
▽		10.000					YHRF	0 0000	IN	
							ZHRF	0 0000	IN	
							SCALE	0 0175		
REFERENCE FILE				CONVAIR TN70-AE-12						

LONG. CHAR. - ELEVATOR EFF. - ST. WING BASIC POS. - FLAPS AND GEAR- V-TAIL=55DEG

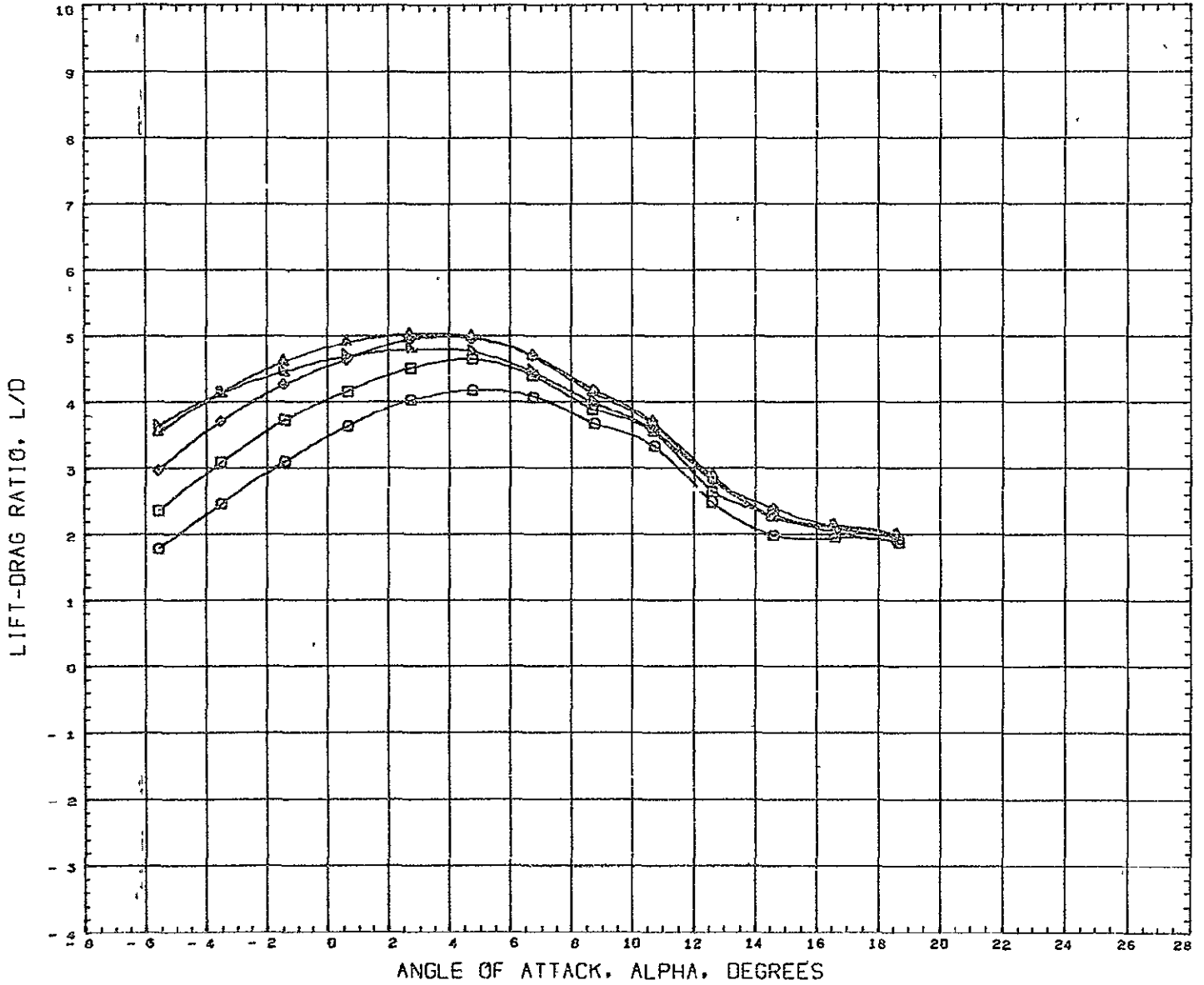

SYMBOL	ELEVTR	PARAMETRIC VALUES				REFERENCE INFORMATION		
○	- 35.000	MACH	0.184	BETA	0.000	REFS	316.2304	SQ IN
□	- 20.000	RUCVTR	0.000	FLAPS	-5.000	REFL	50.1900	IN
◇	- 10.000	SPOILR	0.000			REFB	7.3500	IN
△	0.000					XMRP	29.3920	IN
▽	15.000					YMRP	0.0000	IN
		REFERENCE FILE	CONVAIR TN70-AE-12			ZMRP	0.0000	IN
						SCALE	0.0175	

LONG. CHAR. - ELEVATOR EFF. - ST. WING BASIC POS. - FLAPS AND GEAR- V-TAIL=55DEG

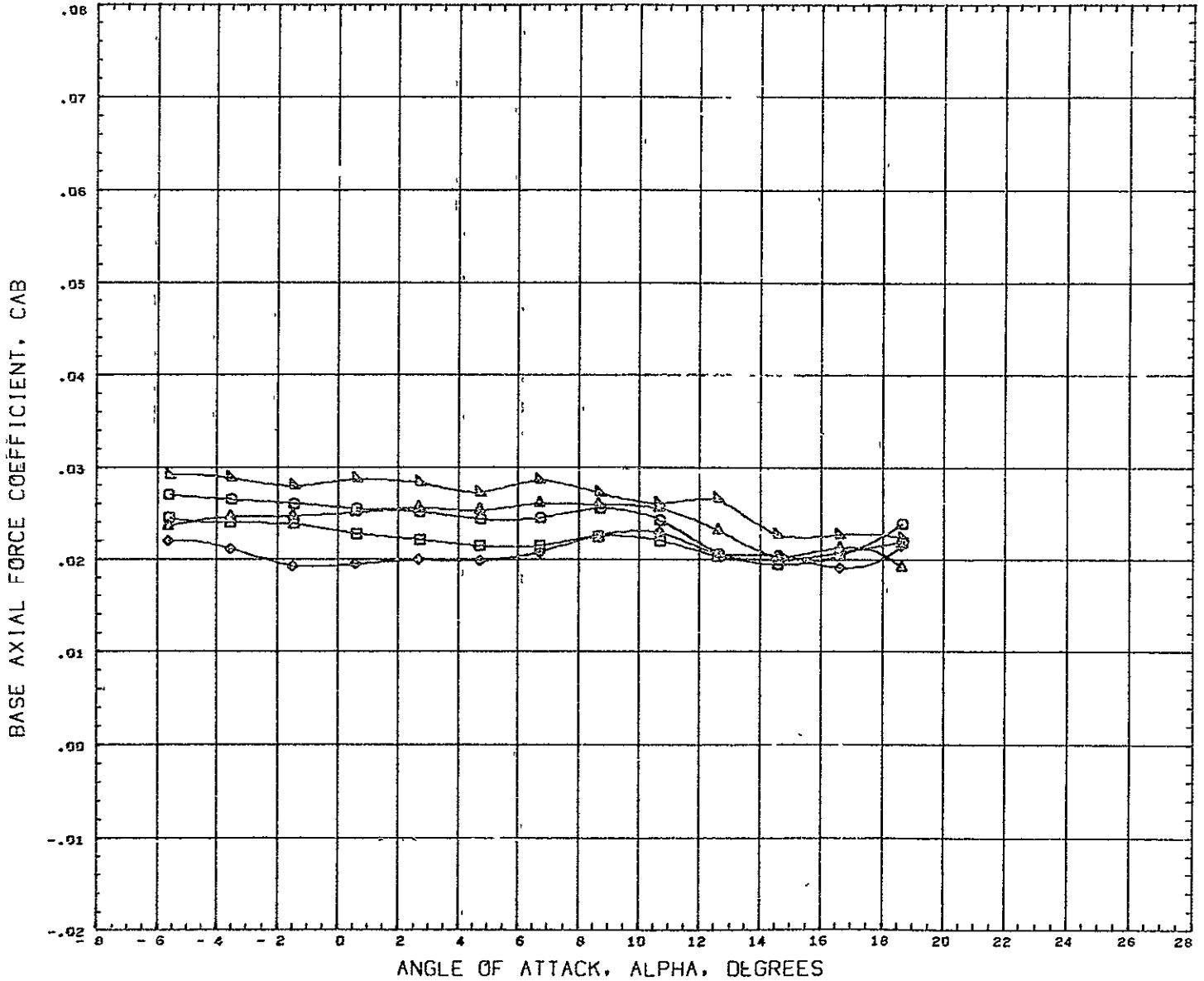

SYMBOL	ELEVTR	PARAMETRIC VALUES				REFERENCE INFORMATION		
○	- 30.000	MACH	0.184	BETA	0.000	REFS	316 2304	SQ IN
□	- 25.000	RUDYTR	0.000	FLAPS	45.000	REFL	50 1900	IN
◇	- 10.000	SFOILR	0.000			REFB	7.3500	IN
△	0.000					XMRP	29 3920	IN
▽	10.000					YMRP	0.0000	IN
		REFERENCE FILE	CONVAIR T170-AE-12			ZMRP	0.0000	IN
						SCALE	0.0175	

LONG. CHAR. - ELEVATOR EFF. - ST. WING BASIC POS. - FLAPS AND GEAR- V-TAIL=55DEG

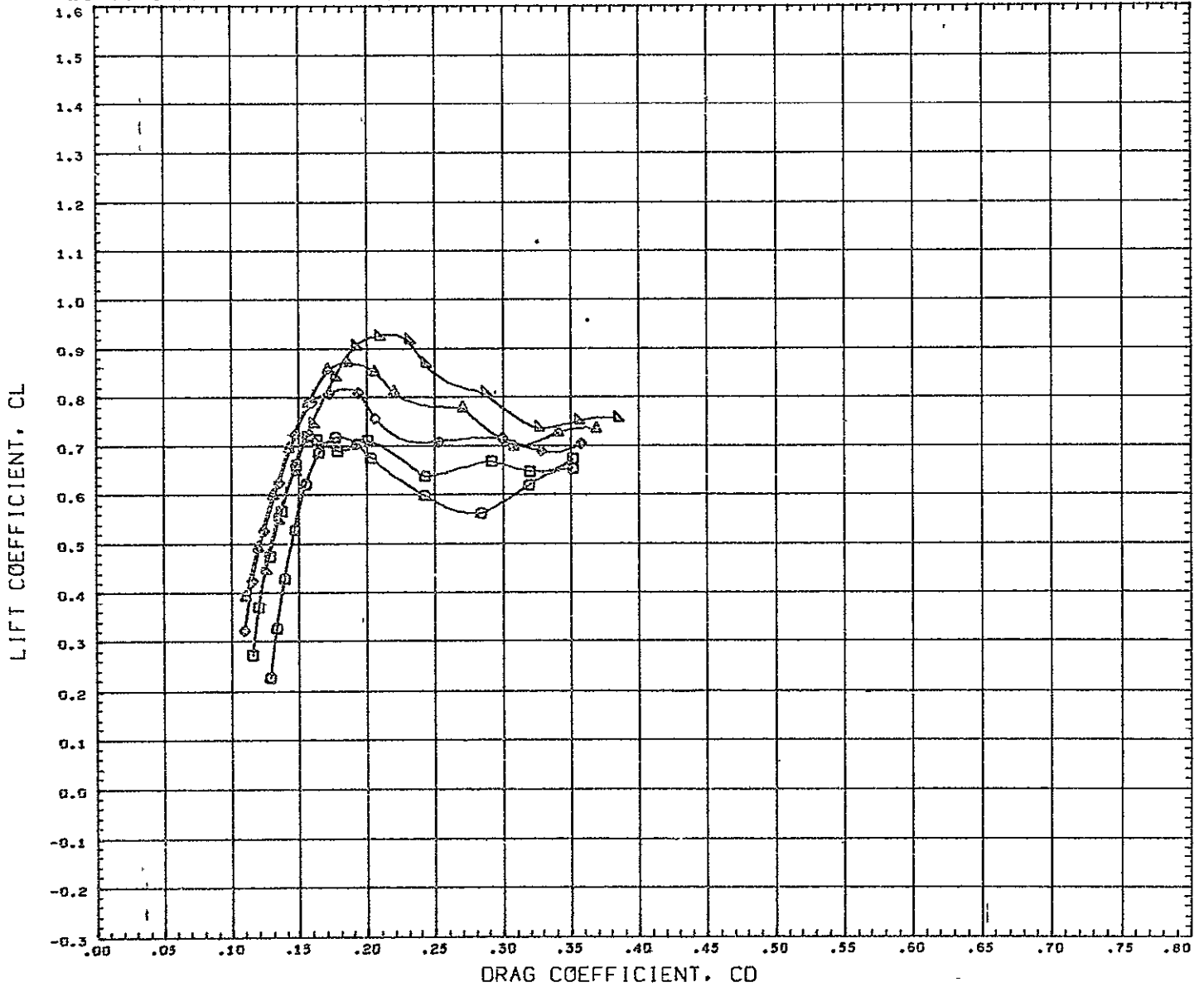

SYMBOL	ELEVTR	PARAMETRIC VALUES			
○	- 30.000	MACH	0.184	BETA	5.000
□	- 20.000	RUDVTR	0.000	FLAPS	45.000
◇	- 10.000	SFOILR	5.500		
△	5.000				
▽	10.000				

REFERENCE INFORMATION		
REFS	316 2304	SQ IN
REFL	50 1900	IN
REFB	7 3500	IN
XMRP	29.3920	IN
YMRP	0.0000	IN
ZMRP	0.0000	IN
SCALE	0 0175	

REFERENCE FILE CONVAIR T170-AE-12



LONG. CHAR. - ELEVATOR EFF. - ST. WING BASIC POS. - FLAPS AND GEAR- V-TAIL=55DEG

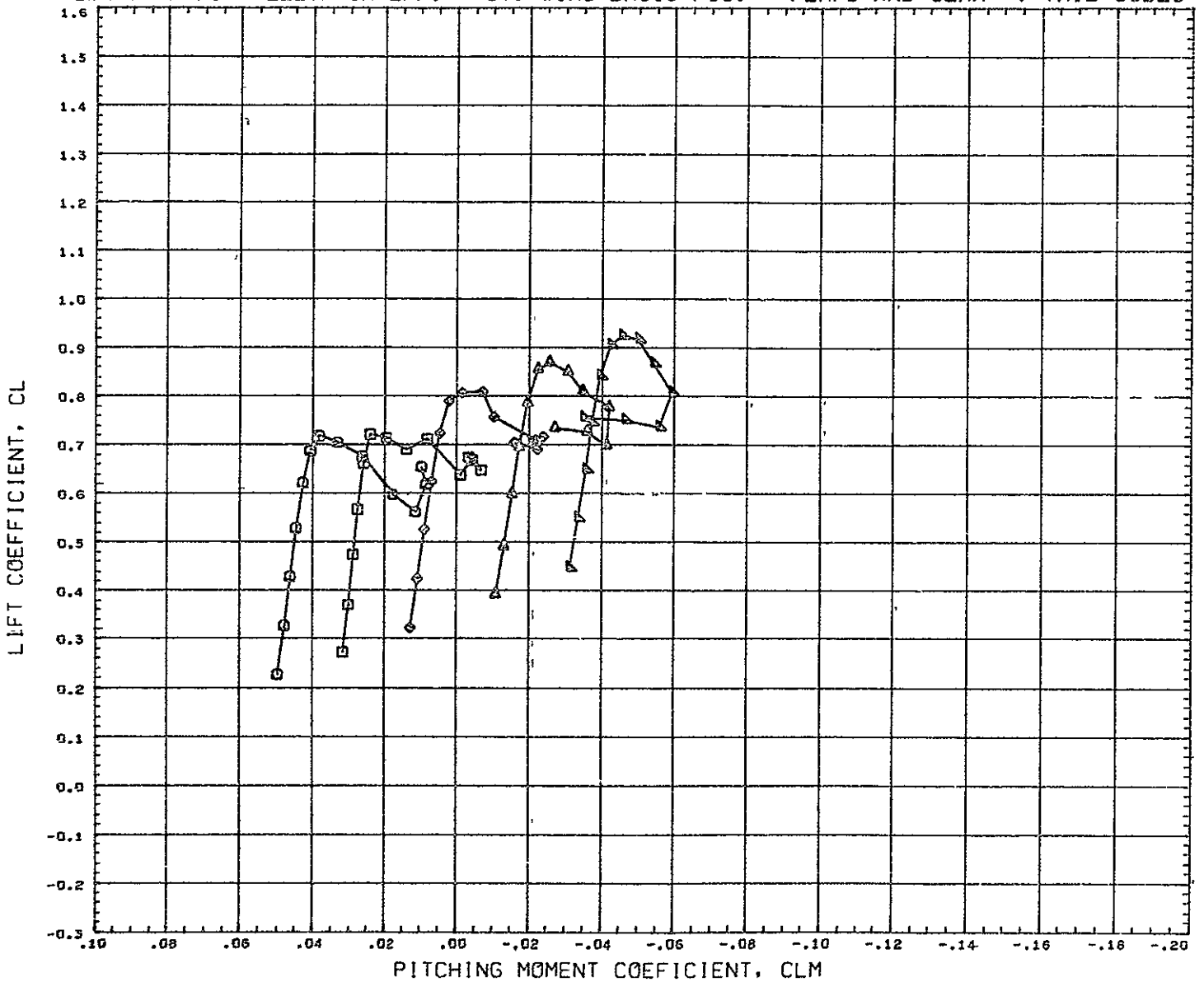

SYMBOL	ELEVTR	PARAMETRIC VALUES			
○	- 30.000	MACH	0.184	BETA	0.000
□	- 20.000	RJDVTR	0.000	FLAPS	45.000
◇	- 10.000	SPOILR	0.000		
△	0.000				
▽	10.000				
REFERENCE FILE		CONVAIR T47D-AE-12			

REFERENCE INFORMATION		
REFS	316 2304	50 IN
REFL	50.1900	IN
REFB	7.3500	IN
YHRF	29.3920	IN
ZHRF	0.0000	IN
SCALE	0.0175	

LONGITUDINAL CONTROL - STRAIGHT WING BASIC POS. - FLAPS AND GEAR - V-TAIL=55DEG

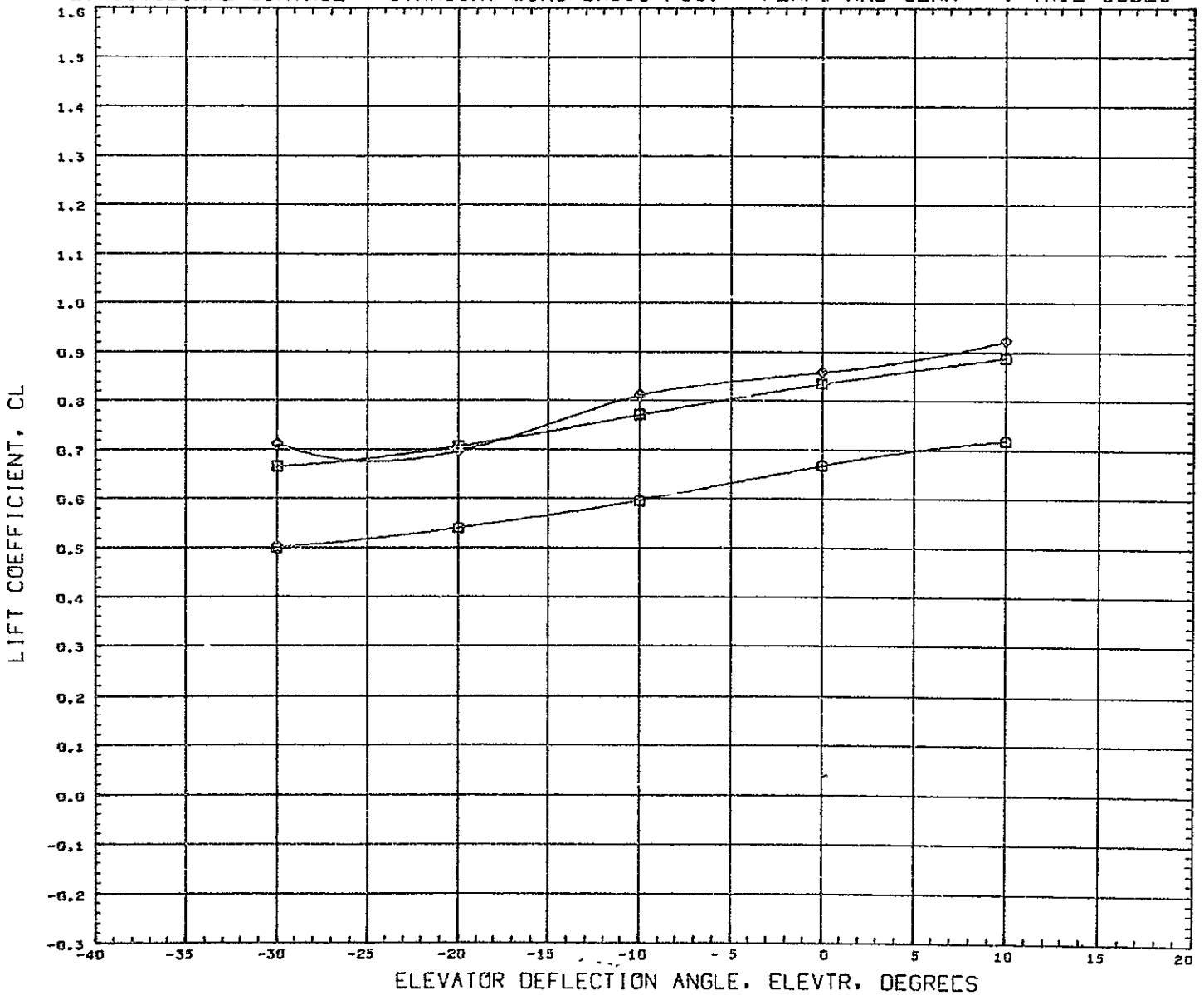

SYMBOL	ALPHA	PARAMETRIC VALUES
○	0.000	MACH 0.184 BETA 0.000
□	4.000	RUDVTR 0.000 FLAPS 45.000
◇	8.000	SFOILR 0.000

REFERENCE INFORMATION		
REFS	316.2304	SQ IN
REFL	50.1900	IN
REFB	7.3500	IN
XMRP	29.3920	IN
YMRP	0.0000	IN
ZMRP	0.0000	IN
SCALE	0.0175	

DATA HIST. CODE 1

LONGITUDINAL CONTROL - STRAIGHT WING BASIC POS. - FLAPS AND GEAR - V-TAIL=55DEG

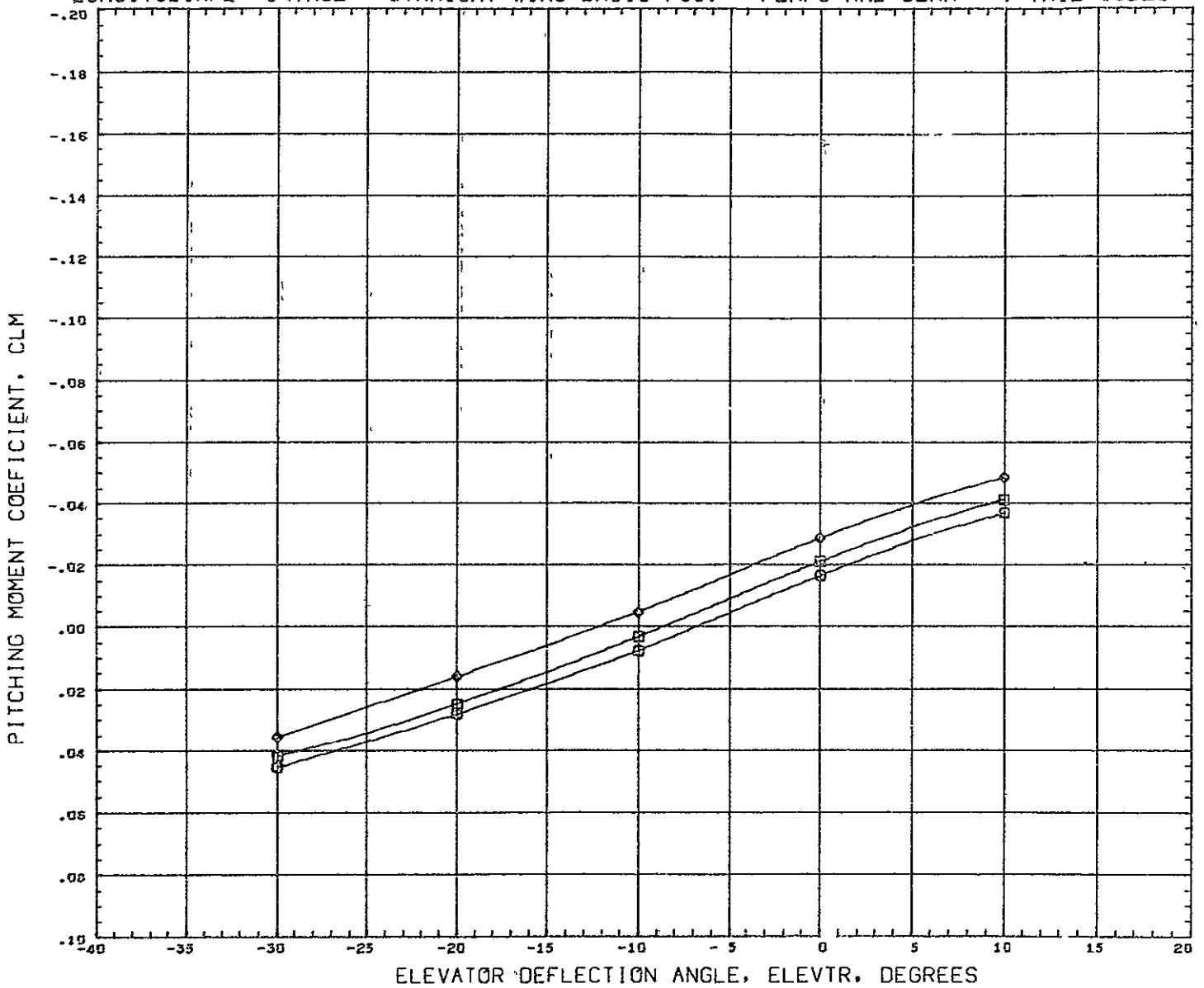

SYMBOL	ALPHA	PARAMETRIC VALUES				REFERENCE INFORMATION		
		MACH	BETA	FLAPS	REFS	SQ IN		
○	0.000	0.184	0.000	45.000	316 2304	IN		
□	4.000	0.000	0.000	45.000	50 1900	IN		
◇	8.000	0.000	0.000	45.000	7 3500	IN		
					29.3920	IN		
					0.0000	IN		
					0.0000	IN		
					0.0175	IN		

DATA HIST. CODE I

LONGITUDINAL CONTROL - STRAIGHT WING BASIC POS. - FLAPS AND GEAR - V-TAIL=55DEG

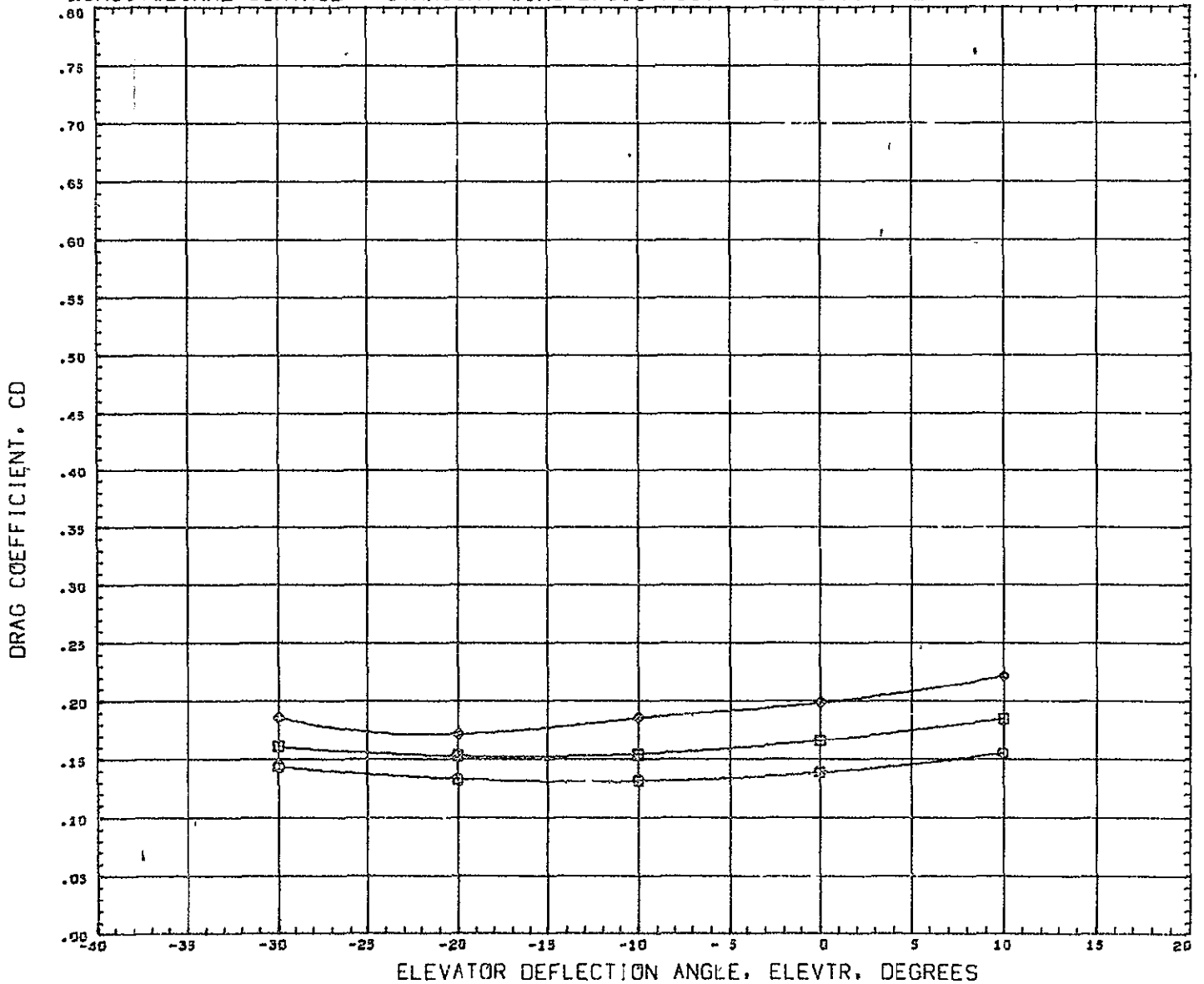

SYMBOL		ALPHA	PARAMETRIC VALUES			REFERENCE INFORMATION			
□	○	0.000	MACH	0.184	BETA	0.000	REFS	316.2304	SQ IN
□	○	4.000	RUDVTR	0.000	FLAPS	45.000	REFL	50.1900	IN
○	○	8.000	SPOILER	0.000			REFB	7.3500	IN
							XMRP	29.3920	IN
							YMRP	0.0000	IN
							ZMRP	0.0000	IN
							SCALE	0.0175	

DATA HIST. CODE 1

LONG. CONTROL DERIVATIVES- STRAIGHT WING BASIC POS- FLAPS AND GEAR- V-TAIL=55DEG

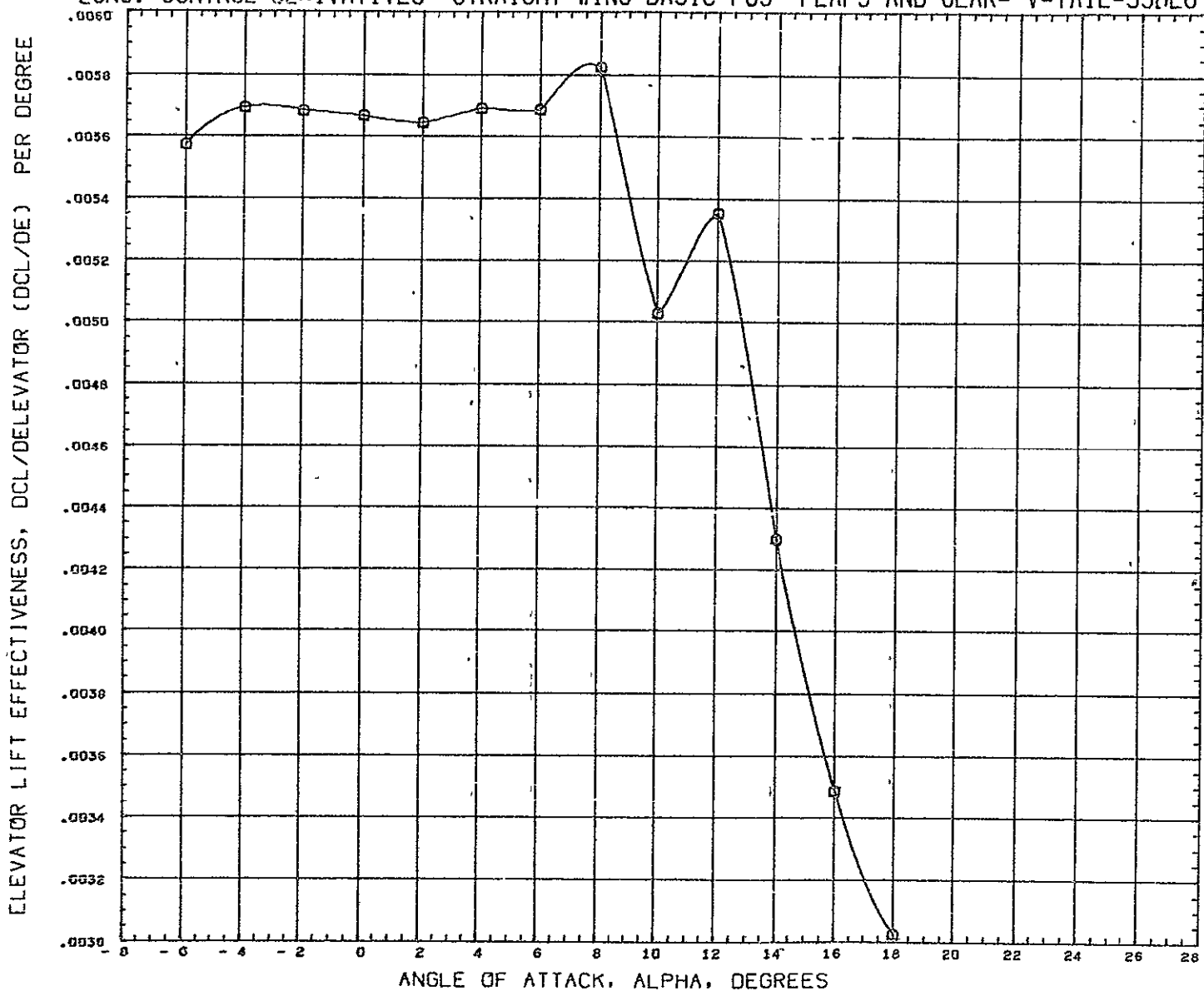

SYMBOL    MACH    PARAMETRIC VALUES  
 O        0.164    BETA    0.000    ELEVTR   - 30.000  
                       FUDVTR    0.000    FLAPS    45.000  
                       SPOILR    0.000

REFERENCE INFORMATION  
 REFS        316 2304    SQ IN  
 REFL        50.1900    IN  
 REFB        7.3500    IN  
 XHRF        29.3920    IN  
 YHRF        0.0000    IN  
 ZHRF        0.0000    IN  
 SCALE       0.0175

DATA HIST. CODE    \*F

LONG. CONTROL DERIVATIVES- STRAIGHT WING BASIC POS- FLAPS AND GEAR- V-TAIL=55DEG

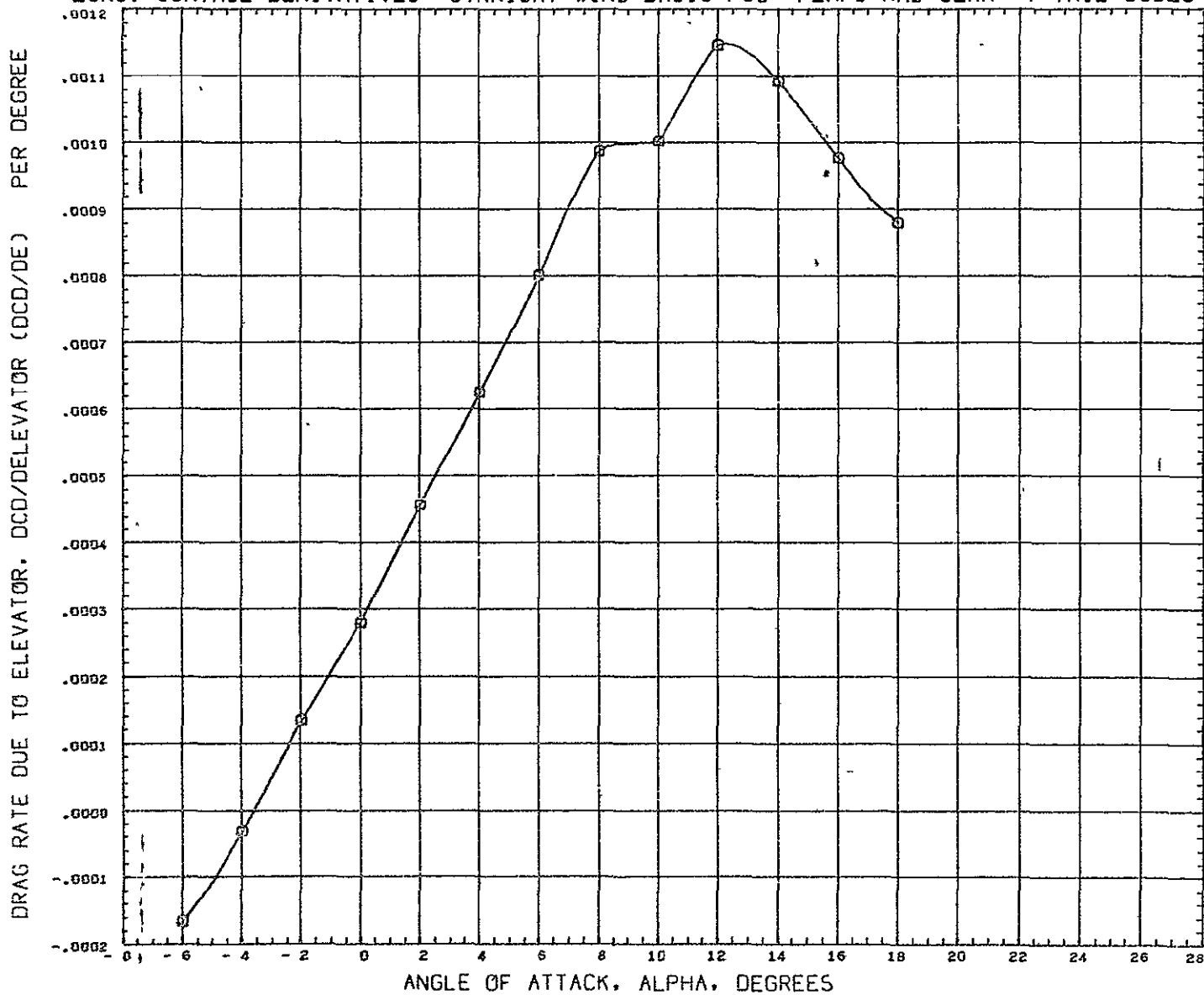

SYMBOL	MACH	PARAMETRIC VALUES			
0	0.184	BETA	0.000	ELEVTR	-30.000
		RUDVTR	0.000	FLAPS	45.000
		SPOILR	0.000		

REFERENCE INFORMATION		
REFS	316 2304	SQ IN
REFL	50.1900	IN
REFB	7.3500	IN
XHRF	29 3920	IN
YHRF	0.0000	IN
ZHRF	0 0000	IN
SCALE	0 0175	

DATA HIST. CODE 2F

LONG. CONTROL DERIVATIVES- STRAIGHT WING BASIC POS- FLAPS AND GEAR- V-TAIL=55DEG

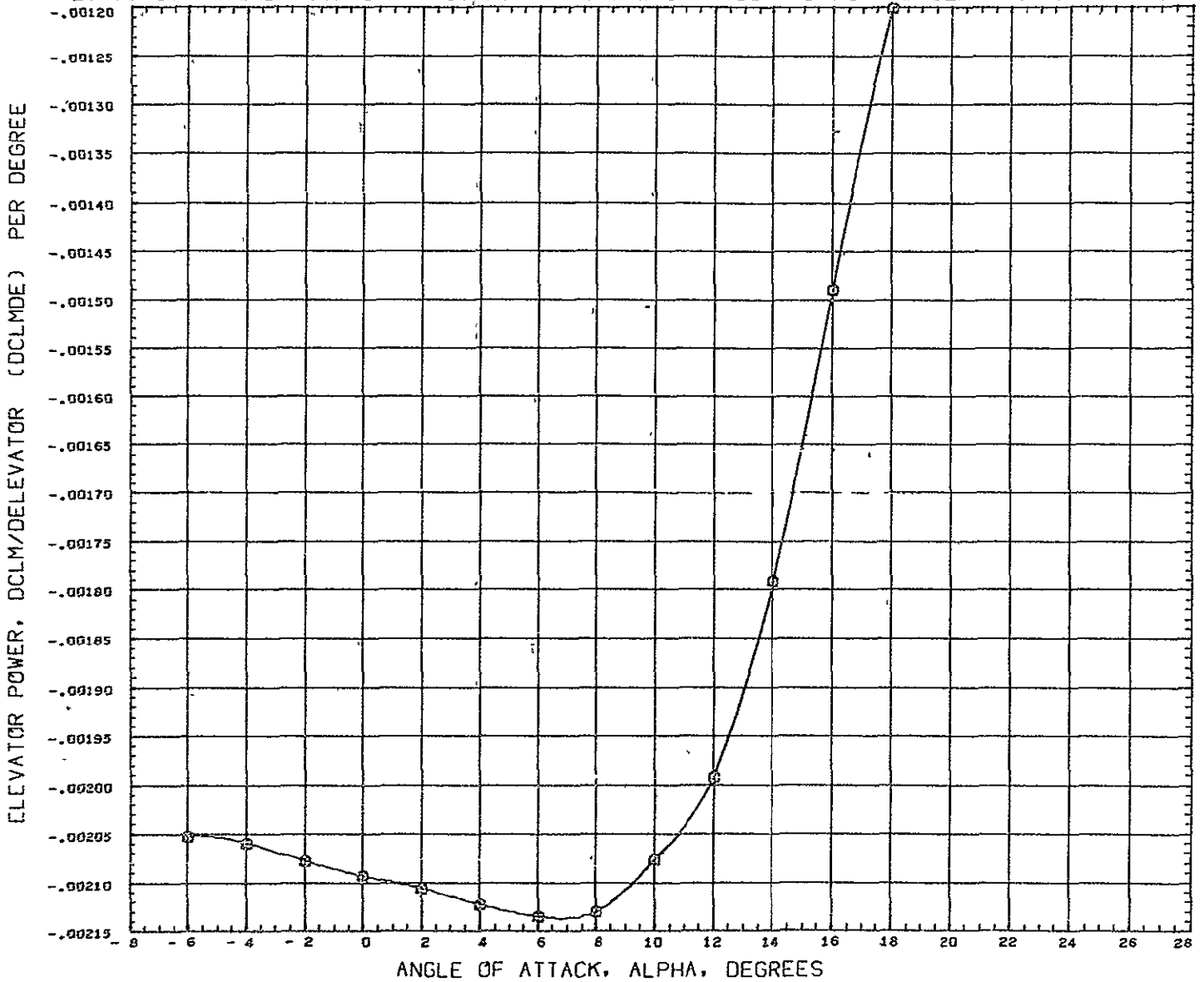

SYMBOL	VAL	PARAMETRIC VALUES	
Q	0.184	BETA	0.000
		ELEVTR	-30.000
		RUDVTR	0.000
		FLAPS	15.000
		SFOILR	0.000

REFERENCE INFORMATION		
REFS	316.2304	SQ IN
REFL	50.1900	IN
REFB	7.3500	IN
XHRF	29.3920	IN
YHRF	0.0000	IN
ZHRF	0.0000	IN
SCALE	0.0175	

DATA HIST. CODE #F

LAT.-DIR. CHAR. - STRAIGHT WING BASIC POSITION - FLAPS AND GEAR - V-TAIL=55DEG

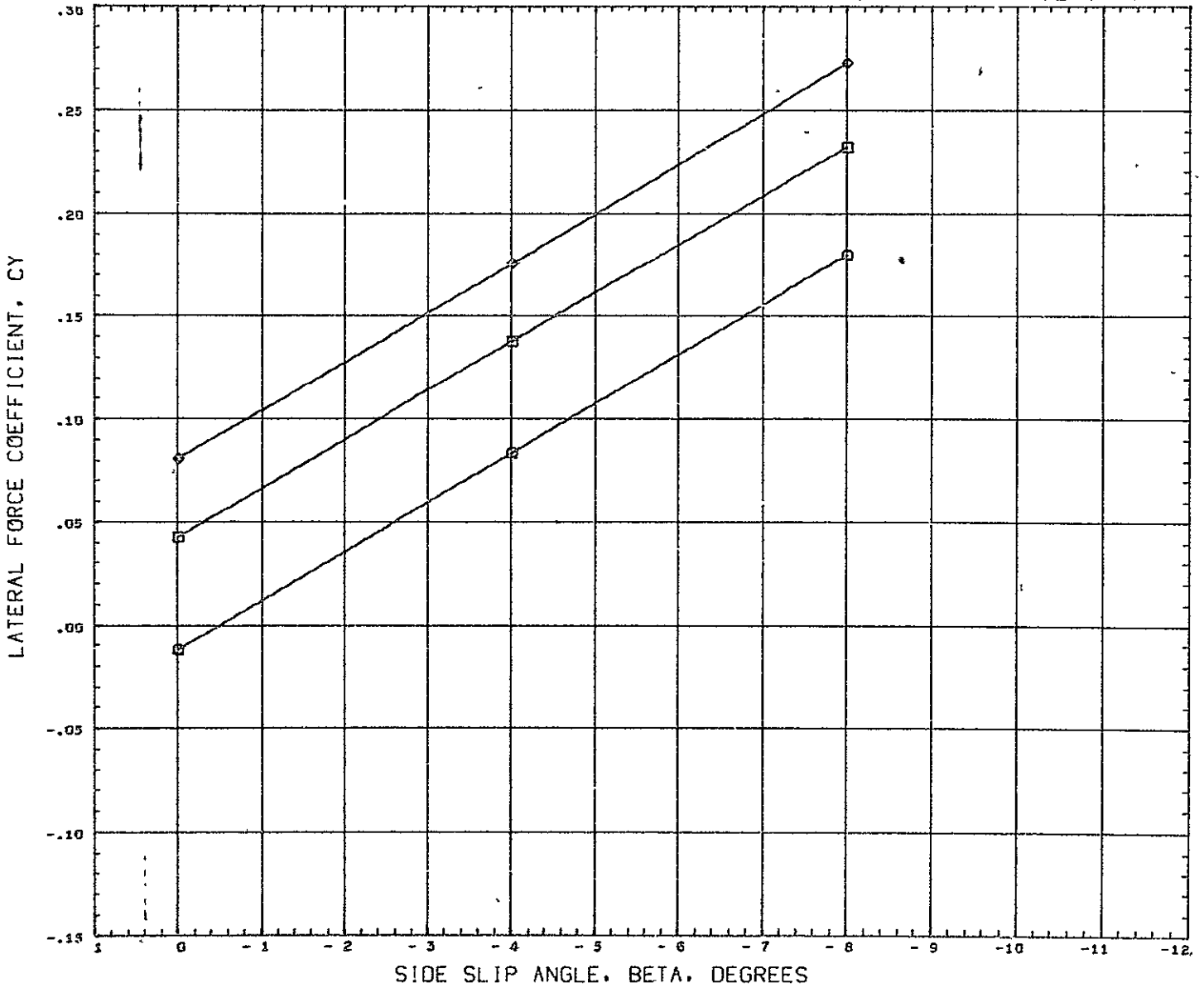

SYMBOL	RUDYTR	PARAMETRIC VALUES			
○	0.000	MACH	0.184	ALPHA	0.000
□	10.000	ELEVTR	0.000	FLAPS	45.000
◇	20.000	SFOILR	0.000		

REFERENCE INFORMATION		
REFS	316.2304	SQ IN
REFL	50.1900	IN
REFB	7.3500	IN
XMRP	29.3920	IN
YMRP	0.0000	IN
ZMRP	0.0000	IN
SCALE	0.0175	

DATA HIST. CODE I



LAT.-DIR. CHAR. - STRAIGHT WING BASIC POSITION - FLAPS AND GEAR - V-TAIL=55DEG

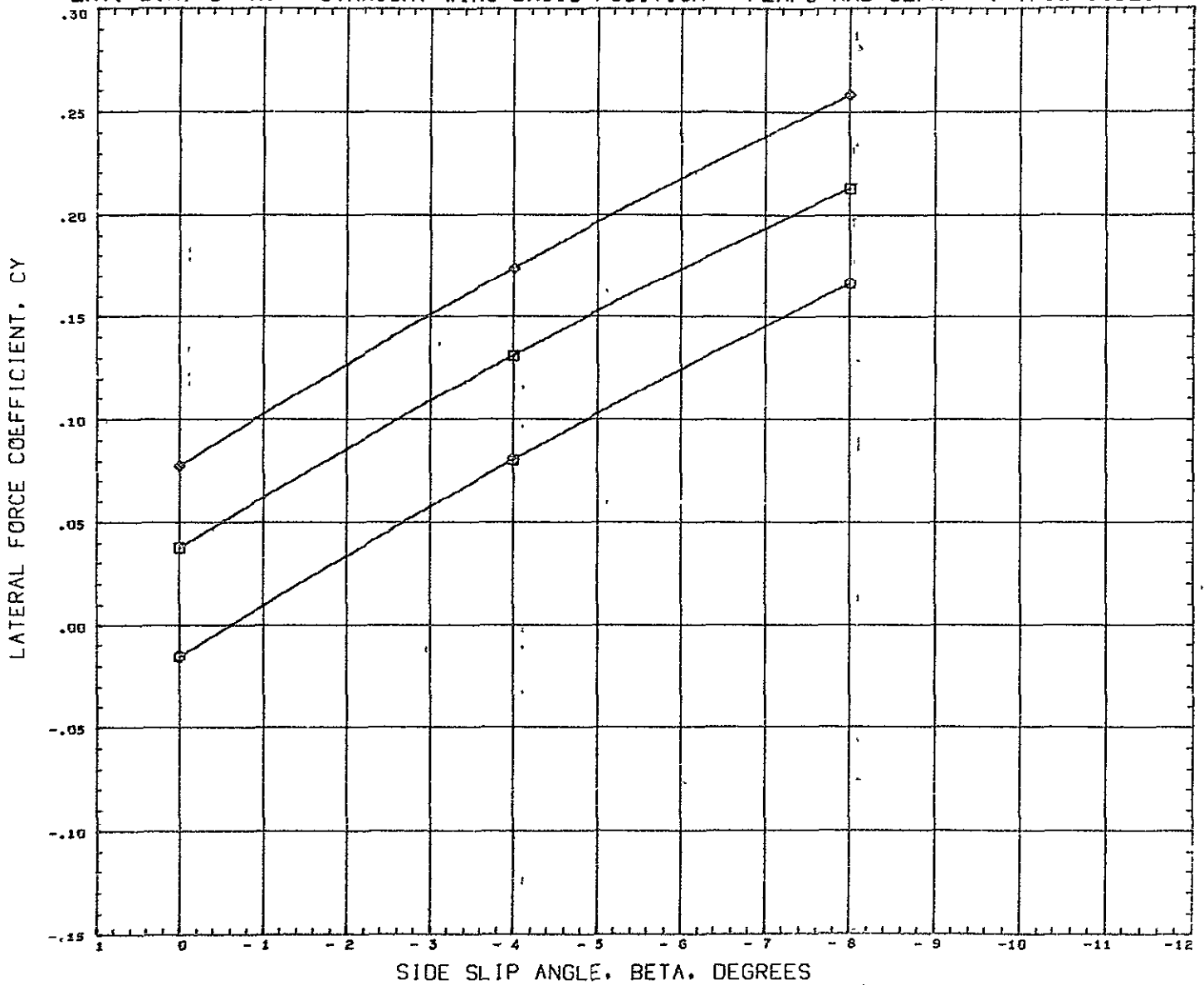

SYMBOL	RUDVTR	PARAMETRIC VALUES			
□	0.000	MACH	0.164	ALPHA	4.000
□	10.000	ELEVTR	0.000	FLAPS	45.000
◇	20.000	SPOILR	0.000		

REFERENCE INFORMATION		
REFS	316.2304	SQ IN
REFL	50.1900	IN
REFB	7.3500	IN
XMRP	29.3920	IN
YMRP	0.0000	IN
ZMRP	0.0000	IN
SCALE	0.0175	

DATA HIST. CODE 1

LAT.-DIR. CHAR. - STRAIGHT WING BASIC POSITION - FLAPS AND GEAR - V-TAIL=55DEG

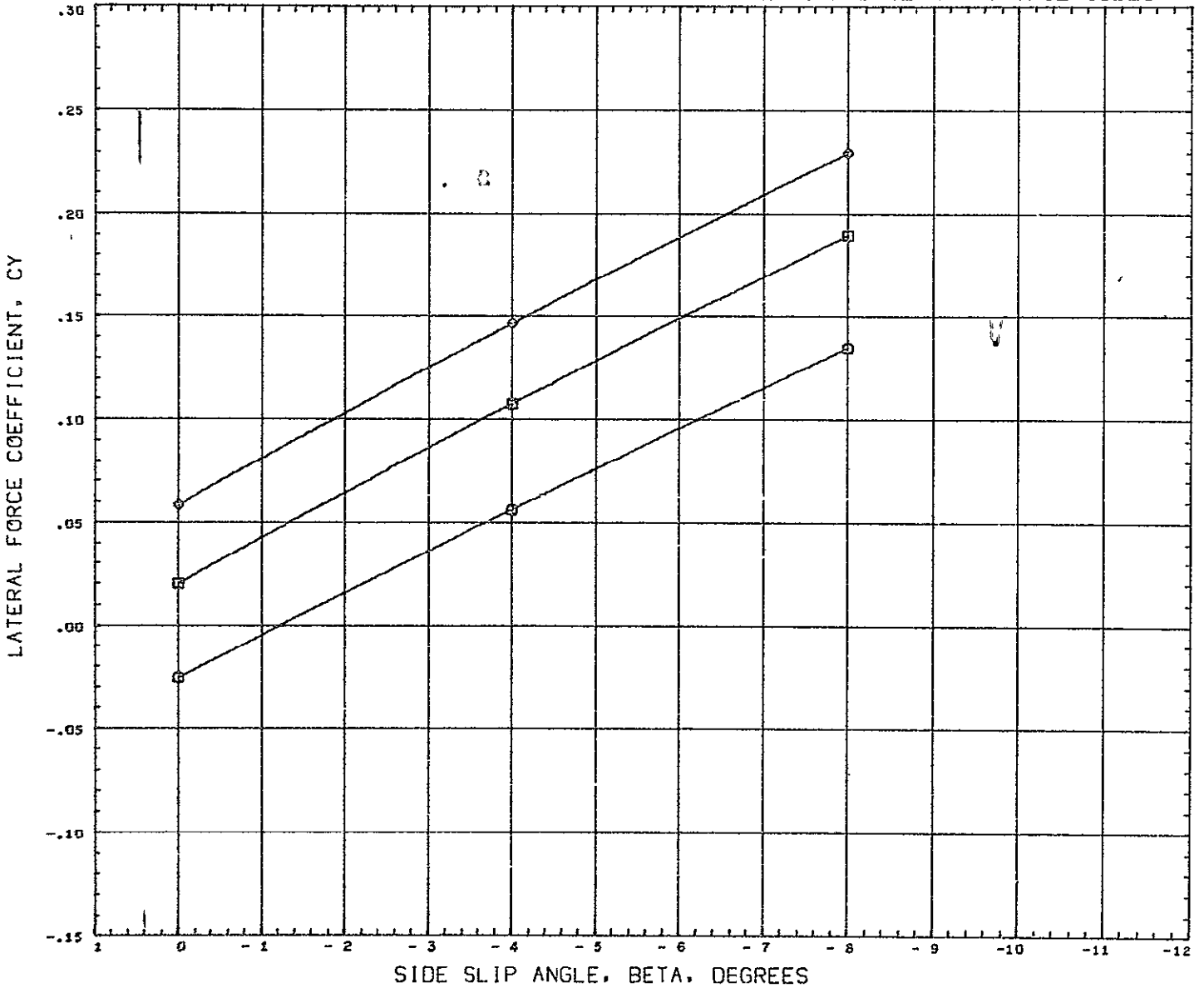

SYMBOL	RUDYTR	PARAMETRIC VALUES				REFERENCE INFORMATION		
◇	0.000	MACH	0.164	ALPHA	8.000	REFS	316.2304	50 IN
□	10.000	ELEVTR	0.000	FLAPS	45.000	REFL	50.1900	IN
○	20.000	SPOILR	0.000			REFB	7.3500	IN
						XMRP	29.3920	IN
						YMRP	0.0000	IN
						ZMRP	0.0000	IN
						SCALE	0.0175	

DATA HIST. CODE 1

LAT.-DIR. CHAR. - STRAIGHT WING BASIC POSITION - FLAPS AND GEAR - V-TAIL=55DEG

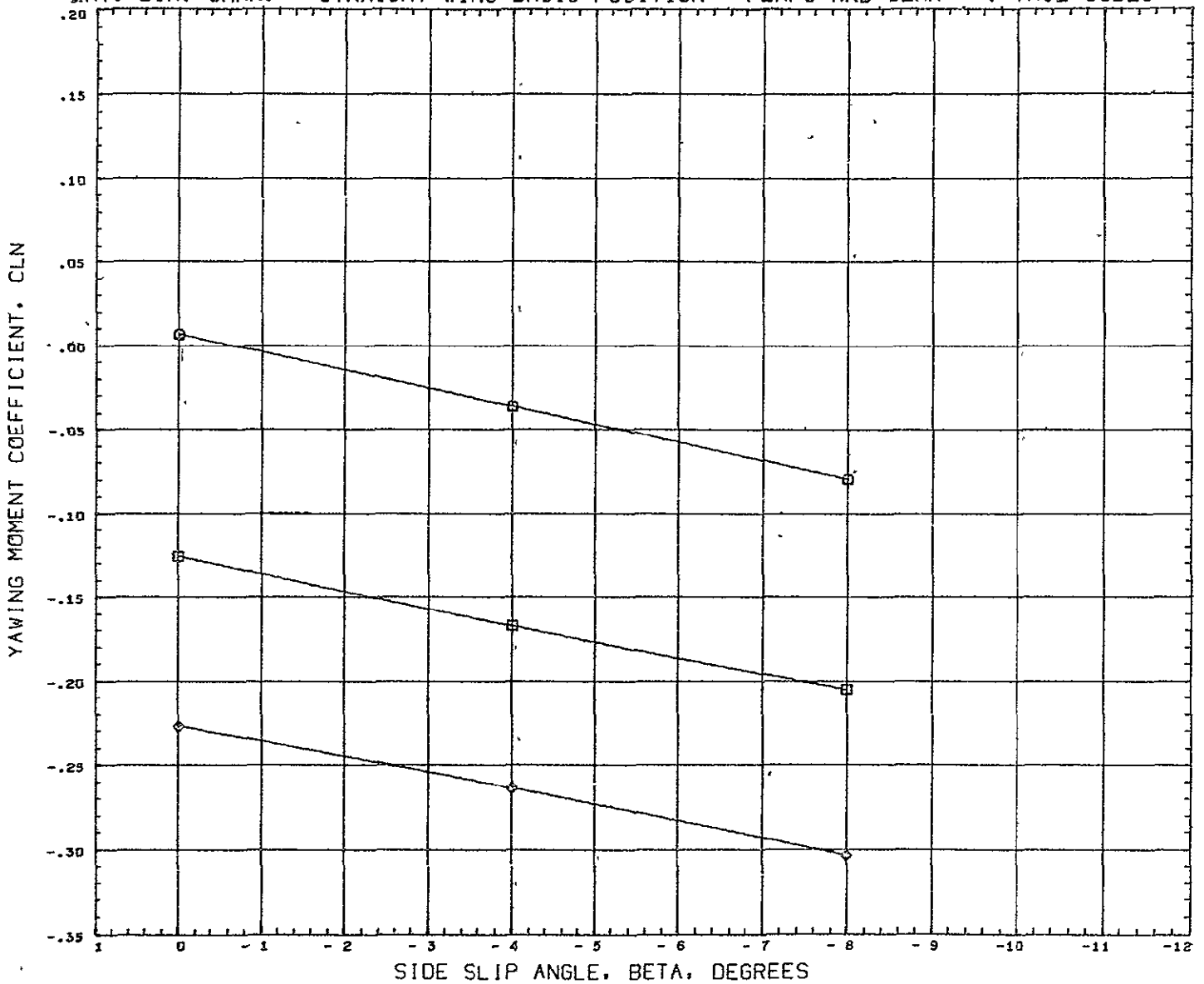

SYMBOL	RUOVTR	PARAMETRIC VALUES			
○	0.000	MACH	0.184	ALPHA	0.000
□	10.000	ELEVTR	0.000	FLAPS	45.000
◇	20.000	SFOILR	0.000		

REFERENCE INFORMATION		
REFS	316 2304	SQ IN
REFL	50.1900	IN
REFB	7.3500	IN
XMRP	29.3920	IN
YMRP	0 0000	IN
ZMRP	0 0000	IN
SCALE	0.0175	

DATA HIST. CODE 1

LAT.-DIR. CHAR. - STRAIGHT WING BASIC POSITION - FLAPS AND GEAR - V-TAIL=55DEG

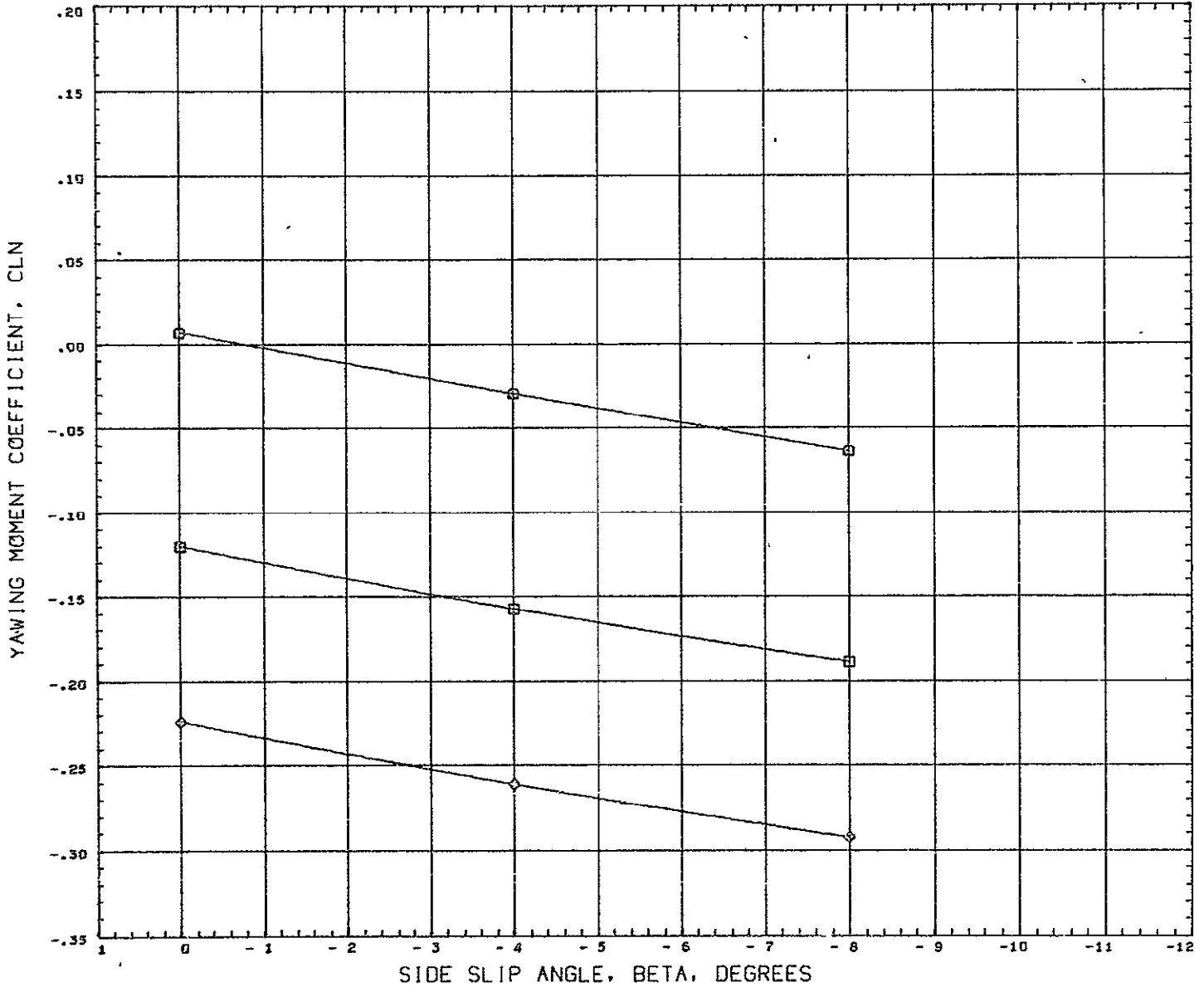

SYMBOL	RUDYTR	PARAMETRIC VALUES				REFERENCE INFORMATION		
○	0.000	MACH	0.184	ALPHA	4.000	REFS	316.2304	SQ IN
□	10.000	ELEVTR	0.000	FLAPS	45.000	REFL	50.1900	IN
◇	25.000	SPOILR	0.000			REFB	7.3500	IN
						XMRP	29.3920	IN
						YMRP	0.0000	IN
						ZMRP	0.0000	IN
						SCALE	0.0175	

DATA HIST. CODE I

LAT.-DIR. CHAR. - STRAIGHT WING BASIC POSITION - FLAPS AND GEAR - V-TAIL=55DEG

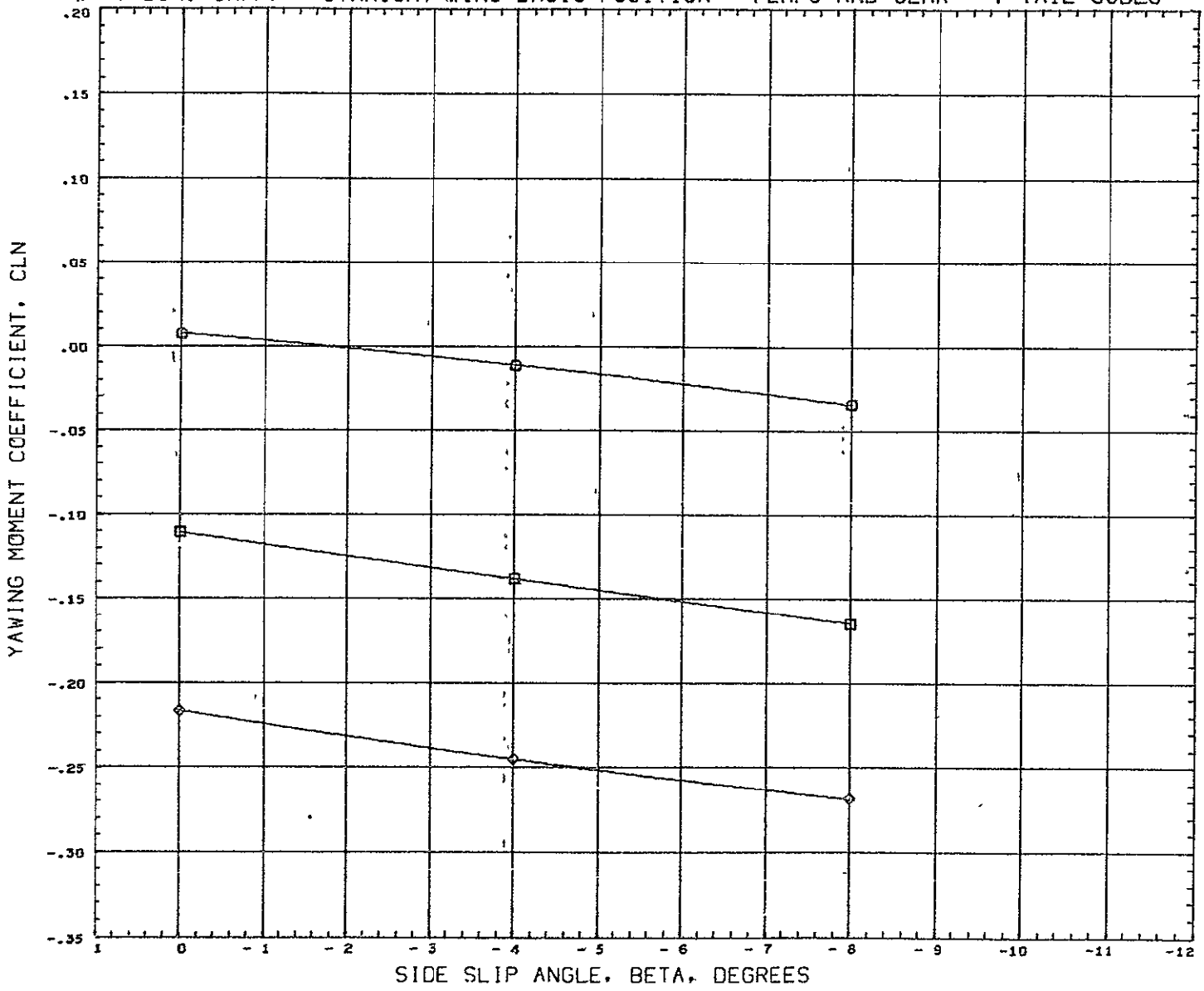

SYMBOL	RUDYTR	PARAMETRIC VALUES			
○	0.000	MACH	0.184	ALPHA	8.000
◇	10.000	ELEVTR	0.000	FLAPS	45.000
□	20.000	SFOILR	0.000		

REFERENCE INFORMATION		
REFS	316.2304	CSQ IN
REFL	50.1900	IN
REFB	7.3500	IN
XMRP	29.3920	IN
YMRP	0.0000	IN
ZMRP	0.0000	IN
SCALE	0.0175	

DATA HIST. CODE I

LAT.-DIR. CHAR. - STRAIGHT WING BASIC POSITION - FLAPS AND GEAR - V-TAIL=55DEG

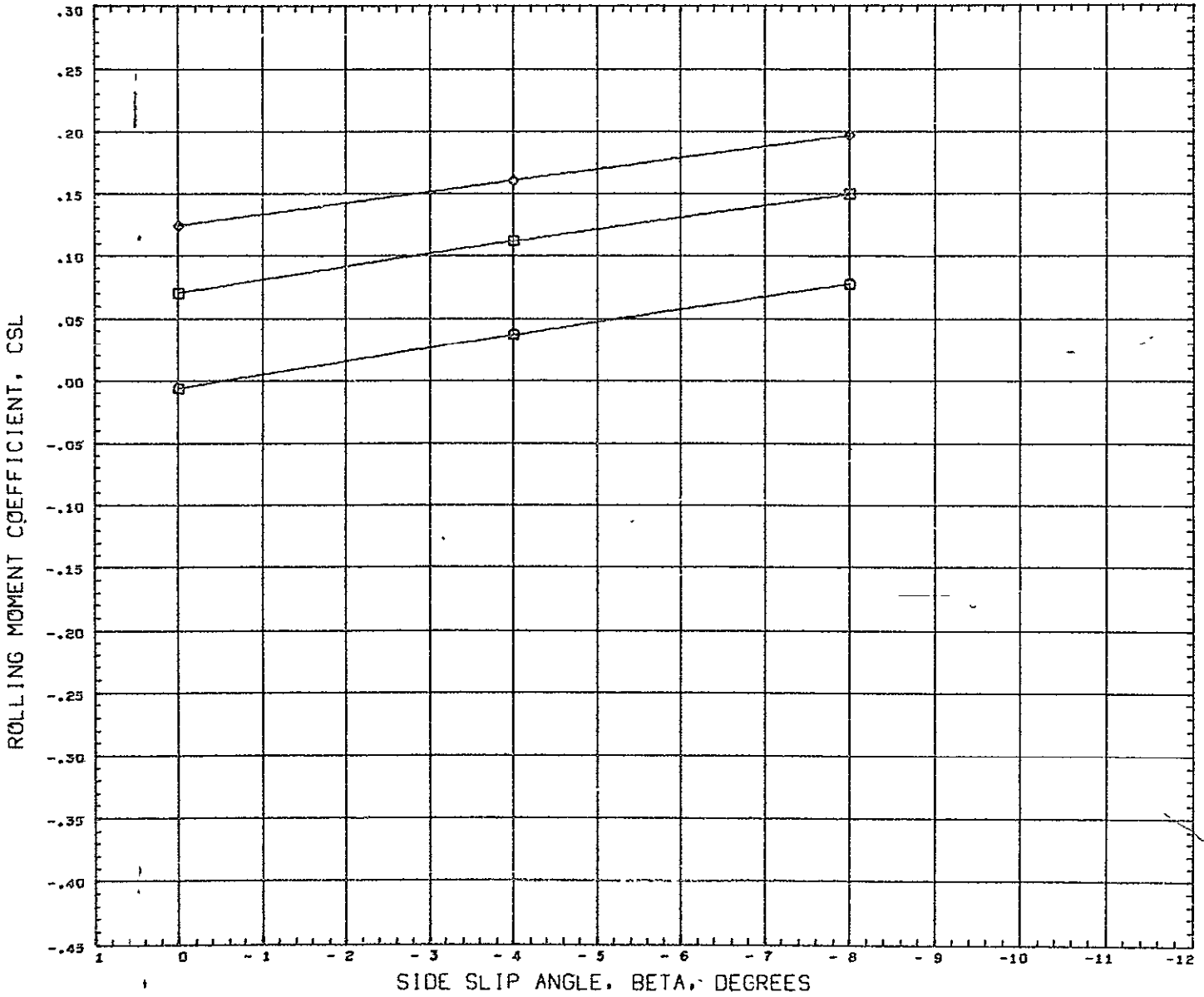

SYMBOL	RUDVTR	PARAMETRIC VALUES			
○	0.000	MACH	0.184	ALPHA	0.000
□	10.000	ELEVTR	0.000	FLAPS	45.000
◇	20.000	SFOILR	0.000		

REFERENCE INFORMATION		
REFS	316.2304	SQ IN
REFL	50.1900	IN
REFB	7.3500	IN
XMRP	29.3920	IN
YMRP	0.0000	IN
ZMRP	0.0000	IN
SCALE	0.0175	

DATA HIST. CODE 1

LAT.-DIR. CHAR. - STRAIGHT WING-BASIC POSITION - FLAPS AND GEAR - V-TAIL=55DEG

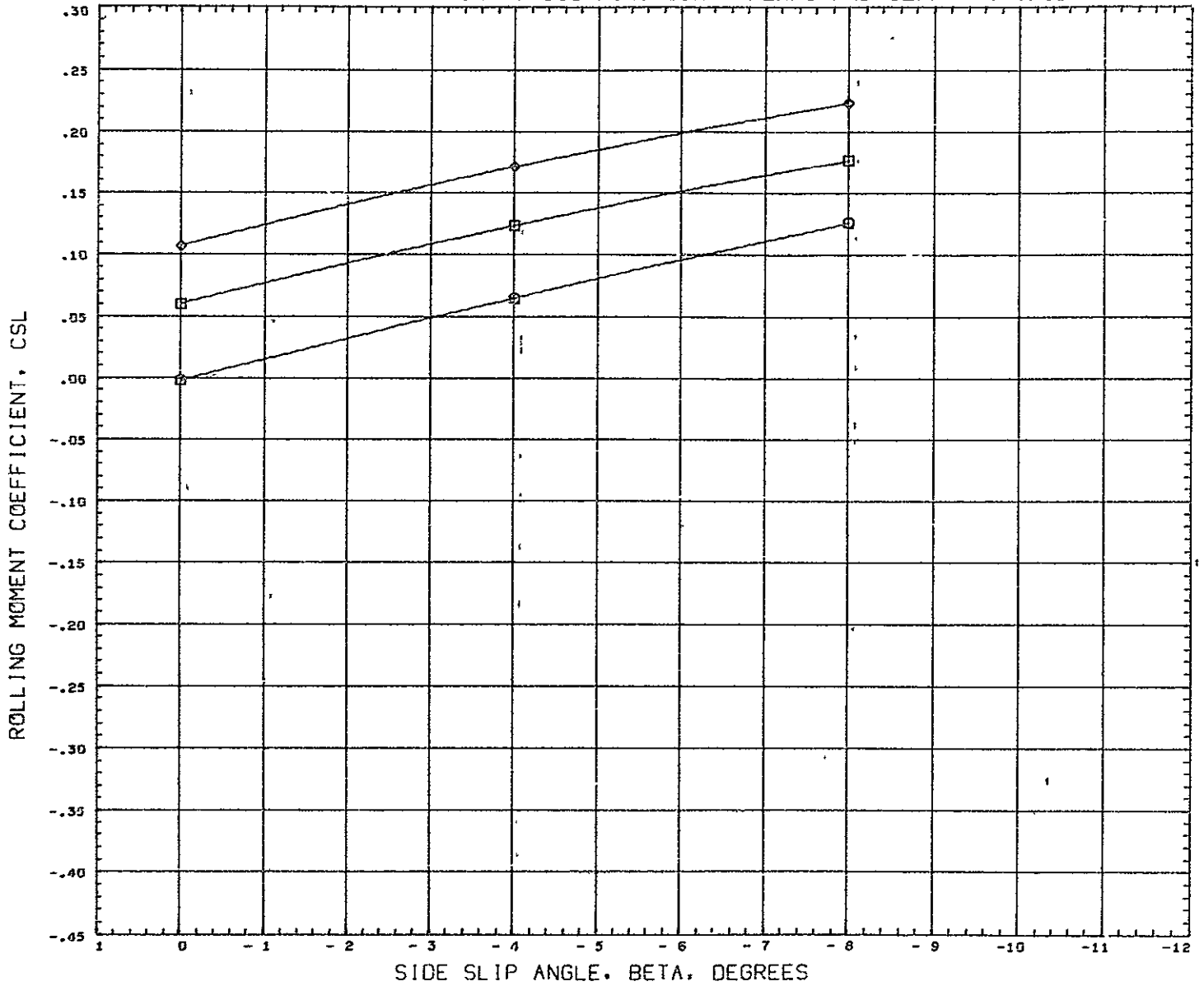

SYMBOL	RUDYTR	PARAMETRIC VALUES			
◇	0.000	MACH	0.184	ALPHA	4.000
□	10.000	ELEVTR	0.000	FLAPS	45.000
○	20.000	SPOILR	0.000		

REFERENCE INFORMATION		
REFS	316 2304	SQ IN
REFL	50.1900	IN
REFB	7 3500	IN
XHRP	29 3920	IN
YHRP	0.0000	IN
ZHRP	0 0000	IN
SCALE	0 0175	

DATA HIST. CODE I

LAT.-DIR. CHAR. - STRAIGHT WING BASIC POSITION - FLAPS AND GEAR - V-TAIL=55DEG

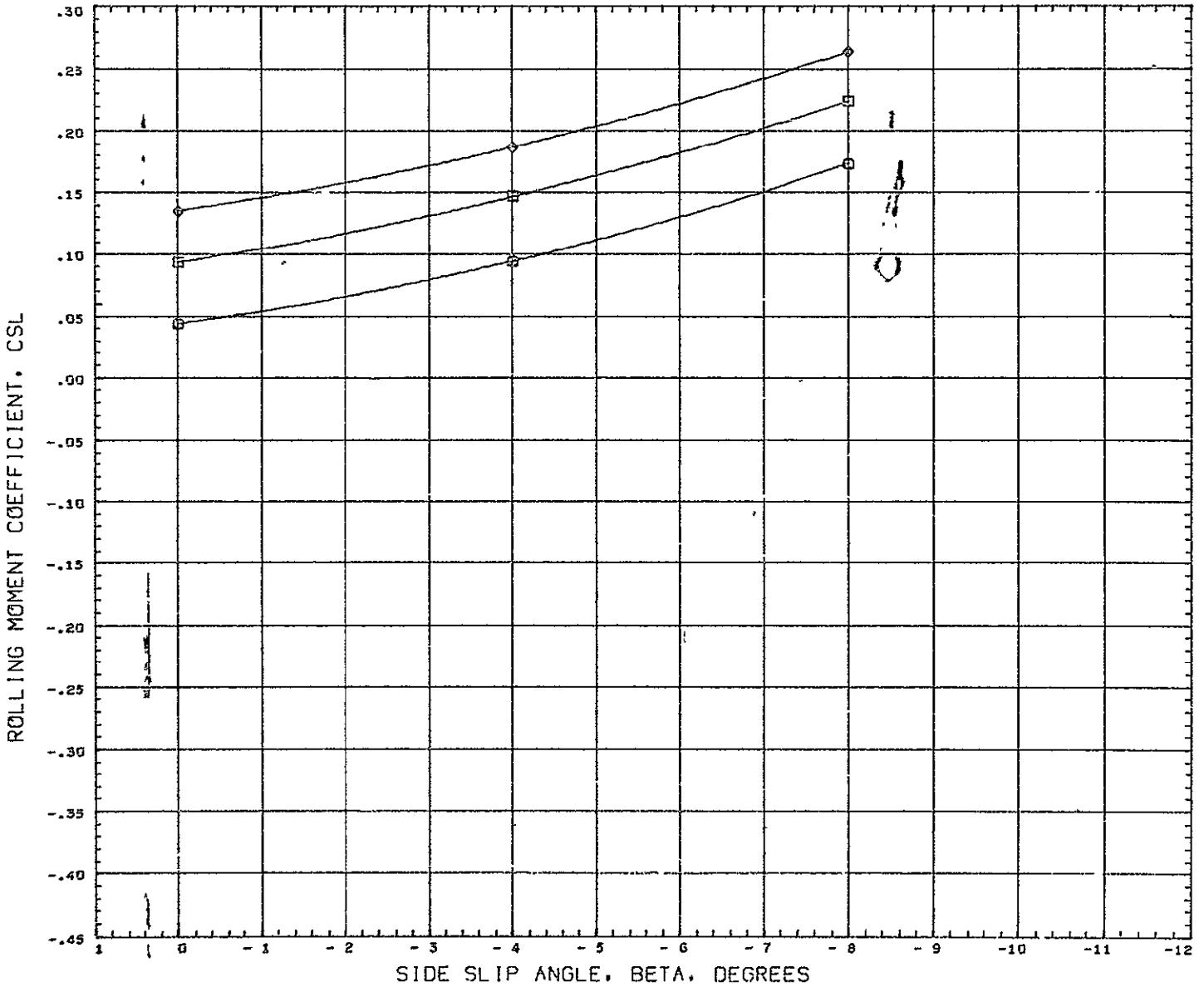

SYMBOL	RUDVTR	PARAMETRIC VALUES				REFERENCE INFORMATION		
○	0.000	MACH	0.184	ALPHA	8.000	REFS	316 2304	SQ IN
□	10.000	ELEVTR	0.000	FLAPS	45.000	REFL	50.1900	IN
◇	20.000	SPOILR	0.000			REFB	7.3500	IN
						XHRF	29.3920	IN
						YHRF	0.0000	IN
						ZHRF	0.0000	IN
						SCALE	0.0175	

DATA HIST CODE I



DIR. CONTROL DERIVATIVES- STRAIGHT WING BASIC POS.- FLAPS AND GEAR- V-TAIL=55DEG

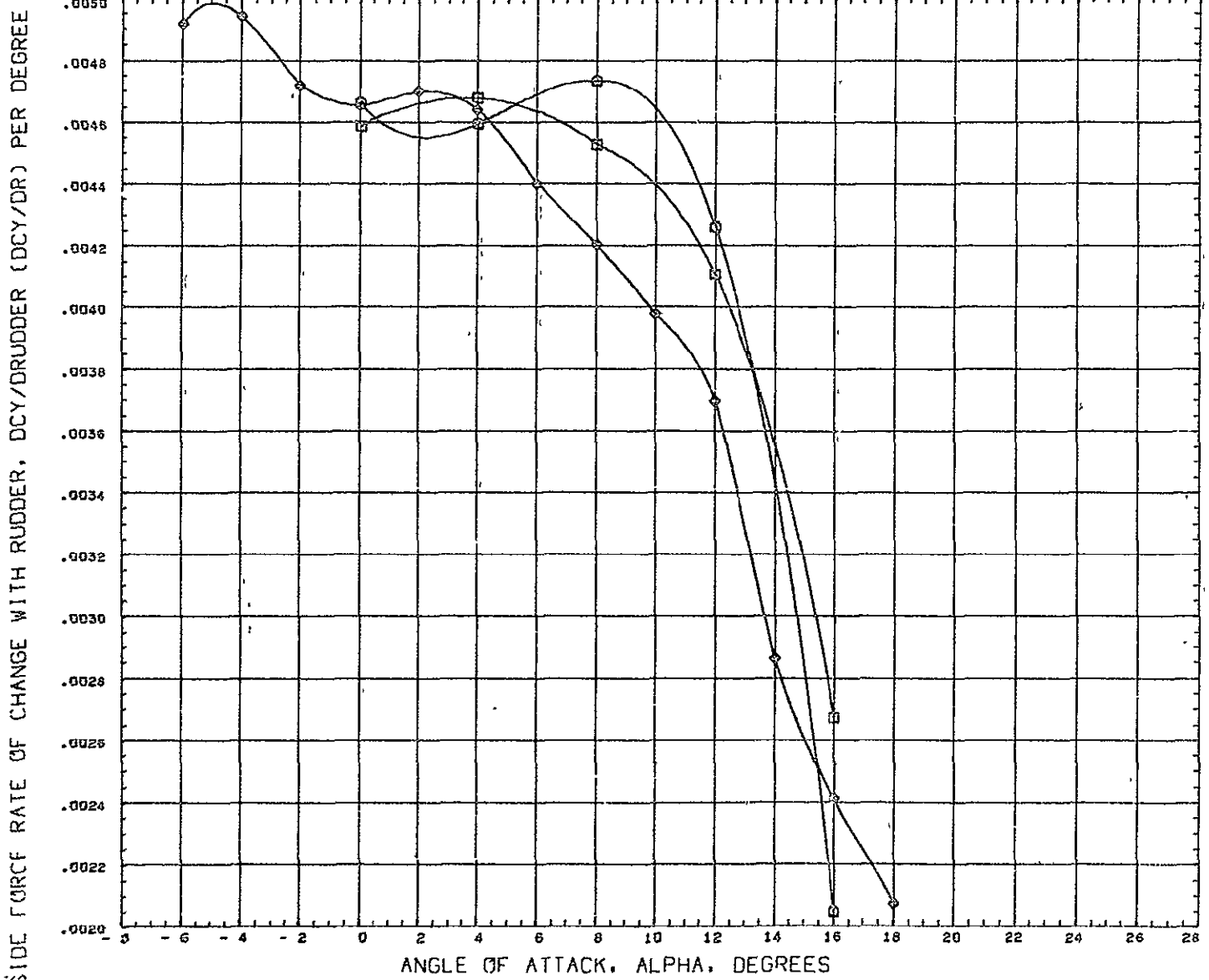

S7NBGL BETA PARAMETRIC VALUES  
 ○ - 8.000 MACH 0.184 ELEVTR 0.000  
 □ - 4.000 RUDVTR 5.000 FLAPS 45.000  
 ◇ 0.000 SPOILR 0.000

REFERENCE INFORMATION  
 REFS 316.2304 SQ IN  
 REFL 50.1900 IN  
 REFB 7.3500 IN  
 XMRP 23.3920 IN  
 YMPF 0.0000 IN  
 ZMRP 0.0000 IN  
 SCALE 0 0175

DATA HIST. CODE #F

DIR. CONTROL DERIVATIVES- STRAIGHT WING BASIC POS.- FLAPS AND GEAR- V-TAIL=55DEG

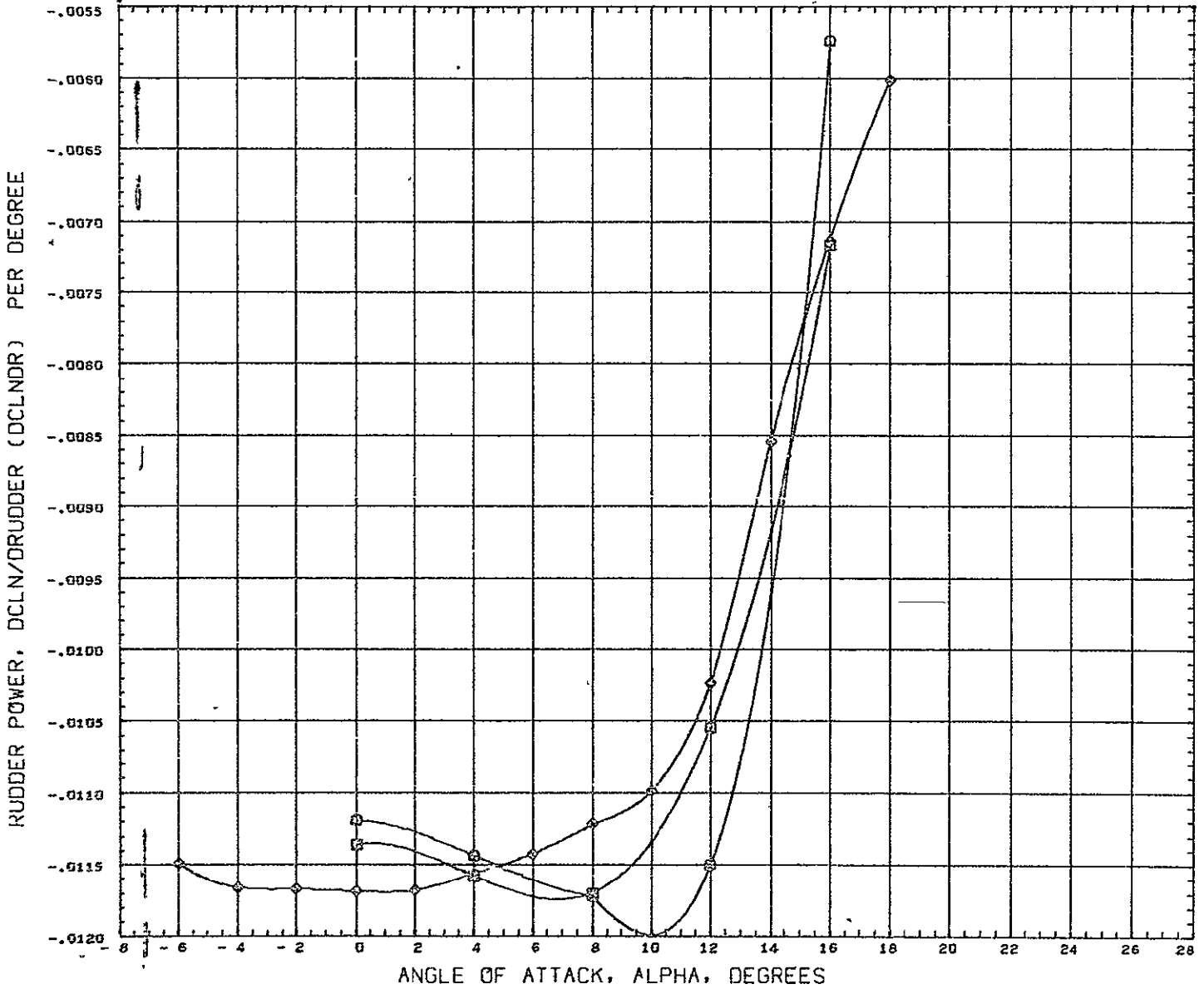

SYMBOL	BETA	PARAMETRIC VALUES				REFERENCE INFORMATION		
□	- 8.000	MACH	0.184	ELEVTR	0.000	REFS	316 2304	sq IN
◇	- 4.000	RUDVTR	0.000	FLAPS	45.000	REFL	50 1900	IN
○	0.000	SFOILR	0.000			REFB	7 3500	IN
						XMRP	29 3920	IN
						YMRP	0.0000	IN
						ZMRP	0.0000	IN
						SCALE	0.0175	

DATA HIST. CODE \*F

DIR. CONTROL DERIVATIVES- STRAIGHT WING BASIC POS.- FLAPS AND GEAR- V-TAIL=55DEG

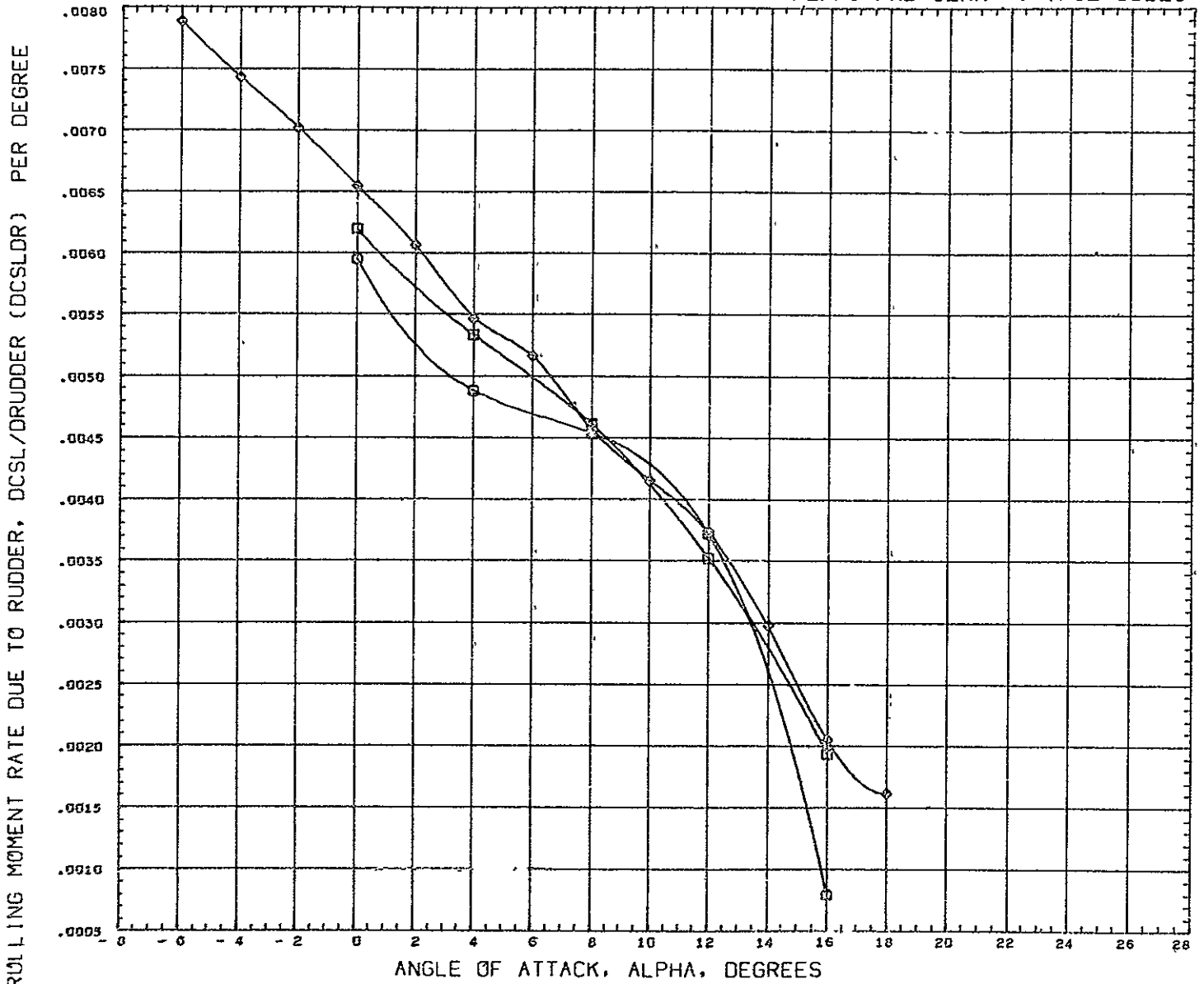

SYMBOL BETA PARAMETRIC VALUES

○	- 8.000	MACH	0.184	ELEVTF	0.000
□	- 4.000	FUDVTR	0.000	FLAFS	45.000
◇	0.000	SFOILR	0.000		

REFERENCE INFORMATION

REFS	316.2304	SQ IN
REFL	50.1900	IN
REFB	7.3500	IN
XMRP	29 3920	IN
YMRP	0 0000	IN
ZMRP	0 0000	IN
SCALE	0 0175	

DATA HIST. CODE #F

LONG. CHAR. - FLAP EFFECTIVENESS - ST. WING BASIC POS. - GEAR DOWN- V-TAIL=55DEG

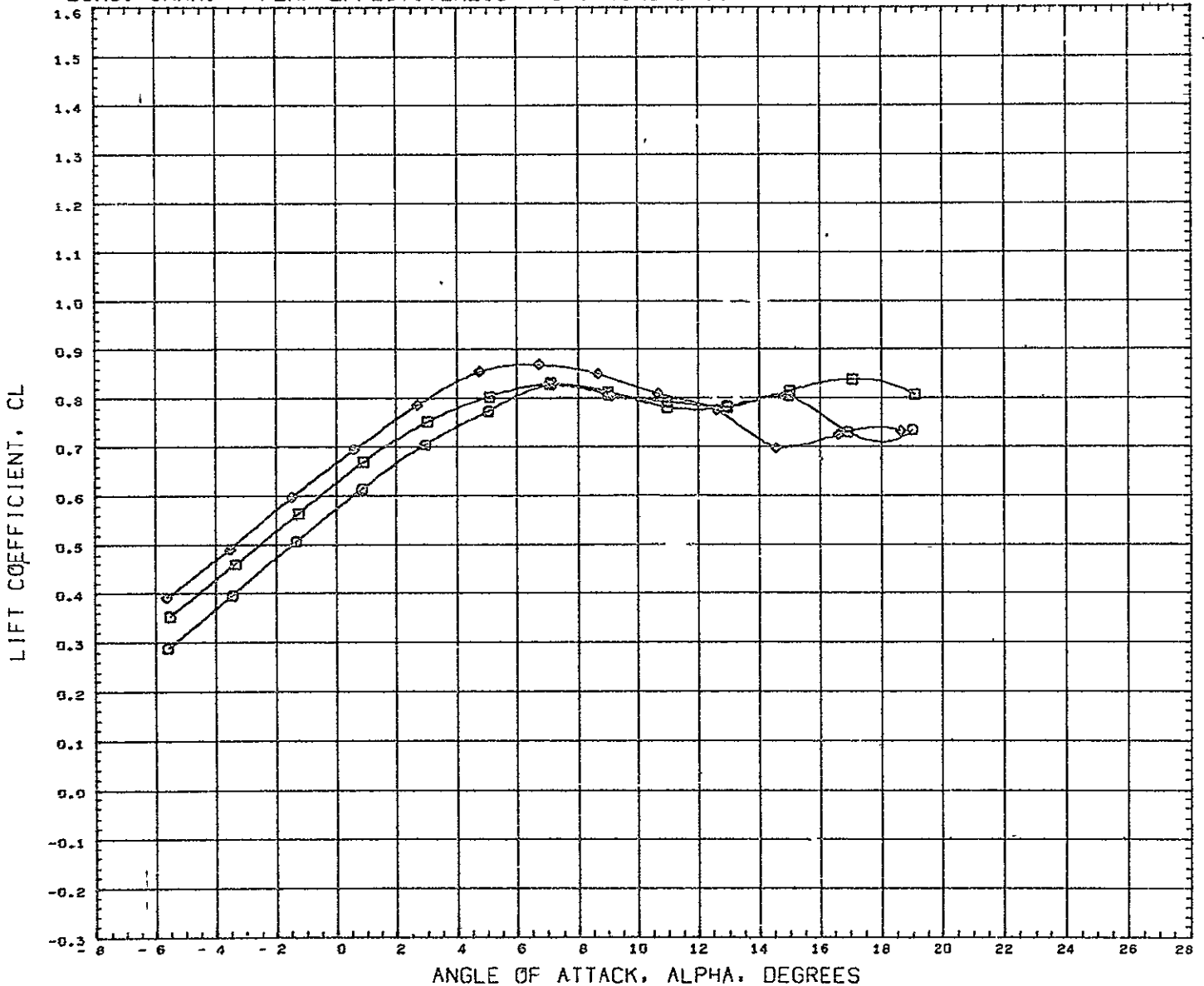

DATA SET SYMBOL	CONFIGURATION DESCRIPTION	PARAMETRIC VALUES			REFERENCE INFORMATION		
(TC7510)	○ FLAP DEFLECTION ANGLE = 25 DEG (MACH 0.259)	BETA	0.000	ELEVTR	0.000	REFS	316 2304 SQ IN
(TC7504)	□ FLAP DEFLECTION ANGLE = 35 DEG (MACH 0.259)	RUDVTR	0.000	SPOILR	0.000	REFL	50 1900 IN
(TC7511)	◇ FLAP DEFLECTION ANGLE = 45 DEG (MACH 0.184)					REFB	7.3500 IN
						XHRF	29.3920 IN
						YHRF	0.0000 IN
						ZHRF	0.0000 IN
						SCALE	0 0175

MACH 0.259

LONG. CHAR. - FLAP EFFECTIVENESS - ST. WING BASIC POS. - GEAR DOWN- V-TAIL=55DEG

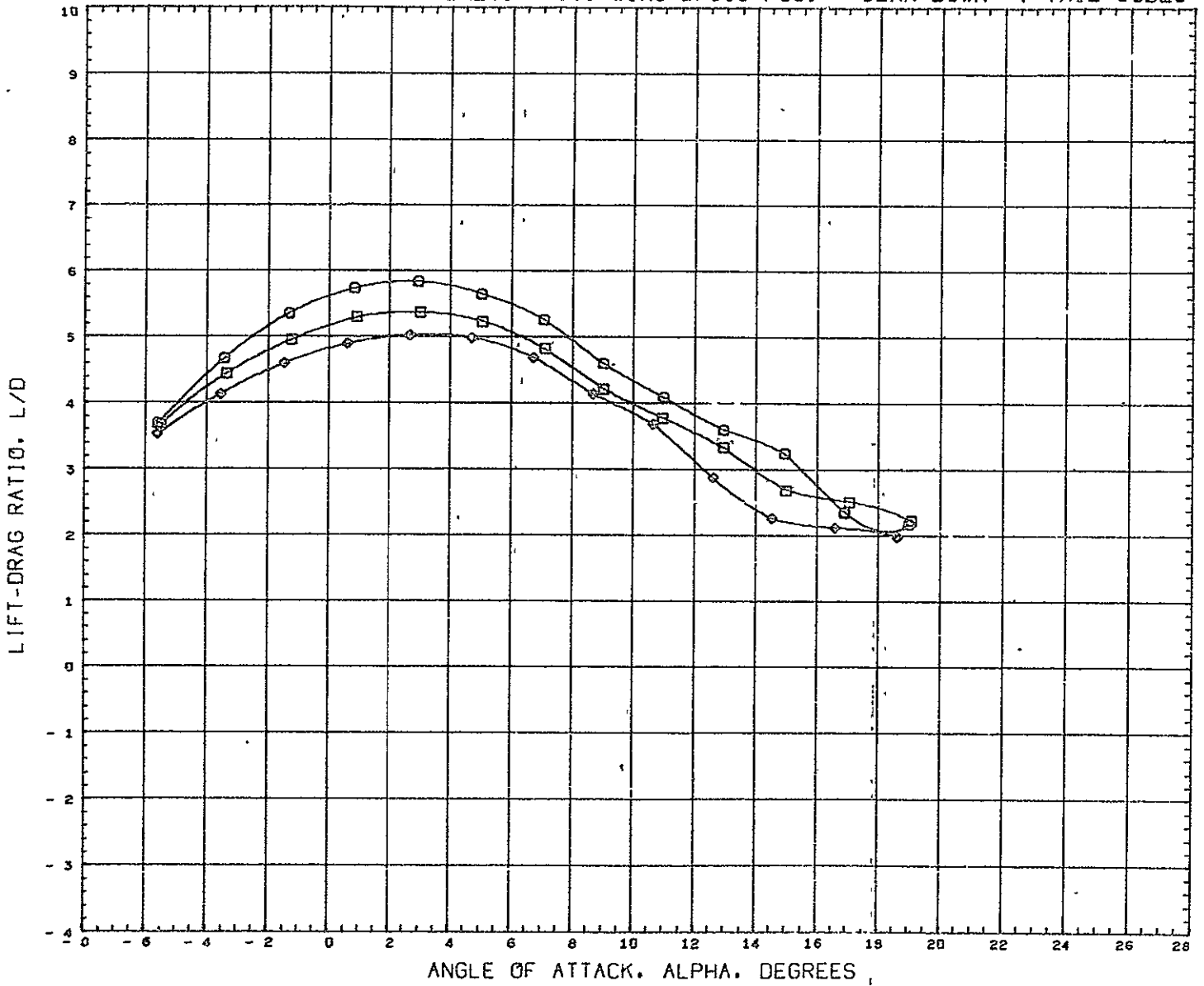

DATA SET SYMBOL	CONFIGURATION DESCRIPTION	PARAMETRIC VALUES	REFERENCE INFORMATION
(TC7010)	□ FLAP DEFLECTION ANGLE = 25 DEG (MACH 0.259)	BETA 0.000 ELEVTR 0.000	REFS 316.2304 SQ IN
(TC7004)	□ FLAP DEFLECTION ANGLE = 35 DEG (MACH 0.259)	RUDVTP 0.000 SPOILR 0.000	PEFL 50 1900 IN
(TC7011)	◇ FLAP DEFLECTION ANGLE = 45 DEG (MACH 0.184)		REFB 7 3500 IN
			XHRF 29.3920 IN
			YHRF 0 0000 IN
			ZHRF 0.0000 IN
			SCALE 0 0175

MACH 0.259

LONG. CHAR. - FLAP EFFECTIVENESS - ST. WING BASIC POS. - GEAR DOWN- V-TAIL=55DEG

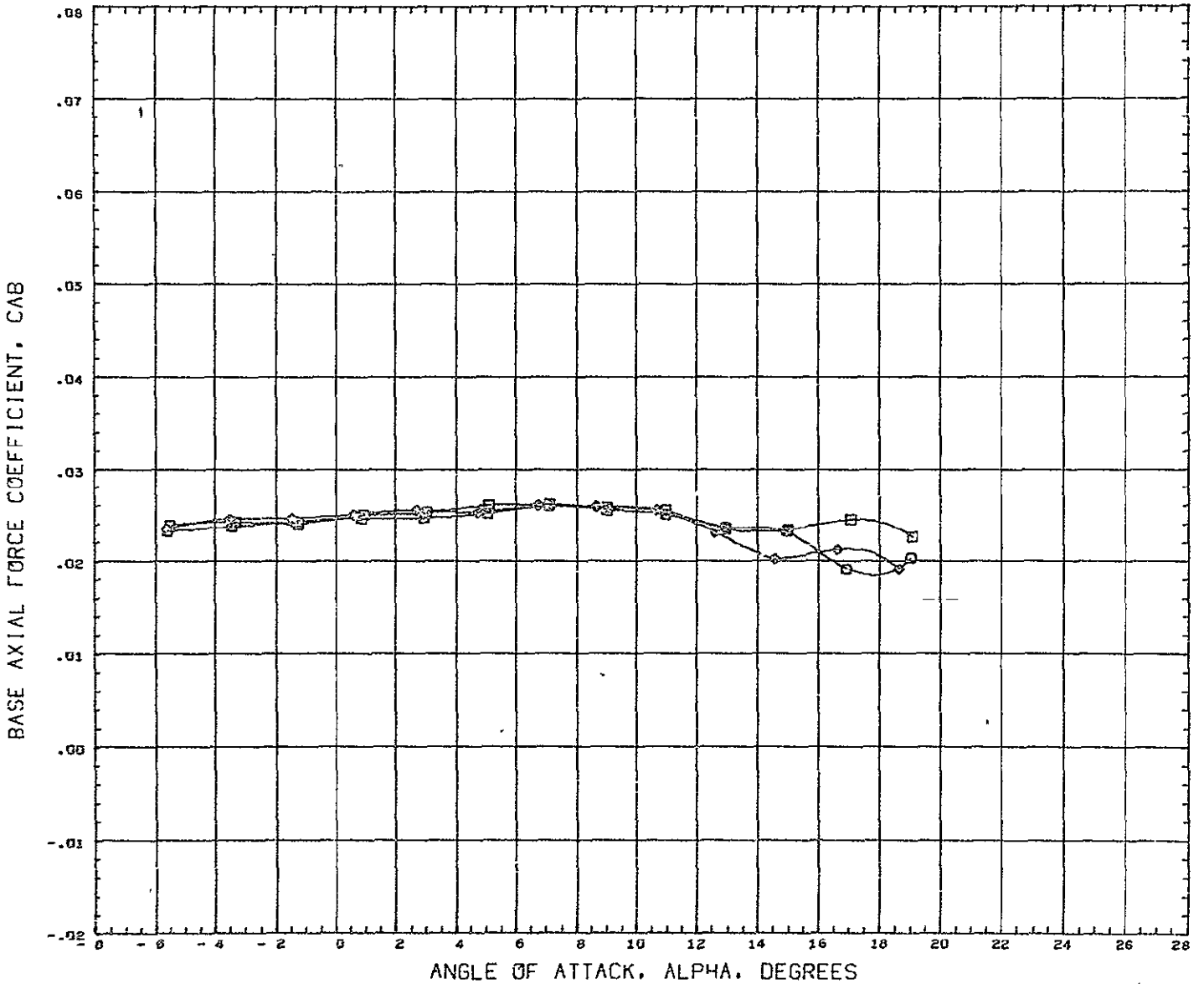

DATA SET SYMBOL	CONFIGURATION DESCRIPTION	PARAMETRIC VALUES	REFERENCE INFORMATION
(TC7010)	○ FLAP DEFLECTION ANGLE = 25 DEG (MACH 0.259)	BETA 0.000 ELEVTR 0.000	REFS 316.2304 SQ IN
(TC7004)	□ FLAP DEFLECTION ANGLE = 35 DEG (MACH 0.259)	RUDVTR 0.000 SPOILR 0.000	REFL 50.1300 IN
(TC7011)	◇ FLAP DEFLECTION ANGLE = 45 DEG (MACH 0.184)		REFB 7.3500 IN
			XHRF 29.3920 IN
			YHRF 0.0000 IN
			ZHRF 0.0000 IN
			SCALE 0.0175

MACH 0.259

LONG. CHAR. - FLAP EFFECTIVENESS - ST. WING BASIC POS. - GEAR DOWN- V-TAIL=55DEG

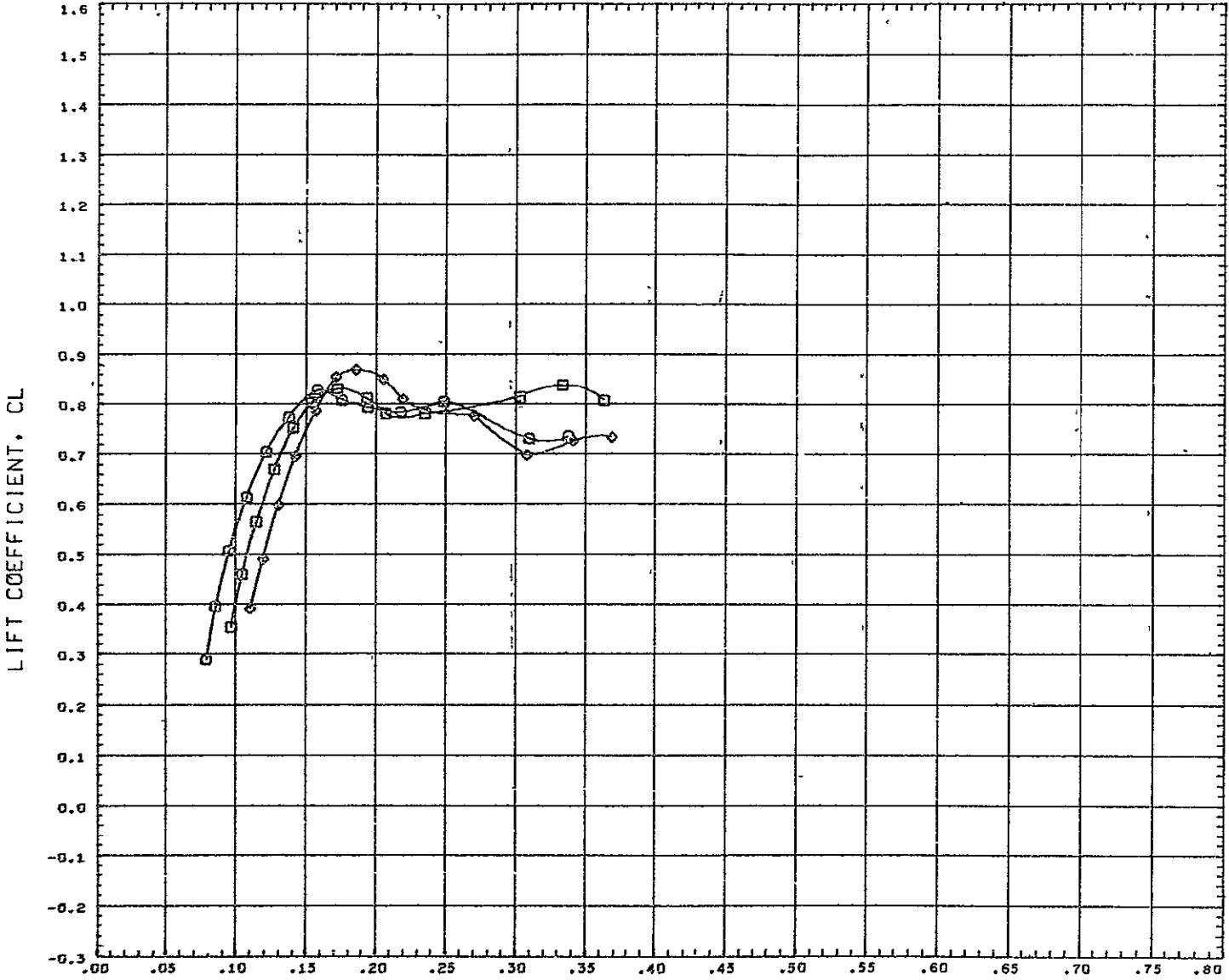

DATA SET SYMBOL	CONFIGURATION DESCRIPTION
(RC7010)	CVLSWT TEST 579-0 B1W1-15T1-55F1-25G1
(RC7004)	CVLSWT TEST 579-0 B1W1-15T1-55F1-35G1
(RC7011)	CVLSWT TEST 579-0 B1W1-15T1-55F1-45G1

PARAMETRIC VALUES	
BETA	0.000
ELEVTR	0.000
RUDVTR	0.000
FLAPS	25.000
SFOILR	0.000

REFERENCE INFORMATION	
REFS	316 2304 SQ IN
REFL	50 1900 IN
REFB	7 3500 IN
XMRP	29.3920 IN
YMRP	0.0000 IN
ZMRP	0.0000 IN
SCALE	0.0175

MACH 0.259

LONG. CHAR. - FLAP EFFECTIVENESS - ST. WING BASIC POS. - GEAR DOWN- V-TAIL=55DEG

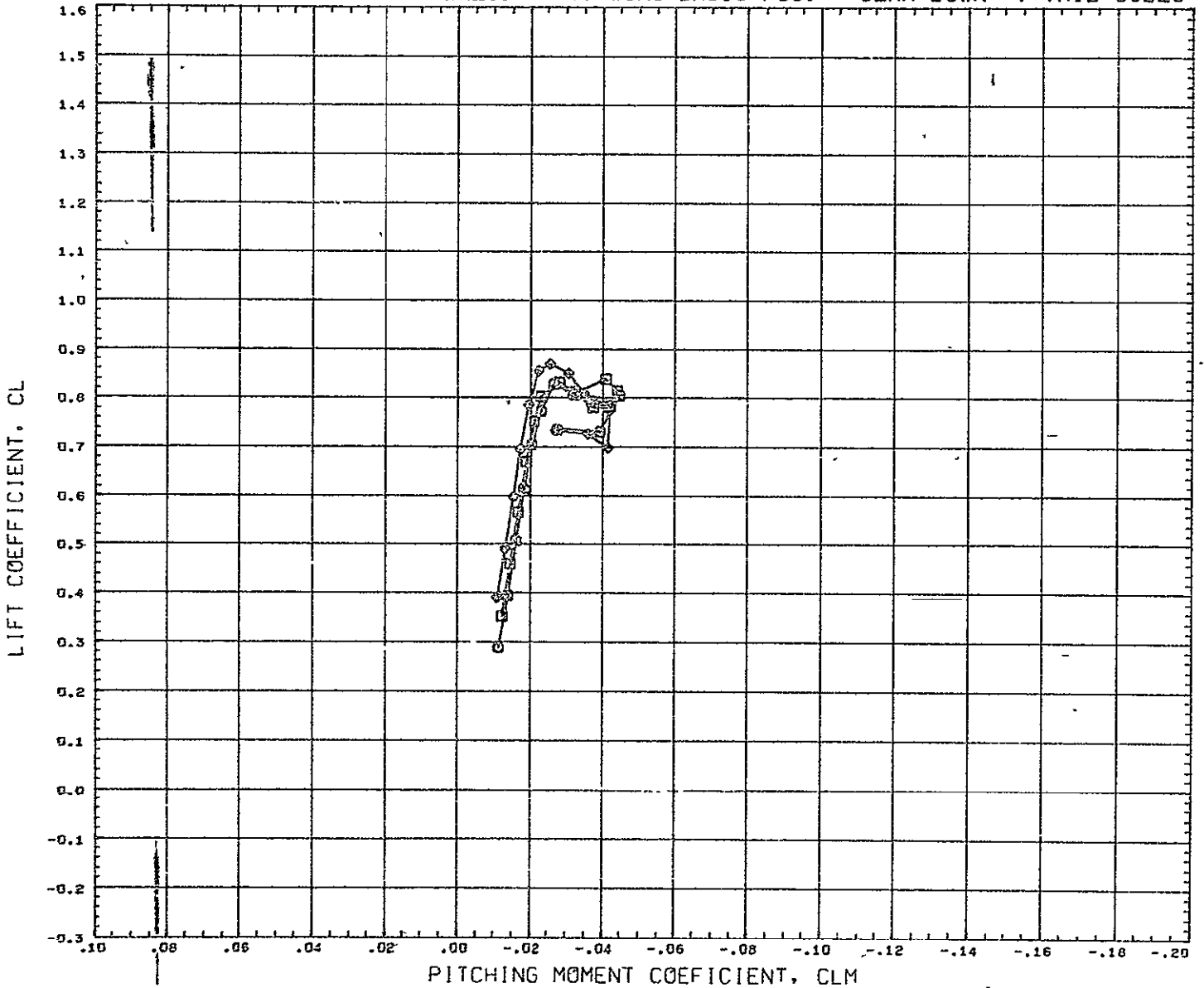

DATA SET SYMBOL	CONFIGURATION DESCRIPTION	PARAMETRIC VALUES				REFERENCE INFORMATION		
(RC7010)	□ CVLSWT TEST 579-D B1W1-15T1-55F1-2501	DETA	0.000	ELEVTR	0.000	REFS	316 2304	SQ IN
(RC7004)	□ CVLSWT TEST 579-D B1W1-15T1-55F1-3501	RUDVTR	0.000	FLAPS	25.000	REFL	50 1900	IN
(RC7011)	○ CVLSWT TEST 579-D B1W1-15T1-55F1-4501	SFOILR	0.000			REFB	7 3500	IN
						XHRF	29 3920	IN
						YHRF	0 0000	IN
						ZHRF	0 0000	IN
						SCALE	5 0175	

MACH 0.259



LONG. CHAR. - FLAP EFFECTIVENESS - STRAIGHT WING AFT - V-TAIL=55DEG

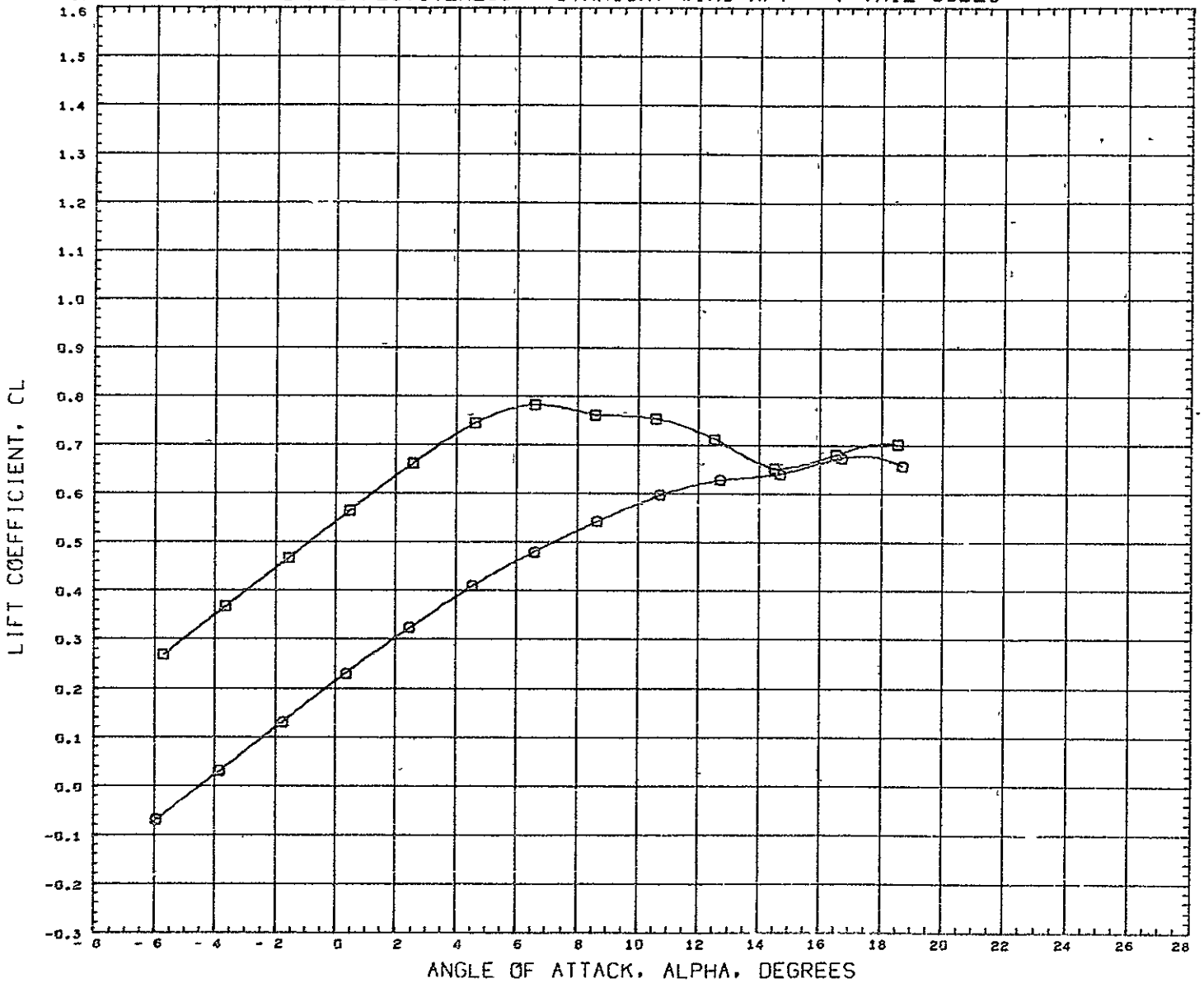

DATA SET SYMBOL	CONFIGURATION DESCRIPTION	PARAMETRIC VALUES	REFERENCE INFORMATION
(TC7132)	○ FLAP DEFLECTION ANGLE = 0 DEG (MACH 0.259)	BETA 0.000 ELEVTR - 10.000	PEFS 316.2304 SQ IN
(TC7133)	□ FLAP DEFLECTION ANGLE = 35 DEG (MACH 0.164)	RUDVTR 0.000 SFOILR 0.000	REFL 50.1900 IN
			REFB 7.3500 IN
			XMRP 29.3920 IN
			YMRP 0.0000 IN
			ZMRP 0.0000 IN
			SCALE 0.0175

MACH 0.259

LONG. CHAR. - FLAP EFFECTIVENESS - STRAIGHT WING AFT - V-TAIL=55DEG

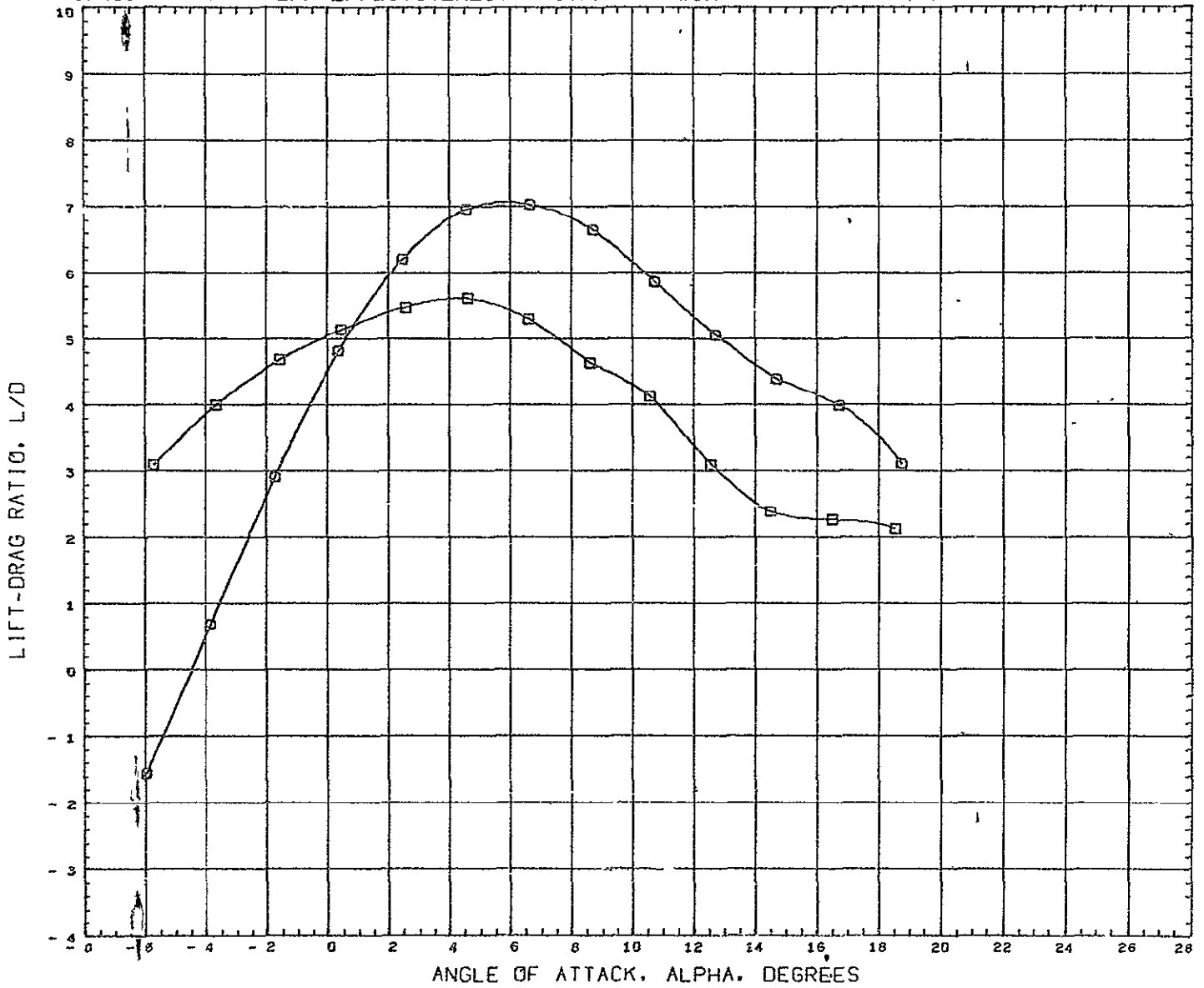

DATA SET SYMBOL	CONFIGURATION DESCRIPTION	PARAMETRIC VALUES		REFERENCE INFORMATION				
(TC7132)	FLAP DEFLECTION ANGLE = 0 DEG (MACH 0.259)	BETA	0.000	ELEVTR	- 10.000	REFS	316 2304	SQ IN
(TC7133)	FLAP DEFLECTION ANGLE = 35 DEG (MACH 0.184)	RUDVTR	0.000	SFOILR	0.005	REFL	50 1900	IN
						REFB	7 3500	IN
						XMRP	29 3920	IN
						YMRP	0.0000	IN
						ZMRP	0.0000	IN
						SCALE	0.0175	

MACH 0.259

LONG. CHAR. - FLAP EFFECTIVENESS - STRAIGHT WING AFT - V-TAIL=55DEG.

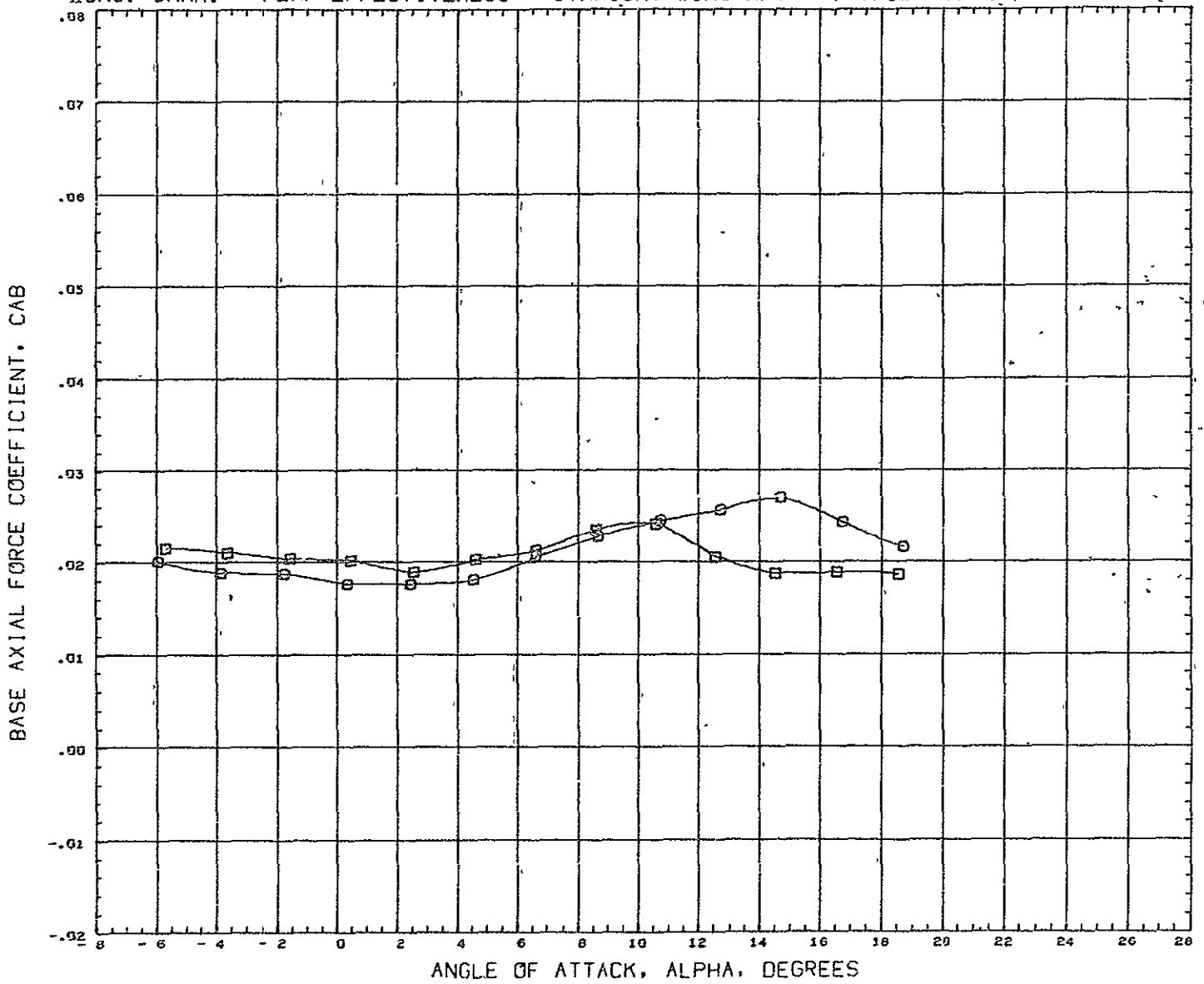

DATA SET SYMBOL	CONFIGURATION DESCRIPTION	PARAMETRIC VALUES	REFERENCE INFORMATION
(TC7132)	FLAP DEFLECTION ANGLE = 0 DEG (MACH 0.259)	BETA 0.000 ELEVTR - 10 000	REFS 316 2364 SQ IN
(TC7133)	FLAP DEFLECTION ANGLE = 35 DEG (MACH 0.184)	RUDYTR 0.000 SPOILR 0 000	REFL 50 1900 IN
			REFB 7.3500 TN
			XHRF 29.3920 IN
			YHRF 0.0000 IN
			ZHRF 0.0000 IN
			SCALE 0.0175

MACH 0.259

LONG. CHAR. - FLAP EFFECTIVENESS - STRAIGHT WING AFT - V-TAIL=55DEG

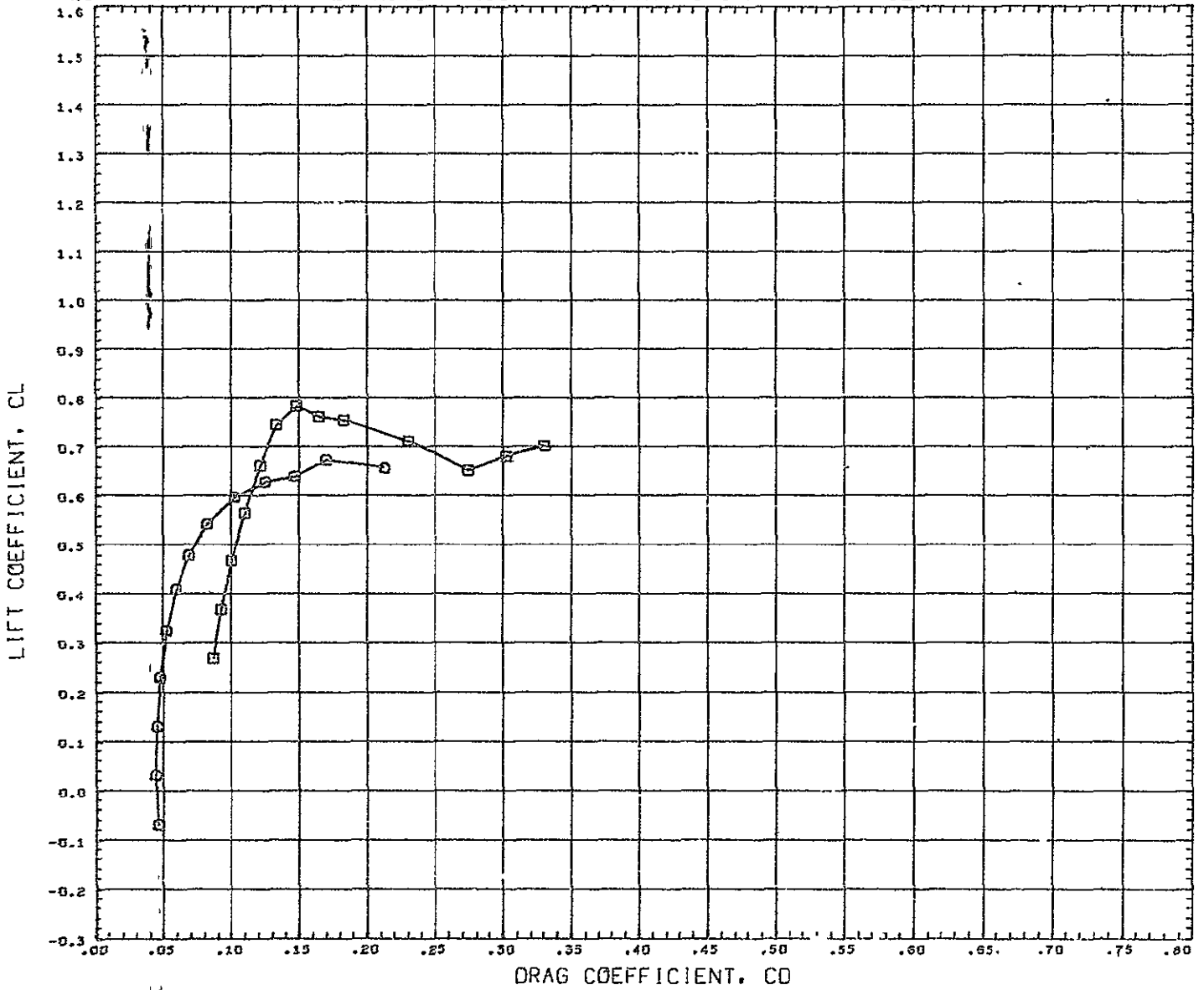

DATA SET SYMBOL	CONFIGURATION DESCRIPTION	PARAMETRIC VALUES			REFERENCE INFORMATION			
(RC7132)	CVLSWT TEST 579-G B1W3AT1-55	BETA	0.000	ELEVTR	- 10 000.	REFS	316 2304	SQ IN
(RC7133)	CVLSWT TEST 579-G B1W3AT1-55F1-35	RUDVTR	0 000	FLAPS	0.000	REFL	50.1900	IN
		SPOILR	0.000			REFB	7 3500	IN
						XNRF	29.3920	IN
						YNRF	0.0000	IN
						ZNRF	0 0000	IN
						SCALE	0.0175	

MACH 0.259

LONG. CHAR. - FLAP EFFECTIVENESS - STRAIGHT WING AFT - V-TAIL=55DEG

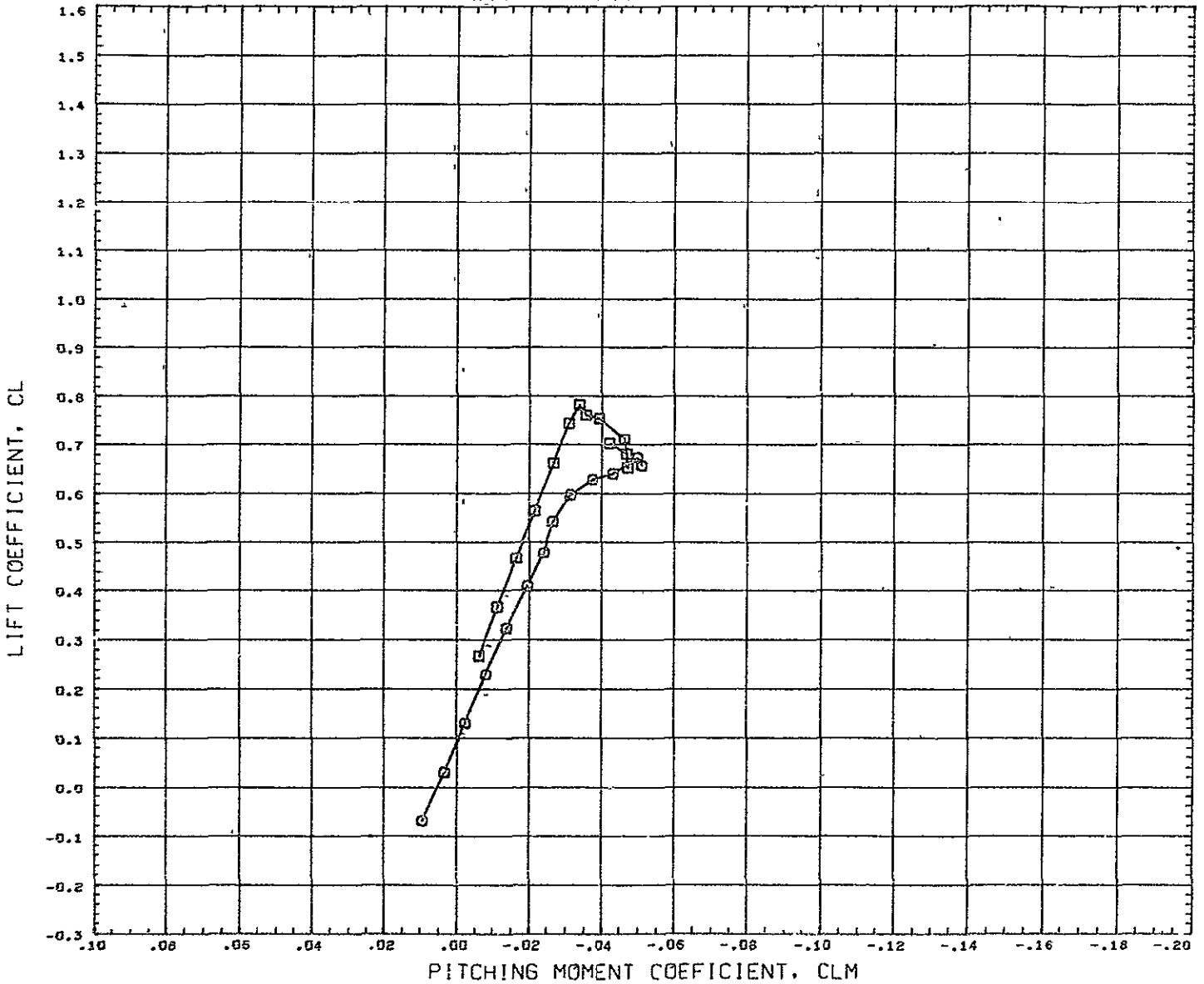

DATA SET SYMBOL    CONFIGURATION DESCRIPTION  
 (RC7132)    □    CVLSWT TEST 579-G B1W3AT1-55  
 (RC7133)    □    CVLSWT TEST 579-G B1W3AT1-55F1-35

PARAMETRIC VALUES  
 BETA    0.000    ELEVTR - 10.000  
 RUDVTR    0.000    FLAPS    0.000  
 SFOILR    0.000

REFERENCE INFORMATION  
 REFS    316 2304    SQ IN  
 REFL    50.1900    IN  
 REFB    7 3500    IN  
 XMRP    29 3920    IN  
 YMRP    0.0000    IN  
 ZMRP    0 0000    IN  
 SCALE    0 0175

MACH    0 259

LONG. CHAR. - SPOILER EFFECTIVENESS- ST. WING BASIC POS. - GEAR DOWN- V-TAIL=55DEG

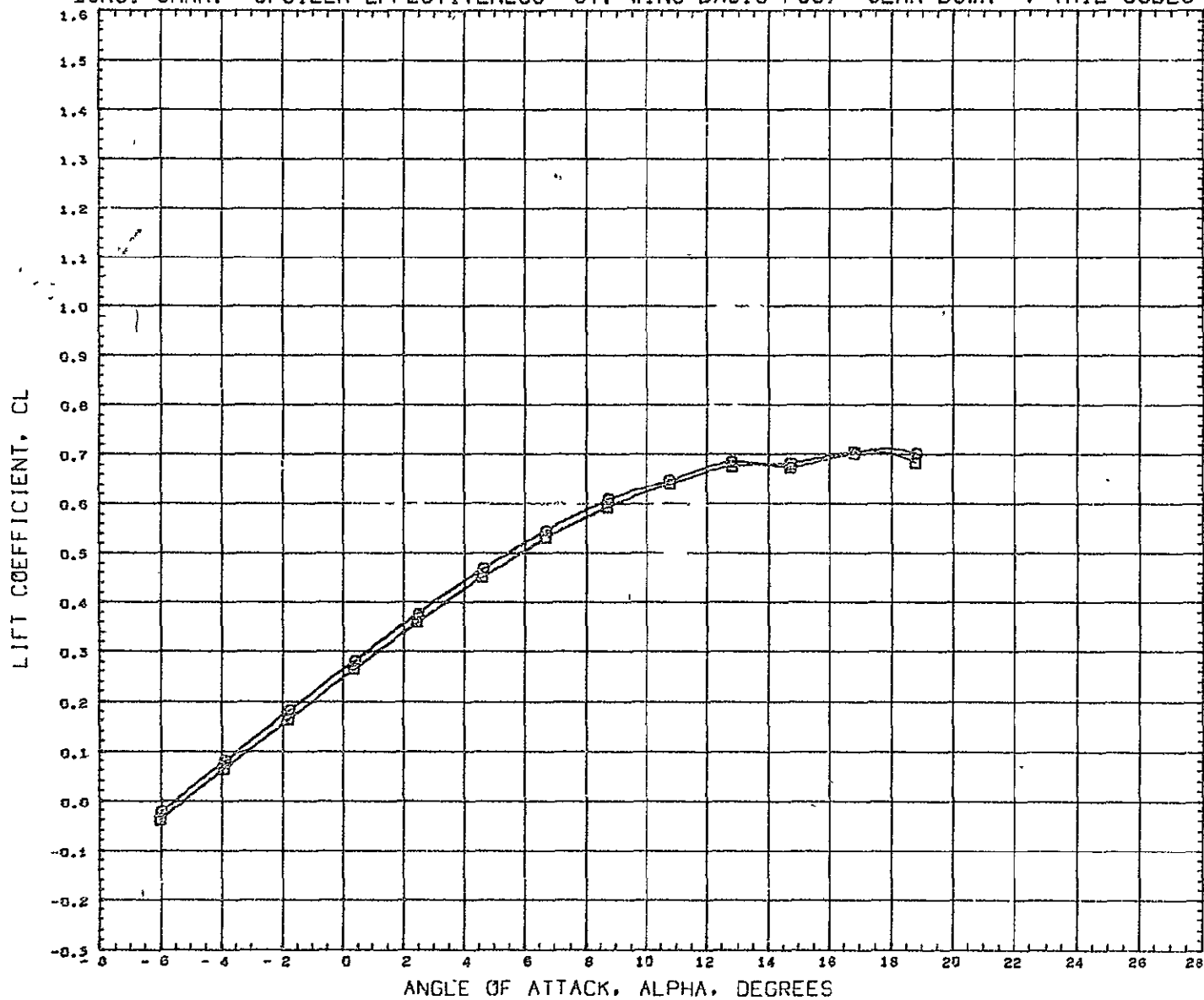

SYMBOL	SPOILER	PARAMETRIC VALUES			
○	30.000	MACH	0.259	BETA	0.000
□	60.000	ELEVTR	0.000	RUCVTR	0.000
		FLAPS	0.000		

REFERENCE INFORMATION		
REFS	316.2304	60 IN
REFL	50.1900	IN
REFB	7.3500	IN
XMRP	29.3520	IN
YMRP	0.0000	IN
ZMRP	0.0000	IN
SCALE	0.0175	

REFERENCE FILE CONVAIR T170-AE-12

LONG. CHAR.- SFOILER EFFECTIVENESS- ST. WING BASIC POS.- GEAR DOWN- V-TAIL=55DEG

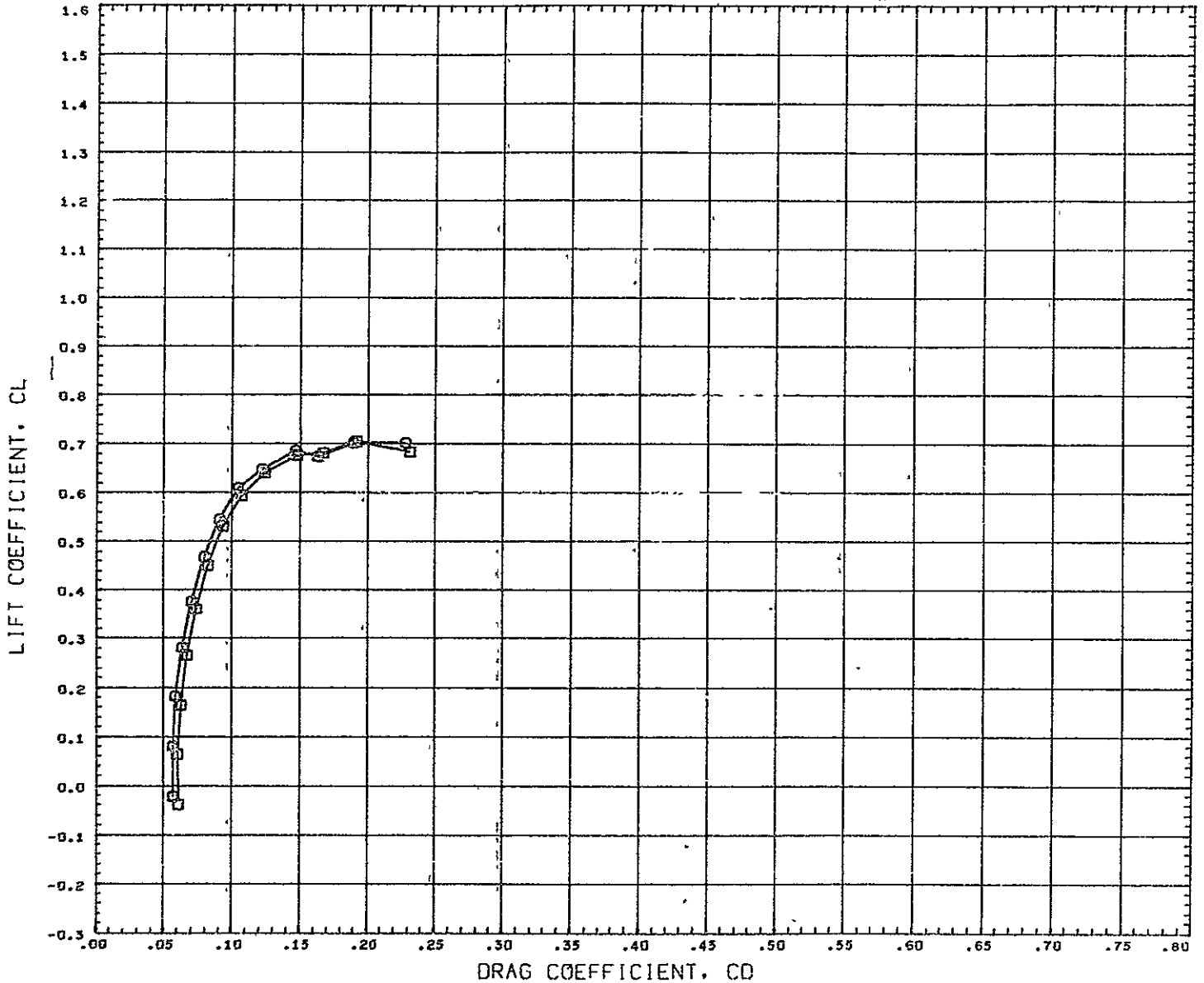

SYMBOL		SFOILER		PARAMETRIC VALUES				REFERENCE INFORMATION		
○	30.000	MACH	0.259	BETA	0.000	REFS	316.2304	SQ	IN	
□	60.000	ELEVTR	0.000	RUCVTF	0.000	REFL	50.1900	IN		
		FLAPS	0.000			REFS	7.3500	IN		
						XMRP	29.3920	IN		
						YMRP	0.0000	IN		
						ZMRP	0.0000	IN		
						SCALE	0.0175			

REFERENCE FILE      CONVAIR TN70-AE-12

LONG. CHAR.- SPOILER EFFECTIVENESS- ST. WING BASIC POS.- GEAR DOWN- V-TAIL=55DEG

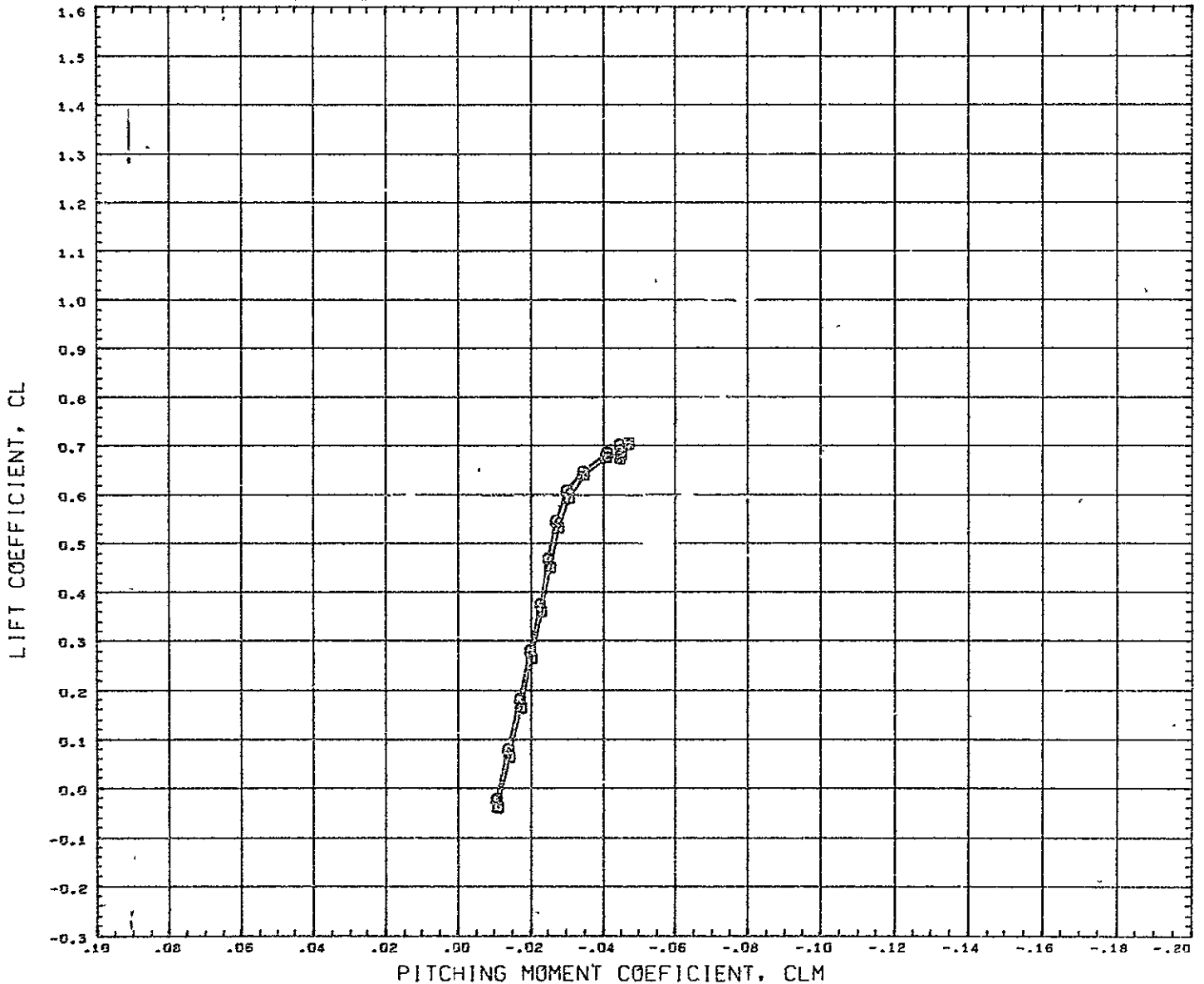

SYMBOL	SPOILER	PARAMETRIC VALUES			
○	30.000	MACH	0.259	BETA	0.000
□	60.000	ELEVTR	0.000	RUDVTR	0.000
		FLAPS	0.000		

REFERENCE INFORMATION		
REFS	316.2304	50 IN
REFL	50.1900	IN
REFB	7.3500	IN
XMRP	29.3920	IN
YMRP	0.0000	IN
ZMRP	0.0000	IN
SCALE	0.0175	

REFERENCE FILE      CONVAIR T70-AE-12



LAT. CHAR. - SPOILER EFFECTIVENESS - ST. WING BASIC POS. - GEAR DOWN - V-TAIL=55DEG

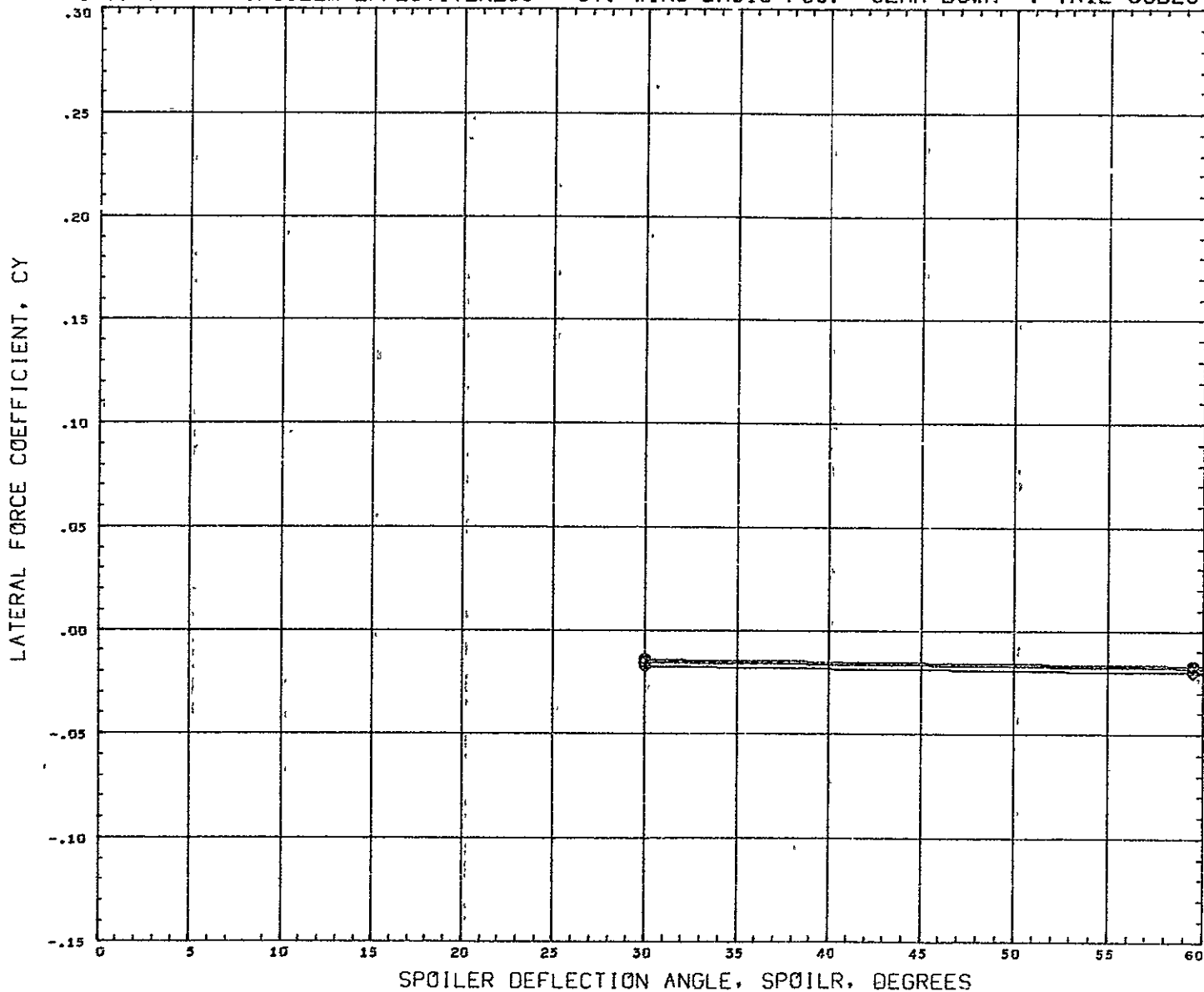

SYMBOL		ALPHA	PARAMETRIC VALUES				REFERENCE INFORMATION		
○		0.000	MACH	0.259	BETA	0.000	REFS	316 2304	50 IN
□		4.000	ELEVTR	0.000	RUDVTR	0.000	REFL	50 1900	IN
◇		8.000	FLAPS	0.000			REFS	7.3500	IN
							XMPF	29.3920	IN
							YHRF	0.0000	IN
							ZHRF	0.0000	IN
							SCALE	0.0175	

DATA HIST. CODE I

LAT. CHAR.- SPOILER EFFECTIVENESS - ST. WING BASIC POS.- GEAR DOWN- V-TAIL=55DEG

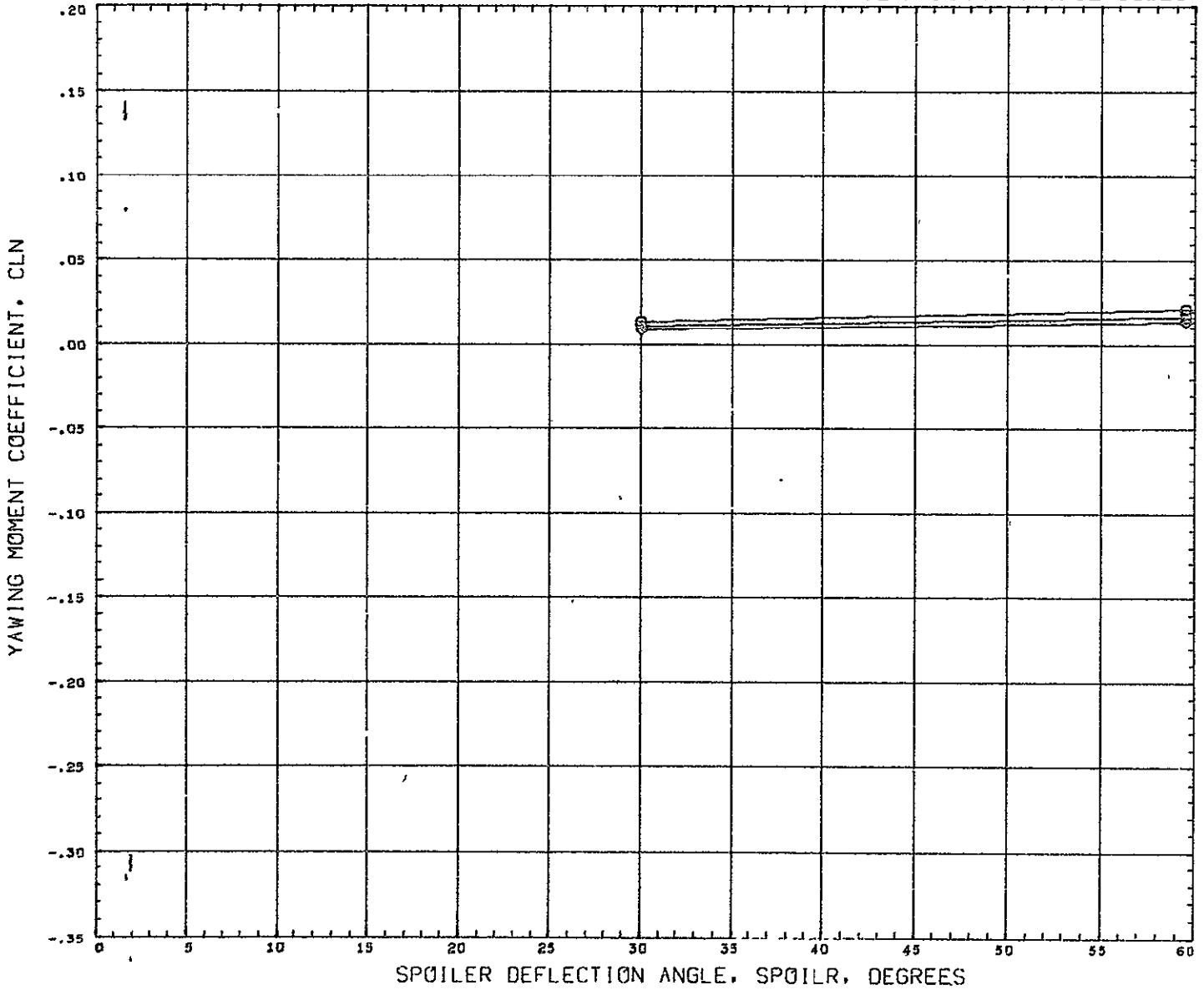

SYMBOL	ALPHA	PARAMETRIC VALUES				REFERENCE INFORMATION		
		MACH	BETA	FUDVTR	REFS	SQ	IN	
○	0.000	0.259	0.000	0.000	316.2304			
□	4.000	0.000	0.000	0.000	50.1900	IN		
◇	8.000	0.000	0.000	0.000	7.3500	IN		
					29.3920	IN		
					0.0000	IN		
					0.0000	IN		
					0.0175			

DATA HIST. CODE 1

LAT. CHAR. - SPOILER EFFECTIVENESS - ST. WING BASIC POS. - GEAR DOWN - V-TAIL=55DEG

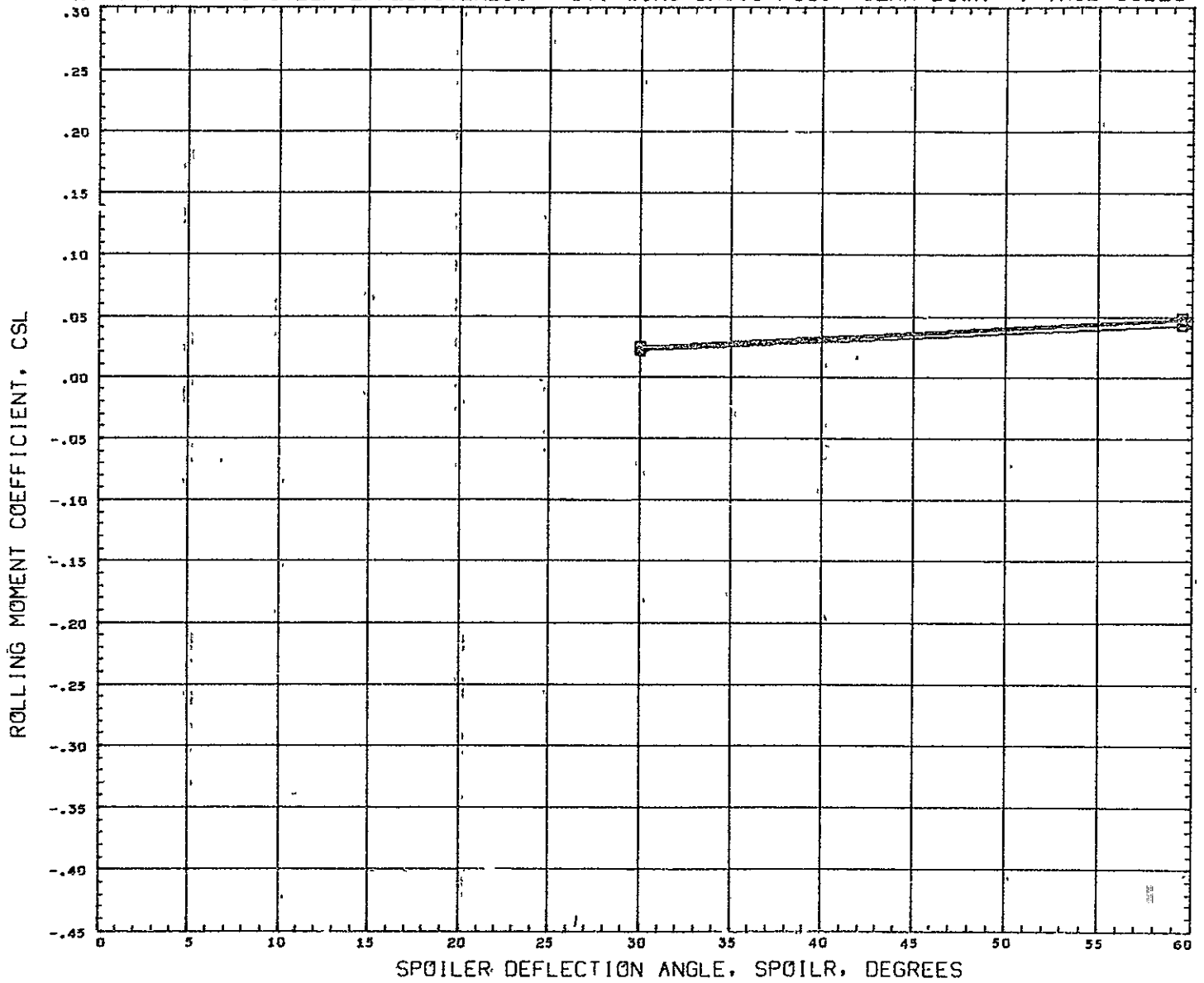

SYMBOL	ALPHA	MACH	PARAMETRIC VALUES			REFERENCE INFORMATION		
			BETA	ELEVTR	RUDVTR	REFS	REFL	SQ IN
○	0.000		0.259	0.000	0.000		316.2304	IN
□	4.000		0.000	0.000	0.000		50.1900	IN
◇	8.000		0.000				7.3500	IN
		FLAPS					29.3920	IN
							0.0000	IN
							0.0000	IN
							0.0175	IN

DATA HIST. CODE 1

LONG. CHAR. - SPOILER EFF. - ST. WING BASIC POS. - FLAPS AND GEAR - V-TAIL=55DEG

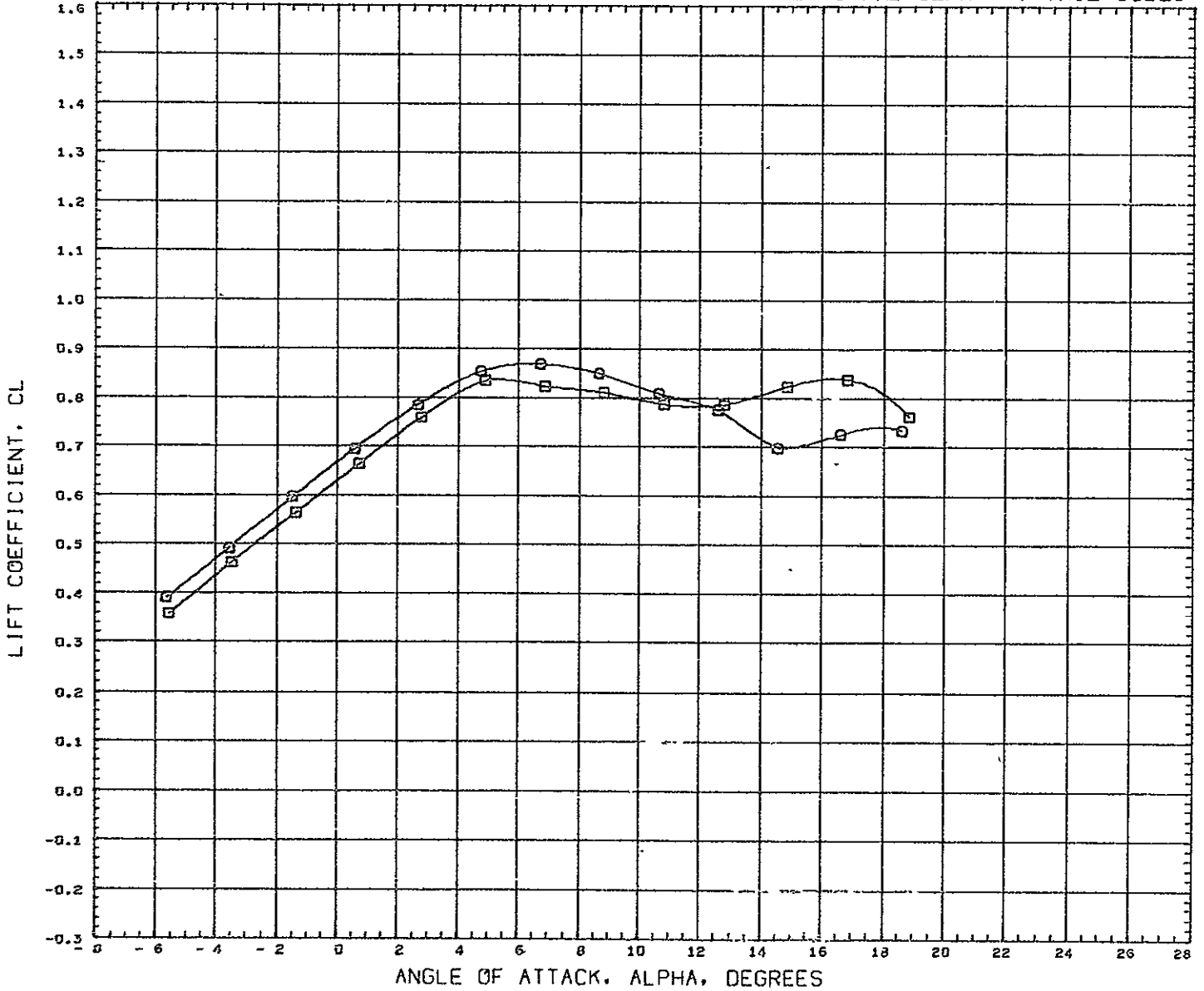

SYMBOL	SPOILER	PARAMETRIC VALUES			
○	0.000	MACH	0.184	BETA	0.000
□	30.000	ELEVTR	0.000	RUDVTR	0.000
		FLAPS	45.000		

REFERENCE INFORMATION		
REFS	316 2304	SQ IN
REFL	50.1900	IN
REFB	7.3500	IN
XMRP	29.3920	IN
YMRP	0.0000	IN
ZMRP	0.0000	IN
SCALE	0.0175	

REFERENCE FILE CONVAIR T170-AE-12

LONG. CHAR. - SPOILER EFF. - ST. WING BASIC POS. - FLAPS AND GEAR - V-TAIL=55DEG

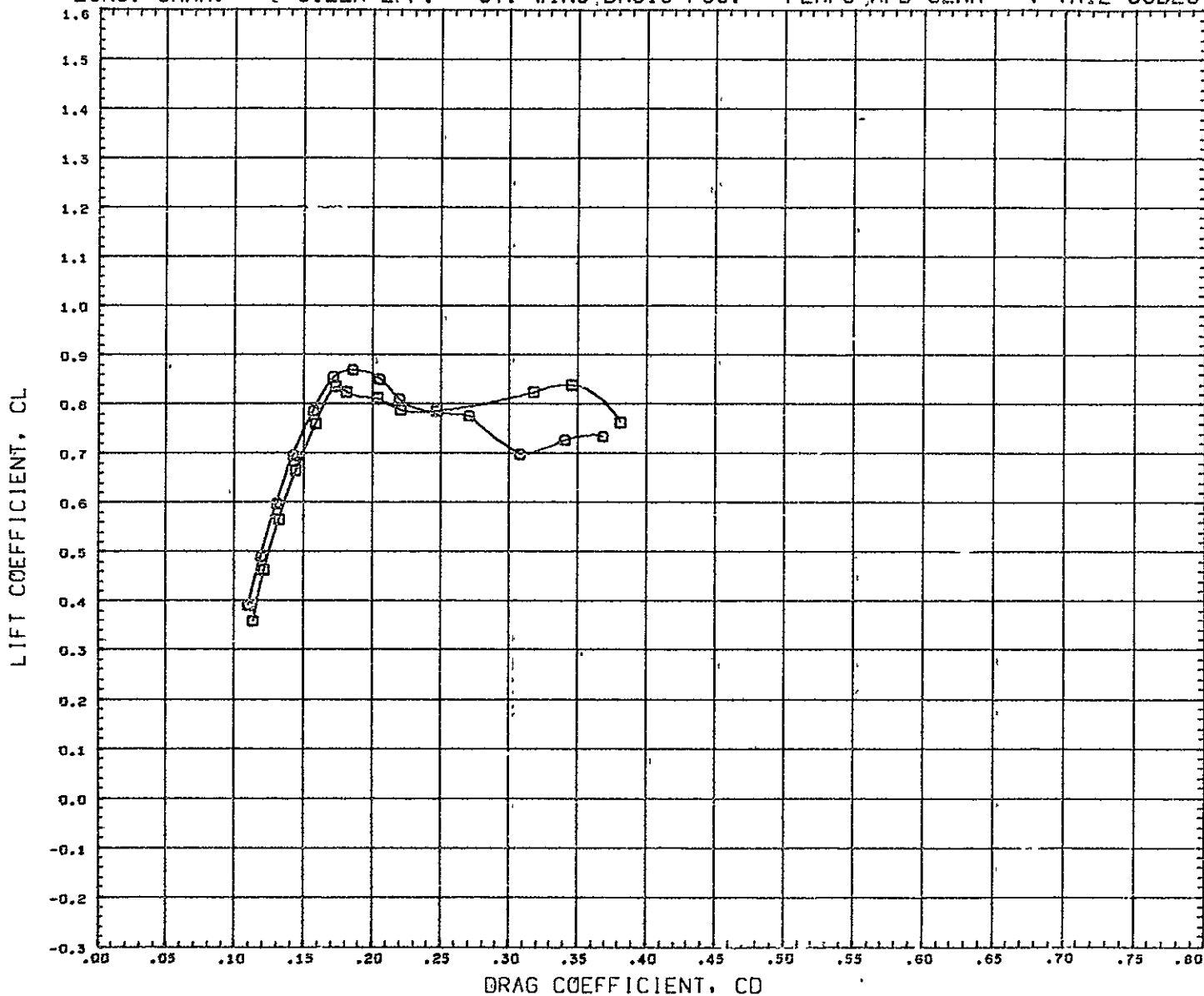

SYMBOL		PARAMETRIC VALUES				REFERENCE INFORMATION		
○	0.000	MACH	0.184	BETA	0.000	REFS	316 2304	SQ IN
□	35.000	ELEVTR	0.000	RUDVTR	0.000	REFL	50.1900	IN
		FLAPS	45.000			REFB	7.3500	IN
						XMRP	29.3920	IN
						YMRP	0.0000	IN
						ZMRP	0.0000	IN
						SCALE	0 0175	

REFERENCE FILE      CONVAIR TN70-AE-12

LONG. CHAR. - SPOILER EFF. - ST. WING BASIC POS. - FLAPS AND GEAR - V-TAIL=55DEG

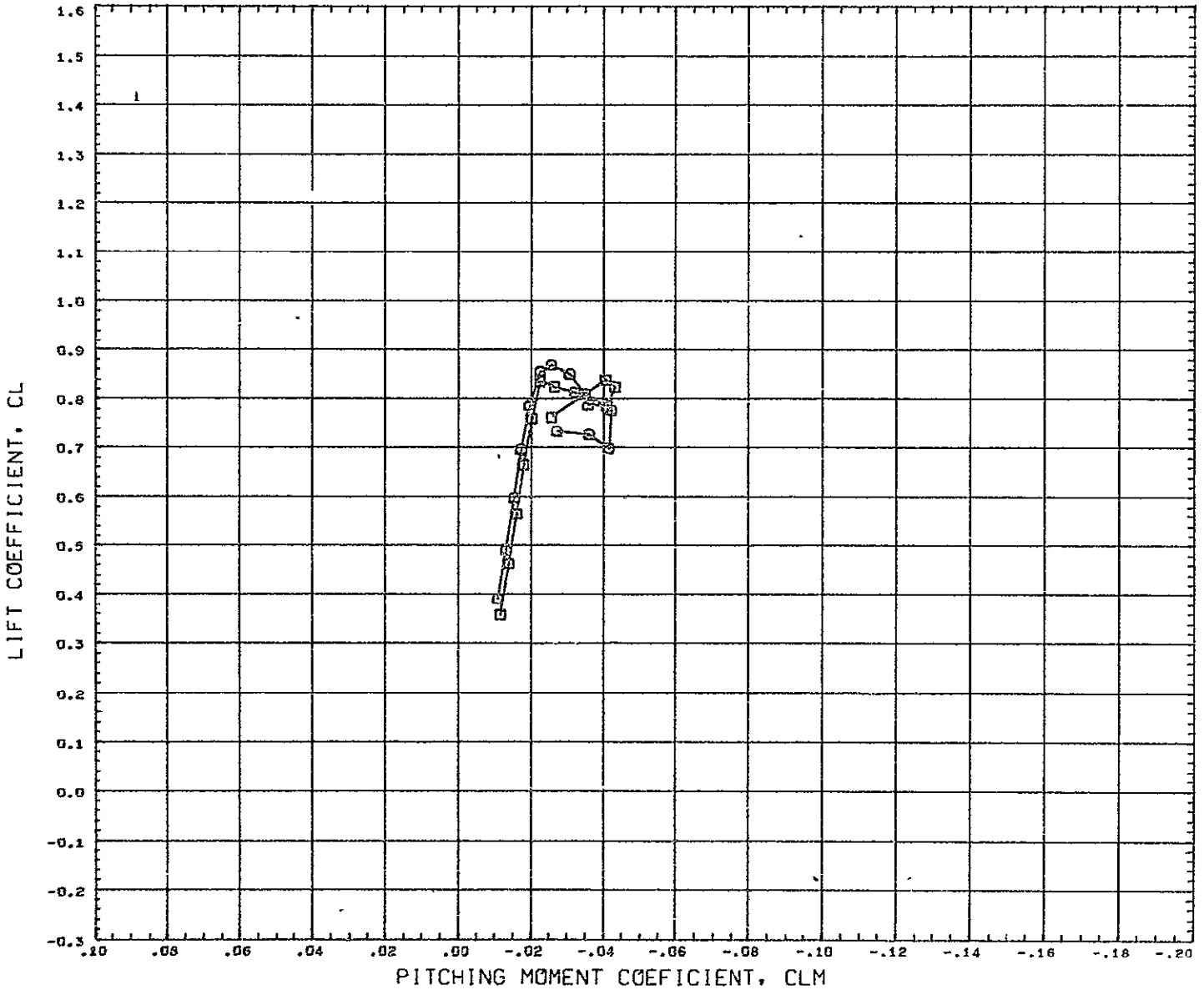

SYMBOL	SPOILER	PARAMETRIC VALUES			
○	0.000	HACH	0.184	BETA	0.000
□	30.000	ELEVTR	0.000	RUDVTR	0.000
		FLAPS	45.000		

REFERENCE INFORMATION		
REFS	316 2304	SQ IN
REFL	50 1900	IN
REFB	7.3500	IN
XMRP	29 3920	IN
YMRP	0.0000	IN
ZMRP	0.0000	IN
SCALE	0.0175	

REFERENCE FILE CONVAIR TN75-AE-12

LATERAL CHAR. - SPOILER EFF. - ST. WING BASIC POS. - FLAPS AND GEAR - V-TAIL=55DEG

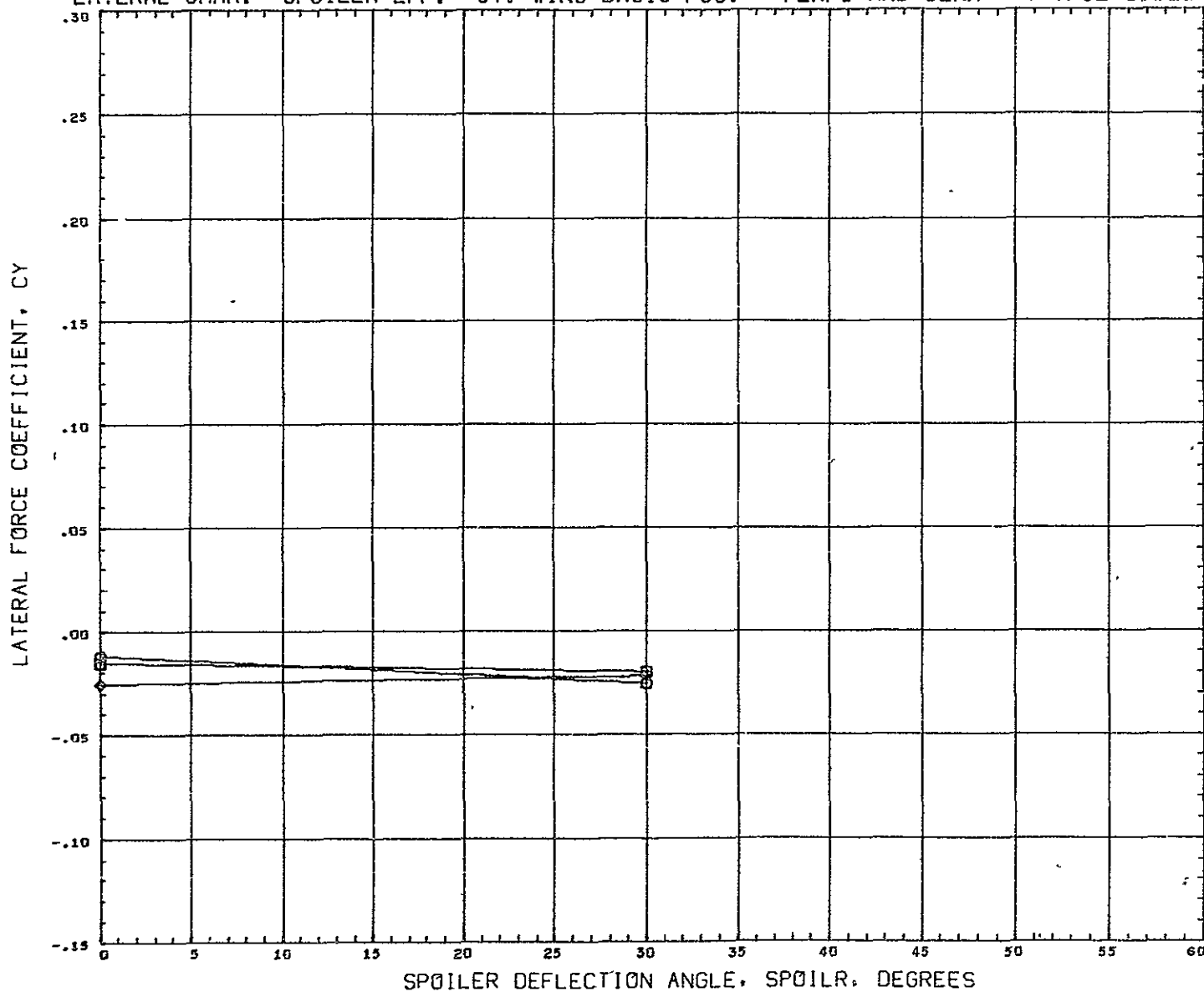

SYMBOL	ALPHA	PARAMETRIC VALUES				REFERENCE INFORMATION		
		MACH	BETA	RUDVTR	REFS	SQ	IN	
□	0.000	0.184	0.000	0.000	316.2304			
◇	4.000	0.000	0.000	0.000	50.1900			
○	0.000	45.000			7.3500			
					XNRF	29.3920	IN	
					YNRF	0.0000	IN	
					ZNRF	0.0000	IN	
					SCALE	0.0175		

DATA HIST. CODE I

LATERAL CHAR.- SPOILER EFF.- ST. WING BASIC POS. - FLAPS AND GEAR - V-TAIL=55DEG

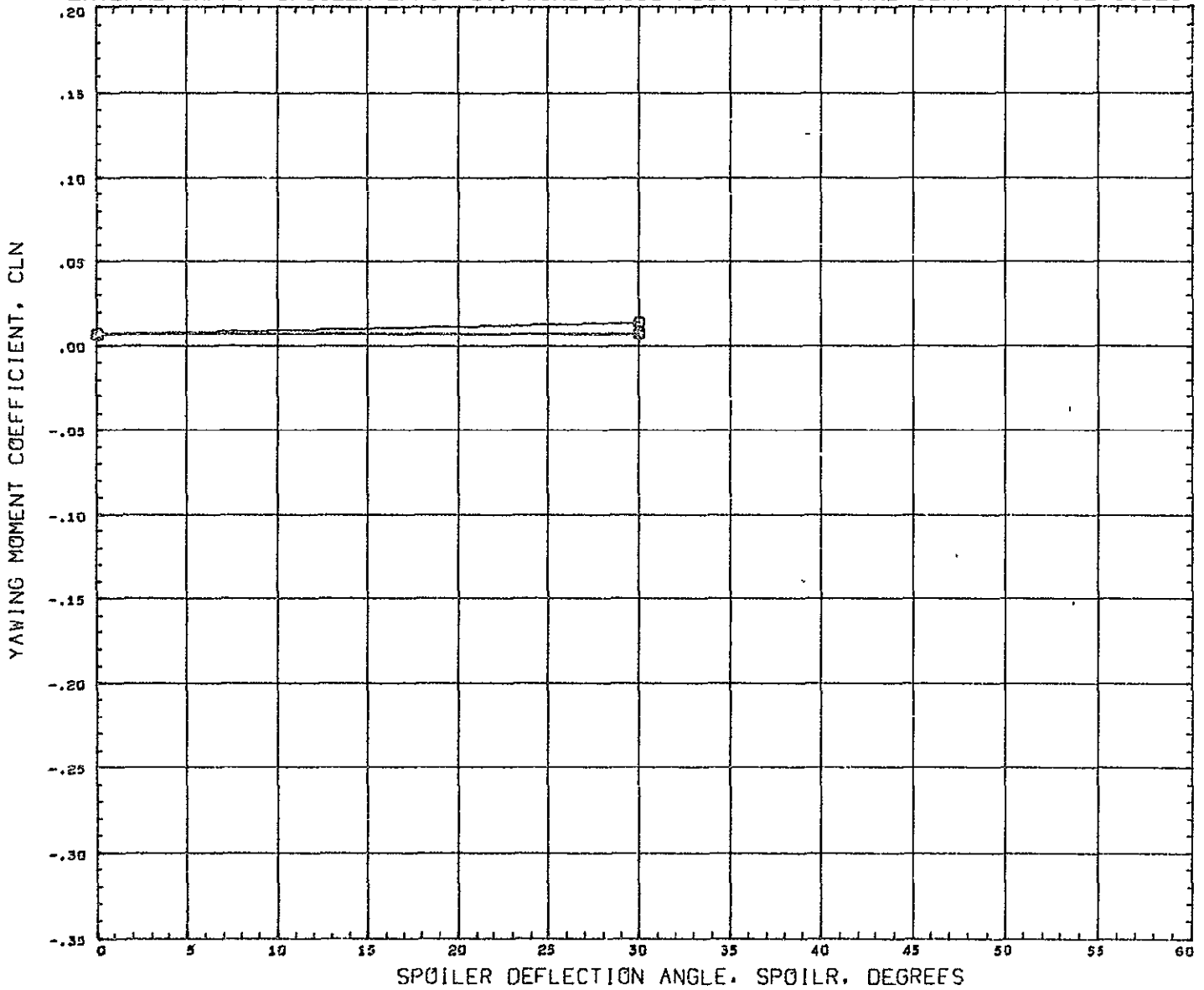

SYMBOL	ALPHA	PARAMETRIC VALUES				REFERENCE INFORMATION		
		MACH	BETA	FLEVTR	RUDYTR	REFS	REFL	REFB
□	0.000	0.184	0.000	0.000	316.2304	50.1900	7.3500	SQ IN
□	4.000	0.000	0.000	0.000	29.3920	0.0000	0.0000	IN
◇	8.000	45.000			0.0000	0.0000	0.0175	IN

DATA HIST. CODE 1



LATERAL CHAR. - SPOILER EFF. - ST. WING BASIC POS. - FLAPS AND GEAR - V-TAIL=55DEG

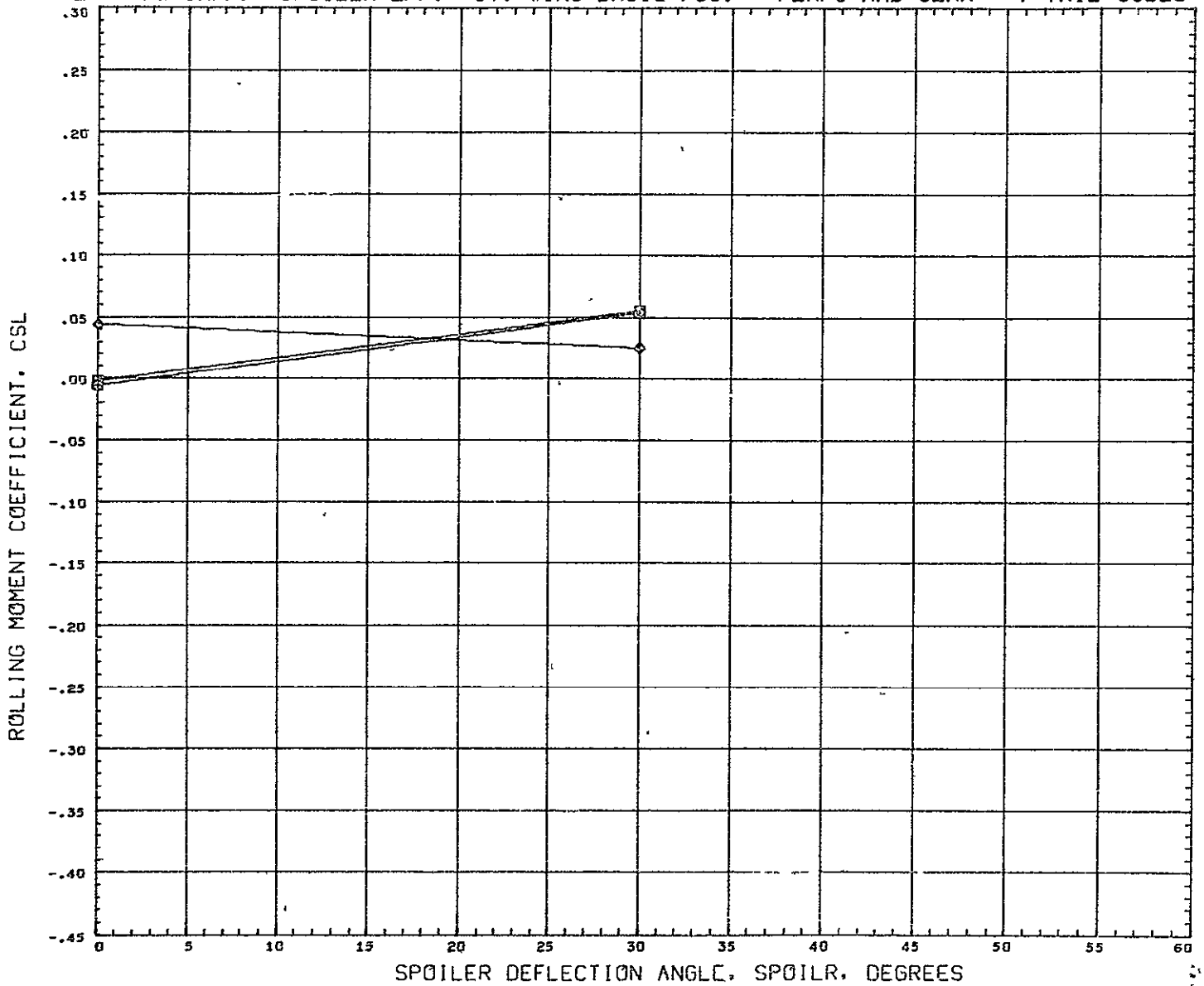

SYMBOL	ALPHA	PARAMETRIC VALUES				REFERENCE INFORMATION		
□	5.000	MACH	5.184	BETA	0.000	REFS	316 2304	50 IN
◇	4.000	ELEVTF	0.000	YUD/TR	0.000	REFL	50.1900	IN
○	6.000	FLAPS	45.000			REFB	7.3500	IN
						XMRP	29 3920	IN
						YMRP	0.0000	IN
						ZMRP	0.0000	IN
						SCALE	0.0175	

DATA HIST. CODE I

LONG. CHAR. - LANDING GEAR EFF. - ST. WING BASIC POS. - WITH FLAPS - V-TAIL=55DEG

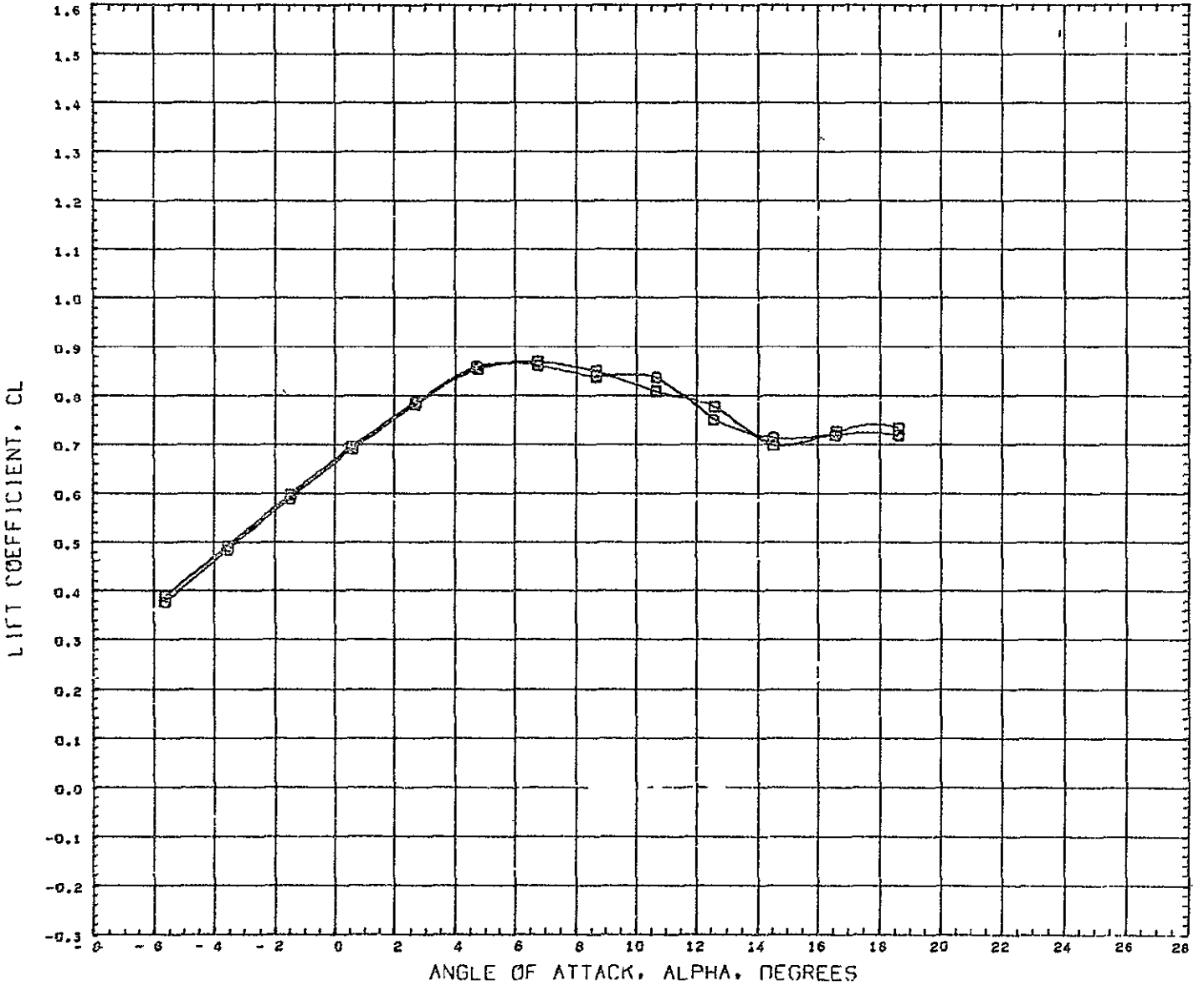

DATA SET SYMBOL	CONFIGURATION DESCRIPTION	PARAMETRIC VALUES		REFERENCE INFORMATION				
(RC7034)	○ CVLSWT TEST 579-D B1W1-15T1-55F1-45	BETA	0.000	ELEVTR	0.000	REFS	316 2304	SQ IN
(RC7011)	□ CVLSWT TEST 579-D B1W1-15T1-55F1-45G1	RUCVTR	0.000	FLAPS	45.000	REFL	50.1906	IN
		SFOILR	0.000			REFB	7.3560	IN
						XMRP	29 3920	IN
						YMRP	0.0000	IN
						ZMRP	0.0000	IN
						SCALE	0.0175	

MACH 0.184

LONG. CHAR. - LANDING GEAR EFF. - ST. WING BASIC POS. - WITH FLAPS - V-TAIL=55DEG

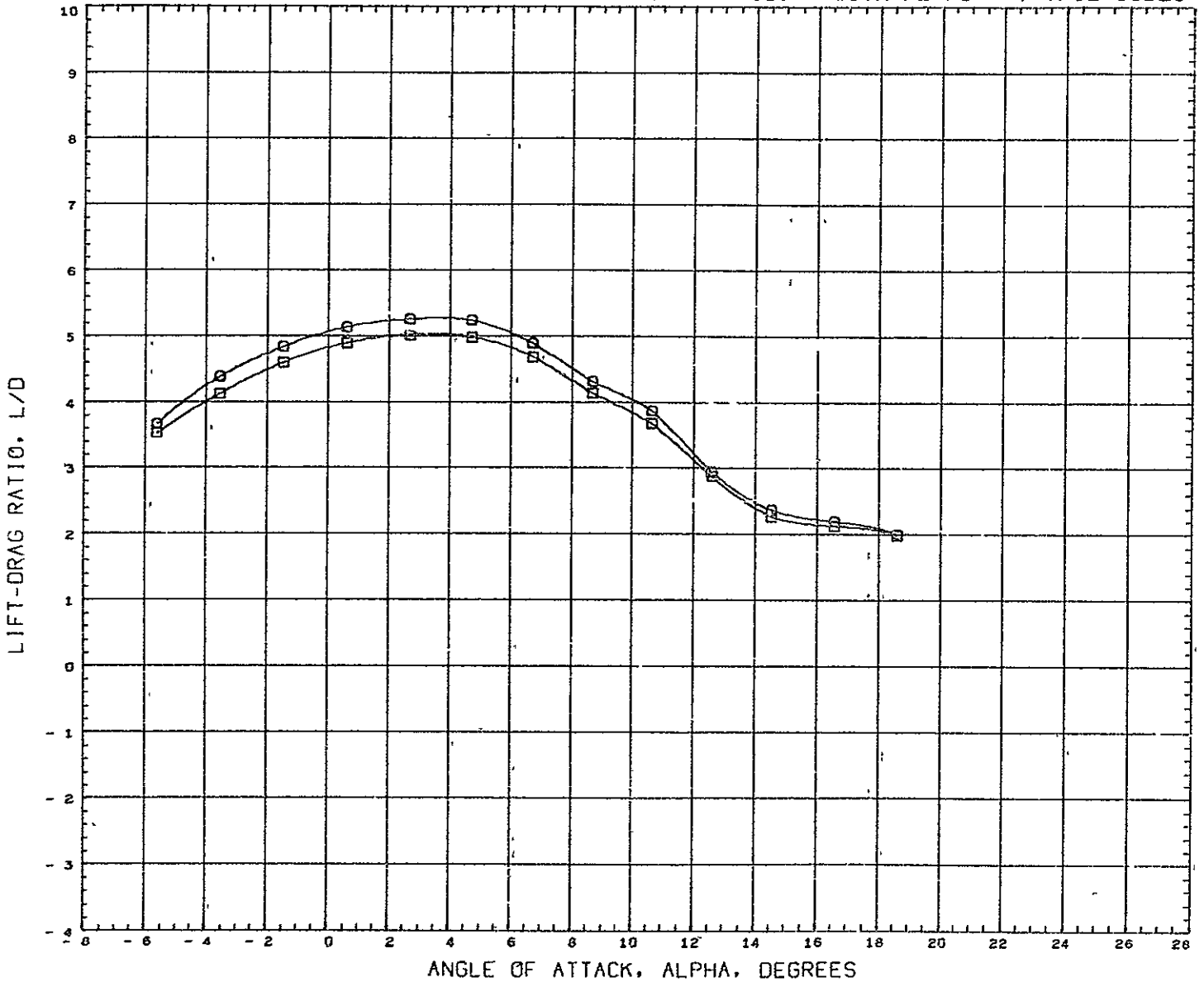

DATA SET SYMBOL    CONFIGURATION DESCRIPTION  
 (RC7034)    ○    CVLSWT TEST 579-0 B1W1-15T1-55F1-45  
 (RC7011)    □    CVLSWT TEST 579-0 B1W1-15T1-55F1-45G1

PARAMETRIC VALUES  
 BETA    0.000    ELEVTR    0.000  
 RUDVTR    0.000    FLAPS    45.000  
 SPOILR    0.000

REFERENCE INFORMATION  
 REFS    316.2304    SQ IN  
 REFL    50.1900    IN.  
 REFB    7.3500    IN  
 XNRF    29.3920    IN  
 YNRF    0.0000    IN  
 ZNRF    0.0000    IN  
 SCALE    0.0175

MACH    0.104

LONG. CHAR. - LANDING GEAR EFF. - ST. WING BASIC POS. - WITH FLAPS - V-TAIL=55DEG

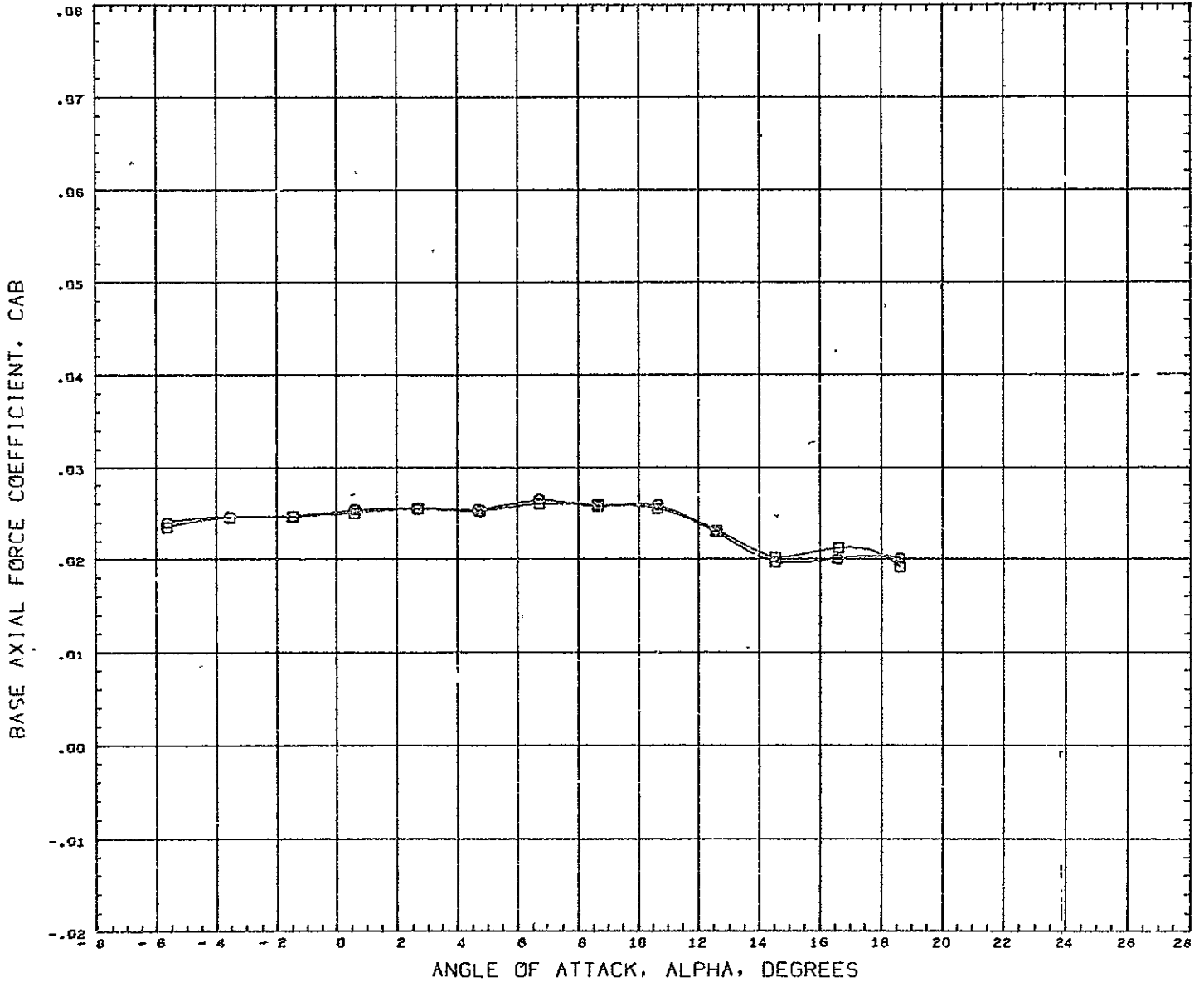

DATA SET SYMBOL CONFIGURATION DESCRIPTION -  
 (RC7534) □ CVLSWT TEST 579-B B1W1-15T1-55F1-45  
 (RC7511) □ CVLSWT TEST 579-B B1W1-15T1-55F1-45G1

PARAMETRIC VALUES  
 BETA 0.000 ELEVTR 0.000  
 RUDYTR 0.000 FLAPS 45.000  
 SPOILF 0.000

REFERENCE INFORMATION  
 REFS 316 2304 SQ IN  
 REFL 50.1900 IN  
 REFB 7.3500 IN  
 XMRP 29.3920 IN  
 YMRP 0.0000 IN  
 ZMRP 0.0000 IN  
 SCALE 0.0175

MACH 0.184

LONG. CHAR. - LANDING GEAR EFF. - ST. WING BASIC POS. - WITH FLAPS - V-TAIL=55DEG

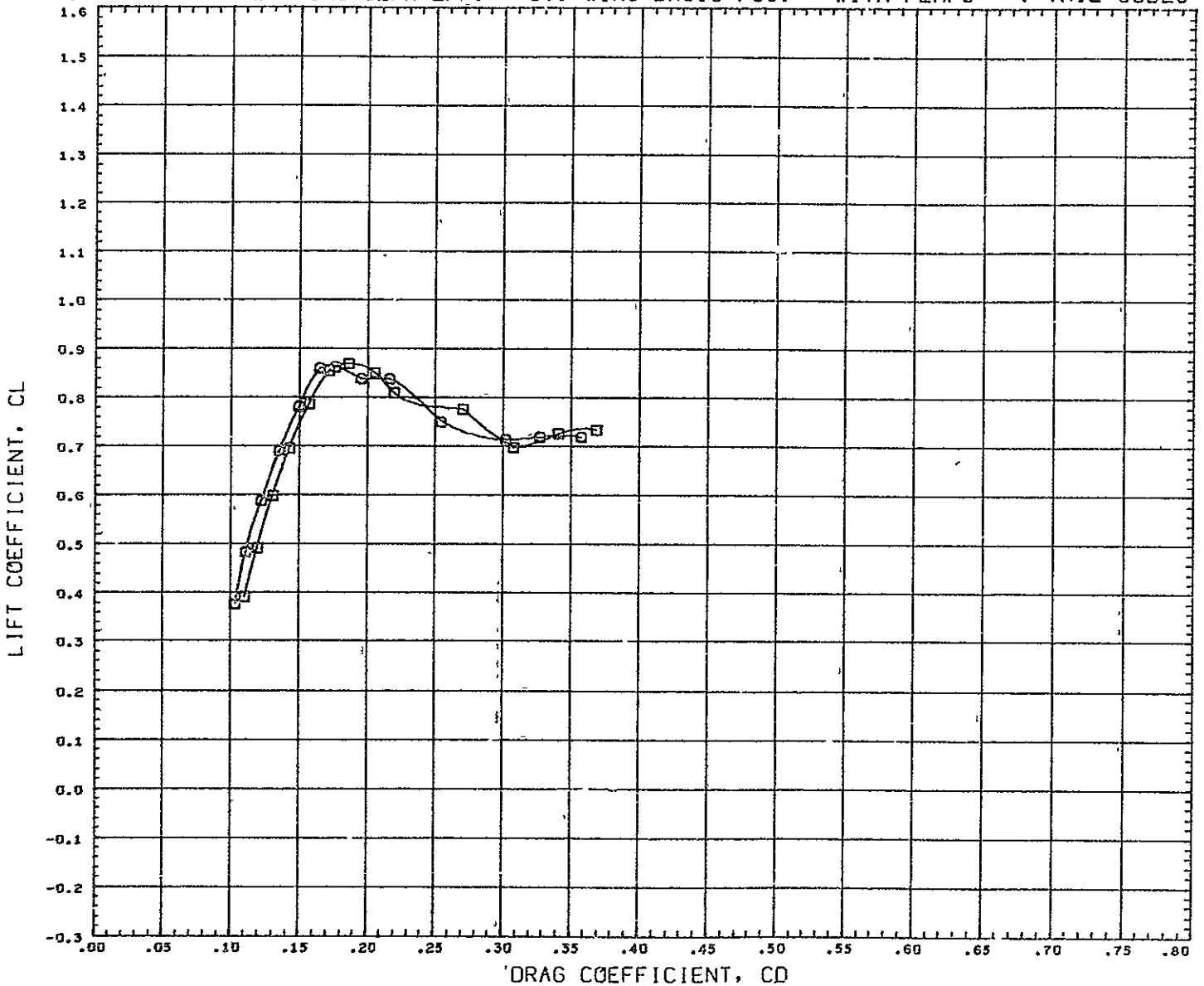

DATA SET SYMBOL    CONFIGURATION DESCRIPTION  
 (RC7034)    □    CVLSWT TEST 579-0 B1W1-15T1-55F1-45  
 (RC7031)    □    CVLSWT TEST 579-0 B1W1-15T1-55F1-45G1

PARAMETRIC VALUES  
 BETA    0.000    ELEVTR    0.000  
 RUDVTR    0.000    FLAPS    45.000  
 SFOILR    0.000

REFERENCE INFORMATION  
 REFS    316 2304    SQ IN  
 REFL    50.1900    IN  
 REFB    7.3500    IN  
 XMRF    29.3920    IN  
 YMRF    0.0000    IN  
 ZMRF    0.0000    IN  
 SCALE    0.0175

MACH    0.184

LONG. CHAR. - LANDING GEAR EFF. - ST. WING BASIC POS. - WITH FLAPS - V-TAIL=55DEG

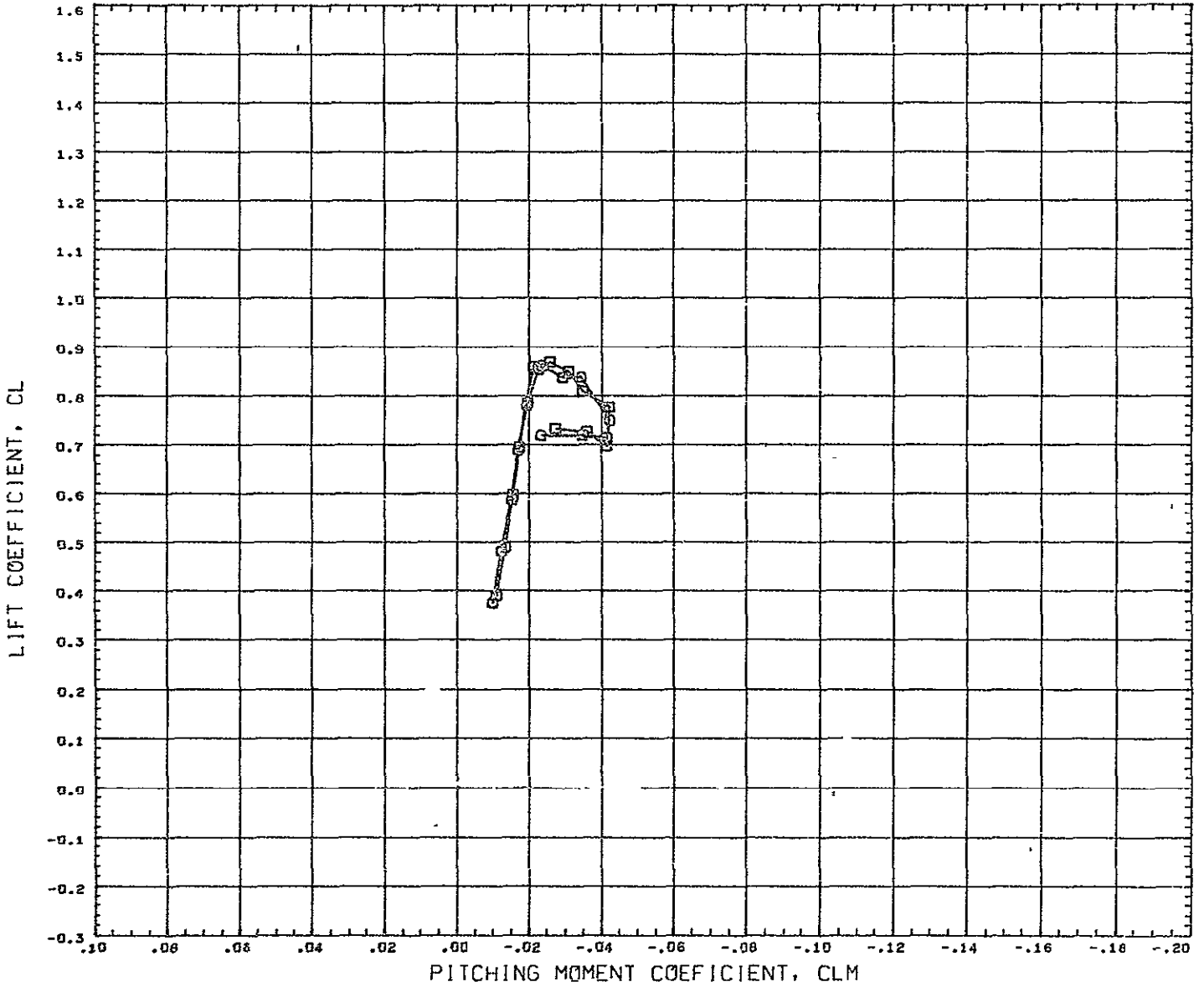

DATA SET S/MBOLE CONFIGURATION DESCRIPTION  
 (RC7034) □ CVLSWT TEST 579-G B1W1-15T1-55F1-45  
 (FC7011) □ CVLSWT TEST 579-G B1W1-15T1-55F1-45G1

PARAMETRIC VALUES				REFERENCE INFORMATION	
BETA	0.000	ELEVTR	0.000	REFS	316 2304 SQ IN
RUDVTR	0.000	FLAPS	45 000	REFL	50.1900 IN
SPOILR	0.000			REFB	7 3500 IN
				XMRP	29 3920 IN
				YMRP	0 0000 IN
				ZMRP	0 0000 IN
				SCALE	0.0175

MACH 0.184

LANDING GEAR FFF.- SIDESLIP DERIV.- ST. WING BASIC POS.-WITH FLAPS- V-TAIL=55DEG

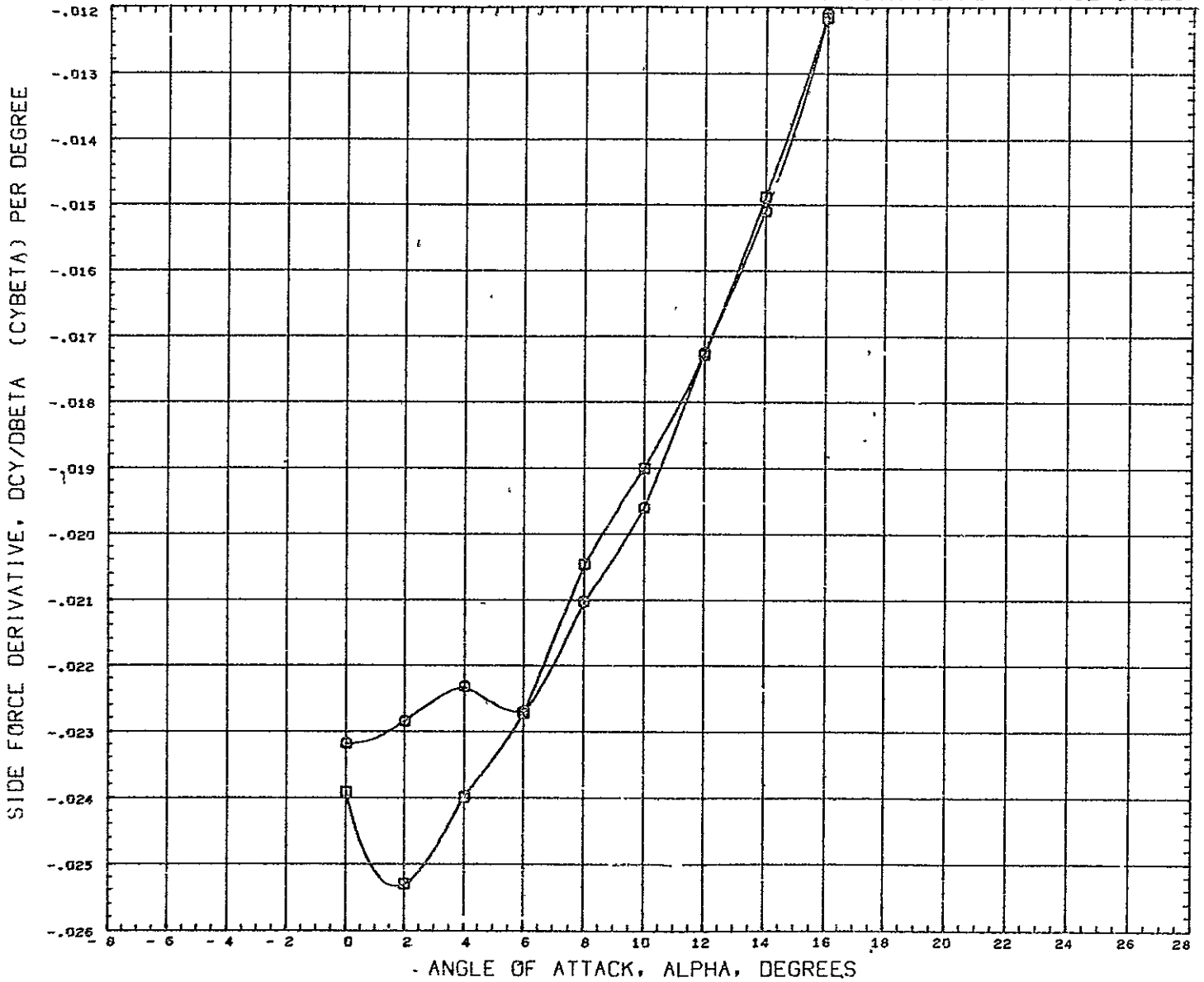

DATA SET SYMBOL	CONFIGURATION DESCRIPTION	PARAMETRIC VALUES			REFERENCE INFORMATION			
(DB7034)	○ CVLSWT TEST 579-0 B1W1-15T1-55F1-45	BETA	0.000	ELEVTR	0.000	REFS	316 2304	SQ IN
(DB7011)	□ CVLSWT TEST 579-0 B1W1-15T1-55F1-45G1	RUDVTR	0.000	FLAPS	45.000	REFL	50.1900	IN
		SFOILR	0.000			REFB	7 3500	IN
						XMRP	29 3920	IN
						YMRP	0 0000	IN
						ZMRP	0 0000	IN
						SCALE	0 0175	

MACH 0.184

LANDING GEAR EFF.- SIDESLIP DERIV.- ST. WING BASIC POS.-WITH FLAPS- V-TAIL=55DEG

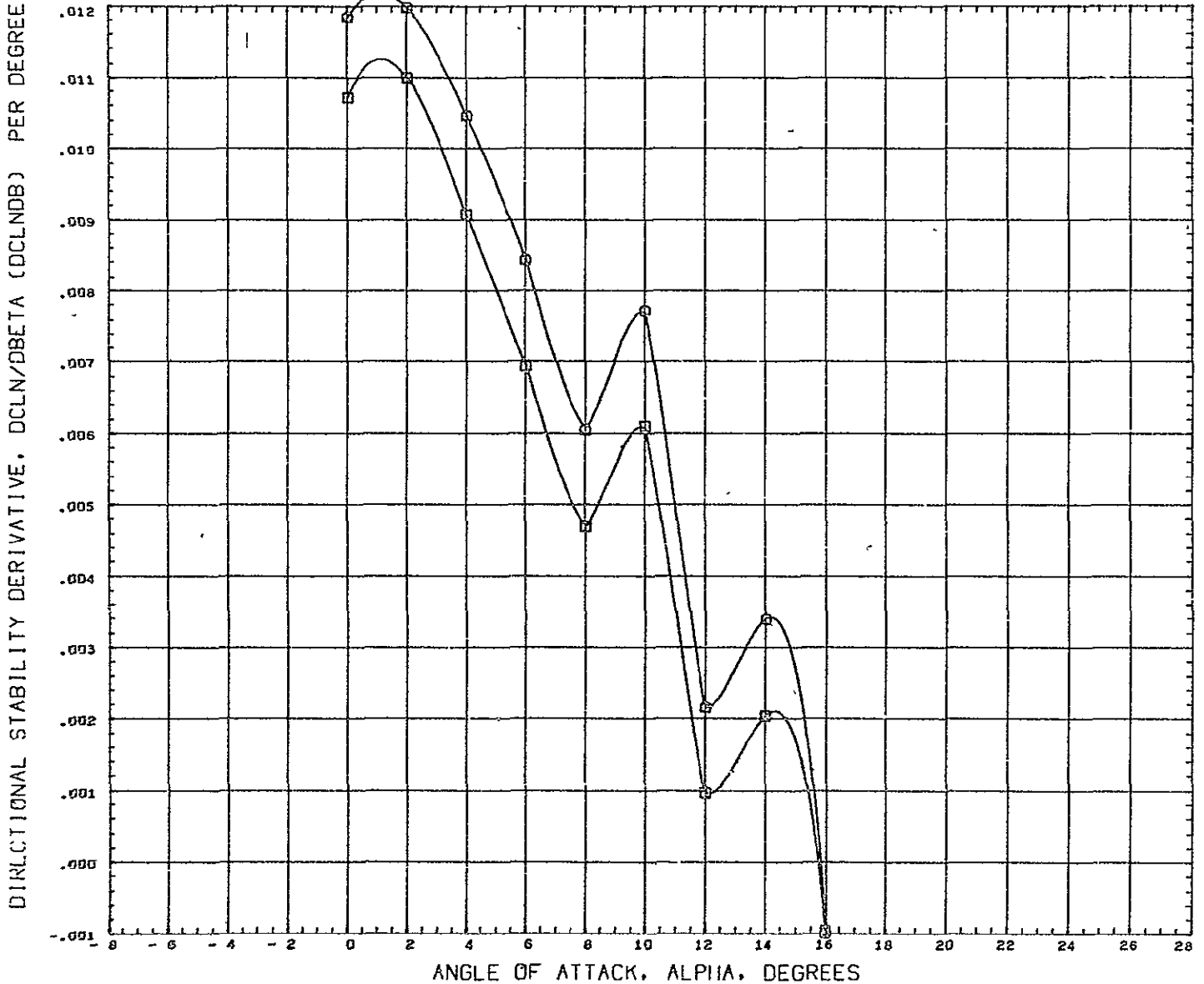

DATA SET SYMBOL	CONFIGURATION DESCRIPTION	PARAMETRIC VALUES		REFERENCE INFORMATION					
(DB7034)	○ CVLSWT TEST 579-0 B1W1-15T1-55F1-45	BETA	0.000	ELEVTR	0.000	REFS	316.2304	SO	IN
(DB7011)	□ CVLSWT TEST 579-0 B1W1-15T1-55F1-45G1	RUDVTR	0.000	FLAPS	45.000	REFL	50.1900	LN	
		SPOILR	0.000			REFB	7.3500	IN	
						XHRF	29.3920	IN	
						YHRF	0.0000	IN	
						ZHRF	0.0000	IN	
						SCALE	0.0175		

MACH 0.184



LANDING GEAR EFF.- SIDESLIP DERIV.- ST. WING BASIC POS.- WITH FLAPS- V-TAIL=55DEG

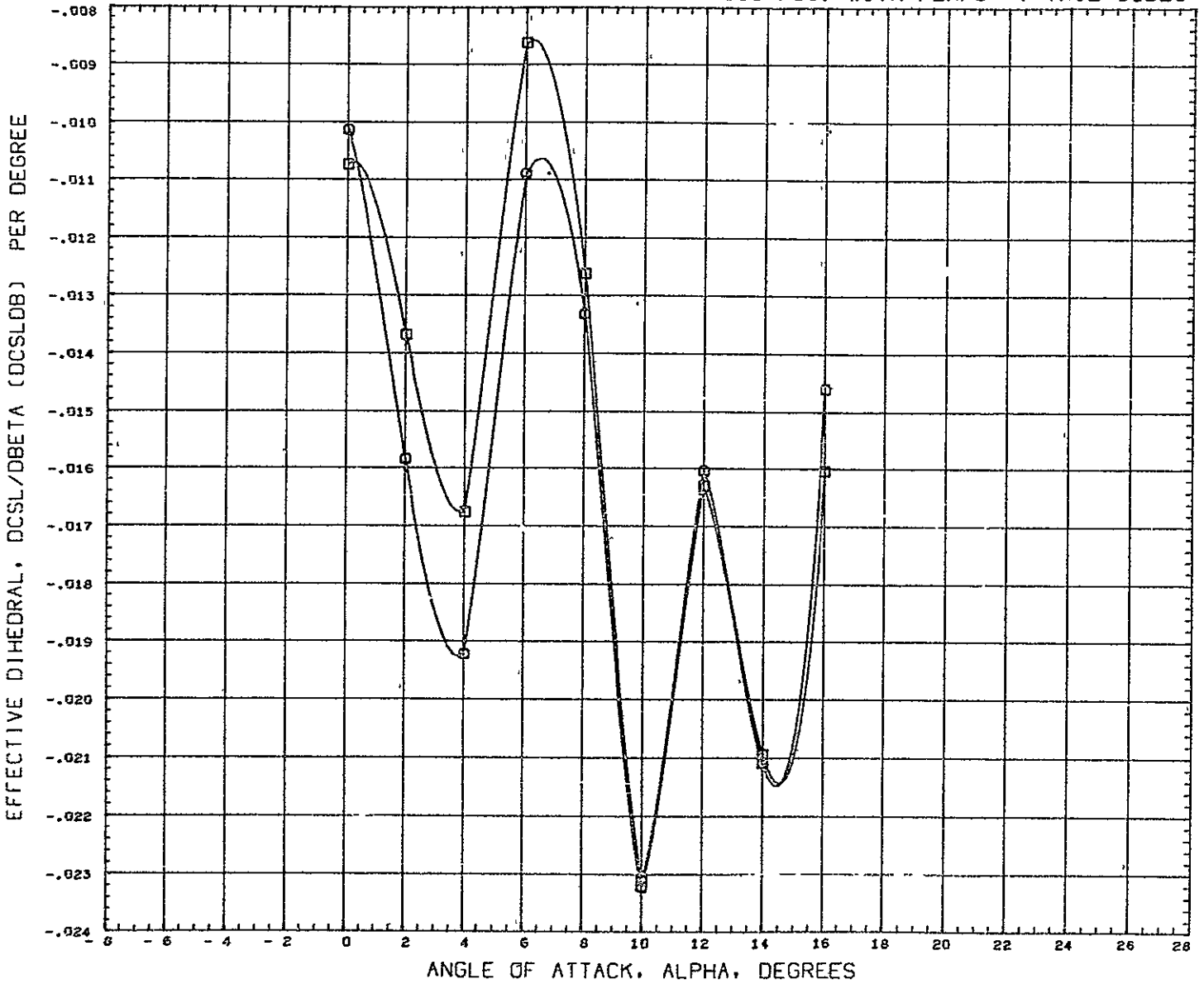

DATA SET SYMBOL	CONFIGURATION DESCRIPTION	PARAMETRIC VALUES			REFERENCE INFORMATION		
(DB7034)	○ CVLSWT TEST 579-D B1W1-15T1-55F1-45	BETA	0.000	ELEVTR	0.000	PEFS	316.2304 SQ IN
(DB7011)	□ CVLSWT TEST 579-D B1W1-15T1-55F1-45G1	RUDYTR	0.000	FLAPS	45.000	REFL	50.1900 IN
		SFOILP	0.000			REFB	7.3500 IN
						XHRF	29.3920 IN
						YHRF	0.0000 IN
						ZHRF	0.0000 IN
						SCALE	0.0175

MACH 0.184

LONG. CHAR. - WING FILLET EFFECT - STRAIGHT WING BASIC POSITION - V-TAIL=55DEG

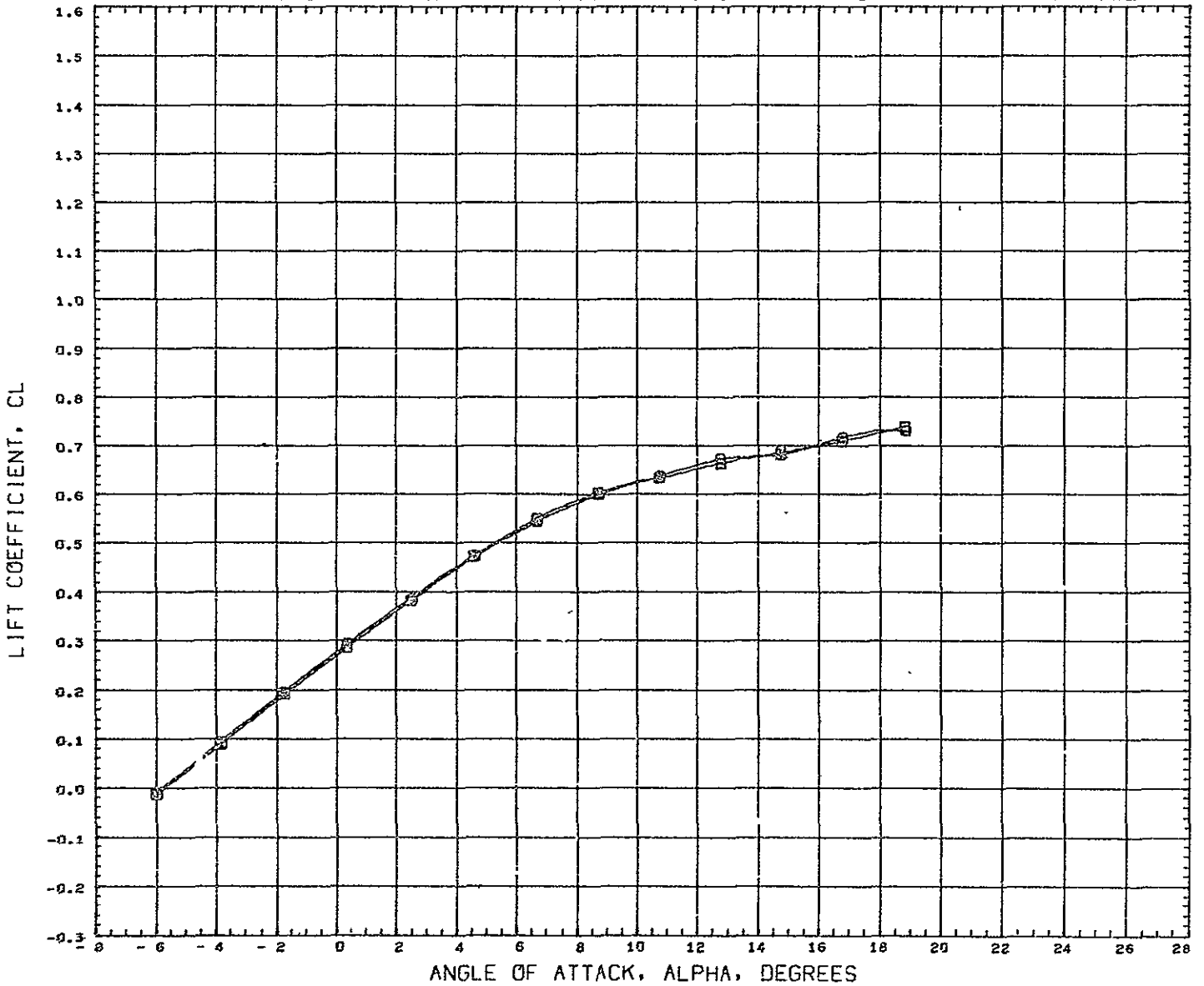

DATA SET SYMBOL    CONFIGURATION DESCRIPTION  
 (SC7001)    ○    CVLSWT TEST 579-D B1W1-15T1-55  
 (RC7003)    □    CVLSWT TEST 579-D B1W1A-15T1-55

PARAMETRIC VALUES  
 BETA    0.000    ELEVTR    0.000  
 RUDVTR    0.000    FLAPS    0.000  
 SFOILR    0.000

REFERENCE INFORMATION  
 REFS    316.2304    SQ IN  
 REFL    50.1900    IN  
 REFB    7.3500    IN  
 XMRF    29.3920    IN  
 YMRF    0.0000    IN  
 ZMRF    0.0000    IN  
 SCALE    0.0175

MACH    0.259

LONG. CHAR. - WING FILLET EFFECT - STRAIGHT WING BASIC POSITION - V-TAIL=55DEG

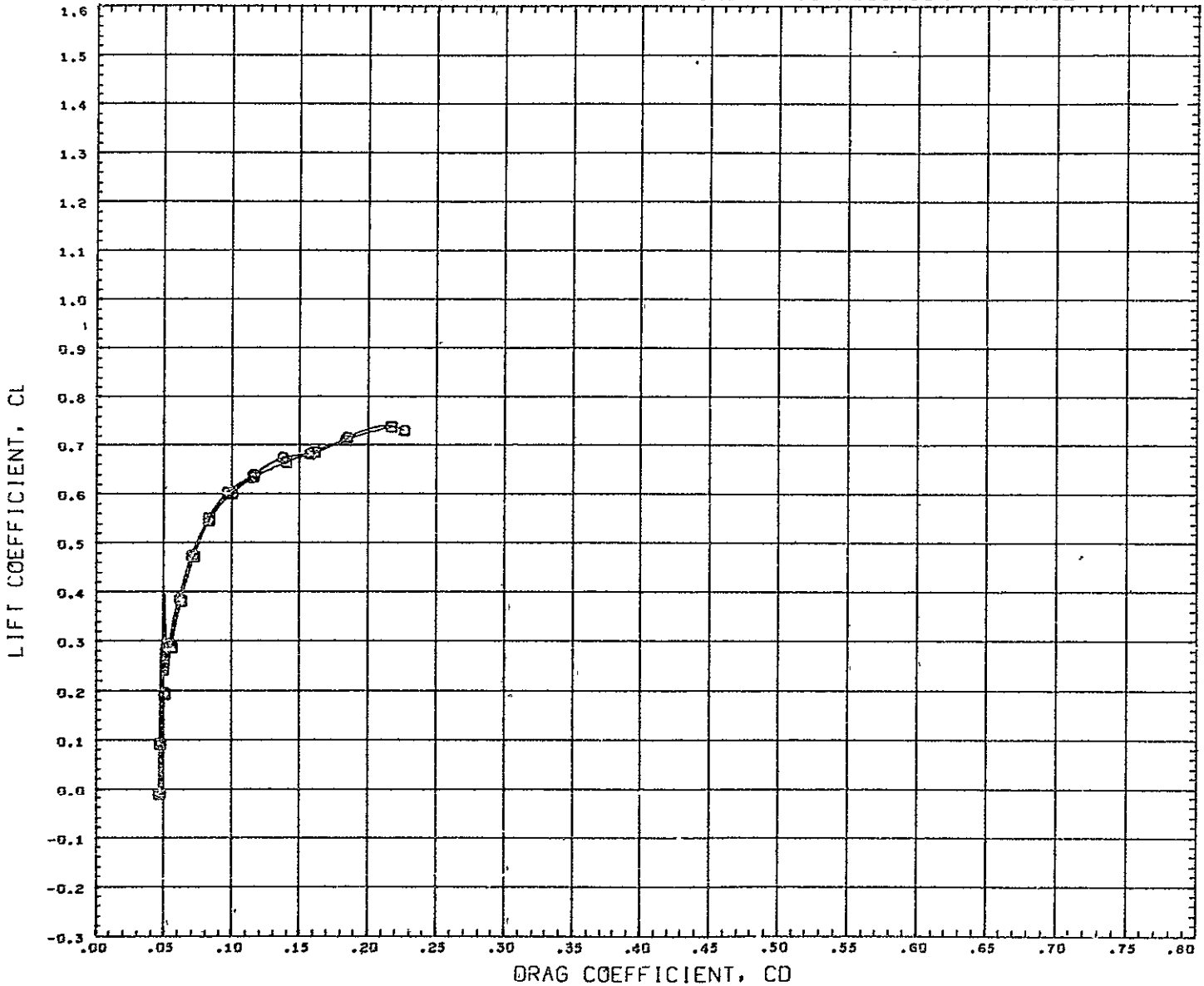

DATA SET SYMBOL    CONFIGURATION DESCRIPTION  
 (SC7001)    ○    CVLSWT TEST 579-G B1W1-15T1-55  
 (RC7063)    □    CVLSWT TEST 579-G B1W1A-15T1-55

PARAMETRIC VALUES  
 BETA    0.000    ELEVTR    0.000  
 RUDVTR    0.000    FLAPS    0.000  
 SFOILR    0.000

REFERENCE INFORMATION  
 REFS    316.2304    SQ IN  
 REFL    50.1900    IN  
 REFB    7.3500    IN  
 XMRP    29.3920    IN  
 YMRP    0.0000    IN  
 ZMRP    0.0000    IN  
 SCALE    0.0175

MACH    0.259

LONG. CHAR. - WING FILLET EFFECT - STRAIGHT WING BASIC POSITION - V-TAIL=55DEG

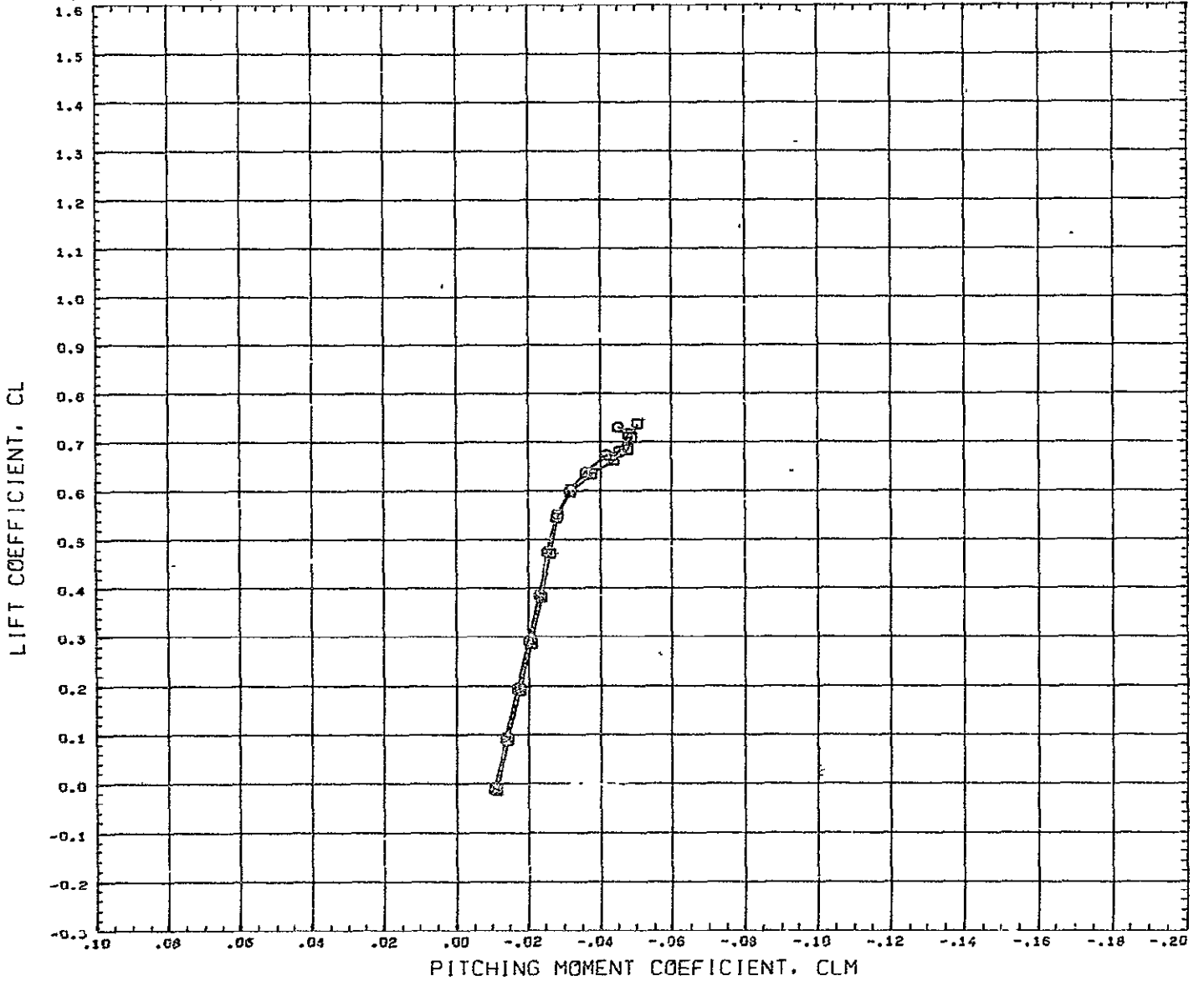

DATA SET SYMBOL    CONFIGURATION DESCRIPTION  
 (SC7001)    □    C/LSWT TEST 579-D B1W1-15T1-55  
 (RC7063)    □    C/LSWT TEST 579-D B1W1A-15T1-55

PARAMETRIC VALUES  
 BETA    0.000    ELEVTR    0.000  
 RUDVTR    0.000    FLAPS    0.000  
 SPOILR    0.000

REFERENCE INFORMATION  
 REFS    316 2304    SQ IN  
 REFL    50 1900    IN  
 REFB    7.3560    IN  
 XNRF    29.3920    IN  
 YNRF    0.0000    IN  
 ZNRF    0.0000    IN  
 SCALE    0.0175

MACH    0.259

LONGITUDINAL CHARACTERISTICS - V-TAIL ROLLOUT EFFECT - STRAIGHT WING BASIC POS.

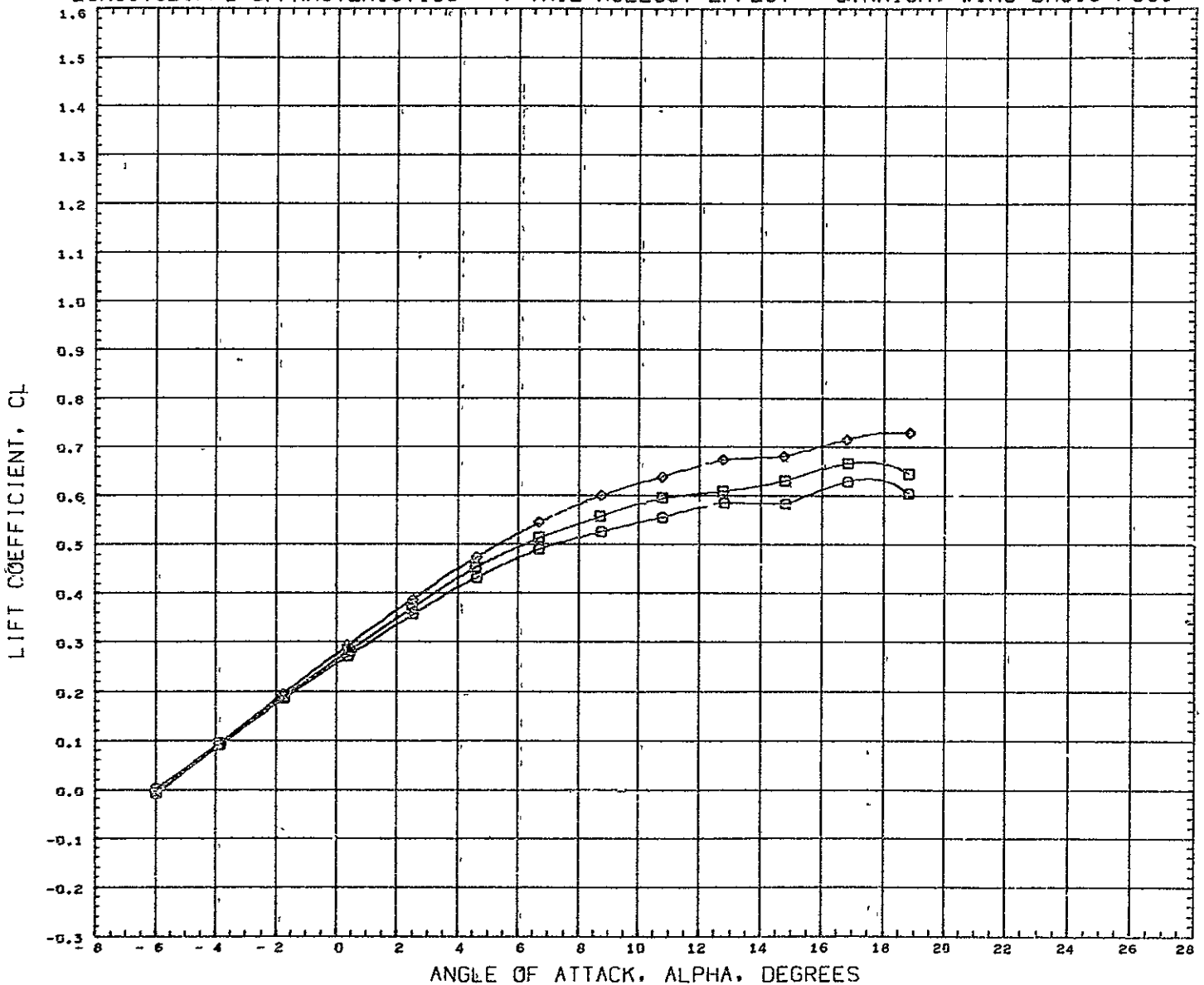

DATA SET SYMBOL	CONFIGURATION DESCRIPTION	PARAMETRIC VALUES			REFERENCE INFORMATION		
(RC7047)	CVLSWT TEST 579-G B1W1-15T1-35	BETA	0.000	ELEVTR	0.000	REFS	316 2304 SQ IN
(RC7045)	CVLSWT TEST 579-D B1W1-15T1-45	RUDVTR	0.000	FLAPS	0.000	REFL	50 1900 IN
(SC7001)	CVLSWT TEST 579-D B1W1-15T1-55	SFOILR	0.000			REFB	7.3500 IN
						XMRP	29.3920 IN
						YMRP	0.0000 IN
						ZMRP	0 0000 IN
						SCALE	0.0175

MACH 0.259

LONGITUDINAL CHARACTERISTICS - V-TAIL ROLLOUT EFFECT - STRAIGHT WING BASIC POS.

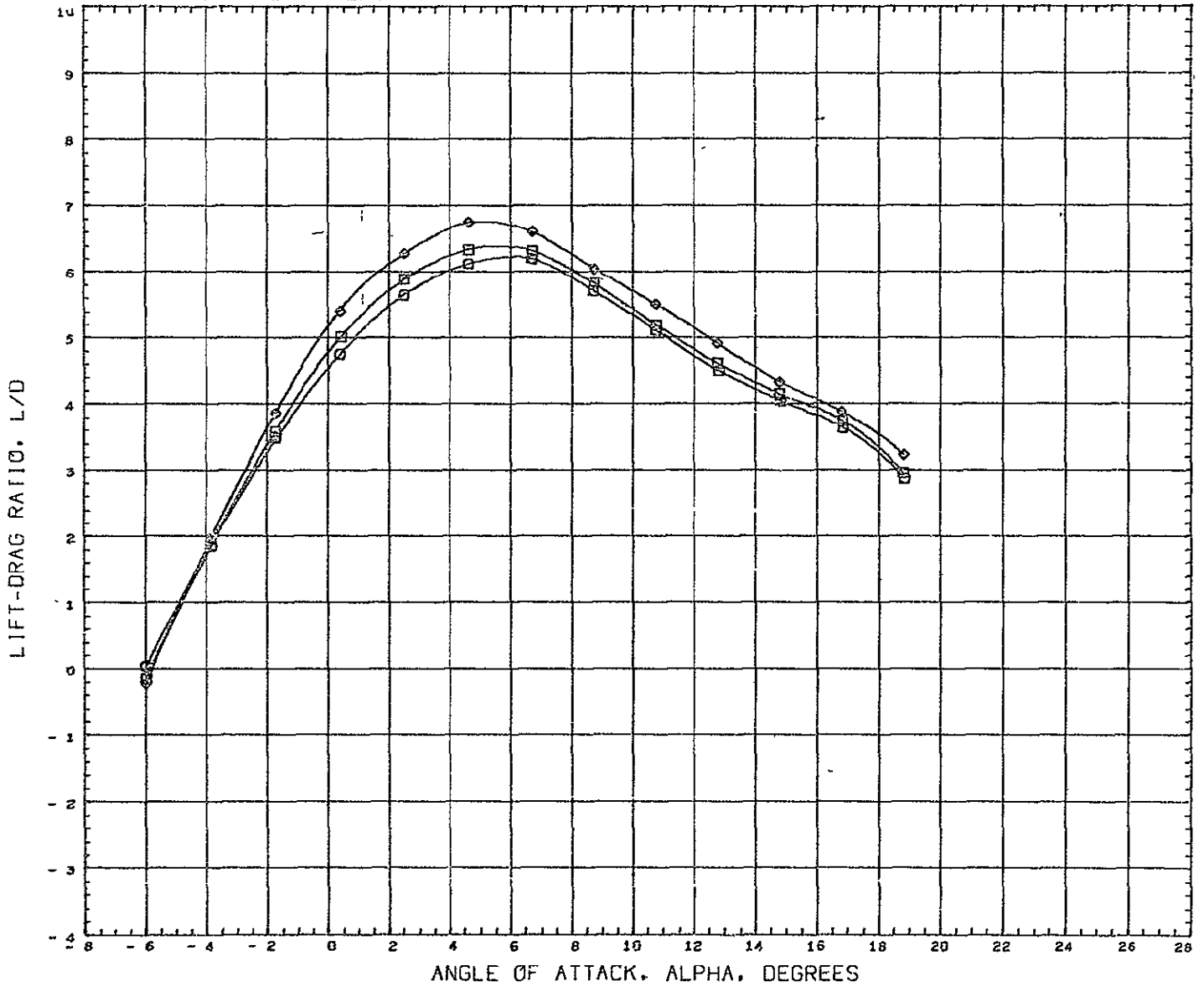

DATA SET SYMBOL	CONFIGURATION DESCRIPTION	PARAMETRIC VALUES			REFERENCE INFORMATION		
(PC7047)	CVLSWT TEST 579-G B1W1-15T1-35	BETA	0.000	ELEVTR	0.000	REFS	316 2304 SQ IN
(RC7045)	CVLSWT TEST 579-G B1W1-15T1-45	RUDVTR	0.000	FLAPS	0.000	REFL	50 1900 IN
(SC7051)	CVLSWT TEST 579-G B1W1-15T1-55	SFOILR	0.000			REFB	7 3500 IN
						XHRF	29.3920 IN
						YHRF	0.0000 IN
						ZHRF	0.0000 IN
						SCALE	0 0175

MACH 0.259

LONGITUDINAL CHARACTERISTICS - V-TAIL ROLLOUT EFFECT - STRAIGHT WING BASIC POS.

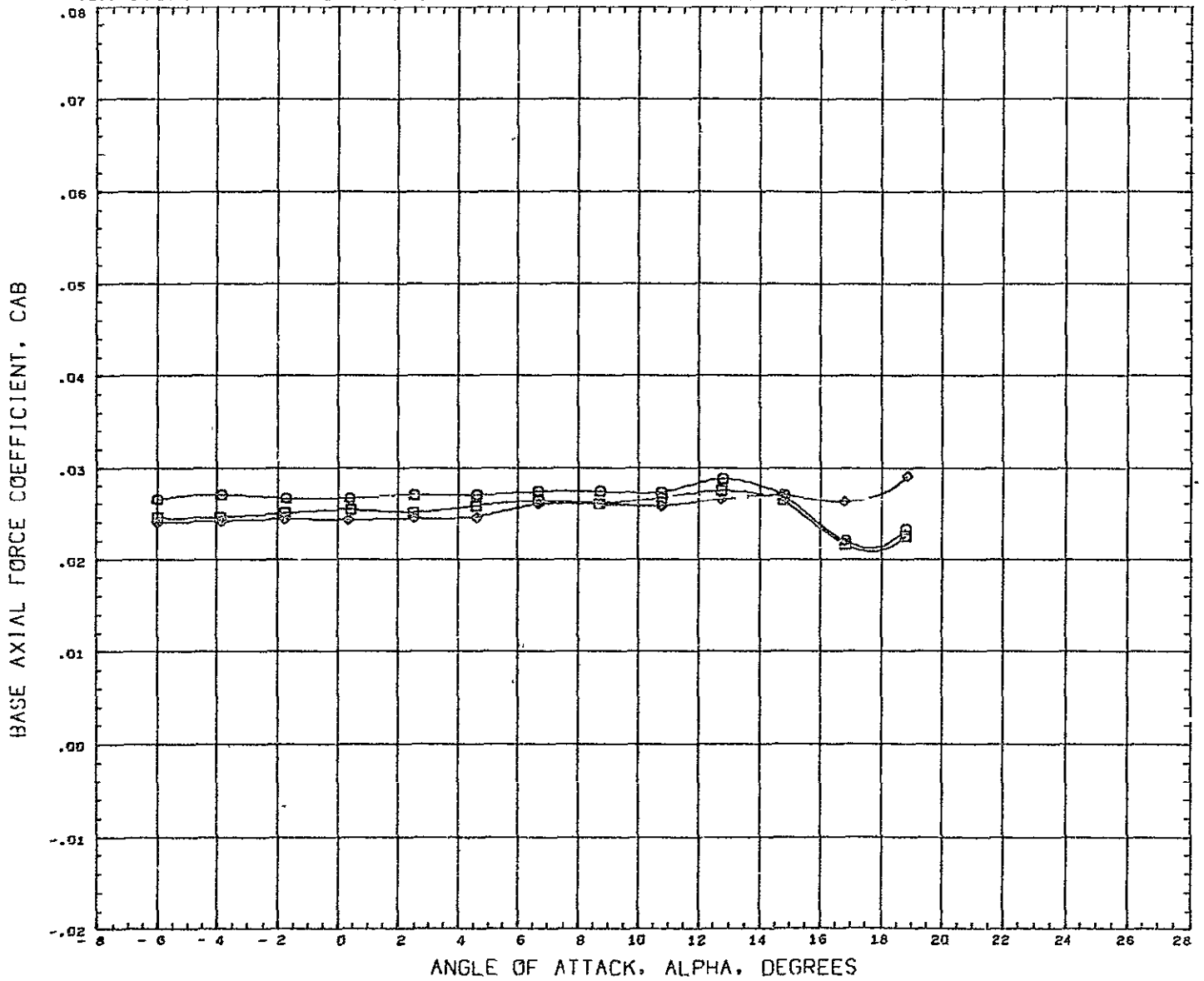

DATA SET SYMBOL	CONFIGURATION DESCRIPTION	PARAMETRIC VALUES				REFERENCE INFORMATION		
(RC7547)	CVLSWT TEST 579-G B1W1-15T1-35	BETA	0.000	ELEVTR	0.000	REFS	316 2304	SQ IN
(RC7545)	CVLSWT TEST 579-G B1W1-15T1-45	RUDVTR	0.000	FLAPS	0.000	REFL	50 1900	IN
(SC7551)	CVLSWT TEST 579-G B1W1-15T1-55	SFOILR	0.000			REFB	7 3500	IN
						XMRP	29.3920	IN
						YMRP	0.0000	IN
						ZMRP	0.0000	IN
						SCALE	0.0175	

MACH 0.259

LONGITUDINAL CHARACTERISTICS - V-TAIL ROLLOUT EFFECT - STRAIGHT WING BASIC POS.

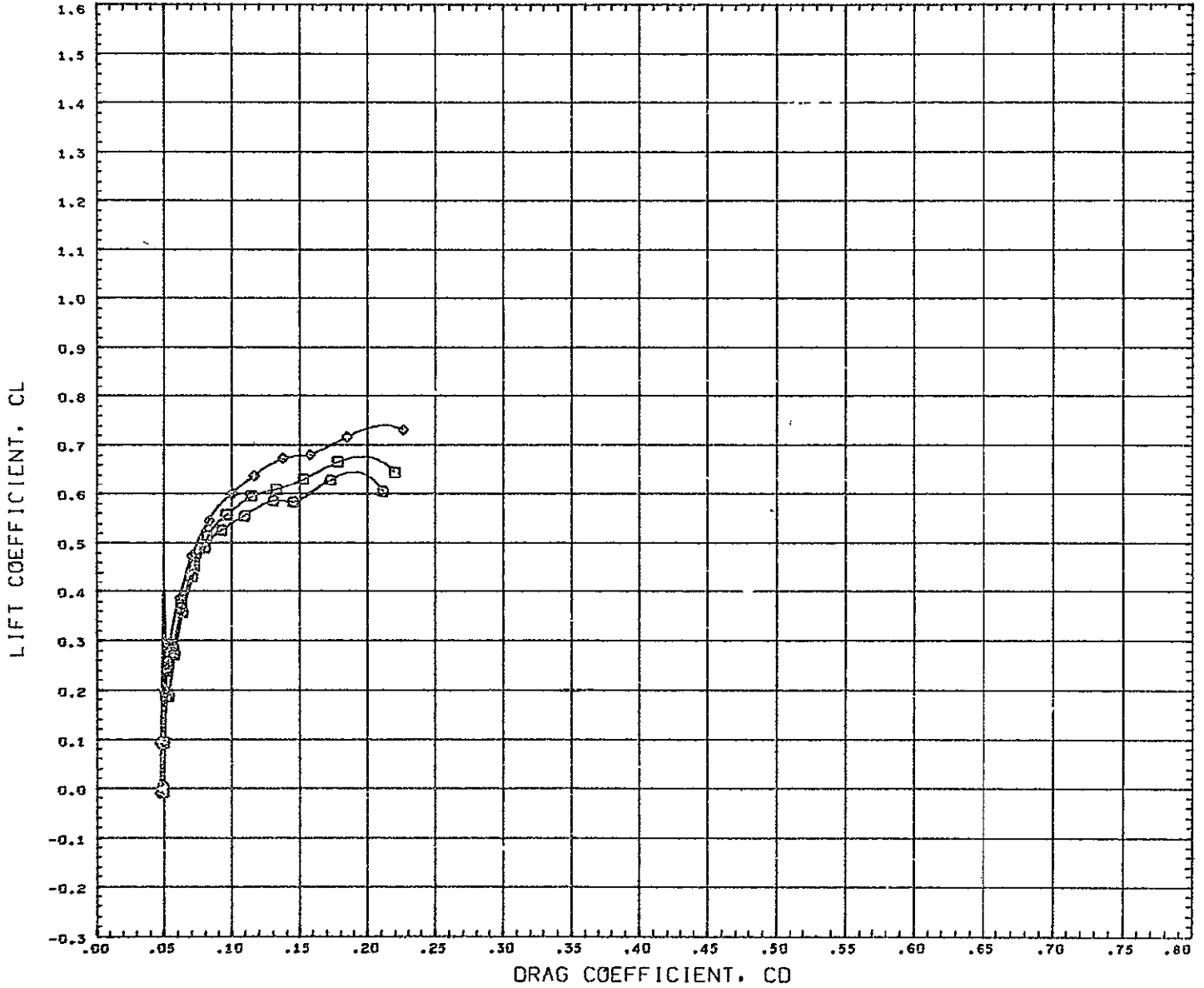

DATA SET SYMBOL	CONFIGURATION DESCRIPTION
(RC7047)	CVLSWT TEST 579-D B1W1-15T1-35
(RC7045)	CVLSWT TEST 579-D B1W1-15T1-45
(RC7052)	CVLSWT TEST 579-D B1W1-15T1-55

PARAMETRIC VALUES	
BETA	0.000
RUDVTR	0.000
SFOILR	0.000
ELEVTR	0.000
FLAPS	0.000

REFERENCE INFORMATION	
REFS	316.2304 SQ IN
REFL	50.1900 IN
REFB	7.3500 IN
XHRF	29.3920 IN
YHRF	0.0000 IN
ZHRF	0.0000 IN
SCALE	0.0175

MACH 0.259



LONGITUDINAL CHARACTERISTICS - V-TAIL ROLLOUT EFFECT - STRAIGHT WING BASIC POS.

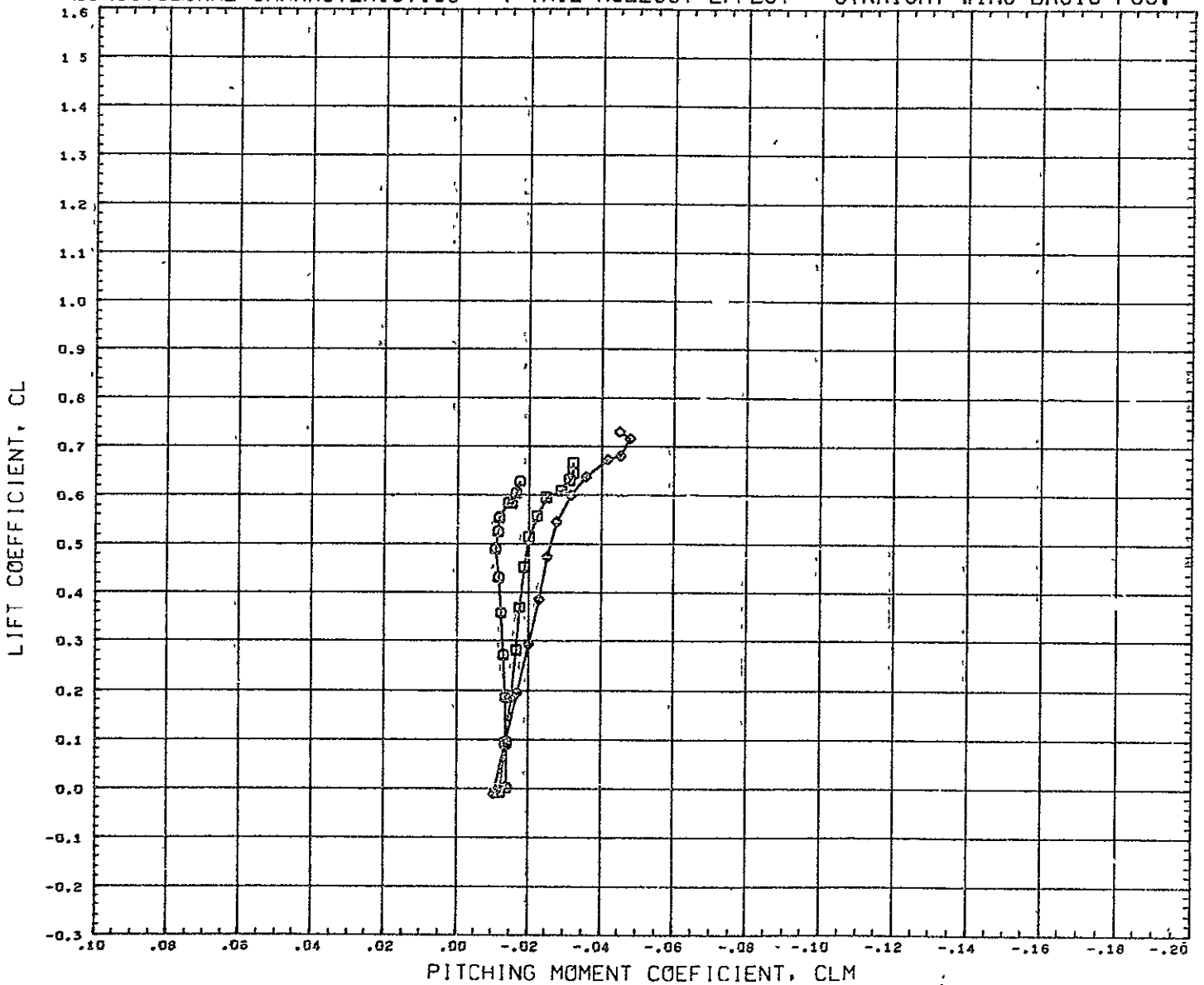

DATA SET SYMBOL	CONFIGURATION DESCRIPTION	PARAMETRIC VALUES			REFERENCE INFORMATION		
(RC7047)	□ CVLSWT TEST 579-G B1W1-15T1-35	BETA	0.000	ELEVTR	0.000	REFS	316 2304 SQ IN
(RC7045)	□ CVLSWT TEST 579-G B1W1-15T1-45	RUDVTR	0.000	FLAPS	0.000	REFL	50.1900 IN
(SC7001)	○ CVLSWT TEST 579-G B1W1-15T1-55	SFOILR	0.000			REFB	7.3500 IN
						XMRP	29.3920 IN
						YMRP	0.0000 IN
						ZMRP	0.0000 IN
						SCALE	0.0175

MACH 0.259

# Y-TAIL ROLLOUT EFFECT - SIDESLIP DERIVATIVES - STRAIGHT WING BASIC POSITION

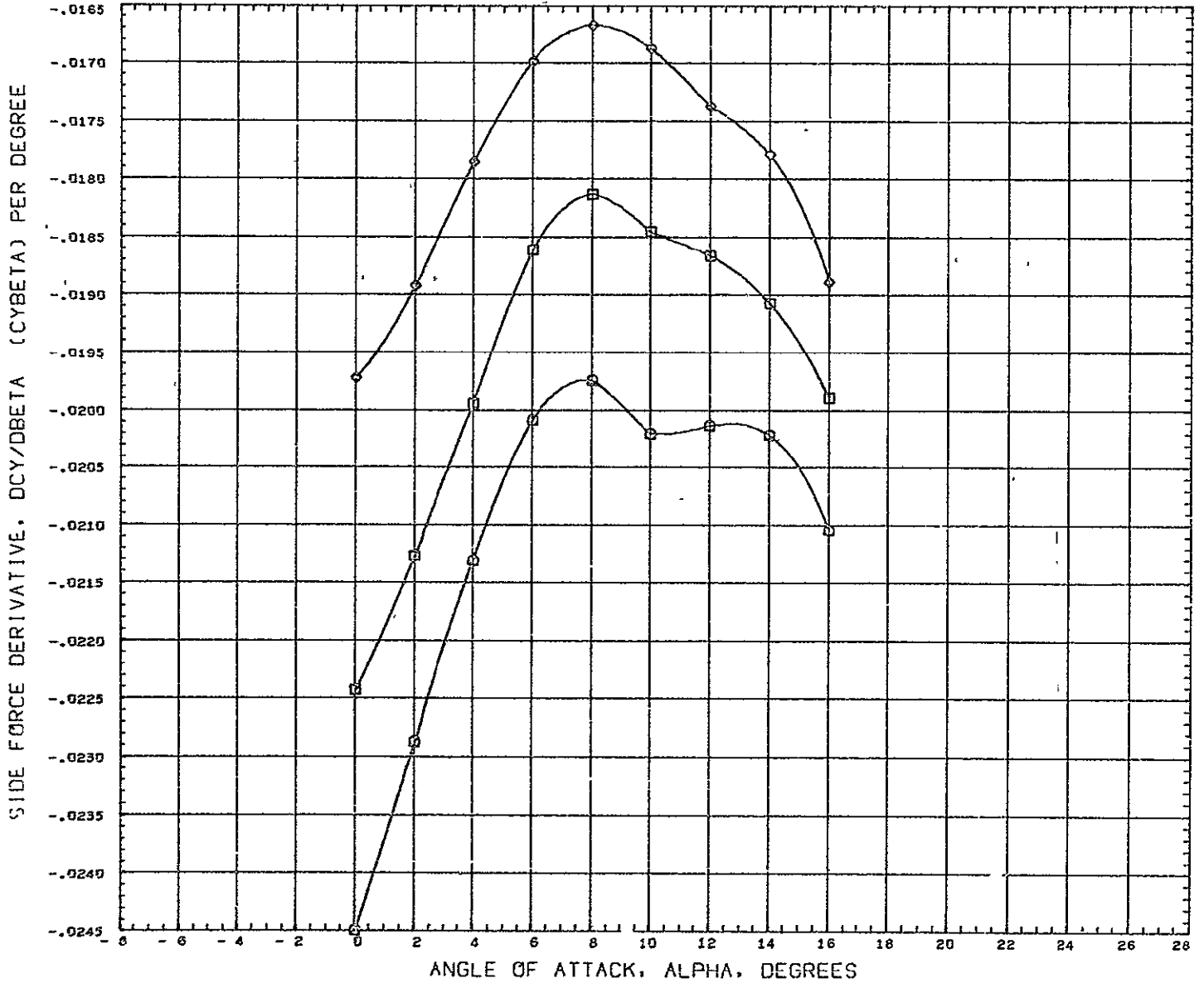

DATA SET SYMBOL	CONFIGURATION DESCRIPTION	PARAMETRIC VALUES			REFERENCE INFORMATION		
(D57047)	□ CVLSWT TEST 579-G B1W1-15T1-35	BETA	0.000	ELEVTR	0.000	REFS	316.2304 SQ IN
(D57045)	□ CVLSWT TEST 579-G B1W1-15T1-45'	RUDVTR	0.000	FLAPS	0.000	REFL	50.1900 IN
(D57001)	○ CVLSWT TEST 579-G B1W1-15T1-35	SFOILR	0.000			REFB	7.3500 IN
						XMRP	29.3920 IN
						YMRP	0.0000 IN
						ZMRP	0.0000 IN
						SCALE	0.0175

MACH 0.259

# V-TAIL ROLLOUT EFFECT - SIDESLIP DERIVATIVES - STRAIGHT WING BASIC POSITION

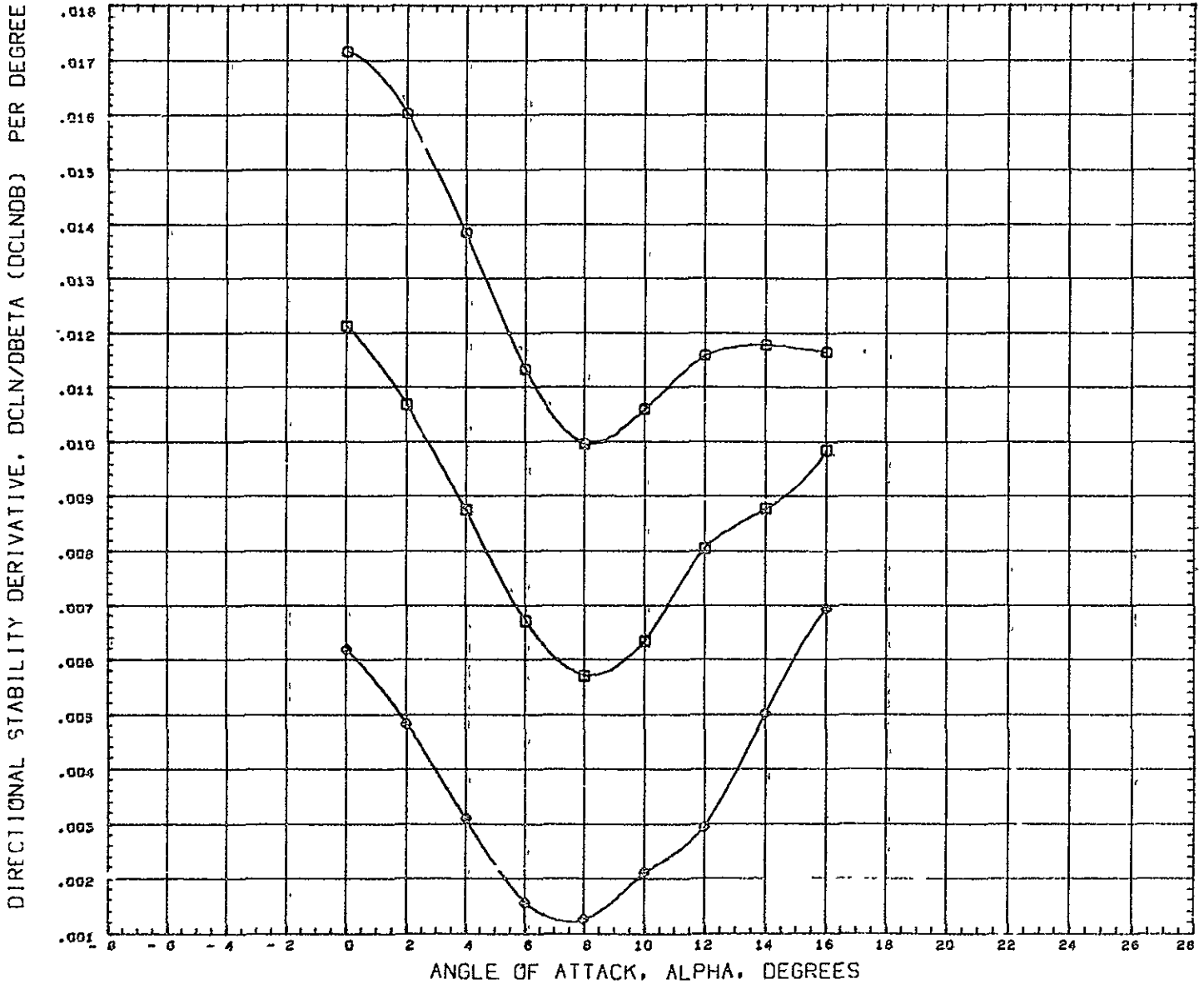

DATA SET SYMBOL	CONFIGURATION DESCRIPTION	PARAMETRIC VALUES			REFERENCE INFORMATION		
(DB7047)	□ CVLSWT TEST 579-G BIW1-1511-35	BETA	0.000	ELEVTR	0.000	REFS	316.2304 SQ IN
(DB7045)	□ CVLSWT TEST 579-G BIW1-1511-45	RUDVTR	0.000	FLAPS	0.000	REFL	50.1900 IN
(DB7001)	◇ CVLSWT TEST 579-G BIW1-1511-55	SPOILR	0.000			REFB	7.3500 IN
						XMRP	29.3920 IN
						YMRP	0.0000 IN
						ZMRP	0.0000 IN
						SCALE	0.0175

MACH 0.259

# V-TAIL ROLLOUT EFFECT - SIDESLIP DERIVATIVES - STRAIGHT WING BASIC POSITION

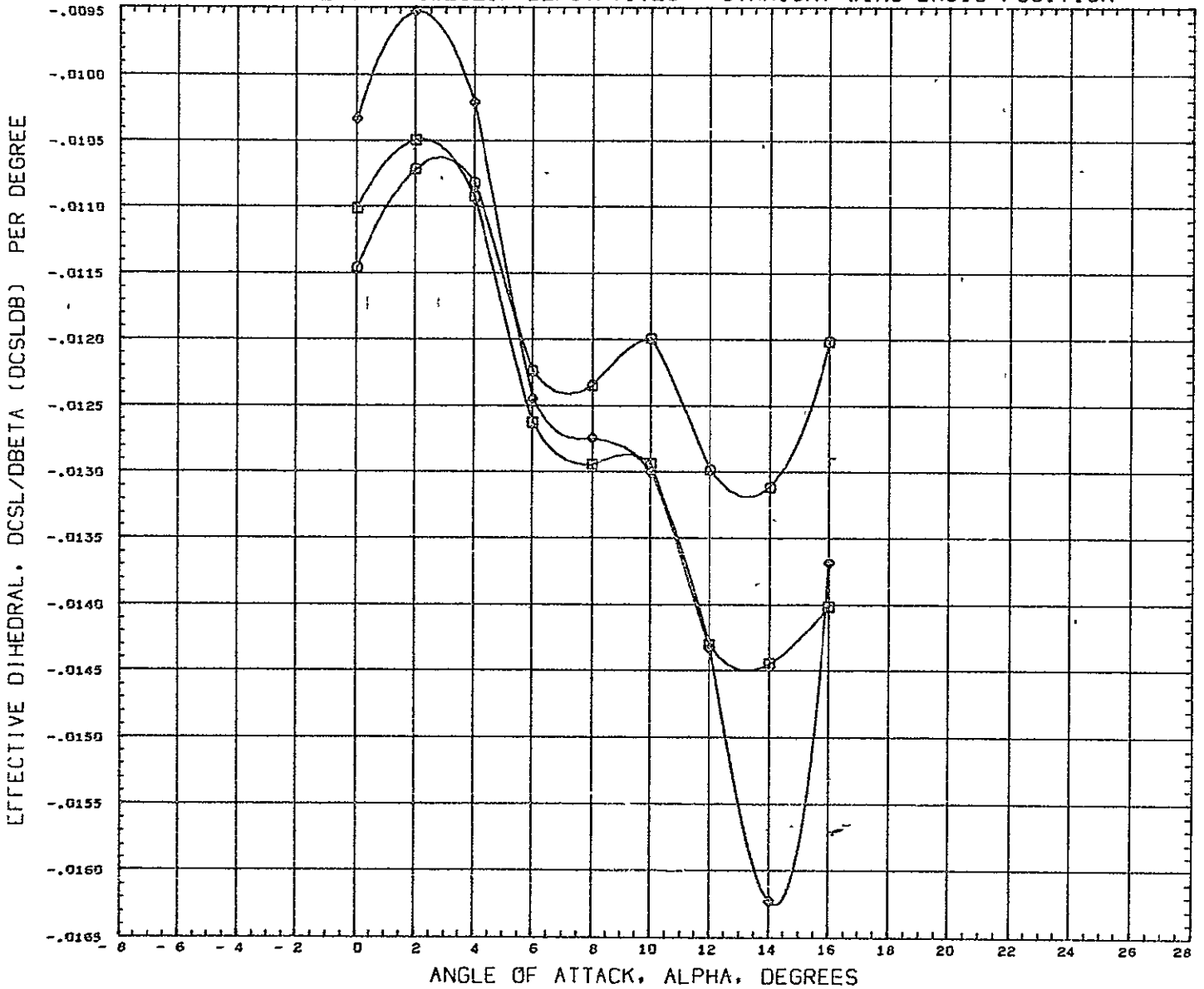

DATA SET SYMBOL	CONFIGURATION DESCRIPTION	PARAMETRIC VALUES			REFERENCE INFORMATION				
(DB7047)	CVLSWT TEST 579-G B1W1-15T1-35	BETA	0.000	ELEVTR	0.000	REFS	316.2304	SQ	IN
(DB7045)	CVLSWT TEST 579-G B1W1-15T1-45	RUDVTR	0.000	FLAPS	0.000	REFL	50.1900	IN	
(DB7051)	CVLSWT TEST 579-G B1W1-15T1-55	SFOILR	0.000			REFB	7.3500	IN	
						XNRF	29.3920	IN	
						YHRF	0.0000	IN	
						ZHRF	0.0000	IN	
						SCALE	0.0175		

MACH 0.259

LONG. CHAR. - V-TAIL SECTION CAMBER EFFECT - STRAIGHT WING AFT - V-TAIL=55DEG

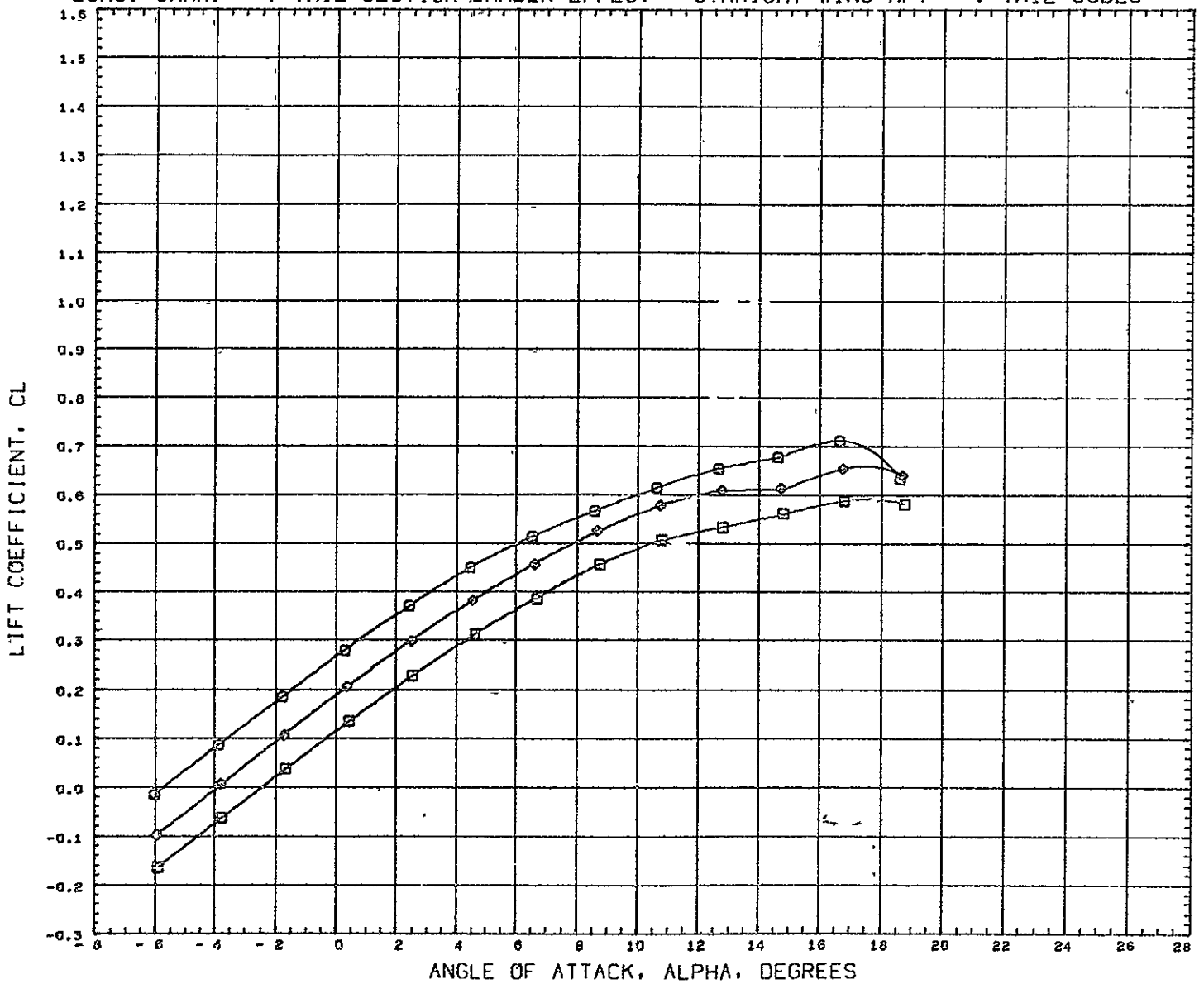

DATA SET SYMBOL	CONFIGURATION DESCRIPTION	PARAMETRIC VALUES				REFERENCE INFORMATION		
(RC7068)	□ CVLSWT TEST 579-0 B1W3AT1-55	BLIA	0.000	ELEVTR	0.000	REFS	316.2304	SQ IN
(RC7116)	□ CVLSWT TEST 579-0 B1W3AT2-55	RUDVTR	0.000	FLAPS	0.000	REFL	50.1900	IN
(RC7118)	◇ CVLSWT TEST 579-0 B1W3AT3-55	SFOILR	0.000			REFB	7.3500	IN
						XMRP	29.3920	IN
						YMRP	0.0000	IN
						ZMRP	0.0000	IN
						SCALE	0.0175	

MACH 0.259

LONG. CHAR. - V-TAIL SECTION CAMBER EFFECT - STRAIGHT WING AFT - V-TAIL=55DEG

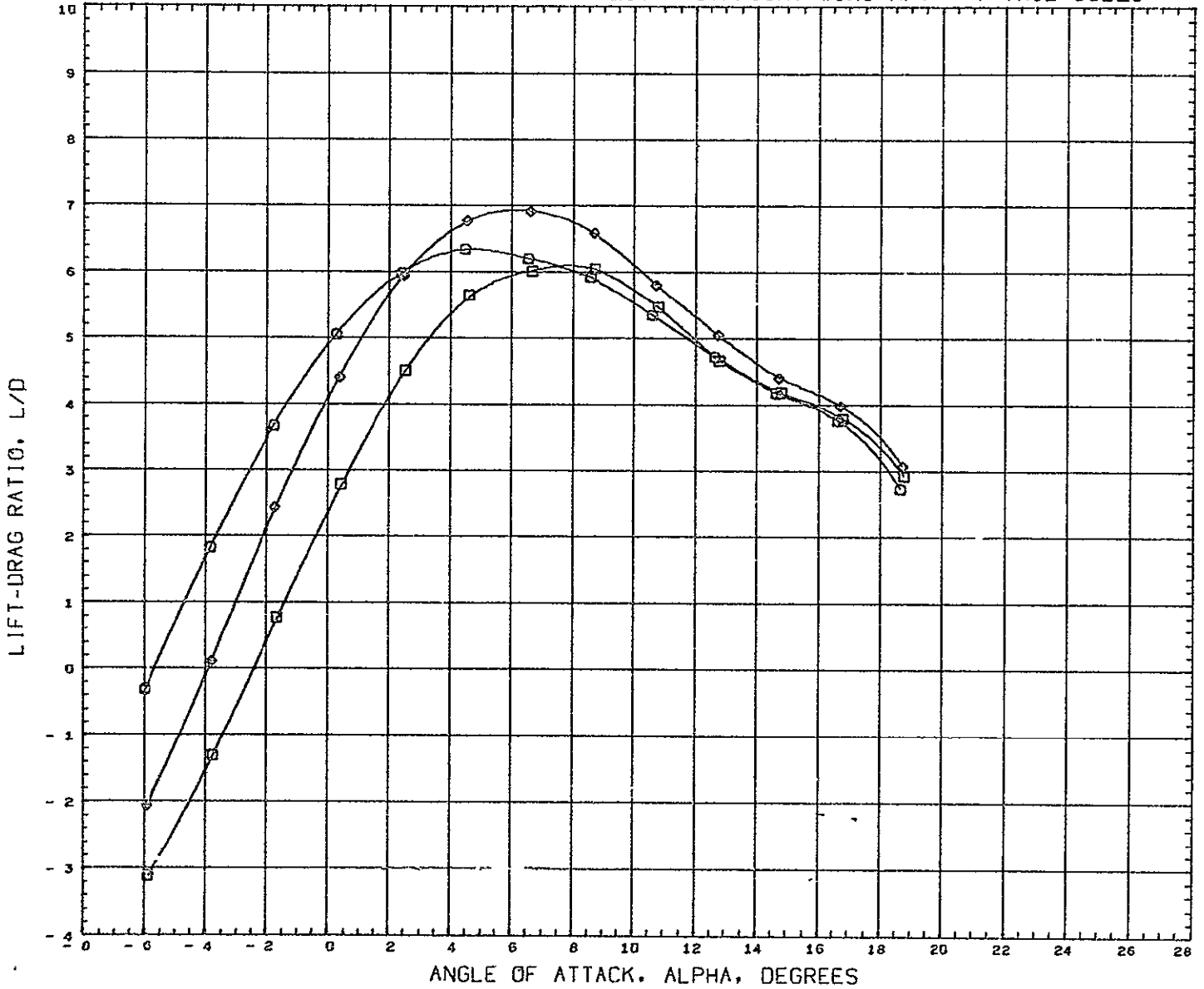

DATA SET SYMBOL CONFIGURATION DESCRIPTION  
 (RC7068) □ CVLSWT TEST 579-D B1W3A11-55  
 (RC7116) □ C+LSWT TEST 579-D B1W3A12-55  
 (RC7118) ○ CVLSWT TEST 579-D B1W3A13-55

PARAMETRIC VALUES  
 BETA 0.000 ELEVTR 0.000  
 RUDVTR 0.000 FLAPS 0.000  
 SPOILR 0.000

REFERENCE INFORMATION  
 REFS 316 2304 SQ IN  
 REFL 50 1900 IN  
 REFB 7.3500 IN  
 XHRF 29.3920 IN  
 YHRF 0.0000 IN  
 ZHRF 0.0000 IN  
 SCALE 0.0175

MACH 0.259

LONG. CHAR. - V-TAIL SECTION CAMBER EFFECT - STRAIGHT WING AFT - V-TAIL=55DEG

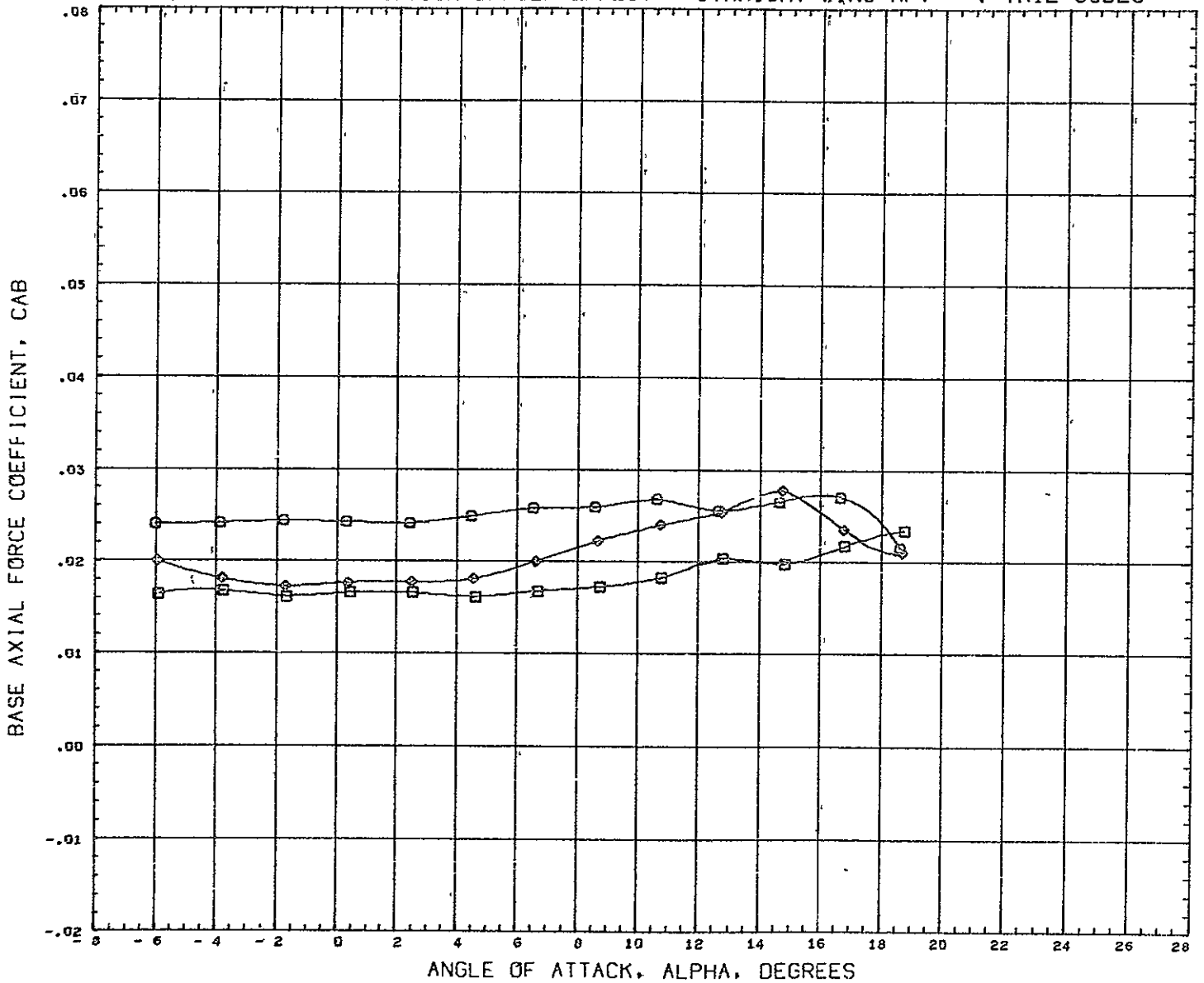

DATA SET SYMBOL	CONFIGURATION DESCRIPTION	PARAMETRIC VALUES			REFERENCE INFORMATION		
(RC7068)	□ CVLSWT TEST 579-G B1W3AT1-55	BETA	0.000	ELEVTR	0.000	REFS	316 2304 SQ IN
(RC7116)	□ CVLSWT TEST 579-G B1W3AT2-55	RUDVTR	0.000	FLAPS	0.000	REFL	50.1900 IN
(RC7116)	◇ CVLSWT TEST 579-G B1W3AT3-55	SPOILR	0.000			REFB	7.3500 IN
						XMRP	29.3920 IN
						YMRP	0.0000 IN
						ZMRP	0.0000 IN
						SCALE	0.0175

MACH 0.259

LONG. CHAR. - V-TAIL SECTION CAMBER EFFECT - STRAIGHT WING AFT - V-TAIL=55DEG

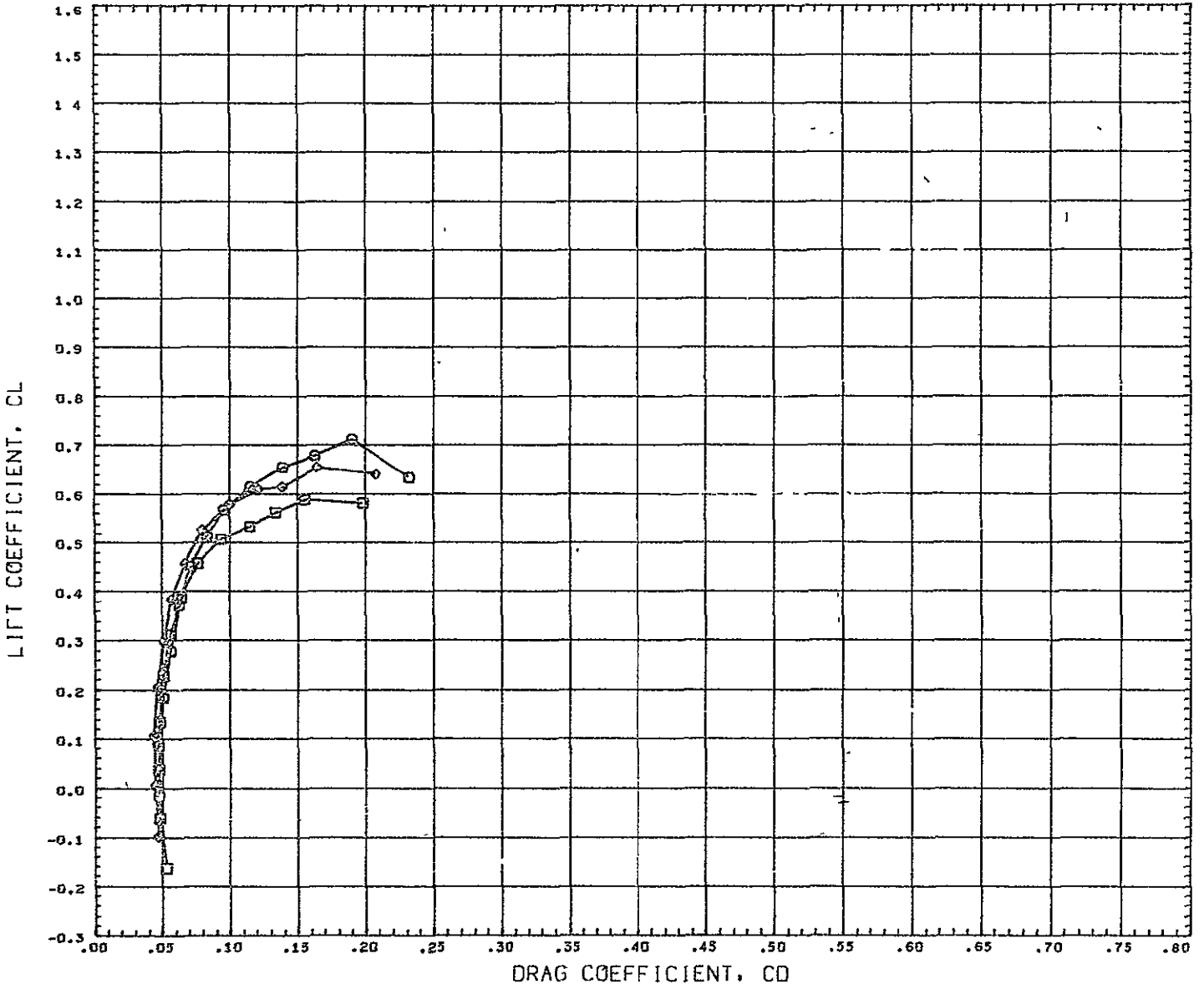

DATA SET SYMBOL    CONFIGURATION DESCRIPTION  
 (FC7068)    □    CVLSWT TEST 579-0 B1W3AT1-55  
 (RC7116)    □    CVLSWT TEST 579-0 B1W3AT2-55  
 (RC7118)    ○    CVLSWT TEST 579-0 B1W3AT3-55

PARAMETRIC VALUES  
 BETA    0.000    ELEVTR    0.000  
 RUDVTR    0.000    FLAPS    0.000  
 SFOILR    0.000

REFERENCE INFORMATION  
 REFS    316.2304    SQ IN  
 REFL    50.1900    IN  
 REFB    7.3500    IN  
 XMRP    29.3920    IN  
 YMRP    0.0000    IN  
 ZMRP    0.0000    IN  
 SCALE    0.0175

MACH    0.259



LONG. CHAR. - V-TAIL SECTION CAMBER EFFECT - STRAIGHT WING AFT - V-TAIL=55DEG

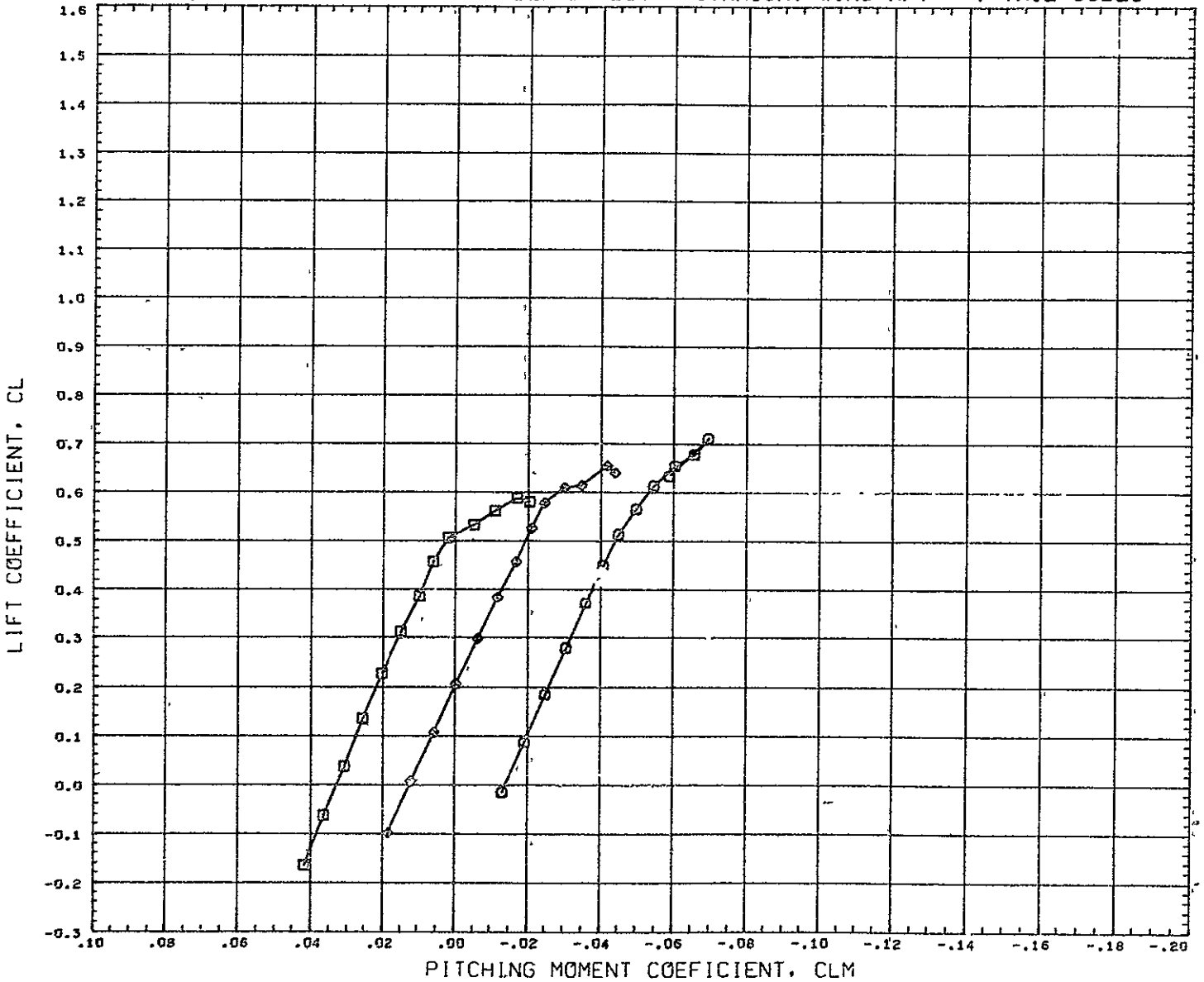

DATA SET SYMBOL	CONFIGURATION DESCRIPTION	PARAMETRIC VALUES				REFERENCE INFORMATION		
(RC7068)	□ CVLSWT TEST 579-D B1W3AT1-55	BETA	0.000	ELEVTR	0.000	PEFS	316.2304	SQ IN
(RC7116)	□ CVLSWT TEST 579-D B1W3AT2-55	RUDYTR	0.000	FLAPS	0.000	REFL	50.1900	IN
(RC7118)	◇ CVLSWT TEST 579-D B1W3AT3-55	SFOILR	0.000			PEFB	7.3500	IN
						XMRP	29.3920	IN
						YMRP	0.0000	IN
						ZMRP	0.0000	IN
						SCALE	0.0175	

MACH 0.259

V-TAIL SECTION CAMBER EFFECT - SIDESLIP DERIV. - STRAIGHT WING AFT- V-TAIL=55DEG

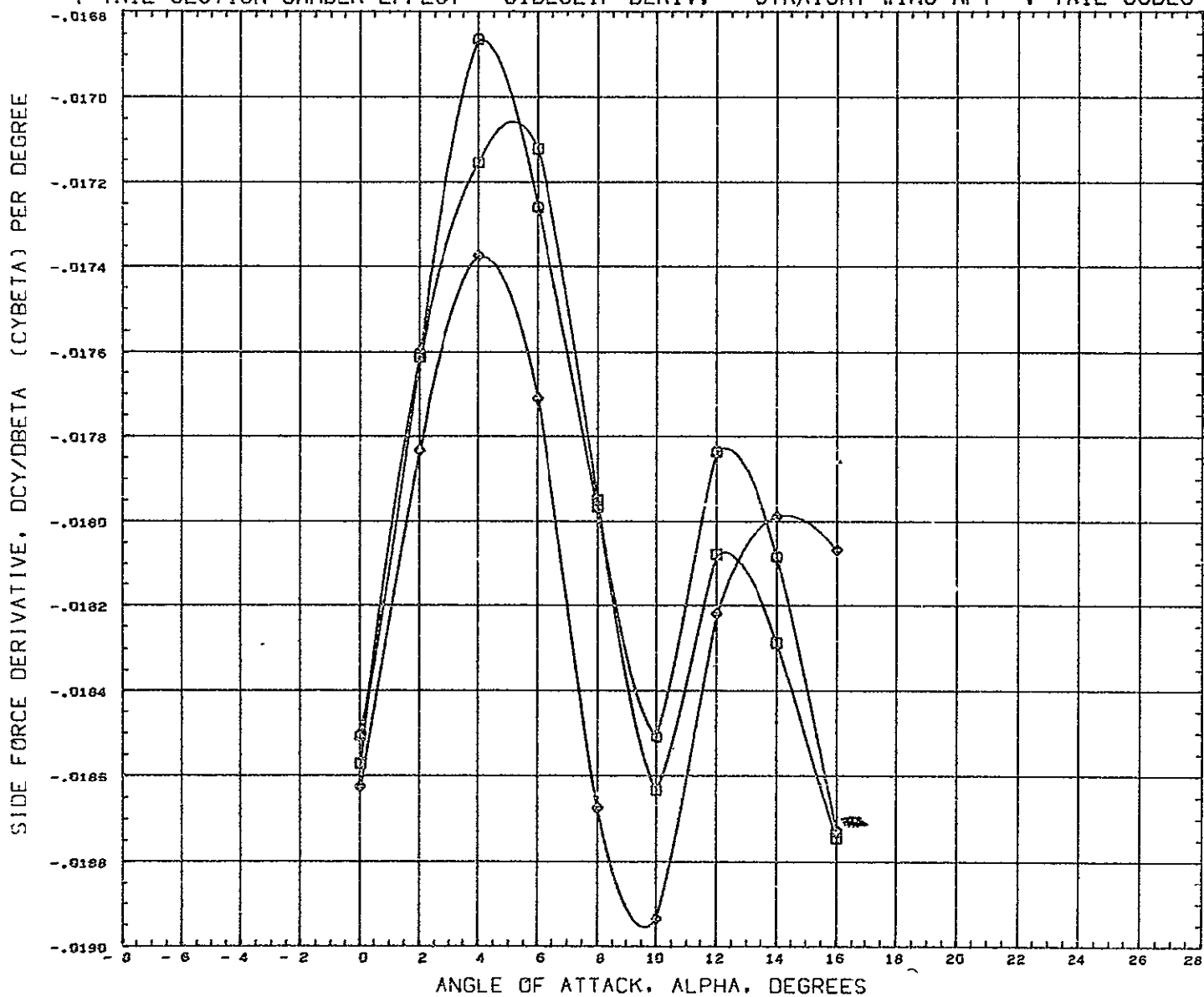

DATA SET SYMBOL	CONFIGURATION DESCRIPTION	PARAMETRIC VALUES			REFERENCE INFORMATION		
(DB7068)	CVLSWT TEST 579-D B1W3AT1-55	BETA	0.000	ELEVTR	0.000	REFS	316.2304 SQ IN
(DB7116)	CVLSWT TEST 579-D B1W3AT2-55	RUCYTR	0.000	FLAPS	0.000	REFL	50.1900 IN
(DB7118)	CVLSWT TEST 579-D B1W3AT3-55	SPOILR	0.000			REFB	7.3500 IN
						XMRP	29.3920 IN
						YMRP	0.0000 IN
						ZMRP	0.0000 IN
						SCALE	0.0175

HACH 0.259

V-TAIL SECTION CAMBER EFFECT - SIDESLIP DERIV. - STRAIGHT WING AFT- V-TAIL=55DEG

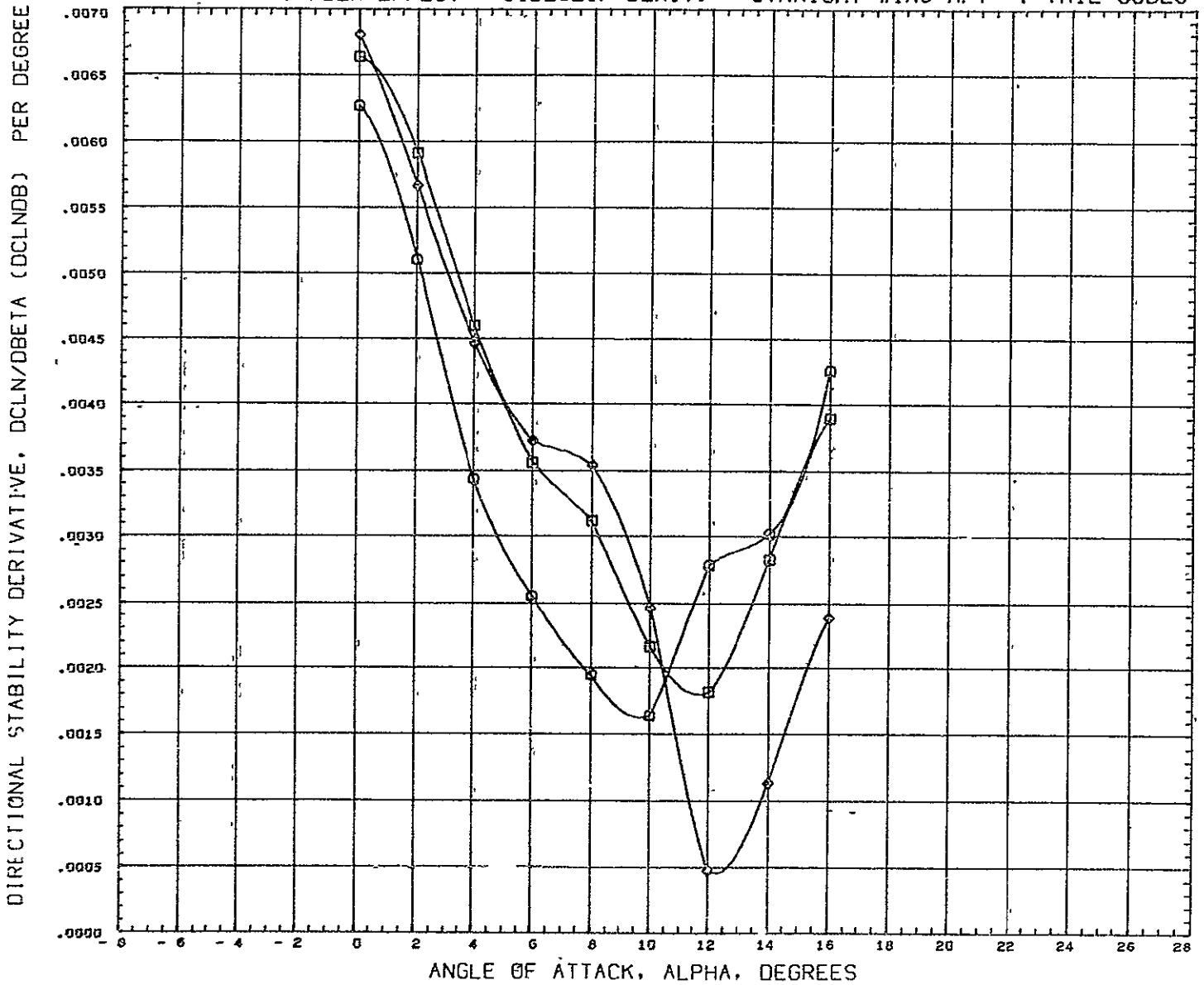

DATA SET SYMBOL	CONFIGURATION DESCRIPTION	PARAMETRIC VALUES			REFERENCE INFORMATION			
(DB7568)	□ CVLSWT TEST 579-D S1W3AT1-55	BETA	0.000	ELEVTR	0.000	REFS	316.2304	SQ IN
(DB7116)	□ CVLSWT TEST 579-D B1W3AT2-55	RUDVTR	0.000	FLAPS	0.000	REFL	50.1900	IN
(DB7118)	◇ CVLSWT TEST 579-D B1W3AT3-55	SFOILR	0.000			REFB	7.3500	IN
						XNFP	29.3920	IN
						YNFP	0.0000	IN
						ZNFP	0.0000	IN
						SCALE	0.0175	

MACH 0.259

V-TAIL SECTION CAMBER EFFECT - SIDESLIP DERIV. - STRAIGHT WING AFT- V-TAIL=55DEG

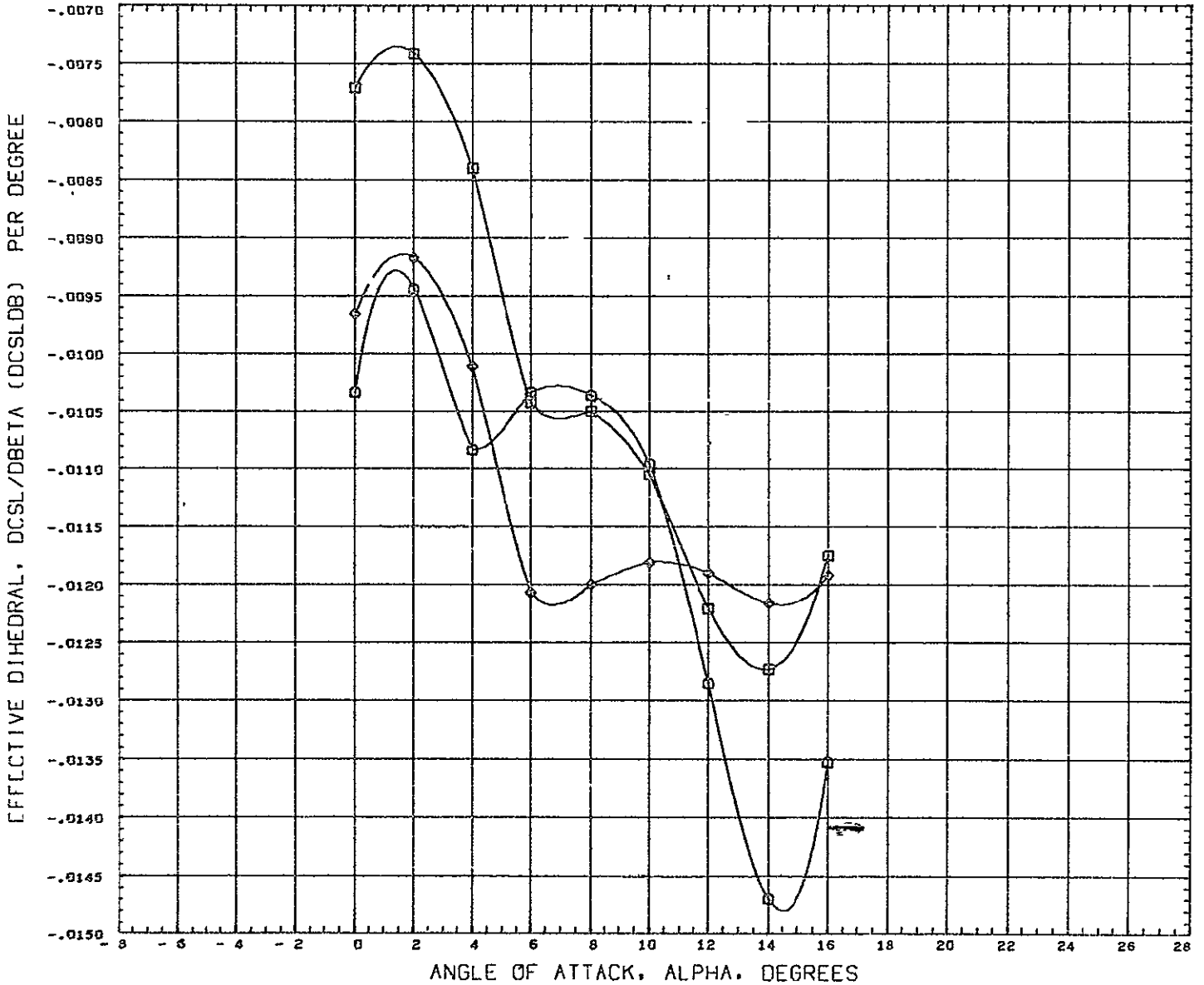

DATA SET SYMBOL	CONFIGURATION DESCRIPTION	PARAMETRIC VALUES			REFERENCE INFORMATION		
(DB7068)	□ CVLSWT TEST 579-G B1W3AT1-55	BETA	0.000	ELEVTR	0 000	REFS	316.2304 SQ IN
(DB7116)	□ CVLSWT TEST 579-G B1W3AT2-55	RUDVTR	0.000	FLAPS	0 000	REFL	50 1900 IN
(DB7118)	◇ CVLSWT TEST 579-G B1W3AT3-55	SFOILR	0.000			REFB	7 3500 IN
						XMRP	29 3920 IN
						YMRP	0.0000 IN
						ZMRP	0 0000 IN
						SCALE	0 0175

MACH 0.259

COMPARISON OF V-TAIL=55DEG WITH HORIZ.-VERT. TAIL CONFIG. - ST. WING BASIC POS.

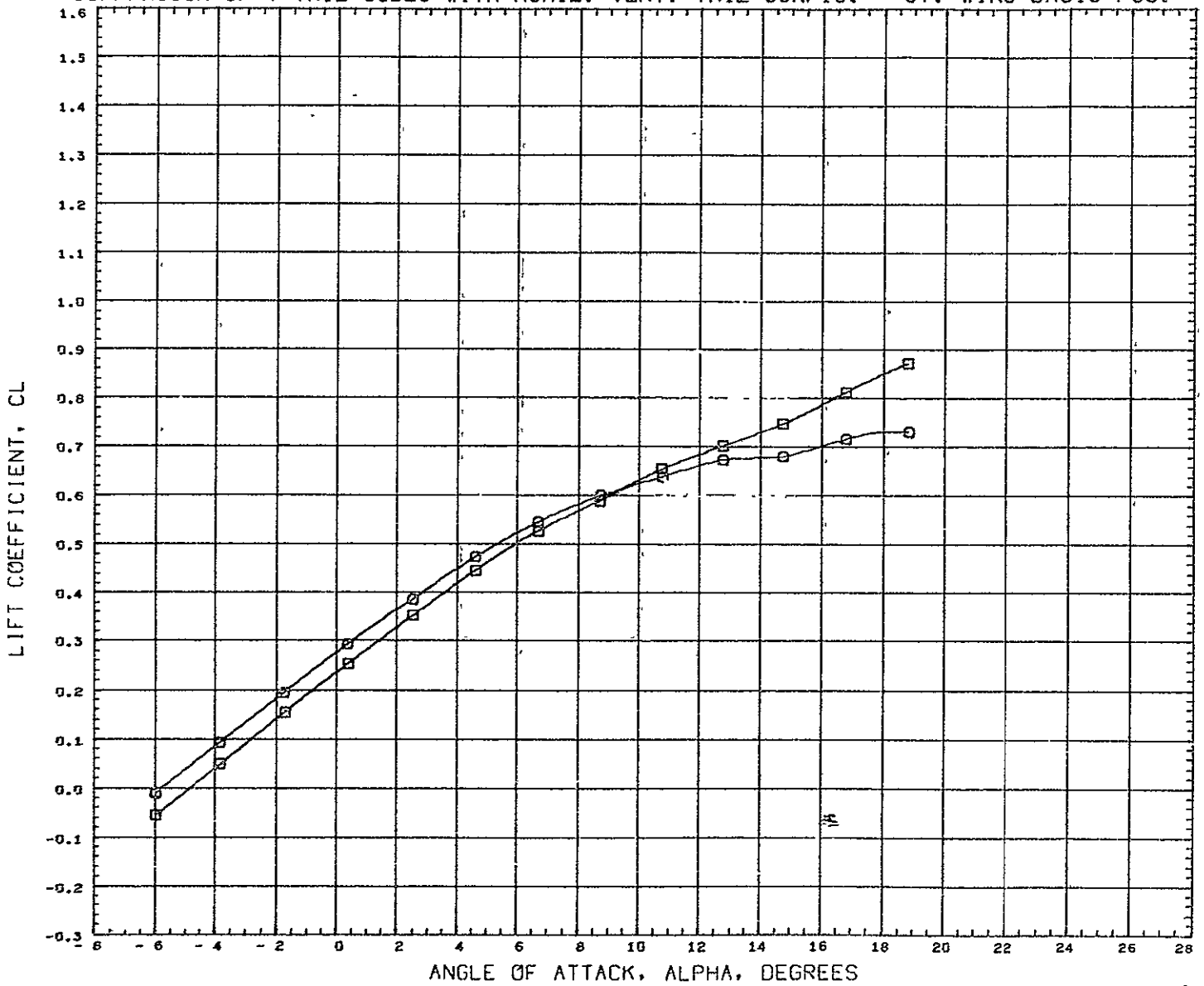

DATA SET SYMBOL	CONFIGURATION DESCRIPTION	PARAMETRIC VALUES			REFERENCE INFORMATION		
{SC7001}	CVLSWT TEST 579-D B1W1-15T1-55	BETA	0.000	ELEVTR	0.000	REFS	316 2304 60 IN
{RC7049}	CVLSWT TEST 579-G B1W1-15T1-90V1	RUDVTR	0.000	FLAPS	0.000	REFL	50 1900 IN
		SFOILR	0.000			REFB	7.3500 IN
						XHRF	29.3920 IN
						YHRF	0.0000 IN
						ZHRF	0.0000 IN
						SCALE	0.0175

MACH 0.259

COMPARISON OF V-TAIL=55DEG WITH HORIZ.-VERT. TAIL CONFIG. - ST. WING BASIC POS.

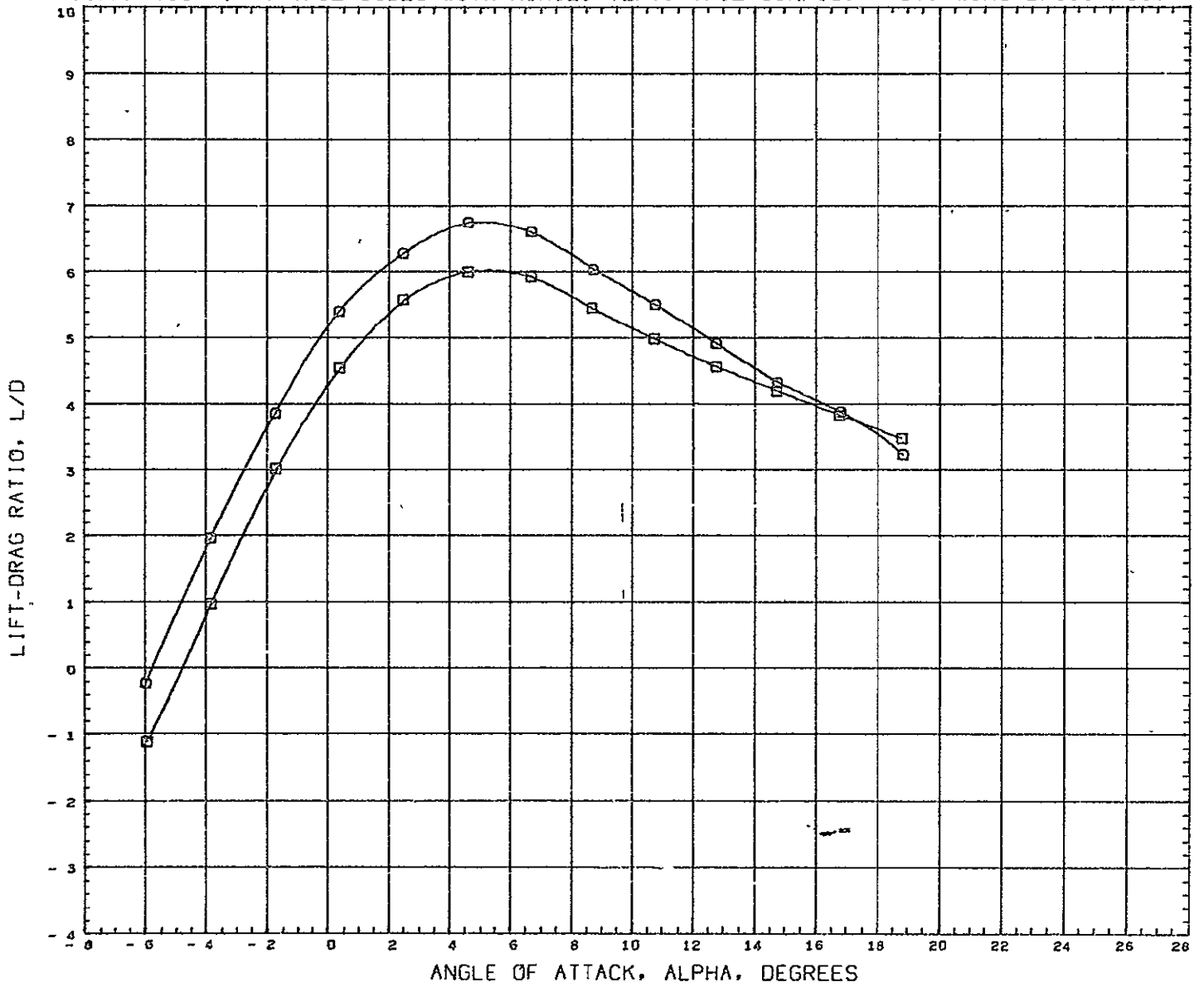

DATA SET SYMBOL	CONFIGURATION DESCRIPTION	PARAMETRIC VALUES			REFERENCE INFORMATION		
(SC7001)	○ CVLSWT TEST 579-0 B1W1-15T1-55	BETA	0.000	ELEVTR	0.000	REFS	316 2304 SQ IN
(RC7049)	□ CVLSWT TEST 579-0 B1W1-15T1-90V1	RUDVTR	0.000	FLAPS	0.000	REFL	50 1900 IN
		SFOILR	0.000			REFB	7.3500 IN
						XNRP	29.3920 IN
						YHRP	0.0000 IN
						ZHRP	0.0000 IN
						SCALE	0 0175

MACH 0.259

COMPARISON OF V-TAIL=55DEG WITH HORIZ.-VERT. TAIL CONFIG. - ST. WING BASIC POS.

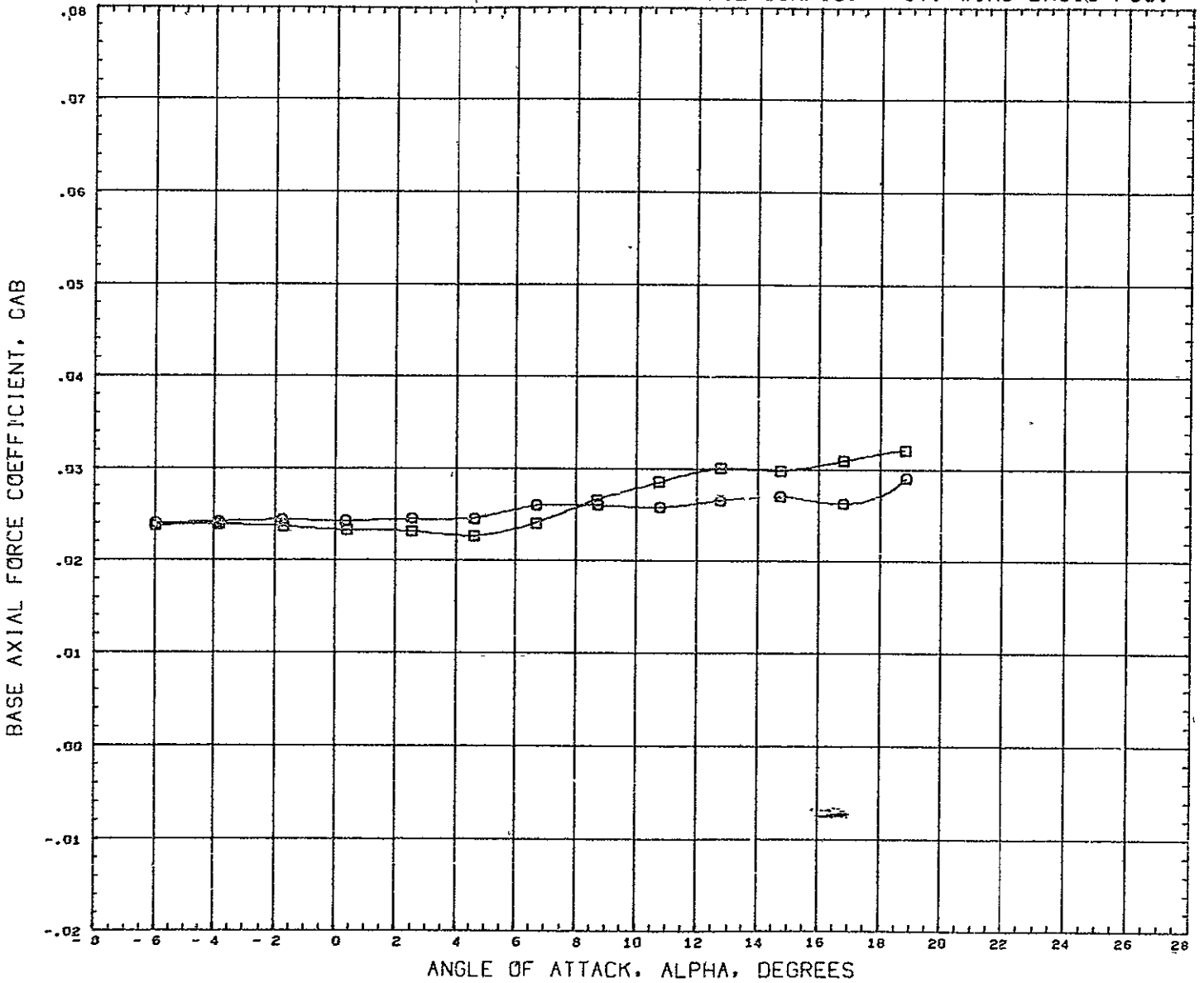

DATA SET SYMBOL	CONFIGURATION DESCRIPTION	PARAMETRIC VALUES			REFERENCE INFORMATION		
(SC7551)	○ CVLSWT TEST 579-D B1W1-15T1-55	BETA	0.000	ELEVTR	0.000	REFS	316 2304 SQ IN
(SC7549)	□ CVLSWT TEST 579-D B1W1-15T1-90V1	RUDVTR	0.000	FLAPS	0.000	PEFL	50,1900 IN
		SFOILR	0.000			REFB	7.3500 IN
						XHRF	29 3920 IN
						YHRF	0.0000 IN
						ZHRF	0.0000 IN
						SCALE	0.0175

MACH 5.259

COMPARISON OF V-TAIL=55DEG WITH HORIZ.-VERT. TAIL CONFIG. - ST. WING BASIC POS.

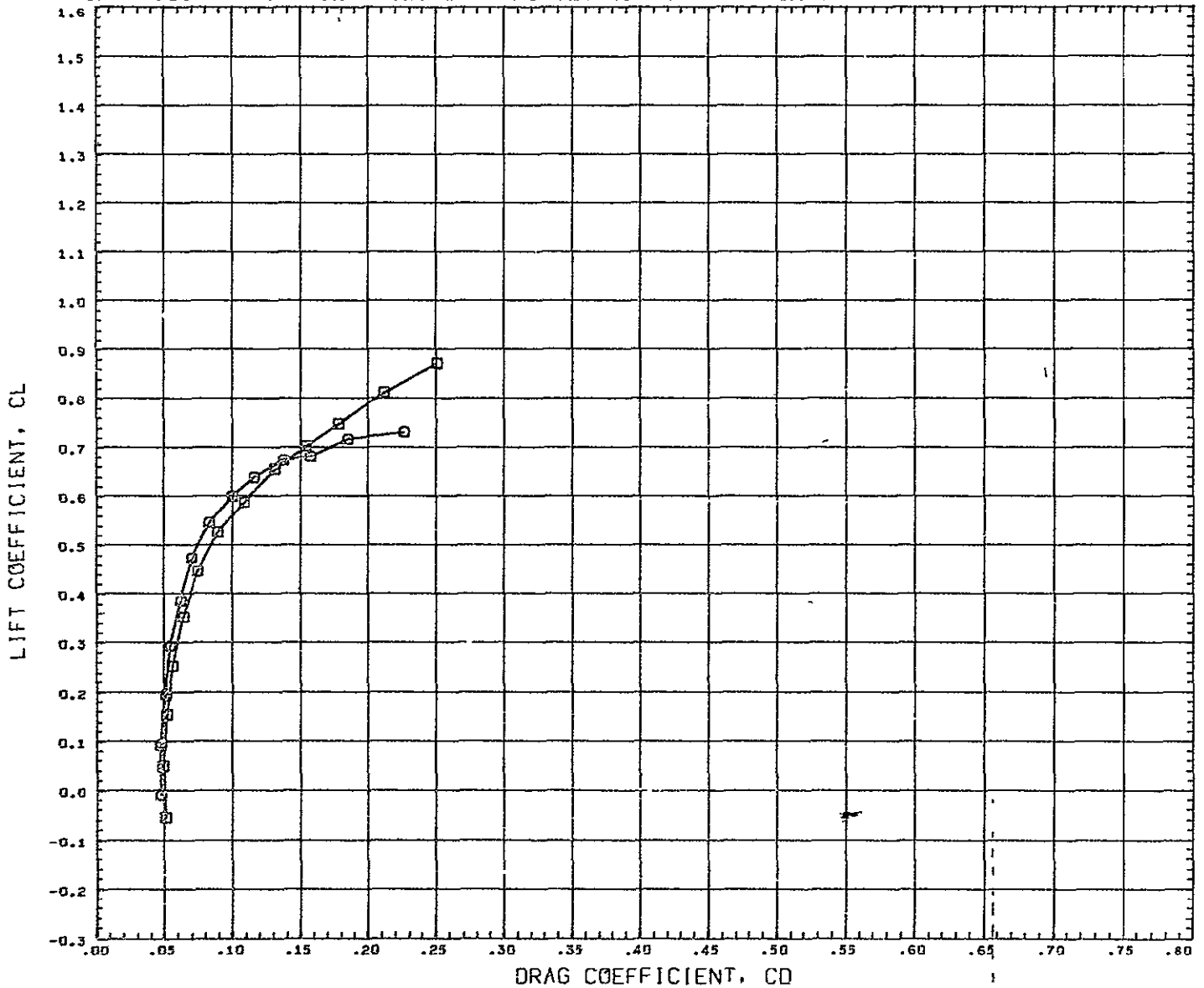

DATA SET SYMBOL    CONFIGURATION DESCRIPTION  
 (SC7001)    □    CVLSWT TEST 579-D B1W1-15T1-55  
 (RC7049)    □    CVLSWT TEST 579-D B1W1-15T1-90V1

PARAMETRIC VALUES  
 BETA    0.000    ELEVTR    0.000  
 RUBVTR    0.000    FLAPS    0.000  
 SPOILR    0.000

REFERENCE INFORMATION  
 REFS    316.2304    SQ IN  
 REFL    50.1900    IN  
 REFB    7.3500    IN  
 XHRF    29.3920    IN  
 YHRF    0.0000    IN  
 ZHRF    0.0000    IN  
 SCALE    0.0175

MACH    0.259



COMPARISON OF V-TAIL=55DEG WITH HORIZ.-VERT. TAIL CONFIG. - ST. WING BASIC POS.

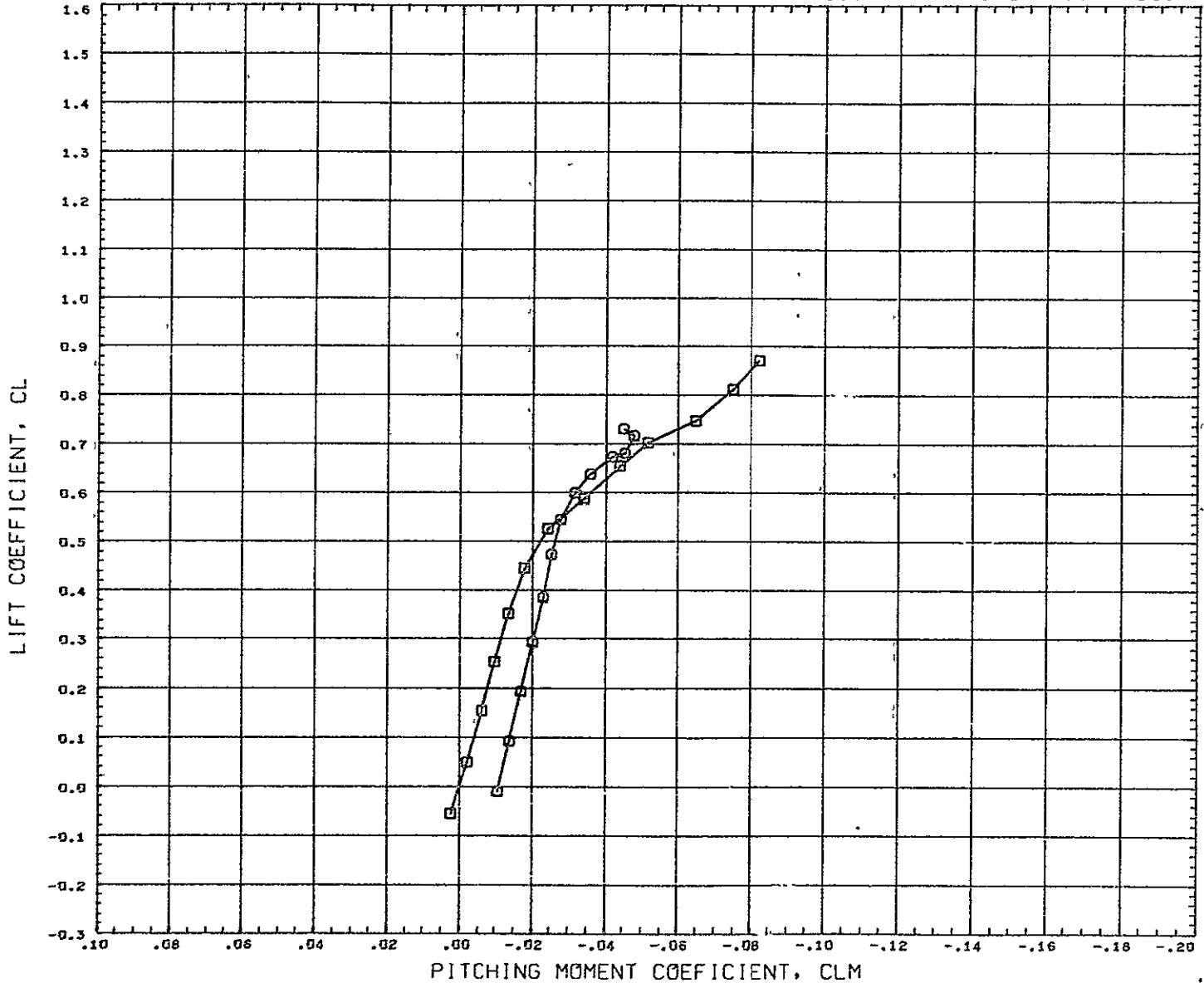

DATA SET SYMBOL	CONFIGURATION DESCRIPTION	PARAMETRIC VALUES			REFERENCE INFORMATION		
(SC7001)	○ CVLSWT TEST 579-D B1W1-15T1-55	BETA	0.000	ELEVTR	0.000	REFS	316 2304 SQ IN
(RC7049)	□ CVLSWT TEST 579-D B1W1-15T1-90V1	RUDVTR	0.000	FLAPS	0.000	REFL	50 1900 IN
		SFOILR	0.000			REFB	7.3500 IN
						XHRF	29.3920 IN
						YHRF	0.0000 IN
						ZHRF	0.0000 IN
						SCALE	0 0175

MACH 0.259

COMPARISON OF V-TAIL=55DEG WITH HORIZ.-VERT. TAIL CONFIG. - ST. WING BASIC POS.

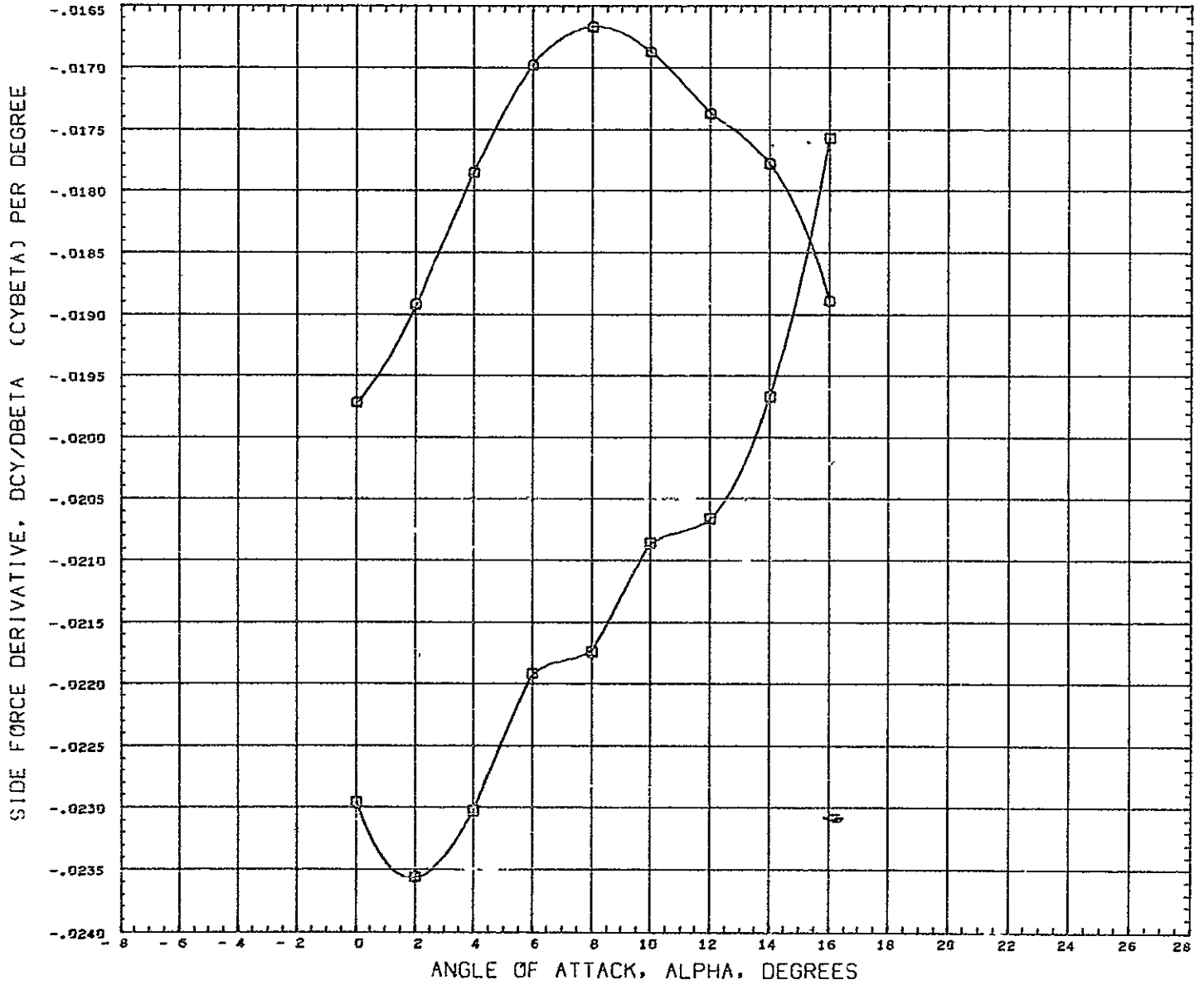

DATA SET SYMBOL	CONFIGURATION DESCRIPTION	PARAMETRIC VALUES				REFERENCE INFORMATION		
(CB7551)	Q CVLSWT TEST 579-D 81W1-15T1-55	PETA	0.000	ELEVTR	0.000	REFS	316 2304	SQ IN
(CB7049)	Q CVLSWT TEST 579-D 81W1-15T1-90V1	RUDVTR	0.000	FLAPS	0.000	REFL	50 1900	IN
		SFOILR	0.000			REFB	7.3500	IN
						XMRP	29.3920	IN
						YMRP	0.0000	IN
						ZMRP	0.0000	IN
						SCALE	0.0175	

MACH 0.259

COMPARISON OF V-TAIL=55DEG WITH HORIZ.-VERT. TAIL CONFIG. - ST. WING BASIC POS.

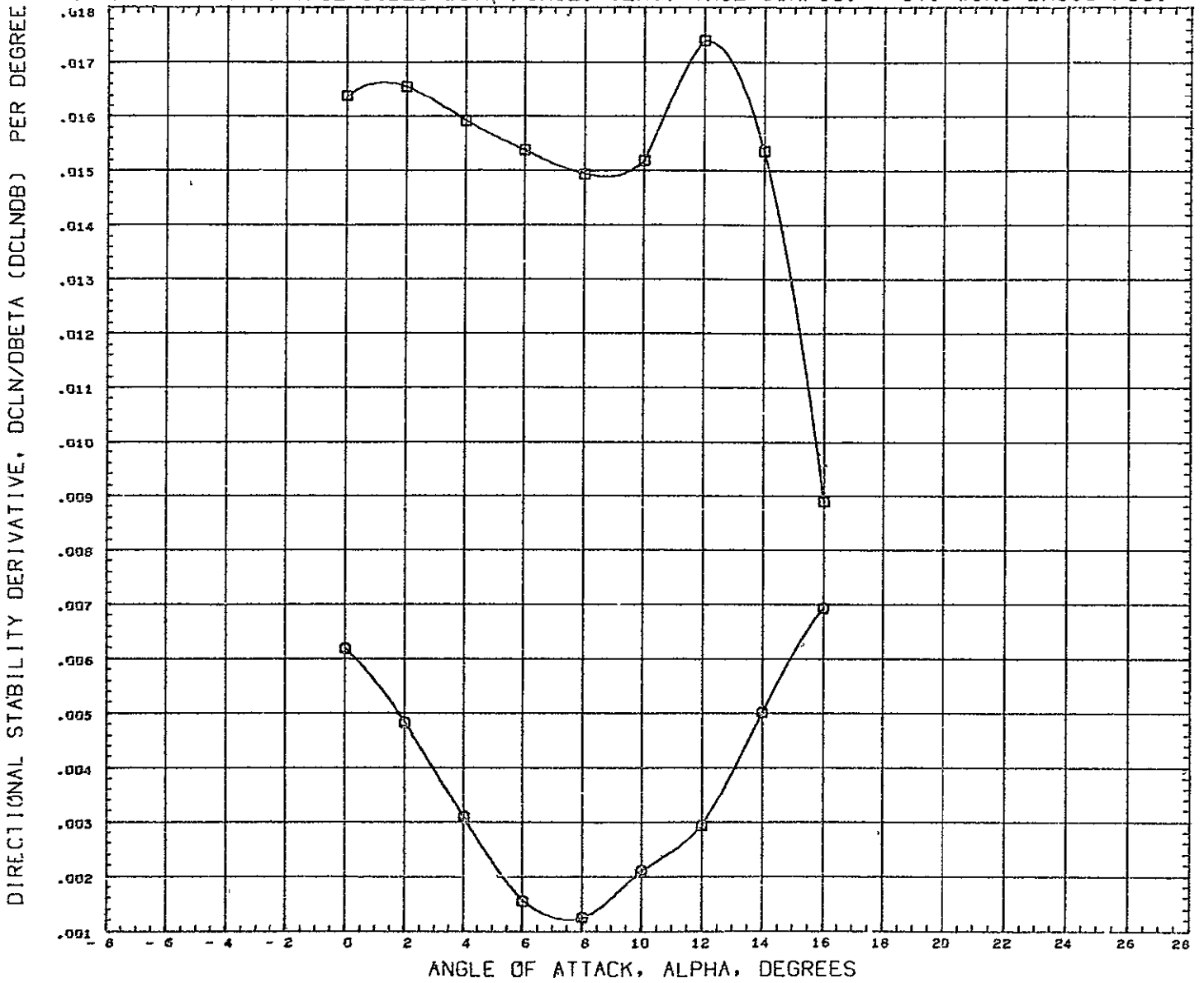

DATA SET SYMBOL	CONFIGURATION DESCRIPTION	PARAMETRIC VALUES			REFERENCE INFORMATION		
(DB7001)	□ CVLSWT TEST 579-0 B1W1-15T1-55	BETA	0.000	ELEVTR	0.000	REFS	316 2304 SQ IN
(DB7049)	○ CVLSWT TEST 579-0 B1W1-15T1-90V1	RUDVTR	0.000	FLAPS	0 000	REFL	50 1900 IN
		SPOILR	0.000			REFB	7 3500 IN
						XMRP	29 3920 IN
						YMRP	0.0000 IN
						ZMRP	0.0000 IN
						SCALE	0 0175

MACH 0.259

COMPARISON OF V-TAIL=55DEG WITH HORIZ.-VERT. TAIL CONFIG. - ST. WING BASIC POS.

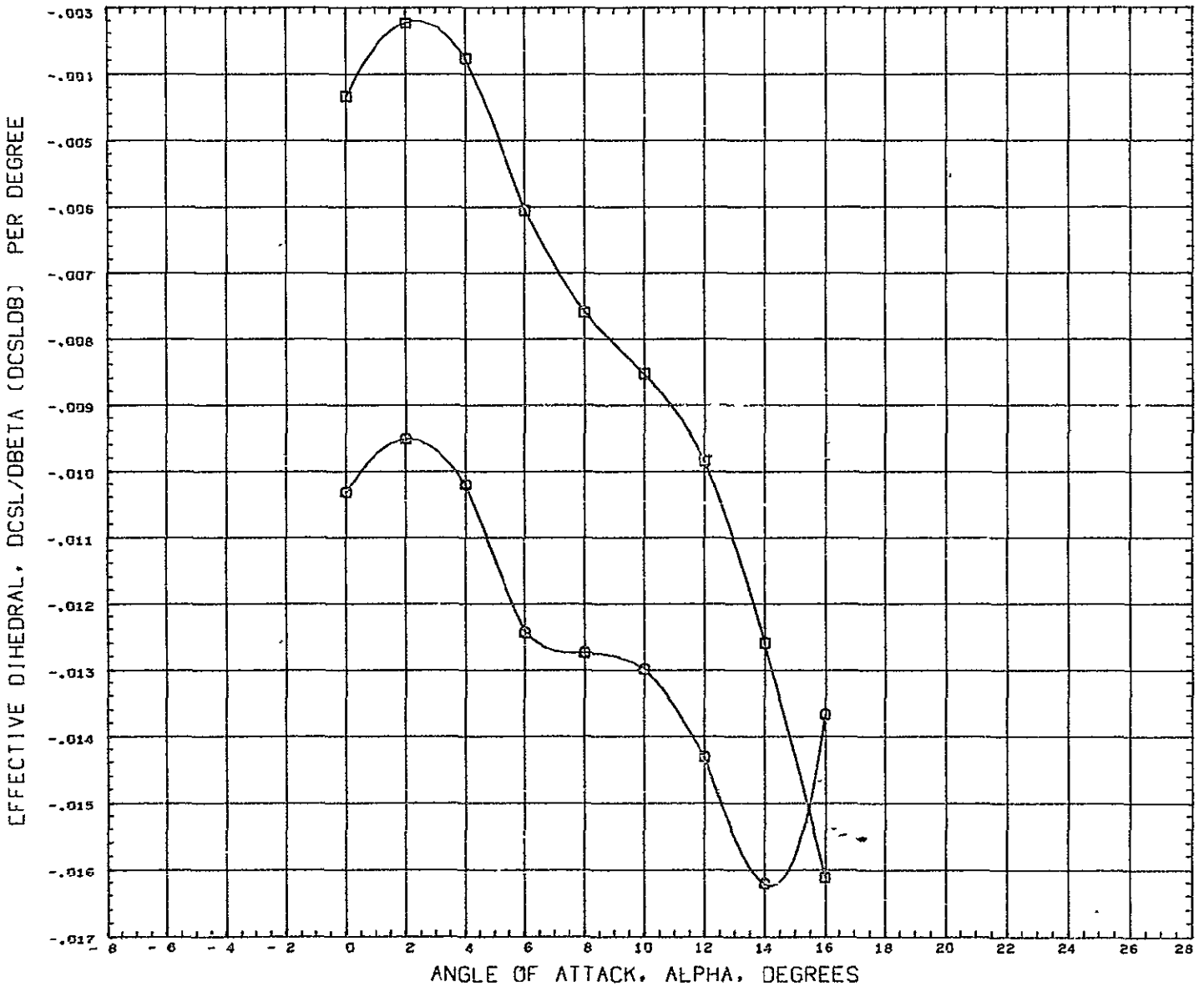

DATA SET SYMBOL CONFIGURATION DESCRIPTION  
 (DB7561) □ CVLSWT TEST 579-D B1W1-15T1-55  
 (DB7549) ○ CVLSWT TEST 579-D B1W1-15T1-9DV1

PARAMETRIC VALUES REFERENCE INFORMATION  
 BETA 0.000 ELEVTR 0.000 REFS 316.2304 SQ IN  
 RUOVTR 0.000 FLAPS 0.000 REFL 50.1900 IN  
 SPOILR 0.000 REFB 7.3500 IN  
 XMRP 29.3920 IN  
 YMRP 0.0000 IN  
 ZMRP 0.0000 IN  
 SCALE 6.0175

MACH 0.259

LONG. CHAR. - ELEVATOR EFF. - STRAIGHT WING BASIC POS. - HORIZ. - VERT. TAIL CONFIG.

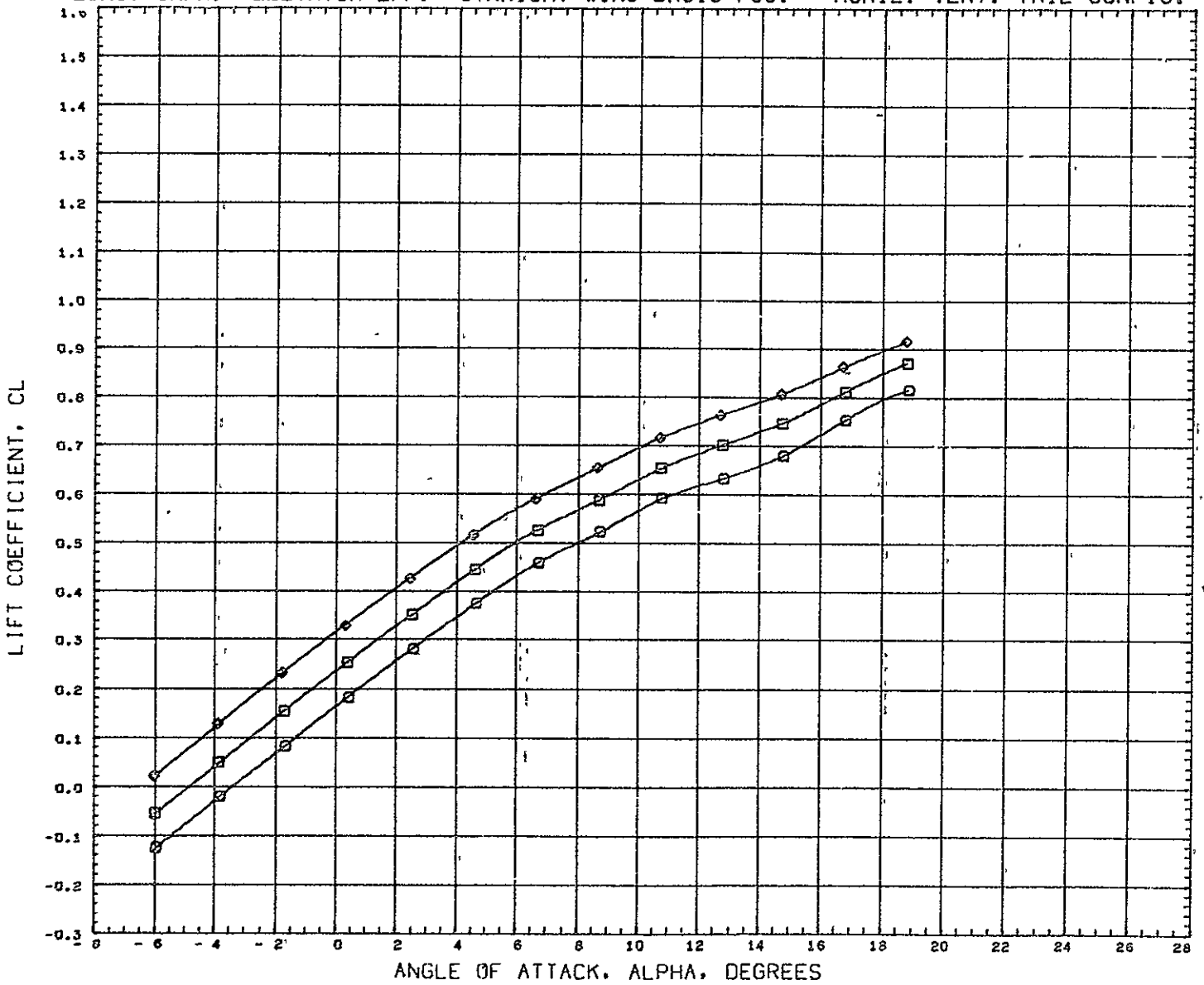

SYMBOL	ELEVTR	PARAMETRIC VALUES			
□	- 10.000	NACH	0.259	BETA	0.000
□	0.000	RUDDER	0.000	FLAPS	0.000
◇	10.000	SFOILR	0.000		

REFERENCE INFORMATION		
REFS	316.2304	SQ IN
REFL	50.1900	IN
REFB	7.3500	IN
XHRF	29.3920	IN
YHRF	0.0000	IN
ZHRF	0.0000	IN
SCALE	0.0175	

REFERENCE FILE CONVAIR T70-AE-12

LONG. CHAR. - ELEVATOR EFF. - STRAIGHT WING BASIC POS. - HORIZ. - VERT. TAIL CONFIG.

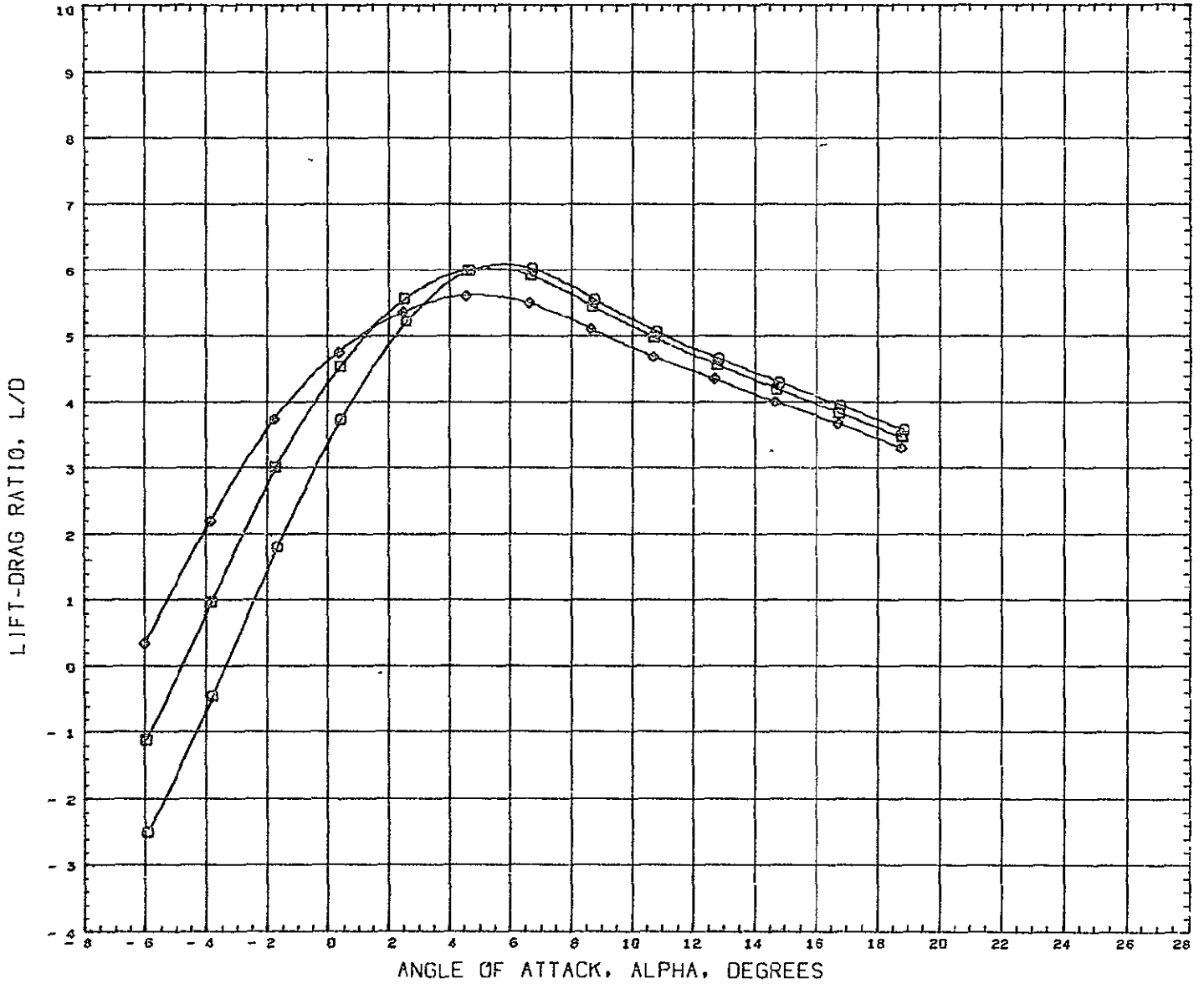

SYMBOL	ELEVTR	PARAMETRIC VALUES			
○	-10.000	HACH	0.259	BETA	0.000
□	0.000	RUDDER	0.000	FLAPS	0.000
◇	10.000	SPOILR	0.000		

REFERENCE INFORMATION		
REFS	316,2304	SQ IN
REFL	50.1900	IN
REFB	7.3500	IN
XMRP	29 3920	IN
YMRP	0 0000	IN
ZMRP	0 0000	IN
SCALE	0.0175	

REFERENCE FILE CGNVAIR IN70-AE-12

LONG. CHAR. - ELEVATOR EFF. - STRAIGHT WING BASIC POS. - HORIZ. - VERT. TAIL CONFIG.

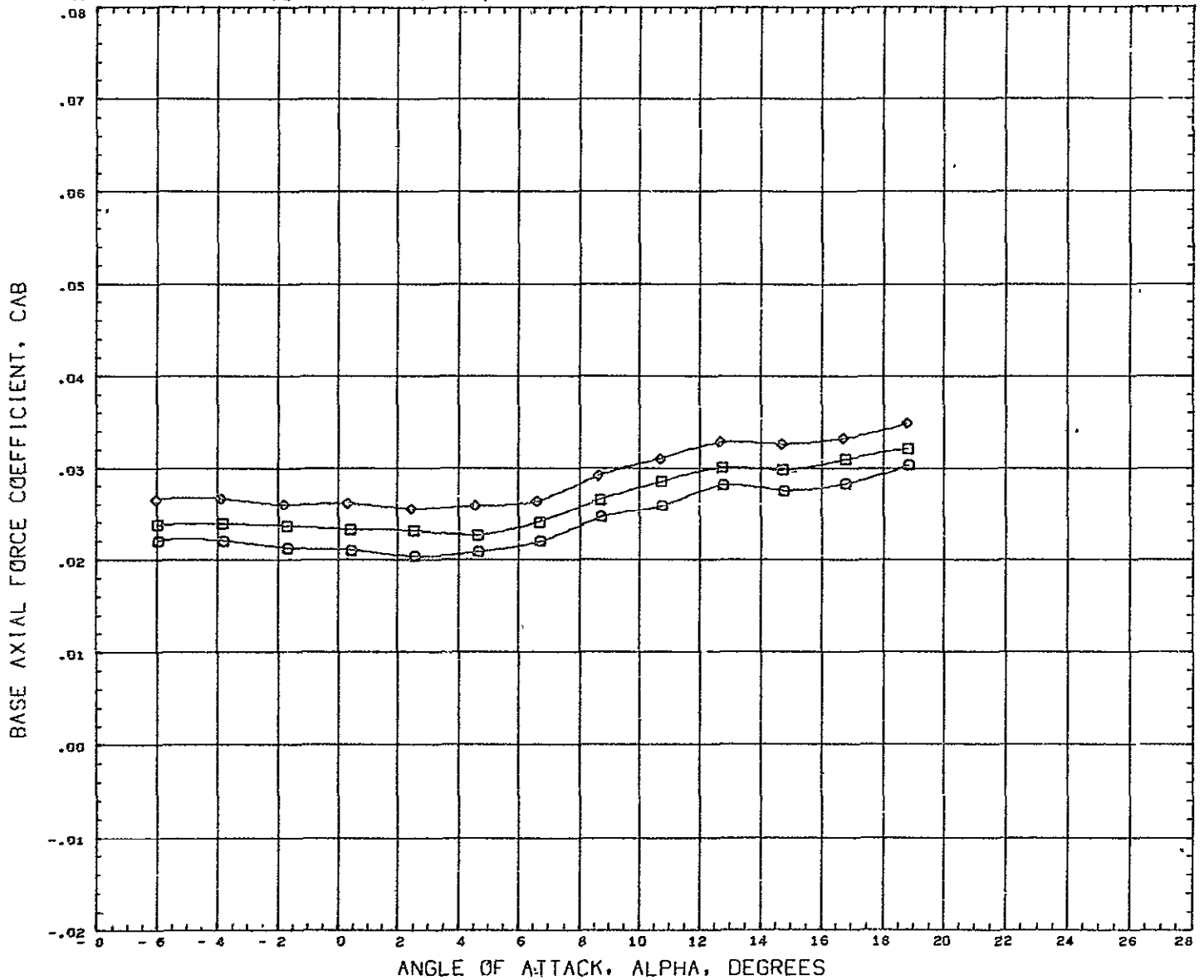

SYMBOL	ELEVTR	PARAMETRIC VALUES			
◇	- 10.000	MACH	0.259	BETA	0.000
□	0.000	RUDDER	0.000	FLAPS	0.000
○	10.000	SFOILR	0.000		

REFERENCE INFORMATION		
REFS	316.2304	SQ IN
REFL	50.1900	IN
REFB	7.3500	IN
XMRP	29.3920	IN
YMRP	0.0000	IN
ZMRP	0.0000	IN
SCALE	0.0175	

REFERENCE FILE CONVAIR T170-AE-12

LONG. CHAR.- ELEVATOR EFF.- STRAIGHT WING BASIC POS. - HORIZ.-VERT. TAIL CONFIG.

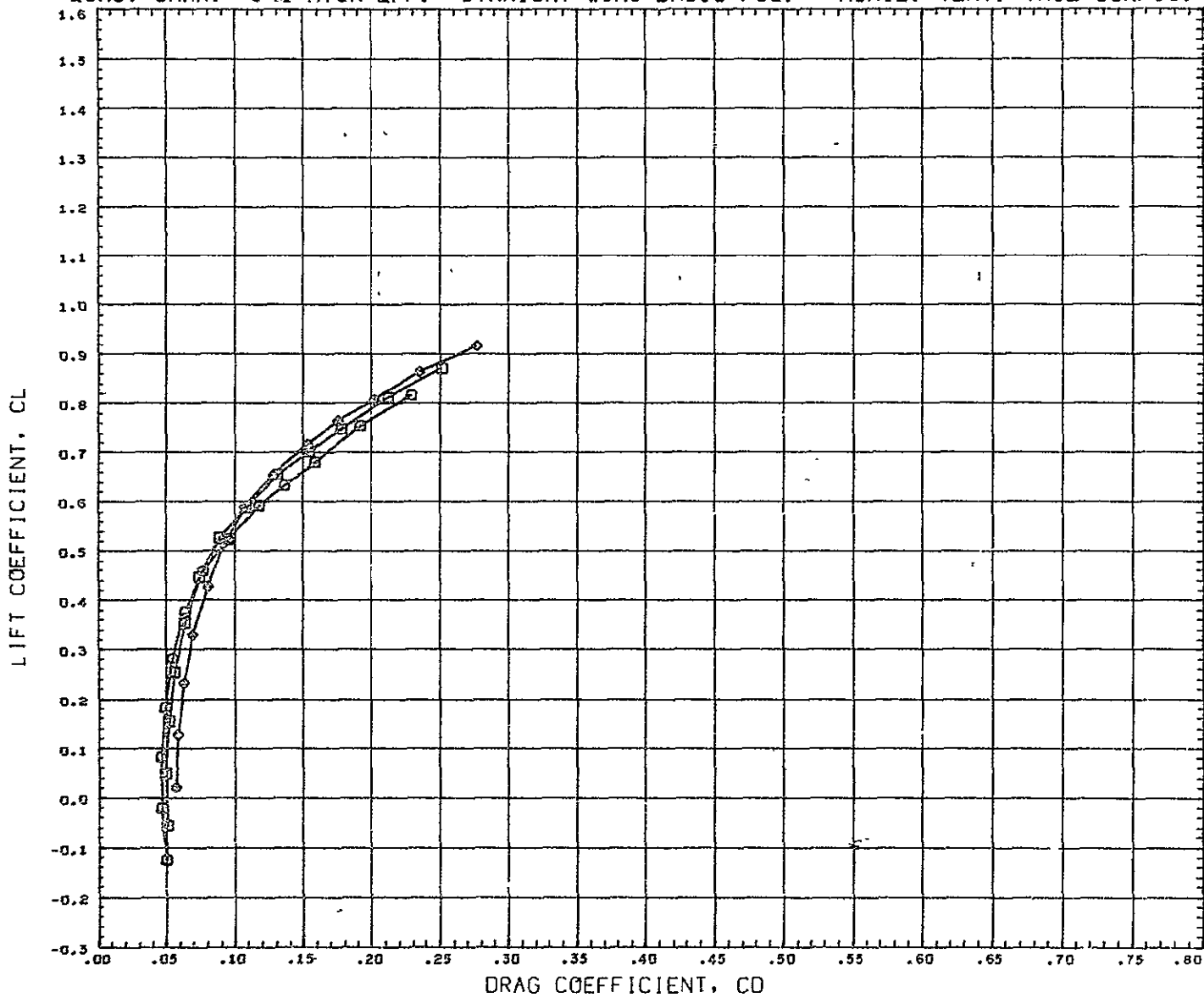

SYMBOL	ELEVTR	PARAMETRIC VALUES
○	10.000	MACH 0.259 BETA 0.000
□	5.000	FUDDER 0.000 FLAPS 0.000
◇	10.000	SFOILR 0.000

REFERENCE INFORMATION		
REFS	316.2304	SQ IN
PEFL	50.1900	IN
REFB	7.3500	IN
XMRP	29.3920	IN
YMRP	0.0000	IN
ZMRP	0.0000	IN
SCALE	0.0175	

REFERENCE FILE CONVAIR T170-AE-12



LONG. CHAR.- ELEVATOR EFF.- STRAIGHT WING BASIC POS. - HORIZ.-VERT, TAIL CONFIG.

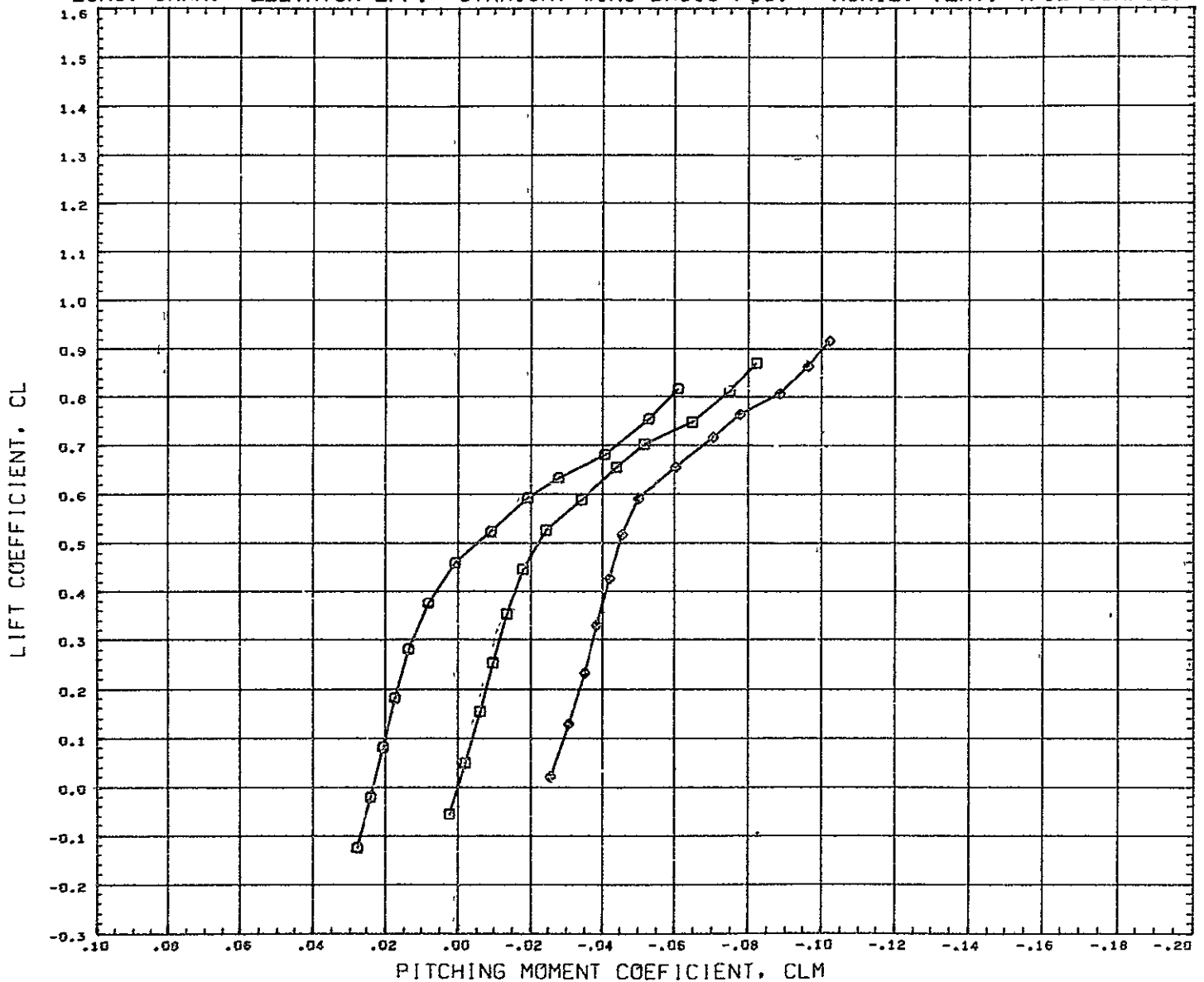

SYMBOL	ELEVTR	PARAMETRIC VALUES			
○	0.000	MACH	0.259	BETA	0.000
□	5.000	RUDDER	0.000	FLAPS	0.000
◇	10.000	SPOILER	0.000		

REFERENCE INFORMATION		
REFS	316.2304	SQ IN
REFL	50.1900	IN
REFB	7.3500	IN
XHRF	29.3920	IN
YHRF	0.0000	IN
ZMFF	0.0000	IN
SCALE	0.0175	

REFERENCE FILE CONV AIR T44-AE-12

LONGITUDINAL CONTROL - STRAIGHT WING BASIC POS. - HORIZ.-VERT. TAIL CONFIG.

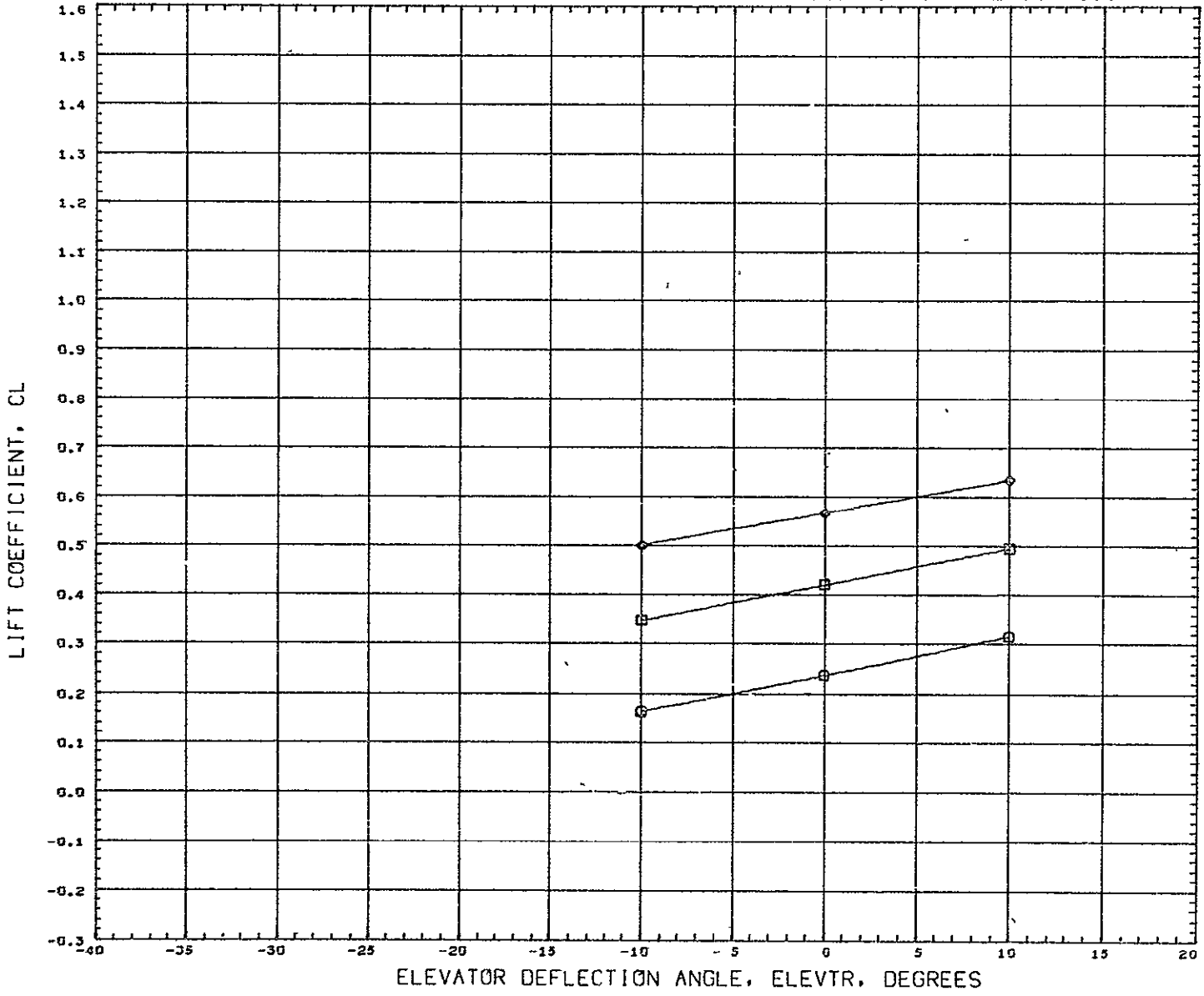

SYMBOL	ALPHA	PARAMETRIC VALUES
○	5.000	MACH 0.259 BETA 0.000
□	4.000	RUDDER 0.000 FLAPS 0.000
◇	8.000	SPOILER 0.000

REFERENCE INFORMATION		
REFS	316 2304	SQ IN
REFL	50 1900	IN
REFB	7.3500	IN
XNRF	29.3920	IN
YNRF	0.0000	IN
ZNRF	0.0000	IN
SCALE	0.0175	

DATA HIST. CODE I

LONGITUDINAL CONTROL - STRAIGHT WING BASIC POS. - HORIZ.-VERT. TAIL CONFIG.

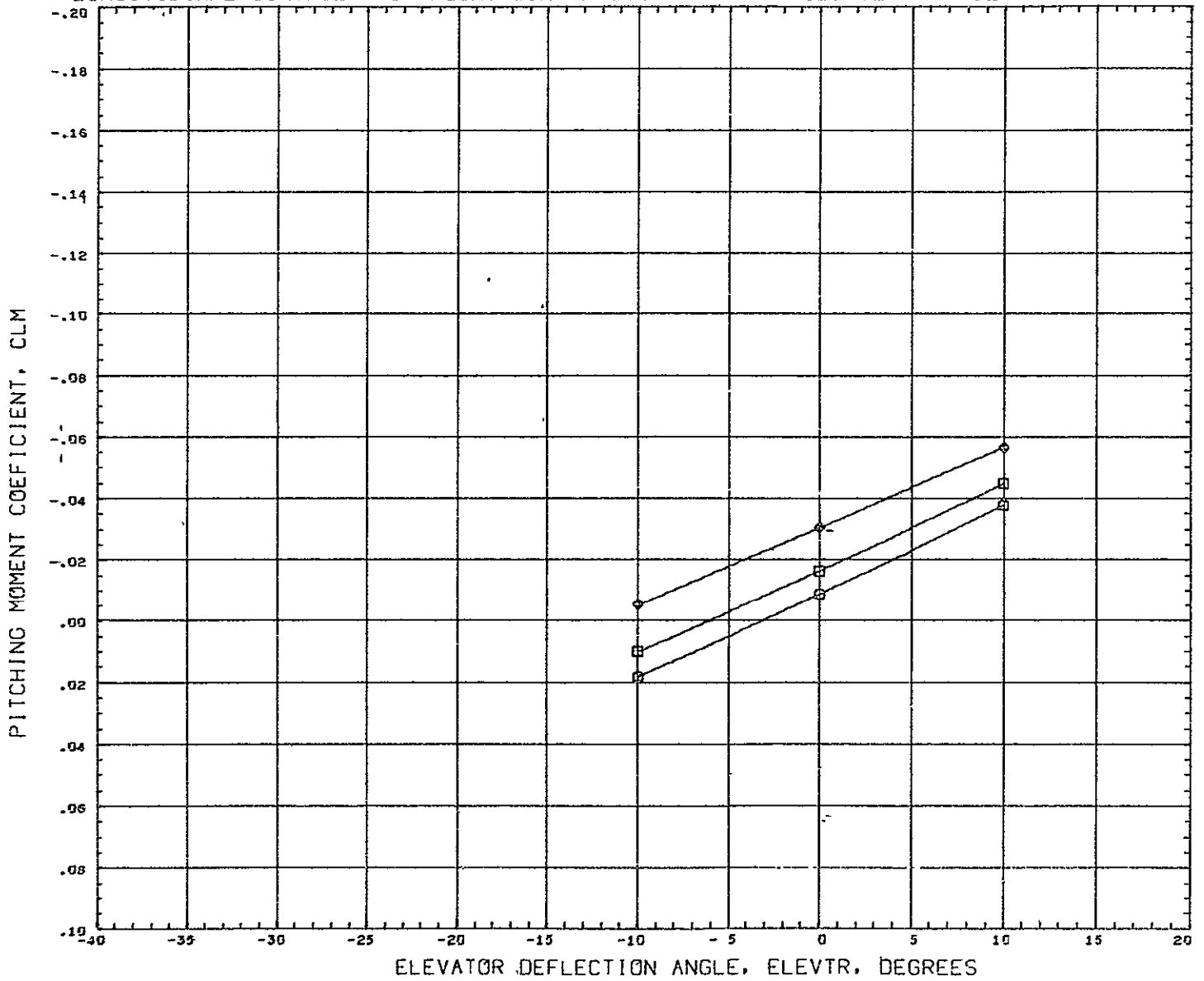

SYMBOL	ALPHA	PARAMETRIC VALUES				REFERENCE INFORMATION		
		MACH	BETA	FLAPS	REFS	REFL	REFB	
○	0.000	0.259	0.000	0.000	316 2304	50.1900	7 3500	
◻	4.000	0.000	0.000	0.000	29 3920	0.0000	0 0000	
◇	8.000	0.000	0.000	0.000	ZMRF	0 0000	SCALE	
							0.0175	

DATA HIST. CODE I

LONGITUDINAL CONTROL - STRAIGHT WING BASIC POS. - HORIZ.-VERT. TAIL CONFIG.

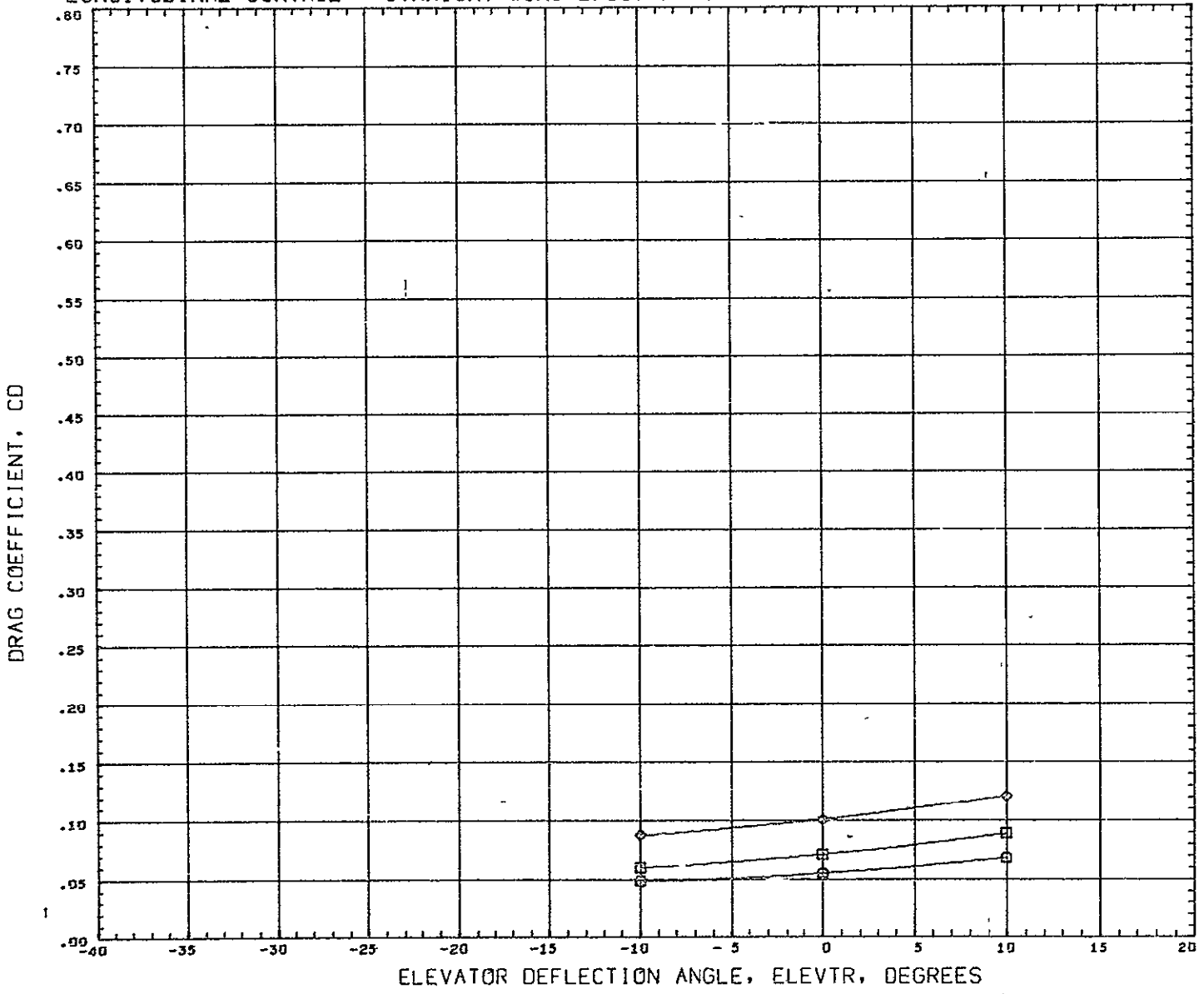

PARAMETRIC VALUES				REFERENCE INFORMATION		
SYMBOL	ALPHA			REFS	316.2304	50 IN
□	9.000	NACH	0.259	BETA	0.000	IN
□	4.000	RUDDER	0.000	FLAPS	0.000	IN
◇	8.000	SPOILER	0.000			IN
				XMRP	29.3920	IN
				YMRP	0.0000	IN
				ZMRP	0.0000	IN
				SCALE	0.0175	

DATA HIST. CODE I

LONG. CONTROL DERIVATIVES - STRAIGHT WING BASIC POS. - HORIZ.-VERT. TAIL CONFIG.

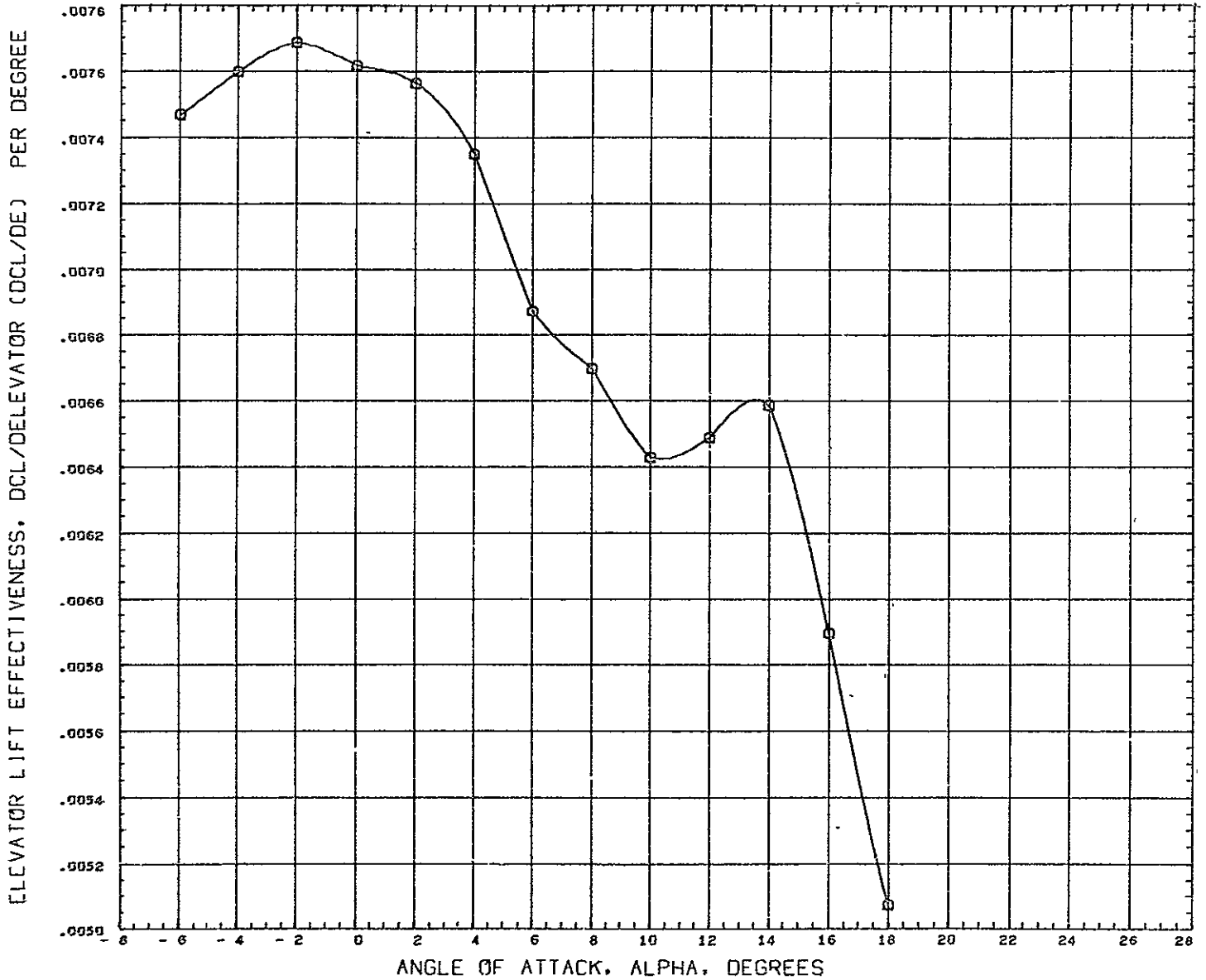

SYMBOL	MACH	PARAMETRIC VALUES				REFERENCE INFORMATION		
0	0.259	BETA	0.000	ELEVTR	- 10.000	REFS	316.2304	50 IN
		RUDDER	0.000	FLAPS	0.000	REFL	50.1900	IN
		SFOILR	0.000			REFB	7.3500	IN
						XNRF	29.3920	IN
						YNRF	0.0000	IN
						ZNRF	0.0000	IN
						SCALE	0.0175	
DATA HIST CODE #F								

LONG. CONTROL DERIVATIVES - STRAIGHT WING BASIC POS. - HORIZ.-VERT. TAIL CONFIG.

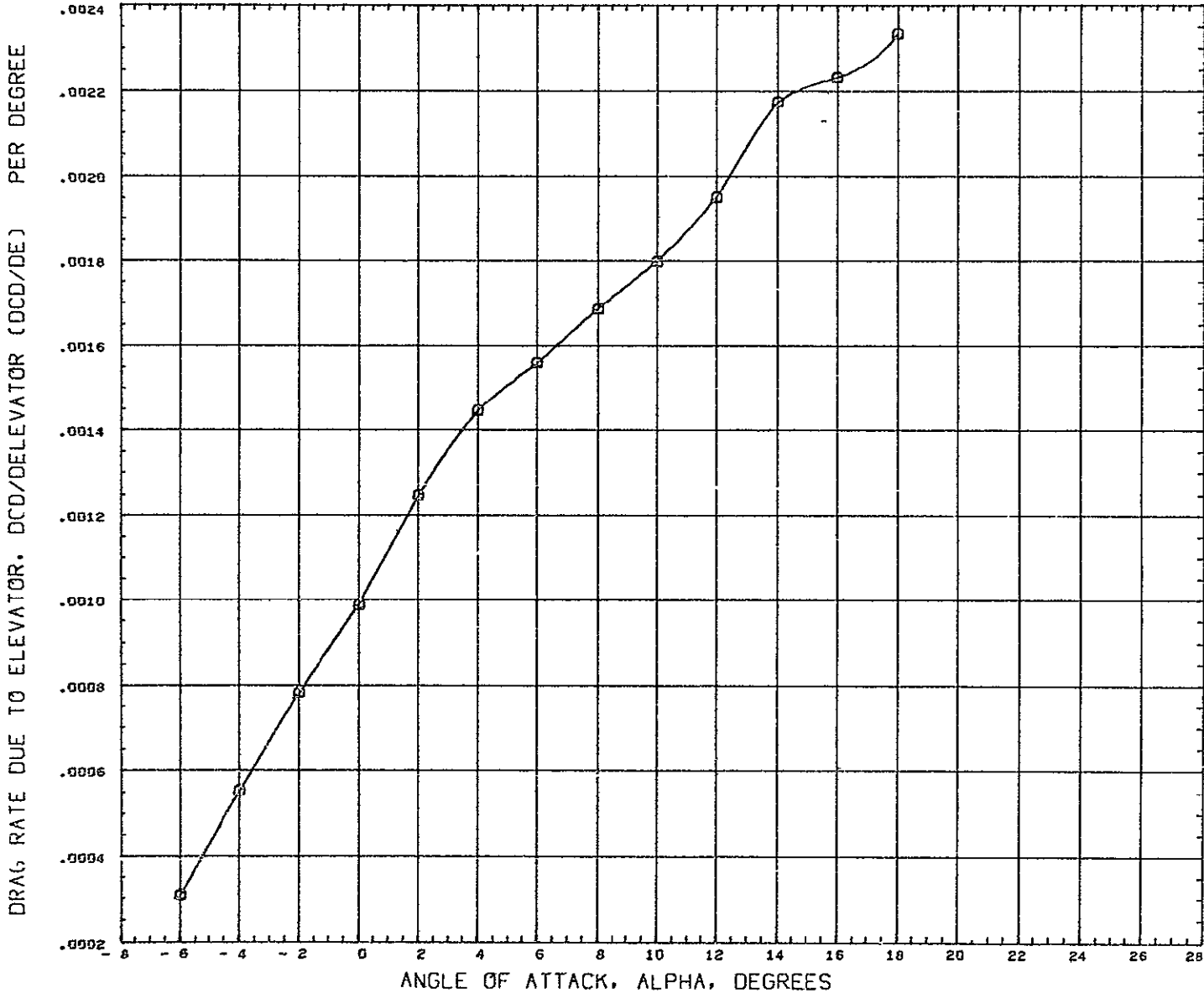

SYMBOL	MACH	PARAMETRIC VALUES				REFERENCE INFORMATION		
C	0.259	BETA	0.000	ELEVTR	- 10.000	REFS	316.2304	SQ IN
		RUDDER	0.000	FLAPS	0.000	REFL	50.1900	IN
		SFOILR	0.000			REFB	7.3500	IN
						XMRP	29.3920	IN
						YMRF	0.0000	IN
						ZMRP	0.0000	IN
						SCALE	0.0175	
DATA HIST. CODE		#P						

LONG. CONTROL DERIVATIVES - STRAIGHT WING BASIC POS. - HORIZ.-VERT. TAIL CONFIG.

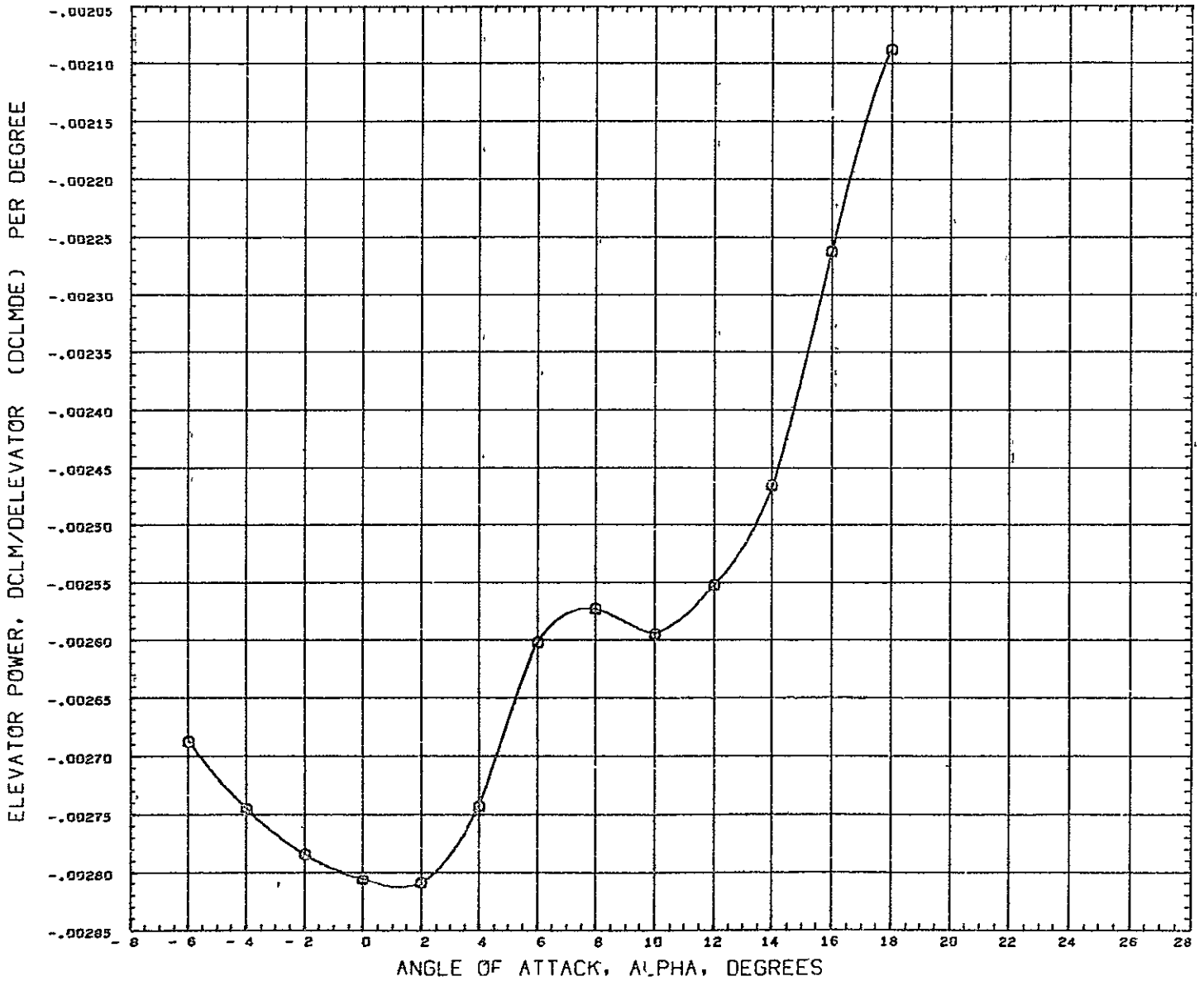

SYMBOL	MACH	PARAMETRIC VALUES	
O	0.259	BETA	0.000 FLEVTR - 10.000
		RUDDER	0.000 FLAPS 0.000
		SPOILR	0.000

REFERENCE INFORMATION		
REFS	316.2304	SQ IN
REFL	50.1900	IN
REFB	7.3500	IN
XHRF	29.3920	IN
YHRF	0.0000	IN
ZHRF	0.0000	IN
SCALE	0.0175	

DATA HIST. CODE #F

LONG. CHAR. - STRAIGHT WING BASIC POS. - FLAPS DOWN - HORIZ.-VERT. TAIL CONFIG.

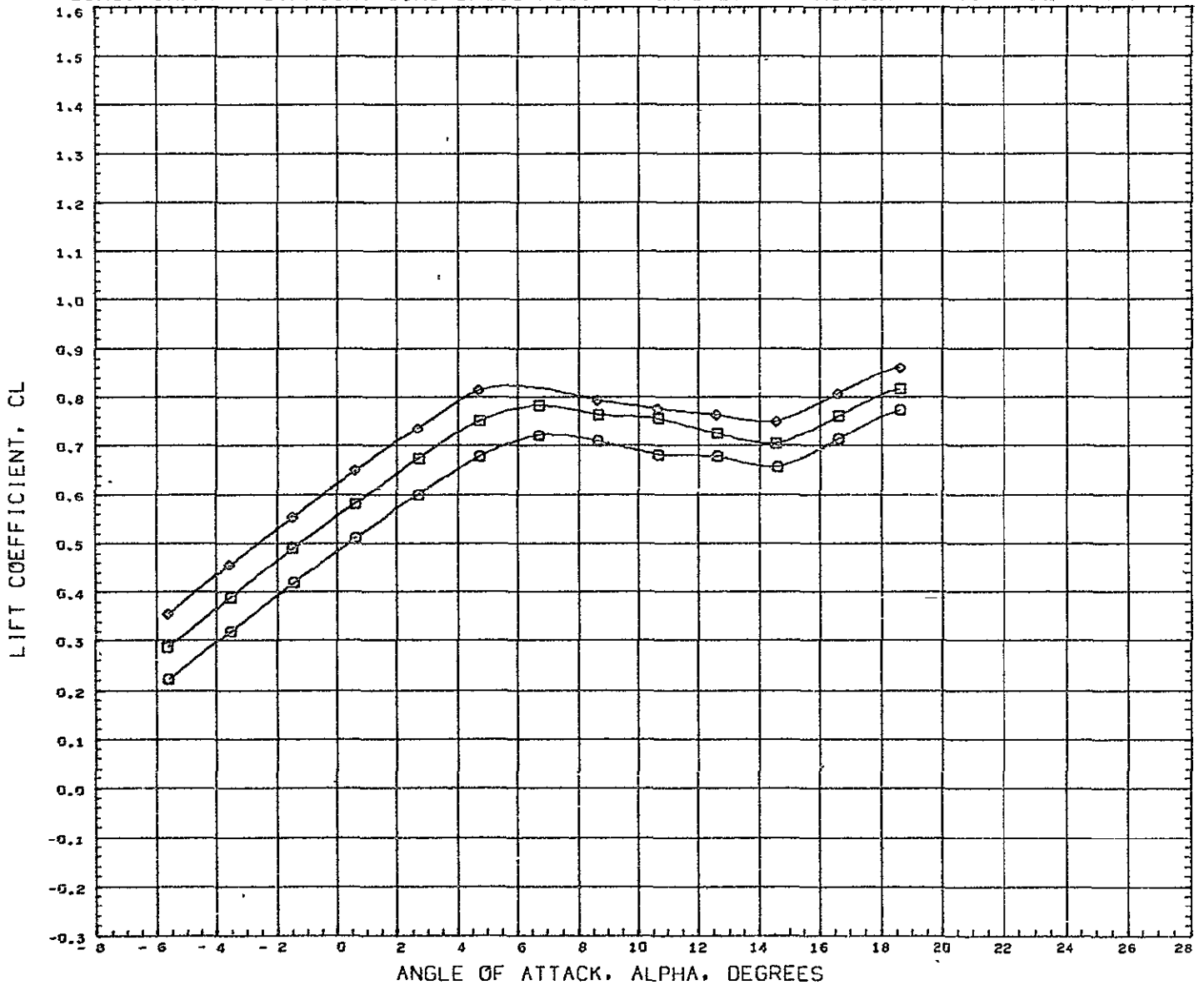

SYMBOL		ELEVTR		PARAMETRIC VALUES			
D	-	15.000	MACH	0.184	BETA	0.000	
D	-	5.000	RUDDER	0.000	FLAPS	45.000	
C	-	10.000	SFOILR	0.000			

REFERENCE INFORMATION		
REFS	316 2304	SQ IN
REFL	50 1900	IN
REFB	7 3500	IN
XHRF	29 3920	IN
YHRF	0.0000	IN
ZHRF	0.0000	IN
SCALE	0.0175	

REFERENCE FILE CONVAIR T470-AE-12



LONG. CHAR. - STRAIGHT WING BASIC POS. - FLAPS DOWN - HORIZ.-VERT. TAIL CONFIG.

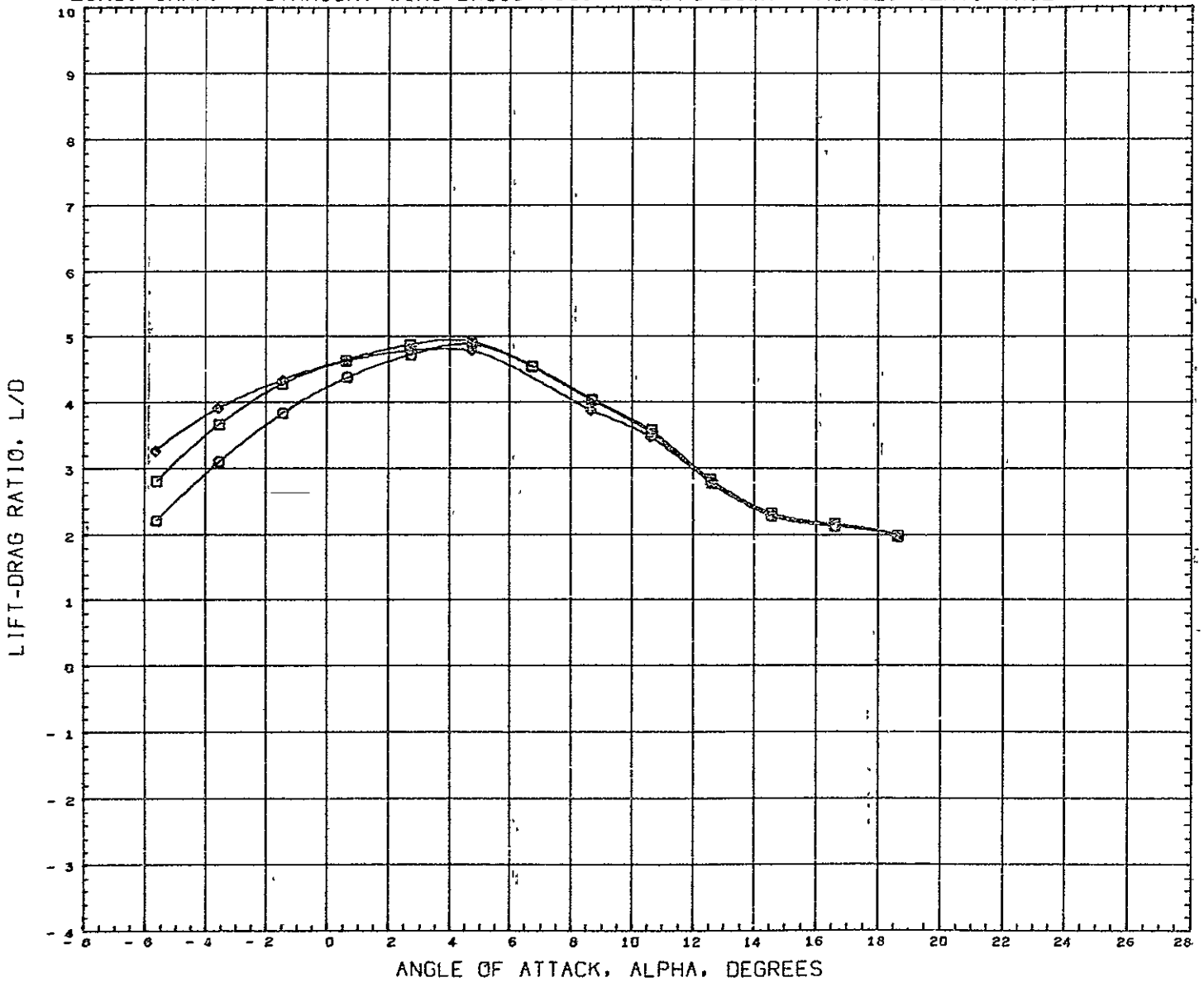

SYMBOL	ELEVTR	PARAMETRIC VALUES
○	10.000	MACH 0.184 BETA 0.000
□	0.000	RUDDER 0.000 FLAPS 45.000
◇	10.000	SFOILR 0.000

REFERENCE INFORMATION		
REFS	316.2304	SQ IN
REFL	50.1900	IN
REFB	7.3500	IN
XMRP	29.3920	IN
YMRP	0.0000	IN
ZMRP	0.0000	IN
SCALE	0.0175	

REFERENCE FILE CONVAIF IN70-AE-12

LONG. CHAR: - STRAIGHT WING BASIC POS. - FLAPS DOWN - HORIZ.-VERT. TAIL CONFIG.

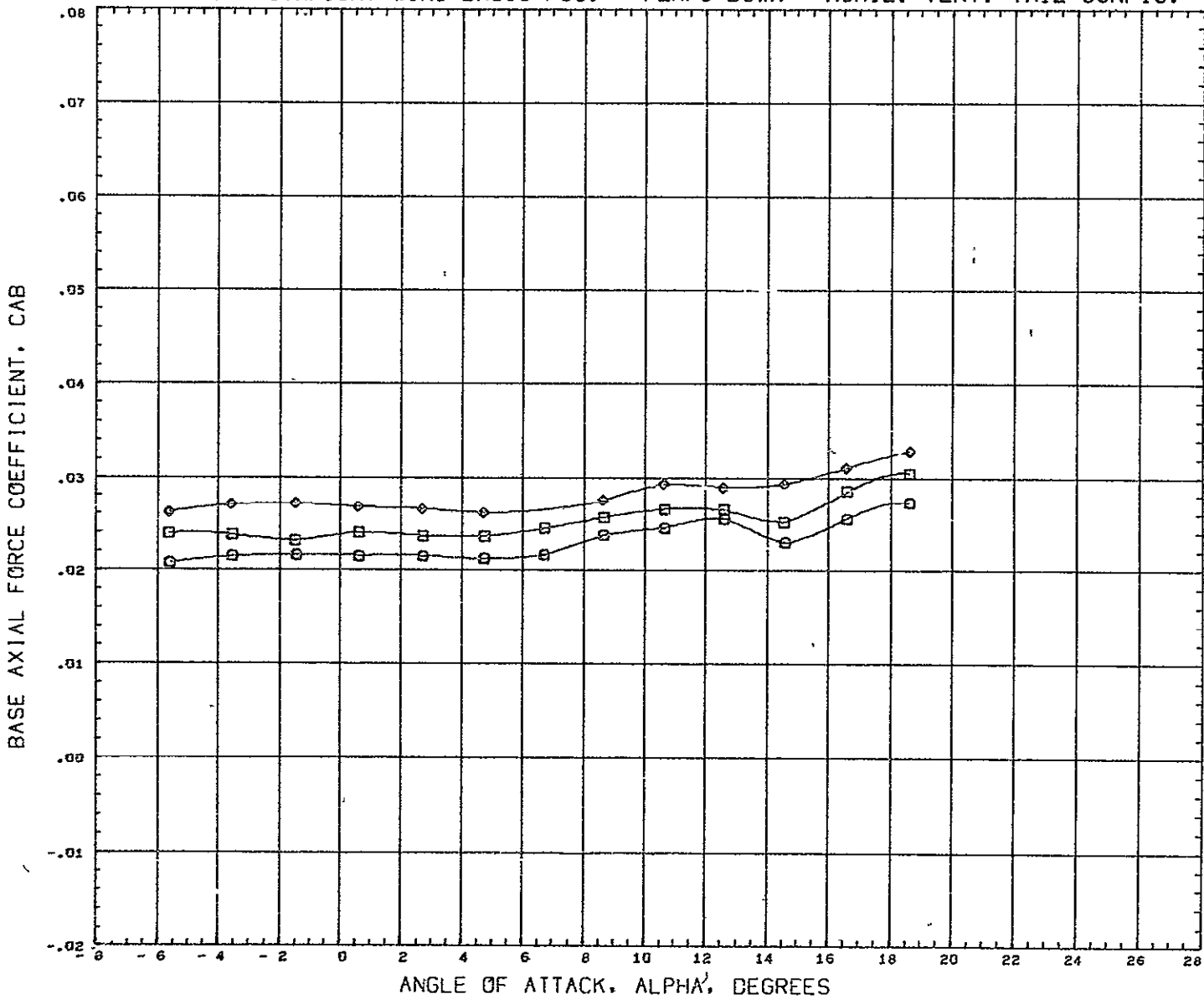

SYMBOL	ELEVTR	PARAMETRIC VALUES			
◇	- 10.000	NACH	0.184	BETA	0.000
□	0.000	RUDDER	0.000	FLAPS	45.000
○	10.000	SFOILR	0.000		

REFERENCE INFORMATION		
REFS	316 2304	SQ IN
REFL	50 1900	IN
REFB	7 3500	IN
XMRP	29 3920	IN
YMRP	0.0000	IN
ZMRP	0.0000	IN
SCALE	0.0175	

REFERENCE FILE CONVAIR T-70-AE-12

LONG. CHAR. - STRAIGHT WING BASIC POS. - FLAPS DOWN - HORIZ.-VERT. TAIL CONFIG.

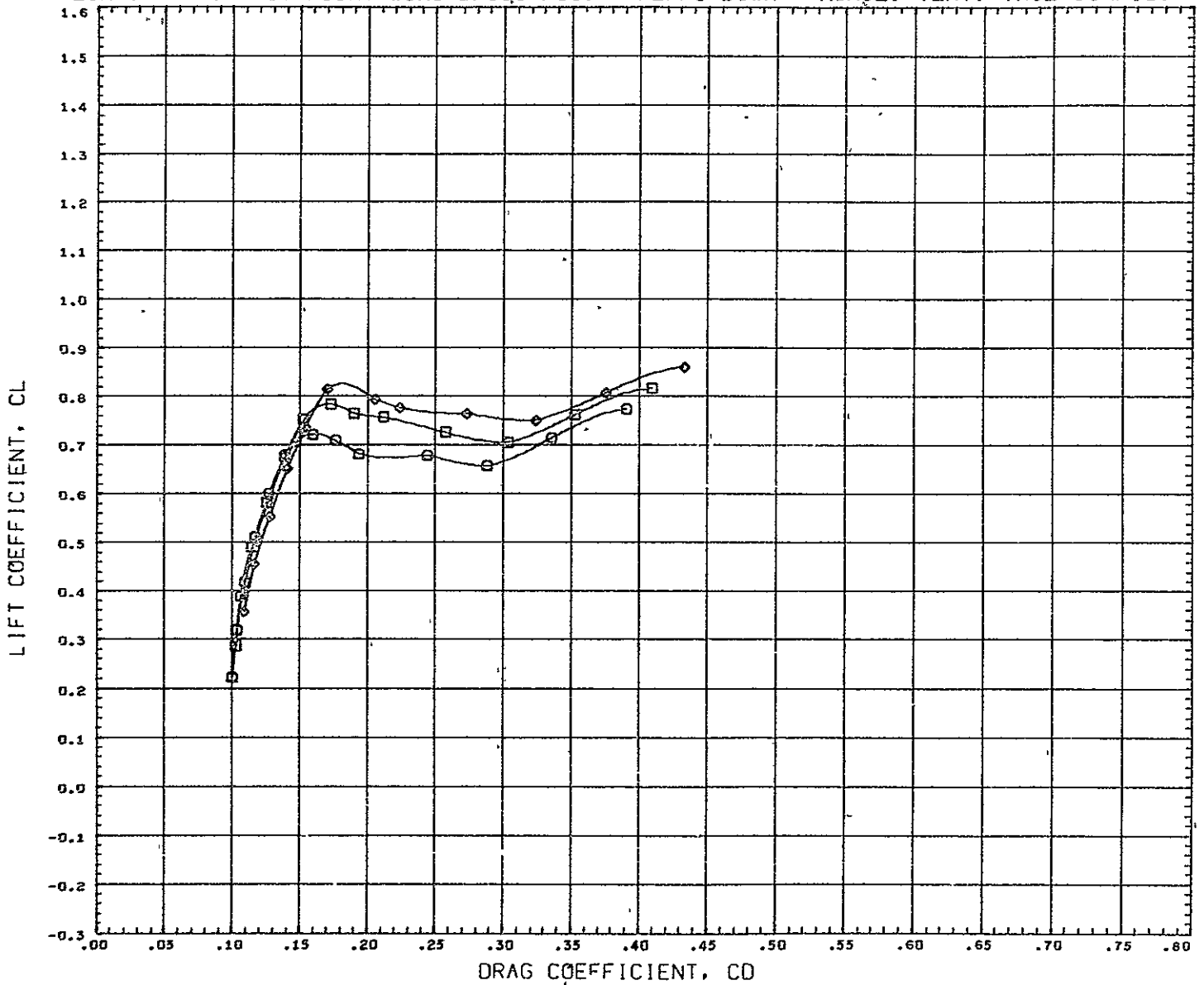

SYMBOL	ELEVTR	PARAMETRIC VALUES			
□	10.000	HACH	0.164	BETA	0.000
○	0.000	RUDDER	0.000	FLAPS	45.000
◇	10.000	SFOILR	0.000		

REFERENCE INFORMATION		
REFS	316 2304	SQ IN
REPL	50 1900	IN
REFB	7.3500	IN
XMRP	29.3920	IN
YMRP	0.0000	IN
ZMRP	0.0000	IN
SCALE	0.0175	

REFERENCE FILE CONV AIR TN79-AE-12

LONG. CHAR. - STRAIGHT WING BASIC POS. - FLAPS DOWN - HORIZ.-VERT. TAIL CONFIG.

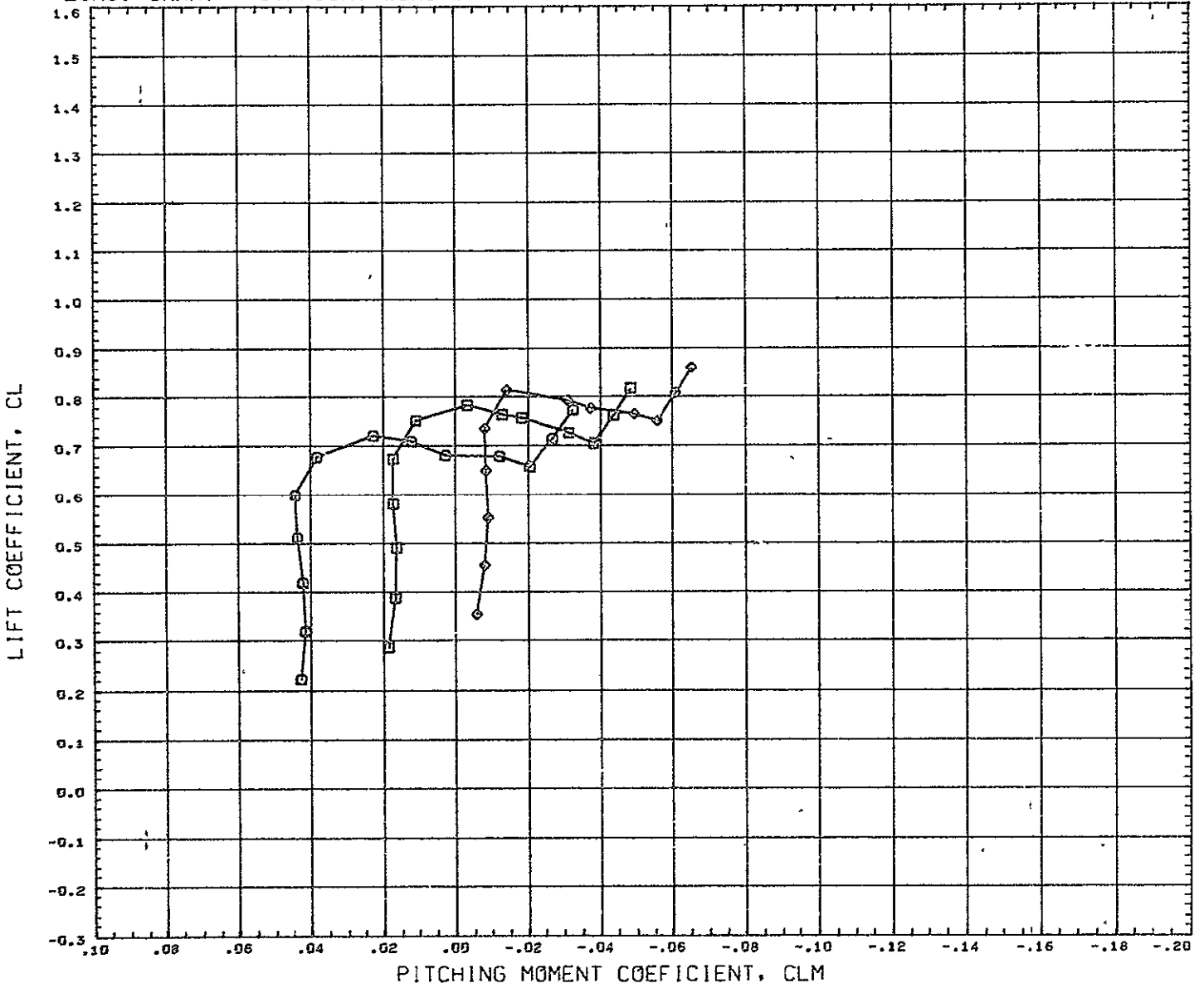

SYMBOL	ELEVTR	PARAMETRIC VALUES
○	10.000	MACH 0.184 BETA 0.000
□	0.000	RUDDER 0.000 FLAPS 45.000
◇	15.000	SFOILR 0.020

REFERENCE INFORMATION		
REFS	316 2304	SQ IN
REFL	50.1900	IN
REFB	7.3500	IN
XMRF	29.3920	IN
YMRF	0.0000	IN
ZMRF	0.0000	IN
SCALE	0 0175	

REFERENCE FILE CONVAIF TN70-AE-12

LONG. CONTROL - STRAIGHT WING BASIC POS. - FLAPS DOWN - HORIZ.-VERT. TAIL CONFIG.

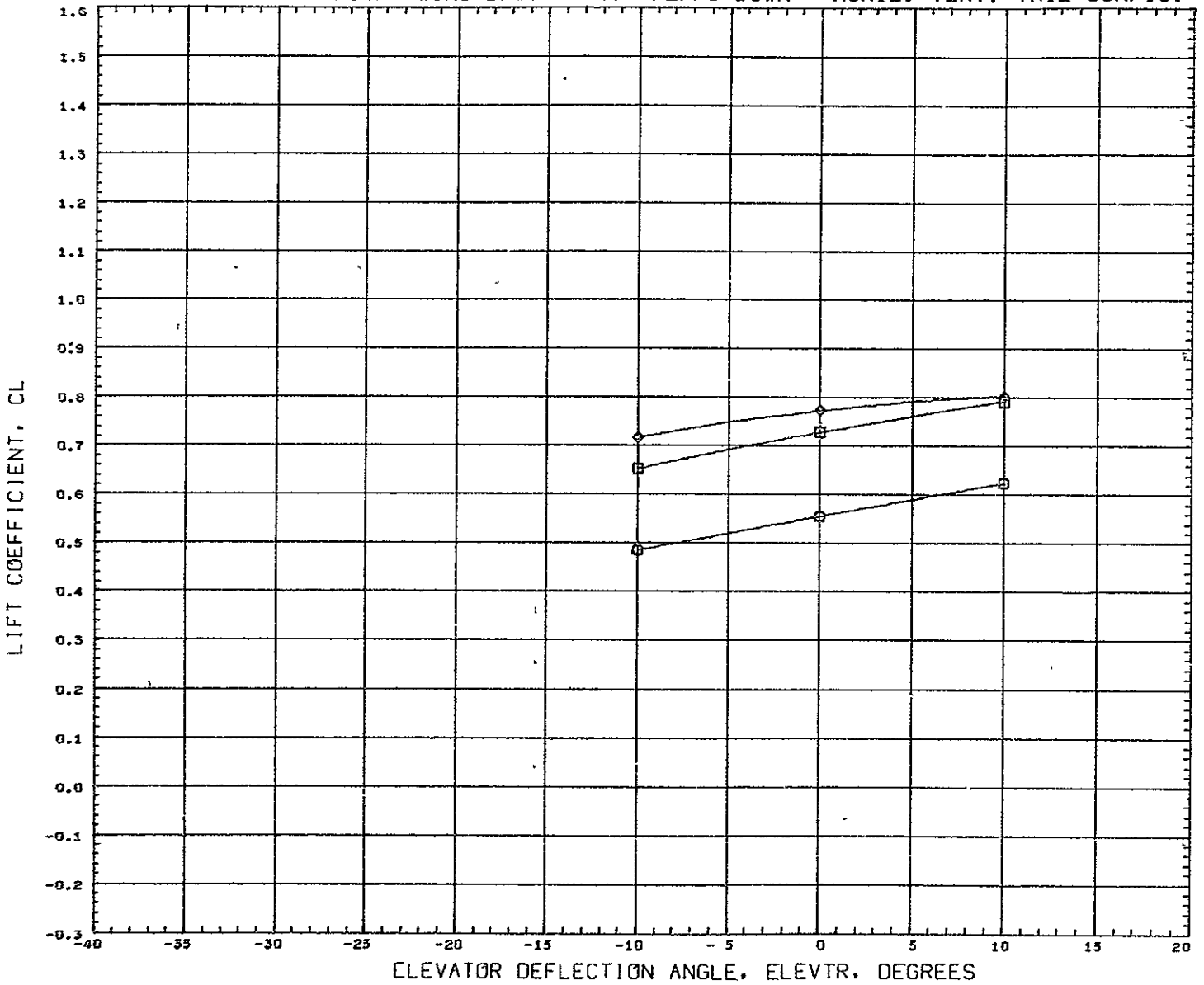

SYMBOL	ALPHA	PARAMETRIC VALUES				REFERENCE INFORMATION		
○	0.000	MACH	0.184	BETA	0.000	REFS	316.2304	SQ IN
□	4.000	RUDDER	0.000	FLAPS	45.000	REFL	50.1900	IN
◇	6.000	SPOILER	0.000			REFB	7.3500	IN
						XHRF	29.3920	IN
						YHRF	0.0000	IN
						ZHRF	0.0000	IN
						SCALE	0.0175	

DATA HIST. CODE I

LONG. CONTROL - STRAIGHT WING BASIC POS. - FLAPS DOWN - HORIZ. - VERT. TAIL CONFIG.

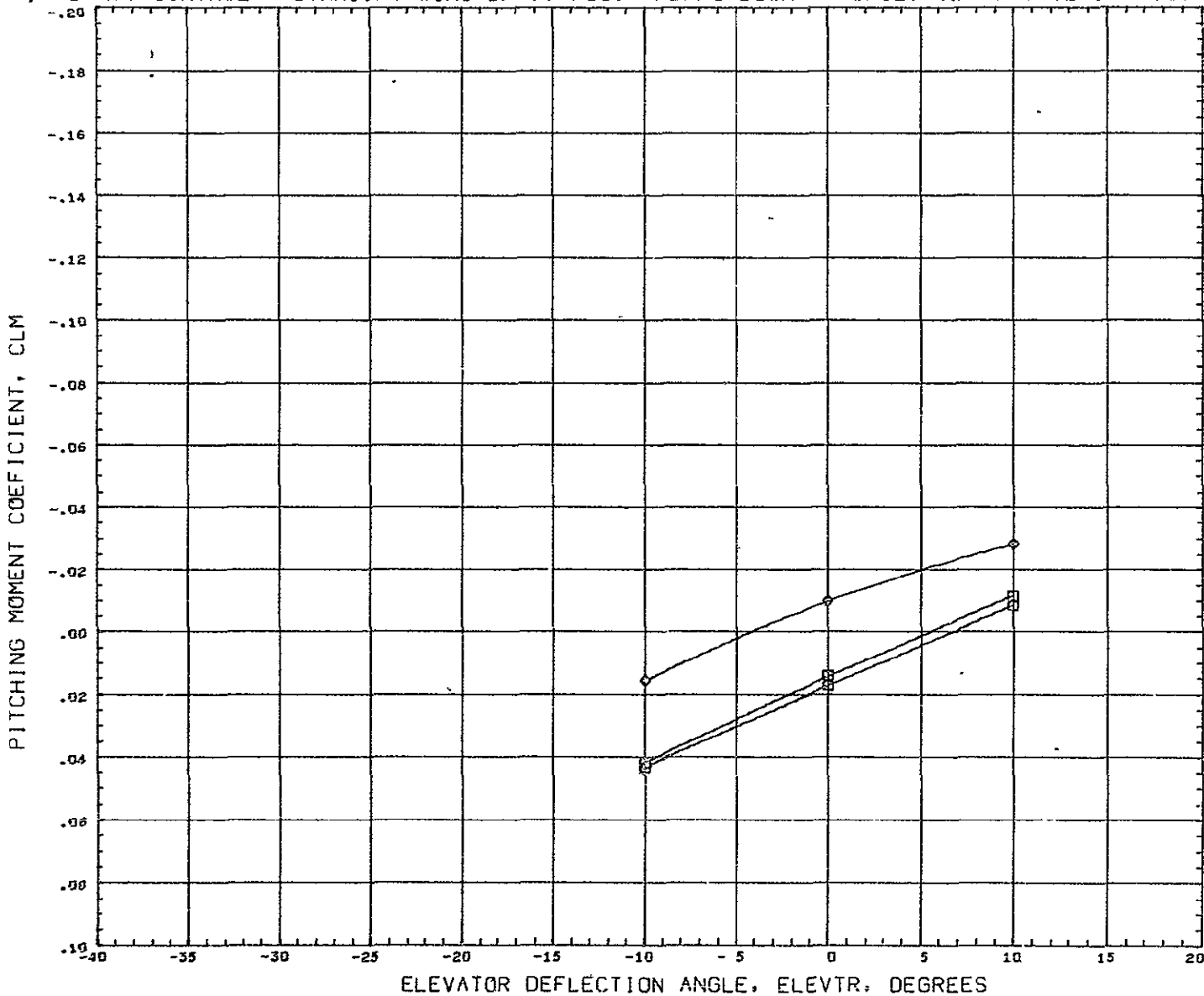

SYMBOL	ALPHA		PARAMETRIC VALUES			REFERENCE INFORMATION		
○	0.000	MACH	0.184	BETA	0.000	REFS	316.2304	50 IN
□	4.000	RUDDER	0.000	FLAPS	45.000	REFL	50.1900	IN
◇	8.000	SFOILR	0.000			REFB	7.3506	IN
						XMRP	29.3920	IN
						YMRP	0.0000	IN
						ZMRP	0.0000	IN
						SCALE	0.0175	

DATA HIST. CODE I

LONG. CONTROL - STRAIGHT WING BASIC POS. - FLAPS DOWN - HORIZ. - VERT. TAIL CONFIG.

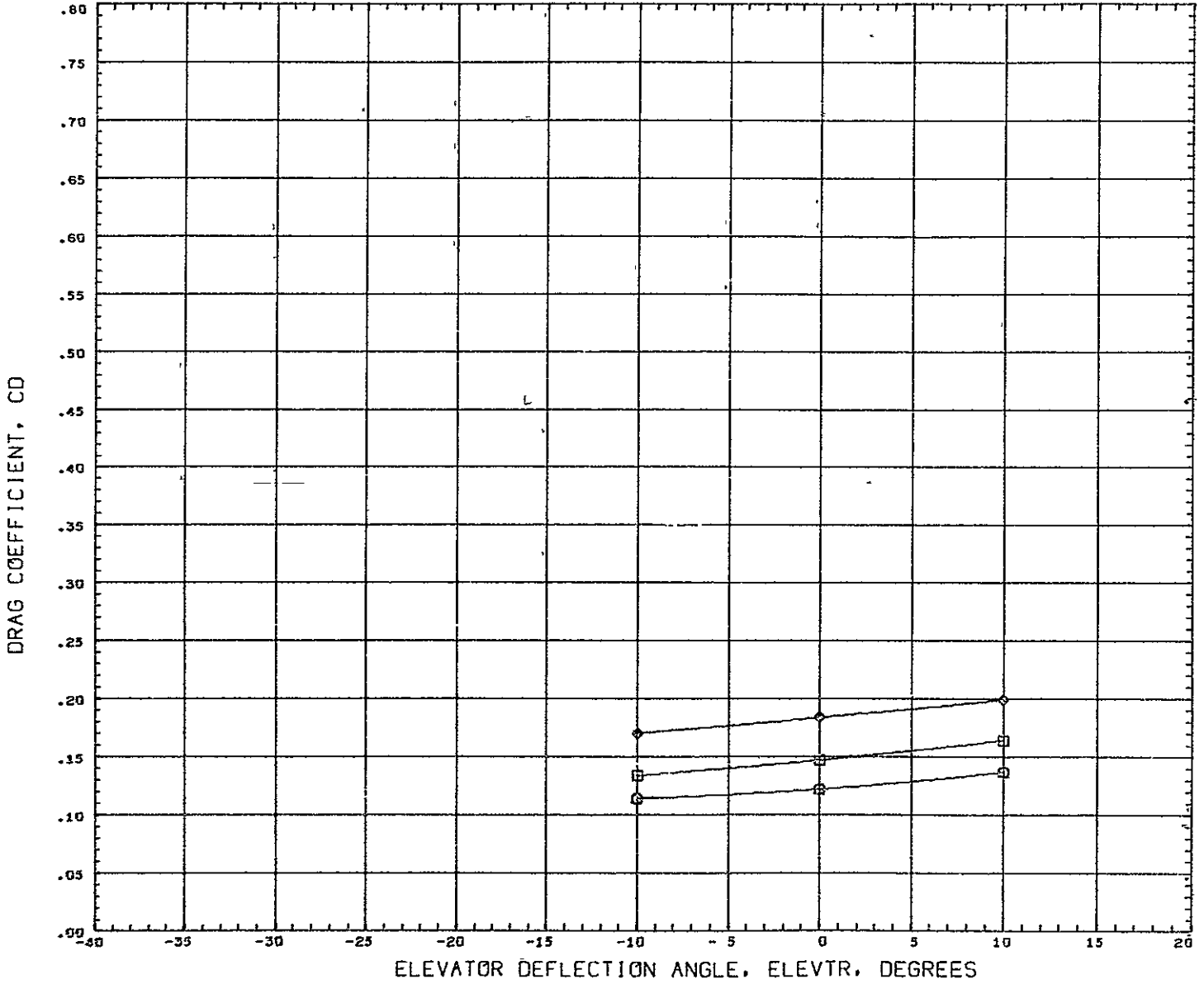

SYMBOL	ALPHA	PARAMETRIC VALUES				REFERENCE INFORMATION		
○	0.000	NACH	0.184	BETA	0.000	REFS	316 2304	SQ IN
□	4.000	RUDDER	0.000	FLAPS	45.000	REFL	50.1900	IN
◇	8.000	SPOILER	0.000			REFB	7.3500	IN
						XMRF	29.3920	IN
						YMRF	0.0000	IN
						ZMRF	0.0000	IN
						SCALE	0.0175	

DATA HIST. CODE I

LONG. CONTROL DERIV.- ST. WING BASIC POS.- FLAPS DOWN- HORIZ.-VERT. TAIL CONFIG.

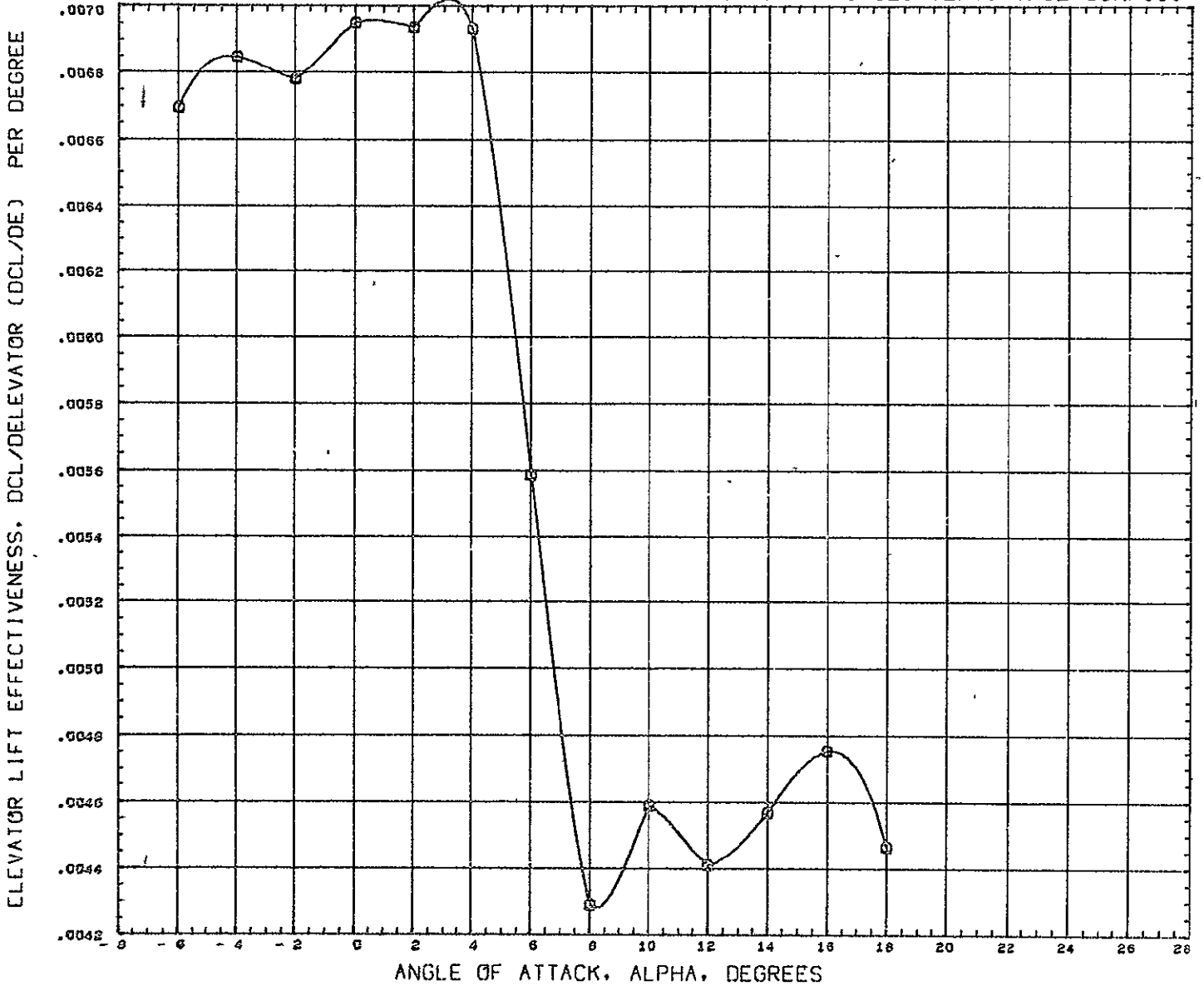

SYMBOL	MACH	PARAMETRIC VALUES				REFERENCE INFORMATION		
0	0.184	BETA	0.000	ELEVTR	- 10.000	REFS	316 2304	SQ IN
		RUDDER	0.000	FLAPS	45 000	REFL	50.1900	IN
		SPOILR	0.000			REFB	7.3500	IN
						XHRF	29.3920	IN
						YHRF	0.0000	IN
						ZHRF	0.0000	IN
						SCALE	0.0175	

DATA HIST. CODE #F



LONG. CONTROL DERIV.- ST. WING BASIC POS.- FLAPS DOWN- HORIZ.-VERT. TAIL CONFIG.

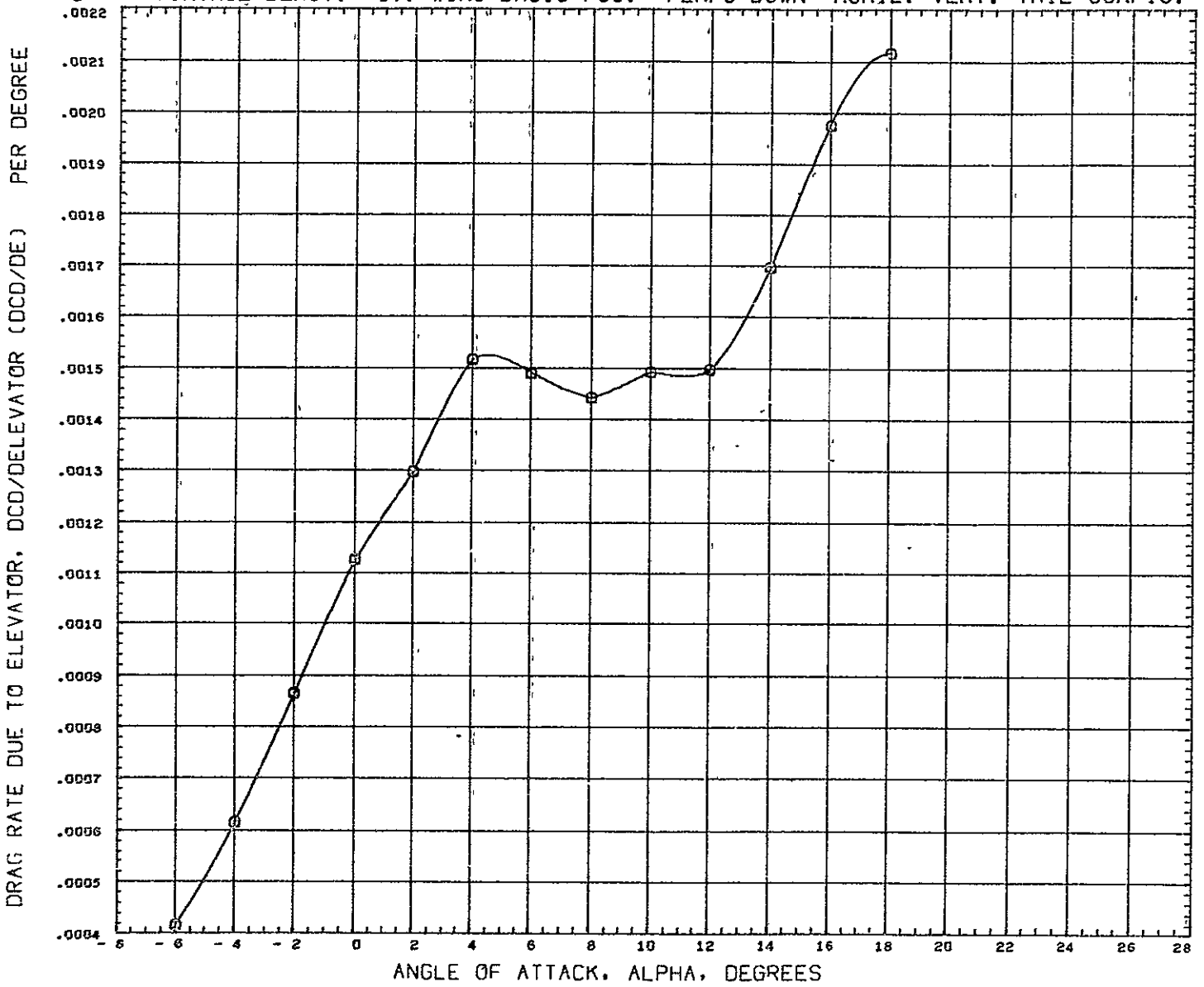

SYMBOL	MACH	PARAMETRIC VALUES				REFERENCE INFORMATION		
⊙	0.184	BETA	0.000	ELEVTR	- 10.000	REFS	316 2304	SQ IN
		FUDDER	0.000	FLAPS	45.000	REFL	50.1900	IN
		SFOILR	0.000			REFB	7.3500	IN
						XMRP	29.3920	IN
						YMRP	0.0000	IN
						ZMRP	0.0000	IN
						SCALE	0.0175	
		DATA HIST. CODE	#F					

LONG. CONTROL DERIV.- ST. WING BASIC POS.- FLAPS DOWN- HORIZ.-VERT. TAIL CONFIG.

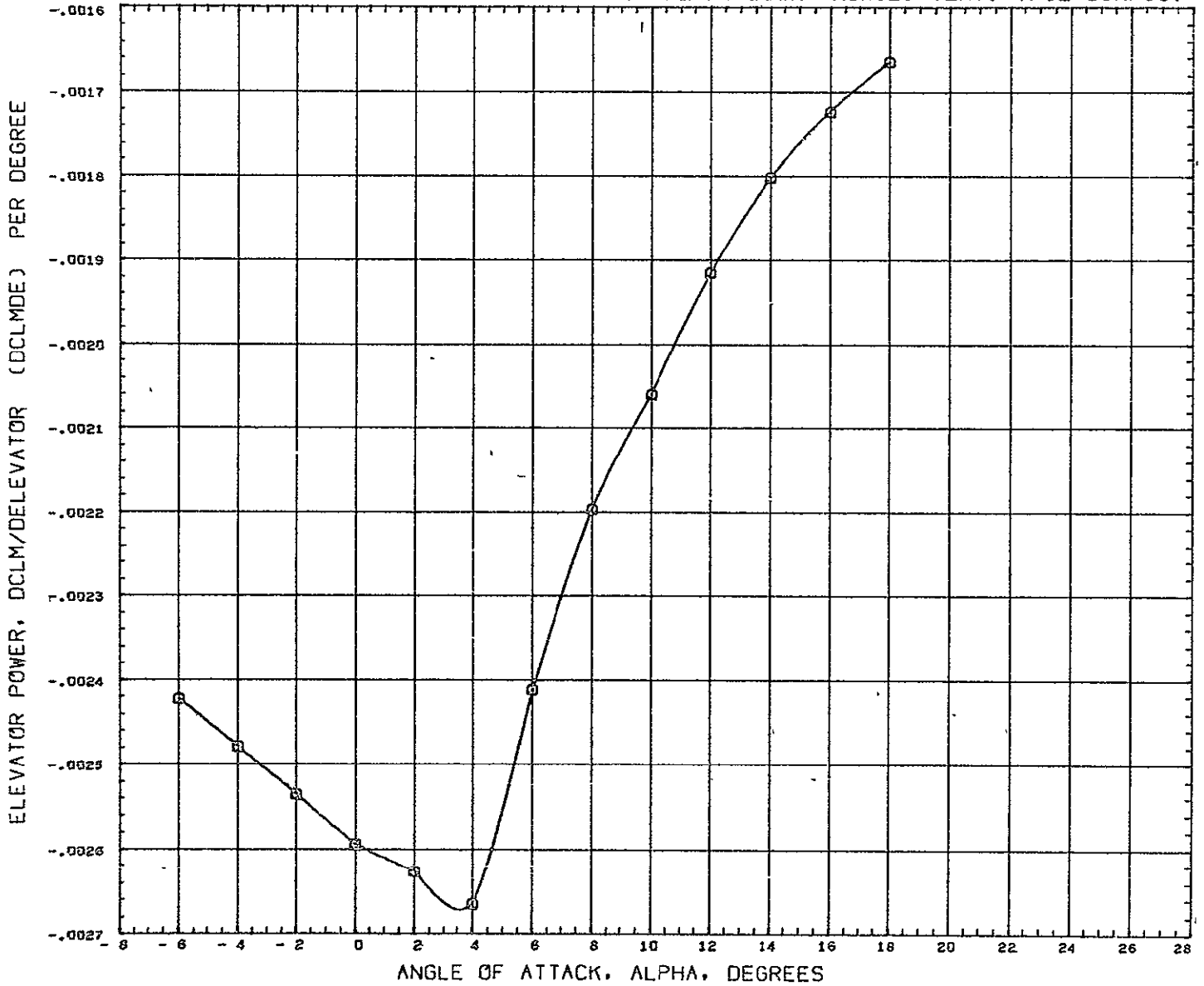

SYMBOL	MACH	PARAMETRIC VALUES	
0	0.184	BETA	0.000
		ELEVTR	- 10.000
		RUDDER	0.000
		FLAPS	45.000
		SFOILR	0.000

REFERENCE INFORMATION		
REFS	316.2304	SQ IN
REFL	50.1900	IN
REFB	7.3500	IN
XMRP	29.3920	IN
YMRP	0.0000	IN
ZMRP	0.0000	IN
SCALE	0.0175	

DATA HIST. CODE #P

LONGITUDINAL CHAR. - EFFECT OF WING INCIDENCE - STRAIGHT WING AFT - V-TAIL=55DEG

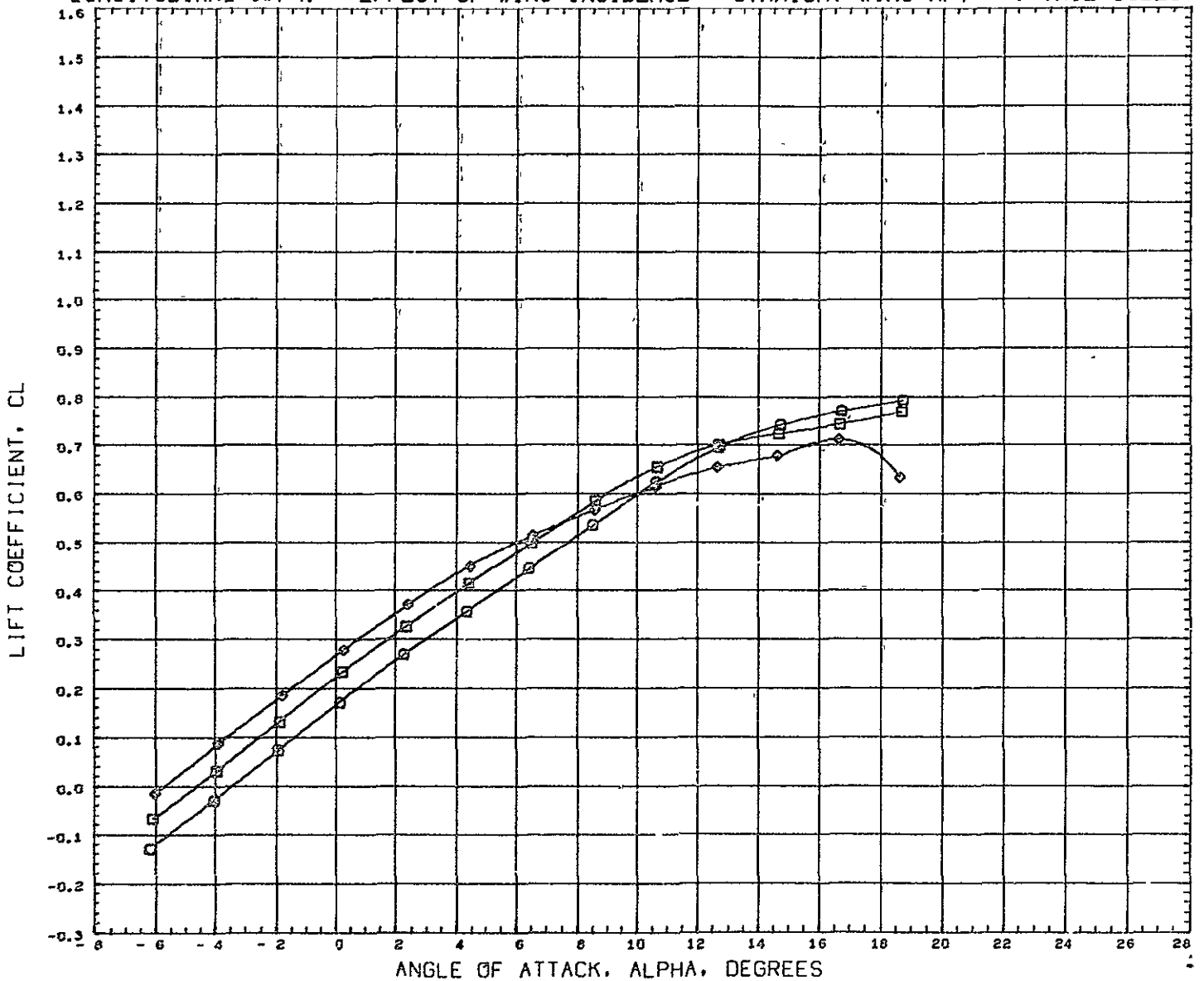

SYMBOL	IW	PARAMETRIC VALUES			
○	0.000	MACH	0.259	BETA	0.000
□	3.000	ELEVTR	0.000	RUDYTR	0.000
◇	6.000	FLAFS	0.000	SFOILR	0.000

REFERENCE INFORMATION		
REFS	316.2304	59 IN
REFL	50.1900	IN
REFS	7.3500	IN
XNRF	29.3920	IN
YNRF	0.0000	IN
ZNRF	0.0000	IN
SCALE	0.0175	

DATA HIST. CODE M

LONGITUDINAL CHAR, - EFFECT OF WING INCIDENCE - STRAIGHT WING AFT - V-TAIL=55DEG

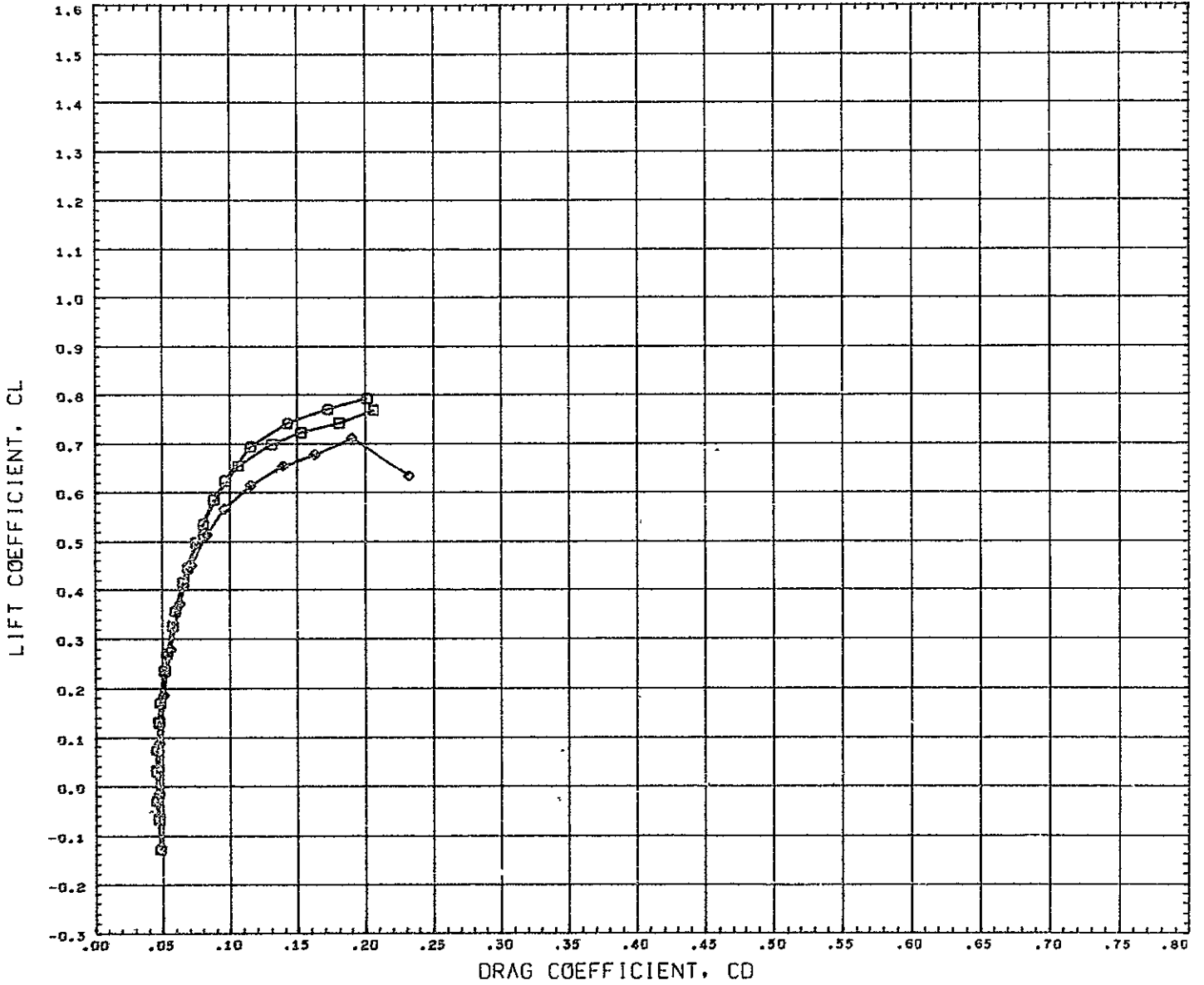

SYMBOL	IW	PARAMETRIC VALUES			
○	0.000	MACH	0.259	BETA	0.000
□	3.000	ELEVTR	0.000	RUDVTR	0.000
◇	6.000	FLAPS	0.000	SPOILR	0.000

REFERENCE INFORMATION		
REFS	316.2304	SQ IN
REFL	50.1900	IN
REFB	7.3500	IN
XMRP	29.3920	IN
YMRP	0.0000	IN
ZMRP	0.0000	IN
SCALE	0.0175	

DATA HIST. CODE M

LONGITUDINAL CHAR. - EFFECT OF WING INCIDENCE - STRAIGHT WING AFT - V-TAIL=55DEG

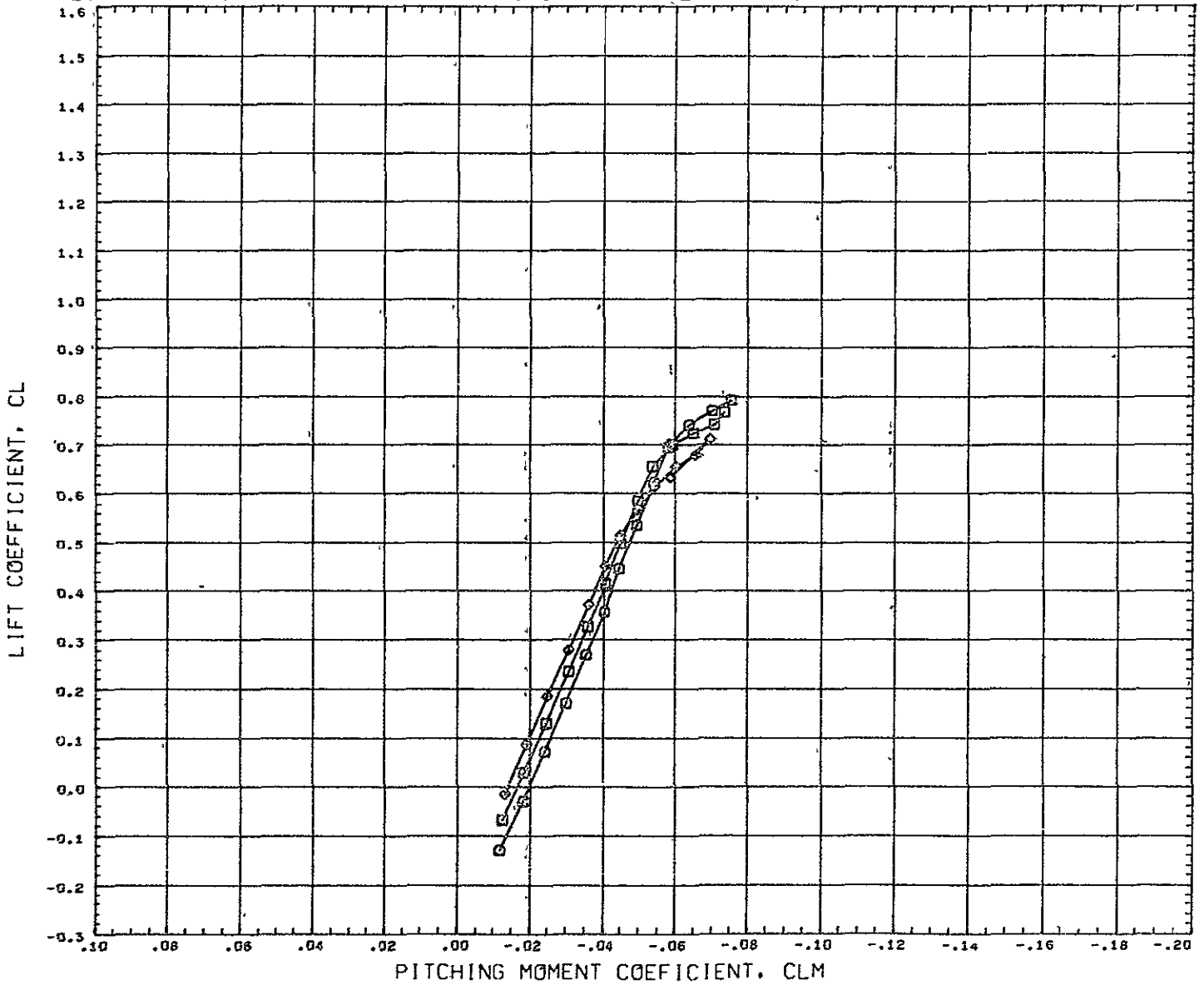

SYMBOL	W	PARAMETRIC VALUES			
○	0.000	MACH	0.259	BETA	0.000
□	3.000	ELEVTR	0.000	RUCVTR	0.000
◇	6.000	FLAFS	0.000	SPOILR	0.000

REFERENCE INFORMATION		
REFS	316.2304	IN
REFL	50.1900	IN
REFB	7.3500	IN
XMRP	29.3920	IN
YMRP	0.0000	IN
ZMRP	0.0000	IN
SCALE	0.0175	

DATA HIST. CODE 4

LONGITUDINAL CHAR. - EFFECT OF WING INCIDENCE - STRAIGHT WING AFT - TAIL OFF

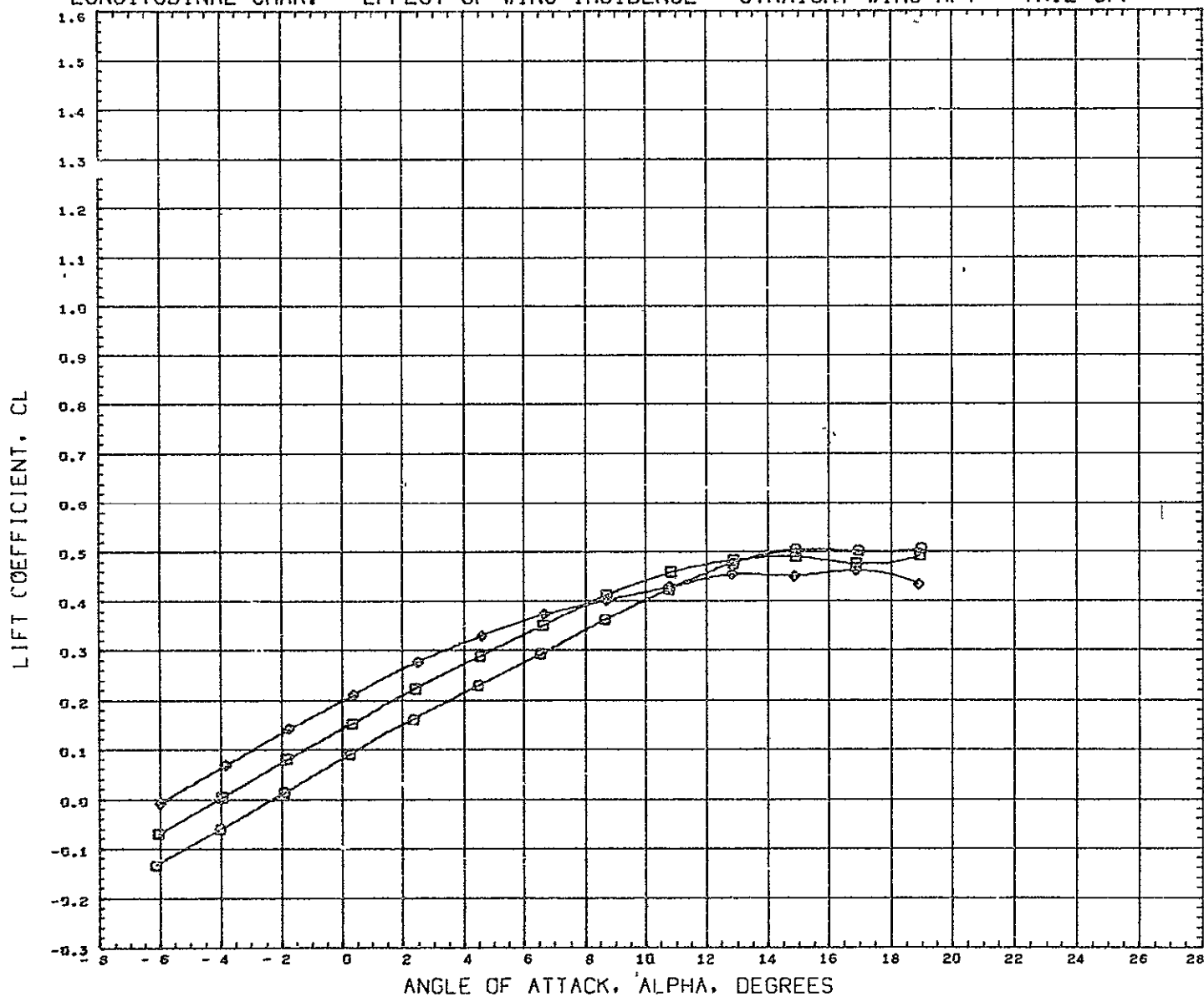

SYMBOL	IW	PARAMETRIC VALUES			
□	0.000	MACH	0.259	BETA	0.000
◇	3.000	FLAPS	0.000	SPOILR	0.000
○	6.000				

REFERENCE INFORMATION		
REFS	316.2304	SQ IN
REFL	50.1900	IN
REFB	7.3500	IN
XMRP	29.3920	IN
YMRP	0.0000	IN
ZMRP	0.0000	IN
SCALE	0.0175	

DATA HIST. CODE H

LONGITUDINAL CHAR. - EFFECT OF WING INCIDENCE - STRAIGHT WING AFT - TAIL OFF

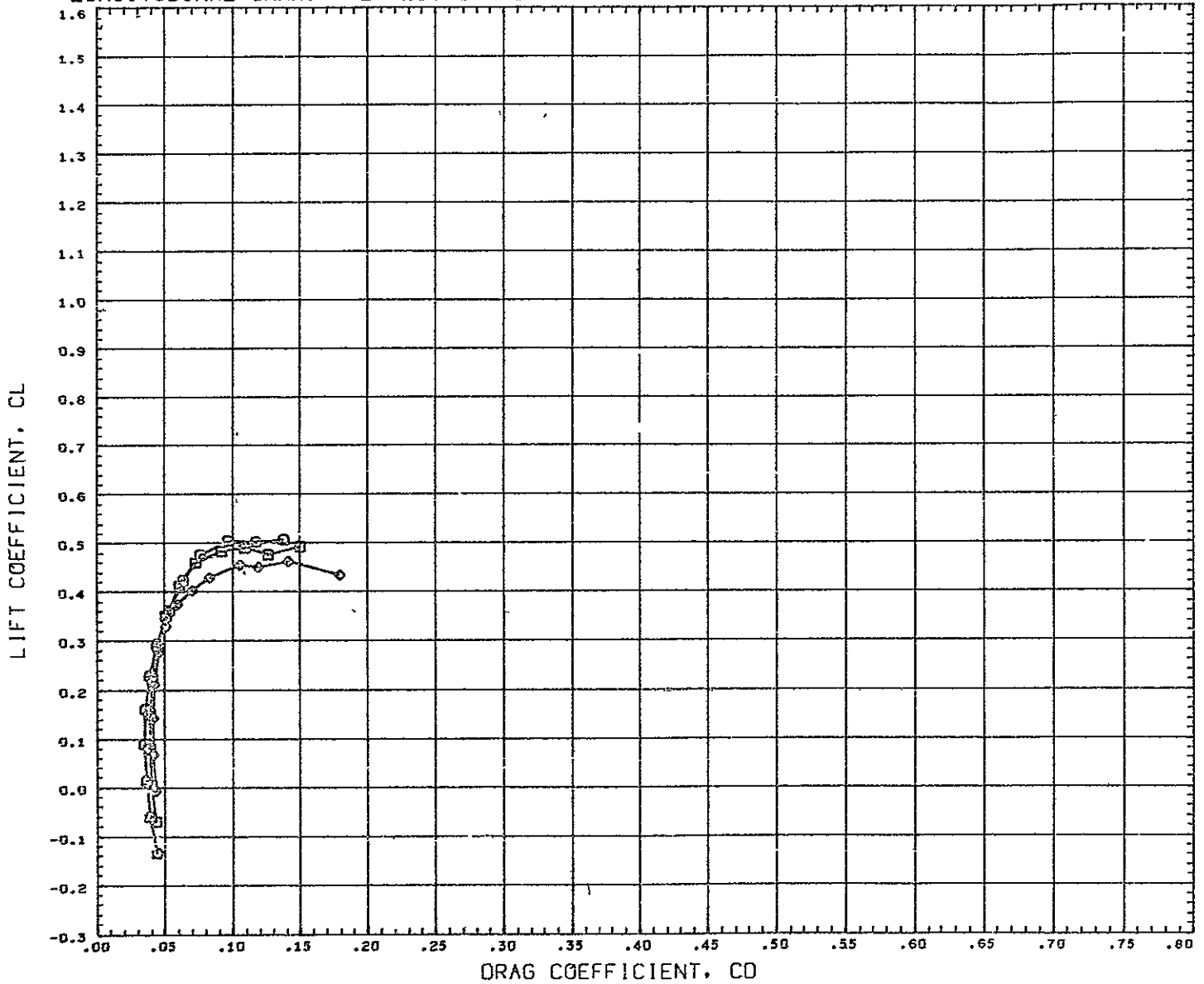

SYMBOL	IW	PARAMETRIC VALUES			
○	0.000	MACH	0.259	BETA	0.000
□	3.000	FLAPS	0.000	SFOILR	0.000
◇	6.000				

REFERENCE INFORMATION		
REFS	316 2304	SQ IN.
FEFL	50.1900	IN
REFB	7 3500	IN
XMRP	29 3920	IN
YMRP	0 0000	IN
ZMRP	0.0000	IN
SCALE	0 0175	

DATA HIST. CODE M

LONGITUDINAL CHAR. - EFFECT OF WING INCIDENCE - STRAIGHT WING AFT - TAIL OFF

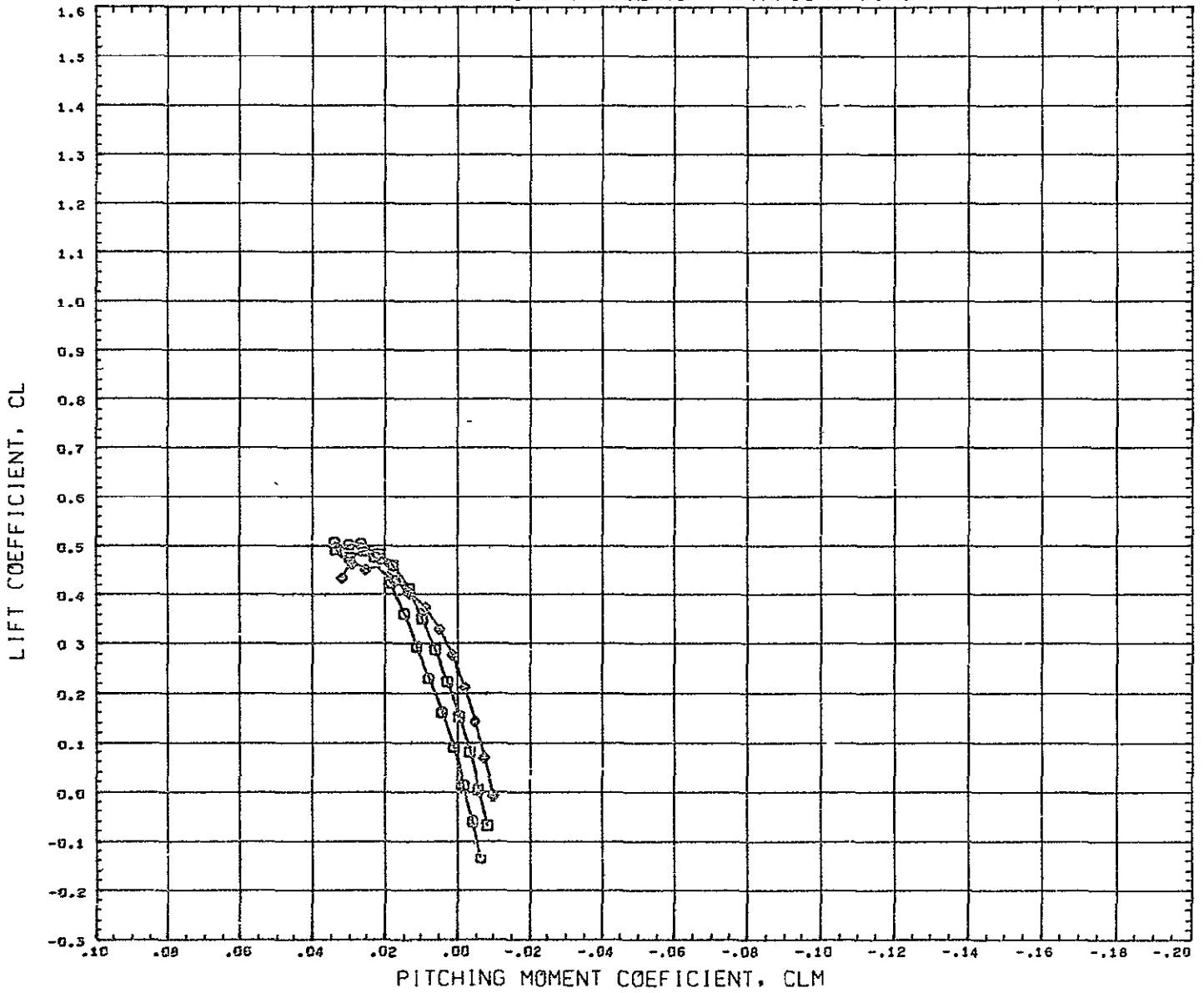

SYMBOL	1W	PARAMETRIC VALUES			
□	0.000	MACH	0.259	BETA	0.000
◇	3.000	FLAPS	0.000	SFOILR	0.000
○	6.000				

REFERENCE INFORMATION		
REFS	316.2304	SQ IN
REFL	50.1900	IN
REFB	7.3500	IN
XMRP	29.3920	IN
YMRP	0.0000	IN
ZMRP	0.0000	IN
SCALE	0.0175	

DATA HIST. CODE H



LONG. CHAR. - EFFECT OF AFTERBODY SHAPE - STRAIGHT WING AFT - V-TAIL=55DEG

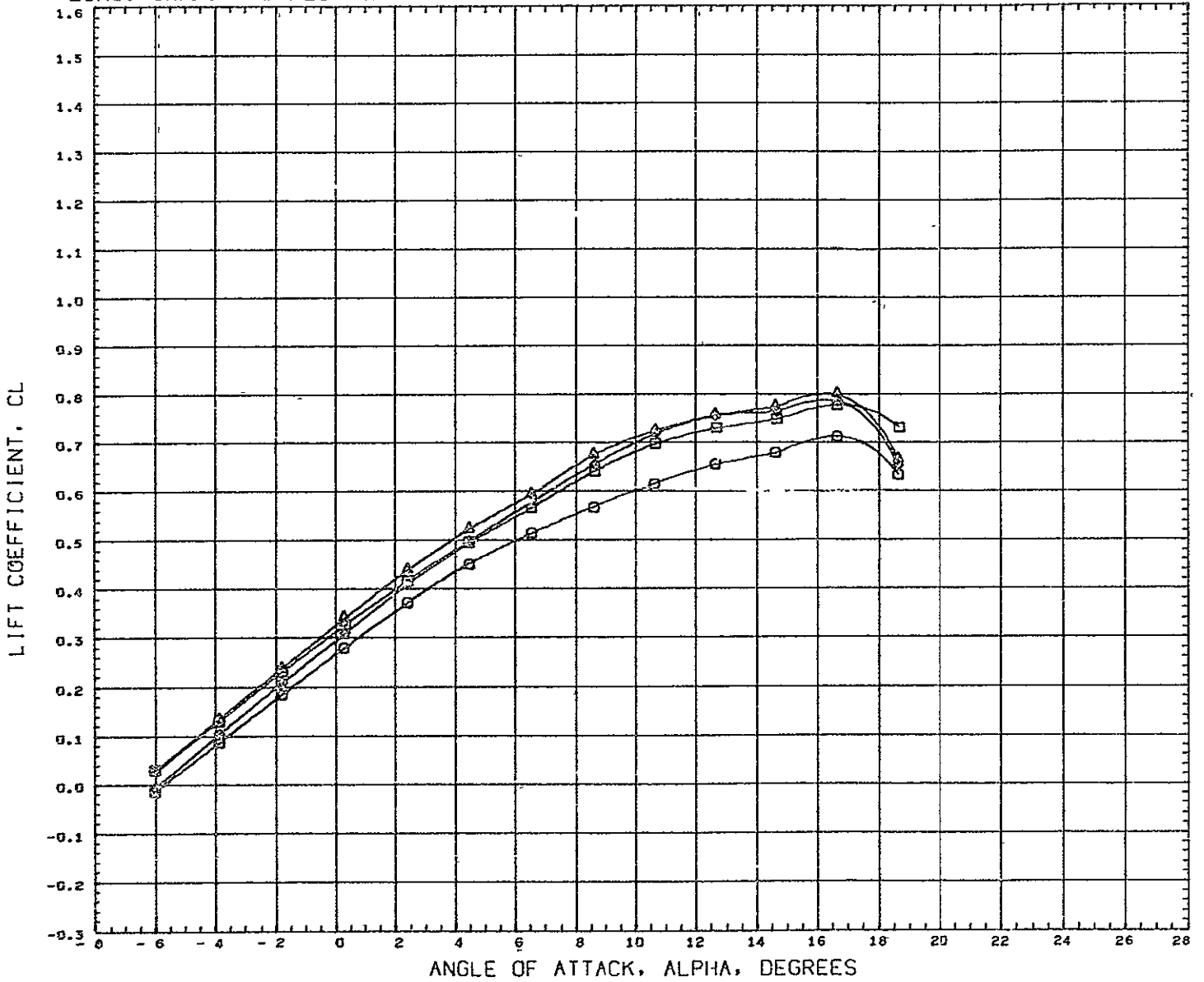

DATA SET SYMBOL	CONFIGURATION DESCRIPTION	PARAMETRIC VALUES			REFERENCE INFORMATION		
(RC7068)	CVLSWT TEST 579-0 B1W3AT1-55	BETA	0.000	ELEVTR	0.000	REFS	316 2304 SQ IN
(RC7122)	CVLSWT TEST 579-0 B4W3AT1-55	RUDVTR	0 000	FLAFS	0 000	REFL	50.1900 IN
(RC7124)	CVLSWT TEST 579-0 B5W3AT1-55	SFOILR	0 000			REFB	7.3500 IN
(RC7130)	CVLSWT TEST 579-0 B6W3AT1-55					XMRP	29.3920 IN
						YMRP	0.0000 IN
						ZMRP	0.0000 IN
						SCALE	0.0175

MACH 0.259

LONG. CHAR. - EFFECT OF AFTERBODY SHAPE - STRAIGHT WING AFT - V-TAIL=55DEG

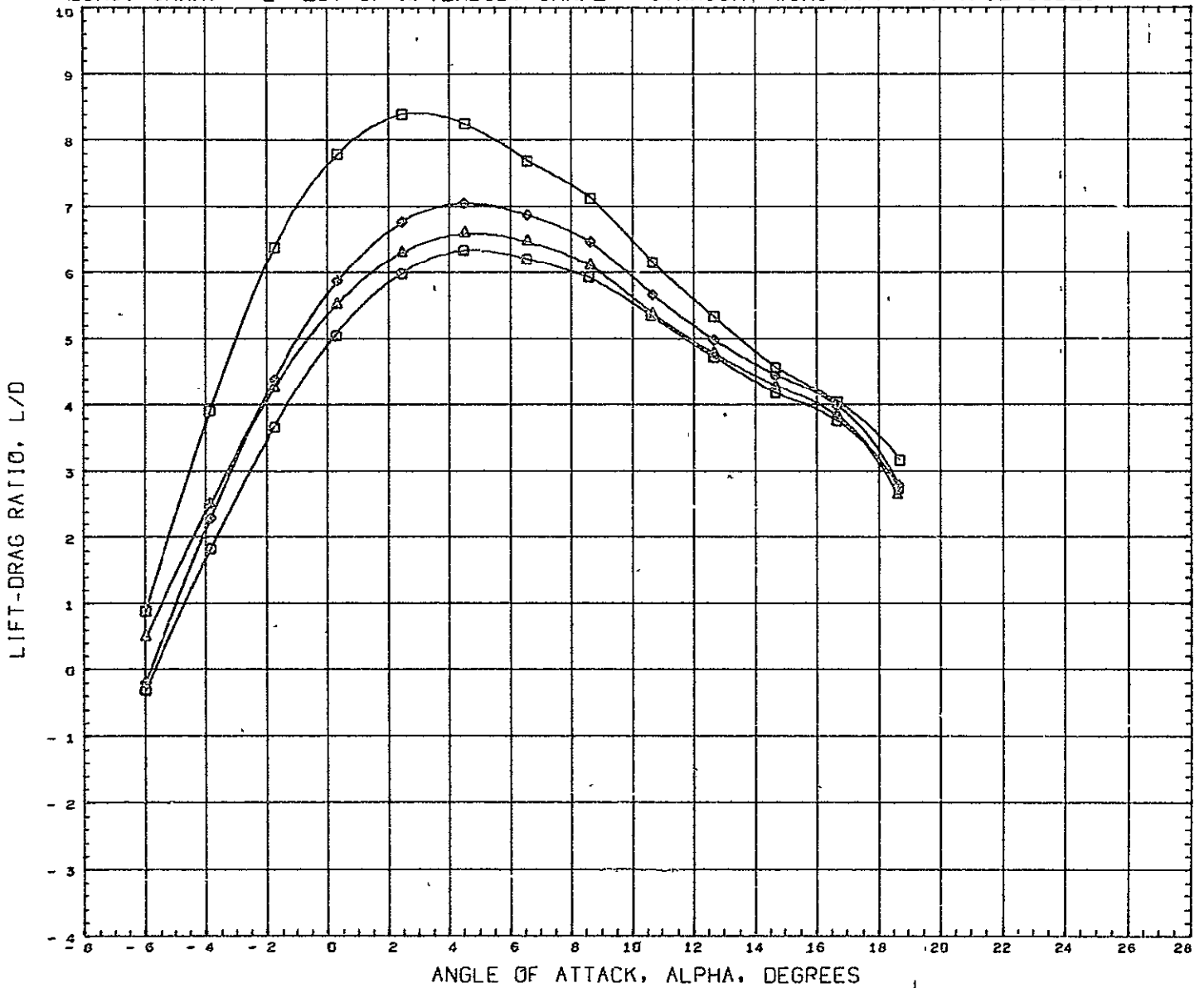

DATA SET SYMBOL CONFIGURATION DESCRIPTION  
 (RC7068) □ CVLSWT TEST 579-D B1W3AT1-55  
 (RC7122) ◊ CVLSWT TEST 579-D B4W3AT1-55  
 (RC7124) ○ CVLSWT TEST 579-D B5W3AT1-55  
 (RC7130) △ CVLSWT TEST 579-D B6W3AT1-55

PARAMETRIC VALUES  
 BETA 0.000 ELEVTR 0.000  
 RUDYTR 0.000 FLAPS 0.000  
 SPOILR 0.000

REFERENCE INFORMATION  
 REFS 316 2304 sq IN  
 REFL 50 1900 IN  
 REFB 7 3500 IN  
 XMRP 29 3920 IN  
 YMRP 0.0000 IN  
 ZMRP 0 0000 IN  
 SCALE 0.0175

MACH 0.259

LONG. CHAR. - EFFECT OF AFTERBODY SHAPE - STRAIGHT WING AFT - V-TAIL=55DEG

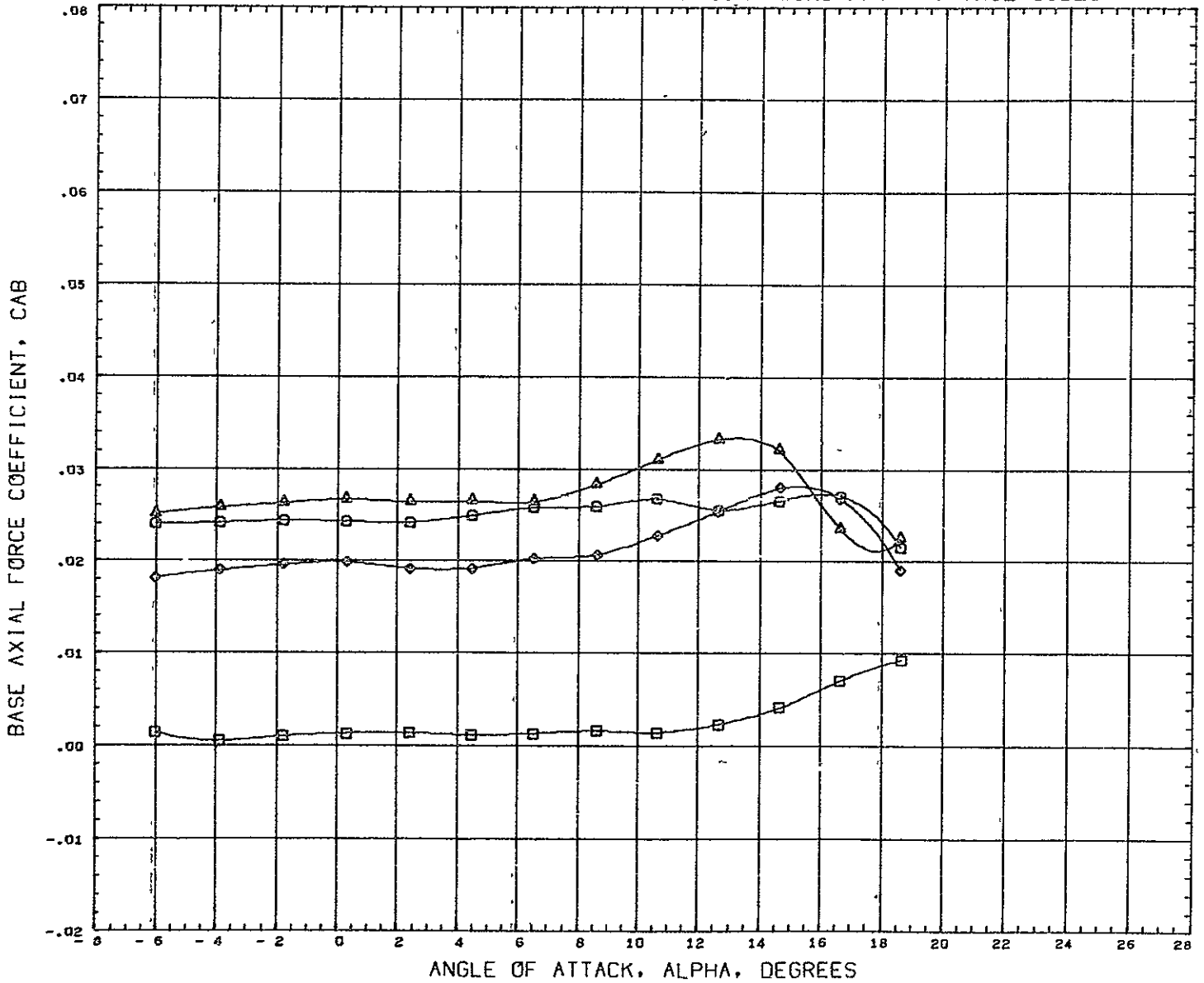

DATA SET SYMBOL	CONFIGURATION DESCRIPTION	PARAMETRIC VALUES		REFERENCE INFORMATION				
(RC7068)	CVLSWT TEST 579-D B1W3AT1-55	BETA	0.000	ELEVTR	0.000	REFS	316.2304	SQ IN
(RC7122)	CVLSWT TEST 579-D B4W3AT1-55	RUDVTR	0.000	FLAPS	0.000	REFL	50.1900	IN
(RC7124)	CVLSWT TEST 579-D B5W3AT1-55	SPOILR	0.000			REFB	7.3500	IN
(RC7130)	CVLSWT TEST 579-D B6W3AT1-55					XMRP	29.3920	IN
						YMRP	0.0000	IN
						ZMRP	0.0000	IN
						SCALE	0.0175	

MACH 0.259

LONG. CHAR. - EFFECT OF AFTERBODY SHAPE - STRAIGHT WING AFT - V-TAIL=55DEG

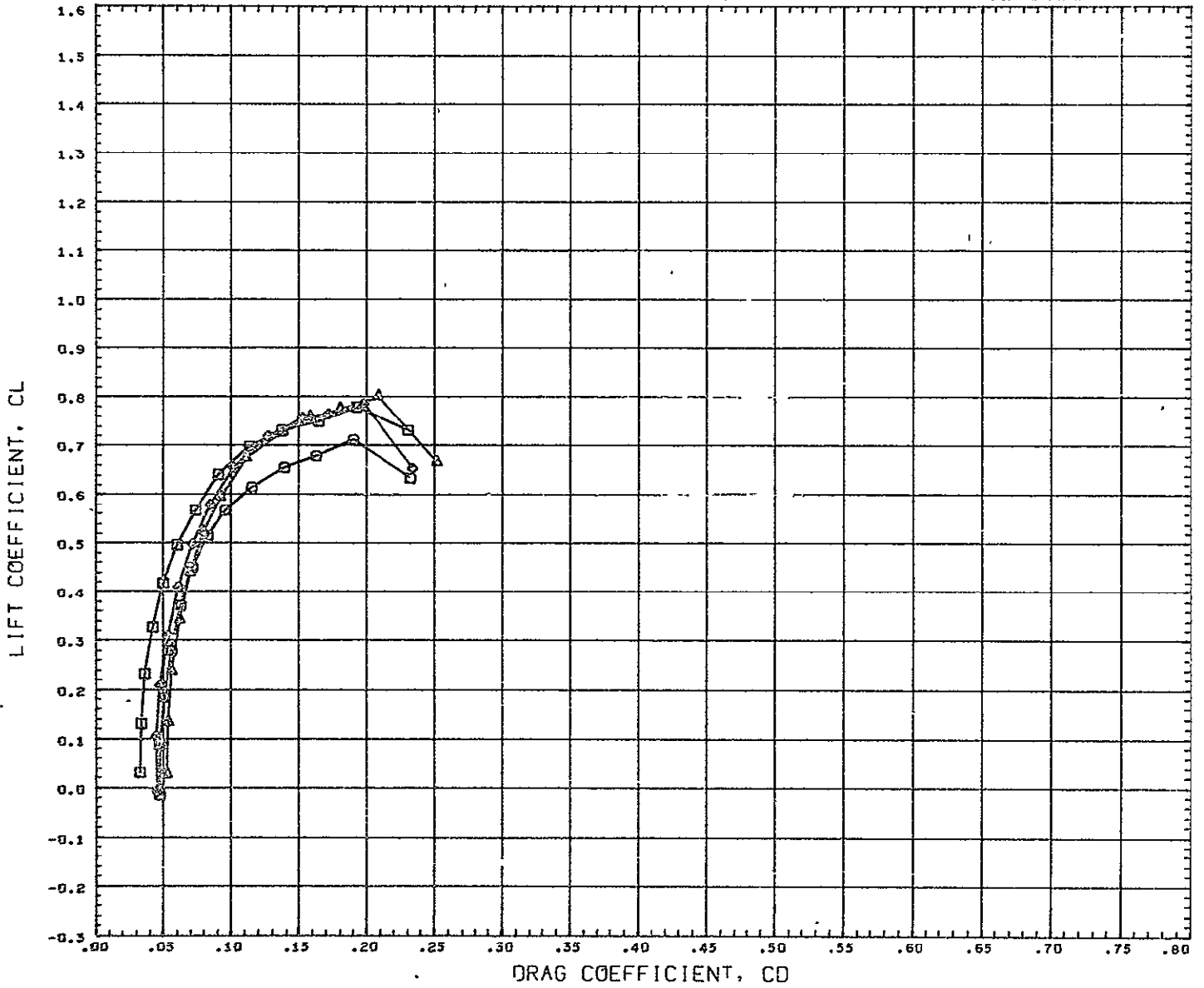

DATA SET SYMBOL	CONFIGURATION DESCRIPTION	PARAMETRIC VALUES			REFERENCE INFORMATION		
(RC7068)	□ CVLSWT TEST 579-D B1W3AT1-55	BETA	0.000	ELEVTR	0.000	REFS	316.2304 SQ IN
(RC7122)	□ CVLSWT TEST 579-D B4W3AT1-55	RUDVTR	0.000	FLAPS	0.000	REFL	50 1900 IN
(RC7124)	◇ CVLSWT TEST 579-D B5W3AT1-55	SFOILR	0.000			REFB	7.3500 IN
(RC7130)	△ CVLSWT TEST 579-D B6W3AT1-55					XMRP	29 3920 IN
						YMRP	0 0000 IN
						ZMRP	0 0000 IN
						SCALE	0 0175

MACH 0.259

LONG. CHAR. - EFFECT OF AFTERBODY SHAPE - STRAIGHT WING AFT - V-TAIL=55DEG

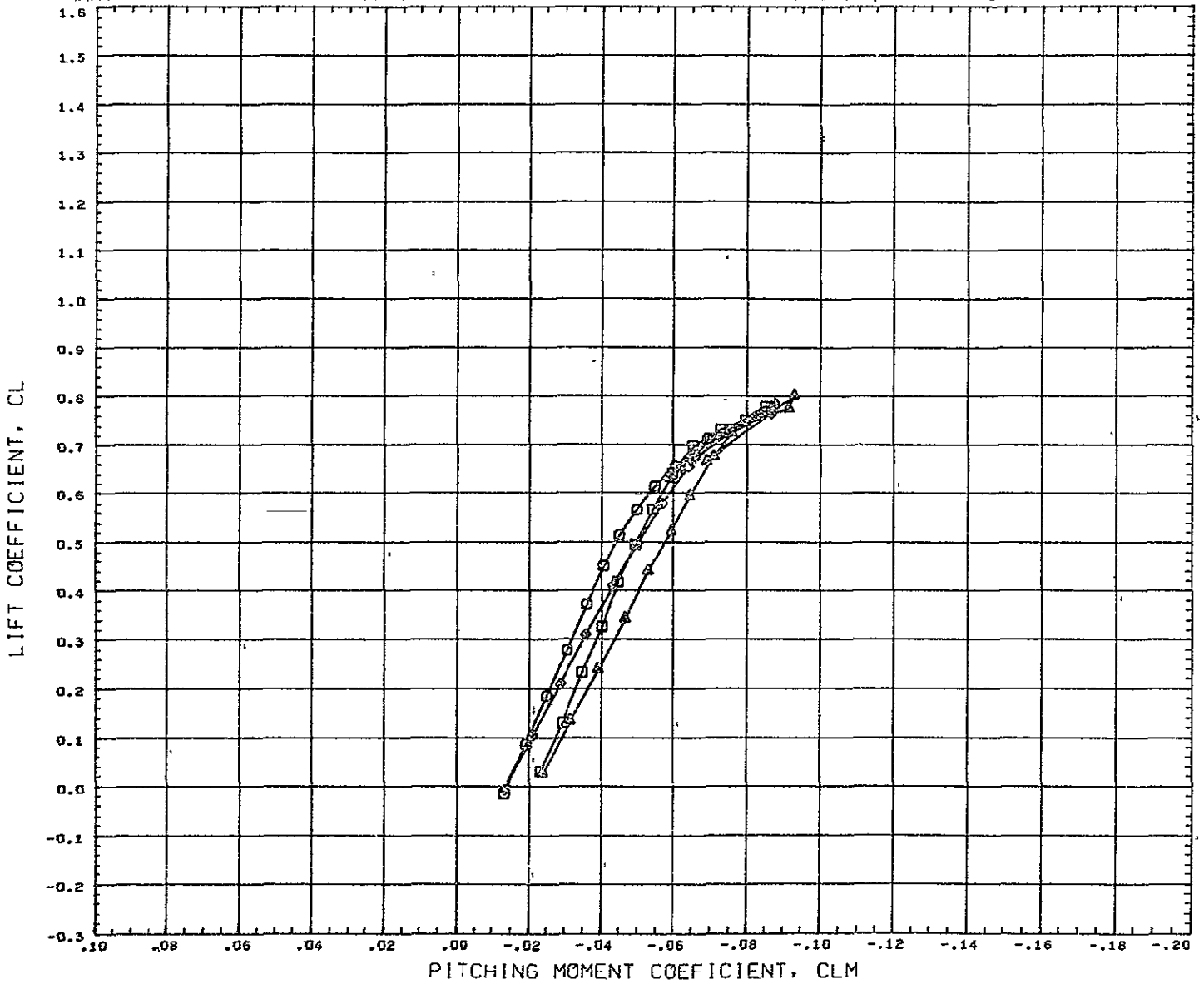

DATA SET SYMBOL	CONFIGURATION DESCRIPTION	PARAMETRIC VALUES				REFERENCE INFORMATION		
(RC7068)	□ CVLSWT TEST 579-D B1W3AT1-55	BETA	0.000	ELEVTR	0.000	REFS	316 2304	SQ IN
(RC7122)	□ CVLSWT TEST 579-D B4W3AT1-55	RUDVTR	0.000	FLAPS	0.000	REFL	50 1900	IN
(RC7124)	◇ CVLSWT TEST 579-D B5W3AT1-55					REFB	7.3500	IN
(RC7130)	△ CVLSWT TEST 579-D B6W3AT1-55	SFOILR	0.000			XMRP	29.3920	IN
						YMRP	0.0000	IN
						ZMRP	0.0000	IN
						SCALE	0.0175	

MACH 0.259

EFFECT OF AFTERBODY SHAPE - SIDESLIP DERIV. - STRAIGHT WING AFT - V-TAIL=55DEG

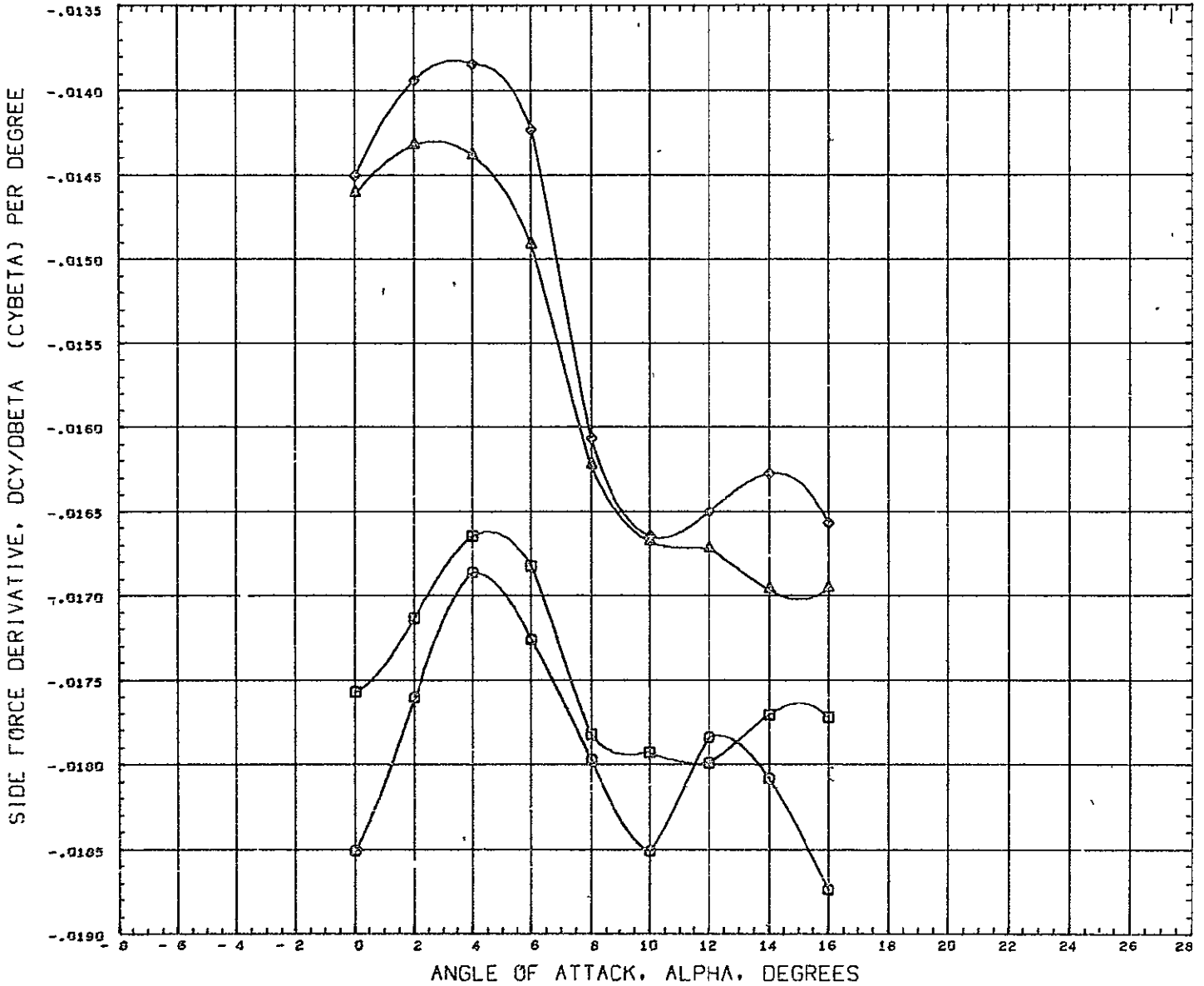

DATA SET SYMBOL	CONFIGURATION DESCRIPTION	PARAMETRIC VALUES				REFERENCE INFORMATION		
(DB7068)	CVLSWT TEST 579-D B1W3AT1-55	BETA	0.000	ELEVTR	0.000	REFS	316.2304	SQ IN
(DB7122)	CVLSWT TEST 579-D B4W3AT1-55	RUDVTR	0.000	FLAPS	0.000	REFL	50.1900	IN
(DB7124)	CVLSWT TEST 579-D B5W3AT1-55					REFB	7.3500	IN
(DB7130)	CVLSWT TEST 579-D B6W3AT1-55	SPOILR	0.000			XNRF	29.3920	IN
						YNRF	0.0000	IN
						ZNRF	0.0000	IN
						SCALE	0.0175	

MACH 0.259

EFFECT OF AFTERBODY SHAPE - SIDESLIP DERIV. - STRAIGHT WING AFT - V-TAIL=55DEG

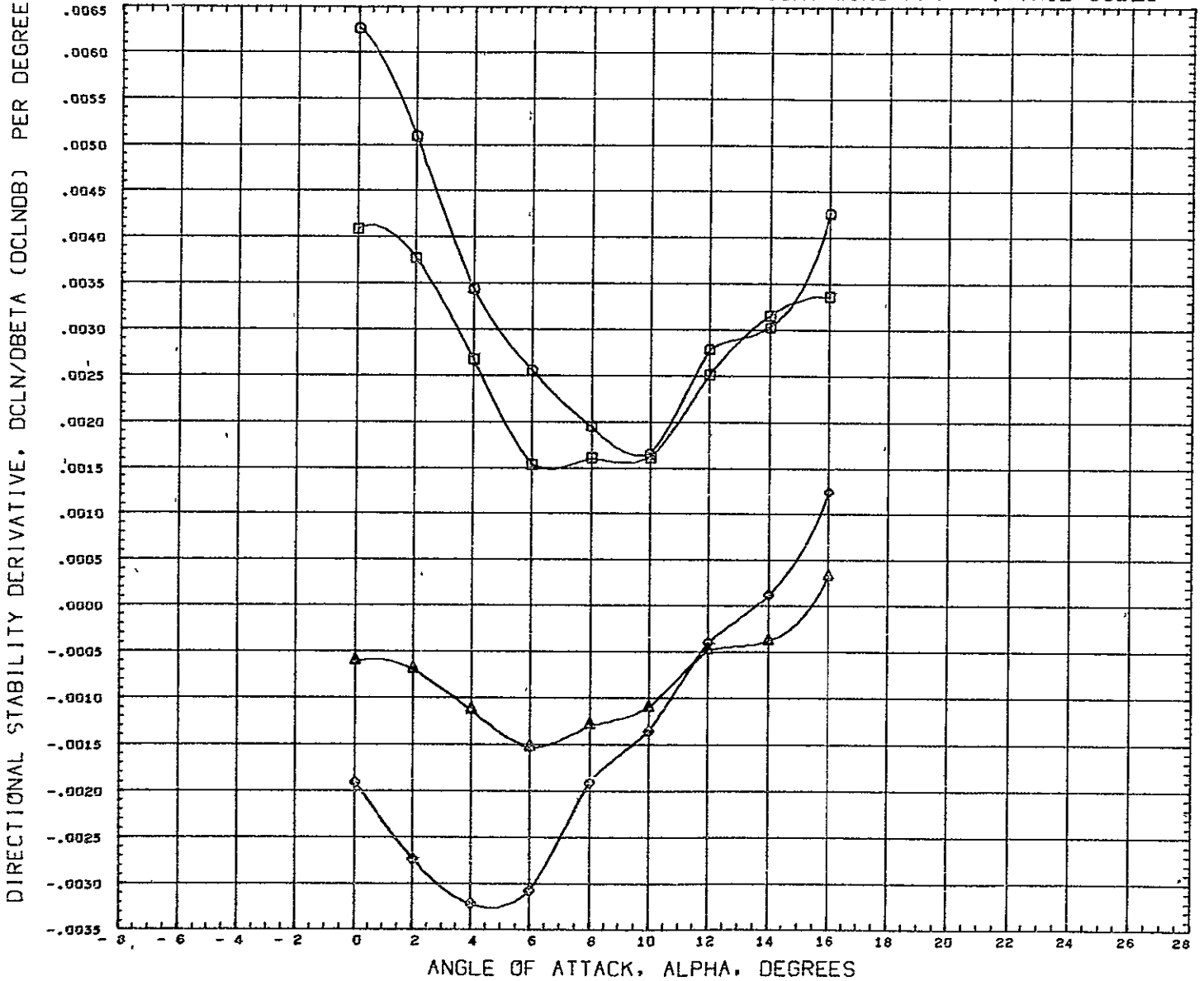

DATA SET SYMBOL	CONFIGURATION DESCRIPTION	PARAMETRIC VALUES			REFERENCE INFORMATION		
(DB7068)	□ CVLSWT TEST 579-G 81W3AT1-55	BETA	0.000	ELEVTR	0.000	REFS	316.2304 SQ IN
(DB7122)	□ CVLSWT TEST 579-G 84W3AT1-55	RUDVTR	0.000	FLAPS	0.000	REFL	50.1900 IN
(DB7124)	○ CVLSWT TEST 579-G 85W3AT1-55	SPOILR	0.000			REFB	7.3500 IN
(DB7130)	△ CVLSWT TEST 579-G 86W3AT1-55					XMRP	29.3920 IN
						YMRP	0.0000 IN
						ZMRP	0.0000 IN
						SCALE	0.0175

MACH 0.259

EFFECT OF AFTERBODY SHAPE - SIDESLIP DERIV. - STRAIGHT WING AFT - V-TAIL=55DEG

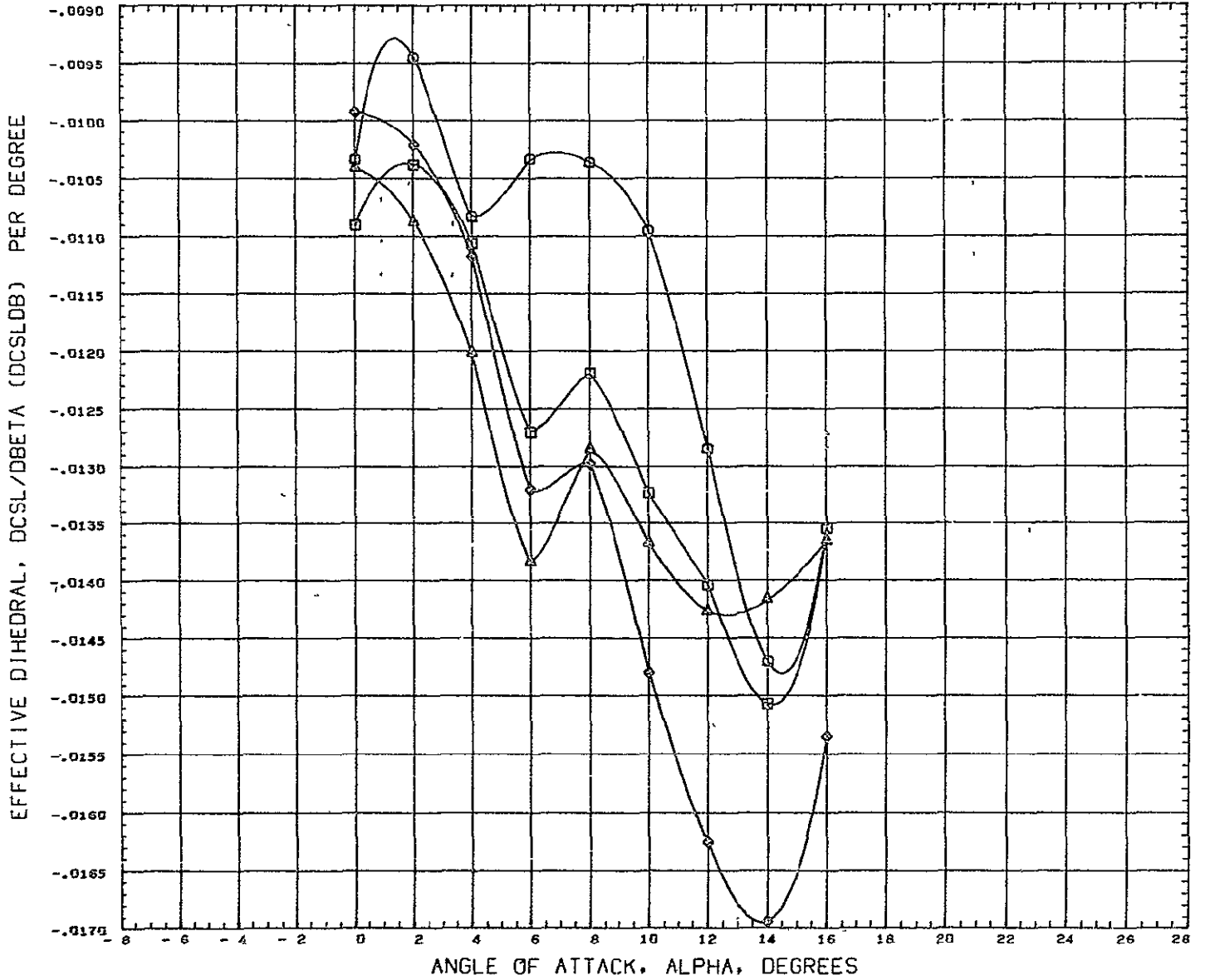

DATA SET SYMBOL	CONFIGURATION DESCRIPTION	PARAMETRIC VALUES				REFERENCE INFORMATION		
(DB7068)	CVLSWT TEST 579-D B1W3AT1-55	BETA	0.000	ELEVTR	0.000	REFS	316.2304	SQ IN
(DB7122)	CVLSWT TEST 579-D B4W3AT1-55	RUDVTR	0.000	FLAPS	0.000	REFL	50.1900	IN
(DB7124)	CVLSWT TEST 579-D B5W3AT1-55	SFOILR	0.000			REFB	7.3500	IN
(DB7130)	CVLSWT TEST 579-D B6W3AT1-55					XMRP	29.3920	IN
						YMRP	0.0000	IN
						ZMRP	0.0000	IN
						SCALE	0.3175	

HACH 5.259



LONGITUDINAL CHAR. - EFFECT OF AFTERBODY SHAPE - STRAIGHT WING AFT - TAIL OFF

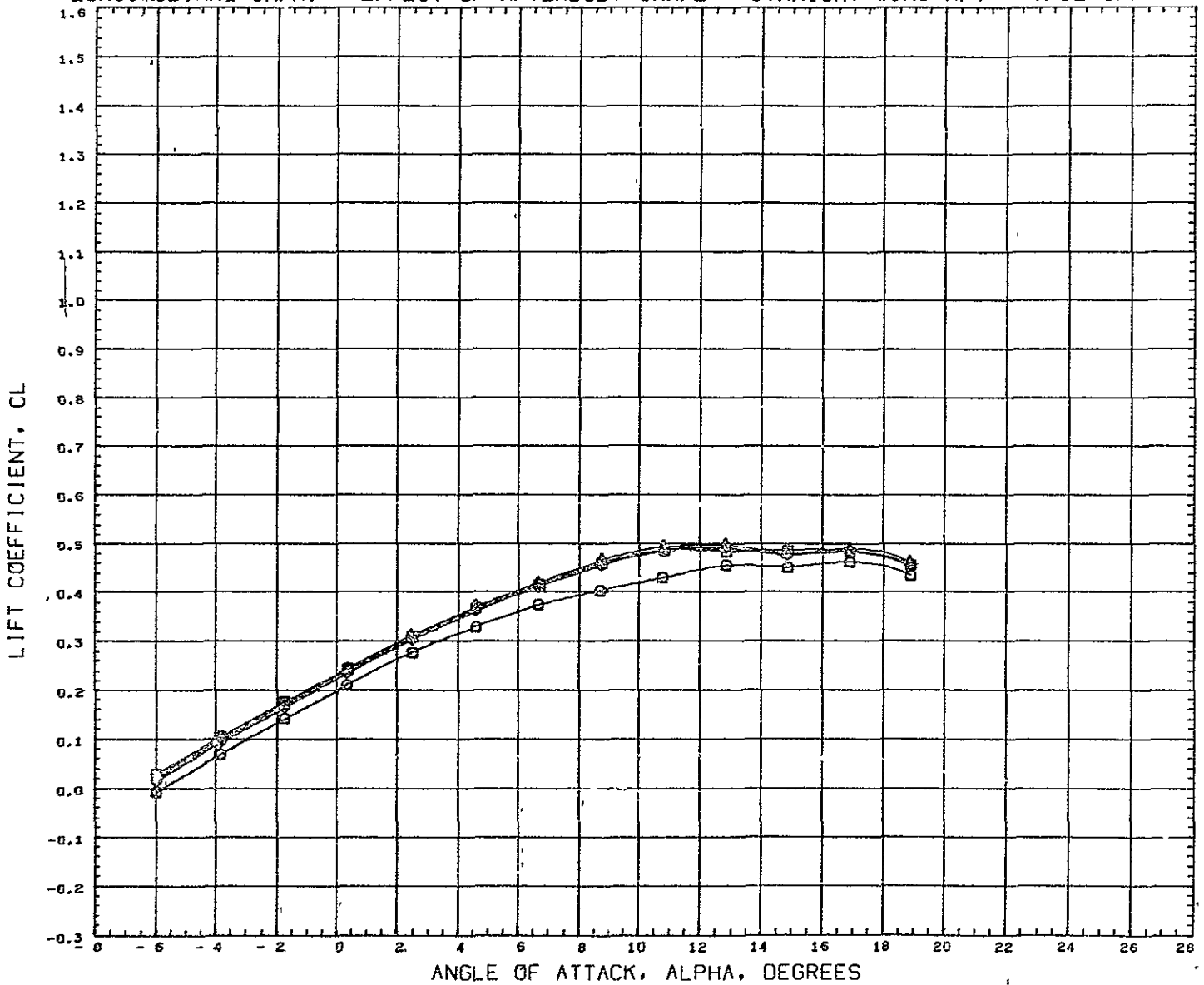

DATA SET	SYMBOL	CONFIGURATION DESCRIPTION	BETA	PARAMETRIC VALUES	FLAPS	SPOILR	REFS	REFERENCE INFORMATION
(RC7076)	○	CVLSWT TEST 579-D B1W3A	0.000	0.000	0.000	0.000	316.2304	SQ IN
(RC7125)	□	CVLSWT TEST 579-D B4W3A	0.000	0.000	0.000	0.000	50.1900	IN
(RC7126)	◇	CVLSWT TEST 579-D B5W3A	0.000	0.000	0.000	0.000	7.3500	IN
(RC7128)	△	CVLSWT TEST 579-D B6W3A	0.000	0.000	0.000	0.000	29.3920	IN
							0.0000	IN
							0.0000	IN
							0.0175	IN

MACH 0.259

LONGITUDINAL CHAR. - EFFECT OF AFTERBODY SHAPE - STRAIGHT WING AFT - TAIL OFF

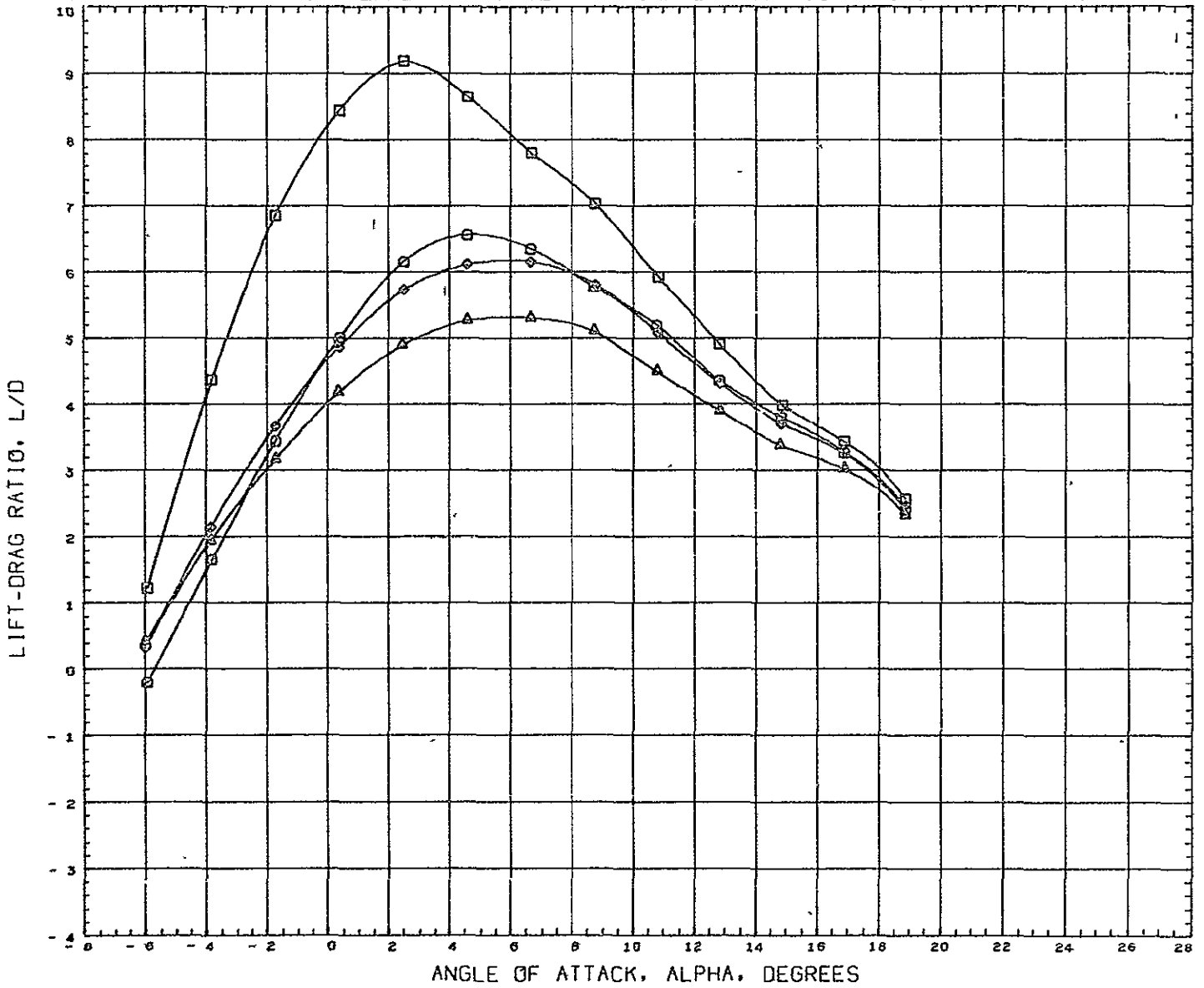

DATA SET SYMBOL	CONFIGURATION DESCRIPTION	PARAMETRIC VALUES			REFERENCE INFORMATION		
(RC7076)	CVLSWT TEST 579-D B1W3A	BETA	0.000	FLAPS	0.000	REFS	316.2304 SQ IN
(RC7120)	CVLSWT TEST 579-D B4W3A	SPOILR	0.000			REFL	50.1900 IN
(RC7126)	CVLSWT TEST 579-D B3W3A					REFB	7.3500 IN
(RC7128)	CVLSWT TEST 579-D B6W3A					XNRF	29.3920 IN
						YNRF	0.0000 IN
						ZNRF	0.0000 IN
						SCALE	0.0175

MACH 0.259

LONGITUDINAL CHAR. - EFFECT OF AFTERBODY SHAPE - STRAIGHT WING AFT - TAIL OFF

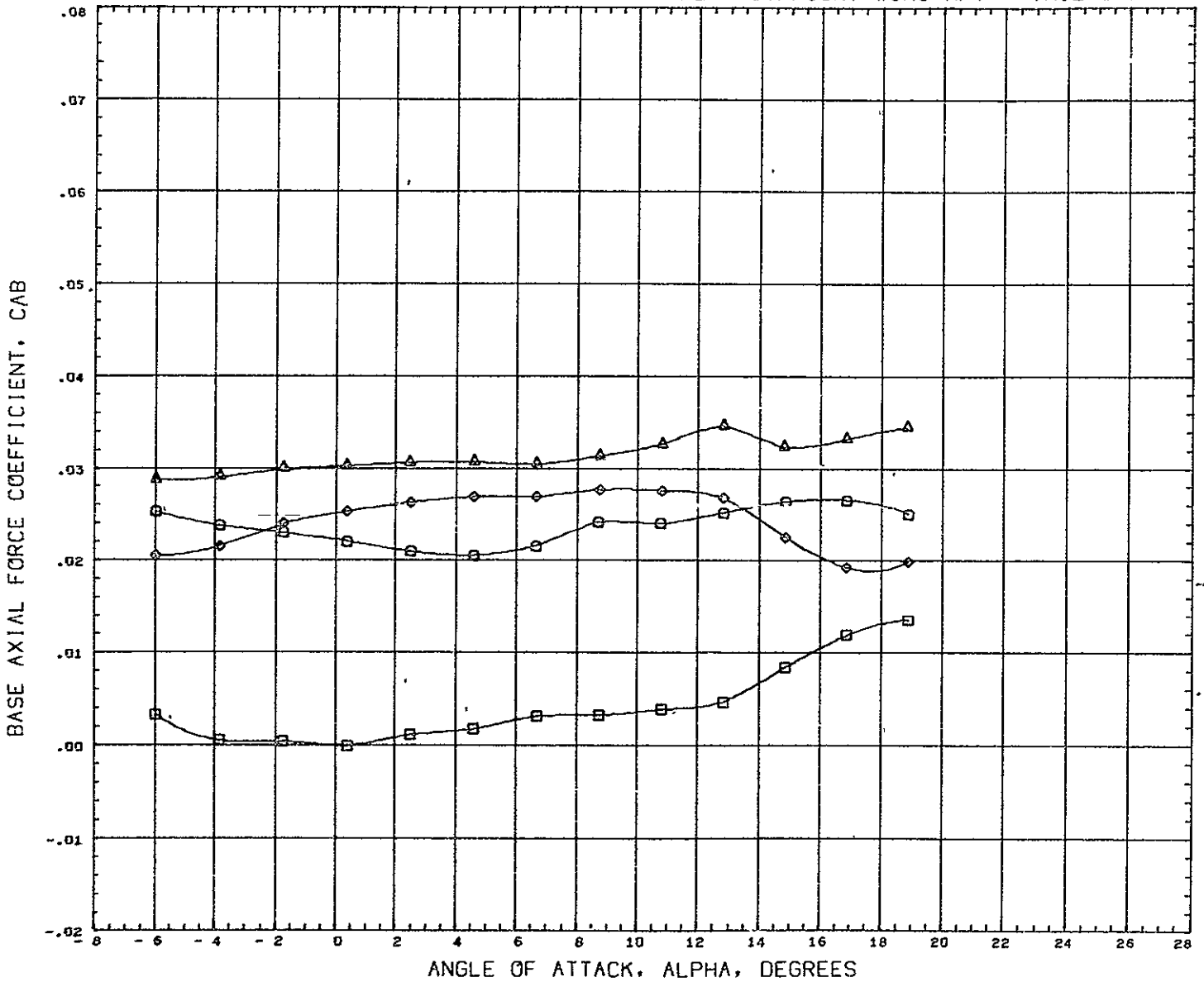

DATA SET SYMBOL	CONFIGURATION DESCRIPTION	PARAMETRIC VALUES			REFERENCE INFORMATION		
(RC7076)	CVLSWT TEST 579-D B1W3A	BETA	0.000	FLAPS	0.000	REFS	316.2304 SQ IN
(RC7120)	CVLSWT TEST 579-D B4W3A	SPOILR	0.000			REFL	50.1900 IN
(RC7126)	CVLSWT TEST 579-D B5W3A					REFB	7.3500 IN
(RC7128)	CVLSWT TEST 579-D B6W3A					XHRF	29.3920 IN
						YHRF	0.0000 IN
						ZHRF	0.0000 IN
						SCALE	0.0175

MACH 0.259

LONGITUDINAL CHAR. - EFFECT OF AFTERBODY SHAPE - STRAIGHT WING AFT - TAIL OFF

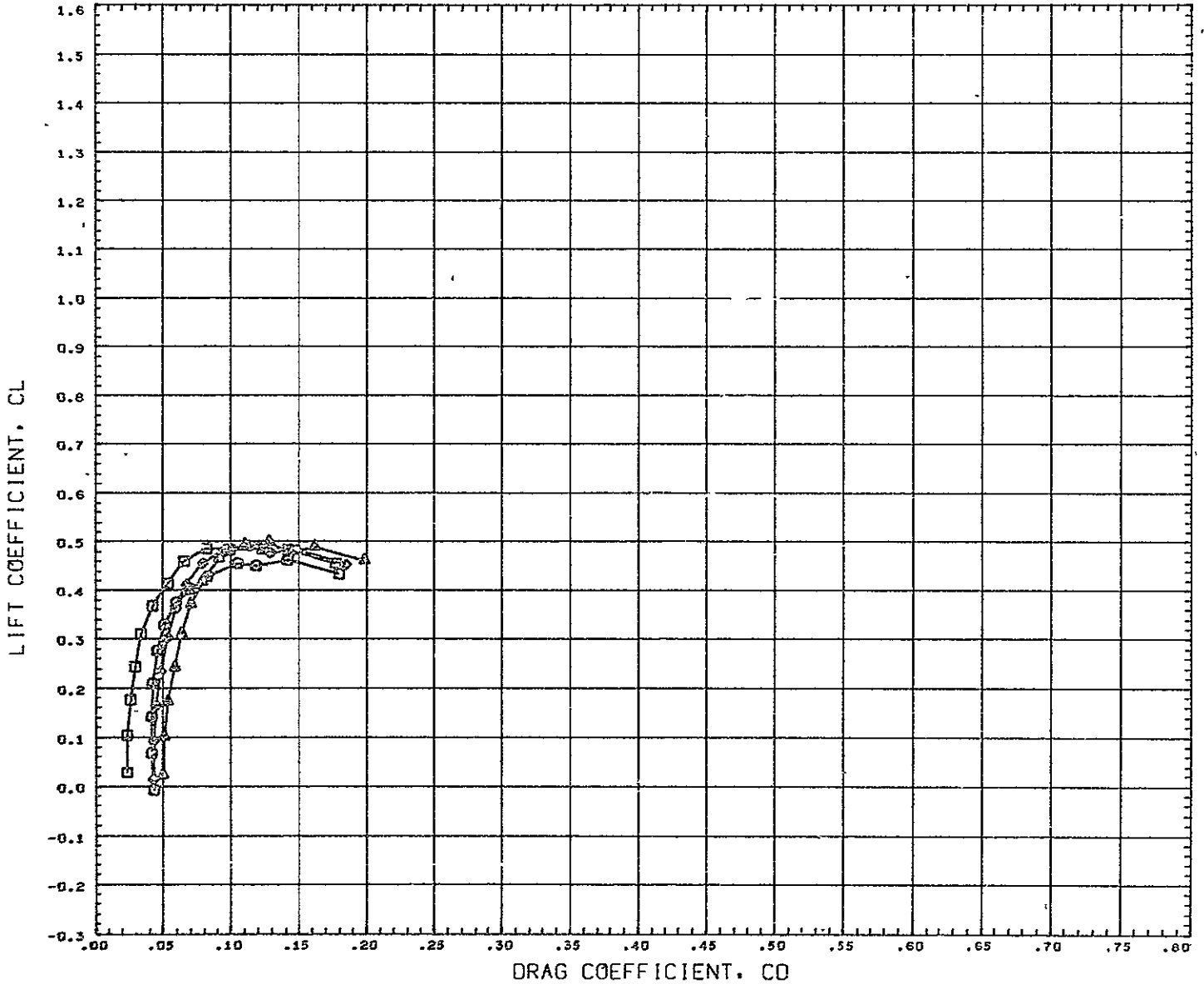

DATA SET SYMBOL	CONFIGURATION DESCRIPTION
(RC7076)	CVLSWT TEST 579-D B1W3A
(RC7125)	CVLSWT TEST 579-D B4W3A
(RC7126)	CVLSWT TEST 579-D B5W3A
(RC7128)	CVLSWT TEST 579-D B6W3A

PARAMETRIC VALUES		REFERENCE INFORMATION	
BETA	0.000	FLAPS	0 000
SFOILR	0.000	REFS	316.2304 SQ IN
		REFL	50 1900 IN
		REFB	7 3500 IN
		XMRP	29 3920 IN
		YMRP	0 0000 IN
		ZMRP	0.0000 IN
		SCALE	0 0175

MACH 0.259

LONGITUDINAL CHAR. - EFFECT OF AFTERBODY SHAPE - STRAIGHT WING AFT - TAIL OFF

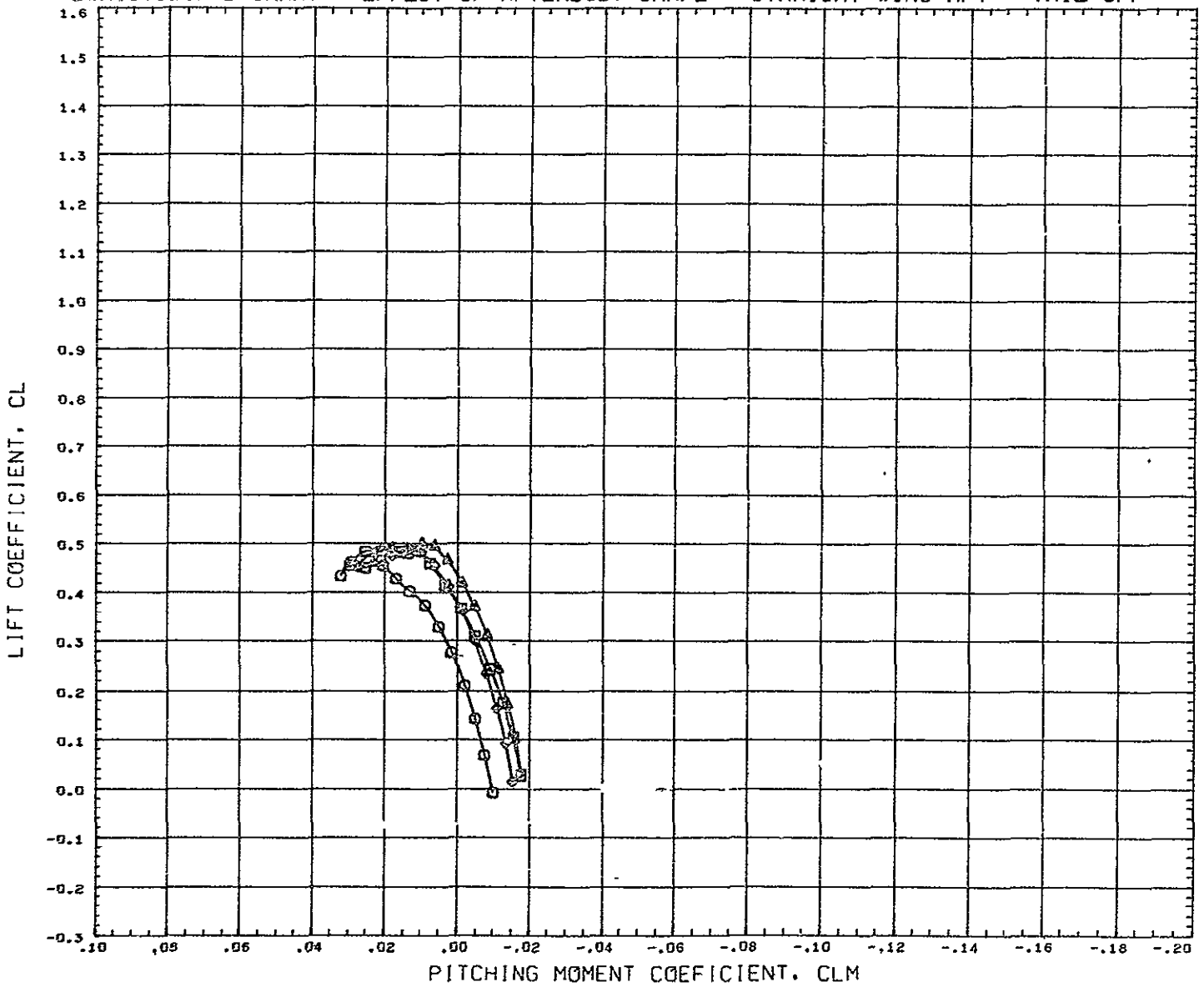

DATA SET SYMBOL	CONFIGURATION DESCRIPTION
(RC7076)	CVLSWT TEST 579-0 B1W3A
(RC7120)	CVLSWT TEST 579-0 B4W3A
(RC7126)	CVLSWT TEST 579-0 B5W3A
(RC7128)	CVLSWT TEST 579-0 B6W3A

PARAMETRIC VALUES	
DETA	0.000
FLAPS	0.000
SPOILR	0.000

REFERENCE INFORMATION		
REFS	316.2304	SQ IN
REFL	50.1900	IN
REFB	7.3500	IN
XMRP	29.3920	IN
YMRP	0.0000	IN
ZMRP	0.0000	IN
SCALE	0.0175	

MACH 0.259

EFFECT OF AFTERBODY SHAPE - SIDESLIP DERIVATIVES - STRAIGHT WING AFT - TAIL OFF

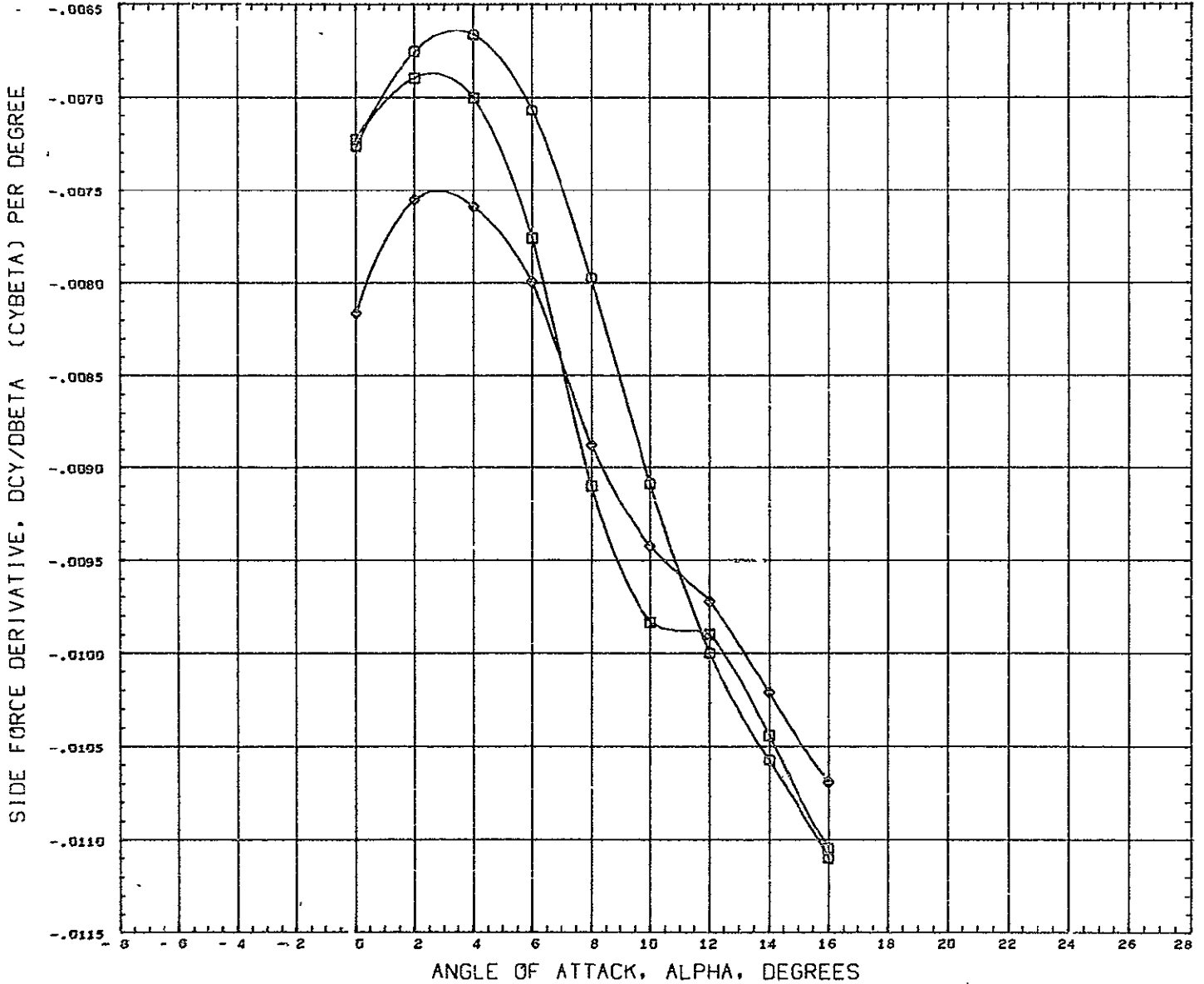

DATA SET SYMBOL    CONFIGURATION DESCRIPTION  
 (DB7120)    □    CVLSWT TEST 579-D B4W3A  
 (DB7126)    ◻    CVLSWT TEST 579-D B5W3A  
 (DB7128)    ◊    CVLSWT TEST 579-D B6W3A

PARAMETRIC VALUES  
 BETA    0.000    FLAPS    0.000  
 SFOILR    0.000

REFERENCE INFORMATION  
 REFS    316.2304    SQ IN  
 REFL    50.1900    IN  
 REFB    7.3500    IN  
 XHRF    29.3920    IN  
 YHRF    0.0000    IN  
 ZHRF    0.0000    IN  
 SCALE    0.0175

MACH    0.259

EFFECT OF AFTERBODY SHAPE - SIDESLIP DERIVATIVES - STRAIGHT WING AFT - TAIL OFF

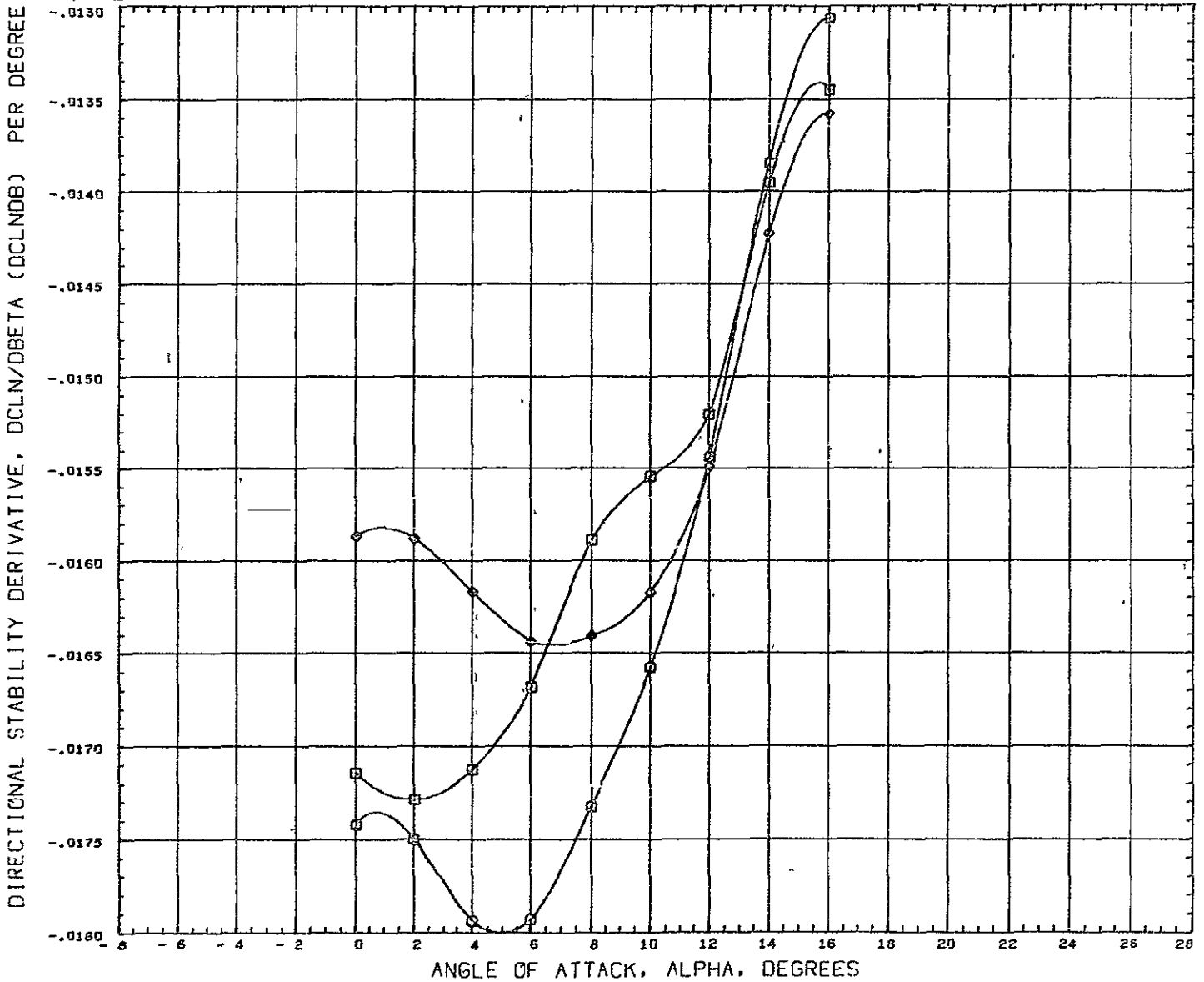

DATA SET SYMBOL	CONFIGURATION DESCRIPTION	PARAMETRIC VALUES			REFERENCE INFORMATION			
(DB7120)	CVLSWT TEST 579-0 B4W3A	BETA	0.000	FLAPS	0 000	REFS	316.2304	SQ IN
(DB7126)	CVLSWT TEST 579-0 B5W3A	SFOILR	0.000			REFL	50.1900	IN
(DB7128)	CVLSWT TEST 579-0 B6W3A					REFB	7.3500	IN
						XMRP	29.3920	IN
						YMRP	0.0000	IN
						ZMRP	0.0000	IN
						SCALE	0 0175	

MACH 0.259

EFFECT OF AFTERBODY SHAPE - SIDESLIP DERIVATIVES - STRAIGHT WING AFT - TAIL OFF

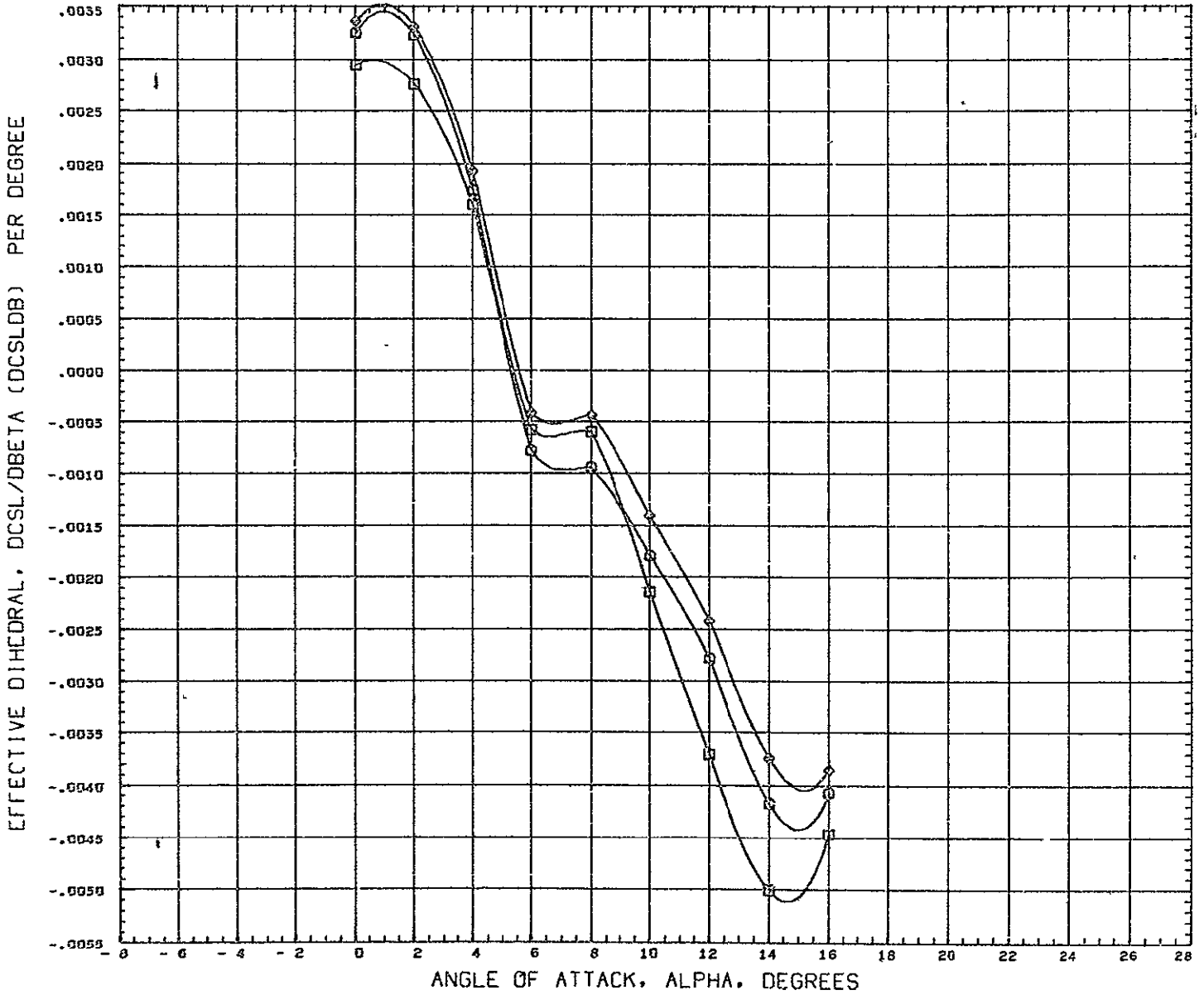

DATA SET SYMBOL	CONFIGURATION DESCRIPTION	PARAMETRIC VALUES			REFERENCE INFORMATION				
(DB7125)	□ CVLSWT TEST 579-0 B4W3A	BETA	0.000	FLAPS	0	GOOD	REFS	316.2304	Sq IN
(DB7126)	□ CVLSWT TEST 579-0 B5W3A	SPOILR	0.000				REPL	50.1900	IN
(DB7128)	◇ CVLSWT TEST 579-0 B6W3A						REFB	7.3500	IN
							XMRP	29.3920	IN
							YMRP	0.0000	IN
							ZMRP	0.0000	IN
							SCALE	0.0175	

MACH 0.259



EFFECT OF RN NO. - ST. WING BASIC - V-TAIL=55DEG - MACH NOS 0.184, 0.259, AND 0.318

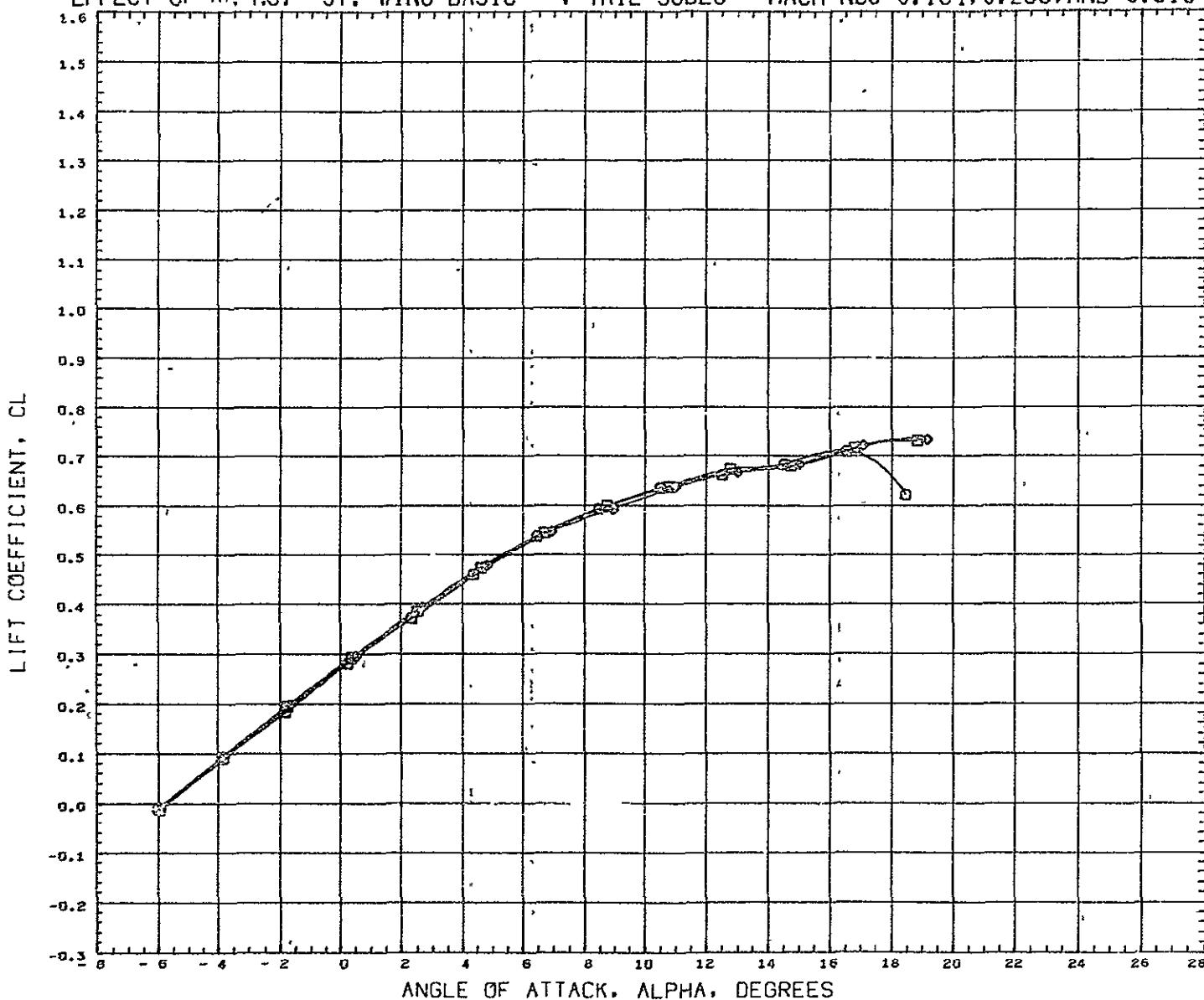

SYMBOL	RN	PARAMETRIC VALUES			
○	1.240	BETA	0.000	ELEVTR	0.000
□	1.750	RUDYTR	0.000	FLAPS	0.000
◇	2.150	SFGILR	0.000		

REFERENCE INFORMATION		
REFS	316 2304	SQ IN
REFL	50.1900	IN
REFB	7.3500	IN
XMRP	29.3920	IN
YMRP	0.0000	IN
ZMRP	0.0000	IN
SCALE	0.0175	

DATA HIST. CODE H

EFFECT OF RN NO. - ST. WING BASIC - V-TAIL=55DEG - MACH NOS 0.184, 0.259, AND 0.318

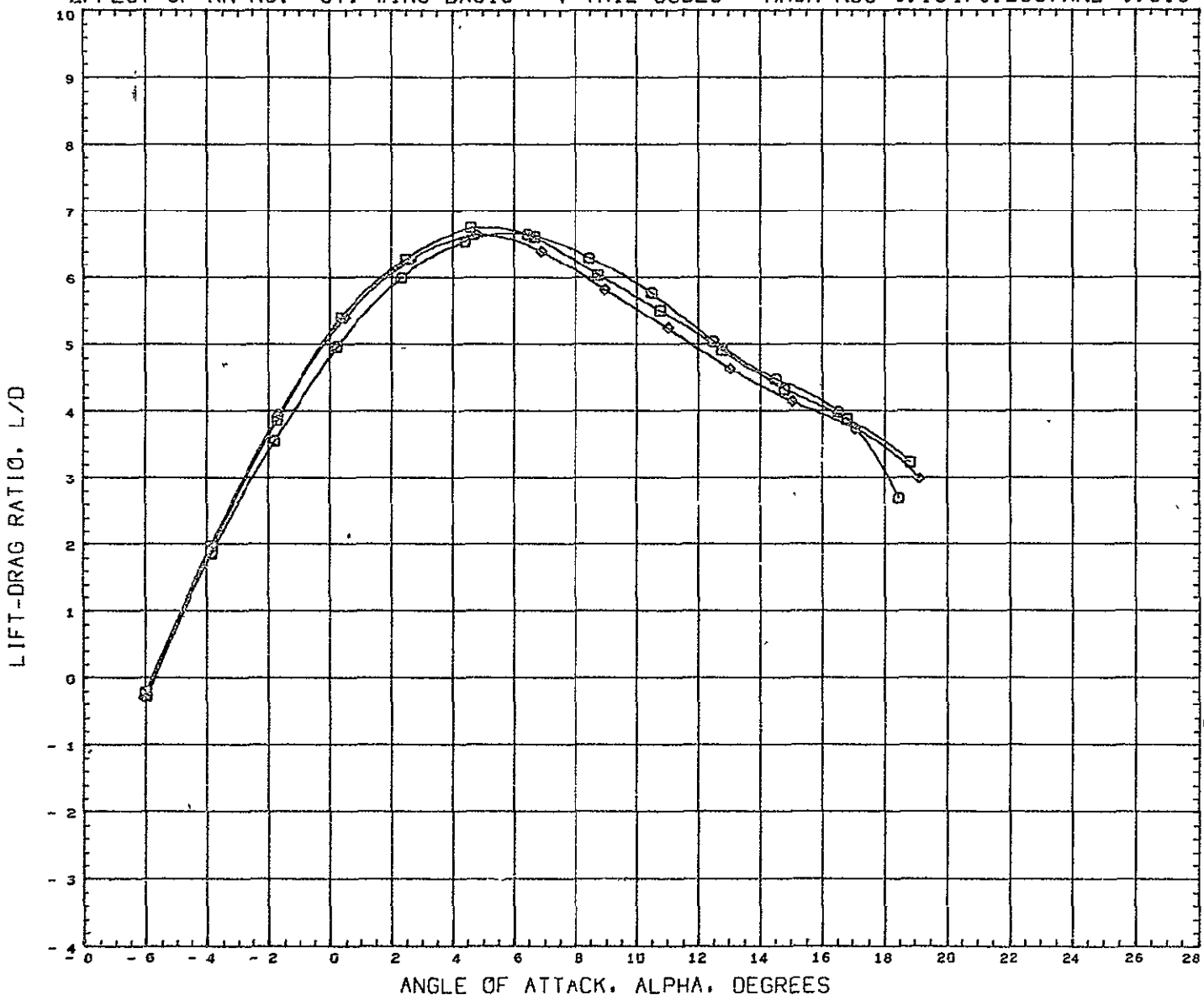

SYMBOL	RN	PARAMETRIC VALUES			
○	1.249	BETA	0.000	ELEVTR	0.000
□	1.750	RUCVTR	0.000	FLAPS	0.000
◇	2.150	SFOJLR	0.000		

REFERENCE INFORMATION		
REFS	316 2304	SQ IN
REFL	50.1900	IN
REFB	7.3500	IN
XMRP	29 3920	IN
YMRP	0 0000	IN
ZMRP	0 0000	IN
SCALE	0.0175	

DATA HIST. CODE H

EFFECT OF RN NO. - ST. WING BASIC. - V-TAIL=55DEG - MACH NOS 0.184, 0.259, AND 0.318

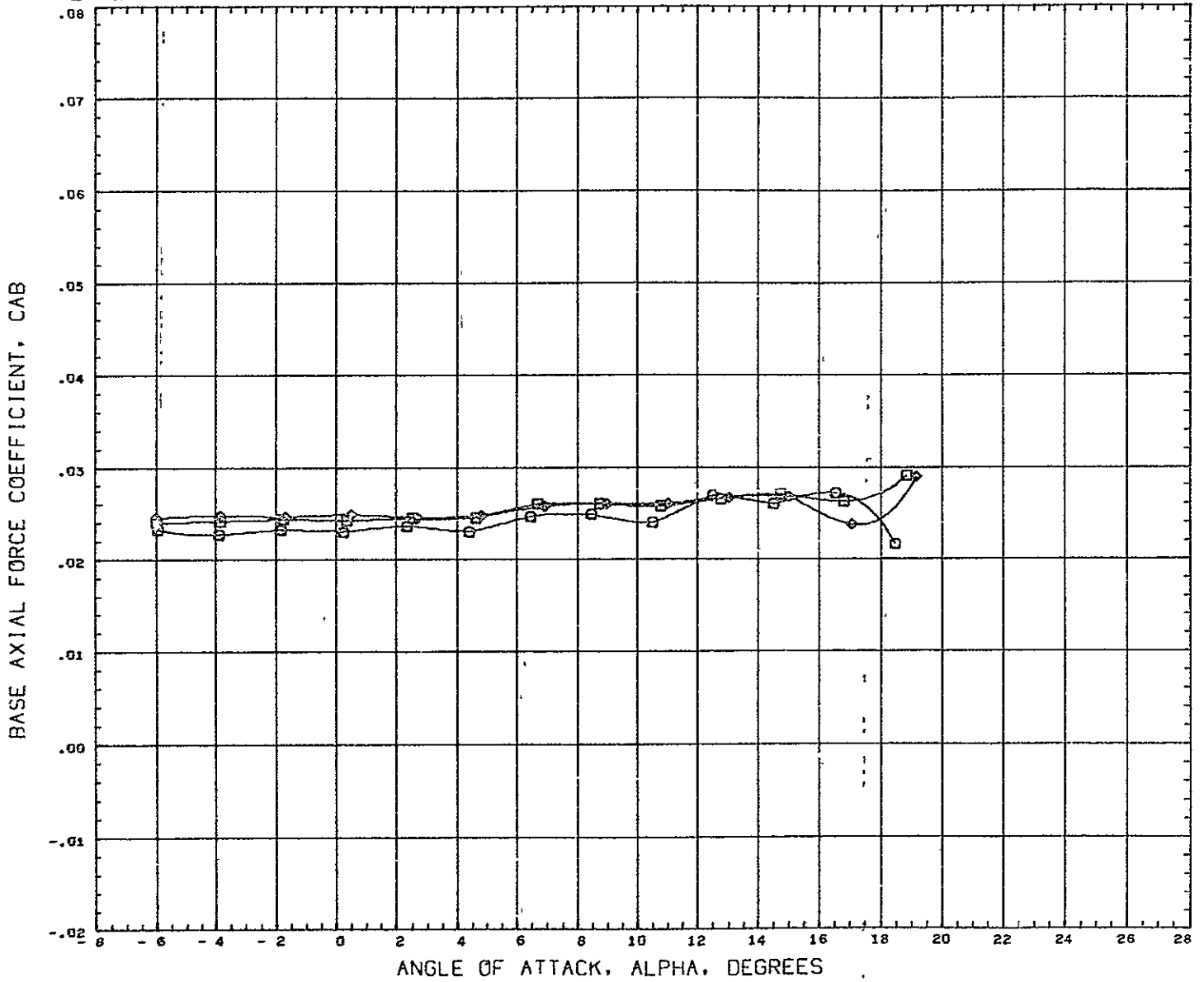

SYMBOL	RN	PARAMETRIC VALUES				REFERENCE INFORMATION		
		BETA	ELEVTR	FLAPS	REFS	SQ	IN	
○	1.249	0.000	0.000	0.000	316 2304	IN		
□	1.750	0.000	0.000	0.000	50 1900	IN		
◇	2.150	0.000	0.000	0.000	7.3500	IN		
					29 3920	IN		
					0 0000	IN		
					0 0000	IN		
					0.0175			

DATA HIST. CODE H

EFFECT OF RN NO. - ST. WING BASIC - V-TAIL=55DEG - MACH NOS 0.184, 0.259, AND 0.318

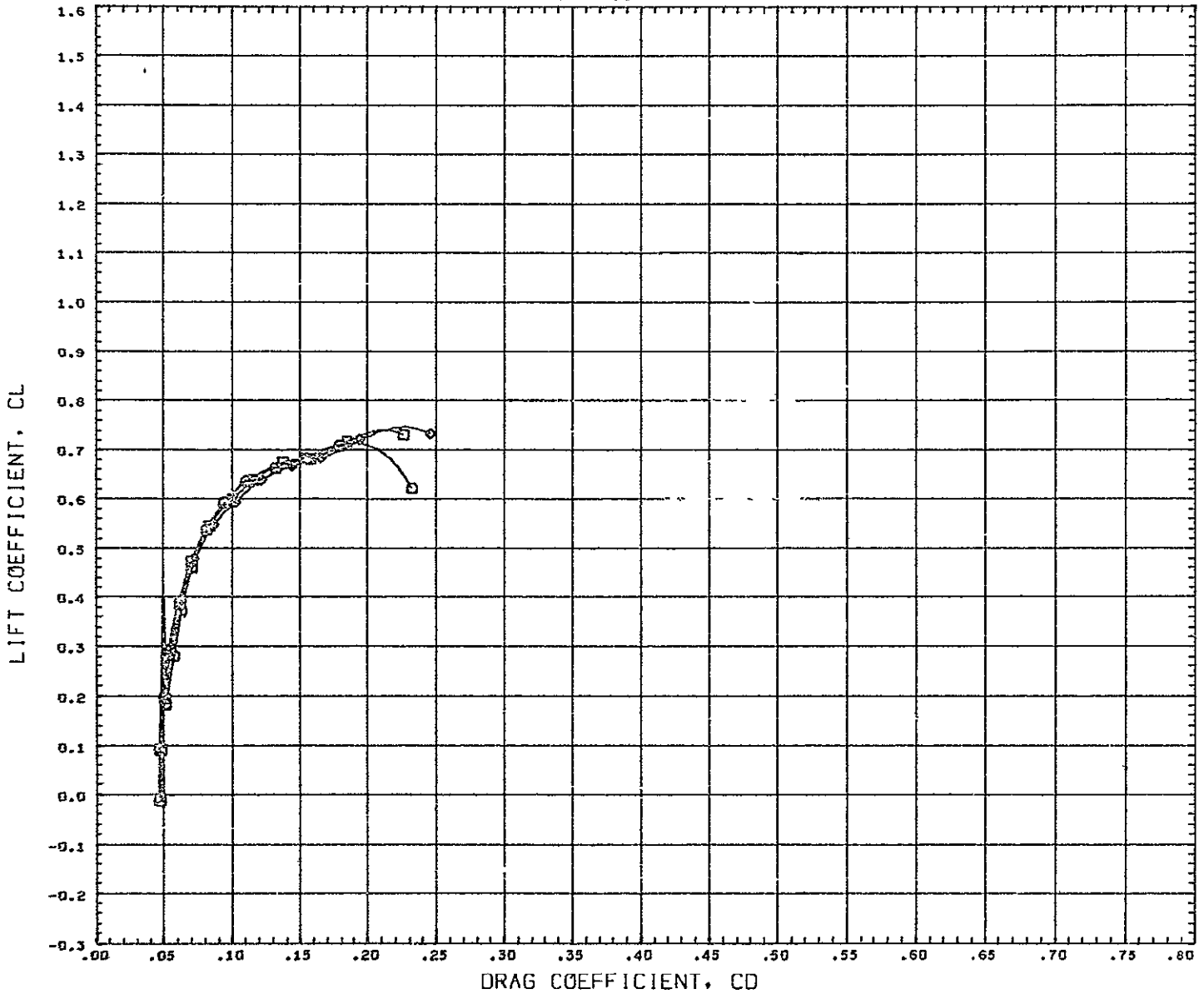

SYMBOL	RN	PARAMETRIC VALUES			
○	1.240	BETA	0.000	ELEVTR	0.000
□	1.750	RUDYTR	0.000	FLAPS	0.000
◇	2.150	SFOILR	0.000		

REFERENCE INFORMATION		
REFS	316 2304	SQ IN
REFL	50 1900	IN
REFB	7 3500	IN
XMRP	29.3920	IN
YHRP	0.0000	IN
ZHRP	0.0000	IN
SCALE	0.0175	

DATA HIST. CODE H

EFFECT OF RN NO. - ST. WING BASIC - V-TAIL=55DEG - MACH NOS 0.184, 0.259, AND 0.318

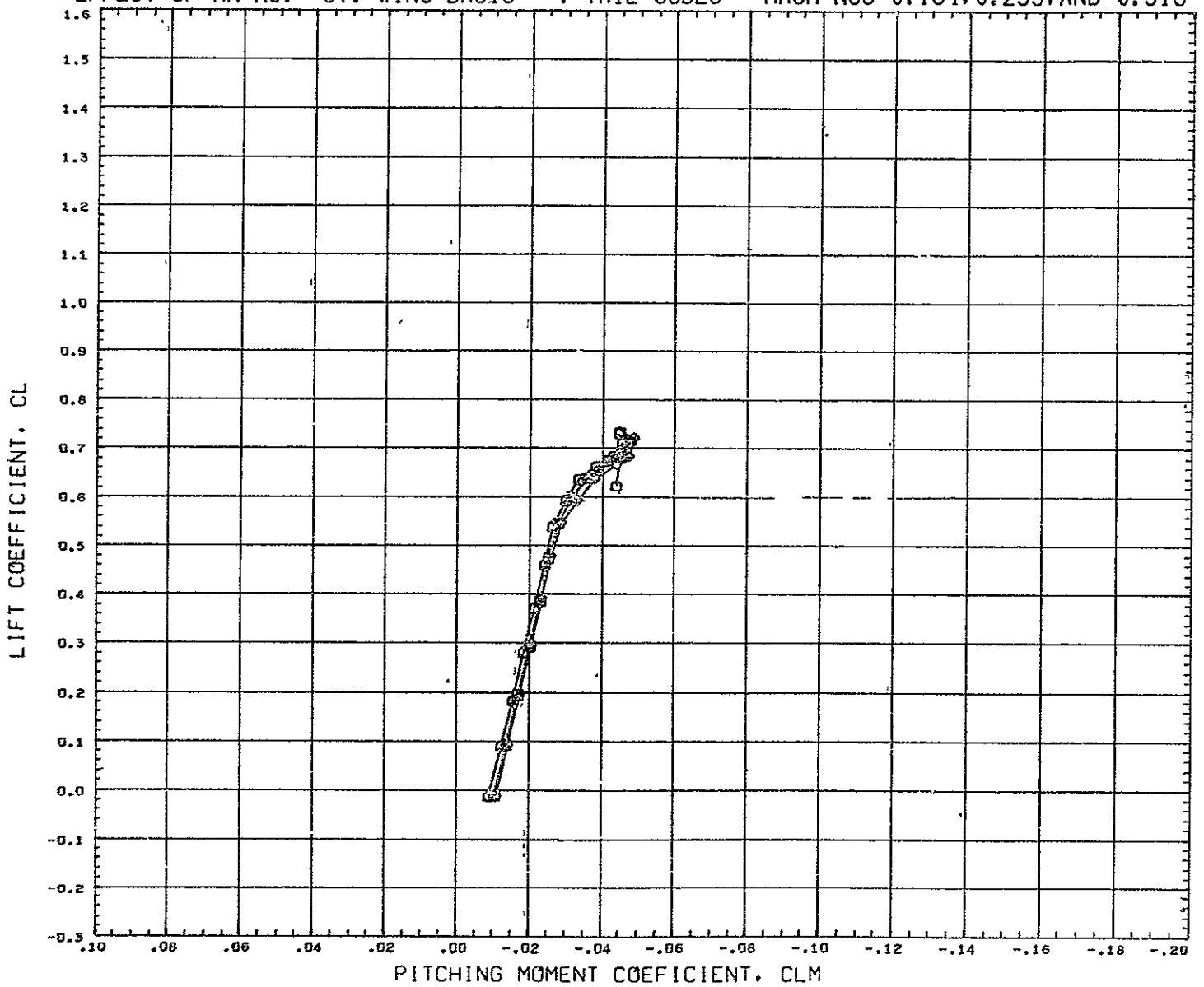

SYMBOL	RN	PARAMETRIC VALUES				REFERENCE INFORMATION		
		BETA	ELEVTR	FLAPS	REFS	'SQ IN	IN	
□	1.240	0.000	0.000	0.000	316.2304			
◇	1.750	0.000	0.000	0.000	50.1900			
○	2.150	0.000	0.000	0.000	7.3500			
					29.3920			
					0.0000			
					0.0000			
					6.0175			

DATA HIST. CODE H

LONG. CHAR. - CRUISE ENGINE EFFECT - STRAIGHT WING BASIC POS. - V-TAIL=55DEG

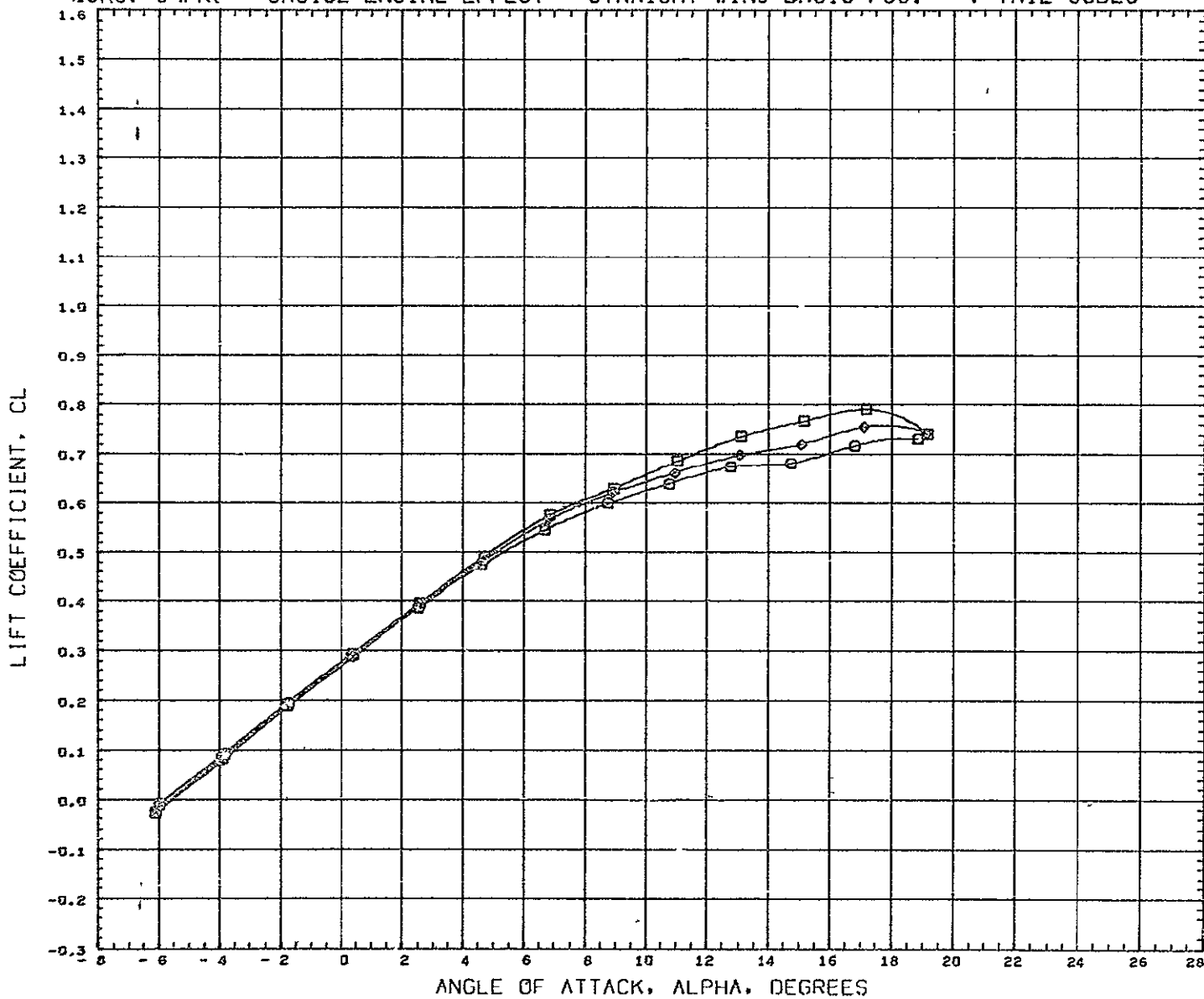

DATA SET SYMBOL	CONFIGURATION DESCRIPTION	PARAMETRIC VALUES				REFERENCE INFORMATION		
(SC7001)	□ CVLSWT TEST 579-D B1W1-15T1-55	DETA	0.000	ELEVTR	0.000	REFS	316 2304	SQ IN
(RC7038)	◇ CVLSWT TEST 579-D B1W1-15T1-55E1	RUDVTR	0.000	FLAPS	0.000	REFL	50 1900	IN
(RC7061)	○ CVLSWT TEST 579-D B1W1-15T1-55E3	SFOILR	0.000			REFB	7.3500	IN
						XMRP	29.3920	IN
						YMRP	0.0000	IN
						ZMRP	0.0000	IN
						SCALE	0.0175	

MACH 0.259

LONG. CHAR. - CRUISE ENGINE EFFECT - STRAIGHT WING BASIC POS. - V-TAIL=55DEG

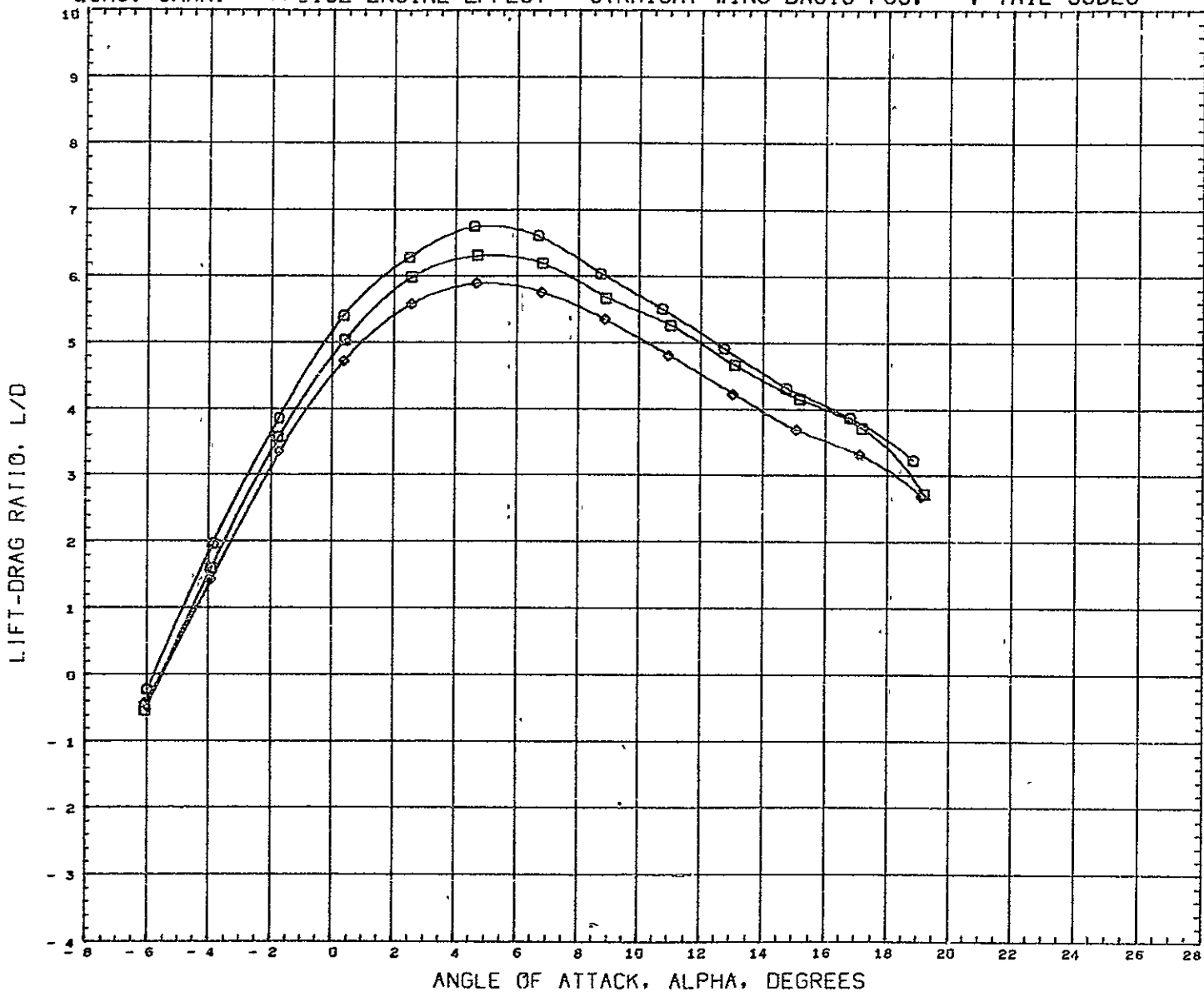

DATA SET SYMBOL	CONFIGURATION DESCRIPTION	PARAMETRIC VALUES		REFERENCE INFORMATION				
(SC7881)	○ CVLSWT TEST 579-D B1W1-15T1-55	BETA	0.000	ELEVTR	0.000	REFS	316.2304	SQ IN
(RC7838)	□ CVLSWT TEST 579-D B1W1-15T1-55E1	RUDVTR	0.000	FLAPS	0.000	REFL	50.1900	IN
(RC7861)	◇ CVLSWT TEST 579-D B1W1-15T1-55E3	SFOILR	0.000			REFB	7.3500	IN
						XMRP	29.3920	IN
						YMRP	0.0000	IN
						ZHRF	0.0000	IN
						SCALE	0.0175	

MACH 0.259

LONG. CHAR. - CRUISE ENGINE EFFECT - STRAIGHT WING BASIC POS. - V-TAIL=55DEG

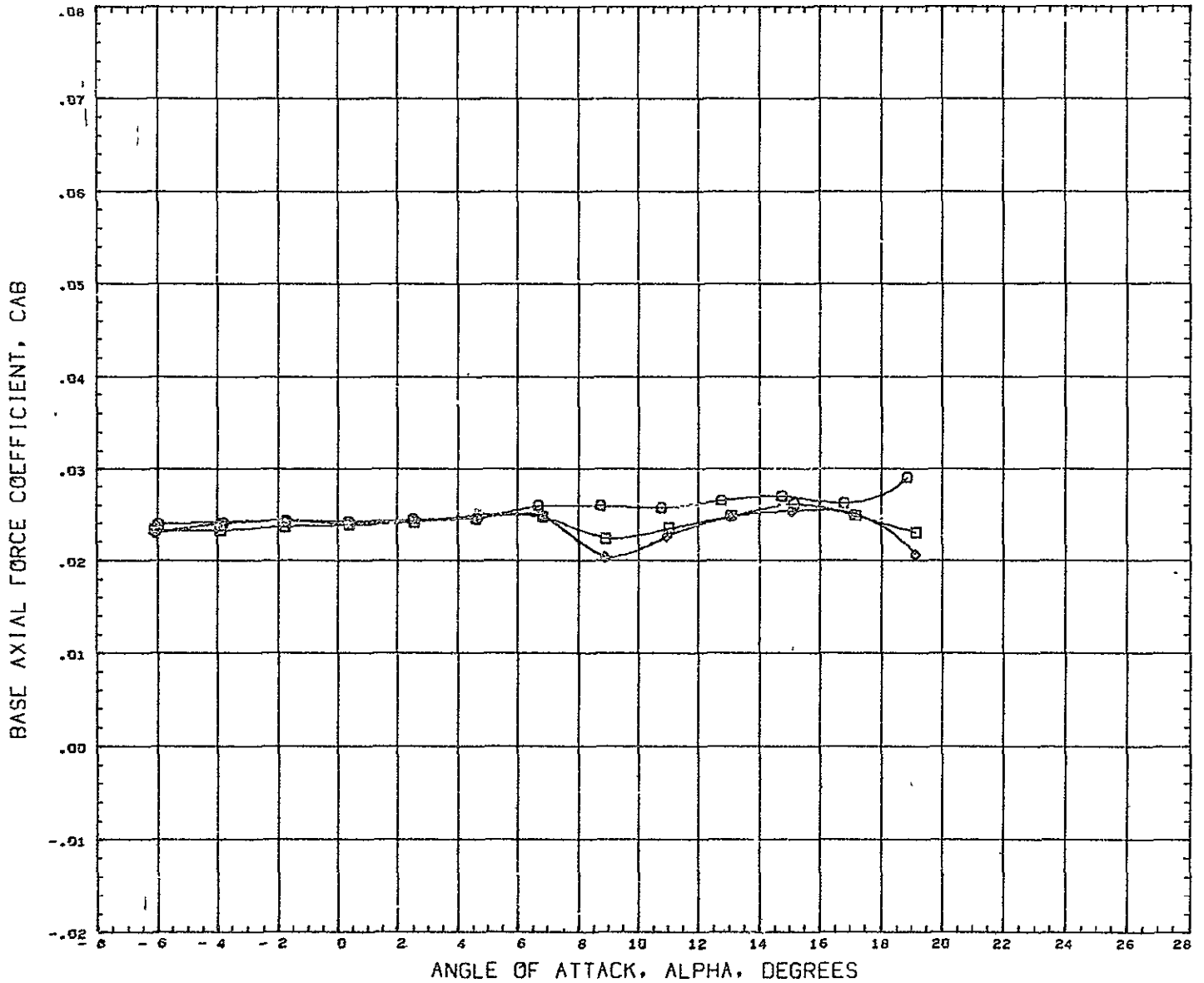

DATA SET SYMBOL	CONFIGURATION DESCRIPTION	PARAMETRIC VALUES			REFERENCE INFORMATION		
(SC7001)	CVLSWT TEST 579-D B1W1-15T1-55	BETA	0.000	ELEVTR	0.000	REFS	316 2304 SQ IN
(RC7038)	CVLSWT TEST 579-D B1W1-15T1-55E1	RUDVTR	0.000	FLAPS	0.000	REFL	50 1900 IN
(RC7051)	CVLSWT TEST 579-D B1W1-15T1-55E3	SFOILR	0.000			REFB	7.3500 IN
						XMRP	29.3920 IN
						YMRP	0.0000 IN
						ZMRP	0.0000 IN
						SCALE	0.0175

MACH 0.259



LONG. CHAR. - CRUISE ENGINE EFFECT - STRAIGHT WING BASIC.POS. - V-TAIL=55DEG

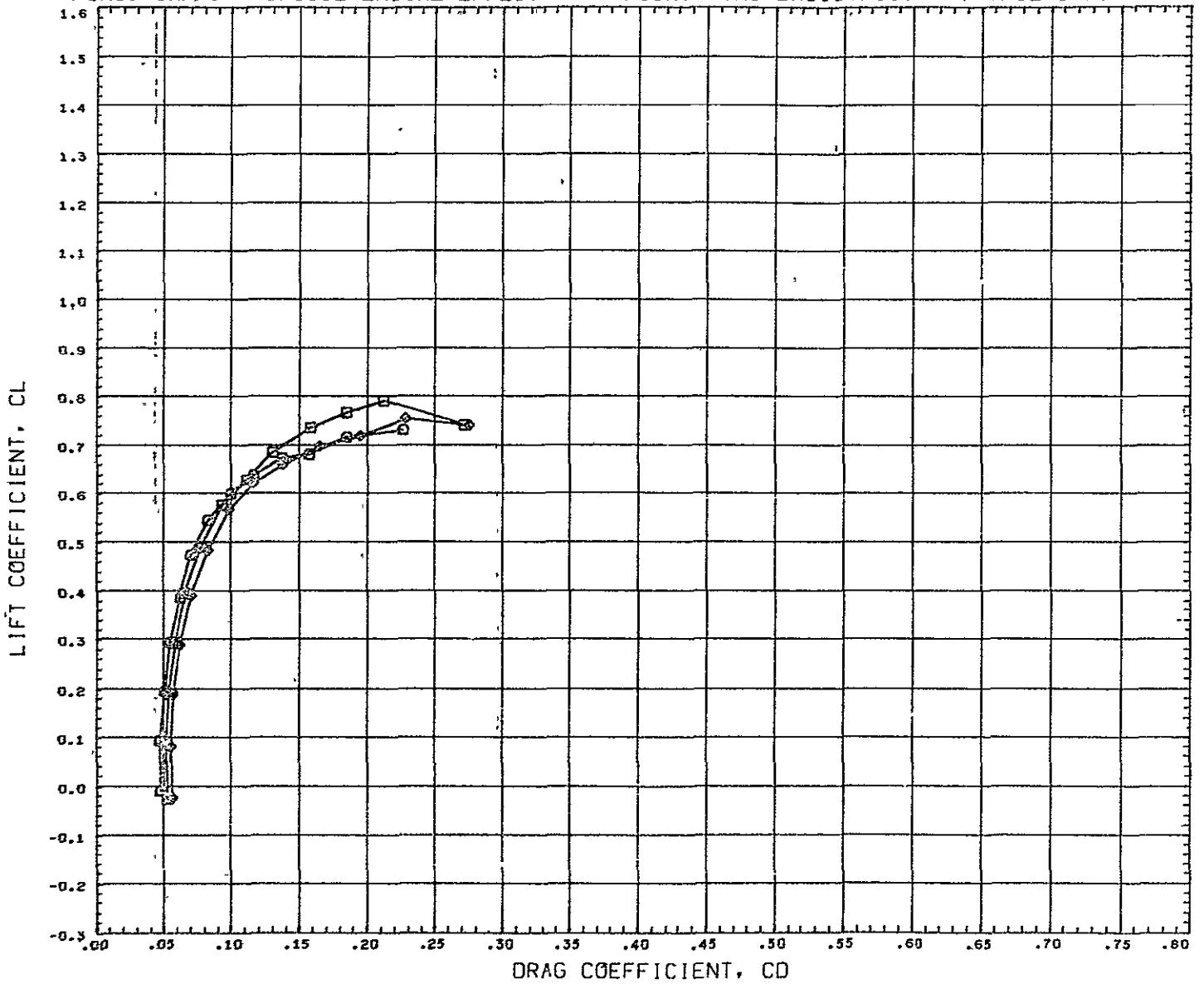

DATA SET SYMBOL	CONFIGURATION DESCRIPTION	PARAMETRIC VALUES			REFERENCE INFORMATION		
(SC7001)	CVLSWT TEST 579-D B1W1-15T1-55	BETA	0.000	ELEVTR	0 000	REFS	316 2304 SQ IN
(RC7030)	CVLSWT TEST 579-D B1W1-15T1-55E1	RUDVTR	0.000	FLAPS	0 000	REFL	50 1900 IN
(RC7061)	CVLSWT TEST 579-D B1W1-15T1-55E3	SFOILP	0.000			REFB	7.3500 IN
						XNRF	29.3920 IN
						YHRF	0.0000 IN
						ZHRF	0.0000 IN
						SCALE	0 0175

MACH C.259

LONG. CHAR. - CRUISE ENGINE EFFECT - STRAIGHT WING BASIC POS. - V-TAIL=55DEG

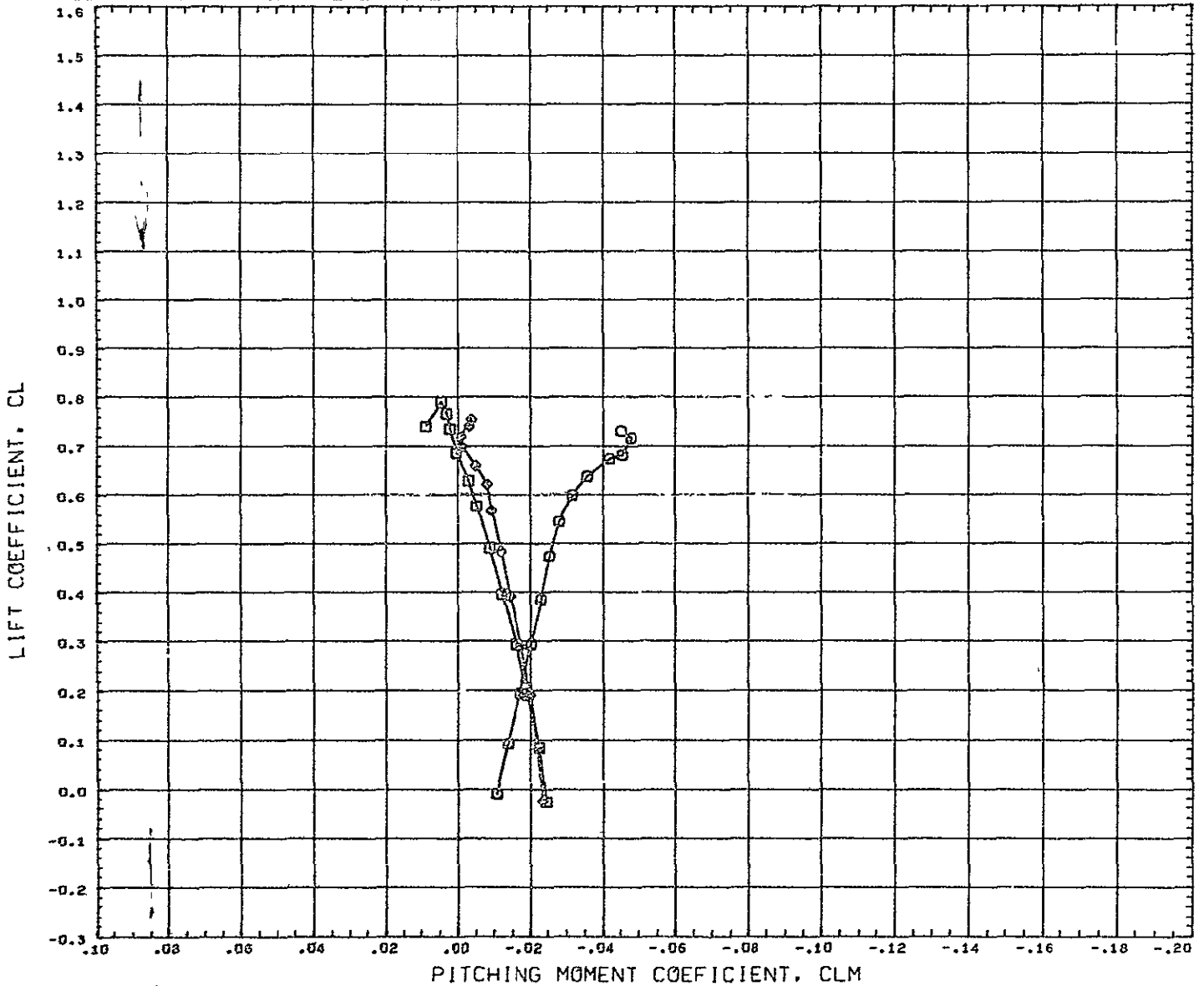

DATA SET SYMBOL	CONFIGURATION DESCRIPTION	PARAMETRIC VALUES				REFERENCE INFORMATION		
(SC7001)	□ CVLSWT TEST 579-D B1W1-15T1-55	BLTA	0.000	ELEVTR	0.000	REFS	316.2304	SQ IN
(RC7038)	□ CVLSWT TEST 579-D B1W1-15T1-55E1	RUDVTR	0.000	FLAPS	0.000	REFL	50.1900	IN
(RC7061)	◇ CVLSWT TEST 579-D B1W1-15T1-55E3	SFOILR	0.000			REFB	7.3500	IN
						XMRP	29.3920	IN
						YMRP	0.0000	IN
						ZMRP	0.0000	IN
						SCALE	0.0175	

MACH 0.259

CRUISE ENGINE EFFECT - SIDESLIP DERIVATIVES - ST. WING BASIC POS. - V-TAIL=55DEG

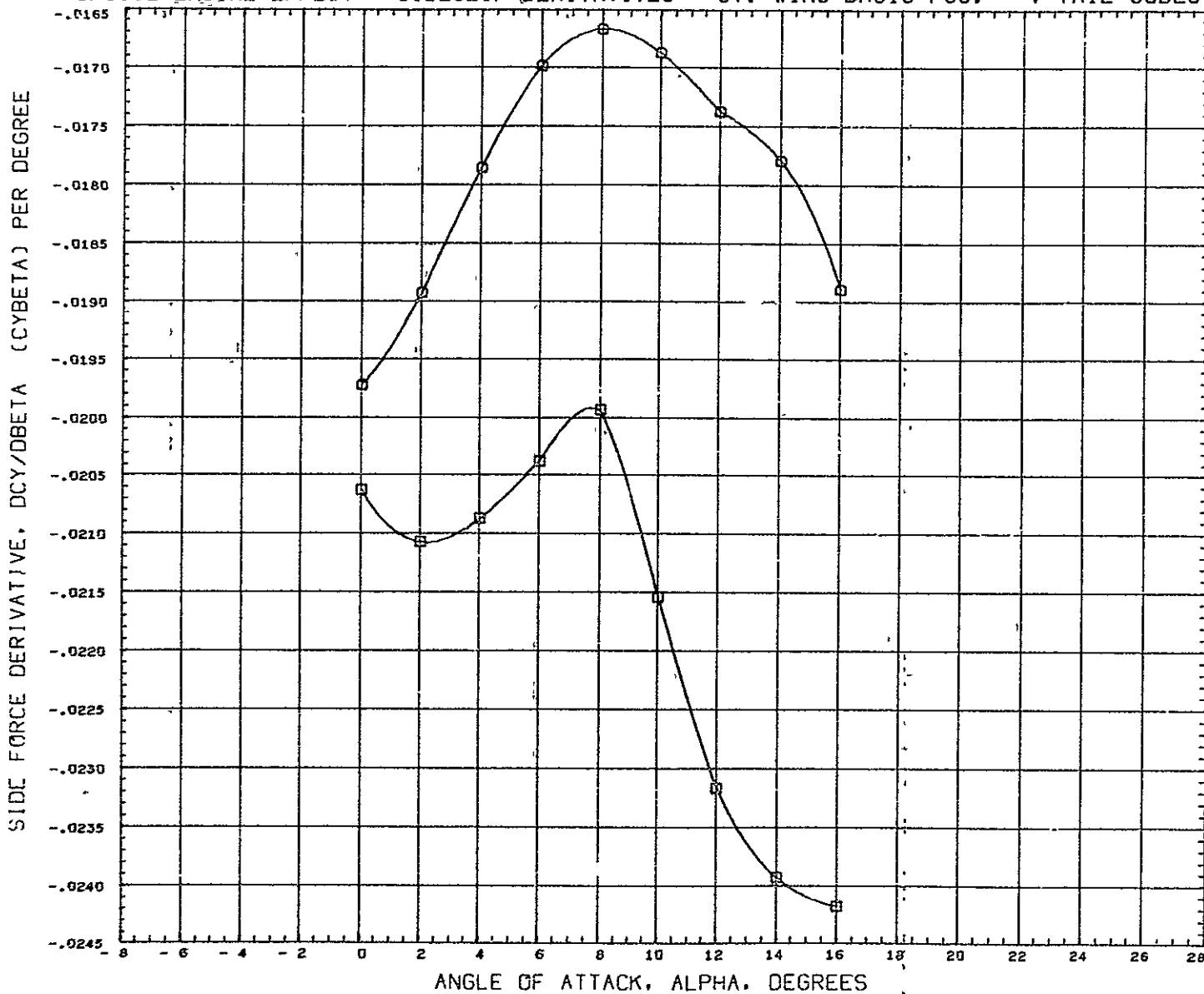

DATA SET SYMBOL    CONFIGURATION DESCRIPTION  
 (D57001)    □    CVLSWT TEST 579-D B1W1-15T1-55  
 (D57038)    □    CVLSWT TEST 579-D B1W1-15T1-55E1

PARAMETRIC VALUES  
 BETA        0.000    ELEVTR    0.000  
 RUDVTR    0.000    FLAPS     0.000  
 SFOILR    0.000

REFERENCE INFORMATION  
 REFS        316 2304    SQ IN  
 REFL        50 1900    IN  
 REFB        7.3500    IN  
 XMRP        29.3920    IN  
 YMRP        0.0000    IN  
 ZMRP        0.0000    IN  
 SCALE       0.0175

MACH        0.259

CRUISE ENGINE EFFECT - SIDESLIP DERIVATIVES - ST. WING BASIC POS. - V-TAIL=55DEG

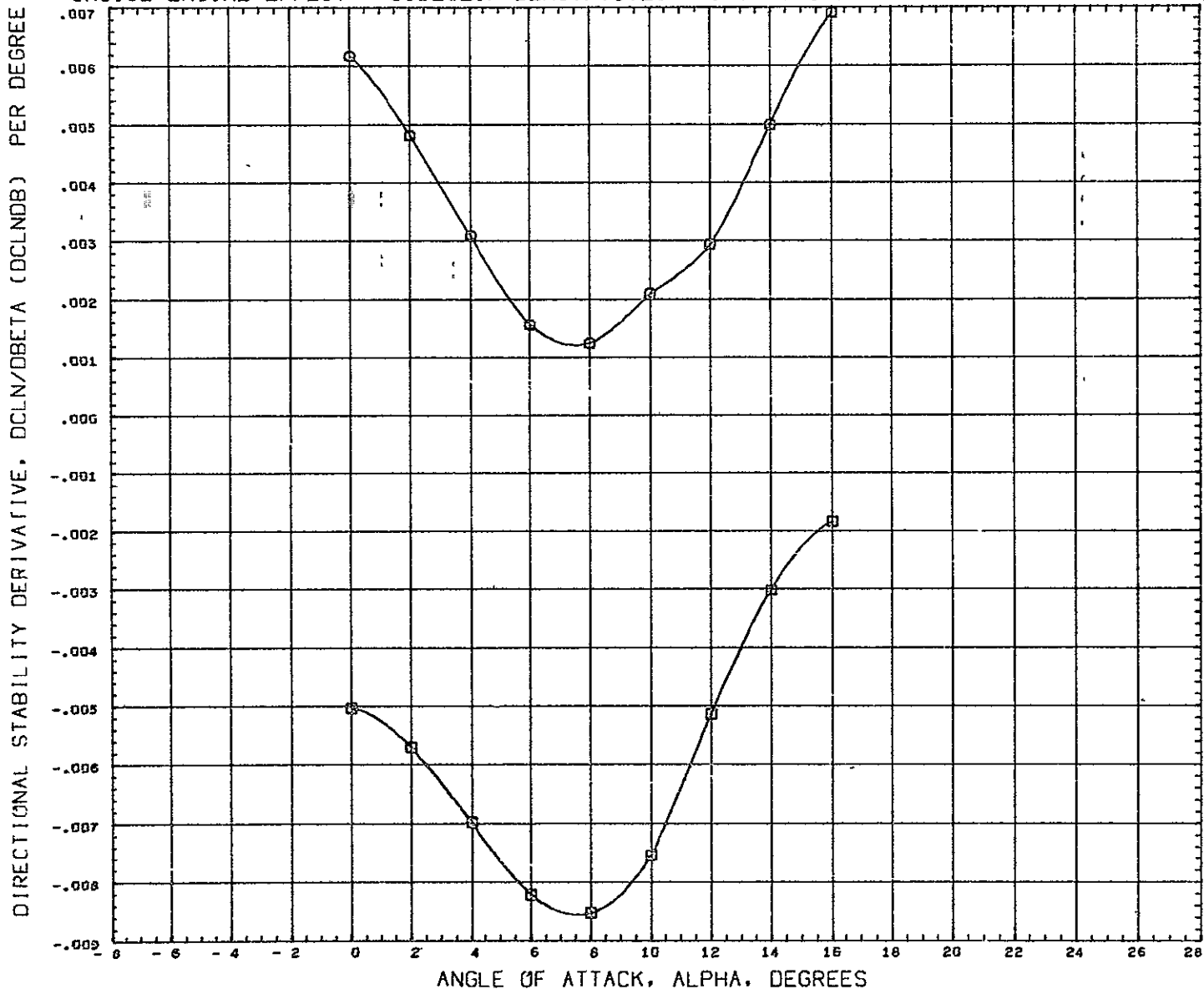

DATA SET SYMBOL	CONFIGURATION DESCRIPTION	PARAMETRIC VALUES			REFERENCE INFORMATION		
(DB7001)	□ CVLSWT TEST 579-0 BiW1-15T1-55	BETA	0.000	ELEVTR	0.000	REFS	316.2304 SQ IN
(DB7030)	□ CVLSWT TEST 579-0 BiW1-15T1-55E1	RUDYTR	0.000	FLAPS	0.000	REFL	50.1900 IN
		SFOILR	0.000			REFB	7.3500 IN
						XMRP	29.3920 IN
						YMRP	0.0000 IN
						ZMRP	0.0000 IN
						SCALE	0 0175

MACH 0.259

CRUISE ENGINE EFFECT - SIDESLIP DERIVATIVES - ST. WING BASIC POS. - V-TAIL=55DEG

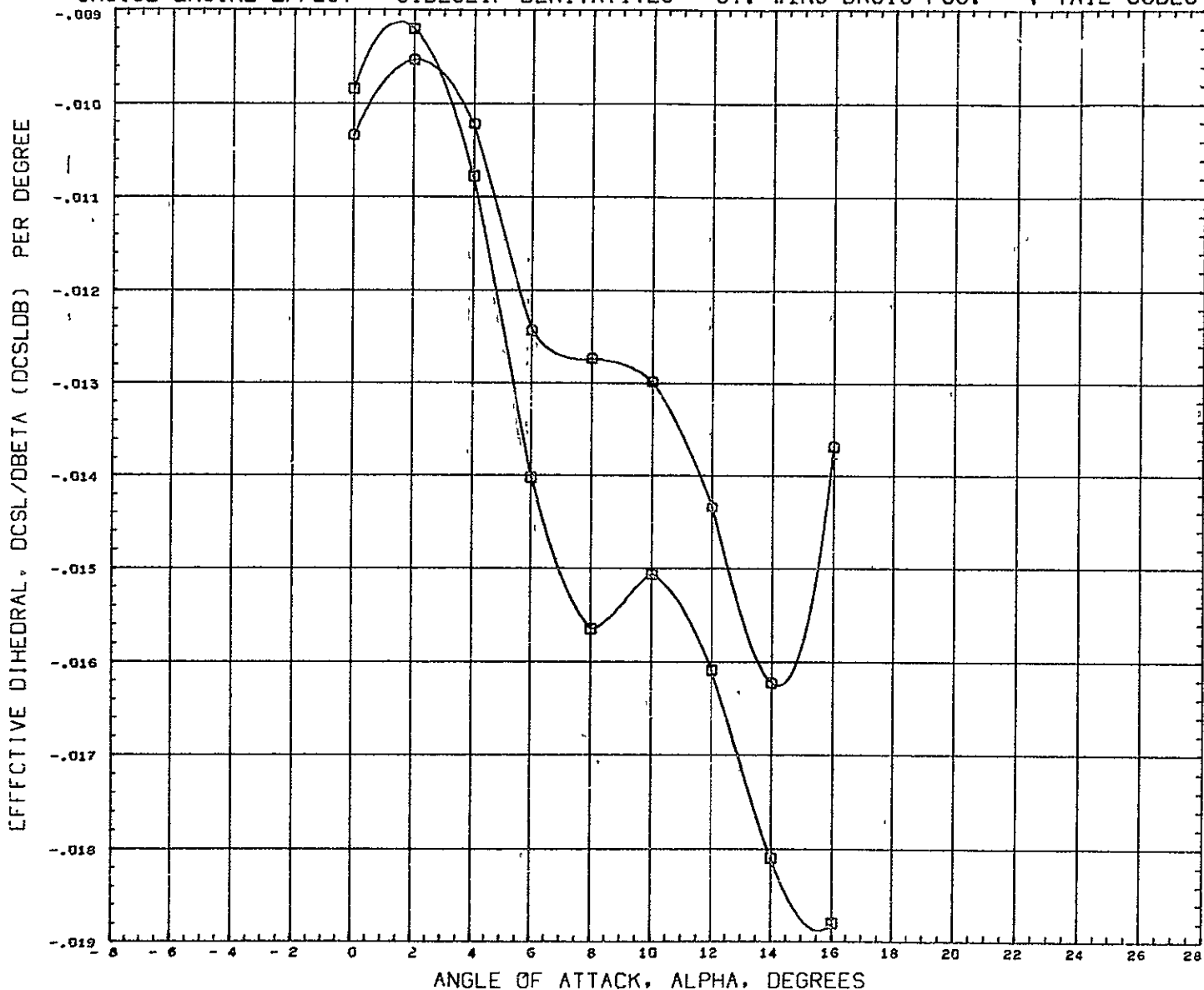

DATA SET SYMBOL	CONFIGURATION DESCRIPTION	PARAMETRIC VALUES			REFERENCE INFORMATION		
(DB7001)	□ CVLSWT TEST 579-G B1W1-15T1-55	BETA	0.000	ELEVTR	0.000	REFS	316 2304 SQ IN
(DB7038)	□ CVLSWT TEST 579-G B1W1-15T1-55E1	RUDVTR	0.000	FLAFS	0.000	REFL	50 1900 IN
		SFOILR	0.000			REFB	7.3500 IN
						XMRP	29.3920 IN
						YMRP	0.0000 IN
						ZMRP	0.0000 IN
						SCALE	0 0175

MACH 0.259

LONG. CHAR. - CRUISE ENGINE EFF. - FLAPS DOWN - ST. WING BASIC POS. - V-TAIL=55DEG

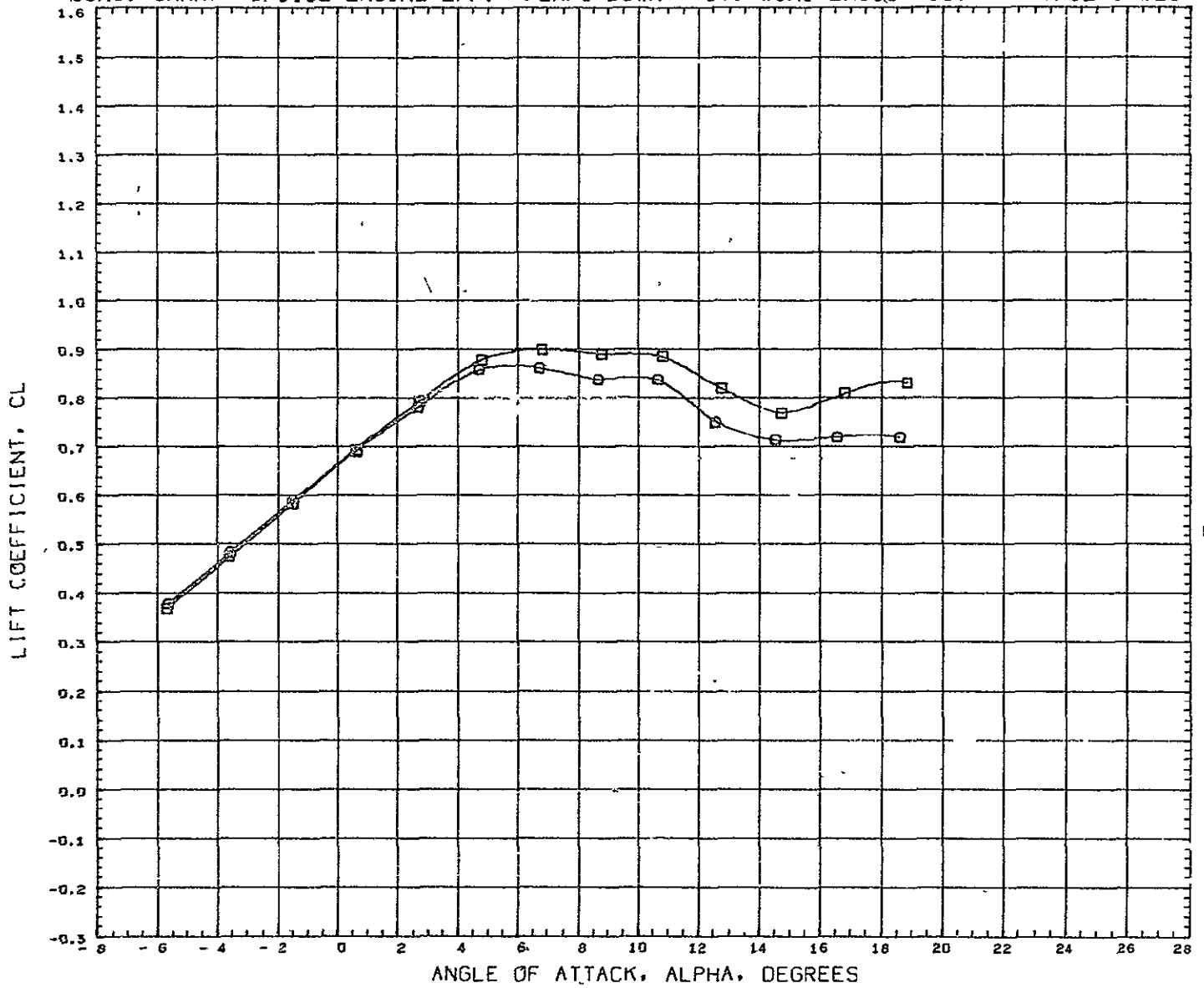

DATA SET SYMBOL	CONFIGURATION DESCRIPTION	PARAMETRIC VALUES			REFERENCE INFORMATION		
(RC7034)	○ CVLSWT TEST 579-D BIWI-157I-55F1-45	RETA	0.000	ELEVTR	0.000	REFS	316.2364 SQ IN
(RC7036)	□ CVLSWT TEST 579-D BIWI-157I-55F1-45E1	RUDVTR	0.000	FLAPS	45.000	REFL	50.1900 IN
		SPOILR	0.000			REFB	7.3500 IN
						XHRF	29.3920 IN
						YHRF	0.0000 IN
						ZHRF	0.0000 IN
						SCALE	0.0175

MACH 0.184

LONG. CHAR. - CRUISE ENGINE EFF. - FLAPS DOWN - ST. WING BASIC POS. - V-TAIL=55DEG

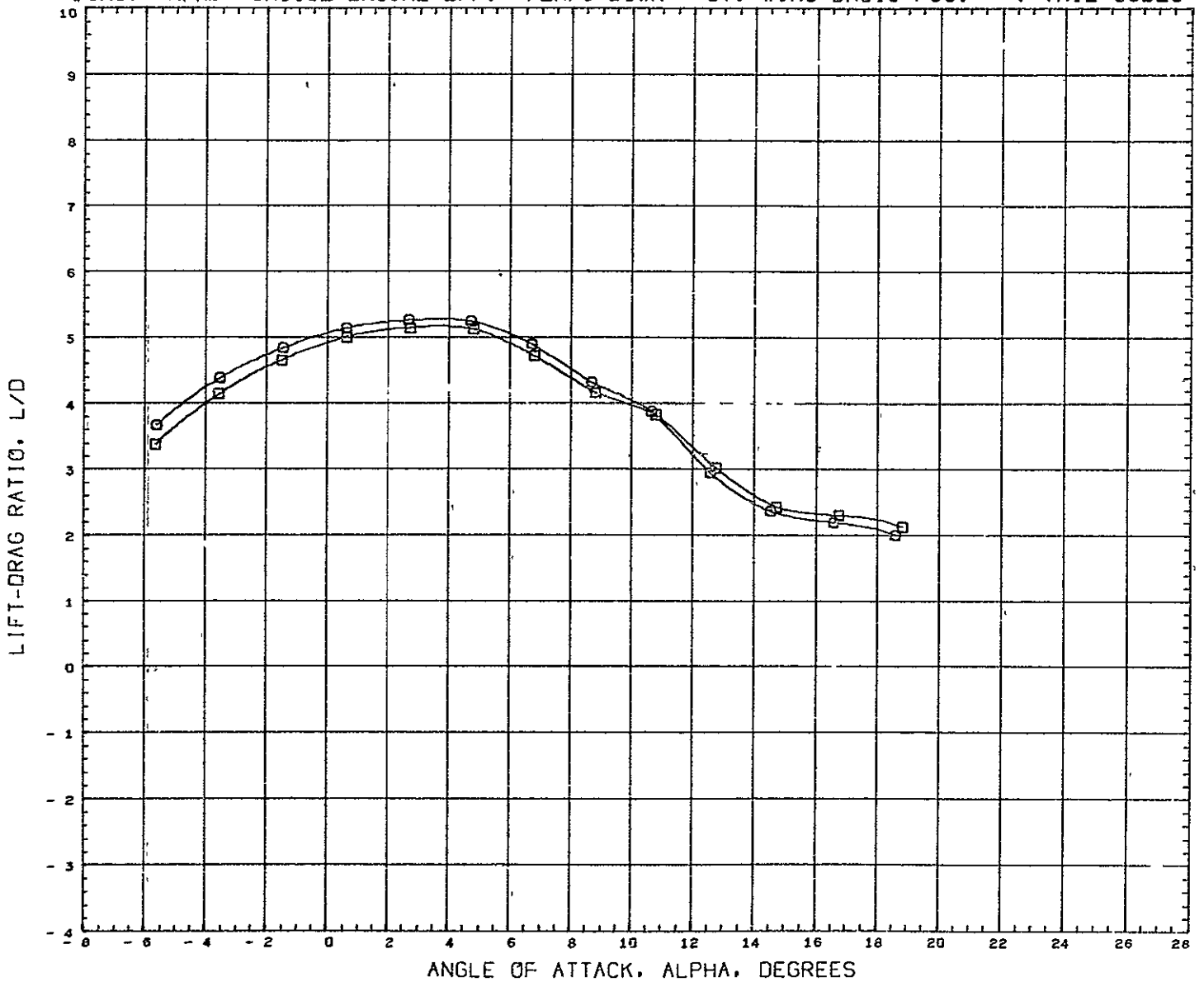

DATA SET SYMBOL	CONFIGURATION DESCRIPTION	PARAMETRIC VALUES				REFERENCE INFORMATION		
(RC7034)	□ CVLSWT TEST 579-D B1W1-15T1-55F1-45	BE*A	0.000	ELEVTR	0.000	REFS	316.2304	SO IN
(RC7036)	□ CVLSWT TEST 579-D B1W1-15T1-55F1-45E1	RUDVTR	0.000	FLAPS	45.000	REFL	50.1900	IN
		SFOILR	0.000			REFB	7.3500	IN
						XMRP	29.3920	IN
						YMRP	0.0000	IN
						ZMRP	0.0000	IN
						SCALE	0.0175	

MACH 0.184

LONG. CHAR.- CRUISE ENGINE EFF.- FLAPS DOWN - ST. WING BASIC POS. - V-TAIL=55DEG

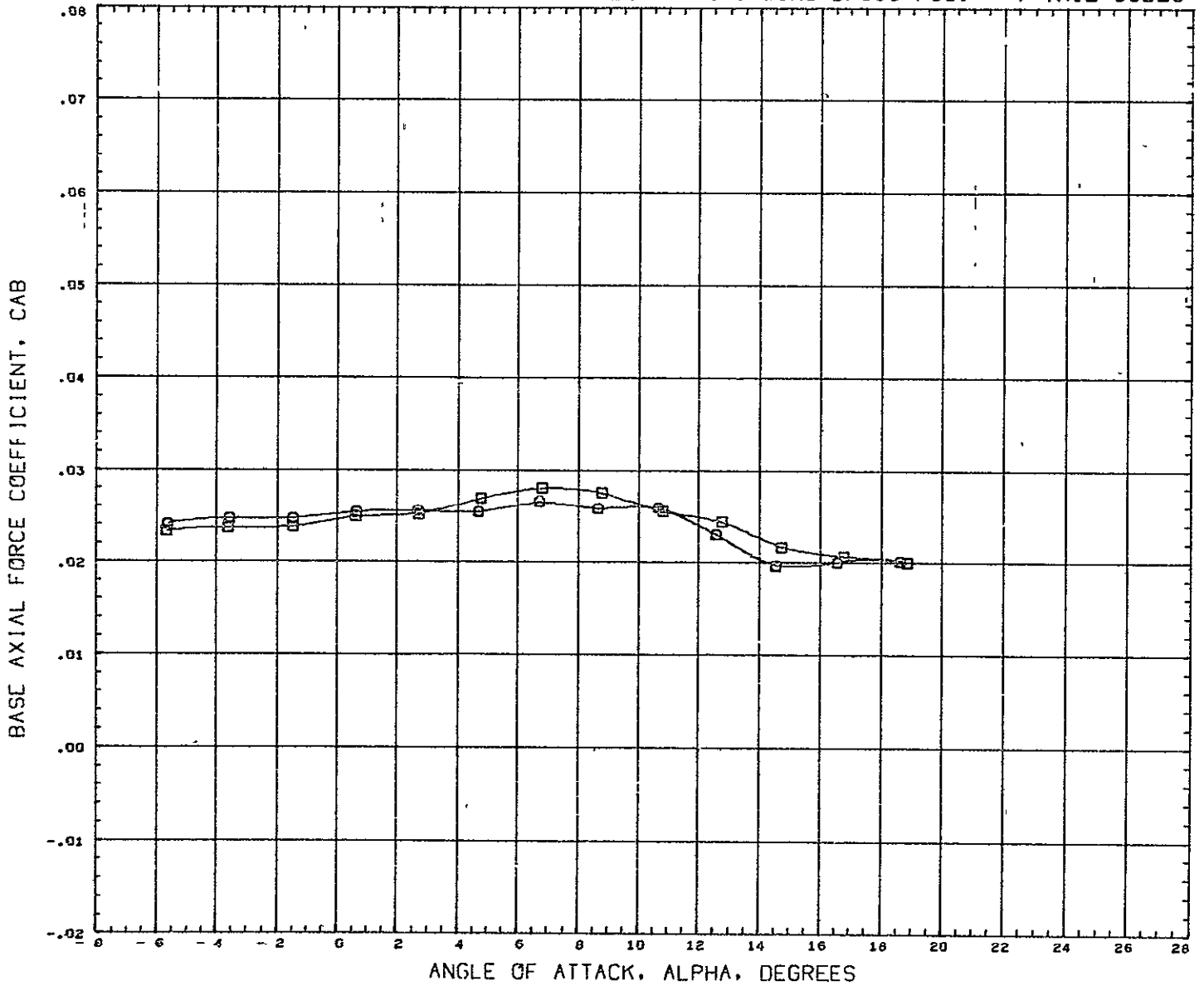

DATA SET SYMBOL	CONFIGURATION DESCRIPTION	PARAMETRIC VALUES			REFERENCE INFORMATION		
(RC7034)	CVLSWT TEST 579-G B1W1-15T1-55F1-45	BETA	0.000	ELEVTR	0.000	REFS	316.2304 SQ IN
(RC7036)	CVLSWT TEST 579-G B1W1-15T1-55F1-45E1	RUDYTR	0.000	FLAPS	45.000	REFL	50.1900 IN
		SPOILR	0.000			REFB	7.3500 IN
						XNRF	29.3920 IN
						YNRF	0.0000 IN
						ZNRF	0.0000 IN
						SCALE	0.0175

MACH 0.194



LONG. CHAR.- CRUISE ENGINE EFF.- FLAPS DOWN - ST. WING BASIC POS. - V-TAIL=55DEG

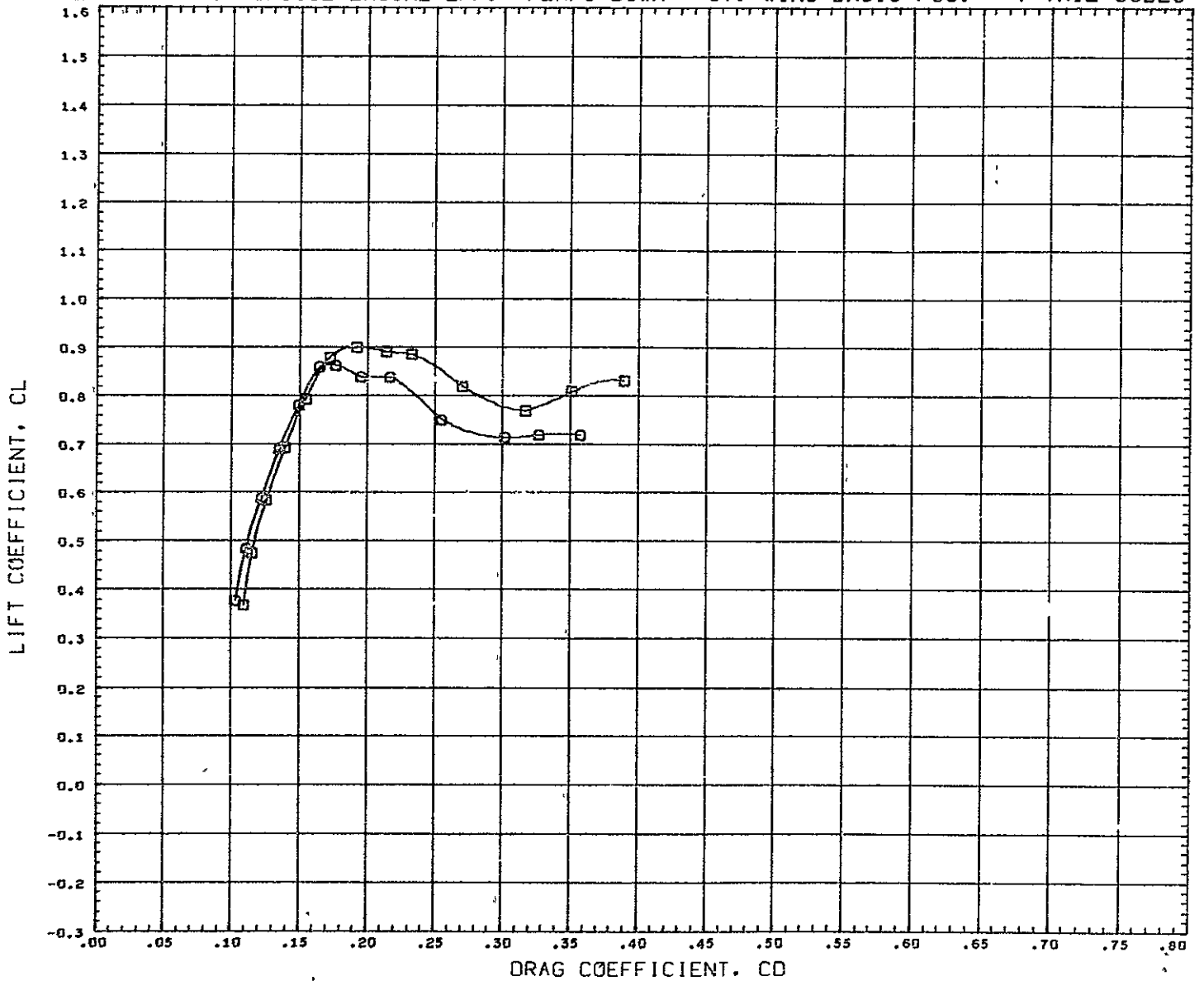

DATA SET SYMBOL	CONFIGURATION DESCRIPTION
(RC7034)	○ CVLSWT TEST 579-D B1W1-15T1-55F1-45
(RC7036)	□ CVLSWT TEST 579-D B1W1-15T1-55F1-45E1

PARAMETRIC VALUES		REFERENCE INFORMATION				
BETA	0.000	ELEVTR	0.000	REFS	316.2304	SQ IN
RUDVTR	0.000	FLAPS	45.000	REFL	50.1900	IN
SFOILR	0.000			REFB	7.3500	IN
				XMRP	29.3920	IN
				YMRP	0.0000	IN
				ZMRP	0.0000	IN
				SCALE	0.0175	

MACH 0.184

LONG. CHAR. - CRUISE ENGINE EFF. - FLAPS DOWN - ST. WING BASIC POS. - V-TAIL=55DEG

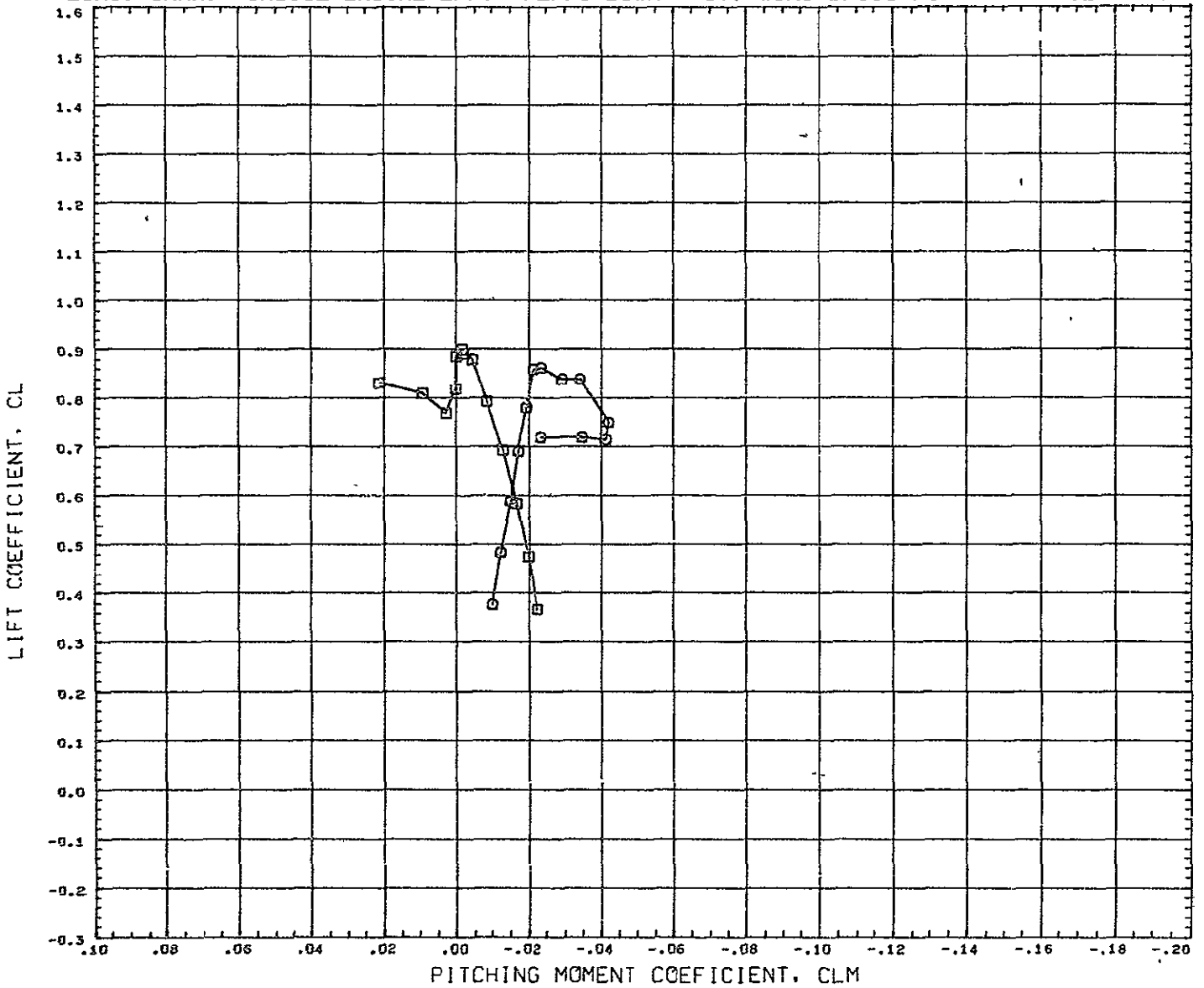

DATA SET SYMBOL	CONFIGURATION DESCRIPTION	PARAMETRIC VALUES			REFERENCE INFORMATION		
(RC7034)	□ CVLSWT TEST 579-0 B1W1-15T1-55F1-45	BETA	0.000	ELEVTR	0.000	REFS	316 2304 SQ IN
(RC7036)	□ CVLSWT TEST 579-0 B1W1-15T1-55F1-45E1	RUDVTR	0.000	FLAPS	45.000	REFL	50.1900 IN
		SPOILR	0.000			REFB	7.3500 IN
						XMRP	29.3920 IN
						YHRF	0 0000 IN
						ZHRF	0 0000 IN
						SCALE	0.0175

MACH 0.184

CRUISE ENGINE EFF. - SIDESLIP DERIV. - FLAPS DOWN - ST. WING BASIC - V-TAIL=55DEG

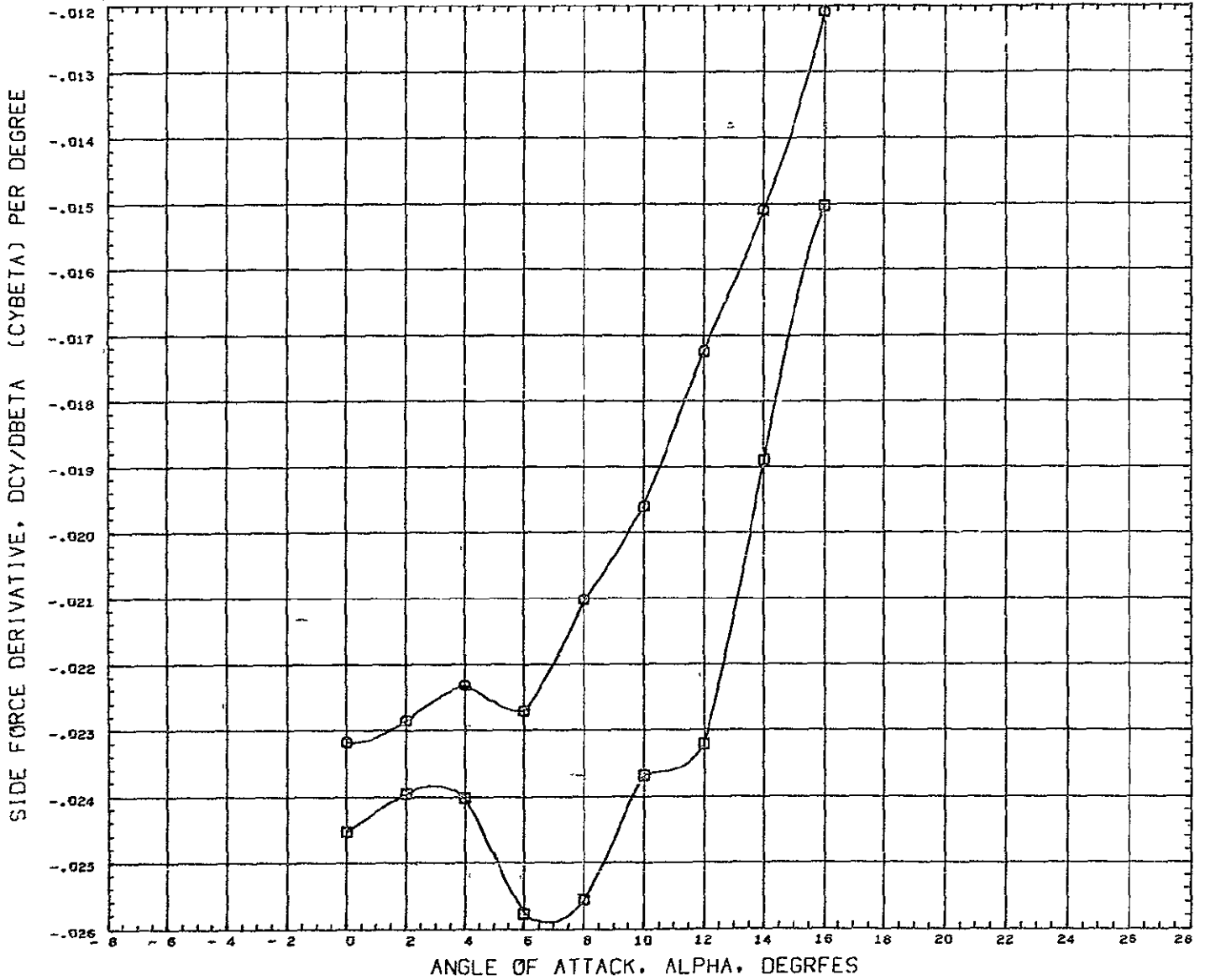

DATA SET SYMBOL    CONFIGURATION DESCRIPTION  
 (DB7034)    □    CVLSWT TEST 579-D B1W1-15T1-55F1-45  
 (DB7036)    □    CVLSWT TEST 579-D B1W1-15T1-55F1-45E1

PARAMETRIC VALUES  
 BETA    0.000    ELEVTR    0.000  
 RUDVTR    0.000    FLAPS    45.000  
 SPOILR    0.000

REFERENCE INFORMATION  
 REFS    316 2304    SQ IN  
 REFL    50.1900    IN  
 REFB    7 3500    IN  
 XMRP    29 3920    IN  
 YMRP    0 0000    IN  
 ZMRP    0.0000    IN  
 SCALE    0 0175

MACH    0.104

CRUISE ENGINE EFF. - SIDESLIP DERIV. - FLAPS DOWN - ST. WING BASIC - V-TAIL=55DEG

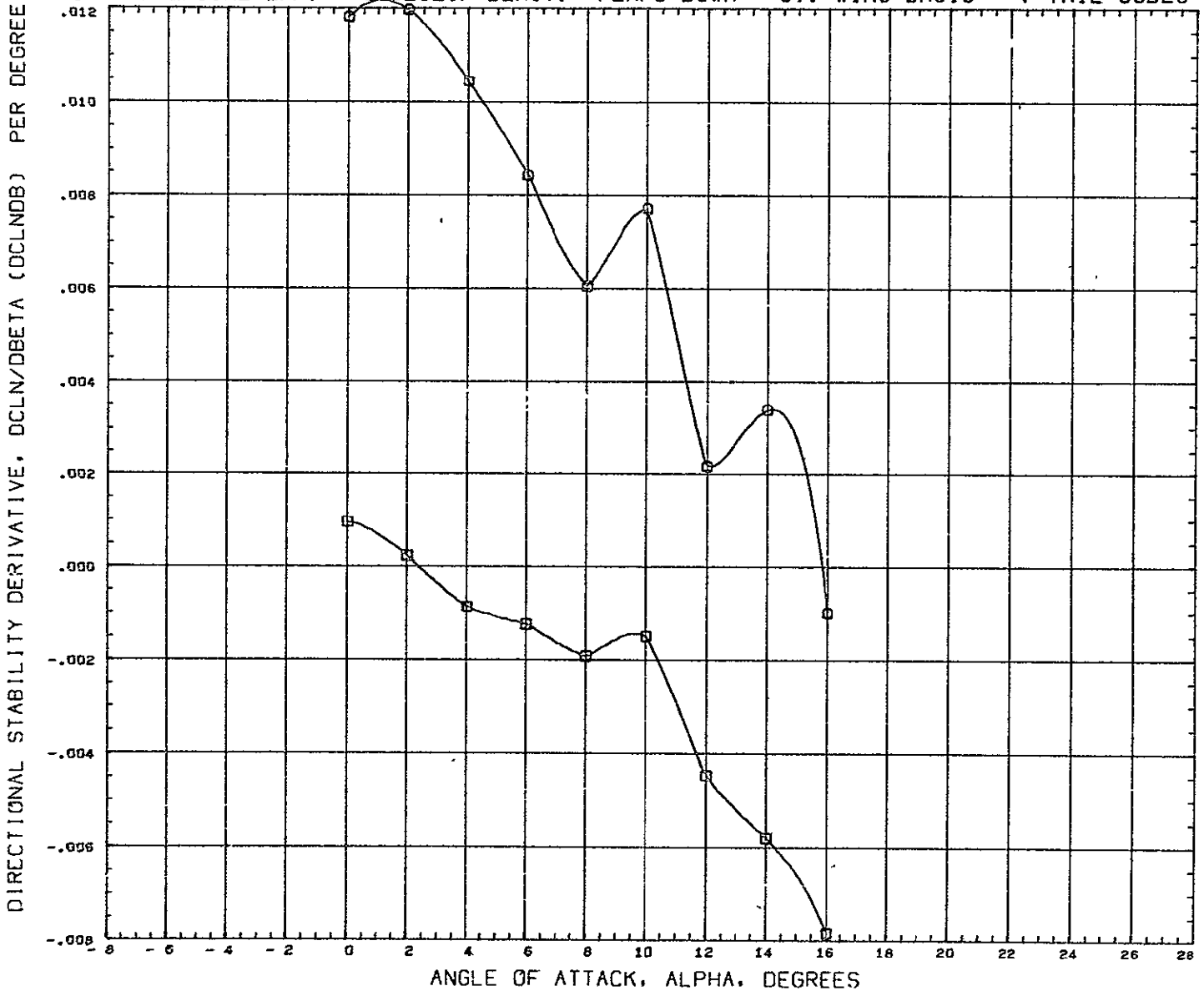

DATA SET SYMBOL	CONFIGURATION DESCRIPTION	PARAMETRIC VALUES			REFERENCE INFORMATION			
(DB7034)	○ CVLSWT TEST 579-D 81W1-15T1-55F1-45	BETA	0.000	ELEVTR	0.000	REFS	316.2304	SQ IN
(DB7036)	□ CVLSWT TEST 579-D 81W1-15T1-55F1-45E1	RUDVTR	0.000	FLAPS	45.000	REFL	50.1900	IN
		SFOILR	0.000			REFB	7.3500	IN
						XMRP	29.3920	IN
						YMRP	0.0000	IN
						ZMRP	0.0000	IN
						SCALE	0.0175	

MACH 0.184

CRUISE ENGINE EFF. - SIDESLIP DERIV.- FLAPS DOWN - ST. WING BASIC - V-TAIL=55DEG

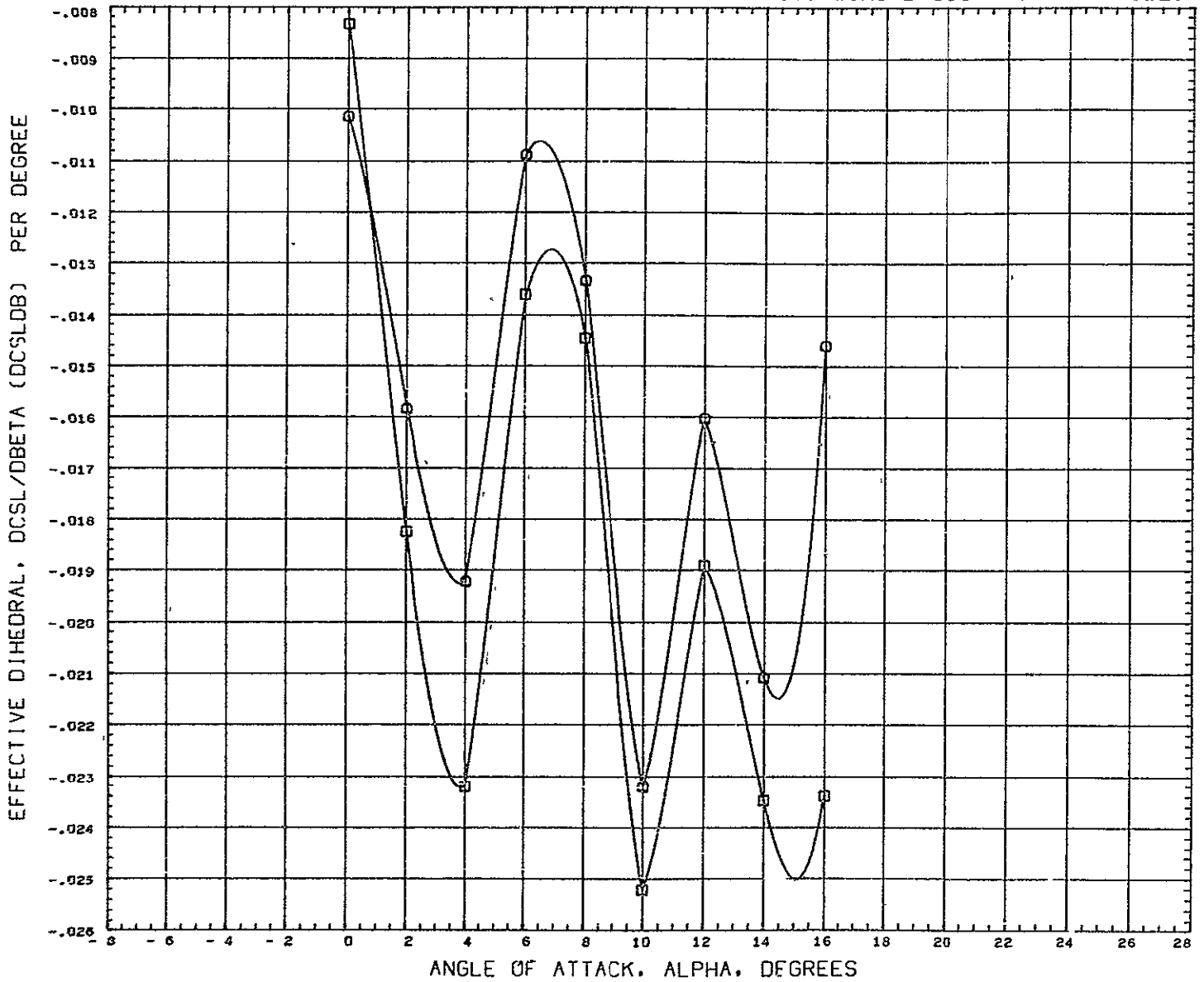

DATA SET SYMBOL	CONFIGURATION DESCRIPTION	PARAMETRIC VALUES				REFERENCE INFORMATION		
(DB7034)	○ CVLSWT TEST 579-D B1W1-15T1-55F1-45	BETA	0.000	ELEVTR	0.000	REFS	316.2304	SQ IN
(DB7036)	□ CVLSWT TEST 579-D B1W1-15T1-55F1-45E1	RUDVTR	0.000	FLAPS	45.000	REFL	50.1900	IN
		SFOILR	0.000			REFB	7.3500	IN
						XNRF	29.3920	IN
						YHRF	0.0000	IN
						ZHRF	0.0000	IN
						SCALE	0.0175	

MACH 0.184

LONGITUDINAL CHAR - CRUISE ENGINE EFFECT - STRAIGHT WING AFT - V-TAIL=55DEG

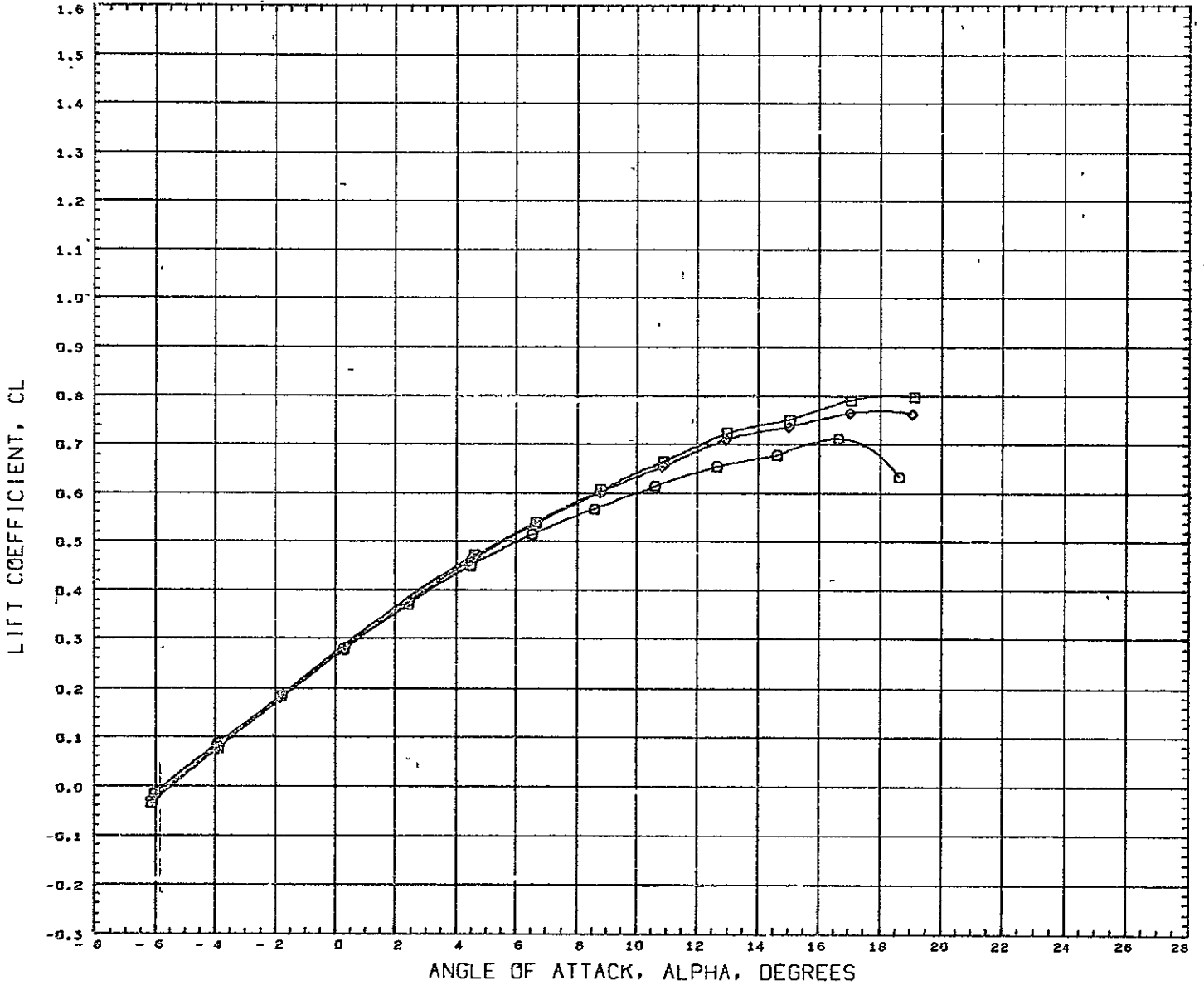

DATA SET SYMBOL    CONFIGURATION DESCRIPTION  
 (RC7068)    ◻    CVLSWT TEST 579-D B1W3AT1-55  
 (RC7071)    ◻    CVLSWT TEST 579-D B1W3AT1-55E1  
 (RC7075)    ◊    CVLSWT TEST 579-D B1W3AT1-55E3

PARAMETRIC VALUES  
 BETA    0.000    ELEVTR    0.000  
 RUDYTR    0.000    FLAPS    0.000  
 SFOILR    0.000

REFERENCE INFORMATION  
 REFS    316.2304    SQ IN  
 REFL    50.1900    IN  
 REFB    7.3500    IN  
 XMRF    29.3920    IN  
 YMRP    0.0000    IN  
 ZMRP    0.0000    IN  
 SCALE    0.0175

MACH    0.259

LONGITUDINAL CHAR. - CRUISE ENGINE EFFECT - STRAIGHT WING AFT - V-TAIL=55DEG

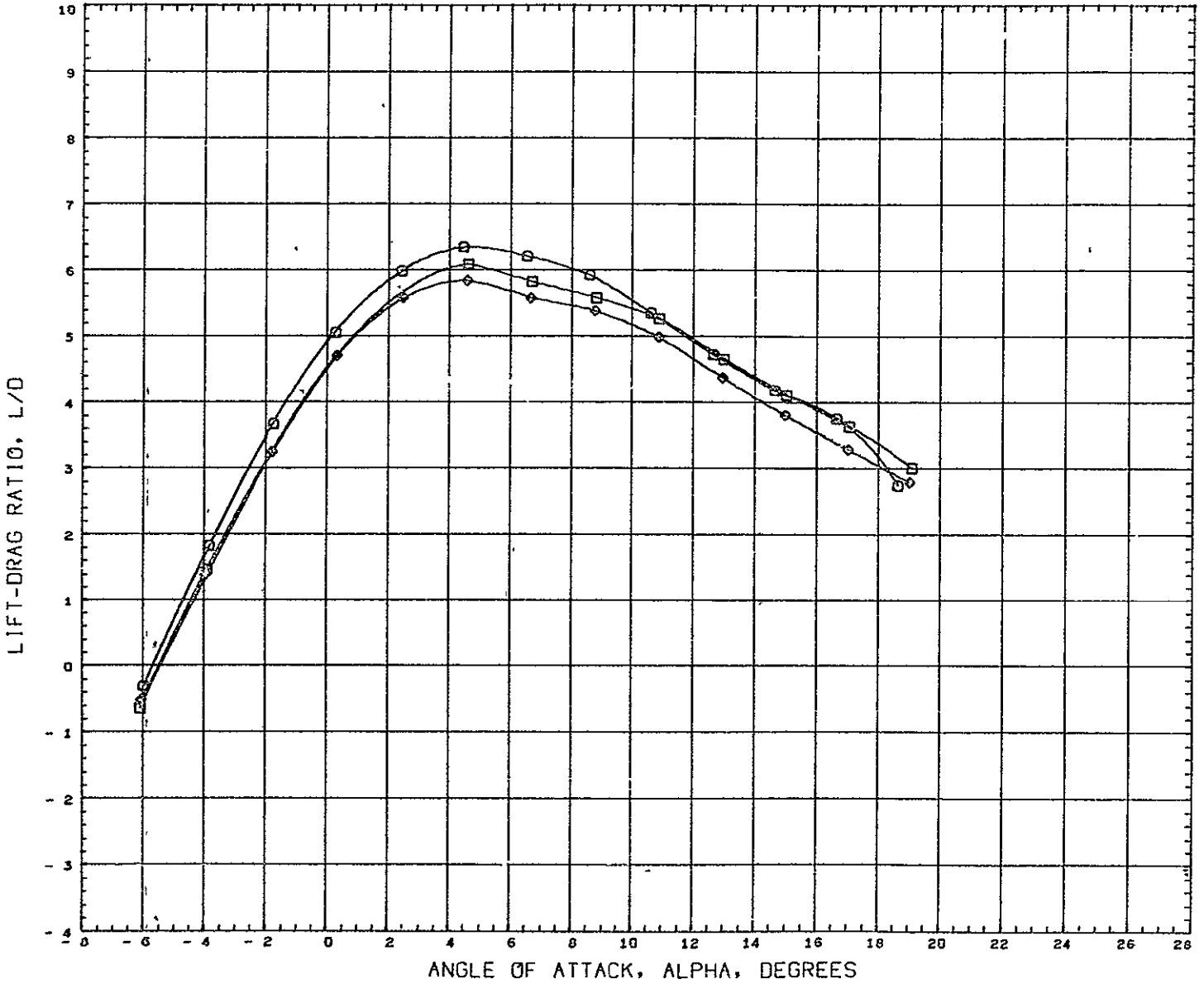

DATA SET SYMBOL	CONFIGURATION DESCRIPTION	PARAMETRIC VALUES			REFERENCE INFORMATION		
(RC7068)	□ CVLSWT TEST 579-D B1W3AT1-55	BETA	0.000	ELEVTR	0.000	REFS	316.2304 SQ IN
(RC7071)	◇ CVLSWT TEST 579-D B1W3AT1-55E1	RUDVTR	0.000	FLAPS	0.000	REFL	50.1900 IN
(RC7079)	○ CVLSWT TEST 579-D B1W3AT1-55E3	SFOILR	0.000			REFB	7.3500 IN
						XNRF	29.3920 IN
						YNRF	0.0000 IN
						ZNRF	0.0000 IN
						SCALE	9.0175

HACH 0.259

LONGITUDINAL CHAR. - CRUISE ENGINE EFFECT - STRAIGHT WING AFT - V-TAIL=55DEG

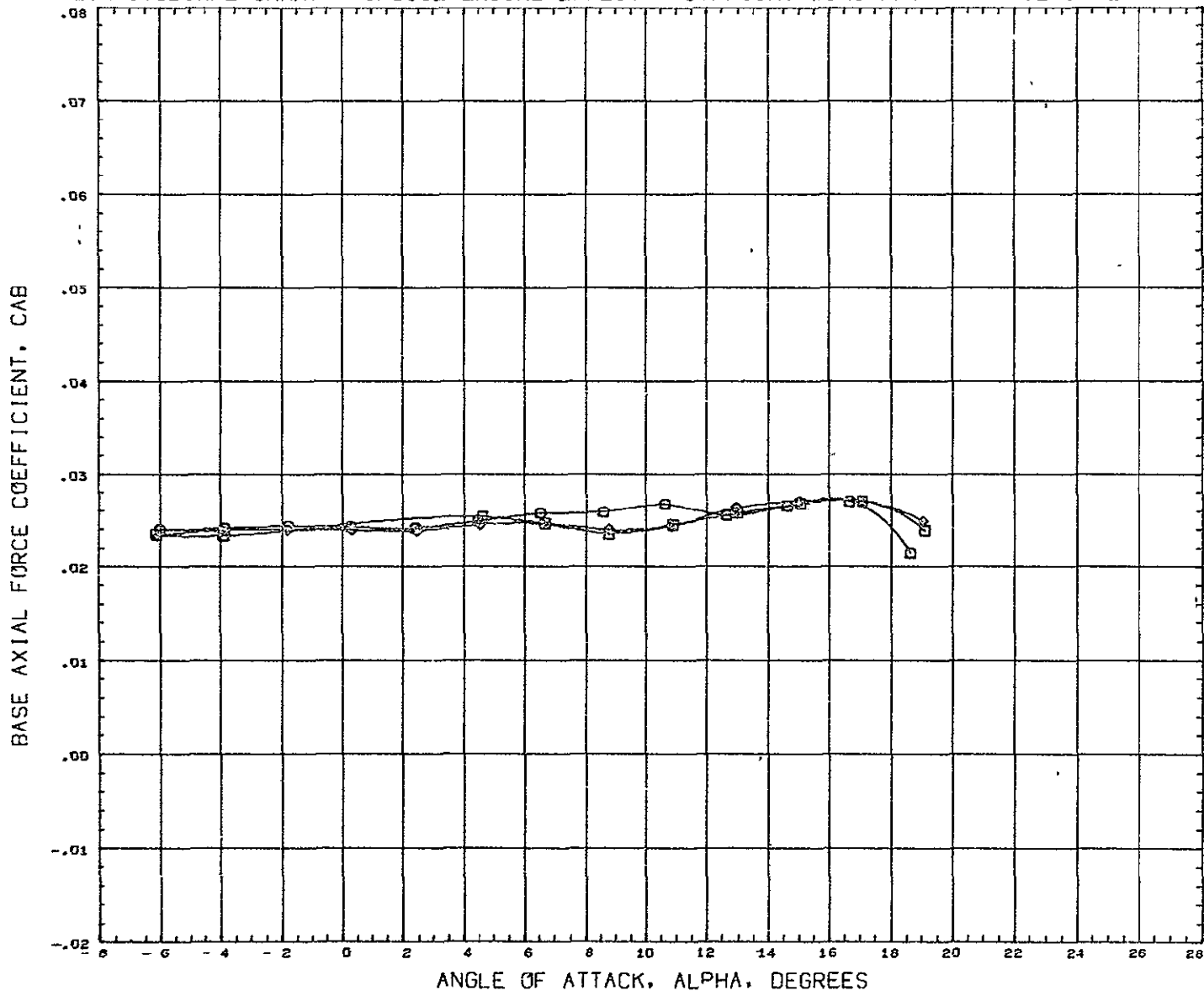

DATA SET SYMBOL	CONFIGURATION DESCRIPTION	PARAMETRIC VALUES				REFERENCE INFORMATION		
(RC7068)	CVLSWT TEST 579-0 B1W3AT1-55	BLTA	0.000	ELEVTR	0.000	REFS	316.2304	SQ IN
(RC7071)	CVLSWT TEST 579-0 B1W3AT1-55E1	RUDVTR	0.000	FLAPS	0.000	REFL	50.1900	IN
(RC7070)	CVLSWT TEST 579-0 B1W3AT1-55E3	SPOILR	0.000			REFB	7.3500	IN
						XMRP	29.3920	IN
						YMRP	0.0000	IN
						ZMRP	0.0000	IN
						SCALE	0.0175	

MACH 0.259



LONGITUDINAL CHAR. - CRUISE ENGINE EFFECT - STRAIGHT WING AFT - V-TAIL=55DEG

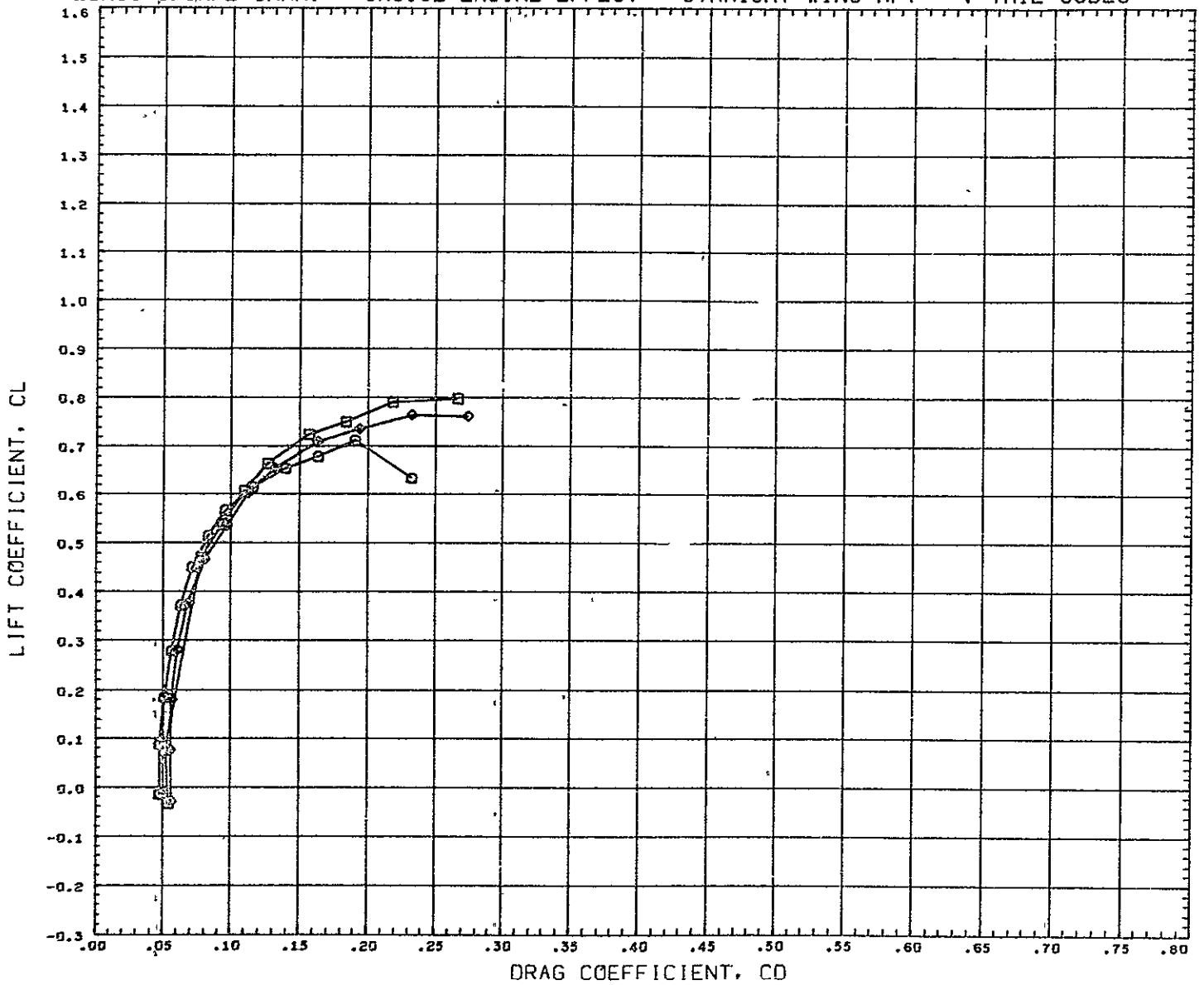

DATA SET SYMBOL	CONFIGURATION DESCRIPTION	PARAMETRIC VALUES			REFERENCE INFORMATION		
(RC7068)	○ CVLSWT TEST 579-D B1W3AT1-55	BETA	0.000	ELEVTR	0.000	REFS	316.2304 SQ IN
(RC7071)	□ CVLSWT TEST 579-D B1W3AT1-55E1	RUDVTR	0.000	FLAPS	0.000	REFL	50.1900 IN
(RC7070)	◇ CVLSWT TEST 579-D B1W3AT1-55E3	SFOILR	0.000			REFB	7.3500 IN
						XHRF	29.3920 IN
						YHRF	0.0000 IN
						ZHRF	0.0000 IN
						SCALE	0.0175

MACH 0.259

LONGITUDINAL CHAR. - CRUISE ENGINE EFFECT - STRAIGHT WING AFT - V-TAIL=55DEG

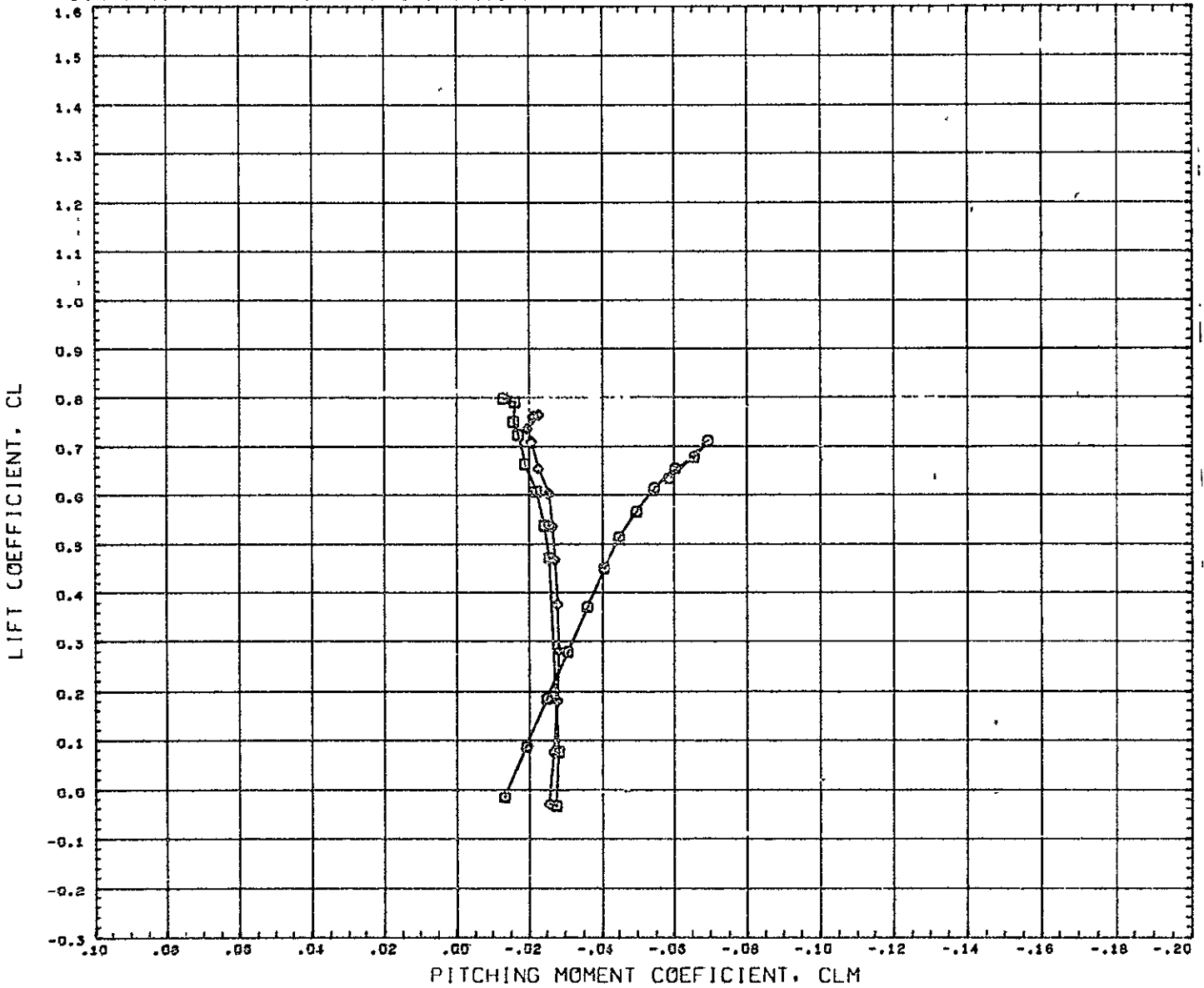

DATA SET SYMBOL	CONFIGURATION DESCRIPTION	PARAMETRIC VALUES			REFERENCE INFORMATION			
(RC7068)	CVLSWT TEST 579-D B1W3AT1-55	BETA	0.000	ELEVTR	0.000	REFS	316.2304	SQ IN
(RC7071)	CVLSWT TEST 579-D B1W3AT1-55E1	RUDVTR	0.000	FLAPS	0.000	REFL	50.1900	IN
(RC7070)	CVLSWT TEST 579-D B1W3AT1-55E3	SPOILR	0.000			REFB	7.3500	IN
						XMRP	29.3920	IN
						YMRP	0.0000	IN
						ZMRP	0.0000	IN
						SCALE	0.0175	

MACH 0.259

LONGITUDINAL CHAR. - CRUISE ENGINE EFFECT - STRAIGHT WING AFT - TAIL OFF

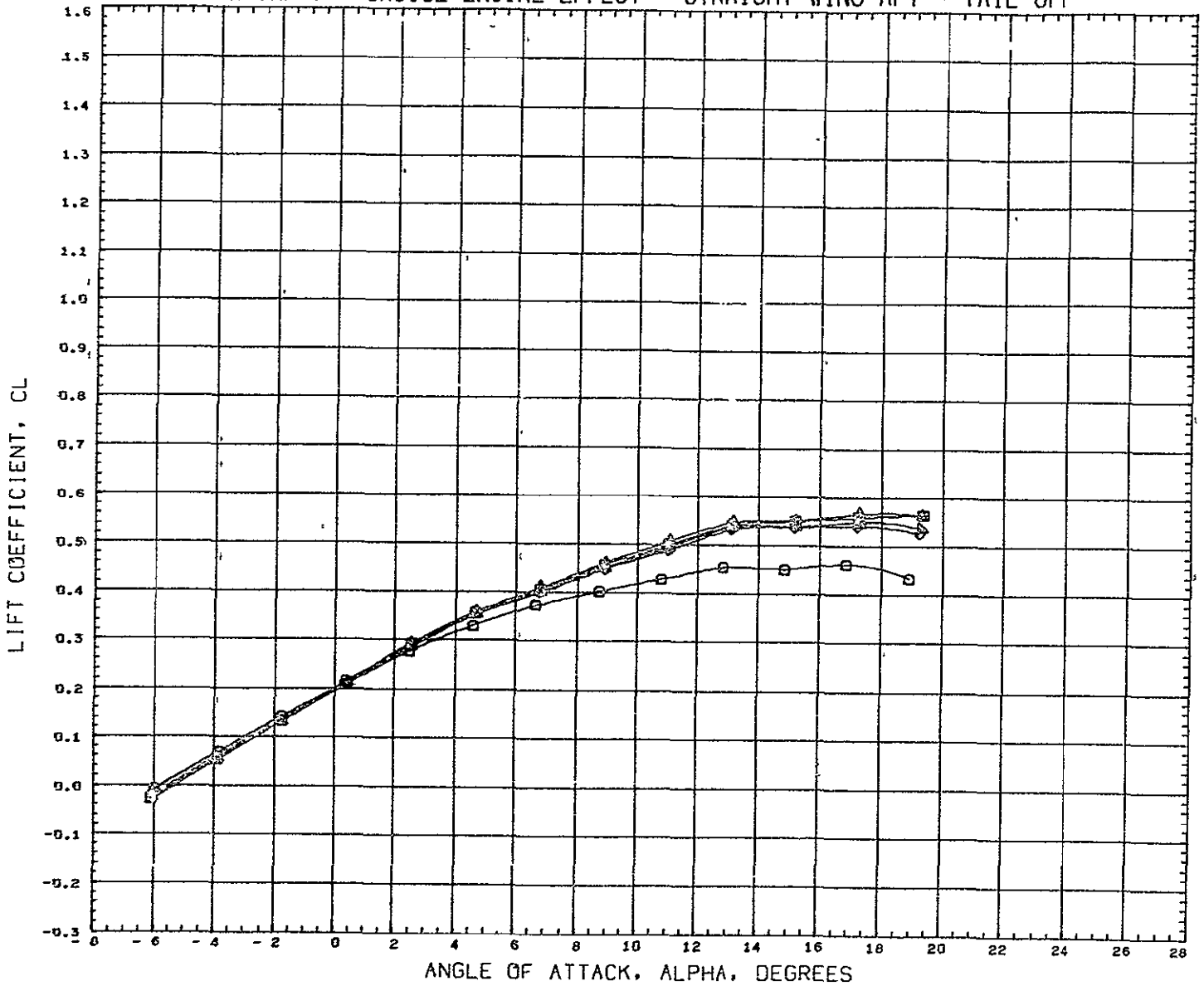

DATA SET SYMBOL	CONFIGURATION DESCRIPTION	PARAMETRIC VALUES			REFERENCE INFORMATION		
(RC7076)	○ CVLSWT TEST 579-G B1W3A	BETA	0 000	FLAPS	0.000	REFS	316.2304 SQ IN
(RC7072)	□ CVLSWT TEST 579-G B1W3AE1	SPOILR	0 000			REFL	50.1900 IN
(RC7073)	△ CVLSWT TEST 579-G B1W3AE3					REFB	7 3500 IN
(RC7074)	◇ CVLSWT TEST 579-G B1W3AE4					XHRF	29.3920 IN
(RC7075)	▽ CVLSWT TEST 579-G B1W3AE5					YHRF	0.0000 IN
						ZHRF	0.0000 IN
						SCALE	0.0175
MACH 0.259							

LONGITUDINAL CHAR. - CRUISE ENGINE EFFECT - STRAIGHT WING AFT - TAIL OFF

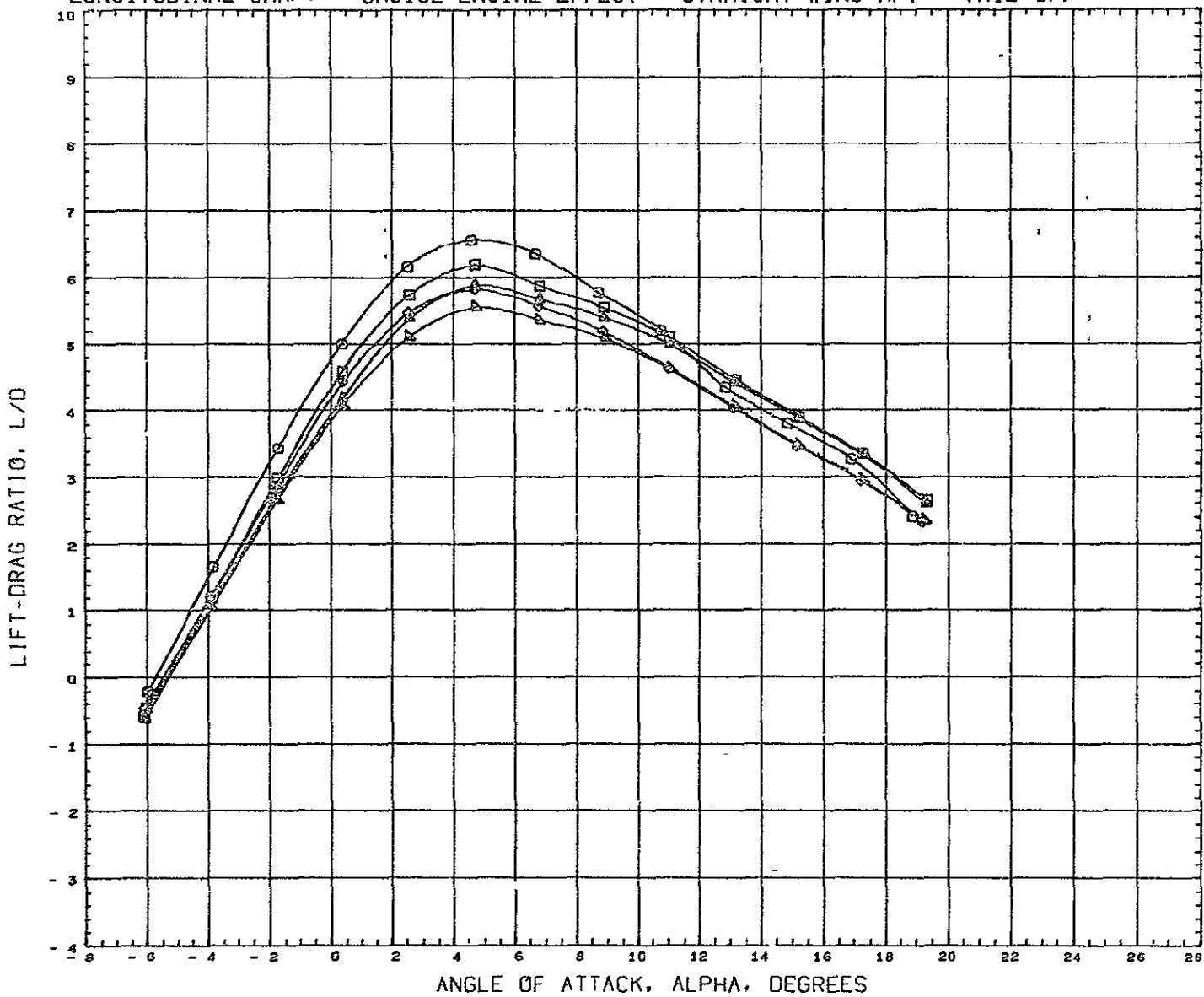

DATA SET SYMBOL	CONFIGURATION DESCRIPTION	PARAMETRIC VALUES			REFERENCE INFORMATION		
(RC7076)	□ CVLSWT TEST 579-D B1W3A	BETA	0.000	FLAPS	0.000	REFS	316.2304 SQ IN
(RC7072)	□ CVLSWT TEST 579-D B1W3AE1	SFOILR	0.000			REFL	50 1900 IN
(RC7073)	○ CVLSWT TEST 579-D B1W3AE3					REFB	7 3500 IN
(RC7074)	△ CVLSWT TEST 579-D B1W3AE4					XMRP	29.3920 IN
(RC7075)	▽ CVLSWT TEST 579-D B1W3AE5					YMRP	0.0000 IN
						ZMRP	0.0000 IN
						SCALE	0.0175

MACH 0.259

LONGITUDINAL CHAR. - CRUISE ENGINE EFFECT - STRAIGHT WING AFT - TAIL OFF

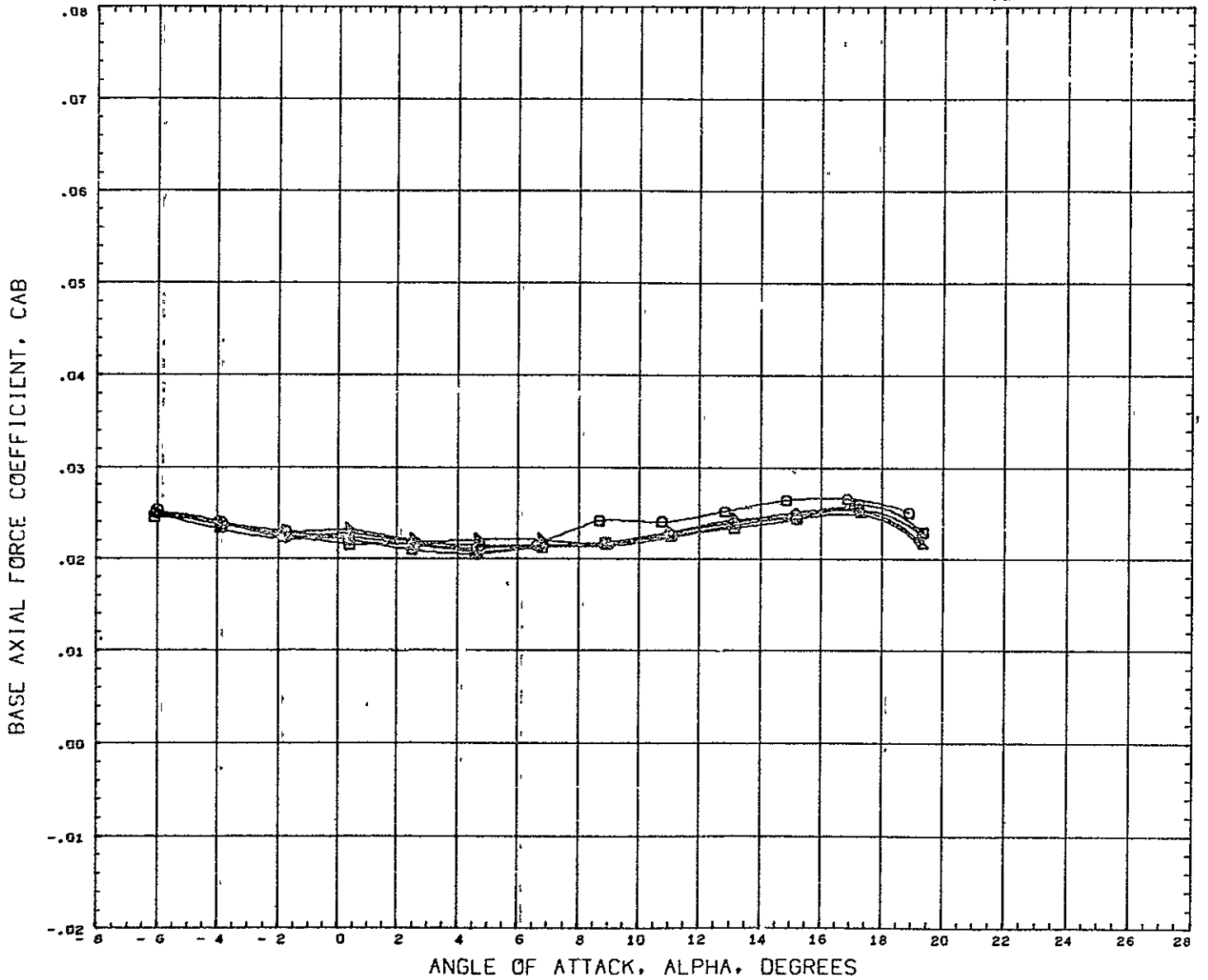

DATA SET	SYMBOL	CONFIGURATION DESCRIPTION	PARAMETRIC VALUES			REFERENCE INFORMATION						
			BETA	FLAPS	SFOILR	REFS	REFL	REFB	XMRP	YMRP	ZMRP	SCALE
(RC7076)	○	CVLSWT TEST 579-0 B1W3A	0.000	0.000	0.000	316.2304	50.1900	7.3500	29.3920	0.0000	0.0000	0.0175
(RC7072)	□	CVLSWT TEST 579-0 B1W3AE1										
(RC7073)	◇	CVLSWT TEST 579-0 B1W3AE3										
(RC7074)	△	CVLSWT TEST 579-0 B1W3AE4										
(RC7075)	▽	CVLSWT TEST 579-0 B1W3AE5										
#ACH		G.259										

LONGITUDINAL CHAR. - CRUISE ENGINE EFFECT - STRAIGHT WING AFT - TAIL OFF

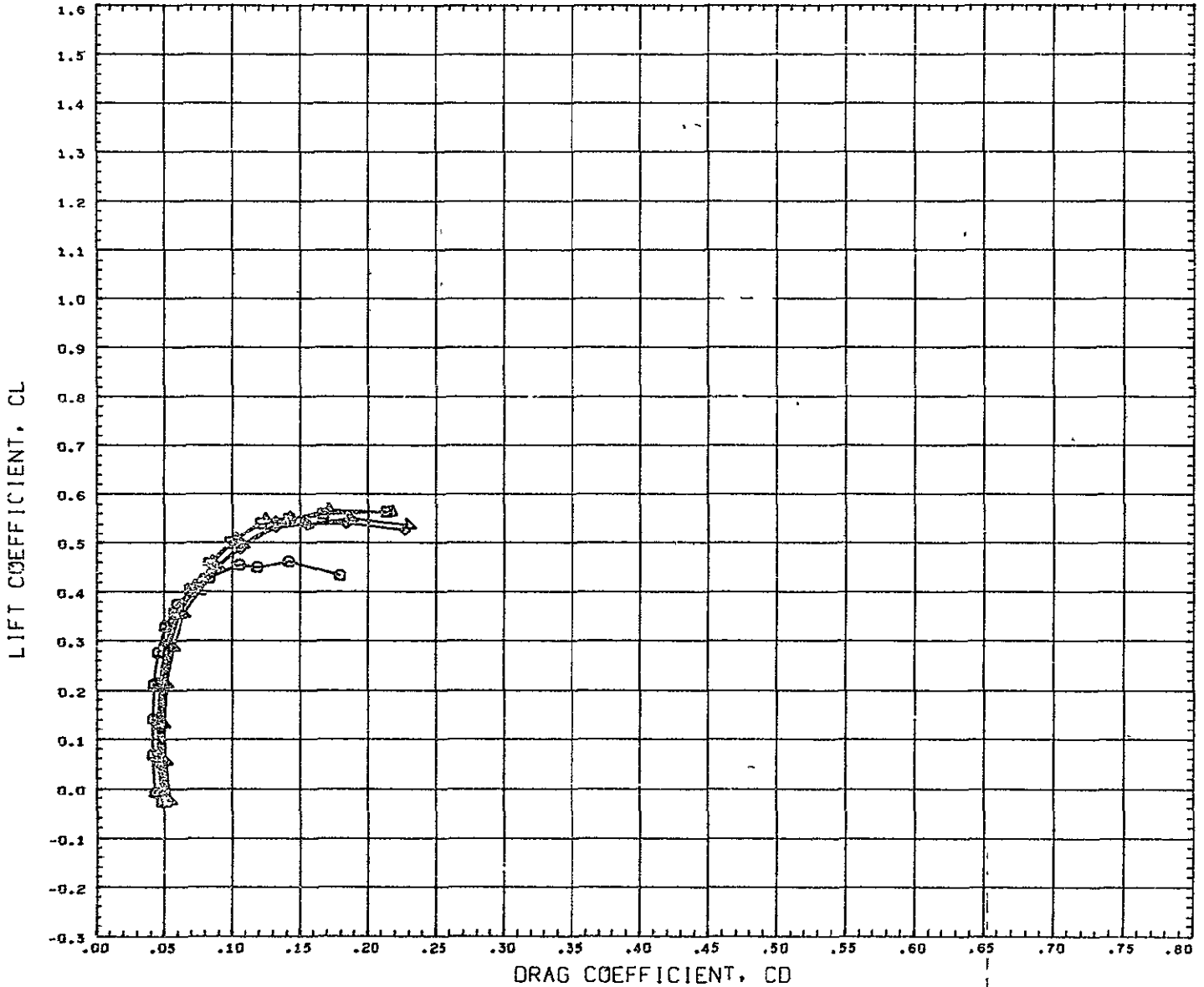

DATA SET SYMBOL	CONFIGURATION DESCRIPTION
(RC7076)	□ CVLSWT TEST 579-0 B1W3A
(RC7072)	□ CVLSWT TEST 579-0 B1W3AE1
(RC7073)	◇ CVLSWT TEST 579-0 B1W3AE3
(RC7074)	△ CVLSWT TEST 579-0 B1W3AE4
(RC7075)	▽ CVLSWT TEST 579-0 B1W3AE5

PARAMETRIC VALUES	
BETA	0.000 FLAPS 0 000
SPOILR	0.000

REFERENCE INFORMATION	
REFS	316.2304 SQ IN
REFL	50.1900 IN
REFB	7.3500 IN
XMRP	29.3920 IN
YMRP	0.0000 IN
ZMRP	0.0000 IN
SCALE	0 0175

MACH 0.259

LONGITUDINAL CHAR. - CRUISE ENGINE EFFECT - STRAIGHT WING AFT - TAIL OFF

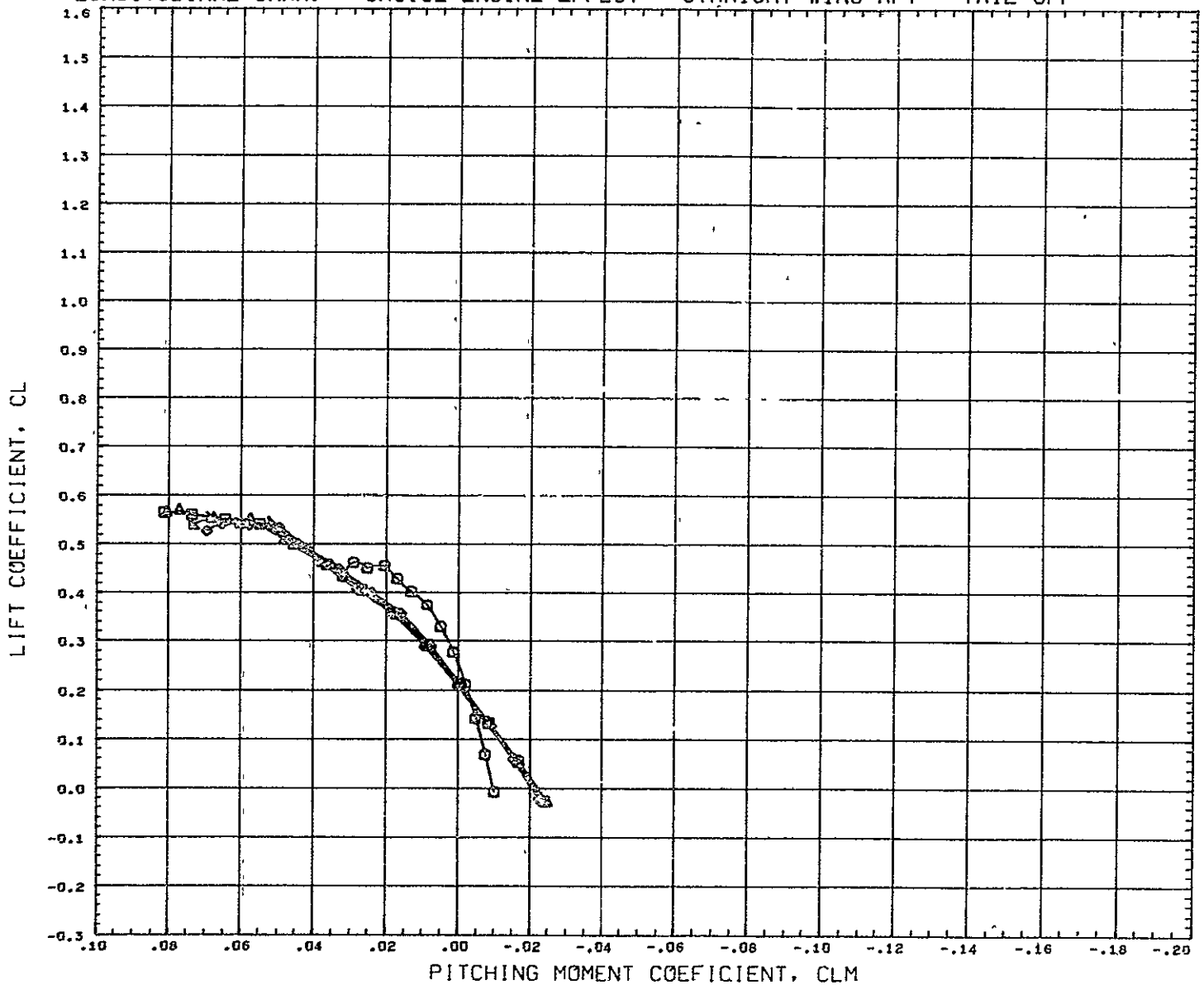

DATA SET SYMBOL	CONFIGURATION DESCRIPTION	PARAMETRIC VALUES			REFERENCE INFORMATION	
(RC7076)	○ CVLSWT TEST 579-D B1W3A	BETA	0.000	FLAPS	0.000	REFS 316.2304 SQ IN
(RC7072)	□ CVLSWT TEST 579-D B1W3AE1	SFOILR	0.005			REFL 50.1900 IN
(RC7073)	◇ CVLSWT TEST 579-D B1W3AE3					REFB 7.3500 IN
(RC7074)	△ CVLSWT TEST 579-D B1W3AE4					XNRF 29.3920 IN
(RC7075)	▽ CVLSWT TEST 579-D B1W3AE5					YMRP 0.0000 IN
						ZMRP 0.0000 IN
						SCALE 0.0175
MACH 0.259						

VERTICAL TAIL EFFECTIVENESS - SIDESLIP DERIVATIVES - STRAIGHT WING BASIC POS.

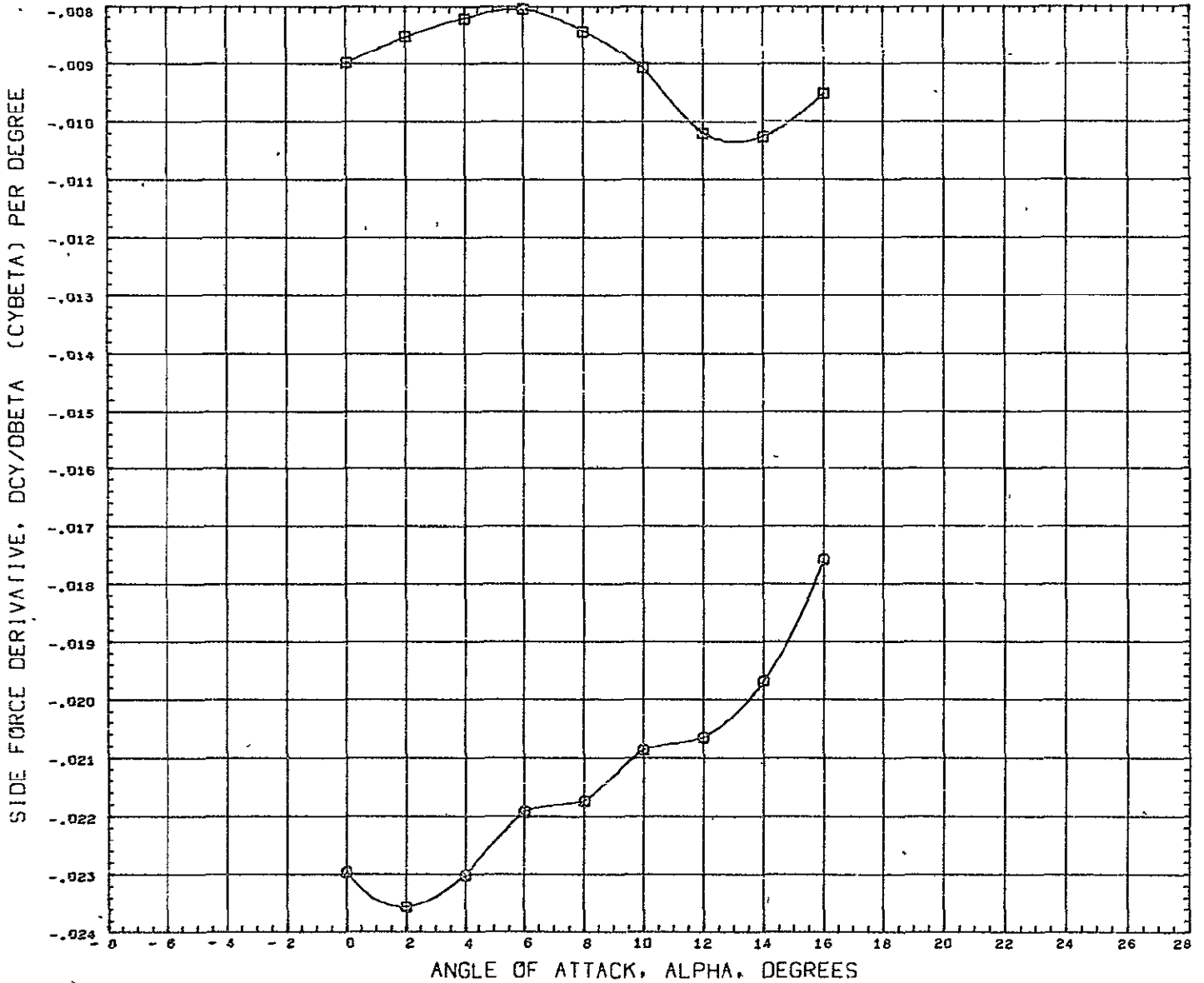

DATA SET SYMBOL CONFIGURATION DESCRIPTION  
 (DB7049) □ CVLSWT TEST 579-D B1W1-15T1-9DV1  
 (DB7057) □ CVLSWT TEST 579-D B1W1-15T1-9D

PARAMETRIC VALUES  
 BETA 0.000 ELEVTR 0.000  
 RUDDER 0.000 FLAPS 0.000  
 SFOILR 0.000

REFERENCE INFORMATION  
 REFS 316 2304 SQ IN  
 REFL 50.1900 IN  
 REFB 7 3500 IN  
 XMRF 29.3920 IN  
 YMRF 0.0000 IN  
 ZMRF -0 0000 IN  
 SCALE 0 0175

MACH 0.259



VERTICAL TAIL EFFECTIVENESS - SIDESLIP DERIVATIVES - STRAIGHT WING BASIC POS.

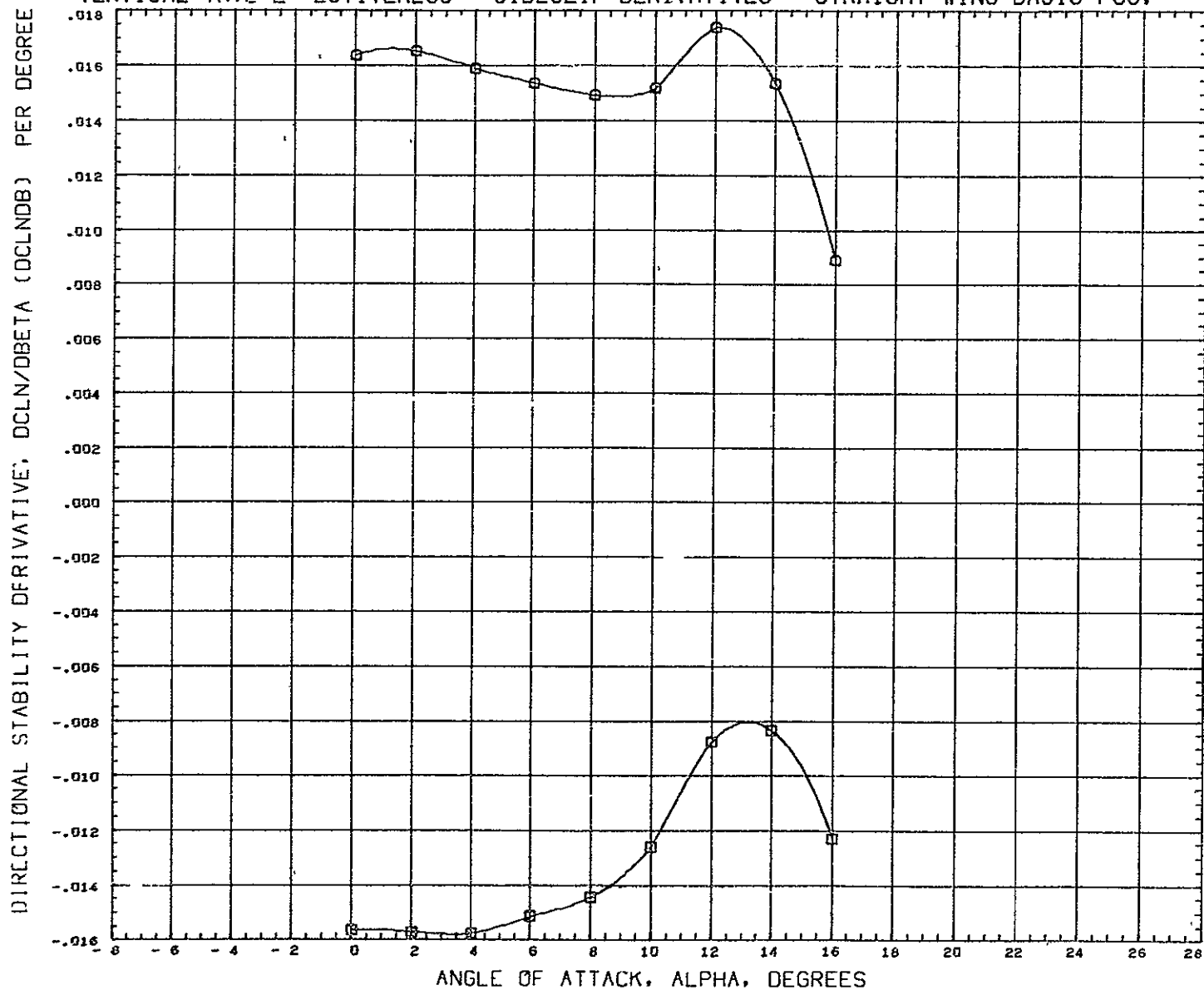

DATA SET SYMBOL    CONFIGURATION DESCRIPTION  
 (DB7049)    ○    CVLSWT TEST 579-D B1W1-15T1-90V1  
 (DB7057)    □    CVLSWT TEST 579-D B1W1-15T1-9D

PARAMETRIC VALUES				REFERENCE INFORMATION		
BETA	0.000	ELEVTR	0.000	REFS	316 2304	SQ IN
RUDDER	0.000	FLAPS	0.000	REFL	50 1900	IN
SPOILR	0.000			REFB	7.3500	IN
				XHRF	29.3920	IN
				YHRF	0.0000	IN
				ZHRF	0.0000	IN
				SCALE	0 0175	

MACH            0 259

VERTICAL TAIL EFFECTIVENESS - SIDESLIP DERIVATIVES - STRAIGHT WING BASIC POS.

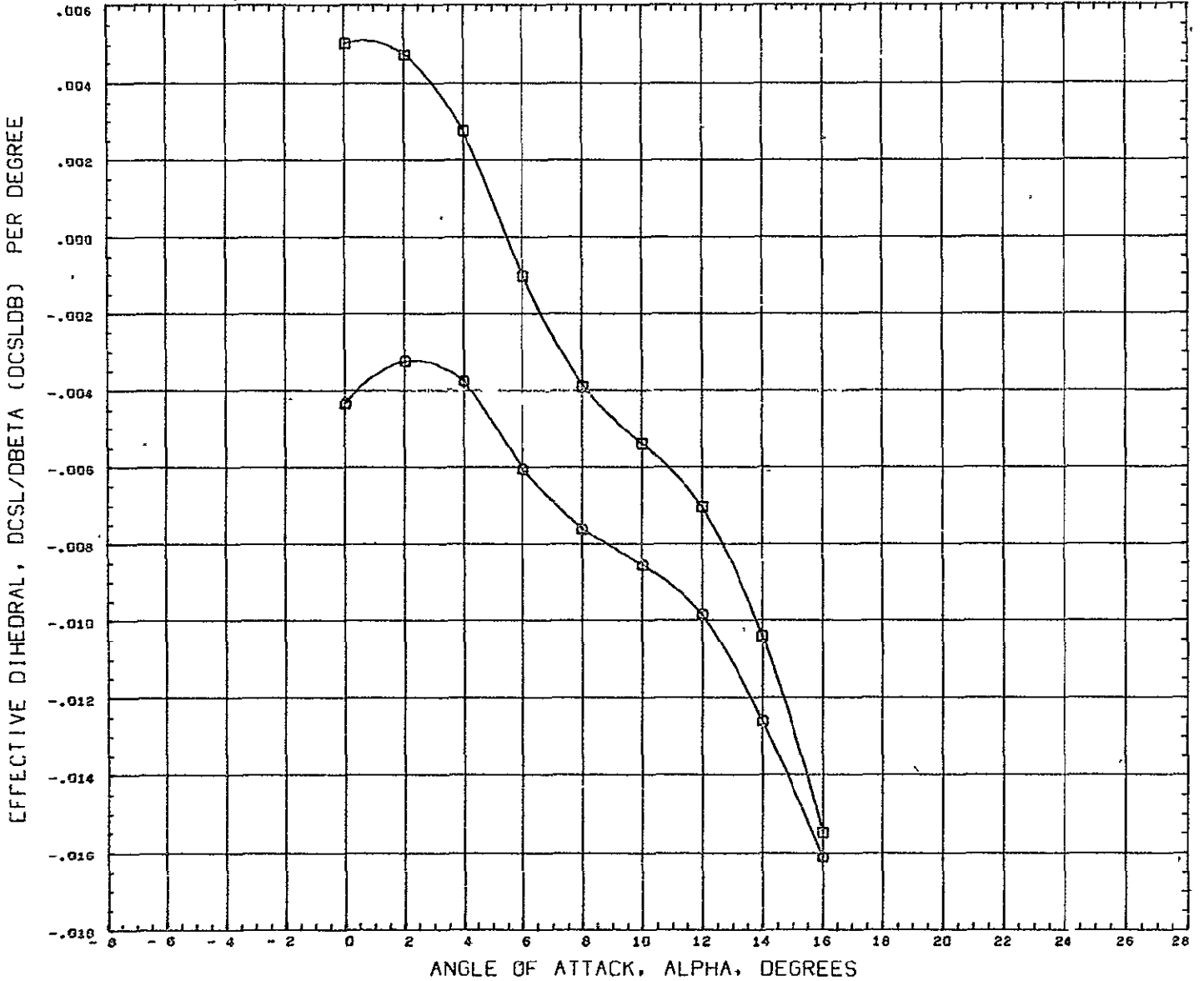

DATA SET SYMBOL    CONFIGURATION DESCRIPTION  
 (DB7049)    ○    CVLSWT TEST 579-0 B1W1-15T1-90V1  
 (DB7057)    □    CVLSWT TEST 579-0 B1W1-15T1-90

PARAMETRIC VALUES  
 BETA    0.000    ELEVTR    0.000  
 RUDDER    0.000    FLAPS    0.000  
 SPOILR    0.000

REFERENCE INFORMATION  
 REFS    316 2304    SQ IN  
 REFL    50.1900    IN  
 REFB    7.3500    IN  
 XHRF    29.3920    IN  
 YHRF    0.0000    IN  
 ZHRF    0.0000    IN  
 SCALE    0.0175

MACH    0.259

LATERAL CHARACTERISTICS - WING-BODY DATA - STRAIGHT WING BASIC POSITION

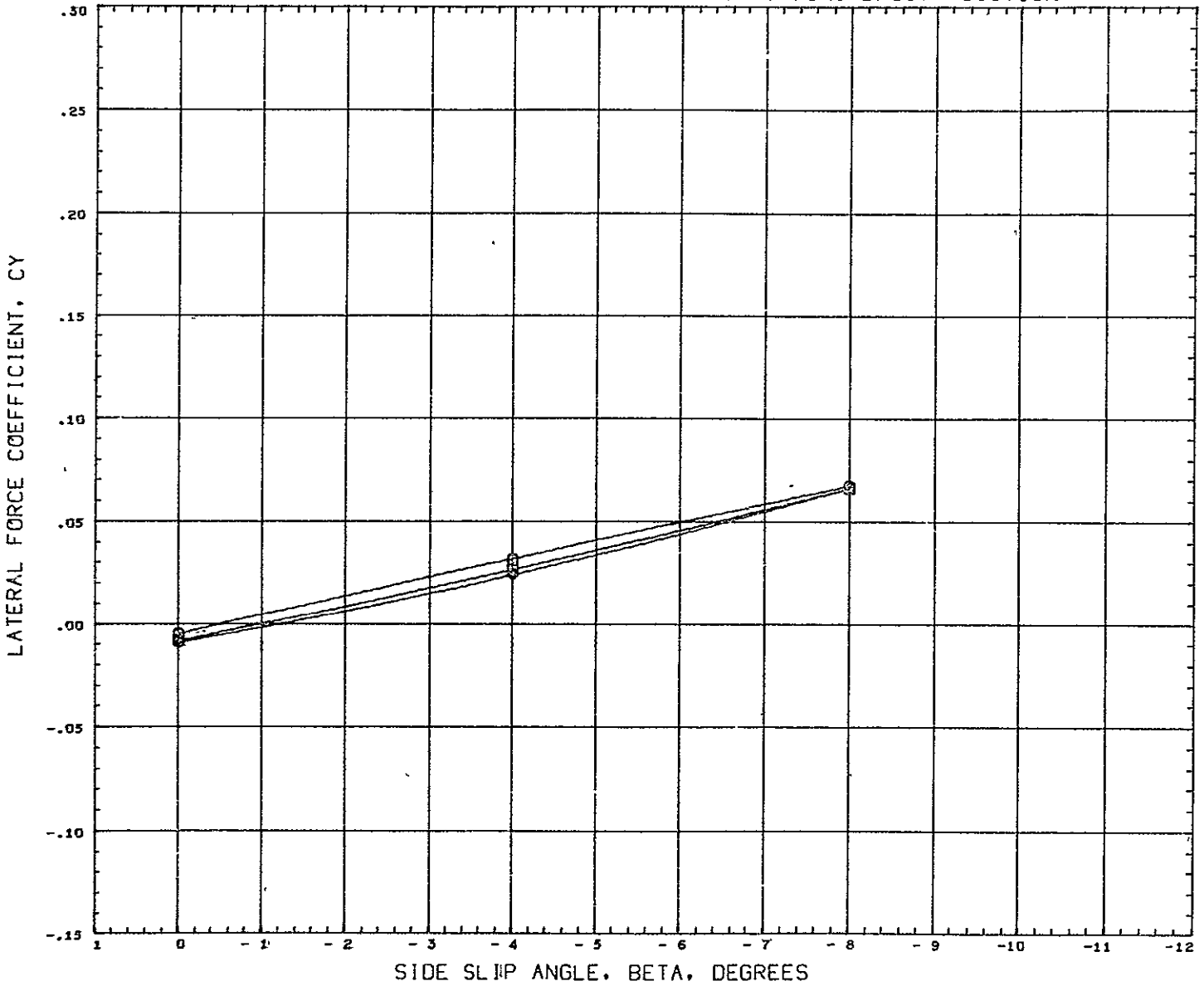

SYMBOL	ALPHA	PARAMETRIC VALUES			
□	0.000	MACH	0.259	FLAPS	0.000
□	4.000	SPOILR	0.000		
◇	6.000				

REFERENCE INFORMATION		
REFS	316.2304	SQ IN
REFL	50.1900	IN
REFB	7.3500	IN
XNRF	29.3920	IN
YNRF	0.0000	IN
ZNRF	0.0000	IN
SCALE	0.0175	

DATA HIST. CODE I

LATERAL CHARACTERISTICS - WING-BODY DATA - STRAIGHT WING BASIC POSITION

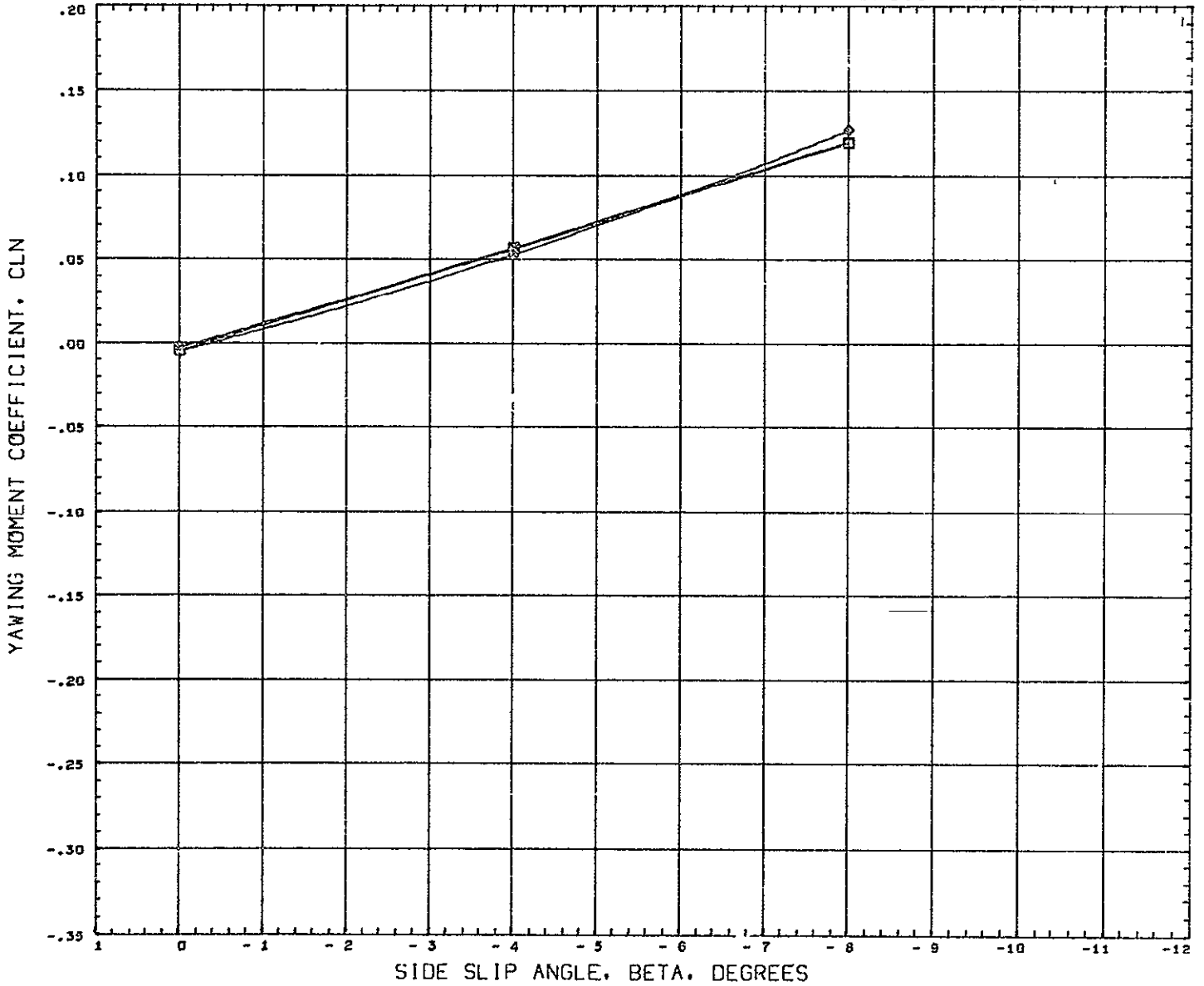

SYMBOL	ALPHA	MACH	PARAMETRIC VALUES	FLAPS	0.000
○	0.000	0.259			
□	4.000	SFOILR	0.000		
◇	8.000				

REFERENCE INFORMATION		
REFS	316 2304	50 IN
REFL	50.1900	IN
REFB	7.3500	IN
XHRF	29.3920	IN
YHRF	0.0000	IN
ZHRF	0.0000	IN
SCALE	0.0175	

DATA HIST. CODE 1

# LATERAL CHARACTERISTICS - WING-BODY DATA - STRAIGHT WING BASIC POSITION

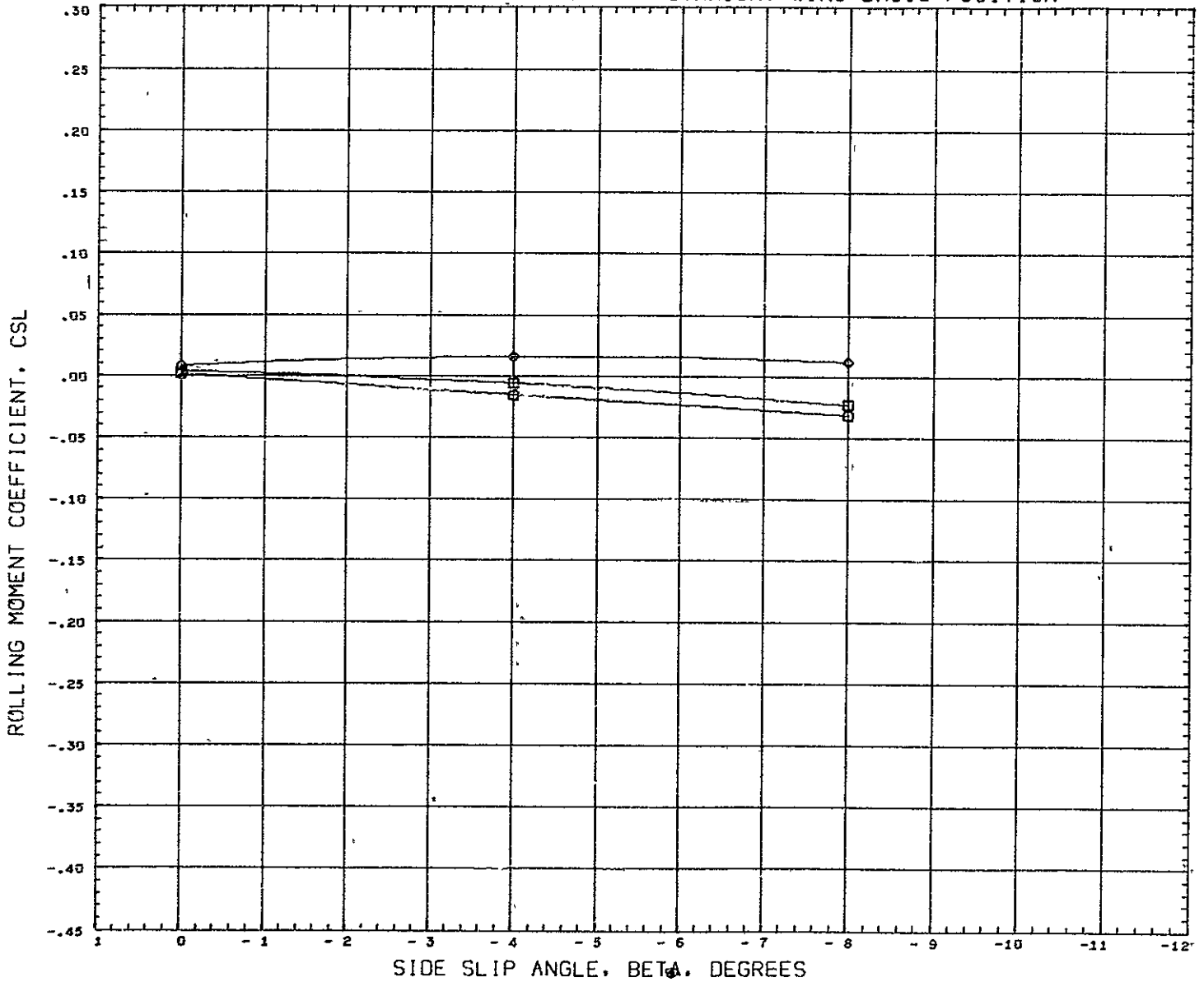

SYMBOL	ALPHA	PARAMETRIC VALUES			
$\square$	0.000	MACH	0.259	FLAPS	0.000
$\square$	4.000	$\delta$ FOLLR	0.000		
$\circ$	8.000				

REFERENCE INFORMATION		
REFS	316 2304	SQ IN
REFL	50.1900	IN
REFB	7.3500	IN
XMRP	29.3920	IN
YHRF	0.0000	IN
ZMRP	0.0000	IN
SCALE	0.0175	

DATA HIST. CODE 1

LONGITUDINAL CHARACTERISTICS - BODY TAIL DATA - V-TAIL=55DEG

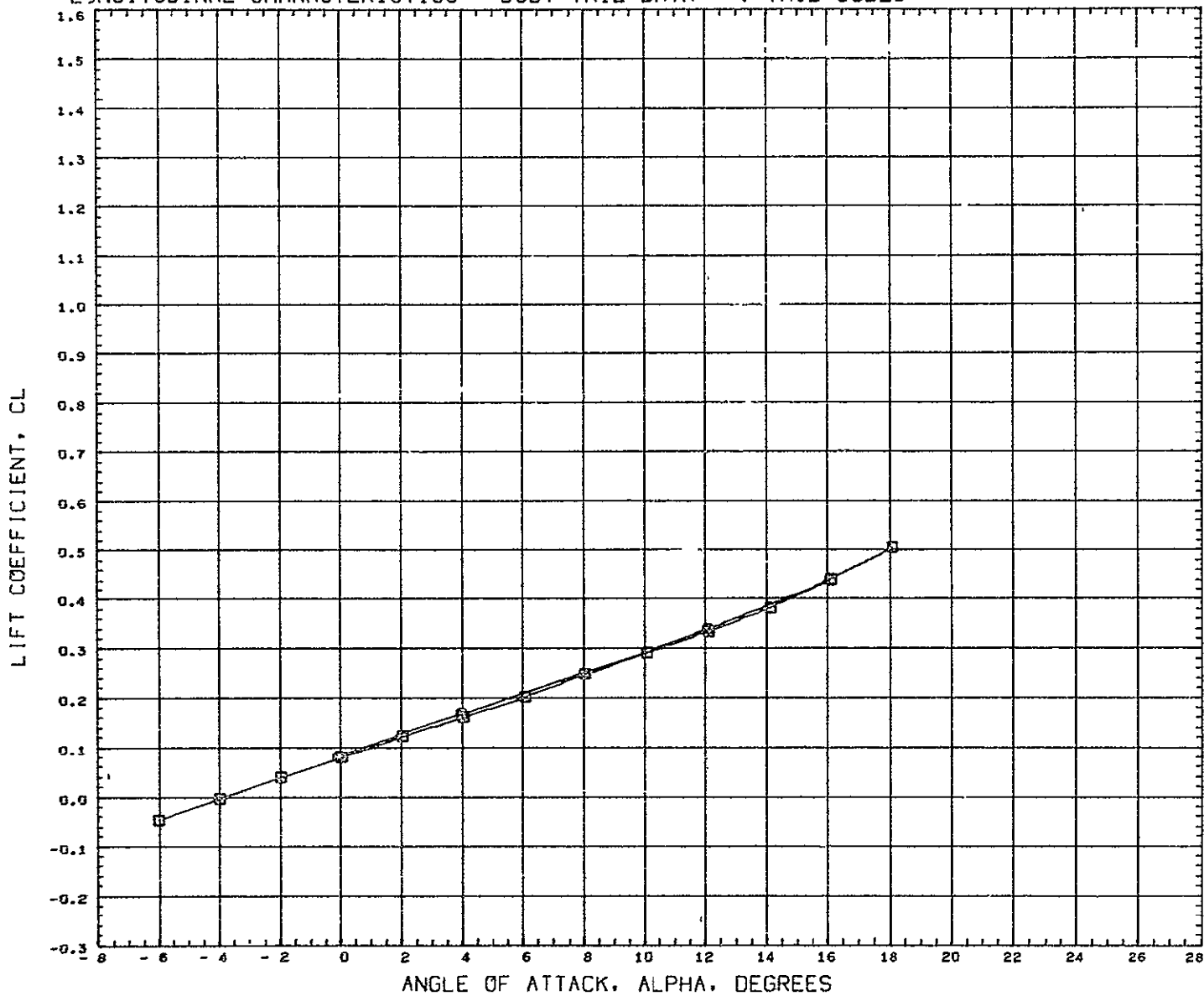

SYMBOL	BETA	PARAMETRIC VALUES			
□	- 4.000	MACH	0.259	ELEVTR	0.000
□	0.000	RUD/TR	0.000		

REFERENCE INFORMATION		
REFS	316 2304	SQ IN
REFL	50 1900	IN
REFB	7.3500	IN
XHRF	29.3920	IN
YHRF	0.0000	IN
ZHRF	0.0000	IN
SCALE	0.0175	

REFERENCE FILE CONVAIR T175-AE-12

LONGITUDINAL CHARACTERISTICS - BODY TAIL DATA - V-TAIL=55DEG

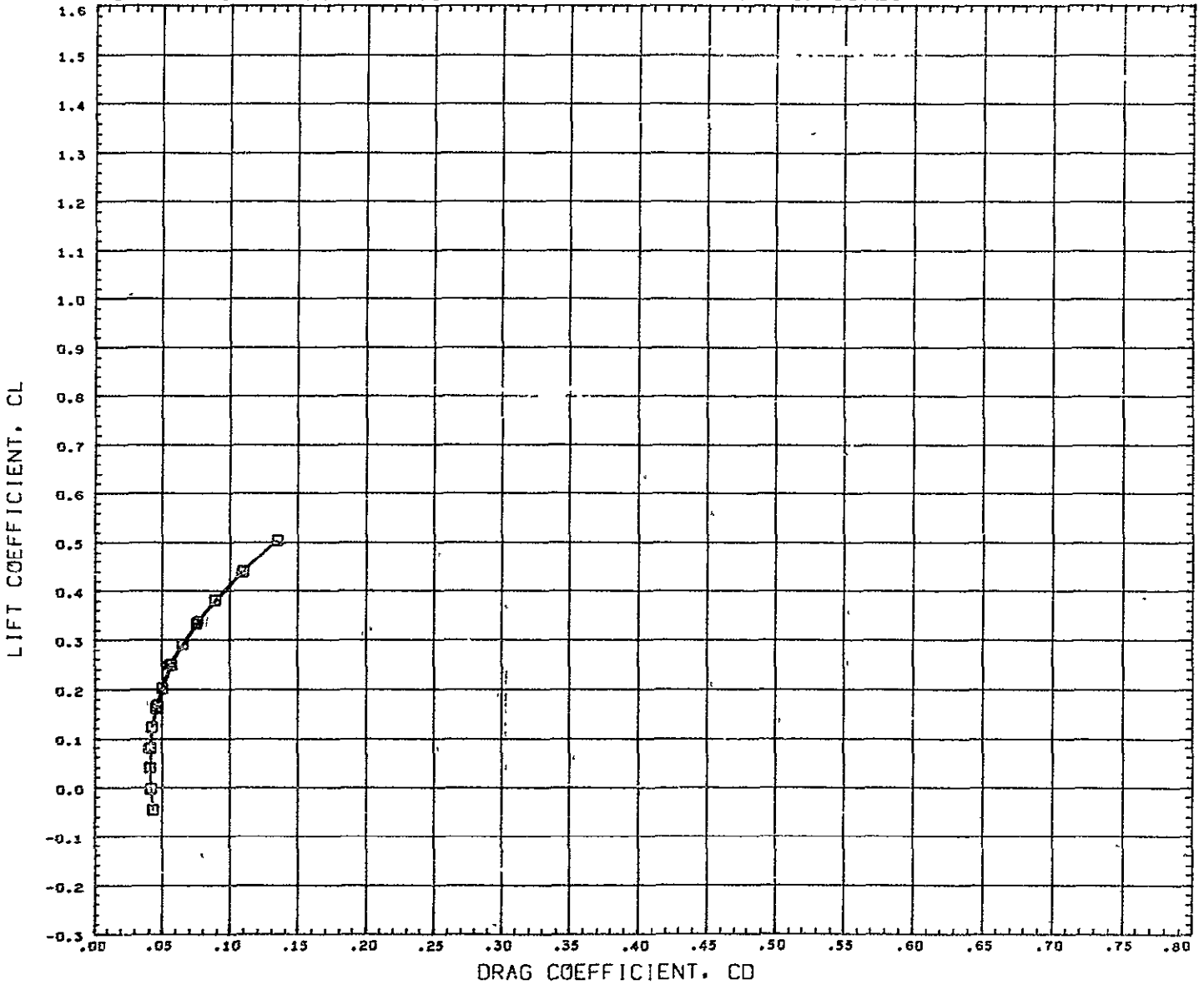

SYMBOL	BETA	PARAMETRIC VALUES			
○	4.000	MACH	0.259	ELEVTR	0.000
□	0.000	RUDYTR	0.000		

REFERENCE INFORMATION		
REFS	316.2304	SQ IN
REFL	50.1900	IN
REFB	7.3500	IN
XHRF	29.3920	IN
YHRF	0.0000	IN
ZHRF	0.0000	IN
SCALE	0.0175	

REFERENCE FILE CONVAIR T470-AE-12

LONGITUDINAL CHARACTERISTICS - BODY TAIL DATA - V-TAIL=55DEG

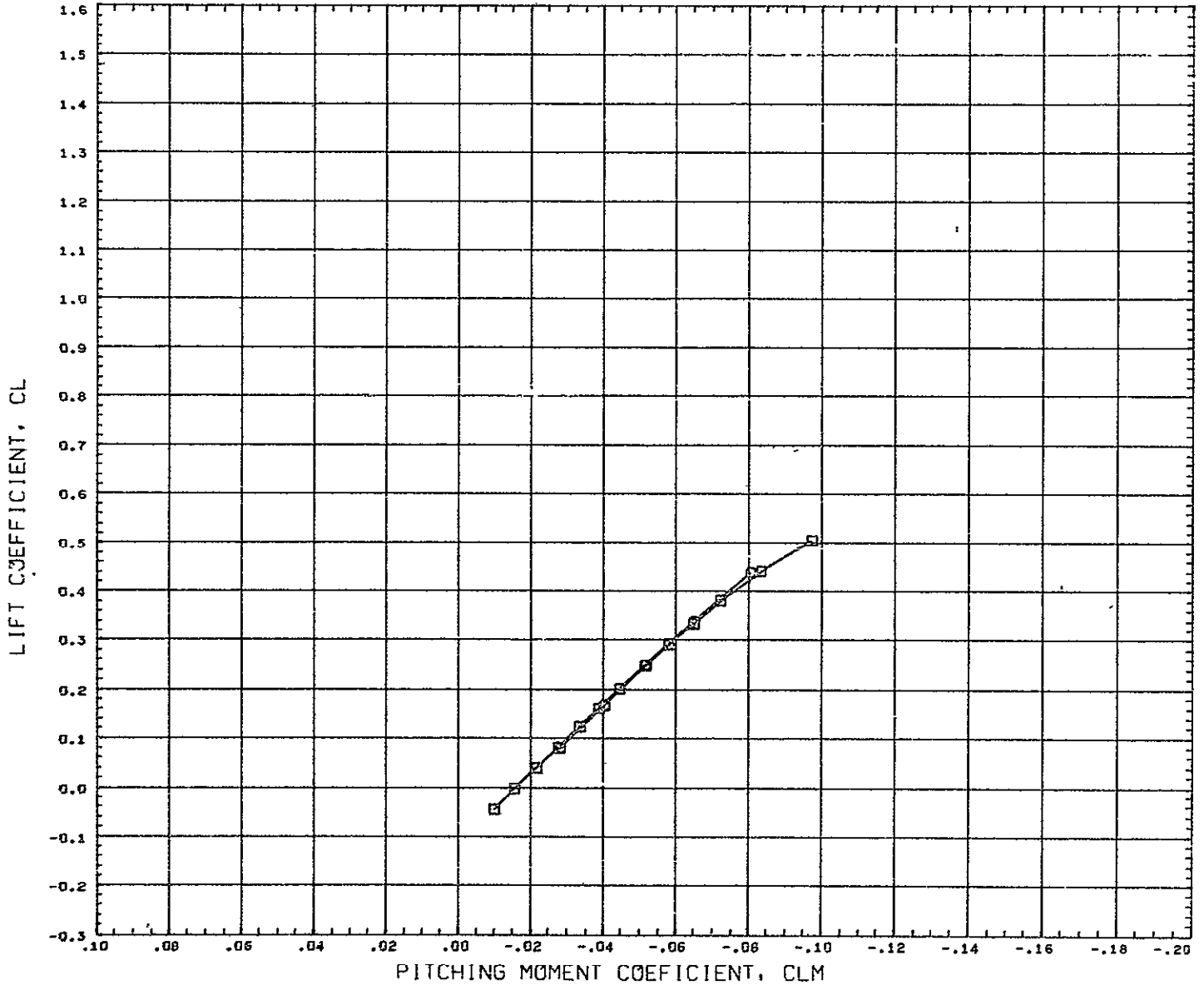

SYMBOL	BETA	PARAMETRIC VALUES			
□	- 4.000	MACH	0.259	ELEVTR	0.000
□	0.000	RUDVTR	0.000		

REFERENCE INFORMATION		
REFS	316 2304	SQ IN
REFL	50.1900	IN
REFB	7.3500	IN
XNRP	29.3920	IN
YNRP	0.0000	IN
ZNRP	0.0000	IN
SCALE	0.0175	

REFERENCE FILE CONVAIR TN70-AE-12



BODY-TAIL DATA - SIDESLIP DERIVATIVES - V-TAIL=55DEG

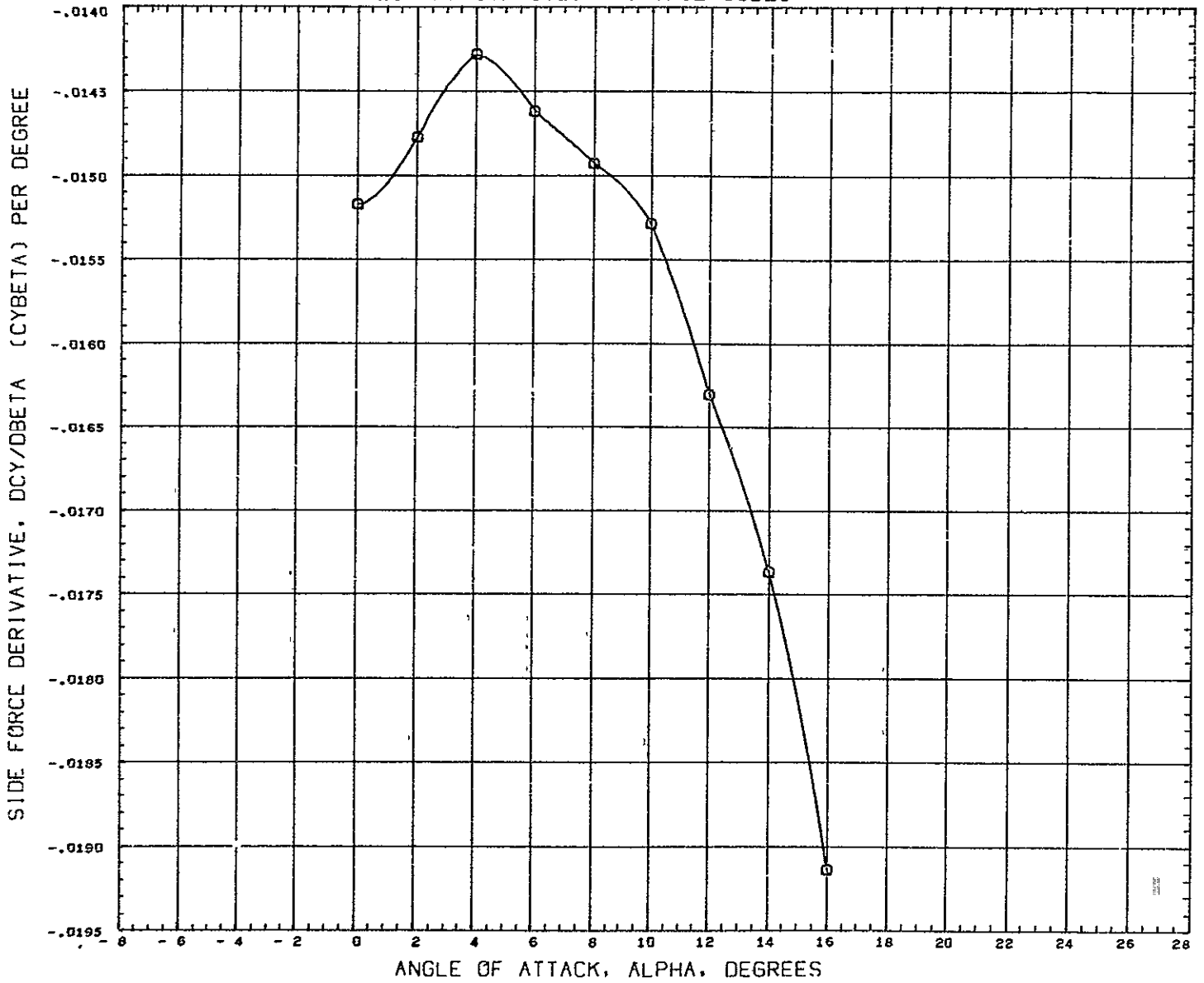

SYMBOL MACH PARAMETRIC VALUES  
 O 0.259 BETA 0.000 ELEVTR 0.000  
 PUDVTR 0.000

REFERENCE INFORMATION  
 REFS 316.2304 SQ IN  
 REFL 50.1900 IN  
 REFB 7.3500 IN  
 XMRP 29.3920 IN  
 YMRP 0 0000 IN  
 ZMRP 0 0000 IN  
 SCALE 0 0175

DATA HIST. CODE \*F

BODY-TAIL DATA - SIDESLIP DERIVATIVES - V-TAIL=55DEG

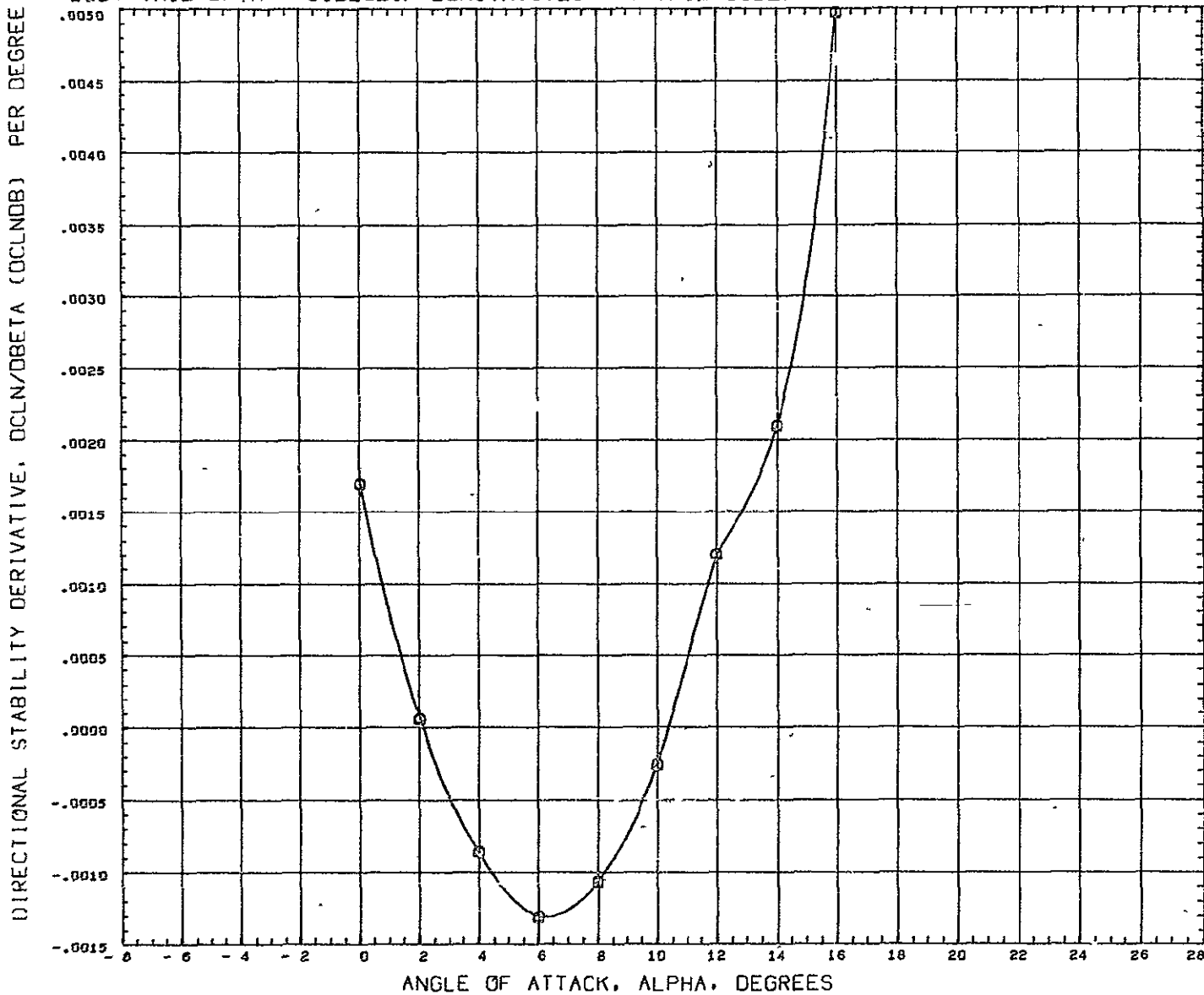

SYMBOL MACH PARAMETRIC VALUES  
 D 0.259 BETA 0.000 ELEVTR 0.000  
 RUDYTR 0.000

REFERENCE INFORMATION  
 REFS 316.2304 SQ IN  
 REFL 50.1900 IN  
 REFB 7.5500 IN  
 XMRP 29.3920 IN  
 YMRP 0.0000 IN  
 ZMRP 0.0000 IN  
 SCALE 0.0175

DATA HIST. CODE #F

BODY-TAIL DATA - SIDESLIP DERIVATIVES - V-TAIL=55DEG

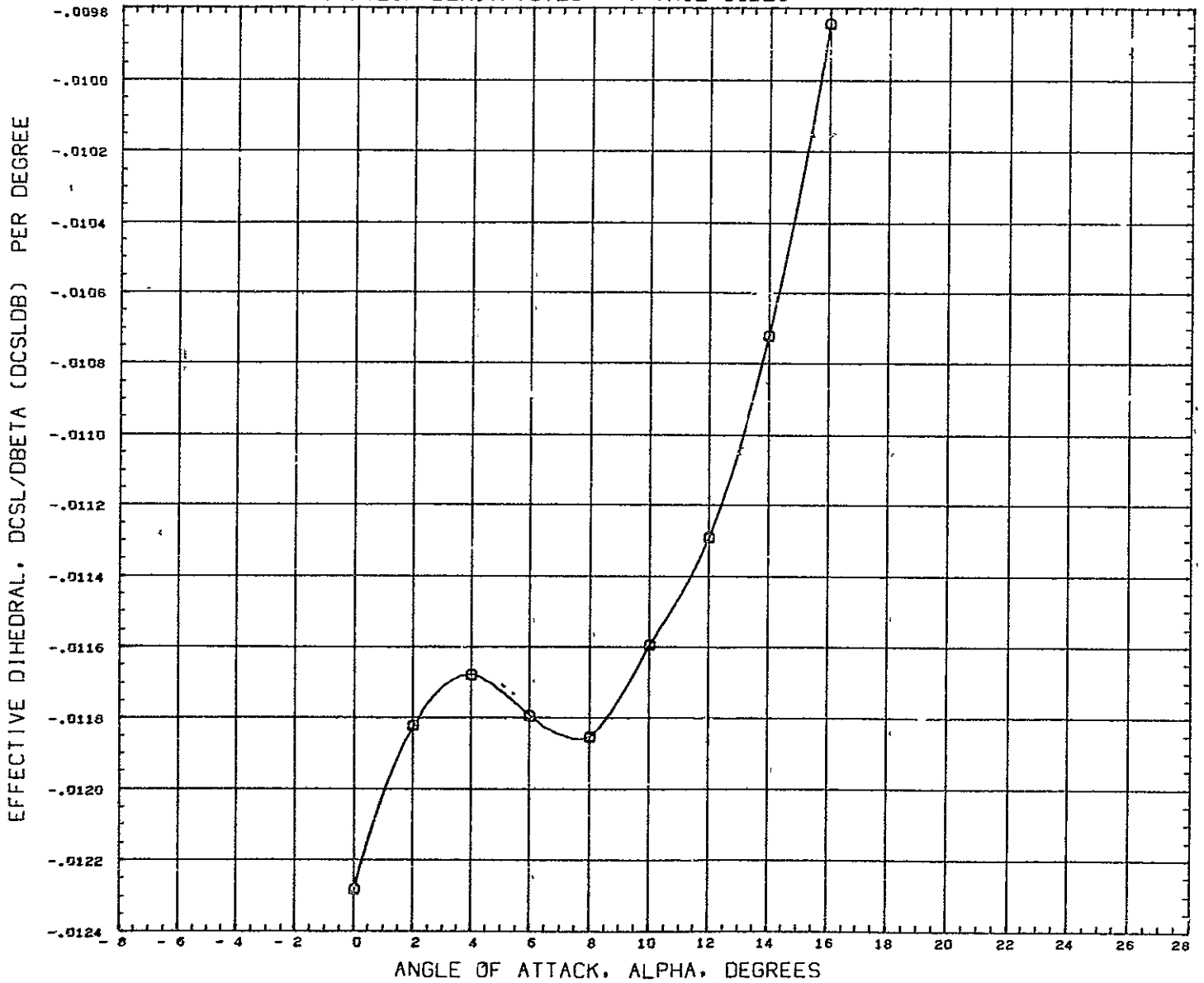

SYMBOL	MACH	PARAMETRIC VALUES			
Q	0.259	BETA	0.000	ELEVTR	0.000
		RUDYTR	0.000		

REFERENCE INFORMATION		
REFS	316.2304	SQ IN
REFL	50.1900	IN
REFB	7.3500	IN
XMRP	29.3920	IN
YMRP	0.0000	IN
ZMRP	0.0000	IN
SCALE	0.0175	

DATA HIST. CODE #F

CONFIGURATION BUILDUP - LONGITUDINAL CHARACTERISTICS - DELTA WING

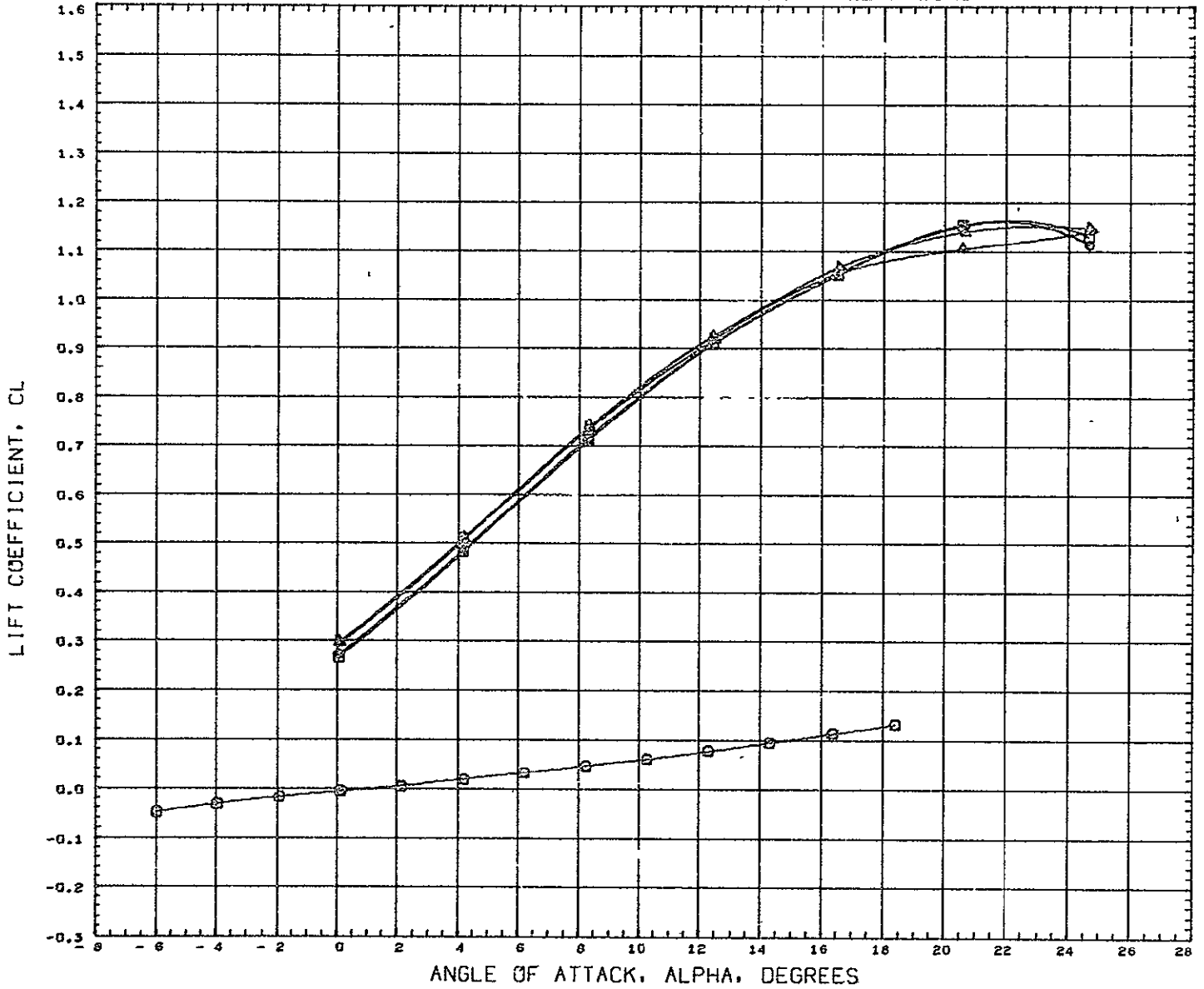

DATA SET	SYMBOL	CONFIGURATION DESCRIPTION
(RC7113)	□	CVLSWT TEST 579-D B7
(RC7109)	□	CVLSWT TEST 579-D B7W5
(RC7083)	◇	CVLSWT TEST 579-D B7W5V1
(RC7102)	△	CVLSWT TEST 579-D B7W5V1E2
(RC7100)	▽	CVLSWT TEST 579-G B7W5V1E2G2

PARAMETRIC VALUES  
 BETA 0.000

REFERENCE INFORMATION		
REFS	316.2304	Sq IN
REFL	50.1900	IN
REFB	7.3500	IN
XMRP	33.9090	IN
YMRP	0.0000	IN
ZMRP	0.0000	IN
SCALE	0.0175	

MACH 0.259

# CONFIGURATION BUILDUP - LONGITUDINAL CHARACTERISTICS - DELTA WING

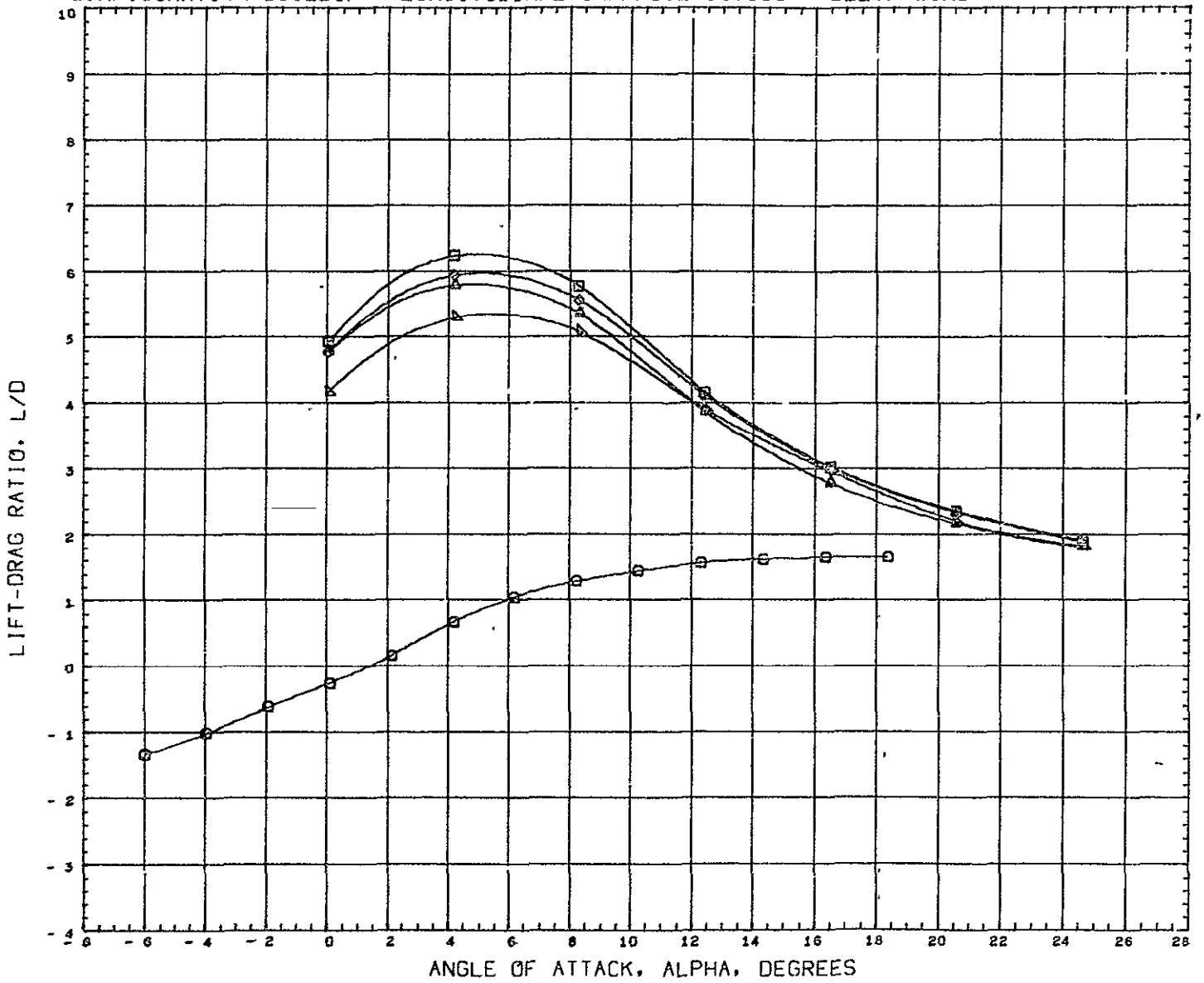

DATA SET SYMBOL	CONFIGURATION DESCRIPTION
(RC7113)	CVLSWT TEST 579-0 B7
(RC7109)	CVLSWT TEST 579-0 B7W5
(RC7083)	CVLSWT TEST 579-0 B7W5V1
(RC7102)	CVLSWT TEST 579-0 B7W5V1E2
(RC7100)	CVLSWT TEST 579-0 B7W5V1E2G2

PARAMETRIC VALUES  
 DELTA 0.000

REFERENCE INFORMATION		
REFS	316.2304	50 IN
REFL	50.1900	IN
REFB	7.3500	IN
XMRP	33.9090	IN
YMRP	0.0000	IN
ZMRP	0.0000	IN
SCALE	0.0175	

MACH 0.259

CONFIGURATION BUILDUP - LONGITUDINAL CHARACTERISTICS - DELTA WING

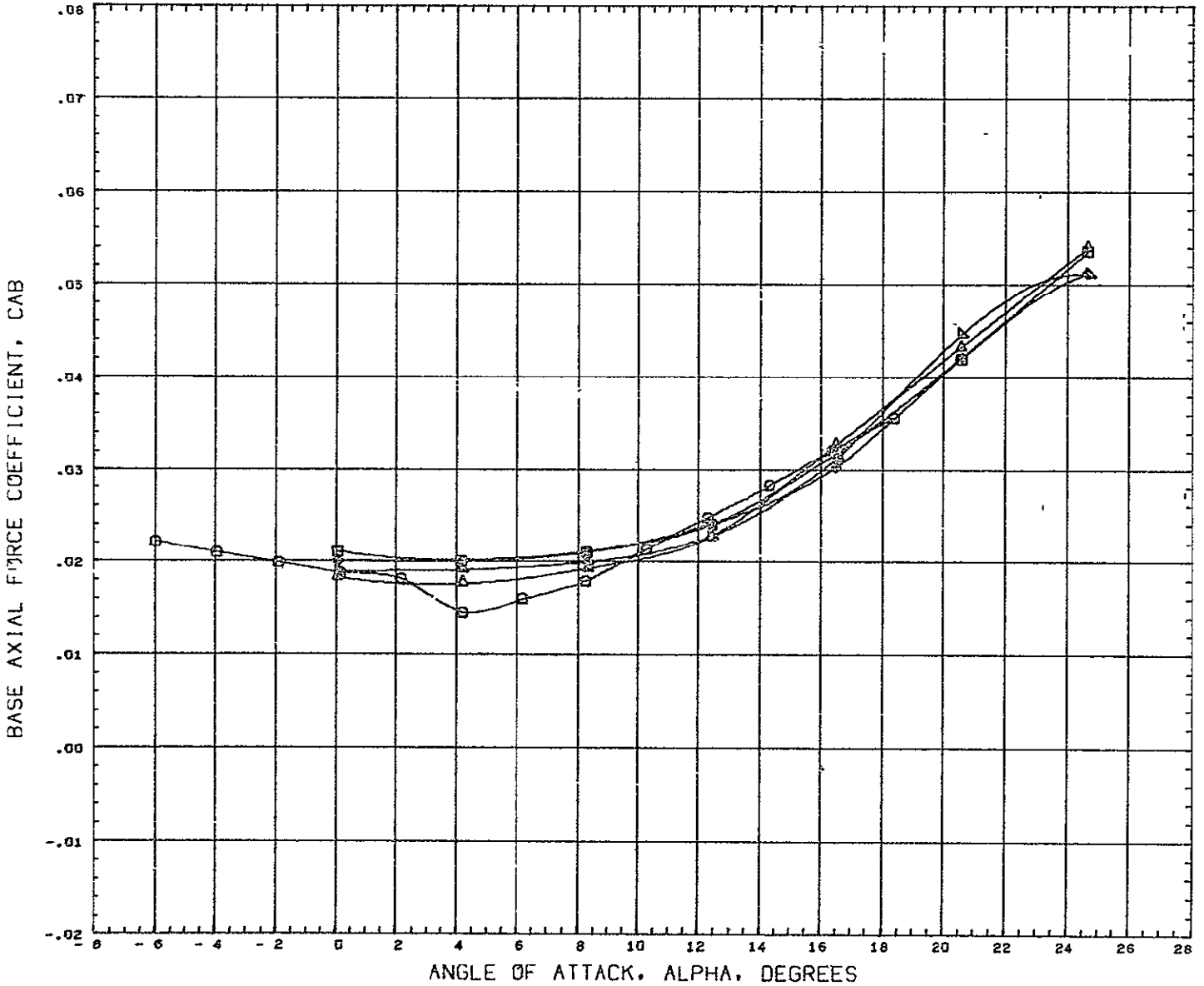

DATA SET SYMBOL	CONFIGURATION DESCRIPTION	PARAMETRIC VALUES	REFERENCE INFORMATION
(RC7113)	CVLSWT TEST 579-G B7	BETA 0.000	REFS 316.2364 SQ IN
(RC7109)	CVLSWT TEST 579-G B7M5		REFL 50.1900 IN
(RC7063)	CVLSWT TEST 579-G B7W5V1		REFB 7.3500 IN
(RC7102)	CVLSWT TEST 579-G B7W5V1E2		XMRP 33.9090 IN
(RC7105)	CVLSWT TEST 579-G B7W5V1E2G2		YMRP 0.0000 IN
			ZMRP 0.0000 IN
			SCALE 0.0175

MACH 0.259

CONFIGURATION BUILDUP - LONGITUDINAL CHARACTERISTICS - DELTA WING

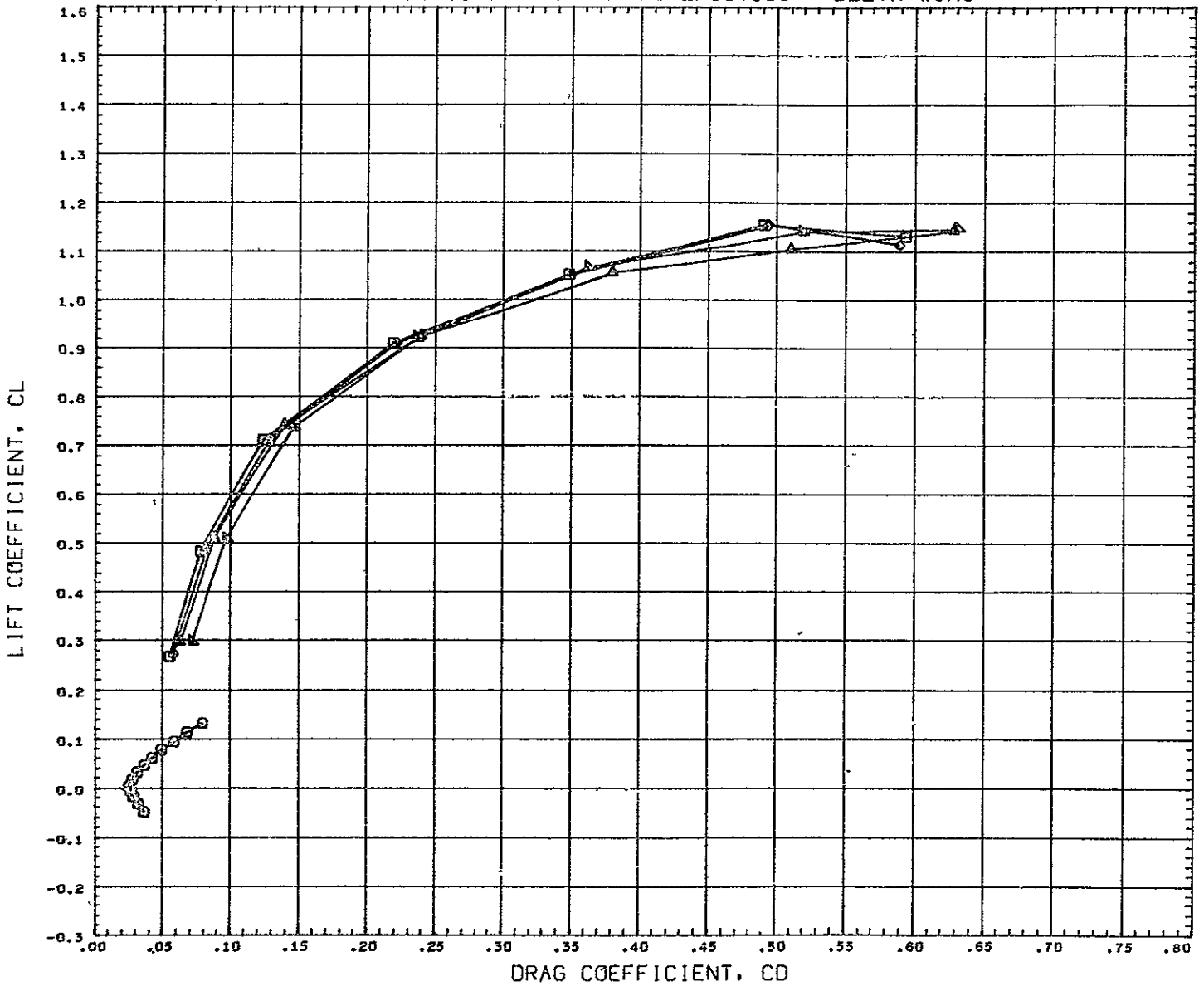

DATA SET SYMBOL	CONFIGURATION DESCRIPTION
(RC7113)	□ CVLSWT TEST 579-G B7
(RC7109)	□ CVLSWT TEST 579-G B7W5
(RC7093)	○ CVLSWT TEST 579-G B7W5V1
(RC7102)	△ CVLSWT TEST 579-G B7W5V1E2
(RC7100)	▽ CVLSWT TEST 579-G B7W5V1E2G2

PARAMETRIC VALUES  
BETA 0.000

REFERENCE INFORMATION		
REFS	316 2304	SQ IN
REFL	50 1900	IN
REFB	7.3500	IN
XMRP	33.9090	IN
YMRP	0.0000	IN
ZMRP	0.0000	IN
SCALE	0.0175	

MACH 0.259

CONFIGURATION BUILDUP - LONGITUDINAL CHARACTERISTICS - DELTA WING

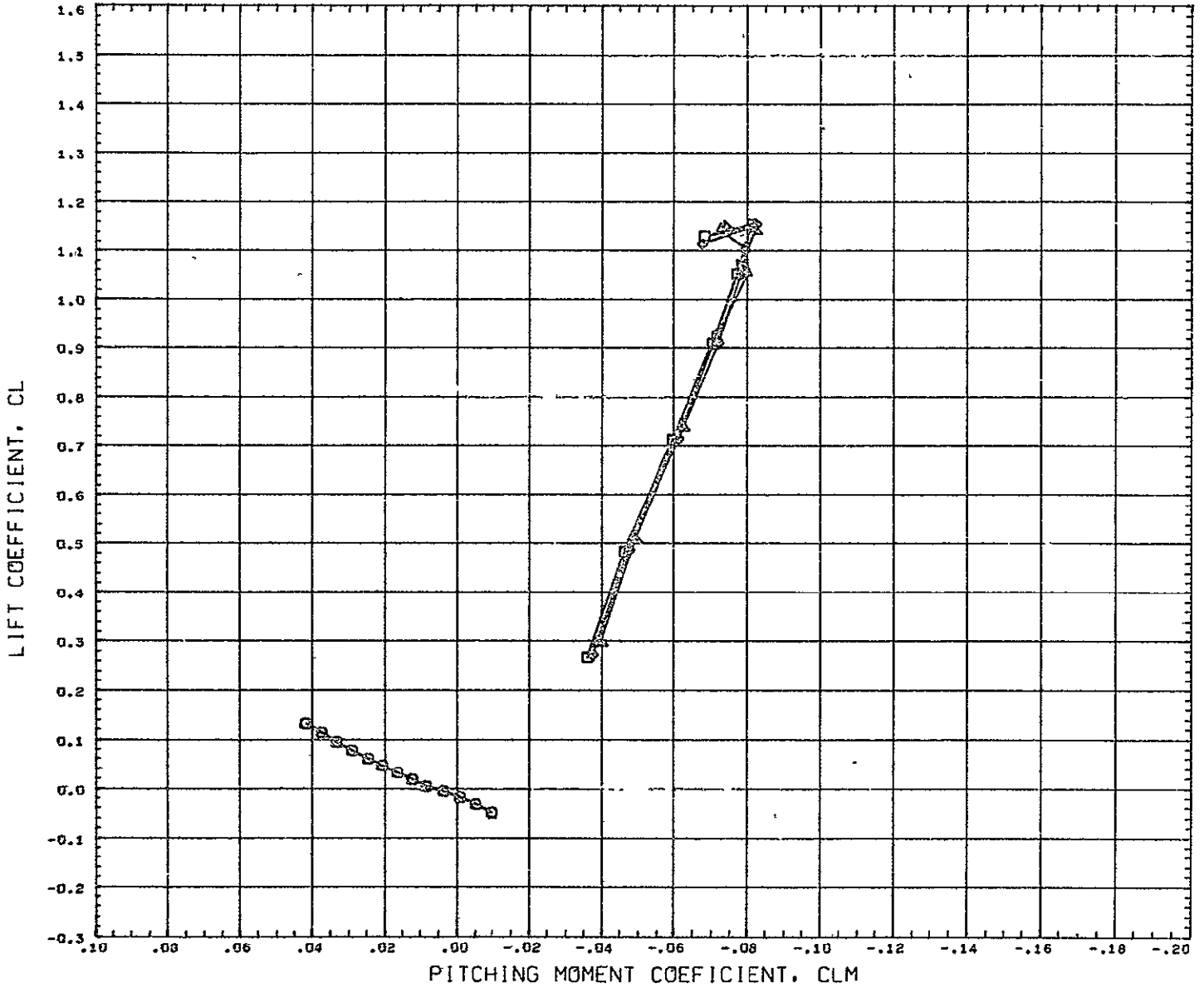

DATA SET SYMBOL	CONFIGURATION DESCRIPTION	PARAMETRIC VALUES	REFERENCE INFORMATION
(RC7113)	CVLSWT TEST 579-D B7	BETA 0.000	REFS 316 2304 SQ IN
(RC7109)	CVLSWT TEST 579-D B7W5		REFL 50 1900 IN
(RC7083)	CVLSWT TEST 579-D B7W5V1		REFB 7.3500 IN
(RC7102)	CVLSWT TEST 579-D B7W5V1E2		XHRF 33.9090 IN
(RC7100)	CVLSWT TEST 579-D B7W5V1E2G2		YHRF 0.0000 IN
			ZHRF 0.0000 IN
			SCALE 0.0175

MACH 0.259



CONFIGURATION BUILDUP - LATERAL CHARACTERISTICS - DELTA WING - BETA=-8 DEG

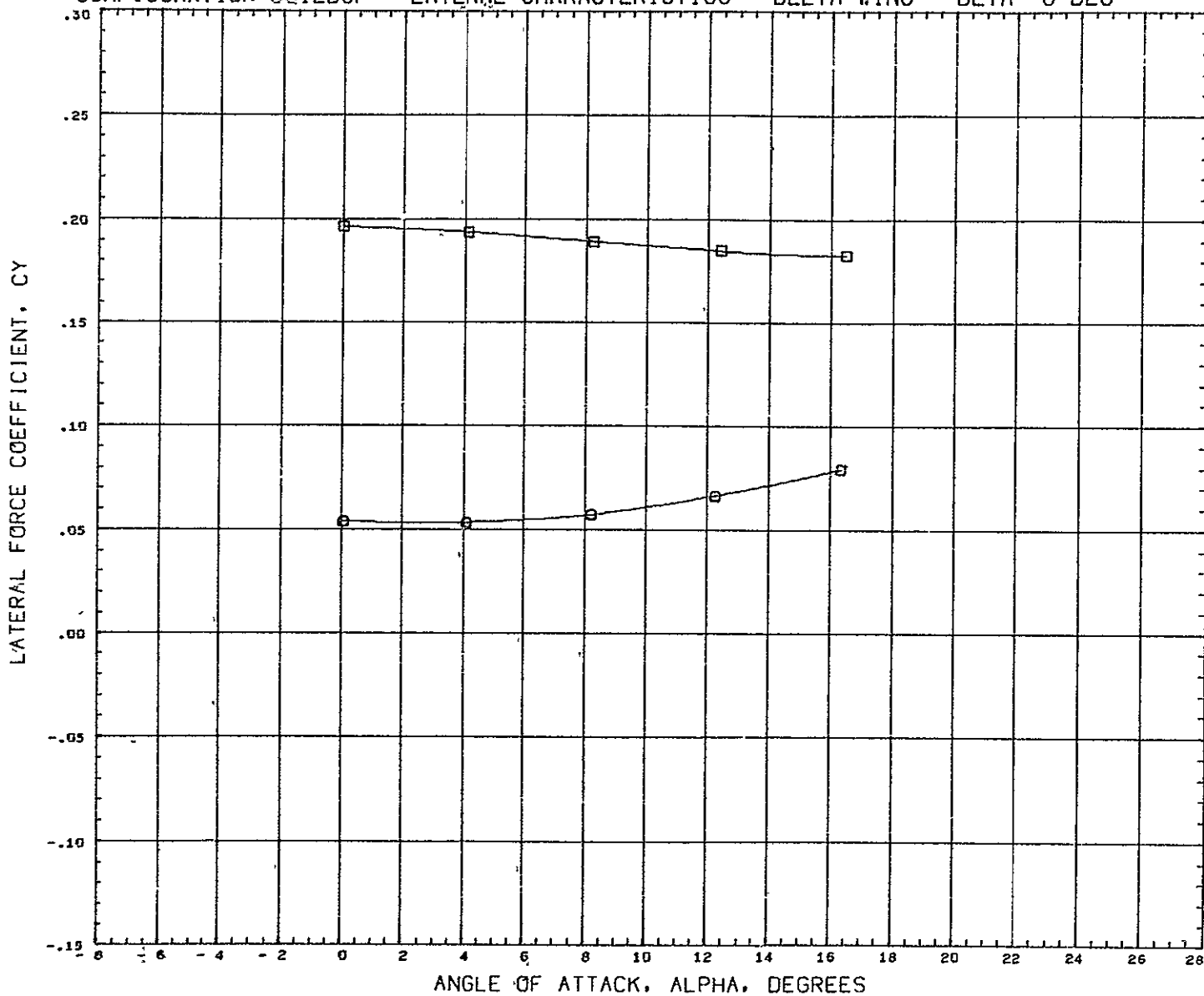

DATA SET SYMBOL    CONFIGURATION DESCRIPTION  
 (RC7114)    ◯    CVLSWT TEST 579-G B7  
 (RC7084)    ◻    CVLSWT TEST 579-G B7W5V1

PARAMETRIC VALUES  
 BETA    -    8.000

REFERENCE INFORMATION  
 REFS    316 2304    SQ IN  
 REFL    50 1900    IN  
 REFB    7.3500    IN  
 XMRP    33.9090    IN  
 YMRP    0.0000    IN  
 ZMRP    0.0000    IN  
 SCALE    0 0175

MACH    0.259

CONFIGURATION BUILDUP - LATERAL CHARACTERISTICS - DELTA WING - BETA=-8 DEG

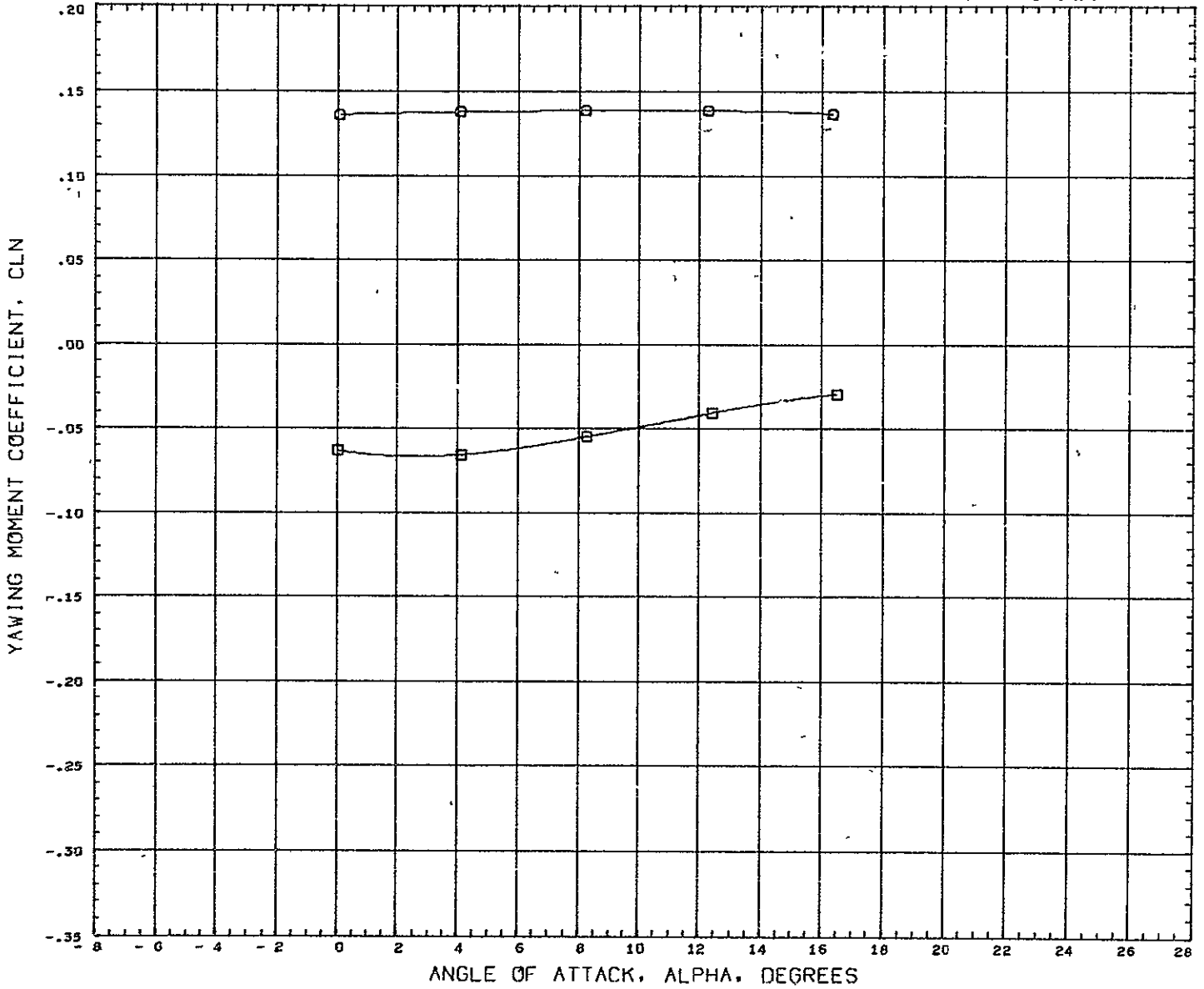

DATA SET SYMBOL    CONFIGURATION DESCRIPTION  
 (RC7114)    □    CVLSWT TEST 579-D B7  
 (RC7084)    □    CVLSWT TEST 579-D B7W5V1

PARAMETRIC VALUES  
 BETA    - 8.000

REFERENCE INFORMATION  
 REFS    316.2304    SQ IN  
 REFL    50.1950    IN  
 REFB    7.3500    IN  
 XMRP    33.9090    IN  
 YMRP    0.0000    IN  
 ZMRP    0.0000    IN  
 SCALE    0.0175

MACH    5.259

CONFIGURATION BUILDUP - LATERAL CHARACTERISTICS - DELTA WING - BETA=-8 DEG

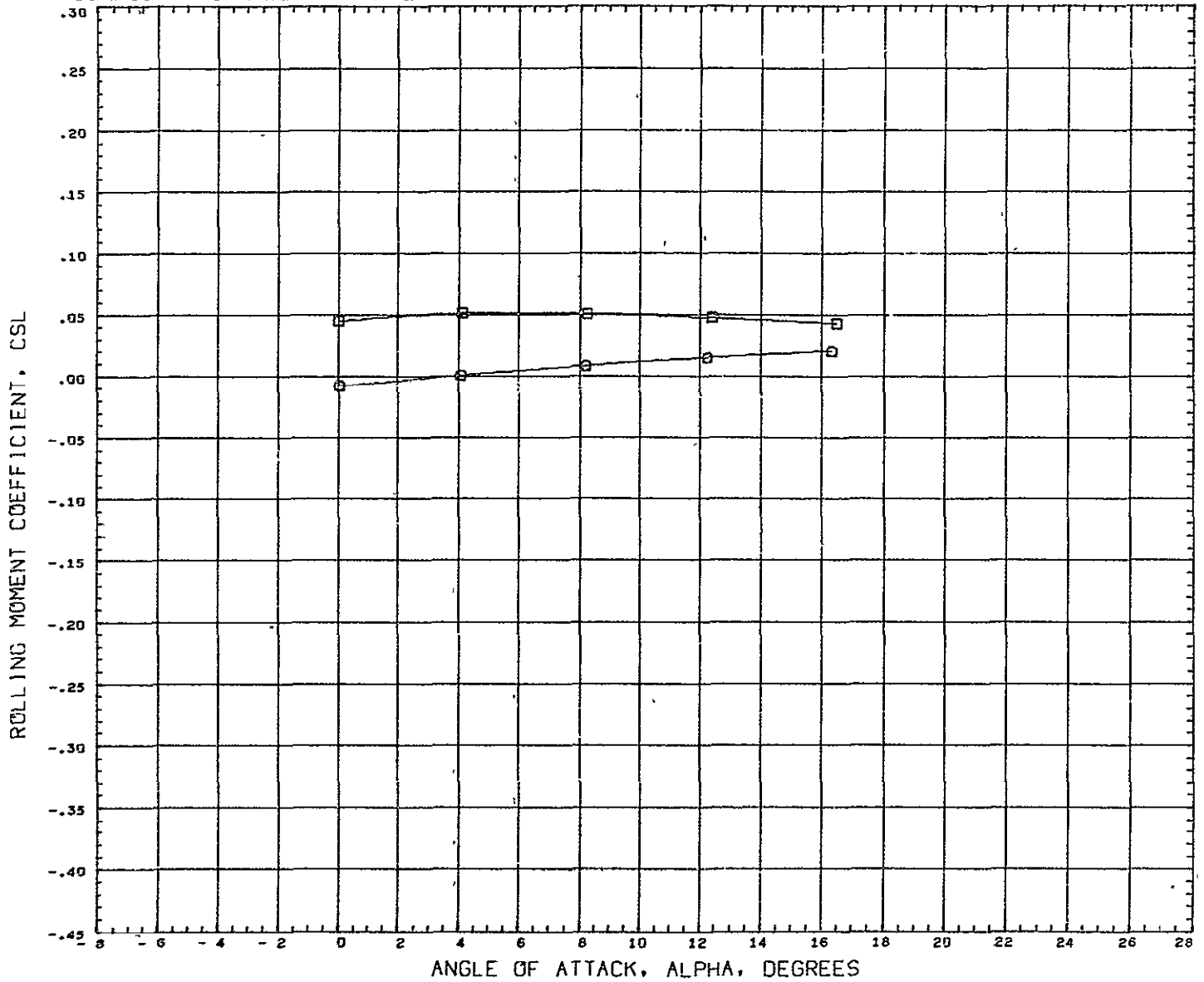

DATA SET SYMBOL    CONFIGURATION DESCRIPTION  
 (RC7114)    □    CVLSWT TEST 579-D B7  
 (RC7084)    □    CVLSWT TEST 579-D B7H5V1

PARAMETRIC VALUES  
 BETA    -    8.000

REFERENCE INFORMATION  
 REFS    316 2304    SQ IN  
 REFL    50.1900    IN  
 REFB    7 3500    IN  
 XMRP    33 9000    IN  
 YMRP    0.0000    IN  
 ZMRP    0 0000    IN  
 SCALE    0 0175

MACH    0.259

CONFIGURATION BUILDUP - LATERAL CHARACTERISTICS - DELTA WING - BETA=-4 DEG

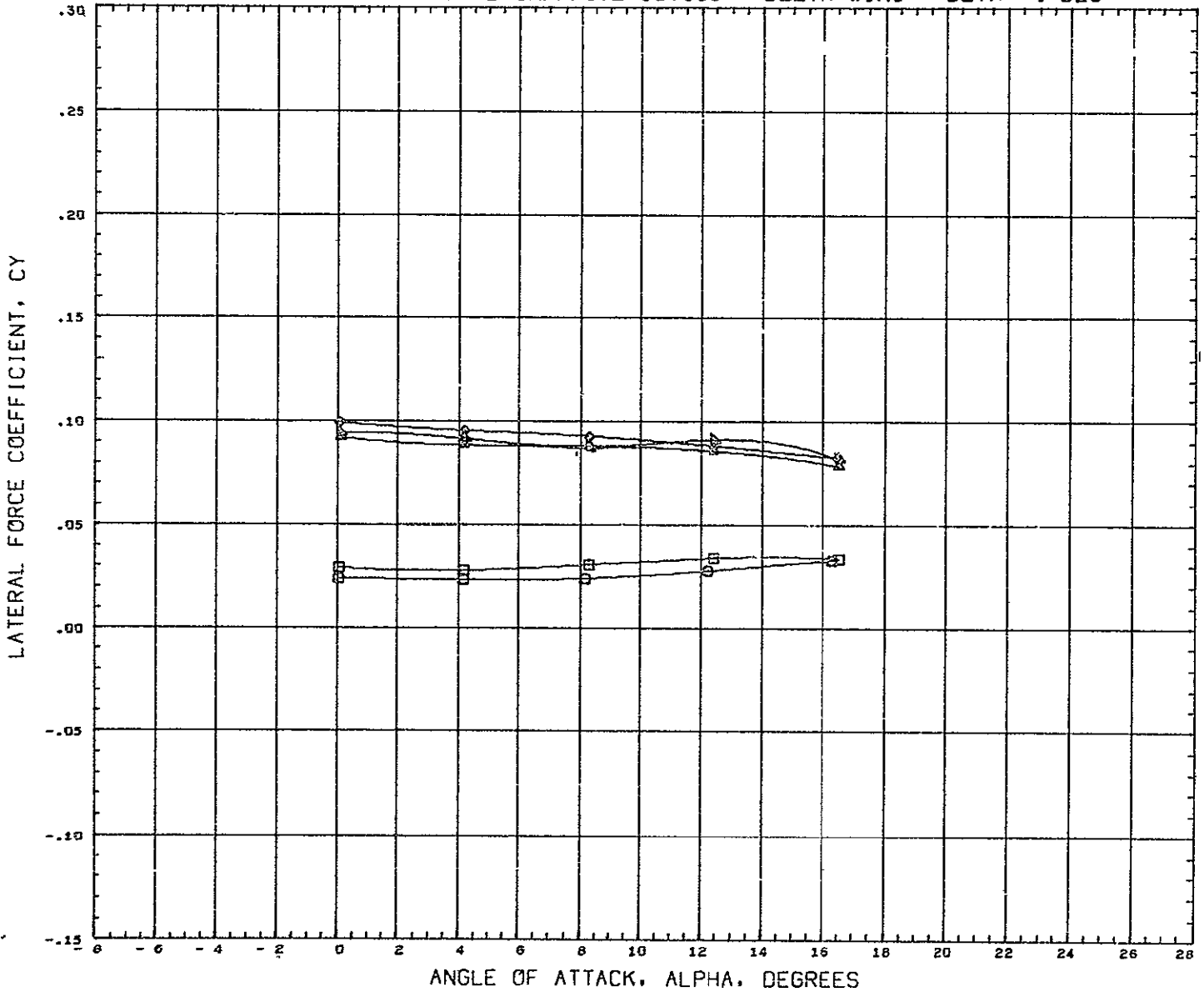

DATA SET SYMBOL	CONFIGURATION DESCRIPTION
(RC7115)	□ CVLSWT TEST 579-G B7
(RC7108)	□ CVLSWT TEST 579-G B7W5
(RC7085)	◇ CVLSWT TEST 579-G B7W5V1
(RC7103)	△ CVLSWT TEST 579-G B7W5V1E2
(RC7101)	▽ CVLSWT TEST 579-G B7W5V1E202

PARAMETRIC VALUES  
BETA - 4.000

REFERENCE INFORMATION		
REFS	316.2304	SQ IN
REFL	50.1900	IN
REFB	7.3500	IN
XHRF	33.9090	IN
YHRF	0.0000	IN
ZHRF	0.0000	IN
SCALE	0.0175	

MACH 0.259

CONFIGURATION BUILDUP - LATERAL CHARACTERISTICS - DELTA WING - BETA=-4 DEG

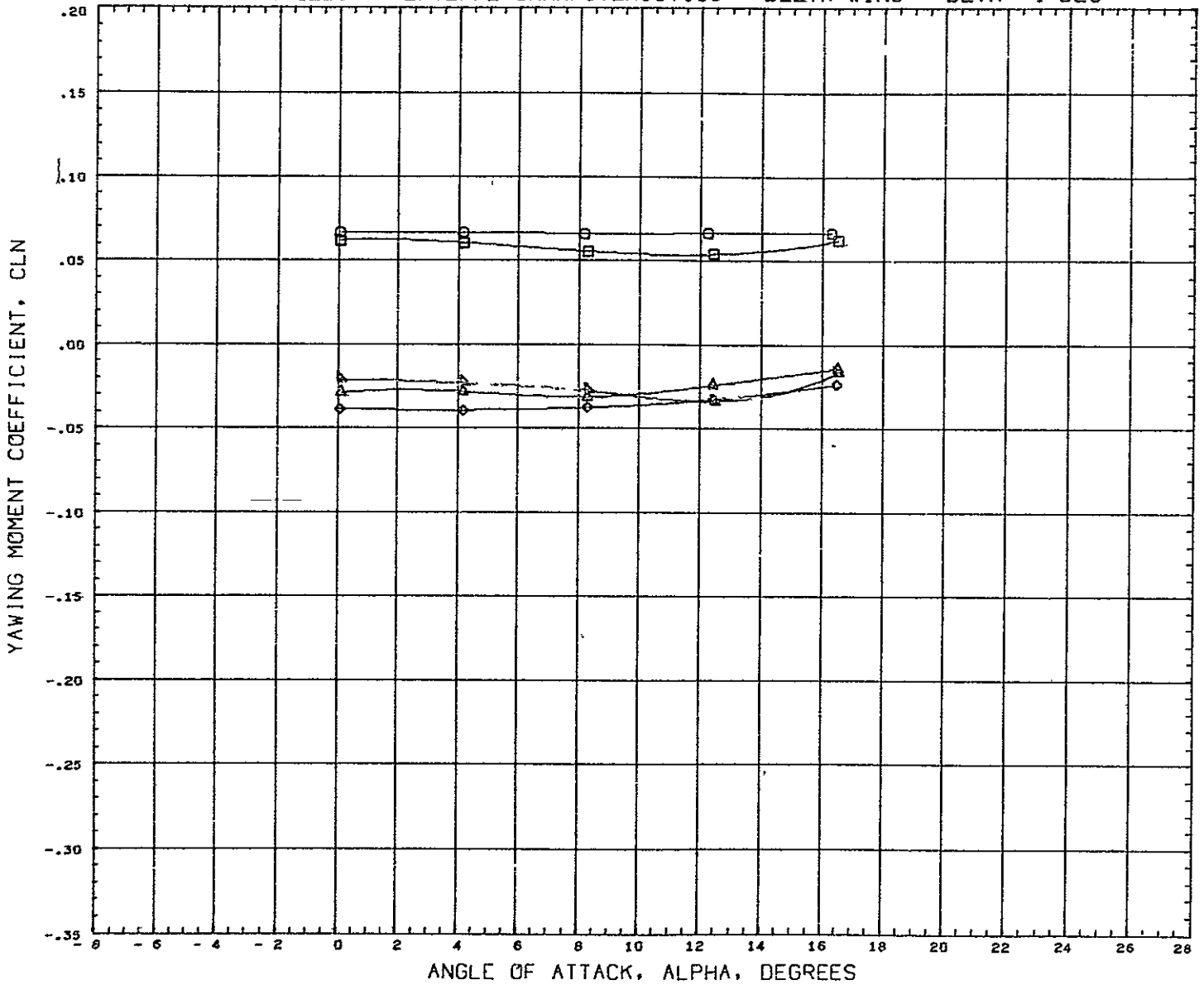

DATA SET SYMBOL	CONFIGURATION DESCRIPTION	PARAMETRIC VALUES	REFERENCE INFORMATION
(RC7115)	□ CVLSWT TEST 579-D B7	BETA - 4.000	REFS 316.2304 SQ IN
(RC7109)	□ CVLSWT TEST 579-D B7W5		REFL 50.1900 IN
(RC7085)	◇ CVLSWT TEST 579-D B7W3V1		REFB 7.3500 IN
(RC7103)	△ CVLSWT TEST 579-D B7W3V1E2		XMRP 33.9090 IN
(RC7101)	▽ CVLSWT TEST 579-D B7W3V1E2G2		YMRP 0.0000 IN
			ZMRP 0.0000 IN
			SCALE 0.0175

MACH 0.259

CONFIGURATION BUILDUP - LATERAL CHARACTERISTICS - DELTA WING - BETA=-4 DEG

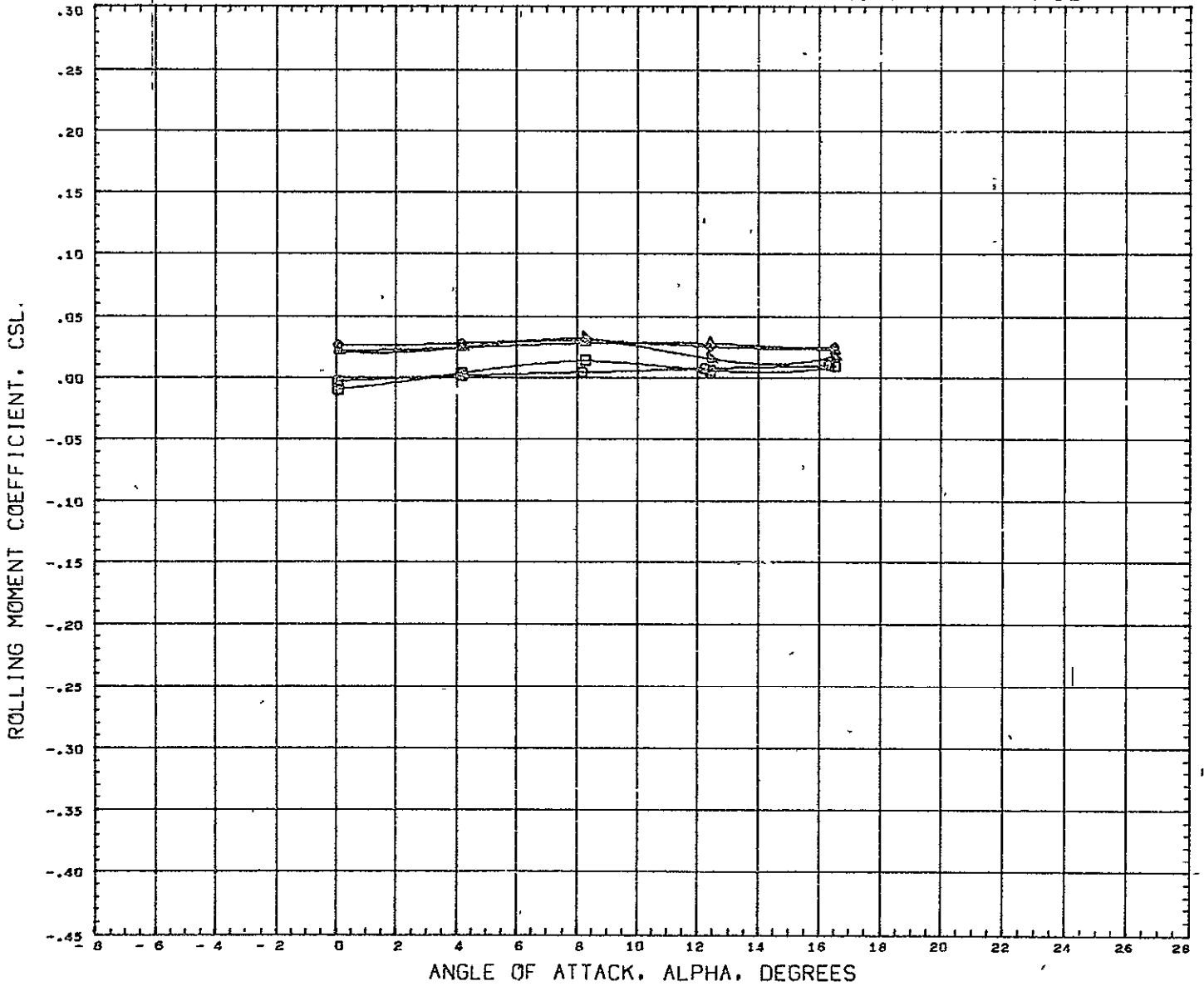

DATA SET SYMBOL	CONFIGURATION DESCRIPTION
(RC7115)	CVLSWT TEST 579-G B7
(RC7108)	CVLSWT TEST 579-G B7W5
(RC7085)	CVLSWT TEST 579-G B7W5V1
(RC7103)	CVLSWT TEST 579-G B7W5V1E2
(RC7101)	CVLSWT TEST 579-G B7W5V1E2G2

PARAMETRIC VALUES  
BETA - 4.000

REFERENCE INFORMATION		
REFS	316 2304	90° IN
REFL	50.1900	IN
REFB	7.3500	IN
XMRP	33.9090	IN
YMRP	0.0000	IN
ZMRP	0.0000	IN
SCALE	0 0175	

MACH 0.250

CONFIGURATION BUILDUP - LATERAL CHARACTERISTICS - DELTA WING - BETA=0 DEG

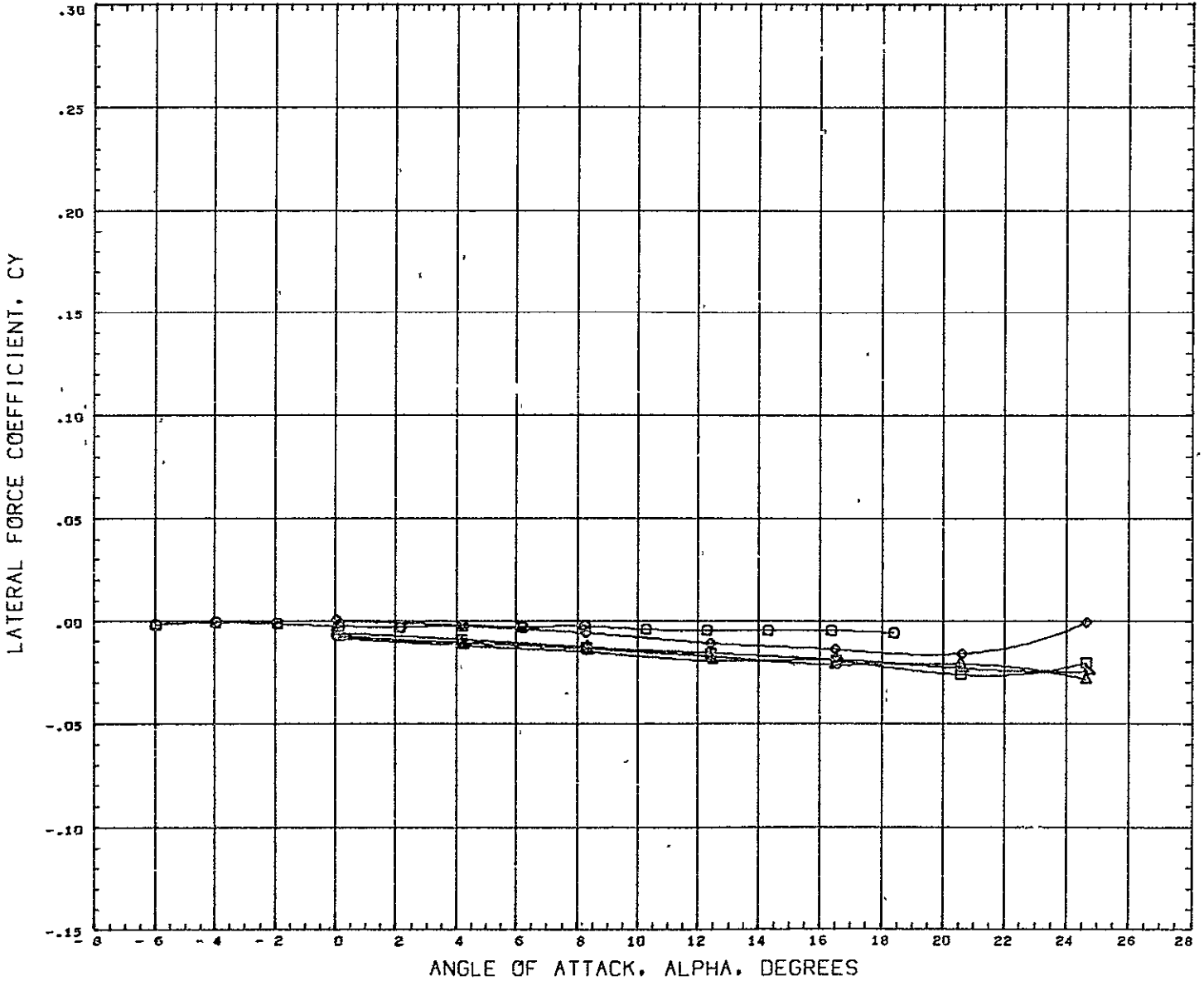

DATA SET SYMBOL	CONFIGURATION DESCRIPTION	PARAMETRIC VALUES	REFERENCE INFORMATION
(RC7113)	CVLSWT TEST 579-D B7	BETA 0 000	REFS 316.2304 SQ IN
(RC7109)	CVLSWT TEST 579-D B7W5		REFL 50 1900 IN
(RC7083)	CVLSWT TEST 579-D B7W5V1		REFB 7.3500 IN
(RC7102)	CVLSWT TEST 579-D B7W5V1E2		XMRFB 33.9090 IN
(RC7105)	CVLSWT TEST 579-D B7W5V1E2G2		YMRFB 0.0000 IN
			ZMRFB 0 0000 IN
			SCALE 0 0175

HACH: 0.259

CONFIGURATION BUILDUP - LATERAL CHARACTERISTICS - DELTA WING - BETA=0 DEG

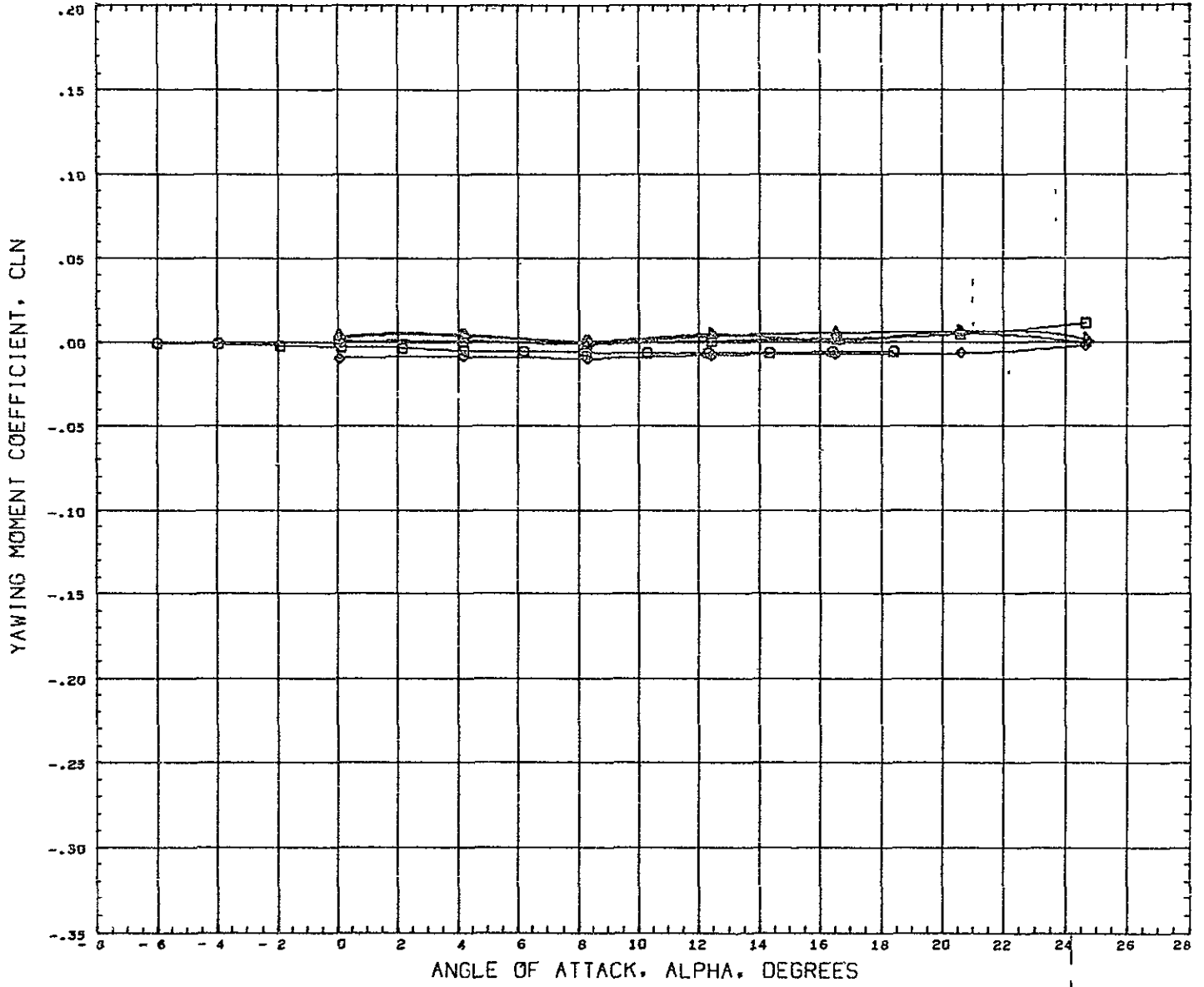

DATA SET SYMBOL	CONFIGURATION DESCRIPTION	PARAMETRIC VALUES	REFERENCE INFORMATION
(RC7113)	CVLSWT TEST 579-D B7	BETA 0.000	REFS 316 2304 SQ IN
(RC7109)	CVLSWT TEST 579-D B7W5		REFL 50 1900 IN
(RC7083)	CVLSWT TEST 579-D B7W5V1		REFB 7.3500 IN
(RC7102)	CVLSWT TEST 579-D B7W5V1E2		XMRF 33 9990 IN
(RC7100)	CVLSWT TEST 579-D B7W5V1E2G2		YMRF 0.0000 IN
			ZMRF 0.0000 IN
			SCALE 0.0175
MACH	0.259		



CONFIGURATION BUILDUP - LATERAL CHARACTERISTICS - DELTA WING - BETA=0 DEG

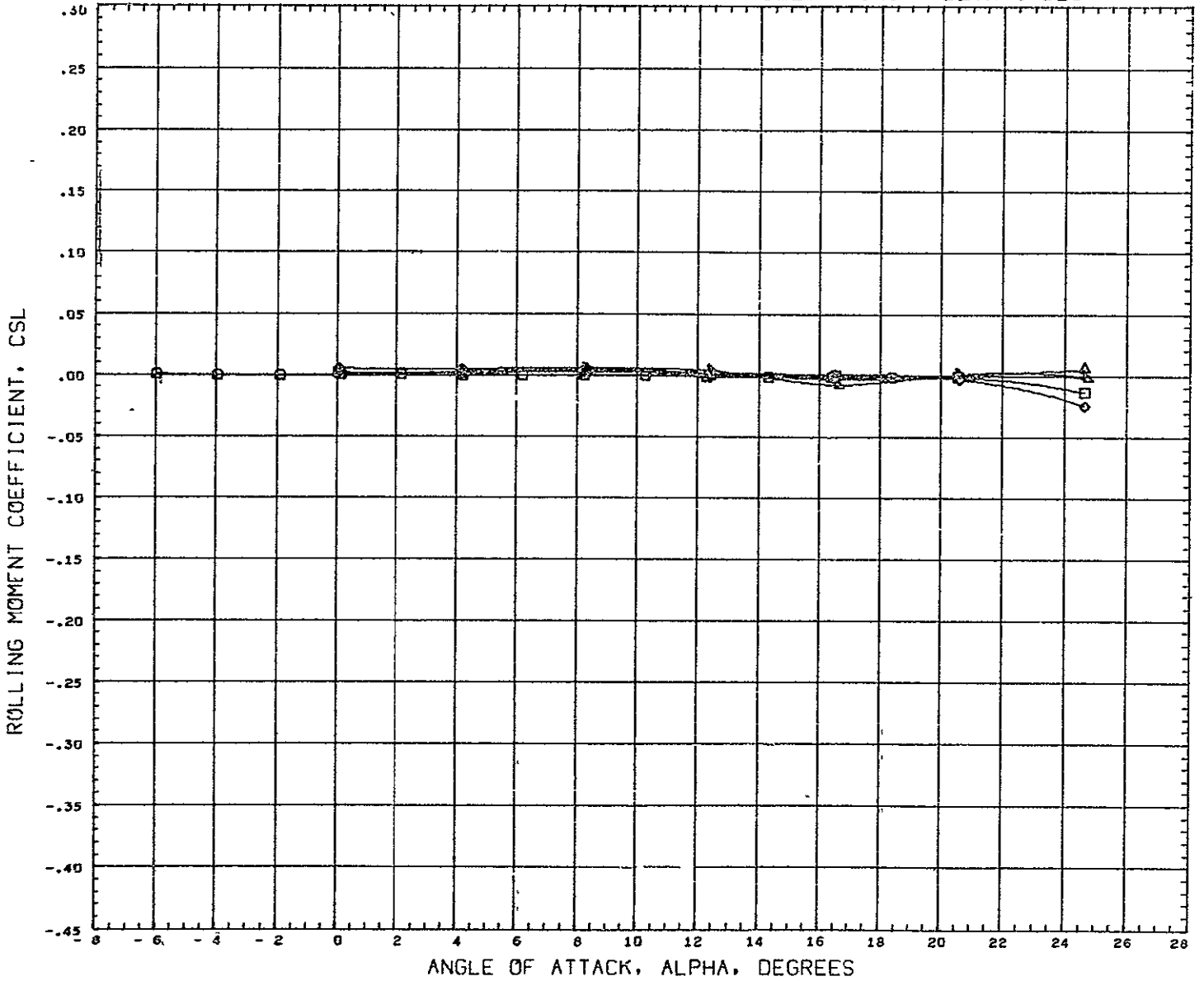

DATA SET	SYMBOL	CONFIGURATION DESCRIPTION
(RC7113)	○	CVLSWT TEST 579-D B7
(RC7109)	□	CVLSWT TEST 579-D B7W5
(RC7083)	◇	CVLSWT TEST 579-D B7W5V1
(RC7192)	△	CVLSWT TEST 579-D B7W5V1E2
(RC7190)	▽	CVLSWT TEST 579-D B7W5V1E2G2

BETA 0.000

REFERENCE INFORMATION		
REFS	316.2304	SQ IN
REFL	50.1900	IN
REFB	7.3500	IN
XMRF	33.9090	IN
YMRF	0.0000	IN
ZMRF	0.0000	IN
SCALE	0.0175	

MACH 0.259

# LATERAL CHARACTERISTICS - DELTA WING CONFIGURATIONS

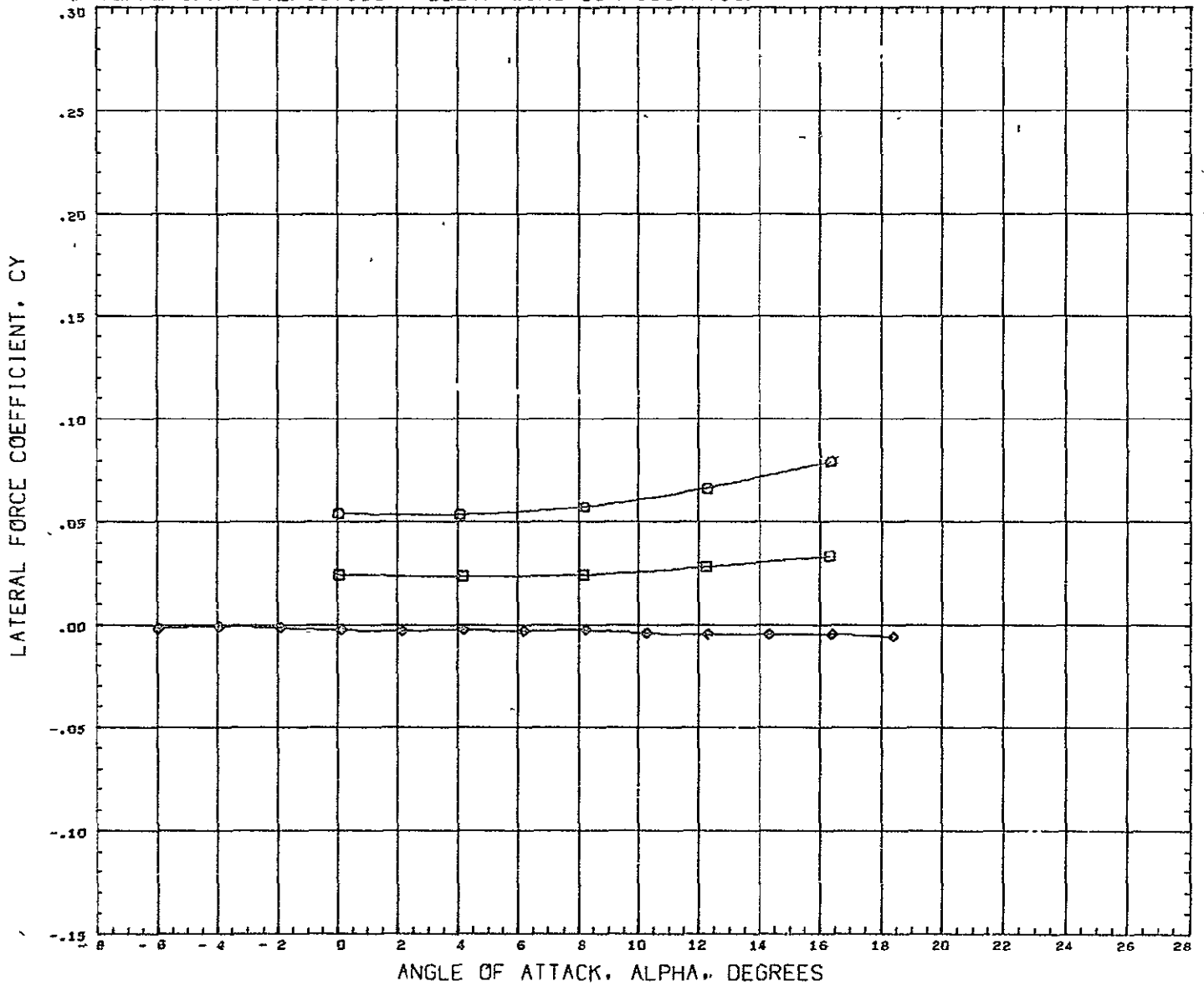

SYMBOL    BETA    MACH    PARAMETRIC VALUES  
 ◻        - 6.000           0.259  
 ◊        - 4.000  
 ◊        0.000

REFERENCE INFORMATION  
 REFS    316 2304    SQ IN  
 REFL    50.1900    IN  
 REFB    7.3500    IN  
 XNRF    33 9090    IN  
 YNRF    0.0000    IN  
 ZNRF    0.0000    IN  
 SCALE    0.0175

REFERENCE FILE    CONVAIR TN70-AE-12

# LATERAL CHARACTERISTICS - DELTA WING CONFIGURATIONS

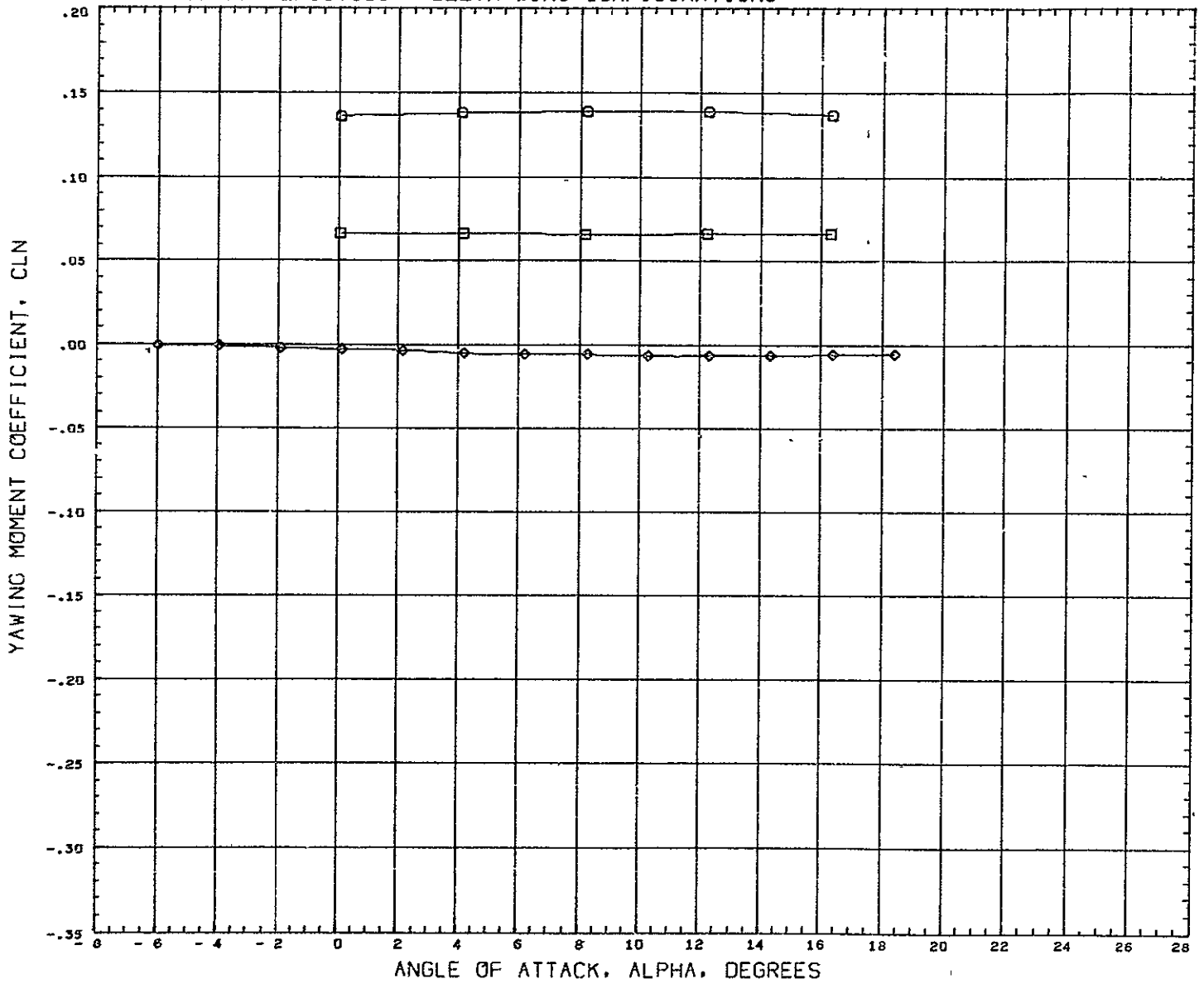

SYMBOL	BETA	PARAMETRIC VALUES
□	8.000	MACH 0.259
□	4.500	
◇	0.000	

REFERENCE INFORMATION		
REFS	316 2304	SB IN
REFL	50.1900	IN
REFB	7.3500	IN
XHRF	33 9090	IN
YHRF	0.0000	IN
ZHRF	0.0000	IN
SCALE	0.0175	

REFERENCE FILE      CONVAIR TN75-AE-12

# LATERAL CHARACTERISTICS - DELTA WING CONFIGURATIONS

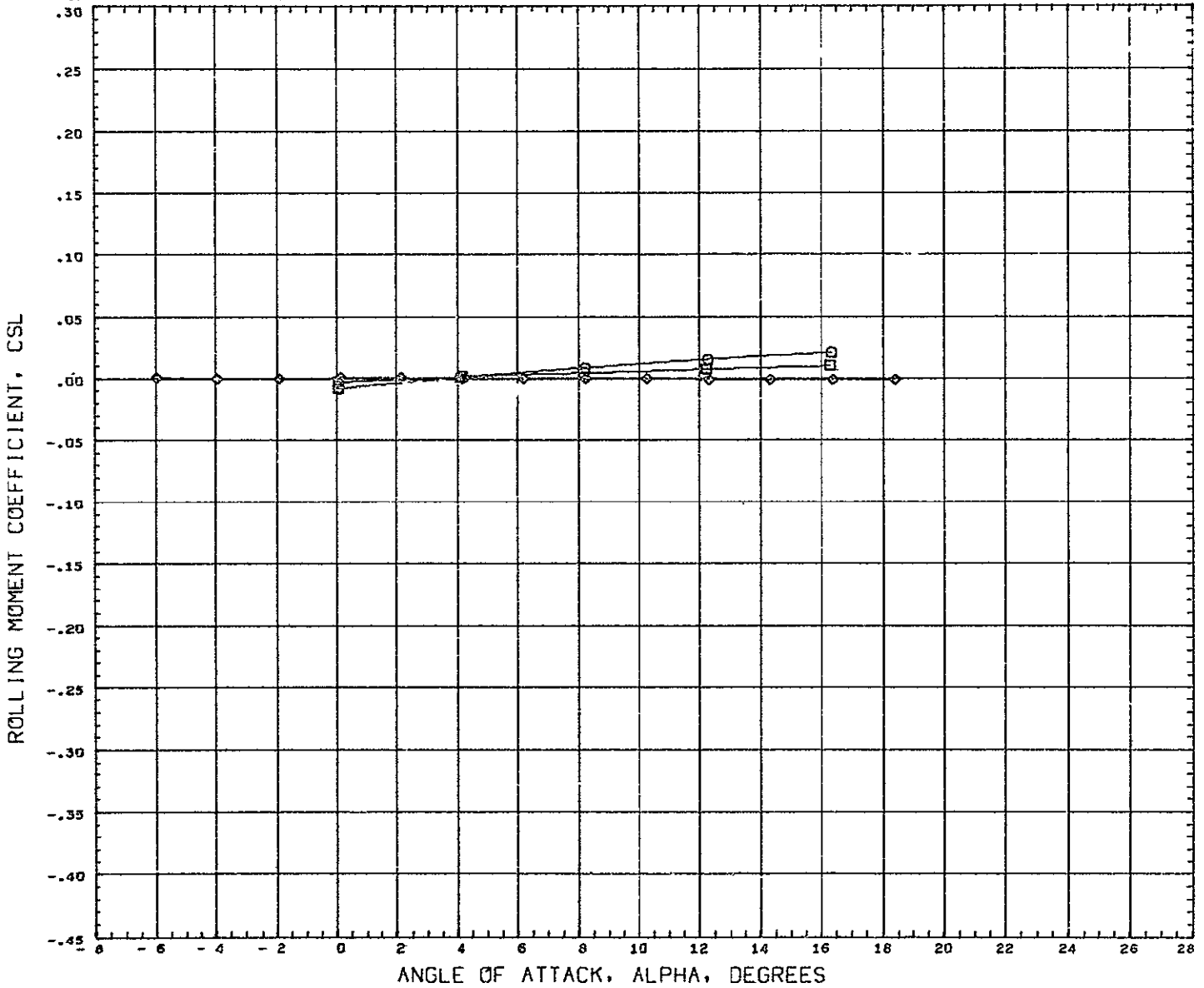

SYMBOL	BETA	PARAMETRIC VALUES
○	8.000 MACH	0.259
□	4.000	
◇	0.000	

REFERENCE INFORMATION		
REFS	316 2304	SG IN
REFL	50 1900	IN
REFB	7.3500	IN
XMRP	33 9090	IN
YMRP	0.0000	IN
ZMRP	0.0000	IN
SCALE	0.0175	

REFERENCE FILE      CONVAIR TN70-AE-12

# LATERAL CHARACTERISTICS - DELTA WING CONFIGURATIONS

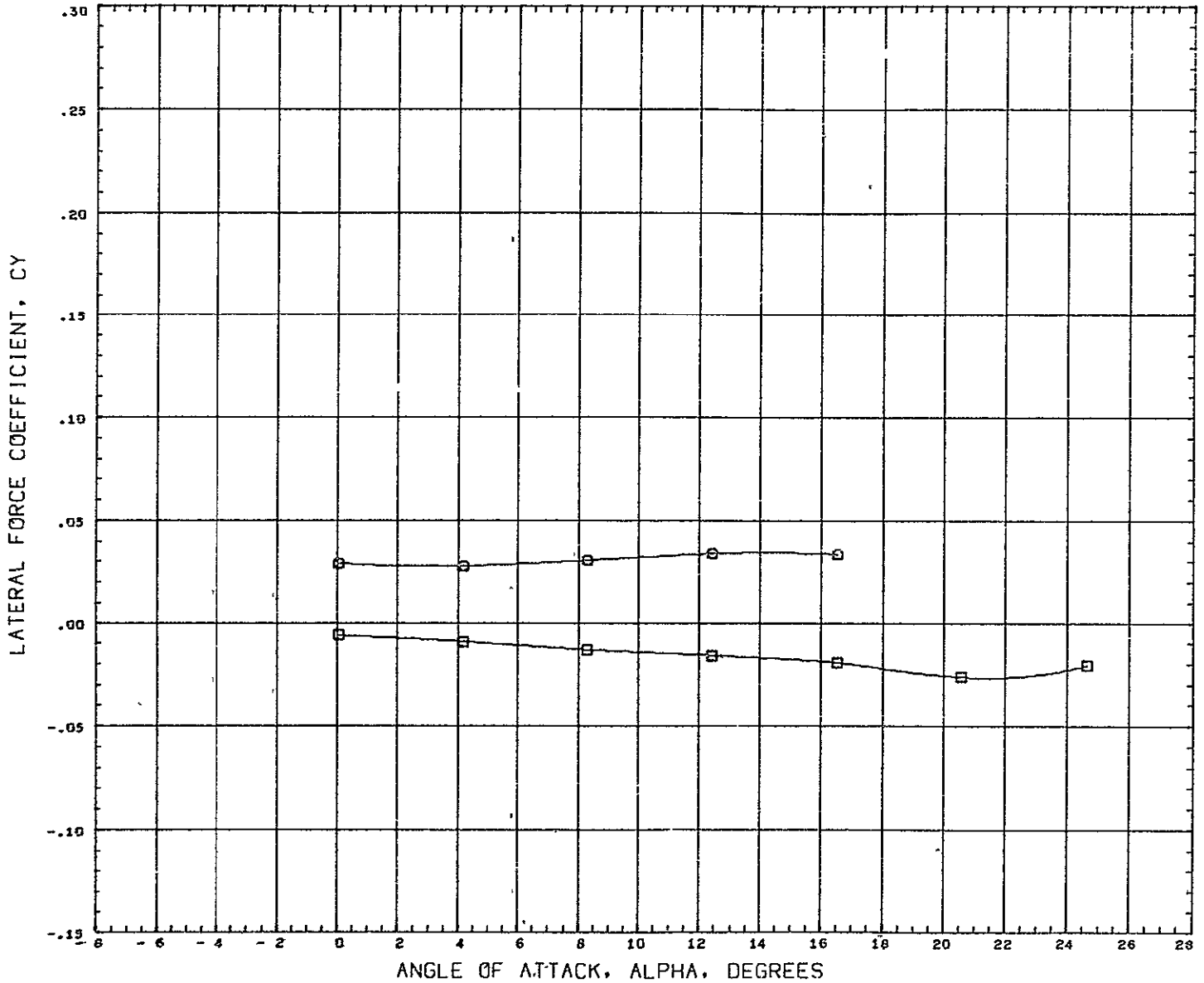

SYMBOL	BETA*	PARAMETRIC VALUES			
○	- 4.000	MACH	0.259	ELEVON	0.000
□	0.000	AILRON	0.000		

REFERENCE INFORMATION		
REFS	316 2304	SO IN
REFL	50 1900	IN
REFB	7.3500	IN
XMRP	33 9090	IN
YMRP	0 0000	IN
ZMRP	0.0000	IN
SCALE	0.0175	

REFERENCE FILE      CONVAIR TN70-AE-12

# LATERAL CHARACTERISTICS - DELTA WING CONFIGURATIONS

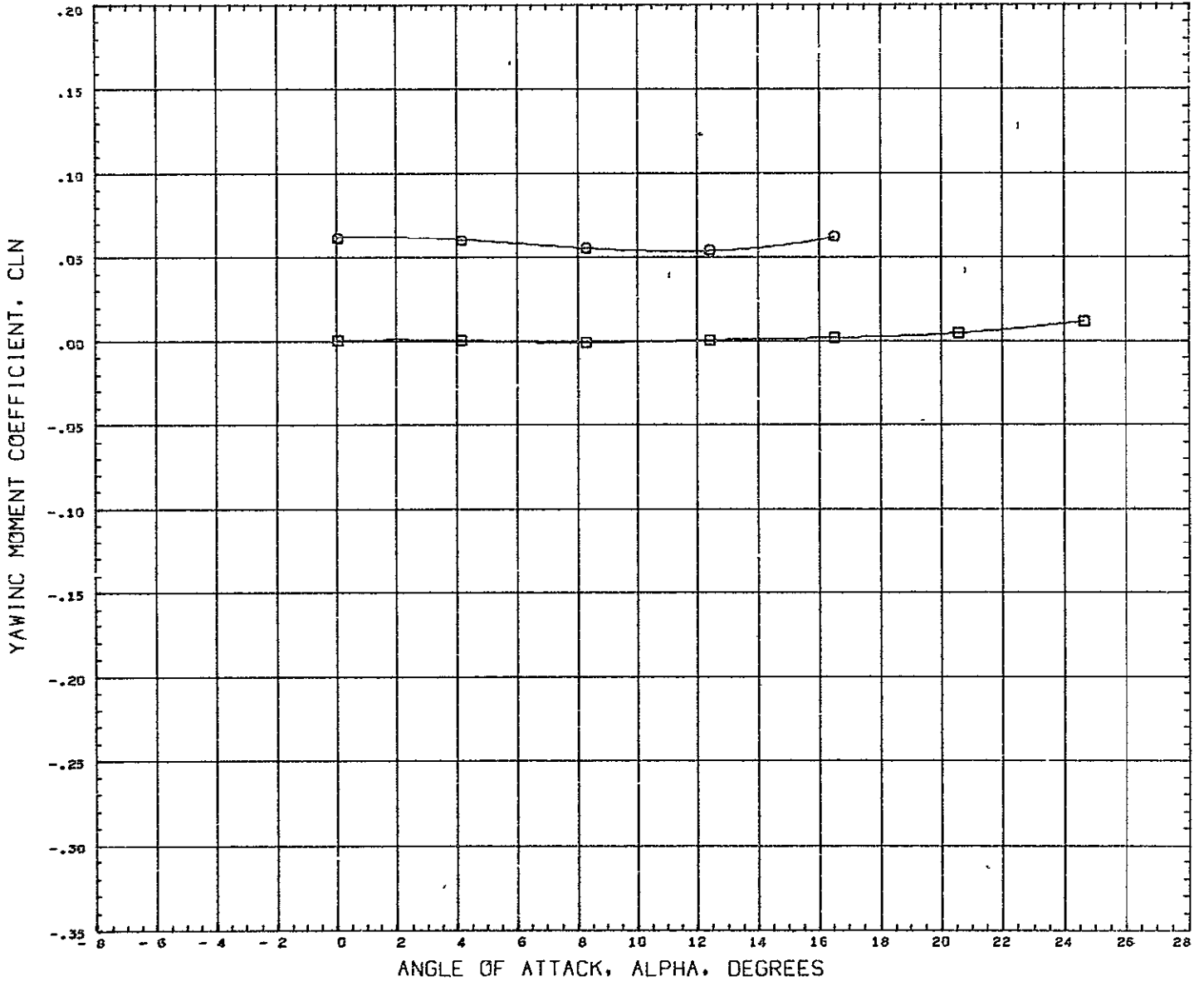

SYMBOL BETA PARAMETRIC VALUES  
 O - 4.000 MACH 0.259 ELEVON 0.000  
 □ 5.000 AILRON 0.000

REFERENCE INFORMATION  
 REFS 316.2304 SQ IN  
 REFL 50.1900 IN  
 REFB 7.3500 IN  
 XMRF 33.9000 IN  
 YMRF 0.0000 IN  
 ZMRF 0.0000 IN  
 SCALE 0.0175

REFERENCE FILE CONVAIR TN70-AE-12

# LATERAL CHARACTERISTICS - DELTA WING CONFIGURATIONS

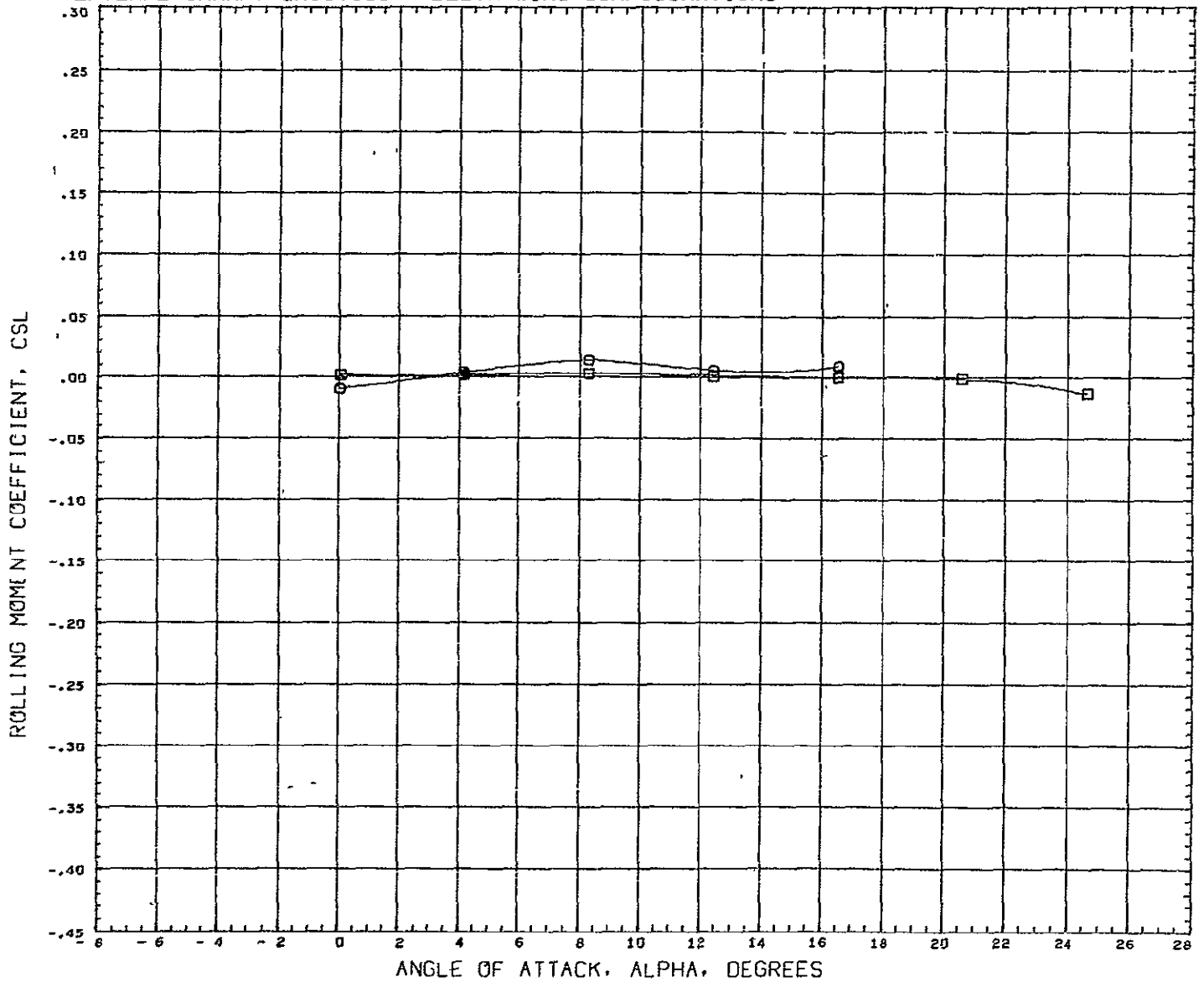

SYMBOL	BETA	PARAMETRIC VALUES			
○	4.000	MACH	0.259	ELEVON	0.000
□	5.000	AILRON	0.000		

REFERENCE INFORMATION		
REFS	316 2304	SQ IN
REFL	59.1900	IN
REFB	7.3500	IN
XMRP	33.9090	IN
YMRP	0.0000	IN
ZMRP	0.0000	IN
SCALE	0.0175	

REFERENCE FILE      CONVAIR IN70-AE-12

# LATERAL CHARACTERISTICS - DELTA WING CONFIGURATIONS

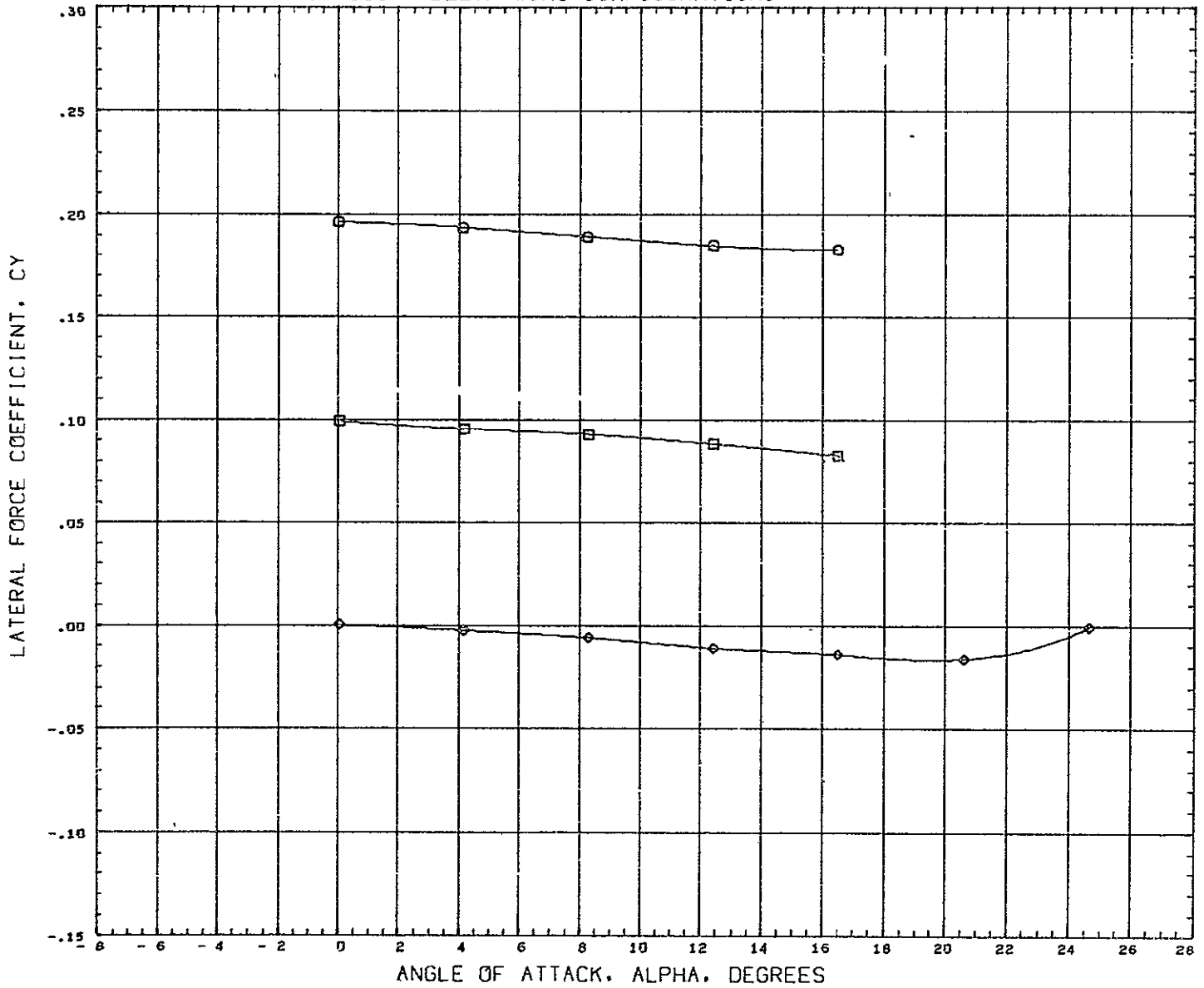

SYMBOL	BETA	PARAMETRIC VALUES			
□	8.000	MACH	0.259	ELEVON	0.000
□	4.000	AILERON	0.000	RUDDER	0.000
◇	0.000				

REFERENCE INFORMATION		
REFS	316.2304	SQ IN
REFL	50.1900	IN
REFB	7.3500	IN
XMRP	33.9090	IN
YMRP	0.0000	IN
ZMRP	0.0000	IN
SCALE	0.0175	

REFERENCE FILE CONVAIR TN79-AE-12



# LATERAL CHARACTERISTICS - DELTA WING CONFIGURATIONS

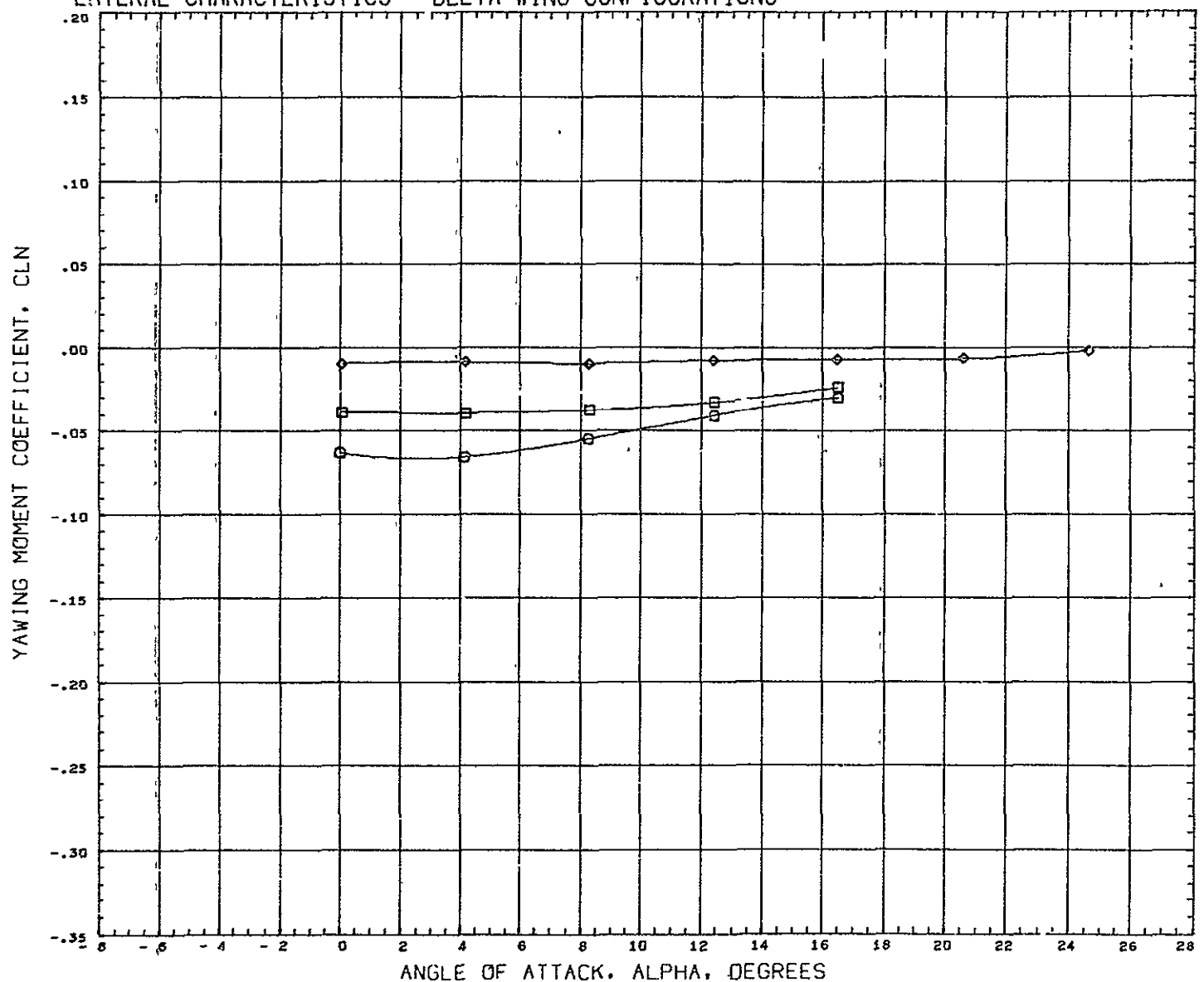

SYMBOL	BETA	PARAMETRIC VALUES				REFERENCE INFORMATION		
○	6.000	NACH	0.259	ELEVON	0.500	REFS	316 2304	SQ IN
□	4.000	AILRON	0.000	RUDDER	0.000	REFL	50.1900	IN
◇	0.000					REFB	7 3500	IN
						XMRP	33 9090	IN
						YMRP	0.0000	IN
						ZMRP	0.0000	IN
						SCALE	0 0175	

REFERENCE FILE    CONVAIR TN70-AE-12

# LATERAL CHARACTERISTICS - DELTA WING CONFIGURATIONS

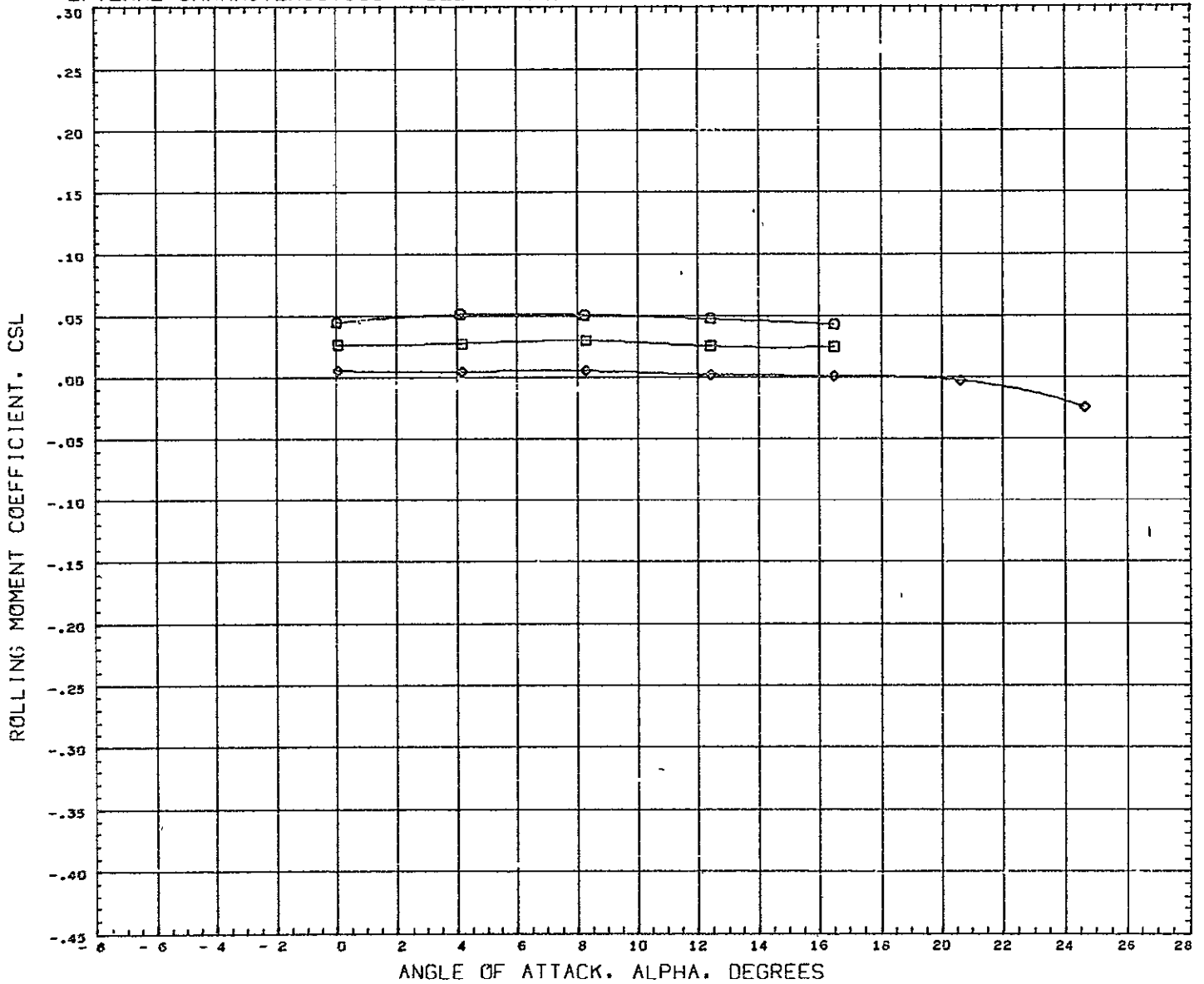

SYMBOL	BETA	PARAMETRIC VALUES			
O	8.000	HACH	0.259	ELEVON	0.000
□	4.000	AILRON	0.000	RUDDEF	0.000
◇	0.000				

REFERENCE INFORMATION		
REFS	316.2304	SQ IN
REFL	50.1900	IN
REFB	7.3500	IN
XMRP	33.9090	IN
YMRP	0.0000	IN
ZMRP	0.0000	IN
SCALE	0.0175	

REFERENCE FILE CONVAIR TN70-AE-12

# LATERAL CHARACTERISTICS - DELTA WING CONFIGURATIONS

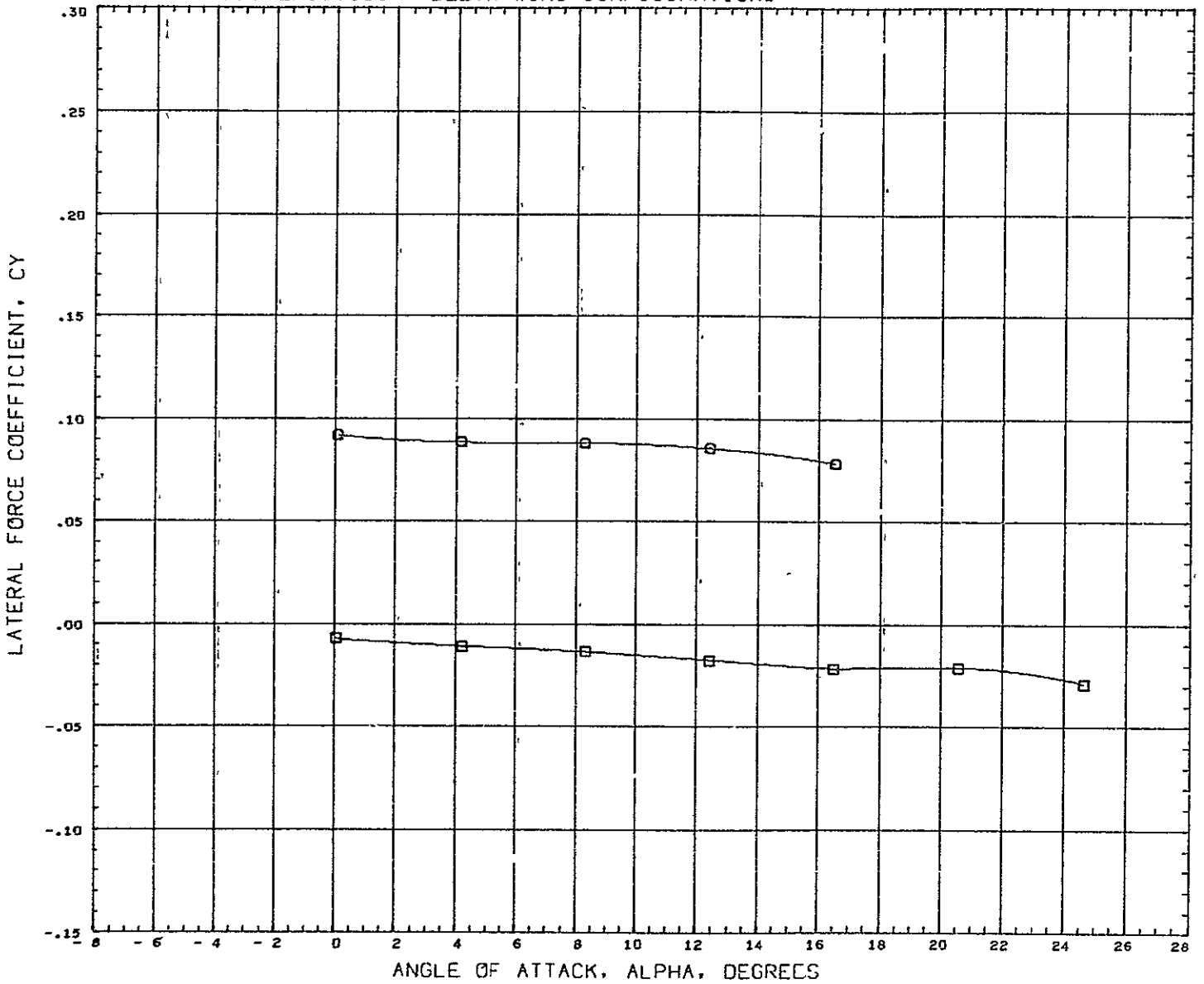

SYMBOL	BETA	PARAMETRIC VALUES			
C	4.000	MACH	0.259	ELEVON	0.000
□	0.000	AILRON	0.000	RUDDER	0.000

REFERENCE INFORMATION		
REFS	316.2304	SQ IN
REFL	50 1900	IN
REFB	7.3500	IN
XNRF	33 9690	IN
YNRF	0 0600	IN
ZNRF	0 0600	IN
SCALE	0.0175	

REFERENCE FILE      CONVAIR TN75-AE-12

# LATERAL CHARACTERISTICS - DELTA WING CONFIGURATIONS

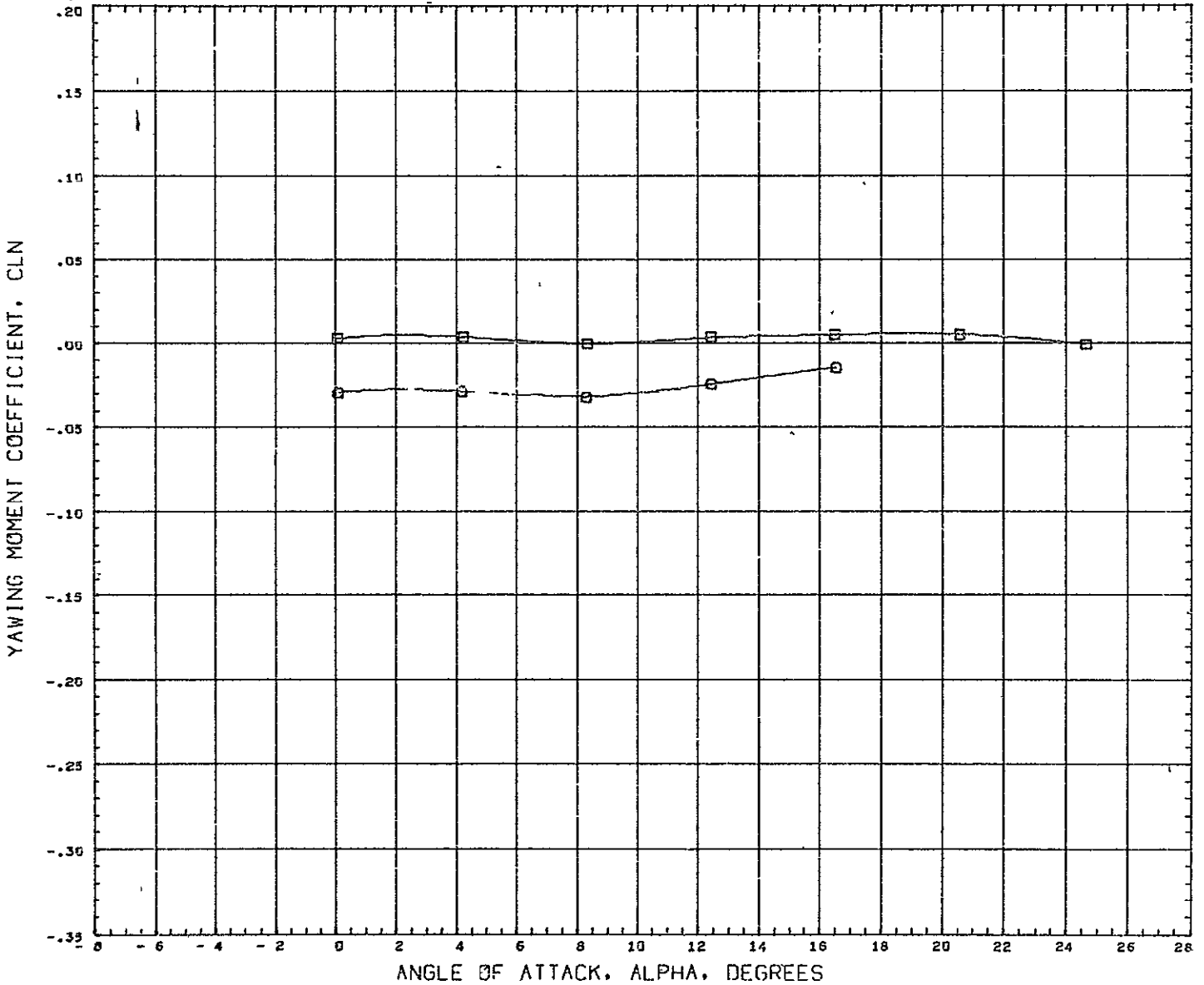

SYMBOL	BETA	PARAMETRIC VALUES			
○	4.000	MACH	0.259	ELEVON	0.000
□	0.000	AILRON	0.000	RUDDEF	0.000

REFERENCE INFORMATION		
REFS	316 2304	SQ IN
REFL	50 1900	IN
REFB	7.3500	IN
XMRP	33.9000	IN
YMRP	0.0000	IN
ZMRP	0.0000	IN
SCALE	0.0175	

REFERENCE FILE    CONVAIR TN70-AE-12

# LATERAL CHARACTERISTICS - DELTA WING CONFIGURATIONS

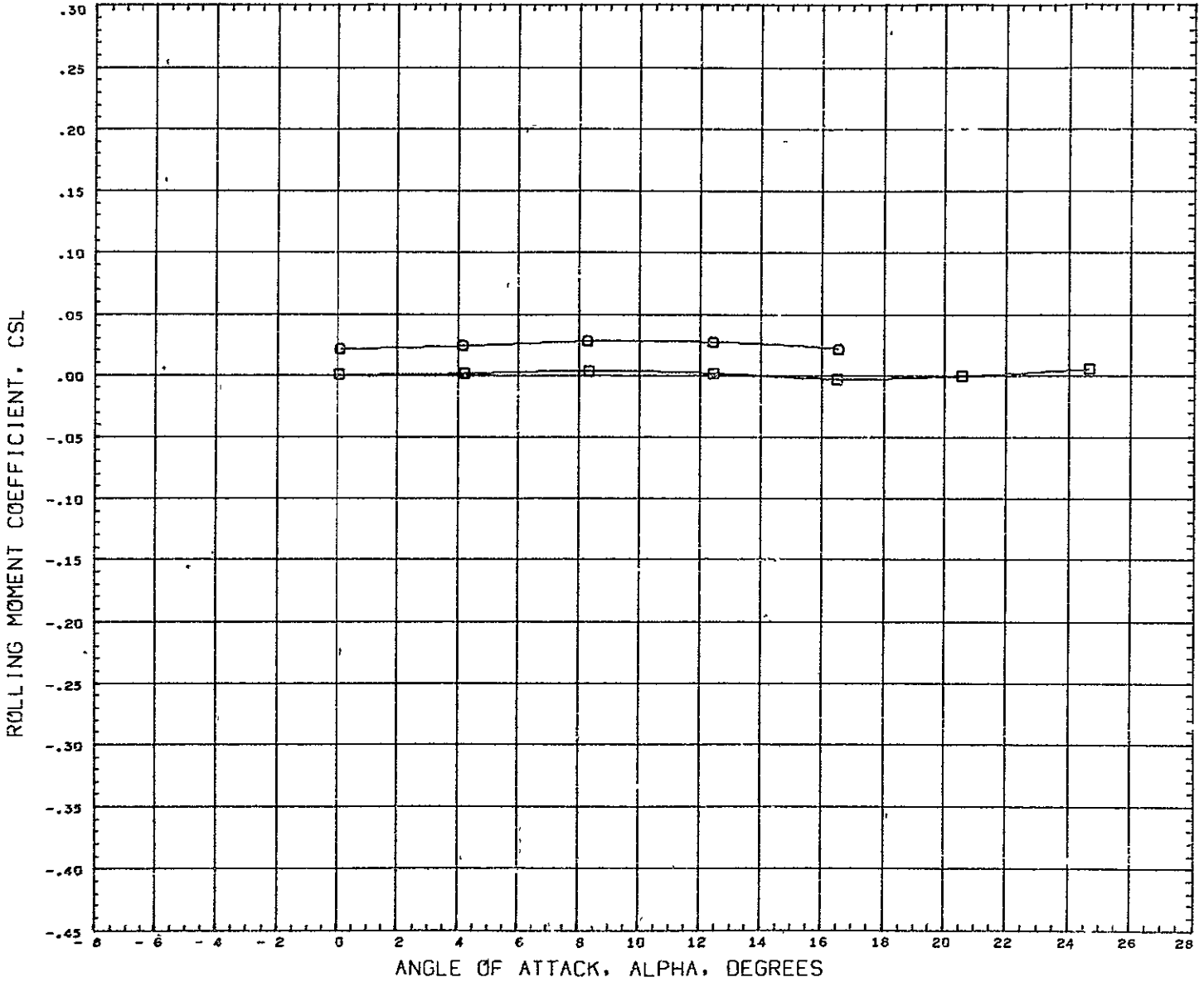

SYMBOL	BETA	PARAMETRIC VALUES			
D	4.000	MACH	0.259	ELEVON	0.000
□	0.000	AILERON	0.000	RUDDER	0.000

REFERENCE INFORMATION		
REFS	316 2304	SQ IN
REFL	50.1900	IN
REFB	7.3500	IN
XNRF	33.9090	IN
YNRF	0.0000	IN
ZNRF	0.0000	IN
SCALE	0.0175	

REFERENCE FILE CONVAI= IN70-AE-12

# LATERAL CHARACTERISTICS - DELTA WING CONFIGURATIONS

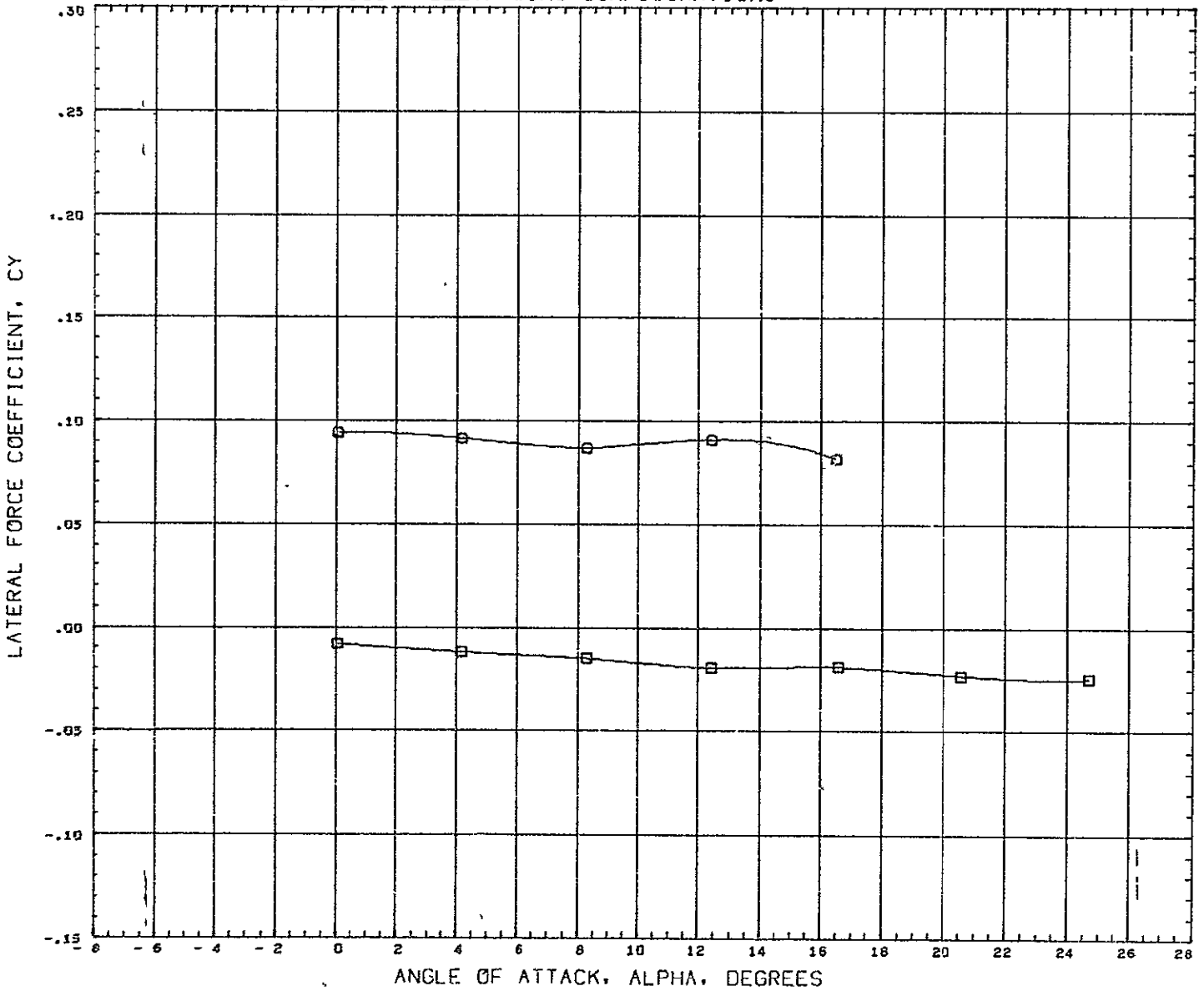

SYMBOL	BETA	PARAMETRIC VALUES			
○	4.000	MACH	0.259	ELEVON	0.000
□	0.000	AILRON	0.000	RUDDER	0.000

REFERENCE INFORMATION		
REFS	316.2304	SQ IN
REFL	50.1900	IN
REFB	7.3500	IN
XMRP	33.9090	IN
YMRP	0.0000	IN
ZMRP	0.0000	IN
SCALE	0.0175	

REFERENCE FILE    CONVAIR TN70-AE-12

# LATERAL CHARACTERISTICS - DELTA WING CONFIGURATIONS

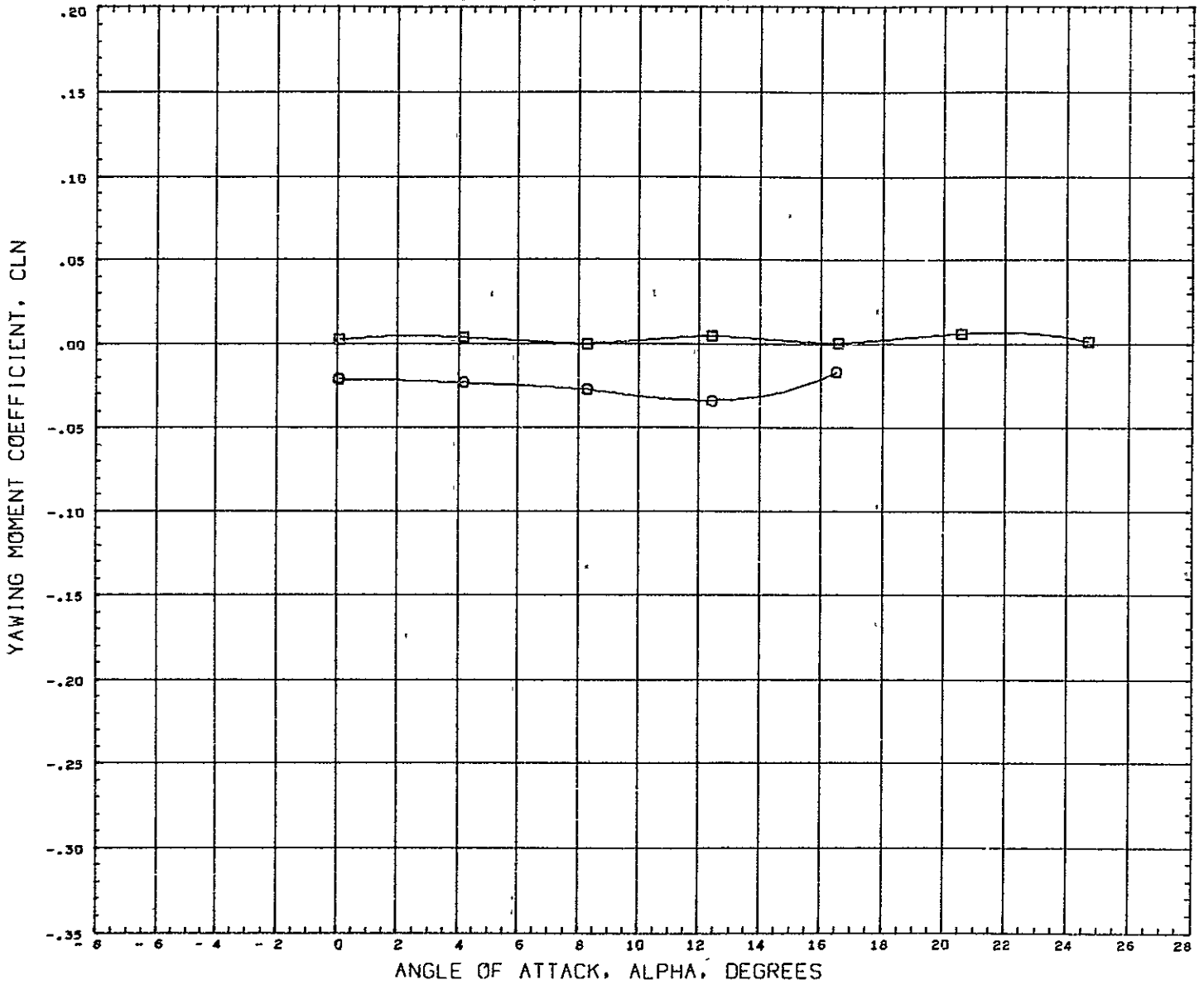

SYMBOL	BETA	PARAMETRIC VALUES			
○	4.000	MACH	0.259	ELEVON	0.000
□	0.000	AILRON	0.000	RUDDER	0.000

REFERENCE INFORMATION		
REFS	316.2304	SQ IN
REFL	50.1900	IN
REFB	7.3500	IN
XMRP	33.9090	IN
YMRP	0.0000	IN
ZMRP	0.0000	IN
SCALE	0.0175	

REFERENCE FILE    CONVAIR TN70-AE-12

# LATERAL CHARACTERISTICS - DELTA WING CONFIGURATIONS

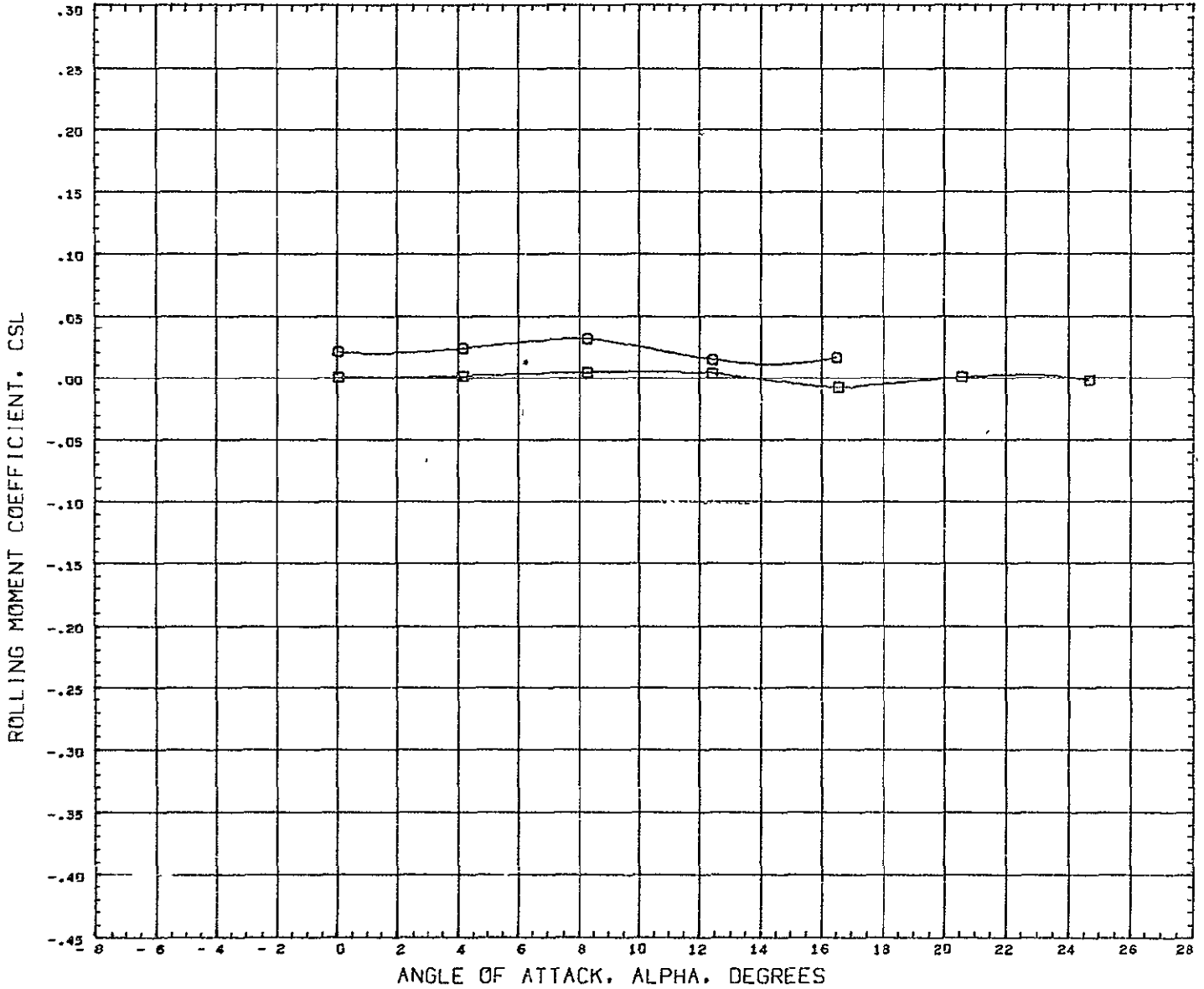

SYMBOL	BETA	PARAMETRIC VALUES			
○	4.000	MACH	0.259	ELEVON	0.000
□	0.000	AILRON	0.000	RUDDER	0.000

REFERENCE INFORMATION		
REFS	316.2304	SQ IN
REFL	50 1900	IN
REFB	7 3500	IN
ANRP	33 9090	IN
YMRF	0 0000	IN
ZMRF	0.0000	IN
SCALE	0 0175	

REFERENCE FILE CONVAIR TN79-AE-12



# CONFIGURATION BUILDUP - SIDESLIP DERIVATIVES - DELTA WING

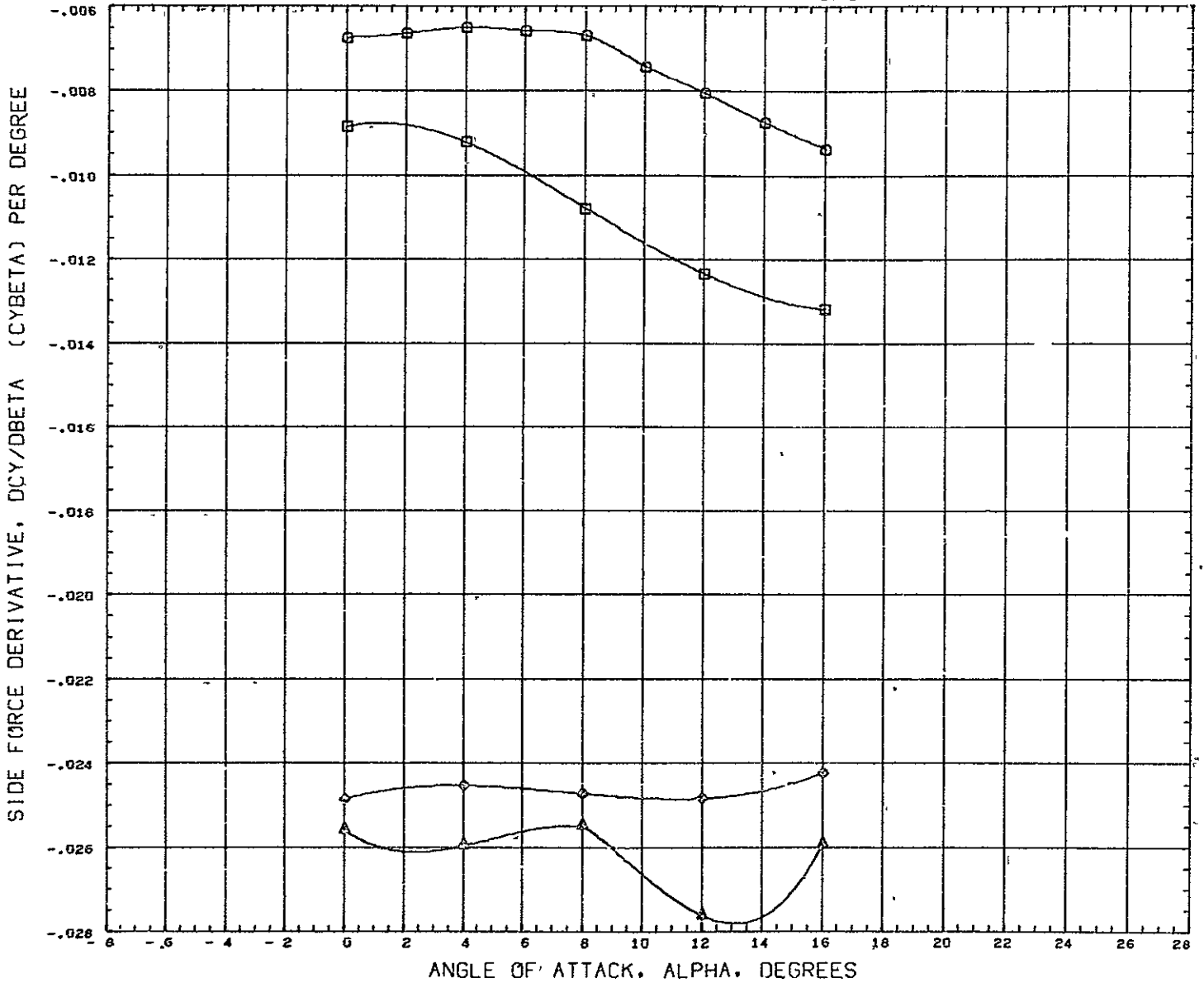

DATA SET SYMBOL, CONFIGURATION DESCRIPTION  
 (DB7113) □ CVLSWT TEST 579-G B7  
 (DB7109) □ CVLSWT TEST 579-G B7W5  
 (DB7083) ◊ CVLSWT TEST 579-G B7W5V1  
 (DB7100) Δ CVLSWT TEST 579-G B7W5V1E2G2

PARAMETRIC VALUES  
 BETA 0.000

REFERENCE INFORMATION  
 REFS 316.2304 SQ IN  
 REFL 50.1900 IN  
 REFB 7.3500 IN  
 XMRP 33.9090 IN  
 YMRP 0.0000 IN  
 ZMRP 0.0000 IN  
 SCALE 0.0175

MACH 0.259

CONFIGURATION BUILDUP - SIDESLIP DERIVATIVES - DELTA WING

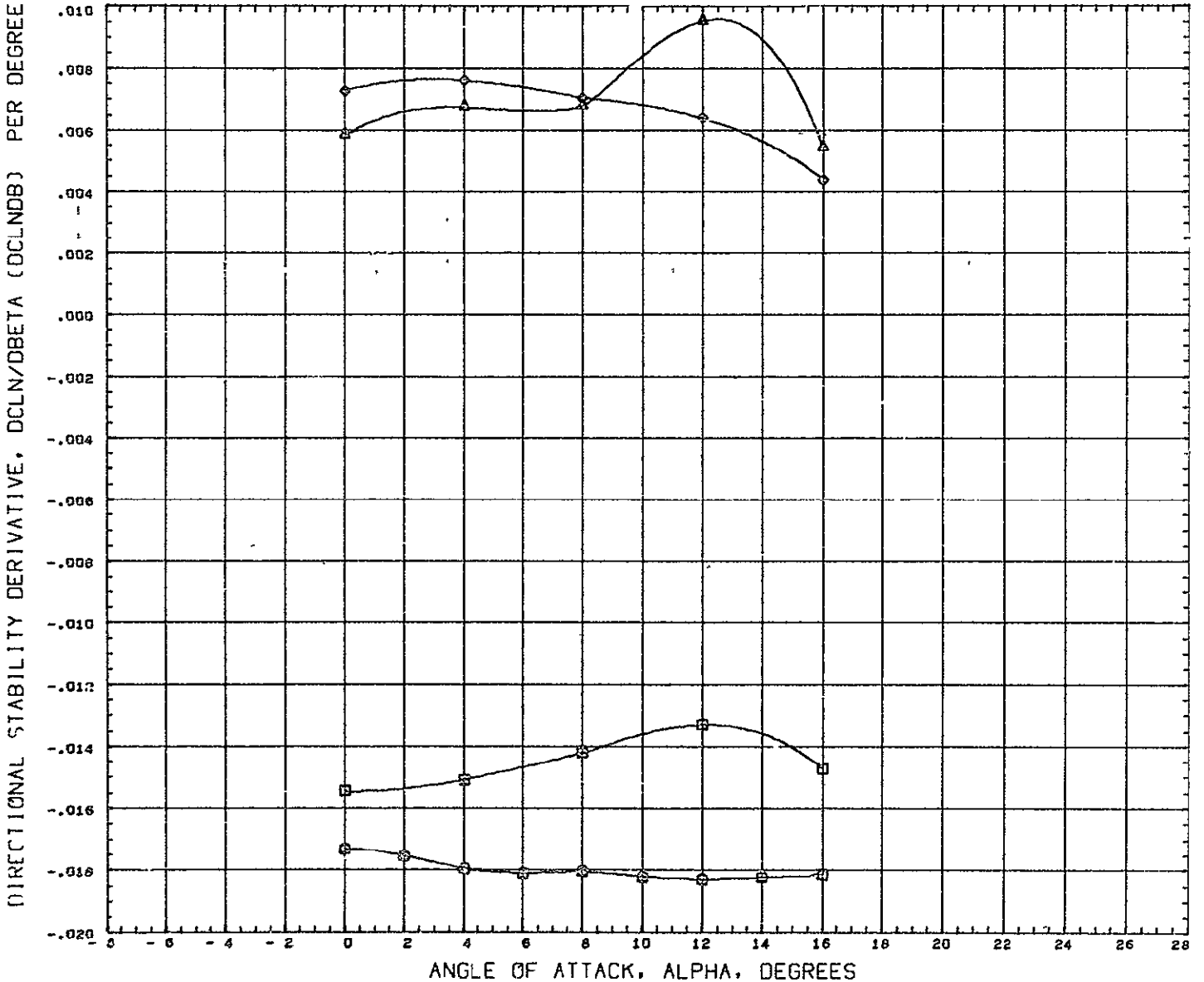

DATA SET SYMBOL	CONFIGURATION DESCRIPTION	PARAMETRIC VALUES	REFERENCE INFORMATION
(DB7113)	○ CVLSWT TEST 579-D B7	BETA 0.000	REFS 316.2304 SQ IN
(DB7109)	□ CVLSWT TEST 579-D B7W3		REFL 50.1900 IN
(DB7083)	○ CVLSWT TEST 579-D B7W3V1		REFB 7.3500 IN
(DB7100)	△ CVLSWT TEST 579-D B7W3V1E262		XMRP 33.9090 IN
			YMRP 0.0000 IN
			ZMRP 0.0000 IN
			SCALE 0.0175

MACH 0.259

# CONFIGURATION BUILDUP - SIDESLIP DERIVATIVES - DELTA WING

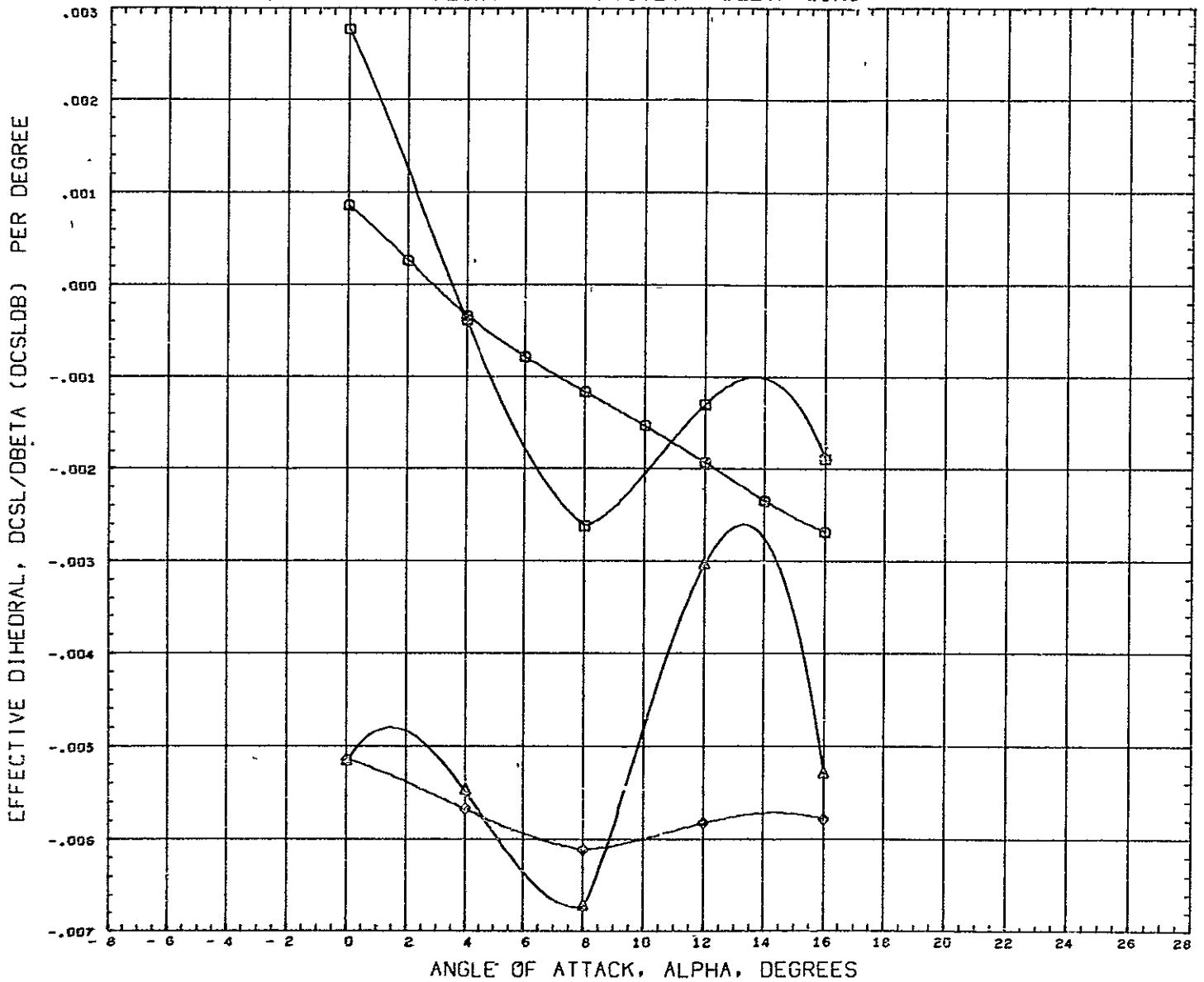

DATA SET SYMBOL	CONFIGURATION DESCRIPTION
(DB7113)	$\circ$ CVLSWT TEST 579-0 B7
(DB7109)	$\square$ CVLSWT TEST 579-0 B7W3
(DB7083)	$\diamond$ CVLSWT TEST 579-0 B7W5V1
(DB7100)	$\triangle$ CVLSWT TEST 579-0 B7W5V1E2G2

PARAMETRIC VALUES  
BETA 0.000

REFERENCE INFORMATION		
REFS	316.2304	SQ IN
REFL	50.1900	IN
REFB	7.3500	IN
XMRP	33.9090	IN
YMRP	0.0000	IN
ZMRP	0.0000	IN
SCALE	0.0175	

MACH 0.259

# LONGITUDINAL CHARACTERISTICS - ELEVON EFFECTIVENESS - DELTA WING

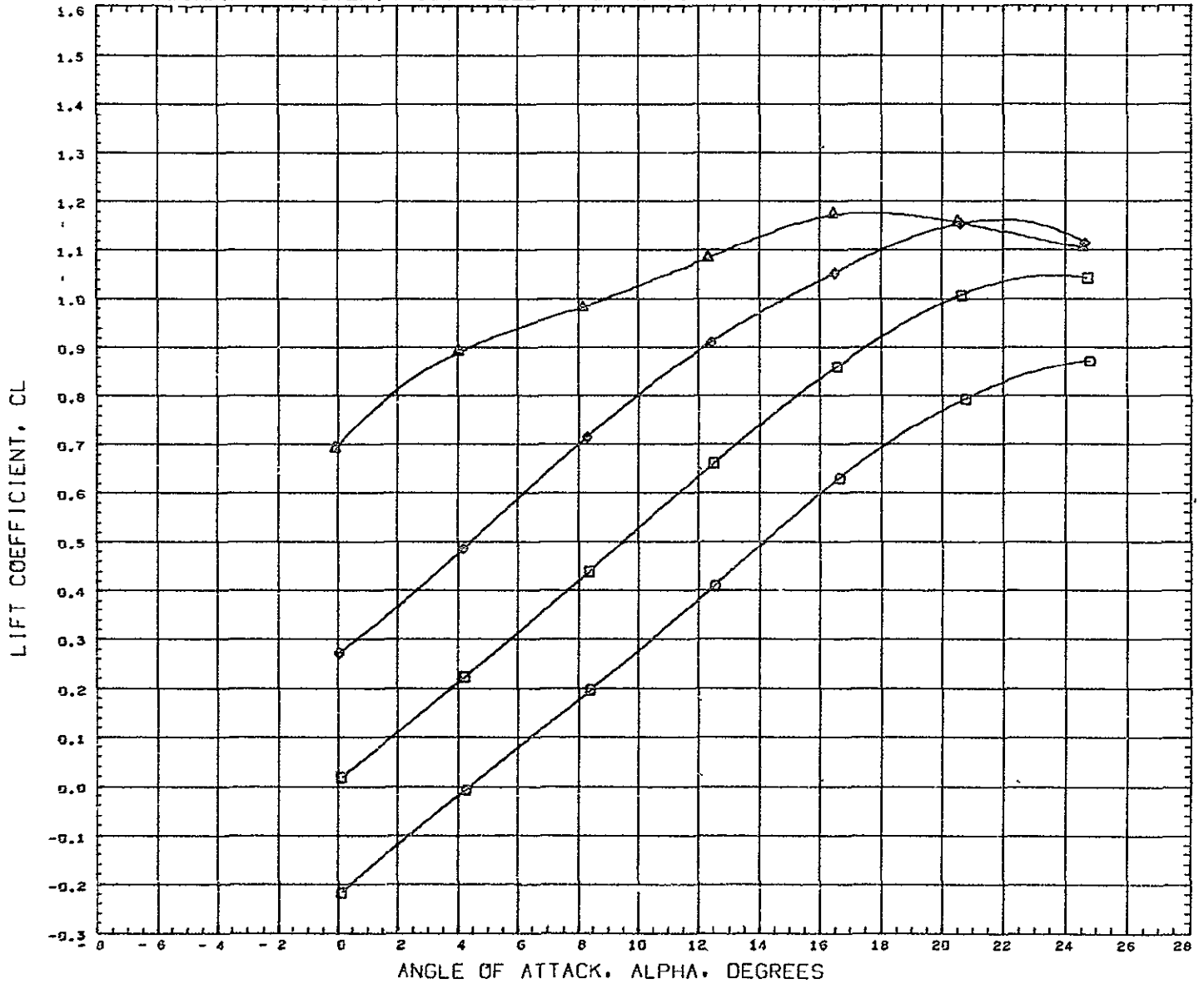

SYMBOL	ELEVON	PARAMETRIC VALUES			
○	- 25.000	MACH	0.259	BETA	0.000
□	- 15.000	AILEON	0.000	RUDDER	0.000
◇	0.000				
△	25.000				

REFERENCE INFORMATION		
REFS	316.2304	SQ IN
REFL	50.1900	IN
REFD	7.3500	IN
XHRF	33.9090	IN
YHRF	0.0000	IN
ZHRF	0.0000	IN
SCALE	0.0175	

REFERENCE FILE      CONVAIR T170-AE-12

# LONGITUDINAL CHARACTERISTICS - ELEVON EFFECTIVENESS - DELTA WING

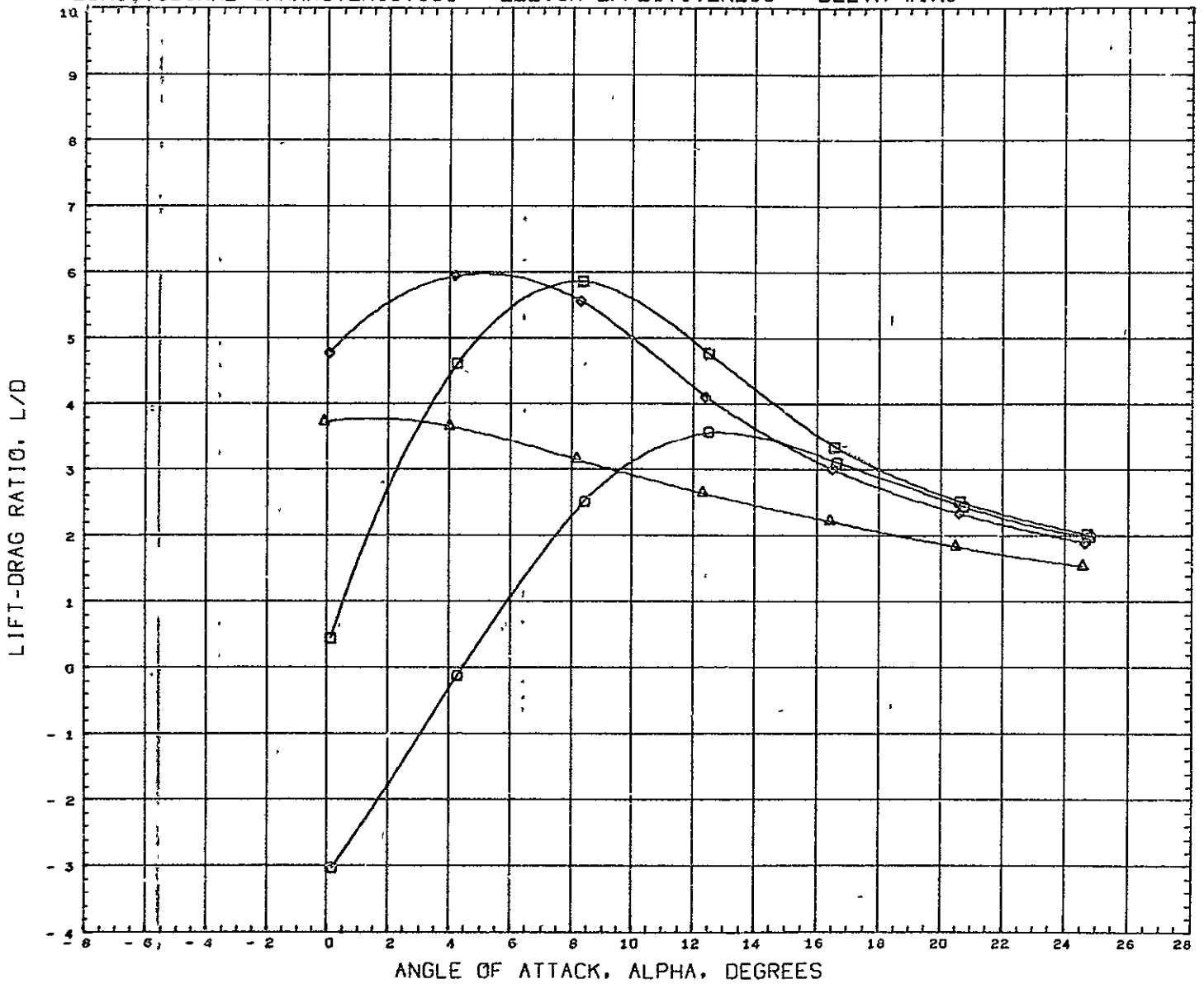

SYMBOL	ELEVON	PARAMETRIC VALUES			
○	- 25.000	MACH	0.259	BETA	0.000
□	- 10.000	A1LRON	0.000	RUDDER	0.000
○	0.000				
△	25.000				

REFERENCE INFORMATION		
REFS	316.2304	SQ IN
REFL	50.1900	IN
REFB	7.3500	IN
XMRP	33.9090	IN
YMRP	0.0000	IN
ZMRP	0.0000	IN
SCALE	0.0175	

REFERENCE FILE CONVAIR TN70-AE-12

# LONGITUDINAL CHARACTERISTICS - ELEVON EFFECTIVENESS - DELTA WING

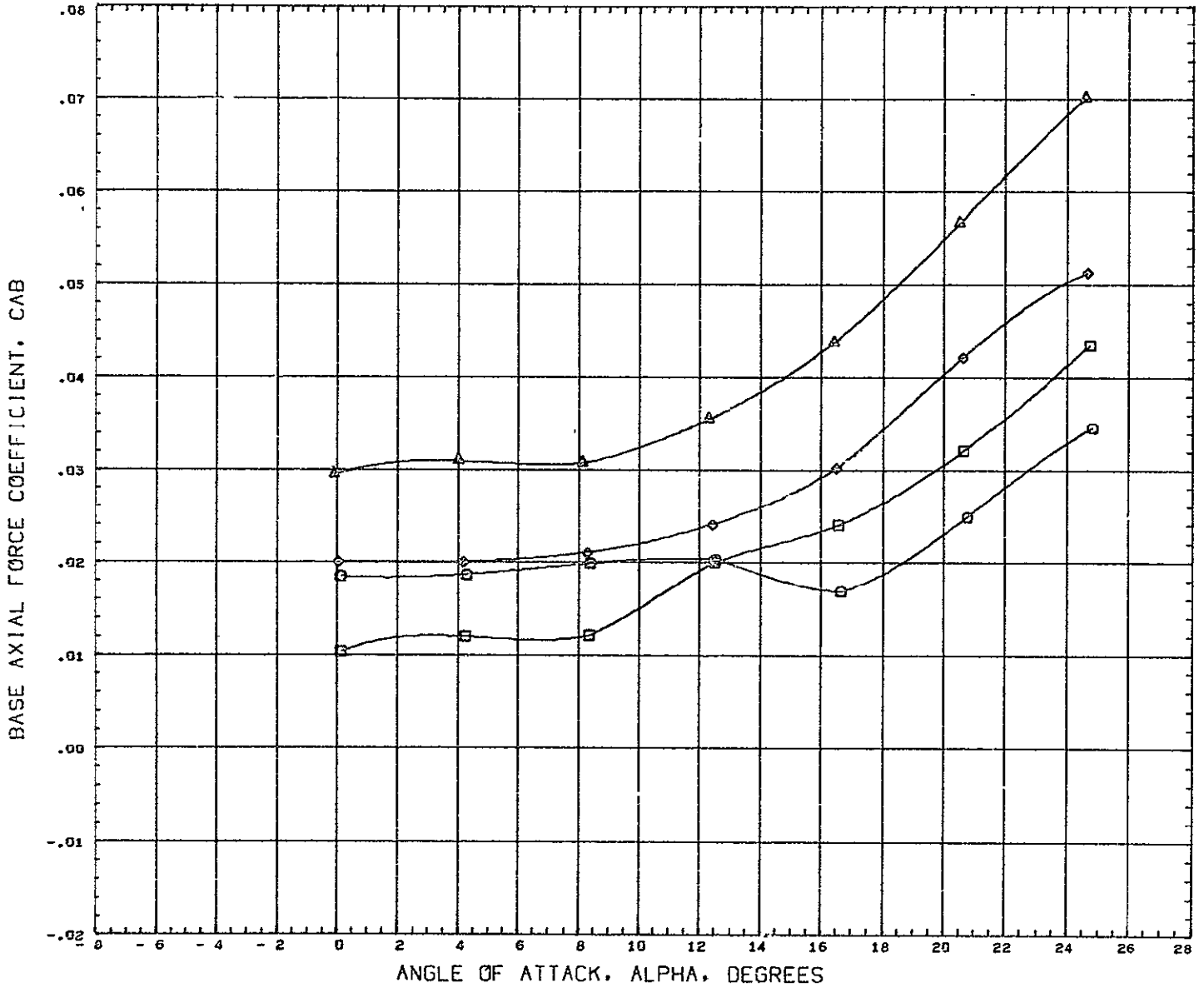

SYMBOL	ELEVON	PARAMETRIC VALUES			
○	- 25.000	MACH	0.259	BETA	0.000
□	- 10.000	AILRON	0.000	RUDDER	0.000
◇	0.000				
△	25.000				

REFERENCE INFORMATION		
REFS	316.2304	SQ IN
REFL	50.1900	IN
REFB	7.3500	IN
XMRP	33.9030	IN
YMRP	0.0000	IN
ZMRP	0.0000	IN
SCALE	0.0175	

REFERENCE FILE    CONVAIR IN70-AE-12

# LONGITUDINAL CHARACTERISTICS - ELEVON EFFECTIVENESS - DELTA WING

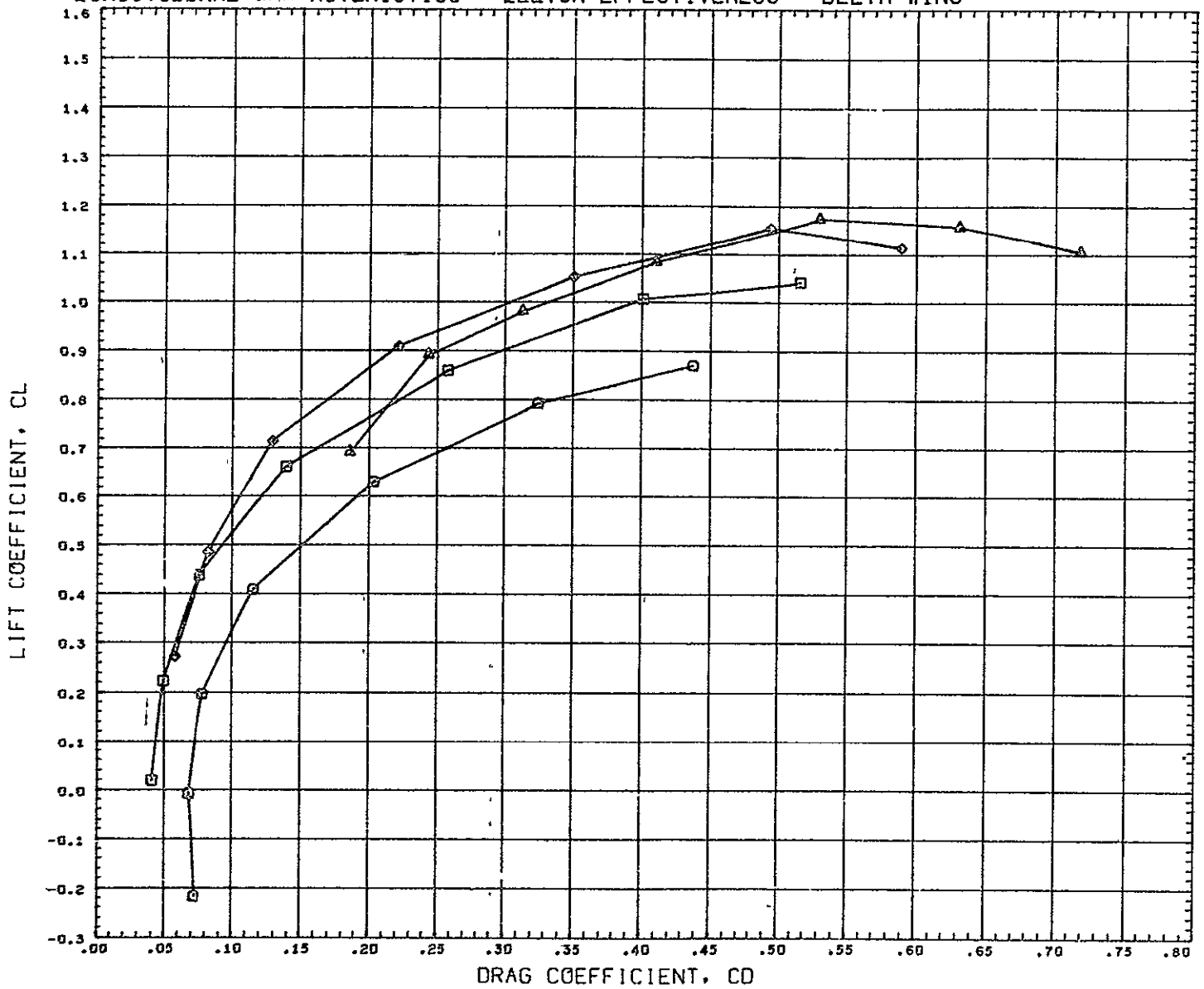

SYMBOL	ELEVON	PARAMETRIC VALUES			
○	- 25.000	MACH	0.259	BETA	0.000
□	- 10.000	AILEON	0.000	RUDGER	0.000
◇	0.000				
△	25.000				

REFERENCE INFORMATION		
REFS	316 2304	SQ IN
REFL	50.1900	IN
REFB	7.3500	IN
XMRP	33.9090	IN
YMRP	0.0000	IN
ZMRP	0.0000	IN
SCALE	0 0175	

REFERENCE FILE      CONVAIR TN70-AE-12

# LONGITUDINAL CHARACTERISTICS - ELEVON EFFECTIVENESS - DELTA WING

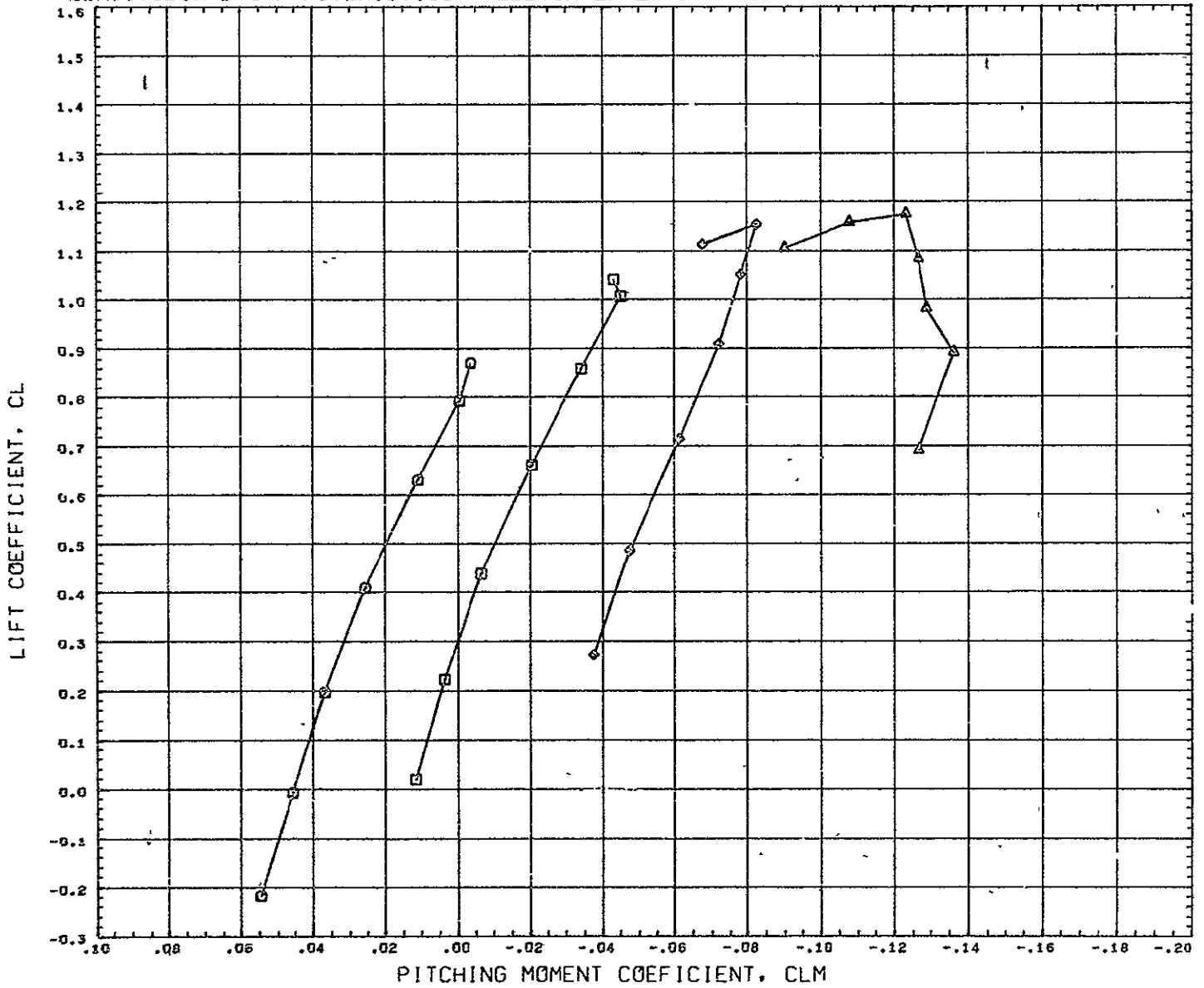

SYMBOL	ELEVON	PARAMETRIC VALUES				REFERENCE INFORMATION		
○	- 25.000	MACH	0.259	BETA	0.000	REFS	316.2304	SG IN
□	- 10.000	AILFCN	0.000	RUDDER	0.000	REFL	50.1900	IN
◇	0.000					REFB	7.3500	IN
△	25.000					XMRP	33.9090	IN
						YMRP	0.0000	IN
						ZMRP	0.0000	IN
						SCALE	0.0175	

REFERENCE FILE      CONVAIF TNYC-AE-12



LONGITUDINAL CONTROL - DELTA WING

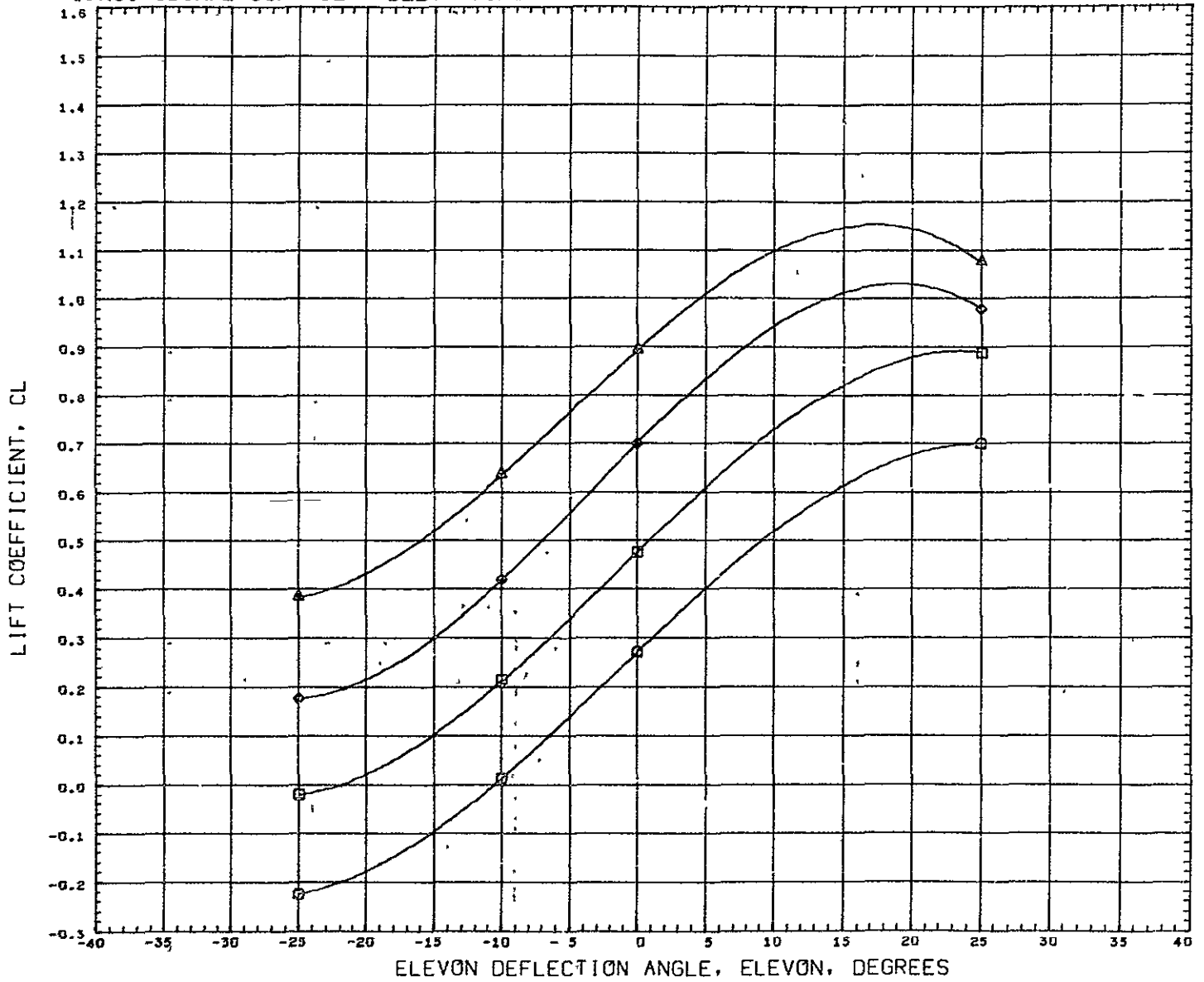

ELEVON DEFLECTION ANGLE, ELEVON, DEGREES

SYMBOL	ALPHA	PARAMETRIC VALUES				REFERENCE INFORMATION		
		MACH	BETA	AILRON	RUDDER	REFS	REFL	REFB
○	0.000	4.000	0.259	0.000	0.000	316 2304	50 1900	7.3500
□	4.000	4.000	0.000	0.000	0.000			
◇	8.000							
△	12.000							

DATA HIST. CODE I

# LONGITUDINAL CONTROL - DELTA WING

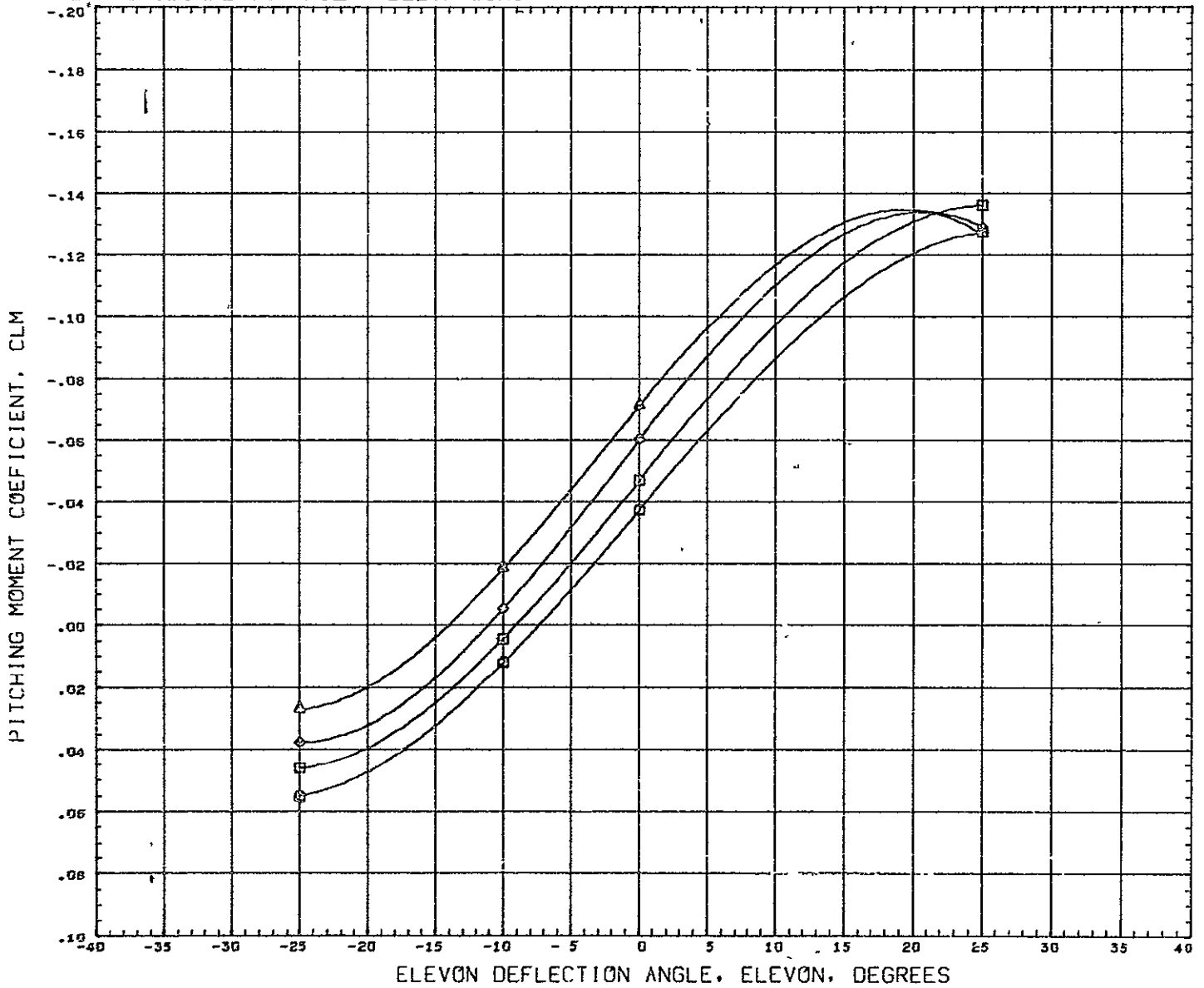

SYMBOL	ALPHA	PARAMETRIC VALUES				REFERENCE INFORMATION		
		MACH	BETA	AILRON	RUDDER	REFS	REFL	REFB
○	0.000	0.259	0.000	0.000	0.000	316.2304	50.1900	7.3500
□	4.000	0.000	0.000	0.000	0.000	33.9090	0.0000	0.0000
◇	6.000					0.0000	0.0000	0.0000
△	12.000					0.0000	0.0175	

DATA HIST. CODE 1

LONGITUDINAL CONTROL - DELTA WING

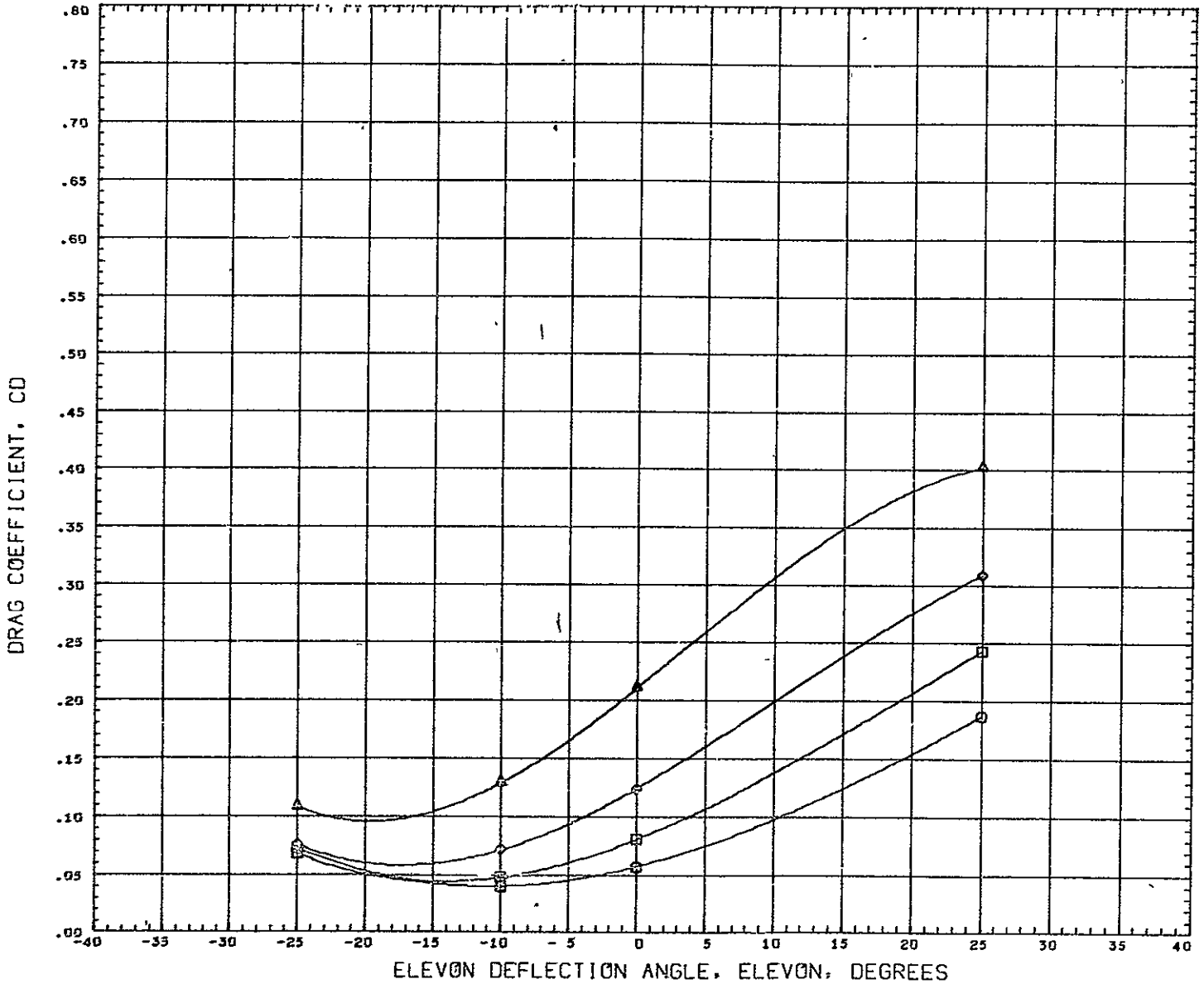

SYMBOL	ALPHA	PARAMETRIC VALUES				REFERENCE INFORMATION		
○	0.000	MACH	0.259	BETA	0.000	REFS	316.2304	SQ IN
□	4.000	AILERON	0.000	RUDDER	0.000	REFL	50.1900	IN
◇	6.000					REFB	7.3500	IN
△	12.000					XMRB	33.9090	IN
						YMRB	0.0000	IN
						ZMRB	0.0000	IN
						SCALE	0.0175	

DATA HIST. CODE I

# LONGITUDINAL CONTROL DERIVATIVES - DELTA WING

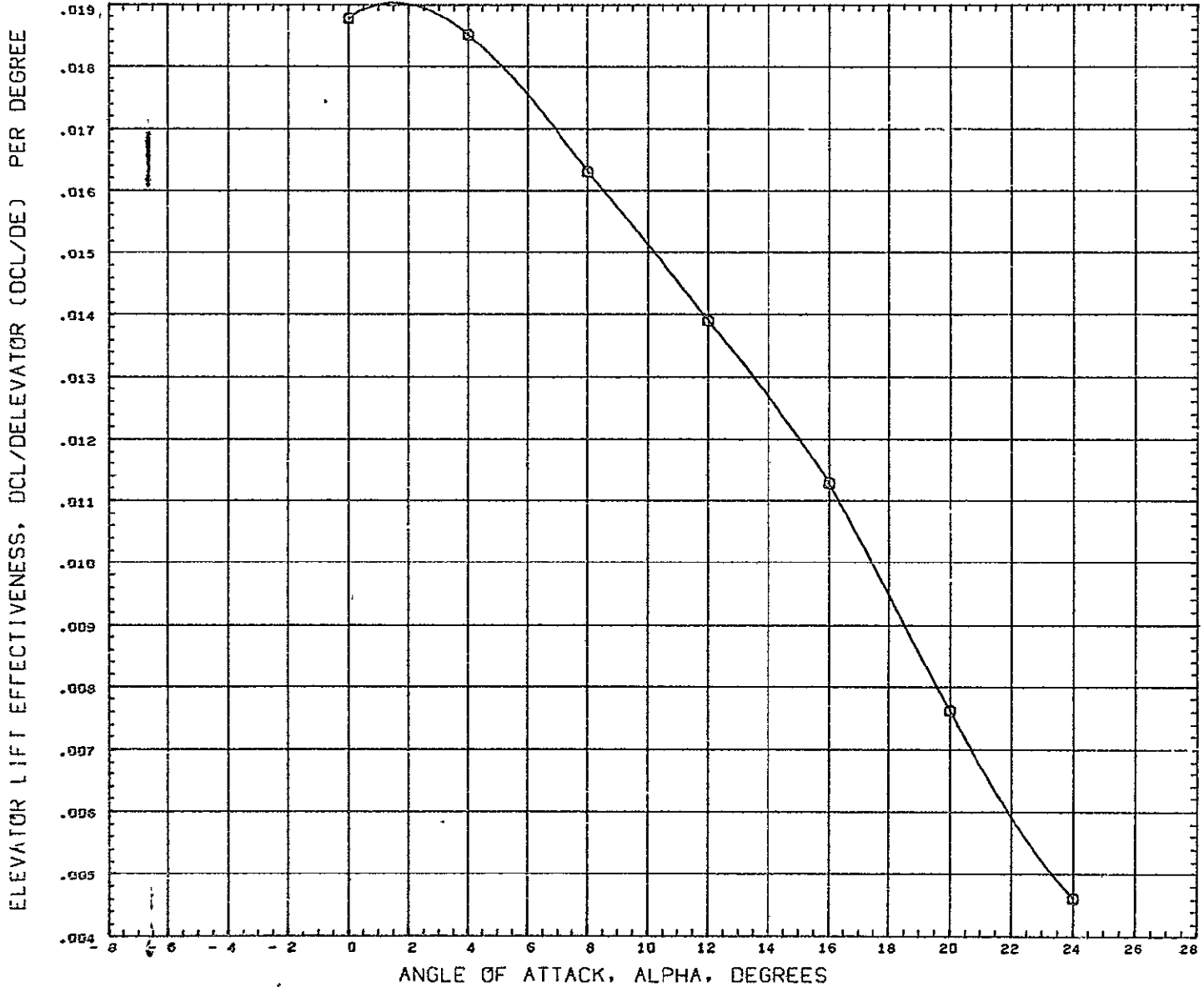

SYMBOL	MACH	PARAMETRIC VALUES				REFERENCE INFORMATION		
O	0.259	BETA	0.000	ELEVON	- 25.000	REFS	316.2304	SQ IN
		AILERON	0.000	RUDDER	0.000	REFL	50.1900	IN
						REFB	7.3500	IN
						XMRP	33 9090	IN
						YMRP	0 0000	IN
						ZMRP	0 0000	IN
						SCALE	0 0175	

DATA HIST. CODE #F

# LONGITUDINAL CONTROL DERIVATIVES - DELTA WING

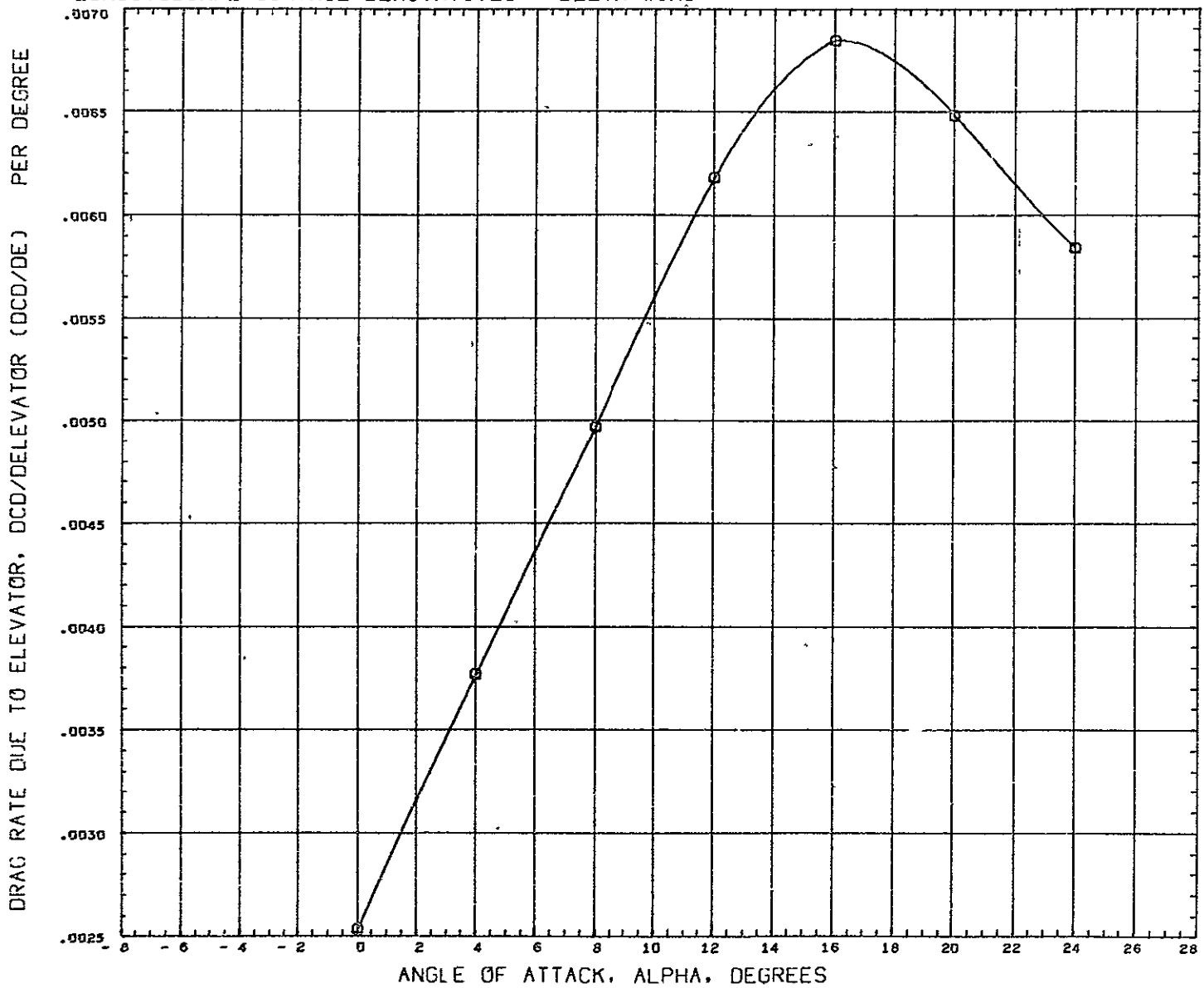

SYMBOL	MACH	PARAMETRIC VALUES			
0	0.259	BETA	0.000	ELEVON	- 25.000
		AILRON	0.000	RUDDER	0.000

REFERENCE INFORMATION		
REFS	316.2304	SQ IN
REFL	50.1900	IN
REFB	7.3500	IN
XMRP	33.9090	IN
YMRP	0.0000	IN
ZMRP	0.0000	IN
SCALE	0.0175	

DATA HIST. CODE #F

# LONGITUDINAL CONTROL DERIVATIVES - DELTA WING

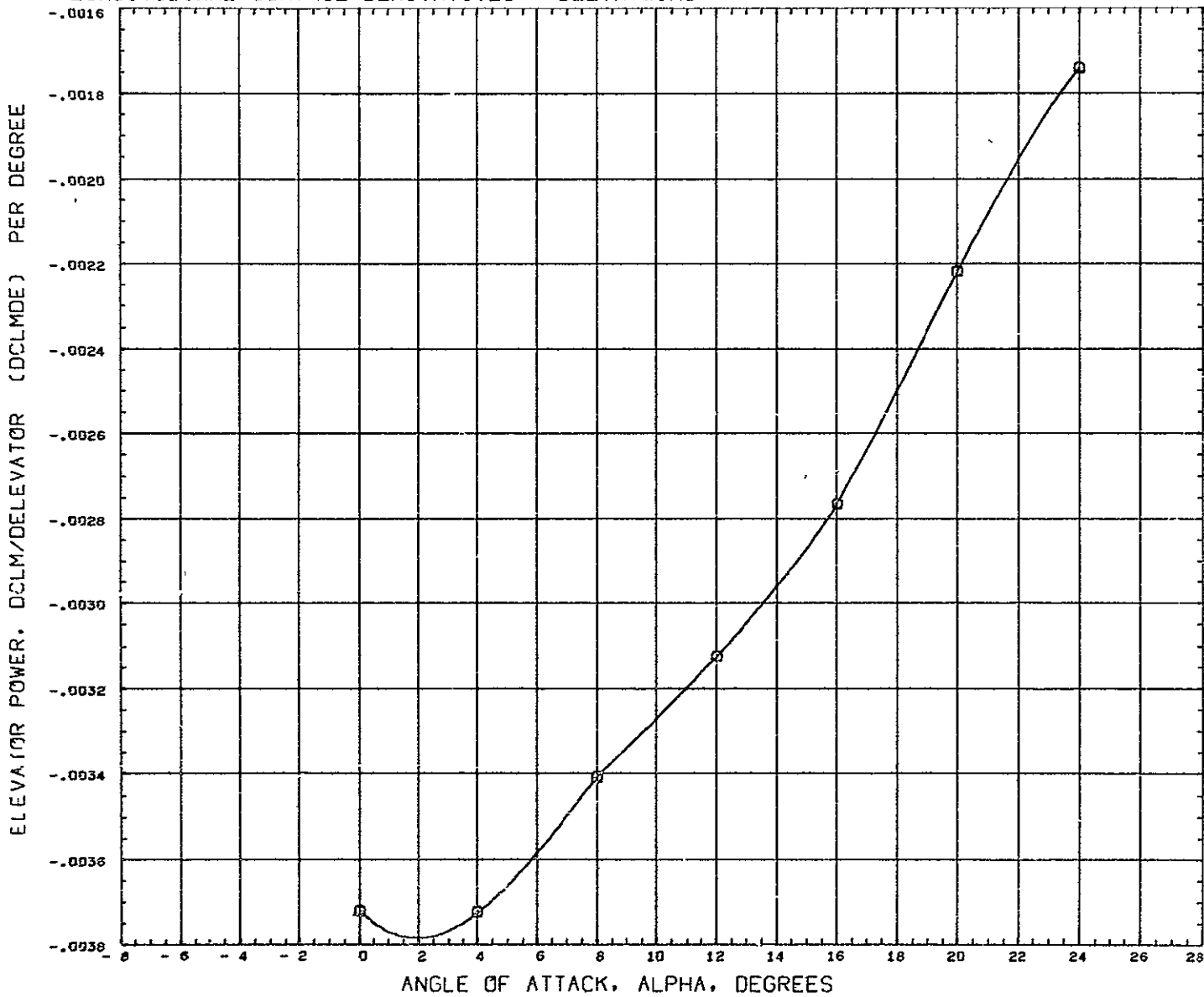

SYMBOL	MACH	PARAMETRIC VALUES			
○	0.259	BETA	0.000	ELEVON	- 25.000
		AILERON	0.000	RUDDER	0.000

REFERENCE INFORMATION		
REFS	316.2304	sq IN
REFL	50.1900	IN
REFB	7.3500	IN
XMRP	33.9090	IN
YMRP	0.0000	IN
ZMRP	0.0000	IN
SCALE	0.0175	

DATA HIST. CODE #F

# LATERAL CHARACTERISTICS - AILERON EFFECTIVENESS - DELTA WING CONFIGURATION

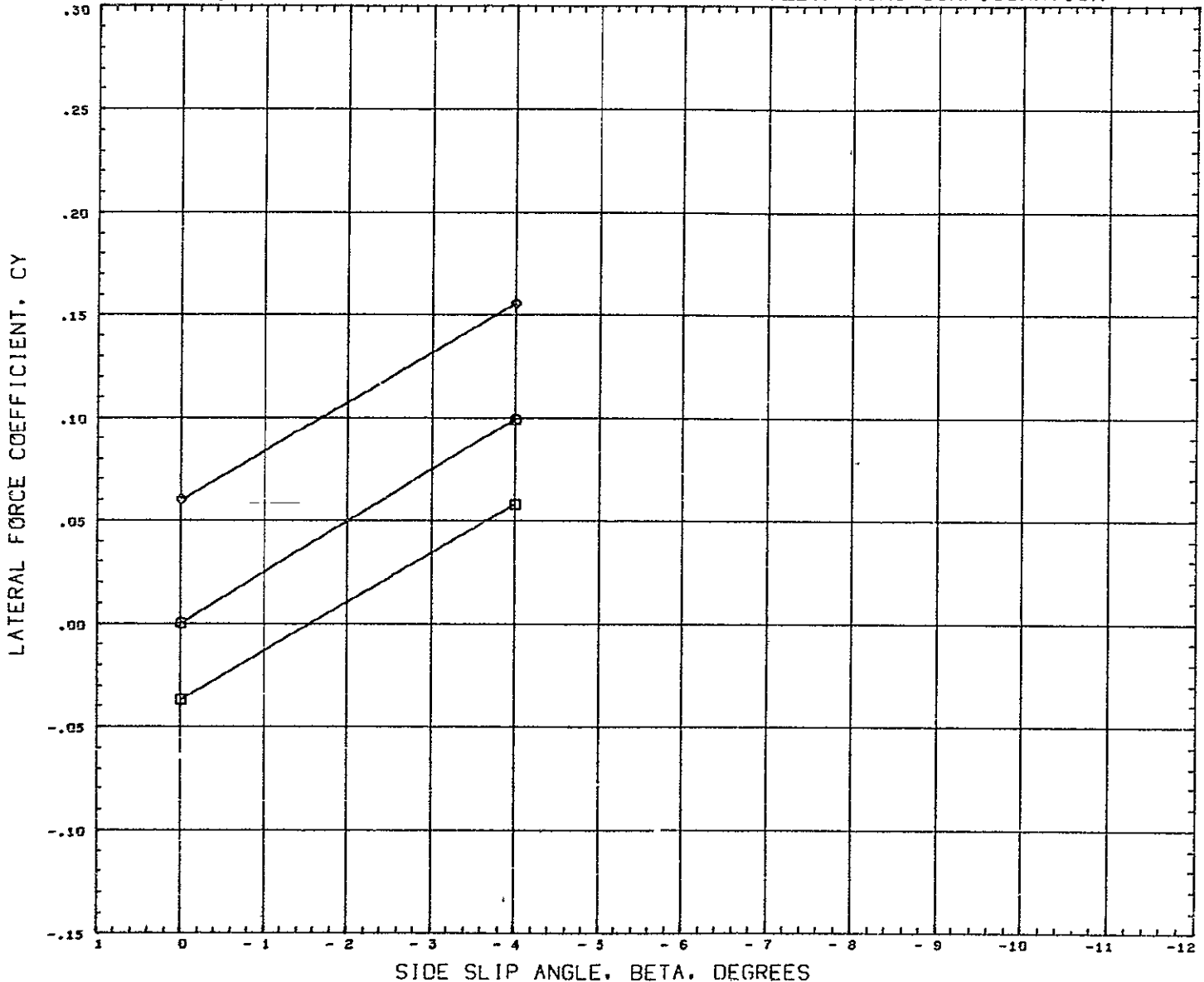

SYMBOL	AILERON	PARAMETRIC VALUES				REFERENCE INFORMATION		
○	0.000	MACH	0.259	ALPHA	0.000	REFS	316.2304	Sq IN <sup>2</sup>
□	10.000	ELEVON	0.000	RUDDER	0.000	REFL	50.1900	IN
◇	25.000					REFB	7.3500	IN
						XMRP	33.9000	IN
						YMRP	0.0000	IN
						ZMRP	0.0000	IN
						SCALE	0.0175	

DATA HIST. CODE I

# LATERAL CHARACTERISTICS - AILERON EFFECTIVENESS - DELTA WING CONFIGURATION

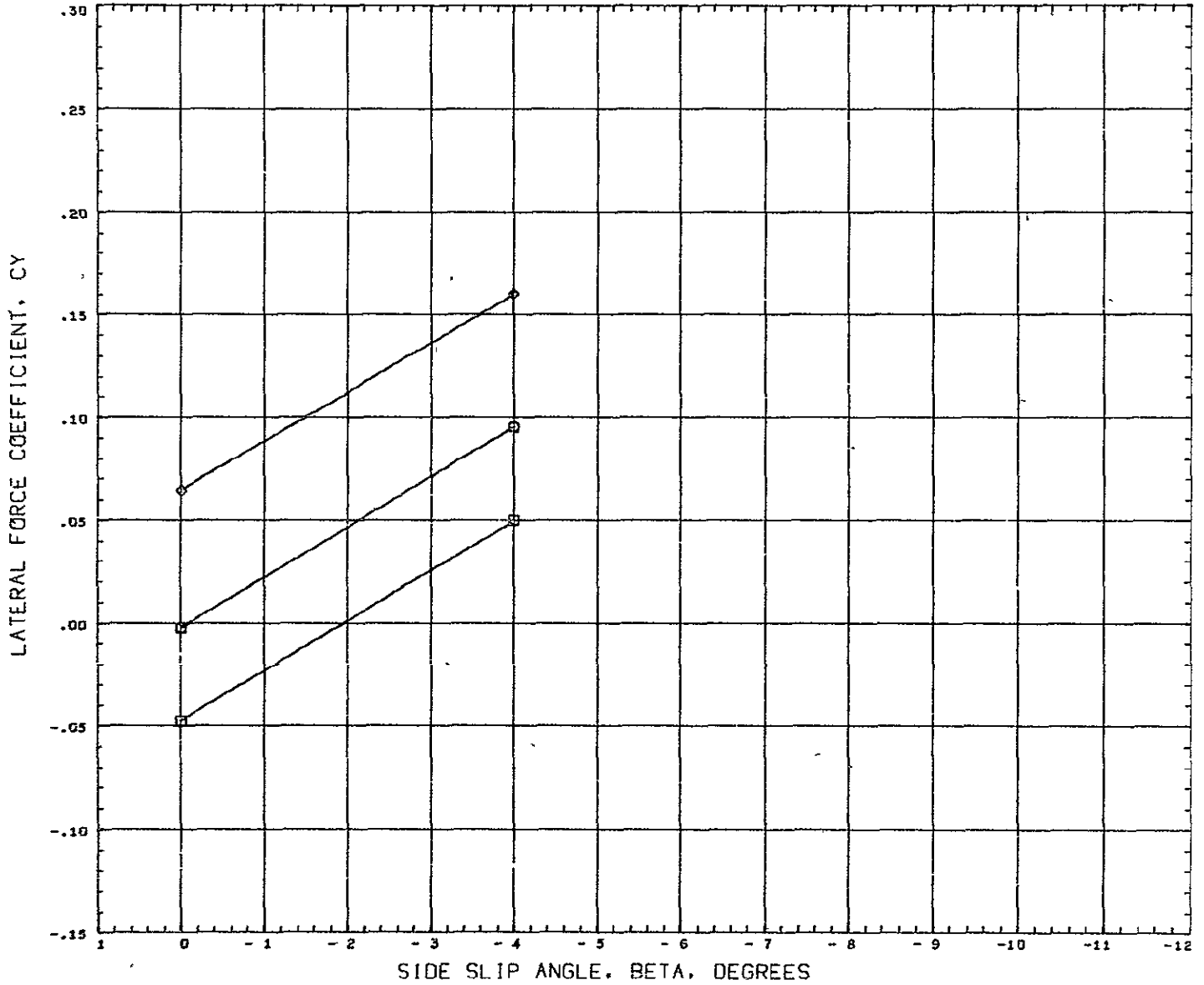

SYMBOL	AILERON	PARAMETRIC VALUES			
□	0.000	MACH	0.259	ALPHA	4.000
○	10.000	ELEVON	0.000	RUDDER	0.000
◇	25.000				

REFERENCE INFORMATION		
REFS	316.2304	SQ IN
REFL	50.1900	IN
REFB	7.3500	IN
XHRF	33.9090	IN
YHRF	0.0000	IN
ZHRF	0.0000	IN
SCALE	0.0175	

DATA HIST CODE 1



# LATERAL CHARACTERISTICS - AILERON EFFECTIVENESS - DELTA WING CONFIGURATION

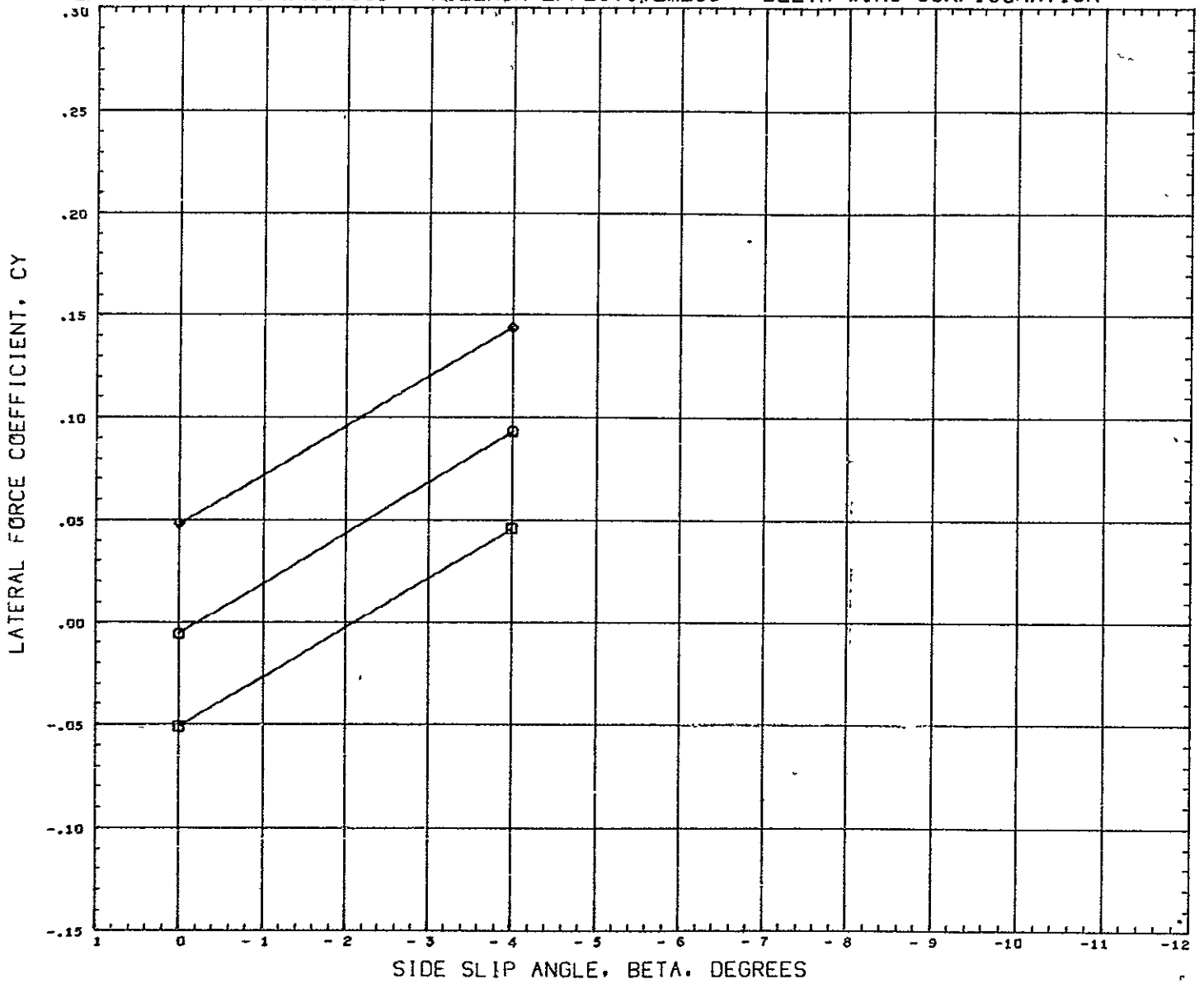

SYMBOL	AILERON	MACH	PARAMETRIC VALUES		
○	0.000	0.259	ALPHA	8.000	
□	15.000	ELEVON	0.000	RUDDER	0.000
◇	25.000				

REFERENCE INFORMATION		
REFS	316.2304	SQ IN
REFL	50.1900	IN
REFB	7.3500	IN
XMRP	33.9090	IN
YMRP	0.0000	IN
ZMRP	0.0000	IN
SCALE	0.0175	

DATA HIST. CODE 1

# LATERAL CHARACTERISTICS - AILERON EFFECTIVENESS - DELTA WING CONFIGURATION

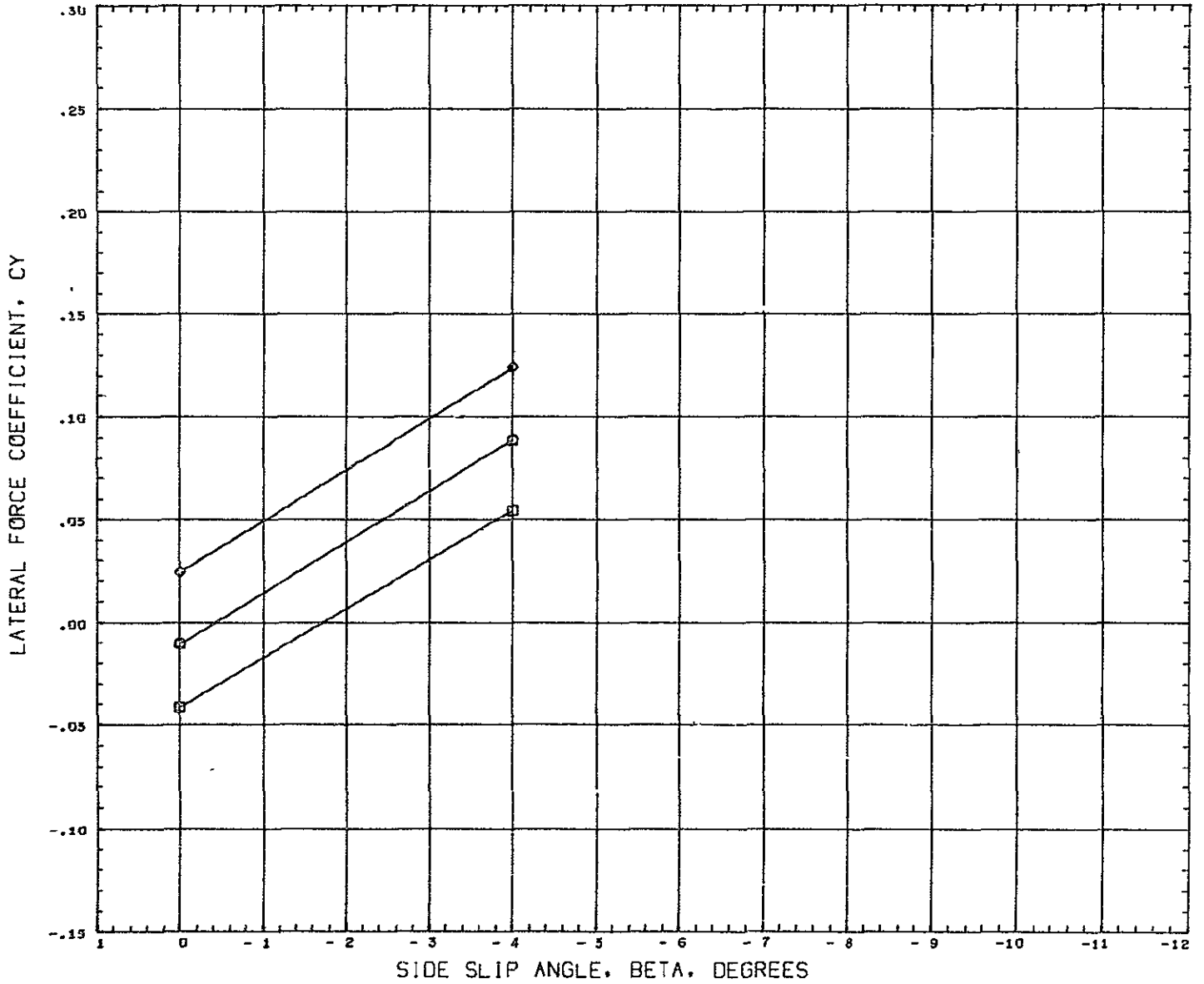

SYMBOL	AILERON	PARAMETRIC VALUES				REFERENCE INFORMATION		
		MACH	ALPHA	RUDDER	REFS	REFL	REFB	SCALE
○	0.000	0.259	12.000	0.000	316 2304	50.1900	7 3500	50 IN
□	10.000	0.000	0.000	0.000	33.9090	0.0000	0.0000	0.0175
◇	25.000							

DATA HIST. CODE 1

LATERAL CHARACTERISTICS - AILERON EFFECTIVENESS - DELTA WING CONFIGURATION

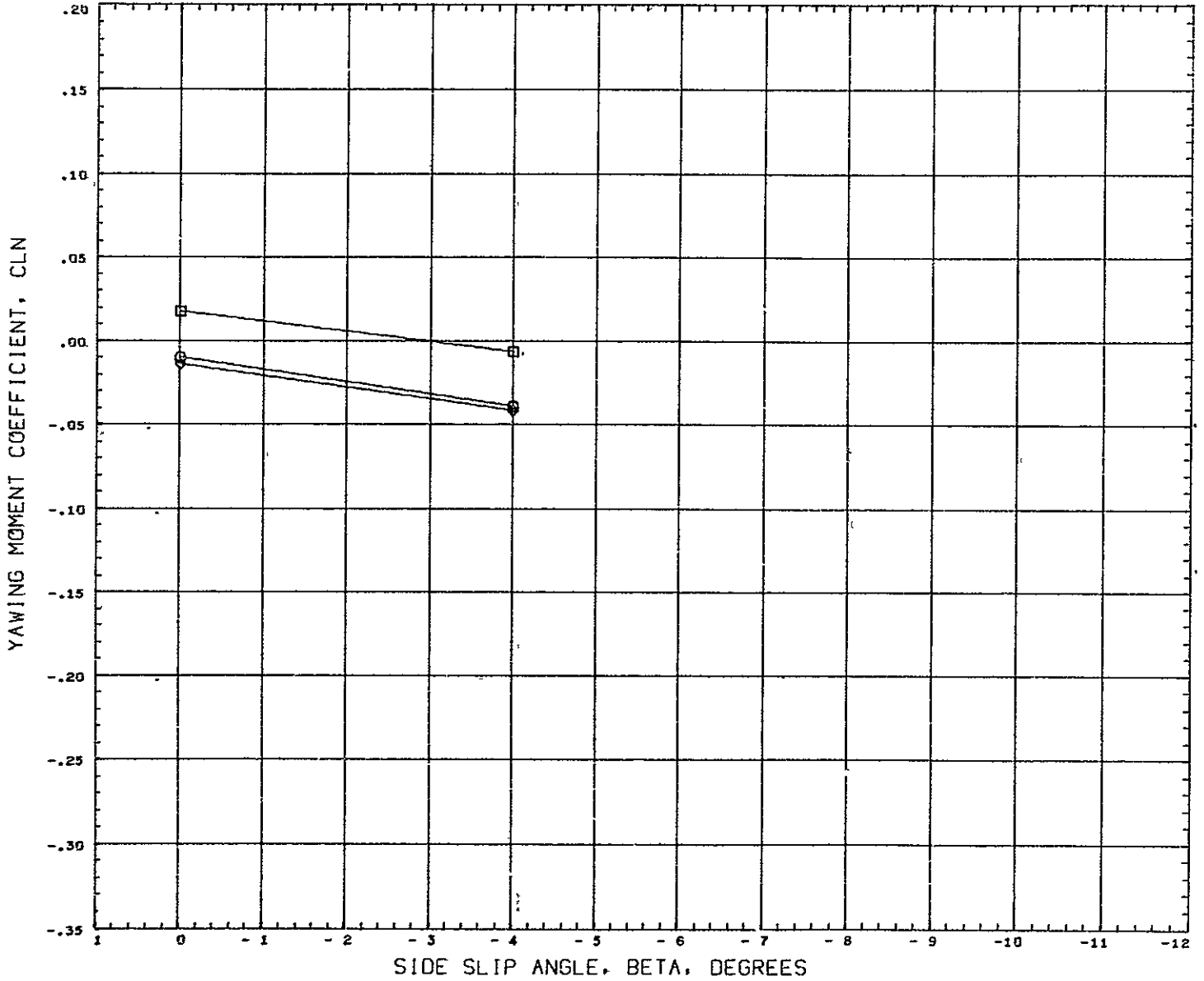

SIDE SLIP ANGLE, BETA, DEGREES

SYMBOL	AILERON		PARAMETRIC VALUES		
	DEFLECTION	ANGLE	MACH	ALPHA	RUDDEF
□	0.000		0.259	0.000	
◻	15.000	ELEVON	0.000		0.000
◇	25.000				

REFERENCE INFORMATION		
REFS	316.2304	SQ IN
REFL	50.1900	IN
REFB	7.3500	IN
XMRP	33.9090	IN
YHRP	0.0000	IN
ZHRP	0.0000	IN
SCALE	0.0175	

DATA HIST. CODE

# LATERAL CHARACTERISTICS - AILERON EFFECTIVENESS - DELTA WING CONFIGURATION

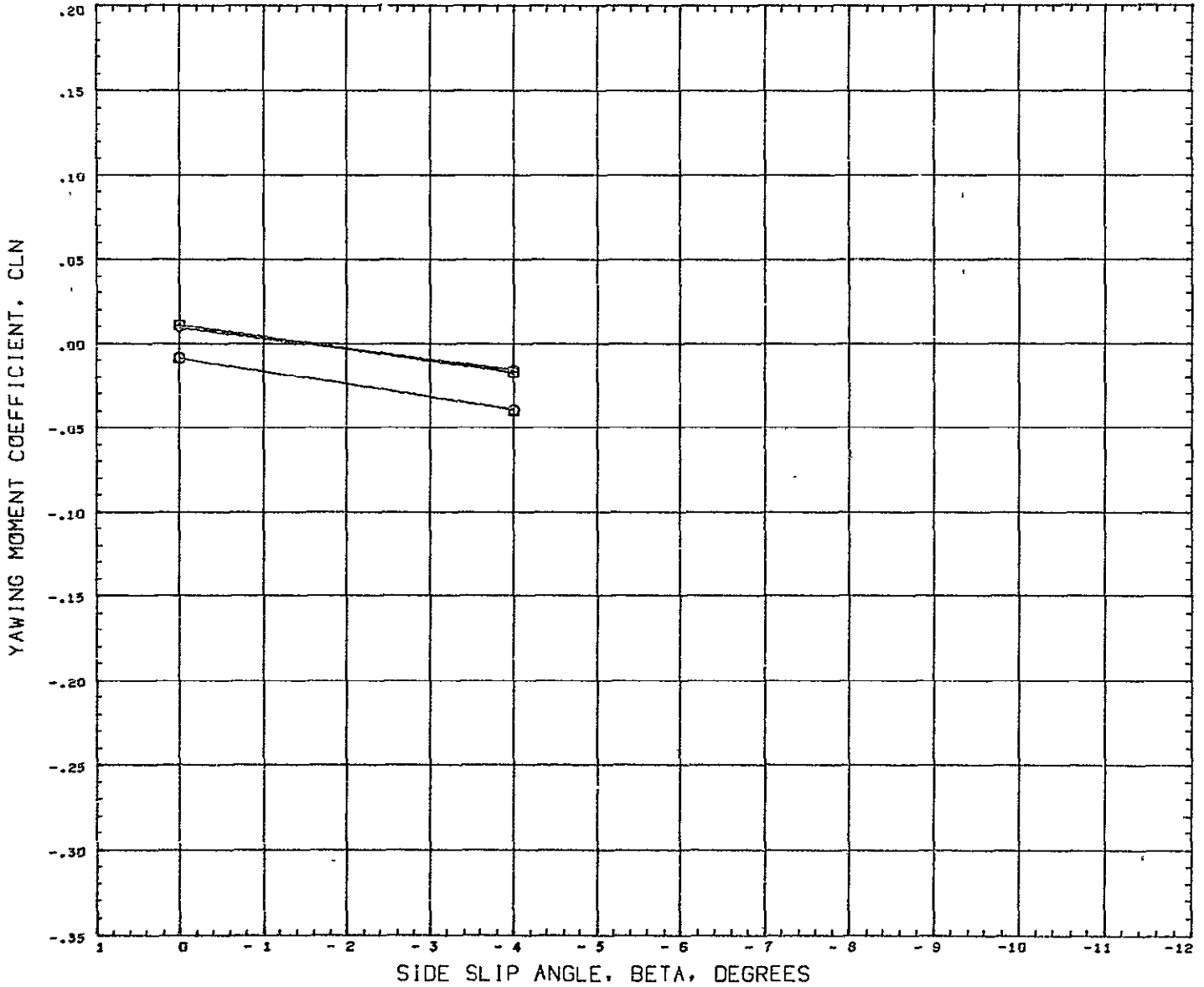

SYMBOL	AILERON	PARAMETRIC VALUES			
□	0.000	MACH	0.259	ALPHA	4.000
□	10.000	ELEVON	0.000	RUDDER	0.000
◇	25.000				

REFERENCE INFORMATION		
REFS	316.2304	SQ IN
REFL	50.1900	IN
REFB	7.3500	IN
XMRP	33.9090	IN
YHRF	0.0000	IN
ZHRF	0.0000	IN
SCALE	0.0175	

DATA HIST. CODE 1

# LATERAL CHARACTERISTICS - AILERON EFFECTIVENESS - DELTA WING CONFIGURATION

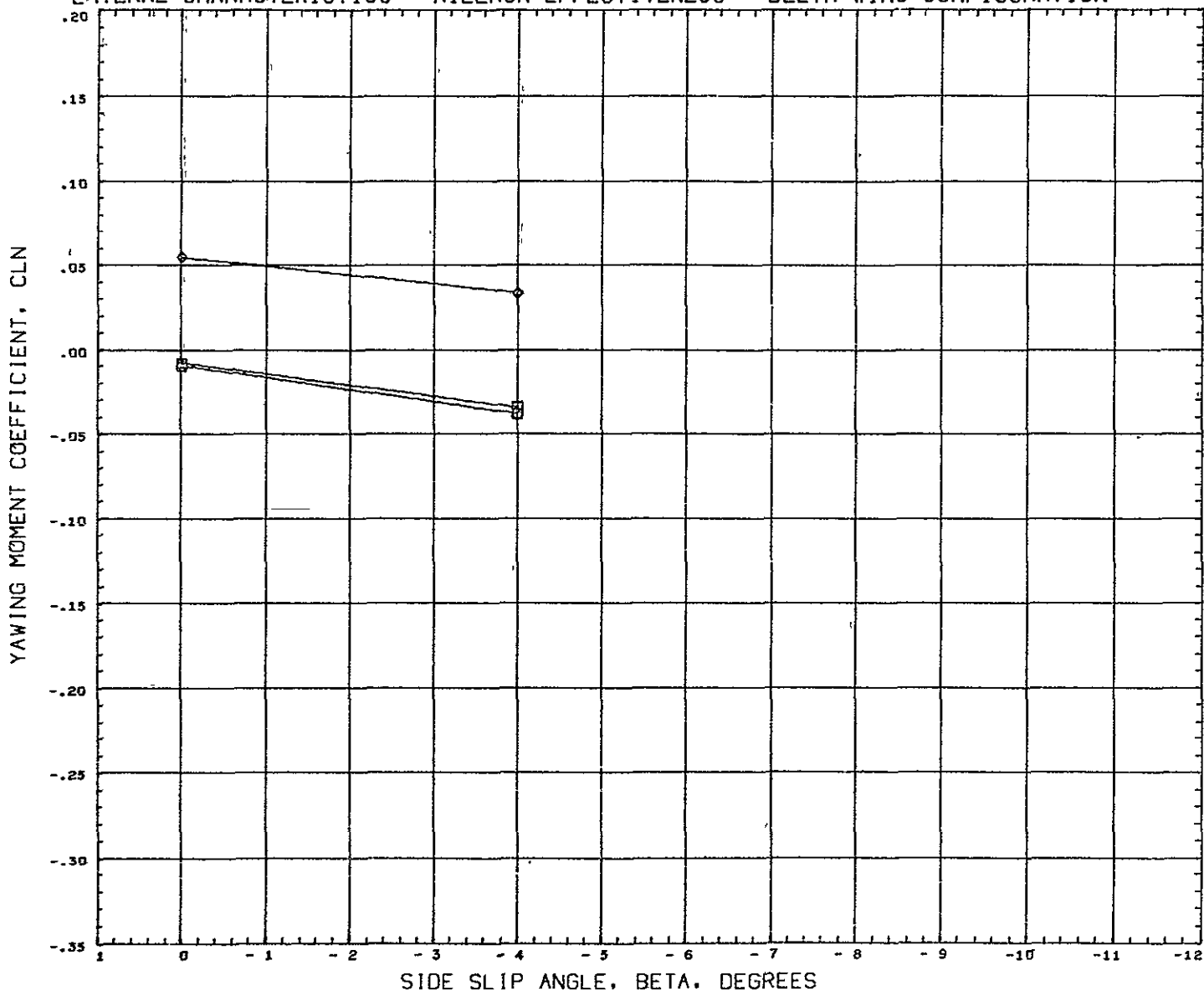

SYMBOL	AILRON	PARAMETRIC VALUES			
○	0.000	MACH	0.259	ALPHA	6.000
□	10.000	ELEVON	0.000	RUDDER	0.000
◇	25.000				

REFERENCE INFORMATION		
REFS	316 2304	SQ IN
REFL	50.1900	IN
REFB	7.3500	IN
XMRP	33.9090	IN
YMRP	0.0000	IN
ZMRP	0.0000	IN
SCALE	0 0175	

DATA HIST. CODE I

# LATERAL CHARACTERISTICS - AILERON EFFECTIVENESS - DELTA WING CONFIGURATION

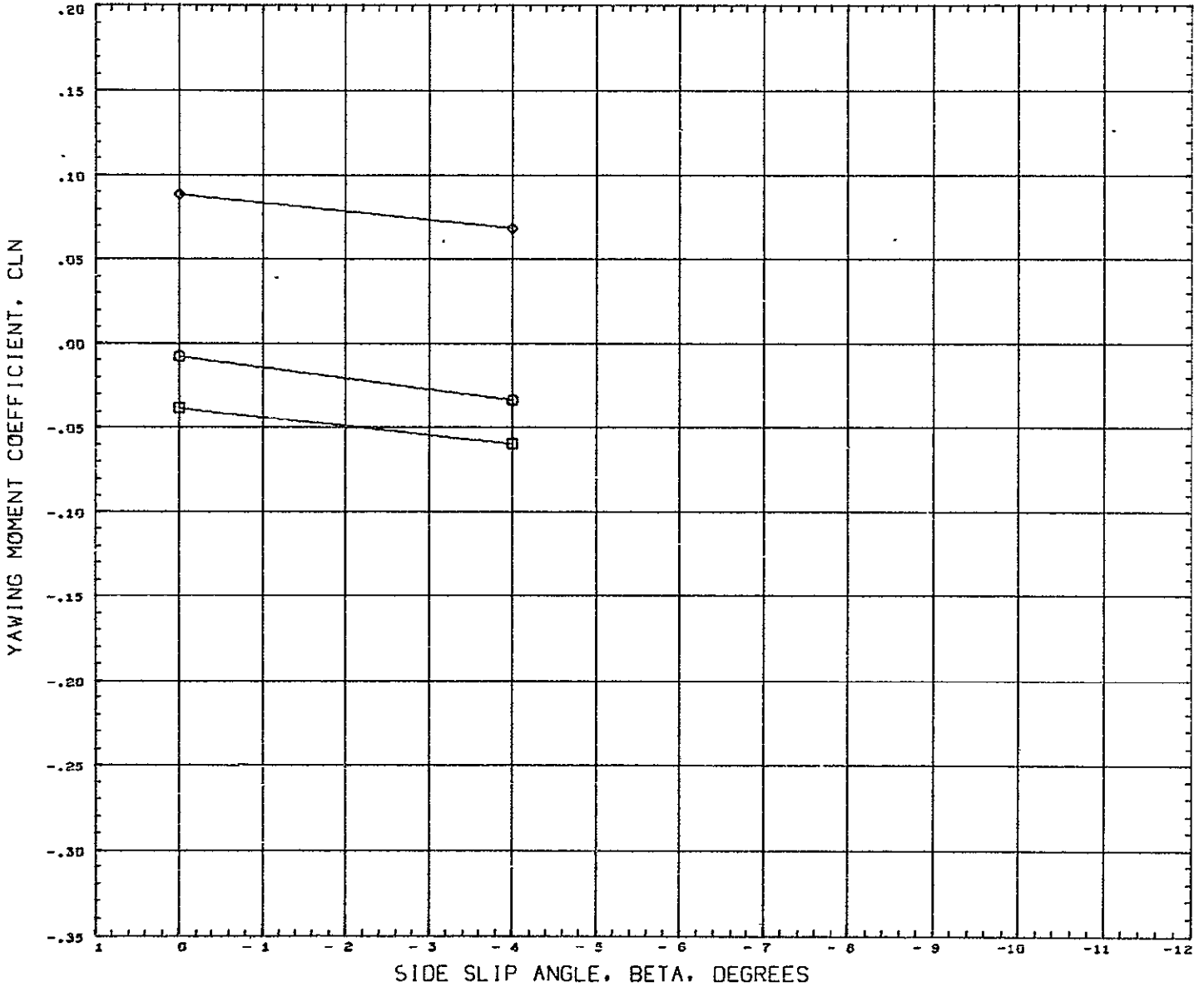

SYMBOL	AILRON	PARAMETRIC VALUES			
◇	0.000	MACH	0.259	ALPHA	12.000
□	10.000	ELEVON	0.000	RUDDER	0.000
◇	25.000				

REFERENCE INFORMATION		
REFS	316 2304	SQ IN
REFL	50.1900	IN
REFB	7.3500	IN
XNRP	33.9090	IN
YNRP	0.0000	IN
ZNRP	0.0000	IN
SCALE	0.0175	

DATA HIST. CODE 1

# LATERAL CHARACTERISTICS - AILERON EFFECTIVENESS - DELTA WING CONFIGURATION

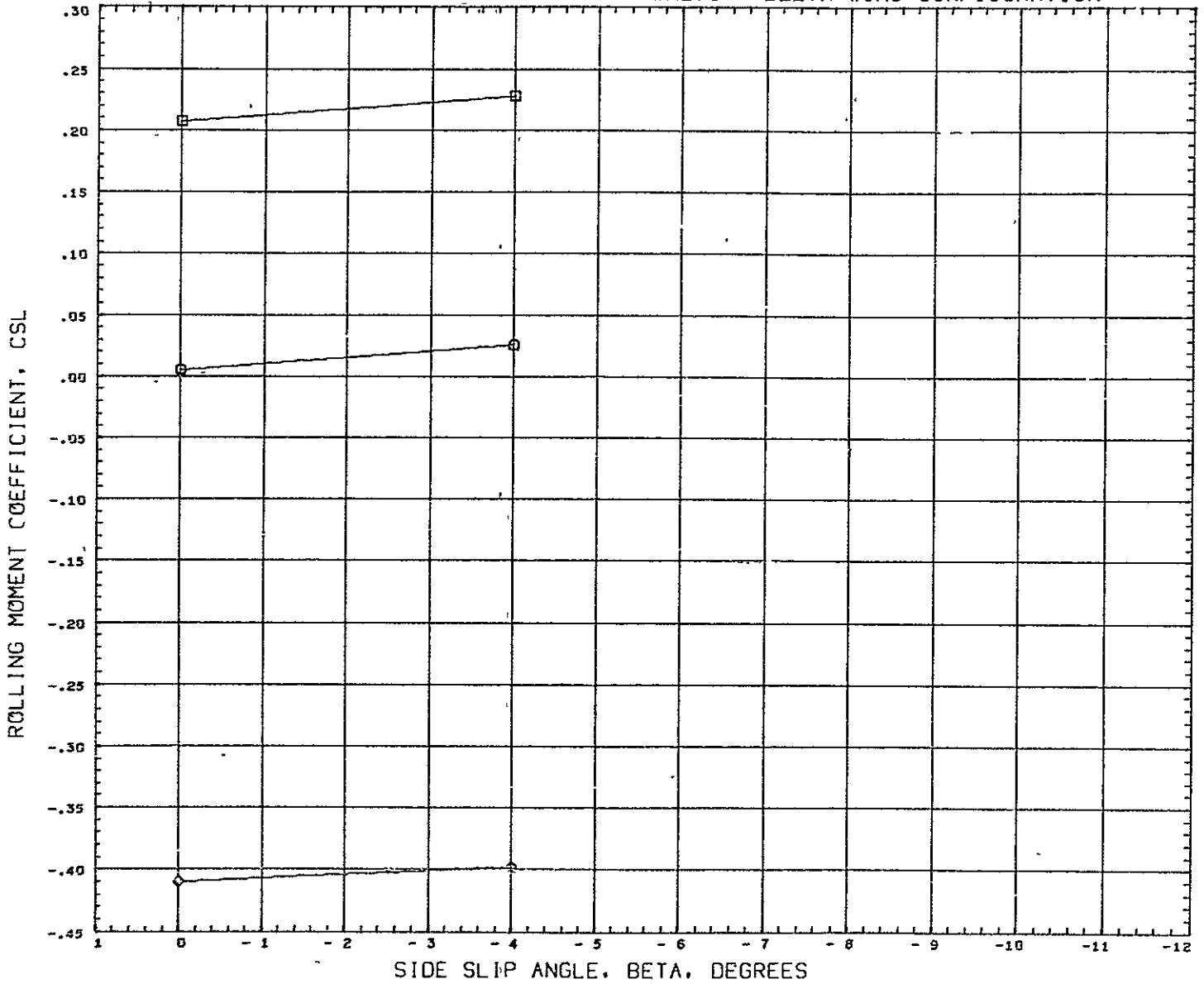

SYMBOL	AILRON	PARAMETRIC VALUES				REFERENCE INFORMATION		
○	0.000	MACH	0.259	ALPHA	0.000	REFS	316.2304	SQ IN
□	10.000	ELEVON	0.000	RUDDER	0.000	REFL	50.1900	IN
◇	25.000					REFS	7.3500	IN
						XMRP	33.9090	IN
						YMRP	0.0000	IN
						ZMRP	0.0000	IN
						SCALE	6.0175	

DATA HIST. CODE 1

# LATERAL CHARACTERISTICS - AILERON EFFECTIVENESS - DELTA WING CONFIGURATION

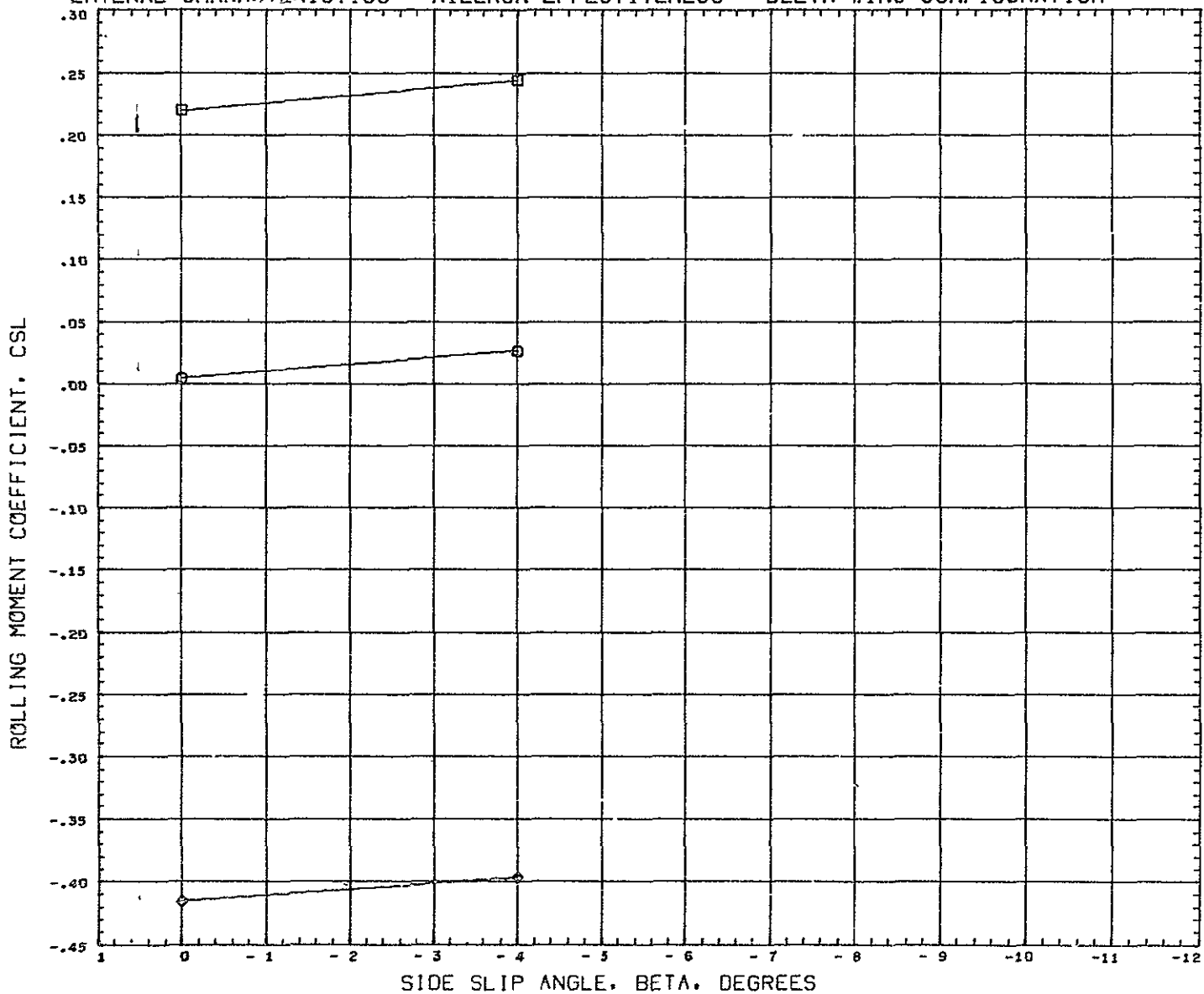

SYMBOL	AILRON	PARAMETRIC VALUES				REFERENCE INFORMATION		
○	0.000	MACH	0.259	ALPHA	4.000	REFS	316 2304	SQ IN
□	10.000	ELEVON	0.000	RUDDER	0.000	REFL	50.1900	IN
◇	25.000					REFB	7.3500	IN
						XMRP	33.9090	IN
						YMRP	0.0000	IN
						ZMRP	0.0000	IN
						SCALE	0.0175	

DATA HIST. CODE I



# LATERAL CHARACTERISTICS - AILERON EFFECTIVENESS - DELTA WING CONFIGURATION

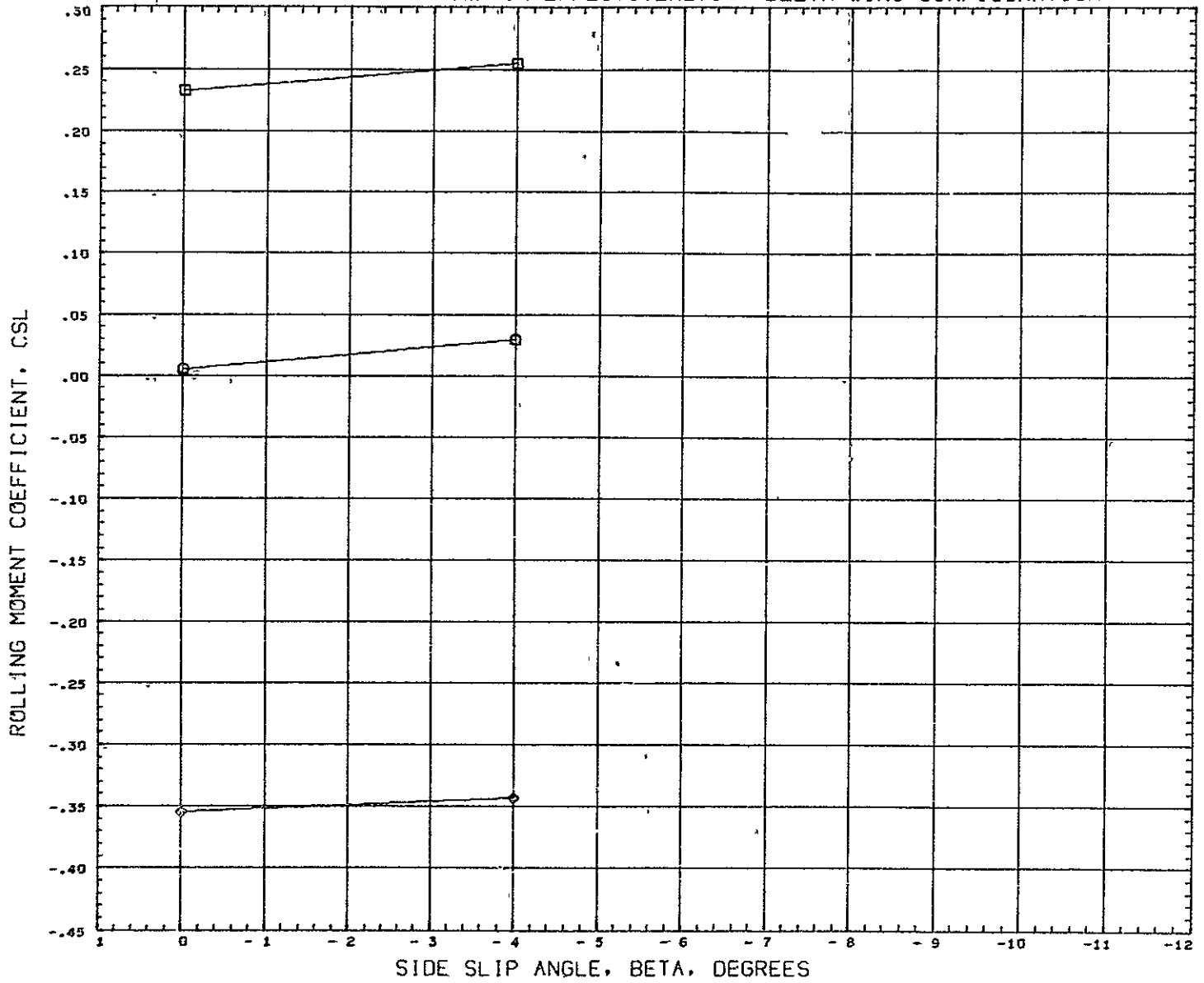

SYMBOL	AILERON	PARAMETRIC VALUES				REFERENCE INFORMATION		
○	0.000	MACH	0.259	ALPHA	8.000	REFS	316.2304	SQ IN
□	15.000	ELEVON	0.000	RUDDER	0.000	REFL	50.1900	IN
◇	25.000					REFB	7.3500	IN
						XMRP	33.9090	IN
						YMRP	0.0000	IN
						ZMRP	0.0000	IN
						SCALE	0.0175	

DATA HIST. CODE 1

# LATERAL CHARACTERISTICS - AILERON EFFECTIVENESS - DELTA WING CONFIGURATION

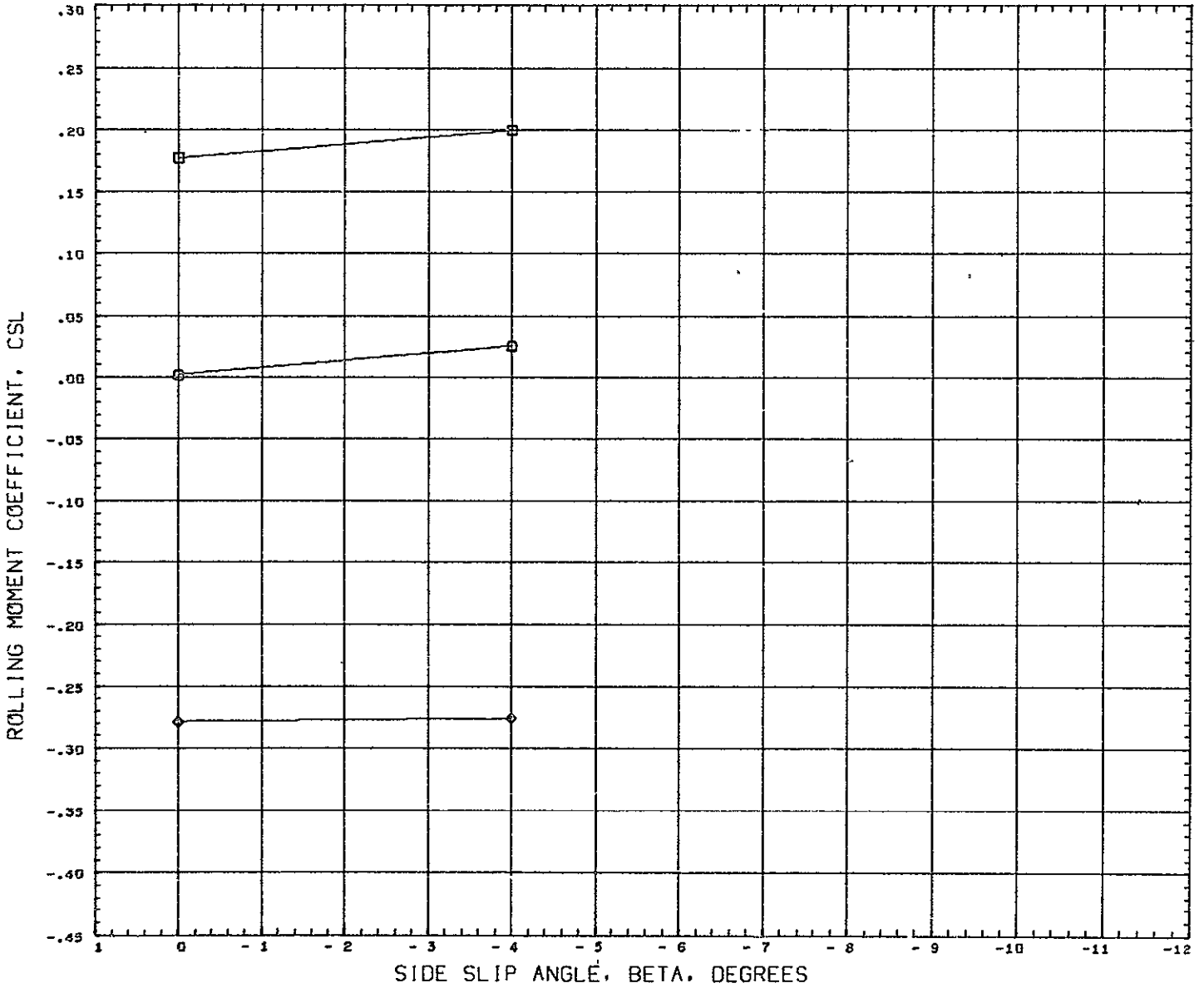

SYMBOL	AILRON	PARAMETRIC VALUES			
□	0.000	MACH	0.259	ALPHA	12.000
◇	19.000	ELEVGN	0.000	RUDDER	0.000
◊	25.000				

REFERENCE INFORMATION		
REFS	316 2304	SQ IN
REFL	50.1900	IN
REFB	7.3500	IN
XMRP	33.9090	IN
YMRP	0.0000	IN
ZMRP	0.0000	IN
SCALE	0.0175	

DATA HIST. CODE I

# LATERAL CONTROL DERIVATIVES - DELTA WING CONFIGURATIONS

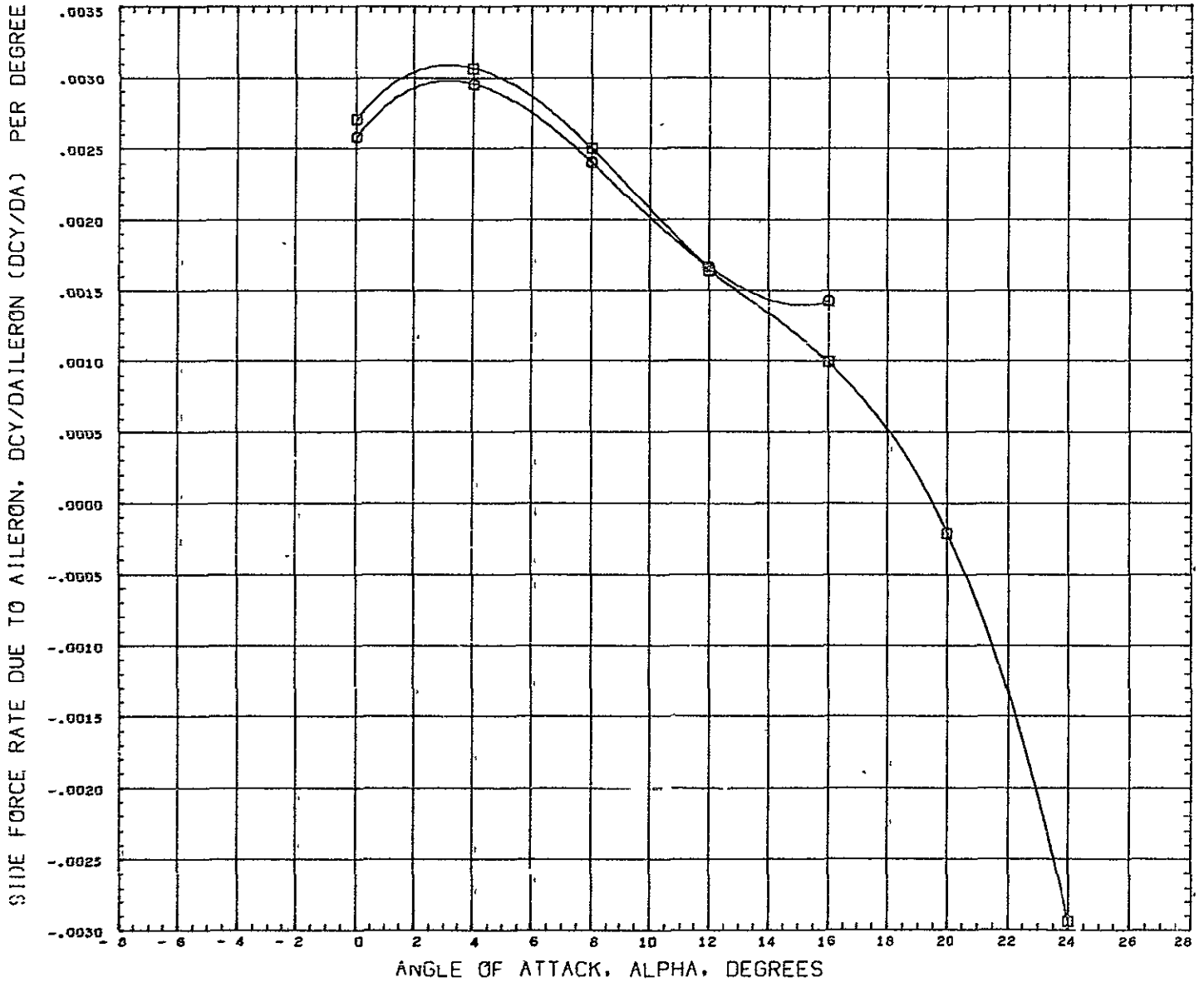

SYMBOL	BETA	PARAMETRIC VALUES			
○	- 4.000	MACH	0.259	ELEVON	0.000
□	0.000	AILRON	0.000	RUDDER	0.000

REFERENCE INFORMATION		
REFS	316.2304	sq IN
REFL	50.1900	IN
REFB	7.3500	IN
XMRP	33.9090	IN
YMRP	0.0000	IN
ZMRP	0.0000	IN
SCALE	0.0175	

DATA HIST. CODE #P

# LATERAL CONTROL DERIVATIVES - DELTA WING CONFIGURATIONS

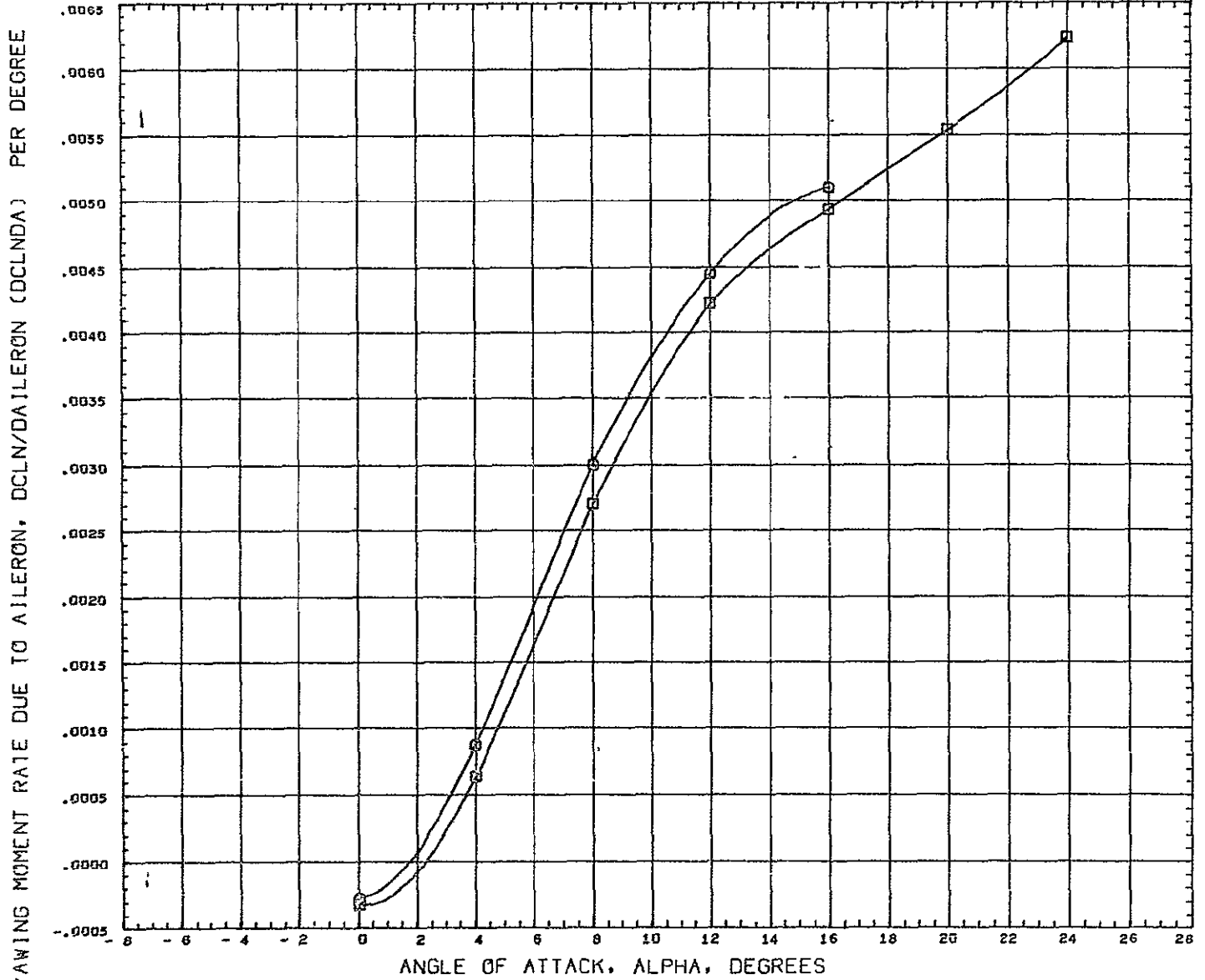

SYMBOL	BETA	PARAMETRIC VALUES			
○	4.000	MACH	0.259	ELEVON	0.000
□	9.000	AILERON	0.000	RUDDER	0.990

REFERENCE INFORMATION		
REFS	316.2304	SG IN
REFL	50.1900	IN
REFB	7.3500	IN
XMRP	33.9090	IN
YMRP	0.0000	IN
ZMRP	0.0000	IN
SCALE	0.0175	

DATA HIST. CODE \*F

# LATERAL CONTROL DERIVATIVES - DELTA WING CONFIGURATIONS

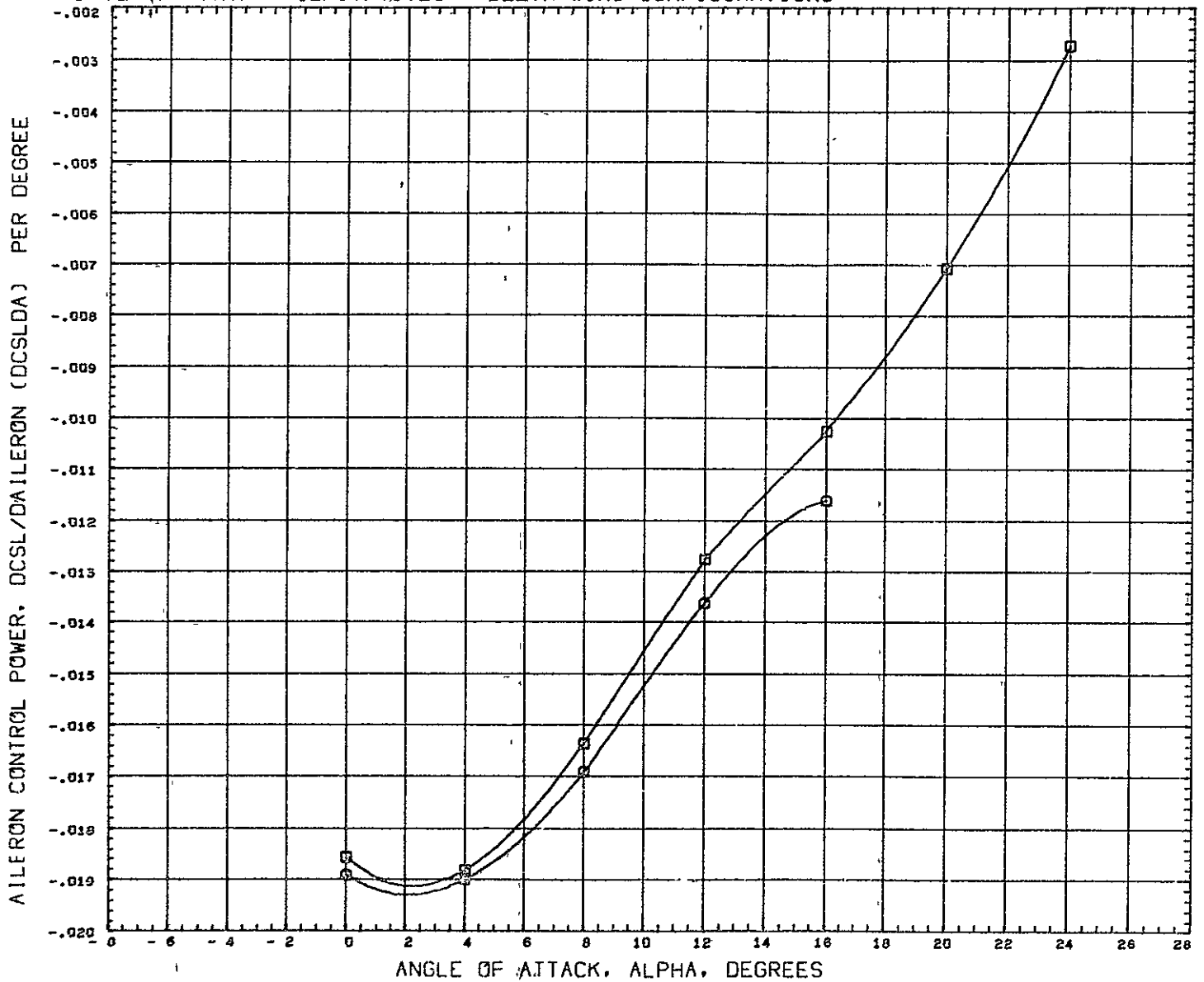

SYMBOL	BETA	PARAMETRIC VALUES				REFERENCE INFORMATION		
○	4.000	MACH	0.259	ELEVON	0.000	REFS	316.2304	SQ IN
□	0.000	AILRON	0.000	RUDDER	0.000	REFL	50.1900	IN
						REFB	7.3500	IN
						XMRP	33.9090	IN
						YMRP	0.0000	IN
						ZMRP	0.0000	IN
						SCALE	0.0175	

DATA HIST. CODE #F

LATERAL CHARACTERISTICS - AILERON EFFECTIVENESS - DELTA WING CONFIG. - BETA=0DEG

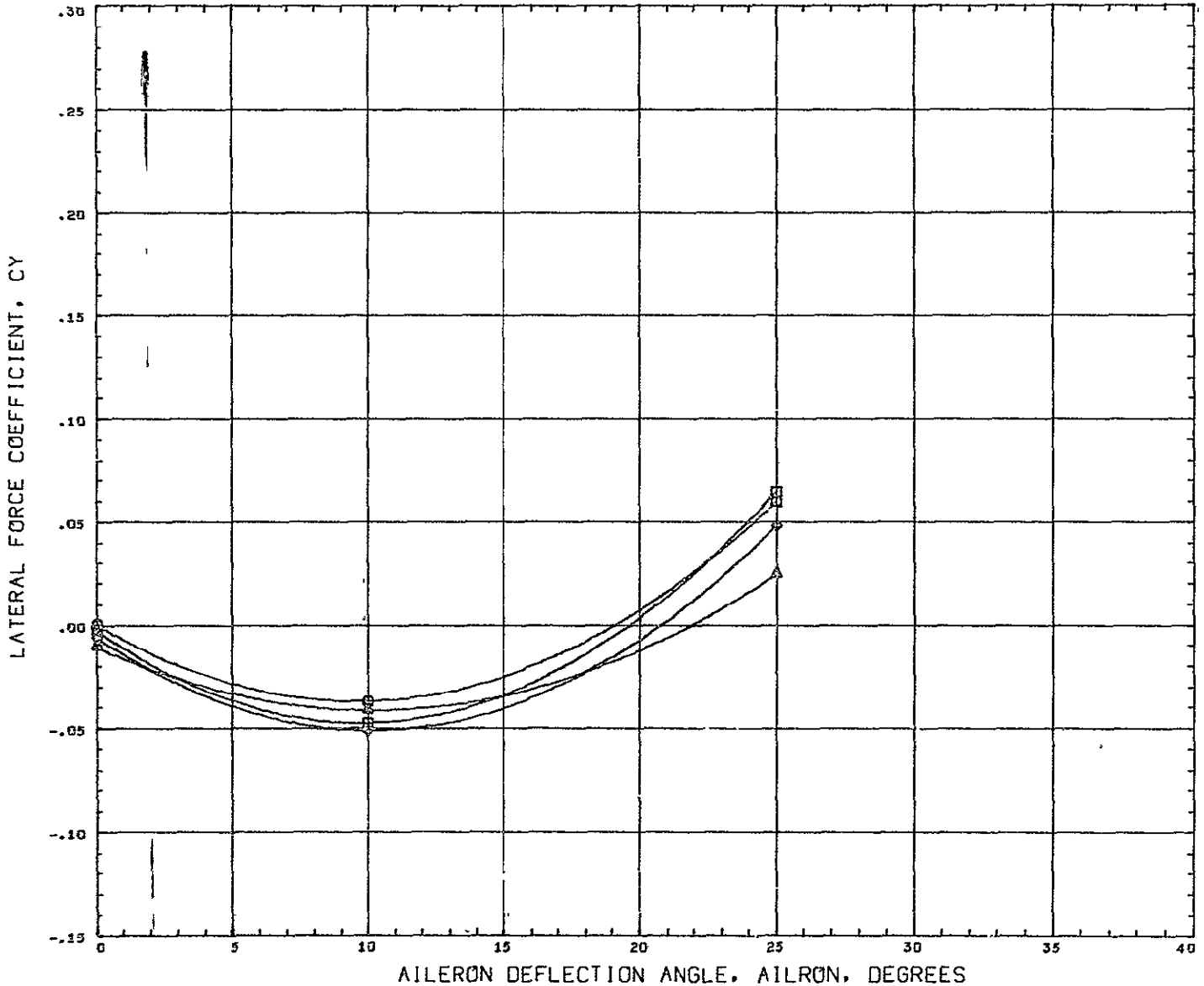

SYMBOL	ALPHA	PARAMETRIC VALUES				REFERENCE INFORMATION		
○	0.000	MACH	0.259	BETA	0.000	REFS	316.2304	SQ IN
□	4.000	ELEVCH	0.000	RUDDER	0.000	REFL	50.1900	IN
◇	8.000					REFB	7.3500	IN
△	12.000					XMRP	33.9090	IN
						YMRP	0.0000	IN
						ZMRP	0.0000	IN
						SCALE	0 0175	

. DATA HIST. CODE 1

LATERAL CHARACTERISTICS - AILERON EFFECTIVENESS - DELTA-WING CONFIG. - BETA=0DEG

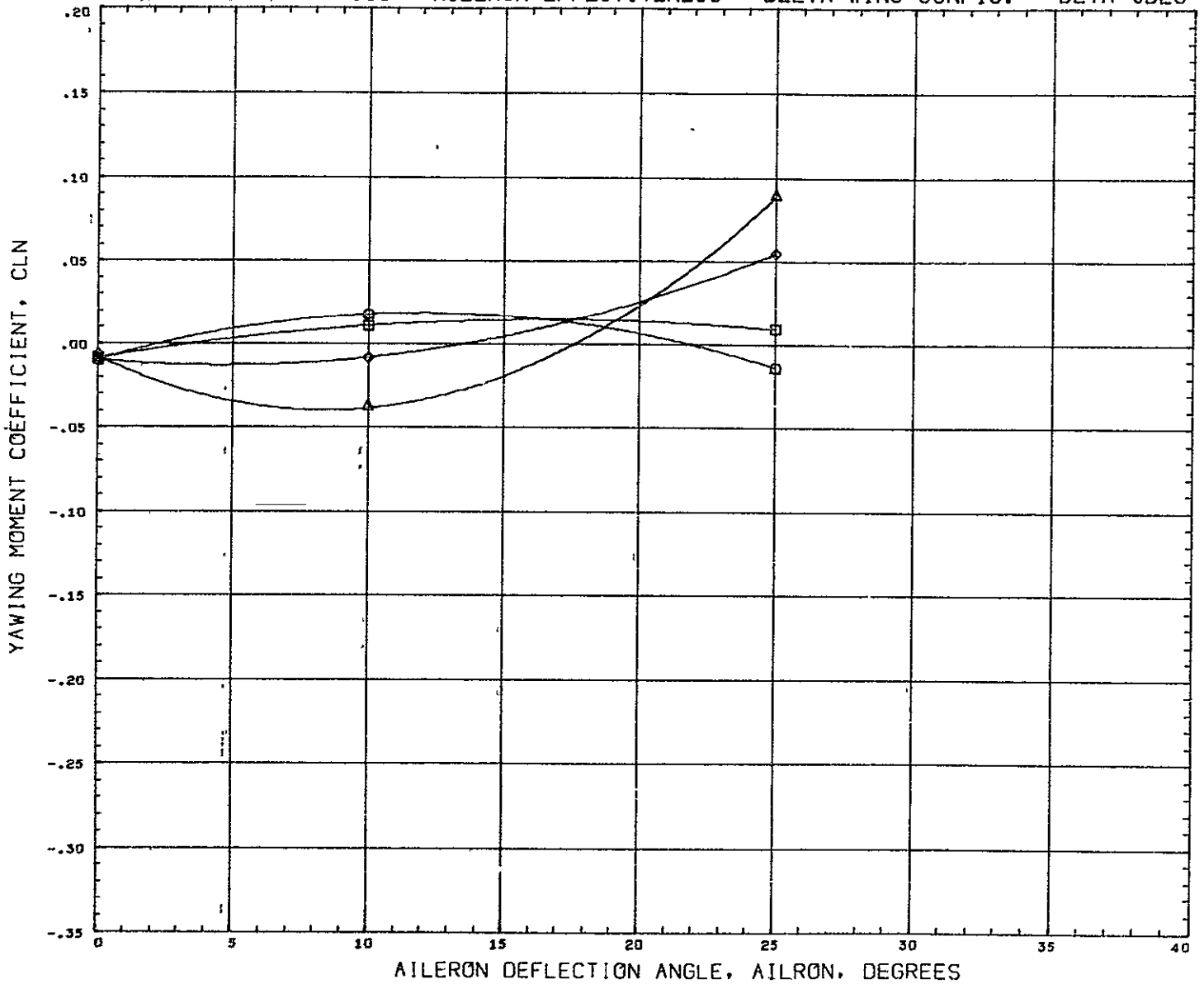

SYMBOL	ALPHA	PARAMETRIC VALUES				REFERENCE INFORMATION		
		MACH	BETA	ELEVON	RUDDER	REFS	REFL	SQ IN
○	0.000	0.259	0.000	0.000	316.2304	50.1900	IN	
◻	4.000	0.000	0.000	0.000	7.3300	33.9090	IN	
◇	8.000				0.0000	0.0000	IN	
△	12.000				0.0000	0.0175	IN	

DATA HIST. CODE I

LATERAL CHARACTERISTICS - AILERON EFFECTIVENESS - DELTA WING CONFIG. - BETA=0DEG

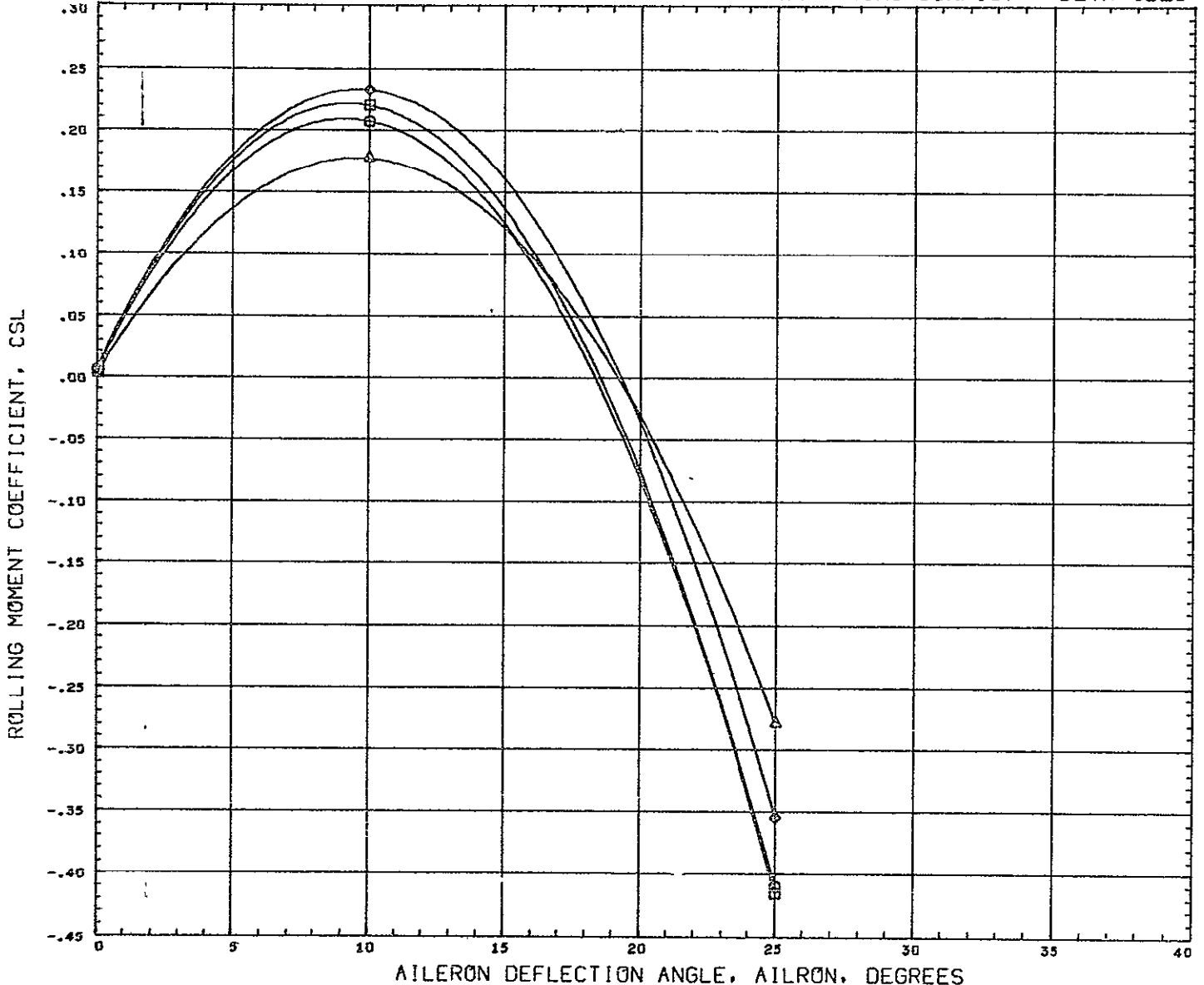

SYMBOL	ALPHA	PARAMETRIC VALUES				REFERENCE INFORMATION		
□	0.000	MACH	0.259	BETA	0.000	REFS	316 2304	SQ IN
□	4.000	ELEVON	0.000	RUDDER	0.000	REFL	50.1900	IN
◇	8.000					REFB	7.3500	IN
◇	12.000					XNRF	33 9090	IN
						YHRF	0.0000	IN
						ZHRF	0.0000	IN
						SCALE	0 0175	

DATA HIST. CODE 1



LATERAL CHARACTERISTICS - AILERON EFFECTIVENESS - DELTA WING CONFIG. - BETA=-4DEG

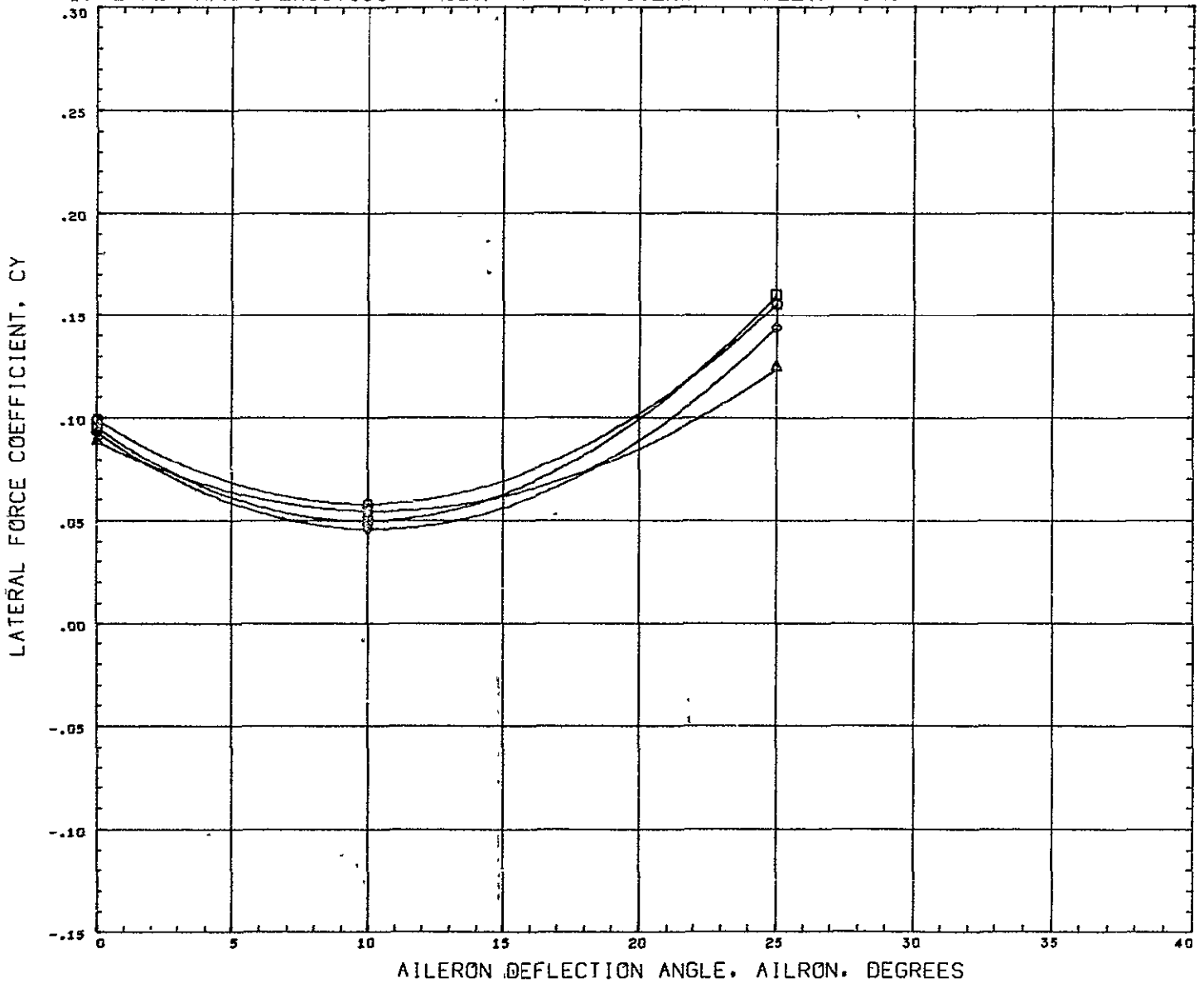

SYMBOL	ALPHA	PARAMETRIC VALUES				REFERENCE INFORMATION		
		MACH	BETA	ELEVON	RUDDER	REFS	REFL	REFB
□	0.000	0.259	- 4.000	0.000	0.000	316.2304	50.1900	7.3500
□	4.000							
○	8.000							
△	12.000							

DATA HIST. CODE 1

LATERAL CHARACTERISTICS - AILERON EFFECTIVENESS - DELTA WING CONFIG. - BETA=-4DEG

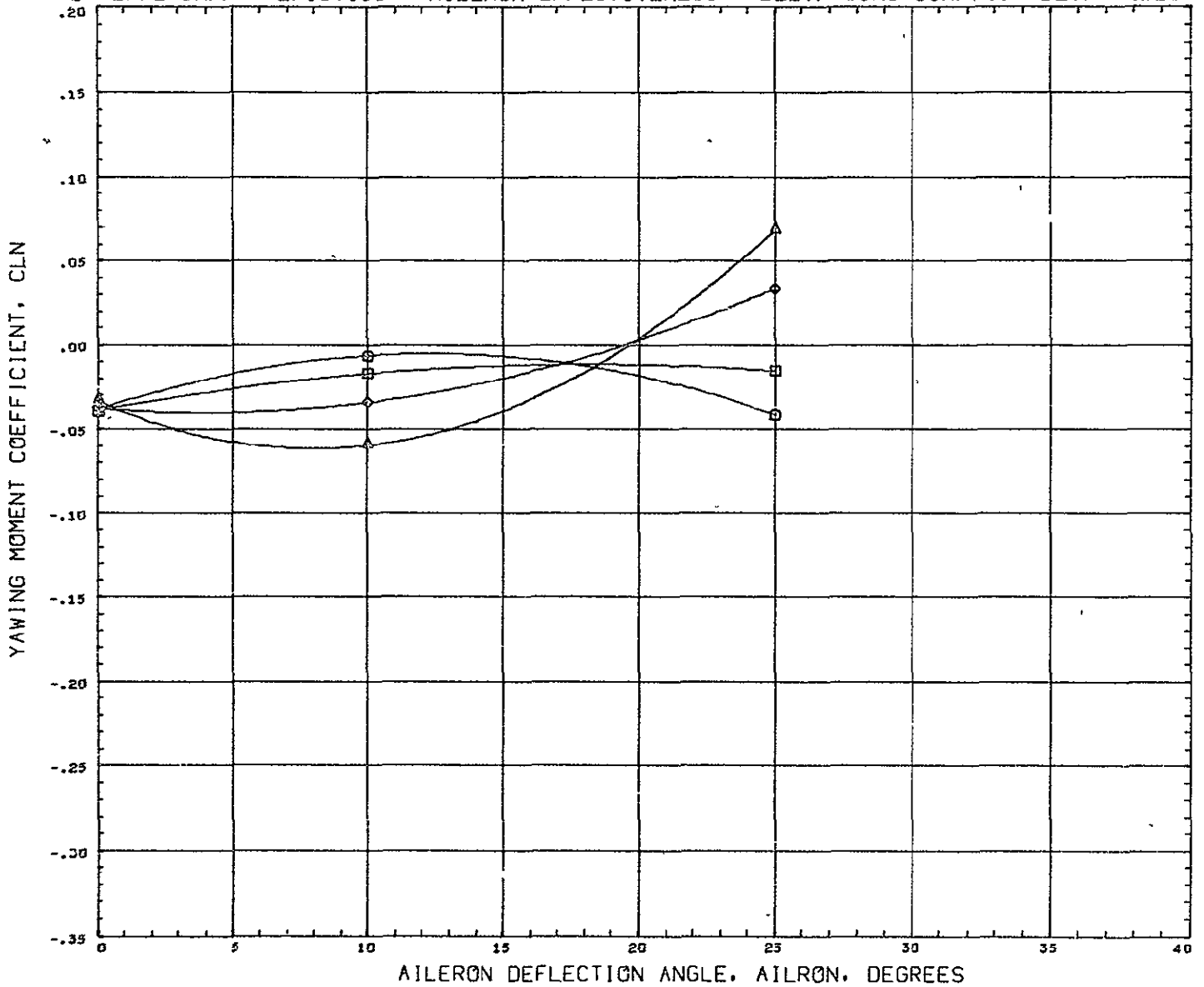

SYMBOL	ALPHA	PARAMETRIC VALUES				REFERENCE INFORMATION		
		MACH	BETA	ELEVON	RUDDER	REFS	REFL	SQ IN
○	0.000	0.259	- 4.000	0.000	0.000	316.2304	IN	
□	4.000	0.259	- 4.000	0.000	0.000	50.1900	IN	
◇	8.000	0.259	- 4.000	0.000	0.000	7.3500	IN	
△	12.000	0.259	- 4.000	0.000	0.000	33.9090	IN	
						0.0000	IN	
						0.0000	IN	
						0.0175	IN	

DATA HIST. CODE 1

LATERAL CHARACTERISTICS - AILERON EFFECTIVENESS - DELTA WING CONFIG. - BETA=-4DEG

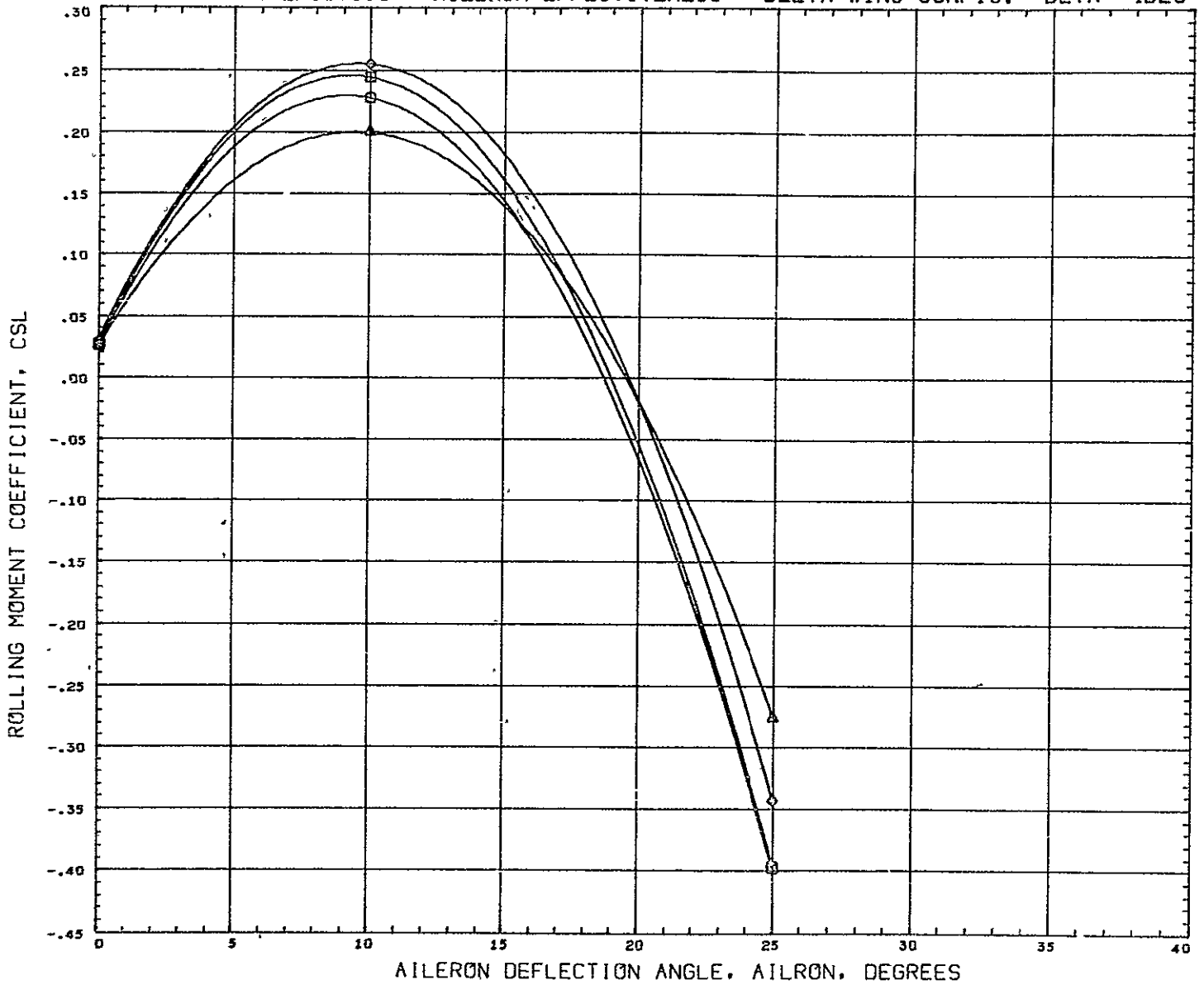

SYMBOL	ALPHA	PARAMETRIC VALUES				REFERENCE INFORMATION		
□	0.000	MACH	0.259	BETA	- 4.000	REFS	316 2304	50 IN
□	4.000	ELEVON	0.000	RUDDER	0.000	REFL	50.1900	IN
◇	8.000					PEFB	7.3500	IN
△	12.000					XNRF	33.9090	IN
						YHRF	0.0000	IN
						ZHRF	0.0000	IN
						SCALE	0.0175	

DATA HIST. CODE I

# DIRECTIONAL CHARACTERISTICS - RUDDER EFFECTIVENESS - DELTA WING CONFIGURATION

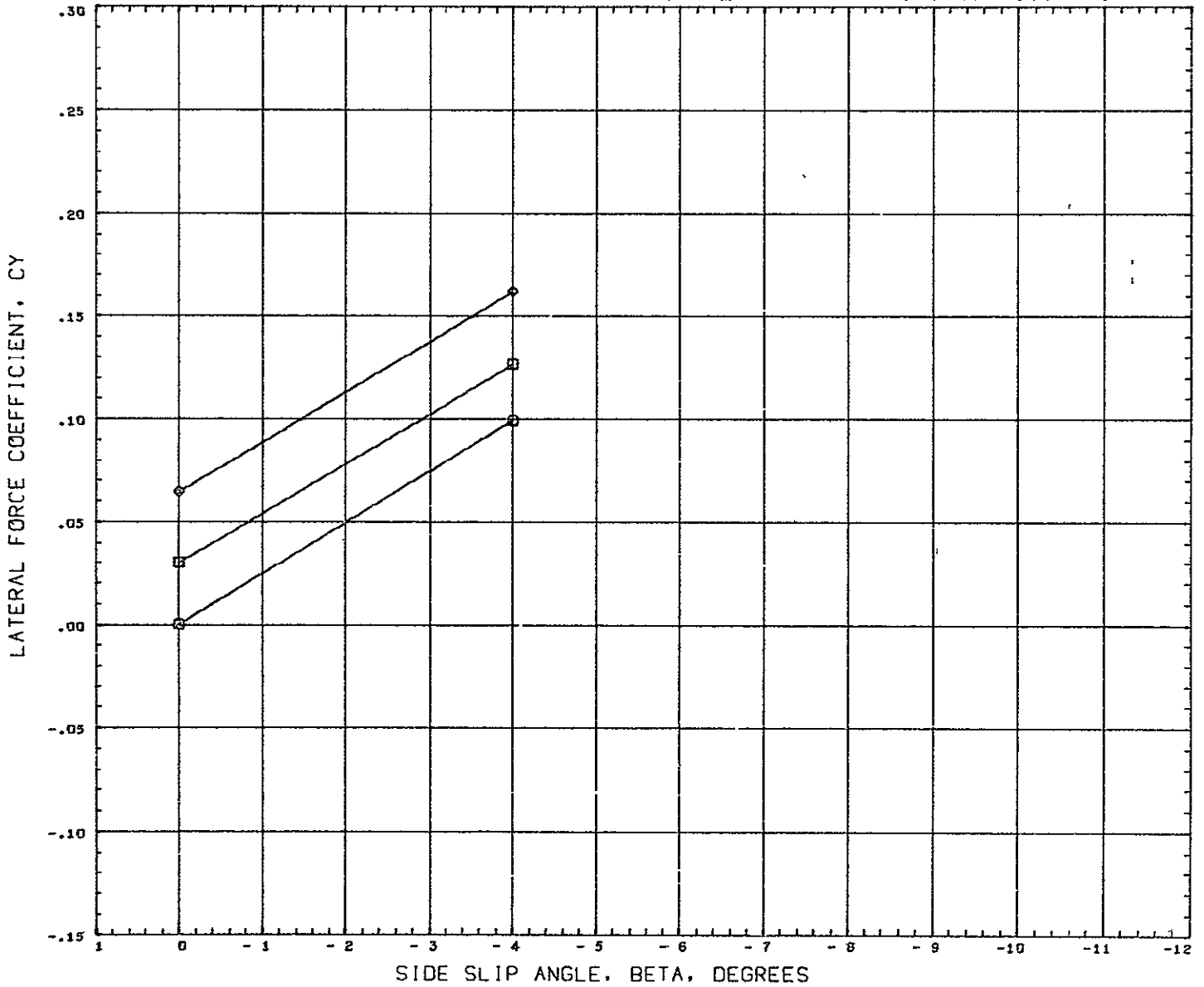

SYMBOL	RUDDER	PARAMETRIC VALUES			
□	0.000	MACH	0.259	ALPHA	0.000
□	10.000	ELEVON	0.000	AILRON	0.000
○	20.000				

REFERENCE INFORMATION		
REFS	316 2304	SQ IN
REFL	50 1900	IN
REFB	7 3500	IN
XMRP	33 9090	IN
YMRP	0.0000	IN
ZMRP	0.0000	IN
SCALE	0 0175	

DATA HIST. CODE I

DIRECTIONAL CHARACTERISTICS - RUDDER EFFECTIVENESS - DELTA WING CONFIGURATION

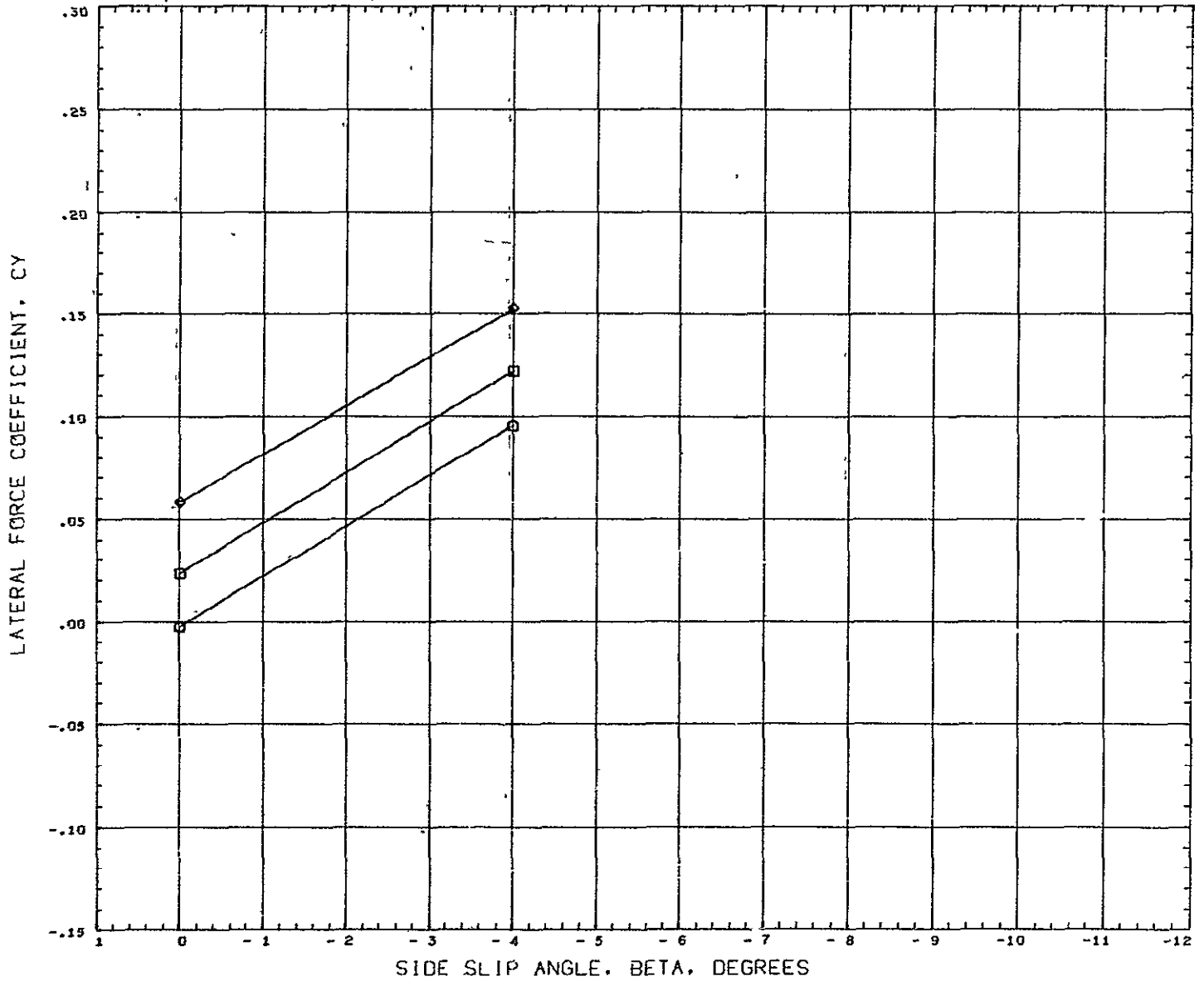

SYMBOL	RUDDER	MACH	PARAMETRIC VALUES		
○	0.000	0.259	ALPHA	4.000	
□	15.000	ELEVON	0.000	AILERON	0.000
◇	20.000				

REFERENCE INFORMATION		
REFS	316.2304	SQ IN
REFL	50.1900	IN
REFB	7.3500	IN
XNRF	33.9000	IN
YMRF	0.0000	IN
ZMRF	0.0000	IN
SCALE	0.0175	

DATA HIST. CODE 1

# DIRECTIONAL CHARACTERISTICS - RUDDER EFFECTIVENESS - DELTA WING CONFIGURATION

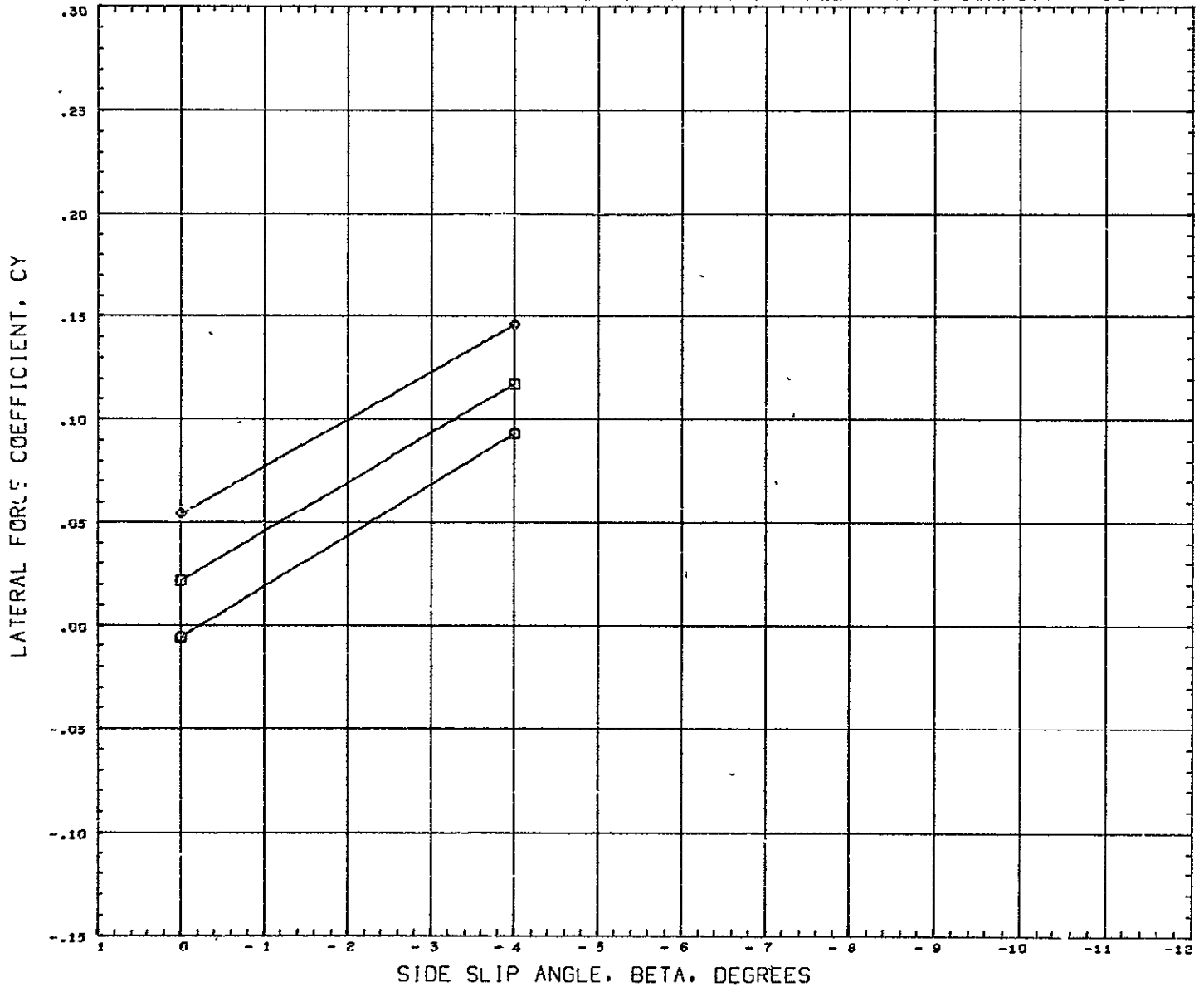

SYMBOL	RUDDER	PARAMETRIC VALUES			
○	0.000	MACH	0.259	ALPHA	8.000
□	10.000	ELEVON	0.000	AIRLON	0.000
◇	20.000				

REFERENCE INFORMATION		
REFS	316.2304	SQ IN
REFL	50.1900	IN
REFB	7.3500	IN
XMRP	33.9090	IN
YMRP	0.0000	IN
ZMRP	0.0000	IN
SCALE	0.0175	

DATA HIST. CODE 1

# DIRECTIONAL CHARACTERISTICS - RUDDER EFFECTIVENESS - DELTA WING CONFIGURATION

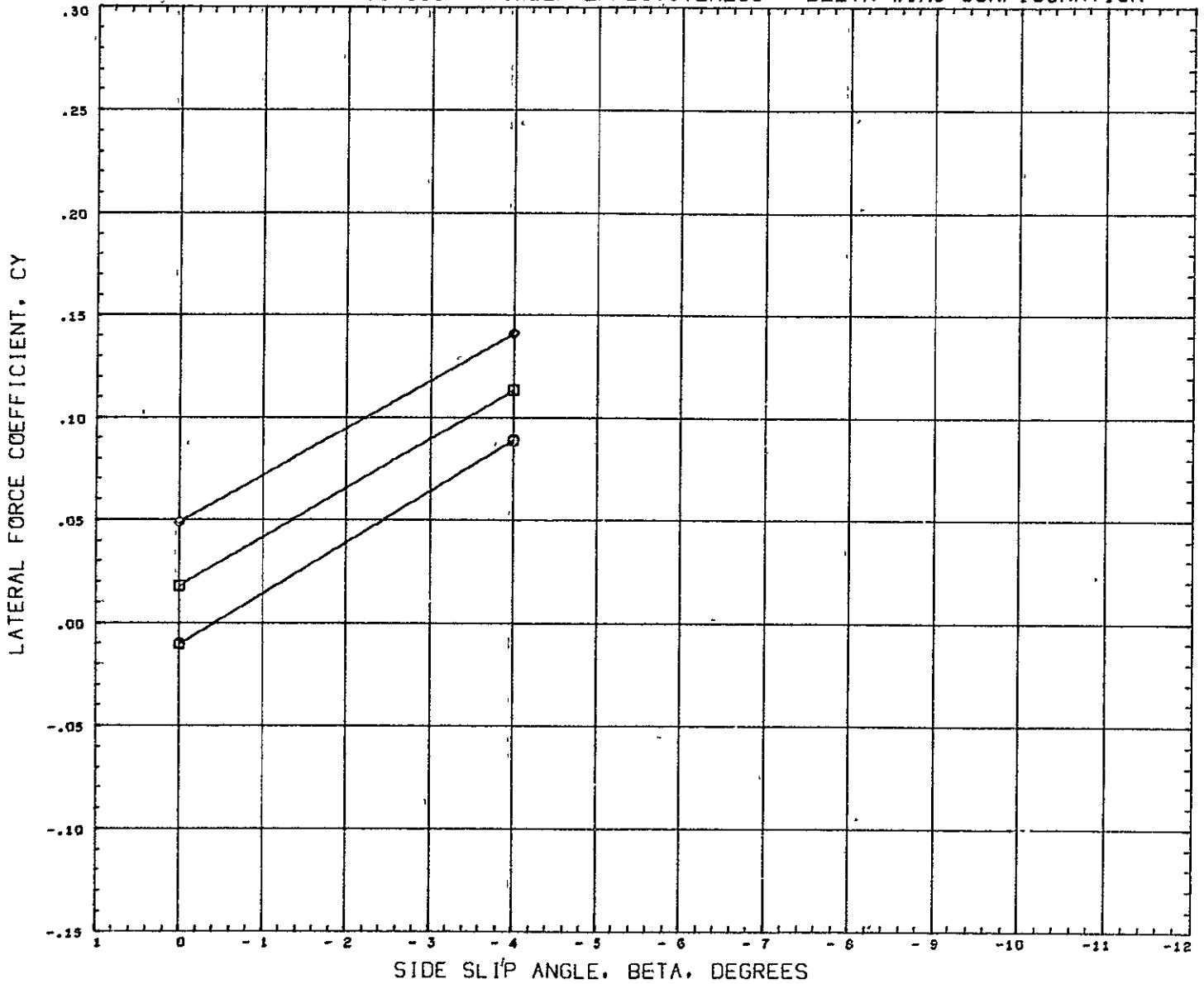

SYMBOL	RUDDER	PARAMETRIC VALUES			
		MACH	ALPHA	ELEVON	AILERON
○	0.000	0.259	12.000	0.000	0.000
□	10.000	0.000	0.000	0.000	0.000
◇	25.000				

REFERENCE INFORMATION		
REFS	316.2304	SQ IN
REFL	50.1900	IN
REFB	7.3500	IN
XMRP	33.9090	IN
YMRP	0.0000	IN
ZMRP	0.0000	IN
SCALE	0.0175	

DATA HIST. CODE 1

# DIRECTIONAL CHARACTERISTICS - RUDDER EFFECTIVENESS - DELTA WING CONFIGURATION

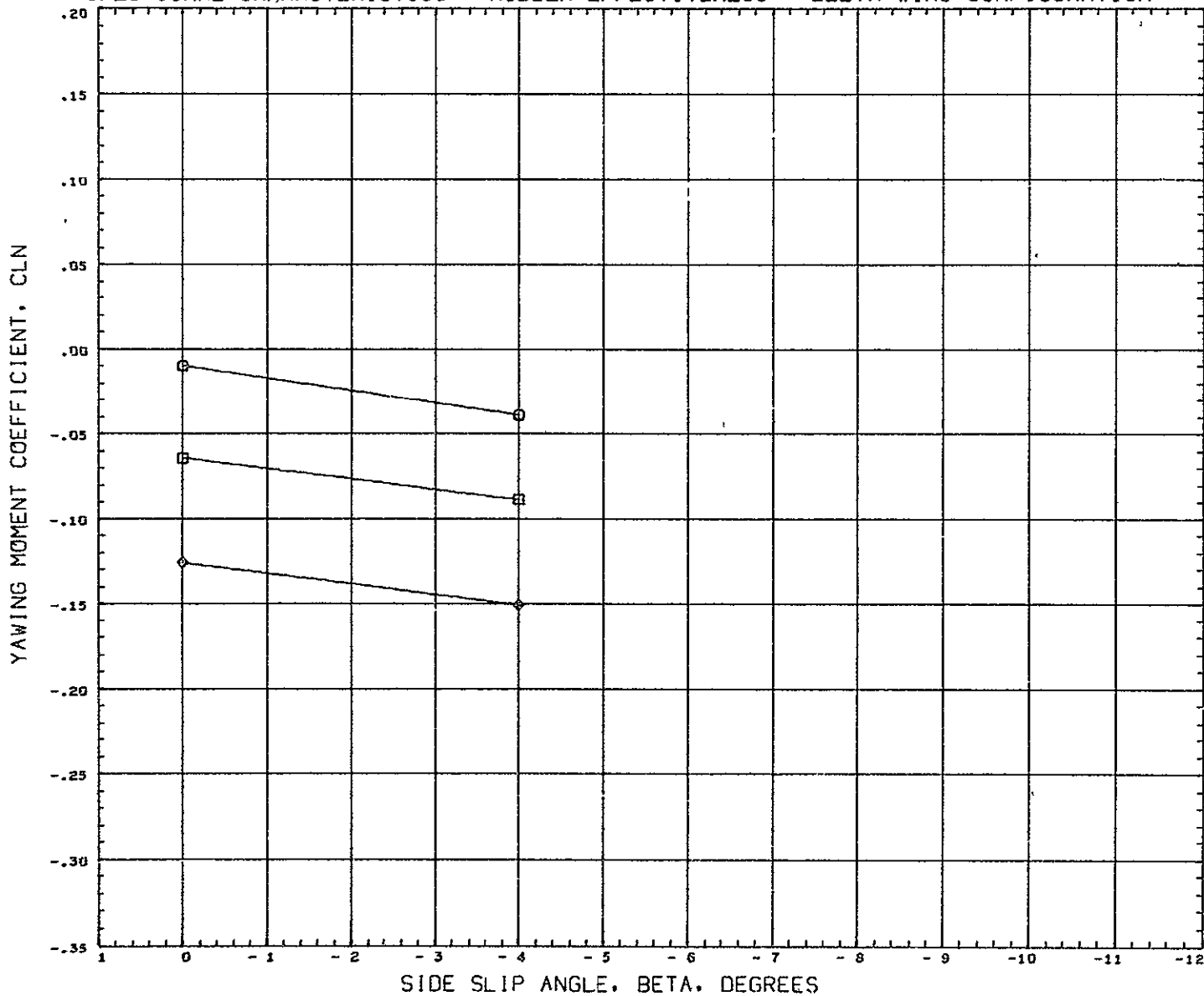

SYMBOL	RUDDER	PARAMETRIC VALUES			
		MACH	ALPHA	ELEVON	AILRON
○	0.000	0.259	0.000	0.000	0.000
□	10.000	0.000	0.000	0.000	0.000
◇	20.000				

REFERENCE INFORMATION		
REFS	316.2304	SQ IN
REFL	50.1900	IN
REFB	7.3500	IN
XHRF	33.9090	IN
YHRF	0.0000	IN
ZHRF	0.0000	IN
SCALE	0.0175	

DATA HIST. CODE 1



# DIRECTIONAL CHARACTERISTICS - RUDDER EFFECTIVENESS - DELTA WING CONFIGURATION

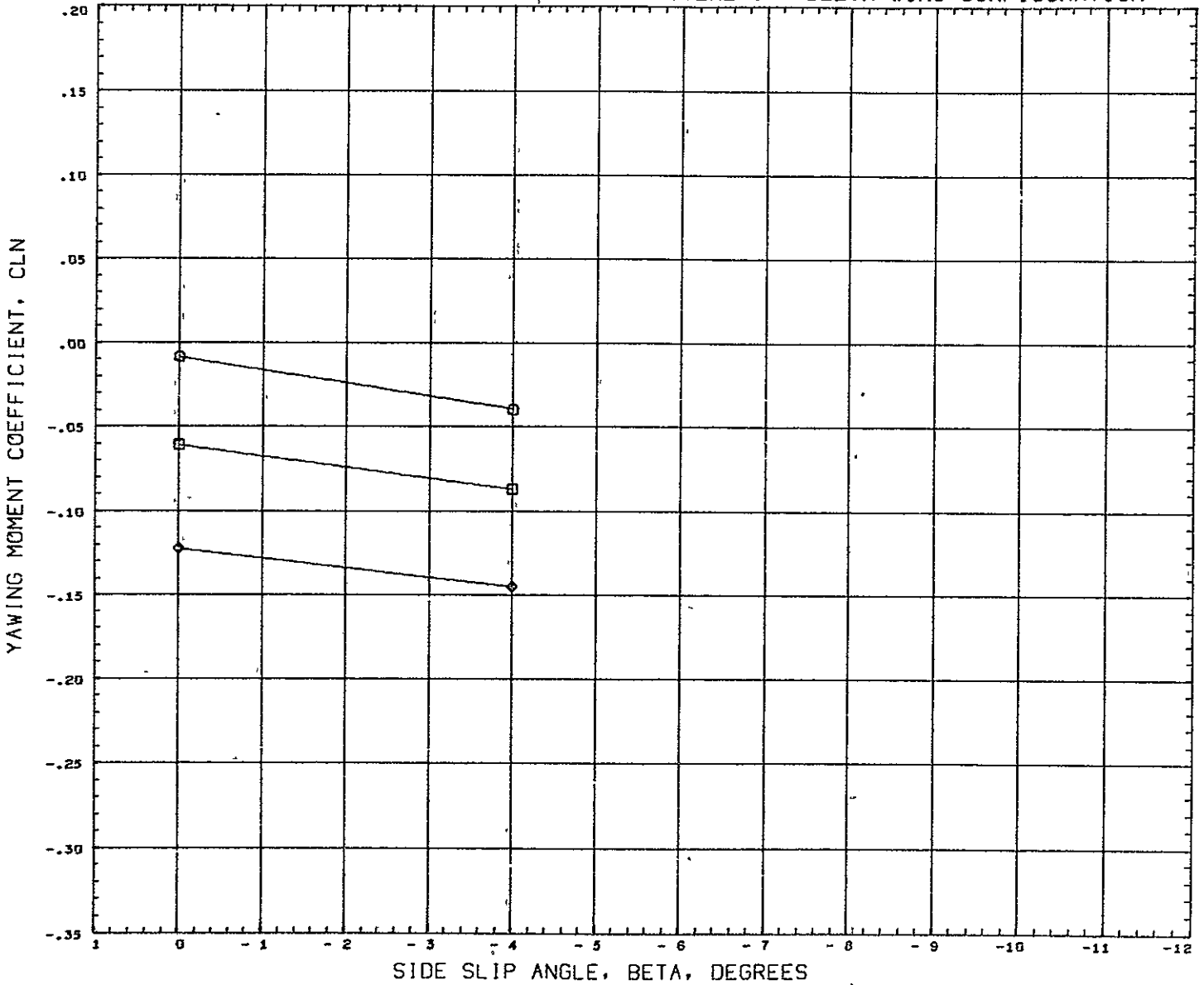

SYMBOL	RUDDER	PARAMETRIC VALUES			
○	0.000	MACH	0.259	ALPHA	4.000
□	10.000	ELEVON	0.000	AIRLON	0.000
◇	20.000				

REFERENCE INFORMATION		
REFS	316.2304	SQ IN
REFL	50.1900	IN
REFB	7.3500	IN
XHRF	33.9090	IN
YHRF	0.0000	IN
ZHRF	0.0000	IN
SCALE	0.0175	

DATA HIST. CODE I

# DIRECTIONAL CHARACTERISTICS - RUDDER EFFECTIVENESS - DELTA WING CONFIGURATION

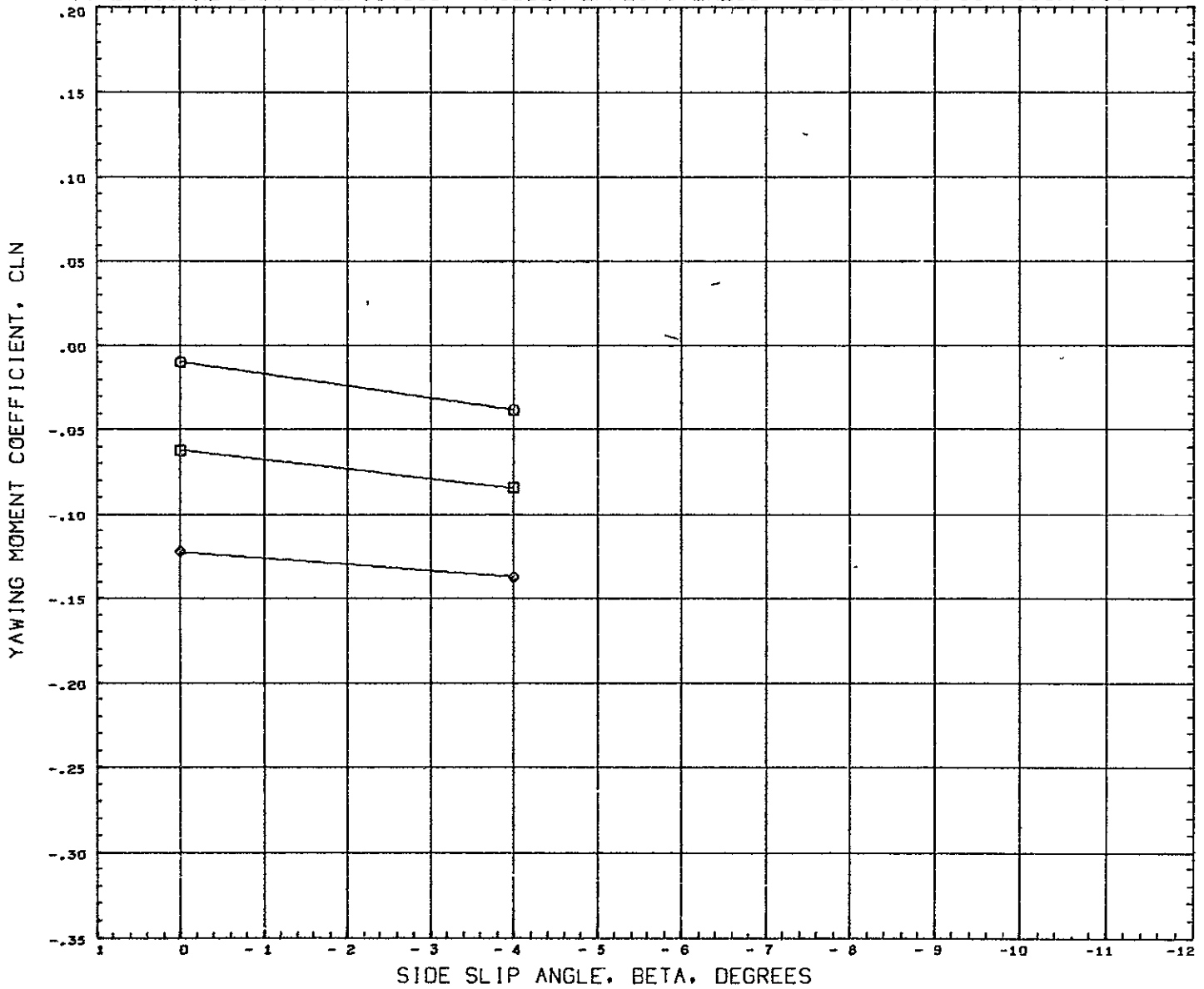

SYMBOL	RUDDER	PARAMETRIC VALUES			
○	0.000	MACH	0.259	ALPHA	8.000
□	10.000	ELEVON	0.000	AIRLON	0.000
◇	20.000				

REFERENCE INFORMATION		
REFS	316.2304	SQ IN
REFL	50.1900	IN
REFB	7.3500	IN
XMRP	33.9090	IN
YMRP	0.0000	IN
ZMRP	0.0000	IN
SCALE	0.0175	

DATA HIST. CODE 1

DIRECTIONAL CHARACTERISTICS - RUDDER EFFECTIVENESS - DELTA WING CONFIGURATION

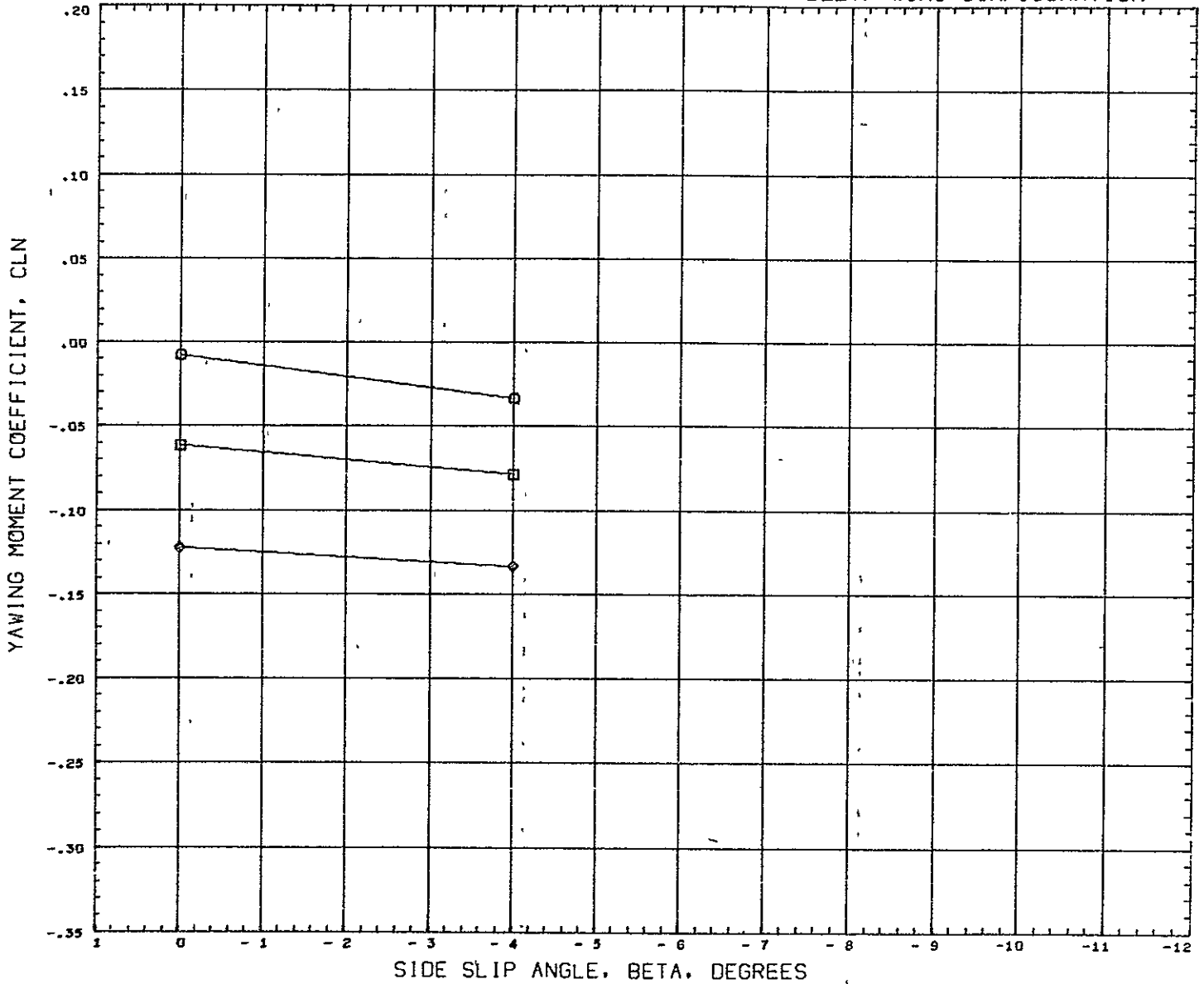

SYMBOL	RUDDER	PARAMETRIC VALUES			
○	5.000	HACH	0.259	ALPHA	12.000
□	15.000	ELEVON	0.000	AILRON	0.000
◇	20.000				

REFERENCE INFORMATION		
REFS	316 2304	sq IN
REFL	50.1900	IN
REFB	7.3500	IN
XMRP	33.9090	IN
YMRP	0.0000	IN
ZMRP	0.0000	IN
SCALE	0.0175	

DATA MIST. CODE 1

DIRECTIONAL CHARACTERISTICS - RUDDER EFFECTIVENESS - DELTA WING CONFIGURATION

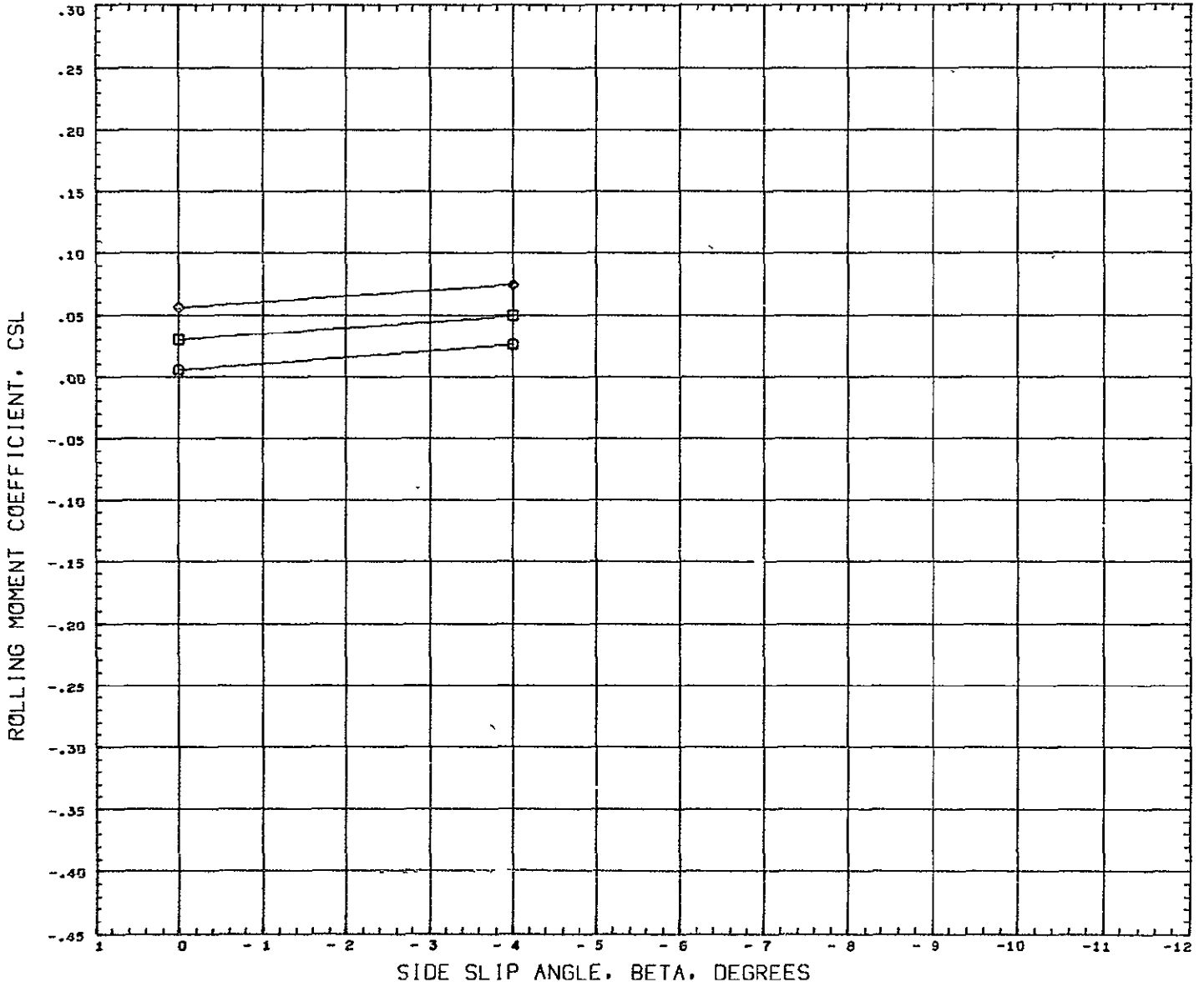

SYMBOL	RUDDER	MACH	PARAMETRIC VALUES	ALPHA	
◇	5.000	0.259	0.000	0.000	
□	15.000	ELEVON	0.000	AILRON	0.000
○	20.000				

REFERENCE INFORMATION		
REFS	316.2304	SQ IN
REFL	50.1900	IN
REFB	7.3500	IN
XMRP	33.9090	IN
YMRP	0.0000	IN
ZMRP	0.0000	IN
SCALE	0.0175	

DATA HIST. CODE 1

# DIRECTIONAL CHARACTERISTICS - RUDDER EFFECTIVENESS - DELTA WING CONFIGURATION

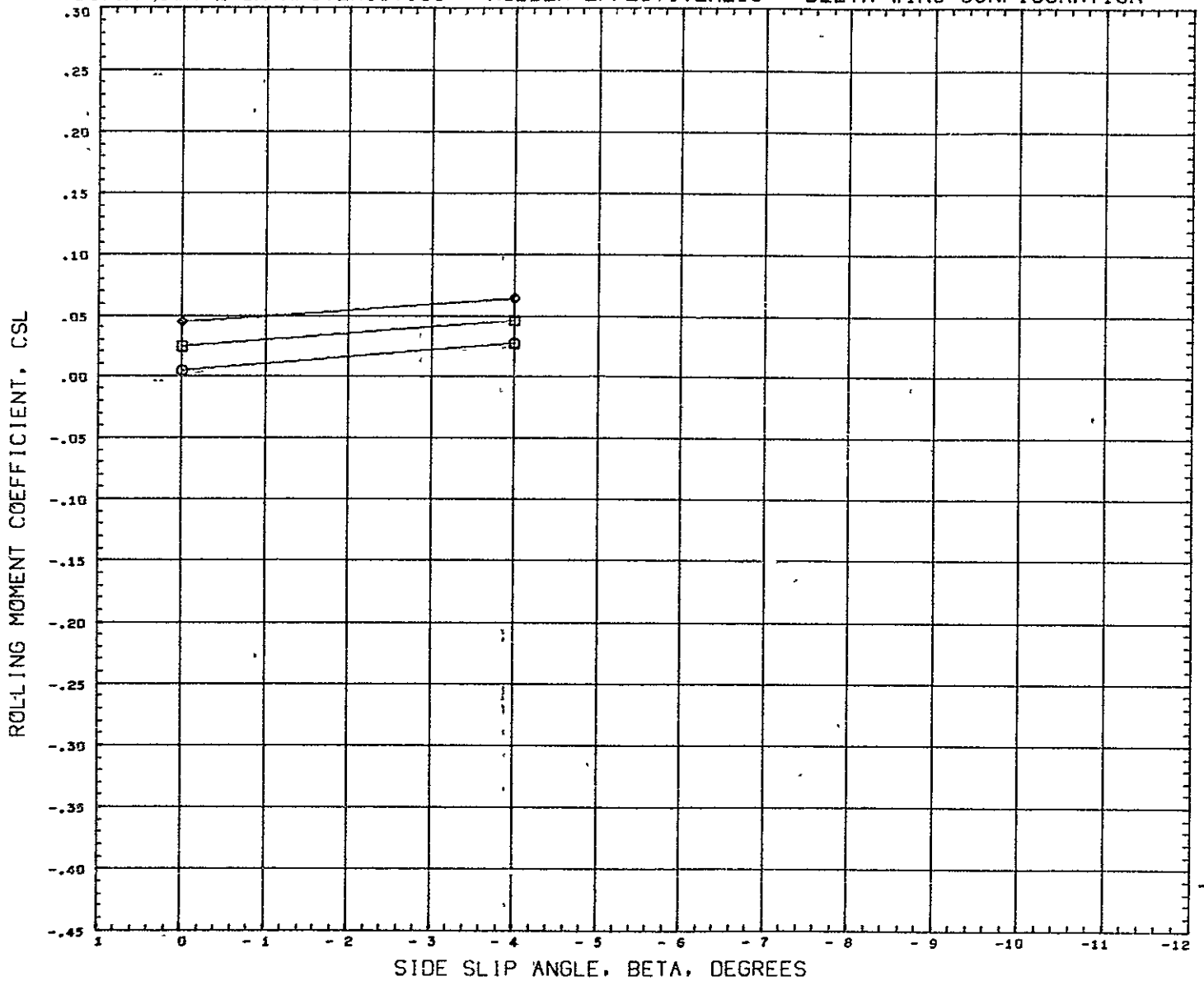

SYMBOL	RUDDER	PARAMETRIC VALUES			
○	5.000	MACH	0.259	ALPHA	4.000
□	10.000	ELEVON	0.000	AILERON	0.000
◇	20.000				

REFERENCE INFORMATION		
REFS	316 2304	SQ IN
REFL	50.1900	IN
PEFB	7.3500	IN
XMRP	33 9090	IN
YMRP	0 0000	IN
ZMRP	0 0000	IN
SCALE	0.0175	

DATA HIST. CODE I

# DIRECTIONAL CHARACTERISTICS - RUDDER EFFECTIVENESS - DELTA WING CONFIGURATION

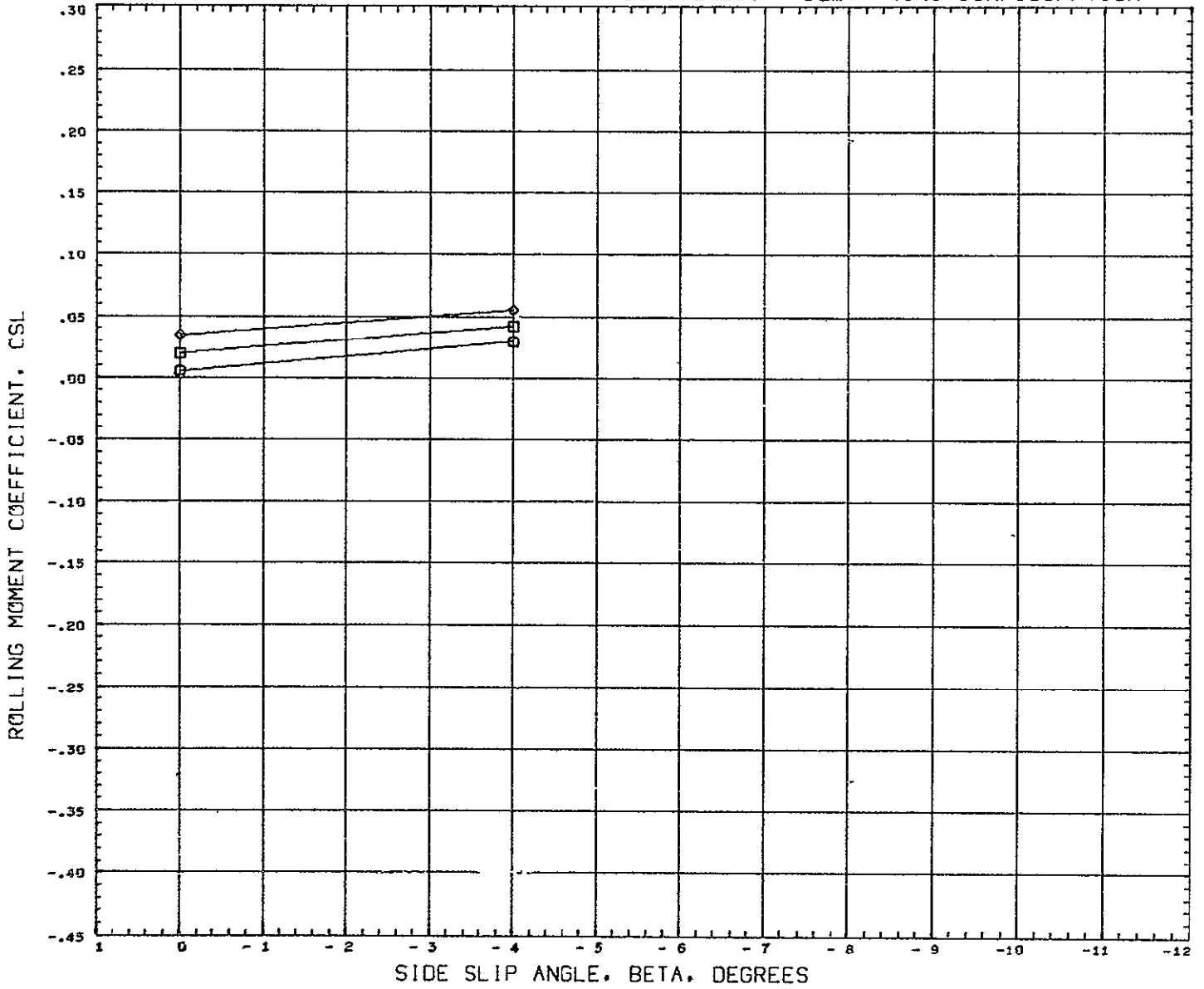

SYMBOL	RUDDER	PARAMETRIC VALUES			
◇	0.000	MACH	0.259	ALPHA	8.000
□	10.000	ELEVON	0.000	AILRON	0.000
○	20.000				

REFERENCE INFORMATION		
REFS	316 2304	SQ IN
REPL	50.1900	IN
REFB	7.3500	IN
XNRF	33 9090	IN
YNRF	0.0000	IN
ZNRF	0.0000	IN
SCALE	0.0175	

DATA HIST. CODE 1

# DIRECTIONAL CHARACTERISTICS - RUDDER EFFECTIVENESS - DELTA WING CONFIGURATION

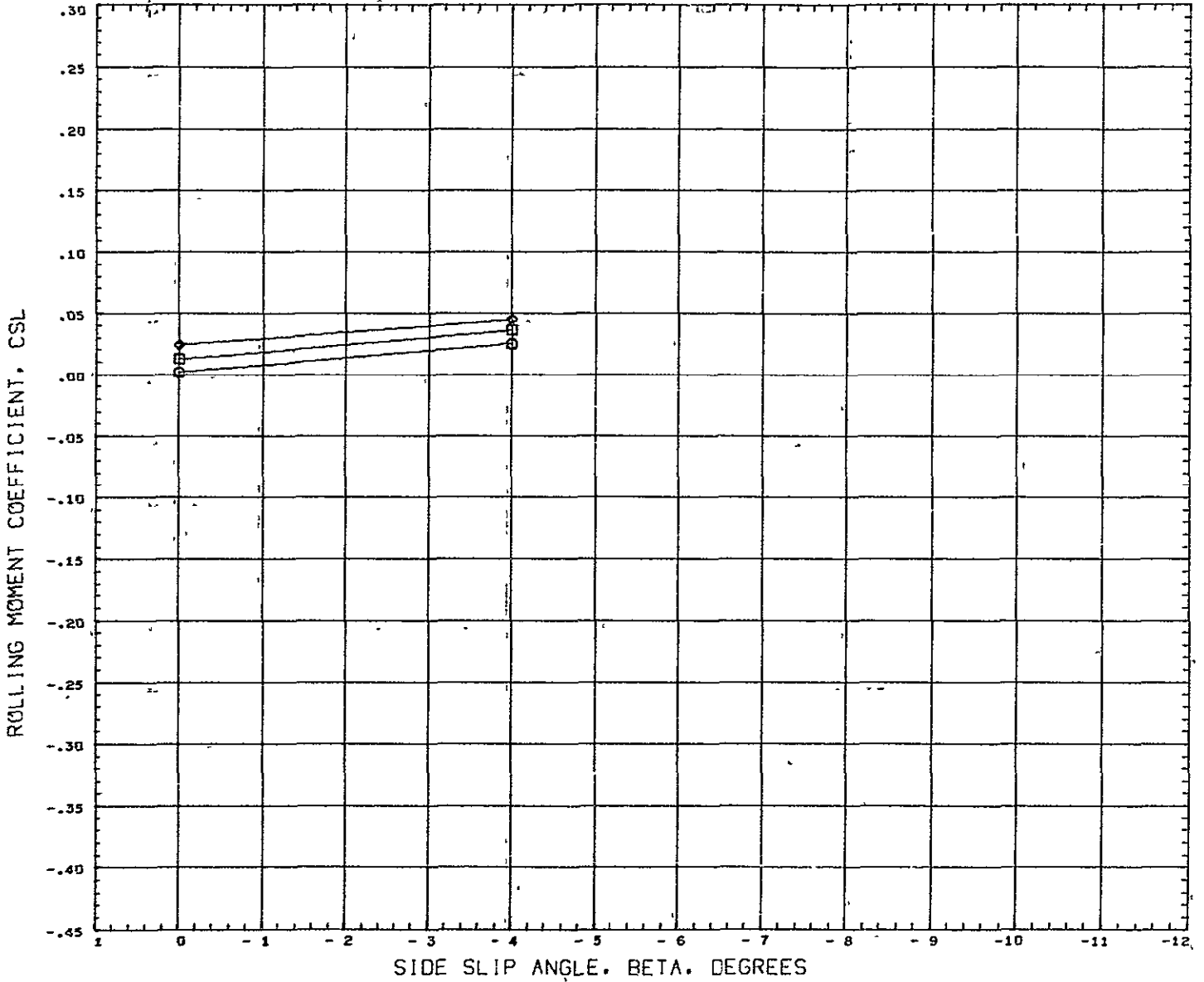

SYMBOL	RUDDER	PARAMETRIC VALUES			REFERENCE INFORMATION			
○	0.000	MACH	0.259	ALPHA	12.000	REFS	316.2304	SQ IN
□	10.000	ELEVON	0.000	AIRLOW	0.000	REFL	50.1900	IN
◇	20.000					REFB	7.3500	IN
						XMRP	33.9090	IN
						YMRP	0.0000	IN
						ZMRP	0.0000	IN
						SCALE	0.0175	

DATA HIST. CODE I

DIRECTIONAL CONTROL DERIVATIVES - DELTA WING CONFIGURATION

SIDE FORCE RATE OF CHANGE WITH RUDDER, DCY/DR (DCY/DR) PER DEGREE

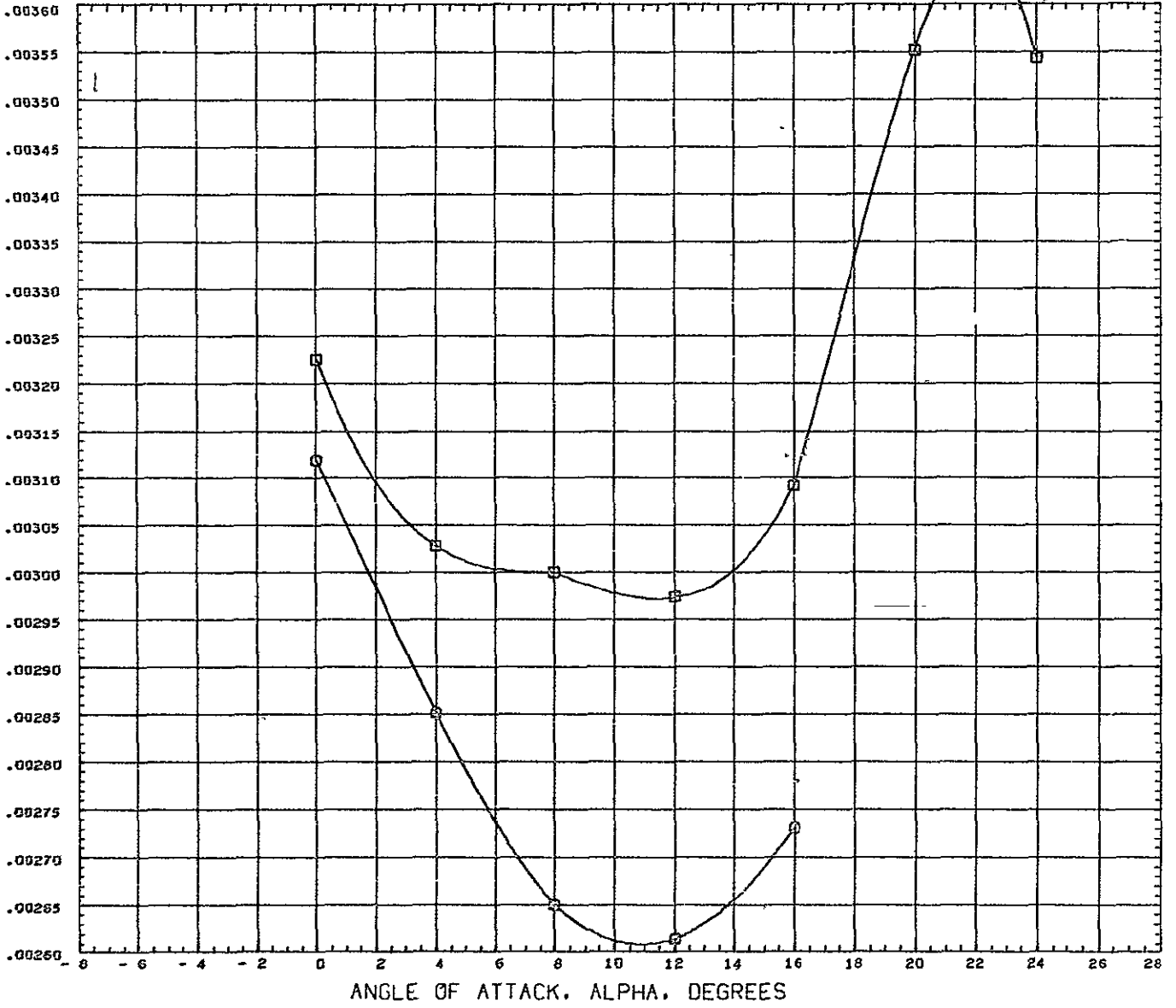

SYMBOL	BETA	PARAMETRIC VALUES				REFERENCE INFORMATION		
□	4.000	MACH	0.259	ELEVON	0.000	REFS	316.2304	SQ IN
○	5.000	AILRON	0.000	RUDDER	0.000	REFL	50.1900	IN
						REFB	7.3500	IN
						XNRF	33.9090	IN
						YNRF	0.0000	IN
						ZNRF	0.0000	IN
						SCALE	0.0175	

DATA HIST. CODE #F



DIRECTIONAL CONTROL DERIVATIVES - DELTA WING CONFIGURATION

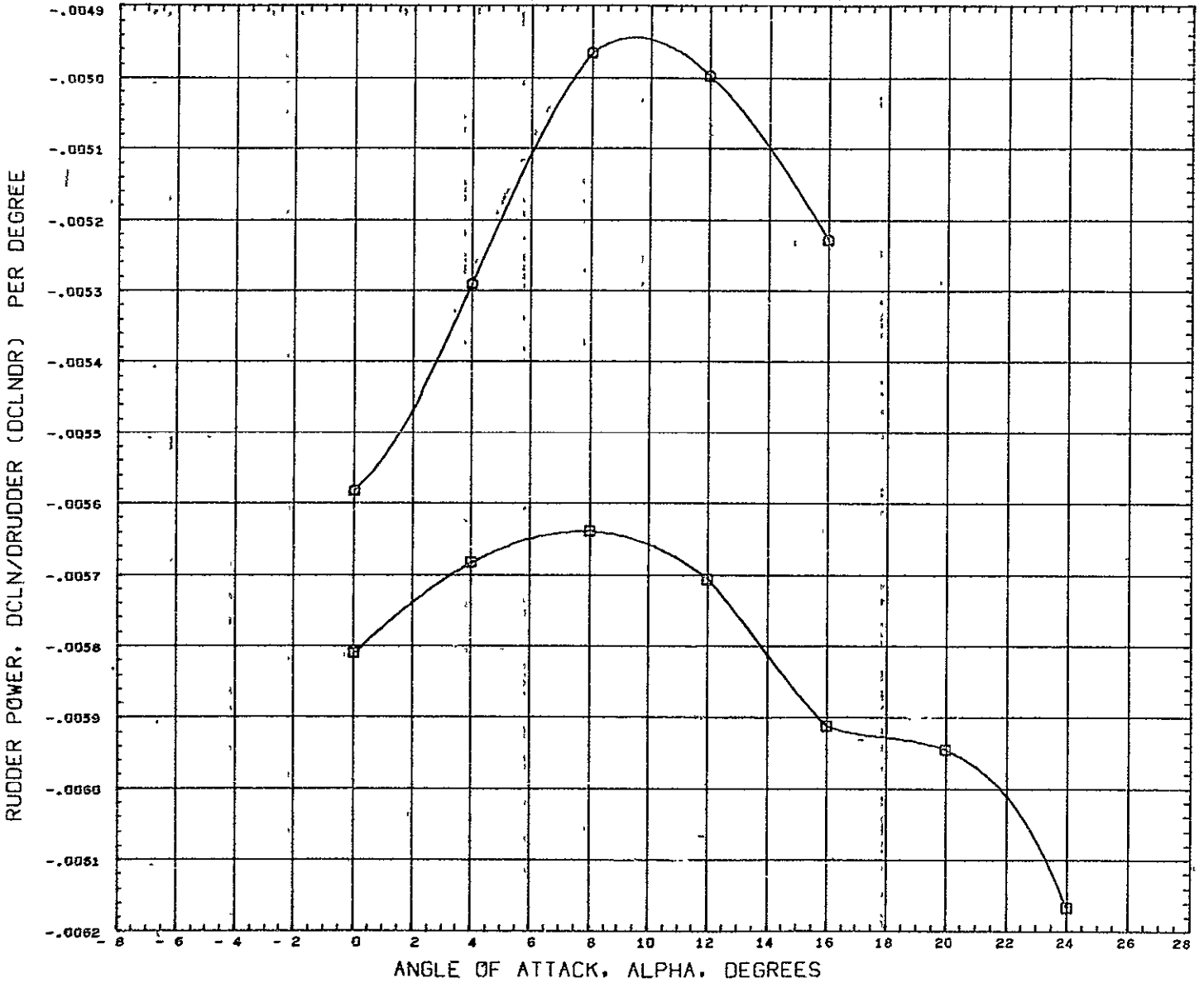

SYMBOL	BETA	PARAMETRIC VALUES			
○	4.000	MACH	0.259	ELEVON	0.000
□	0.000	AILRON	0.000	RUDDER	0.000

REFERENCE INFORMATION		
REFS	316.2304	58 IN
REFL	50.1900	IN
REFB	7.3500	IN
XHRF	33.9090	IN
YHRF	0.0000	IN
ZHRF	0.0000	IN
SCALE	0.0175	

DATA HIST. CODE #F

# DIRECTIONAL CONTROL DERIVATIVES - DELTA WING CONFIGURATION

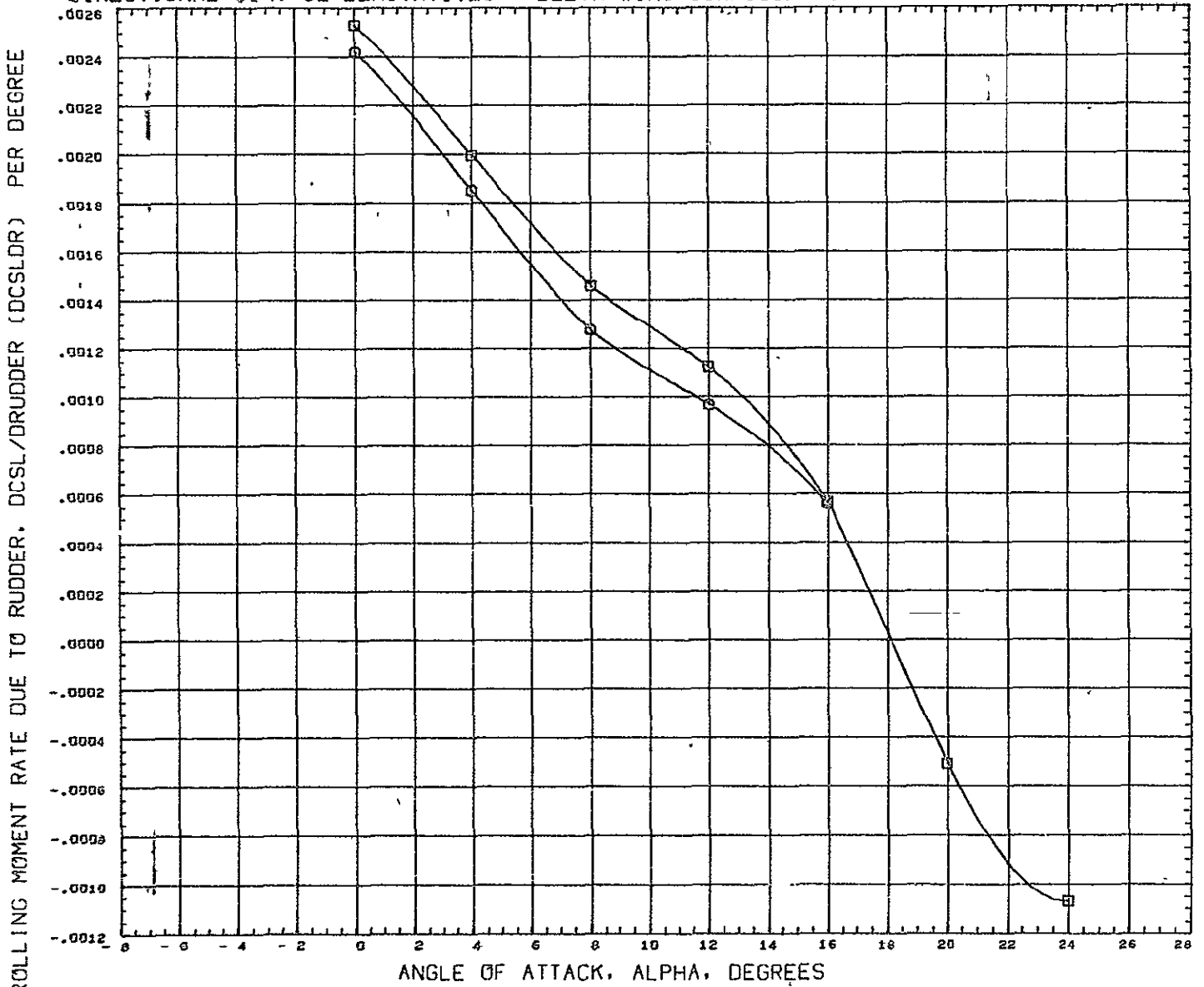

SYMBOL	BETA		PARAMETRIC VALUES		
○	4.000	MACH	0.259	ELEVON	0.000
□	0.000	AILRON	0.000	RUDDER	0.000

REFERENCE INFORMATION		
REFS	316.2304	SQ IN
REFL	50.1900	IN
REFB	7.3500	IN
XHRP	33.9090	IN
YHRP	0.0000	IN
ZHRP	0.0000	IN
SCALE	0.0175	

DATA HIST. CODE \*F

LATERAL CHARACTERISTICS - RUDDER EFFECTIVENESS - DELTA WING CONFIG. - BETA=0 DEG

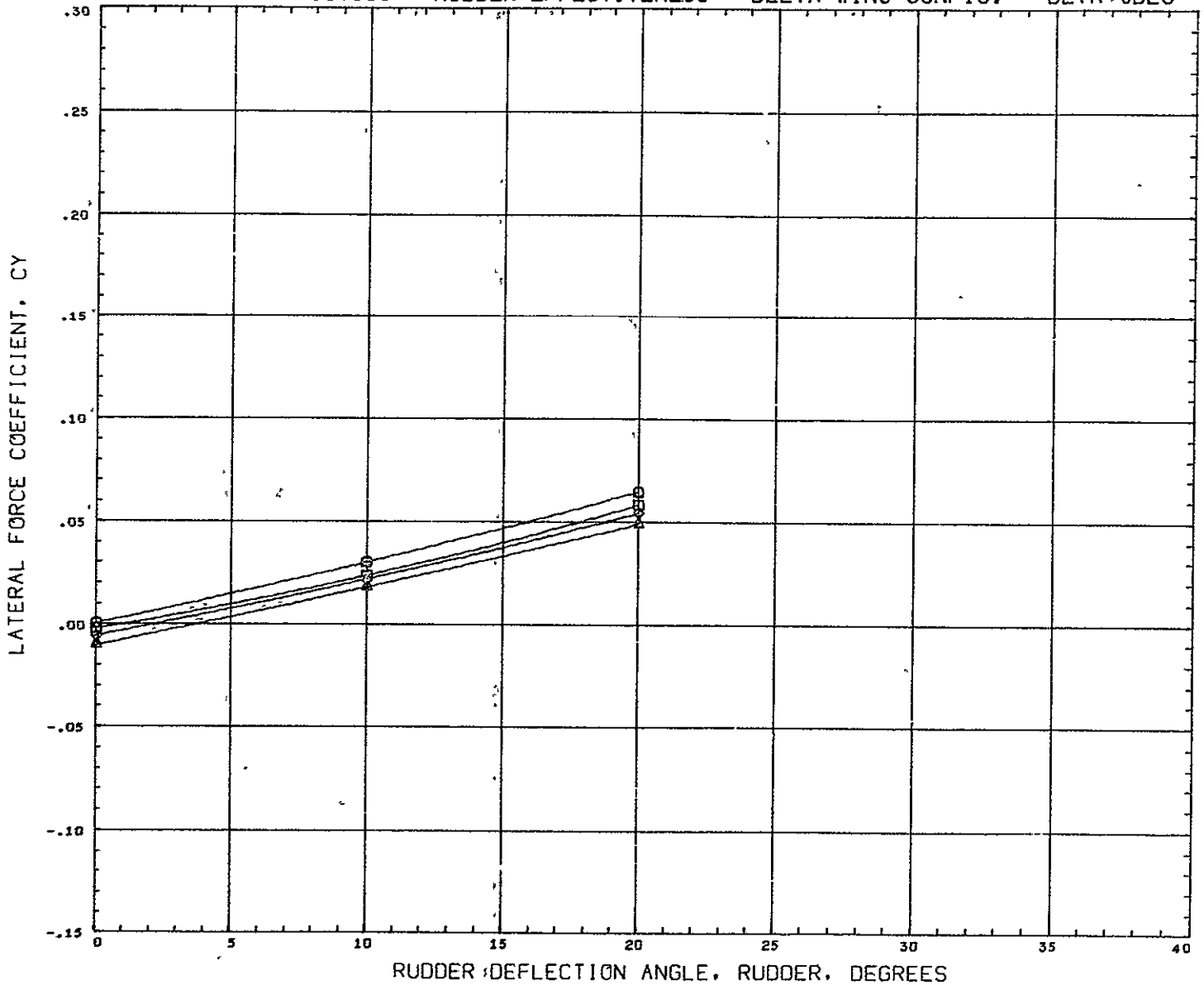

SYMBOL	ALPHA	PARAMETRIC VALUES				REFERENCE INFORMATION		
○	0.000	MACH	0.259	BETA	0.000	REFS	316.2304	sq IN
◊	4.000	ELEVON	0.000	AILRON	0.000	REFL	50.1900	IN
◇	8.000					REFB	7.3500	IN
△	12.000					XMRP	33.9090	IN
						YMRP	0.0000	IN
						ZMRP	0.0000	IN
						SCALE	0.0175	

DATA HIST. CODE I

LATERAL CHARACTERISTICS - RUDDER EFFECTIVENESS - DELTA WING CONFIG. - BETA=0DEG

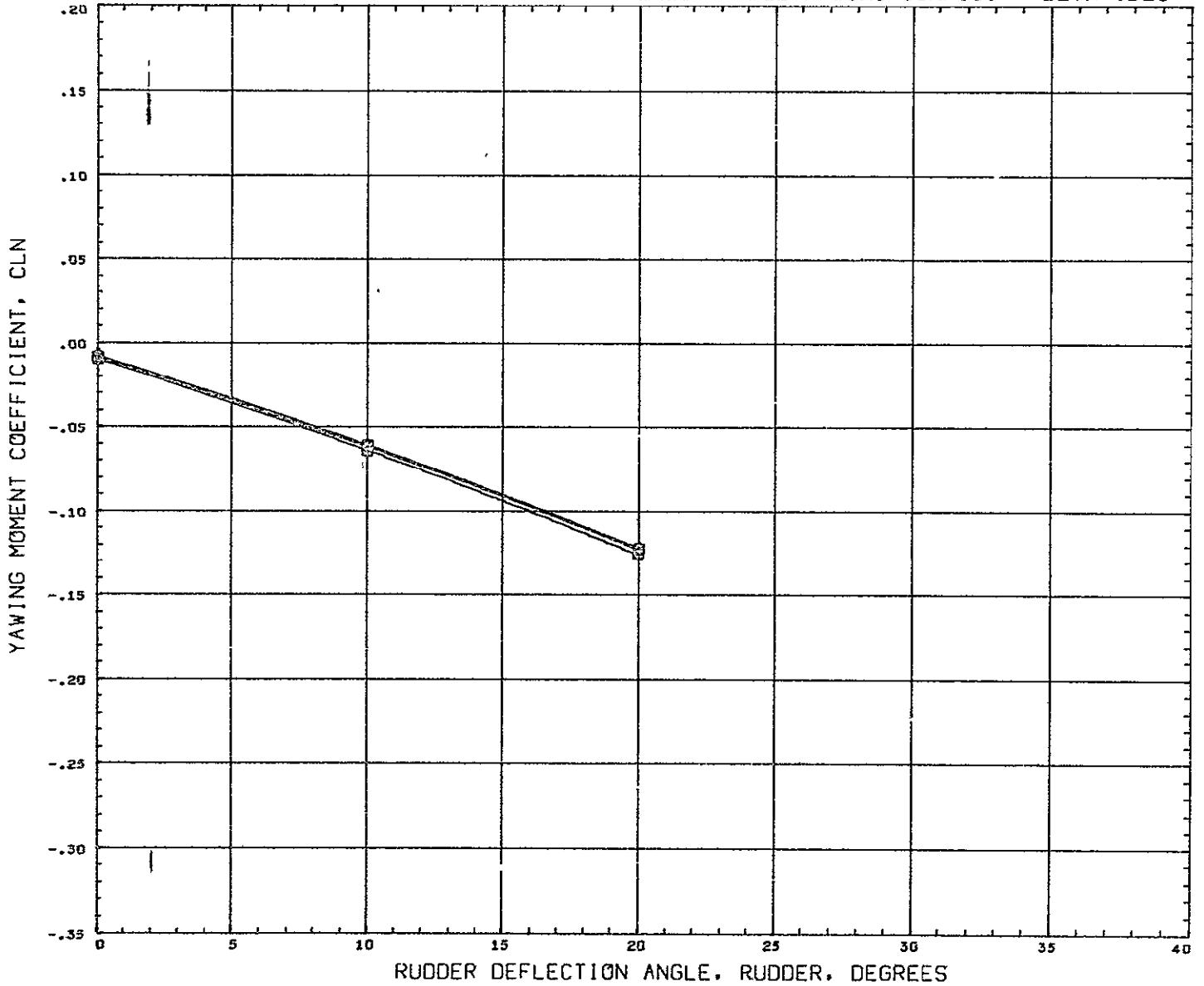

SYMBOL	ALPHA	PARAMETRIC VALUES				REFERENCE INFORMATION		
○	0.000	MACH	0.259	BETA	0.000	REFS	316.2304	SQ IN
□	4.000	ELEVON	0.000	AILERON	0.000	REFL	50.1900	IN
◇	8.000					REFB	7.3500	IN
△	12.000					XMRP	53.9090	IN
						YMRP	0.0000	IN
						ZMRP	0.0000	IN
						SCALE	0.0175	

DATA HIST. CODE 1

LATERAL CHARACTERISTICS - RUDDER EFFECTIVENESS - DELTA WING CONFIG. - BETA=0DEG

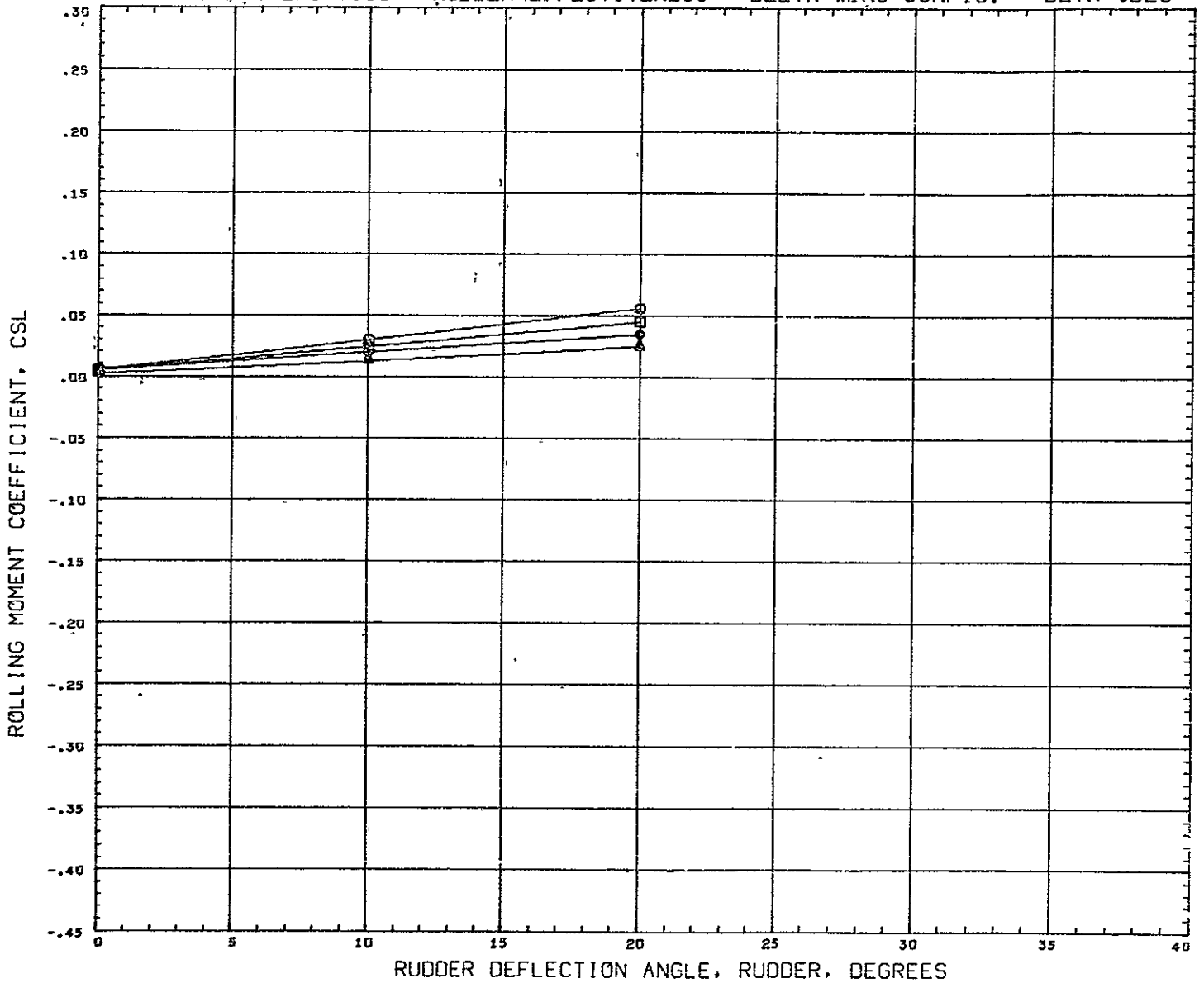

SYMBOL	ALPHA	PARAMETRIC VALUES	REFERENCE INFORMATION
○	0.000	MACH 0.259 BETA 0.000	REFS 316.2304 SQ IN
□	4.000	ELEVON 0.000 AILRON 0.000	REFL 50.1900 IN
◇	8.000		REFB 7.3500 IN
△	12.000		XMRP 33.9000 IN
			YMRP 0.0000 IN
			ZMRP 0.0000 IN
			SCALE 0.0175

DATA HIST. CODE 1

LATERAL CHARACTERISTICS - RUDDER EFFECTIVENESS - DELTA WING CONFIG. - BETA=-4DEG

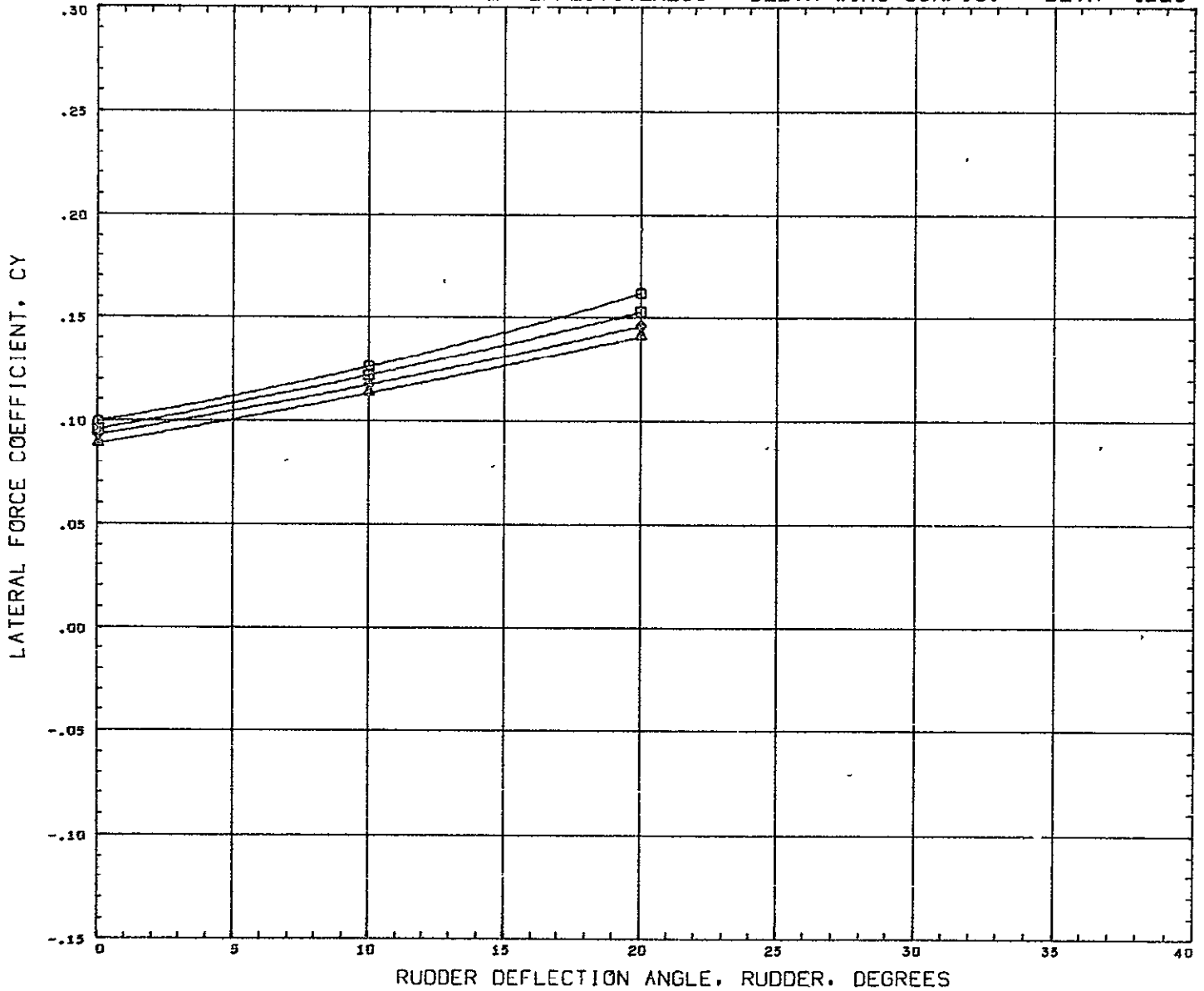

SYMBOL	ALPHA	PARAMETRIC VALUES
□	0.000	MACH 0.259 BETA - 4.000
○	4.000	ELEVON 0.000 AILRON 0.000
○	8.000	
△	12.000	

REFERENCE INFORMATION		
REFS	316 2304	SQ IN
REFL	50.1900	IN
REFB	7.3500	IN
XMRP	33.9090	IN
YMRP	0.0000	IN
ZMRP	0.0000	IN
SCALE	0.0175	

DATA HIST. CODE 1

LATERAL CHARACTERISTICS - RUDDER EFFECTIVENESS - DELTA WING CONFIG. - BETA=-4DEG

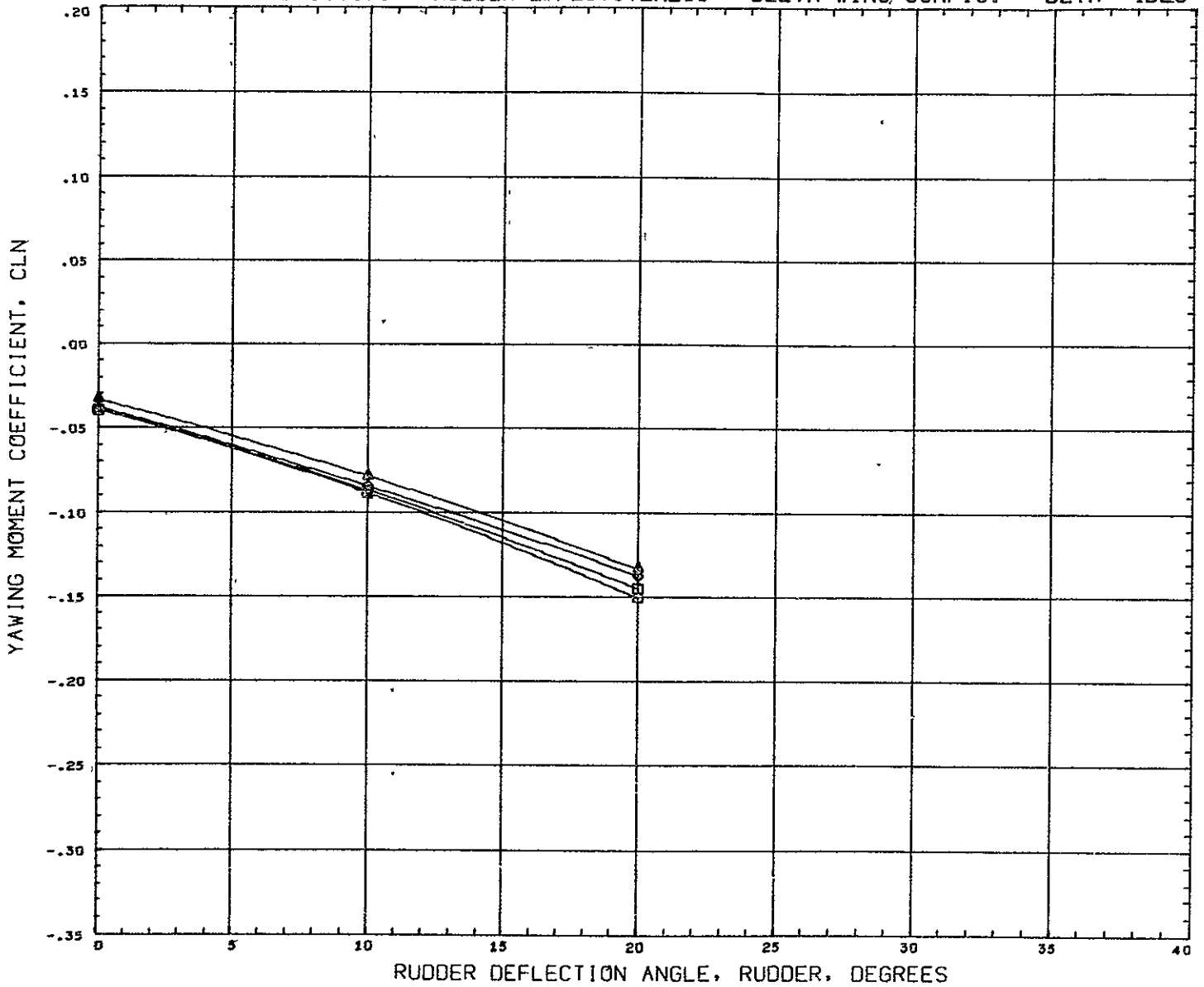

SYMBOL	ALPHA	PARAMETRIC VALUES				REFERENCE INFORMATION		
○	0.000	MACH	0.259	BETA	- 4.000	REFS	316 2304	SQ IN
□	4.000	ELEVON	0.000	AILRON	0.000	REFL	50.1900	IN
◇	8.000					REFB	7.3500	IN
△	12.000					XMRP	33.9000	IN
						YMRP	0.0000	IN
						ZMRP	0.0000	IN
						SCALE	0.0175	

DATA HIST. CODE I

LATERAL CHARACTERISTICS - RUDDER EFFECTIVENESS - DELTA WING CONFIG. - BETA=-4DEG

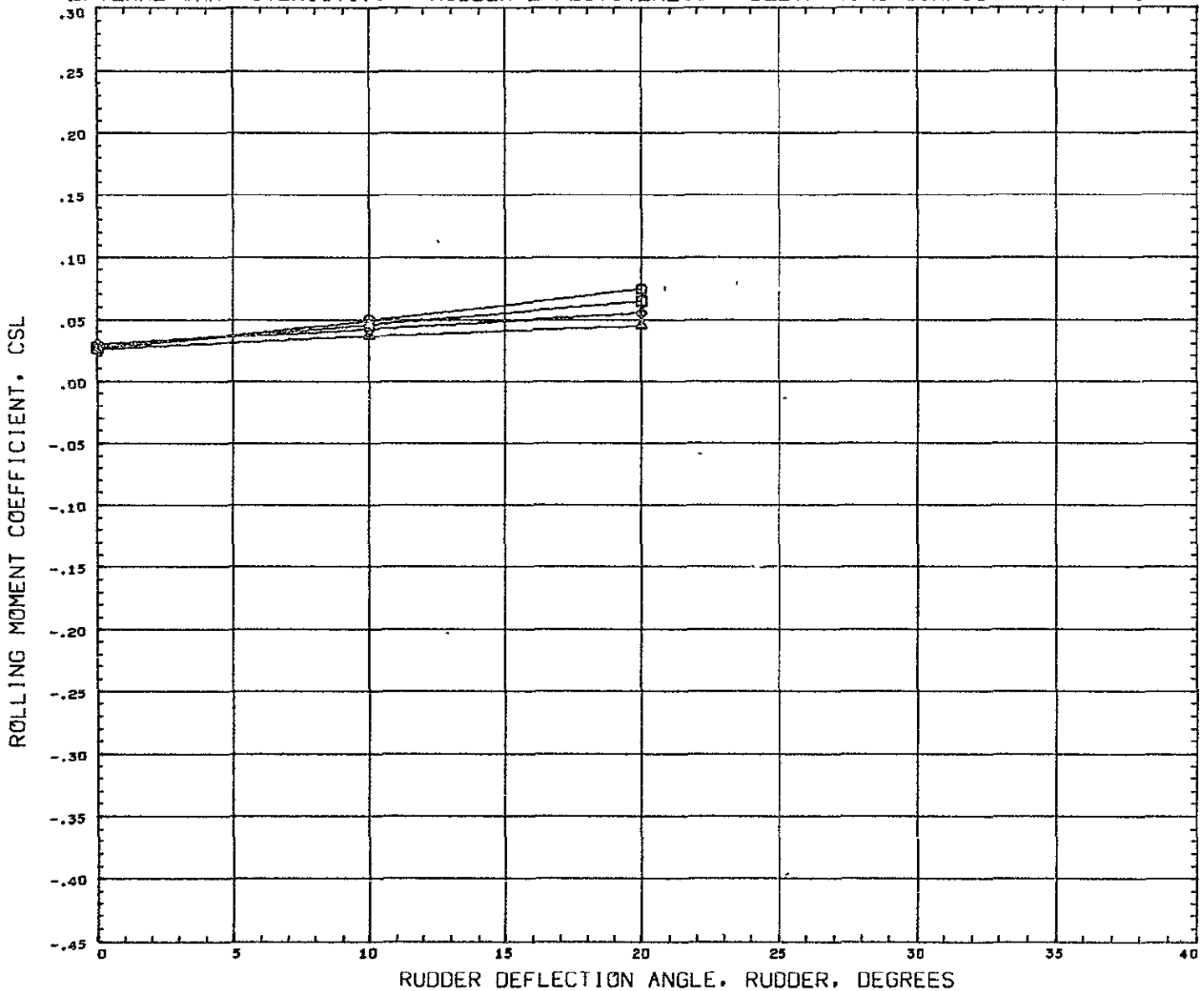

SYMBOL	ALPHA	MACH	PARAMETRIC VALUES	
○	0.000	0.259	BETA	- 4.000
□	4.000	ELEVON	0.000	AILRON 0.000
◇	6.000			
△	12.000			

REFERENCE INFORMATION		
REFS	316.2304	SQ IN
REFL	50.1900	IN
REFB	7.3500	IN
XMRP	33.9000	IN
YMRP	0.0000	IN
ZMRP	0.0000	IN
SCALE	0.0175	

DATA HIST. CODE I



# LONGITUDINAL CHARACTERISTICS - EFFECT OF LANDING GEAR - DELTA WING CONFIGURATION

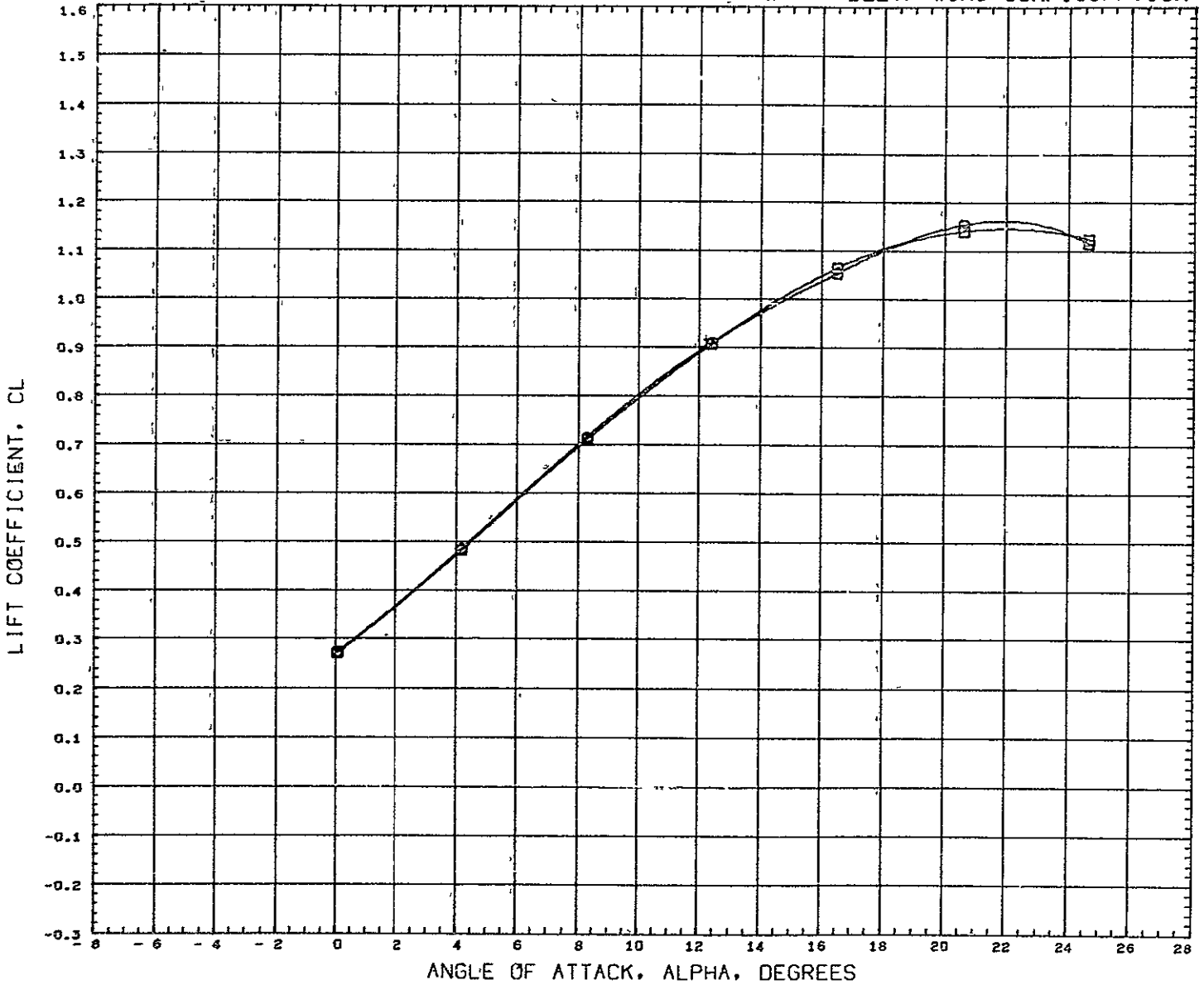

DATA SET SYMBOL    CONFIGURATION DESCRIPTION  
 (RC7083)    □    CVLSWT TEST 579-D B7W5V1  
 (RC7096)    □    CVLSWT TEST 579-D B7W5V1G2

PARAMETRIC VALUES  
 DELTA    0.000    ELEVON    0.000  
 AILRON    0.000    RUDDER    0.000

REFERENCE INFORMATION  
 REFS    316.2304    SQ IN  
 REFL    50.1900    IN  
 REFB    7.3500    IN  
 XMRP    33.9090    IN  
 YMRP    0.0000    IN  
 ZMRP    0.0000    IN  
 SCALE    0.0175

MACH        0.259

# LONGITUDINAL CHARACTERISTICS - EFFECT OF LANDING GEAR - DELTA WING CONFIGURATION

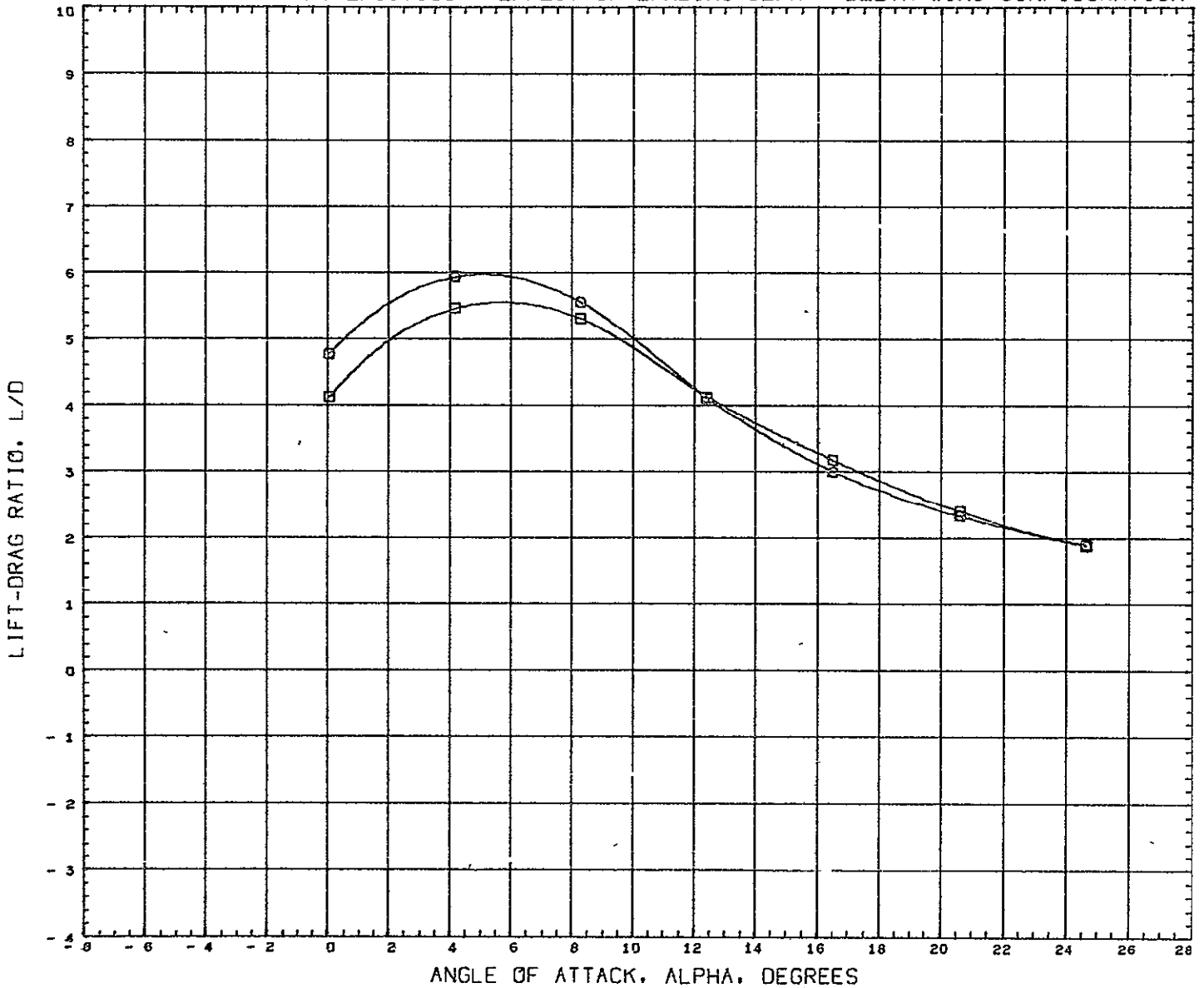

DATA SET SYMBOL    CONFIGURATION DESCRIPTION

{RC7083}    □    CVLSWT TEST 579-D 87W5V1

{RC7098}    □    CVLSWT TEST 579-D 87W5V162

PARAMETRIC VALUES

BETA    0.000    ELEVON    0.000

AILRON    0.000    RUDDER    0.000

REFERENCE INFORMATION

REFS    316 2304    SQ IN

REFL    50 1900    IN

REFB    7.3500    IN

XMRP    33 9090    IN

YHRF    0 0000    IN

ZHRF    0 0000    IN

SCALE    0 0175

HACH    0.259

# LONGITUDINAL CHARACTERISTICS - EFFECT OF LANDING GEAR - DELTA WING CONFIGURATION

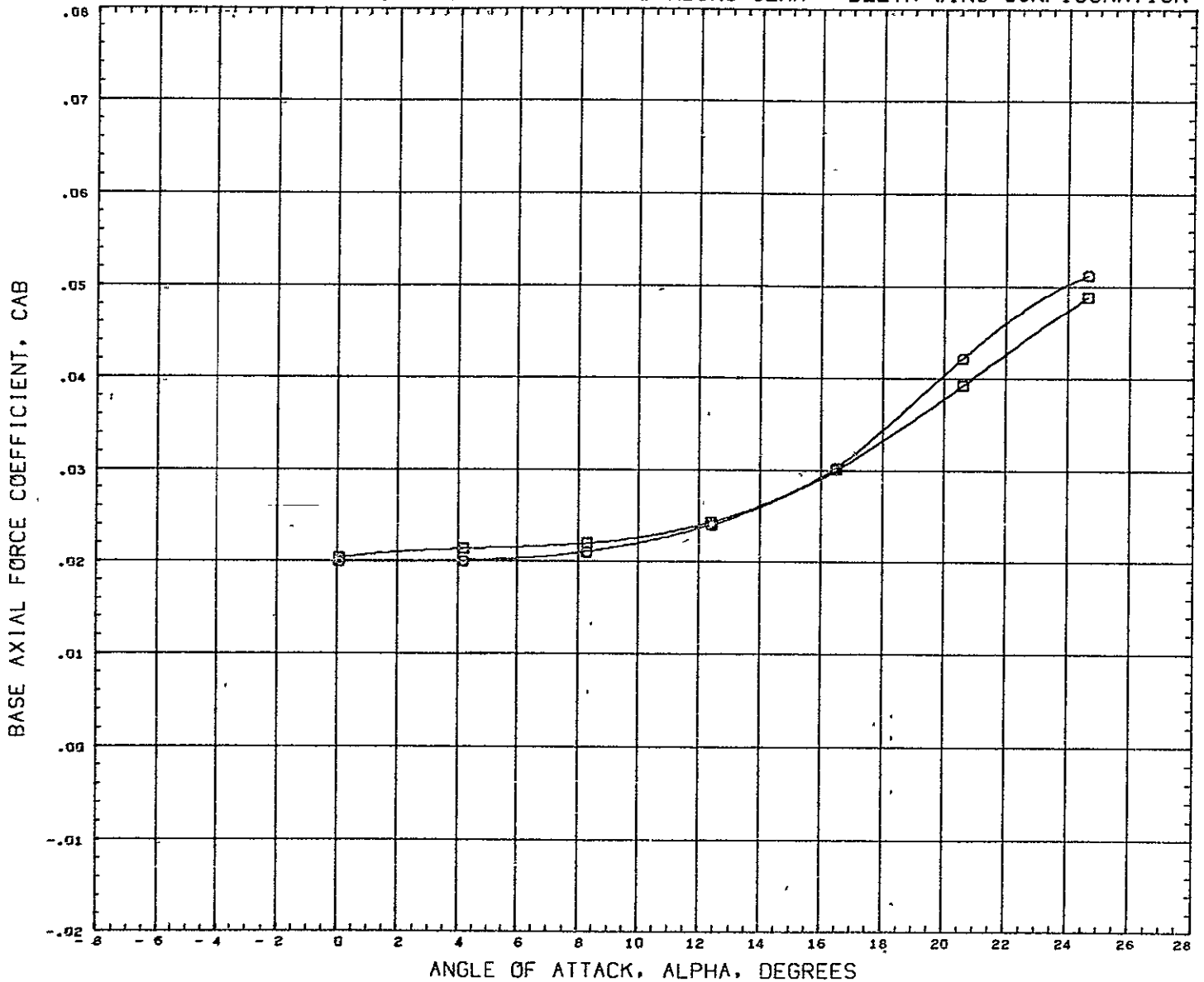

DATA SET SYMBOL    CONFIGURATION DESCRIPTION  
 (RG7983)    ○    CVLSWT TEST 579-D B7W5V1  
 (RC7098)    □    CVLSWT TEST 579-D B7W5V1G2

PARAMETRIC VALUES  
 BETA    0.000    ELEVON    0.000  
 AILRON    0.000    RUDDER    0.000

REFERENCE INFORMATION  
 REFS    316 2304    SQ IN  
 REFL    50 1900    IN  
 REFB    7.3500    IN  
 XMRP    33.9090    IN  
 YMRP    0.0000    IN  
 ZMRP    0.0000    IN  
 SCALE    0.0175

HACH    0.259

# LONGITUDINAL CHARACTERISTICS - EFFECT OF LANDING GEAR - DELTA WING CONFIGURATION

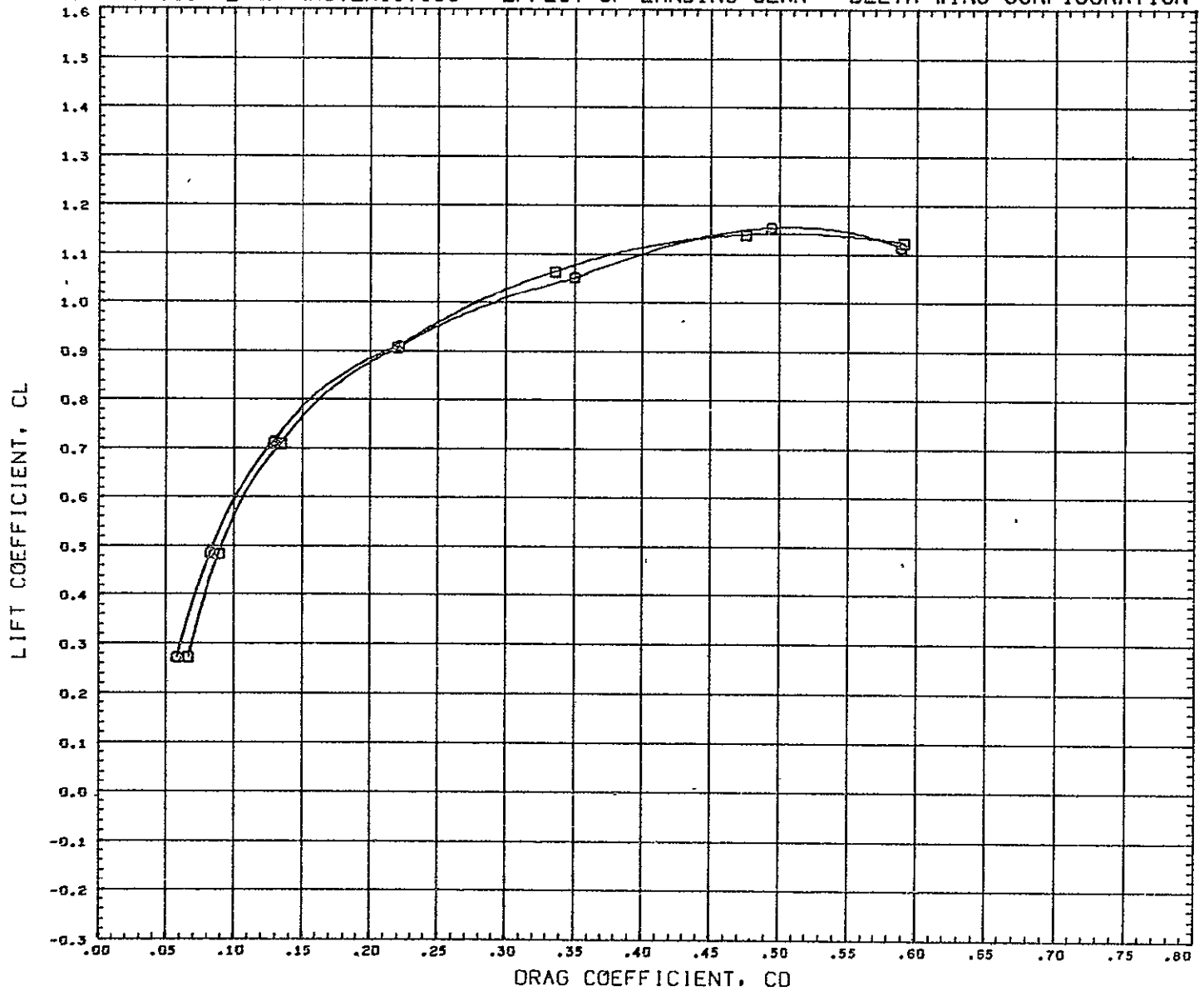

DATA SET SYMBOL    CONFIGURATION DESCRIPTION  
 (RC7083)    □    CVLSWT TEST 579-0 67W5V1  
 (RC7098)    □    CVLSWT TEST 579-0 87W5V102

PARAMETRIC VALUES  
 BETA    0.000    ELEVON    0 000  
 AILRON    0.000    RUDDER    0 000

REFERENCE INFORMATION  
 REFS    316.2304    SQ IN  
 REFL    50.1900    IN  
 REFB    7 3500    IN  
 XMRF    33.9090    IN  
 YMRF    0 0000    IN  
 ZMRF    0.0000    IN  
 SCALE    0 0175

MACH    0.259

LONGITUDINAL CHARACTERISTICS - EFFECT OF LANDING GEAR - DELTA WING CONFIGURATION

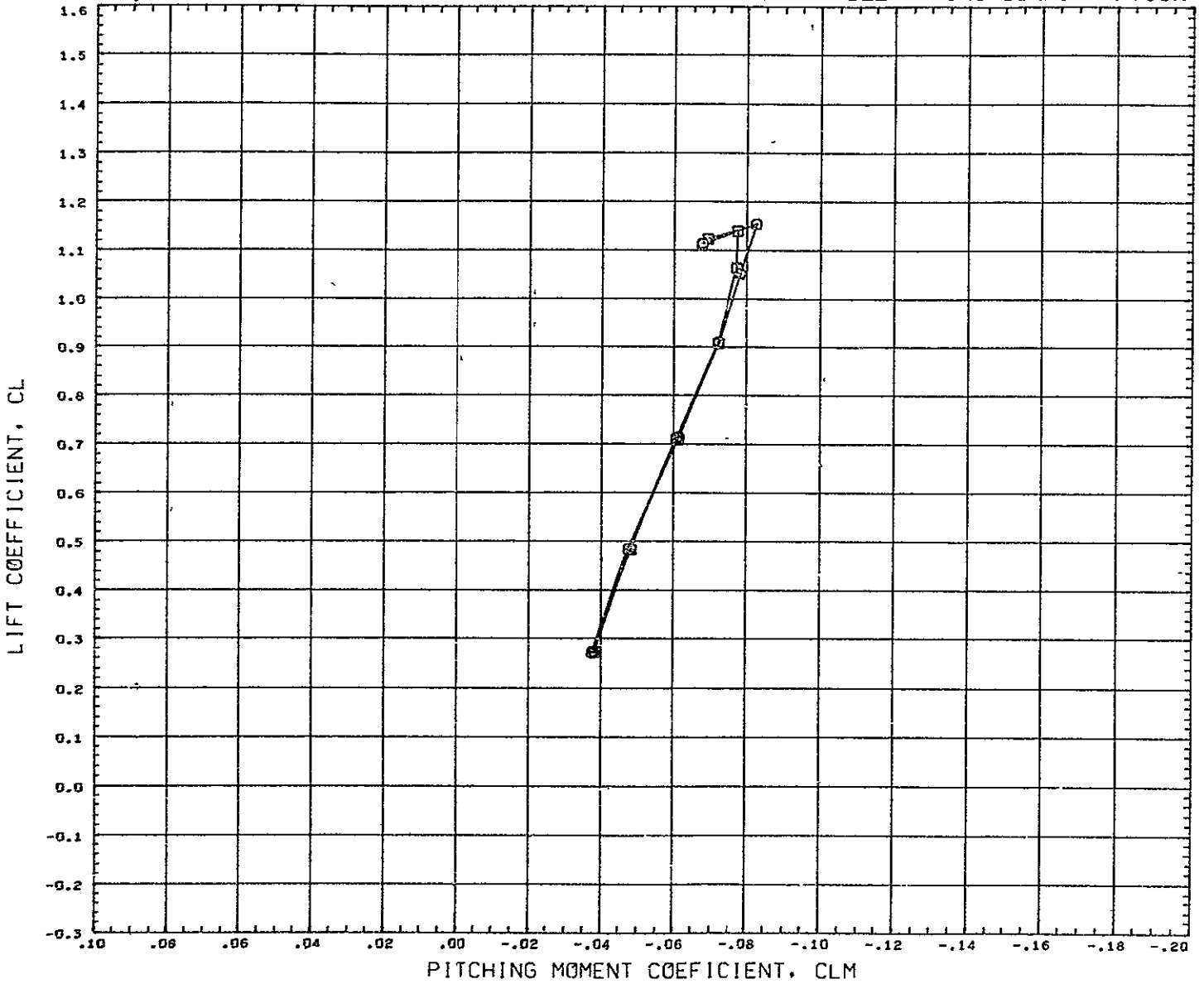

DATA SET SYMBOL    CONFIGURATION DESCRIPTION  
 (RC7083)    □    CVLSWT TEST 579-D B7W5V1  
 (RC7098)    □    CVLSWT TEST 579-G B7W5V1G2

PARAMETRIC VALUES				REFERENCE INFORMATION		
BETA	0.000	ELEVON	0.000	REFS	316.2304	SQ IN
AILRON	0.000	RUDDER	0.000	REFL	50.1900	IN
				REFB	7.3500	IN
				XMRP	33.9090	IN
				YMRP	0.0000	IN
				ZMRP	0.0000	IN
				SCALE	0.0175	

MACH            0.259

EFFECT OF LANDING GEAR - SIDESLIP DERIVATIVES - DELTA WING CONFIGURATION

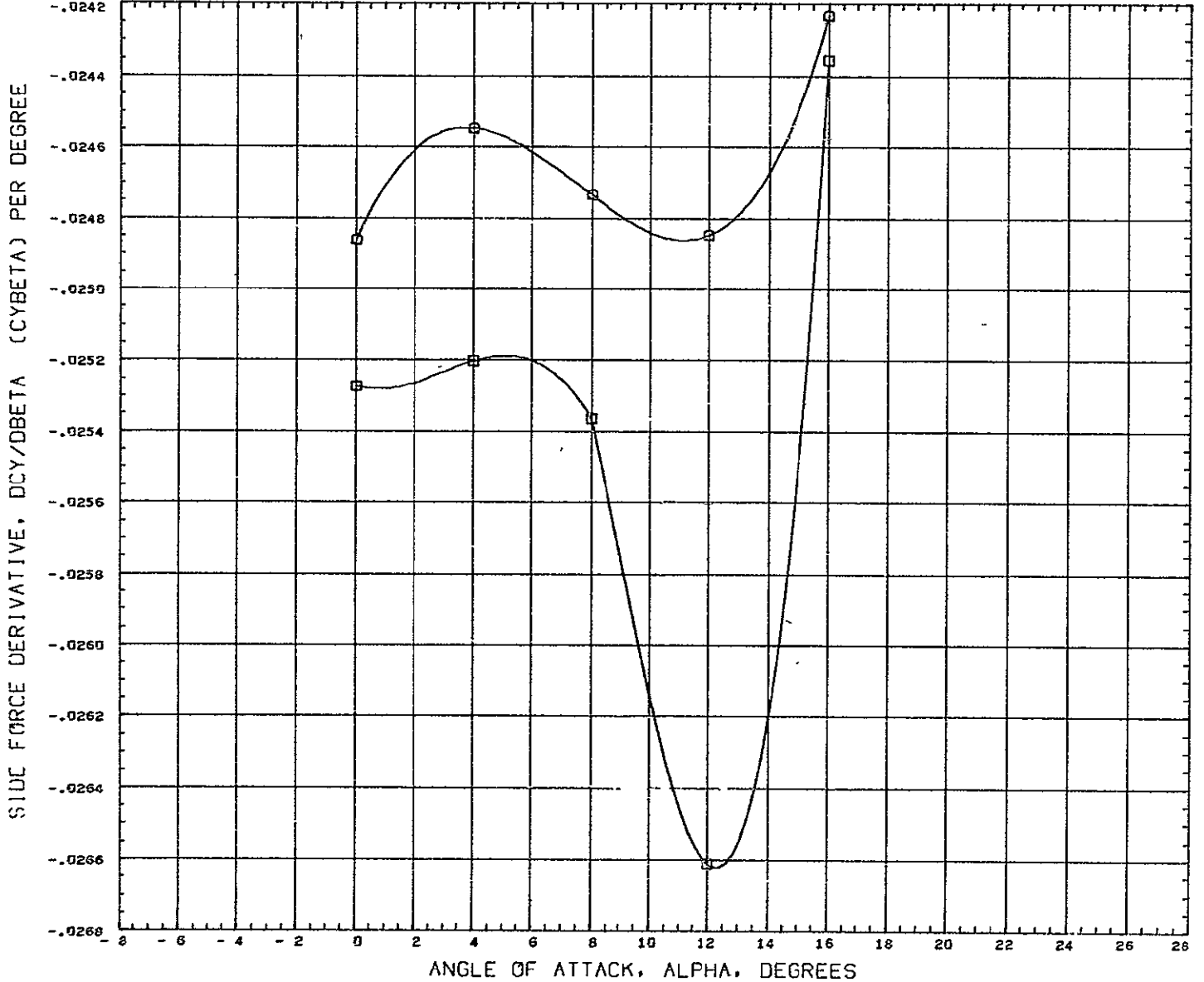

DATA SET SYMBOL    CONFIGURATION DESCRIPTION  
 (DB7083)    □    CVLSWT TEST 579-G B7W5V1  
 (DB7098)    □    CVLSWT TEST 579-G B7W5V1G2

PARAMETRIC VALUES  
 BETA    0.000    ELEVON    0.000  
 AILRON    0.000    RUDDER    0.000

REFERENCE INFORMATION  
 REFS    316 2304    SQ IN  
 REFL    50 1900    IN  
 REFB    7 3500    IN  
 XMRP    33.9090    IN  
 YMRP    0.0000    IN  
 ZMRP    0.0000    IN  
 SCALE    0.0175

HACH    0.259

EFFECT OF LANDING GEAR - SIDESLIP DERIVATIVES - DELTA WING CONFIGURATION

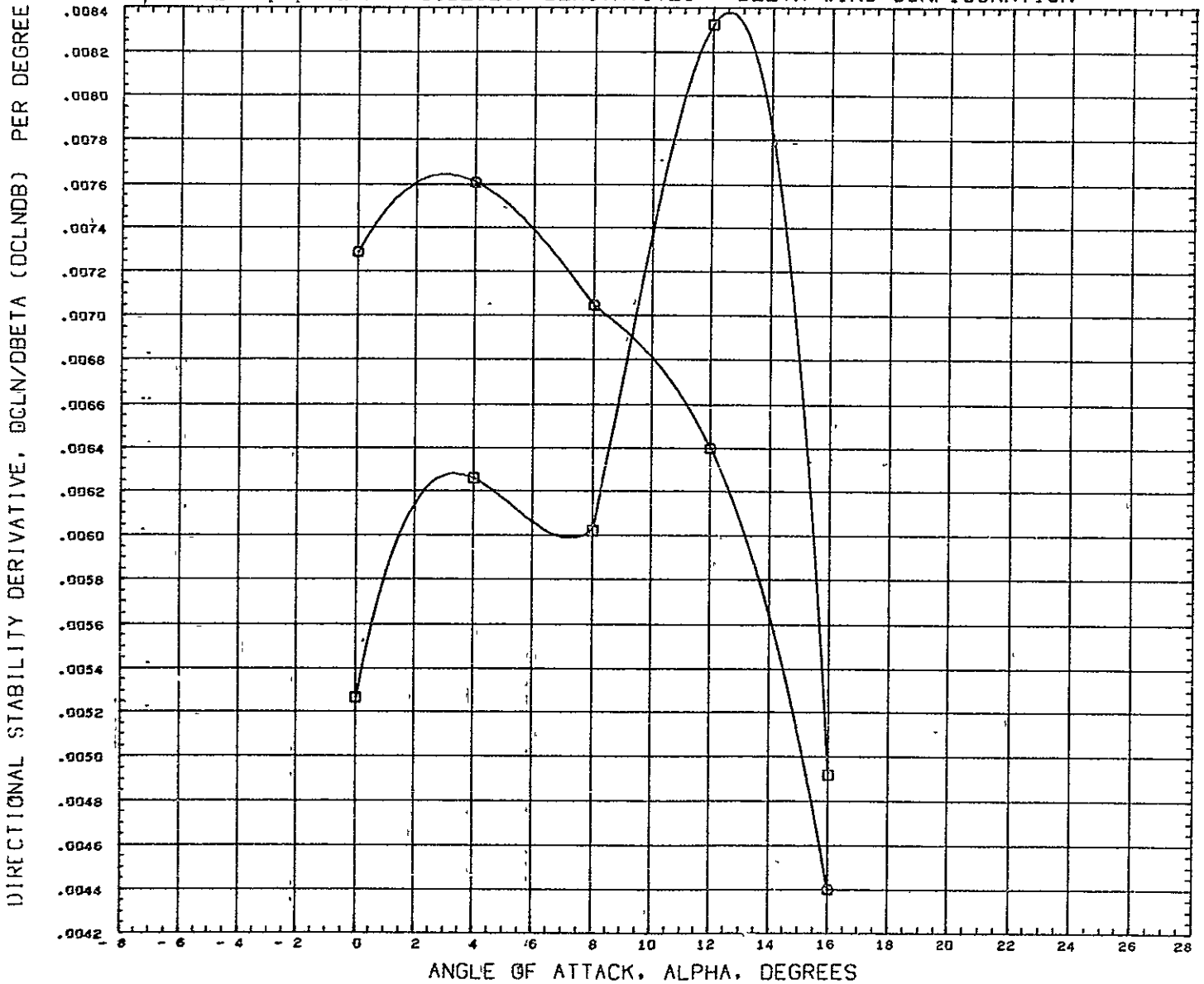

DATA SET SYMBOL    CONFIGURATION DESCRIPTION  
 (DB7083)    □    CVLSWT TEST 579-0 B7W5V1  
 (DB7098)    □    CVLSWT TEST 579-0 B7W5V102

PARAMETRIC VALUES  
 BETA    0.000    ELEVON    0.000  
 AILRON    0.000    RUDDER    0.000

REFERENCE INFORMATION  
 REFS    316.2304    SQ IN  
 REFL    50.1900    IN  
 REFB    7.3500    IN  
 XMRP    33.9090    IN  
 YMRP    0.0000    IN  
 ZMRP    0.0000    IN  
 SCALE    0.0175

MACH    0.259

EFFECT OF LANDING GEAR - SIDESLIP DERIVATIVES - DELTA WING CONFIGURATION

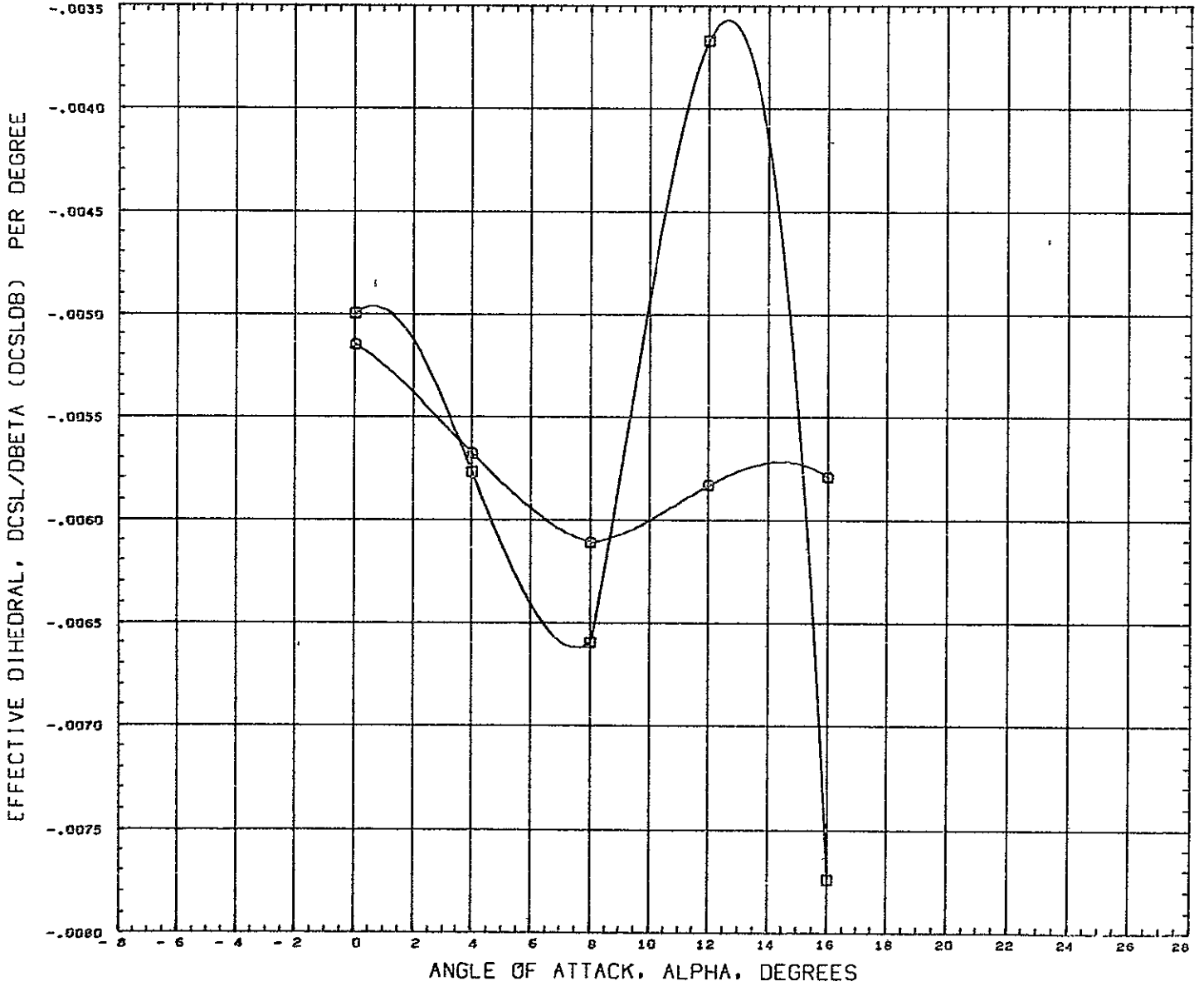

DATA SET SYMBOL    CONFIGURATION DESCRIPTION  
 (DB7083)    □    CVLSWT TEST 579-D B745V1  
 (DB7098)    □    CVLSWT TEST 579-D B745V1G2

PARAMETRIC VALUES  
 BETA    0.000    ELEVON    0.000  
 AILRON    0.000    RUDDER    0.000

REFERENCE INFORMATION  
 REFS    316.2304    SQ IN  
 REFL    50.1900    IN  
 REFB    7.3500    IN  
 XMRP    33.9090    IN  
 YMRP    0.0000    IN  
 ZMRP    0.0000    IN  
 SCALE    0.0175

HACH    0.259



LONG. CHAR. - EFFECT OF LANDING GEAR WITH ENGINES ON - DELTA WING - BETA=0DEG

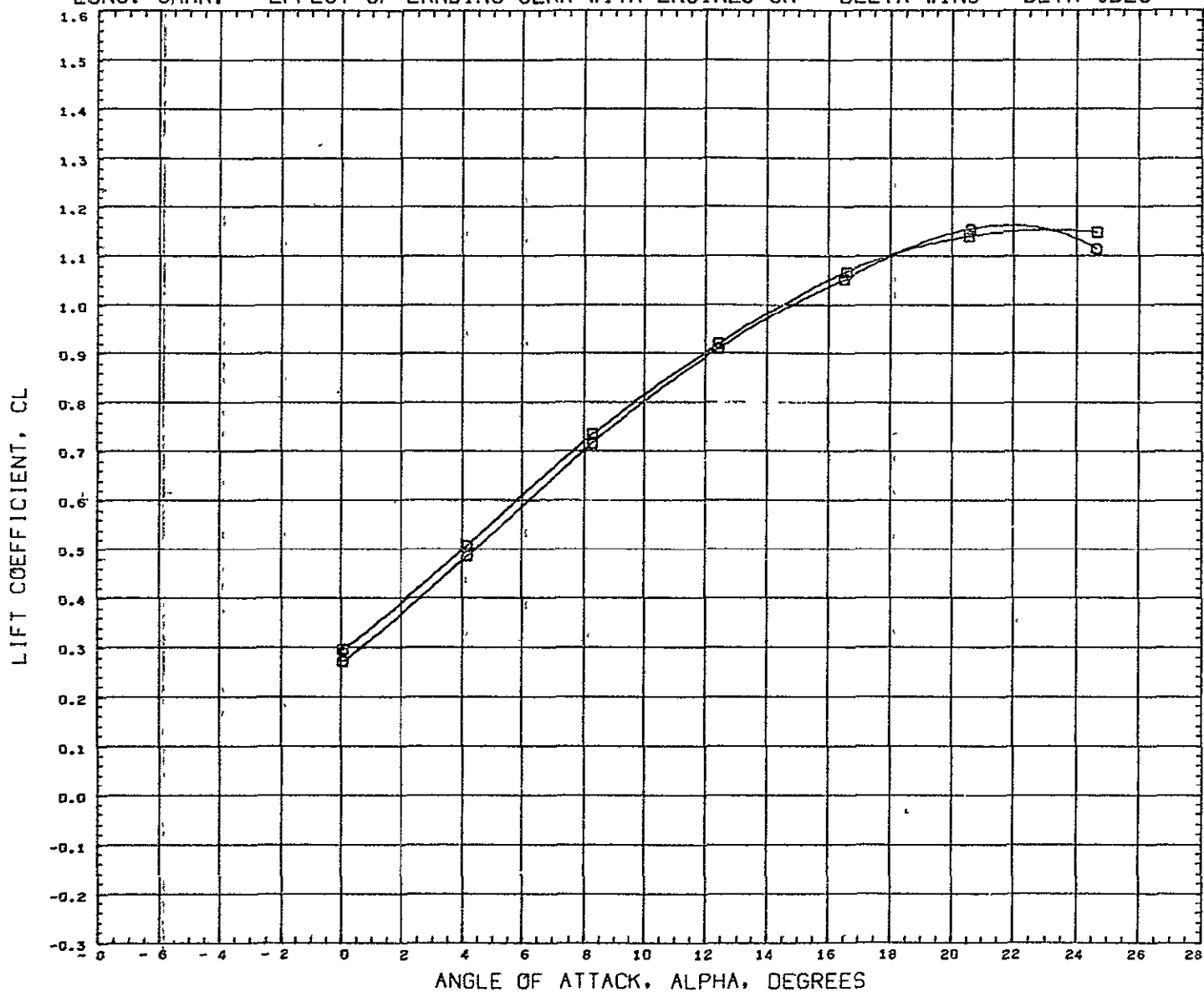

DATA SET SYMBOL CONFIGURATION DESCRIPTION  
 (RC7083) □ CVLSWT TEST 579-0 B7W5V1  
 (RC7100) □ CVLSWT TEST 579-0 B7W5V1E202

PARAMETRIC VALUES  
 BETA 0.000 ELEVON 0.000  
 AILRON 0.000 RUDDER 0.000

REFERENCE INFORMATION  
 REFS 316.2304 SQ IN  
 REFL 50.1900 IN  
 REFB 7.3500 IN  
 XMRP 33.9090 IN  
 YMRP 0.0000 IN  
 ZMRP 0.0000 IN  
 SCALE 0.0175

MACH 0.259

LONG. CHAR. - EFFECT OF LANDING GEAR WITH ENGINES ON - DELTA WING - BETA=0DEG

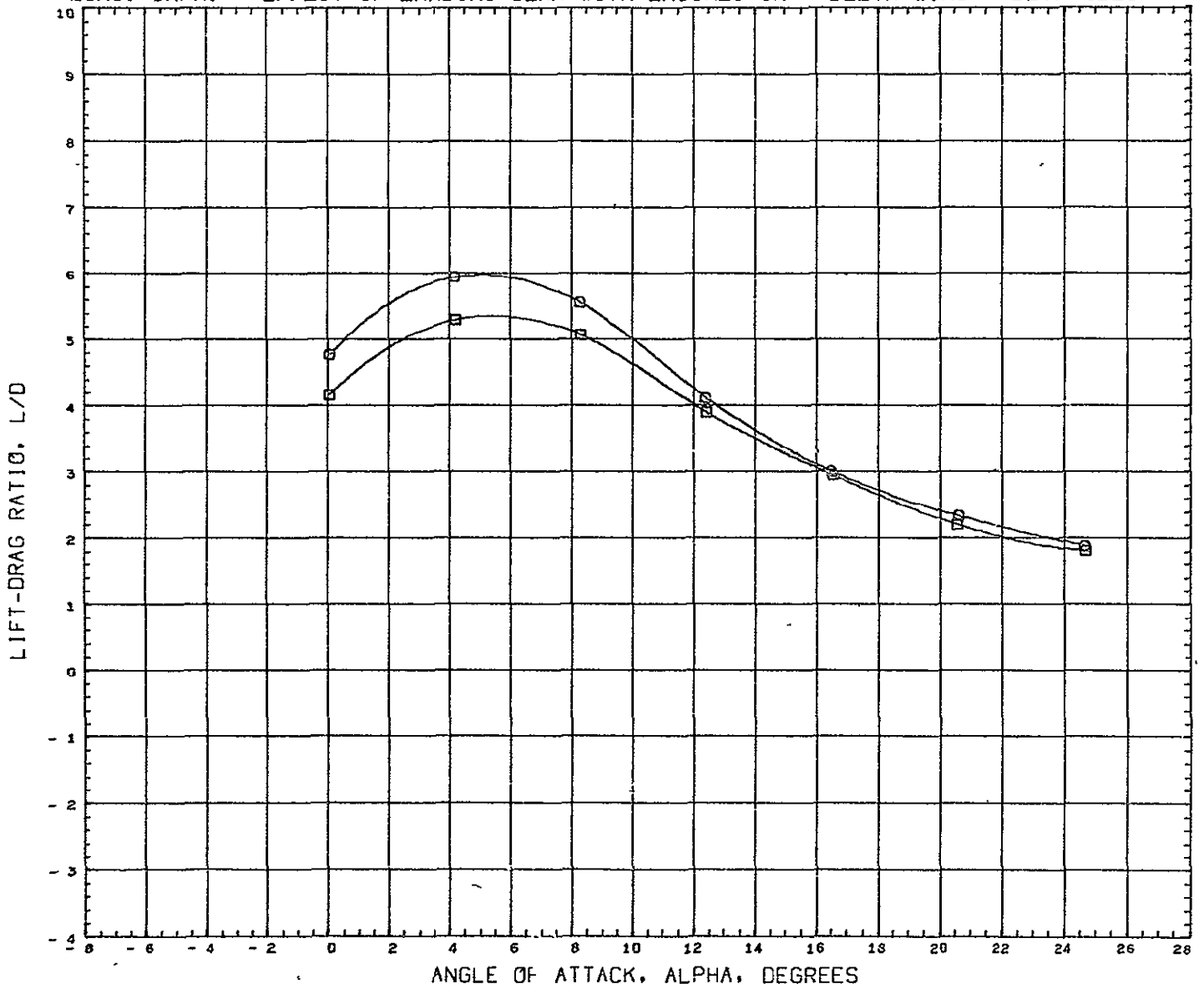

DATA SET SYMBOL	CONFIGURATION DESCRIPTION	PARAMETRIC VALUES				REFERENCE INFORMATION		
(RC7083)	○ CVLSWT TEST 579-0 B7W5V1	BETA	0.000	ELEVON	0.000	REFS	316 2304	SQ IN
(RC7100)	□ CVLSWT TEST 579-0 B7W5V1E202	AILRON	0.000	RUDDER	0.000	REFL	50.1900	IN
						REFB	7.3500	IN
						XMRP	33.9090	IN
						YMRP	0.0000	IN
						ZMRP	0.0000	IN
						SCALE	0 0175	

MACH 0.259

LONG. CHAR. - EFFECT OF LANDING GEAR WITH ENGINES ON - DELTA WING - BETA=0DEG

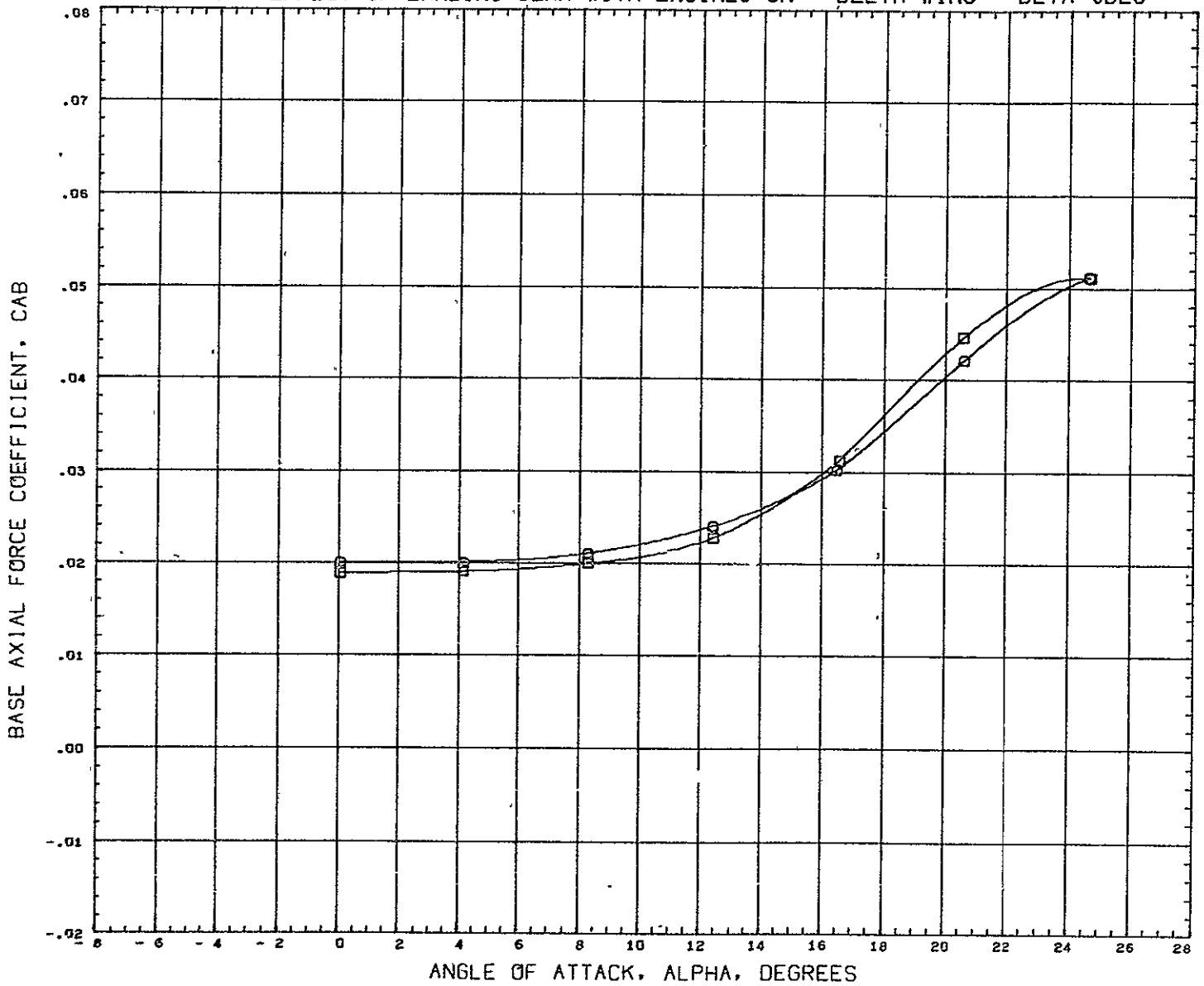

DATA SET SYMBOL    CONFIGURATION DESCRIPTION  
 (RC7083)    ○    CVLSWT TEST 579-D B7W5V1  
 (RC7105)    □    CVLSWT TEST 579-D B7W5V1E2G2

PARAMETRIC VALUES  
 BETA    0.000    ELEVON    0.000  
 AILRON    0.000    RUDDER    0.000

REFERENCE INFORMATION  
 REFS    316 2304    SQ IN  
 REFL    50.1900    IN  
 REFB    7.3500    IN  
 XMRF    33.9090    IN  
 YMRF    0.0000    IN  
 ZMRF    0.0000    IN  
 SCALE    0.0175

MACH    0.259

1

LONG. CHAR. - EFFECT OF LANDING GEAR WITH ENGINES ON - DELTA WING - BETA=0DEG

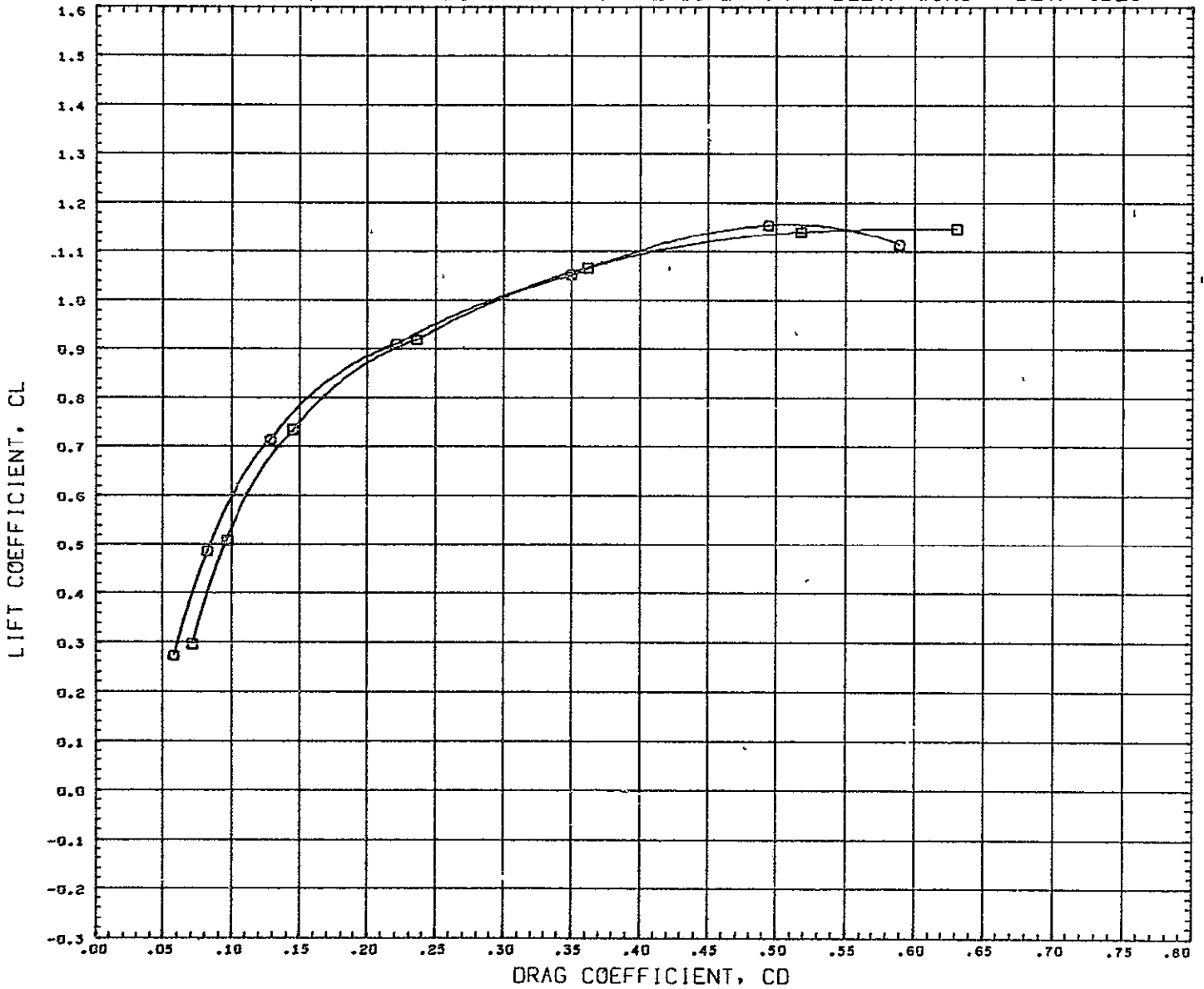

DATA SET SYMBOL CONFIGURATION DESCRIPTION  
 (FC7083) □ CVLSWT TEST 579-D B7W5V1  
 (RC7100) □ CVLSWT TEST 579-D B7W5V1E2G2

PARAMETRIC VALUES  
 BETA 0.000 ELEVON 0.000  
 AILRON 0.000 RUDDER 0.000

REFERENCE INFORMATION  
 REFS 316.2304 SQ IN  
 REFL 50.1900 IN  
 REFB 7.3500 IN  
 XMRF 33.9090 IN  
 YMRF 0.0000 IN  
 ZMRF 0.0000 IN  
 SCALE 0.0175

MACH 0.259

LONG. CHAR. - EFFECT OF LANDING GEAR WITH ENGINES ON - DELTA WING - BETA=0DEG

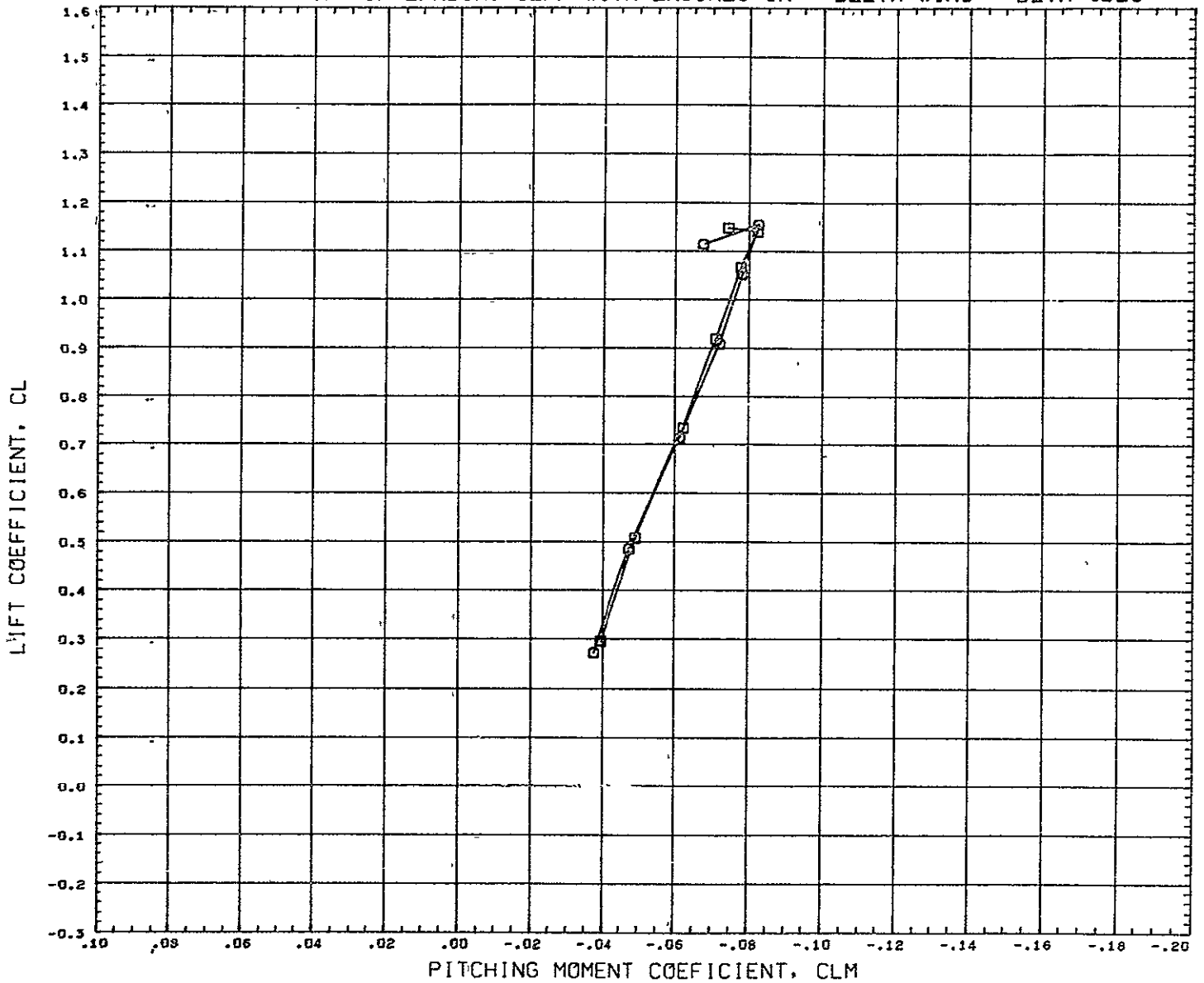

DATA SET SYMBOL    CONFIGURATION DESCRIPTION  
 (RC7083)    □    CVLSWT TEST 579-D B7W5V1  
 (RC7100)    □    CVLSWT TEST 579-D B7W5V1E2G2

PARAMETRIC VALUES  
 BETA    0.000    ELEVON    0.000  
 AILRON    0.000    RUDDER    0.000

REFERENCE INFORMATION  
 REFS    316.2304    SQ IN  
 REFL    50.1900    IN  
 REFB    7.3500    IN  
 XMRP    33.9000    IN  
 YMRP    0.0000    IN  
 ZMRP    0.0000    IN  
 SCALE    0.0175

MACH    0.259

LONG. CHAR. - EFFECT OF LANDING GEAR WITH ENGINES ON - DELTA WING - BETA=-4DEG

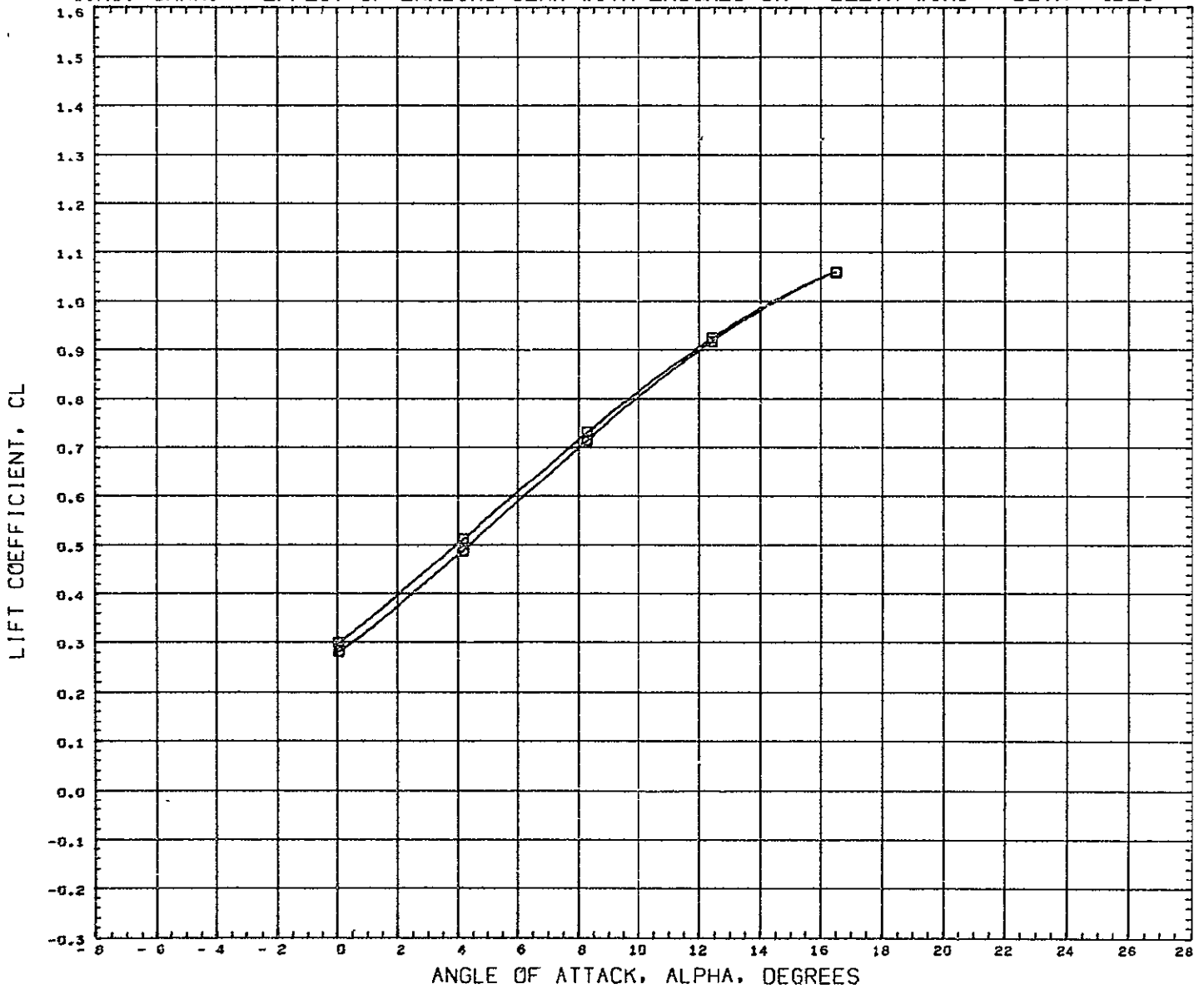

DATA SET SYMBOL CONFIGURATION DESCRIPTION  
 (RC7085) ○ CVLSWT TEST 579-G B7W5V1  
 (RC7101) □ CVLSWT TEST 579-G B7W5V1E262

PARAMETRIC VALUES  
 BETA - 4.000 ELEVON 0.000  
 AILRON 0.000 RUDDER 0.000

REFERENCE INFORMATION  
 REFS 316.2304 SQ IN  
 REFL 50.1900 IN  
 REFB 7.3500 IN  
 XMRP 33.9090 IN  
 YMRP 0.0000 IN  
 ZMRP 0.0000 IN  
 SCALE 0.0175

MACH 0.259

LONG. CHAR. - EFFECT OF LANDING GEAR WITH ENGINES ON - DELTA WING - BETA=-4DEG

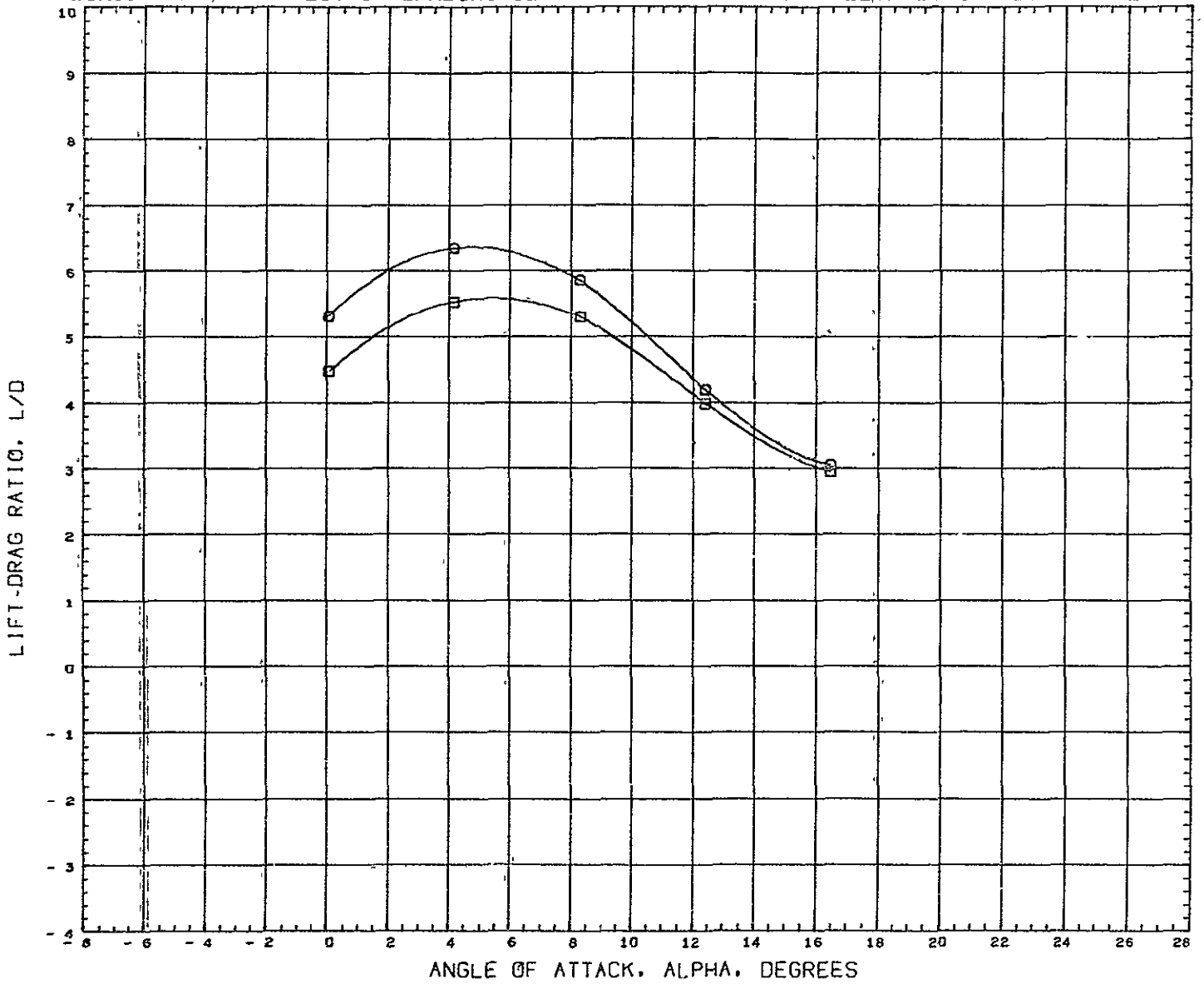

DATA SET SYMBOL	CONFIGURATION DESCRIPTION	PARAMETRIC VALUES		REFERENCE INFORMATION				
(RC7085)	□ CVLSWT TEST 579-0 B7W5V1	BETA	- 4.000	ELEVON	0.000	REFS	316.2304	Sq IN
(RC7101)	□ CVLSWT TEST 579-0 B7W5V1E2G2	AILRON	0.000	RUDDER	0.000	REFL	50.1900	IN
						REFB	7.3500	IN
						XMRP	33.9090	IN
						YMRP	0.0000	IN
						ZMRP	0.0000	IN
						SCALE	0.0175	

MACH 0.259

LONG. CHAR. - EFFECT OF LANDING GEAR WITH ENGINES ON - DELTA WING - BETA=-4DEG

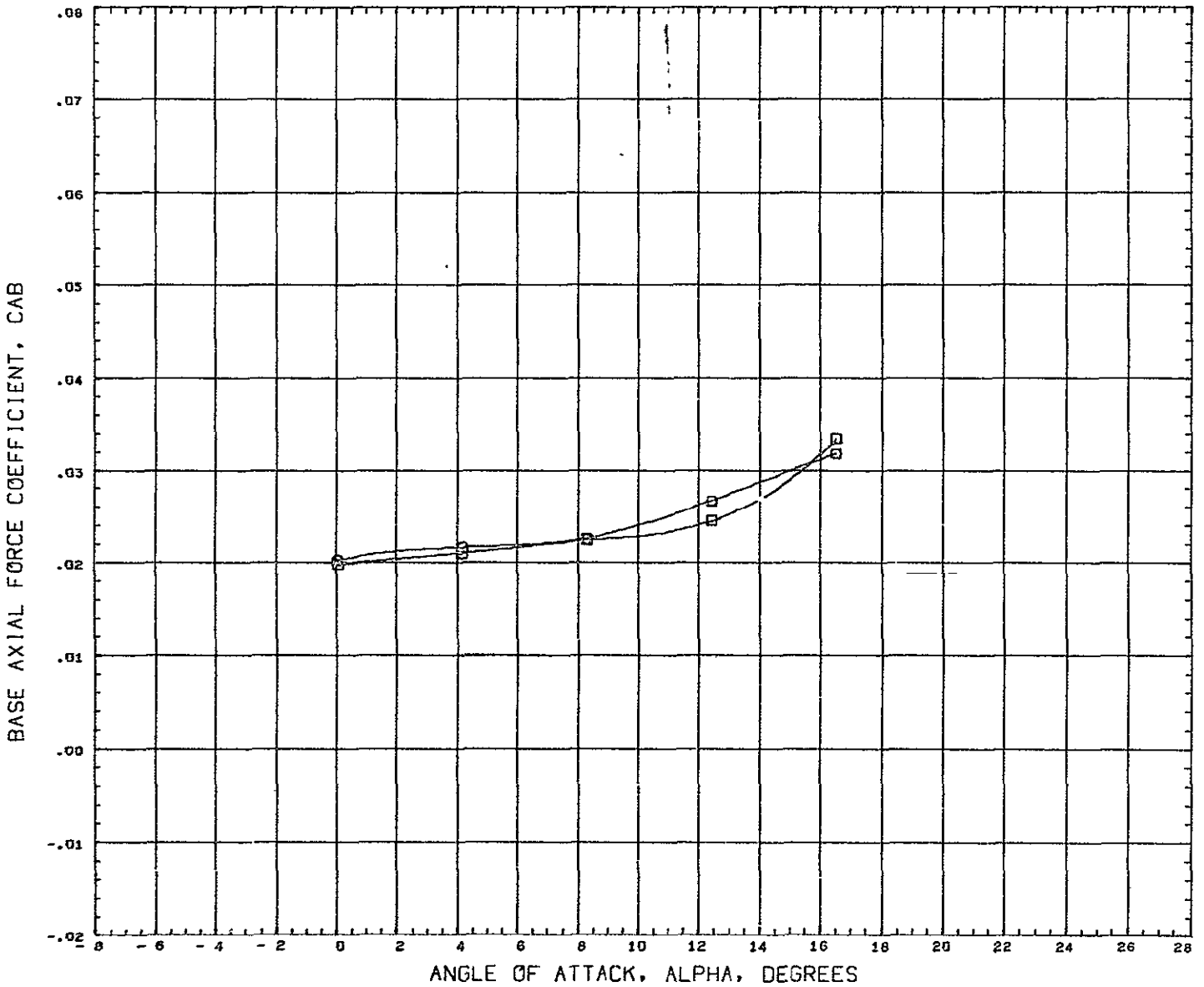

DATA SET SYMBOL CONFIGURATION DESCRIPTION  
 (RC7085) ○ CVLSWT TEST 579-0 B7W5V1  
 (RC7101) □ CVLSWT TEST 579-0 B7W5V1E2G2

PARAMETRIC VALUES  
 BETA - 4.000 ELEVON 0.000  
 AILRON 0.000 RUDDER 0.000

REFERENCE INFORMATION  
 REFS 316.2304 SQ IN  
 REFL 50.1900 IN  
 REFB 7.3500 IN  
 XMRP 33 9090 IN  
 YMRP 0.0000 IN  
 ZMRP 0.0000 IN  
 SCALE 0.0175

MACH 0.259



LONG. CHAR. - EFFECT OF LANDING GEAR WITH ENGINES ON - DELTA WING - BETA=-4DEG

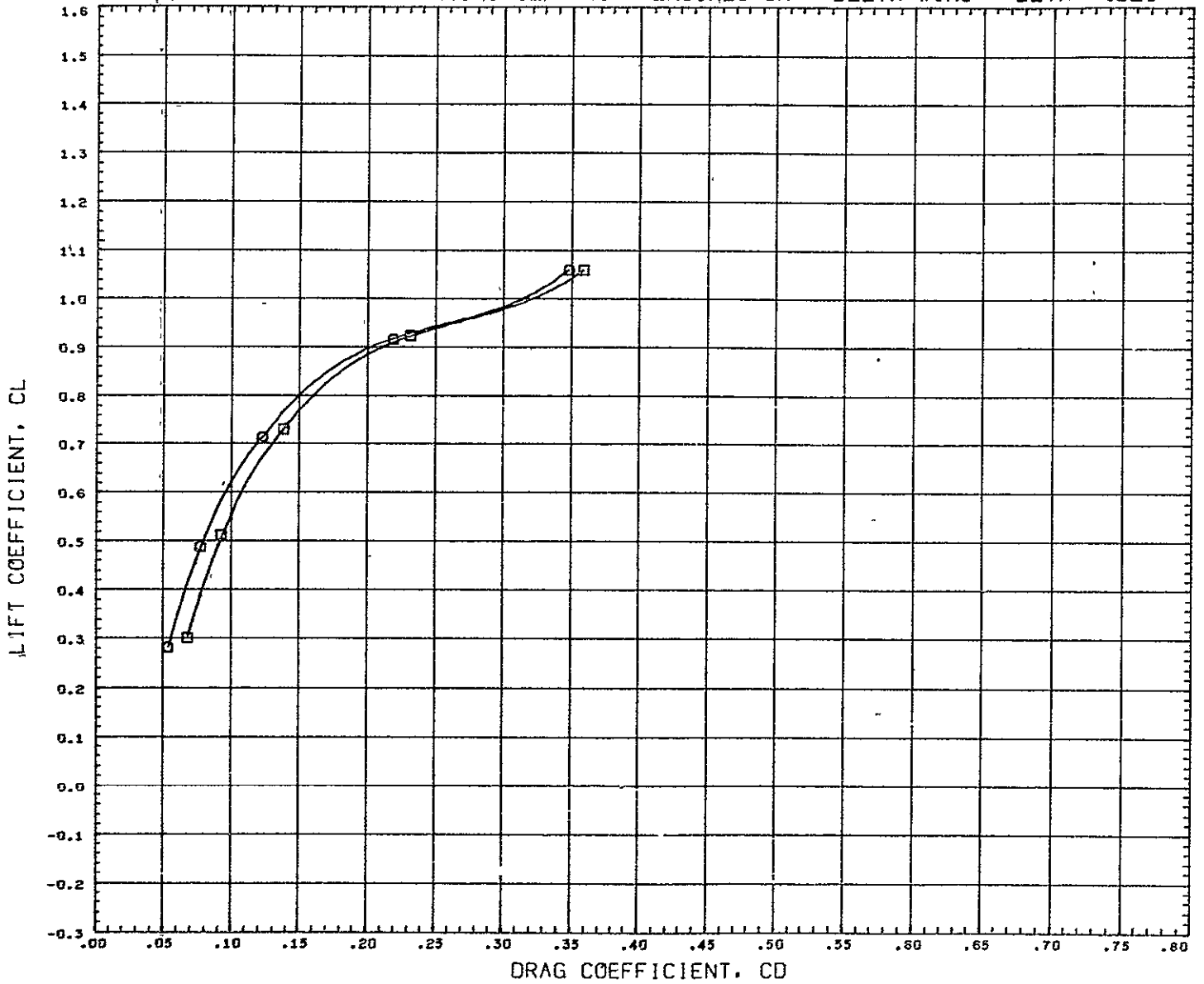

DATA SET SYMBOL CONFIGURATION DESCRIPTION  
 (RC7005) O CVLSWT TEST 579-G B7W5V1  
 (RC7101) □ CVLSWT TEST 579-G B7W5V1E202

PARAMETRIC VALUES  
 BETA - 4.000 ELEVON 0.000  
 AILRON 0.000 RUDDER 0.000

REFERENCE INFORMATION  
 REFS 316.2304 SQ IN  
 REFL 50.1900 IN  
 REFB 7.3500 IN  
 XMRP 33.9090 IN  
 YMRP 0.0000 IN  
 ZMRP 0.0000 IN  
 SCALE 0.0175

MACH 0.259

LONG. CHAR. - EFFECT OF LANDING GEAR WITH ENGINES ON - DELTA WING - BETA=-4DEG

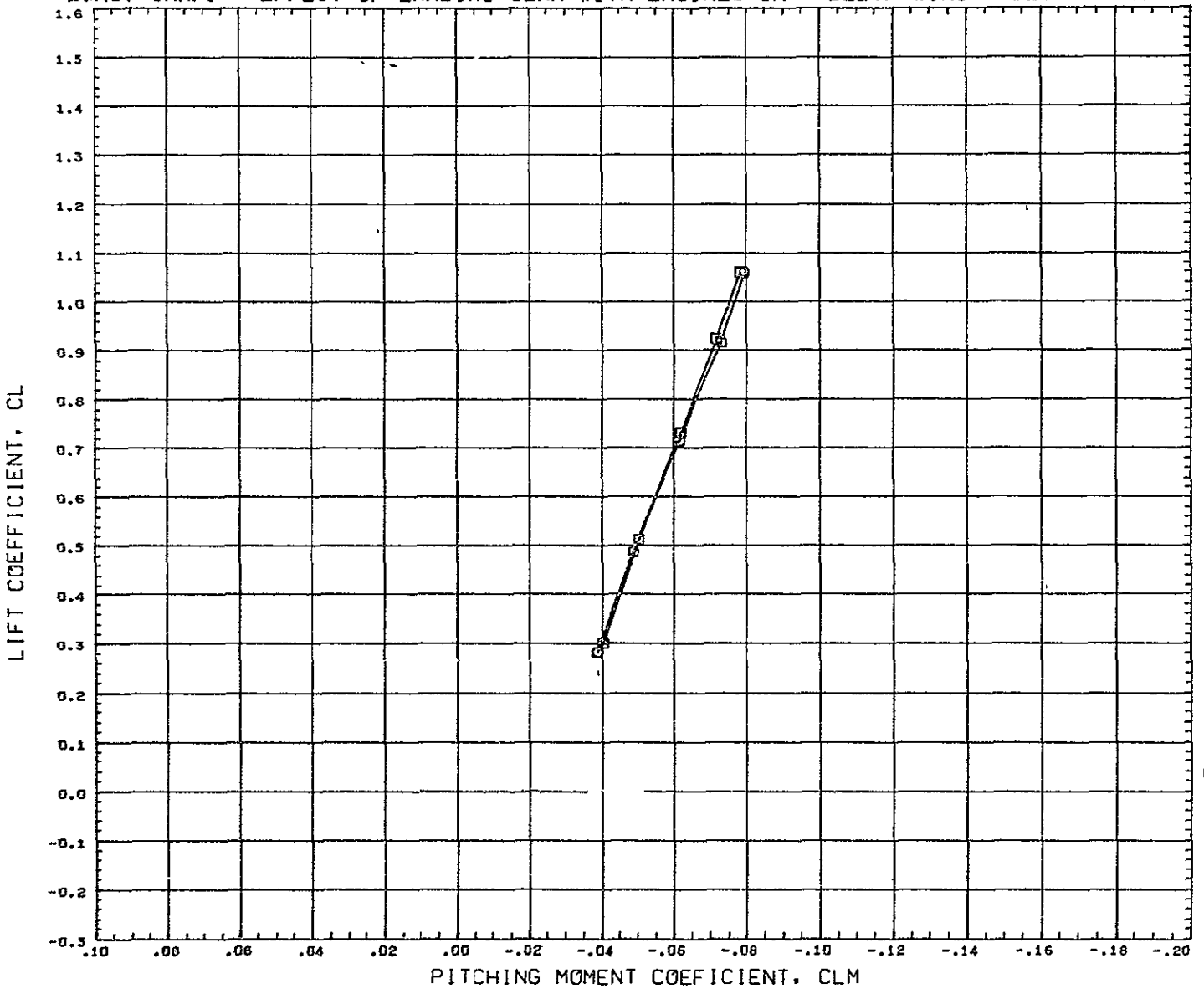

DATA SET SYMBOL    CONFIGURATION DESCRIPTION  
 (RC7085)    □    CVLSWT TEST 579-0 B7W5V1  
 (RC7101)    □    CVLSWT TEST 579-0 B7W5V1E2G2

PARAMETRIC VALUES				REFERENCE INFORMATION		
BETA	- 4.000	ELEVON	0 000	REFS	316.2304	SQ IN
AILRON	0.000	RUDDER	0 000	REFL	50 1900	IN
				REFB	7.3500	IN
				XMRP	33.9090	IN
				YMRP	0 0000	IN
				ZMRP	0 0000	IN
				SCALE	0 0175	

MACH            0.259

EFFECT OF LANDING GEAR WITH ENGINES ON - SIDESLIP DERIVATIVES - DELTA WING

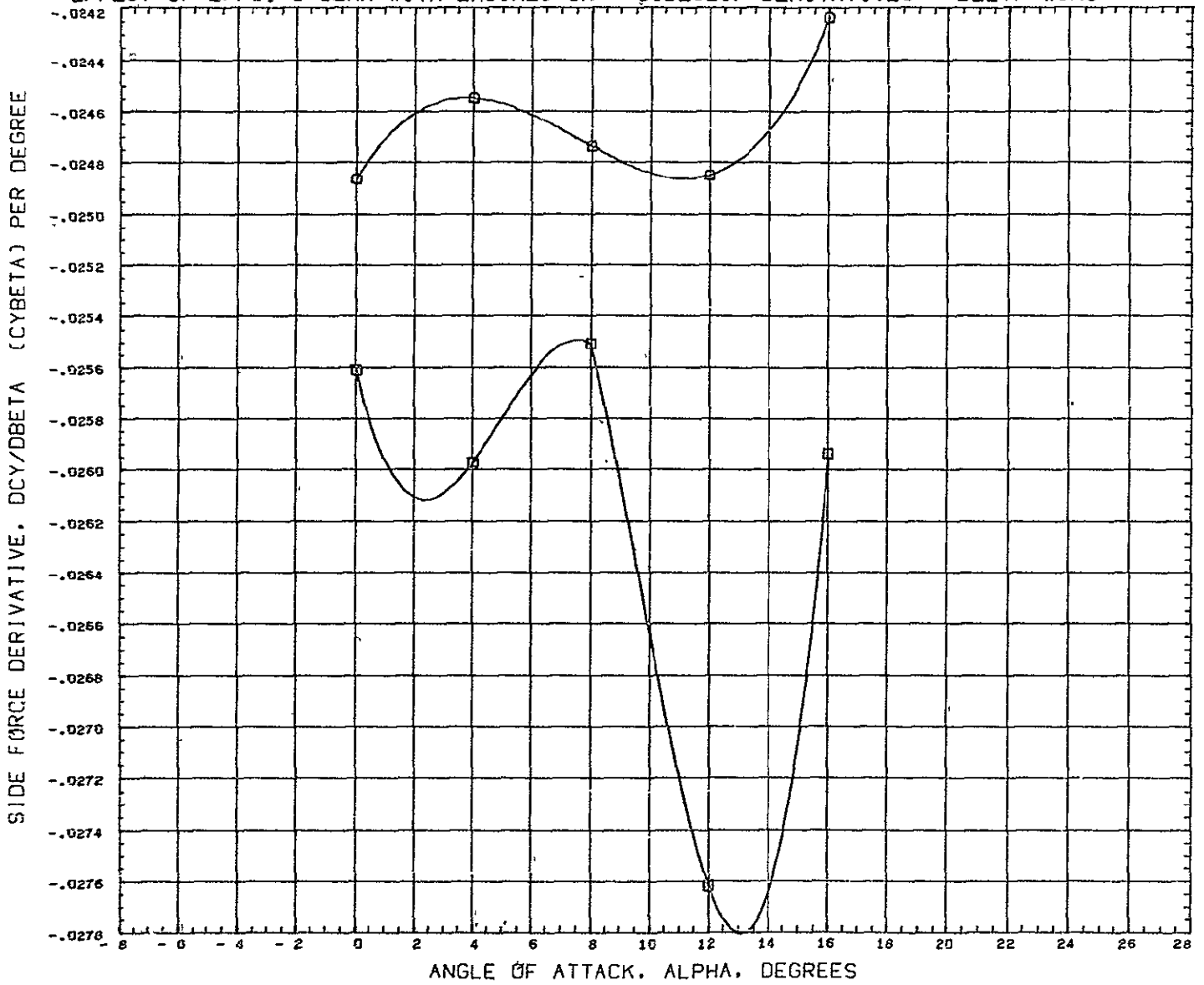

DATA SET SYMBOL    CONFIGURATION DESCRIPTION  
 (DB7083)    □    CVLSWT TEST 579-0 B7W5V1  
 (CB7100)    □    CVLSWT TEST 579-0 B7W5V1E262

PARAMETRIC VALUES  
 BETA    0.000    ELEVON    0.000  
 AILRON    0.000    RUDDER    0.000

REFERENCE INFORMATION  
 REFS    316.2304    SQ IN  
 REFL    50.1900    IN  
 REFB    7.3500    IN  
 XMRP    33.9090    IN  
 YMRP    0.0000    IN  
 ZMRP    0.0000    IN  
 SCALE    0.0175

MACH    0.259

EFFECT OF LANDING GEAR WITH ENGINES ON - SIDESLIP DERIVATIVES - DELTA WING

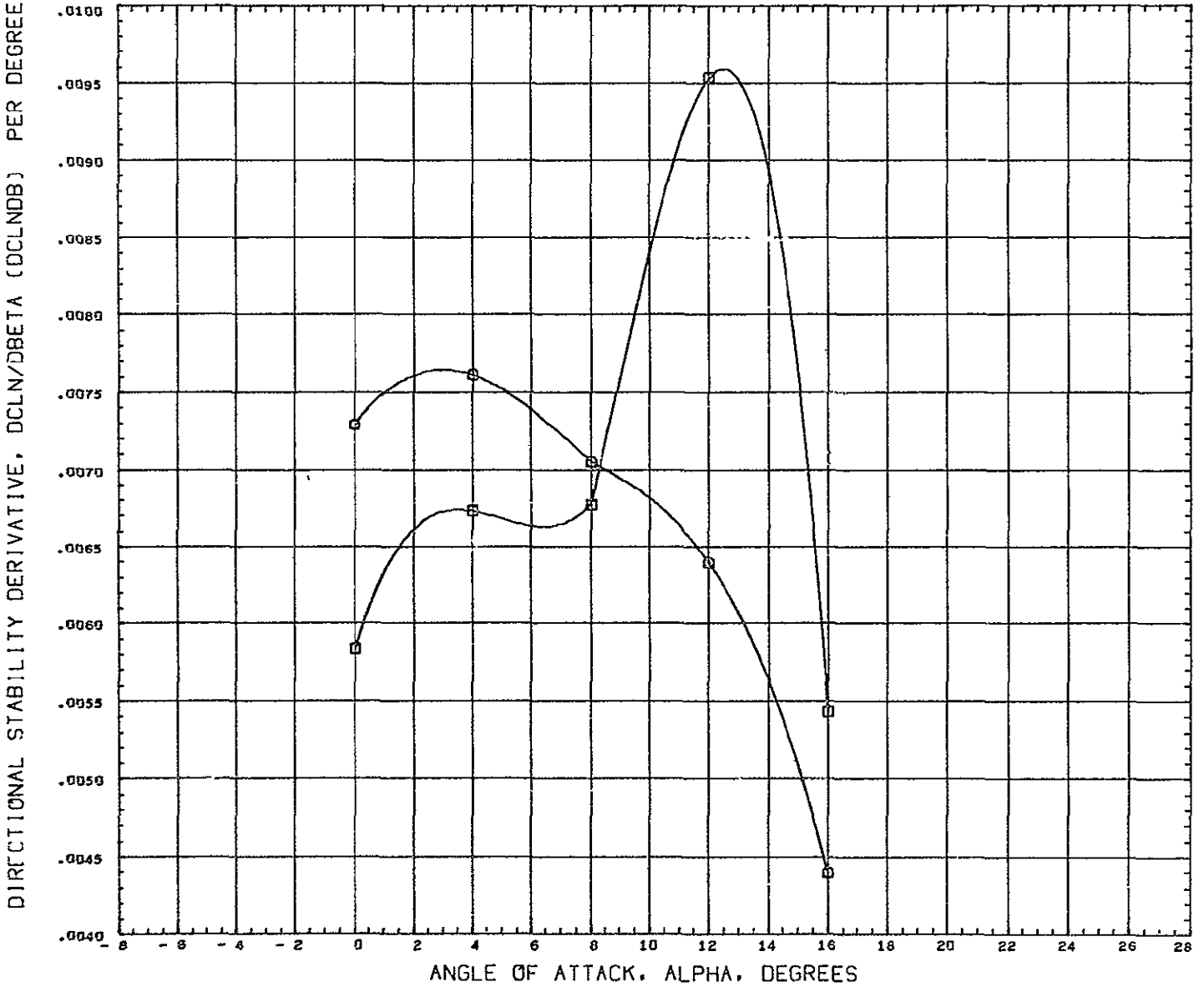

DATA SET SYMBOL CONFIGURATION DESCRIPTION  
 (DB7583) ○ CVLSWT TEST 579-G B7W5V1  
 (DB7100) □ CVLSWT TEST 579-G B7W5V1E262

PARAMETRIC VALUES  
 BETA 0.000 ELEVON 0.000  
 AILRON 0.000 RUDDER 0.000

REFERENCE INFORMATION  
 REFS 316 2304 SQ IN  
 REFL 50 1900 IN  
 REFB 7.3500 IN  
 XMRP 33.9000 IN  
 YMRP 0.0000 IN  
 ZMRP 0.0000 IN  
 SCALE 0.0175

MACH 0.259

EFFECT OF LANDING GEAR WITH ENGINES ON - SIDESLIP DERIVATIVES - DELTA WING

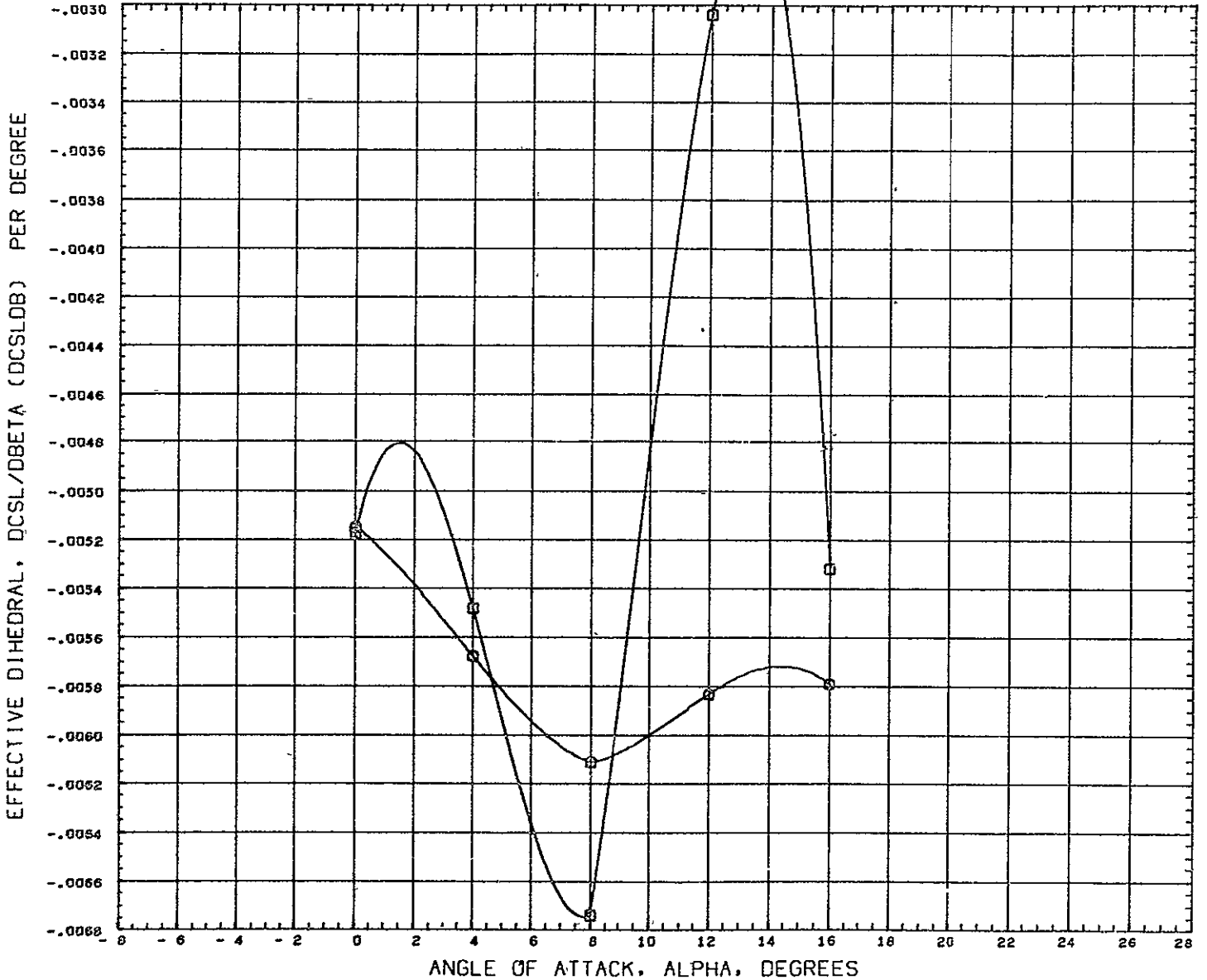

DATA SET SYMBOL	CONFIGURATION DESCRIPTION	PARAMETRIC VALUES				REFERENCE INFORMATION		
(CB7083)	□ CVLSWT TEST 579-0 B7W5V1	BETA	0.000	ELEVON	0.000	REFS	316.2304	SQ IN
(DB7100)	□ CVLSWT TEST 579-0 B7W3V1E2G2	AILRON	0.000	RUDDER	0.000	REFL	50.1900	IN
						REFB	7.3500	IN
						XNRF	33.9090	IN
						YNRF	0.0000	IN
						ZNRF	0.0000	IN
						SCALE	0.0175	

MACH 0.259

LONGITUDINAL CHARACTERISTICS - EFFECT OF CRUISE ENGINE CONFIG. - DELTA WING

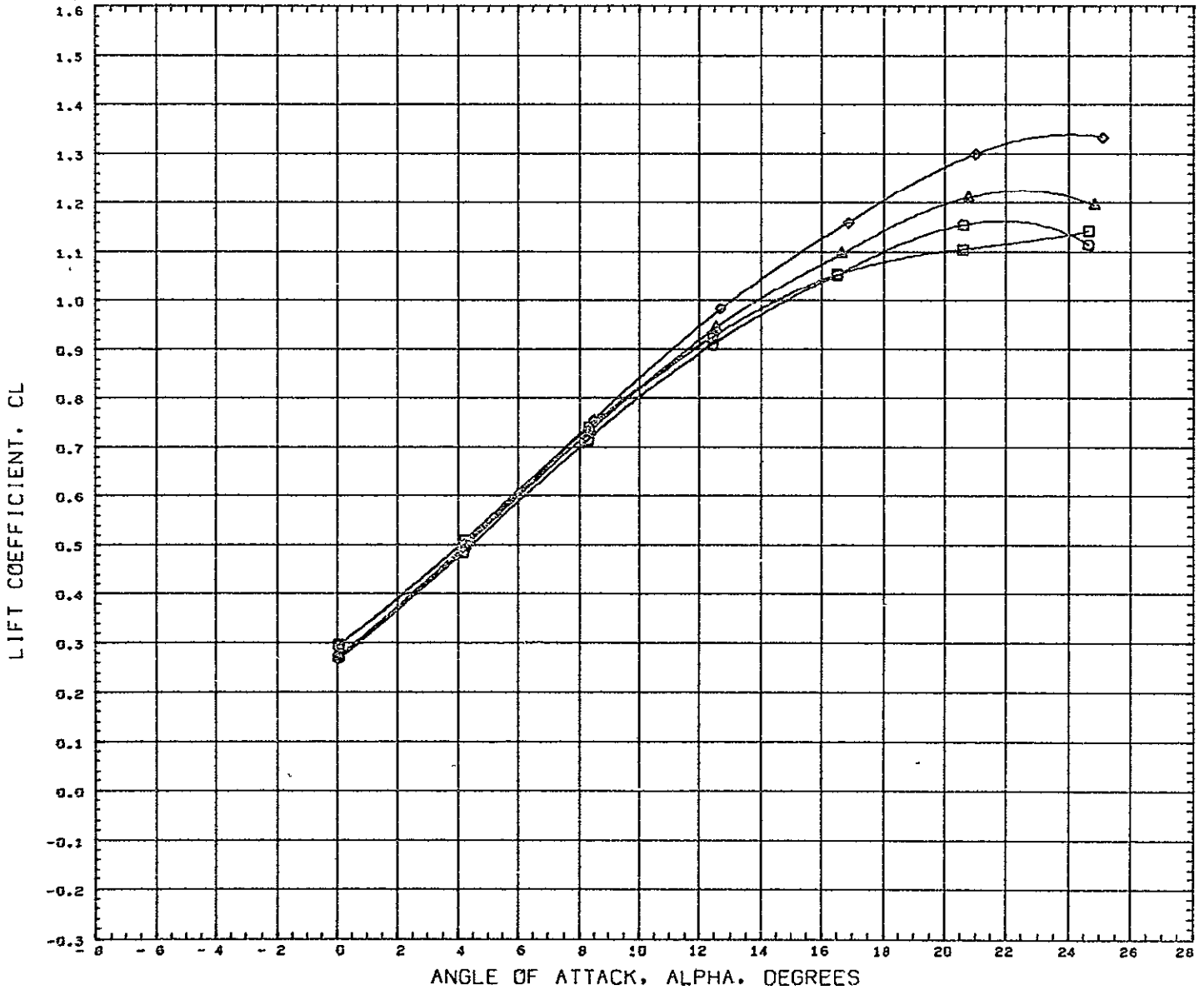

DATA SET SYMBOL    CONFIGURATION DESCRIPTION  
 (RC7083)    □    CVLSWT TEST 579-D B7W5V1  
 (RC7102)    □    CVLSWT TEST 579-D B7W5V1E2  
 (RC7104)    ◊    CVLSWT TEST 579-D B7W5V1E4  
 (RC7106)    Δ    CVLSWT TEST 579-D B7W5V1E6

PARAMETRIC VALUES  
 BETA    0.000    ELEVON    0.000  
 AILRON    0.000    RUDDER    0.000

REFERENCE INFORMATION  
 REFS    316.2304    SQ IN  
 REFL    50.1900    IN  
 REFB    7.3500    IN  
 XMRP    33.9090    IN  
 YMRP    0.0000    IN  
 ZMRP    0.0000    IN  
 SCALE    0.0175

MACH    0.259

LONGITUDINAL CHARACTERISTICS - EFFECT OF CRUISE ENGINE CONFIG. - DELTA WING

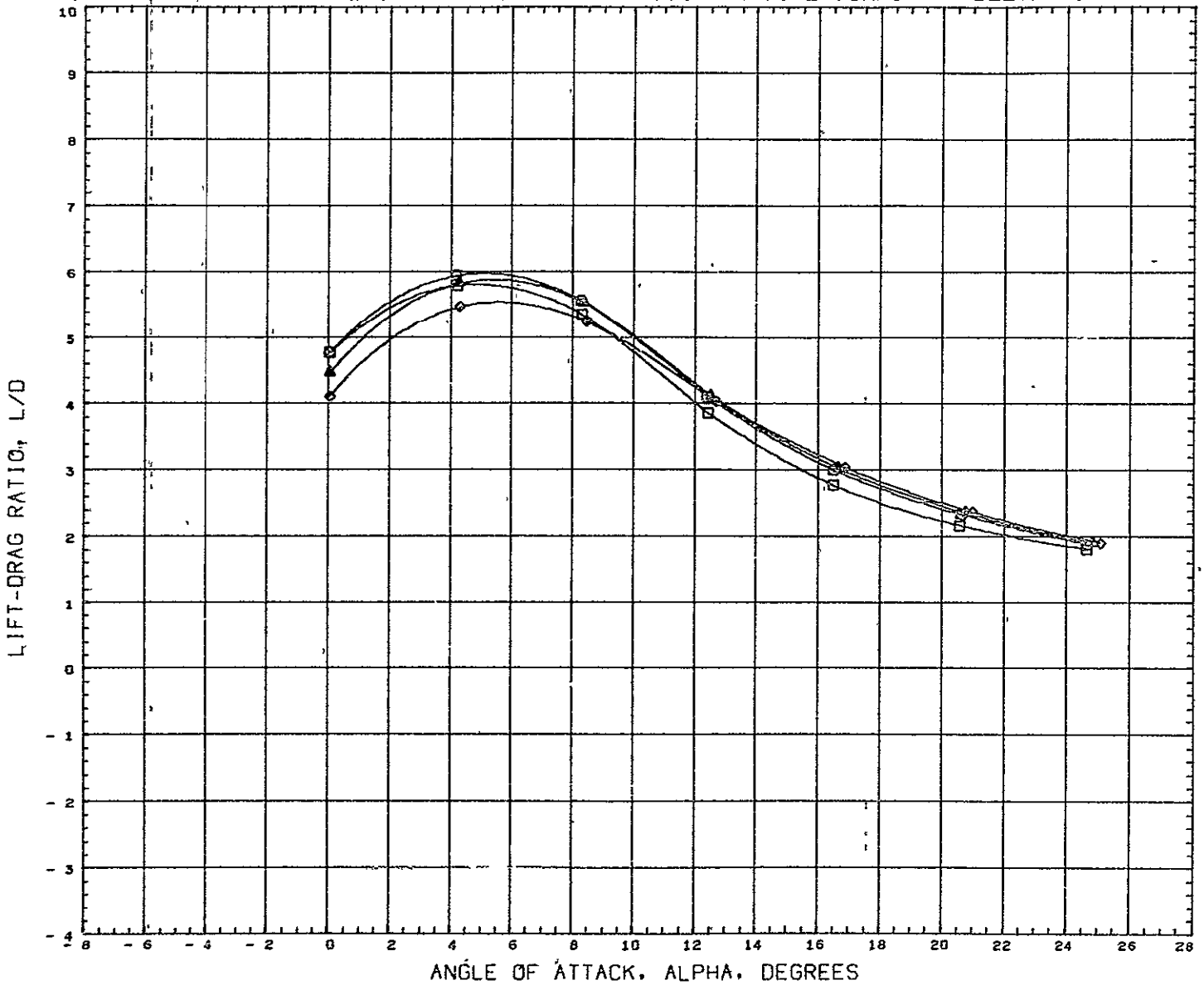

DATA SET SYMBOL	CONFIGURATION DESCRIPTION
(RC7083)	CVLSWT TEST 579-D B7W5V1
(RC7102)	CVLSWT TEST 579-D B7W5V1E2
(RC7104)	CVLSWT TEST 579-D B7W5V1E4
(RC7106)	CVLSWT TEST 579-D B7W5V1E6

PARAMETRIC VALUES			
BETA	0.000	ELEVON	0.000
AILRON	0.000	RUDDER	0.000

REFERENCE INFORMATION		
REFS	316.2304	SQ IN
REFL	50.1900	IN
REFB	7.3500	IN
XMRP	33.9090	IN
YMRP	0.0000	IN
ZMRP	0.0000	IN
SCALE	0.0175	

MACH 0.259

# LONGITUDINAL CHARACTERISTICS - EFFECT OF CRUISE ENGINE CONFIG. - DELTA WING

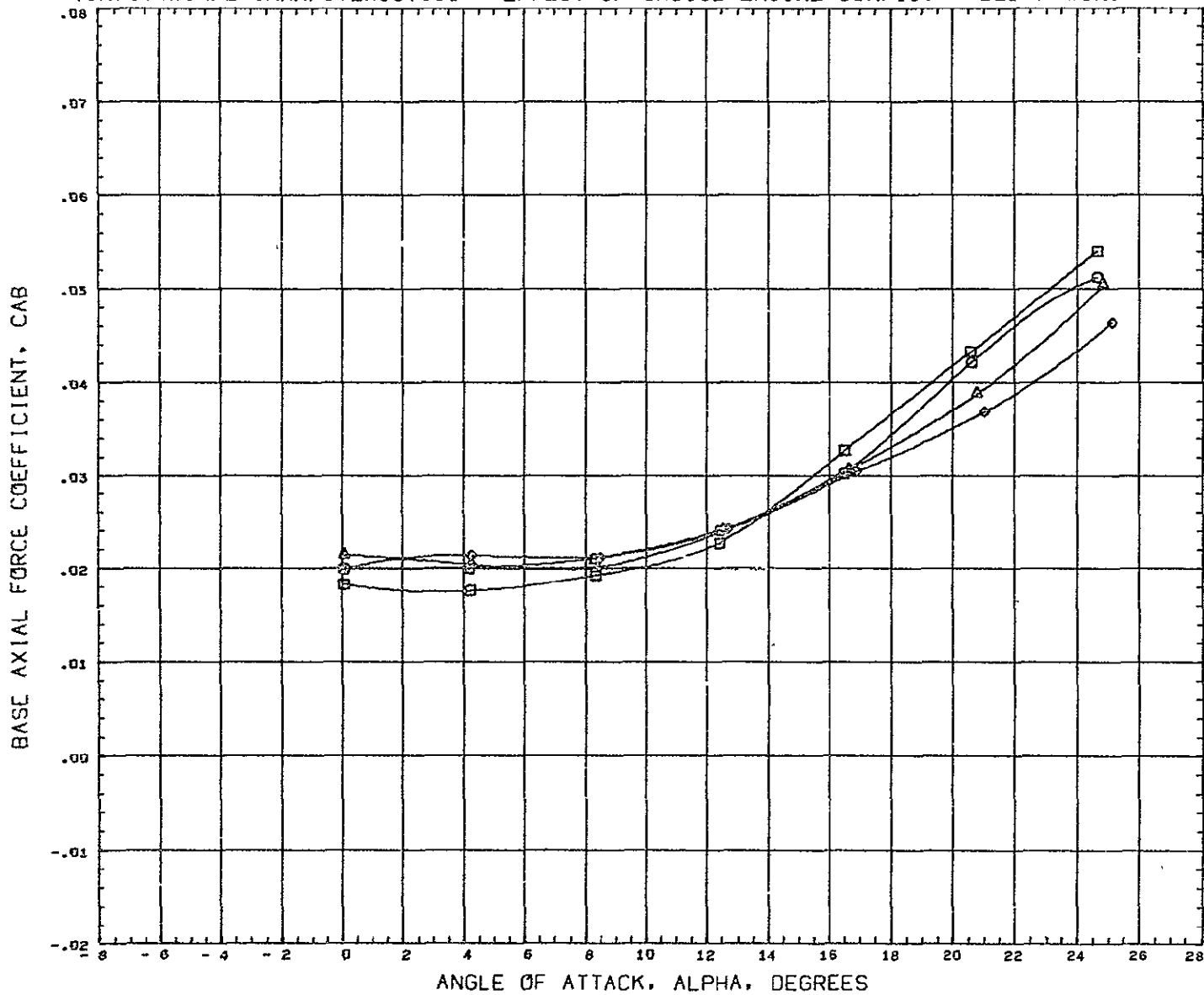

DATA SET	SYMBOL	CONFIGURATION DESCRIPTION
(RC7083)	□	CVLSWT TEST 579-B B7W5V1
(RC7102)	○	CVLSWT TEST 579-B B7W3V1E2
(RC7104)	◇	CVLSWT TEST 579-B B7W3V1E4
(RC7106)	△	CVLSWT TEST 579-B B7W5V1E6

PARAMETRIC VALUES				REFERENCE INFORMATION		
BETA	0.000	ELEVON	0.000	REFS	316.2304	SQ IN
AILRON	0.000	RUDDER	0.000	REFL	50.1900	IN
				REFB	7.3500	IN
				XMRP	33.9090	IN
				YMRP	0.0000	IN
				ZMRP	0.0000	IN
				SCALE	0.0175	

MACH 0.259



# LONGITUDINAL CHARACTERISTICS - EFFECT OF CRUISE ENGINE CONFIG. - DELTA WING

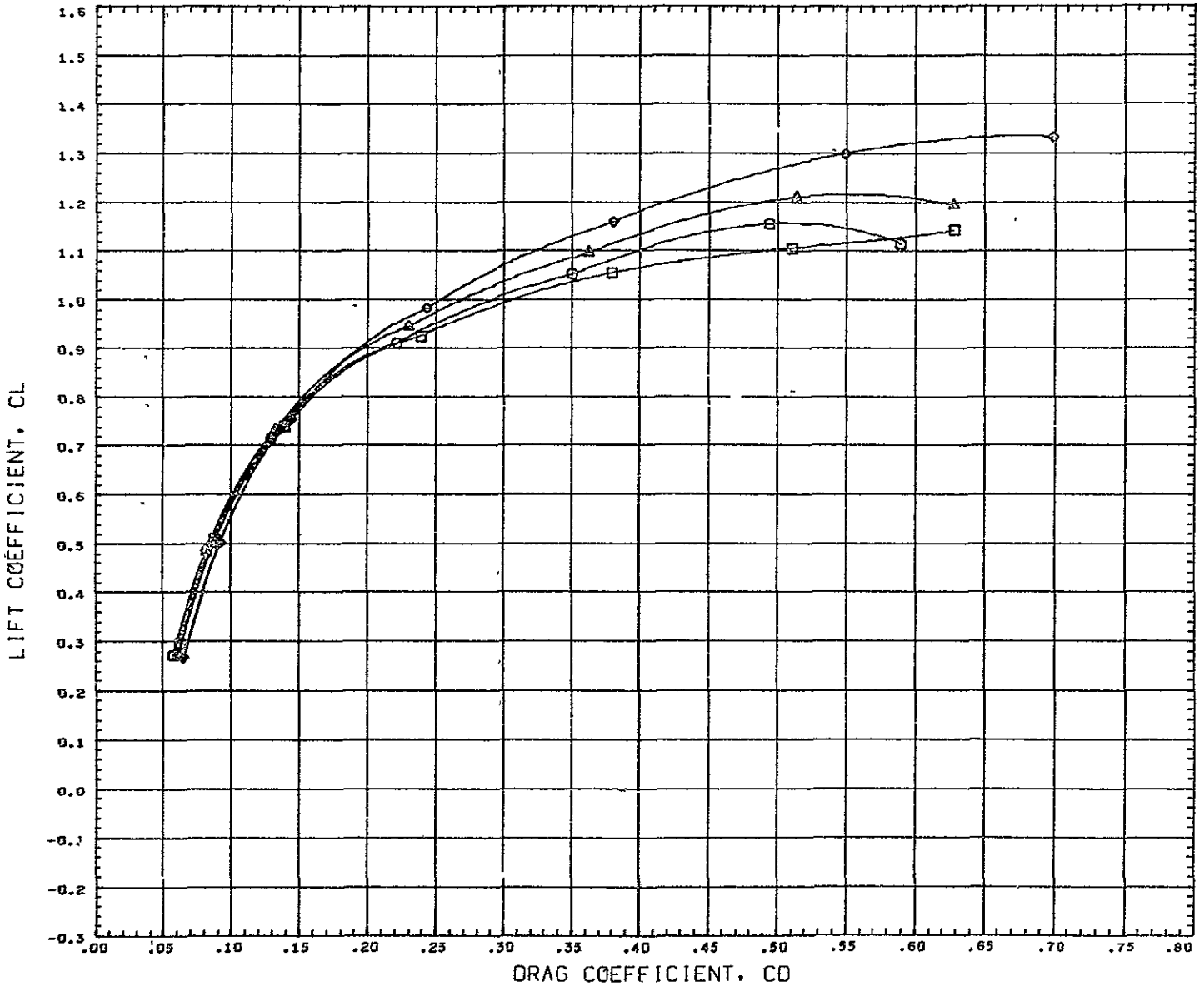

DATA SET	SYMBOL	CONFIGURATION DESCRIPTION
(RC7083)	○	CVLSWT TEST 579-G B7W5V1
(RC7102)	□	CVLSWT TEST 579-G B7W5V1E2
(RC7104)	◇	CVLSWT TEST 579-G B7W5V1E4
(RC7106)	△	CVLSWT TEST 579-G B7W5V1E6

PARAMETRIC VALUES			
BETA	0.000	ELEVON	0.000
AILRON	0.000	RUDDER	0.000

REFERENCE INFORMATION		
REFS	316.2304	SQ IN
REFL	50.1900	IN
REFB	7.3500	IN
XMRP	33.9090	IN
YMRP	0.0000	IN
ZMRP	0.0000	IN
SCALE	0.0175	

MACH 0.259

LONGITUDINAL CHARACTERISTICS - EFFECT OF CRUISE ENGINE CONFIG. - DELTA WING

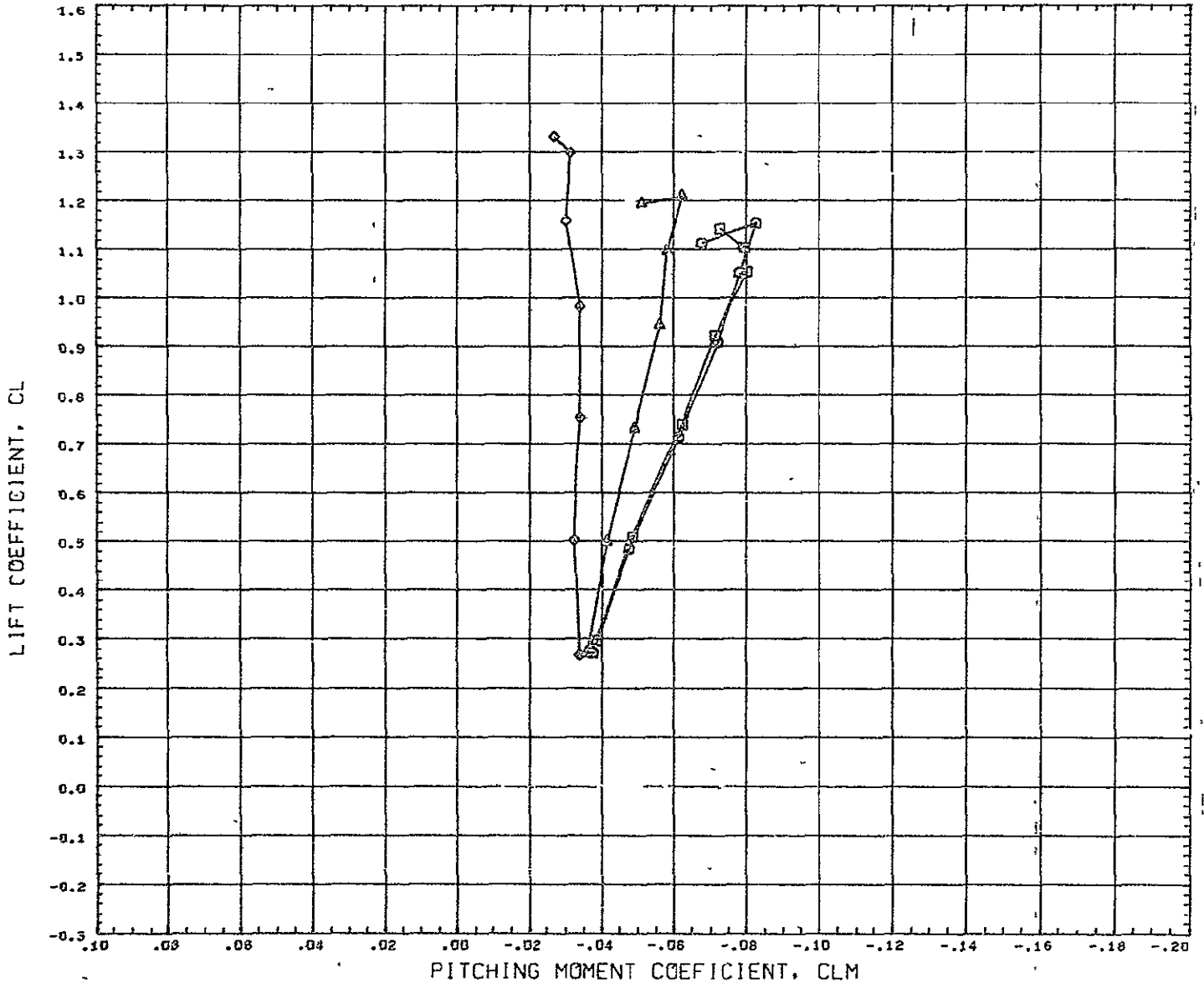

DATA SET SYMBOL CONFIGURATION DESCRIPTION

(RC7083) □ CVLSWT TEST 579-D B7W5V1

(RC7102) □ CVLSWT TEST 579-D B7W5V1E2

(RC7104) ◇ CVLSWT TEST 579-D B7W5V1E4

(RC7106) △ CVLSWT TEST 579-D B7W5V1E6

PARAMETRIC VALUES REFERENCE INFORMATION

BETA 0.000 ELEVON 0 000 REFS 316.2304 SQ IN

AILRON 0 000 RUDDER 0 000 REFL 50 1900 IN

XRRF 33 9090 IN

YRRF 0.0000 IN

ZRRF 0.0000 IN

SCALE 0.0175

MACH 0.259

EFFECT OF CRUISE ENGINE CONFIGURATION - SIDESLIP DERIVATIVES - DELTA WING

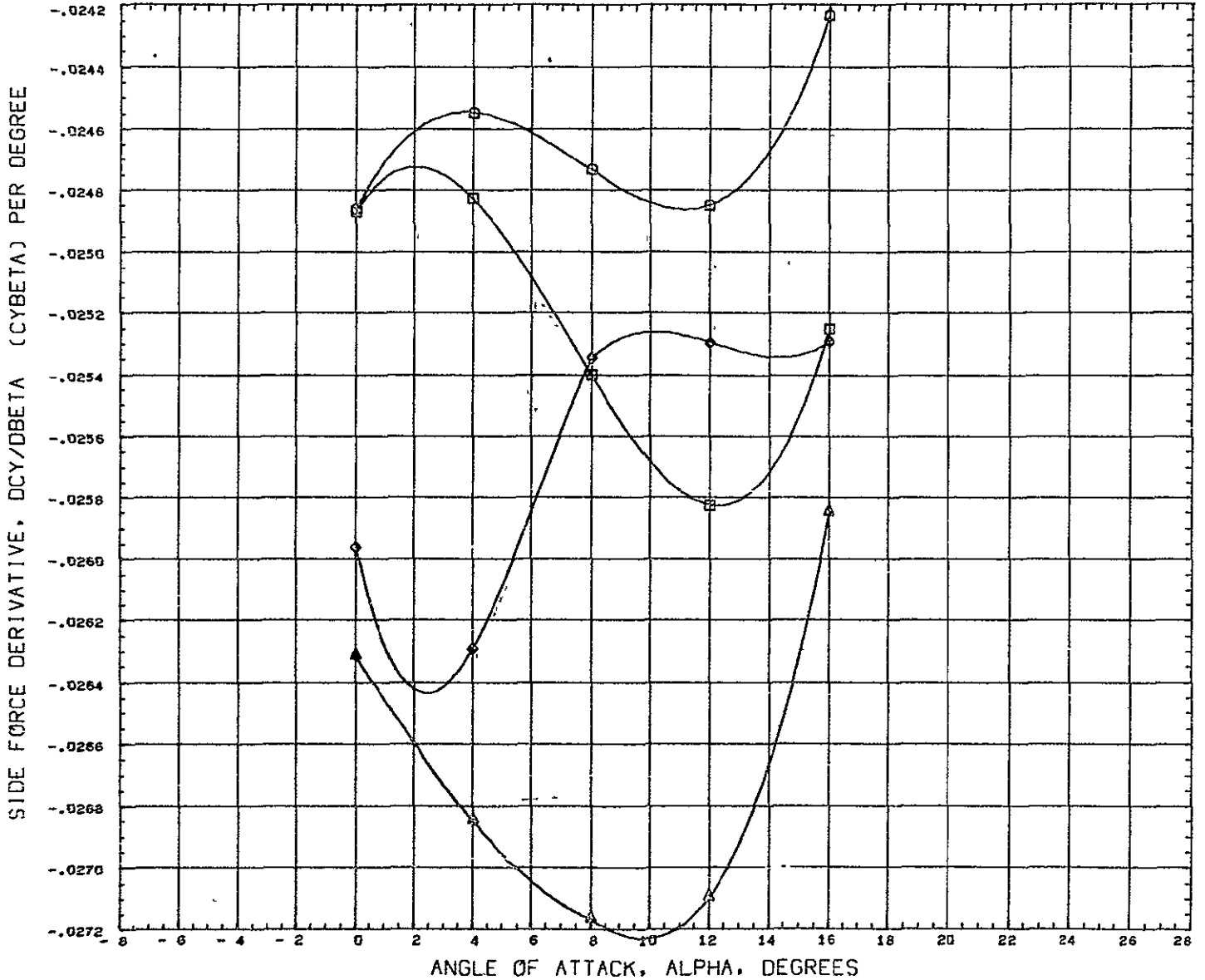

DATA SET SYMBOL	CONFIGURATION DESCRIPTION	PARAMETRIC VALUES			REFERENCE INFORMATION		
{DB7083}	CVLSWT TEST 579-G B7W5V1	BETA	0.000	ELEVON	0.000	REFS	316.2304 SQ IN
{DB7102}	CVLSWT TEST 579-G B7W5V1E2	AILRON	0.000	RUDDER	0.000	REFL	50.1900 IN
{DB7104}	CVLSWT TEST 579-G B7W5V1E4					REFB	7.3300 IN
{DB7106}	CVLSWT TEST 579-G B7W5V1E6					KMRF	33.9000 IN
						YMRF	0.0000 IN
						ZMRF	0.0000 IN
						SCALE	0.0175

MACH 0.259

EFFECT OF CRUISE ENGINE CONFIGURATION - SIDESLIP DERIVATIVES - DELTA WING

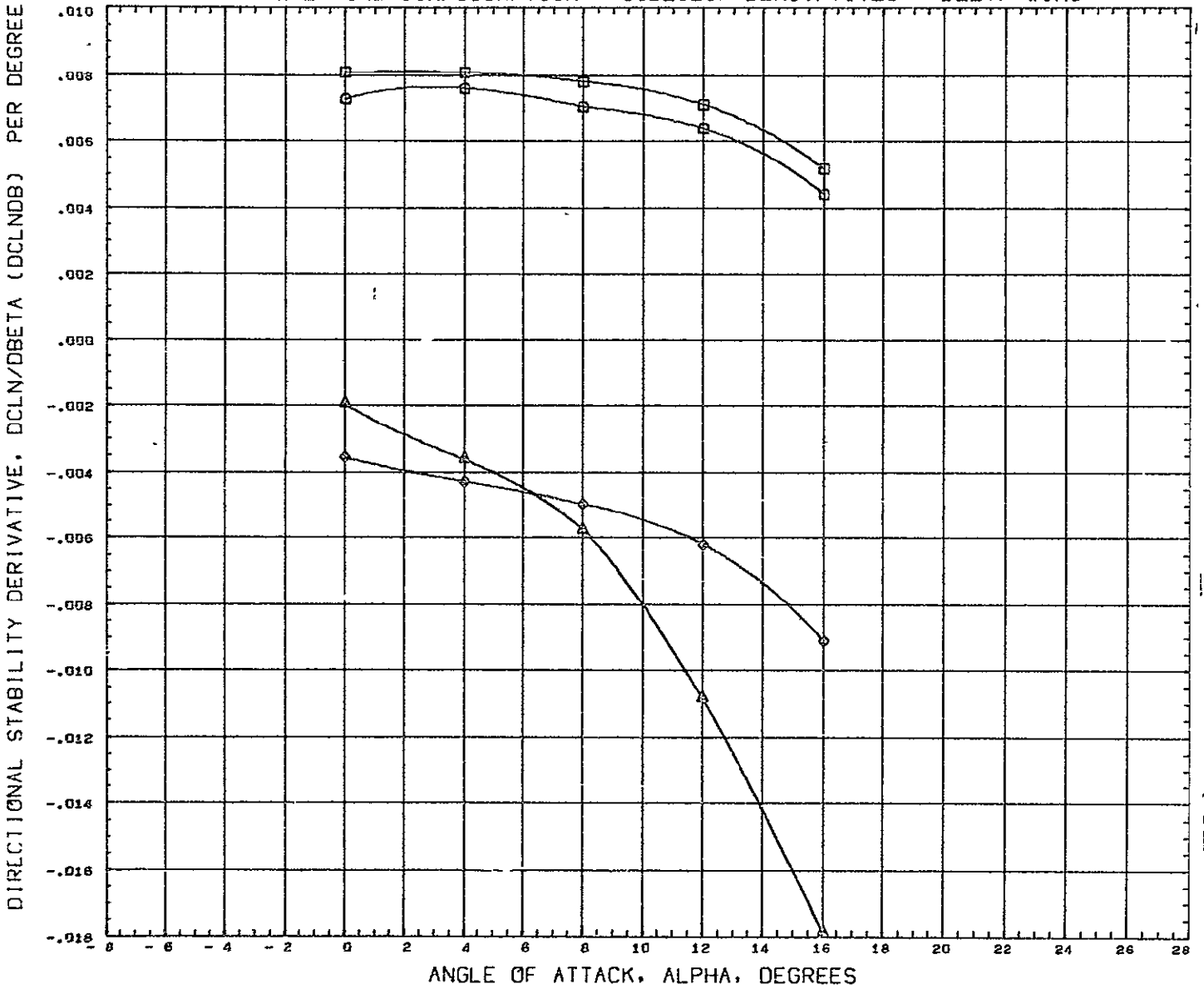

DATA SET SYMBOL    CONFIGURATION DESCRIPTION  
 (DB7083)    □    CVLSWT TEST 579-0 B7W5V1  
 (DB7102)    □    CVLSWT TEST 579-0 B7W5V1E2  
 (DB7104)    ◇    CVLSWT TEST 579-0 B7W3V1E4  
 (DB7106)    △    CVLSWT TEST 579-0 B7W3V1E6

PARAMETRIC VALUES  
 BETA    0.000    ELEVON    0.000  
 AILRON    0.000    RUDDER    0.000

REFERENCE INFORMATION  
 REFS    316.2304    SQ IN  
 REFL    50.1900    IN  
 REFB    7.3500    IN  
 XMRP    33.9090    IN  
 YMRP    0.0000    IN  
 ZMRP    0.0000    IN  
 SCALE    0.0175

MACH    0.259

# EFFECT OF CRUISE ENGINE CONFIGURATION - SIDESLIP DERIVATIVES - DELTA WING

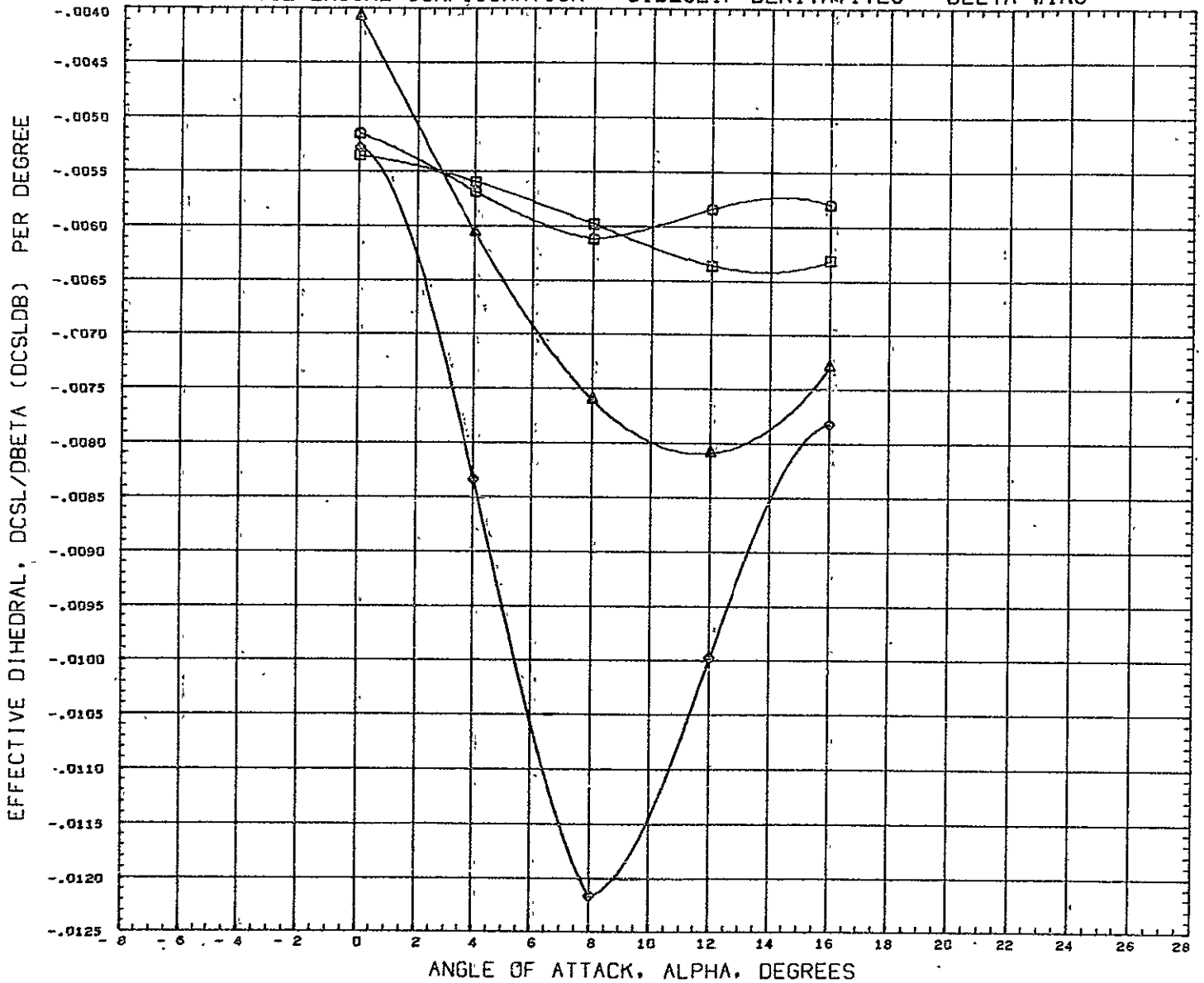

DATA SET SYMBOL	CONFIGURATION DESCRIPTION
(DB7083)	□ CVLSWT TEST 579-D B7W5V1
(DB7102)	□ CVLSWT TEST 579-D B7W5V1E2
(DB7104)	◇ CVLSWT TEST 579-D B7W5V1E4
(DB7106)	△ CVLSWT TEST 579-D B7W5V1E6

PARAMETRIC VALUES			
BETA	0.000	ELEVON	0.000
AILRON	0.000	RUDDER	0.000

REFERENCE INFORMATION		
REFS	316.2304	SQ IN
REFL	50.1900	IN
REFB	7.3500	IN
XMRP	33.9090	IN
YMRP	0.0000	IN
ZMRP	0.0000	IN
SCALE	0.0175	

MACH 0.259

COMPARISON OF CONFIG. - B7W5(CONFIG 1.) B7W5V1(CONFIG 2.) AND B7W5V2(CONFIG 3.)

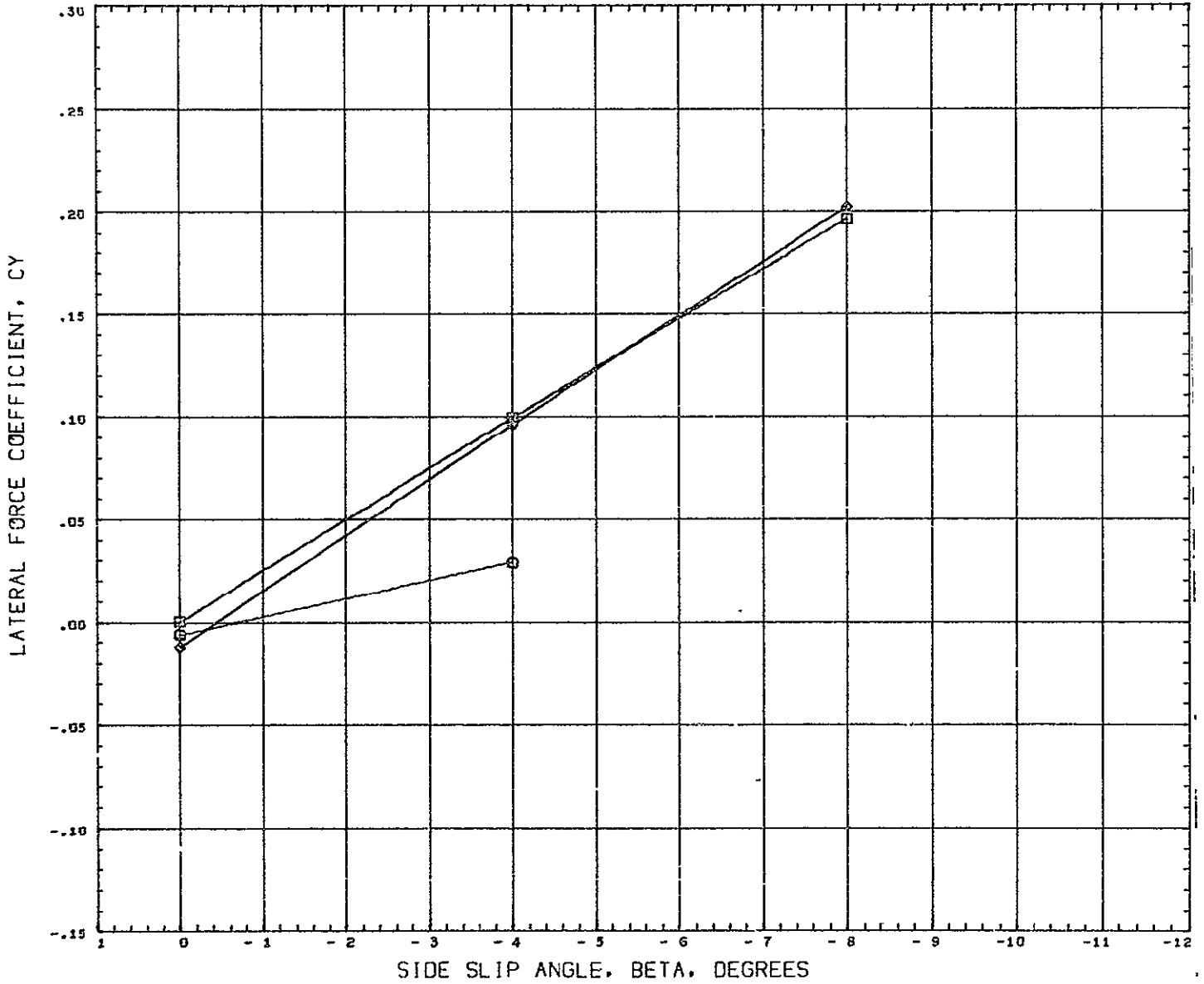

SYMBOL		CONFIG	PARAMETRIC VALUES			REFERENCE INFORMATION			
□		1.000	MACH	0.259	ALPHA	0.000	REFS	316.2304	SQ IN
□		2.000	ELEVON	0.000	AILRON	0.000	PEFL	50.1900	IN
◇		3.000					REFB	7.3500	IN
							XMRP	33.9000	IN
							YMRP	0.0000	IN
							ZMRP	0.0000	IN
							SCALE	0.0175	

DATA HIST. CODE IH

COMPARISON OF CONFIG. - B7W5(CONFIG 1.) B7W5V1(CONFIG 2.) AND B7W5V2(CONFIG 3.)

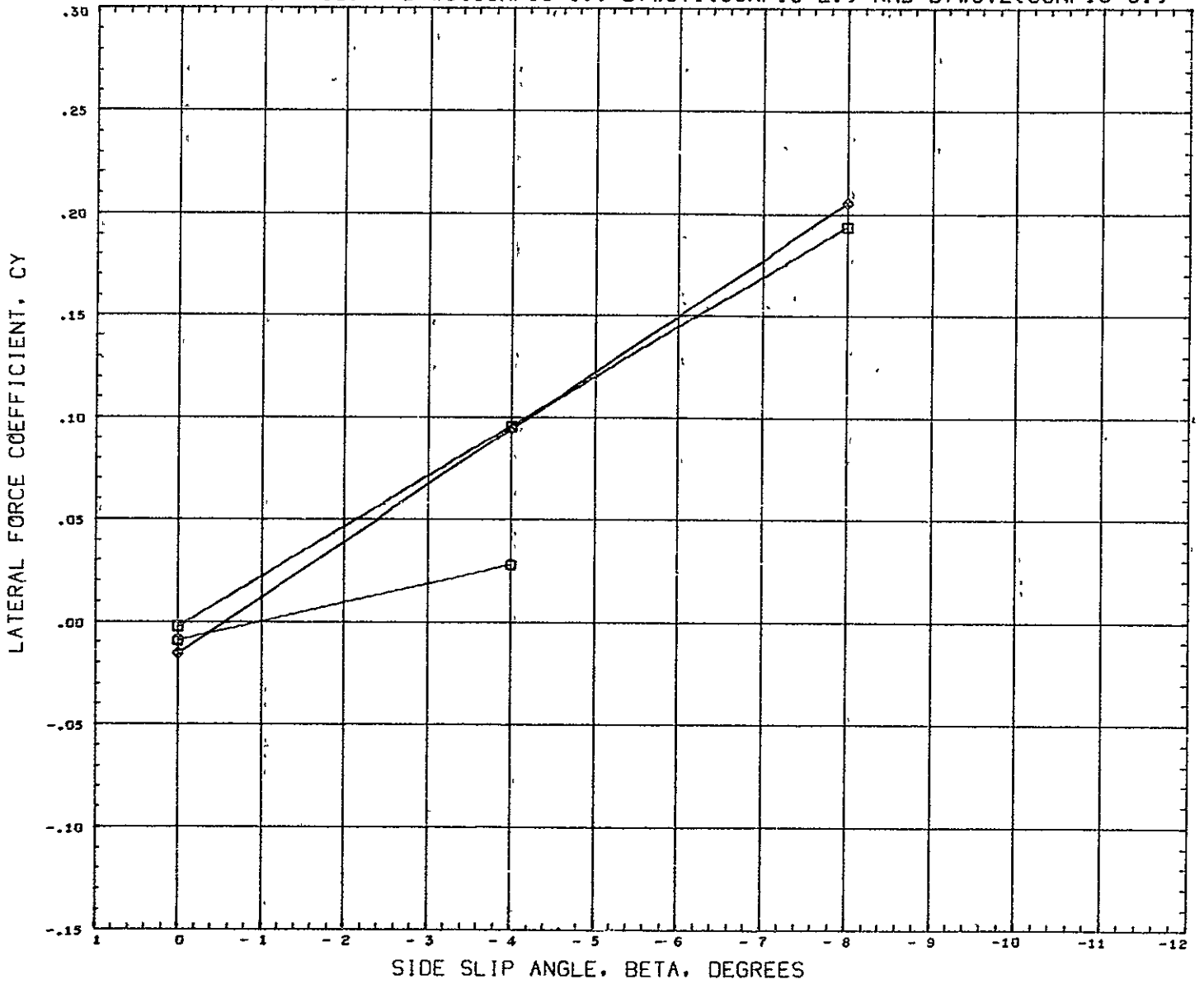

SYMBOL	CONFIG	PARAMETRIC VALUES			
○	1.000	MACH	0.259	ALPHA	4.000
□	2.000	ELEVON	0.000	AILRON	0.000
◇	3.000				

REFERENCE INFORMATION		
REFS	316 2304	SQ IN
REFL	50.1900	IN
REFB	7.3500	IN
XMRP	33 9090	IN
YMRP	0 0000	IN
ZMRP	0.0000	IN
SCALE	0.0175	

DATA HIST. CODE IN

COMPARISON OF CONFIG. - B7W5(CONFIG 1.) B7W5V1(CONFIG 2.) AND B7W5V2(CONFIG 3.)

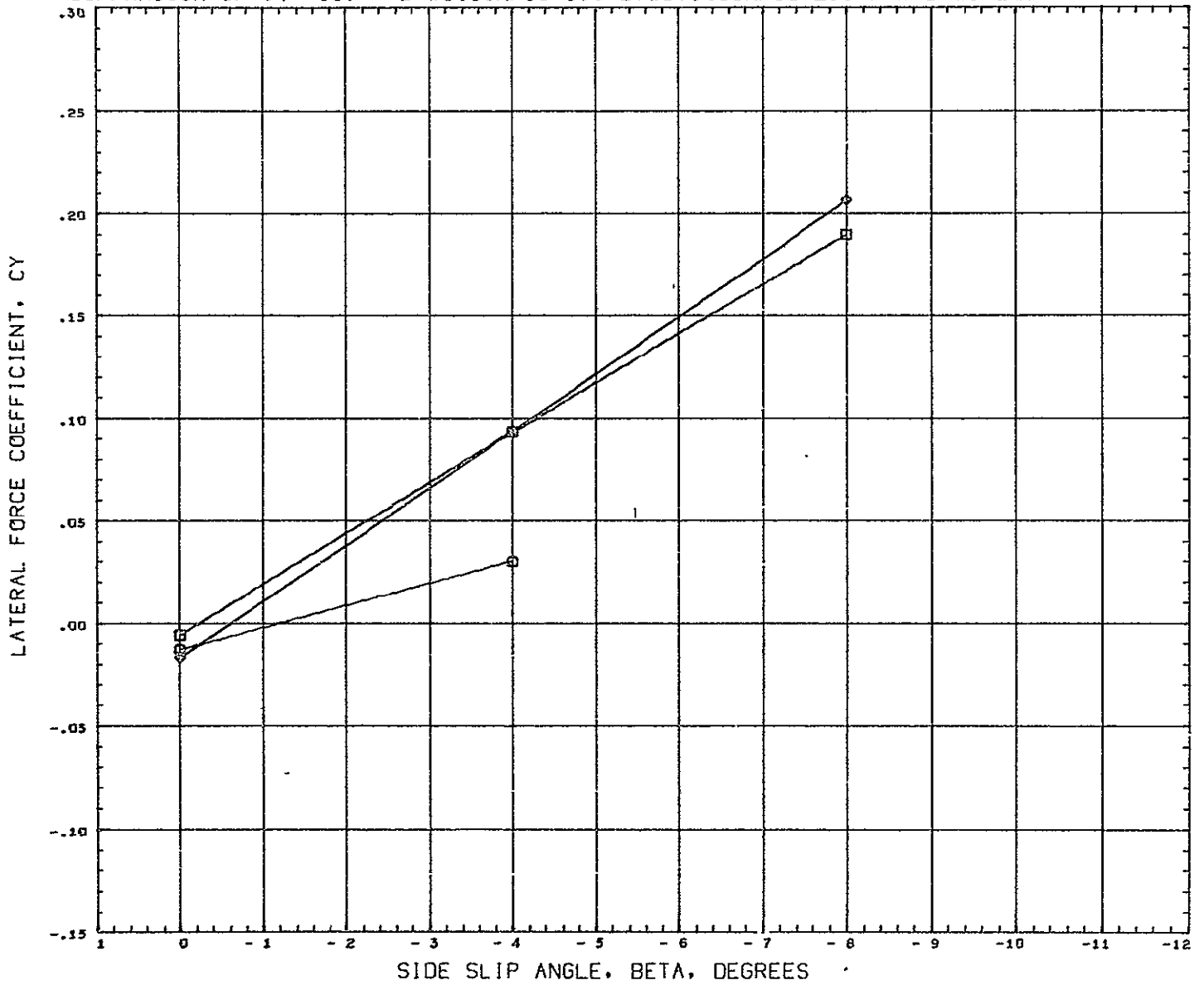

SYMBOL	CONFIG	PARAMETRIC VALUES				REFERENCE INFORMATION		
		NACH	ALPHA	AILRON	REFS	SQ	IN	
○	1.000	0.259	8.000		316	2304		
□	2.000	0.000	0.000		50.1900		IN	
◇	3.000				7.3500		IN	
					33.9090		IN	
					0.0000		IN	
					0.0000		IN	
					0.0175			

DATA HIST. CODE IH



COMPARISON OF CONFIG. - B7W5(CONFIG 1.) B7W5V1(CONFIG 2.) AND B7W5V2(CONFIG 3.)

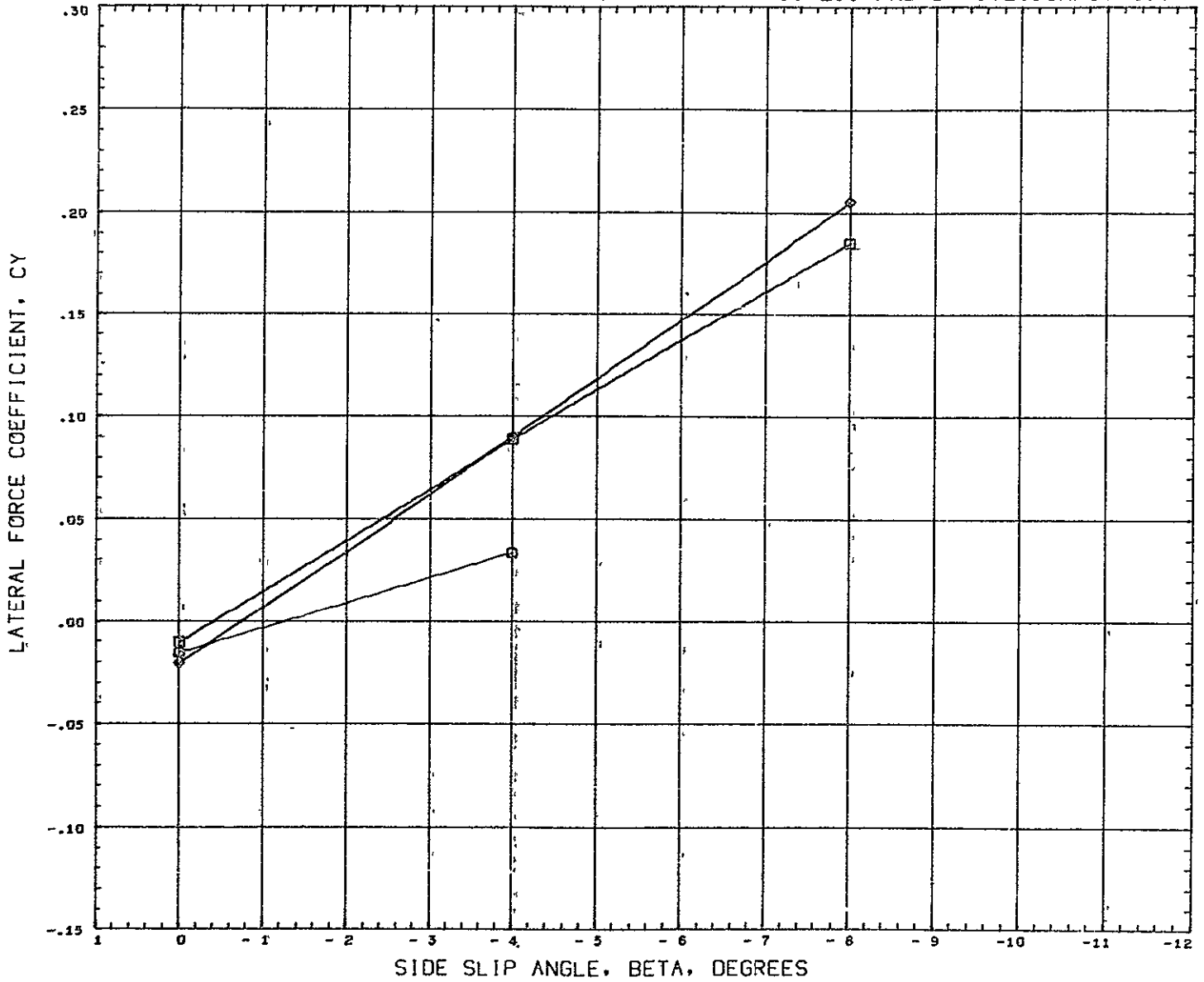

SYMBOL	CONFIG	PARAMETRIC VALUES			
○	1.000	MACH	0.259	ALPHA	12.000
□	2.000	ELEVON	0.000	AILRON	0.000
◇	3.000				

REFERENCE INFORMATION		
REFS	316 2304	SQ IN
REFL	50 1900	IN
FEFB	7.3500	IN
XNRF	33 9090	IN
YNRF	0 0000	IN
ZNRF	0 0000	IN
SCALE	0 0175	

DATA HIST. CODE IH

COMPARISON OF CONFIG. - B7W5(CONFIG 1.) B7W5V1(CONFIG 2.) AND B7W5V2(CONFIG 3.)

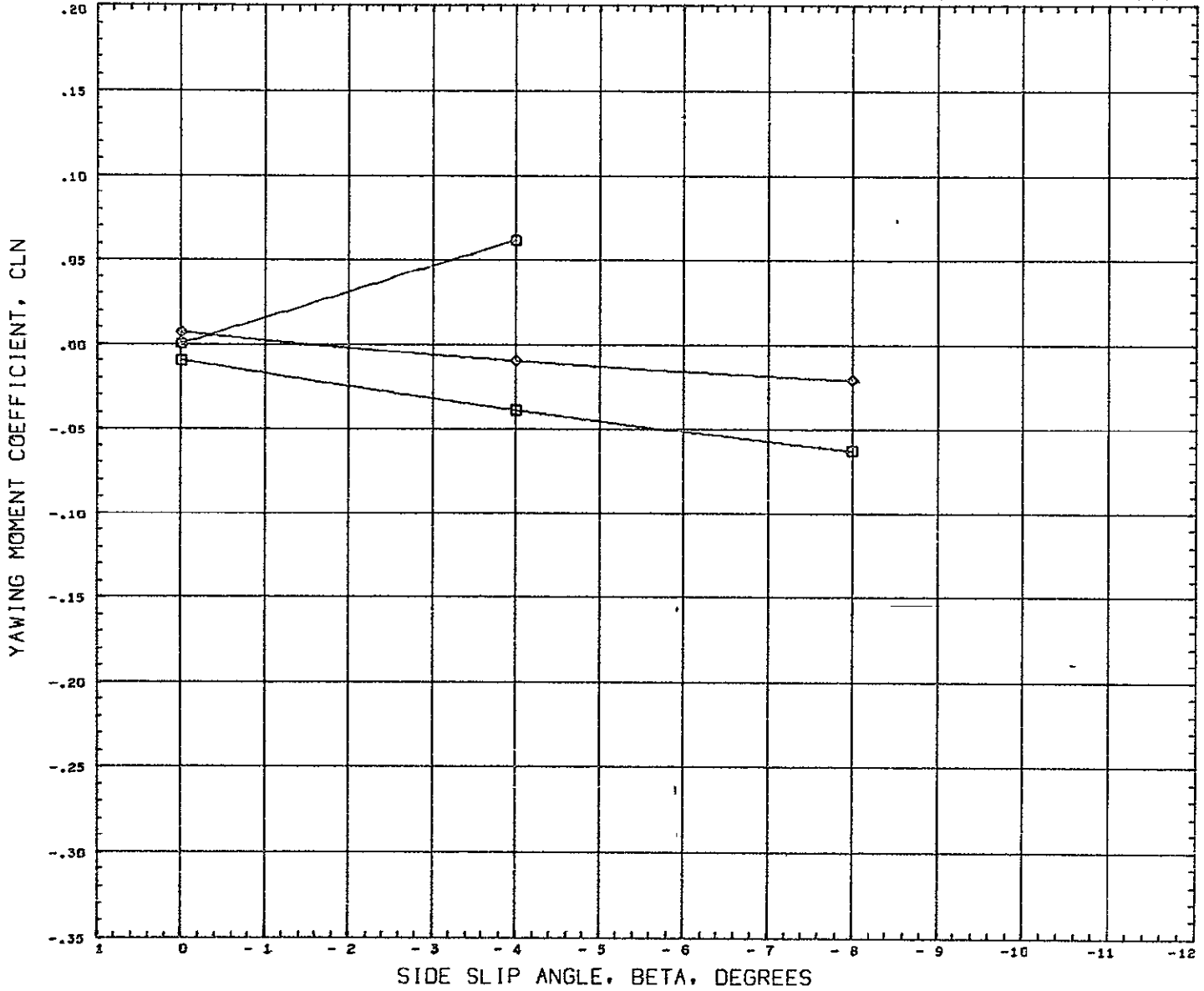

SYMBOL	CONFIG	PARAMETRIC VALUES			
○	1.000	HACH	0.259	ALPHA	0.000
□	2.000	ELEVON	0.000	AILRON	0.000
◇	3.000				

REFERENCE INFORMATION		
REFS	316.2304	SQ IN
REFL	50.1900	IN
REFB	7.3500	IN
XMRP	33.9090	IN
YMRP	0.0000	IN
ZMRP	0.0000	IN
SCALE	0.0175	

DATA HIST. CODE 1H

COMPARISON OF CONFIG. - B7W5(CONFIG 1.) B7W5V1(CONFIG 2.) AND B7W5V2(CONFIG 3.)

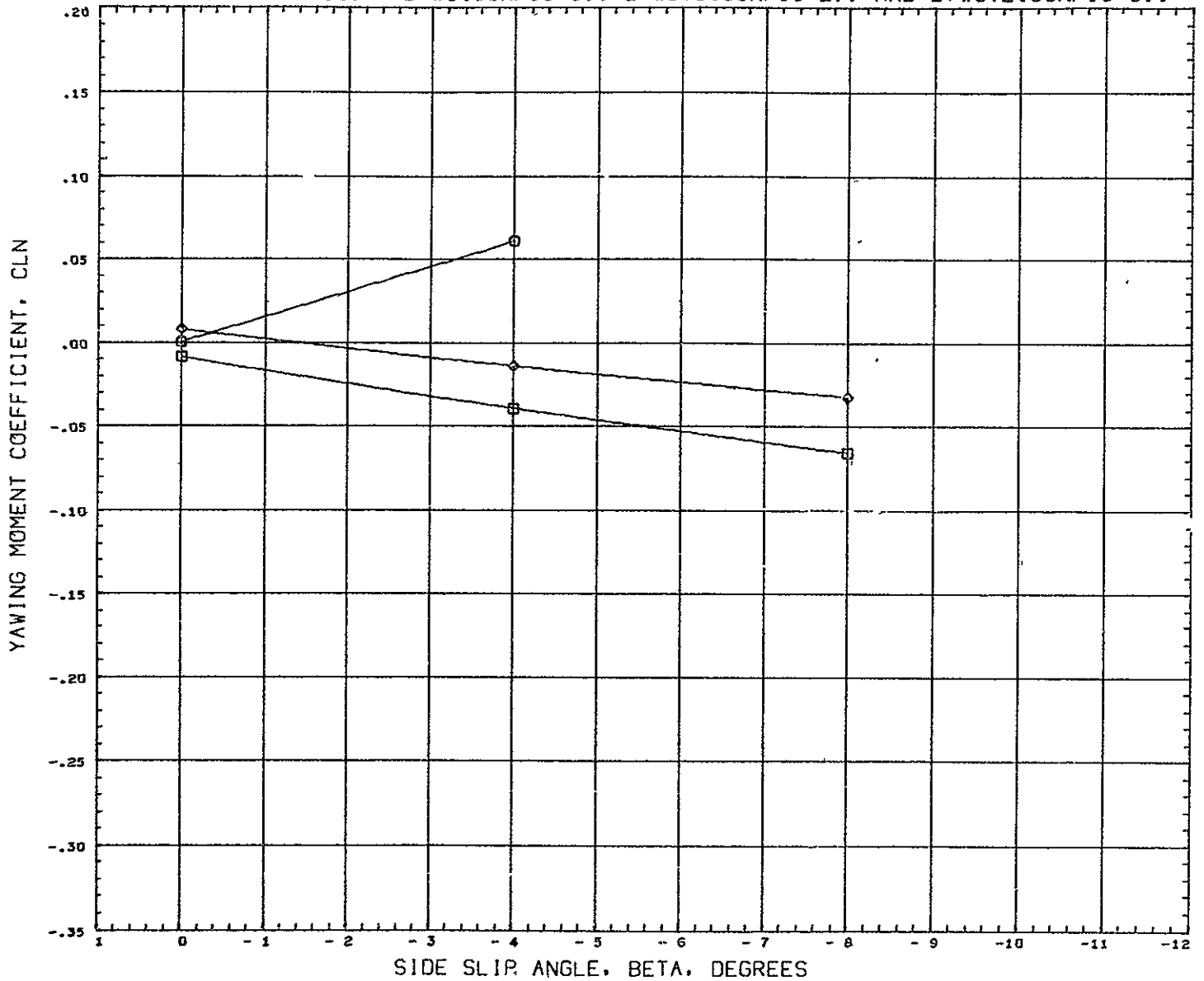

SYMBOL	CONFIG	PARAMETRIC VALUES				REFERENCE INFORMATION		
		MACH	ALPHA	ELEVON	AILERON	REFS	REFL	SQ IN
◇	1.000	0.259	4.000			316	2304	
□	2.000	0.000	0.000			50.1900		IN
○	3.000					7	3500	IN
						33.9000		IN
						0	0000	IN
						0	0000	IN
						SCALE	0.0175	

DATA HIST. CODE IM

COMPARISON OF CONFIG. - B7W5(CONFIG 1.) B7W5V1(CONFIG 2.) AND B7W5V2(CONFIG 3.)

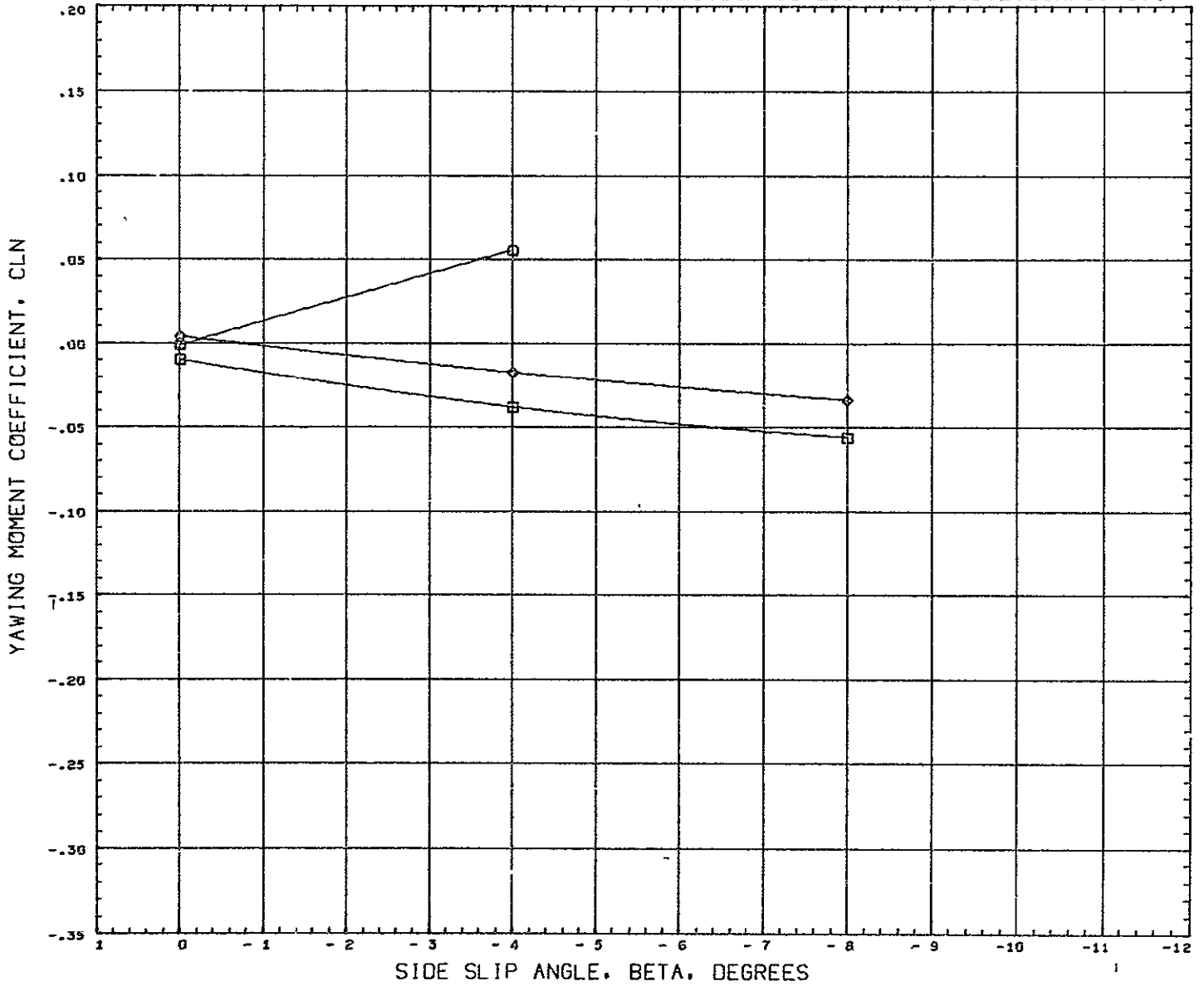

SYMBOL	CONFIG	AERODYNAMIC VALUES				REFERENCE INFORMATION		
□	1.000	MACH	0.259	ALPHA	8.000	REFS	316.2304	SQ IN
◇	2.000	ELEVON	0.000	AILRON	0.000	REFL	50.1900	IN
○	3.000					REFB	7.3500	IN
						XMRP	33.9090	IN
						YMRP	0.0000	IN
						ZMRP	0.0000	IN
						SCALE	0.0175	

DATA HIST. CODE IN

COMPARISON OF CONFIG. - B7W5(CONFIG 1.) B7W5V1(CONFIG 2.) AND B7W5V2(CONFIG 3.)

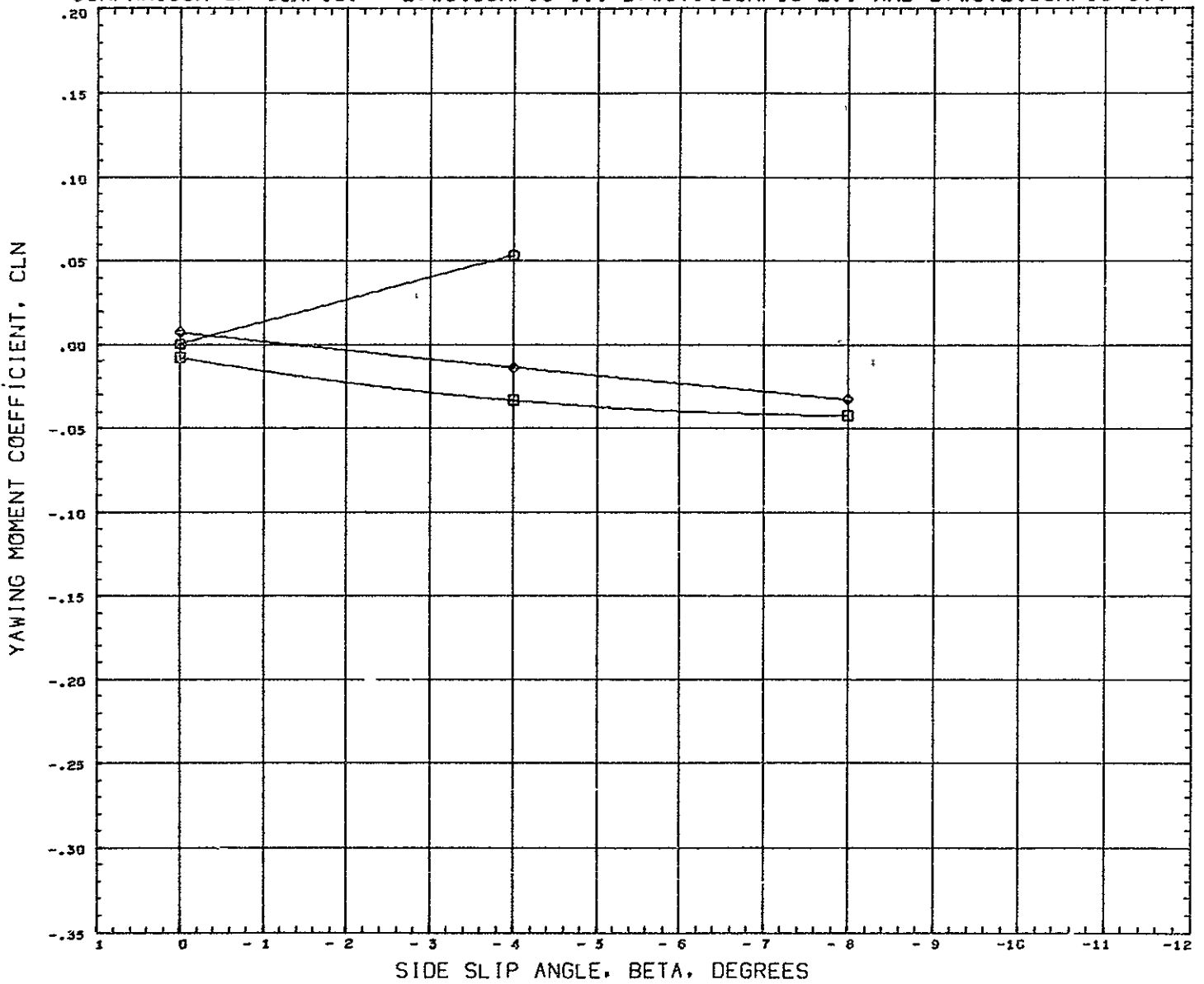

SYMBOL	CONFIG	PARAMETRIC VALUES			
□	1.000	MACH	0.259	ALPHA	12.000
□	2.000	ELEVON	0.000	AILERON	0.000
◇	3.000				

REFERENCE INFORMATION		
REFS	316.2304	SQ IN
REFL	50.1900	IN
REFB	7.3500	IN
XMRP	33.9090	IN
YMRP	0.0000	IN
ZMRP	0.0000	IN
SCALE	0.0175	

DATA HIST. CODE IM

COMPARISON OF CONFIG. - B7W5(CONFIG 1.) B7W5V1(CONFIG 2.) AND B7W5V2(CONFIG 3.)

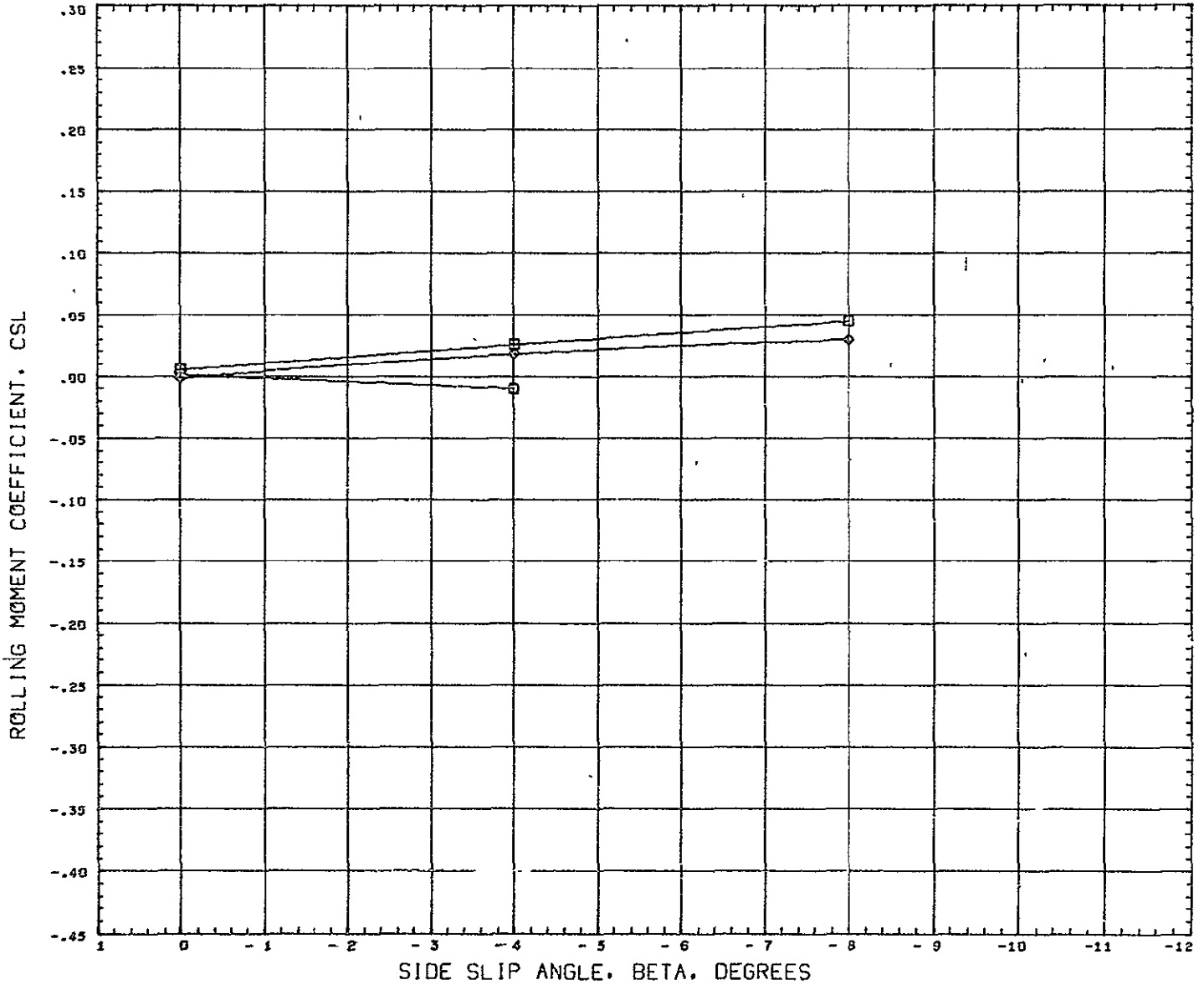

SYMBOL	CONFIG	PARAMETRIC VALUES				REFERENCE INFORMATION	
		MACH	ALPHA	AILRON			
○	1.000	0.259	0.000	0.000	REFS	316.2304	SQ IN
□	2.000	ELEVON	0.000	0.000	REFL	50.1900	IN
◇	3.000				REFB	7.3500	IN
					XMRP	33.9000	IN
					YMRP	0.0000	IN
					ZMRP	0.0000	IN
					SCALE	0.0175	

DATA HIST. CODE IH

COMPARISON OF CONFIG. - B7W5(CONFIG 1.) B7W5V1(CONFIG 2.) AND B7W5V2(CONFIG 3.)

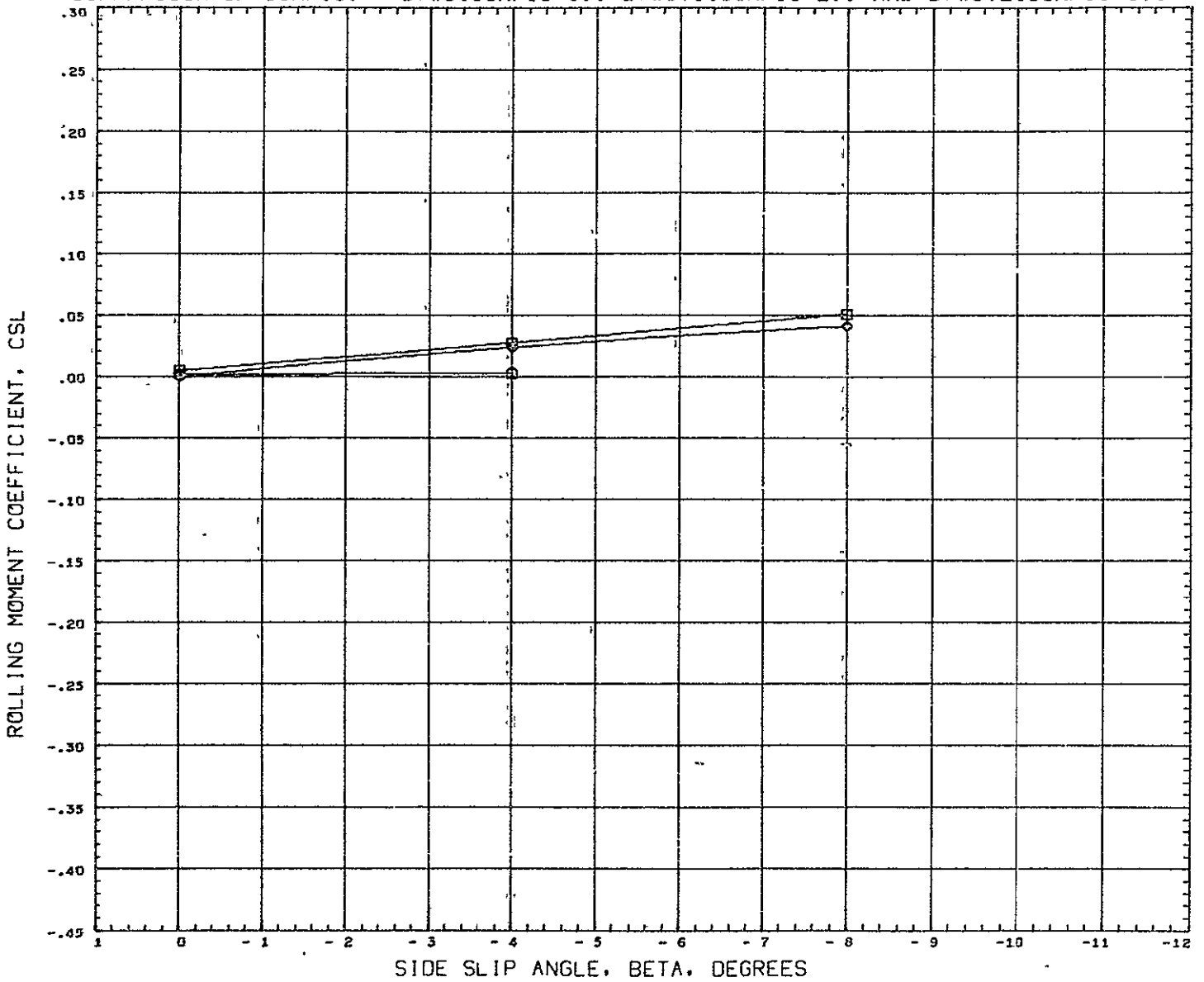

SY-BCL	CONFIG	PARAMETRIC VALUES			
○	1.000	MACH	0.259	ALPHA	4.000
□	2.000	ELEVON	0.000	AILRON	0.000
◇	3.000				

REFERENCE INFORMATION		
REFS	316.2304	SG IN
REFL	50.1900	IN
REFB	7.3500	IN
XMRP	33.9090	IN
YMRP	0.0000	IN
ZMRP	0.0000	IN
SCALE	0.9175	

DATA HIST. CODE IM

COMPARISON OF CONFIG. - B7W5(CONFIG 1.) B7W5V1(CONFIG 2.) AND B7W5V2(CONFIG 3.)

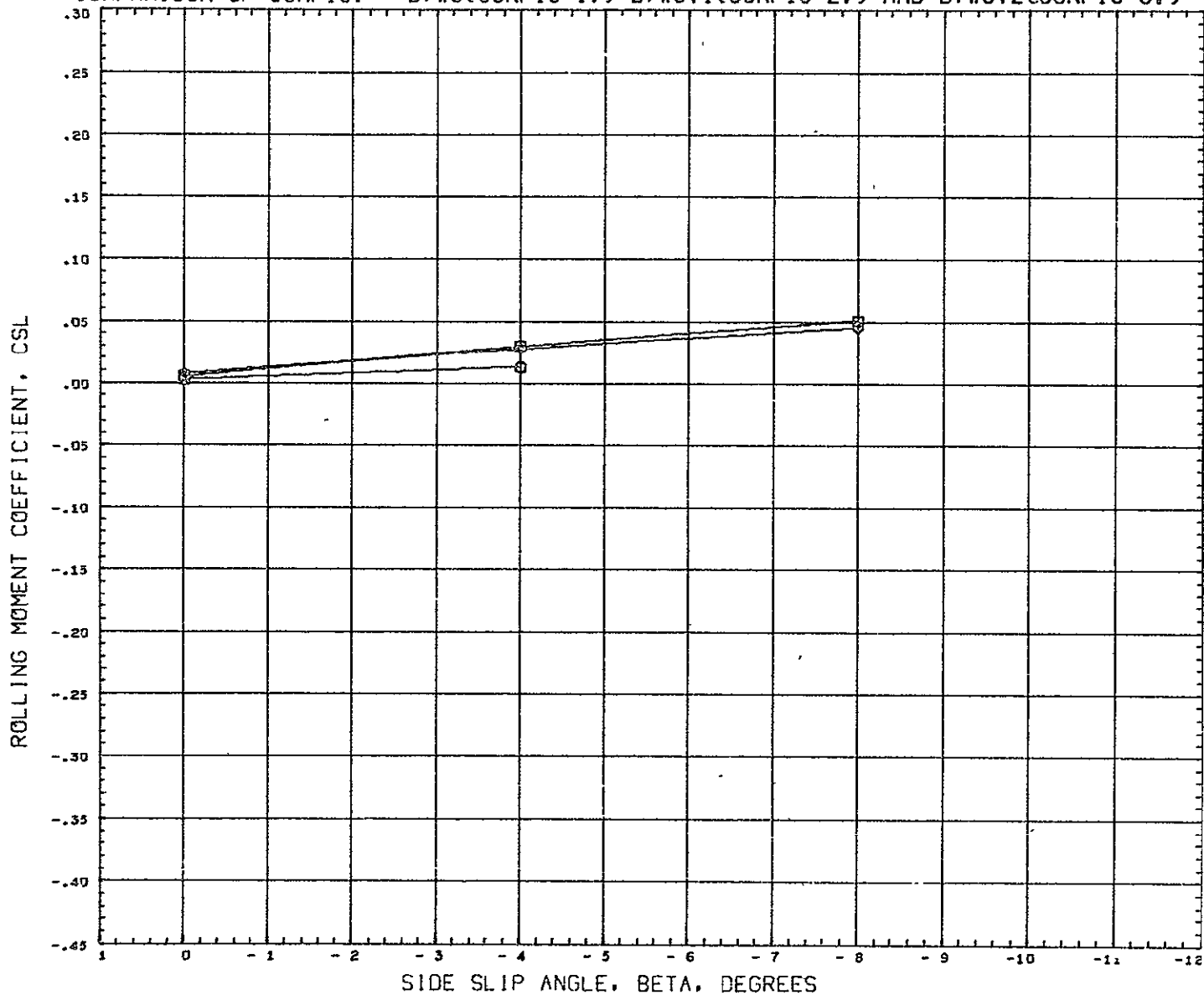

SYMBOL	CONFIG	PARAMETRIC VALUES			
○	1.000	WACH	0.259	ALPHA	8.000
□	2.000	ELEVON	0.000	AILRON	0.000
◇	3.000				

REFERENCE INFORMATION		
REFS	316.2304	SQ IN
REFL	50.1900	IN
REFB	7.3500	IN
XMRP	33.9090	IN
YMRP	0.0000	IN
ZMRP	0.0000	IN
SCALE	0.0175	

DATA HIST. CODE IN



COMPARISON OF CONFIG. - B7W5(CONFIG 1.) B7W5V1(CONFIG 2.) AND B7W5V2(CONFIG 3.)

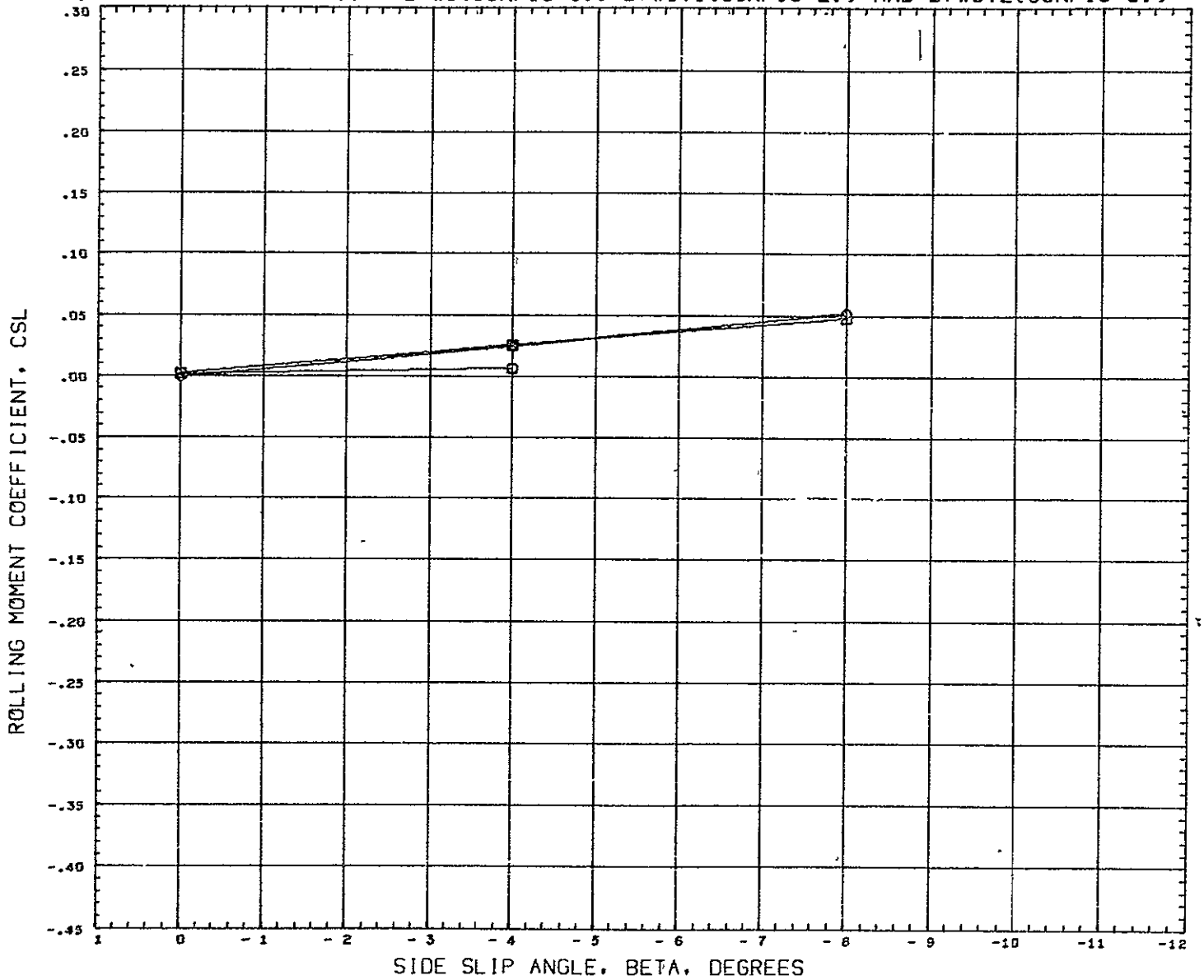

SYMBOL	CONFIG	PARAMETRIC VALUES				REFERENCE INFORMATION	
		MACH	ALPHA	ELEVGN	AILRON	REFS	SQ IN
□	1.000	0.259	12.000			316.2304	SQ IN
□	2.000	0.000	0.000			50.1900	IN
◇	3.000					7.3500	IN
						33.9090	IN
						0.0000	IN
						0.0000	IN
						0.0175	

DATA HIST. CODE IM

LONGITUDINAL CHARACTERISTICS - EFFECT OF BODY LENGTH WITH ENGINES - DELTA WING

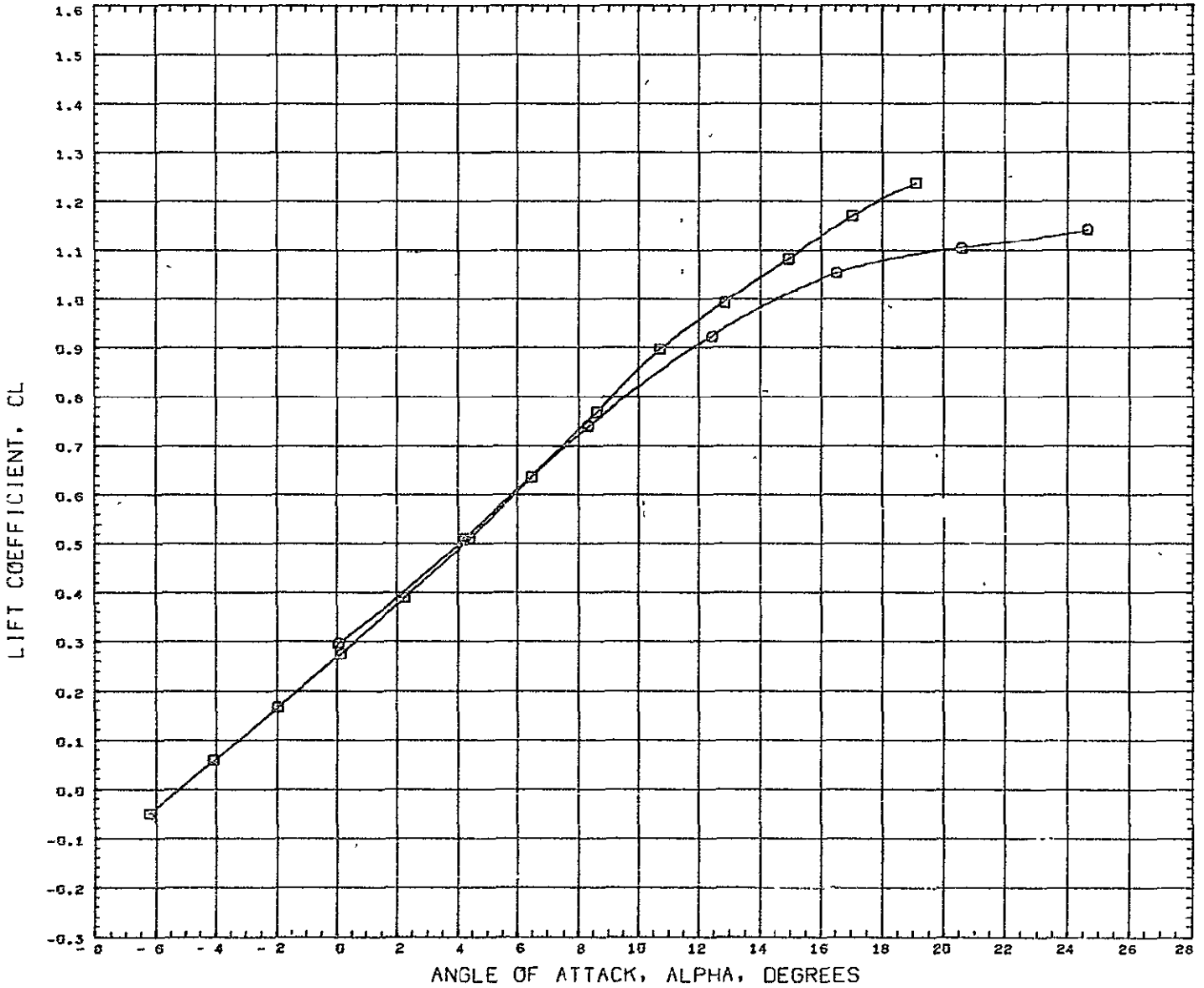

DATA SET SYMBOL    CONFIGURATION DESCRIPTION  
 (RC7102)    ○    CVLSWT TEST 579-G B7W5V1E2  
 (RC7081)    □    CVLSWT TEST 579-G B1W5V1E4

PARAMETRIC VALUES  
 BETA    0.000    ELEVON    0.000  
 AILRON    0.000    RUDDER    0.000

REFERENCE INFORMATION  
 REFS    316 2304    SQ IN  
 REFL    50 1900    IN  
 REFB    7 3500    IN  
 XMRP    33.9090    IN  
 YMRP    0.0000    IN  
 ZMRP    0.0000    IN  
 SCALE    0.0175

MACH    0.239

# LONGITUDINAL CHARACTERISTICS - EFFECT OF BODY LENGTH WITH ENGINES - DELTA WING

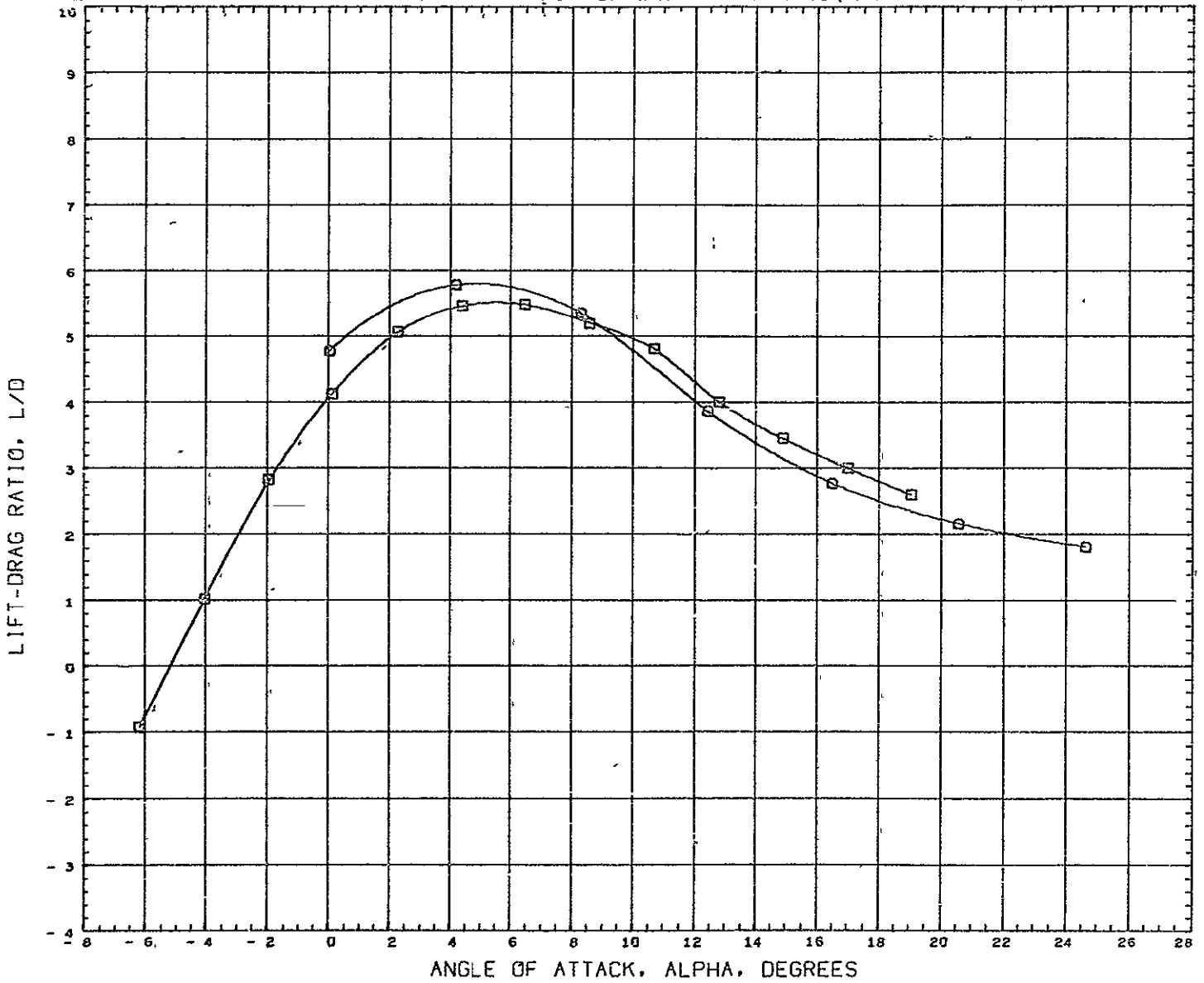

DATA SET SYMBOL	CONFIGURATION DESCRIPTION	PARAMETRIC VALUES		REFERENCE INFORMATION				
(RC7192)	□ CVLSWT TEST 579-D B7W3V1E2	BETA	0.000	ELEVON	0.000	REFS	316.2304	SQ IN
(RC7681)	□ CVLSWT TEST 579-G B1W3V1E4	AILRON	0.000	PUDDER	0.000	REFL	50.1900	IN
						REFB	7.3500	IN
						XMRP	33.9090	IN
						YMRP	0.0000	IN
						ZMRP	0.0000	IN
						SCALE	0.0175	

MACH,      0.259

# LONGITUDINAL CHARACTERISTICS - EFFECT OF BODY LENGTH WITH ENGINES - DELTA WING

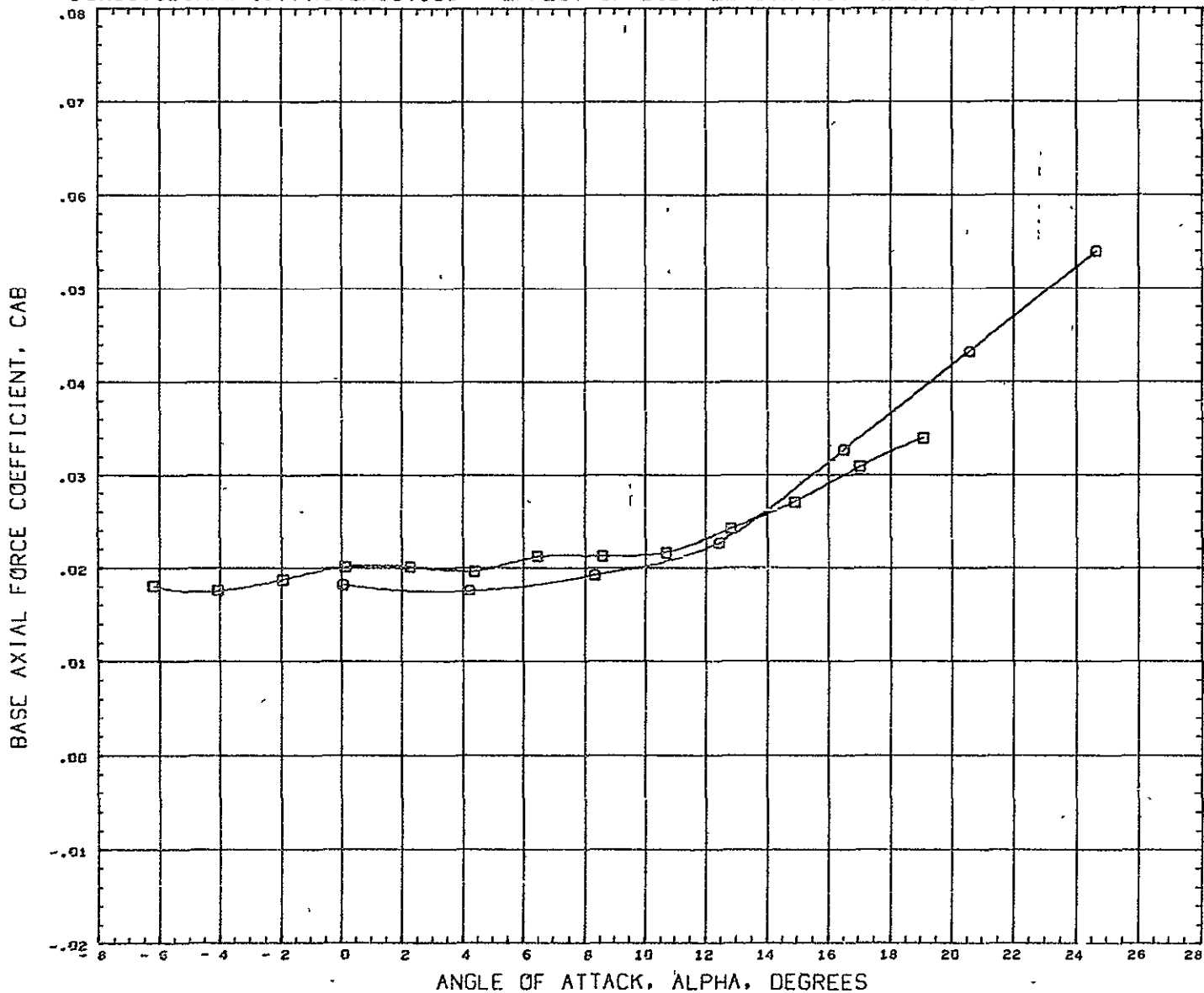

DATA SET SYMBOL	CONFIGURATION DESCRIPTION
(RCT102)	□ CVLSWT TEST 579-G B7W5V1E2
(FCT681)	□ CVLSWT TEST 579-G B1W5V1E4

PARAMETRIC VALUES			
BETA	0.000	ELEVON	0.000
AILRON	0.000	RUDDER	0.000

REFERENCE INFORMATION		
REFS	316	2304 sq IN
REFL	50	1900 IN
REFB	7	3500 IN
XMRP	33.9090	IN
YMRP	0	0000 IN
ZMRP	0	0000 IN
SCALE	0	0175

MACH            0.259

LONGITUDINAL CHARACTERISTICS - EFFECT OF BODY LENGTH WITH ENGINES - DELTA WING

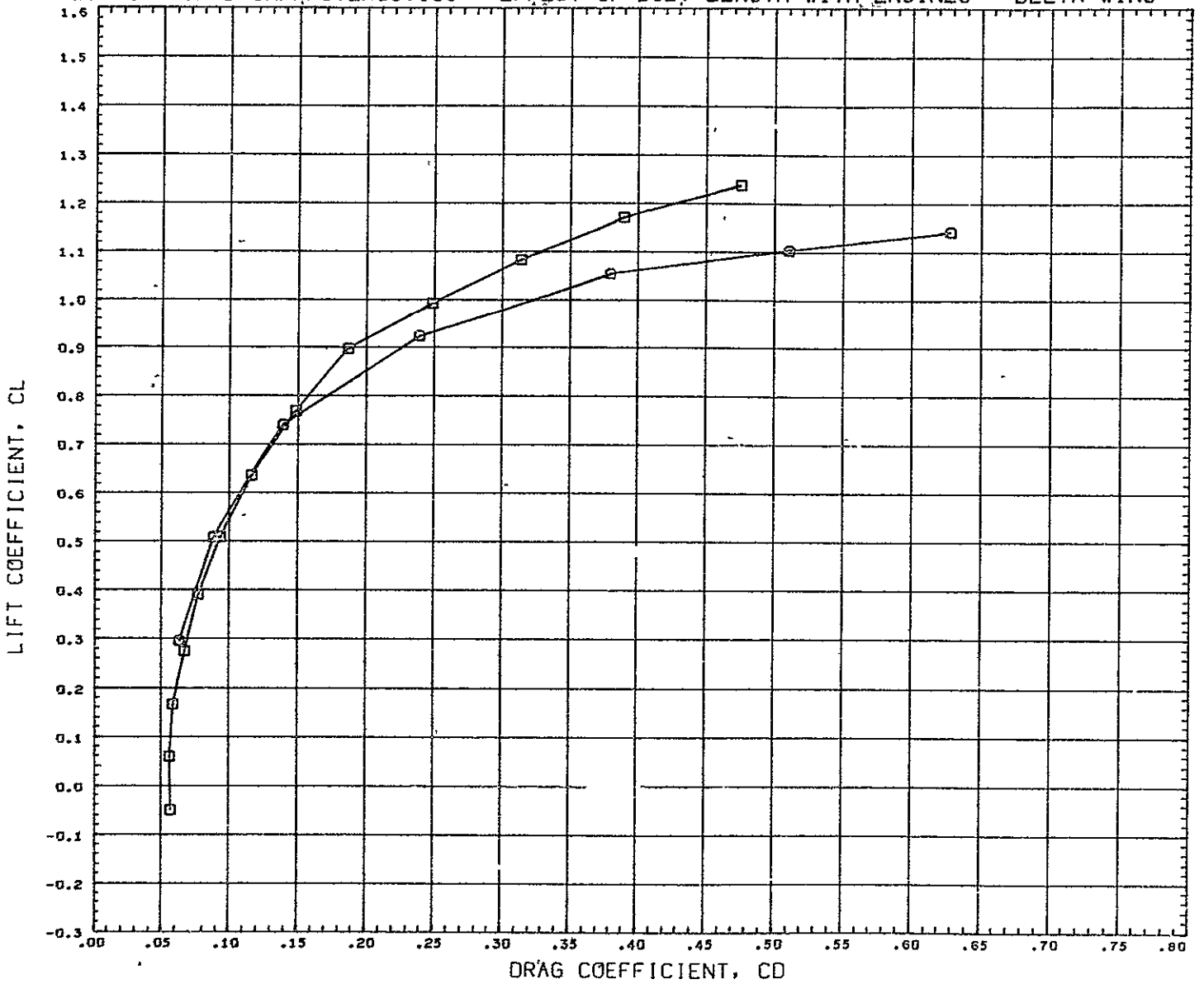

DATA SET SYMBOL    CONFIGURATION DESCRIPTION  
 (RC71G2)    ◯    CVLSWT TEST 579-G B7W5V1E2  
 (RC7G81)    ◻    CVLSWT TEST 579-G B1W5V1E4

PARAMETRIC VALUES  
 BETA    0.000    ELEVON    0.000  
 AILRON    0.000    RUDDER    0.000

REFERENCE INFORMATION  
 REFS    316 2304    SQ IN  
 REFL    50.1900    IN  
 REFB    7 3500    IN  
 XNRF    33 9090    IN  
 YNRF    0.0000    IN  
 ZNRF    0.0000    IN  
 SCALE    0 0175

MACH    0.259

LONGITUDINAL CHARACTERISTICS - EFFECT OF BODY LENGTH WITH ENGINES - DELTA WING

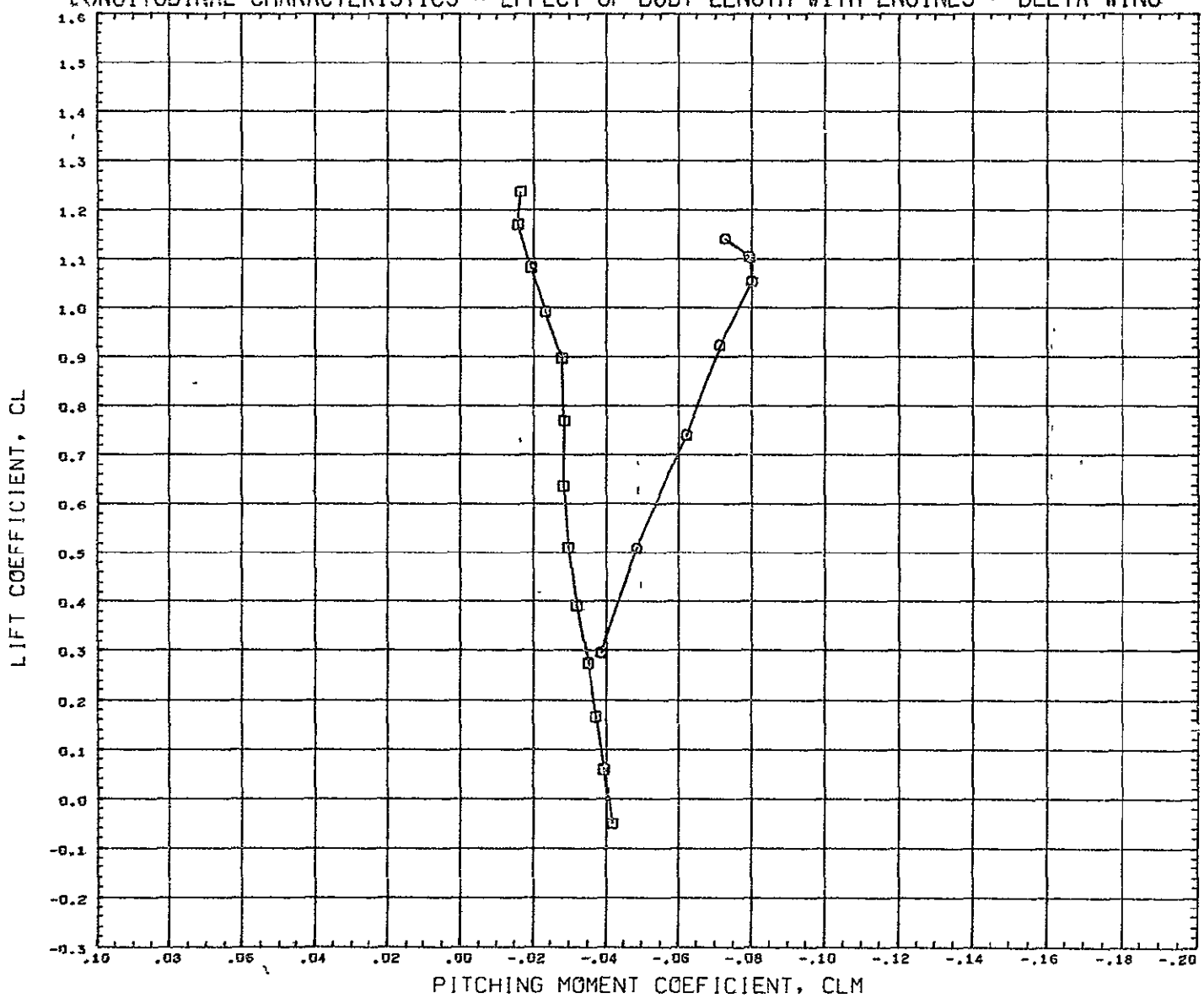

DATA SET SYMBOL	CONFIGURATION DESCRIPTION	PARAMETRIC VALUES		REFERENCE INFORMATION				
(RC71G2)	○ CVLSWT TEST 579-0 B7W5V1E2	BETA	0 000	ELEVON	0.000	REFS	316.2304	50 IN
(RC75B1)	□ CVLSWT TEST 579-0 B1W5V1E4	AILRON	0 000	RUDDER	0.000	REFL	50.1900	IN
						REFB	7.3500	IN
						XMRP	33.9990	IN
						YMRP	0.0000	IN
						ZMRP	0.0000	IN
						SCALE	0.0175	

MACH 0 259

# EFFECT OF BODY LENGTH WITH ENGINES - SIDESLIP DERIVATIVES - DELTA WING

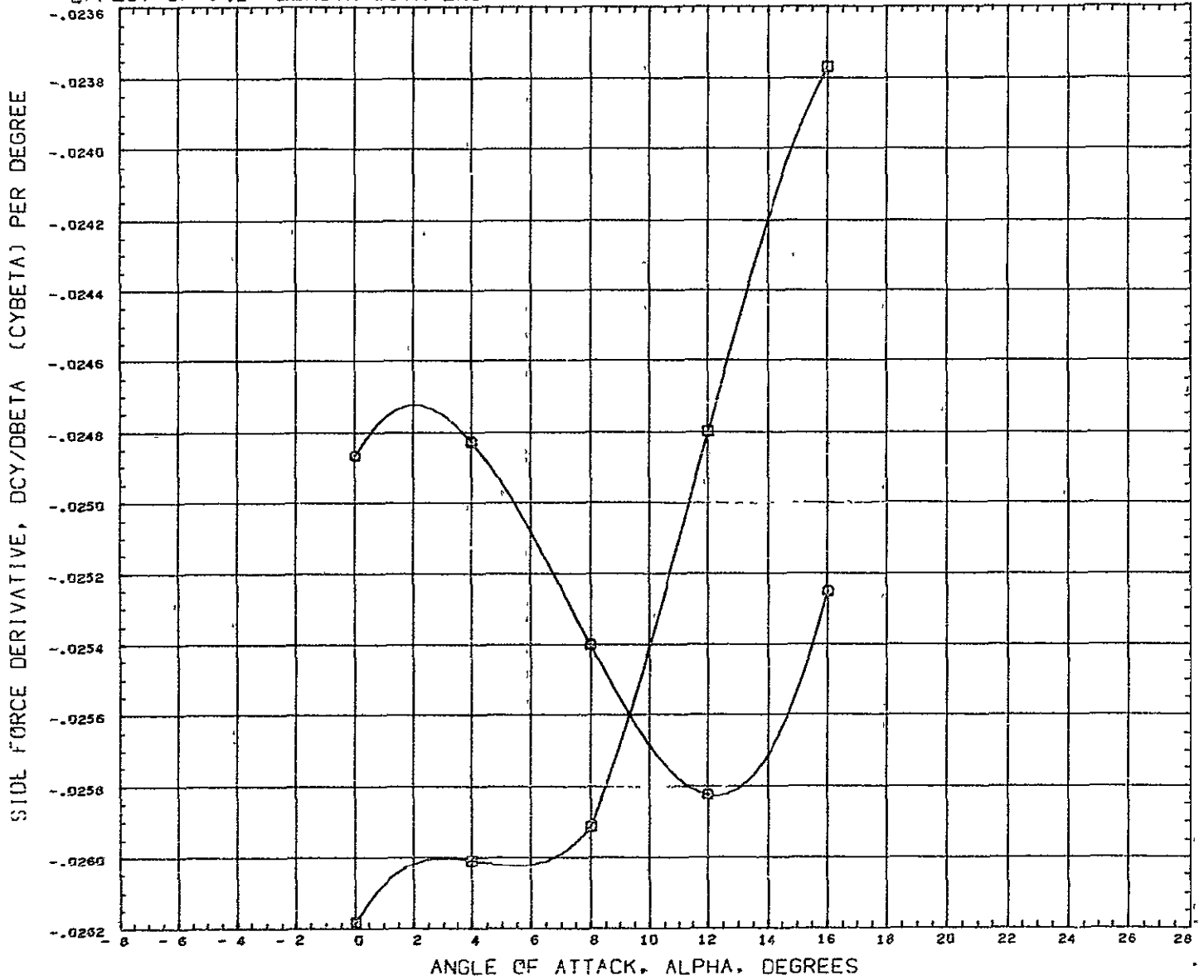

DATA SET SYMBOL    CONFIGURATION DESCRIPTION  
 (DB7152)    □    CVLSWT TEST 579-D B7W5VIE2  
 (DB7061)    □    CVLSWT TEST 579-D B1W5VIE4

PARAMETRIC VALUES  
 BETA    0.000    ELEVON    0.000  
 AILRON    0.000    PUDDER    0.000

REFERENCE INFORMATION  
 PEFS    316.2304    SQ IN  
 REFL    50.1900    IN  
 REFB    7.3560    IN  
 XMRF    33.9090    IN  
 YMRF    0.0000    IN  
 ZMRF    0.0000    IN  
 SCALE    0.0175

MACH    0.259

# EFFECT OF BODY LENGTH WITH ENGINES - SIDESLIP DERIVATIVES - DELTA WING

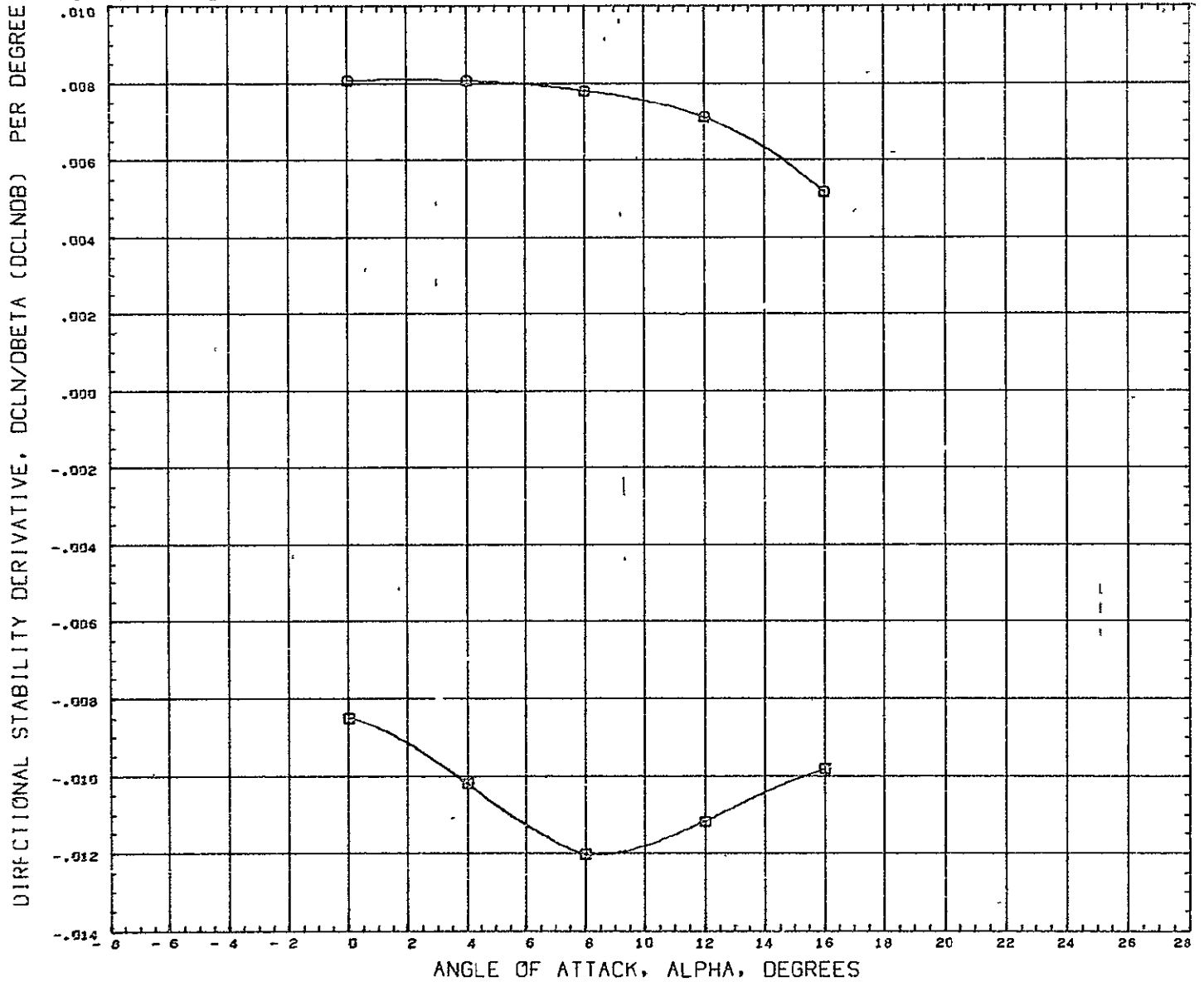

DATA SET SYMBOL    CONFIGURATION DESCRIPTION  
 (DB7102)    □    CVLSWT TEST 579-0 B7W5V1E2  
 (DB7061)    □    CVLSWT TEST 579-0 B1W5V1E4

PARAMETRIC VALUES  
 BETA    0.000    ELEVON    0.000  
 AILPON    0.000    RUDDER    0.000

REFERENCE INFORMATION  
 REFS    316 2304    SQ IN  
 REFL    50.1900    IN  
 REFB    7.3500    IN  
 XMRP    33.9090    IN  
 YMRP    0.0000    IN  
 ZMRP    0.0000    IN  
 SCALE    0.0175

MACH    0.259



# EFFECT OF BODY LENGTH WITH ENGINES - SIDESLIP DERIVATIVES - DELTA WING

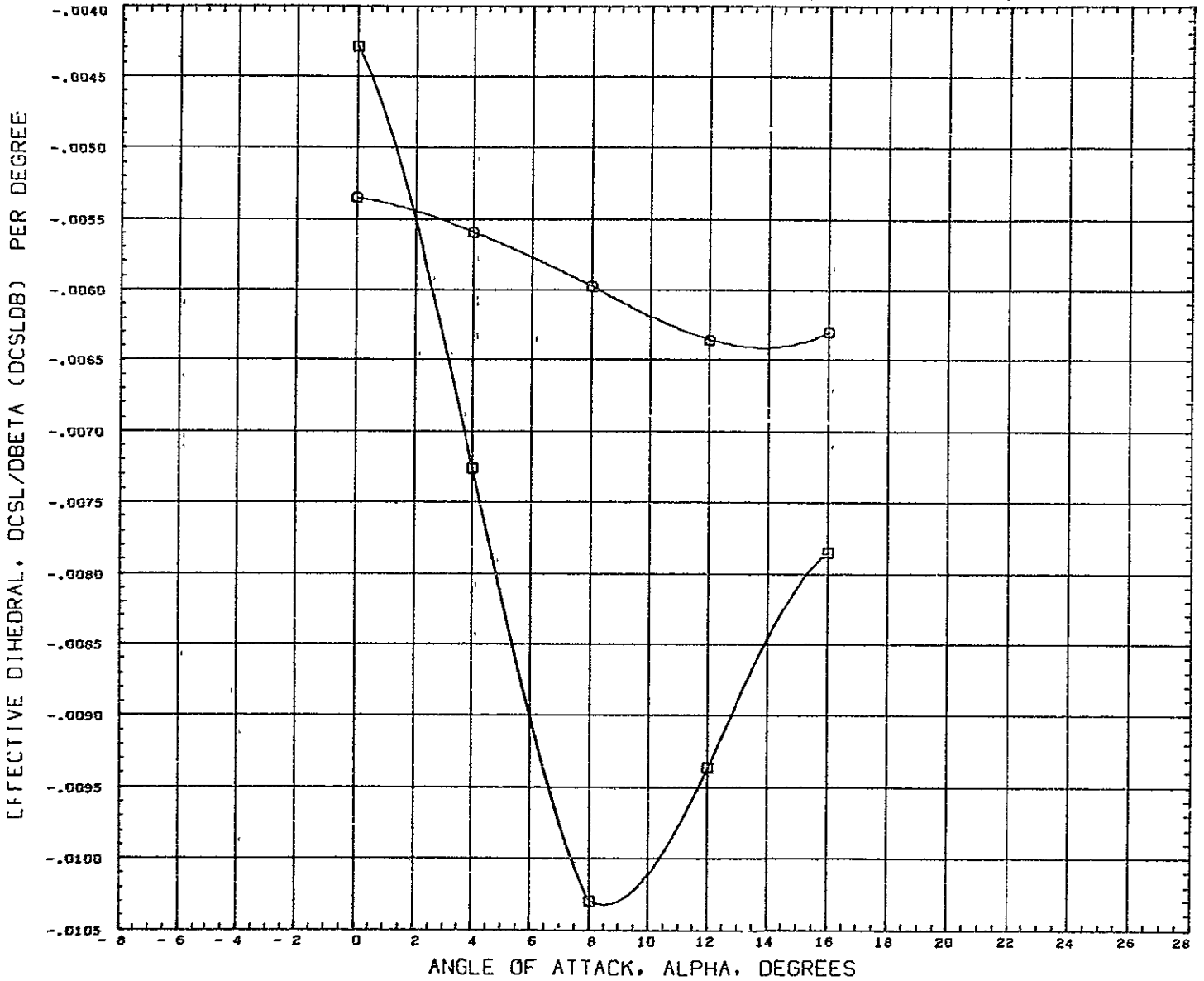

DATA SET SYMBOL    CONFIGURATION DESCRIPTION  
 (DB7102)    □    CVLSWT TEST 579-D B7W5V1E2  
 (DB7081)    □    CVLSWT TEST 579-G B1W3V1E4

PARAMETRIC VALUES		REFERENCE INFORMATION					
BETA	0 000	ELEVON	0.000	REFS	316 2304	SQ	IN
AILRON	0 000	RUDDER	0 000	REFL	50 1900	IN	
				REFB	7.3500	IN	
				XMRP	33.9090	IN	
				YMRP	0.0000	IN	
				ZMRP	0.0000	IN	
				SCALE	0 0175		

MACH            0 259

LONGITUDINAL TRIM CHARACTERISTICS - DELTA WING - X/L = 0.68

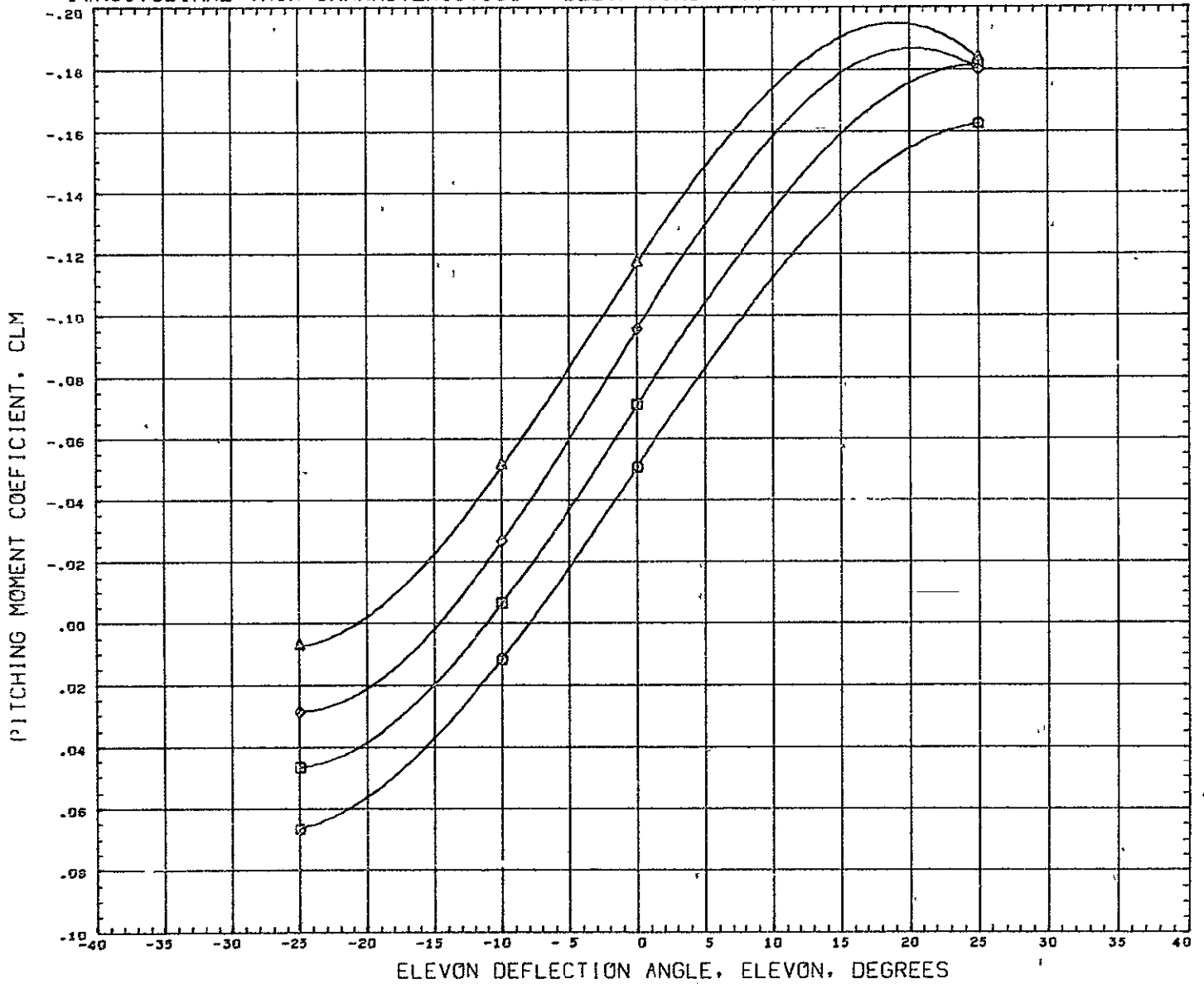

SYMBOL	ALPHA	PARAMETRIC VALUES				REFERENCE INFORMATION							
		MACH	BETA	RUDDER	REFS	REFL	REFB	XMRF	YHRF	ZHRF	SCALE		
○	0.000	0.259	0.000	0.000	316	2304	50.1900	7	3500	31.3990	0.0000	0.0000	0.0175
□	4.000	0.000	0.000	0.000									
◇	6.000												
△	12.000												

DATA HIST. CODE S1

LONGITUDINAL TRIM CHARACTERISTICS - DELTA WING - X/L = 0.68

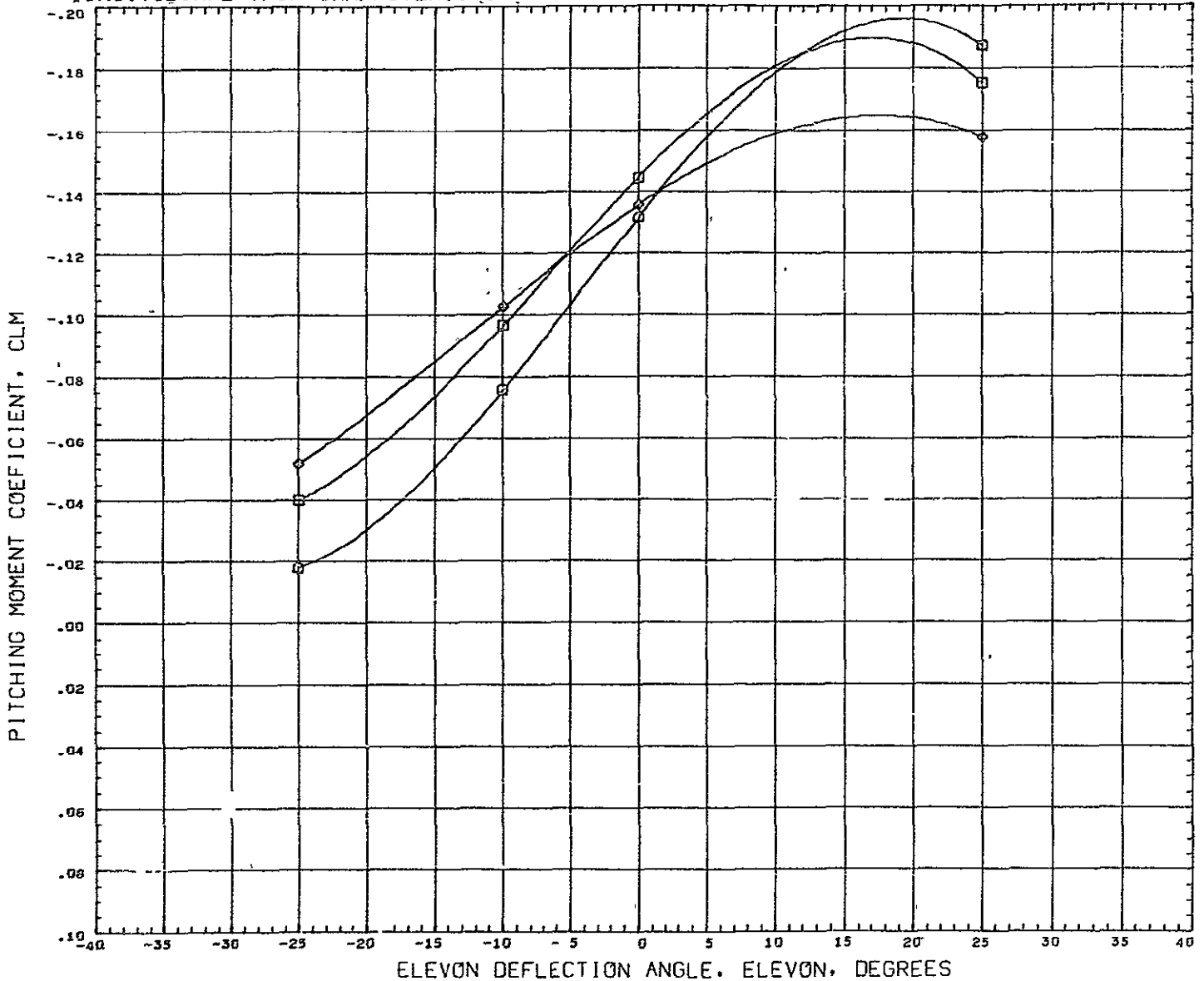

SYMBOL	ALPHA	PARAMETRIC VALUES			REFERENCE INFORMATION			
□	16.000	HACH	0.259	BETA	0.000	REFS	316.2304	SQ IN
◻	20.000	AILRON	0.000	RUDDER	0.000	REFL	50.1900	IN
◊	24.000					REFB	7.3500	IN
						XMRP	31.3990	IN
						YMRP	0.0000	IN
						ZMRP	0.0000	IN
						SCALE	0.0175	

DATA HIST. CODE SI

LONGITUDINAL TRIM CHARACTERISTICS - DELTA WING - X/L = 0.68

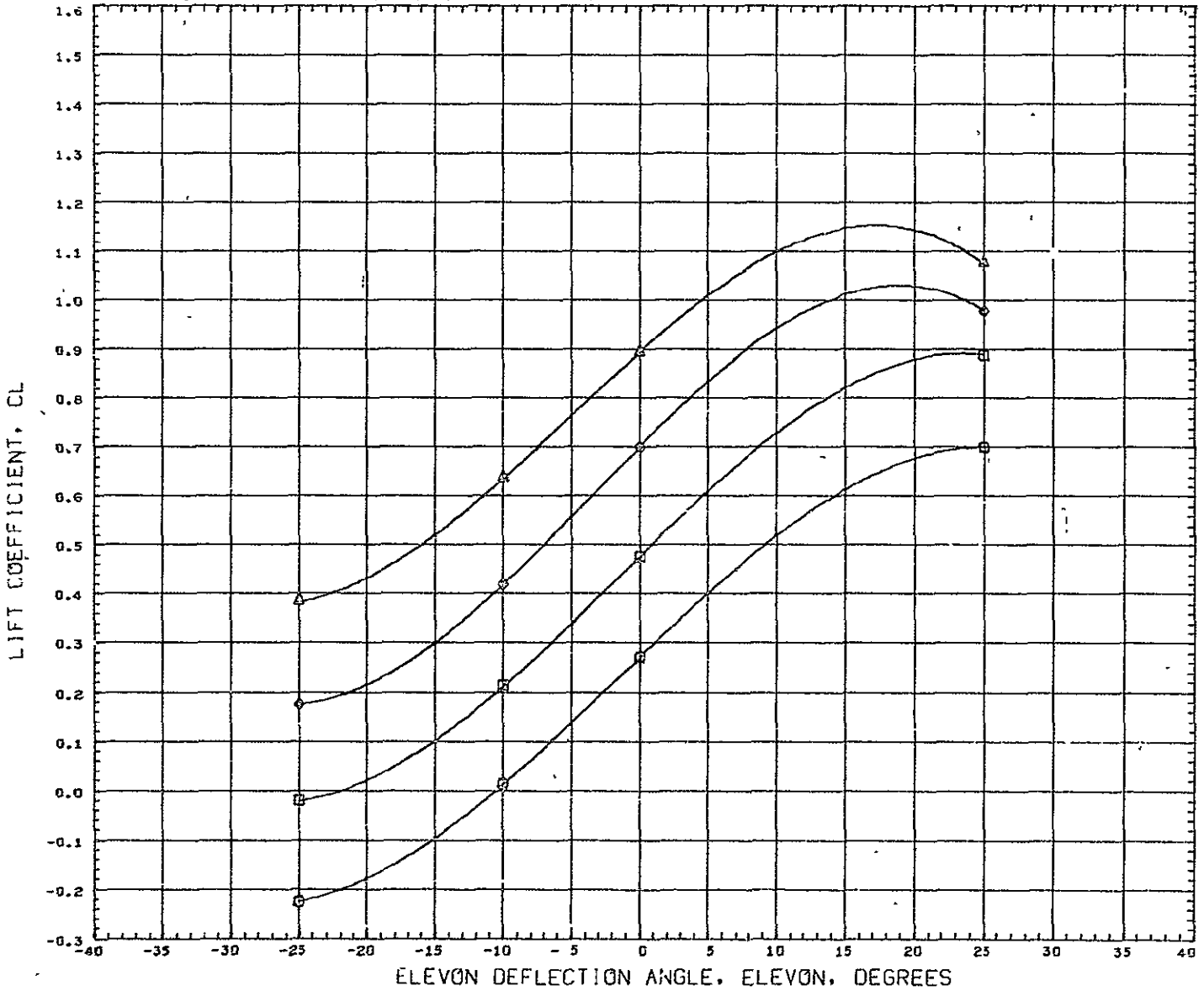

SYMBOL		PARAMETRIC VALUES				REFERENCE INFORMATION		
○	0.000	MACH	0.259	BETA	0.000	REFS	316 2304	SQ IN
□	4.000	AILRON	0.000	RUDDER	0.000	REFL	50.1900	IN
◇	8.000					REFB	7.3500	IN
△	12.000					XNRF	31.3990	IN
						YMRF	0.0000	IN
						ZMRF	0.0000	IN
						SCALE	0.0175	

DATA HIST. CODE SI

LONGITUDINAL TRIM CHARACTERISTICS - DELTA WING - X/L = 0.68

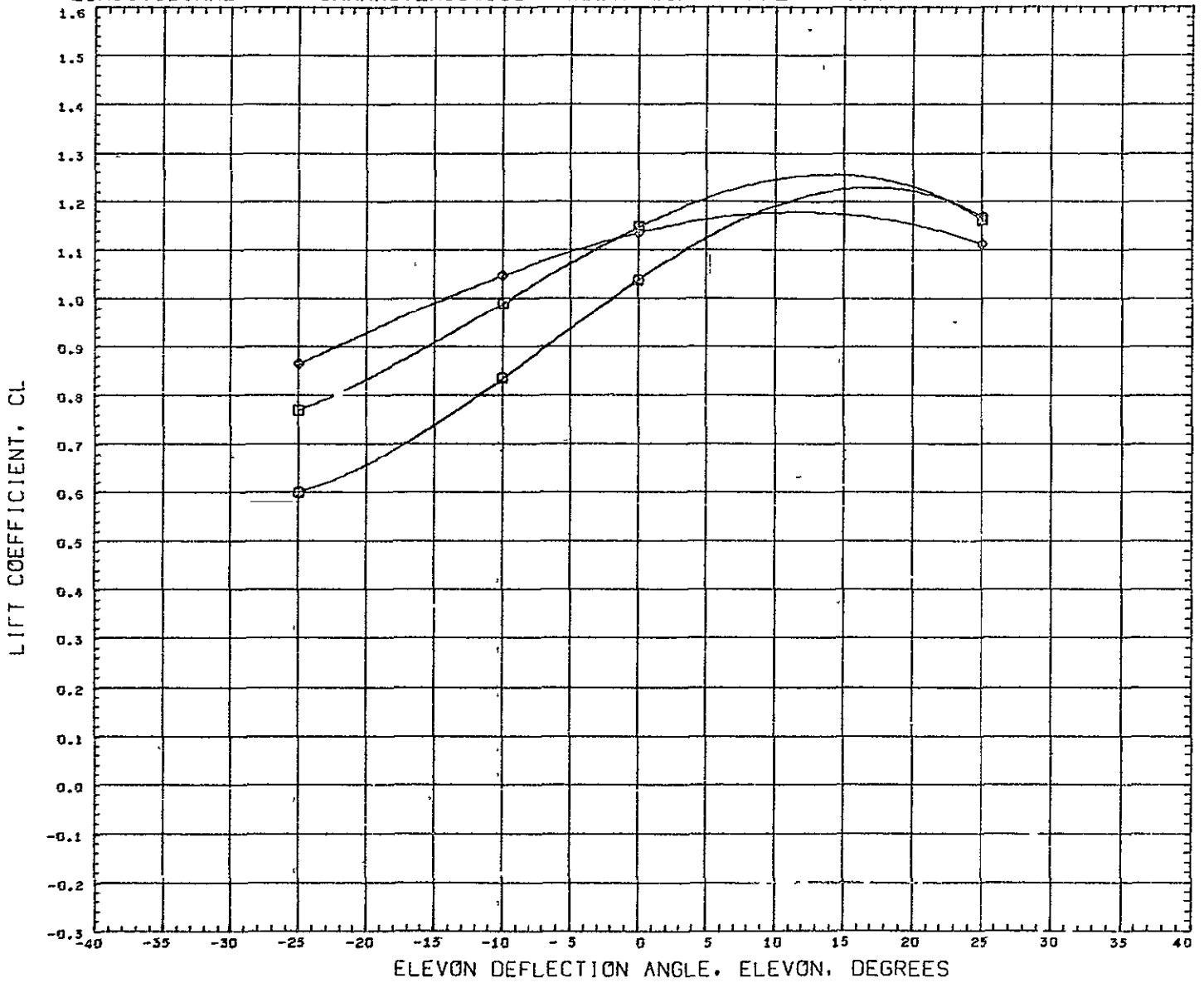

SYMBOL	ALPHA	PARAMETRIC VALUES				REFERENCE INFORMATION		
○	16.000	MACH	0.259	BETA	0.000	REFS	316 2304	50 IN
□	20.000	ATLCON	0.000	RUDDER	0.000	REFL	50 1900	1N
◇	24.000					REFB	7 3500	1N
						XMRP	31 3990	1N
						YMRP	0.0000	1N
						ZMRP	0.0000	1N
						SCALE	0 0175	

DATA HIST. CODE SI

LONGITUDINAL TRIM CHARACTERISTICS - DELTA WING - X/L = 0.68

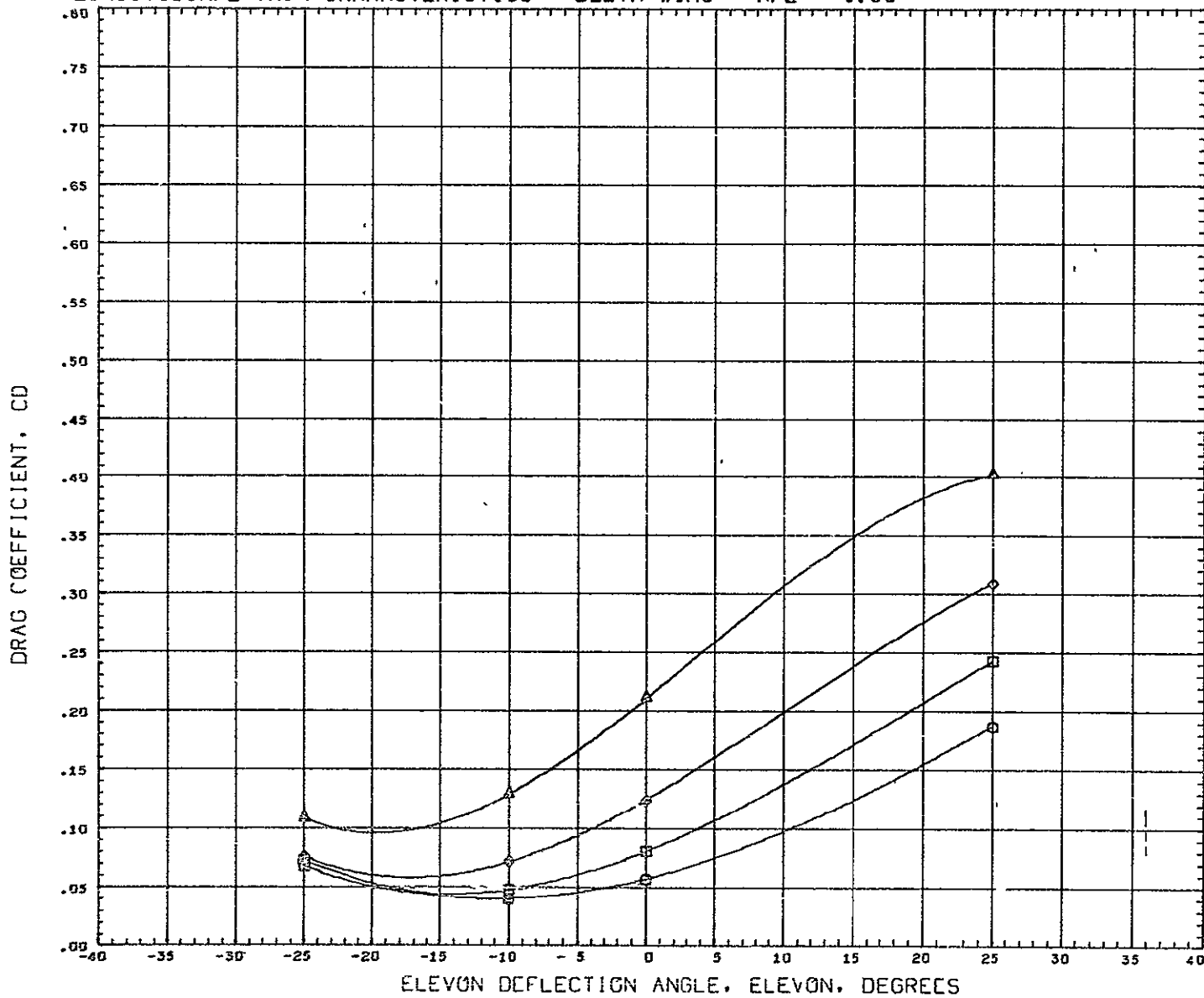

SYMBOL	ALPHA	PARAMETRIC VALUES				REFERENCE INFORMATION		
○	0.000	MACH	0.259	BETA	0.000	REFS	316 2304	50 IN
□	4.000	AILERON	0.000	RUDDER	0.000	REFL	50.1900	IN
◇	8.000					REFB	7 3500	IN
△	12.000					XMRP	31 3990	IN
						YMRP	0.0000	IN
						ZMRP	0.0000	IN
						SCALE	0 0175	

DATA HIST. CODE SI

LONGITUDINAL TRIM CHARACTERISTICS - DELTA WING - X/L = 0.68

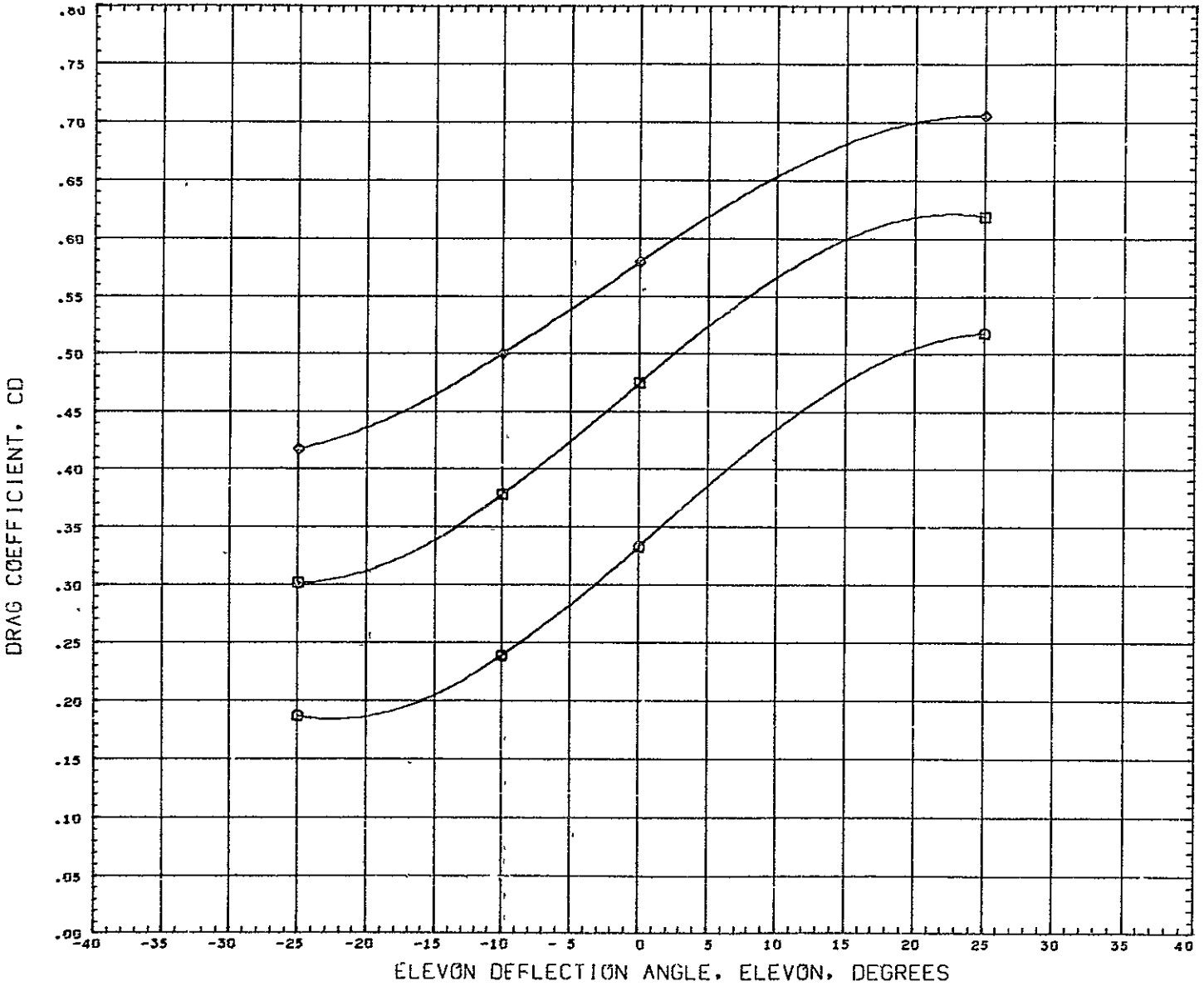

SYMBOL	ALPHA	PARAMETRIC VALUES				REFERENCE INFORMATION		
○	16.000	MACH	0.259	BETA	0.000	REFS	316 2304	SQ IN
□	25.000	A1LRON	0.000	RUDDER	0.000	REFL	50 1900	IN
◇	24.000					REFB	7 3500	IN
						XMRP	31.3990	IN
						YMRP	0.0000	IN
						ZMRP	0.0000	IN
						SCALE	0 0175	

DATA HIST. CODE SI

LONGITUDINAL TRIM CHARACTERISTICS - DELTA WING - X/L = 0.73

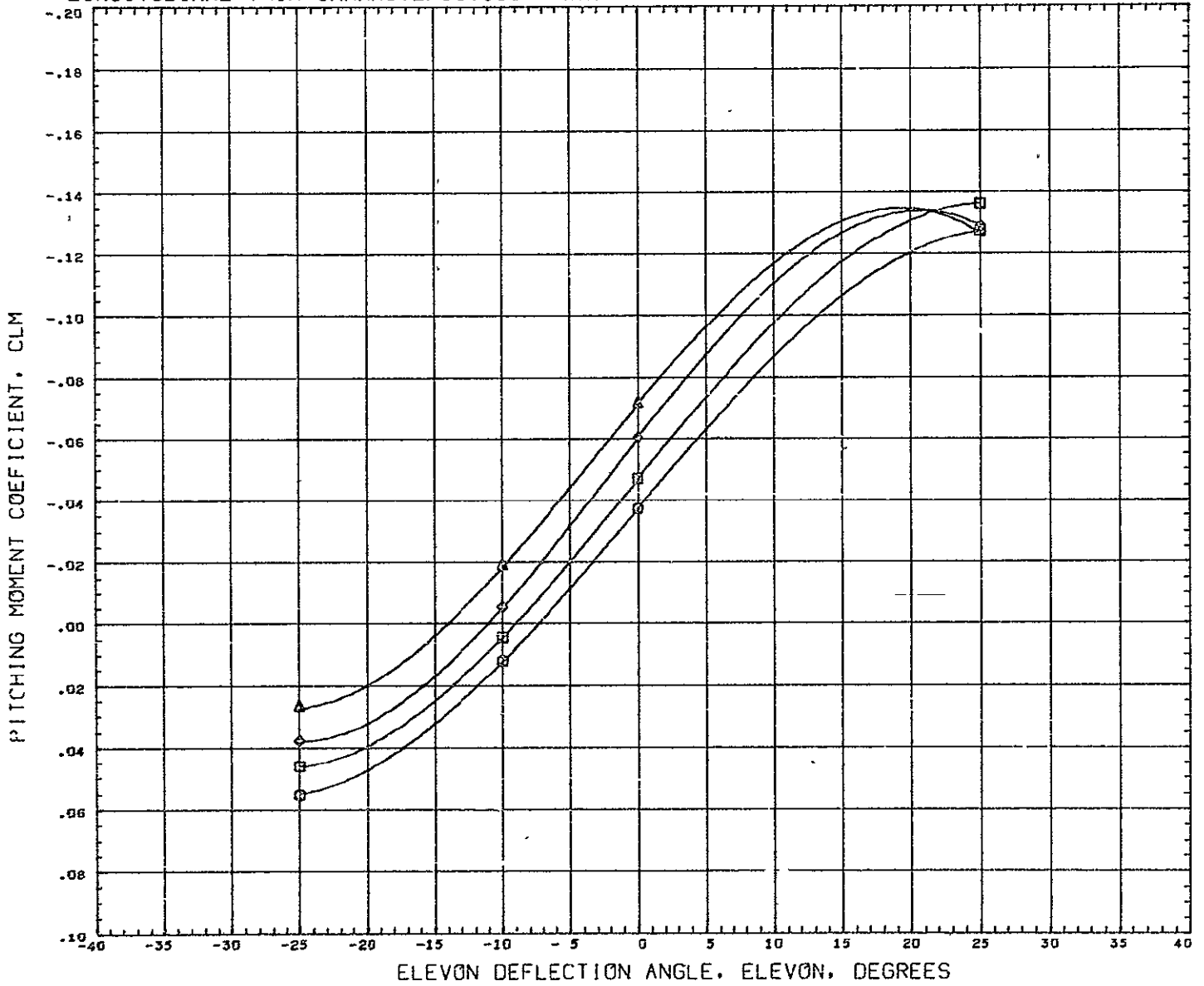

SYMBOL	ALPHA	PARAMETRIC VALUES				REFERENCE INFORMATION		
		MACH	BETA	AILRON	RUDDER	REFS	REFL	REFB
○	5.000	5.259	0.000	0.000	0.000	316.2304	50.1900	33.9090
□	4.000	0.000	0.000	0.000	0.000	7.3500	0.0000	0.0000
◇	3.000					0.0000	0.0000	0.0000
△	2.000					0.0175		

DATA HIST. CODE 1



LONGITUDINAL TRIM CHARACTERISTICS - DELTA WING - X/L = 0.73

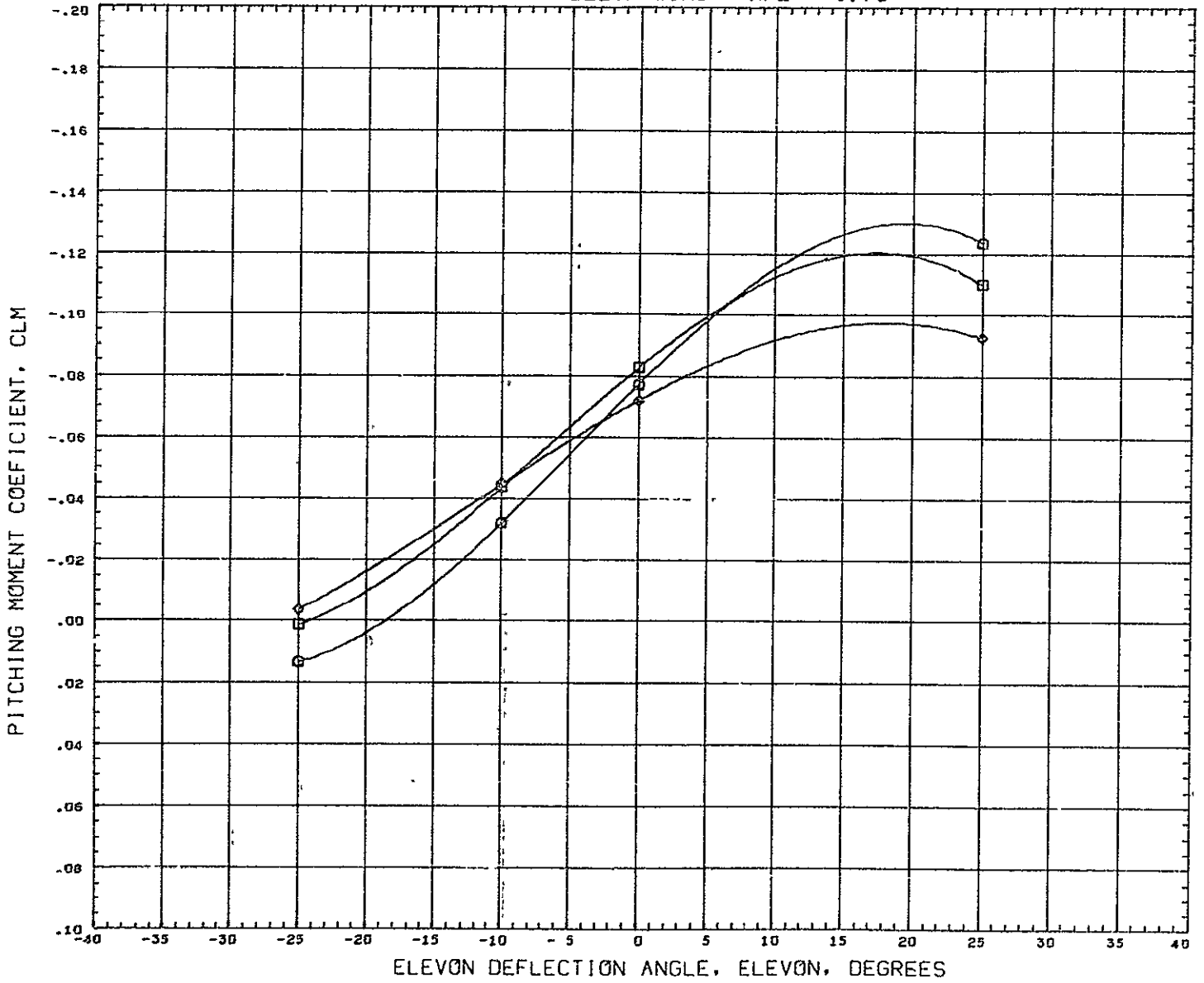

SYMBOL	ALPHA	PARAMETRIC VALUES				REFERENCE INFORMATION		
		MACH	BETA	AILRON	RUDDER	REFS	SQ	IN
○	16.000	0.259	0.000	0.000	316	2304		
□	25.000	0.000	0.000	0.000	50	1900	IN	
◇	24.000				7	3500	IN	
					33	9090	IN	
					0	0000	IN	
					0	0000	IN	
					0	0175		

DATA HIST. CODE 1

LONGITUDINAL TRIM CHARACTERISTICS - DELTA WING - X/L = 0.73

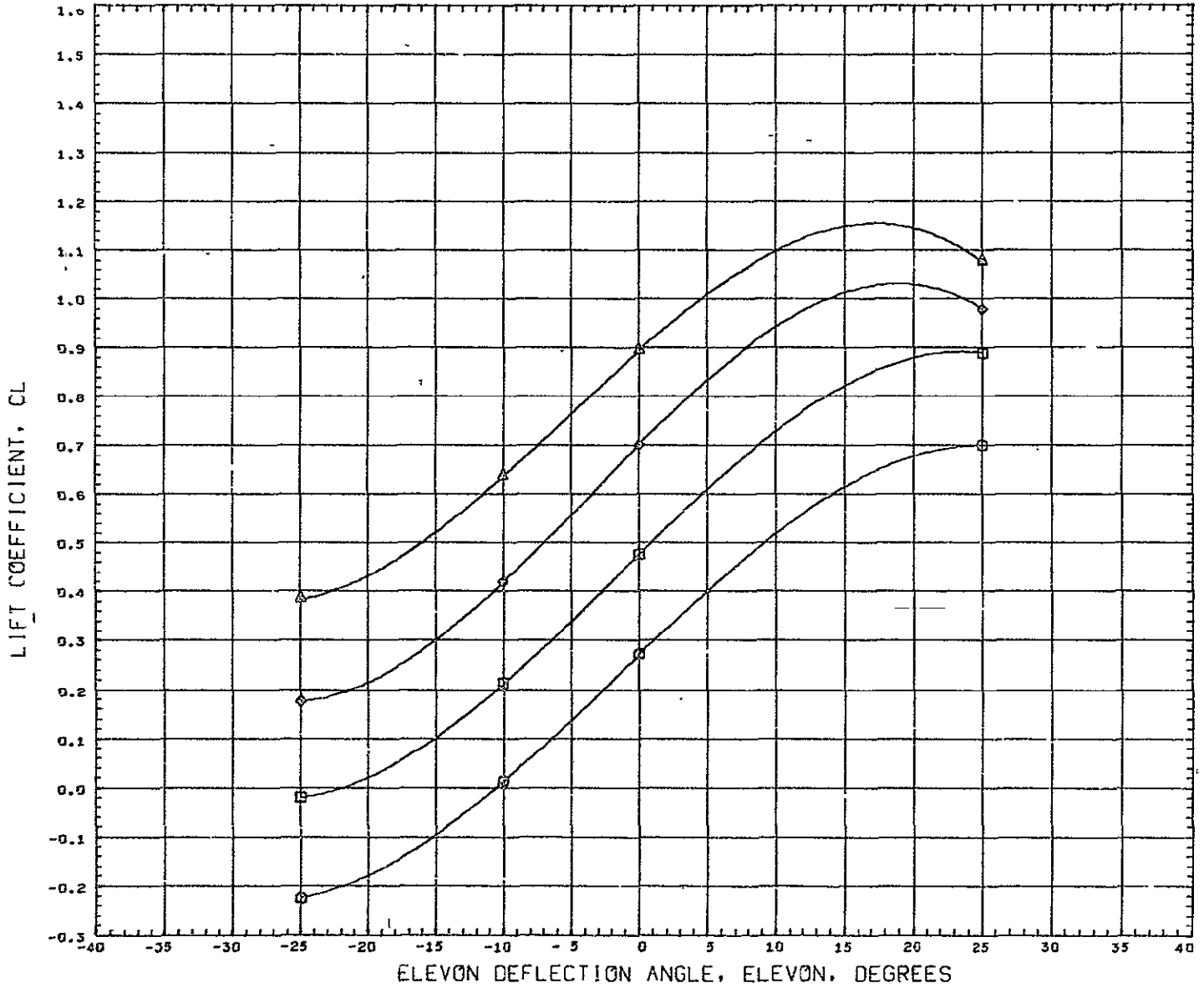

SYMBOL		ALPHA	PARAMETRIC VALUES			REFERENCE INFORMATION		
○		0.000	MACH	0.259	BETA	0.000	REFS	316 2304 SQ IN
□		4.000	AILERON	0.000	RUDDER	0.000	REFL	50 1900 IN
◇		8.000					REFB	7.3500 IN
△		12.000					XNRF	33 9090 IN
							YNRF	0 0000 IN
							ZNRF	0 0000 IN
							SCALE	0 0175

DATA HIST. CODE 1

LONGITUDINAL TRIM CHARACTERISTICS - DELTA WING - X/L = 0.73

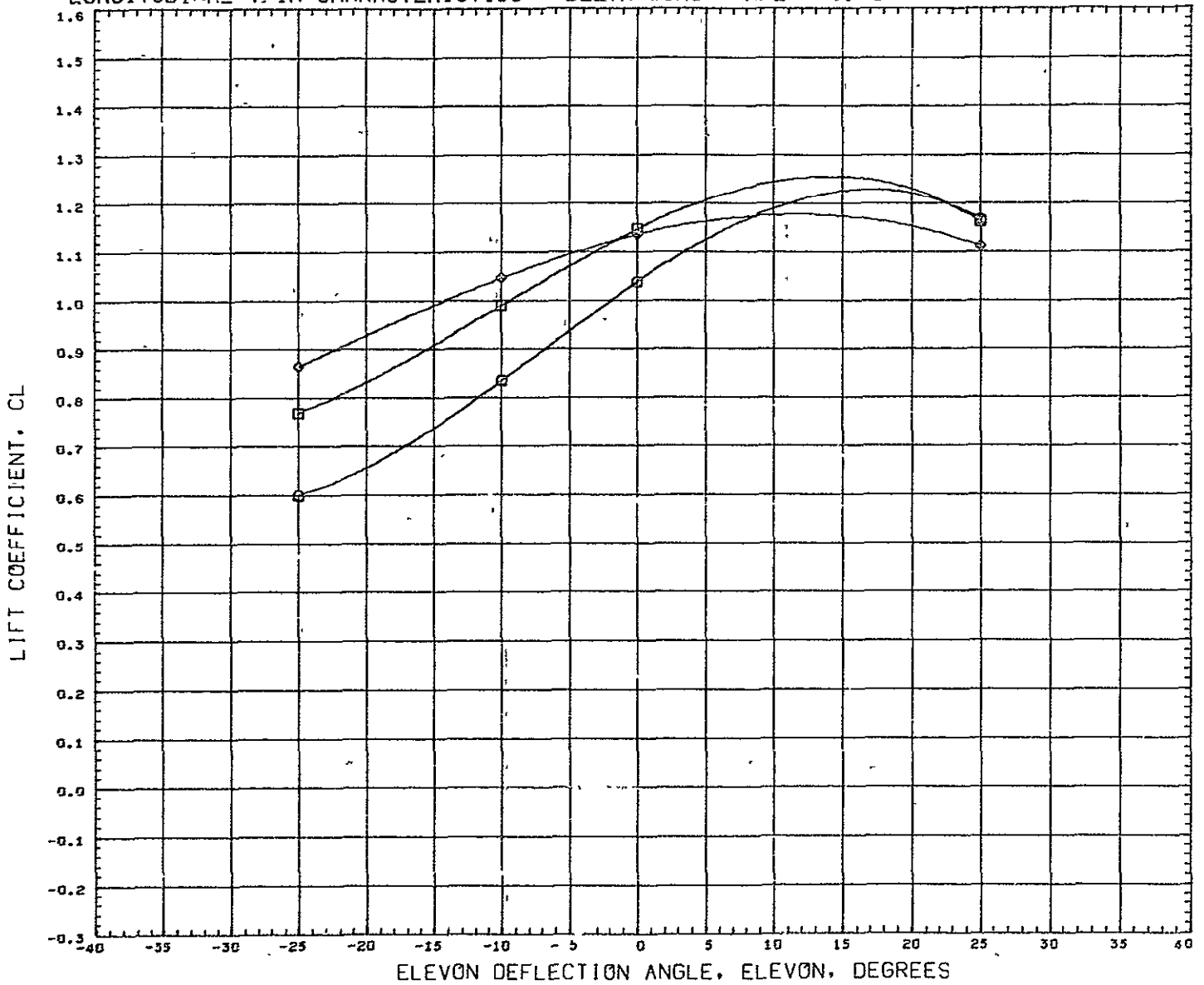

PARAMETRIC VALUES					REFERENCE INFORMATION		
SYMBOL	ALPHA	MACH	BETA	RUDDER	REFS	316.2304	SQ IN
○	16.000	25.000	0.259	0.000	REFL	50.1900	IN
□	25.000	24.000	0.000	0.000	REFB	7.3500	IN
◇	24.000				XMRP	33.9090	IN
					YMRP	0.0000	IN
					ZMRP	0.0000	IN
					SCALE	0.0175	

DATA HIST. CODE 1

LONGITUDINAL TRIM CHARACTERISTICS - DELTA WING - X/L = 0.73

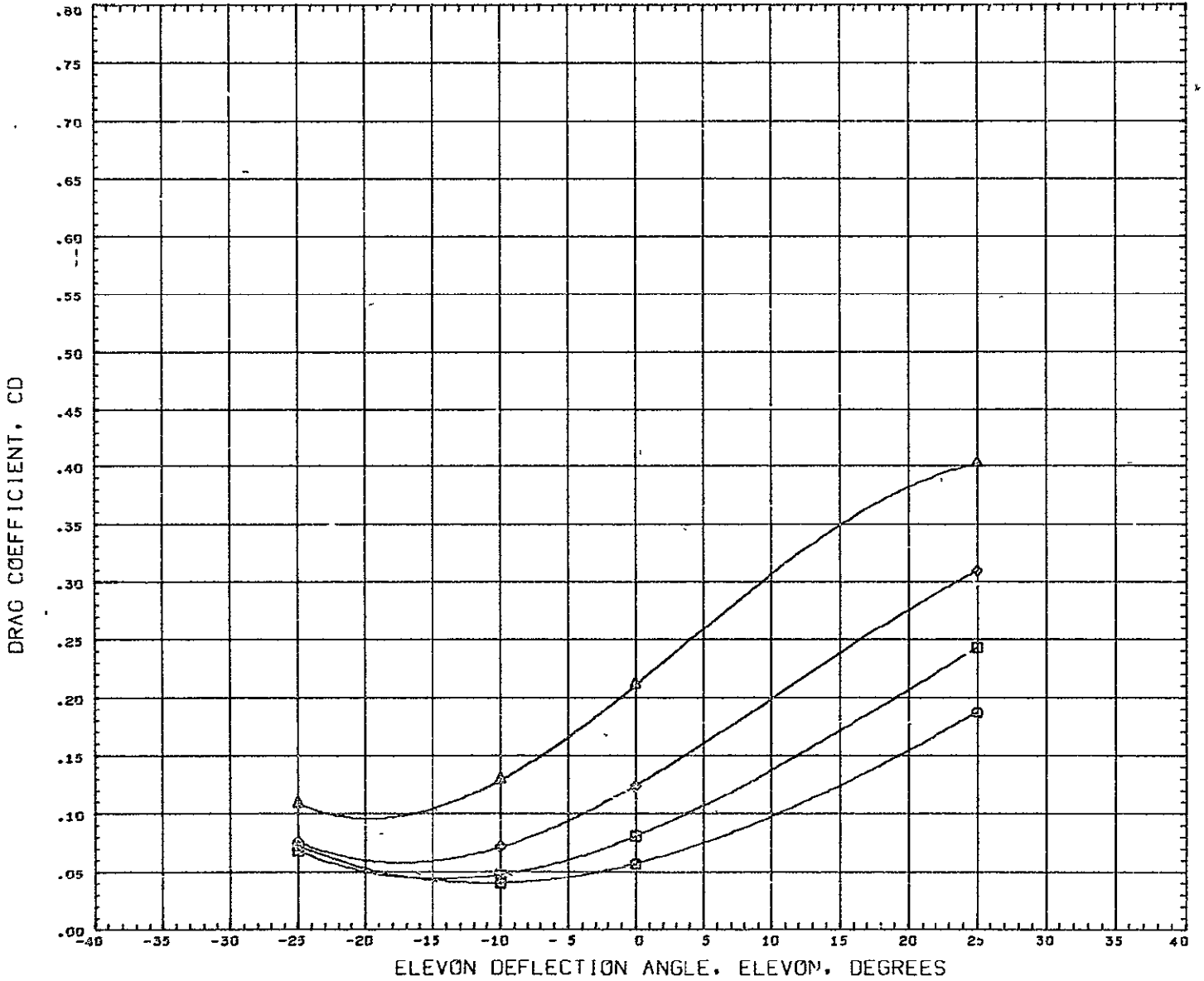

SYMBOL	ALPHA	PARAMETRIC VALUES				REFERENCE INFORMATION		
		MACH	BETA	RUDDER	REFS	IN	IN	
○	0.000	0.259	0.000	0.000	316.2304	50.1900	7.3500	
□	4.000	0.000	0.000	0.000	33.9090	0.0000	0.0000	
◇	8.000				0.0000	0.0000	0.0175	
△	12.000							

DATA HIST. CODE 1

LONGITUDINAL TRIM CHARACTERISTICS - DELTA WING - X/L = 0.73

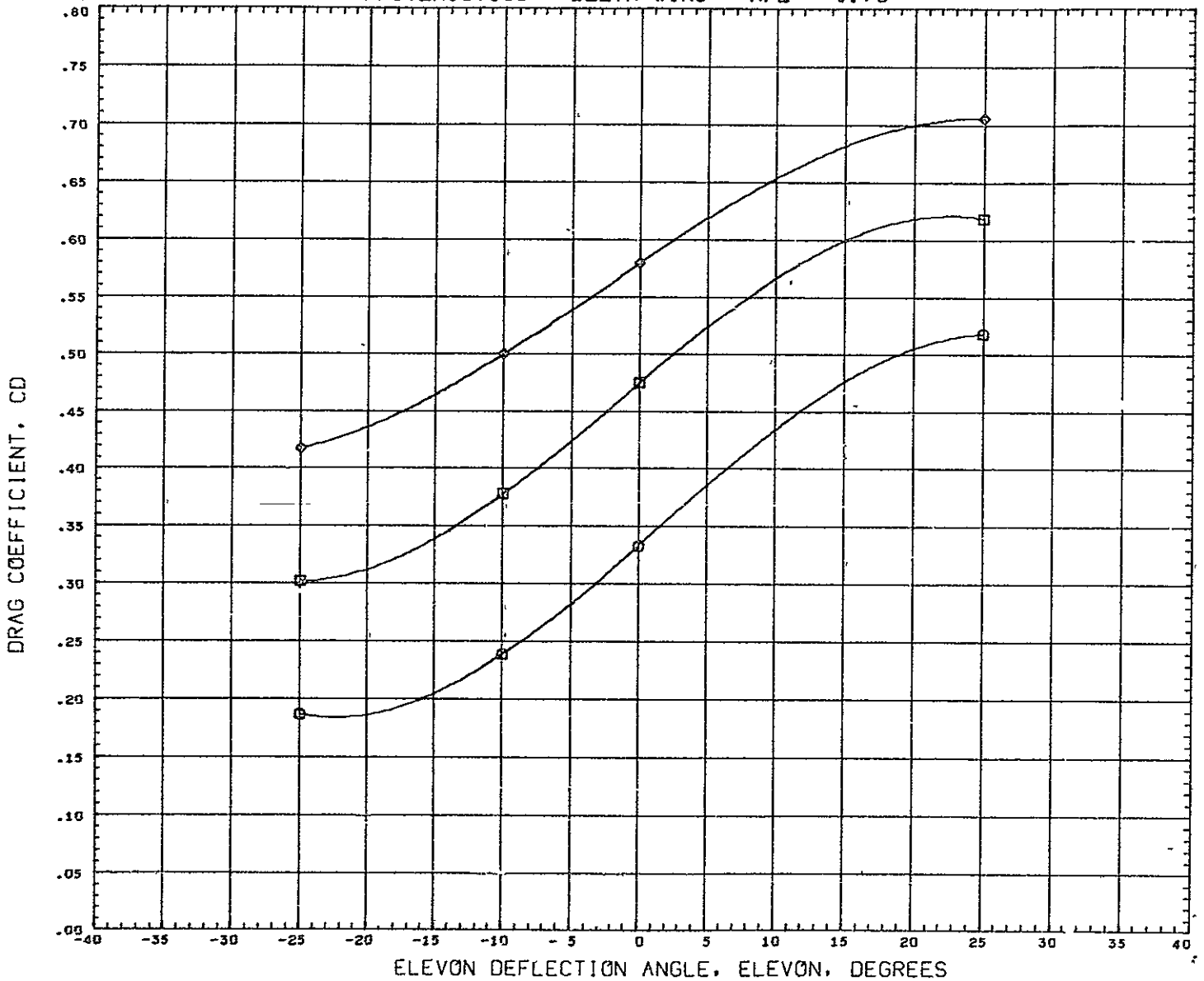

SYMBOL	ALPHA	MACH	PARAMETRIC VALUES			REFERENCE INFORMATION		
○	16.000	0.259	BETA	0.000	REFS	316 2304	SQ	IN
□	20.000	0.000	RUDDEF	0.000	REFL	50.1900	IN	
◇	24.000				REFB	7.3500	IN	
					XMPF	33 9090	IN	
					YMPF	0 0000	IN	
					ZMPF	0 0000	IN	
					SCALE	0 0175		

DATA HIST. CODE 1

LONGITUDINAL TRIM CHARACTERISTICS - DELTA WING - X/L = 0.78

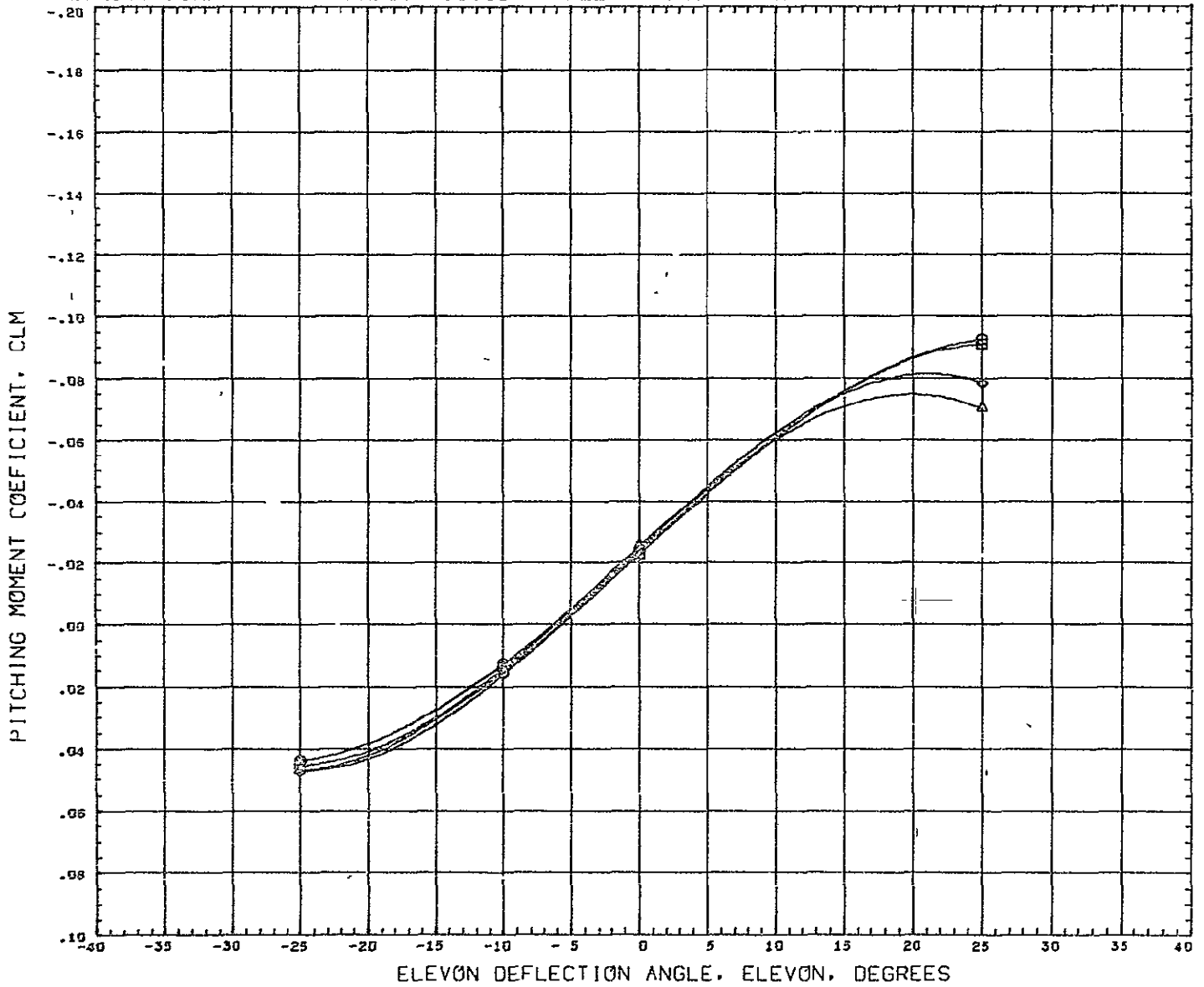

PARAMETRIC VALUES						REFERENCE INFORMATION		
SYMBOL	ALPHA	MACH	BETA	BETA	0.000	REFS	316.2304	SQ IN
□	4.000	AIRCAN	0.000	RUDDER	0.000	REFL	50.1900	IN
◇	8.000					PEFB	7.3500	IN
△	12.000					XMRP	36.4180	IN
						YMRP	0.0000	IN
						ZMRP	0.0000	IN
						SCALE	0.0175	

DATA HIST. CODE SI

LONGITUDINAL TRIM CHARACTERISTICS - DELTA WING - X/L = 0.78

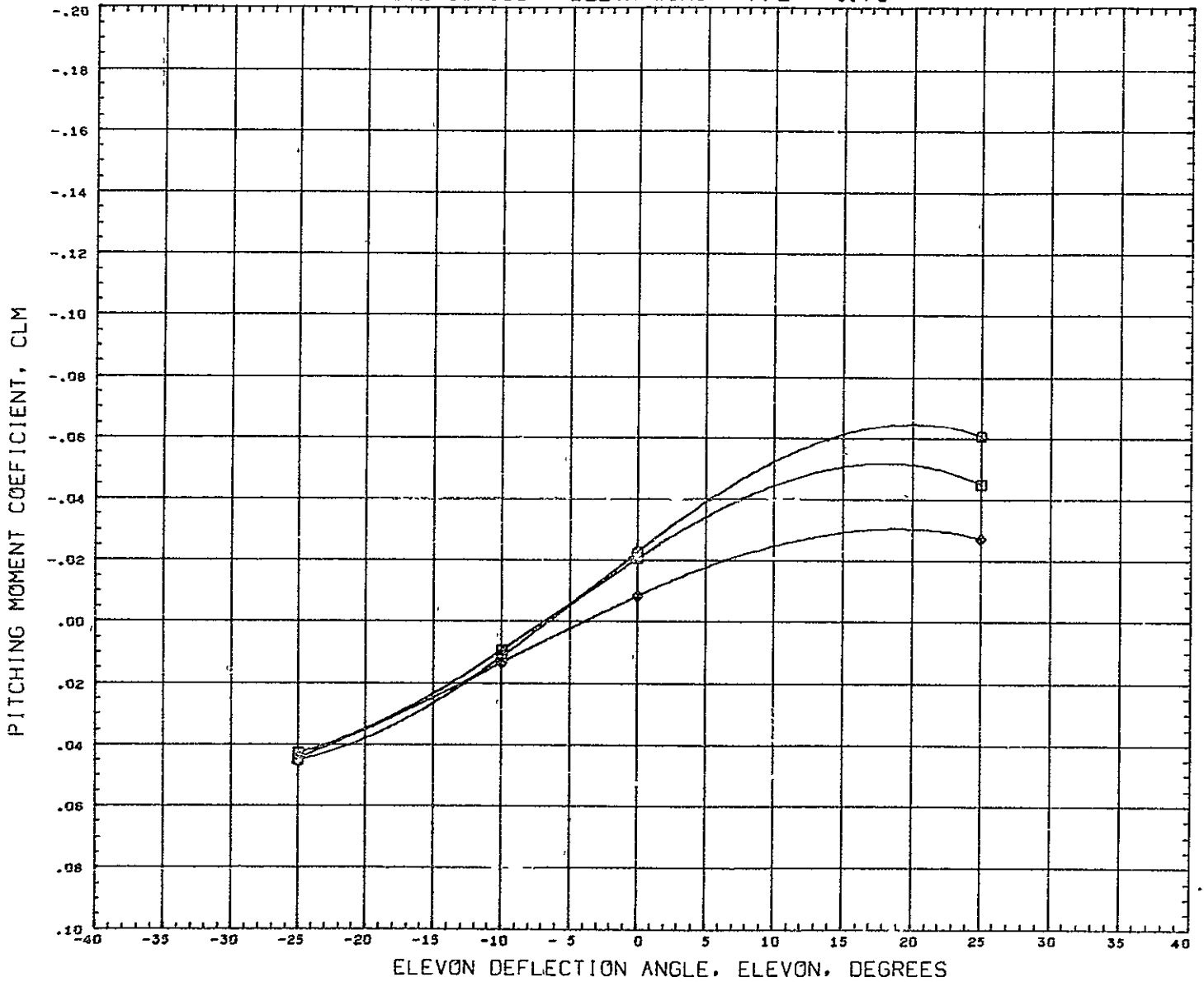

SYMBOL	ALPHA	PARAMETRIC VALUES				REFERENCE INFORMATION		
○	16.000	MACH	0.259	BETA	0.000	REFS	316 2304	SQ IN
□	20.000	ALLRON	0.500	RUDDER	0.000	REFL	50 1900	IN
○	24.000					REFB	7 3500	IN
						XMRP	36 4180	IN
						YMRP	0.0000	IN
						ZMRP	0.0000	IN
						SCALE	0 0175	

DATA HIST. CODE SI

LONGITUDINAL TRIM CHARACTERISTICS - DELTA WING - X/L = 0.78

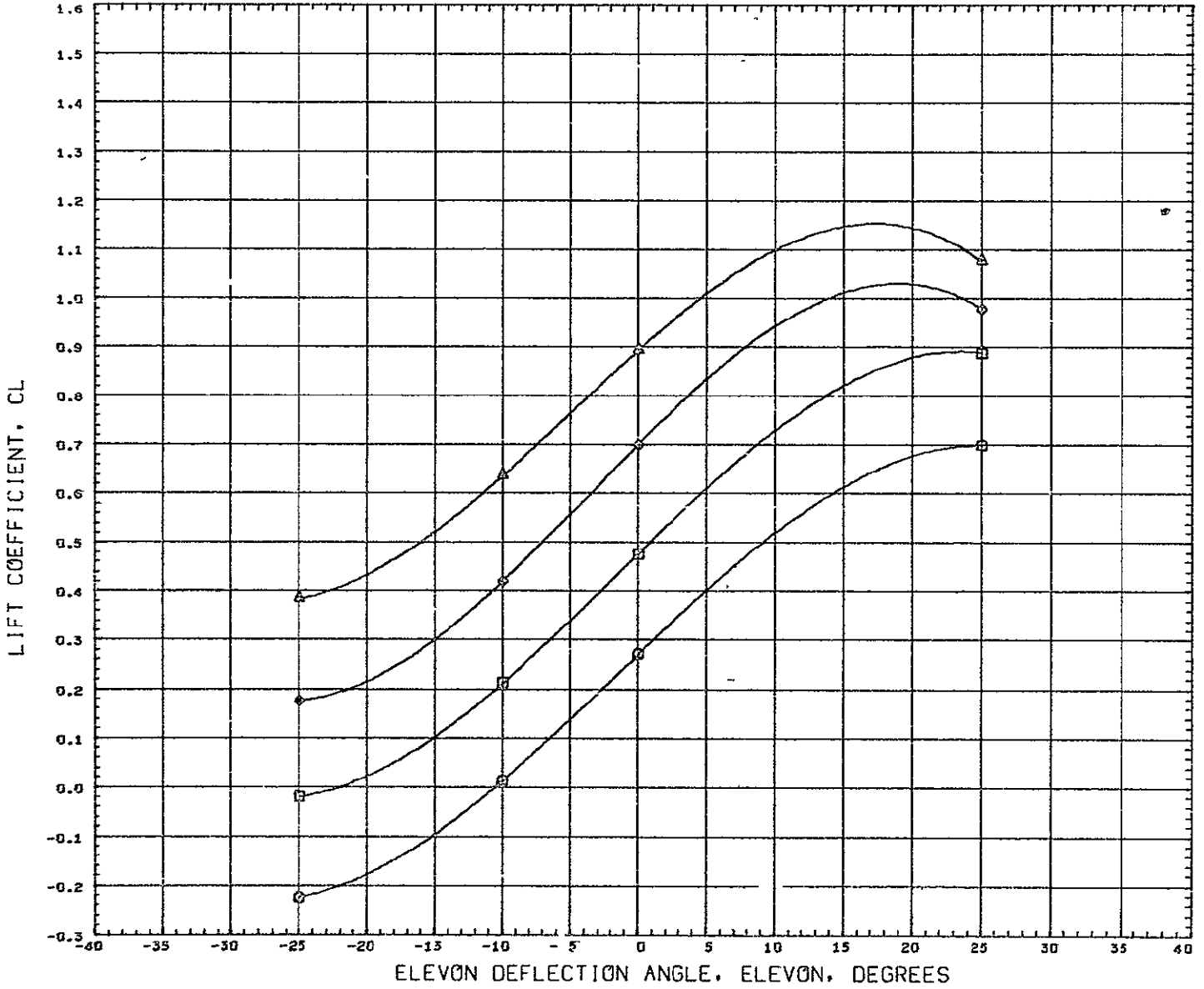

SYMBOL	ALPHA	PARAMETRIC VALUES			
○	5.000	MACH	0.259	BETA	0.000
□	4.000	A <sub>1</sub> LRON	0.000	RUDDER	0.000
◇	6.000				
△	12.000				

REFERENCE INFORMATION		
REFS	316 2304	SQ IN
REFL	50.1900	IN
PEFB	7.3500	IN
XMRP	36 4180	IN
YMRP	0.0000	IN
ZMRP	0 0000	IN
SCALE	0 0175	

DATA HIST. CODE 51



LONGITUDINAL TRIM CHARACTERISTICS - DELTA WING - X/L = 0.78

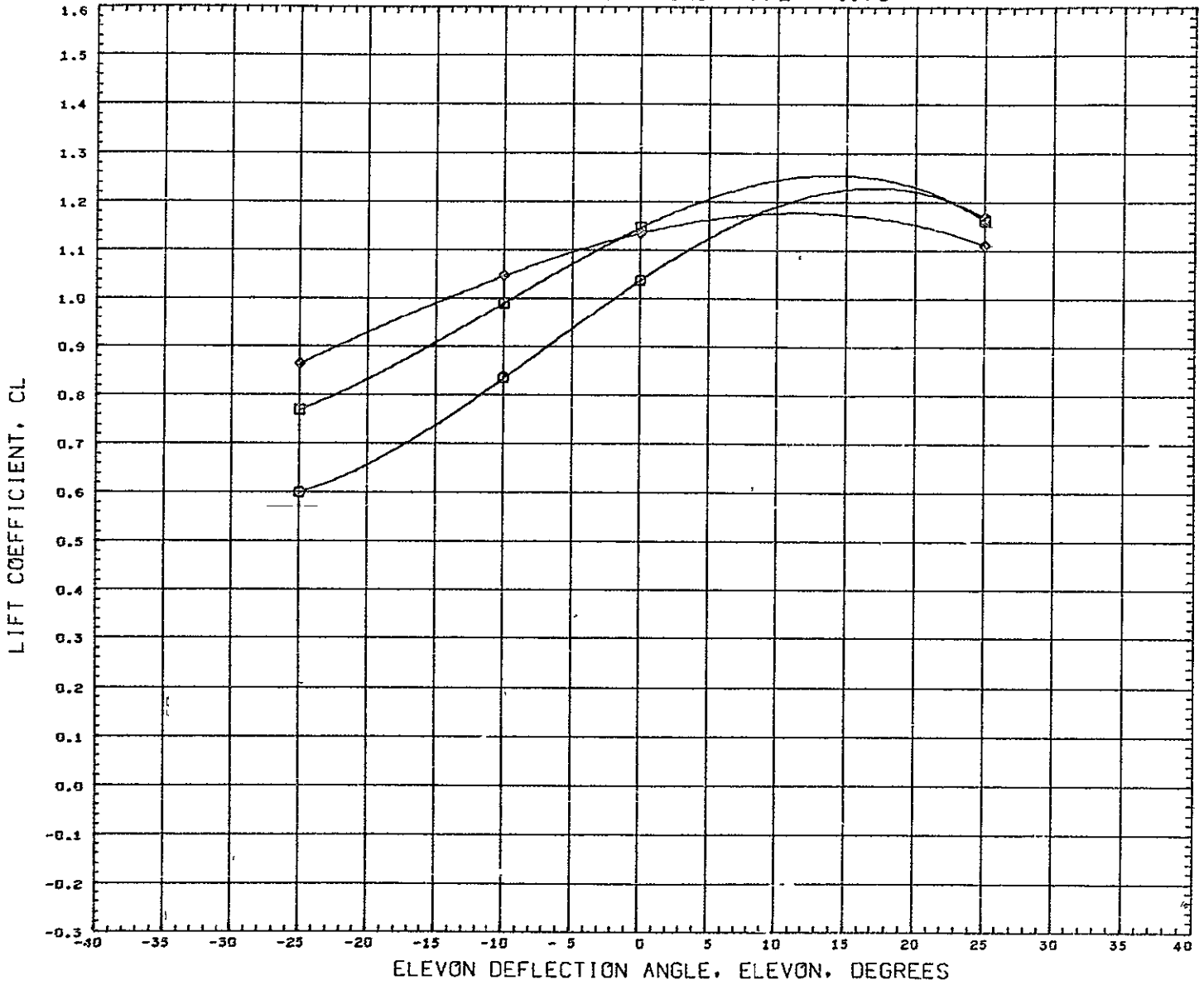

SYMBOL	ALPHA	PARAMETRIC VALUES				REFERENCE INFORMATION		
		MACH	BETA	PUDDER	REFS	IN	IN	
○	16.000	0.259	0.000		316.2304	50.1900	7.3500	
□	20.000	0.000	0.000		36.4180	0.0000	0.6175	
◇	24.000							

DATA HIST CODE SI

LONGITUDINAL TRIM CHARACTERISTICS - DELTA WING - X/L = 0.78

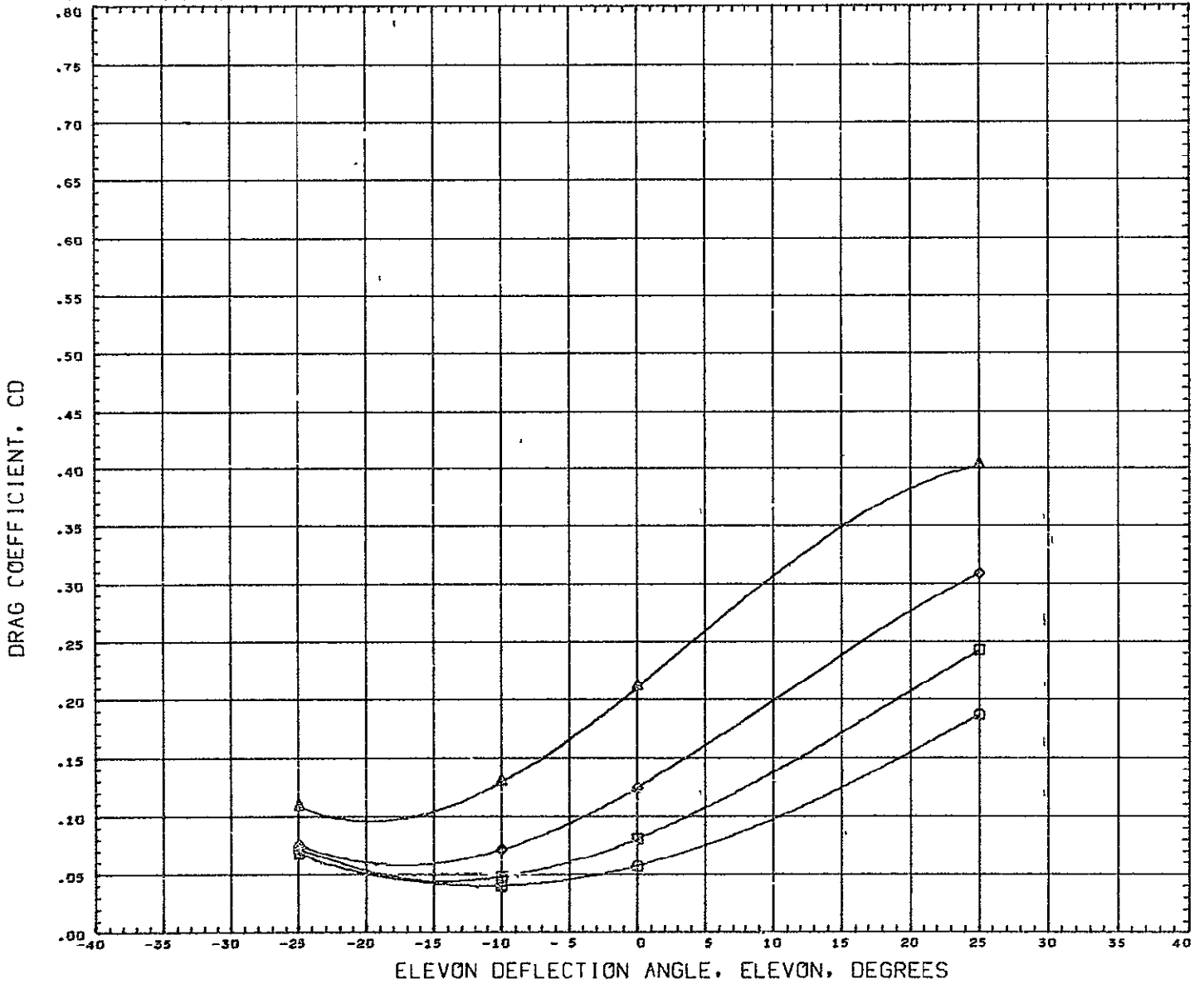

SYMBOL	ALPHA	PARAMETRIC VALUES				REFERENCE INFORMATION		
		MACH	BETA	AILRON	RUDDER	REFS	SQ IN	
○	0.000	0.259	0.000	0.000	316.2304	IN		
◻	4.000	0.000	0.000	0.000	50.1900	IN		
◇	8.000				7.3500	IN		
△	12.000				36.4180	IN		
					0.0000	IN		
					0.0000	IN		
					0.0175	IN		

DATA HIST CODE 51

LONGITUDINAL TRIM CHARACTERISTICS - DELTA WING - X/L = 0.78

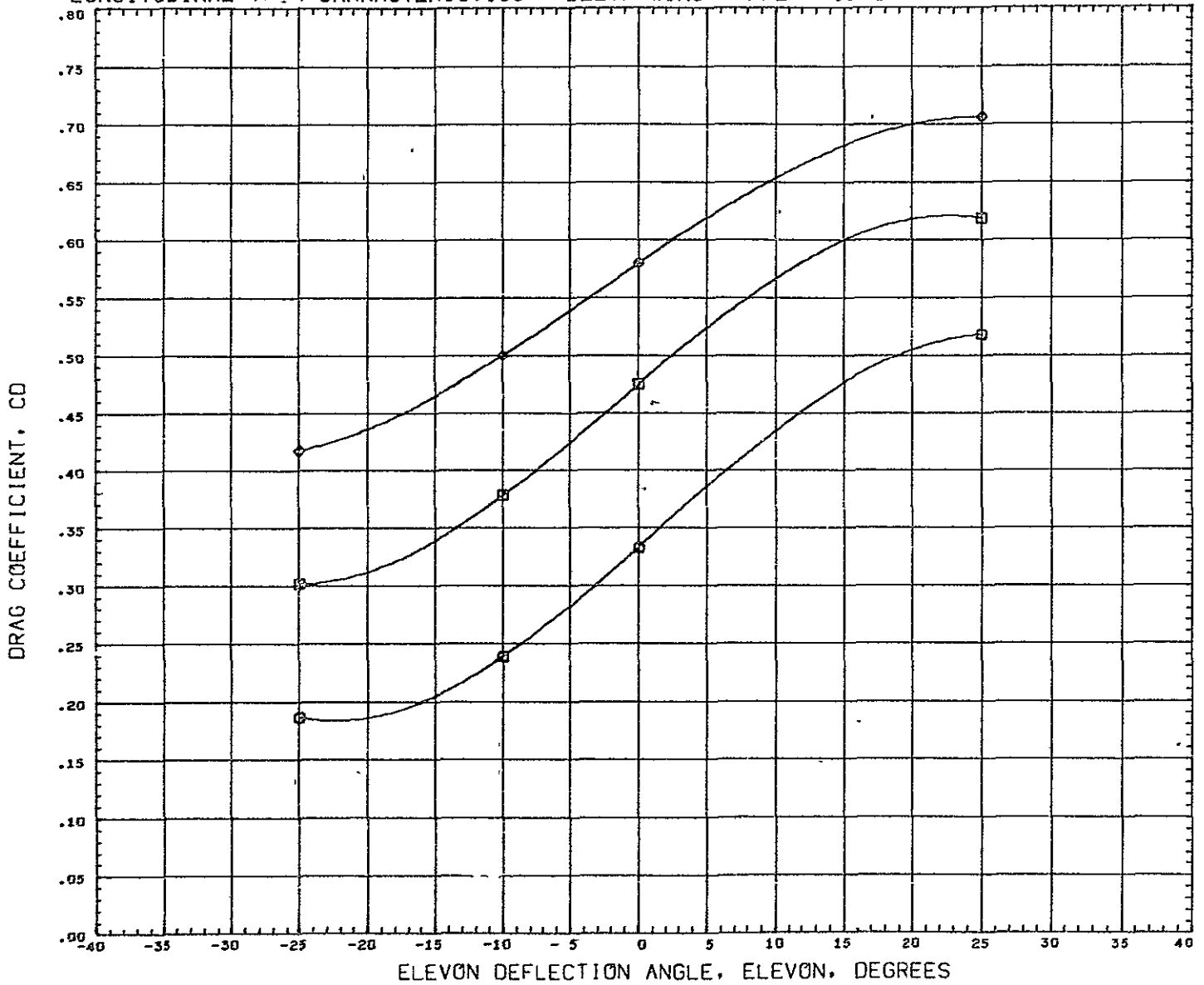

SYMBOL	ALPHA	PARAMETRIC VALUES				REFERENCE INFORMATION		
		MACH	BETA	RUDDER	REFS	REFL	REFB	
○	16.000	0.259	0.000		316 2304	50.1900	7.3500	
□	20.000	0.300	0.000		36.4180	0.0000	0.0000	
◇	24.000				0.0000	0.0000	0.0175	

DATA HIST. CODE SI

FLAP EFFECTIVENESS - STRAIGHT WING BASIC POSITION - GEARS DOWN - V-TAIL=55DEG

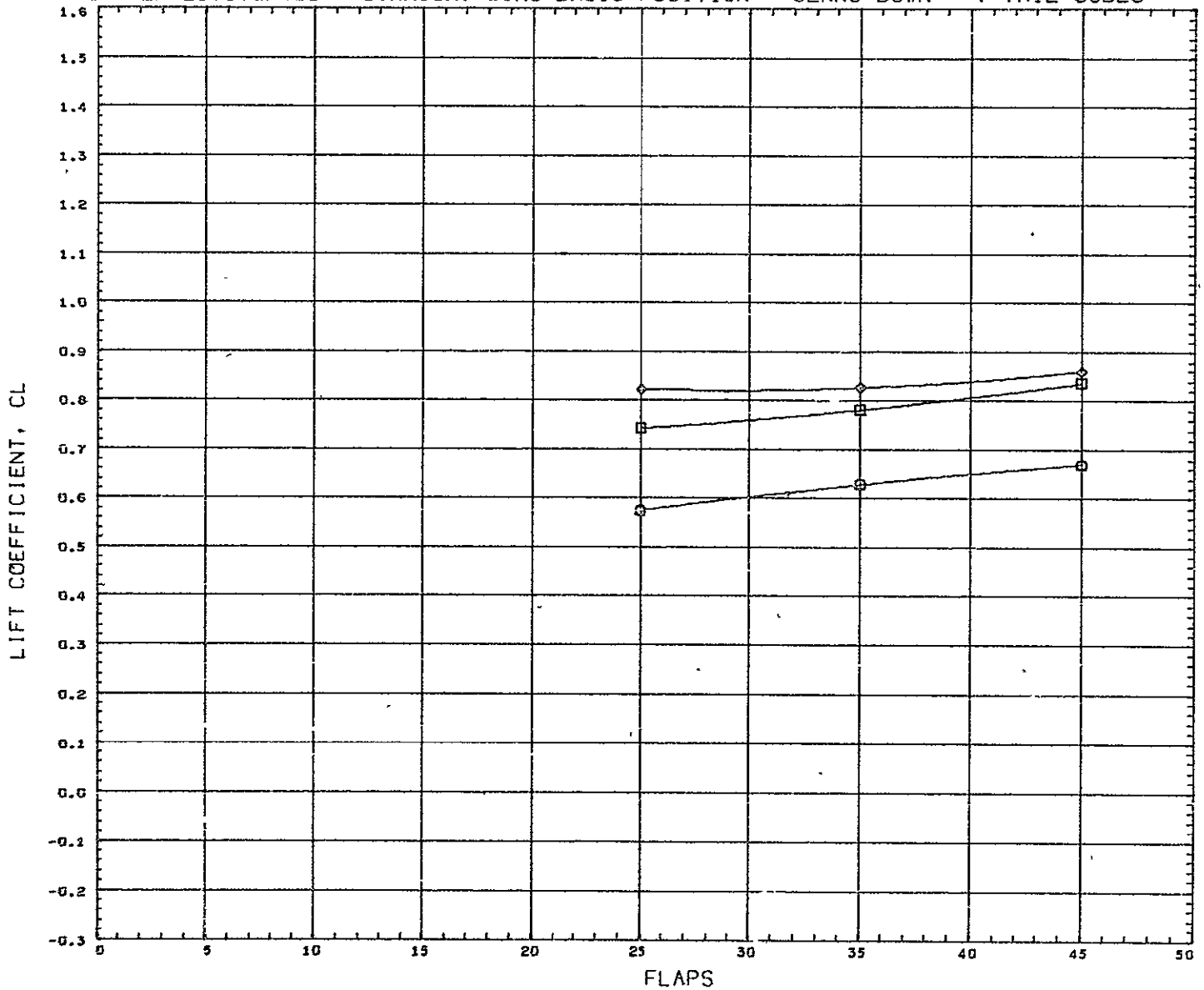

SYMBOL	ALPHA	MACH	PARAMETRIC VALUES		
○	0.000	0.259	BETA	0.000	
□	4.000	ELEVTR	0.000	RUDVTR	0.000
◇	8.000	SFOILR	0.000		

REFERENCE INFORMATION		
REFS	316 2304	SQ IN
REFL	50 1900	IN
REFB	7.3500	IN
XMRP	29.3920	IN
YMRP	0.0000	IN
ZMRP	0.0000	IN
SCALE	0.0175	

DATA HIST. CODE 1

FLAP EFFECTIVENESS - STRAIGHT WING BASIC POSITION - GEARS DOWN - V-TAIL=55DEG

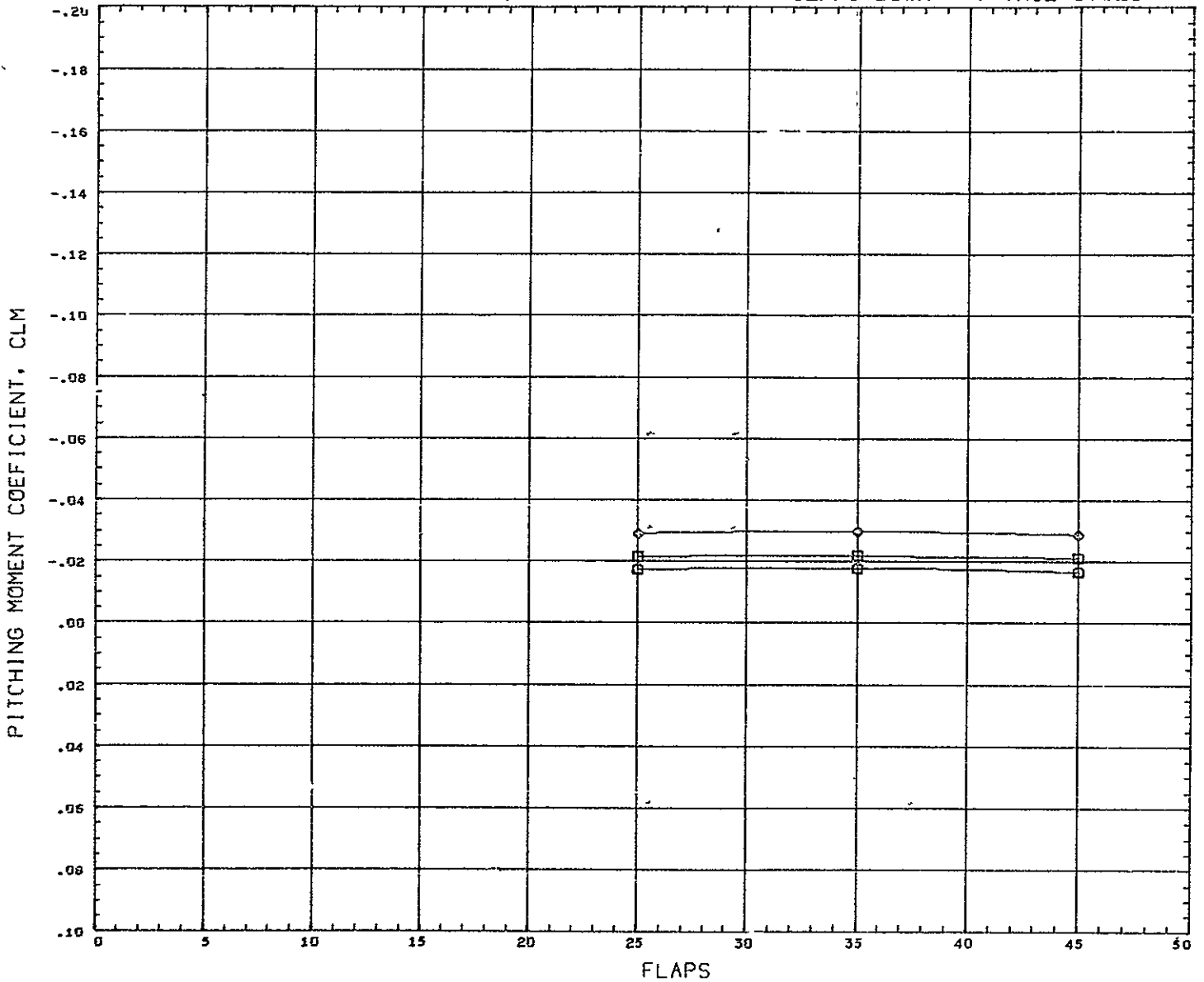

SYMBOL	ALPHA	PARAMETRIC VALUES			
□	0.000	MACH	0.259	BETA	0.000
□	4.000	ELEVTR	0.000	RUDVTR	0.000
◇	8.000	SFOILR	0.000		

REFERENCE INFORMATION		
REFS	316 2304	SQ IN
PEFL	50 1900	IN
REFB	7.3500	IN
XNRF	29.3920	IN
YHRF	0.0000	IN
ZHRF	0.0000	IN
SCALE	0 0175	

DATA HIST. CODE I

FLAP EFFECTIVENESS - STRAIGHT WING BASIC POSITION - GEARS DOWN - V-TAIL=55DEG

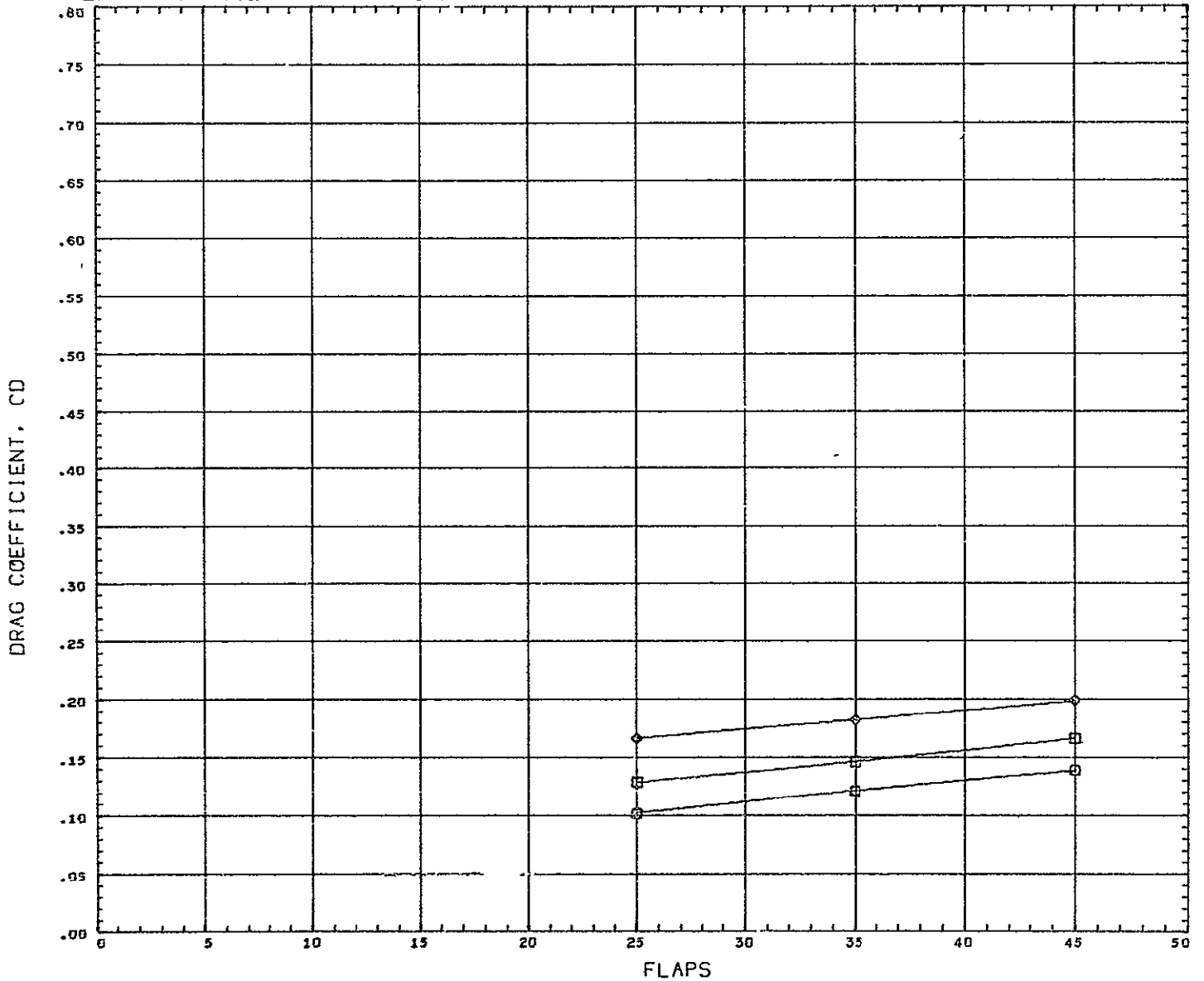

SYMBOL	ALPHA	PARAMETRIC VALUES			
○	0.000	MACH	0.259	BETA	0.000
□	4.000	ELEVTR	0.000	RUDVTR	0.000
◇	8.000	SFOILR	0.000		

REFERENCE INFORMATION		
REFS	316.2304	SG IN
REFL	50 1900	IN
REFB	7.3500	IN
XMRP	29 3920	IN
YMRP	0.0000	IN
ZMRP	0 0000	IN
SCALE	0 0175	

DATA HIST. CODE 1



FLAP EFFECTIVENESS - STRAIGHT WING BASIC POSITION - V-TAIL=55DEG

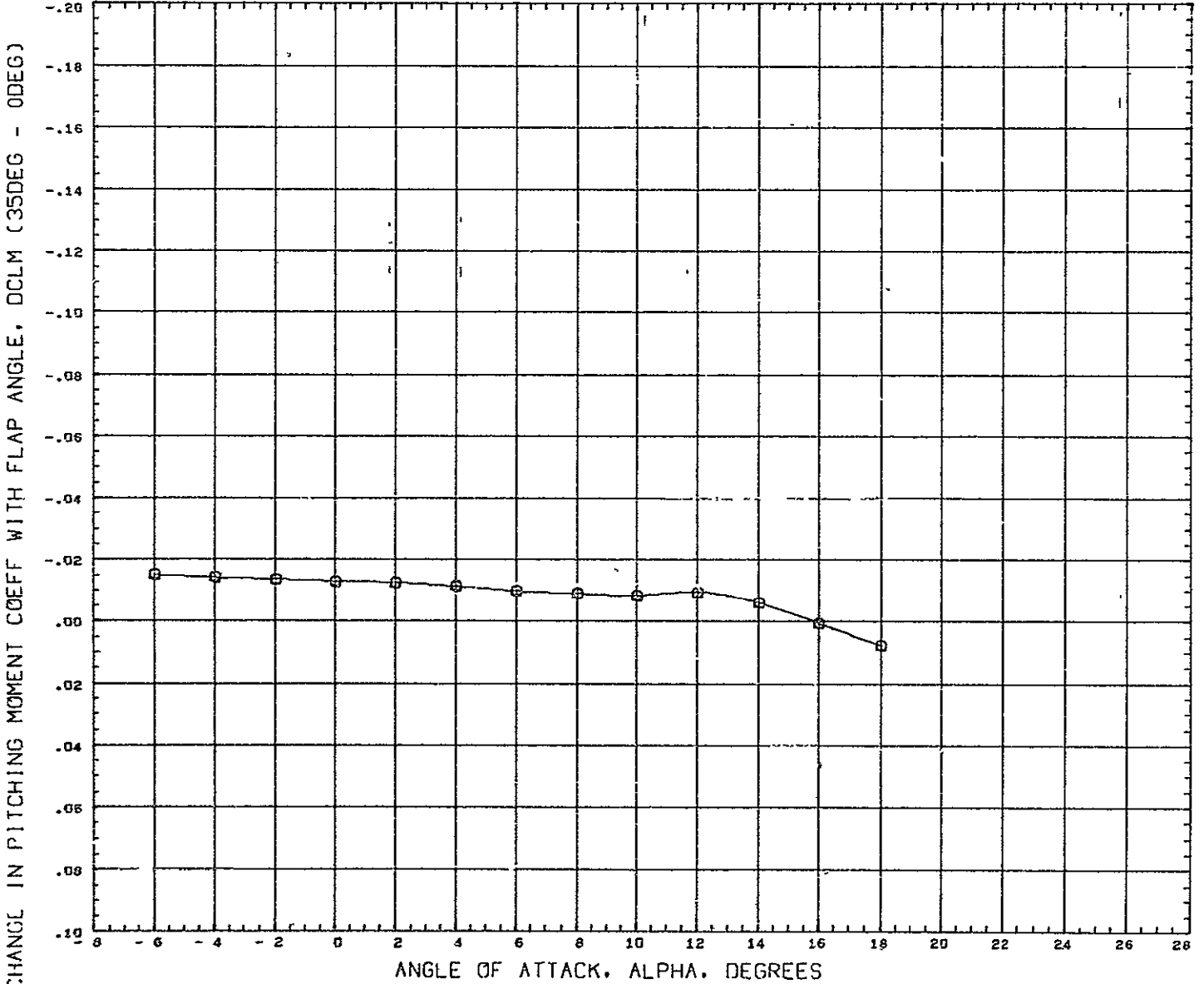

SYMBOL MACH PARAMETRIC VALUES  
 D 0.259 BETA 0.000 ELEVTR - 10.000  
 SPOILR 0.000

REFERENCE INFORMATION  
 REFS 316.2304 SQ IN  
 REFL 50 1900 IN  
 REFB 7.3500 IN  
 XMRP 29 3920 IN  
 YMRP 0.0000 IN  
 ZMRP 0.0000 IN  
 SCALE 0.0175

DATA HIST. CODE I\*CM



FLAP EFFECTIVENESS - STRAIGHT WING BASIC POSITION - V-TAIL=55DEG

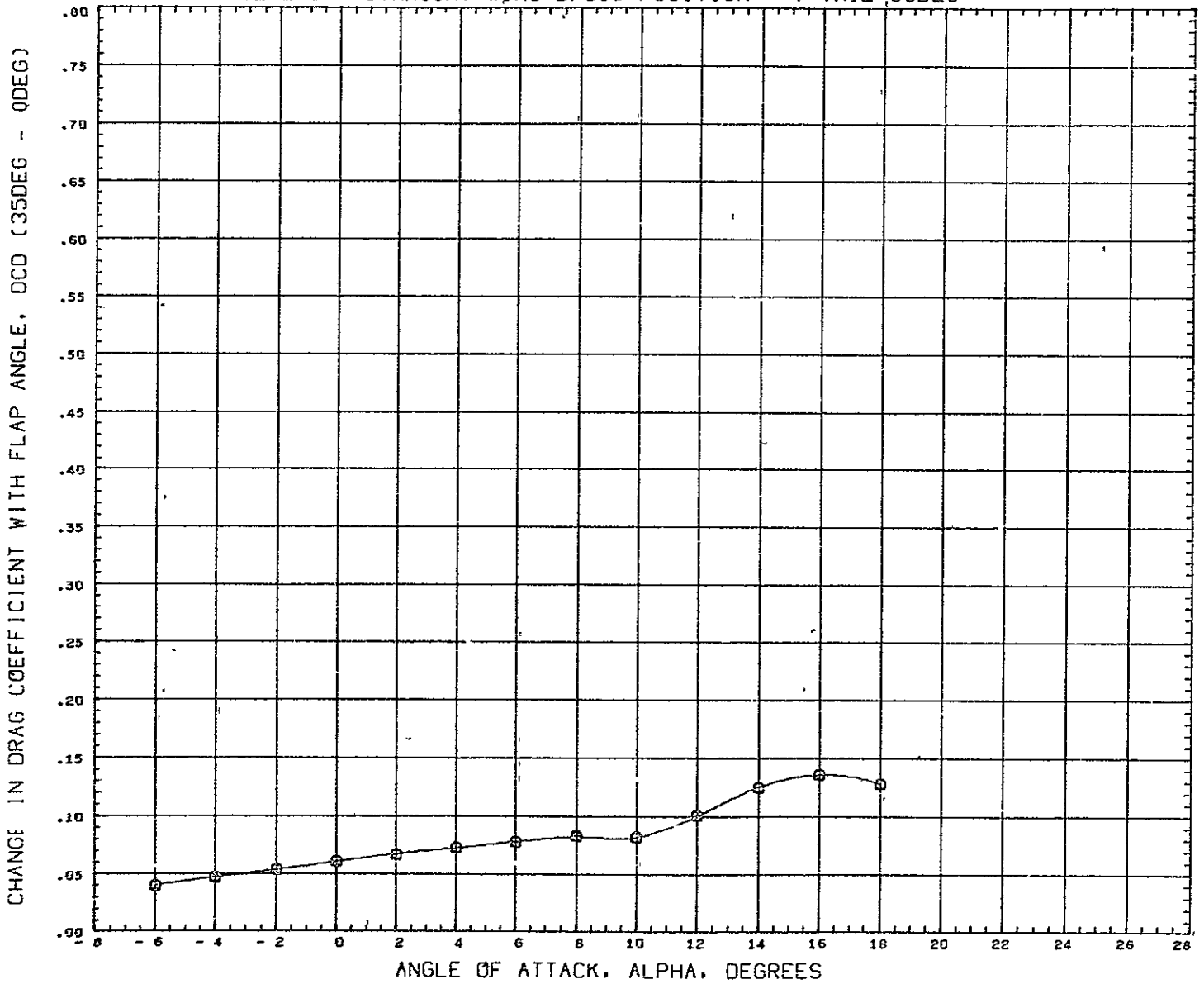

SYMBOL MACH PARAMETRIC VALUES  
 Q 0.259 BETA 0.000 ELEVTR - 10.000  
 SPOILER 0.000

REFERENCE INFORMATION  
 REFS 316 2304 SQ IN  
 REFL 50.1900 IN  
 REFB 7.3500 IN  
 XNRF 29.3920 IN  
 YNRF 0.0000 IN  
 ZNRF 0.0000 IN  
 SCALE 0.0175

DATA HIST. CODE I4CM

LONGITUDINAL TRIM CHAR. - STRAIGHT WING BASIC POS. - V-TAIL=55DEG - X/L = 0.56

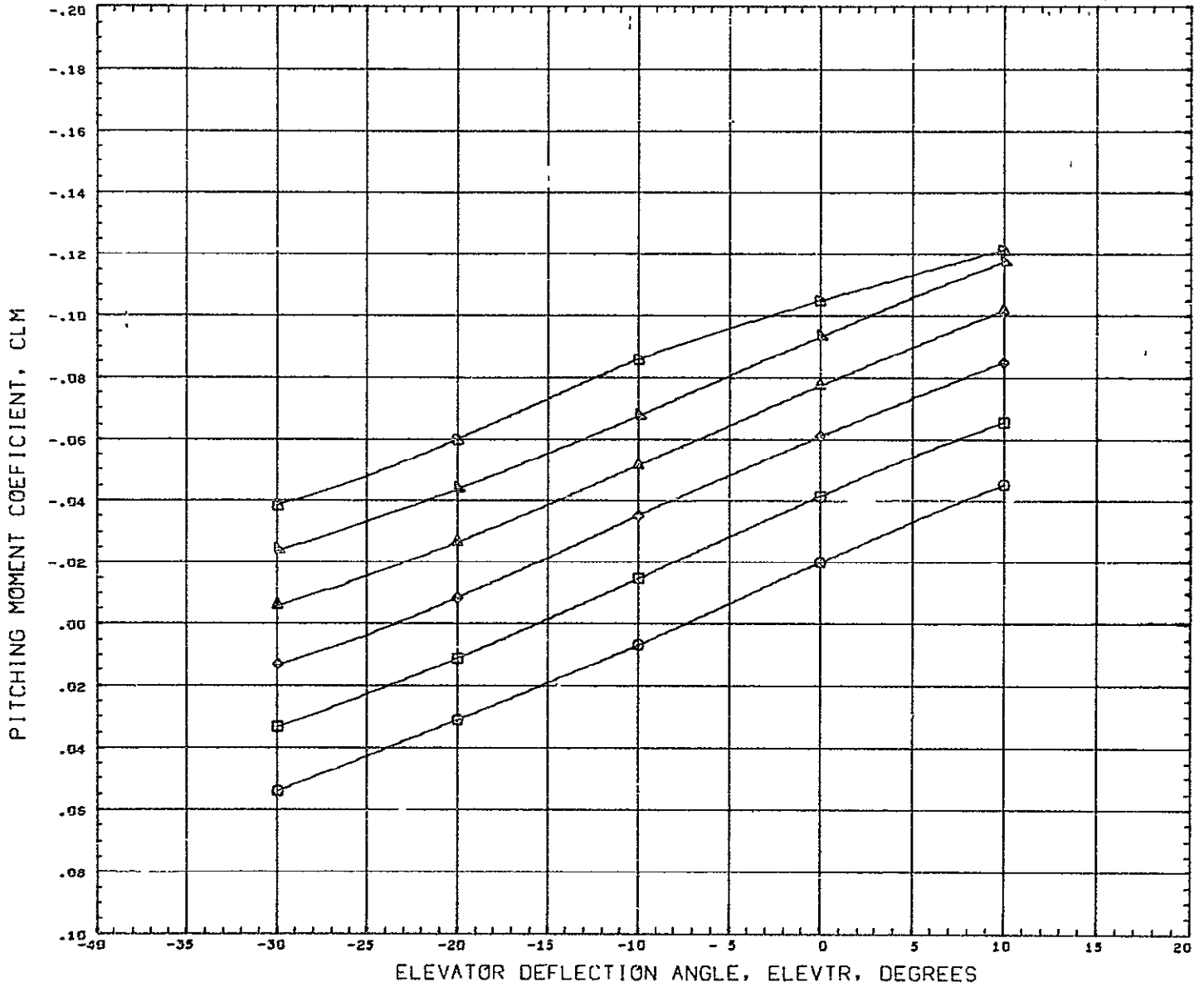

SYMBOL	ALPHA	PARAMETRIC VALUES				REFERENCE INFORMATION		
○	4.000	MACH	0.259	BETA	0.000	REFS	316 2304	SQ IN
□	6.000	PUDYTR	0.000	FLAPS	0.000	REFL	50.1900	IN
◇	8.000	SPOILR	0.000			REFB	7.3500	IN
△	12.000					XMRP	25.3760	IN
▽	16.000					YMRP	0.0000	IN
◇		DATA HIST. CODE	SI			ZMRP	0.0000	IN
						SCALE	0.0175	

LONGITUDINAL TRIM CHAR. - STRAIGHT WING BASIC POS. - V-TAIL=55DEG - X/L = 0.56

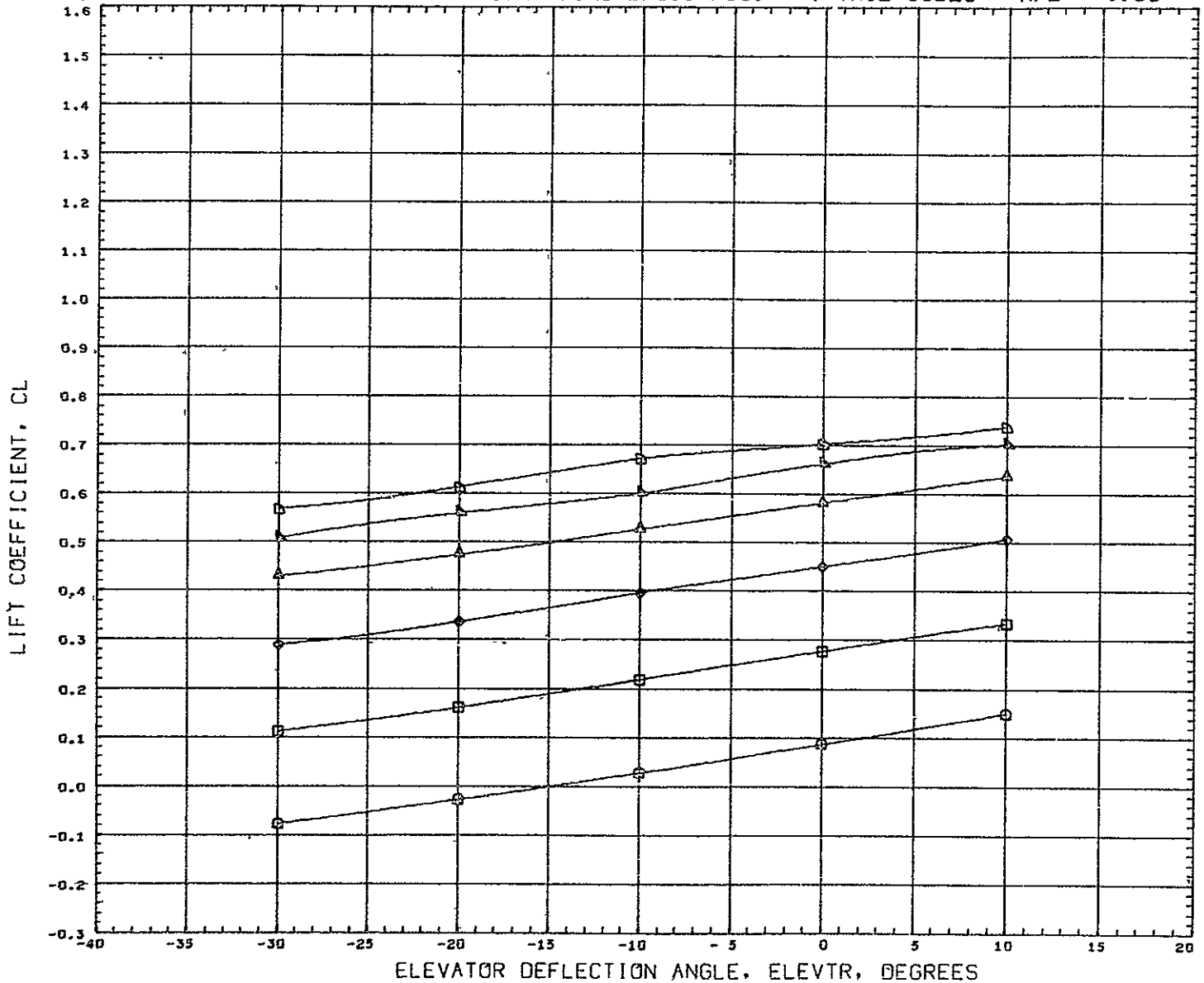

SYMBOL	ALPHA	PARAMETRIC VALUES				REFERENCE INFORMATION		
○	4.000	MACH	0.259	BETA	0.000	REFS	316.2304	SQ IN
◻	0.000	ELEVTR	0.000	FLAPS	0.000	REFL	50.1900	IN
◇	4.000	SFOILR	0.000			REFB	7.3500	IN
△	4.000					XMRP	25.3760	IN
▽	12.000					YMRP	0.0000	IN
◻	16.000	DATA HIST. CODE	51			ZMRP	0.0000	IN
						SCALE	0.0175	

LONGITUDINAL TRIM CHAR. - STRAIGHT WING BASIC POS. - V-TAIL=55DEG - X/L = 0.56

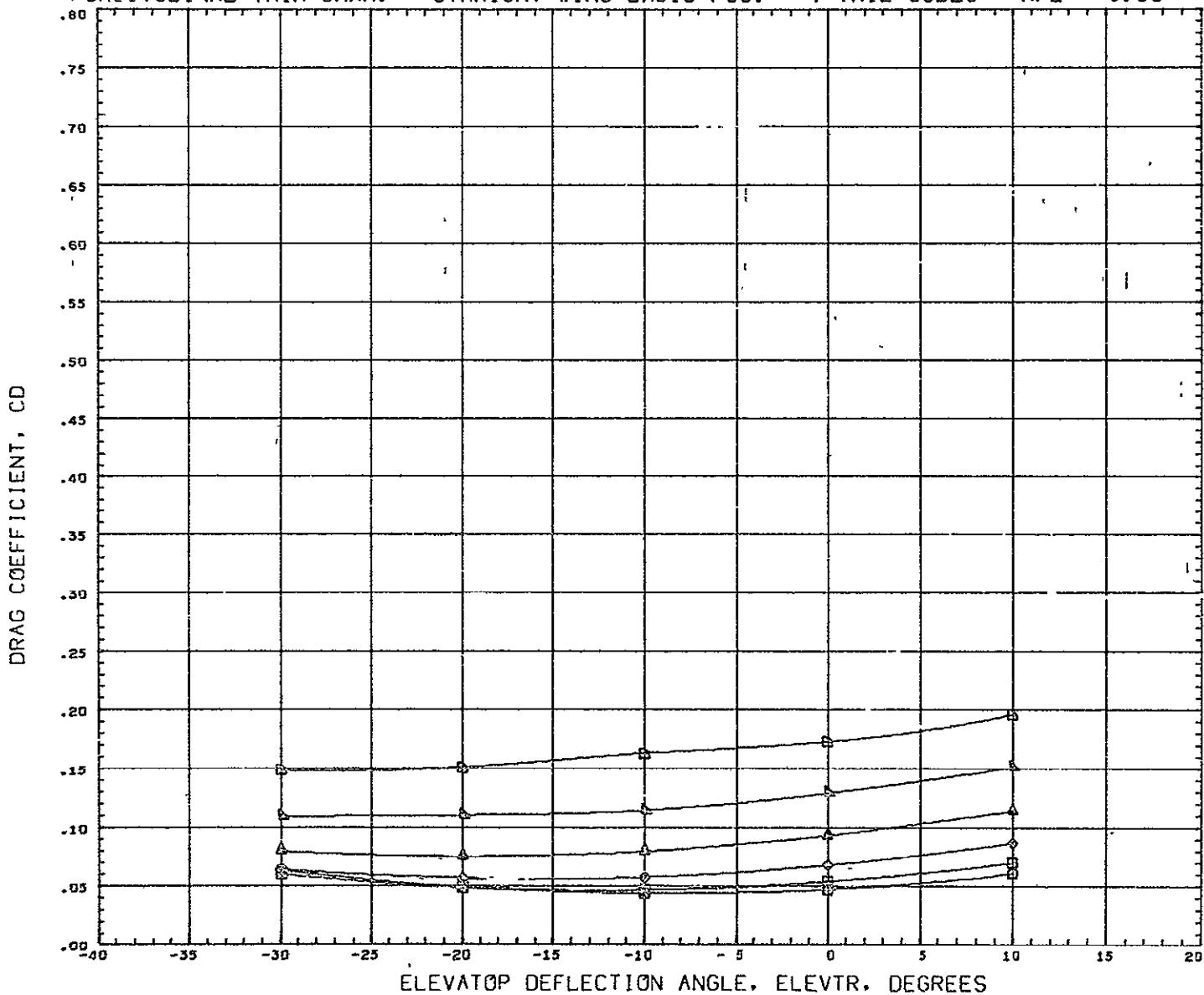

SYMBOL	ALPHA	PARAMETRIC VALUES				REFERENCE INFORMATION		
○	4.000	HACH	0.259	BETA	0.000	REFS	316.2304	50 IN
□	8.000	°UDVTF	0.000	FLAFS	0.000	REFL	50.1900	IN
◇	12.000	SFOILR	0.000			REFB	7.3500	IN
△	16.000					XMRP	25.3760	IN
▽						YMRP	0.0000	IN
◇						ZMRP	0.0000	IN
		DATA HIST. CODE	51			SCALE	0.0175	

LONGITUDINAL TRIM CHAR. - STRAIGHT WING BASIC POS. - V-TAIL=55DEG - X/L = 0.60

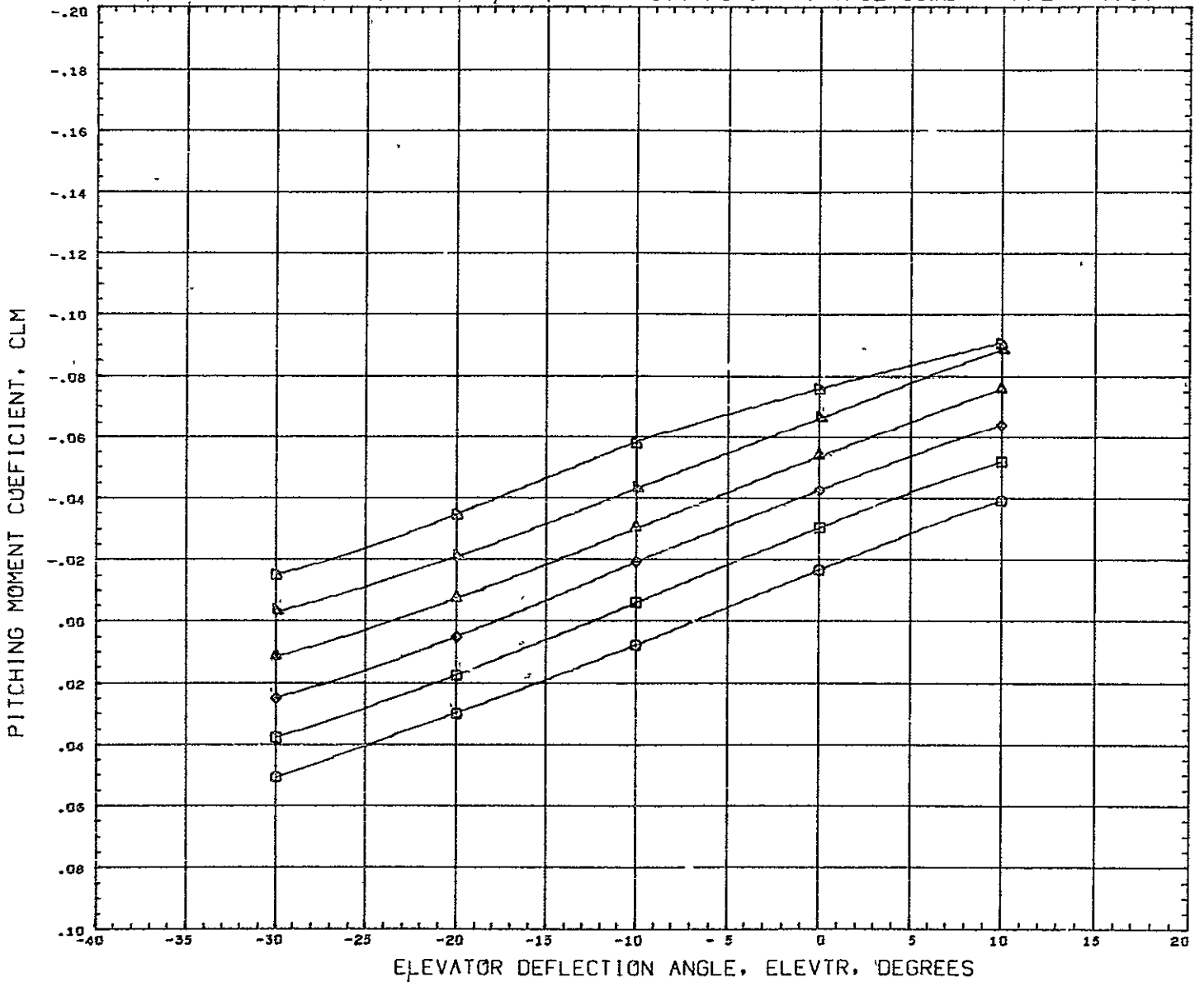

SYMBOL	ALPHA	PARAMETRIC VALUES				REFERENCE INFORMATION		
□	4.000	MACH	0.259	BETA	0.000	REFS	316.2304	SQ IN
◇	8.000	ρUDVTR	0.000	FLAPS	0.000	REFL	50.1900	IN
◇	4.000	SPOILER	0.000			REFB	7.3500	IN
△	8.000					XMRP	27.3840	IN
▽	12.000					YMRP	0.0000	IN
◇	16.000					ZMRP	0.0000	IN
		DATA HIST. CODE	SI			SCALE	0.0175	

LONGITUDINAL TRIM CHAR. - STRAIGHT WING BASIC POS. - V-TAIL=55DEG - X/L = 0.60

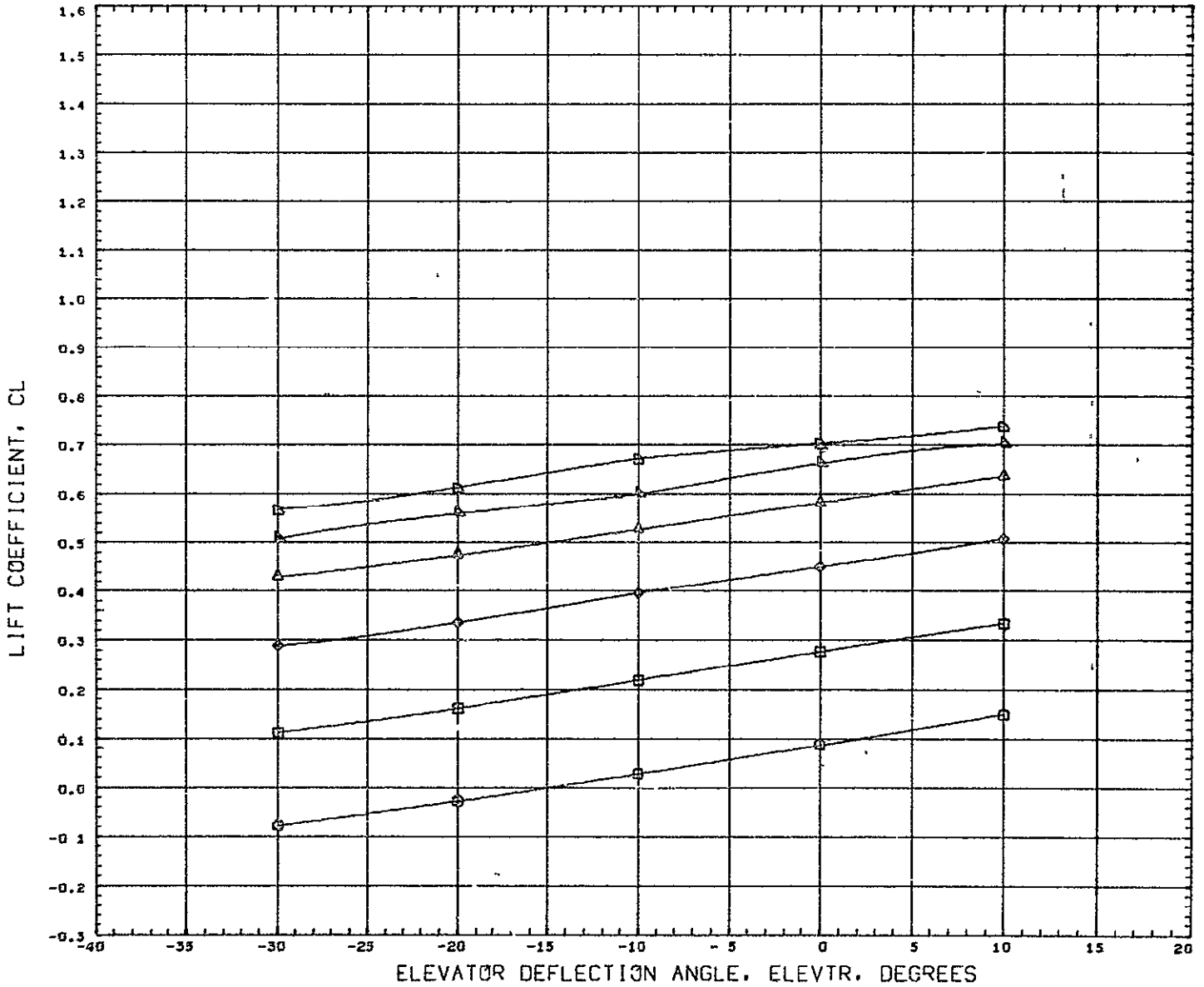

SYMBOL	ALPHA	PARAMETRIC VALUES
○	4.000	MACH 0.259 BETA 0.000
□	8.000	NUDVTR 0.000 FLAPS 0.000
◇	4.000	SFOILR 0.000
△	8.000	
▽	12.000	
⊠	16.000	DATA HIST. CODE SI

REFERENCE INFORMATION		
REFS	316.2304	SQ IN
REFL	50.1900	IN
REFB	7.3500	IN
XMRF	27.3840	IN
YMRF	0.0000	IN
ZMRF	0.0000	IN
SCALE	0.0175	

LONGITUDINAL TRIM CHAR. - STRAIGHT WING BASIC POS. - V-TAIL=55DEG - X/L = 0.60

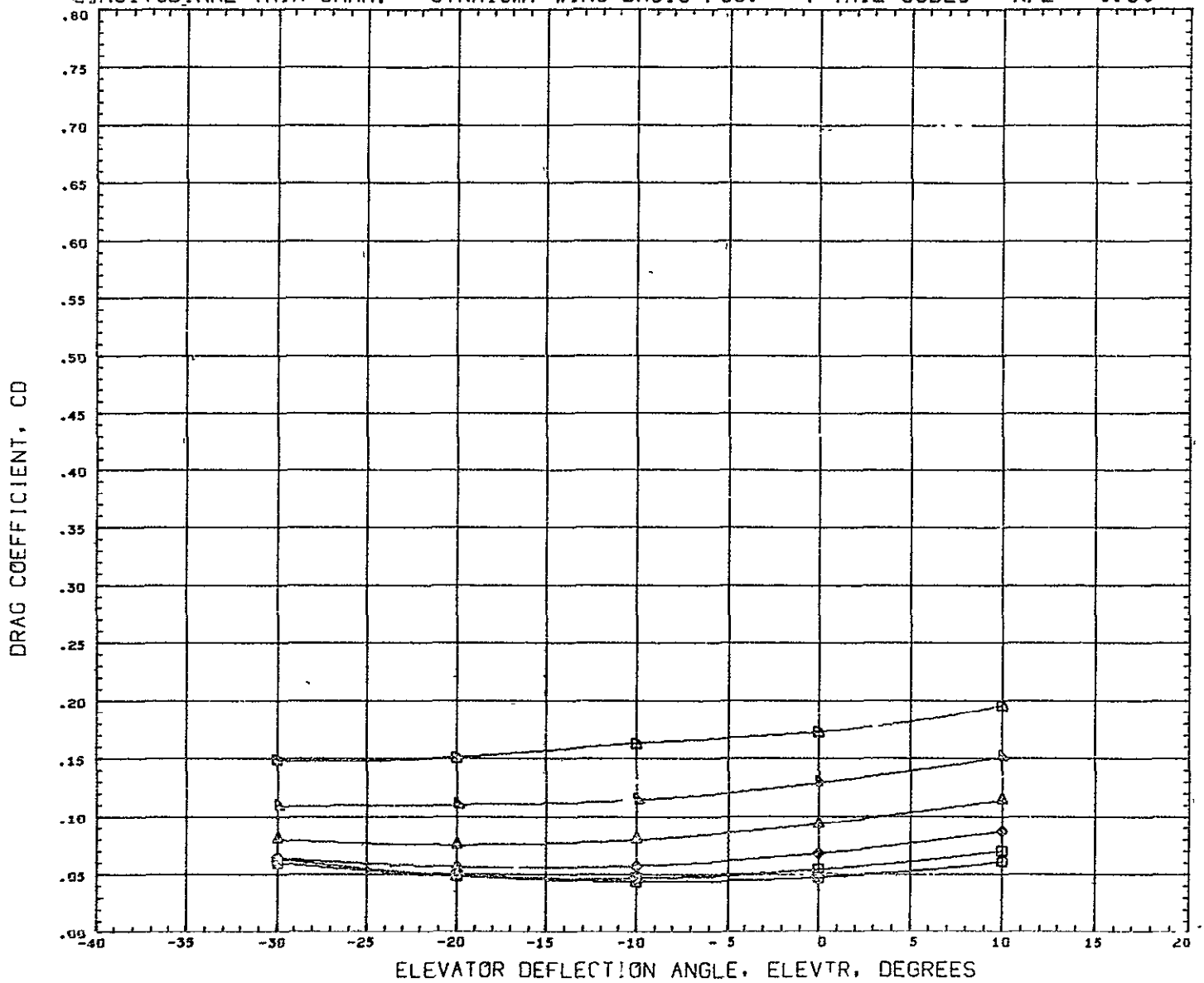

ELEVATOR DEFLECTION ANGLE, ELEVTR, DEGREES

SYMBOL	ALPHA	PARAMETRIC VALUES				REFERENCE INFORMATION		
○	4.000	MACH	0.259	BETA	0.000	REFS	316 2304	SQ IN
□	8.000	RJCYTR	0.000	FLAPS	0.000	REFL	50.1306	IN
◇	4.000	SFOILE	0.000			REFB	7 3500	IN
△	8.000					XMRP	27 3846	IN
▽	12.000					YHRF	0 0000	IN
D	16.000	DATA HIST. CODE	51			ZHRF	0.0000	IN
						SCALE	0.0175	

LONGITUDINAL TRIM CHAR. - STRAIGHT WING BASIC POS. - V-TAIL=55DEG - X/L = 0.64

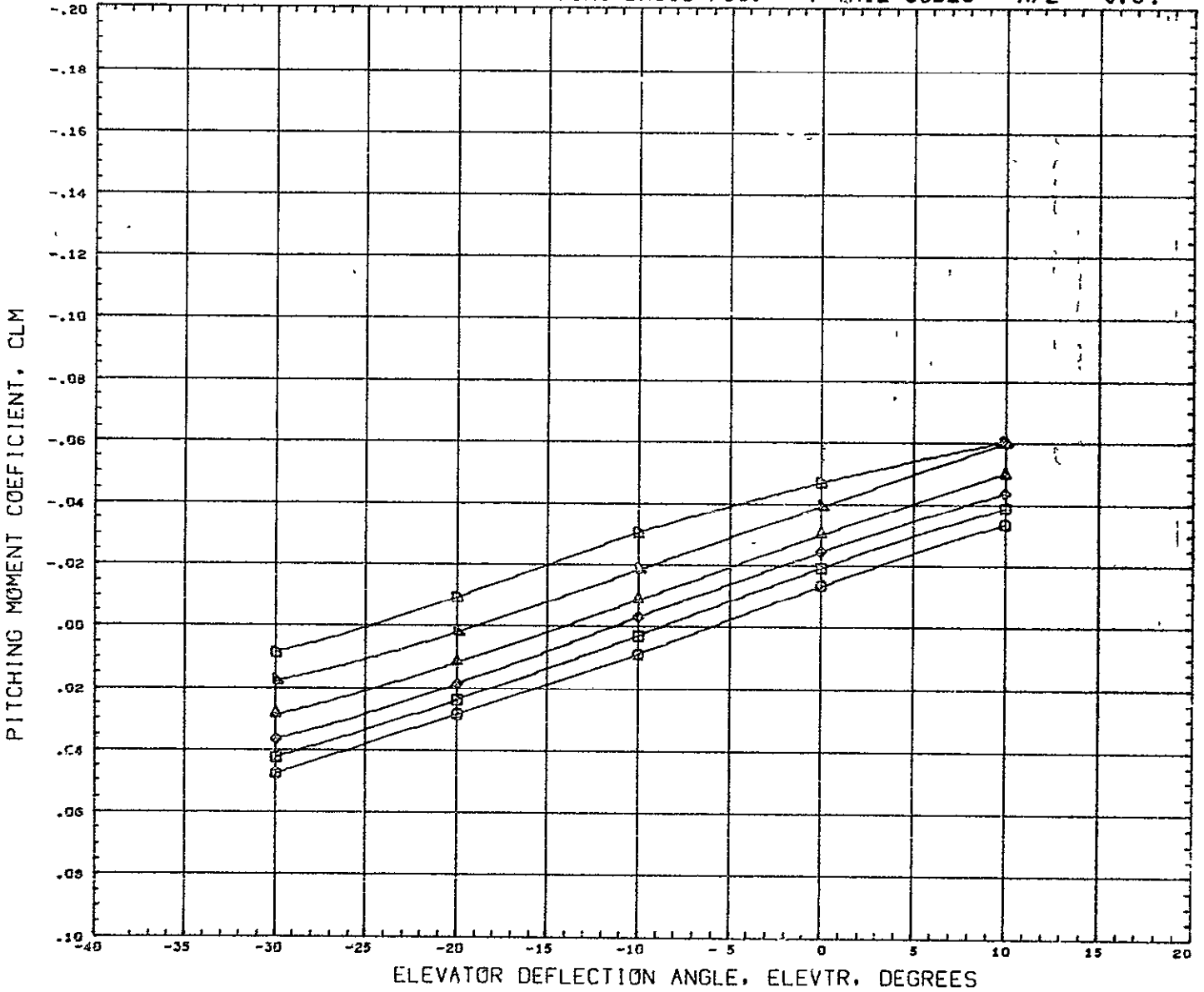

SYMBOL	ALPHA	PARAMETRIC VALUES			
○	4.000	HACH	0.259	BETA	0.000
□	6.000	RUDVTR	0.000	FLAFS	0.000
◇	8.000	SPOILR	0.000		
△	10.000				
▽	12.000				
◊	14.000	DATA HIST. CODE	1		

REFERENCE INFORMATION		
REFS	316 2304	SQ IN
REFL	50.1900	IN
REFB	7.3500	IN
XMRP	29.3920	IN
YMRP	0.0000	IN
ZMRP	0.0000	IN
SCALE	0.0175	



LONGITUDINAL TRIM CHAR. - STRAIGHT WING BASIC POS. - V-TAIL=55DEG - X/L = 0.64

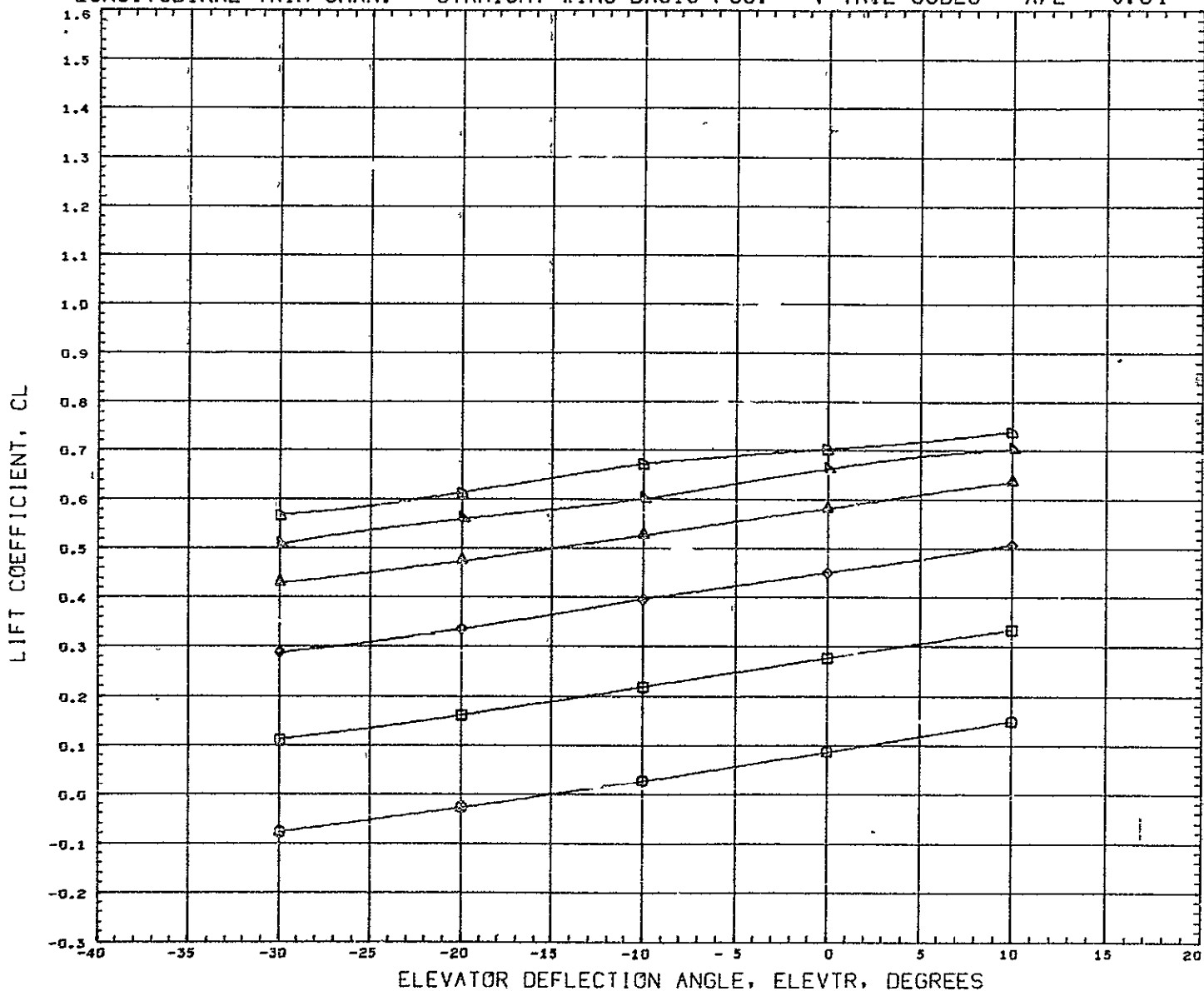

SYMBOL	ALPHA	PARAMETRIC VALUES				REFERENCE INFORMATION		
○	4.000	MACH	0.259	BETA	0.000	REFS	316.2304	SQ IN
□	0.000	RUEVTR	0.000	FLAPS	0.000	REFL	50.1900	IN
◇	4.000	SFOILR	0.000			REFJ	7.3500	IN
△	0.000					XNRF	29.3920	IN
▽	12.000					YMFP	0.0000	IN
⊖	16.000	DATA HIST. CODE	1			ZNRF	0.0000	IN
						SCALE	0.0175	

LONGITUDINAL TRIM CHAR. - STRAIGHT WING BASIC POS. - V-TAIL=55DEG - X/L = 0.64

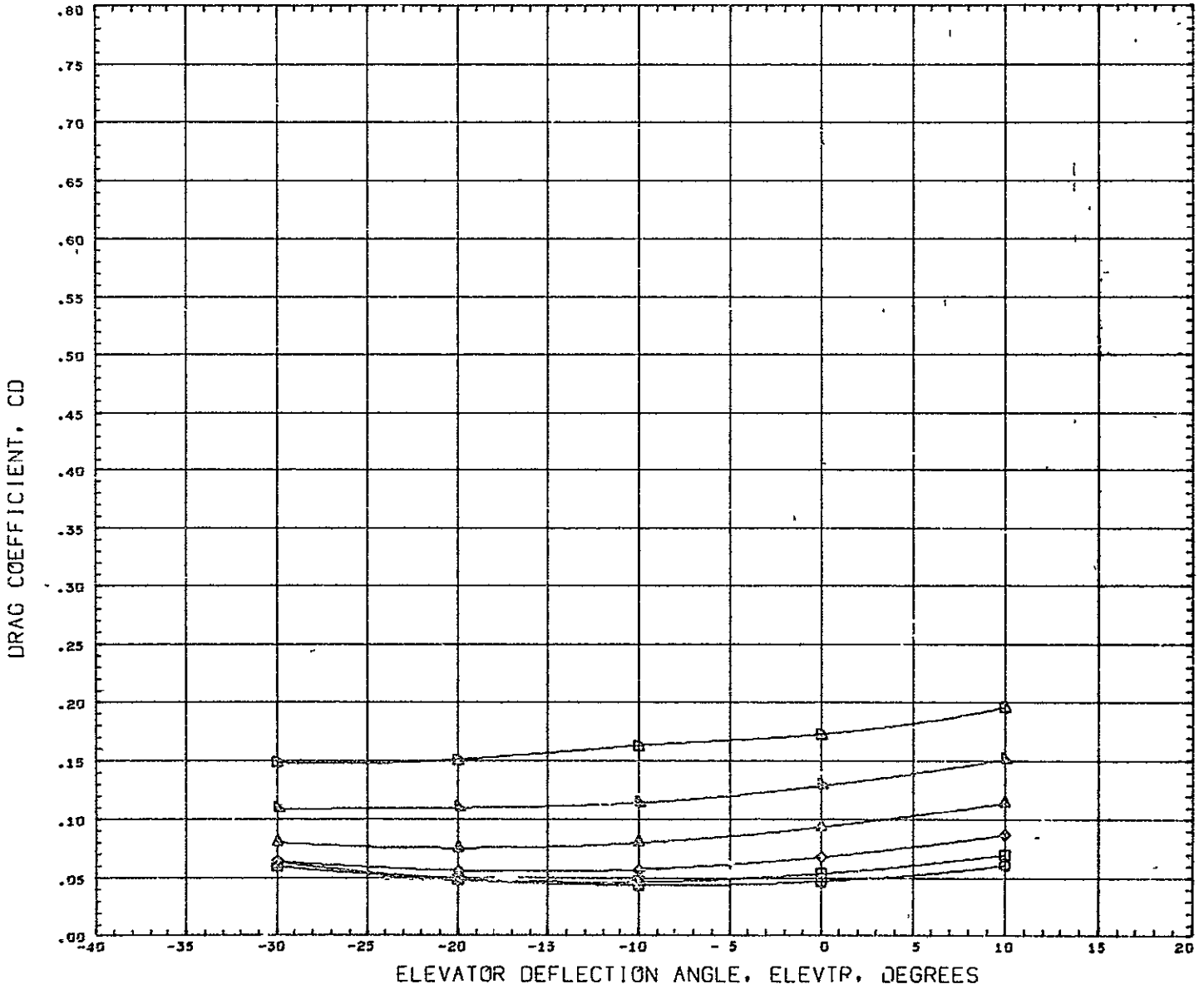

SYMBOL	ALPHA	PARAMETRIC VALUES				REFERENCE INFORMATION		
○	4.000	HACH	5.259	BETA	0.000	REFS	316 2304	SQ IN
□	6.000	FUDVTR	0.000	FLAPS	0.000	REFL	50.1900	IN
◇	8.000	SPOILR	0.000			REFB	7.3500	IN
△	10.000					XMRP	29.3920	IN
▽	12.000					YMRP	0.0000	IN
∩	16.000	DATA HIST CODE	1			ZMRP	0.0000	IN
						SCALE	0.0175	

LONGITUDINAL TRIM CHAR. - STRAIGHT WING BASIC POS. - V-TAIL=55DEG - X/L = 0.68

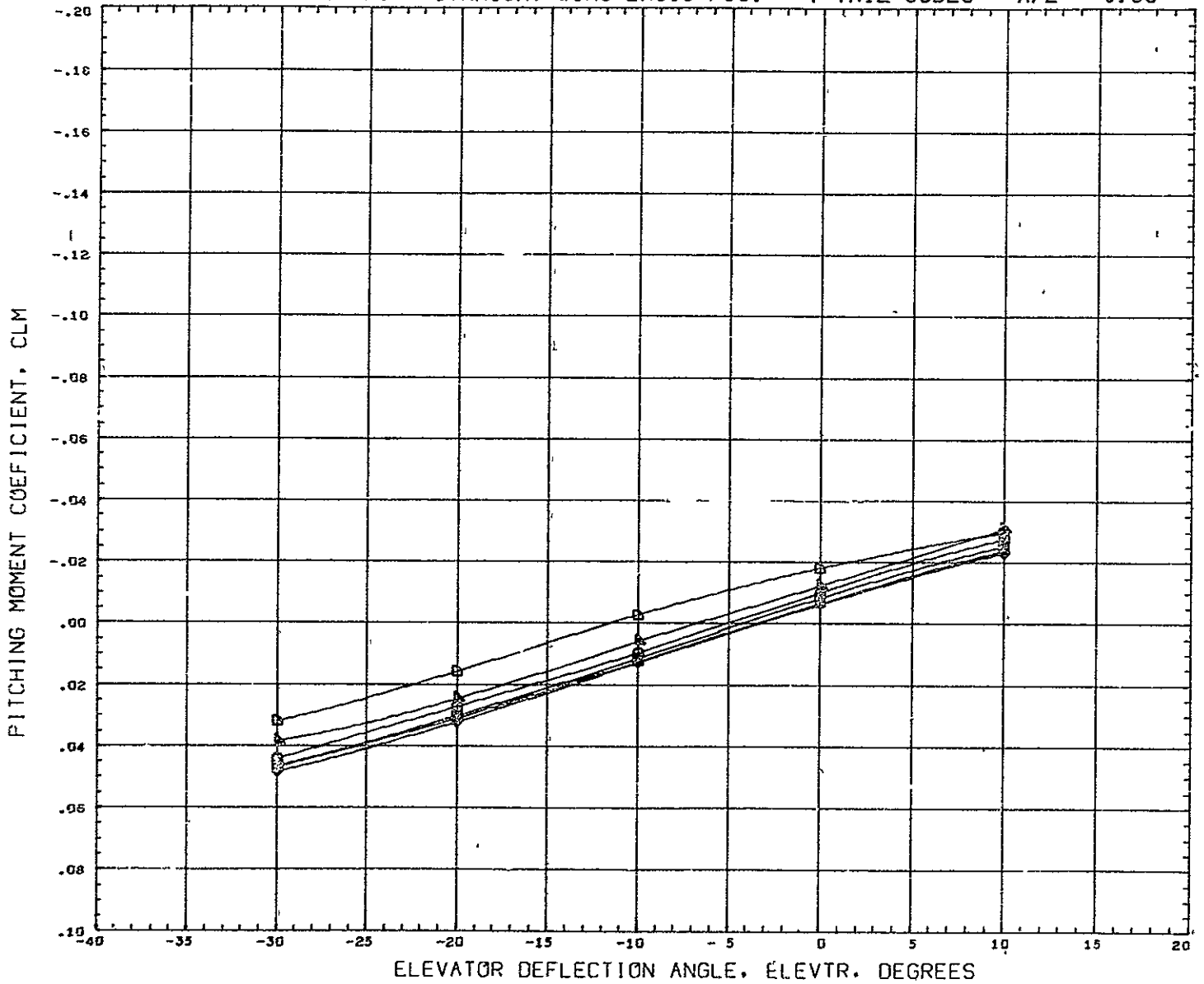

SYMBOL	ALPHA	PARAMETRIC VALUES				REFERENCE INFORMATION		
○	4.000	MACH	0.259	BETA	0.000	REFS	316.2304	SQ IN
□	5.000	FUDYTR	0.000	FLAPS	0.000	REFL	50.1900	IN
◇	4.000	SPOILR	0.000			REFB	7.3500	IN
△	8.000					XNRF	31.3990	IN
▽	12.000					YNRF	0.0000	IN
◊	16.000	DATA HIST. CODE	SI			ZNRF	0.0000	IN
						SCALE	0.0175	

LONGITUDINAL TRIM CHAR. - STRAIGHT WING BASIC POS. - V-TAIL=55DEG - X/L = 0.68

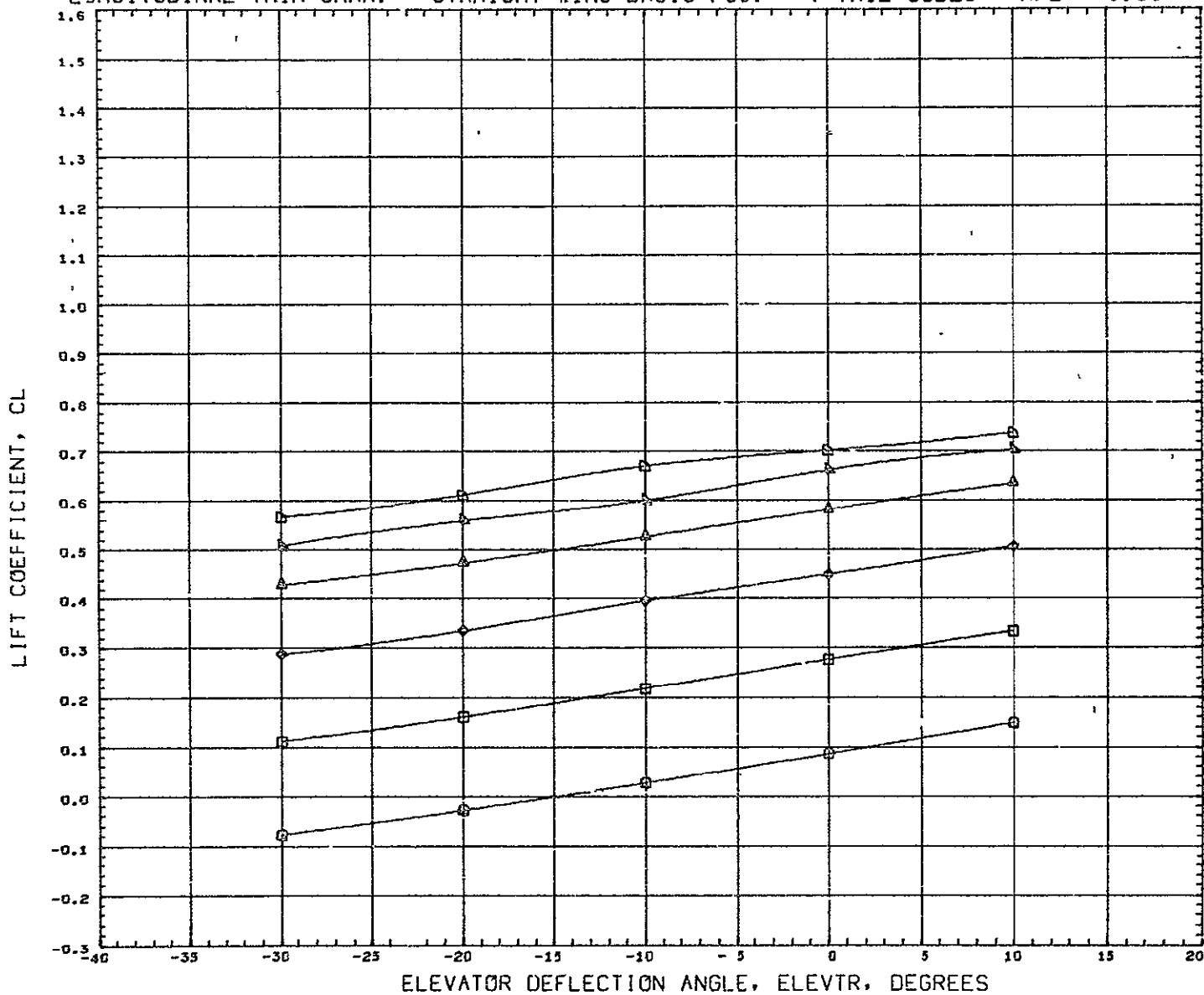

SYMBOL		ALPHA	PARAMETRIC VALUES				REFERENCE INFORMATION		
○	-	4.000	MACH	0.259	BETA	0.000	REFS	316 2304	50 IN
□		0.000	RUD/TR	0.000	FLAPS	0.000	REFL	50 1900	IN
◇		4.000	SFOILR	0.000			REFB	7.3500	IN
△		8.000					XMRP	31.3990	IN
▽		12.000					YMRP	0.0000	IN
◻		16.000	DATA HIST. CODE	SI			ZMRP	0.0000	IN
							SCALE	0.0175	

LONGITUDINAL TRIM CHAR. - STRAIGHT WING BASIC POS. - V-TAIL=55DEG - X/L = 0.68

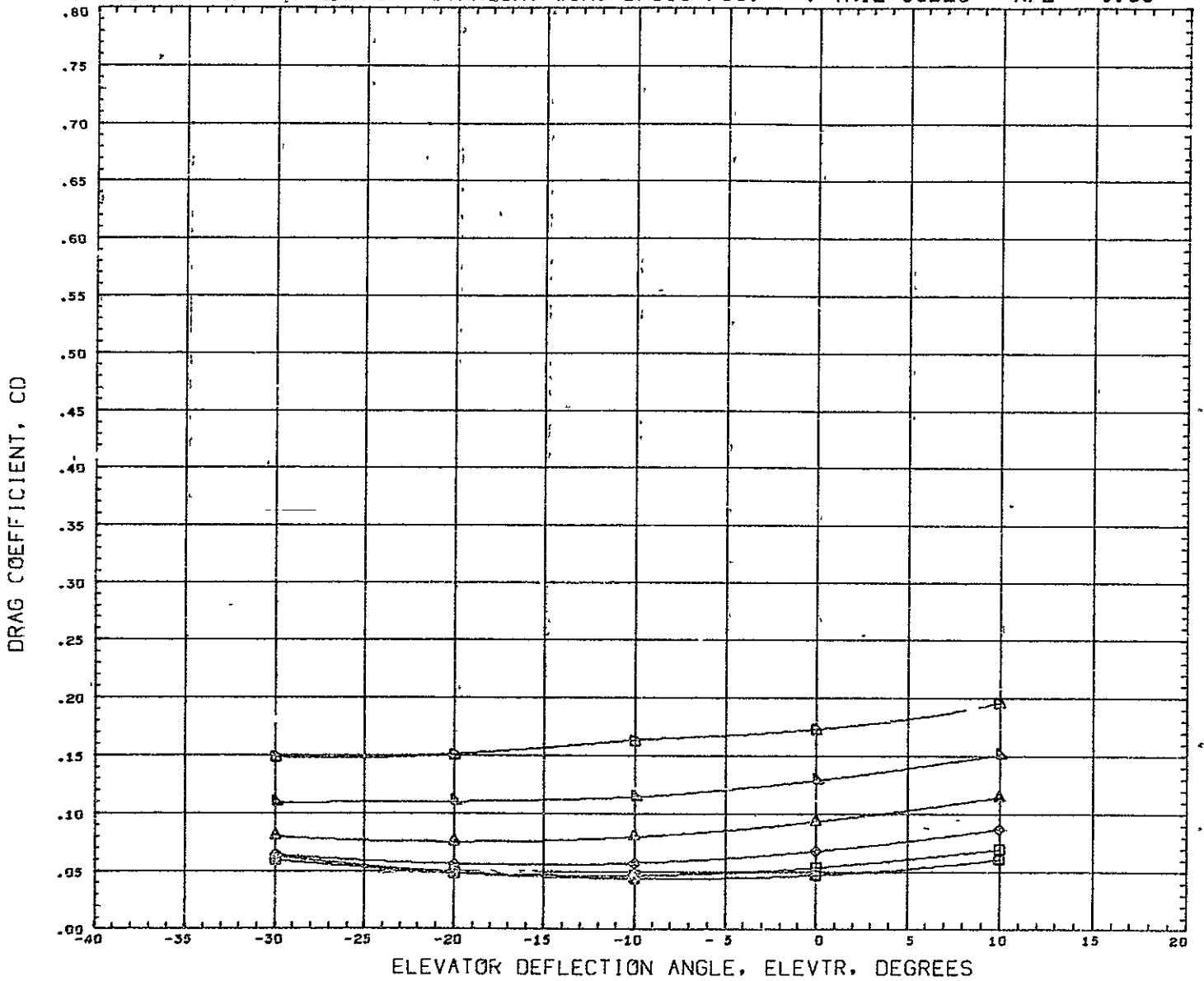

ELEVATOR DEFLECTION ANGLE, ELEVTR, DEGREES

SYMBOL	ALPHA	PARAMETRIC VALUES				REFERENCE INFORMATION		
○	4.000	HACH	0.259	BETA	0.000	REFS	316 2304	SQ IN
□	0.000	ELEVTR	0.000	FLAPS	0.000	REFL	50.1900	IN
◇	4.000	SFOILR	0.5			PEFB	7 3500	IN
△	6.000					XNRF	31 3990	IN
▽	12.000					YMRF	0.0000	IN
◇	16.000	DATA HIST. CODE	51			ZNRF	0.0000	IN
						SCALE	0.0175	

LONG. TRIM CHAR.- ST. WING BASIC POS.- FLAPS AND GEAR - V-TAIL=55DEG- X/L = 0.56

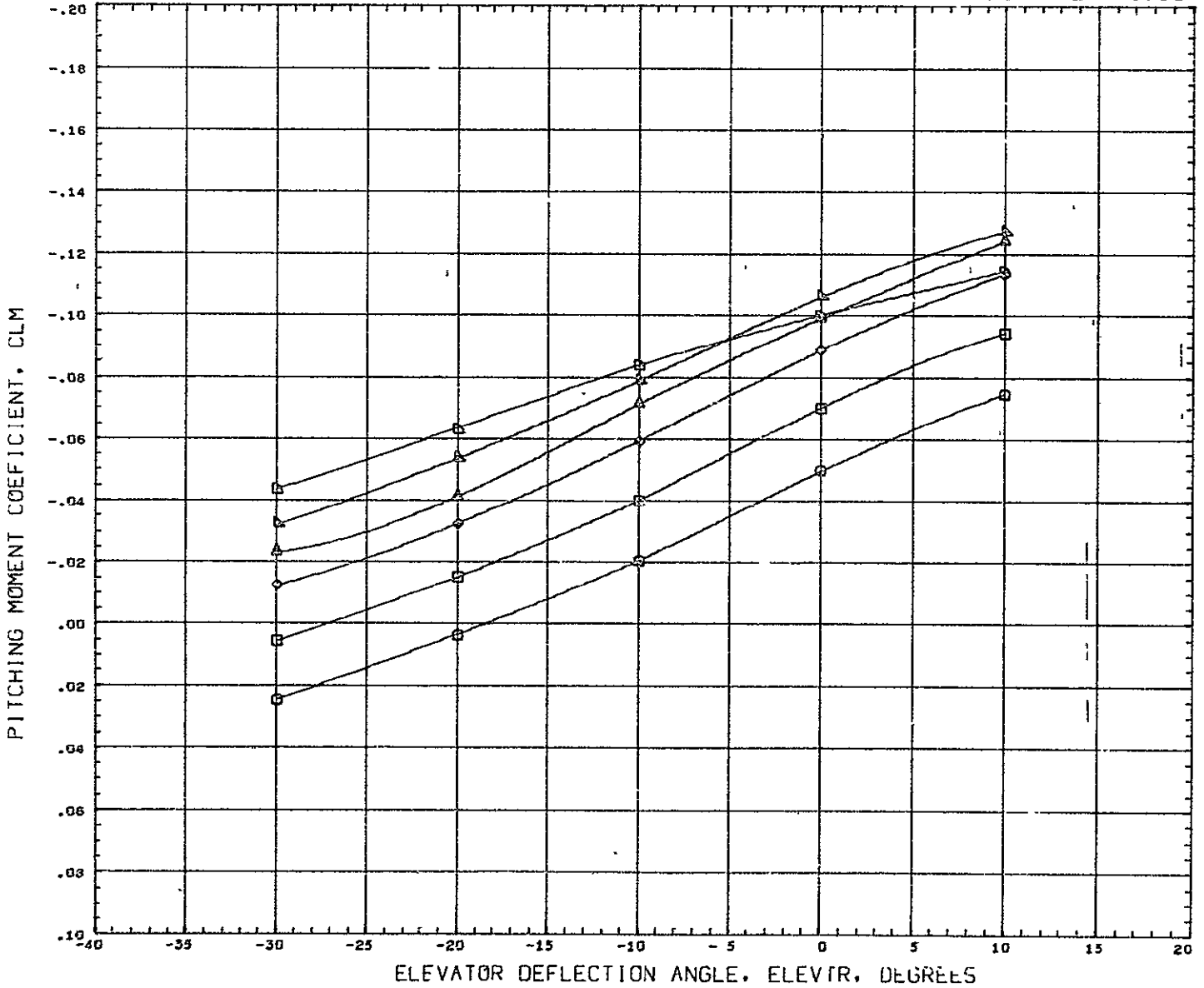

SYMBOL	ALPHA	PARAMETRIC VALUES	REFERENCE INFORMATION
○	4.000	MACH 0.184 BETA 0.000	REFS 316.2304 SQ IN
□	6.000	RUDYTR 0.000 FLAPS 45.000	REFL 50.1900 IN
◇	4.000	SPOILR 0.000	REFB 7.3500 IN
△	6.000		XMRP 25.3760 IN
▽	12.000		YMRP 0.0000 IN
◻	16.000	DATA HIST. CODE SI	ZMRP 0.0000 IN
			SCALE 0.0175

LONG. TRIM CHAR. - ST. WING BASIC POS. - FLAPS AND GEAR - V-TAIL=55DEG- X/L = 0.56

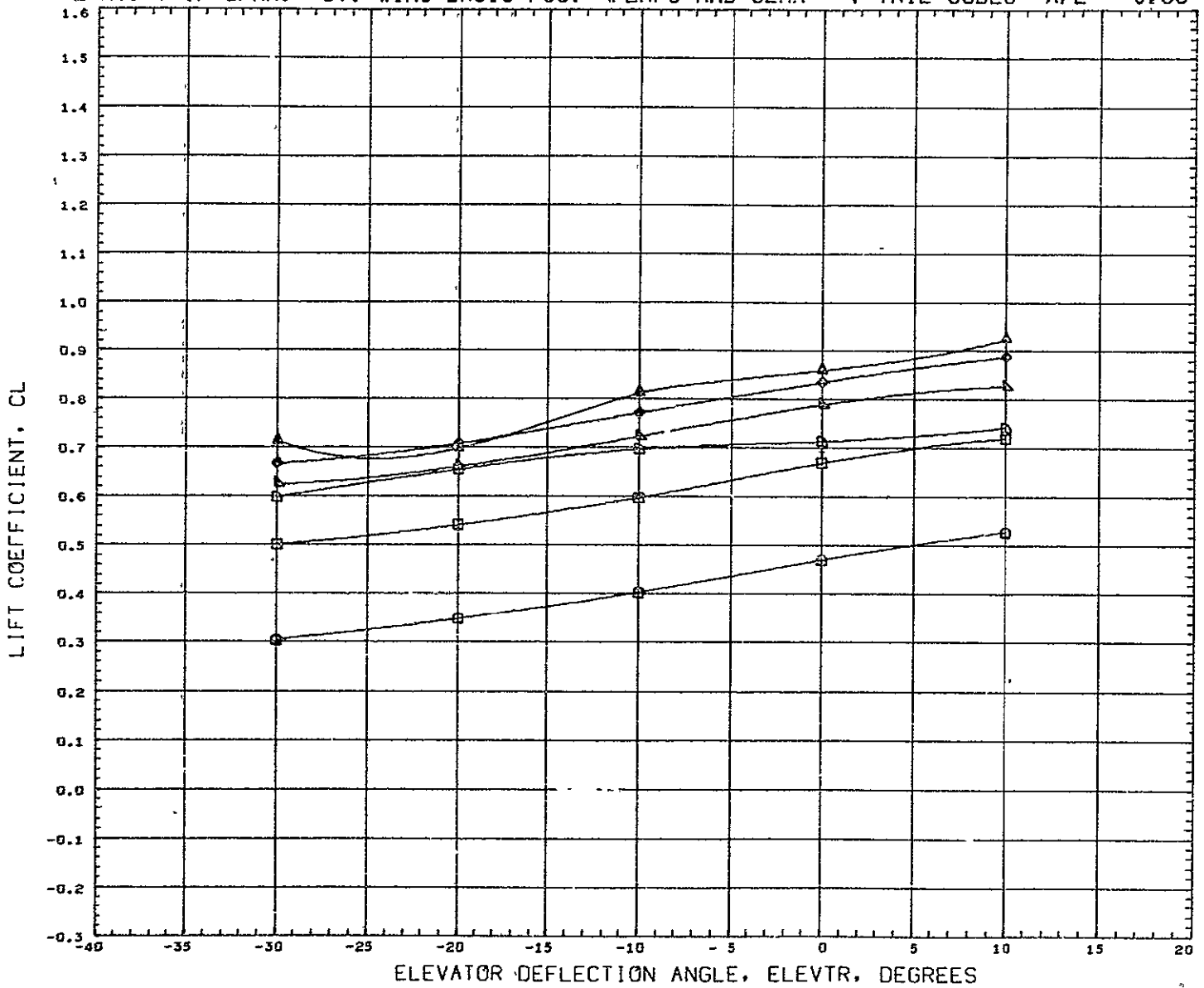

SYMBOL		ALPHA	PARAMETRIC VALUES				REFERENCE INFORMATION		
○	-	4.000	MACH	0.184	BETA	0.000	REFS	316.2304	SQ IN
□		0.000	RUDVTR	0.000	FLAPS	45.000	REFL	50.1900	IN
◇		4.000	SFOILR	0.000			REFB	7.3500	IN
△		8.000					XMRP	25.3760	IN
▽		12.000					YMRP	0.0000	IN
◻		16.000	DATA HIST. CODE	51			ZMRP	0.0000	IN
							SCALE	0.0175	

LONG. TRIM CHAR.- ST. WING BASIC POS.- FLAPS AND GEAR - V-TAIL=55DEG- X/L = 0.56

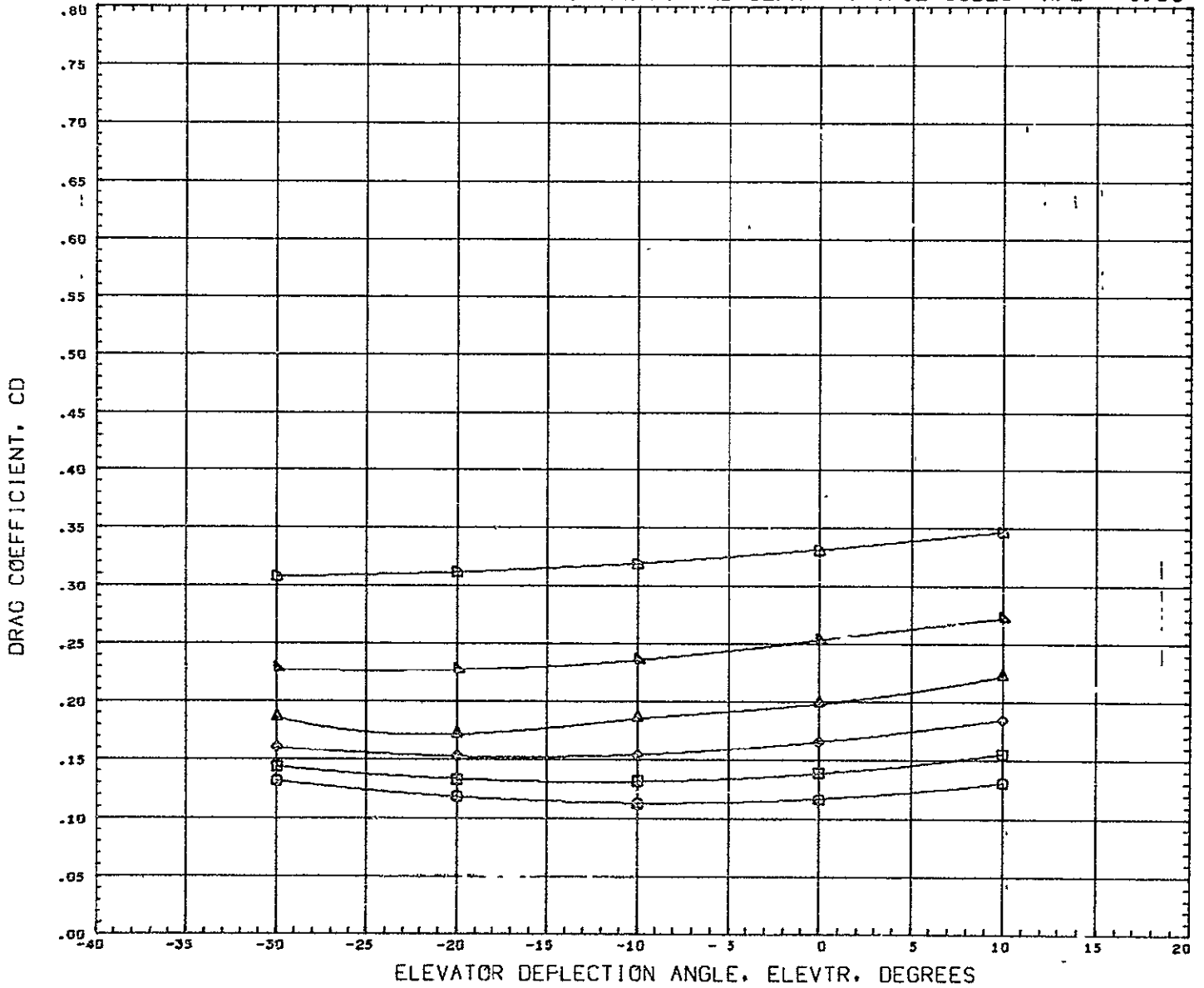

SYMBOL	ALPHA	PARAMETRIC VALUES				REFERENCE INFORMATION		
○	4.000	HACH	0.184	BETA	0.000	REFS	316 2304	SQ IN
□	0.000	RCDVTR	0.000	FLAPS	45.000	REFL	50.1900	IN
◇	4.000	SPOILR	0.000			REFS	7.3500	IN
△	8.000					XMRP	25 3760	IN
▽	12.000					YMRP	0.0000	IN
◻	16.000	DATA HIST. CODE	S1			ZMRP	0 0000	IN
						SCALE	0.0175	



LONG. TRIM CHAR. - ST. WING BASIC POS. - FLAPS AND GEAR - V-TAIL=55DEG- X/L = 0.60

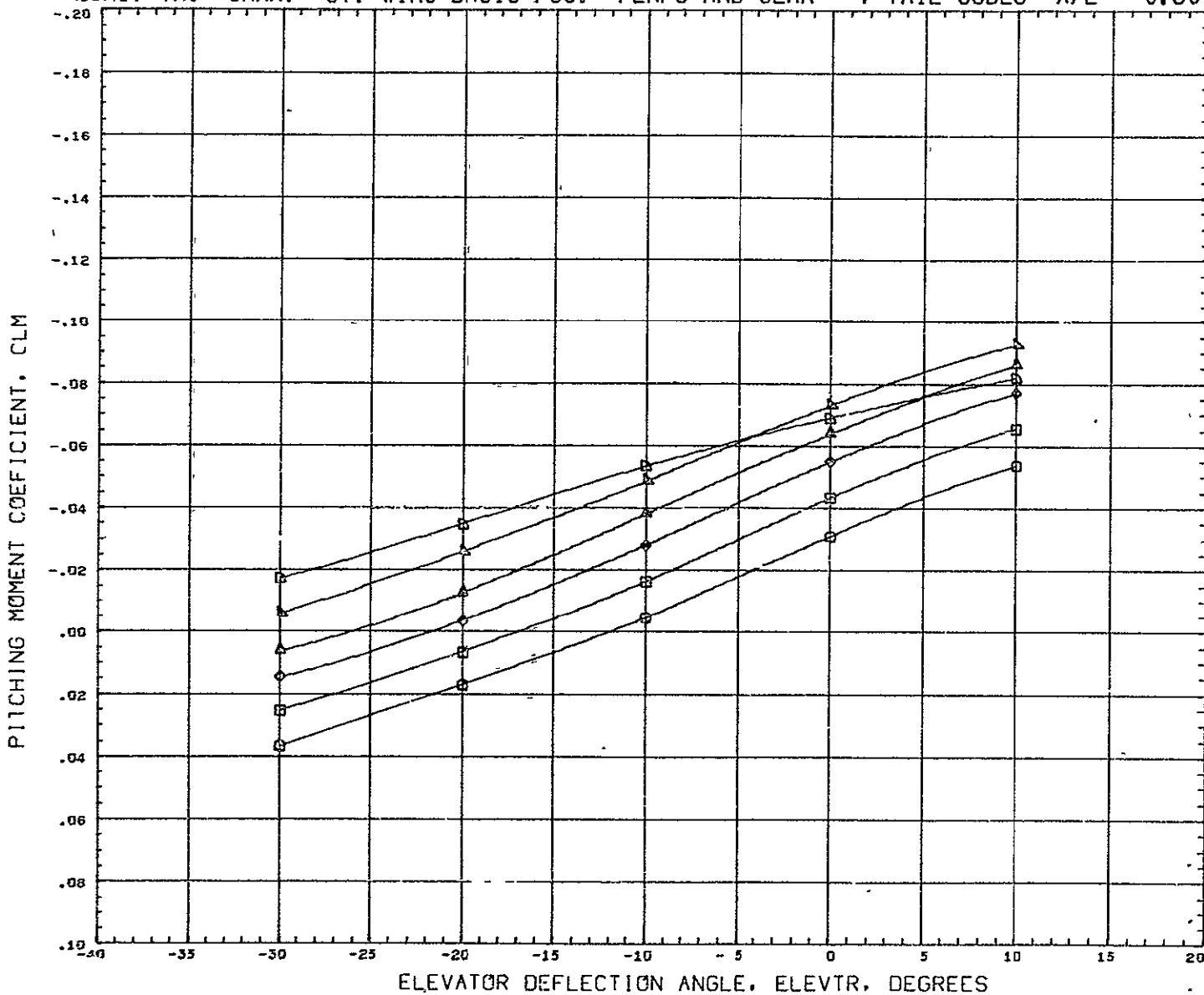

SYMBOL		ALPHA	PARAMETRIC VALUES				REFERENCE INFORMATION		
○	-	4.000	MACH	0.184	BETA	0.000	REFS	316 2304	SQ IN
□		0.000	RUDVTR	0.000	FLAPS	45.000	REFL	50 1900	IN
◇		4.000	SFOILR	0.000			REFB	7.3500	IN
△		8.000					XMRP	27.3840	IN
▽		12.000					YMRP	0 0000	IN
◊		16.000	DATA HIST. CODE	51			ZMRP	0 0000	IN
							SCALE	0 0175	

LONG. TRIM CHAR. ST. WING BASIC POS.- FLAPS AND GEAR - V-TAIL=55DEG- X/L = 0.60

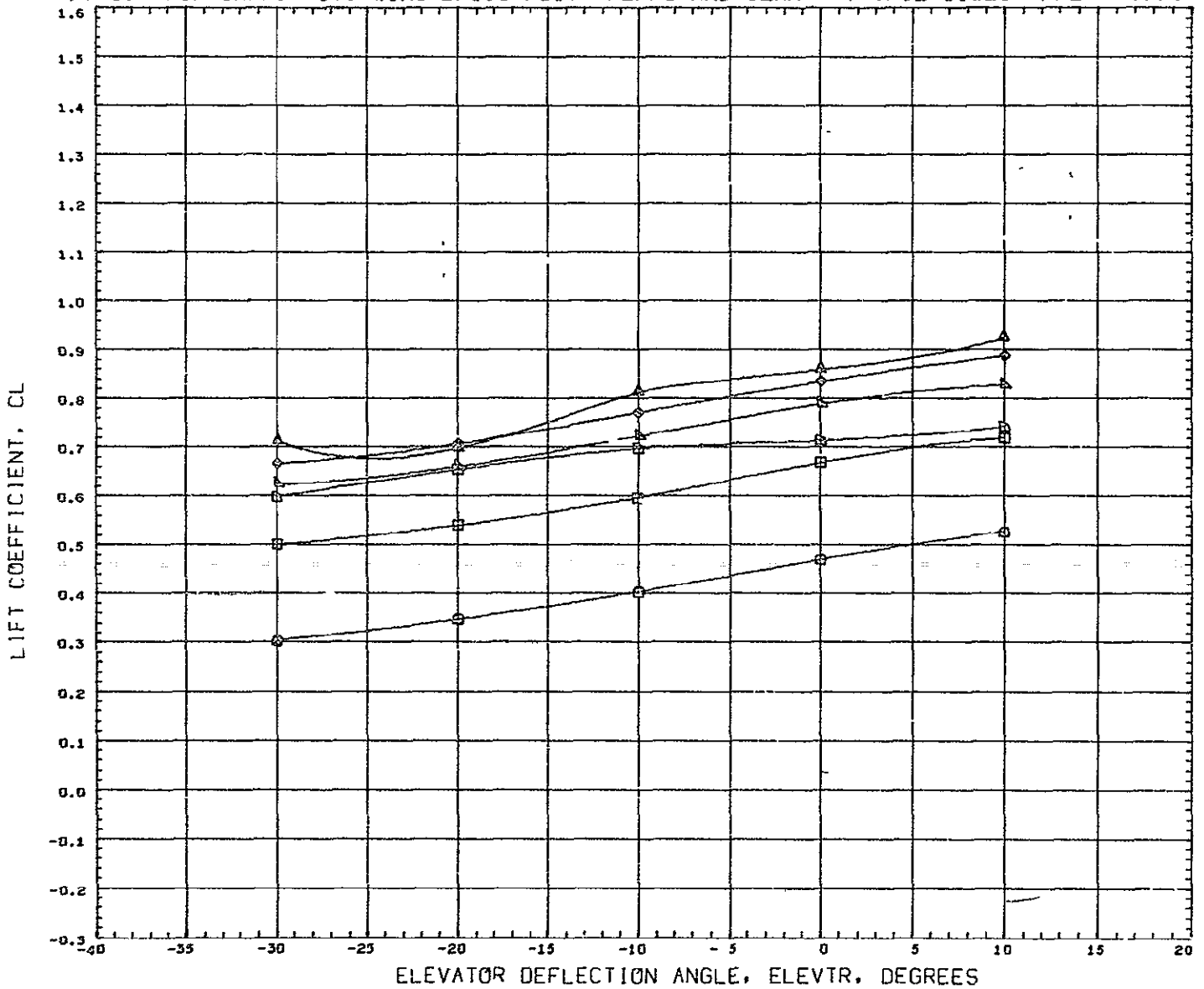

PARAMETRIC VALUES				REFERENCE INFORMATION		
SYMBOL	ALPHA	MACH	BETA	REFS	IN	IN
○	4.000	0.184	0.000	316.2304	50.1900	7.3500
□	0.000	FLAPS	45.000	27.3840	0.0000	0.0000
△	8.000			0.0000	0.0000	0.0175
◇	12.000					
DATA HIST. CODE	SI					

LONG. TRIM CHAR. - ST. WING BASIC POS. - FLAPS AND GEAR - V-TAIL=55DEG- X/L = .0.60

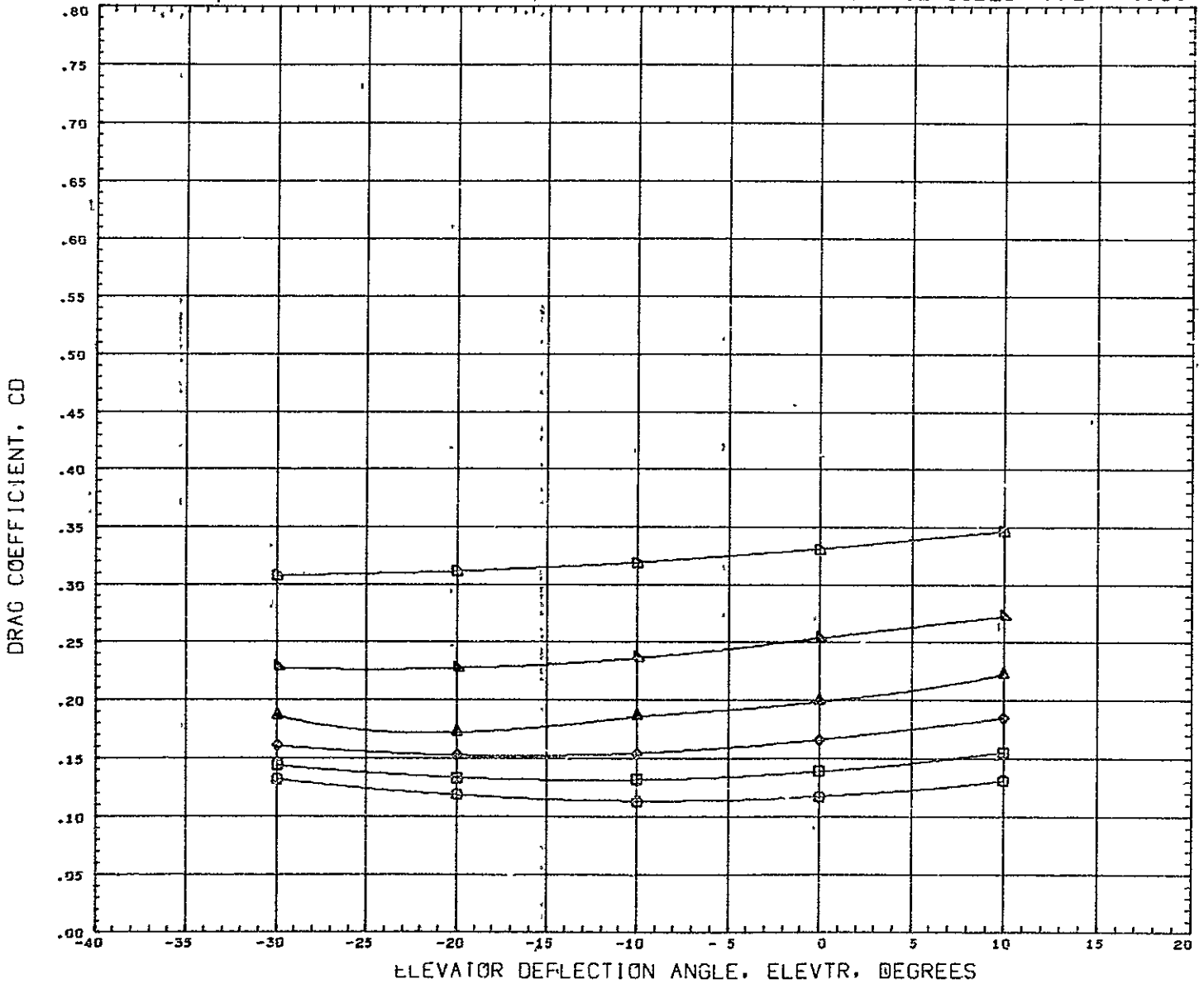

SYMBOL	ALPHA	PARAMETRIC VALUES	REFERENCE INFORMATION
○	4.000	MACH 0.184 BETA 0.000	REFS 316 2304 SQ IN
◻	6.000	RUDVTR 0.000 FLAPS 45.000	REFL 50 1900 IN
◇	4.000	SFOILR 0.000	REFB 7.3500 IN
△	8.000		XNRF 27.3840 IN
▽	12.000		YHRF 0.0000 IN
◊	16.000		ZHRF 0.0000 IN
		DATA HIST. CODE SI	SCALE 0.0175

LONG. TRIM CHAR. - ST. WING BASIC POS. - FLAPS AND GEAR - V-TAIL=55DEG- X/L = 0.64

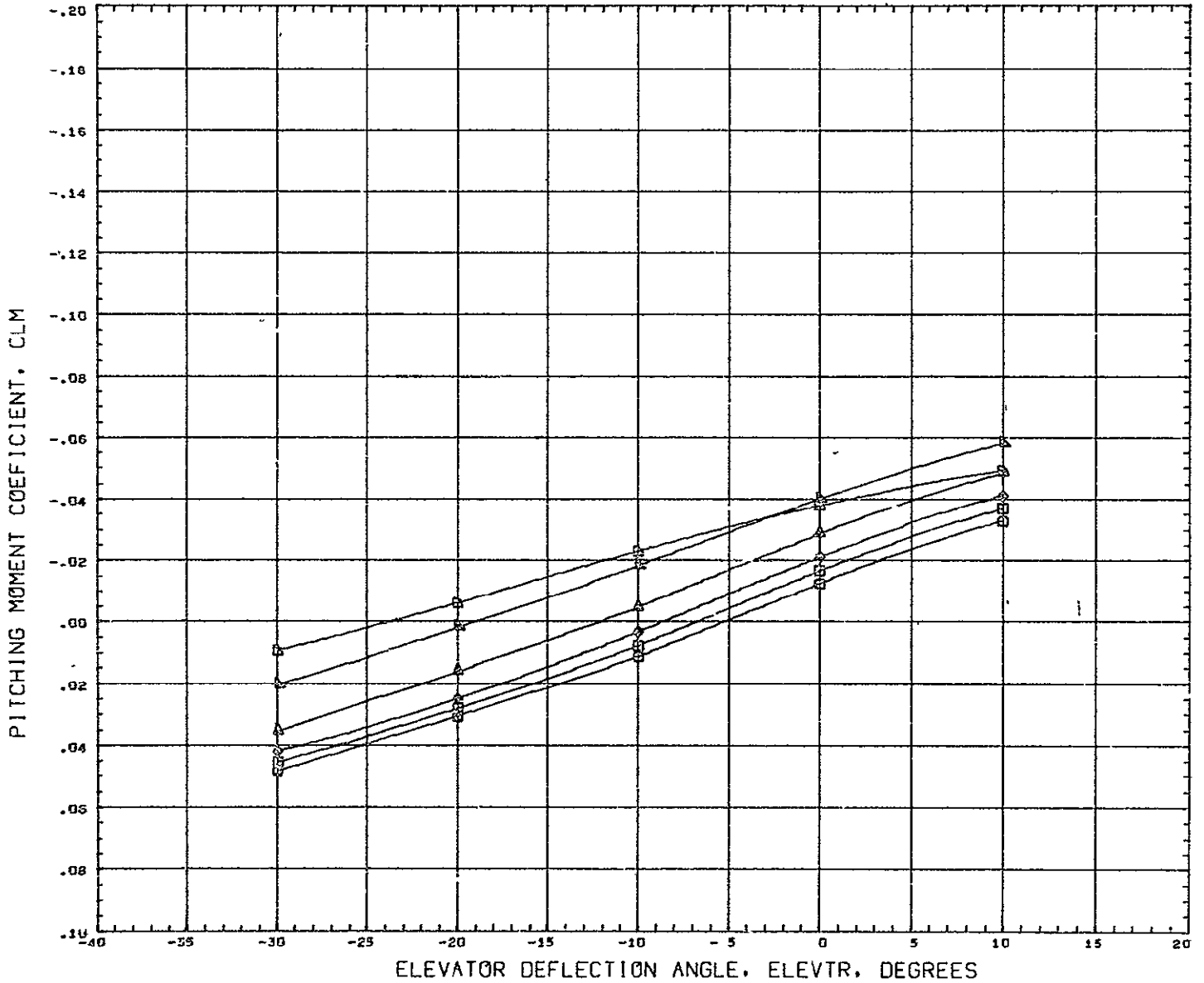

SYMBOL		ALPHA	PARAMETRIC VALUES				REFERENCE INFORMATION		
□	-	4.000	MACH	0.184	BETA	0.000	REFS	316.2304	SQ IN
□		8.000	RUDVTR	0.000	FLAPS	45.000	REFL	50 1900	IN
◇		12.000	SFOILR	0.000			REFB	7 3500	IN
△		16.000					XMRP	29 3920	IN
△							YMRP	0 0000	IN
△							ZMRP	0 0000	IN
□			DATA HIST. CODE	1			SCALE	0 0175	

LONG. TRIM CHAR.- ST. WING BASIC POS.- FLAPS AND GEAR - V-TAIL=55DEG- X/L = 0.64

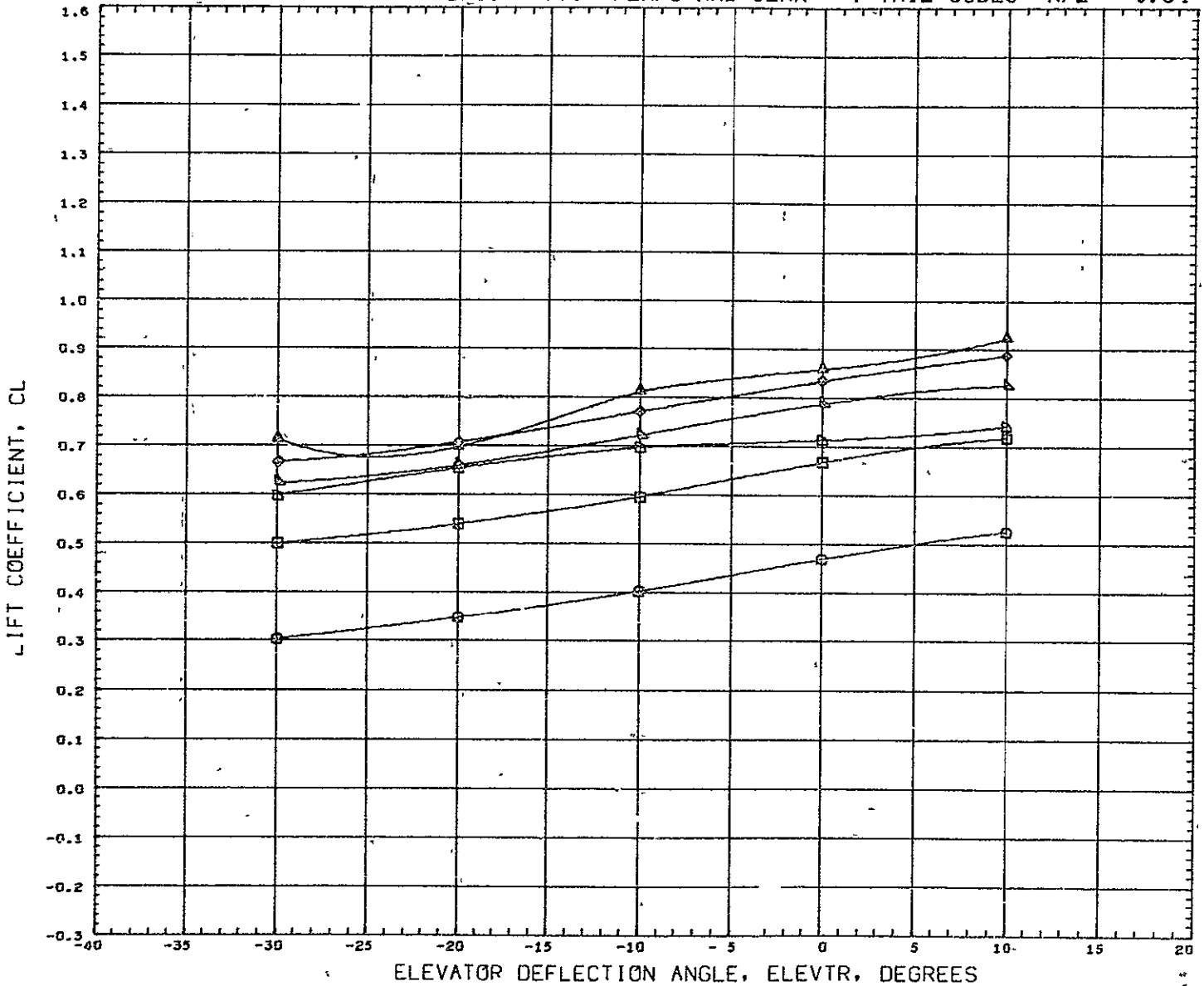

SYMBOL	ALPHA	PARAMETRIC VALUES				REFERENCE INFORMATION		
○	4.000	MACH	0.184	BETA	0.000	REFS	316.2304	SQ IN
□	5.000	SUDVTR	0.000	FLAPS	45.000	REFL	50.1900	IN
◇	4.000	SPOILR	0.000			REFB	7.3500	IN
△	6.000					XMRP	29.3920	IN
▽	12.000					YMRP	0.0000	IN
◻	16.000	DATA HIST. CODE	1			ZMRP	0.0000	IN
						SCALE	0.0175	

LONG. TRIM CHAR.- ST. WING BASIC POS.- FLAPS AND GEAR - V-TAIL=55DEG- X/L = 0.64

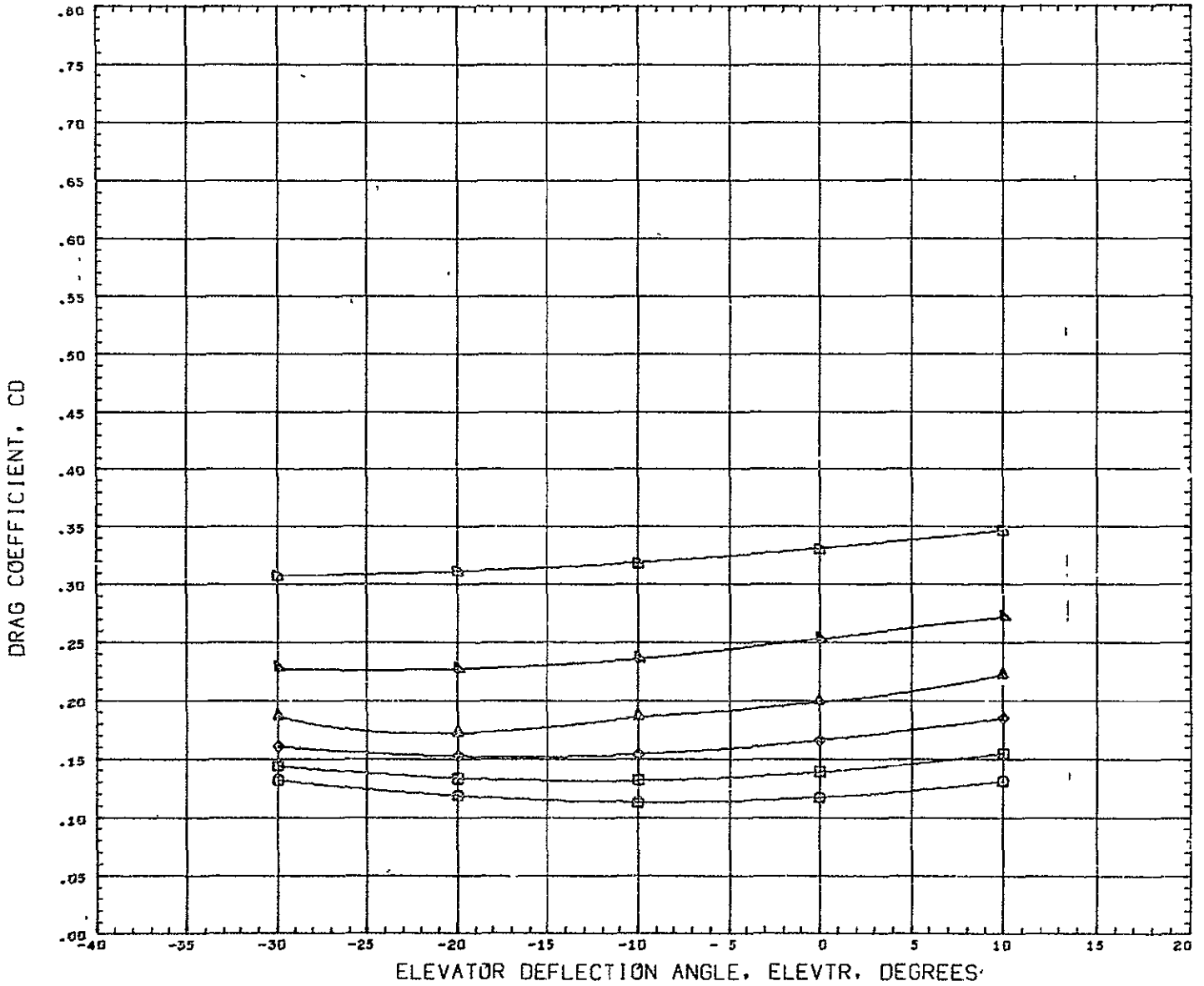

SYMBOL	ALPHA	PARAMETRIC VALUES				REFERENCE INFORMATION	
□	4.000	HACH	0.194	BETA	0.000	REFS	316.2304 SQ IN
◇	0.000	RUDVTR	0.000	FLAPS	45.000	REFL	50.1900 IN
◇	4.000	SFOILR	0.000			REFB	7.3500 IN
△	8.000					XMRP	29.3920 IN
▽	12.000					YHRF	0.0000 IN
○	16.000					ZMRP	0.0000 IN
		DATA HIST. CODE	I			SCALE	0.0175

LONG. TRIM CHAR.- ST. WING BASIC POS.- FLAPS AND GEAR - V-TAIL=55DEG- X/L = 0.68

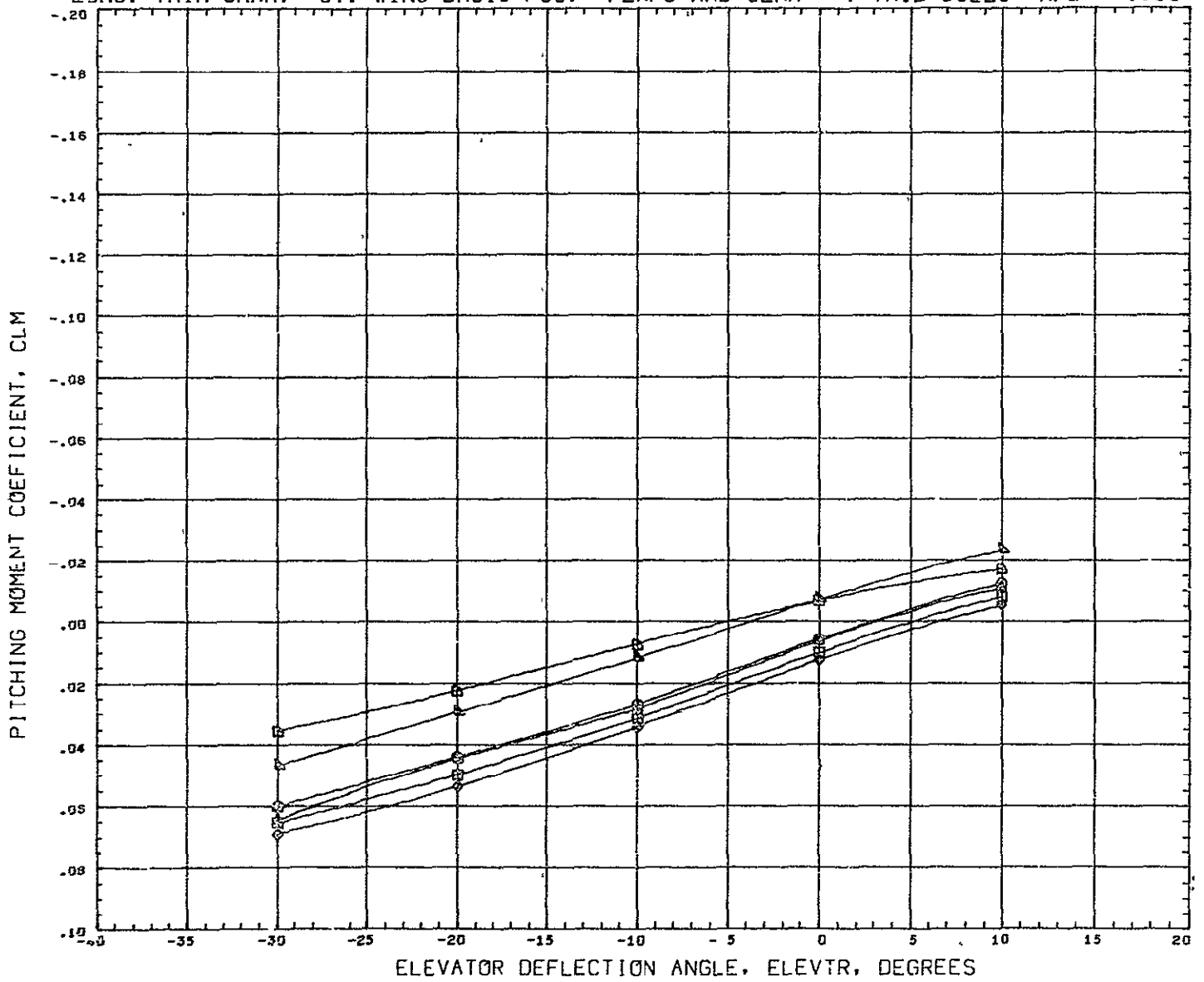

SYMBOL	ALPHA	PARAMETRIC VALUES				REFERENCE INFORMATION		
		MACH	BETA	FLAPS	REFS	SQ	IN	
○	4.000	0.184	0.000	45.000	316	2304	SQ IN	
□	8.000	0.000	0.000	0.000	50	1900	IN	
◇	4.000	0.000	0.000	0.000	7	3500	IN	
△	8.000	0.000	0.000	0.000	31	3990	IN	
▽	12.000	0.000	0.000	0.000	0	0000	IN	
◇	16.000	0.000	0.000	0.000	ZMRF	0.0000	IN	
		DATA HIST. CODE	S1		SCALE	0.0175		

LONG. TRIM CHAR.- ST. WING BASIC POS.- FLAPS AND GEAR - V-TAIL=55DEG- X/L = 0.68

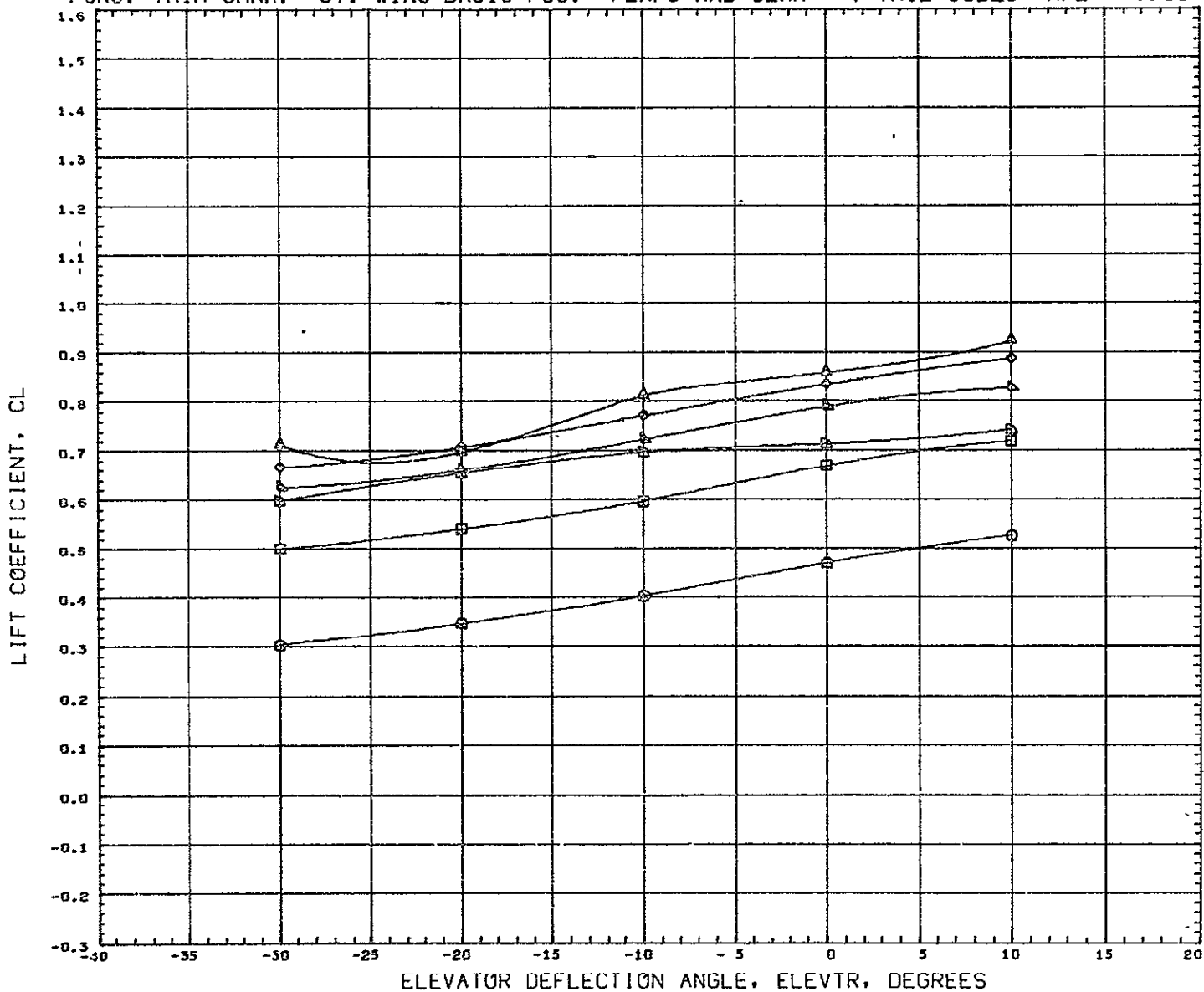

SYMBOL	ALPHA	PARAMETRIC VALUES				REFERENCE INFORMATION		
○	4.000	MACH	0.184	BETA	0.000	REFS	316.2304	SQ IN
□	6.000	RUDVTR	0.000	FLAPS	45.000	REFL	50.1900	IN
◇	8.000	SFOILR	0.000			REFB	7.3500	IN
△	10.000					XMRP	31.3990	IN
▽	12.000					YMRP	0.0000	IN
◇	16.000	DATA HIST. CODE	SI			ZMRP	0.0000	IN
						SCALE	0.0175	



LONG. TRIM CHAR. - ST. WING BASIC POS. - FLAPS AND GEAR - V-TAIL=55DEG- X/L = 0.68

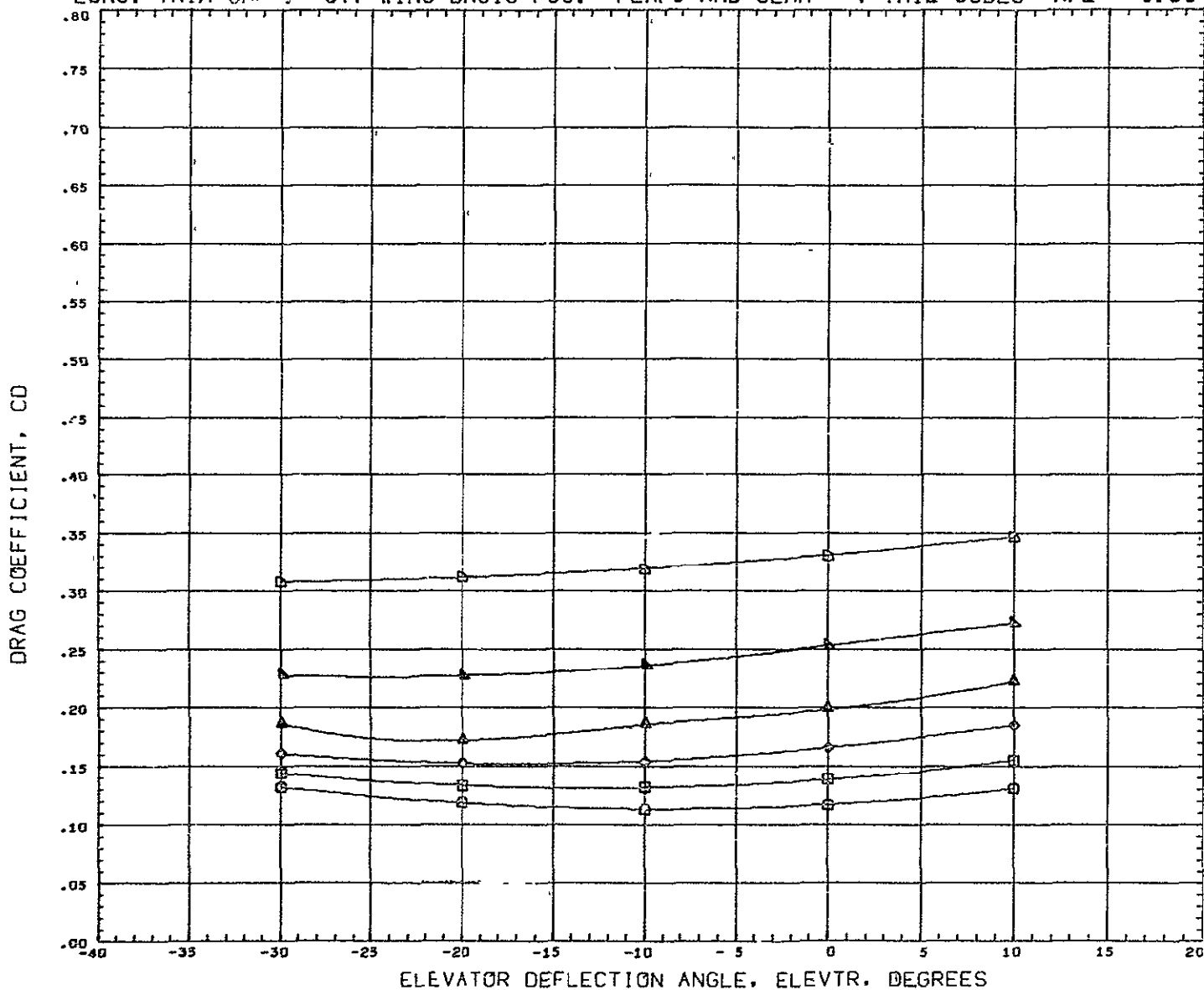

SYMBOL	ALPHA	PARAMETRIC VALUES				REFERENCE INFORMATION		
○	4.000	MACH	0.184	BETA	0.000	REFS	316 2304	SQ IN
□	6.000	RUDYTR	0.000	FLAPS	45.000	REFL	50.1900	IN
◇	8.000	SFOILR	0.000			PEFB	7.3500	IN
△	12.000					XMRP	31.3990	IN
▽	16.000					YMRP	0.0000	IN
D		DATA HIST. CODE	SI			ZMRP	0.0000	IN
						SCALE	0.0175	

LONG. TRIM CHAR.- ST. WING BASIC- CONVENT. HORIZ-VERT TAIL WITH FLAPS- X/L=0.56

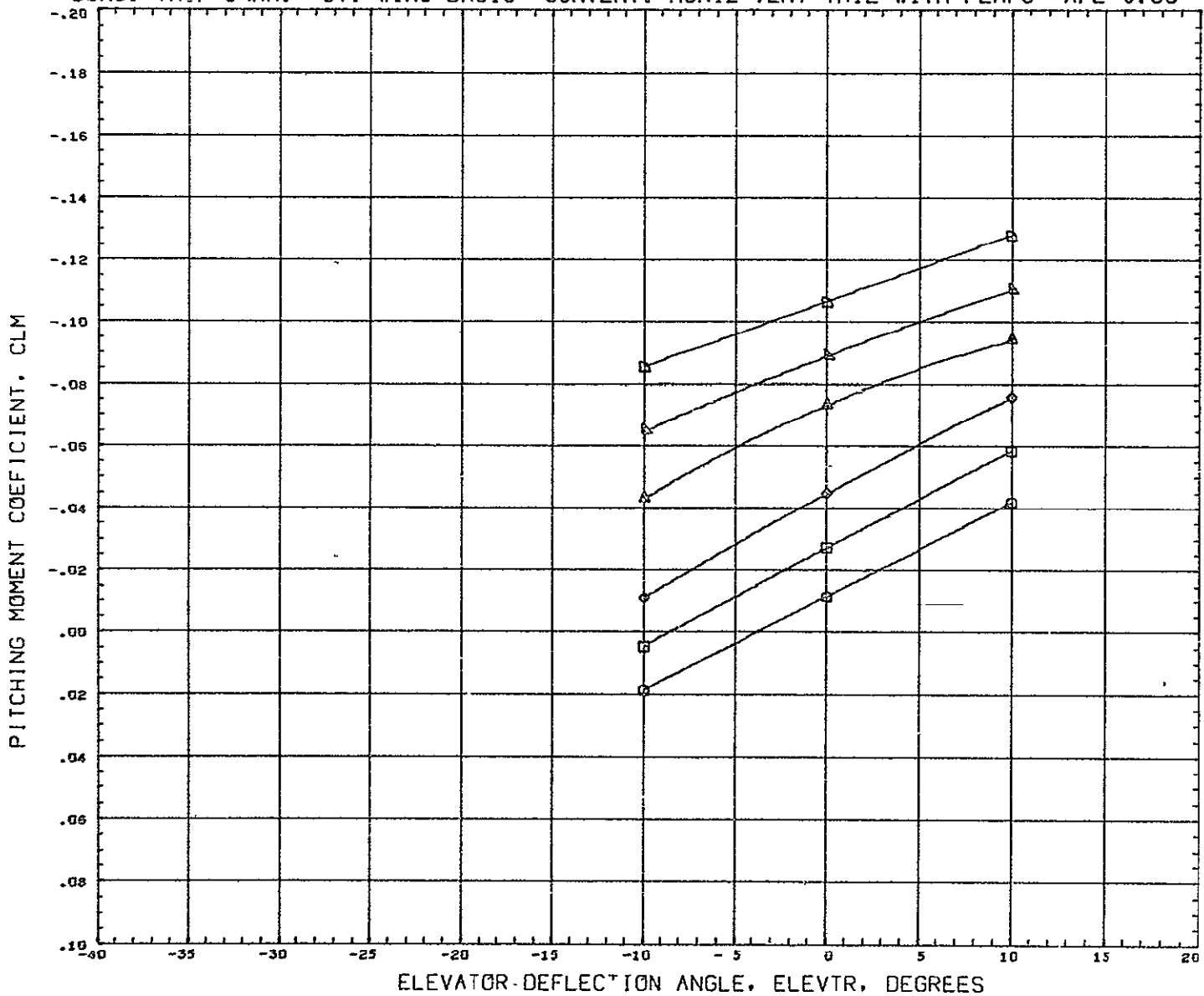

SYMBOL	ALPHA	PARAMETRIC VALUES				REFERENCE INFORMATION		
○	4.000	MACH	0.184	BETA	0.000	REFS	316 2304	SQ IN
□	6.000	QUDDER	0.000	FLAPS	45.000	REFL	50.1900	IN
◇	4.000	SFOILR	0.000			REFB	7.3500	IN
△	8.000					ΔMRF	25.3760	IN
▽	12.000					YMR	0.0000	IN
◇	16.000	DATA HIST. CODE	51			ZMRP	0.0000	IN
						SCALE	0.0175	

LONG. TRIM CHAR. - ST. WING BASIC- CONVENT. HORIZ-VERT TAIL WITH FLAPS- X/L=0.56

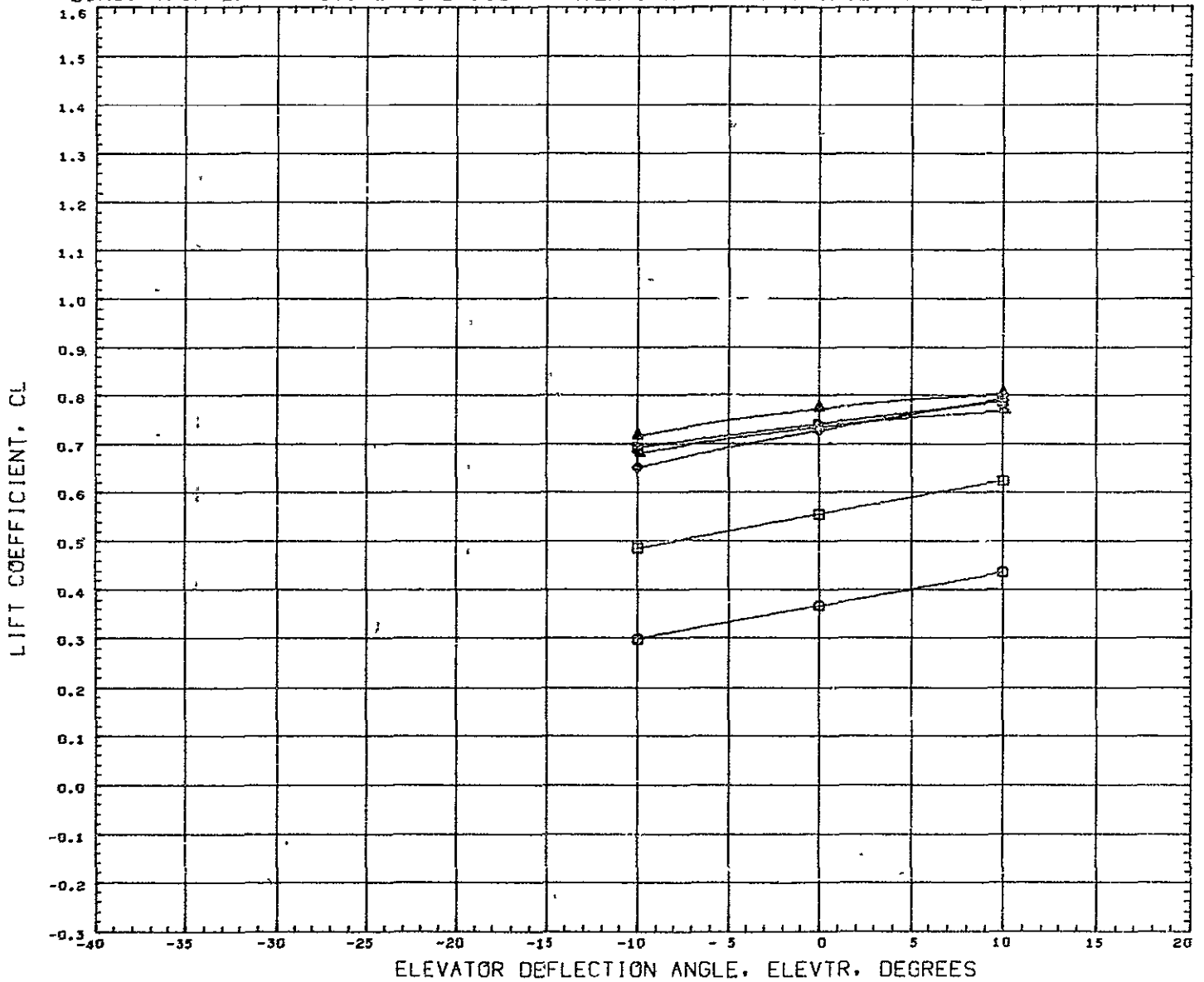

SYMBOL	ALPHA	PARAMETRIC VALUES				REFERENCE INFORMATION		
		MACH	BETA	FLAPS	REFS	REFL	SCALE	
●	4.000	0.184	0.000		316.2304	50.1900	50 IN	
○	0.000	0.000	45.000		7.3500	25.3760	IN	
▲	4.000	0.000			0.0000	0.0000	IN	
▽	6.000				0.0000	0.0000	IN	
◇	12.000				0.0000	0.0175	IN	
D	16.000	DATA HIST. CODE	SI					

LONG. TRIM CHAR.- ST. WING BASIC- CONVENT. HORIZ-VERT TAIL WITH FLAPS- X/L=0.56

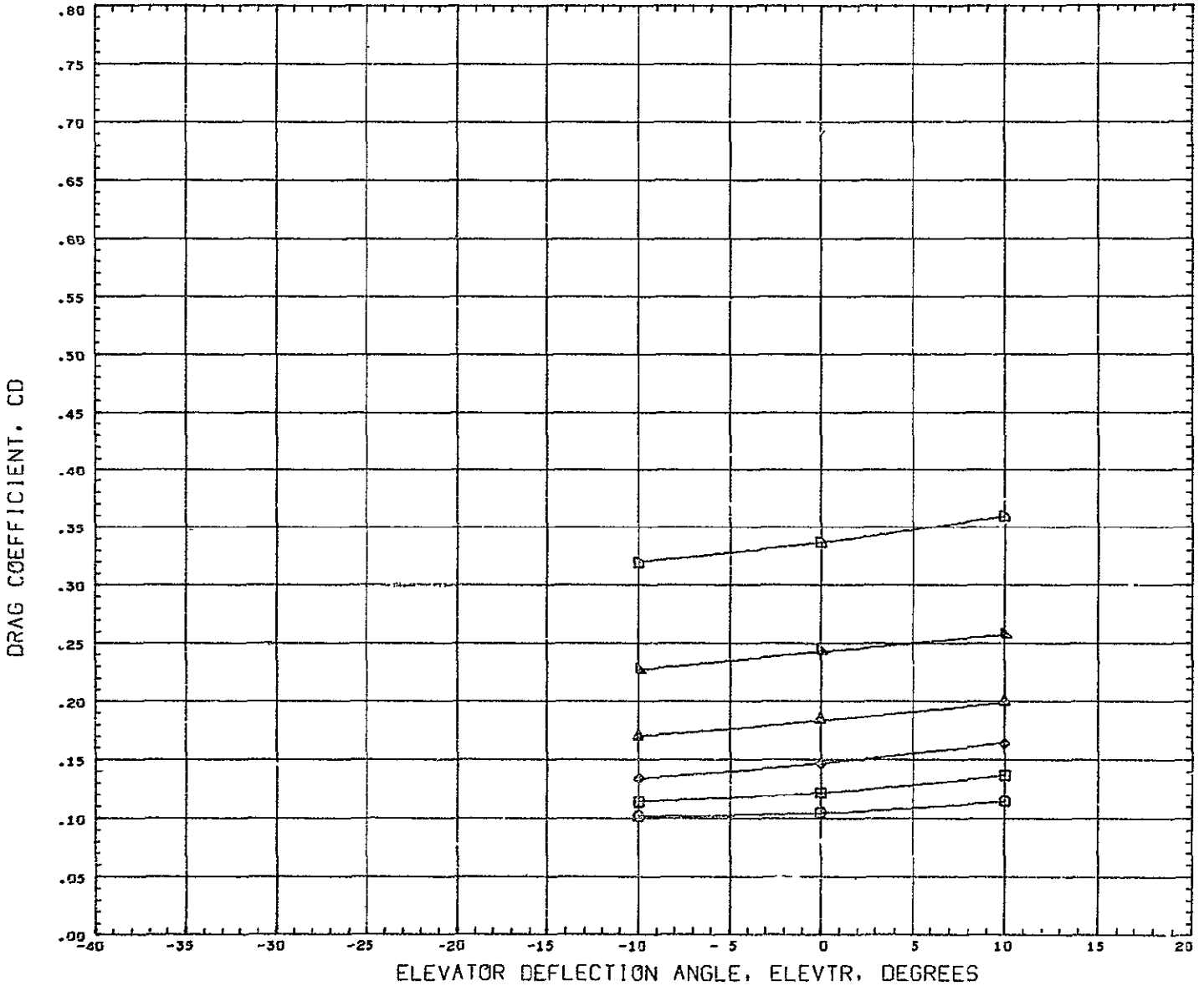

SYMBOL	ALPHA	PARAMETRIC VALUES				REFERENCE INFORMATION		
◇	4.000	MACH	0.184	BETA	0.000	REFS	316.2304	SQ IN
□	9.000	RUDDER	0.000	FLAPS	45.000	REFL	50.1900	IN
◇	4.000	SPOILER	0.000			REFB	7.3500	IN
△	4.000					XMRP	25.3760	IN
▽	12.000					YMRP	0.0000	IN
◇	16.000	DATA HIST. CODE	SI			ZMRP	0.0000	IN
						SCALE	0.0175	

LONG. TRIM CHAR. - ST. WING BASIC- CONVENT. HORIZ-VERT TAIL WITH FLAPS- X/L=0.60

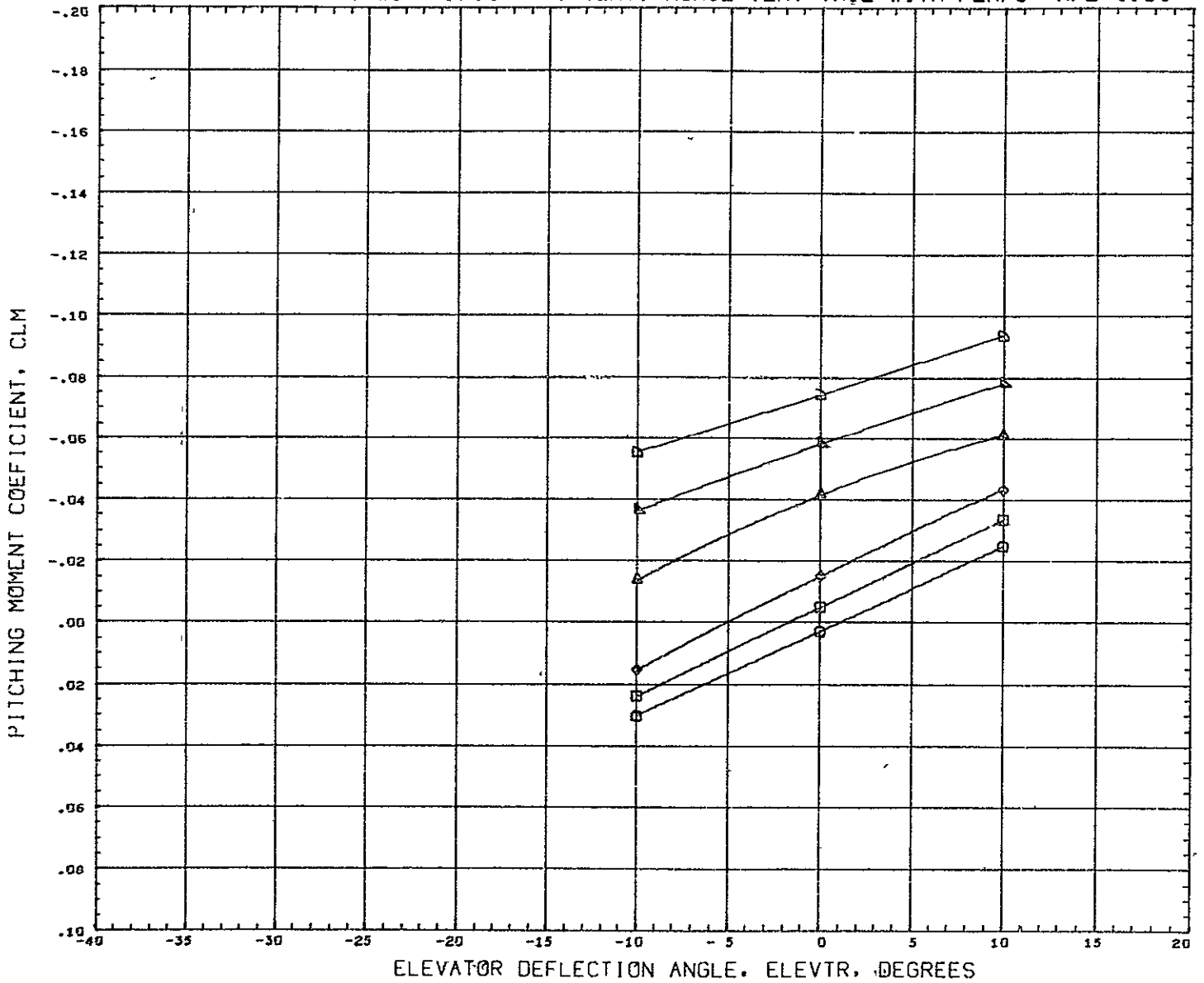

SYMBOL	ALPHA	PARAMETRIC VALUES				REFERENCE INFORMATION		
		MACH	BETA	FLAPS	FEFS	SQ IN	IN	
○	4.000	0.184	0.000	45.000	316 2304			
□	8.000	0.000	0.000	0.000	50 1900			
◇	12.000	0.000	0.000	0.000	7.3500			
△	16.000	0.000	0.000	0.000	27.3840			
▽					YNRP	0.0000	IN	
D					ZMRP	0.0000	IN	
					SCALE	0.0175		

LONG. TRIM CHAR. - ST. WING BASIC- CONVNT. HORIZ-VERT TAIL WITH FLAPS- X/L=0.60

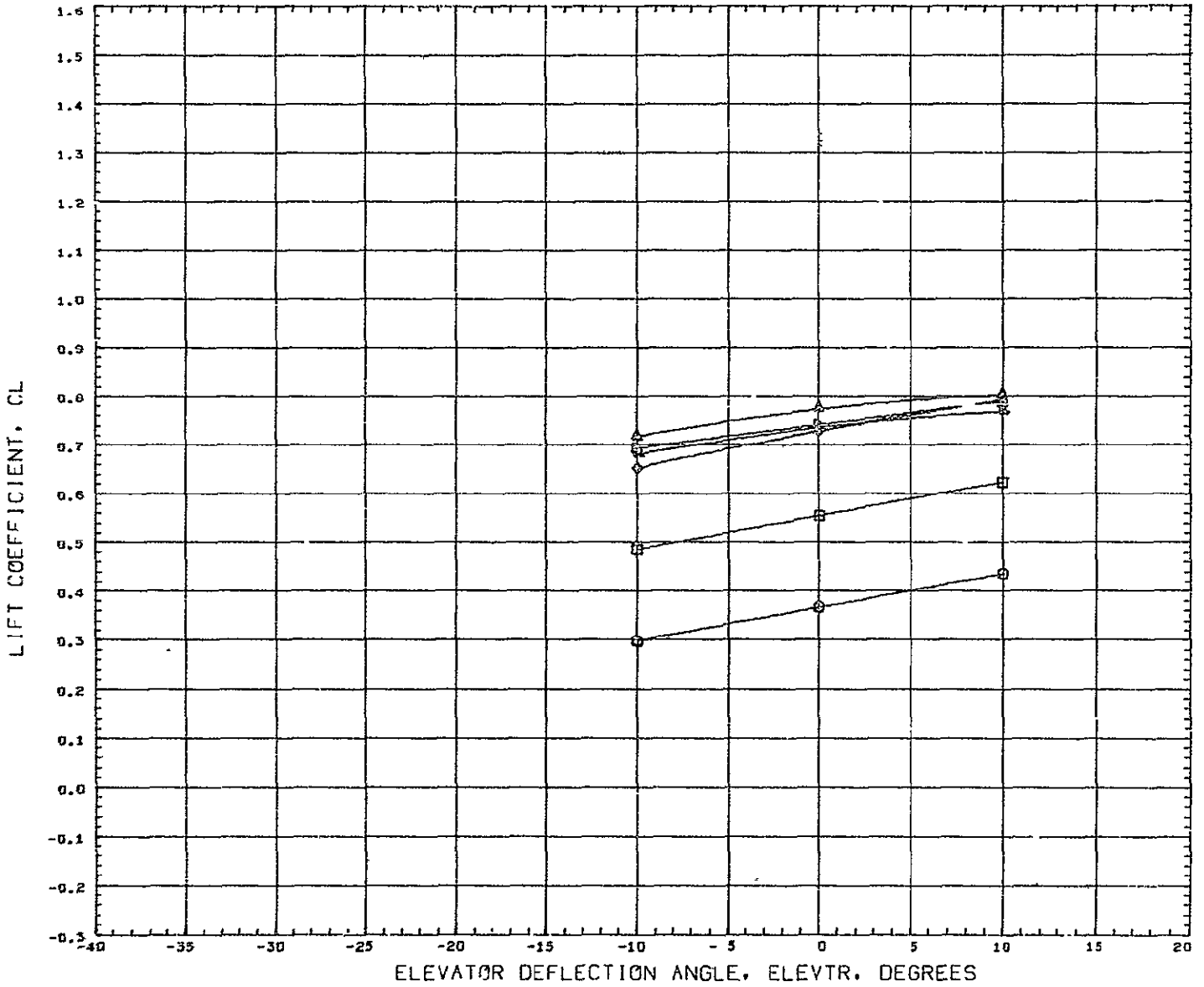

SYMBOL		ALPHA	PARAMETRIC VALUES			REFERENCE INFORMATION		
○	-	4.000	MACH	0.184	BETA	0.000	REFS	316 2304 SQ IN
□		8.000	FUDLER	0.000	FLAPS	45.000	REFL	50.1900 IN
◇		4.000	SFOILR	0.000			REFB	7 3500 IN
△		8.000					XMRP	27.3840 IN
▽		12.000					YMRP	0.0000 IN
◻		16.000					ZMRP	0.0000 IN
			DATA HIST. CODE	SI			SCALE	0 0175

LONG. TRIM CHAR. - ST. WING BASIC- CONVENT. HORIZ-VERT TAIL WITH FLAPS- X/L=0.60

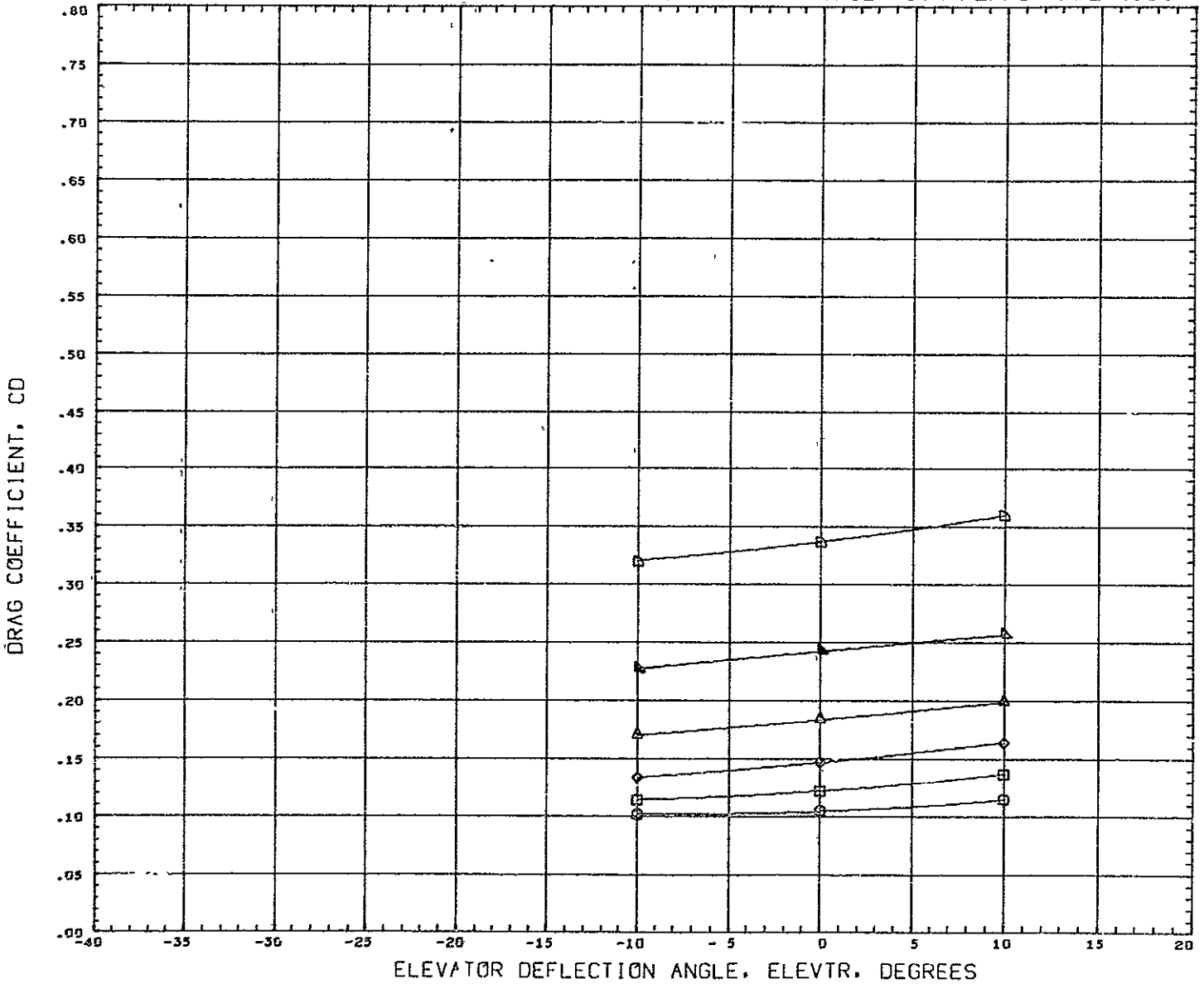

SYMBOL	ALPHA	PARAMETRIC VALUES				REFERENCE INFORMATION		
○	4.000	MACH	0.184	BETA	0.000	REFS	316 2304	SQ IN
◇	8.000	UNDER	0.000	FLAPS	45.000	REFL	50.1900	IN
△	12.000	SFOILR	0.000			REFB	7 3500	IN
▽	16.000					XMRP	27 3840	IN
D		DATA HIST. CODE	SI			YMRP	0.0000	IN
						ZMRP	0.0000	IN
						SCALE	0 0175	

LONG. TRIM CHAR.- ST. WING BASIC- CONVENT. HORIZ-VERT TAIL WITH FLAPS- X/L=0.64

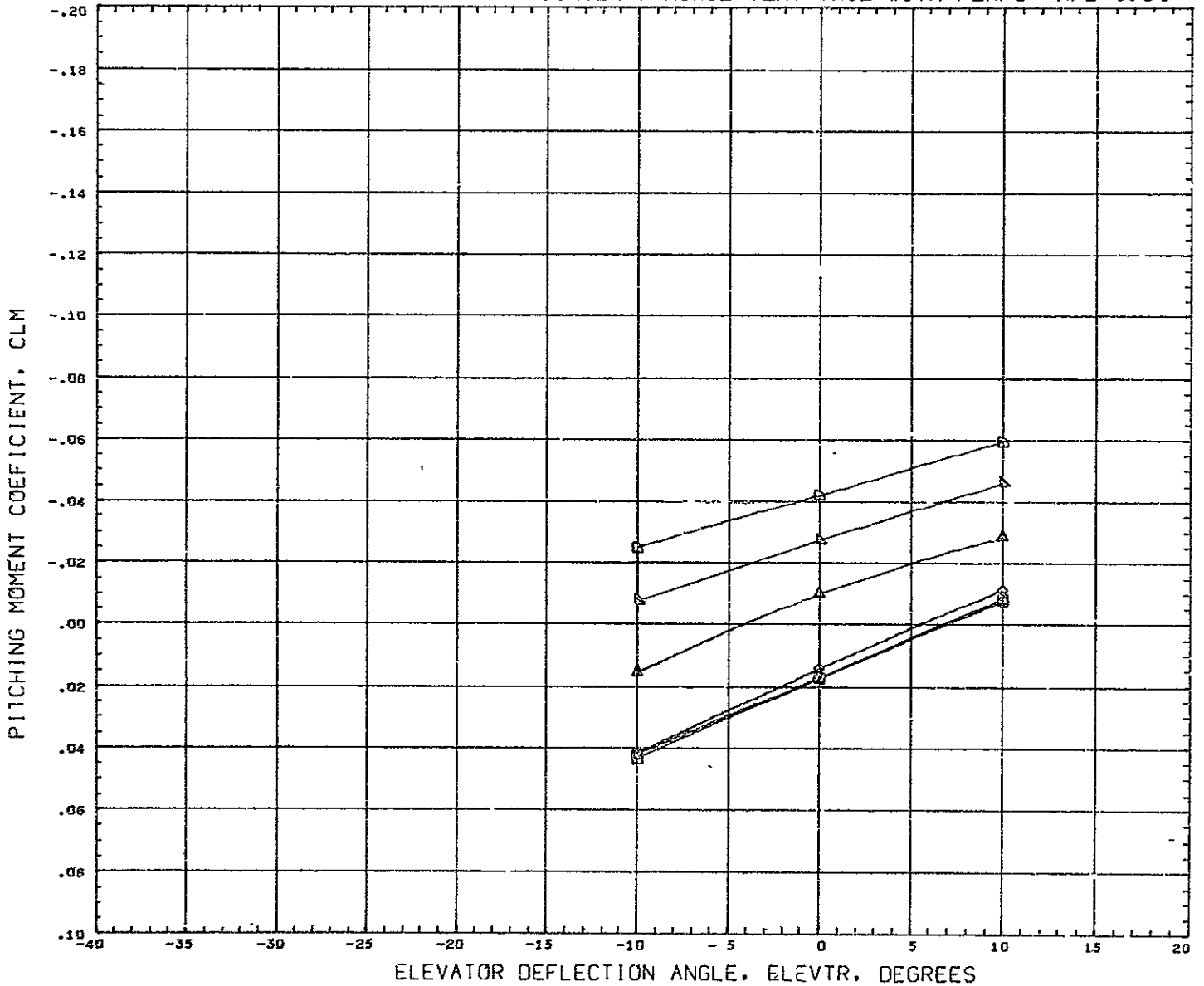

SYMBOL		ALPHA	PARAMETRIC VALUES			REFERENCE INFORMATION		
□	○	4.000	NACH	0.184	BETA	0.000	REFS	316 2304 SQ IN
□	○	6.000	FUDDER	0.000	FLAPS	15.000	REFL	50 1900 IN
◇	△	8.000	SPOILER	0.000			REFB	7 3500 IN
▽		12.000					XMRP	29 3920 IN
◇		16.000	DATA HIST CODE	1			YMRP	0.0000 IN
							ZMRP	0.0000 IN
							SCALE	0.0175



LONG. TRIM CHAR.- ST. WING BASIC- CONVENT. HORIZ-VERT TAIL WITH FLAPS- X/L=0.64

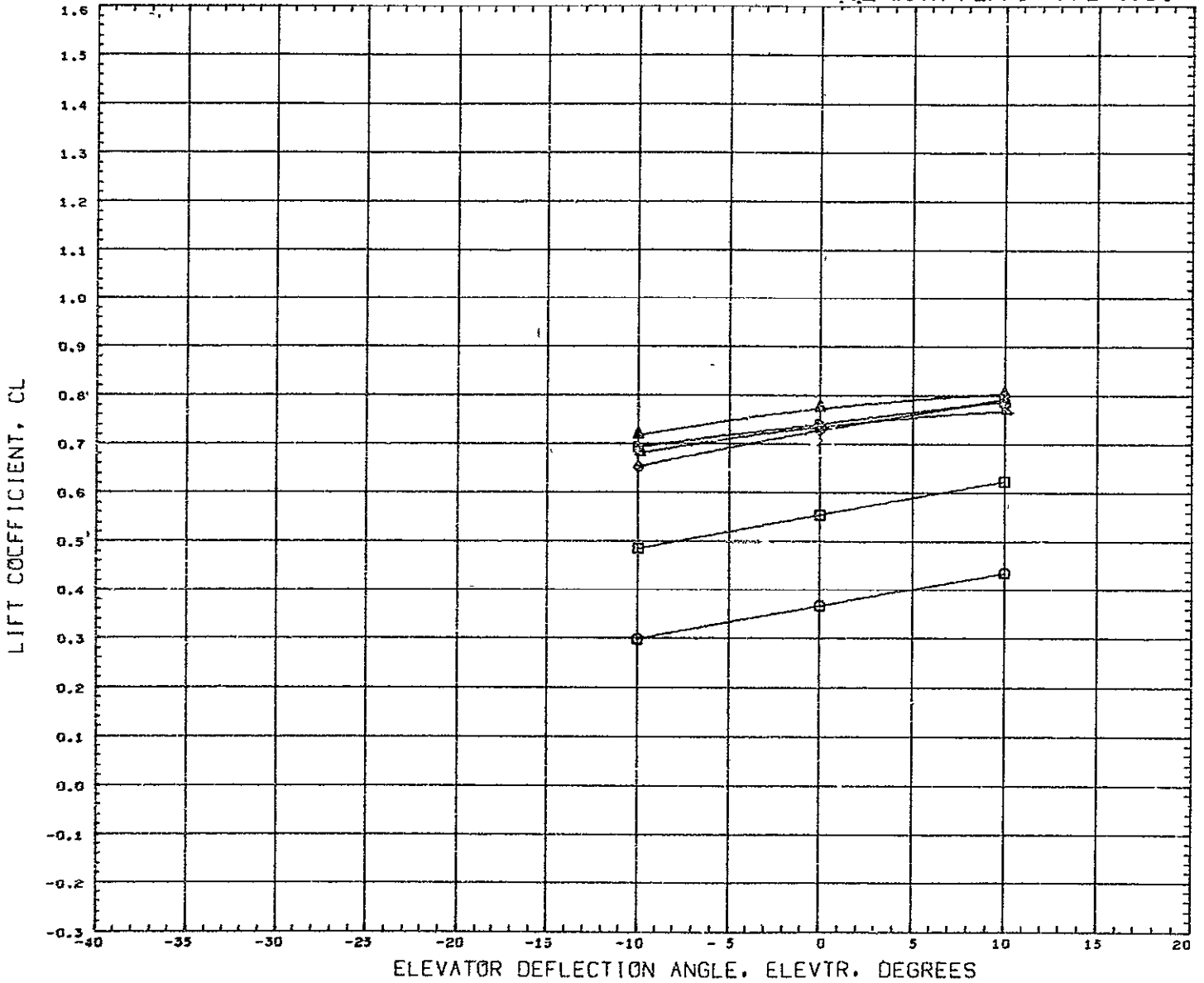

SYMBOL	ALPHA	PARAMETRIC VALUES			
○	4.000	MACH	0.184	BETA	0.000
□	6.000	RUDDER	0.000	FLAPS	45.000
◇	4.000	SPCLR	0.000		
△	6.000				
▽	12.000				
◊	16.000	DATA HIST. CODE	1		

REFERENCE INFORMATION		
REFS	316 2304	SQ IN
REF1	50 1900	IN
REFB	7.3500	IN
XMRP	29.3920	IN
YMRP	0.0000	IN
ZMRP	0.0000	IN
SCALE	0 0175	

LONG. TRIM CHAR. - ST. WING BASIC- CONVENT. HORIZ-VERT TAIL WITH FLAPS- X/L=0.64

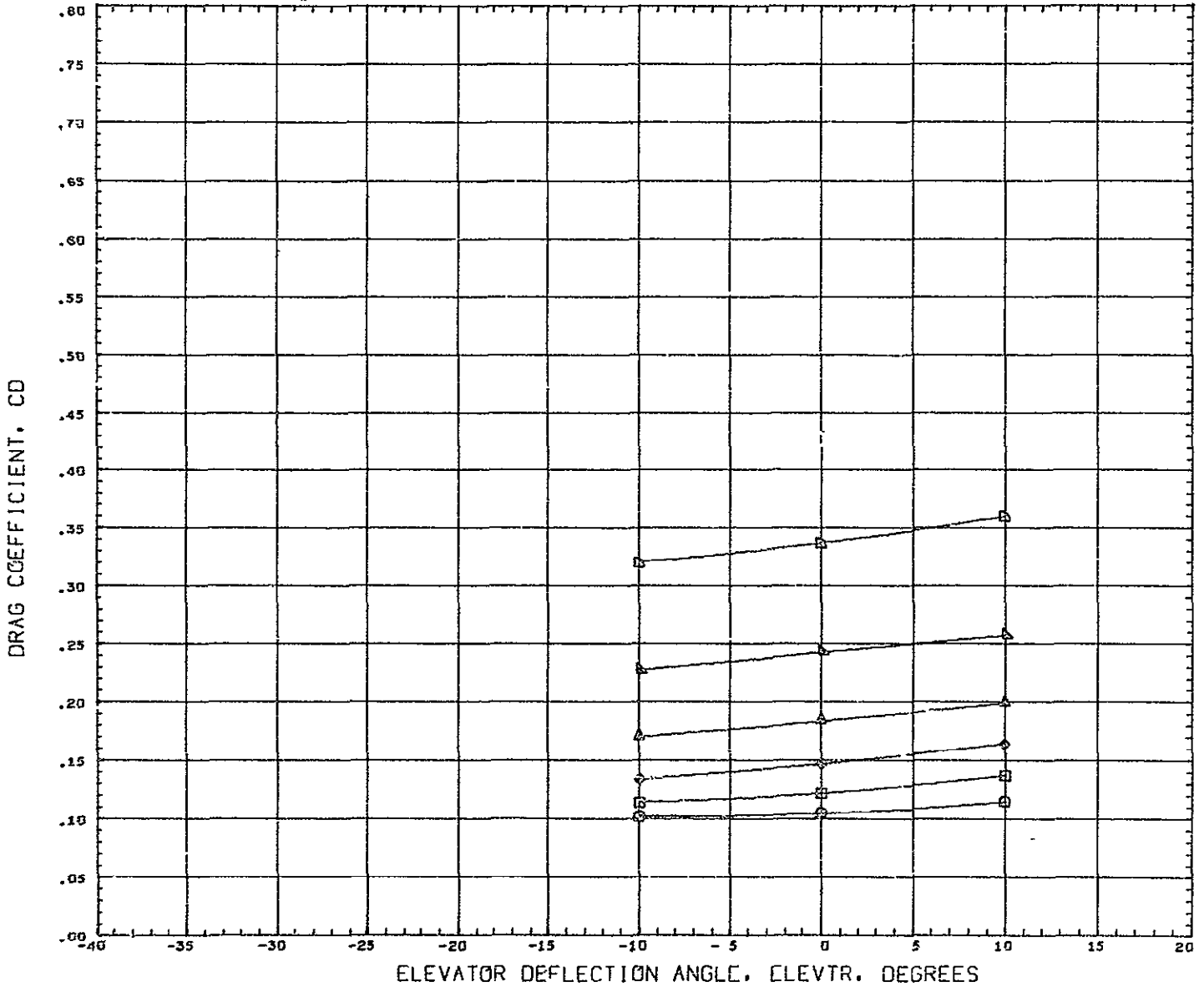

SYMBOL	ALPHA	PARAMETRIC VALUES				REFERENCE INFORMATION		
		MACH	BETA	FLAPS	REFS	REFL	SQ IN	
□	4.000	0.104	0.000	0.000	316	2304	IN	
△	0.000	0.000	0.000	43.000	50	1900	IN	
◇	4.000	0.000	0.000		7	3500	IN	
△	0.000				29	3929	IN	
▽	12.000				0	0000	IN	
○	16.000				0	0000	IN	
		DATA HIST. CODE	1		SCALE	0	0175	

LONG. TRIM CHAR.- ST. WING BASIC- CONVENT. HORIZ-VERT TAIL WITH FLAPS- X/L=0.68

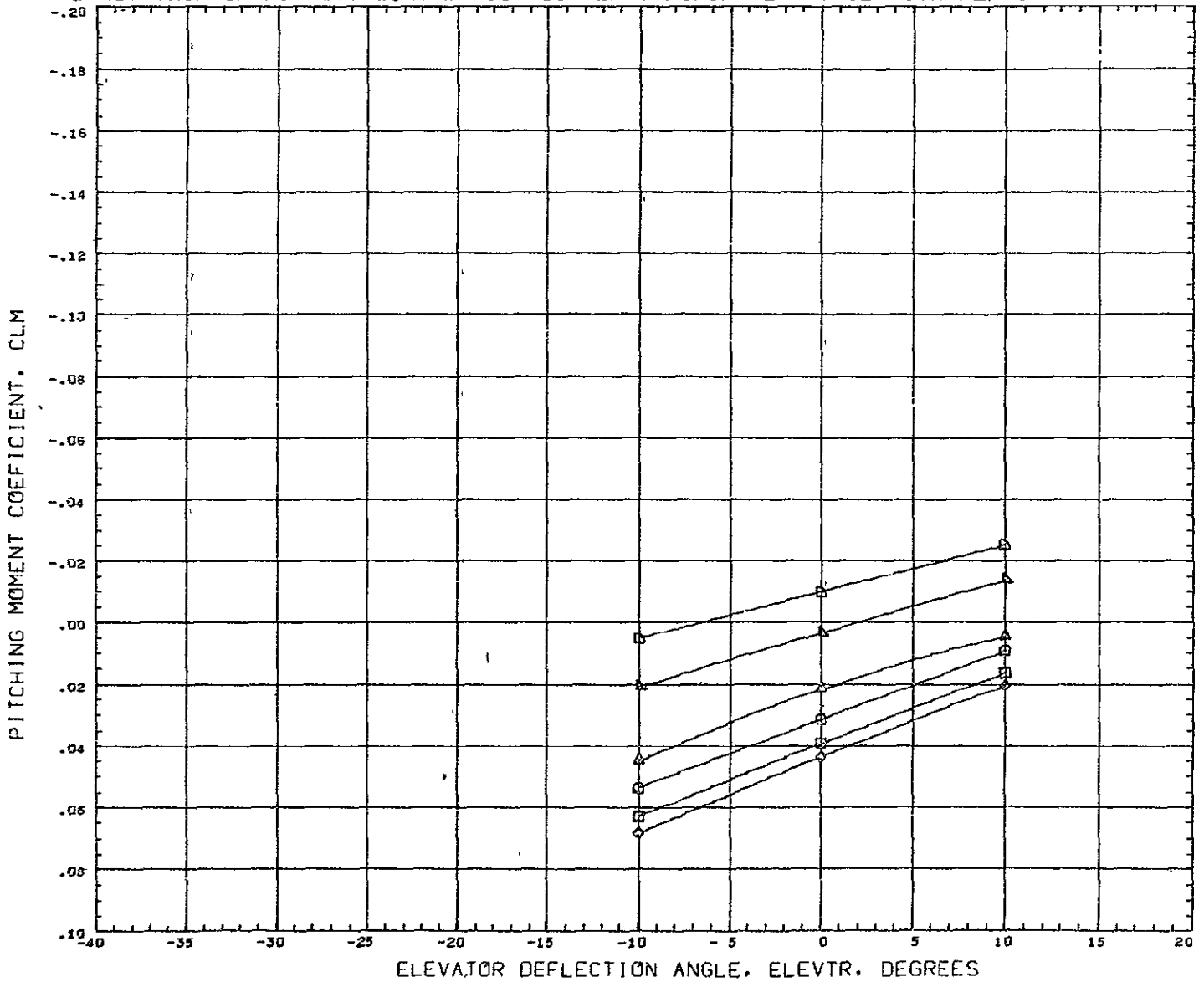

SYMBOL	ALPHA	PARAMETRIC VALUES				REFERENCE INFORMATION		
○	4.000	MACH	0.184	BETA	0.000	REFS	316 2304	SQ IN
◊	6.000	RUDDER	0.000	FLAPS	45.000	REFL	50.1900	IN
◊	4.000	SFOILR	0.000			REFB	7 3500	IN
△	8.000					XNRP	31 3990	IN
▽	12.000					YNRP	0.0000	IN
○	16.000	DATA HIST. CODE	SI			ZNRP	0.0000	IN
						SCALE	0 0175	

LONG. TRIM CHAR.- ST. WING BASIC- CONVENT. HORIZ-VERT TAIL WITH FLAPS- X/L=0.68

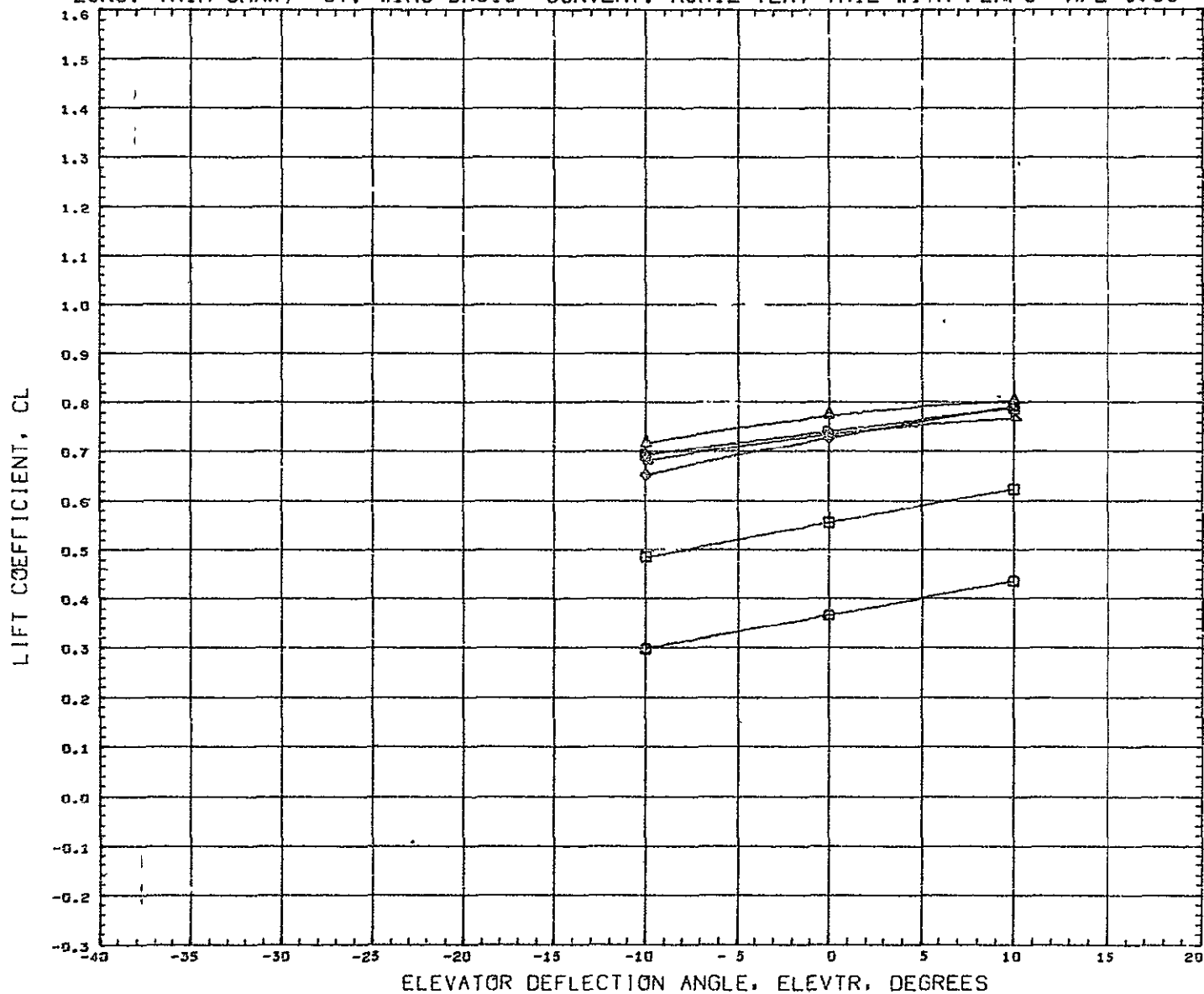

SYMBOL	ALPHA	PARAMETRIC VALUES				REFERENCE INFORMATION		
○	4.000	MACH	0.184	BETA	0.000	REFS	316.2304	90 IN
□	0.000	RUDDER	0.000	FLAPS	45.000	REFL	50.1900	1N
◇	4.000	SPOILER	0.000			REFB	7.3500	1N
△	8.000					XMRP	31.3990	1N
▽	12.000					YMRP	0.0000	1N
◻	16.000	DATA HIST. CODE	SI			ZMRP	0.0000	1N
						SCALE	0.6175	

LONG. TRIM CHAR.- ST. WING BASIC- CONVENT. HORIZ-VERT TAIL WITH FLAPS- X/L=0.68

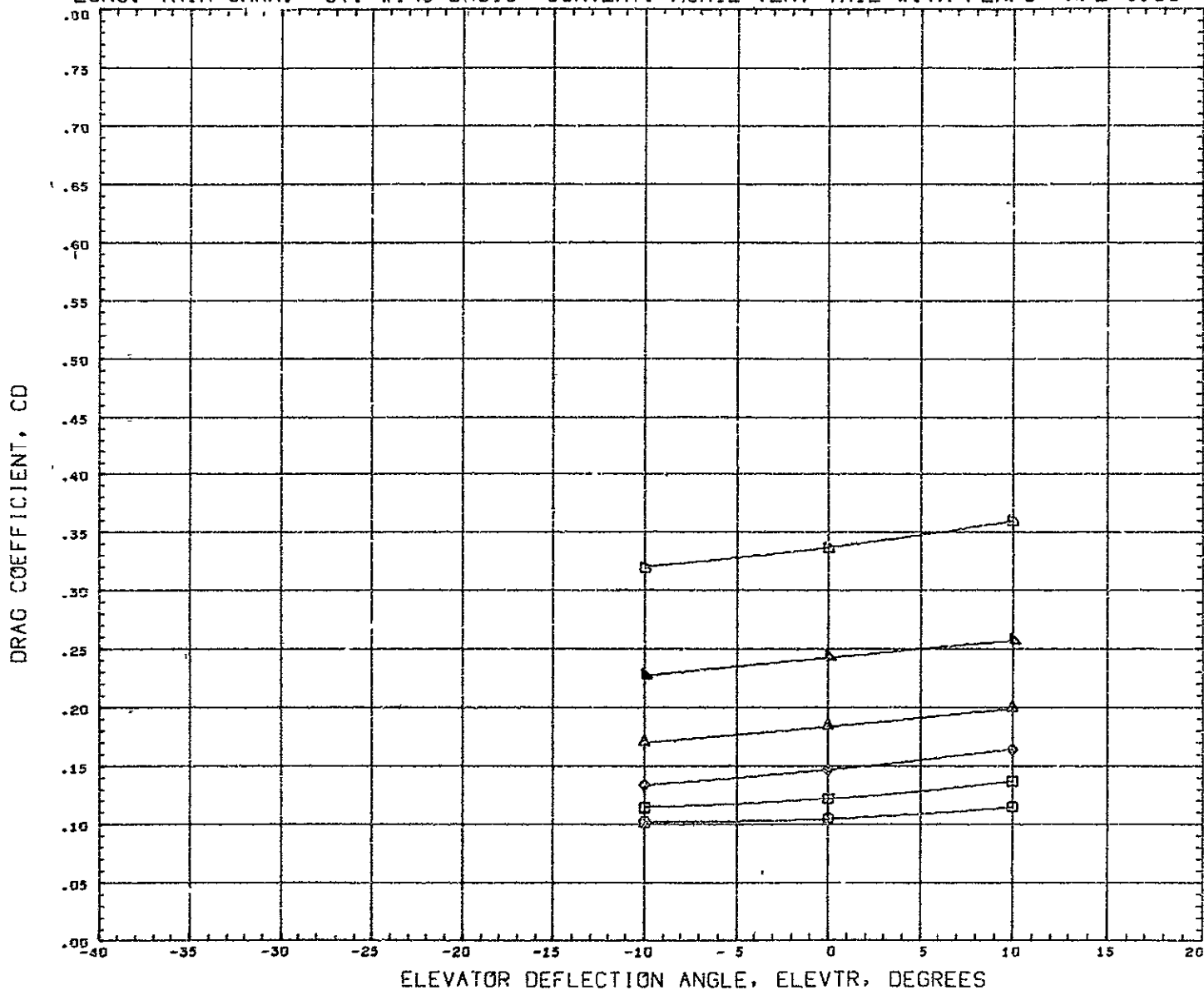

SYMBOL	ALPHA	PARAMETRIC VALUES				REFERENCE INFORMATION		
○	4.000	MACH	0.184	BETA	0.000	REFS	316 2304	50 IN
□	0.000	RUDDER	0.000	FLAPS	45.000	REFL	50 1900	IN
◇	4.000	SFOILR	0.000			REFB	7.3500	IN
△	8.000					XMRP	31 3990	IN
▽	12.000					YMRP	0.0000	IN
□	16.000	DATA HIST. CODE	51			ZMRP	0.0000	IN
						SCALE	0.0175	

APPENDIX A  
LONGITUDINAL  
TRIM DATA

## LONGITUDINAL TRIM DATA

DATASET IDENTIFIER	X/L	ALFTRM	GLTRM	CDTRM	L/DTRM	XLTRM
4X7096	0.68	-				
5X7096	0.73	-				
6X7096	0.78	-				
4X7083	0.68	-				
5X7083	0.73	-				
6X7083	0.78	-				
4X7090	0.68	2.560	0.139	0.43	3.289	-0.090
5X7090	0.73	5.840	0.307	0.057	5.459	-0.046
6X7090	0.78	-				
4X7093	0.68	13.280	0.452	0.128	3.601	-0.118
5X7093	0.73	20.640	0.791	0.320	2.474	-0.052
6X7093	0.78	-				
1X7024	0.56	-				
2X7024	0.60	-				
3X7024	0.64	-				
4X7024	0.68	-				
1X7001	0.56	-				
2X7001	0.60	-				
3X7001	0.64	-				
4X7001	0.68	-				
1X7025	0.56	-2.800	0.086	0.044	2.039	-0.112
2X7025	0.60	-1.760	0.136	0.044	3.141	-0.072
3X7025	0.64	1.840	0.302	0.050	5.989	-0.033
4X7025	0.68	14.720	0.650	0.146	4.455	-0.121

LONGITUDINAL TRIM DATA (CONT.)

DATASET IDENTIFIER	X/L	ALFTRM	CLTRM	CDTRM	L/DTRM	XLTRM
1X7029	0.56	2.240	0.263	0.051	5.097	-0.111
2X7029	0.60	5.600	0.396	0.062	6.404	-0.091
3X7029	0.64	12.720	0.572	0.117	4.884	-0.215
4X7029	0.68	-				
1X7033	0.56	6.720	0.391	0.073	5.294	-0.135
2X7033	0.60	11.040	0.492	0.101	4.872	-0.184
3X7033	0.64	-				
4X7033	0.68	-				
1X7023	0.56	-				
2X7023	0.60	-				
3X7023	0.64	-				
4X7023	0.68	-				
1X7011	0.56	-				
2X7011	0.60	-				
3X7011	0.64	-				
4X7011	0.68	10.000	0.837	0.223	3.799	0.191
1X7014	0.56	-				
2X7014	0.60	-				
3X7014	0.64	5.760	0.807	0.167	4.867	-0.199
4X7014	0.68	-				
1X7018	0.56	-3.280	0.385	0.121	3.183	-0.097
2X7018	0.60	2.480	0.665	0.145	4.555	-0.060
3X7018	0.64	12.640	0.658	0.239	2.773	1.788
4X7018	0.68	-				



## LONGITUDINAL TRIM DATA (CONT.)

DATASET IDENTIFIER	X/L	ALFTRM	CLTRM	CDTRM	L/DTRM	XLTRM
1X7022	0.56	1.120	0.551	0.148	3.728	-0.107
2X7022	0.60	10.080	0.659	0.203	3.246	0.133
3X7022	0.64	-				
4X7022	0.68	-				
1X7053	0.56	-				
2X7053	0.60	-				
3X7053	0.64	-				
4X7053	0.68	9.120	0.799	0.213	3.785	0.510
1X7055	0.56	-				
2X7055	0.60	-2.480	0.441	0.110	3.996	-0.042
3X7055	0.64	6.240	0.764	0.165	4.596	-0.537
4X7055	0.68	12.880	0.734	0.260	2.834	-1.810
1X7054	0.56	1.200	0.538	0.119	4.512	-0.093
2X7054	0.60	6.080	0.700	0.150	4.610	-0.448
3X7054	0.64	10.560	0.689	0.202	3.409	0.610
4X7054	0.68	-				

