

2
M 17

DATA MANAGEMENT COPY #

CR-119859
DMS-DR-1074
MARCH, 1971



SPACE SHUTTLE
PRELIMINARY DATA

DETERMINATION OF SUBSONIC
AERODYNAMIC CHARACTERISTICS
FOR McDONNELL-DOUGLAS
GENERIC HIGH CROSS RANGE
SHUTTLE ORBITER

By

L. S. White, M/D-East

FACILITY FORM 502

N71-35097
(ACCESSION NUMBER)

316 (THRU) 63
(PAGES)

CR-119859 (CODE)
(NASA CR OR TMX OR AD NUMBER)

31 (CATEGORY)

DOUGLAS AIRCRAFT
COMPANY LOW SPEED
WIND TUNNEL

SADSAC SPACE SHUTTLE
AEROTHERMODYNAMIC
DATA MANAGEMENT SYSTEM

CONTRACT NAS8-4016
AMENDMENT 130
DRL 184-58
MARSHALL SPACE FLIGHT CENTER

SPACE DIVISION  CHRYSLER CORPORATION



ABSTRACT

A 1-1/3% scale generic High Cross Range Shuttle Orbiter wind tunnel test was conducted in the Douglas Aircraft Company Low Speed Wind Tunnel in Long Beach, California from 3-11 December 1970. The test objective is to provide subsonic aerodynamic data for a number of body shapes, wing planforms, wing airfoil sections, and vertical tail geometry to aid in the selection of an improved design. In addition, elevon effectiveness and leading edge fillet effects were obtained on one configuration. Nominal tunnel conditions were at a dynamic pressure of 50 lb/ft², Mach number .18, and Reynolds number of approximately 1.2×10^6 per foot.

Transition strips consisting of 0.0065 inch thick tape cut with pinking shears were placed on the body ~ 1-1/2 inch aft of the nose. Similar strips were placed on the wings and vertical tail surfaces at ~ 6-10% chord.

TABLE OF CONTENTS

	<u>PAGE NUMBER</u>
TITLE PAGE	i
ABSTRACT	ii
LIST OF FIGURES	2
LIST OF TABLES	3
AXIS SYSTEM DEFINITION	4
SUMMARY	5
SUMMARY OF NOMENCLATURE	7
CONFIGURATIONS INVESTIGATED	8
DATASET COLLATION SHEET	11
TEST FACILITY DESCRIPTION	18
TEST CONDITIONS	19
DATA REDUCTION	21
SUMMARY DATA PLOT INDEX	23
FIGURES	24
MODEL COMPONENT DESCRIPTIONS	44
STANDARD NOMENCLATURE	65
ADDITIONS TO STANDARD NOMENCLATURE	73
TABULATED DATA LISTING	74
PLOTTED DATA	75
APPENDIX	A-1
COMPREHENSIVE DATA PLOT INDEX	

LIST OF FIGURES

<u>FIGURE NUMBER</u>	<u>TITLE</u>	<u>PAGE NUMBER</u>
1	Axis System	4
2	Bodies B _{1A} and B _{1B}	25
3	Bodies B _{1C} and B ₂	26
4	Body B _{3A}	27
5	Bodies B _{3B} and B _{3C}	28
6	Body B ₄ and Simulated Engine Pods P ₁ and P ₂	29
7	Wing W ₃	30
8	Wing W ₄ and Wing W ₄ Leading Edge Fillets(Strakes)	31
9	Wings W ₅ and W ₆	32
10	Wings W ₇ and W ₈	33
11	Wings W _{9A} and W _{9B}	34
12	Vertical Tails V ₃ and V ₄ as Mounted on Body B ₁	35
13	Vertical Tails V ₄ and V ₅ as Mounted on Body B ₃	36
14	Base and Balance Cavity Pressure Probes	37
15	Model Photographs	38

LIST OF TABLES

<u>TABLE NUMBER</u>	<u>TITLE</u>	<u>PAGE NUMBER</u>
I	Summary of SADSAC Nomenclature	7
II	Test Conditions	20
III	Summary Data Plot Index	23

Notes:

1. Positive directions of force coefficients, moment coefficients, and angles are indicated by arrows.
2. For clarity, origins of wind and stability axes have been displaced from the center of gravity.

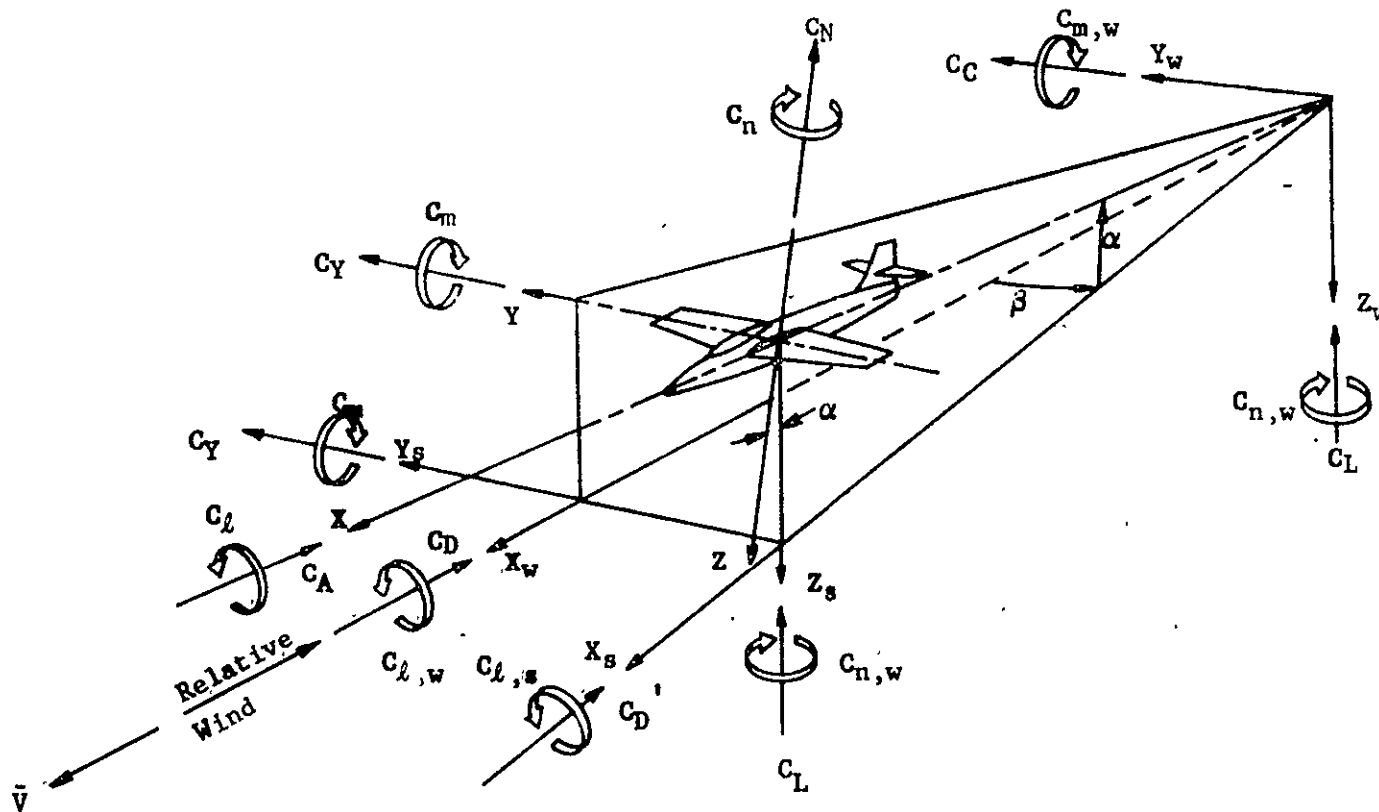

Figure 1. Axis systems, showing direction and sense of force and moment coefficients; angle of attack, and sideslip angle

SUMMARY

A 1-1/3% scale generic High Cross Range Shuttle Orbiter wind tunnel test was conducted in the Douglas Aircraft Company Low Speed Wind Tunnel in Long Beach, California from 3-11 December 1970. The test objective is to provide subsonic aerodynamic data for a number of body shapes, wing planforms, wing airfoil sections, and vertical tail geometry to aid in the selection of an improved design. In addition, elevon effectiveness and leading edge fillet effects were obtained on one configuration. Nominal tunnel conditions were at a dynamic pressure of 50 lb/ft², Mach number .18, and Reynolds number of approximately 1.2×10^6 per foot.

Transition strips consisting of 0.0065 inch thick tape cut with pinking shears were placed on the body ~1-1/2 inch aft of the nose. Similar strips were placed on the wings and vertical tail surfaces at ~6-10% chord. Detailed configuration information for the component variations tested are given in the Configurations Investigated section. The Dataset Collations show the run schedule for the various combinations and parametric variations tested.

The objectives of this test program were to obtain qualitative data using available equipment and low cost models. Hence, the data are not as accurate as normal but fulfill the objectives of evaluations of relative effects. These considerations and a discussion of some results are pre-

sented in Test Conditions.

The Summary Data Plot Index (Table III) provides a synopsis of the test results as well as a plot index.

TABLE I

COEFFICIENT	COEFFICIENT NAME	SADSAC NOMENCLATURE		
		BODY AXIS	STABILITY AXIS	WIND AXIS
C _A	Total Axial Force	CA	-	-
C _{AB}	Base Axial Force	CAB	---	-
C _{AF}	Forebody Axial Force	CAF	-	-
C _D	Total Drag Force	-	CD	CDTOTL
C _{DB}	Base Drag Force	-	CDB	CDBASE
C _{DF}	Forebody Drag Force	-	CDF	CDFORE
C _L	Lift Force	-	CL	CL
C _N	Normal Force	CN	-	-
C _Y	Side Force	CY	CY	CC
C	Rolling Moment	CBL	CSL	CWL
C _m	Pitching Moment	CLM	CLM	CPM
C _n	Yawing Moment	CYN	CLN	CLN
L/D	Lift-To-Drag Force Ratio	-	L/D	CL/CD
L/D	Lift-To-Forebody Drag Force Ratio	-	L/DF	CL/CDF
N/A	Normal-To-Axial Force Ratio	N/A	-	-
N/A	Normal-To-Forebody Axial Force Ratio	CN/CAF	-	-

SUMMARY OF SADSAC NOMENCLATURE - AERODYNAMIC FORCE AND MOMENT COEFFICIENTS

CONFIGURATIONS INVESTIGATED

MODEL COMPONENT DESCRIPTION

BODIES

- B_{1A} - Basic "029" fuselage to be mated with various wings (Figure 2)
- B_{1B} - Basic "029" fuselage mated with the W_{4A} wing (Figure 2)
- B_{1C} - B_{1A} body with a 2° incidence shim in place (Figure 3)
- B₂ - Basic "029" fuselage with the nose ramp increased 4° (Figure 3)
- B_{3A} - Basic "045" fuselage (Figure 4)
- B_{3B} - B_{3A} body with a 4° incidence shim in place (Figure 5)
- B_{3C} - B_{3A} body with the body flap removed (Figure 5)
- B₄ - B_{1B} body with the boattail removed (Figure 6)

WINGS

- W₃ - Basic "029" wing (Figure 7)
- W_{4A} - Test "baseline" wing with replaceable strakes and elevons.
Mated with B_{1B} (Figure 8)
- W_{4B} - Test "baseline" wing without replaceable strakes and elevons.
Made from W₅
- W₅ - W₄ wing planform and section with wing tip extensions to a true "delta" (Figure 9)
- W₆ - W₄ wing planform and section with 5° of twist (washout) (Figure 9)
- W₇ - Alternate planform wing, 20° trailing edge sweep instead of 0°
(Figure 10)
- W₈ - W₄ wing planform with a 44XX series airfoil. Made from W_{4B} and has 0° strake (Figure 10)
- W_{9A} - Basic "045" wing with a 00XX-64 airfoil section. Mated with B₃ (Figure 11)
- W_{9B} - W_{9A} moved 1.2 inches (model scale) forward (Figure 11)

CONFIGURATIONS INVESTIGATED (Continued)

MODEL COMPONENT DESCRIPTION

VERTICAL TAILS

- V₃ - Old "4% ICR V.T." tested on the "4% HCR" MCAIR LSWT test (Figure 12).
- V₄ - MSC "optimum" V.T. geometry (Figures 12 and 13).
- V₅ - V₄ V.T. with the tip cut off to approximate the "050" V.T. geometry (Figure 13).

STRAKES (L.E. FILLETS) - Figure 8

- ST₁ - $\Lambda_{st} = 6^\circ$
- ST₂ - $\Lambda_{st} = 8^\circ$
- ST₃ - $\Lambda_{st} = 10^\circ$
- ST₄ - $\Lambda_{st} = 0^\circ$ or no L.E. fillet

ENGINE PODS - Figure 6

- P₁ - Simulated "all engines running" case. All 4 pods have the "teardrop" shape.
- P₂ - Simulated "one engine out" case. One "teardrop" shape cut to actual engine pod shape.

COMBINATIONS TESTED

B _{1A}	B ₄ W _{4A} ST ₂ V ₄	B _{1B} W _{4A} ST ₂ V ₄	B ₂
B _{1A} W ₃		B _{1B} W _{4A} ST ₂	B ₂ W ₆ V ₄
B _{1A} W ₃ V ₃	B _{1C}	B _{1B} W _{4A} ST ₄ V ₄	
B _{1A} W ₃ V ₄	B _{1C} W ₈ V ₄	B _{1B} W _{4A} ST ₁ V ₄	B _{3A} W _{9A} V ₄
B _{1A} W ₅ V ₄		B _{1B} W _{4A} ST ₃ V ₄	B _{3A} W _{9A}
B _{1A} W ₆ V ₄	B _{1B} W _{4A} ST ₂ V ₄ P ₁		B _{3A} W _{9A} V ₅

CONFIGURATIONS INVESTIGATED (Continued)

MODEL COMPONENT DESCRIPTION

COMBINATIONS TESTED

B_{1A}W_{4B}V₄

B_{1B}W_{4A}ST₂V₄P₂

B_{3A}

B_{1A}W₇V₄

B_{3A}W_{9B}V₅

B_{1A}W₈V₄

B_{3B}

B_{3C}W_{9A}V₅

B_{3B}W_{9A}V₅

TEST DLSWT TEST No 138 DATA SET COLLATION SHEET

PRETEST
 POSTTEST

DATA SET IDENTIFIER	CONFIGURATION	SCHD.		ELEVON CONTROL DEFLECTION				NO. of RUNS	MACH NUMBERS												
		α	β	δ_{eLo}	δ_{eRo}	δ_{eLr}	δ_{eRr}		0.18												
RCNO44	BIBW4A ST2V4	A	0	-10	0	-10	0		44												
46	BIBW4AST4V4			0		0			46												
47			-2.90						47												
49	BIBW4AST1V4		0						49												
51	BIBW4AST3V4								51												
59	BIAW8V4								59												
60			-2.90						60												
62	BIC		0	-	-	-	-		62												
64	BICW8V4			0	0	0	0		64												
66	BIBW4AST2V4P1								66												15
67			-2.85						67												
RCNO68	BIBW4AST2V4P2		0						68												

1 7 13 19 25 31 37 43 49 55 61 67 7576

COEFFICIENTS: $\alpha: A = -8 \frac{A Z}{\dots} + 20$ IDPVAR(1) IDPVAR(2) NDV

α or β

SCHEDULES

TEST FACILITY DESCRIPTION

The Douglas Low Speed Wind Tunnel is a closed circuit, single return, atmospheric tunnel with a test section 38 inches high, 54 inches wide, and 120 inches long. It is capable of a maximum continuous velocity of 195 mph (90 psf). For model sizes similar to the 1-1/3% scale HCR orbiter, the tunnel is operated at a dynamic pressure of 50 psf which yields a Mach number of 0.18 and a Reynolds number of 1.2×10^6 per foot.

The tunnel fan motor is rated at 100 hp and the tunnel is uncooled. For the data acquisition system available at the time of this test, pressure data are available only on manometer boards.

TEST CONDITIONS

Table II presents a summary of the tunnel conditions existing during the test. The data accuracy is not specified in Table I; however, the overall accuracy is considered to be less than normal. This is due to the coarse tolerances on the models and the placement of the model quite far forward in the test section, to enable usage of existing sting and balance hardware.

This test program was designed to be a parametric experiment, and for expediency and economy, the models were built with coarse tolerances specified. The data were measured using existing sting and balance hardware with the result of placing the model quite far forward in the test section. For these reasons the overall data accuracy is undefinable but less than normal. The user should therefore bear this in mind when evaluating the quantitative results. The data are, on the other hand, an excellent indication of the effects achieved by the several configuration changes, and they do give valid trends with test condition variables.

The measured base drag data show inordinate values which are felt to be due to sting effects. The sting was not exceptionally large (one inch diameter). Base pressure data from earlier tests with a 4% scale strut mounted model have implied considerable flow over the base as indicated by a considerable pressure gradient. The sting effect is probably related to this flow.

DATA REDUCTION

The reference area and lengths used in this test are the individual theoretical wing areas, spans, and mean aerodynamic chords. All body alone data, except the B₃ body, is reduced about the W₄ wing. Wing W₉ is used as the reference for the B₃ alone data. The table below gives the reference values (full-scale) for the different wings:

	W ₃	W ₄	W ₅	W ₆	W ₇	W ₈	W ₉
S ref = S theoretical ft ²	6168	5057	5171	5057	5424	5057	5370
\bar{c} ref = \bar{c} theoretical in	971	701	687	701	691	701	760
b ref = b theoretical in	1040	1230	1444	1230	1230	1230	1138

Note: 1) W_{4A} and W_{4B} are supposedly identical wings which differ only through the builder's tolerance.

2) W_{9A} and W_{9B} are the same wing in two different positions. W_{9B} is shifted 1.20 inches (model-scale) forward of the original position.

The moment reference point for all the data is 67% of the body length, on the model lateral centerline, and approximately 47% - 62% of the vehicle height. The table below lists the reference c.g. for the different bodies:

	B _{1A}	B _{1B}	B _{1C}	B ₂	B _{3A}	B _{3B}	B _{3C}	B ₄
Fuselage Station (F.S. 0 at Nose)	1266	1266	1266	1263	1273	1273	1273	1266
Water Line (W.L. 0 at Bottom)	163	163	163	163	214	214	214	163
Buttline (B.L. 0 at Body \bar{c})	0	0	0	0	0	0	0	0

The cavity effects on axial force have been corrected by the use of the average of two cavity pressure taps and four base pressure taps according to the following equation:

$$(C_A)_{\text{corrected}} = (C_A)_{\text{balance}} + \left[(C_{P \text{ ave}})_{\text{base}} - (C_{P \text{ ave}})_{\text{cavity}} \right] \times \left[\frac{\text{cavity area}}{\text{reference area}} \right].$$

There are no corrections applied for the effects of the sting on the base and cavity pressure.

TABLE III
SUMMARY DATA PLOT INDEX

TITLE NUMBER	TITLE	PLOTTED COEFFICIENTS SCHEDULE	CONDITIONS VARYING	PAGES
1	Leading Edge Fillet (Strake) Effect	A, B	Strake, Beta	1-11
2	Full - Span Elevon Power	A,B,C	Elevtr, Beta	12-24
3	Partial - Span Elevon Power	A, C	Elevtr	25-31
4	Roll Control Power	A,B,D	Ailron, Beta	32-48
5	Incidence Effect	A	Configuration	49-58
6	Body Nose Ramp Effect	A, B	Configuration, Beta	59-69
7	Wing Planform Comparison	A, B	Configuration, Beta	70-98
8	Wing Twist Effect	A, B	Configuration, Beta	99-109
9	Wing Airfoil Section Effect	A, B	Configuration, Beta	110-120
10	Boat Tail Effect	A, B	Configuration, Beta	121-131
11	Comparison of Wind Tunnel Models	A, B	Configuration, Beta	132-142
12	Engine Pod Effect	A, B	Configuration, Beta	143-153
13	Basic Configuration Buildup	A, B	Configuration, Beta	154-186
14	Body Flap Effect	A	Configuration	187-191
15	Wing Position Effect	A	Configuration	192-196
16	Vertical Tail Position	B	Configuration, Beta	197-208

COEFFICIENT SCHEDULES:

- A: CL, CLM, L/D vs ALPHA, CL vs CD, CL vs CIM
- B: CY, CYN, CBL, CYBETA, DCYNDB, DCBLDB vs ALPHA
- C: DCLDE, DCIMDE vs ALPHA
- D: DCYDA, DCYNDA, DCBLDA vs ALPHA

NOTE: See Appendix, Page A-1, for Comprehensive Data Plot Index

FIGURES

BODIES B_{1A} & B_{1B}

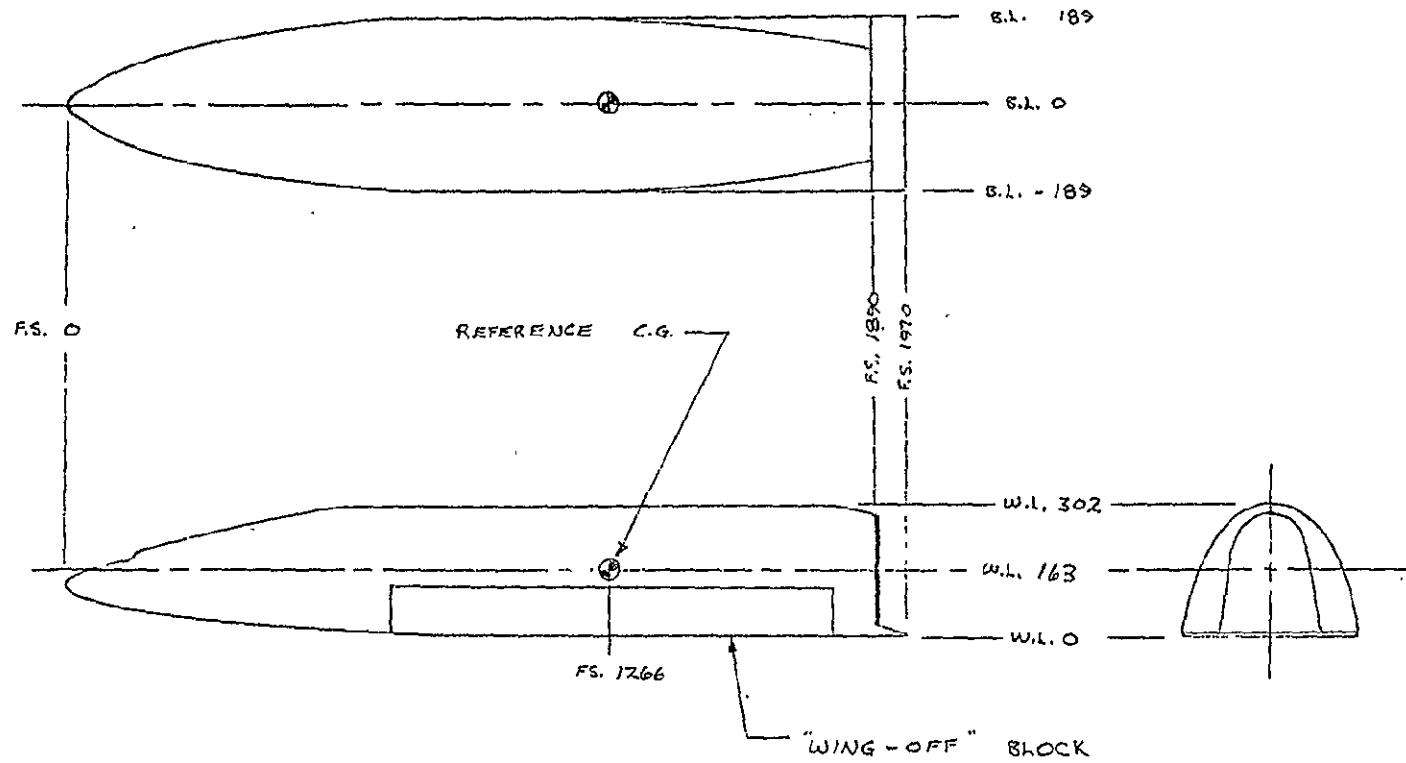
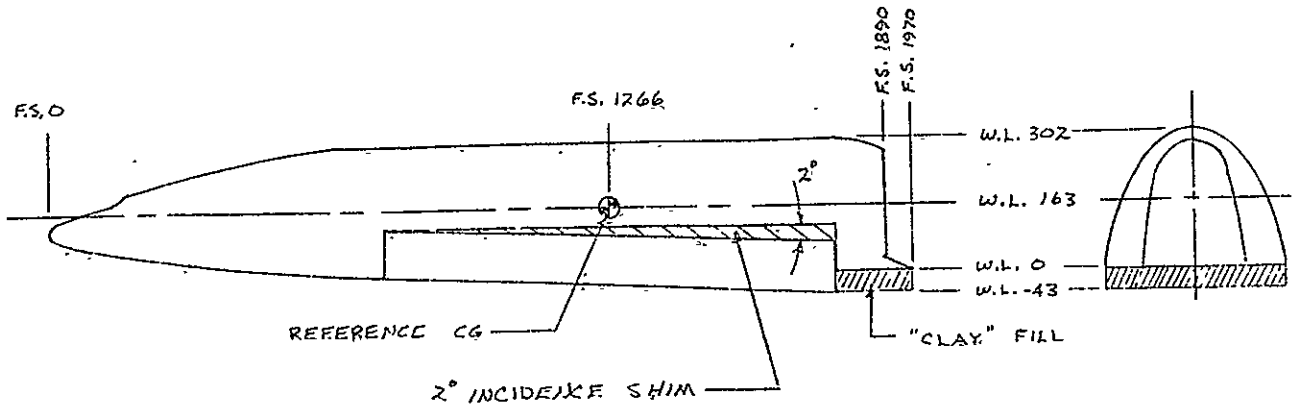

FIGURE 2. BODIES B_{1A} and B_{1B}

NOTE: BASIC B_{1A} BODY WITH A 2° INCIDENCE SHIM BETWEEN THE BODY AND THE WING/WING-OFF BLOCK



BODY B₂

NOTE: B_{1A} BODY SHAPE WITH A 4° WEDGE INSERTED AT F.S. 700 TO INCREASE THE FORWARD BODY RAMP ANGLE.

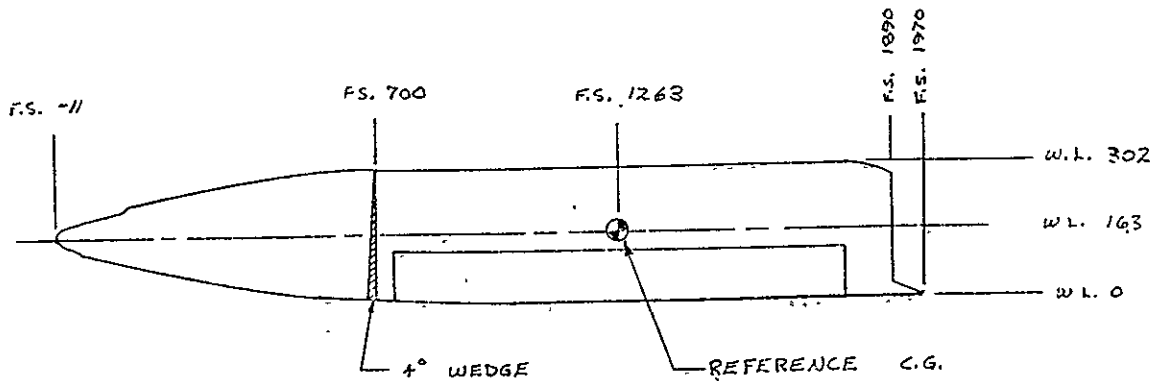

FIGURE 3. BODIES B_{1C} and B₂

BODY B_{3A}

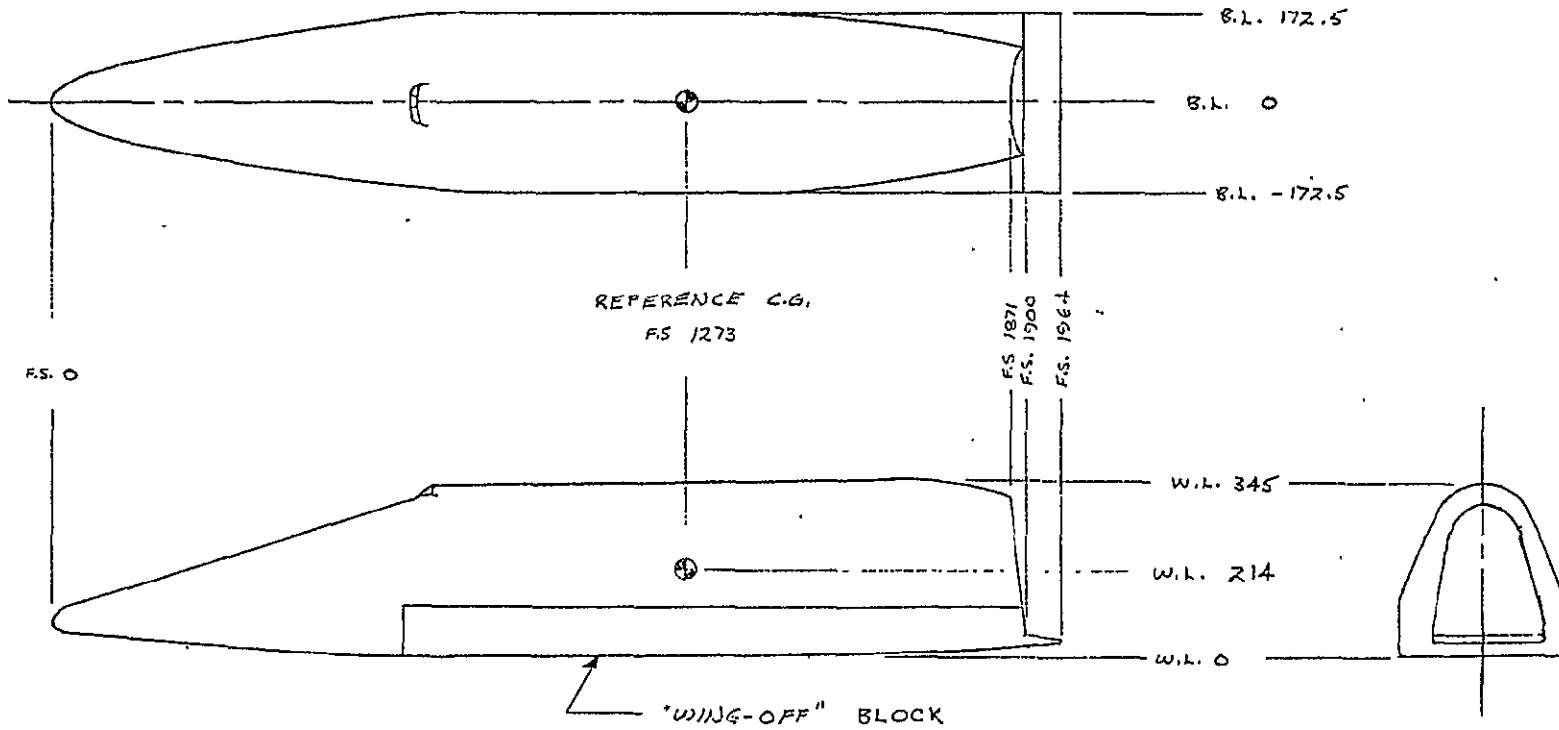
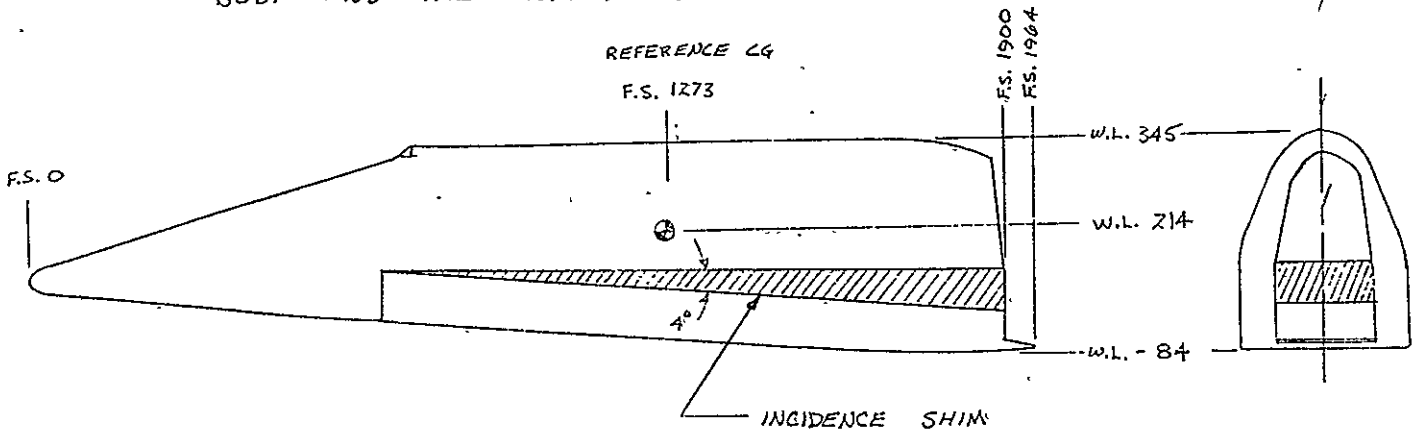

FIGURE 4. BODY B_{3A}

BODY B_{3B}

NOTE: BASIC B_{3A} BODY WITH A 4° INCIDENCE SHIM BETWEEN THE BODY AND THE WING / WING-OFF BLOCK



BODY B_{3C}

NOTE: BASIC B_{3A} BODY WITH THE BODY FLAP REMOVED. DUE TO A MIX-UP IN THE MODEL DESIGN, THE PORTION REMOVED AS A BODY FLAP IS ACTUALLY WIDER THAN THE "WING-OFF" BODY FLAP

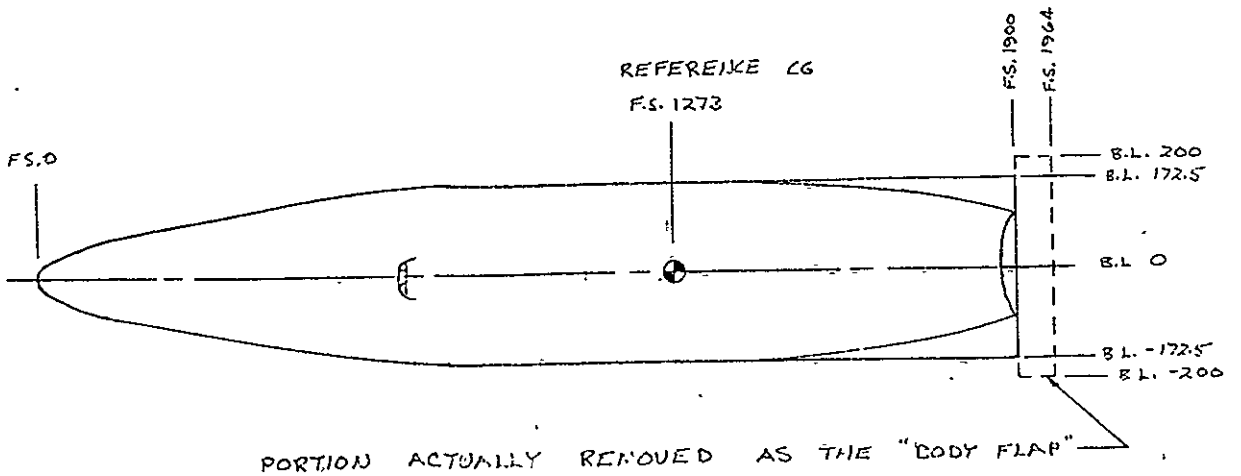
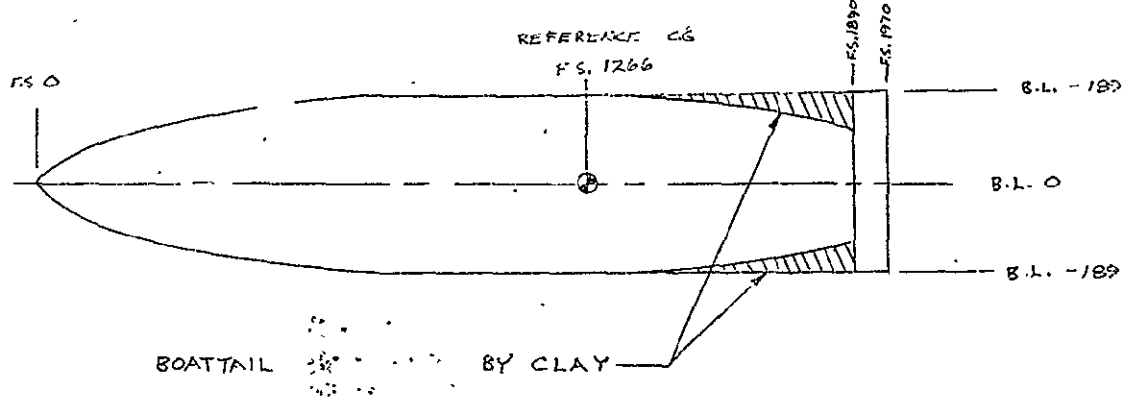

FIGURE 5. BODIES B_{3B} and B_{3C}

NOTE: BASIC B₁₈ BODY WITH THE BOATTAIL REMOVED IN THE PLANFORM VIEW, ACCOMPLISHED BY JUDICIOUS APPLICATION OF MODEL CLAY.



SIMULATED ENGINE PODS - P₁ & P₂

NOTE: ENGINE PODS WERE SIMULATED BY THESE "TEARDROP" SHAPES. FOR THE "ALL ENGINES RUNNING" CASE (P₁) ALL 4 ENGINE PODS HAD THE "TEARDROP" SHAPE. FOR THE "ONE ENGINE OUT" CASE (P₂) THE LEFT OUTBOARD POD WAS CUT AS SHOWN. ALL PODS ARE BODIES OF REVOLUTION.

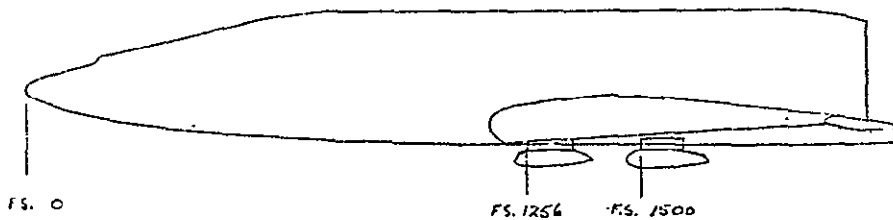
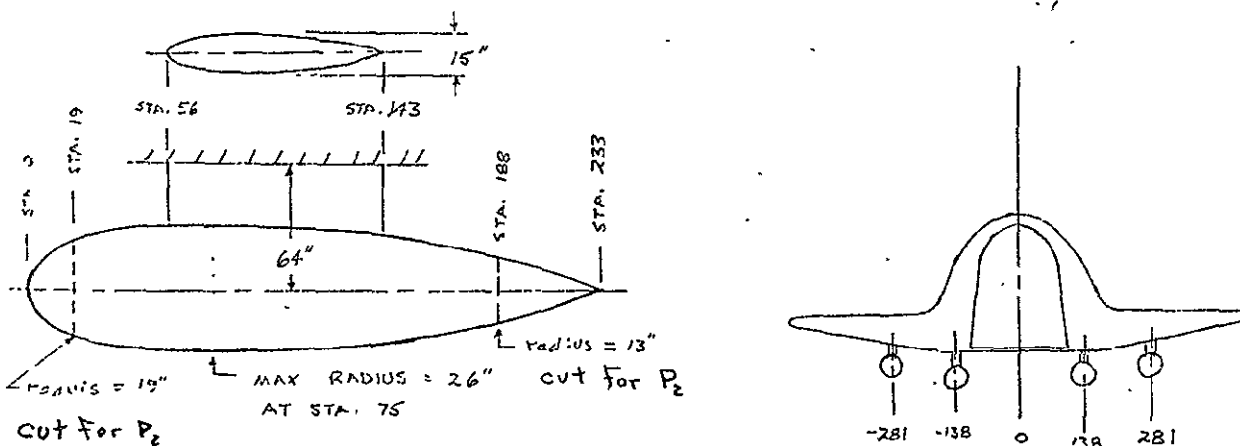

AS MOUNTED ON THE
B₁₈ W_{4A} CONFIG.

FIGURE 6. BODY B₄ and SIMULATED ENGINE PODS P₁ and P₂

WING W₂ - BASIC "025" WING

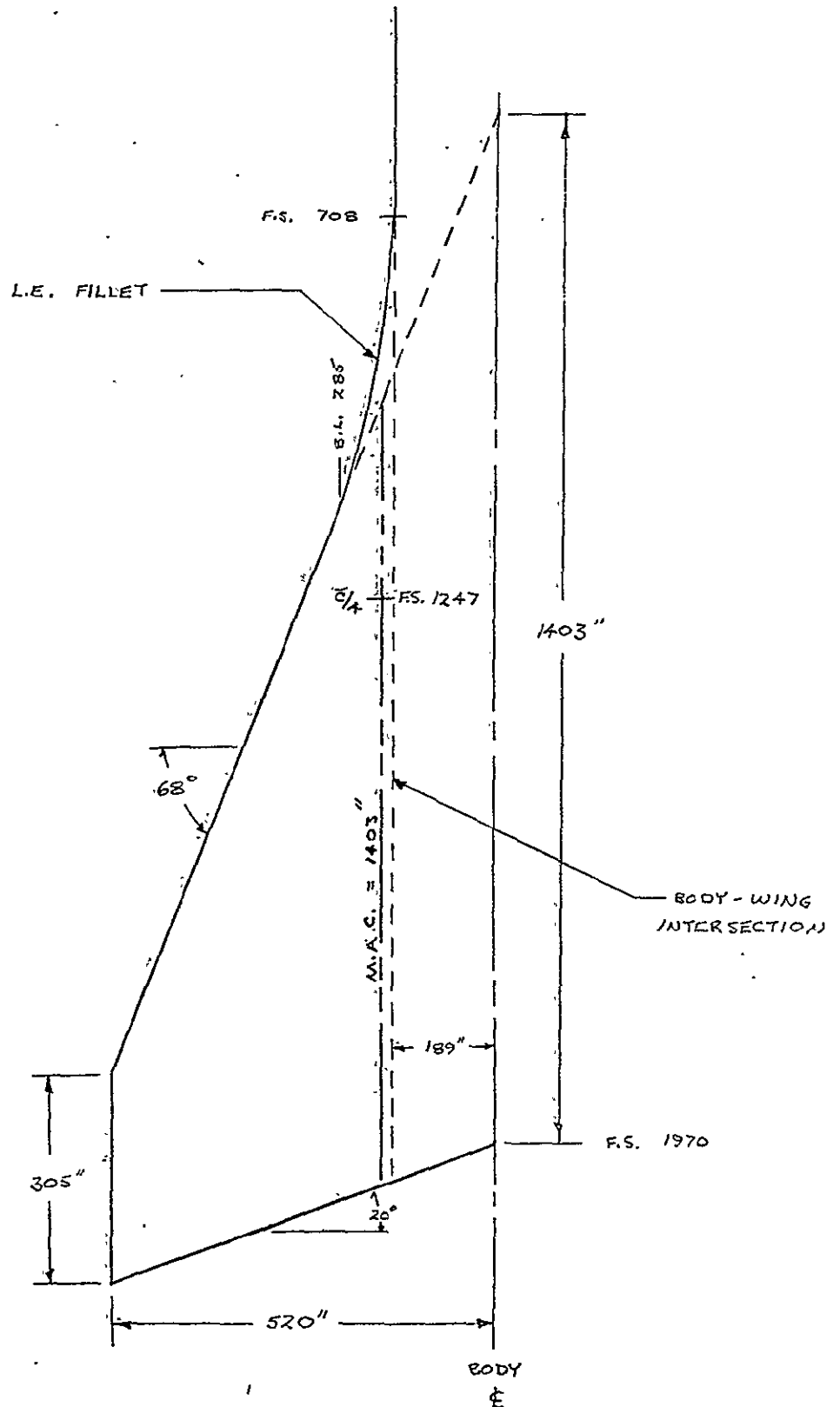
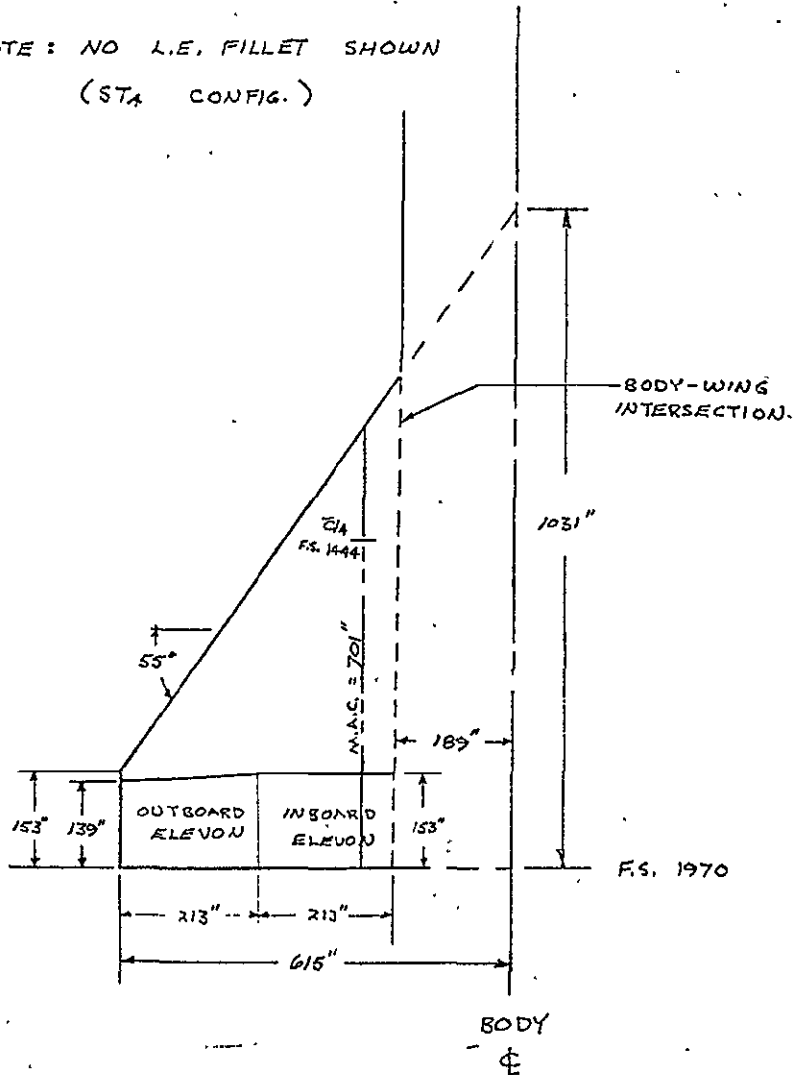

FIGURE 7. WING W₃

WING W₄

NOTE: NO L.E. FILLET SHOWN
(ST_A CONFIG.)



WING W₄ L.E. FILLETS (STRAKES)

NOTE: ST₄ IS NO L.E. FILLET

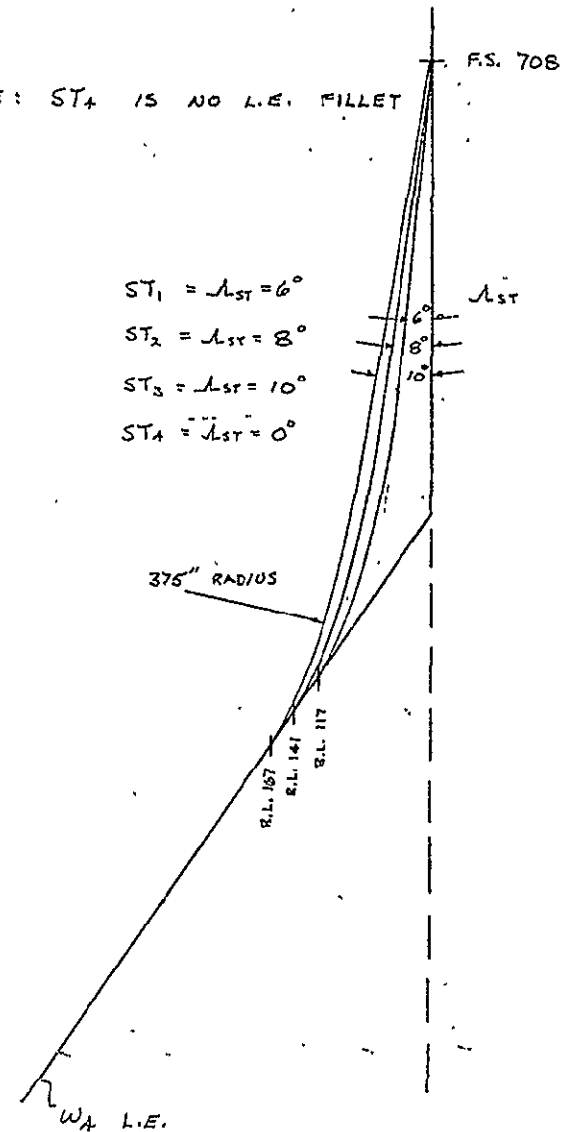
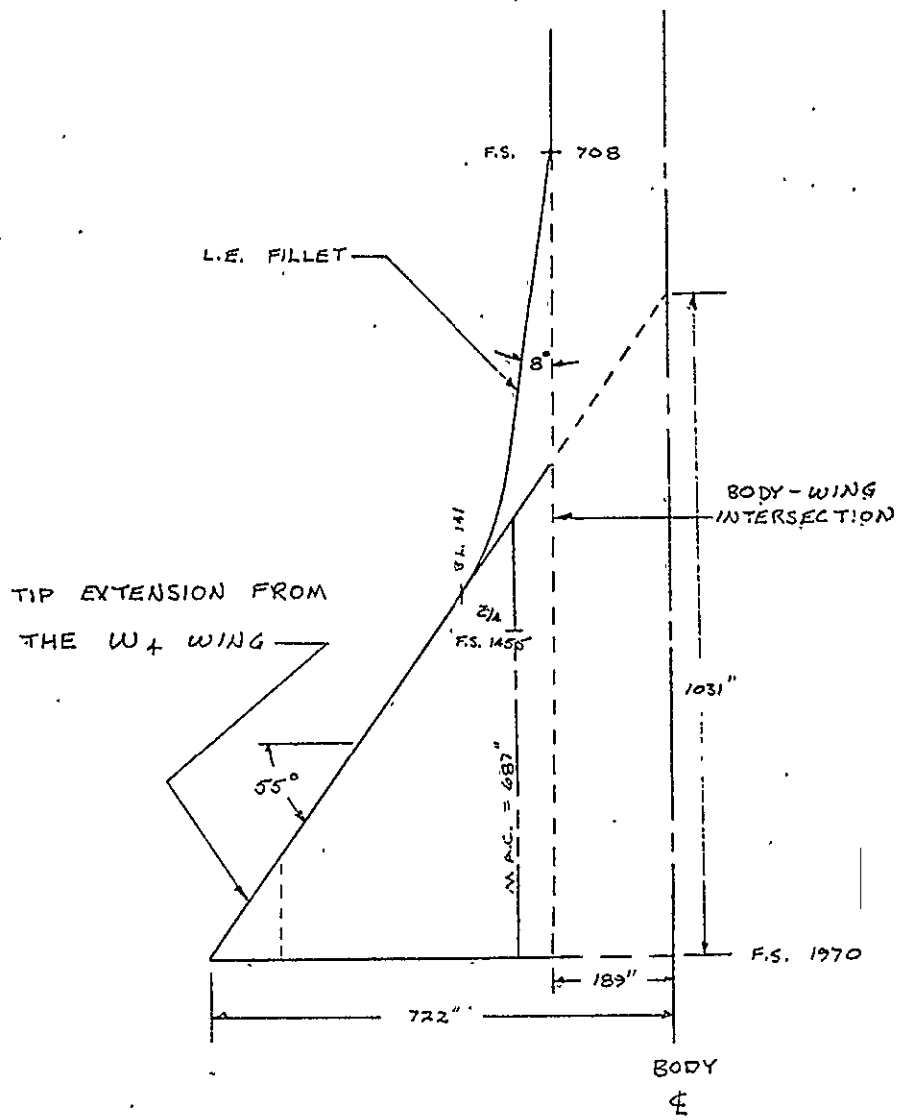

FIGURE 8. WING W₄ AND WING W₄ LEADING EDGE FILLETS (STRAKES)

WING W₅



WING W₆

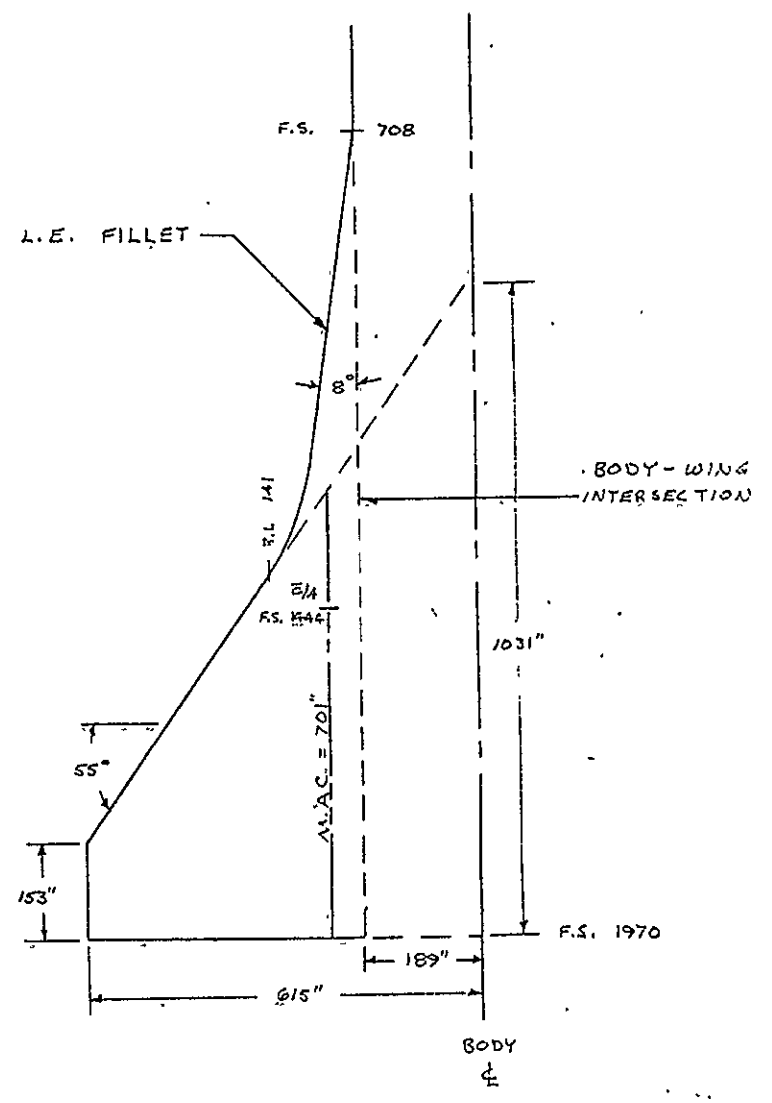

FIGURE 9. WINGS W₅ AND W₆

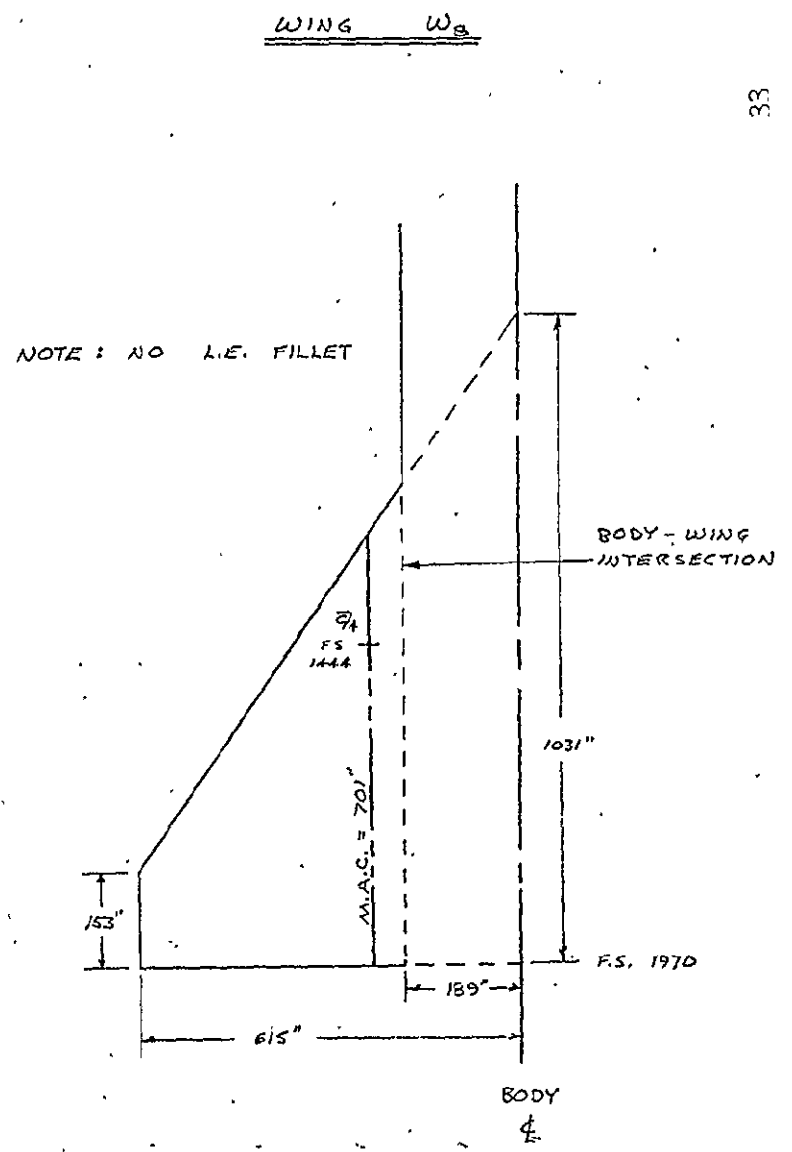
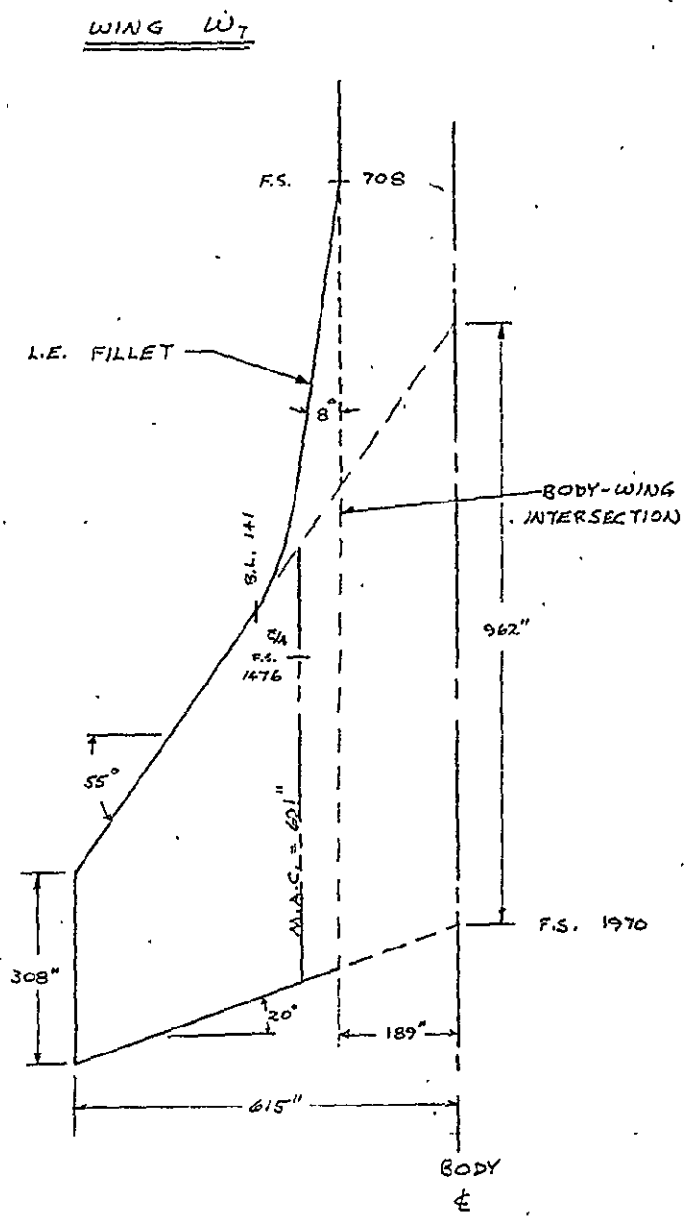

FIGURE 10. WINGS W₇ AND W₈

WING W_{9A} & W_{9B}

NOTE: THE ONLY DIFFERENCE BETWEEN W_{9A} AND W_{9B} IS THE LOCATION OF THE WING ON THE BODY

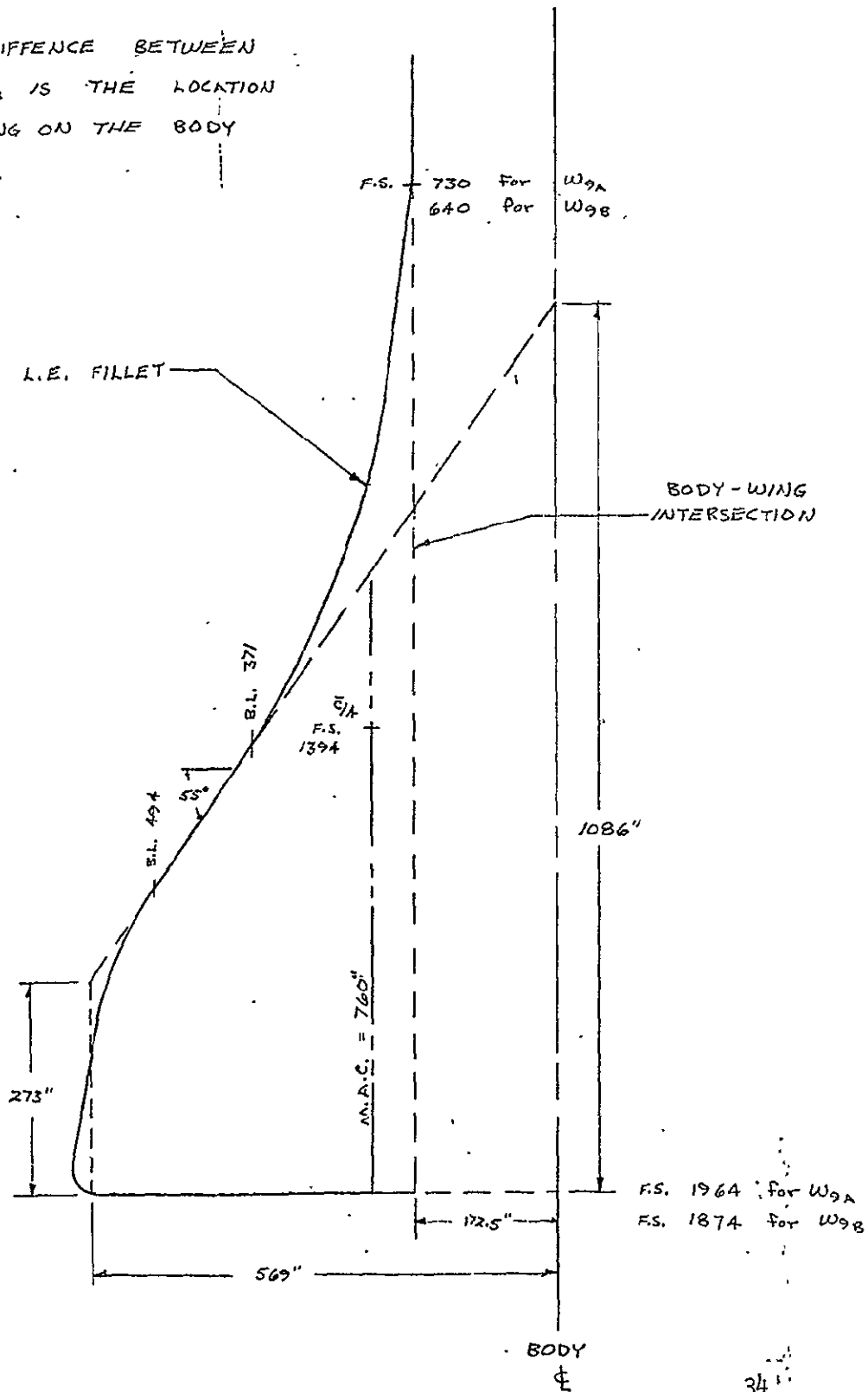
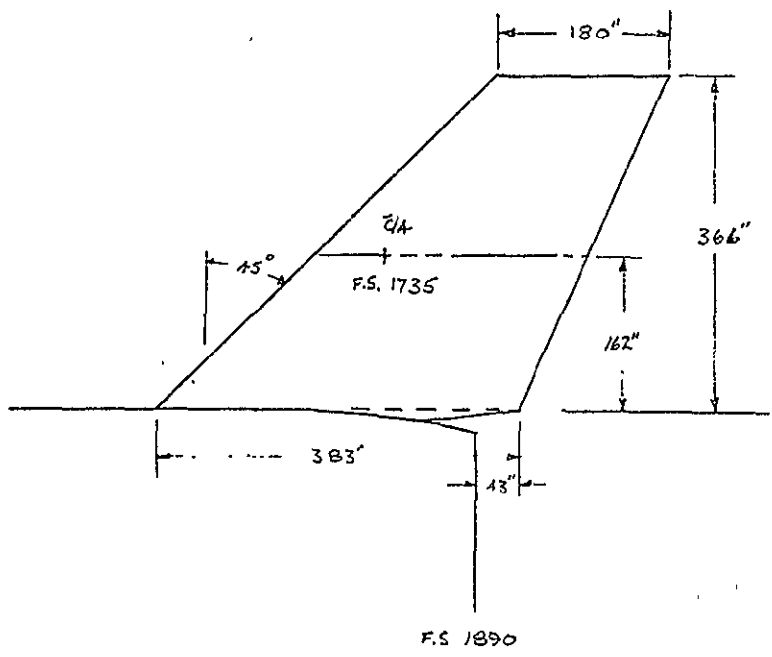

FIGURE 11. WINGS W_{9A} AND W_{9B}

VERTICAL TAIL V₃

VERTICAL TAIL V₄

NOTE : AS MOUNTED ON BODY B₁



W.L. 302

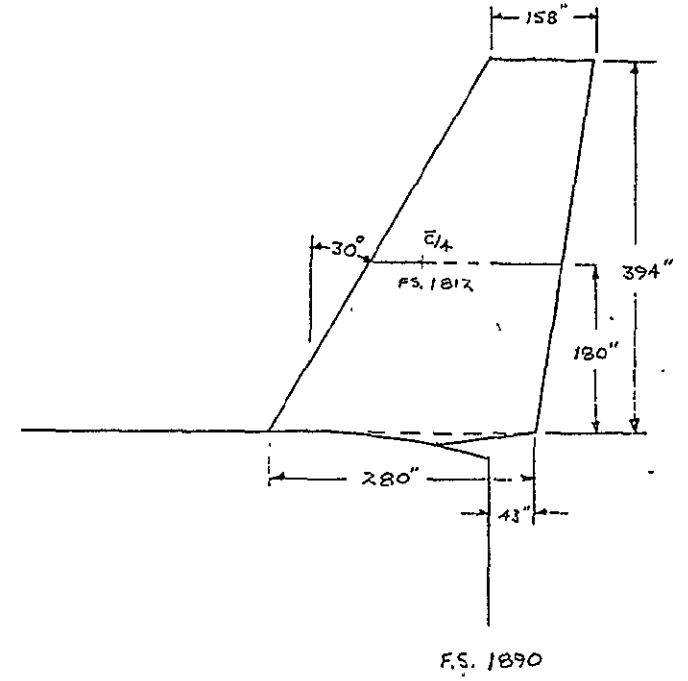

25

FIGURE 12. VERTICAL TAILS V₃ AND V₄ AS MOUNTED ON BODY B₁

VERTICAL TAIL V₄

VERTICAL TAIL V₅

NOTE: AS MOUNTED ON BODY B₃

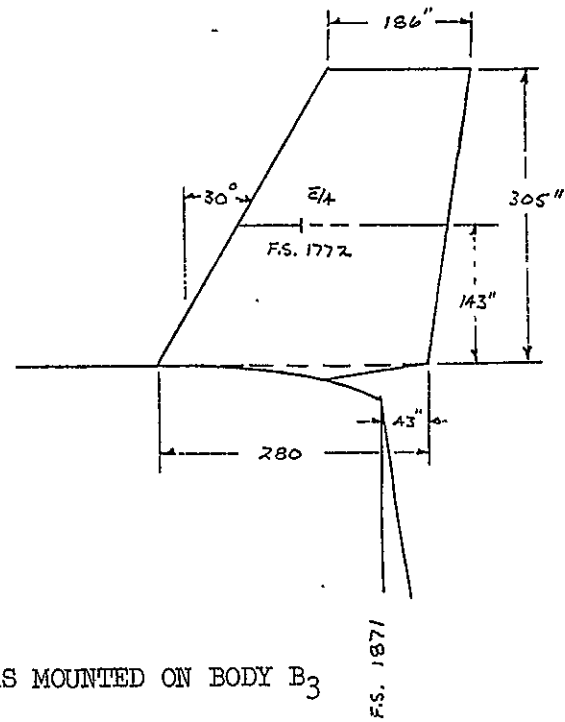
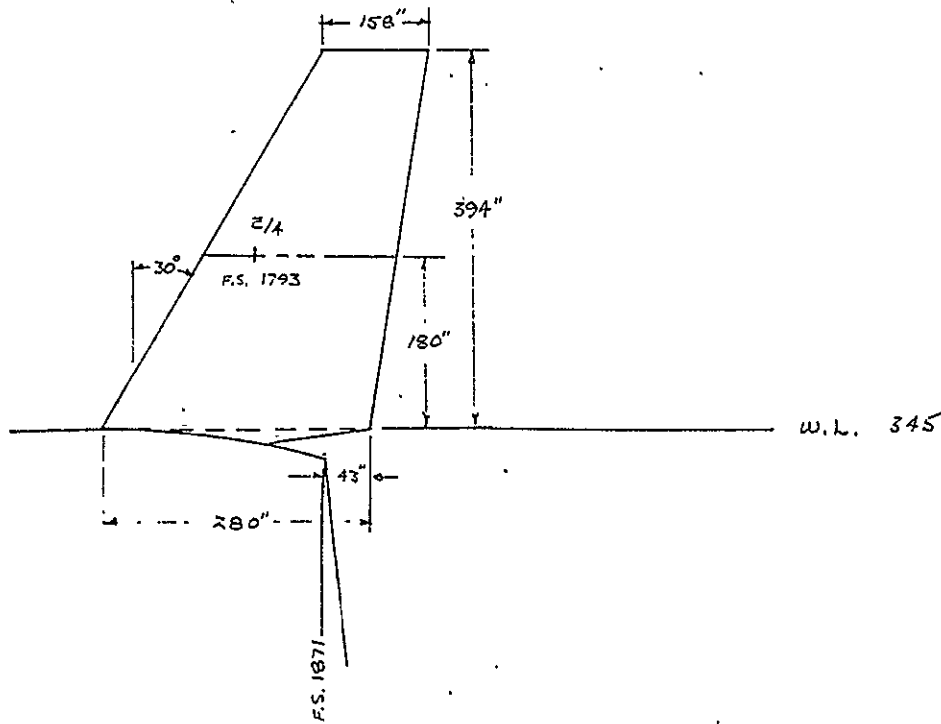
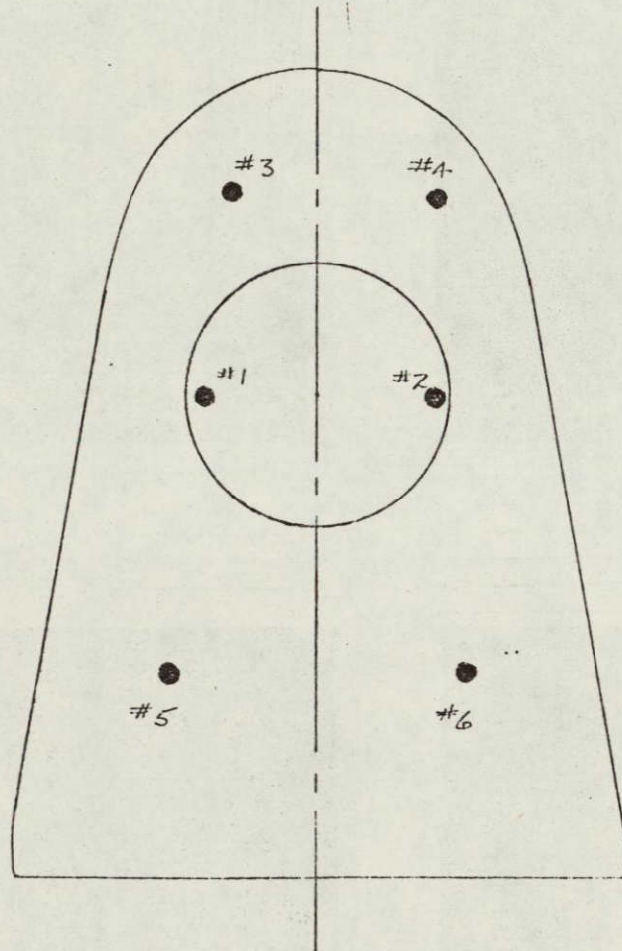

FIGURE 13. VERTICAL TAILS V₄ AND V₅ AS MOUNTED ON BODY B₃

BASE AND BALANCE CAVITY PRESSURE PROBES



NOTE : • PROBES #1 & #2 ARE LOCATED IN THE BALANCE CAVITY
• PROBES #3 → #6 ARE LOCATED FLUSH WITH THE BASE
MIDWAY BETWEEN THE BALANCE CAVITY AND THE EDGE
OF THE BODY BASE

FIGURE 14. BASE AND BALANCE CAVITY PRESSURE PROBES

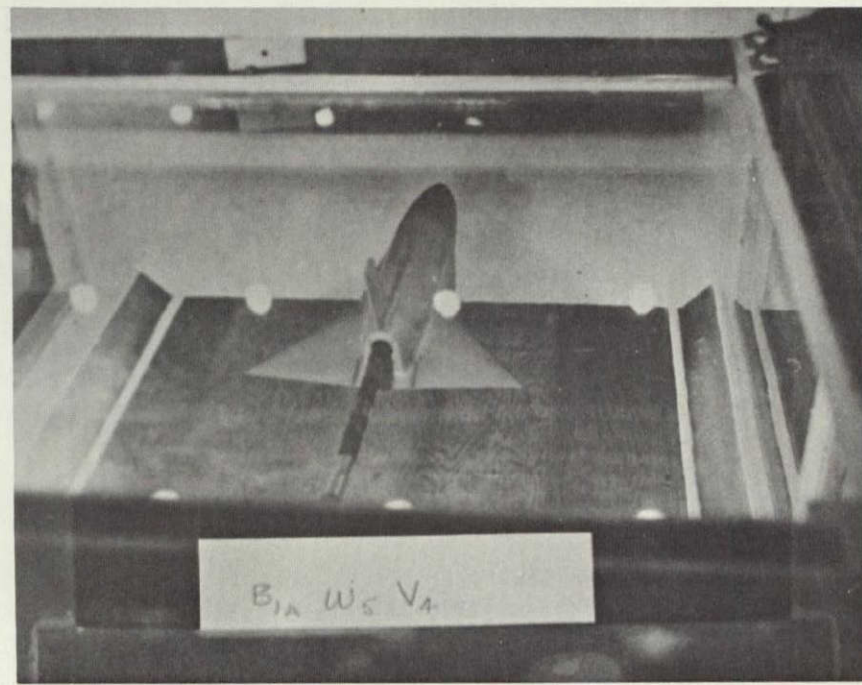
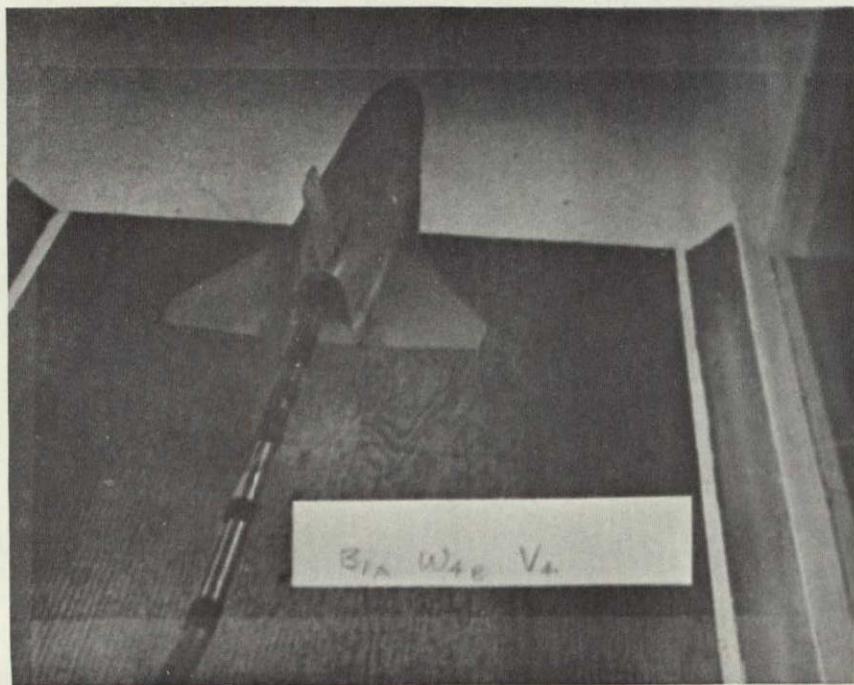
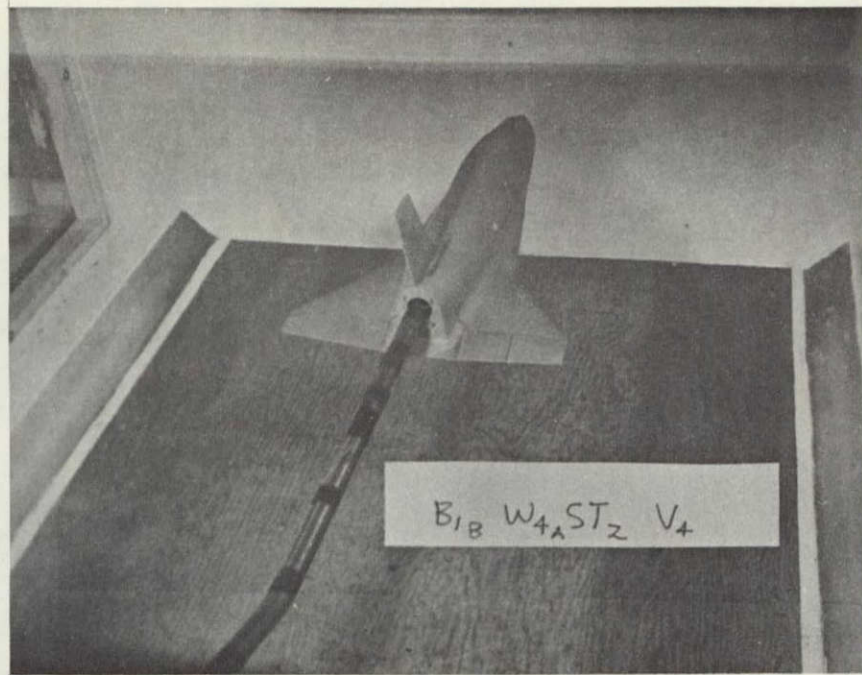
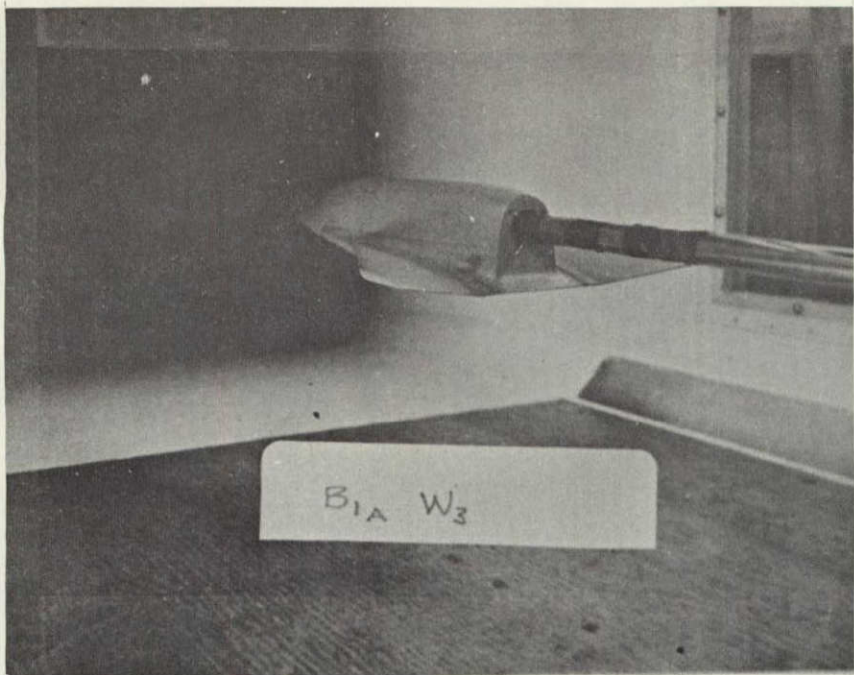

FIGURE 15. MODEL PHOTOGRAPHS

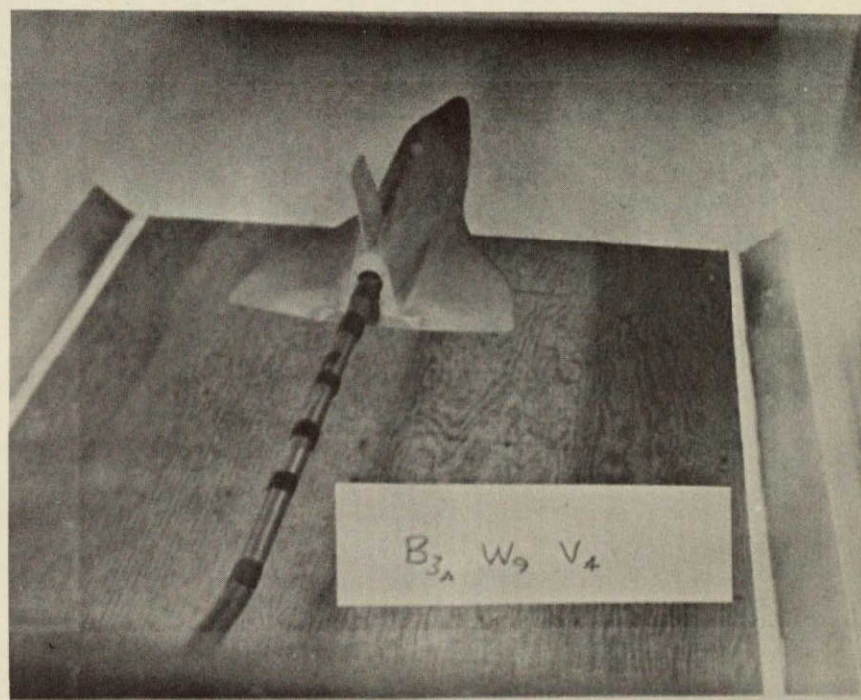
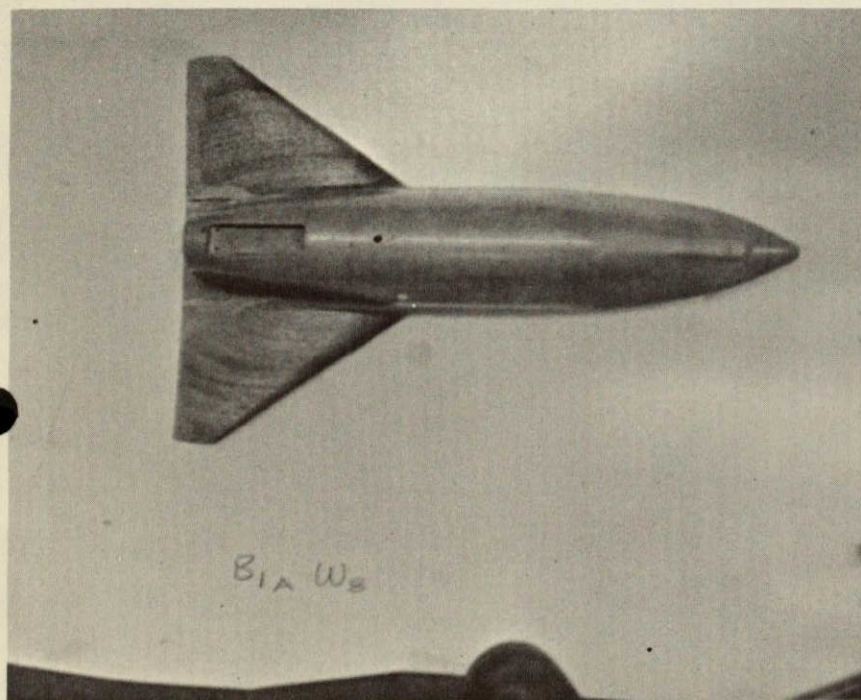
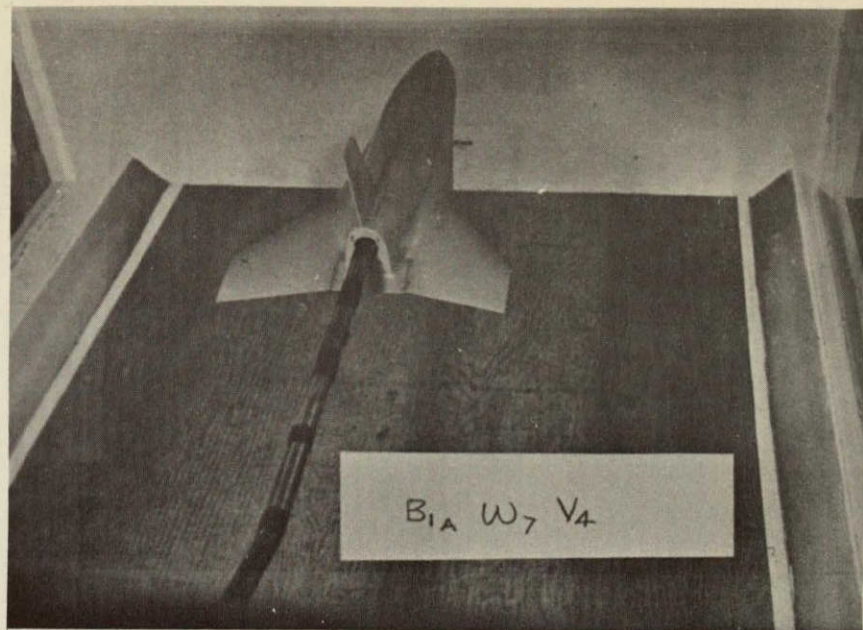
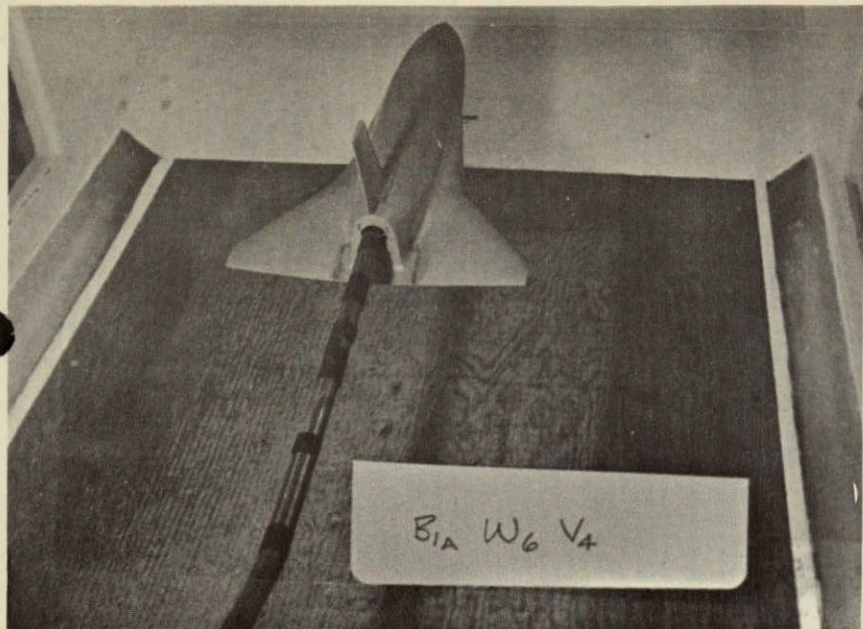

FIGURE 15. (CONTINUED)

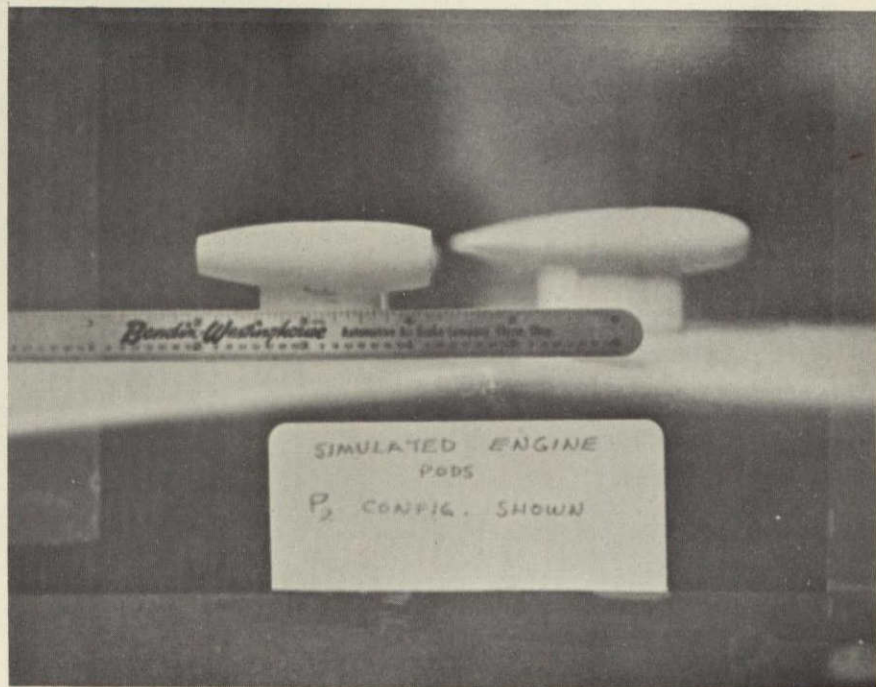
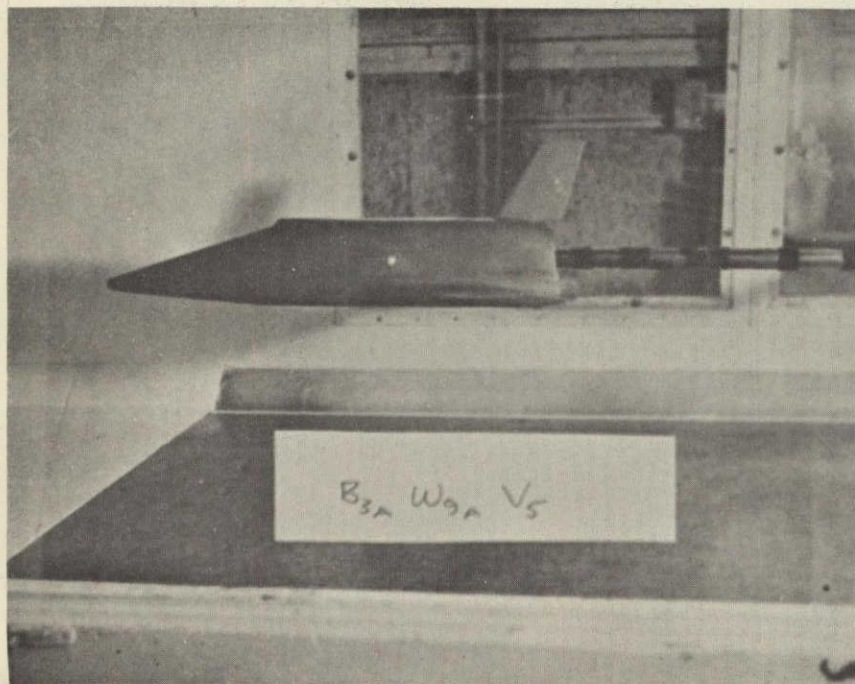
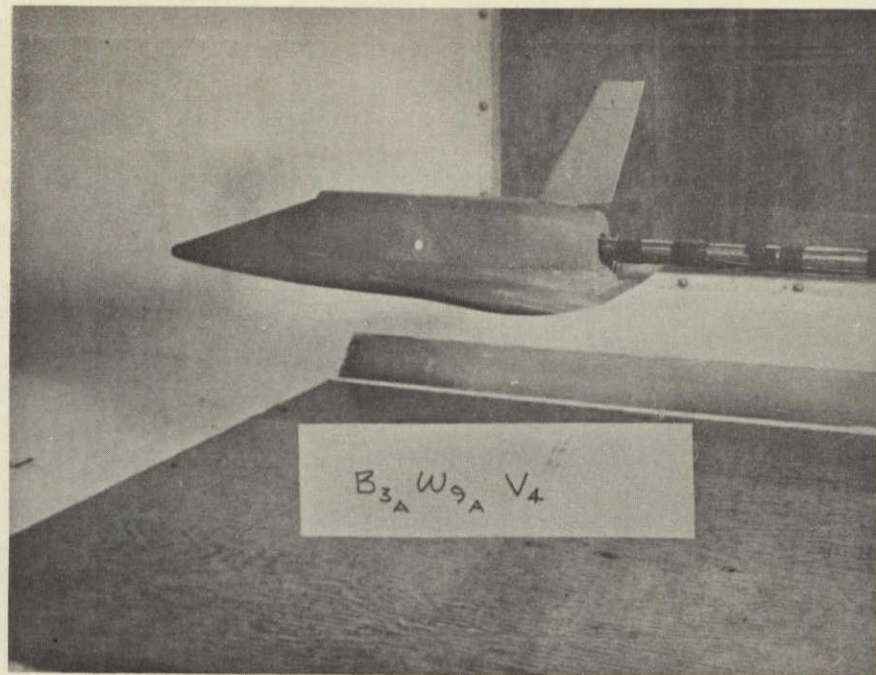
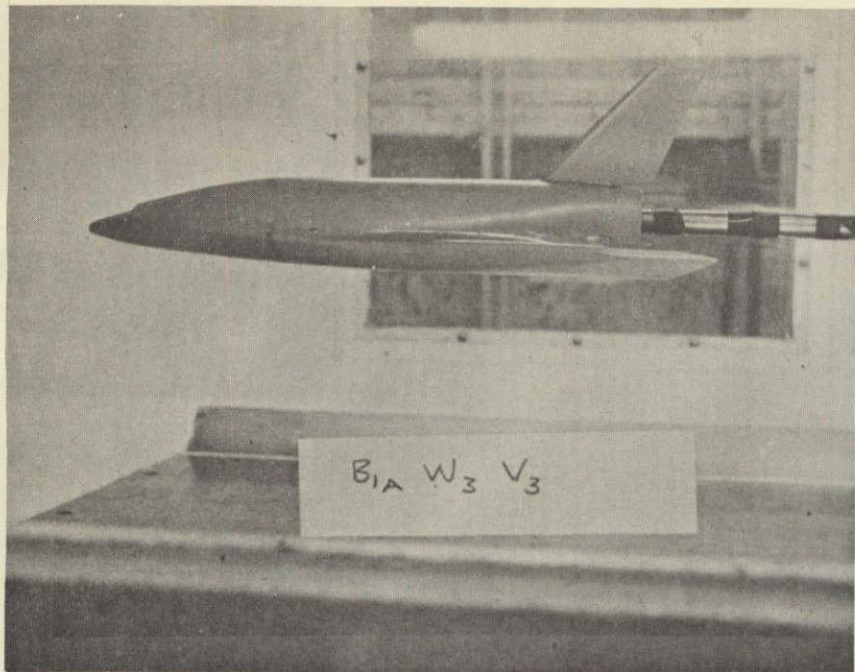
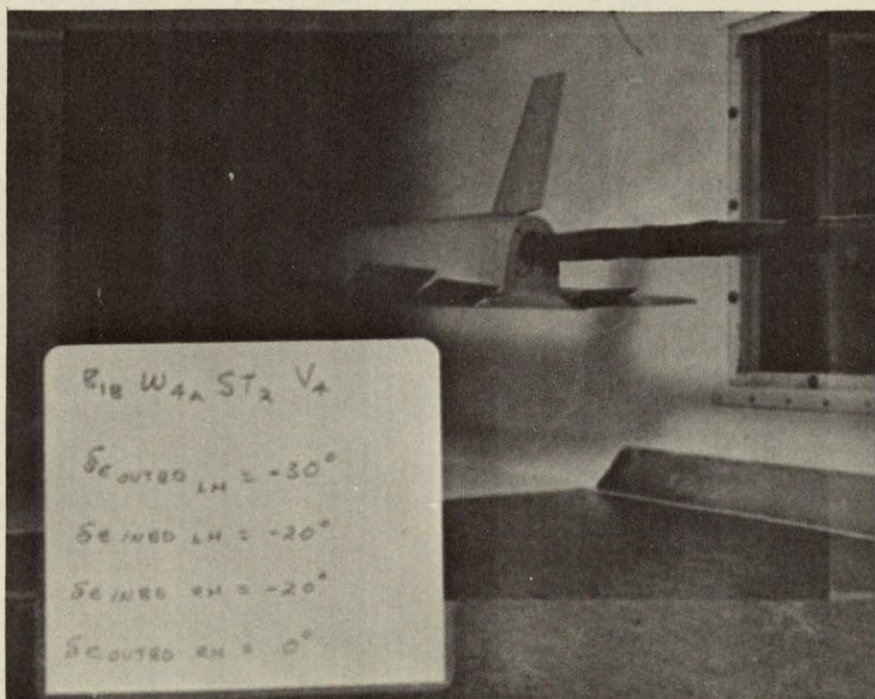
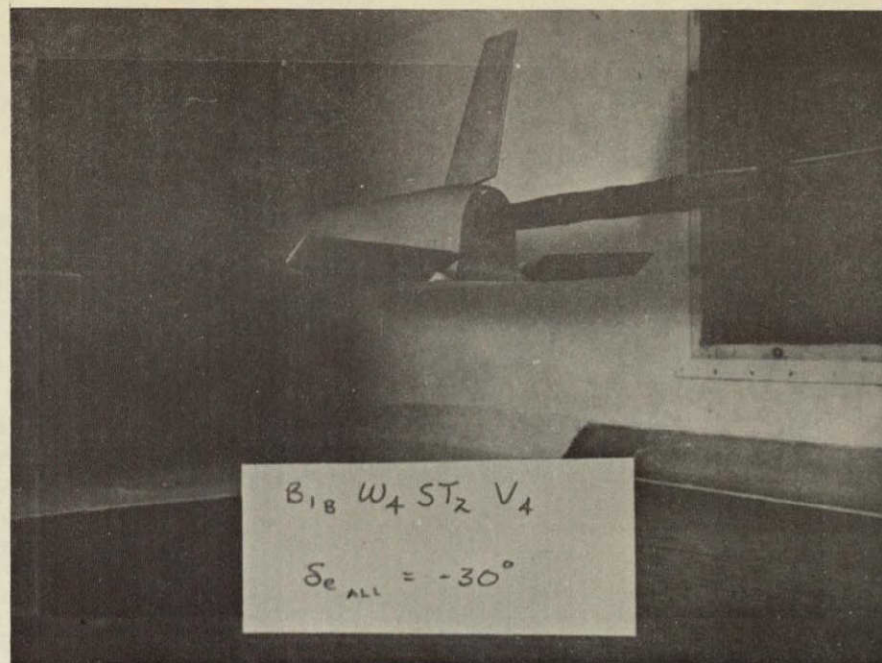
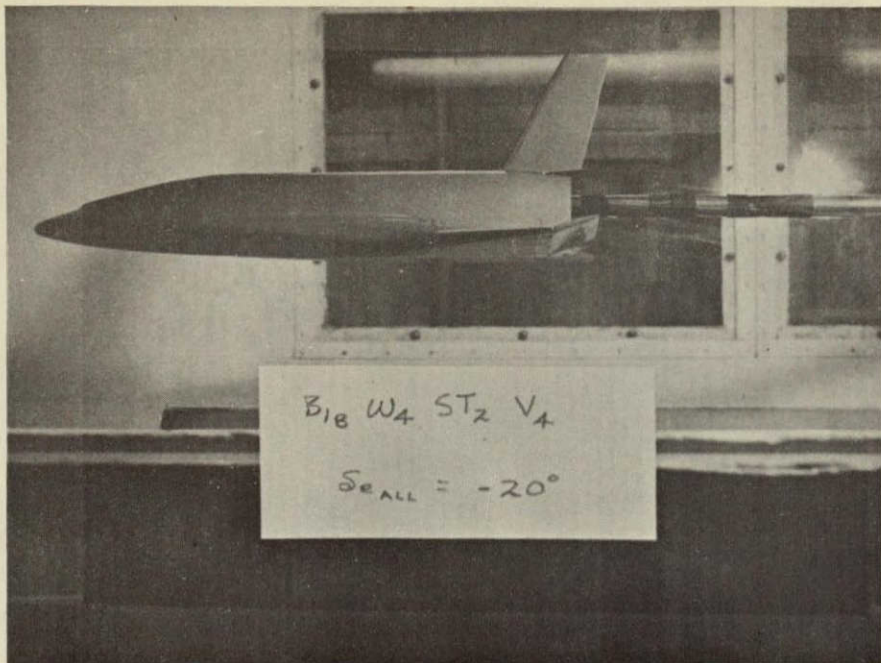

FIGURE 15. (CONTINUED)



NOT REPRODUCIBLE

FIGURE 15. (CONTINUED)

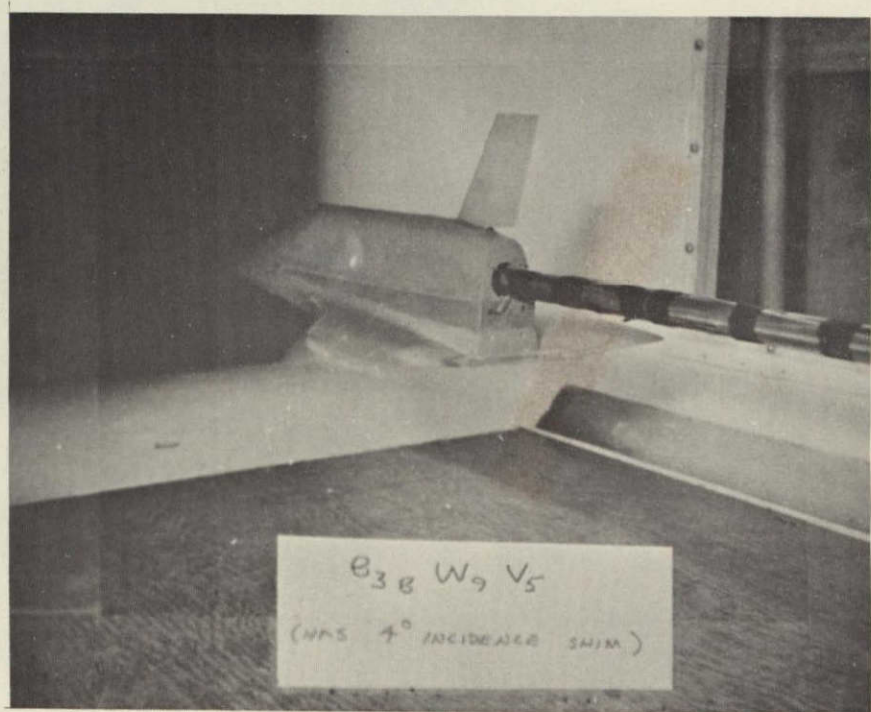
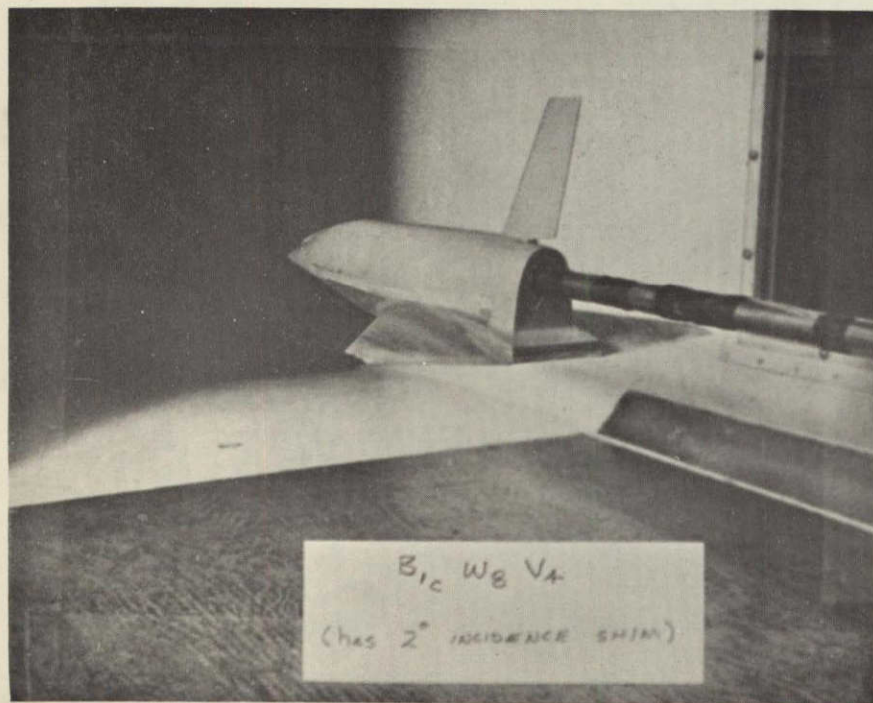
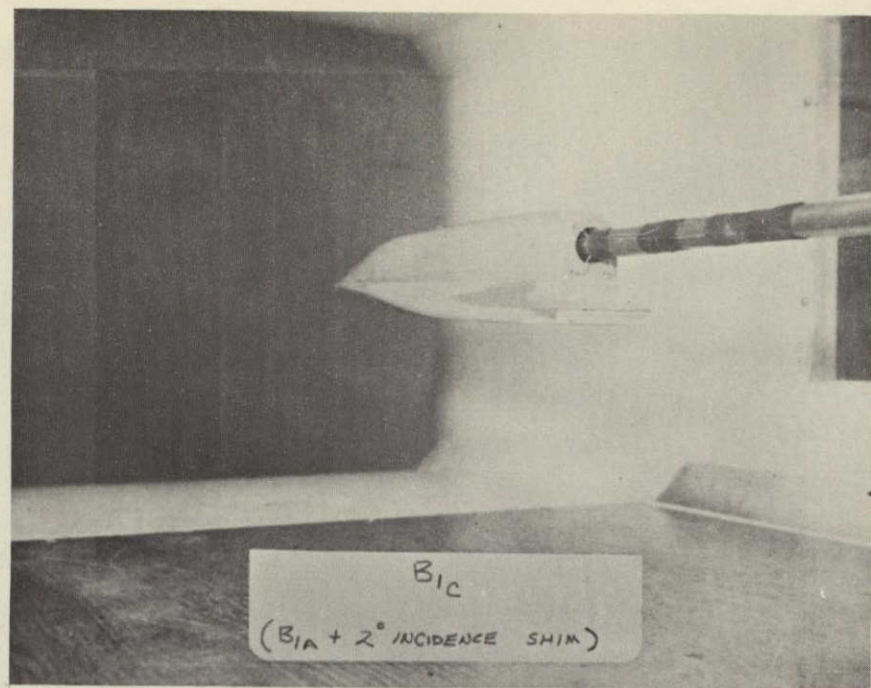
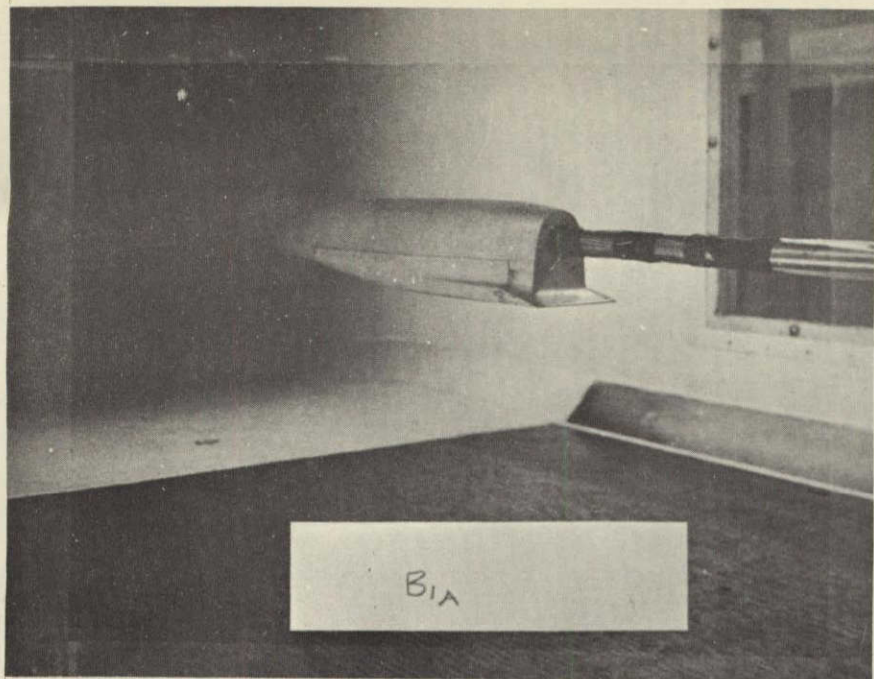

FIGURE 15. (CONTINUED)

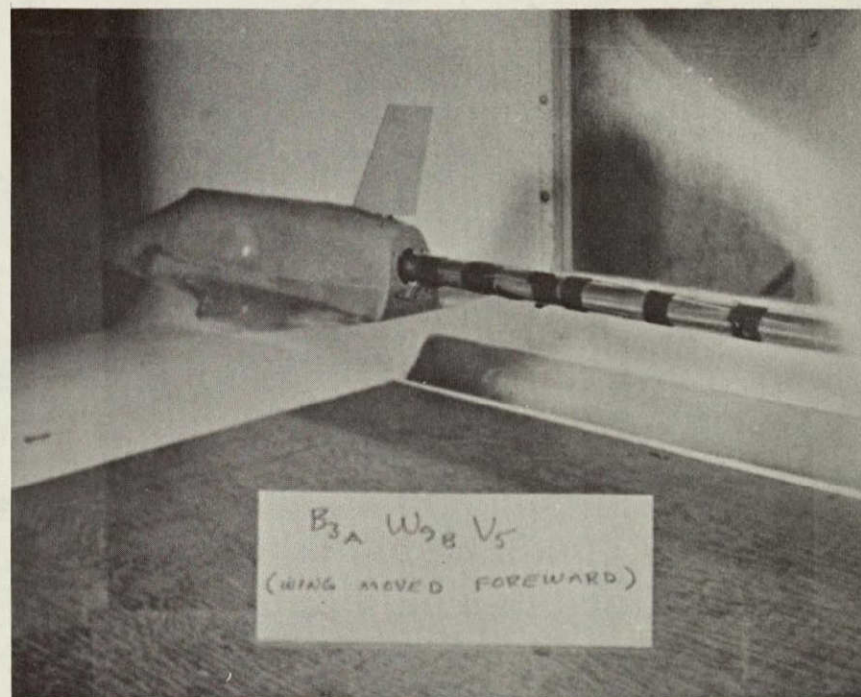
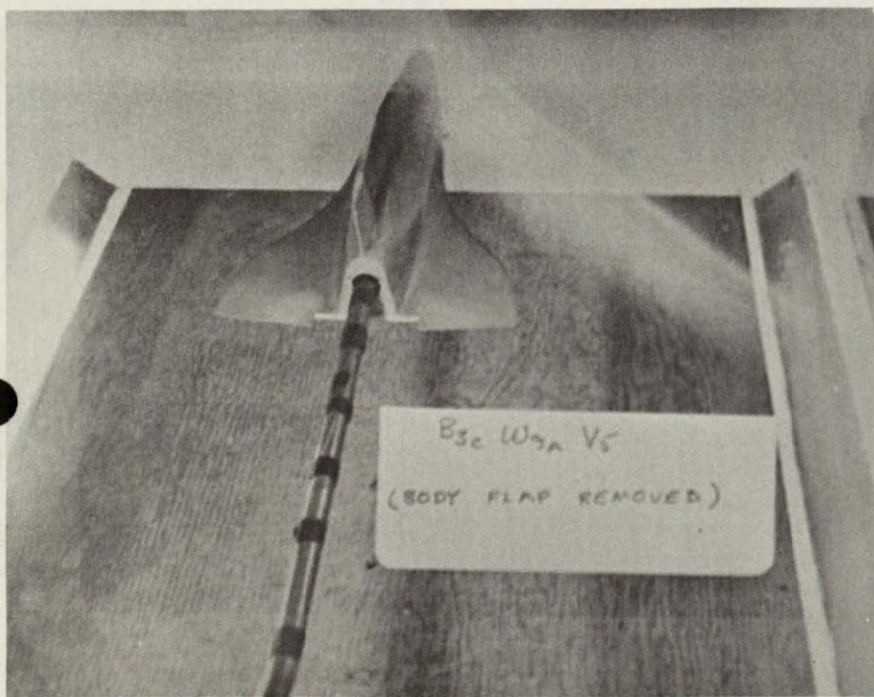
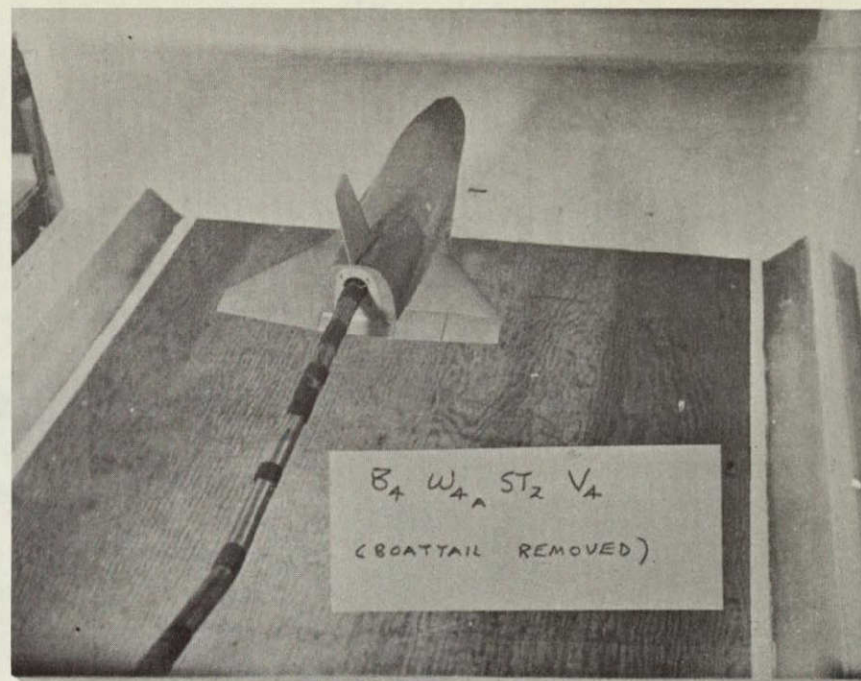
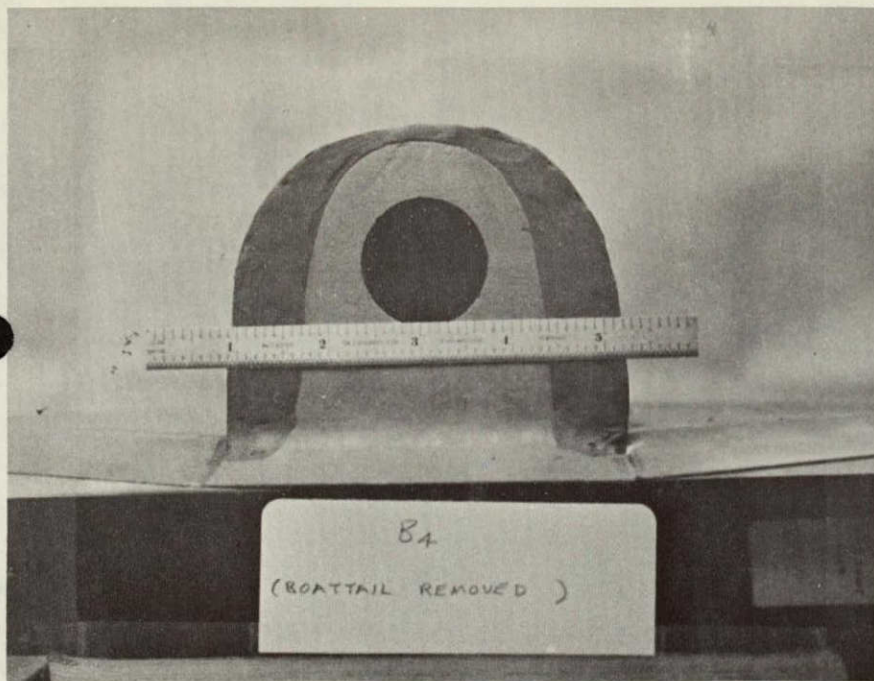

FIGURE 15. (CONTINUED)

MODEL COMPONENT: BODY - B1A & B1B

GENERAL DESCRIPTION: BASELINE BODY FOR THE 1 1/3 % HCB
ORBITER GENERIC TEST

DRAWING NUMBER: Z55BT00040

<u>DIMENSIONS:</u>	<u>FULL-SCALE</u>	<u>MODEL SCALE</u>
		<u>1 1/3 %</u>
Length , IN.	<u>1890</u>	<u>25.20</u>
Max. Width , IN.	<u>378</u>	<u>5.04</u>
Max. Depth , IN.	<u>302</u>	<u>4.03</u>
Fineness Ratio	<u>-</u>	<u>-</u>
Area		
Max. Cross-Sectional	<u>-</u>	<u>-</u>
Planform , FT ² (BODY FLAP EXCLUDED)	<u>4210</u>	<u>.7484</u>
Wetted	<u>-</u>	<u>-</u>
Base , FT ²	<u>362</u>	<u>.0644</u>

MODEL COMPONENT: BODY - BIC

GENERAL DESCRIPTION: BASELINE BODY WITH A 2° INCIDENCE

SHIM IN PLACE

DRAWING NUMBER: _____

<u>DIMENSIONS:</u>	<u>FULL-SCALE</u>	<u>MODEL SCALE</u> <u>1/3%</u>
Length	<u>1890"</u>	<u>25.20"</u>
Max. Width	<u>378"</u>	<u>5.04"</u>
Max. Depth	<u>345"</u>	<u>4.60"</u>
Fineness Ratio	<u>—</u>	<u>—</u>
Area		
Max. Cross-Sectional	<u>—</u>	<u>—</u>
Planform (<i>Body flop</i> <i>included</i>)	<u>4210 ft²</u>	<u>.7484 ft²</u>
Wetted	<u>—</u>	<u>—</u>
Base	<u>157 ft²</u>	<u>.0812 ft²</u>

MODEL COMPONENT: B_{1A}, B_{1B}, B_{1C}, B₂, B₄ BODY FLAP

GENERAL DESCRIPTION: FIXED BODY FLAP AT LOWER FUSELAGE
AFT END. ALL THESE BODIES HAVE IDENTICAL BODY FLAPS

DRAWING NUMBER: Z55BT00040

<u>DIMENSIONS:</u>	<u>FULL-SCALE</u>	<u>MODEL SCALE</u>
Area, FT ²	<u>180</u>	<u>1 1/3 %</u> <u>.032</u>
Span (equivalent), in.	<u>324</u>	<u>4.32</u>
Inb'd equivalent chord, in.	<u>80</u>	<u>1.07</u>
Outb'd equivalent chord, in.	<u>80</u>	<u>1.07</u>
Ratio movable surface chord/ total surface chord		
At Inb'd equiv. chord	<u>—</u>	<u>—</u>
At Outb'd equiv. chord	<u>—</u>	<u>—</u>
Sweep Back Angles, degrees		
Leading Edge	<u>0</u>	<u>0</u>
Trailing Edge	<u>0</u>	<u>0</u>
Hingeline	<u>0</u>	<u>0</u>
Area Moment (Normal to hinge line)	<u>—</u>	<u>—</u>

MODEL COMPONENT: BODY - B₂

GENERAL DESCRIPTION: BASELINE B₁ WITH A 4° WEDGE INSERTED
AT MODEL F.S. 9.33 TO RAISE THE NOSE AND INCREASE THE
NOSE RAMP ANGLE

DRAWING NUMBER: 255BT00040

<u>DIMENSIONS:</u>	<u>FULL-SCALE</u>	<u>MODEL SCALE</u>
Length <u>, IN.</u>	<u>1901</u>	<u>25.34</u>
Max. Width <u>, IN.</u>	<u>378</u>	<u>5.04</u>
Max. Depth <u>, IN.</u>	<u>302</u>	<u>4.03</u>
Fineness Ratio	<u>—</u>	<u>—</u>
Area		
Max. Cross-Sectional	<u>—</u>	<u>—</u>
Planform <u>, FT²</u>	<u>4212</u>	<u>.7488</u>
Wetted	<u>—</u>	<u>—</u>
Base <u>, FT²</u>	<u>362</u>	<u>.0644</u>

MODEL COMPONENT: BODY - B_{3A}

GENERAL DESCRIPTION: NEW BODY SHAPE AS PER DRAWING

2558T00045

DRAWING NUMBER: 2558T00045

<u>DIMENSIONS:</u>	<u>FULL-SCALE</u>	<u>MODEL SCALE</u>
Length, <u>IN.</u>	<u>1900</u>	<u>25.33</u>
Max. Width, <u>IN.</u>	<u>345</u>	<u>4.60</u>
Max. Depth, <u>IN.</u>	<u>345</u>	<u>4.60</u>
Fineness Ratio	<u>—</u>	<u>—</u>
Area		
Max. Cross-Sectional	<u>—</u>	<u>—</u>
Planform, <u>FT²</u>	<u>3934</u>	<u>.6993</u>
Wetted	<u>—</u>	<u>—</u>
Base, <u>FT²</u>	<u>4.05</u>	<u>.0720</u>

MODEL COMPONENT: BODY - B38

GENERAL DESCRIPTION: B3A body with a 4° incidence
skin in place.

DRAWING NUMBER: NONE

<u>DIMENSIONS:</u>	<u>FULL-SCALE</u>	<u>MODEL SCALE</u>
		<u>1/3%</u>
Length	<u>1900"</u>	<u>25.33"</u>
Max. Width	<u>345"</u>	<u>4.60"</u>
Max. Depth	<u>429"</u>	<u>5.72"</u>
Fineness Ratio	<u>—</u>	<u>—</u>
Area		
Max. Cross-Sectional	<u>—</u>	<u>—</u>
Planform	<u>3934 ft²</u>	<u>.6993 ft²</u>
Wetted	<u>—</u>	<u>—</u>
Base	<u>545 ft²</u>	<u>.0969 ft²</u>

MODEL COMPONENT: B3 BODY FLAP

GENERAL DESCRIPTION: FIXED BODY FLAP AT LOWER FUSELAGE

AFT END.

DRAWING NUMBER: 2558J00045

<u>DIMENSIONS:</u>	<u>FULL-SCALE</u>	<u>MODEL SCALE</u>
Area, FT ²	<u>153</u>	<u>0.272</u>
Span (equivalent), in.	<u>345</u>	<u>4.60</u>
Inb'd equivalent chord, in.	<u>64</u>	<u>.85</u>
Outb'd equivalent chord, in.	<u>64</u>	<u>.85</u>
Ratio movable surface chord/ total surface chord		
At Inb'd equiv. chord	<u>—</u>	<u>—</u>
At Outb'd equiv. chord	<u>—</u>	<u>—</u>
Sweep Back Angles, degrees		
Leading Edge	<u>0</u>	<u>0</u>
Tailing Edge	<u>0</u>	<u>0</u>
Hingeline	<u>0</u>	<u>0</u>
Area Moment (Normal to hinge line)	<u>—</u>	<u>—</u>

MODEL COMPONENT: BODY - B+

GENERAL DESCRIPTION: B18 body with the keel removed

DRAWING NUMBER: NONE

<u>DIMENSIONS:</u>	<u>FULL-SCALE</u>	<u>MODEL SCALE</u> <u>1/3%</u>
Length	<u>1890"</u>	<u>25.20"</u>
Max. Width	<u>378"</u>	<u>5.04"</u>
Max. Depth	<u>302"</u>	<u>4.03"</u>
Fineness Ratio	<u>—</u>	<u>—</u>
Area		
Max. Cross-Sectional	<u>—</u>	<u>—</u>
Planform (<i>body flap included</i>)	<u>4216 ft²</u>	<u>.7484 ft²</u>
Wetted	<u>—</u>	<u>—</u>
Base	<u>627 ft²</u>	<u>.1115 ft²</u>

MODEL COMPONENT: WING - W3

GENERAL DESCRIPTION: LARGE LEADING EDGE SWEEP AND LOW
ASPECT RATIO WING, PREVIOUSLY TESTED IN THE 4% SCALE
MCAIR LSMT HCR ORBITER TEST.

DRAWING NUMBER: 2558T00040

<u>DIMENSIONS:</u>	<u>FULL-SCALE</u>	<u>MODEL SCALE</u>
<u>TOTAL DATA</u> - THEORETICAL		<u>1/370</u>
Area		
Planform, FT ²	<u>6168</u>	<u>1.0964</u>
Wetted	<u>—</u>	<u>—</u>
Span (equivalent), IN.	<u>1040</u>	<u>13.87</u>
Aspect Ratio	<u>1.218</u>	<u>1.218</u>
Rate of Taper	<u>—</u>	<u>—</u>
Taper Ratio	<u>.217</u>	<u>.217</u>
Dihedral Angle, degrees*	<u>10</u>	<u>10</u>
Incidence Angle, degrees**	<u>4.3 / 3.5</u>	<u>4.3 / 3.5</u>
Aerodynamic Twist, degrees	<u>0</u>	<u>0</u>
Toe-In Angle	<u>—</u>	<u>—</u>
Cant Angle	<u>—</u>	<u>—</u>
Sweep Back Angles, degrees		
Leading Edge	<u>68</u>	<u>68</u>
Trailing Edge	<u>20</u>	<u>20</u>
.25 Element Line	<u>62.8</u>	<u>62.8</u>
Chords:		
Root (Wing Sta. 0.0), IN.	<u>1403</u>	<u>18.71</u>
Tip, (equivalent), IN.	<u>305</u>	<u>4.07</u>
MAC, IN.	<u>971</u>	<u>12.95</u>
Fus. Sta. of .25 MAC	<u>1247</u>	<u>16.63</u>
W.P. of .25 MAC	<u>—</u>	<u>—</u>
B.L. of .25 MAC	<u>204</u>	<u>2.72</u>
Airfoil Section		
Root	<u>MOD "A"</u>	<u>MOD "A"</u>
Tip	<u>MOD "A"</u>	<u>MOD "A"</u>
<u>EXPOSED DATA</u>		
Area, FT ²	<u>3009</u>	<u>.5349</u>
Span, (equivalent), IN.	<u>662</u>	<u>8.83</u>
Aspect Ratio	<u>1.012</u>	<u>1.012</u>
Taper Ratio	<u>.304</u>	<u>.304</u>
Chords		
Root	<u>1004</u>	<u>13.39</u>
Tip	<u>305</u>	<u>4.07</u>
MAC	<u>—</u>	<u>—</u>
Fus. Sta. of .25 MAC	<u>—</u>	<u>—</u>
W.P. of .25 MAC	<u>—</u>	<u>—</u>
B.L. of .25 MAC	<u>—</u>	<u>—</u>

* MEASURED W.R.T. WING TRAILING EDGE

** MEASURED AT EXPOSED ROOT CHORD / TIP CHORD

MODEL COMPONENT: WING - WA (Includes both WA & WA8)

GENERAL DESCRIPTION: REDUCED LEADING EDGE SWEEP AND INCREASED ASPECT RATIO. SERVES AS "BASELINE" WING FOR THIS TEST.

DRAWING NUMBER: 255BT00040

DIMENSIONS:

TOTAL DATA

Area

Planform, FT²
Wetted

Span (equivalent), IN

Aspect Ratio

Rate of Taper

Taper Ratio

Dihedral Angle, degrees*

Incidence Angle, degrees

Aerodynamic Twist, degrees

Toe-In Angle

Cant Angle

Sweep Back Angles, degrees

Leading Edge

Trailing Edge

0.25 Element Line

Chords:

Root (Wing Sta. 0.0), IN

Tip, (equivalent), IN

MAC, IN

Fus. Sta. of .25 MAC

W.P. of .25 MAC

B.L. of .25 MAC

Airfoil Section

Root

Tip

EXPOSED DATA

Area, FT²

Span, (equivalent), IN

Aspect Ratio

Taper Ratio

Chords

Root, IN

Tip, IN

MAC

Fus. Sta. of .25 MAC

W.P. of .25 MAC

B.L. of .25 MAC

FULL-SCALE

MODEL SCALE

1/3 %

50.57

.8990

—

—

123.0

16.40

2.078

2.078

—

—

.148

.148

5

5

1.5

1.5

0

0

—

—

—

—

—

—

55

55

0

0

47

47

—

—

1031

13.75

153

2.04

701

9.35

1444

19.25

—

—

237

3.09

MOD "B"

MOD "B"

MOD "B"

MOD "B"

—

—

—

—

—

—

2704

.4807

852

11.36

1.864

1.864

.201

.201

—

—

761

10.15

153

2.04

—

—

—

—

—

—

—

—

—

—

* MEASURED W.R.T. WING TRAILING EDGE

MODEL COMPONENT: WA INBOARD ELEVON EN1

GENERAL DESCRIPTION: PLAIN FLAP WITH SEALED GAP

DRAWING NUMBER: 255 BT 00040

<u>DIMENSIONS:</u>	<u>FULL-SCALE</u>	<u>MODEL SCALE</u> <u>1/32</u>
Area	<u>226 FT²</u>	<u>5.794 IN²</u>
Span (equivalent)	<u>213 IN</u>	<u>2.84 IN</u>
Inb'd equivalent chord	<u>.153 IN</u>	<u>2.04 IN</u>
Outb'd equivalent chord	<u>153 IN</u>	<u>2.04 IN</u>
Ratio movable surface chord/ total surface chord		
At Inb'd equiv. chord	<u>.201</u>	<u>.201</u>
At Outb'd equiv. chord	<u>.335</u>	<u>.335</u>
Sweep Back Angles, degrees		
Leading Edge	<u>0</u>	<u>0</u>
Trailing Edge	<u>0</u>	<u>0</u>
Hingeline	<u>0</u>	<u>0</u>
Area Moment (Normal to hinge line)	<u>—</u>	<u>—</u>

MODEL COMPONENT: WA OUTBOARD ELEVON E-12

GENERAL DESCRIPTION: PLAIN FLAP WITH SEALED GAP

DRAWING NUMBER: 255BT00040

<u>DIMENSIONS:</u>	<u>FULL-SCALE</u>	<u>MODEL SCALE</u> <u>1/8%</u>
Area	<u>216 FT²</u>	<u>5.524 IN</u>
Span (equivalent)	<u>213 IN</u>	<u>2.84 IN</u>
Inb'd equivalent chord	<u>153 IN</u>	<u>2.04 IN</u>
Outb'd equivalent chord	<u>139 IN</u>	<u>1.85 IN</u>
Ratio movable surface chord/ total surface chord		
At Inb'd equiv. chord	<u>.335</u>	<u>.355</u>
At Outb'd equiv. chord	<u>.908</u>	<u>.908</u>
Sweep Back Angles, degrees		
Leading Edge	<u>3.8</u>	<u>3.8</u>
Tailing Edge	<u>0</u>	<u>0</u>
Hingeline	<u>3.8</u>	<u>3.8</u>
Area Moment (Normal to hinge line)	<u>—</u>	<u>—</u>

MODEL COMPONENT: WING - WS

GENERAL DESCRIPTION: W1 WING PLATFORM WITH TIP EXTENSION
TO FORM A TRUE DELTA WING

DRAWING NUMBER: NONE

DIMENSIONS: FULL-SCALE MODEL SCALE

TOTAL DATA

	FULL-SCALE	MODEL SCALE
Area		<u>1 1/3 %</u>
Planform, FT ²	<u>5171</u>	<u>.9192</u>
Wetted	<u>—</u>	<u>—</u>
Span (equivalent), IN	<u>1444</u>	<u>19.25</u>
Aspect Ratio	<u>2.800</u>	<u>2.800</u>
Rate of Taper	<u>—</u>	<u>—</u>
Taper Ratio	<u>0</u>	<u>0</u>
Dihedral Angle, degrees*	<u>5</u>	<u>5</u>
Incidence Angle, degrees	<u>1.5</u>	<u>1.5</u>
Aerodynamic Twist, degrees	<u>0</u>	<u>0</u>
Toe-In Angle	<u>—</u>	<u>—</u>
Cant Angle	<u>—</u>	<u>—</u>
Sweep Back Angles, degrees		
Leading Edge	<u>55</u>	<u>55</u>
Trailing Edge	<u>0</u>	<u>0</u>
0.25 Element Line	<u>47</u>	<u>47</u>
Chords:		
Root (Wing Sta. 0.0), IN	<u>1031</u>	<u>13.75</u>
Tip, (equivalent), IN	<u>0</u>	<u>0</u>
MAC, IN	<u>687</u>	<u>9.16</u>
Fus. Sta. of .25 MAC	<u>1455</u>	<u>19.40</u>
W.P. of .25 MAC	<u>—</u>	<u>—</u>
B.L. of .25 MAC	<u>241</u>	<u>3.21</u>
Airfoil Section		
Root	<u>MOD "8"</u>	<u>MOD "8"</u>
Tip	<u>MOD "8"</u>	<u>MOD "8"</u>

EXPOSED DATA

Area, FT ²	<u>2818</u>	<u>.5010</u>
Span, (equivalent), IN	<u>1066</u>	<u>14.21</u>
Aspect Ratio	<u>2.800</u>	<u>2.800</u>
Taper Ratio	<u>0</u>	<u>0</u>
Chords		
Root, IN	<u>761</u>	<u>10.15</u>
Tip, IN	<u>0</u>	<u>0</u>
MAC	<u>—</u>	<u>—</u>
Fus. Sta. of .25 MAC	<u>—</u>	<u>—</u>
W.P. of .25 MAC	<u>—</u>	<u>—</u>
B.L. of .25 MAC	<u>—</u>	<u>—</u>

* MEASURED W.R.T. WING TRAILING EDGE

MODEL COMPONENT: WING - W6

GENERAL DESCRIPTION: SAME AS W4 WING EXCEPT TIP CHORD HAS
5° OF WASHOUT

DRAWING NUMBER: 255 BT 00040

DIMENSIONS:

TOTAL DATA

FULL-SCALE

MODEL SCALE

1 1/3%

Area

Planform, FT²
Wetted

5057

.8990

Span (equivalent), IN

1230

16.40

Aspect Ratio

2.078

2.078

Rate of Taper

—

—

Taper Ratio

.148

.148

Dihedral Angle, degrees *

5

5

Incidence Angle, degrees

1.5

1.5

Aerodynamic Twist, degrees

-5

-5

Toe-In Angle

—

—

Cant Angle

—

—

Sweep Back Angles, degrees

—

—

Leading Edge

55

55

Trailing Edge

0

0

.0.25 Element Line

47

47

Chords:

Root (Wing Sta. 0.0), IN

1031

13.75

Tip, (equivalent), IN

153

2.04

MAC, IN

701

9.35

Fus. Sta. of .25 MAC

1444

19.25

W.P. of .25 MAC

232

3.09

B.L. of .25 MAC

—

—

Airfoil Section

Root

MOD "B"

MOD "B"

Tip

MOD "B"

MOD "B"

EXPOSED DATA

Area, FT²

2704

.4807

Span, (equivalent), IN

852

11.36

Aspect Ratio

1.864

1.864

Taper Ratio

.201

.201

Chords

Root, IN

761

12.15

Tip, IN

153

2.04

MAC

—

—

Fus. Sta. of .25 MAC

—

—

W.P. of .25 MAC

—

—

B.L. of .25 MAC

—

—

* MEASURED W.R.T. WING TRAILING EDGE

MODEL COMPONENT: WING - W7

GENERAL DESCRIPTION: ALTERNATE PLATFORM WING

DRAWING NUMBER: 255RT00040

DIMENSIONS: FULL-SCALE MODEL SCALE

TOTAL DATA

1 1/3 %

Area

Planform, FT²
Wetted

54.74

96.42

Span (equivalent), IN

12.30

16.40

Aspect Ratio

1.937

1.937

Rate of Taper

—

—

Taper Ratio

.320

.320

Dihedral Angle, degrees *

5

5

Incidence Angle, degrees

1.5

1.5

Aerodynamic Twist, degrees

0

0

Toe-In Angle

—

—

Cant Angle

—

—

Sweep Back Angles, degrees

Leading Edge

55

55

Trailing Edge

20

20

0.25 Element Line

49.3

49.3

Chords:

Root (Wing Sta. 0.0), IN

96.2

12.83

Tip, (equivalent), IN

30.9

4.11

MAC, IN

6.91

9.21

Fus. Sta. of .25 MAC

14.76

19.68

W.P. of .25 MAC

—

—

B.L. of .25 MAC

2.55

3.40

Airfoil Section

Root

MOD "B"

MOD "B"

Tip

MOD "B"

MOD "B"

EXPOSED DATA

Area, FT²

316.2

56.21

Span, (equivalent), IN

8.52

11.36

Aspect Ratio

1.597

1.597

Taper Ratio

.405

.405

Chords

Root, IN

761

10.15

Tip, IN

30.8

4.11

MAC

—

—

Fus. Sta. of .25 MAC

—

—

W.P. of .25 MAC

—

—

B.L. of .25 MAC

—

—

* MEASURED W.R.T. WING TRAILING EDGE

MODEL COMPONENT: WING - WB

GENERAL DESCRIPTION: SAME AS W4 EXCEPT HAS NACA

44XX SERIES AIRFOIL

DRAWING NUMBER: NONE

DIMENSIONS: FULL-SCALE MODEL SCALE

TOTAL DATA

	<u>FULL-SCALE</u>	<u>MODEL SCALE</u> <u>1/3%</u>
Area		
Planform, FT ²	<u>5057</u>	<u>.8990</u>
Wetted	<u>—</u>	<u>—</u>
Span (equivalent), W	<u>1230</u>	<u>16.40</u>
Aspect Ratio	<u>2.078</u>	<u>2.078</u>
Rate of Taper	<u>—</u>	<u>—</u>
Taper Ratio	<u>.148</u>	<u>.147</u>
Diehedral Angle, degrees *	<u>5</u>	<u>5</u>
Incidence Angle, degrees	<u>1.5</u>	<u>1.5</u>
Aerodynamic Twist, degrees	<u>0</u>	<u>0</u>
Toe-In Angle	<u>—</u>	<u>—</u>
Cant Angle	<u>—</u>	<u>—</u>
Sweep Back Angles, degrees		
Leading Edge	<u>.55</u>	<u>.55</u>
Trailing Edge	<u>0</u>	<u>0</u>
0.25 Element Line	<u>47</u>	<u>47</u>
Chords:		
Root (Wing Sta. 0.0), W	<u>1031</u>	<u>13.75</u>
Tip, (equivalent), W	<u>153</u>	<u>2.04</u>
MAC, W	<u>701</u>	<u>9.35</u>
Fus. Sta. of .25 MAC	<u>1444</u>	<u>19.25</u>
W.P. of .25 MAC	<u>—</u>	<u>—</u>
B.L. of .25 MAC	<u>232</u>	<u>3.09</u>
Airfoil Section		
Root, exposed	<u>4410</u>	<u>4410</u>
Tip	<u>4408</u>	<u>4408</u>

EXPOSED DATA

Area, FT ²	<u>2704</u>	<u>.4807</u>
Span, (equivalent), W	<u>852</u>	<u>11.36</u>
Aspect Ratio	<u>1.864</u>	<u>1.864</u>
Taper Ratio	<u>.201</u>	<u>.201</u>
Chords		
Root	<u>761</u>	<u>10.15</u>
Tip	<u>153</u>	<u>2.04</u>
MAC	<u>—</u>	<u>—</u>
Fus. Sta. of .25 MAC	<u>—</u>	<u>—</u>
W.P. of .25 MAC	<u>—</u>	<u>—</u>
B.L. of .25 MAC	<u>—</u>	<u>—</u>

* MEASURED W.R.T. WING TRAILING EDGE

MODEL COMPONENT: WING - W_{9A}

GENERAL DESCRIPTION: THE "BASELINE" WING PLATFORM FOR THE B₃ BODY WITH A SYMMETRICAL AIRFOIL SECTION

DRAWING NUMBER: 255 BT 00045, SHEET 2

DIMENSIONS: FULL-SCALE MODEL SCALE

TOTAL DATA 1 1/2 %

	FULL-SCALE	MODEL SCALE
Area		
Planform, FT ²	5370	.9546
Wetted	—	—
Span (equivalent), IN	1138	15.18
Aspect Ratio	1.675	1.675
Rate of Taper	—	—
Taper Ratio	.251	.251
Dihedral Angle, degrees *	5	5
Incidence Angle, degrees	10	0
Aerodynamic Twist, degrees	0	0
Toe-In Angle	—	—
Cant Angle	—	—
Sweep Back Angles, degrees		
Leading Edge	55	55
Trailing Edge	0	0
.0.25 Element Line	47	47
Chords:		
Root (Wing Sta. 0.0), IN	1086	14.48
Tip, (equivalent), IN	273	3.64
MAC, IN	760	10.13
Fus. Sta. of .25 MAC	1394	18.59
M.P. of .25 MAC	—	—
B.L. of .25 MAC	228	3.04
Airfoil Section		
Root - exposed - F.S. 200	0009-64	0009-64
Tip	0012-64	0012-64

EXPOSED DATA

Area, FT ²	3049	54.30
Span, (equivalent), IN	791	10.54
Aspect Ratio	1.423	1.423
Taper Ratio	.326	.326
Chords		
Root, IN	838	11.17
Tip, IN	273	3.64
MAC	—	—
Fus. Sta. of .25 MAC	—	—
M.P. of .25 MAC	—	—
B.L. of .25 MAC	—	—

* MEASURED W.R.T. WING TRAILING EDGE

MODEL COMPONENT: WING - W9 B 1

GENERAL DESCRIPTION: W9 A shifted forward on the B3

DRAWING NUMBER: NONE

DIMENSIONS: FULL-SCALE MODEL SCALE

TOTAL DATA

	<u>FULL-SCALE</u>	<u>MODEL SCALE</u>
Area		<u>1 1/3 20</u>
Planform	<u>5320 ft²</u>	<u>.9546 ft²</u>
Wetted	<u>—</u>	<u>—</u>
Span (equivalent)	<u>1138"</u>	<u>15.18"</u>
Aspect Ratio	<u>1.675</u>	<u>1.675</u>
Rate of Taper	<u>—</u>	<u>—</u>
Taper Ratio	<u>.251</u>	<u>.251</u>
Dihedral Angle, degrees	<u>5°</u>	<u>5</u>
Incidence Angle, degrees	<u>0</u>	<u>0</u>
Aerodynamic Twist, degrees	<u>0</u>	<u>0</u>
Toe-In Angle	<u>—</u>	<u>—</u>
Cant Angle	<u>—</u>	<u>—</u>
Sweep Back Angles, degrees		
Leading Edge	<u>55</u>	<u>55</u>
Trailing Edge	<u>0</u>	<u>0</u>
0.25 Element Line	<u>47</u>	<u>47</u>
Chords:		
Root (Wing Sta. 0.0)	<u>1086"</u>	<u>14.48"</u>
Tip, (equivalent)	<u>273"</u>	<u>3.64"</u>
MAC	<u>760"</u>	<u>10.13"</u>
Fus. Sta. of .25 MAC	<u>1304</u>	<u>17.39</u>
W.P. of .25 MAC	<u>—</u>	<u>—</u>
B.L. of .25 MAC	<u>228"</u>	<u>3.041</u>
Airfoil Section		
Root - exposed, F.S. 200	<u>0009-64</u>	<u>0009-64</u>
Tip	<u>0012-64</u>	<u>0012-64</u>

EXPOSED DATA

Area	<u>3049 ft²</u>	<u>.5420 ft²</u>
Span, (equivalent)	<u>791"</u>	<u>10.54"</u>
Aspect Ratio	<u>1.423</u>	<u>1.423</u>
Taper Ratio	<u>.326</u>	<u>.326</u>
Chords		
Root	<u>838"</u>	<u>11.17"</u>
Tip	<u>273"</u>	<u>3.64"</u>
MAC	<u>—</u>	<u>—</u>
Fus. Sta. of .25 MAC	<u>—</u>	<u>—</u>
W.P. of .25 MAC	<u>—</u>	<u>—</u>
B.L. of .25 MAC	<u>—</u>	<u>—</u>

MODEL COMPONENT: VERTICAL TAIL - V3

GENERAL DESCRIPTION: THIS V.T. WAS TESTED IN THE MCAIR LSUIT

4% SCALE HCR ORBITER TEST.

DRAWING NUMBER: 2558T00040

DIMENSIONS: FULL-SCALE MODEL SCALE

TOTAL DATA

	<u>FULL-SCALE</u>	<u>MODEL SCALE</u>
Area		
Planform		
Wetted		
Span (equivalent)		
Aspect Ratio		
Rate of Taper		
Taper Ratio		
Diehedral Angle, degrees		
Incidence Angle, degrees		
Aerodynamic Twist, degrees		
Toe-In Angle		
Cant Angle		
Sweep Back Angles, degrees		
Leading Edge	<u>45°</u>	<u>45°</u>
Trailing Edge		
0.25 Element Line		
Chords:		
Root (Wing Sta. 0.0)		
Tip, (equivalent)		
MAC		
Fus. Sta. of .25 MAC		
W.P. of .25 MAC		
B.L. of .25 MAC		
Airfoil Section		
Root	<u>0012-64</u>	<u>0012-64</u>
Tip	<u>0012-64</u>	<u>0012-64</u>

EXPOSED DATA

Area	<u>716</u>	<u>.1273</u>
Span, (equivalent)	<u>366</u>	<u>4.88</u>
Aspect Ratio	<u>1.30</u>	<u>1.30</u>
Taper Ratio	<u>.47</u>	<u>.47</u>
Chords		
Root	<u>383</u>	<u>5.11</u>
Tip	<u>180</u>	<u>2.40</u>
MAC	<u>297</u>	<u>3.97</u>
Fus. Sta. of .25 MAC	<u>1735</u>	<u>23.13</u>
W.P. of .25 MAC	<u>539</u>	<u>7.19</u>
B.L. of .25 MAC	<u>0</u>	<u>0</u>

MODEL COMPONENT: VERTICAL TAIL - V4

GENERAL DESCRIPTION: THIS V.T. HAS THE "OPTIMUM" GEOMETRY,

AS DETERMINED BY THE MSC NASA "OPTIMUM" V.T. STUDY

DRAWING NUMBER: NONE

DIMENSIONS: FULL-SCALE MODEL SCALE

TOTAL DATA

	<u>FULL-SCALE</u>	<u>MODEL SCALE</u> <u>1/270</u>
Area		
Planform		
Wetted		
Span (equivalent)		
Aspect Ratio		
Rate of Taper		
Taper Ratio		
Dihedral Angle, degrees		
Incidence Angle, degrees		
Aerodynamic Twist, degrees		
Toe-In Angle		
Cant Angle		
Sweep Back Angles, degrees		
Leading Edge	<u>30°</u>	<u>30°</u>
Trailing Edge		
0.25 Element Line		
Chords:		
Root (Wing Sta. 0.0)		
Tip, (equivalent)		
MAC		
Fus. Sta. of .25 MAC		
W.P. of .25 MAC		
B.L. of .25 MAC		
Airfoil Section		
Root	<u>0009</u>	<u>0009</u>
Tip	<u>0009</u>	<u>0009</u>

EXPOSED DATA

Area, FT ²	<u>600</u>	<u>1067</u>
Span, (equivalent), IN	<u>394</u>	<u>5.25</u>
Aspect Ratio	<u>1.80</u>	<u>1.80</u>
Taper Ratio	<u>5.566</u>	<u>5.66</u>
Chords, IN		
Root	<u>280</u>	<u>3.73</u>
Tip	<u>158</u>	<u>2.11</u>
MAC	<u>225</u>	<u>2.99</u>
Fus. Sta. of .25 MAC *	<u>1812</u>	<u>24.16</u>
W.P. of .25 MAC *	<u>557</u>	<u>7.42</u>
B.L. of .25 MAC	<u>0</u>	<u>0</u>

* Referenced to B, body

MODEL COMPONENT: VERTICAL TAIL - V5

GENERAL DESCRIPTION: this v.t. is the V5 Tail with the tip cut off to yield a lower aspect ratio

DRAWING NUMBER: NONE

DIMENSIONS: FULL-SCALE MODEL SCALE

TOTAL DATA

	<u>FULL-SCALE</u>	<u>MODEL SCALE</u>
Area		<u>1 1/3 %</u>
Planform		
Wetted		
Span (equivalent)		
Aspect Ratio		
Rate of Taper		
Taper Ratio		
Dihedral Angle, degrees		
Incidence Angle, degrees		
Aerodynamic Twist, degrees		
Toe-In Angle		
Cant Angle		
Sweep Back Angles, degrees		
Leading Edge	<u>30</u>	<u>30</u>
Trailing Edge		
0.25 Element Line		
Chords:		
Root (Wing Sta. 0.0)		
Tip, (equivalent)		
MAC		
Fus. Sta. of .25 MAC		
W.P. of .25 MAC		
B.L. of .25 MAC		
Airfoil Section		
Root	<u>0009</u>	<u>0009</u>
Tip	<u>0009</u>	<u>0009</u>

EXPOSED DATA

Area	<u>493 ft²</u>	<u>.0876 ft²</u>
Span, (equivalent)	<u>305"</u>	<u>4.07"</u>
Aspect Ratio	<u>1.310</u>	<u>1.310</u>
Taper Ratio	<u>.665</u>	<u>.665</u>
Chords		
Root	<u>280"</u>	<u>3.73"</u>
Tip	<u>186"</u>	<u>2.48"</u>
MAC	<u>736"</u>	<u>3.15"</u>
Fus. Sta. of .25 MAC *	<u>1772</u>	<u>23.63</u>
W.P. of .25 MAC *	<u>499</u>	<u>6.51</u>
B.L. of .25 MAC	<u>0</u>	<u>0</u>

* Referenced to B₃ body

NOMENCLATURE

<u>SYMBOL</u>	<u>SADSAC SYMBOL</u>	<u>DEFINITION</u>
A_b		base area; m^2 , ft^2 , in^2
a		speed of sound; m/sec, ft/sec
AR	ASPECT	aspect ratio, b^2/S
b	REFB	wing span or reference span; m, ft, in
c		wing chord; m, ft, in
\bar{c}		wing mean aerodynamic chord or reference chord; m, ft, in (see l_{ref} or refl)
c.g.		center of gravity
C.P.		center of pressure
C_A	CA	axial force coefficient, F_A/qS_{ref}
C_{A_b}	CAB	base axial force coefficient, $[(p_\infty - p_b)/q] (A_b/S_{ref})$
C_{A_f}	CAF	forebody axial force coefficient, $C_A - C_{A_b}$
C_D	CDTOTL	drag force coefficient in the wind axis system, $F_D/q S_{ref}$

NOMENCLATURE (continued)

<u>SYMBOL</u>	<u>SADSAC SYMBOL</u>	<u>DEFINITION</u>
C_D	CD	drag force coefficient in the stability axis system, $F_D / q S_{ref}$
C_L	CL	lift force coefficient (stability or wind axis) $F_L / q S_{ref}$
C_{l}	CBL	rolling moment coefficient in body axis system, $M_x / q S_{ref} b$
$C_{l,s}$	CSL	rolling moment coefficient in the stability axis system, $M_{x,s} / q S_{ref} b$
$C_{l,w}$	CWL	rolling moment coefficient in the wind axis system, $M_{x,w} / q S_{ref} b$
C_m	CLM	pitching moment coefficient in the body axis system, $M_y / q S_{ref} l_{ref}$
$C_{m,s}$	CLM	pitching moment coefficient in the stability axis system, $C_{m,s} = C_m$
$C_{m,w}$	CPM	pitching moment coefficient in the wind axis system, $M_{y,w} / q S_{ref} l_{ref}$
C_N	CN	normal force coefficient in the body axis system, $F_N / q S_{ref}$

NOMENCLATURE (continued)

<u>SYMBOL</u>	<u>SADSAC SYMBOL</u>	<u>DEFINITION</u>
C_n	CYN	yawing moment coefficient in the body axis system, $M_z/q S_{ref} b$
$C_{n,s}$	CLN	yawing moment coefficient in the stability axis system, $C_{n,s} = C_n$
$C_{n,w}$	CLN	yawing moment coefficient in the wind axis system, $M_{z,w}/q S_{ref} b$
C_p	CP	pressure coefficient, $(p-p_\infty)/q$
C_y	CY	side force coefficient (body or stability axis system), $F_y/q S_{ref}$
C_c	CC	side force coefficient (wind axis system), $F_y/q S_{ref}$
F_A		axial force; N, lb
F_D		drag force in wind axis system; N, lb
F'_D		drag force in the stability axis system; N, lb
F_L		lift force (stability or wind axis system); N, lb
F_N		normal force; N, lb

NOMENCLATURE (continued)

<u>SYMBOL</u>	<u>SADSAC SYMBOL</u>	<u>DEFINITION</u>
F_Y		side force; N, lb
	N/A	normal to axial force ratio
l_{ref}	REFL	reference length; m, ft, in (see \bar{c})
L/D	L/D	lift-to-drag ratio, C_L/C_D (stability axis system)
L/D	CL/CD	lift-to-drag ratio, C_L/C_D (wind axis system)
M	MACH	Mach number
MRP	MRP	abbreviation for moment reference point
	XMRP	abbreviation for moment reference point on x-axis
	YMRP	abbreviation for moment reference point on y-axis
	ZMRP	abbreviation for moment reference point on z-axis
M_x		rolling moment in the body axis system; N-m, ft-lb
$M_{x,s}$		rolling moment in the stability axis system; N-m, ft-lb

NOMENCLATURE (continued)

<u>SYMBOL</u>	<u>SADSAC SYMBOL</u>	<u>DEFINITION</u>
$M_{x,w}$		rolling moment in the wind axis system; N-m, ft-lb
M_y		pitching moment in the body (or stability) axis system; N-m, ft-lb
$M_{y,w}$		pitching moment in the wind axis system; N-m, ft-lb
M_z		yawing moment in the body axis system; N-m, ft-lb
$M_{z,w}$		yawing moment in the wind axis system; N-m, ft-lb
p		static pressure; N/m ² ; psi
P		total pressure; N/m ² ; psi
q	Q(PSI) Q(PSF)	dynamic pressure; N/m ² , psi, psf
RN/L	RN/L	Reynold's number per unit length; million/ft.
S		wing area; m ² , ft ²
S_{ref}	REFS	reference area; m ² , ft ²
T		temperature; °K, °C, °R, °F
V		speed of vehicle relative to surrounding atmosphere; m/sec, ft/sec

NOMENCLATURE (continued)

<u>SYMBOL</u>	<u>SADSAC SYMBOL</u>	<u>DEFINITION</u>
i_T		tail incidence positive when trailing edge down, deg
\bar{V}		velocity of vehicle relative to surrounding atmosphere; m/sec, ft/sec
α	ALPHA	angle of attack, angle between the projection of the wind X_w -axis on the body X, Z-plane and the body X-axis; deg
β	BETA	sideslip angle, angle between the wind X_w -axis and the projection of this axis on the body X-Z-plane; deg
γ		ratio of specific heats
Γ	DIHDRL	wing dihedral angle; deg
δ		control surface deflection angle; deg
		positive deflections are:
	AILRON	aileron - left aileron trailing edge down
	ELEVTR	elevator - trailing edge down
	RUDDER	rudder - trailing edge to the left
	FLAP	flap - trailing edge down
	TAB	tab - trailing edge down with respect to control surface
ρ		air density; K_g/m^3 , slugs/ft ³

NOMENCLATURE (continued)

<u>SYMBOL</u>	<u>SADSAC SYMBOL</u>	<u>DEFINITION</u>
θ		pitch angle, angle of rotation about the body Y-axis, positive when the positive Z-axis is rotated toward the positive X-axis; deg
ϕ	PHI	roll angle, angle of rotation about the body X-axis, positive when the positive Y-axis is rotated toward the positive Z-axis; deg
ψ	PSI	yaw angle, angle of rotation about the body Z-axis, positive when the positive X-axis is rotated toward the positive Y-axis; deg

NOMENCLATURE (continued)

<u>SUBSCRIPTS</u>	<u>DEFINITION</u>
a	aileron
b	base
c	canard
e	elevator or elevon
f	flap
r	rudder or ruddervator
s	stability axis system
t	tail, or total conditions
w	wind axis system
ref	reference conditions
∞	freestream condition

ADDITIONS TO STANDARD NOMENCLATURE

<u>SYMBOL</u>	<u>SADSAC SYMBOL</u>	<u>DEFINITION</u>
δ_{eLO}	LOBE	left hand outboard ELEVON
δ_{eRO}	ROBE	right hand outboard ELEVON
δ_{eLI}	LINE	left hand inboard ELEVON
δ_{eRI}	RINE	right hand inboard ELEVON

TABULATED DATA LISTING

A tabulated data listing, consisting of all aero data sets, both original and those created in arriving at the plotted material to be presented subsequently, is available as an addendum to this report. The tabular listing is made up in two sections:

- (a) a brief summary list of all data sets containing the identifier, the descriptor, and the resident dependent variables.
- (b) a full list of all data sets containing all resident or selected aerodynamic coefficients of the data sets as well as the above mentioned information.

The listing is currently sent on limited distribution to the following organizations:

NASA AMES	Mr. V. Stevens
NASA MSC	Mr. Ray Nelson
M/D-East	Mr. J. Hrenak

If copies of this listing are desired, please contact the above or the cognizant SADSAC personnel who, for this data, is:

B. J. Fricken
Department 2780
Chrysler Corporation Space Division
New Orleans, La. 70129

(504) 255-2304

DATA

NOTE:

Datasets based on different reference information appear grouped together on the same plot page at several places in the following data presentation. No reference information is specified on such plot pages; the appropriate information is presented below.

Dataset Identifier	Plot Pages	Reference Data
RCN011	70-74	A
RCN018	70-74	B
RCN023	70-74	C
RCN025	70-74	D
RCN013	154-158	C
RCN007	154-158	A
RCN011	154-158	A
TCN015	169-171	C
TCN013	169-171	C
TCN009	169-171	A
TCN007	169-171	A
TCN010	169-171	A
TCN011	169-171	A
PCN013	172-174	C
PCN007	172-174	A
PCN011	172-174	A

Reference Data	S_{REF}, ft^2	l_{REF}, in	b_{REF}, in	XMRP, in	YMRP, in	ZMRP, in
A	6168.	971.	1040.	1266.	0.	163.
B	5171.	687.	1444.	1266.	0.	163.
C	5057.	701.	1230.	1266.	0.	163.
D	5424.	691.	1230.	1266.	0.	163.

DLSWT TEST 138- LEADING EDGE FILLET(STRAKE) EFFECT

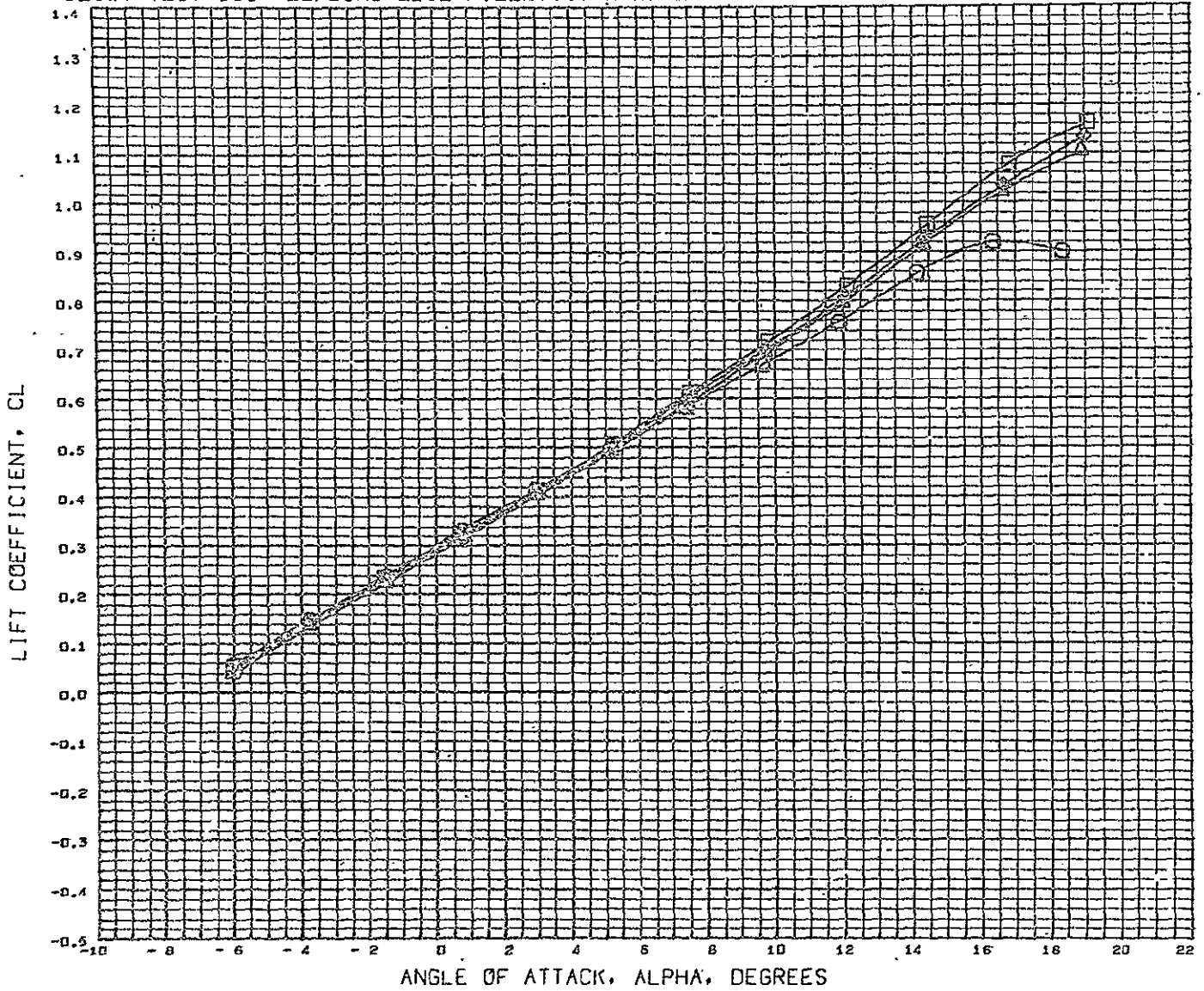

SYMBOL	STRAKE	PARAMETRIC VALUES	DATA SOURCE	REFERENCE INFORMATION
○	5.000	CASH 0.169 BETA 0.000	DATASET STRAKE 0.000	REFS 5057.0040 SQ. FT
△	6.000	LOBE 0.000 PUBE 0.000	RCN046 0.000 RCN049 6.000	REFL 701.0004 IN.
◇	8.000	LINE 0.000 RIPC 0.000	RCN051 8.000 RCN051 10.000	REFS 1230.0040 IN.
□	10.000			XMRP 1266.0040 IN.
				YMRP 0.0000 IN.
				ZNRF 163.0004 IN.
				SCALE 100.0000 PERCNT

DLSWT TEST 138- LEADING EDGE FILLET(STRAKE) EFFECT

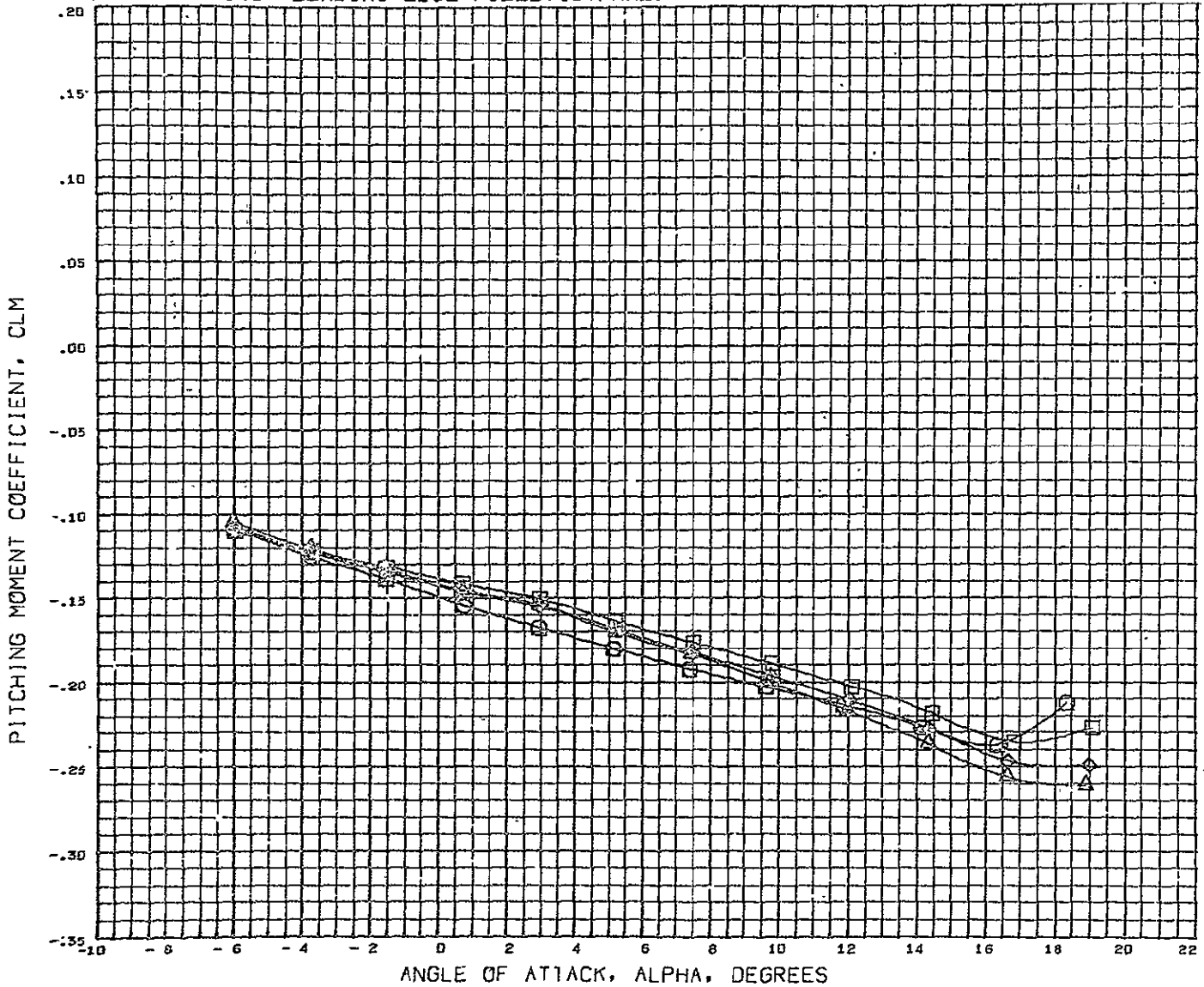

SYMBOL	STRAKE	PARAMETRIC VALUES				DATA SOURCE			REFERENCE INFORMATION								
		MACH	BETA	ROBE	RINE	RCN046	RCN049	RCN051	REFS	REFL	REFB	XMRP	YMRP	ZMRP	SCALE	PERCNT	
○	0.000	0.100	0.000	0.000	0.000	RCN046	0.000	RCN049	6.000	5057.0040	701.0004	1230.0040	1266.0040	0.0000	163.0004	100.0000	SQ. FT
△	6.000	0.100	0.000	0.000	0.000	RCN046	0.000	RCN049	6.000	5057.0040	701.0004	1230.0040	1266.0040	0.0000	163.0004	100.0000	IN.
◇	8.000	0.100	0.000	0.000	0.000	RCN031	0.000	RCN051	10.000	5057.0040	701.0004	1230.0040	1266.0040	0.0000	163.0004	100.0000	IN.
□	10.000	0.100	0.000	0.000	0.000	RCN031	0.000	RCN051	10.000	5057.0040	701.0004	1230.0040	1266.0040	0.0000	163.0004	100.0000	IN.

REFERENCE FILE

DLSWT TEST 138- LEADING EDGE FILLET(STRAKE) EFFECT

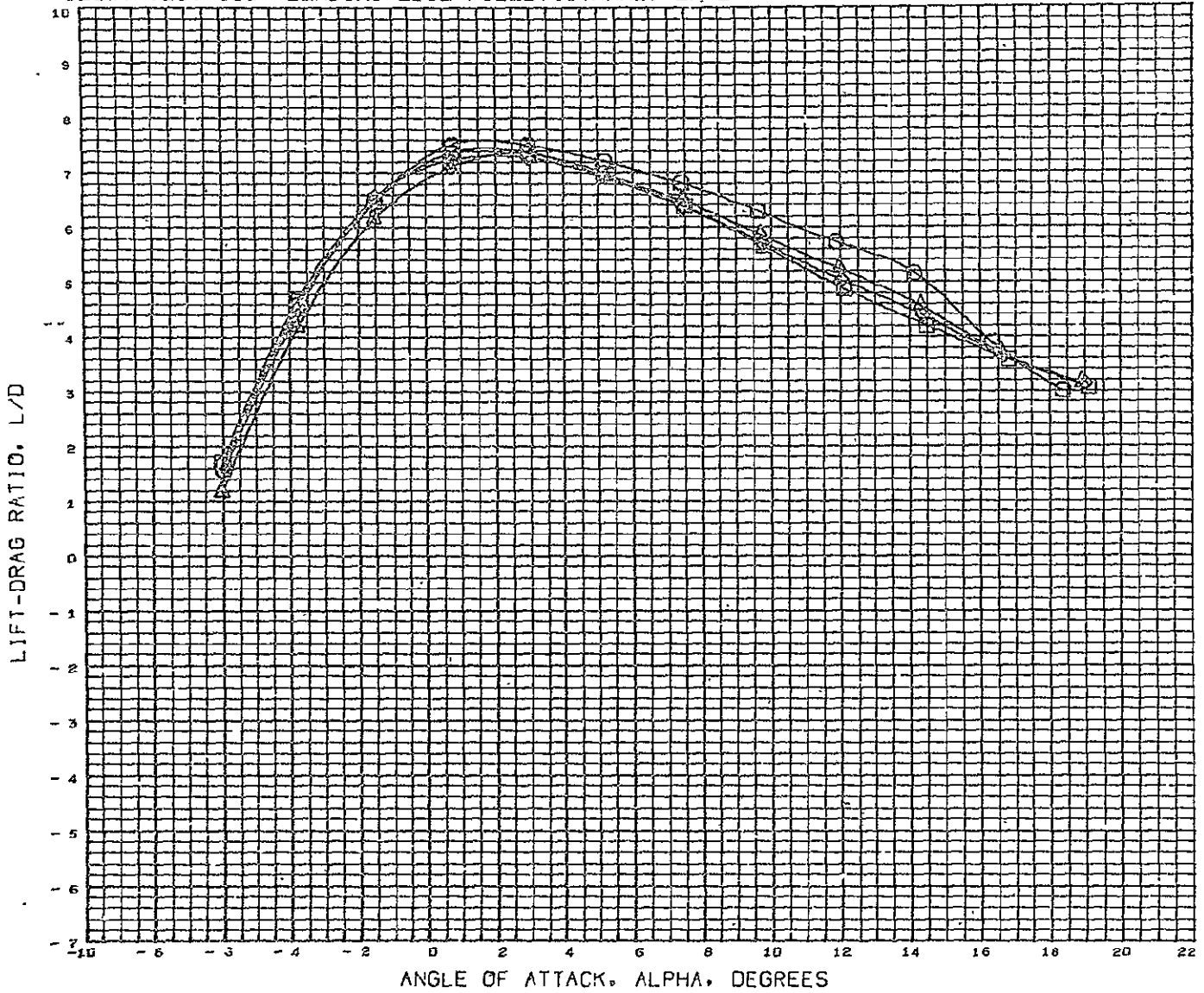

SYMBOL	STRAKE	PARAMETRIC VALUES			DATA SOURCE			REFERENCE INFORMATION		
		BETA	ROBE	RINE	DATASET	STRAKE	DATASET	STRAKE	REFS	SQ. FT
○	0.000	0.100	0.000	0.000	RCN046	0.000	RCN049	6.000	5057.0040	IN.
△	6.000	0.000	0.000	0.000	RCN046	0.000	RCN049	6.000	701.0004	IN.
◇	8.000	0.000	0.000	0.000	RCN031	8.000	RCN051	10.000	1236.0040	IN.
□	10.000								1266.0040	IN.
									0.0000	IN.
									163.0004	IN.
									100.0000	PERCNT

REFERENCE FILE

DLSWT TEST 138- LEADING EDGE FILLET(STRAKE) EFFECT

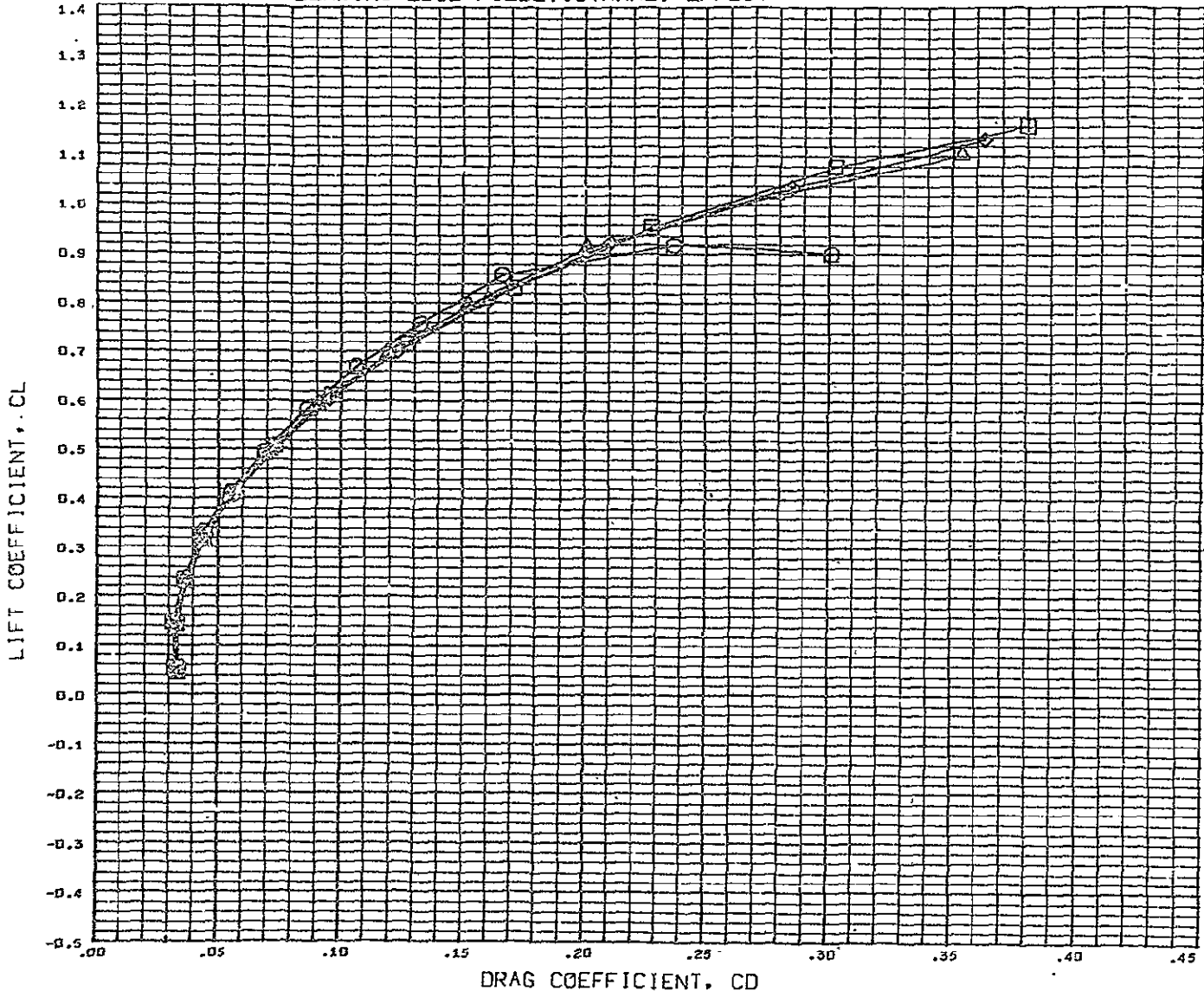

SYMBOL	STRAKE	PARAMETRIC VALUES				DATA SOURCE			REFERENCE INFORMATION		
		MACH	BETA	ROBE	RINE	STRAKE	DATASET	STRAKE	REFS	SQ. FT	
○	0.000	0.180	0.000	0.000	0.000	RCN046	0.000	RCN049	5057.0040	IN.	
△	6.000	0.000	0.000	0.000	0.000	RCN046	0.000	RCN049	791.0004	IN.	
◇	8.000	0.000	0.000	0.000	0.000	RCN031	8.000	RCN051	1230.0040	IN.	
□	10.000	0.000	0.000	0.000	0.000				1266.0040	IN.	
									YMRP	0.0000	IN.
									ZMRP	163.0004	IN.
									SCALE	100.0000	PERCENT

REFERENCE FILE

DLSWT TEST 138- LEADING EDGE FILLET(STRAKE) EFFECT

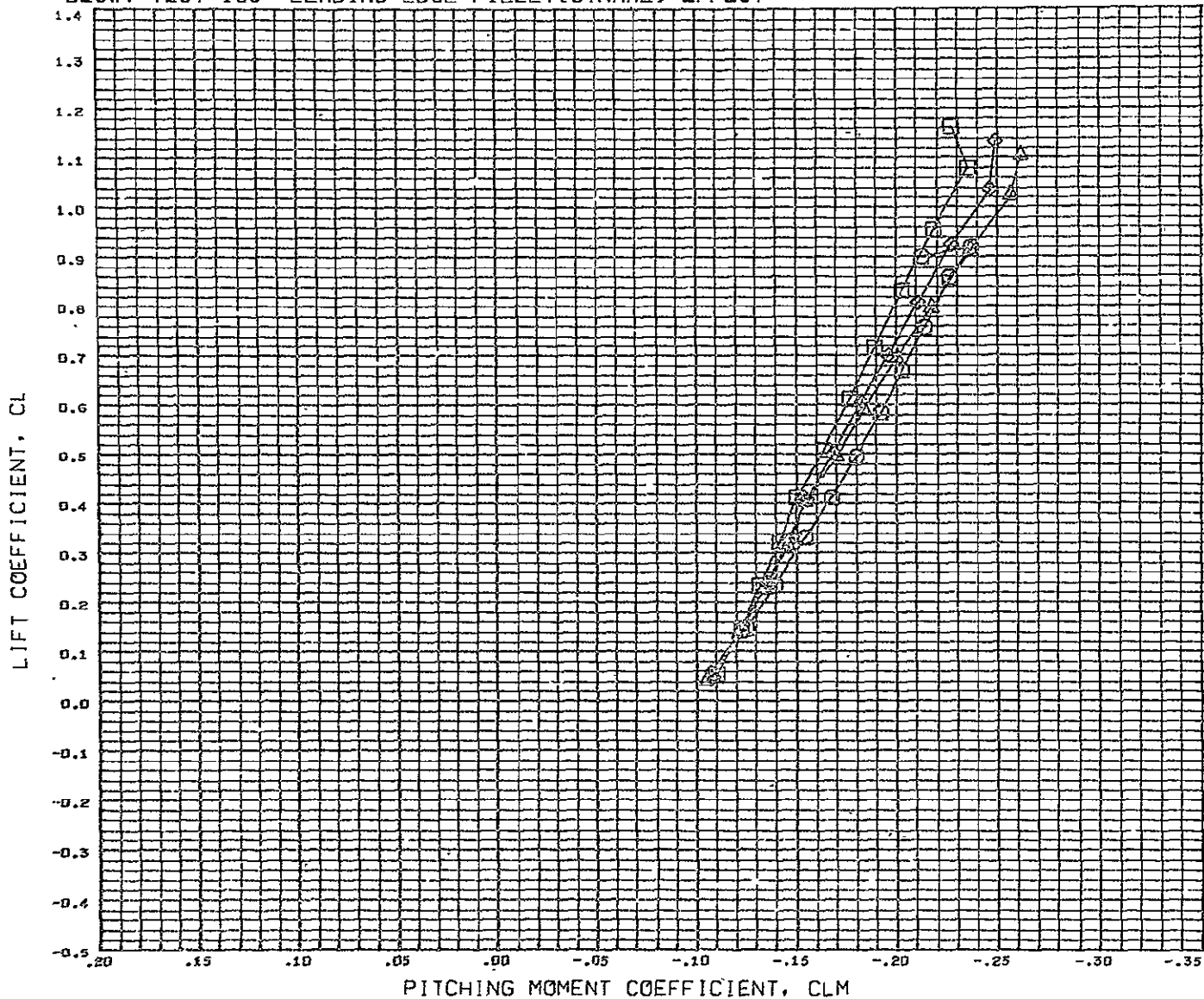

SYMBOL	STRAKE	PARAMETRIC VALUES				DATA SOURCE			REFERENCE INFORMATION		
○	0.000	HACH	0.100	DETA	0.000	DATASET	STRAKE	REFS	9057.0040	SQ. FT	
△	6.000	LODE	0.000	TOBE	0.000	RCN046	0.000	RCN049	6.000	IN.	
◇	8.000	LINE	0.000	PINE	0.000	RCN031	8.000	RCN031	10.000	IN.	
□	10.000									IN.	
										IN.	
										IN.	
										IN.	
										IN.	
										IN.	
										IN.	

REFERENCE FILE

DLSWT TEST 138- LEADING EDGE FILLET (STRAKE) EFFECT

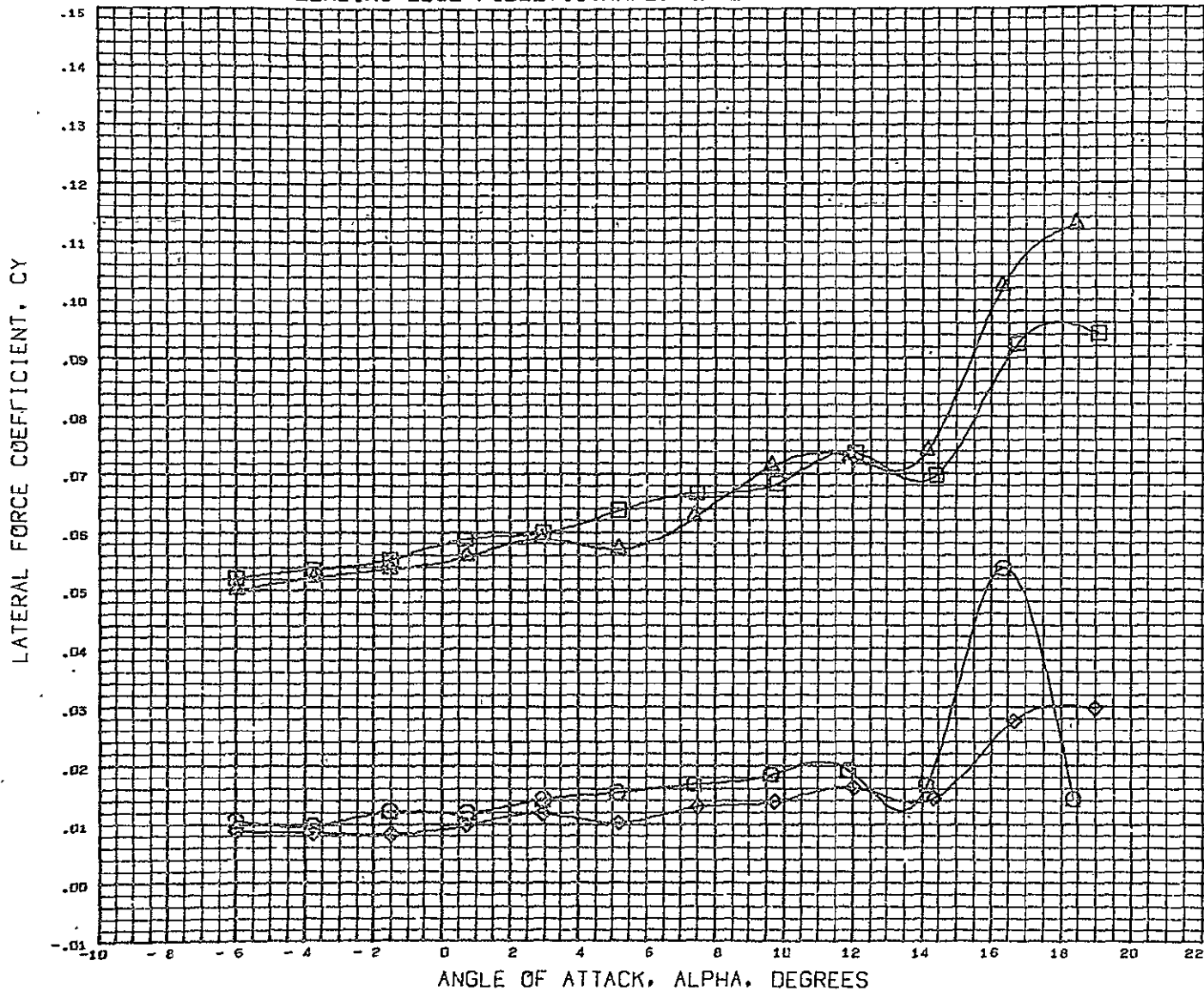

DATA SET SYMBOL	CONFIGURATION DESCRIPTION	BETA	STRAKE	REFERENCE INFORMATION
(TCN026)	DLSWT 138 0.0133 SC. GENERIC HCR 02 B1BWAASTV4	0.000	0.000	REFS 5057.0040 SQ. FT
(TCN027)	DLSWT 138 0.0133 SC. GENERIC HCR 02 B1BWAASTV4	-2.900	0.000	REFL 701.0034 IN.
(TCN031)	DLSWT 138 0.0133 SC. GENERIC HCR 02 B1BWAASTV4	0.000	8.000	REFD 1230.0040 IN.
(TCN032)	DLSWT 138 0.0133 SC. GENERIC HCR 02 B1EW4ASTV4	-2.680	8.000	XNRP 1266.0040 IN.
				YNRP 0.0000 IN.
				ZNRP 163.0004 IN.
				SCALE 100.0000 PERCENT

MACH 0.160

DLSWT TEST 138- LEADING EDGE FILLET(STRAKE) EFFECT

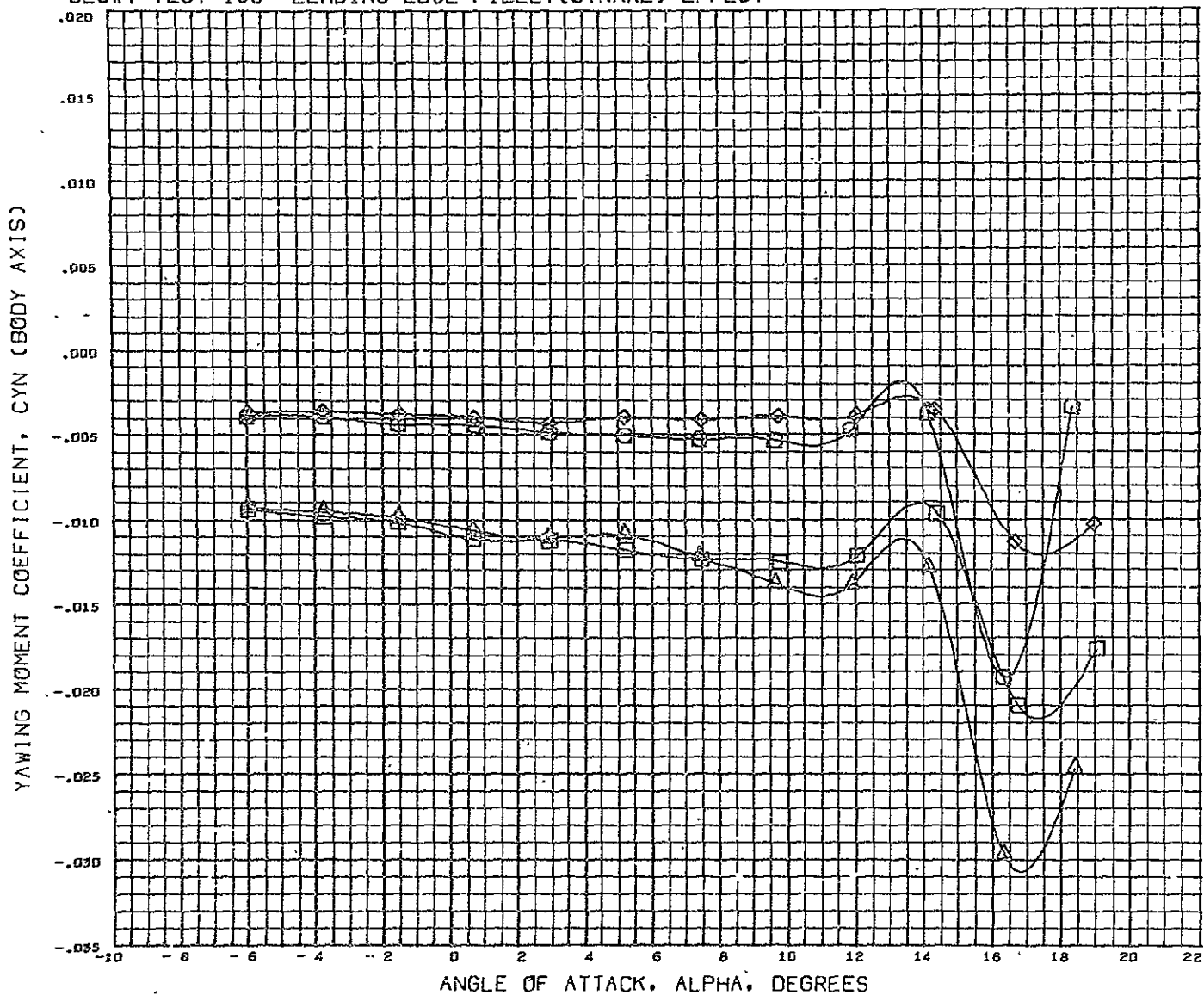

DATA SET SYMBOL	CONFIGURATION DESCRIPTION	BETA	STRAKE	REFERENCE INFORMATION
(TCN046)	DLSWT 138 0.0133 SC. GENERIC HCR 02 B1BWASTV4	0.000	0.000	REFS 5057.0040 SQ. FT
(TCN047)	DLSWT 138 0.0133 SC. GENERIC HCR 02 B1BWASTV4	-2.900	0.000	REFL 701.0004 IN.
(TCN031)	DLSWT 138 0.0133 SC. GENERIC HCP 02 B1BWASTV4	0.000	8.000	REFB 1230.0040 IN.
(TCN022)	DLSWT 138 0.0133 SC. GENERIC HCR 02 B1BWASTV4	-2.880	8.000	XMRP 1266.0040 IN.
				YMRP 0.0000 IN.
				ZMRP 163.0004 IN.
				SCALE 100.0000 PERCENT

VACH 0.180

DLSWT TEST 138- LEADING EDGE FILLET (STRAKE) EFFECT

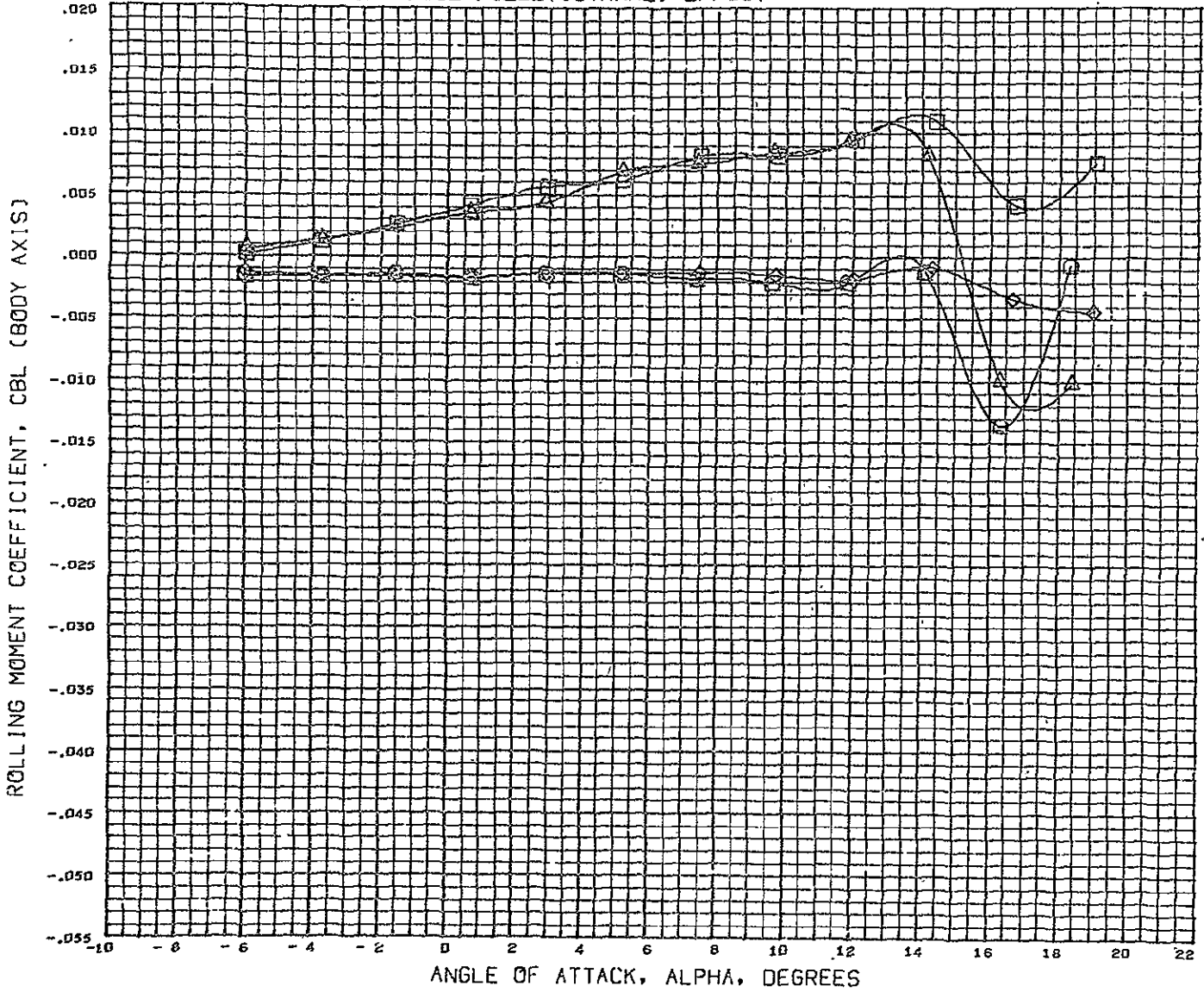

DATA SET SYMBOL	CONFIGURATION DESCRIPTION	BETA	STRAKE	REFERENCE INFORMATION
(TCND46)	DLSWT 138 0.0133 SC. GENERIC HCR 02 B1BWA5TV4	0.000	0.000	REFS 5057.0040 IN. FT
(TCND47)	DLSWT 138 0.0133 SC. GENERIC HCR 02 B1BWA5TV4	-2.900	0.000	REFL 701.0004 IN.
(TCND31)	DLSWT 138 0.0133 SC. GENERIC HCR 02 B1BWA5TV4	0.000	0.000	REFD 1230.0040 IN.
(TCND32)	DLSWT 138 0.0133 SC. GENERIC HCR 02 B1BWA5TV4	-2.880	0.000	XMRP 1266.0040 IN.
				YNRP 0.0000 IN.
				ZMRP 163.0004 IN.
				SCALE 100.0000 PERCENT

MACH 0.130

DLSWT TEST 138- LEADING EDGE FILLET(STRAKE) EFFECT

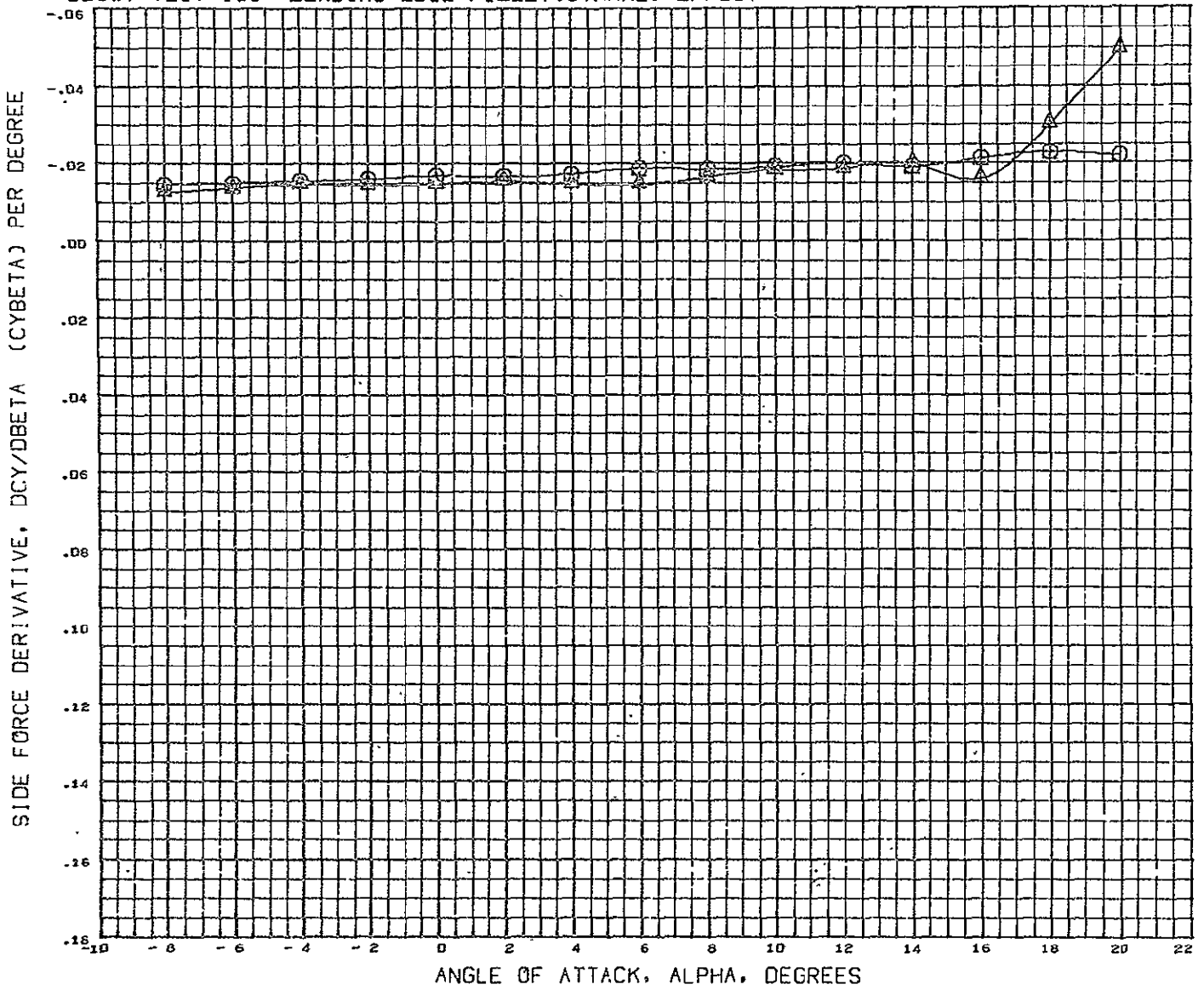

DATA SET	SYMBOL	CONFIGURATION DESCRIPTION	STRAKE	REFERENCE INFORMATION
(PCNB31)	○	DLSWT 138 0.0133 SC. GENERIC HCR 02 B1B4ASTV4	8.000	REFS 5057.0040 SQ.FT.
(PCNB46)	△	DLSWT 138 0.0133 SC. GENERIC HCR 02 B1B4ASTV4	0.000	REFL 701.0J04 IN.
				REFB 1230.00J IN.
				XNRF 1266.0040 IN.
				YNRF 0.0000 IN.
				ZNRF 163.0004 IN.
				SCALE 100.0000 PERCENT

PACH C.180

DLSWT TEST 138- LEADING EDGE FILLET(STRAKE) EFFECT

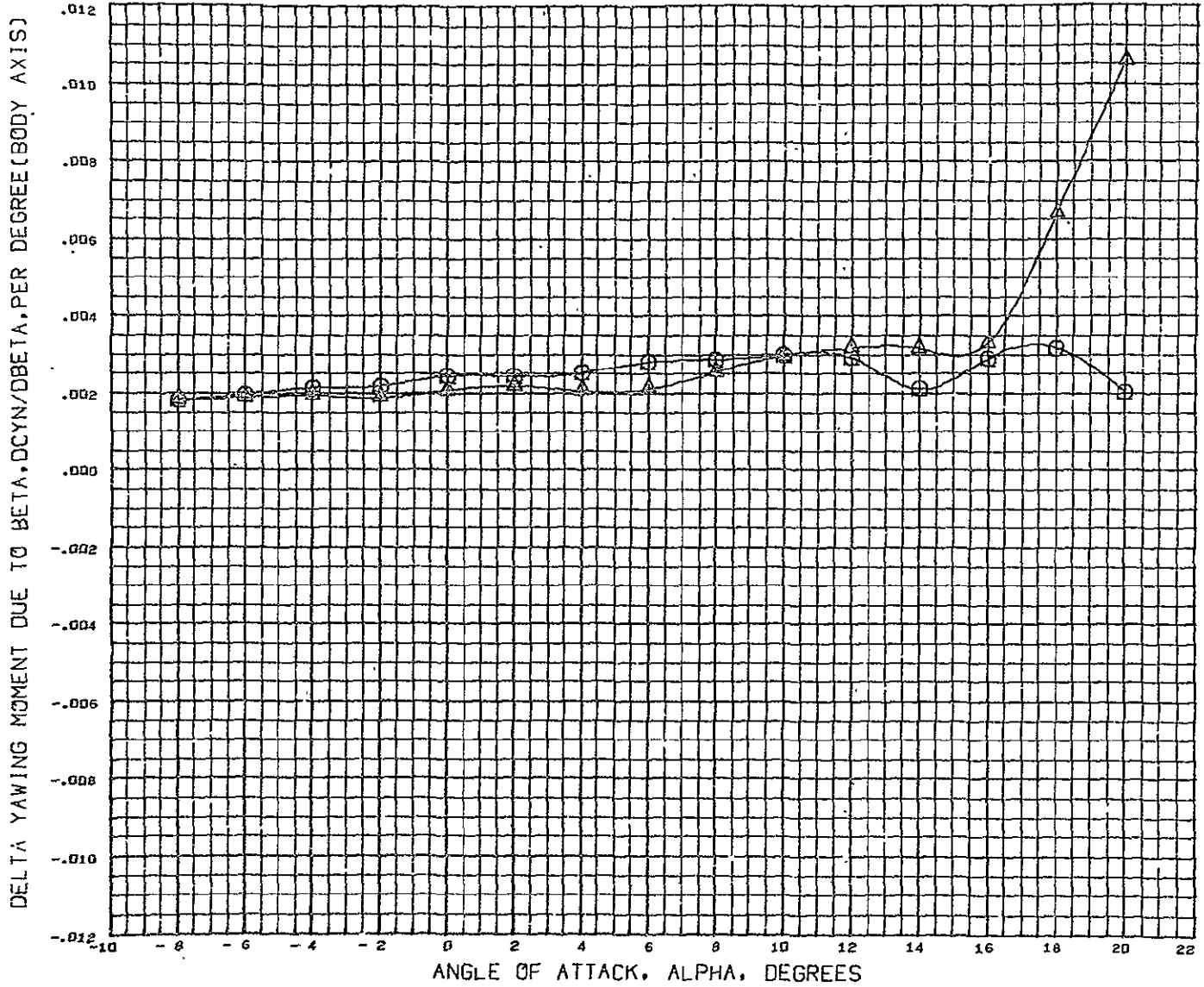

DATA SET SYMBOL	CONFIGURATION DESCRIPTION	STRAKE	REFERENCE INFORMATION
(PCNG31)	DLSWT 138 D.0133 SC. GENERIC HCR 02 B1BWASTV4	8.000	REFS 5057.0040 SQ.FT.
(PCNG46)	DLSWT 138 D.0133 SC. GENERIC HCR 02 B1BWASTV4	0.000	REFL 701.0004 IN.
			REFB 1230.0040 IN.
			XMRP 1266.0040 IN.
			YNRP 0.0000 IN.
			ZNRP 163.0004 IN.
			SCALE 100.0000 PERCENT

MACH 0.180

DLSWT TEST 138- LEADING EDGE FILLET(STRAKE) EFFECT

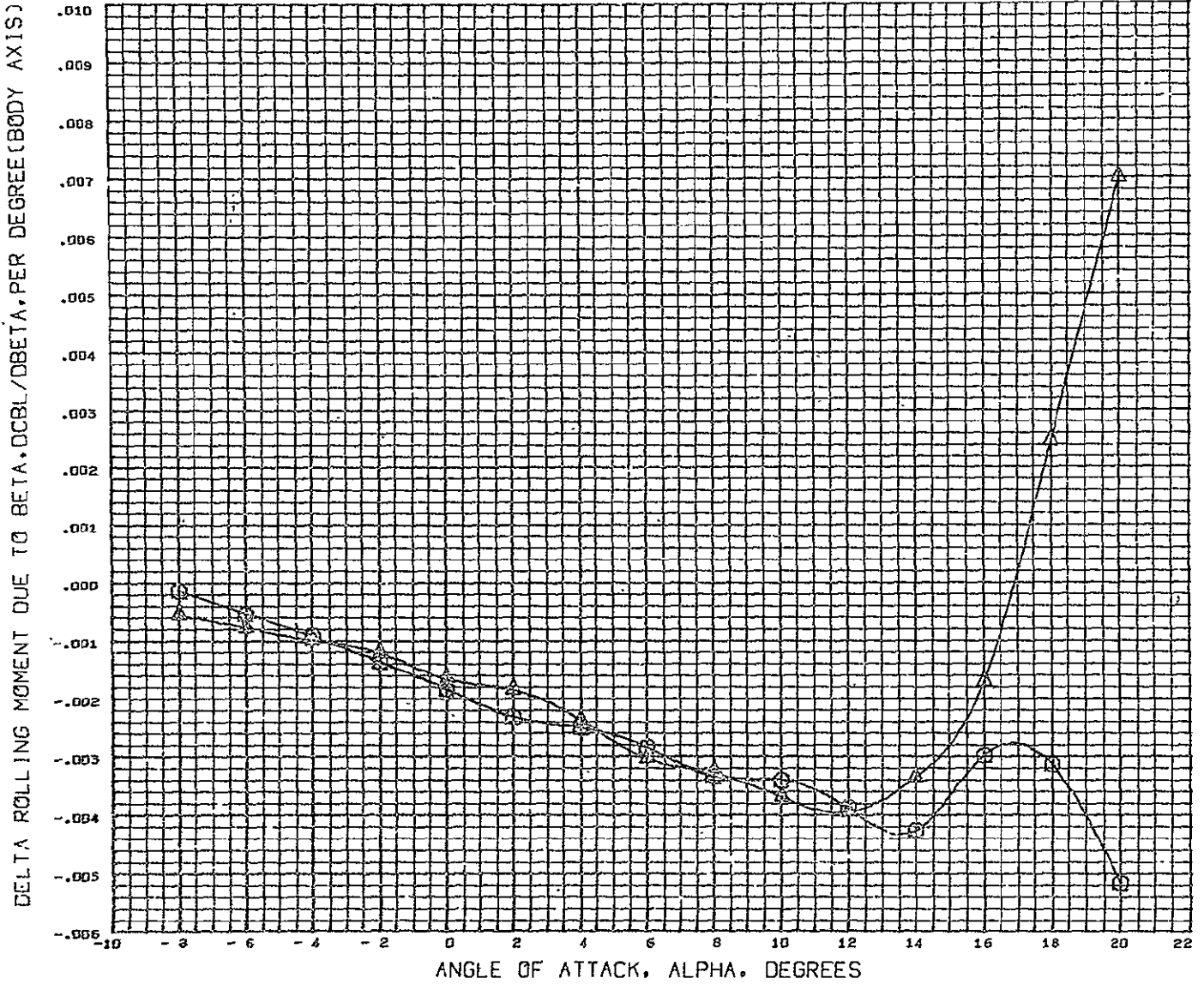

DATA SET SYMBOL	CONFIGURATION DESCRIPTION	STRAKE
(PCN03) 1	DLSWT 138 0.0133 SC. GENERIC HCR 02 BIDW4ASTV4	8.000
(PCN046)	DLSWT 138 0.0133 SC. GENERIC HCR 02 BIDW4ASTV4	0.000

VACH 0.180

REFERENCE INFORMATION		
REFS	5957.0040	SQ.FT.
REFL	701.0004	IN.
REFB	1230.0040	IN.
XMRP	1266.0040	IN.
YMRP	0.0000	IN.
ZMRP	163.0004	IN.
SCALE	100.0000	PERCENT

DLSWT TEST 138- FULL-SPAN ELEVON POWER

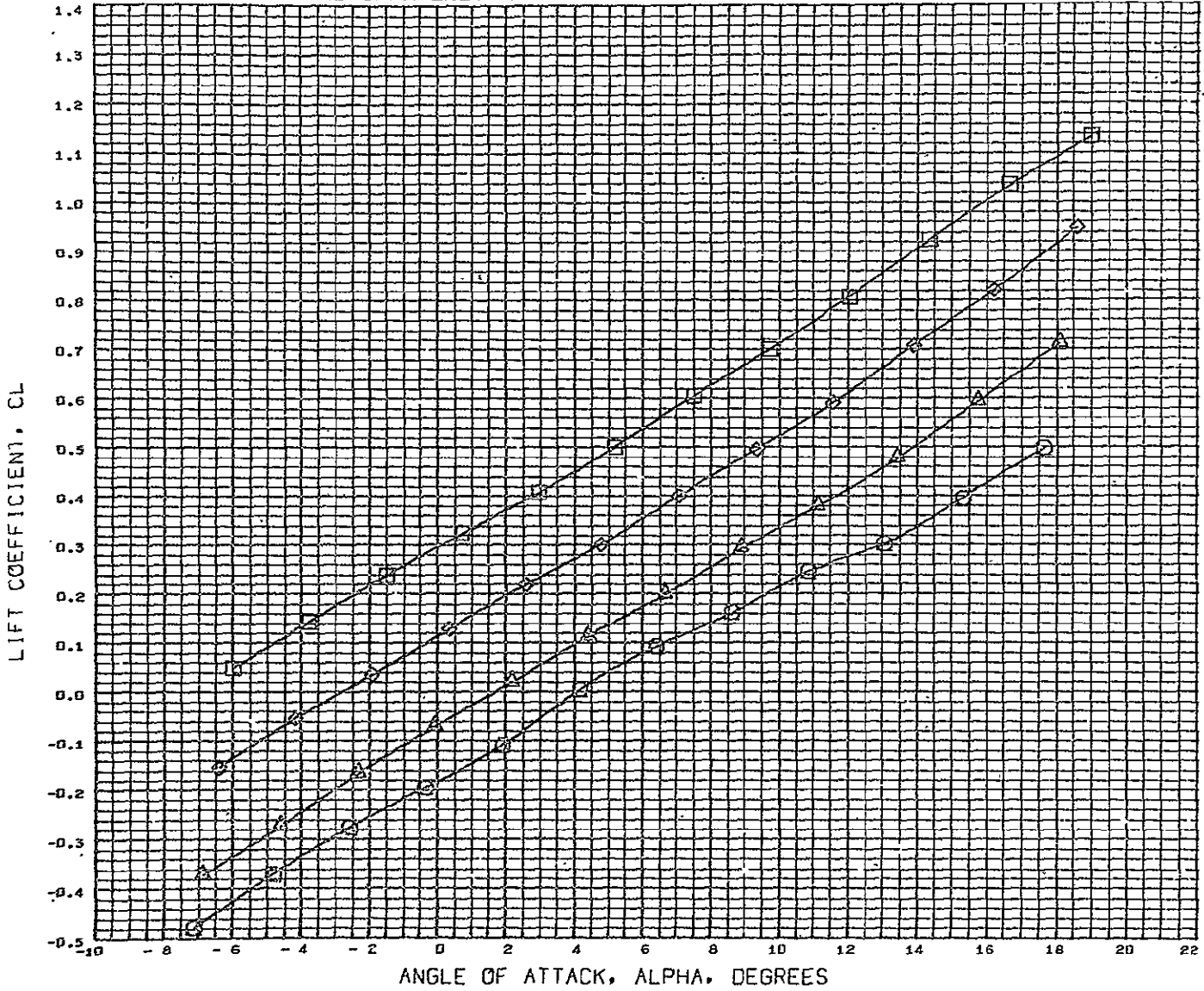

SYMBOL	ELEVTR	PARAMETRIC VALUES				DATA SOURCE			REFERENCE INFORMATION		
○	- 30.000	MACH	0.180	BETA	0.000	DATASET	ELEVTR	REFS	5057.0040	50. FT.	
△	- 20.000	LOBE	- 30.000	ROPE	- 30.000	RCN038	- 30.000	REFL	701.0004	IN.	
◇	- 10.000	LINE	- 30.000	RINE	- 30.000	RCN036	- 10.000	REFB	1255.0040	IN.	
□	0.000	STRAKE	8.000					XMRP	1266.0040	IN.	
								YMRP	0.0000	IN.	
								ZMRP	163.0004	IN.	
								SCALE	100.0000	PFRCNT	

DATA HIST. CODE MM

DLSWT TEST 138- FULL-SPAN ELEVON POWER

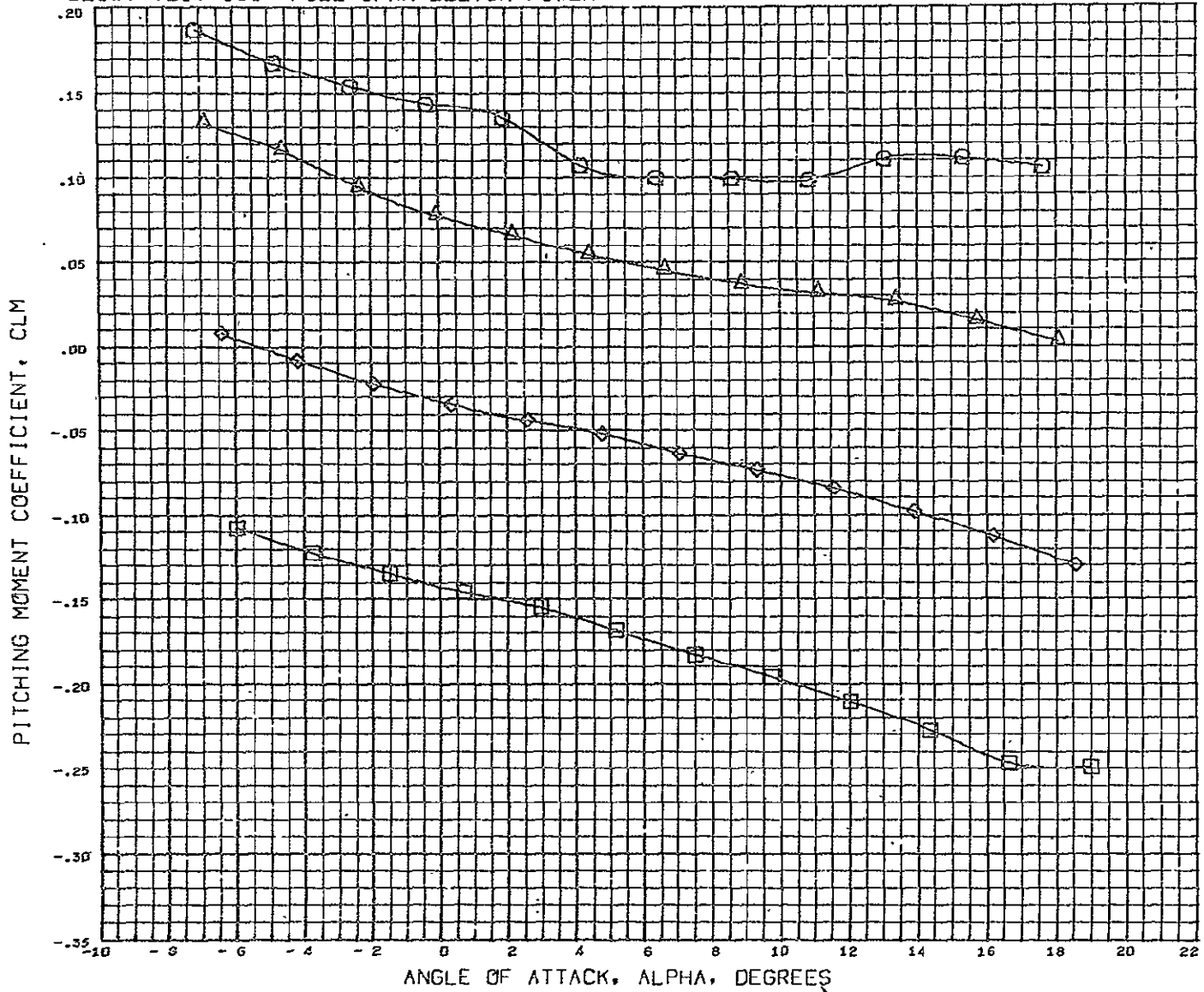

SYMBOL		ELEVTR		PARAMETRIC VALUES				DATA SOURCE			REFERENCE INFORMATION					
○	-	30.000	MACH	0.100	BETA	0.000	RCN038	-	30.000	RCN037	-	20.000	REFS	5057.0040	SQ.FT.	
△	-	20.000	LOBE	-	30.000	ROBE	-	30.000	RCN036	-	10.000	RCN031	0.000	REFL	701.0004	IN.
◇	-	10.000	LINE	-	30.000	RINE	-	30.000					REFB	1230.0040	IN.	
□	-	0.000	STRAKE	8.000									XMRP	1266.0040	IN.	
													YMRP	0.0000	IN.	
													ZHRP	163.0004	IN.	
													SCALE	100.0000	FT/CNT	

DATA HIST. CODE HM

DLSWT TEST 138- FULL-SPAN ELEVON POWER

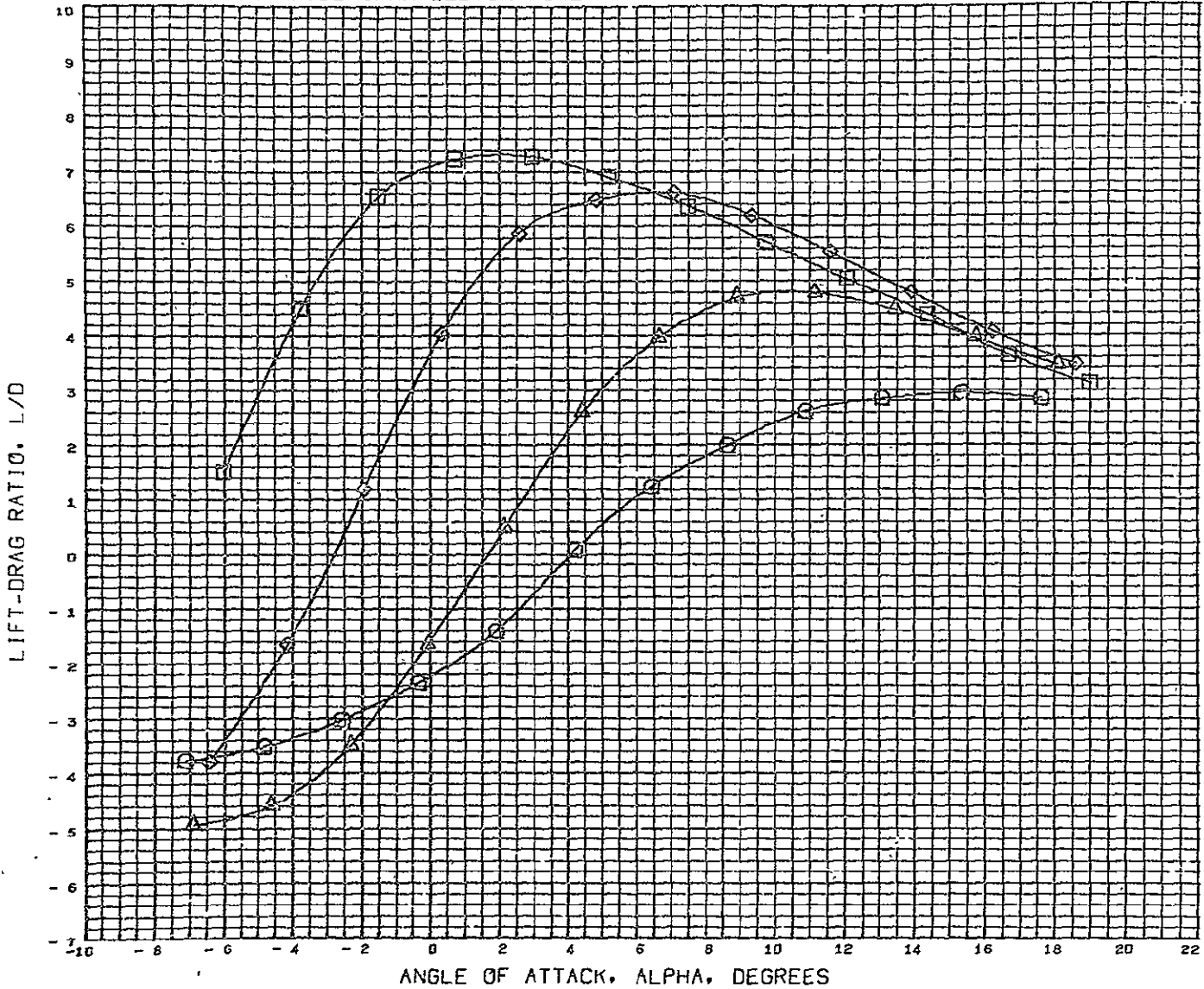

SYMBOL	ELEVTR	PARAMETRIC VALUES	DATA SOURCE	REFERENCE INFORMATION
○	- 30.000	MACH 5.180 BETA 0.000	RCN038 - 30.000	REFS 5057.0040 SQ.FT.
△	- 20.000	LOSE - 30.000 ROSE - 30.000	RCN037 - 20.000	REFL 701.0004 IN.
◇	- 10.000	LINE - 30.000 RINE - 30.000	RCN036 - 10.000	REFD 1230.0040 IN.
□	0.000	SIFAKE 0.000	RCN031 0.000	XMRP 1266.0040 IN.
				YMRP 0.0000 IN.
				ZMRP 163.0004 IN.
				SCALE 100.0000 FRCNT

DATA HIST. CODE MH

DLSWT TEST 138- FULL-SPAN ELEVON POWER

ELEVATOR LIFT EFFECTIVENESS, DCL/DELEVATOR (DCL/DE) PER DEGREE

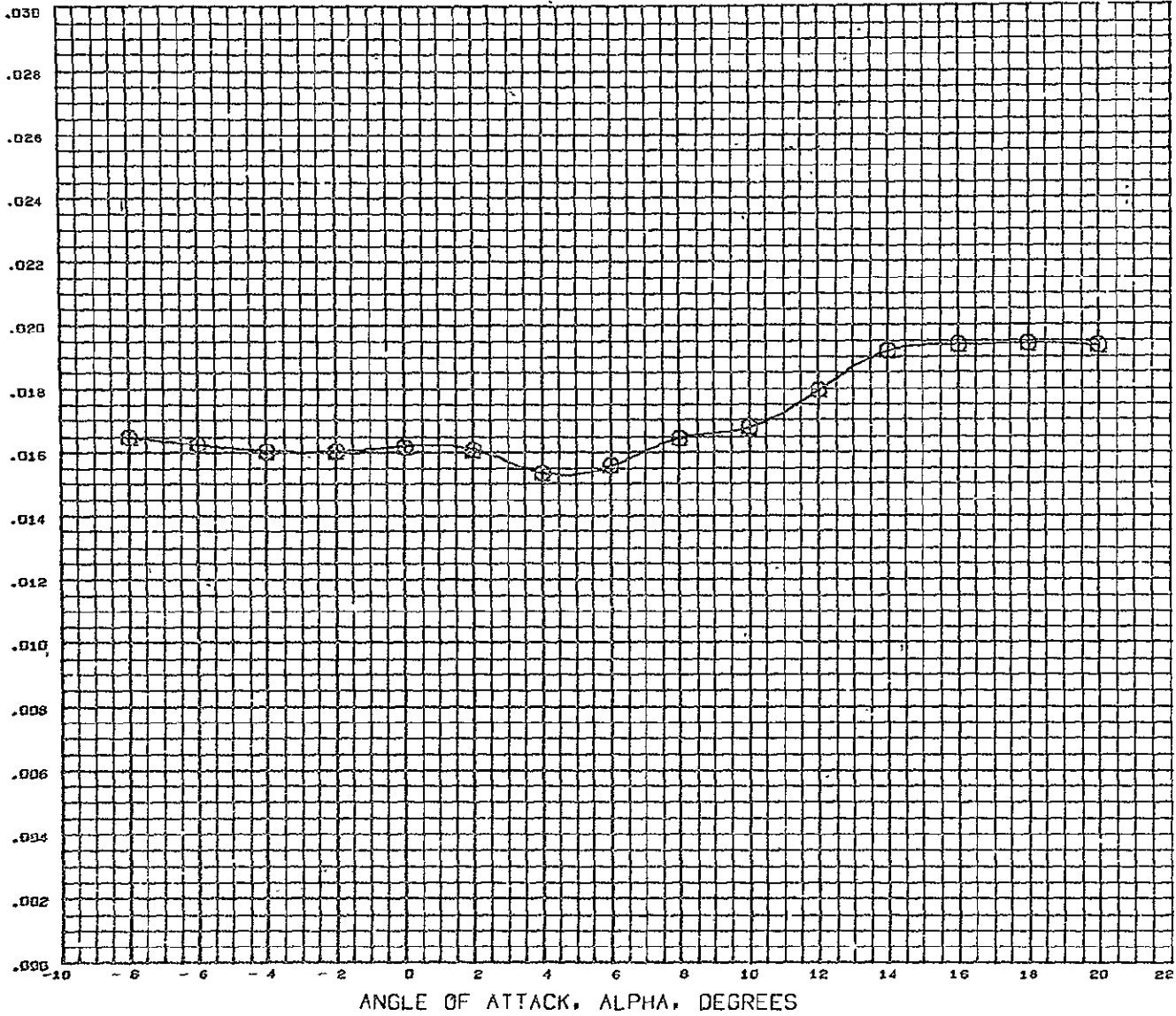

SYMBOL \bigcirc PACH 5.160 BETA 0.000 STRAKE 6.000

REFERENCE INFORMATION

REFS 5057.0040 SQ.FT.
 REFL 791.0004 IN.
 REFB 1230.0040 IN.
 XMRP 1266.0040 IN.
 YMRP 0.0000 IN.
 ZMRP 163.0004 IN.
 SCALE 100.0000 PPRCNT

DATA HIST. CODE 9F

DLSWT TEST 138- FULL-SPAN ELEVON POWER

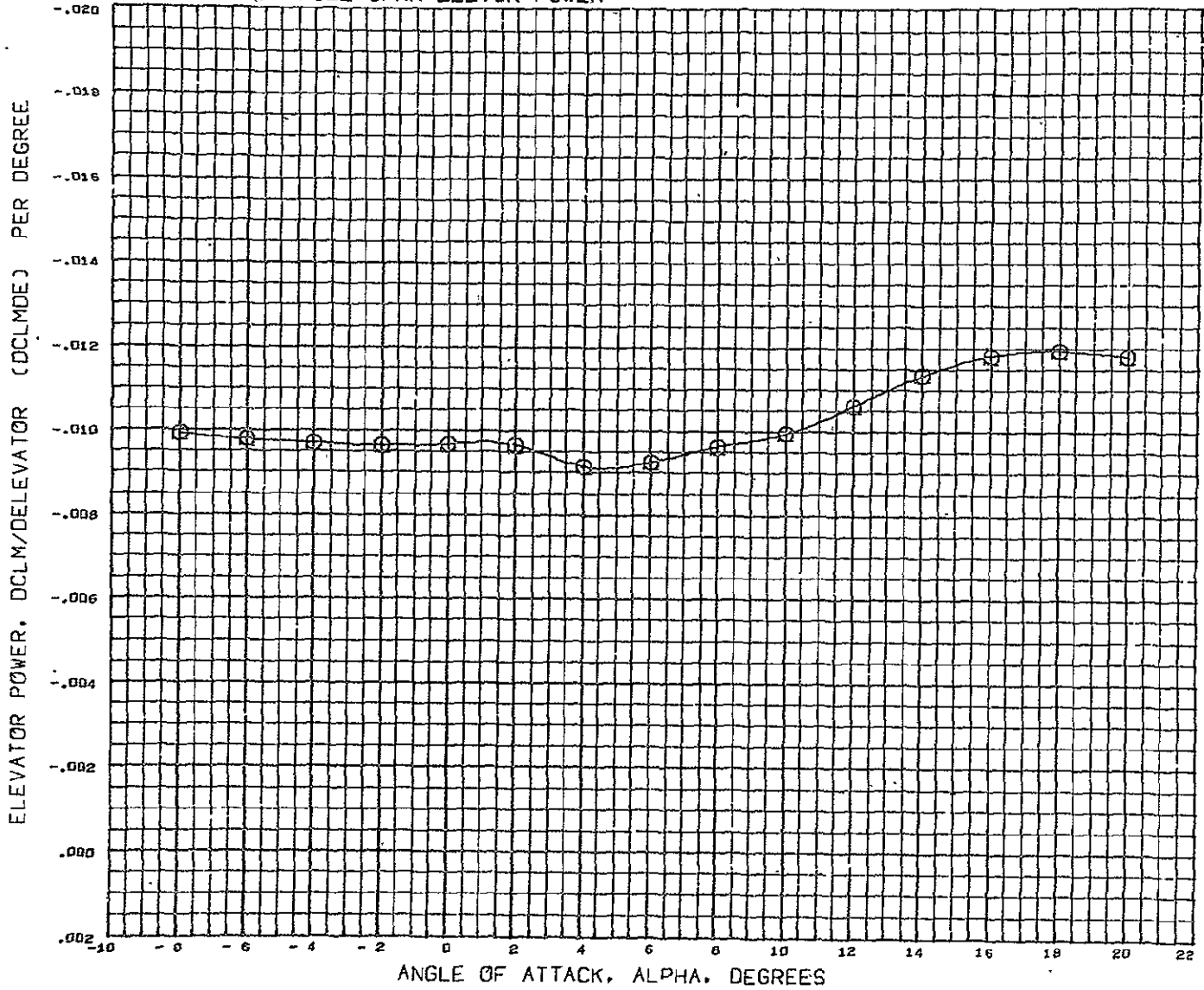

SYMBOL \circ PACH 0.180 BETA 0.000 STRAKE 8.000

PARAMETRIC VALUES

REFERENCE INFORMATION

REFS	5057.0040	SQ.FT.
REPL	701.0004	IN.
REPB	1230.0040	IN.
XMRP	1266.0040	IN.
YMRP	0.0000	IN.
ZMRP	163.0004	IN.
SCALE	100.0000	PERCENT

DATA HIST. CODE #F

DLSWT TEST 138- FULL-SPAN ELEVON POWER

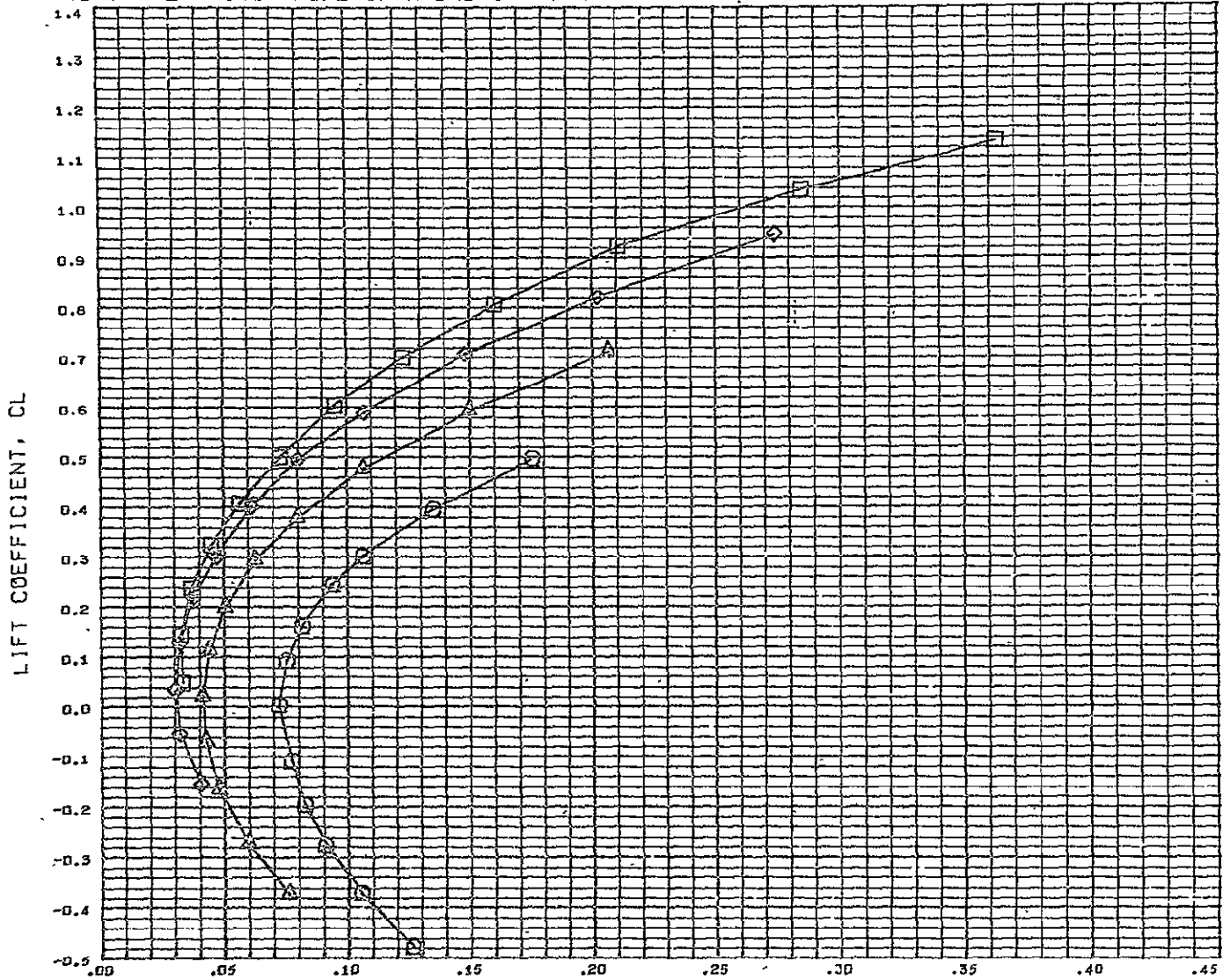

SYMBOL	ELEVTR	PARAMETRIC VALUES	DATA SOURCE	REFERENCE INFORMATION
○	- 30.000	HACH 0.100 BETA 0.000	DATASET ELEVTR DATASET ELEVTR	REFS 5957.0040 SQ.FT.
△	- 20.000	LOBE - 30.000 ROGE - 30.000	RCN038 - 30.000 RCN037 - 20.000	REFL 701.0004 IN.
◇	- 10.000	LINE - 30.000 RINE - 30.000	RCN036 - 10.000 RCN031 0.000	REFS 1230.0040 IN.
□	0.000	STPARE 0.000		XMRP 1266.0040 IN.
				YMRF 0.0000 IN.
				ZMRP 163.0004 IN.
				SCALE 100.0000 PERCENT

DATA HIST. CODE MK

DLSWT TEST 138- FULL-SPAN ELEVON POWER

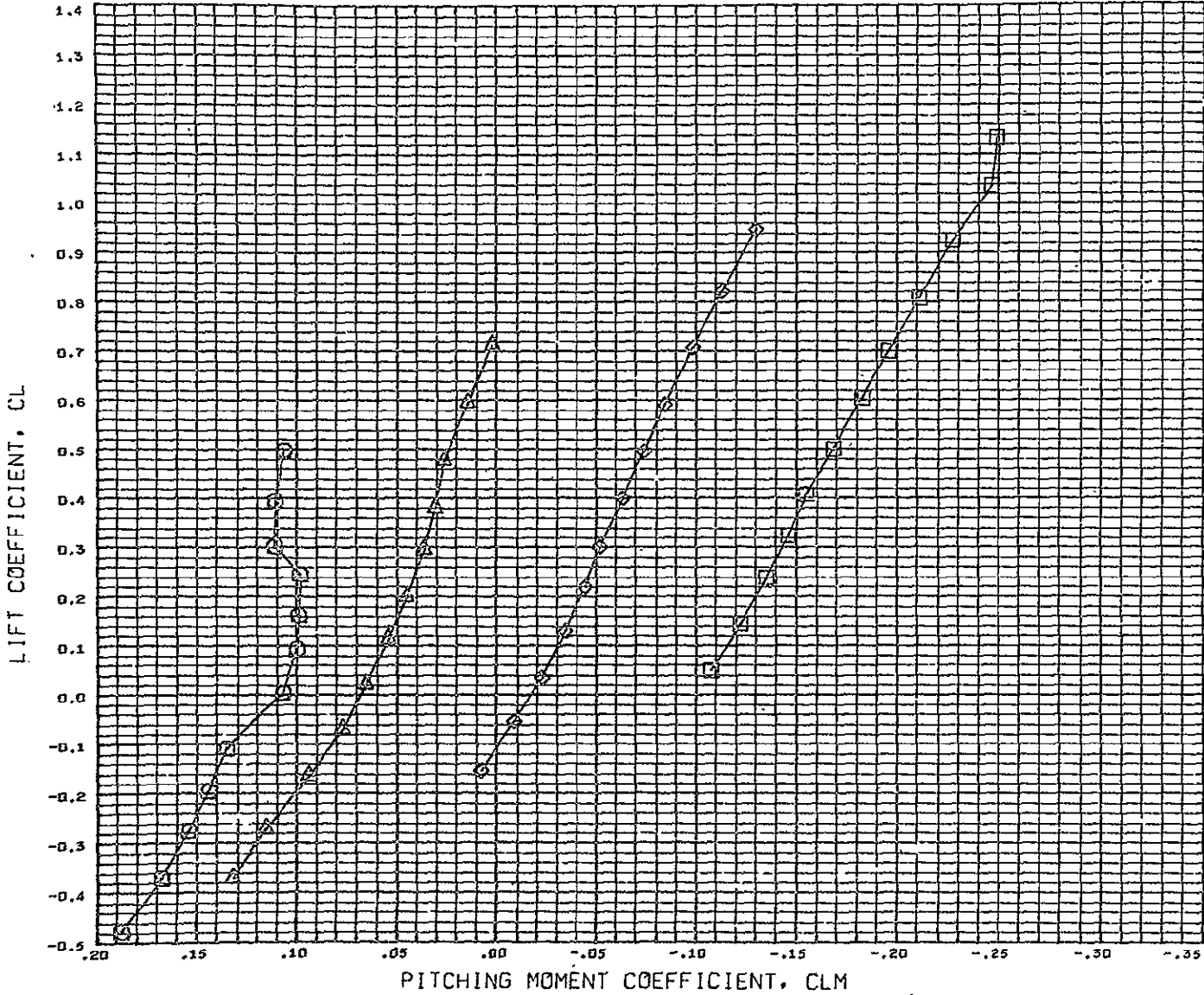

SYMBOL	ELEVTR	PARAMETRIC VALUES				DATA SOURCE				REFERENCE INFORMATION		
○	- 30.000	MACH	0.180	BETA	0.000	DATASET	ELEVTR	DATASET	ELEVTR	REFS	5057.0040	53.FT.
△	- 20.000	LOBE	- 30.000	ROBE	- 30.000	RCN038	- 30.000	RCN037	- 20.000	REFL	701.0004	IN.
◇	- 10.000	LINE	- 30.000	RINE	- 30.000	RCN036	- 10.000	RCN031	0.000	REFB	1230.0040	IN.
□	0.000	STRAKE	8.000							XMRF	1266.0040	IN.
										YMRF	0.0000	IN.
										ZMRF	163.0004	IN.
										SCALE	100.0000	PERCNT

DATA HIST. CODE MM

DLSWT TEST 138- FULL-SPAN ELEVON POWER

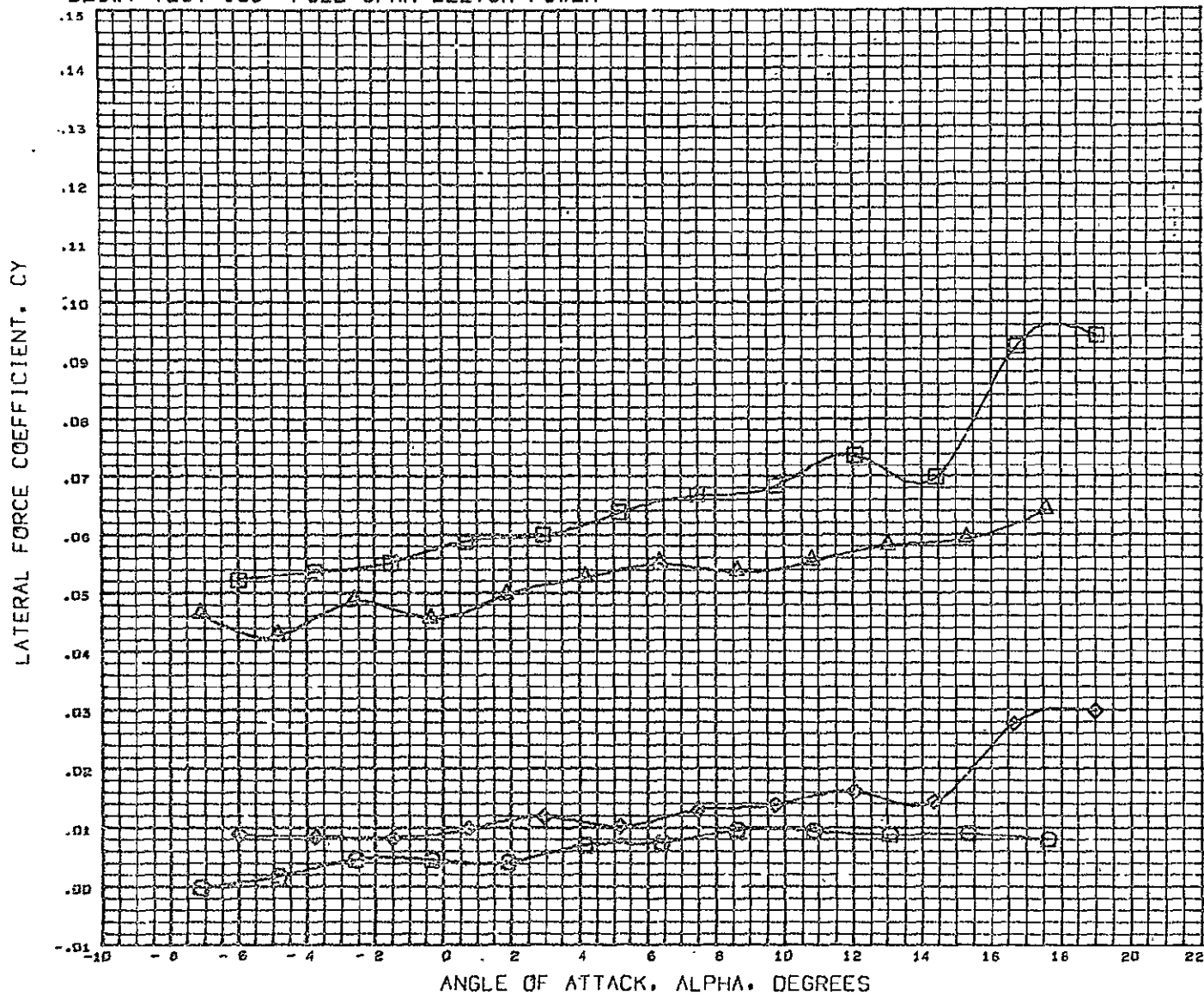

DATA SET SYMBOL	CONFIGURATION DESCRIPTION	ELEVTR	BETA	REFERENCE INFORMATION
(TCN038)	DLSWT 138 0.0133 SC. GENERIC HCR 02 B1BW4ASTV4	-30.000	0.000	REFS 5057.0040 SQ.FT.
(TCN039)	DLSWT 138 0.0133 SC. GENERIC HCR 02 B1BW4ASTV4		-2.900	REFL 701.0004 IN.
(TCN031)	DLSWT 138 0.0133 SC. GENERIC HCR 02 B1BW1ASTV4	0.000	0.000	REFB 1230.0040 IN.
(TCN032)	DLSWT 138 0.0133 SC. GENERIC HCR 02 B1BW4ASTV4		-2.880	XMRP 1266.0040 IN.
				YMRP 0.0000 IN.
				ZMRP 163.0004 IN.
				SCALE 100.0000 PERCENT

MACH 0.160

DLSWT TEST 138- FULL-SPAN ELEVON POWER

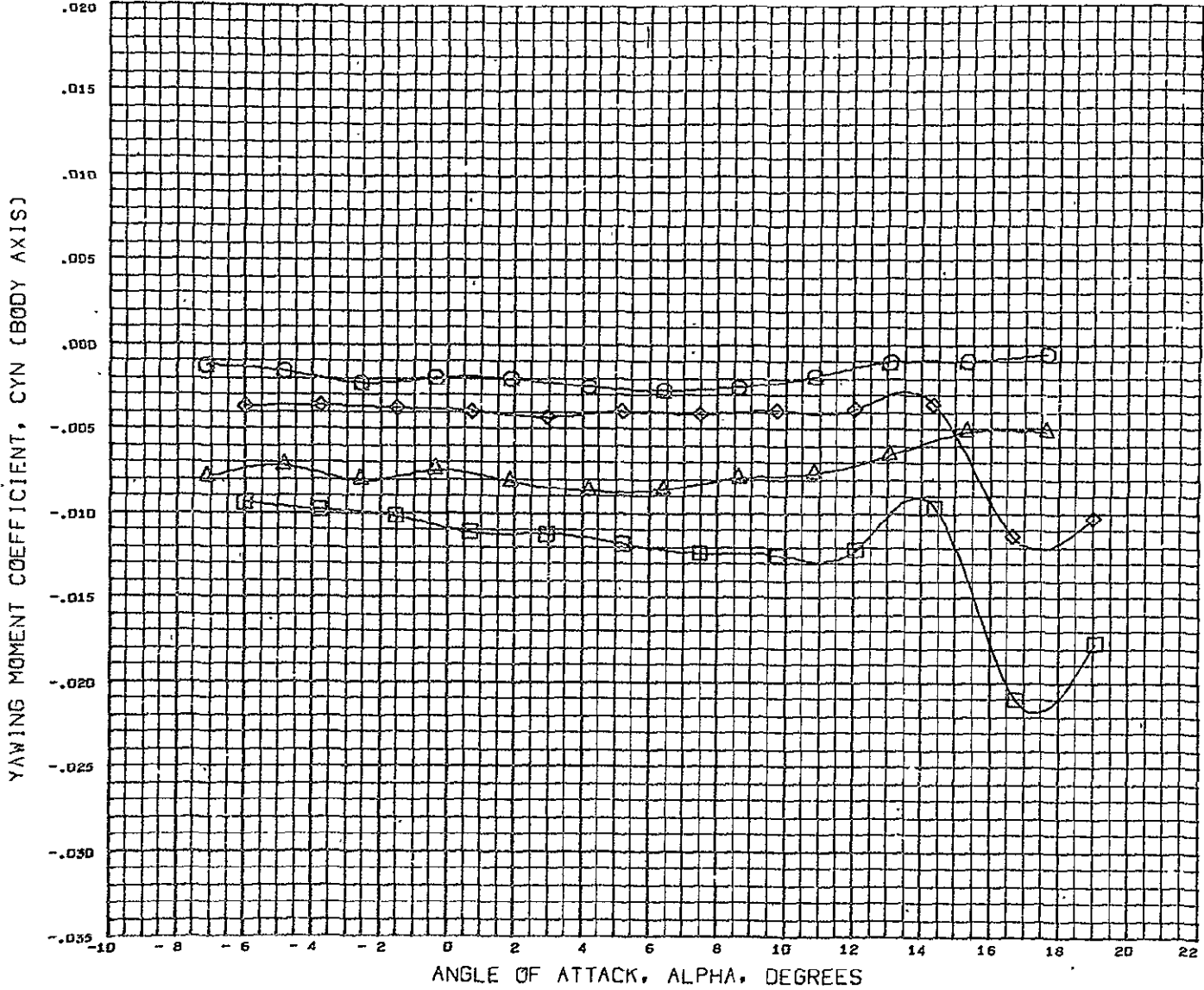

DATA SET SYMBOL	CONFIGURATION DESCRIPTION
(TCN038)	DLSWT 138 0.0133 SC. GENERIC HCR 02 B1BW4ASTV4
(TCN039)	DLSWT 138 0.0133 SC. GENERIC HCR 02 B1BW4ASTV4
(TCN031)	DLSWT 138 0.0133 SC. GENERIC HCR 02 B1BW4ASTV4
(TCN032)	DLSWT 138 0.0133 SC. GENERIC HCR 02 B1BW4ASTV4

ELEVTR	BETA
-30.000	0.000
-2.900	0.000
0.000	0.000
-2.880	0.000

REFERENCE INFORMATION		
REFS	5057.0040	SQ.FT.
REFL	701.0004	IN.
REFB	1230.0040	IN.
XMRP	1266.0040	IN.
YMRP	0.0000	IN.
ZMRP	163.0004	IN.
SCALE	100.0000	PERCENT

VACH 0.180

DLSWT TEST 138- FULL-SPAN ELEVON POWER

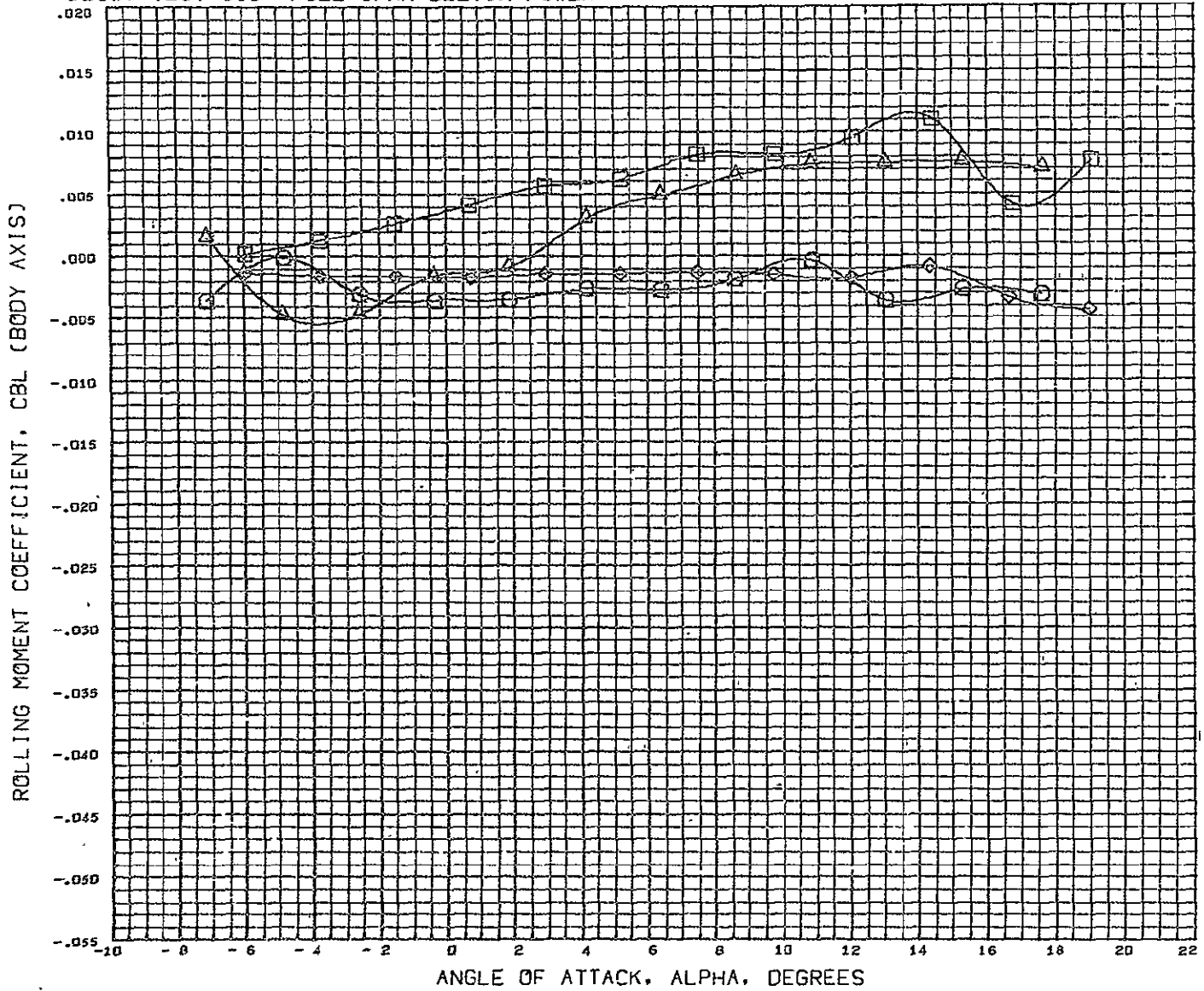

DATA SET SYMBOL	CONFIGURATION DESCRIPTION	ELEVTR	BETA	REFERENCE INFORMATION
(TCHD38)	DLSWT 138 0.0133 SC. GENERIC HCR 02 B1BWA4ASTV4	-30.000	0.000	REFS 5057.0040 30.FT.
(TCHD39)	DLSWT 138 0.0133 SC. GENERIC HCR 02 B1BWA4ASTV4		-2.900	REFL 701.0004 IN.
(TCHD31)	DLSWT 138 0.0133 SC. GENERIC HCF 02 B1BWA4ASTV4	0.000	0.000	REFB 1230.0040 IN.
(TCHD22)	DLSWT 138 0.0133 SC. GENERIC HCR 02 B1BWA4ASTV4		-2.880	XMRP 1266.0040 IN.
				YMRP 0.0000 IN.
				ZMRP 163.0004 IN.
				SCALE 100.0000 PERCENT

MACH 0.180

DLSWT TEST 138- FULL-SPAN ELEVON POWER

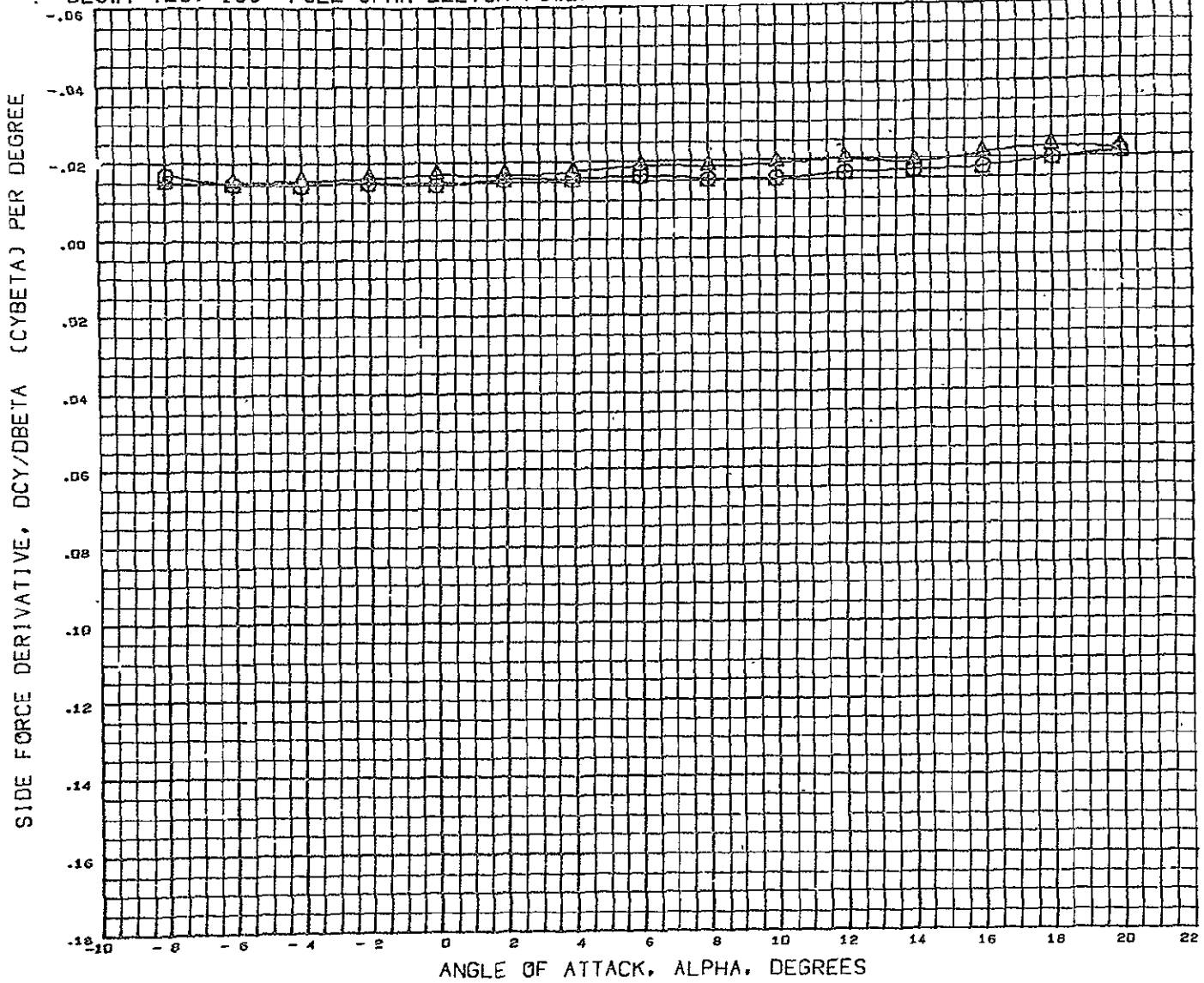

DATA SET SYMBOL	CONFIGURATION DESCRIPTION	LOBE	ROBE	LINE	RINE	REFERENCE INFORMATION	
(PCL938)	DLSWT 138 0.9133 SC. GENERIC HCR 02 B1BWAASTV4	-30.000	-30.000	-30.000	-30.000	REFS	5057.0040 SQ.FT.
(FCH931)	DLSWT 138 0.9133 SC. GENERIC HCR 02 B1BWAASTV4	0.000	0.000	0.000	0.000	REFL	791.0004 IN.
						REFB	1230.0040 IN.
						XMRP	1266.0040 IN.
						YMRP	0.0000 IN.
						ZMRP	163.0004 IN.
						SCALE	100.0000 PERCENT

MACH 5.180

DLSWT TEST 138- FULL-SPAN ELEVON POWER

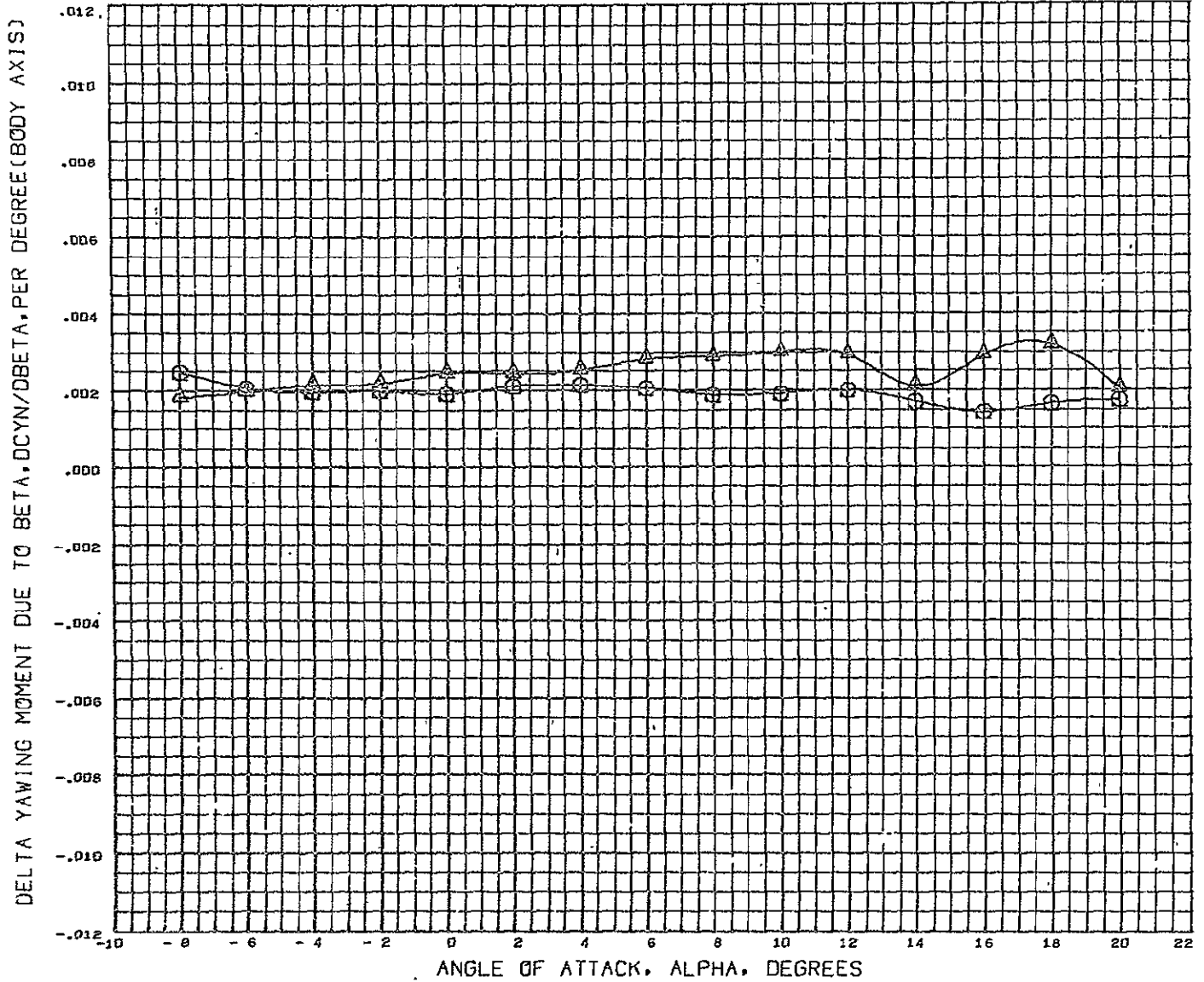

DATA SET SYMBOL	CONFIGURATION DESCRIPTION	LOBE	ROBE	LINE	RINE	REFERENCE INFORMATION
(PCND38)	⊙ DLSWT 138 0.0133 SC. GENERIC HCR 02 B1BW4ASTV4	-30.000	-30.000	-30.000	-30.000	REFS 5057.0040 SQ.FT.
(PCND31)	△ DLSWT 138 0.0133 SC. GENERIC HCR 02 B1BW4ASTV4	0.000	0.000	0.000	0.000	REFL 701.0004 IN.
						REFB 1230.0040 IN.
						XMRP 1266.0040 IN.
						YMRP 0.0000 IN.
						ZMRP 163.0004 IN.
						SCALE 100.0000 PERCENT

MACH 0.180

DLSWT TEST 138- FULL-SPAN ELEVON POWER

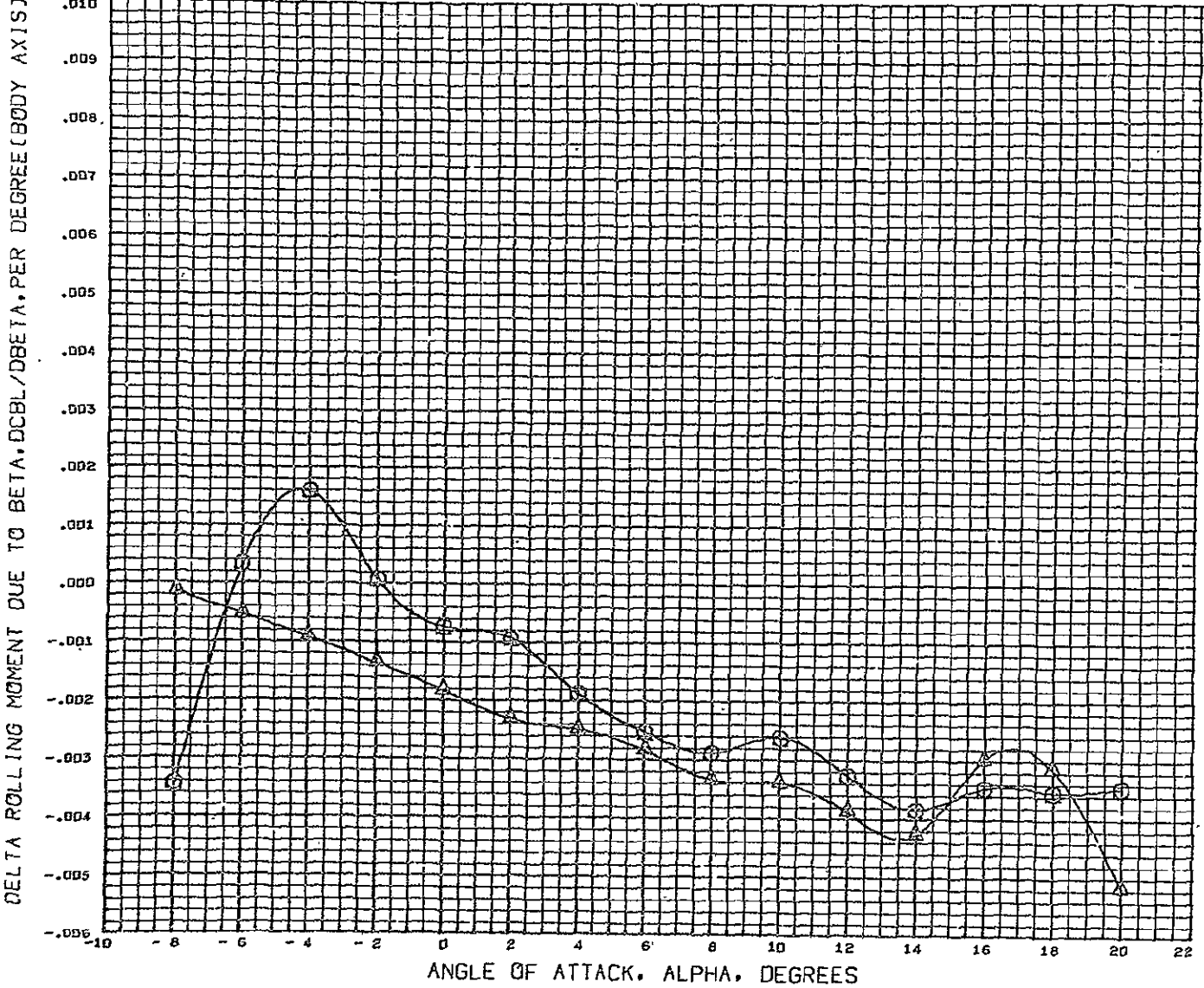

DATA SET SYMBOL	CONFIGURATION DESCRIPTION	LOBE	ROBE	LINE	RINE	REFERENCE INFORMATION
(PCND38)	⊙ DLSWT 138 0.0133 SC. GENERIC HCR 02 B18W4ASTV4	-30.000	-30.000	-30.000	-30.000	REFS 5057.0040 SQ.FT.
(PCND31)	△ DLSWT 138 0.0133 SC. GENERIC HCR 02 B18W4ASTV4	0.000	0.000	0.000	0.000	REFL 791.0004 IN.
						REFD 1230.0040 IN.
						XMRP 1266.0040 IN.
						YMRP 0.0000 IN.
						ZMRP 163.0004 IN.
						SCALE 100.0000 P*RCNT

MACH 0.80

DLSWT TEST 138- PARTIAL-SPAN ELEVON POWER

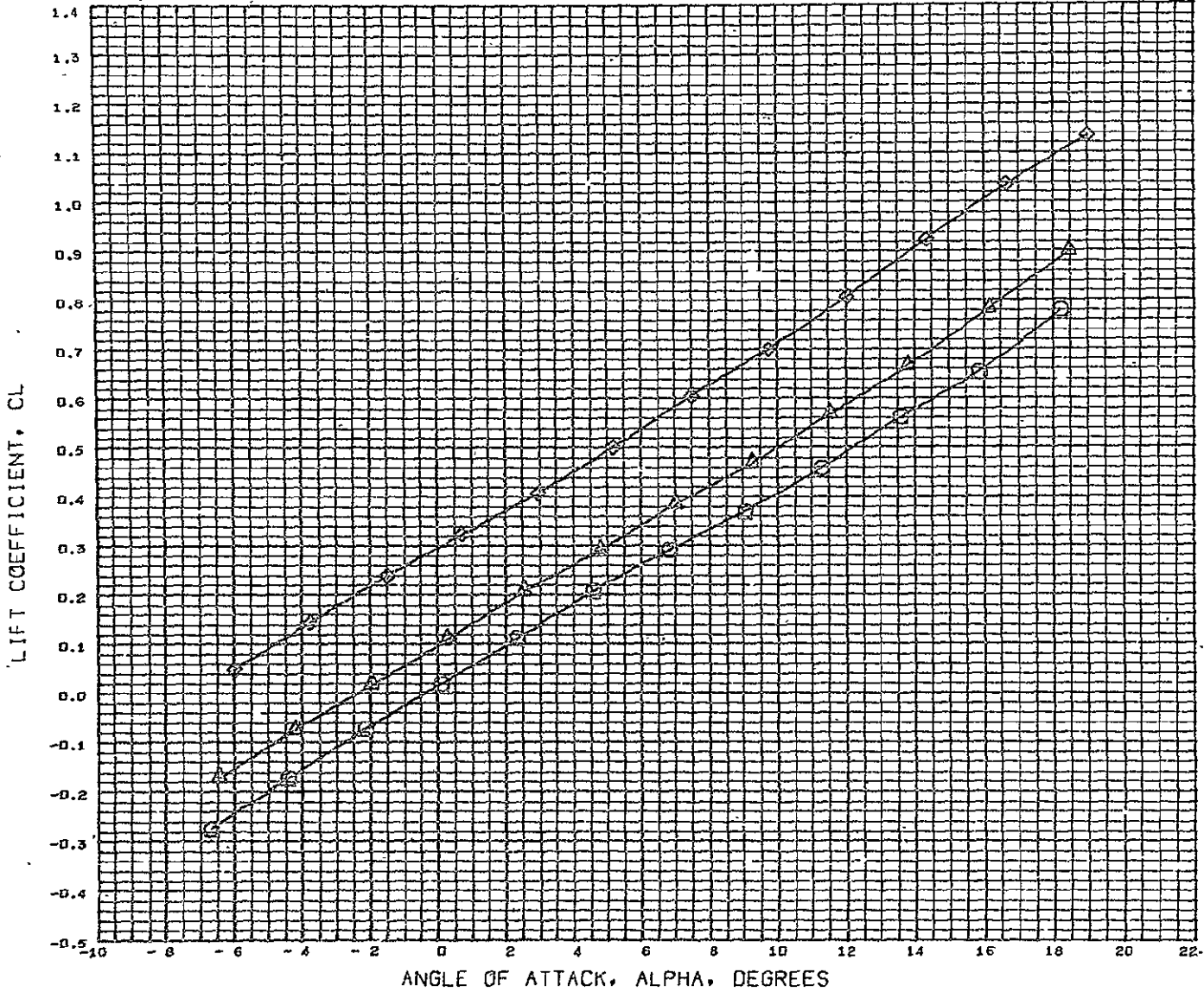

SYMBOL	ELEVTR	PARAMETRIC VALUES				DATA SOURCE				REFERENCE INFORMATION							
		MACH	ROBE	SET	RCNG31	RCN043	RCN042	REFS	REFL	REFB	XHRP	YHRP	ZHRP	SCALE			
○	- 30.000	0.185	0.000	0.000	0.000	RCN043	- 30.000	RCN042	- 20.000	5057.0040	701.0004	1230.0040	1266.0040	0.0000	163.0004	100.0000	SQ.FT.
△	- 20.000	0.000	0.000	0.000	0.000	RCN043	- 30.000	RCN042	- 20.000	701.0004	1230.0040	1266.0040	0.0000	163.0004	100.0000	IN.	
◇	0.000	0.000	0.000	0.000	0.000	RCN043	- 30.000	RCN042	- 20.000	1230.0040	1266.0040	0.0000	163.0004	100.0000	IN.	PLRCNT	

REFERENCE FILE

DLSWT TEST 138- PARTIAL-SPAN ELEVON POWER

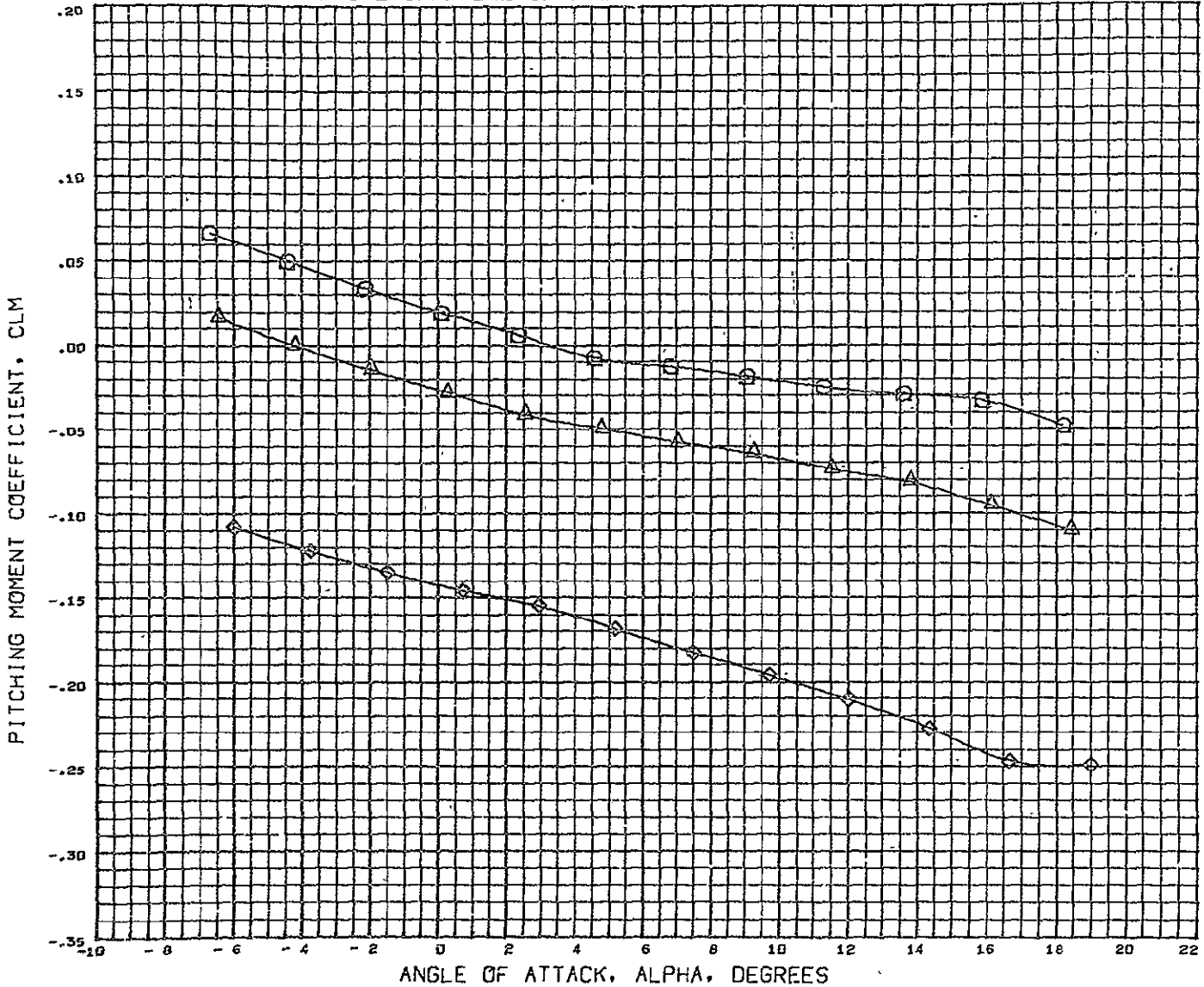

SYMBOL	ELEVTR	PARAMETRIC VALUES	DATA SOURCE	REFERENCE INFORMATION
○	- 30.000	MACH 0.100 BETA 0.000	RCND31 0.000	REFS 5057.0040 SQ. FT.
△	- 20.000	LOBE 0.000 ROBE 0.000	RCND43 - 30.000 RCND42 - 20.000	REFL 701.0004 IN.
◇	0.000	LINE - 30.000 RINE - 30.000		REFB 1230.0040 IN.
		STRAKE 8.000 AILRON 0.000		XMRP 1266.0040 IN.
				YMRP 0.0000 IN.
				ZMRP 163.0004 IN.
				SCALE 100.0000 PLRCNT

REFERENCE FILE

DLSWT TEST 138- PARTIAL-SPAN ELEVON POWER

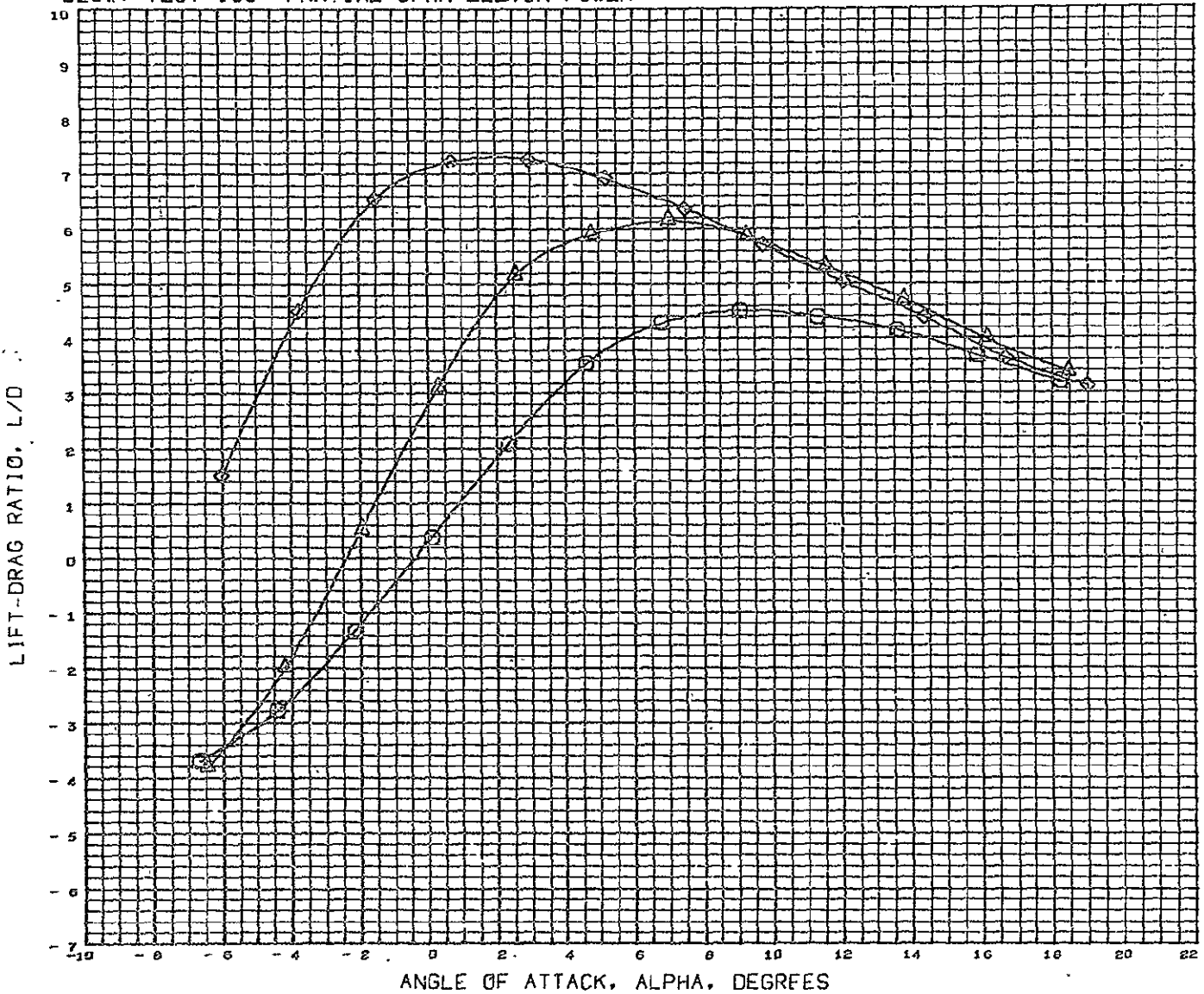

SYMBOL	ELEVTR	PARAMETRIC VALUES	DATA SOURCE	REFERENCE INFORMATION
○	- 30.000	MACH 0.180 BETA 0.000	DATASET ELEVTR DATASET ELEVTR	REFS 5057.0040 SQ.FT.
△	- 20.000	LOBE 0.000 ROBE 0.000	RCN043 - 30.000 RCN042 - 20.000	REFL 701.0004 IN.
◇	0.000	LINE - 30.000 RINE - 30.000	RCN031 0.000	REFB 1230.0040 IN.
		STRAKE 8.000 AIRLON 0.000		XMRP 1266.0040 IN.
				YMRP 0.0000 IN.
				ZMRP 163.0004 IN.
				SCALE 100.0000 PERCENT

REFERENCE FILE

DLSWT TEST 138- PARTIAL-SPAN ELEVON POWER

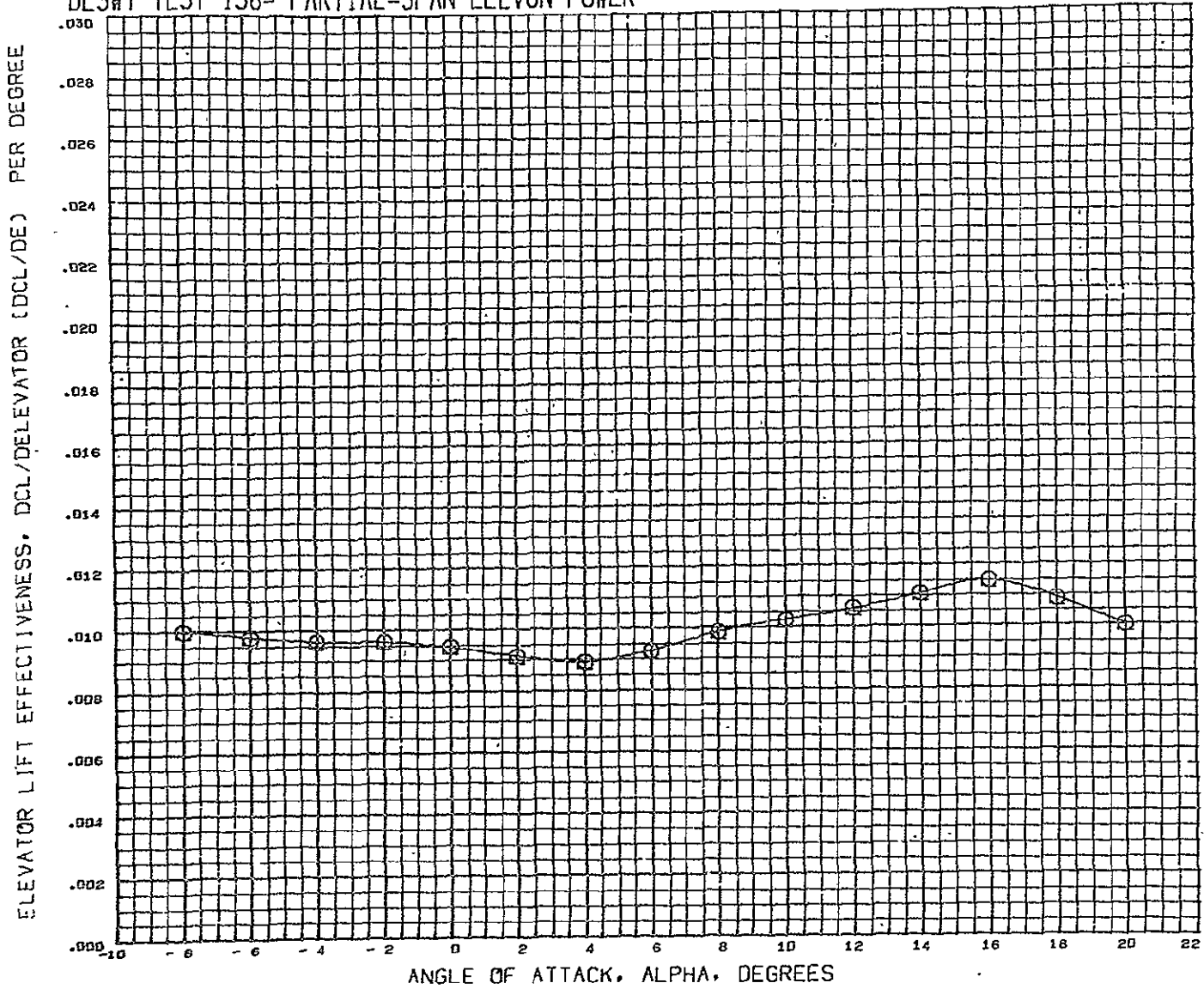

SYMBOL	MACH	PARAMETRIC VALUES			
○	0.180	BETA	0.000	LOBE	0.000
		POSE	0.005	STRAKE	0.000
		AIRCN	0.000		

REFERENCE INFORMATION		
REFS	5057.0040	SR. FT.
REFL	701.0004	IN.
REFD	1230.0040	IN.
XMRP	1266.0040	IN.
YMRP	0.0000	IN.
ZMRP	163.0004	IN.
SCALE	100.0000	PERCENT

DATA HIST. CODE #F

DLSWT TEST 138- PARTIAL-SPAN ELEVON POWER

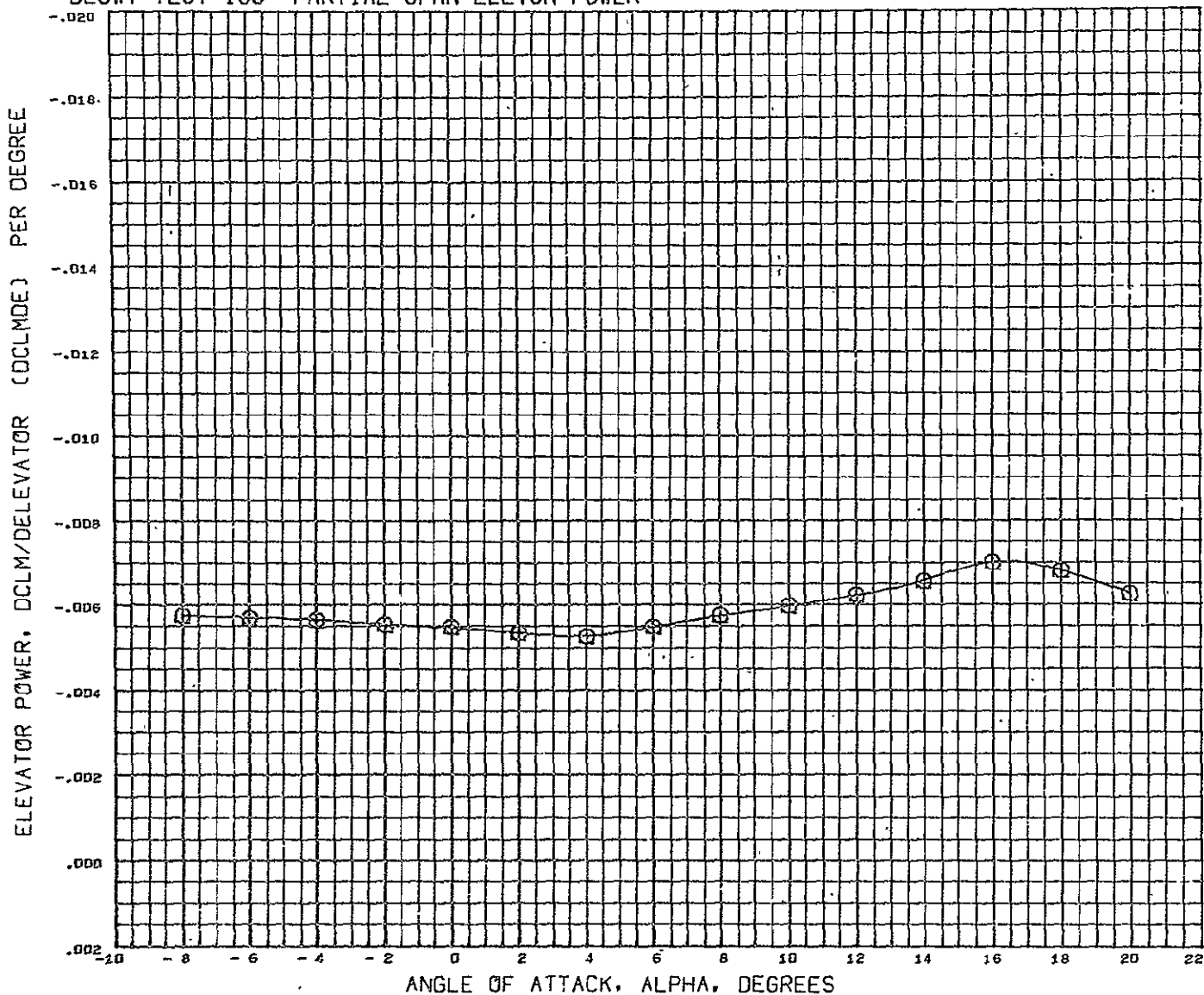

SYMBOL	MACH	PARAMETRIC VALUES				REFERENCE INFORMATION		
○	0.105	BETA	0.050	LOBE	0.005	REFS	5057.0040	SQ. FT.
		ROBE	0.005	STRAKE	8.000	REFL	701.0004	IN.
		AIRPCN	0.005			REFB	1230.0040	IN.
						XMRP	1266.0040	IN.
						YMRP	0.0000	IN.
						ZMRP	163.0004	IN.
						SCALE	100.0000	PERCENT

DATA HIST. CODE #F

DLSWT TEST 138- PARTIAL-SPAN ELEVON POWER

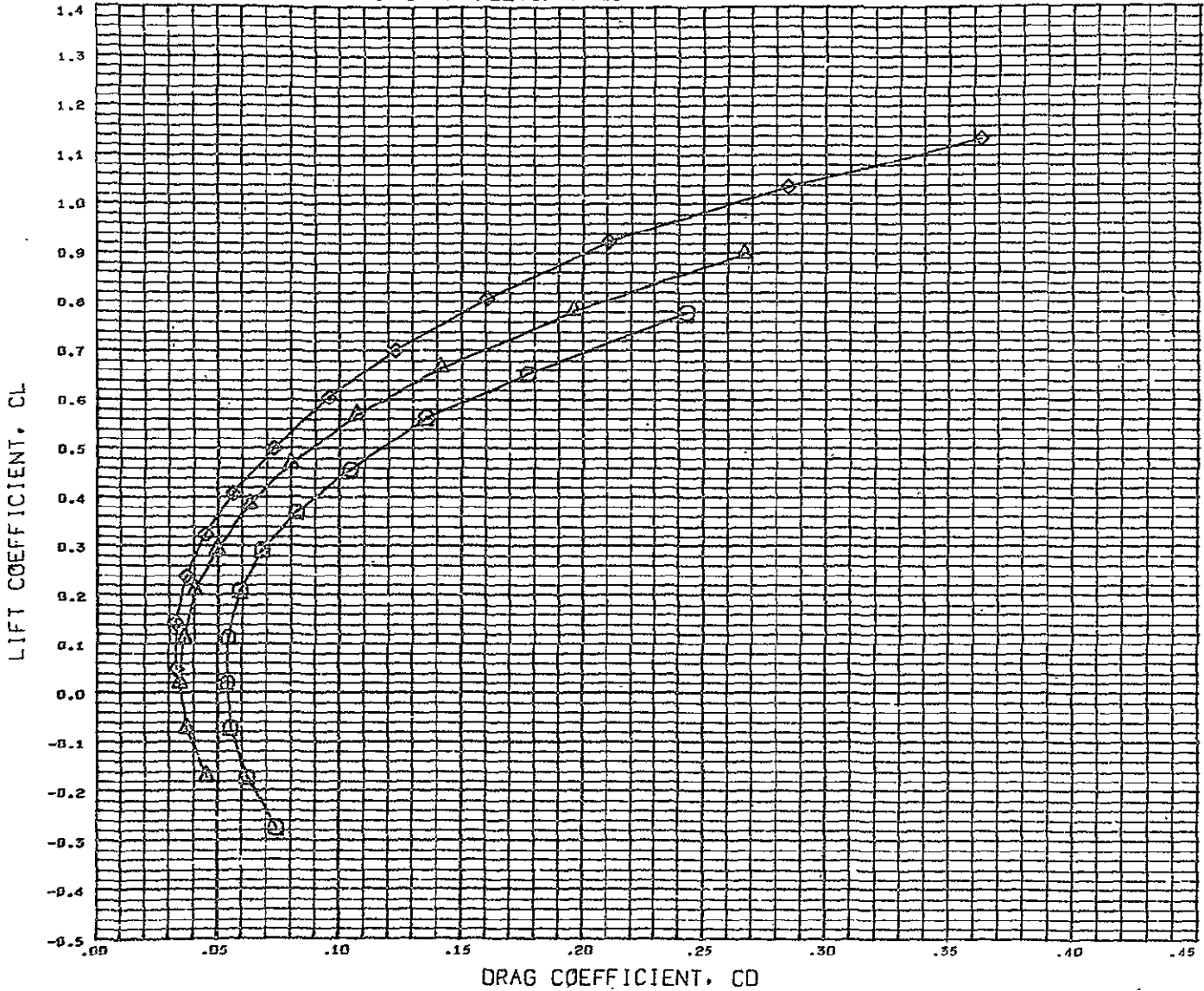

SYMBOL	ELEVTR	PARAMETRIC VALUES				DATA SOURCE				REFERENCE INFORMATION			
		MACH	BETA	ROBE	RINE	DATASET	ELEVTR	DATASET	ELEVTR	REFS	SCALE	PERCNT	
○	- 30.000	0.100	0.000	0.000	0.000	RCN043	- 30.000	RCN042	- 20.000	9057.0040	100.0000	50.FT.	
△	- 20.000	0.000	0.000	0.000	0.000	RCN043	- 30.000	RCN042	- 20.000	701.0004	100.0000	IN.	
◇	0.000	8.000	0.000	0.000	0.000	RCN031	0.000			1230.0040	100.0000	IN.	
		STFAKE								XMRP	1266.0040	100.0000	IN.
										YMRP	0.0000	100.0000	IN.
										ZMRP	100.0004	100.0000	IN.
													PERCNT

REFERENCE FILE

DLSWT TEST 138- PARTIAL-SPAN ELEVON POWER.

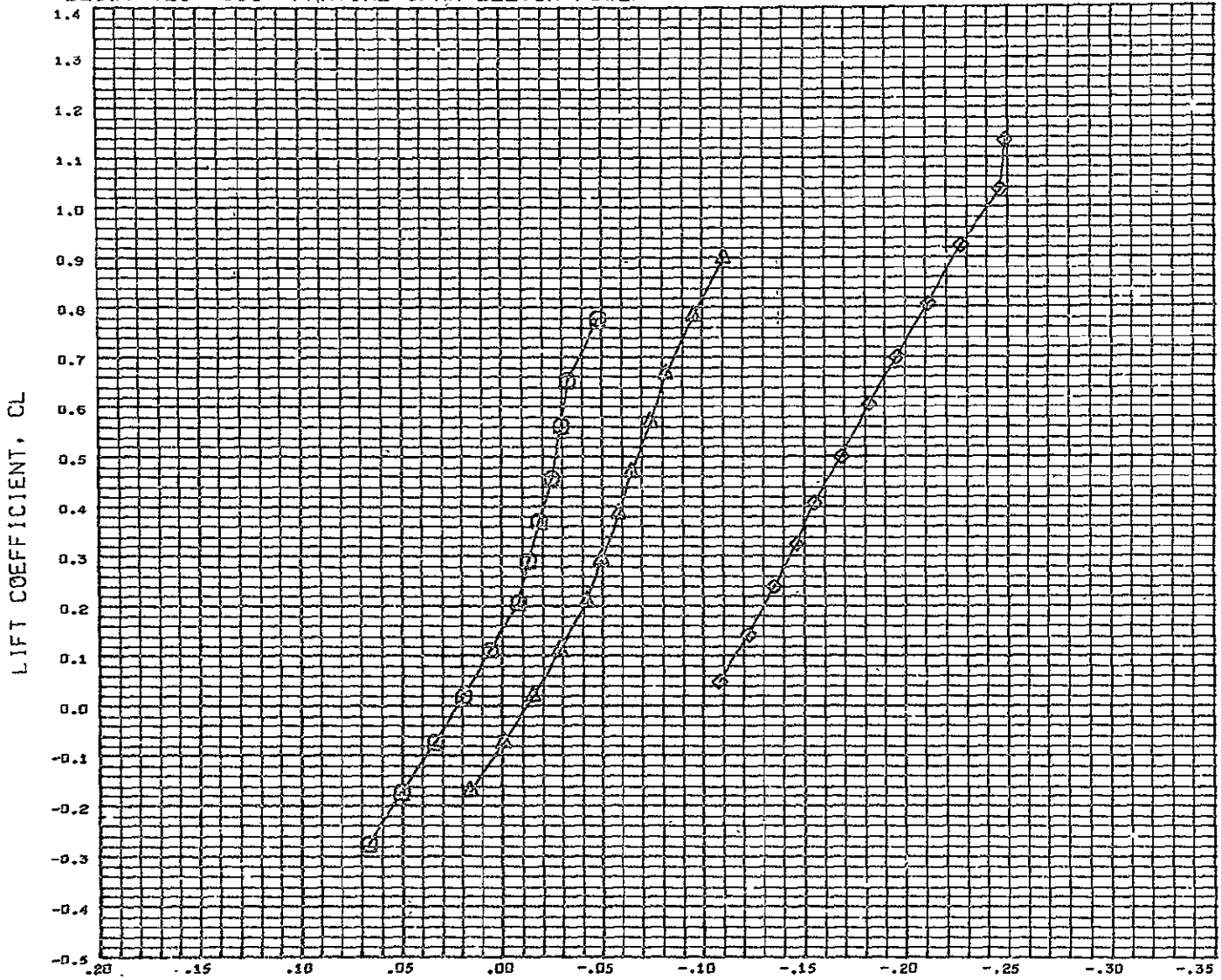

SYMBOL	ELEVTR	PARAMETRIC VALUES				DATA SOURCE				REFERENCE INFORMATION		
○	- 30.000	MACH	0.100	BETA	0.000	DATASET	ELEVTR	DATASET	ELEVTR	REFS	5057.0040	SG.FT.
△	- 20.000	LOBE	0.000	ROSE	0.000	RCN043	- 30.000	RCN042	- 20.000	REFL	701.0004	IN.
◇	0.000	LINE	- 30.000	RINE	- 30.000	RCN031	0.000			REFB	1230.0040	IN.
		STPAKE	8.000	AILRON	0.000					XMRP	1266.0040	IN.
										YMRP	6.0000	IN.
										ZHRP	163.0004	IN.
										SCALE	100.0000	PERCNT

REFERENCE FILE

DLSWT TEST 138- ROLL CONTROL POWER

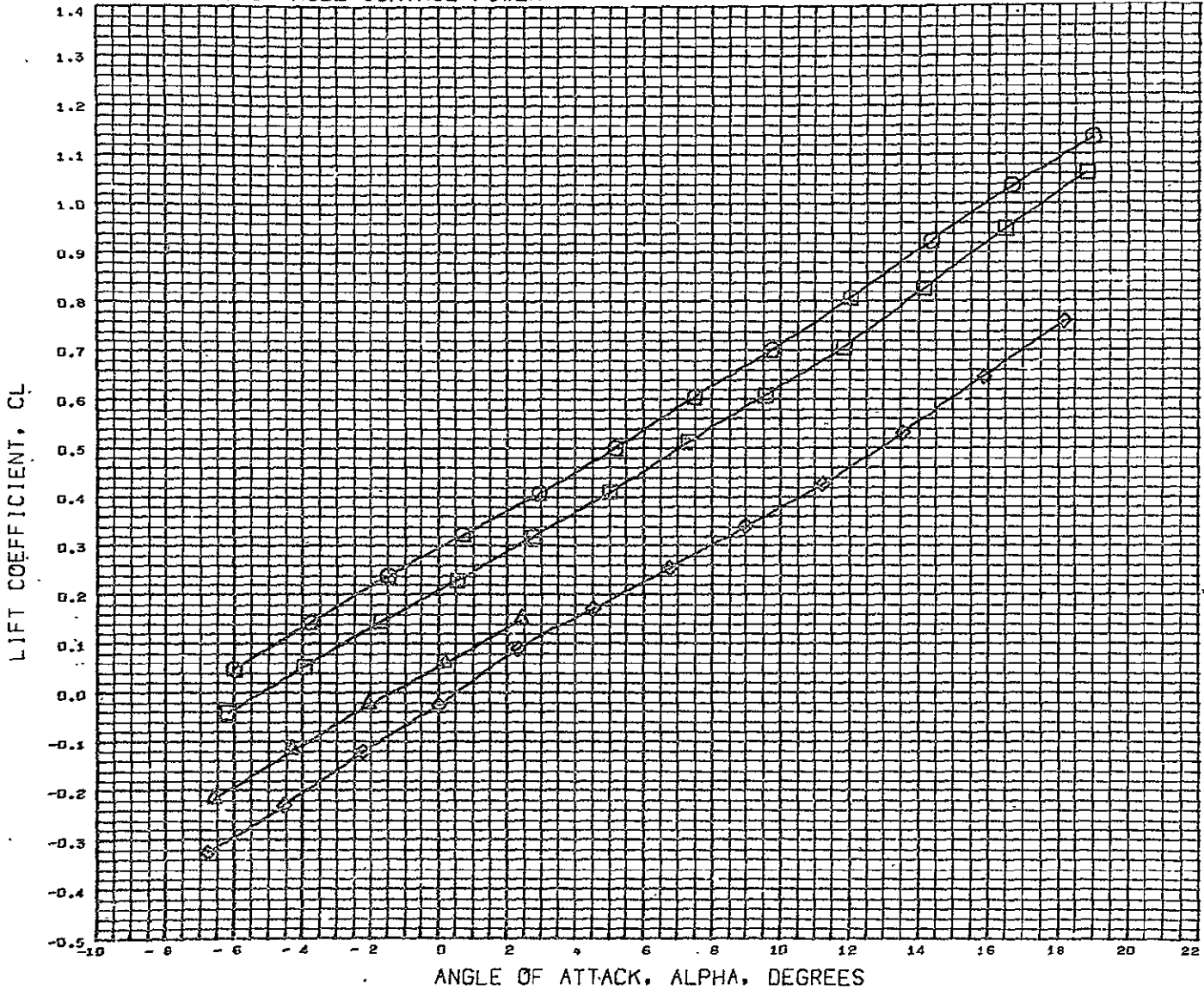

DATA SET SYMBOL	CONFIGURATION DESCRIPTION	AILRON	BETA	REFERENCE INFORMATION
(RCND31)	DLSWT 138 0.0133 SC. GENERIC HCR 02 B18W4ASTV4	0.000	0.000	REFS 5057.0040 SQ.FT.
(RCND40)	DLSWT 138 0.0133 SC. GENERIC HCR 02 B18W4ASTV4	-15.000	-2.800	REFL 701.0004 IN.
(RCND41)	DLSWT 138 0.0133 SC. GENERIC HCR 02 B18W4ASTV4	-15.000	0.000	REFB 1230.0040 IN.
(RCND42)	DLSWT 138 0.0133 SC. GENERIC HCR 02 B18W4ASTV4	-5.000	0.000	XMRP 1266.0040 IN.
				YMRP 0.0000 IN.
				ZMRP 163.0004 IN.
				SCALE 100.0000 PERCENT

MACH 0.180

DLSWT TEST 138- ROLL CONTROL POWER

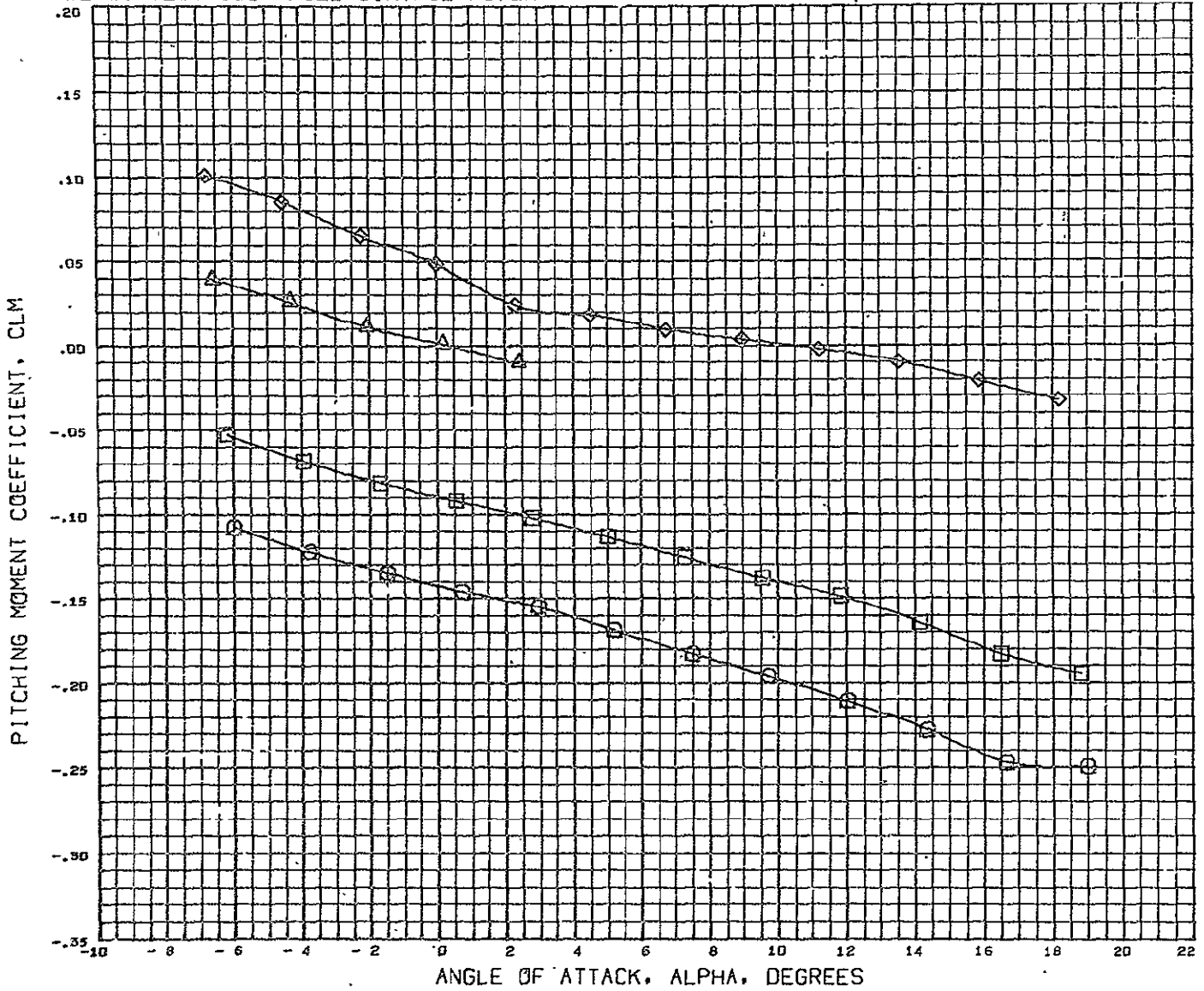

DATA SET SYMBOL	CONFIGURATION DESCRIPTION	AILRON	BETA	REFERENCE INFORMATION
(RCND31)	DLSWT 138 0.0133 SC. GENERIC HCR 02 B18W4ASTV4	0.000	0.000	REFS 5057.0040 SQ.FT.
(RCND40)	DLSWT 138 0.0133 SC. GENERIC HCR 02 B18W4ASTV4	-15.000	-2.880	REFL 701.0004 IN.
(RCND41)	DLSWT 138 0.0133 SC. GENERIC HCR 02 B18W4ASTV4	-15.000	0.000	REFB 1230.0040 IN.
(RCND44)	DLSWT 138 0.0133 SC. GENERIC HCR 02 B18W4ASTV4	-5.000	0.000	XMRP 1266.0040 IN.
				YMRP 0.0000 IN.
				ZMRP 163.0004 IN.
				SCALE 100.0000 ERCNT

HACH 0.180

DLSWT TEST 138- ROLL CONTROL POWER

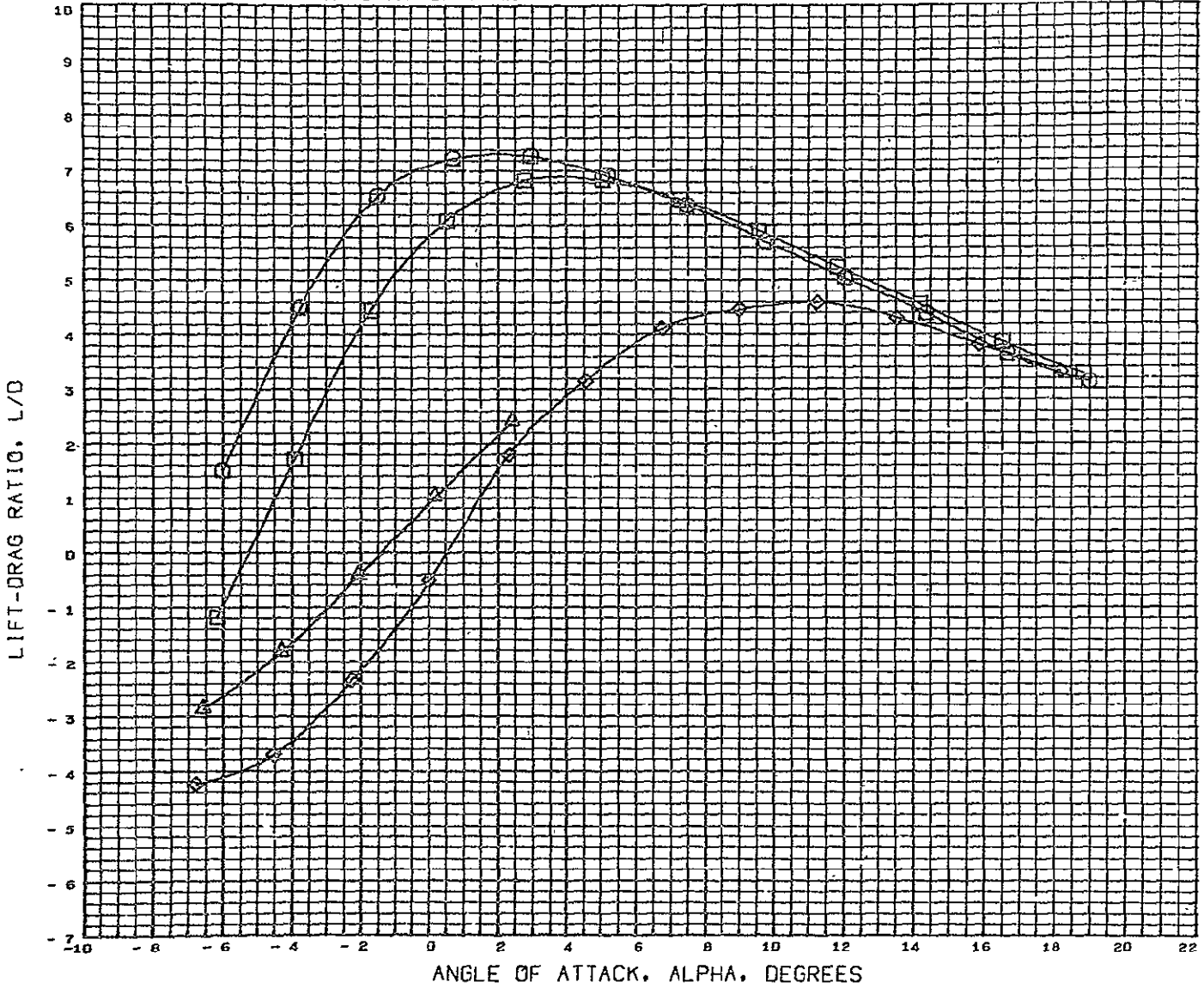

DATA SET SYMBOL	CONFIGURATION DESCRIPTION	AILRON	BETA
(RCND31)	DLSWT 138 D.0133 SC. GENERIC HCR 02 B1B4ASTV4	0.000	0.000
(RCND40)	DLSWT 138 D.0133 SC. GENERIC HCR 02 B1B4ASTV4	-15.000	-2.880
(RCND41)	DLSWT 138 D.0133 SC. GENERIC HCR 02 B1B4ASTV4	-15.000	0.000
(RCND44)	DLSWT 138 D.0133 SC. GENERIC HCR 02 B1B4ASTV4	-5.000	0.000

REFERENCE INFORMATION	
REFS	5057.0040 SQ.FT.
REFL	701.0024 IN.
REFB	1230.004C IN.
XMRF	1266.0040 IN.
YMRF	0.0000 IN.
ZMRF	163.0004 IN.
SCALE	100.0000 PERCNT

MACH 0.180

DLSWT TEST 138- ROLL CONTROL POWER

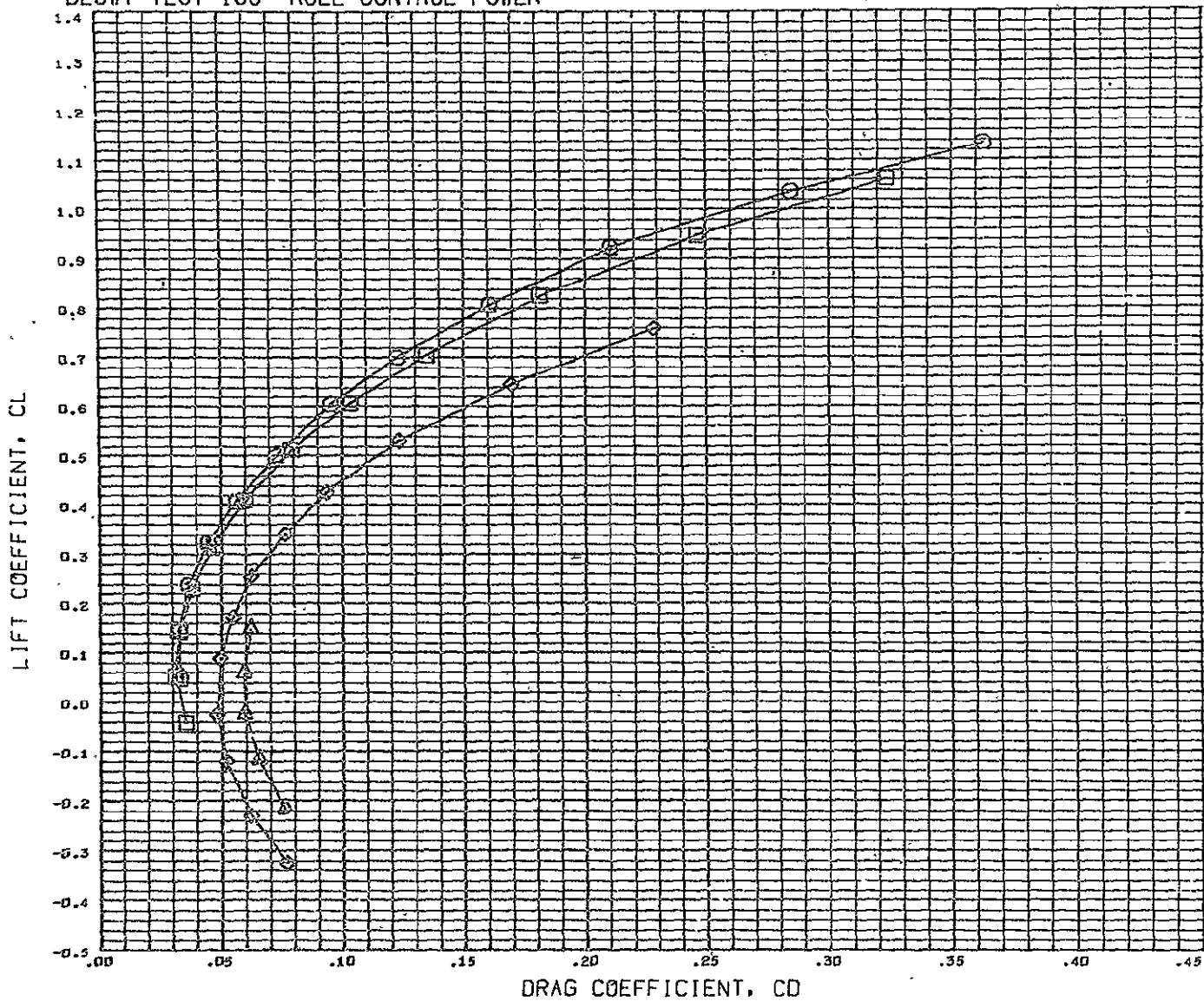

DATA SET SYMBOL	CONFIGURATION DESCRIPTION	AILRON	BETA	REFERENCE INFORMATION
(RCND31)	DLSWT 138 0.0133 SC. GENERIC HCR O2 81BW4ASTV4	0.000	0.000	REFS 5057.0040 SQ.FT.
(RCND36)	DLSWT 138 0.0133 SC. GENERIC HCR O2 81BW4ASTV4	-15.000	-2.880	REFL 701.0504 IN.
(RCND41)	DLSWT 138 0.0133 SC. GENERIC HCR O2 81BW4ASTV4	-15.000	0.000	REFB 1230.0040 IN.
(RCND44)	DLSWT 138 0.0133 SC. GENERIC HCR O2 81BW4ASTV4	-5.000	0.000	XHRF 1266.0040 IN.
				YHRF 0.0000 IN.
				ZHRF 163.0004 IN.
				SCALE 100.0000 PERCENT

MACH 0.180

DLSWT TEST 138- ROLL CONTROL POWER

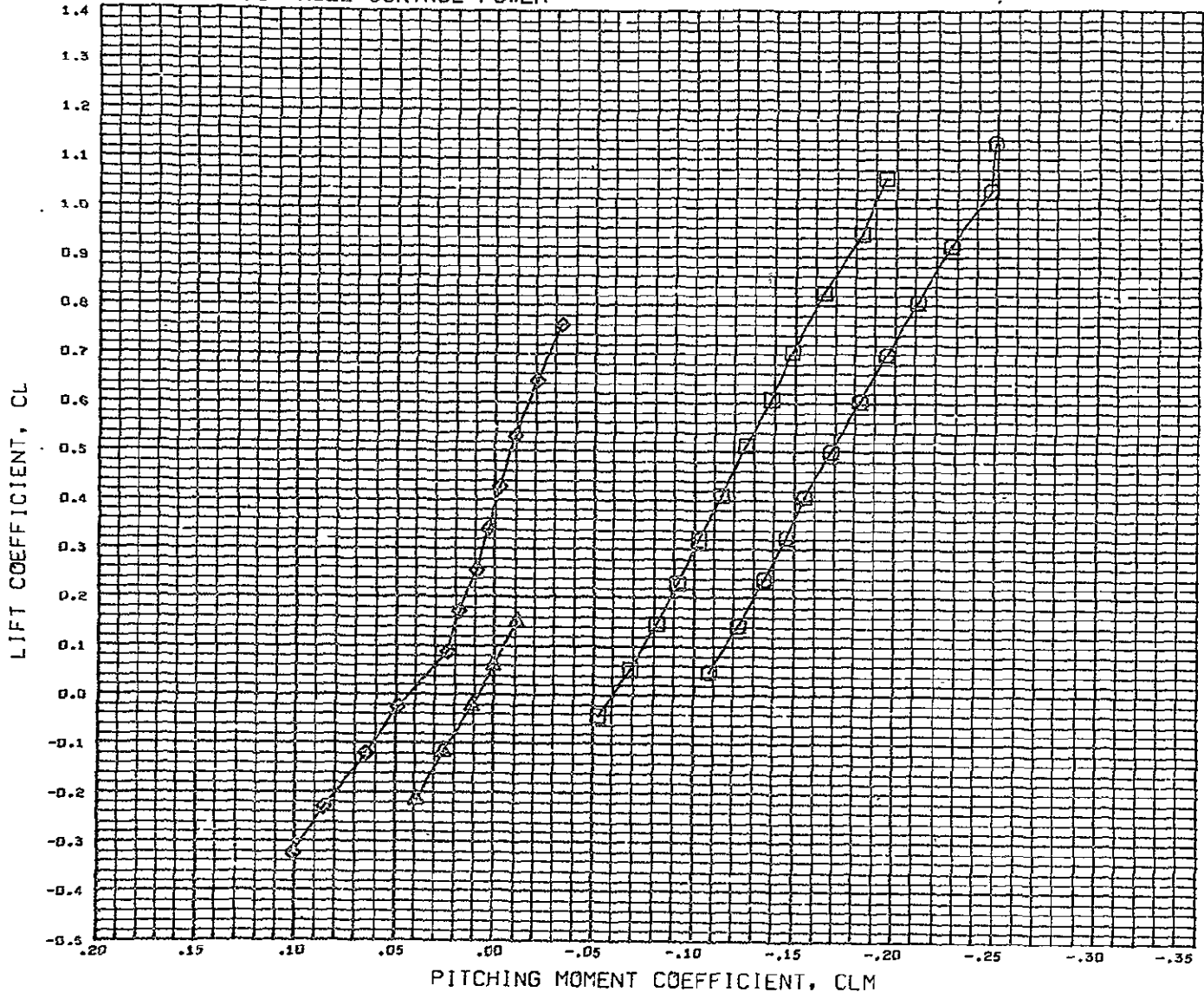

DATA SET SYMBOL	CONFIGURATION DESCRIPTION	AILRON	BETA	REFERENCE INFORMATION
(RCND31)	DLSWT 138 0.0133 SC. GENERIC HCR 02 B1BWA5TV4	0.000	0.000	REFS 5057.0040 SQ.FT.
(RCND40)	DLSWT 138 0.0133 SC. GENERIC HCR 02 B1BWA5TV4	-15.000	-2.880	REFL 701.0004 IN.
(RCND41)	DLSWT 138 0.0133 SC. GENERIC HCR 02 B1BWA5TV4	-15.000	0.000	REFB 1230.0040 IN.
(RCND44)	DLSWT 138 0.0133 SC. GENERIC HCR 02 B1BWA5TV4	-5.000	0.000	XMRP 1266.0040 IN.
				YNRP 0.0000 IN.
				ZNRP 163.0004 IN.
				SCALE 100.0000 PERCNT

VACH 5.180

DLSWT TEST 138- ROLL CONTROL POWER

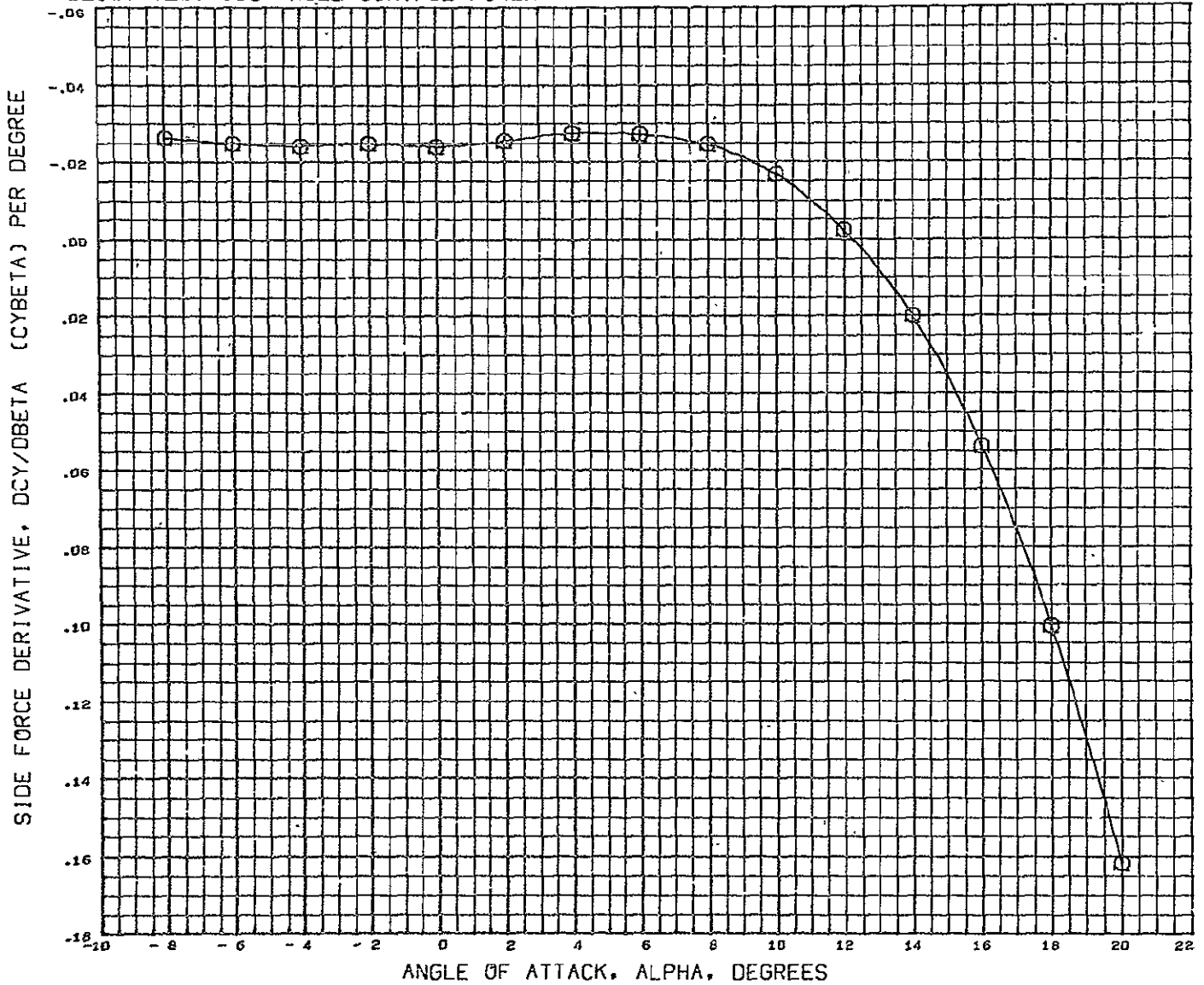

SYMBOL	MACH	PARAMETRIC VALUES			
Q	0.185	LOBE	- 35.000	ROBE	0.000
		STRAKE	8.000	AILRON	- 15.000

REFERENCE INFORMATION		
REFS	5057.0040	SQ. FT.
REFL	701.0004	IN.
REFB	1230.0040	IN.
XMRP	1266.0040	IN.
YMRP	0.0000	IN.
ZMRP	163.0004	IN.
SCALE	100.0000	PERCNT

DATA HIST. CODE #P

DLSWT TEST 138- ROLL CONTROL POWER

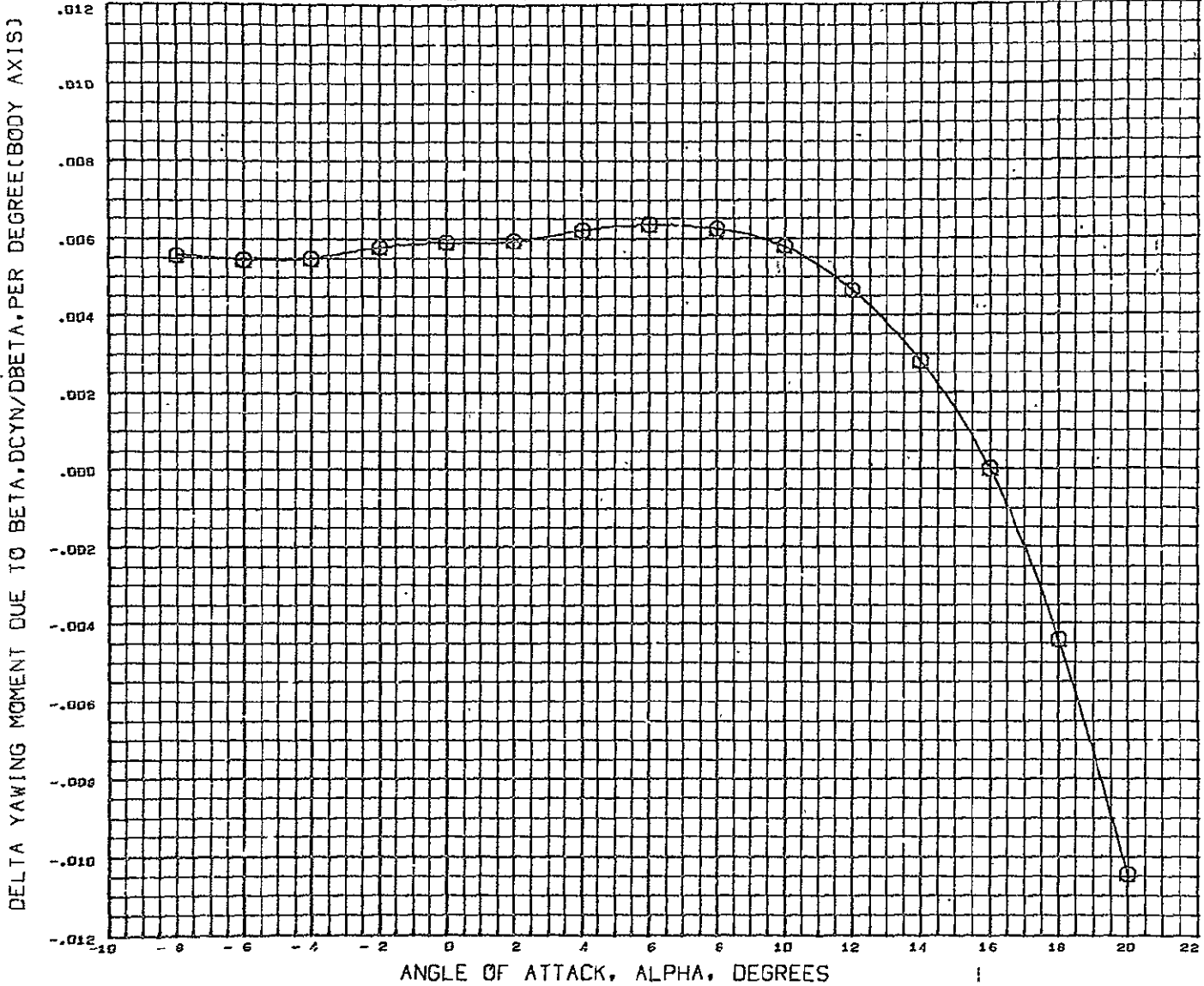

SYMBOL	MACH	PARAMETRIC VALUES			
○	0.160	LOBE	- 30.000	ROBE	0.000
		STAKE	8.000	AILRON	- 15.000

REFERENCE INFORMATION

REFS	5057.0040	90.FT.
REFL	701.0004	IN.
REFB	1230.0040	IN.
XHRF	1266.0040	IN.
YHRF	0.0000	IN.
ZHRF	163.0004	IN.
SCALE	100.0000	PERCNT

DATA HIST. CODE 2F

DLSWT TEST 138- ROLL CONTROL POWER

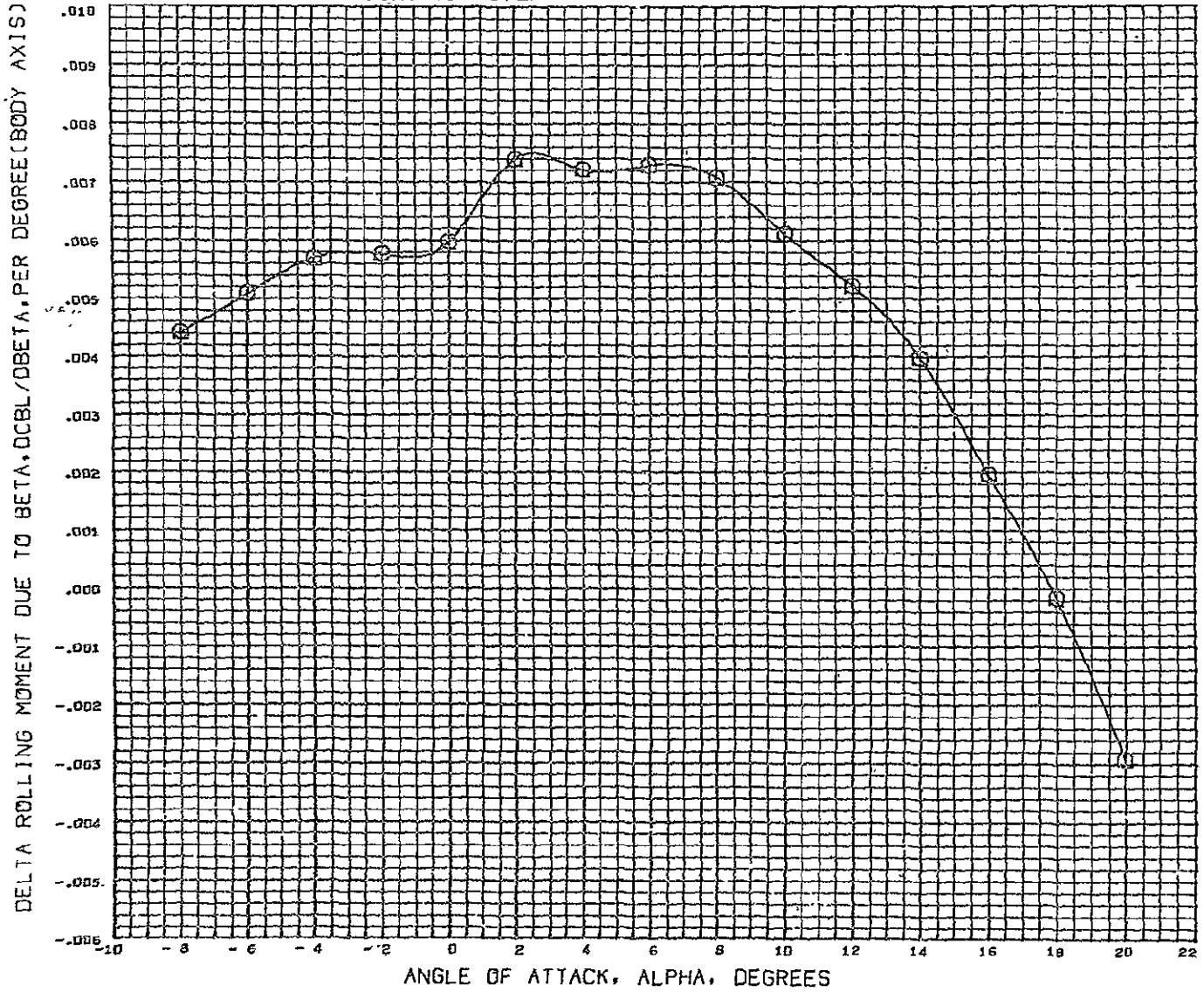

SYMBOL MACH PARAMETRIC VALUES
 ○ 0.130 LOSE - 30.000 ROBF 0.000
 STRAKE 0.000 AILRON - 15.000

REFERENCE INFORMATION
 REFS 5057.0040 30. FT.
 REFL 701.0004 IN.
 REFB 1230.0040 IN.
 XMRP 1266.0040 IN.
 YMRP 0.0000 IN.
 ZMRP 163.0004 IN.
 SCALE 100.0000 PERCENT

DATA HIST. CODE SF

30

⊕ Σ

DLSWT TEST 138- ROLL CONTROL POWER

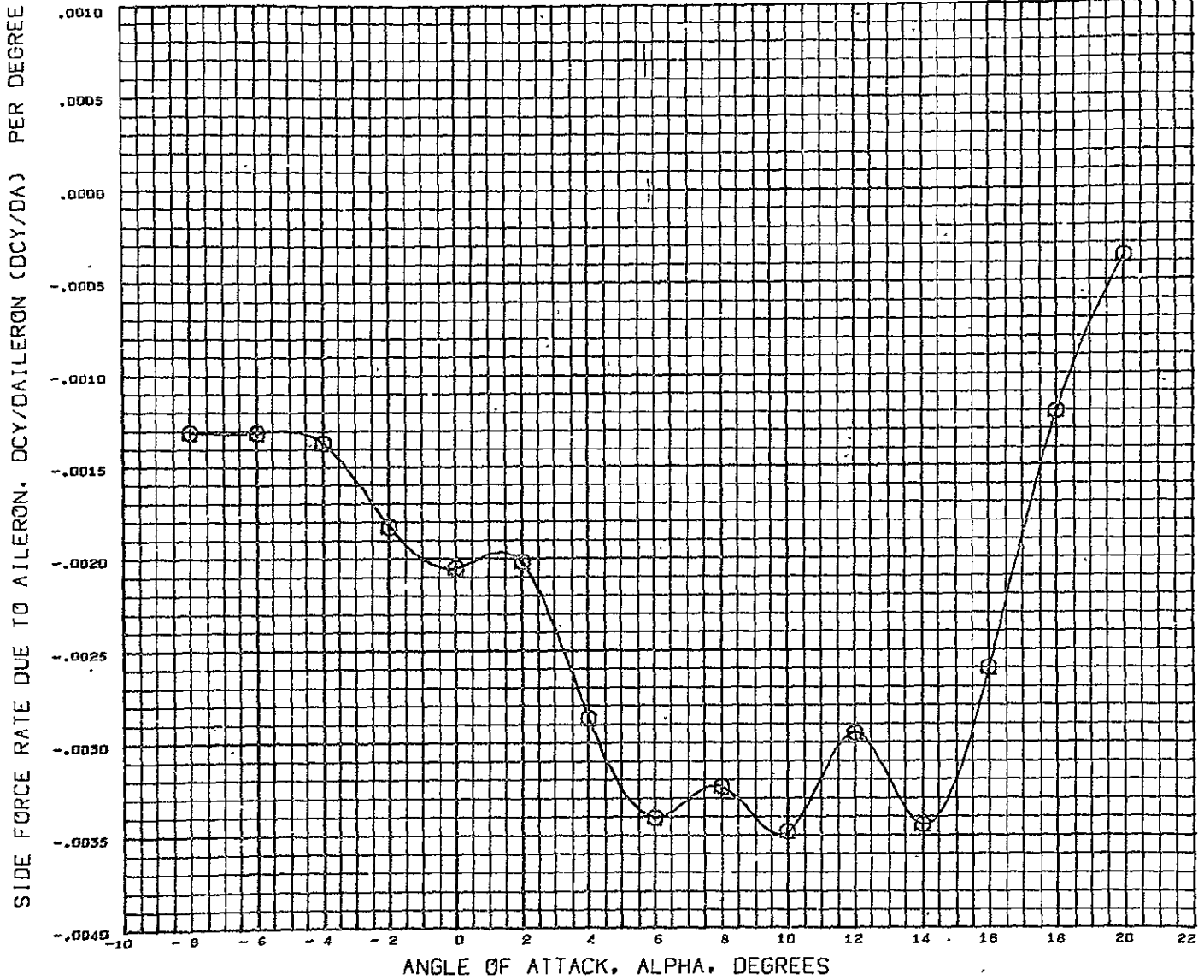

SYMBOL	MACH	PARAMETRIC VALUES			
○	0.185	DELTA	0.000	ROBE	0.000
		PINE	0.500	STRAKE	8.000

REFERENCE INFORMATION		
REFS	5057.0040	SG.FT.
REFL	701.0004	IN.
REFS	1230.0040	IN.
XMRP	1266.0040	IN.
YMRP	0.0000	IN.
ZMRP	163.0004	IN.
SCALE	100.0000	PERCENT

DATA HIST. CODE 4F

DLSWT TEST 138- ROLL CONTROL POWER

YAWING MOMENT RATE DUE TO AILERON, DCYN/DAILERON (DCYNDA) PER DEGREE

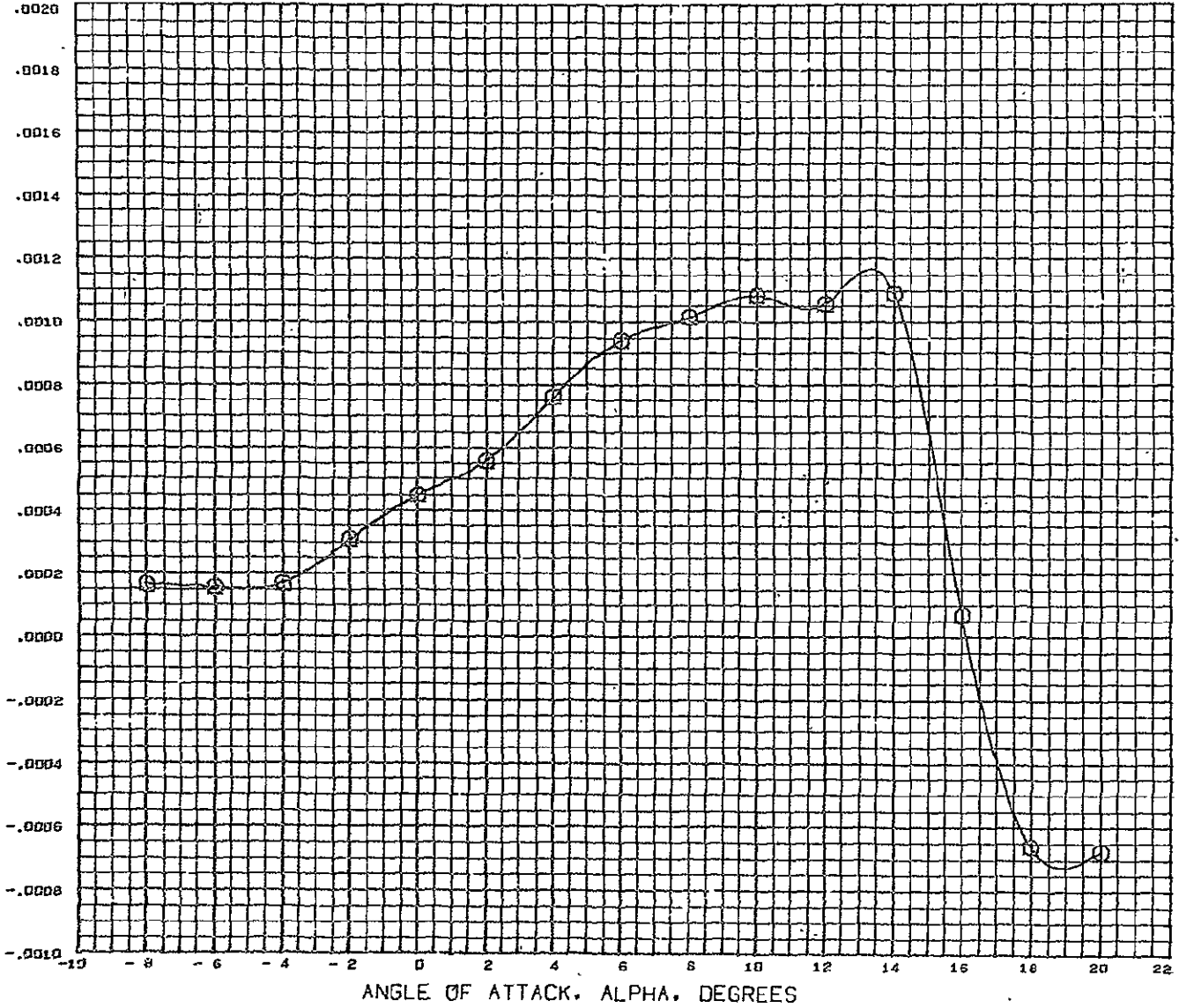

○	HACH	PARAMETRIC VALUES			
	9.180	BETA	0.000	ROBE	0.000
		RINE	0.000	STAKE	8.000

REFERENCE INFORMATION		
REFS	5057.0040	SQ.FT.
REFL	701.0004	IN.
REFB	1230.0040	IN.
XHRF	1266.0040	IN.
YHRF	0.0000	IN.
ZHRF	163.0004	IN.
SCALE	100.0000	PERCENT

DATA HIST. CODE #F

DLSWT TEST 138- ROLL CONTROL POWER

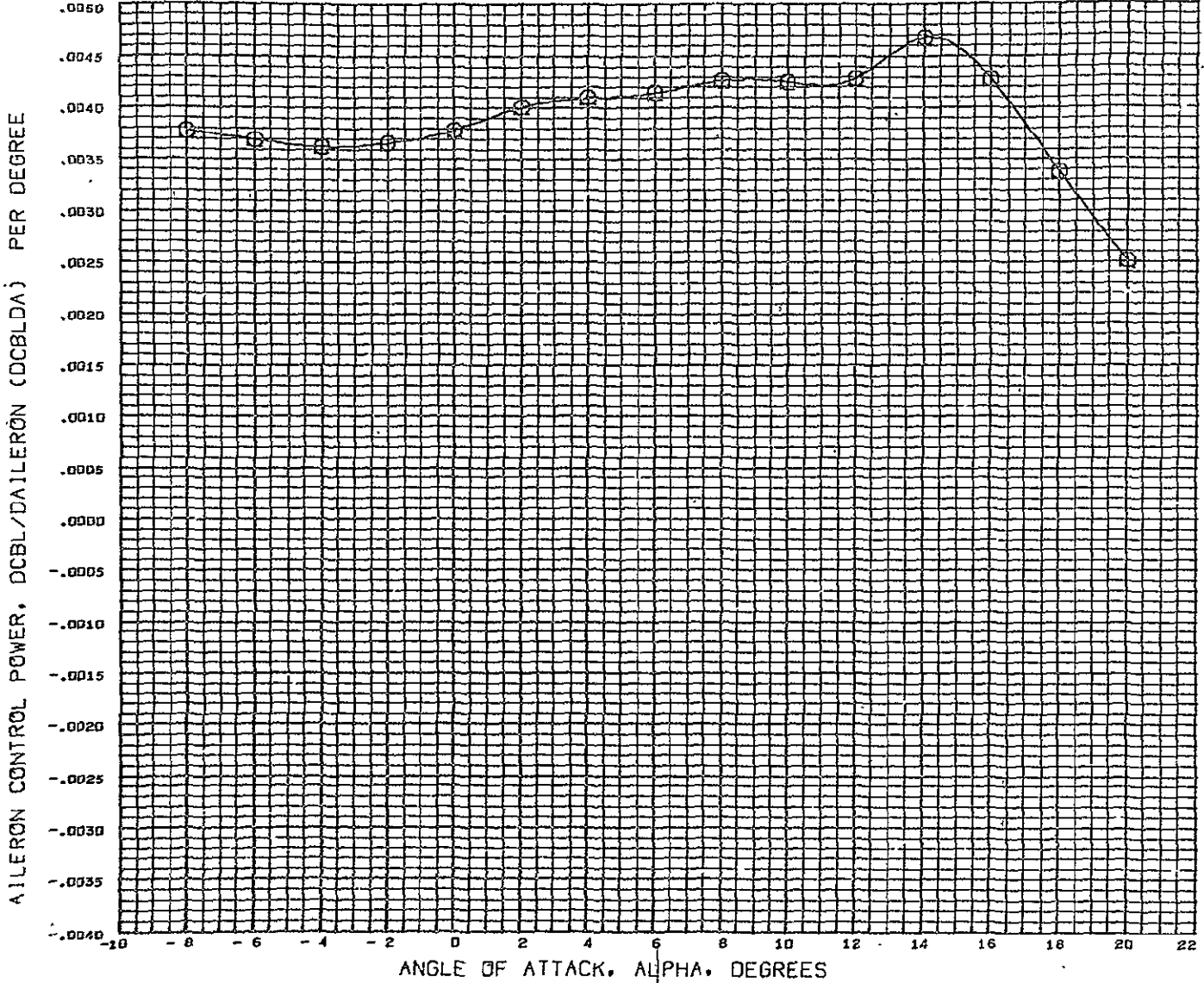

SYMBOL	MACH	PARAMETRIC VALUES			
○	0.189	BETA	0.000	ROBE	0.000
		RINE	0.000	STRAKE	8.000

REFERENCE INFORMATION		
REFS	5057.0040	38.FT.
REFL	701.0004	IN.
REFB	1230.0040	IN.
XMRP	1266.0040	IN.
YMRF	0.0000	IN.
ZMRP	163.0004	IN.
SCALE	100.0000	PERCNT

DATA HIST. CODE 4P

DLSWT TEST 138- ROLL CONTROL POWER

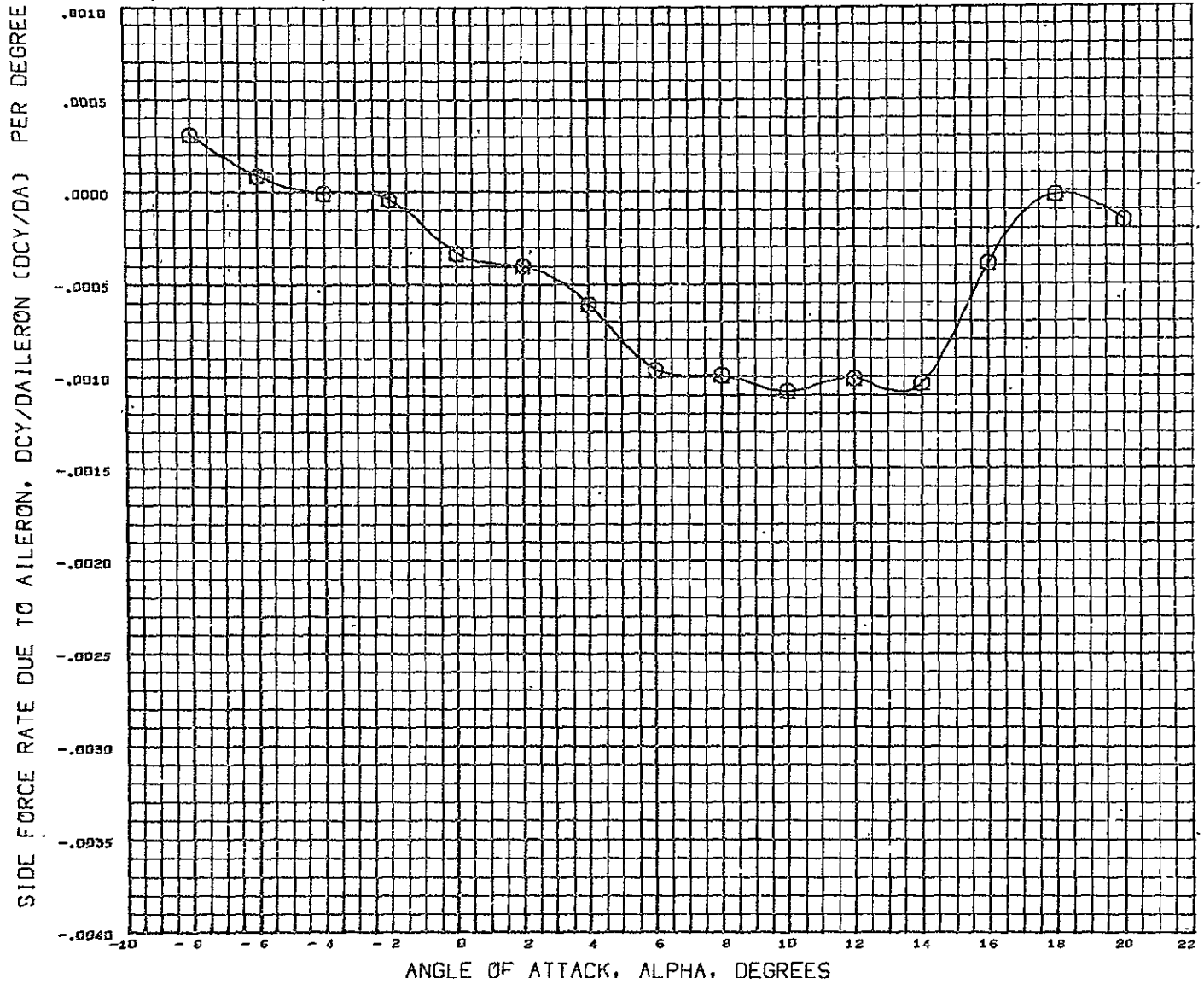

SYMBOL MACH PARAMETRIC VALUES
 O 0.180 BETA 0.000 ROBE 0.000
 STRAKE 8.000

REFERENCE INFORMATION
 REFS 5057.0040 SQ.FT.
 REFL 701.0004 IN.
 REFB 1230.0040 IN.
 XMRP 1266.0040 IN.
 YMRP 0.0000 IN.
 ZMRP 163.0004 IN.
 SCALE 100.0000 PERCNT

DATA HIST. CODE #F

DLSWT TEST 138- ROLL CONTROL POWER

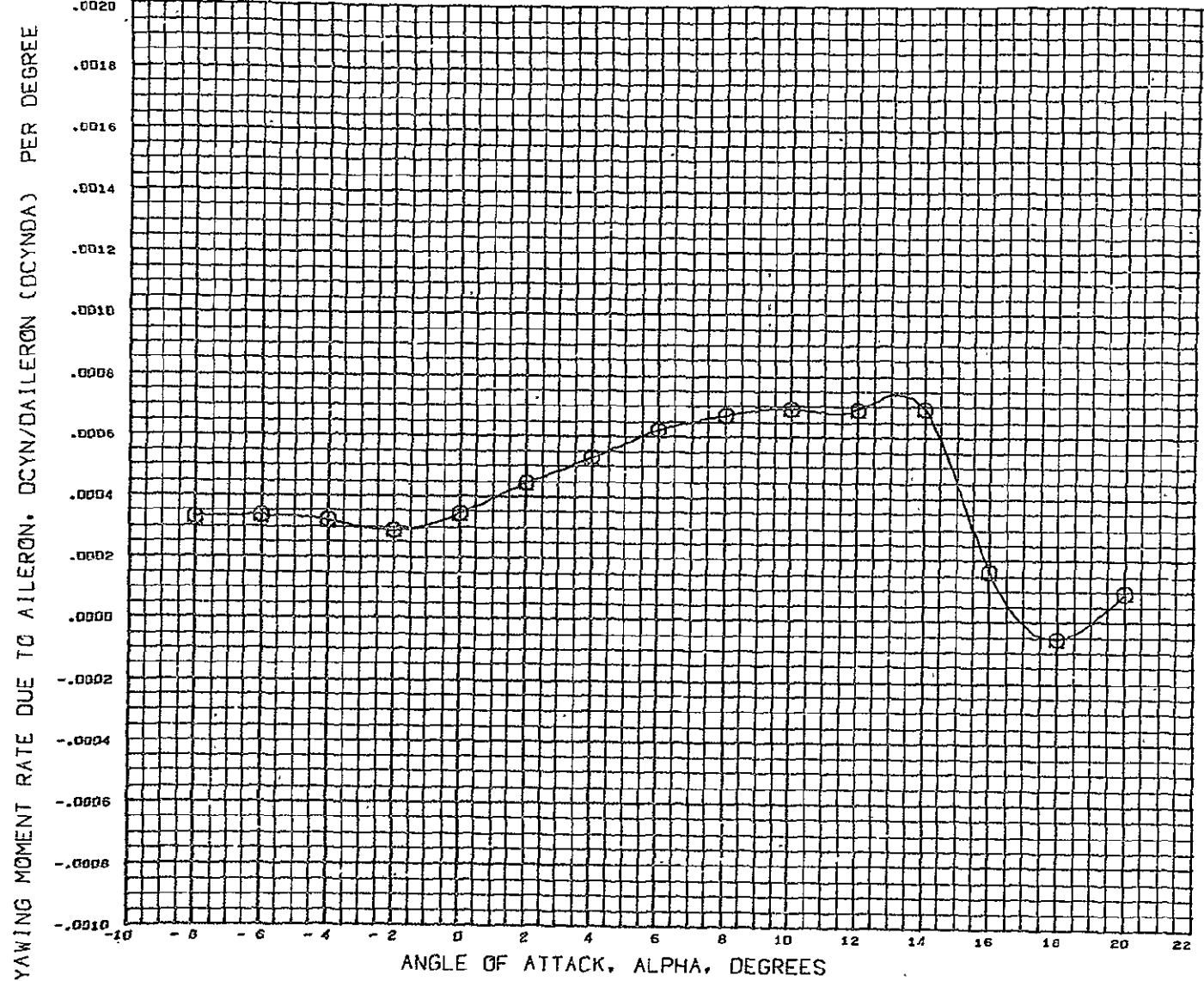

SYMBOL MACH PARAMETRIC VALUES
 O 0.189 BETA 0.000 ROBE 0.000
 STRAKE 8.000

REFERENCE INFORMATION
 REFS 5057.0040 SQ.FT.
 REFL 701.0001 IN.
 REFB 1230.0040 IN.
 XMRP 1266.0040 IN.
 YMRP 0.0000 IN.
 ZMRP 163.0004 IN.
 SCALE 100.0000 PERCNT

DATA HIST. CODE 9F

DLSWT TEST 138- ROLL CONTROL POWER

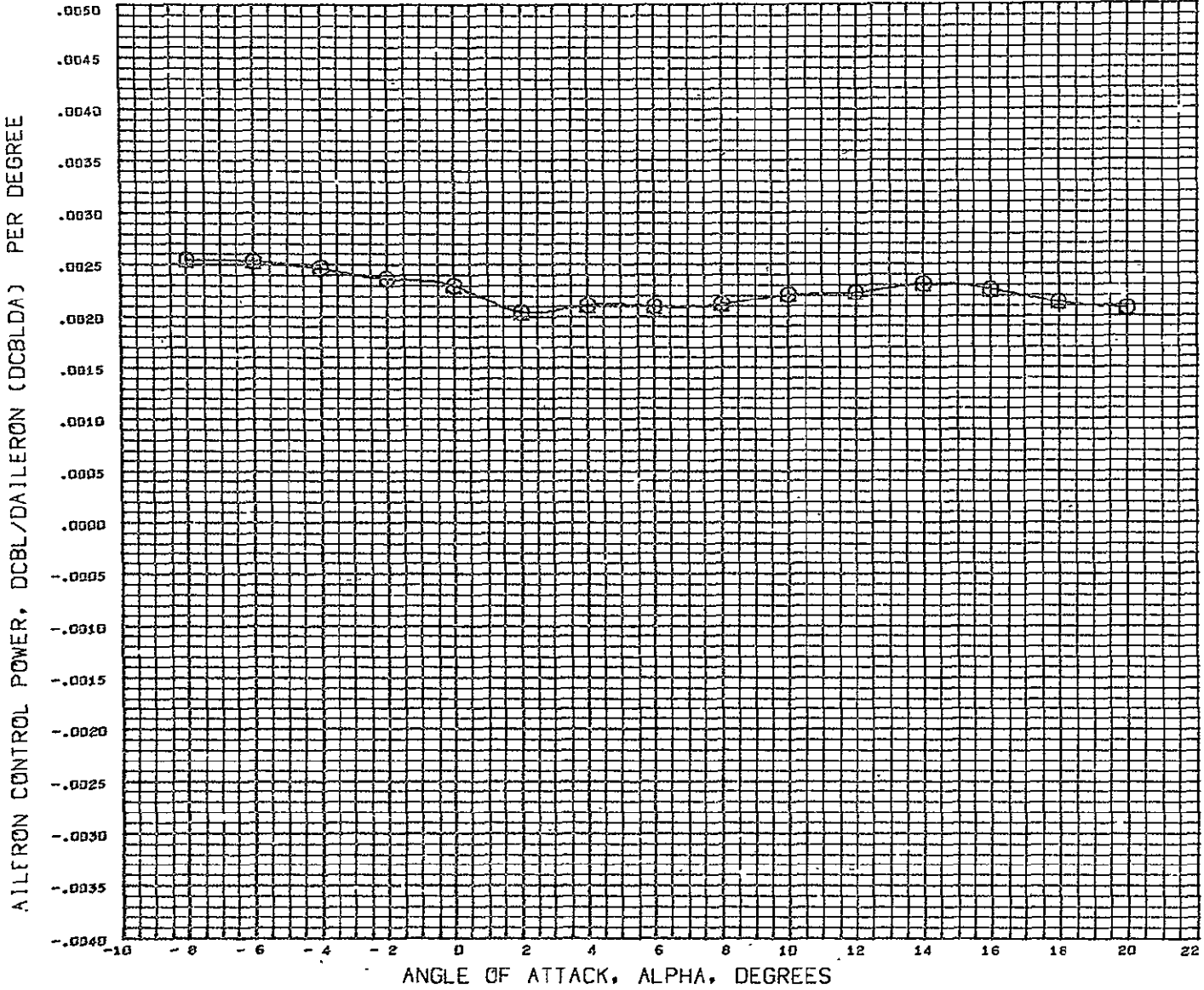

SYMBOL MACH PARAMETRIC VALUES
 O 0.160 BETA 0.000 ROBE 0.000
 STPAKE 6.000

REFERENCE INFORMATION
 REF3 5057.0040 SQ.FT.
 REFL 701.0004 IN.
 REFB 1230.0040 IN.
 XMRF 1266.0040 IN.
 YMRP 0.0000 IN.
 ZMRP 163.0004 IN.
 SCALE 100.0000 PERCENT

DATA HIST. CODE #F

DLSWT TEST 138- ROLL CONTROL POWER

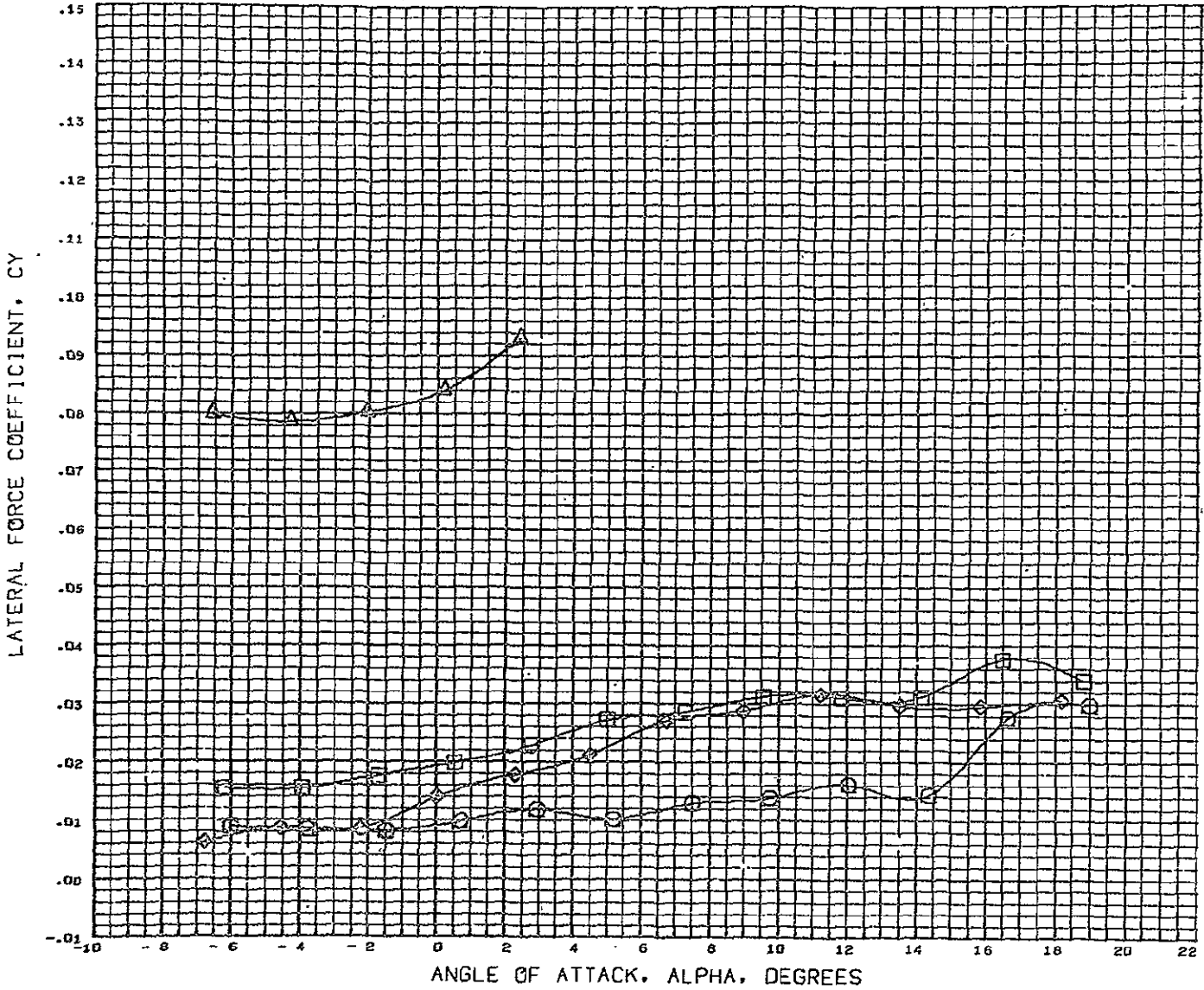

DATA SET	SYMBOL	CONFIGURATION DESCRIPTION	AILRON	BETA	REFERENCE INFORMATION	
(TCN031)	△	DLSWT 138 0.0133 SC. GENERIC HCR 02 B1BWA4STV4	0.000	0.000	REFS	5057.0040 SQ.FT.
(TCN040)	□	DLSWT 138 0.0133 SC. GENERIC HCR 02 B1BWA4STV4	-15.000	-2.880	REFL	701.0004 IN.
(TCN041)	◇	DLSWT 138 0.0133 SC. GENERIC HCR 02 B1BWA4STV4	-15.000	0.000	REFB	1230.0040 IN.
(TCN042)	○	DLSWT 138 0.0133 SC. GENERIC HCR 02 B1BWA4STV4	-5.000	0.000	XMRP	1266.0040 IN.
					YMRP	0.0000 IN.
					ZMRP	163.0004 IN.
					SCALE	100.0000 PERCENT

*ACP 0.180

DLSWT TEST 138- ROLL CONTROL POWER

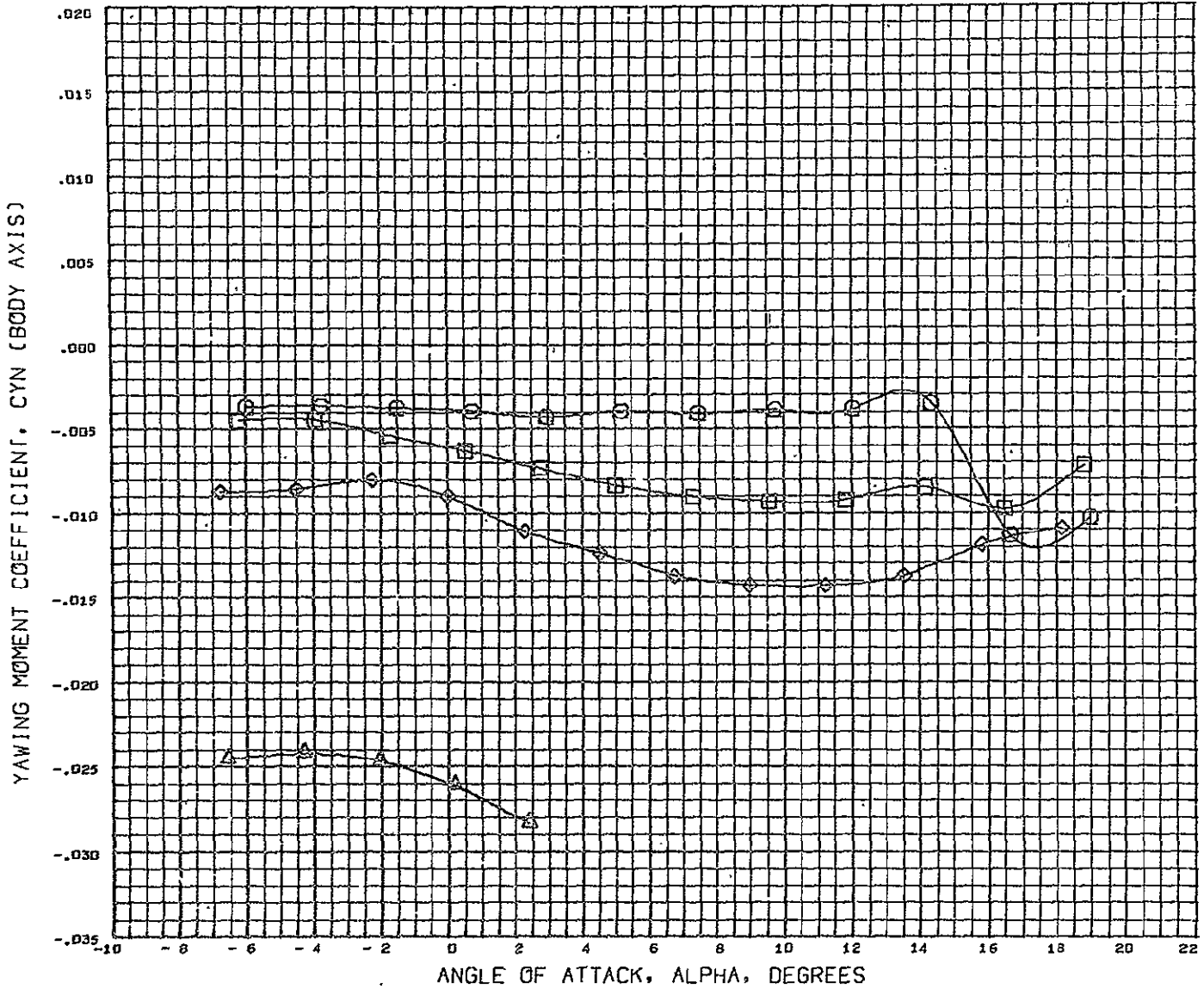

DATA SET SYMBOL	CONFIGURATION DESCRIPTION	AILRON	DELTA	REFERENCE INFORMATION
(TCN531)	DLSWT 138 0.0133 SC. GENERIC HCR 02 B1BWAAS7V4	0.000	0.000	REFS 5057.0040 SQ.FT.
(TCN540)	DLSWT 138 0.0133 SC. GENERIC HCR 02 B1BWAAS7V4	-15.000	-2.880	REFL 701.0004 IN.
(TCN541)	DLSWT 138 0.0133 SC. GENERIC HCR 02 B1BWAAS7V4	-15.000	0.000	REFB 1230.0040 IN.
(TCN544)	DLSWT 138 0.0133 SC. GENERIC HCR 02 B1BWAAS7V4	-5.000	0.000	XHRP 1266.0040 IN.
				YMRP 0.0000 IN.
				ZMRP 163.0004 IN.
				SCALE 100.0000 PERCENT

MACH 0.100

DLSWT TEST 138- ROLL CONTROL POWER

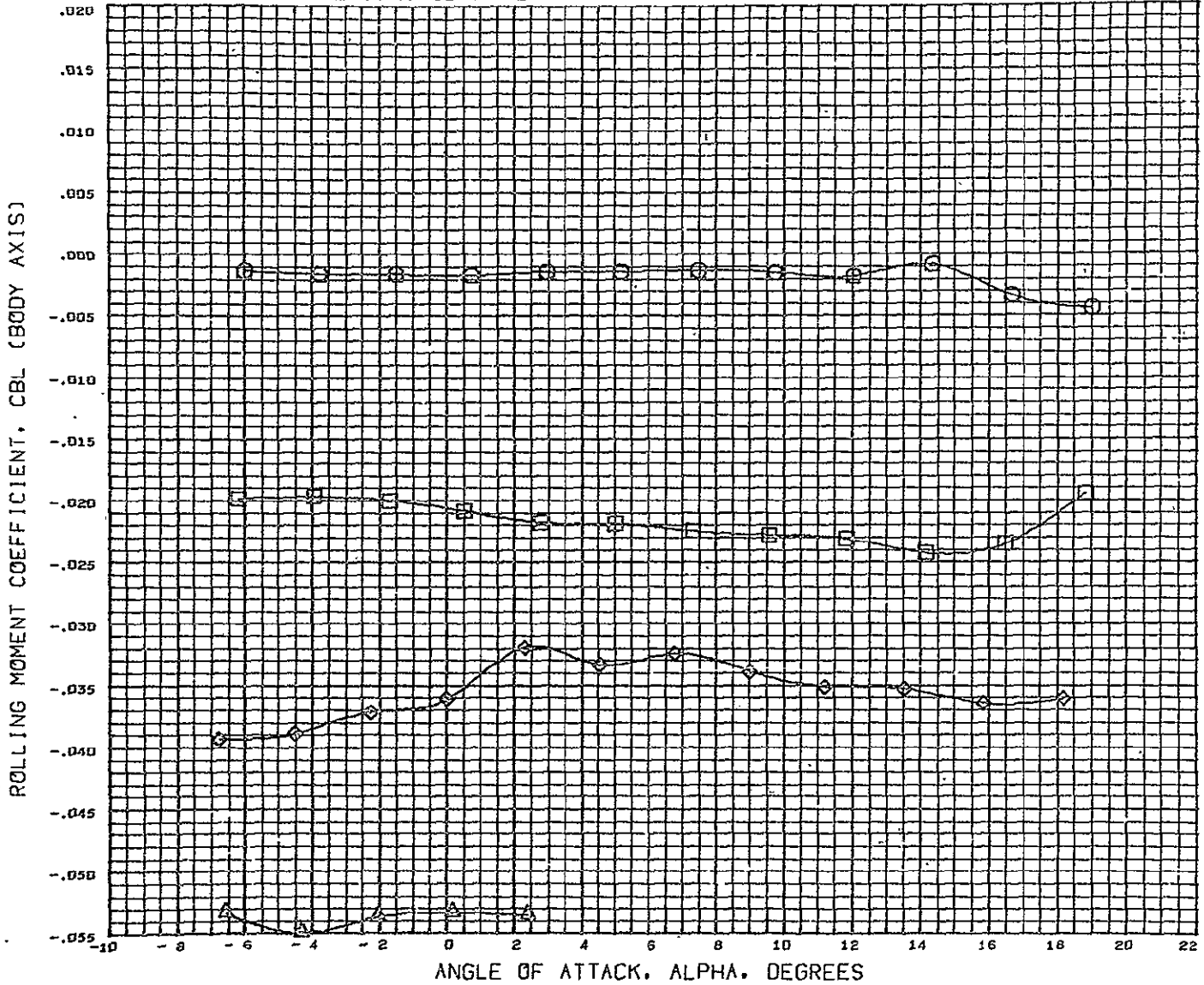

DATA SET SYMBOL	CONFIGURATION DESCRIPTION	AILRON	BETA	REFERENCE INFORMATION
(TCN031)	DLSWT 138 0.0133 SC. GENERIC HCR 02 B1BW4ASTV4	0.000	0.000	REFS 5057.0040 SQ.FT.
(TCN040)	DLSWT 138 0.0133 SC. GENERIC HCR 02 B1BW4ASTV4	-15.000	-2.880	REFL 701.0004 IN.
(TCN041)	DLSWT 138 0.0133 SC. GENERIC HCR 02 B1BW4ASTV4	-15.000	0.000	REFB 1230.0040 IN.
(TCN044)	DLSWT 138 0.0133 SC. GENERIC HCR 02 B1EW4ASTV4	-5.000	0.000	XMRP 1266.0040 IN.
				YMRP 0.0000 IN.
				ZMRP 163.0004 IN.
				SCALE 100.0000 PERCENT

MACH 0.180

DLSWT TEST 138- INCIDENCE EFFECT

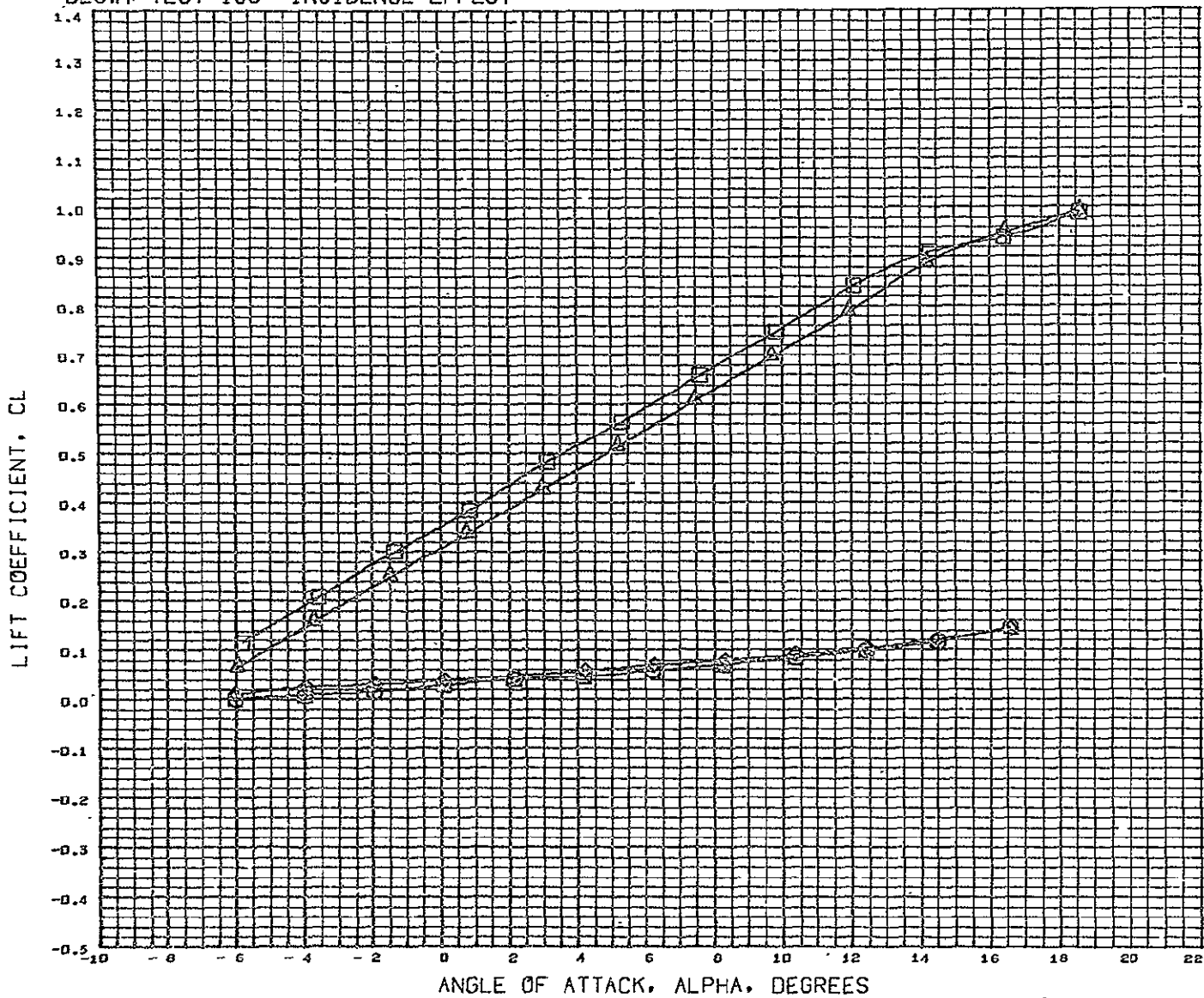

DATA SET SYMBOL	CONFIGURATION DESCRIPTION
(RCND13)	DLSWT 138 0.0133 SC. GENERIC HCR 02 B1A
(RCND59)	DLSWT 138 0.0133 SC. GENERIC HCR 02 B1AWB4
(PCND62)	DLSWT 138 0.0133 SC. GENERIC HCR 02 B1C
(RCND64)	DLSWT 138 0.0133 SC. GENERIC HCR 02 B1CW84

MACH 0.100

REFERENCE INFORMATION		
REFS	5057.0040	SQ.FT.
REFL	791.0004	IN.
REFD	1230.0040	IN.
XMRP	1266.0040	IN.
YMRP	0.0000	IN.
ZMRP	163.0004	IN.
SCALE	100.0000	PERCENT

DLSWT TEST 138- INCIDENCE EFFECT

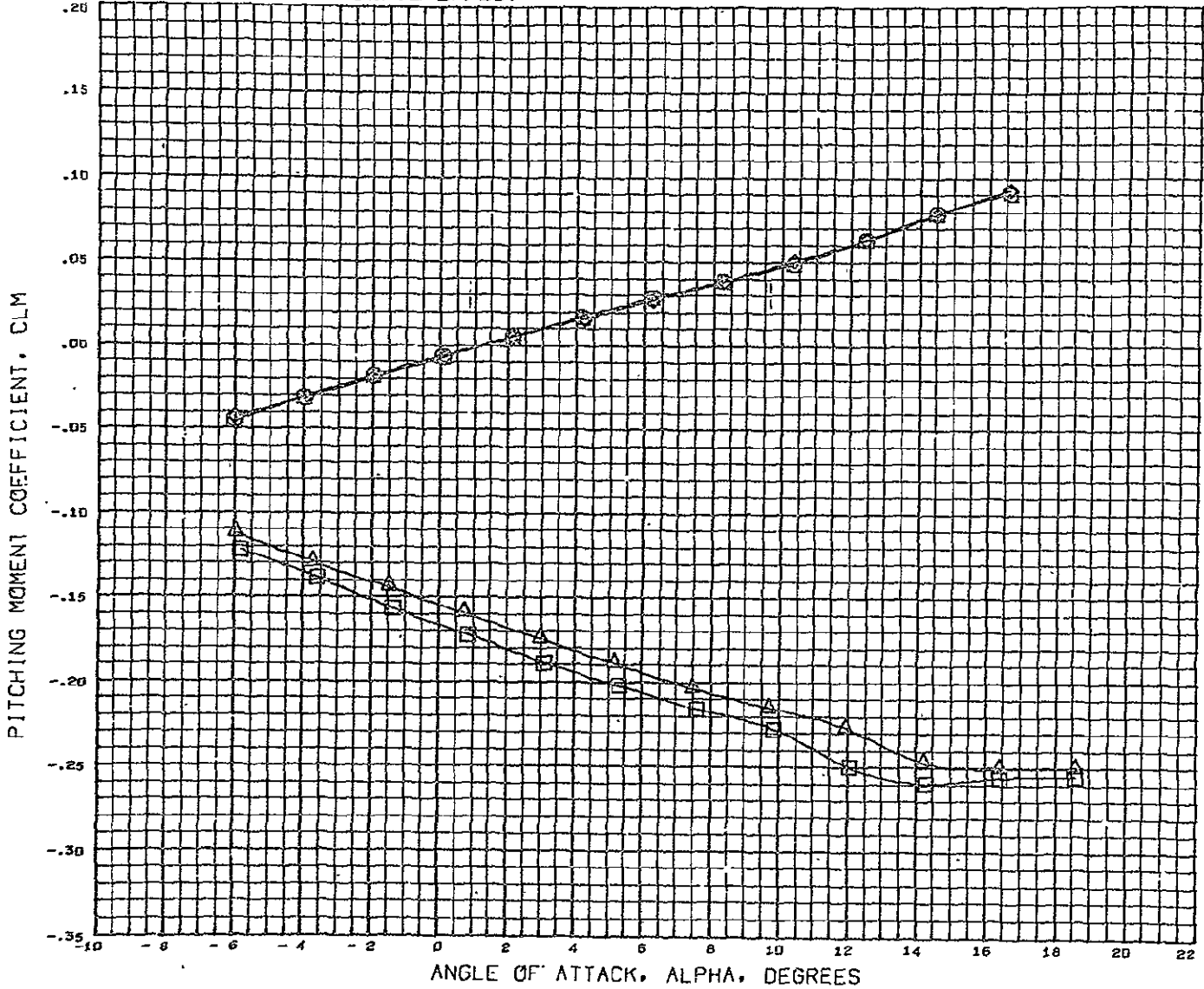

DATA SET SYMBOL	CONFIGURATION DESCRIPTION
(RCND13)	DLSWT 138 0.9133 SC. GENERIC HCR 02 B1A
(RCND59)	DLSWT 138 0.9133 SC. GENERIC HCR 02 B1AWBVA
(RCND62)	DLSWT 138 0.9133 SC. GENERIC HCR 02 B1C
(RCND64)	DLSWT 138 0.9133 SC. GENERIC HCR 02 B1CW8VA

REFERENCE INFORMATION	
REFS	5057.0040 SQ. FT.
REFL	791.0004 IN.
REFB	1230.0010 IN.
XMRF	1266.0040 IN.
YNRF	0.0000 IN.
ZNRF	163.0004 IN.
SCALE	100.0000 PERCENT

MACH 0.180

DLSWT TEST 138- INCIDENCE EFFECT

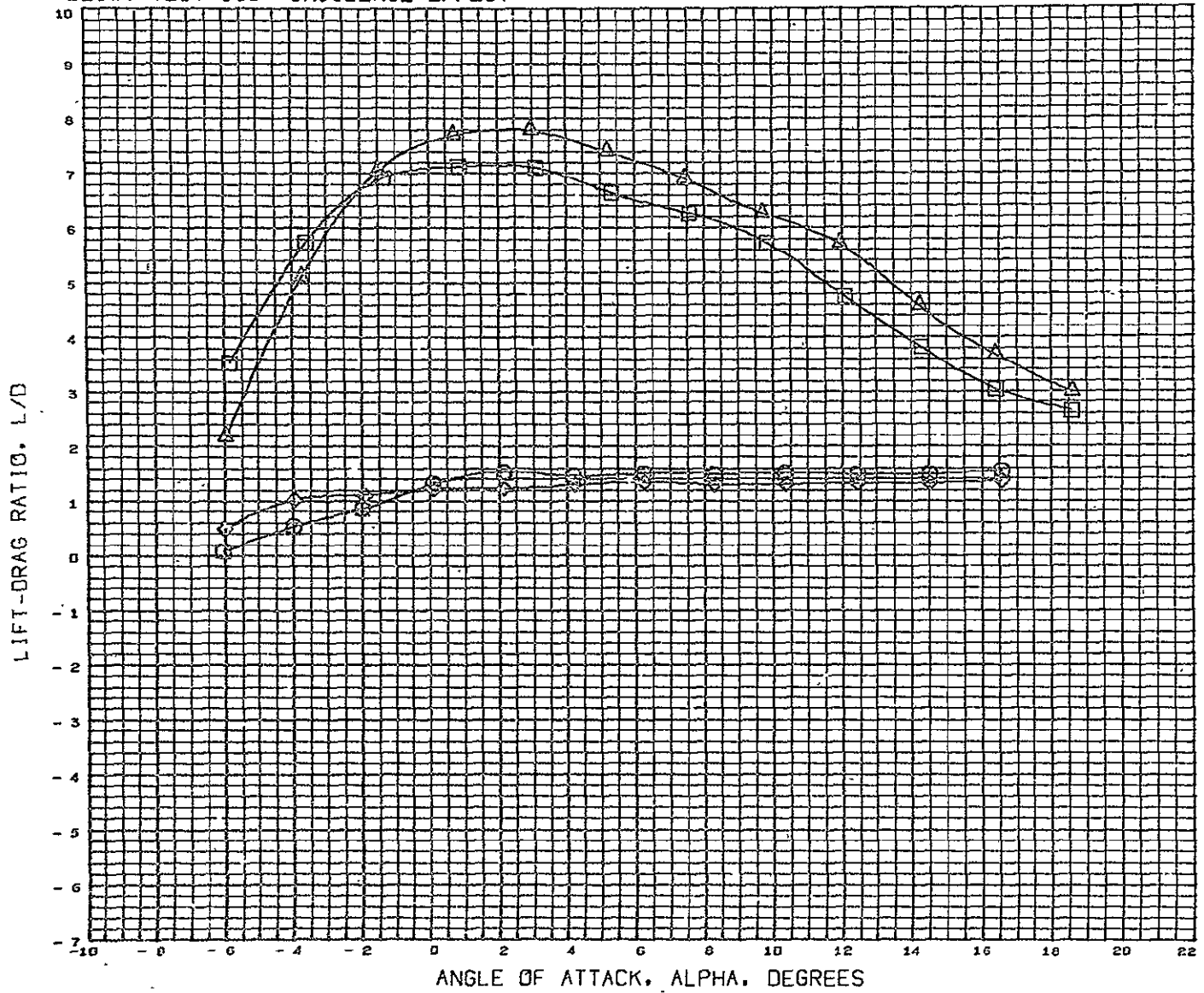

DATA SET SYMBOL	CONFIGURATION DESCRIPTION
(RCND13)	DLSWT 138 D.0133 SC. GENERIC HCR 02 B1A
(RCND59)	DLSWT 138 D.0133 SC. GENERIC HCR 02 B1AWB4
(RCND62)	DLSWT 138 D.0133 SC. GENERIC HCP 02 B1C
(RCND64)	DLSWT 138 D.0133 SC. GENERIC HCR 02 B1CW84

MACH 0.180

REFERENCE INFORMATION		
REFS	5057.0040	SQ.FT.
REF1	701.0004	IN.
REF2	1230.0040	IN.
XMRP	1266.0540	IN.
YMRP	0.0000	IN.
ZMRP	163.0004	IN.
SCALE	100.0000	PERCNT

REFERENCE INFORMATION
 REFS 5057.0048 SQ.FT.
 REF1 701.0004 IN.
 REF2 1230.0040 IN.
 XHRF 1266.0045 IN.
 YHRF 0.0000 IN.
 ZHRF 163.0007 IN.
 SCALE 100.0000 PERCENT

MACH 5.180

DATA SET SYMBOL CONFIGURATION DESCRIPTION
 (RCND12) DLSWT 138 0.0133 SC. GENERIC HCR Q2 B1A
 (RCND19) DLSWT 138 0.0133 SC. GENERIC HCR Q2 B1AMBVA
 (RCND22) DLSWT 138 0.0133 SC. GENERIC HCR Q2 B1C
 (FCI 054) DLSWT 128 0.0133 SC. GENERIC HCR Q2 B1CMBVA

DRAG COEFFICIENT, CD

LIFT COEFFICIENT, CL

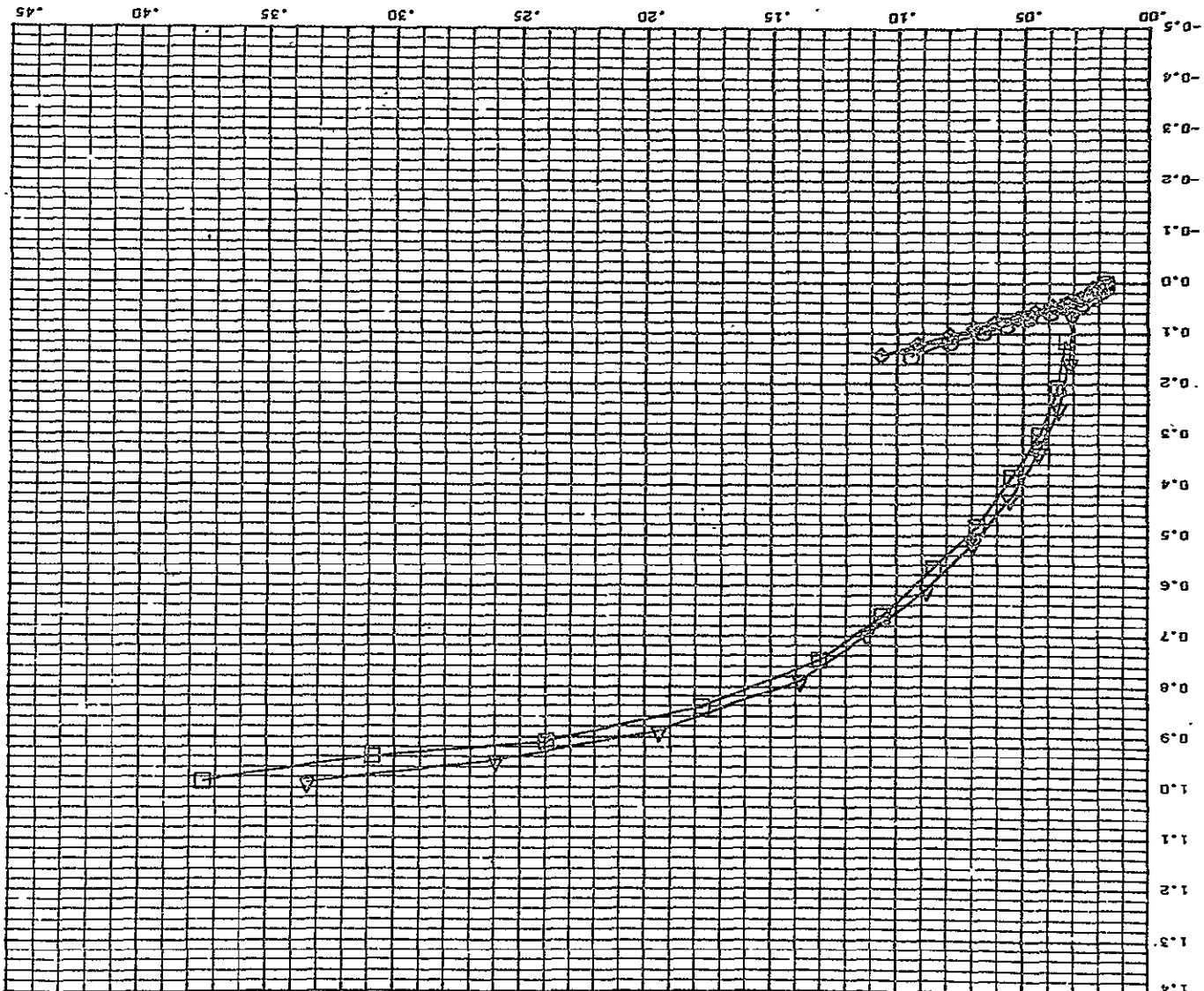

DLSWT TEST 138- INCIDENCE EFFECT

DLSWT TEST 138- INCIDENCE EFFECT

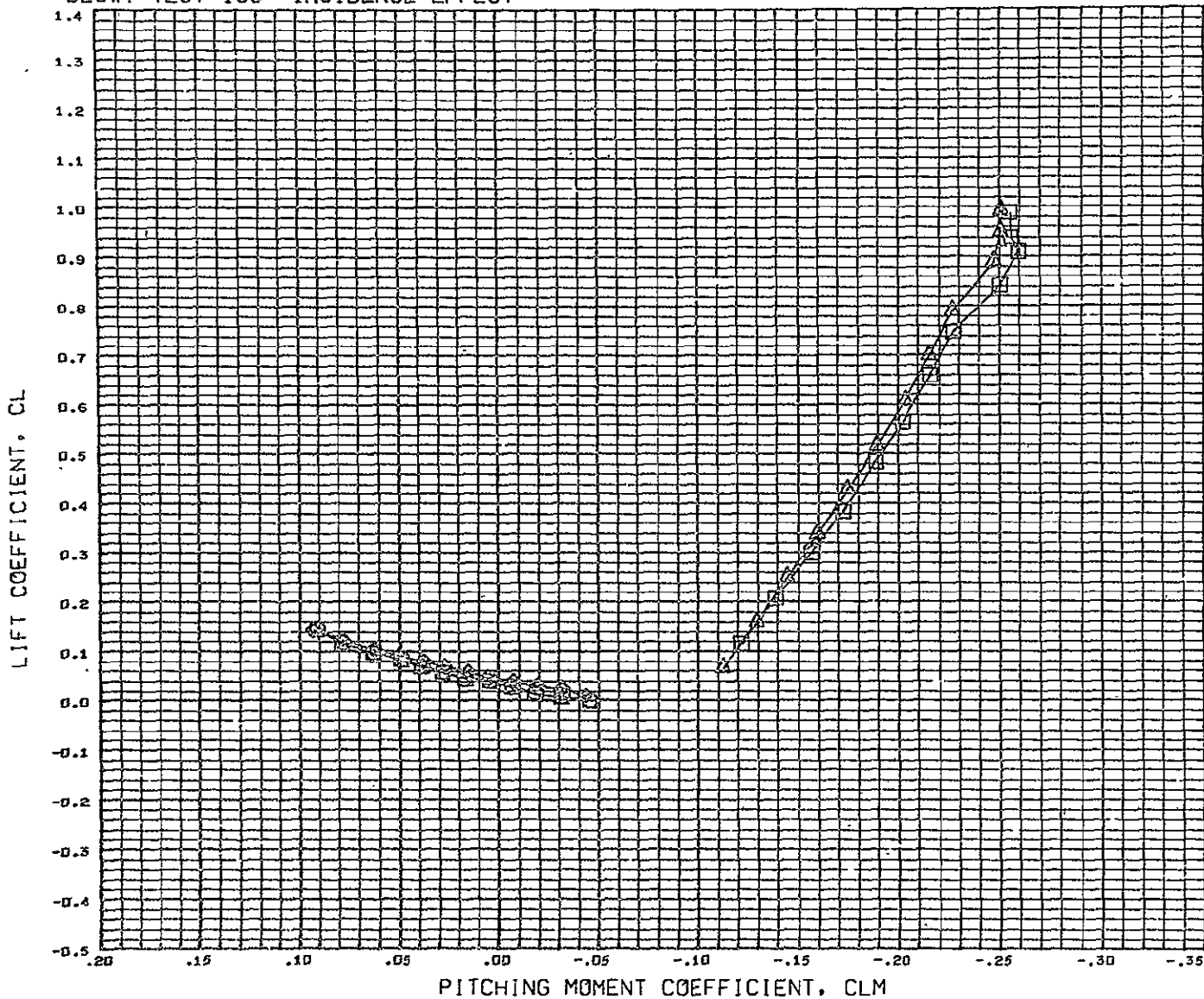

DATA SET SYMBOL	CONFIGURATION DESCRIPTION
(FCND13)	DLSWT 138 G.0133 SC. GENERIC HCR 02 B1A
(FCND59)	DLSWT 138 G.0133 SC. GENERIC HCR 02 B1AMBV4
(FCND62)	DLSWT 138 G.0133 SC. GENERIC HCR 02 E1C
(FCND64)	DLSWT 138 D.0133 SC. GENERIC HCR 02 D1CW8V4

REFERENCE INFORMATION		
REFS	5057.0040	SR.FT.
REFL	701.0004	IN.
REFB	1230.0040	IN.
XMRP	1266.0040	IN.
YMRP	0.0000	IN.
ZMRP	163.0004	IN.
SCALE	100.0000	PERCENT

PACH 0.180

DLSWT TEST 138- INCIDENCE EFFECT

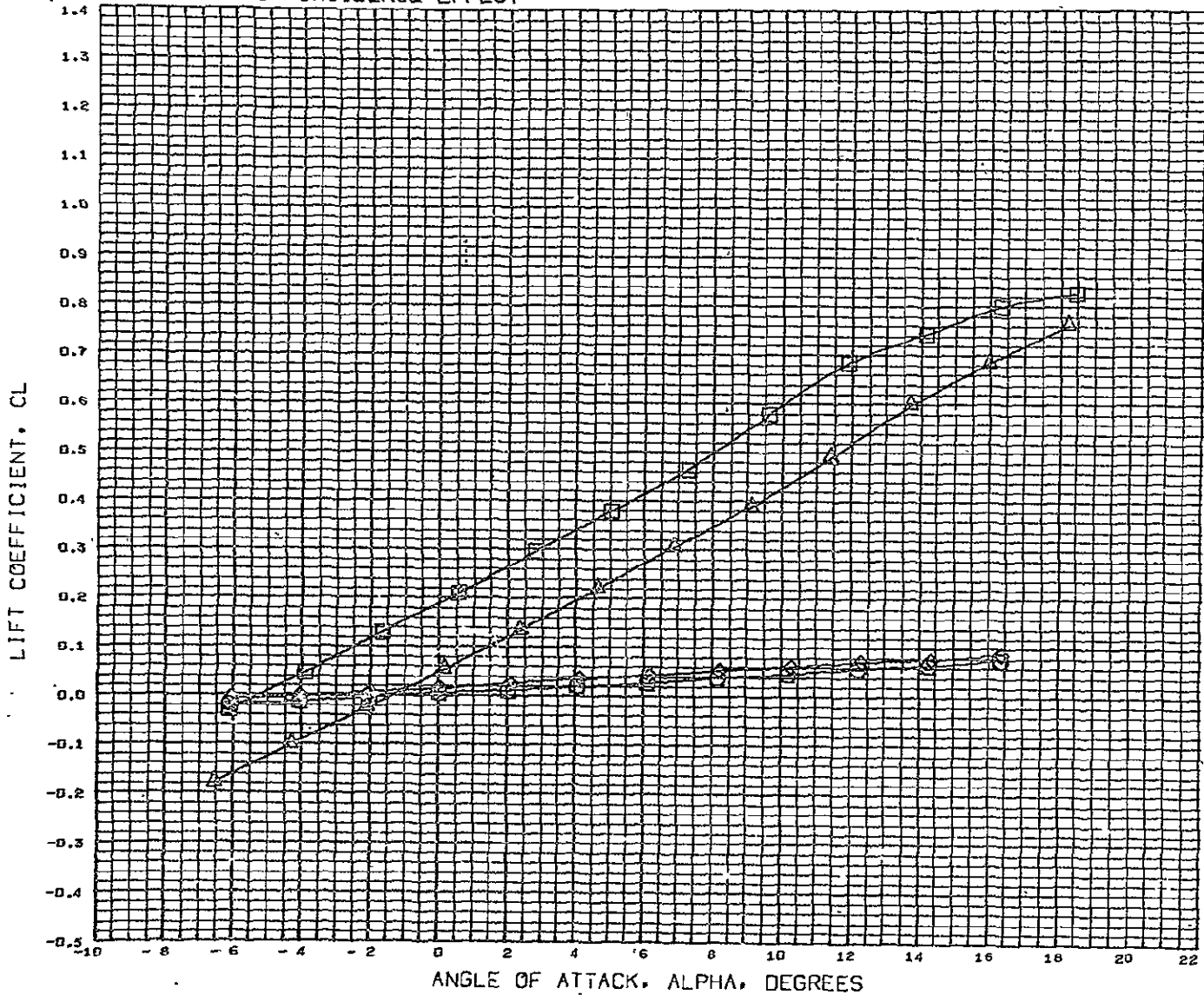

DATA SET SYMBOL	CONFIGURATION DESCRIPTION
(RCN880)	DLSWT 138 0.0133 SC. GENERIC HCR 02 B3A
(RCN874)	DLSWT 138 0.0133 SC. CLNERIC HCR 02 B3AW9AV5
(RCN882)	DLSWT 138 0.0133 SC. GENERIC HCR 02 B3B
(RCN884)	DLSWT 138 0.0133 SC. GENERIC HCR 02 B3B9AV5

REFERENCE INFORMATION		
REFS	5370.0040	SQ. FT
REFL	760.0000	IN.
REFB	1138.0040	IN.
XHRF	1273.0040	IN.
YHRF	0.0000	IN.
ZHRF	214.0004	IN.
SCALE	100.0000	PERCNT

VACH 0.180

DLSWT TEST 138- INCIDENCE EFFECT

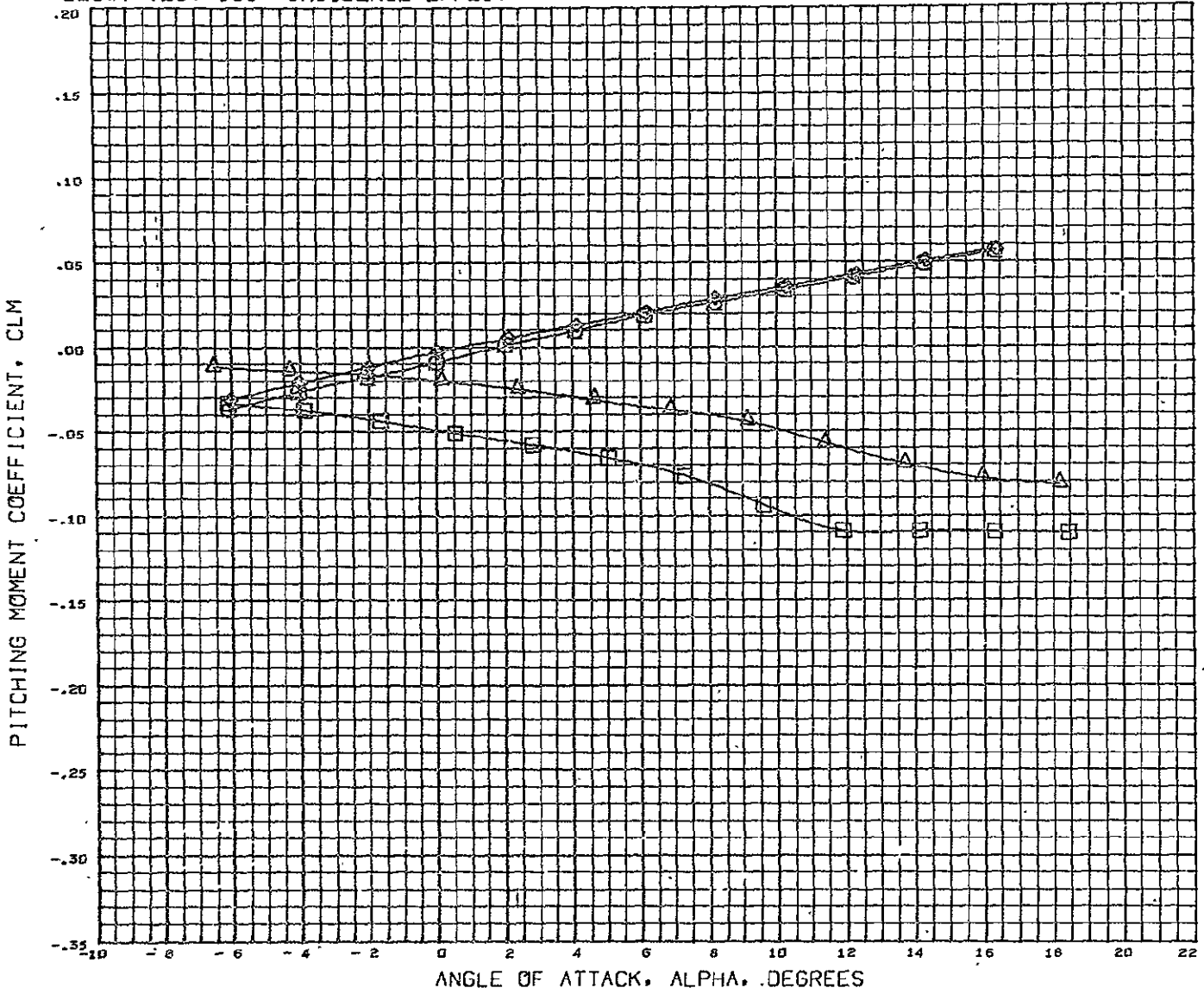

DATA SET SYMBOL	CONFIGURATION DESCRIPTION
(RCN380)	DLSWT 138 0.0133 SC. GENERIC HCR 02 B3A
(RCN376)	DLSWT 138 0.0133 SC. GENERIC HCR 02 B3AW9AVJ
(RCN382)	DLSWT 138 0.0133 SC. GENERIC HCR 02 B3B
(RCN384)	DLSWT 138 0.0133 SC. GENERIC HCR 02 B3EW9AV5

REFERENCE INFORMATION		
REFS	9370.0040	SQ. FT
REPL	760.0074	IN.
REFS	1138.0040	IN.
XMRP	1273.0040	IN.
YMRP	0.0000	IN.
ZMRP	214.0004	IN.
SCALE	100.0000	PERCNT

MACH 0.100

DLSWT TEST 138- INCIDENCE EFFECT

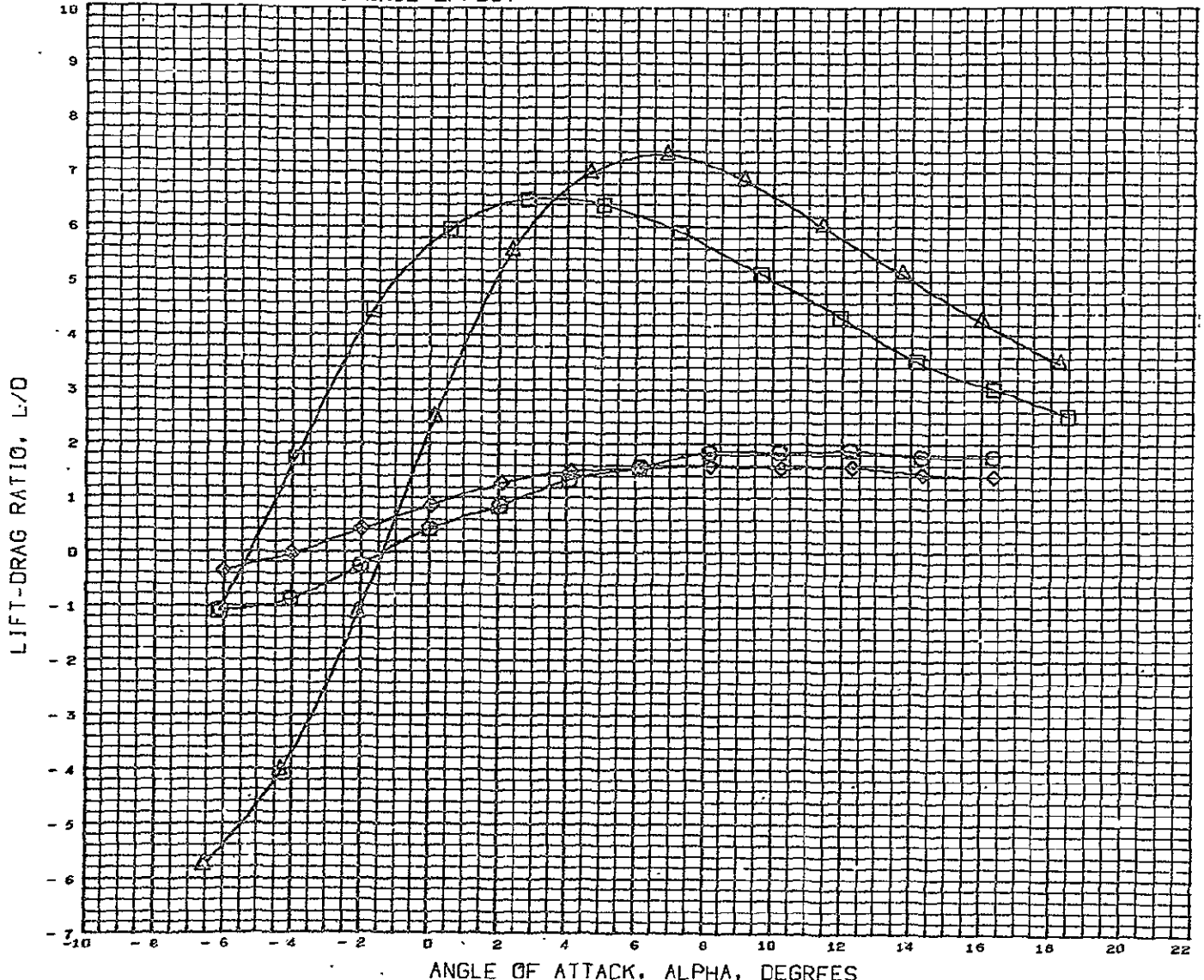

DATA SET SYMBOL	CONFIGURATION DESCRIPTION
(RCN080)	DLSWT 138 0.0133 SC. GENERIC HCR 02 B3A
(RCN076)	DLSWT 138 0.0133 SC. GENLRIC HCR 02 B3AW9AV
(RCN082)	DLSWT 138 0.0133 SC. GENERIC HCR 02 B3B
(RCN084)	DLSWT 138 0.0133 SC. GENERIC HCR 02 B3BW9AV5

REFERENCE INFORMATION		
REFS	5370.0040	SQ. FT
REFL	760.0004	IN.
REFB	1138.0040	IN.
XMRP	1273.0040	IN.
YMRP	0.0000	IN.
ZMRP	214.0004	IN.
SCALE	100.0000	PERCENT

PACH 0.100

DLSWT TEST 138- INCIDENCE EFFECT

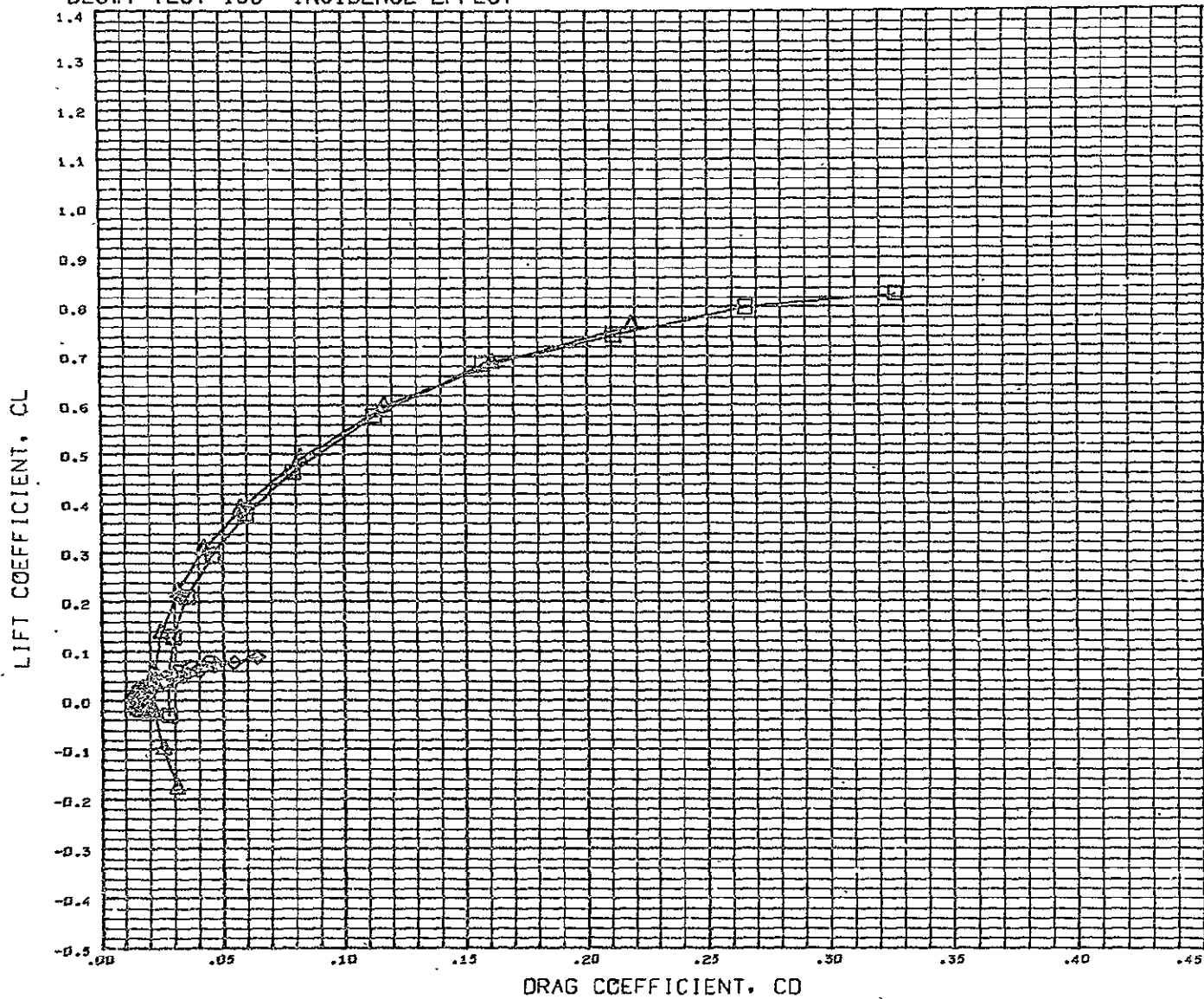

DATA SET	SYMBOL	CONFIGURATION DESCRIPTION
(RCNG80)	○	DLSWT 138 0.0133 SC. GENERIC HCR 02 B3A
(RCNG76)	△	DLSWT 138 0.0133 SC. GENERIC HCR 02 B3AW9AV5
(RCNG82)	◇	DLSWT 138 0.0133 SC. GENERIC HCR 02 B3B
(RCNG84)	□	DLSWT 138 0.0133 SC. GENERIC HCR 02 B3BW9AV5

REFERENCE INFORMATION		
REFS	5370.0040	SQ. FT
REFL	760.0004	IN.
REFB	1138.0040	IN.
XMRP	1273.0040	IN.
YMRP	0.0000	IN.
ZMRP	214.0004	IN.
SCALE	100.0000	PERCENT

MACH 5.180

DLSWT TEST 138- INCIDENCE EFFECT

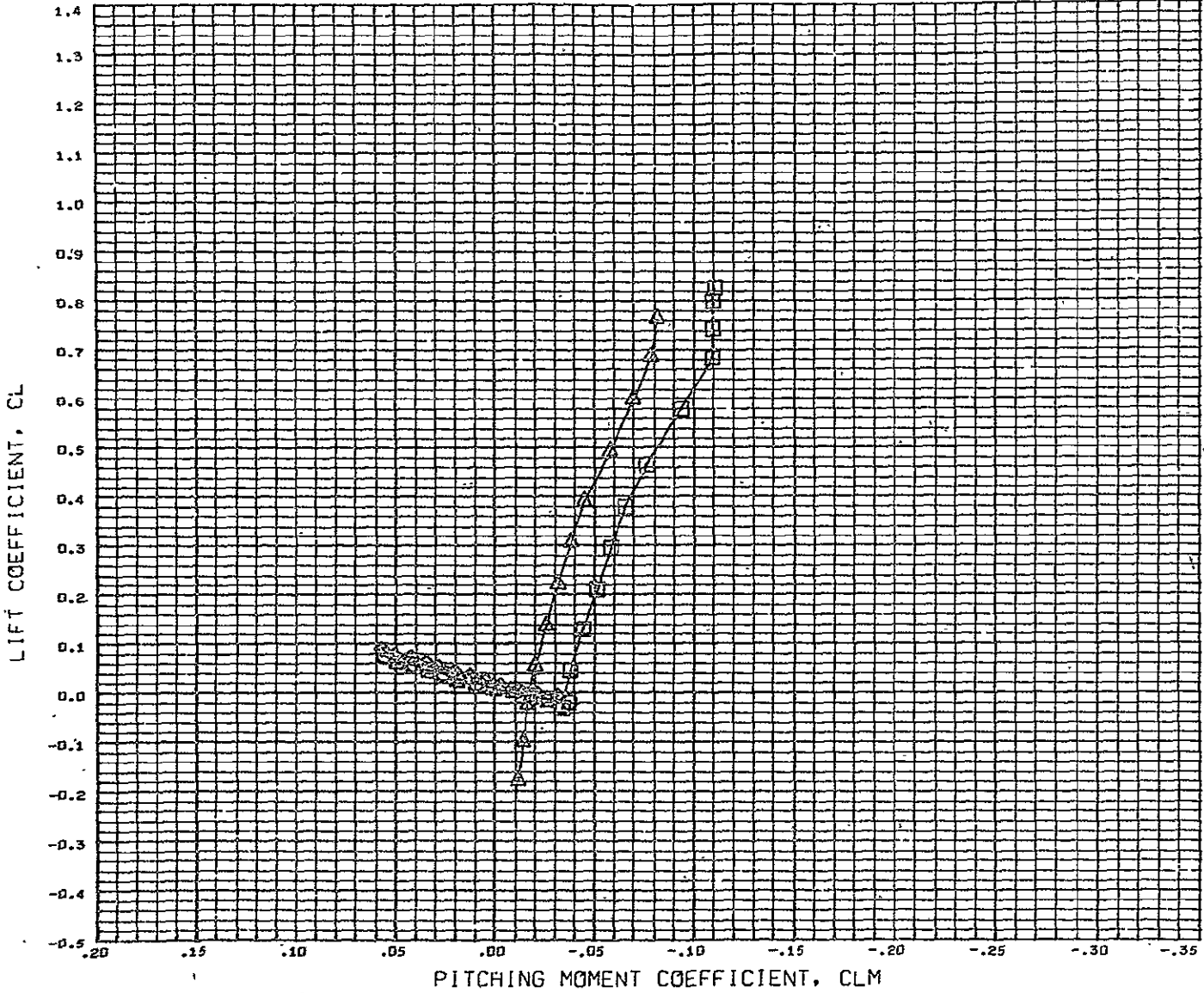

DATA SET SYMBOL	CONFIGURATION DESCRIPTION
(RCND80)	DLSWT 138 D.0133 SC. GENERIC HCR 02 B3A
(RCND76)	DLSWT 138 D.0133 SC. GENERIC HCR 02 B3AW9AV5
(RCND82)	DLSWT 138 D.0133 SC. GENERIC HCR 02 B3C
(RC1984)	DLSWT 138 D.0133 SC. GENERIC HCR 02 B3BW9AV5

REFERENCE INFORMATION		
REFS	5370,0040	SQ. FT
REFL	760,0004	IN.
REFB	1138,0040	IN.
XMRP	1273,0040	IN.
YMRP	0,0000	IN.
ZMRP	214,0004	IN.
SCALE	100,0000	PERCENT

MACH 0.185

DLSWT TEST 138- BODY NOSE RAMP EFFECT

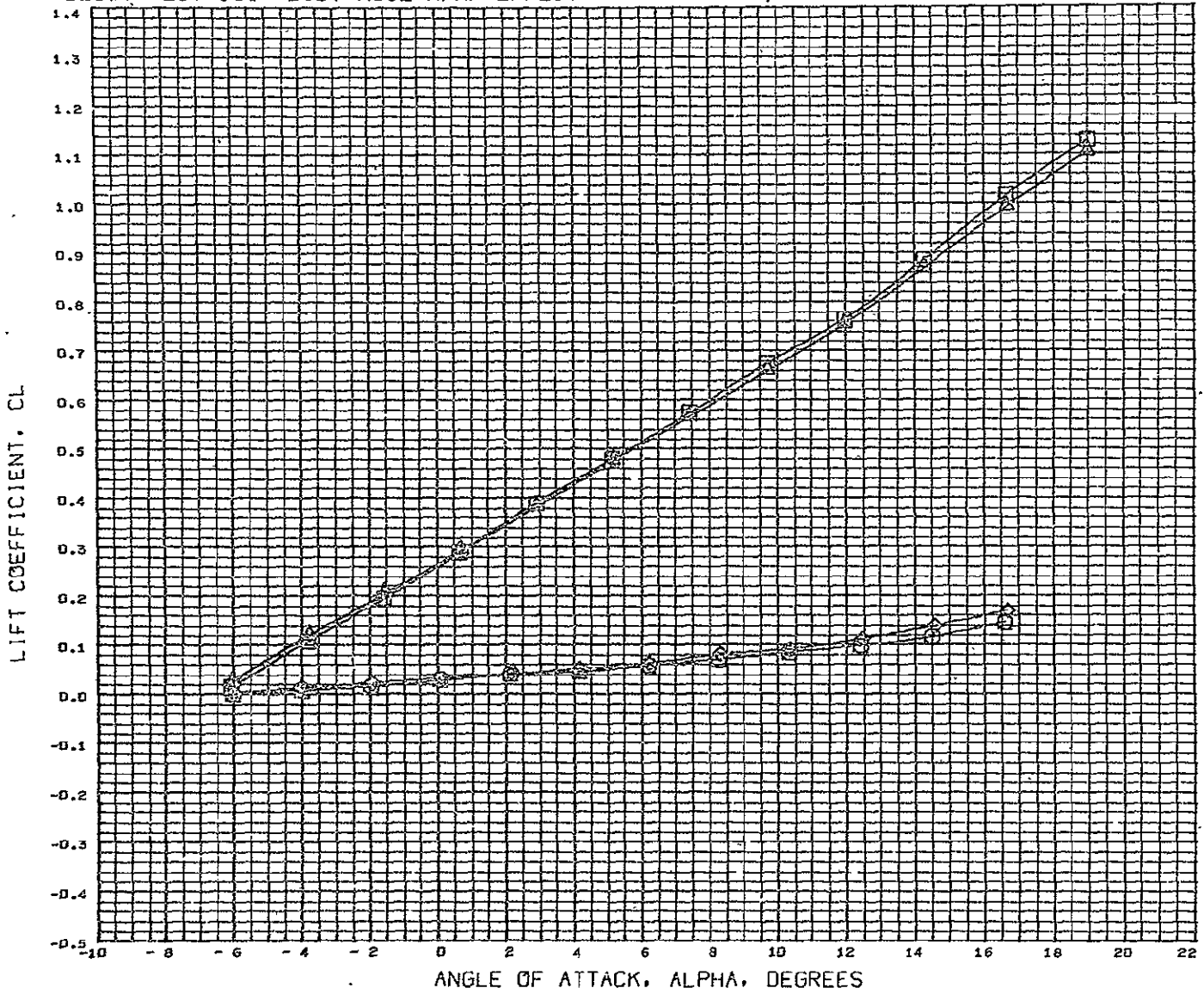

DATA SET SYMBOL	CONFIGURATION DESCRIPTION
(RCND13)	DLSWT 138 0.0133 SC. GENERIC HCR 02 B1A
(RCND20)	DLSWT 138 0.0133 SC. GENERIC HCR 02 B1AW6V4
(PCND53)	DLSWT 138 0.0133 SC. GENERIC HCR 02 B2
(RCND57)	DLSWT 138 0.0133 SC. GENERIC HCR 02 B2W6V4

MACH 0.185

REFERENCE INFORMATION		
REFS	5057.0040	SQ. FT.
REFL	701.0204	IN.
REFB	1230.0040	IN.
XMRP	1266.0026	IN.
YMRP	0.0000	IN.
ZMRP	163.0004	IN.
SCALE	100.0000	PERCENT

DLSWT TEST 138- BODY NOSE RAMP EFFECT

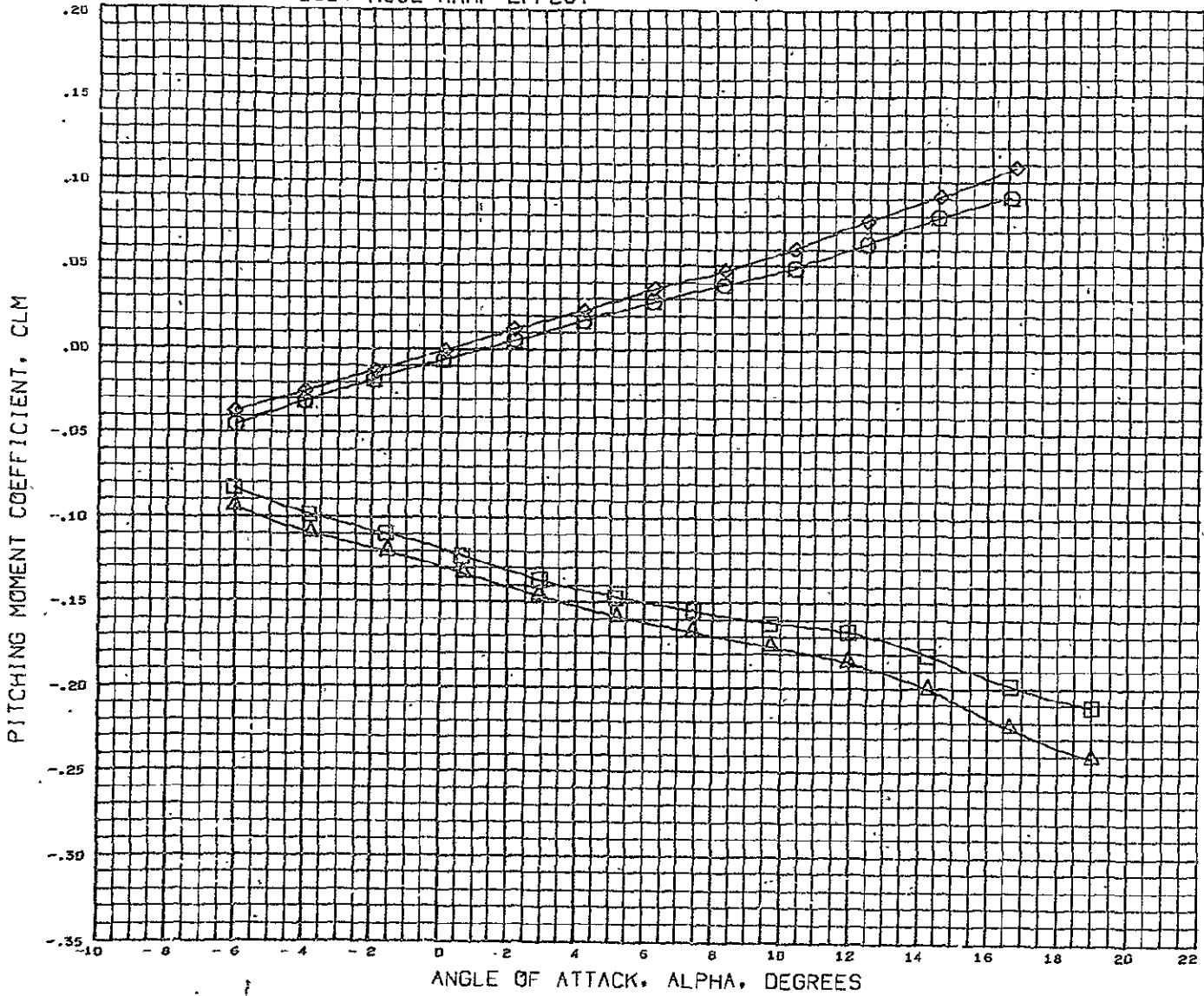

DATA SET SYMBOL	CONFIGURATION DESCRIPTION
(RCN013)	DLSWT 138 0.0133 SC. GENERIC HCR 02 B1A
(RCN020)	DLSWT 138 0.0133 SC. GENERIC HCR 02 B1A6V4
(RCN063)	DLSWT 138 0.0133 SC. GENERIC HCR 02 B2
(RCN097)	DLSWT 138 0.0133 SC. GENERIC HCR 02 B2.6V4

REFERENCE INFORMATION		
REFS	5057.0040	SQ. FT.
REFL	701.0004	IN.
REFB	1230.0040	IN.
XMRP	1266.0040	IN.
YMRP	0.0000	IN.
ZMRP	163.0004	IN.
SCALE	100.0000	PERCNT

MACH 0.180

DLSWT TEST 138- BODY NOSE RAMP EFFECT

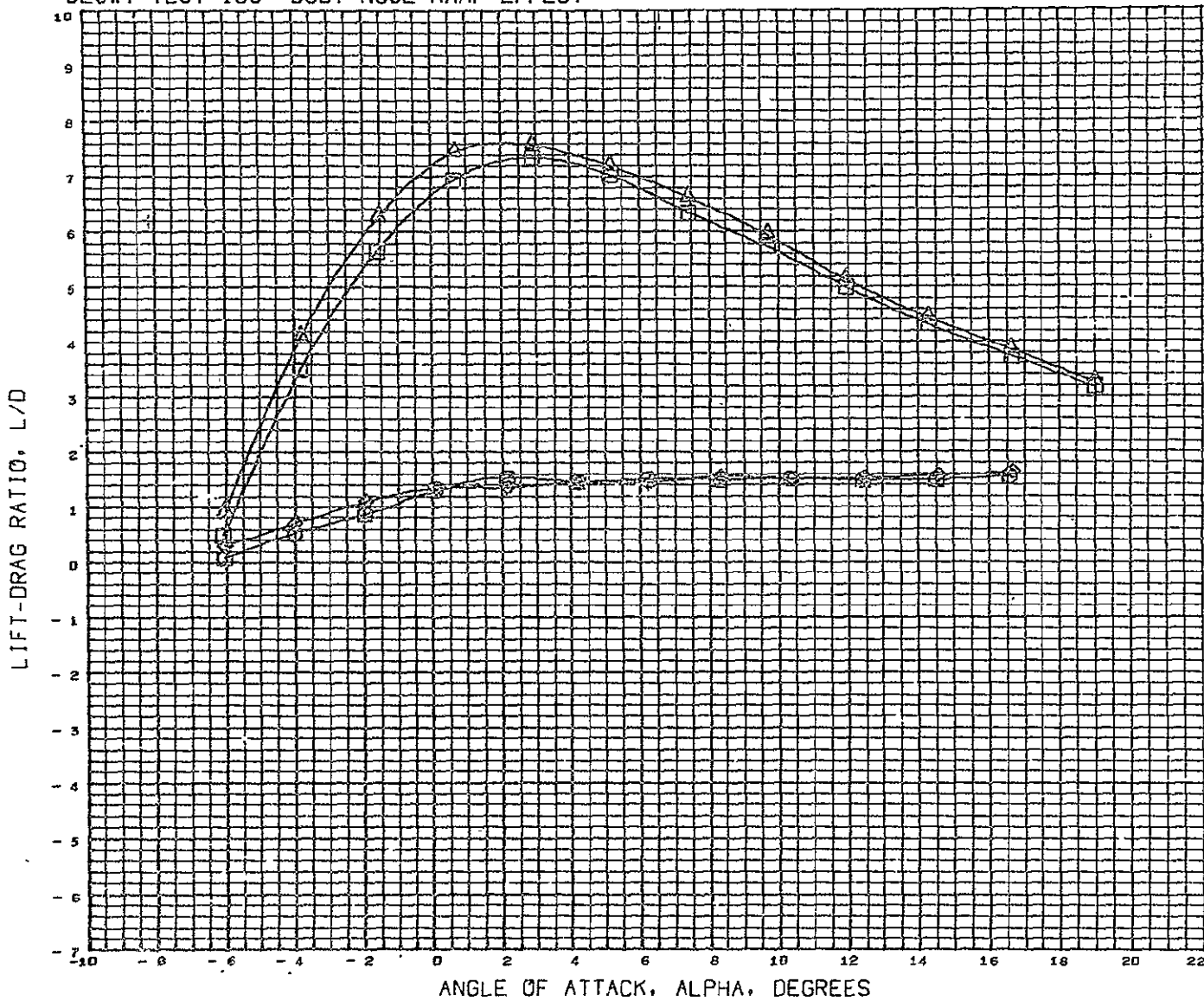

DATA SET SYMBOL	CONFIGURATION DESCRIPTION
(RCND13)	DLSWT 138 0.0133 SC. GENERIC HCR 02 B1A
(PCND20)	DLSWT 138 0.0133 SC. GENERIC HCR 02 B1AW6V4
(RCND53)	DLSWT 138 0.0133 SC. GENERIC HCR 02 B2
(RCND57)	DLSWT 138 0.0133 SC. GENERIC HCR 02 B2W6V4

MACH 0.160

REFERENCE INFORMATION		
REFS	5057.0040	SQ.FT.
REFL	701.0064	IN.
REFB	1230.0040	IN.
XMRP	1266.0040	IN.
YMRP	0.0000	IN.
ZMRP	163.0004	IN.
SCALE	100.0000	PERCNT

DLSWT TEST 138- BODY NOSE RAMP EFFECT

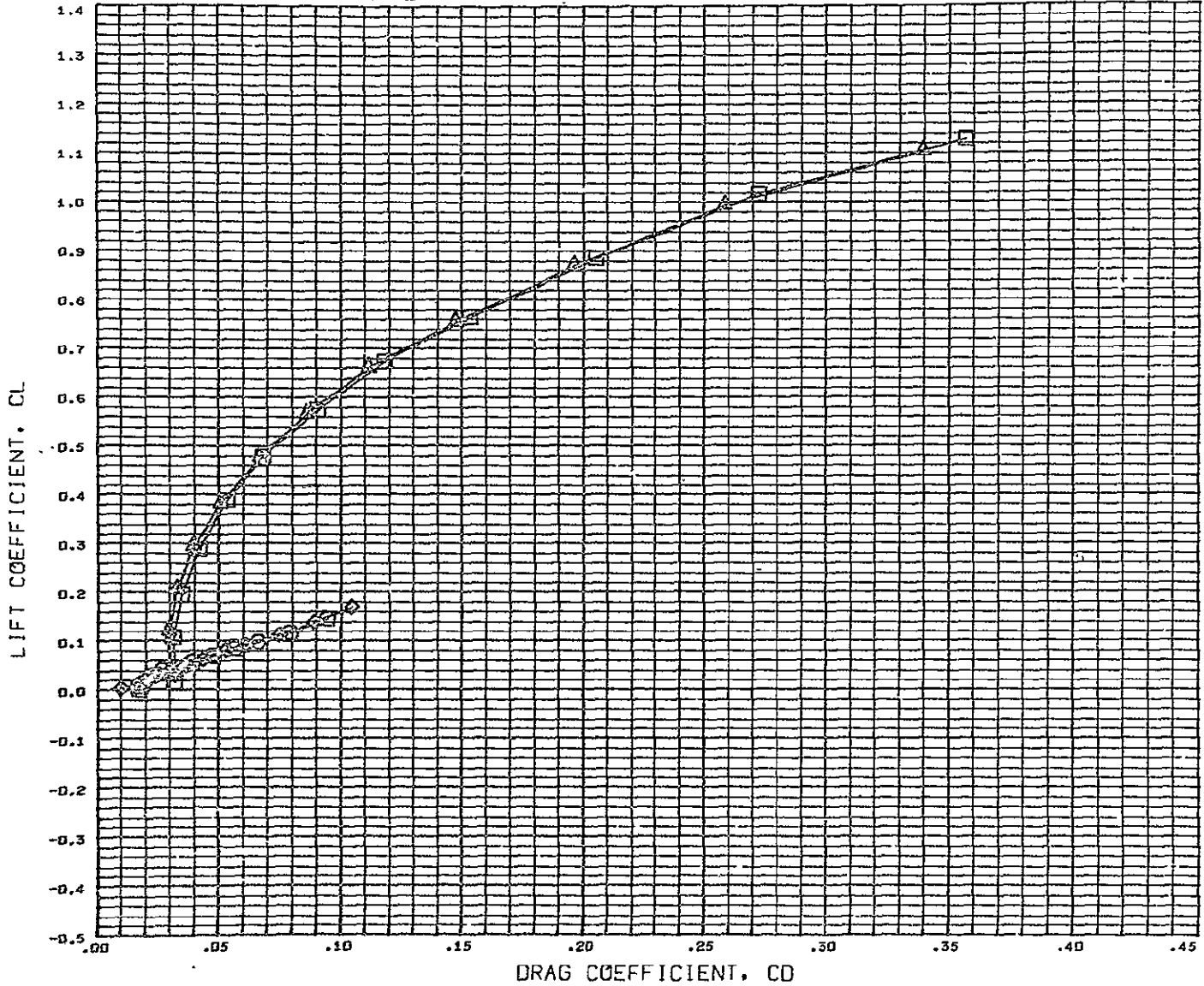

DATA SET SYMBOL	CONFIGURATION DESCRIPTION
(PCND13)	DLSWT 138 G.D133 SC. GENERIC HCR O2 B1A
(PCND25)	DLSWT 138 C.D133 SC. GENERIC HCR O2 B1AWEV4
(PCND53)	DLSWT 138 G.D133 SC. GENERIC HCR O2 B2
(PCND57)	DLSWT 138 G.D133 SC. GENERIC HCR O2 B2W6V4

REFERENCE INFORMATION		
REFS	5057.0040	SQ.FT.
REFL	701.0094	IN.
REFB	1230.0040	IN.
XNRF	1266.0040	IN.
YNRF	0.0000	IN.
ZNRF	163.0094	IN.
SCALE	100.0000	PERCENT

PACH 0.180

DLSWT TEST 138- BODY NOSE RAMP EFFECT

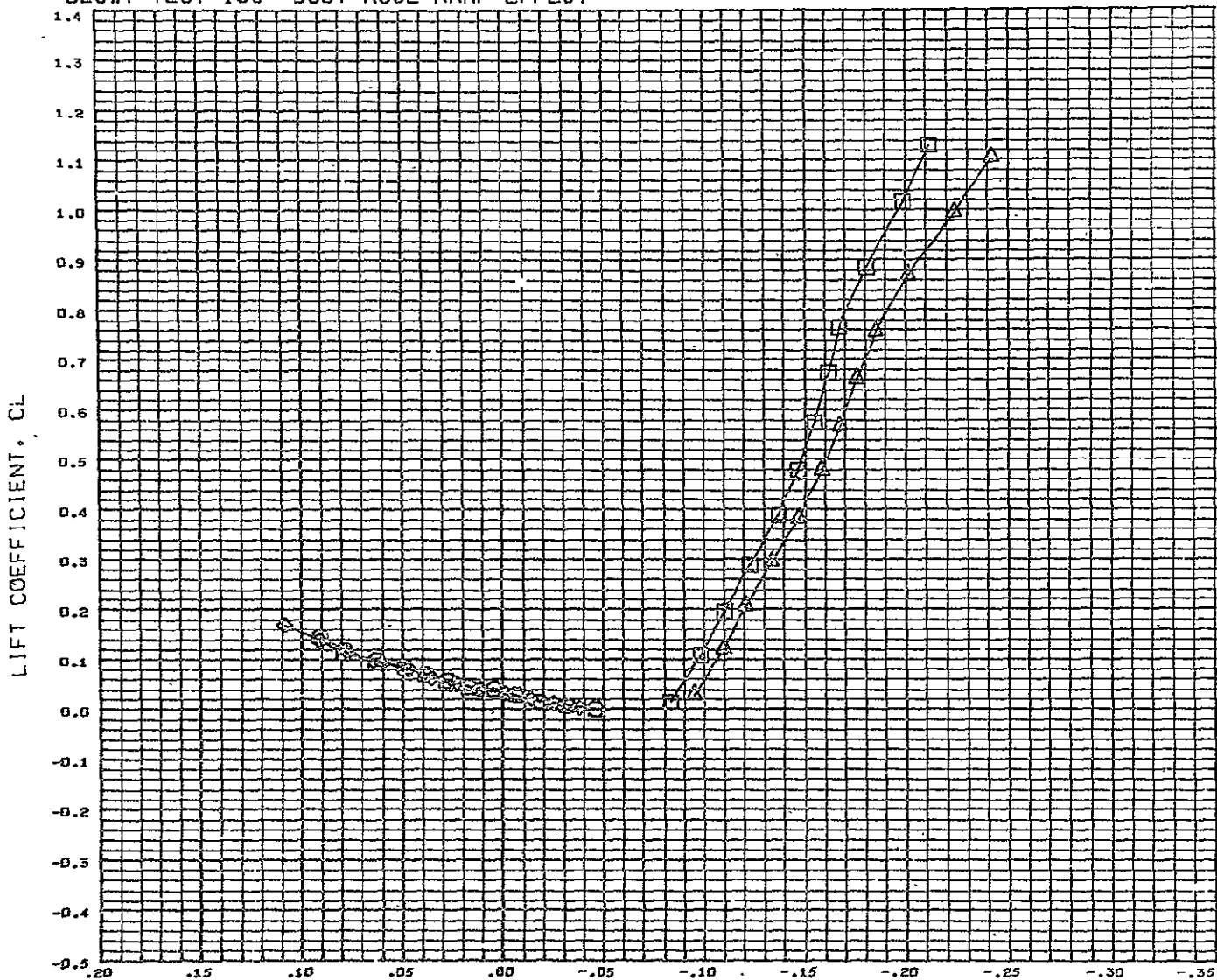

PITCHING MOMENT COEFFICIENT, CLM

DATA SET SYMBOL	CONFIGURATION DESCRIPTION
(RCH013)	⊙ DLSWT 138 0.0133 SC. GENERIC HCR 02 B1A
(RCH020)	⊙ DLSWT 138 0.0133 SC. GENERIC HCR 02 B1AW6V4
(PCN053)	⊙ DLSWT 138 0.0133 SC. GENERIC HCR 02 B2
(PCN057)	⊙ DLSWT 138 0.0133 SC. GENERIC HCR 02 B2W6V4

REFERENCE INFORMATION		
REFS	5057.0040	SQ.FT.
REFL	701.0004	IN.
REFD	1230.0040	IN.
XMRP	1266.0040	IN.
YHRP	0.0000	IN.
ZHRP	163.0004	IN.
SCALE	100.0000	F.PCNT

MACH 0.105

DLSWT TEST 138- BODY NOSE RAMP EFFECT

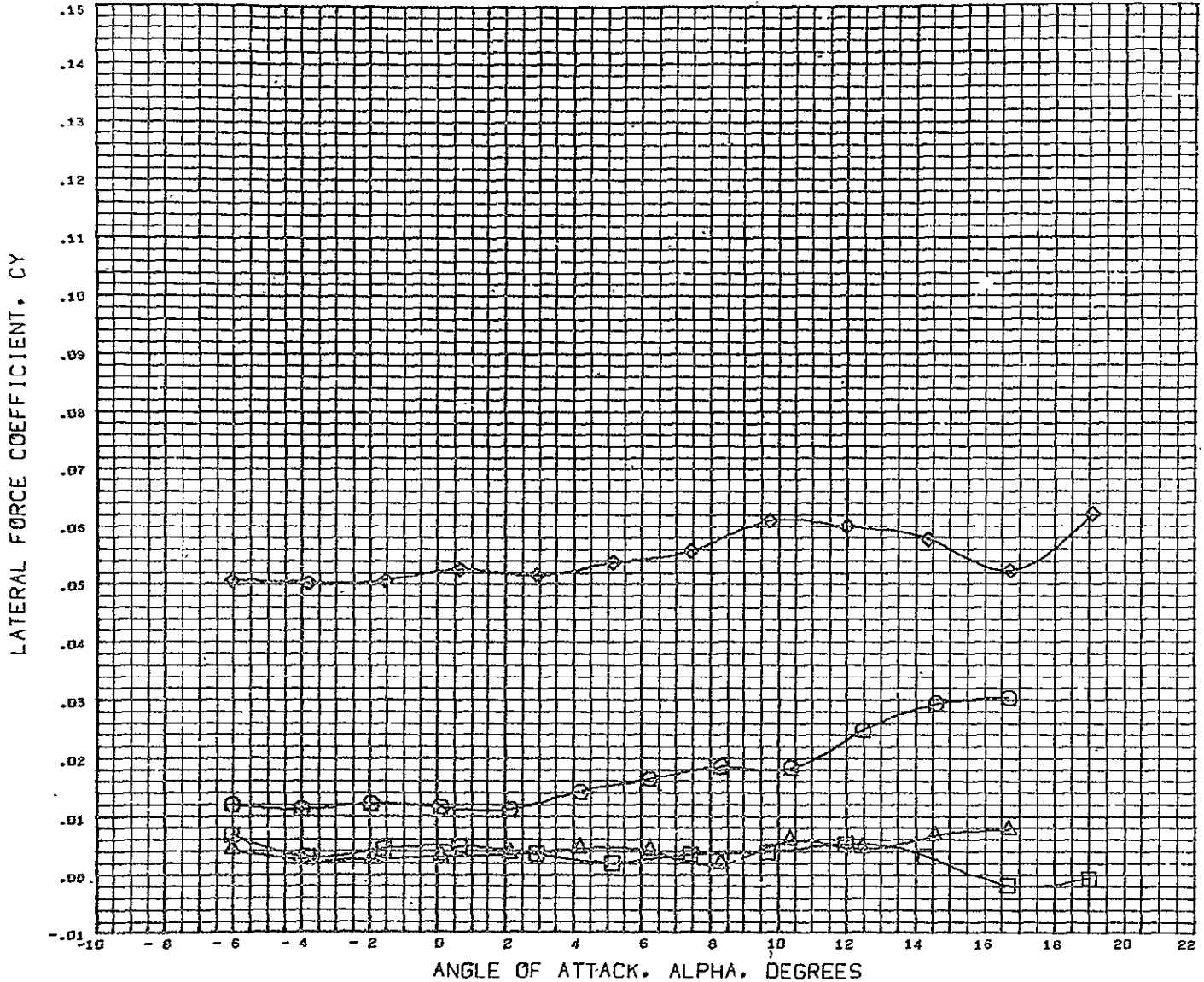

DATA SET	SYMBOL	CONFIGURATION DESCRIPTION
(TCND54)	○	DLSWT 138 0.0133 SC. GENERIC HCR 02 B2
(TCND53)	△	DLSWT 138 0.0133 SC. GENERIC HCR 02 B2
(TCND56)	◇	DLSWT 138 0.0133 SC. GENERIC HCR 02 B2 JCV4
(TCND57)	□	DLSWT 138 0.0133 SC. GENERIC HCR 02 B2 H6V4

BETA
-2.950
0.000
-2.900
0.000

REFERENCE INFORMATION		
REFS	5057.0040	SQ. FT
REFL	701.0004	IN.
REFB	1230.0040	IN.
XMRP	1263.0040	IN.
YMRP	0.0000	IN.
ZMRP	163.0004	IN.
SCALE	100.0000	PERCENT

MACH 0.180

DLSWT TEST 138- BODY NOSE RAMP EFFECT

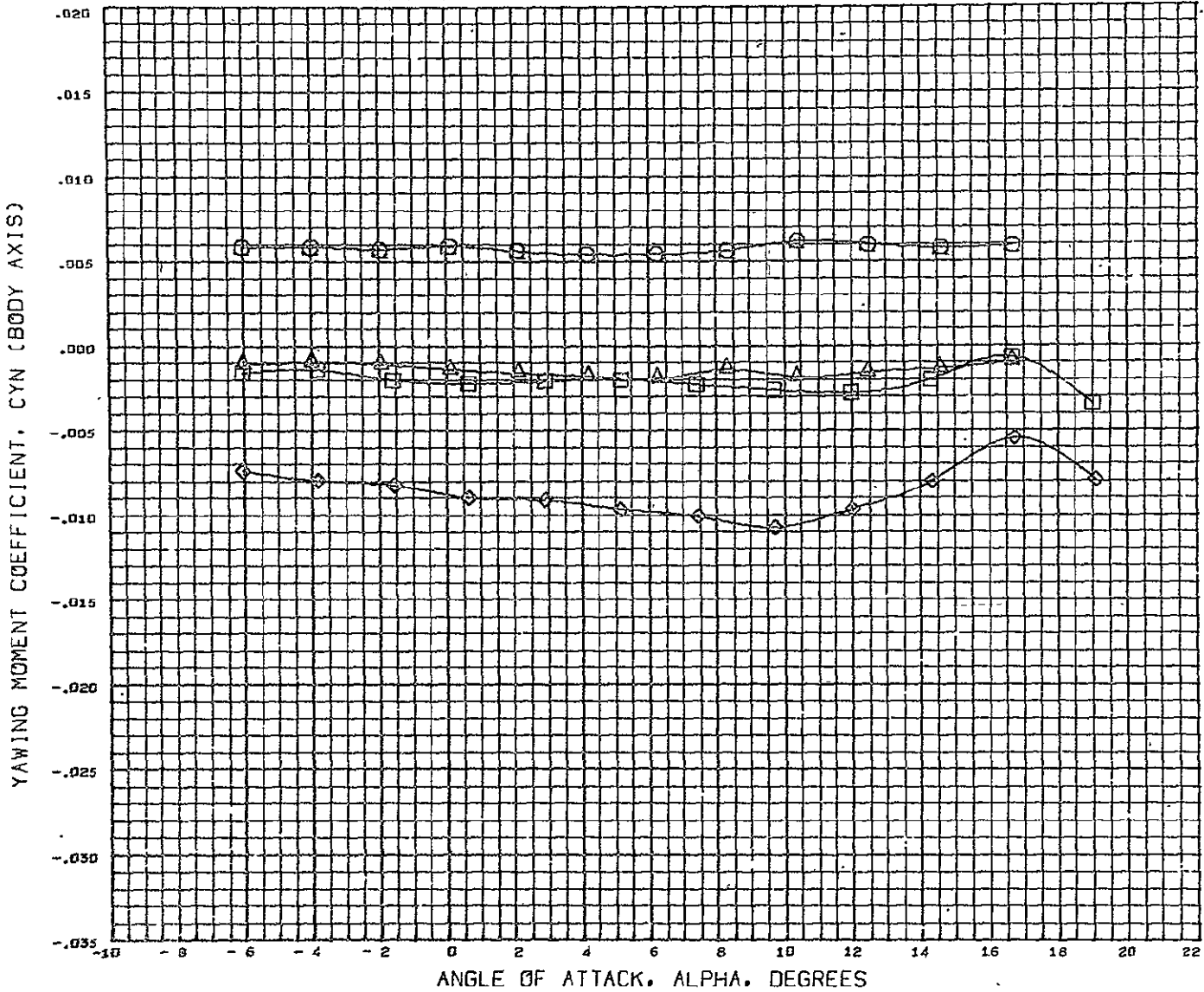

DATA SET SYMBOL	CONFIGURATION DESCRIPTION	BETA	REFERENCE INFORMATION
(TCN554)	DLSWT 138 0.0133 SC. GENERIC HCR 02 B2	-2.950	REFS 5057.0040 SQ. FT
(TCN553)	DLSWT 138 0.0133 SC. GENERIC HCR 02 B2	0.000	REFL 701.0004 IN.
(TCN556)	DLSWT 138 0.0133 SC. GENERIC HCR 02 B2W6V4	-2.900	REFB 1230.0040 IN.
(TCN557)	DLSWT 138 0.0133 SC. GENERIC HCR 02 B2W6V4	0.000	XMRP 1263.0040 IN.
			YMRP 0.0000 IN.
			ZMRP 163.0004 IN.
			SCALE 100.0000 P. RCNT

MACH 0.285

DLSWT TEST 138- BODY NOSE RAMP EFFECT

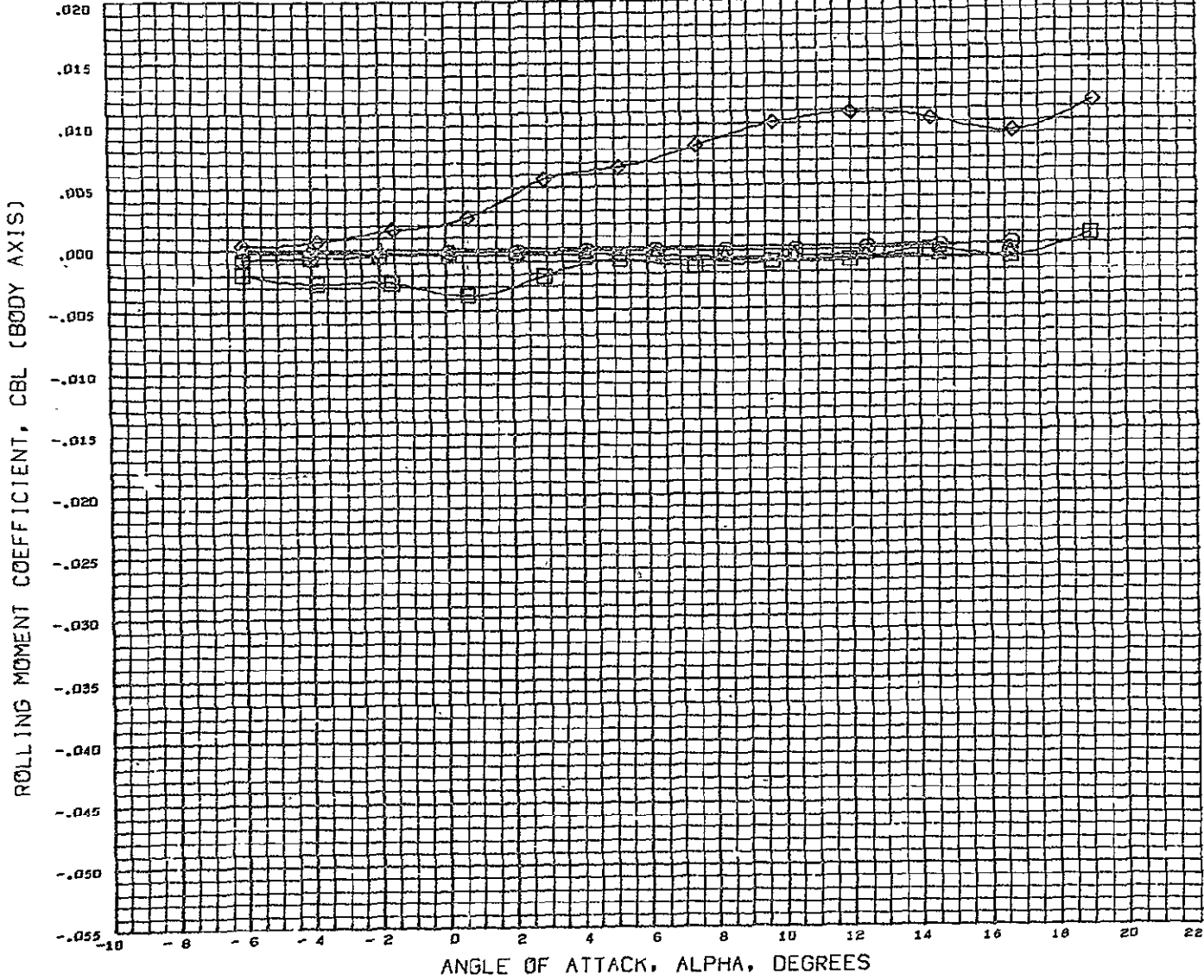

DATA SET SYMBOL	CONFIGURATION DESCRIPTION	BETA	REFERENCE INFORMATION
(TCN054)	DLSWT 138 0.0133 SC. GENERIC HCR 02 B2	-2.950	REFS 5957.0040 SQ. FT
(TCN053)	DLSWT 138 0.0133 SC. GENERIC HCR 02 B2	0.000	REFL 701.0004 IN.
(TCN056)	DLSWT 138 0.0133 SC. GENERIC HCR 02 B2W6V4	-2.900	REFB 1230.0000 IN.
(TCN057)	DLSWT 138 0.0133 SC. GENERIC HCR 02 B2W6V4	0.000	XMRP 1263.0040 IN.
			YMRP 0.0000 IN.
			ZMRP 163.0004 IN.
			SCALE 100.0000 PERCENT

MACH 0.180

DLSWT TEST 138- BODY NOSE RAMP EFFECT

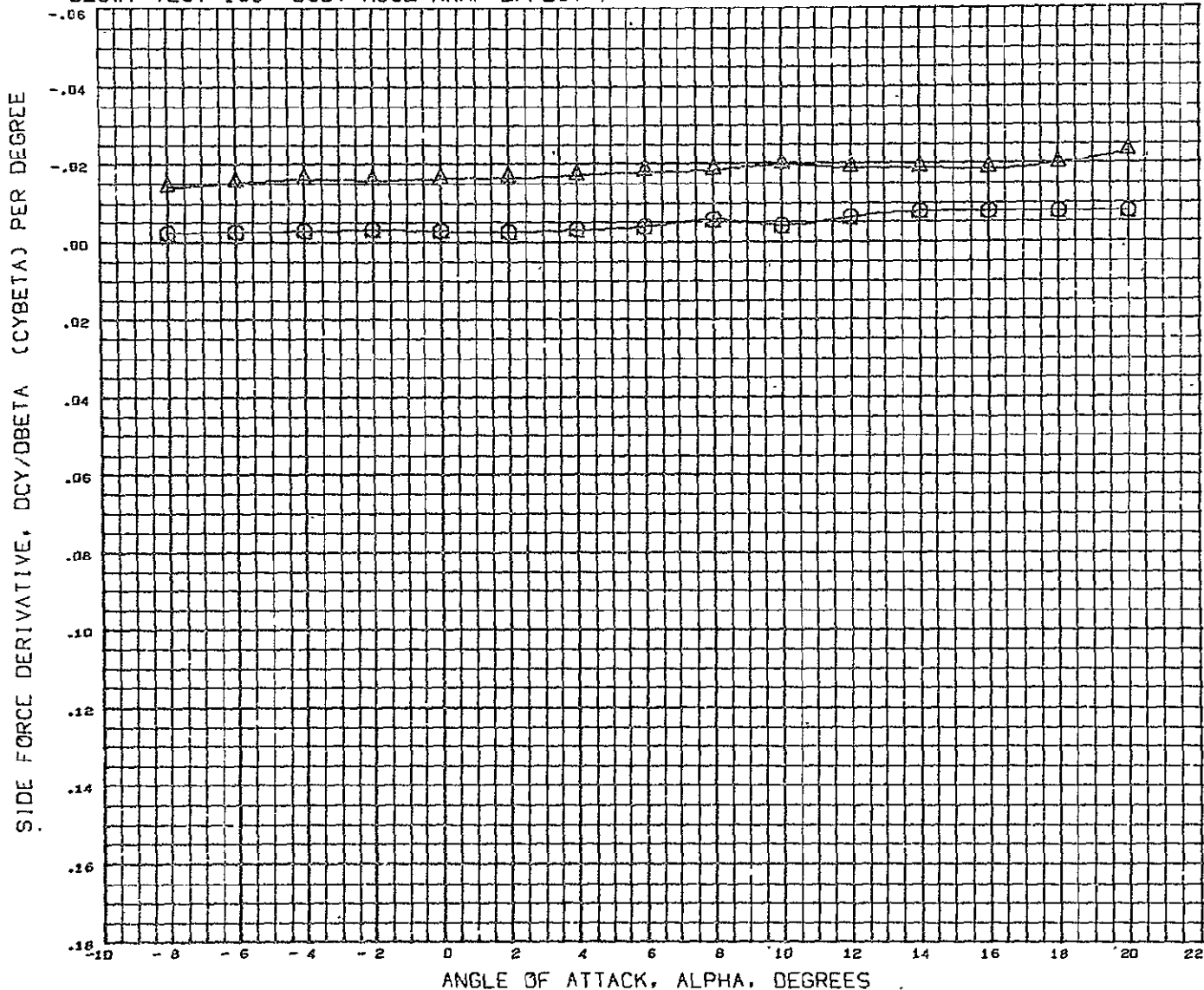

DATA SET SYMBOL CONFIGURATION DESCRIPTION
 (PCND53) Δ DLSWT 138 0.0133 SC. GENERIC HCR 02 B2
 (PCND57) \circ DLSWT 138 0.0133 SC. GENERIC HCR 02 B2W6V1

REFERENCE INFORMATION
 REFS 5057.0040 SQ. FT
 REFL 701.0034 IN.
 REFB 1230.0040 IN.
 XMRF 1263.0040 IN.
 YHRF 0.0000 IN.
 ZHRF 163.0004 IN.
 SCALE 100.0000 PERCENT

MACH 0.180

DLSWT TEST 138- BODY NOSE RAMP EFFECT

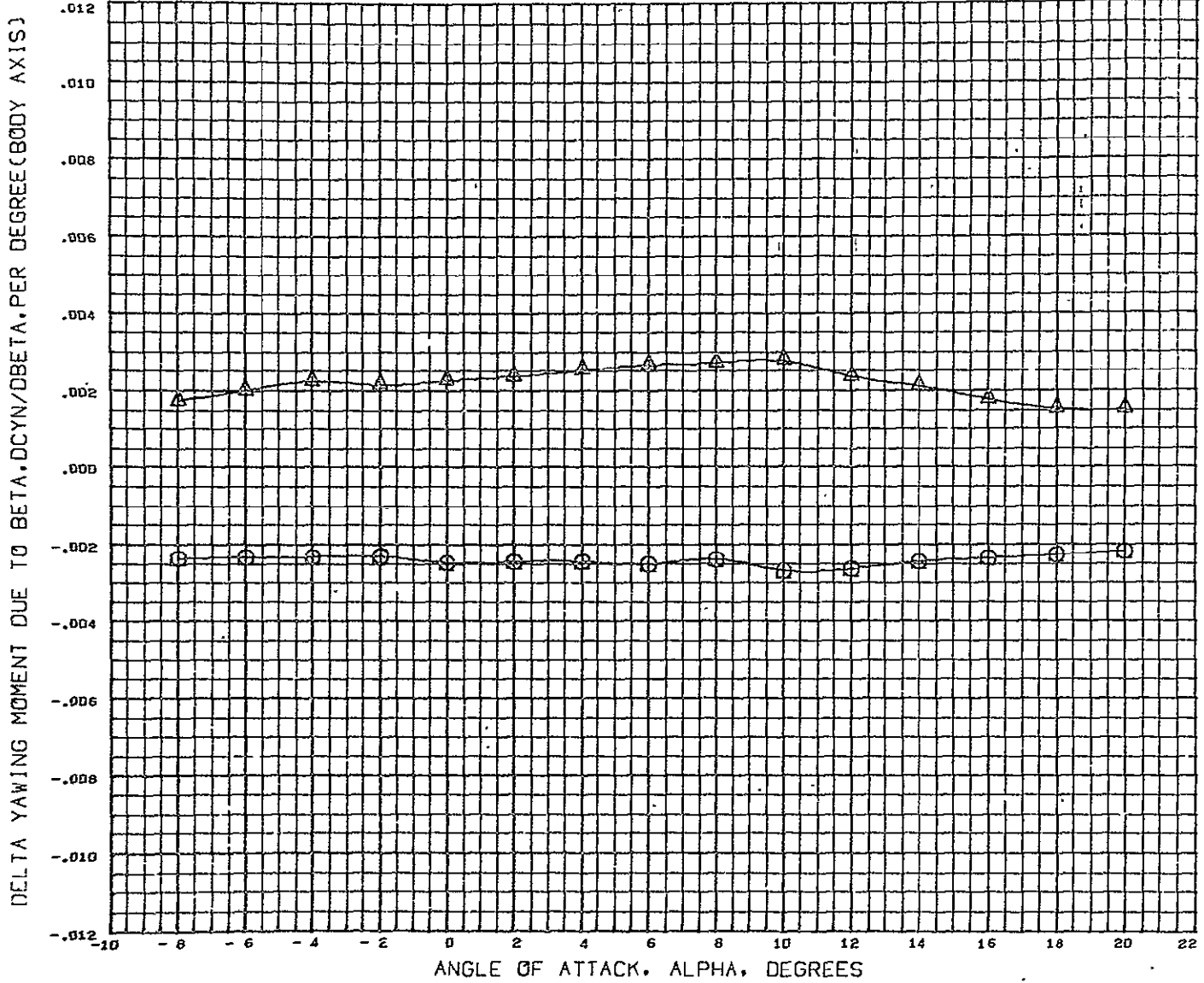

DATA SET SYMBOL CONFIGURATION DESCRIPTION
 (PCN053) DLSWT 138 0.0133 SC. GENERIC HCR 02 B2
 (PCN057) DLSWT 138 0.0133 SC. GENERIC HCR 02 B2W6V4

REFERENCE INFORMATION
 REFS 5057.0040 SQ. FT
 REFL 701.0054 IN.
 REFB 1230.0040 IN.
 XHRF 1263.0040 IN.
 YHRF 0.0000 IN.
 ZHRF 163.0004 IN.
 SCALE 100.0000 PERCENT

MACH 0.165

DLSWT TEST 138- BODY NOSE RAMP EFFECT

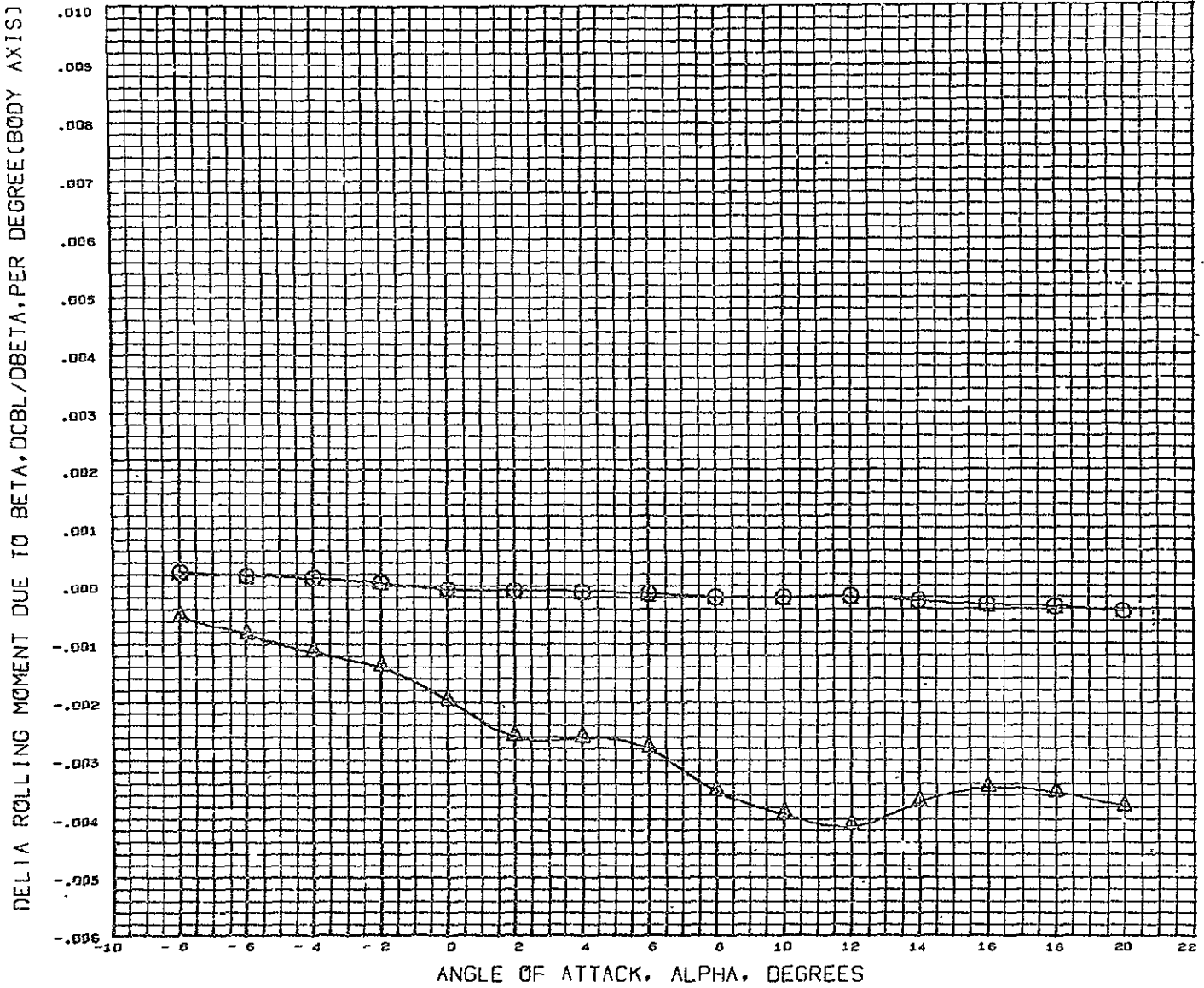

DATA SET SYMBOL CONFIGURATION DESCRIPTION
 (PCN053) \odot DLSWT 138 D.0133 SC. GENERIC HCR 02 B2
 (PCN057) \triangle DLSWT 138 D.0133 SC. GENERIC HCR 02 B2W6V4

REFERENCE INFORMATION
 REFS 5057.0040 SQ. FT
 REFL 701.0004 IN.
 REFB 1230.0040 IN.
 XMRP 1263.0040 IN.
 YMRP 0.0000 IN.
 ZMRP 163.0004 IN.
 SCALE 100.0000 PFCNT

MACH 0.180

DLSWT TEST 138- WING PLANFORM COMPARISON

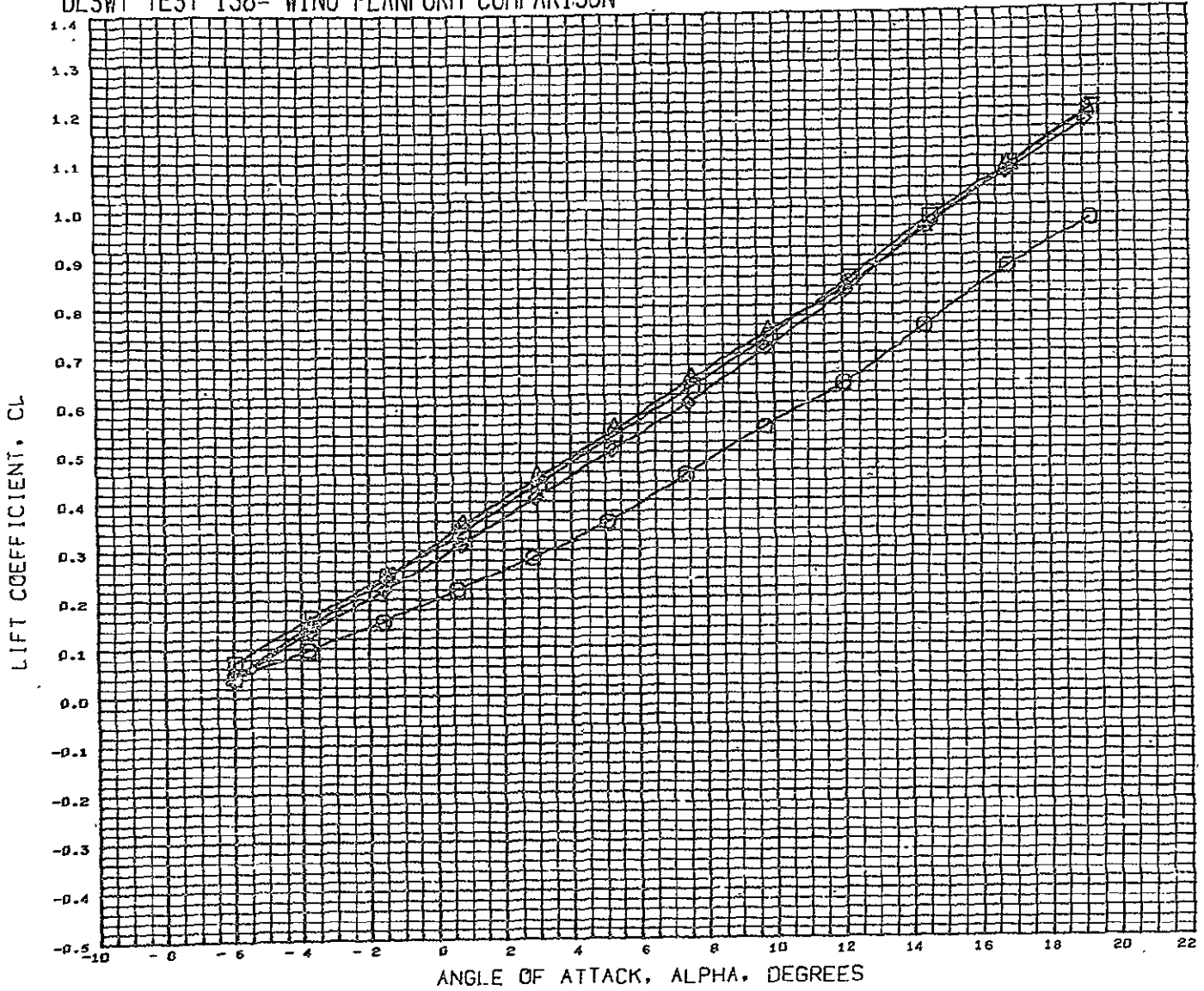

DATA SET SYMBOL	CONFIGURATION DESCRIPTION
(RCN011)	DLSWT 138 0.0133 SC. GENERIC HCR 02 B1AW3V4
(RCN018)	DLSWT 138 0.0133 SC. GENERIC HCR 02 B1AW5V4
(RCN023)	DLSWT 138 0.0133 SC. GENERIC HCR 02 B1AW4BV4
(RCN025)	DLSWT 138 0.0133 SC. GENERIC HCR 02 B1AW7V4

SEE THE ASSOCIATED DATA DOCUMENT FOR REFERENCE CHARACTERISTICS

MACH 0.180

DLSWT TEST 138- WING PLANFORM COMPARISON

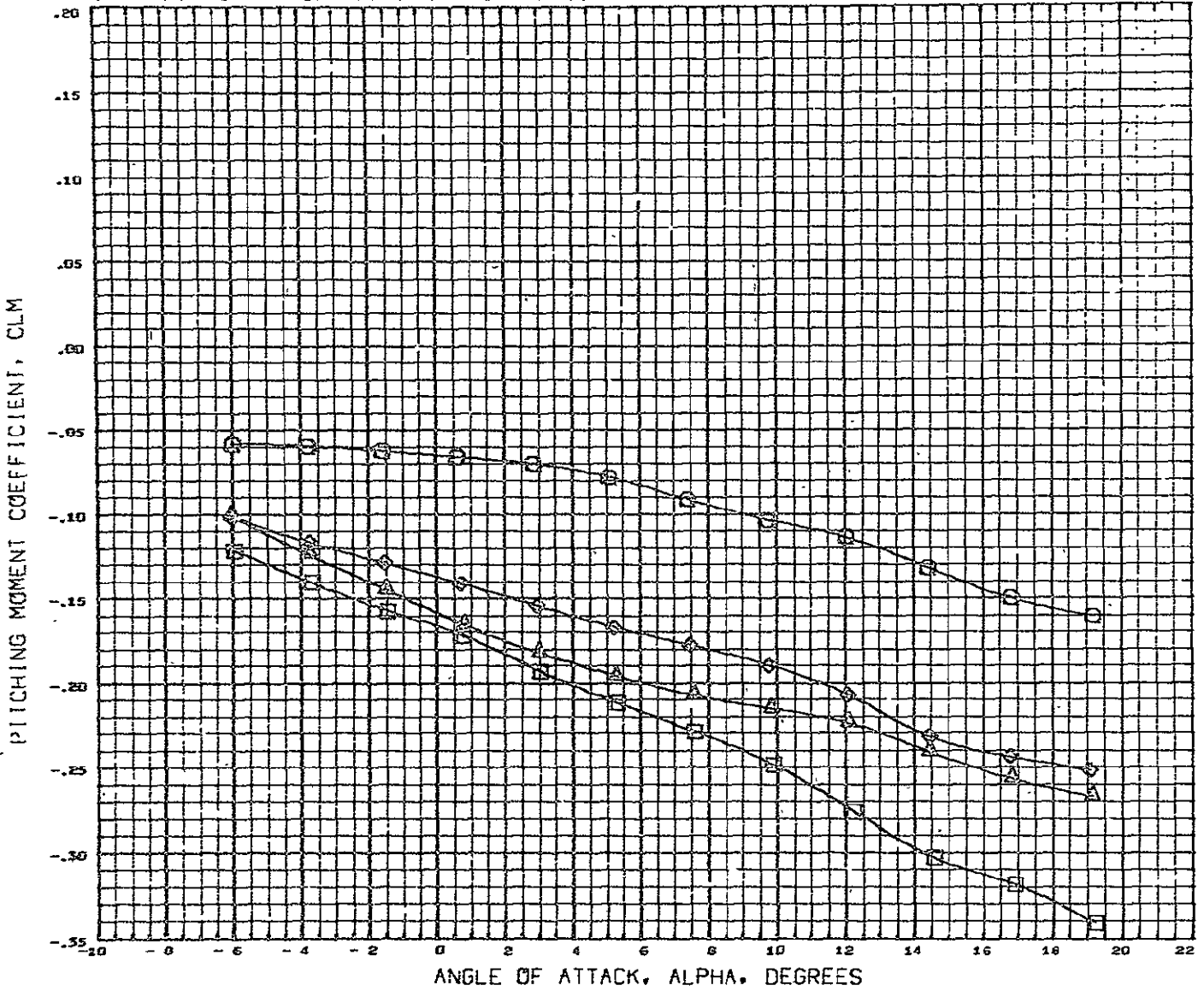

DATA SET SYMBOL	CONFIGURATION DESCRIPTION
(PCND11)	DLSWT 138 0.0133 SC. GENERIC HCR 02 B1AW3V4
(PCND18)	DLSWT 138 0.0133 SC. GENERIC HCR 02 B1AW5V4
(PCND23)	DLSWT 138 0.0133 SC. GENERIC HCF 02 B1AW48V4
(PCND25)	DLSWT 138 0.0133 SC. GENERIC HCR 02 B1AW7V4

SEE THE ASSOCIATED DATA DOCUMENT FOR REFERENCE CHARACTERISTICS

MACH 0.185

DLSWT TEST 138- WING PLANFORM COMPARISON

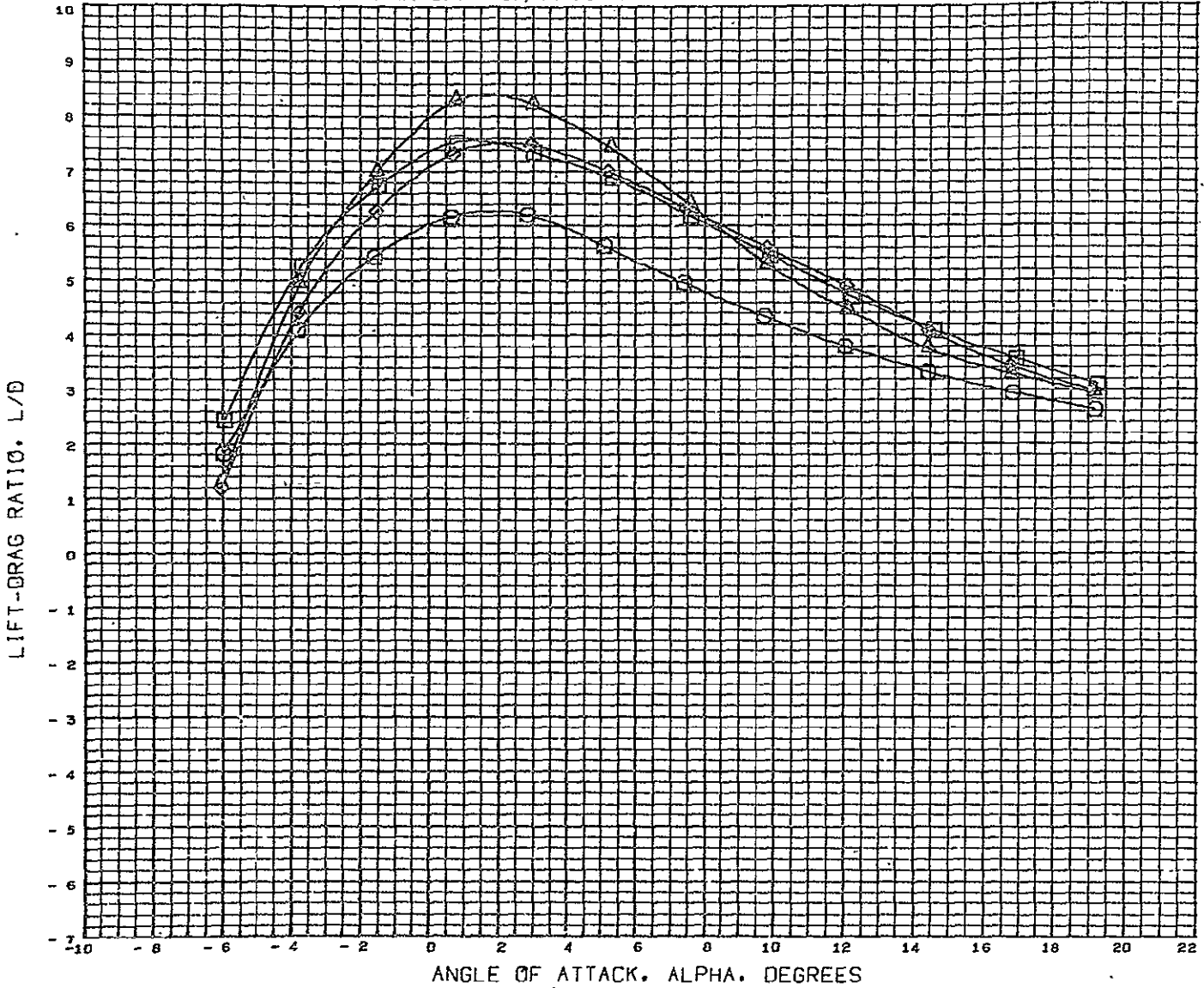

DATA SET SYMBOL	CONFIGURATION DESCRIPTION
(RCNG11)	DLSWT 138 0.0133 SC. GENERIC HCR 02 B1AW3V4
(RCNG18)	DLSWT 138 0.0133 SC. GENERIC HCR 02 B1AW5V4
(RCNG23)	DLSWT 138 0.0133 SC. GENERIC HCR 02 B1AW4BV4
(RCNG25)	DLSWT 138 0.0133 SC. GENERIC HCR 02 B1AW7V4

SEE THE ASSOCIATED DATA DOCUMENT FOR REFERENCE CHARACTERISTICS

MACH 5.189

DLSWT TEST 138- WING PLANFORM COMPARISON

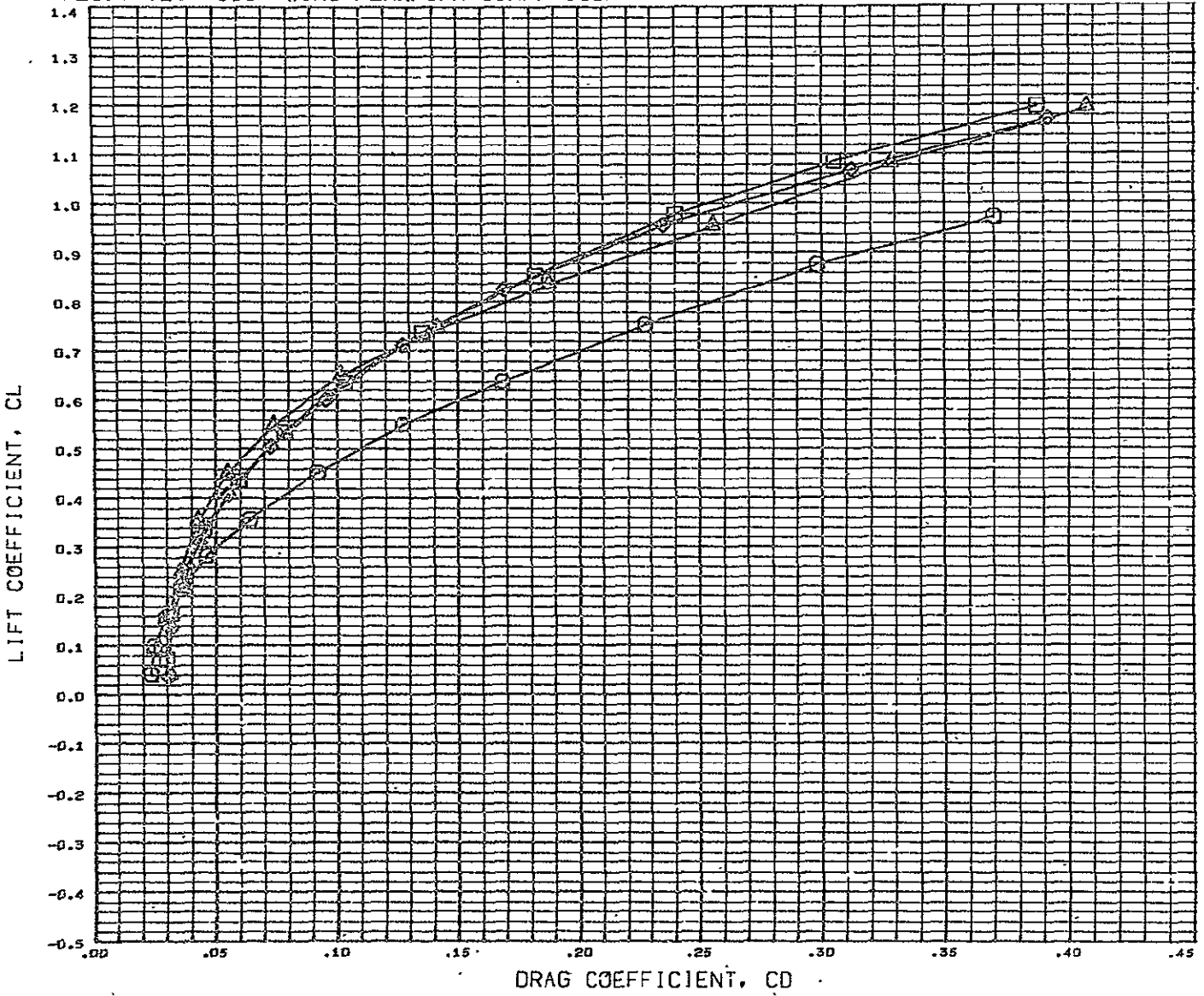

DATA SET SYMBOL	CONFIGURATION DESCRIPTION
(RCND11)	DLSWT 138 0.5133 SC. GENERIC HCR 02 01AW3V4
(RCND18)	DLSWT 136 0.5133 SC. GENERIC HCR 02 01AW5V4
(FCND23)	DLSWT 138 0.5133 SC. GENERIC HCR 02 01AW4BV4
(FCND25)	DLSWT 136 0.5133 SC. GENERIC HCR 02 01AW7V4

SEE THE ASSOCIATED DATA DOCUMENT FOR REFERENCE CHARACTERISTICS

MACH 0.185

DLSWT TEST 138- WING PLANFORM COMPARISON

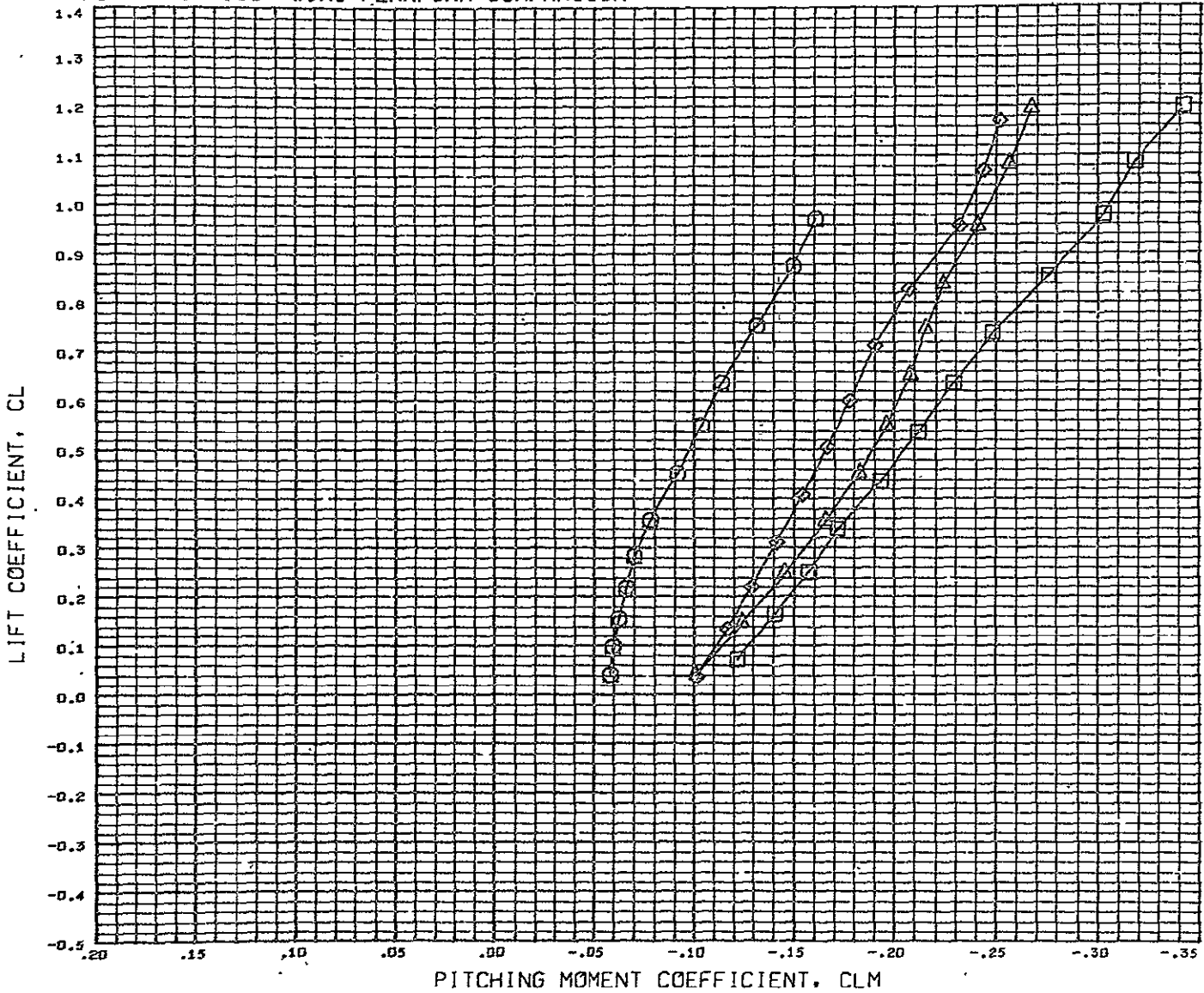

DATA SET SYMBOL	CONFIGURATION DESCRIPTION
(RCND11)	DLSWT 138 D.0133 SC. GENERIC HCR 02 B1AW3V4
(RCND18)	DLSWT 138 D.0133 SC. GENERIC HCR 02 B1AW5V4
(FCND23)	DLSWT 138 D.0133 SC. GENERIC HCR 02 B1AW4BV4
(RCND25)	DLSWT 138 D.0133 SC. GENERIC HCR 02 B1AW7V4

SEE THE ASSOCIATED DATA DOCUMENT FOR REFERENCE CHARACTERISTICS

DLSWT TEST 138- WING PLANFORM COMPARISON

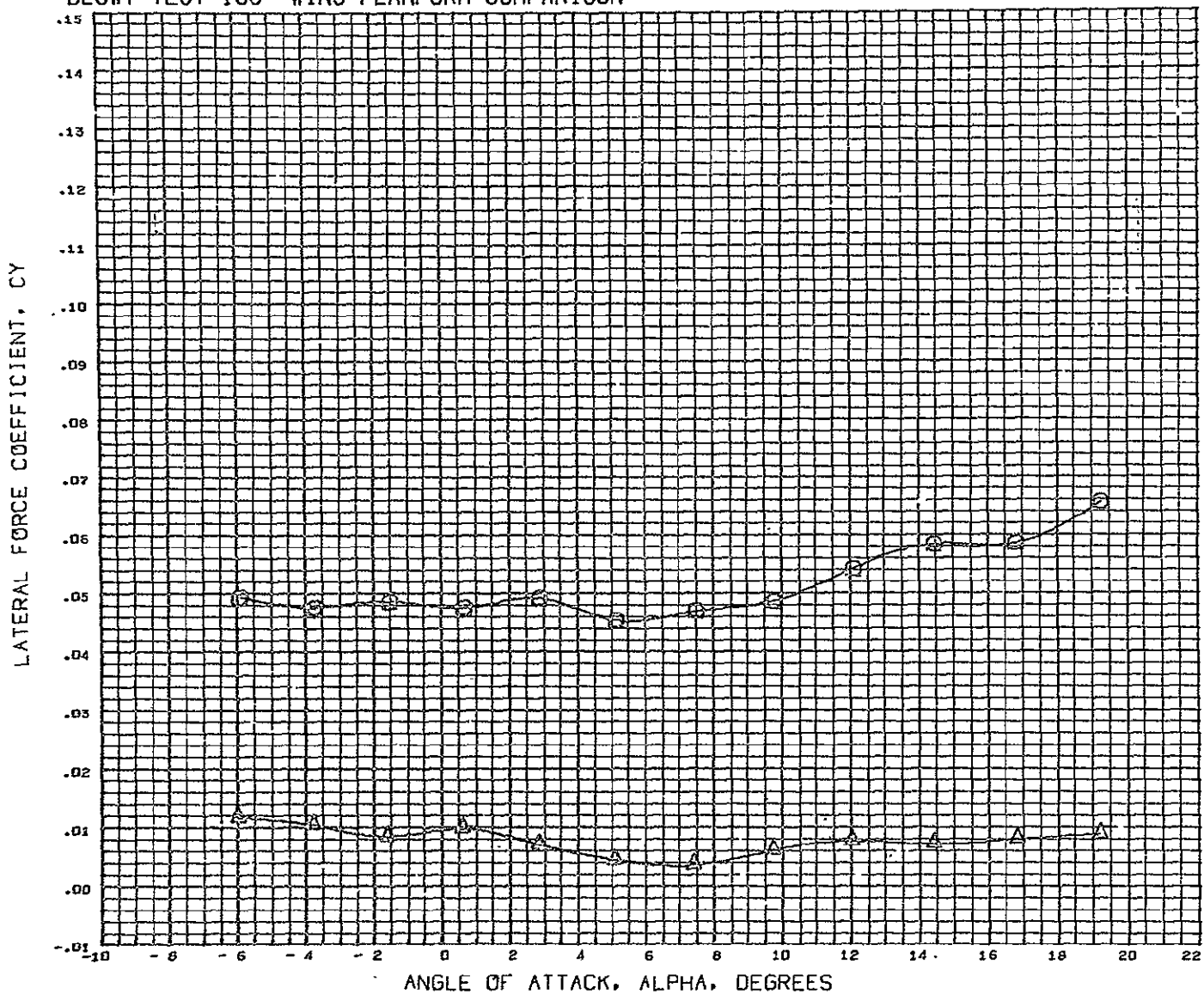

SYMBOL	BETA	PARAMETRIC VALUES	DATA SOURCE	REFERENCE INFORMATION
○	2.890	0.180 LORE	0.000 DATASET BETA	REFS 6168.0040 SQ. FT
△	0.500	0.000 LINE	0.000 TCND10 - 2.890 TCND11	REFL 971.0004 IN.
		0.000		REFB 1040.0040 IN.
				XMRP 1266.0040 IN.
				YMRP 0.0000 IN.
				ZMRP 163.0004 IN.
				SCALE 100.0000 PERCENT

DATA HIST. CODE T

DLSWT TEST 138- WING PLANFORM COMPARISON

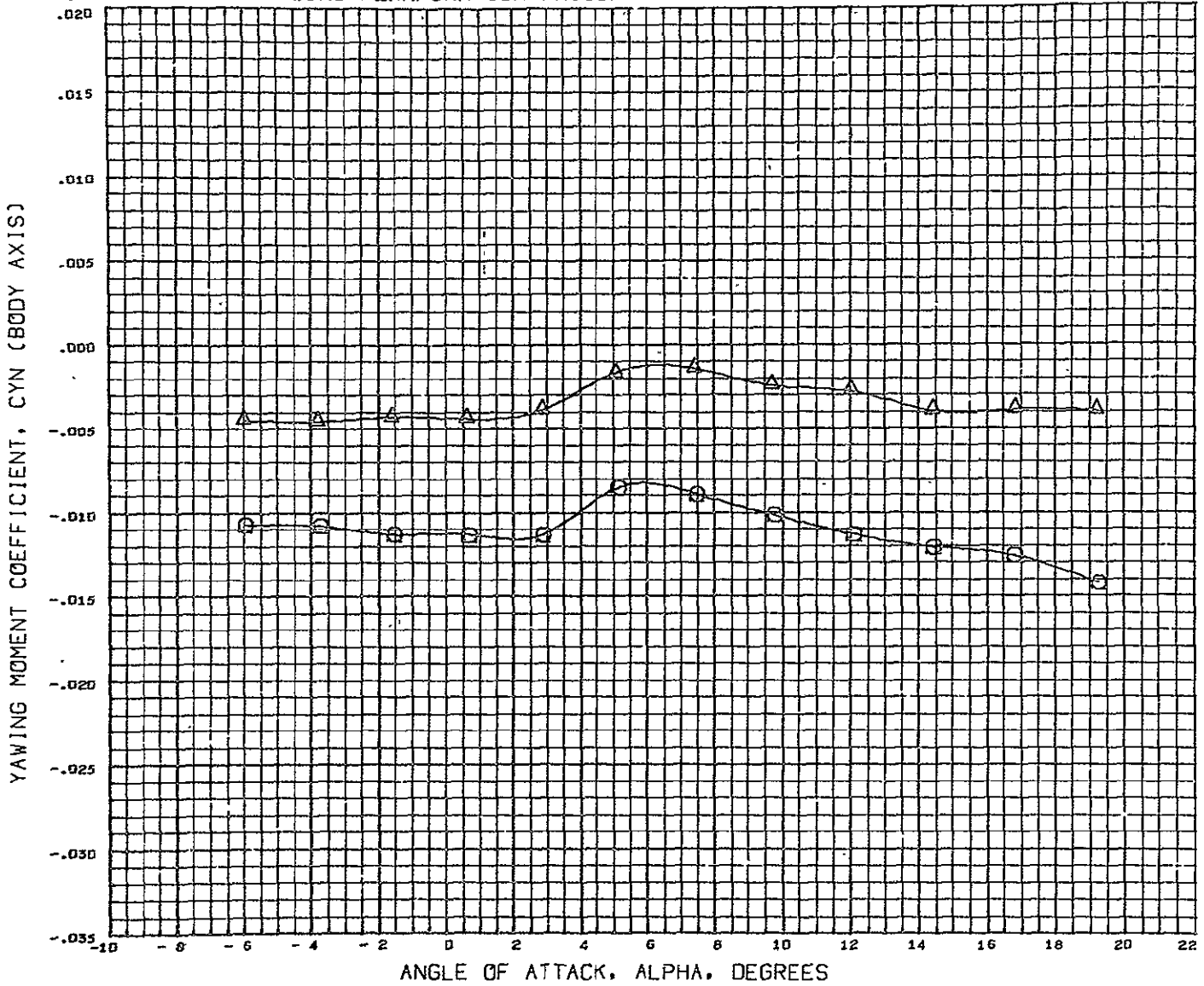

ANGLE OF ATTACK, ALPHA, DEGREES

SYMBOL	BETA	PARAMETRIC VALUES			DATA SOURCE			REFERENCE INFORMATION		
○	2.890	MACH	0.180	LOBE	0.000	DATASET	BETA	REFS	6168.0040	SQ. FT
△	0.000	ROBE	0.000	LINE	0.000	TCN010	- 2.890	REFL	971.0004	IN.
		RINE	0.000					REFB	1040.0040	IN.
								XHRF	1266.0040	IN.
								YHRF	0.0000	IN.
								ZHRF	163.0004	IN.
								SCALE	100.0000	F*RCNT

DATA HIST. CODE T

DLSWT TEST 138- WING PLANFORM COMPARISON

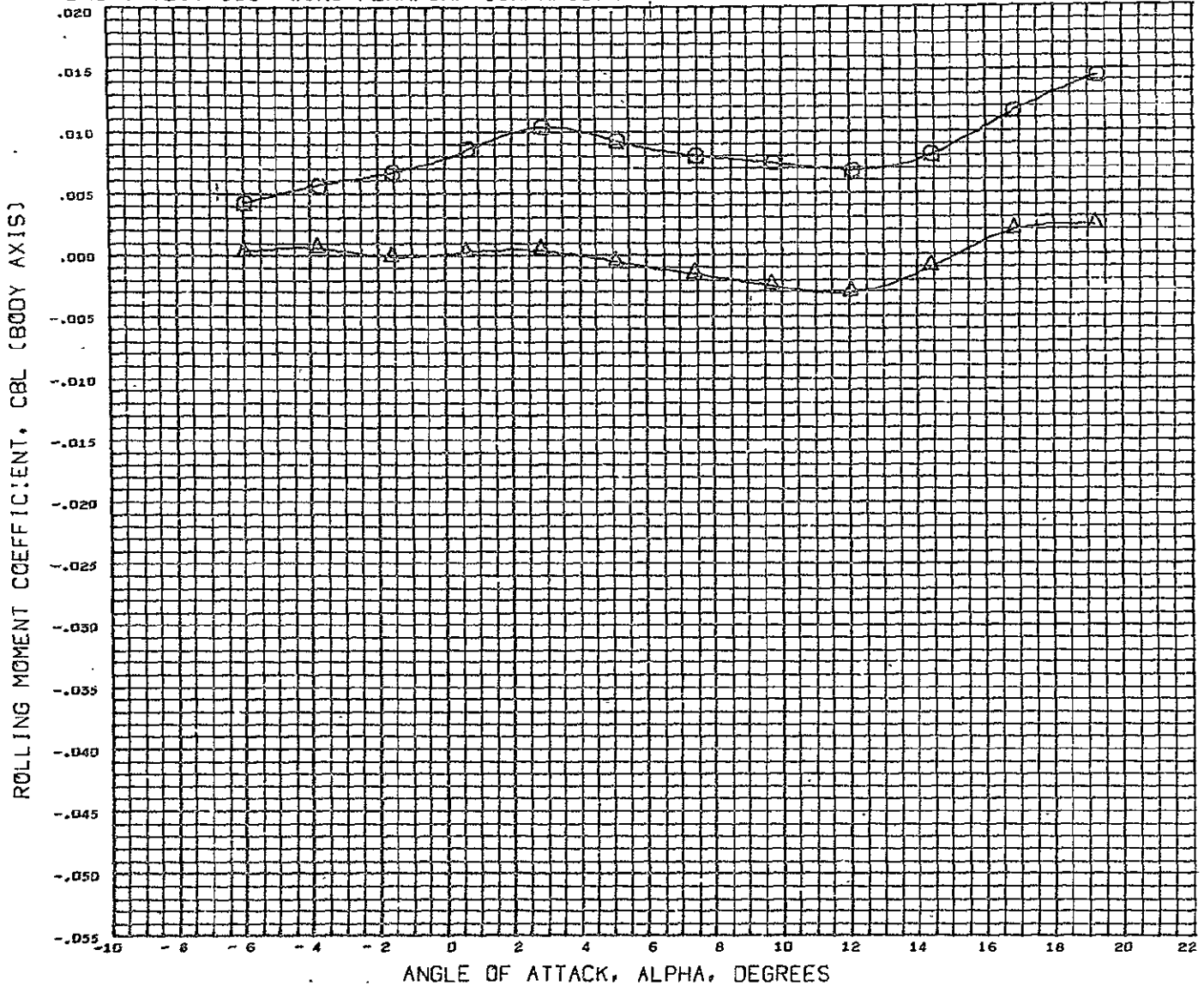

SYMBOL	BETA	PARAMETRIC VALUES			DATA SOURCE			REFERENCE INFORMATION				
○	2.895	MACH	0.100	LOBE	0.000	DATASET	BETA	DATASET	BETA	REFS	6168.0040	SQ. FT
△	5.555	ROBE	0.900	LINE	0.900	TCN010	- 2.895	TCN011	0.000	REFL	971.0004	IN.
		RINE	0.900							REFB	1040.0040	IN.
										XMRP	1266.0040	IN.
										YMRP	0.0000	IN.
										ZMRP	163.0004	IN.
										SCALE	100.0000	PERCENT

DATA HIST. CODE T

DLSWT TEST 138- WING PLANFORM COMPARISON

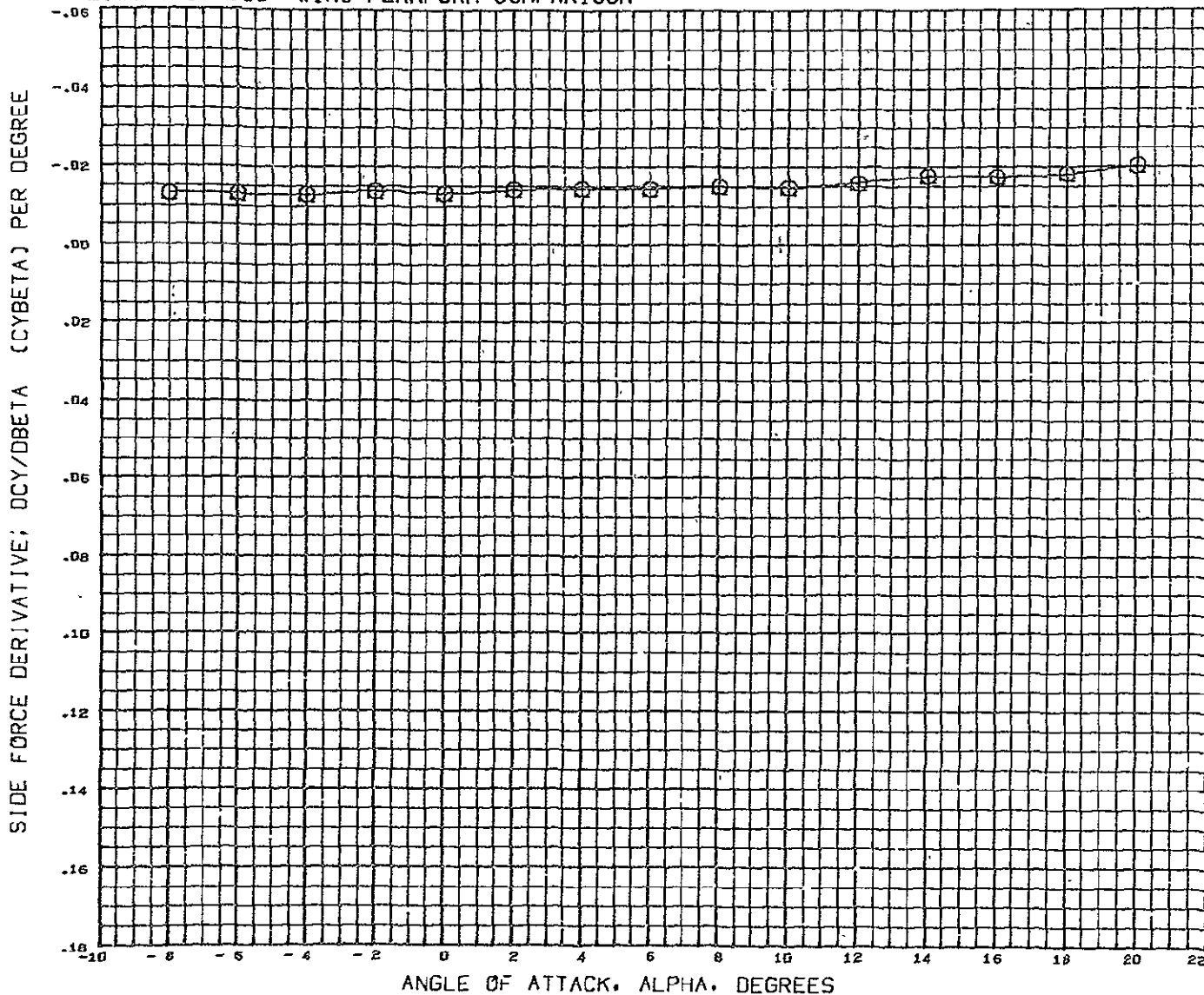

SYMBOL	MACH	PARAMETRIC VALUES				REFERENCE INFORMATION	
		LODE	ROBE	RINE	REFS	SCALE	
○	0.190	0.000	0.000	0.000	6168.0040	100.0000	SQ. FT
		LINE			971.0004		IN.
					1040.0040		IN.
					1266.0040		IN.
					0.0000		IN.
					163.0004		IN.
							PERCENT

DATA HIST. CODE #P

DLSWT TEST 138- WING PLANFORM COMPARISON

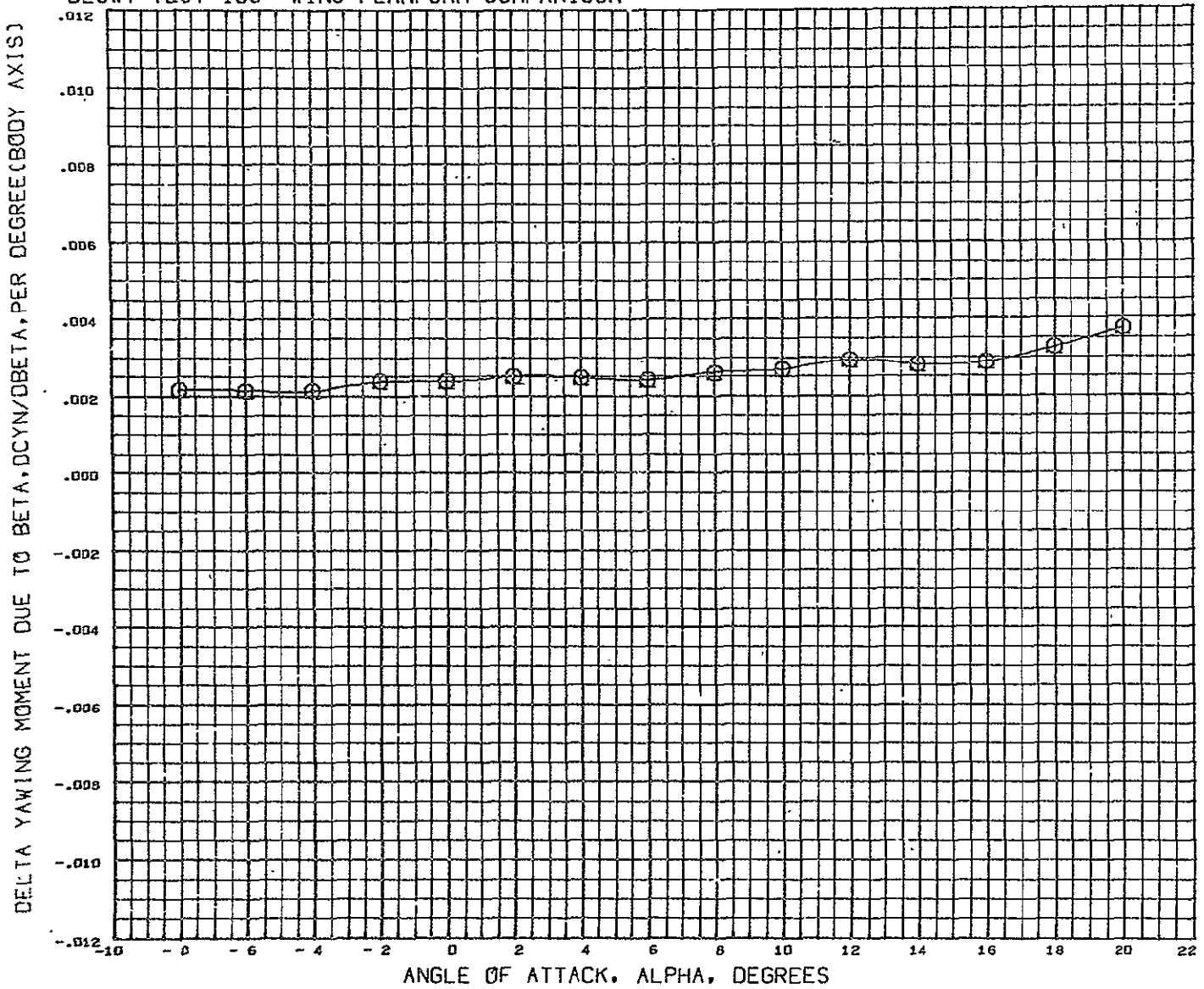

SYMBOL	MACH	PARAMETRIC VALUES				REFERENCE INFORMATION	
○	0.180	LOBE	0.000	ROPE	0.000	REFS	6168.0040 SQ. FT
		LINE	0.000	RINE	0.000	REFL	971.0004 IN.
						REFB	1040.0040 IN.
						XMRP	1266.0040 IN.
						YMRP	0.0000 IN.
						ZMRP	163.0004 IN.
						SCALE	100.0000 PERCENT

DATA HIST. CODE #P

DLSWT TEST 138- WING PLANFORM COMPARISON

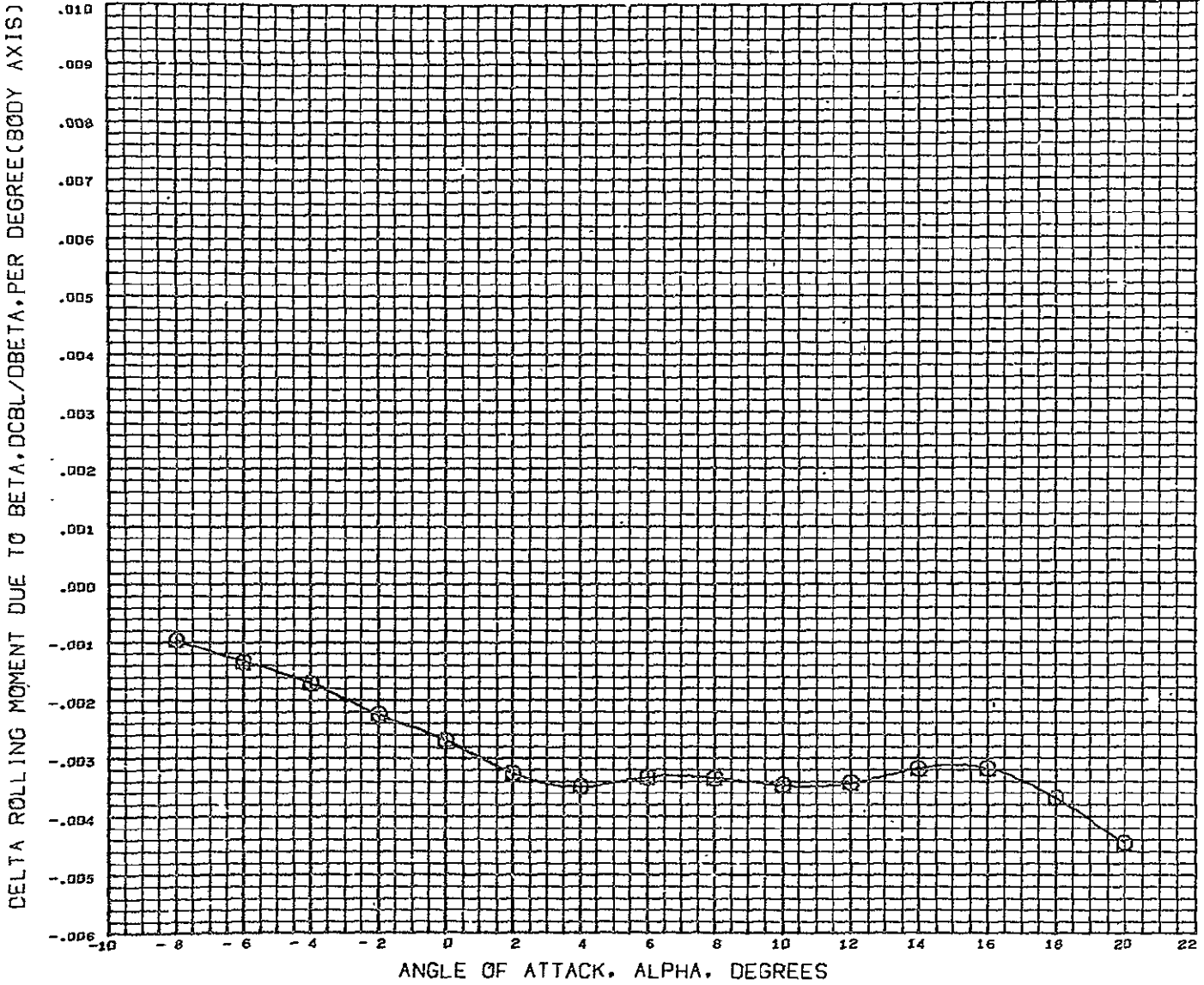

SYMBOL	MACH	PARAMETRIC VALUES			
○	0.120	LOBE	0.000	ROCE	0.000
		LINE	0.000	RINE	0.000

REFERENCE INFORMATION		
REFS	6168.0040	SQ. FT
REFL	971.0004	IN.
REFB	1040.0040	IN.
XMRP	1266.0040	IN.
YMRP	0.0000	IN.
ZMRP	163.0004	IN.
SCALE	100.0000	PERCENT

DATA HIST. CODE #F

DLSWT TEST 138- WING PLANFORM COMPARISON

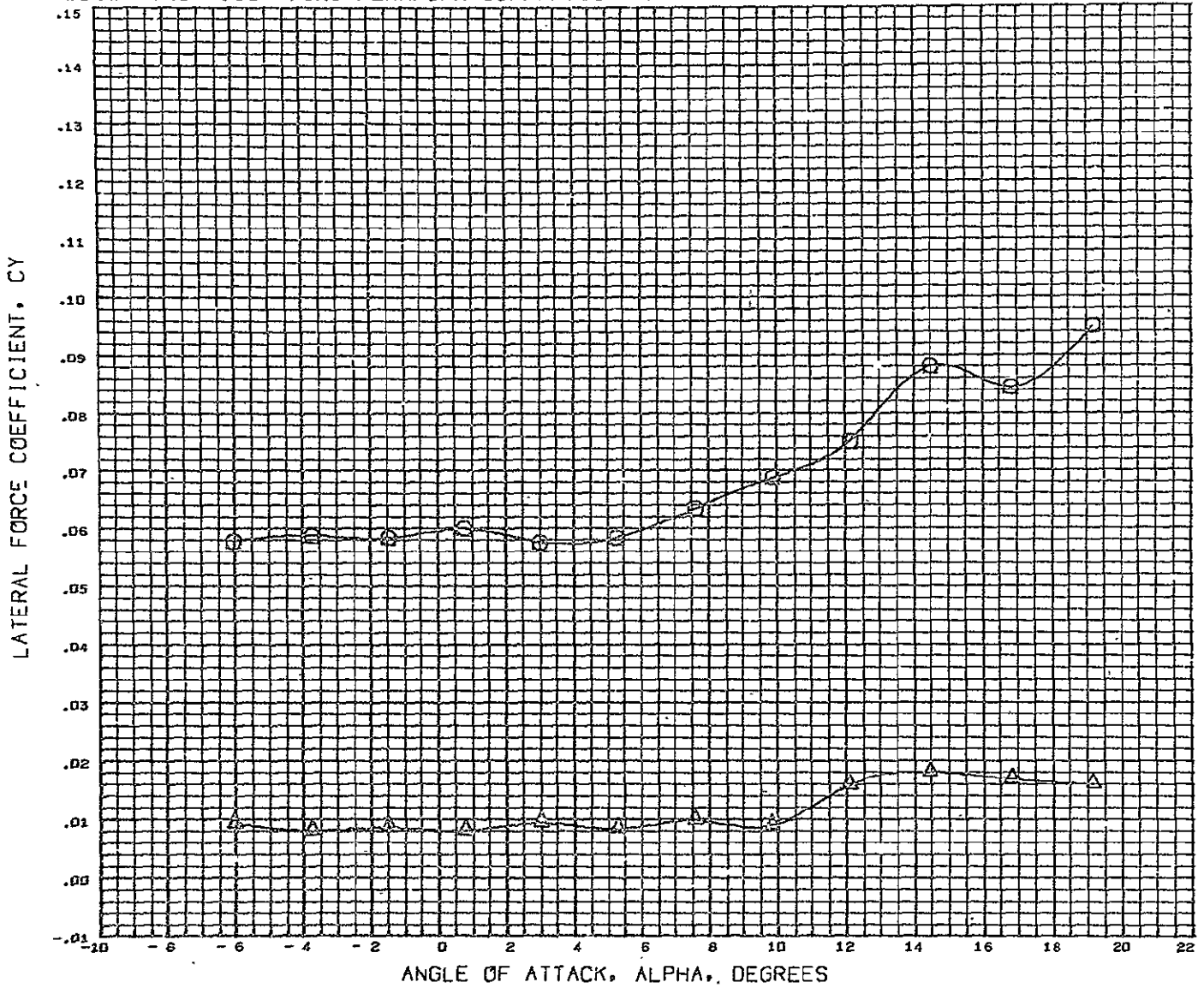

SYMBOL	BETA	PARAMETRIC VALUES			DATA SOURCE			REFERENCE INFORMATION				
○	2.900	<u>MACH</u>	2.100	LOBE	0.000	DATASET	BETA	DATASET	BETA	REFS	5171.0040	SQ. FT
△	2.000	<u>ROBE</u>	0.000	LINE	0.000	TCN017	- 2.900	TCN018	0.000	REFL	687.0004	IN.
		<u>RINE</u>	0.000							REFB	1444.0040	IN.
										XMRP	1266.0040	IN.
										YMRP	0.0000	IN.
										ZMRP	163.0004	IN.
										SCALE	100.0000	PERCNT

DATA HIST. CODE 7

DLSWT TEST 138- WING PLANFORM COMPARISON

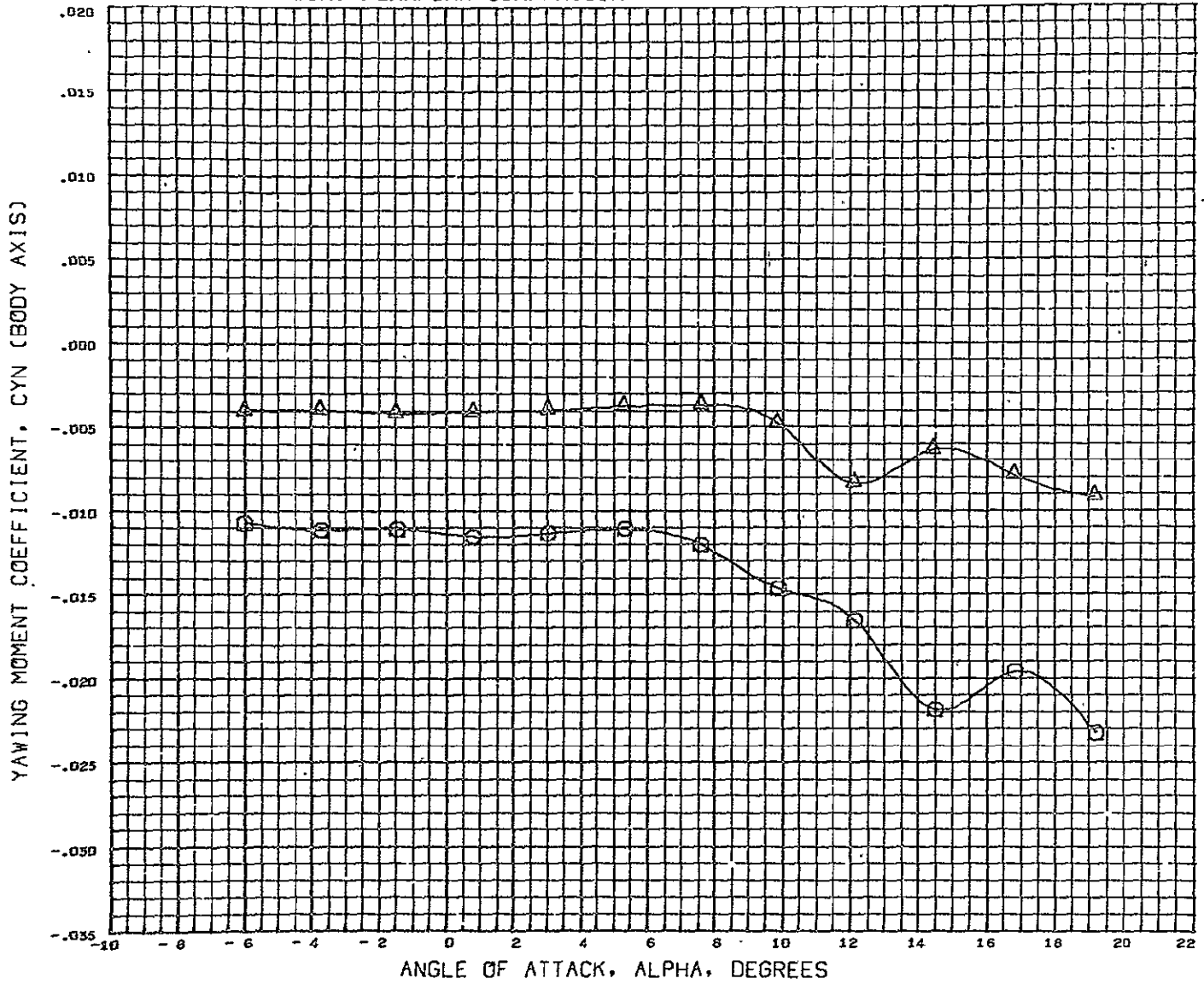

SYMBOL	BETA	MACH	PARAMETRIC VALUES	DATA SOURCE	DATA SOURCE	BETA	REFERENCE INFORMATION
○	2.900	0.100	LOBE	0.000	TCN017	2.900	REFS 5171.0040 SQ. FT
△	9.000	0.100	LINE	0.000	TCN016	9.000	REFL 687.0004 IN.
							REFB 1444.0040 IN.
							XMRP 1266.0040 IN.
							YMRP 0.0000 IN.
							ZMRP 163.0004 IN.
							SCALE 100.0000 PERCENT

DATA HIST. CODE T

DLSWT TEST 138- WING PLANFORM COMPARISON

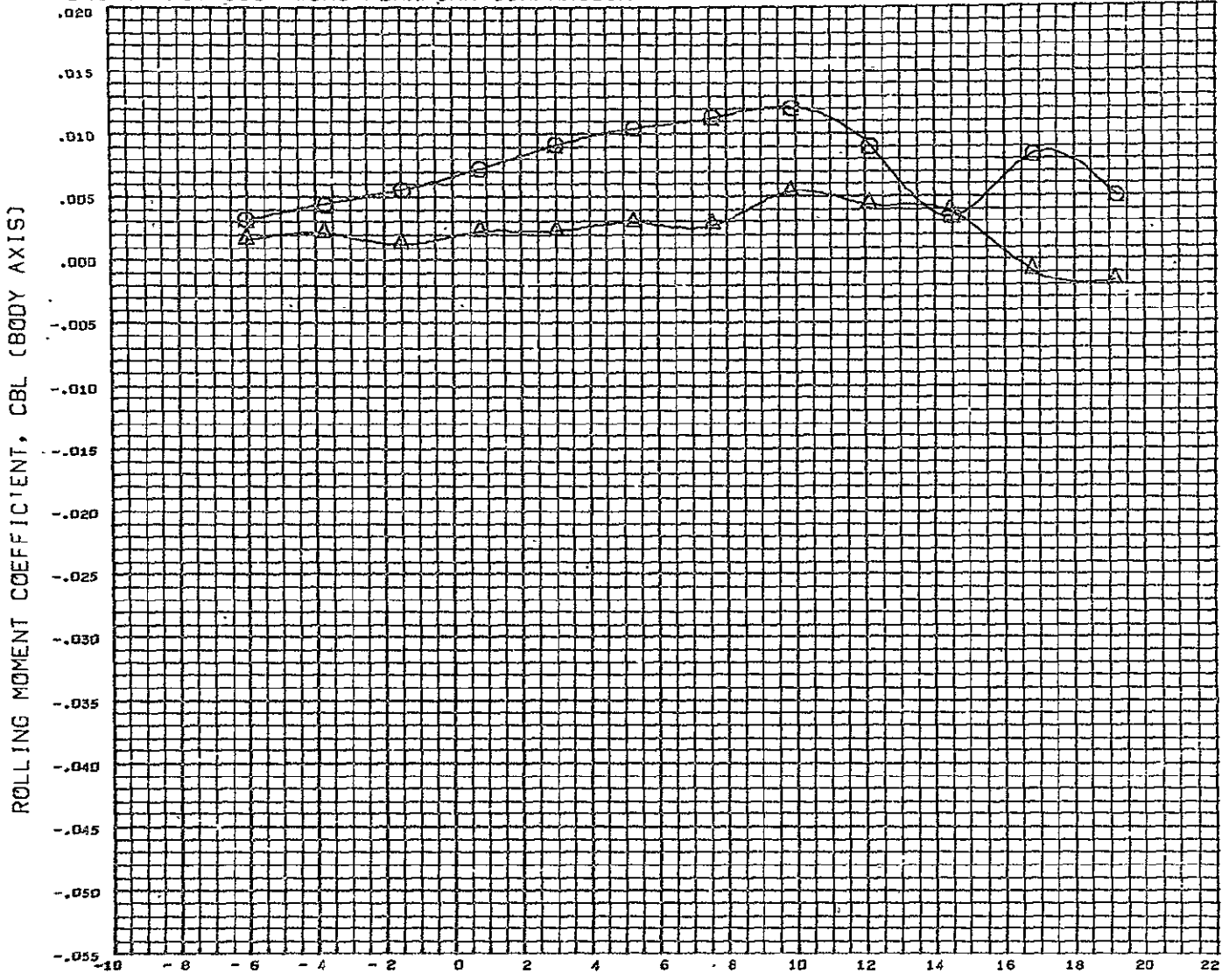

ANGLE OF ATTACK, ALPHA, DEGREES

SYMBOL	BETA	PARAMETRIC VALUES				DATA SOURCE				REFERENCE INFORMATION		
○	2.900	MACH	0.180	LOBE	0.000	DATASET	BETA	DATASET	BETA	REFS	5171.0040	SQ. FT
△	0.000	ROBE	0.000	LINE	0.000	TCN017	- 2.900	TCN018	0.000	REFL	687.0004	IN.
		PINE	0.000							REFB	1442.0040	IN.
										XMRP	1266.0040	IN.
										YMRP	0.0000	IN.
										ZMRP	163.0004	IN.
										SCALE	100.0000	PERCENT

DATA HIST. CODE T

DLSWT TEST 138- WING PLANFORM COMPARISON

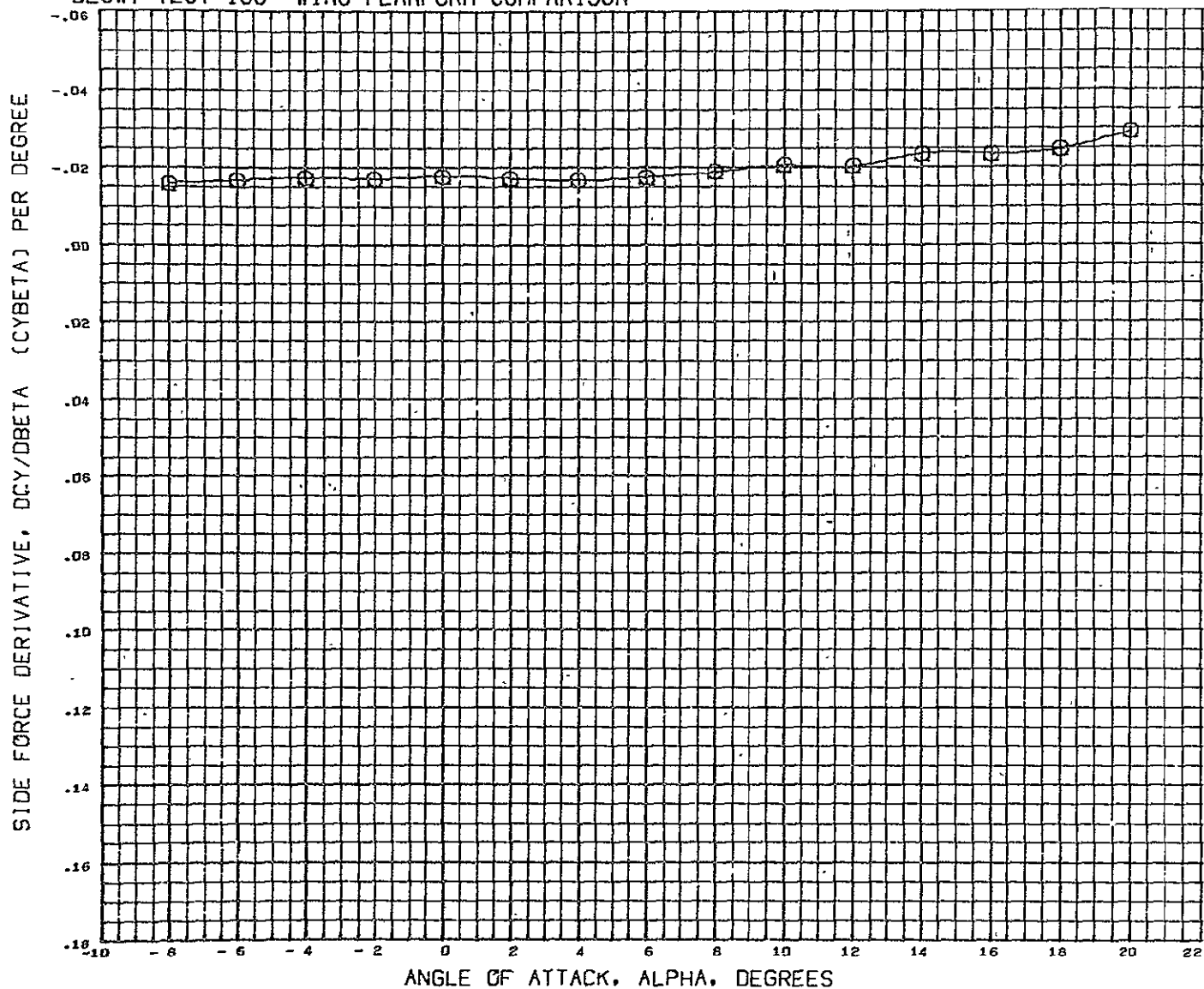

SYMBOL	MACH	PARAMETRIC VALUES			
○	0.180	LOBE	0.000	ROBE	0.000
		LINE	0.000	RINE	0.000

REFERENCE INFORMATION		
REFS	5171.0040	SQ. FT
REFL	687.0004	IN.
REFB	1444.0040	IN.
XMRP	1266.0040	IN.
YMRP	0.0000	IN.
ZMRP	163.0004	IN.
SCALE	100.0000	PERCNT

DATA HIST. CODE #P

DLSWT TEST 138- WING PLANFORM COMPARISON

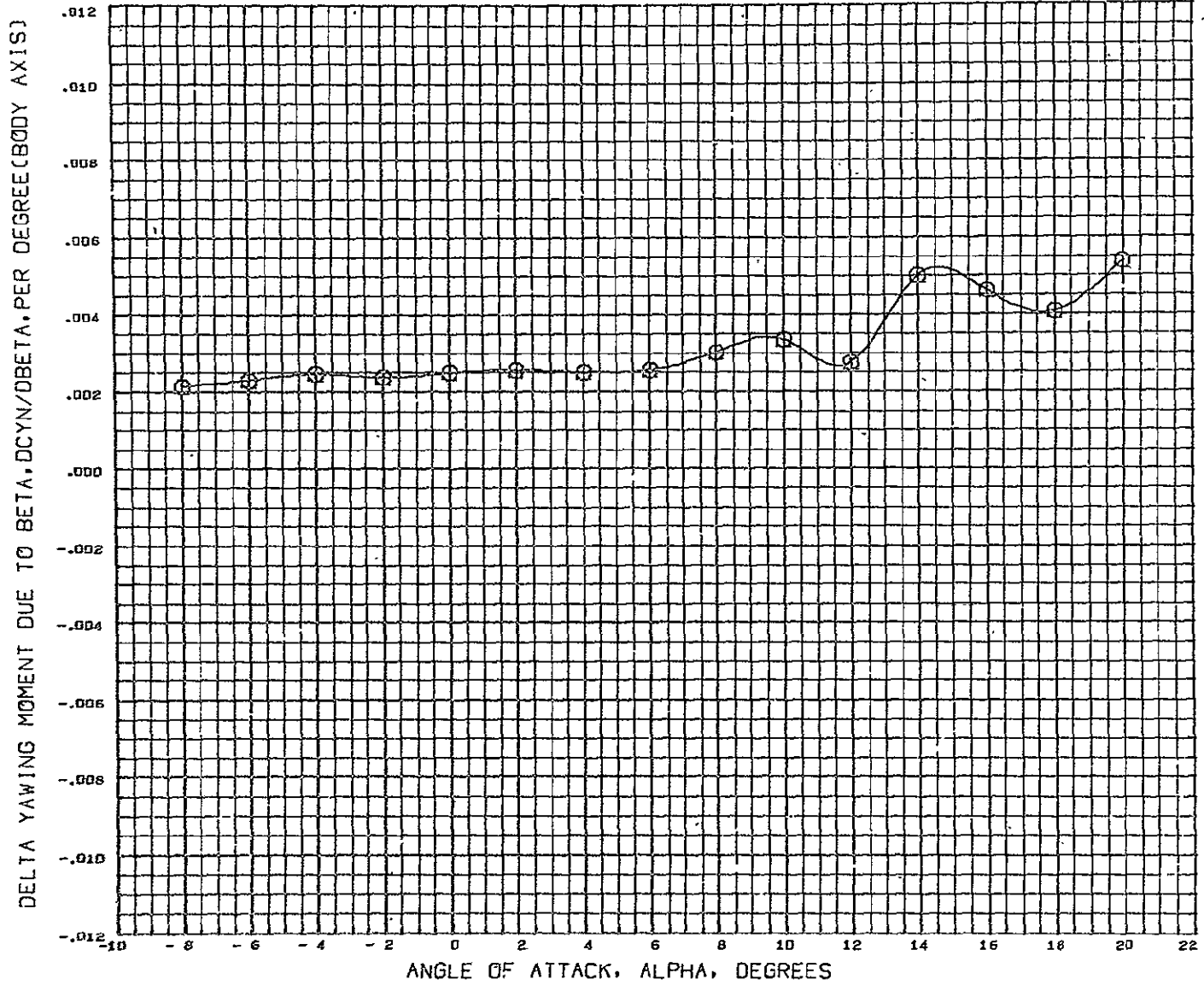

SYMBOL	PACH	PARAMETRIC VALUES				REFERENCE INFORMATION			
○	0.180	LOBE	0.000	ROBE	0.000	REFS	5171.0040	SQ. FT	
		LINE	0.000	RINE	0.000	REFL	687.0004	IN.	
						REFB	1444.0040	IN.	
						XMRP	1266.0040	IN.	
						YMRP	0.0000	IN.	
						ZMRP	163.0004	IN.	
						SCALE	100.0000	PERCENT	
DATA HIST. CODE		#F							

DLSWT TEST 138- WING PLANFORM COMPARISON

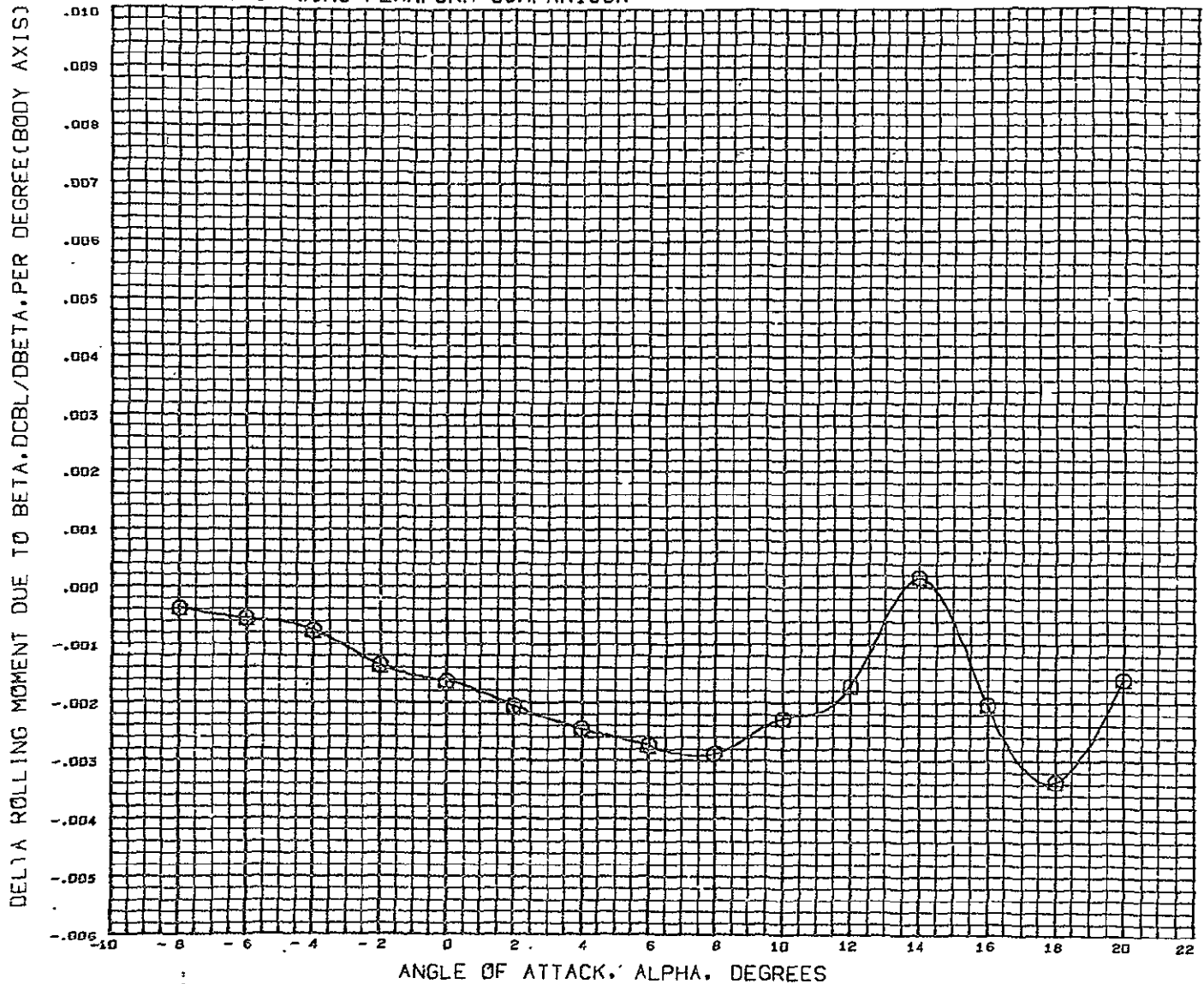

SYMBOL		MACH	PARAMETRIC VALUES			REFERENCE INFORMATION			
O		0.180	LOBE	0.000	ROBE	0.000	REFS	5171.0040	SQ. FT
			LINE	0.000	RINE	0.000	REFL	687.0004	IN.
							REFS	1444.0040	IN.
							XMRP	1266.0040	IN.
							YMRP	0.0000	IN.
							ZMRP	163.0004	IN.
							SCALE	100.0000	PERCNT

DATA HIST. CODE #F

DLSWT TEST 138- WING PLANFORM COMPARISON

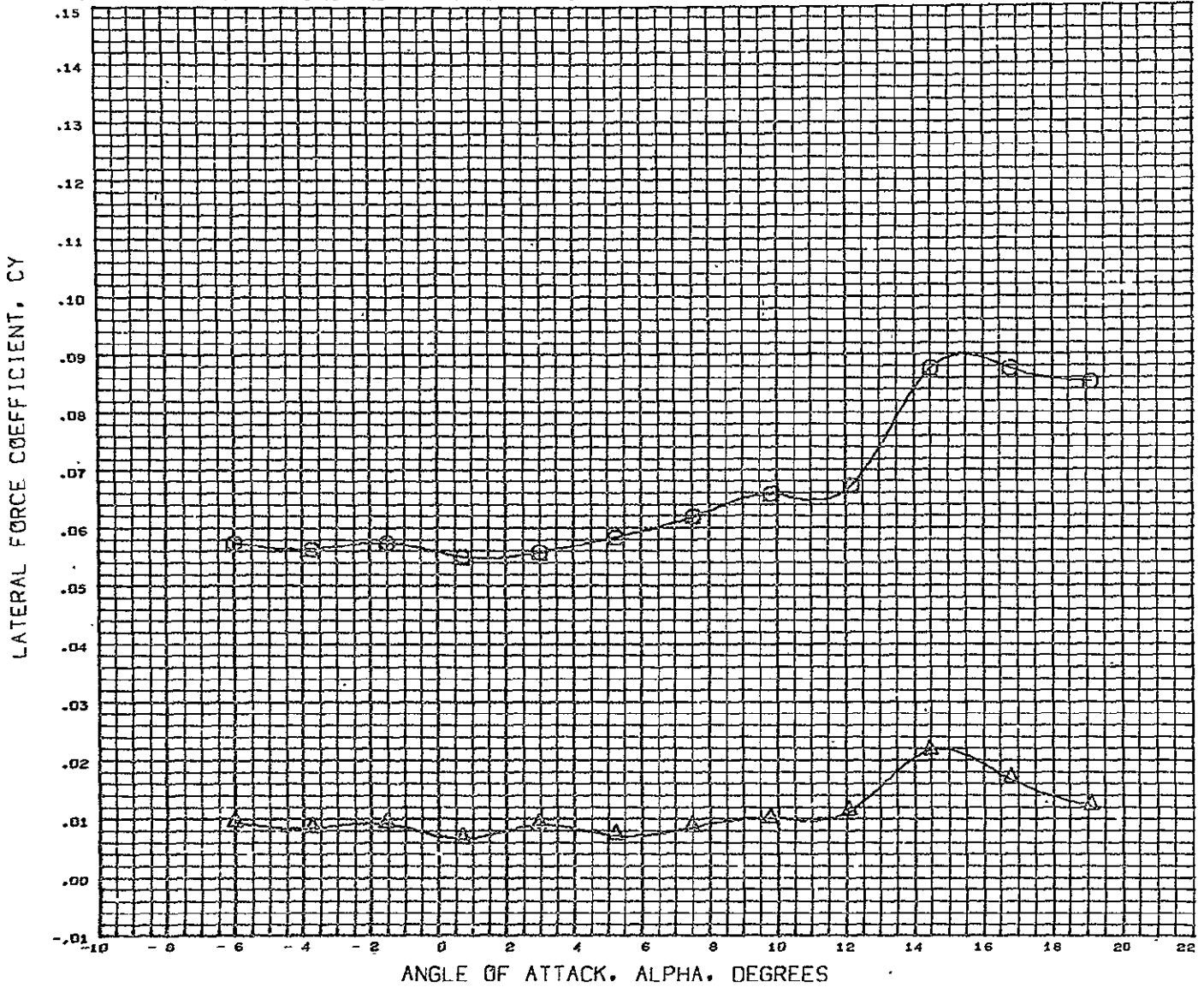

SYMBOL	BETA	PARAMETRIC VALUES				DATA SOURCE				REFERENCE INFORMATION		
○	2.999	MACH	0.100	LOPE	0.000	DATASET	BETA	DATASET	BETA	REFS	5057.0040	SQ.FT.
△	0.000	ROBE	0.000	LINE	0.000	TCN022	- 2.900	TCN023	0.000	REFL	701.0004	IN.
		R11E	0.000							REFB	1230.0040	IN.
										XMRP	1266.0040	IN.
										YMRP	0.0000	IN.
										ZMRP	163.0004	IN.
										SCALE	100.0000	PERCNT

DATA HIST. CODE T

DLSWT TEST 138- WING PLANFORM COMPARISON

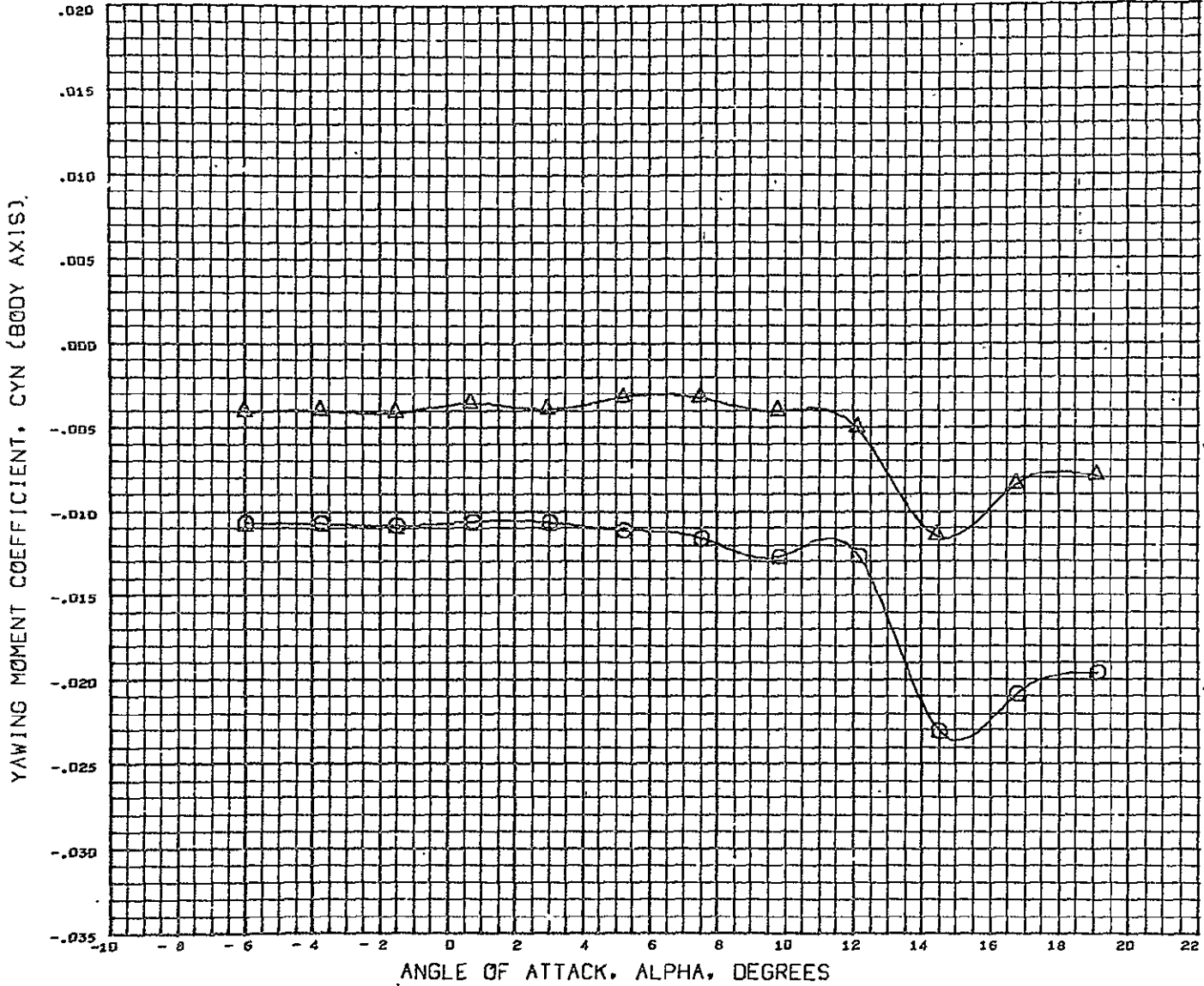

SYMBOL	BETA	PARAMETRIC VALUES				DATA SOURCE			REFERENCE INFORMATION			
○	2.950	MACH	0.180	LCBE	0.000	DATASET	BETA	DATASET	BETA	REFS	5057.0040	SQ. FT.
△	0.000	ROBE	0.000	LINE	0.000	TCN022	- 2.900	TCN023	0.000	REFL	701.0004	IN.
		RINE	0.000							REFB	1230.0040	IN.
										XMRP	1266.0040	IN.
										YMRP	0.0000	IN.
										ZMRP	163.0004	IN.
										SCALE	100.0000	%ERCNT

DATA HIST. CODE T

DLSWT TEST 138- WING PLANFORM COMPARISON

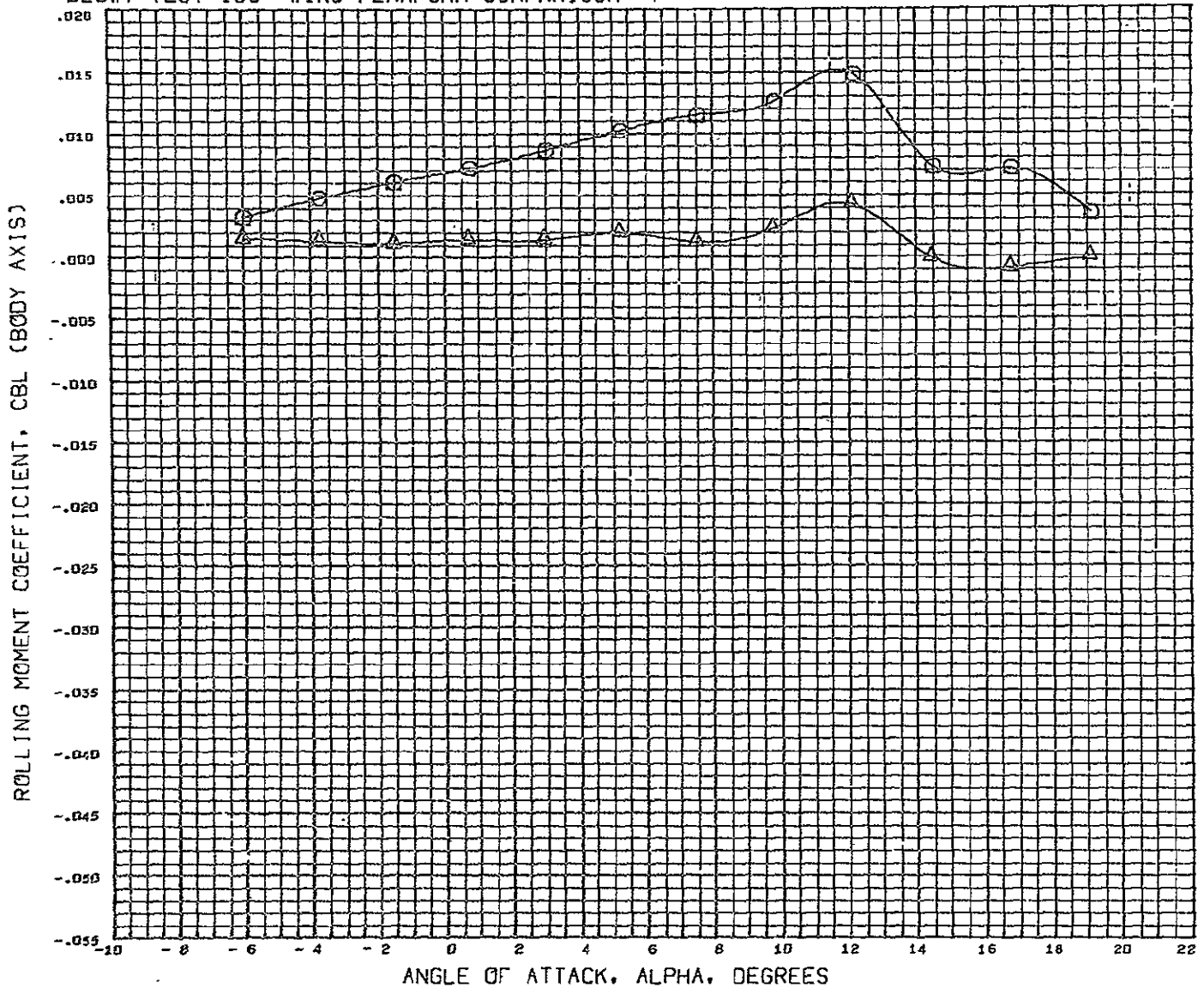

SYMBOL	BETA	PARAMETRIC VALUES			DATA SOURCE			REFERENCE INFORMATION				
○	2.350	MACH	0.180	LOBE	0.000	DATASET	BETA	DATASET	BETA	REFS	5057.0040	SQ.FT.
△	0.000	ROBE	0.000	LINE	0.000	TCN022	- 2.900	TCN023	0.000	REFL	701.0004	IN.
		RINE	0.000							REFB	1230.0040	IN.
										XNRP	1266.0040	IN.
										YMRP	0.0000	IN.
										ZMRP	163.0004	IN.
										SCALE	100.0000	PERCNT

DATA HIST. CODE I

DLSWT TEST 138- WING PLANFORM COMPARISON

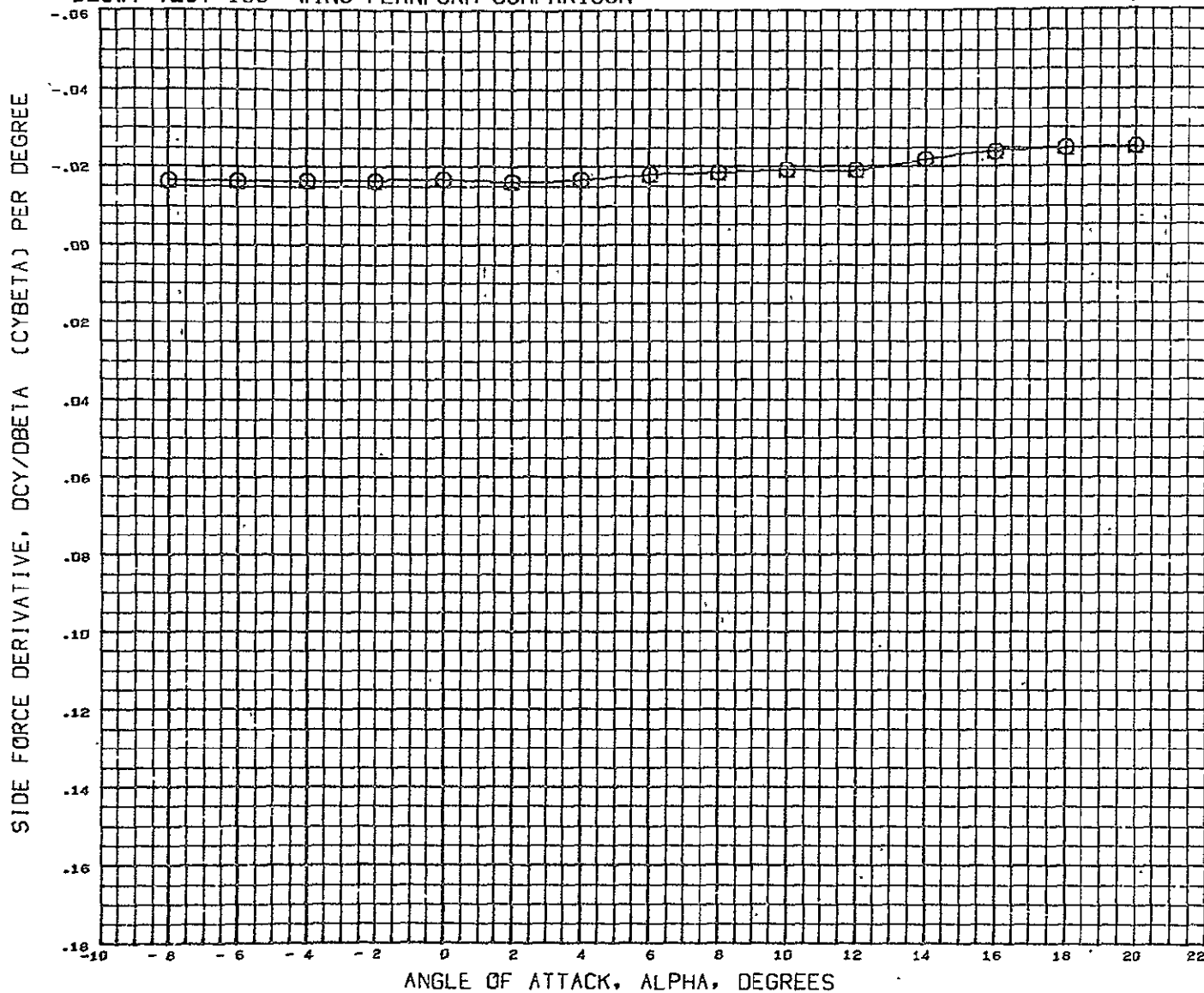

SYMBOL	MACH	PARAMETRIC VALUES			
○	0.180	LOBE	0.000	ROBE	0.000
		LINE	0.000	RINE	0.000

REFERENCE INFORMATION		
REFS	5057.0040	SQ.FT.
REFL	701.0004	IN.
REFD	1230.0040	IN.
XMRP	1266.0040	IN.
YMRP	0.0000	IN.
ZMRP	163.0004	IN.
SCALE	100.0000	PERCNT

DATA HIST. CODE #P

DLSWT TEST 138- WING PLANFORM COMPARISON

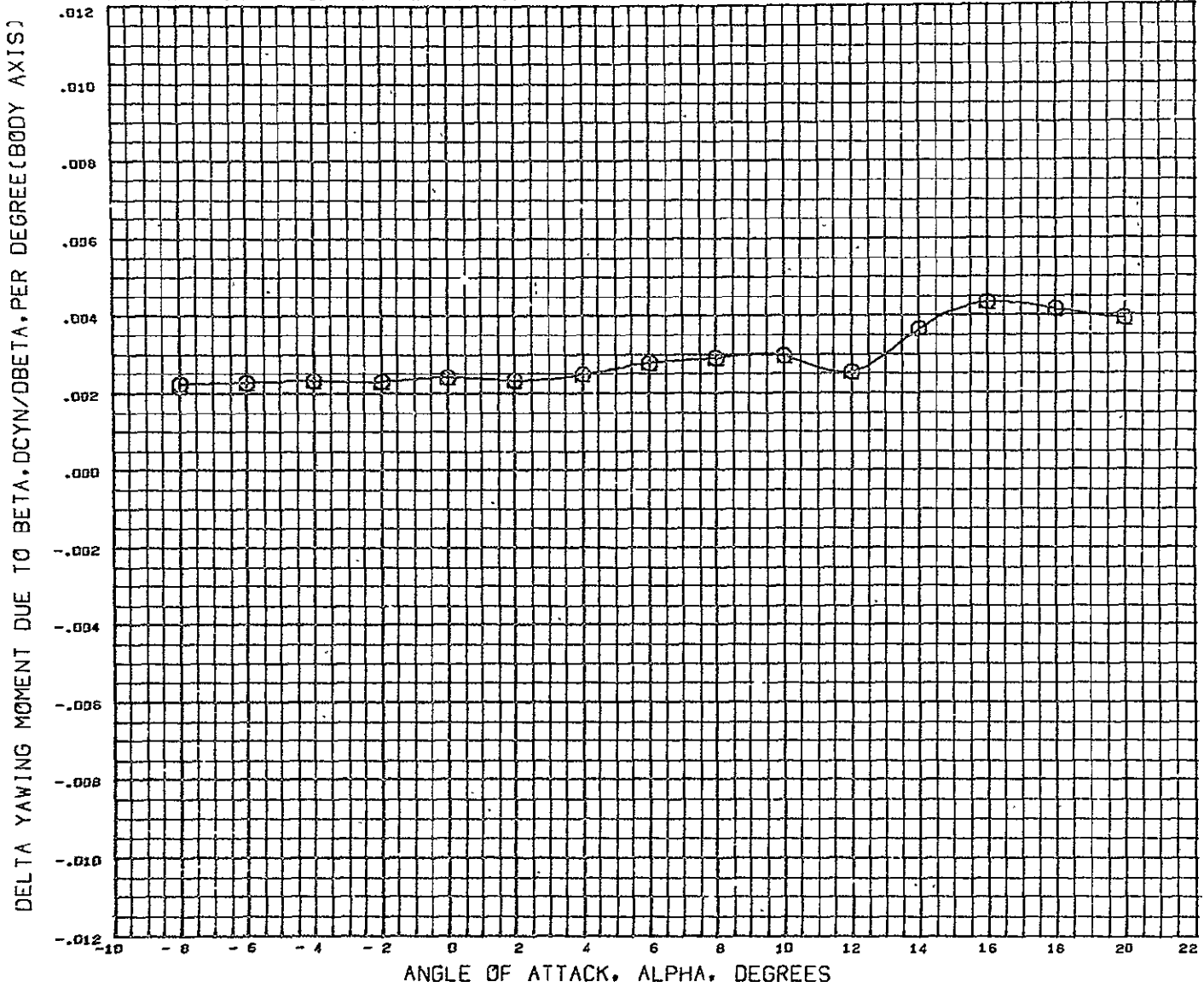

SYMBOL	KACH	PARAMETRIC VALUES	REFERENCE INFORMATION
○	0.180	LOBE 0.000 ROBE 0.000 LINE 0.000 RTNE 0.000	REFS 5057.0040 SQ.FT. REFL 701.0004 IN. REFB 1250.0043 IN. XMRP 1266.0040 IN. YMRP 0.0000 IN. ZMRP 163.0004 IN. SCALE 100.0000 PERCNT

DATA HIST. CODE #P

DLSWT TEST 138- WING PLANFORM COMPARISON

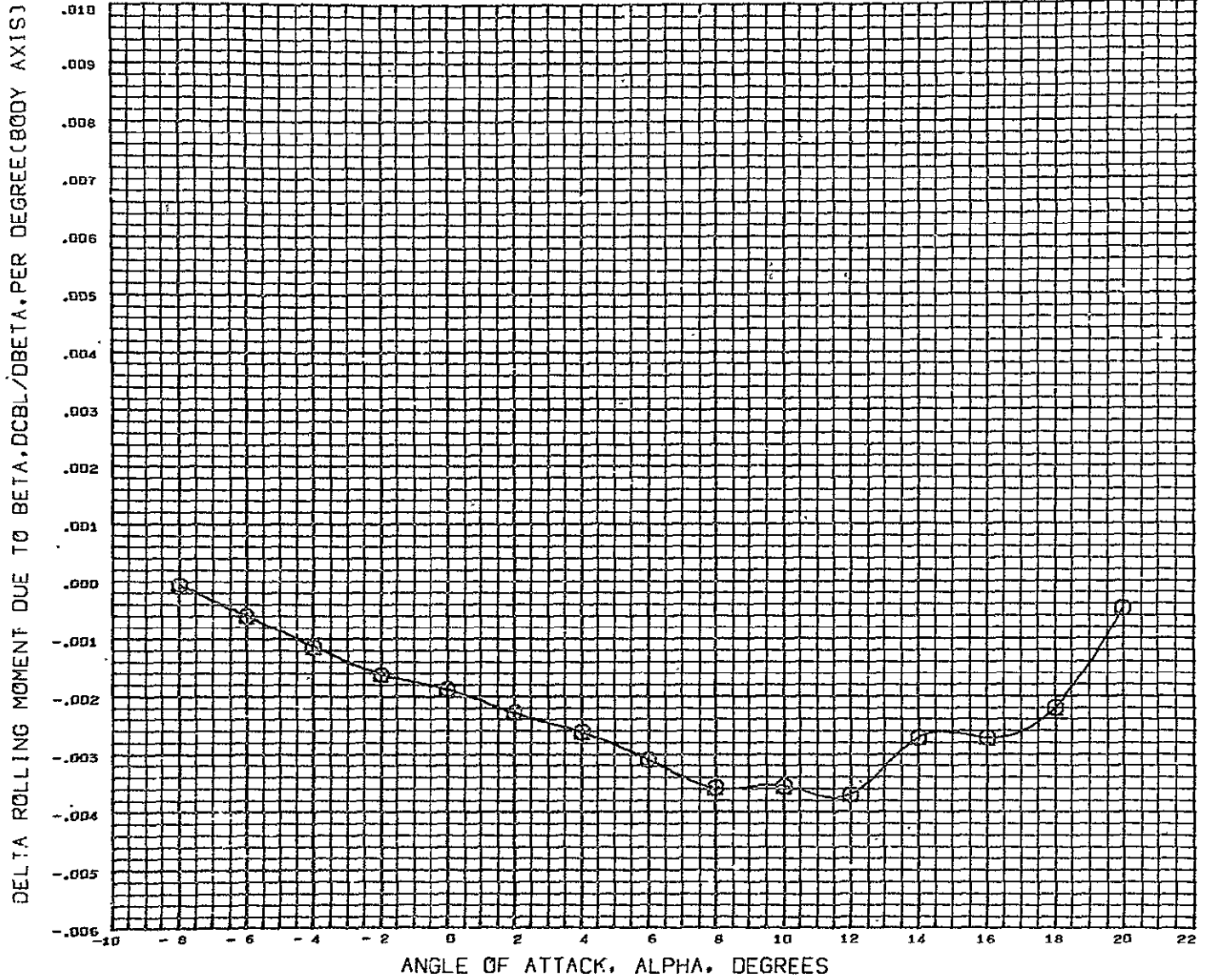

SYMBOL	MACH	PARAMETRIC VALUES			REFERENCE INFORMATION			
○	0.180	LOBE	0.000	ROBE	0.000	REFS	5057.0040	SQ.FT.
		LINE	0.000	RINE	0.000	REFL	701.0004	IN.
						REFB	1230.0040	IN.
						XMRP	1266.0040	IN.
						YMRP	0.0000	IN.
						ZMRP	163.0004	IN.
						SCALE	100.0000	PERCNT

DATA HIST. CODE #F

DLSWT TEST 138- WING PLANFORM COMPARISON

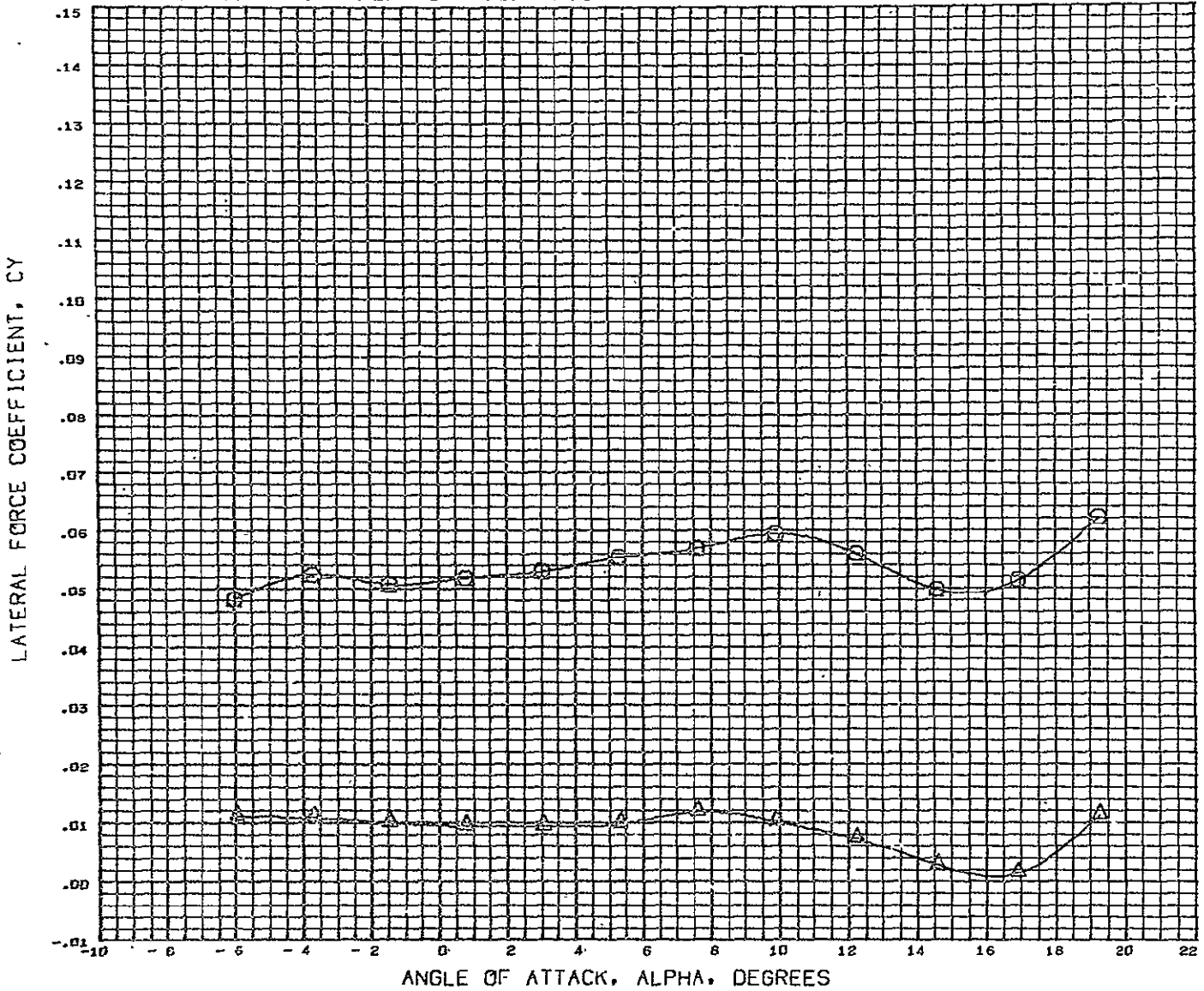

SYMBOL	BETA	PARAMETRIC VALUES				DATA SOURCE				REFERENCE INFORMATION		
○	- 2.900	<u>HACH</u>	0.180	LOBE	0.000	TCN026	BETA	TCN025	0.000	REFS	5424.0040	SQ. FT
△	0.000	ROBE	0.000	LINE	0.000	TCN026	- 2.900	TCN025	0.000	REFL	691.9004	IN.
		RIAE	0.000							REFB	1230.0040	IN.
										XMRP	1266.0040	IN.
										YMRP	0.0000	IN.
										ZMRP	163.0004	IN.
										SCALE	100.0000	PERCENT

DATA HIST. CODE T

DLSWT TEST 138- WING PLANFORM COMPARISON

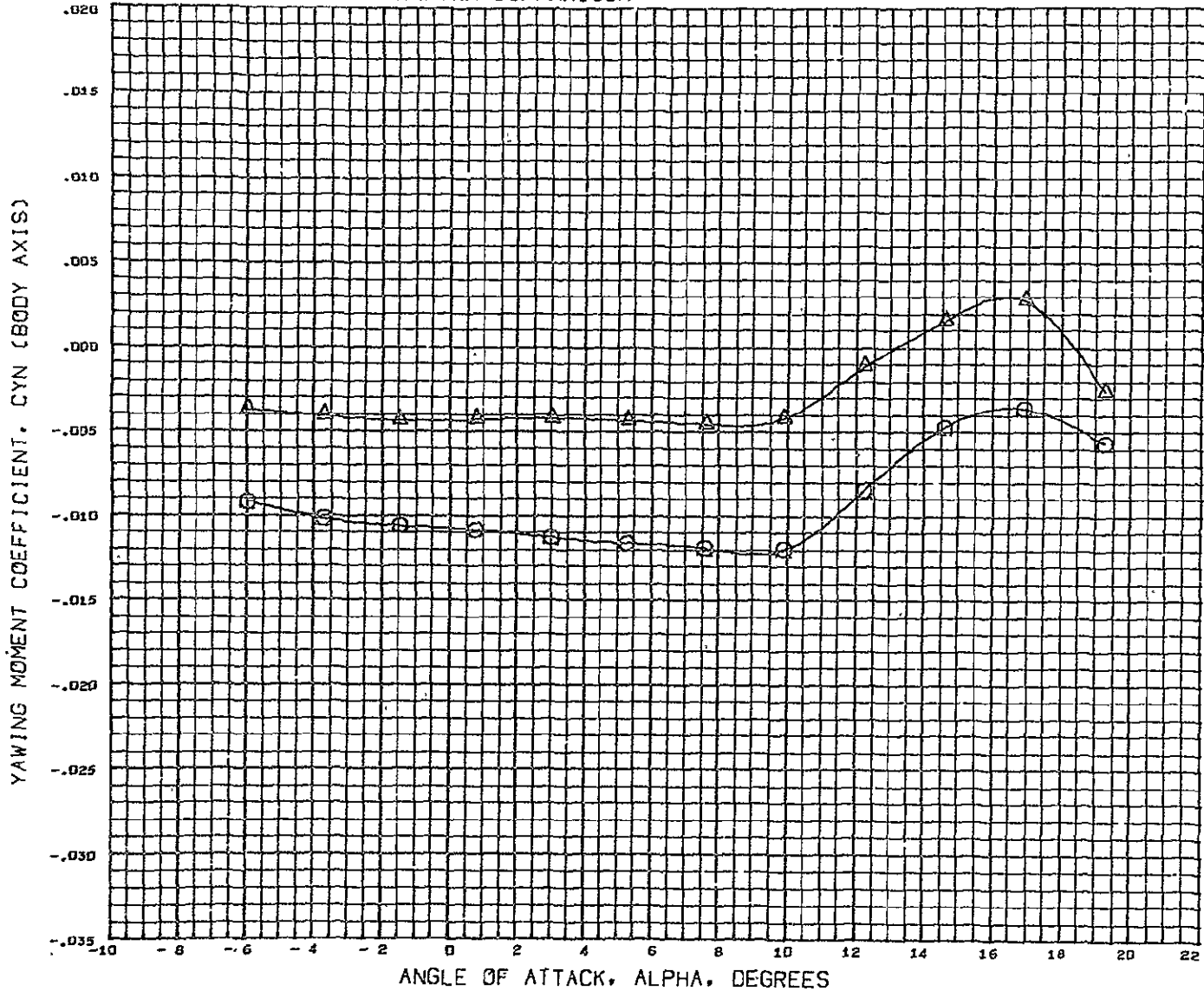

SYMBOL	BETA	PARAMETRIC VALUES				DATA SOURCE			REFERENCE INFORMATION			
○	2.900	MACH	5.180	LOPE	0.000	DATASET	BETA	DATASET	BETA	REFS	5424.0040	SQ. FT
△	0.000	ROBE	0.000	LINE	0.000	TCN026	- 2.900	TCN025	0.000	REFL	691.0004	IN.
		RINE	0.000							REFB	1230.0040	IN.
										XMRP	1266.0040	IN.
										YMRP	0.0000	IN.
										ZMRP	163.0004	IN.
										SCALE	100.0000	PERCENT

DATA HIST. CODE T

DLSWT TEST 138- WING PLANFORM COMPARISON

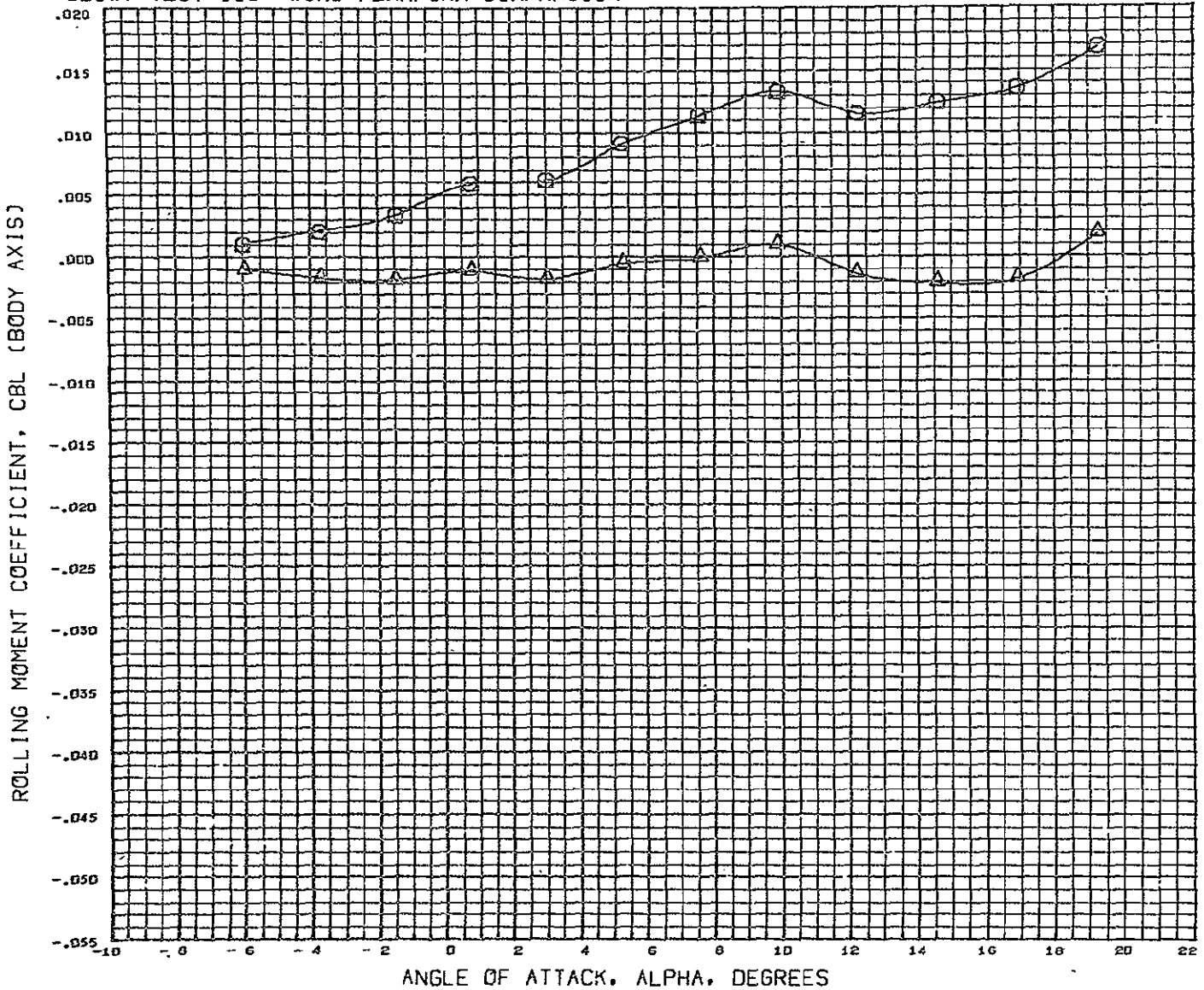

SYMBOL	BETA	PARAMETRIC VALUES			DATA SOURCE				REFERENCE INFORMATION			
○	2.955	MACH	0.180	LOBE	0.000	DATASET	BETA	DATASET	BETA	REFS	5424.0040	SQ. FT
△	0.555	ROBE	0.000	LINE	0.000	TCN026	- 2.955	TCN025	0.000	REFL	691.0004	IN.
		RINE	0.555							REFB	1230.0040	IN.
										XMRP	1266.0040	IN.
										YMRP	0.0000	IN.
										ZMRP	163.0004	IN.
										SCALE	100.0000	PERCENT

DATA HIST. CODE T

DLSWT TEST 138- WING PLANFORM COMPARISON

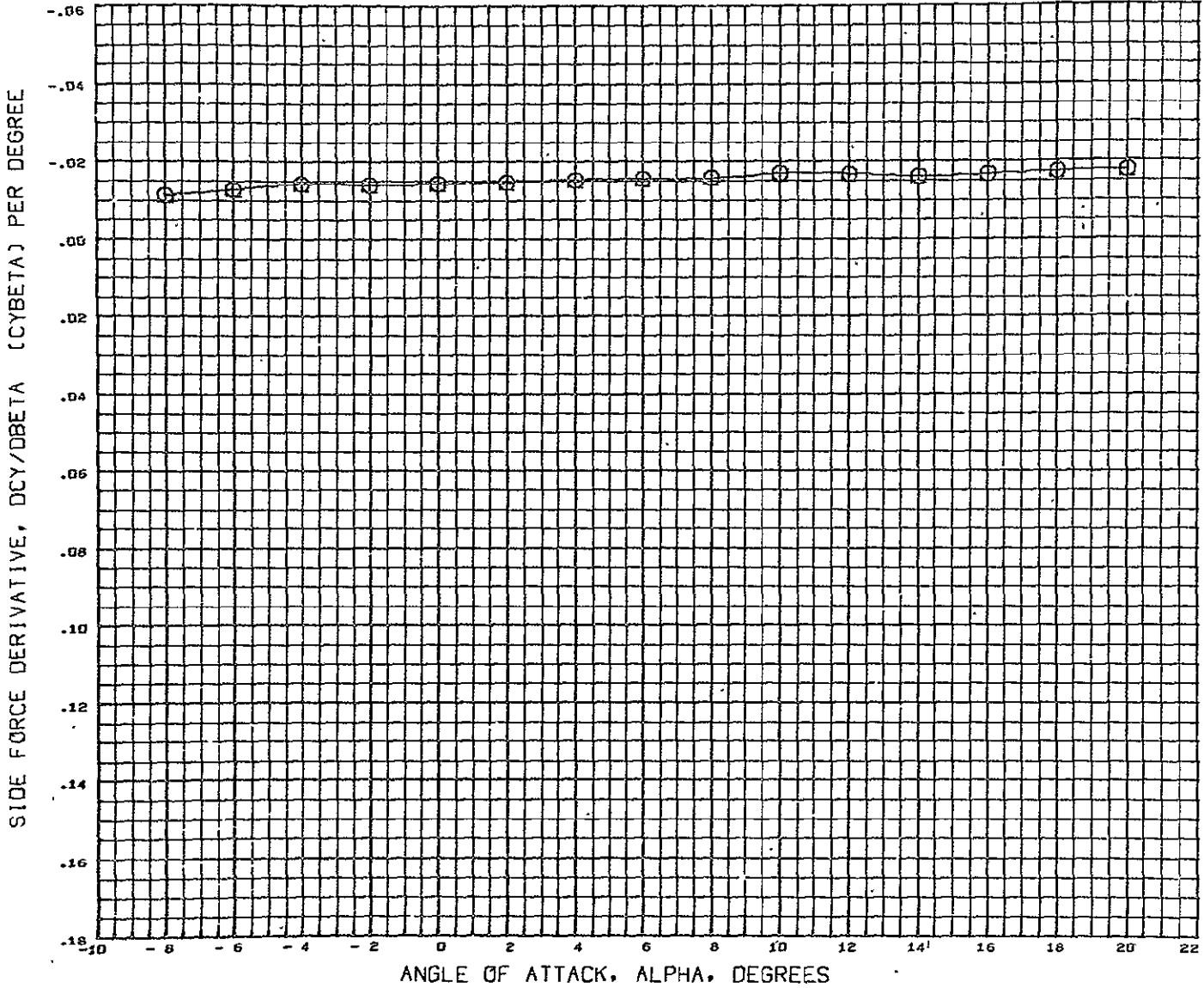

SYMBOL	MACH	PARAMETRIC VALUES			REFERENCE INFORMATION			
○	0.180	LCBE	0.000	ROBE	0.000	REFS	5424.0040	Sq. FT
		LINE	0.000	RILE	0.000	REFL	691.0004	IN.
						REFB	1230.0040	IN.
						XMRP	1266.0040	IN.
						YMRP	0.0000	IN.
						ZMRP	163.0004	IN.
						SCALE	100.0000	PERCENT

DATA HIST. CODE #P

DLSWT TEST 138- WING PLANFORM COMPARISON

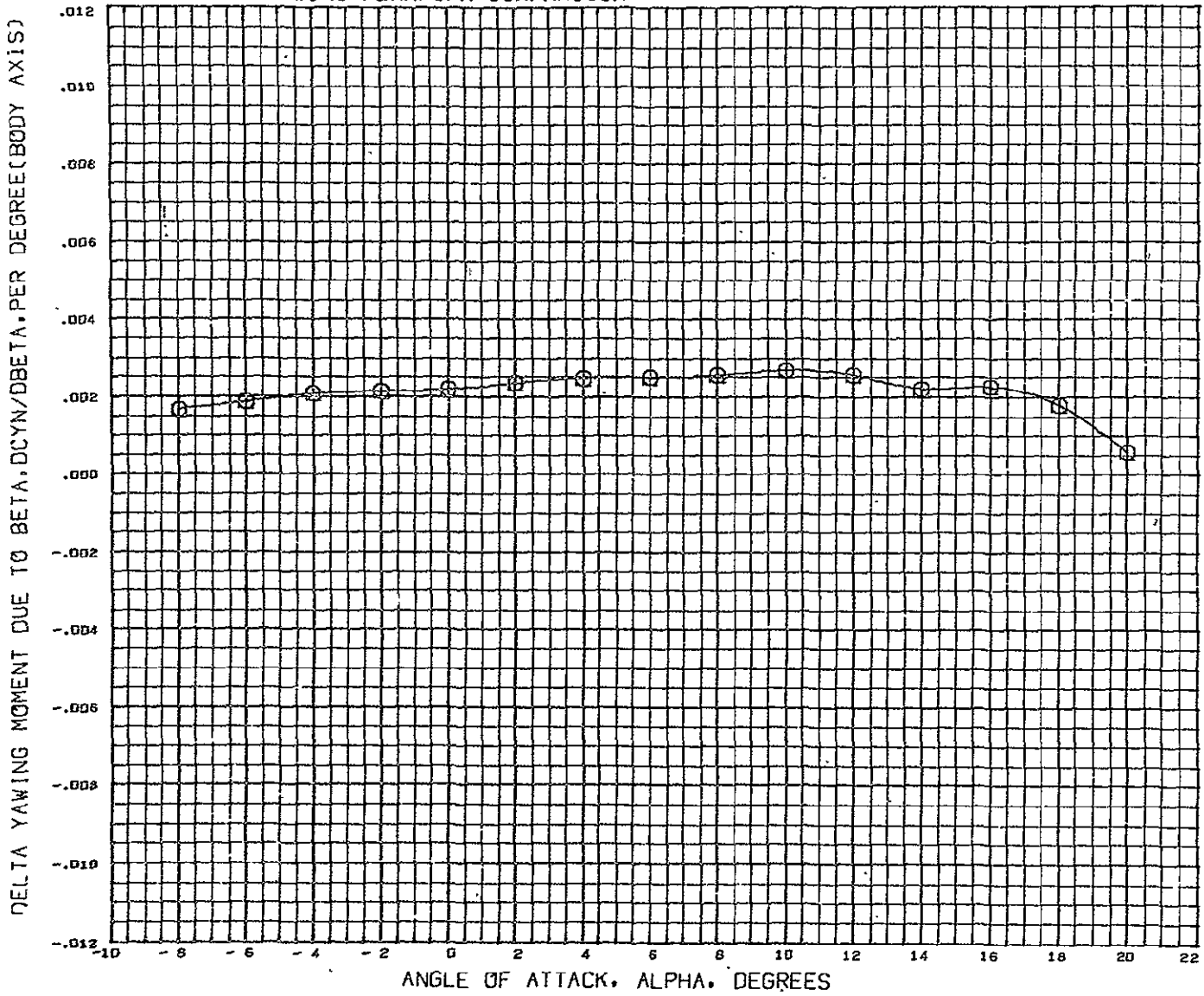

SYMBOL	MACH	PARAMETRIC VALUES			
○	0.185	LOBE	0.000	ROBE	0.000
		LINE	0.000	RINE	0.000

REFERENCE INFORMATION	
REFS	5424.0040 SQ. FT
REFL	691.0004 IN.
REFD	1230.0040 IN.
XMRP	1266.0040 IN.
YMRP	0.0000 IN.
ZMRP	163.0004 IN.
SCALE	100.0000 PERCENT

DATA HIST. CODE #P



DLSWT TEST 138- WING PLANFORM COMPARISON

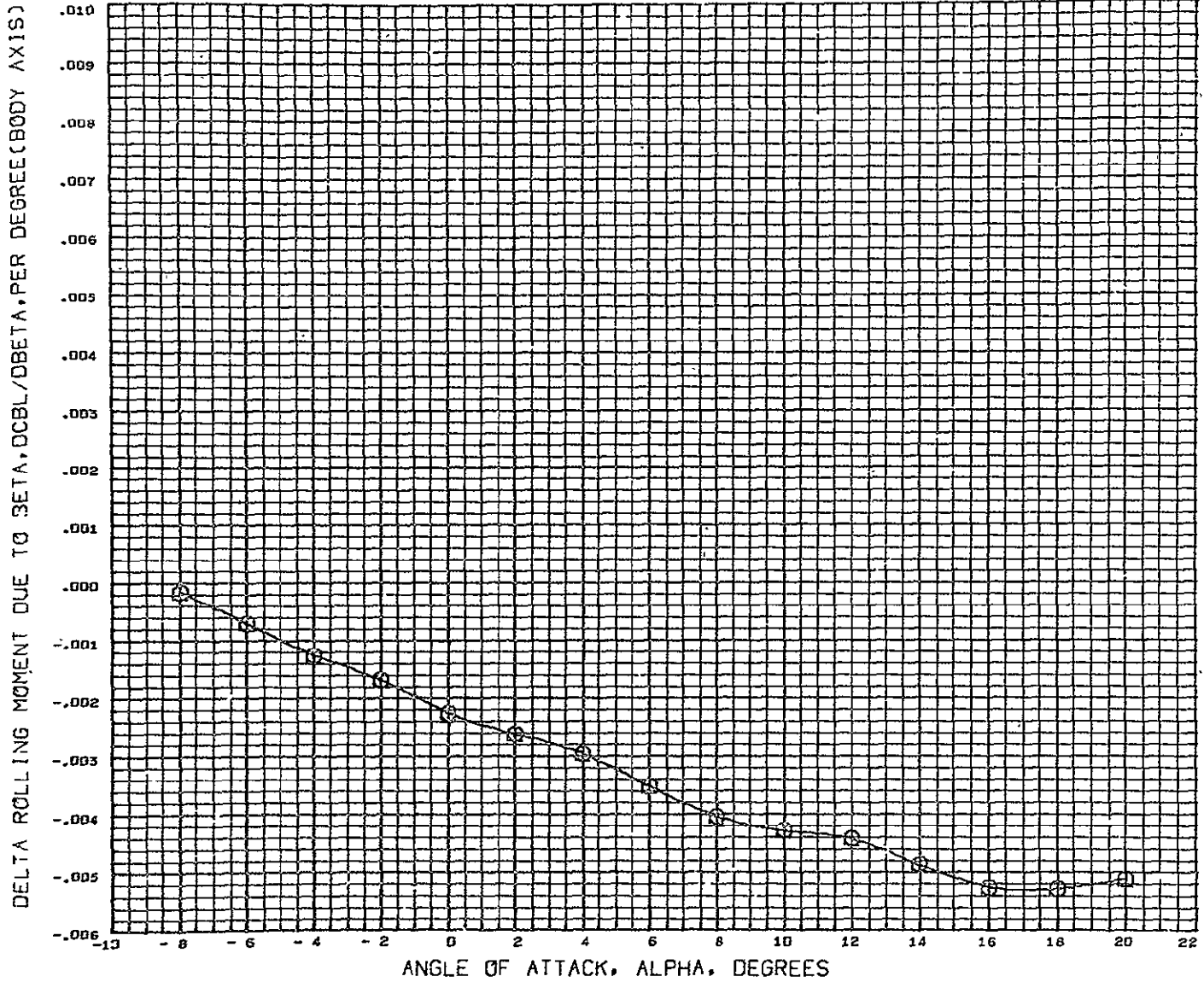

SYMBOL	MACH	PARAMETRIC VALUES			
○	0.180	LODE 0.000	ROBE 0.000		
		LINE 0.000	RINE 0.000		

REFERENCE INFORMATION		
REFS	5424.0040	SQ. FT
REFL	691.0004	IN.
REFB	1230.0040	IN.
XMRP	1266.0040	IN.
YMRP	0.0000	IN.
ZMRP	163.0004	IN.
SCALE	100.0000	PERCNT

DATA HIST. CODE *F

DLSWT TEST 138- WING TWIST EFFECT

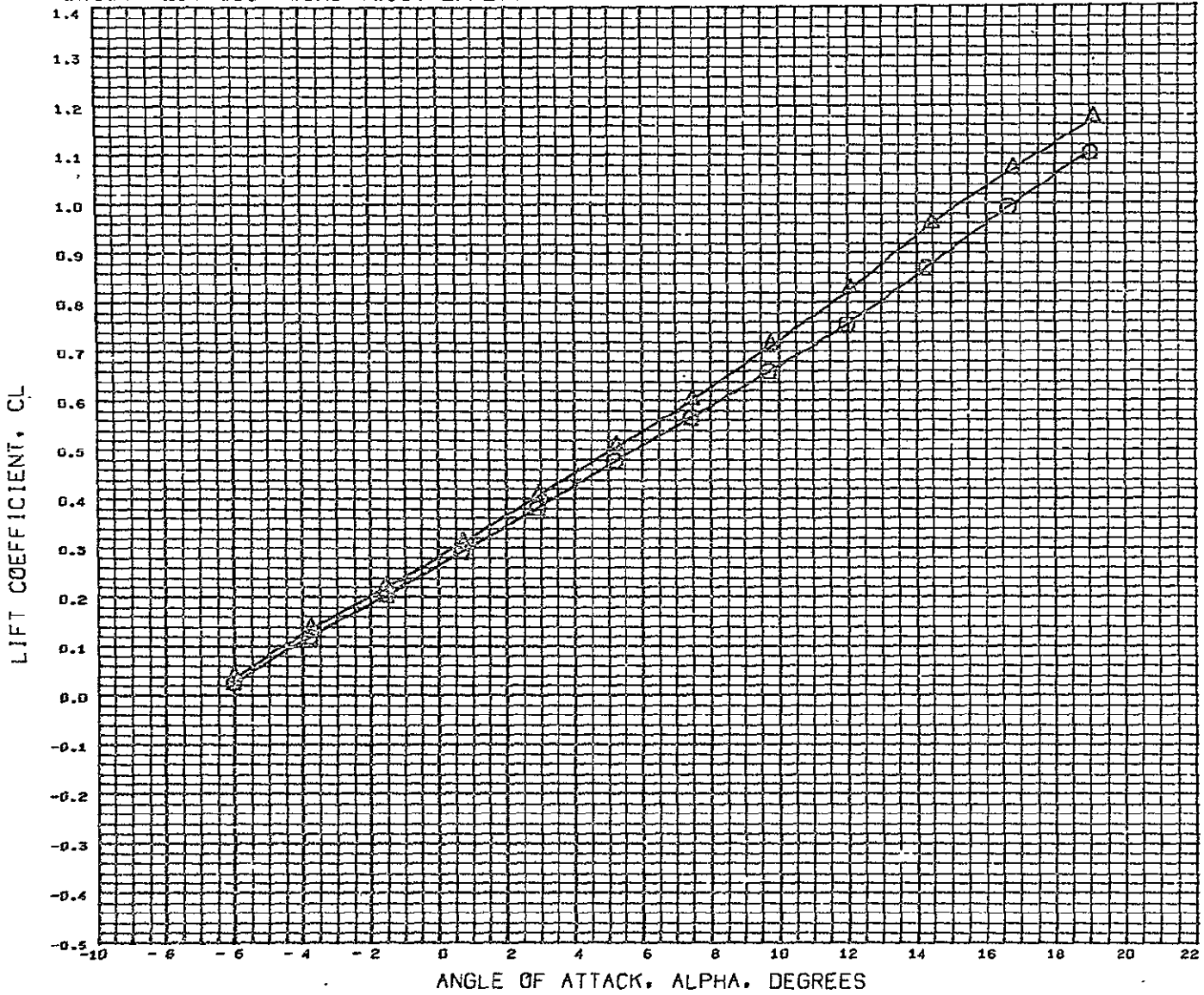

DATA SET SYMBOL CONFIGURATION DESCRIPTION
 (RCN020) Ⓞ DLSWT 138 5.0133 SC. GENERIC HCR 02 B1A46V4
 (RCN023) ⓤ DLSWT 138 5.0133 SC. GENERIC HCR 02 B1A46V-

REFERENCE INFORMATION
 REFS 5057.0040 SQ.FT.
 REFL 701.0004 IN.
 REFB 1230.0040 IN.
 XNRF 1266.0040 IN.
 YNRF 0.0000 IN.
 ZNRF 163.0004 IN.
 SCALE 100.0000 PERCENT

MACH 0.180

DLSWT TEST 138- WING TWIST EFFECT

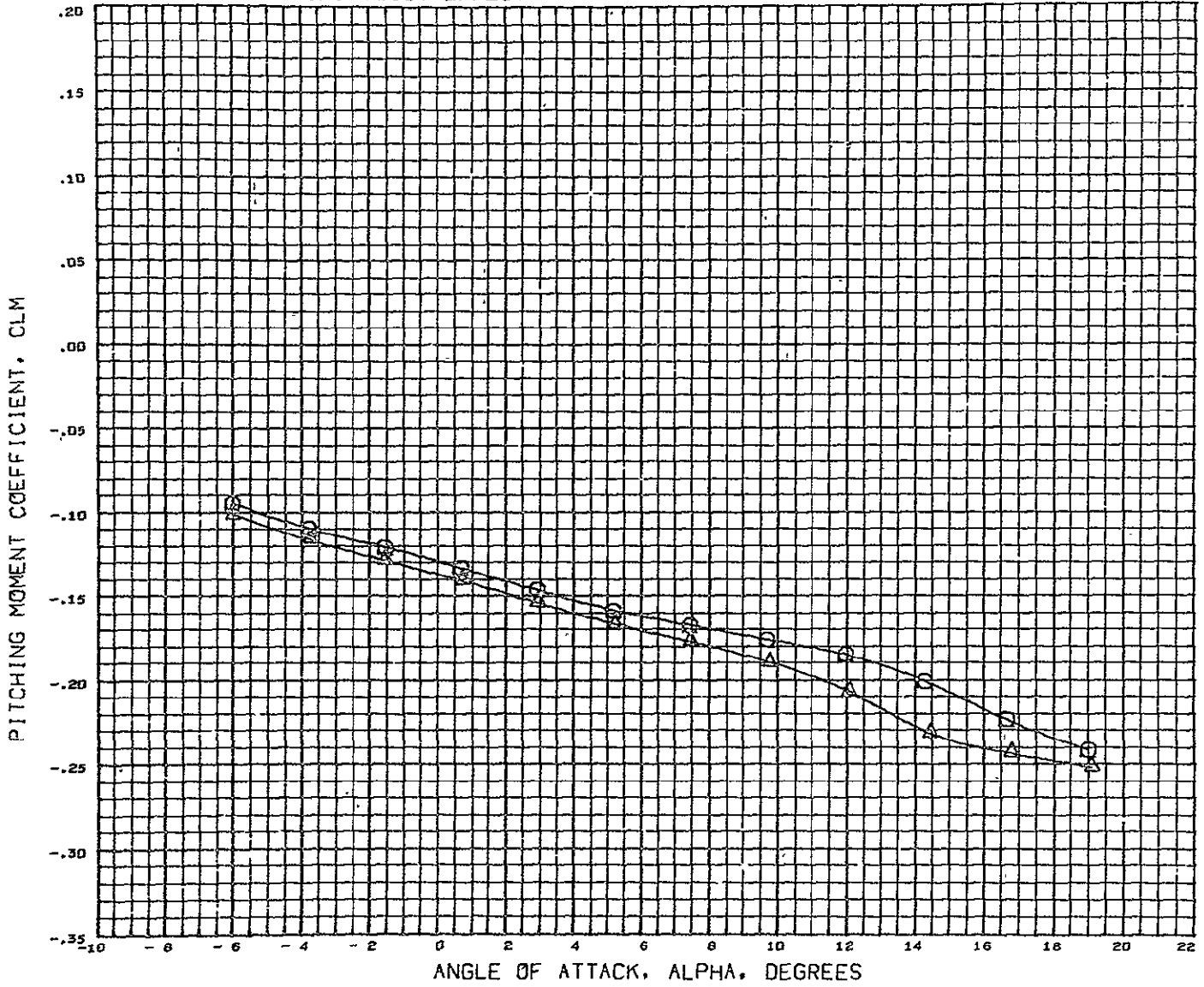

DATA SET SYMBOL CONFIGURATION DESCRIPTION
 (RCND20) ○ DLSWT 138 0.0133 SC. GENERIC HCR 02 B1AW6V4
 (RCND23) △ DLSWT 138 0.0133 SC. GENERIC HCR 02 B1AW6V4

REFERENCE INFORMATION
 REFS 5057.0040 SQ.FT.
 REFL 701.0004 IN.
 REFB 1230.0040 IN.
 XMRP 1266.0040 IN.
 YMRP 0.0000 IN.
 ZMRP 163.0004 IN.
 SCALE 100.0000 PFCNT

MACH 0.185

DLSWT TEST 138- WING TWIST EFFECT

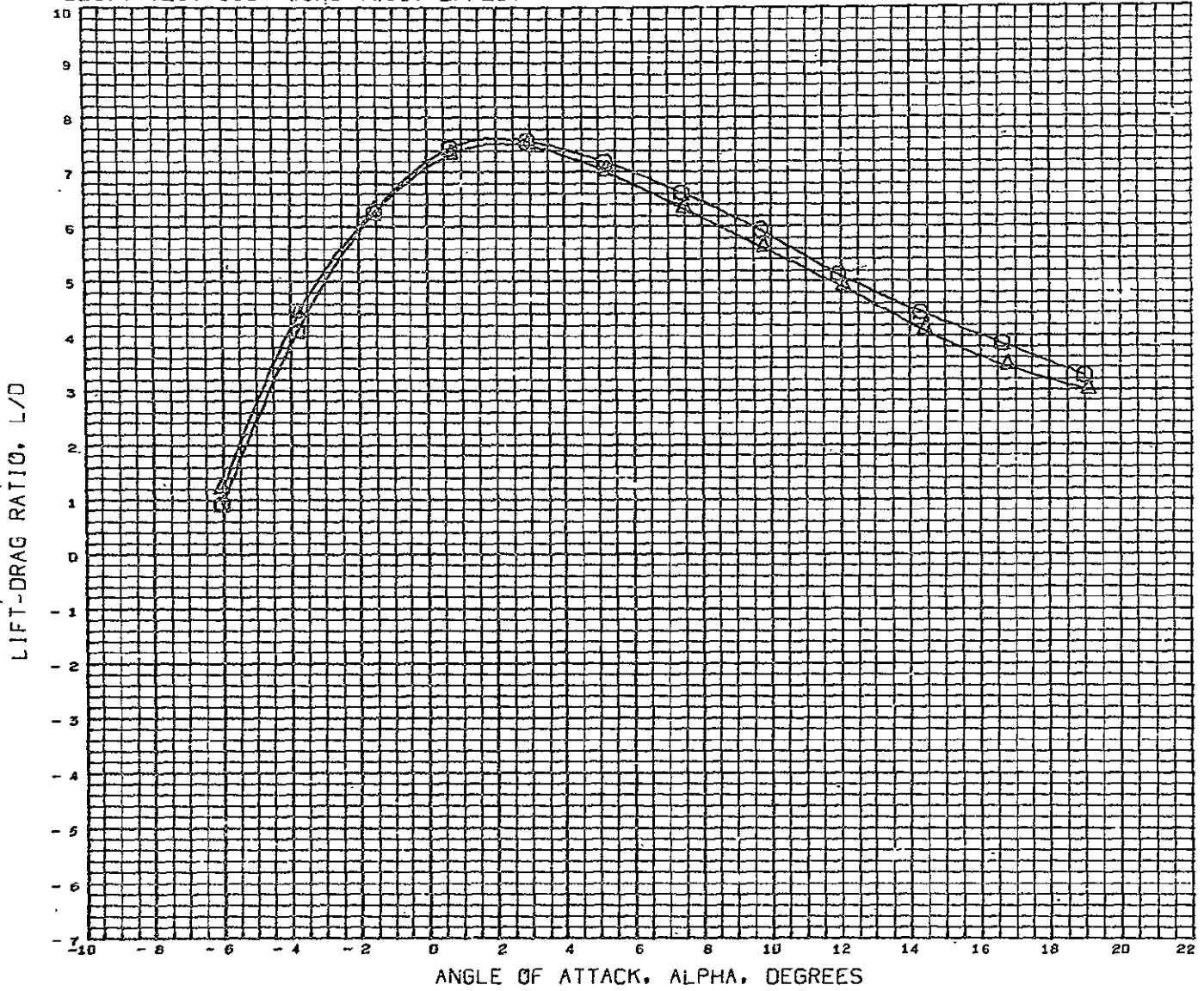

DATA SET SYMBOL CONFIGURATION DESCRIPTION
 (RCND20) \bigcirc DLSWT 138 0.0133 SC. GENERIC HCR 02 B1AW6V4
 (RCND23) \triangle DLSWT 138 0.0133 SC. GENERIC HCR 02 B1AW4BV4

MACH 0.180

REFERENCE INFORMATION
 REFS 5057.0040 SQ.FT.
 REFL 791.0004 IN.
 REFB 1230.0040 IN.
 XMRP 1266.0040 IN.
 YMRP 0.0000 IN.
 ZMRP 163.0004 IN.
 SCALE 100.0000 PERCENT

DLSWT TEST 138- WING TWIST EFFECT

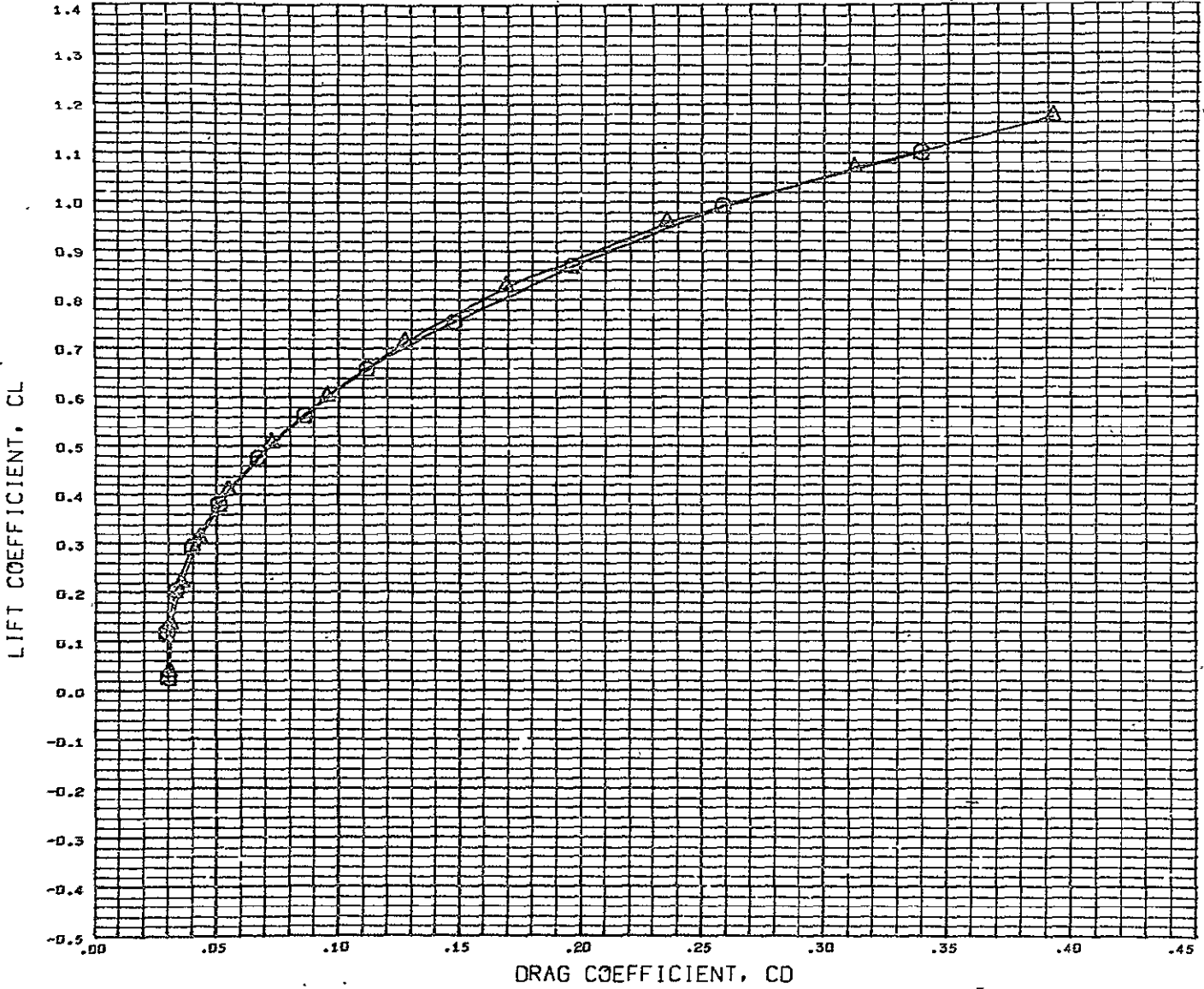

DATA SET SYMBOL	CONFIGURATION DESCRIPTION
(RCH020) ○	DLSWT 138 0.0133 SC. GENERIC HCR 02 B1AW6V4
(RCH023) △	DLSWT 138 0.0133 SC. GENERIC HCR 02 B1AW6V4

REFERENCE INFORMATION		
REFS	5057.0040	SQ.FT.
REFL	701.0004	IN.
REFD	1230.0040	IN.
XNRF	1266.0040	IN.
YNRF	0.0000	IN.
ZNRF	163.0004	IN.
SCALE	100.0000	PERCENT

MACH 0.160

DLSWT TEST 138- WING TWIST EFFECT

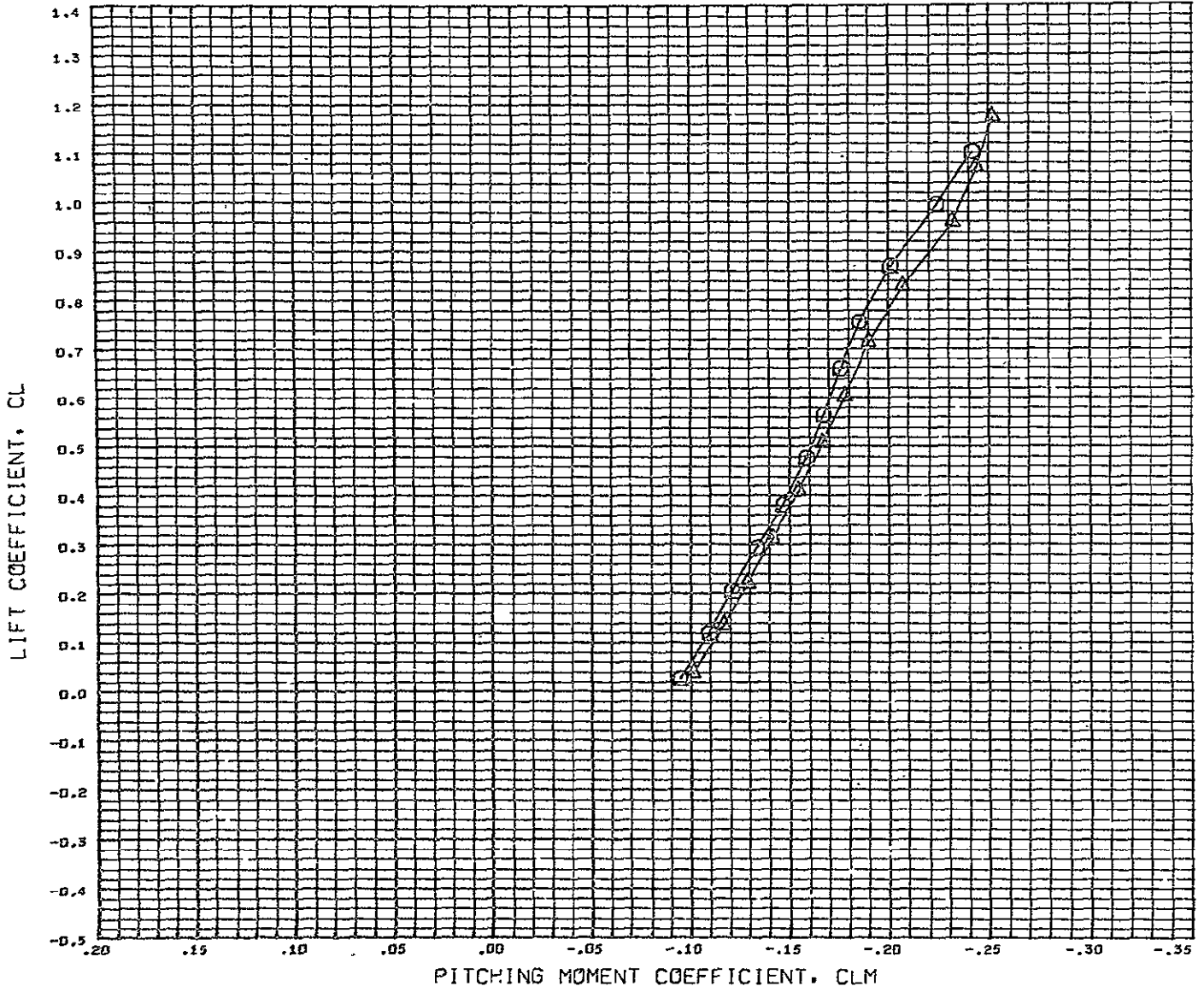

DATA SET SYMBOL CONFIGURATION DESCRIPTION
 (RCNG20) Q DLSWT 138 0.0133 SC. GENERIC HCR 02 B1AW6V4
 (RCNG23) A DLSWT 138 0.0133 SC. GENERIC HCR 02 B1AW4BV4

REFERENCE INFORMATION
 REFS 5057.0040 SQ.FT.
 REFL 701.0004 IN.
 REFB 1230.0040 IN.
 XMRF 1266.0040 IN.
 YMRF 0.0000 IN.
 ZMRF 163.0004 IN.
 SCALE 100.0000 PERCENT

MACH 0.180

DLSWT TEST 138- WING TWIST EFFECT

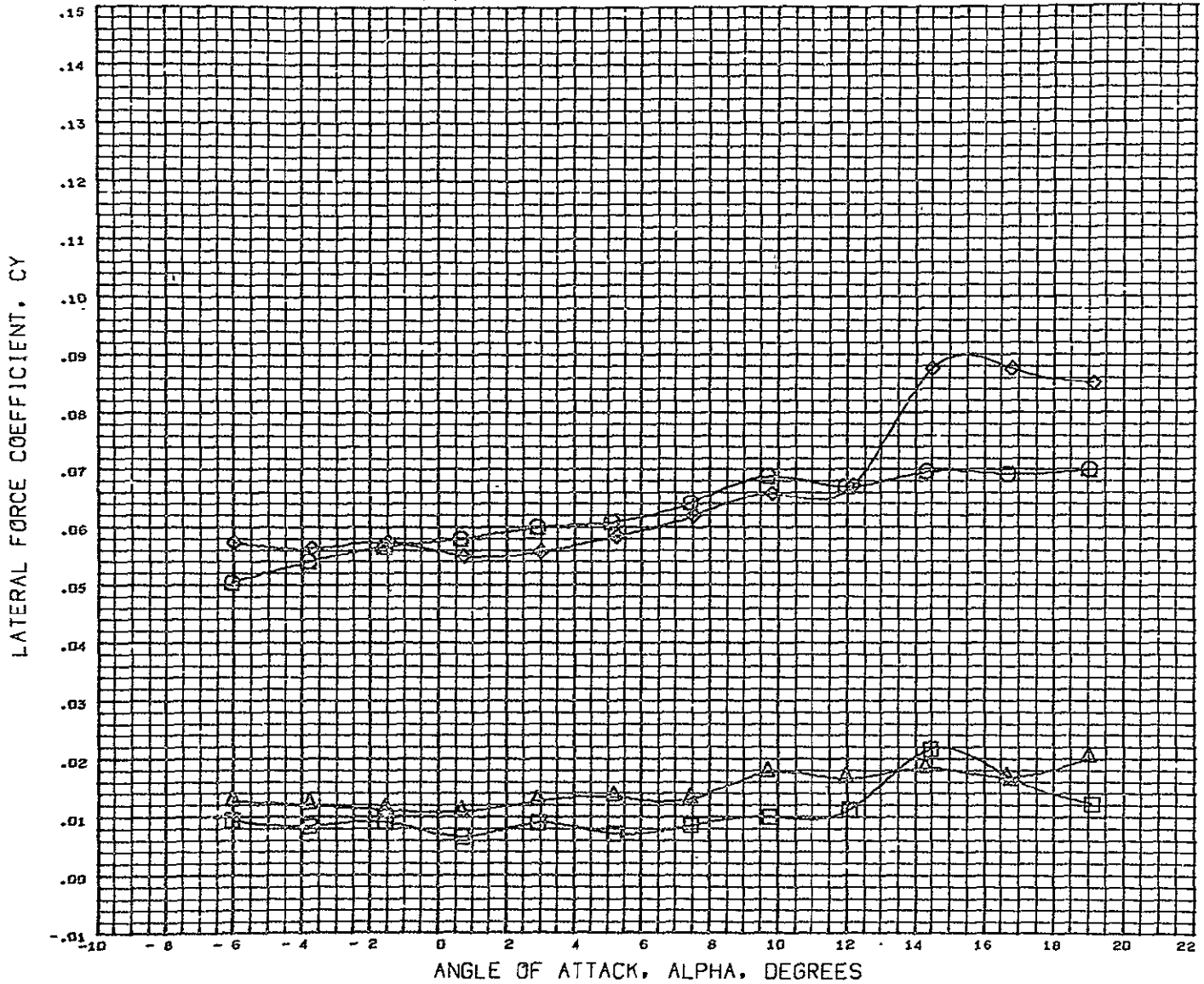

DATA SET	SYMBOL	CONFIGURATION DESCRIPTION	BETA
(TCND21)	○	DLSWT 138 G.0133 SC. GENERIC HCR 02 B1AW6V4	-2.880
(TCND20)	△	DLSWT 138 G.0133 SC. GENERIC HCR 02 B1AW6V4	0.000
(TCND22)	◇	DLSWT 138 G.0133 SC. GENERIC HCR 02 B1AW4BV4	-2.900
(TCND23)	□	DLSWT 138 G.0133 SC. GENERIC HCR 02 B1AW4BV4	0.000

REFERENCE INFORMATION	
REFS	5057.0040 SQ.FT.
REFL	701.0004 IN.
REFB	1230.0040 IN.
XMRP	1266.0040 IN.
YMRP	0.0000 IN.
ZMRP	163.0004 IN.
SCALE	100.0000 PERCENT

VACH 5.180

DLSWT TEST 138- WING TWIST EFFECT

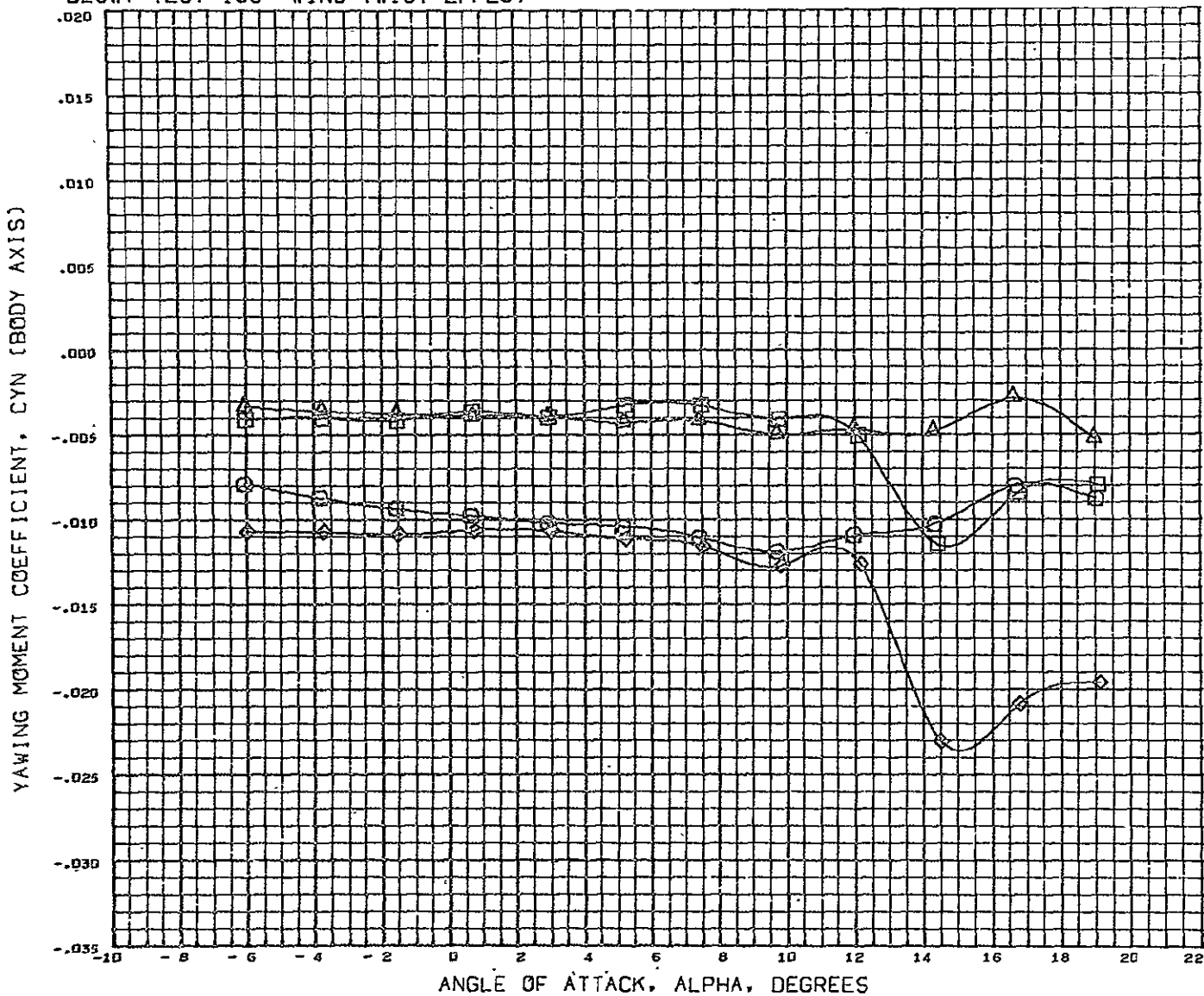

DATA SET SYMBOL	CONFIGURATION DESCRIPTION
(TCND21)	DLSWT 138 0.0133 SC. GENERIC HCR 02 B1AW6V4
(TCND25)	DLSWT 138 0.0133 SC. GENERIC HCR 02 B1AW6V4
(TCND22)	DLSWT 138 0.0133 SC. GENERIC HCR 02 B1AW4BV4
(TCND23)	DLSWT 138 0.0133 SC. GENERIC HCR 02 B1AW4BV4

BETA
-2.880
0.000
-2.900
0.000

REFERENCE INFORMATION		
REFS	5057.0040	SQ.FT.
REFL	701.0000	IN.
REFB	1230.0040	IN.
XMRP	1266.0040	IN.
YMRP	0.0000	IN.
ZMRP	163.0004	IN.
SCALE	100.0000	PERCENT

MACH 0.100

DLSWT TEST 138- WING TWIST EFFECT

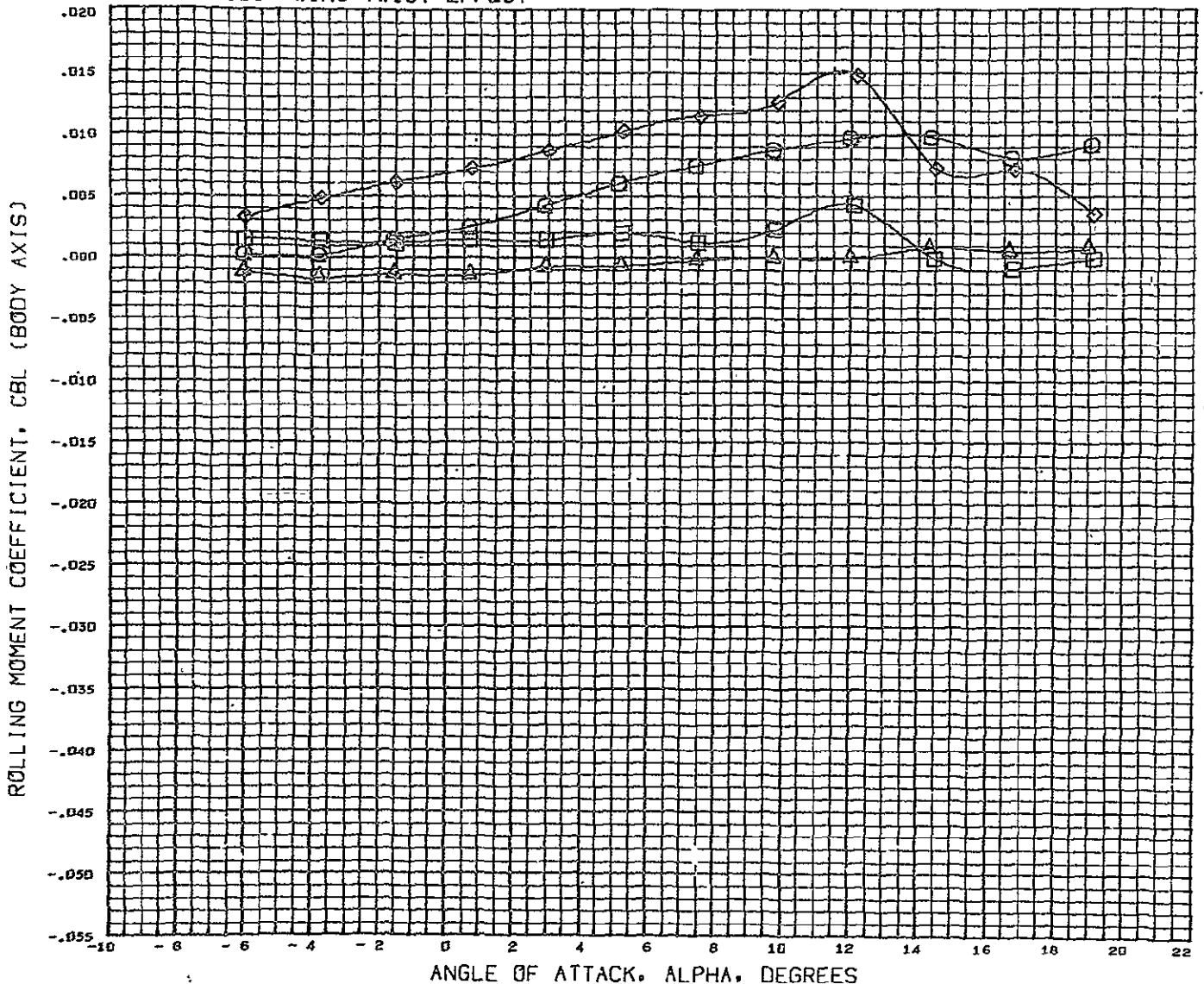

DATA SET SYMBOL	CONFIGURATION DESCRIPTION	BETA	REFERENCE INFORMATION
(TCN021)	DLSWT 138 D.0133 SC. GENERIC HCR 02 B1AW6V4	-2.880	REFS 5057.0040 SQ.FT.
(TCN020)	DLSWT 138 D.0133 SC. GENERIC HCR 02 B1AW6V4	0.000	REFL 701.0104 IN.
(TCN022)	DLSWT 138 D.0133 SC. GENERIC HCR 02 B1AW6V4	-2.900	REFB 1230.0045 IN.
(TCN023)	DLSWT 138 D.0133 SC. GENERIC HCR 02 B1AW6V4	0.000	XNRF 1266.0040 IN.
			YNRF 0.0000 IN.
			ZNRF 163.0004 IN.
			SCALE 100.0000 PERCNT

*AC4 0.180

DLSWT TEST 138- WING TWIST EFFECT

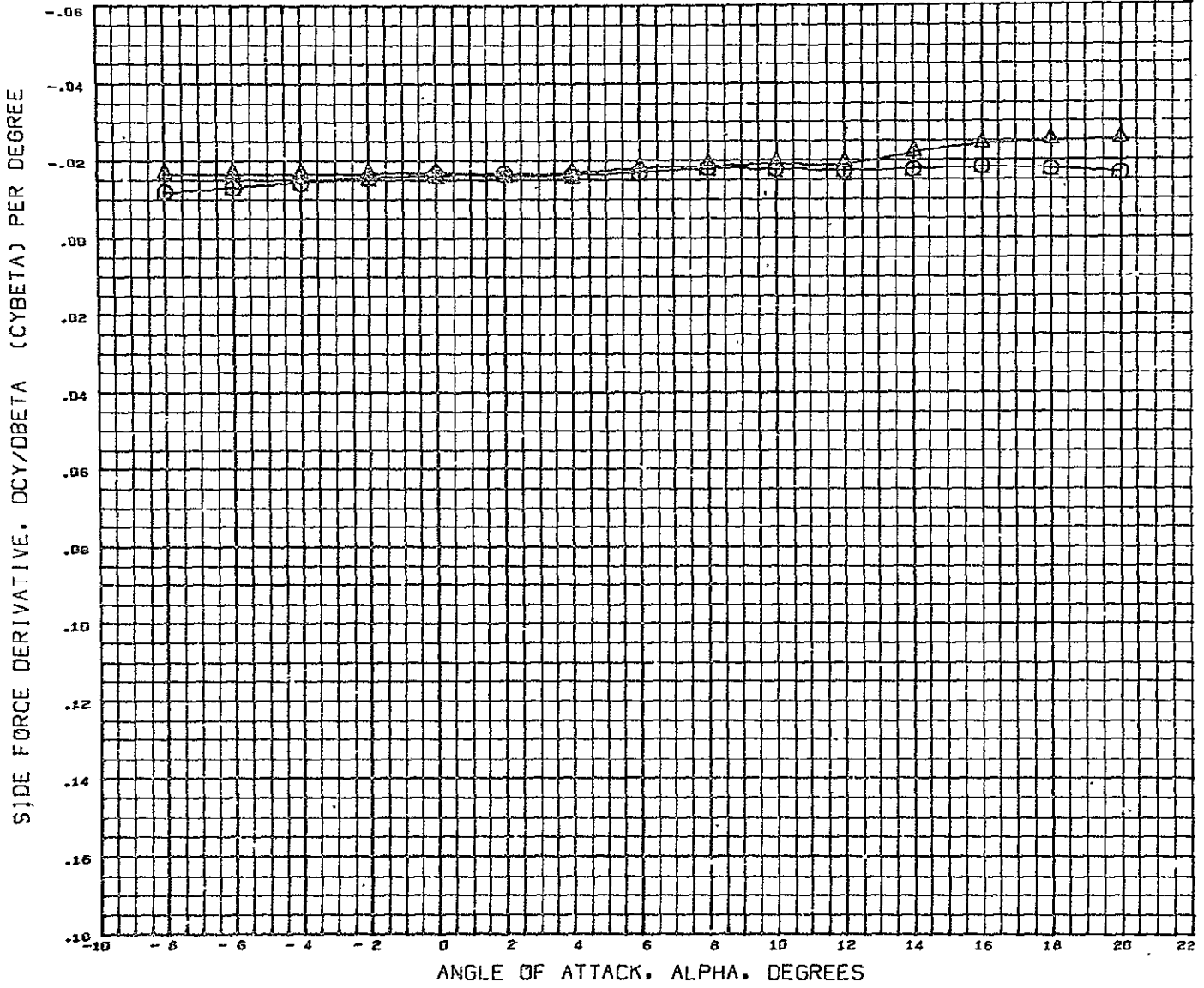

DATA SET SYMBOL CONFIGURATION DESCRIPTION
 (PCND20) \circ DLSWT 138 0.0133 SC. GENERIC HCR 02 B1AW6V4
 (PCND23) Δ DLSWT 138 0.0133 SC. GENERIC HCR 02 B1AW4BV4

REFERENCE INFORMATION
 REFS 5057.0040 SQ. FT.
 REFL 701.0004 IN.
 REFB 1230.0040 IN.
 XMRP 1266.0040 IN.
 YMRP 0.0000 IN.
 ZMRP 163.0004 IN.
 SCALE 100.0000 P. RCNT

MACH 0.185

DLSWT TEST 138- WING TWIST EFFECT

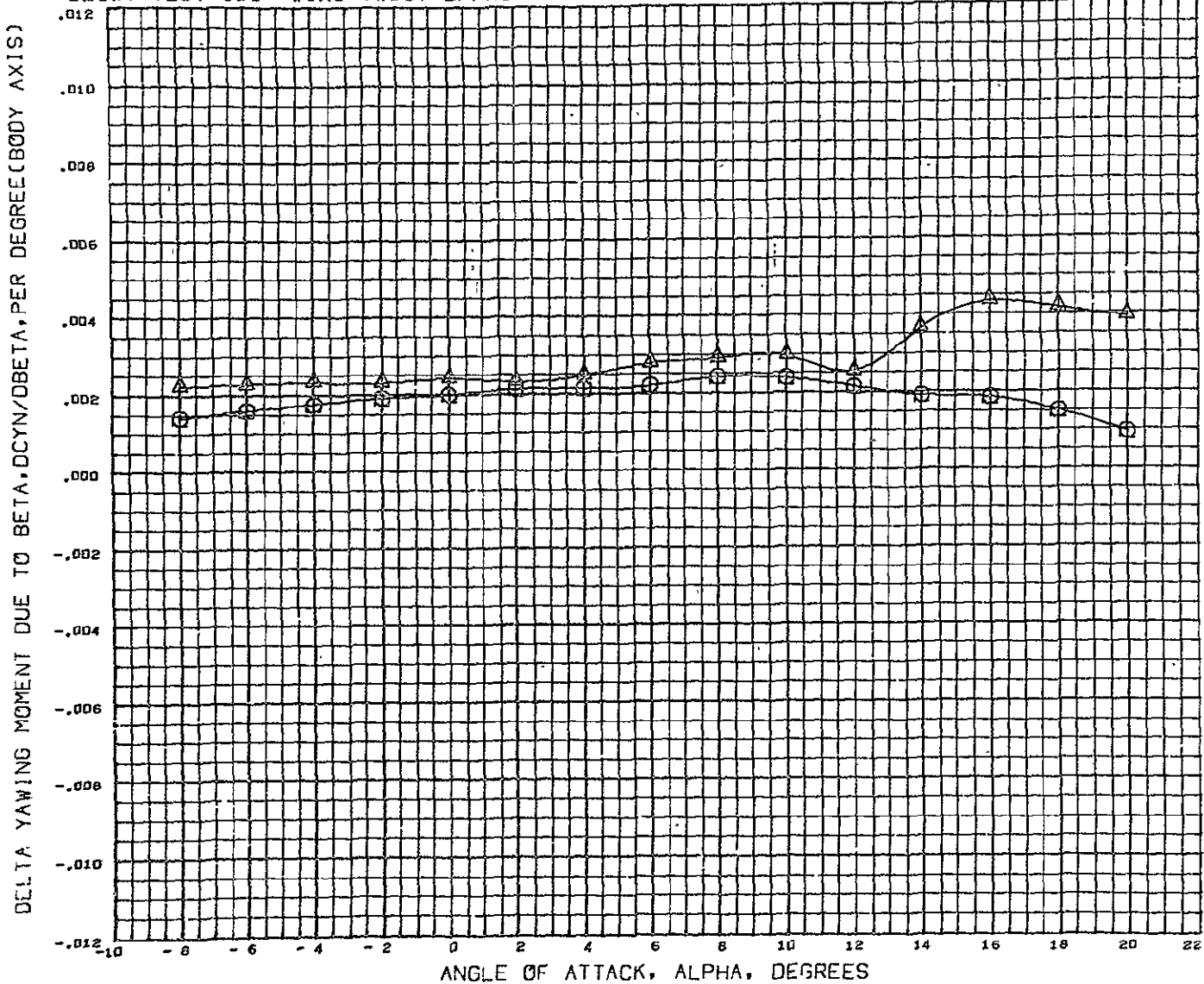

DATA SET SYMBOL CONFIGURATION DESCRIPTION
 (FCN925) (C) DLSWT 138 0.0133 SC. GENERIC HCR 02 B1AW6V4
 (PCN925) (A) DLSWT 138 0.0133 SC. GENERIC HCP 02 B1AW4BV4

REFERENCE INFORMATION
 REFS 5057.0040 SQ.FT.
 REFL 701.0004 IN.
 REFB 1230.0040 IN.
 XMRF 1266.0040 IN.
 YMRF 0.0000 IN.
 ZMRF 163.0004 IN.
 SCALE 100.0000 PERCENT

HACH 0.180

DLSWT TEST 138- WING TWIST EFFECT

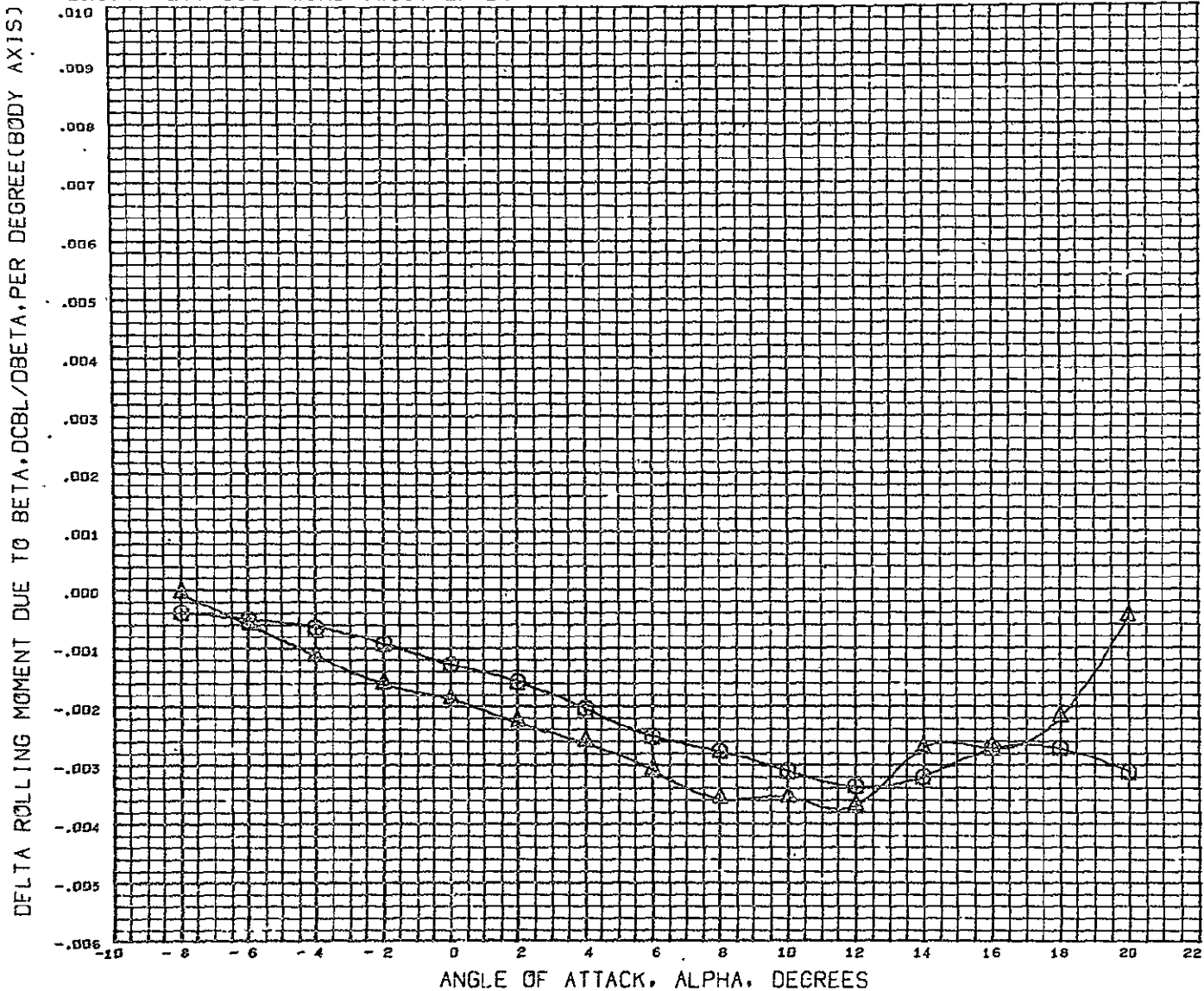

DATA SET SYMBOL CONFIGURATION DESCRIPTION
 (FCND22) ○ DLSWT 138 0.0133 SC. GENERIC HCR 02 B1AW6V4
 (FCND23) △ DLSWT 138 0.0133 SC. GENERIC HCR 02 B1AW4BV4

REFERENCE INFORMATION
 REFS 5057.0040 SQ. FT.
 REFL 701.0004 IN.
 REFB 1230.0040 IN.
 XMRP 1266.0040 IN.
 YMRP 0.0000 IN.
 ZMRP 163.0004 IN.
 SCALE 100.0000 PERCENT

MACH 0.180

DLSWT TEST 138- WING AIRFOIL SECTION EFFECT

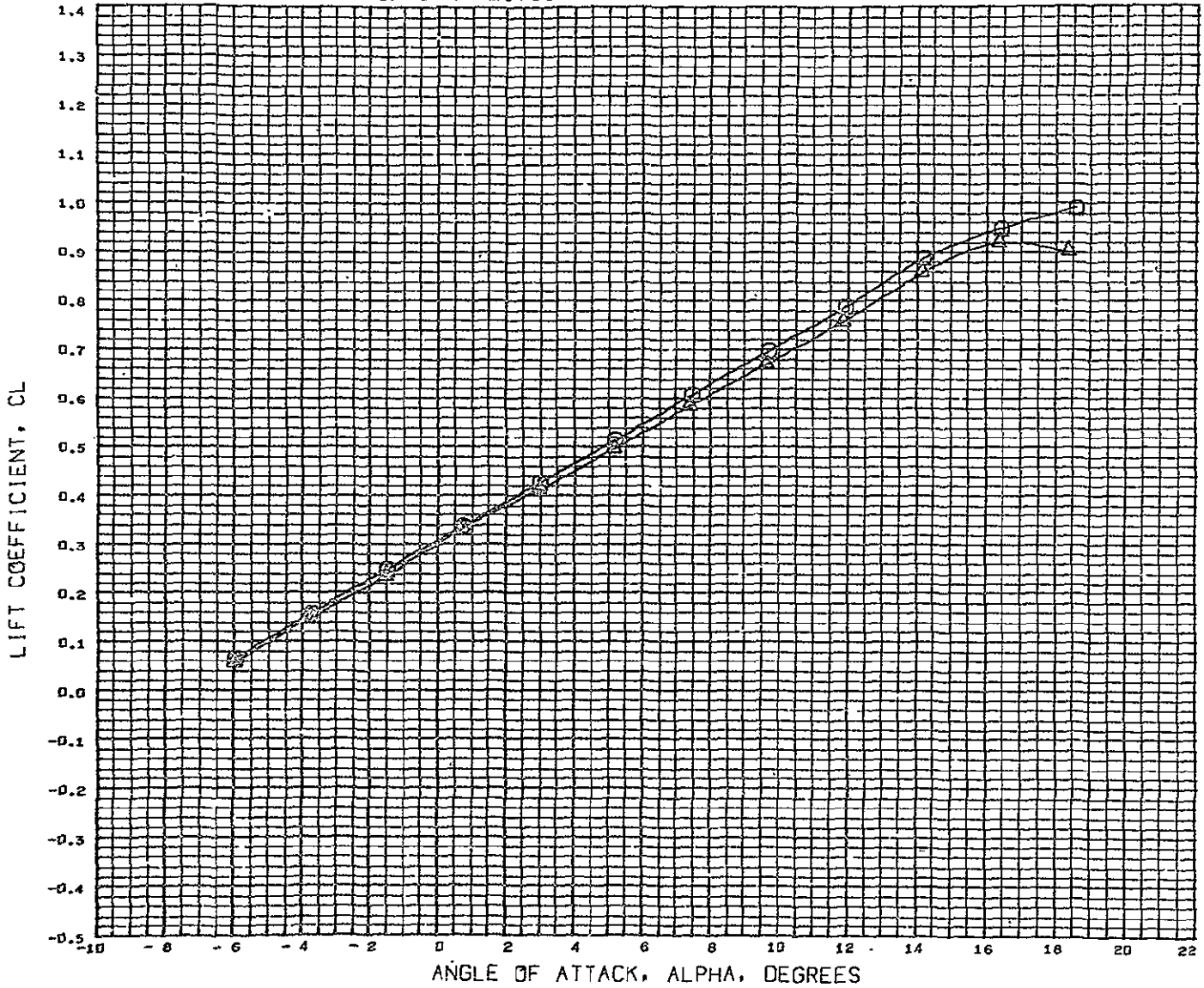

DATA SET SYMBOL CONFIGURATION DESCRIPTION
 (RCND59) ○ DLSWT 138 0.0133 SC. GENERIC HCR 02 B1AW8V4
 (RCND66) △ DLSWT 138 0.0133 SC. GENERIC HCR 02 B1BW4ASTV4

REFERENCE INFORMATION
 REFS 5057.0040 SQ. FT
 REFL 791.0004 IN.
 REFB 1230.0040 IN.
 XMRP 1266.0040 IN.
 YMRP 0.0000 IN.
 ZMRP 163.0004 IN.
 SCALC 100.0000 PERCENT

MACH 0.185

DLSWT TEST 138- WING AIRFOIL SECTION EFFECT

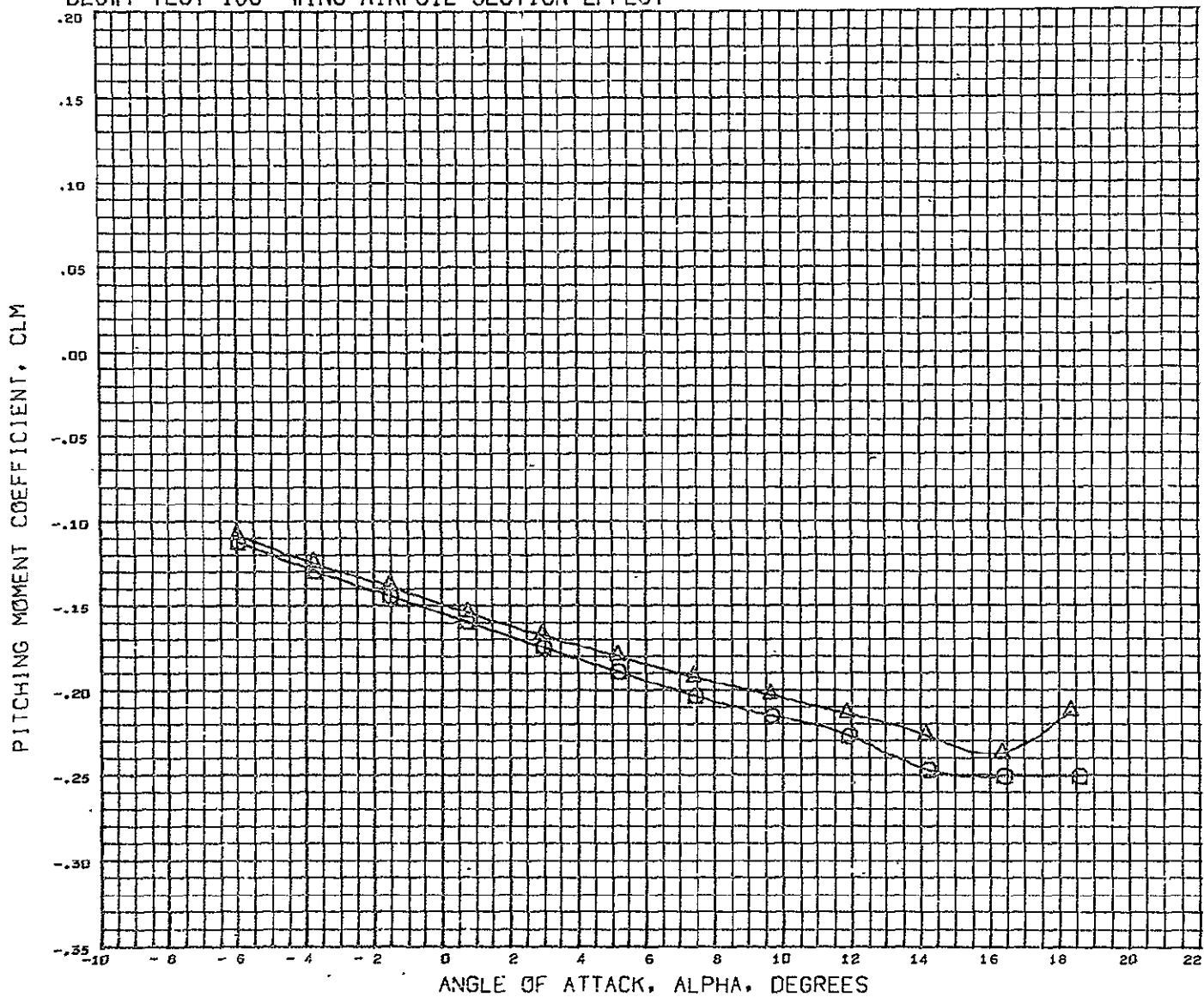

DATA SET SYMBOL	CONFIGURATION DESCRIPTION
(RCND59) ○	DLSWT 138 D.5133 SC. GENERIC HCR OZ 01AN8V1
(PCNG4E) △	DLSWT 138 D.5133 SC. GENERIC HCR OZ 01BWKASTV4

REFERENCE INFORMATION		
REFS	5057.0040	SQ. FT
REFL	701.0004	IN.
REFB	1230.0040	IN.
XHRP	1266.0040	IN.
YHRP	0.0000	IN.
ZHRP	163.0004	IN.
SCALE	100.0000	PERCENT

MACH 0.180

DLSWT TEST 138- WING AIRFOIL SECTION EFFECT

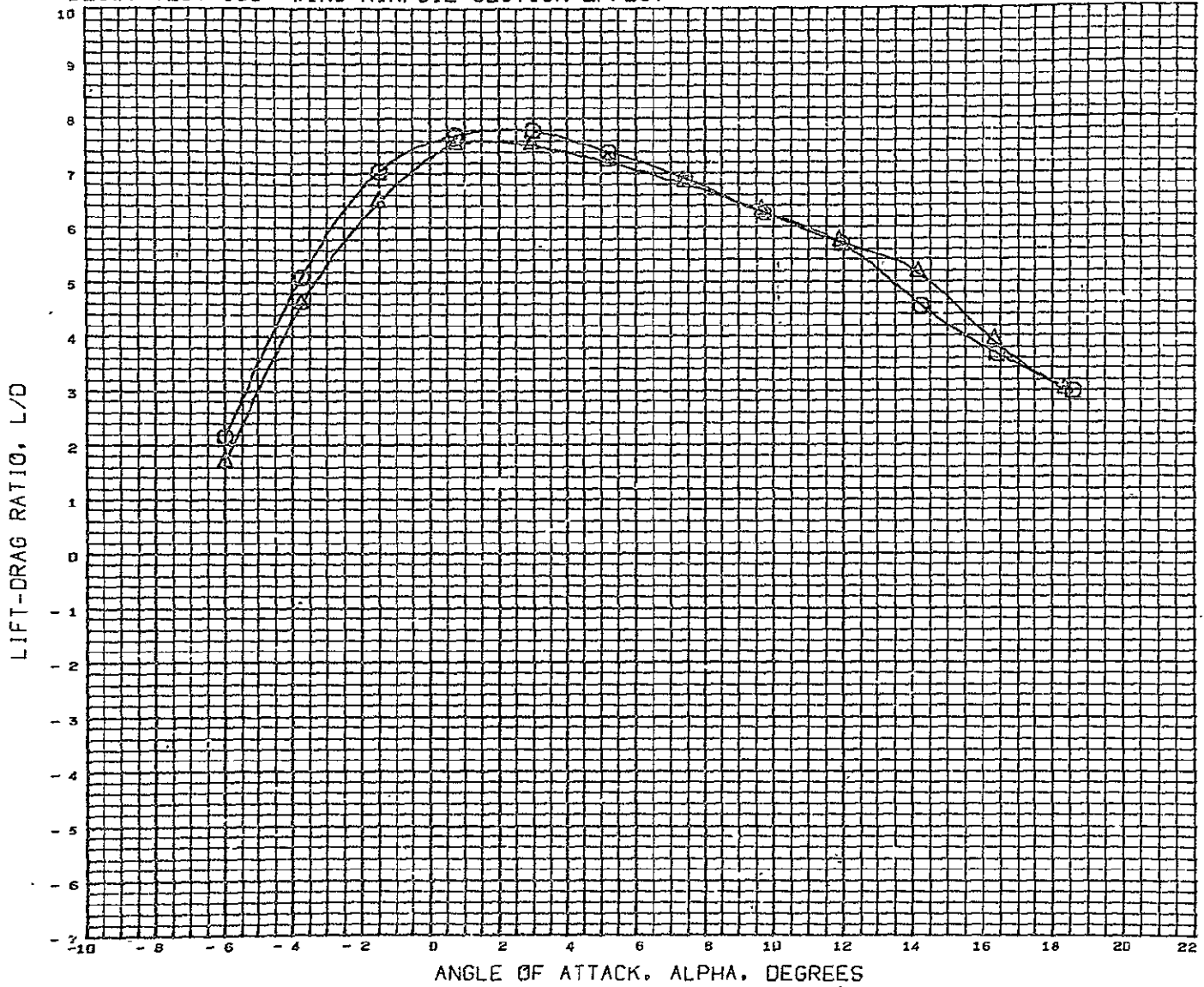

DATA SET SYMBOL CONFIGURATION DESCRIPTION
 (RCND59) ○ DLSWT 138 D.0133 SC. GENERIC HCR 02 B1AW8V4
 (RCND46) △ DLSWT 138 D.0133 SC. GENERIC HCR 02 B1BWA8TV4

REFERENCE INFORMATION
 REFS 5057.0040 SQ. FT
 REFL 701.0004 IN.
 REFS 1230.0040 IN.
 XNRF 1266.0040 IN.
 YNRF 0.0000 IN.
 ZNRF 163.0004 IN.
 SCALE 100.0000 PERCENT

MACH 0.185

DLSWT TEST 138- WING AIRFOIL SECTION EFFECT

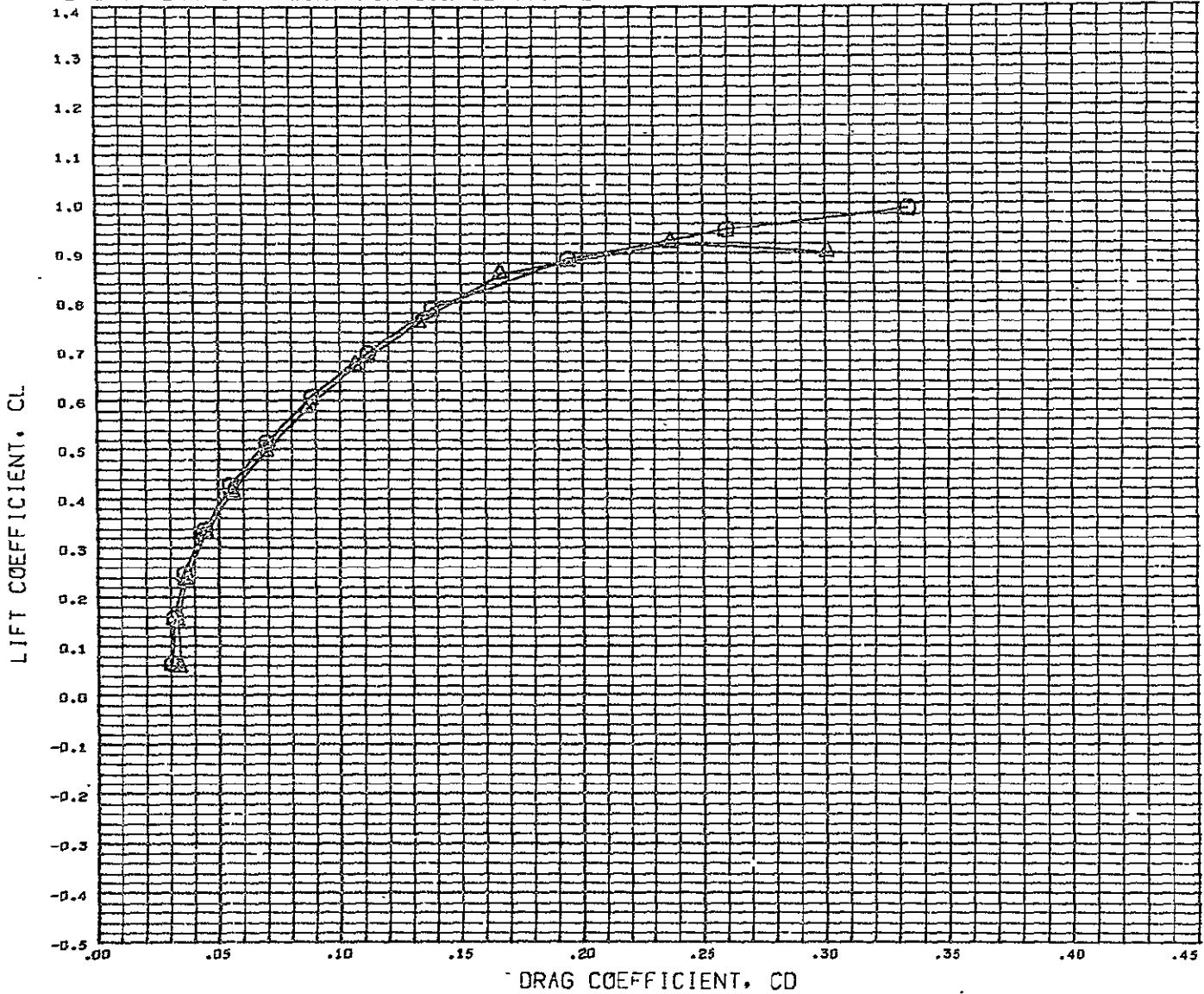

DATA SET SYMBOL CONFIGURATION DESCRIPTION
 (RCH059) ○ DLSWT 138 0.0133 SC. GENERIC HCR 02 B1AW8V4
 (RCH026) △ DLSWT 138 0.0133 SC. GENERIC HCR 02 B1BW4ASTV4

REFERENCE INFORMATION
 REFS 5057.0029 SQ. FT
 REFL 701.0004 IN.
 REFB 1230.0040 IN.
 XMRF 1266.0040 IN.
 YMRF 0.0000 IN.
 ZMRF 163.0004 IN.
 SCALE 100.0000 PERCENT

MACH 0.180

DLSWT TEST 138- WING AIRFOIL SECTION EFFECT

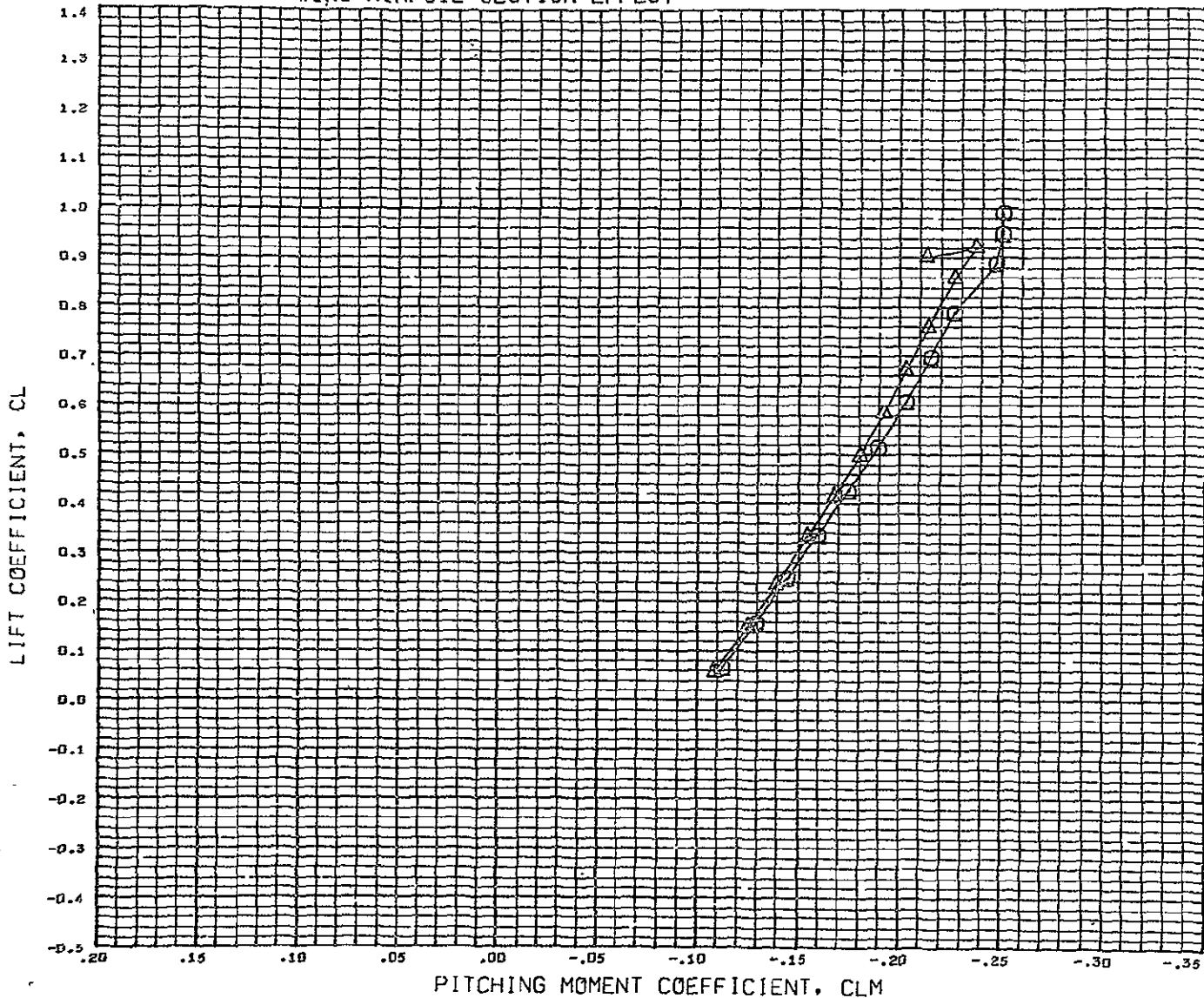

DATA SET SYMBOL CONFIGURATION DESCRIPTION
 (RCND59) ○ DLSWT 138 D.0133 SC. GENERIC HCR 02 B1AWBV4
 (RCND26) △ DLSWT 138 D.0133 SC. GENERIC HCR 02 B1EW4ASTV4

REFERENCE INFORMATION
 REFS 5057.0040 SQ. FT
 REFL 701.0004 IN.
 REFB 1230.0040 IN.
 XMRP 1266.0040 IN.
 YMRP 0.0000 IN.
 ZMRP 163.0004 IN.
 SCALE 100.0000 PERCENT

PACH 0.180

DLSWT TEST 138- WING AIRFOIL SECTION EFFECT

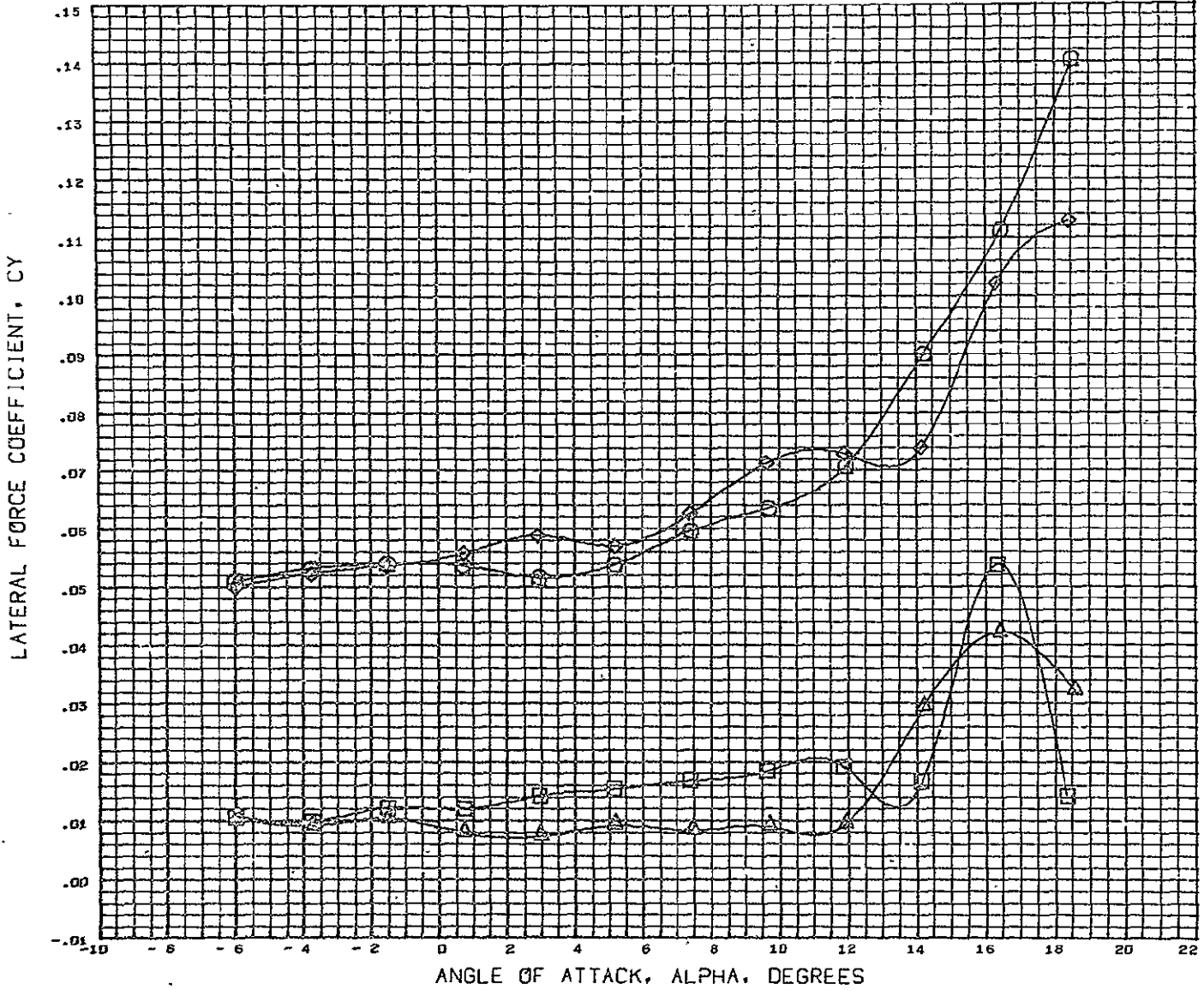

DATA SET SYMBOL	CONFIGURATION DESCRIPTION	BETA	REFERENCE INFORMATION
(TCND66)	DLSWT 138 0.0133 SC. GENERIC HCR 02 B1AW8V4	-2.900	REFS 5057.0040 SQ. FT
(TCND59)	DLSWT 138 0.0133 SC. GENERIC HCR 02 B1AW8V4	0.000	REFL 701.0004 IN.
(TCND47)	DLSWT 138 0.0133 SC. GENERIC HCR 02 B1BW4ASTV4	-2.900	REFB 1230.0040 IN.
(TCND46)	DLSWT 138 0.0133 SC. GENERIC HCR 02 B1BW4ASTV4	0.000	XMRP 1266.0040 IN.
			YMRP 0.0000 IN.
			ZMRP 163.0004 IN.
			SCALE 100.0000 PERCENT

MACH 0.180

DLSWT TEST 138- WING AIRFOIL SECTION EFFECT

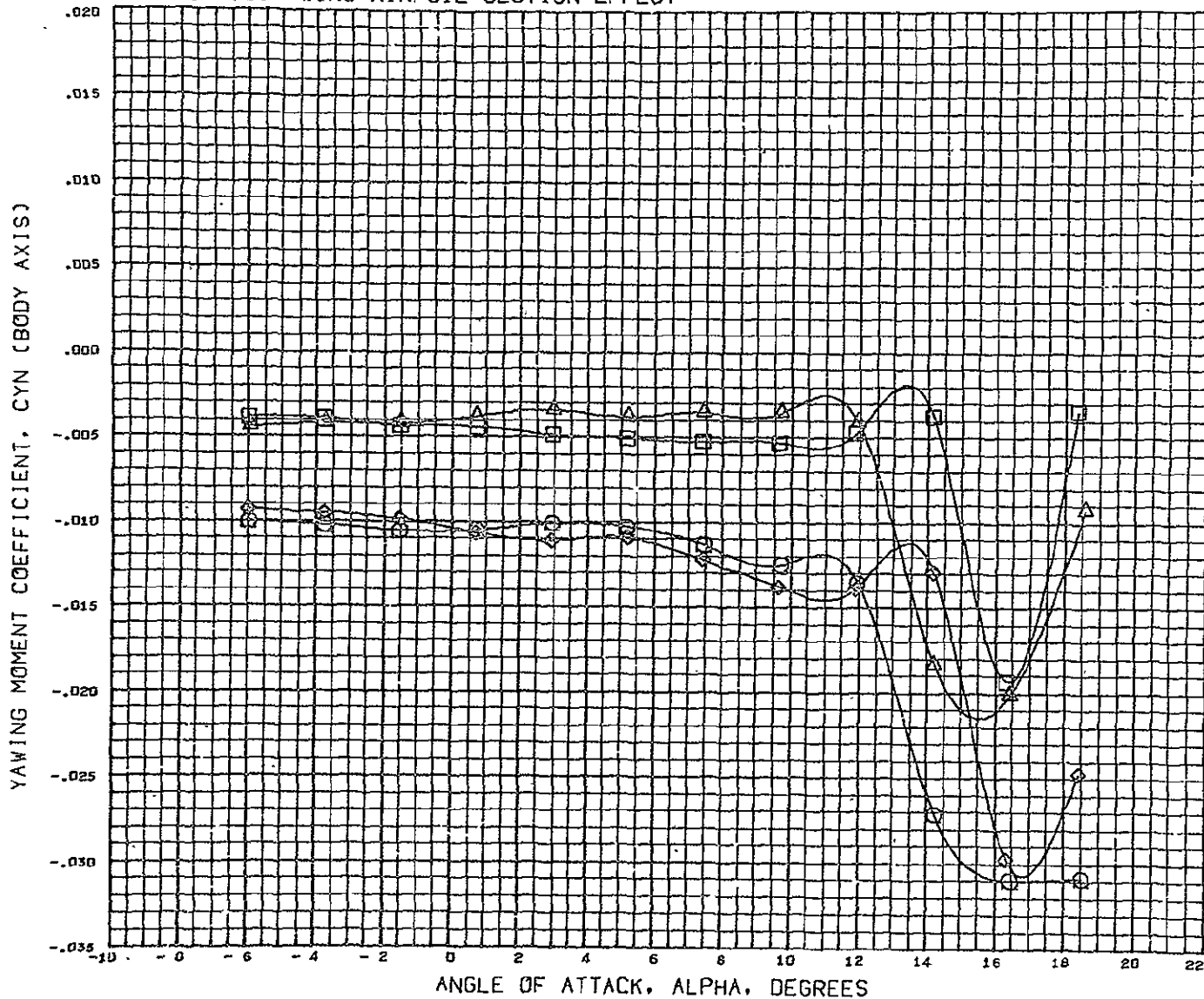

DATA SET SYMBOL	SYMBOL	CONFIGURATION DESCRIPTION
(TCND60)	○	DLSWT 138 0.0133 SC. GENERIC HCR 02 B1AW8V4
(TCND59)	△	DLSWT 138 0.0133 SC. GENERIC HCR 02 B1AW8VJ
(TCND47)	◇	DLSWT 138 0.0133 SC. GENERIC HCR 02 B1BW4ASTV4
(TCND45)	□	DLSWT 138 0.0133 SC. GENERIC HCR 02 B1BW4ASTV4

BETA

-2.900
0.000
-2.900
0.000

REFERENCE INFORMATION

REFS	5057.0040	SQ. FT
REFL	701.0004	IN.
REFB	1230.0040	IN.
XMRP	1266.0040	IN.
YMRP	0.0000	IN.
ZMRP	163.0004	IN.
SCALE	100.0000	PERCENT

MACH 0.180

DLSWT TEST 138- WING AIRFOIL SECTION EFFECT

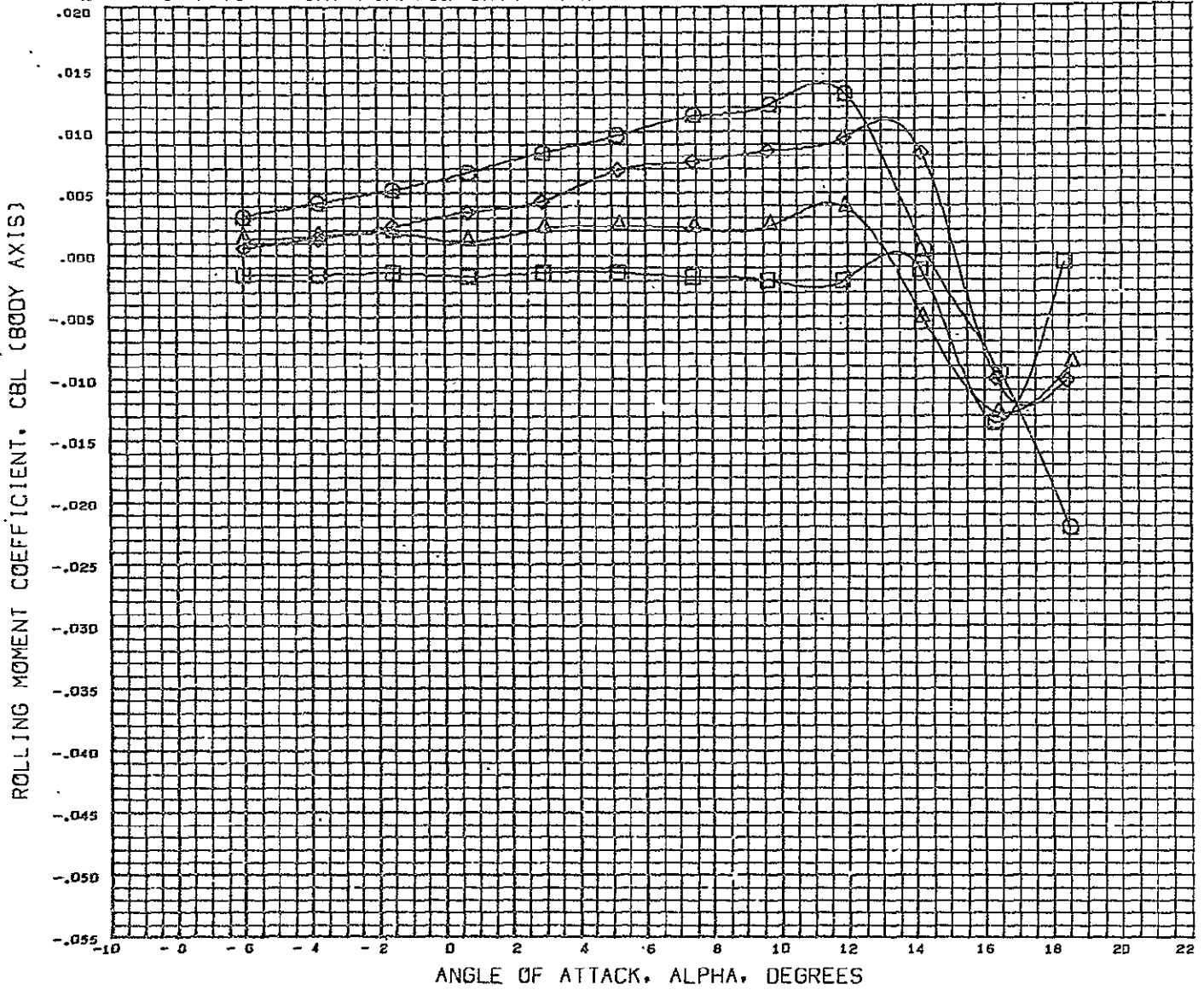

DATA SET SYMBOL	CONFIGURATION DESCRIPTION	BETA	REFERENCE INFORMATION
(TCN060)	DLSWT 138 D.0133 SC. GENERIC HCR 02 B1A48V4	-2.900	REFS 5057.0040 SQ. FT
(TCN059)	DLSWT 138 D.0133 SC. GENERIC HCR 02 B1A48V4	0.000	REFL 701.0004 IN.
(TCN047)	DLSWT 138 D.0133 SC. GENERIC HCR 02 B1B44ASTV4	-2.900	REFB 1230.0040 IN.
(TCN045)	DLSWT 138 D.0133 SC. GENERIC HCR 02 B1B44ASTV4	0.000	XMRP 1266.0040 IN.
			YMRP 0.0000 IN.
			ZMRP 163.0004 IN.
			SCALE 100.0000 PERCENT

MACH 0.480

DLSWT TEST 138- WING AIRFOIL SECTION EFFECT

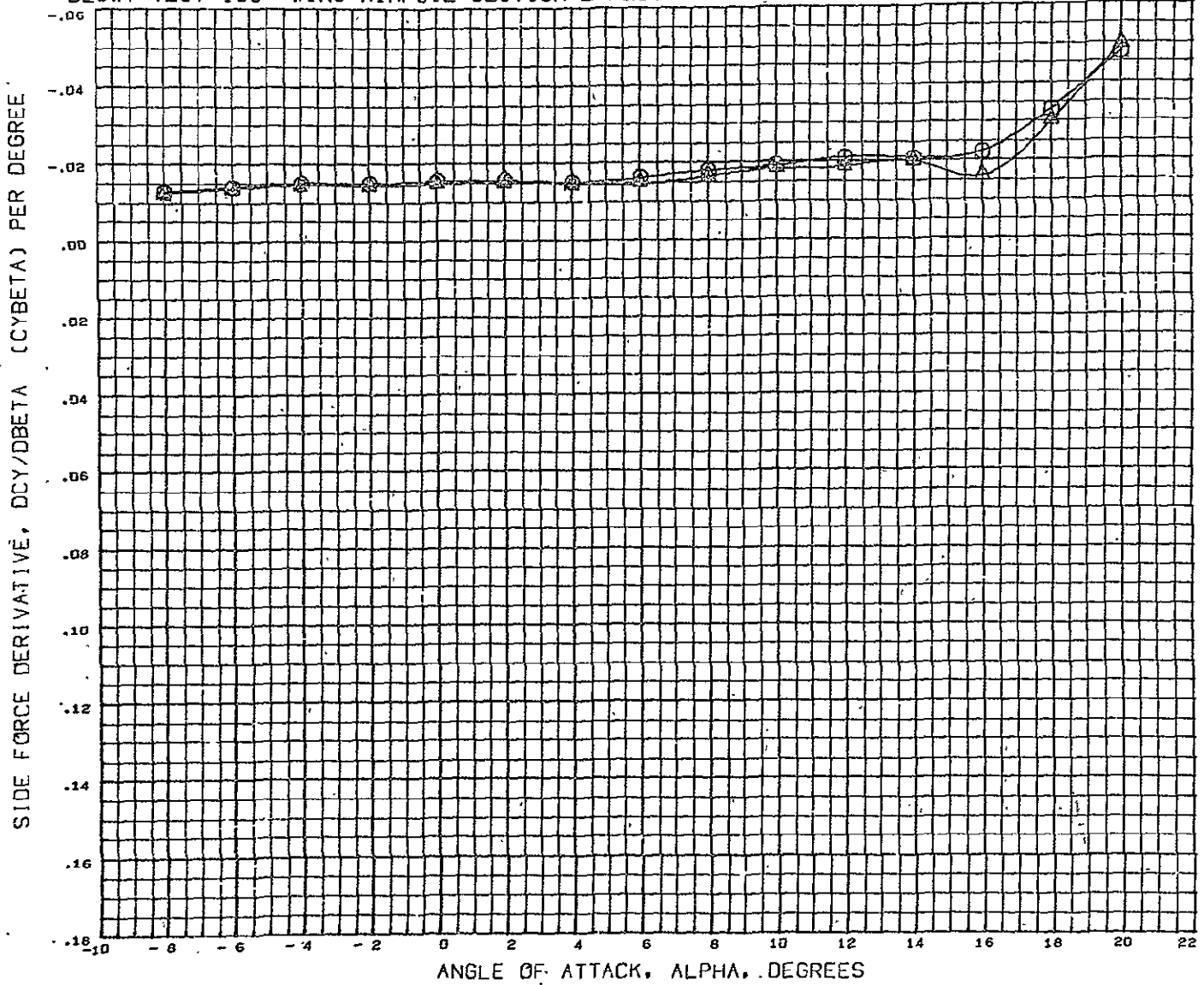

DATA SET SYMBOL CONFIGURATION DESCRIPTION
 (FCN659) ○ DLSWT 138 0.0133 SC. GENERIC HCR 02 B1A48V4
 (FCN64E) △ DLSWT 138 0.0133 SC. GENERIC HCR 02 B1B44ASTV4

REFERENCE INFORMATION
 REFS 5057.0040 SQ. FT
 REFL 761.0004 IN.
 REFB 1230.0049 IN.
 XMRF 1266.0046 IN.
 YMRF 0.0000 IN.
 ZMRF 163.0004 IN.
 SCALE 100.0000 PERCENT

MACH 5.165

DLSWT TEST 138- WING AIRFOIL SECTION EFFECT

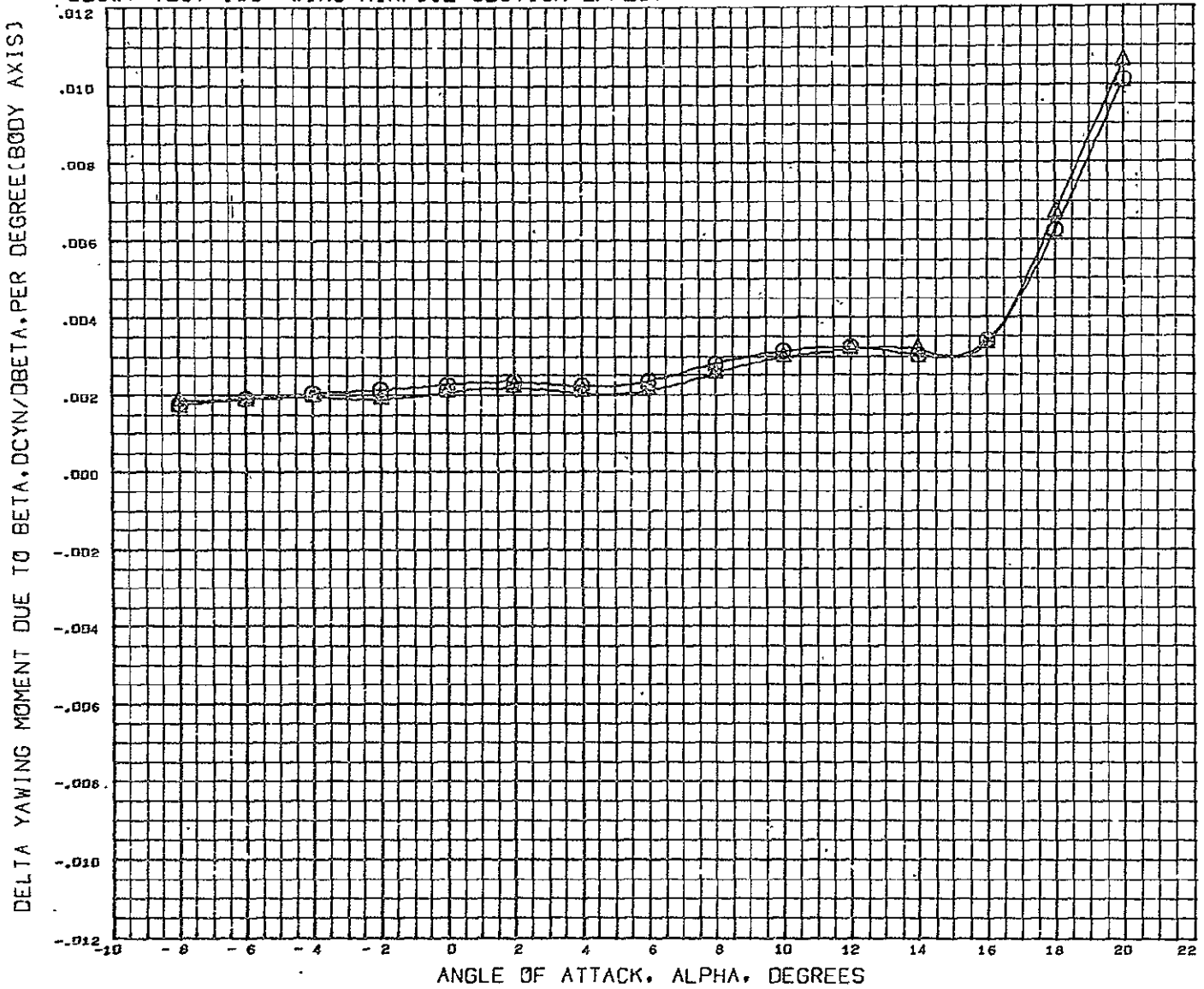

DATA SET SYMBOL CONFIGURATION DESCRIPTION
(PCN059) \odot DLSWT 138 0.0133 SC. GENERIC HCR 02 B1A48V4
(PCN046) \triangle DLSWT 138 0.0133 SC. GENERIC HCR 02 B1B48V4

REFERENCE INFORMATION
REFS 5057.0040 SQ. FT
REFL 701.0004 IN.
REFB 1230.0040 IN.
XMRP 1256.0040 IN.
YMRP 0.0000 IN.
ZMRP 163.0004 IN.
SCALE 100.0000 PERCNT

MACH 0.189

DLSWT TEST 138- WING AIRFOIL SECTION EFFECT

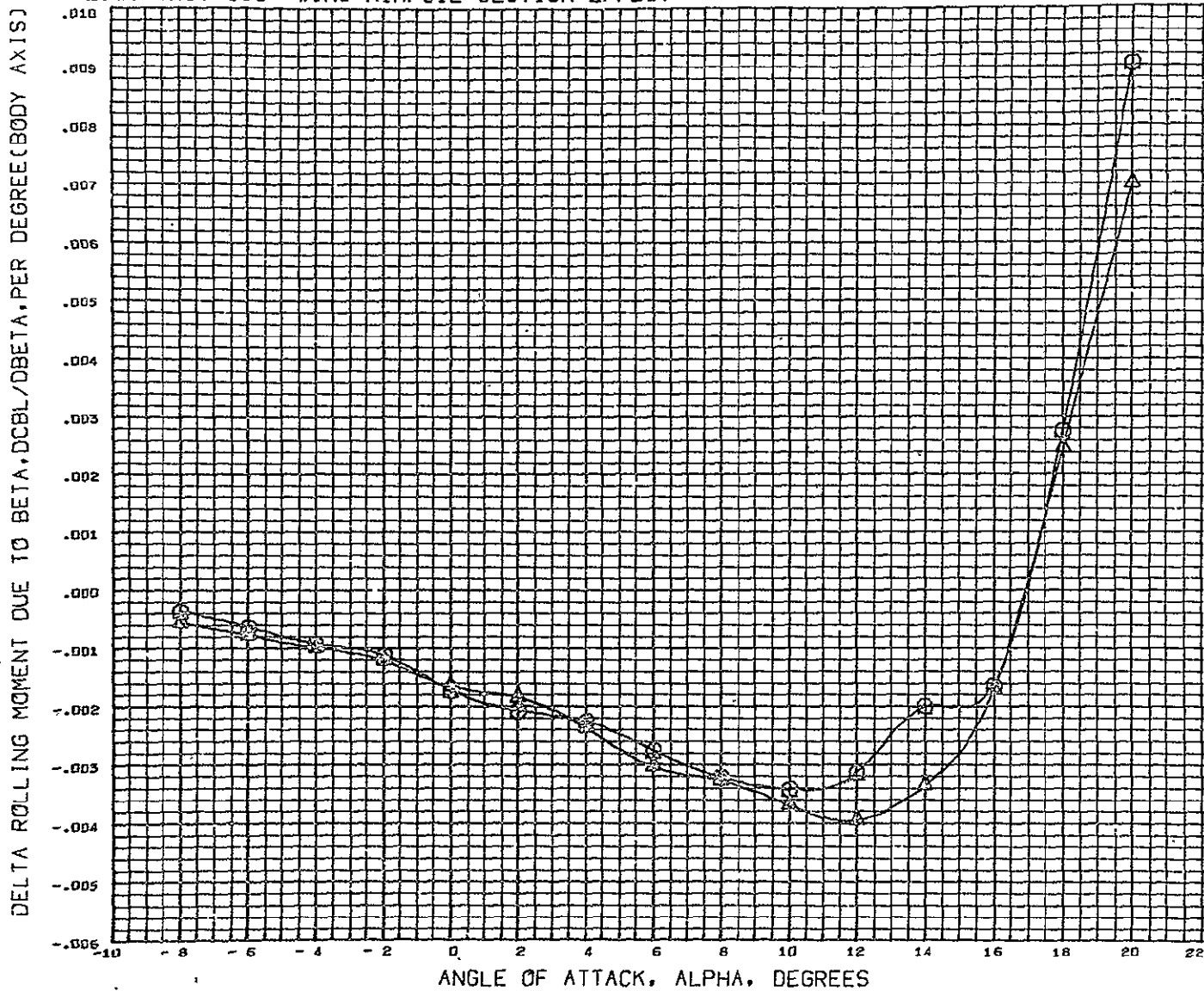

DATA SET SYMBOL CONFIGURATION DESCRIPTION
 (FCND59) \circ DLSWT 138 0.0133 SC. GENERIC HCR 02 B1AW8V4
 (FCND46) Δ DLSWT 138 0.0133 SC. GENERIC HCR 02 B1BW4ASTV4

REFERENCE INFORMATION
 REFS 5057.0040 SQ. FT
 REFL 701.0004 IN.
 REFB 1230.0040 IN.
 XHRF 1266.0040 IN.
 YHRF 0.0000 IN.
 ZHRF 163.0004 IN.
 SCALE 100.0000 PERCENT

VACH 0.180

DLSWT TEST 138- BOAT TAIL EFFECT

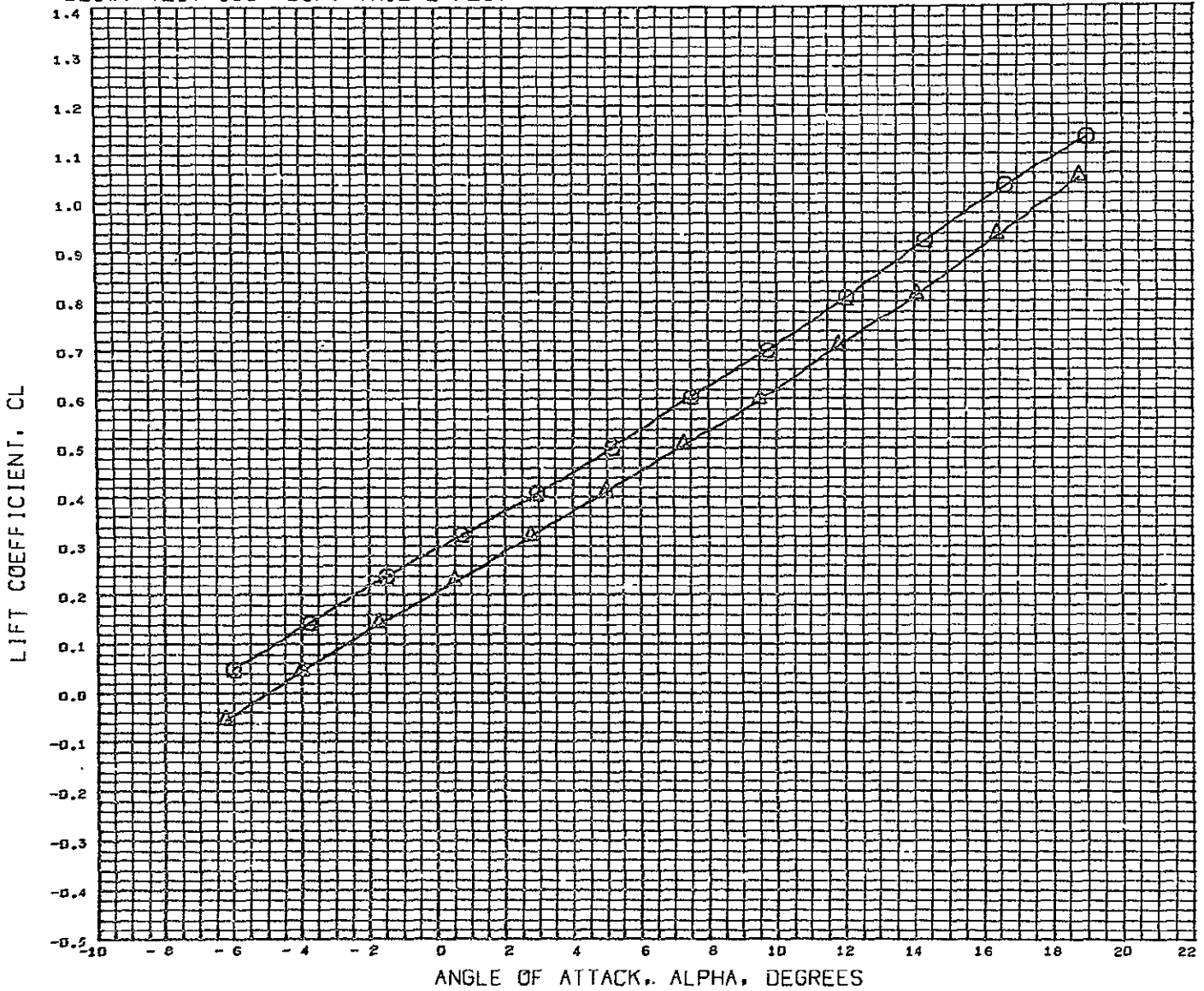

DATA SET SYMBOL CONFIGURATION DESCRIPTION
 (FCNG31) ○ DLSWT 138 0.5133 SC. GENERIC HCR 02 61BW4ASTV4
 (RCNG29) △ DLSWT 138 0.5133 SC. GENERIC HCR 02 84W4ASTV4

REFERENCE INFORMATION
 REFS 5057.0040 SQ. FT.
 REFL 791.0094 IN.
 REFB 1230.0040 IN.
 XMRP 1266.0040 IN.
 YMRP 0.0000 IN.
 ZMRP 163.0004 IN.
 SCALE 100.0000 PERCENT

MACH 0.180

DLSWT TEST 138- BOAT TAIL EFFECT

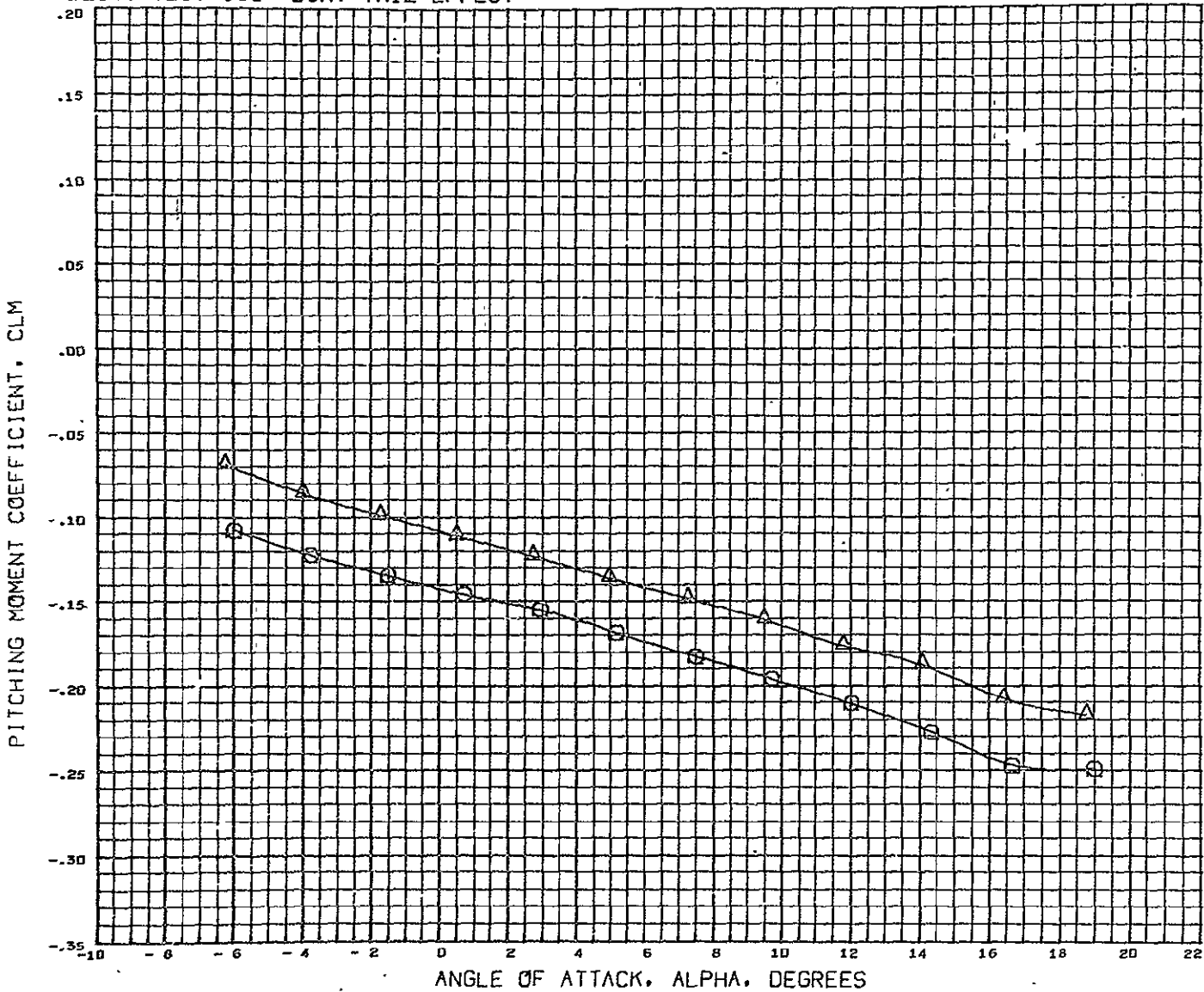

DATA SET SYMBOL CONFIGURATION DESCRIPTION
 (PCN031) \circ DLSWT 138 0.0133 SC. GENERIC HCR 02 B16WASTV4
 (RCN029) Δ DLSWT 138 0.0133 SC. GENERIC HCR 02 B4WASTV4

REFERENCE INFORMATION
 REFS 5057.0040 SQ.FT.
 REFL 701.0004 IN.
 REFB 1230.0040 IN.
 XMRP 1266.0040 IN.
 YMRP 0.0000 IN.
 ZMRP 163.0004 IN.
 SCALE 100.0000 PERCNT

MACH 0.160

DLSWT TEST 138- BOAT TAIL EFFECT

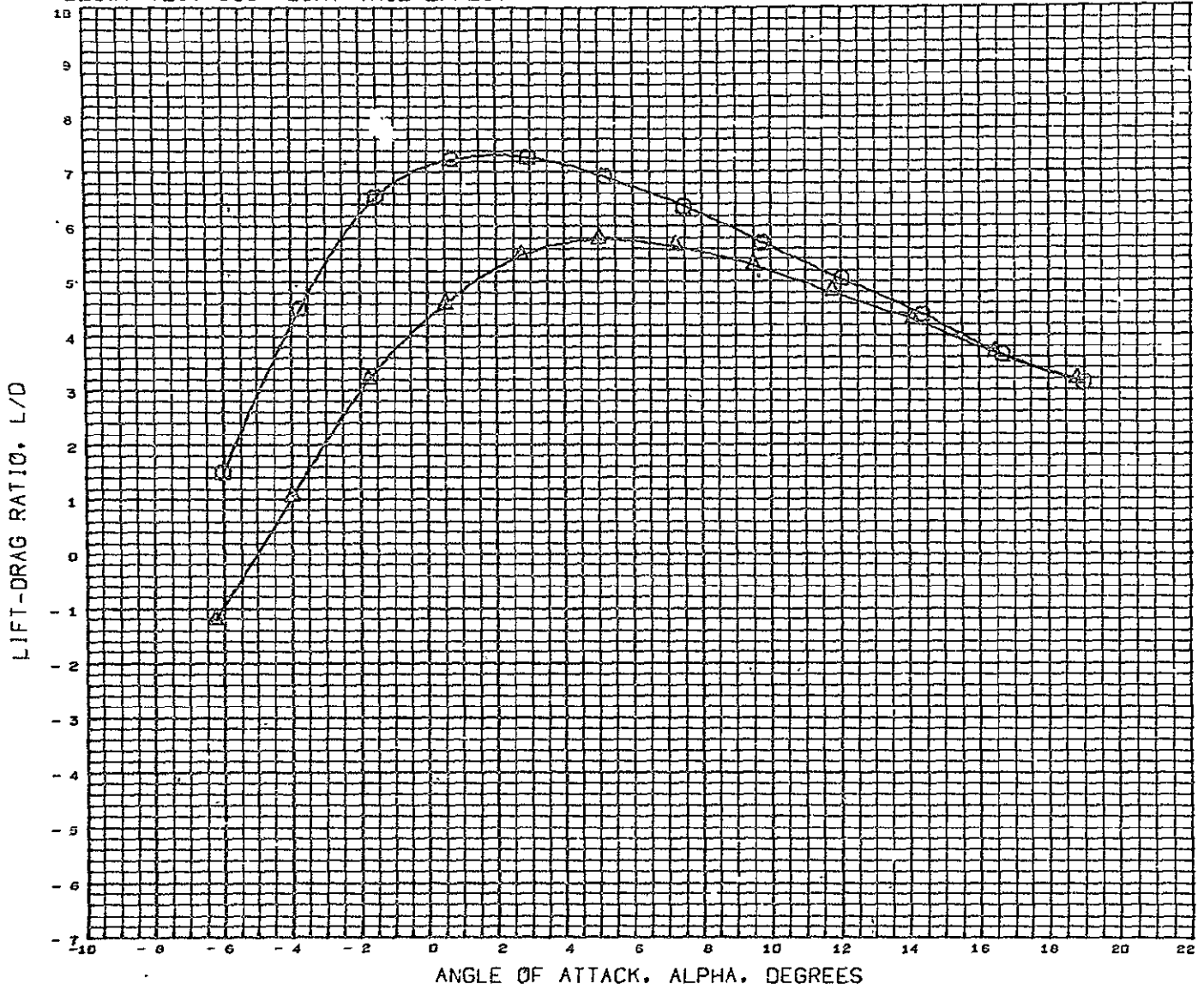

DATA SET SYMBOL CONFIGURATION DESCRIPTION
 (RCND31) ○ DLSWT 138 D.0133 SC. GENERIC HCR 02 B16W4ASTV4
 (RCND29) △ DLSWT 138 D.0133 SC. GENERIC HCR 02 B4W4ASTV4

MACH 0.180

REFERENCE INFORMATION
 REFS 5057.0040 SQ.FT.
 REFL 701.0004 IN.
 REFB 1250.0040 IN.
 XMRP 1266.0040 IN.
 YMRP 0.0000 IN.
 ZMRP 163.0004 IN.
 SCALE 100.0000 PERCNT

DLSWT TEST 138- BOAT TAIL EFFECT

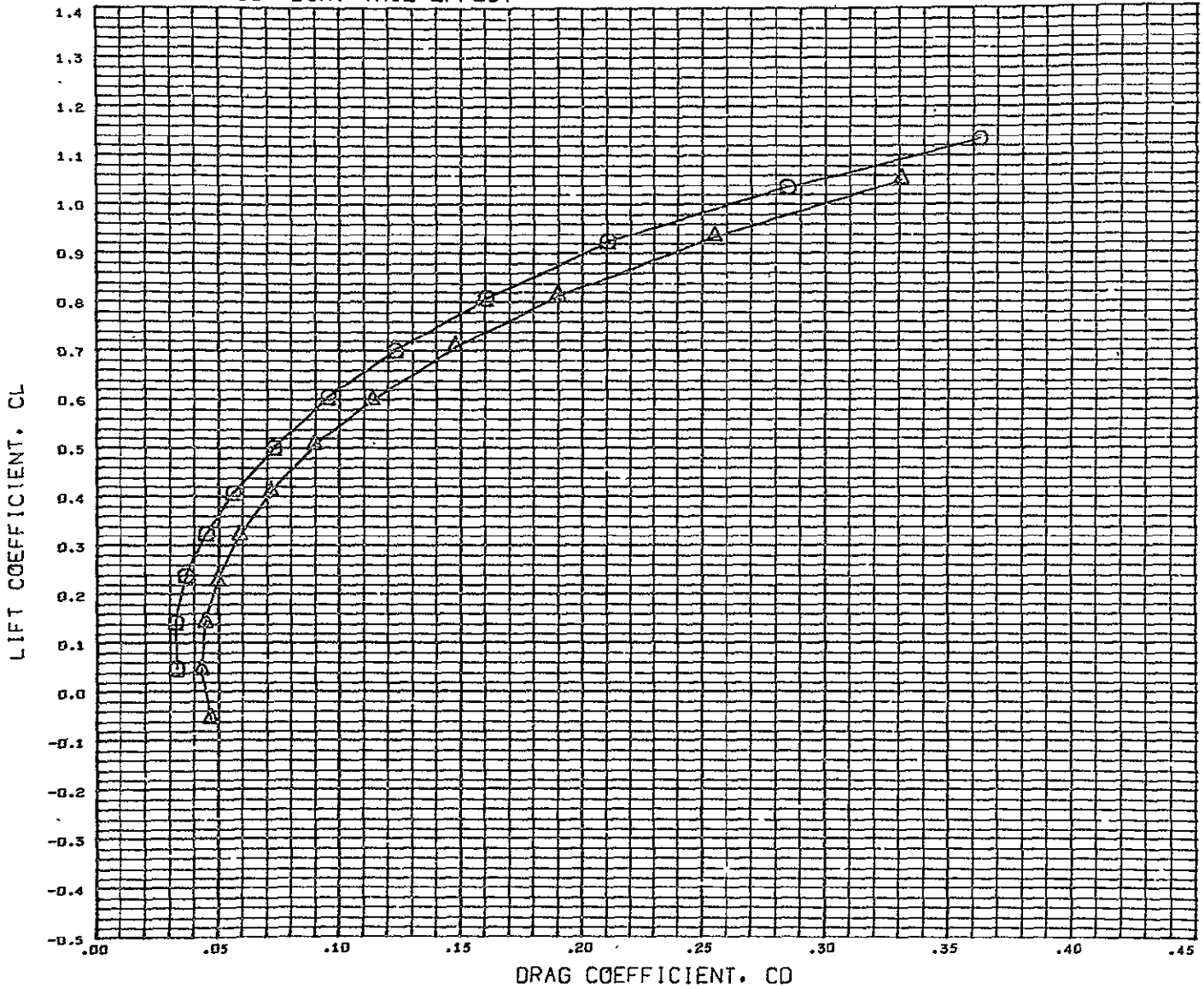

DATA SET	SYMBOL	CONFIGURATION DESCRIPTION
(RCNG31)	○	DLSWT 138 G.0133 SC. GENERIC HCR 02 B18WASTV4
(RCNG29)	△	DLSWT 138 G.0133 SC. GENERIC HCR 02 B4WASTV4

REFERENCE INFORMATION		
REFS	5057.0040	SQ. FT.
REFL	701.0000	IN.
REFB	1230.0040	IN.
XMRP	1266.0040	IN.
YMRP	0.0000	IN.
ZMRP	163.0004	IN.
SCALE	100.0000	PERCENT

PACH 5.180

DLSWT TEST 138- BOAT TAIL EFFECT

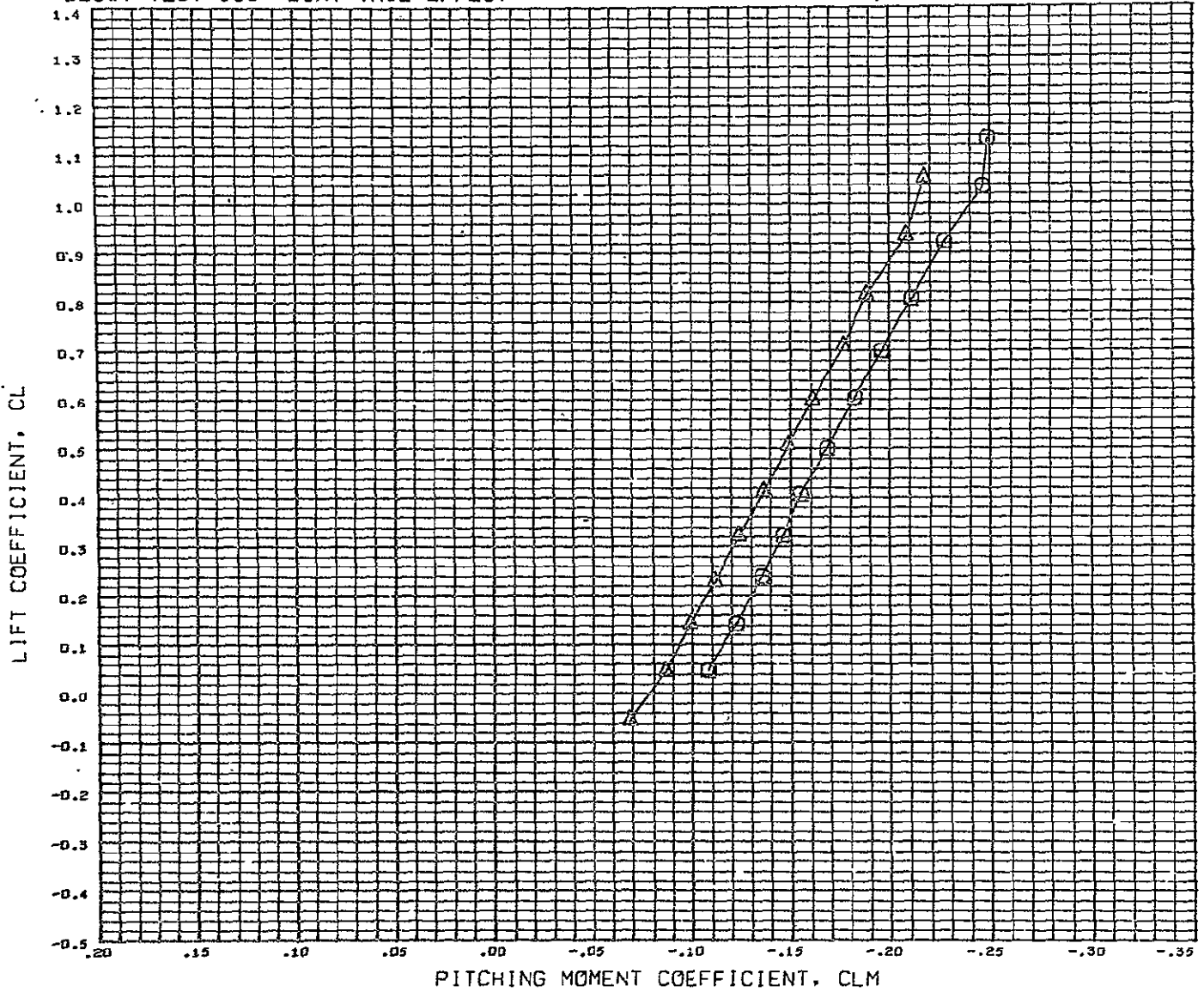

DATA SET SYMBOL CONFIGURATION DESCRIPTION
 (RCN031) DLSWT 138 0,0133 SC. GENERIC HCR 02 B10W4ASTV4
 (RCN029) DLSWT 138 0,0133 SC. GENERIC HCR 02 B4W4ASTV4

REFERENCE INFORMATION
 REFS 5057.0040 SQ. FT.
 REFL 701.6204 IN.
 REFB 1230.0040 IN.
 XMRP 1266.0040 IN.
 YMRP 0.0000 IN.
 ZMRP 163.0004 IN.
 SCALE 100.0000 PERCENT

MACH 0.180

DLSWT TEST 138- BOAT TAIL EFFECT

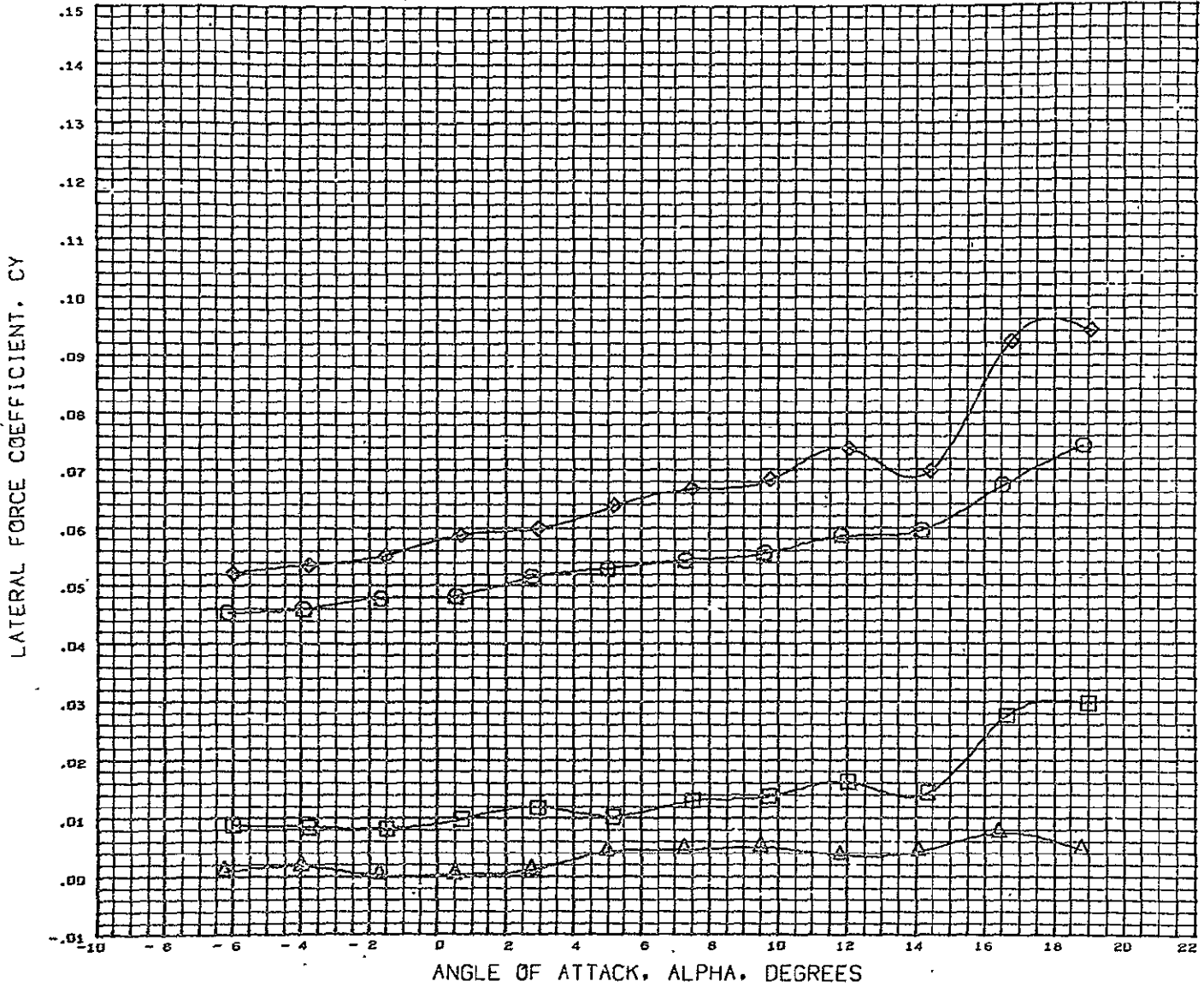

DATA SET SYMBOL	CONFIGURATION DESCRIPTION	BETA
(TCN028)	DLSWT 138 D.0133 SC. GENERIC HCR 02 B4W4ASTV4	-2.900
(TCN029)	DLSWT 138 D.0133 SC. GENERIC HCR 02 B4W4ASTV4	0.000
(TCN032)	DLSWT 138 D.0133 SC. GENERIC HCR 02 B10W4ASTV4	-2.880
(TCN033)	DLSWT 138 D.0133 SC. GENERIC HCR 02 B12W4ASTV4	0.000

REFERENCE INFORMATION	
REFS	5057.0040 SQ.FT.
REFL	701.0004 IN.
REFB	1230.0040 IN.
XNRF	1266.0040 IN.
YNRF	0.0000 IN.
ZNRF	163.0004 IN.
SCALE	100.0000 PERCENT

"ACH 0.180

DLSWT TEST 138- BOAT TAIL EFFECT

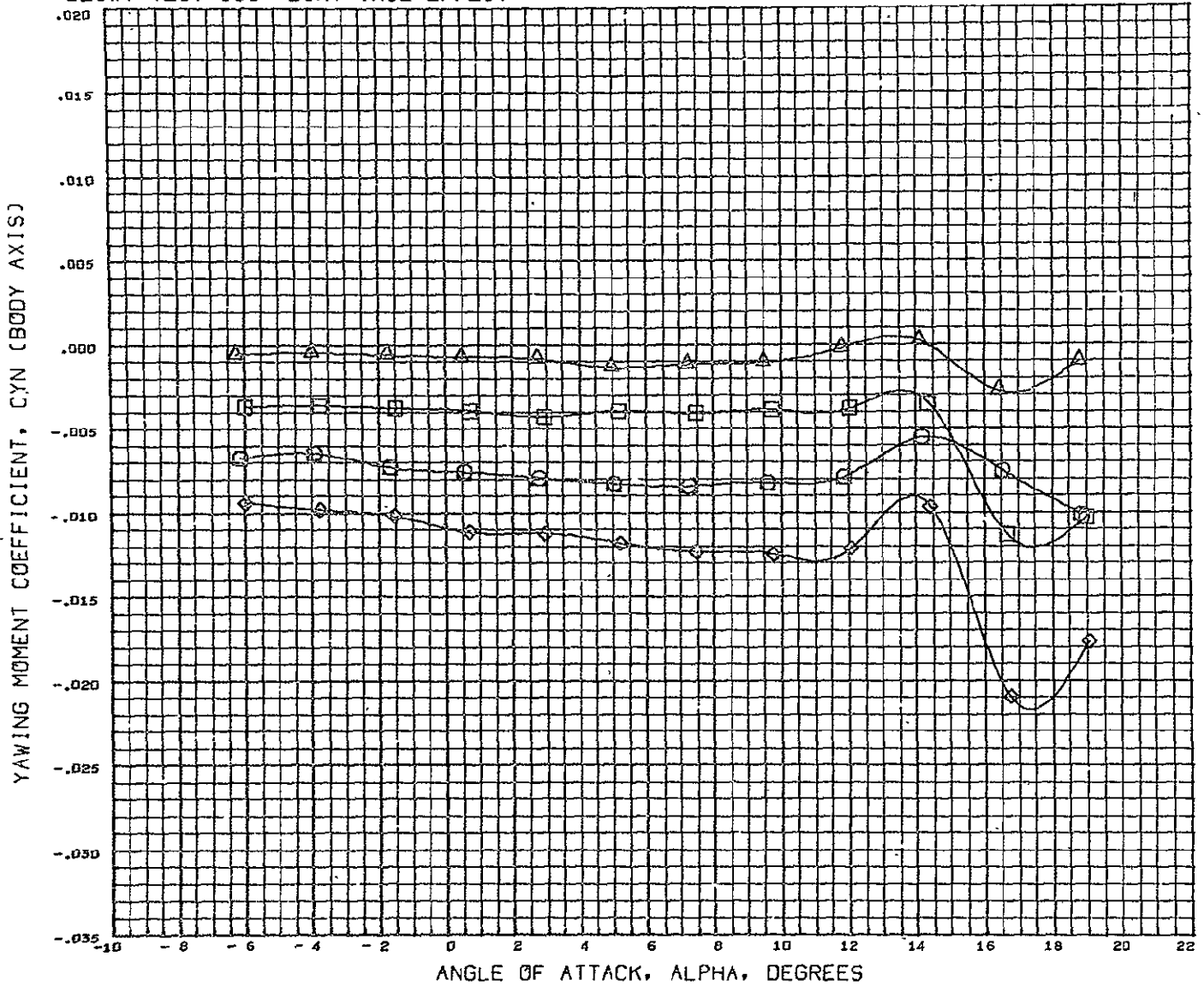

DATA SET SYMBOL	CONFIGURATION DESCRIPTION	BETA	REFERENCE INFORMATION
(TCND28)	DLSWT 138 0.0133 SC. GENERIC HCR 02 B4W4ASTV4	-2.900	REFS 5057.0040 SQ. FT.
(TCND29)	DLSWT 138 0.0133 SC. GENERIC HCR 02 B4W4ASTV4	0.000	REFL 701.0004 IN.
(TCND32)	DLSWT 138 0.0133 SC. GENERIC HCR 02 B1B4ASTV4	-2.880	REFS 1130.0040 IN.
(TCND33)	DLSWT 138 0.0133 SC. GENERIC HCR 02 B1B4ASTV4	0.000	XMRP 1266.0040 IN.
			YMRP 0.5000 IN.
			ZMRP 163.0004 IN.
			SCALE 100.0000 PERCNT

MACH 0.180

DLSWT TEST 138- BOAT TAIL EFFECT

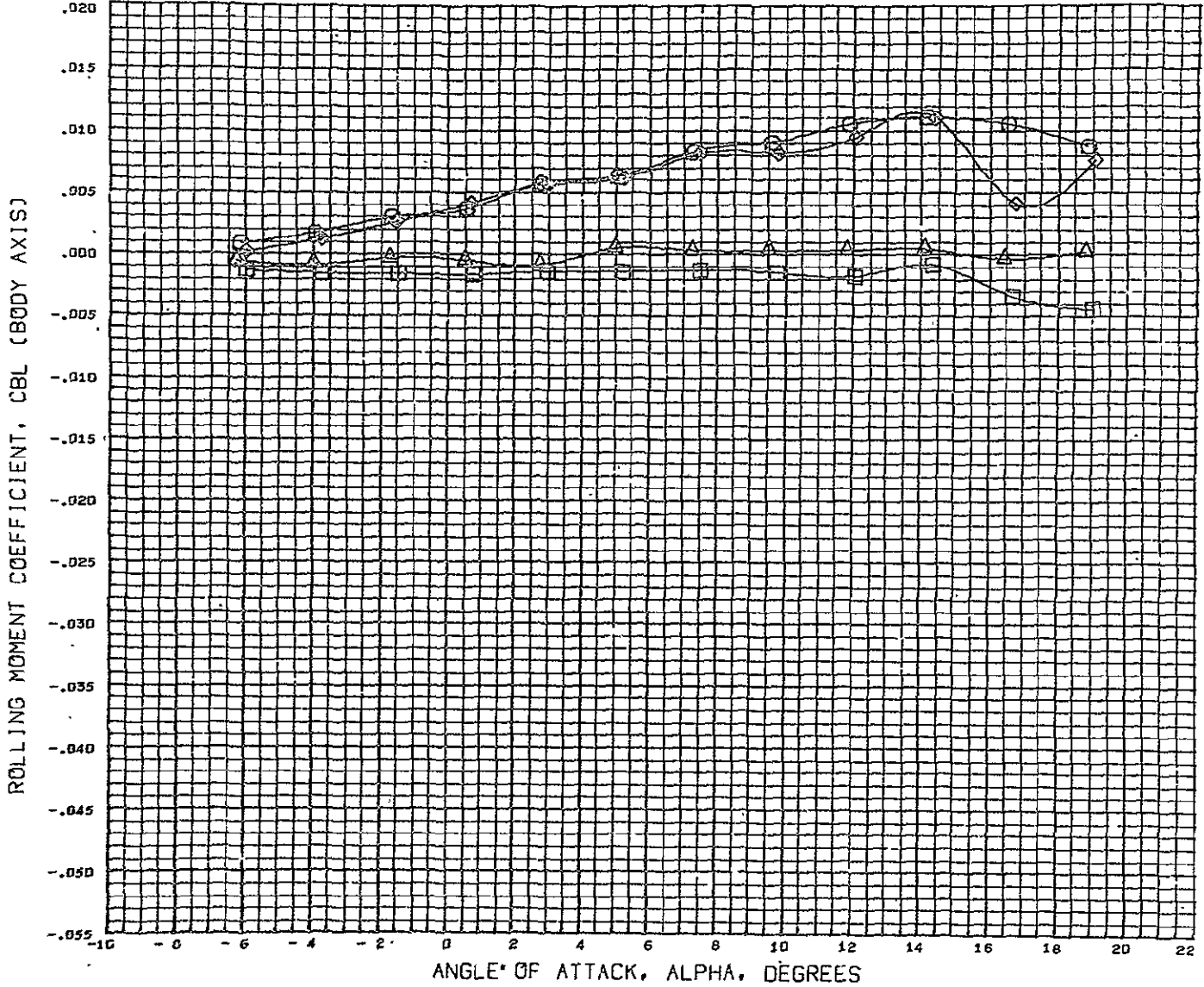

DATA SET SYMBOL	CONFIGURATION DESCRIPTION	BETA	REFERENCE INFORMATION
(TCND28)	DLSWT 138 0.0133 SC. GENERIC HCR 02 B4W4ASTV4	-2.900	REFS 5057.0040 SQ. FT.
(TCND29)	DLSWT 138 0.0133 SC. GENERIC HCR 02 B4W4ASTV4	0.000	REFL 701.0004 IN.
(TCND32)	DLSWT 138 0.0133 SC. GENERIC HCR 02 B10W4ASTV4	-2.880	REFB 1230.0040 IN.
(TCND31)	DLSWT 138 0.0133 SC. GENERIC HCR 02 B10W4ASTV4	0.000	XMRP 1266.0040 IN.
			YMRP 0.0000 IN.
			ZMRP 163.0004 IN.
			SCALE 100.0000 PERCENT

MACH 0.180

DLSWT TEST 138- BOAT TAIL EFFECT

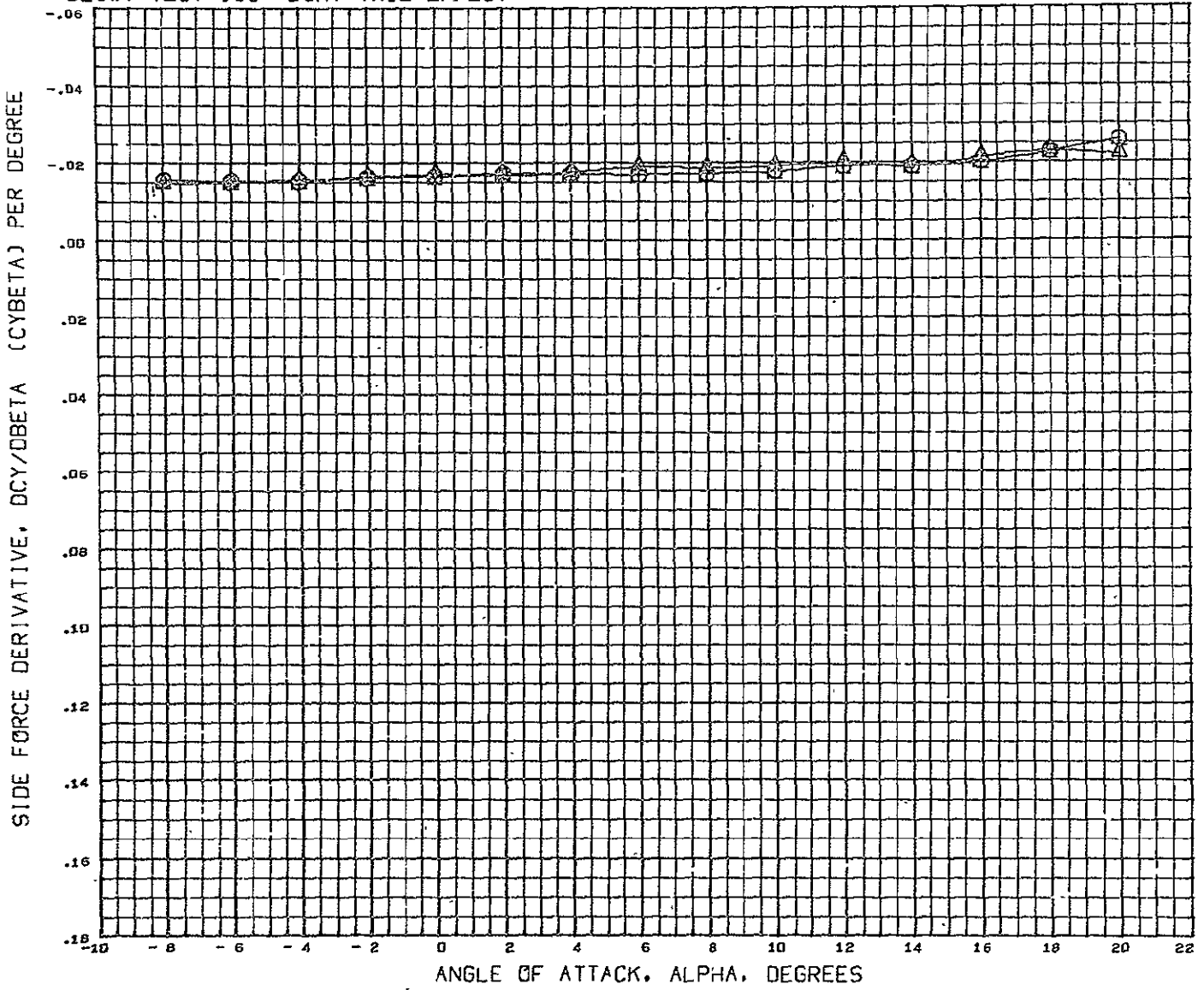

DATA SET SYMBOL CONFIGURATION DESCRIPTION
 (PCNG29) Δ DLSWT 138 D.0133 SC. GENERIC HCR 02 B4W4ASTV4
 (PCNG31) Δ DLSWT 138 D.0133 SC. GENERIC HCR 02 B1BW4ASTV4

REFERENCE INFORMATION
 REFS 5057.0040 SQ.FT.
 REFL 701.0J04 IN.
 REFB 1230.0070 IN.
 XMRP 1266.0040 IN.
 YMRP 0.0000 IN.
 ZMRP 163.0004 IN.
 SCALE 100.0000 PERCENT

MACH 0.180

DLSWT TEST 138- BOAT TAIL EFFECT

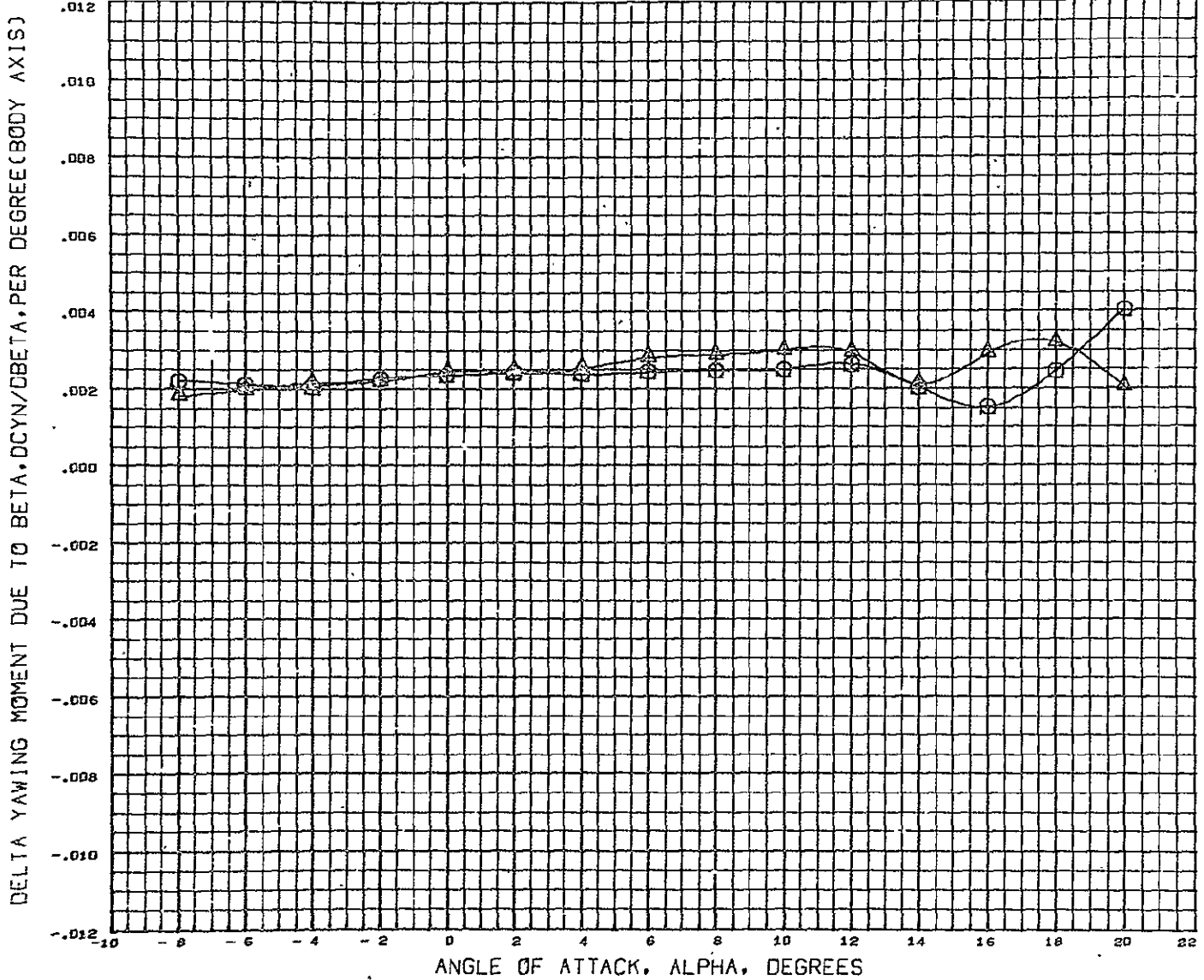

DATA SET SYMBOL CONFIGURATION DESCRIPTION
 (PCND29) \circ DLSWT 138 0.0133 SC. GENERIC HCR 02 B4WASTV4
 (PCND31) Δ DLSWT 138 0.0133 SC. GENERIC HCR 02 B1BWASTV4

REFERENCE INFORMATION
 REFS 5057.0040 SQ.FT.
 REFL 791.0034 IN.
 REFB 1230.0040 IN.
 XMRP 1266.0040 IN.
 YMRP 0.0000 IN.
 ZMRP 163.0004 IN.
 SCALE 100.0000 PERCENT

MACH 0.180

DLSWT TEST 138- BOAT TAIL EFFECT

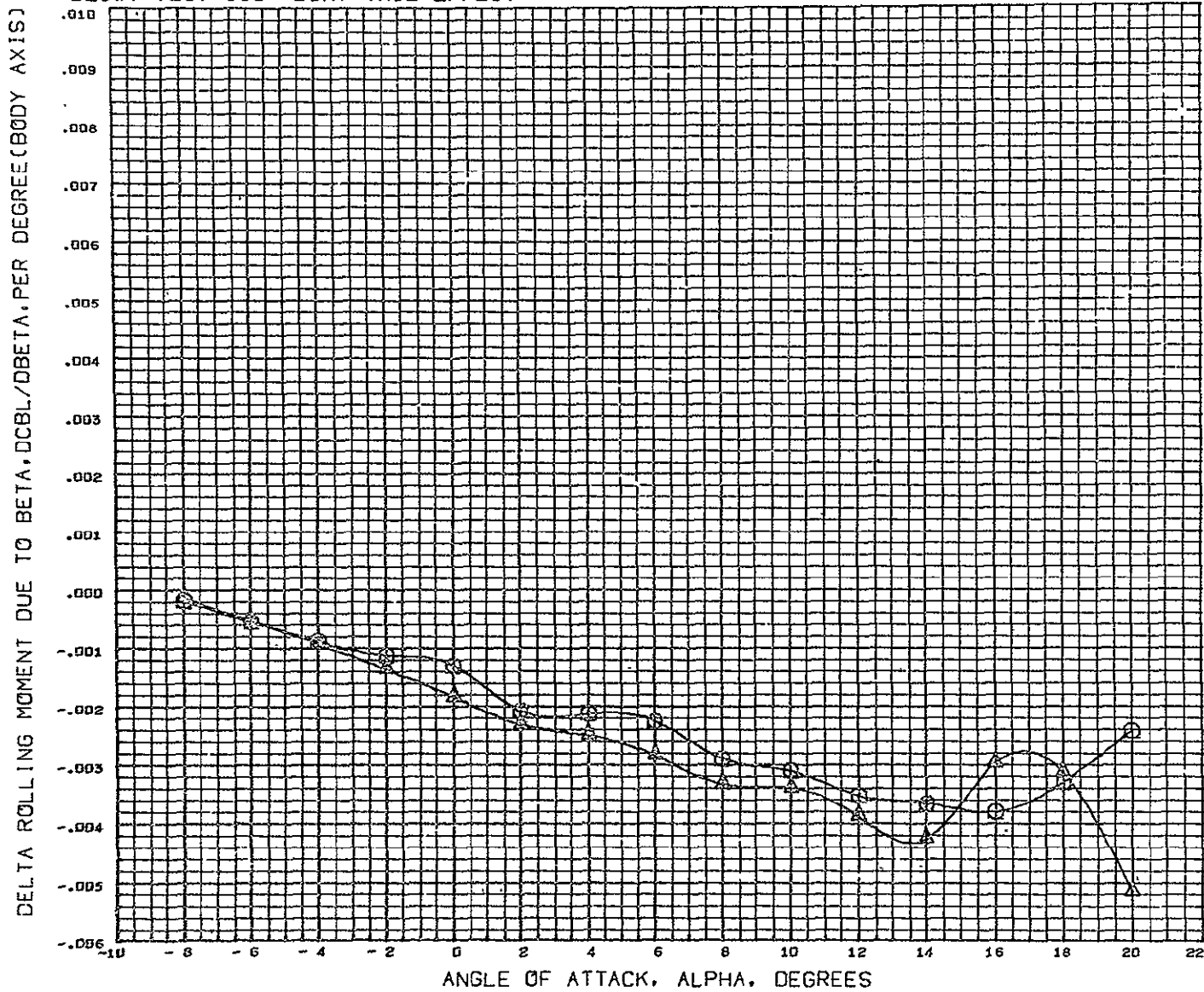

DATA SET SYMBOL CONFIGURATION DESCRIPTION
 (PCN029) QLSWT 138 D.0133 SC. GENERIC HCR 02 B4W4ASTV4
 (PCN031) Δ DLSWT 138 D.0133 SC. GENERIC HCR 02 B1B4ASTV4

REFERENCE INFORMATION
 REFS 5057.0040 SQ.FT.
 REFL 701.0004 IN.
 REFB 1230.0040 IN.
 XMRP 1266.0040 IN.
 YMRP 0.0000 IN.
 ZMRP 163.0004 IN.
 SCALE 100.0000 PERCNT

PAGE 0.100

DLSWT TEST 138- COMPARISON OF WIND TUNNEL MODELS

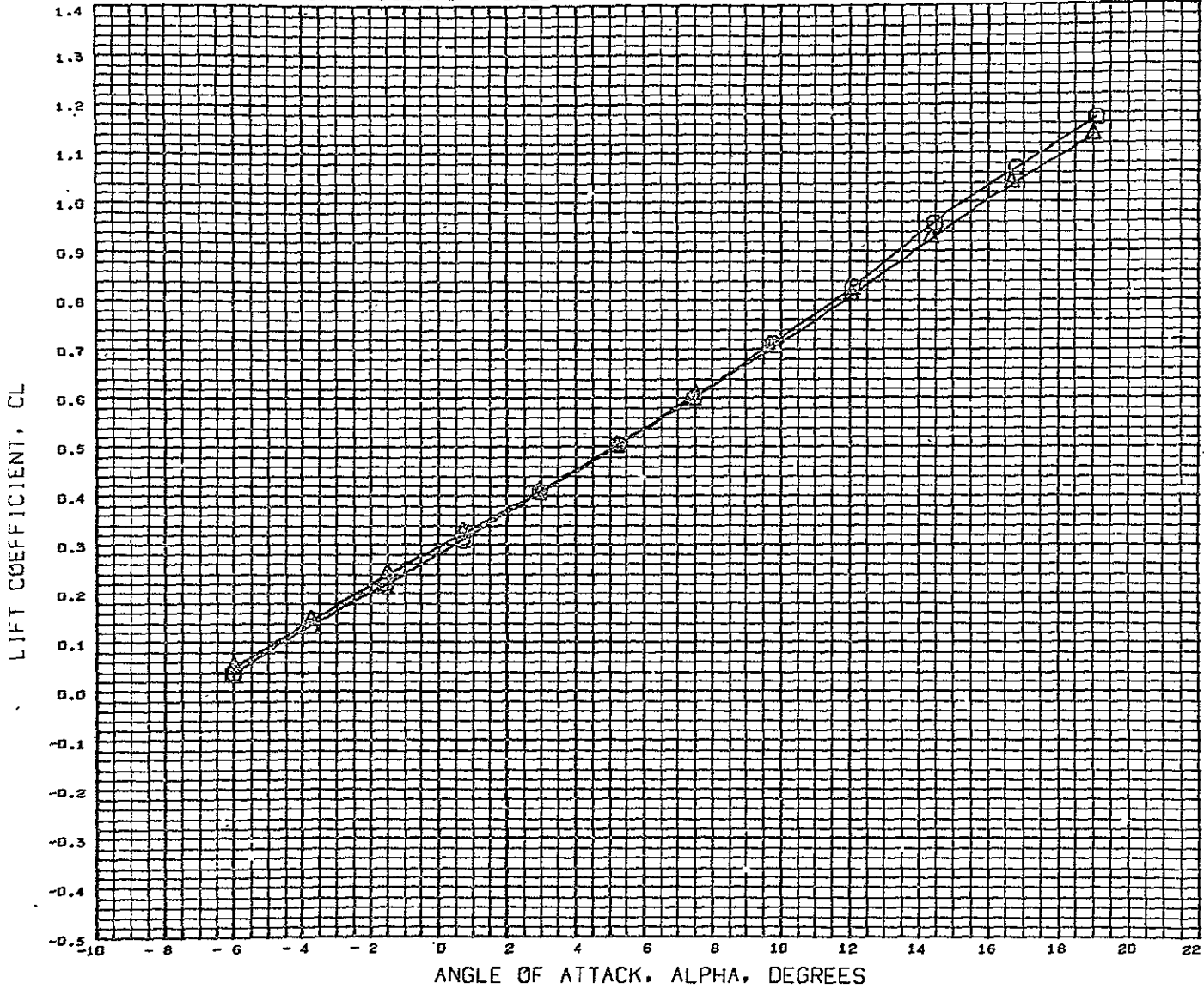

DATA SET SYMBOL	CONFIGURATION DESCRIPTION
(RCN023) ○	DLSWT 138 0.0133 SC. GENERIC HCR 02 B1AW2V4
(RCN031) △	DLSWT 138 0.0133 SC. GENERIC HCR 02 B1BW4S1V4

REFERENCE INFORMATION		
REFS	5057.0040	SQ.FT.
REPL	701.0004	IN.
REFB	1230.0040	IN.
XMRP	1266.0040	IN.
YMRP	0.0000	IN.
ZMRP	163.0004	IN.
SCALE	100.0000	PFCNT

MACH 0.180

DLSWT TEST 138- COMPARISON OF WIND TUNNEL MODELS

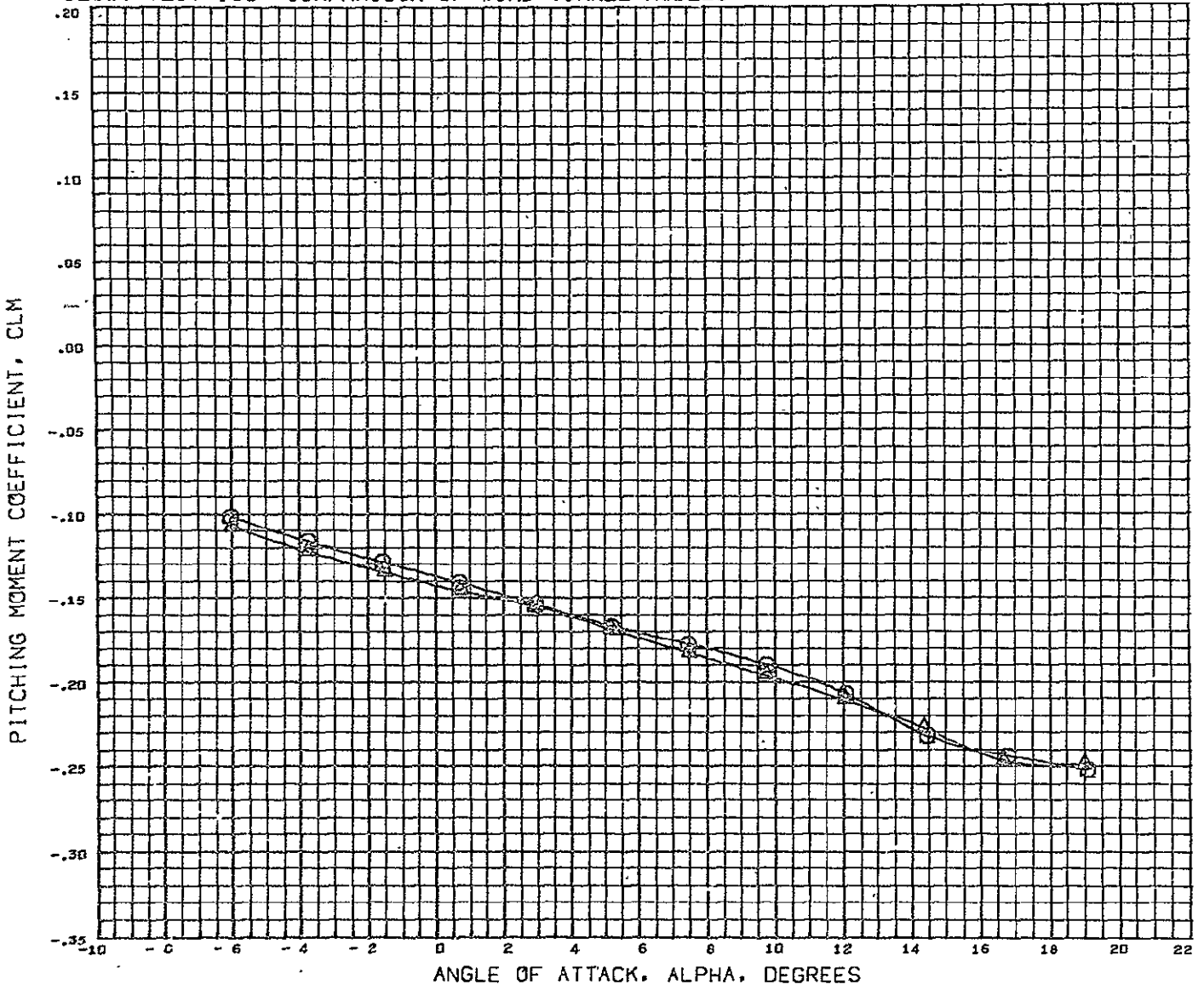

DATA SET SYMBOL CONFIGURATION DESCRIPTION
 (RCN523) DLSWT 138 5.0133 SC. GENERIC HCR 02 B1AW4BV4
 (RCN531) DLSWT 138 0.0133 SC. GENERIC HCR 02 B1BW4ACTV4

REFERENCE INFORMATION
 REFS 5857.0040 SQ. FT.
 REFL 701.0004 IN.
 REFB 1230.0040 IN.
 XMRP 1266.0040 IN.
 YMRP 0.0000 IN.
 ZMRP 163.0004 IN.
 SCALE 100.0000 PERCNT

MACH 0.180

DLSWT TEST 138- COMPARISON OF WIND TUNNEL MODELS

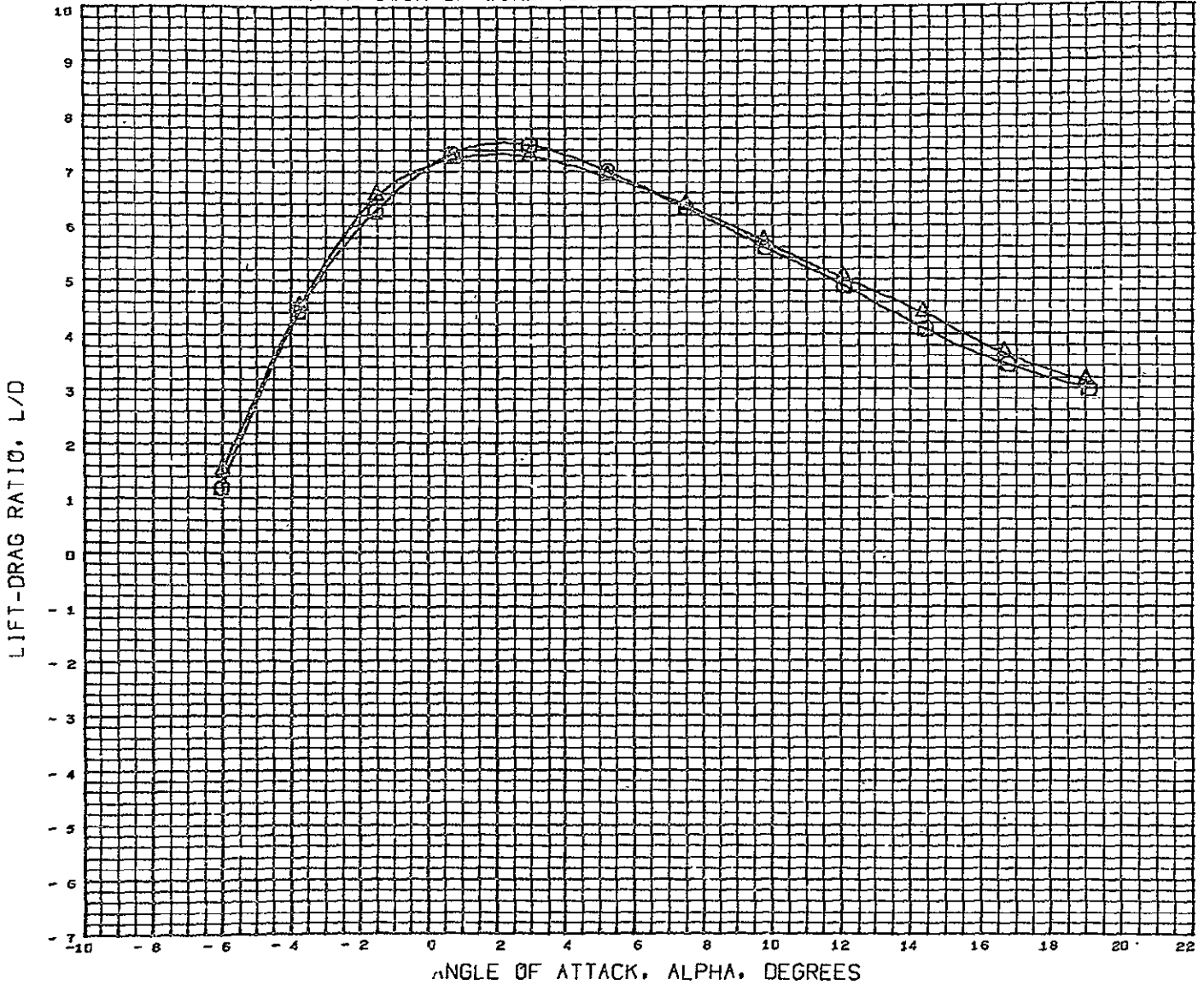

DATA SET SYMBOL	CONFIGURATION DESCRIPTION
(RCH023) ○	DLSWT 138 0.0133 SC. GENERIC HCR 02 B1AW4B1V4
(RCH031) △	DLSWT 138 0.0133 SC. GENERIC HCR 02 B1BWA5T1V4

REFERENCE INFORMATION		
REFS	5057.0040	SQ.FT.
REFL	701.0004	IN.
REFB	1230.0040	IN.
XMRP	1266.0040	IN.
YMRP	0.0000	IN.
ZMRP	163.0004	IN.
SCALE	100.0000	PERCNT

MACH 0.180

DLSWT TEST 138- COMPARISON OF WIND TUNNEL MODELS

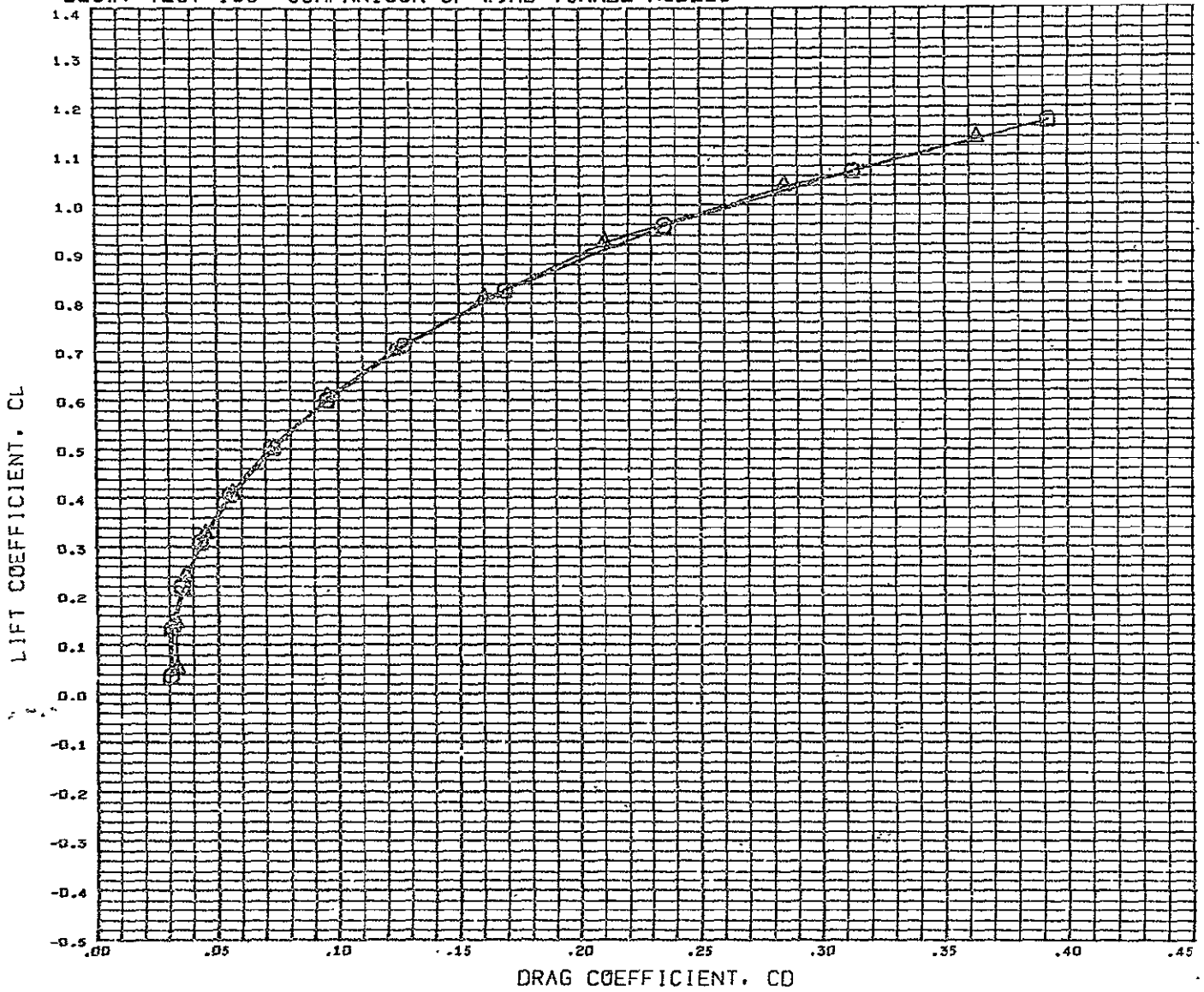

DATA SET SYMBOL	CONFIGURATION DESCRIPTION
(RCN023) ○	DLSWT 138 D.D133 SC. GENERIC HCR 02 B1AW4BV4
(RCN031) △	DLSWT 138 D.D133 SC. GENERIC HCR 02 B1BW4ASTV4

REFERENCE INFORMATION		
REFS	5057.0040	SQ.FT.
REFL	701.0004	IN.
REFE	1230.0040	IN.
XNRF	1266.0040	IN.
YNRF	0.0000	IN.
ZNRF	163.0004	IN.
SCALE	100.0000	PERCENT

PAGE 0.180

DLSWT TEST 138- COMPARISON OF WIND TUNNEL MODELS

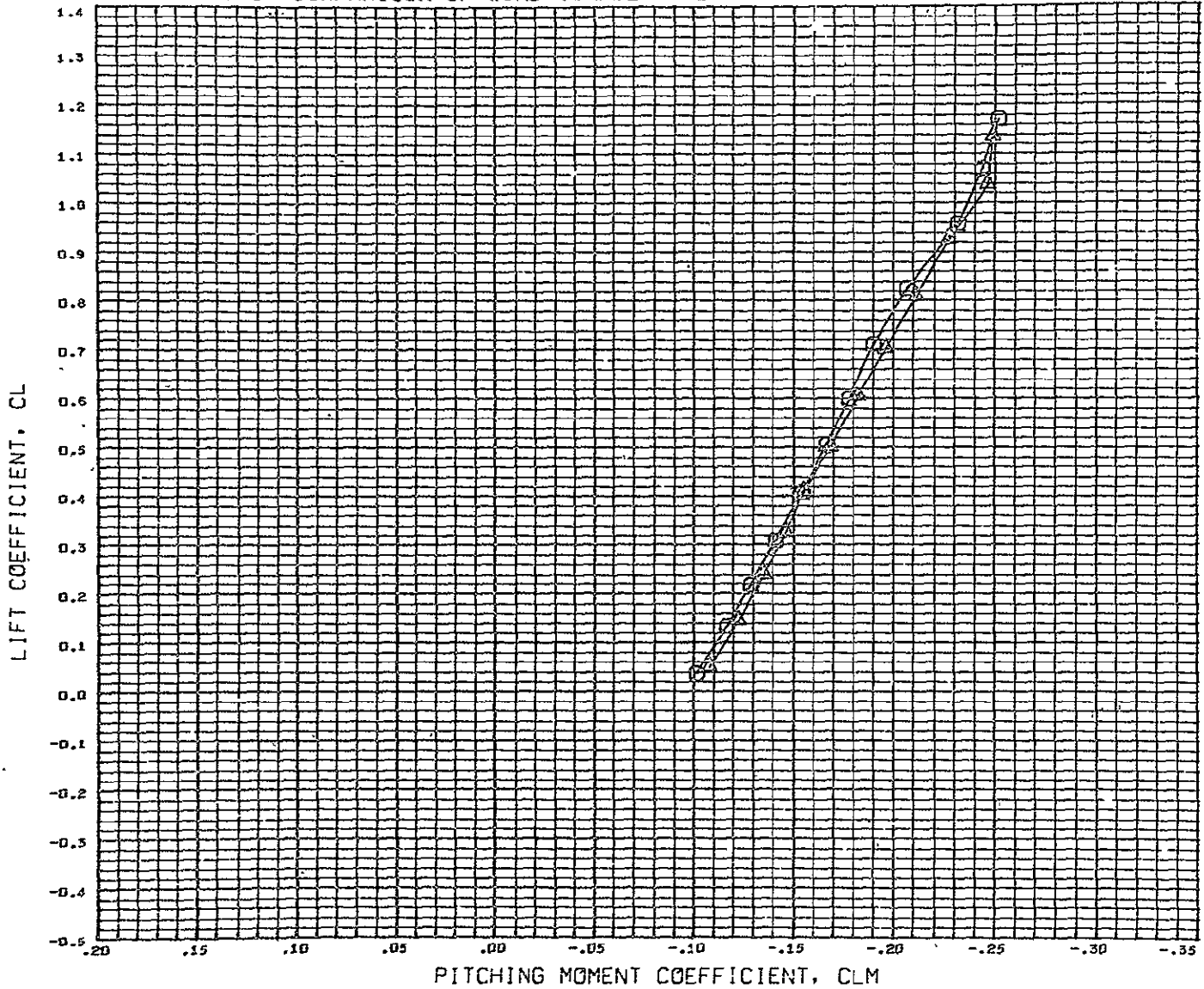

DATA SET SYMBOL	CONFIGURATION DESCRIPTION
(RCN023) ○	DLSWT 138 0.0133 SC. GENERIC HCR 02 B1A4B4V4
(RCN031) △	DLSWT 138 0.0133 SC. GENERIC HCR 02 E13WA4STV4

REFERENCE INFORMATION		
REFS	5057.0040	SQ.FT.
REFL	701.0004	IN.
REFB	1230.0040	IN.
XMRP	1266.0040	IN.
YMRP	0.0000	IN.
ZMRP	163.0004	IN.
SCALE	100.0000	PERCENT

MACH 0.100

DLSWT TEST 138- COMPARISON OF WIND TUNNEL MODELS

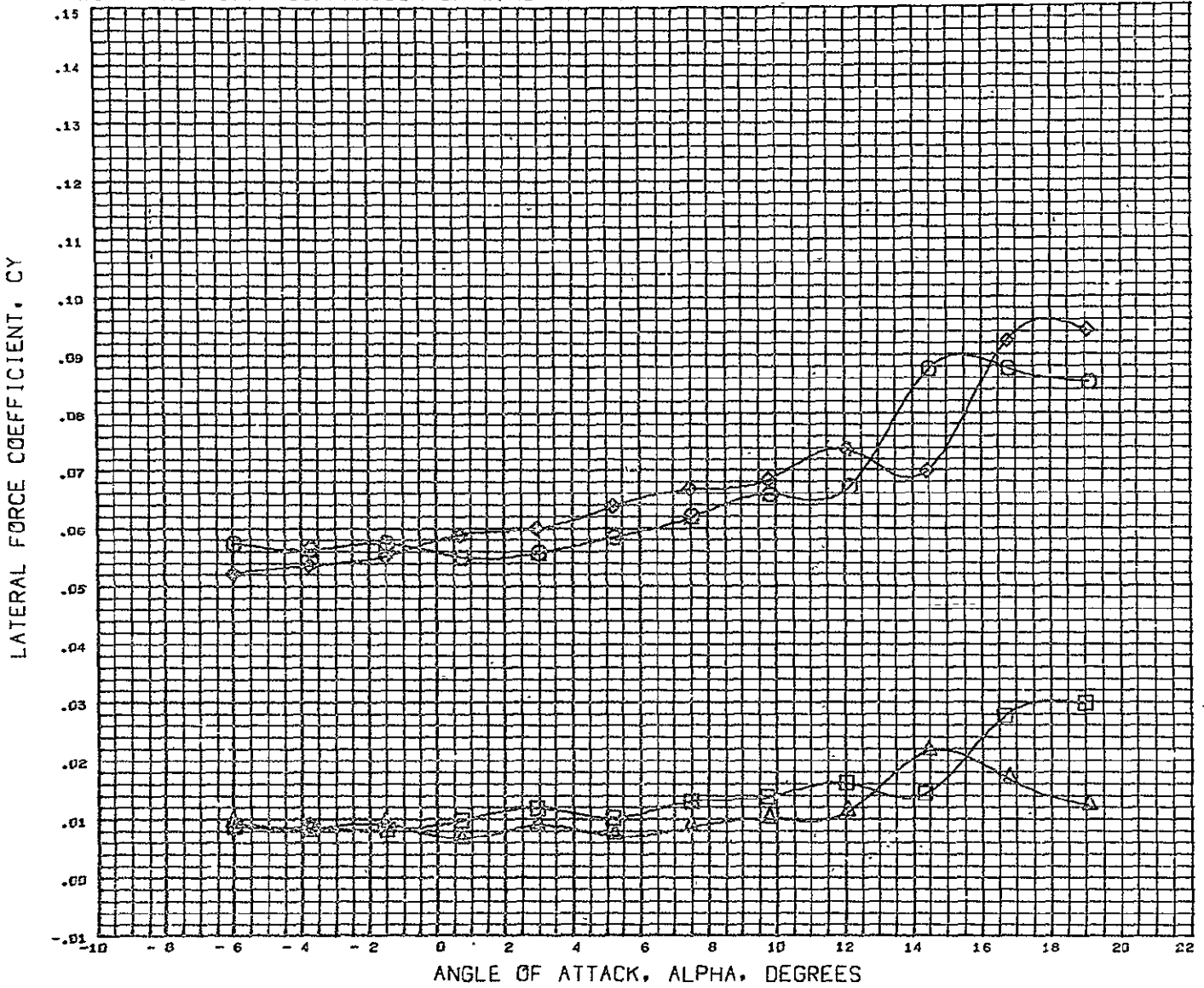

DATA SET SYMBOL	SYMBOL	CONFIGURATION DESCRIPTION	BETA	REFERENCE INFORMATION
(TCND22)	○	DLSWT 138 0.0133 SC. GENERIC HCR 02 B1AW4B4	-2.900	REFS 5057.0040 SQ.FT.
(TCND23)	△	DLSWT 138 0.0133 SC. GENERIC HCR 02 B1AW4B4	0.000	REFL 701.0004 IN.
(TCND32)	◇	DLSWT 138 0.0133 SC. GENERIC HCR 02 B1BW4ASTV4	-2.880	REFB. 1230.0040 IN.
(TCND31)	□	DLSWT 138 0.0133 SC. GENERIC HCR 02 B1BW4ASTV4	0.000	XMRP 1266.0040 IN.
				YMRP 0.0000 IN.
				ZMRP 163.0004 IN.
				SCALE 100.0000 -ERCNT

MACH 0.180

DLSWT TEST 138- COMPARISON OF WIND TUNNEL MODELS

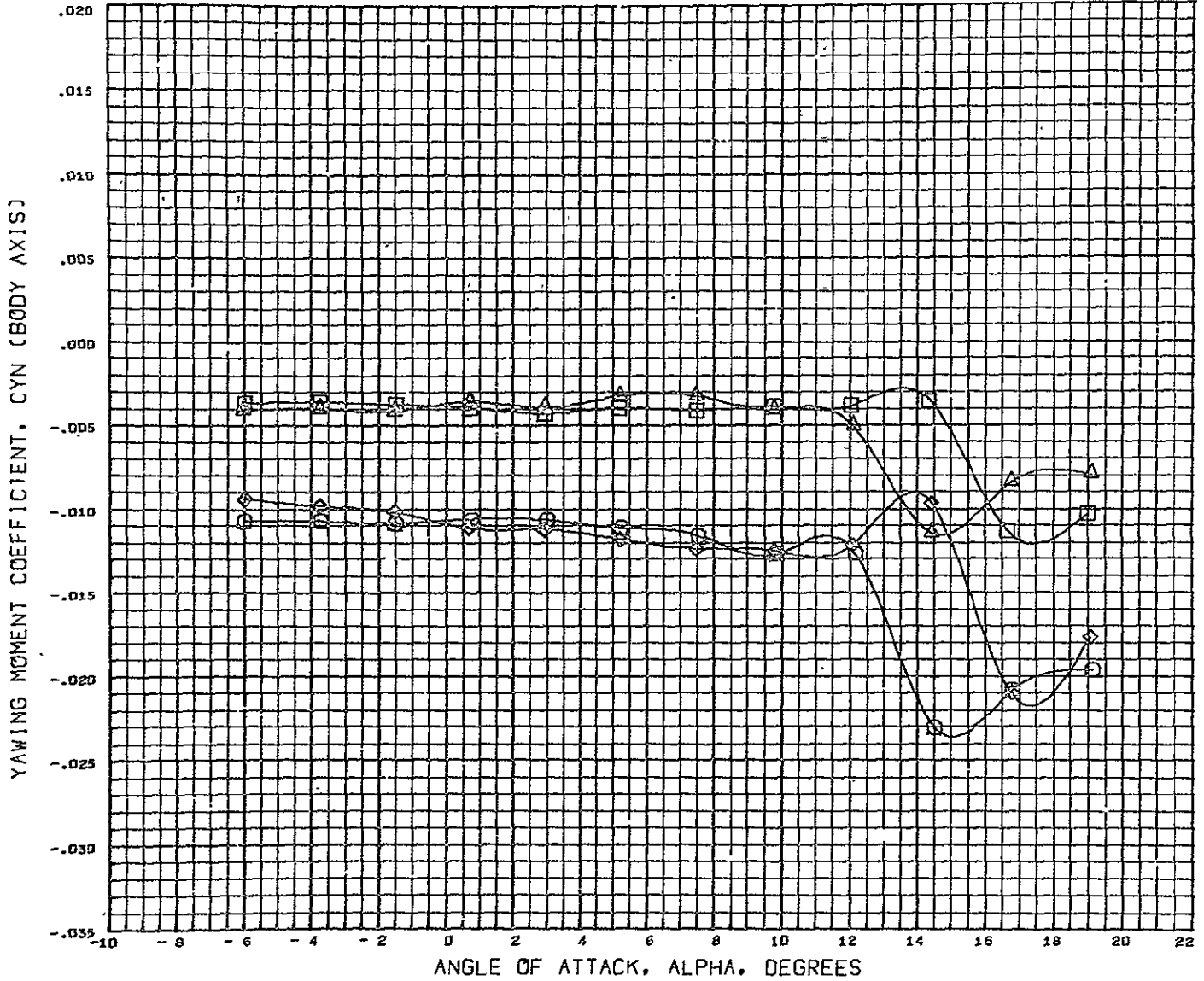

DATA SET SYMBOL	CONFIGURATION DESCRIPTION	BETA
(TCN022)	DLSWT 138 0.0133 SC. GENERIC HCR 02 B1AW4BV4	-2.900
(TCN023)	DLSWT 138 0.0133 SC. GENERIC HCR 02 B1AW4BV4	0.000
(TCN032)	DLSWT 138 0.0133 SC. GENERIC HCR 02 B1BW4ASTV4	-2.880
(TCN031)	DLSWT 138 0.0133 SC. GENERIC HCR 02 B1BW4ASTV4	0.000

REFERENCE INFORMATION		
REFS	5057.0040	SQ. FT.
REFL	701.6304	IN.
REFB	1230.0040	IN.
XHRF	1266.0040	IN.
YHRF	0.0000	IN.
ZHRF	163.0004	IN.
SCALE	100.0000	PERCENT

MACH E.180

DLSWT TEST 138- COMPARISON OF WIND TUNNEL MODELS

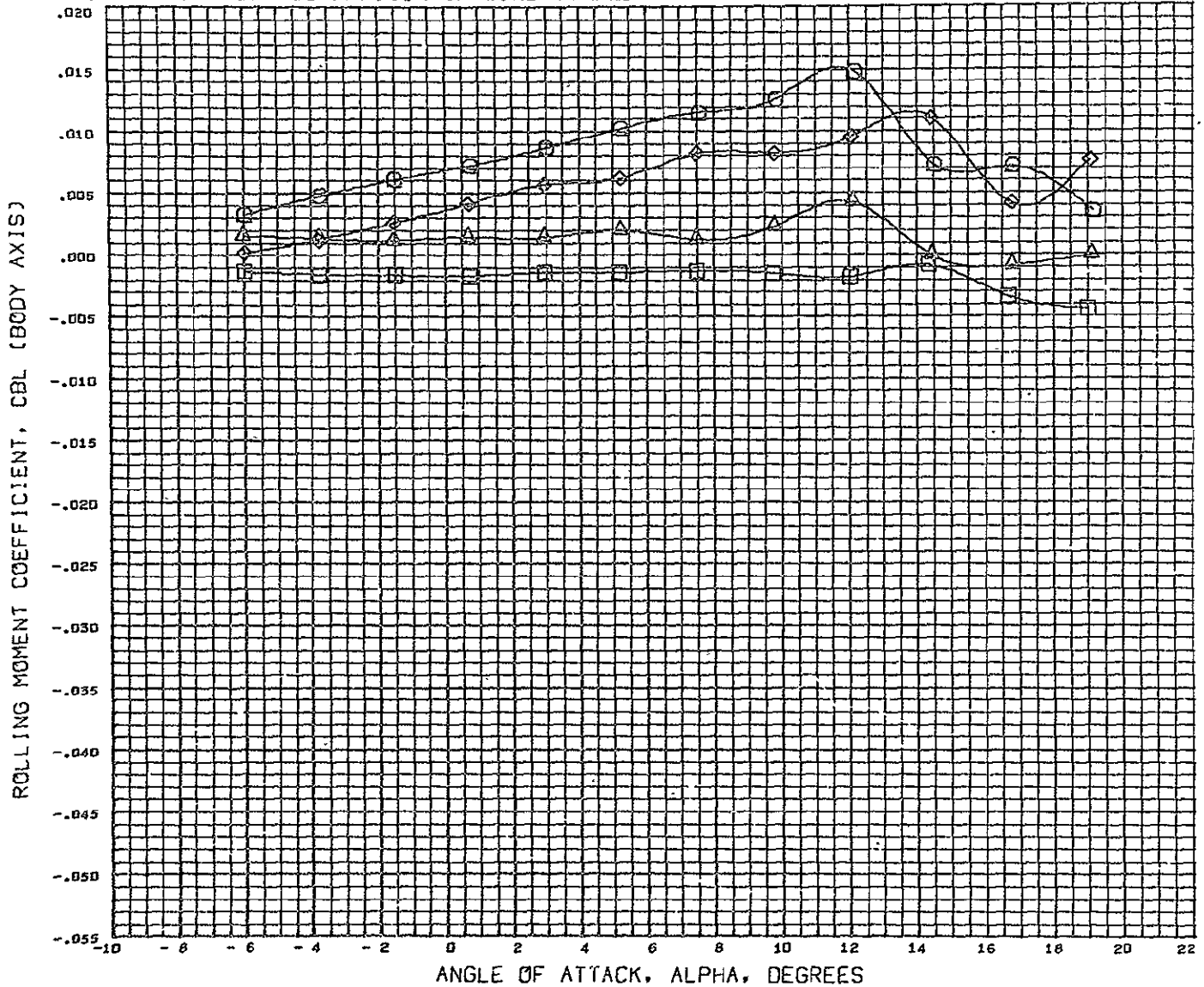

DATA SET SYMBOL	CONFIGURATION DESCRIPTION	BETA	REFERENCE INFORMATION
(TCN922)	DLSWT 138 0.0133 SC, GENERIC HCR 02 01AW4BV4	-2.900	REFS 5057.0040 SQ.FT.
(TCN923)	DLSWT 138 0.0133 SC, GENERIC HCR 02 01AW4BV4	0.000	REFL 701.0004 IN.
(TCN932)	DLSWT 138 0.0133 SC, GENERIC HCR 02 01BW4ASTV4	-2.880	REFB 1230.0040 IN.
(TCN931)	DLSWT 138 0.0133 SC, GENERIC HCR 02 01BW4ASTV4	0.000	XMRP 1266.0040 IN.
			YMRP 0.0000 IN.
			ZMRP 163.0004 IN.
			SCALE 100.0000 PERCENT

MACH 3.180

DLSWT TEST 138- COMPARISON OF WIND TUNNEL MODELS

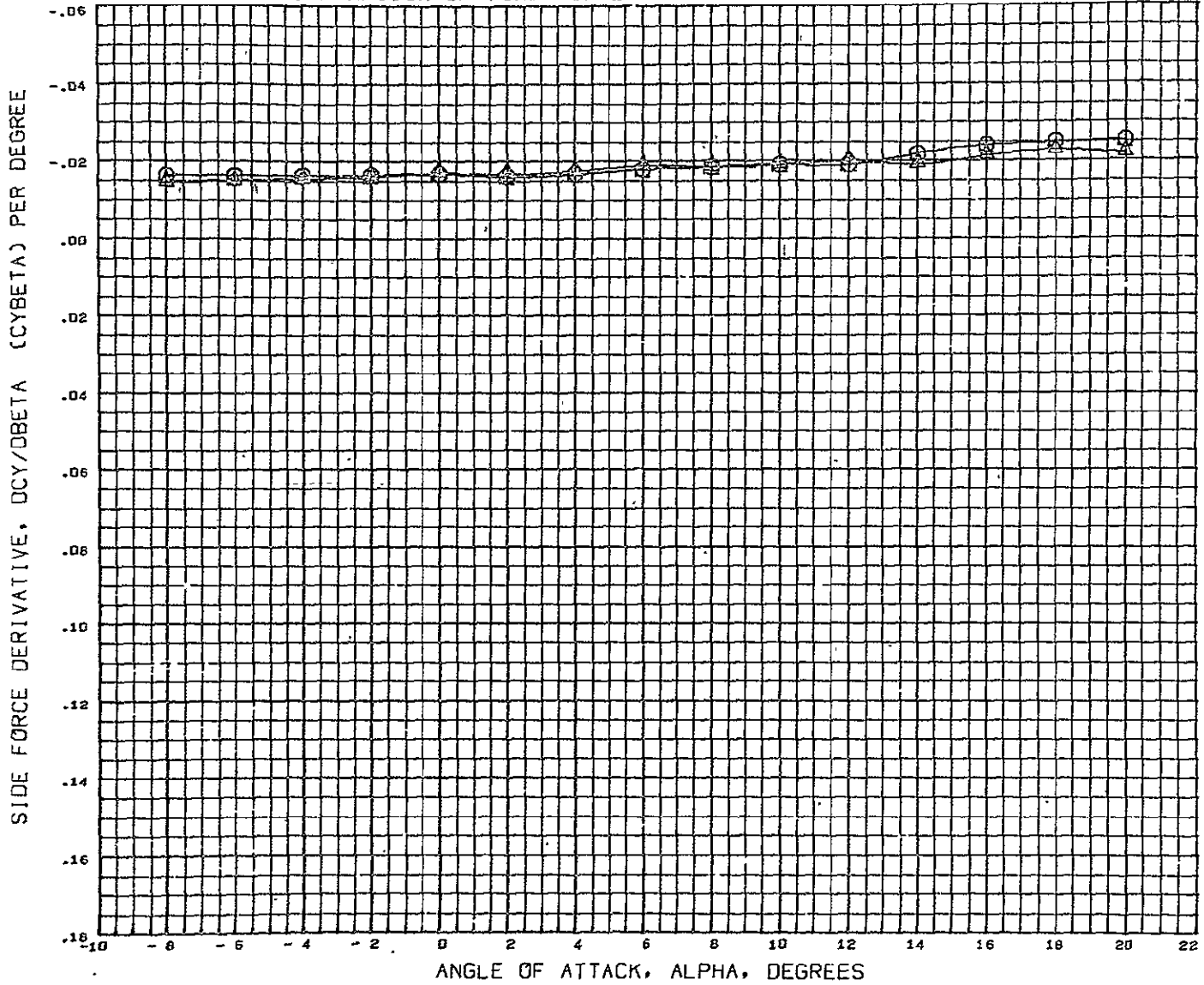

DATA SET SYMBOL	CONFIGURATION DESCRIPTION
(FCNB23) ○	DLSWT 138 0.0133 SC. GENERIC HCR 02 B1AW4BV4
(FCNB31) △	DLSWT 138 0.0133 SC. GENERIC HCR 02 B1BW4ASTV4

REFERENCE INFORMATION	
REFS	5057.0040 SQ.FT.
REFL	701.0004 IN.
REFB	1230.0040 IN.
XMRP	1266.0040 IN.
YMRP	0.0000 IN.
ZMRP	163.0004 IN.
SCALE	100.0000 PERCENT

MACH 0.180

DLSWT TEST 138- COMPARISON OF WIND TUNNEL MODELS

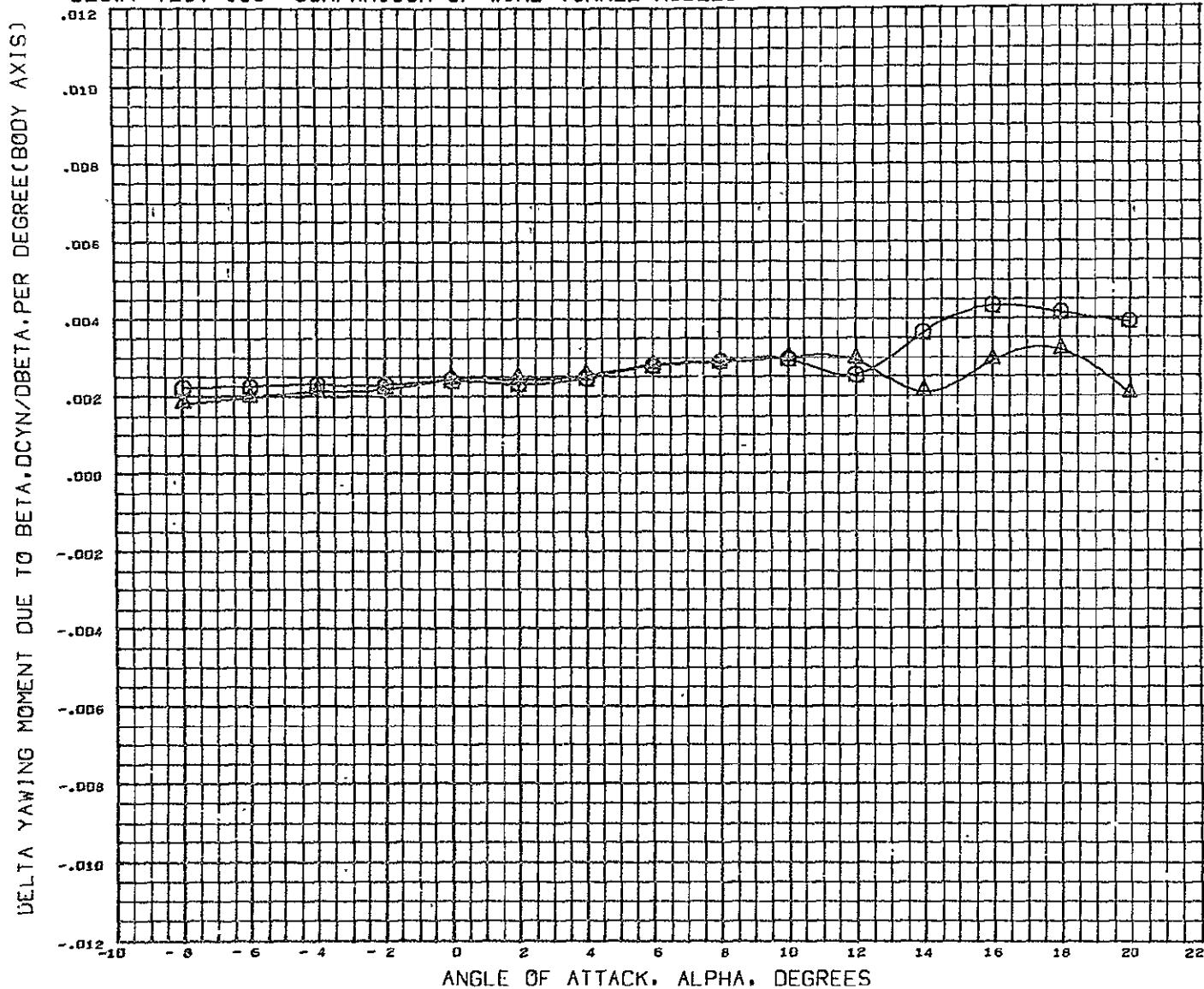

DATA SET SYMBOL CONFIGURATION DESCRIPTION
 (FCN023) ○ DLSWT 138 0.0133 SC. GENERIC HCR 02 B1AW4BV4
 (FCN031) △ DLSWT 138 0.0133 SC. GENERIC HCR 02 B1BW4ASTV4

REFERENCE INFORMATION
 REFS 5057.0040 SQ. FT.
 REFL 701.0004 IN.
 REFB 1230.0040 IN.
 XMRP 1266.0040 IN.
 YMRP 0.0000 IN.
 ZMRP 163.0004 IN.
 SCALE 100.0000 PERCENT

MACH 5.180

DLSWT TEST 138- COMPARISON OF WIND TUNNEL MODELS

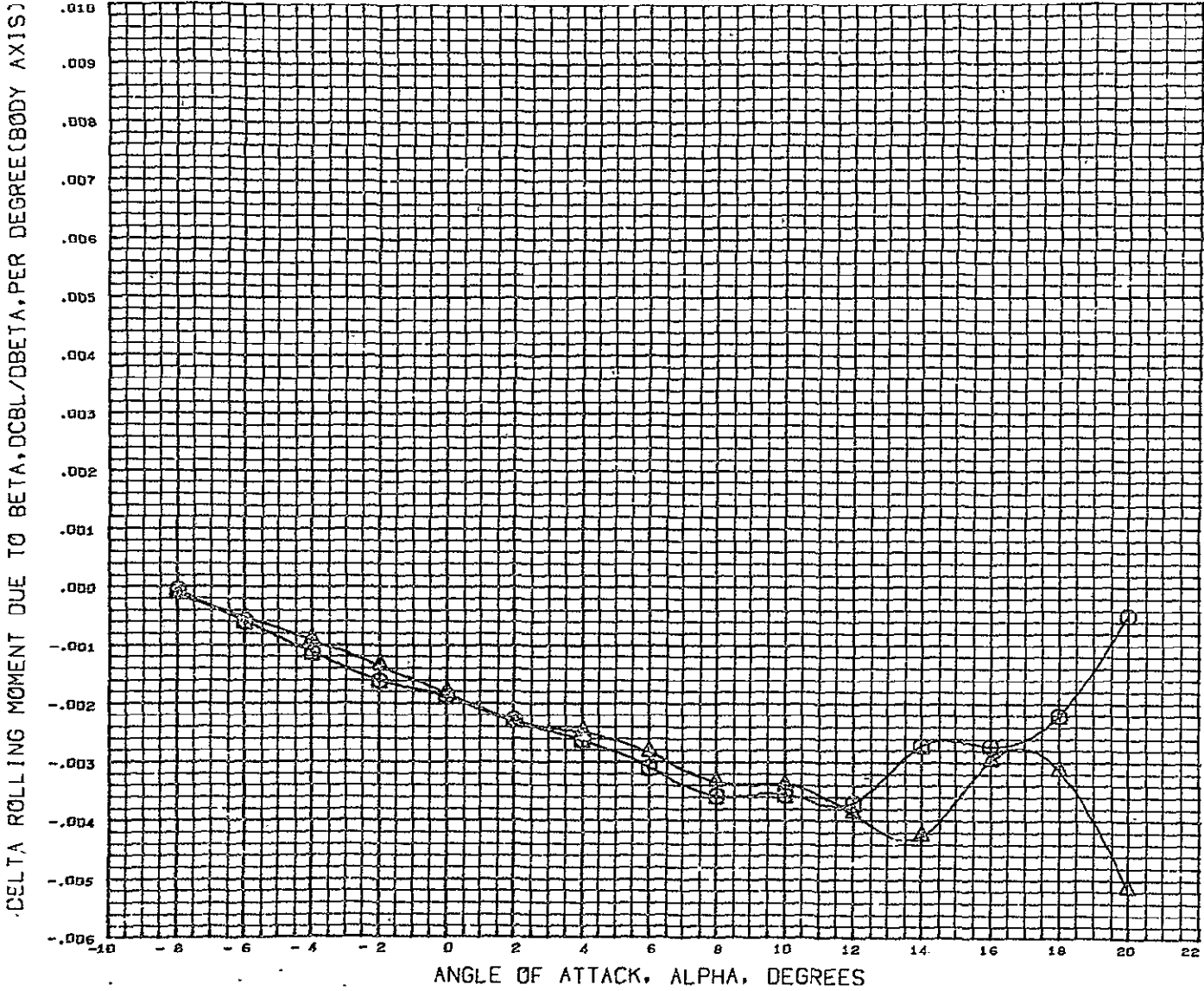

DATA SET SYMBOL CONFIGURATION DESCRIPTION
 (PCN023) ○ DLSWT 138 0.0133 SC. GENERIC HCR 02 B1AW4DV4
 (PCN031) △ DLSWT 138 0.0133 SC. GENERIC HCR 02 B1BW4ASTV4

REFERENCE INFORMATION
 REFS 5057.0040 SQ.FT.
 REFL 701.0004 IN.
 REFB 1230.0043 IN.
 XMRP 1266.0040 IN.
 YMRP 0.0000 IN.
 ZMRP 163.0004 IN.
 SCALE 100.0000 PERCENT

MACH 0.180

DLSWT TEST 138- ENGINE POD EFFECT

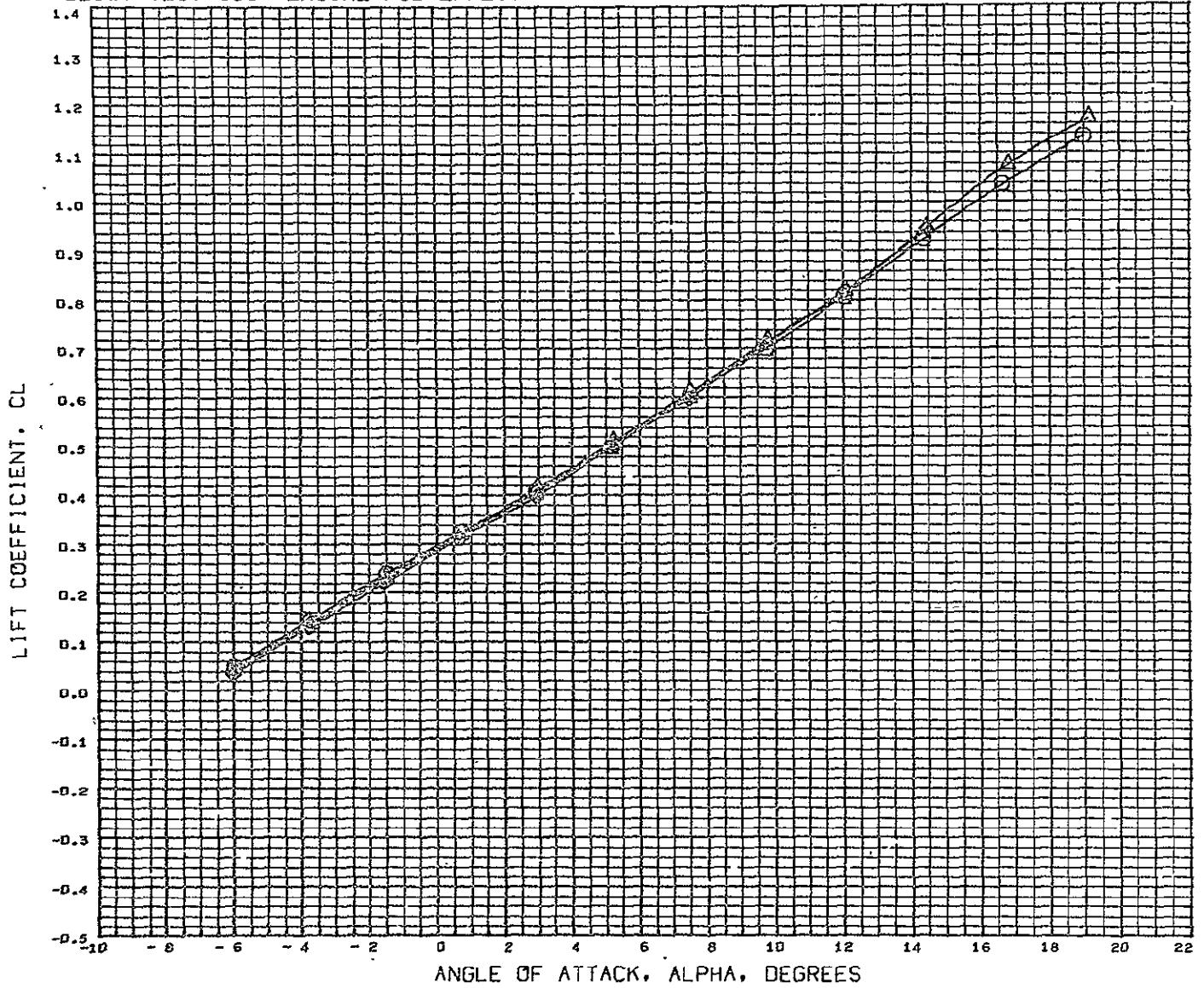

DATA SET SYMBOL	CONFIGURATION DESCRIPTION
(RCN031) ○	DLSWT 138 0.0133 SC. GENERIC HCR 02 B1BW4ASTV4
(RCN066) △	DLSWT 138 0.0133 SC. GENERIC HCR 02 B1BW4ASTV4P1
(RCN068) ◇	DLSWT 138 0.0133 SC. GENERIC HCP 02 B1BW4ASTV4P2

REFERENCE INFORMATION		
REFS	5057.0040	SQ. FT.
REFL	701.0004	IN.
REFB	1230.0040	IN.
XNRF	1266.0040	IN.
YNRF	0.0000	IN.
ZNRF	163.0004	IN.
SCALE	100.0000	PERCENT

MACH 0.180

DLSWT TEST 138- ENGINE POD EFFECT

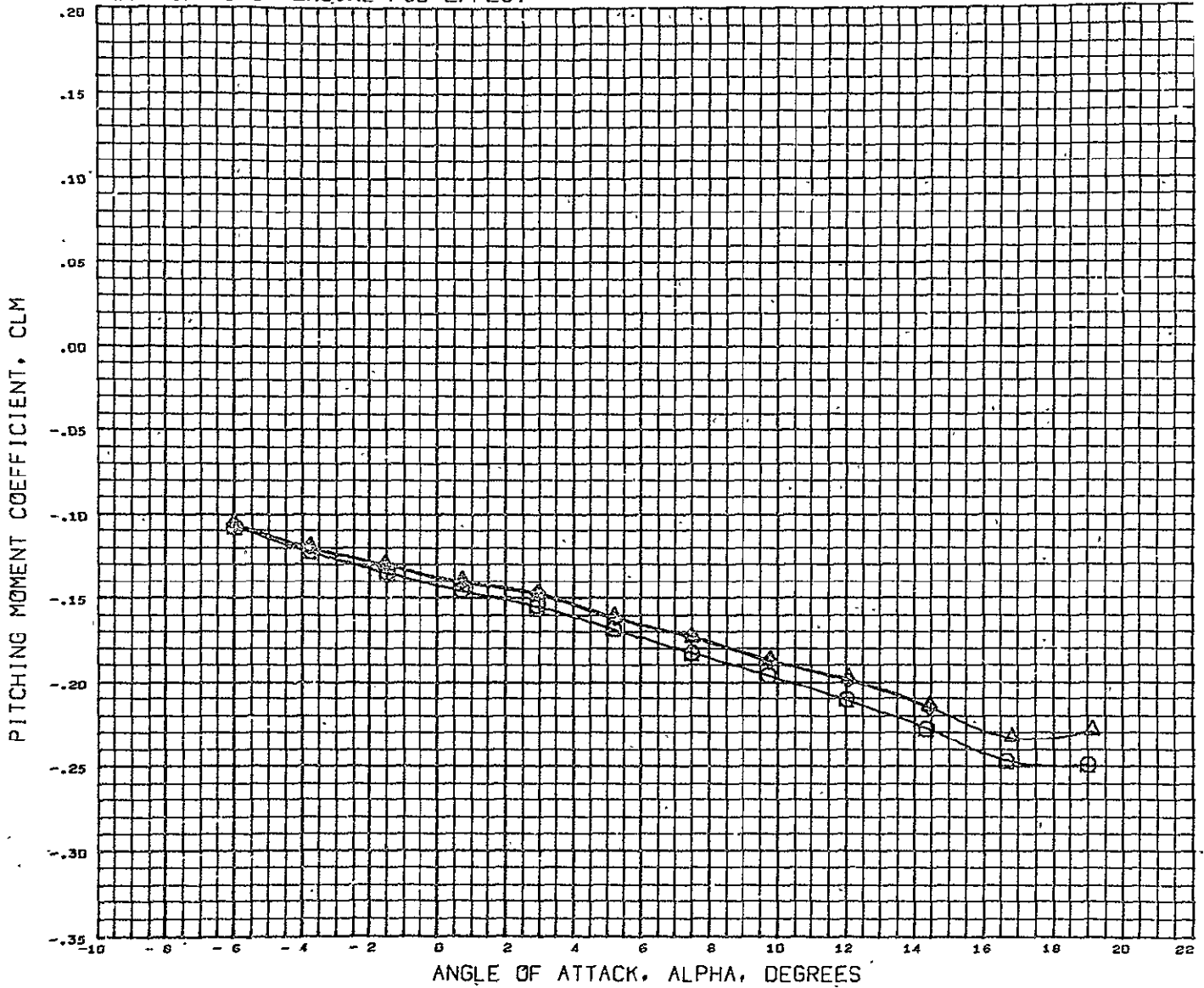

DATA SET SYMBOL	CONFIGURATION DESCRIPTION
(RCN031)	DLSWT 138 D.0133 SC. GENERIC HCR 02 B1B4ASTV4
(RCN066)	DLSWT 138 D.0133 SC. GENERIC HCR 02 B1B4ASTV4P1
(RCN068)	DLSWT 138 D.0133 SC. GENERIC HCR 02 B1B4ASTV4P2

REFERENCE INFORMATION		
REFS	5057.0040	SQ.FT.
REFL	701.0004	IN.
REFB	1230.0040	IN.
XMRP	1266.0040	IN.
YMRP	0.0000	IN.
ZMRP	163.0004	IN.
SCALE	100.0000	PERCENT

PACH 0.180

DLSWT TEST 138- ENGINE POD EFFECT

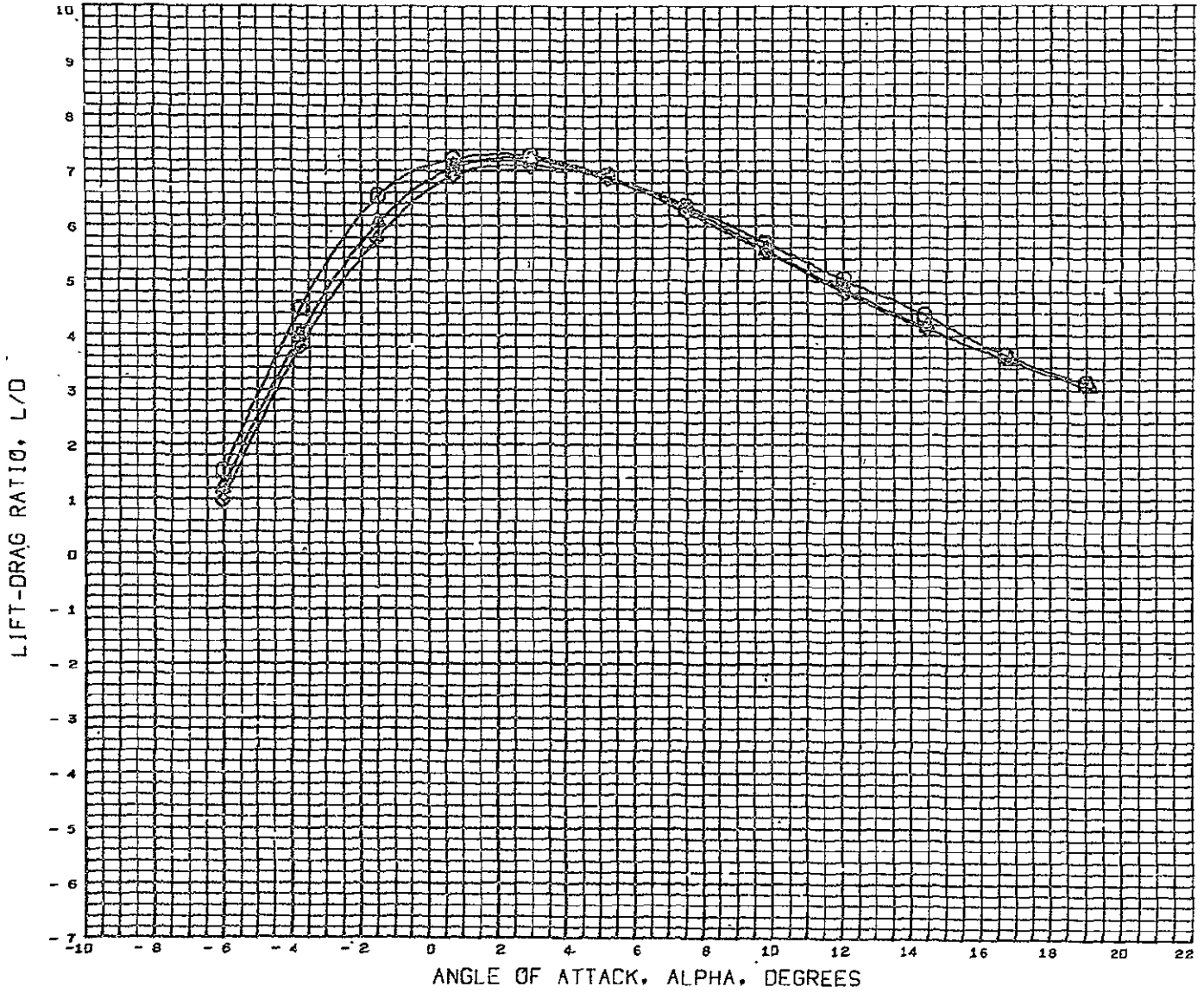

DATA SET SYMBOL	CONFIGURATION DESCRIPTION
(RCN631) ○	DLSWT 138 D.0133 SC. GENERIC HCR 02 B1BMASTV4
(RCN666) △	DLSWT 138 D.0133 SC. GENERIC HCR 02 B1BMASTV4P1
(RCN668) ◇	DLSWT 138 D.0133 SC. GENERIC HCR 02 B1BMASTV4P2

REFERENCE INFORMATION		
REFS	5057.0040	SQ. FT.
REFL	701.0004	IN.
REFB	1230.0040	IN.
XMRP	1266.0040	IN.
YMRP	0.0000	IN.
ZMRP	163.0004	IN.
SCALE	100.0000	PERCNT

MACH 0.180

DLSWT TEST 138- ENGINE POD EFFECT

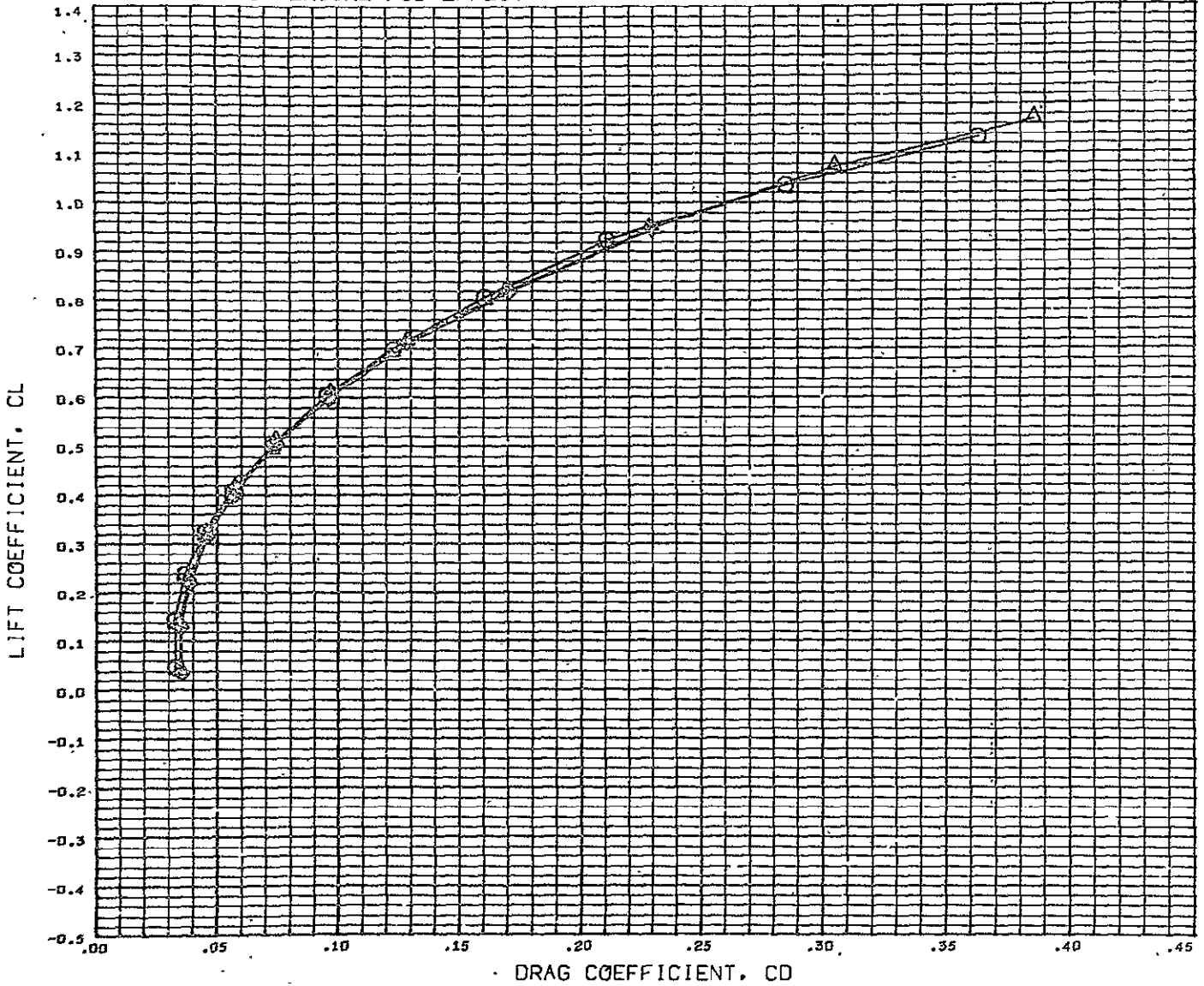

DATA SET SYMBOL	CONFIGURATION DESCRIPTION
(RCND31)	○ DLSWT 138 0.0133 SC. GENERIC HCR 02 B1BW4ASTV4
(RCND66)	△ DLSWT 138 0.0133 SC. GENERIC HCR 02 B1BW4ASTV4P1
(RCND68)	◇ DLSWT 138 0.0133 SC. GENERIC HCF 02 B1BW4ASTV4P2

REFERENCE INFORMATION		
REFS	5057.0040	SQ. FT.
REFL	701.0004	IN.
REFB	1230.0040	IN.
XMRP	1266.0040	IN.
YMRP	0.0000	IN.
ZMRP	165.0004	IN.
SCALE	100.0000	PERCENT

MACH 0.180

DLSWT TEST 138- ENGINE POD EFFECT

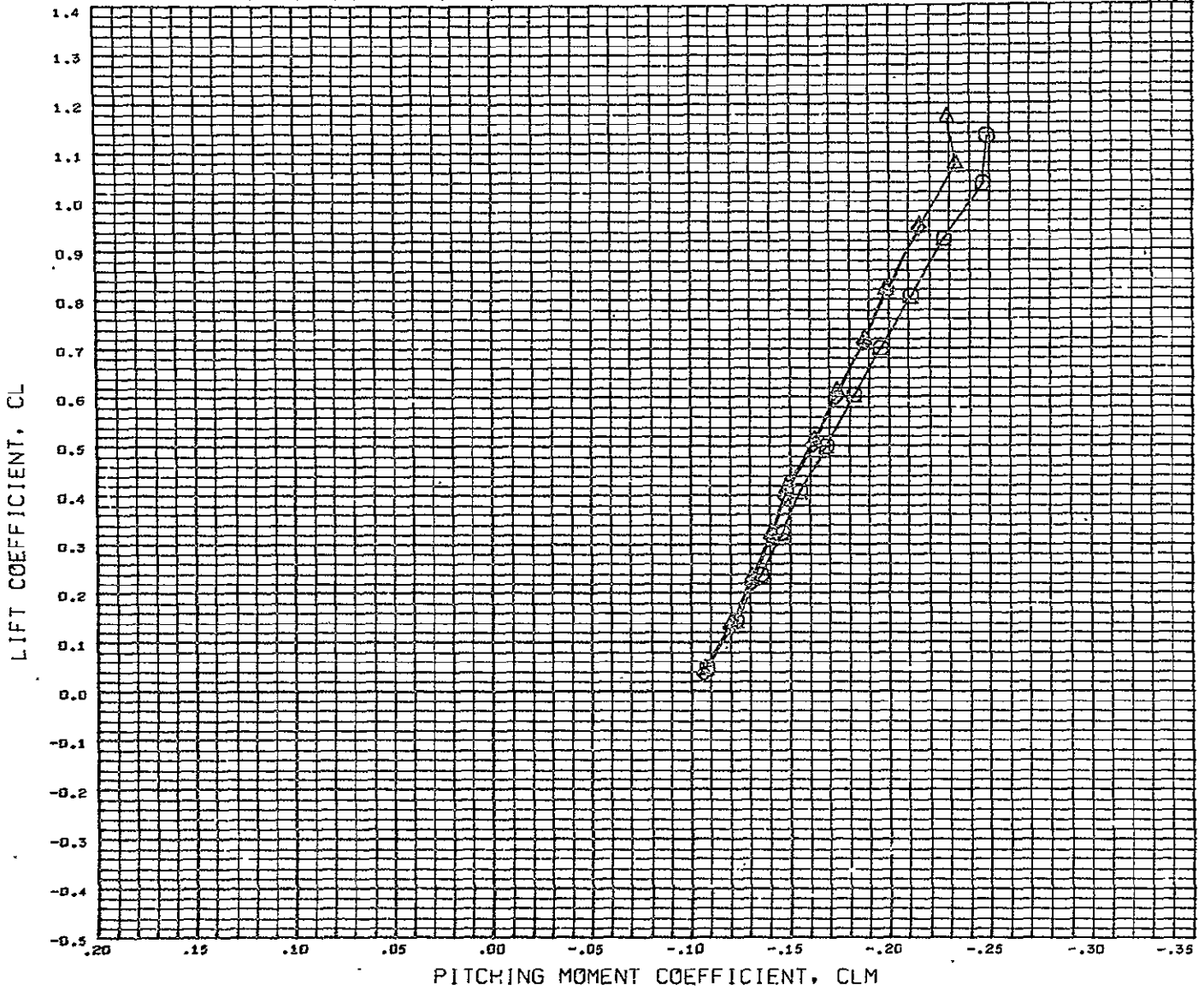

DATA SET SYMBOL	CONFIGURATION DESCRIPTION
(RCND31)	DLSWT 138 0.0133 SC. GENERIC HCR 02 B1BW4ASTV4
(RCND66)	DLSWT 138 0.0133 SC. GENERIC HCR 02 B1BW4ASTV4P1
(RCND68)	DLSWT 138 0.0133 SC. GENERIC HCR 02 B1BW4ASTV4P2

REFERENCE INFORMATION	
REFS	5057.0040 SQ.FT.
REFL	701.0004 IN.
REFB	1230.0040 IN.
XMRP	1266.0040 IN.
YMRP	0.0000 IN.
ZMRP	163.0004 IN.
SCALE	100.0000 PERCNT

MACH 0.180

DLSWT TEST 138- ENGINE POD EFFECT

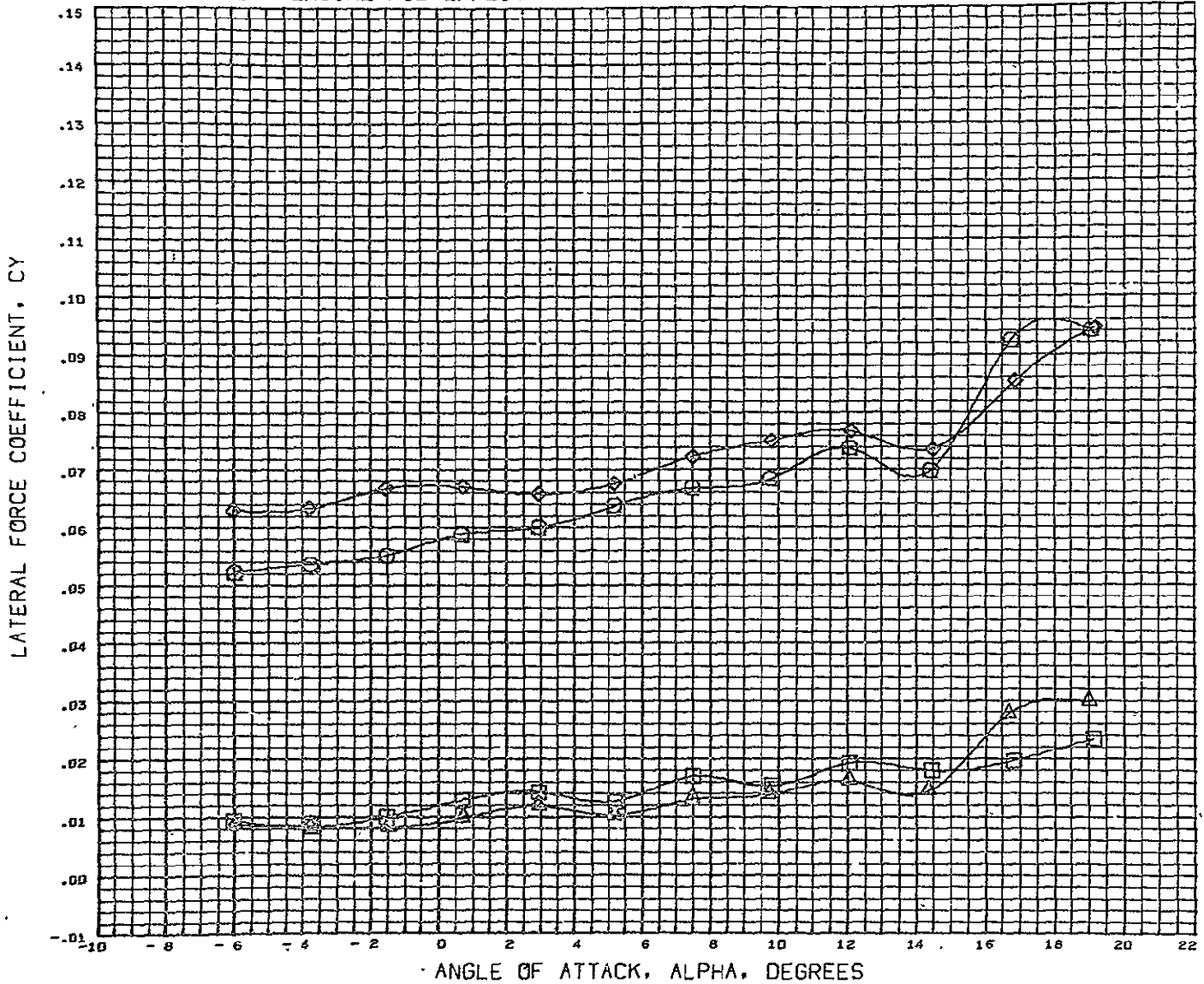

DATA SET SYMBOL	CONFIGURATION DESCRIPTION	BETA
(TCND32)	DLSWT 138 0.0133 SC. GENERIC HCR 02 B1BWASTV4	-2.880
(TCND31)	DLSWT 138 0.0133 SC. GENERIC HCR 02 B1BWASTV4	0.000
(TCND67)	DLSWT 138 0.0133 SC. GENERIC HCR 02 B1BWASTV4P1	-2.880
(TCND66)	DLSWT 138 0.0133 SC. GENERIC HCR 02 B1BWASTV4P1	0.000

REFERENCE INFORMATION		
REFS	5057.0040	SQ. FT.
REFL	701.0004	IN.
REFB	1230.0040	IN.
XMRP	1266.0040	IN.
YMRP	0.0000	IN.
ZMRP	163.0004	IN.
SCALE	100.0000	PERCNT

MACH 0 180

DLSWT TEST 138- ENGINE POD EFFECT

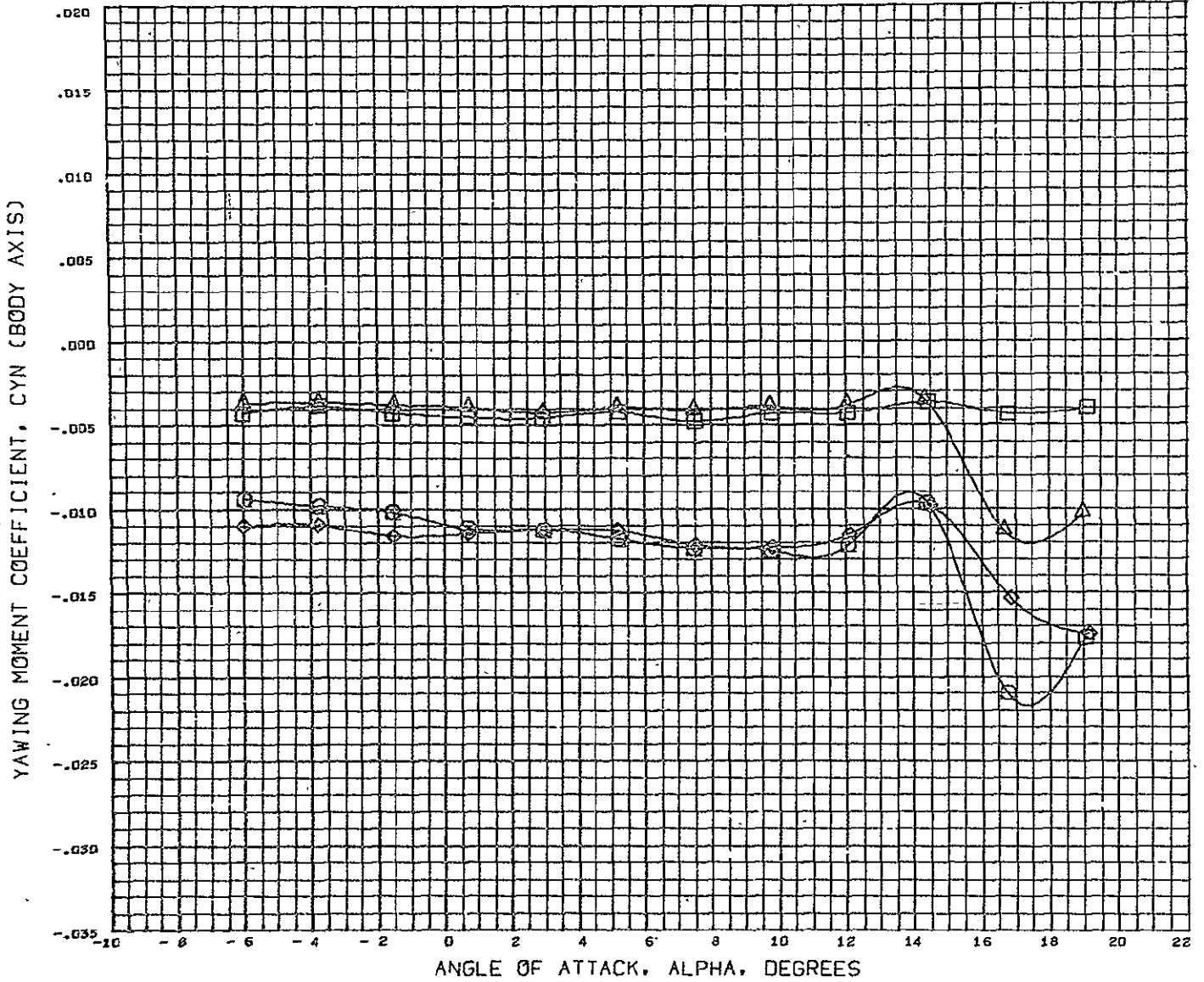

DATA SET SYMBOL	CONFIGURATION DESCRIPTION	BETA	REFERENCE INFORMATION
(TCND32)	DLSWT 138 0.0133 SC. GENERIC HCR 02 B18W4ASTV4	-2.880	REFS 5057.0040 SQ.FT.
(TCND31)	DLSWT 138 0.0133 SC. GENERIC HCR 02 B18W4ASTV4	0.000	REFL 701.0004 IN.
(TCND67)	DLSWT 138 0.0133 SC. GENERIC HCR 02 B18W4ASTV4P1	-2.880	REFS 1230.0040 IN.
(TCND66)	DLSWT 138 0.0133 SC. GENERIC HCR 02 B18W4ASTV4P1	0.000	XMRP 1266.0040 IN.
			YMRP 0.0000 IN.
			ZMRP 163.0004 IN.
			SCALE 100.0000 PERCENT

MACH 0.105

DLSWT TEST 138- ENGINE POD EFFECT

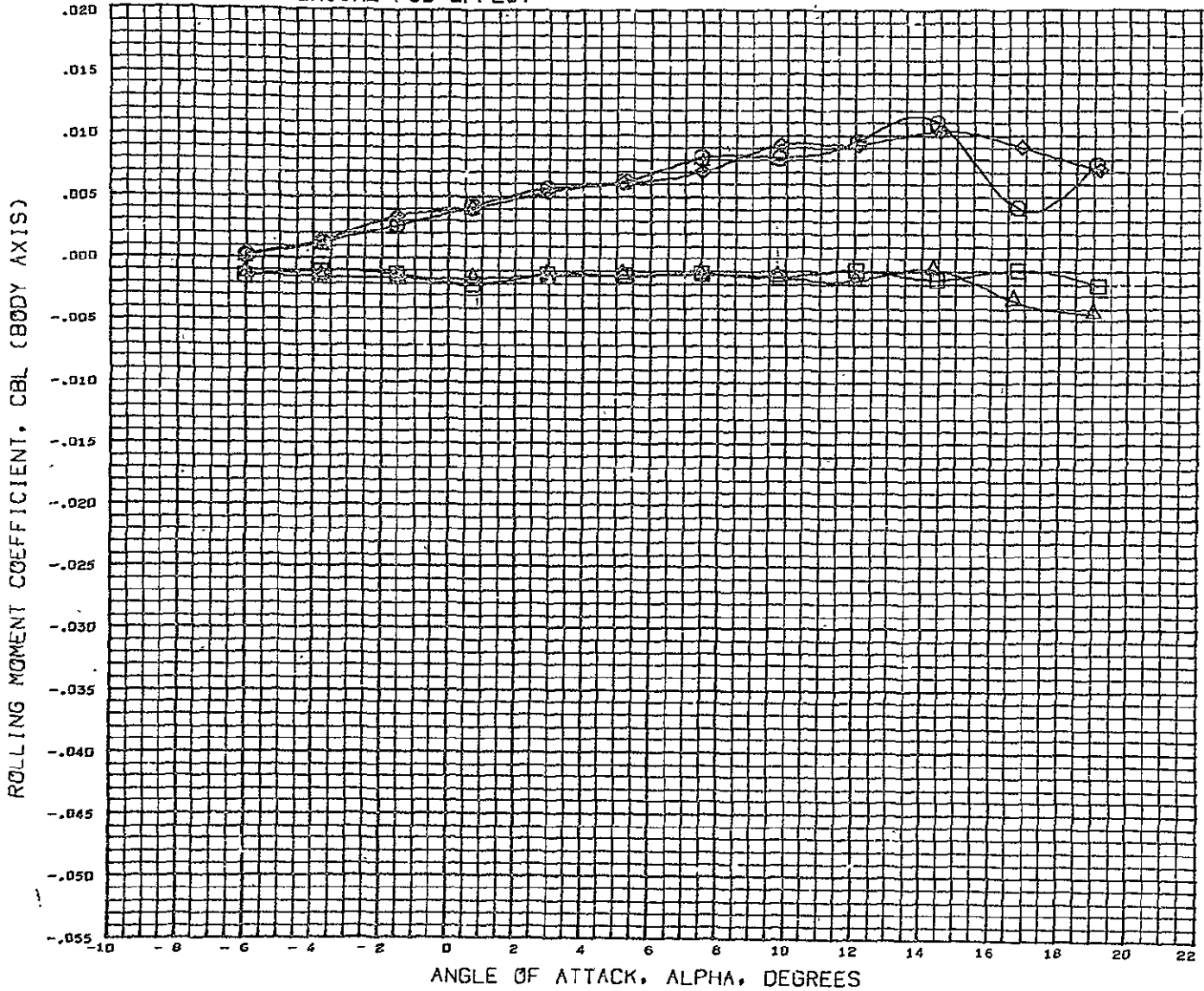

DATA SET SYMBOL	CONFIGURATION DESCRIPTION	BETA	REFERENCE INFORMATION
(TCND32)	DLSWT 138 D.0133 SC. GENERIC HCR 02 B1BW4ASTV4	-2.880	REFS 5057.0045 SQ.FT.
(TCND31)	DLSWT 138 D.0133 SC. GENERIC HCR 02 B1BW4ASTV4	0.000	REFL 701.0004 IN.
(TCND67)	DLSWT 138 D.0133 SC. GENERIC HCR 02 B1BW4ASTV4P1	-2.880	REFB 1230.0045 IN.
(TCND66)	DLSWT 138 D.0133 SC. GENERIC HCR 02 B1BW4ASTV4P1	0.000	XNRF 1266.0045 IN.
			YNRF 0.0000 IN.
			ZNRF 163.0004 IN.
			SCALE 100.0000 PERCENT

MACH 0.180

DLSWT TEST 138- ENGINE POD EFFECT

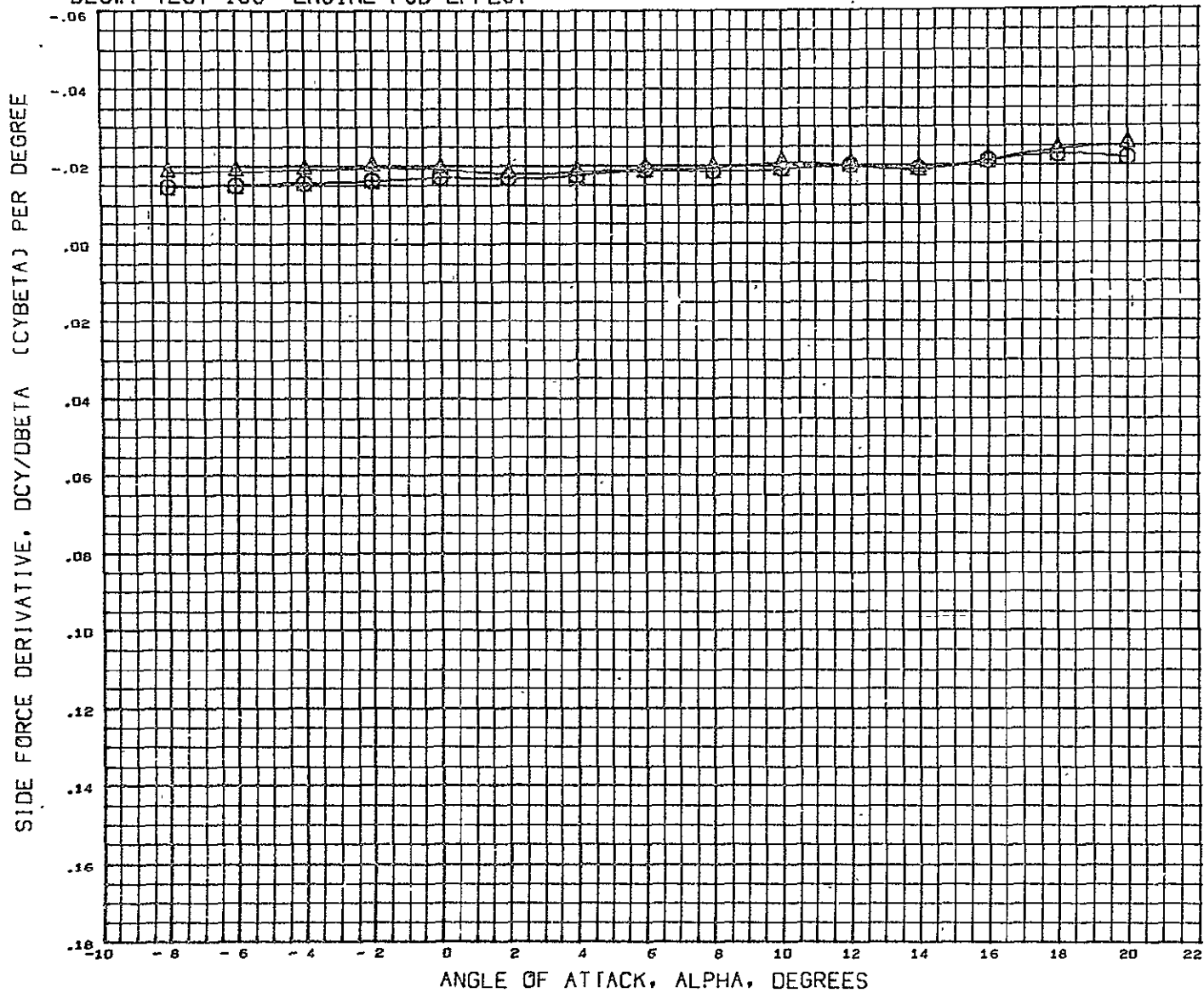

DATA SET SYMBOL CONFIGURATION DESCRIPTION
 (PCN031) \circ DLSWT 138 0.0133 SC. GENERIC HCR 02 B1BW4ASTV4
 (PCN066) \triangle DLSWT 138 0.0133 SC. GENERIC HCR 02 B1BW4ASTV4F1

REFERENCE INFORMATION
 REFS 5057.0040 SQ.FT.
 REFL 701.0004 IN.
 REFB 1230.0040 IN.
 XMRP 1266.0040 IN.
 YMRP 0.0000 IN.
 ZMRP 163.0004 IN.
 SCALE 100.0000 PERCENT

MACH 0.180

DLSWT TEST 138- ENGINE POD EFFECT

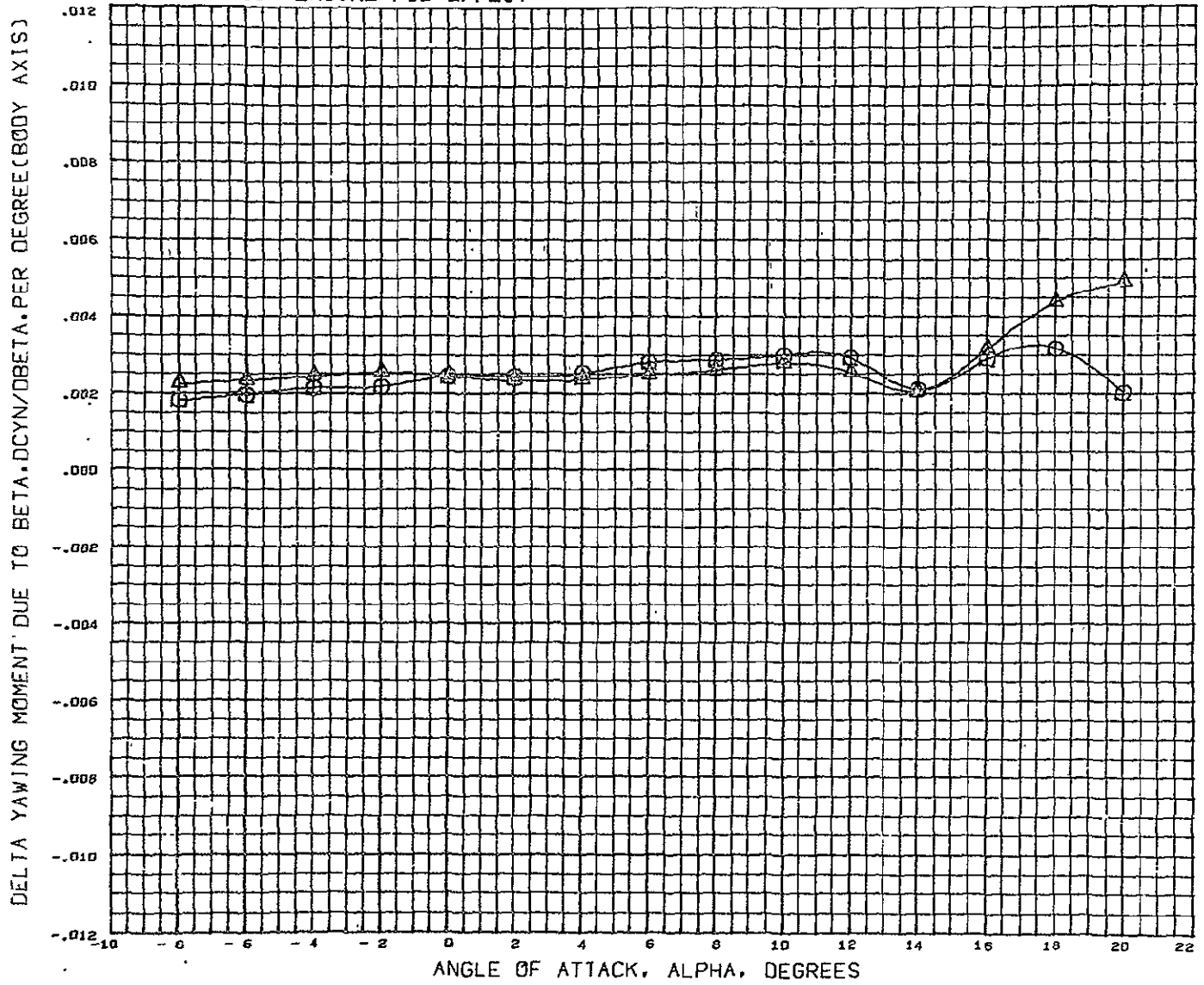

DATA SET SYMBOL CONFIGURATION DESCRIPTION
 (PCND31) X DLSWT 138 0.0133 SC. GENERIC HCR 02 B1BWA4STV4
 (PCND66) X DLSWT 138 0.0133 SC. GENERIC HCR 02 B1BWA4STV4P1

MACH 0.185

REFERENCE INFORMATION
 REFS 5057.0040 SQ.FT.
 REFL 701.0004 IN.
 REF3 1230.0010 IN.
 XHRF 1266.0040 IN.
 YHRF 0.0000 IN.
 ZHRF 163.0004 IN.
 SCALE 100.0000 PERCENT

DLSWT TEST 138- ENGINE POD EFFECT

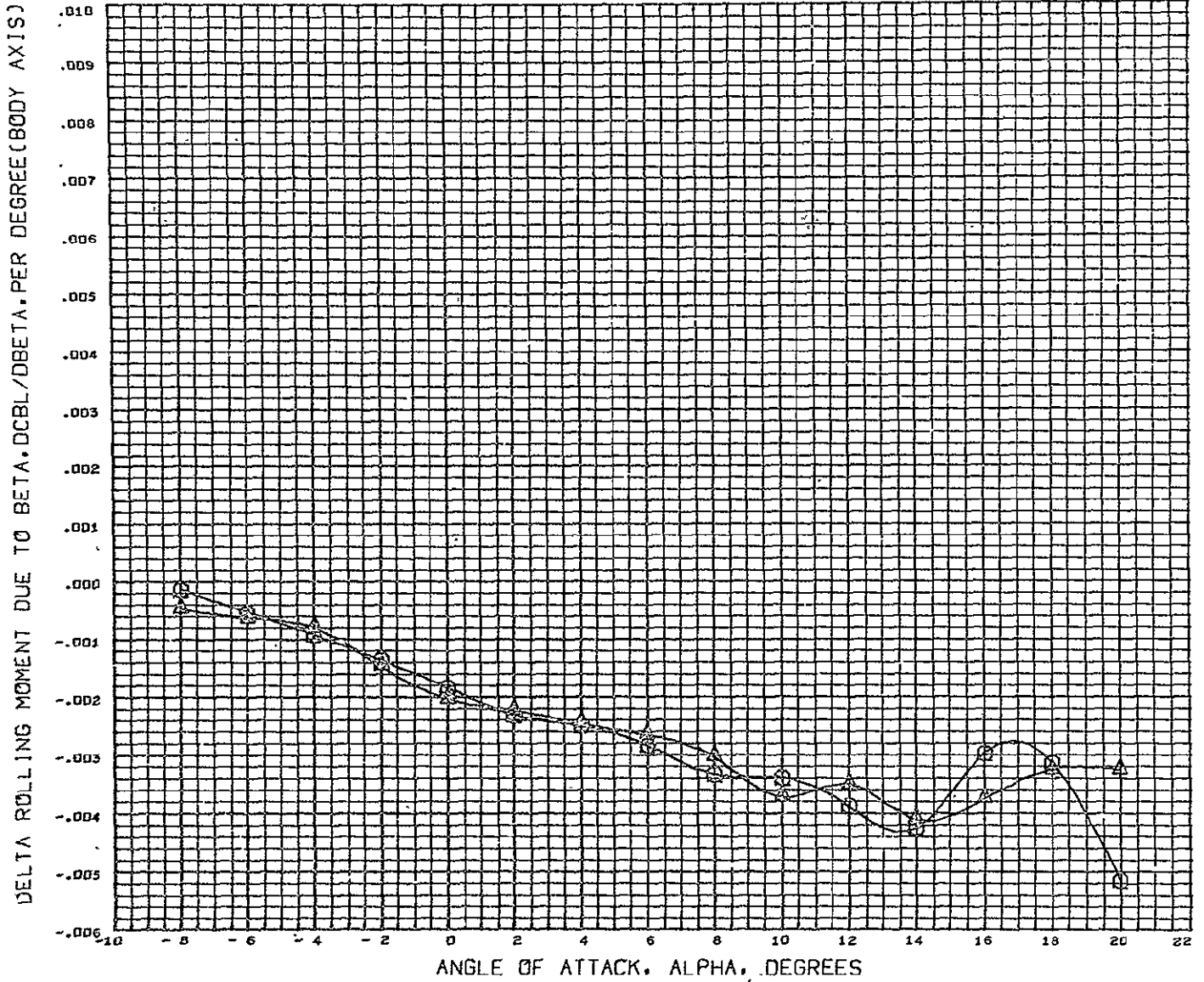

DATA SET SYMBOL	CONFIGURATION DESCRIPTION
(FCN031) ○	DLSWT 138 0.033 SC. GENERIC HCR 02 B1BW4ASTV4
(FCN066) △	DLSWT 138 0.0133 SC. GENERIC HCR 02 B1BW4ASTV4F1

REFERENCE INFORMATION	
REFS	5057.0040 SQ.FT.
REFL	701.5004 IN.
REFB	1230.0040 IN.
XMRP	1266.0040 IN.
YMRP	0.0000 IN.
ZMRP	163.0004 IN.
SCALE	100.0000 PERCENT

MACH 0.180

DLSWT TEST 138- BASIC CONFIGURATION BUILDUP

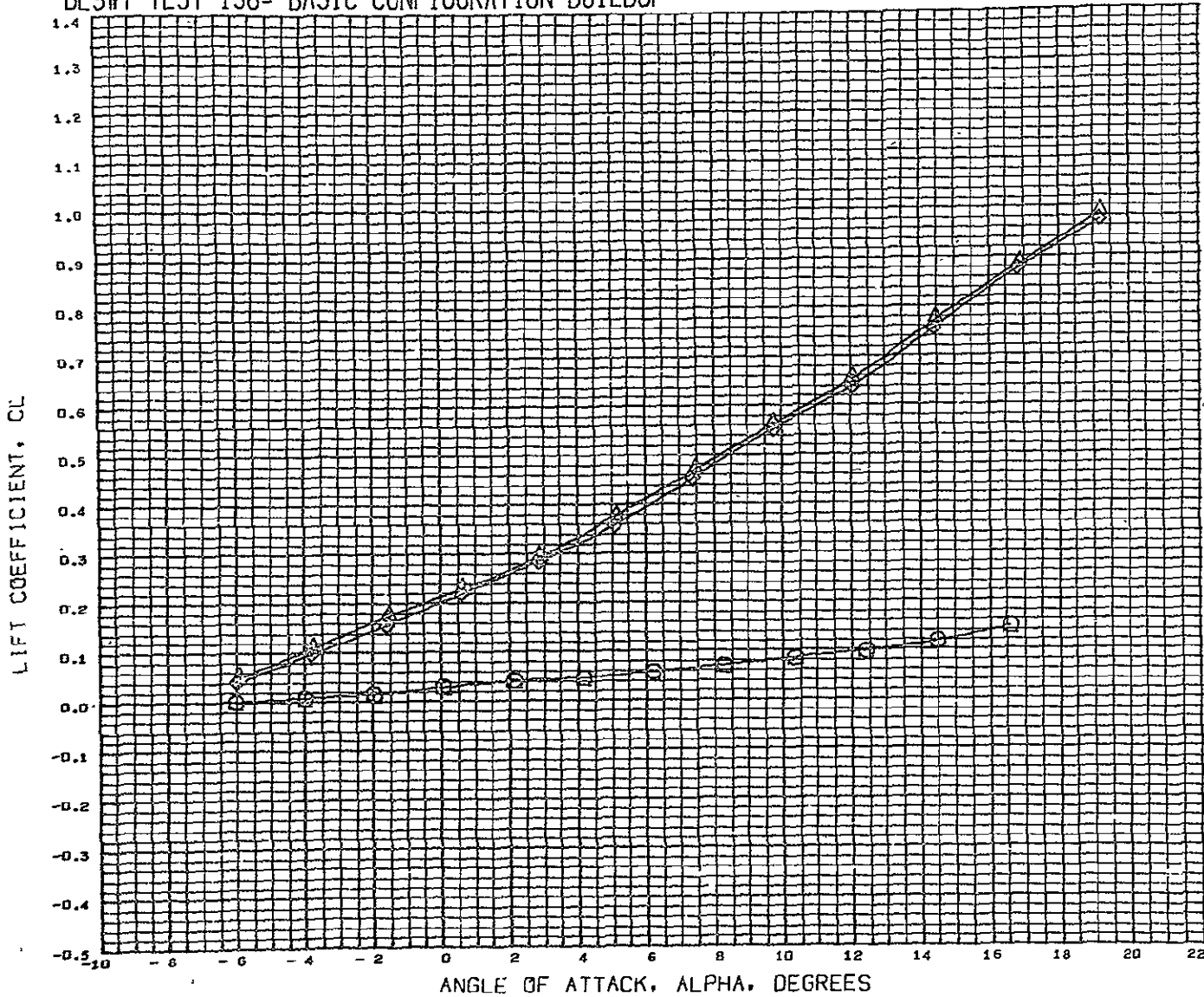

DATA SET SYMBOL	CONFIGURATION DESCRIPTION
(RCN013)	DLSWT 138 G.D133 SC. GENERIC MCR 02 B1A
(RCN007)	DLSWT 138 G.D133 SC. GENERIC MCR 02 B1AW3
(RCN011)	DLSWT 138 G.D133 SC. GENERIC MCR 02 B1AW3V4

SEE THE ASSOCIATED DATA DOCUMENT FOR REFERENCE CHARACTERISTICS

MACH 0.180

DLSWT TEST 138- BASIC CONFIGURATION BUILDUP

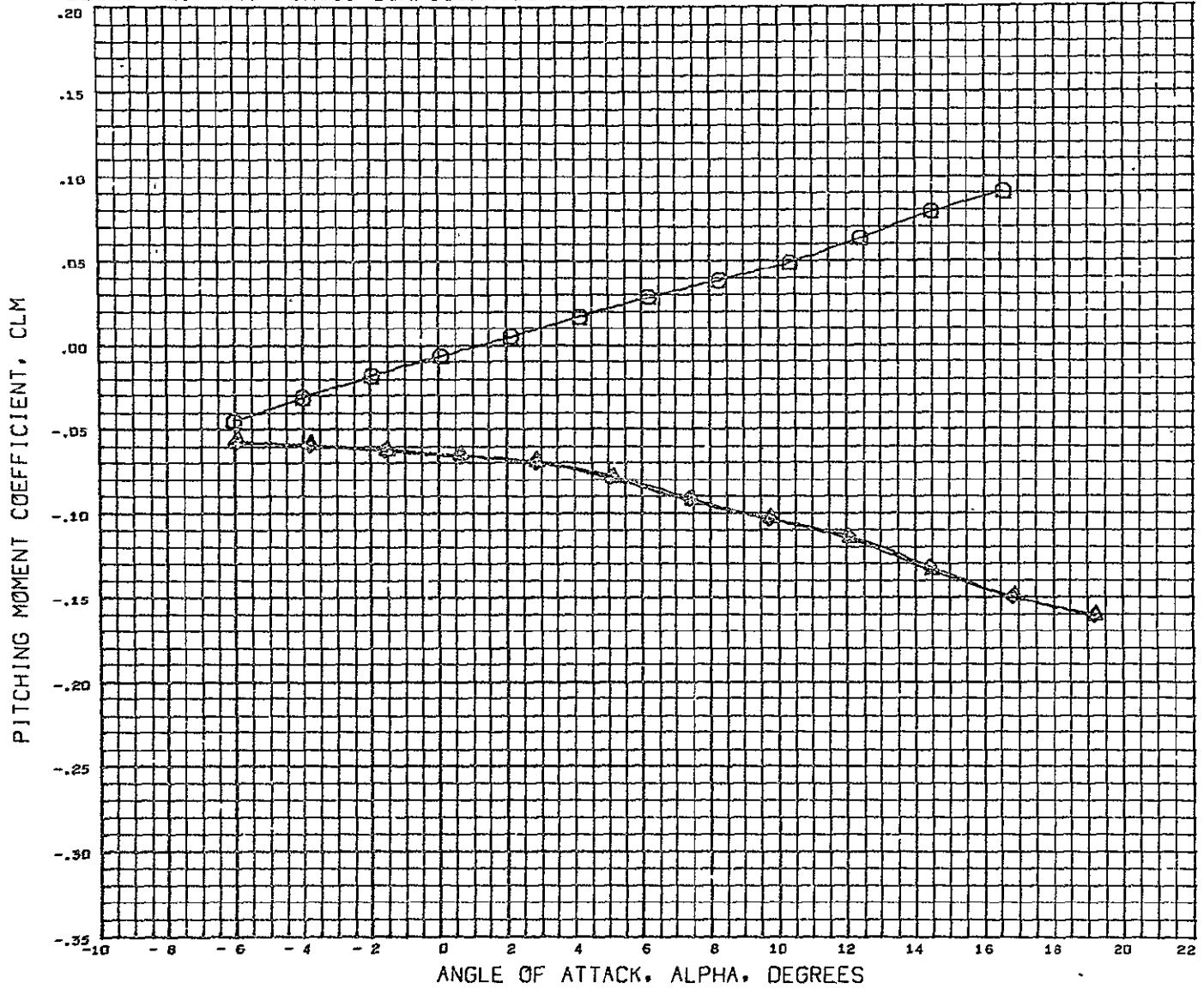

DATA SET SYMBOL	CONFIGURATION DESCRIPTION
(RCND13)	○ DLSWT 138 D.0133 SC. GENERIC HCR 02 B1A
(RCND07)	△ DLSWT 138 U.0133 SC. GENERIC HCR 02 B1AW3
(RCND11)	◇ DLSWT 138 D.0133 SC. GENERIC HCR 02 B1AW3V4

SEE THE ASSOCIATED DATA DOCUMENT FOR REFERENCE CHARACTERISTICS

MACH 0.185

DLSWT TEST 138- BASIC CONFIGURATION BUILDUP

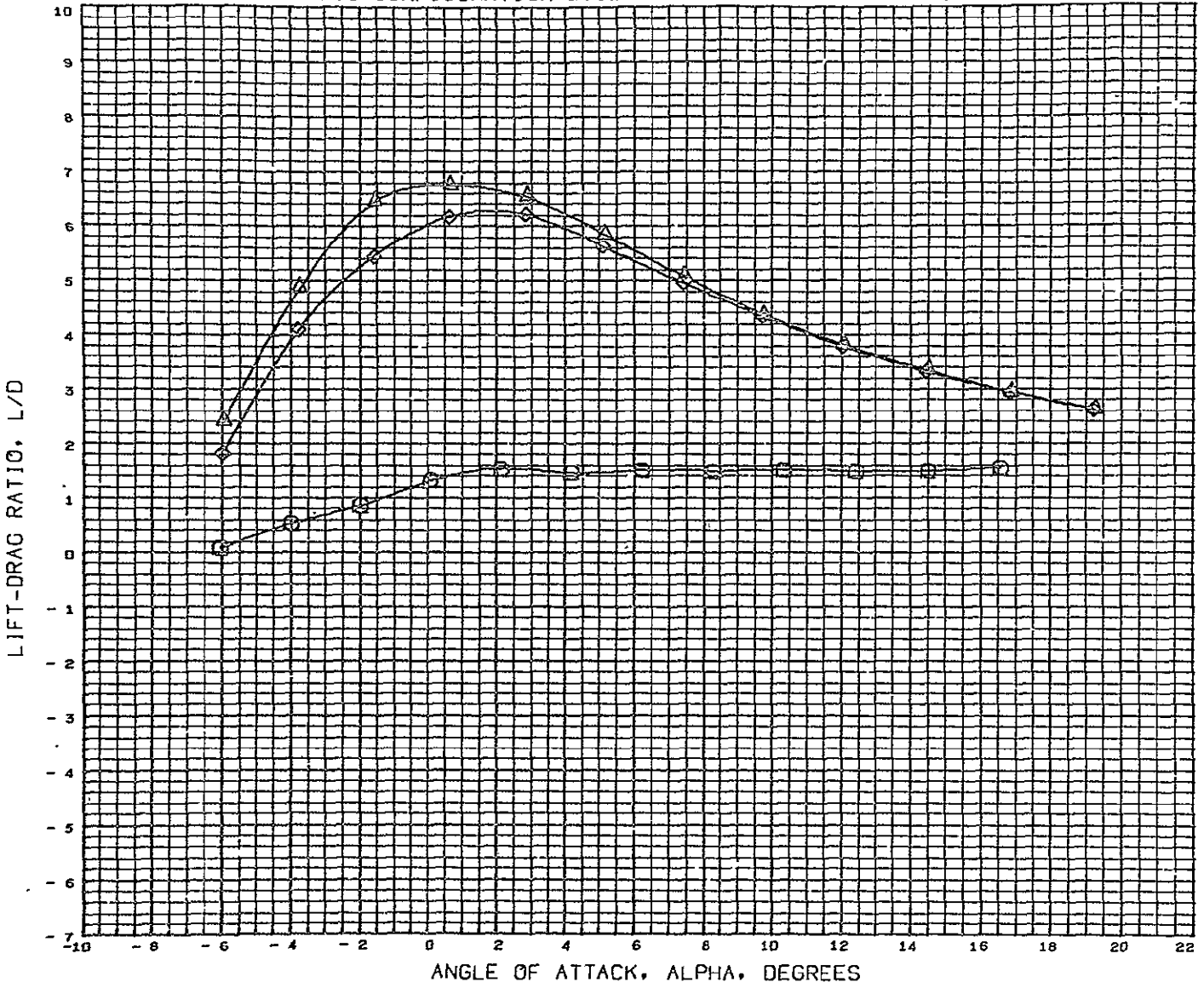

DATA SET SYMBOL CONFIGURATION DESCRIPTION
 (RCND13) ○ DLSWT 138 D.0133 SC. GENERIC HCR 02 B1A
 (RCND07) △ DLSWT 138 D.0133 SC. GENERIC HCR 02 B1AW3
 (RCND11) ◇ DLSWT 138 D.0133 SC. GENERIC HCR 02 B1AW3V4

SEE THE ASSOCIATED DATA DOCUMENT FOR REFERENCE CHARACTERISTICS

MACH 0.185

DLSWT TEST 138- BASIC CONFIGURATION BUILDUP

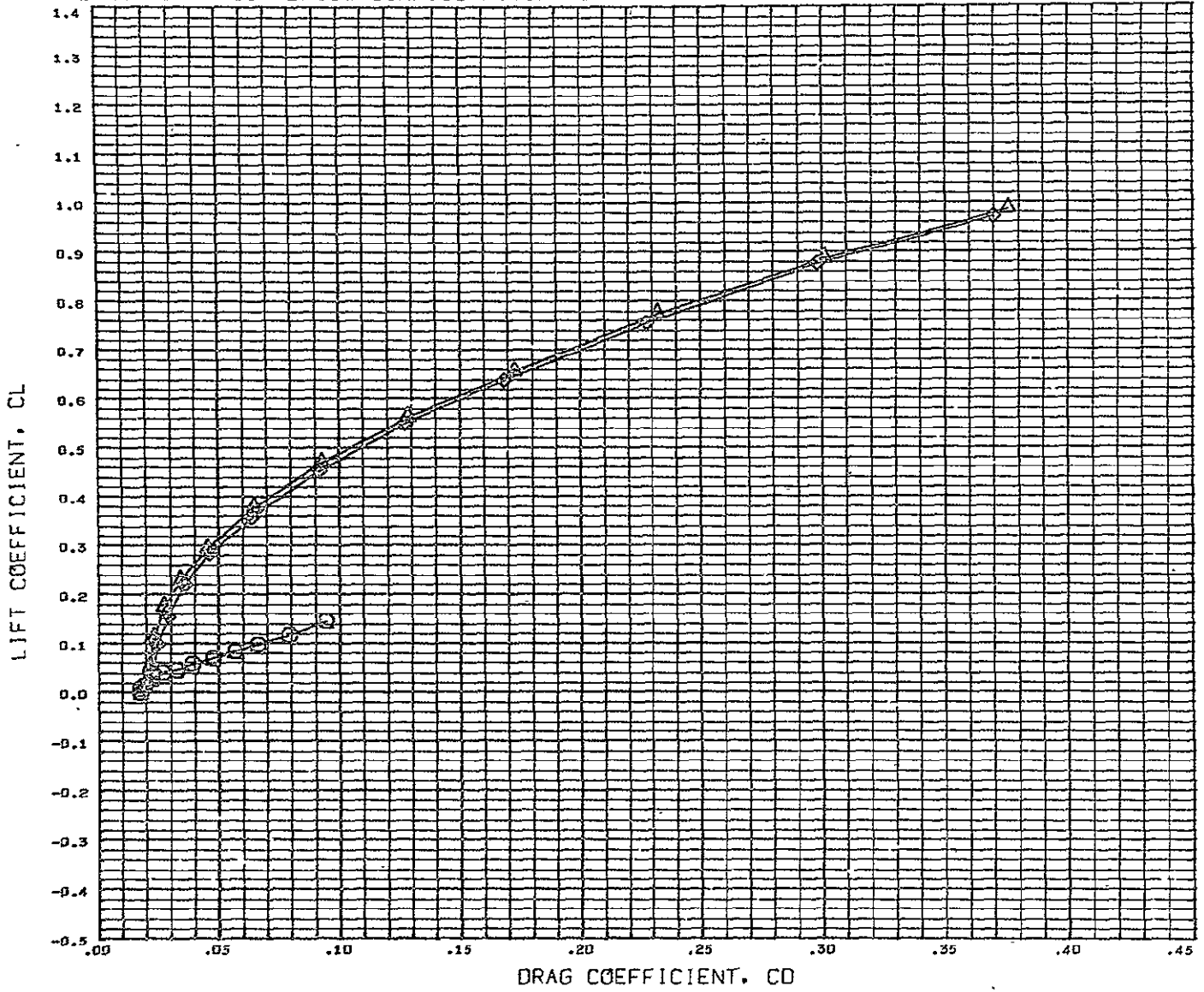

DATA SET SYMBOL	CONFIGURATION DESCRIPTION
(RCND13)	DLSWT 138 0.0133 SC. GENERIC HCR 02 B1A
(RCNS07)	DLSWT 138 0.0133 SC. GENERIC HCR 02 B1AW3
(FCNS11)	DLSWT 138 0.0133 SC. GENERIC HCR 02 B1AW3V4

SEE THE ASSOCIATED DATA DOCUMENT FOR REFERENCE CHARACTERISTICS

MACH 0.185



DLSWT TEST 138- BASIC CONFIGURATION BUILDUP

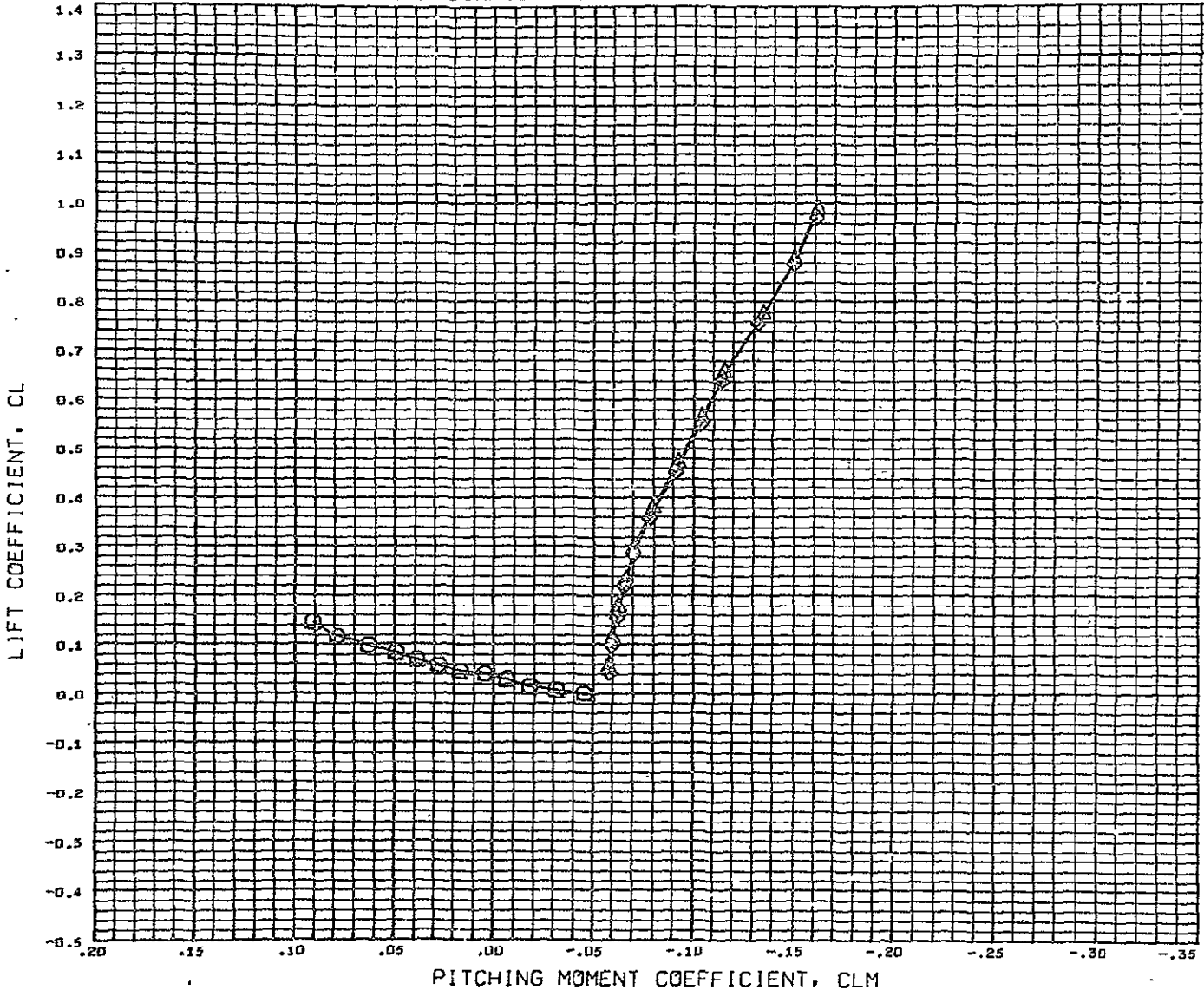

DATA SET SYMBOL	SYMBOL	CONFIGURATION DESCRIPTION
(RCND13)	○	DLSWT 138 D.0133 SC. GENERIC HCR 02 B1A
(RCND07)	△	DLSWT 138 D.0133 SC. GENERIC HCR 02 B1AW3
(RCND11)	◇	DLSWT 138 D.0133 SC. GENERIC HCR 02 B1AWV4

SEE THE ASSOCIATED DATA DOCUMENT FOR REFERENCE CHARACTERISTICS

DLSWT TEST 138- BASIC CONFIGURATION BUILDUP

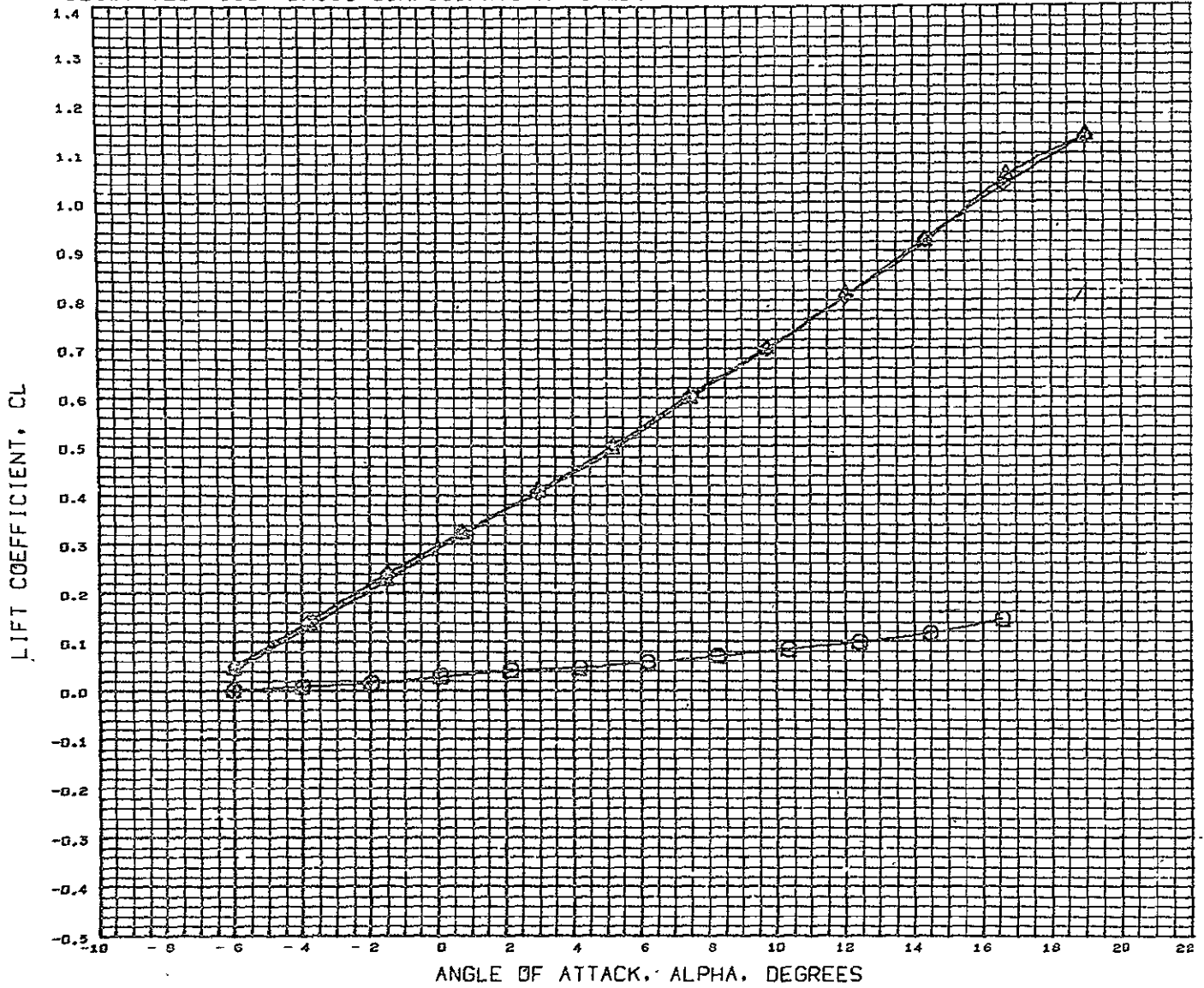

DATA SET SYMBOL	CONFIGURATION DESCRIPTION
(RCN913)	○ DLSWT 138 0.0133 SC. GENERIC HCR 02 B1A
(RCN935)	△ DLSWT 138 0.0133 SC. GENERIC HCR 02 B18W4AST
(RCN935)	◇ DLSWT 138 0.0133 SC. GENERIC HCR 02 B18W4ASTV4

REFERENCE INFORMATION		
REFS	5057.0040	SQ.FT.
REFL	701.5004	IN.
REFB	1230.0040	IN.
XMRF	1266.0040	IN.
YMRF	0.0000	IN.
ZMRF	163.0004	IN.
SCALE	100.0000	PERCNT

MACH 0.180



DLSWT TEST 138- BASIC CONFIGURATION BUILDUP

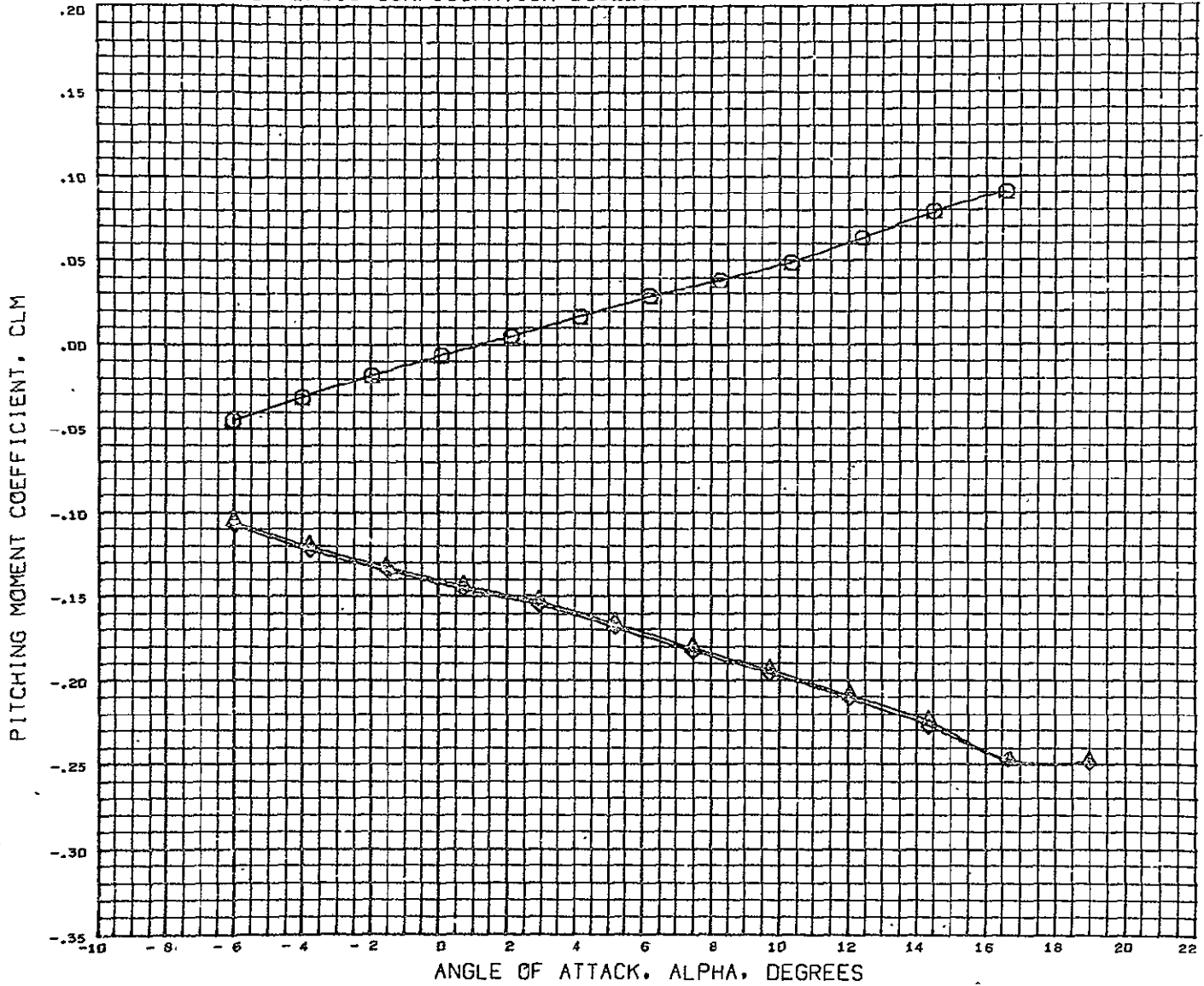

DATA SET SYMBOL	CONFIGURATION DESCRIPTION
(RCND12)	○ DLSWT 138 0.0133 SC. GENERIC HCR 02 B1A
(RCND35)	△ DLSWT 138 0.0133 SC. GENERIC HCR 02 B1BWAAS
(RCND31)	◇ DLSWT 138 0.0133 SC. GENERIC HCR 02 B1BWAAS TV4

REFERENCE INFORMATION		
REFS	5057.0045	SQ.FT.
REFL	701.0004	IN.
REFB	1230.0070	IN.
XMRP	1266.0040	IN.
YMRP	0.0000	IN.
ZMRP	163.0004	IN.
SCALE	100.0000	PERCENT

MACH 3.180

DLSWT TEST 138- BASIC CONFIGURATION BUILDUP

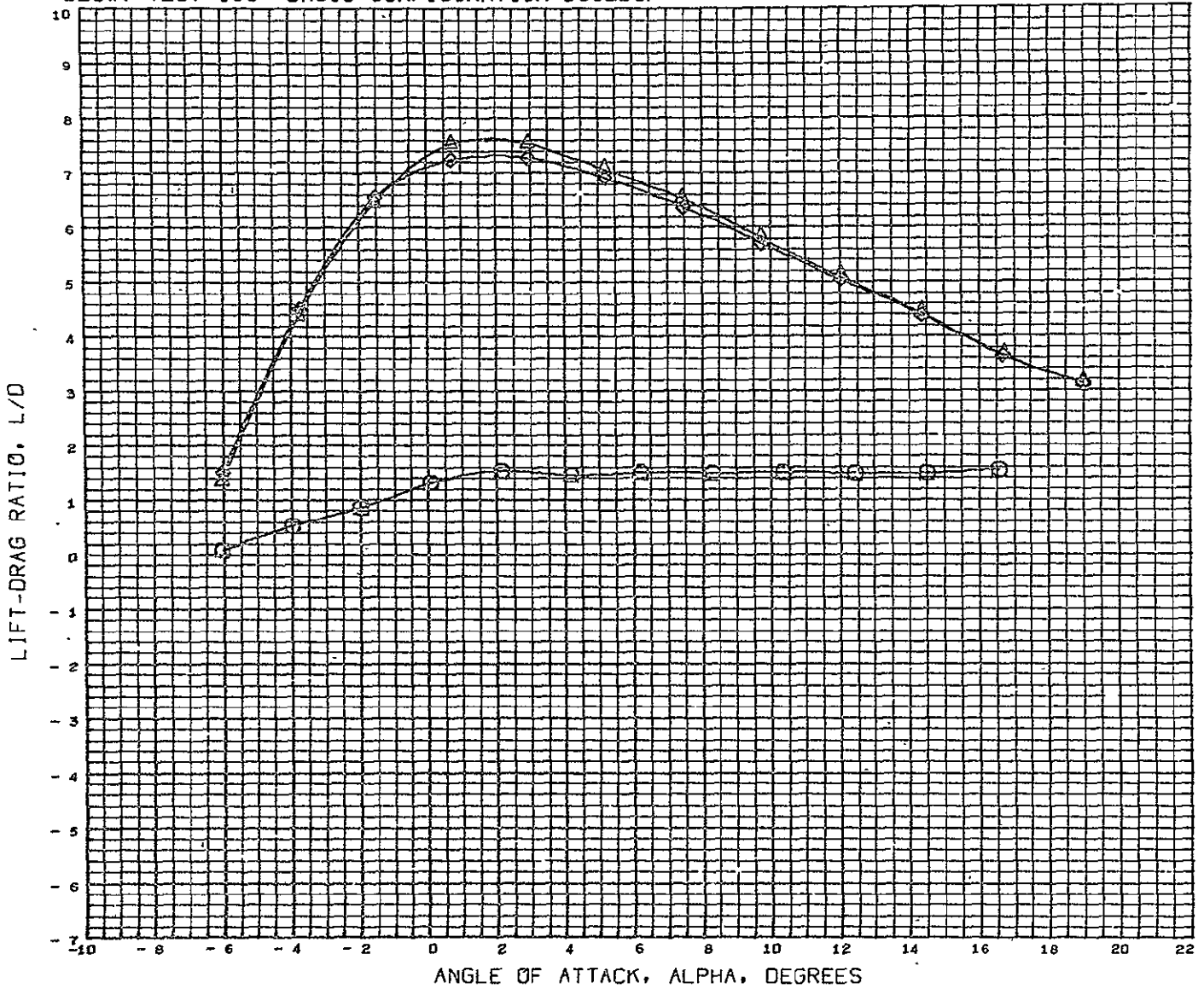

DATA SET SYMBOL	CONFIGURATION DESCRIPTION
(RCNG13)	△ DLSWT 138 0.0133 SC. GENERIC HCR 02 B1A
(RCNG35)	△ DLSWT 138 0.0133 SC. GENERIC HCR 02 B10W4AST
(RCNG31)	◇ DLSWT 138 0.0133 SC. GENERIC HCR 02 B10W4ASTV4

REFERENCE INFORMATION		
REFS	5057.0040	SQ.FT.
REFL	701.0004	IN.
REFB	1230.0049	IN.
XMRP	1266.0040	IN.
YMRP	0.0000	IN.
ZMRP	163.0004	IN.
SCALE	100.0000	PERCNT

MACH 0.180

DLSWT TEST 138- BASIC CONFIGURATION BUILDUP

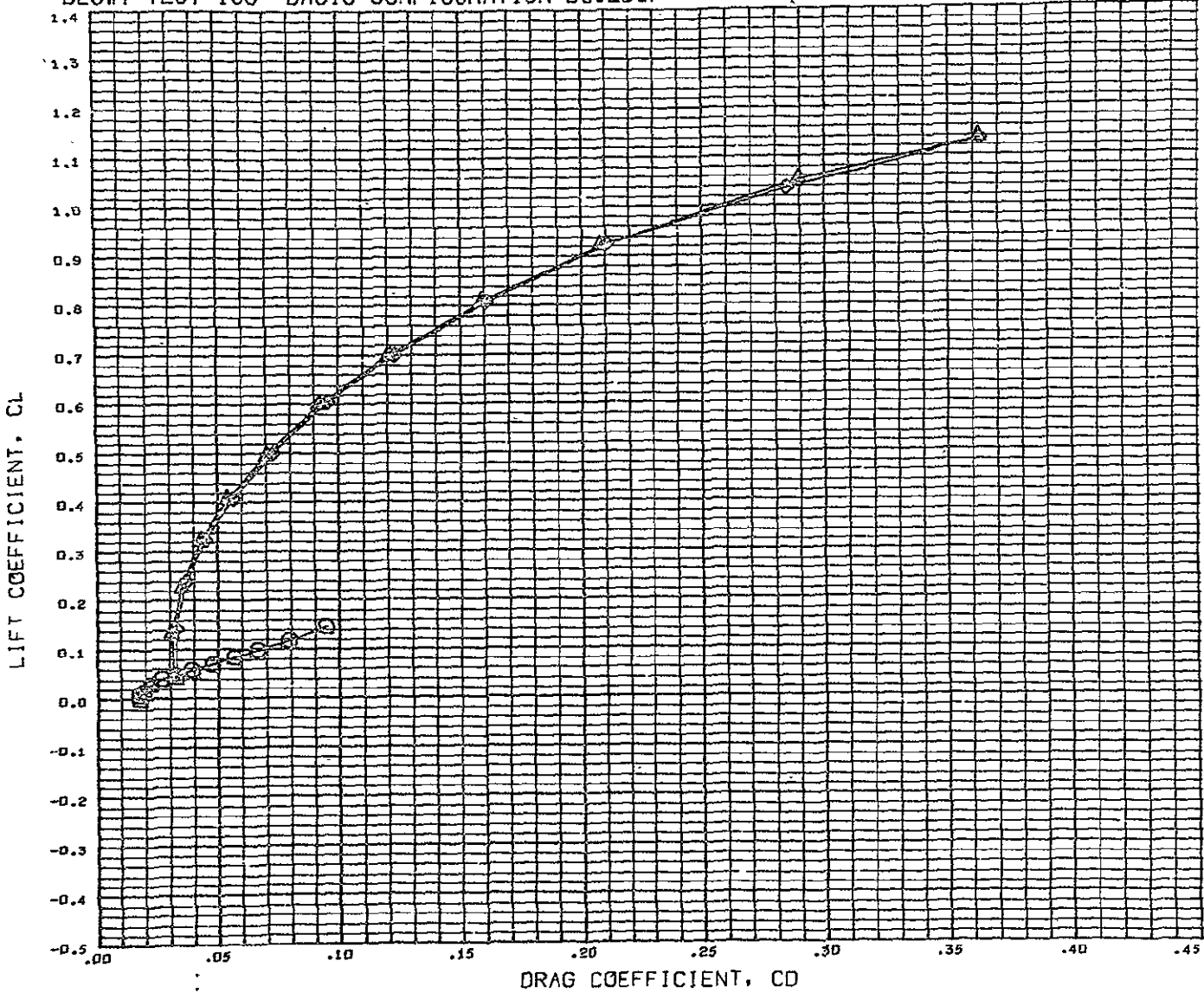

DATA SET SYMBOL	CONFIGURATION DESCRIPTION
(RCNS13)	DLSWT 138 D.0133 SC. GENERIC HCR 02 B1A
(RCNS35)	DLSWT 138 C.0133 SC. GENERIC HCR 02 B1BWZAST
(RCNS31)	DLSWT 138 D.0133 SC. GENERIC HCR 02 B1BW4ASTV4

REFERENCE INFORMATION		
REFS	5057.0040	SQ.FT.
REFL	701.0004	IN.
REFB	1230.0043	IN.
XMRP	1266.0040	IN.
YMRP	0.0000	IN.
ZMRP	163.0004	IN.
SCALE	100.0000	PERCNT

MACH 0.185

DLSWT TEST 138- BASIC CONFIGURATION BUILDUP

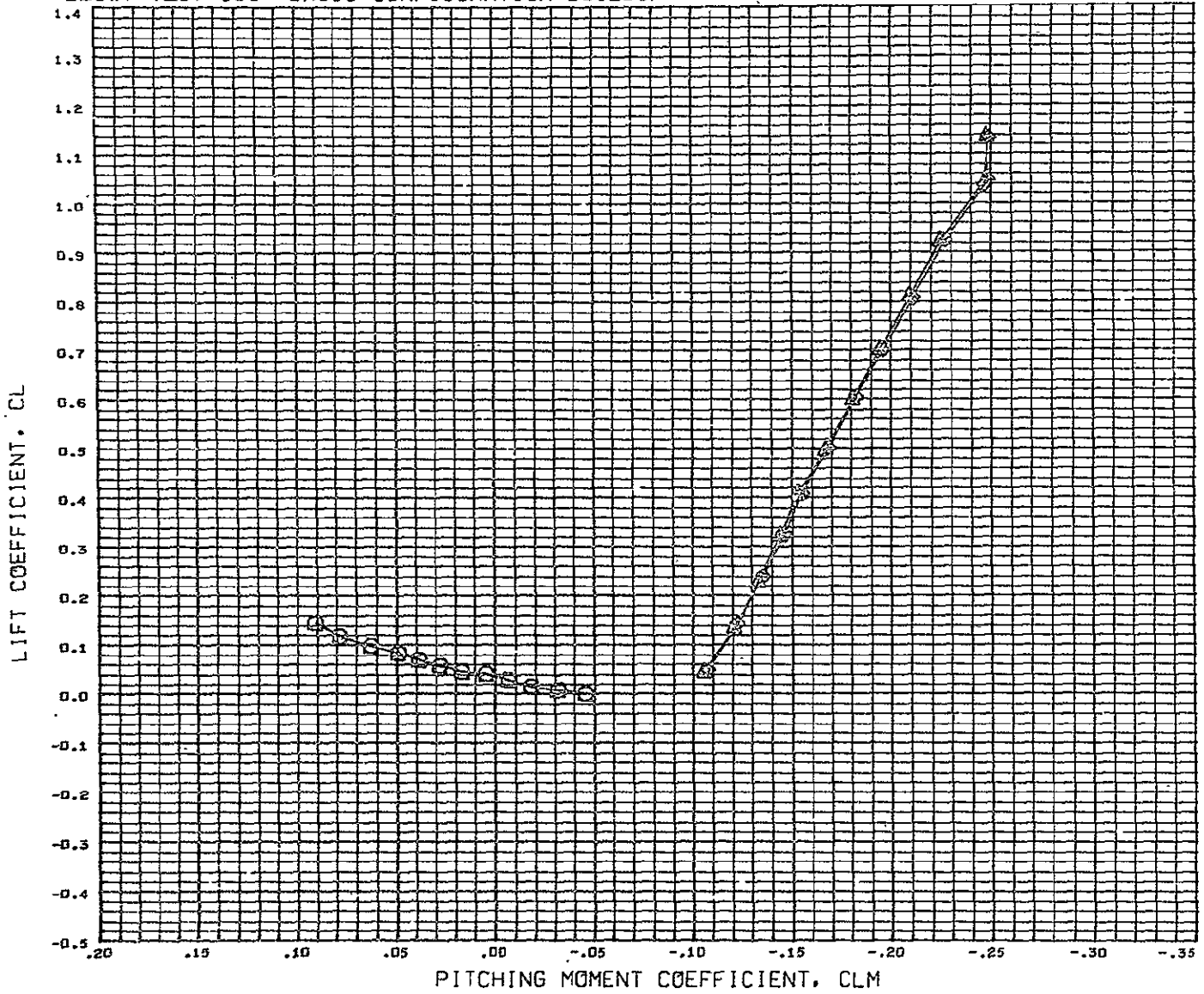

DATA SET SYMBOL	CONFIGURATION DESCRIPTION
(RCN013)	○ DLSWT 138 0.0133 SC. GENERIC HCR 02 B1A
(RCN035)	△ DLSWT 138 0.0133 SC. GENERIC HCR 02 B1BWAAST
(RCN031)	◇ DLSWT 138 0.0133 SC. GENERIC HCR 02 B1BWAASTV4

REFERENCE INFORMATION		
REFS	5057.0040	SQ.FT.
REFL	701.0004	IN.
REFB	1230.0040	IN.
XMRP	1266.0040	IN.
YMRP	0.0000	IN.
ZMRP	163.0004	IN.
SCALE	100.0000	PERCENT

MACH 0.180

DLSWT TEST 138- BASIC CONFIGURATION BUILDUP

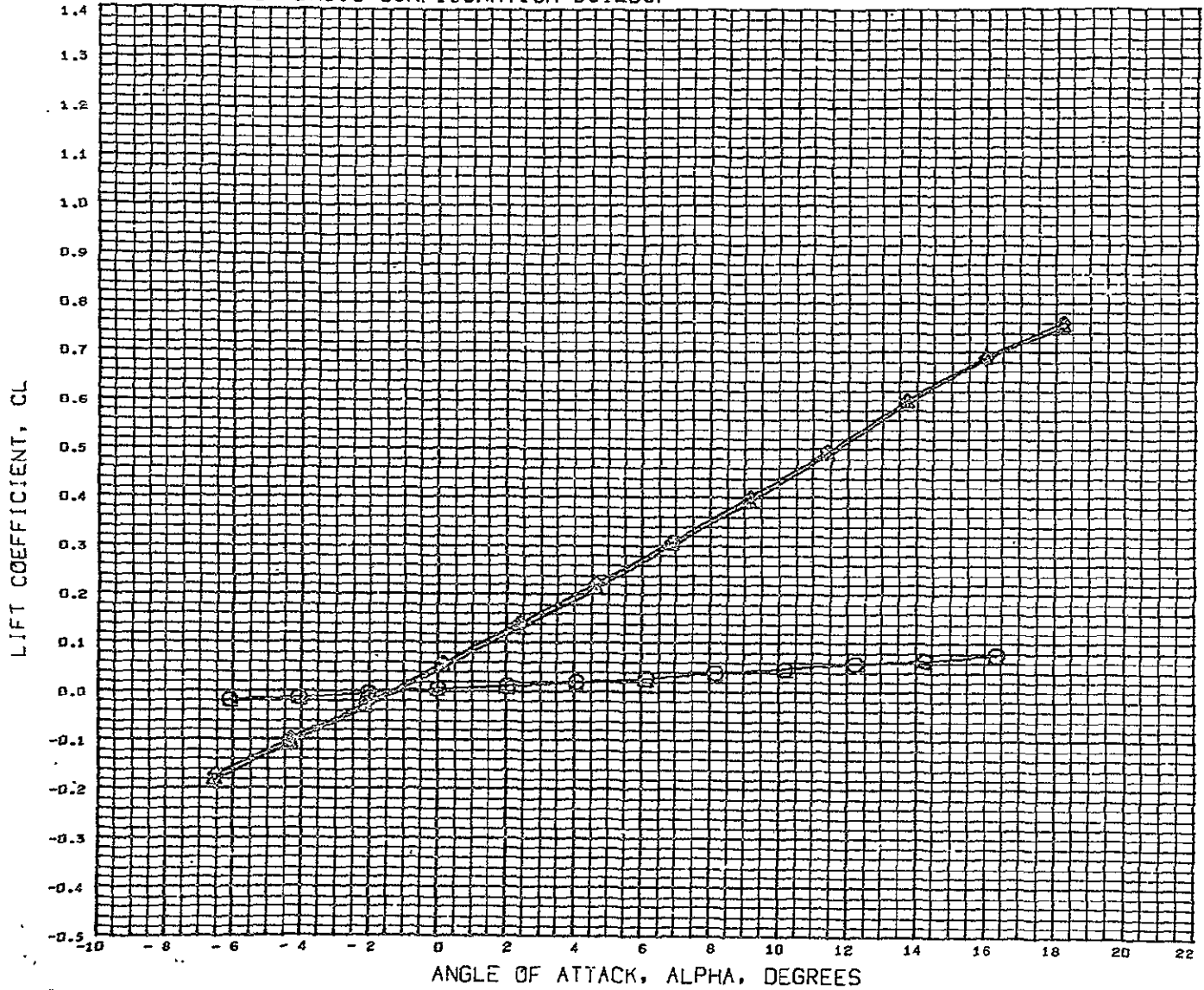

DATA SET SYMBOL	CONFIGURATION DESCRIPTION
(RCND80)	○ DLSWT 138 0.0133 SC. GENERIC HCR 02 B3A
(RCND74)	△ DLSWT 138 0.0133 SC. GENERIC HCR 02 B3AN9A
(RCND70)	◇ DLSWT 138 0.0133 SC. GENERIC HCR 02 B3AN9AV4

REFERENCE INFORMATION		
REFS	5370.0040	SQ. FT
REFL	760.0004	IN.
REFB	1138.0040	IN.
XMRP	1273.0040	IN.
YMRP	0.0000	IN.
ZMRP	214.0004	IN.
SCALE	100.0000	PERCENT

MACH 0.180

DLSWT TEST 138- BASIC CONFIGURATION BUILDUP

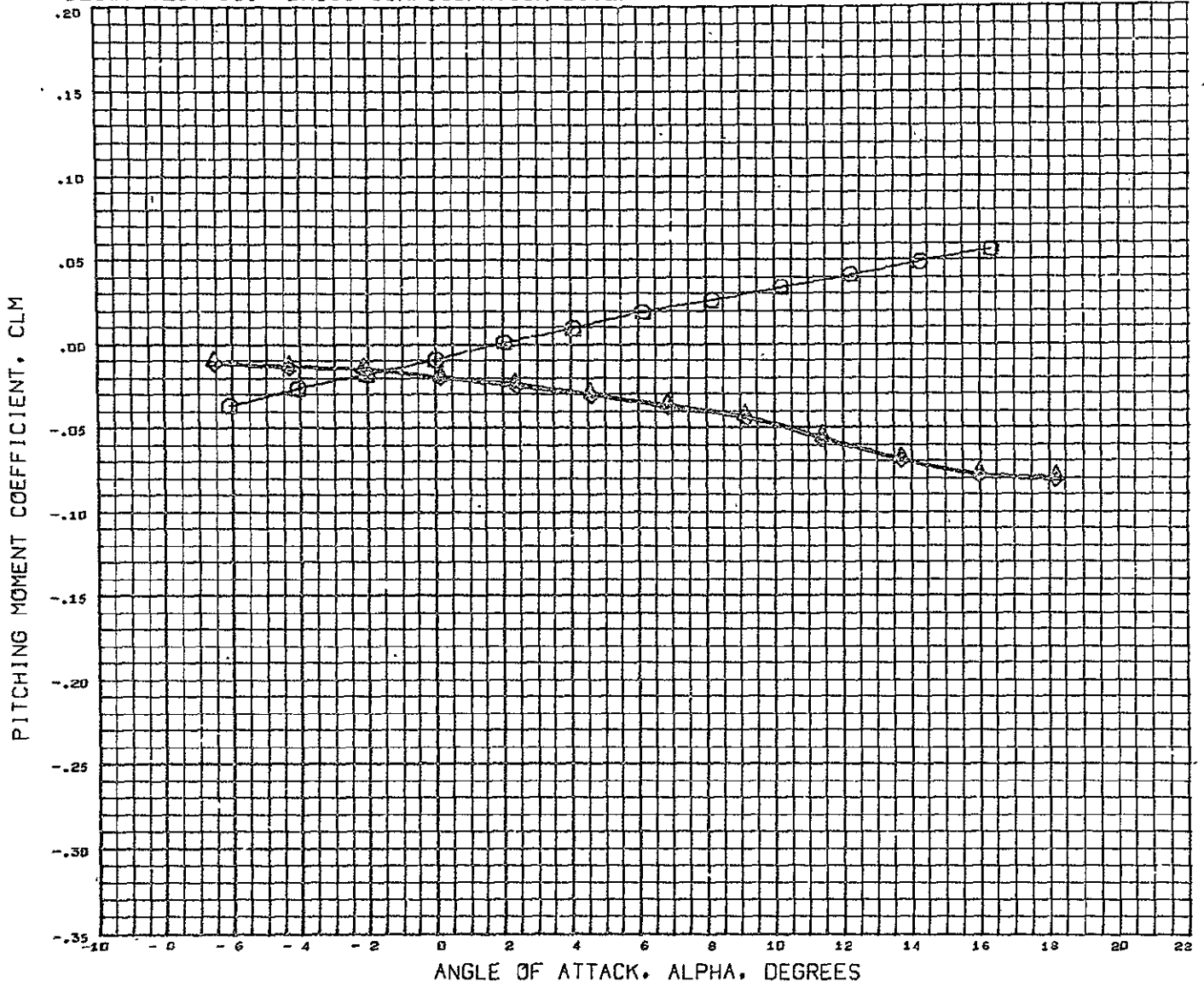

DATA SET SYMBOL	CONFIGURATION DESCRIPTION
(RCN080)	○ DLSWT 138 0.0133 SC. GENERIC HCR 02 B3A
(PCN074)	△ DLSWT 138 0.0133 SC. GENERIC HCR 02 B3AW9A
(RCN070)	◇ DLSWT 138 0.0133 SC. GENERIC HCR 02 B3AW9AV4

REFERENCE INFORMATION		
REFS	5370.0040	SQ. FT
REFL	760.0004	IN.
REFB	1138.0040	IN.
XMRP	1273.0040	IN.
YMRP	0.0000	IN.
ZMRP	214.0004	IN.
SCALE	100.0000	ERCNT

MACH 0.180

DLSWT TEST 138- BASIC CONFIGURATION BUILDUP

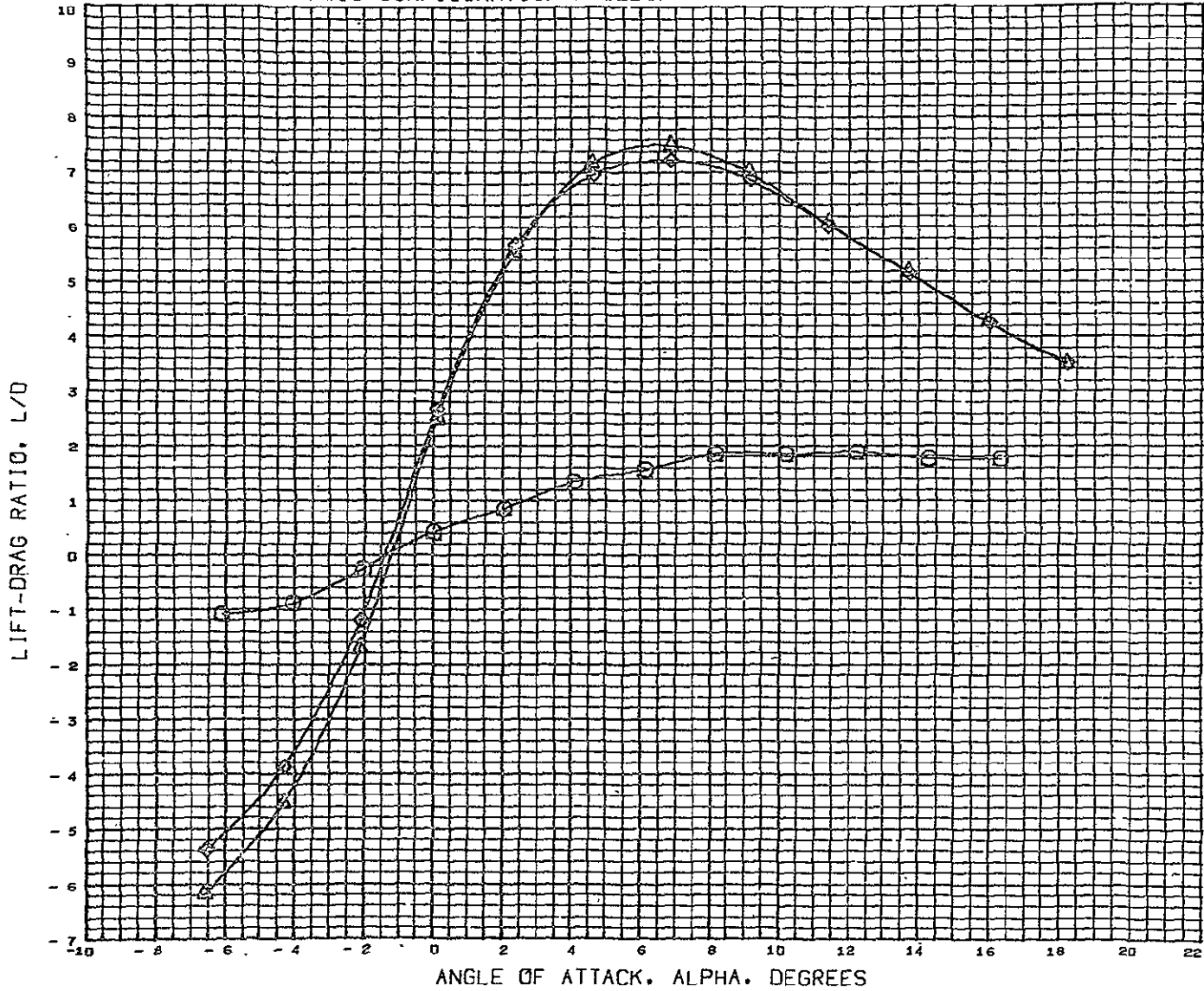

DATA SET SYMBOL	CONFIGURATION DESCRIPTION
(RCND85) ○	DLSWT 138 0.0133 SC. GENERIC HCR 02 B3A
(RCND74) △	DLSWT 138 0.0133 SC. GENERIC HCR 02 B3AW9A
(RCND79) ◇	DLSWT 138 0.0133 SC. GENERIC HCR 02 B3AW9AV4

REFERENCE INFORMATION		
REFS	5370.0040	SQ. FT
REFL	760.0004	IN.
REFB	1138.0040	IN.
XMRP	1273.0040	IN.
YMRP	0.0000	IN.
ZMRP	214.0004	IN.
SCALE	100.0000	PERCENT

MACH 0.180

DLSWT TEST 138- BASIC CONFIGURATION BUILDUP.

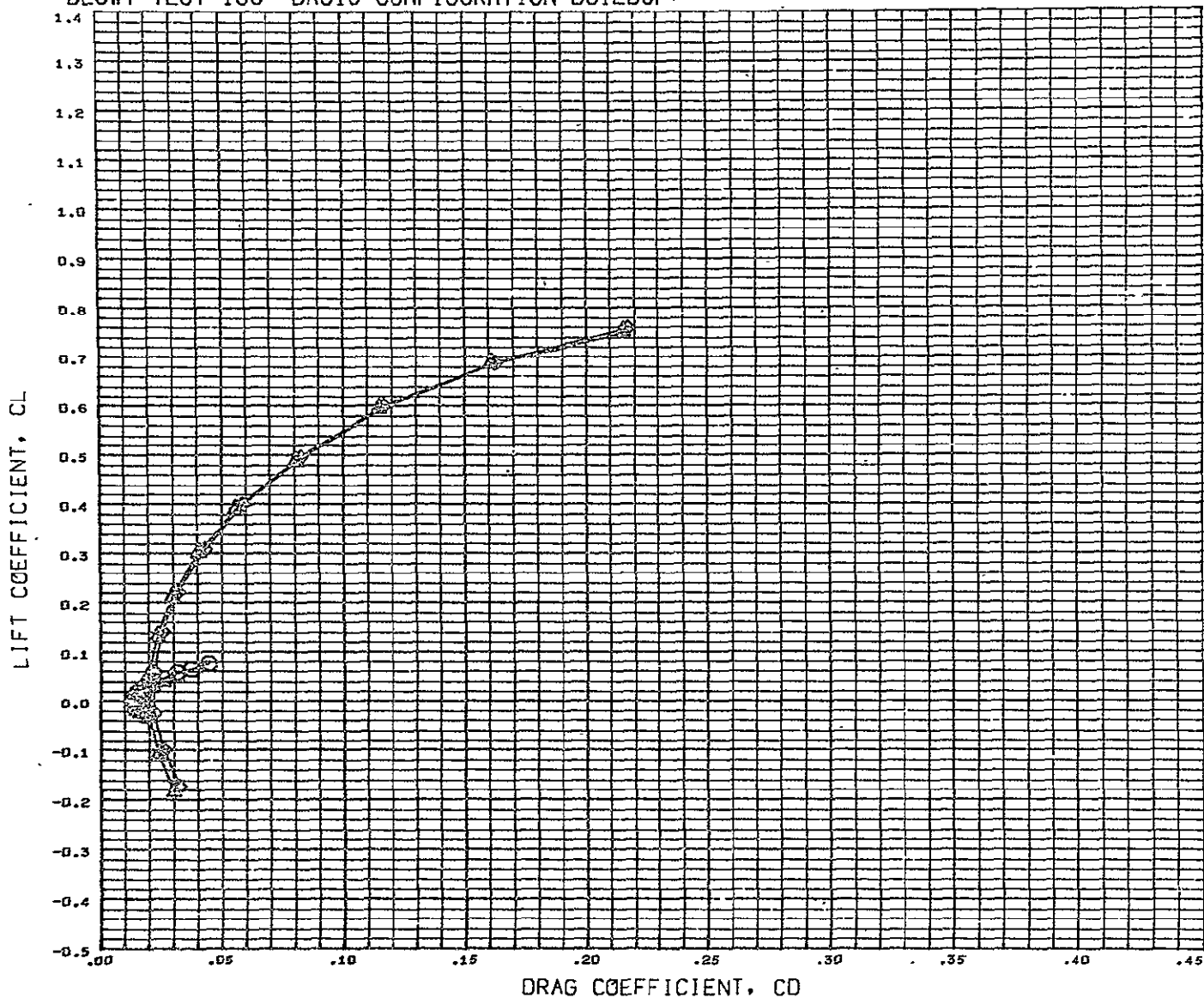

DATA SET SYMBOL	CONFIGURATION DESCRIPTION
(RCND85)	⊙ DLSWT 138 0.0133 SC. GENERIC HCR 02 B3A
(PCND74)	△ DLSWT 138 0.0133 SC. GENERIC HCR 02 B3AW9A
(RCND75)	◇ DLSWT 138 0.0133 SC. GENERIC HCR 02 B3AW9AV4

REFERENCE INFORMATION		
REFS	5370.0040	SQ. FT
REFL	760.0004	IN.
REFB	1138.0040	IN.
XMRP	1273.0040	IN.
YMRP	0.0000	IN.
ZMRP	214.0004	IN.
SCALE	100.0000	PERCENT

MACH 0.180

DLSWT TEST 138- BASIC CONFIGURATION BUILDUP

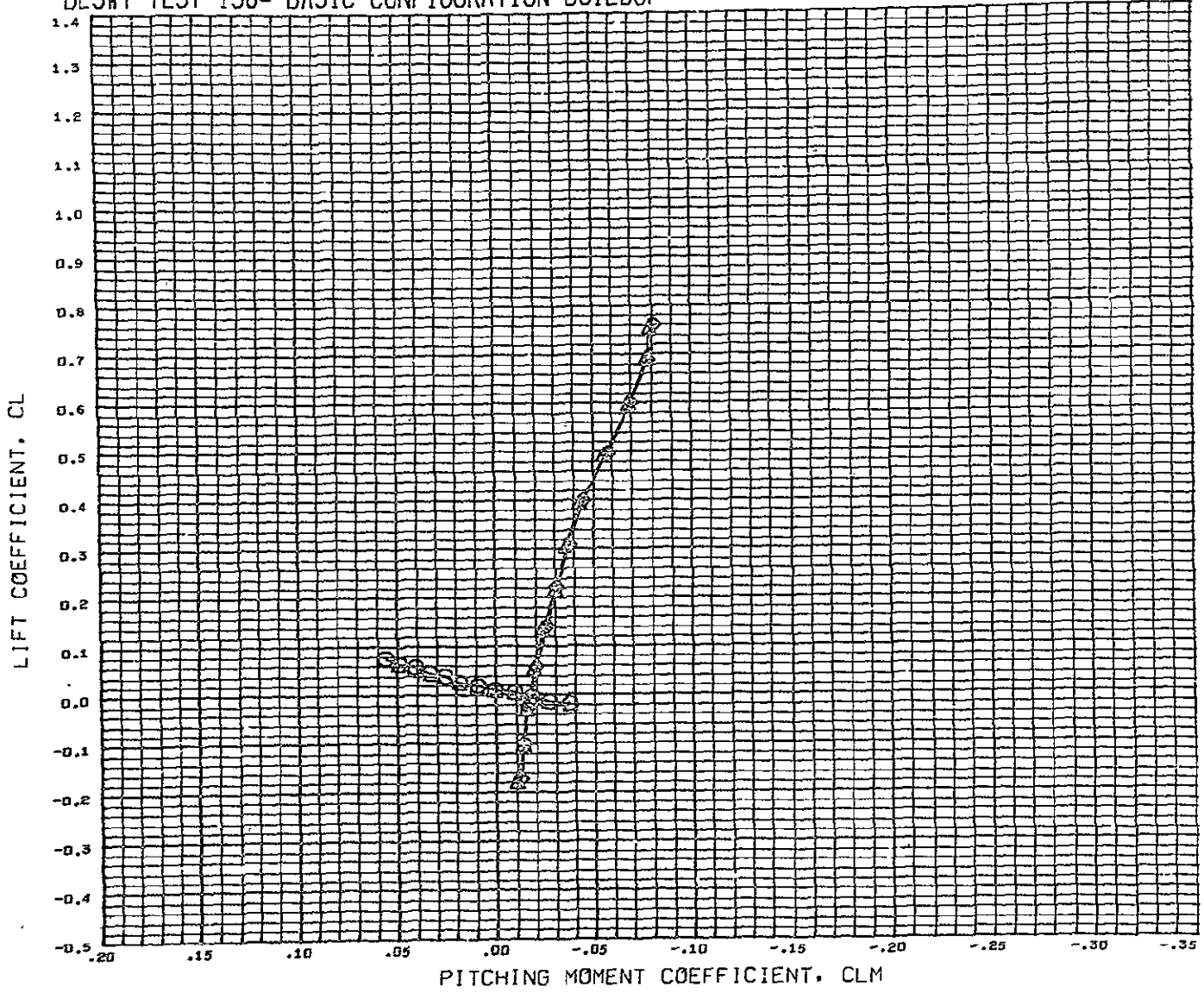

DATA SET SYMBOL	CONFIGURATION DESCRIPTION
(RCND80)	DLSWT 138 0.0133 SC. GENERIC HCR 02 B3A
(RCND74)	DLSWT 138 0.0133 SC. GENERIC HCR 02 B3AW3A
(RCND75)	DLSWT 138 0.0133 SC. GENERIC HCR 02 B3AW3AV4

REFERENCE INFORMATION		
REFS	5370.0040	SQ. FT
REFL	760.0004	IN.
REFB	1138.0040	IN.
XHRF	1275.0040	IN.
YHRF	0.0000	IN.
ZHRF	214.0004	IN.
SCALE	100.0000	PERCNT

MACH 0.100

DLSWT TEST 138- BASIC CONFIGURATION BUILDUP

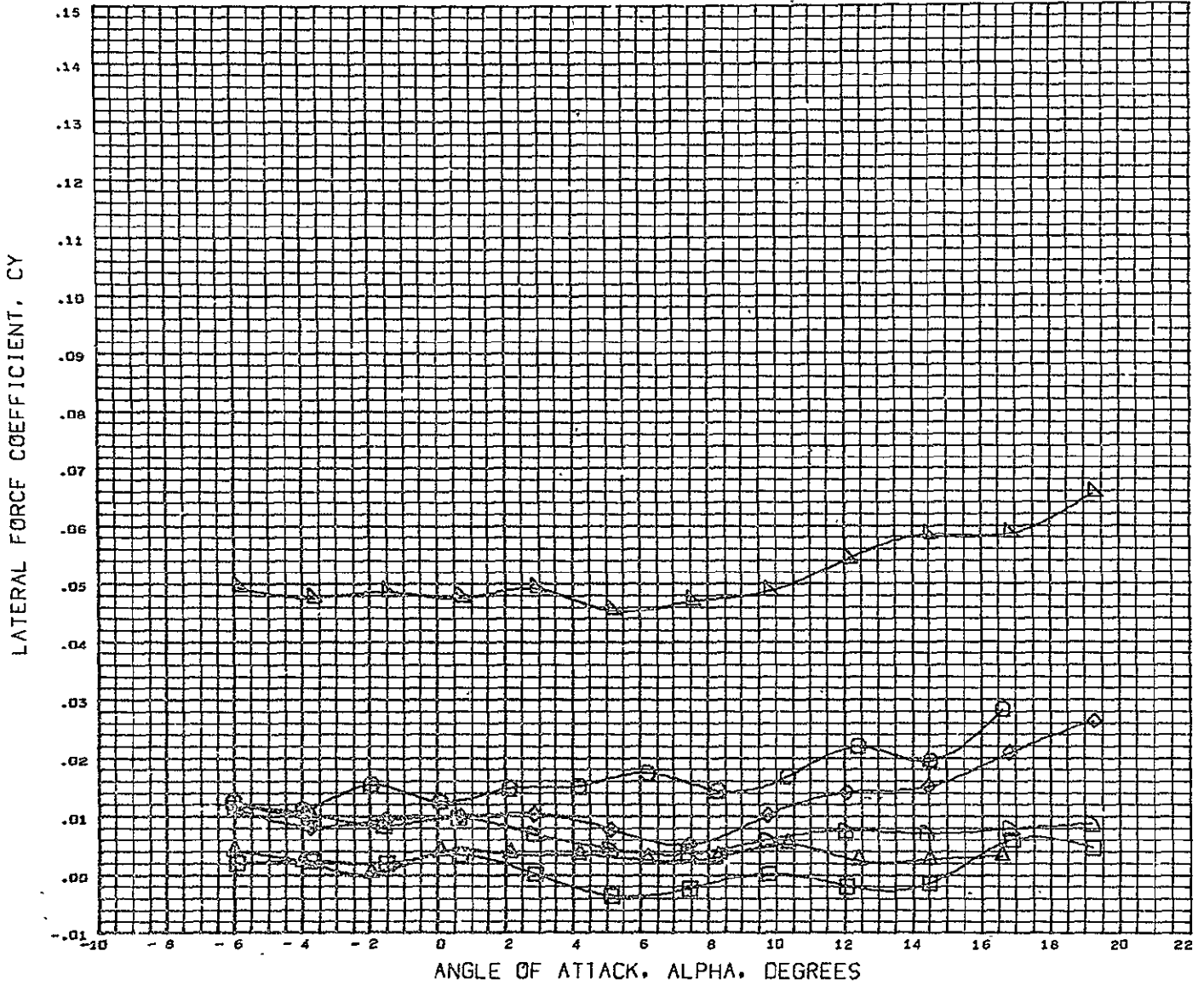

DATA SET SYMBOL	CONFIGURATION DESCRIPTION	BETA
(TCN015)	DLSWT 138 0.0133 SC. GENERIC HCR 02 B1A	-2.950
(TCN013)	DLSWT 138 0.0133 SC. GENERIC HCR 02 B1A	0.000
(TCN009)	DLSWT 138 0.0133 SC. GENERIC HCR 02 B1AW3	-2.960
(TCN007)	DLSWT 138 0.0133 SC. GENERIC HCR 02 B1AW3	0.000
(TCN010)	DLSWT 138 0.0133 SC. GENERIC HCR 02 B1AW3V4	-2.890
(TCN011)	DLSWT 138 0.0133 SC. GENERIC HCR 02 B1AW3V4	0.000

MACH 5.189

SEE THE ASSOCIATED DATA DOCUMENT FOR REFERENCE CHARACTERISTICS

DLSWT TEST 138- BASIC CONFIGURATION BUILDUP

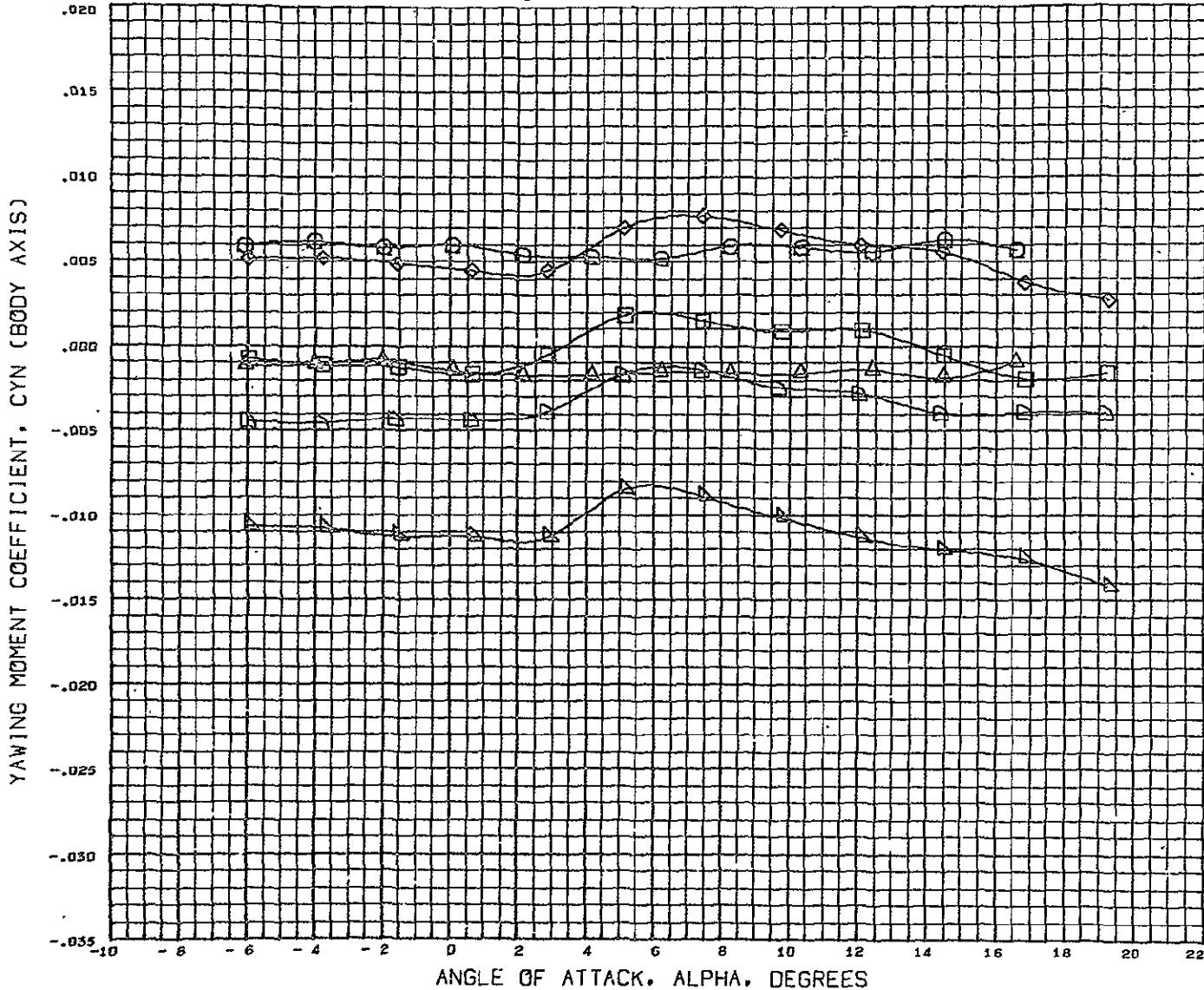

DATA SET SYMBOL	CONFIGURATION DESCRIPTION	BETA
(TCND15)	DLSWT 138 0.0133 SC. GENERIC HCR O2 B1A	-2.950
(TCND13)	DLSWT 138 0.0133 SC. GENERIC HCR O2 B1A	0.000
(TCND09)	DLSWT 138 0.0133 SC. GENERIC HCR O2 B1AW3	-2.960
(TCND07)	DLSWT 138 0.0133 SC. GENERIC HCR O2 B1AW3	0.000
(TCND10)	DLSWT 138 0.0133 SC. GENERIC HCR O2 B1AW3V4	-2.890
(TCND11)	DLSWT 138 0.0133 SC. GENERIC HCR O2 B1AW3V4	0.000

SEE THE ASSOCIATED DATA DOCUMENT FOR REFERENCE CHARACTERISTICS

MACH 0.180

DLSWT TEST 138- BASIC CONFIGURATION BUILDUP

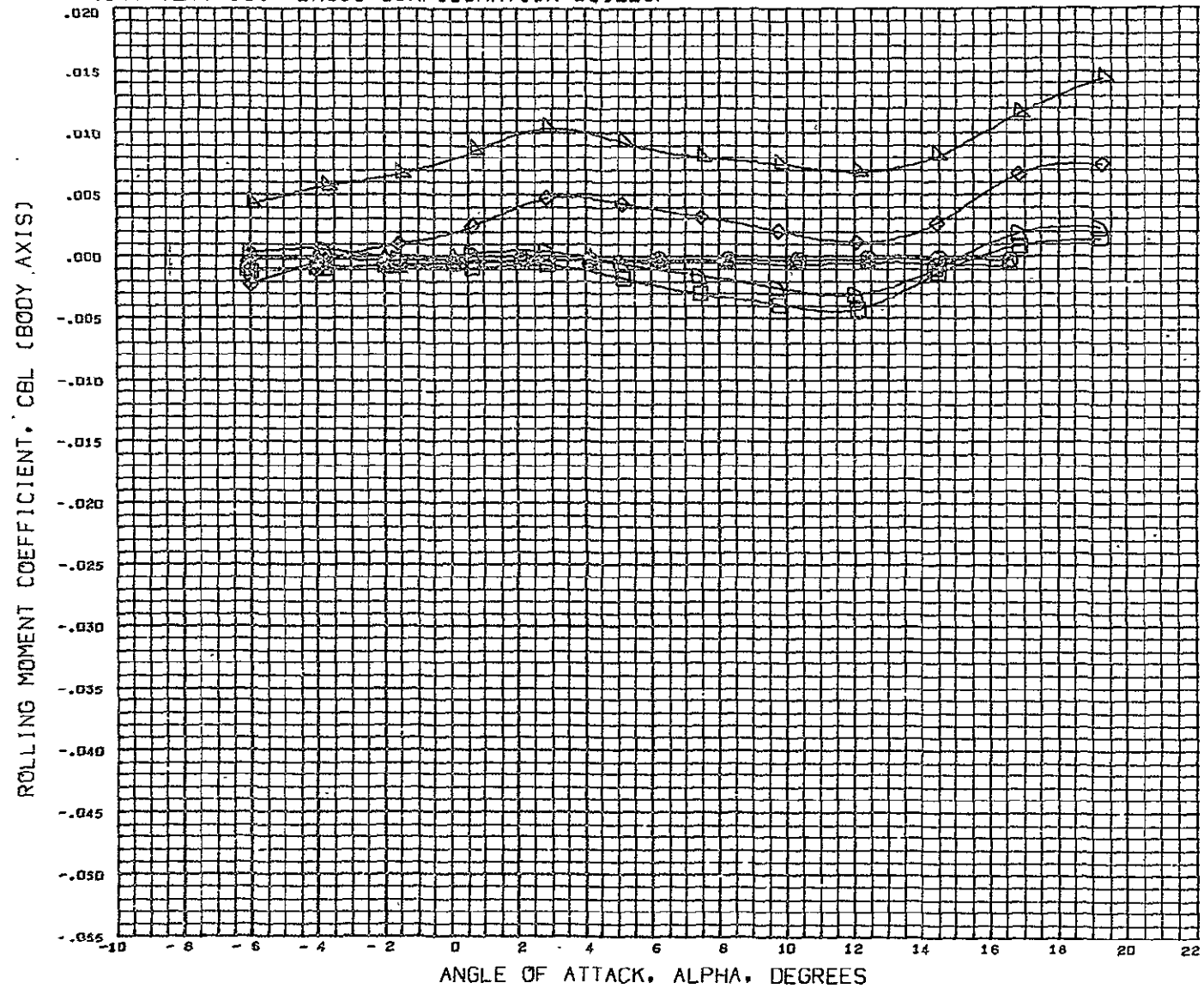

DATA SET SYMBOL	CONFIGURATION DESCRIPTION	BETA
(TCND15)	DLSWT 138 0.0133 SC. GENERIC HCR 02 B1A	-2.950
(TCND13)	DLSWT 138 0.0133 SC. GENERIC HCR 02 B1A	0.000
(TCND09)	DLSWT 138 0.0133 SC. GENERIC HCR 02 B1AW3	-2.960
(TCND07)	DLSWT 138 0.0133 SC. GENERIC HCR 02 B1AW3	0.000
(TCND10)	DLSWT 138 0.0133 SC. GENERIC HCR 02 B1AW3V4	-2.890
(TCND11)	DLSWT 138 0.0133 SC. GENERIC HCR 02 B1AW3V4	0.000

MACH 3.180

SEE THE ASSOCIATED DATA DOCUMENT FOR REFERENCE CHARACTERISTICS

DLSWT TEST 138- BASIC CONFIGURATION BUILDUP

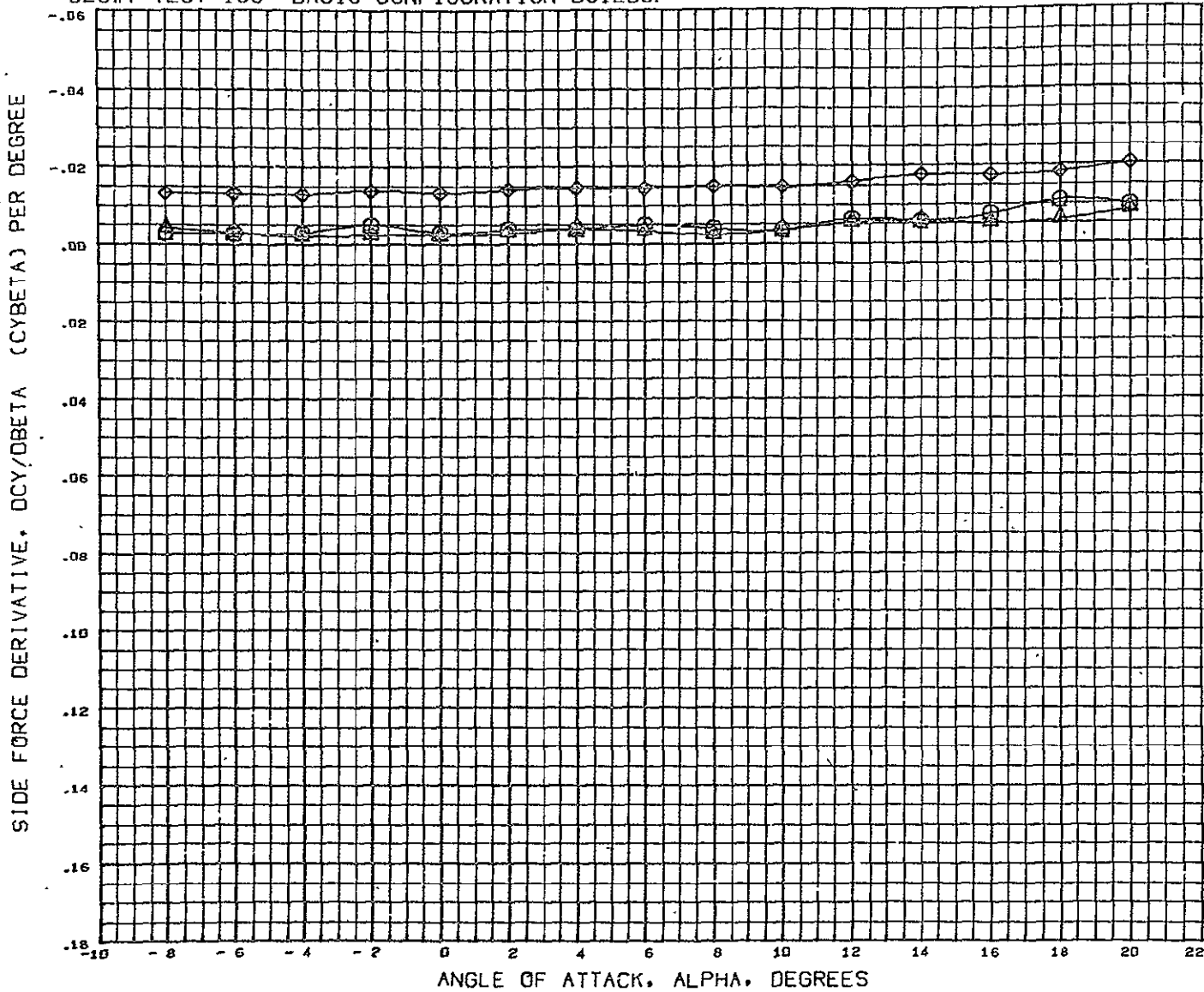

DATA SET SYMBOL	CONFIGURATION DESCRIPTION
(PCND13)	DLSWT 138 0.0133 SC. GENERIC HCR 02 B1A
(PCND07)	DLSWT 138 0.0133 SC. GENERIC HCR 02 B1AW3
(PCNS11)	DLSWT 138 0.0133 SC. GENERIC HCR 02 B1AW3V4

SEE THE ASSOCIATED DATA DOCUMENT FOR REFERENCE CHARACTERISTICS

MACH 9.180

DLSWT TEST 138- BASIC CONFIGURATION BUILDUP

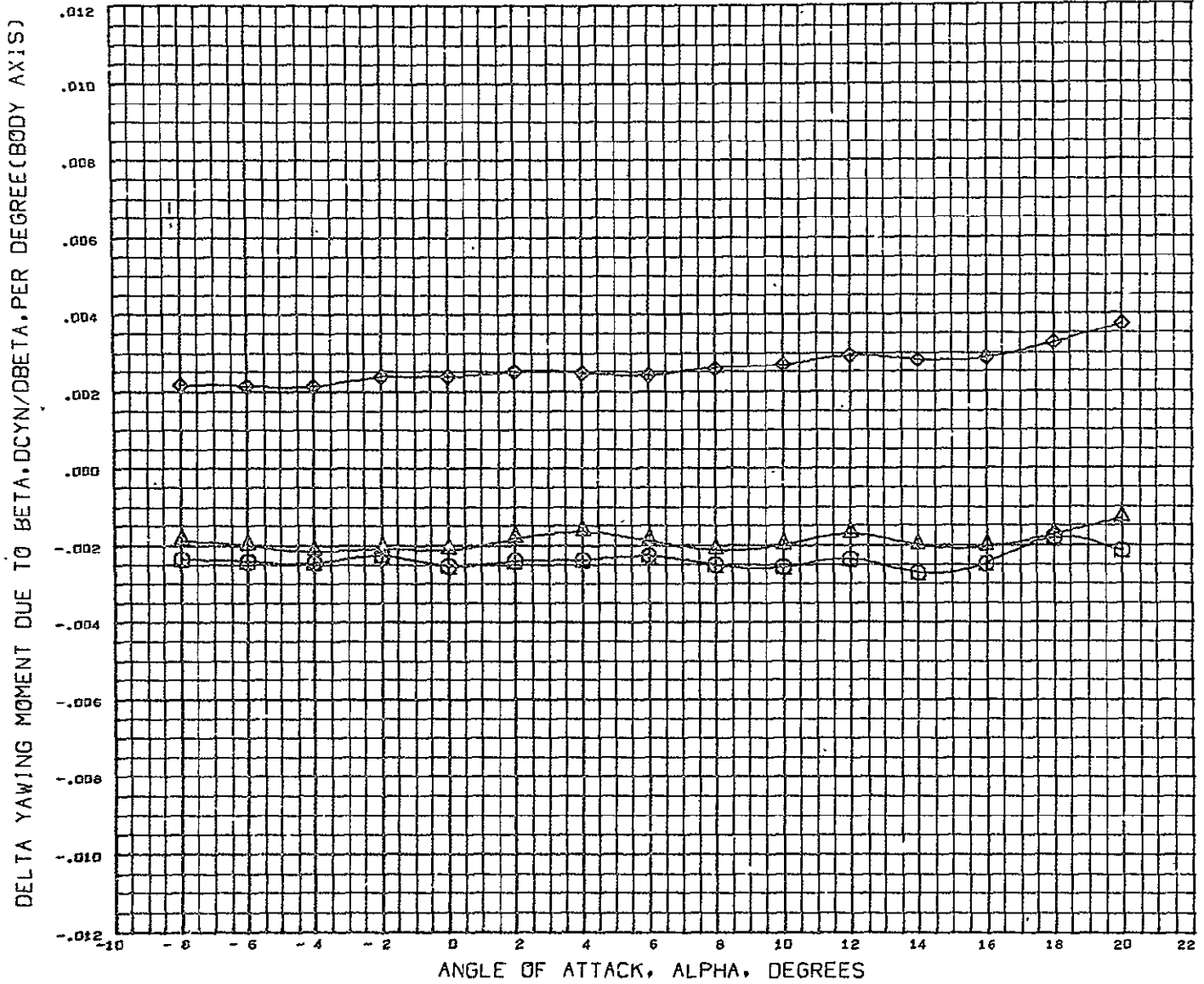

DATA SET SYMBOL	CONFIGURATION DESCRIPTION
(FCNS013)	DLSWT 138 0.0133 SC. GENERIC HCR 02 61A
(FCNS007)	DLSWT 138 0.0133 SC. GENERIC HCR 02 B1AW3
(FCNS011)	DLSWT 138 0.0133 SC. GENERIC HCR 02 B1AW3V4

SEE THE ASSOCIATED DATA DOCUMENT FOR REFERENCE CHARACTERISTICS

MACH 0.189

DLSWT TEST 138- BASIC CONFIGURATION BUILDUP

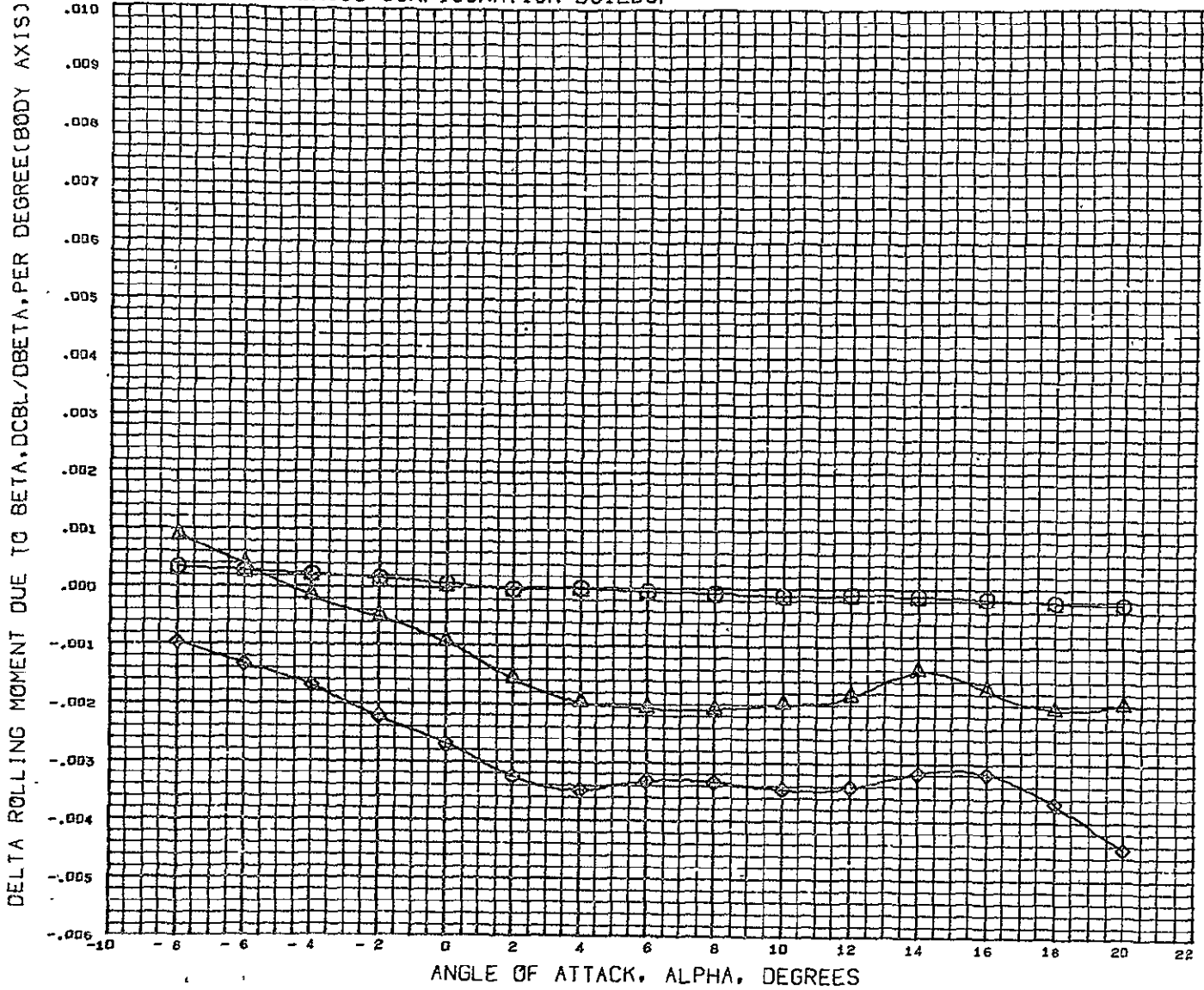

DATA SET SYMBOL CONFIGURATION DESCRIPTION
 (PCN013) ○ DLSWT 138 D.0133 SC. GENERIC HCF 02 01A
 (PCN007) △ DLSWT 138 D.0133 SC. GENERIC HCF 02 01AW3
 (PCN011) ◇ DLSWT 138 D.0133 SC. GENERIC HCF 02 01A43V4

SEE THE ASSOCIATED DATA DOCUMENT FOR REFERENCE CHARACTERISTICS

MACH 0.180

DLSWT TEST 138- BASIC CONFIGURATION BUILDUP

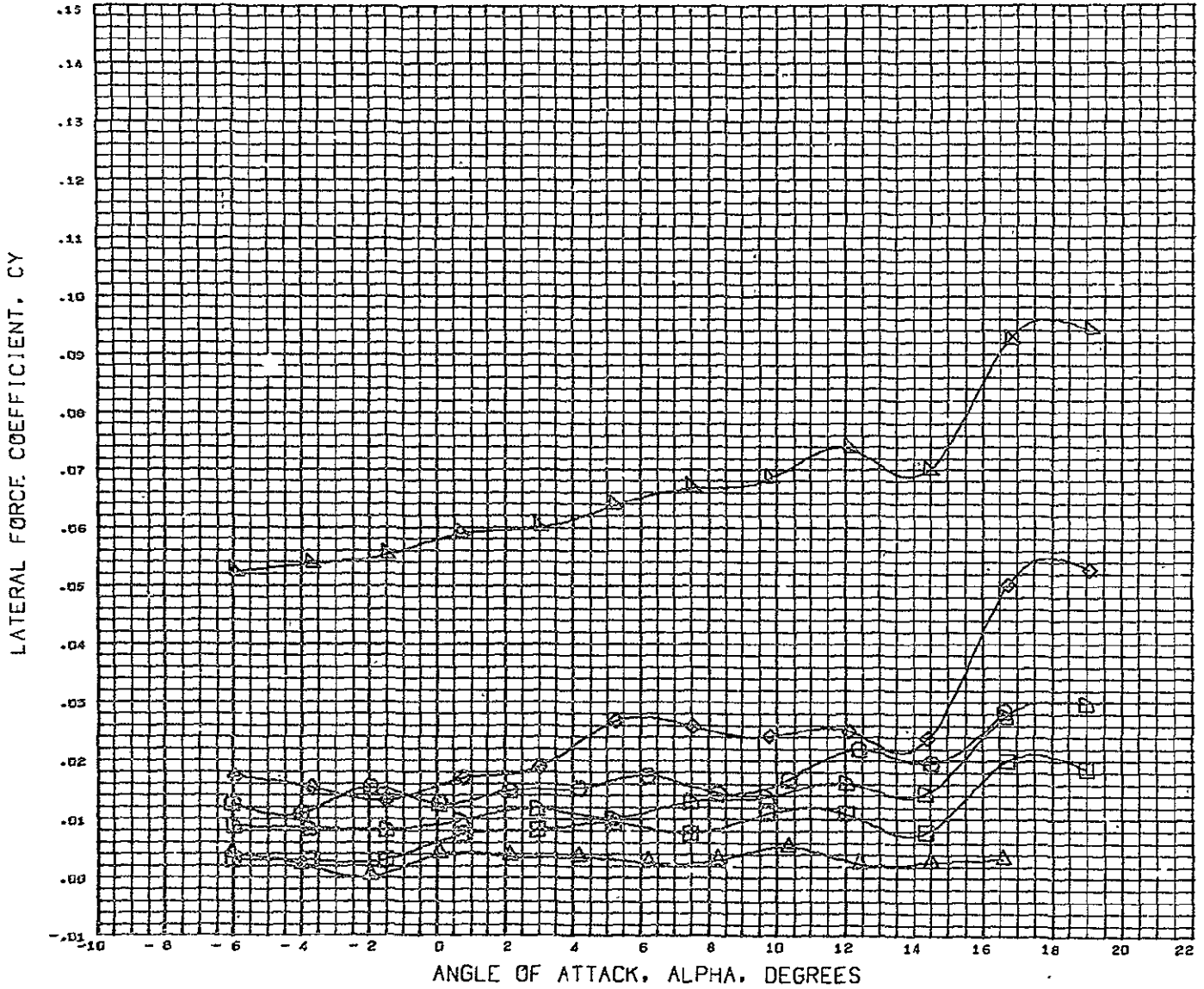

DATA SET SYMBOL	CONFIGURATION DESCRIPTION	BETA	REFERENCE INFORMATION
(TCN915)	DLSWT 138 0.0133 SC. GENERIC HCR 02 B1A	-2.950	REFS 5057.0040 SQ.FT.
(TCN913)	DLSWT 138 0.0133 SC. GENERIC HCR 02 B1A	0.000	REFL 701.0004 IN.
(TCN934)	DLSWT 138 0.0133 SC. GENERIC HCR 02 B1BWA4ST	-2.930	REFB 1230.0040 IN.
(TCN925)	DLSWT 138 0.0133 SC. GENERIC HCR 02 B1BWA4ST	0.000	XMRF 1266.0040 IN.
(TCN922)	DLSWT 138 0.0133 SC. GENERIC HCR 02 B1BWA4STV4	-2.880	YMRF 0.0000 IN.
(TCN931)	DLSWT 138 0.0133 SC. GENERIC HCR 02 B1BWA4STV4	0.000	ZMRF 163.0004 IN.
	HACH 0.185		SCALE 100.0000 PERCENT

DLSWT TEST 138- BASIC CONFIGURATION BUILDUP

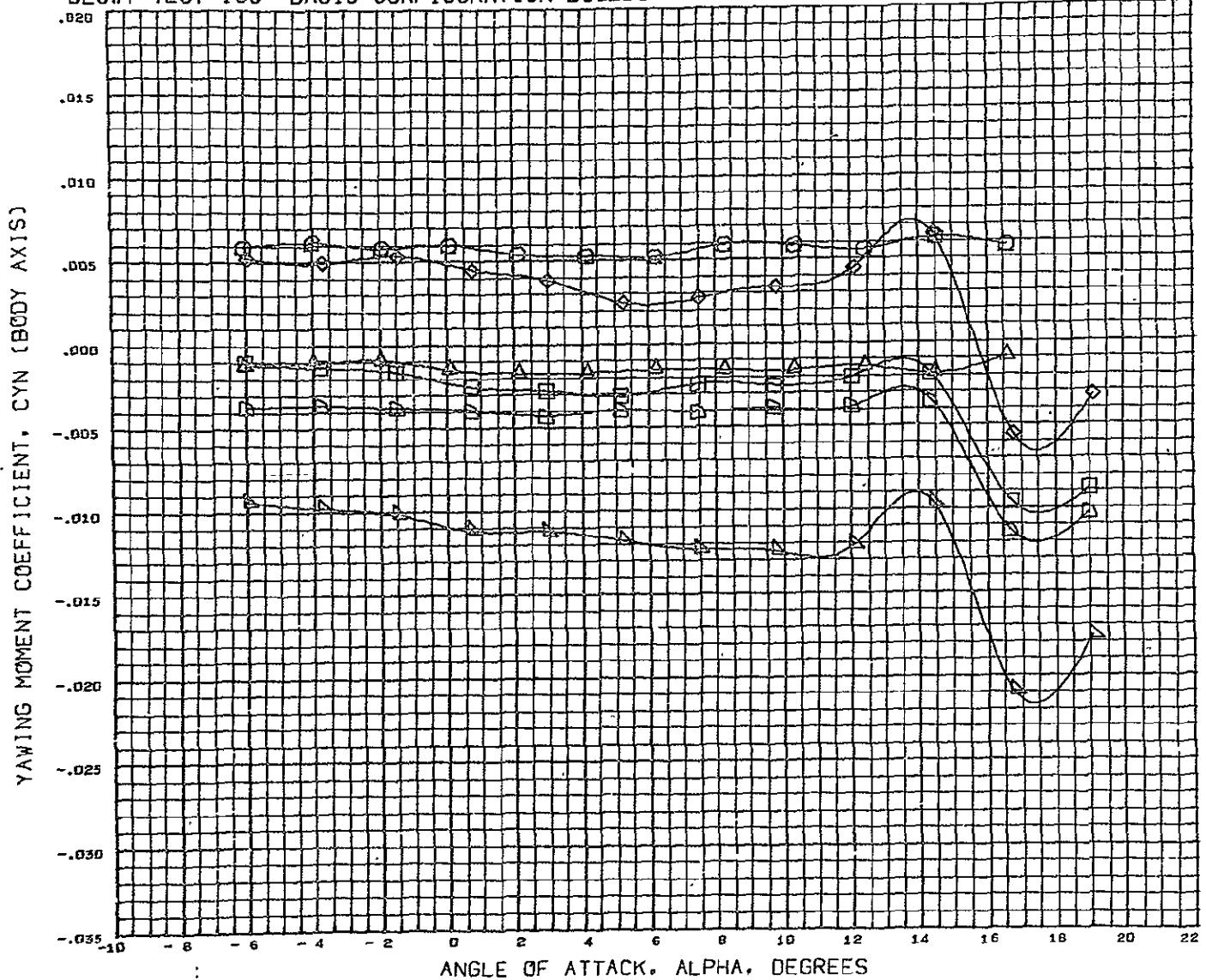

DATA SET SYMBOL	CONFIGURATION DESCRIPTION	BETA	REFERENCE INFORMATION
(TCN015)	DLSWT 138 0.0133 SC. GENERIC HCR 02 B1A	-2.950	REFS 5057.0040 SQ.FT.
(TCN013)	DLSWT 138 0.0133 SC. GENERIC HCR 02 B1A	0.000	REFL 701.0004 IN.
(TCN034)	DLSWT 138 0.0133 SC. GENERIC HCR 02 B1BWA4ST	-2.930	REF6 1230.0040 IN.
(TCN035)	DLSWT 138 0.0133 SC. GENERIC HCR 02 B1BWA4ST	0.000	XMRP 1266.0040 IN.
(TCN032)	DLSWT 138 0.0133 SC. GENERIC HCR 02 B1BWA4STV4	-2.880	YMRP 0.0000 IN.
(TCN031)	DLSWT 138 0.0133 SC. GENERIC HCR 02 B1BWA4STV4	0.000	ZMRP 163.0004 IN.
	MACH 0.185		SCALE 100.0000 PERCENT

DLSWT TEST 138- BASIC CONFIGURATION BUILDUP

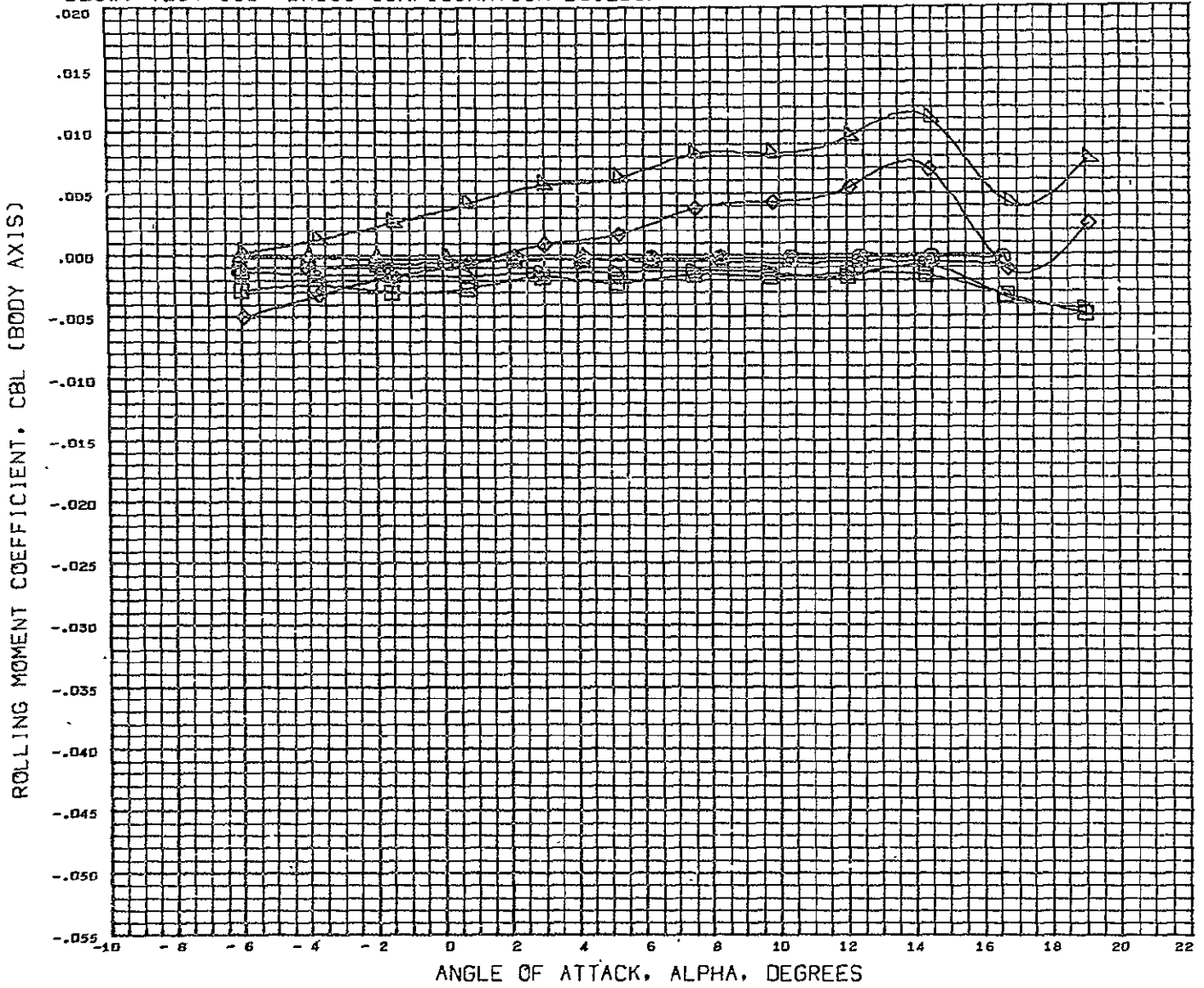

DATA SET SYMBOL	CONFIGURATION DESCRIPTION	BETA	REFERENCE INFORMATION
(TCN515)	DLSWT 138 0.0133 SC. GENERIC HCR O2 B1A	-2.950	REFS 5957.0040 SQ.FT.
(TCN513)	DLSWT 138 0.0133 SC. GENERIC HCR O2 B1A	0.000	REF' 701.0004 IN.
(TCN534)	DLSWT 138 0.0133 SC. GENERIC HCF O2 B1BWA4ST	-2.930	REFB 1230.0049 IN.
(TCN535)	DLSWT 138 0.0133 SC. GENERIC HCR O2 B1BWA4ST	0.000	XMRF 1266.0049 IN.
(TCN532)	DLSWT 138 0.0133 SC. GENERIC HCR O2 B1BWA4STV4	-2.880	YMRF 0.0000 IN.
(TCN531)	DLSWT 138 0.0133 SC. GENERIC HCR O2 B1BWA4STV4	0.000	ZMRF 163.0004 IN.
MACH 0.180			SCALE 100.0000 PERCENT

DLSWT TEST 138- BASIC CONFIGURATION BUILDUP

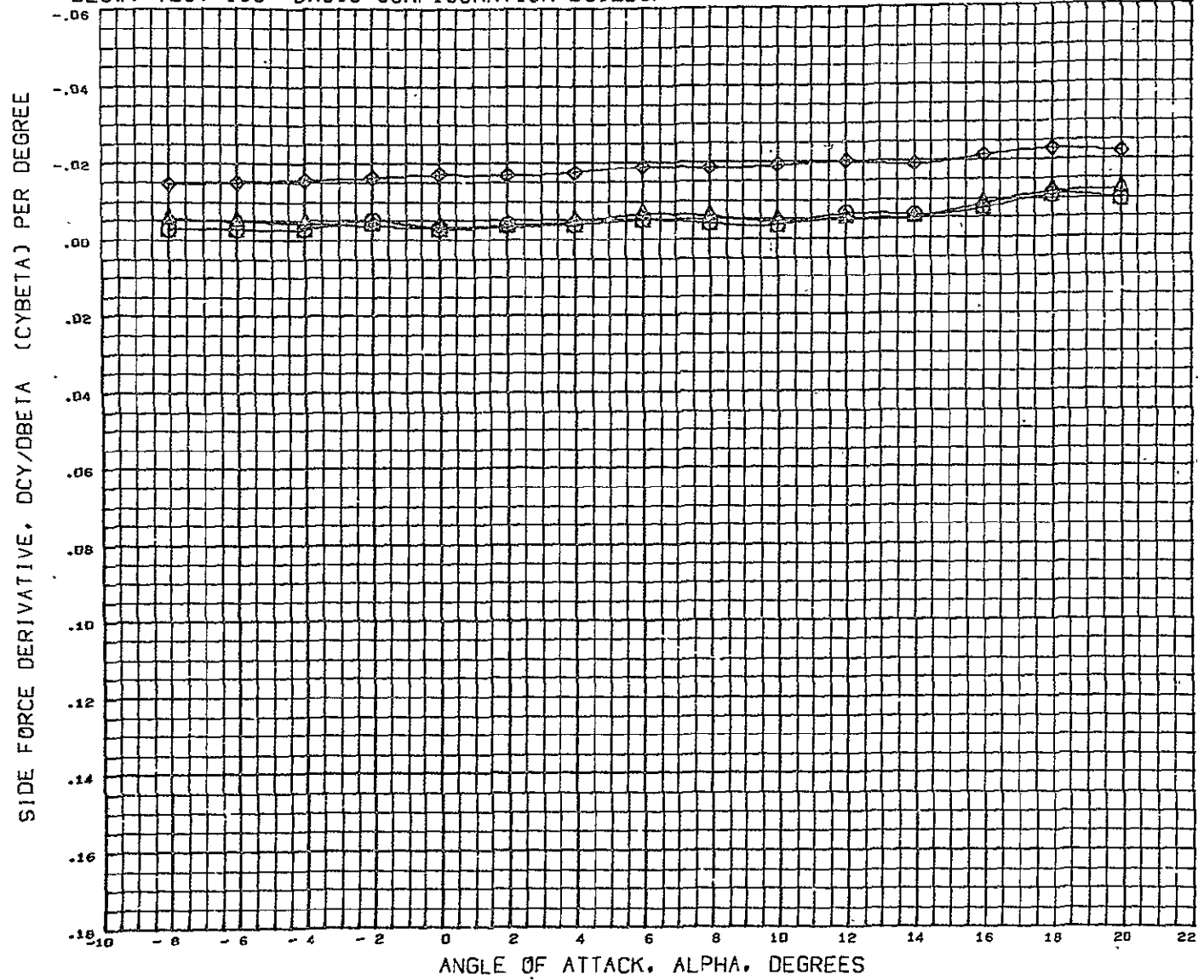

DATA SET SYMBOL CONFIGURATION DESCRIPTION
 (FCN113) ○ DLSWT 138 0.0133 SC. GENERIC HCR 02 B1A
 (FCN135) △ DLSWT 138 0.0133 SC. GENERIC HCR 02 B1B4AST
 (FCN131) ◇ DLSWT 138 0.0133 SC. GENERIC HCR 02 B1B4ASTV4

REFERENCE INFORMATION
 REFS 5057.0040 SQ.FT.
 REFL 701.0004 IN.
 REFB 1230.0040 IN.
 XMRP 1266.0040 IN.
 YMRP 0.0000 IN.
 ZMRP 163.0004 IN.
 SCALE 100.0000 PERCENT

MACH 0.100

DLSWT TEST 138- BASIC CONFIGURATION BUILDUP

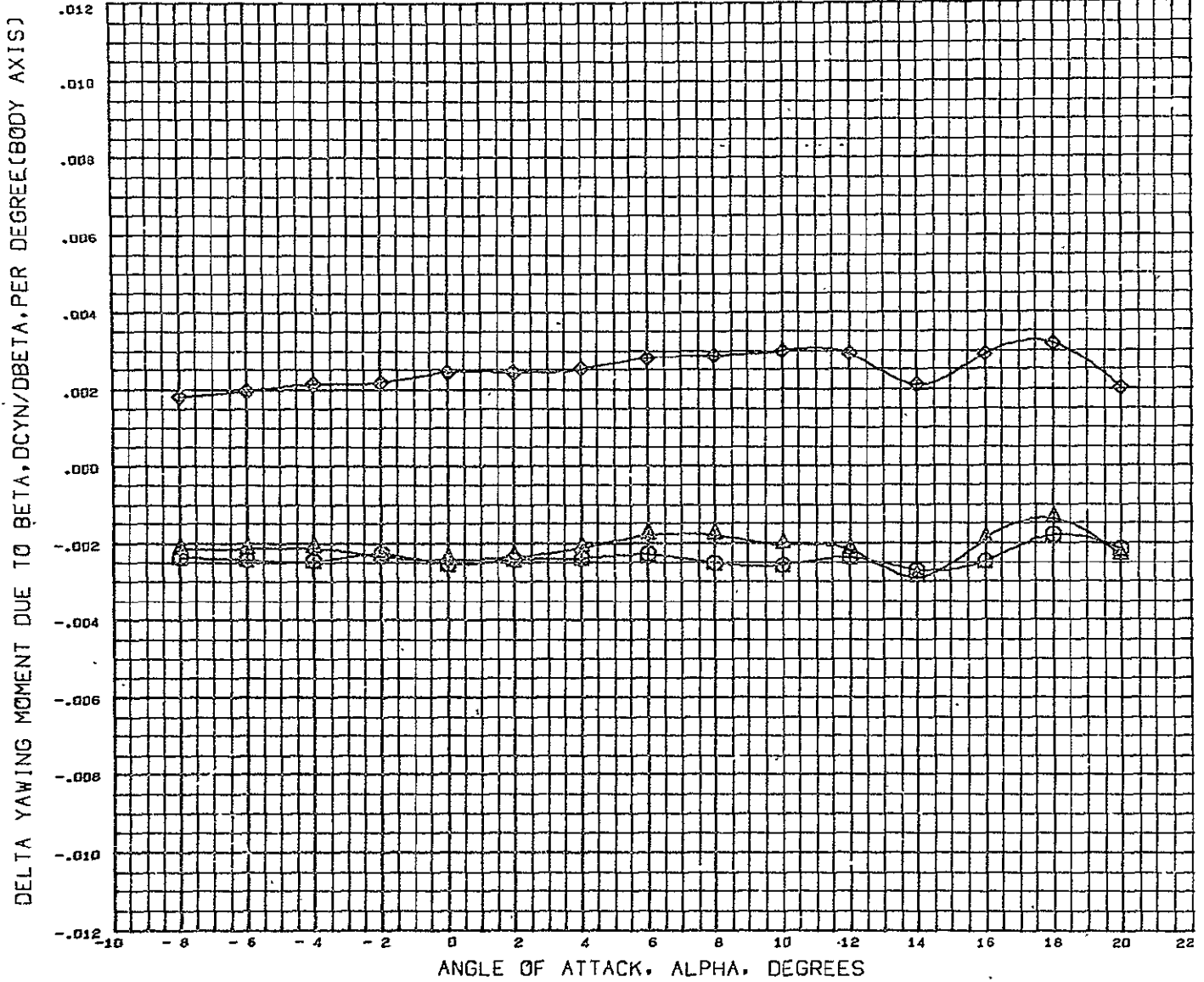

DATA SET SYMBOL	CONFIGURATION DESCRIPTION
(FCND13)	⊙ DLSWT 138 0.0133 SC. GENERIC HCR 02 B1A
(FCND35)	△ DLSWT 138 0.0133 SC. GENERIC HCR 02 B1BW4AST
(FCND31)	◇ DLSWT 138 0.0133 SC. GENERIC HCR 02 B1BW4ASTV4

REFERENCE INFORMATION		
REFS	5057.0040	SQ.FT.
REFL	701.0004	IN.
REFB	1230.0040	IN.
XMRP	1266.0040	IN.
YMRP	0.0000	IN.
ZMRP	163.0004	IN.
SCALE	100.0000	PERCNT

MACH 0.180

DLSWT TEST 138- BASIC CONFIGURATION BUILDUP

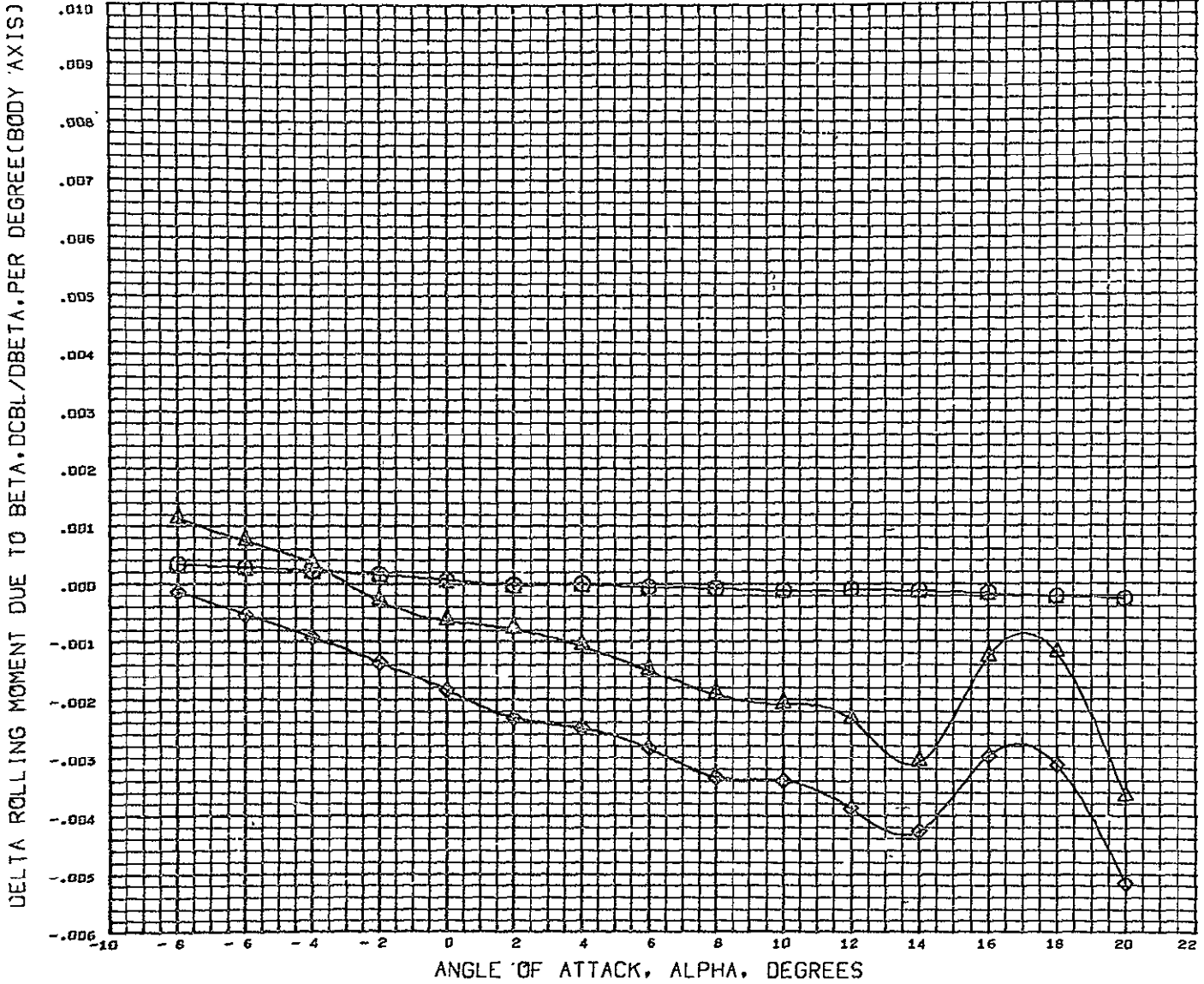

DATA SET SYMBOL	CONFIGURATION DESCRIPTION
(FCN013)	DLSWT 138 0.0133 SC. GENERIC HCR O2 B1A
(FCN035)	DLSWT 138 0.0133 SC. GENERIC HCR O2 B1B4AST
(FCN031)	DLSWT 138 0.0133 SC. GENERIC HCR O2 B1B4ASTV4

REFERENCE INFORMATION		
REFS	5057.0040	SQ. FT.
REFL	701.0000	IN.
REFB	1230.0040	IN.
XMRP	1266.0040	IN.
YMRP	0.0000	IN.
ZMRP	163.0004	IN.
SCALE	100.0000	PERCNT

MACH 0.185

DLSWT TEST 138- BASIC CONFIGURATION BUILDUP

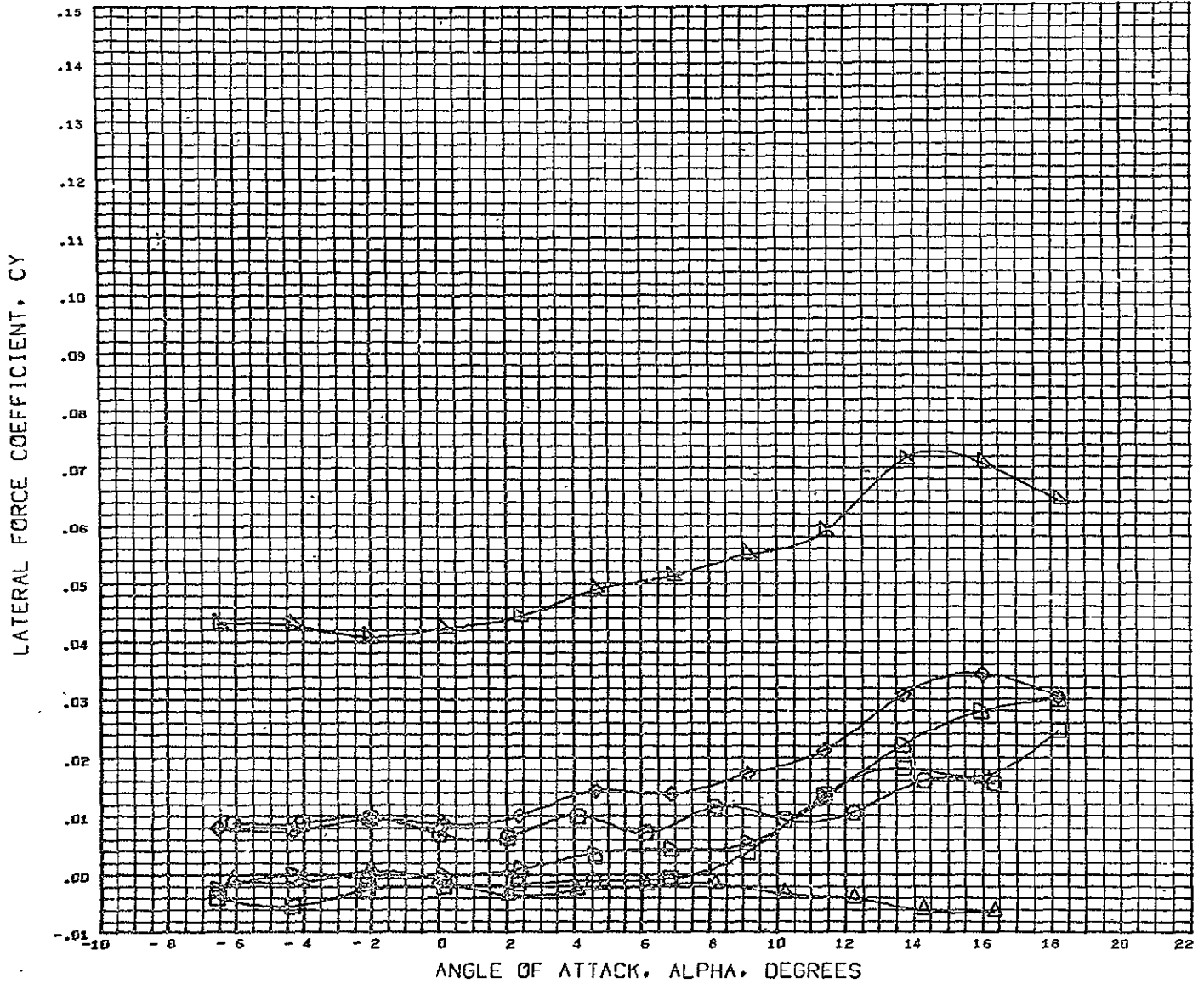

DATA SET SYMBOL	CONFIGURATION DESCRIPTION	BETA	REFERENCE INFORMATION
(TCND79)	DLSWT 138 0.0133 SC. GENERIC HCR 02 B3A	-2.950	REFS 5370.0040 SQ. FT
(TCND80)	DLSWT 138 0.0133 SC. GENERIC HCR 02 B3A	0.000	REFL 760.0004 IN.
(TCND73)	DLSWT 138 0.0133 SC. GENERIC HCR 02 B3AW9A	-2.950	REFB 1138.0043 IN.
(TCND74)	DLSWT 138 0.0133 SC. GENERIC HCR 02 B3AW9A	0.000	XMRP 1273.0040 IN.
(TCND71)	DLSWT 138 0.0133 SC. GENERIC HCR 02 B3AW9AV4	-2.690	YMRP 0.0000 IN.
(TCND70)	DLSWT 138 0.0133 SC. GENERIC HCR 02 B3AW9AV4	0.000	ZMRP 214.0004 IN.
	MACH 0.100		SCALE 100.0000 PERCNT

DLSWT TEST 138- BASIC CONFIGURATION BUILDUP

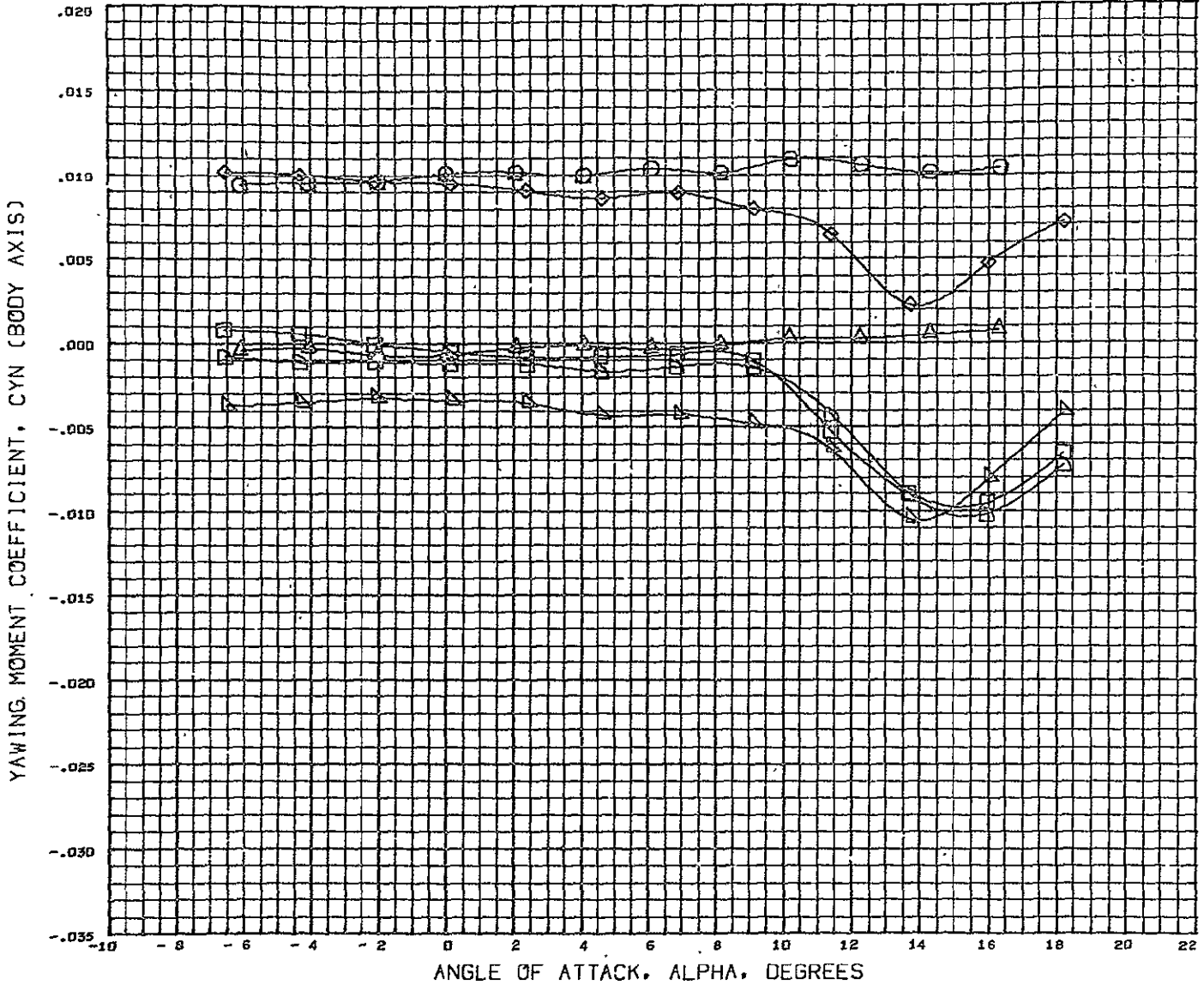

DATA SET SYMBOL	CONFIGURATION DESCRIPTION	BETA	REFERENCE INFORMATION
(TCN079)	DLSWT 138 0.0133 SC. GENERIC HCR 02 B3A	-2.950	REFS 5370.0040 Sq. FT
(TCN080)	DLSWT 138 0.0133 SC. GENERIC HCR 02 B3A	0.000	REFL 760.0004 IN.
(TCN073)	DLSWT 138 0.0133 SC. GENERIC HCR 02 B3AW9A	-2.950	REFB 1138.0040 IN.
(TCN074)	DLSWT 138 0.0133 SC. GENERIC HCR 02 B3AW9A	0.700	XMRP 1273.0040 IN.
(TCN071)	DLSWT 138 0.0133 SC. GENERIC HCR 02 B3AW9AV4	-2.690	YMRP 0.0000 IN.
(TCN070)	DLSWT 138 0.0133 SC. GENERIC HCR 02 B3AW9AV4	0.000	ZMRP 214.0004 IN.
			SCALE 100.0000 PERCENT

MACH 0.180

DLSWT TEST 138- BASIC CONFIGURATION BUILDUP

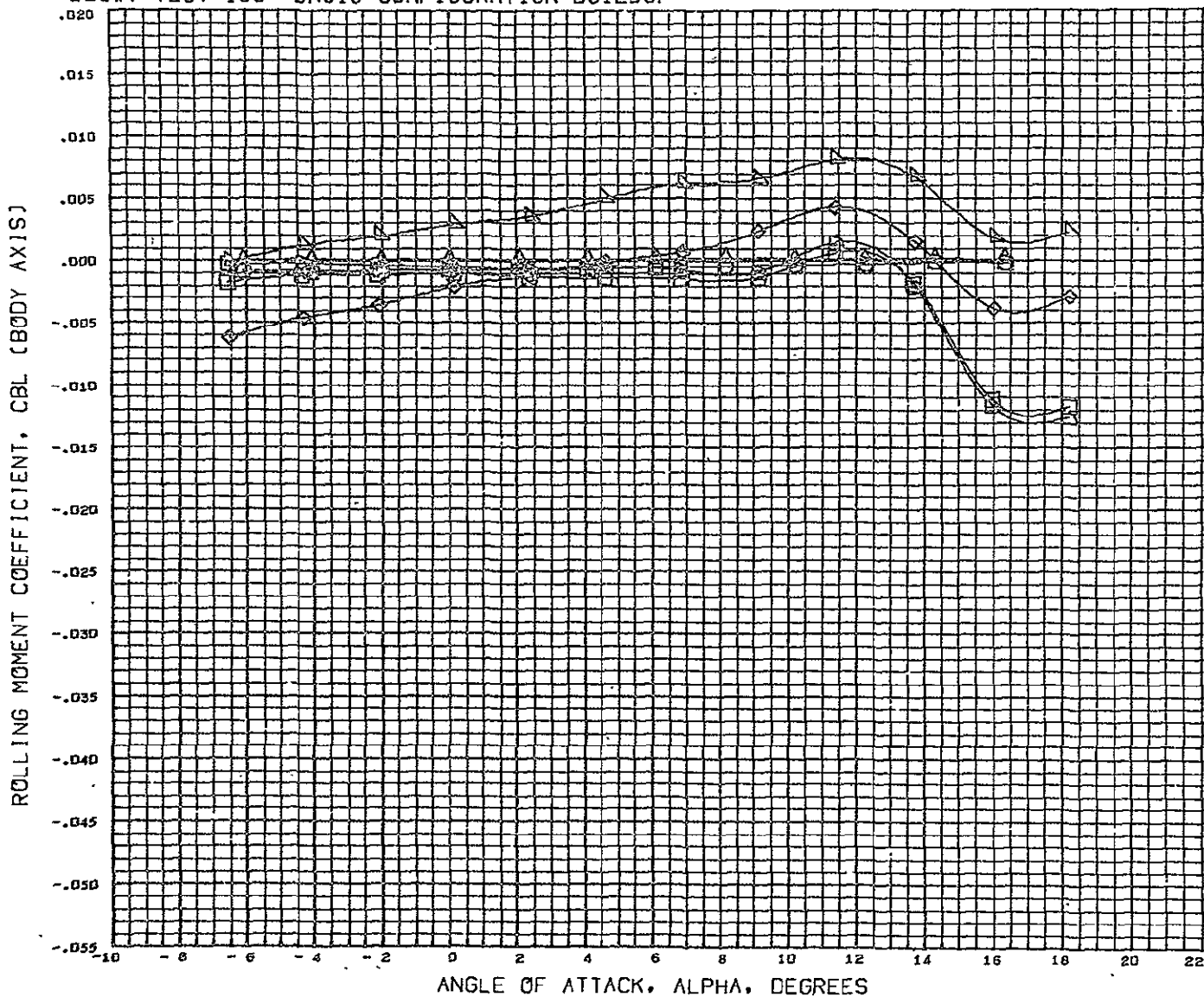

DATA SET SYMBOL	CONFIGURATION DESCRIPTION	BETA	REFERENCE INFORMATION
(TCN079)	DLSWT 138 0.0133 SC. GENERIC HCR 02 B3A	-2.950	REFS 5370.0040 SQ. FT
(TCN080)	DLSWT 138 0.0133 SC. GENERIC HCR 02 B3A	0.000	REFL 760.0004 IN.
(TCN073)	DLSWT 138 0.0133 SC. GENERIC HCR 02 B3AW9A	-2.950	REFB 1138.0010 IN.
(TCN074)	DLSWT 138 0.0133 SC. GENERIC HCR 02 B3AW9A	0.000	XMRP 1273.0040 IN.
(TCN071)	DLSWT 138 0.0133 SC. GENERIC HCR 02 B3AW9AV4	-2.890	YMRP 0.0000 IN.
(TCN070)	DLSWT 138 0.0133 SC. GENERIC HCR 02 B3AW9AV4	0.000	ZMRP 214.0004 IN.
MACH 0.180			SCALE 100.0000 PERCENT

DLSWT TEST 138- BASIC CONFIGURATION BUILDUP

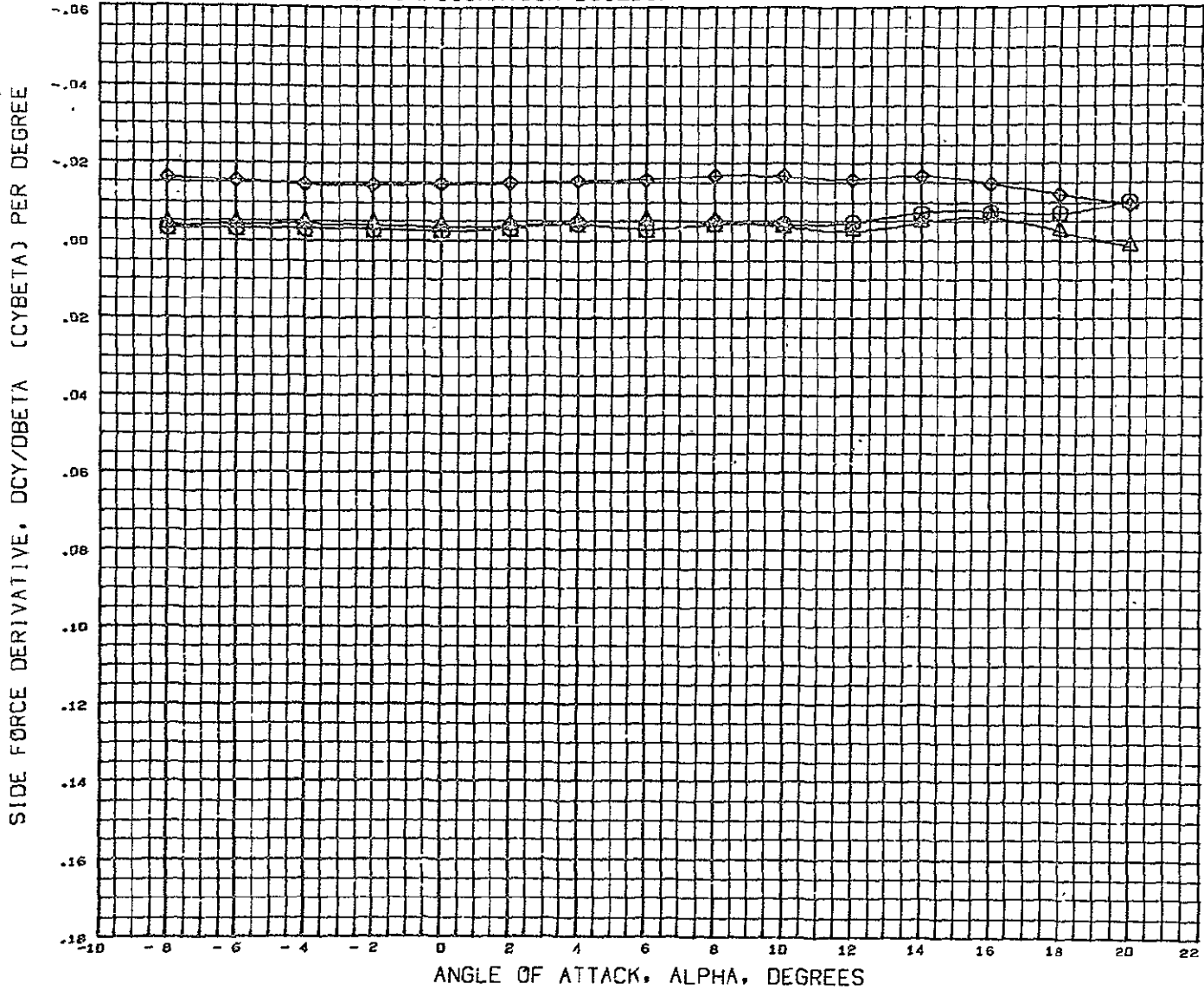

DATA SET SYMBOL	CONFIGURATION DESCRIPTION
(FCN980)	⊙ DLSWT 138 0.0133 SC. GENERIC HCR 02 B3A
(FCN974)	△ DLSWT 138 0.0133 SC. GENERIC HCR 02 B3AW9A
(FCN970)	◇ DLSWT 138 0.0133 SC. GENERIC HCR 02 B3AW9AV4

REFERENCE INFORMATION	
REFS	5370.0040 SQ. FT
REFL	760.0004 IN.
REFB	1136.0049 IN.
XMRP	1273.0040 IN.
YMRP	0.0000 IN.
ZMRP	214.0004 IN.
SCALE	100.0000 PERCENT

MACH 0.180

DLSWT TEST 138- BASIC CONFIGURATION BUILDUP

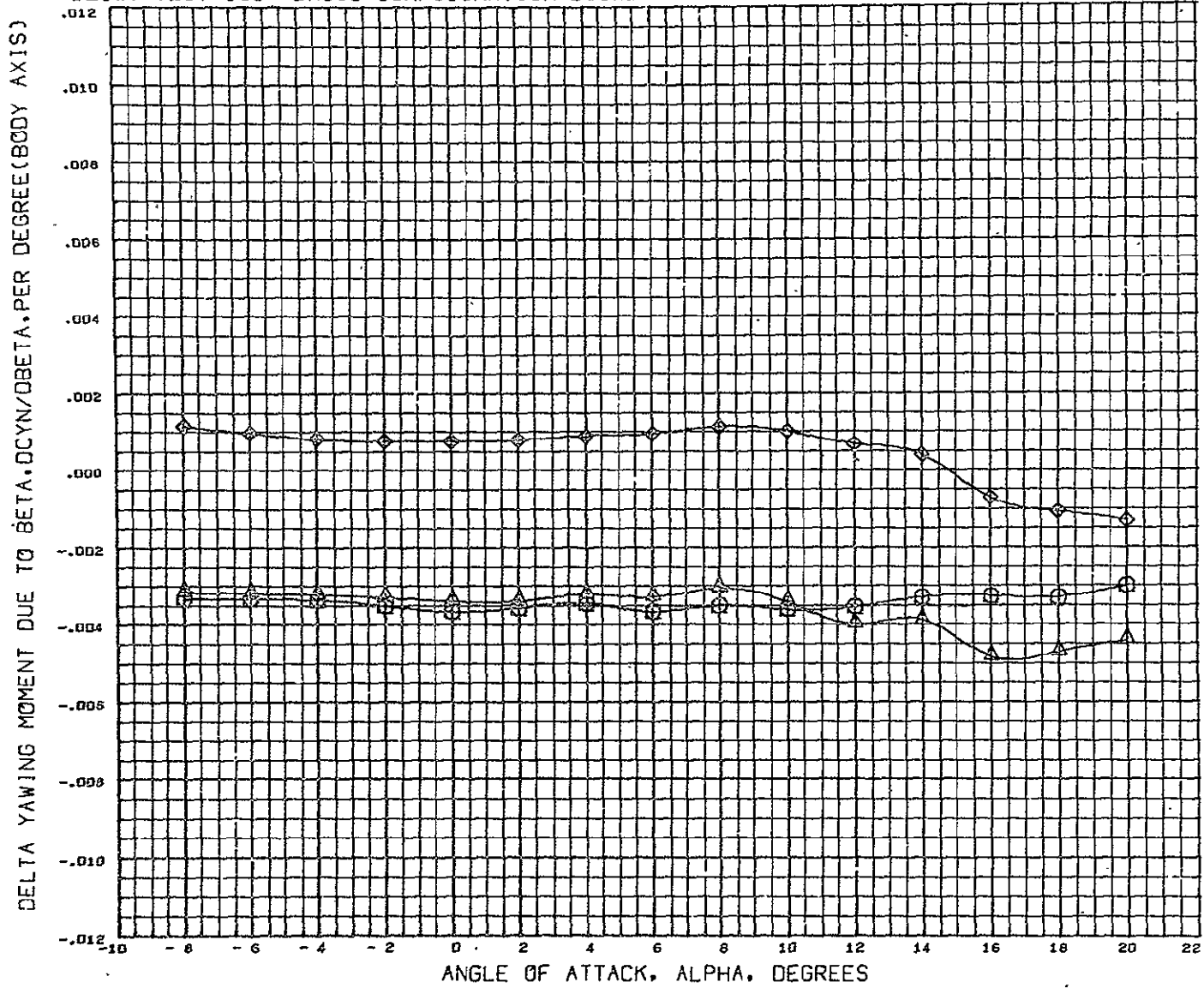

DATA SET SYMBOL	CONFIGURATION DESCRIPTION
(PCNS85)	○ DLSWT 138 D.0133 SC. GENERIC HCR 02 B3A
(PCNS74)	△ DLSWT 138 D.0133 SC. GENERIC HCR 02 B3AW9A
(PCNS75)	◇ DLSWT 138 D.0133 SC. GENERIC HCR 02 B3AW9AV4

REFERENCE INFORMATION	
REFS	5370.0040 SQ. FT
REPL	760.0004 IN.
REFB	1138.0040 IN.
XMRP	1273.0040 IN.
YMRP	0.0000 IN.
ZMRP	214.0004 IN.
SCALE	100.0000 PERCNT

MACH 0.100

DLSWT TEST 138- BASIC CONFIGURATION BUILDUP

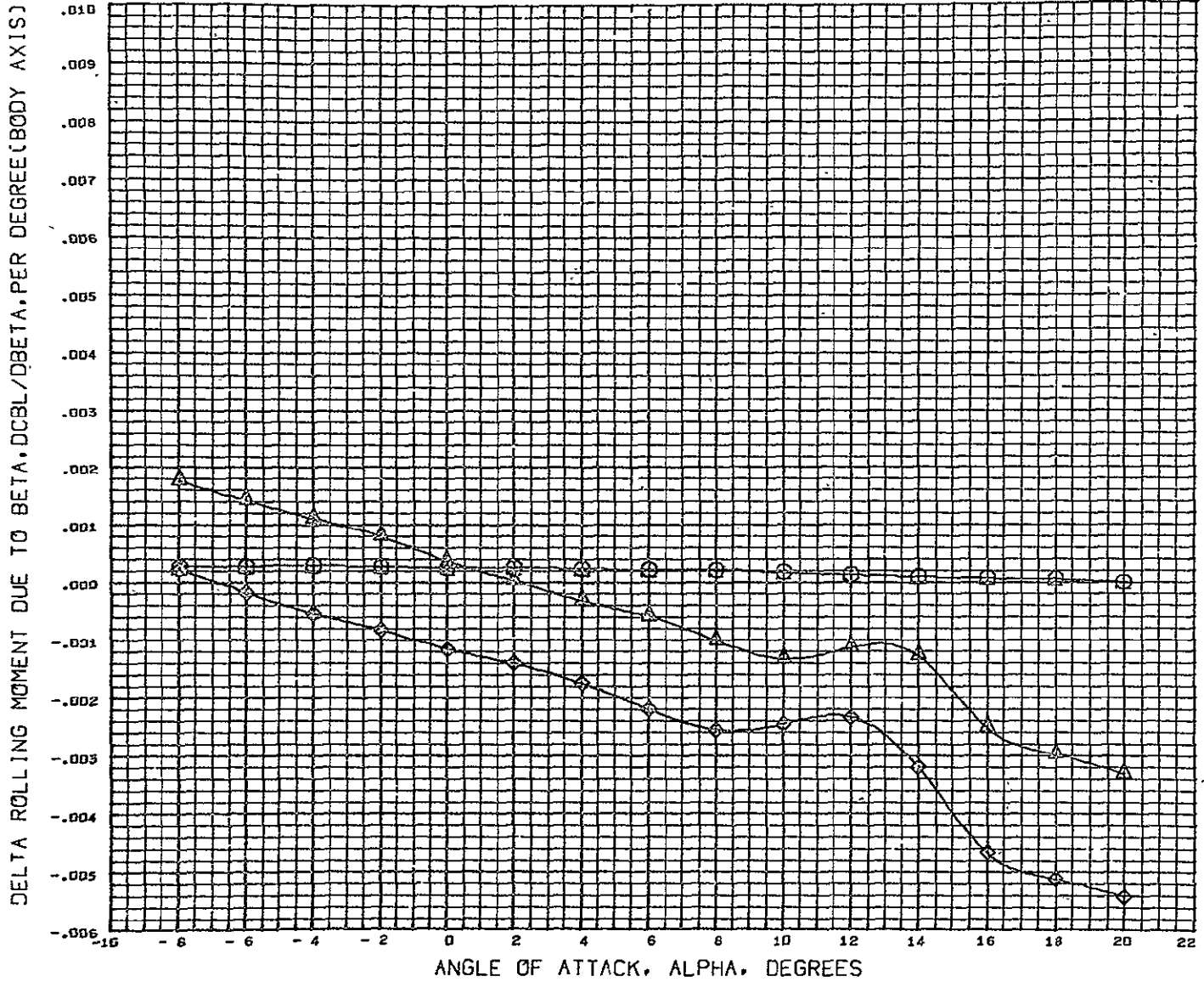

DATA SET	SYMBOL	CONFIGURATION DESCRIPTION
(FCN085)	○	DLSWT 138 0.0133 SC. GENERIC HCR 02 B3A
(FCN074)	△	DLSWT 138 0.0133 SC. GENERIC HCR 02 B3AW9A
(FCN075)	◇	DLSWT 138 0.0133 SC. GENERIC HCR 02 B3AW9AV4

REFERENCE INFORMATION		
REFS	5370.0040	SQ. FT
REFL	760.0004	IN.
REFB	1138.0040	IN.
XNRF	1273.0040	IN.
YNRF	0.0000	IN.
ZNRF	214.0004	IN.
SCALE	100.0000	PERCNT

MACH 0.180

DLSWT TEST 138- BODY FLAP EFFECT

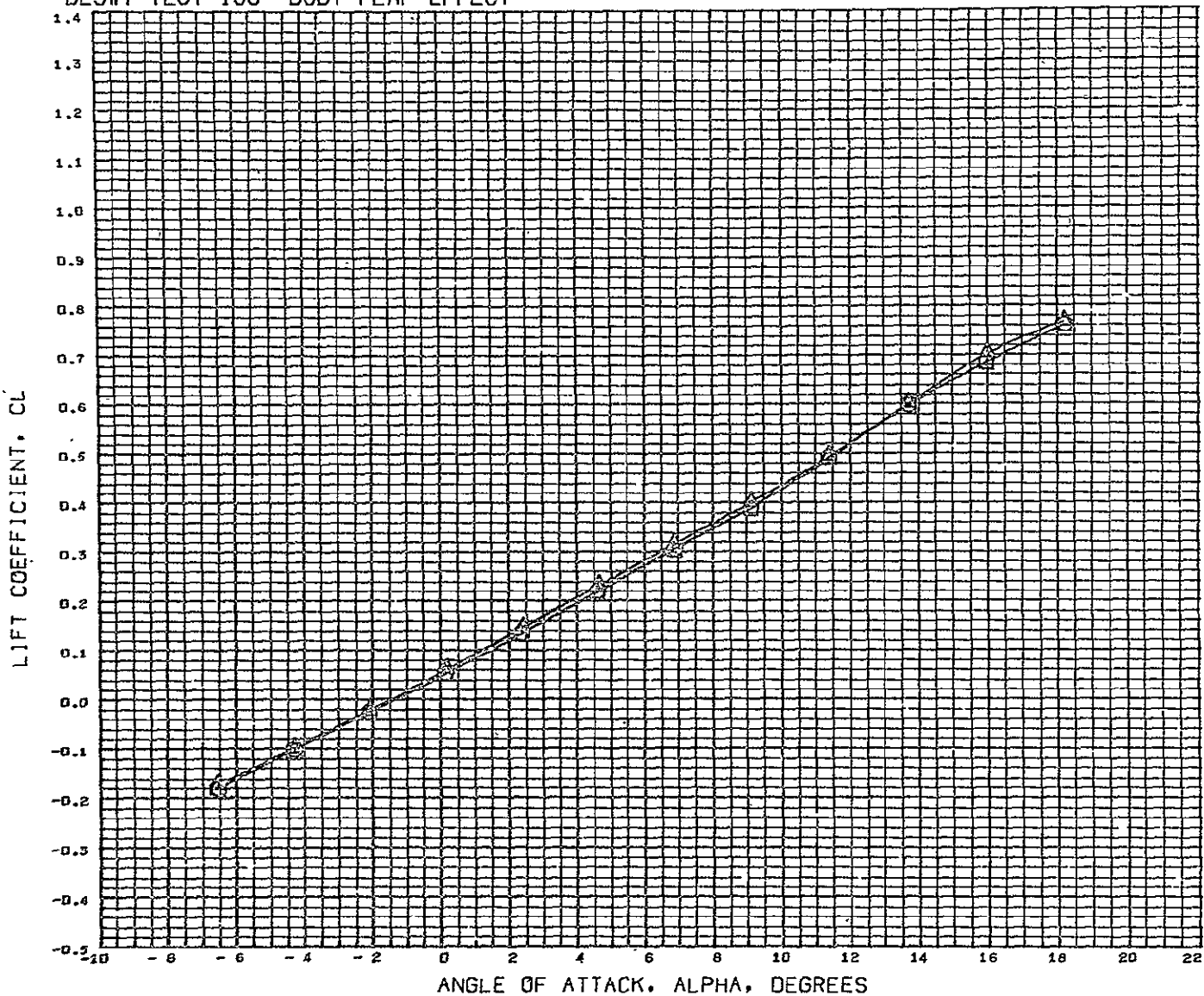

DATA SET SYMBOL CONFIGURATION DESCRIPTION
 (RCN076) \square DLSWT 138 G.0133 SC. GENERIC HCR 02 B3AW9AV5
 (RCN088) \triangle DLSWT 138 G.0133 SC. GENERIC HCR 02 B3CW9AV5

REFERENCE INFORMATION
 REFS 5370.0040 SQ. FT
 REFL 760.0004 IN.
 REFB 1138.0040 IN.
 XMRP 1275.0040 IN.
 YMRP 0.0000 IN.
 ZMRP 214.0004 IN.
 SCALE 100.0000 PERCENT

MACH 0.180

DLSWT TEST 138- BODY FLAP EFFECT

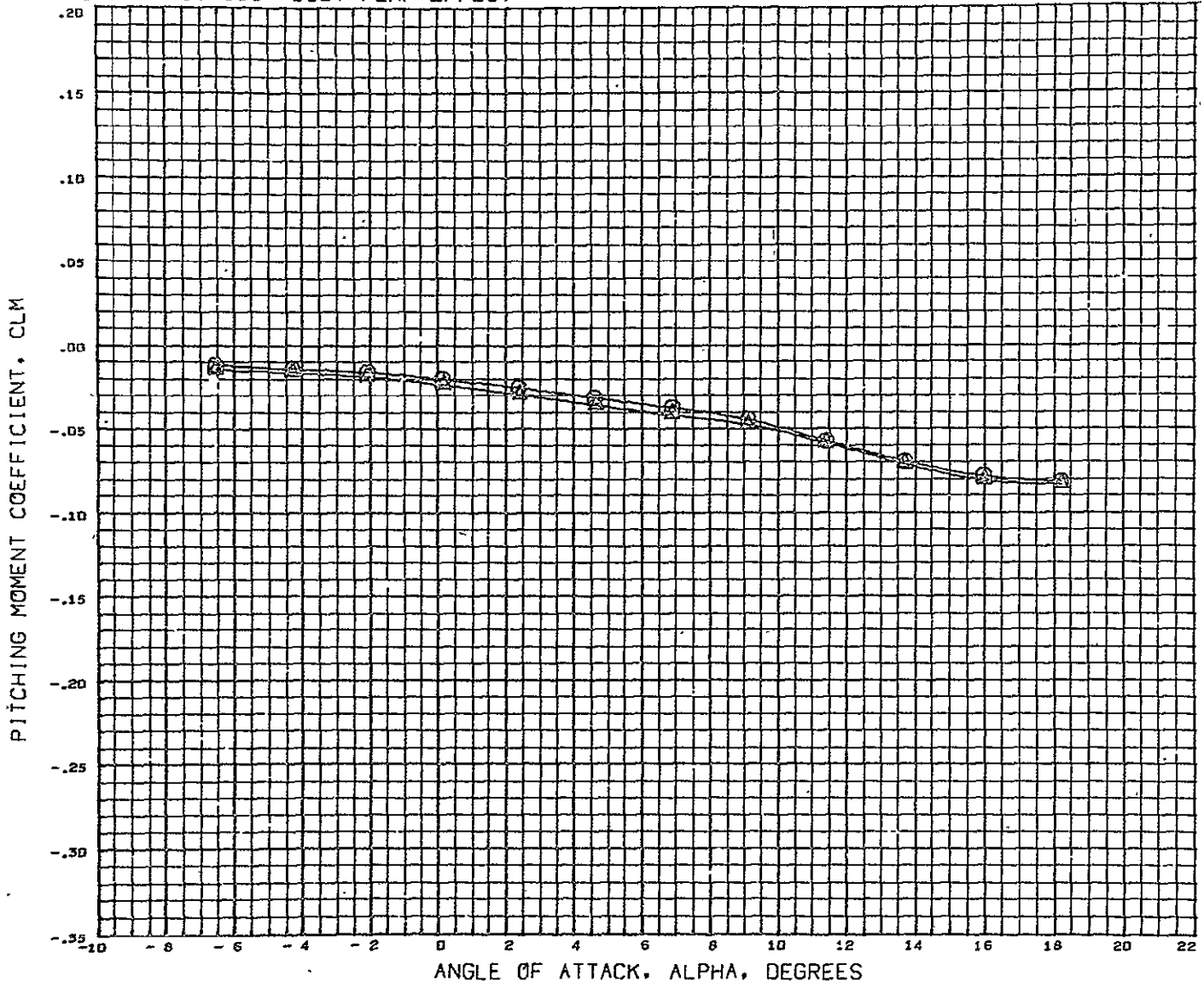

DATA SET SYMBOL CONFIGURATION DESCRIPTION
 (RCND76) DLSWT 138 D.G133 SC. GENERIC HCR 02 B3AW9AV5
 (RCND88) DLSWT 138 D.G133 SC. GENERIC HCR 02 B3CW9AV5

REFERENCE INFORMATION
 REFS 5370.0040 SQ. FT
 REFL 760.0054 IN.
 REFB 1138.0040 IN.
 XMRP 1273.0040 IN.
 YHRP 0.0000 IN.
 ZMRP 214.0004 IN.
 SCALE 100.0000 PERCENT

MACH 0.180

DLSWT TEST 138- BODY FLAP EFFECT

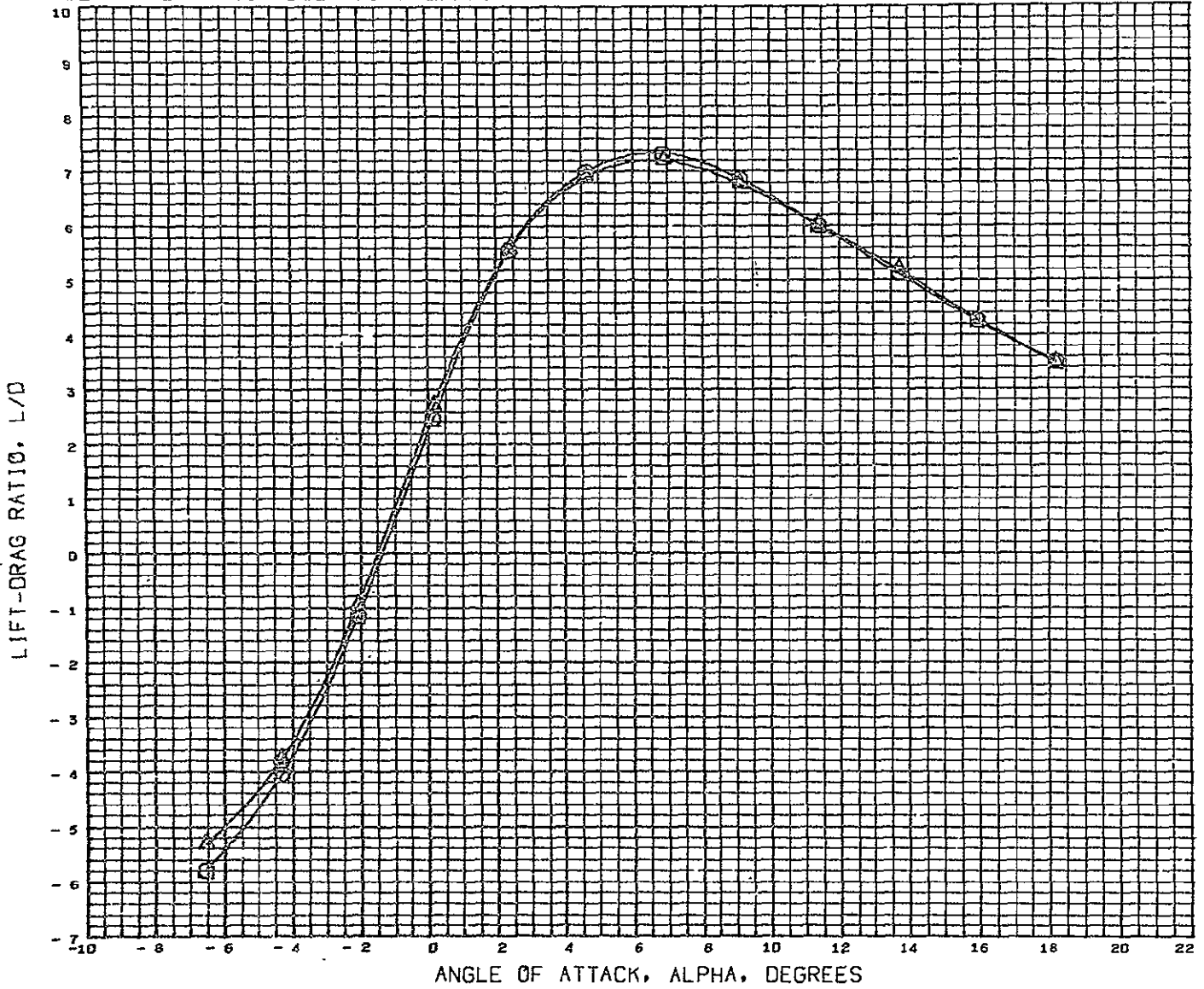

DATA SET SYMBOL	CONFIGURATION DESCRIPTION
(RCNG76) ○	DLSWT 138 D.G133 SC. GENERIC HCR O2 B3AW9AV5
(RCNG88) △	DLSWT 138 D.G133 SC. GENERIC HCR O2 B3CW9AV5

REFERENCE INFORMATION		
REFS	5370.0040	SQ. FT
REFL	760.0004	IN.
REFB	1138.0040	IN.
XMRP	1273.0040	IN.
YMRP	0.0000	IN.
ZMRP	214.0004	IN.
SCALE	100.0000	PERCNT

HACH 0.180

DLSWT TEST 138- BODY FLAP EFFECT

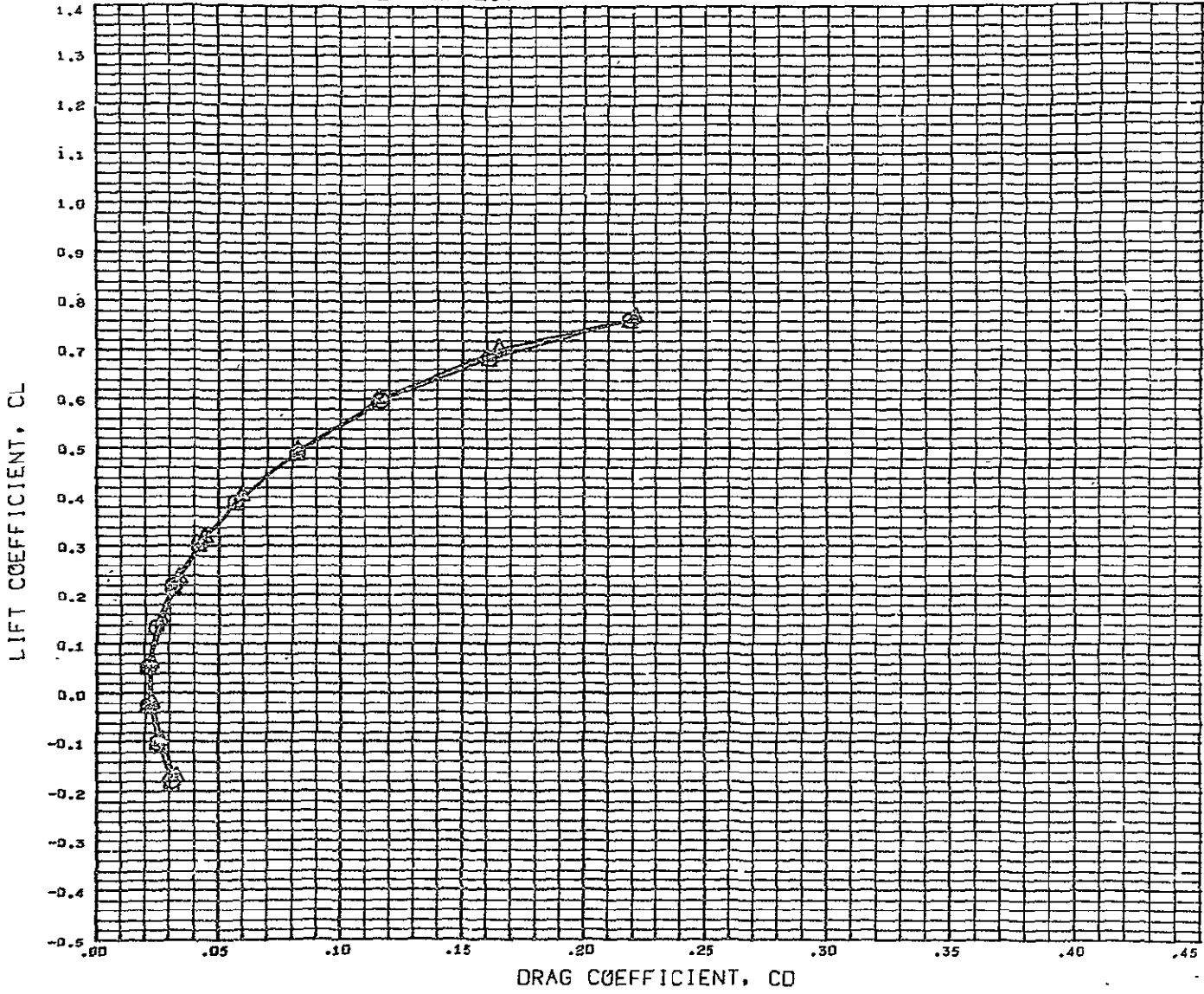

DATA SET SYMBOL	CONFIGURATION DESCRIPTION
(RCN876)	⊙ DLSWT 138 D.0133 SC, GENERIC HCR 02 B3AW9AV5
(RCN888)	⊗ DLSWT 138 D.0133 SC, GENERIC HCR 02 B3CW9AV5

REFERENCE INFORMATION

REFS	5370.0040	SQ. FT
REFL	760.0004	IN.
REFB	1138.0047	IN.
XMRP	1273.0046	IN.
YMRP	6.0008	IN.
ZMRP	214.0004	IN.
SCALE	100.0000	PERCENT

MACH 9.180

DLSWT TEST 138- BODY FLAP EFFECT

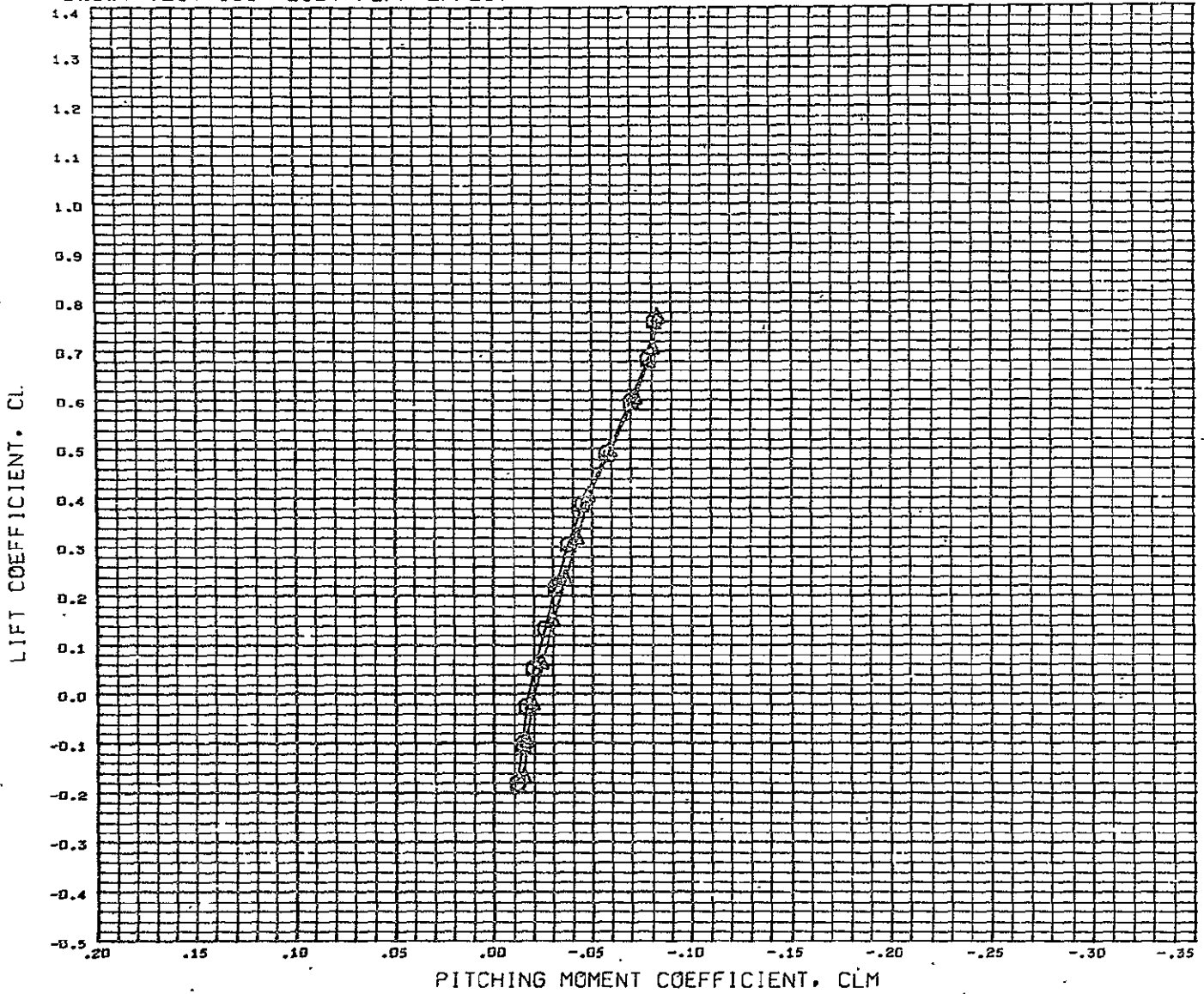

DATA SET SYMBOL CONFIGURATION DESCRIPTION
 (RCN576) Ⓚ DLSWT 138 D.0133 SC. GENERIC HCR 02 B3AW9AV5
 (RCN088) Ⓚ DLSWT 138 D.0133 SC. GENERIC HCR 02 B3CW9AV5

REFERENCE INFORMATION
 REFS 5370.0040 SQ. FT
 REFL 750.0004 IN.
 REFB 1138.0040 IN.
 XMRP 1273.0040 IN.
 YMRP 0.0000 IN.
 ZMRP 214.0004 IN.
 SCALE 100.0000 PERCENT

MACH 0.180

DLSWT TEST 138- WING POSITION EFFECT

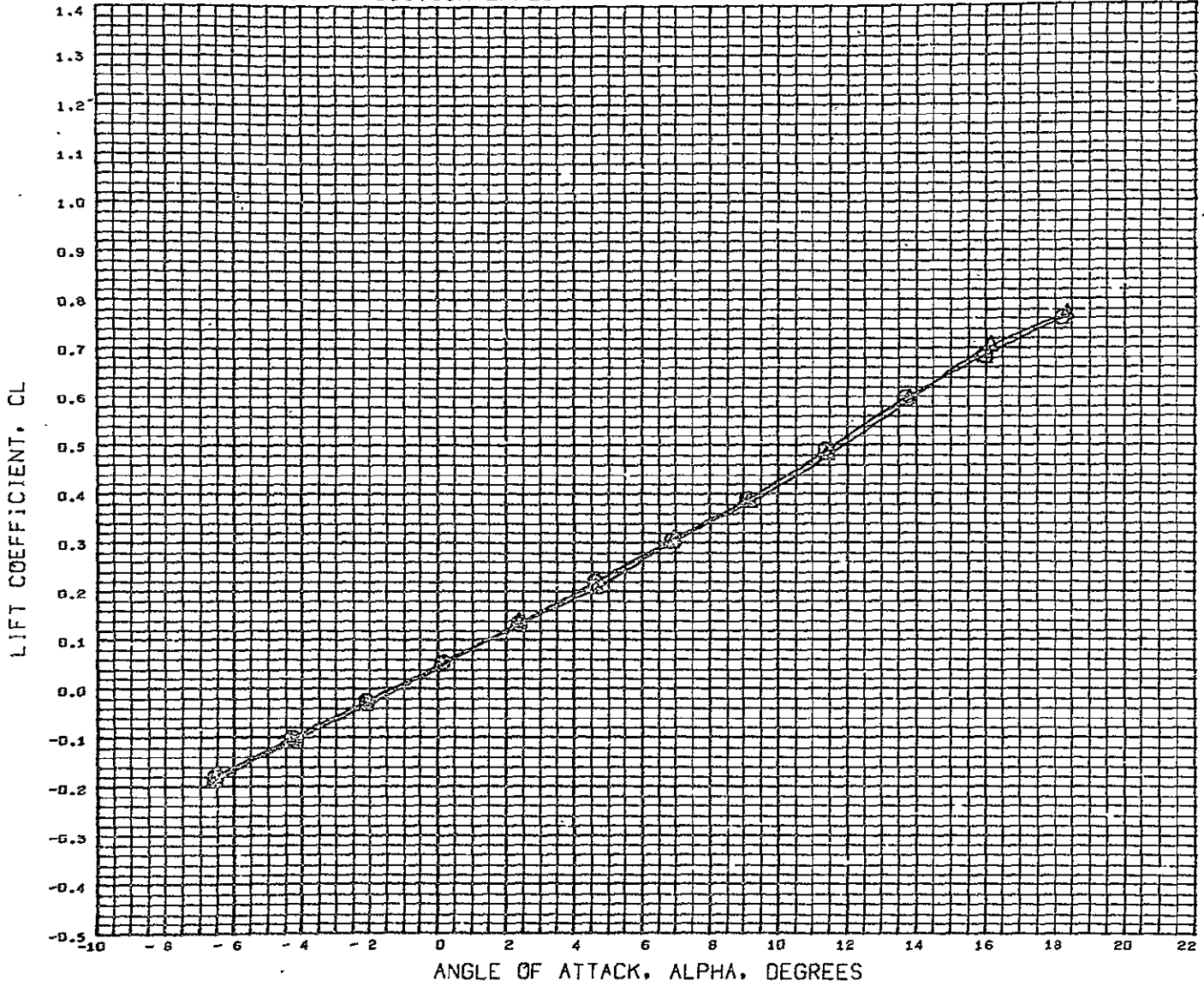

DATA SET SYMBOL CONFIGURATION DESCRIPTION
 (RCND76) \odot DLSWT 138 0.0133 SC. GENERIC HCR 02 B3AM9AV5
 (RCND86) \triangle DLSWT 138 0.0133 SC. GENERIC HCR 02 B3AM9BV5

REFERENCE INFORMATION
 REFS 5370.0040 SQ. FT
 REFL 760.0004 IN.
 REFB 1138.0070 IN.
 XMRP 1273.0040 IN.
 YMRP 0.0000 IN.
 ZMRP 214.0004 IN.
 SCALE 100.0000 PERCENT

MACH 5.185

DLSWT TEST 138- WING POSITION EFFECT

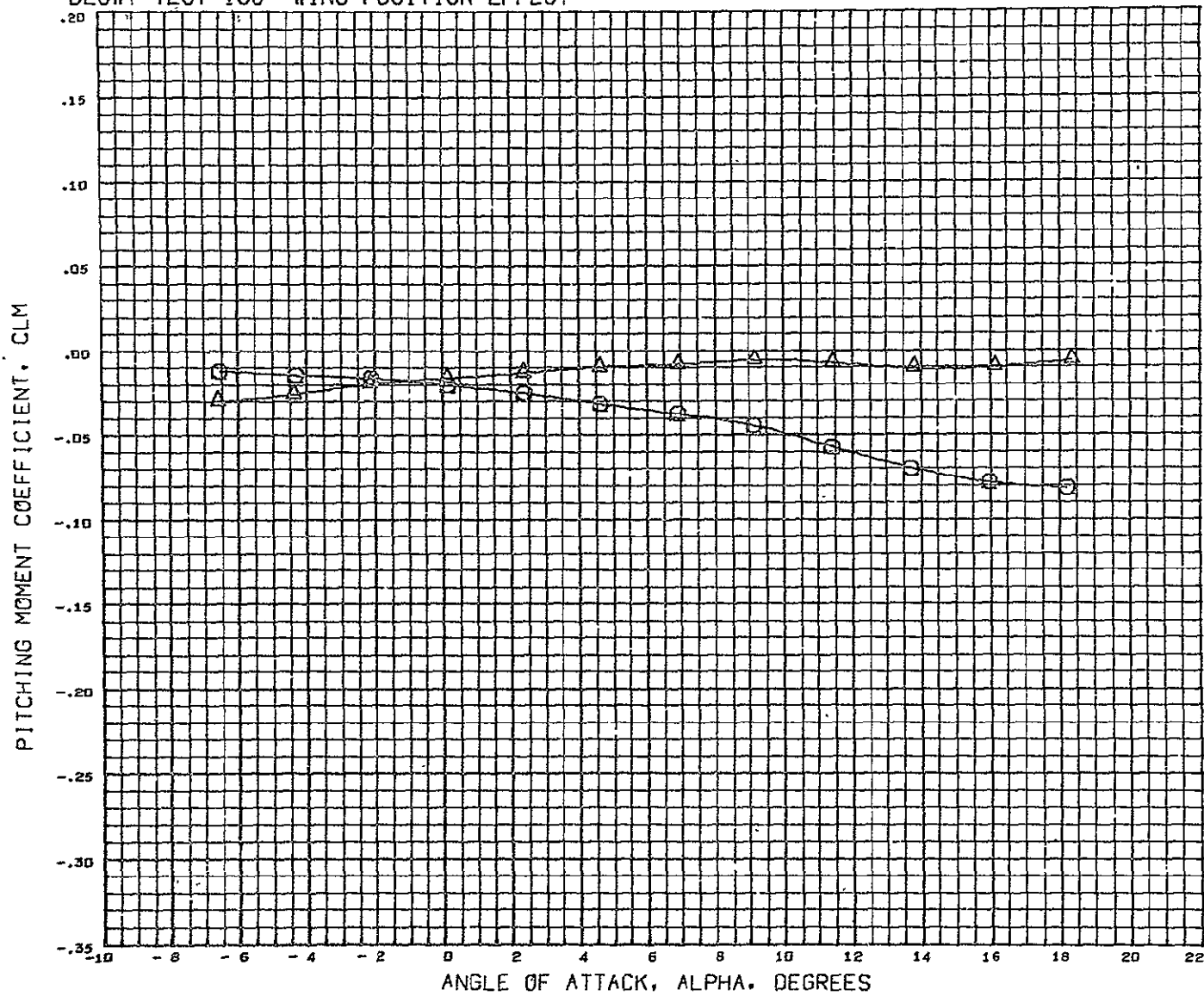

DATA SET SYMBOL CONFIGURATION DESCRIPTION
 (RCNS76) ○ DLSWT 138 0.0133 SC. GENERIC HCR 02 B3AW9AV5
 (RCN086) △ DLSWT 138 0.0133 SC. GENERIC HCR 02 B3AW9BV5

REFERENCE INFORMATION
 REFS 5370.0040 SQ. FT
 REFL 760.0004 IN.
 REFB 1138.0040 IN.
 XMRP 1273.0040 IN.
 YMRP 0.0000 IN.
 X'F 214.0004 IN.
 LE 100.0000 PERCENT

PACH 0.180

DLSWT TEST 138- WING POSITION EFFECT

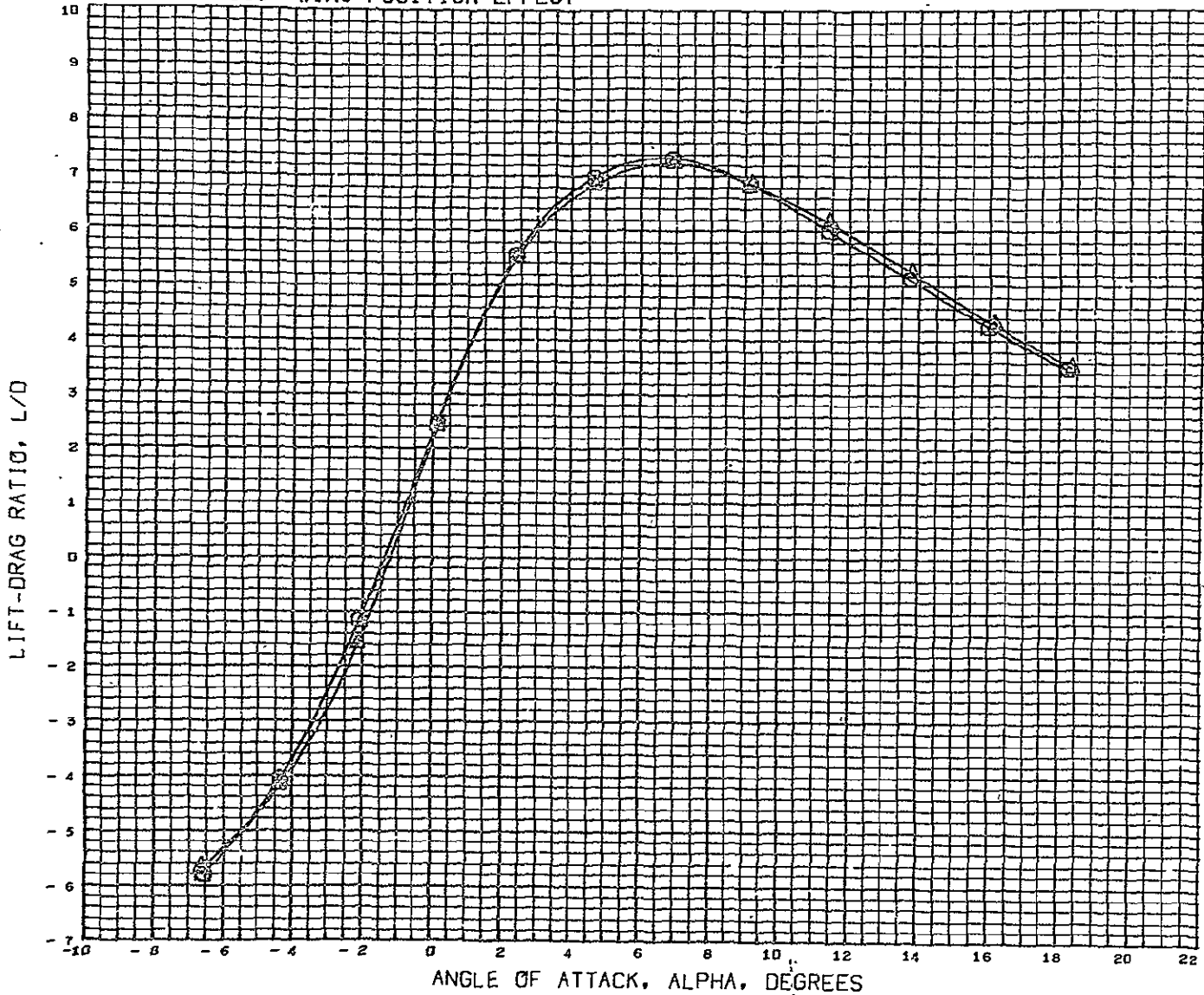

DATA SET SYMBOL CONFIGURATION DESCRIPTION
 (RCN076) ○ DLSWT 138 U.0133 SC. GENERIC MCR O2 B3AW9A45
 (RCN086) △ DLSWT 138 U.0133 SC. GENERIC MCR O2 B3AW9B45

REFERENCE INFORMATION
 REFS 5370.0040 SQ. FT
 REFL 760.0004 IN.
 REFB 1138.0040 IN.
 XMRP 1273.0040 IN.
 YMRP 0.0000 IN.
 ZMRP 214.0004 IN.
 SCALE 100.0000 -ERCNT

MACH 0.180

DLSWT TEST 138- WING POSITION EFFECT

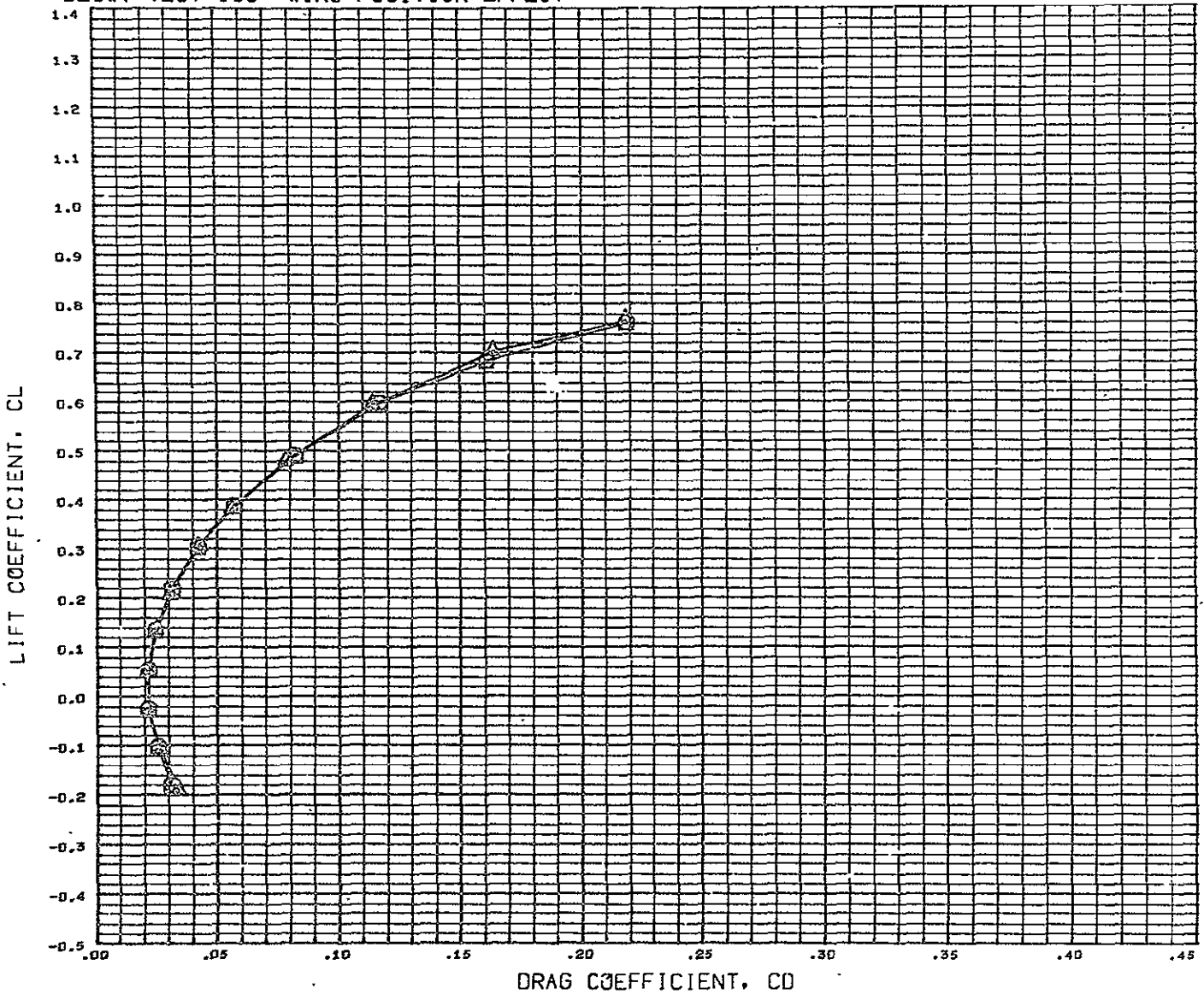

DATA SET SYMBOL CONFIGURATION DESCRIPTION
 (RCND76) \square DLSWT 138 0.0133 SC. GENERIC HCR O2 B3AW9AV5
 (RCND86) \triangle DLSWT 138 0.0133 SC. GENERIC HCR O2 B3AW9BV5

REFERENCE INFORMATION
 REFS 5370.0040 SQ. FT
 REFL 760.0004 IN.
 REFB 1130.0040 IN.
 XMRP 1273.0040 IN.
 YMRP 0.0000 IN.
 ZMRP 214.0004 IN.
 SCALE 100.0000 PERCENT

MACH 0.180

DLSWT TEST 138- WING POSITION EFFECT

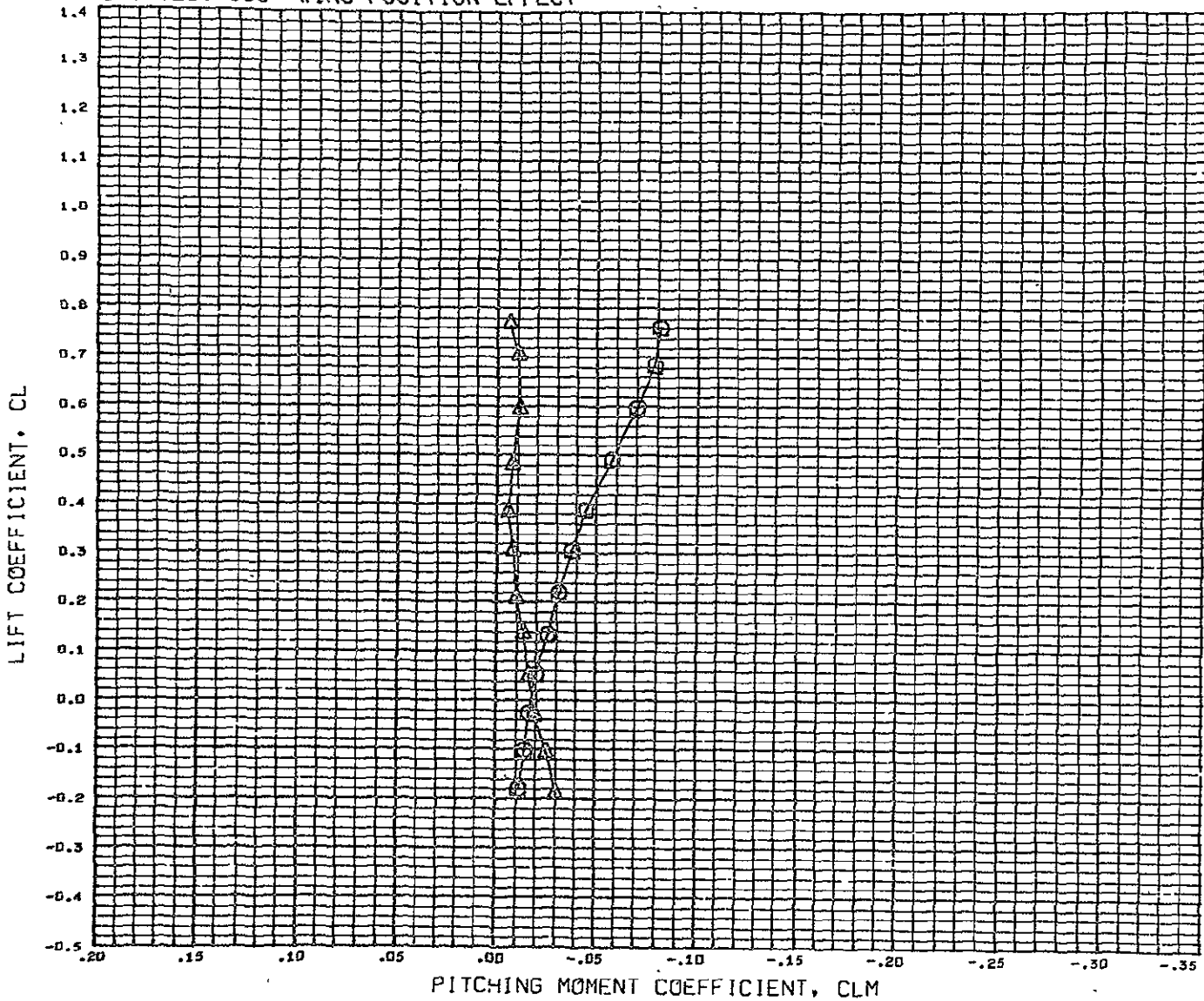

DATA S.I. SYMBOL CONFIGURATION DESCRIPTION
 (RCH076) ○ DLSWT 138 0.0133 SC. GENERIC MCR OF B3AW9AV5
 (RCH086) △ DLSWT 138 0.0133 SC. GENERIC MCR OF B3AW9BV5

REFERENCE INFORMATION
 REFS 5370.0040 SQ. FT
 REPL 760.0002 IN.
 REFB 1138.0040 IN.
 XMRP 1273.0040 IN.
 YMRP 0.0000 IN.
 ZMRP 214.0004 IN.
 SCALE 100.0000 PERCENT

MACH 0.180

DLSWT TEST 138- VERTICAL TAIL POSITION

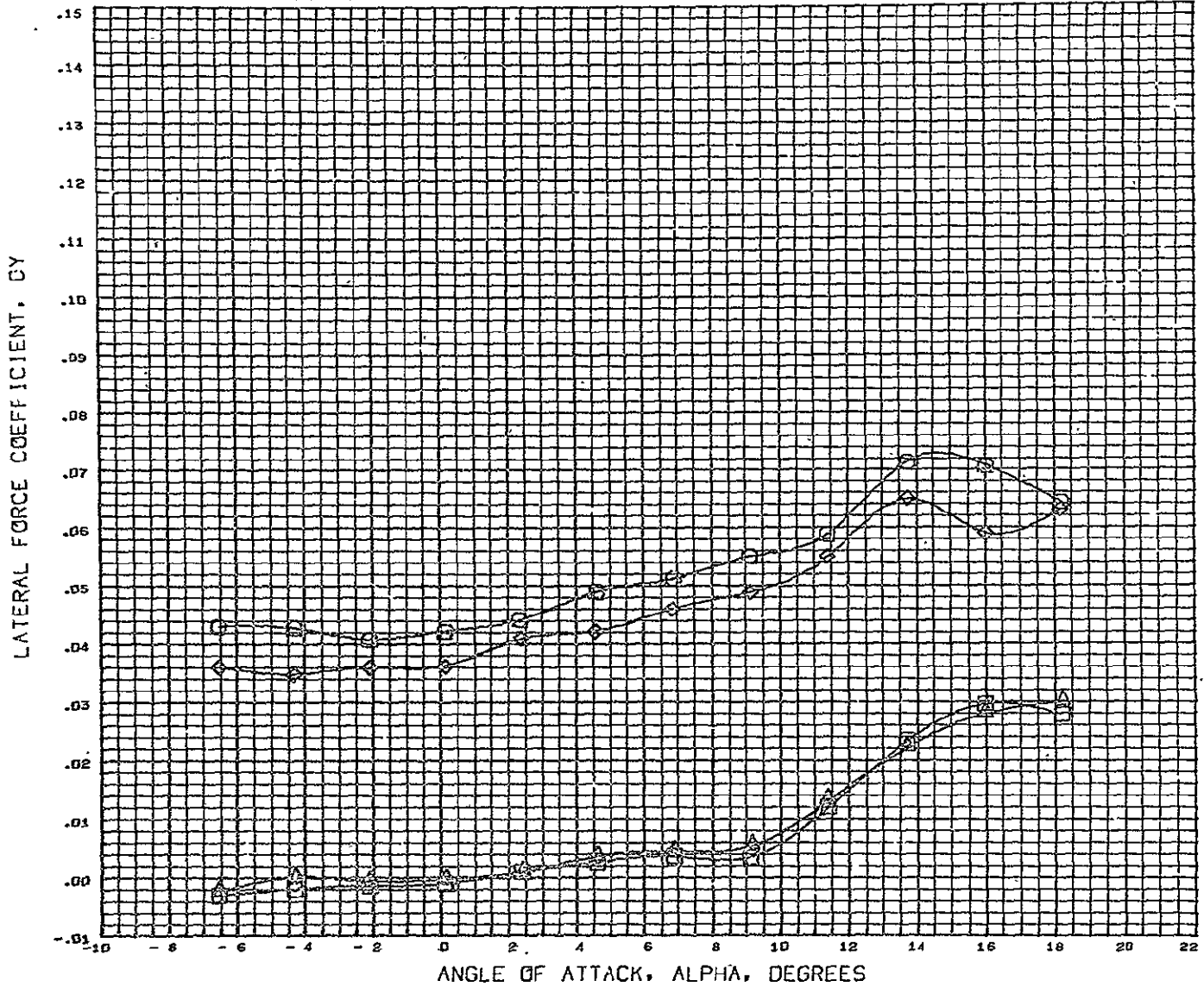

DATA SET SYMBOL	CONFIGURATION DESCRIPTION	BETA	REFERENCE INFORMATION
(TCN671)	DLSWT 138 0.0133 SC. GENERIC HCR 02 B3AW9AV4	-2.890	REFS 5370.0040 SQ. FT
(TCN672)	DLSWT 138 0.0133 SC. GENERIC HCR 02 B3AW9AV4	0.000	REFL 760.0004 IN.
(TCN677)	DLSWT 138 0.0133 SC. GENERIC HCR 02 B3AW9AV5	-2.900	REFB 1138.0049 IN.
(TCN678)	DLSWT 136 0.0133 SC. GENERIC HCR 02 B3AW9AV5	0.000	XNRF 1273.0040 IN.
			YMRF 0.0000 IN.
			ZNRF 214.0004 IN.
			SCALE 100.0000 PERCNT

MACH 0.180

DLSWT TEST 138- VERTICAL TAIL POSITION

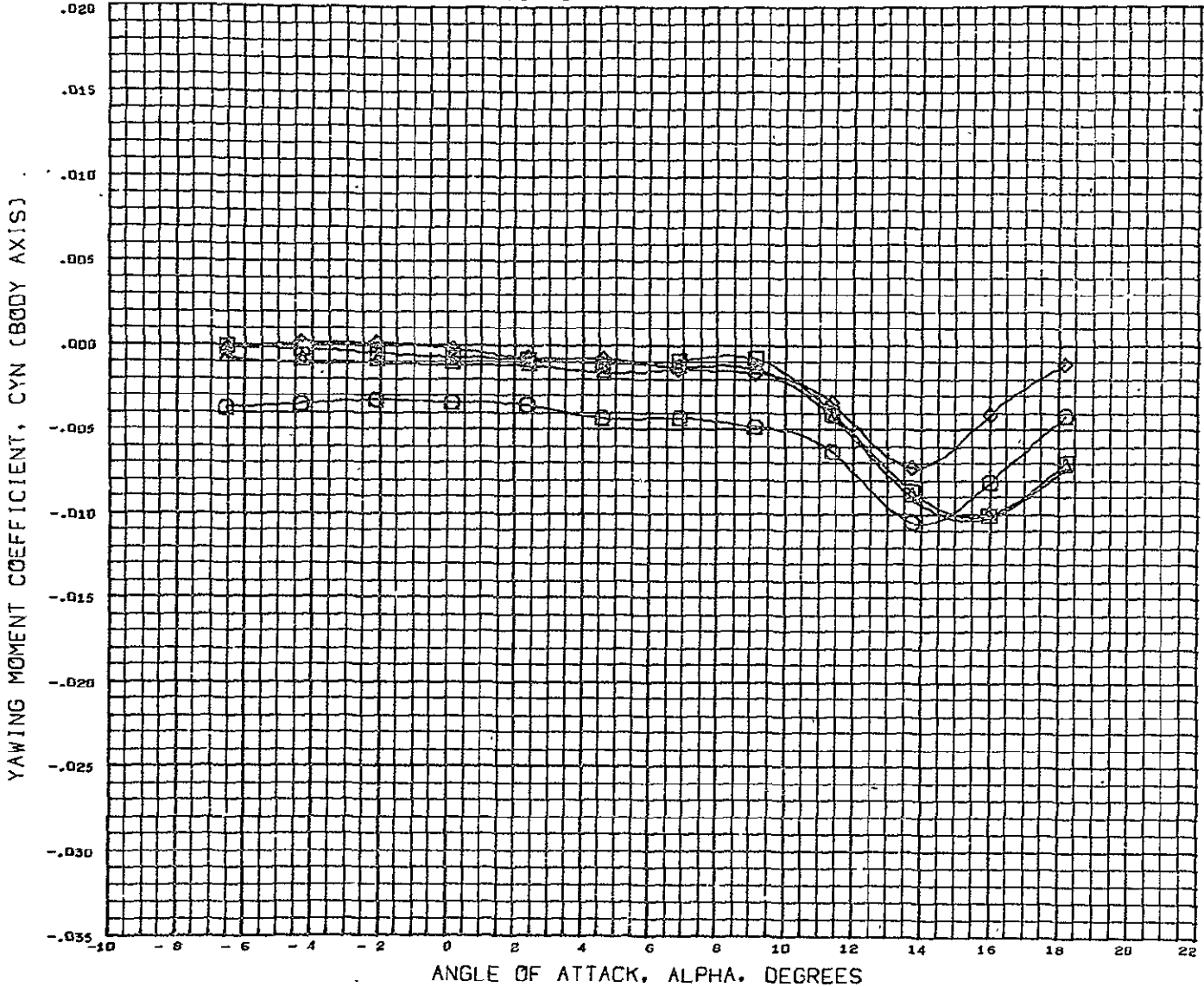

DATA SET SYMBOL	CONFIGURATION DESCRIPTION	BETA	REFERENCE INFORMATION
(TCN071)	DLSWT 138 0.0133 SC. GENERIC HCR 02 B3AW9AV4	-2.890	REFS 5370.0040 SQ. FT
(TCN075)	DLSWT 138 0.0133 SC. GENERIC HCR 02 B3AW9AV4	0.000	REFL 760.0004 IN.
(TCN077)	DLSWT 138 0.0133 SC. GENERIC HCR 02 B3AW9AV5	-2.990	REFB 1138.0040 IN.
(TCN076)	DLSWT 138 0.0133 SC. GENERIC HCR 02 B3AW9AV5	0.000	XIRF 1273.0040 IN.
			YMRP 0.0000 IN.
			ZNRP 214.0004 IN.
			SCALE 100.0000 PERCENT

MACH 0.160

DLSWT TEST 138- VERTICAL TAIL POSITION

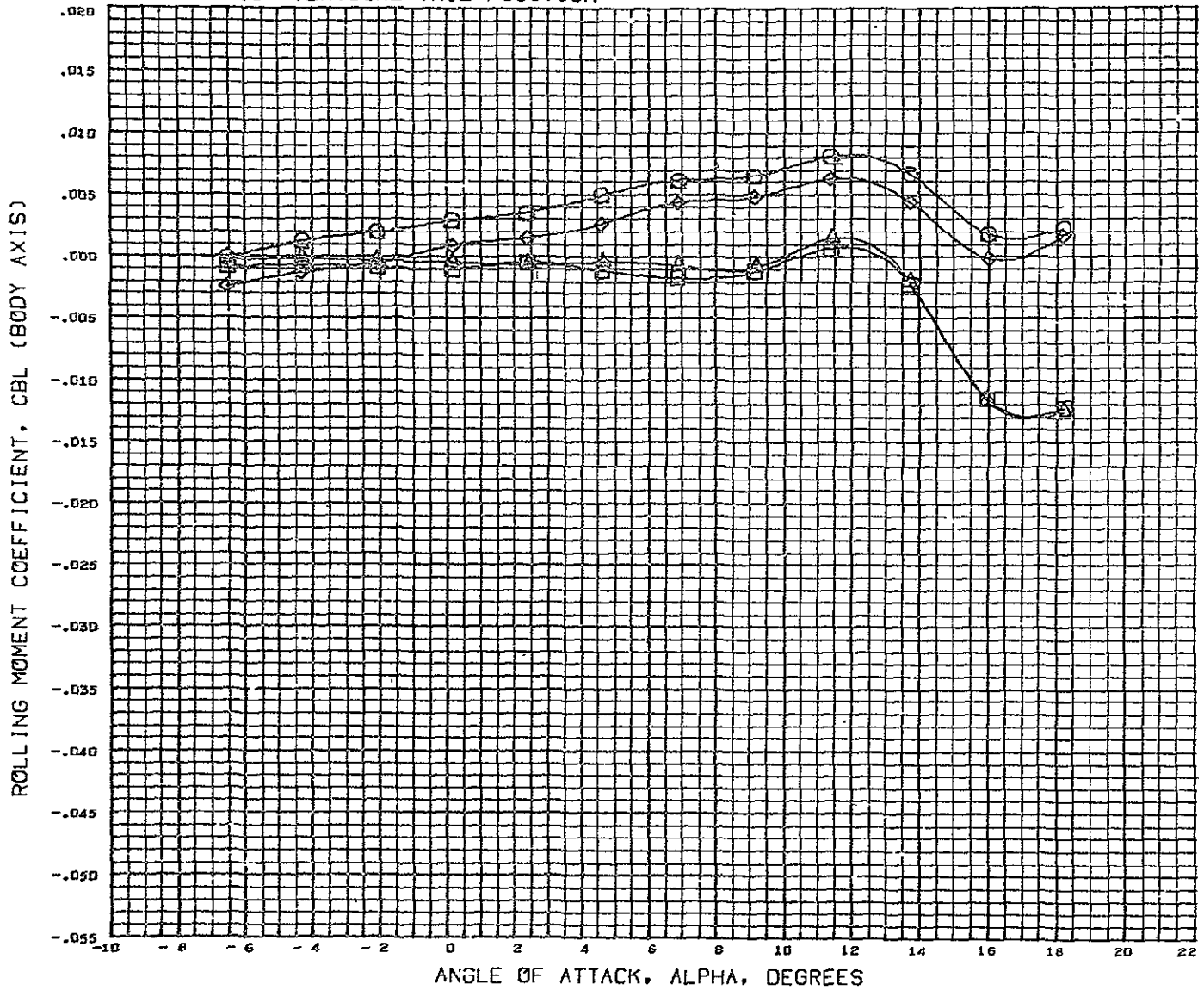

DATA SET SYMBOL	CONFIGURATION DESCRIPTION	BETA	REFERENCE INFORMATION
(TCH371)	DLSWT 138 D.0133 SC. GENERIC HCR 02 B3AW9AV4	-2.890	REFS 5370.0040 SQ. FT
(TCH375)	DLSWT 138 D.0133 SC. GENERIC HCR 02 B3AW9AV4	0.000	REFL 760.0004 IN.
(TCH377)	DLSWT 138 D.0133 SC. GENERIC HCR 02 B3AW9AV5	-2.900	REFB 1138.0040 IN.
(TCH376)	DLSWT 138 D.0133 SC. GENERIC HCR 02 B3AW9AV5	0.000	XMRF 1273.0043 IN.
			YMRF 0.0000 IN.
			ZMRF 214.0004 IN.
			SCALE 100.0000 PERCENT

MACH 0.180

DLSWT TEST 138- VERTICAL TAIL POSITION

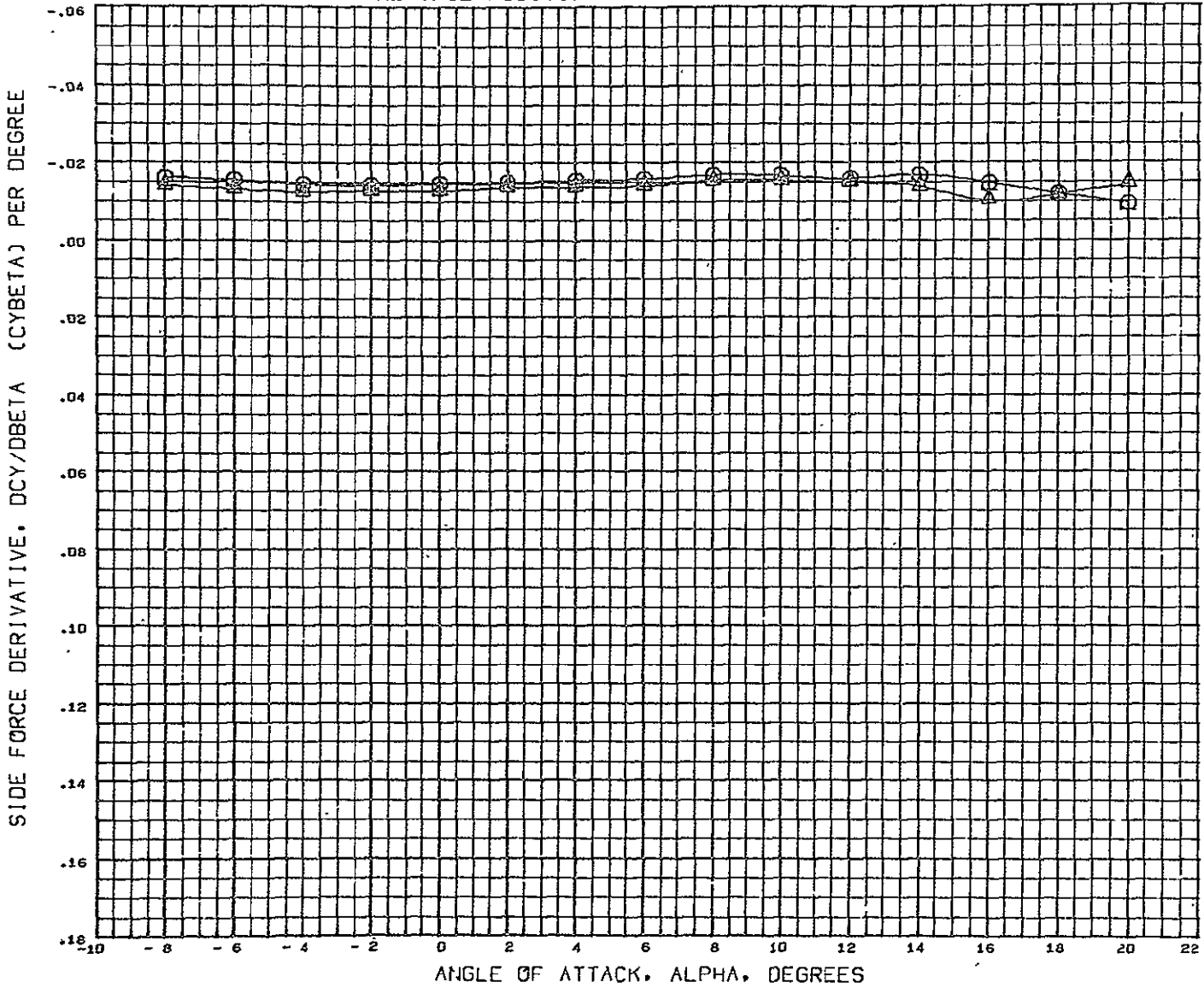

DATA SET SYMBOL	CONFIGURATION DESCRIPTION
(FCN070) ○	DLSWT 138 0.0133 SC. GENERIC HCR 02 B3AW9AV4
(FCN076) △	DLSWT 138 0.0133 SC. GENERIC HCR 02 B3AW9AV5

REFERENCE INFORMATION		
REFS	5370.0000	SQ. FT
REFL	760.0004	IN.
REFB	1138.0000	IN.
XMRP	1273.0000	IN.
YMRP	0.0000	IN.
ZMRP	214.0004	IN.
SCALE	100.0000	PERCENT

MACH 0.180

DLSWT TEST 138- VERTICAL TAIL POSITION

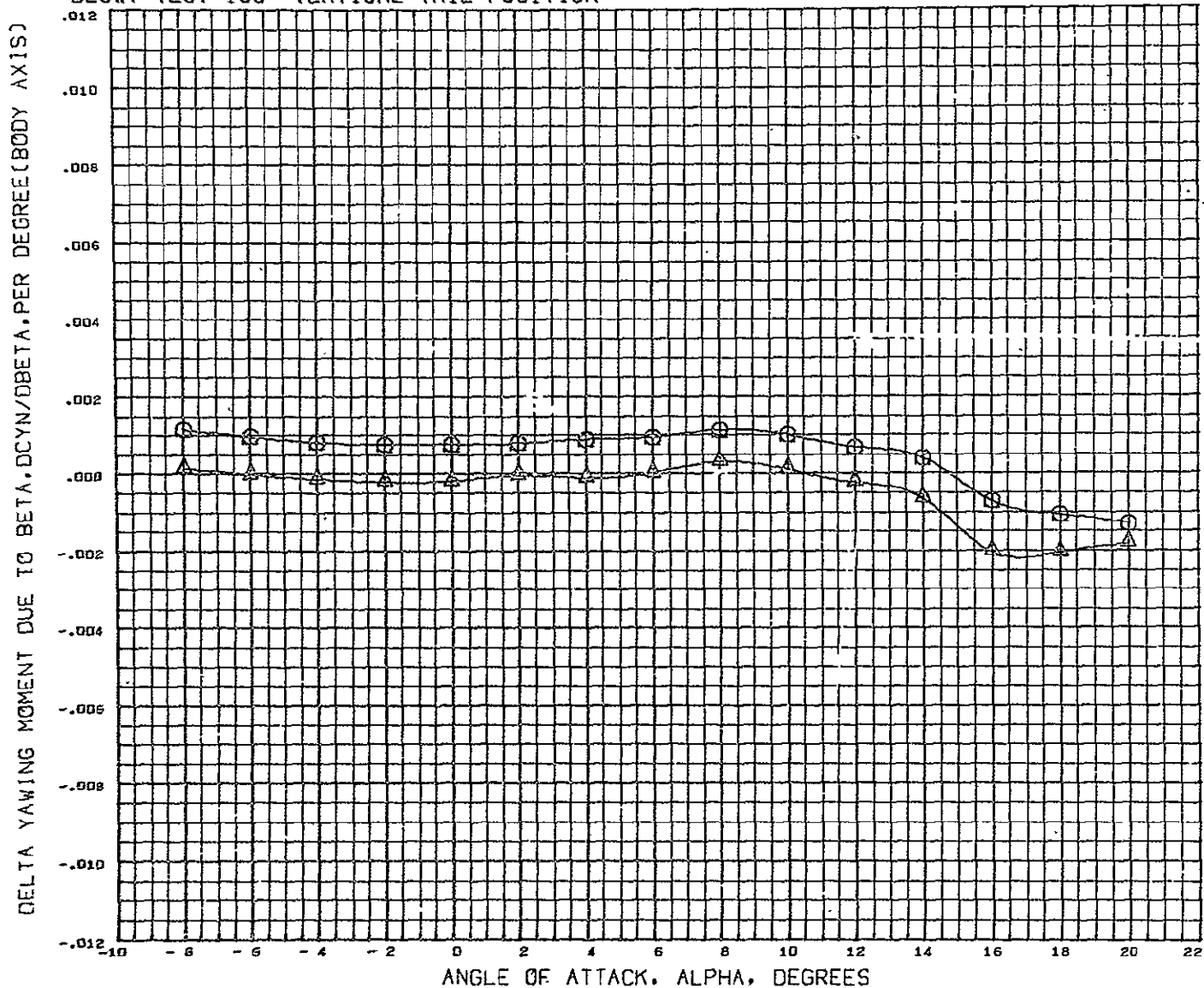

DATA SET SYMBOL CONFIGURATION DESCRIPTION
 (PCND70) (C) DLSWT 138 0.0133 SC. GENERIC HCR 02 B3AW9AV4
 (PCND76) (A) DLSWT 138 0.0133 SC. GENERIC HCR 02 B3AW9AV5

REFERENCE INFORMATION
 REFS 5370.0040 SQ. FT
 REFL 760.0004 IN.
 REFB 1138.0040 IN.
 XMRP 1273.0040 IN.
 YMRP 0.0000 IN.
 ZMRP 214.0004 IN.
 SCALE 100.0000 PERCENT

MACH 5.185

DLSWT TEST 138- VERTICAL TAIL POSITION

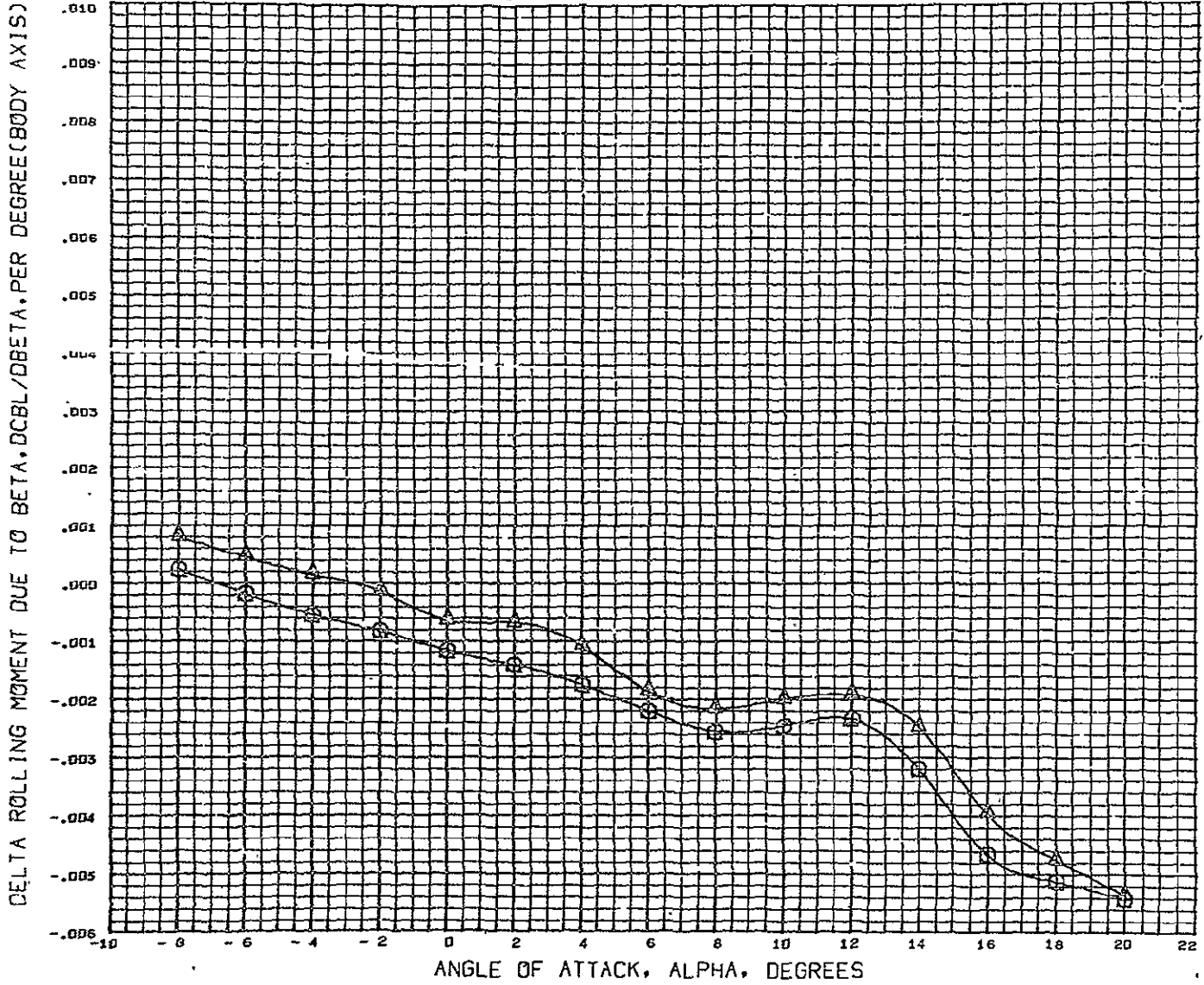

DATA SET SYMBOL CONFIGURATION DESCRIPTION
 (FCN975) (C) DLSWT 138 0.0133 SC. GENERIC HCR 02 B3AM9AV4
 (FCN976) (A) DLSWT 138 0.0133 SC. GENERIC HCR 02 B3AM9AV5

REFERENCE INFORMATION
 REFS 5370.0040 SQ. FT
 REFL 760.0004 IN.
 REFB 1138.0040 IN.
 XMRF 1273.0040 IN.
 YMRF 0.0000 IN.
 ZMRF 214.0004 IN.
 SCALE 100.0000 PERCNT

MACH 0 185

DLSWT TEST 138- VERTICAL TAIL POSITION

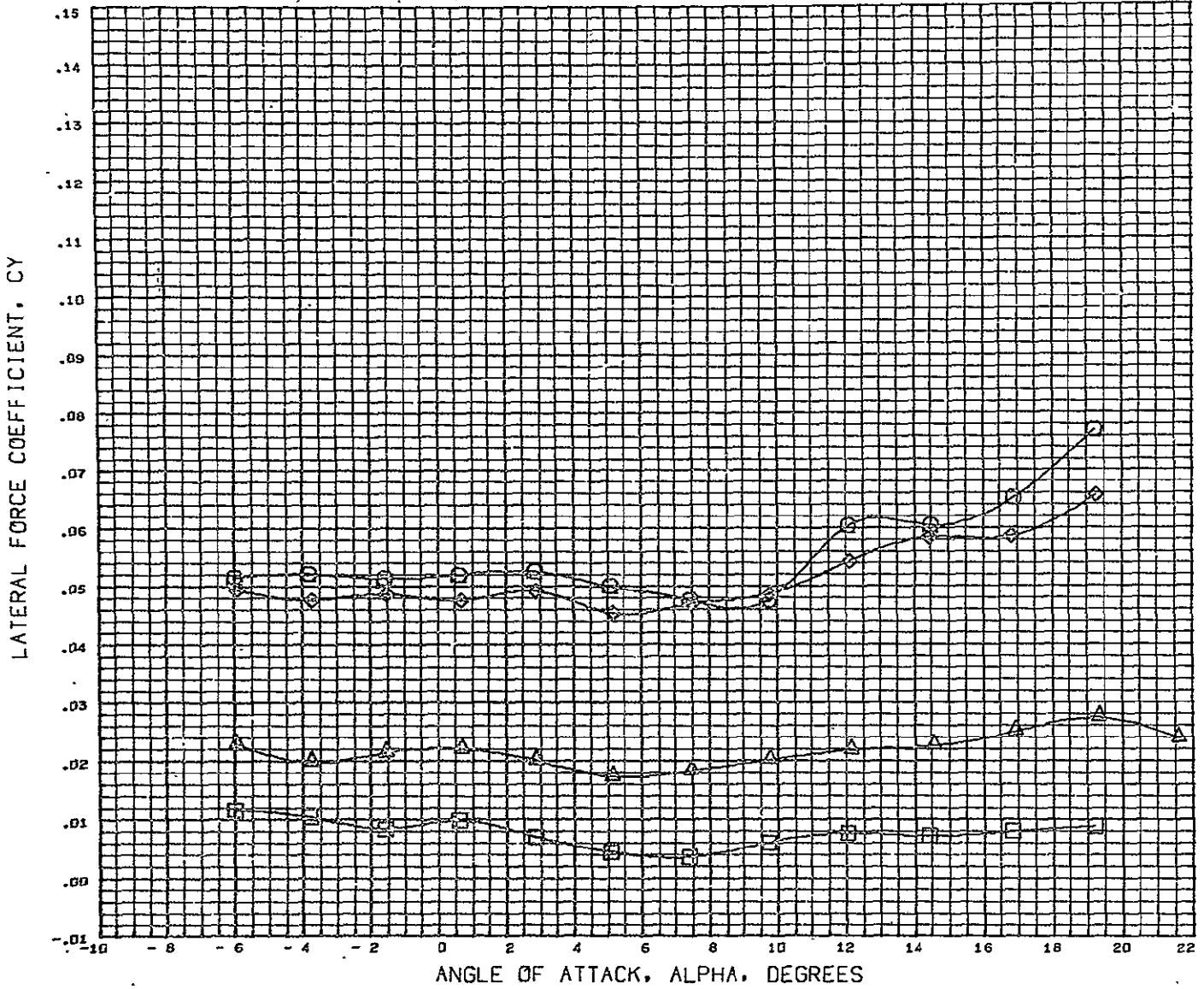

DATA SET SYMBOL	CONFIGURATION DESCRIPTION	BETA
(TCN004)	DLSWT 138 0.0133 SC. GENERIC HCR 02 B1AW3V3	-3.880
(TCN002)	DLSWT 138 0.0133 SC. GENERIC HCR 02 B1AW3V3	-1.000
(TCN015)	DLSWT 138 0.0133 SC. GENERIC HCR 02 B1AW3V4	-2.890
(TCN011)	DLSWT 138 0.0133 SC. GENERIC HCR 02 B1AW3V4	0.000

REFERENCE INFORMATION		
REFS	6168.0040	SQ. FT
REFL	971.0004	IN.
REFB	1040.0040	IN.
XNRP	1266.0040	IN.
YNRP	0.0000	IN.
ZNRP	163.0004	IN.
SCALE	100.0000	PERCENT

MACH 0.180

DLSWT TEST 138- VERTICAL TAIL POSITION

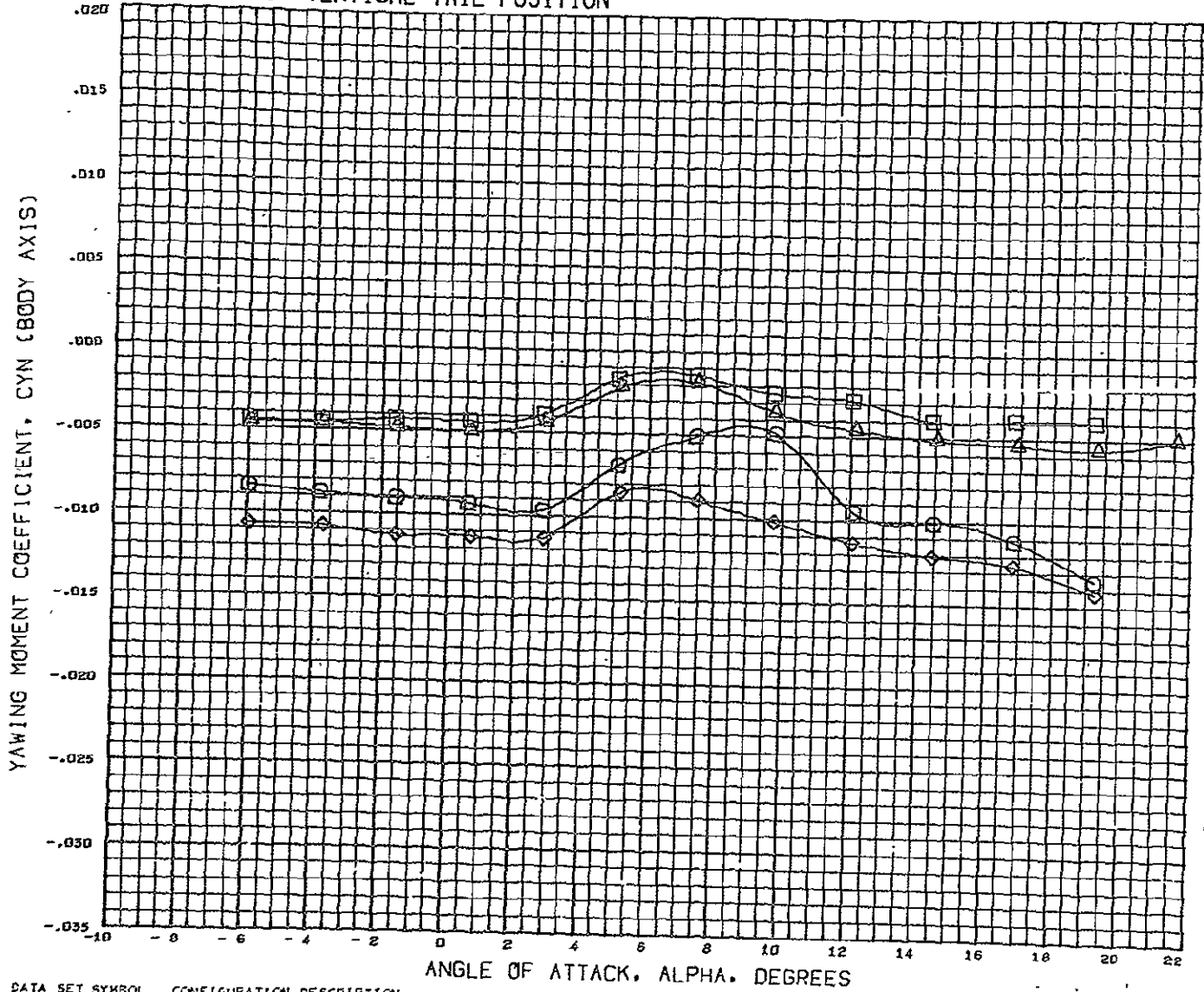

DATA SET SYMBOL	CONFIGURATION DESCRIPTION	BETA
(TCNS04)	DLSWT 138 0.0133 SC. GENERIC HCR 02 B1AW3V3	-3.880
(TCNS02)	DLSWT 138 0.0133 SC. GENERIC HCR 02 B1AW3V3	-1.000
(TCNS10)	DLSWT 138 0.0133 SC. GENERIC HCR 02 B1AW3V4	-2.890
(TCNS11)	DLSWT 138 0.0133 SC. GENERIC HCR 02 B1AW3V4	0.050

REFERENCE INFORMATION		
REFS	6168.0040	SQ. FT
REFL	971.0064	IN.
REFB	1040.0040	IN.
XMRP	1266.0040	IN.
YMRP	0.0000	IN.
ZMRP	165.0064	IN.
SCALE	100.0000	PERCENT

MACH 0.85

DLSWT TEST 138- VERTICAL TAIL POSITION

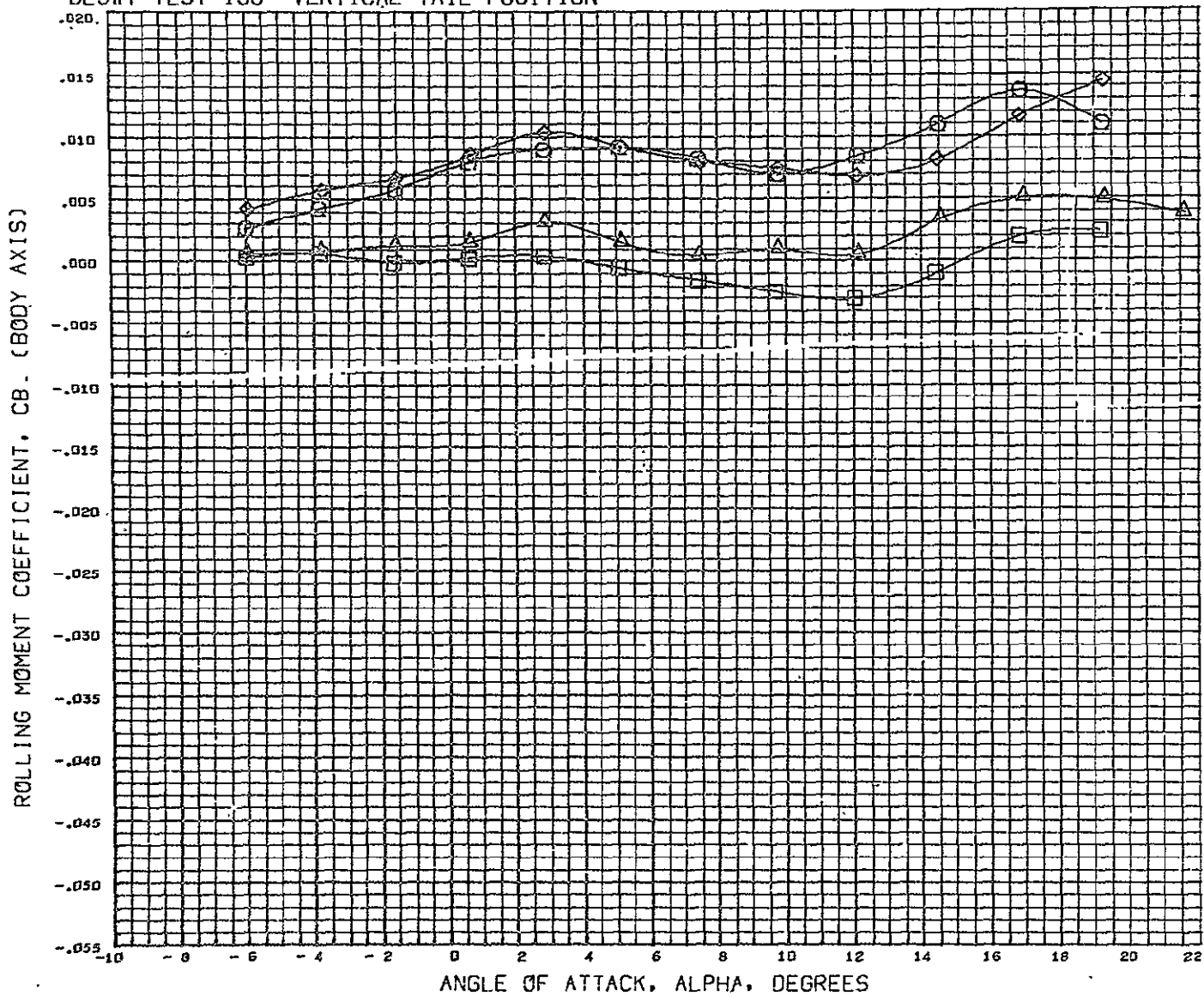

DATA SET	SYMBOL	CONFIGURATION DESCRIPTION	BETA	REFERENCE INFORMATION
(TCN004)	○	DLSWT 138 0.0133 SC. GENERIC HCR 02 B1AW3V3	-3.880	REFS 6168.0040 SQ. FT
(TCN002)	◇	DLSWT 138 0.0133 SC. GENERIC HCR 02 B1AW3V3	-1.000	REFL 971.0004 IN.
(TCN010)	△	DLSWT 138 0.0133 SC. GENERIC HCR 02 B1AW3V4	-2.890	REFB 1040.0040 IN.
(TCN011)	□	DLSWT 138 0.0133 SC. GENERIC HCR 02 B1AW3V4	0.000	XMRP 1266.0040 IN.
				YMRP 0.0000 IN.
				ZMRP 163.0004 IN.
				SCALE 100.0003 PERCNT

MACH 0.185

DLSWT TEST 138- VERTICAL TAIL POSITION

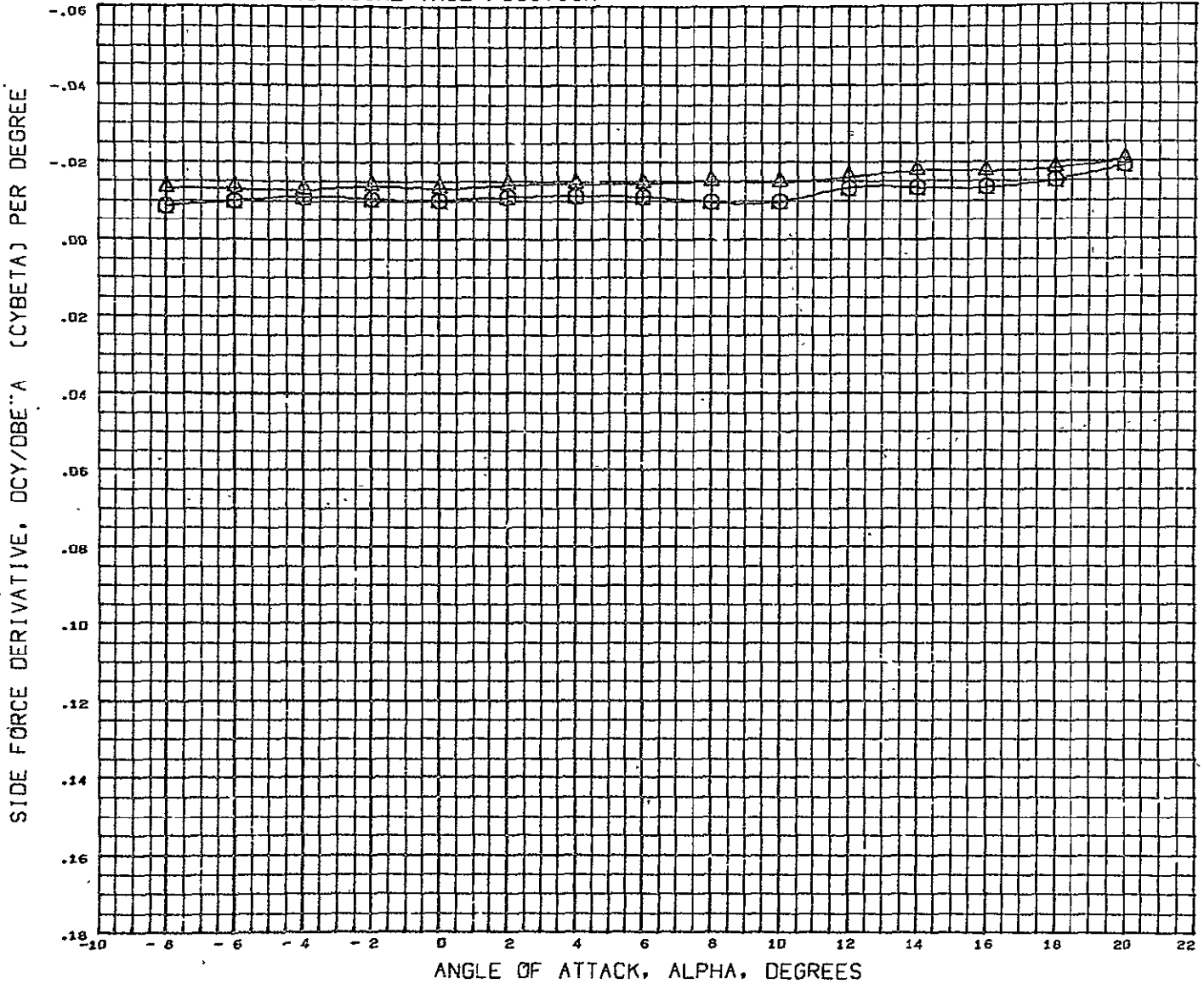

DATA SET SYMBOL CONFIGURATION DESCRIPTION
 (PCND02) \circ DLSWT 138 0.0133 SC. GENERIC HCR 02 B1AW3V3
 (PCND11) \triangle DLSWT 138 0.0133 SC. GENERIC HCR 02 B1AW3V4

REFERENCE INFORMATION
 REFS 6168.0040 SQ. FT
 REFL 971.0004 IN.
 REFB 1040.0040 IN.
 XNRP 1266.0040 IN.
 YNRP 0.0000 IN.
 ZNRP 163.0054 IN.
 SCALE 100.0000 PERCENT

MACH 0.180

DLSWT TEST 138- VERTICAL TAIL POSITION

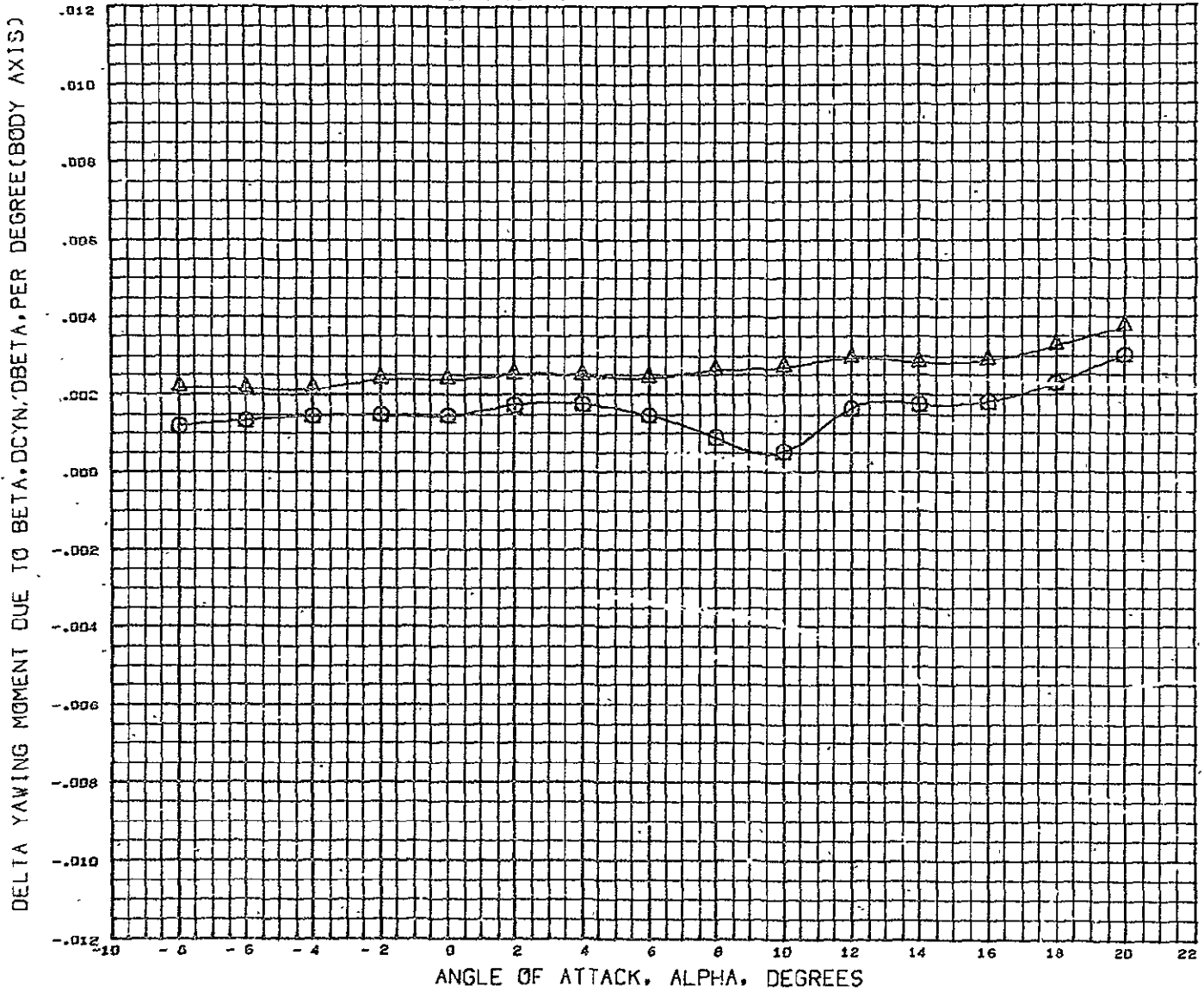

DATA SET SYMBOL CONFIGURATION DESCRIPTION
 (PCN002) ○ DLSWT 138 0.0133 SC. GENERIC HCR 02 B1AW3V3
 (PCN011) △ DLSWT 138 0.0133 SC. GENERIC HCR 02 B1AW3V4

REFERENCE INFORMATION
 REFS .0160.0010 SQ. FT
 REFL 971.0004 IN.
 REFB 1040.0040 IN.
 XMRP 1266.0040 IN.
 YMRP 0.0000 IN.
 ZMRP 163.0004 IN.
 SCALE 100.0000 FLRCNT

MACH 0.180

DLSWT TEST 138- VERTICAL TAIL POSITION

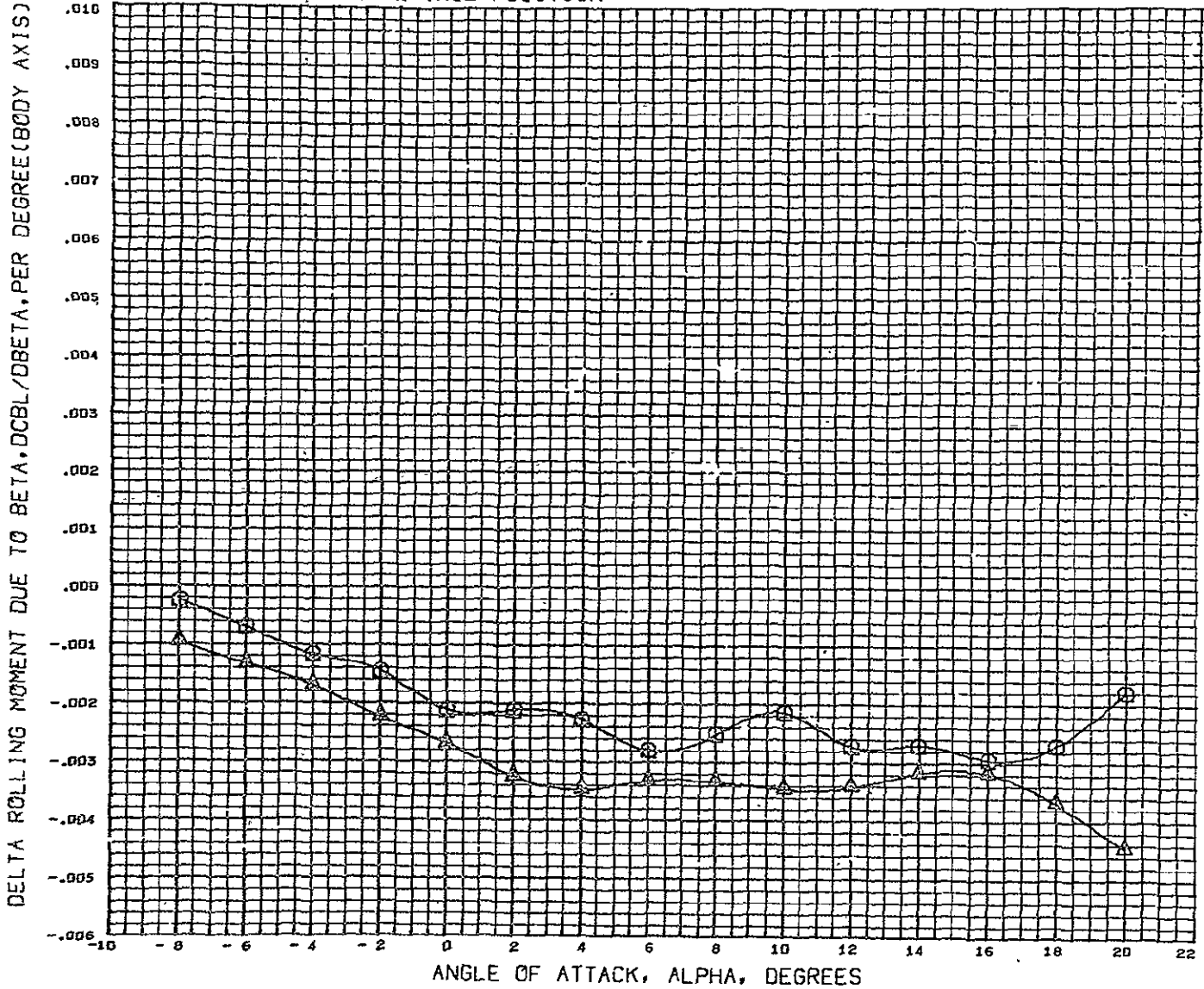

DATA SET SYMBOL CONFIGURATION DESCRIPTION
 (PCND02) ○ DLSWT 138 0.0133 SC. GENERIC HCR 02 B1AW3VZ
 (PCND11) △ DLSWT 138 0.0133 SC. GENERIC HCR 02 B1AW3V4

REFERENCE INFORMATION
 REFS 6168.8040 SR. FT
 REFL 971.0004 IN.
 REFB 1040.0040 IN.
 XMRF 1266.0040 IN.
 YMRF 0.0000 IN.
 ZMRF 163.0004 IN.
 SCALE 100.0000 PERCENT

MACH 0.180

COMPREHENSIVE
DATA PLOT INDEX

NOTE: See Page 11 for Consolidated Data Plot Index

DATA PLOT INDEX

DLSWT TEST 138- LEADING EDGE FILLET (STRAKE) EFFECT

DEPENDENT VARIABLE VS INDEPENDENT VARIABLE, PARAMETRIC STUDY

DATASETS PLOTTED:

RCN046 RCN049 RCN031 RCN051

DEPENDENT VARIABLE	INDEPENDENT VARIABLE	PLOT PAGE BEGINNING / ENDING	
CL	ALPHA	1	1
CLM	ALPHA	2	2
L/D	ALPHA	3	3

DLSWT TEST 138- LEADING EDGE FILLET (STRAKE) EFFECT

DEPENDENT VARIABLE VS DEPENDENT VARIABLE, PARAMETRIC STUDY

DATASETS PLOTTED:

RCN046 RCN049 RCN031 RCN051

DEPENDENT VARIABLE	DEPENDENT VARIABLE	PLOT PAGE BEGINNING / ENDING	
CL	CD	4	4
CL	CLM	5	5

DLSWT TEST 138- LEADING EDGE FILLET(STRAKE) EFFECT

DEPENDENT VARIABLE VS INDEPENDENT VARIABLE, MULTIPLE DATASETS

DATASETS PLOTTED:

TCN046 TCN047 TCN031 TCN032

DEPENDENT VARIABLE	INDEPENDENT VARIABLE	PLOT PAGE BEGINNING / ENDING	
CY	ALPHA	6	6
CYN	ALPHA	7	7
CBL	ALPHA	8	8

DATASETS PLOTTED:

PCN031 PCN046

DEPENDENT VARIABLE	INDEPENDENT VARIABLE	PLOT PAGE BEGINNING / ENDING	
CYBETA	ALPHA	9	9
DCYNDB	ALPHA	10	10
DCBLDB	ALPHA	11	11

DLSWT TEST 138- FULL-SPAN ELEVON POWER

DEPENDENT VARIABLE VS INDEPENDENT VARIABLE, PARAMETRIC STUDY

DATASETS PLOTTED:

RCN038	RCN037	RCN036	RCN031	
DEPENDENT VARIABLE	INDEPENDENT VARIABLE		PLOT PAGE BEGINNING / ENDING	
CL		ALPHA	12	12
CLM		ALPHA	13	13
L/D		ALPHA	14	14

DLSWT TEST 138- FULL-SPAN ELEVON POWER

DEPENDENT VARIABLE VS INDEPENDENT VARIABLE, (FSALFA)

DATASETS PLOTTED	DEPENDENT VARIABLE	INDEPENDENT VARIABLE	PLOT PAGE BEGINNING / ENDING	
ECN031	DCL/DE	ALPHA	15	15
ECN031	DCLMDE	ALPHA	16	16

DLSWT TEST 138- FULL-SPAN ELEVON POWER

DEPENDENT VARIABLE VS DEPENDENT VARIABLE, PARAMETRIC STUDY

DATASETS PLOTTED:

RCN038	RCN037	RCN036	RCN031	
DEPENDENT VARIABLE	DEPENDENT VARIABLE		PLOT PAGE BEGINNING / ENDING	
CL	CD		17	17
CL	CLM		18	18

DLSWT TEST 138- FULL-SPAN ELEVON POWER

DEPENDENT VARIABLE VS INDEPENDENT VARIABLE, MULTIPLE DATASETS

DATASETS PLOTTED:

TCN038	TCN039	TCN031	TCN032
DEPENDENT VARIABLE	INDEPENDENT VARIABLE	PLOT PAGE BEGINNING / ENDING	
CY	ALPHA	19	19
CYN	ALPHA	20	20
CBL	ALPHA	21	21

DATASETS PLOTTED:

PCN038	PCN031	PLOT PAGE BEGINNING / ENDING	
DEPENDENT VARIABLE	INDEPENDENT VARIABLE	PLOT PAGE BEGINNING / ENDING	
CYBETA	ALPHA	22	22
DCYNDB	ALPHA	23	23
DCBLDB	ALPHA	24	24

DLSWT TEST 138- PARTIAL-SPAN ELEVON POWER

DEPENDENT VARIABLE VS INDEPENDENT VARIABLE, PARAMETRIC STUDY

DATASETS PLOTTED:

RCN043 RCN042 RCN031

DEPENDENT VARIABLE	INDEPENDENT VARIABLE	PLOT PAGE BEGINNING / ENDING	
CL	ALPHA	25	25
CLM	ALPHA	26	26
L/D	ALPHA	27	27

DLSWT TEST 138- PARTIAL-SPAN ELEVON POWER

DEPENDENT VARIABLE VS INDEPENDENT VARIABLE, (FSALFA)

DATASETS PLOTTED	DEPENDENT VARIABLE	INDEPENDENT VARIABLE	PLOT PAGE BEGINNING / ENDING	
FCN031	DCL/DE	ALPHA	28	28
FCN031	DCLMDE	ALPHA	29	29

DLSWT TEST 138- PARTIAL-SPAN ELEVON POWER

DEPENDENT VARIABLE VS DEPENDENT VARIABLE, PARAMETRIC STUDY

DATASETS PLOTTED:

RCN043 RCN042 RCN031

DEPENDENT VARIABLE	DEPENDENT VARIABLE	PLOT PAGE BEGINNING / ENDING	
CL	CD	30	30
CL	CLM	31	31

DLSWT TEST 138- ROLL CONTROL POWER

DEPENDENT VARIABLE VS INDEPENDENT VARIABLE, MULTIPLE DATASETS

DATASETS PLOTTED:

	RCN031	RCN040	RCN041	RCN044
DEPENDENT VARIABLE	INDEPENDENT VARIABLE			PLOT PAGE BEGINNING / ENDING
CL			ALPHA	32 32
CLM			ALPHA	33 33
L/D			ALPHA	34 34

DLSWT TEST 138- ROLL CONTROL POWER

DEPENDENT VARIABLE VS DEPENDENT VARIABLE, MULTIPLE DATASETS

DATASETS PLOTTED:

	RCN031	RCN040	RCN041	RCN044
DEPENDENT VARIABLE	DEPENDENT VARIABLE			PLOT PAGE BEGINNING / ENDING
CL			CD	35 35
CL			CLM	36 36



DLSWT TEST 138- ROLL CONTROL POWER

DEPENDENT VARIABLE VS INDEPENDENT VARIABLE, (FSALFA)

DATASETS PLOTTED	DEPENDENT VARIABLE	INDEPENDENT VARIABLE	PLOT PAGE	
			BEGINNING	ENDING
PCN041	CYBETA	ALPHA	37	37
PCN041	DCYNDB	ALPHA	38	38
PCN041	DCBLDB	ALPHA	39	39
GCN031	DCY/DA	ALPHA	40	40
GCN031	DCYNDA	ALPHA	41	41
GCN031	DCBLDA	ALPHA	42	42
HCN031	DCY/DA	ALPHA	43	43
HCN031	DCYNDA	ALPHA	44	44
HCN031	DCBLDA	ALPHA	45	45

DLSWT TEST 138- ROLL CONTROL POWER

DEPENDENT VARIABLE VS INDEPENDENT VARIABLE, MULTIPLE DATASETS

DATASETS PLOTTED:

TCN031 TCN040 TCN041 TCN044

DEPENDENT VARIABLE	INDEPENDENT VARIABLE	PLOT PAGE	
		BEGINNING	ENDING
CY	ALPHA	46	46
CYN	ALPHA	47	47
CBL	ALPHA	48	48

DLSWT TEST 138- INCIDENCE EFFECT

DEPENDENT VARIABLE VS INDEPENDENT VARIABLE, MULTIPLE DATASETS

DATASETS PLOTTED:

RCN013 RCN059 RCN062 RCN064

DEPENDENT VARIABLE	INDEPENDENT VARIABLE	PLOT PAGE	
		BEGINNING	ENDING
CL	ALPHA	49	49
CLM	ALPHA	50	50
L/D	ALPHA	51	51

DLSWT TEST 138- INCIDENCE EFFECT

DEPENDENT VARIABLE VS DEPENDENT VARIABLE, MULTIPLE DATASETS

DATASETS PLOTTED:

RCN013 RCN059 RCN062 RCN064

DEPENDENT VARIABLE	DEPENDENT VARIABLE	PLOT PAGE	
		BEGINNING	ENDING
CL	CD	52	52
CL	CLM	53	53

DLSWT TEST 138- INCIDENCE EFFECT

DEPENDENT VARIABLE VS INDEPENDENT VARIABLE, MULTIPLE DATASETS

DATASETS PLOTTED:

RCN080 RCN076 RCN082 RCN084

DEPENDENT VARIABLE	INDEPENDENT VARIABLE	PLOT PAGE	
		BEGINNING	ENDING
CL	ALPHA	54	54
CLM	ALPHA	55	55
L/D	ALPHA	56	56

DLSWT TEST 138- INCIDENCE EFFECT

DEPENDENT VARIABLE VS DEPENDENT VARIABLE, MULTIPLE DATASETS

DATASETS PLOTTED:

RCN080 RCN076 RCN082 RCN084

DEPENDENT VARIABLE	DEPENDENT VARIABLE	PLOT PAGE	
		BEGINNING	ENDING
CL	CD	57	57
CL	CLM	58	58

DLSWT TEST 138- BODY NOSE RAMP EFFECT

DEPENDENT VARIABLE VS INDEPENDENT VARIABLE, MULTIPLE DATASETS

DATASETS PLOTTED:

RCN013 RCN020 RCN053 RCN057

DEPENDENT VARIABLE	INDEPENDENT VARIABLE	PLOT PAGE	
		BEGINNING	ENDING
CL	ALPHA	59	59
CLM	ALPHA	60	60
L/D	ALPHA	61	61

DLSWT TEST 138- BODY NOSE RAMP EFFECT

DEPENDENT VARIABLE VS DEPENDENT VARIABLE, MULTIPLE DATASETS

DATASETS PLOTTED:

RCN013 RCN020 RCN053 RCN057

DEPENDENT VARIABLE	DEPENDENT VARIABLE	PLOT PAGE	
		BEGINNING	ENDING
CL	CD	62	62
CL	CLM	63	63

DLSWT TEST 138- BODY NOSE RAMP EFFECT

DEPENDENT VARIABLE VS INDEPENDENT VARIABLE, MULTIPLE DATASETS

DATASETS PLOTTED:

TCN054 TCN053 TCN056 TCN057

DEPENDENT VARIABLE	INDEPENDENT VARIABLE	PLOT PAGE BEGINNING / ENDING	
CY	ALPHA	64	64
CYN	ALPHA	65	65
CBL	ALPHA	66	66

DATASETS PLOTTED:

PCN053 PCN057

DEPENDENT VARIABLE	INDEPENDENT VARIABLE	PLOT PAGE BEGINNING / ENDING	
CYBETA	ALPHA	67	67
DCYNDB	ALPHA	68	68
DCBLDB	ALPHA	69	69

DLSWT TEST 138- WING PLANFORM COMPARISON

DEPENDENT VARIABLE VS INDEPENDENT VARIABLE, MULTIPLE DATASETS

DATASETS PLOTTED:

RCNO11 RCNO18 RCNO23 RCNO25

DEPENDENT VARIABLE	INDEPENDENT VARIABLE	PLOT PAGE	
		BEGINNING	ENDING
CL	ALPHA	70	70
CLM	ALPHA	71	71
L/D	ALPHA	72	72

DLSWT TEST 138- WING PLANFORM COMPARISON

DEPENDENT VARIABLE VS INDEPENDENT VARIABLE, PARAMETRIC STUDY

DATASETS PLOTTED:

TCNO10 TCNO11

DEPENDENT VARIABLE	INDEPENDENT VARIABLE	PLOT PAGE	
		BEGINNING	ENDING
CY	ALPHA	75	75
CYN	ALPHA	76	76
CBL	ALPHA	77	77

DLSWT TEST 138- WING PLANFORM COMPARISON

DEPENDENT VARIABLE VS INDEPENDENT VARIABLE, (FSALFA)

DATASETS PLOTTED	DEPENDENT VARIABLE	INDEPENDENT VARIABLE	PLOT PAGE	
			BEGINNING	ENDING
PCNO11	CYBETA	ALPHA	78	78
PCNO11	DCYNDB	ALPHA	79	79
PCNO11	DCBLDB	ALPHA	80	80

DLSWT TEST 138- WING PLANFORM COMPARISON

DEPENDENT VARIABLE VS INDEPENDENT VARIABLE, PARAMETRIC STUDY

DATASETS PLOTTED:

TCNO17 TCNO18

DEPENDENT VARIABLE	INDEPENDENT VARIABLE	PLOT PAGE BEGINNING / ENDING	
CY	ALPHA	81	81
CYN	ALPHA	82	82
CBL	ALPHA	83	83

DLSWT TEST 138- WING PLANFORM COMPARISON

DEPENDENT VARIABLE VS INDEPENDENT VARIABLE, (FSALFA)

DATASETS PLOTTED DEPENDENT VARIABLE INDEPENDENT VARIABLE PLOT PAGE BEGINNING / ENDING

PCNO18	CYBETA	ALPHA	84	84
PCNO18	DCYNDB	ALPHA	85	85
PCNO18	DCBLDB	ALPHA	86	86

DLSWT TEST 138- WING PLANFORM COMPARISON

DEPENDENT VARIABLE VS INDEPENDENT VARIABLE, PARAMETRIC STUDY

DATASETS PLOTTED:

TCNO22 TCNO23

DEPENDENT VARIABLE	INDEPENDENT VARIABLE	PLOT PAGE BEGINNING / ENDING	
CY	ALPHA	87	87
CYN	ALPHA	88	88
CBL	ALPHA	89	89

DLSWT TEST 138- WING PLANFORM COMPARISON

DEPENDENT VARIABLE VS INDEPENDENT VARIABLE,

DATASETS PLOTTED	DEPENDENT VARIABLE	INDEPENDENT VARIABLE	PLOT PAGE BEGINNING / ENDING	
PCN023	CYBETA	ALPHA	90	90
PCN023	DCYNDB	ALPHA	91	91
PCN023	DCBLDB	ALPHA	92	92

DLSWT TEST 138- WING PLANFORM COMPARISON

DEPENDENT VARIABLE VS INDEPENDENT VARIABLE, PARAMETRIC STUDY

DATASETS PLOTTED:

TCN026 TCN025

	DEPENDENT VARIABLE	INDEPENDENT VARIABLE	PLOT PAGE BEGINNING / ENDING	
	CY	ALPHA	93	93
	CYN	ALPHA	94	94
	CBL	ALPHA	95	95

DLSWT TEST 138- WING PLANFORM COMPARISON

DEPENDENT VARIABLE VS INDEPENDENT VARIABLE, (FSALFA)

DATASETS PLOTTED	DEPENDENT VARIABLE	INDEPENDENT VARIABLE	PLOT PAGE BEGINNING / ENDING	
PCN025	CYBETA	ALPHA	96	96
PCN025	DCYNDB	ALPHA	97	97
PCN025	DCBLDB	ALPHA	98	98

DLSWT TEST 138- WING TWIST EFFECT

DEPENDENT VARIABLE VS INDEPENDENT VARIABLE, MULTIPLE DATASETS

DATASETS PLOTTED:

RCN020 RCN023

DEPENDENT VARIABLE	INDEPENDENT VARIABLE	PLOT PAGE BEGINNING / ENDING	
CL	ALPHA	99	99
CLM	ALPHA	100	100
L/D	ALPHA	101	101

DLSWT TEST 138- WING TWIST EFFECT

DEPENDENT VARIABLE VS DEPENDENT VARIABLE, MULTIPLE DATASETS

DATASETS PLOTTED:

RCN020 RCN023

DEPENDENT VARIABLE	DEPENDENT VARIABLE	PLOT PAGE BEGINNING / ENDING	
CL	CD	102	102
CL	CLM	103	103

DLSWT TEST 138- WING TWIST EFFECT

DEPENDENT VARIABLE VS INDEPENDENT VARIABLE, MULTIPLE DATASETS

DATASETS PLOTTED:

TCN021 TCN020 TCN022 TCN023

DEPENDENT VARIABLE	INDEPENDENT VARIABLE	PLOT PAGE BEGINNING / ENDING	
CY	ALPHA	104	104
CYN	ALPHA	105	105
CBL	ALPHA	106	106

DATASETS PLOTTED:

PCN020 PCN023

DEPENDENT VARIABLE	INDEPENDENT VARIABLE	PLOT PAGE BEGINNING / ENDING	
CYBETA	ALPHA	107	107
DCYNDB	ALPHA	108	108
DCBLDB	ALPHA	109	109

DLSWT TEST 138- WING AIRFOIL SECTION EFFECT

DEPENDENT VARIABLE VS INDEPENDENT VARIABLE, MULTIPLE DATASETS

DATASETS PLOTTED:

RCN059 RCN046

DEPENDENT VARIABLE	INDEPENDENT VARIABLE	PLOT PAGE BEGINNING / ENDING	
CL	ALPHA	110	110
CLM	ALPHA	111	111
L/D	ALPHA	112	112

DLSWT TEST 138- WING AIRFOIL SECTION EFFECT

DEPENDENT VARIABLE VS DEPENDENT VARIABLE, MULTIPLE DATASETS

DATASETS PLOTTED:

RCN059 RCN046

DEPENDENT VARIABLE	DEPENDENT VARIABLE	PLOT PAGE BEGINNING / ENDING	
CL	CD	113	113
CL	CLM	114	114

DLSWT TEST 138- WING AIRFOIL SECTION EFFECT

DEPENDENT VARIABLE VS INDEPENDENT VARIABLE, MULTIPLE DATASETS

DATASETS PLOTTED:

TCN060 TCN059 TCN047 TCN046

DEPENDENT VARIABLE	INDEPENDENT VARIABLE	PLOT PAGE BEGINNING / ENDING	
CY	ALPHA	115	115
CYN	ALPHA	116	116
CBL	ALPHA	117	117

DATASETS PLOTTED:

PCN059 PCN046

DEPENDENT VARIABLE	INDEPENDENT VARIABLE	PLOT PAGE BEGINNING / ENDING	
CYBETA	ALPHA	118	118
DCYNDB	ALPHA	119	119
DCBLDB	ALPHA	120	120

DLSWT TEST 138- BOAT TAIL EFFECT

DEPENDENT VARIABLE VS INDEPENDENT VARIABLE, MULTIPLE DATASETS

DATASETS PLOTTED:

RCN031 RCN029

DEPENDENT VARIABLE	INDEPENDENT VARIABLE	PLOT PAGE BEGINNING / ENDING	
CL	ALPHA	121	121
CLM	ALPHA	122	122
L/D	ALPHA	123	123

DLSWT TEST 138- BOAT TAIL EFFECT

DEPENDENT VARIABLE VS DEPENDENT VARIABLE, MULTIPLE DATASETS

DATASETS PLOTTED:

RCN031 RCN029

DEPENDENT VARIABLE	DEPENDENT VARIABLE	PLOT PAGE BEGINNING / ENDING	
CL	CD	124	124
CL	CLM	125	125

DLSWT TEST 138- BOAT TAIL EFFECT

DEPENDENT VARIABLE VS INDEPENDENT VARIABLE, MULTIPLE DATASETS

DATASETS PLOTTED:

TCN028 TCN029 TCN032 TCN031

DEPENDENT VARIABLE	INDEPENDENT VARIABLE	PLOT PAGE BEGINNING / ENDING	
CY	ALPHA	126	126
CYN	ALPHA	127	127
CBL	ALPHA	128	128

DATASETS PLOTTED:

PCN029 PCN031

DEPENDENT VARIABLE	INDEPENDENT VARIABLE	PLOT PAGE BEGINNING / ENDING	
CYBETA	ALPHA	129	129
DCYNDB	ALPHA	130	130
DCBLDB	ALPHA	131	131

DLSWT TEST 138- COMPARISON OF WIND TUNNEL MODELS

DEPENDENT VARIABLE VS INDEPENDENT VARIABLE, MULTIPLE DATASETS

DATASETS PLOTTED:

RCN023 RCN031

DEPENDENT VARIABLE	INDEPENDENT VARIABLE	PLOT PAGE BEGINNING / ENDING	
CL	ALPHA	132	132
CLM	ALPHA	133	133
L/D	ALPHA	134	134

DLSWT TEST 138- COMPARISON OF WIND TUNNEL MODELS

DEPENDENT VARIABLE VS DEPENDENT VARIABLE, MULTIPLE DATASETS

DATASETS PLOTTED:

RCN023 RCN031

DEPENDENT VARIABLE	DEPENDENT VARIABLE	PLOT PAGE BEGINNING / ENDING	
CL	CD	135	135
CL	CLM	136	136

DLSWT TEST 138- COMPARISON OF WIND TUNNEL MODELS

DEPENDENT VARIABLE VS INDEPENDENT VARIABLE, MULTIPLE DATASETS

DATASETS PLOTTED:

TCN022 TCN023 TCN032 TCN031

DEPENDENT VARIABLE	INDEPENDENT VARIABLE	PLOT PAGE BEGINNING / ENDING	
CY	ALPHA	137	137
CYN	ALPHA	138	138
CBL	ALPHA	139	139

DATASETS PLOTTED:

PCN023 PCN031

DEPENDENT VARIABLE	INDEPENDENT VARIABLE	PLOT PAGE BEGINNING / ENDING	
CYBETA	ALPHA	140	140
DCYNDB	ALPHA	141	141
DCBLDB	ALPHA	142	142

DLSWT TEST 138- ENGINE POD EFFECT

DEPENDENT VARIABLE VS INDEPENDENT VARIABLE, MULTIPLE DATASETS

DATASETS PLOTTED:

RCN031 RCN066 RCN068

DEPENDENT VARIABLE	INDEPENDENT VARIABLE	PLOT PAGE BEGINNING / ENDING	
CL	ALPHA	143	143
CLM	ALPHA	144	144
L/D	ALPHA	145	145

DLSWT TEST 138- ENGINE POD EFFECT

DEPENDENT VARIABLE VS DEPENDENT VARIABLE, MULTIPLE DATASETS

DATASETS PLOTTED:

RCN031 RCN066 RCN068

DEPENDENT VARIABLE	DEPENDENT VARIABLE	PLOT PAGE BEGINNING / ENDING	
CL	CD	146	146
CL	CLM	147	147

DLSWT TEST 138- ENGINE POD EFFECT

DEPENDENT VARIABLE VS INDEPENDENT VARIABLE, MULTIPLE DATASETS

DATASETS PLOTTED:

TCN032 TCN031 TCN067 TCN066

DEPENDENT VARIABLE	INDEPENDENT VARIABLE	PLOT PAGE BEGINNING / ENDING	
CY	ALPHA	148	148
CYN	ALPHA	149	149
CBL	ALPHA	150	150

DATASETS PLOTTED:

PCN031 PCN066

DEPENDENT VARIABLE	INDEPENDENT VARIABLE	PLOT PAGE BEGINNING / ENDING	
CYBETA	ALPHA	151	151
DCYNDB	ALPHA	152	152
DCBLDB	ALPHA	153	153

DLSWT TEST 138- BASIC CONFIGURATION BUILDUP

DEPENDENT VARIABLE VS INDEPENDENT VARIABLE, MULTIPLE DATASETS

DATASETS PLOTTED:

RCN013 RCN007 RCN011

DEPENDENT VARIABLE	INDEPENDENT VARIABLE	PLOT PAGE BEGINNING / ENDING	
CL	ALPHA	154	154
CLM	ALPHA	155	155
L/D	ALPHA	156	156

DLSWT TEST 138- BASIC CONFIGURATION BUILDUP

DEPENDENT VARIABLE VS DEPENDENT VARIABLE, MULTIPLE DATASETS

DATASETS PLOTTED:

RCN013 RCN007 RCN011

DEPENDENT VARIABLE	DEPENDENT VARIABLE	PLOT PAGE BEGINNING / ENDING	
CL	CD	157	157
CL	CLM	158	158

DLSWT TEST 138- BASIC CONFIGURATION BUILDUP

DEPENDENT VARIABLE VS INDEPENDENT VARIABLE, MULTIPLE DATASETS

DATASETS PLOTTED:

RCN013 RCN035 RCN031

DEPENDENT VARIABLE	INDEPENDENT VARIABLE	PLOT PAGE BEGINNING / ENDING	
CL	ALPHA	159	159
CLM	ALPHA	160	160
L/D	ALPHA	161	161

DLSWT TEST 138- BASIC CONFIGURATION BUILDUP

DEPENDENT VARIABLE VS DEPENDENT VARIABLE, MULTIPLE DATASETS

DATASETS PLOTTED:

RCN013 RCN035 RCN031

DEPENDENT VARIABLE	DEPENDENT VARIABLE	PLOT PAGE BEGINNING / ENDING	
CL	CD	162	162
CL	CLM	163	163

DLSWT TEST 138- BASIC CONFIGURATION BUILDUP

DEPENDENT VARIABLE VS INDEPENDENT VARIABLE, MULTIPLE DATASETS

DATASETS PLOTTED:

RCN080 RCN074 RCN070

DEPENDENT VARIABLE	INDEPENDENT VARIABLE	PLOT PAGE BEGINNING / ENDING	
CL	ALPHA	164	164
CLM	ALPHA	165	165
L/D	ALPHA	166	166

DLSWT TEST 138- BASIC CONFIGURATION BUILDUP

DEPENDENT VARIABLE VS DEPENDENT VARIABLE, MULTIPLE DATASETS

DATASETS PLOTTED:

RCN080 RCN074 RCN070

DEPENDENT VARIABLE	DEPENDENT VARIABLE	PLOT PAGE BEGINNING / ENDING	
CL	CD	167	167
CL	CLM	168	168

DLSWT TEST 138- BASIC CONFIGURATION BUILDUP

DEPENDENT VARIABLE VS INDEPENDENT VARIABLE, MULTIPLE DATASETS

DATASETS PLOTTED:

TCN015	TCN013	TCN009	TCN007	TCN010	TCN011
DEPENDENT VARIABLE	INDEPENDENT VARIABLE	PLOT PAGE BEGINNING / ENDING			
CY	ALPHA	169	169		
CYN	ALPHA	170	170		
CBL	ALPHA	171	171		

DATASETS PLOTTED:

PCN013	PCN007	PCN011			
DEPENDENT VARIABLE	INDEPENDENT VARIABLE	PLOT PAGE BEGINNING / ENDING			
CYBETA	ALPHA	172	172		
DCYNDB	ALPHA	173	173		
DCBLDB	ALPHA	174	174		

DLSWT TEST 138- BASIC CONFIGURATION BUILDUP

DEPENDENT VARIABLE VS INDEPENDENT VARIABLE, MULTIPLE DATASETS

DATASETS PLOTTED:

TCN015	TCN013	TCN034	TCN035	TCN032	TCN031
DEPENDENT VARIABLE	INDEPENDENT VARIABLE	PLOT PAGE BEGINNING / ENDING			
CY	ALPHA	175	175		
CYN	ALPHA	176	176		
CBL	ALPHA	177	177		

DATASETS PLOTTED:

PCN013	PCN035	PCN031			
DEPENDENT VARIABLE	INDEPENDENT VARIABLE	PLOT PAGE BEGINNING / ENDING			
CYBETA	ALPHA	178	178		
DCYNDB	ALPHA	179	179		
DCBLDB	ALPHA	180	180		

DLSWT TEST 138- BASIC CONFIGURATION BUILDUP

DEPENDENT VARIABLE VS INDEPENDENT VARIABLE, MULTIPLE DATASETS

DATASETS PLOTTED:

	TCN079	TCN080	TCN073	TCN074	TCN071	TCN070
DEPENDENT VARIABLE	INDEPENDENT VARIABLE		PLOT PAGE BEGINNING / ENDING			
CY	ALPHA		181	181		
CYN	ALPHA		182	182		
CBL	ALPHA		183	183		

DATASETS PLOTTED:

	PCN080	PCN074	PCN070		
DEPENDENT VARIABLE	INDEPENDENT VARIABLE		PLOT PAGE BEGINNING / ENDING		
CYBETA	ALPHA		184	184	
DCYNDB	ALPHA		185	185	
DCBLDB	ALPHA		186	186	

DLSWT TEST 138- BODY FLAP EFFECT

DEPENDENT VARIABLE VS INDEPENDENT VARIABLE, MULTIPLE DATASETS

DATASETS PLOTTED:

RCN076 RCN088

DEPENDENT VARIABLE	INDEPENDENT VARIABLE	PLOT PAGE BEGINNING / ENDING	
CL	ALPHA	187	187
CLM	ALPHA	188	188
L/D	ALPHA	189	189

DLSWT TEST 138- BODY FLAP EFFECT

DEPENDENT VARIABLE VS DEPENDENT VARIABLE, MULTIPLE DATASETS

DATASETS PLOTTED:

RCN076 RCN088

DEPENDENT VARIABLE	DEPENDENT VARIABLE	PLOT PAGE BEGINNING / ENDING	
CL	CD	190	190
CL	CLM	191	191

DLSWT TEST 138- WING POSITION EFFECT

DEPENDENT VARIABLE VS INDEPENDENT VARIABLE, MULTIPLE DATASETS

DATASETS PLOTTED:

RCN076 RCN086

DEPENDENT VARIABLE	INDEPENDENT VARIABLE	PLOT PAGE BEGINNING / ENDING	
CL	ALPHA	192	192
CLM	ALPHA	193	193
L/D	ALPHA	194	194

DLSWT TEST 138- WING POSITION EFFECT

DEPENDENT VARIABLE VS DEPENDENT VARIABLE, MULTIPLE DATASETS

DATASETS PLOTTED:

RCN076 RCN086

DEPENDENT VARIABLE	DEPENDENT VARIABLE	PLOT PAGE BEGINNING / ENDING	
CL	CD	195	195
CL	CLM	196	196

DLSWT TEST 138- VERTICAL TAIL POSITION

DEPENDENT VARIABLE VS INDEPENDENT VARIABLE, MULTIPLE DATASETS

DATASETS PLOTTED:

TCN071 TCN070 TCN077 TCN076

DEPENDENT VARIABLE	INDEPENDENT VARIABLE	PLOT PAGE BEGINNING / ENDING	
CY	ALPHA	197	197
CYN	ALPHA	198	198
CBL	ALPHA	199	199

DATASETS PLOTTED:

PCN070 PCN076

DEPENDENT VARIABLE	INDEPENDENT VARIABLE	PLOT PAGE BEGINNING / ENDING	
CYBETA	ALPHA	200	200
DCYNDB	ALPHA	201	201
DCBLDB	ALPHA	202	202

DLSWT TEST 138- VERTICAL TAIL POSITION

DEPENDENT VARIABLE VS INDEPENDENT VARIABLE, MULTIPLE DATASETS

DATASETS PLOTTED:

TCN004 TCN002 TCN010 TCN011

DEPENDENT VARIABLE	INDEPENDENT VARIABLE	PLOT PAGE BEGINNING / ENDING	
CY	ALPHA	203	203
CYN	ALPHA	204	204
CBL	ALPHA	205	205

DATASETS PLOTTED:

PCN002 PCN011

DEPENDENT VARIABLE	INDEPENDENT VARIABLE	PLOT PAGE BEGINNING / ENDING	
CYBETA	ALPHA	206	206
DCYNDB	ALPHA	207	207
DCBLDB	ALPHA	208	208