

N.T.

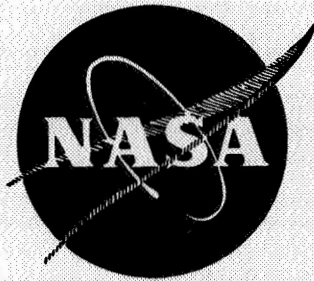

DEVELOPMENT OF A BRAZING PROCESS FOR
Cb-1Zr HEAT RECEIVER TUBES

by

C. E. SMELTZER

W. A. COMPTON

CONTRACT NAS3-10603

SOLAR DIVISION OF INTERNATIONAL HARVESTER COMPANY

FACILITY FORM 602	<u>N 68-28640</u>	(THRU)
	<u>83</u>	(CODE)
	<u>CR-95481</u>	<u>15</u>
	(ACCESSION NUMBER)	(CATEGORY)
	(PAGES)	
	(NASA CR OR TMX OR AD NUMBER)	

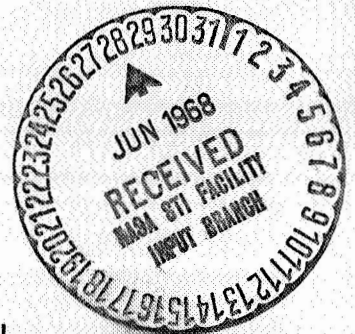

NATIONAL AERONAUTICS AND SPACE ADMINISTRATION
LEWIS RESEARCH CENTER, CLEVELAND, OHIO

NOTICE

This report was prepared as an account of Government sponsored work. Neither the United States, nor the National Aeronautics and Space Administration (NASA), nor any person acting on behalf of NASA:

- A.) Makes any warranty or representation, expressed or implied, with respect to the accuracy, completeness, or usefulness of the information contained in this report, or that the use of any information, apparatus, method, or process disclosed in this report may not infringe privately owned rights; or
- B.) Assumes any liabilities with respect to the use of, or for damages resulting from the use of any information, apparatus, method or process disclosed in this report.

As used above, "person acting on behalf of NASA" includes any employee or contractor of NASA, or employee of such contractor, to the extent that such employee or contractor of NASA, or employee of such contractor prepares, disseminates, or provides access to, any information pursuant to his employment or contract with NASA, or his employment with such contractor.

RDR 1611

FINAL REPORT
DEVELOPMENT OF A BRAZING PROCESS FOR
Cb-1Zr HEAT RECEIVER TUBES

by

C. E. SMELTZER

W. A. COMPTON

SOLAR DIVISION OF INTERNATIONAL HARVESTER COMPANY

1 MAY 1967 THROUGH 31 JANUARY 1968

CONTRACT NAS3-10603

SPACE POWER SYSTEMS DIVISION
NASA LEWIS RESEARCH CENTER
CLEVELAND, OHIO
PAUL E. MOORHEAD, PROJECT MANAGER

NATIONAL AERONAUTICS AND SPACE ADMINISTRATION
LEWIS RESEARCH CENTER, CLEVELAND, OHIO

FOREWORD

This final report was prepared by the Research Laboratories at the Solar Division of International Harvester Company under NASA Contract NAS3-10603. The program was administered by the Lewis Research Center of the National Aeronautics and Space Administration, with Mr. Paul E. Moorehead acting as Project Manager. The period covered by this report is 1 May 1967 through 31 January 1968.

Research personnel supervising the program and contributing to this report were Mr. W. A. Compton, Program Manager and Mr. C. E. Smeltzer, Principal Investigator. Acknowledgement is given to Mr. R. K. Malik, Research Engineer, who conducted preliminary braze alloy evaluations.

The contractor's report number is RDR 1611.

This technical report has been reviewed and is approved.

ABSTRACT

A two-phase program was conducted to develop a suitable braze process for attaching internal fins of Cb-1Zr foil to Cb-1Zr heat receiver tubes. Phase I was concerned with the selection, development, and evaluation of candidate braze systems, as well as with the determination of fabrication feasibility and brazing studies upon subscale heat receiver tube modules. Phase II involved actual fabrication and vacuum brazing of two full scale heat receiver tubes employing the optimum braze alloy, Zr-28V-16Ti-0.1Be.



PRECEDING PAGE BLANK NOT FILMED.

SUMMARY

A two-phase program was conducted to develop a suitable braze process for attaching internal fins of Cb-1Zr foil to Cb-1Zr heat receiver tubes. Phase I was concerned with the selection, development, and evaluation of candidate braze systems, as well as with the determination of fabrication feasibility and brazing studies upon subscale heat receiver tube modules. Phase II involved actual fabrication and vacuum brazing of two full scale heat receiver tubes employing the optimum braze alloy, Zr-28V-16Ti-0.1Be.

Fifteen candidate braze alloys (representing Cu-, Au-, Ti/Zr- and Zr-bases) were selected and evaluated in Phase I upon Cb-1Zr T-joint and lap-joint specimens. Braze screening tests included assessments of relative braze performance and braze structure, T-joint bend tests, and tensile-shear strength (room temperature and 1750°F) and brazement remelt determinations upon single lap-joint specimens. Brazement peel tests also were conducted upon sections of brazed, subscale heat receiver tubes. To rate the relative thermal stabilities of candidate brazements in a simulated space environment, specimens were mechanically tested and analyzed by electron microprobe in the as-brazed condition and after 1000 hours of vacuum aging at 1750°F (chamber pressure $\leq 1.0 \times 10^{-8}$ Torr). The three braze alloys which performed best throughout the screening tests, as well as in subscale module brazing, were Cu-2Ni (2300°F), Zr-28V-16Ti (2250°F), and Zr-28V-16Ti-0.1Be (2130°F). The braze alloy, Zr-28V-16Ti-0.1Be, ultimately was chosen for Phase II work because of its superior braze fluidity and filleting characteristics with Cb-1Zr sheet and foil.

Two full scale heat receiver tubes were fabricated and brazed successfully in Phase II using the fin design and vacuum brazing technique developed in subscale module work. Adjacent sections of each heat receiver tube were heated inductively (in sequence) for brazing using a moving primary induction coil. Repair brazing proved to be a significant problem, because of the intricacy of the internal fin assembly. However, the braze process developed is adequate for the production of heat receiver tubes.

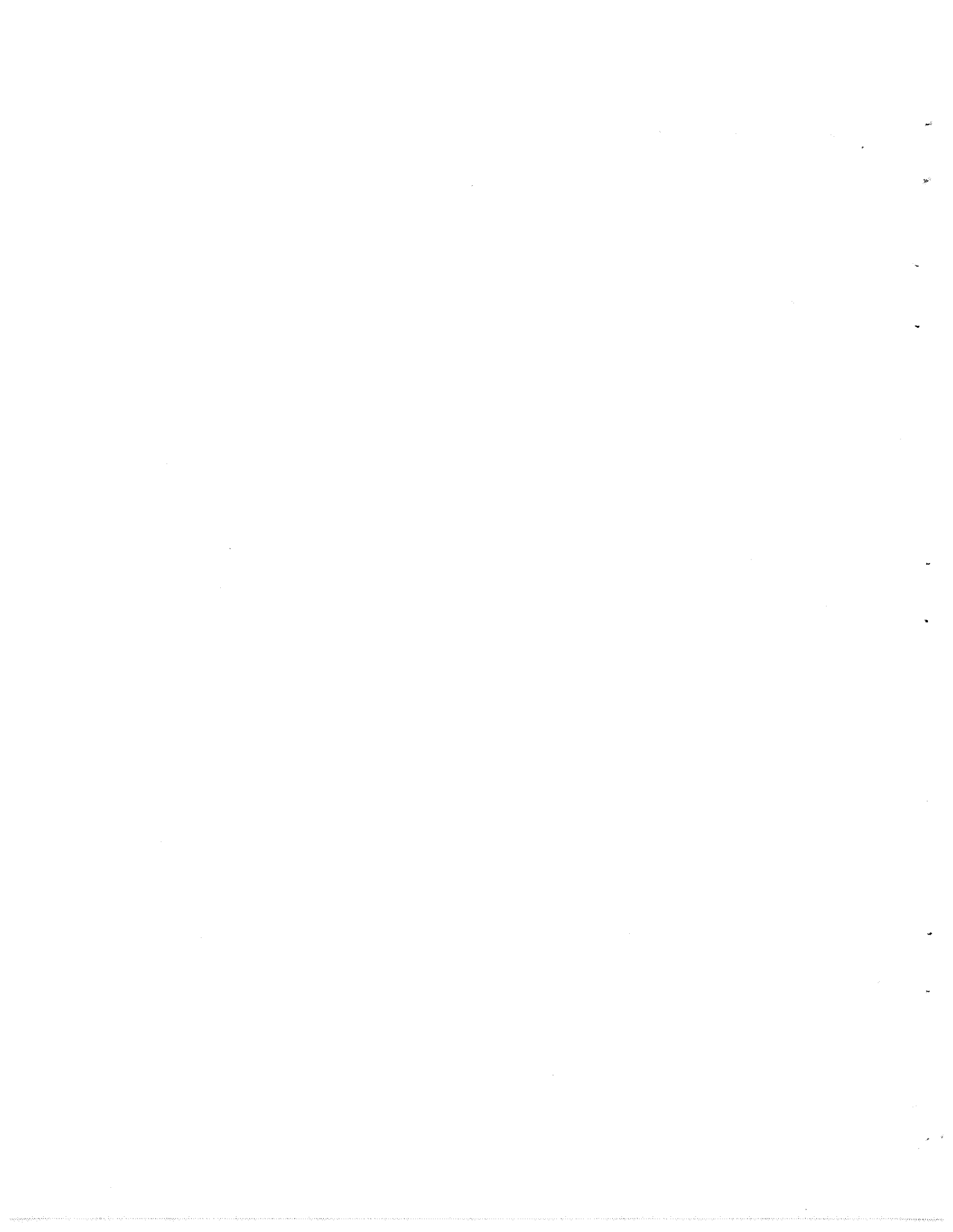

PRECEDING PAGE BLANK NOT FILMED.

CONTENTS

<u>Section</u>		<u>Page</u>
1	INTRODUCTION	1
2	DEVELOPMENT OF BRAZING PROCESSES - PHASE I	3
2.1	Experimental Procedures	3
2.1.1	Braze Alloy Preparation	3
2.1.2	Specimen Preparation and Testing	4
2.2	Selection of Braze Alloy Compositions	9
2.3	Braze Structural Studies	11
2.3.1	Copper-Base Alloys	11
2.3.2	Gold Foil	11
2.3.3	Zr- and Ti/Zr-Base Alloys	15
2.4	Braze Thermal Stability and Strength Studies	19
2.4.1	Short-Term Aging Runs	19
2.4.2	Long-Term Stability Runs	30
2.5	Fabrication Feasibility Studies - 18-Inch Tube Modules	54
2.5.1	Internal Fin Design and Evaluation	54
2.5.2	Brazing 18-Inch Heat Receiver Tubes	58
2.5.3	Evaluation of Subscale Module Brazements	62
2.6	Final Braze Alloy Selection	65
3	FABRICATION AND BRAZING OF FULL SCALE HEAT RECEIVER TUBES - PHASE II	67
3.1	Procurement of Materials	67
3.2	Fabrication of Internal Fin Modules	67
3.3	Brazing Procedure	67
3.4	Inspection and Repair Procedures	69
4	CONCLUSIONS AND RECOMMENDATIONS	71
	REFERENCES	73



PRECEDING PAGE BLANK NOT FILMED.

ILLUSTRATIONS

<u>Figure</u>		<u>Page</u>
1	Principal Elements of an Internally Finned Tube	2
2	Brazed Cb-1Zr T-Joint Specimen; Metallography and Bend Tests	5
3	Induction Brazing Furnace for Brazing T-Joints	5
4	Schematic Diagram of the Laboratory Brazing Furnace	6
5	Brazed Single-Lap Shear Specimen	7
6	Apparatus for Braze Separation (Remelt) Test and 1750°F Tensile Tests of Shear Specimens	8
7	Cb-1Zr T-Joint Brazed with Cu-2Ni; As-Brazed Condition	14
8	Cb-1Zr T-Joint Brazed with Pure Gold Foil; As-Brazed Condition	14
9	Cb-1Zr T-Joint Brazed with Ti-48Zr-4Be; As-Brazed Condition	15
10	Cb-1Zr T-Joint Brazed with Ti-46.5Zr-4V-3Be; As-Brazed Condition	16
11	Cb-1Zr T-Joint Brazed with Ti-45Zr-7Cb-3Be; As-Brazed Condition	17
12	Cb-1Zr T-Joint Brazed with Zr-19Cb-6V-3Be; As-Brazed Condition	17
13	Cb-1Zr T-Joint Brazed with Zr-28V-16Ti; As-Brazed Condition	18
14	Cb-1Zr T-Joint Brazed with Zr-28V-16Ti-0.1Be; As-Brazed Condition	19
15	Cb-1Zr T-Joint Brazed with Gold	20
16	Cb-1Zr T-Joint Vacuum Brazed with Cu-2Ni Alloy	26
17	Cb-1Zr T-Joint Vacuum Brazed with Zr-28V-16Ti Alloy	26

ILLUSTRATIONS (Cont)

<u>Figure</u>		<u>Page</u>
18	Cb-1Zr T-Joint Vacuum Brazed with Zr-28V-16Ti-0.1 Be Alloy	27
19	Vacuum Aging Furnace; Triode-Ion Pump - 250 L/S	31
20	Vacuum Aging Furnace Hot Zone; Internal View Showing Specimen Pack	33
21	Lap-Joint Brazements of Cu-2Ni Braze Alloy	34
22	Lap-Joint Brazements of Zr-28V-16Ti Braze Alloy	36
23	Lap-Joint Brazements of Zr-28V-16Ti-0.1Be Braze Alloy	37
24	Brazed T-Joint Specimens for Microprobe Analysis; Zr-28V-16Ti Braze Alloy	41
25	Brazed T-Joint Specimens for Microprobe Analysis; Zr-28V-16Ti-0.1Be Braze Alloy	42
26	Brazed T-Joint Specimens for Microprobe Analysis; Cu-2Ni Braze Alloy	43
27	Electron Microprobe Traverses; Zr-28V-16Ti Alloy	45
28	Electron Microprobe Traverses; Zr-28V-16Ti-0.1Be Alloy	47
29	Electron Microprobe Traverses; Cu-2Ni Alloy	49
30	Electron Microprobe Traverses; Cu-2Ni Lap Joint	51
31	Rates of Diffusion in Binary Couples of Columbium/Zirconium, Columbium/Titanium, and Columbium/Vanadium (Ref. 6)	53
32	Schematic of First Fin Redesign; Design A	56
33	Fixture for Fabrication and Sizing of Internal Fins (Design A) and a Brazed Heat Receiver Tube Section (Left)	56
34	Schematic of Second Fin Redesign; Design B	57
35	Corrugating Gear and Sizing Fixture for Fabricating Design B Fin Modules	58
36	Internal View of 18-Inch Heat Receiver Tube (1.25 In. Major Dia.); Design B Fin Modules Brazed in Position	59
37	Vacuum Induction Brazing Setup for 18-Inch Heat Receiver Tubes	60

ILLUSTRATIONS (Cont)

<u>Figure</u>		<u>Page</u>
38	End Views of Four 18-Inch and Two 36-Inch Heat Receiver Tubes; Post-Brazing	62
39	Typical Heat Receiver Tube Sections; Brazed and Prepared for Long-Term Aging	63
40	Transverse Sections Through Tube/Fin Brazements Made with Cu-2Ni Braze Alloy; Fin Design A	64
41	Transverse Sections Through Tube/Fin Brazements Made with Zr-28V-16Ti-0.1Be Braze Alloy; Fin Design A	65
42	Transverse Sections Through Tube/Fin Brazements Made with Zr-28V-16Ti Braze Alloy; Fin Design A	66
43	Vacuum Induction Brazing Setup for 36-Inch Heat Receiver Tubes	68
44	External Side Views of Four 18-Inch and Two 36-Inch Heat Receiver Tubes; Post Brazing	69

TABLES

<u>Table</u>		<u>Page</u>
I	Characteristics of Candidate Braze Alloys for Joining Cb-1Zr Foil	12
II	Characteristics of First and Second Generation Candidate Braze Alloys for Joining Cb-1Zr Foil	13
III	Results of Preliminary Braze Thermal Stability Studies	21
IV	Properties of Thermally Aged Braze Alloys - Phase I	23
V	Properties of Candidate Brazements	28
VI	Microhardnesses of Candidate Brazements	29
VII	Comparison of Properties for Candidate Alloy Brazements	35
VIII	Microhardnesses of Candidate Brazements	38

1

INTRODUCTION

Solar power sources based on the Brayton Cycle and advanced for long-term deployment in space all rely upon efficient heat transfer systems. A key unit in the heat exchange function is the heat receiver tube, which enables uniform transfer of heat from a solar-heated thermal reservoir (typically LiF) to the working gas (typically argon). The charter of the subject program was to develop, evaluate, and demonstrate a suitable braze process for fabricating heat receiver tubes of Cb-1Zr alloy, compatible with a system service-life requirement of 10,000 hours continuous operation at 1650°F.

The specific function of the ultimate braze process is to permanently attach internal fins of 0.005-inch Cb-1Zr foil within Cb-1Zr tubing (1.25 in. OD by 0.025 in. wall thickness) to form the desired heat receiver tube. (A typical heat receiver tube design suggested by the sponsor is shown in Figure 1.) The purpose of the internal fins is to inhibit strictly laminar gas flow, thereby enhancing the efficiency of heat transfer. Consequently, the actual design of the fin arrangement and configuration is not fixed, but must be related to limitations of the braze process, manufacturing feasibility, argon pressure buildup, and structural stability in long-term service as well as to thermal exchange considerations.

The program was divided into two consecutive phases, Phase I and Phase II. Phase I was concerned with the selection, development, and evaluation of candidate braze systems in addition to fabrication feasibility studies upon subscale heat receiver tubes (up to 18 inches long). Phase II involved actual fabrication and brazing of two full scale (prototype) heat receiver tubes, each 36 inches long. Each phase of the program is reported in proper sequence.

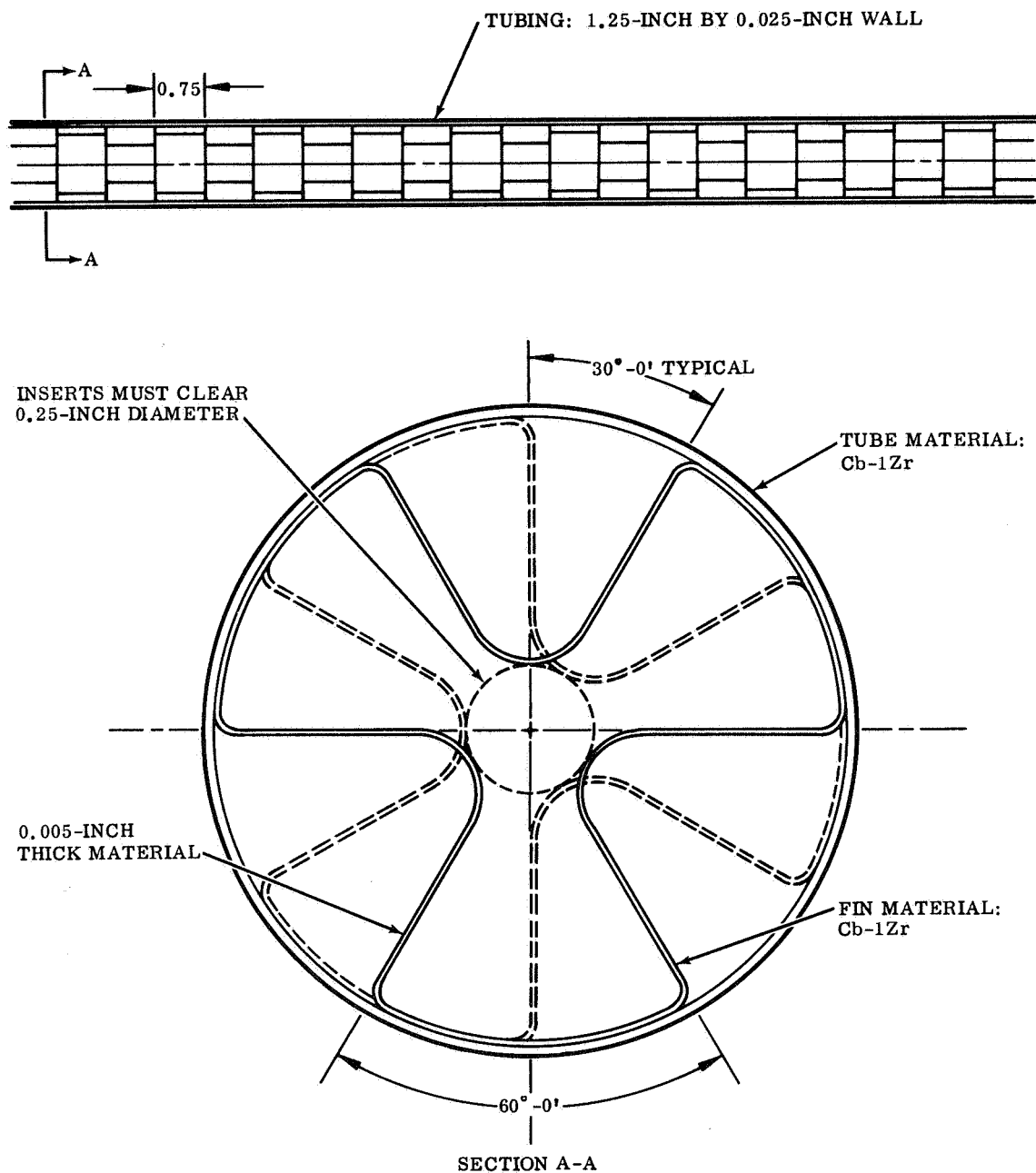

FIGURE 1. PRINCIPAL ELEMENTS OF AN INTERNALLY FINNED TUBE

2

DEVELOPMENT OF BRAZING PROCESSES - PHASE I

2.1 EXPERIMENTAL PROCEDURES

2.1.1 Braze Alloy Preparation

Candidate braze alloys of various compositions were made up for evaluation by nonconsumable electrode arc-melting elemental 10-gram charges in a water-cooled copper crucible. The melt chamber atmosphere was argon, gettered by passing first through chemical dryers, then through a tower containing titanium chips at 1250°F. The resulting 10-gram button ingots were reduced to particle sizes suitable for brazing (e.g., -9/+12 mesh) by mechanical crushing in a steel mortar and pestle, if sufficiently friable (viz., the Zr- and Ti/Zr-base alloys), or by pressing and cutting with shears, if sectile (viz., the Cu-base alloys). Every button ingot was remelted four to five times on alternate sides to ensure thorough and uniform mixing of elements in the molten state. Pure gold and pure copper were evaluated as braze materials in the form of purchased, two-mil thick foils.

Zirconium- and Ti/Zr-base braze alloys which contain more than 1.0 percent beryllium are difficult to make structurally homogeneous by arc-melting alone because of their strong propensity for macro-segregation during solidification. Consequently, they were levitation melted and splatter cast to inhibit segregation and thereby promote structural homogeneity. For alloys containing lithium, an additional 50 percent of lithium was added to account for loss of this element during arc melting by vaporization. Similarly, for alloys containing beryllium, about five percent more beryllium was added to compensate for beryllium loss during melting. All braze alloy buttons, on microscopic examination, were found to be homogeneous.

The following tabulation describes elemental melting materials employed to make up ingot melt charges.

<u>Element</u>	<u>Form</u>	<u>Purity (%)</u>	<u>Source</u>
Zirconium	Crystal Bar	99.95 (+)	Atomergic Chemetals Co.
Titanium	Crystal Bar Turnings	99.9 (+)	Chicago Development Corp.
Vanadium	Granules	99.7 (+)	Union Carbide Corp.
Columbium	Pellets	99.9 (+)	Atomergic Chemetals Co.
Beryllium	Ingot Sheet, Type IS-2	99.8 (+)	The Beryllium Corp.
Copper	OFHC wire	99.99 (+)	United Mineral and Chemical Corp.
Nickel	Zone-refined, wire	99.95 (+)	G. S. Parsons Co.
Lithium	Reactor Grade, Rod	99.8 (+)	Research Inorganic Chemical Co.
Gold Foil	Zone refined - 0.002 inch	99.99 (+)	Western Gold and Platinum Co.
Copper Foil	OFHC - 0.002 inch	99.99 (+)	Atomergic Chemetals Co.

2.1.2 Specimen Preparation and Testing

Initial screening tests of candidate braze alloys were conducted using the metallography T-joint shown in Figure 2. Each T-joint was comprised of a 0.5-inch square vertical member of 0.005-inch thick Cb-1Zr foil set perpendicularly to a horizontal base member of 0.025-inch Cb-1Zr sheet, which in effect simulates the internal fin/tube joint of interest. Both members were held in place with faying surfaces in contact by tack welded one-mil tantalum or columbium foil straps. Next a small particle of braze alloy was lightly tack welded to the horizontal member immediately adjacent to the joint interface. (Tacking under an argon blanket eliminated the need for organic binders, such as polybutene, which are sources of undesirable interstitial-element contaminants.) In the case of foil alloys, a small piece of foil was interposed between the faying surfaces along the entire bond line. Finally, each T-joint loaded with a specific candidate braze alloy was heated inductively to the minimum braze temperature in the vacuum brazing rig shown in Figure 3 (15 kw Lepel high-frequency induction furnace). A cylindrical tantalum susceptor around each specimen provided rapid and uniform specimen heating - an approximate average of 400 degrees F/minute (Fig. 4). Specimen temperature was measured with a Pyro micro-optical pyrometer, previously calibrated and corrected for emissivity variation against a Pt/Pt-13Rh thermocouple installed on a dummy specimen. A vacuum brazing environment of 1×10^{-5} Torr or better was maintained throughout each braze cycle,

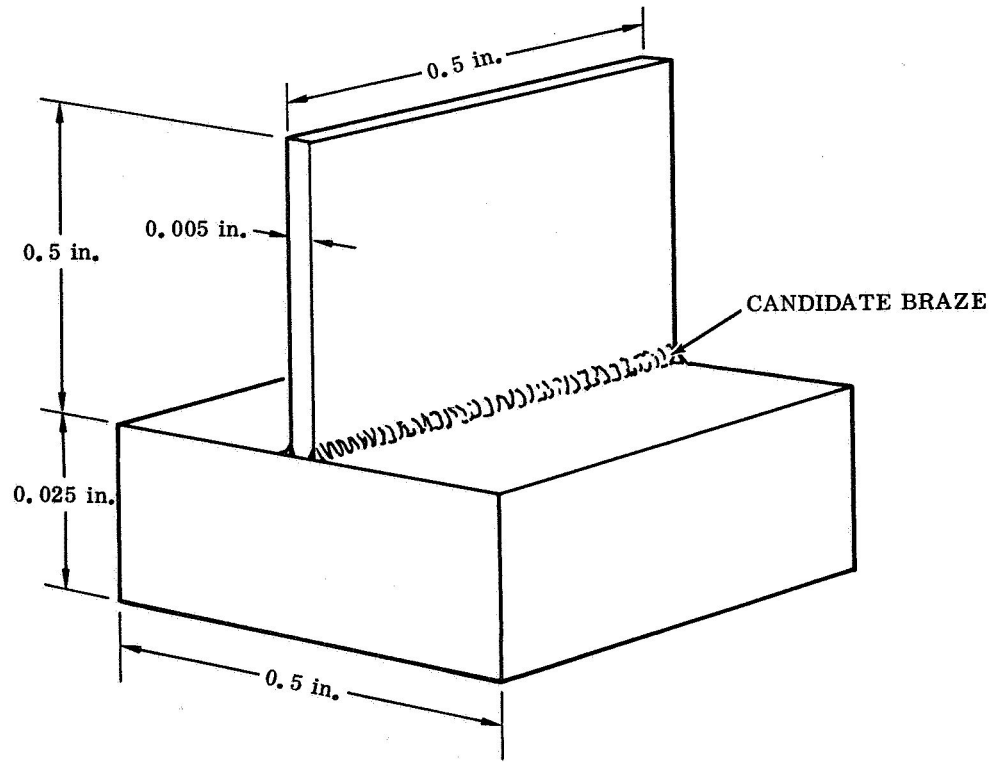

FIGURE 2. BRAZED Cb-1Zr T-JOINT SPECIMEN; Metallography and Bend Tests

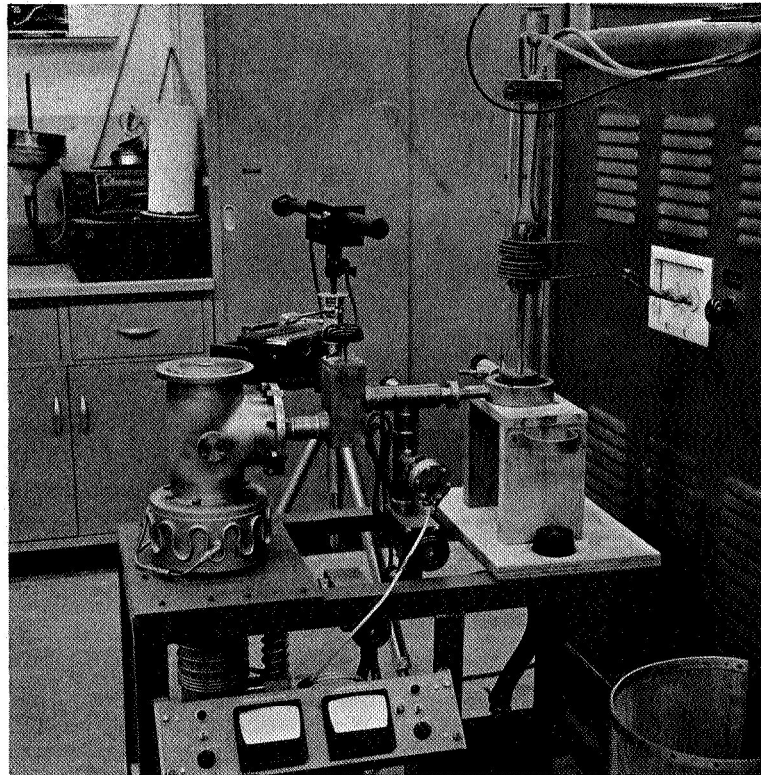

FIGURE 3. INDUCTION BRAZING FURNACE FOR BRAZING T-JOINTS

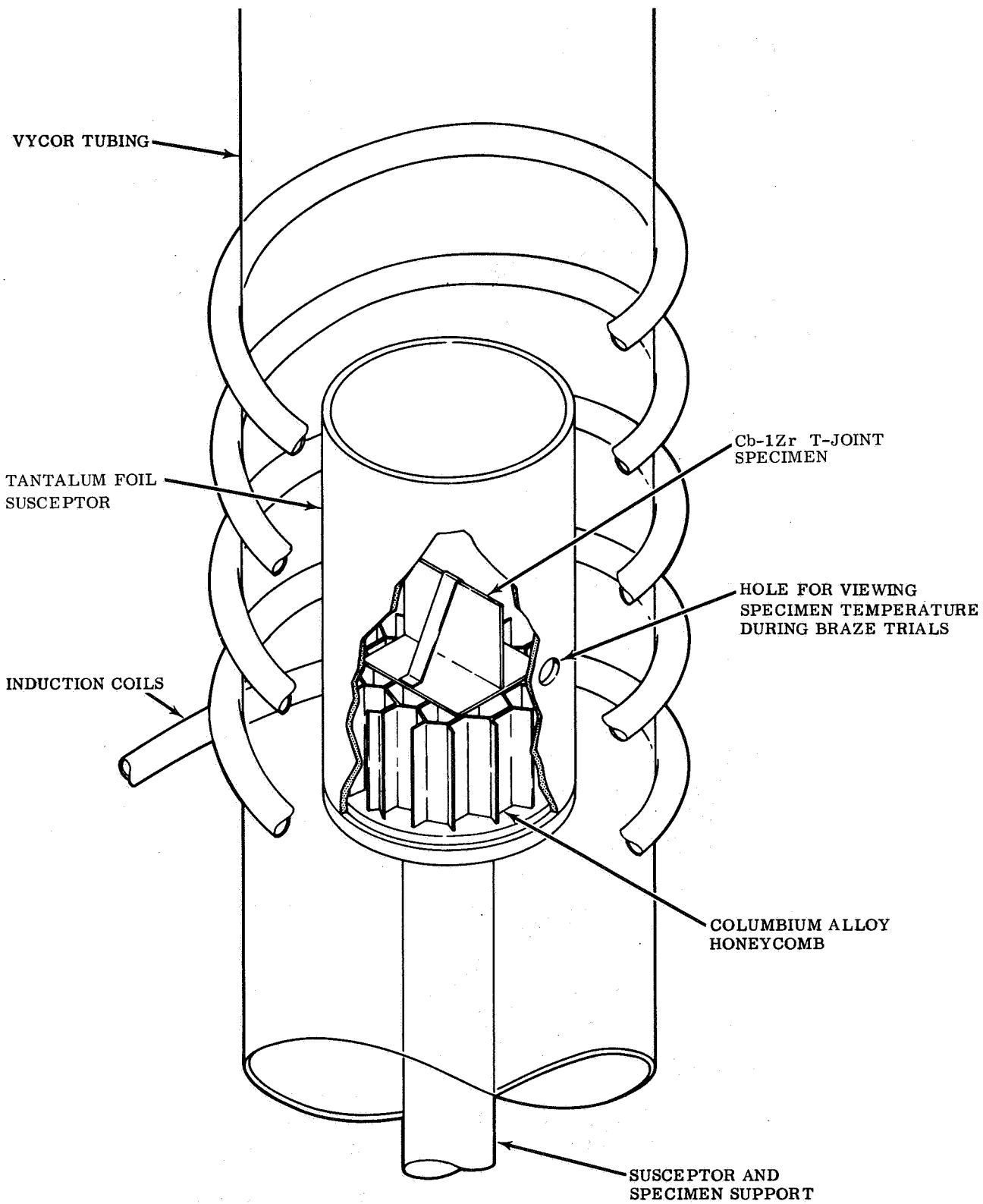

FIGURE 4. SCHEMATIC DIAGRAM OF THE LABORATORY BRAZING FURNACE

which included a typical three- to five-minute hold at the optimum braze temperature. In all cases, optimum braze temperature proved to be the minimum braze temperature. The transparent Vycor furnace tube around the specimen permitted direct observation of all brazing characteristics, including the apparent melt temperature, the minimum and optimum braze temperatures, wettability, the degree of braze fluidity, filleting behavior, residue formation, and erosion tendency. In addition to being easily adaptable to metallographic examination and microhardness study, the brazed T-joint specimen served to indicate relative bend toughness of candidate brazements. Manual bend tests were carried out by bending the vertical member from 0 through 90 degrees, and observing the angle at which braze cracking (detected either visually or audibly) occurs.

Shear strengths of candidate brazements were determined by testing the single-lap shear specimens shown in Figure 5. Each specimen was composed of two 0.025-inch thick by 0.5-inch wide by 1.5-inch long pieces of Cb-1Zr sheet, joined by a one thickness (0.025 inch) overlap along the superimposed length dimension. Retention of the overlap position prior to and during brazing was accomplished by light tack welding at either end of the joint (~one mil faying surface gap). Vacuum brazing was carried out as with the previously described T-joint specimens.

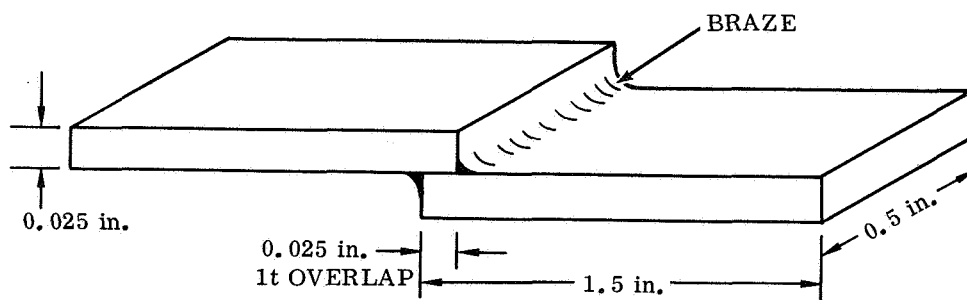

FIGURE 5. BRAZED SINGLE-LAP SHEAR SPECIMEN

Tensile-shear tests were conducted at room temperature with a Riehle Universal Tester, at a strain rate of approximately 0.005 inch/inch/minute (or a loading rate of approximately 75,000 psi/min). The shear specimen was designed so that nominal shear stress at the joint and nominal uniaxial tensile stress in the parent metal are equal at all applied loads. Tensile-shear tests at 1750°F were conducted in a Vycor vertical-tube furnace, by dead-weight loading specimens heated inductively in an argon atmosphere (Fig. 6). Lead shot was used to load the specimens progressively - approximately 5000 psi/minute. Specimens were held five minutes at the test temperature before loading to permit temperature equalization.

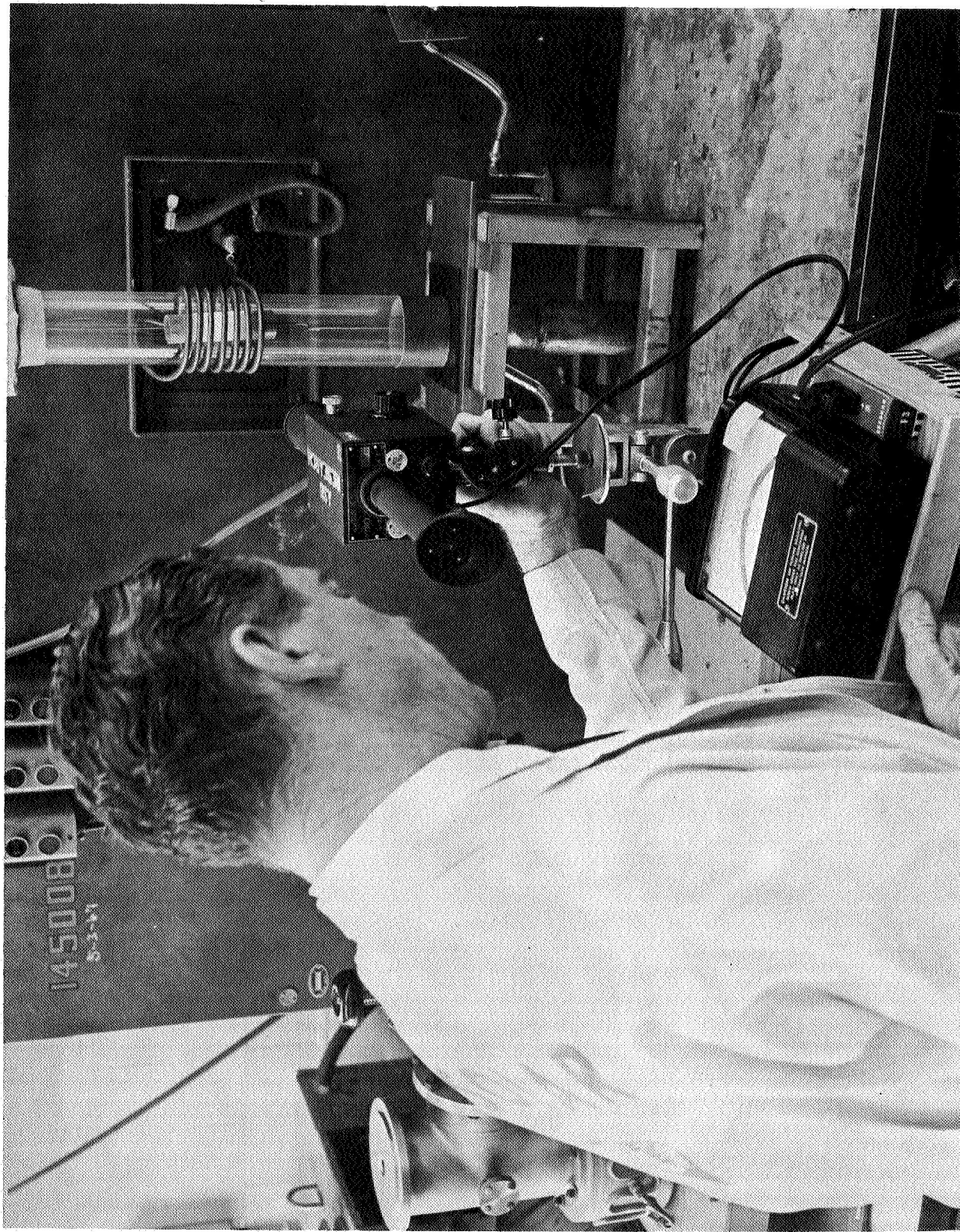

FIGURE 6. APPARATUS FOR BRAZE SEPARATION (REMELT) TEST AND 1750°F TENSILE TESTS OF SHEAR SPECIMENS

All Cb-1Zr foil stock (0.005 in.) and all Cb-1Zr tubing (1.25 in. OD by 0.025 in. wall thickness by 20 in. long) used in the program was provided by the sponsor. Solar purchased the 0.025-inch Cb-1Zr sheet stock used in Phase I work from Wah Chang Corp., Albany, Oregon. The following cleaning procedure was applied to Cb-1Zr specimen components prior to brazing.

- Light acid cleaning in a solution of 20% HNO_3 -5% HF -75% H_2O (vol.) at room temperature.
- Distilled H_2O rinse.
- Acetone rinse.

2.2 SELECTION OF BRAZE ALLOY COMPOSITIONS

It is fortunate that the 1650 to 1750°F service temperature range scheduled for heat receiver tube application lies well below the 2300 to 2350°F recrystallization temperature for Cb-1Zr alloy. The significant loss of ductility and toughness suffered by Cb-1Zr foil with the advance of recrystallization and grain growth $\geq 2300^\circ\text{F}$ is well known. Therefore, it is reasonable to take full advantage of this favorable thermal condition in braze process selection, and choose braze alloys which flow $\leq 2300^\circ\text{F}$ and have been recommended for joining columbium-base alloys. A search of the literature revealed four braze systems with good potential for brazing Cb-1Zr $\leq 2300^\circ\text{F}$.

During 1961-63, Fox, Gilliland, and Slaughter of Oak Ridge National Laboratory (Ref. 1) investigated various low-melting eutectic and hypoeutectic compositions of the ternary systems, Ti-Zr-Be and Zr-Cb-Be, for brazing columbium. The most promising braze characteristics and joint strengths were obtained with the following alloys: 48Ti-48Zr-4Be (flow point - 1920°F) and 75 Zr-19Cb-6Be (flow point - 1920°F). These highly reactive alloys were found to be self-fluxing in inert environments, and displayed very good wetting and flow on columbium alloys with minimal erosion. Thermal cycling tests of these brazements (between 700 and 1500°F) and 100-hour aging tests (1500°F) showed them to be very resistant to thermal shock cracking as well as structurally stable, in spite of high volume percentages of equilibrium beryllides (~30 to 40 percent). In later work, Welty, Smeltzer, et al, (Ref. 2) evaluated several variants of beryllium-containing alloys and concluded that the hypoeutectic composition, Zr-21Cb-4Be (flow point - 2200°F), was most suitable for brazing columbium alloys. A distinct advantage of the Zr- and Ti/Zr-base braze alloys is their close structural similarity to the Cb-1Zr alloy; which, in conjunction with the low solubilities and high thermal stabilities of the associated beryllide phases, promotes strong metallurgical bond formation with a minimum likelihood of interfacial films.

In 1962, W. R. Young of the General Electric Co. (Ref. 3) evaluated and recommended a low-melting Zr-V-Ti ternary alloy for brazing Cb-1Zr. The self-fluxing alloy, Zr-28V-16Ti, was found to flow very well at 2300°F with negligible erosion. The composition represents a logical modification of the Zr-30V binary eutectic (melting point $\approx 2250^\circ\text{F}$), which is not a useful engineering material because the volume proportion of equilibrium ZrV_2 intermetallic phase it contains exceeds 50 percent. Alloying with titanium suppresses the formation of ZrV_2 appreciably (to about 30 volume percent). Young reported excellent thermal stability of brazements, based upon aging studies (e. g., 65 hours at 1800°F).

The sponsor suggested exploratory evaluation of ductile Group I metals, such as copper and gold, which because of structural dissimilarity with columbium should be nearly mutually immiscible in the solid state (Ref. 4). Advantages of superior thermal stability of brazements might result from the low degrees of braze/Cb-1Zr interaction and interdiffusion characteristic of these systems. (Retention of the unique Cb-1Zr chemistry and identity at the Cb-1Zr tube/LiF interface is very important, hence the desire for minimal braze/Cb-1Zr interaction.) Minor alloying additions of nickel to improve braze strength and lithium to improve the self-fluxing capability were recommended.

The following candidate braze alloys were chosen for evaluation:

<u>Composition (wt %)</u>	<u>Anticipated Melting Temperature (°F)</u>
48Ti-48Zr-4Be	1920
75Zr-21Cb-4Be	2200
39Ti-39Zr-20Cb-2Be (low beryllide content; experimental)	2250 (?)
56Zr-28V-16Ti	2300
Pure Copper	1980
98Cu-2Ni-0.2Li	2000 to 2100
99.8 Cu-0.2Li	2000
Pure Gold	1950

2.3 BRAZE STRUCTURAL STUDIES

The primary objective of the braze structural studies was to quickly and thoroughly screen all candidate braze systems to determine which ones should be eliminated for lack of merit and which ones should be retained for further study and modification. Testing centered around the metallography T-joint (par. 2.1), principally to rate the braze alloys in terms of relative braze performance, bend toughness, and microstructure (Table I).

2.3.1 Copper-Base Alloys

In the initial copper series, only pure copper foil was found to yield marginally satisfactory brazing characteristics, although at a considerably higher minimum braze temperature than anticipated (viz., 2150°F). Cb-1Zr foil erosion was negligible with pure copper, and a ductile 90-degree bend was attained without cracking. By contrast, the two lithium-bearing copper alloys exhibited poor brazing characteristics up to the limiting braze temperature of 2300°F. The Cu-2Ni-0.2Li and Cu-0.2Li alloys proved incapable of wetting the Cb-1Zr surface more than superficially, and balled up when melting at 2130 and 2150°F, respectively. Presumably, the lithium addition increased the surface tension of the braze liquids. Large unmelted residues were also observed. An alternate explanation could be that the heavy evolution of lithium noted during vacuum brazing prevented wetting. The lithium-bearing alloys and pure copper were eliminated from the study at this point. Several new copper alloy modifications were selected for a second-generation screening study. They were Cu-2Ni, Cu-5Ni, Cu-5Mn, Cu-5Sn, Cu-1Zr, and Cu-2Zr. Main alloying objectives were to increase braze strength and fluidity (Ni), depress the flow temperature (Mn and Sn), and induce self-fluxing capability (Zr). Among the second generation alloys, only Cu-2Ni showed promise (Table II). The remainder exhibited sluggish flow, poor filleting behavior, and heavy unmelted residues up to the limiting braze temperature of 2300°F. The Cu-2Ni alloy did not flow well until the limiting braze temperature of 2300°F was reached, and moderate copper evaporation was noted. However, flow and filleting behaviors at 2300°F were very good, foil erosion minimal, and good bend toughness was indicated (Fig. 7). The Cu-2Ni alloy was designated for further study.

2.3.2 Gold Foil

Pure gold foil was found to have excellent braze characteristics upon Cb-1Zr T-joint specimens, in terms of wetting, flow, and fillet formation. Minimum flow temperature was determined to be 2100°F (Table II). Metallographic examination revealed that the braze liquid was not erosive to Cb-1Zr foil (Fig. 8). The 90-degree bend test result was ductile. Gold foil passed the screening tests and was selected for further study.

TABLE I
CHARACTERISTICS OF CANDIDATE BRAZE ALLOYS FOR JOINING Cb-1Zr FOIL

Braze Alloy		Hardness of Button (R_C) (Converted From R_{15N})	Probable Microconstituents	Microhardness (R_C) (Converted From KHN 50-gram Load)	Brazing Temperature (°F)	Braze Flow and Filletting	Unmelted Residue	Manual Bend (90-deg bend)
Composition (wt %)	Form							
Copper	Foil, 0.002 in. thick	----	Copper	----	2150	Fair	None	Ductile
Cu-2Ni-0.2Li ⁽¹⁾	Arc Melted	----	Copper Solid Solution	----	2300	Poor	Large	Ductile
Cu-0.2Li ⁽¹⁾	Arc Melted	----	Copper Solid Solution	----	2400	Poor	Large	----
Ti-48Zr-4Be	Levitation Melted	46 to 50	Eutectic Matrix (Beryllides, 65 R_C)	49 to 55 R_C (Eutectic Matrix)	1950	Excellent	None	Ductile
Ti-39Zr-20Cb- 2Be	Levitation Melted	34	Eutectic Matrix (Beryllides, 65 R_C)	28 to 36 R_C (Eutectic Matrix)	2200 to 2330	Good	Large	Ductile
75Zr-21Cb-4Be	Levitation Melted	47	Eutectic Matrix (Beryllides, 65 R_C)	41 to 42 R_C (Eutectic Matrix)	1900 to 1950	Excellent	None	Ductile
56Zr-28V-16Ti	Levitation Melted	----	Eutectic Matrix (ZrV ₂ , R_C 55)	35 R_C (Eutectic Matrix)	2200	Excellent	Negligible	Ductile

1. Vaporization of lithium was observed during brazing.

TABLE II
CHARACTERISTICS OF FIRST AND SECOND GENERATION CANDIDATE BRAZE ALLOYS FOR JOINING Cb-1Zr FOIL

Braze Alloy		Microhardness Braze Alloy Button (R _C) (Converted from KHN 50-gram load)	Probable Microconstituents	Braze Characteristics				Microhardness of Braze Joint (Converted from DPH 100-gram load)	T-joint Bend Test (As Brazed condition)	Joint Separation ⁽¹⁾ (Remelt) Temperature (°F)	Remarks
Composition (wt %)	Form			Melting Point (°F)	Flow Point (°F)	Flow and Fillet	Residue				
Copper	Foil 0.002-in. thick	----	Copper	2100	2150	Fair	Large	None	-----	-----	-----
Cu-2Ni-0.2Li	Arc Melted	----	Copper solid solution	2130	>2300	Poor	Large	None	-----	-----	Alloy balled up and did not flow. Vaporization of Li occurred during brazing.
Cu-0.2Li	Arc Melted	----	Copper solid solution	2150	>2400	Poor	Large	-----	-----	-----	Alloy balled up and did not flow. Vaporization of Li occurred during brazing.
Cu-2Ni	Arc Melted	----	Copper solid solution	2150	2300	Good	Slight	None	-----	-----	Selected for further study. Some vaporization of copper occurred during brazing.
Gold	Foil 0.002-in. thick	----	Gold	2050	2100	Excellent overall	None	None	-----	2200, 2240	Selected for further study
Ti-48Zr-4Be	Levitation Melted	49 to 55 (Eutectic Matrix)	Eutectic Matrix (Beryllides 65 R _C)	1880	1950	Excellent overall	None	Slight	-----	-----	-----
Ti-46.5Zr-4V-3Be	Levitation Melted	42 to 46 (Eutectic Matrix)	Eutectic Matrix (Beryllides 65 R _C)	1950	1950	Excellent overall	None	None	-----	1700, 1730	Selected for further study.
Ti-39Zr-20Cb-2Be	Levitation Melted	28 to 36 (Eutectic Matrix)	Eutectic Matrix (Beryllides 65 R _C)	2200	2330	Poor	Large	Negligible	-----	-----	-----
Ti-38.5Zr-20Cb-3Be	Levitation Melted	44 to 46 (Eutectic Matrix)	Eutectic Matrix (Beryllides 65 R _C)	1990	2080	Good flow, small fillets	Large	None	-----	-----	-----
Ti-45Zr-7Cb-3Be	Levitation Melted	48 to 51 (Eutectic Matrix)	Eutectic Matrix (Beryllides 65 R _C)	1950	1980	Excellent	Slight	None	-----	1900, 1915	Selected for further study.
Zr-21Cb-4Be	Levitation Melted	41 to 42 (Eutectic Matrix)	Eutectic Matrix (Beryllides 65 R _C)	1900	1950	Good flow, and fair fillets	None	None	-----	-----	-----
Zr-19Cb-6V-3Be	Levitation Melted	42 to 46 (Eutectic Matrix)	Eutectic Matrix (Beryllides 65 R _C)	1980	1980	Excellent overall	None	None	-----	1940, 1950	Selected for further study.
Zr-28V-16Ti	Levitation Melted	35 (Eutectic Matrix)	Eutectic Matrix (ZrV ₂ 55 to 60 R _C)	2200	2200	Good overall	None	None	-----	2350, 2360	Selected for further study
Zr-28V-16Ti-0.1Be	Levitation Melted	35 (Eutectic Matrix)	Eutectic Matrix (ZrV ₂ 55 to 60 R _C)	2130	2130	Excellent overall	None	None	-----	2150, 2210	Selected for further study
1. Lap shear specimen (0.15 inch by 0.25 inch overlap) of Cb-1Zr sheet (0.030 inch thick by 1.0 inch long) heated at the rate of 100 degrees F/minute under constant foil stress of 1.0 ksi.											

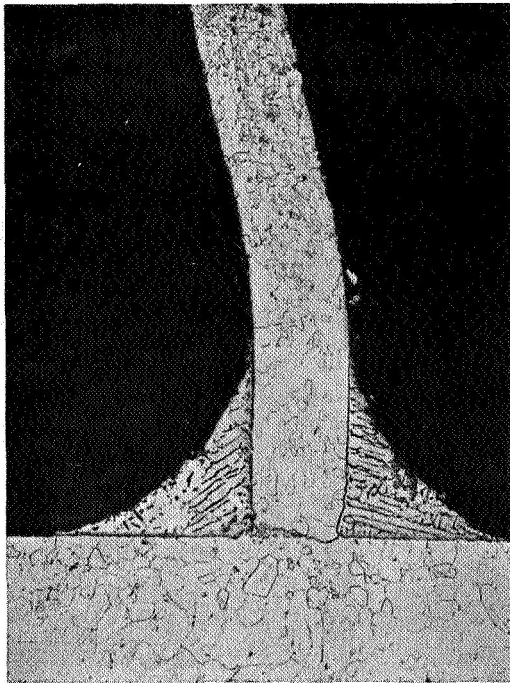

→ | | ← 0.005 in.
Etched
Magnification: 100X

FIGURE 7. Cb-1Zr T-JOINT BRAZED WITH Cu-2Ni; As-Brazed Condition

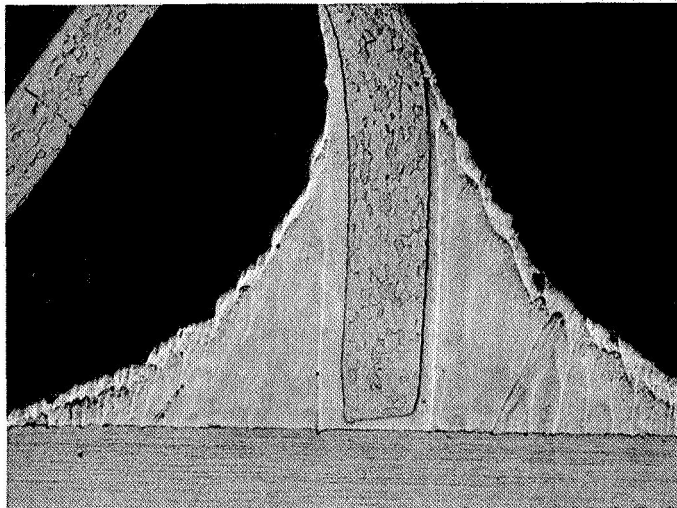

→ | | ← 0.005 in.
Post-Bend Test
Etched
Magnification: 75X

FIGURE 8. Cb-1Zr T-JOINT BRAZED WITH PURE GOLD FOIL;
As-Brazed Condition

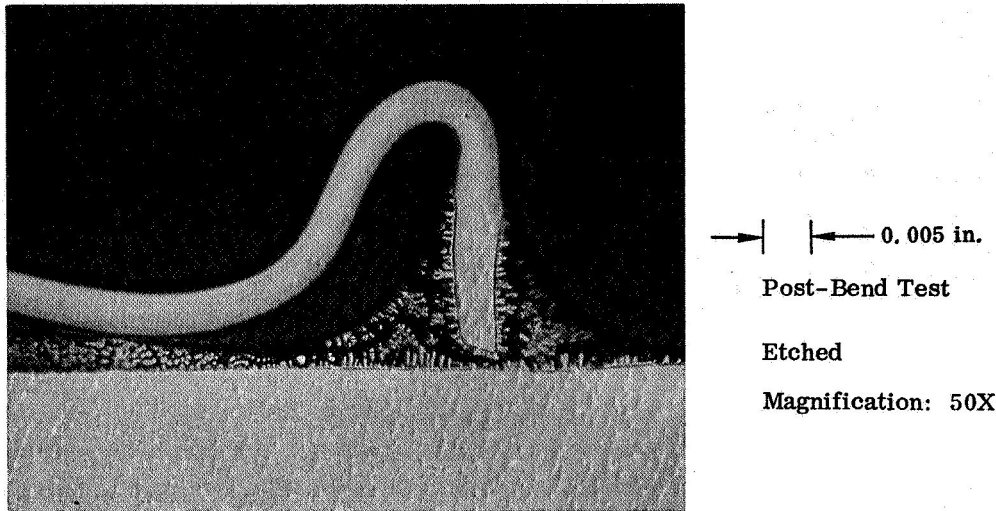
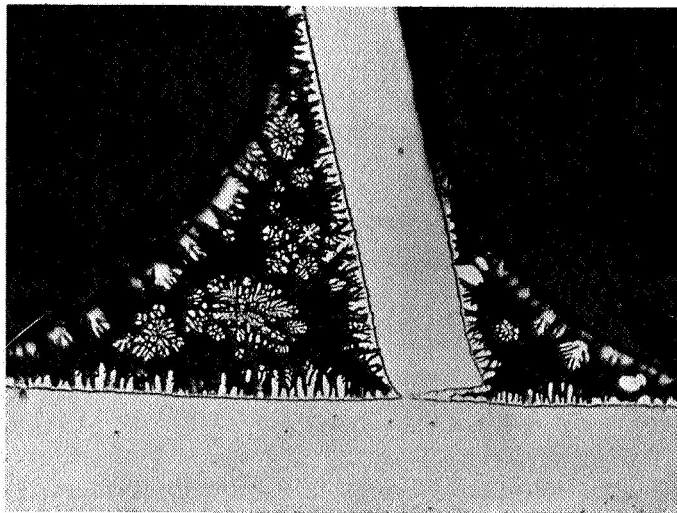

FIGURE 9. Cb-1Zr T-JOINT BRAZED WITH Ti-48Zr-4Be; As-Brazed Condition

2.3.3 Zr- and Ti/Zr-Base Alloys

In the initial series, the alloy, Ti-48Zr-4Be, was rated excellent in braze performance, with only slight foil erosion noted at the braze temperature of 1950°F (Table I and Fig. 9). The bend test indicated a ductile brazement. A second generation modification of this alloy with four percent vanadium addition and three percent beryllium also possessed excellent brazing characteristics at 1950°F, with no evidence of foil erosion (Table II, Fig. 10). This modified alloy with a lower beryllide content showed good bend toughness and was selected for further evaluation.

The initial series alloy, 39Ti-39Zr-20Cb-2Be, was designed to take advantage of melting point minima in both the Ti-Zr and Zr-Cb binary systems (Ref. 5) to reduce the beryllium level and hard beryllide content of the alloy. (Beryllium is the most potent melting point depressant in this series, but four percent beryllium alloys typically possess matrix hardnesses of 45 to 55 R_C, rendering them marginally ductile and difficult to form.) The subject two percent beryllium alloy (Table II) showed a major reduction in matrix hardness (28 to 36 R_C), which raised the possibility of its being formed into foil, wire, and similarly versatile and useful braze preforms. Unfortunately, the brazing characteristics of this alloy left much to be desired. Flow and filleting behaviors were poor, even at 2300°F, and a large unmelted residue indicated a large and intolerable spread between solidus and liquidus temperatures.



→ | ← 0.005 in.
Etched
Magnification: 100X

FIGURE 10. Cb-1Zr T-JOINT BRAZED WITH Ti-46.5Zr-4V-3Be;
As-Brazed Condition

Increasing the beryllium content to three percent (Table II) improved the braze performance only slightly, while matrix hardness jumped to 44 to 46 R_C . Experimental reduction of the columbium level to seven percent (retaining three percent beryllium) yielded a suitable compromise in the Ti-Zr-Cb-Be system (Table II). Matrix hardness remained high (48 to 51 R_C), but excellent braze characteristics (with no erosion) were obtained at 1980°F with good bend toughness (Fig. 11). The columbium content of this series was expected to enhance thermal stability by slowing down columbium diffusion from the Cb-1Zr foil into the braze during service (i. e., by reducing the initial columbium gradient at the joint interface). For this reason, the seven percent columbium alloy was chosen for further study.

Moving on to the zirconium base alloys, the initial series alloy, Zr-21Cb-4Be, was found to have reasonably good fluidity on Cb-1Zr surfaces, but only small and variable fillets were produced. No residue or erosion problems were encountered during brazing at 1950°F. A minor modification of this alloy containing 19 percent columbium with six percent vanadium substituted for one percent beryllium as the melting point depressant, showed much improved braze characteristics at 1980°F (Table II). This modified alloy also passed all screening tests and was selected for continued study (Fig. 12).

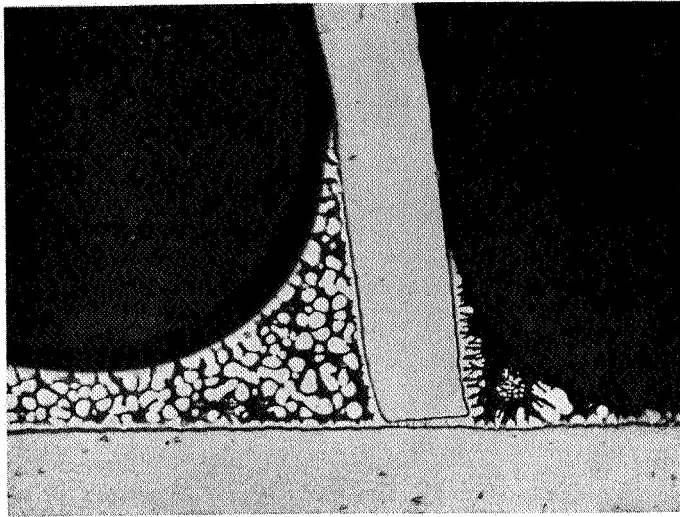

0.005 in.

Etched

Magnification: 100X

FIGURE 11. Cb-1Zr T-JOINT BRAZED WITH Ti-45Zr-7Cb-3Be;
As-Brazed Condition

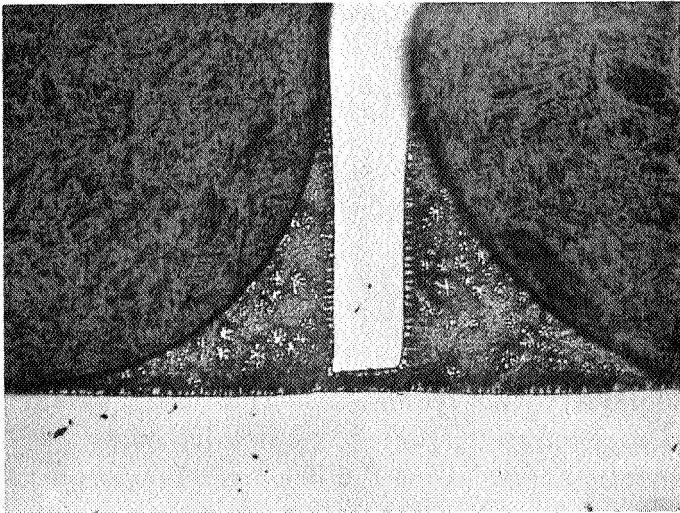

0.005 in.

Etched

Magnification: 100X

FIGURE 12. Cb-1Zr T-JOINT BRAZED WITH Zr-19Cb-6V-3Be;
As-Brazed Condition

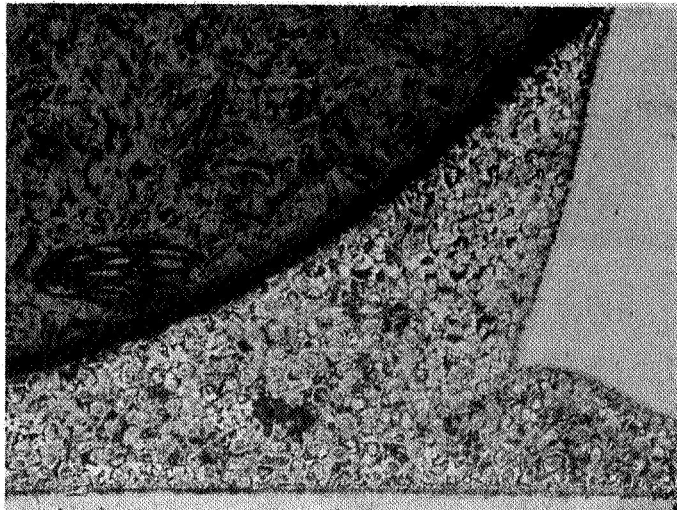

← 0.005 in. →

Fillet Area

Etched

Magnification: 250X

FIGURE 13. Cb-1Zr T-JOINT BRAZED WITH Zr-28V-16Ti; As-Brazed Condition

The beryllium-free alloy, Zr-28V-16Ti, exhibited good brazing performance at 2200°F. Some minor sluggishness of flow was the only problem noted; no erosion tendency was observed (Fig. 13) and good bend toughness was indicated. Also of importance, this alloy and its brazements possessed the lowest hardness ($\sim R_C 35$) among all of the Zr- and Ti/Zr-base candidate braze alloys screened (Table II). The moderate hardness level indicated a good potential for the alloy to be rolled into foil or wire forms.

To improve braze fluidity and internal scavenging, the Zr-V-Ti alloy was modified with minor additions of beryllium (viz., levels of 0.1, 0.5, and 1.0 percent beryllium). These modifications will be discussed in more detail in the next section.

It was found in screening tests that the 0.1 percent beryllium addition produced the best improvement in braze performance (Table II). This modification appeared extremely promising in all screening categories, especially in its 120°F lower braze temperature and significantly better braze fluidity and filleting characteristics with Cb-1Zr foils (Fig. 14). The Zr-28V-16Ti and Zr-28V-16Ti-0.1Be alloys (Table II), were selected for additional study.

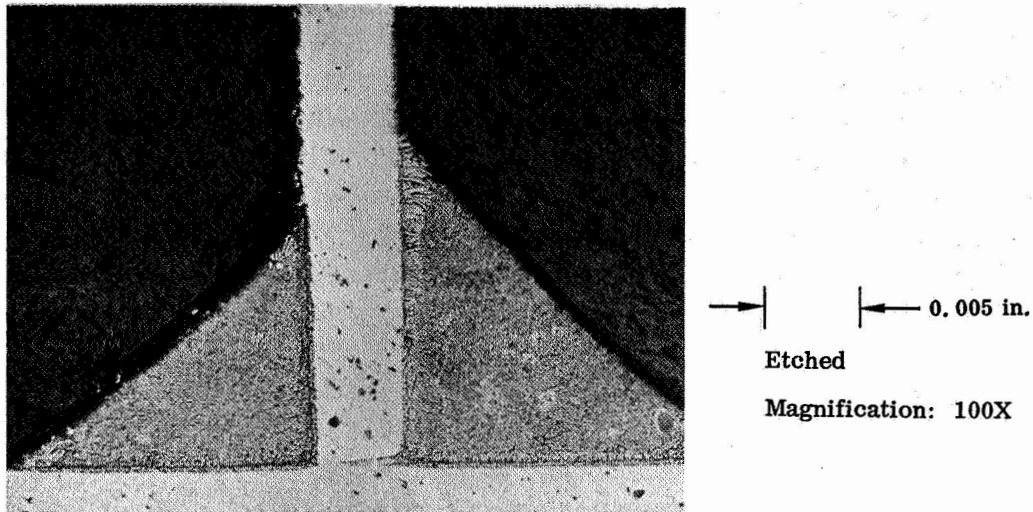

FIGURE 14. Cb-1Zr T-JOINT BRAZED WITH Zr-28V-16Ti-0.1Be;
As-Brazed Condition

2.4 BRAZE THERMAL STABILITY AND STRENGTH STUDIES

2.4.1 Short-Term Aging Runs

Prior to long-term thermal stability studies, a series of exploratory, short-term aging runs was conducted on brazements of the seven, first- and second-generation candidate alloys selected for further investigation (Table II). It was felt reasonable that suitable braze systems must show structural compatibility and thermal stability in the form of Cb-1Zr brazements up to temperatures at least 150 degrees F higher than the maximum anticipated service temperature of 1650°F (i. e., to 1800°F). Typical signs of thermal instability are significant alteration of braze structure (e. g., excessive interdiffusion or solid-state erosion (assimilation) of fin components by the braze), reduction of T-joint bend toughness, greatly increased hardness coupled with embrittlement, and lowering of the effective brazement remelt temperature $\leq 1800^\circ\text{F}$. Any one of these indications of instability would be intolerable. To evaluate thermal stability, metallography T-joint specimens and tensile-shear specimens were vacuum brazed using the seven candidate alloys; then they were subjected to the following short-term aging treatments in an NRC vacuum bell-jar furnace, Model 3114 (90Ta-10W cage-type resistors and heat shielding; 1.0×10^{-4} to 1.0×10^{-5} Torr vacuum environment provided by an oil-diffusion pump).

- One hour at 1800°F
- Sixty hours and 143 hours at 1750°F
- Twenty-seven hours at 1650°F

The only new test scheduled in this late screening phase was the brazement remelt or braze-joint separation test. Standard tensile-shear specimens were machined down from a 0.5 to a 0.25 inch width, then dead-weight loaded in the high-temperature tensile tester to impose 1000 psi shear stress on the lap-joint interface. Specimen temperature was increased (under load) from 1500°F at the constant rate of 100 degrees F/minute until joint separation occurred. The temperature of separation, or "separation temperature" was taken as the effective solidus or braze remelt temperature. Visual examination of the failed joint surfaces confirmed the validity of this assumption.

The results of the first short-term stability tests are listed in Table III. The gold braze joints exhibited very poor thermal stability at all three test temperatures. Rapid interdiffusion and interaction of braze and substrate were observed (Fig. 15), resulting in severe joint embrittlement, porosity, and increased joint hardness. Formation of a gold-columbium intermetallic phase was suspected, but published information on the Au-Cb binary system is too sketchy to confirm this suspicion. Gold was dismissed as a braze candidate at this point. The three beryllium-containing alloys - Ti-46.5Zr-4V-3Be, Ti-45Zr-7Cb-3Be, and Zr-19Cb-6V-3Be - also displayed poor thermal stability in terms of low braze remelt temperatures ($\ll 1800^\circ\text{F}$) following 1800°F aging (Table III). In addition, metallographic examination of the first two Ti/Zr-base alloys named showed extensive interdiffusion and strong foil assimilation tendencies almost as severe as with gold at 1750°F. For these reasons, all of the three percent beryllium alloys were screened out of the program.

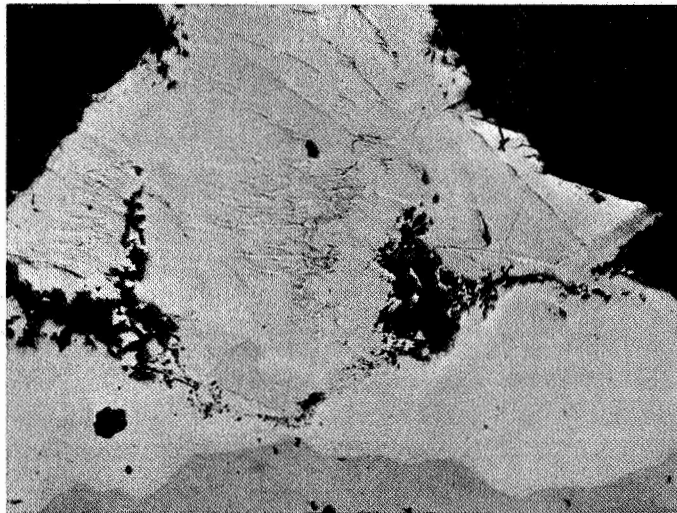

→ | ← 0.005 in.

Post-Braze Treatment

60 Hours

1750°F (Vacuum)

Note extensive interaction of
braze and substrate.

Unetched

Magnification: 100X

FIGURE 15. Cb-1Zr T-JOINT BRAZED WITH GOLD

TABLE III
RESULTS OF PRELIMINARY BRAZE THERMAL STABILITY STUDIES

Braze Alloy	Thermal Exposure in Vacuum (10-5 Torr)	T-Joint Bend Test (90 deg)	Percent Assimilation of Cb-1Zr Foil (0.005 in.)	Microhardness of Brazement (Converted from DPH 100-gram load)	Braze Separation (Remelt) Temperature (°F)
Cu-2Ni	As brazed 60 hours at 1750°F 1 hour at 1800°F	Ductile Ductile Ductile	None Negligible Negligible	51, 59 RB 37, 34 RB -----	1950, 2000 2050, 2100 2100, 2100, 2150
Gold	As brazed 1 hour at 1800°F 60 hours at 1750°F 27 hours at 1650°F	Ductile Braze failure Braze failure Braze failure	None 50 90 ---	20, 25 RB ----- 35, 39 RC -----	2200, 2240 2160, 2030 ---- ----
Ti-46.5Zr-4V-3Be	As brazed 1 hour at 1800°F 60 hours at 1750°F 27 hours at 1650°F	Ductile --- Ductile Ductile	None Negligible 75 25	44, 44 RC 35, 39 RC 39, 39 RC 35, 35 RC	1700, 1730 1630, 1520 ---- ----
Ti-45Zr-7Cb-3Be	As brazed 1 hour at 1800°F 60 hours at 1750°F 27 hours at 1650°F	Ductile --- Ductile Ductile	None 5 to 10 60 5 to 10	50, 52 RC --- 52, 51, 43 RC ---	1900, 1915 1730, 1670 ---- ----
Zr-19Cb-6V-3Be	As brazed 1 hour at 1800°F 60 hours at 1750°F 27 hours at 1650°F	Ductile --- Ductile Ductile	None None 10 ---	35, 35 RC 33, 34 RC 33, 34 RC ---	1940, 1950 1640, 1580 -----
Zr-28V-16Ti	As brazed 1 hour at 1800°F 60 hours at 1750°F 27 hours at 1650°F	Ductile --- Ductile Ductile	None None 5 to 10 5	33, 28 RC 34, 39 RC 38, 39 RC 31, 33 RC	2210, 2150 2210, 2140

At this juncture, an attempt was made to salvage the desirable Zr-19Cb base (Table III) by substituting vanadium for the more potent but troublesome melting-point depressant, beryllium. A series of four alloys of the base, Zr-19Cb-0.3Be, was made up with vanadium levels of 6, 10, 20, and 30 weight percent. Unfortunately, none of these alloys flowed $\leq 2350^{\circ}\text{F}$, and this endeavor was dropped.

The candidate braze compositions, Cu-2Ni and Zr-28V-16Ti, exhibited much better thermal stability than the other candidates just described. Braze separation temperatures were maintained $\geq 1950^{\circ}\text{F}$ for all three short-term aging treatments (Tables III and IV). Some braze hardening was noted for the zirconium-base alloy but bend toughness of all aged T-joints remained high. Very little alteration in brazement structures occurred during aging, especially for the immiscible Cu-2Ni brazements. Only 5 to 10 percent assimilation of Cb-1Zr foils was observed with the Zr-28V-16Ti alloy after 60 or 143 hours at 1750°F (Fig. 16 and 17). Evaporation of copper from the Cu-2Ni brazements, although noted during brazing, was not discerned at any of the short-term aging temperatures. Both of these promising braze alloys were selected for further study, including braze strength determination.

Because of the variable and frequently marginal fluidity of the Zr-28V-16Ti alloy, several efforts were made to improve its fluidity.

- It was reasoned that excessive amounts of the incongruent-melting compound, ZrV_2 , might form during simultaneous melt down of all three constituent elements because of imperfect mixing. Consequently, an improved melting procedure was developed whereby the titanium and vanadium were first melted down separately and then added gradually to the zirconium melt. This procedure markedly improved the braze fluidity. Moreover, the new melting practice elevated the separation temperatures from 2150°F (min) to 2550°F (min) for the as-brazed condition; and from 2140°F (min) to 2620°F (min) after aging one hour at 1800°F (Table IV).
- Intentional additions of 5 and 10 percent columbium were made also to this improved alloy base with the hope of producing further improvements in thermal stability. Unfortunately the alloys did not flow well $\leq 2300^{\circ}\text{F}$, Table IV.
- Optimum brazing characteristics were obtained by adding minor amounts of beryllium (0.1 to 1.0 percent) to the basic Zr-28V-16Ti alloy. Although the braze temperature was reduced, the higher beryllium levels of 0.5 and 1.0 percent were found inadvisable because the resultant beryllides promoted minor braze cracking during bend testing (Table IV). Minimum remelt temperatures below 1800°F were detected also at the one percent beryllium level (Table IV). Cyclic-annealing heat treatment, applied after brazing to break up and spheroidize the beryllide network, was not successful in imparting braze toughness (Table IV). Adding five percent columbium to the one percent beryllium alloy did not improve the minimum remelt temperature after short-term aging at 1800°F .

TABLE IV

PROPERTIES OF THERMALLY AGED BRAZE ALLOYS - PHASE I

Brazing Alloy	Normal Brazing Cycle (vac)	Prior Thermal History (high vac)	Erosion of Cb-1Zr Folios (0.005 in.)	Microhardness of Brazing Joint (Converted from DPH 100-gram load)	T-Joint Bend Test (90 deg)	Lap-Joint Test Data			Comments
						0.025 in. sheets 0.025 in. overlap		Separation ⁽²⁾ Remelt Temperature (°F)	
						Tensile Strength ⁽¹⁾ psi			
					Room Temperature	1750°F Argon			
Cu-2Ni	5 minutes at 2300°F	As brazed	Negligible	51 to 59 R _B	Ductile	38,600(3)	12,500(4)	1950	Good brazing characteristics. Heavy evolution of copper-vapor during brazing cycle.
						38,600(3)		2000	
						37,600(4)	11,350(4)		
Cu-5Ni	---	Brazed + 1800°F, 1 hour	Negligible	---	Ductile	---	15,350(4)	2100	Good structural stability indicated.
							14,700(4)	2100	
								2150	
Cu-1Zr Cu-2Zr	---	Brazed + 1750°F, 60 hours	Negligible	34 to 37 R _B	Ductile				Good structural stability indicated. No braze flow <2400°F. Unsuitable for Cb-1Zr.
Cu-5Mn Cu-5Sn	---	As brazed	Negligible	33 to 35 R _C	Ductile	30,000(4)		1940	Poor braze flow (2350 to 2400°F). Unsuitable for Cb-1Zr. No braze flow <2400°F. Neither alloy suitable for Cb-1Zr.
						38,700(4)		1950	
						33,700(4)			
Zr-19Cb-6V-3Be	5 minutes at 1980°F	As brazed	Negligible	28 to 33 R _C	Ductile	35,500(4)			Good brazing characteristics. High remelt temperature
						32,000(4)			
Zr-28V-16Ti (preliminary studies)	5 minutes at 2250°F	As brazed	Negligible	28 to 33 R _C	Ductile	37,300(3)		2150	Good structural stability. Good structural stability.
						37,000(4)		2210	
						38,400(4)			
Zr-28V-16Ti (improved melting procedure)	5 minutes at 2250°F	Brazed + 1800°F, 1 hour	Negligible	34 to 39 R _C	Ductile	---	16,900(3)(4)	2140	Good structural stability.
							17,700(3)(4)	2210	
Zr-28V-16Ti (improved melting procedure)	5 minutes at 2250°F	Brazed + 1750°F, 60 hours	~5 percent	38 to 39 R _C	Ductile	---	---	2175	Good structural stability.
Zr-28V-16Ti (improved melting procedure)	5 minutes at 2250°F	Brazed + 1650°F, 27 hours	~5 percent	31 to 33 R _C	Ductile	---	---	2160	Good structural stability.
Zr-28V-16Ti (improved melting procedure)	5 minutes at 2250°F	As brazed	Negligible	28 to 33 R _C	Ductile	37,900(3)	17,200(4)	2550	Improved brazing characteristics. Higher remelt temperature
						39,100(3)	18,000(3)(4)	>2550	
						38,000(3)			
Zr-28V-16Ti (improved melting procedure)	5 minutes at 2250°F	As brazed	Negligible	28 to 33 R _C	Ductile	39,200(3)			Improved brazing characteristics. Higher remelt temperature

TABLE IV (Cont)

PROPERTIES OF THERMALLY AGED BRAZE ALLOYS - PHASE I

Brazing Alloy	Normal Braze Cycle (vac)	Prior Thermal History (high vac)	Erosion of Cb-1Zr Folds (0.005 in.)	Microhardness of Braze Joint (Converted from DPH 100-gram load)	T-Joint Bend Test (90 deg)	Lap-Joint Test Data (0.025 in. sheets overlap)			Comments
						Tensile Strength ⁽¹⁾ psi		Separation ⁽²⁾ Remelt Temperature (°F)	
						Room Temperature	1750°F Argon		
Zr-28V-16Ti (improved melting procedure)		Brazed + 1800°F, 1 hour	Negligible	34 to 39 R _C	Ductile	38,400(3) 38,400(3)	16,900(3)(4) 17,700(3)(4)	2690 2620	Excellent retention of room temperature and 1750°F strength following extended 1800°F service simulation.
Zr-25.2V-14.4Ti-10Cb (improved melting procedure)		Brazed + cyclic anneal X (1450°F for 10 minutes + 1550°F for 10 minutes cycle repeated three times)	Negligible	---	Ductile	37,900(3) 37,700(3)	---	2550 2600	No significant change or improvement in braze properties through cyclic annealing.
Zr-28V-16Ti-10Cb (Zr-28V-16Ti-10Cb) (Zr-28V-16Ti-5Cb)									
Zr-28V-16Ti-1Be (improved melting procedure)	5 minutes at 2000°F	As brazed	---	---	Tendency for minor braze cracking	30,800(4) 32,900(4)	---	1740 1750	Marginal braze characteristics (2300 to 2400°F). No braze flow (<2400°F). Unsuitable for Cb-1Zr. Low remelt temperatures. Good braze characteristics.
		Brazed + 1800°F, 1 hour	---	---	Tendency for minor braze cracking	28,000(4) 28,400(4)	---	1825 1900	Remelt temperatures still low. Marginal braze toughness indicated.
		Brazed + cyclic anneal X	---	---	Tendency for minor braze cracking	30,200(4) 30,600(4)	---	1820 2020	No definite improvement in remelt temperature or braze toughness due to cyclic anneal.
Zr-28V-16Ti-5Cb-1Be (improved melting procedure)	5 minutes at 2030°F	As brazed	---	---	Tendency for minor braze cracking	34,400(4) 35,500(4)	---	1920 2000	Good braze characteristics. Marginal braze toughness.
		Brazed + 1800°F, 1 hour	---	---	Tendency for minor braze cracking	29,600(4) 29,000(4)	---	1900 1730	Poor thermal stability indicated by lowered strength and remelt temperature.

TABLE IV (Cont)

PROPERTIES OF THERMALLY AGED BRAZE ALLOYS - PHASE I

Braze Alloy	Normal Braze Cycle (vac)	Prior Thermal History (high vac)	Erosion of Cb-1Zr Foils (0.005 in.)	Microhardness of Braze Joint (Converted from DPH 100-gram load)	T-Joint Bend Test (90 deg)	Lap-Joint Test Data {0.025 in. sheets 0.025-in. overlap			Comments
						Tensile Strength(1) psi		Separation(2) Remelt Temperature (°F)	
						Room Temperature	1750°F Argon		
Zr-28V-16Ti-0.5Be (improved melting procedure)	5 minutes at 2130°F	Brazed + cyclic anneal X	---	---	Tendency for minor braze cracking	---	---	1770	No improvement in thermal stability or braze toughness due to cyclic anneal.
		As brazed	---	---	Tendency for minor braze cracking	---	---	1830	Excellent braze characteristics. Marginal braze toughness.
	Brazed + 1800°F, 1 hour	---	---	Tendency for minor braze cracking	---	---	---	2050	Thermal stability at 1800°F questionable.
	Brazed + cyclic anneal X	---	---	Tendency for minor braze cracking	---	---	---	2330	Definite improvement in strength retention and remelt temperature due to cyclic anneal. Braze toughness remains marginal.
Zr-28V-16Ti-0.1Be (improved melting procedure)	5 minutes at 2130°F	As brazed	Negligible	30 to 35 R _C	Ductile	---	---	12,500(4) 11,400(4)	Excellent braze characteristics. Promising in all respects.
		Brazed + 1800°F, 1 hour	Negligible	34 to 38 R _C	Ductile	---	---	11,500(4) 13,400(4)	Good thermal stability indicated.
	Brazed + cyclic anneal X	---	---	Tendency for minor braze cracking	---	---	---	2220	Definite improvement in strength retention and remelt temperature due to cyclic anneal. Braze toughness remains marginal.
	Brazed + cyclic anneal X	---	---	Tendency for minor braze cracking	---	---	---	2410	Definite improvement in strength retention and remelt temperature due to cyclic anneal. Braze toughness remains marginal.

1. Stress in sheet member at specimen failure (also shear stress on braze joint at specimen failure).
2. Specimen heated at rate of 100 degrees F/minute (argon) under constant shear stress of 1000 psi.
3. Parent metal failure.
4. Braze joint failure.

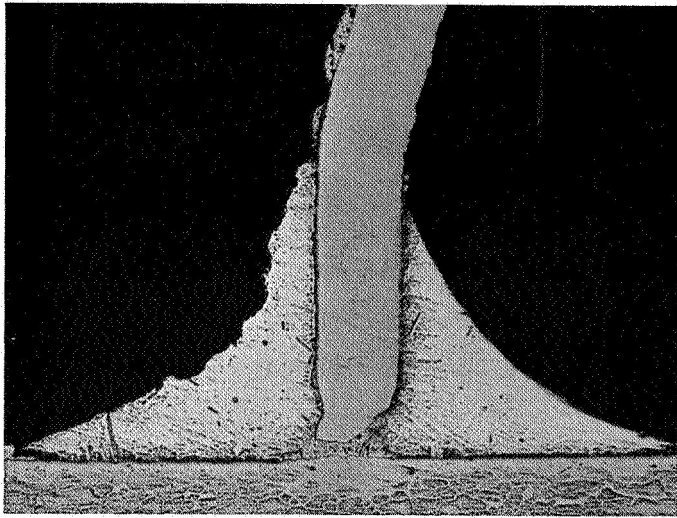

→ | ← 0.005 in.

Post-Braze Treatment
143 Hours
1750°F (2×10^{-4} Torr)
Etchant: 10 Lactic-5HNO₃-5HF
Magnification: 100X

FIGURE 16. Cb-1Zr T-JOINT VACUUM BRAZED WITH Cu-2Ni ALLOY

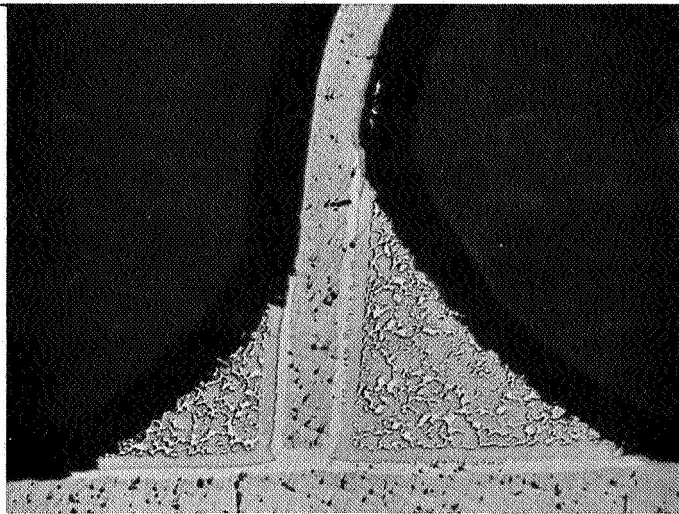

→ | ← 0.005 in.

Post-Braze Treatment
143 Hours
1750°F (2×10^{-4} Torr)
Etchant: Kroll's
Magnification: 75X

FIGURE 17. Cb-1Zr T-JOINT VACUUM BRAZED WITH Zr-28V-16Ti ALLOY

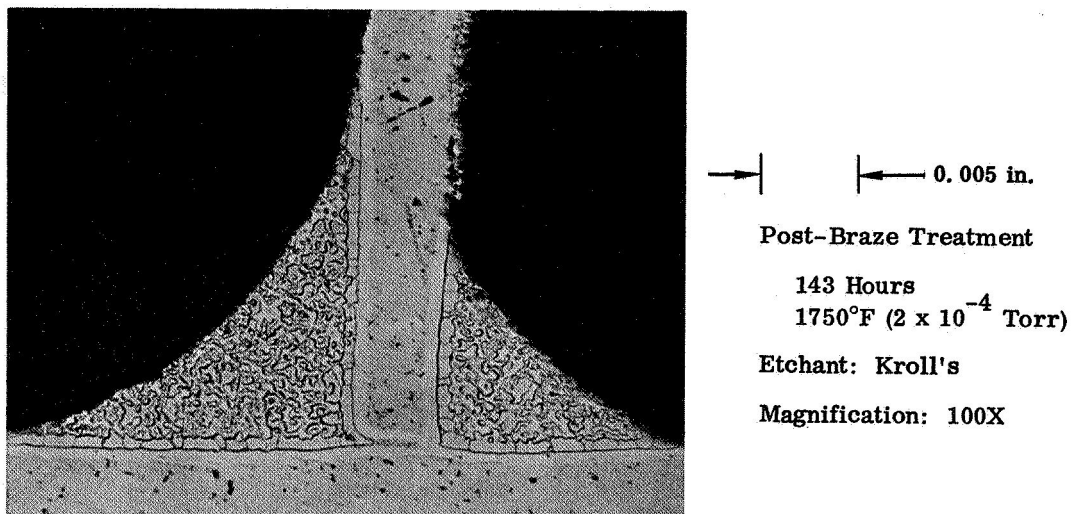

FIGURE 18. Cb-1Zr T-JOINT VACUUM BRAZED WITH Zr-28V-16Ti-0.1Be ALLOY

In view of the above, the best compromise was seen to be a 0.1 percent beryllium addition, which produced negligible beryllide, yet retained excellent braze characteristics at the reduced braze temperature of 2130°F. In addition, the 0.1 percent beryllium alloy possessed satisfactory ratings for the categories of thermal stability, high remelt temperatures, good bend toughness, and stable microstructure (Table IV and cf Fig. 14 and 18).

The final segment of the short-term aging test program was concerned with determining the effective strengths and microhardness patterns of three remaining candidate alloy brazements, as brazed and after 143 hours of vacuum aging at 1750°F.

- Cu-2Ni
- Zr-28V-16Ti (improved melting procedure)
- Zr-28V-16Ti-0.1Be (improved melting procedure)

Tensile-shear strength data are compiled in Tables IV and V. Room temperature shear strengths, surprisingly, are quite similar for all candidate alloys in the as-brazed condition (see Table IV):

<u>Braze Alloy</u>	<u>Range of Strengths (psi)</u>	<u>Average Strength (psi)</u>
Cu-2Ni	37,200 to 38,600	38,100
Zr-28V-16Ti	37,900 to 39,200	38,500
Zr-28V-16Ti-0.1Be	37,400 to 37,700	37,600

TABLE V
 PROPERTIES OF CANDIDATE BRAZEMENTS

Braze Alloy	Braze Cycle (vac)	Post-Braze Thermal History (vac)	T-Joint Bend Test (90 deg)	Lap-Joint Test Data { 0.025 in. sheets 0.025 in. overlap		
				Tensile Strength ⁽¹⁾ psi		Separation ⁽²⁾ Remelt Temperature (°F)
				Room Temperature	1750°F Argon	
Cu-2Ni	5 minutes at 2300°F	143 hours at 1750°F	Ductile	41,500 ⁽³⁾ 41,700 ⁽³⁾	12,800 ⁽⁴⁾ 19,000 ⁽⁴⁾	2010 1980
Zr-28V-16Ti	5 minutes at 2250°F	143 hours at 1750°F	Ductile	31,600 ⁽⁴⁾ 33,900 ⁽⁴⁾	14,600 ⁽⁴⁾ 18,000 ⁽⁴⁾	2390 >2500
Zr-28V-16Ti-0.1Be	5 minutes at 2130°F	143 hours at 1750°F	Ductile	31,800 ⁽⁴⁾ 32,600 ⁽⁴⁾	14,800 ⁽⁴⁾ 17,800 ⁽⁴⁾	>2500 >2500

1. Stress in sheet member at specimen failure (also shear stress in braze joint at specimen failure).
2. Specimen heated at rate of 100 degrees F/minute (argon) under constant shear stress of 1000 psi.
3. Parent metal failure.
4. Braze joint failure.

The preponderant mode of specimen failure was through the parent metal (Cb-1Zr) sheet, adjacent to the braze. (The failures in the Zr-28V-16Ti-0.1Be specimens showed considerably more braze involvement.) However, it is believed that structural instability associated with the braze joint configuration (viz., the high-peel moment) initiated failure at about the same nominal shear (and sheet tensile) stress in every test. The normal range of ultimate tensile strength is ~45,000 to 50,000 psi for annealed Cb-1Zr sheet. Strength levels of the candidate braze joints therefore were felt to be adequate for the subject application.

After aging at 1750°F, the Cu-2Ni brazements were strengthened slightly in room temperature tests (average strength; 41,600 psi) (Table V). Inasmuch as the failure mode remained through the parent metal, the strength change is not believed related to braze instability. However, significant increases in Cu-2Ni braze metal and braze/Cb-1Zr interface microhardness were effected by 1750°F aging (Table VI). No internal compound formation or interfacial films were observed; therefore, environmental contamination was more suspect. The post-aged strength of the zirconium-base alloys dropped somewhat in room-temperature tests (to 32,800 psi average for Zr-28V-16Ti and to 32,200 psi average for Zr-28V-16Ti-0.1Be). The failure mode changed to shear failure through the braze joint. Increases in microhardness, especially in the braze and at the braze/substrate interface, again suggested progressive contamination from environmental sources during aging (Table VI).

TABLE VI
MICROHARDNESSES OF CANDIDATE BRAZEMENTS
(Metallography Joints)

Braze Alloy	Condition	Hardness of Specific Regions (DPH 50-gram load)						
		Braze Metal		Braze/Substrate Interface		Cb-1Zr Substrate		
		DPH Number	Approximate Rockwell Number	DPH Number	Approximate Rockwell Number	DPH Number	Approximate Rockwell Number	Depth Below Initial Interface (mil)
Zr-28V-16Ti	As brazed	302 to 373	30 to 38 R _C	152	79 R _B	100 98 103 121	56 R _B 55 58 68	1 2 3 12 (⊕) ⁽¹⁾
	143 hours at 1750°F in vacuum	380 to 498	39 to 49 R _C	339	34 R _C	91 93 91 94 91	49 R _B 51 49 52 49	1 2 3 4 12 (⊕) ⁽¹⁾
Zr-28V-16Ti-0.1Be	As brazed	322 to 354	32 to 36 R _C	155	80 R _B	93 103 98 100	51 R _B 58 55 56	1 2 3 12 (⊕) ⁽¹⁾
	143 hours at 1750°F in vacuum	373 to 380	38 to 39 R _C	354 to 380	36 to 39 R _C	91 84 89 91 89 81	49 R _B 39 47 49 47 35	1 2 4 6 7 12 (⊕) ⁽¹⁾
Cu-2Ni	As brazed	100 to 103	56 to 58 R _B	128	70 R _B	128 125 125 103	70 R _B 69 69 58	1 2 3 12 (⊕) ⁽¹⁾
	143 hours at 1750°F in vacuum	115 to 121	65 to 68 R _B	155	80 R _B	138 121 125 98 97	74 R _B 68 69 55 54	1 2 3 4 12 (⊕) ⁽¹⁾

1. Centerline of base sheet

Tensile-shear strength data for candidate brazements tested at 1750°F are summarized below for the as-brazed condition:

Braze Alloy	Tensile Strength at 1750°F	
	Range (psi)	Average (psi)
Cu-2Ni	11,350 to 12,500	11,900
Zr-28V-16Ti	17,200 to 18,100	17,700
Zr-28V-16Ti-0.1Be	11,400 to 12,500	12,000

The strength superiority of the Zr-28V-16Ti alloy at 1750°F is evident. The predominant mode of failure for all specimens was through the braze joint. (Typical ultimate strength for annealed Cb-1Zr sheet at 1750°F is ~20,000 to 25,000 psi.) Inasmuch as the minimum brazement shear strengths are about one-half the normal Cb-1Zr tensile strength at 1750°F, all candidate braze alloys were felt to possess sufficient strength for the subject application.

Following aging at 1750° F for 143 hours, the Cu-2Ni and Zr-28V-16Ti-0.1Be alloy brazements showed appreciably increased average strength at 1750°F, although point scatter also widened. The Zr-28V-16Ti alloy brazements dropped slightly in average 1750° F strength.

<u>Braze Alloy</u>	<u>Tensile Strength at 1750° F After Aging 143 Hours</u>	
	<u>Range (psi)</u>	<u>Average (psi)</u>
Cu-2Ni	12, 800 to 19, 000	15, 900
Zr-28V-16Ti	14, 600 to 18, 000	16, 300
Zr-28V-16Ti-0.1Be	14, 800 to 17, 800	16, 300

The comments regarding 1750°F aging effects upon 1750°F strength apply equally well to the effects of 1800°F (one hour) aging (Table IV). Inasmuch as no significant alterations in braze or substrate structures were evidenced by 1750 or 1800°F aging (except for development of narrow interdiffusion zones), it was held that changes in brazement strength were primarily effected by interstitial element contamination derived from the aging furnace environment. Therefore, the decision on final braze alloy selection was deferred until the results of long-term aging studies conducted in the superior vacuum environments of $\leq 1.0 \times 10^{-8}$ Torr became available.

2.4.2 Long-Term Stability Runs

To evaluate the long-term thermal stability of candidate alloy brazements, metallography T-joints and tensile-shear specimens brazed of the three remaining braze alloy candidates⁽¹⁾ were isothermally aged at 1750°F for 1000 hours in a high-vacuum environment of 1.0×10^{-8} Torr or better. Cleaned specimens were loosely wrapped in one-mil pure columbium foil and positioned in the hot zone of the vacuum aging furnace shown in Figures 19 and 20. A Vac-Ion pump and vacuum furnace system was employed. The high-vacuum system consisted of a #250 L/S triode-ion pump, working in conjunction with a titanium sublimation pump and a foreline baffle. A water-cooled stainless steel bell jar was used to encompass the furnace chamber (Fig. 19).

1. Cu-2Ni, Zr-28V-16Ti and Zr-28V-16Ti-0.1Be

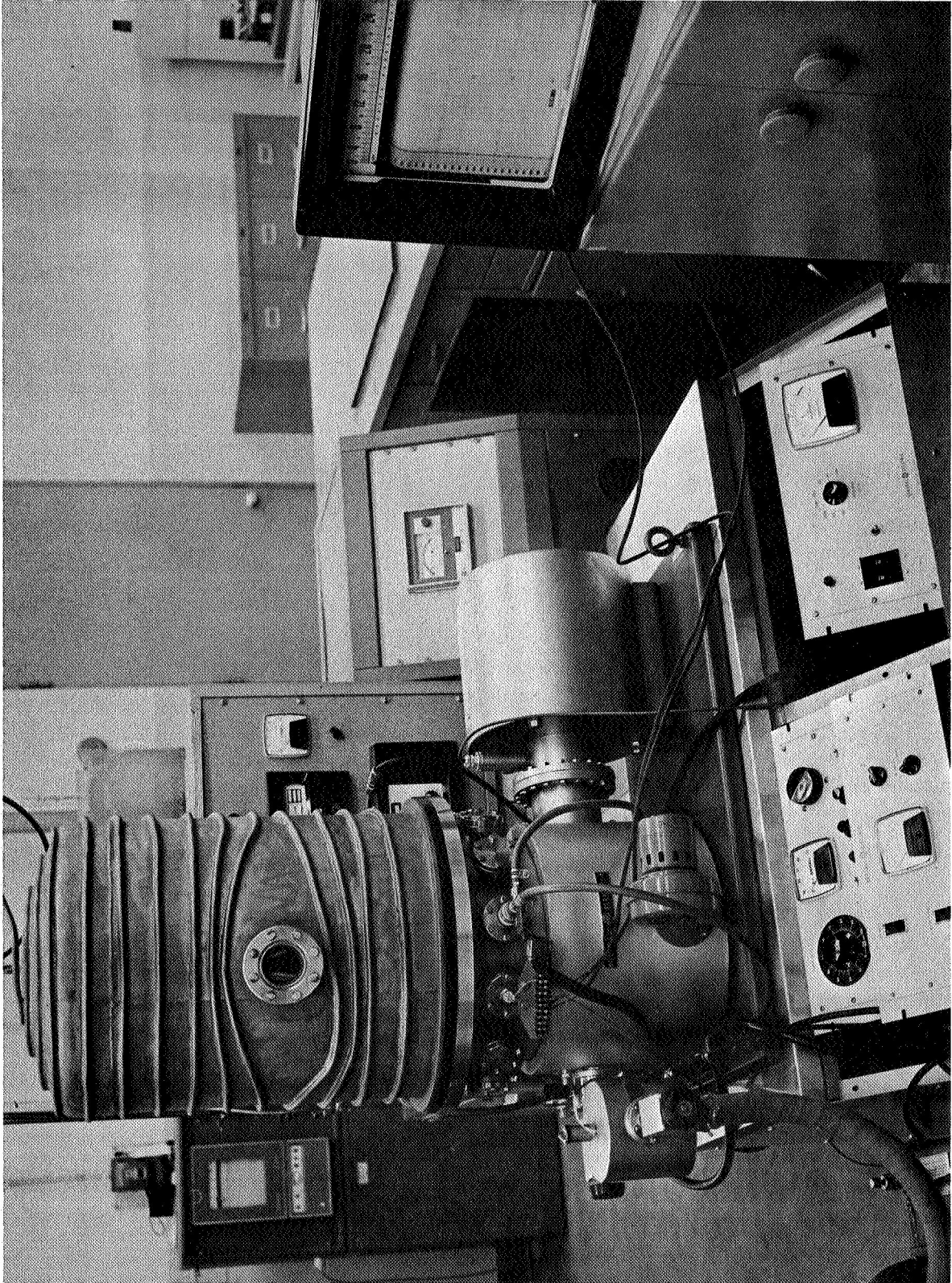

FIGURE 19. VACUUM AGING FURNACE; Triode-Ion Pump - 250 L/S

Instrumentation ports on the bell jar were fitted with metal/metal seals, while the principal seal between the bell jar and the vacuum-pump platform was maintained with a Viton-A elastomer gasket. Specimens were heated inside a cage-type resistance furnace (six-inch cube) made of 90Ta-10W strip resistors connected in parallel, with pure columbium-foil heat shielding all around (Fig. 20). Hollow copper electrodes were water cooled. Power was provided by a 2.5 kw silicon controlled rectifier. Specimen temperature was measured and controlled using two Pt/Pt-13Rh thermocouples attached to the braze specimen wrappers and to a digiset controller and multipoint recorder. Temperature was maintained at $1750^{\circ}\text{F} \pm 2$ degrees F. Chamber pressure was measured throughout the 1000-hour aging run at 1.0×10^{-8} Torr or better (typically 2.0 to 5.0×10^{-10} Torr).

The subject 1000-hour aging run was interrupted at the 650-hour point to add small sections of brazed heat receiver tubes (par. 2.5). At this time, it was observed that considerable copper vapor had condensed upon cool metallic surfaces within the bell jar and furnace chamber from evaporation of the Cu-2Ni brazements at 1750°F . (The equilibrium vapor pressure of pure copper at 1750°F is $\sim 1.0 \times 10^{-6}$ Torr. This may explain why no copper evaporation was noted in the short-term aging studies at chamber pressures of 1.0×10^{-4} to 10^{-5} Torr.) The specimen capsules were not broken open to examine the brazements at the 650-hour point. However, subsequent metallographic and visual examination of the candidate alloy brazements (T-joint and single-lap joint) following the full 1000-hour age revealed much information relevant to the candidates' structural and thermal stabilities. The Cu-2Ni brazements proved least stable by far, due to extensive evaporation of copper during high-vacuum aging. In almost every instance, all exposed fillet regions on both T-joints and lap joints were completely eradicated by evaporation (Fig. 21). This phenomenon effectively destroyed all the T-joint bonds, leaving only a superficial adhesion. Bend tests resulted in very premature failures (Table VII). Evaporation caused undercutting of the lap-joint regions, decreasing the joint area of the laps by about one-third (Fig. 21). It is believed that the very low chamber pressure was primarily responsible for the accelerated evaporation rate of copper, inasmuch as no evaporation was noted in a previous 143-hour run (1750°F) at 1.0×10^{-4} Torr. In contrast, the original braze dimensions of the two zirconium-base brazements were not significantly altered by aging (viz., Zr-28V-16Ti and Zr-28V-16Ti-0.1Be) as shown in Figures 22 and 23. Only about 0.002 inch of the original 0.025 inch thickness of all Cb-1Zr sheet components were visibly altered by Cb-1Zr/braze interdiffusion. There was no void formation along any of the bond lines. Bend toughness remained good after aging (Table VII). The major structural change attributable to aging occurred within the two eutectic braze structures, wherein the finely divided "rosette" mix of eutectic phases, characteristic of the rapidly cooled as-brazed condition, was transformed into a more spheroidized structure of much coarser particles (cf Fig. 22 and 23). Both eutectic braze structures are comprised of about 60 percent by volume zirconium-rich terminal solid solution and 40 percent by volume of the intermetallic ZrV_2 , or a related (Zr, Ti, Cb) V_2 variant, as indicated by microprobe analyses (to be discussed later). Fortunately, no interfacial films between braze and substrate were observed in any candidate brazement post aging.

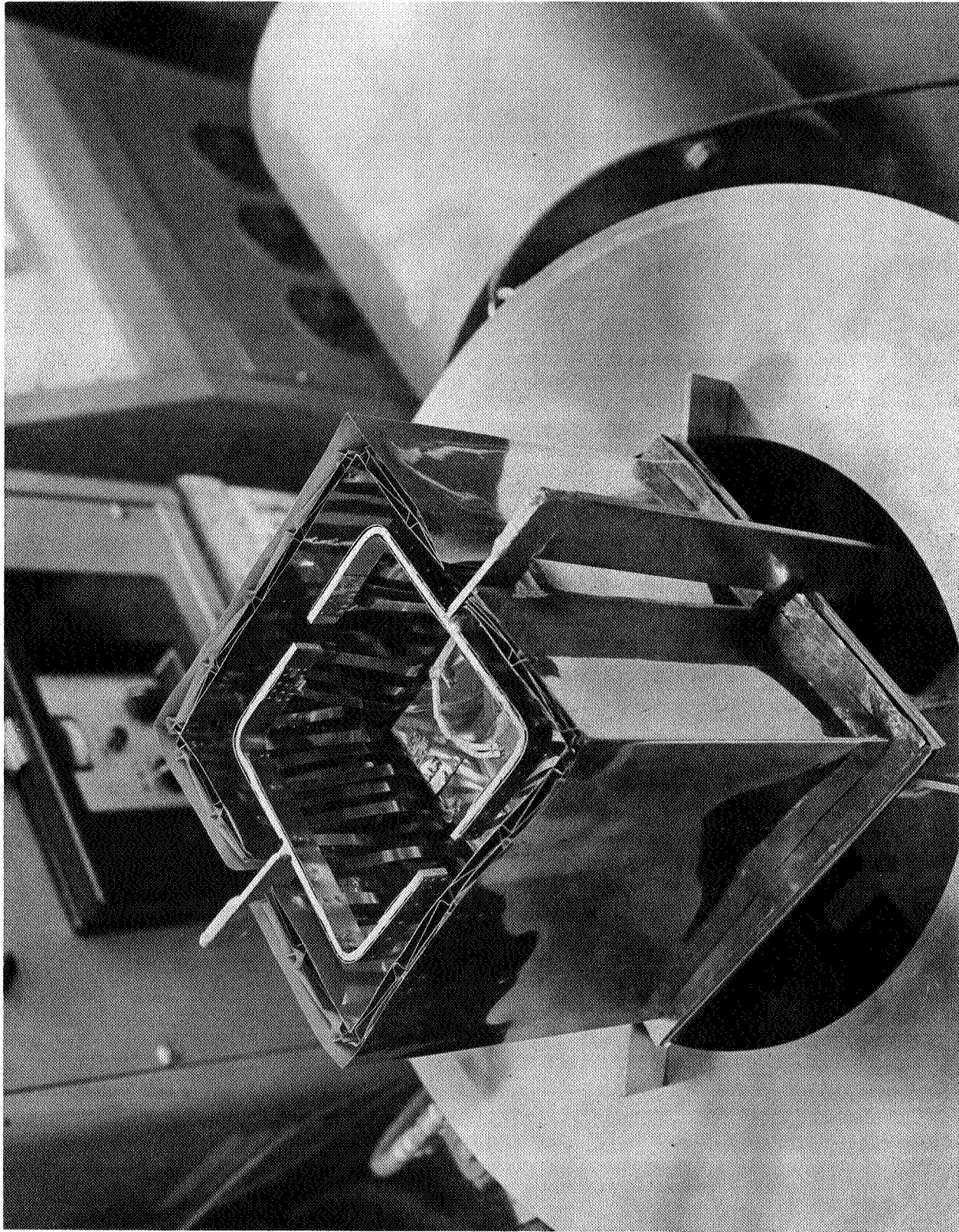
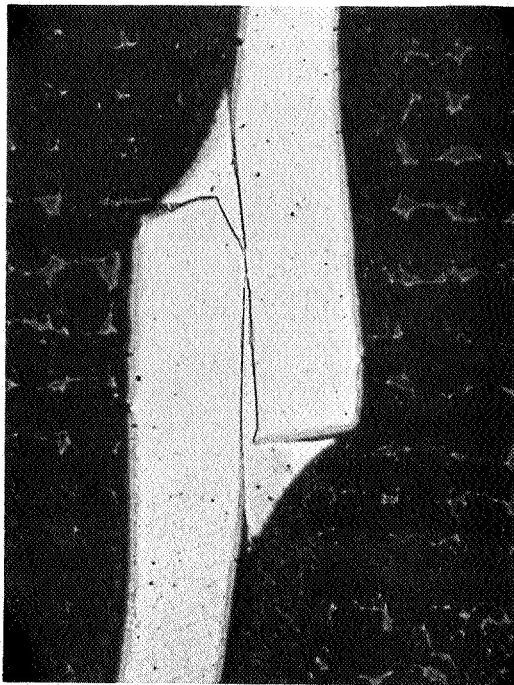
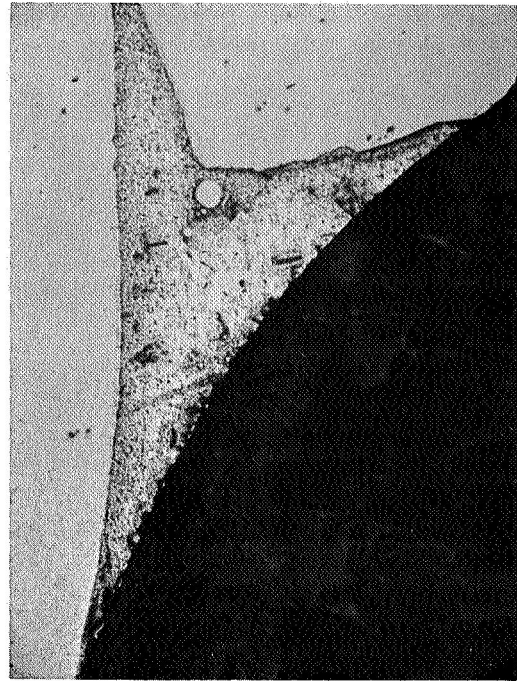

FIGURE 20. VACUUM AGING FURNACE HOT ZONE; Internal View Showing Specimen Pack



Magnification: 25X

As Brazed
5 Minutes
2300°F



Magnification: 100X

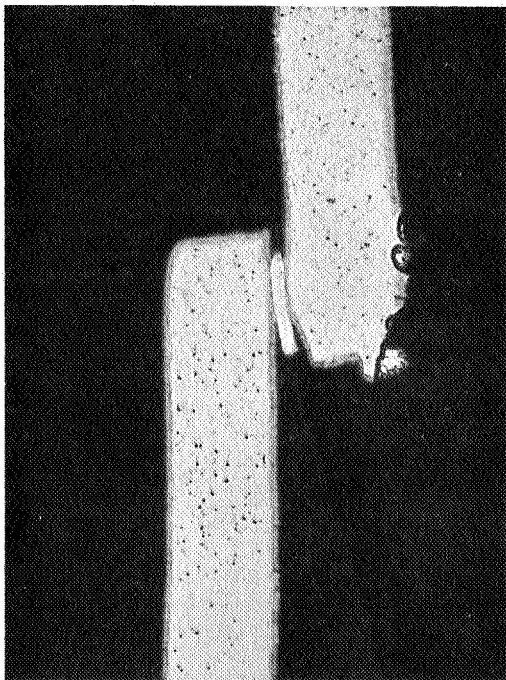

Magnification: 25X

Vacuum Aged
1000 Hours
1750°F

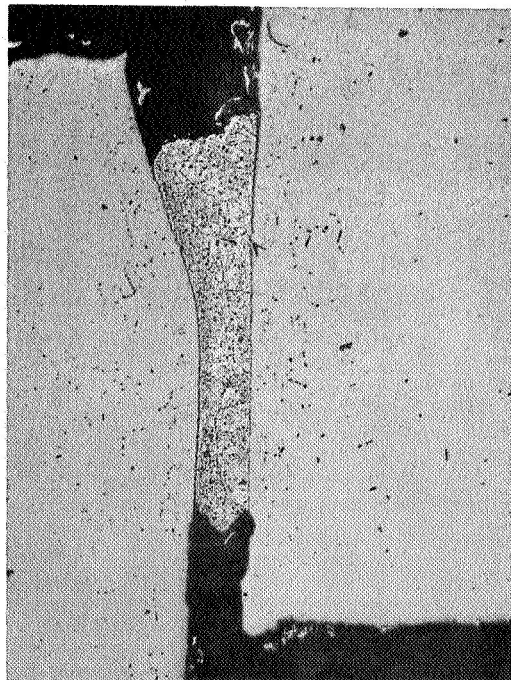

Magnification: 100X

FIGURE 21. LAP-JOINT BRAZEMENTS OF Cu-2Ni BRAZE ALLOY

TABLE VII

**COMPARISON OF PROPERTIES FOR CANDIDATE ALLOY BRAZEMENTS
(As Brazed vs 1750°F Aged Conditions)**

Brazing Alloy	Normal Braze Cycle (vac)	Prior Thermal History (high vac)	Erosion of Cb-1Zr Foils (0.005 in.)	T-Joint Bend Test (90 deg)	Lap-Joint Test Data (0.025 in. sheets overlap)			Comments	
					Tensile Strength ⁽¹⁾ psi		Separation ⁽²⁾ Remelt Temperature (°F)		
					Room Temperature	1750°F Argon			
Zr-28V-16Ti-0.1Be	5 minutes at 2130°F	As brazed	Negligible	Ductile	37,700 ⁽³⁾ (4)	12,500 ⁽⁴⁾	2120	Excellent braze characteristics. Promising in all respects	
					37,400 ⁽³⁾ (4)	11,400 ⁽⁴⁾	2160		
					26,700 ⁽⁴⁾	9,600 ⁽⁴⁾	>2450		Good thermal stability.
					24,000 ⁽⁴⁾	12,900 ⁽⁴⁾	2300		
Cu-2Ni	5 minutes at 2300°F	As brazed	Variable (light to heavy)	Ductile	29,600 ⁽⁴⁾	11,100 ⁽⁴⁾	2350	Good brazing characteristics. Heavy evolution of copper vapor during braze cycle	
					38,600 ⁽³⁾	12,500 ⁽⁴⁾	1950		
					38,600 ⁽³⁾	11,350 ⁽⁴⁾	2000		
					37,600 ⁽⁴⁾				
Zr-28V-16Ti	5 minutes at 2250°F	As brazed	Negligible	Poor (joints failed at 5 to 10 deg bend)	37,500 ⁽⁴⁾	16,400 ⁽⁴⁾	2060	Progressive evaporation of copper virtually destroyed all T-joint bonds and 1/3 of lap joint areas. Poor thermal stability indicated.	
					37,900 ⁽⁴⁾	5,200 ⁽⁴⁾	2140		
					37,900 ⁽³⁾ (4)	8,400 ⁽⁴⁾			
					37,900 ⁽³⁾	17,200 ⁽⁴⁾	2550		
Zr-28V-16Ti	5 minutes at 2250°F	As brazed	Negligible	Ductile	39,100 ⁽³⁾	18,100 ⁽³⁾ (4)	>2550	Good brazing characteristics. Requires 120 degrees F higher braze temperature (than version with Be) to obtain good braze wetting and fluidity.	
					38,000 ⁽³⁾				
					39,200 ⁽³⁾				
					29,000 ⁽⁴⁾	9,300 ⁽⁴⁾	>2450		
Zr-28V-16Ti	5 minutes at 2250°F	As brazed	Negligible	Ductile	25,500 ⁽⁴⁾	9,500 ⁽⁴⁾	>2450	Good thermal stability indicated.	
					32,600 ⁽⁴⁾	14,300 ⁽⁴⁾			

1. Stress in sheet member at specimen failure (also shear stress on braze joint at specimen failure).
2. Specimen heated at rate of 100 degrees F/minute (argon) under constant shear stress of 1000 psi.
3. Parent metal failure.
4. Braze joint failure.

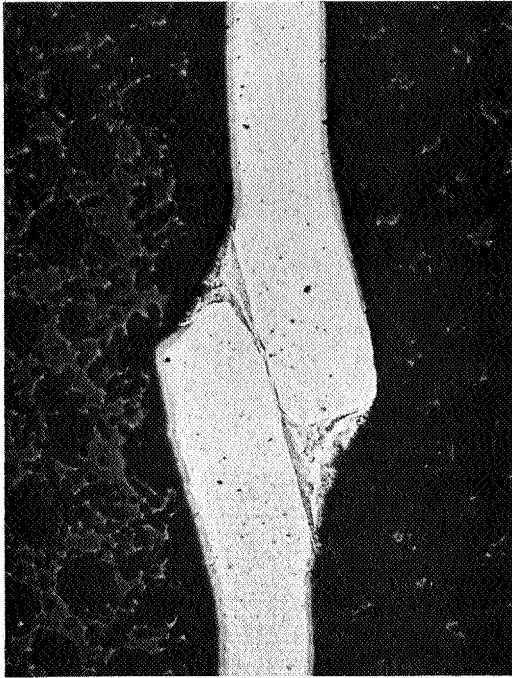

As Brazed
5 Minutes
2250°F

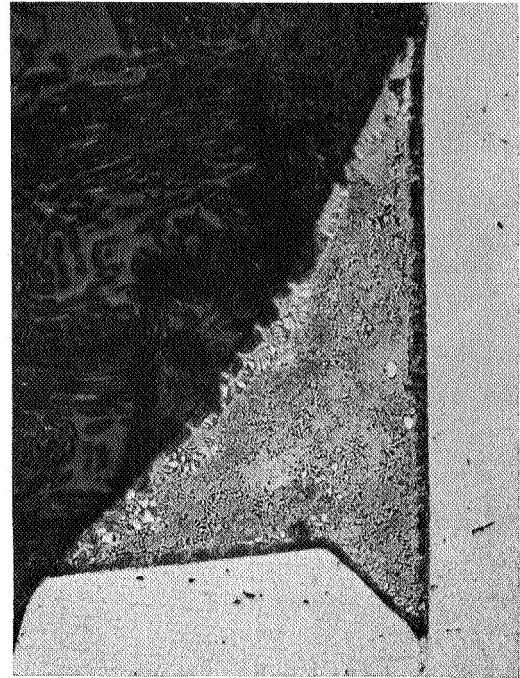

Magnification: 100X

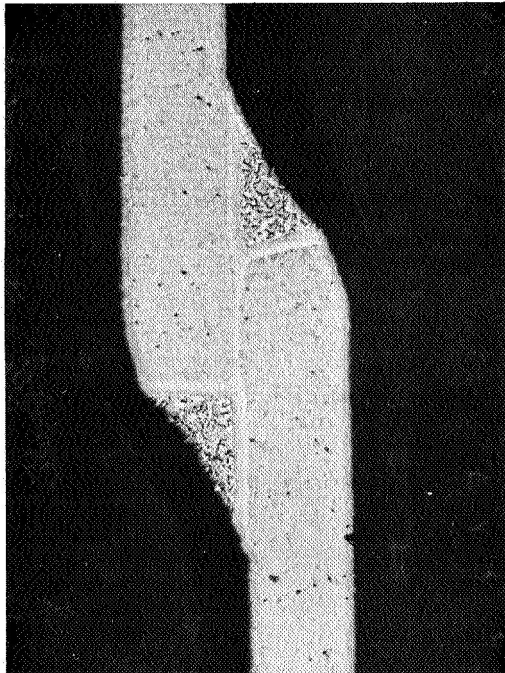

Vacuum Aged
1000 Hours
1750°F

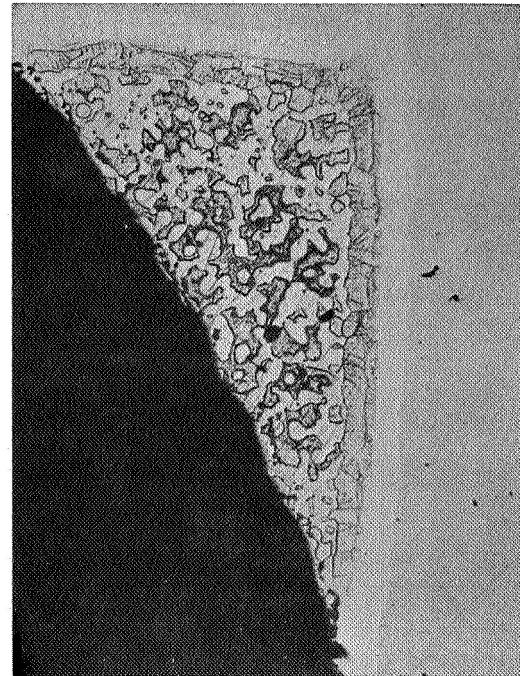

Magnification: 100X

FIGURE 22. LAP-JOINT BRAZEMENTS OF Zr-28V-16Ti BRAZE ALLOY



Magnification: 25X

As Brazed
5 Minutes
2130°F

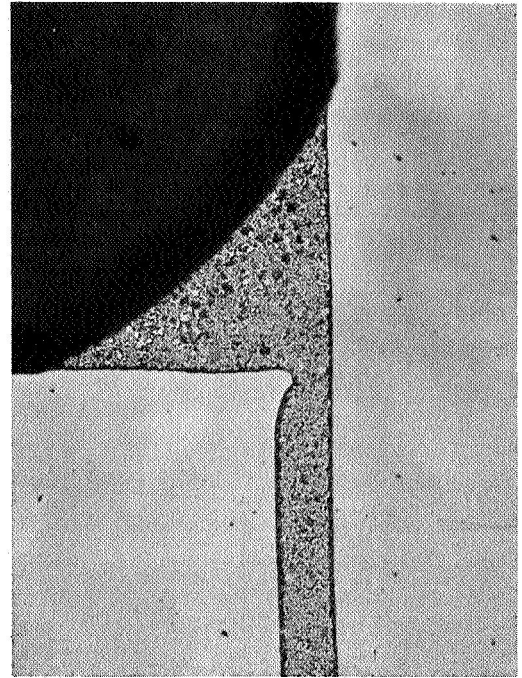

Magnification: 100X

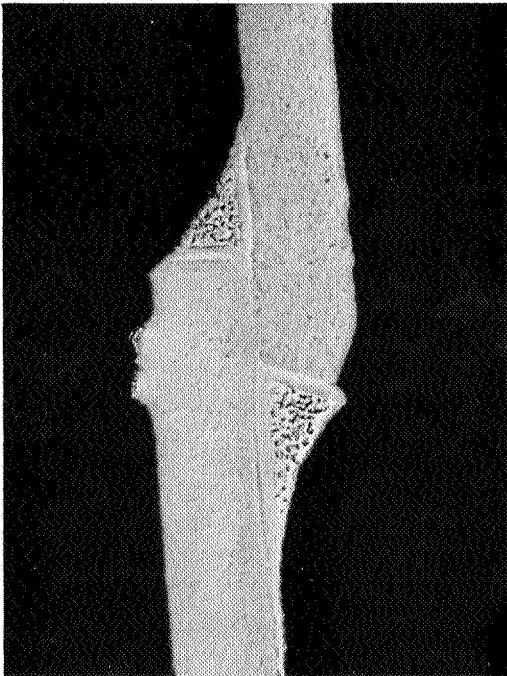

Magnification: 25X

Vacuum Aged
1000 Hours
1750°F

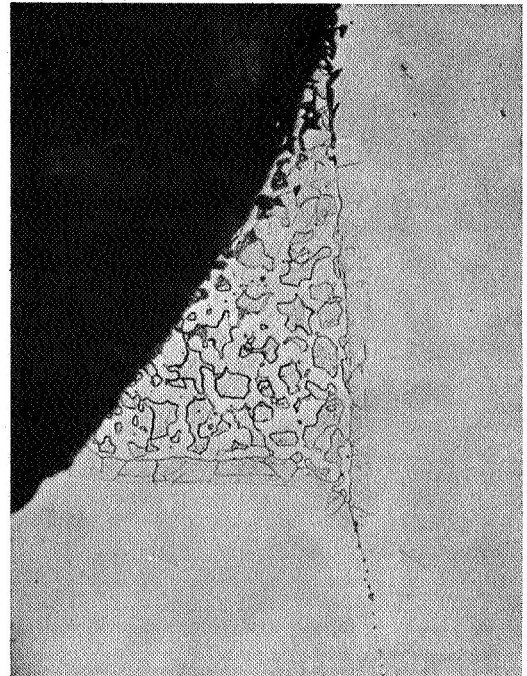

Magnification: 100X

FIGURE 23. LAP-JOINT BRAZEMENTS OF Zr-28V-16Ti-0.1Be BRAZE ALLOY

TABLE VIII
MICROHARDNESSES OF CANDIDATE BRAZEMENTS
(Metallography T-Joints)

Braze Alloy	Condition	Hardness of Specific Regions (DPH 50-gram load)						
		Braze Metal		Braze/Substrate Interface		Cb-1Zr Substrate		
		DPH Number	Approximate Rockwell Number	DPH Number	Approximate Rockwell Number	DPH Number	Approximate Rockwell Number	Depth Below Initial Interface (mil)
Zr-28V-16Ti	As brazed	302 to 373	30 to 38 R _C	152	79 R _B	100	56 R _B	1
						98	55 R _B	2
						103	58 R _B	3
						121	68 R _B	12 (Q) ⁽¹⁾
	1000 hours at 1750°F	Zr-Terminal Solution		380 to 392	39 to 40 R _C	357	36 R _C	1
		419 to 432	43 to 44 R _C			88	46 R _B	2
Zr-28V-16Ti-0.1Be	As brazed	322 to 354	32 to 36 R _C	155	80 R _B	93	51 R _B	1
						103	58 R _B	2
						98	55 R _B	3
						100	56 R _B	12 (Q) ⁽¹⁾
	1000 hours at 1750°F	Zr-Terminal Solution		368 to 392	38 to 40 R _C	93	51 R _B	1
		503 to 513	49 to 50 R _C			88	46 R _B	2
Cu-2Ni	As brazed	100 to 103	56 to 58 R _B	128	70 R _B	128	70 R _B	1
						125	69 R _B	2
						125	69 R _B	3
						103	58 R _B	12 (Q) ⁽¹⁾
	1000 hours at 1750°F	Copper Braze Evaporated		74	~28 R _B	136	73 R _B	1
		128	70 R _B			2		
						121	68 R _B	3
						131	71 R _B	5
						121	68 R _B	10
						119	67 R _B	12 (Q) ⁽¹⁾

1. Centerline of base sheet

Microhardness Data

Microhardness surveys (DPH 50-gram load) made on both as-brazed and aged T-joint specimens yielded much informative data (Tables VI and VIII). In the as-brazed condition, the hardness of the Cb-1Zr sheet ranged from about 98 to 128 DPH (~55 to 70 R_B). This is a normal range also for annealed Cb-1Zr sheet. For Cu-2Ni brazements aged for times up to 1000 hours at 1750°F, the Cb-1Zr substrate hardness remained in this range. However, significant reduction in aged Cb-1Zr

hardness in areas immediately adjacent to braze fillet regions were discovered for the zirconium-base brazements. For example, in Zr-28V-16Ti brazements following 1000 hours of aging, the Cb-1Zr hardness range dropped to 79 to 88 DPH (~ 30 to $46 R_B$); while corresponding hardnesses in Zr-28V-16Ti-0.1Be brazements were lowered to 87 to 93 DPH (~ 45 to $51 R_B$). These hardness changes are similar to those found after short-term aging at 1750°F in poorer vacuums (Table VI). The substrate hardness reduction probably reflects a depletion of interstitial element contaminants (oxygen, nitrogen, hydrogen, carbon) originally dissolved in the Cb-1Zr, by migration into the zirconium-base braze alloys (Ref. 6). This premise is substantiated by the fact that the Cb-1Zr sheet 0.0625 inch or more away from the braze experienced no significant change in hardness during 143 or 1000 hours of aging. Considered together, the data indicate that the Cb-1Zr sheet itself could provide the greatest source of contamination for the braze, even greater than that provided by gaseous contaminants in the simulated space environments.

In line with the above reasoning, hardness increases anticipated for the zirconium-base braze materials during long-term aging were realized. Typical as-brazed hardnesses for the eutectic structures of the Zr-28V-16Ti and the Zr-28V-16Ti-0.1Be alloys ranged between 302 to 373 DPH ($\sim R_C$ 30 to 38). Following 1000-hour aging, the hardness of the zirconium-rich terminal solution alone increased to 419 to 432 DPH ($\sim R_C$ 43 to 44) for the first named alloy, and to 503 to 513 DPH ($\sim R_C$ 49 to 50) for the latter alloy. The hardness of the associated ZrV_2 intermetallic phase was measured at 672 to 740 DPH (~ 59 to $62 R_C$). Although brazement strength, toughness, and ductility properties are believed still adequate after 1000 hours vacuum exposure at 1750°F, the effect upon these properties of additional aging time and possibly continued braze hardening cannot be predicted.

Strength Data

The results of braze strength studies performed upon all candidate alloy brazements, both as-brazed and after 1000 hours of vacuum aging at 1750°F, are given in Table VII. Tabulated strength data indicate both the tensile stress in the sheet component and the shear stress over the lap-joint area at the point of specimen failure.

Cu-2Ni

As-brazed shear strength at room temperature averaged about 38,100 psi, with little scatter (range of ± 700 psi). Aging at 1750°F effected no appreciable change in useful room temperature strength (average strength - 37,800 psi), in spite of the fact that all of the braze fillets and one-third of the braze lap-joint material in each specimen were removed by evaporation. Aging caused the locus of failure to move from the Cb-1Zr sheet to the braze joint. This good retention of strength under an

adverse structural situation indicated exceptional braze toughness and insensitivity to notching. (However, in the particular case where nearly all the braze material evaporated during aging, as in T-joints, bend toughness proved seriously impaired - Table VI.)

At the test temperature of 1750° F (argon), as-brazed shear strength averaged about 11,900 psi, again with little scatter. Vacuum aging at 1750° F, with attendant variable evaporation, resulted in considerable scatter of strength data at 1750° F, with one reading as low as 5200 psi and one as high as 16,400 psi. The average strength post aging dropped somewhat, to 10,000 psi. (All failures occurred in the braze joint at 1750° F.)

Zr-28V-16Ti and Zr-28V-16Ti-0.1Be

In the as-brazed condition, the basic Zr-V-Ti alloy proved somewhat stronger than the version with the 0.1 beryllium addition. This was especially true in testing at 1750° F, where both versions tended to fail by shear through the braze joint (e.g., an average 17,700 psi for Zr-V-Ti versus 12,000 psi for Zr-V-Ti-Be). At room temperature, the strength ratio was not nearly so great, although it was sufficient to promote parent metal (Cb-1Zr) failure for Zr-V-Ti brazements, as against predominantly braze and braze-affected parent metal failures for Zr-V-Ti-Be brazements (average strengths of 38,500 and 37,600 psi, respectively). In all of the as-brazed strength tests conducted, the range of data scatter was ~2000 psi or less. Small to moderate strength decreases occurred in both braze alloys after aging at 1750° F, presumably the result of increases in braze hardness and associated braze contamination. All failures in aged specimens occurred through the braze joint. Data scatter increased after aging, with typical ranges of 4000 to 7000 psi. Average strengths for the Zr-28V-16Ti alloy brazements after 1750° F aging were measured as follows: 29,000 psi (room temperature) and 11,000 psi (1750° F). Corresponding average strength levels for the Zr-27V-16Ti-0.1Be alloy were 26,800 psi (room temperature) and 11,200 psi (1750° F). These strength levels are believed adequate for the subject application. However, accurate information on thermal stability for longer periods of time can only be derived by actual experiment.

Microprobe Analysis

To assess the degree of interdiffusion of the braze alloy and Cb-1Zr sheet, as another indication of thermal stability at 1750° F, a series of electron microprobe analyses were conducted on the as-brazed and the aged T-joint specimens shown in Figures 24 through 26. A line traverse with a one-micron diameter beam was made across the 0.025 inch thickness dimension (horizontal member) of each Cb-1Zr T-joint, directly under the braze fillet, which then was continued 0.005 to 0.006 inch into the braze fillet region. The traverse on each specimen was initiated at the bottom or exterior edge of the horizontal Cb-1Zr member (Point O of Fig. 24 through 26). The

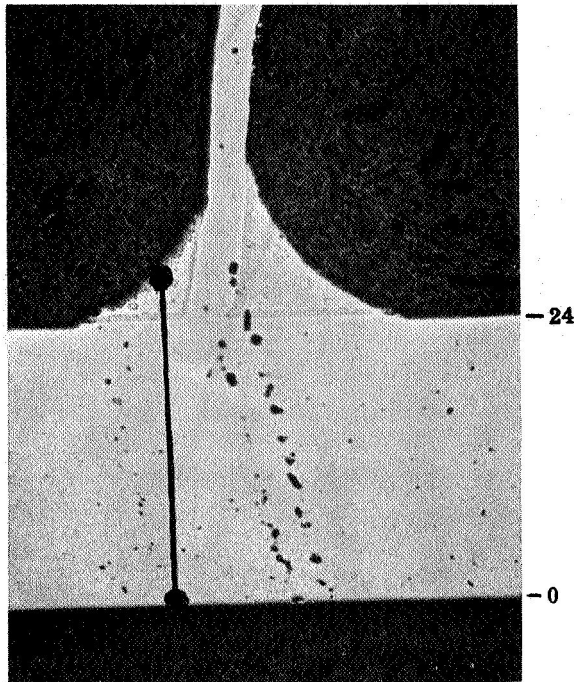

As-Brazed Condition

Unetched

Magnification: 50X

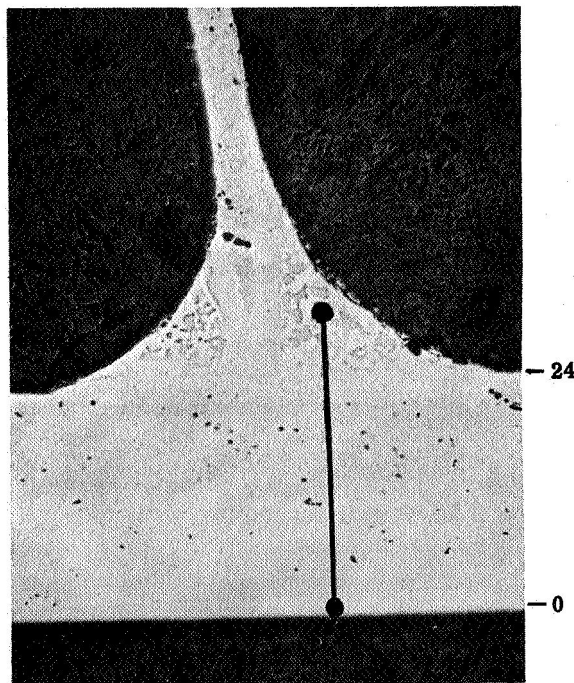

Vacuum Aged

1000 Hours
1750°F

Unetched

Magnification: 50X

Black lines indicate location of microprobe traverses.

FIGURE 24. BRAZED T-JOINT SPECIMENS FOR MICROPROBE ANALYSIS;
Zr-28V-16Ti Braze Alloy

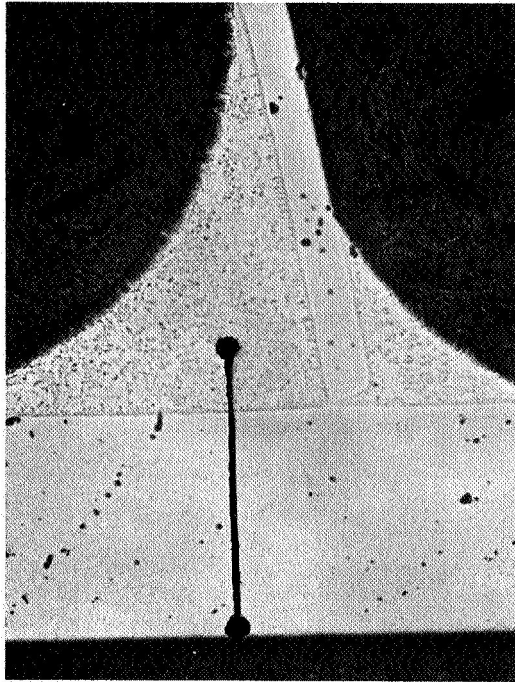

As-Brazed Condition

Unetched

Magnification: 50X

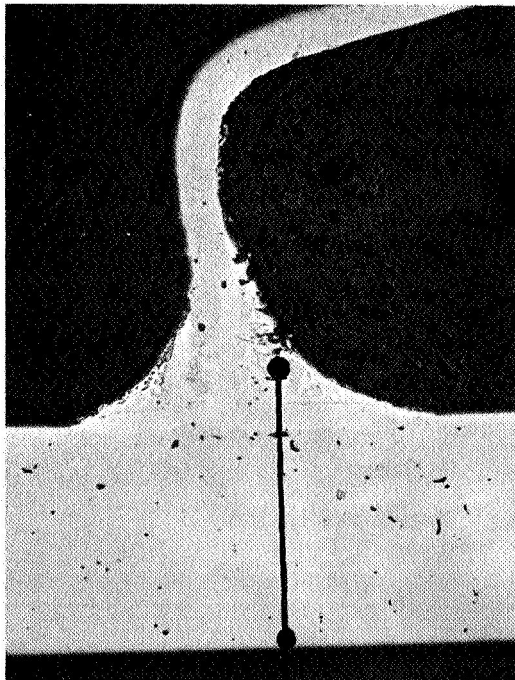

Vacuum Aged

1000 Hours

1750°F

Unetched

Magnification: 50X

Black lines indicate location of microprobe traverses.

FIGURE 25. BRAZED T-JOINT SPECIMENS FOR MICROPROBE ANALYSIS;
Zr-28V-16Ti-0.1Be Braze Alloy

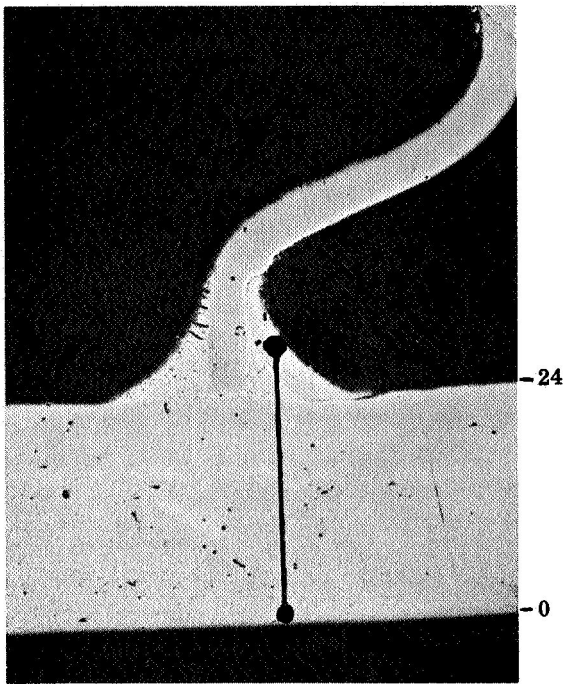

As-Brazed Condition

Unetched

Magnification: 50X

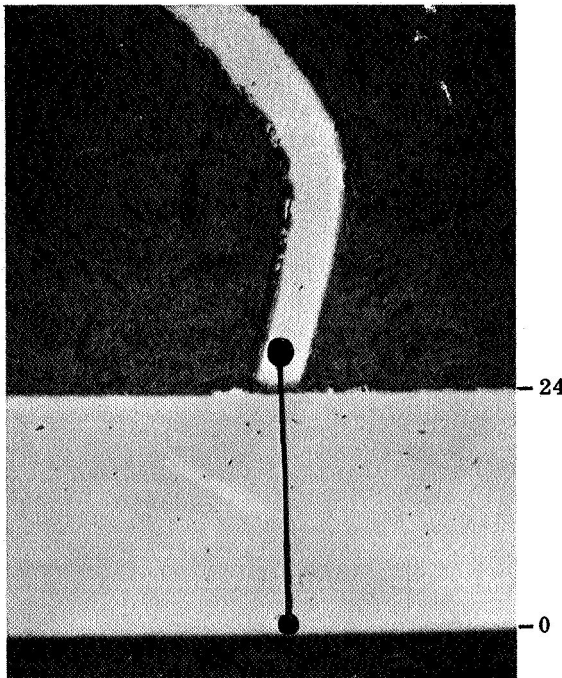

Vacuum Aged

1000 Hours
1750°F

Unetched

Magnification: 50X

Black lines indicate location of microprobe traverses.

FIGURE 26. BRAZED T-JOINT SPECIMENS FOR MICROPROBE ANALYSIS;
Cu-2Ni Braze Alloy

traverse was continued to Point 24 on the same figures, representing the top or interior edge of the horizontal member, and the braze/Cb-1Zr interface for the as-brazed condition; then on into the braze. The rate of beam movement was 12.5 microns/minute. Two superimposed traverses were made for each specimen. For the zirconium-base braze alloys, the first traverse detected and analyzed columbium and vanadium; the second traverse detected and analyzed titanium and zirconium. Because of its low atomic number, beryllium could not be analyzed. With the Cu-2Ni alloy, the first traverse analyzed copper and zirconium; the second analyzed columbium and nickel. Figures 27 through 30 graphically present the analytical data developed by the line traverses.

Zirconium-base alloys. As a result of brazing, the liquid portion of the braze alloy, within 0.006 inch of the original braze interface, picks up about five percent by weight columbium from the Cb-1Zr sheet. This pickup is due to the dissolution of the Cb-1Zr by the liquid braze. As a result of vacuum aging (1750°F for 1000 hours), the level of columbium in the same braze region is raised by solid-state diffusion to about 30 to 35 percent (Zr-V-Ti alloy) or to about 45 to 50 percent (Zr-V-Ti-Be alloy) in the zirconium-rich terminal solid solution phase, and to about 20 percent (wt) in the associated intermetallic phase [ostensibly (Zr, Ti, Cb)V₂].

Neither zirconium, titanium, nor vanadium diffuse into the Cb-1Zr sheet to any great extent as a result of brazing or as a result of aging at 1750° F. In fact, no zirconium, titanium, or vanadium could be discerned by microprobe in the Cb-1Zr sheet farther than 0.002 inch beyond the original joint interface. This 0.002 inch wide band corresponds to the visible diffusion zone produced by 1000 hours aging at 1750° F.

Columbium and zirconium depletion from the Cb-1Zr sheet, beyond the visible diffusion zone adjacent to the braze, is negligible (post aging). Consequently, the original 0.025 inch thick Cb-1Zr sheet retains its identity during 1000 hours of aging (across the thickness dimension) at least 0.023 inch from its external wall. In spite of published diffusion data indicating unbalanced diffusion in binary couples of Cb-Zr, Cb-Ti, and Cb-V (Fig. 31, Ref. 6), no evidence of void formation was disclosed by the microprobe analyses or metallography.

Cu-2Ni alloy. In the as-brazed condition, the braze structure and the microprobe indicated that two immiscible liquids were in existence at the braze temperature of 2300° F; viz., the original Cu-2Ni alloy, essentially unreacted (coppery lustre), and a second liquid (~10 to 50 percent of the total liquid volume) which might be characterized as a reaction product (~70Cb-20Cu-10Ni - silvery lustre). This two-liquid phenomenon was also observed visually and metallographically (Fig. 26).

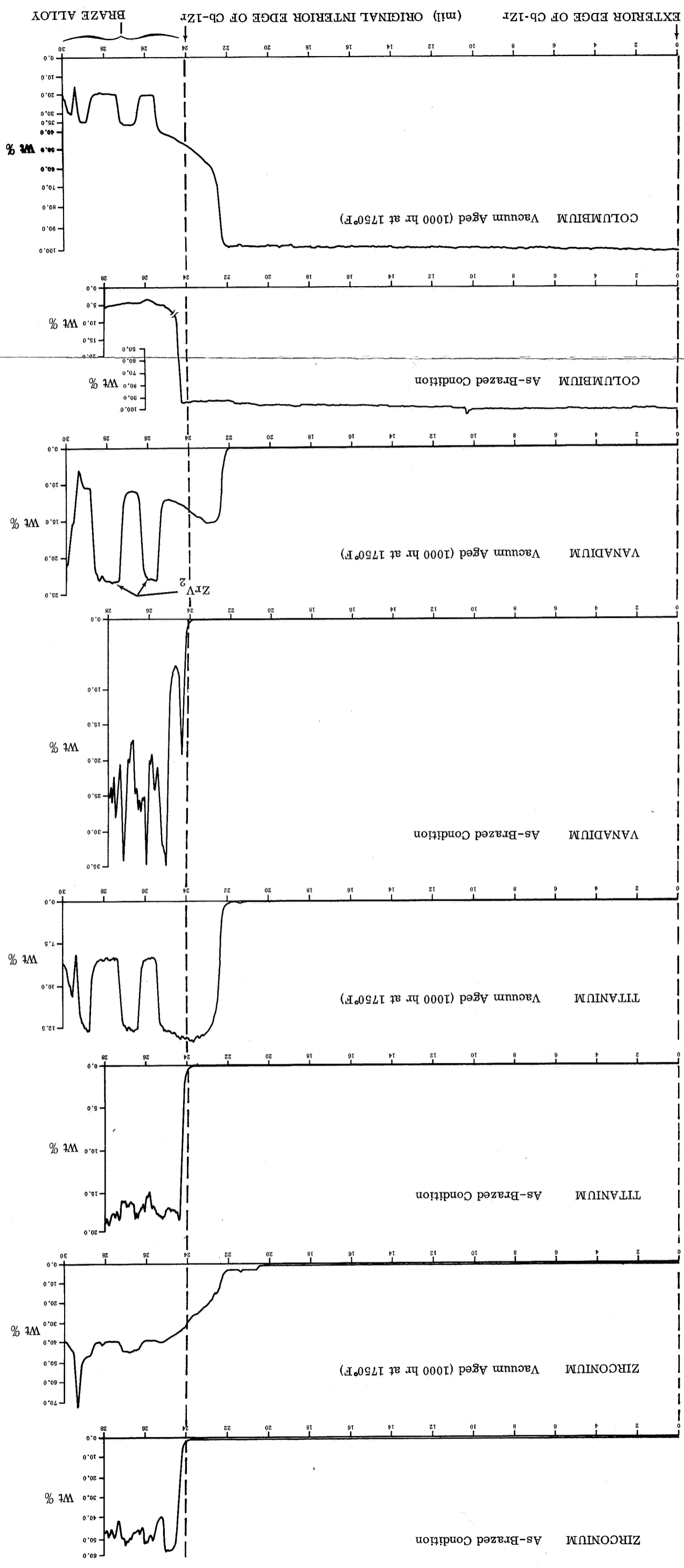

FIGURE 27. ELECTRON MICROPROBE TRAVERSES;
Zr-28V-16Ti Alloy

45

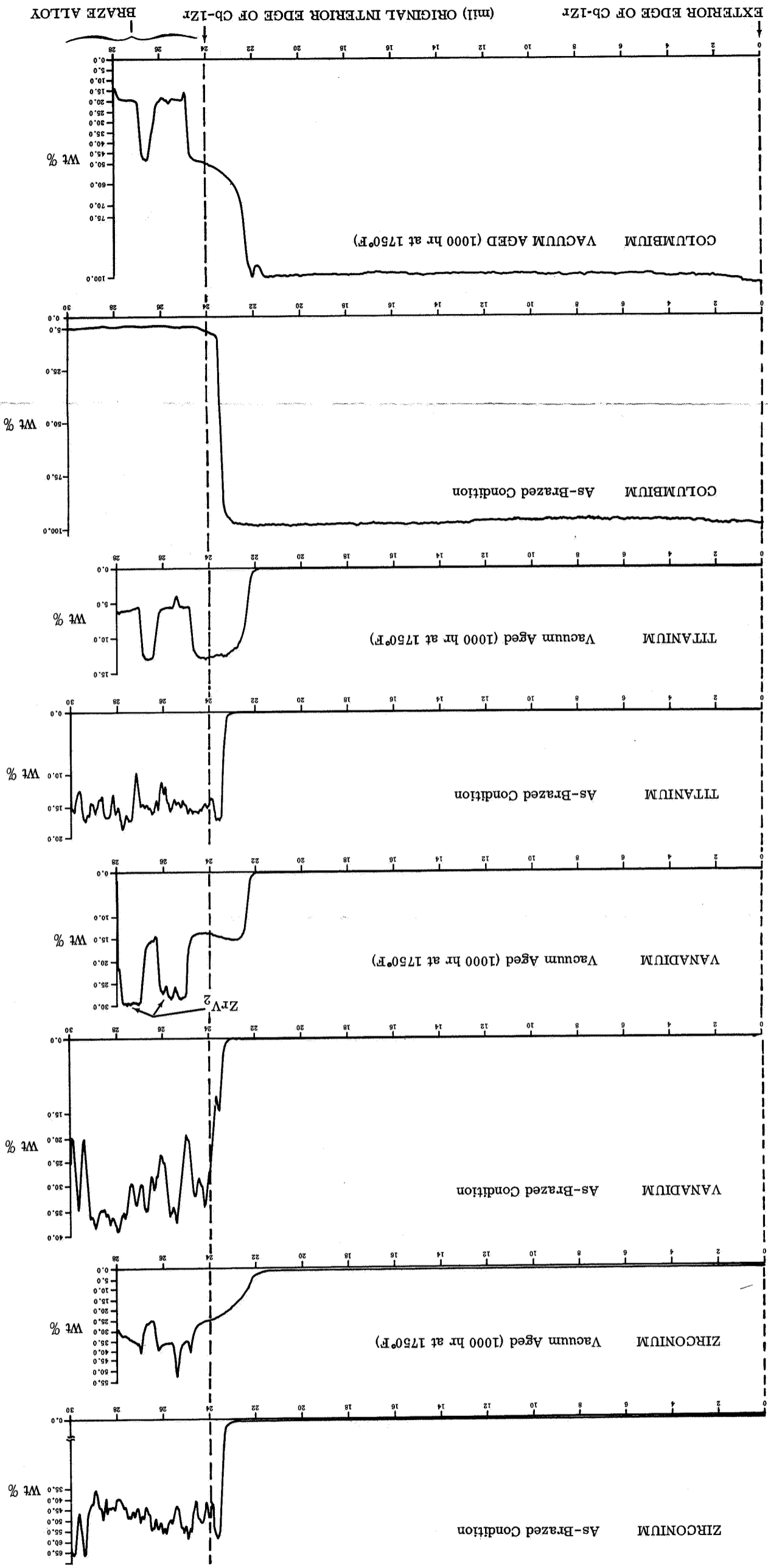

FIGURE 28. ELECTRON MICROPROBE TRAVERSES;
Zr-28V-16Ti-0.1 Be Alloy

47

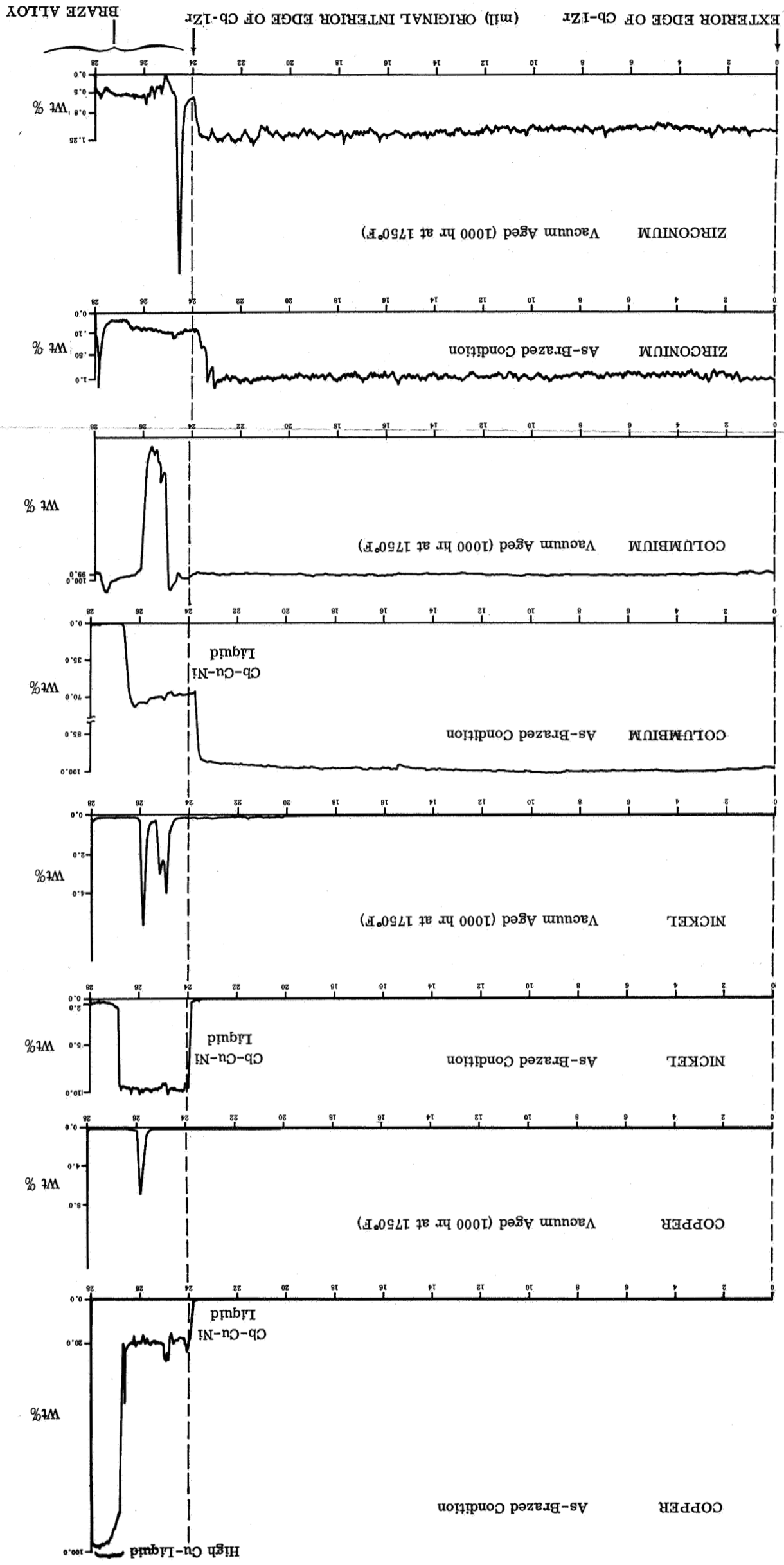

FIGURE 29. ELECTRON MICROPROBE TRAVERSES;
Cu-2Ni Alloy

49

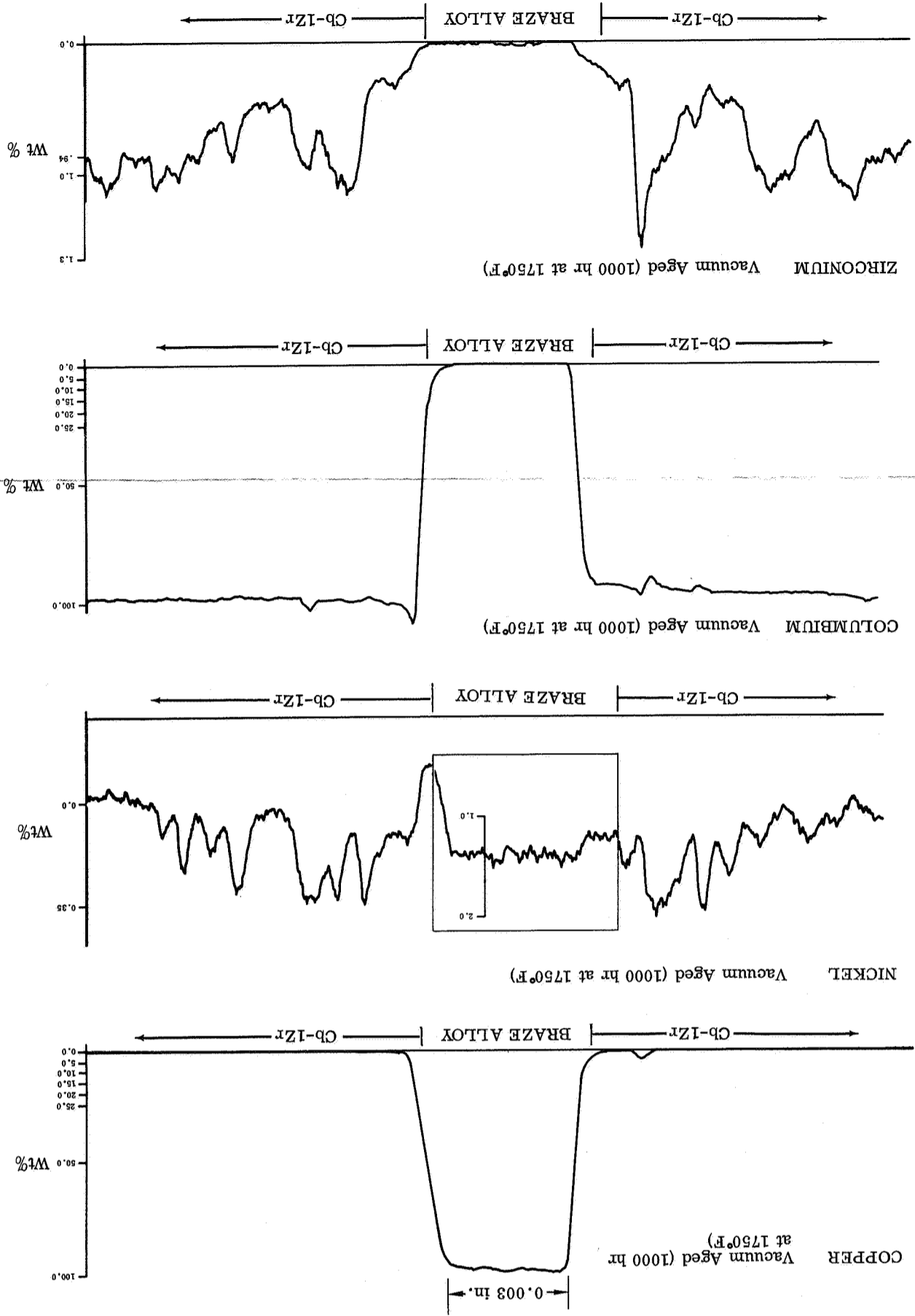

FIGURE 30. ELECTRON MICROPROBE TRAVERSES;
Cu-2Ni Lap Joint

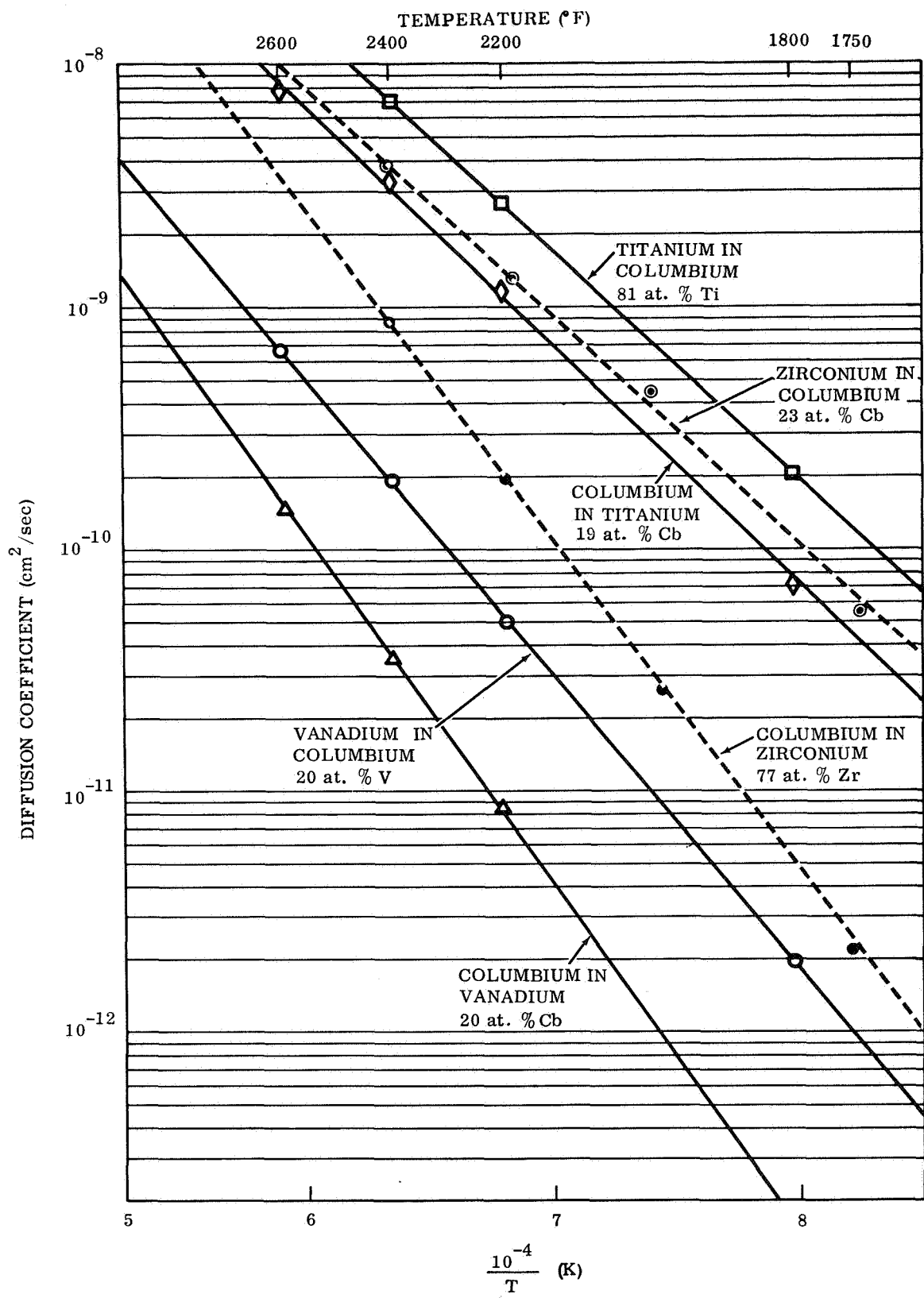

FIGURE 31. RATES OF DIFFUSION IN BINARY COUPLES OF COLUMBIUM/ZIRCONIUM, COLUMBIUM/TITANIUM, AND COLUMBIUM/VANADIUM (Ref. 6)

Although metallography indicated significant erosion of Cb-1Zr in some areas and negligible erosion in others, the as-brazed region checked by microprobe showed little columbium or zirconium depletion in the original Cb-1Zr sheet. The situation remained essentially the same even after aging.

After aging, only traces of nickel (≤ 0.35 percent) and a negligible amount of copper (≤ 0.05 percent) were detected within the Cb-1Zr sheet adjacent to the braze. Beyond about the 0.005 inch depth level, not even traces of nickel were found. Thus, the extensive losses of copper due to evaporation were confirmed by microprobe analysis.

Only minor vestiges of the original braze material remained after aging, so that meaningful braze analysis was impossible on the metallography T-joint. However, a microprobe traverse was made across a remnant of braze alloy found in the over-lap area of an aged tensile-shear specimen (Fig. 21 and 30). The analysis revealed that the 0.0025 to 0.0030 inch thick braze segment was comprised essentially of Cu-1.3Ni, with negligible columbium or zirconium dissolution. Likewise, the adjacent undepleted Cb-1Zr areas exhibited quite sharp boundary zones with the braze (columbium and copper traverses). Only traces of nickel were detected in the Cb-1Zr, as previously determined for the aged T-joint. The zirconium and nickel concentrations in the Cb-1Zr adjacent to the braze showed erratic variations, indicating internal segregation tendencies of some sort. The data strengthened the initial contention of very limited mutual miscibility of Cu-2Ni braze and Cb-1Zr sheet in the solid state.

2.5 FABRICATION FEASIBILITY STUDIES - 18-INCH TUBE MODULES

2.5.1 Internal Fin Design and Evaluation

The internal fin design suggested originally by the sponsor (Fig. 1), by virtue of its expansive faying surface area, was felt more applicable to a weld-joining process than a braze process. The reasons advanced for the design's marginal applicability to brazing were:

- Large faying over-lap areas with dimensions of 0.625 inch by 0.750 inch are extremely difficult to cover entirely by braze alloy flowing in from peripheral loading zones. Peripheral braze loading would be required for the great majority of candidate braze alloys, because their intermediate hardnesses, heavy intermetallic contents, and marginal working characteristics preclude (at present) rolling into braze foil preforms.
- Where thin-foil preforms are available and in situ braze loading (i. e. , directly on faying surfaces) is possible, as with copper- and gold-base alloys, the need still exists to slide the braze-loaded faying surfaces of the internal fin component for long distances (up to 36 inches) along the

ID surface of the full scale heat receiver tube. This extensive sliding action would be required to get the interconnected fins into brazing position. It was felt that this method of braze loading and positioning would very likely damage at least one (and probably more) of the delicate foil preforms, even if tack welded in place. It is likely that a damaged preform would not braze properly, and would be extremely difficult to repair.

In view of the above argument, it was decided to design and evaluate several improved internal fin configurations, with the prime objective of making fin fabrication, braze loading and positioning, as well as initial brazing and repair brazing more feasible and flexible operations.

Fin Design A shown in Figure 32 and 33 was approved by the sponsor and adopted for preliminary feasibility studies. The configuration of the unit module consisted of six single fins, deployed radially, braze joined at the common center, and with equal separation angles of 60 degrees. The unit module length was 0.75 inch. Alternate modules were staggered (30-degree intervals) when positioned for brazing inside the heat receiver tube (Fig. 32). A simple fixture to fabricate these fins together with a set of fins assembled in a 1.25-inch diameter tube and tacked along the fin center line is shown in Figure 33. Unlike the original design, each module or set of fins was a separate entity not interconnected with its neighbors.

Six such sets of fins were prepared for experimental braze attachment to 1.25-inch diameter Cb-1Zr tubing. Successful brazing of internal fins to Cb-1Zr tubing was demonstrated by high-frequency induction heating in the high-vacuum Vycor tube furnace (10^{-5} Torr) using braze materials both in the form of foil (pure gold) and in the form of -9/+12 mesh particles (Zr-28V-16Ti alloy). The receiver tubes were positioned vertically in the furnace, the 0.025-inch wall tubing acting as its own heater-susceptor. Two 2.25-inch long Cb-1Zr heat receiver tubes were brazed, one with pure gold and the second with Zr-28V-16Ti alloy. No organic binder was used in either case. The gold foil was lightly tack welded onto the faying surfaces of the Cb-1Zr fins, and the whole fin assembly was then slipped into the Cb-1Zr tube. In the case of Zr-28V-16Ti alloy, the alloy pieces (-9/+12 mesh size) were tack welded onto the side of each fin, adjacent to the joint. Light spring pressure provided by the slightly flexed fin arms held the faying surfaces of the fin and tube together for brazing. In both cases excellent brazements were obtained. A section of a brazed heat receiver tube, complete with internal fins brazed with pure gold is shown in Figure 33. The feasibility of vacuum induction brazing the new fin configuration by peripheral or in situ braze loading was thus demonstrated for a short receiver tube section.

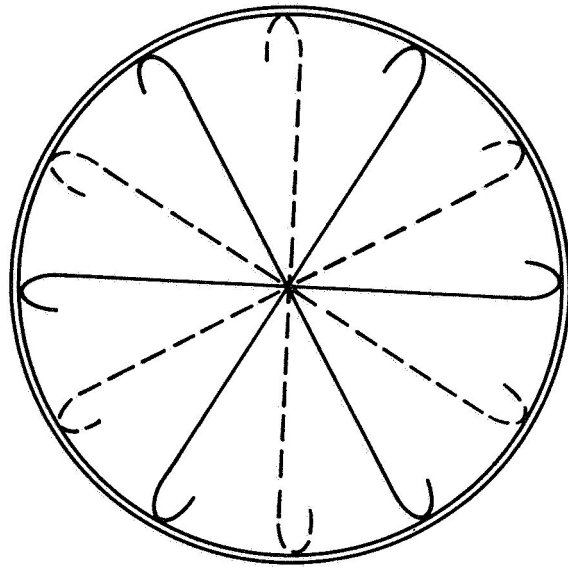

MAJOR DIAMETER: 1.25 INCHES
FIN LENGTH: 0.75 INCH

FIGURE 32. SCHEMATIC OF FIRST FIN REDESIGN; Design A

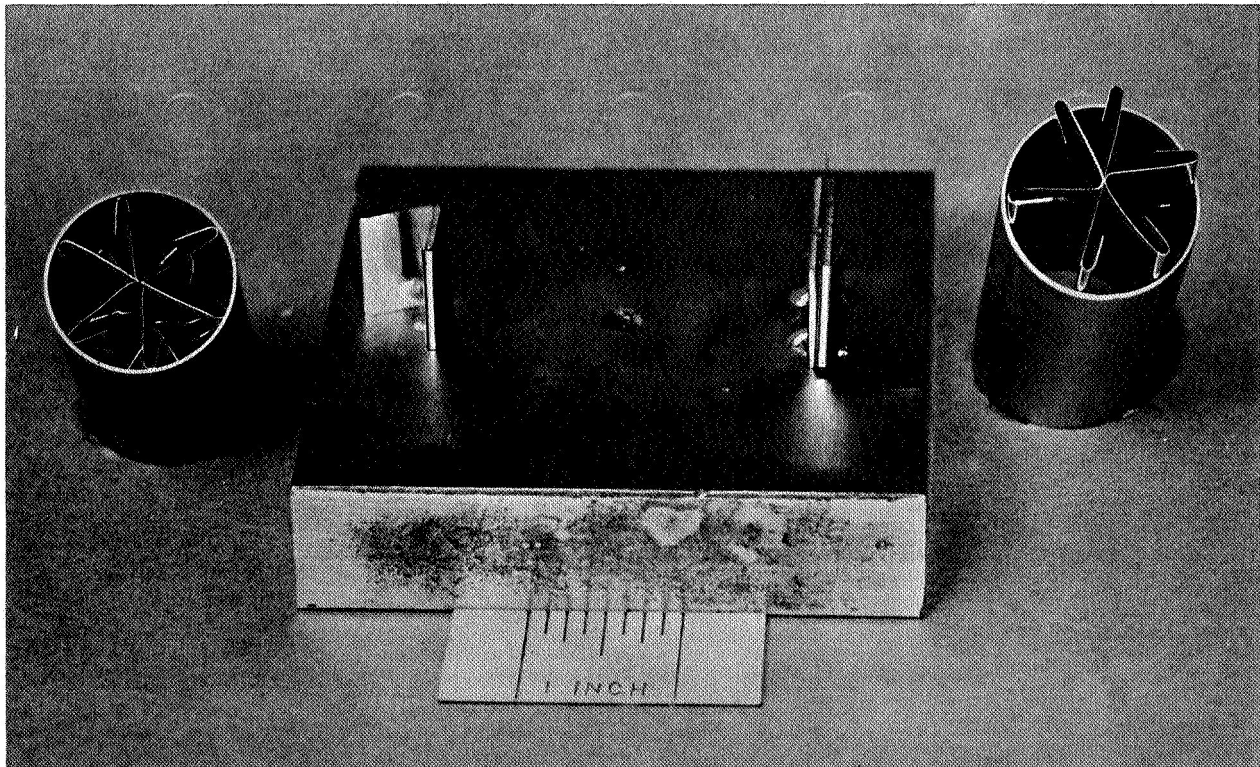
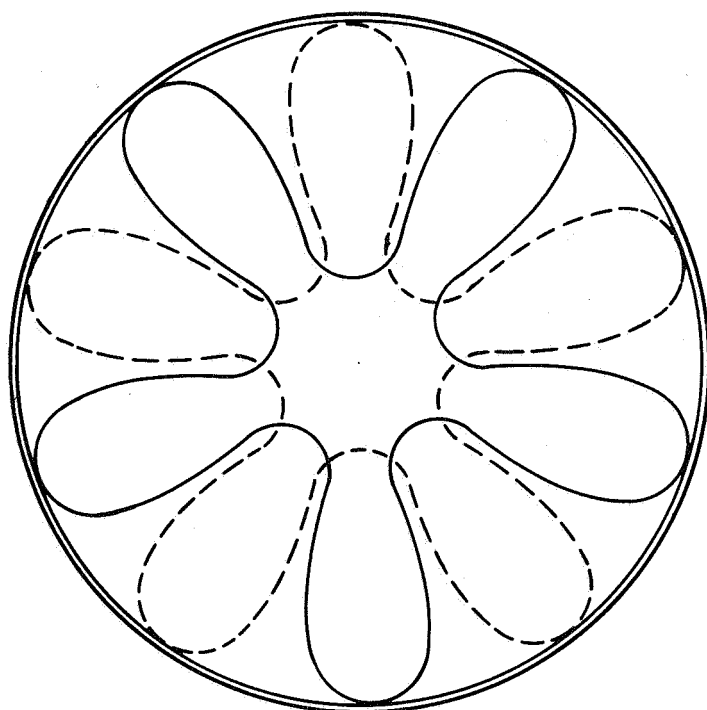

FIGURE 33. FIXTURE FOR FABRICATION OF INTERNAL FINS (DESIGN A)
AND BRAZED HEAT RECEIVER TUBE SECTION (LEFT)

However, serious problems arose with this particular fin design in brazing the longer, 18-inch receiver tubes; the chief problem being that the six radial fin elements were much too willowy and dimensionally unstable to ensure good fit up overall. In virtually every 0.75-inch fin module brazed, one or more of the six radial elements became distorted during positioning and/or during brazing, so that many fin/tube faying surfaces were badly misaligned. This situation required repositioning and braze repair on practically every fin. Consequently, only one 0.75-inch fin module could be brazed or repaired per braze cycle, rather than clusters of four or more fin modules as originally planned. Only two 18-inch tube modules were fabricated and brazed using fin Design A.

An improved fin Design B (Fig. 34) was evaluated at Solar and eventually approved by the sponsor for all subsequent brazing of tube modules. Both fin designs weighed approximately the same - 3.4 grams/inch of tube length. However, the corrugated five-point fin design shown in Figure 34 was a much sturdier and more rigid configuration, and a stronger spring-pressure fit inside the tube provided more positive faying surface pressurization and alignment. The new fin design B more closely approximated the original fin configuration suggested by the sponsor. As in the original configuration, alternate modules were staggered (36 degree intervals) when positioned for brazing inside the heat receiver tube (Fig. 34). Brazing tests in short tube sections demonstrated that two to three modules of Design B could be brazed simultaneously, with very little or no repair brazing required.



MAJOR DIAMETER: 1.25 INCHES
FIN LENGTH: 1.0 INCH
DIAMETER OF CENTRAL HOLE: 0.25 INCH

FIGURE 34. SCHEMATIC OF SECOND FIN REDESIGN; Design B

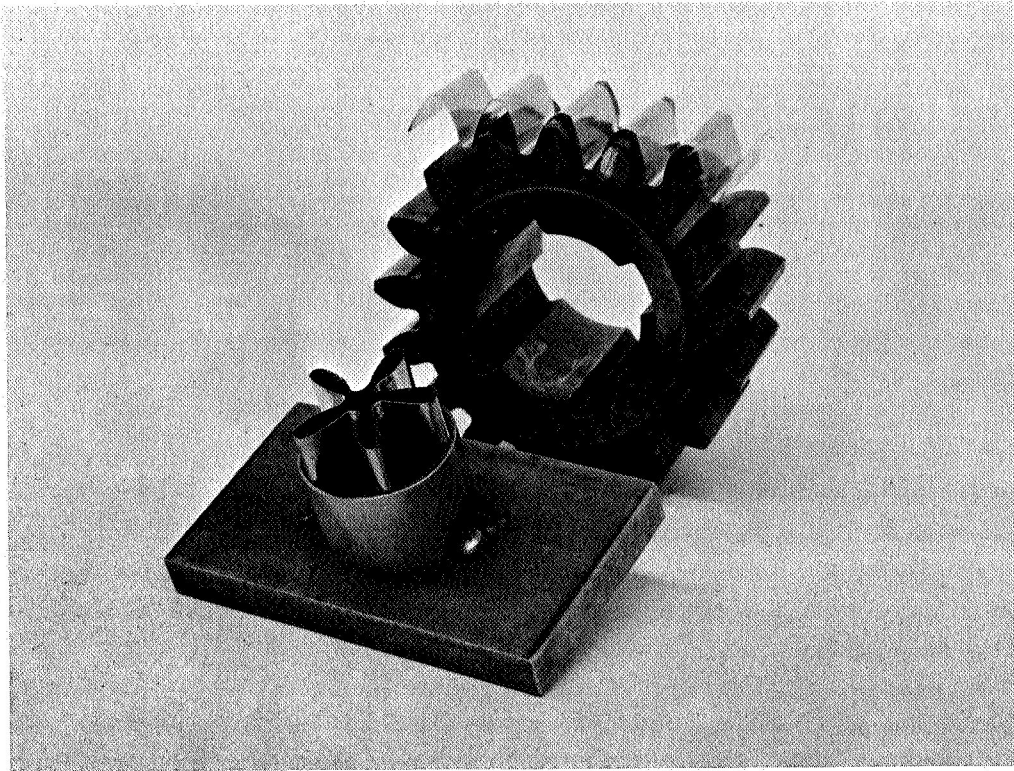

FIGURE 35. CORRUGATING GEAR AND SIZING FIXTURE FOR FABRICATING DESIGN B FIN MODULES

Figure 35 shows a corrugating gear used to form the fin elements of Design B from 0.005-inch Cb-1Zr strip. After corrugating, a sufficient length of the strip was cut for hand working and tack joining of each five-point fin module. This work was done inside a small section of the receiver tube for proper sizing (Fig. 35).

Three 18-inch and two 36-inch receiver tubes were fabricated and brazed using Design B. A photograph made through one of the 18-inch tube modules shows the excellent positioning of fin elements made possible by Design B (Fig. 36).

2.5.2 Brazing 18-inch Heat Receiver Tubes

The brazing procedure developed for the subscale (18-inch) tubes was found to be directly transferable to brazing the full scale (36-inch) tube modules. This was the original intent and the objective of all subscale work.

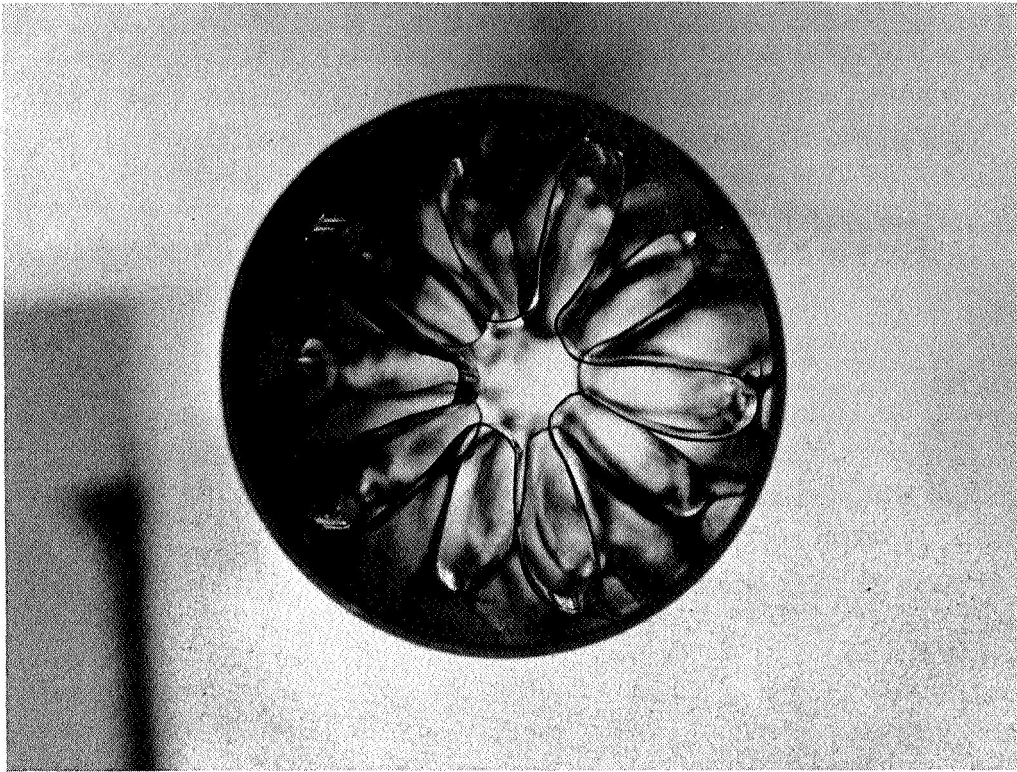

FIGURE 36. INTERNAL VIEW OF 18-INCH HEAT RECEIVER TUBE (1.25 in. Major Dia.); Design B Fin Modules Brazed in Position

The brazing procedure for 18-inch receiver tubes consisted of the following steps:

- Braze Loading and Fin Positioning - Individual particles of braze alloy were lightly tack welded (under an argon blanket) to the top edge of each fin element (Fig. 32 and 34) for each fin design. Organic binders were not used because of the danger of braze contamination. The braze loading rate (Design B) depended upon the braze alloy used (e. g. , 60 milligrams/fin element using zirconium-base alloys, or 100 milligrams using Cu-2Ni alloy). The loaded fin modules then were slid into position inside the heat receiver tube for brazing. With fin Design A, only one fin module could be brazed per braze cycle, starting at the tube mid-length position. With fin Design B, the technique adopted was to braze one to two fin modules/braze cycle at and near the tube mid-length position (to facilitate visual braze inspection and repair brazing); then graduate to two to four fin modules/braze cycle from about the tube quarter-length outward, as visibility and maneuverability improved.

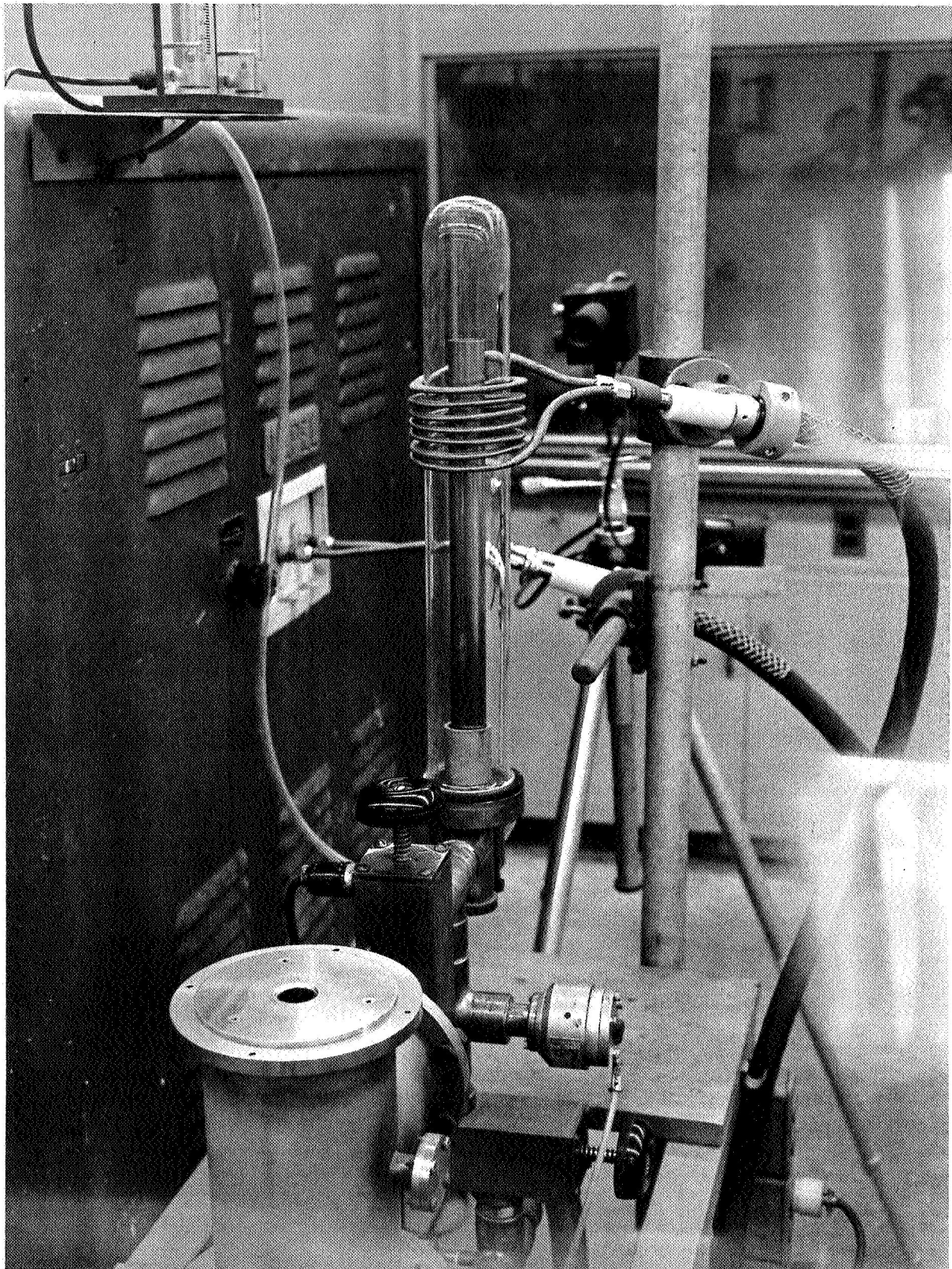

FIGURE 37. VACUUM INDUCTION BRAZING SETUP FOR 18-INCH HEAT RECEIVER TUBES

- Brazing Procedure - Sections of each 18-inch tube were brazed sequentially, using the same vacuum Vycor tube furnace and braze conditions described for brazing test specimens (vacuum chamber pressure 1×10^{-5} Torr or better). The Cb-1Zr tube was positioned vertically and concentrically inside the Vycor tube, so that all braze flow was essentially vertical (Fig. 37). A uniform hot zone of ~three inches of receiver tube length was obtained with a four-inch induction coil positioned externally. The Cb-1Zr tube itself served as heater-susceptor. Tube temperature was measured with a Pyro micro-optical pyrometer (Fig. 37), although braze flow was observed visually through the Vycor as a positive check. Time at braze temperature was limited to 3 to 5 minutes. The original intent was to braze all of the fin modules in place during one braze cycle, by employing a flexible coaxial cable with the induction coil (Fig. 37). It was hoped that by sequentially heating and brazing three- to four-inch tube increments in a single braze operation (as opposed to heating and brazing the entire tube in one cycle in a conventional radiant furnace) problems arising from uniform tube temperature, post-braze thermal distortion, and high braze alloy pressure heads might be avoided. In addition, the total time required for the braze process would be minimized. Although the concept proved feasible, it was found that brazing clusters of more than four fin modules at a time was impractical, because of the extreme difficulty of visual inspection and repair brazing. However, the flexible cable proved very convenient for variable positioning of the induction coil as required in the adopted procedure.
- Inspection and Repair - After initial brazing, each fin cluster was carefully inspected visually to determine the extent of braze coverage and confirm fillet formation. Inspection was carried out by employing end lighting with a high-intensity light source and a 5X magnifying lens. Suspect brazements were repair brazed, in-situ, using the same braze loading and brazing techniques described for initial brazing. Fortunately, all defective brazements proved repairable, and did not require removal.

In early brazing studies with one- and two-inch tube sections, it was found that Zr-28V-16Ti-0.1Be possessed significantly superior brazing characteristics and reliability for fin/tube brazing over its base alloy, Zr-28V-16Ti. The Cu-2Ni alloy was rated third in brazing performance. Consequently, the Zr-28V-16Ti-0.1Be braze alloy was used to braze all subscale tube models, with the exception of one 18-inch tube on which the Cu-2Ni alloy was applied at the sponsor request. The following 18-inch modules were successfully brazed:

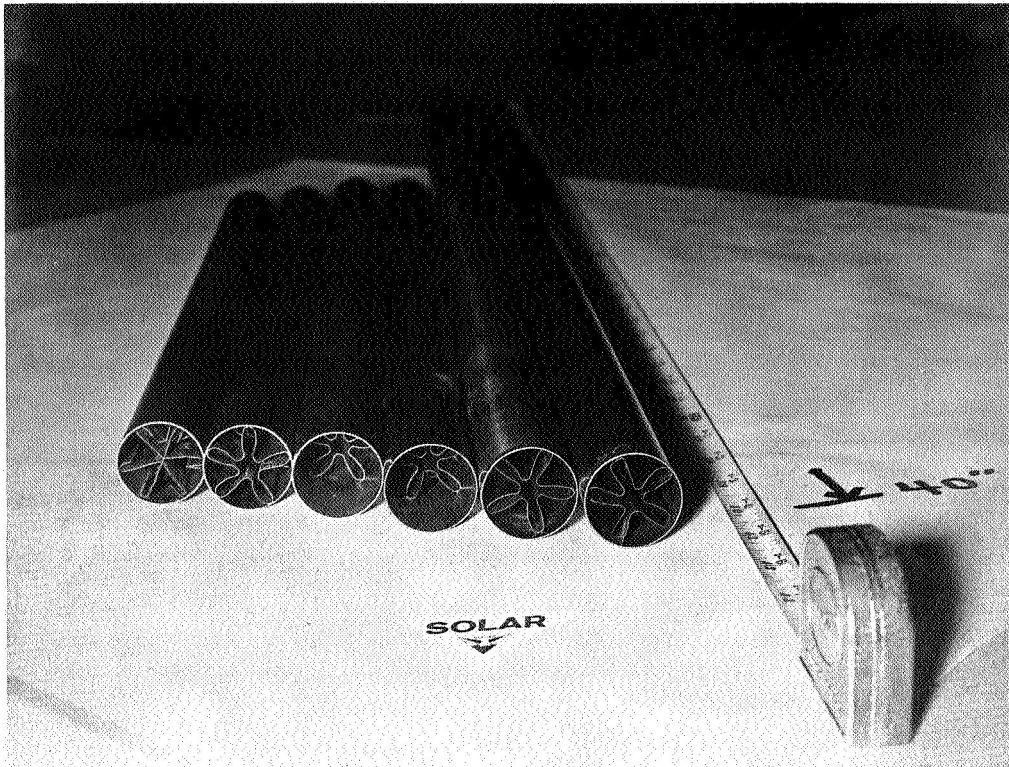

FIGURE 38. END VIEWS OF FOUR 18-INCH AND TWO 36-INCH HEAT RECEIVER TUBES; Post-Brazing

<u>Number Brazed</u>	<u>Fin Design</u>	<u>Braze Alloy</u>
2	A	Zr-28V-16Ti-0.1Be
2	B	Zr-28V-16Ti-0.1Be
1	B	Cu-2Ni

Four of these tube modules are shown in Figure 38.

2.5.3 Evaluation of Subscale Module Brazements

One- and two-inch long receiver tube sections were fabricated using Design A fin modules, and were then vacuum brazed with the three semi-final braze alloy candidates to permit test evaluation of subscale module brazements (Fig. 39). Tests were conducted in the as-brazed condition and also following 1000 hours of vacuum aging at 1750° F in the Vac-Ion furnace (chamber pressure $\leq 1.0 \times 10^{-8}$ Torr or better). All selected brazements were first visually inspected and then X-rayed to make sure that they were free of braze cracking, voids, and unbrazed areas. Aging did not cause or promote any of these structural problems to be evidenced prior to testing. Subsequent peel tests and metallographic examination of selected brazements confirmed the visual and X-ray indications of braze soundness.

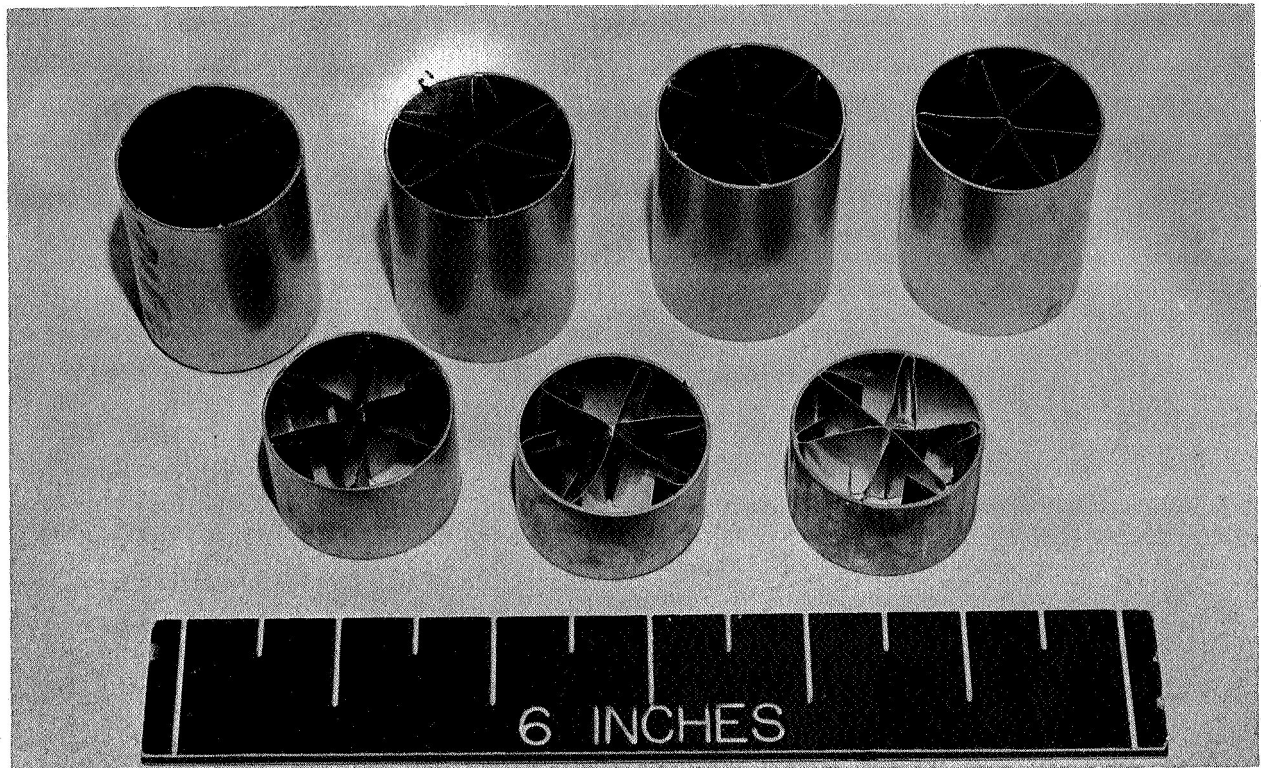
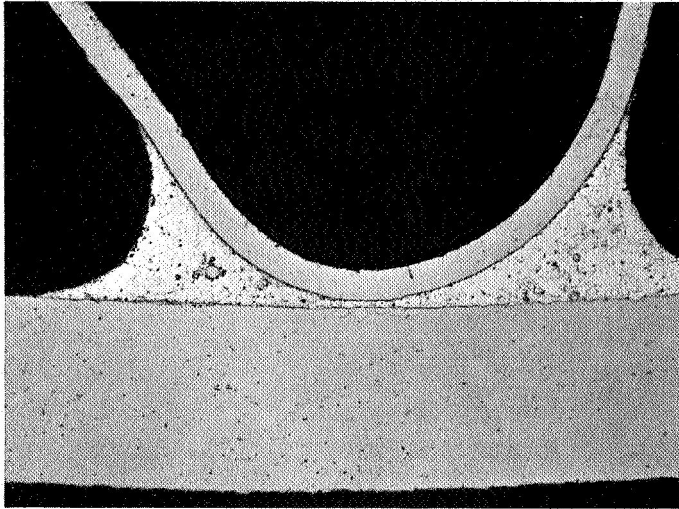

FIGURE 39. TYPICAL HEAT RECEIVER TUBE SECTIONS; Brazed and Prepared for Long-Term Aging

Sections of brazed tubes were subjected to manual peel tests in both the as-brazed condition and post aging. The three candidate braze alloys, Zr-28V-16Ti, Zr-28V-16Ti-0.1Be, and Cu-2Ni were represented. A peel force was exerted on the internal fin/tube braze joints with needle-nose pliers applied to each fin approximately 0.25 inch above the joint. The following tabulation indicates relative resistances to joint peeling as well as locii of peel failures.

Braze Alloy	Relative Resistance to Initial Peel Failure		Locus of Failure	
	As Brazed	Post Aging	As Brazed	Post Aging
Cu-2Ni	Good	Variable(1)	Fin material	Braze affected foil (fin) or joint interface.
Zr-28V-16Ti	Moderate	Fair	Braze affected foil (fin)	Joint interface
Zr-28V-16Ti-0.1Be	Moderate	Moderate	Braze affected foil (fin)	Braze affected foil (fin)

1. Good to poor, depending upon degree of joint deterioration resulting from copper evaporation.



As-Brazed Condition

Note globules of immiscible, second phase in braze metal.

Magnification: 35X

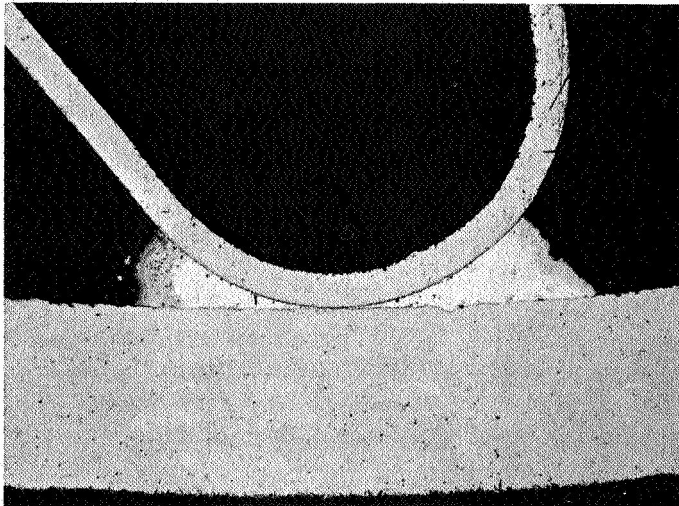

Vacuum Aged (5.0×10^{-10} Torr)

1000 Hours

1750°F

Note that about one-half of the original fillet material has evaporated.

Magnification: 35X

FIGURE 40. TRANSVERSE SECTIONS THROUGH TUBE/FIN BRAZEMENTS MADE WITH Cu-2Ni BRAZE ALLOY; Fin Design A

In spite of significant evaporation of copper during the brazing cycle, the brazing characteristics for Cu-2Ni alloy with respect to braze joining 18-inch tubes must be rated as good. However, heavy and progressive evaporation of copper from the tube brazements occurred during 1750° F vacuum aging, leaving the Cu-2Ni braze fillets in a very porous condition and with extremely variable peel resistance.

Metallographic examination of as-brazed and aged brazements revealed braze structures very similar to the single lap-joint brazements evaluated in Paragraph 2. 4. 2 (Fig. 40 through 42). Although the most promising all-around braze alloy, Zr-28V-16Ti-0.1Be, tended to fail in braze-affected foil with moderate peel resistance (as brazed or aged), metallographic examination disclosed that peel testing did initiate

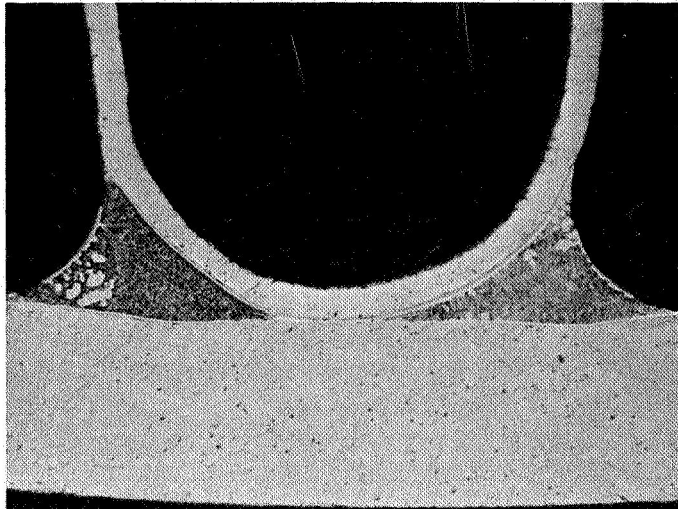

As-Brazed Condition

Magnification: 35X

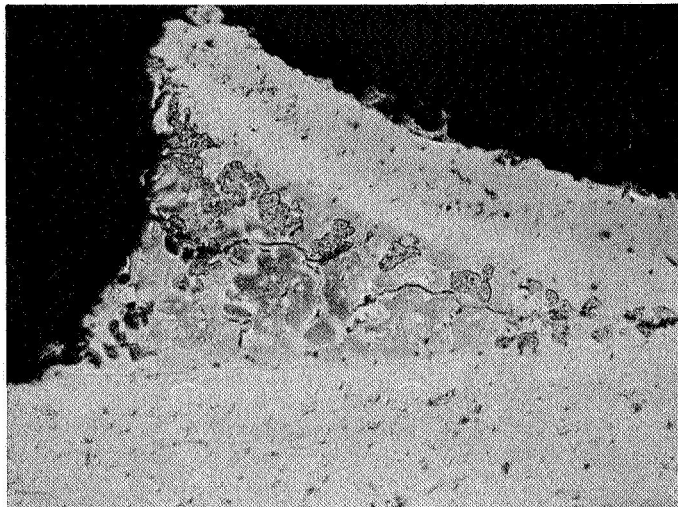

Vacuum Aged (5.0×10^{-10} Torr)

1000 Hours

1750°F

Note that peel test after aging has resulted in primary failure of braze-affected foil and one secondary crack in the braze metal.

Magnification: 100X

FIGURE 41. TRANSVERSE SECTIONS THROUGH TUBE/FIN BRAZEMENTS MADE WITH Zr-28V-16Ti-0.1Be BRAZE ALLOY; Fin Design A

some secondary cracks in the aged braze material (Fig. 41). No secondary cracks were observed in the braze material for the as-brazed condition (after peel test). This indicated that notch sensitivity of the subject alloy under stress was increased somewhat by 1000 hours of aging. Progressive braze contamination and/or coarsening of the two-phase braze structure during aging was believed responsible.

2.6 FINAL BRAZE ALLOY SELECTION

In reviewing all the data generated on the three remaining candidate braze alloys, it was concluded that the Zr-28V-16Ti-0.1Be alloy had the best over-all qualifications for successful application to heat receiver tube brazing. The principal

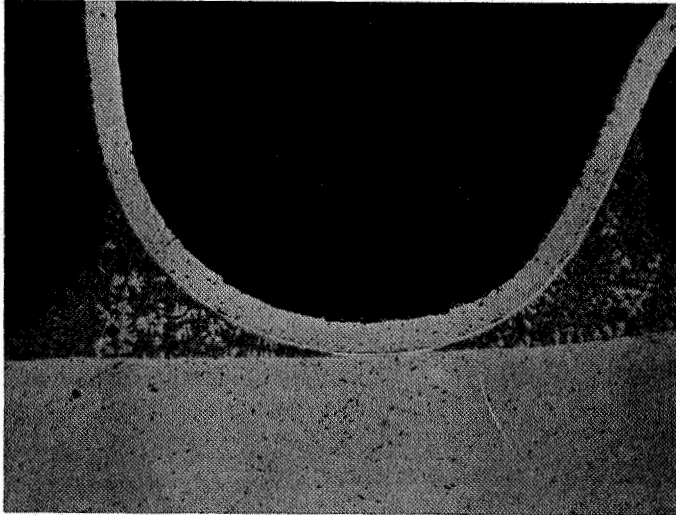

As-Brazed Condition

Magnification: 35X

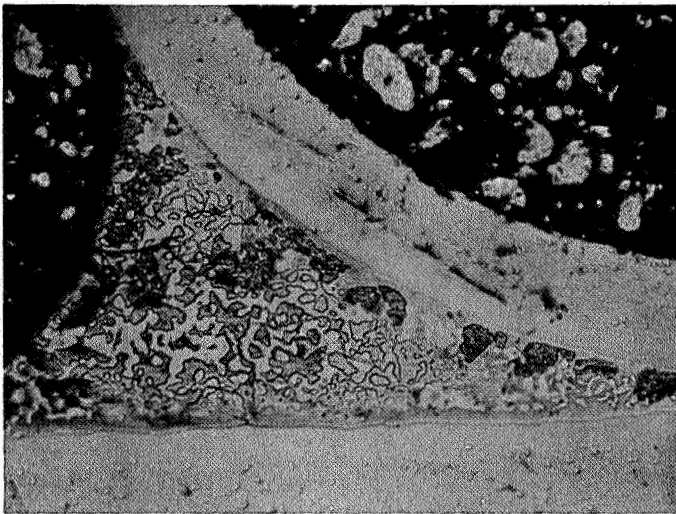

Vacuum Aged (5.0×10^{-10} Torr)

1000 Hours

1750° F

Note secondary crack in braze metal due to peel test after aging. Primary peel failure occurred in braze-affected foil.

Magnification: 100 X

FIGURE 42. TRANSVERSE SECTIONS THROUGH TUBE/FIN BRAZEMENTS MADE WITH Zr-28V-16Ti BRAZE ALLOY; Fin Design A

reason for this belief was its demonstrated superior braze fluidity and filleting characteristics, which are vital to obtaining 100 percent joint coverage in the blind brazing situation characteristic of the heat receiver tubes. The need for repair brazing also would be minimized. Other attributes such as braze strength, bend toughness, peel resistance, thermal stability, and structural integrity were believed more than adequate for the heat receiver tube application. It was recommended to the sponsor that Zr-28V-16Ti-0.1Be alloy be selected for brazing the full scale 36-inch tube modules (Phase II). Sponsor approval was received at the close of Phase I.

3

FABRICATION AND BRAZING OF FULL SCALE HEAT RECEIVER TUBES - PHASE II

3.1 PROCUREMENT OF MATERIALS

Two Cb-1Zr tubes (40-inch length by 1.25-inch OD by 0.25-inch wall thickness) as well as Cb-1Zr foil stock (0.005 inch) for internal fin modules were provided by the sponsor. Cleaning procedures were identical to those used in Phase I work. The Zr-28V-16Ti-0.1Be braze alloy selected for Phase II work was manufactured at Solar using the procedures outlined in Phase I. Braze alloy particles of the Zr-28V-16Ti-0.1Be alloy graded to -9/+12 mesh were employed.

3.2 FABRICATION OF INTERNAL FIN MODULES

Seventy-two internal fin modules of the Design B (Fig. 34) were fabricated as in Phase I, 36 modules for each heat receiver tube. Braze alloy particles, totalling ~60 milligrams/fin element, were tack welded into position near the faying surface of each fin (Fig. 34). Only the top of the fin module was loaded, to take advantage of initial gravity feed into the capillary produced by the tube/fin faying surfaces in contact (par. 2.5.1).

3.3 BRAZING PROCEDURE

One-inch to two-inch long sections of each 36-inch receiver tube were brazed sequentially, using the same vacuum Vycor tube furnace and brazing conditions described for the 18-inch tube modules. Vacuum chamber pressure was 1.0×10^{-5} Torr or better (Fig. 43). The only difference in apparatus was that a longer, five-foot, Vycor tube was employed to accommodate the longer, 36-inch receiver tubes. The Cb-1Zr tube with internal fins in brazing position was positioned concentrically and vertically inside the Vycor tube. A uniform hot zone of ~three inches of receiver tube length was obtained with a four-inch induction coil on a flexible, coaxial cable, positioned externally. The Cb-1Zr tube itself served as heater-susceptor. External tube temperature was measured with a Pyro micro-optical pyrometer (Fig. 43), although actual braze flow was observed visually through the Vycor (by the use of mirrors) as a positive check on temperature. Time at braze temperature was limited to five minutes.

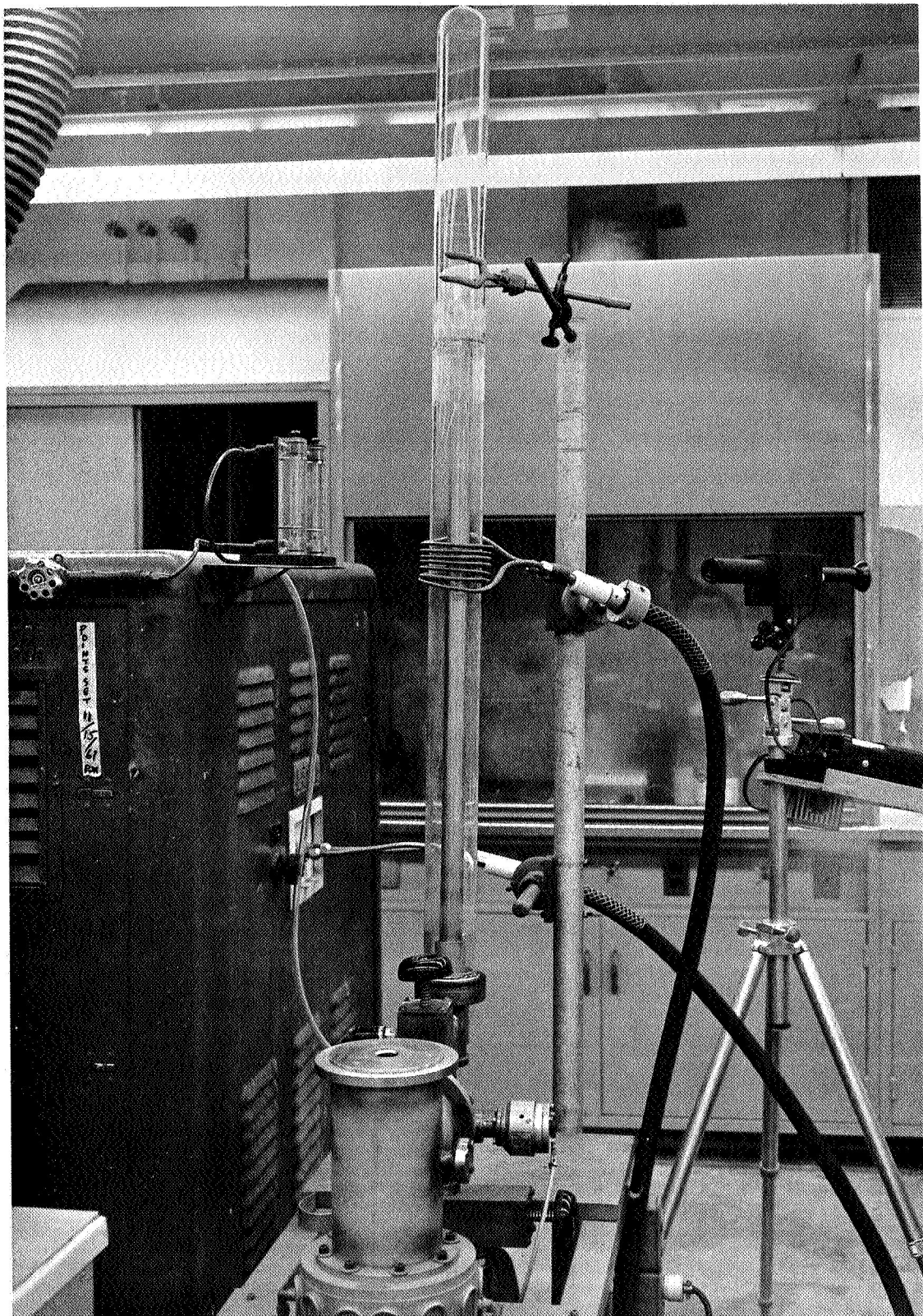

FIGURE 43. VACUUM INDUCTION BRAZING SETUP FOR 36-INCH HEAT RECEIVER TUBES

Inasmuch as fin Design B was employed, two fin modules were brazed per braze cycle, starting at the tube mid-length position and working outward toward each end of the tube. This procedure was maintained to within six inches of the tube ends. From this point outward, three to four fin modules were brazed per cycle, as visibility and maneuverability (for repair brazing) improved. It was determined that brazing clusters of more than two to four fin modules/cycle was impractical, because of the extreme difficulty of visual inspection and repair brazing.

3.4 INSPECTION AND REPAIR PROCEDURES

After initial brazing, each cluster of two to four fin modules was carefully inspected visually to determine the extent of braze coverage and confirm fillet formation. Inspection was carried out by employing end lighting with a high-intensity light source and a 5X magnifying lens. Even though much longer sections of the brazed tube could have been inspected by X-ray, it would not have been useful because repair brazing can be accomplished readily only over short lengths corresponding to two to four fin modules. Suspect brazements were repair brazed, in situ, using the same braze loading and brazing techniques described for initial brazing. The chief need for repair brazing was lack of sufficient braze alloy entering the joint area. Faying surface misalignment was not a problem requiring repair with fin Design B. Fortunately, all defective brazements proved repairable, and did not require removal or replacement.

The two brazed and inspected 36-inch tubes are shown in Figure 44. These full scale heat receiver tubes were later capped and sealed in polyethylene bags and shipped to the sponsor.

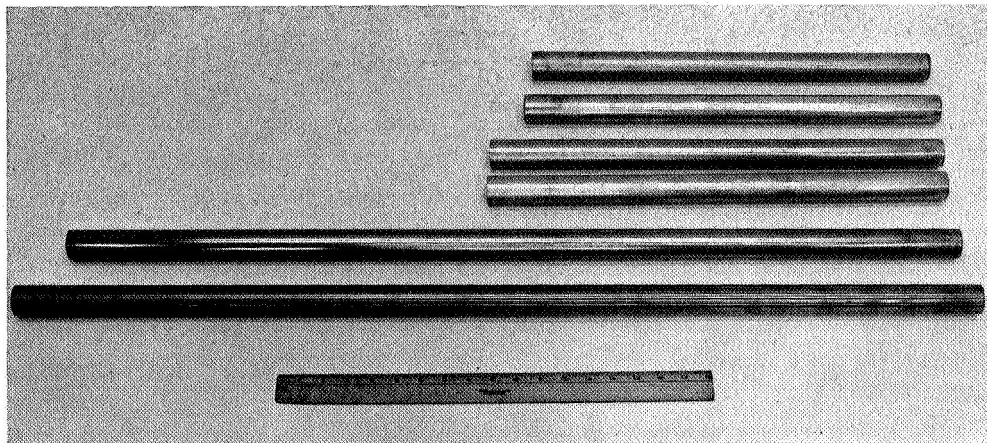
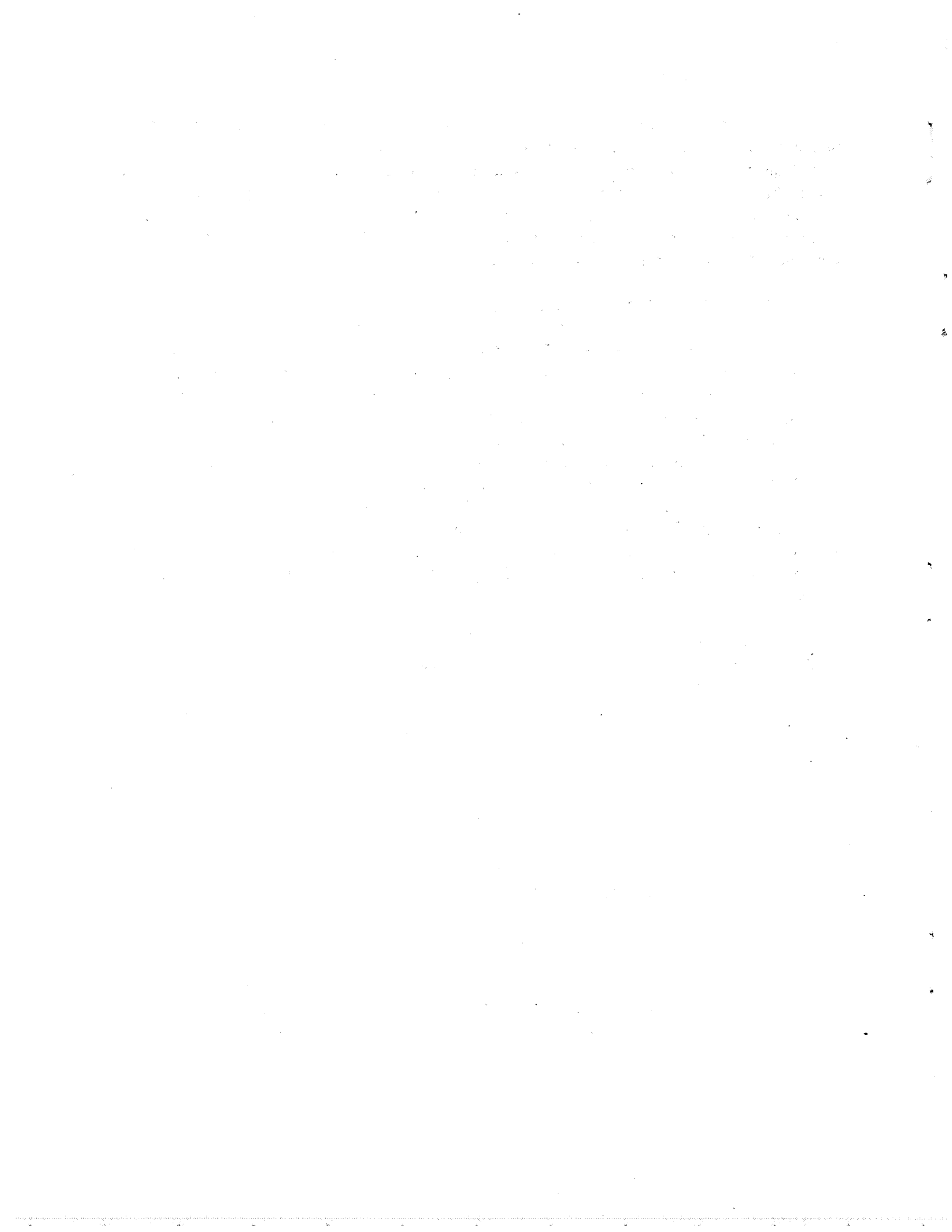

FIGURE 44. EXTERNAL SIDE VIEWS OF FOUR 18-INCH AND TWO 36-INCH HEAT RECEIVER TUBES; Post Brazing



4

CONCLUSIONS AND RECOMMENDATIONS

The zirconium-base alloy, Zr-28V-16Ti-0.1Be, applied in conjunction with a good vacuum brazing technique, provides an acceptable joining process for the manufacture of Cb-1Zr heat receiver tubes. The specific braze joining process is acceptable for Cb-1Zr joints slated for long-term deployment in space environments over the temperature range room temperature to 1650°F, in terms of brazement strength, bend toughness, peel resistance, and thermal stability. These conclusions are based upon tests conducted upon brazed T-joint and lap-joint specimens and brazed receiver tubes, both in the as-brazed condition and after 1000 hours of isothermal aging at 1750° F in a high-vacuum chamber (pressure of $\leq 1.0 \times 10^{-8}$ Torr). Minor losses in braze strength and a moderate increase in notch sensitivity were noted post aging. These changes were believed to be the result of gradual increases in interstitial element contaminant levels within the braze during aging, and/or general coarsening of the two-phase braze structure. Chemical alteration of the external Cb-1Zr surface by solid-state diffusion from internal surface brazements is not a problem. However, to qualify the subject braze process for application periods of up to 10,000 hours at 1650°F, it is recommended that further isothermal stability tests be conducted in simulated space environments for at least 5000 hours at 1750°F or 10,000 hours at 1650°F.

The chief problem encountered in brazing heat receiver tubes is the problem presented by the internal fin configuration itself. The configurations tested are so intricate that repair brazing is virtually impossible except for short fin sections. Hence, the job of brazing a 36-inch receiver tube must be segmented into 30 or more separate initial braze operations, with a good possibility of an additional 15 or more braze repair operations. If the receiver tube is to be produced in quantity, it is recommended that some thought be applied to developing a new fin design which can more readily be repaired through longer fin-module lengths.

The possible future development of a braze material in foil form which could be tacked between the fin and the ID of the 1.25-inch tube should enhance the brazing process and minimize the need for braze repair.



PRECEDING PAGE BLANK NOT FILMED.

REFERENCES

1. Fox, C. W. , Gilliland, R. W. , and Slaughter, G. M. , Development of Alloys for Brazing Columbium. Welding Journal, Vol. 42, No. 12, Research Supplement, 535s-540s (December 1963).
2. Welty, J. W. , Valdez, P. J. , Smeltzer, C. E. , Jr. and Davis, C. P. , Joining of Refractory Metal Foils. Technical Documentary Report ASD-TDR-63-799, Part I (July 1963).
3. Young, W. R. , Alloy Systems for Brazing of Columbium and Tungsten. Technical Documentary Report, ASD-TR-61-592 (January 1962).
4. Elliott, R. P. , "Constitution of Binary Alloys". McGraw-Hill Book Company, New York, New York. (First Supplement 1965).
5. Hansen, M. , "Constitution of Binary Alloys". McGraw-Hill Book Company (Second Edition 1958).
6. Brentnall, W. D. and Metcalfe, A. G. , Interstitial Sink Effects in Columbium Alloys. Interim Engineering Progress Report. Contract AF33(615)-5233 1 September 1966-30 November 1966.