

LAGERSCHALEN
COUSSINETS
COJINETES



Globally reliable



ENGINE BEARINGS



B5/1



Globally reliable

B5/1 Engine Bearings

Einleitung	Seite	4
Introduction	page	14
Introduction	page	24
Introducción	página	34

Weitere Kataloge und Produktinformationen

Über den vorliegenden Katalog hinaus erhalten Sie auch weitere Produkte über den Vertrieb der Firma NPR of Europe GmbH.

Fragen Sie nach unserem kompletten Programm und nutzen Sie auch unseren Produktmanager, der zum Download auf unserer Homepage zur Verfügung steht.

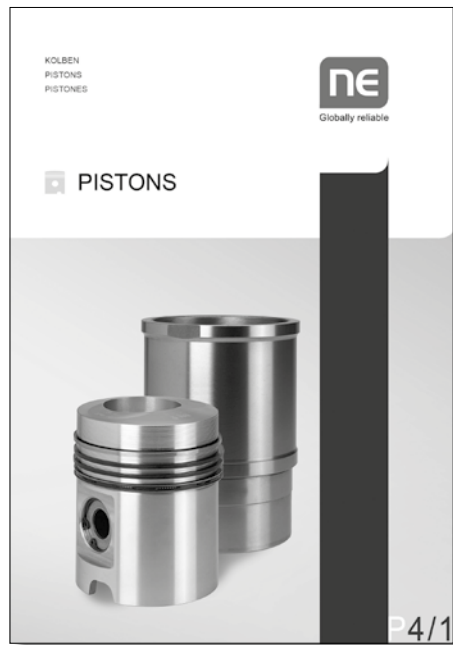

Katalog P4/1: Kolben

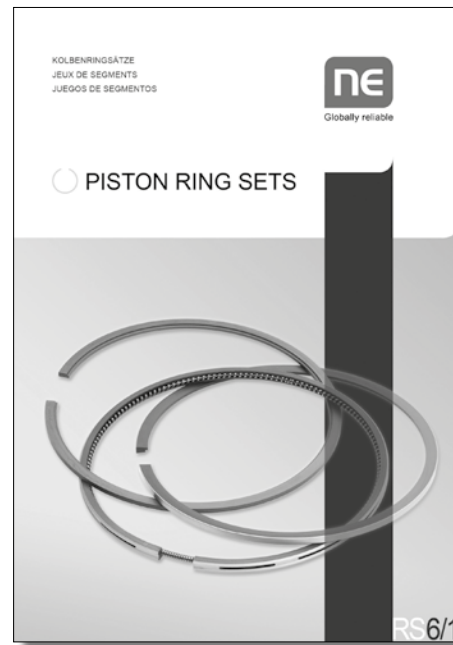

Katalog RS6/1: Kolbenringsätze

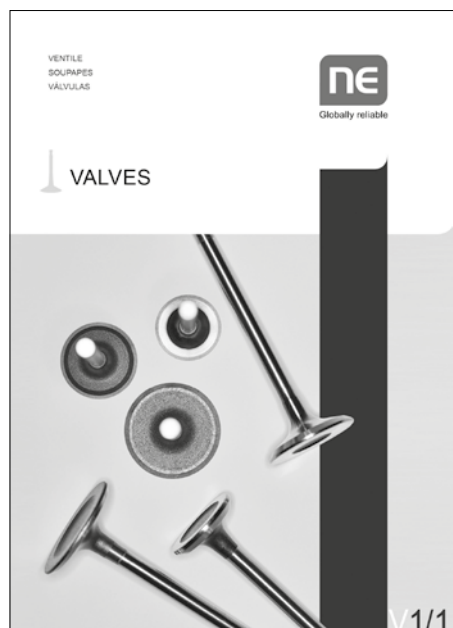

Katalog V1/1: Ventile



Produktmanager:
Das gesamtes Programm online.

Inhaltsverzeichnis

	Seite
Hinweise zum Katalog	6
Kennzeichnung der Übermaße und Nummernschlüssel	7
Nummernschlüssel Bestellnummern	7
Werkstoffe	8
Motorenaufbau	9
Hinweise zur Benutzung des Kataloges	10
Herstellerverzeichnis	13
Sicherheitsprüfung	309
Allgemeine Geschäftsbedingungen	310

Hinweise zum Katalog

Damit wir unseren Kunden mit diesem Katalog möglichst korrekte Daten bieten können, wurden alle Artikel mit größter Sorgfalt zusammengestellt und kontrolliert. Wir haften jedoch nicht für die Folgen etwaiger Irrtümer oder Auslassungen. Weiterhin behalten wir uns notwendige oder technisch vertretbare Änderung in der Spezifikation der Lager vor.

Die Lagerschalen sind so ausgeführt, dass sie ohne jegliche Nacharbeit der Gehäuse und Wellen eingebaut werden können. Die Ausführung der Lager in Material und Maß ist an die Erstausrüstung der Motorenhersteller angelehnt.

Die Auswahl an Lagern ist ständigen Änderungen unterworfen, daher können teilweise ungängige Lager nur noch aus laufenden Lagerbeständen geliefert werden. Andererseits besteht für neu aufgenommene Lagerschalen eine Liefermöglichkeit. Lagerschalen für Rennsport, Kompressoren und weitere spezielle Anwendungen können auf Anfrage ebenfalls angeboten werden. Des Weiteren können wir Lagerschalen, die nicht in diesem Katalog aufgeführt sind, auf Anfrage gerne anbieten.

Seriennummern, Fabrikate sowie Fahrzeug- und Herstellernamen werden lediglich zur Transparenz verwendet.

Aufträge werden grundsätzlich nach unseren „Allgemeinen Liefer- und Zahlungsbedingungen“ angenommen. Ausnahmen bedürfen unserer schriftlichen Bestätigung. Nachdruck und Änderung dieses Katalogs dürfen nicht ohne unsere Genehmigung erfolgen.

Zertifizierung

Da wir wissen, dass sowohl unsere Produkte als auch unser Service jeder Prüfung standhalten, lassen wir uns gerne von externen Prüfern unsere Qualität bestätigen.

Aus diesem Grund sind wir nach ISO/TS 16949:2016 und nach ISO 9001:2015 zertifiziert. Dadurch können Sie auch für Ihre Produkte in unseren Service und in unsere Produkte vertrauen.

Kennzeichnung der Übermaße

Kürzel	Übermaße	Kürzel	Übermaße
00	STD	21	0,50 mm
01	.001	22	.020
02	0,05 mm	23	0,60 mm
03	.002	24	0,65 mm
04	0,06 mm	25	0,70 mm
05	.0025	26	0,75 mm
06	.003	27	.030
07	0,08 mm	28	0,80 mm
08	0,10 mm	29	1,00 mm
09	0,12 mm	30	.040
10	0,125 mm	31	1,25 mm
11	.005	32	.050
12	0,15 mm	33	1,50 mm
13	.0075	34	.060
14	0,20 mm	35	2,00 mm
15	0,25 mm	99	Semi
16	.010		
17	0,30 mm		
18	0,35 mm		
19	.015		
20	0,40 mm		

Nummernschlüssel Bestellnummer

	alt		neu
Hauptlager	60	→	180
Pleuellager	61	→	181
Anlaufscheiben	62	→	182
Nockenwellenlager	63	→	183
Pleuelbuchse	64	→	184

Werkstoffe

Chemische Zusammensetzung		Beschichtung gemäß SAE	NE Referenz
CuPb23Sn4		SAE 794	SR
AlSn12Si2.5Pb1.7Cu		SAE 788	SSI
CuPb24Sn2	3-metal	SAE 799	S3S
AlSn20Cu	2-metal	SAE 783	SAL
S3S + SAL	3/2-metal	SAE 788 / 783	S32S
CuPb10Sn10		SAE 797	SL
PVDAlSn20		Sputter	SPVD
P4Z - Sn		repl. Sputter (Cerrox)	S4S
AlSn			AL
PAI + Graphite + MOS2		Polymer	Nefrox

Alle verwendeten Materialien entsprechen der Serienausführung.

Motorenaufbau

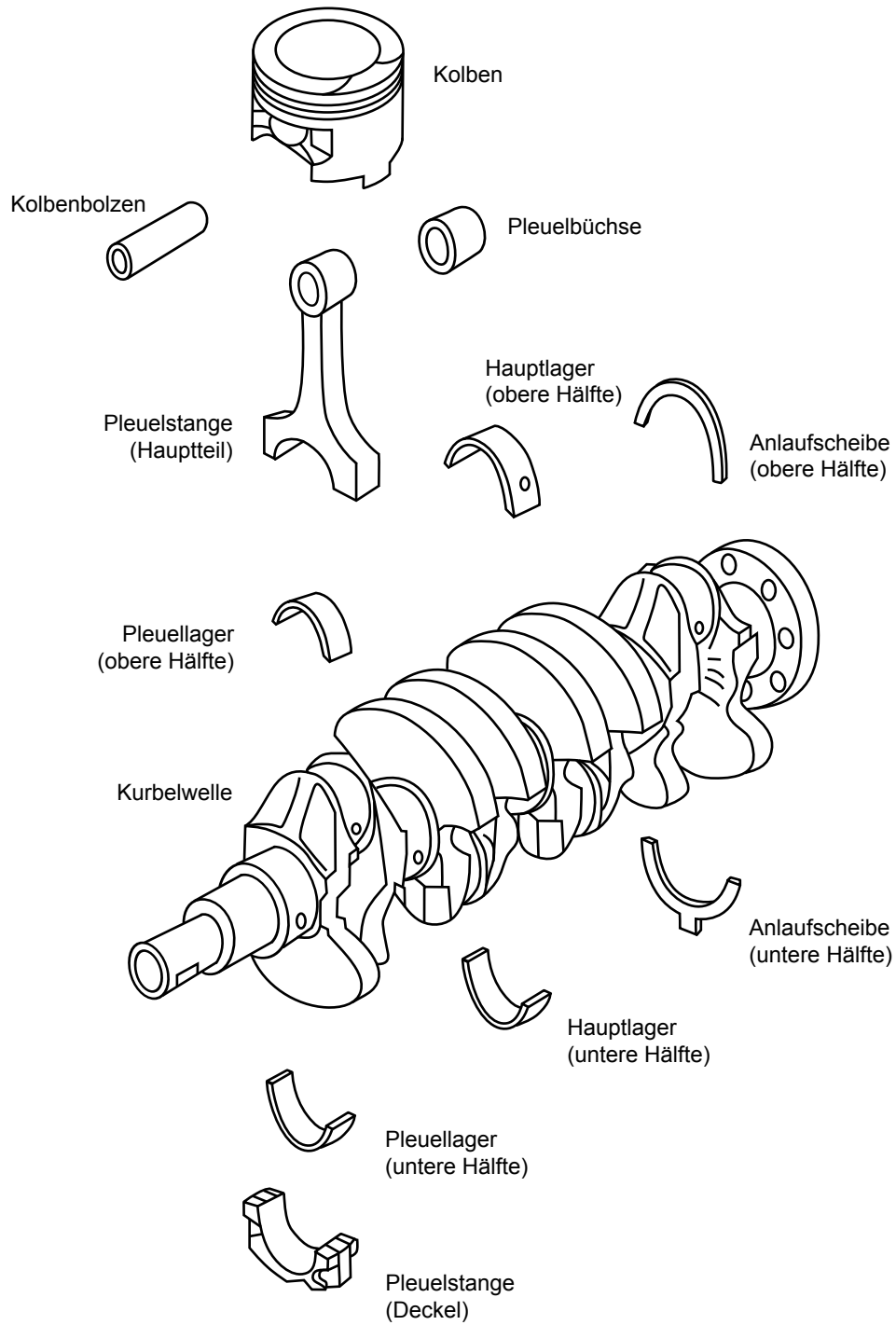

Hinweise zur Benutzung des Kataloges

Katalogteil

Zu Beginn des jeweiligen Motorenherstellers können Sie die zu Ihrem Motorcode und Fahrzeugmodell passende(n) Lagerschalen-Artikelnummer(n) finden.

Die angegebene Positionsreihenfolge ist nach dem Bohrungsdurchmesser des Motors aufsteigend sortiert und führt Sie im späteren Kapitel zu den genaueren Produktdaten.

Fahrzeughersteller		Bohrung		Modell		NE-Artikelnummer		Positionsreihenfolge	
Motorbezeichnung (Motorcode)	Hubraum	Zylinder-Anzahl	Maß	Modell	Bohrung	NE-Artikelnummer	Bohrung	Maß	Pos.
HB, HC, HD	1093	4	69,50	Audi 50 1.1i	69,50	180 050 0002 180 050 0006 180 050 0008 181 050 0010 183 050 0001 183 050 0002 184 050 0002	Std, 0,25, 0,50, 0,75 Std, 0,25, 0,50 Std, 0,25, 0,50, 0,75, 1,00 Std, 0,25, 0,50 Std, Semi Std, Semi Semi		1
FY, FZ, HH	1272	4	75,00	Audi 50 1.3i, Audi 80 1.3i	75,00	180 050 0006 181 050 0010 183 050 0001 183 050 0002 184 050 0002	Std, 0,25, 0,50 Std, 0,25, 0,50 Std, Semi Std, Semi Semi		2

Produktdaten

Entsprechend der Positionsreihenfolge aus dem Katalogteil finden Sie hier technische Daten und Beschreibungen zu allen relevanten Artikelnummern.

Positionsreihenfolge
Die Positionsreihenfolge im Katalogteil richtet sich nach dem Bohrungsdurchmesser des Motors.

Bohrungsdurchmesser des Motors

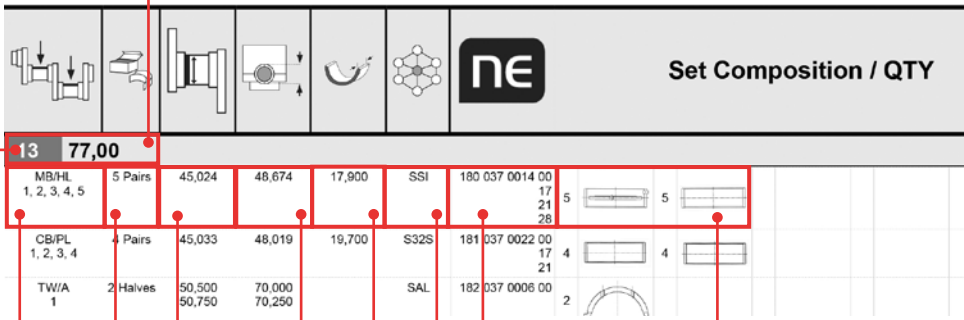

												NE		Set Composition / QTY		
13	77,00															
MB/HL 1, 2, 3, 4, 5	5 Pairs	45,024	48,674	17,900	SSI	180 037 0014 00	17	21	28	5		5				
CB/PL 1, 2, 3, 4	4 Pairs	45,033	48,019	19,700	S32S	181 037 0022 00	17	21		4		4				
TW/A 1	2 Halves	50,500 50,750	70,000 70,250		SAL	182 037 0006 00				2						

Wellenmaß

NE-Artikelnummer

Anzahl Hälften / Paare

Material / Werkstoff

Bestückung mit Anzahl

Bezeichnung / Lagerstelle

Lagerbreite

Gehäusemaß



Globally reliable

EINLEITUNG

Herstellerverzeichnis

	Seite		Seite
Air Compressor	45	RVI	232
Alfa Romeo	47	Saab	236
Audi	51	Scania	239
BMW	63	Seat	243
BYD	74	Skoda	245
Chery	77	Steyr	247
Citroën	78	Subaru	250
Dacia	87	Suzuki	253
Daewoo - Chevrolet (GM)	89	Toyota	257
DAF	92	Volkswagen	273
Daihatsu	96	Volvo	300
DS	100		
Fiat	102		
Fiat-Iveco	114		
Ford	116		
Great Wall	121		
Honda	123		
Hyundai	129		
IHC - Case IH	135		
Isuzu	137		
Jaguar	144		
KHD	146		
Kia	150		
Lancia	153		
Lexus	155		
Lifan	157		
M.A.N.	159		
Mazda	161		
Mercedes-Benz	168		
Mitsubishi	187		
MWM	192		
Nissan	194		
Opel	203		
Perkins	212		
Peugeot	214		
Renault	224		

Other catalogues and product information

Further to the products in this catalogue NPR of Europe's sales department has also other parts at your disposal. Please ask for our entire range of products and consult the „Product Manager“ on our home page, which is updated at regular intervals.

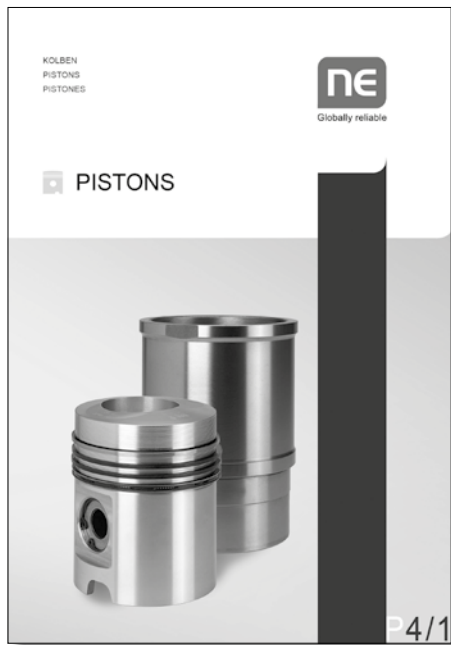

Catalogue P4/1: Pistons

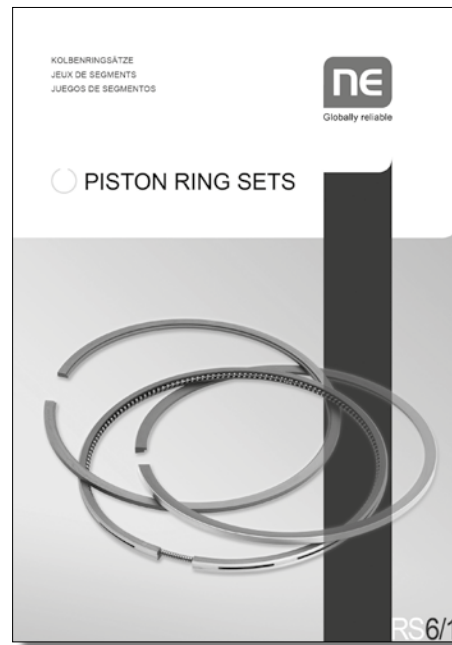

Catalogue RS6/1: Piston ring sets

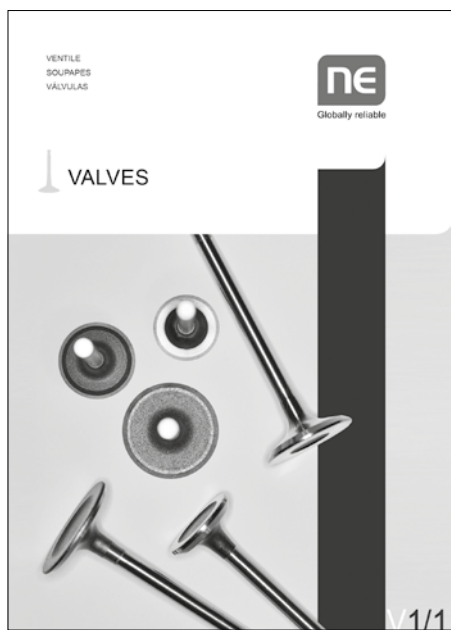

Catalogue V1/1: Valves



Product Manager: entire program online.

Table of contents

	page
Hints to the use of this catalogue	16
Oversize marking	17
Numerical code part number / order number	17
Materials	16
Engine structure diagram	19
How to use this catalogue	20
Index of manufacturers	23
Security check	309
General Terms and Conditions	310

Hints to the use of this catalogue

In order to offer to our customers correct data in this catalogue, all of the references have been assembled and controlled with much care. However, we cannot be held responsible for the consequences of possible errors or omissions. Furthermore we reserve the right to make necessary or technically reasonable changes in the specification of the bearings. NPR of Europe GmbH is OE-supplier to many well-known engine manufacturers. This successful relationship started in 1998 with us being supplier for the bearings of the ACTROS series 500.

The bearings may be fitted without altering the housings or shafts. The design of material and dimensions is based on the original equipment of the engine manufacturers. supply until our stocks last, on the other hand newly added bearings may be available from stock. Please ask our sales staff if you are looking for bearings you may not find in this catalogue or for racing, compressors or any other special applications. Serial numbers and trademarks as well as model and producer's names are only used for reference and transparency.

All orders are accepted and executed according to our General Terms and Conditions, exceptions need our written confirmation. Reprints of and alterations to this catalogue need our written acceptance.

Certification

As we feel sure that our products as well as our service will withstand every exam, we gladly have our quality confirmed by external auditors. For this reason we are certified according to ISO/TS 16949:2016 and ISO 9001:2015. So you may always rely on our service and the quality of our products.

Oversize marking

Kürzel	Übermaße	Kürzel	Übermaße
00	STD	21	0,50 mm
01	.001	22	.020
02	0,05 mm	23	0,60 mm
03	.002	24	0,65 mm
04	0,06 mm	25	0,70 mm
05	.0025	26	0,75 mm
06	.003	27	.030
07	0,08 mm	28	0,80 mm
08	0,10 mm	29	1,00 mm
09	0,12 mm	30	.040
10	0,125 mm	31	1,25 mm
11	.005	32	.050
12	0,15 mm	33	1,50 mm
13	.0075	34	.060
14	0,20 mm	35	2,00 mm
15	0,25 mm	99	Semi
16	.010		
17	0,30 mm		
18	0,35 mm		
19	.015		
20	0,40 mm		

Numerical code part number / order number

	old		new
Main bearing	60	→	180
Conrod bearing	61	→	181
Thrust washer	62	→	182
Camshaft bearing	63	→	183
Small-end bush	64	→	184

Materials

Chemical composition		Coating according to SAE	NE reference
CuPb23Sn4		SAE 794	SR
AlSn12Si2.5Pb1.7Cu		SAE 788	SSI
CuPb24Sn2	3-metal	SAE 799	S3S
AlSn20Cu	2-metal	SAE 783	SAL
S3S + SAL	3/2-metal	SAE 788 / 783	S32S
CuPb10Sn10		SAE 797	SL
PVDAlSn20		Sputter	SPVD
P4Z - Sn		repl. Sputter (Cerrox)	S4S
AlSn			AL
PAI + Graphite + MOS2		Polymer	Nefrox

All materials used are according to the series construction / production run construction.

Engine structure diagram

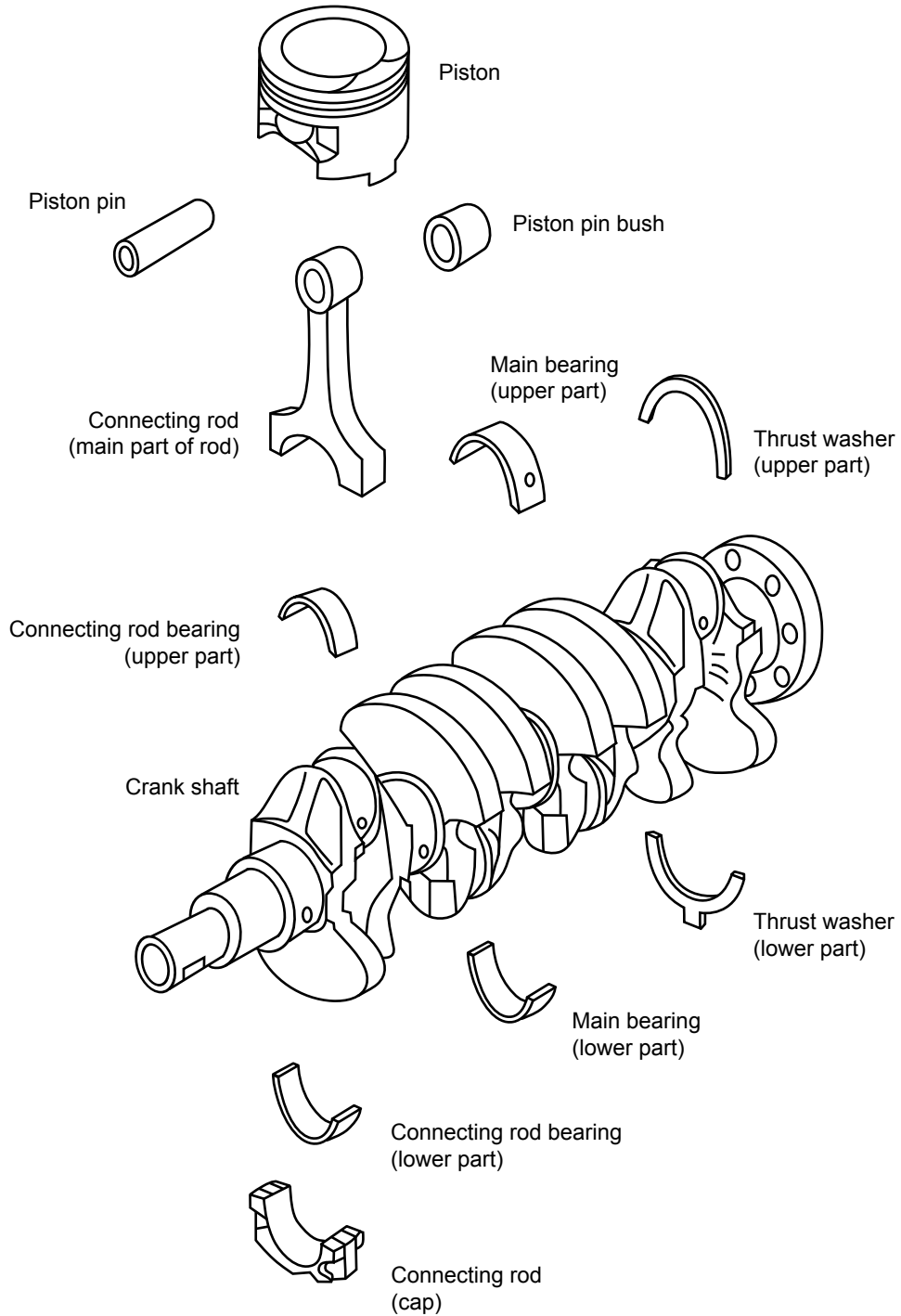

How to use this catalogue correctly



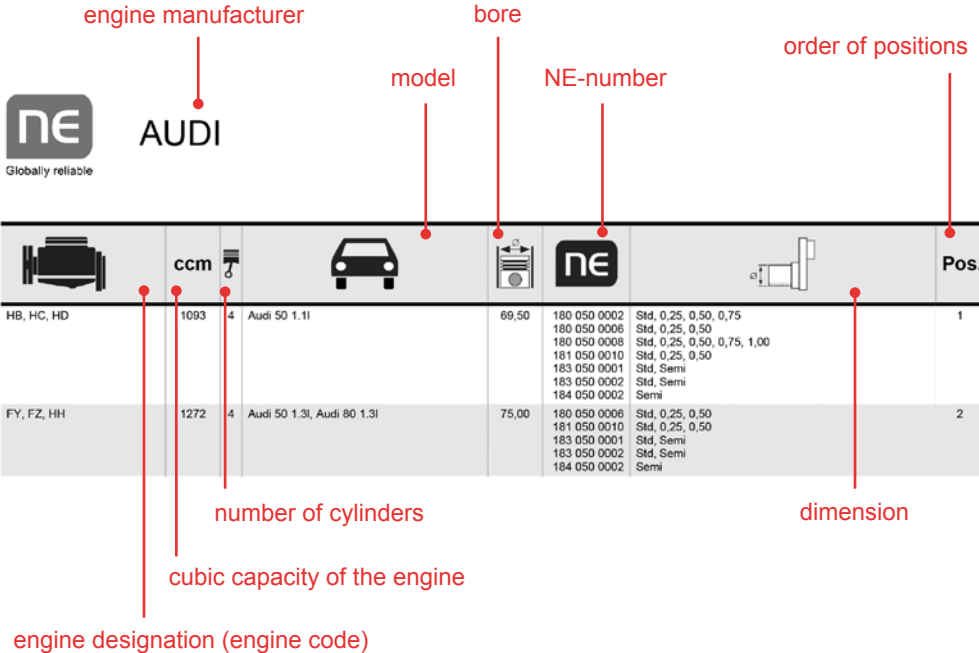

Catalogue part

At the beginning of the relevant engine manufacturer, you may find the engine bearing article number(s) matching to your engine code and vehicle model.

The position number is assorted in an alphanumeric ascending order according to the bore diameter of the engine and leads you to the correct product data on the next chapter.



The diagram illustrates the structure of an engine bearing article number. It shows a table with columns for engine manufacturer, model, bore, NE-number, and order of positions. Red lines point from labels to specific parts of the article number and table headers.

engine manufacturer	model	bore	NE-number	order of positions	
NE Globally reliable AUDI					
					
HB, HC, HD	ccm 1093 4 Audi 50 1.1i	69,50	180 050 0002 180 050 0006 180 050 0008 181 050 0010 183 050 0001 183 050 0002 184 050 0002	Std, 0,25, 0,50, 0,75 Std, 0,25, 0,50 Std, 0,25, 0,50, 0,75, 1,00 Std, 0,25, 0,50 Std, Semi Semi	1
FY, FZ, HH	1272 4 Audi 50 1.3i, Audi 80 1.3i	75,00	180 050 0006 181 050 0010 183 050 0001 183 050 0002 184 050 0002	Std, 0,25, 0,50 Std, 0,25, 0,50 Std, Semi Std, Semi Semi	2

Labels for the table structure:

- number of cylinders
- cubic capacity of the engine
- engine designation (engine code)
- dimension

Product data

According to the position number from the catalog part, you may find here the technical data and descriptions of all relevant article numbers.

Position
In the following catalogue part the positions are assorted by engine bore.

engine bore



		Set Composition / QTY							
13	77,00								
MB/HL 1, 2, 3, 4, 5	5 Pairs	45,024	48,674	17,900	SSI	180 037 0014 00 17 21 28	5	5	
CB/PL 1, 2, 3, 4	4 Pairs	45,033	48,019	19,700	S32S	181 037 0022 00 17 21	4	4	
TW/A 1	2 Halves	50,500 50,750	70,000 70,250		SAL	182 037 0006 00		2	

units in packing

bearing position

shaft dimension

bearing width

housing dimension

material

NE-number

set composition – QTY



INTRODUCTION

Index of manufacturers

	page		page
Air Compressor	45	RVI	232
Alfa Romeo	47	Saab	236
Audi	51	Scania	239
BMW	63	Seat	243
BYD	74	Skoda	245
Chery	77	Steyr	247
Citroën	78	Subaru	250
Dacia	87	Suzuki	253
Daewoo - Chevrolet (GM)	89	Toyota	257
DAF	92	Volkswagen	273
Daihatsu	96	Volvo	300
DS	100		
Fiat	102		
Fiat-Iveco	114		
Ford	116		
Great Wall	121		
Honda	123		
Hyundai	129		
IHC - Case IH	135		
Isuzu	137		
Jaguar	144		
KHD	146		
Kia	150		
Lancia	153		
Lexus	155		
Lifan	157		
M.A.N.	159		
Mazda	161		
Mercedes-Benz	168		
Mitsubishi	187		
MWM	192		
Nissan	194		
Opel	203		
Perkins	212		
Peugeot	214		
Renault	224		

Autres catalogues et informations sur nos produits

Au-delà de ce catalogue, vous pouvez également obtenir plus de produits à travers le service commercial de la société NPR of Europe GmbH.

Renseignez-vous sur notre programme complet et utilisez notre Produit-Manager, qui est mis à jour régulièrement.

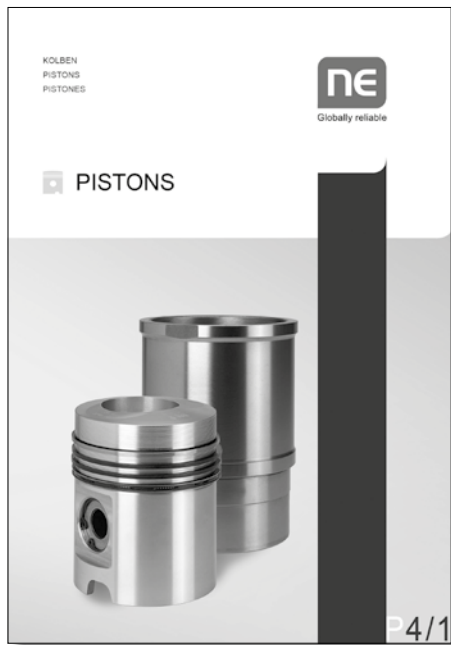

Catalogue P4/1: Pistons

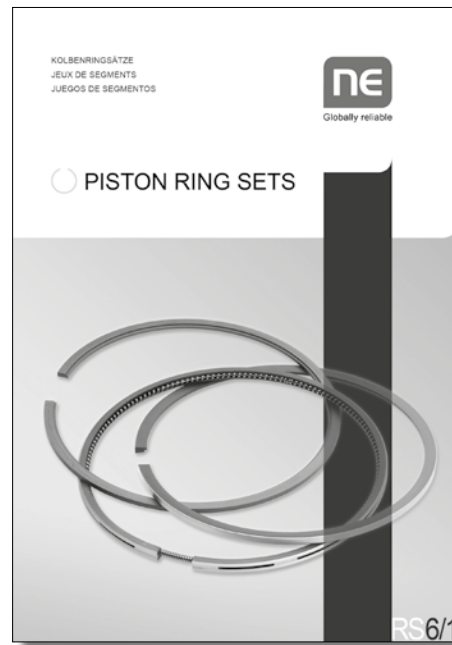

Catalogue RS6/1: Jeux de segments

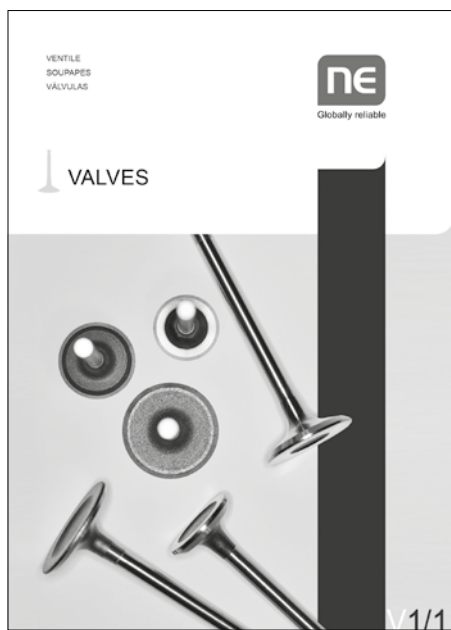

Catalogue V1/1: Soupapes



Produit-Manager: tout le programme online

Table des matières

	page
Informations dans ce catalogue	26
Identification des côtes de réparations	27
Clé numérique des références	27
Matériaux	28
Conception du moteur	29
Indications sur l'utilisation du catalogue	30
Index des constructeurs	33
Vérification de la sécurité	309
Termes et conditions de vente de NPR of Europe GmbH	310



Globally reliable

INTRODUCTION

Informations dans ce catalogue

Toutes les informations de ce catalogue ont été mises ensemble et contrôlées avec le plus grand soin pour offrir à nos clients des données les plus correctes que possibles. Cependant, on ne peut pas nous faire responsable pour les conséquences des erreurs ou des omissions éventuelles. En plus nous nous réservons le droit des changements nécessaires ou raisonnables de la technique et spécification des coussinets.

Les coussinets sont livrés prêt-à-monter, ce qui ne nécessite pas un retouchement supplémentaire du boîtier. Pour les dimensions et matériaux des coussinets nous nous sommes orientés à l'équipement des constructeurs.

La sélection des coussinets est soumise à un changement permanent, ainsi que quelques références à très faible demande peuvent être livrées jusqu'à l'épuisement du stock. Les nouvelles références de notre programme sont par contre livrables. N'hésitez pas à nous contacter si vous cherchez des coussinets pour application spéciale (par exemple voitures de courses, compresseurs...) ou qui ne sont pas mentionnés dans ce catalogue.

Les numéros de série, noms du modèle, du véhicule et le nom du fabricant sont seulement utilisés pour raison de transparence.

Les commandes sont généralement acceptées et traitées selon nos conditions générales de livraison et de paiement. Exceptions nécessitent notre confirmation écrite. Les réimpressions et changements de ce catalogue sont soumises à notre autorisation écrite.

Certificat

On est sûr de la qualité de nos produits ainsi que de notre service. Pour cette raison, nous sommes certifiés selon la norme ISO / TS 16949:2016 et ISO 9001:2015.

C'est pour cela, vous pouvez faire confiance à nos produits ainsi qu'à notre service.

Identification des côtes de réparations

Initiale	côte de réparation	Initiale	côte de réparation
00	STD	21	0,50 mm
01	.001	22	.020
02	0,05 mm	23	0,60 mm
03	.002	24	0,65 mm
04	0,06 mm	25	0,70 mm
05	.0025	26	0,75 mm
06	.003	27	.030
07	0,08 mm	28	0,80 mm
08	0,10 mm	29	1,00 mm
09	0,12 mm	30	.040
10	0,125 mm	31	1,25 mm
11	.005	32	.050
12	0,15 mm	33	1,50 mm
13	.0075	34	.060
14	0,20 mm	35	2,00 mm
15	0,25 mm	99	Semi
16	.010		
17	0,30 mm		
18	0,35 mm		
19	.015		
20	0,40 mm		

Clé numérique des références

	ancienne		nouvelle
Coussinet principaux	60	→	180
Coussinet de palier	61	→	181
Rondelles de guidage	62	→	182
Coussinets d'arbre à cames	63	→	183
Bagues de bielle	64	→	184

Matériaux

Composition chimique		Revêtement selon (SAE)	NE référence
CuPb23Sn4		SAE 794	SR
AlSn12Si2.5Pb1.7Cu		SAE 788	SSI
CuPb24Sn2	3-metal	SAE 799	S3S
AlSn20Cu	2-metal	SAE 783	SAL
S3S + SAL	3/2-metal	SAE 788 / 783	S32S
CuPb10Sn10		SAE 797	SL
PVDAlSn20		Sputter	SPVD
P4Z - Sn		repl. Sputter (Cerrox)	S4S
AlSn			AL
PAI + Graphite + MOS2		Polymer	Nefrox

Tous les matériaux utilisés sont conformes au ceux de la première monte.

Conception du moteur

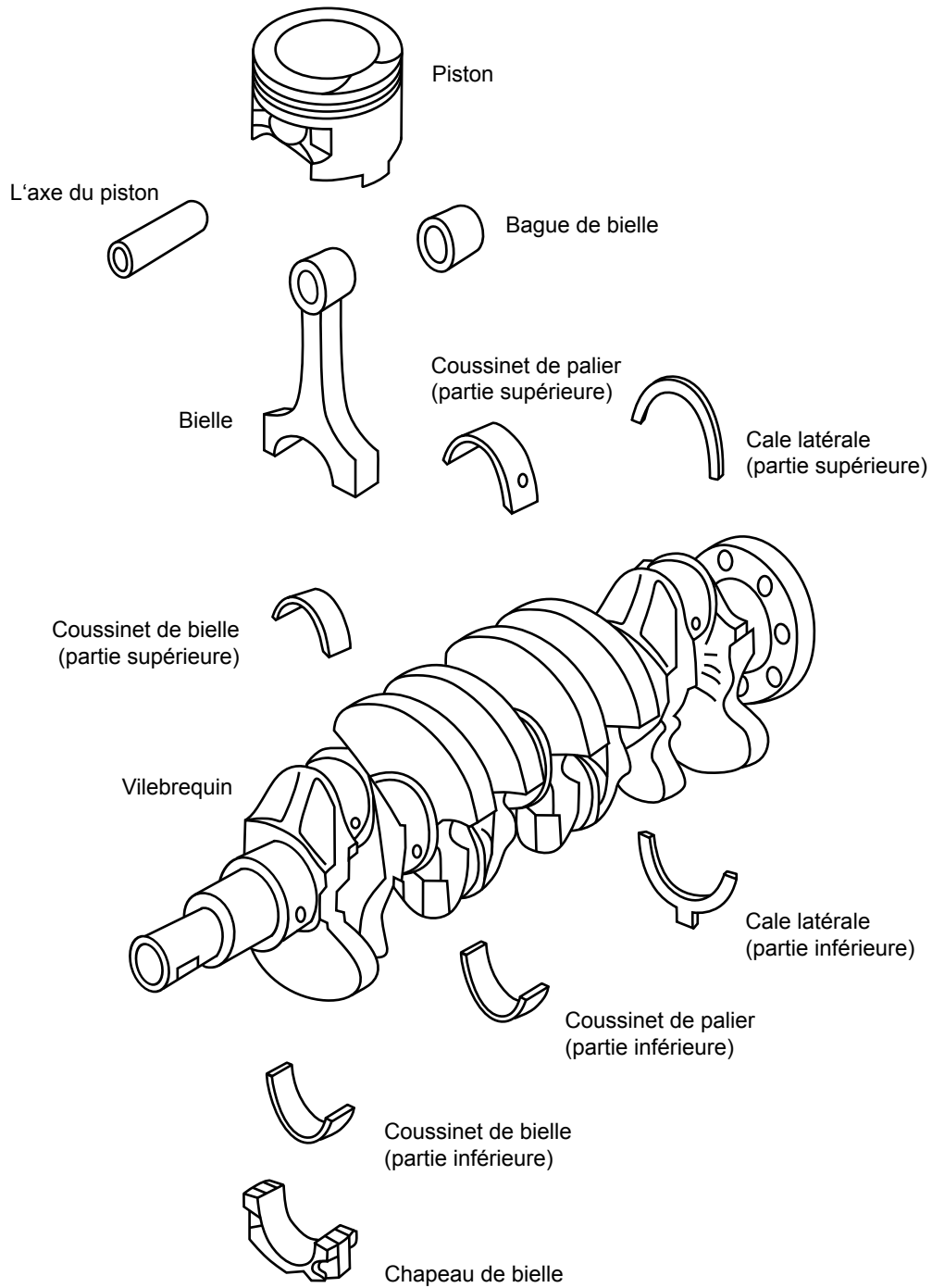

Indications sur l'utilisation du catalogue

La partie catalogue

Au début de chaque chapitre (Constructeur de moteur), vous pouvez trouver facilement la Référence du coussinets qui correspond à votre code du moteur et le type de véhicule recherché.

La séquence des positions indiquée (dans la colonne Pos.) est triée par ordre croissant en fonction du diamètre de l'alésage du moteur et vous conduit dans le chapitre constructeur de moteur exactement aux données relatives à votre recherche.

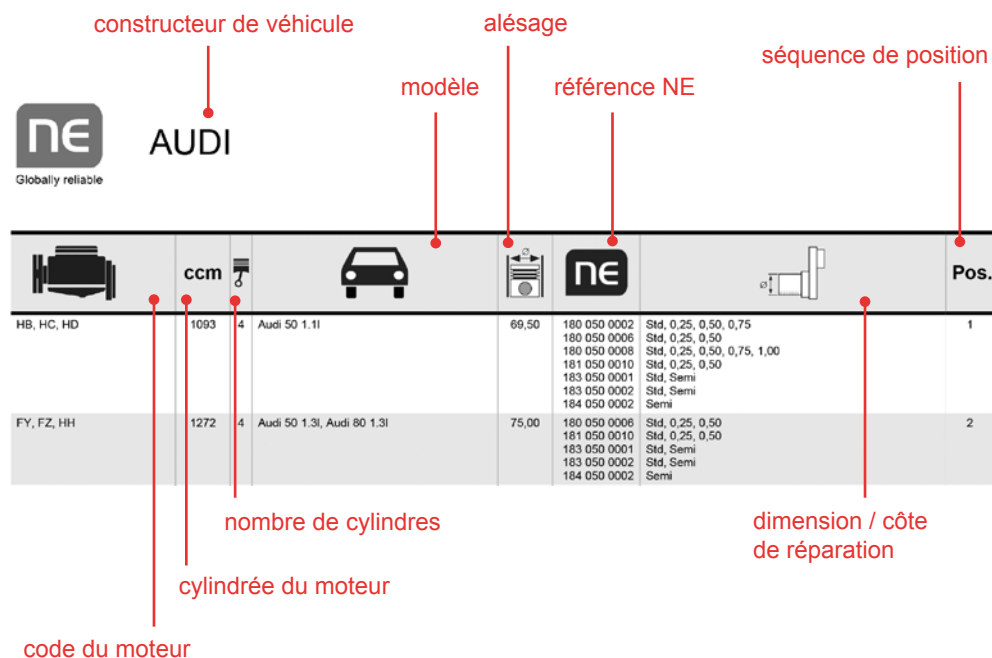

Code	ccm	Modèle	Alésage	Référence NE	Pos.
HB, HC, HD	1093	4 Audi 50 1.1i	69,50	180 050 0002 Std, 0,25, 0,50, 0,75 180 050 0006 Std, 0,25, 0,50 180 050 0008 Std, 0,25, 0,50, 0,75, 1,00 181 050 0010 Std, 0,25, 0,50 183 050 0001 Std, Semi 183 050 0002 Std, Semi 184 050 0002 Semi	1
FY, FZ, HH	1272	4 Audi 50 1.3i, Audi 80 1.3i	75,00	180 050 0006 Std, 0,25, 0,50 181 050 0010 Std, 0,25, 0,50 183 050 0001 Std, Semi 183 050 0002 Std, Semi 184 050 0002 Semi	2

Données sur le produit

Selon la séquence des positions dans le catalogue vous trouvez les données techniques et les descriptions de toutes les références.

Séquence de position
 La séquence de position dans la partie catalogue suivante est déterminée selon le diamètre du cylindre en moteur.

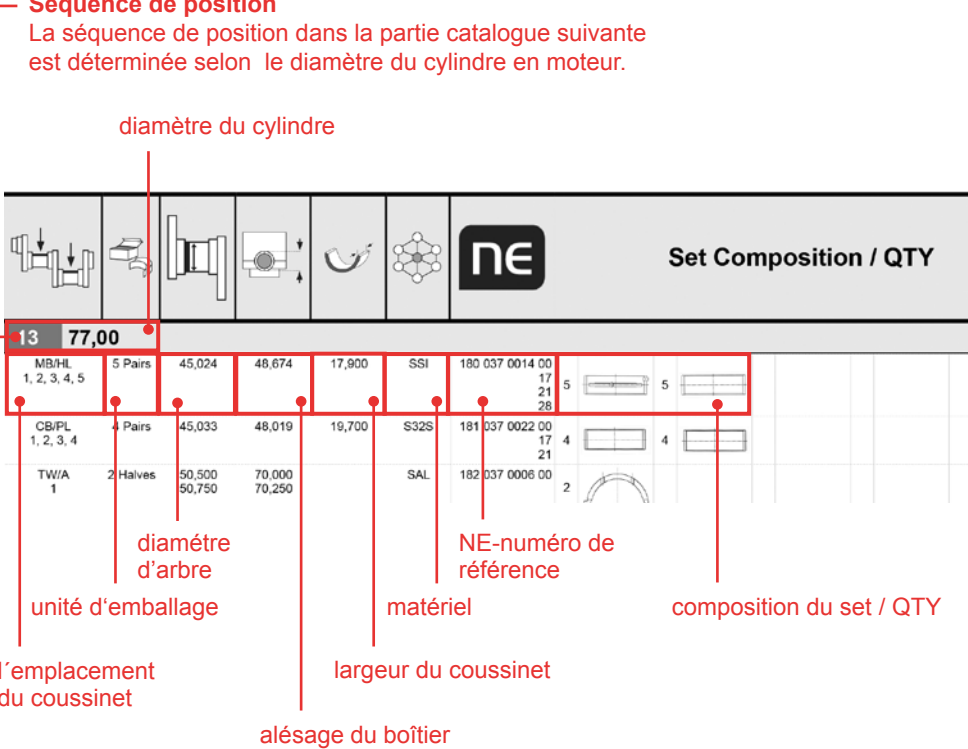

Set Composition / QTY							
13	77,00						
MB/HL 1, 2, 3, 4, 5	5 Pairs	45,024	48,674	17,900	SSI	180 037 0014 00 17 21 28	5 5
CB/PL 1, 2, 3, 4	4 Pairs	45,033	48,019	19,700	S32S	181 037 0022 00 17 21	4 4
TW/A 1	2 Halves	50,500 50,750	70,000 70,250		SAL	182 037 0006 00	2

Annotations:

- diamètre du cylindre
- diamètre d'arbre
- unité d'emballage
- l'emplacemnt du coussinet
- alésage du boîtier
- matériel
- NE-numéro de référence
- composition du set / QTY



INTRODUCTION

Index des constructeurs

	page		page
Air Compressor	45	RVI	232
Alfa Romeo	47	Saab	236
Audi	51	Scania	239
BMW	63	Seat	243
BYD	74	Skoda	245
Chery	77	Steyr	247
Citroën	78	Subaru	250
Dacia	87	Suzuki	253
Daewoo - Chevrolet (GM)	89	Toyota	257
DAF	92	Volkswagen	273
Daihatsu	96	Volvo	300
DS	100		
Fiat	102		
Fiat-Iveco	114		
Ford	116		
Great Wall	121		
Honda	123		
Hyundai	129		
IHC - Case IH	135		
Isuzu	137		
Jaguar	144		
KHD	146		
Kia	150		
Lancia	153		
Lexus	155		
Lifan	157		
M.A.N.	159		
Mazda	161		
Mercedes-Benz	168		
Mitsubishi	187		
MWM	192		
Nissan	194		
Opel	203		
Perkins	212		
Peugeot	214		
Renault	224		

Otros catálogos e información acerca de nuestros productos

Además de los productos del presente catálogo, NPR of Europe posee otras piezas de motor a su disposición.

Consulte nuestro programa completo y utilice también nuestra aplicación „Product Manager”, la cual es posible descargar desde nuestra página web.

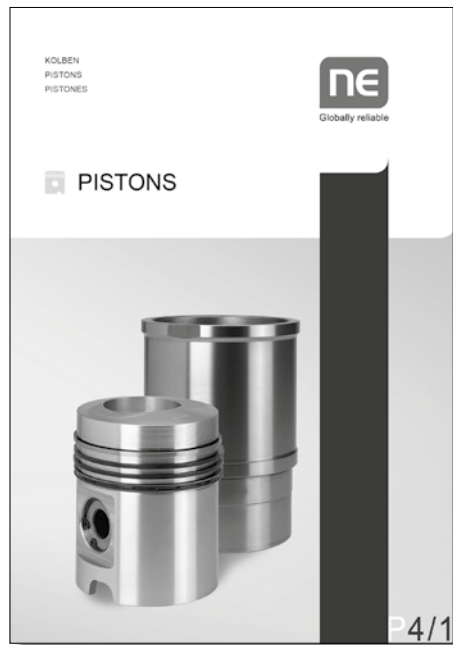

Catálogo P4/1: Pistones

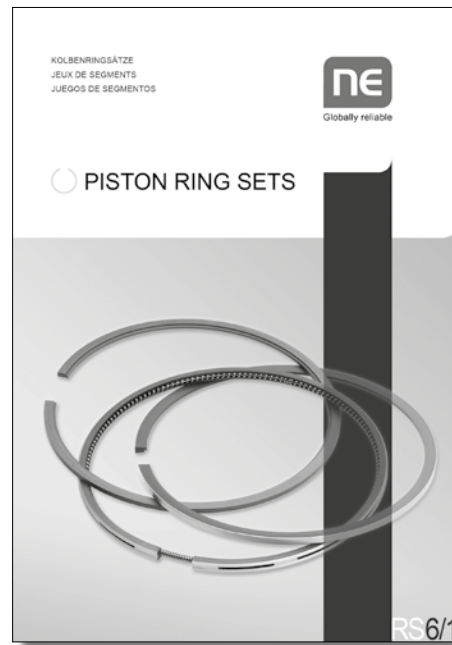

Catálogo RS6/1: Juegos de segmentos

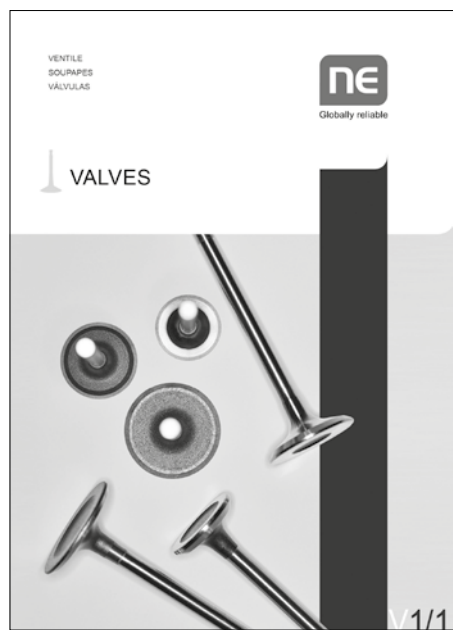

Catálogo V1/1: Válvulas



Product Manager: catálogo completo online

Tabla de contenidos

	página
Indicaciones para el uso del catálogo	36
Acerca de sobremedidas	37
Código numérico de las piezas	37
Materiales	38
Esquema de motor	39
Como utilizar correctamente este catálogo	41
Índice de fabricantes	43
Verificación de seguridad y genuinidad	309
Condiciones generales de contratación	310



Globally reliable

INTRODUCCIÓN

Indicaciones para el uso del catálogo

Este catálogo ha sido elaborado y controlado con suma diligencia para que nuestros clientes trabajen con la información mas precisa posible. No asumimos responsabilidad por la exactitud u omisión de los datos aqui brindados. Nos reservamos el derecho de realizar modificaciones en las especificaciones técnicas de los cojinetes.

Nuestros cojinetes son fabricados de modo que pueden montarse sin necesidad de modificaciones previas en el block o en el cigüeñal. Acerca de materiales y medidas nos orientamos en las especificaciones de equipamiento original de fabricantes de automóviles.

El repertorio de cojinetes sufre constantes cambios, por lo que suplimos en principio utilizando las existencias en bodega, pero a la vez atendiendo y supliendo nuevos desarrollos de cojinetes. Podemos desarrollar también según su necesidad cojinetes para uso deportivo, compresores, y usos especiales. Si no encuentra en el presente catálogo los cojinetes deseados, por favor consúltenos.

Los nombres, explicaciones y otras informaciones de vehículos y fabricantes indicados en este catálogo lo son solo a modo comparativo.

Todas las órdenes son aceptadas bajo nuestras condiciones generales de contratación y toda excepción requiere nuestro consentimiento escrito.

La copia y/o reproducción total o parcial de este catálogo esta prohibida, las imágenes y diseños estan protegidas por leyes de propiedad intelectual.

Certificación

Con la plena certeza que nuestros productos y servicio se mantienen firmes en cada examinación, es que permitimos gustosos que nos certifiquen auditores externos para confirmar nuestra calidad.

Nuestra gestión de calidad esta certificada según normas ISO 9001:2015.

Asimismo nuestros clientes fabricantes de vehículos nos han llevado a cumplir requisitos extras para proveer a sus terminales automotrices y por ello poseemos la certificación ISO/TS 16949:2016.

Por todo ello puede confiar en el servicio y la calidad de nuestro producto NE.

Identificación de sobremedidas

Abreviatura	Tamaño	Abreviatura	Tamaño
00	STD	21	0,50 mm
01	.001	22	.020
02	0,05 mm	23	0,60 mm
03	.002	24	0,65 mm
04	0,06 mm	25	0,70 mm
05	.0025	26	0,75 mm
06	.003	27	.030
07	0,08 mm	28	0,80 mm
08	0,10 mm	29	1,00 mm
09	0,12 mm	30	.040
10	0,125 mm	31	1,25 mm
11	.005	32	.050
12	0,15 mm	33	1,50 mm
13	.0075	34	.060
14	0,20 mm	35	2,00 mm
15	0,25 mm	99	Semi
16	.010		
17	0,30 mm		
18	0,35 mm		
19	.015		
20	0,40 mm		

Código numérico de las piezas

	antiguo		nuevo
Cojinete de bancada	60	→	180
Cojinete de biela	61	→	181
arandelas axiales	62	→	182
Cojinete de árbol de levas	63	→	183
Bujes de biela	64	→	184

Material

Composición química		Revestimiento según SAE	Referencia NE
CuPb23Sn4		SAE 794	SR
AlSn12Si2.5Pb1.7Cu		SAE 788	SSI
CuPb24Sn2	3-metal	SAE 799	S3S
AlSn20Cu	2-metal	SAE 783	SAL
S3S + SAL	3/2-metal	SAE 788 / 783	S32S
CuPb10Sn10		SAE 797	SL
PVDAlSn20		Sputter	SPVD
P4Z - Sn		repl. Sputter (Cerrox)	S4S
AlSn			AL
PAI + Graphite + MOS2		Polymer	Nefrox

Todos los materiales utilizados de acuerdo a especificaciones de equipamiento original.

Esquema de motor

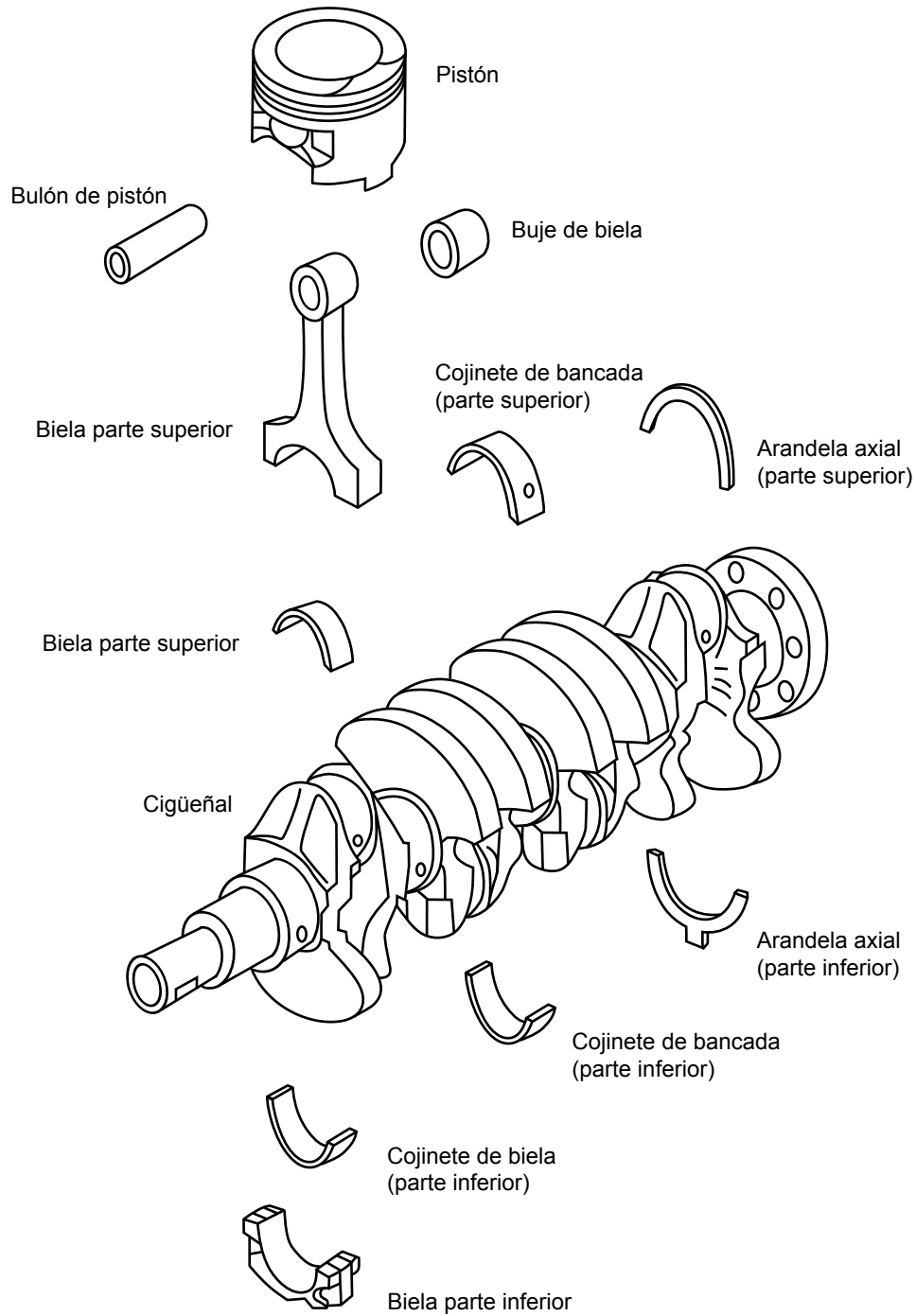

Como utilizar correctamente este catálogo

Partes del catálogo

Al comienzo de cada capítulo dedicado a un fabricante de motor usted encontrará según el correspondiente código de motor y modelo, las pertinentes referencias de cojinetes.

El orden de posición en cada capítulo se rige por el criterio de diámetro del cilindro en forma ascendente, el cual en los capítulos posteriores le guiará a los datos del producto.

HB, HC, HD	1093	4	Audi 50 1.1i	69,50	180 050 0002 180 050 0006 180 050 0008 181 050 0010 183 050 0001 183 050 0002 184 050 0002	Std, 0,25, 0,50, 0,75 Std, 0,25, 0,50 Std, 0,25, 0,50, 0,75, 1,00 Std, 0,25, 0,50 Std, Semi Std, Semi Semi	1
FY, FZ, HH	1272	4	Audi 50 1.3i, Audi 80 1.3i	75,00	180 050 0006 181 050 0010 183 050 0001 183 050 0002 184 050 0002	Std, 0,25, 0,50 Std, 0,25, 0,50 Std, Semi Std, Semi Semi	2

fabricante del automóvil: NE, AUDI
 modelo: Audi 50 1.1i, Audi 50 1.3i, Audi 80 1.3i
 diámetro: 69,50, 75,00
 referencia NE: 180 050 0002, 180 050 0006, 180 050 0008, 181 050 0010, 183 050 0001, 183 050 0002, 184 050 0002
 secuencia de posición: 1, 2
 cantidad de cilindros: 4
 desplazamiento del motor: HB, HC, HD, FY, FZ, HH
 dimensiones: Std, 0,25, 0,50, 0,75, 1,00, Semi





denominación del motor - código de motor -

Datos del producto

De acuerdo al orden de posición en la parte del catálogo, usted encontrará los datos técnicos y las descripciones relevantes al número de la referencia.

Número de posición
El orden en las secciones del catálogo se orienta según el diámetro del orificio del motor.

el diámetro del orificio del motor

												NE		Set Composition / QTY	
13	77,00														
MB/HL 1, 2, 3, 4, 5	5 Pairs	45,024	48,674	17,900	SSI	180 037 0014 00		5		5					
CB/PL 1, 2, 3, 4	4 Pairs	45,033	48,019	19,700	S32S	181 037 0022 00		4		4					
TW/A 1	2 Halves	50,500 50,750	70,000 70,250		SAL	182 037 0006 00		2							

unidad de embalaje

posición del cojinete

diámetro eje

anchura

diámetro orificio

material

referencia NE

composición del set



INTRODUCCIÓN

Índice de fabricantes





	página		página
Air Compressor	45	RVI	232
Alfa Romeo	47	Saab	236
Audi	51	Scania	239
BMW	63	Seat	243
BYD	74	Skoda	245
Chery	77	Steyr	247
Citroën	78	Subaru	250
Dacia	87	Suzuki	253
Daewoo - Chevrolet (GM)	89	Toyota	257
DAF	92	Volkswagen	273
Daihatsu	96	Volvo	300
DS	100		
Fiat	102		
Fiat-Iveco	114		
Ford	116		
Great Wall	121		
Honda	123		
Hyundai	129		
IHC - Case IH	135		
Isuzu	137		
Jaguar	144		
KHD	146		
Kia	150		
Lancia	153		
Lexus	155		
Lifan	157		
M.A.N.	159		
Mazda	161		
Mercedes-Benz	168		
Mitsubishi	187		
MWM	192		
Nissan	194		
Opel	203		
Perkins	212		
Peugeot	214		
Renault	224		



Globally reliable

AIR COMPRESSOR









	ccm					Pos.
KOMPRESSOR / West. Monoblock	1	1 Wabco Kompressor 4110123404 for Mercedes, DAF, Iveco, MAN	90,00	181 300 0000	Std	1











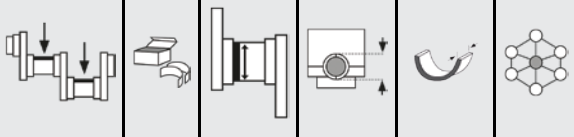

























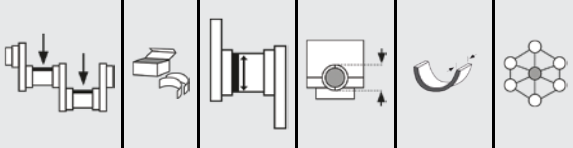











Globally reliable

AIR COMPRESSOR

								Set Composition / QTY						
1	90,00	CB/PL 1	1 Pair	34,975 34,991	37,600 37,616	21,000	181 300 0000 00	2						







	ccm						Pos.
105, 105/28, AR06100, AR61101	1570	4	Alfa 75, Giuletta, Spider	78,00	180 001 0001 181 001 0001 182 001 0001	Std, 0,25, 0,50 Std, 0,25, 0,50 Std	1
301.00, 301.04	1186	4	Alfa Sud	80,00	180 001 0002 181 001 0002 181 001 0003 182 001 0002	Std, 0,25, 0,50, 0,75 Std, 0,25, 0,50, 0,75 Std, 0,25, 0,50, 0,75 Std	2
301.80	1286	4	Alfa Sud	80,00	180 001 0002 181 001 0002 181 001 0003 182 001 0002	Std, 0,25, 0,50, 0,75 Std, 0,25, 0,50, 0,75 Std, 0,25, 0,50, 0,75 Std	2
301.68, 305.02, 305.68, 305.86, 305.87, 307.32, 307.53, 307.55	1350	4	Alfa 145, Alfa 146, Alfa 33, Alfa Sud, Arna, Sprint Coupe	80,00	180 001 0002 181 001 0002 181 001 0003 182 001 0002	Std, 0,25, 0,50, 0,75 Std, 0,25, 0,50, 0,75 Std, 0,25, 0,50, 0,75 Std	2
548/80, AR6202, AR61201, AR6168	1779	4	Alfa 75, Alfetta, Giuletta	80,00	180 001 0001 181 001 0001 182 001 0001	Std, 0,25, 0,50 Std, 0,25, 0,50 Std	1
335.03, 385.01	1370	4	Alfa 145 16V, Alfa 146 16V	82,00	180 020 0007 181 001 0005 181 020 0010 182 020 0002	Std, .010, .020 Std, 0,25 Std, 0,25 Std	3
321.01, 676.01, 382.01, 321.03, 321.04, 372.03	1598	4	Alfa 145, Alfa 146, Alfa 155	82,00	180 020 0007 181 001 0005 181 001 0006 182 020 0002	Std, .010, .020 Std, 0,25 Std, 0,25 Std	4
AR32201, AR67106, AR32205, AR38401	1747	4	Alfa 145, Alfa 146, Alfa 155, Alfa 156, Alfa GTV, Alfa Spider	82,00	180 020 0007 181 020 0008 182 020 0002	Std, .010, .020 Std, .010 Std	8
AR32302, AR37101, 182B4.000, 182B9.000, 186A8.000, 192A1.000, 937A2.000, Z19DTJ	1910	4	Alfa 145 1.9 JTD 8V, Alfa 146 1.9 JTD 8V, Alfa 147 1.9 JTD 8V, Alfa 156 1.9 JTD 8V	82,00	180 020 0005 181 020 0008 182 020 0001	Std, 0,25 Std, .010 Std	5
192A5.000, 192B1.000, 199A5.000, 937A4.000, 937A5.000, 939A1.000, Z19DTH	1910	4	Alfa 147 1.9 JTD 16V, Alfa 156 1.9 JTD 16V,	82,00	180 020 0006 181 020 0009 182 020 0001	Std, .010, .020, .030 Std, .010, .020, .030 Std	6
160A6.046, 160B6.046, 160D1.000, 160A6.000, AR33601, AR67501	1929	4	Alfa 145 1.9TD, Alfa 1461.9TD, Alfa 155 1.9TD	82,60	180 001 0003 181 020 0005 182 020 0004	Std, 0,25, 0,50 Std, .010, .020 Std	7
AR16201, AR32301, AR32303, AR32310, AR34103, AR36301, AR67204	1970	4	Alfa 145, Alfa 146, Alfa 147, Alfa 155, Alfa 156, Alfa 166, Alfa GTV, Alfa Spider	83,00	180 020 0007 181 020 0008 182 020 0002	Std, .010, .020 Std, .010 Std	8
AR67105	1748	4	Alfa 155	83,40	180 001 0001 181 001 0001 182 001 0001	Std, 0,25, 0,50 Std, 0,25, 0,50 Std	1
301.46, 305.04, 305.20, 305.88, 307.34, 307.50, 307.51	1490	4	Alfa 33, Alfa 33 Break, Alfa Sud, Sprint Coupe	84,00	180 001 0002 181 001 0002 181 001 0003 182 001 0002	Std, 0,25, 0,50, 0,75 Std, 0,25, 0,50, 0,75 Std, 0,25, 0,50, 0,75 Std	2
332.01	1596	4	Alfa 147, Alfa 156	84,00	180 020 0007 181 001 0005 182 020 0002	Std, .010, .020 Std, 0,25 Std	9
AR67102	1773	4	Alfa 155	84,00	180 001 0001 181 001 0001 182 001 0001	Std, 0,25, 0,50 Std, 0,25, 0,50 Std	1
017.13, 116.33, AR1655, AR6212, AR6224, AR1588	1962	4	Alfa 164, Alfa 75, Alfa 90, Alfetta, Giuletta, GTV, Spider	84,00	180 001 0001 181 001 0001 182 001 0001	Std, 0,25, 0,50 Std, 0,25, 0,50 Std	1
AR67103, AR67202	1995	4	Alfa 155	84,00	180 001 0001 181 001 0001 182 001 0001	Std, 0,25, 0,50 Std, 0,25, 0,50 Std	1
AR67203, 175A1.000, 175A4.000, 836A2.000, 831E5.000, 831E5.046	1995	4	Alfa 155 2.0 Turbo 16V, Alfa 155 2.0 Turbo 16V 4WD	84,00	180 001 0003 181 020 0008 182 020 0004	Std, 0,25, 0,50 Std, .010 Std	10
305.50, 305.58, 307.36, 307.37	1712	4	Alfa 33, Alfa 33 Break, Sprint Coupe	87,00	180 001 0002 181 001 0002 181 001 0003 182 001 0002	Std, 0,25, 0,50, 0,75 Std, 0,25, 0,50, 0,75 Std, 0,25, 0,50, 0,75 Std	2
VM4HT/2, VM488HT/HR, VM80A	1995	4	Alfa 75 2.0TD, Alfetta 2.0TD, Giuletta 2.0TD	88,00	180 001 0004 181 001 0004 182 001 0003	Std, 0,25, 0,50 Std, 0,25, 0,50, 0,75 Std	11
VM588HT/HR	2494	5	Alfa 6 2.5TD, Alfetta 2.5TD, Giuletta 2.5TD	88,00	181 001 0004 182 001 0003	Std, 0,25, 0,50, 0,75 Std	12
VM392HT, VM82A, VM96A	1779	3	Alfa 33 1.8TD	92,00	181 001 0004 182 001 0003	Std, 0,25, 0,50, 0,75 Std	12
VM492HTI, HR492HTI, VM08B, VM84A	2499	4	Alfa 155 2.5TD, Alfa 164 2.5TD	92,00	181 001 0004 182 001 0003	Std, 0,25, 0,50, 0,75 Std	12
VM492HT, VM4HT 2.4, VM81A	2392	4	Alfa 75 2.4TD, Alfa 90 2.4TD, Alfetta 2.4TD	92,00	180 001 0004 181 001 0004 182 001 0003	Std, 0,25, 0,50 Std, 0,25, 0,50, 0,75 Std	11
VM07B, VM08B, VM31B, VM492HR/HS, VM425CH/CL/SL	2499	4	Alfa 155 2.5TD, Alfa 164 2.5TD	92,00	180 001 0005 181 001 0004 182 001 0003	Std, 0,25, 0,50 Std, 0,25, 0,50, 0,75 Std	13

							 		Set Composition / QTY											
1	78,00																			
MB/HL 1, 3, 5	3 Pairs	59,960 59,973	63,657 63,676	25,530	S3S	180 001 0001 00 15	6		4											
MB/HL 2, 4	2 Pairs	59,960 59,973	63,657 63,676	18,360	S3S	21														
CB/PL 1, 2, 3, 4	4 Pairs	49,988 49,998	53,695 53,709	23,440	S3S	181 001 0001 00 15 21	8													
TW/A 1	4 Halves	65,786 66,040	82,423 82,677		SAL	182 001 0001 00	2		2											
2	80,00																			
MB/HL 1, 2, 3	3 Pairs	59,944 59,957	63,663 63,673	23,400	SAL	180 001 0002 00 15 21 26	6													
CB/PL 1, 2, 3, 4	4 Pairs	49,984 50,000	53,696 53,708	17,800	SAL	181 001 0002 00 15 21 26	8													
CB/PL 1, 2, 3, 4	4 Pairs	49,992 50,000	53,696 53,708	17,800	SAL	181 001 0003 00 15 21 26	8													
TW/A 1	2 Halves	65,790 66,040	82,420 82,680		SAL	182 001 0002 00	2													
3	82,00																			
MB/HL 1, 2, 3, 4, 5	5 Pairs	52,982 53,000	56,705 56,718	20,750	SAL	180 020 0007 00 16 22	8		2											
CB/PL 1, 2, 3, 4	4 Pairs	40,870 40,890	44,000 44,012	19,100	S3S	181 001 0005 00 15	8													
CB/PL 1, 2, 3, 4	4 Pairs	40,870 40,890	44,000 44,012	19,100	SAL	181 020 0010 00 15	8													
TW/A 1	2 Halves	58,808 59,062	73,486 73,740		SAL	182 020 0002 00	2													
4	82,00																			
MB/HL 1, 2, 3, 4, 5	5 Pairs	52,982 53,000	56,705 56,718	20,750	SAL	180 020 0007 00 16 22	8		2											
CB/PL 1, 2, 3, 4	4 Pairs	40,870 40,890	44,000 44,012	19,100	S3S	181 001 0005 00 15	8													
CB/PL 1, 2, 3, 4	4 Pairs	48,226 48,244	51,354 51,366	19,100	S3S	181 001 0006 00 15	8													
TW/A 1	2 Halves	58,808 59,062	73,486 73,740		SAL	182 020 0002 00	2													
5	82,00																			
MB/HL 1, 2, 3, 4, 5	5 Pairs	59,586 60,000	63,705 63,718	20,750	S3S	180 020 0005 00 15	10													
CB/PL 1, 2, 3, 4	4 Pairs	50,787 50,805	53,901 53,913	19,500	S3S	181 020 0008 00 16	8													
TW/A 1	2 Halves	67,785 68,040	82,425 82,677		SAL	182 020 0001 00	2													

 							Set Composition / QTY													
6	82,00																			
MB/HL 1, 2, 3, 4, 5	5 Pairs	59,986 60,000	63,705 63,718	20,750	SSI	180 020 0006 00 16 22 27	5		5											
CB/PL 1, 2, 3, 4	4 Pairs	50,787 50,805	53,901 53,913	19,500	S3S	181 020 0009 00 16 22 27	8													
TW/A 1	2 Halves	67,785 68,040	82,425 82,677		SAL	182 020 0001 00	2													
7	82,60																			
MB/HL 1, 2, 3, 4, 5	5 Pairs	52,990 53,010	56,717 56,735	24,250	SAL	180 001 0003 00 15 21	2		8											
CB/PL 1, 2, 3, 4	4 Pairs	50,787 50,807	53,897 53,919	19,500	S3S	181 020 0005 00 16 22	8													
TW/A 1	2 Halves	59,000 59,250	73,600 73,850		SAL	182 020 0004 00	2													
8	83,00																			
MB/HL 1, 2, 3, 4, 5	5 Pairs	52,982 53,000	56,705 56,718	20,750	SAL	180 020 0007 00 16 22	8		2											
CB/PL 1, 2, 3, 4	4 Pairs	50,787 50,805	53,901 53,913	19,500	S3S	181 020 0008 00 16	8													
TW/A 1	2 Halves	58,808 59,062	73,486 73,740		SAL	182 020 0002 00	2													
9	84,00																			
MB/HL 1, 2, 3, 4, 5	5 Pairs	52,982 53,000	56,705 56,718	20,750	SAL	180 020 0007 00 16 22	8		2											
CB/PL 1, 2, 3, 4	4 Pairs	40,870 40,890	44,000 44,012	19,100	S3S	181 001 0005 00 15	8													
TW/A 1	2 Halves	58,808 59,062	73,486 73,740		SAL	182 020 0002 00	2													
10	84,00																			
MB/HL 1, 2, 3, 4, 5	5 Pairs	52,990 53,010	56,717 56,735	24,250	SAL	180 001 0003 00 15 21	2		8											
CB/PL 1, 2, 3, 4	4 Pairs	50,787 50,805	53,901 53,913	19,500	S3S	181 020 0008 00 16	8													
TW/A 1	2 Halves	59,000 59,250	73,600 73,850		SAL	182 020 0004 00	2													









							Set Composition / QTY												
11 88,00																			
MB/HL 1	1 Pair	62,995 63,010	67,025 67,050	32,250	SAL	180 001 0004 00	15												
MB/HL 2, 3, 4	3 Pairs	63,005 63,020	66,670 66,687	28,000	SAL		21												
MB/HL 5	1 Pair	69,980 70,000	75,005 75,030	32,250	SAL														
CB/PL 1	1 Pair	53,940 53,955	57,563 57,582	23,250	S3S	181 001 0004 00	15 21 26	2											
TW/A 1	2 Halves	74,250 74,500	88,000 88,100		SAL	182 001 0003 00		1		1									
12 88,00																			
CB/PL 1	1 Pair	53,940 53,955	57,563 57,582	23,250	S3S	181 001 0004 00	15 21 26	2											
TW/A 1	2 Halves	74,250 74,500	88,000 88,100		SAL	182 001 0003 00		1		1									
13 92,00																			
MB/HL 1, 2, 3	3 Pairs	63,005 63,020	66,670 66,687	28,000	SAL	180 001 0005 00	15	6											
MB/HL 4	1 Pair	62,995 63,010	67,025 67,050	28,250	SAL		21												
MB/HL 5	1 Pair	69,985 70,000	75,005 75,030	22,250	SAL														
CB/PL 1	1 Pair	53,940 53,955	57,563 57,582	23,250	S3S	181 001 0004 00	15 21 26	2											
TW/A 1	2 Halves	74,250 74,500	88,000 88,100		SAL	182 001 0003 00		1		1									







	ccm						Pos.
HB, HC, HD	1093	4	Audi 50 1.1l	69,50	180 050 0002 180 050 0006 180 050 0008 181 050 0010 183 050 0001 183 050 0002 184 050 0002	Std, 0,25, 0,50, 0,75 Std, 0,25, 0,50 Std, 0,25, 0,50 Std, 0,25, 0,50, 0,75 Std, Semi Std, Semi Semi	1
FY, FZ, HH	1272	4	Audi 50 1.3l, Audi 80 1.3l	75,00	180 050 0006 181 050 0010 183 050 0001 183 050 0002 184 050 0002	Std, 0,25, 0,50 Std, 0,25, 0,50, 0,75 Std, Semi Std, Semi Semi	2
AUA, BBY	1390	4	A2 1.4i 16V	76,50	180 050 0004 181 050 0002 182 050 0001 184 050 0004	Std, 0,25, 0,50 Std, 0,25, 0,50, 0,75 Std Semi	8
CR, CY	1598	4	Audi 80 1.6l D, Audi 80 1.6lTD	76,50	180 050 0002 181 050 0009 184 050 0005	Std, 0,25, 0,50, 0,75 Std, 0,25, 0,50, 0,75 Semi	5
JK	1598	4	Audi 80 1.6l D	76,50	180 050 0002 180 050 0007 180 050 0013 181 050 0009 182 050 0002 184 050 0005	Std, 0,25, 0,50, 0,75 Std, 0,25, 0,50 Std, 0,25, 0,50, 1,00 Std, 0,25, 0,50, 0,75 Std, 0,25, 0,50, 0,20 Semi	6
RA, SB	1588	4	Audi 80 1.6l TD	76,50	180 050 0007 180 050 0013 181 050 0009 182 050 0002 184 050 0005	Std, 0,25, 0,50 Std, 0,25, 0,50, 1,00 Std, 0,25, 0,50, 0,75 Std, 0,25, 0,50, 0,20 Semi	7
ANY	1191	3	A2 1.2TDI	76,50	181 050 0021	Std, 0,25, 0,50	10
BAG	1598	4	A3 1.6 FSI 16V	76,50	181 050 0013 184 050 0004	Std, 0,25, 0,50 Semi	3
BLF, BLP	1598	4	A3 1.6 FSI 16V	76,50	180 050 0004 181 050 0005 182 050 0002 184 050 0004	Std, 0,25, 0,50 Std, 0,25, 0,50 Std, 0,25, 0,50, 0,20 Semi	4
BAD	1598	4	A2 1.6 FSI 16V	76,50	180 050 0004 181 050 0013 182 050 0002 184 050 0004	Std, 0,25, 0,50 Std, 0,25, 0,50 Std, 0,25, 0,50, 0,20 Semi	9
1Y	1896	4	Audi 80 1.9l D	79,50	180 050 0007 180 050 0013 181 050 0009 182 050 0002 184 050 0007	Std, 0,25, 0,50 Std, 0,25, 0,50, 1,00 Std, 0,25, 0,50, 0,75 Std, 0,25, 0,50, 0,20 Semi	11
1Z, AAZ, AFF, AGR, AHH, AHU, ALH, AFN, AHF, AJM, APD, ASV, ASZ, ATD, ATJ, AVB, AVF, AVG, AWW, AXR, BKC	1896	4	Audi 80 1.9l TD, Audi 80 1.9l TDI, A3 1.9PDI, A3 1.9TDI, A4 1.9TDI, A4 1.9TDI PDE, A6 1.9TDI, A6 1.9TDI PDE	79,50	180 050 0007 180 050 0013 181 050 0012 181 050 0017 181 050 0022 182 050 0002 183 050 0001 183 050 0002 183 050 0003 184 050 0006	Std, 0,25, 0,50 Std, 0,25, 0,50, 1,00 Std, 0,25, 0,50, 0,75 Std, 0,25 Std, 0,25, 0,50 Std, 0,25, 0,50, 0,20 Std, Semi Std, Semi Std Semi	12
AMF, ATL	1422	3	A2 1.4TD, A2 1.4TDI	79,50	181 050 0021	Std, 0,25, 0,50	10
PP, RN	1595	4	Audi 80 1.6l	81,00	180 050 0014 181 050 0001 182 050 0002 183 050 0001 183 050 0002	Std, 0,25, 0,50, 0,75, 1,00 Std, 0,25, 0,50, 0,75, 1,00 Std, 0,25, 0,50, 0,20 Std, Semi Std, Semi	13
ABB, ABM, ADA	1595	4	Audi 80 1.6i	81,00	180 050 0014 181 050 0001 182 050 0002 183 050 0001 183 050 0002 184 050 0008	Std, 0,25, 0,50, 0,75, 1,00 Std, 0,25, 0,50, 0,75, 1,00 Std, 0,25, 0,50, 0,20 Std, Semi Std, Semi Semi	14
ADP	1595	4	A4 1.6i	81,00	180 050 0014 181 050 0001 182 050 0002 184 050 0008	Std, 0,25, 0,50, 0,75, 1,00 Std, 0,25, 0,50, 0,75, 1,00 Std, 0,25, 0,50, 0,20 Semi	15
ADR	1781	4	A4 1.8i 20V, A6 1.8i 20V, Cabriolet 1.8i 20V	81,00	180 050 0013 180 050 0014 181 050 0001 182 050 0002 184 050 0008	Std, 0,25, 0,50, 1,00 Std, 0,25, 0,50, 0,75, 1,00 Std, 0,25, 0,50, 0,75, 1,00 Std, 0,25, 0,50, 0,20 Semi	16
AEH, AKL, APF	1595	4	A3 1.6i	81,00	180 050 0009 181 050 0001 182 050 0001 184 050 0008	Std, 0,25, 0,50 Std, 0,25, 0,50, 0,75, 1,00 Std Semi	17
AHL, ARM	1595	4	A4 1.6i	81,00	180 050 0003 180 050 0009 181 050 0001 181 050 0003 182 050 0001 182 050 0003 184 050 0008	Std, 0,25, 0,50, 0,75 Std, 0,25, 0,50 Std, 0,25, 0,50, 0,75, 1,00 Std, 0,25, 0,50, 0,75 Std Std Semi	20











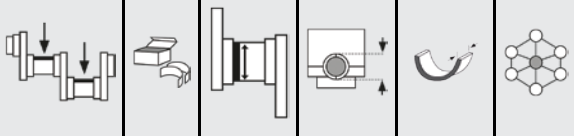























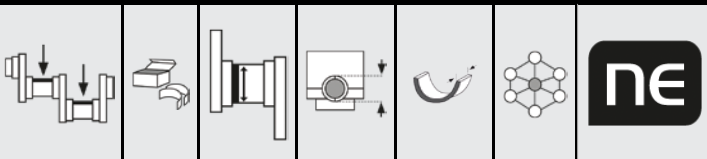

















AUDI











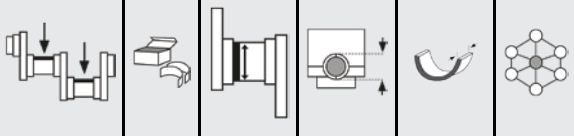











Globally reliable

	ccm						Pos.
ALZ, ANA, AVU, BFQ, BGU, BSE, BSF	1595	4	A3 1.6i, A4 1.6i	81,00	180 050 0003 181 050 0003 182 050 0003	Std, 0,25, 0,50, 0,75 Std, 0,25, 0,50, 0,75 Std	21
DT, JU	1595	4	Audi 80 1.6i	81,00	180 050 0002 180 050 0008 180 050 0014 181 050 0001 182 050 0002 183 050 0001 183 050 0002	Std, 0,25, 0,50, 0,75 Std, 0,25, 0,50 Std, 0,25, 0,50, 0,75, 1,00 Std, 0,25, 0,50, 0,75, 1,00 Std, 0,25, 0,50, 0,20 Std, Semi Std, Semi	26
SA	1595	4	Audi 80 1.6	81,00	180 050 0002 180 050 0008 181 050 0001 183 050 0001 183 050 0002	Std, 0,25, 0,50, 0,75 Std, 0,25, 0,50 Std, 0,25, 0,50, 0,75, 1,00 Std, Semi Std, Semi	29
AFM	2393	6	A6 2.4i 30V	81,00	180 050 0012 181 050 0008 182 050 0004	Std, 0,25, 0,50 Std, 0,25, 0,50 Std	30
4B, NP, PH, PM, RS, RU, SF	1781	4	Audi 80 1.8i, Audi 100 1.8i, Audi 100 1.8i	81,00	180 050 0014 181 050 0001 182 050 0002 183 050 0001 183 050 0002	Std, 0,25, 0,50, 0,75, 1,00 Std, 0,25, 0,50, 0,75, 1,00 Std, 0,25, 0,50, 0,20 Std, Semi Std, Semi	13
AJP, AQE, ARH	1781	4	A6 1.8i, A6 1.8i 20V	81,00	180 050 0009 181 050 0001 182 050 0001 184 050 0008	Std, 0,25, 0,50 Std, 0,25, 0,50, 0,75, 1,00 Std Semi	17
AFY, AJL	1781	4	A4 1.8i, A4 1.8i Turbo 20V, A6 1.8i, A6 1.8i Turbo 20V	81,00	180 050 0009 180 050 0013 180 050 0014 181 050 0001 182 050 0002 184 050 0008	Std, 0,25, 0,50 Std, 0,25, 0,50, 1,00 Std, 0,25, 0,50, 0,75, 1,00 Std, 0,25, 0,50, 0,75, 1,00 Std, 0,25, 0,50, 0,20 Semi	18
AGN, APG, APT, ARG	1781	4	A3 1.8i 16V, A3 1.8i 20V, A4 1.8i 20V	81,00	180 050 0009 181 050 0001 182 050 0002 184 050 0008	Std, 0,25, 0,50 Std, 0,25, 0,50, 0,75, 1,00 Std, 0,25, 0,50, 0,20 Semi	19
AMB, ARX, AVJ, BEX, BFB	1781	4	A3 1.8i Turbo 20V, A4 1.8i Turbo 20V	81,00	180 050 0009 181 050 0011 182 050 0002	Std, 0,25, 0,50 Std, 0,25, 0,50, 0,75 Std, 0,25, 0,50, 0,20	22
ARY, AUM, AUQ	1781	4	A3 1.8i Turbo 20V, TT 1.8i Turbo 20V	81,00	180 050 0009 181 050 0011 182 050 0002 184 050 0008	Std, 0,25, 0,50 Std, 0,25, 0,50, 0,75 Std, 0,25, 0,50, 0,20 Semi	23
AVV	1781	4	A4 1.8i 20V	81,00	180 050 0009 181 050 0001 182 050 0002 183 050 0001 183 050 0002 184 050 0008	Std, 0,25, 0,50 Std, 0,25, 0,50, 0,75, 1,00 Std, 0,25, 0,50, 0,20 Std, Semi Std, Semi Semi	24
AWT	1781	4	A4 1.8i Turbo 20V, A6 1.8i Turbo 20V	81,00	180 050 0009 181 050 0011 182 050 0002 184 050 0008	Std, 0,25, 0,50 Std, 0,25, 0,50, 0,75 Std, 0,25, 0,50, 0,20 Semi	23
DR, DS, DZ, JN, JV, JW, SH	1781	4	Audi 80 1.8i, Audi 100 1.8i	81,00	180 050 0008 180 050 0014 181 050 0001 182 050 0002 183 050 0001 183 050 0002	Std, 0,25, 0,50 Std, 0,25, 0,50, 0,75, 1,00 Std, 0,25, 0,50, 0,75, 1,00 Std, 0,25, 0,50, 0,20 Std, Semi Std, Semi	25
MG, MU	1781	4	Audi 80 1.8i	81,00	180 050 0008 181 050 0001 182 050 0002 183 050 0001 183 050 0002	Std, 0,25, 0,50 Std, 0,25, 0,50, 0,75, 1,00 Std, 0,25, 0,50, 0,20 Std, Semi Std, Semi	27
NE, PV	1781	4	Audi 80 1.8, Audi 1.8i	81,00	180 050 0008 180 050 0014 181 050 0001 182 050 0005 183 050 0001 183 050 0002	Std, 0,25, 0,50 Std, 0,25, 0,50, 0,75, 1,00 Std, 0,25, 0,50, 0,75, 1,00 Std Std, Semi Std, Semi	28
AGB, AJK, ARE, AZA, AZB, BES	2671	6	A6 2.7i Turbo 30V, A6 Allroad 2.7i Turbo 30V, S4 2.7i 30V	81,00	180 050 0012 181 050 0008 182 050 0004	Std, 0,25, 0,50 Std, 0,25, 0,50 Std	30
AZV, BKD, BLB, BMM, BMN, BNA, BRE, BRF	1968	4	A3 2.0TDI, A3 2.0TDI 16V, A3 Sportback 2.0TDI, A4 2.0TDI 16V, A4 2.0TDI DSG, A6 2.0TDI 16V	81,00	180 050 0015 181 050 0019 183 050 0003	Std, 0,25, 0,50, 0,75 Std, 0,25, 0,50 Std	31
ACV	2461	5	100 2.5TDI, A6 2.5TDI	81,00	180 050 0016 180 050 0017 181 050 0018 182 050 0005 184 050 0005	Std, 0,25, 0,50 Std, 0,25, 0,50 Std, 0,25, 0,50 Std Semi	32
ABC, ACZ	2598	6	A4 2.6i, A6 2.6i, Cabriolet 2.6i, Coupe 2.6i, Audi 80 2.6i, Audi 100 2.6i	82,50	180 050 0012 181 050 0008 182 050 0004	Std, 0,25, 0,50 Std, 0,25, 0,50 Std	30





	ccm						Pos.
SD	1857	4	Audi 80 1.9i	82,50	180 050 0014 181 050 0001 182 050 0002 183 050 0001 183 050 0002	Std, 0,25, 0,50, 0,75, 1,00 Std, 0,25, 0,50, 0,75, 1,00 Std, 0,25, 0,50, 0,20 Std, Semi Std, Semi	13
AAH, ACK, AEJ, AFC, AGE, ALG, AMX, APR, AQD, ATX	2771	6	A4 2.8i 24V, A4 2.8i 30V, A6 2.8i 24V, A6 2.8i 30V, A8 2.8i, A8 2.8i 30V, Cabriolet 2.8i, Coupe 2.8i, Audi 80 2.8i, Audi 100 2.8i	82,50	180 050 0012 181 050 0008 182 050 0004	Std, 0,25, 0,50 Std, 0,25, 0,50 Std	30
3A, 6A, ACE	1984	4	Audi 80 2.0i, Audi 80 2.0i 16V, Audi 100 2.0i 16V, A6 2.0i 16V, Cabriolet 2.0i 16V, Coupe 2.0i, Coupe 2.0i 16V	82,50	180 050 0014 181 050 0001 182 050 0002 183 050 0001 183 050 0002 184 050 0008	Std, 0,25, 0,50, 0,75, 1,00 Std, 0,25, 0,50, 0,75, 1,00 Std, 0,25, 0,50, 0,20 Std, Semi Std, Semi Semi	14
AAD, AAE, ABK, ABT, ADW	1984	4	A6 2.0i, Coupe 2.0i, Audi 100 2.0i	82,50	180 050 0014 181 050 0001 182 050 0002 183 050 0001 183 050 0002	Std, 0,25, 0,50, 0,75, 1,00 Std, 0,25, 0,50, 0,75, 1,00 Std, 0,25, 0,50, 0,20 Std, Semi Std, Semi	13
ALT, AWA, AXW, AXX, BGB, BLR, BLX, BLY, BMB, BPY, BUL, BVY, BVZ, BWA, BWE	1984	4	A3 2.0 FSI 16V, A3 2.0 TFSI 16V, A4 2.0 FSI 16V, A4 2.0 TFSI 16V, TT 2.0 FSI 16V	82,50	180 050 0009 181 050 0011 182 050 0001	Std, 0,25, 0,50 Std, 0,25, 0,50, 0,75 Std	33
ASN, AVK, BBJ	2976	6	A4 3.0i 30V, A6 3.0i 30V, A8 3.0i 30V	82,50	180 050 0012 181 050 0008 182 050 0004	Std, 0,25, 0,50 Std, 0,25, 0,50 Std	30
BUB	3189	6	A3 3.2i 24V, TT 3.2i 24V	84,00	180 050 0011 181 050 0007	Std, 0,25, 0,50 Std, 0,25, 0,50	34
BHK	3597	6	Q7 3.6 FSI 24V	89,00	180 050 0011 181 050 0007	Std, 0,25, 0,50 Std, 0,25, 0,50	34





 							Set Composition / QTY														
1 69,50																					
MB/HL 1, 2, 3, 4	4 Pairs	53,958 53,978	59,000 59,019	18,500	S3S	180 050 0002 00 15	4		4		1		1								
MB/HL 5	1 Pair	53,958 53,978	59,000 59,019	24,930	S3S	21 26															
MB/HL 1, 2, 3, 4	4 Pairs	53,958 53,978	59,000 59,019	18,500	SAL	180 050 0006 00 15	8		2												
MB/HL 5	1 Pair	53,958 53,978	59,000 59,019	24,930	SAL	21															
MB/HL 1, 2, 3, 4	4 Pairs	53,958 53,978	59,000 59,019	18,500	S3S	180 050 0008 00 15	5		3		1		1								
MB/HL 5	1 Pair	53,958 53,978	59,000 59,019	24,930	S3S	21															
CB/PL 1, 2, 3, 4	4 Pairs	41,955 41,970	45,000 45,016	18,000	S3S	181 050 0010 00 15 21 26	8														
Cbush/NWL 1	1 Pair	42,959 42,975	46,000 46,025	15,000	SAL	183 050 0001 00 99															
Cbush/NWL 1	1 Pair	41,959 41,975	45,000	15,000	SAL	183 050 0002 00 99															
Bush/PB 1, 2, 3, 4	4 Pairs	20,000	23,000 23,052	24,000	SL	184 050 0002 99															
2 75,00																					
MB/HL 1, 2, 3, 4	4 Pairs	53,958 53,978	59,000 59,019	18,500	SAL	180 050 0006 00 15	8		2												
MB/HL 5	1 Pair	53,958 53,978	59,000 59,019	24,930	SAL	21															
CB/PL 1, 2, 3, 4	4 Pairs	41,955 41,970	45,000 45,016	18,000	S3S	181 050 0010 00 15 21 26	8														
Cbush/NWL 1	1 Pair	42,959 42,975	46,000 46,025	15,000	SAL	183 050 0001 00 99															
Cbush/NWL 1	1 Pair	41,959 41,975	45,000	15,000	SAL	183 050 0002 00 99															
Bush/PB 1, 2, 3, 4	4 Pairs	20,000	23,000 23,052	24,000	SL	184 050 0002 99															
3 76,50																					
CB/PL 1, 2, 3, 4	4 Pairs	47,763 47,778	50,600 50,612	17,200	S32S	181 050 0013 00 15 21	4		4												
Bush/PB 1, 2, 3, 4	4 Pairs	17,000	20,000 20,033	20,500	SL	184 050 0004 99															
4 76,50																					
MB/HL 1, 2, 3, 4, 5	5 Pairs	53,963 53,978	59,000 59,019	18,500	SAL	180 050 0004 00 15 21	5		5												
CB/PL 1, 2, 3, 4	4 Pairs	47,763 47,778	50,600 50,612	17,200	SAL	181 050 0005 00 15 21	8														
TW/A 1	4 Halves	59,500 59,750	72,950 73,200		SAL	182 050 0002 00 15 21 14	2		2												
Bush/PB 1, 2, 3, 4	4 Pairs	17,000	20,000 20,033	20,500	SL	184 050 0004 99															





							Set Composition / QTY													
5	76,50																			
MB/HL 1, 2, 3, 4	4 Pairs	53,958 53,978	59,000 59,019	18,500	S3S	180 050 0002 00 15	4		4		1		1							
MB/HL 5	1 Pair	53,958 53,978	59,000 59,019	24,930	S3S	21 26														
CB/PL 1, 2, 3, 4	4 Pairs	47,758 47,778	50,600 50,619	19,000	S3S	181 050 0009 00 15 21 26	8													
Bush/PB 1, 2, 3, 4	4 Pairs	24,000	27,000 27,052	25,000	SL	184 050 0005 99														
6	76,50																			
MB/HL 1, 2, 3, 4	4 Pairs	53,958 53,978	59,000 59,019	18,500	S3S	180 050 0002 00 15	4		4		1		1							
MB/HL 5	1 Pair	53,958 53,978	59,000 59,019	24,930	S3S	21 26														
MB/HL 1, 2, 3, 4, 5	5 Pairs	53,958 53,978	59,000 59,019	18,500	S3S	180 050 0007 00 15 21	5		5											
MB/HL 1, 2, 3, 4, 5	5 Pairs	53,958 53,978	59,000 59,019	18,500	SAL	180 050 0013 00 15 21 29	5		5											
CB/PL 1, 2, 3, 4	4 Pairs	47,758 47,778	50,600 50,619	19,000	S3S	181 050 0009 00 15 21 26	8													
TW/A 1	4 Halves	59,500 59,750	72,950 73,200		SAL	182 050 0002 00 15 21 14	2		2											
Bush/PB 1, 2, 3, 4	4 Pairs	24,000	27,000 27,052	25,000	SL	184 050 0005 99														
7	76,50																			
MB/HL 1, 2, 3, 4, 5	5 Pairs	53,958 53,978	59,000 59,019	18,500	S3S	180 050 0007 00 15 21	5		5											
MB/HL 1, 2, 3, 4, 5	5 Pairs	53,958 53,978	59,000 59,019	18,500	SAL	180 050 0013 00 15 21 29	5		5											
CB/PL 1, 2, 3, 4	4 Pairs	47,758 47,778	50,600 50,619	19,000	S3S	181 050 0009 00 15 21 26	8													
TW/A 1	4 Halves	59,500 59,750	72,950 73,200		SAL	182 050 0002 00 15 21 14	2		2											
Bush/PB 1, 2, 3, 4	4 Pairs	24,000	27,000 27,052	25,000	SL	184 050 0005 99														
8	76,50																			
MB/HL 1, 2, 3, 4, 5	5 Pairs	53,963 53,978	59,000 59,019	18,500	SAL	180 050 0004 00 15 21	5		5											
CB/PL 1, 2, 3, 4	4 Pairs	47,763 47,778	50,600 50,612	18,500	SAL	181 050 0002 00 15 21 26	8													
TW/A 1	2 Halves	59,500 59,750	71,550 71,800		SAL	182 050 0001 00	2													
Bush/PB 1, 2, 3, 4	4 Pairs	17,000	20,000 20,033	20,500	SL	184 050 0004 99														







 							Set Composition / QTY														
9												76,50									
MB/HL 1, 2, 3, 4, 5	5 Pairs	53,963 53,978	59,000 59,019	18,500	SAL	180 050 0004 00 15 21	5		5												
CB/PL 1, 2, 3, 4	4 Pairs	47,763 47,778	50,600 50,612	17,200	S32S	181 050 0013 00 15 21	4		4												
TW/A 1	4 Halves	59,500 59,750	72,950 73,200		SAL	182 050 0002 00 15 21 14	2		2												
Bush/PB 1, 2, 3, 4	4 Pairs	17,000	20,000 20,033	20,500	SL	184 050 0004 99															
10												76,50									
CB/PL 1, 2, 3	3 Pairs	47,758 47,778	50,600 50,612	20,000	S4S	181 050 0021 00 15 21															
11												79,50									
MB/HL 1, 2, 3, 4, 5	5 Pairs	53,958 53,978	59,000 59,019	18,500	S3S	180 050 0007 00 15 21	5		5												
MB/HL 1, 2, 3, 4, 5	5 Pairs	53,958 53,978	59,000 59,019	18,500	SAL	180 050 0013 00 15 21 29	5		5												
CB/PL 1, 2, 3, 4	4 Pairs	47,758 47,778	50,600 50,619	19,000	S3S	181 050 0009 00 15 21 26	8														
TW/A 1	4 Halves	59,500 59,750	72,950 73,200		SAL	182 050 0002 00 15 21 14	2		2												
Bush/PB 1, 2, 3, 4	4 Pairs	24,000	27,000 27,052	25,000	SL	184 050 0007 99															
12												79,50									
MB/HL 1, 2, 3, 4, 5	5 Pairs	53,958 53,978	59,000 59,019	18,500	S3S	180 050 0007 00 15 21	5		5												
MB/HL 1, 2, 3, 4, 5	5 Pairs	53,958 53,978	59,000 59,019	18,500	SAL	180 050 0013 00 15 21 29	5		5												
CB/PL 1, 2, 3, 4	4 Pairs	47,758 47,778	50,600 50,619	20,000	S3S	181 050 0012 00 15 21 26	8														
CB/PL 1, 2, 3, 4	4 Pairs	47,758 47,778	50,600 50,612	20,000	S4S	181 050 0017 00 15															
CB/PL 1, 2, 3, 4	4 Pairs	47,758 47,778	50,600 50,612	20,000	S4S	181 050 0022 00 15 21															
TW/A 1	4 Halves	59,500 59,750	72,950 73,200		SAL	182 050 0002 00 15 21 14	2		2												
Cbush/NWL 1	1 Pair	42,959 42,975	46,000 46,025	15,000	SAL	183 050 0001 00 99															
Cbush/NWL 1	1 Pair	41,959 41,975	45,000	15,000	SAL	183 050 0002 00 99															
Cbush/NWL 1, 2, 3, 4, 5	5 Pairs	28,939 28,960	32,000 32,025	25,000	S3S	183 050 0003 00															
Bush/PB 1, 2, 3, 4	4 Pairs	26,000	29,000 29,052	25,000	SL	184 050 0006 99															











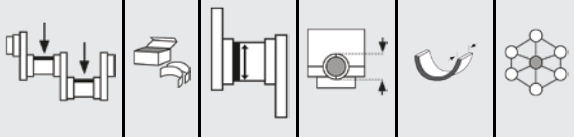





























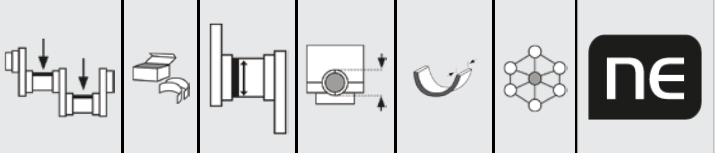











13 81,00																		
MB/HL 1, 2, 3, 4, 5	5 Pairs	53,958 53,978	59,000 59,019	18,500	SAL	180 050 0014 00	6		4									
CB/PL 1, 2, 3, 4	4 Pairs	47,758 47,778	50,600 50,612	19,000	S3S	181 050 0001 00	8											
TW/A 1	4 Halves	59,500 59,750	72,950 73,200		SAL	182 050 0002 00	2		2									
Cbush/NWL 1	1 Pair	42,959 42,975	46,000 46,025	15,000	SAL	183 050 0001 00												
Cbush/NWL 1	1 Pair	41,959 41,975	45,000	15,000	SAL	183 050 0002 00												

14 81,00																		
MB/HL 1, 2, 3, 4, 5	5 Pairs	53,958 53,978	59,000 59,019	18,500	SAL	180 050 0014 00	6		4									
CB/PL 1, 2, 3, 4	4 Pairs	47,758 47,778	50,600 50,612	19,000	S3S	181 050 0001 00	8											
TW/A 1	4 Halves	59,500 59,750	72,950 73,200		SAL	182 050 0002 00	2		2									
Cbush/NWL 1	1 Pair	42,959 42,975	46,000 46,025	15,000	SAL	183 050 0001 00												
Cbush/NWL 1	1 Pair	41,959 41,975	45,000	15,000	SAL	183 050 0002 00												
Bush/PB 1, 2, 3, 4	4 Pairs	20,000	23,000 23,021	25,000	SL	184 050 0008 99												

15 81,00																		
MB/HL 1, 2, 3, 4, 5	5 Pairs	53,958 53,978	59,000 59,019	18,500	SAL	180 050 0014 00	6		4									
CB/PL 1, 2, 3, 4	4 Pairs	47,758 47,778	50,600 50,612	19,000	S3S	181 050 0001 00	8											
TW/A 1	4 Halves	59,500 59,750	72,950 73,200		SAL	182 050 0002 00	2		2									
Bush/PB 1, 2, 3, 4	4 Pairs	20,000	23,000 23,021	25,000	SL	184 050 0008 99												

16 81,00																		
MB/HL 1, 2, 3, 4, 5	5 Pairs	53,958 53,978	59,000 59,019	18,500	SAL	180 050 0013 00	5		5									
MB/HL 1, 2, 3, 4, 5	5 Pairs	53,958 53,978	59,000 59,019	18,500	SAL	180 050 0014 00	6		4									
CB/PL 1, 2, 3, 4	4 Pairs	47,758 47,778	50,600 50,612	19,000	S3S	181 050 0001 00	8											
TW/A 1	4 Halves	59,500 59,750	72,950 73,200		SAL	182 050 0002 00	2		2									
Bush/PB 1, 2, 3, 4	4 Pairs	20,000	23,000 23,021	25,000	SL	184 050 0008 99												

							 		Set Composition / QTY																
17 81,00																									
MB/HL 1, 2, 3, 4, 5	5 Pairs	53,963 53,983	59,000 59,010	18,500	SAL	180 050 0009 00 15 21	5		5																
CB/PL 1, 2, 3, 4	4 Pairs	47,758 47,778	50,600 50,612	19,000	S3S	181 050 0001 00 15 21 26 29	8																		
TW/A 1	2 Halves	59,500 59,750	71,550 71,800		SAL	182 050 0001 00	2																		
Bush/PB 1, 2, 3, 4	4 Pairs	20,000	23,000 23,021	25,000	SL	184 050 0008 99																			
18 81,00																									
MB/HL 1, 2, 3, 4, 5	5 Pairs	53,963 53,983	59,000 59,010	18,500	SAL	180 050 0009 00 15 21	5		5																
MB/HL 1, 2, 3, 4, 5	5 Pairs	53,958 53,978	59,000 59,019	18,500	SAL	180 050 0013 00 15 21 29	5		5																
MB/HL 1, 2, 3, 4, 5	5 Pairs	53,958 53,978	59,000 59,019	18,500	SAL	180 050 0014 00 15 21 26 29	6		4																
CB/PL 1, 2, 3, 4	4 Pairs	47,758 47,778	50,600 50,612	19,000	S3S	181 050 0001 00 15 21 26 29	8																		
TW/A 1	4 Halves	59,500 59,750	72,950 73,200		SAL	182 050 0002 00 15 21 14	2		2																
Bush/PB 1, 2, 3, 4	4 Pairs	20,000	23,000 23,021	25,000	SL	184 050 0008 99																			
19 81,00																									
MB/HL 1, 2, 3, 4, 5	5 Pairs	53,963 53,983	59,000 59,010	18,500	SAL	180 050 0009 00 15 21	5		5																
CB/PL 1, 2, 3, 4	4 Pairs	47,758 47,778	50,600 50,612	19,000	S3S	181 050 0001 00 15 21 26 29	8																		
TW/A 1	4 Halves	59,500 59,750	72,950 73,200		SAL	182 050 0002 00 15 21 14	2		2																
Bush/PB 1, 2, 3, 4	4 Pairs	20,000	23,000 23,021	25,000	SL	184 050 0008 99																			
20 81,00																									
MB/HL 1, 2, 3, 4, 5	5 Pairs	47,958 47,978	53,000 53,010	18,500	SAL	180 050 0003 00 15 21 26	5		5																
MB/HL 1, 2, 3, 4, 5	5 Pairs	53,963 53,983	59,000 59,010	18,500	SAL	180 050 0009 00 15 21	5		5																
CB/PL 1, 2, 3, 4	4 Pairs	47,758 47,778	50,600 50,612	19,000	S3S	181 050 0001 00 15 21 26 29	8																		
CB/PL 1, 2, 3, 4	4 Pairs	41,965 41,980	45,000 45,016	19,000	S3S	181 050 0003 00 15 21 26	4		4																
TW/A 1	2 Halves	59,500 59,750	71,550 71,800		SAL	182 050 0001 00	2																		
TW/A 1	2 Halves	53,500 53,750	65,550 65,800		SAL	182 050 0003 00	2																		

							Set Composition / QTY													
Bush/PB 1, 2, 3, 4	4 Pairs	20,000	23,000 23,021	25,000	SL	184 050 0008 99														
21	81,00																			
MB/HL 1, 2, 3, 4, 5	5 Pairs	47,958 47,978	53,000 53,010	18,500	SAL	180 050 0003 00 15 21 26	5		5											
CB/PL 1, 2, 3, 4	4 Pairs	41,965 41,980	45,000 45,016	19,000	S3S	181 050 0003 00 15 21 26	4		4											
TW/A 1	2 Halves	53,500 53,750	65,550 65,800		SAL	182 050 0003 00	2													
22	81,00																			
MB/HL 1, 2, 3, 4, 5	5 Pairs	53,963 53,983	59,000 59,010	18,500	SAL	180 050 0009 00 15 21	5		5											
CB/PL 1, 2, 3, 4	4 Pairs	47,763 47,778	50,600 50,612	18,500	S32S	181 050 0011 00 15 21 26	4		4											
TW/A 1	4 Halves	59,500 59,750	72,950 73,200		SAL	182 050 0002 00 15 21 14	2		2											
23	81,00																			
MB/HL 1, 2, 3, 4, 5	5 Pairs	53,963 53,983	59,000 59,010	18,500	SAL	180 050 0009 00 15 21	5		5											
CB/PL 1, 2, 3, 4	4 Pairs	47,763 47,778	50,600 50,612	18,500	S32S	181 050 0011 00 15 21 26	4		4											
TW/A 1	4 Halves	59,500 59,750	72,950 73,200		SAL	182 050 0002 00 15 21 14	2		2											
Bush/PB 1, 2, 3, 4	4 Pairs	20,000	23,000 23,021	25,000	SL	184 050 0008 99														
24	81,00																			
MB/HL 1, 2, 3, 4, 5	5 Pairs	53,963 53,983	59,000 59,010	18,500	SAL	180 050 0009 00 15 21	5		5											
CB/PL 1, 2, 3, 4	4 Pairs	47,758 47,778	50,600 50,612	19,000	S3S	181 050 0001 00 15 21 26 29	8													
TW/A 1	4 Halves	59,500 59,750	72,950 73,200		SAL	182 050 0002 00 15 21 14	2		2											
Cbush/NWL 1	1 Pair	42,959 42,975	46,000 46,025	15,000	SAL	183 050 0001 00 99														
Cbush/NWL 1	1 Pair	41,959 41,975	45,000	15,000	SAL	183 050 0002 00 99														
Bush/PB 1, 2, 3, 4	4 Pairs	20,000	23,000 23,021	25,000	SL	184 050 0008 99														



AUDI

Globally reliable



Set Composition / QTY

25										81,00									
MB/HL 1, 2, 3, 4	4 Pairs	53,958 53,978	59,000 59,019	18,500	S3S	180 050 0008 00	15	5		3		1		1					
MB/HL 5	1 Pair	53,958 53,978	59,000 59,019	24,930	S3S		21												
MB/HL 1, 2, 3, 4, 5	5 Pairs	53,958 53,978	59,000 59,019	18,500	SAL	180 050 0014 00	15	6		4									
CB/PL 1, 2, 3, 4	4 Pairs	47,758 47,778	50,600 50,612	19,000	S3S	181 050 0001 00	15	8											
TW/A 1	4 Halves	59,500 59,750	72,950 73,200		SAL	182 050 0002 00	15	2		2									
Cbush/NWL 1	1 Pair	42,959 42,975	46,000 46,025	15,000	SAL	183 050 0001 00	99												
Cbush/NWL 1	1 Pair	41,959 41,975	45,000	15,000	SAL	183 050 0002 00	99												

26										81,00									
MB/HL 1, 2, 3, 4	4 Pairs	53,958 53,978	59,000 59,019	18,500	S3S	180 050 0002 00	15	4		4		1		1					
MB/HL 5	1 Pair	53,958 53,978	59,000 59,019	24,930	S3S		21												
MB/HL 1, 2, 3, 4	4 Pairs	53,958 53,978	59,000 59,019	18,500	S3S	180 050 0008 00	15	5		3		1		1					
MB/HL 5	1 Pair	53,958 53,978	59,000 59,019	24,930	S3S		21												
MB/HL 1, 2, 3, 4, 5	5 Pairs	53,958 53,978	59,000 59,019	18,500	SAL	180 050 0014 00	15	6		4									
CB/PL 1, 2, 3, 4	4 Pairs	47,758 47,778	50,600 50,612	19,000	S3S	181 050 0001 00	15	8											
TW/A 1	4 Halves	59,500 59,750	72,950 73,200		SAL	182 050 0002 00	15	2		2									
Cbush/NWL 1	1 Pair	42,959 42,975	46,000 46,025	15,000	SAL	183 050 0001 00	99												
Cbush/NWL 1	1 Pair	41,959 41,975	45,000	15,000	SAL	183 050 0002 00	99												

27										81,00									
MB/HL 1, 2, 3, 4	4 Pairs	53,958 53,978	59,000 59,019	18,500	S3S	180 050 0008 00	15	5		3		1		1					
MB/HL 5	1 Pair	53,958 53,978	59,000 59,019	24,930	S3S		21												
CB/PL 1, 2, 3, 4	4 Pairs	47,758 47,778	50,600 50,612	19,000	S3S	181 050 0001 00	15	8											
TW/A 1	4 Halves	59,500 59,750	72,950 73,200		SAL	182 050 0002 00	15	2		2									
Cbush/NWL 1	1 Pair	42,959 42,975	46,000 46,025	15,000	SAL	183 050 0001 00	99												
Cbush/NWL 1	1 Pair	41,959 41,975	45,000	15,000	SAL	183 050 0002 00	99												







						NE		Set Composition / QTY													
28												81,00									
MB/HL 1, 2, 3, 4	4 Pairs	53,958 53,978	59,000 59,019	18,500	S3S	180 050 0008 00	15	5		3		1		1							
MB/HL 5	1 Pair	53,958 53,978	59,000 59,019	24,930	S3S		21														
MB/HL 1, 2, 3, 4, 5	5 Pairs	53,958 53,978	59,000 59,019	18,500	SAL	180 050 0014 00	15	6		4											
CB/PL 1, 2, 3, 4	4 Pairs	47,758 47,778	50,600 50,612	19,000	S3S	181 050 0001 00	15	8													
TW/A 1	4 Halves	63,500 63,750	76,950 77,200		SAL	182 050 0005 00		2		2											
Cbush/NWL 1	1 Pair	42,959 42,975	46,000 46,025	15,000	SAL	183 050 0001 00	99														
Cbush/NWL 1	1 Pair	41,959 41,975	45,000	15,000	SAL	183 050 0002 00	99														
29												81,00									
MB/HL 1, 2, 3, 4	4 Pairs	53,958 53,978	59,000 59,019	18,500	S3S	180 050 0002 00	15	4		4		1		1							
MB/HL 5	1 Pair	53,958 53,978	59,000 59,019	24,930	S3S		21														
MB/HL 1, 2, 3, 4	4 Pairs	53,958 53,978	59,000 59,019	18,500	S3S	180 050 0008 00	15	5		3		1		1							
MB/HL 5	1 Pair	53,958 53,978	59,000 59,019	24,930	S3S		21														
CB/PL 1, 2, 3, 4	4 Pairs	47,758 47,778	50,600 50,612	19,000	S3S	181 050 0001 00	15	8													
Cbush/NWL 1	1 Pair	42,959 42,975	46,000 46,025	15,000	SAL	183 050 0001 00	99														
Cbush/NWL 1	1 Pair	41,959 41,975	45,000	15,000	SAL	183 050 0002 00	99														
30												81,00									
MB/HL 1, 2, 3, 4	4 Pairs	64,959 64,978	70,000 70,019	18,500	S3S	180 050 0012 00	15	4		4											
CB/PL 1, 2, 3, 4, 5, 6	6 Pairs	53,958 53,978	57,600 57,612	17,000	S3S	181 050 0008 00	15	12													
TW/A 1	4 Halves	70,500 70,750	84,650 84,900		SAL	182 050 0004 00		2		2											
31												81,00									
MB/HL 1, 2, 3, 4, 5	5 Pairs	53,958 53,978	59,000 59,012	18,500	S3S	180 050 0015 00	15	5		5											
CB/PL 1, 2, 3, 4	4 Pairs	50,858 50,878	53,700 53,712	20,400	S4S	181 050 0019 00	15														
Cbush/NWL 1, 2, 3, 4, 5	5 Pairs	28,939 28,960	32,000 32,025	25,000	S3S	183 050 0003 00															















AUDI







Globally reliable





						Set Composition / QTY					
32 81,00											
MB/HL 1, 2, 4, 5, 6	5 Pairs	57,958 57,978	63,000 63,019	18,500	S3S	180 050 0016 00 15 21	5	5	1	1	
MB/HL 3	1 Pair	57,958 57,978	63,000 63,019	24,930	S3S						
MB/HL 1, 2, 3, 4, 5, 6	6 Pairs	57,958 57,978	63,000 63,019	18,500	S3S	180 050 0017 00 15 21	6	6			
CB/PL 1, 2, 3, 4, 5	5 Pairs	47,758 47,778	50,600 50,612	20,000	S4S	181 050 0018 00 15 21					
TW/A 1	4 Halves	63,500 63,750	76,950 77,200		SAL	182 050 0005 00	2	2			
Bush/PB 1, 2, 3, 4	4 Pairs	24,000	27,000 27,052	25,000	SL	184 050 0005 99					
33 82,50											
MB/HL 1, 2, 3, 4, 5	5 Pairs	53,963 53,983	59,000 59,010	18,500	SAL	180 050 0009 00 15 21	5	5			
CB/PL 1, 2, 3, 4	4 Pairs	47,763 47,778	50,600 50,612	18,500	S32S	181 050 0011 00 15 21 26	4	4			
TW/A 1	2 Halves	59,500 59,750	71,550 71,800		SAL	182 050 0001 00	2				
34 84,00											
MB/HL 1, 2, 3, 4, 5, 6, 7	7 Pairs	59,958 59,978	65,000 65,010	17,000	SAL	180 050 0011 00 15 21	7	7			
CB/PL 1, 2, 3, 4, 5, 6	6 Pairs	53,958 53,978	56,800 56,819	17,000	SAL	181 050 0007 00 15 21	12				







	ccm						Pos.
1ND-TV from 02/2004	1364	4	MINI (R50, R53) One D	73,00	180 096 0031 181 096 0041 182 096 0028	Std, 0,25, 0,50 Std, 0,25, 0,50 Std	1
1ND-TV till 02/2004	1364	4	MINI (R50, R53) One D	73,00	180 096 0031 181 096 0040 182 096 0028	Std, 0,25, 0,50 Std, 0,25, 0,50 Std	2
W10B16A	1598	4	Mini Cabriolet (R52) One Mini (R50, R53) One Mini Cabriolet (R52) Cooper Mini (R50, R53) Cooper	77,00	180 007 0010 181 007 0006	Std, 0,25, 0,50 Std, 0,25, 0,50	3
N13 B16 A	1598	4	1'(F20) 114 i, 1'(F20) 116 i, 1'(F20) 118 i, 1'(F20) 120 i, 1'(F21) 114 i, 1'(F21) 116 i, 1'(F21) 118 i, 1'(F21) 120 i, 3'(F30, F80) 316 i, 3'(F30, F80) 320 i ed, 3'(F31) 316 i,	77,00	180 037 0014 181 037 0022 182 037 0006	Std, 0,30, 0,50, 0,80 Std, 0,30, 0,50 Std	4
N16 B16 A	1598	4	MINI PACEMAN (R61) Cooper, MINI PACEMAN (R61) Cooper ALL4, MINI Coupe (R58) Cooper, MINI Roadster (R59) Cooper, MINI Cabriolet (R57) One, MINI Cabriolet (R57) Cooper, MINI CLUBMAN (R55) Cooper, MINI (R56) One	77,00	180 037 0014 181 037 0022 182 037 0006	Std, 0,30, 0,50, 0,80 Std, 0,30, 0,50 Std	4
N18 B16 A	1598	4	MINI PACEMAN (R61) Cooper S ALL4, MINI PACEMAN (R61) Cooper S, MINI PACEMAN (R61) Cooper ALL4, MINI Coupe (R58) Cooper S, MINI Coupe (R58) Cooper S JCW, MINI Roadster (R59) Cooper S, MINI Roadster (R59) Cooper S JCW, MINI Cabriolet (R57) Cooper S, MINI CLUBMAN (R55) Cooper S, MINI (R56) Cooper S	77,00	180 037 0014 181 037 0022 182 037 0006	Std, 0,30, 0,50, 0,80 Std, 0,30, 0,50 Std	4
N18 B16 C	1598	4	MINI PACEMAN (R61) JCW, MINI Roadster (R59) JCW, MINI CLUBMAN (R55) JCW, MINI (R56) JCW GP	77,00	180 037 0014 181 037 0022 182 037 0006	Std, 0,30, 0,50, 0,80 Std, 0,30, 0,50 Std	4
N14 B16 C	1598	4	MINI Coupe (R58) JCW, MINI Roadster (R59) JCW, MINI Cabriolet (R57) JCW, MINI CLUBMAN (R55) JCW, MINI (R56) JCW	77,00	180 037 0014 181 037 0022 182 037 0006	Std, 0,30, 0,50, 0,80 Std, 0,30, 0,50 Std	4
N14 B16 A	1598	4	MINI Coupe (R58) Cooper S, MINI Cabriolet (R57) Cooper S, MINI CLUBMAN (R55) Cooper S, MINI (R56) Cooper S	77,00	180 037 0014 181 037 0022 182 037 0006	Std, 0,30, 0,50, 0,80 Std, 0,30, 0,50 Std	4
N12 B16 A	1598	4	MINI Cabriolet (R57) Cooper, MINI (R56) Cooper	77,00	180 037 0014 181 037 0022 182 037 0006	Std, 0,30, 0,50, 0,80 Std, 0,30, 0,50 Std	4
20 6 S3, M20B20, M50B20, M52B20	1991	6	320 2.0i(E30), 320 2.0i 24V(E36), 320 2.0i 24V(E46), 520 2.0i 24V(E39), 520 2.0i(E28), 520 2.0i(E34), 520 2.0i 24V(E34), Z3 2.0i 24V(E36/7)	80,00	180 007 0001 180 007 0003 181 007 0001	Std, 0,25, 0,50, 0,75, 1,00 Std, 0,25, 0,50, 0,75, 1,00 Std, 0,25, 0,50, 0,75, 1,00	5
M20B23	2316	6	323 2.3i(E21), 323 2.3i(E30)	80,00	180 007 0001 180 007 0003 181 007 0001	Std, 0,25, 0,50, 0,75, 1,00 Std, 0,25, 0,50, 0,75, 1,00 Std, 0,25, 0,50, 0,75, 1,00	5
M21 D25	2443	6	324 2.4D, 324 2.4TDS, 524 2.4D, 524 2.4TDS	80,00	180 007 0001 181 035 0012	Std, 0,25, 0,50, 0,75, 1,00 Std, 0,25, 0,50	7
M41 D18	1665	4	318 Compact TDS, 318 TDS, 318 Touring TDS	80,00	180 007 0002 181 035 0011	Std, 0,25, 0,50, 0,75 Std, 0,25, 0,50	6
M21 D25, M51 D25	2498	6	325 2.5TD, 525 TD	80,00	180 007 0001 181 035 0012	Std, 0,25, 0,50, 0,75, 1,00 Std, 0,25, 0,50	7
N43 B16 A	1599	4	3'(E92) 316 i, 1'(E81) 116 i, 3'(E90) 316 i, 3'(E90) 320 i, 3'(E91) 316 i	82,00	180 007 0007 181 007 0005	Std, 0,25, 0,50 Std, 0,25, 0,50	8
M60 B30	2997	8	530i 32V, 730i 32V, 730i, 730iL	84,00	180 007 0006 181 007 0004	Std, 0,25, 0,50, 0,75 Std, 0,25	9
16 4 E1, 16 4 E2 Gas, 16 4 E3 Gas, M40 B16, M43 B16 Gas	1596	4	316 1.6i(E30), 316 1.6i(E36), 316g 1.6i(E36)	84,00	180 007 0004 181 007 0002	Std, 0,25, 0,50, 0,75 Std, 0,25, 0,50, 0,75	10
N45 B16 A	1596	4	1'(E81) 116 i, 1'(E87) 116 i, 3'(E46) 316 ti, 3'(E90) 316 i,	84,00	180 007 0007 181 007 0005	Std, 0,25, 0,50 Std, 0,25, 0,50	8
N40 B16 A	1596	4	3'(E46) 316 ti	84,00	180 007 0007 181 007 0005	Std, 0,25, 0,50 Std, 0,25, 0,50	8







	ccm						Pos.
25 6 E1, 25 6 E2, 26 6 K1, 25 6 S1, 25 6 S2, 25 6 S3, 25 6 S4, 25 6 S5, M20 B25, M50 B25, M52 B25	2494	6	325 2.5i(E30), 325 2.5i 24V(E36), 323 2.5i 24V(E46), 325 2.5i 24V(E46), 523 2.5i 24V(E39), 525 2.5i 24V(E39), 525 2.5i(E34), 525 2.5i 24V(E34), 525 2.5i 24V(E60), 525 2.5i 24V(E61), X3 2.5i 24V(E83), Z1 2.5i, Z4 2.5i 24V(E85)	84,00	180 007 0001 180 007 0003 181 007 0001	Std, 0,25, 0,50, 0,75, 1,00 Std, 0,25, 0,50, 0,75, 1,00 Std, 0,25, 0,50, 0,75, 1,00	5
M62 B35	3498	8	535i, 735i 32V V8(E38/39)	84,00	180 007 0006 181 007 0004	Std, 0,25, 0,50, 0,75 Std, 0,25	9
18 4 E1, 18 4 E2 Gas, M40 B18, M42 B18, M43 B18 Gas	1796	4	318 1.8i(E30), 318 1.8i 16V(E30), 318 1.8i(E36), 318 1.8i 16V(E36), 318g 1.8i(E36), 518 1.8i(E34), 518g 1.8i(E34)	84,00	180 007 0004 181 007 0002	Std, 0,25, 0,50, 0,75 Std, 0,25, 0,50, 0,75	10
M20 B27	2693	6	325e 2.7(E30), 525e 2.7i(E28), 528e 2.7i(E28)	84,00	180 007 0001 180 007 0003 181 007 0001	Std, 0,25, 0,50, 0,75, 1,00 Std, 0,25, 0,50, 0,75, 1,00 Std, 0,25, 0,50, 0,75, 1,00	5
28 6 S1, 28 6 S2, M52 B28	2793	6	328 2.8i 24V(E36), 328 2.8i 24V(E46), 528 2.8i 24V(E39), 728 2.8i 24V(E38), Z3 2.8i 24V(E36/7)	84,00	180 007 0001 180 007 0003 181 007 0001	Std, 0,25, 0,50, 0,75, 1,00 Std, 0,25, 0,50, 0,75, 1,00 Std, 0,25, 0,50, 0,75, 1,00	5
N54 B30 A N54 B30 B N55 B30 A	2979	6	1 (F20) M 135 i 1 (F20) M 135 i xDrive 1 (F21) M 135 i 1 (F21) M 135 i xDrive 1 Cabriolet (E88) 135 i 1 Coupe (E82) 135 i 1 Coupe (E82) M 2 Cabriolet (F23) M 235 i 2 Cabriolet (F23) M 235 i xDrive 2 Coupe (F22, F87) M 235 i 2 Coupe (F22, F87) M 235 i xDrive 2 Coupe (F22, F87) M2 3 (E90) 335 i 3 (E90) 335 i xDrive 3 (E90) 335 xi 3 (F30, F80) 335 i 3 (F30, F80) 335 i xDrive 3 (F30, F80) ActiveHybrid 3 Cabriolet (E93) 335 i 3 Coupe (E92) 335 i 3 Coupe (E92) 335 i xDrive 3 Coupe (E92) 335 xi 3 Gran Turismo (F34) 335 i 3 Gran Turismo (F34) 335 i xDrive 3 Touring (E91) 335 i 3 Touring (E91) 335 i xDrive 3 Touring (E91) 335 xi 3 Touring (F31) 335 i 3 Touring (F31) 335 i xDrive	84,00	180 007 0008 181 007 0010	Std, 0,25, 0,50 Std, 0,25, 0,50	13
N54 B30 A N54 B30 B N55 B30 A	2979	6	4 Cabriolet (F33, F83) 435 i 4 Cabriolet (F33, F83) 435 i xDrive 4 Coupe (F32, F82) 435 i 4 Coupe (F32, F82) 435 i xDrive 4 Gran Coupe (F36) 435 i 4 Gran Coupe (F36) 435 i xDrive 5 (E60) 535 i 5 (F10) 535 i 5 (F10) 535 i xDrive 5 (F10) ActiveHybrid 5 Gran Turismo (F07) 535 i 5 Gran Turismo (F07) 535 i xDrive 5 Touring (F11) 535 i 5 Touring (F11) 535 i xDrive 6 Cabriolet (F12) 640 i 6 Cabriolet (F12) 640 i xDrive 6 Coupe (F13) 640 i 6 Coupe (F13) 640 i xDrive 6 Gran Coupe (F06) 640 i 6 Gran Coupe (F06) 640 i xDrive 7 (F01, F02, F03, F04) 740 i, Li 7 (F01, F02, F03, F04) 740 i, Li xDrive 7 (F01, F02, F03, F04) ActiveHybrid X3 (F25) xDrive 35 i X4 (F26) M 40 i X4 (F26) xDrive 35 i X5 (E70) xDrive 35 i X5 (E70) xDrive 40 i X5 (F15, F85) xDrive 35 i X6 (E71, E72) xDrive 35 i X6 (F16, F86) xDrive 35 i Z4 Roadster (E89) sDrive 35 i Z4 Roadster (E89) sDrive 35 is	84,00	180 007 0008 181 007 0010	Std, 0,25, 0,50 Std, 0,25, 0,50	13
N42 B20 A	1995	4	3'(E46) 318 Ci, 3'(E46) 316 ti,	84,00	180 007 0007 181 007 0005	Std, 0,25, 0,50 Std, 0,25, 0,50	8
B47 D20 A, B47 D20 B	1995	4	1 (F20), 1 (F21) 118 d, 118 d xDrive, 120 d, 120 d xDrive, 125 d	84,00	180 007 0014 181 007 0011	Std, 0,25, 0,50 Std, 0,25, 0,50	11

	ccm						Pos.
B47 C20 A	1995	4	MINI (F55) Cooper SD, MINI (F56) Cooper SD, MINI Cabriolet (F57) Cooper SD, MINI CLUBMAN (F54) Cooper SD, MINI CLUBMAN (F54) Cooper D, MINI COUNTRYMAN (F60) Cooper SD, MINI COUNTRYMAN (F60) Cooper D	84,00	180 007 0014 181 007 0011	Std, 0,25, 0,50 Std, 0,25, 0,50	11
B47 C20 A, B47 D20 A, B47 D20 B	1995	4	2 (F23), 2 (F45), 2 (F22, F87), 2 GT (F46) 218 d, 218 d xDrive, 220 d, 220 d xDrive, 225 d	84,00	180 007 0014 181 007 0011	Std, 0,25, 0,50 Std, 0,25, 0,50	11
B47 D20 B	1995	4	X5 (F15, F85) sDrive 25 d, xDrive 25 d	84,00	180 007 0014 181 007 0011	Std, 0,25, 0,50 Std, 0,25, 0,50	11
B47 D20 A	1995	4	X4 (F26) xDrive 20 d	84,00	180 007 0014 181 007 0011	Std, 0,25, 0,50 Std, 0,25, 0,50	11
B47 D20 A	1995	4	X3 (G01) xDrive 20 d	84,00	180 007 0014 181 007 0011	Std, 0,25, 0,50 Std, 0,25, 0,50	11
B47 D20 A	1995	4	X3 (F25) sDrive 18 d, xDrive 20 d	84,00	180 007 0014 181 007 0011	Std, 0,25, 0,50 Std, 0,25, 0,50	11
B47 C20 A, B47 C20 B	1995	4	X2 (F39) xDrive 20 d, xDrive 25 d	84,00	180 007 0014 181 007 0011	Std, 0,25, 0,50 Std, 0,25, 0,50	11
B47 C20 A, B47 C20 B	1995	4	X1 (F48) sDrive 18 d, sDrive 20 d, xDrive 18 d, xDrive 20 d, xDrive 25 d	84,00	180 007 0014 181 007 0011	Std, 0,25, 0,50 Std, 0,25, 0,50	11
B47 D20 B	1995	4	7 (G11, G12) 725 d, Ld	84,00	180 007 0014 181 007 0011	Std, 0,25, 0,50 Std, 0,25, 0,50	11
B47 D20 A	1995	4	3 (F30, F80), 3 GT (F34), 3 (F31), 4 (F33, F83), 4 (F32, F82), 4 Gran Coupe (F36), 5 (F10), 5 (G30, F90), 5 (F11), 5 (G31) 318 d, 318 d xDrive, 320 d, 320 d xDrive, 418 d, 420 d, 420 d xDrive, 518 d, 520 d, 520 d xDrive,	84,00	180 007 0014 181 007 0011	Std, 0,25, 0,50 Std, 0,25, 0,50	11
B47 D20 B	1995	4	3 (F30, F80), 3 GT (F34), 3 (F31), 4 (F33, F83), 4 (F32, F82), 4 Gran Coupe (F36), 5 (G30, F90), 5 (G31), 325 d, 425 d, 525 d	84,00	180 007 0014 181 007 0011	Std, 0,25, 0,50 Std, 0,25, 0,50	11

	ccm						Pos.
B47 D20 A	1995	4	3 (F30, F80), 3 GT(F34), 3 (F31), 4 (F33, F83), 4 (F32, F82), 4 Gran Coupe (F36), 5 (F10), 5 (F11) 316 d, 318 d, 320 d, 320 d xDrive, 418 d, 420 d, 420 d xDrive, 518 d, 520 d	84,00	180 007 0014 181 007 0011	Std, 0,25, 0,50 Std, 0,25, 0,50	11
B47 D20 A	1995	4	5 (F11), 4 (F36), 5 (F10), 3 (F30, F80), 4 (F33, F83), 4 (F32, F82), 3 (F30, F80), 3 GT (F34), 3 (F31) 518 d, 520 d 420 d, 418 d 520 d 320 d, 316 d, 318 d, 320 d xDrive 320 d, 316 d, 320 d xDrive, 318 d 320 d, 320 d xDrive 420 d, 420 d xDrive	84,00	180 007 0014 181 007 0011	Std, 0,25, 0,50 Std, 0,25, 0,50	11
N47 C20 A N47 D20 A N47 D20 A N47 D20 B N47 D20 C N47 D20 D	1995	4	1 (E81) 116 d 1 (E81) 118 d 1 (E81) 120 d 1 (E81) 123 d 1 (E87) 116 d 1 (E87) 118 d 1 (E87) 120 d 1 (E87) 123 d 1 (F20) 116 d 1 (F20) 118 d 1 (F20) 118 d xDrive 1 (F20) 120 d 1 (F20) 120 d xDrive 1 (F20) 125 d 1 (F21) 116 d 1 (F21) 118 d 1 (F21) 118 d xDrive 1 (F21) 120 d 1 (F21) 120 d xDrive 1 (F21) 125 d 1 Cabriolet (E88) 118 d 1 Cabriolet (E88) 120 d 1 Cabriolet (E88) 123 d 1 Coupe (E82) 118 d 1 Coupe (E82) 120 d 1 Coupe (E82) 123 d	84,00	180 007 0011 181 007 0007	Std, 0,25, 0,50 Std, 0,25, 0,50	14
N47 C20 A N47 D20 A N47 D20 B N47 D20 C N47 D20 D	1995	4	2 Coupe (F22, F87) 218 d 2 Coupe (F22, F87) 220 d 2 Coupe (F22, F87) 225 d 3 (E90) 316 d 3 (E90) 318 d 3 (E90) 320 d 3 (E90) 320 d xDrive 3 (F30, F80) 316 d 3 (F30, F80) 318 d 3 (F30, F80) 318 d xDrive 3 (F30, F80) 320 d 3 (F30, F80) 320 d xDrive 3 (F30, F80) 325 d 3 Cabriolet (E93) 320 d 3 Coupe (E92) 320 d 3 Coupe (E92) 320 d xDrive 3 Gran Turismo (F34) 318 d 3 Gran Turismo (F34) 320 d 3 Gran Turismo (F34) 320 d xDrive 3 Gran Turismo (F34) 325 d 3 Touring (E91) 316 d 3 Touring (E91) 318 d 3 Touring (E91) 320 d 3 Touring (E91) 320 d xDrive 3 Touring (F31) 316 d 3 Touring (F31) 318 d 3 Touring (F31) 318 d xDrive 3 Touring (F31) 320 d 3 Touring (F31) 320 d xDrive 3 Touring (F31) 325 d	84,00	180 007 0011 181 007 0007	Std, 0,25, 0,50 Std, 0,25, 0,50	14

	ccm					Pos.	
N47 C20 A N47 D20 A N47 D20 B N47 D20 C N47 D20 D	1995	4	4 Cabriolet (F33, F83) 420 d 4 Cabriolet (F33, F83) 425 d 4 Coupe (F32, F82) 420 d 4 Coupe (F32, F82) 420 d xDrive 4 Coupe (F32, F82) 425 d 4 Gran Coupe (F36) 418 d 4 Gran Coupe (F36) 420 d 4 Gran Coupe (F36) 420 d xDrive 5 (E60) 520 d 5 (F10) 518 d 5 (F10) 520 d 5 (F10) 520 d xDrive 5 (F10) 525 d 5 (F10) 525 d xDrive 5 Gran Turismo (F07) 520 d 5 Touring (E61) 520 d 5 Touring (F11) 518 d 5 Touring (F11) 520 d 5 Touring (F11) 520 d xDrive 5 Touring (F11) 525 d 5 Touring (F11) 525 d xDrive	84,00	180 007 0011 181 007 0007	Std, 0,25, 0,50 Std, 0,25, 0,50	14
N47 C20 A N47 D20 A N47 D20 B N47 D20 C N47 D20 D	1995	4	MINI (R56) Cooper D MINI (R56) Cooper SD MINI Cabriolet (R57) Cooper D MINI Cabriolet (R57) Cooper SD MINI CLUBMAN (R55) Cooper D MINI CLUBMAN (R55) Cooper SD MINI CLUBVAN (R55) Cooper D MINI COUNTRYMAN (R60) Cooper D MINI COUNTRYMAN (R60) Cooper D ALL4 MINI COUNTRYMAN (R60) Cooper SD MINI COUNTRYMAN (R60) Cooper SD ALL4 MINI Coupe (R58) Cooper SD MINI PACEMAN (R61) Cooper D MINI PACEMAN (R61) Cooper D ALL4 MINI PACEMAN (R61) Cooper SD MINI PACEMAN (R61) Cooper SD ALL4 MINI Roadster (R59) Cooper SD	84,00	180 007 0011 181 007 0007	Std, 0,25, 0,50 Std, 0,25, 0,50	14
N47 C20 A N47 D20 A N47 D20 B N47 D20 C N47 D20 D	1995	4	X1 (E84) sDrive 16 d X1 (E84) sDrive 18 d X1 (E84) sDrive 20 d X1 (E84) xDrive 18 d X1 (E84) xDrive 20 d X1 (E84) xDrive 23 d X1 (E84) xDrive 25 d X3 (E83) 2.0 d X3 (E83) xDrive 18 d X3 (E83) xDrive 20 d X3 (F25) sDrive 18 d X3 (F25) xDrive 20 d X5 (F15, F85) sDrive 25 d X5 (F15, F85) xDrive 25 d	84,00	180 007 0011 181 007 0007	Std, 0,25, 0,50 Std, 0,25, 0,50	14
N57 D30 C	2993	6	5 (F10) M 550 d xDrive 5 Touring (F11) M 550 d xDrive 7 (F01, F02, F03, F04) 750 d xDrive X5 (E70) M 50 d X5 (F15, F85) M 50 d X6 (E71, E72) M 50 d X6 (F16, F86) M 50 d	84,00	180 007 0013 181 007 0009	Std, 0,25, 0,50 Std, 0,25, 0,50	15
N46 B20 A, N46 B20 B	1995	4	Z4'(E85) 2.0 i, X3'(E83) 2.0 i, X3'(E83) xDrive 20 i, X1'(E84) sDrive 18 i, 3'(E93) 320 i, 3'(E92) 320 i, 3'(E91) 320 i, 3'(E91) 318 i, 1'(E88) 118 i, 1'(E88) 120 i, 1'(E82) 120 i, 1'(E81) 118 i, 1'(E81) 120 i, 1'(E87) 120 i, 1'(E87) 118 i, 3'E46) 318 Ci, 3' (E46) 318 ti, 3'(E91) 318 i, 3'(E91) 320 i	84,00	180 007 0007 181 007 0005	Std, 0,25, 0,50 Std, 0,25, 0,50	8







	ccm						Pos.
N43 B20 A	1995	4	5'(E61) 520 i, 5'(E60) 520 i, 3'(E93) 318 i, 3'(E93) 320 i, 3'(E92) 318 i, 3'(E92) 320 i, 1'(E88) 118 i, 1'(E88) 120 i, 1'(E82) 120 i, 1'(E81) 116 i, 1'(E81) 118 i, 1'(E81) 120 i, 1'(E87) 116 i, 1'(E87) 118 i, 1'(E87) 120 i, 3'(E90) 320 i, 3'(E91) 318 i, 3'(E91) 320 i	84,00	180 007 0007 181 007 0005	Std, 0,25, 0,50 Std, 0,25, 0,50	8
N57 D30 B	2993	6	X5 (E70) xDrive 40 d X6 (E71, E72) xDrive 40 d 3 (F30, F80) 335 d xDrive 3 Gran Turismo (F34) 335 d xDrive 3 Touring (F31) 335 d xDrive 4 Cabriolet (F33, F83) 435 d xDrive 4 Coupe (F32, F82) 435 d xDrive 4 Gran Coupe (F36) 435 d xDrive 5 (F10) 535 d 5 (F10) 535 d xDrive 5 Gran Turismo (F07) 535 d 5 Gran Turismo (F07) 535 d xDrive 5 Touring (F11) 535 d 5 Touring (F11) 535 d xDrive 6 Cabriolet (F12) 640 d 6 Cabriolet (F12) 640 d xDrive 6 Coupe (F13) 640 d 6 Coupe (F13) 640 d xDrive 6 Gran Coupe (F06) 640 d 6 Gran Coupe (F06) 640 d xDrive 7 (F01, F02, F03, F04) 740 d 7 (F01, F02, F03, F04) 740 d xDrive X3 (F25) xDrive 35 d X4 (F26) xDrive 35 d X5 (F15, F85) xDrive 40 d X6 (F16, F86) xDrive 40 d	84,00	180 007 0013 181 007 0009	Std, 0,25, 0,50 Std, 0,25, 0,50	15
N57 D30 A	2993	6	3 (E90) 325 d 3 (E90) 330 d 3 (E90) 330 d xDrive 3 (F30, F80) 330 d 3 (F30, F80) 330 d xDrive 3 Cabriolet (E93) 325 d 3 Cabriolet (E93) 330 d 3 Coupe (E92) 325 d 3 Coupe (E92) 330 d 3 Coupe (E92) 330 d xDrive 3 Coupe (E92) 330 xd 3 Gran Turismo (F34) 330 d 3 Gran Turismo (F34) 330 d xDrive 3 Touring (E91) 325 d 3 Touring (E91) 330 d 3 Touring (E91) 330 d xDrive 3 Touring (F31) 330 d 3 Touring (F31) 330 d xDrive 3 Touring Van (F31) 330 d 3 Touring Van (F31) 330 d xDrive	84,00	180 007 0013 181 007 0009	Std, 0,25, 0,50 Std, 0,25, 0,50	15
N57 D30 A	2993	6	4 Cabriolet (F33, F83) 430 d 4 Coupe (F32, F82) 430 d 4 Coupe (F32, F82) 430 d xDrive 4 Gran Coupe (F36) 430 d 4 Gran Coupe (F36) 430 d xDrive 5 (F10) 525 d 5 (F10) 530 d 5 (F10) 530 d xDrive 5 Gran Turismo (F07) 530 d 5 Gran Turismo (F07) 530 d xDrive 5 Touring (F11) 525 d 5 Touring (F11) 530 d 5 Touring (F11) 530 d xDrive 7 (F01, F02, F03, F04) 730 d 7 (F01, F02, F03, F04) 730 d xDrive X3 (F25) xDrive 30 d X4 (F26) xDrive 30 d X5 (E70) xDrive 30 d X5 (F15, F85) xDrive 25 d X5 (F15, F85) xDrive 30 d X6 (E71, E72) xDrive 30 d X6 (F16, F86) xDrive 30 d	84,00	180 007 0013 181 007 0009	Std, 0,25, 0,50 Std, 0,25, 0,50	15











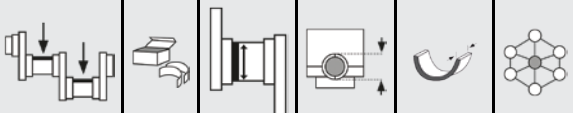



















	ccm						Pos.
N20 B20 A, N20 B20 B, N20 B20 D, N26 B20 A	1997	4	5 (F10) 520 i 1 (F20) 125 i X1 (E84) xDrive 28 i 5 (F10) 520 i 5 (F10) 528 i 5 (F10) 528 i xDrive 5 Touring (F11) 520 i 5 Touring (F11) 528 i 5 Touring (F11) 528 i xDrive Z4 Roadster (E89) sDrive 20 i Z4 Roadster (E89) sDrive 28 i X1 (E84) sDrive 20 i X1 (E84) xDrive 20 i X3 (F25) xDrive 20 i	84,00	180 007 0012 181 007 0008	Std, 0,25, 0,50 Std, 0,25, 0,50	12
N20 B20 A N20 B20 B N20 B20 D N26 B20 A	1997	4	3 (F30, F80) 328 i 3 (F30, F80) 320 i 4 Coupe (F32, F82) 420 i 4 Coupe (F32, F82) 420 i xDrive 3 Touring (F31) 320 i 3 Touring (F31) 328 i X3 (F25) xDrive 28 i 3 (F30, F80) 320 i xDrive 3 (F30, F80) 328 i xDrive 2 Coupe (F22, F87) 220 i 4 Cabriolet (F33, F83) 428 i 1 (F21) 125 i Z4 Roadster (E89) sDrive 18 i 3 Gran Turismo (F34) 320 i 3 Gran Turismo (F34) 328 i 3 (F30, F80) 320 i xDrive 3 Touring (F31) 328 i xDrive 3 Touring (F31) 320 i xDrive 3 Gran Turismo (F34) 320 i xDrive 3 Gran Turismo (F34) 328 i xDrive	84,00	180 007 0012 181 007 0008	Std, 0,25, 0,50 Std, 0,25, 0,50	12
N20 B20 A N20 B20 B N20 B20 D N26 B20 A	1997	4	4 Coupe (F32, F82) 428 i 4 Coupe (F32, F82) 428 i xDrive 5 Gran Turismo (F07) 528 i 4 Cabriolet (F33, F83) 428 i xDrive 4 Gran Coupe (F36) 420 i 4 Gran Coupe (F36) 428 i 4 Gran Coupe (F36) 428 i xDrive 1 (F20) 125 i 1 (F21) 125 i X3 (F25) sDrive 20 i X4 (F26) xDrive 20 i X4 (F26) xDrive 28 i 2 Coupe (F22, F87) 228 i 4 Cabriolet (F33, F83) 420 i 4 Gran Coupe (F36) 420 i xDrive X1 (E84) sDrive 20 i Flex 1 (F21) 125 i Active Flex 3 (F30, F80) 328 i ActiveFlex 2 Cabriolet (F23) 220 i 2 Cabriolet (F23) 228 i 1 (F20) 120 i Active Flex X5 (F15, F85) xDrive 40e 1 (F20) 125 i Active Flex X5 (F15, F85) xDrive 40e 3 Gran Turismo (F34) 320 i 3 Gran Turismo (F34) 320 i xDrive	84,00	180 007 0012 181 007 0008	Std, 0,25, 0,50 Std, 0,25, 0,50	12
N20 B20 A N20 B20 B N20 B20 D N26 B20 A	1997	4	4 Coupe (F32, F82) 420 i 4 Coupe (F32, F82) 420 i xDrive 4 Cabriolet (F33, F83) 420 i 4 Gran Coupe (F36) 420 i 4 Gran Coupe (F36) 420 i xDrive Z4 Roadster (E89) sDrive 20 i 5 Touring (F11) 520 i X5 (F15, F85) xDrive 40e X5 (F15, F85) xDrive 40e X6 (F16, F86) xDrive 28 i 3 (F30, F80) 320 i ActiveFlex X1 (E84) xDrive 28 i Flex 3 Touring (F31) 320 i 3 Touring (F31) 320 i xDrive	84,00	180 007 0012 181 007 0008	Std, 0,25, 0,50 Std, 0,25, 0,50	12
19 4 E1, 19 4 S1, M43TU B19, M44 B19	1895	4	316 1.9i(E36), 316 1.9i 16V(E36), 316 1.9i(E46), 318 1.9i(E46), Z3 1.9i(E36/7), Z3 1.9i 16V(E36/7)	85,00	180 007 0004 181 007 0002	Std, 0,25, 0,50, 0,75 Std, 0,25, 0,50, 0,75	10
N53 B30 A	2996	6	3 (E90), (E91), (E92), (E93) 325 i, 325 i xDrive, 325 xi, 330 i, 330 xi, 330 i xDrive 5 (F10), (F11) 523 i, 528 i	85,00	180 007 0008 181 007 0090	Std, 0,25, 0,50 Std, 0,25, 0,50	16
M30 B25	2494	6	2.5CS(E9), 2500(E3), 525 2.5(E12), 525 2.5i(E28)	86,00	180 007 0005 181 007 0003	Std, 0,25, 0,50, 0,75 Std, 0,25, 0,50, 0,75	17
M30 B28	2788	6	2800(E3), 2.8(E3), 528 2.8(E12), 528i(E12), 528 2.8i(E28), 628 CSI(E24), 728 2.8(E23), 728 2.8i(E23)	86,00	180 007 0005 181 007 0003	Std, 0,25, 0,50, 0,75 Std, 0,25, 0,50, 0,75	17
M30 B30	2986	6	3.0(E9), 3.0(E3), 3.0CSI(E3), 3.0SI(E3), 3.0i Bavaria(E3), 528i(E12), 530 3.0i(E12), 530 3.0i(E34), 630CS(E24), 730 3.0(E23), 730 3.0i(E32)	89,00	180 007 0005 181 007 0003	Std, 0,25, 0,50, 0,75 Std, 0,25, 0,50, 0,75	17



BMW

Globally reliable

	ccm						Pos.
M60 B40	3982	8	540 32V, 540i, 740 4.0i 32V, 740i, 840 4.0i 32V	89,00	180 007 0006 181 007 0004	Std, 0,25, 0,50, 0,75 Std, 0,25	9
M30 B32	3210	6	3.3Li(E3), 533 3.2i(E28), 633CSi(E24), 633i(E24), 635CSi(E24), 728 3.2i(E23), 732 3.2i(E23), 733 3.2i(E23), 735i(E23), 745i Turbo(E23)	89,00	180 007 0005 181 007 0003	Std, 0,25, 0,50, 0,75 Std, 0,25, 0,50, 0,75	17
N63 B44 A, N63 B44 B, N63 B44 C	4395	8	5 (F10) 550 i 5 (F10) 550 i xDrive, 5 GT (F07) 550 i 5 GT (F07) 550 i xDrive, 5 (F11) 550 i, 6 (F12) 650 i, 6 (F12) 650 i xDrive, 6 (F13) 650 i, 6 (F13) 650 i xDrive, 6 Gran Coupe (F06)650 i, 650 i xDrive, 7 (F01, F02, F03, F04) 750 i, Li, x Drive, 7 (G11, G12) 750 i, Li xDrive, X5 (F15, F85) xDrive 50 i, X6 (E71, E72) xDrive 50 i, X6 (F16, F86) xDrive 50 i	89,00	180 007 0015 181 007 0091	Std, 0,25, 0,50, 0,75 Std, 0,25, 0,50, 0,75	18
M62 B44LEV	4398	8	X5 4.4i	92,00	180 007 0006 181 007 0004	Std, 0,25, 0,50, 0,75 Std, 0,25	9
34 6 KB, M30 B34, M30 B35	3453	6	535 3.4i(E28), M 535 3.4i(E28), 535 3.5i(E34), 635 CSi(E24), 735i(E23), 745i Turbo(E23), 735 3.5i(E32)	92,00	180 007 0005 181 007 0003	Std, 0,25, 0,50, 0,75 Std, 0,25, 0,50, 0,75	17
M30 B35	3453	6	635 CSi(E24), 735i(E23)	93,40	180 007 0005 181 007 0003	Std, 0,25, 0,50, 0,75 Std, 0,25, 0,50, 0,75	17





















							 		Set Composition / QTY											
1	73,00																			
MB/HL 1, 2, 3, 4, 5	5 Pairs	46,000	50,000	16,000	SAL	180 096 0031 00 15 21	5		5											
CB/PL 1, 2, 3, 4	4 Pairs	44,000	47,000	15,600	S3S	181 096 0041 00 15 21	8													
TW/A 1	2 Halves	53,750	69,750		SAL	182 096 0028 00	2													
2	73,00																			
MB/HL 1, 2, 3, 4, 5	5 Pairs	46,000	50,000	16,000	SAL	180 096 0031 00 15 21	5		5											
CB/PL 1, 2, 3, 4	4 Pairs	40,000	43,000	13,700	S3S	181 096 0040 00 15 21	8													
TW/A 1	2 Halves	53,750	69,750		SAL	182 096 0028 00	2													
3	77,00																			
MB/HL 1, 2, 3, 4, 5	5 Pairs	48,000	52,000	18,900	SAL	180 007 0010 00 15 21	4		5		1									
CB/PL 1, 2, 3, 4	4 Pairs	44,000	47,000	16,200	SAL	181 007 0006 00 15 21	8													
4	77,00																			
MB/HL 1, 2, 3, 4, 5	5 Pairs	45,024	48,674	17,900	SSI	180 037 0014 00 17 21 28	5		5											
CB/PL 1, 2, 3, 4	4 Pairs	44,975 44,991	48,000 48,019	19,700	S32S	181 037 0022 00 17 21	4		4											
TW/A 1	2 Halves	50,500 50,750	70,000 70,250		SAL	182 037 0006 00	2													
5	80,00																			
MB/HL 1, 2, 3, 4, 5, 6	6 Pairs	59,971 59,990	65,000 65,019	20,000	SAL	180 007 0001 00 15 21 26 29	6		6		1		1							
MB/HL 7	1 Pair	59,971 59,990	65,000 65,019	24,940	SAL															
MB/HL 1, 2, 3, 4, 5, 6	6 Pairs	59,971 59,990	65,000 65,019	20,000	SAL	180 007 0003 00 15 21 26 29	12		2											
MB/HL 7	1 Pair	59,971 59,990	65,000 65,019	24,940	SAL															
CB/PL 1, 2, 3, 4, 5, 6	6 Pairs	44,975 44,991	48,000 48,010	18,000	S3S	181 007 0001 00 15 21 26 29	12													
6	80,00																			
MB/HL 1, 2, 3, 4	4 Pairs	59,971 59,990	65,000 65,019	20,000	SAL	180 007 0002 00 15 21 26	4		4		1		1							
MB/HL 5	1 Pair	59,971 59,990	65,000 65,019	24,940	SAL															
CB/PL 1, 2, 3, 4	4 Pairs	44,975 44,991	48,000 48,016	18,000	S4S	181 035 0011 00 15 21														









BMW



Globally reliable





							Set Composition / QTY												
7	80,00																		
MB/HL 1, 2, 3, 4, 5, 6	6 Pairs	59,971 59,990	65,000 65,019	20,000	SAL	180 007 0001 00 15	6		6		1		1						
MB/HL 7	1 Pair	59,971 59,990	65,000 65,019	24,940	SAL		21 26 29												
CB/PL 1, 2, 3, 4, 5, 6	6 Pairs	44,975 44,991	48,000 48,016	18,000	S4S	181 035 0012 00 15	21												
8	82,00																		
MB/HL 1, 2, 3	3 Pairs	56,000	61,000	18,800	SAL	180 007 0007 00 15	3		4		1		1		1		1		
MB/HL 4	1 Pair	56,000	61,000	23,500	SAL		21												
MB/HL 5	1 Pair	65,000	70,000	19,800	SAL														
CB/PL 1, 2, 3, 4	4 Pairs	49,975 49,991	53,600 53,616	17,550	S3S	181 007 0005 00 15	21	8											
9	84,00																		
MB/HL 1, 2, 3, 4, 5	5 Pairs	69,971 69,990	75,000 75,019	24,000	SAL	180 007 0006 00 15	5	5		5									
CB/PL 1, 2, 3, 4, 5, 6, 7, 8	8 Pairs	47,975 47,991	52,000 52,013	17,000	S3S	181 007 0004 00 15	16	16											
10	84,00																		
MB/HL 1, 2, 3, 4	4 Pairs	59,971 59,990	65,000 65,019	20,000	SAL	180 007 0004 00 15	4	4		5		1							
MB/HL 5	1 Pair	59,971 59,990	65,000 65,019	24,900	SAL		21 26												
CB/PL 1, 2, 3, 4	4 Pairs	44,975 44,991	48,000 48,010	18,000	S3S	181 007 0002 00 15	21 26	8											
11	84,00																		
MB/HL 1, 2, 3, 4	4 Pairs	54,971 54,990	60,000 60,019	18,500	S32S	180 007 0014 00 15	4	4		4		1		1					
MB/HL 5	1 Pair	54,971 54,990	60,000 60,019	24,800	S32S		21												
CB/PL 1, 2, 3, 4	4 Pairs	49,975 49,991	53,600 53,619	18,300	SPVD	181 007 0011 00 15	21	4		4									
12	84,00																		
MB/HL 1, 2, 3, 4	4 Pairs	49,980 50,001	55,000 55,019	17,300	SSI	180 007 0012 00 15	1	1		1		4		4					
MB/HL 5	1 Pair	49,980 50,001	55,000 55,019	23,950	SSI		21												
CB/PL 1, 2, 3, 4	4 Pairs	49,973 49,993	53,600 53,616	17,550	SPVD	181 007 0008 00 15	21												
13	84,00																		
MB/HL 1, 2, 3, 4, 5	5 Pairs	56,000	61,000	18,800	SAL	180 007 0008 00 15	5	5		6		1		1		1			
MB/HL 6	1 Pair	56,000	61,000	23,500	SAL		21												
MB/HL 7	1 Pair	65,000	70,000	19,800	SAL														
CB/PL 1, 2, 3, 4, 5, 6	6 Pairs	49,973 49,993	53,600 53,616	17,550	SPVD	181 007 0010 00 15	21												





							Set Composition / QTY											
14 84,00																		
MB/HL 1, 2, 3, 4	4 Pairs	54,971 54,990	60,000 60,019	18,800	SAL	180 007 0011 00 15	4		4		1		1					
MB/HL 5	1 Pair	54,971 54,990	60,000 60,019	24,930	SAL	21												
CB/PL 1, 2, 3, 4	4 Pairs	49,975 49,991	53,600 53,619	18,300	SPVD	181 007 0007 00 15	4		4									
15 84,00																		
MB/HL 1, 2, 3, 4, 5, 6	6 Pairs	54,971 54,990	60,000 60,019	18,800	SAL	180 007 0013 00 15	6		6		1		1					
MB/HL 7	1 Pair	54,971 54,990	60,000 60,019	24,930	SAL	21												
CB/PL 1, 2, 3, 4, 5, 6	6 Pairs	49,975 49,991	53,600 53,619	18,300	SPVD	181 007 0009 00 15	6		6									
16 85,00																		
MB/HL 1, 2, 3, 4, 5	5 Pairs	56,000	61,000	18,800	SAL	180 007 0008 00 15	5		6		1		1		1			
MB/HL 6	1 Pair	56,000	61,000	23,500	SAL	21												
MB/HL 7	1 Pair	65,000	70,000	19,800	SAL													
CB/PL 1, 2, 3, 4, 5, 6	6 Pairs	49,975 49,991	53,600 53,616	17,550	S3S	181 007 0090 00 15												
17 86,00																		
MB/HL 1, 2, 3, 4, 5, 6	6 Pairs	59,971 59,990	65,000 65,019	24,000	SAL	180 007 0005 00 15	12		2									
MB/HL 7	1 Pair	59,971 59,990	65,000 65,019	29,940	SAL	21 26												
CB/PL 1, 2, 3, 4, 5, 6	6 Pairs	47,975 47,991	52,000 52,015	20,000	S3S	181 007 0003 00 15 21 26	12											
18 89,00																		
MB/HL 1, 2, 3	3 Pairs	1,000 3,000	1,000 70,000	22,400		180 007 0015 00 15												
MB/HL 4	1 Pair	1,000 3,000	1,000 70,000	27,050		21 26												
CB/PL 1, 2, 3, 4, 5, 6, 7, 8	8 Pairs	53,970 53,990	57,600 57,615	14,800		181 007 0091 00 15 21 26												

	ccm						Pos.
F3	1	4	BYD F3	1,00	180 711 0001 181 711 0001	Std, 0,25, 0,50, 0,75, 1,00 Std, 0,25, 0,50, 0,75, 1,00	1

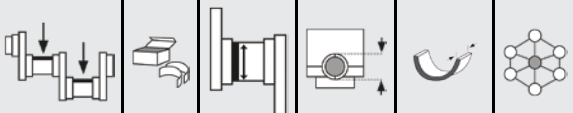

1		1,00																		
MB/HL 1, 2, 3, 4, 5	5 Pairs	54,024	58,062	17,000	SAL	180 711 0001 00	15													
							21	5		5										
							26													
							29													
CB/PL 1, 2, 3, 4	4 Pairs	43,015	46,025	13,500	SAL	181 711 0001 00	15													
							21	8												
							26													
							29													







	ccm				Pos.	
1.5	1	4	Chery A13 Fulwin 1.5	1,00 180 717 0001 181 717 0001	Std, 0,25, 0,50, 0,75, 1,00 Std, 0,25, 0,50, 0,75, 1,00	1







									Set Composition / QTY								
1	1,00																
MB/HL 1, 2, 3, 4, 5	5 Pairs	53,300	57,576	19,500	SAL	180 717 0001 00	15 21 26 29	5		5							
CB/PL 1, 2, 3, 4	4 Pairs	47,700	50,674	17,500	SAL	181 717 0001 00	15 21 26 29	8									



















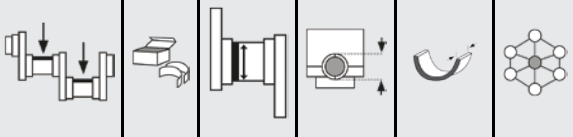















CITROËN

Globally reliable

	ccm						Pos.
C1A, TU 9K, TU 9M/Z	954	4	AX 1.0, C15 1.0	70,00	180 037 0001 182 037 0001	Std, 0,30, 0,50, 0,80 Std, 0,10, 0,20	1
1KR-FE	998	3	C1 1.0	71,00	180 096 0032 181 096 0042 182 096 0030	Std, 0,25, 0,50, 0,75 Std, 0,25, 0,50, 0,75 Std	2
H1A, H1B, HAZ, HDY, HDZ, HFX, TU 1K, TU 1M, TU 1M/Z	1124	4	AX 1.1, AX 1.1i, Berlingo 1.1i, BX 1.1, C2 1.1i, C3 1.1i, C15 1.1, C15 1.1i, Saxo 1.1i, ZX 1.1, ZX 1.1i	72,00	180 037 0001 181 037 0001 182 037 0001	Std, 0,30, 0,50, 0,80 Std, 0,30, 0,50 Std, 0,10, 0,20	3
TU 1JP	1124	4	Berlingo 1.1i, C2 1.1i, C3 1.1i, Saxo 1.1i	72,00	180 037 0001 181 037 0002 182 037 0001	Std, 0,30, 0,50, 0,80 Std, 0,30, 0,50, 0,80 Std, 0,10, 0,20	4
8HT (DV4TD)	1398	4	C1 1.4 HDi	73,70	180 051 0001 181 037 0015 182 051 0001	Std, 0,25, 0,30, 0,50, 0,80 Std, 0,30, 0,50 Std	5
8HX (DV4TD), 8HZ (DV4TD)	1398	4	C2 1.4 HDi	73,70	180 051 0001 181 037 0015 182 051 0001	Std, 0,25, 0,30, 0,50, 0,80 Std, 0,30, 0,50 Std	5
8HS (DV4TED)	1398	4	NEMO 1.4 HDi	73,70	180 051 0001 181 037 0015 182 051 0001	Std, 0,25, 0,30, 0,50, 0,80 Std, 0,30, 0,50 Std	5
8HR (DV4C)	1398	4	DS3 1.4 HDi 70, C3 II 1.4 HDi 70	73,70	180 051 0001 181 037 0015 182 051 0001	Std, 0,25, 0,30, 0,50, 0,80 Std, 0,30, 0,50 Std	5
8HX (DV4TD), 8HZ (DV4TD)	1398	4	C3 Pluriel 1.4 HDi, C3 I + II 1.4 HDi, XSARA II 1.4 HDi	73,70	180 051 0001 181 037 0015 182 051 0001	Std, 0,25, 0,30, 0,50, 0,80 Std, 0,30, 0,50 Std	5
8HY (DV4TED4)	1398	4	C3 I 1.4 16V HDi	73,70	180 051 0001 181 037 0015 182 051 0001	Std, 0,25, 0,30, 0,50, 0,80 Std, 0,30, 0,50 Std	5
ET3 J4	1361	4	C3 1.4i 16V	75,00	180 037 0001 181 037 0002 182 037 0001	Std, 0,30, 0,50, 0,80 Std, 0,30, 0,50, 0,80 Std, 0,10, 0,20	4
K1A, K1B, K1F, K1G, K1H, K3A, K5A, KAY, KAZ, KDX, KDY, KDZ, KFW, KFX, KFY, TU 3, TU 3.2/K, TU 3.2/Z, TU 3.2TR/K, TU 3A, TU 3A/K, TU 3M, TU 3M/Z, TU 3MC, TU 3MC/Z, TU3 3S	1361	4	AX 1.4, AX 1.4i, Berlingo 1.4, Berlingo 1.4i, BX 1.4, BX 1.4i, C3 1.4i, C3 Pluriel 1.4i, C15 1.4, C15 1.4i, Saxo 1.4i, Visa 1.4, Xsara 1.4i, ZX 1.4, ZX 1.4i	75,00	180 037 0001 181 037 0001 182 037 0001	Std, 0,30, 0,50, 0,80 Std, 0,30, 0,50 Std, 0,10, 0,20	3
TU 3FM	1361	4	C15 1.4i	75,00	180 037 0002 181 037 0001 182 037 0001	Std, 0,30, 0,50 Std, 0,30, 0,50 Std, 0,10, 0,20	6
TU 3JP	1361	4	C2 1.4i, C3 1.4i, Xsara 1.4i	75,00	180 037 0001 181 037 0002 181 037 0003 182 037 0001	Std, 0,30, 0,50, 0,80 Std, 0,30, 0,50, 0,80 Std, 0,30, 0,50 Std, 0,10, 0,20	7
TUD 3Y	1361	4	AX 1.4D, ZX 1.4D	75,00	180 037 0001 181 037 0003 182 037 0001	Std, 0,30, 0,50, 0,80 Std, 0,30, 0,50 Std, 0,10, 0,20	8
K9A, K9Y, TUD 3	1361	4	AX 1.4D, ZX 1.4D	75,00	180 037 0001 182 037 0001	Std, 0,30, 0,50, 0,80 Std, 0,10, 0,20	1
YHR (DV5RUCd), YHS (DV5RCE), YHV (DV5RUC), YHW (DV5RE), YHX (DV5RC), YHY (DV5RD), YHZ (DV5RC)	1499	4	BERLINGO 1.5 BlueHDi 75/100/130, SPACETOURER 1.5 BlueHDi 100/120, JUMPY 1.5 BlueHDi 100/120, GRAND C4 SPACETOURER 1.5 BlueHDi 130, C-ELYSEE 1.5 BlueHDi 100, C5 AIRCROSS 1.5 BlueHDi 130, C4 SPACETOURER 1.5 BlueHDi 130, C4 III 1.5 BlueHDi 130, C4 CACTUS 1.5 BlueHDi 100/120, C3 III 1.5 BlueHDi 100, C3 AIRCROSS II 1.5 BlueHDi 100/110/120	75,00	180 037 0015 181 037 0023 182 051 0001	Std, 0,25, 0,50 Std, 0,25, 0,50 Std	11
9HZ (DV6TED4)	1560	4	C2 1.6 HDi	75,00	180 051 0001 181 051 0001 182 051 0001	Std, 0,25, 0,30, 0,50, 0,80 Std, 0,25, 0,30, 0,50, 0,80 Std	10
HMT (EB2D)	1199	3	C1 II 1.2 VTi 82	75,00	180 037 0013 181 037 0020 182 037 0005	Std, 0,30, 0,50, 0,80, 1,00 Std, 0,30, 0,50, 0,80, 1,00 Std	9
EB2DT	1199	3	C4 Picasso II 1.2 THP 110	75,00	180 037 0013 181 037 0020 182 037 0005	Std, 0,30, 0,50, 0,80, 1,00 Std, 0,30, 0,50, 0,80, 1,00 Std	9
HNY (EB2DTS)	1199	3	C4 Picasso II 1.2 THP 130	75,00	180 037 0013 181 037 0020 182 037 0005	Std, 0,30, 0,50, 0,80, 1,00 Std, 0,30, 0,50, 0,80, 1,00 Std	9
HMU (EB2D)	1199	3	C4 CACTUS 1.2 VTi 75	75,00	180 037 0013 181 037 0020 182 037 0005	Std, 0,30, 0,50, 0,80, 1,00 Std, 0,30, 0,50, 0,80, 1,00 Std	9
HMZ (EB2F)	1199	3	C4 CACTUS 1.2 VTi 82, C3 II 1.2 VTi 82	75,00	180 037 0013 181 037 0020 182 037 0005	Std, 0,30, 0,50, 0,80, 1,00 Std, 0,30, 0,50, 0,80, 1,00 Std	9
HNZ (EB2DT)	1199	3	C4 CACTUS 1.2 THP 110	75,00	180 037 0013 181 037 0020 182 037 0005	Std, 0,30, 0,50, 0,80, 1,00 Std, 0,30, 0,50, 0,80, 1,00 Std	9

	ccm						Pos.
HMV (EB2M)	1199	3	C-ELYSEE 1.2 VTi 72	75,00	180 037 0013 181 037 0020 182 037 0005	Std, 0,30, 0,50, 0,80, 1,00 Std, 0,30, 0,50, 0,80, 1,00 Std	9
EB2F	1199	3	C-ELYSEE 1.2 VTi 82	75,00	180 037 0013 181 037 0020 182 037 0005	Std, 0,30, 0,50, 0,80, 1,00 Std, 0,30, 0,50, 0,80, 1,00 Std	9
HMZ (EB2F)	1199	3	DS3 1.2 VTi 82	75,00	180 037 0013 181 037 0020 182 037 0005	Std, 0,30, 0,50, 0,80, 1,00 Std, 0,30, 0,50, 0,80, 1,00 Std	9
HNZ (EB2DT)	1199	3	DS3 1.2 THP 110	75,00	180 037 0013 181 037 0020 182 037 0005	Std, 0,30, 0,50, 0,80, 1,00 Std, 0,30, 0,50, 0,80, 1,00 Std	9
HNY (EB2DTS)	1199	3	DS4 1.2 THP 130	75,00	180 037 0013 181 037 0020 182 037 0005	Std, 0,30, 0,50, 0,80, 1,00 Std, 0,30, 0,50, 0,80, 1,00 Std	9
HNZ (EB2DT)	1199	3	C3 Picasso 1.2 THP 110, BERLINGO (B9) 1.2 PureTech 110	75,00	180 037 0013 181 037 0020 182 037 0005	Std, 0,30, 0,50, 0,80, 1,00 Std, 0,30, 0,50, 0,80, 1,00 Std	9
HNZ (EB2DT)	1199	3	C3 II 1.2 THP 110, C4 II (B7) 1.2 THP 110	75,00	180 037 0013 181 037 0020 182 037 0005	Std, 0,30, 0,50, 0,80, 1,00 Std, 0,30, 0,50, 0,80, 1,00 Std	9
TUD5	1527	4	AX 1.5D, Saxo 1.5D, Xsara 1.5D, ZX 1.5D	77,00	180 037 0002 181 037 0012	Std, 0,30, 0,50 Std, 0,30, 0,50	12
5FK (EP6CB)	1598	4	BERLINGO 1.6 VTi 95	77,00	180 037 0014 181 037 0022 182 037 0006	Std, 0,30, 0,50, 0,80 Std, 0,30, 0,50 Std	14
5FS (EP6C)	1598	4	BERLINGO 1.6 VTi 120, C3 II 1.6 VTi 120, C3 Picasso 1.6 VTi 120, C4 Picasso II 1.6 VTi 120, C5 III 1.6 VTi 120, DS4 1.6 VTi 120, C4 II 1.6 VTi 120, C4 Grand Picasso II 1.6 VTi 120, DS3 1.6 VTi 120, DS3 Cabriolet 1.6 VTi 120	77,00	180 037 0014 181 037 0022 182 037 0006	Std, 0,30, 0,50, 0,80 Std, 0,30, 0,50 Std	14
5GM (EP6FDTX)	1598	4	DS5 1.6 THP 210	77,00	180 037 0014 181 037 0022 182 037 0006	Std, 0,30, 0,50, 0,80 Std, 0,30, 0,50 Std	14
5FM (EP6DT), 5FR (EP6DT), 5FX (EP6DT)	1598	4	DS3 1.6, C4 1.6	77,00	180 037 0014 181 037 0021 182 037 0006	Std, 0,30, 0,50, 0,80 Std, 0,30, 0,50, 0,80 Std	13
5FT (EP6DT), 5FX (EP6DT)	1598	4	C4 Grand Picasso I 1.6 16V, C4 Picasso I 1.6 THP 140, C4 I 1.6 THP 140	77,00	180 037 0014 181 037 0021 182 037 0006	Std, 0,30, 0,50, 0,80 Std, 0,30, 0,50, 0,80 Std	13
5FP (EP6)	1598	4	C3 Picasso 1.6 VTRi	77,00	180 037 0014 181 037 0021 182 037 0006	Std, 0,30, 0,50, 0,80 Std, 0,30, 0,50, 0,80 Std	13
5FW (EP6)	1598	4	C3 Picasso 1.6 VTi 120, C4 1.6 VTi 120, C4 Grand Picasso I 1.6 VTi 120, C4 Picasso I 1.6 VTi 120	77,00	180 037 0014 181 037 0021 182 037 0006	Std, 0,30, 0,50, 0,80 Std, 0,30, 0,50, 0,80 Std	13
5FV (EP6CDT)	1598	4	C4 Picasso 1.6 THP 155, C4 Grand Picasso 1.6 THP 155, C4 II 1.6 THP 155, DS3 1.6 THP 155, DS3 Cabriolet 1.6 THP 155, DS4 1.6 THP 155, DS5 1.6 THP 155	77,00	180 037 0014 181 037 0022 182 037 0006	Std, 0,30, 0,50, 0,80 Std, 0,30, 0,50 Std	14
5GZ (EP6FDT)	1598	4	C4 Picasso II 1.6 THP 165, C4 Grand Picasso II 1.6 THP 165, DS3 1.6 Turbo, DS3 Cabriolet 1.6 THP 165, DS4 1.6 THP 165, DS5 1.6 THP 165	77,00	180 037 0014 181 037 0022 182 037 0006	Std, 0,30, 0,50, 0,80 Std, 0,30, 0,50 Std	14
5FN (EP6CDT)	1598	4	C5 III 1.6 THP 150, DS3 1.6 THP 150, DS3 Cabriolet 1.6 THP 150	77,00	180 037 0014 181 037 0022 182 037 0006	Std, 0,30, 0,50, 0,80 Std, 0,30, 0,50 Std	14
TU 5J4, TU 5JP	1587	4	Saxo 1.6i, Saxo 1.6i 16V, Xsara 1.6i, Xsara Picasso 1.6i, ZX 1.6i	78,50	180 037 0002 181 037 0001 181 037 0003 182 037 0001	Std, 0,30, 0,50 Std, 0,30, 0,50 Std, 0,30, 0,50 Std, 0,10, 0,20	15
TU 5JP4	1587	4	Berlingo 1.6i 16V, C3 1.6i 16V, Xsara 1.6i 16V	78,50	180 037 0002 181 037 0003 182 037 0001	Std, 0,30, 0,50 Std, 0,30, 0,50 Std, 0,10, 0,20	16
161A, A9A, XUD 7	1769	4	Berlingo 1.8D, BX 1.8D, C15 1.8D, Visa 1.8D, Xsara 1.8D	80,00	180 037 0003 181 037 0004 182 037 0002	Std, 0,30, 0,50, 0,80 Std, 0,30, 0,50, 0,80 Std, 0,30, 0,50, 0,10, 0,20	17
XUD 7TE	1769	4	BX 1.8TD	80,00	180 037 0003 181 037 0005	Std, 0,30, 0,50, 0,80 Std, 0,30, 0,50	18
DW8, DW8 B, DW8 TD, WJC, WJY, WJZ	1868	4	Berlingo 1.9D, Berlingo 1.9TD, Jumpy 1.9D, Jumpy 1.9TD, Xsara 1.9D	82,20	180 037 0003 181 037 0004 182 037 0002	Std, 0,30, 0,50, 0,80 Std, 0,30, 0,50, 0,80 Std, 0,30, 0,50, 0,10, 0,20	17
171B, XU 51C/K	1581	4	BX 1.6	83,00	180 037 0004 181 037 0006 182 037 0002	Std, 0,30, 0,50, 0,80 Std, 0,30, 0,50, 0,80 Std, 0,30, 0,50, 0,10, 0,20	20

	ccm						Pos.
171BZ, 171C, 171D, 171Z, 180Z, XU 52C, XU 5S	1581	4	BX 1.6, BX 1.6i	83,00	180 037 0004 181 037 0006 182 037 0002	Std, 0,30, 0,50, 0,80 Std, 0,30, 0,50, 0,80 Std, 0,30, 0,50, 0,10, 0,20	20
B1A/A, B2C, B4A, BDY, BDZ, BFZ, XU 5JP, XU 5M, XU 5M4Z	1581	4	BX 1.6, BX 1.6i, Xantia 1.6i, ZX 1.6i	83,00	180 037 0004 181 037 0006 182 037 0002	Std, 0,30, 0,50, 0,80 Std, 0,30, 0,50, 0,80 Std, 0,30, 0,50, 0,10, 0,20	20
XU 7JB, XU 7JP, XU 7JP4, XU 7JPZ	1762	4	Berlingo 1.8i, Evasion 1.8i, Xantia 1.8i, Xantia 1.8i 16V, Xsara 1.8i, Xsara 1.8i 16V, Xsara Picasso 1.8i 16V, ZX 1.8i	83,00	180 037 0004 181 037 0008 182 037 0002	Std, 0,30, 0,50, 0,80 Std, 0,30, 0,50, 0,80 Std, 0,30, 0,50, 0,10, 0,20	21
159A, D 61 A, D6A, XU 92C, XU 9S	1905	4	BX 1.9D, BX 1.9i,	83,00	180 037 0004 181 037 0007 182 037 0002	Std, 0,30, 0,50, 0,80 Std, 0,30, 0,50 Std, 0,30, 0,50, 0,10, 0,20	19
D6D	1905	4	BX 1.9i	83,00	180 037 0004 181 037 0007 182 037 0002	Std, 0,30, 0,50, 0,80 Std, 0,30, 0,50 Std, 0,30, 0,50, 0,10, 0,20	19
162, D9A, D9B, DJY, DJZ, XUD 9, XUD 9A, XUD 9Y	1905	4	Berlingo 1.9D, BX 1.9D, C25 1.9D, Jumper 1.9D, Jumpy 1.9D, Xantia 1.9D, ZX 1.9D	83,00	180 037 0003 181 037 0004 182 037 0002	Std, 0,30, 0,50, 0,80 Std, 0,30, 0,50, 0,80 Std, 0,30, 0,50, 0,10, 0,20	17
XUD 9BSD, XUD 9BTF, XUD 9SD, XUD 9TE, XUD 9TF, XUD 9TFU	1905	4	BX 1.9TD, Evasion 1.9TD, Jumper 1.9TD, Jumpy 1.9TD, Xantia 1.9TD, Xsara 1.9TD, ZX 1.9TD	83,00	180 037 0003 181 037 0005	Std, 0,30, 0,50, 0,80 Std, 0,30, 0,50	18
169B, XM 7T	1796	4	C25 1.8	84,00	180 037 0006 181 037 0010 182 037 0003	Std, 0,30, 0,50, 0,80, 1,00 Std, 0,30, 0,50, 0,80, 1,00 Std, 0,30, 0,50, 0,80, 0,10, 0,20	22
DW10	1997	4	C8 2.0 HDi 16V, Jumpy 2.0 HDi 16V, Jumper I 2.0 HDi, Jumper II 2.0 HDi 16V, Jumpy 2.0 HDi 95, Jumpy 2.0 HDi 125, C4 II 2.0 HDi, C4 Picasso 2.0 HDi 165, C5 II 2.0 HDi 165, C8 2.0 HDi 165, DS4 2.0 HDi 165, DS5 2.0 HDi 165, Jumpy 2.0 HDi 165, C8 2.0 HDi 16V	85,00	180 037 0003 181 037 0019 182 037 0002	Std, 0,30, 0,50, 0,80 Std, 0,30, 0,50 Std, 0,30, 0,50, 0,10, 0,20	23
DW12	2179	4	Jumper II 2.2 HDi 16V, C-Crosser 2.2 HDi 16V	85,00	180 037 0003 181 037 0019 182 037 0002	Std, 0,30, 0,50, 0,80 Std, 0,30, 0,50 Std, 0,30, 0,50, 0,10, 0,20	23
R2A, R5B, R6A, R6D, RDZ, RFT, RFU, RFV, RFW, RFX, RFY, RGX	1998	4	Evasion 2.0i 16V, Evasion 2.0i Turbo, Jumper 2.0, Jumper 2.0i, Xantia 2.0i, Xantia 2.0i 16V, Xantia 2.0i Turbo, XM 2.0, XM 2.0i, XM 2.0i 16V, XM 2.0i Turbo, Xsara 2.0i 16V, ZX 2.0i, ZX 2.0i 16V	86,00	180 037 0003 181 037 0007	Std, 0,30, 0,50, 0,80 Std, 0,30, 0,50	24
XU 10 2C, XU 10MZ, XU 10J2, XU 10J4	1998	4	Evasion 2.0i, Evasion 2.0i 16V, Evasion 2.0i Turbo, Jumper 2.0, Jumper 2.0i, Xantia 2.0i, Xantia 2.0i 16V, Xantia 2.0i Turbo, XM 2.0, XM 2.0i, XM 2.0i 16V, XM 2.0i Turbo, Xsara 2.0i 16V, ZX 2.0i, ZX 2.0i 16V	86,00	180 037 0003 181 037 0007 181 037 0009	Std, 0,30, 0,50, 0,80 Std, 0,30, 0,50 Std, 0,30, 0,50	25
4HV (P22DTE)	2198	4	JUMPER 2.2 HDi 100	86,00	180 021 0009 181 021 0011	Std, 0,25, 0,50 Std, 0,25, 0,50	26
4HG (P22DTE)	2198	4	JUMPER 2.2 HDi 110	86,00	180 021 0009 181 021 0011	Std, 0,25, 0,50 Std, 0,25, 0,50	26
4HU (P22DTE)	2198	4	JUMPER 2.2 HDi 120	86,00	180 021 0009 181 021 0011	Std, 0,25, 0,50 Std, 0,25, 0,50	26
4HH (P22DTE)	2198	4	JUMPER 2.2 HDi 130	86,00	180 021 0009 181 021 0011	Std, 0,25, 0,50 Std, 0,25, 0,50	26
4HJ (P22DTE)	2198	4	JUMPER 2.2 HDi 150	86,00	180 021 0009 181 021 0011	Std, 0,25, 0,50 Std, 0,25, 0,50	26
170A, 170B, 170C, 170D, XN 1T, XN 1TA	1971	4	C25 2.0	88,00	180 037 0006 181 037 0010 182 037 0003	Std, 0,30, 0,50, 0,80, 1,00 Std, 0,30, 0,50, 0,80, 1,00 Std, 0,30, 0,50, 0,80, 0,10, 0,20	22
J6TA 500	2165	4	CX22D	88,00	180 038 0005 181 038 0004 181 038 0005 182 038 0003	Std, 0,25, 0,50 Std, 0,25, 0,50, 0,75 Std, 0,25, 0,50 Std, 0,05	27
8140.43S	2798	4	Jumper 2.8 HDI	94,40	180 020 0004 181 020 0012	Std, .010, .020, .030 Std, .010, .020, .030	28
F1CE3481E (F30DTE), F1CE0481D (F30DT)	2999	4	JUMPER 3.0 HDI	95,80	180 121 0016 181 121 0017	Std, 0,25, 0,50, 0,75 Std, 0,25, 0,50, 0,75	29











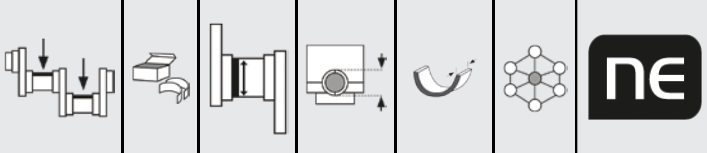













							 		Set Composition / QTY									
1	70,00																	
MB/HL 1, 2, 3, 4, 5	5 Pairs	49,965 49,981	53,655 53,674	17,290	SAL	180 037 0001 00 17 21 28	4		6									
TW/A 1	2 Halves	55,250 55,500	71,450 71,700		S3S	182 037 0001 00 08 14	2											
2	71,00																	
MB/HL 1, 2, 3, 4	4 Pairs	44,000	48,000	14,900	SAL	180 096 0032 00 15 21 26	4		4									
CB/PL 1, 2, 3	3 Pairs	40,000	43,000	13,500	SAL	181 096 0042 00 15 21 26	6											
TW/A 1	2 Halves	52,000	63,000		SAL	182 096 0030 00	2											
3	72,00																	
MB/HL 1, 2, 3, 4, 5	5 Pairs	49,965 49,981	53,655 53,674	17,290	SAL	180 037 0001 00 17 21 28	4		6									
CB/PL 1, 2, 3, 4	4 Pairs	44,975 44,991	48,655 48,671	19,750	SAL	181 037 0001 00 17 21	8											
TW/A 1	2 Halves	55,250 55,500	71,450 71,700		S3S	182 037 0001 00 08 14	2											
4	72,00																	
MB/HL 1, 2, 3, 4, 5	5 Pairs	49,965 49,981	53,655 53,674	17,290	SAL	180 037 0001 00 17 21 28	4		6									
CB/PL 1, 2, 3, 4	4 Pairs	44,975 44,991	48,655 48,671	19,750	SAL	181 037 0002 00 17 21 28	4		4									
TW/A 1	2 Halves	55,250 55,500	71,450 71,700		S3S	182 037 0001 00 08 14	2											
5	73,70																	
MB/HL 1, 2, 3, 4, 5	5 Pairs	49,962 49,981	53,655 53,674	19,900	SAL	180 051 0001 00 15 17 21 28	5		5									
CB/PL 1, 2, 3, 4	4 Pairs	44,975 44,991	48,665 48,671	17,050	S4S	181 037 0015 00 17 21	4		4									
TW/A 1	2 Halves	55,200 55,480	71,350 71,700		SAL	182 051 0001 00	2											
6	75,00																	
MB/HL 1, 2, 3, 4, 5	5 Pairs	49,965 49,984	53,712 53,731	17,300	SAL	180 037 0002 00 17 21	4		6									
CB/PL 1, 2, 3, 4	4 Pairs	44,975 44,991	48,655 48,671	19,750	SAL	181 037 0001 00 17 21	8											
TW/A 1	2 Halves	55,250 55,500	71,450 71,700		S3S	182 037 0001 00 08 14	2											



CITROËN

Globally reliable

								Set Composition / QTY																		
7	75,00																									
MB/HL 1, 2, 3, 4, 5	5 Pairs	49,965 49,981	53,655 53,674	17,290	SAL	180 037 0001 00	4		6																	
CB/PL 1, 2, 3, 4	4 Pairs	44,975 44,991	48,655 48,671	19,750	SAL	181 037 0002 00	4		4																	
CB/PL 1, 2, 3, 4	4 Pairs	44,975 44,991	48,655 48,671	19,750	SAL	181 037 0003 00	4		4																	
TW/A 1	2 Halves	55,250 55,500	71,450 71,700		S3S	182 037 0001 00	2																			
8	75,00																									
MB/HL 1, 2, 3, 4, 5	5 Pairs	49,965 49,981	53,655 53,674	17,290	SAL	180 037 0001 00	4		6																	
CB/PL 1, 2, 3, 4	4 Pairs	44,975 44,991	48,655 48,671	19,750	SAL	181 037 0003 00	4		4																	
TW/A 1	2 Halves	55,250 55,500	71,450 71,700		S3S	182 037 0001 00	2																			
9	75,00																									
MB/HL 1, 2, 3, 4	4 Pairs	41,984 42,000	45,600 45,619	16,100	SAL	180 037 0013 00	2		2		4															
CB/PL 1, 2, 3	3 Pairs	41,984 42,000	45,000 45,016	16,000	SAL	181 037 0020 00	6																			
TW/A 1	2 Halves	47,800	65,000		SAL	182 037 0005 00	2																			
10	75,00																									
MB/HL 1, 2, 3, 4, 5	5 Pairs	49,962 49,981	53,655 53,674	19,900	SAL	180 051 0001 00	5		5																	
CB/PL 1, 2, 3, 4	4 Pairs	46,975 46,991	50,655 50,674	17,000	S3S	181 051 0001 00	8																			
TW/A 1	2 Halves	55,200 55,480	71,350 71,700		SAL	182 051 0001 00	2																			
11	75,00																									
MB/HL 1, 2, 3, 4, 5	5 Pairs	1,000 2,000	3,000 4,000	19,900	SAL	180 037 0015 00	5																			
CB/PL 1, 2, 3, 4	4 Pairs	44,350 44,366	48,000 48,018	17,100	SPVD	181 037 0023 00	8																			
TW/A 1	2 Halves	55,200 55,480	71,350 71,700		SAL	182 051 0001 00	2																			

							Set Composition / QTY																
12 77,00																							
MB/HL 1, 2, 3, 4, 5	5 Pairs	49,965 49,984	53,712 53,731	17,300	SAL	180 037 0002 00 17 21	4		6														
CB/PL 1, 2, 3, 4	4 Pairs	44,975 44,991	48,655 48,671	17,300	SAL	181 037 0012 00 17 21	8																
13 77,00																							
MB/HL 1, 2, 3, 4, 5	5 Pairs	45,024	48,674	17,900	SSI	180 037 0014 00 17 21 28	5		5														
CB/PL 1, 2, 3, 4	4 Pairs	45,000	48,000	19,700	SSI	181 037 0021 00 17 21 28	8																
TW/A 1	2 Halves	50,500 50,750	70,000 70,250		SAL	182 037 0006 00	2																
14 77,00																							
MB/HL 1, 2, 3, 4, 5	5 Pairs	45,024	48,674	17,900	SSI	180 037 0014 00 17 21 28	5		5														
CB/PL 1, 2, 3, 4	4 Pairs	44,975 44,991	48,000 48,019	19,700	S32S	181 037 0022 00 17 21	4		4														
TW/A 1	2 Halves	50,500 50,750	70,000 70,250		SAL	182 037 0006 00	2																
15 78,50																							
MB/HL 1, 2, 3, 4, 5	5 Pairs	49,965 49,984	53,712 53,731	17,300	SAL	180 037 0002 00 17 21	4		6														
CB/PL 1, 2, 3, 4	4 Pairs	44,975 44,991	48,655 48,671	19,750	SAL	181 037 0001 00 17 21	8																
CB/PL 1, 2, 3, 4	4 Pairs	44,975 44,991	48,655 48,671	19,750	SAL	181 037 0003 00 17 21	4		4														
TW/A 1	2 Halves	55,250 55,500	71,450 71,700		S3S	182 037 0001 00 08 14	2																
16 78,50																							
MB/HL 1, 2, 3, 4, 5	5 Pairs	49,965 49,984	53,712 53,731	17,300	SAL	180 037 0002 00 17 21	4		6														
CB/PL 1, 2, 3, 4	4 Pairs	44,975 44,991	48,655 48,671	19,750	SAL	181 037 0003 00 17 21	4		4														
TW/A 1	2 Halves	55,250 55,500	71,450 71,700		S3S	182 037 0001 00 08 14	2																



CITROËN

Globally reliable



Set Composition / QTY











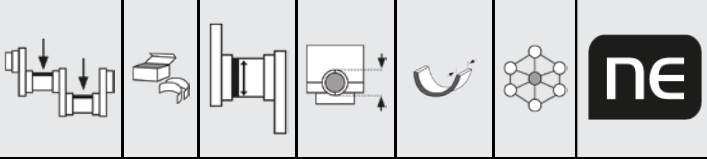















17 80,00																			
MB/HL 1, 2, 3, 4, 5	5 Pairs	59,981 60,000	63,731 63,750	20,290	SAL	180 037 0003 00	5		5										
CB/PL 1, 2, 3, 4	4 Pairs	49,984 50,000	53,695 53,708	20,050	SAL	181 037 0004 00	8												
TW/A 1	4 Halves	67,050 67,300	83,050 83,300		S3S	182 037 0002 00	2		2										





















18 80,00																			
MB/HL 1, 2, 3, 4, 5	5 Pairs	59,981 60,000	63,731 63,750	20,290	SAL	180 037 0003 00	5		5										
CB/PL 1, 2, 3, 4	4 Pairs	49,984 50,000	53,695 53,708	19,800	S3S	181 037 0005 00	8												







19 83,00																			
MB/HL 1, 2, 3, 4, 5	5 Pairs	59,990 60,000	63,718 63,727	20,290	SAL	180 037 0004 00	5		5										
CB/PL 1, 2, 3, 4	4 Pairs	49,984 50,000	53,695 53,708	20,250	SAL	181 037 0007 00	8												
TW/A 1	4 Halves	67,050 67,300	83,050 83,300		S3S	182 037 0002 00	2		2										

20 83,00																			
MB/HL 1, 2, 3, 4, 5	5 Pairs	59,990 60,000	63,718 63,727	20,290	SAL	180 037 0004 00	5		5										
CB/PL 1, 2, 3, 4	4 Pairs	44,975 44,991	48,655 48,671	20,250	SAL	181 037 0006 00	8												
TW/A 1	4 Halves	67,050 67,300	83,050 83,300		S3S	182 037 0002 00	2		2										

21 83,00																			
MB/HL 1, 2, 3, 4, 5	5 Pairs	59,990 60,000	63,718 63,727	20,290	SAL	180 037 0004 00	5		5										
CB/PL 1, 2, 3, 4	4 Pairs	44,975 44,991	48,655 48,671	22,750	SAL	181 037 0008 00	8												
TW/A 1	4 Halves	67,050 67,300	83,050 83,300		S3S	182 037 0002 00	2		2										

							Set Composition / QTY									
																
22	84,00															
MB/HL 1	1 Pair	59,401 59,416	63,227 63,246	29,500	SAL	180 037 0006 00 17	1		1		1		1		1	
MB/HL 2	1 Pair	58,548 58,573	62,384 62,403	21,500	SAL	21 28										
MB/HL 3	1 Pair	57,174 57,189	61,000 61,019	29,500	SAL	29										
MB/HL 4	1 Pair	56,140 56,165	59,976 59,995	21,500	SAL											
MB/HL 5	1 Pair	54,905 54,920	58,731 58,750	29,400	SAL											
CB/PL 1, 2, 3, 4	4 Pairs	49,975 49,991	53,655 53,674	23,400	SAL	181 037 0010 00 17 21 28 29	8									
TW/A 1	4 Halves	61,400 61,650	72,550 72,800		S3S	182 037 0003 00 17 21 28 08 14	2		2							
23	85,00															
MB/HL 1, 2, 3, 4, 5	5 Pairs	59,981 60,000	63,731 63,750	20,290	SAL	180 037 0003 00 17 21 28	5		5							
CB/PL 1, 2, 3, 4	4 Pairs	49,984 50,000	53,695 53,708	20,000	S4S	181 037 0019 00 17 21										
TW/A 1	4 Halves	67,050 67,300	83,050 83,300		S3S	182 037 0002 00 17 21 28 08 14	2		2							
24	86,00															
MB/HL 1, 2, 3, 4, 5	5 Pairs	59,981 60,000	63,731 63,750	20,290	SAL	180 037 0003 00 17 21 28	5		5							
CB/PL 1, 2, 3, 4	4 Pairs	49,984 50,000	53,695 53,708	20,250	SAL	181 037 0007 00 17 21	8									
25	86,00															
MB/HL 1, 2, 3, 4, 5	5 Pairs	59,981 60,000	63,731 63,750	20,290	SAL	180 037 0003 00 17 21 28	5		5							
CB/PL 1, 2, 3, 4	4 Pairs	49,984 50,000	53,695 53,708	20,250	SAL	181 037 0007 00 17 21	8									
CB/PL 1, 2, 3, 4	4 Pairs	49,984 50,000	53,695 53,708	20,250	SAL	181 037 0009 00 17 21	8									
26	86,00															
MB/HL 1, 2	2 Pairs	65,020	69,520	23,400	SSI	180 021 0009 00 15	4		1		3		1		1	
MB/HL 3	1 Pair	65,020	69,520	24,200	SSI	21										
MB/HL 4	1 Pair	65,020	69,520	29,000	SSI											
MB/HL 5	1 Pair	70,020	74,520	19,700	SSI											
CB/PL 1, 2	2 Pairs	53,000	56,000	23,300	SSI	181 021 0011 00 15	4		4							
CB/PL 3, 4	2 Pairs	53,000	56,000	24,500	SSI	21										

									Set Composition / QTY											
27							88,00													
MB/HL 1, 2, 3, 4, 5	5 Pairs	62,873 62,892	66,668 66,687	23,500	SAL	180 038 0005 00 15 21	5		5											
CB/PL 1, 2, 3, 4	4 Pairs	56,267 56,286	60,000 60,019	20,750	SAL	181 038 0004 00 15 21 26	4		4											
CB/PL 1, 2, 3, 4	4 Pairs	56,267 56,286	60,000 60,019	20,750	SAL	181 038 0005 00 15 21	4		4											
TW/A 1	2 Halves	71,200 71,450	87,840 88,090		SAL	182 038 0003 00 02	2													
28							94,40													
MB/HL 1, 2, 3, 4	4 Pairs	80,182 80,208	84,588 84,614	23,800	S3S	180 020 0004 00 16	4		4		1		1							
MB/HL 5	1 Pair	86,182 86,208	90,588 90,614	30,950	S3S	22 27														
CB/PL 1, 2, 3, 4	4 Pairs	56,520 56,535	60,333 60,345	24,700	S3S	181 020 0012 00 16 22 27	8													
29							95,80													
MB/HL 1, 2, 3, 4, 5	5 Pairs	1,000	1,000	1,000	SAL	180 121 0016 00 15 21 26	1		4		3		1		1					
CB/PL 1, 2, 3, 4	4 Pairs	64,015 64,038	67,833 67,848	26,800	S3S	181 121 0017 00 15 21 26	4		4											

	ccm						Pos.
H5F 402, H5F 404, H5F 408, H5F 410	1197	4	LODGY 1.2 Tce, DOKKER 1.2 Tce, DUSTER 1.2 Tce	72,20	180 038 0016 181 038 0021 182 038 0008	Std, 0,25, 0,50 Std, 0,25, 0,50 Std	1
H4B.400, H4B.408, H4B.405, H4B.410	898	3	SANDERO II TCe 90, LOGAN MCV II TCe 90 LOGAN II TCe 90	72,20	180 038 0017 181 038 0022 182 038 0008	Std, 0,25, 0,50 Std, 0,25, 0,50 Std	2



DACIA

Globally reliable









Set Composition / QTY

1	72,20																		
MB/HL 1, 2, 3, 4, 5	5 Pairs	1,000	1,000	16,050	SAL	180 038 0016 00 15 21	5		5										
CB/PL 1, 2, 3, 4	4 Pairs	2,000	2,000	17,000	SAL	181 038 0021 00 15 21	8												
TW/A 1	2 Halves	54,900 55,100	73,900 74,000		SAL	182 038 0008 00	2												

2	72,20																		
MB/HL 1, 2, 3, 4	4 Pairs	1,000	1,000	16,050	SAL	180 038 0017 00 15 21	4		4										
CB/PL 1, 2, 3	3 Pairs	3,000	3,000	17,000	SAL	181 038 0022 00 15 21	6												
TW/A 1	2 Halves	54,900 55,100	73,900 74,000		SAL	182 038 0008 00	2												

DAEWOO - CHEVROLET (GM)













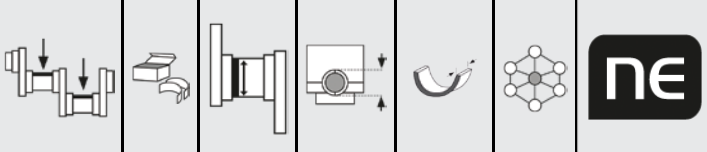



	ccm						Pos.
F8C	796	3	Tico, Matiz, Spark	68,50	180 309 0001 181 309 0001 182 094 0003	Std, 0,25, 0,50, 0,75, 1,00 Std, 0,25, 0,50, 0,75, 1,00 Std	1
F8B	796	3	Damas	68,50	180 094 0006 181 094 0001 182 094 0002	Std, 0,25, 0,50, 0,75, 1,00 Std, 0,25, 0,50, 0,75, 1,00 Std	2
B10S	995	4	Tico, Matiz	68,50	180 309 0002 181 094 0003 182 094 0002	Std, 0,25, 0,50, 0,75, 1,00 Std, 0,25, 0,50, 0,75, 1,00 Std	3
A15MF, G15MF	1498	4	Cielo, Espero, Nexia, Racer	76,50	180 035 0001 181 035 0001	Std, 0,25, 0,50, 0,75, 1,00 Std, 0,25, 0,50, 0,75, 1,00	4
LBS (A 20 DTH) Main Bearing Outside Oversize + 1,00 mm	1956	4	MALIBU 2.0 D	83,00	180 035 0011 181 035 0014 182 035 0001	Std, .010, .020 Std, .010, .020 Std, .005	5
LBS (A 20 DTH)	1956	4	MALIBU 2.0 D	83,00	180 035 0009 181 035 0014 182 035 0001	Std, .010, .020 Std, .010, .020 Std, .005	6
LBS (A 20 DTH) Main Bearing Outside Oversize + 0,50 mm	1956	4	MALIBU 2.0 D	83,00	180 035 0010 181 035 0014 182 035 0001	Std, .010, .020 Std, .010, .020 Std, .005	7
C20NE	1998	4	Espero	86,00	180 035 0002 181 035 0002	Std, 0,25, 0,50, 0,75, 1,00 Std, 0,25, 0,50, 0,75, 1,00	8
X22SE	2198	4	Leganza	86,00	180 035 0002 181 035 0002	Std, 0,25, 0,50, 0,75, 1,00 Std, 0,25, 0,50, 0,75, 1,00	8









































Globally reliable



































DAEWOO - CHEVROLET (GM)

									Set Composition / QTY													
1 68,50																						
MB/HL 1, 2, 3, 4	4 Pairs	43,983 44,000	48,000 48,012	17,000	SAL	180 309 0001 00	15 21 26 29	8														
CB/PL 1, 2, 3	3 Pairs	37,982 38,000	41,000 41,018	18,200	SAL	181 309 0001 00	15 21 26 29	6														
TW/A 1	2 Halves	52,250	68,000		SAL	182 094 0003 00		2														
2 68,50																						
MB/HL 1, 2, 3, 4	4 Pairs	50,000	54,000	17,100	SAL	180 094 0006 00	15 21 26 29	8														
CB/PL 1, 2, 3	3 Pairs	38,000	41,000	18,100	SAL	181 094 0001 00	15 21 26 29	6														
TW/A 1	2 Halves	57,250	73,000		SAL	182 094 0002 00		2														
3 68,50																						
MB/HL 1, 2, 3, 4, 5	5 Pairs	43,985 44,000	48,000	17,000	SAL	180 309 0002 00	15 21 26 29	10														
CB/PL 1, 2, 3, 4	4 Pairs	38,000	41,000	18,100	SAL	181 094 0003 00	15 21 26 29	8														
TW/A 1	2 Halves	57,250	73,000		SAL	182 094 0002 00		2														
4 76,50																						
MB/HL 1, 2, 3, 4, 5	5 Pairs	54,972 54,985	59,000 59,013	19,500	SAL	180 035 0001 00	15 21 26 29	8		2												
CB/PL 1, 2, 3, 4	4 Pairs	42,971 42,987	46,000 46,012	16,600	SAL	181 035 0001 00	15 21 26 29	8														
5 83,00																						
MB/HL 1, 2, 3, 4, 5	5 Pairs	60,034	64,218	20,750	SAL	180 035 0011 00	16 22	5		5												
CB/PL 1, 2, 3, 4	4 Pairs	50,844 50,860	53,950 53,966	19,500	Nefrox	181 035 0014 00	16 22	4		4												
TW/A 1	2 Halves	68,040	82,670		SAL	182 035 0001 00	11	2														

							Set Composition / QTY													
6 83,00																				
MB/HL 1, 2, 3, 4, 5	5 Pairs	60,034	63,718	20,750	SAL	180 035 0009 00 16 22	5		5											
CB/PL 1, 2, 3, 4	4 Pairs	50,844 50,860	53,950 53,966	19,500	Nefrox	181 035 0014 00 16 22	4		4											
TW/A 1	2 Halves	68,040	82,670		SAL	182 035 0001 00 11	2													
7 83,00																				
MB/HL 1, 2, 3, 4, 5	5 Pairs	60,034	64,218	20,750	SAL	180 035 0010 00 16 22	5		5											
CB/PL 1, 2, 3, 4	4 Pairs	50,844 50,860	53,950 53,966	19,500	Nefrox	181 035 0014 00 16 22	4		4											
TW/A 1	2 Halves	68,040	82,670		SAL	182 035 0001 00 11	2													
8 86,00																				
MB/HL 1, 2, 3, 4	4 Pairs	57,982 57,995	62,000 62,013	19,500	SAL	180 035 0002 00 15 21 26 29	8		2											
MB/HL 5	1 Pair	57,982 57,995	62,000 62,013	25,900	SAL															
CB/PL 1, 2, 3, 4	4 Pairs	48,971 48,987	52,000 52,012	19,300	S3S	181 035 0002 00 15 21 26 29	4		4											









	ccm						Pos.
F4AE 0481(Iveco), BE99/110/123C(DAF) Please check the position of the location lug on the removed parts.	3922	4	LF Series 45, LF Series 45 LHD, LF Series 55 LHD	102,00	180 121 0006 180 121 0007 181 121 0001 181 121 0012	Std, 0,25, 0,50 Std, 0,25, 0,50 Std, 0,25, 0,50 Std, 0,25, 0,50	1
F4AE 0681-F4GE(Iveco), CE136/162/184C(DAF) Please check the position of the location lug on the removed parts.	5883	6	CF Series 65, LF Series 45, LF Series 55, LF Series 55 ECAS, LF Series 55 LHD, LF Series 65	102,00	180 121 0006 180 121 0007 181 121 0001 181 121 0012	Std, 0,25, 0,50 Std, 0,25, 0,50 Std, 0,25, 0,50 Std, 0,25, 0,50	1
DNS620, DNT133, DNT620, DNTD620	6240	6	Serie F	104,17	180 013 0005 181 013 0005 182 013 0004	Std, 0,25, 0,50 Std, 0,25, 0,50 Std	2
DH825, DHB825, DHR825, DHS825, DHT825, DH825, DHU825, DU825, H825, S825	8250	6	Serie F, SB2000/5 Series, SB2300/5 Series, TB2100 Series	118,00	180 013 0003 180 013 0004 181 013 0003 182 013 0003	Std, 0,25 Std, 0,25, 0,50, 0,75 Std, 0,25, 0,50 Std	3
RS180L, RS200L, RS222L	8661	6	F75	118,00	180 013 0006 181 013 0007 182 013 0005	Std, 0,25, 0,50 Std, 0,25, 0,50 Std	4
DK1160, DKB1160	11630	6	Serie F, TE2400 Series, VE2400 Series	130,00	180 013 0001 180 013 0002 181 013 0001 182 013 0001	Std, 0,25 Std, 0,75 Std, 0,25, 0,50 Std	5
DKA1160, DKC1160, DKCL1160, DKDL1160, DKFL1160, DKL1160, DKS1160, DKSB1160, DKSE1160, DKT1160, DKTD1160, DKTL1160, DKV1160, DKVL1160, DKX1160, DKXE1160, DKZ1160	11630	6	Serie F, Serie MB200, Serie MB205, Serie MB230, Serie N2800, Serie N2826, Serie N3300, Serie SB201, Serie SB210, Serie SB220, Serie SB3000, Serie TE2600	130,00	180 013 0001 180 013 0002 181 013 0001 181 013 0002 181 013 0008 182 013 0001	Std, 0,25 Std, 0,75 Std, 0,25, 0,50 Std, 0,25, 0,50, 0,75 1,00 Std	6
DKX1160ATI, DKXE1160ATI, DKZ1160ATI, LT160, LT195, LT210	11630	6	Serie F, Serie SB3000, Serie SB220, Serie N3300	130,00	180 013 0001 180 013 0002 181 013 0002 182 013 0001	Std, 0,25 Std, 0,75 Std, 0,25, 0,50, 0,75 Std	7
WS222, WS242, WS268, WS295, WS315	11630	6	Series 80.300, 80.330, 85.300, 85.330, 85.360, 85.400, 95.300, 95.360, 95.430	130,00	180 013 0001 180 013 0002 181 013 0002	Std, 0,25 Std, 0,75 Std, 0,25, 0,50, 0,75	8
WS225, WS242, WS259, WS268, WS282, WS295, WS315	11630	6	Series 85.430, 95.310, 95.330, 95.350, 95.360, 95.380, 95.400, 95.430	130,00	180 013 0001 180 013 0002 181 013 0002 182 013 0001	Std, 0,25 Std, 0,75 Std, 0,25, 0,50, 0,75 Std	7
XF250M, XF280M, XF315M, XF355	12583	6	85CF 380, 85CF 430, 95XF 380, 95XF 430, XF Series, XF95	130,00	180 013 0001 181 013 0004 182 013 0002	Std, 0,25 Std, 0,25 Std	9
XF 355 M	12580	6	CF 8, FTP 85.480	130,00	181 013 0010	Std	10
XF 315 M	12580	6	95 XF, FAD 95 XF 430 85 CF, FA 85 CF 430	130,00	181 013 0010	Std	10
XF 280 M	12580	6	85 CF, FA 85 CF 380 95 XF, FAD 95 XF 380	130,00	181 013 0010	Std	10
XF 250 M	12580	6	85 CF, FA 85 CF 340 85 CF, FAD 85 CF 340	130,00	181 013 0010	Std	10
XE 250 C	12580	6	CF 85, FA 85.340	130,00	181 013 0009	Std, 0,25, 0,50	11
XE 280 C	12580	6	95 XF, 85 CF, XF 95, CF 85	130,00	181 013 0009	Std, 0,25, 0,50	11
XE 315 C	12580	6	95 XF, FA 95 XF 430, CF 85, FA 85.430 XF 95, FTG 95.430	130,00	181 013 0009	Std, 0,25, 0,50	11
XE 355 C	12580	6	95 XF, FA 95 XF 480, CF 85, FAT 85.480, XF 95, FA 95.480	130,00	181 013 0009	Std, 0,25, 0,50	11









									Set Composition / QTY												
1 102,00																					
MB/HL 1	1 Pair	83,003 83,075	88,000 88,013	28,900	SAL	180 121 0006 00 15 21	1		1												
MB/HL 1	1 Pair	83,003 83,075	88,000 88,013	37,330	SAL	180 121 0007 00 15 21	1		1												
CB/PL 1	1 Pair	69,000 69,077	73,000 73,013	31,000	S3S	181 121 0001 00 15 21	1		1												
CB/PL 1	1 Pair	69,000 69,077	73,000 73,013	31,000	S3S	181 121 0012 00 15 21	2														
2 104,17																					
MB/HL 1, 4, 7	3 Pairs	79,980 80,080	84,200 84,225	40,300	S3S	180 013 0005 00 15	4		4		6										
MB/HL 2, 3, 5, 6	4 Pairs	79,980 80,080	84,200 84,225	27,400	S3S	21															
CB/PL 1, 2, 3, 4, 5, 6	6 Pairs	63,980 64,020	67,610 67,630	31,500	S3S	181 013 0005 00 15 21	12														
TW/A 1	4 Halves	88,750 89,250	103,750 104,000		S3S	182 013 0004 00	2		2												
3 118,00																					
MB/HL 1	1 Pair	87,990 88,010	92,050 92,075	46,150	S3S	180 013 0003 00 15	8		4		2										
MB/HL 2, 3, 5, 6	4 Pairs	87,990 88,010	92,050 92,075	30,650	S3S																
MB/HL 4, 7	2 Pairs	87,990 88,010	92,050 92,075	38,150	S3S																
MB/HL 1	1 Pair	87,990 88,010	92,050 92,075	46,150	S3S	180 013 0004 00 15	1		1		4		4		4						
MB/HL 2, 3, 5, 6	4 Pairs	87,990 88,010	92,050 92,075	30,650	S3S	21 26															
MB/HL 4, 7	2 Pairs	87,990 88,010	92,050 92,075	38,150	S3S																
CB/PL 1, 2, 3, 4, 5, 6	6 Pairs	74,990 75,010	78,564 78,575	40,150	S3S	181 013 0003 00 15 21	12														
TW/A 1	4 Halves	97,850 98,150	117,150 117,450		S3S	182 013 0003 00	2		2												
4 118,00																					
MB/HL 1, 7	2 Pairs	87,980 88,020	92,050 92,075	36,200	S3S	180 013 0006 00 15	1		1		4		4		4						
MB/HL 2, 3, 5, 6	4 Pairs	87,980 88,020	92,050 92,075	28,700	S3S	21															
MB/HL 4	1 Pair	87,980 88,020	92,050 92,075	44,200	S3S																
CB/PL 1, 2, 3, 4, 5, 6	6 Pairs	79,980 80,020	83,564 83,576	38,200	S3S	181 013 0007 00 15 21	12														
TW/A 1	4 Halves	97,880 98,120	117,230 117,470		S3S	182 013 0005 00	2		2												

							Set Composition / QTY									
5 130,00																
MB/HL 1	1 Pair	97,980 98,020	103,070 103,100	39,150	S3S	180 013 0001 00 15	4		4		2		2		2	
MB/HL 2, 3, 5, 6	4 Pairs	97,980 98,020	103,070 103,100	32,050	S3S											
MB/HL 4, 7	2 Pairs	97,980 98,020	103,070 103,100	52,150	S3S											
MB/HL 1	1 Pair	97,980 98,020	103,070 103,100	39,150	S3S	180 013 0002 00 26	8		2		4					
MB/HL 2, 3, 5, 6	4 Pairs	97,980 98,020	103,070 103,100	32,050	S3S											
MB/HL 4, 7	2 Pairs	97,980 98,020	103,070 103,100	52,150	S3S											
CB/PL 1, 2, 3, 4, 5, 6	6 Pairs	79,190 79,230	82,830 82,840	45,400	S3S	181 013 0001 00 15 21	12									
TW/A 1	4 Halves	102,080 102,320	126,380 126,620		S3S	182 013 0001 00	2		2							
6 130,00																
MB/HL 1	1 Pair	97,980 98,020	103,070 103,100	39,150	S3S	180 013 0001 00 15	4		4		2		2		2	
MB/HL 2, 3, 5, 6	4 Pairs	97,980 98,020	103,070 103,100	32,050	S3S											
MB/HL 4, 7	2 Pairs	97,980 98,020	103,070 103,100	52,150	S3S											
MB/HL 1	1 Pair	97,980 98,020	103,070 103,100	39,150	S3S	180 013 0002 00 26	8		2		4					
MB/HL 2, 3, 5, 6	4 Pairs	97,980 98,020	103,070 103,100	32,050	S3S											
MB/HL 4, 7	2 Pairs	97,980 98,020	103,070 103,100	52,150	S3S											
CB/PL 1, 2, 3, 4, 5, 6	6 Pairs	79,190 79,230	82,830 82,840	45,400	S3S	181 013 0001 00 15 21	12									
CB/PL 1, 2, 3, 4, 5, 6	6 Pairs	82,980 83,020	86,630 86,640	42,700	S3S	181 013 0002 00 15 21 26	12									
CB/PL 1, 2, 3, 4, 5, 6	6 Pairs	82,980 83,020	86,625 86,637	42,500	S3S	181 013 0008 29	12									
TW/A 1	4 Halves	102,080 102,320	126,380 126,620		S3S	182 013 0001 00	2		2							
7 130,00																
MB/HL 1	1 Pair	97,980 98,020	103,070 103,100	39,150	S3S	180 013 0001 00 15	4		4		2		2		2	
MB/HL 2, 3, 5, 6	4 Pairs	97,980 98,020	103,070 103,100	32,050	S3S											
MB/HL 4, 7	2 Pairs	97,980 98,020	103,070 103,100	52,150	S3S											
MB/HL 1	1 Pair	97,980 98,020	103,070 103,100	39,150	S3S	180 013 0002 00 26	8		2		4					
MB/HL 2, 3, 5, 6	4 Pairs	97,980 98,020	103,070 103,100	32,050	S3S											
MB/HL 4, 7	2 Pairs	97,980 98,020	103,070 103,100	52,150	S3S											
CB/PL 1, 2, 3, 4, 5, 6	6 Pairs	82,980 83,020	86,630 86,640	42,700	S3S	181 013 0002 00 15 21 26	12									
TW/A 1	4 Halves	102,080 102,320	126,380 126,620		S3S	182 013 0001 00	2		2							











Set Composition / QTY











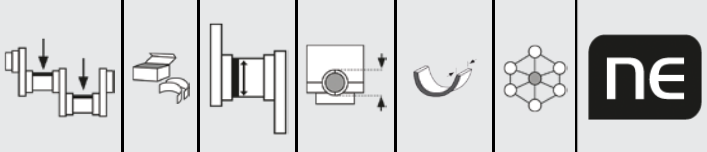







8	130,00																			
MB/HL 1	1 Pair	97,980 98,020	103,070 103,100	39,150	S3S	180 013 0001 00 15	4		4		2		2		2					
MB/HL 2, 3, 5, 6	4 Pairs	97,980 98,020	103,070 103,100	32,050	S3S															
MB/HL 4, 7	2 Pairs	97,980 98,020	103,070 103,100	52,150	S3S															
MB/HL 1	1 Pair	97,980 98,020	103,070 103,100	39,150	S3S	180 013 0002 00 26	8		2		4									
MB/HL 2, 3, 5, 6	4 Pairs	97,980 98,020	103,070 103,100	32,050	S3S															
MB/HL 4, 7	2 Pairs	97,980 98,020	103,070 103,100	52,150	S3S															
CB/PL 1, 2, 3, 4, 5, 6	6 Pairs	82,980 83,020	86,630 86,640	42,700	S3S	181 013 0002 00 15 21 26	12													

9	130,00																			
MB/HL 1	1 Pair	97,980 98,020	103,070 103,100	39,150	S3S	180 013 0001 00 15	4		4		2		2		2					
MB/HL 2, 3, 5, 6	4 Pairs	97,980 98,020	103,070 103,100	32,050	S3S															
MB/HL 4, 7	2 Pairs	97,980 98,020	103,070 103,100	52,150	S3S															
CB/PL 1, 2, 3, 4, 5, 6	6 Pairs	87,980 88,020	92,594 92,606	39,000	S3S	181 013 0004 00 15	12													
TW/A 1	4 Halves	108,200	126,512		S3S	182 013 0002 00	2		2											

10	130,00																			
CB/PL 1, 2, 3, 4, 5, 6	6 Pairs	87,980 88,020	92,594 92,606	39,000	SPVD	181 013 0010 00														

11	130,00																			
CB/PL 1, 2, 3, 4, 5, 6	6 Pairs	91,980 92,020	96,594 96,606	33,000	SPVD	181 013 0009 00 15 21	6		6											

	ccm						Pos.
EB	547	3	Cuore, Mira, Hijet, Atrai 8/85-7/90	62,00	180 070 0002 182 070 0002	Std, 0,25, 0,50, 0,75, 1,00 Std	1
ED	846	3	Kanchil	66,60	180 070 0001 181 070 0001 182 070 0001	Std, 0,25, 0,50 Std, 0,25, 0,50 Std	2
EF	659	3	Cuore, Mira, Hijet, Atrai 3/1990-	68,00	180 070 0002 182 070 0002	Std, 0,25, 0,50, 0,75, 1,00 Std	1
CD	843	3	Charade, Hijet 5/82-8/84	70,00	180 070 0011 181 070 0003 182 070 0003	Std, 0,25, 0,50 Std, 0,25, 0,50, 0,75 Std	7
CD	843	3	Charade, Hijet 8/1984-	70,00	180 070 0003 181 070 0003 182 070 0003	Std, 0,25, 0,50, 0,75 Std, 0,25, 0,50, 0,75 Std	8
1KR-FE	998	3	CHARADE 1.0, SIRION 1.0, BOON 1.0, CUORE VII 1.0	71,00	180 096 0032 181 096 0042 182 096 0030	Std, 0,25, 0,50, 0,75 Std, 0,25, 0,50, 0,75 Std	3
AB	547	2	Cuore, Hijet, Fronte 4/76-7/84	71,50	180 070 0009 181 070 0009 182 070 0003	Std, 0,25, 0,50 Std, 0,25, 0,50 Std	4
AB	547	2	Fronte, Mira, Hijet 8/84-10/88	71,50	180 070 0010 181 070 0009 182 070 0003	Std, 0,25, 0,50 Std, 0,25, 0,50 Std	5
K3, YRV	1297	4	Boon, Passo	72,00	180 070 0008 181 070 0008 182 070 0001	Std, 0,25, 0,50 Std, 0,25, 0,50, 0,75 Std	6
AD	617	2	Cuore, Hijet, Fronte 5/82-7/84	76,00	180 070 0009 181 070 0009 182 070 0003	Std, 0,25, 0,50 Std, 0,25, 0,50 Std	4
AD	617	2	Fronte, Mira, Hijet 8/84-5/85	76,00	180 070 0010 181 070 0009 182 070 0003	Std, 0,25, 0,50 Std, 0,25, 0,50 Std	5
HC	1295	4	Charade, Rocky, Applause 1/1988-	76,00	180 070 0007 181 070 0006 182 070 0005	Std, 0,25, 0,50 Std, 0,25, 0,50 Std	11
CB	993	3	Charade, Hijet 10/77-8/84	76,00	180 070 0011 181 070 0003 182 070 0003	Std, 0,25, 0,50 Std, 0,25, 0,50, 0,75 Std	7
CL	993	3	Charade, Hijet 1/83-8/84	76,00	180 070 0011 181 070 0003 182 070 0003	Std, 0,25, 0,50 Std, 0,25, 0,50, 0,75 Std	7
CB	993	3	Charade, Hijet 8/1984-	76,00	180 070 0003 181 070 0003 182 070 0003	Std, 0,25, 0,50, 0,75 Std, 0,25, 0,50, 0,75 Std	8
CB-T	993	3	Charade, Hijet 8/84-11/90	76,00	180 070 0003 181 070 0003 182 070 0003	Std, 0,25, 0,50, 0,75 Std, 0,25, 0,50, 0,75 Std	8
CL	993	3	Charade, Hijet 8/1984-	76,00	180 070 0003 181 070 0003 182 070 0003	Std, 0,25, 0,50, 0,75 Std, 0,25, 0,50, 0,75 Std	8
CB	993	3	Charade 5/1985-	76,00	180 070 0004 182 070 0004	Std, 0,25, 0,50 Std	9
CL-T	993	3	Charade 8/1984-	76,00	180 070 0004 181 070 0004 182 070 0004	Std, 0,25, 0,50 Std, 0,25, 0,50 Std	10
HD	1589	4	Charade, Rocky, Applause 6/1989-	78,00	180 070 0007 181 070 0006 182 070 0005	Std, 0,25, 0,50 Std, 0,25, 0,50 Std	11
DG	2530	4	Delta 1977-81	88,00	180 070 0005 181 070 0007	Std, 0,25, 0,50, 0,75 Std, 0,25, 0,50, 0,75	12
DG	2530	4	Delta 1982-4/84	88,00	180 070 0005 181 070 0007	Std, 0,25, 0,50, 0,75 Std, 0,25, 0,50, 0,75	12
DL	2765	4	Delta, Tafto, Rocky, Rugger 10/82-4/84	92,00	180 070 0005 181 070 0007	Std, 0,25, 0,50, 0,75 Std, 0,25, 0,50, 0,75	12
DL	2765	4	Delta, Tafto, Rocky, Rugger 4/84-8/87	92,00	180 070 0005 181 070 0007	Std, 0,25, 0,50, 0,75 Std, 0,25, 0,50, 0,75	12
DL-T	2765	4	Delta, Tafto, Rocky, Rugger 4/84-8/87	92,00	180 070 0005 181 070 0007	Std, 0,25, 0,50, 0,75 Std, 0,25, 0,50, 0,75	12
DL	2765	4	Delta, Tafto, Rocky, Rugger 9/1987-	92,00	180 070 0006 181 070 0007	Std, 0,25, 0,50 Std, 0,25, 0,50, 0,75	13
DL-T	2765	4	Delta, Tafto, Rocky, Rugger 9/1987-	92,00	180 070 0006 181 070 0007	Std, 0,25, 0,50 Std, 0,25, 0,50, 0,75	13



							Set Composition / QTY															
1	62,00																					
MB/HL 1, 2, 3, 4	4 Pairs	41,990	46,000	16,000	SAL	180 070 0002 00 15 21 26 29	4		4													
TW/A 1	2 Halves	48,250	59,000		SAL	182 070 0002 00																
2	66,60																					
MB/HL 1, 2, 3, 4	4 Pairs	45,760	50,020	16,000	SAL	180 070 0001 00 15 21	4		4													
CB/PL 1, 2, 3	3 Pairs	38,760	43,020	16,000	SAL	181 070 0001 00 15 21	6															
TW/A 1	2 Halves	52,250	63,000		SAL	182 070 0001 00	2															
3	71,00																					
MB/HL 1, 2, 3, 4	4 Pairs	44,000	48,000	14,900	SAL	180 096 0032 00 15 21 26	4		4													
CB/PL 1, 2, 3	3 Pairs	40,000	43,000	13,500	SAL	181 096 0042 00 15 21 26	6															
TW/A 1	2 Halves	52,000	63,000		SAL	182 096 0030 00	2															
4	71,50																					
MB/HL 1, 2, 3	3 Pairs	41,990	46,000	19,500	SAL	180 070 0009 00 15 21	6															
CB/PL 1, 2	2 Pairs	40,000	43,000	18,000	SAL	181 070 0009 00 15 21																
TW/A 1	2 Halves	48,250	62,000		SAL	182 070 0003 00	2															
5	71,50																					
MB/HL 1, 2, 3	3 Pairs	41,990	46,000	19,500	SAL	180 070 0010 00 15 21																
CB/PL 1, 2	2 Pairs	40,000	43,000	18,000	SAL	181 070 0009 00 15 21																
TW/A 1	2 Halves	48,250	62,000		SAL	182 070 0003 00	2															
6	72,00																					
MB/HL 1, 2, 3, 4, 5	5 Pairs	46,000	50,000	14,900	SAL	180 070 0008 00 15 21	5		5													
CB/PL 1, 2, 3, 4	4 Pairs	40,000	43,000	13,200	SAL	181 070 0008 00 15 21 26	8															
TW/A 1	2 Halves	52,250	63,000		SAL	182 070 0001 00	2															







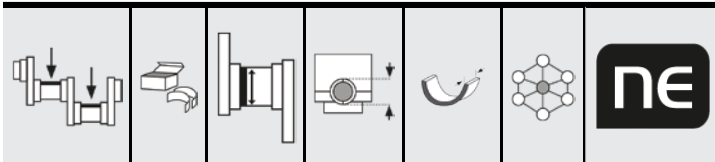

DAIHATSU



Globally reliable

							Set Composition / QTY													
7	76,00																			
MB/HL 1, 2, 3, 4	4 Pairs	41,990	46,000	19,500	SAL	180 070 0011 00 15 21														
CB/PL 1, 2, 3	3 Pairs	40,000	43,000	18,000	SAL	181 070 0003 00 15 21 26	6													
TW/A 1	2 Halves	48,250	62,000		SAL	182 070 0003 00	2													
8	76,00																			
MB/HL 1, 2, 3, 4	4 Pairs	41,990	46,000	19,500	SAL	180 070 0003 00 15 21 26	4		4											
CB/PL 1, 2, 3	3 Pairs	40,000	43,000	18,000	SAL	181 070 0003 00 15 21 26	6													
TW/A 1	2 Halves	48,250	62,000		SAL	182 070 0003 00	2													
9	76,00																			
MB/HL 1, 2, 3, 4	4 Pairs	47,990	52,004	19,500	SAL	180 070 0004 00 15 21														
TW/A 1	2 Halves	54,250	68,000		SAL	182 070 0004 00														
10	76,00																			
MB/HL 1, 2, 3, 4	4 Pairs	47,990	52,004	19,500	SAL	180 070 0004 00 15 21														
CB/PL 1, 2, 3	3 Pairs	45,000	48,000	20,100	SAL	181 070 0004 00 15 21														
TW/A 1	2 Halves	54,250	68,000		SAL	182 070 0004 00														
11	76,00																			
MB/HL 1, 2, 3, 4, 5	5 Pairs	50,000	54,000	18,100	SAL	180 070 0007 00 15 21	10													
CB/PL 1, 2	2 Pairs	45,000	48,000	18,000	SAL	181 070 0006 00 15 21	2													
TW/A 1	2 Halves	57,200	76,400		SAL	182 070 0005 00	2													
12	88,00																			
MB/HL 1, 2	2 Pairs	67,970	72,000	30,250	SAL	180 070 0005 00 15	2		2		3		2		1					
MB/HL 3, 4	2 Pairs	67,970	72,000	24,250	SAL	21 26														
MB/HL 5	1 Pair	67,970	72,000	37,950	SAL															
CB/PL 1, 2, 3, 4	4 Pairs	54,980	58,000	27,630	SAL	181 070 0007 00 15 21 26	8													

							Set Composition / QTY								
13	92,00														
MB/HL 1, 2, 3, 4	4 Pairs	67,970	72,000	24,250	SAL	180 070 0006 00									
MB/HL 5	1 Pair	67,970	72,000	37,950	SAL	15 21									
CB/PL 1, 2, 3, 4	4 Pairs	54,980	58,000	27,630	SAL	181 070 0007 00									
						15 21 26	8								

	ccm						Pos.
YHS (DV5RCE), YHY (DV5RD), YHZ (DV5RC)	1499	4	DS 3 CROSSBACK 1.5 BlueHDi 110, DS 3 CROSSBACK 1.5 BlueHDi 130 DS 7 Crossback 1.5 BlueHDi 130	75,00	180 037 0015 181 037 0023 182 051 0001	Std, 0,25, 0,50 Std, 0,25, 0,50 Std	1















1		75,00																		
MB/HL 1, 2, 3, 4, 5	5 Pairs	1,000 2,000	3,000 4,000	19,900	SAL	180 037 0015 00 15 21														
CB/PL 1, 2, 3, 4	4 Pairs	44,350 44,366	48,000 48,018	17,100	SPVD	181 037 0023 00 15 21	8													
TW/A 1	2 Halves	55,200 55,480	71,350 71,700		SAL	182 051 0001 00	2													



FIAT

Globally reliable







	ccm						Pos.
156A4.000, 156A4.048	769	4	Panda 750	65,00	180 020 0008 181 020 0003	Std, 0,25, 0,50 Std, .010, .020	1
156A2.000, 156A2.100, 156A3.000, 156A3.146, 156A2.050, 156A2.246, 156C.000, 156C.046, 156C1.046, 151C1.156	999	4	Panda 1.0, Panda 1.0 4WD, Panda 1.0 Fire, Uno 1.0, Uno 1.0i, Uno 45 1.0 Fire	70,00	180 020 0008 181 020 0003	Std, 0,25, 0,50 Std, .010, .020	1
160A3.000, 176A6.000, 176B2.000, 187A1.000, M204 A.A.11	1108	4	Cinquecento 1100, Panda 1.1, Panda 1.1 4WD, Punto 1.1, Seicento 1.1, Seicento 1100, Tipo 1.1, Uno 1.1	70,00	180 020 0008 181 020 0003	Std, 0,25, 0,50 Std, .010, .020	1
176A7.000, 840A3.000, 176A8.000, 176B4.000, 178B7.045, 178C4.066, 178E2.000, 176B9.000, 182B2.000, 178B5.000, 188A4.000, 223A5.000	1242	4	500 1.2 8V, Brava 1.2 16V, Bravo 1.2 16V, Doblo 1.2 8V, Idea 1.2i 16V, Palio 1.2 8V, Palio 1.2 16V, Panda 1.2 4WD, Panda 1.2 8V, Punto 1.2, Punto 1.2 8V, Punto 1.2 16V, Siena 1.2 8V, Stilo 1.2 160V, Strada 1.2 8V, Strada 1.2 16V	70,80	180 020 0001 181 020 0002	Std, 0,25, 0,50, 0,75 Std, 0,25, 0,50, 0,75	2
192B2.000, 843A1.000	1367	4	500 1.4 16V, Bravo 1.4 16V, Idea 1.4 16V, Panda 1.4 16V, Punto 1.4 16V, Stilo 1.4 16V	72,00	180 020 0001 181 020 0002	Std, 0,25, 0,50, 0,75 Std, 0,25, 0,50, 0,75	2
146 A7.011	994	4	UNO 1.0	76,00	180 020 0010 181 020 0001	Std, .010, .020 Std, .010, .020	3
127 A1.000	1049	4	127 1.0 Sport	76,00	180 020 0010 181 020 0001	Std, .010, .020 Std, .010, .020	3
146 A6.000	1116	4	UNO Box 60 1.1, DUNA 60 1.1	76,00	180 020 0010 181 020 0001	Std, .010, .020 Std, .010, .020	3
146 A9.000	1116	4	FIORINO 1.1 60	76,00	180 020 0010 181 020 0001	Std, .010, .020 Std, .010, .020	3
146 A5.000	1301	4	FIORINO Box 70 1.3, ELBA 1.3, DUNA 70 1.3	76,00	180 020 0010 181 020 0001	Std, .010, .020 Std, .010, .020	3
156 A.000	1049	4	FIORINO 1.0	76,10	180 020 0010 181 020 0001	Std, .010, .020 Std, .010, .020	3
127 A5.000	1302	4	127 1.3 Diesel, FIORINO 1.3 D, 147 1.3 D, ELBA CSL 1.3 D	76,10	180 020 0010 181 020 0001	Std, .010, .020 Std, .010, .020	3
146 B1.000	1301	4	UNO 1.3 Super Diesel	76,10	180 020 0010 181 020 0001	Std, .010, .020 Std, .010, .020	3
156 A5.000	1302	4	PANDA 1300 D	76,10	180 020 0010 181 020 0001	Std, .010, .020 Std, .010, .020	3
M16A	1586	4	SEDICI 1.6 16V	78,00	180 094 0008 181 094 0009 182 094 0004	Std, 0,25, 0,50 Std, 0,25, 0,50 Std	4
132A.000, 132B.000, 132A9.000	1592	4	124 1.6	80,00	180 020 0002 181 020 0004 182 020 0004	Std, .010, .020, .030 Std, .010, .020, .030 Std	5
R9M.408, R9M.413, R9M.450, R9M.452	1598	4	TALENTO 1.6 D	80,00	180 038 0015 181 038 0020 182 815 0006	Std, 0,25, 0,50 Std, 0,25, 0,50 Std	6
146A2.000, 146A2.146, 146A2.246	1301	4	Uno 1.3 Turbo	80,50	180 020 0009 181 020 0006	Std, 0,25, 0,50 Std, 0,25, 0,50	7
146A8.000, 146A8.046, 146AR55A, 146C1.000, 146D5.000, 159A2.000, 160A1.000, 160A1.046, 160A1.048, 836A4.000, 176A4.000, 176B6.000	1372	4	Doblo 1.4 8V, Fiorino 1.4, Innocenti Elba 1.4ie, Punto 1.4 Turbo, Qubo 1.4 8V, Tempra 1.4, Tipo 1.4, Uno 1.4, Uno 1.4 Turbo	80,50	180 020 0009 181 020 0006	Std, 0,25, 0,50 Std, 0,25, 0,50	7
182A3.000, 182A5.000, 840A2.000, 840A4.000	1370	4	Brava 1.4 12V, Bravo 1.4 12V, Marea 1.4 12V	82,00	180 020 0007 181 020 0010 182 020 0002	Std, .010, .020 Std, 0,25 Std	8
182A2.000, 183A1.000, 839A4.000, 188A6.000, 192A4.000, 839A7.000	1747	4	Barchetta 1.8 16V, Brava 1.8 16V, Bravo 1.8 16V, Coupe 1.8 16V, Marea 1.8 16V, Punto 1.8 16V, Stilo 1.8 16V	82,00	180 020 0007 181 020 0008 182 020 0002	Std, .010, .020 Std, .010 Std	9
188A3.000, 223A6.000	1910	4	Doblo 1.9 D, Palio 1.9 D, Punto 1.9 D, Strada 1.9 D	82,00	180 020 0007 181 020 0005 182 020 0002	Std, .010, .020 Std, .010, .020 Std	10
182A7.000, 182A8.000	1910	4	Brava 1.9 TD, Bravo 1.9 TD, Marea 1.9 TD	82,00	180 020 0007 181 020 0008 182 020 0002	Std, .010, .020 Std, .010 Std	9
188A2.000, 186A6.000, 188A7.000, 188A8.000, 188B2.000, 192A3.000, 182B4.000, 182B9.000, 186A8.000, 192A1.000, 937A2.000, Z19DTH	1910	4	Brava 1.9 JTD 8V, Bravo 1.9 JTD 8V, Doblo 1.9 JTD 8V, Idea 1.9 JTD 8V, Marea 1.9 JTD 8V, Marengo 1.9 JTD 8V, Multipla 1.9 JTD 8V, Palio 1.9 JTD 8V, Punto 1.9 JTD 8V, Punto 1.9 MJT 8V, Sedici 1.9 JTD 8V, Stilo 1.9 JTD 8V, Strada 1.9 JTD 8V	82,00	180 020 0005 181 020 0011 182 020 0001	Std, 0,25 Std, .010 Std	11
192A5.000, 192B1.000, 199A5.000, 937A4.000, 937A5.000, 939A1.000, Z19DTH	1910	4	Bravo 1.9 JTD 16V, Cromia 1.9 JTD 16V, Punto 1.9 MJT 16V, Stilo 1.9 JTD 16V	82,00	180 020 0006 181 020 0009 182 020 0001	Std, .010, .020, .030 Std, .010, .020, .030 Std	12
DW8, WJZ	1868	4	Scudo 1.9 D	82,20	180 037 0003 181 037 0004 182 037 0002	Std, 0,30, 0,50, 0,80 Std, 0,30, 0,50, 0,80 Std, 0,30, 0,50, 0,10, 0,20	13
146D7.000, 176A5.000, 176B7.000, 176A3.000	1697	4	Fiorino 1.7 TD, Palio 1.7 TD, Punto 1.7 TD, Strada 1.7 TD	82,60	180 001 0003 181 020 0005 182 020 0004	Std, 0,25, 0,50 Std, .010, .020 Std	14







	ccm						Pos.
146B2.000, 149B2.000, 149B3.000, 149B4.000, 149B4.046, 149B3.000, 178B3.000, 138B6.000	1697	4	Duna 1.7 D, Fiorino 1.7 D, Innocenti Elba 1.7 Eco SW, Innocenti Mille 1.7 Clip, Penny 1.7 D, Punto 1.7 D, Regata 1.7 D, Ritmo 1.7 D, Strada 1.7 D, Uno 1.7 D	82,60	180 020 0002 181 020 0004 181 020 0005 182 020 0004	Std, .010, .020, .030 Std, .010, .020, .030 Std, .010, .020 Std	15
154D1.000, 154C6.000	1929	4	Croma 1.9 Tdi	82,60	180 001 0003 181 020 0005 182 020 0004	Std, 0,25, 0,50 Std, .010, .020 Std	14
149A1.000, 149B1.000, 230A2.000, 160A7.000	1929	4	Brava 1.9 D, Bravo 1.9 D, Marengo 1.9 D, Regata 1.9 D, Ritmo 1.9 D, Talento 1.9 D, Tempra 1.9 D, Tipo 1.9 D	82,60	180 020 0002 181 020 0004 181 020 0005 182 020 0004	Std, .010, .020, .030 Std, .010, .020, .030 Std, .010, .020 Std	15
160A6.046, 160B6.046, 160D1.000, 160A6.000, AR33601, AR67501, 230A3.000, 230A4.000, 280A1.000	1929	4	Ducato 1.9 TD, Marengo 1.9 TD, Tempra 1.9 TD, Tipo 1.9 TD	82,60	180 001 0003 181 020 0005 182 020 0004	Std, 0,25, 0,50 Std, .010, .020 Std	14
XU7 JP(LFW - LFZ - L6A)	1762	4	Ulysse 1.8	83,00	180 037 0004 181 037 0008 182 037 0002	Std, 0,30, 0,50, 0,80 Std, 0,30, 0,50, 0,80 Std, 0,30, 0,50, 0,10, 0,20	16
XUD9 (D9A - DJZ - 162), XUD9 A (D9B - DJY)	1905	4	Ducato 1.9 D, Scudo 1.9 D	83,00	180 037 0003 181 037 0004 182 037 0002	Std, 0,30, 0,50, 0,80 Std, 0,30, 0,50, 0,80 Std, 0,30, 0,50, 0,10, 0,20	13
XUD9 BSD, XUD9 BTF, XUD9 TF/L, XUD9 TE	1905	4	Ducato 1.9 TD, Scudo 1.9 TD, Talento 1.9 TD, Ulysse 1.9 TD	83,00	180 037 0003 181 037 0005	Std, 0,30, 0,50, 0,80 Std, 0,30, 0,50	17
132AB.0A.0, 132B.B.000	1585	4	Spider 1.6	84,00	180 020 0002 181 020 0004 182 020 0004	Std, .010, .020, .030 Std, .010, .020, .030 Std	5
132A.000, 132B.000, 132B1.000, 132C1.000, 132AB1.000, 132AC.000, 132AS1.000	1756	4	132 1.8, Spider 1.8, 124 1.8, 124 1.8 Abarth	84,00	180 020 0002 181 020 0004 182 020 0004	Std, .010, .020, .030 Std, .010, .020, .030 Std	5
159A4.000, 159A4.046, 836A5.000, 836A6.000, 835C4.000, 836C4.000, 835C2.000	1756	4	Tempra 1.8, Tempra 1.8i.e., Tipo 1.8, Tipo 1.8i.e.	84,00	180 020 0002 181 020 0007 182 020 0004	Std, .010, .020, .030 Std, .010 Std	18
160A5.000	1756	4	Tipo 1.8 16V	84,00	180 001 0003 181 020 0008 182 020 0004	Std, 0,25, 0,50 Std, .010 Std	19
XM7 T (169B)	1796	4	Ducato 10 1.8	84,00	180 037 0005 180 037 0006 181 037 0010 182 037 0003	Std, 0,30, 0,50, 0,80, 1,00 Std, 0,30, 0,50, 0,80, 1,00 Std, 0,30, 0,50, 0,80, 1,00 Std, 0,30, 0,50, 0,80, 0,10, 0,20	20
124B3.000, 131A1.000, 131B2.000, 131C4.000, 131AR.000, 132C3.00, 132D1.000, 132DB.2A, 132E.000, 138AR1.000, 138AR2.000	1995	4	124 2.0 Spider, 131 2.0, 131 2.0 Racing, 131 2.0 Spider, 132 2.0, 132 Brava 2.0, 242 2.0, Argenta 2.0, Argenta 2.0 VX, Campagnola 2.0, Ritmo 2.0 TC, Spidereuropa 2.0	84,00	180 020 0002 181 020 0004 182 020 0004	Std, .010, .020, .030 Std, .010, .020, .030 Std	5
834B.048, 834B.146, 834B1.000	1995	4	Croma 2.0	84,00	180 020 0002 181 020 0007 182 020 0004	Std, .010, .020, .030 Std, .010 Std	18
154E1.000, 836A3.000, 834F1.000, 175A1.000, 175A4.000, 836A2.000, 831E5.000, 831E5.046	1995	4	Coupe 2.0 16V, Coupe 2.0 16V Turbo, Croma 2.0 16V, Tipo 2.0 16V	84,00	180 001 0003 181 020 0008 182 020 0004	Std, 0,25, 0,50 Std, .010 Std	19
154A1.000, 154C5.000	1995	4	Croma 2.0	84,00	180 001 0003 181 020 0007 182 020 0004	Std, 0,25, 0,50 Std, .010 Std	21
154C3.046, 834B.000, 834B.048, 834B.146, 835A5.000	1995	4	Croma 2.0, Tempra 2.0	84,00	180 020 0002 181 020 0008 182 020 0004	Std, .010, .020, .030 Std, .010 Std	22
DW10	1997	4	Ducato II (230) 2.0 JTD, Ducato II (244) 2.0 JTD, Scudo 2.0 JTD 140 16V, Ulysse 2.0 JTD 16V	85,00	180 037 0003 181 037 0019 182 037 0002	Std, 0,30, 0,50, 0,80 Std, 0,30, 0,50 Std, 0,30, 0,50, 0,10, 0,20	23
DW12	2179	4	Ulysse 2.2 JTD 16V	85,00	180 037 0003 181 037 0019 182 037 0002	Std, 0,30, 0,50, 0,80 Std, 0,30, 0,50 Std, 0,30, 0,50, 0,10, 0,20	23
XU10 2C, XU10 J2, XU 10 J4	1998	4	Ducato 2.0, Ducato 2.0i, Scudo 2.0i 16V, Ulysse 2.0 16V, Ulysse 2.0i 16V, Ulysse 2.0i 8V, Ulysse 2.0 8V Turbo	86,00	180 037 0003 181 037 0007	Std, 0,30, 0,50, 0,80 Std, 0,30, 0,50	24
4HV	2198	4	DUCATO 100 Multijet 2,2 D	86,00	180 021 0009 181 021 0011	Std, 0,25, 0,50 Std, 0,25, 0,50	25
138A4.000, 138B3.000, 149C1.000, 138C2.048, 149A5.000, 831B1.000, 831B1.048	1498	4	Fiorino 1.5, Ritmo 1.5, Uno 1.5, X 1.9 Bertone 1.5, X 1/9 1.5	86,40	180 020 0009 181 020 0006	Std, 0,25, 0,50 Std, 0,25, 0,50	7
159A3.000, 160A2.000, 159A3.046, 159A3.048, 176A9.000, 178B3.000, 182A4.000, 182A6.000, 185A3.000, 220A2.000, 835A1.000, 835A1.046, 835C1.000	1581	4	Brava 1.6 16V, Bravo 1.6 16V, Doblo 1.6i 16V, Fiorino 1.6i, Innocenti Elba 1.6ie SW, Marea 1.6i 16V, Multipla 1.6i 16V, Palio 1.6i 16V, Punto 1.6, Scudo 1.6i, Sedici 1.6 16V, Stilo 1.6 16V, Tempra 1.6, Tempra 1.6i, Tipo 1.6, Tipo 1.6i	86,40	180 020 0009 181 020 0006	Std, 0,25, 0,50 Std, 0,25, 0,50	7











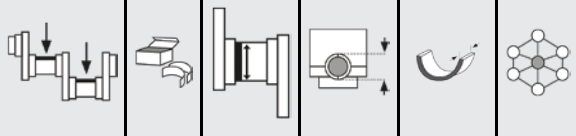























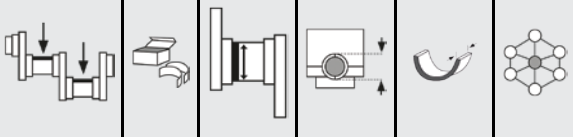













FIAT

Globally reliable

	ccm						Pos.
YN1 T (170A - 170B - 170C)	1971	4	Ducato 2.0, Talento 2.0	88,00	180 037 0005 180 037 0006 181 037 0010 182 037 0003	Std, 0,30, 0,50, 0,80, 1,00 Std, 0,30, 0,50, 0,80, 1,00 Std, 0,30, 0,50, 0,80, 1,00 Std, 0,30, 0,50, 0,80, 0,10, 0,20	20
F1AE 0481AA/BA/BB/C	2286	4	Ducato 2.3 JTD 16V	88,00	180 121 0005 181 121 0011	Std, 0,25, 0,50, 0,75 Std, 0,25, 0,50	26
8140.21, 8140.61, 8144.21, 8144.61	2445	4	132 2.5 D, Argenta 2.5 D, Campagnola 2.5 D, Ducato 2.5 D	93,00	180 020 0003 180 121 0015 181 020 0012 181 020 0013	Std, .010, .020, .030 Std, 0,25, 0,50, 0,75 Std, .010, .020, .030 Std, 0,25, 0,50, 0,75	27
8140.27, 8140.47, 8140.67, 8144.97	2499	4	Ducato 2.5 TD, Ducato TD 4WD, Ducato 2.5 Tdi	93,00	180 020 0003 180 121 0015 181 020 0012 181 020 0013	Std, .010, .020, .030 Std, 0,25, 0,50, 0,75 Std, .010, .020, .030 Std, 0,25, 0,50, 0,75	27
8140.23, 8140.43, 8140.63	2798	4	Ducato 14 2.8 D, Ducato 14 2.8TD, Ducato 2.8 D, Ducato 2.8 JTD, Ducato Maxi 2.8 D, Ducato Maxi 2.8TD	94,40	180 020 0004 181 020 0012	Std, .010, .020, .030 Std, .010, .020, .030	28
F1CE0481D, F1CE3481M	2999	4	DUCATO Multijet 3,0 D	95,80	180 121 0016 181 121 0017	Std, 0,25, 0,50, 0,75 Std, 0,25, 0,50, 0,75	29
F4AE 0481(Iveco), BE99/110/123C(DAF)	3922	4	.	102,00	180 121 0006 180 121 0007 181 121 0001 181 121 0012	Std, 0,25, 0,50 Std, 0,25, 0,50 Std, 0,25, 0,50 Std, 0,25, 0,50	30
Please check the position of the location lug on the removed parts.							
F4AE 0681-F4GE(Iveco), CE136/162/184C(DAF)	5883	6	.	102,00	180 121 0006 180 121 0007 181 121 0001 181 121 0012	Std, 0,25, 0,50 Std, 0,25, 0,50 Std, 0,25, 0,50 Std, 0,25, 0,50	30
Please check the position of the location lug on the removed parts.							
8040.05, 8040.25, 8040.45	3908	4	.	104,00	180 121 0001 180 121 0002 181 121 0007 181 121 0014 182 121 0001	Std, 0,25, 0,50, 0,75 Std, 0,25, 0,50, 0,75 Std, 0,25, 0,50, 0,75 Std, 0,25, 0,50, 0,75 Std, .005	31
8051.05	4885	5	.	104,00	180 121 0001 180 121 0002 181 121 0007 181 121 0014 182 121 0001	Std, 0,25, 0,50, 0,75 Std, 0,25, 0,50, 0,75 Std, 0,25, 0,50, 0,75 Std, 0,25, 0,50, 0,75 Std, .005	31
8060.05, 8060.25, 8060.45	5861	6	.	104,00	180 121 0001 180 121 0002 181 121 0007 181 121 0014 182 121 0001	Std, 0,25, 0,50, 0,75 Std, 0,25, 0,50, 0,75 Std, 0,25, 0,50, 0,75 Std, 0,25, 0,50, 0,75 Std, .005	31
8360.04, 8360.04	6850	6	.	115,00	180 121 0008 181 121 0002 181 121 0015 182 121 0001	Std, 0,25, 0,50, 0,75 Std, 0,25, 0,50, 0,75 Std, 0,25, 0,50, 0,75 Std, .005	32
8340.04	4570	4	.	115,00	180 121 0008 181 121 0002 181 121 0015 182 121 0001	Std, 0,25, 0,50, 0,75 Std, 0,25, 0,50, 0,75 Std, 0,25, 0,50, 0,75 Std, .005	32
F2B 21682/E0681/E0682/E1682 -Euro 3, F2B E0681 - Euro 2	7790	6	.	115,00	180 121 0009 181 121 0016	Std, 0,25, 0,50 Std, 0,25, 0,50	33
8361Si10, 8361Si11, 8361Si12, 8361.25, 8361.45, 8360.03, 8360.05, 8361.05, 8365.05	8101	6	.	115,00	180 121 0008 181 121 0002 181 121 0015 182 121 0001	Std, 0,25, 0,50, 0,75 Std, 0,25, 0,50, 0,75 Std, 0,25, 0,50, 0,75 Std, .005	32
8340.05	5401	4	.	115,00	180 121 0008 181 121 0002 181 121 0015 182 121 0001	Std, 0,25, 0,50, 0,75 Std, 0,25, 0,50, 0,75 Std, 0,25, 0,50, 0,75 Std, .005	32
8200.01.220, 8200.11, 8205.01	9161	6	.	120,00	180 121 0014 181 121 0002 181 121 0013	Std, 0,25, 0,50, 0,75 Std, 0,25, 0,50, 0,75 Std, 0,25, 0,50, 0,75	35
8460.21, 8460.41	9500	6	.	120,00	180 121 0010 181 121 0006 182 121 0003	Std, 0,25, 0,50 Std, 0,25, 0,50 Std	34
8200.02, 8200.12, 8205.02	9819	6	.	122,00	180 121 0014 181 121 0002 181 121 0013	Std, 0,25, 0,50, 0,75 Std, 0,25, 0,50, 0,75 Std, 0,25, 0,50, 0,75	35
F3AE 0681D/E/BA/EA017/024/031	10300	6	.	125,00	180 121 0011 181 121 0005	Std, 0,25, 0,50 Std, 0,25, 0,50	36
8200.03, 8200.13, 8205.03	10308	6	.	125,00	180 121 0014 181 121 0002 181 121 0013	Std, 0,25, 0,50, 0,75 Std, 0,25, 0,50, 0,75 Std, 0,25, 0,50, 0,75	35
F3BE 0681C/E/A	12882	6	.	135,00	180 121 0012 181 121 0004	Std, 0,25, 0,50 Std, 0,25, 0,50	37
8210.02, 8210.12, 8210.22, 8210.42, 8211.02, 8211.22, 8215.02, 8215.22, 8217.32	13798	6	.	137,00	180 121 0004 181 121 0009 181 121 0010	Std, 0,25, 0,50, 0,75 Std, 0,25, 0,50, 0,75 Std, 0,25, 0,50, 0,75	38

	ccm						Pos.
8280.42, 8280.42S	17174	8	190 E 52, 190.48, 240 E 52, 440 E 52, Astra HD7	145,00	180 121 0013 181 121 0003 182 121 0002	Std, 0,25, 0,50 Std, 0,25, 0,50 Std	39

						 		Set Composition / QTY														
1 65,00																						
MB/HL 1, 2, 3, 4	4 Pairs	43,980 44,000	47,705 47,718	19,000	SAL	180 020 0008 00 15	10															
MB/HL 5	1 Pair	43,980 44,000	47,705 47,718	23,820	SAL	21																
CB/PL 1, 2, 3, 4	4 Pairs	37,998 38,008	41,128 41,140	19,000	SAL	181 020 0003 00 16 22	8															
2 70,80																						
MB/HL 1, 2, 3, 4	4 Pairs	47,980 48,000	51,705 51,718	19,000	SAL	180 020 0001 00 15	9		1													
MB/HL 5	1 Pair	47,980 48,000	51,705 51,718	23,950	SAL	21 26																
CB/PL 1, 2, 3, 4	4 Pairs	41,988 42,008	45,127 45,140	19,000	SAL	181 020 0002 00 15 21 26	8															
3 76,00																						
MB/HL 1, 2, 3, 4	4 Pairs	48,189 48,209	51,921 51,934	17,700	SAL	180 020 0010 00 16 22	8		2													
MB/HL 5	1 Pair	48,189 48,209	51,921 51,934	25,500	SAL	22																
CB/PL 1, 2, 3, 4	4 Pairs	43,988 44,008	47,130 47,142	18,500	SAL	181 020 0001 00 16 22	8															
4 78,00																						
MB/HL 1, 2, 3, 4, 5	5 Pairs	52,000	56,000	18,000	SAL	180 094 0008 00 15 21	5		5													
CB/PL 1, 2, 3, 4	4 Pairs	42,000	45,000	18,000	SAL	181 094 0009 00 15 21	8															
TW/A 1	2 Halves	59,250	75,000		SAL	182 094 0004 00	2															
5 80,00																						
MB/HL 1, 2, 3, 4	4 Pairs	52,985 53,005	56,717 56,730	20,750	SAL	180 020 0002 00 16 22 27	8		2													
MB/HL 5	1 Pair	52,985 53,005	56,717 56,730	24,250	SAL	22 27																
CB/PL 1, 2, 3, 4	4 Pairs	50,782 50,802	53,897 53,913	19,500	SAL	181 020 0004 00 16 22 27	8															
TW/A 1	2 Halves	59,000 59,250	73,600 73,850		SAL	182 020 0004 00	2															
6 80,00																						
MB/HL 1, 2, 3, 4, 5	5 Pairs	51,500	55,500	17,250	SSI	180 038 0015 00 15 21	5		5													
CB/PL 1, 2, 3, 4	4 Pairs	48,000 48,018	51,600 51,618	20,700	Nefrox	181 038 0020 00 15 21	4		4													
TW/A 1	2 Halves	58,050	80,250		SAL	182 815 0006 00	2															

							 		Set Composition / QTY											
7	80,50																			
MB/HL 1, 2, 3, 4	4 Pairs	50,780 50,800	54,507 54,520	20,250	SAL	180 020 0009 00 15	8		2											
MB/HL 5	1 Pair	50,780 50,800	54,507 54,520	22,750	SAL	21														
CB/PL 1, 2, 3, 4	4 Pairs	45,508 45,528	48,629 48,646	19,200	SAL	181 020 0006 00 15 21	8													
8	82,00																			
MB/HL 1, 2, 3, 4, 5	5 Pairs	52,982 53,000	56,705 56,718	20,750	SAL	180 020 0007 00 16 22	8		2											
CB/PL 1, 2, 3, 4	4 Pairs	40,870 40,890	44,000 44,012	19,100	SAL	181 020 0010 00 15	8													
TW/A 1	2 Halves	58,808 59,062	73,486 73,740		SAL	182 020 0002 00	2													
9	82,00																			
MB/HL 1, 2, 3, 4, 5	5 Pairs	52,982 53,000	56,705 56,718	20,750	SAL	180 020 0007 00 16 22	8		2											
CB/PL 1, 2, 3, 4	4 Pairs	50,787 50,805	53,901 53,913	19,500	S3S	181 020 0008 00 16	8													
TW/A 1	2 Halves	58,808 59,062	73,486 73,740		SAL	182 020 0002 00	2													
10	82,00																			
MB/HL 1, 2, 3, 4, 5	5 Pairs	52,982 53,000	56,705 56,718	20,750	SAL	180 020 0007 00 16 22	8		2											
CB/PL 1, 2, 3, 4	4 Pairs	50,787 50,807	53,897 53,919	19,500	S3S	181 020 0005 00 16 22	8													
TW/A 1	2 Halves	58,808 59,062	73,486 73,740		SAL	182 020 0002 00	2													
11	82,00																			
MB/HL 1, 2, 3, 4, 5	5 Pairs	59,586 60,000	63,705 63,718	20,750	S3S	180 020 0005 00 15	10													
CB/PL 1, 2, 3, 4	4 Pairs	50,787 50,805	53,901 53,913	19,500	S3S	181 020 0011 00 16	8													
TW/A 1	2 Halves	67,785 68,040	82,425 82,677		SAL	182 020 0001 00	2													
12	82,00																			
MB/HL 1, 2, 3, 4, 5	5 Pairs	59,986 60,000	63,705 63,718	20,750	SSI	180 020 0006 00 16 22 27	5		5											
CB/PL 1, 2, 3, 4	4 Pairs	50,787 50,805	53,901 53,913	19,500	S3S	181 020 0009 00 16 22 27	8													
TW/A 1	2 Halves	67,785 68,040	82,425 82,677		SAL	182 020 0001 00	2													







FIAT





Globally reliable













									Set Composition / QTY														
13 82,20							MB/HL 1, 2, 3, 4, 5	5 Pairs	59,981 60,000	63,731 63,750	20,290	SAL	180 037 0003 00 17 21 28	5		5							
							CB/PL 1, 2, 3, 4	4 Pairs	49,984 50,000	53,695 53,708	20,050	SAL	181 037 0004 00 17 21 28	8									
							TW/A 1	4 Halves	67,050 67,300	83,050 83,300		S3S	182 037 0002 00 17 21 08 14	2		2							
14 82,60							MB/HL 1, 2, 3, 4, 5	5 Pairs	52,990 53,010	56,717 56,735	24,250	SAL	180 001 0003 00 15 21	2		8							
							CB/PL 1, 2, 3, 4	4 Pairs	50,787 50,807	53,897 53,919	19,500	S3S	181 020 0005 00 16 22	8									
							TW/A 1	2 Halves	59,000 59,250	73,600 73,850		SAL	182 020 0004 00	2									
15 82,60							MB/HL 1, 2, 3, 4	4 Pairs	52,985 53,005	56,717 56,730	20,750	SAL	180 020 0002 00 16	8		2							
							MB/HL 5	1 Pair	52,985 53,005	56,717 56,730	24,250	SAL	22 27										
							CB/PL 1, 2, 3, 4	4 Pairs	50,782 50,802	53,897 53,913	19,500	SAL	181 020 0004 00 16 22 27	8									
							CB/PL 1, 2, 3, 4	4 Pairs	50,787 50,807	53,897 53,919	19,500	S3S	181 020 0005 00 16 22	8									
							TW/A 1	2 Halves	59,000 59,250	73,600 73,850		SAL	182 020 0004 00	2									
16 83,00							MB/HL 1, 2, 3, 4, 5	5 Pairs	59,990 60,000	63,718 63,727	20,290	SAL	180 037 0004 00 17 21 28	5		5							
							CB/PL 1, 2, 3, 4	4 Pairs	44,975 44,991	48,655 48,671	22,750	SAL	181 037 0008 00 17 21 28	8									
							TW/A 1	4 Halves	67,050 67,300	83,050 83,300		S3S	182 037 0002 00 17 21 08 14	2		2							
17 83,00							MB/HL 1, 2, 3, 4, 5	5 Pairs	59,981 60,000	63,731 63,750	20,290	SAL	180 037 0003 00 17 21 28	5		5							
							CB/PL 1, 2, 3, 4	4 Pairs	49,984 50,000	53,695 53,708	19,800	S3S	181 037 0005 00 17 21	8									

















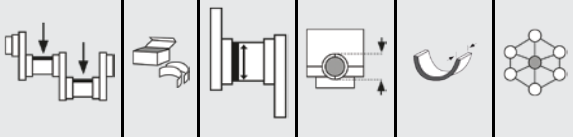

























Set Composition / QTY





































18	84,00																			
MB/HL 1, 2, 3, 4	4 Pairs	52,985 53,005	56,717 56,730	20,750	SAL	180 020 0002 00 16	8		2											
MB/HL 5	1 Pair	52,985 53,005	56,717 56,730	24,250	SAL		22 27													
CB/PL 1, 2, 3, 4	4 Pairs	50,792 50,805	53,892 53,910	19,500	S3S	181 020 0007 00 16	8													
TW/A 1	2 Halves	59,000 59,250	73,600 73,850		SAL	182 020 0004 00			2											

19	84,00																			
MB/HL 1, 2, 3, 4, 5	5 Pairs	52,990 53,010	56,717 56,735	24,250	SAL	180 001 0003 00 15 21	2		8											
CB/PL 1, 2, 3, 4	4 Pairs	50,787 50,805	53,901 53,913	19,500	S3S	181 020 0008 00 16	8													
TW/A 1	2 Halves	59,000 59,250	73,600 73,850		SAL	182 020 0004 00			2											

20	84,00																			
MB/HL 1	1 Pair	59,401 59,416	63,227 63,246	29,500	SAL	180 037 0005 00 17	2		2		2		2		2					
MB/HL 2	1 Pair	58,548 58,573	62,384 62,403	21,500	SAL		21 28													
MB/HL 3	1 Pair	57,174 57,189	61,000 61,019	29,500	SAL		29													
MB/HL 4	1 Pair	56,140 56,165	59,976 59,995	21,500	SAL															
MB/HL 5	1 Pair	54,905 54,920	58,731 58,750	29,400	SAL															
MB/HL 1	1 Pair	59,401 59,416	63,227 63,246	29,500	SAL	180 037 0006 00 17	1		1		1		1		1					
MB/HL 2	1 Pair	58,548 58,573	62,384 62,403	21,500	SAL		21 28													
MB/HL 3	1 Pair	57,174 57,189	61,000 61,019	29,500	SAL		29													
MB/HL 4	1 Pair	56,140 56,165	59,976 59,995	21,500	SAL															
MB/HL 5	1 Pair	54,905 54,920	58,731 58,750	29,400	SAL															
CB/PL 1, 2, 3, 4	4 Pairs	49,975 49,991	53,655 53,674	23,400	SAL	181 037 0010 00 17 21 28 29	8													
TW/A 1	4 Halves	61,400 61,650	72,550 72,800		S3S	182 037 0003 00 17 21 28 08 14	2		2											

21	84,00																			
MB/HL 1, 2, 3, 4, 5	5 Pairs	52,990 53,010	56,717 56,735	24,250	SAL	180 001 0003 00 15 21	2		8											
CB/PL 1, 2, 3, 4	4 Pairs	50,792 50,805	53,892 53,910	19,500	S3S	181 020 0007 00 16	8													
TW/A 1	2 Halves	59,000 59,250	73,600 73,850		SAL	182 020 0004 00			2											

 							Set Composition / QTY															
22 84,00																						
MB/HL 1, 2, 3, 4	4 Pairs	52,985 53,005	56,717 56,730	20,750	SAL	180 020 0002 00 16	8		2													
MB/HL 5	1 Pair	52,985 53,005	56,717 56,730	24,250	SAL																	
CB/PL 1, 2, 3, 4	4 Pairs	50,787 50,805	53,901 53,913	19,500	S3S	181 020 0008 00 16	8															
TW/A 1	2 Halves	59,000 59,250	73,600 73,850		SAL	182 020 0004 00	2															
23 85,00																						
MB/HL 1, 2, 3, 4, 5	5 Pairs	59,981 60,000	63,731 63,750	20,290	SAL	180 037 0003 00 17 21 28	5		5													
CB/PL 1, 2, 3, 4	4 Pairs	49,984 50,000	53,695 53,708	20,000	S4S	181 037 0019 00 17 21																
TW/A 1	4 Halves	67,050 67,300	83,050 83,300		S3S	182 037 0002 00 17 21 08 14	2		2													
24 86,00																						
MB/HL 1, 2, 3, 4, 5	5 Pairs	59,981 60,000	63,731 63,750	20,290	SAL	180 037 0003 00 17 21 28	5		5													
CB/PL 1, 2, 3, 4	4 Pairs	49,984 50,000	53,695 53,708	20,250	SAL	181 037 0007 00 17 21	8															
25 86,00																						
MB/HL 1, 2	2 Pairs	65,020	69,520	23,400	SSI	180 021 0009 00 15	4		1		3		1		1							
MB/HL 3	1 Pair	65,020	69,520	24,200	SSI		21															
MB/HL 4	1 Pair	65,020	69,520	29,000	SSI																	
MB/HL 5	1 Pair	70,020	74,520	19,700	SSI																	
CB/PL 1, 2	2 Pairs	53,000	56,000	23,300	SSI	181 021 0011 00 15	4		4													
CB/PL 3, 4	2 Pairs	53,000	56,000	24,500	SSI		21															
26 88,00																						
MB/HL 1, 2, 3, 4	4 Pairs	71,182 71,208	75,588 75,614	27,000	SAL	180 121 0005 00 15	3		4		1		1		1							
MB/HL 5	1 Pair	76,182 76,208	80,588 80,614	27,000	SAL		21 26															
CB/PL 1, 2, 3, 4	4 Pairs	59,015 59,038	62,833 62,848	23,750	S3S	181 121 0011 00 15	4		4													
27 93,00																						
MB/HL 1, 2, 3, 4	4 Pairs	76,187 76,200	80,586 80,607	24,990	S3S	180 020 0003 00 16	1		1		4		4									
MB/HL 5	1 Pair	76,187 76,200	80,586 80,607	31,950	S3S		22 27															
MB/HL 1, 2, 3, 4	4 Pairs	76,187 76,200	80,586 80,607	24,990	S3S	180 121 0015 00 15	4		4		1		1									
MB/HL 5	1 Pair	76,187 76,200	80,586 80,607	31,950	S3S		21 26															
CB/PL 1, 2, 3, 4	4 Pairs	56,520 56,535	60,333 60,345	24,700	S3S	181 020 0012 00 16 22 27	8															
CB/PL 1, 2, 3, 4	4 Pairs	56,520 56,535	60,333 60,345	24,700	S3S	181 020 0013 00 15 21 26	8															











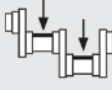

							Set Composition / QTY															
28 94,40																						
MB/HL 1, 2, 3, 4	4 Pairs	80,182 80,208	84,588 84,614	23,800	S3S	180 020 0004 00 16	4		4		1		1									
MB/HL 5	1 Pair	86,182 86,208	90,588 90,614	30,950	S3S	22 27																
CB/PL 1, 2, 3, 4	4 Pairs	56,520 56,535	60,333 60,345	24,700	S3S	181 020 0012 00 16 22 27	8															
29 95,80																						
MB/HL 1, 2, 3, 4, 5	5 Pairs	1,000	1,000	1,000	SAL	180 121 0016 00 15 21 26	1		4		3		1		1							
CB/PL 1, 2, 3, 4	4 Pairs	64,015 64,038	67,833 67,848	26,800	S3S	181 121 0017 00 15 21 26	4		4													
30 102,00																						
MB/HL 1	1 Pair	83,003 83,075	88,000 88,013	28,900	SAL	180 121 0006 00 15 21	1		1													
MB/HL 1	1 Pair	83,003 83,075	88,000 88,013	37,330	SAL	180 121 0007 00 15 21	1		1													
CB/PL 1	1 Pair	69,000 69,077	73,000 73,013	31,000	S3S	181 121 0001 00 15 21	1		1													
CB/PL 1	1 Pair	69,000 69,077	73,000 73,013	31,000	S3S	181 121 0012 00 15 21	2															
31 104,00																						
MB/HL 1	1 Pair	79,791 79,810	84,200 84,230	25,000	S3S	180 121 0001 00 15 21 26	1		1													
MB/HL 1	1 Pair	79,791 79,810	84,200 84,230	25,000	S3S	180 121 0002 00 15 21 26	1		1													
CB/PL 1	1 Pair	63,725 63,744	67,407 67,422	28,700	S3S	181 121 0007 00 15 21 26	1		1													
CB/PL 1	1 Pair	63,725 63,744	67,407 67,422	28,700	S3S	181 121 0014 00 15 21 26	2															
TW/A 1	4 Halves	87,779 88,003	111,510 111,764		S3S	182 121 0001 00 11	2		2													
32 115,00																						
MB/HL 1, 4, 7	3 Pairs	79,782 79,800	84,206 84,226	42,500	S3S	180 121 0008 00 15 21 26	4		4		3		3									
MB/HL 2, 3, 5, 6	4 Pairs	79,782 79,800	84,206 84,226	32,500	S3S	21 26																
CB/PL 1	1 Pair	72,492 72,504	76,695 76,718	34,930	S3S	181 121 0002 00 15 21 26	2															
CB/PL 1	1 Pair	72,482 72,500	76,695 76,713	34,930	S3S	181 121 0015 00 15 21 26	2															
TW/A 1	4 Halves	87,779 88,003	111,510 111,764		S3S	182 121 0001 00 11	2		2													



FIAT

Globally reliable







							Set Composition / QTY													
33	115,00																			
MB/HL 1, 2, 3, 4, 5, 6	6 Pairs	82,910 82,940	89,000 89,030	33,000	S3S	180 121 0009 00 15	6		6		1		1							
MB/HL 7	1 Pair	82,910 82,940	89,000 89,030	39,850	S3S	21														
CB/PL 1, 2, 3, 4, 5, 6	6 Pairs	72,915 72,945	77,000 77,030	35,500	S3S	181 121 0016 00 15	12													
34	120,00																			
MB/HL 1, 2, 3, 5, 6, 7	6 Pairs	89,958 89,980	96,000 96,022	32,750	S3S	180 121 0010 00 15	6		6		1		1							
MB/HL 4	1 Pair	89,958 89,980	96,000 96,022	44,500	S3S	21														
CB/PL 1	1 Pair	81,978 82,000	86,213 86,235	35,400	S3S	181 121 0006 00 15	1		1											
TW/A 1	4 Halves	99,800 100,200	123,650 124,000		S3S	182 121 0003 00	2		2											
35	120,00																			
MB/HL 1, 7	2 Pairs	92,085 92,107	96,570 96,596	37,340	S3S	180 121 0014 00 15														
MB/HL 2, 3, 5, 6	4 Pairs	92,085 92,107	96,570 96,596	32,760	S3S	21 26														
MB/HL 4	1 Pair	92,085 92,107	96,570 96,596	59,430	S3S															
CB/PL 1	1 Pair	72,492 72,504	76,695 76,718	34,930	S3S	181 121 0002 00 15	2													
CB/PL 1, 2, 3, 4, 5, 6	6 Pairs	74,950 74,971	78,705 78,721	33,910	S3S	181 121 0013 00 15														
36	125,00																			
MB/HL 1, 2, 3, 4, 5, 6	6 Pairs	92,970 93,000	99,000 99,030	37,000	S3S	180 121 0011 00 15	6		6		1		1							
MB/HL 7	1 Pair	92,970 93,000	99,000 99,030	46,850	S3S	21														
CB/PL 1, 2, 3, 4, 5, 6	6 Pairs	82,970 83,000	87,000 87,030	40,500	S3S	181 121 0005 00 15	12													
37	135,00																			
MB/HL 1, 2, 3, 4, 5, 6	6 Pairs	99,970 100,000	106,300 106,330	39,000	S3S	180 121 0012 00 15	6		6		1		1							
MB/HL 7	1 Pair	99,970 100,000	106,300 106,330	44,300	S3S	21														
CB/PL 1, 2, 3, 4, 5, 6	6 Pairs	89,970 90,000	94,000 94,030	43,500	S3S	181 121 0004 00 15	12													
38	137,00																			
MB/HL 1, 7	2 Pairs	102,878 102,900	107,975 108,000	37,410	S3S	180 121 0004 00 15	2		1		1		4		4					
MB/HL 2, 3, 5, 6	4 Pairs	102,878 102,900	107,975 108,000	34,820	S3S	21 26														
MB/HL 4	1 Pair	102,878 102,900	107,975 108,000	54,380	S3S															
CB/PL 1, 2, 3, 4, 5, 6	6 Pairs	84,713 84,735	88,482 88,504	41,250	S3S	181 121 0009 00 15	12													
CB/PL 1, 2, 3, 4, 5, 6	6 Pairs	84,713 84,735	88,482 88,504	40,250	S3S	181 121 0010 00 15	12													











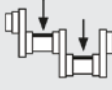



									Set Composition / QTY									
39	145,00																	
MB/HL 1	1 Pair	112,975 112,995	118,000 118,022	40,550	S3S	180 121 0013 00 15 21	1		1									
CB/PL 1	1 Pair	94,219 94,242	97,950 97,972	33,770	S3S	181 121 0003 00 15 21	2											
TW/A 1	4 Halves	123,750 124,000	146,050 146,304		S3S	182 121 0002 00	2		2									



Globally reliable







FIAT-IVECO







	ccm						Pos.
F1CE0481A, F1CE0481E, F1CE0481B, F1CE0481F, F1CE0481H, F1CE0481L, F1CE3481C	2999	4	MASSIF 3.0 HPI, HPT, DAILY III, IV 3.0 D	95,80	180 121 0016 181 121 0017	Std, 0,25, 0,50, 0,75 Std, 0,25, 0,50, 0,75	1

									Set Composition / QTY									
1	95,80																	
MB/HL 1, 2, 3, 4, 5	5 Pairs	1,000	1,000	1,000	SAL	180 121 0016 00	15 21 26	1		4		3		1		1		
CB/PL 1, 2, 3, 4	4 Pairs	64,015 64,038	67,833 67,848	26,800	S3S	181 121 0017 00	15 21 26	4		4								

**FORD**

Globally reliable

	ccm						Pos.
TLB	999	4	Fiesta 1.0	68,70	180 021 0007 181 021 0001 182 021 0002	Std, 0,25, 0,50 Std, 0,25, 0,50 Std	1
G6A, GUD, GUE	1119	4	Escort 1.1, Fiesta 1.1, Fiesta 1.1i, Fiesta III 1.1	68,70	180 021 0007 181 021 0001 182 021 0002	Std, 0,25, 0,50 Std, 0,25, 0,50 Std	1
DHA, DHB, DHC, DHD, DHE, DHF, DHG	1242	4	Fiesta IV 1.25i 16V	71,90	180 021 0002 181 021 0005	Std, 0,25, 0,50 Std, 0,25, 0,50	2
M1CA, M1CB	999	3	FORD MONDEO V 1.0 EcoBoost	71,90	180 021 0010 181 021 0012	Std, 0,25, 0,50 Std, 0,25, 0,50	3
M1DA	998	3	FORD C-MAX II 1.0 EcoBoost FORD FOCUS III 1.0 EcoBoost FORD GRAND C-MAX 1.0 EcoBoost FORD ECOSPORT 1.0 Ti-VCT Ecoboost	71,90	180 021 0010 181 021 0012	Std, 0,25, 0,50 Std, 0,25, 0,50	3
M1JA	998	3	FORD B-MAX 1.0 EcoBoost	71,90	180 021 0010 181 021 0012	Std, 0,25, 0,50 Std, 0,25, 0,50	3
M1JC	998	3	FORD ECOSPORT 1.0 EcoBoost	71,90	180 021 0010 181 021 0012	Std, 0,25, 0,50 Std, 0,25, 0,50	3
M1JE, M1JH	998	3	FORD B-MAX 1.0 EcoBoost FORD FIESTA VI 1.0 EcoBoost	71,90	180 021 0010 181 021 0012	Std, 0,25, 0,50 Std, 0,25, 0,50	3
M2DA, SFDA	998	3	FORD C-MAX II 1.0 EcoBoost FORD FOCUS III 1.0 EcoBoost FORD GRAND C-MAX 1.0 EcoBoost	71,90	180 021 0010 181 021 0012	Std, 0,25, 0,50 Std, 0,25, 0,50	3
M2GA, M2GB	998	3	FORD TOURNEO CONNECT 1.0 EcoBoost FORD GRAND TOURNEO CONNECT 1.0 EcoBoost FORD TRANSIT CONNECT 1.0 EcoBoost	71,90	180 021 0010 181 021 0012	Std, 0,25, 0,50 Std, 0,25, 0,50	3
P4JA, P4JB, P4JC, P4JD	998	3	FORD FIESTA VI 1.0 EcoBoost	71,90	180 021 0010 181 021 0012	Std, 0,25, 0,50 Std, 0,25, 0,50	3
SFCA, SFCB, SFCC, SFCD	998	3	FORD TOURNEO COURIER 1.0 EcoBoost FORD TRANSIT COURIER 1.0 EcoBoost	71,90	180 021 0010 181 021 0012	Std, 0,25, 0,50 Std, 0,25, 0,50	3
SFJA, SFJB, SFJC, SFJD	998	3	FORD B-MAX 1.0 EcoBoost FORD FIESTA VI 1.0 EcoBoost	71,90	180 021 0010 181 021 0012	Std, 0,25, 0,50 Std, 0,25, 0,50	3
XMJA, XMJB	998	3	FORD FIESTA VI 1.0 EcoBoost	71,90	180 021 0010 181 021 0012	Std, 0,25, 0,50 Std, 0,25, 0,50	3
YYJA, YYJB	998	3	FORD FIESTA VI 1.0 EcoBoost	71,90	180 021 0010 181 021 0012	Std, 0,25, 0,50 Std, 0,25, 0,50	3
YYJC	998	3	FORD B-MAX 1.0 EcoBoost	71,90	180 021 0010 181 021 0012	Std, 0,25, 0,50 Std, 0,25, 0,50	3
YYJD	998	3	FORD ECOSPORT 1.0 EcoBoost	71,90	180 021 0010 181 021 0012	Std, 0,25, 0,50 Std, 0,25, 0,50	3
F6JA, F6JB	1399	4	FIESTA IV + V 1.4 TDCi, FUSION 1.4 TDCi	73,70	180 051 0001 181 037 0015 182 051 0001	Std, 0,25, 0,30, 0,50, 0,80 Std, 0,30, 0,50 Std	4
JBA, JBB, JLB	1297	4	Escort 1.3, Fiesta 1.3	73,96	180 021 0004 181 021 0001 182 021 0002	Std, 0,25, 0,50 Std, 0,25, 0,50 Std	5
J4B, J4C, J6A, J6B, JBC, JJA, JJD	1299	4	Escort 1.3, Fiesta 1.3, Fiesta 1.3i, Ka 1.3i, Orion 1.3	74,00	180 021 0004 181 021 0001 182 021 0002	Std, 0,25, 0,50 Std, 0,25, 0,50 Std	5
FHA, FHD, FHE, FHF, FXDA, FXDB, FXDC, FXDD	1388	4	Fiesta IV 1.4i 16V, Focus 1.4 16V, Puma 1.4 16V	76,00	180 021 0002 181 021 0005	Std, 0,25, 0,50 Std, 0,25, 0,50	2
L1E, L1F, L1G, L1H, L1J, L1K	1597	4	Escort 1.6 16V, Escort VI 1.6 16V XR3i, Escort VI 1.6i 16V, Escort VII 1.6 16V, Fiesta III 1.6i 16V, Mondeo 1.6i 16V, Orion III 1.6i 16V	76,00	180 021 0003 181 021 0004	Std, 0,25, 0,50 Std, 0,25, 0,50	6
F4B, F6D, F6G, F4A, F6B, F6E, F6F, FUA, FUAA, FUC, FUG, FUH, FUJ	1392	4	Escort 1.4i, Escort '91 Express 1.4, Escort 1.4, Fiesta III 1.4, Orion 1.4, Reliant Sabre 1400, Reliant Scimitar 1400	77,25	180 021 0005 181 021 0003 182 021 0004	Std, 0,25, 0,50, 0,75 Std, 0,25, 0,50 Std	7
ZH16 Zetec S	1597	4	Fiesta 16V, Focus 16V, Puma 16V	79,00	180 021 0002 181 021 0006	Std, 0,25, 0,50 Std, 0,25, 0,50	8
L6B, LJF, LJB, LNB, LP1, LP2, LPA, LR1, LR2, LRA, LRB, LUA, LUB, LUC, LUD, LUG, L4B, LHA, LJD, LUJ, LUK	1597	4	Escort 1.6, Fiesta 1.6 Turbo, Fiesta 1.6 XR2i, Orion 1.6	80,00	180 021 0005 181 021 0003 182 021 0004	Std, 0,25, 0,50, 0,75 Std, 0,25, 0,50 Std	7
MHA	1679	4	Puma 1.7 16V	80,00	180 021 0002 181 021 0005	Std, 0,25, 0,50 Std, 0,25, 0,50	2
MHB	1679	4	Puma 1.7 16V	80,00	180 021 0003 181 021 0004	Std, 0,25, 0,50 Std, 0,25, 0,50	6
RDA, RDB, RKA, RKB, RKC, RKF, RKH, RKJ, RKK, RQB, RQC	1796	4	Escort 1.8 16V, Escort 1.8 16V XR3i, Escort 1.8 16V 4x4, Fiesta III 1.8 16V, Fiesta III 1.8 XR2i 16V, Mondeo 1.8i 16V, Orion III 1.8i 16V	80,60	180 021 0003 181 021 0004	Std, 0,25, 0,50 Std, 0,25, 0,50	6
AAA, AMY, AYL	2792	6	Galaxy 2.8 V6, Galaxy 2.8i V6, Galaxy 2.8i V6 4x4	81,00	180 050 0011 181 050 0007	Std, 0,25, 0,50 Std, 0,25, 0,50	9
RTA, RTB, RTC, RTD, RTE, RTF, RTG, RTH, RTJ, RTK	1753	4	Escort 1.8D, Fiesta 1.8D, Orion 1.8D	82,50	180 021 0001 181 021 0002 182 021 0001	Std, 0,25, 0,50 Std, 0,25, 0,50 Std	10











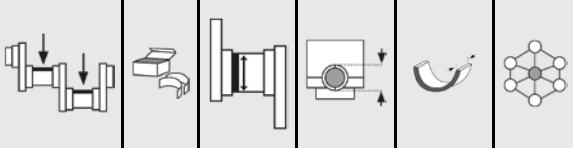

















	ccm						Pos.
BHDA, BHDB, C9DA, C9DB, C9DC, D18TC, RFA, RFB, RFD, RFK, RFL, RFM, RFN, RFS, RFU, RTN, RTP, RTQ, RVA	1753	4	Escort 1.8TD, Fiesta 1.8 TDI, Focus 1.8 DI, Mondeo 1.8TD, Orion 1.8TD, Sierra 1.8TD	82,50	180 021 0001 181 021 0010 182 021 0001	Std, 0,25, 0,50 Std, 0,25, 0,50 Std	11
YLFS, YLF6, YLFA, YLFB, YMFS, YMF6, YMR6, YMFA, YMFB, BKFA, BKFB, BLFA, BLFB	1995	4	TRANSIT CUSTOM 2.0 EcoBlue, TOURNEO CUSTOM 2.0 EcoBlue	84,01	180 021 0011 181 021 0013	Std, 0,25, 0,50 Std, 0,25, 0,50	12
EDBA, EDBB, EDBC, EDBD, EDDB, EDDC, EDDF, NGA	1988	4	Cougar 2.0 16V, Focus 2.0 16V, Mondeo 2.0i 16V	84,80	180 021 0003 181 021 0004	Std, 0,25, 0,50 Std, 0,25, 0,50	6
ABFA, D3FA, D5BA, D6BA, F3FA, FMBA, HJBA, HJBB, HJBC, PHFA, PHFC	1998	4	C-Max 2.0 TDCi, Kuga 2.0 TDCi, Mondeo 2.0 TD, Mondeo 2.0 TDCi, Mondeo 2.0 16V DI/TDDi, Transit 2.0 DI, Transit 2.0 TD, Transit 2.0 TDCi	86,00	180 021 0008 181 021 0007	Std, 0,25, 0,50 Std, 0,25, 0,50	13
AJ	2967	6	ESCAPE 3.0 V6 24V	89,00	180 085 0014 181 085 0018	Std, 0,25, 0,50, 0,75 Std, 0,25, 0,50, 0,75	14
D2FA, D4FA, F4FA	2402	4	Transit 2.4 DI, Transit 2.4 Tdi, Transit 2.4 Tddi	89,90	180 021 0008 181 021 0007	Std, 0,25, 0,50 Std, 0,25, 0,50	13
4AB, 4BA, 4BC, 4CA, 4CC, 4DA, 4EA, 4EB, 4EC, 4ED, 4FA, 4FB, 4FC, 4FD, 4GA, 4GB, 4GC, 4GD, 4GE, 4GF, 4HA, 4HB, 4HC, 4HD	2496	4	Transit 2.5 D, Transit 2.5 DI, Transit 2.5 TD, Transit 2.5 TDI, Transit Tourneo 2.5 DI, Transit Tourneo 2.5 TD	93,67	180 021 0006 181 021 0008 181 021 0009 182 021 0003	Std, 0,25, 0,50 Std, 0,25, 0,50 Std, 0,25 Std	15



FORD

Globally reliable

									Set Composition / QTY													
1	68,70																					
MB/HL 1, 2, 3	3 Pairs	56,990 57,000	60,623 60,636	18,700	SAL	180 021 0007 00 15 21	3		3													
CB/PL 1, 2, 3, 4	4 Pairs	40,990 41,010	43,990 44,010	17,950	SAL	181 021 0001 00 15 21	8															
TW/A 1	2 Halves	63,350 63,600	77,850 78,100		SAL	182 021 0002 00	2															
2	71,90																					
MB/HL 1, 2, 3, 4	4 Pairs	47,980 48,000	54,020 54,038	16,100	SAL	180 021 0002 00 15 21	4		5		1											
MB/HL 5	1 Pair	47,980 48,000	54,020 54,038	23,800	SAL																	
CB/PL 1, 2, 3, 4	4 Pairs	39,980 40,000	43,025 43,045	15,100	SSI	181 021 0005 00 15 21	8															
3	71,90																					
MB/HL 1	1 Pair	44,000	48,000	15,950	SAL	180 021 0010 00 15 21	1		1		2		1		3							
MB/HL 2, 4	2 Pairs	44,000	48,000	17,100	SAL																	
MB/HL 3	1 Pair	44,000	48,000	18,600	SAL																	
CB/PL 1, 2, 3	3 Pairs	40,000	43,000	15,600	SAL	181 021 0012 00 15 21	6															
4	73,70																					
MB/HL 1, 2, 3, 4, 5	5 Pairs	49,962 49,981	53,655 53,674	19,900	SAL	180 051 0001 00 15 17 21 28	5		5													
CB/PL 1, 2, 3, 4	4 Pairs	44,975 44,991	48,665 48,671	17,050	S4S	181 037 0015 00 17 21	4		4													
TW/A 1	2 Halves	55,200 55,480	71,350 71,700		SAL	182 051 0001 00	2															
5	73,96																					
MB/HL 1, 2, 3, 4, 5	5 Pairs	56,990 57,000	60,623 60,636	18,700	SAL	180 021 0004 00 15 21	5		5													
CB/PL 1, 2, 3, 4	4 Pairs	40,990 41,010	43,990 44,010	17,950	SAL	181 021 0001 00 15 21	8															
TW/A 1	2 Halves	63,350 63,600	77,850 78,100		SAL	182 021 0002 00	2															
6	76,00																					
MB/HL 1, 2, 3, 4	4 Pairs	57,980 58,000	62,287 62,300	19,350	SSI	180 021 0003 00 15 21	4		5		1											
MB/HL 5	1 Pair	57,980 58,000	62,287 62,300	24,680	SSI																	
CB/PL 1, 2, 3, 4	4 Pairs	46,890 46,910	49,890 49,910	20,100	SSI	181 021 0004 00 15 21	8															







 							Set Composition / QTY															
7 77,25																						
MB/HL 1, 2, 3, 4, 5	5 Pairs	57,990 58,000	62,287 62,300	22,400	SAL	180 021 0005 00 15 21 26	5		5													
CB/PL 1, 2, 3, 4	4 Pairs	47,890 47,910	50,890 50,910	19,300	SAL	181 021 0003 00 15 21	8															
TW/A 1	2 Halves	64,600 64,850	80,850 81,100		SAL	182 021 0004 00	2															
8 79,00																						
MB/HL 1, 2, 3, 4	4 Pairs	47,980 48,000	54,020 54,038	16,100	SAL	180 021 0002 00 15 21	4		5		1											
MB/HL 5	1 Pair	47,980 48,000	54,020 54,038	23,800	SAL																	
CB/PL 1, 2, 3, 4	4 Pairs	44,000	47,035 47,045	15,270	SAL	181 021 0006 00 15 21	8															
9 81,00																						
MB/HL 1, 2, 3, 4, 5, 6, 7	7 Pairs	59,958 59,978	65,000 65,010	17,000	SAL	180 050 0011 00 15 21	7		7													
CB/PL 1, 2, 3, 4, 5, 6	6 Pairs	53,958 53,978	56,800 56,819	17,000	SAL	181 050 0007 00 15 21	12															
10 82,50																						
MB/HL 1, 2, 3, 4	4 Pairs	53,970 53,990	57,683 57,696	22,900	SAL	180 021 0001 00 15	4		4		2											
MB/HL 5	1 Pair	53,970 53,990	57,683 57,696	22,150	SAL		21															
CB/PL 1, 2, 3, 4	4 Pairs	48,970 48,990	52,000 52,020	21,590	SAL	181 021 0002 00 15 21	8															
TW/A 1	2 Halves	59,346 59,690	74,498 74,752		SAL	182 021 0001 00	2															
11 82,50																						
MB/HL 1, 2, 3, 4	4 Pairs	53,970 53,990	57,683 57,696	22,900	SAL	180 021 0001 00 15	4		4		2											
MB/HL 5	1 Pair	53,970 53,990	57,683 57,696	22,150	SAL		21															
CB/PL 1, 2, 3, 4	4 Pairs	48,970 48,990	52,000 52,020	21,590	S3S	181 021 0010 00 15 21	8															
TW/A 1	2 Halves	59,346 59,690	74,498 74,752		SAL	182 021 0001 00	2															
12 84,01																						
MB/HL 1, 2, 3, 4	4 Pairs	1,000	1,000	1,000	S3S	180 021 0011 00 15	1		4		5											
MB/HL 5	1 Pair	1,000	1,000	23,300	S3S		21															
CB/PL 1, 2, 3, 4	4 Pairs	49,978 49,990	53,000 53,016	19,500	Nefrox	181 021 0013 00 15 21	4		4													



FORD

Globally reliable

							Set Composition / QTY									
13 86,00																
MB/HL 1, 2	2 Pairs	64,940 65,014	69,500 69,520	23,300	S3S	180 021 0008 00 15	1		1		1		4		3	
MB/HL 3	1 Pair	64,940 65,014	69,500 69,520	24,080	S3S	21										
MB/HL 4	1 Pair	64,940 65,014	69,500 69,520	19,580	S3S											
MB/HL 5	1 Pair	69,940 70,014	74,500 74,520	30,150	S3S											
CB/PL 1, 2, 3, 4	4 Pairs	52,980 53,000	55,996 56,016	24,550	S3S	181 021 0007 00 15	8									
14 89,00																
MB/HL 1, 2, 3	3 Pairs	62,969 62,992	67,998 68,021	17,960	SSI	180 085 0014 00 15	4		3		1					
MB/HL 4	1 Pair	62,969 62,992	67,998 68,021	22,310	SSI	21 26										
CB/PL 1, 2, 3, 4, 5, 6	6 Pairs	49,972 49,990	53,015 53,035	17,950	SSI	181 085 0018 00 15 21 26	12									
15 93,67																
MB/HL 1, 2, 4	3 Pairs	69,990 70,000	74,000 74,010	23,130	SAL	180 021 0006 00 15	1		1		3		3		2	
MB/HL 3	1 Pair	69,990 70,000	74,000 74,010	27,000	SAL	21										
MB/HL 5	1 Pair	76,990 77,000	81,000 81,010	22,000	SAL											
CB/PL 1, 2, 3, 4	4 Pairs	59,980 60,000	63,506 63,520	26,110	SAL	181 021 0008 00 15 21	8									
CB/PL 1, 2, 3, 4	4 Pairs	59,980 60,000	63,506 63,520	26,100	S3S	181 021 0009 00 15	8									
TW/A 1	4 Halves	78,750 79,000	94,000 94,250		SAL	182 021 0003 00	2		2							

	ccm 					Pos.	
GW4G15	1497	4	Great Wall 1.5	1,00	180 739 0001 181 739 0001	Std, 0,25, 0,50, 0,75, 1,00 Std, 0,25, 0,50, 0,75, 1,00	1









GREAT WALL

Globally reliable









1		1,00																				
MB/HL 1, 2, 3, 4, 5	5 Pairs	50,016	54,010	16,100	SAL	180 739 0001 00	15	5		5												
						21																
						26																
						29																
CB/PL 1, 2, 3, 4	4 Pairs	43,016	46,008	13,500	SAL	181 739 0001 00	15	4		4												
						21																
						26																
						29																









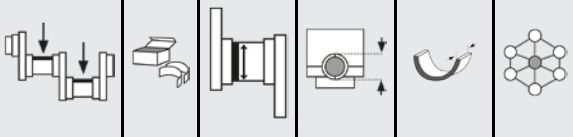

	ccm						Pos.
ER	1231	4	City 11/81-10/86	66,00	180 076 0005 181 076 0007 182 076 0003	Std, 0,25, 0,50, 0,75 Std, 0,25, 0,50 Std	1
D12A	1237	4	Civic 10/1986-	72,00	180 076 0008 181 076 0011 182 076 0003	Std, 0,25, 0,50 Std, 0,25, 0,50 Std	2
EE	1238	4	Civic 8/75-6/79	72,00	181 076 0003 182 076 0003	Std, 0,25, 0,50 Std	3
EJ	1335	4	Civic 5/78-10/83	72,00	181 076 0003 182 076 0003	Std, 0,25, 0,50 Std	3
EN	1335	4	Civic 10/79-10/83	72,00	181 076 0003 182 076 0003	Std, 0,25, 0,50 Std	3
L13A	1339	4	Fit, Mobilio, CivicHybrid	73,00	180 076 0011 181 076 0016 182 076 0001	Std, 0,25, 0,50 Std, 0,25, 0,50 Std	4
LDA	1339	4	Fit, Mobilio, CivicHybrid	73,00	180 076 0011 181 076 0016 182 076 0001	Std, 0,25, 0,50 Std, 0,25, 0,50 Std	4
L15A	1496	4	Fit, Mobilio, CivicHybrid	73,00	180 076 0011 181 076 0016 182 076 0001	Std, 0,25, 0,50 Std, 0,25, 0,50 Std	4
D13C	1296	4	Civic 8/1988-	73,70	180 076 0008 181 076 0011 182 076 0003	Std, 0,25, 0,50 Std, 0,25, 0,50 Std	2
EV	1342	4	Civic 7/83-10/87	74,00	181 076 0004 182 076 0003	Std, 0,25, 0,50 Std	6
EC	1488	4	Civic 11/74-10/79	74,00	181 076 0005 182 076 0003	Std, 0,25, 0,50 Std	5
ED	1488	4	Civic 12/73-10/86	74,00	181 076 0005 182 076 0003	Std, 0,25, 0,50 Std	5
EM	1488	4	Civic 6/79-10/83	74,00	181 076 0005 182 076 0003	Std, 0,25, 0,50 Std	5
EW	1488	4	Civic 8/80-5/89	74,00	181 076 0006 182 076 0003	Std, 0,25, 0,50 Std	7
EF	1599	4	Civic 4/76-10/86	74,00	181 076 0005 182 076 0003	Std, 0,25, 0,50 Std	5
D13A2	1343	4	Civic, Logo 9/87-7/88	75,00	180 076 0005 181 076 0004 182 076 0003	Std, 0,25, 0,50, 0,75 Std, 0,25, 0,50 Std	8
D13B	1343	4	Civic, Logo 6/1987-	75,00	180 076 0005 181 076 0004 182 076 0003	Std, 0,25, 0,50, 0,75 Std, 0,25, 0,50 Std	8
D15A	1493	4	Civic 8/87-7/88	75,00	180 076 0005 181 076 0006 182 076 0003	Std, 0,25, 0,50, 0,75 Std, 0,25, 0,50 Std	9
D15B	1493	4	Civic 6/1987-	75,00	180 076 0005 181 076 0006 182 076 0003	Std, 0,25, 0,50, 0,75 Std, 0,25, 0,50 Std	9
D15Z	1493	4	Civic 9/1991-	75,00	180 076 0005 181 076 0006 182 076 0003	Std, 0,25, 0,50, 0,75 Std, 0,25, 0,50 Std	9
D15B	1493	4	Civic 9/1991-	75,00	180 076 0005 181 076 0009 182 076 0003	Std, 0,25, 0,50, 0,75 Std, 0,25, 0,50 Std	10
D15Z	1493	4	Civic 9/1991-	75,00	180 076 0005 181 076 0009 182 076 0003	Std, 0,25, 0,50, 0,75 Std, 0,25, 0,50 Std	10
D16A	1590	4	Accura, Integra 10/86-90	75,00	180 076 0006 181 076 0009 182 076 0006	Std, 0,25, 0,50 Std, 0,25, 0,50 Std	11
ZC	1590	4	Integra, Ballade10/1984-	75,00	180 076 0006 181 076 0009 182 076 0006	Std, 0,25, 0,50 Std, 0,25, 0,50 Std	11
D17A	1688	4	Civic, Stream	75,00	180 076 0002 181 076 0002 182 076 0002	Std, 0,25 Std, 0,25, 0,50 Std	14
EP	1601	4	Civic 2/80-10/86	77,00	181 076 0005 182 076 0003	Std, 0,25, 0,50 Std	5
EK	1750	4	Civic 9/78-6/83	77,00	181 076 0005 182 076 0003	Std, 0,25, 0,50 Std	5
A18A	1829	4	Accord, Vigor 6/85-9/89	80,00	180 076 0004 181 076 0008 182 076 0003	Std, 0,25, 0,50 Std, 0,25, 0,50 Std	12
ES	1829	4	Vigor 11/82-4/87	80,00	180 076 0004 181 076 0008 182 076 0003	Std, 0,25, 0,50 Std, 0,25, 0,50 Std	12
ET	1829	4	Vigor 6/83-10/86	80,00	180 076 0004 181 076 0008 182 076 0003	Std, 0,25, 0,50 Std, 0,25, 0,50 Std	12
B16A	1595	4	Integra 4/1989-	81,00	180 076 0001 181 076 0001 182 076 0001	Std, 0,25, 0,50 Std, 0,25, 0,50 Std	13



HONDA

Globally reliable

	ccm						Pos.
B16A	1595	4	Civic, Stream	81,00	180 076 0002 181 076 0002 182 076 0002	Std, 0,25 Std, 0,25, 0,50 Std	14
B16B	1595	4	Civic, Stream	81,00	180 076 0002 181 076 0002 182 076 0002	Std, 0,25 Std, 0,25, 0,50 Std	14
B18A	1834	4	Prelude, Accord 5/1985-	81,00	180 076 0006 181 076 0008 182 076 0006	Std, 0,25, 0,50 Std, 0,25, 0,50 Std	15
B18A	1834	4	Accura, Integra 1990-93	81,00	180 076 0001 181 076 0008 182 076 0001	Std, 0,25, 0,50 Std, 0,25, 0,50 Std	16
B18B	1834	4		81,00	180 076 0001 181 076 0008 182 076 0001	Std, 0,25, 0,50 Std, 0,25, 0,50 Std	16
B18A	1834	4	Accura, Integra 1986-89	81,00	180 076 0006 181 076 0009 182 076 0006	Std, 0,25, 0,50 Std, 0,25, 0,50 Std	11
B20A	1958	4	Prelude, Accord 5/1985-	81,00	180 076 0006 181 076 0008 182 076 0006	Std, 0,25, 0,50 Std, 0,25, 0,50 Std	15
B20A	1958	4	5/1985-	81,00	180 076 0006 181 076 0010 182 076 0006	Std, 0,25, 0,50 Std, 0,25, 0,50 Std	17
B21A	1958	4	5/1991-	81,00	180 076 0006 181 076 0010 182 076 0006	Std, 0,25, 0,50 Std, 0,25, 0,50 Std	17
C20A	1996	6	Legend 10/85-10/90	82,00	181 076 0012 182 076 0003	Std, 0,25 Std	18
C20A-T	1996	6	Legend 10/88-10/90	82,00	181 076 0012 182 076 0003	Std, 0,25 Std	18
A20A	1955	4	Accord, Vigor 4/1987-	82,70	180 076 0004 181 076 0008 182 076 0003	Std, 0,25, 0,50 Std, 0,25, 0,50 Std	12
B20B	1972	4		84,00	180 076 0001 181 076 0008 182 076 0001	Std, 0,25, 0,50 Std, 0,25, 0,50 Std	16
F18B	1849	4	Accord	85,00	180 076 0009 181 076 0008 182 076 0007	Std, 0,25, 0,50 Std, 0,25, 0,50 Std	19
F20B	1997	4	Accord, Ascot, Prelude	85,00	180 076 0009 181 076 0008 182 076 0007	Std, 0,25, 0,50 Std, 0,25, 0,50 Std	19
F20A	1997	4	Accord, Prelude	85,00	180 076 0009 181 076 0010 182 076 0007	Std, 0,25, 0,50 Std, 0,25, 0,50 Std	20
F22B	2156	4	Accord, Prelude	85,00	180 076 0009 181 076 0010 182 076 0007	Std, 0,25, 0,50 Std, 0,25, 0,50 Std	20
K20A	1998	4	Stream, CR-V, Accord, Accord WGN, Integra, Civic, Step WGN	86,00	180 076 0010 181 076 0014 182 076 0009 184 076 0001	Std, 0,25 Std, 0,25, 0,50 Std Std	21
K24A	2354	4	Accord, Accord WGN, CR-V	87,00	180 076 0010 181 076 0015 182 076 0009 184 076 0001	Std, 0,25 Std, 0,25, 0,50 Std Std	22











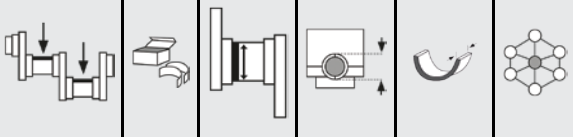





							 		Set Composition / QTY												
1	66,00																				
MB/HL 1, 2, 3, 4, 5	5 Pairs	45,000	49,000	20,000	SAL	180 076 0005 00 15 21 26	10														
CB/PL 1, 2, 3, 4	4 Pairs	37,000	40,000	17,500	S3S	181 076 0007 00 15 21															
TW/A 1	2 Halves	56,250	78,000		SAL	182 076 0003 00															
2	72,00																				
MB/HL 1, 2, 3, 4, 5	5 Pairs	43,000	47,000	20,000	SAL	180 076 0008 00 15 21															
CB/PL 1, 2, 3, 4	4 Pairs	39,000	42,000	18,500	S3S	181 076 0011 00 15 21															
TW/A 1	2 Halves	56,250	78,000		SAL	182 076 0003 00															
3	72,00																				
CB/PL 1, 2, 3, 4	4 Pairs	40,000	43,000	17,500	S3S	181 076 0003 00 15 21	8														
TW/A 1	2 Halves	56,250	78,000		SAL	182 076 0003 00															
4	73,00																				
MB/HL 1, 2, 3, 4, 5	5 Pairs	50,000	54,000	17,000	SAL	180 076 0011 00 15 21	5		5												
CB/PL 1, 2, 3, 4	4 Pairs	40,000	43,000	13,500	SAL	181 076 0016 00 15 21	8														
TW/A 1	2 Halves	61,250	82,000		SAL	182 076 0001 00	2														
5	74,00																				
CB/PL 1, 2, 3, 4	4 Pairs	42,000	45,000	17,500	S3S	181 076 0005 00 15 21	8														
TW/A 1	2 Halves	56,250	78,000		SAL	182 076 0003 00															
6	74,00																				
CB/PL 1, 2, 3, 4	4 Pairs	40,000	43,000	18,500	S3S	181 076 0004 00 15 21	8														
TW/A 1	2 Halves	56,250	78,000		SAL	182 076 0003 00															
7	74,00																				
CB/PL 1, 2, 3, 4	4 Pairs	42,000	45,000	18,500	S3S	181 076 0006 00 15 21	8														
TW/A 1	2 Halves	56,250	78,000		SAL	182 076 0003 00															



HONDA

Globally reliable

											Set Composition / QTY										
8 75,00																					
MB/HL 1, 2, 3, 4, 5	5 Pairs	45,000	49,000	20,000	SAL	180 076 0005 00	15 21 26	10													
CB/PL 1, 2, 3, 4	4 Pairs	40,000	43,000	18,500	S3S	181 076 0004 00	15 21	8													
TW/A 1	2 Halves	56,250	78,000		SAL	182 076 0003 00															
9 75,00																					
MB/HL 1, 2, 3, 4, 5	5 Pairs	45,000	49,000	20,000	SAL	180 076 0005 00	15 21 26	10													
CB/PL 1, 2, 3, 4	4 Pairs	42,000	45,000	18,500	S3S	181 076 0006 00	15 21	8													
TW/A 1	2 Halves	56,250	78,000		SAL	182 076 0003 00															
10 75,00																					
MB/HL 1, 2, 3, 4, 5	5 Pairs	45,000	49,000	20,000	SAL	180 076 0005 00	15 21 26	10													
CB/PL 1, 2, 3, 4	4 Pairs	45,000	48,000	18,500	S3S	181 076 0009 00	15 21	8													
TW/A 1	2 Halves	56,250	78,000		SAL	182 076 0003 00															
11 75,00																					
MB/HL 1, 2, 3, 4, 5	5 Pairs	55,000	59,000	20,000	S3S	180 076 0006 00	15 21	10													
CB/PL 1, 2, 3, 4	4 Pairs	45,000	48,000	18,500	S3S	181 076 0009 00	15 21	8													
TW/A 1	2 Halves	61,250	82,000		SAL	182 076 0006 00		2													
12 80,00																					
MB/HL 1, 2, 3, 4, 5	5 Pairs	50,000	54,000	20,000	S3S	180 076 0004 00	15 21														
CB/PL 1, 2, 3, 4	4 Pairs	45,000	48,000	19,500	S3S	181 076 0008 00	15 21	8													
TW/A 1	2 Halves	56,250	78,000		SAL	182 076 0003 00															
13 81,00																					
MB/HL 1, 2, 3, 4, 5	5 Pairs	55,000	59,000	20,000	S3S	180 076 0001 00	15 21														
CB/PL 1, 2, 3, 4	4 Pairs	45,000	48,000	19,500	S3S	181 076 0001 00	15 21														
TW/A 1	2 Halves	61,250	82,000		SAL	182 076 0001 00		2													







							 		Set Composition / QTY											
14 81,00																				
MB/HL 1, 2, 3, 4, 5	5 Pairs	55,000	59,000	20,000	SAL	180 076 0002 00	15	5		5										
CB/PL 1, 2, 3, 4	4 Pairs	45,000	48,000	15,500	S3S	181 076 0002 00	15 21	8												
TW/A 1	2 Halves	61,250	82,000		SAL	182 076 0002 00		2												
15 81,00																				
MB/HL 1, 2, 3, 4, 5	5 Pairs	55,000	59,000	20,000	S3S	180 076 0006 00	15 21	10												
CB/PL 1, 2, 3, 4	4 Pairs	45,000	48,000	19,500	S3S	181 076 0008 00	15 21	8												
TW/A 1	2 Halves	61,250	82,000		SAL	182 076 0006 00		2												
16 81,00																				
MB/HL 1, 2, 3, 4, 5	5 Pairs	55,000	59,000	20,000	S3S	180 076 0001 00	15 21													
CB/PL 1, 2, 3, 4	4 Pairs	45,000	48,000	19,500	S3S	181 076 0008 00	15 21	8												
TW/A 1	2 Halves	61,250	82,000		SAL	182 076 0001 00		2												
17 81,00																				
MB/HL 1, 2, 3, 4, 5	5 Pairs	55,000	59,000	20,000	S3S	180 076 0006 00	15 21	10												
CB/PL 1, 2, 3, 4	4 Pairs	48,000	51,000	19,400	S3S	181 076 0010 00	15 21	8												
TW/A 1	2 Halves	61,250	82,000		SAL	182 076 0006 00		2												
18 82,00																				
CB/PL 1, 2, 3, 4, 5, 6	6 Pairs	45,000	48,000	17,500	S3S	181 076 0012 00	15													
TW/A 1	2 Halves	56,250	78,000		SAL	182 076 0003 00														
19 85,00																				
MB/HL 1, 2, 3, 4, 5	5 Pairs	50,000	54,000	20,000	S3S	180 076 0009 00	15 21													
CB/PL 1, 2, 3, 4	4 Pairs	45,000	48,000	19,500	S3S	181 076 0008 00	15 21	8												
TW/A 1	2 Halves	57,750	78,000		SAL	182 076 0007 00		2												



















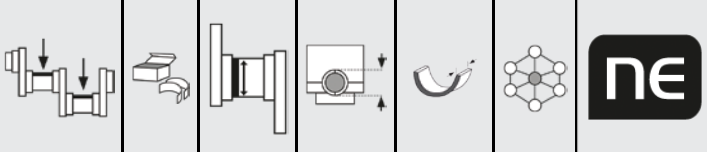















HONDA











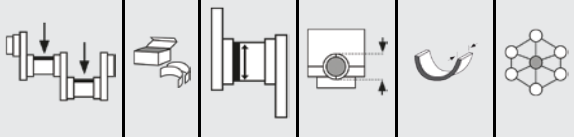











Globally reliable











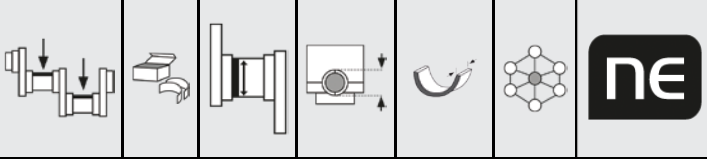

















							Set Composition / QTY													
20	85,00																			
MB/HL 1, 2, 3, 4, 5	5 Pairs	50,000	54,000	20,000	S3S	180 076 0009 00 15 21														
CB/PL 1, 2, 3, 4	4 Pairs	48,000	51,000	19,400	S3S	181 076 0010 00 15 21	8													
TW/A 1	2 Halves	57,750	78,000		SAL	182 076 0007 00	2													
21	86,00																			
MB/HL 1, 2, 3, 4, 5	5 Pairs	55,000	59,000	20,000	SAL	180 076 0010 00 15	5		5											
CB/PL 1, 2, 3, 4	4 Pairs	45,000	48,000	15,500	S3S	181 076 0014 00 15 21	8													
TW/A 1	2 Halves	62,750	81,750		SAL	182 076 0009 00	2													
Bush/PB 1, 2, 3, 4	4 Pairs	21,965	23,969	19,800	SL	184 076 0001 00														
22	87,00																			
MB/HL 1, 2, 3, 4, 5	5 Pairs	55,000	59,000	20,000	SAL	180 076 0010 00 15	5		5											
CB/PL 1, 2, 3, 4	4 Pairs	48,000	51,000	15,500	S3S	181 076 0015 00 15 21	8													
TW/A 1	2 Halves	62,750	81,750		SAL	182 076 0009 00	2													
Bush/PB 1, 2, 3, 4	4 Pairs	21,965	23,969	19,800	SL	184 076 0001 00														

	ccm						Pos.
G4HC	999	4	Atos SOHC 12V	66,00	180 087 0003 181 087 0003 182 087 0002	Std, 0,25, 0,50, 0,75, 1,00 Std, 0,25, 0,50, 0,75, 1,00 Std	1
G4HG	1086	4	Santro	67,00	180 087 0003 181 087 0003 182 087 0002	Std, 0,25, 0,50, 0,75, 1,00 Std, 0,25, 0,50, 0,75, 1,00 Std	1
G4LA	1248	4	i10 1.2, i20 1.2, GRAND i10 1.2	71,00	180 087 0010 181 087 0009 182 087 0004	Std, 0,25, 0,50, 0,75 Std, 0,25, 0,50, 0,75 Std	2
G4EA, G4EH	1341	4	Getz, Verna SOHC 12V, Accent SOHC 12V	71,50	180 087 0001 181 087 0001	Std, 0,25, 0,50, 0,75, 1,00 Std, 0,25, 0,50, 0,75, 1,00	5
D4FA For OE No.: 23060-2A922 21020-2A923 21021-2A921	1493	4	ACCENT III 1.5 CRDi, ELANTRA LAVITA 1.5 CRDi, GETZ 1.5 CRDi, MATRIX 1.5 CRDi, VERNA 1.5 CRDi	75,00	180 087 0011 181 087 0010	Std, 0,25, 0,50, 0,75 Std, 0,25, 0,50, 0,75	3
G4AJ, G4DJ, 4G15	1468	4	Excel, Scoupe	75,50	180 088 0005 181 088 0006 181 088 0007	Std, 0,25, 0,50, 0,75, 1,00 Std, 0,25, 0,50 Std, 0,25, 0,50, 0,75, 1,00	4
G4EK	1495	4	Lantra, Excel, Accent	75,50	180 087 0001 181 087 0001	Std, 0,25, 0,50, 0,75, 1,00 Std, 0,25, 0,50, 0,75, 1,00	5
G4CM	1597	4	Elantra	76,90	180 087 0002 181 087 0002 182 087 0001	Std, 0,25, 0,50, 0,75, 1,00 Std, 0,25, 0,50, 0,75, 1,00 Std	11
G4FA For OE No.: 23060-2B020 21020-2B010 21030-2B000	1396	4	ACCENT IV 1.4, i20 1.4, i30 1.4, ix20 1.4	77,00	180 087 0017 181 087 0016 182 087 0005	Std, 0,25, 0,50, 0,75, 1,00 Std, 0,25, 0,50, 0,75, 1,00 Std	6
G4FA For OE No.: 23060-2B002 21020-2B000 21030-2B000	1396	4	ACCENT IV 1.4, i20 1.4, i30 1.4, ix20 1.4	77,00	180 087 0012 181 087 0011 182 087 0005	Std, 0,25, 0,50, 0,75 Std, 0,25, 0,50, 0,75 Std	7
G4FC For OE No.: 23060-2B020 21020-2B010 21030-2B000	1591	4	ACCENT 1.6, ELANTRA 1.6, i20 1.6, i30 1.6, ix20 1.6, VELOSTER 1.6	77,00	180 087 0017 181 087 0016 182 087 0005	Std, 0,25, 0,50, 0,75, 1,00 Std, 0,25, 0,50, 0,75, 1,00 Std	6
G4FD For OE No.: 23060-2B002 21020-2B000 21030-2B000	1591	4	ACCENT IV 1.6 GDI, i30 1.6 GDI, i40 1.6 GDI, ix35 1.6, TUCSON 1.6, VELOSTER 1.6 GDI	77,00	180 087 0012 181 087 0011 182 087 0005	Std, 0,25, 0,50, 0,75 Std, 0,25, 0,50, 0,75 Std	7
G4FG For OE No.: 23060-2B002 21020-2B000 21030-2B000	1591	4	ACCENT 1.6, ELANTRA 1.6, i30 1.6, i35 1.6, VELOSTER 1.6	77,00	180 087 0012 181 087 0011 182 087 0005	Std, 0,25, 0,50, 0,75 Std, 0,25, 0,50, 0,75 Std	7
G4FC For OE No.: 23060-2B002 21020-2B000 21030-2B000	1591	4	ACCENT 1.6, ELANTRA 1.6, i20 1.6, i30 1.6, ix20 1.6, VELOSTER 1.6	77,00	180 087 0012 181 087 0011 182 087 0005	Std, 0,25, 0,50, 0,75 Std, 0,25, 0,50, 0,75 Std	7
4G51	1850	4	Grace	81,00	180 088 0006 181 088 0009	Std, 0,25, 0,50, 0,75, 1,00 Std, 0,25, 0,50, 0,75, 1,00	8
G4NA	1999	4	ELANTRA 2.0, i40 2.0 CVT, TUCSON 2.0 IX35 2.0, SONATA VI 2.0,	81,00	180 087 0019 181 087 0019	Std, 0,25, 0,50, 0,75, 1,00 Std, 0,25, 0,50, 0,75, 1,00	9
G4CN	1836	4	Elantra, Sonata	81,50	180 088 0007 181 088 0008	Std, 0,25, 0,50, 0,75, 1,00, 1,25, 1,50 Std, 0,25, 0,50, 0,75, 1,00, 1,25, 1,50	10
G4GM	1795	4	Coupe, Lantra	82,00	180 087 0002 181 087 0002 182 087 0001	Std, 0,25, 0,50, 0,75, 1,00 Std, 0,25, 0,50, 0,75, 1,00 Std	11
G4CR	1596	4	Elantra, Lantra	82,30	180 088 0007 181 088 0008	Std, 0,25, 0,50, 0,75, 1,00, 1,25, 1,50 Std, 0,25, 0,50, 0,75, 1,00, 1,25, 1,50	10
D3EA	1493	3	MATRIX 1.5 CRDi, GETZ 1.5 CRDi, ELANTRA LAVITA 1.5 CRDi, ACCENT II 1.5 CRDi	83,00	180 087 0004 181 087 0004	Std, 0,25, 0,50 Std, 0,25, 0,50	12
D4EA, D4EA-F, D4EA-V	1991	4	TUCSON 2.0 CRDi, TRAJET 2.0 CRDi, SANTA FÉ I + II 2.0 CRDi, ELANTRA 2.0 CRDi, SONATA IV + V 2.0 CRDi, i30 2.0 CRDi	83,00	180 087 0005 181 087 0005	Std, 0,25, 0,50, 0,75 Std, 0,25, 0,50, 0,75	13
D4HA	1995	4	ix35 2.0 CRDi, TUCSON 2.0 CRDi, SANTA FÉ II + III 2.0 CRDi	84,00	180 087 0009 181 087 0008 182 087 0003	Std, 0,25, 0,50, 0,75 Std, 0,25, 0,50, 0,75 Std	14
G4CP	1997	4	Elantra, Lantra	85,00	180 088 0007 181 088 0008	Std, 0,25, 0,50, 0,75, 1,00, 1,25, 1,50 Std, 0,25, 0,50, 0,75, 1,00, 1,25, 1,50	10

	ccm						Pos.
D4HB	2199	4	Grand Santa Fe 2.2 CRDI, Santa Fe II + III 2.2 CRDI	85,40	180 087 0009 181 087 0018 182 087 0003	Std, 0,25, 0,50, 0,75 Std, 0,25, 0,50, 0,75 Std	15
G4CS	2350	4	Sonata, Grace, Gandeur	86,50	180 088 0007 181 088 0008	Std, 0,25, 0,50, 0,75, 1,00, 1,25, 1,50 Std, 0,25, 0,50, 0,75, 1,00, 1,25, 1,50	10
G6BA	2656	6	GRANDEUR 2.7, SANTA FÉ 2.7, TUCSON 2.7	86,70	180 087 0014 181 087 0013	Std, 0,25, 0,50, 0,75, 1,00 Std, 0,25, 0,50, 0,75, 1,00	16
G6AT, G6AV	2972	6	Sonata, Grandeur, Marcia	91,00	180 088 0009 181 088 0013 182 088 0017	Std, 0,25, 0,50, 0,75, 1,00 Std, 0,25, 0,50, 0,75, 1,00 Std	17
D4CB	2497	4	Starex, Terracon, Libero, Porter II, Kia Sorento 2.5 CRDI	91,00	180 087 0006 181 087 0006 182 087 0006	Std, 0,25, 0,50, 0,75 Std, 0,25, 0,50, 0,75 Std	18
G6AT	2972	6	Galloper II 3.0, Sonata I 3.0i V6, Sonata II 3.0i, Sonata III 3.0i, XG 3.0i 24V	91,10	180 088 0009 181 088 0013 182 088 0017	Std, 0,25, 0,50, 0,75, 1,00 Std, 0,25, 0,50, 0,75, 1,00 Std	17
G6DG	2999	6	AZERA 3.0	92,00	180 087 0016 181 087 0015	Std, 0,25, 0,50, 0,75, 1,00 Std, 0,25, 0,50, 0,75, 1,00	19
G6DF	3342	6	GRAND SANTA FÉ 3.3	92,00	180 087 0016 181 087 0015	Std, 0,25, 0,50, 0,75, 1,00 Std, 0,25, 0,50, 0,75, 1,00	19
G6DC	3470	6	SANTA FÉ II 3.5	92,00	180 087 0016 181 087 0015	Std, 0,25, 0,50, 0,75, 1,00 Std, 0,25, 0,50, 0,75, 1,00	19
G6DA	3778	6	ix55 3.8 V6	96,00	180 087 0016 181 087 0015	Std, 0,25, 0,50, 0,75, 1,00 Std, 0,25, 0,50, 0,75, 1,00	19
G6DA	3778	6	EQUUS / CENTENNIAL 3.8	96,00	180 087 0016 181 087 0015	Std, 0,25, 0,50, 0,75, 1,00 Std, 0,25, 0,50, 0,75, 1,00	19
G6DA	3778	6	GENESIS Coupe 3.8	96,00	180 087 0016 181 087 0015	Std, 0,25, 0,50, 0,75, 1,00 Std, 0,25, 0,50, 0,75, 1,00	19
D4AE (4D30, 4D31)	3298	4	Mighty	100,00	180 088 0001 181 088 0001 182 088 0002	Std, 0,25, 0,50, 0,75 Std, 0,25, 0,50, 0,75 Std	20
D4AE	3298	4	Chrorus 3.3 TD	100,00	180 088 0001 181 088 0001 182 088 0002	Std, 0,25, 0,50, 0,75 Std, 0,25, 0,50, 0,75 Std	20
D6BR (6D16)	7545	6	.	118,00	180 088 0002 181 088 0003	Std, 0,25, 0,50 Std, 0,25, 0,50	21

							Set Composition / QTY														
1 66,00																					
MB/HL 1, 2, 3, 4, 5	5 Pairs	42,000	46,000	16,100	SAL	180 087 0003 00	15	5		5											
							21	8													
							26	2													
							29														
CB/PL 1, 2, 3, 4	4 Pairs	38,000	41,000	14,600	SAL	181 087 0003 00	15														
							21														
							26														
							29														
TW/A 1	2 Halves	1,000	1,000		SAL	182 087 0002 00	00														
							00														
2 71,00																					
MB/HL 1, 2, 3, 4, 5	5 Pairs	43,000	47,000	15,100	SAL	180 087 0010 00	15	5		5											
							21	8													
							26	2													
							00														
CB/PL 1, 2, 3, 4	4 Pairs	39,000	42,000	14,000	SAL	181 087 0009 00	15														
							21														
							26														
							00														
TW/A 1	2 Halves	48,000	61,750		SAL	182 087 0004 00	00														
							00														
3 75,00																					
MB/HL 1, 2, 3, 4	4 Pairs	54,000	58,000	18,100	SAL	180 087 0011 00	15	4		4		1		1							
MB/HL 5	1 Pair	54,000	58,000	24,000	SAL	21	26														
							00	4		1											
CB/PL 1, 2, 3, 4	4 Pairs	46,000	49,000	18,700	S32S	181 087 0010 00	15														
							21														
							26														
							00														
4 75,50																					
MB/HL 1, 2, 4, 5	4 Pairs	48,000	52,000	19,130	SAL	180 088 0005 00	15	4		4		2									
MB/HL 3	1 Pair	48,000	52,000	23,950	SAL	21	26														
							29	8													
CB/PL 1, 2, 3, 4	4 Pairs	42,000	45,000	17,630	SAL	181 088 0006 00	15														
							21	8													
							00														
CB/PL 1, 2, 3, 4	4 Pairs	42,000	45,000	15,630	SAL	181 088 0007 00	15														
							21	8													
							26														
							29														
5 75,50																					
MB/HL 1, 2, 3, 4	4 Pairs	50,000	54,000	18,000	SAL	180 087 0001 00	15	4		4		2									
							21														
							26														
							29														
MB/HL 5	1 Pair	50,000	54,000	22,920	SAL	21	26														
							29														
CB/PL 1, 2, 3, 4	4 Pairs	45,000	48,000	19,100	SAL	181 087 0001 00	15	4		4											
							21														
							26														
							29														

							 		Set Composition / QTY											
6							77,00													
MB/HL 1, 2, 3, 4, 5	5 Pairs	48,000	52,000	16,000	SAL	180 087 0017 00	15 21 26 29	5		5										
CB/PL 1, 2, 3, 4	4 Pairs	42,000	45,000	14,300	SAL	181 087 0016 00	15 21 26 29	8												
TW/A 1	2 Halves	54,000	71,000		SAL	182 087 0005 00		2												
7							77,00													
MB/HL 1, 2, 3, 4, 5	5 Pairs	48,000	52,000	16,000	SAL	180 087 0012 00	15 21 26	5		5										
CB/PL 1, 2, 3, 4	4 Pairs	42,000	45,000	14,500	SAL	181 087 0011 00	15 21 26	8												
TW/A 1	2 Halves	54,000	71,000		SAL	182 087 0005 00		2												
8							81,00													
MB/HL 1, 2, 4, 5	4 Pairs	66,000	70,000	25,130	SAL	180 088 0006 00	15	4		4		1		1						
MB/HL 3	1 Pair	66,000	70,000	30,950	SAL		21 26 29													
CB/PL 1, 2, 3, 4	4 Pairs	53,000	56,007	25,130	SAL	181 088 0009 00	15 21 26 29	8												
9							81,00													
MB/HL 1, 2, 3, 4, 5	5 Pairs	54,942 54,960	59,000 59,018	18,130	SAL	180 087 0019 00	15 21 26 29	5		5										
CB/PL 1, 2, 3, 4	4 Pairs	44,954 44,972	48,000 48,018	16,100	S3S	181 087 0019 00	15 21 26 29	8												
10							81,50													
MB/HL 1, 2, 4, 5	4 Pairs	57,000	61,000	23,130	SAL	180 088 0007 00	15	4		4		2								
MB/HL 3	1 Pair	57,000	61,000	28,950	SAL		21 26 29 31 33													
CB/PL 1, 2, 3, 4	4 Pairs	45,000	48,000	23,630	SAL	181 088 0008 00	15 21 26 29 31 33	8												







									Set Composition / QTY																		
11 82,00							MB/HL 1, 2, 3, 4, 5	5 Pairs	58,000	61,000	21,000	SAL	180 087 0002 00 15 21 26 29	4		4		2									
							CB/PL 1, 2, 3, 4	4 Pairs	45,000	48,000	21,000	SAL	181 087 0002 00 15 21 26 29	8													
							TW/A 1	2 Halves	63,000	84,700		SAL	182 087 0001 00	2													
12 83,00							MB/HL 1, 2, 3	3 Pairs	60,000	64,000	21,500	SAL	180 087 0004 00 15	3		3		1		1							
							MB/HL 4	1 Pair	60,000	64,000	27,250	SAL	21														
							CB/PL 1, 2, 3	3 Pairs	50,000	53,000	22,000	S3S	181 087 0004 00 15 21	6													
13 83,00							MB/HL 1, 2, 3, 4	4 Pairs	60,000	64,000	21,500	SAL	180 087 0005 00 15	4		4		1		1							
							MB/HL 5	1 Pair	60,000	64,000	27,850	SAL	21 26														
							CB/PL 1, 2, 3, 4	4 Pairs	50,000	53,000	22,000	S3S	181 087 0005 00 15 21 26	8													
14 84,00							MB/HL 1, 2, 3, 4, 5	5 Pairs	60,000	64,000	18,900	S3S	180 087 0009 00 15 21 26	5		5											
							CB/PL 1, 2, 3, 4	4 Pairs	48,000	51,000	20,900	S3S	181 087 0008 00 15 21 26	4		4											
							TW/A 1	2 Halves	66,100	88,100		SAL	182 087 0003 00	2													
15 85,40							MB/HL 1, 2, 3, 4, 5	5 Pairs	60,000	64,000	18,900	S3S	180 087 0009 00 15 21 26	5		5											
							CB/PL 1, 2, 3, 4	4 Pairs	52,000 52,018	55,000 55,018	20,930	Nefrox	181 087 0018 00 15 21 26	4		4											
							TW/A 1	2 Halves	66,100	88,100		SAL	182 087 0003 00	2													
16 86,70							MB/HL 1, 2, 3, 4	4 Pairs	62,000	66,000	17,000	SAL	180 087 0014 00 15 21 26 29	4		4											
							CB/PL 1, 2, 3, 4, 5, 6	6 Pairs	48,000	51,000	15,000	SAL	181 087 0013 00 15 21 26 29	12													



HYUNDAI

Globally reliable

							Set Composition / QTY															
17 91,00																						
MB/HL 1, 2, 3, 4	4 Pairs	60,000	64,000	18,130	SAL	180 088 0009 00	15 21 26 29	4		4												
CB/PL 1, 2, 3, 4, 5, 6	6 Pairs	50,000	53,000	15,500	SAL	181 088 0013 00	15 21 26 29	12														
TW/A 1	4 Halves	66,250	77,700		SAL	182 088 0017 00		2		2												
18 91,00																						
MB/HL 1, 2, 3, 4, 5	5 Pairs	67,000	71,000	24,000	SAL	180 087 0006 00	15 21 26	5		5												
CB/PL 1, 2, 3, 4	4 Pairs	57,000	60,000	27,000	S3S	181 087 0006 00	15 21 26	8														
TW/A 1	4 Halves	73,000 73,250	89,500 89,750		SAL	182 087 0006 00		4														
19 92,00																						
MB/HL 1, 2, 3, 4	4 Pairs	69,000	73,500	18,000	S3S	180 087 0016 00	15 21 26 29	4		4												
CB/PL 1, 2, 3, 4, 5, 6	6 Pairs	55,000	58,000	16,000	S3S	181 087 0015 00	15 21 26 29	6		6												
20 100,00																						
MB/HL 1, 2, 3, 4, 5	5 Pairs	77,960	82,000	27,130	S3S	180 088 0001 00	15 21 26	5		5												
CB/PL 1, 2, 3, 4	4 Pairs	59,965	64,000	33,130	S3S	181 088 0001 00	15 21 26	4		4												
TW/A 1	3 Halves	83,250	104,000		SL	182 088 0002 00		3														
21 118,00																						
MB/HL 1, 2, 3, 4, 5, 6, 7	7 Pairs	79,955	85,000	28,130	S3S	180 088 0002 00	15 21	7		7												
CB/PL 1, 2, 3, 4, 5, 6	6 Pairs	64,940	69,000	34,130	S3S	181 088 0003 00	15 21	6		6												







	ccm						Pos.
BC-144	2358	4	.	85,72	180 027 0001 181 027 0001	Std, 0,25, 0,50, 0,75 Std, 0,25, 0,50, 0,75	1
BD154	2713	4	.	88,90	180 027 0001 181 027 0001	Std, 0,25, 0,50, 0,75 Std, 0,25, 0,50, 0,75	1



IHC - CASE IH

Globally reliable







									Set Composition / QTY								
1	85,72																
MB/HL 1, 2, 3, 4	4 Pairs	53,950 53,975	58,336 58,356	27,200	SAL	180 027 0001 00	4		4		2						
MB/HL 5	1 Pair	53,950 53,975	58,336 58,356	32,290	SAL												
CB/PL 1	1 Pair	44,425 44,450	47,638 47,650	27,270	S3S	181 027 0001 00	2										







	ccm						Pos.
4JF1	1496	4	1987-	75,30	180 079 0011 181 079 0009 182 079 0007 183 079 0006 184 079 0004	Std, 0,25, 0,50, 0,75 Std, 0,25, 0,50, 0,75 Std, 0,25 Std Std	8
4EC1	1487	4	3/85-2/90	76,00	180 079 0006 180 079 0007 181 079 0006 182 079 0004	Std, 0,25 Std, 0,25, 0,50, 0,75 Std, 0,25, 0,50, 0,75 Std	1
4XC1	1471	4	1985-	77,00	180 079 0015 181 079 0010 181 079 0011 181 079 0012 182 079 0005 182 079 0009	Std, 0,25 Std, 0,25 Std Std Std Std	2
4EE1-T	1686	4	2/1990-	79,00	180 079 0007 181 079 0006 182 079 0005 184 079 0005	Std, 0,25, 0,50, 0,75 Std, 0,25, 0,50, 0,75 Std Std	3
4XE1	1588	4	1/1988-	80,00	180 079 0015 181 079 0010 181 079 0011 181 079 0012 182 079 0005 182 079 0009	Std, 0,25 Std, 0,25 Std Std Std Std	2
4ZA1	1584	4	1/1981-	82,00	180 079 0014 181 079 0013 182 079 0010	Std, 0,25, 0,50 Std, 0,25, 0,50 Std	6
C221	2207	4	1968-7/79	83,00	180 079 0004 181 079 0005 182 079 0008	Std, 0,25, 0,50 Std, 0,25, 0,50 Std, 0,25	4
4ZB1	1817	4	3/81-6/90	84,00	180 079 0014 181 079 0013 182 079 0010	Std, 0,25, 0,50 Std, 0,25, 0,50 Std	6
4JE1	1862	4	1987-	84,00	180 079 0011 181 079 0009 182 079 0007 183 079 0006 184 079 0004	Std, 0,25, 0,50, 0,75 Std, 0,25, 0,50, 0,75 Std, 0,25 Std Std	8
4JD1	2039	4	1987-	84,00	180 079 0011 181 079 0009 182 079 0007 183 079 0006 184 079 0004	Std, 0,25, 0,50, 0,75 Std, 0,25, 0,50, 0,75 Std, 0,25 Std Std	8
C190	1951	4	1971-83	86,00	180 079 0005 181 079 0005 182 079 0007	Std, 0,25, 0,50 Std, 0,25, 0,50 Std, 0,25	5
C240	2369	4	1969-	86,00	180 079 0004 181 079 0005 182 079 0008	Std, 0,25, 0,50 Std, 0,25, 0,50 Std, 0,25	4
G200	1949	4	4/88-89	87,00	180 079 0014 181 079 0013 182 079 0010	Std, 0,25, 0,50 Std, 0,25, 0,50 Std	6
4ZC1	1994	4	3/86-	88,00	180 079 0014 181 079 0013 182 079 0010	Std, 0,25, 0,50 Std, 0,25, 0,50 Std	6
4JC1	2238	4	1/84-	88,00	180 079 0011 181 079 0009 182 079 0007 183 079 0006 184 079 0004	Std, 0,25, 0,50, 0,75 Std, 0,25, 0,50, 0,75 Std, 0,25 Std Std	8
D201	2238	2	85-8/88	88,00	180 079 0011 181 079 0009 182 079 0007 183 079 0006 184 079 0004	Std, 0,25, 0,50, 0,75 Std, 0,25, 0,50, 0,75 Std, 0,25 Std Std	8
4ZD1	2254	4	5/84-	89,30	180 079 0014 181 079 0013 182 079 0010	Std, 0,25, 0,50 Std, 0,25, 0,50 Std	6
4ZE1	2559	4	1987-	92,60	180 079 0016 181 079 0014 182 079 0010	Std, 0,25, 0,50 Std, 0,25, 0,50 Std	7
4JA1	2499	4	5/1984-	93,00	180 079 0011 181 079 0009 182 079 0007 183 079 0006 184 079 0004	Std, 0,25, 0,50, 0,75 Std, 0,25, 0,50, 0,75 Std, 0,25 Std Std	8
UM4JA1	2499	4	7/84-89	93,00	180 079 0011 181 079 0009 182 079 0007 183 079 0006 184 079 0004	Std, 0,25, 0,50, 0,75 Std, 0,25, 0,50, 0,75 Std, 0,25 Std Std	8











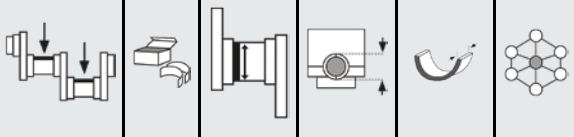





















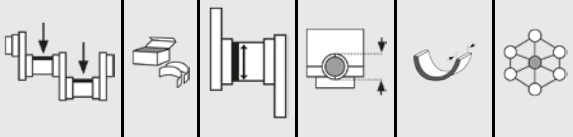



ISUZU

Globally reliable

	ccm						Pos.
4JB1	2771	4	1984-	93,00	180 079 0012 181 079 0009 182 079 0008 183 079 0006 184 079 0004 184 079 0009	Std, 0,25, 0,50, 0,75 Std, 0,25, 0,50, 0,75 Std, 0,25 Std Std Std	9
UM4JB1	2771	4	1984-	93,00	180 079 0012 181 079 0009 182 079 0008 183 079 0006 184 079 0004 184 079 0009	Std, 0,25, 0,50, 0,75 Std, 0,25, 0,50, 0,75 Std, 0,25 Std Std Std	9
4JH1-T	2999	4	.	95,40	180 079 0012 181 079 0009 182 079 0008 183 079 0006 184 079 0004 184 079 0009	Std, 0,25, 0,50, 0,75 Std, 0,25, 0,50, 0,75 Std, 0,25 Std Std Std	9
4JG2	3059	4	.	95,40	180 079 0012 181 079 0009 182 079 0008 183 079 0006 184 079 0004 184 079 0009	Std, 0,25, 0,50, 0,75 Std, 0,25, 0,50, 0,75 Std, 0,25 Std Std Std	9
4BA1	2775	4	10/85-5/88	98,00	180 079 0009 181 079 0008 182 079 0002 182 079 0011 183 079 0003 184 079 0002 184 079 0007	Std, 0,25, 0,50 Std, 0,25, 0,50 Std Std Std Std Std	10
UM4BA1	2775	4	10/85-5/88	98,00	180 079 0009 181 079 0008 182 079 0002 182 079 0011 183 079 0003 184 079 0002 184 079 0007	Std, 0,25, 0,50 Std, 0,25, 0,50 Std Std Std Std Std	10
4BC2	3268	4	2/80-	102,00	180 079 0009 181 079 0008 182 079 0002 182 079 0011 183 079 0003 184 079 0002 184 079 0007	Std, 0,25, 0,50 Std, 0,25, 0,50 Std Std Std Std Std	10
UM4BC2	3268	4	7/81-89	102,00	180 079 0009 181 079 0008 182 079 0002 182 079 0011 183 079 0003 184 079 0002 184 079 0007	Std, 0,25, 0,50 Std, 0,25, 0,50 Std Std Std Std Std	10
6BB1	5393	6	5/1980-	102,00	180 079 0002 181 079 0003 182 079 0003 183 079 0002 184 079 0003	0,25 0,50 Std Std Std	11
UM6BB1	5393	6	5/80-89	102,00	180 079 0002 181 079 0003 182 079 0003 183 079 0002 184 079 0003	0,25 0,50 Std Std Std	11
4BB1	3595	4	10/85-89	102,00	180 079 0009 181 079 0008 182 079 0002 182 079 0011 183 079 0003 184 079 0002 184 079 0007	Std, 0,25, 0,50 Std, 0,25, 0,50 Std Std Std Std Std	10
UM4BB1	3595	4	10/85-89	102,00	180 079 0009 181 079 0008 182 079 0002 182 079 0011 183 079 0003 184 079 0002 184 079 0007	Std, 0,25, 0,50 Std, 0,25, 0,50 Std Std Std Std Std	10
6BD1	5785	6	5/1980-	102,00	180 079 0002 181 079 0003 182 079 0003 183 079 0002 184 079 0003	0,25 0,50 Std Std Std	11
UM6BD1	5785	6	5/1980-	102,00	180 079 0002 181 079 0003 182 079 0003 183 079 0002 184 079 0003	0,25 0,50 Std Std Std	11

	ccm						Pos.
4BE1	3636	4	1/1985-	105,00	180 079 0009 181 079 0008 182 079 0002 182 079 0011 183 079 0003 184 079 0002 184 079 0007	Std, 0,25, 0,50 Std, 0,25, 0,50 Std Std Std Std Std	10
4BE2	3636	4	6/1986-	105,00	180 079 0009 181 079 0008 182 079 0002 182 079 0011 183 079 0003 184 079 0002 184 079 0007	Std, 0,25, 0,50 Std, 0,25, 0,50 Std Std Std Std Std	10
6BF1	6130	6	5/80-88	105,00	180 079 0002 181 079 0003 182 079 0003 183 079 0002 184 079 0003	0,25 0,50 Std Std Std	11
6BG1	6494	6	1/1984-	105,00	180 079 0002 181 079 0003 182 079 0003 183 079 0002 184 079 0003	0,25 0,50 Std Std Std	11
UM6BG1	6494	6	5/1985-	105,00	180 079 0002 181 079 0003 182 079 0003 183 079 0002 184 079 0003	0,25 0,50 Std Std Std	11
4HE1-T	4751	4	ISUZU N	110,00	180 079 0008 181 079 0007 181 079 0015 182 079 0006 183 079 0004	Std, 0,25, 0,50 Std, 0,25, 0,50 Std, 0,25, 0,50 Std Std	14
6HE1	7127	6	.	110,00	181 079 0001 182 079 0006	Std, 0,25, 0,50 Std	12
6HE1-T	7127	6	.	110,00	181 079 0002 182 079 0006 183 079 0001 184 079 0001	Std, 0,25 Std Std Std	13
4HF1	4334	4	5/90-	112,00	180 079 0008 181 079 0007 181 079 0015 182 079 0006 183 079 0004	Std, 0,25, 0,50 Std, 0,25, 0,50 Std, 0,25, 0,50 Std Std	14
4HG1	4570	4	NQR 71 R	115,00	180 079 0008 181 079 0007 182 079 0006 183 079 0005	Std, 0,25, 0,50 Std, 0,25, 0,50 Std Std	15
4HJ1	4985	4	.	115,00	180 079 0008 181 079 0007 182 079 0006	Std, 0,25, 0,50 Std, 0,25, 0,50 Std	16
6HH1	8226	6	-	115,00	181 079 0001 182 079 0006	Std, 0,25, 0,50 Std	12

 							Set Composition / QTY													
1 76,00																				
MB/HL 1, 2, 3, 4, 5	5 Pairs	47,938	51,976	15,530	SAL	180 079 0006 00 15														
MB/HL 1, 2, 3, 4, 5	5 Pairs	51,938	55,976	15,530	SAL	180 079 0007 00 15 21 26	5		5											
CB/PL 1, 2, 3, 4	4 Pairs	45,945	48,982	16,830	SAL	181 079 0006 00 15 21 26	8													
TW/A 1	2 Halves	59,000	69,950		SAL	182 079 0004 00														
2 77,00																				
MB/HL 1, 2, 3, 4, 5	5 Pairs	47,938	51,976	17,130	SAL	180 079 0015 00 15														
CB/PL 1, 2, 3, 4	4 Pairs	39,945	42,982	17,130	SAL	181 079 0010 00 15														
CB/PL 1, 2, 3, 4	4 Pairs	39,945	42,982	17,130	S3S	181 079 0011 00														
CB/PL 1, 2, 3, 4	4 Pairs	39,945	42,982	17,130	S3S	181 079 0012 00														
TW/A 1	2 Halves	59,000	73,700		SAL	182 079 0005 00	2													
TW/A 1	2 Halves	55,250	69,950		SAL	182 079 0009 00														
3 79,00																				
MB/HL 1, 2, 3, 4, 5	5 Pairs	51,938	55,976	15,530	SAL	180 079 0007 00 15 21 26	5		5											
CB/PL 1, 2, 3, 4	4 Pairs	45,945	48,982	16,830	SAL	181 079 0006 00 15 21 26	8													
TW/A 1	2 Halves	59,000	73,700		SAL	182 079 0005 00	2													
Bush/PB 1, 2, 3, 4	4 Pairs	27,000	30,000	23,750	SL	184 079 0005 00														
4 83,00																				
MB/HL 1, 5	2 Pairs	69,920	73,975	30,630	S3S	180 079 0004 00 15	4		4		2									
MB/HL 2, 4	2 Pairs	69,920	73,975	21,530	S3S	21														
MB/HL 3	1 Pair	69,920	73,975	36,130	S3S															
CB/PL 1, 2, 3, 4	4 Pairs	52,930	55,985	21,530	SAL	181 079 0005 00 15 21	8													
TW/A 1	2 Halves	78,050	92,950		SAL	182 079 0008 00 15	2													
5 86,00																				
MB/HL 1, 5	2 Pairs	59,932	63,975	30,630	S3S	180 079 0005 00 15	4		4		2									
MB/HL 2, 4	2 Pairs	59,932	63,975	23,130	S3S	21														
MB/HL 3	1 Pair	59,932	63,975	38,130	S3S															
CB/PL 1, 2, 3, 4	4 Pairs	52,930	55,985	21,530	SAL	181 079 0005 00 15 21	8													
TW/A 1	2 Halves	73,050	86,950		SAL	182 079 0007 00 15	2													

 							Set Composition / QTY														
6	87,00																				
MB/HL 1, 2, 3, 4, 5	5 Pairs	55,932	59,980	21,860	SAL	180 079 0014 00 15 21															
CB/PL 1, 2, 3, 4	4 Pairs	48,940	51,985	21,630	SAL	181 079 0013 00 15 21															
TW/A 1	2 Halves	64,000	80,200		SAL	182 079 0010 00															
7	92,60																				
MB/HL 1, 2, 3, 4, 5	5 Pairs	55,932	59,980	21,860	SAL	180 079 0016 00 15 21															
CB/PL 1, 2, 3, 4	4 Pairs	48,940	51,985	22,130	SAL	181 079 0014 00 15 21															
TW/A 1	2 Halves	64,000	80,200		SAL	182 079 0010 00															
8	93,00																				
MB/HL 1, 2, 3, 4, 5	5 Pairs	59,932	64,000	23,030	SAL	180 079 0011 00 15 21 26	5		5												
CB/PL 1, 2, 3, 4	4 Pairs	52,930	56,000	25,830	SAL	181 079 0009 00 15 21 26	8														
TW/A 1	2 Halves	73,050	86,950		SAL	182 079 0007 00 15	2														
Cbush/NWL 1	1 Pair	49,975	54,000	25,000	SAL	183 079 0006 00															
Cbush/NWL 2, 3	2 Pairs	49,975	54,000	22,000	SAL																
Bush/PB 1, 2, 3, 4	4 Pairs	31,000	34,000	33,000	SL	184 079 0004 00															
9	93,00																				
MB/HL 1, 2, 3, 4, 5	5 Pairs	69,932	74,000	23,030	SAL	180 079 0012 00 15 21 26	5		5												
CB/PL 1, 2, 3, 4	4 Pairs	52,930	56,000	25,830	SAL	181 079 0009 00 15 21 26	8														
TW/A 1	2 Halves	78,050	92,950		SAL	182 079 0008 00 15	2														
Cbush/NWL 1	1 Pair	49,975	54,000	25,000	SAL	183 079 0006 00															
Cbush/NWL 2, 3	2 Pairs	49,975	54,000	22,000	SAL																
Bush/PB 1, 2, 3, 4	4 Pairs	31,000	34,000	33,000	SL	184 079 0004 00															
Bush/PB 1, 2, 3, 4	4 Pairs	34,000	37,000	33,100	SL	184 079 0009 00															
10	98,00																				
MB/HL 1, 2, 3, 4, 5	5 Pairs	75,920	81,000	27,830	S3S	180 079 0009 00 15 21															
CB/PL 1, 2, 3, 4	4 Pairs	63,944	68,000	29,930	S3S	181 079 0008 00 15 21	8														
TW/A 1	4 Halves	88,250	101,000		SAL	182 079 0002 00	2		2												
TW/A 1	4 Halves	84,250	101,000		S3S	182 079 0011 00	2		2												
Cbush/NWL 1, 2, 3	3 Pairs	55,970	60,000	20,000	SL	183 079 0003 00															
Bush/PB 1, 2, 3, 4	4 Pairs	35,000	38,000	38,000	SL	184 079 0002 00															







ISUZU





Globally reliable







							Set Composition / QTY													
Bush/PB 1, 2, 3, 4	4 Pairs	33,000	36,000	38,000	SL	184 079 0007 00														
11	102,00																			
MB/HL 1, 2, 3, 4, 5, 6, 7	7 Pairs	79,920	85,000	26,830	S3S	180 079 0002 15	7		7											
CB/PL 1, 2, 3, 4, 5, 6	6 Pairs	63,944	68,000	29,930	S3S	181 079 0003 21	12													
TW/A 1	4 Halves	88,250	101,000		S3S	182 079 0003 00	2		2											
Cbush/NWL 1, 2, 3, 4, 5, 6	6 Pairs	55,970	60,000	20,000	SL	183 079 0002 00														
Bush/PB 1, 2, 3, 4, 5, 6	6 Pairs	35,000	38,000	38,000	SL	184 079 0003 00														
12	110,00																			
CB/PL 1, 2, 3, 4, 5, 6	6 Pairs	65,922	69,985	30,430	S3S	181 079 0001 00 15 21	12													
TW/A 1	3 Halves	92,750	109,750		SAL	182 079 0006 00	1		2											
13	110,00																			
CB/PL 1, 2, 3, 4, 5, 6	6 Pairs	72,922	77,985	30,430	S3S	181 079 0002 00 15	12													
TW/A 1	3 Halves	92,750	109,750		SAL	182 079 0006 00	1		2											
Cbush/NWL 1, 2, 3, 4, 5, 6, 7, 8	8 Pairs	39,975	43,000	26,130	S3S	183 079 0001 00														
Bush/PB 1, 2, 3	3 Pairs	40,000	44,000	28,700	SL	184 079 0001 00														
Bush/PB 4, 5, 6	3 Pairs	40,000	44,000	40,850	SL															
14	112,00																			
MB/HL 1, 2, 3, 4, 5	5 Pairs	81,915	87,000	27,330	S3S	180 079 0008 00 15 21	5		5											
CB/PL 1, 2, 3, 4	4 Pairs	65,922	69,985	30,430	S3S	181 079 0007 00 15 21	8													
CB/PL 1, 2, 3, 4	4 Pairs	72,922	77,985	25,830	S3S	181 079 0015 00 15 21														
TW/A 1	3 Halves	92,750	109,750		SAL	182 079 0006 00	1		2											
Half 1, 2, 3, 4, 5	5 Pairs	39,975	43,000	22,130	SAL	183 079 0004 00														









Set Composition / QTY







15	115,00																			
MB/HL 1, 2, 3, 4, 5	5 Pairs	81,915	87,000	27,330	S3S	180 079 0008 00 15 21	5		5											
CB/PL 1, 2, 3, 4	4 Pairs	65,922	69,985	30,430	S3S	181 079 0007 00 15 21	8													
TW/A 1	3 Halves	92,750	109,750		SAL	182 079 0006 00	1		2											
Half 1, 2, 3, 4, 5	5 Pairs	39,975	43,000	16,130	SAL	183 079 0005 00														











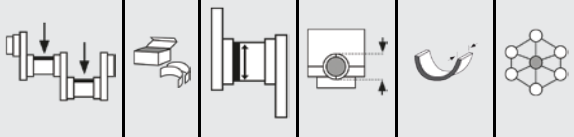











16	115,00																				
MB/HL 1, 2, 3, 4, 5	5 Pairs	81,915	87,000	27,330	S3S	180 079 0008 00 15 21	5		5												
CB/PL 1, 2, 3, 4	4 Pairs	65,922	69,985	30,430	S3S	181 079 0007 00 15 21	8														
TW/A 1	3 Halves	92,750	109,750		SAL	182 079 0006 00	1		2												











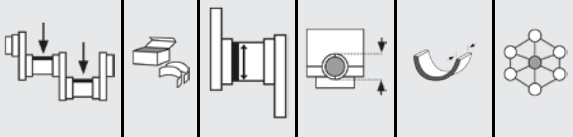









	ccm						Pos.
204DTD	1999	4	XE, XF II, 2.0 D E-PACE / F-PAGE 2.0 D	83,00	180 820 0000	Std	1

									Set Composition / QTY												
1	83,00	MB/HL 1, 2, 3, 4, 5	5 Pairs	54,979 55,000	59,014 59,032	21,500	SAL	180 820 0000 00													

	ccm						Pos.
F2L 1011	1366	2	.	91,00	180 015 0007 181 015 0006 182 015 0003	Std, 0,25, 0,50 Std, 0,25, 0,50 Std	1
F2L 1011F Euro1	1366	2	.	91,00	180 015 0007 181 015 0006 182 015 0003	Std, 0,25, 0,50 Std, 0,25, 0,50 Std	1
F3L 1011	2049	3	.	91,00	180 015 0007 181 015 0006 182 015 0003	Std, 0,25, 0,50 Std, 0,25, 0,50 Std	1
F3L 1011F Euro1	2049	3	.	91,00	180 015 0007 181 015 0006 182 015 0003	Std, 0,25, 0,50 Std, 0,25, 0,50 Std	1
BF4L 1011	2732	4	.	91,00	180 015 0007 181 015 0006 182 015 0003	Std, 0,25, 0,50 Std, 0,25, 0,50 Std	1
BF4L 1011F Euro1, BF4L 1011FT Euro1	2732	4	.	91,00	180 015 0007 181 015 0006 182 015 0003	Std, 0,25, 0,50 Std, 0,25, 0,50 Std	1
F4L 1011	2732	4	.	91,00	180 015 0007 181 015 0006 182 015 0003	Std, 0,25, 0,50 Std, 0,25, 0,50 Std	1
F4L 1011F Euro1	2732	4	.	91,00	180 015 0007 181 015 0006 182 015 0003	Std, 0,25, 0,50 Std, 0,25, 0,50 Std	1
F2M 1011F Euro1	1366	2	.	91,00	180 015 0007 181 015 0006 182 015 0003	Std, 0,25, 0,50 Std, 0,25, 0,50 Std	1
F3M 1011, BF3M 1011 Euro1	2185	3	.	91,00	180 015 0007 181 015 0006 182 015 0003	Std, 0,25, 0,50 Std, 0,25, 0,50 Std	1
BF3M 1011F	2185	3	.	91,00	180 015 0007 181 015 0006 182 015 0003	Std, 0,25, 0,50 Std, 0,25, 0,50 Std	1
F3M 1011F Euro1	2185	3	.	91,00	180 015 0007 181 015 0006 182 015 0003	Std, 0,25, 0,50 Std, 0,25, 0,50 Std	1
BF4M 1011F Euro1	2912	4	.	91,00	180 015 0007 181 015 0006 182 015 0003	Std, 0,25, 0,50 Std, 0,25, 0,50 Std	1
F4M 1011F Euro1	2914	4	.	91,00	180 015 0007 181 015 0006 182 015 0003	Std, 0,25, 0,50 Std, 0,25, 0,50 Std	1
F2L 2011, F2M 2011	1550	2	.	94,00	180 015 0007 181 015 0006 182 015 0003	Std, 0,25, 0,50 Std, 0,25, 0,50 Std	1
BF3L 2011, BF3M 2011	2330	3	.	94,00	180 015 0007 181 015 0006 182 015 0003	Std, 0,25, 0,50 Std, 0,25, 0,50 Std	1
F3L 2011, F3M 2011	2330	3	.	94,00	180 015 0007 181 015 0006 182 015 0003	Std, 0,25, 0,50 Std, 0,25, 0,50 Std	1
BF4L 2011, BF4M 2011, BF4M 2011M	3110	4	.	94,00	180 015 0007 181 015 0006 182 015 0003	Std, 0,25, 0,50 Std, 0,25, 0,50 Std	1
F4L 2011, F4M 2011	3110	4	.	94,00	180 015 0007 181 015 0006 182 015 0003	Std, 0,25, 0,50 Std, 0,25, 0,50 Std	1
BF4M1012 Euro1, BF4M1012C Euro1, BF4M 1012E Euro2, BF4M1012EC Euro2, F4M1012 Euro1	3192	4	Agroplus 75/80/85/90/95, Agrottron 4.70/4.80/4.85/4.90/4.95, Agrottron 80/85/90/100	94,00	180 015 0006 181 015 0005 182 015 0004	Std, 0,25, 0,50 Std, 0,25, 0,50 Std	2
BF6M1012Euro1, BF6M1012C Euro1, BF6M1012E Euro2, BF6M1012EC Euro2	4788	6	Agroplus 100, Agrottron 6.00/6.01/6.05/6.15, Agrottron 100/105/106/110/115	94,00	180 015 0006 181 015 0005 182 015 0004	Std, 0,25, 0,50 Std, 0,25, 0,50 Std	2
F3L912D, F3L912W	2826	3		100,00	180 015 0001 181 015 0001 182 015 0001	Std, 0,25, 0,50, 0,75, 1,00 Std, 0,25, 0,50, 0,75, 1,00 Std, 0,25	3
F4L912D, F4L912W	3770	4		100,00	180 015 0001 181 015 0001 182 015 0001	Std, 0,25, 0,50, 0,75, 1,00 Std, 0,25, 0,50, 0,75, 1,00 Std, 0,25	3
F5L912D, F5L912W	4712	5		100,00	180 015 0001 181 015 0001 182 015 0001	Std, 0,25, 0,50, 0,75, 1,00 Std, 0,25, 0,50, 0,75, 1,00 Std, 0,25	3
BF6L912, F6L912D, F6L912W	5655	6		100,00	180 015 0001 181 015 0001 182 015 0001	Std, 0,25, 0,50, 0,75, 1,00 Std, 0,25, 0,50, 0,75, 1,00 Std, 0,25	3
F3L912F, F3L913, F3L913G	3064	3		102,00	180 015 0001 181 015 0001 182 015 0001	Std, 0,25, 0,50, 0,75, 1,00 Std, 0,25, 0,50, 0,75, 1,00 Std, 0,25	3
BF4L913, BF4L913C, BF4L913T	4086	4		102,00	180 015 0002 181 015 0002 182 015 0002	Std, 0,25, 0,50, 0,75, 1,00 Std, 0,25, 0,50, 0,75 Std	4

	ccm						Pos.
F4L912F, F4L913	4086	4		102,00	180 015 0001 181 015 0001 182 015 0001	Std, 0,25, 0,50, 0,75, 1,00 Std, 0,25, 0,50, 0,75, 1,00 Std, 0,25	3
F5L912F, F5L913	5107	5		102,00	180 015 0001 181 015 0001 182 015 0001	Std, 0,25, 0,50, 0,75, 1,00 Std, 0,25, 0,50, 0,75, 1,00 Std, 0,25	3
BF6L913, BF6L913C, BF6L913T	6128	6		102,00	180 015 0002 181 015 0002 182 015 0002	Std, 0,25, 0,50, 0,75, 1,00 Std, 0,25, 0,50, 0,75 Std	4
F6L912F, F6L913	6128	6		102,00	180 015 0001 181 015 0001 182 015 0001	Std, 0,25, 0,50, 0,75, 1,00 Std, 0,25, 0,50, 0,75, 1,00 Std, 0,25	3
BF 6 M 1013 FC Euro 3	7146	6	Agrotron 210 05.2003- Agrotron 215 05.2003- Agrotron 230 01.1998-07.2003 Agrotron 235 05.2003- Agrotron 260 01.1998-07.2003 Agrotron 720 05.2003-	108,00	180 015 0008 181 015 0007 181 015 0008 183 015 0002	Std, 0,25, 0,50, 0,75 Std, 0,25, 0,50, 0,75 Std, 0,25, 0,50, 0,75, 1,00 Std	5
BF 4 M 1013 FC Euro 2	4764	4	Industriemotor	108,00	180 015 0008 181 015 0007 181 015 0008 183 015 0001	Std, 0,25, 0,50, 0,75 Std, 0,25, 0,50, 0,75 Std, 0,25, 0,50, 0,75, 1,00 Std	6
BF 4 M 1013 C Euro 1 BF 4 M 1013 E Euro 2 BF 4 M 1013 EC Euro 2 BF 4 M 1013 Euro 1	4764	4	Agrotron 90,	108,00	180 015 0008 181 015 0007 183 015 0001	Std, 0,25, 0,50, 0,75 Std, 0,25, 0,50, 0,75 Std	7
BF 6 M 1013 C Euro 1 BF 6 M 1013 E Euro 2 BF 6 M 1013 Euro 1	7146	6	Mährescher Series 5680 06.1999- Mährescher Series 5690 06.1999- Agrotron 1125 04.2000- Agrotron 1140 04.2000- Agrotron 1155 04.2000- Agrotron 120 01.1998-12.2003 Agrotron 135 01.1998-12.2003 Agrotron 150 01.1998-12.2003 Agrotron 160 01.1998-12.2003 Agrotron 165 01.1999-11.2003 Agrotron 175 01.1998- Agrotron 6.20 09.1995- Agrotron 6.30 09.1995- Agrotron 6.45 09.1995- Agrotron 1130 02.2001- Agrotron 1145 02.2001- Agrotron 1160 02.2001- Agrotron 130 10.2003- Agrotron 140 10.2003- Agrotron 150 10.2003- Agrotron 155 10.2003- Agrotron 165 10.2003- Agrotron 180 10.2003- Agrotron 200 01.1998- Agrotron 230 01.1998- Agrotron 260 01.1998-	108,00	180 015 0008 181 015 0007 183 015 0002	Std, 0,25, 0,50, 0,75 Std, 0,25, 0,50, 0,75 Std	8
TCD2013 L04 2V Euro3	4764	4	.	108,00	180 059 0010 181 059 0016 182 059 0008	Std, 0,25, 0,50 Std, 0,25, 0,50 Std	9
TCD2013 L06 2V Euro3, TCD2013 L06 4V Euro3	7146	6	.	108,00	180 059 0010 181 059 0016 182 059 0008	Std, 0,25, 0,50 Std, 0,25, 0,50 Std	9
BF6L413F, BF6L413FW, BF6L513 125, BF6L513C, BF6L513F, BF6L513FW, F6L413F, F6L413FW, F6L513FW	9572	6		125,00	180 015 0003 180 015 0004 181 015 0003	Std, 0,25, 0,50, 0,75, 1,00 Std, 0,25, 0,50, 0,75, 1,00 Std, 0,25, 0,50, 0,75, 1,00	10
BF10L413F, BF10L413FW, BF10L 513 125, BF10L513C, BF10L513F, F10L413F, F10L413FW, F10L413FZ, F10L513F	15953	10		125,00	180 015 0003 180 015 0004 181 015 0003	Std, 0,25, 0,50, 0,75, 1,00 Std, 0,25, 0,50, 0,75, 1,00 Std, 0,25, 0,50, 0,75, 1,00	10
BF12L413F, BF12L413FW, BF12L513 125, BF12L513C, BF12L513F, BF12L513FW, F12L413F, F12L413FW, F12L413FZ, F12L513F, F12L513FW	19144	12		125,00	180 015 0003 180 015 0004 181 015 0003	Std, 0,25, 0,50, 0,75, 1,00 Std, 0,25, 0,50, 0,75, 1,00 Std, 0,25, 0,50, 0,75, 1,00	10
BF6L513 128, F6L513, F6L513F, F6L513T	10038	6		128,00	180 015 0003 180 015 0004 181 015 0003	Std, 0,25, 0,50, 0,75, 1,00 Std, 0,25, 0,50, 0,75, 1,00 Std, 0,25, 0,50, 0,75, 1,00	10
BF8L513 128, F8L513, F8L513T	13382	8		128,00	180 015 0003 180 015 0004 181 015 0003	Std, 0,25, 0,50, 0,75, 1,00 Std, 0,25, 0,50, 0,75, 1,00 Std, 0,25, 0,50, 0,75, 1,00	10
BF10L513 128, F10L513, F10L513L, F10L513T	16728	10		128,00	180 015 0003 180 015 0004 181 015 0003	Std, 0,25, 0,50, 0,75, 1,00 Std, 0,25, 0,50, 0,75, 1,00 Std, 0,25, 0,50, 0,75, 1,00	10
BF12L513 128, F12L513, F12L513L, F12L513T	20074	12		128,00	180 015 0003 180 015 0004 181 015 0003	Std, 0,25, 0,50, 0,75, 1,00 Std, 0,25, 0,50, 0,75, 1,00 Std, 0,25, 0,50, 0,75, 1,00	10
F8L513L	14410	8		128,00	180 015 0003 180 015 0004 181 015 0003	Std, 0,25, 0,50, 0,75, 1,00 Std, 0,25, 0,50, 0,75, 1,00 Std, 0,25, 0,50, 0,75, 1,00	10







							 		Set Composition / QTY													
1							91,00															
MB/HL 1	1 Pair	69,970 69,990	75,000 75,019	28,000	SAL	180 015 0007 00 15 21	2															
CB/PL 1	1 Pair	54,970 54,990	58,510 58,525	25,600	SAL	181 015 0006 00 15 21	2															
TW/A 1	2 Halves	75,500 75,750	89,750 90,000		SAL	182 015 0003 00	2															
2							94,00															
MB/HL 1	1 Pair	73,980 74,000	79,000 79,019	29,000	SAL	180 015 0006 00 15 21	2															
CB/PL 1	1 Pair	57,980 58,000	61,600 61,620	26,600	S3S	181 015 0005 00 15 21	2															
TW/A 1	4 Halves	79,000 79,250	101,750 102,000		SAL	182 015 0004 00	2		2													
3							100,00															
MB/HL 1	1 Pair	69,971 69,990	74,500 74,519	27,000	S3S	180 015 0001 00 15 21 26 29	2															
CB/PL 1	1 Pair	59,941 59,960	64,000 64,019	25,000	S3S	181 015 0001 00 15 21 26 29	1		1													
TW/A 1	4 Halves	79,000 79,300	94,614 94,964		SAL	182 015 0001 00 15	2		2													
4							102,00															
MB/HL 1	1 Pair	74,971 74,990	79,000 79,019	25,000	S3S	180 015 0002 00 15 21 26 29	2															
CB/PL 1	1 Pair	65,971 65,990	70,000 70,019	25,000	S3S	181 015 0002 00 15 21 26	1		1													
TW/A 1	4 Halves	87,000 87,350	100,614 100,964		SAL	182 015 0002 00	2		2													
5							108,00															
MB/HL 1	1 Pair	84,980 85,000	90,500 90,520	31,000	SAL	180 015 0008 00 15 21 26	2															
CB/PL 1	1 Pair	67,980 68,000	72,500 72,520	30,000	S3S	181 015 0007 00 15 21 26	2															
CB/PL 1	1 Pair	67,980 68,000	72,500 72,520	30,000	S3S	181 015 0008 00 15 21 26 29	1		1													
Cbush/NWL 1, 2, 3	3 Pairs	64,930 64,950	69,000 69,030	22,000	SR	183 015 0002 00																
Cbush/NWL 4, 5, 6, 7	4 Pairs	64,930 64,950	69,000 69,030	27,000	SR																	























							 		Set Composition / QTY													
6	108,00																					
MB/HL 1	1 Pair	84,980 85,000	90,500 90,520	31,000	SAL	180 015 0008 00 15 21 26	2															
CB/PL 1	1 Pair	67,980 68,000	72,500 72,520	30,000	S3S	181 015 0007 00 15 21 26	2															
CB/PL 1	1 Pair	67,980 68,000	72,500 72,520	30,000	S3S	181 015 0008 00 15 21 26 29	1		1													
Cbush/NWL 1, 2	2 Pairs	64,930 64,950	69,000 69,030	22,000	SR	183 015 0001 00																
Cbush/NWL 3, 4, 5	3 Pairs	64,930 64,950	69,000 69,030	27,000	SR																	
7	108,00																					
MB/HL 1	1 Pair	84,980 85,000	90,500 90,520	31,000	SAL	180 015 0008 00 15 21 26	2															
CB/PL 1	1 Pair	67,980 68,000	72,500 72,520	30,000	S3S	181 015 0007 00 15 21 26	2															
Cbush/NWL 1, 2	2 Pairs	64,930 64,950	69,000 69,030	22,000	SR	183 015 0001 00																
Cbush/NWL 3, 4, 5	3 Pairs	64,930 64,950	69,000 69,030	27,000	SR																	
8	108,00																					
MB/HL 1	1 Pair	84,980 85,000	90,500 90,520	31,000	SAL	180 015 0008 00 15 21 26	2															
CB/PL 1	1 Pair	67,980 68,000	72,500 72,520	30,000	S3S	181 015 0007 00 15 21 26	2															
Cbush/NWL 1, 2, 3	3 Pairs	64,930 64,950	69,000 69,030	22,000	SR	183 015 0002 00																
Cbush/NWL 4, 5, 6, 7	4 Pairs	64,930 64,950	69,000 69,030	27,000	SR																	
9	108,00																					
MB/HL 1	1 Pair	84,980 85,000	90,500 90,520	26,500	S3S	180 059 0010 00 15 21	1		1													
CB/PL 1	1 Pair	74,980 75,000	80,000 80,020	29,200	SPVD	181 059 0016 00 15 21	1		1													
TW/A 1	4 Halves	91,400	114,000		SAL	182 059 0008 00	2		2													
10	125,00																					
MB/HL 1	1 Pair	94,966 94,988	101,000 101,022	29,000	S3S	180 015 0003 00 15 21 26 29	1		1													
MB/HL 1	1 Pair	94,966 94,988	101,000 101,022	40,820	S3S	180 015 0004 00 15 21 26 29	1		1													
CB/PL 1	1 Pair	74,971 74,990	80,000 80,019	27,800	S3S	181 015 0003 00 15 21 26 29	2															



KIA

Globally reliable

	ccm						Pos.
B1	1138	4	Pride	68,00	180 085 0001 181 085 0001 182 085 0001	Std, 0,25, 0,50, 0,75, 1,00 Std, 0,25, 0,50, 0,75, 1,00, 1,25, 1,50 Std	1
B3	1324	4	Avella, Pride	71,00	180 085 0001 181 085 0001 182 085 0001	Std, 0,25, 0,50, 0,75, 1,00 Std, 0,25, 0,50, 0,75, 1,00, 1,25, 1,50 Std	1
B6	1598	4	Sephia	78,00	180 085 0001 181 085 0003 182 085 0001	Std, 0,25, 0,50, 0,75, 1,00 Std, 0,25, 0,50, 0,75, 1,00 Std	2
D4EA, D4EA-F	1991	4	SPORTAGE 2.0 CRDi, MAGENTIS 2.0 CRDi, CERATO 2.0 CRDi, CARENS III 2.0 CRDi, CEE'D 2.0 CRDi, PRO CEE'D 2.0 CRDi	83,00	180 087 0005 181 087 0005	Std, 0,25, 0,50, 0,75 Std, 0,25, 0,50, 0,75	3
D4HA	1995	4	SPORTAGE 2.0 CRDi, SORENTO II 2.0 CRDi	84,00	180 087 0009 181 087 0008 182 087 0003	Std, 0,25, 0,50, 0,75 Std, 0,25, 0,50, 0,75 Std	4
4G63	1997	4	Magentis	85,00	180 088 0008 181 088 0010	Std, 0,25, 0,50, 0,75, 1,00 Std, 0,25, 0,50, 0,75, 1,00	5
D4HB	2199	4	Sorento II + III 2.2 CRDI	85,40	180 087 0009 181 087 0018 182 087 0003	Std, 0,25, 0,50, 0,75 Std, 0,25, 0,50, 0,75 Std	6
G6BA	2656	6	OPTIMA / MAGENTIS 2.7, SPORTAGE 2.7	86,70	180 087 0014 181 087 0013	Std, 0,25, 0,50, 0,75, 1,00 Std, 0,25, 0,50, 0,75, 1,00	7







						NE		Set Composition / QTY															
1 68,00																							
MB/HL 1, 2, 3, 4, 5	5 Pairs	49,955	54,000	17,030	SAL	180 085 0001	00 15 21 26 29	5		5													
CB/PL 1, 2, 3, 4	4 Pairs	39,956	43,000	17,130	SAL	181 085 0001	00 15 21 26 29 31 33	8															
TW/A 1	2 Halves	57,250	69,000		SAL	182 085 0001	00	2															
2 78,00																							
MB/HL 1, 2, 3, 4, 5	5 Pairs	49,955	54,000	17,030	SAL	180 085 0001	00 15 21 26 29	5		5													
CB/PL 1, 2, 3, 4	4 Pairs	44,956	48,000	17,130	SAL	181 085 0003	00 15 21 26 29	8															
TW/A 1	2 Halves	57,250	69,000		SAL	182 085 0001	00	2															
3 83,00																							
MB/HL 1, 2, 3, 4	4 Pairs	60,000	64,000	21,500	SAL	180 087 0005	00 15	4		4		1		1									
MB/HL 5	1 Pair	60,000	64,000	27,850	SAL		21 26																
CB/PL 1, 2, 3, 4	4 Pairs	50,000	53,000	22,000	S3S	181 087 0005	00 15 21 26	8															
4 84,00																							
MB/HL 1, 2, 3, 4, 5	5 Pairs	60,000	64,000	18,900	S3S	180 087 0009	00 15 21 26	5		5													
CB/PL 1, 2, 3, 4	4 Pairs	48,000	51,000	20,900	S3S	181 087 0008	00 15 21 26	4		4													
TW/A 1	2 Halves	66,100	88,100		SAL	182 087 0003	00	2															
5 85,00																							
MB/HL 1, 2, 4, 5	4 Pairs	57,000	61,000	20,630	SAL	180 088 0008	00 15	4		4		2											
MB/HL 3	1 Pair	57,000	61,000	25,450	SAL		21 26 29																
CB/PL 1, 2, 3, 4	4 Pairs	45,000	48,000	21,230	SAL	181 088 0010	00 15 21 26 29	8															



KIA

Globally reliable

							Set Composition / QTY										
6	85,40																
MB/HL 1, 2, 3, 4, 5	5 Pairs	60,000	64,000	18,900	S3S	180 087 0009 00	5		5								
						15											
						21											
						26											
CB/PL 1, 2, 3, 4	4 Pairs	52,000 52,018	55,000 55,018	20,930	Nefrox	181 087 0018 00	4		4								
						15											
						21											
						26											
TW/A 1	2 Halves	66,100	88,100		SAL	182 087 0003 00	2										
7	86,70																
MB/HL 1, 2, 3, 4	4 Pairs	62,000	66,000	17,000	SAL	180 087 0014 00	4		4								
						15											
						21											
						26											
						29											
CB/PL 1, 2, 3, 4, 5, 6	6 Pairs	48,000	51,000	15,000	SAL	181 087 0013 00	12										
						15											
						21											
						26											
						29											







	ccm						Pos.
DW10	1997	4	Phedra 2.0 JTD 16V	85,00	180 037 0003 181 037 0019 182 037 0002	Std, 0,30, 0,50, 0,80 Std, 0,30, 0,50 Std, 0,30, 0,50, 0,10, 0,20	1
DW12	2179	4	Phedra 2.2 JTD 16V	85,00	180 037 0003 181 037 0019 182 037 0002	Std, 0,30, 0,50, 0,80 Std, 0,30, 0,50 Std, 0,30, 0,50, 0,10, 0,20	1



LANCIA

Globally reliable

									Set Composition / QTY									
1	85,00																	
MB/HL 1, 2, 3, 4, 5	5 Pairs	59,981 60,000	63,731 63,750	20,290	SAL	180 037 0003 00 17 21 28	5		5									
CB/PL 1, 2, 3, 4	4 Pairs	49,984 50,000	53,695 53,708	20,000	S4S	181 037 0019 00 17 21												
TW/A 1	4 Halves	67,050 67,300	83,050 83,300		S3S	182 037 0002 00 17 21 08 14	2		2									

	ccm						Pos.
1UR-FE, 1UR-FSE	4608	8	GX 460 4WD, LS 460, GS 460	94,00	180 096 0037 181 096 0052	Std Std	1









LEXUS

Globally reliable



Set Composition / QTY

1	94,00																		
MB/HL 1, 2, 3, 4, 5	5 Pairs	1,000	1,000	1,000		180 096 0037 00													
CB/PL 1, 2, 3, 4, 5, 6, 7, 8	8 Pairs	52,980	56,020	17,000	SAL	181 096 0052 00													

	ccm						Pos.
LF479Q1	1342	4	LIFAN 520 1.3	1,00	180 768 0001 181 768 0001	Std, 0,25, 0,50, 0,75, 1,00 Std, 0,25, 0,50, 0,75, 1,00	1









LIFAN

Globally reliable



1		1,00																				
MB/HL 1, 2, 3, 4, 5	5 Pairs	52,000	56,000	20,000	SAL	180 768 0001 00	15	5		5												
						21																
						26																
						29																
CB/PL 1, 2, 3, 4	4 Pairs	43,000	45,980	17,000	SAL	181 768 0001 00	15	8														
						21																
						26																
						29																







	ccm						Pos.
D0826 K, D0826 LUH18, D0826 LUH21, D0826 T, D0826 TF, D0826 TOH	6596	6		108,00	180 031 0003 181 031 0003	Std, 0,25, 0,50, 0,75 Std, 0,25, 0,50, 0,75	2
D0824 Euro 1/2/3	4580	4		108,00	180 031 0002 181 031 0002	Std, 0,25 Std, 0,25, 0,50, 0,75	1
D0826 F, D0826 GF, D0826 LE, D0826 LF	6871	6		108,00	180 031 0003 181 031 0003	Std, 0,25, 0,50, 0,75 Std, 0,25, 0,50, 0,75	2
D2556	11045	6		125,00	180 031 0001 181 031 0001 181 031 0004 183 100 0001	Std, 0,25, 0,50, 0,75, 1,00 Std, 0,25, 0,50, 0,75, 1,00 Std, 0,25, 0,50, 0,75, 1,00 Std	3
D2566	11407	6		125,00	180 031 0001 181 031 0001 181 031 0004 183 100 0001	Std, 0,25, 0,50, 0,75, 1,00 Std, 0,25, 0,50, 0,75, 1,00 Std, 0,25, 0,50, 0,75, 1,00 Std	3
D2848	14618	8		128,00	180 100 0001 180 100 0002 181 100 0009	Std, 0,25, 0,50, 0,75, 1,00 Std, 0,25, 0,50, 0,75, 1,00 Std, 0,25, 0,50, 0,75	5
D2840	18273	10		128,00	180 100 0001 180 100 0002 181 100 0009	Std, 0,25, 0,50, 0,75, 1,00 Std, 0,25, 0,50, 0,75, 1,00 Std, 0,25, 0,50, 0,75	5
D2842, E2842	21930	12		128,00	180 100 0001 180 100 0002 181 100 0009	Std, 0,25, 0,50, 0,75, 1,00 Std, 0,25, 0,50, 0,75, 1,00 Std, 0,25, 0,50, 0,75	5
D2858	15442	8		128,00	180 100 0001 180 100 0002 181 100 0009	Std, 0,25, 0,50, 0,75, 1,00 Std, 0,25, 0,50, 0,75, 1,00 Std, 0,25, 0,50, 0,75	5
D2866	11967	6		128,00	180 031 0001 181 031 0001 181 031 0004 183 100 0001	Std, 0,25, 0,50, 0,75, 1,00 Std, 0,25, 0,50, 0,75, 1,00 Std, 0,25, 0,50, 0,75, 1,00 Std	3
D2876, E2876, G2876	12816	6		128,00	180 031 0001 181 031 0005	Std, 0,25, 0,50, 0,75, 1,00 Std, 0,25, 0,50	4



M.A.N.

Globally reliable







									Set Composition / QTY								
1 108,00																	
MB/HL 1, 2, 3, 4	4 Pairs	76,981 77,000	82,000 82,022	26,000	S3S	180 031 0002 00	15	4		4		1		1			
MB/HL 5	1 Pair	76,981 77,000	82,000 82,022	33,850	S3S												
CB/PL 1, 2, 3, 4	4 Pairs	64,981 65,000	69,000 69,019	31,000	S3S	181 031 0002 00	15 21 26	8									
2 108,00																	
MB/HL 1, 2, 3, 4, 5, 6	6 Pairs	76,981 77,000	82,000 82,022	26,000	S3S	180 031 0003 00	15	6		6		1		1			
MB/HL 7	1 Pair	76,981 77,000	82,000 82,022	33,850	S3S		21 26										
CB/PL 1, 2, 3, 4, 5, 6	6 Pairs	64,981 65,000	69,000 69,019	31,000	S3S	181 031 0003 00	15 21 26	12									
3 125,00																	
MB/HL 1, 2, 3, 4, 5, 6	6 Pairs	103,980 104,000	111,000 111,022	36,000	S3S	180 031 0001 00	15	6		6		1		1			
MB/HL 7	1 Pair	103,980 104,000	111,000 111,022	45,810	S3S		21 26 29										
CB/PL 1, 2, 3, 4, 5, 6	6 Pairs	89,980 90,000	95,000 95,022	36,200	S3S	181 031 0001 00	15 21 26 29	12									
CB/PL 1	1 Pair	89,980 90,000	95,000 95,022	36,200	S4S	181 031 0004 00	15 21 26 29										
Cbush/NWL 1	1 Pair	69,910 69,940	75,000 75,030	36,000	SAL	183 100 0001 00											
Cbush/NWL 2, 3, 4, 5, 6	5 Pairs	69,910 69,940	75,000 75,030	28,000	SAL												
Cbush/NWL 7	1 Pair	69,910 69,940	76,000 76,030	39,000	SAL												
4 128,00																	
MB/HL 1, 2, 3, 4, 5, 6	6 Pairs	103,980 104,000	111,000 111,022	36,000	S3S	180 031 0001 00	15	6		6		1		1			
MB/HL 7	1 Pair	103,980 104,000	111,000 111,022	45,810	S3S		21 26 29										
CB/PL 1	1 Pair	89,980 90,000	95,000 95,022	36,200	S4S	181 031 0005 00	15 21										
5 128,00																	
MB/HL 1	1 Pair	103,980 104,000	111,000 111,022	30,500	S3S	180 100 0001 00	15 21 26 29	1		1							
MB/HL 1	1 Pair	103,980 104,000	111,000 111,022	37,810	S3S	180 100 0002 00	15 21 26 29	1		1							
CB/PL 1	1 Pair	89,980 90,000	95,000 95,022	31,000	S4S	181 100 0009 00	15 21 26										













	ccm						Pos.
PB	987	4	Familia, Bongo 12/68-6/69	68,00	180 085 0005 181 085 0007 182 085 0005	Std, 0,25, 0,50 Std, 0,25, 0,50 Std	3
PB	987	4	Familia, Bongo 1967-7/90	68,00	180 085 0005 181 085 0007 182 085 0004	Std, 0,25, 0,50 Std, 0,25, 0,50 Std	4
B1	1138	4	Familia, Demio 10/85-3/89	68,00	180 085 0007 181 085 0001 182 085 0001	Std, 0,25, 0,50, 0,75, 1,00, 1,25, 1,50 Std, 0,25, 0,50, 0,75, 1,00, 1,25, 1,50 Std	1
B1	1138	4	3/1989-	68,00	180 085 0001 181 085 0001 182 085 0001	Std, 0,25, 0,50, 0,75, 1,00 Std, 0,25, 0,50, 0,75, 1,00, 1,25, 1,50 Std	2
E1	1071	4	Familia 5/80-11/86	70,00	180 085 0007 181 085 0001 182 085 0003	Std, 0,25, 0,50, 0,75, 1,00, 1,25, 1,50 Std, 0,25, 0,50, 0,75, 1,00, 1,25, 1,50 Std	6
TA	1169	4	Familia, Bongo 3/1970-73	70,00	180 085 0005 181 085 0007 182 085 0004	Std, 0,25, 0,50 Std, 0,25, 0,50 Std	4
TB	1169	4	Familia, Bongo 12/68-7/90	70,00	180 085 0005 181 085 0007 182 085 0004	Std, 0,25, 0,50 Std, 0,25, 0,50 Std	4
B3	1323	4	Familia, Demio 12/86-3/89	71,00	180 085 0007 181 085 0001 182 085 0001	Std, 0,25, 0,50, 0,75, 1,00, 1,25, 1,50 Std, 0,25, 0,50, 0,75, 1,00, 1,25, 1,50 Std	1
B3	1323	4	3/1989-	71,00	180 085 0001 181 085 0001 182 085 0001	Std, 0,25, 0,50, 0,75, 1,00 Std, 0,25, 0,50, 0,75, 1,00, 1,25, 1,50 Std	2
TC	1272	4	Familia 1/77-12/85	73,00	180 085 0007 181 085 0001 182 085 0003	Std, 0,25, 0,50, 0,75, 1,00, 1,25, 1,50 Std, 0,25, 0,50, 0,75, 1,00, 1,25, 1,50 Std	6
F6JA, F6JB	1399	4	MAZDA 2 1.4 CD, MAZDA DEMIO 1.4 CD	73,70	180 051 0001 181 037 0015 182 051 0001	Std, 0,25, 0,30, 0,50, 0,80 Std, 0,30, 0,50 Std	5
Z5	1489	4		75,30	180 085 0001 181 085 0001 182 085 0001	Std, 0,25, 0,50, 0,75, 1,00 Std, 0,25, 0,50, 0,75, 1,00, 1,25, 1,50 Std	2
E3	1296	4	Familia 5/1980-	77,00	180 085 0007 181 085 0001 182 085 0003	Std, 0,25, 0,50, 0,75, 1,00, 1,25, 1,50 Std, 0,25, 0,50, 0,75, 1,00, 1,25, 1,50 Std	6
UC	1415	4	Familia 12/76-7/90	77,00	180 085 0007 181 085 0001 182 085 0003	Std, 0,25, 0,50, 0,75, 1,00, 1,25, 1,50 Std, 0,25, 0,50, 0,75, 1,00, 1,25, 1,50 Std	6
D5	1490	4	Familia 10/1985-	77,00	180 085 0007 181 085 0001 182 085 0003	Std, 0,25, 0,50, 0,75, 1,00, 1,25, 1,50 Std, 0,25, 0,50, 0,75, 1,00, 1,25, 1,50 Std	6
E5	1490	4	Familia 5/1980-	77,00	180 085 0007 181 085 0001 182 085 0003	Std, 0,25, 0,50, 0,75, 1,00, 1,25, 1,50 Std, 0,25, 0,50, 0,75, 1,00, 1,25, 1,50 Std	6
BJ	1290	4	Etude, Familia 10/1986-	78,00	180 085 0001 181 085 0003 182 085 0001 184 085 0001	Std, 0,25, 0,50, 0,75, 1,00 Std, 0,25, 0,50, 0,75, 1,00 Std Std	8
UB	1490	4	Luce, Bongo, Cosmo 5/70-7/73	78,00	180 085 0006 181 085 0019 182 085 0007	Std, 0,25, 0,50, 0,75, 1,00 Std, 0,25, 0,50 Std	10
B5	1498	4	Familia, Demio 12/86-3/89	78,00	180 085 0007 181 085 0001 182 085 0001	Std, 0,25, 0,50, 0,75, 1,00, 1,25, 1,50 Std, 0,25, 0,50, 0,75, 1,00, 1,25, 1,50 Std	1
B5	1498	4	3/1989-	78,00	180 085 0001 181 085 0001 182 085 0001	Std, 0,25, 0,50, 0,75, 1,00 Std, 0,25, 0,50, 0,75, 1,00, 1,25, 1,50 Std	2
ZL	1498	4		78,00	180 085 0001 181 085 0001 182 085 0001	Std, 0,25, 0,50, 0,75, 1,00 Std, 0,25, 0,50, 0,75, 1,00, 1,25, 1,50 Std	2
NA	1586	4	Familia, Bongo 5/70-11/83	78,00	180 085 0006 181 085 0002 182 085 0007	Std, 0,25, 0,50, 0,75, 1,00 Std, 0,25, 0,50, 0,75, 1,00 Std	9
NA	1586	4	Familia, Bongo 5/70-11/83	78,00	180 085 0006 181 085 0019 182 085 0007	Std, 0,25, 0,50, 0,75, 1,00 Std, 0,25, 0,50 Std	10
B6	1597	4	Familia, Roadstar 9/85-10/86	78,00	180 085 0007 181 085 0003 182 085 0001 184 085 0001	Std, 0,25, 0,50, 0,75, 1,00, 1,25, 1,50 Std, 0,25, 0,50, 0,75, 1,00 Std Std	7
B6	1597	4	Etude, Familia 10/1986-	78,00	180 085 0001 181 085 0003 182 085 0001 184 085 0001	Std, 0,25, 0,50, 0,75, 1,00 Std, 0,25, 0,50, 0,75, 1,00 Std Std	8
PN	1720	4	6/1985-	78,00	180 085 0010 182 085 0012	Std, 0,25, 0,50 Std	11
VB	1796	4	Luce, Capella, Pick up 10/68-10/77	78,00	180 085 0006 181 085 0020 182 085 0007	Std, 0,25, 0,50, 0,75, 1,00 Std, 0,25, 0,50 Std	12



MAZDA

Globally reliable

	ccm						Pos.
VC	1769	4	Luce, Bongo, Cosmo 4/73-8/86	80,00	180 085 0006 181 085 0019 182 085 0007	Std, 0,25, 0,50, 0,75, 1,00 Std, 0,25, 0,50 Std	10
MA	1970	4	Luce, Capella, Pick up 3/77-4/89	80,00	180 085 0006 181 085 0020 182 085 0007	Std, 0,25, 0,50, 0,75, 1,00 Std, 0,25, 0,50 Std	12
KJ	2254	6		80,30	180 085 0009 181 085 0008 182 085 0008	Std, 0,25 Std, 0,25 Std	13
F6	1587	4	Bongo, Capello 9/82-3/87	81,00	180 085 0002 181 085 0004	Std, 0,25, 0,50, 0,75, 1,00 Std, 0,25, 0,50, 0,75, 1,00, 1,25, 1,50	14
F6	1587	4	Capella 4/1987-	81,00	180 085 0003 181 085 0004	Std, 0,25, 0,50, 0,75, 1,00, 1,25, 1,50 Std, 0,25, 0,50, 0,75, 1,00, 1,25, 1,50	16
BP	1839	4	Roadstar 6/1989-	83,00	180 085 0001 181 085 0003 182 085 0001 184 085 0001	Std, 0,25, 0,50, 0,75, 1,00 Std, 0,25, 0,50, 0,75, 1,00 Std Std	8
FP	1839	4	Capella, Premacy	83,00	180 085 0004 181 085 0006 182 085 0002	Std, 0,25, 0,50, 0,75, 1,00 Std, 0,25, 0,50, 0,75, 1,00 Std	15
FS	1991	4	Capella, Premacy	83,00	180 085 0004 181 085 0006 182 085 0002	Std, 0,25, 0,50, 0,75, 1,00 Std, 0,25, 0,50, 0,75, 1,00 Std	15
KL	2496	6		84,50	180 085 0009 181 085 0008 182 085 0008	Std, 0,25 Std, 0,25 Std	13
F8	1789	4	Bongo, Capello 10/82-3/87	86,00	180 085 0002 181 085 0004	Std, 0,25, 0,50, 0,75, 1,00 Std, 0,25, 0,50, 0,75, 1,00, 1,25, 1,50	14
F8	1789	4	Capella 4/1987-	86,00	180 085 0003 181 085 0004	Std, 0,25, 0,50, 0,75, 1,00, 1,25, 1,50 Std, 0,25, 0,50, 0,75, 1,00, 1,25, 1,50	16
F8	1789	4	Capella 2/1990-	86,00	180 085 0003 181 085 0005	Std, 0,25, 0,50, 0,75, 1,00, 1,25, 1,50 Std, 0,25, 0,50	17
FE	1998	4	Bongo, Capello 9/82-3/87	86,00	180 085 0002 181 085 0004	Std, 0,25, 0,50, 0,75, 1,00 Std, 0,25, 0,50, 0,75, 1,00, 1,25, 1,50	14
FE	1998	4	Capella 4/1987-	86,00	180 085 0003 181 085 0004	Std, 0,25, 0,50, 0,75, 1,00, 1,25, 1,50 Std, 0,25, 0,50, 0,75, 1,00, 1,25, 1,50	16
FE	1998	4	Capella 4/1987-	86,00	180 085 0003 181 085 0005	Std, 0,25, 0,50, 0,75, 1,00, 1,25, 1,50 Std, 0,25, 0,50	17
RF	1998	4	Bongo, Capella 5/1983-	86,00	180 085 0011 181 085 0004 182 085 0013	Std, 0,25, 0,50 Std, 0,25, 0,50, 0,75, 1,00, 1,25, 1,50 Std	18
RF	1998	4	Bongo, Capelo 6/1986	86,00	180 085 0011 181 085 0013 182 085 0013	Std, 0,25, 0,50 Std, 0,25, 0,50 Std	19
RF-T	1998	4	Bongo, Capelo 12/1988-	86,00	180 085 0011 181 085 0013 182 085 0013	Std, 0,25, 0,50 Std, 0,25, 0,50 Std	19
F2	2184	4	Capella 5/1988-	86,00	180 085 0003 181 085 0004	Std, 0,25, 0,50, 0,75, 1,00, 1,25, 1,50 Std, 0,25, 0,50, 0,75, 1,00, 1,25, 1,50	16
R2	2184	4	Bongo, Capella 5/1983-	86,00	180 085 0011 181 085 0004 182 085 0013	Std, 0,25, 0,50 Std, 0,25, 0,50, 0,75, 1,00, 1,25, 1,50 Std	18
LF	1998	4	Atenza, Axcela	87,50	180 085 0012 181 085 0015	Std, 0,25, 0,50 Std, 0,25, 0,50	21
L3	2260	4	Atenza, Axcela, MPV	87,50	180 085 0012 181 085 0016	Std, 0,25, 0,50 Std, 0,25, 0,50	20
AJ	2967	6	MPV (LW) 3.0 i V6, TRIBUTE (EP) 3.0 V6	89,00	180 085 0014 181 085 0018	Std, 0,25, 0,50, 0,75 Std, 0,25, 0,50, 0,75	22
JE	2954	6	Luce, Sentia 7/1987-	90,00	181 085 0009 182 085 0008	Std, 0,25 Std	23
WL, WL-T	2499	4		93,00	180 085 0013 181 085 0014 182 085 0014 184 085 0003	Std, 0,25, 0,50, 0,75, 1,00 Std, 0,25, 0,50, 0,75, 1,00 Std Std	24

















							Set Composition / QTY														
1 68,00																					
MB/HL 1, 2, 3, 4, 5	5 Pairs	49,955	54,000	17,030	SAL	180 085 0007 00	15														
							21	10													
							26														
							29														
							31														
							33														
CB/PL 1, 2, 3, 4	4 Pairs	39,956	43,000	17,130	SAL	181 085 0001 00	15														
							21	8													
							26														
							29														
							31														
							33														
TW/A 1	2 Halves	57,250	69,000		SAL	182 085 0001 00		2													
2 68,00																					
MB/HL 1, 2, 3, 4, 5	5 Pairs	49,955	54,000	17,030	SAL	180 085 0001 00	15														
							21	5		5											
							26														
							29														
CB/PL 1, 2, 3, 4	4 Pairs	39,956	43,000	17,130	SAL	181 085 0001 00	15														
							21	8													
							26														
							29														
							31														
							33														
TW/A 1	2 Halves	57,250	69,000		SAL	182 085 0001 00		2													
3 68,00																					
MB/HL 1, 2, 4	3 Pairs	55,955	60,000	20,130	SAL	180 085 0005 00	15														
MB/HL 3, 5	2 Pairs	55,955	60,000	23,130	SAL		21														
CB/PL 1, 2, 3, 4	4 Pairs	44,955	48,002	19,630	SAL	181 085 0007 00	15														
							21														
TW/A 1	4 Halves	62,250	78,000		SAL	182 085 0005 00															
4 68,00																					
MB/HL 1, 2, 4	3 Pairs	55,955	60,000	20,130	SAL	180 085 0005 00	15														
MB/HL 3, 5	2 Pairs	55,955	60,000	23,130	SAL		21														
CB/PL 1, 2, 3, 4	4 Pairs	44,955	48,002	19,630	SAL	181 085 0007 00	15														
							21														
TW/A 1	4 Halves	62,250	78,000		SAL	182 085 0004 00															
5 73,70																					
MB/HL 1, 2, 3, 4, 5	5 Pairs	49,962 49,981	53,655 53,674	19,900	SAL	180 051 0001 00	15														
							17	5		5											
							21														
							28														
CB/PL 1, 2, 3, 4	4 Pairs	44,975 44,991	48,665 48,671	17,050	S4S	181 037 0015 00	17														
							21	4		4											
TW/A 1	2 Halves	55,200 55,480	71,350 71,700		SAL	182 051 0001 00		2													



MAZDA

Globally reliable

							Set Composition / QTY											
6 77,00																		
MB/HL 1, 2, 3, 4, 5	5 Pairs	49,955	54,000	17,030	SAL	180 085 0007 00	15											
							21											
							26	10										
							29											
							31											
							33											
CB/PL 1, 2, 3, 4	4 Pairs	39,956	43,000	17,130	SAL	181 085 0001 00	15											
							21											
							26	8										
							29											
							31											
							33											
TW/A 1	4 Halves	57,250	69,000		SAL	182 085 0003 00	00											
							00	2		2								
7 78,00																		
MB/HL 1, 2, 3, 4, 5	5 Pairs	49,955	54,000	17,030	SAL	180 085 0007 00	15											
							21											
							26	10										
							29											
							31											
							33											
CB/PL 1, 2, 3, 4	4 Pairs	44,956	48,000	17,130	SAL	181 085 0003 00	15											
							21											
							26	8										
							29											
TW/A 1	2 Halves	57,250	69,000		SAL	182 085 0001 00	00											
							00	2										
Bush/PB 1, 2, 3, 4	4 Pairs	19,993	23,000	21,800	SL	184 085 0001 00	00											
8 78,00																		
MB/HL 1, 2, 3, 4, 5	5 Pairs	49,955	54,000	17,030	SAL	180 085 0001 00	15											
							21											
							26	5		5								
							29											
CB/PL 1, 2, 3, 4	4 Pairs	44,956	48,000	17,130	SAL	181 085 0003 00	15											
							21											
							26	8										
							29											
TW/A 1	2 Halves	57,250	69,000		SAL	182 085 0001 00	00											
							00	2										
Bush/PB 1, 2, 3, 4	4 Pairs	19,993	23,000	21,800	SL	184 085 0001 00	00											
9 78,00																		
MB/HL 1, 2, 4	3 Pairs	62,955	67,000	18,130	SAL	180 085 0006 00	15											
							21											
							26	2		2		6						
							29											
MB/HL 3, 5	2 Pairs	62,955	67,000	24,130	SAL	180 085 0006 00	21											
							26											
							29											
CB/PL 1, 2, 3, 4	4 Pairs	52,955	56,002	20,930	SAL	181 085 0002 00	15											
							21											
							26	8										
							29											
TW/A 1	4 Halves	71,750	86,400		SL	182 085 0007 00	00											
							00	2		2								

							Set Composition / QTY									
10 78,00																
MB/HL 1, 2, 4	3 Pairs	62,955	67,000	18,130	SAL	180 085 0006 00	2		2		6					
MB/HL 3, 5	2 Pairs	62,955	67,000	24,130	SAL	21 26 29										
CB/PL 1, 2, 3, 4	4 Pairs	52,950	56,002	22,130	SAL	181 085 0019 00										
TW/A 1	4 Halves	71,750	86,400		SL	182 085 0007 00	2		2							
11 78,00																
MB/HL 1, 2, 3, 4, 5	5 Pairs	55,955	60,000	17,630	SAL	180 085 0010 00										
TW/A 1	2 Halves	62,250	79,000		SAL	182 085 0012 00										
12 80,00																
MB/HL 1, 2, 4	3 Pairs	62,955	67,000	18,130	SAL	180 085 0006 00	2		2		6					
MB/HL 3, 5	2 Pairs	62,955	67,000	24,130	SAL	21 26 29										
CB/PL 1, 2, 3, 4	4 Pairs	52,950	56,002	22,130	SAL	181 085 0020 00										
TW/A 1	4 Halves	71,750	86,400		SL	182 085 0007 00	2		2							
13 80,30																
MB/HL 1, 2, 3	3 Pairs	61,955	67,000	18,130	S3S	180 085 0009 00										
MB/HL 4	1 Pair	61,955	67,000	22,030	S3S	15										
CB/PL 1, 2, 3, 4, 5, 6	6 Pairs	52,955	56,000	17,030	S3S	181 085 0008 00										
TW/A 1	4 Halves	68,250	80,000		SAL	182 085 0008 00										
14 81,00																
MB/HL 1, 2, 4, 5	4 Pairs	59,955	64,000	18,530	SAL	180 085 0002 00	9		1							
MB/HL 3	1 Pair	59,955	64,000	27,990	SAL	21 26 29										
CB/PL 1, 2, 3, 4	4 Pairs	50,955	54,002	21,130	SAL	181 085 0004 00	8									
15 83,00																
MB/HL 1, 2, 3, 4, 5	5 Pairs	55,955	60,000	17,630	SAL	180 085 0004 00	5		5							
CB/PL 1, 2, 3, 4	4 Pairs	47,956	51,000	17,130	SAL	181 085 0006 00	8									
TW/A 1	2 Halves	62,250	82,000		SAL	182 085 0002 00	2									



MAZDA

Globally reliable







														Set Composition / QTY						
16 86,00																				
MB/HL 1, 2, 4, 5	4 Pairs	59,955	64,000	18,530	SAL	180 085 0003 00	4		5		1									
MB/HL 3	1 Pair	59,955	64,000	27,990	SAL		21													
							26													
							29													
							31													
							33													
CB/PL 1, 2, 3, 4	4 Pairs	50,955	54,002	21,130	SAL	181 085 0004 00	8													
							15													
							21													
							26													
							29													
							31													
							33													
17 86,00																				
MB/HL 1, 2, 4, 5	4 Pairs	59,955	64,000	18,530	SAL	180 085 0003 00	4		5		1									
MB/HL 3	1 Pair	59,955	64,000	27,990	SAL		21													
							26													
							29													
							31													
							33													
CB/PL 1, 2, 3, 4	4 Pairs	50,955	54,002	21,130	SAL	181 085 0005 00	8													
							15													
							21													
18 86,00																				
MB/HL 1, 2, 4, 5	4 Pairs	59,955	64,000	18,530	SAL	180 085 0011 00	8		2											
MB/HL 3	1 Pair	59,955	64,000	21,130	SAL		21													
CB/PL 1, 2, 3, 4	4 Pairs	50,955	54,002	21,130	SAL	181 085 0004 00	8													
							15													
							21													
							26													
							29													
							31													
							33													
TW/A 1	4 Halves	69,250	84,400		SAL	182 085 0013 00	2		2											
							15													
							21													
19 86,00																				
MB/HL 1, 2, 4, 5	4 Pairs	59,955	64,000	18,530	SAL	180 085 0011 00	8		2											
MB/HL 3	1 Pair	59,955	64,000	21,130	SAL		21													
CB/PL 1, 2, 3, 4	4 Pairs	50,955	54,002	21,130	SAL	181 085 0013 00	8													
							15													
							21													
TW/A 1	4 Halves	69,250	84,400		SAL	182 085 0013 00	2		2											
							15													
							21													
20 87,50																				
MB/HL 1, 2, 4, 5	4 Pairs	52,000	57,020	19,100	SAL	180 085 0012 00	4		5		1									
MB/HL 3	1 Pair	52,000	57,020	25,780	SAL		21													
CB/PL 1, 2, 3, 4	4 Pairs	50,000	53,025	16,900	SAL	181 085 0016 00	8													
							15													
							21													







							Set Composition / QTY														
21	87,50																				
MB/HL 1, 2, 4, 5	4 Pairs	52,000	57,020	19,100	SAL	180 085 0012 00	15	4		5		1									
MB/HL 3	1 Pair	52,000	57,020	25,780	SAL		21														
CB/PL 1, 2, 3, 4	4 Pairs	47,000	50,025	16,900	SAL	181 085 0015 00	15	8													
							21														
22	89,00																				
MB/HL 1, 2, 3	3 Pairs	62,969 62,992	67,998 68,021	17,960	SSI	180 085 0014 00	15	4		3		1									
MB/HL 4	1 Pair	62,969 62,992	67,998 68,021	22,310	SSI		21 26														
CB/PL 1, 2, 3, 4, 5, 6	6 Pairs	49,972 49,990	53,015 53,035	17,950	SSI	181 085 0018 00	15	12													
							21 26														
23	90,00																				
CB/PL 1, 2, 3, 4, 5, 6	6 Pairs	52,955	56,000	17,030	SAL	181 085 0009 00	15	12													
TW/A 1	4 Halves	68,250	80,000		SAL	182 085 0008 00															
24	93,00																				
MB/HL 1, 2, 3, 4, 5	5 Pairs	66,955	71,000	22,600	SAL	180 085 0013 00	15	5		5											
							21 26 29														
CB/PL 1, 2, 3, 4	4 Pairs	54,955	58,000	23,600	SAL	181 085 0014 00	15	8													
							21 26 29														
TW/A 1	4 Halves	75,200	91,800		SAL	182 085 0014 00		2		2											
Bush/PB 1, 2, 3, 4	4 Pairs	32,000	35,000	30,800	SL	184 085 0003 00															



Globally reliable

MERCEDES BENZ







	ccm						Pos.
M160 R3	599	3	City Cabrio 600i, City Cabrio 600i Turbo, Crossblade 600i, Fortwo City Coupe 600i Turbo, Passion 600i Turbo, Pulse 600i Turbo, Pure 600i Turbo	63,50	180 110 0001 181 110 0002 182 110 0001	Std, 0,25, 0,50 Std, 0,25, 0,50 Std	1
OM 660.914	799	3	Fortwo City Cabrio 800 CDI, Fortwo City Coupe 800 CDI	65,50	180 110 0002 181 110 0003 182 110 0001	Std, 0,25, 0,50 Std, 0,25, 0,50 Std	2
M 132.910 M1 32.930	999	3	Fortwo Cabrio, Fortwo Coupe, Fortwo Cabrio Turbo, Fortwo Coupe Turbo, Fortwo Cabrio Brabus, Fortwo Coupe Brabus, Fortwo Cabrio Turbo Brabus, Fortwo Coupe Turbo Brabus	72,00	180 110 0003 181 110 0001 182 110 0002	Std, 0,25, 0,50 Std, 0,25, 0,50 Std	3
M 281.910	898	3	FORFOUR 0.9	72,20	180 038 0017 181 038 0022 182 038 0008	Std, 0,25, 0,50 Std, 0,25, 0,50 Std	4
M 271.940 / .946 / .948	1796	4	C180 Compr.16V, C200 Compr. 16V, C-Class 230 Compr. 16V, CLC 180 Compr. 16V, CLK 200 Compr. 16V	82,00	180 010 0012 181 010 0017 182 010 0003	Std, 0,25 Std, 0,25 Std	5
OM 654.920	1950	4	E-CLASS E 200 d E-CLASS E 220 d E-CLASS E 220 d 4-matic E-CLASS E 300 d E-CLASS E 300 de E-CLASS E 300 de 4-matic	82,00	180 010 0022 181 010 0022	Std Std	6
OM 654.920	1950	4	C-CLASS C 300 d C-CLASS C 300 d 4-matic C-CLASS C 300 d C-CLASS C 220 d 4-matic C-CLASS C 220 d C-CLASS C 200 d	82,00	180 010 0022 181 010 0022	Std Std	6
OM 654.920	1950	4	A-CLASS A 180 d A-CLASS A 200 d A-CLASS A 200 d 4-matic A-CLASS A-KLASSE A 220 d A-CLASS A-KLASSE A 220 d 4-matic A-CLASS A 200 d A-CLASS A 220 d A-CLASS A 220 d 4-matic B-CLASS B 180 d B-CLASS B 200 d B-CLASS B 200 d 4-matic B-CLASS B 220 d B-CLASS B 220 d 4-matic	82,00	180 010 0022 181 010 0022	Std Std	6
OM 654.920	1950	4	GLA 180 d GLA 200 d GLA 200 d 4-matic GLA 220 d GLA 220 d 4-matic GLB 180 d GLB 200 d GLB 200 d 4-matic GLB 220 d GLB 220 d 4-matic GLC 200 d GLC 200 d 4-matic GLC 220 d GLC 220 d 4-matic GLC 300 d 4-matic GLC 300 de 4-matic GLE 300 d 4-matic GLE 350 de 4-matic	82,00	180 010 0022 181 010 0022	Std Std	6
OM 654.920	1950	4	V-CLASS V 220 CDI / d V-CLASS V 220 CDI / d 4-matic V-CLASS V 250 CDI / d V-CLASS V 250 CDI / d 4-matic V-CLASS V 300 CDI / d V-CLASS V 300 CDI / d 4-matic V-CLASS V-KLASSE V 300 CDI / d VITO 114 CDI VITO 114 CDI 4x4 VITO 116 CDI VITO 116 CDI 4x4 VITO 119 CDI VITO 119 CDI 4x4	82,00	180 010 0022 181 010 0022	Std Std	6
OM 654.920	1950	4	SPRINTER 3,5-t 311 CDI RWD SPRINTER 3,5-t 315 CDI RWD SPRINTER 3,5-t 317 CDI RWD SPRINTER 3-t 211 CDI RWD SPRINTER 3-t 215 CDI RWD SPRINTER 3-t 217 CDI RWD SPRINTER 4-t 417 CDI RWD	82,00	180 010 0022 181 010 0022	Std Std	6







	ccm						Pos.
OM 656.929	2925	6	CLS 350 d CLS 350 d 4-matic CLS 400 d 4-matic E-CLASS E 350 d E-CLASS E 400 d E-CLASS E 400 d 4-matic E-CLASS E-KLASSEE 400 d G-CLASS G 350 d 4-matic G-CLASS G 400 d 4-matic GLC 400 d 4-matic GLE 350 d 4-matic GLE 400 d 4-matic GLS 350 d 4-matic GLS 400 d 4-matic S-CLASS S 350 d S-CLASS S 350 d 4-matic S-CLASS S 400 d S-CLASS S 400 d 4-matic	82,00	181 010 0023	Std	8
OM 654.820	1992	4	C-CLASS C 220 D C-CLASS C 300 D CLS 300 d 4-matic CLS 350 D EQ BOOST 4-MATIC E-CLASS E 300 d 4-matic E-CLASS E 350 D EQ BOOST 4-MATIC	82,00	181 010 0022	Std	7
M103.940-943	2599	6	190E 2.6(201), 260E(124), 260E(126), 300E 2.6(124)	82,90	180 010 0005 181 010 0010 182 010 0002	Std, 0,25, 0,50 Std, 0,25, 0,50 Std, 0,10, 0,20	9
M266.920	1498	4	A-Class A150, A-Class A160, B-Class B150, B-Class B160	83,00	180 010 0016 182 010 0003	Std, 0,25 Std	10
M266.940	1699	4	A-Class A170, A-Class A180, B-Class B170, B-Class B180	83,00	180 010 0016 182 010 0003	Std, 0,25 Std	10
OM 642.XXX	2987	6	C-Class: C 300 CDI, C 320 CDI, C 350 CDI CLK: 320 CDI CLS: 320 CDI, 350 BlueTEC / d, 350 CDI E-Class: E 280 CDI, E 300 BlueTEC, E 300 CDI, E 320 CDI, E 320 T CDI, E 350 BlueTEC E 350 BlueTEC / d, E 350 CDI E 350 d G-Class: G 280 CDI, G 300 CDI, G 320 CDI, G 350 CDI, G 350 d GLC 350 d 4-matic GL-Class: 320 CDI / 350 BlueTEC 4-matic 350 CDI / BlueTec 4-matic, GLE 350 d 4-matic, GLK-Class: 320 CDI 4-matic, 350 CDI 4-matic GLS 350 d 4-matic, M-Class: 280 CDI 4-matic, 300 CDI 4-matic 320 CDI 4-matic 350 BlueTEC 4-matic, 350 CDI 4-matic, R-Class: 280 CDI, 300 CDI, 320 CDI, 350 CDI S-Class: 320 CDI, 350 BlueTec, 350 BlueTEC / d, 350 CDI X-CLASS X 350 d 4-matic, VIANO CDI 3.0, VITO / MIXTO 120 CDI / 122 CDI SPRINTER 3,5-t: 318 CDI, 319 CDI, 319 CDI / BlueTEC, 319 CDI Allrad SPRINTER 3-t: 218 CDI, 219 CDI / BlueTEC SPRINTER 4,6-t 418 CDI, 419 CDI SPRINTER 4-t 419 CDI RWD, SPRINTER 5-t: 518 CDI, 519 CDI, 519 CDI / BlueTEC, 519 CDI Allrad	83,00	180 010 0021 181 010 0021	Std, 0,25, 0,50 Std, 0,25, 0,50	12
M266.960, M266.980	2034	4	A-Class A200, A-Class A200 Turbo, B-Class B200, B-Class B200 Turbo, B-Class B170 NGT, B-Class B180 NGT	83,00	180 010 0016 182 010 0003	Std, 0,25 Std	10













Globally reliable

MERCEDES BENZ

	ccm						Pos.
OM651.911, OM651.912, OM651.913, OM651.916, OM651.924, OM651.925, OM651.940, OM651.955, OM651.956, OM651.957, OM651.961	2143	4	C 220 CDI 01.2007- C 250 CDI 10.2007- E 220 CDI 01.2010- E 250 CDI 01.2009- GLK 220 CDI 12.2008- GLK 250 CDI 09.2009- C 180 CDI 01.2011- C 200 CDI 01.2011- GLK 200 CDI 07.2010- CLS 250 CDI 01.2011- E 200 CDI 01.2009- E 300 CDI BlueTEC Hybrid 12.2011- Shooting Brake 250 CDI 10.2012- Vito 110 CDI 09.2010- Vito 113 CDI 09.2010- Vito 116 CDI 09.2010- Sprinter 210 CDI 03.2009- Sprinter 310 CDI 03.2009- Sprinter 313 CDI 03.2009- Sprinter 510 CDI 03.2009- Sprinter 513 CDI 06.2006- Sprinter 213 CDI 03.2009- Sprinter 216 CDI 06.2006- Sprinter 316 CDI 03.2009- Sprinter 416 CDI 03.2009- Sprinter 516 CDI 03.2009- ML 250 CDI 06.2011 S 250 CDI 12.2010-06.2013	83,00	180 010 0014 180 010 0015 181 010 0001	Std, 0,25, 0,50 Std, 0,25, 0,50 Std, 0,25, 0,50	11
M112.910, M112.911	2398	6	C240, E240	83,20	180 010 0006 181 010 0011	Std, 0,20 Std, 0,20	13
M 111.920-921	1799	4	C180(202)	85,30	180 010 0001 181 010 0007 182 010 0002 184 010 0002	Std, 0,25, 0,50, 0,75 Std, 0,25, 0,50, 0,75 Std, 0,10, 0,20 Semi	14
M115.923, M115.926, M115.938-.939	1988	4	200(115), 200(123)	87,00	180 010 0004 181 010 0008 181 010 0018 184 010 0003	Std, 0,25, 0,50, 0,75 Std, 0,25, 0,50, 0,75 Std, 0,25, 0,50, 0,75 Semi	15
OM601.911-.913	1997	4	C200 D(202), E200 D(124), 190D (201)	87,00	180 010 0001 181 010 0004 181 010 0009 182 010 0002 184 010 0004	Std, 0,25, 0,50, 0,75 Std, 0,25, 0,50, 0,75 Std, 0,25, 0,50 Std, 0,10, 0,20 Semi	16
OM602.961-.962, OM602.970, OM602.993	2497	5	E250 D Turbo (124/210), 190 D 2.5 Turbo (201), 300 D 2.5 Turbo (124)	87,00	180 010 0008 181 010 0002 181 010 0013 182 010 0002	Std, 0,25, 0,50, 0,75 Std, 0,25, 0,50 Std, 0,25, 0,50 Std, 0,10, 0,20	17
OM603.950, OM603.960-.963, OM606.961-.962, OM606.964	2996	6	E300 D Turbo (124/210), G300 D Turbo (463), S300 D Turbo (140), 300SD Turbo (126)	87,00	180 010 0005 181 010 0002 181 010 0013 182 010 0002	Std, 0,25, 0,50 Std, 0,25, 0,50 Std, 0,25, 0,50 Std, 0,10, 0,20	18
OM604.915, OM604.917	1997	4	C200 D(202), E200 D(210)	87,00	180 010 0001 181 010 0009 182 010 0002	Std, 0,25, 0,50, 0,75 Std, 0,25, 0,50 Std, 0,10, 0,20	20
OM602.911-912, 930-931, 938-939, 990	2497	5	190D 2.5, 250 D, 250 GD	87,00	180 010 0008 181 010 0015 182 010 0002	Std, 0,25, 0,50, 0,75 Std, 0,25, 0,50, 0,75 Std, 0,10, 0,20	21
OM601.921(USA)	2197	4	190D 2.2(201)	87,00	180 010 0001 181 010 0004 181 010 0009 182 010 0002	Std, 0,25, 0,50, 0,75 Std, 0,25, 0,50, 0,75 Std, 0,25, 0,50 Std, 0,10, 0,20	19
M 272.911 M 272.920, M 272.921, M 272.922	2496	6	C-CLASS (W203) C 230, C-CLASS (W204) C 230, C-CLASS Coupe (CL203) C 230, C-CLASS T-Model (S203) C 230, C-CLASS T-Model (S204) C 230, C-CLASS T-Model (S204) C 250, CLC-CLASS (CL203) CLC 230, CLC-CLASS (CL203) CLC 250, E-CLASS (W211) E 230, E-CLASS T-Model (S211) E 230 T	88,00	180 010 0019 181 010 0019	Std, 0,25, 0,50, 0,75 Std, 0,25, 0,50, 0,75	24

	ccm						Pos.
M 272.940, M 272.941, M 272.942, M 272.943, M 272.944, M 272.945, M 272.946, M 272.947, M 272.948, M 272.949, M 272.952	2996	6	C-CLASS (W203) C 280, C-CLASS (W203) C 280 4-matic, C-CLASS (W204) C 280, C-CLASS (W204) C 280 4-matic, C-CLASS (W204) C 300, C-CLASS (W204) C 300 4-matic, C-CLASS T-Model (S203) C 280, C-CLASS T-Model (S204) C 280, C-CLASS T-Model (S204) C 300, CLK (C209) 280, CLK Cabriolet (A209) CLK 280, CLS (C219) CLS 280, CLS (C219) CLS 300, E-CLASS (W211) E 280, E-CLASS (W211) E 280 4-matic, E-CLASS (W212) E 300, E-CLASS T-Model (S211) E 280 T, E-CLASS T-Model (S212) E 300, GLK-CLASS (X204) 280 4-matic, GLK-CLASS (X204) 300 4-matic, M-CLASS (W164) ML 300 4-matic, R-CLASS (W251, V251) R 280, R-CLASS (W251, V251) R 280 4-matic, R-CLASS (W251, V251) R 300, R-CLASS (W251, V251) R 300 4-matic, S-CLASS (W221) S 280, S-CLASS (W221) S 300, SL (R230) 280, SL (R230) 300, SLK (R171) 280, SLK (R171) 300	88,00	180 010 0019 181 010 0019	Std, 0,25, 0,50, 0,75 Std, 0,25, 0,50, 0,75	24
OM611.960-.962, OM611.980-.981, OM611.983, OM611.987, OM646.951, OM646.961-.963, OM646.966, OM646.982-.984	2151	4	C200 CDI (202/203), C220 CDI (202/203), CLC220 CDI (203), E220 CDI (210/211), Sprinter 209 CDI, Sprinter 211 CDI, Sprinter 213 CDI, Sprinter 218 CDI, Sprinter 308 CDI, Sprinter 309 CDI, Sprinter 311 CDI, Sprinter 313 CDI, Sprinter 408 CDI, Sprinter 411 CDI, Sprinter 413 CDI, Viano 220 CDI, Vito 109 CDI, Vito 110 CDI, Vito 112 CDI, Vito 115 CDI	88,00	180 010 0009 180 010 0013 181 010 0003 181 010 0014 182 010 0002 184 010 0005	Std, 0,25, 0,50 Std, 0,25, 0,50 Std, 0,25, 0,50 Std, 0,25, 0,50 Std, 0,10, 0,20 Semi	22
OM612.961-.963, OM612.965-.967, OM612.981, OM612.983, OM647.961, OM647.981	2686	5	C270 CDI (203), CLK270 CDI (209), E270 CDI (210/211), G270 CDI (461/463), Sprinter 216 CDI, Sprinter 308 CDI, Sprinter 311 CDI, Sprinter 314 CDI, Sprinter 316 CDI, Sprinter 408 CDI, Sprinter 411 CDI, Sprinter 413 CDI, Sprinter 414 CDI, Sprinter 416 CDI, Sprinter 616 CDI	88,00	180 010 0009 180 010 0013 181 010 0003 181 010 0014 182 010 0002	Std, 0,25, 0,50 Std, 0,25, 0,50 Std, 0,25, 0,50 Std, 0,25, 0,50 Std, 0,10, 0,20	23
OM613.960-.961, OM648.960	3222	6	E320 CDI (210), S320 CDI (220),	88,00	180 010 0009 180 010 0013 181 010 0003 181 010 0014 182 010 0002	Std, 0,25, 0,50 Std, 0,25, 0,50 Std, 0,25, 0,50 Std, 0,25, 0,50 Std, 0,10, 0,20	23
M103.980-.985, M103.987, M104.980-.981	2962	6	300 E (124), 300 GE (463), 300 SE (126), 300 SL (107), 300 SL (129)	88,50	180 010 0005 181 010 0010 182 010 0002	Std, 0,25, 0,50 Std, 0,25, 0,50 Std, 0,10, 0,20	9
M102.910, M102.919	1797	4	190 E 1.8 (201)	89,00	180 010 0001 181 010 0006 181 010 0007 182 010 0001 182 010 0002 184 010 0001 184 010 0002	Std, 0,25, 0,50, 0,75 Std, 0,25, 0,50, 0,75, 1,00 Std, 0,25, 0,50, 0,75 Std Std, 0,10, 0,20 Semi Semi	25
M102.965	1997	4	200 GE (463)	89,00	180 010 0001 181 010 0006 181 010 0007 182 010 0001 182 010 0002 184 010 0001 184 010 0002	Std, 0,25, 0,50, 0,75 Std, 0,25, 0,50, 0,75, 1,00 Std, 0,25, 0,50, 0,75 Std Std, 0,10, 0,20 Semi Semi	25
M102.920, M102.938-.939	1997	4	190 2.0(201), 200(123)	89,00	180 010 0003 181 010 0006 181 010 0007 182 010 0001 182 010 0002 184 010 0001 184 010 0002	Std, 0,25, 0,50, 0,75, 1,00 Std, 0,25, 0,50, 0,75, 1,00 Std, 0,25, 0,50, 0,75 Std Std, 0,10, 0,20 Semi Semi	26
M102.921-.922, M102.924, M102.961-.963, M102.964	1997	4	190 2.0(201), 190 E 2.0(201), 200(124), 200 E(124), 200 GE (460)	89,00	180 010 0001 180 010 0003 181 010 0006 181 010 0007 182 010 0001 182 010 0002 184 010 0001 184 010 0002	Std, 0,25, 0,50, 0,75 Std, 0,25, 0,50, 0,75, 1,00 Std, 0,25, 0,50, 0,75, 1,00 Std, 0,25, 0,50, 0,75 Std Std, 0,10, 0,20 Semi Semi	27
OM604.910, OM604.912	2155	4	C 220 D(202), E 220 D(210)	89,00	180 010 0001 181 010 0009 182 010 0002	Std, 0,25, 0,50, 0,75 Std, 0,25, 0,50 Std, 0,10, 0,20	20
OM601.900-000, OM601.940-.943	2299	4	Sprinter 208 D 2.3, Sprinter 308 D 2.3, Sprinter 408 D 2.3, Vito 108 D 2.3	89,00	180 010 0001 181 010 0009 182 010 0002 184 010 0004	Std, 0,25, 0,50, 0,75 Std, 0,25, 0,50 Std, 0,10, 0,20 Semi	28







	ccm					Pos.	
OM601.970	2299	4	V230 TD (638), Viano 110 D 2.3, Vito 110 2.3 D	89,00	180 010 0001 181 010 0002 181 010 0013 182 010 0002	Std, 0,25, 0,50, 0,75 Std, 0,25, 0,50 Std, 0,25, 0,50 Std, 0,10, 0,20	29
OM602.980-.986, OM602.986	2874	5	E290 D Turbo (210), Sprinter 210 D 2.9, Sprinter 212 D 2.9, Sprinter 310 D 2.9, Sprinter 312 D 2.9, Sprinter 410 D 2.9, Sprinter 412 D 2.9, Vario 512 D 2.9, Vario 612 D 2.9, Vario 614 D 2.9, Vario 810 D 2.9, Vario 812 D 2.9, Vario 814 D 2.9, Vario 815 D 2.9, U90 Turbo, U100 Turbo	89,00	180 010 0008 180 010 0009 180 010 0013 181 010 0002 181 010 0013 182 010 0002	Std, 0,25, 0,50, 0,75 Std, 0,25, 0,50 Std, 0,25, 0,50 Std, 0,25, 0,50 Std, 0,25, 0,50 Std, 0,10, 0,20	30
OM603.970-.972	3449	6	G350 D Turbo (463), S350 D Turbo (140), 300 SD 3.5 Turbo (140)	89,00	180 010 0005 181 010 0002 181 010 0013 182 010 0002	Std, 0,25, 0,50 Std, 0,25, 0,50 Std, 0,25, 0,50 Std, 0,10, 0,20	18
OM661.911	2299	4	MB 100 2.3 D	89,00	180 010 0001 181 010 0009 182 010 0002 184 010 0004	Std, 0,25, 0,50, 0,75 Std, 0,25, 0,50 Std, 0,10, 0,20 Semi	28
OM602 900, 940-942, 946-948, 991, 994-995	2874	5	290 GD, City Bus 2.9, O405 GTZ, U100	89,00	180 010 0008 181 010 0009 182 010 0002	Std, 0,25, 0,50, 0,75 Std, 0,25, 0,50 Std, 0,10, 0,20	31
OM662.911	2874	5	MB 100 2.9D	89,00	180 010 0008 181 010 0009 182 010 0002	Std, 0,25, 0,50, 0,75 Std, 0,25, 0,50 Std, 0,10, 0,20	31
M112.912-915, M112.917	2597	6	C240, CLK240, E240	89,90	180 010 0006 181 010 0011	Std, 0,20 Std, 0,20	13
M112.920-.923, M112.925	2799	6	C280, E280, S280	89,90	180 010 0006 181 010 0011	Std, 0,20 Std, 0,20	13
M104.941-.945	2799	6	C 280(202), E 280(124), E 280(210), S 280(140), SL 280(129)	89,90	180 010 0005 181 010 0010 182 010 0002	Std, 0,25, 0,50 Std, 0,25, 0,50 Std, 0,10, 0,20	9
M 111.940-.948, M 111.950-.951, M 111.955-.958	1998	4	C200(202), C200 Kompressor(202), C200 Kompressor(203), CLK 200(208), CLK 200 Kompressor(208), E 200(124), E 200(210), E 200 Kompressor(210), SLK 200 Kompressor(170), Vito 113 2.0, 200 E(124), V 200(638), Viano 200	89,90	180 010 0001 181 010 0007 182 010 0002 184 010 0002	Std, 0,25, 0,50, 0,75 Std, 0,25, 0,50, 0,75 Std, 0,10, 0,20 Semi	14
M112.940-.947, M112.949	3199	6	C320, E320, CLK320, G320, ML320, SL320, SLK320	89,90	180 010 0006 181 010 0011	Std, 0,20 Std, 0,20	13
M113.940-.944	4266	8	CLK430, E430, ML430	89,90	180 010 0007 181 010 0012	Std, 0,20 Std, 0,20	32
M104.990-.992, M104.994-.996	3199	6	E 320(124), E 320(210), G 320(463), G 320(460), S 320(140), SL 320(129)	89,90	180 010 0005 181 010 0010 182 010 0002	Std, 0,25, 0,50 Std, 0,25, 0,50 Std, 0,10, 0,20	9
M 111.960-.961	2199	4	C 220(202), E 220(124)	89,90	180 010 0001 181 010 0007 182 010 0002 184 010 0002	Std, 0,25, 0,50, 0,75 Std, 0,25, 0,50, 0,75 Std, 0,10, 0,20 Semi	14
M 111.970, M 111.973-.975, M 111.977-.984	2295	4	C 230(202), C 230 Kompressor(202), C 230 Kompressor(203), CLK 230 Kompressor(208), E 230(210), SLK 230 Kompressor(170), Sprinter 214 2.3, Sprinter 314 2.3, Sprinter 414 2.3, V 230(638), Viano 230, Vito 114	90,90	180 010 0001 181 010 0007 182 010 0002 184 010 0002	Std, 0,25, 0,50, 0,75 Std, 0,25, 0,50, 0,75 Std, 0,10, 0,20 Semi	14
OM617.912, .913, .919, .931, .932	2998	5	300 D, 300 D Turbo	90,90	180 010 0011 181 010 0016	Std, 0,25, 0,50, 0,75 Std, 0,25, 0,50	33
OM616	2399	4	240 D, Unimog	91,00	180 010 0002 181 010 0005	Std, 0,25, 0,50, 0,75 Std, 0,25, 0,50, 0,75	34
M 273.923, M 273.922, M 273.924	4663	8	GL-CLASS (X164) GL 450 4-matic, S-CLASS (W221) S 450, S-CLASS (W221) S 450 4-matic	92,90	180 010 0020 181 010 0020	Std, 0,25, 0,50, 0,75 Std, 0,25, 0,50, 0,75	36
M 272.960, M 272.961, M 272.963, M 272.964, M 272.965, M 272.966, M 272.967, M 272.968, M 272.969, M 272.970, M 272.971, M 272.972, M 272.974, M 272.975, M 272.977, M 272.978, M 272.979, M 272.982, M 272.983, M 272.985, M 272.991,	3498	6	C-CLASS (W203) C 350 C-CLASS (W203) C 350 4-matic C-CLASS (W204) C 350 C-CLASS (W204) C 350 4-matic C-CLASS (W204) C 350 CGI C-CLASS Coupe (CL203) C 350 C-CLASS T-Model (S203) C 350 C-CLASS T-Model (S203) C 350 4-matic C-CLASS T-Model (S204) C 350 CLC-CLASS (CL203) CLC 350 CLK (C209) 350 CLK Cabriolet (A209) CLK 350 CLS (C219) CLS 350 CLS (C219) CLS 350	92,90	180 010 0019 181 010 0019	Std, 0,25, 0,50, 0,75 Std, 0,25, 0,50, 0,75	24







	ccm						Pos.
M 272.960, M 272.961, M 272.963, M 272.964, M 272.965, M 272.966, M 272.967, M 272.968, M 272.969, M 272.970, M 272.971, M 272.972, M 272.974, M 272.975, M 272.977, M 272.978, M 272.979, M 272.982, M 272.983, M 272.985, M 272.991,	3498	6	E-CLASS (W211) E 350 E-CLASS (W211) E 350 4-matic E-CLASS (W211) E 350 CGI E-CLASS (W212) E 350 4-matic E-CLASS (W212) E 350 CGI E-CLASS T-Model (S211) 3.5 4-matic E-CLASS T-Model (S211) 350 CGI E-CLASS T-Model (S211) E 350 T E-CLASS T-Model (S211) E 350 T 4-matic E-CLASS T-Model (S212) E 350 4-matic E-CLASS T-Model (S212) E 350 CGI GLK-CLASS (X204) 350 GLK-CLASS (X204) 350 4-matic M-CLASS (W164) ML 350 4-matic M-CLASS (W164)ML 350	92,90	180 010 0019 181 010 0019	Std, 0,25, 0,50, 0,75 Std, 0,25, 0,50, 0,75	24
M 272.960, M 272.961, M 272.963, M 272.964, M 272.965, M 272.966, M 272.967, M 272.968, M 272.969, M 272.970, M 272.971, M 272.972, M 272.974, M 272.975, M 272.977, M 272.978, M 272.979, M 272.982, M 272.983, M 272.985, M 272.991,	3498	6	R-CLASS (W251, V251) R 350 R-CLASS (W251, V251) R 350 4-matic S-CLASS (W221) S 350 S-CLASS (W221) S 350 4-matic S-CLASS (W221) S 400 Hybrid SL (R230) 350 SL (R230) 350 SLK (R171) 350 SLK (R171) 350 SPRINTER 3,5-t (906) 324 SPRINTER 3,5-t (906) 324 SPRINTER 3,5-t (906) 324 SPRINTER 3-t (906) 224 SPRINTER 3-t (906) 224 SPRINTER 3-t (906) 224 SPRINTER 4,6-t (906) 424 SPRINTER 4,6-t (906) 424 SPRINTER 5-t (906) 524 SPRINTER 5-t (906) 524 VIANO (W639) 3,5 VITO (W639) 126 VITO / MIXTO (W639) 126	92,90	180 010 0019 181 010 0019	Std, 0,25, 0,50, 0,75 Std, 0,25, 0,50, 0,75	24
M115.951, M115.952, M115.954, M115.955, M115.970, M115.971, M115.972, M115.973, M115.974	2307	4	230.4 (115) 08.1973-12.1976 O 309 2.3 01.1975-08.1982 Series 408 2.3 01.1975-08.1982 Series 409 2.3 01.1975-08.1982 Series 410 2.3 01.1975-08.1982 230 (123) 02.1976-03.1981 230.4 (115) 08.1973-08.1973 G 230 03.1979-07.1993 230 G (460) 03.1979-03.1982	93,75	180 010 0004 181 010 0008 181 010 0018 184 010 0003	Std, 0,25, 0,50, 0,75 Std, 0,25, 0,50, 0,75 Std, 0,25, 0,50, 0,75 Semi	15
M102.942-.943, M102.945, M102.958, M102.981-.983, M102.985, M102.987, M102.997-.998	2299	4	190 E 2.3(201), 190 E 2.3-16(201), 230 E(124), 230 GE(460), 230 GE(461), O 309 2.3, Serie 208 2.3, Serie 210 2.3, Serie 308 2.3, Serie 310 2.3, Serie 408 2.3, Serie 409 2.3, Serie 410 2.3	95,50	180 010 0001 180 010 0003 181 010 0006 181 010 0007 182 010 0001 182 010 0002 184 010 0001 184 010 0002	Std, 0,25, 0,50, 0,75 Std, 0,25, 0,50, 0,75, 1,00 Std, 0,25, 0,50, 0,75, 1,00 Std, 0,25, 0,50, 0,75 Std Std, 0,10, 0,20 Semi Semi	27
M102.946, M102.979, M102.989, M102.996	2299	4	G 230(463), 230 GE(461),	95,50	180 010 0001 181 010 0006 181 010 0007 182 010 0001 182 010 0002 184 010 0001 184 010 0002	Std, 0,25, 0,50, 0,75 Std, 0,25, 0,50, 0,75, 1,00 Std, 0,25, 0,50, 0,75 Std Std, 0,10, 0,20 Semi Semi	25
M102.959, M102.980	2299	4	230 E(123), O 309 2.3	95,50	180 010 0003 181 010 0006 181 010 0007 182 010 0001 182 010 0002 184 010 0001 184 010 0002	Std, 0,25, 0,50, 0,75, 1,00 Std, 0,25, 0,50, 0,75, 1,00 Std, 0,25, 0,50, 0,75 Std Std, 0,10, 0,20 Semi Semi	26
M102.990	2498	4	190 E 2.5-16(201)	95,50	180 010 0001 181 010 0006 181 010 0007 182 010 0001 182 010 0002 184 010 0001 184 010 0002	Std, 0,25, 0,50, 0,75 Std, 0,25, 0,50, 0,75, 1,00 Std, 0,25, 0,50, 0,75 Std Std, 0,10, 0,20 Semi Semi	25
M113.960-.964, M113.967-.968, M113.980	4966	8	CLK500, CLS500, E500, G500, ML500, CL500, S500, SL500	97,00	180 010 0007 181 010 0012	Std, 0,20 Std, 0,20	32
M113.981, M113.984	5439	8	CLK55 AMG, E55 AMG, ML55 AMG	97,00	180 010 0007 181 010 0012	Std, 0,20 Std, 0,20	32
OM356, OM357, OM366, OM372, OM376, OM377	5958	6	O301, O370, O371, O402, MB-Trac.1000, MB-Trac.1100, MB-Trac.1300 turbo, MB-Trac.1400 turbo, MB-Trac.-1600 turbo, U900, U1000, U1200, U1250, U1300, U1350, U1400, U1450, U1550, U1600, U1650, U1700, U1750, U1800, U1850, U2100, U2150, U2400, U2450, Serie 814/817/914/917	97,50	180 010 0010 181 100 0007	Std, 0,25, 0,50, 0,75, 1,00 Std, 0,25, 0,50, 0,75, 1,00	35



Globally reliable

MERCEDES BENZ







	ccm						Pos.
M 273.960, M 273.961, M 273.962, M 273.963, M 273.963, M 273.965, M 273.966, M 273.967, M 273.968, M 273.970, M 273.971	5461	8	S-CLASS (W221) S 500, CLK (C209) 500, CLK Cabriolet (A209) CLK 500, CLS (C219) CLS 500, E-CLASS (W211) E 500 4-matic, E-CLASS (W211) E 500, E-CLASS (W212) E 500, E-CLASS (W212) E 500 4-matic, E-CLASS Cabriolet (A207) E 500, E-CLASS Coupe (C207) E 500, E-CLASS T-Model (S211) E 500 T, E-CLASS T-Model (S212) E 500, G-CLASS (W463) G 500, G-CLASS Cabrio (W463) G 500, GL-CLASS (X164) GL 500 4-matic, M-CLASS (W164) ML 500 4-matic, R-CLASS (W251, V251) R 500 4-matic, S-CLASS (W221) S 500 4-matic, S-CLASS (W221) S 500 4-matic, S-CLASS Coupe (C216) CL 500, S-CLASS Coupe (C216) CL 500 4-matic, SL (R230) 500 (230.471)	98,00	180 010 0020 181 010 0020	Std, 0,25, 0,50, 0,75 Std, 0,25, 0,50, 0,75	36
OM 904.941	4249	4	OF Series 8000	102,00	180 100 0010 181 100 0011	Std, 0,25, 0,50 Std, 0,25, 0,50	37
OM 902.914, OM 902.931	6374	6	AXOR 2 1826 K, AK, LS	102,00	180 100 0010 181 100 0011	Std, 0,25, 0,50 Std, 0,25, 0,50	37
OM 906.910	6374	6	ATEGO 823-2223	102,00	180 100 0010 181 100 0011	Std, 0,25, 0,50 Std, 0,25, 0,50	37
OM 904.910, OM 904.916, OM 904.930	4250	4	ATEGO 714-1214 L,K	102,00	180 100 0010 181 100 0011	Std, 0,25, 0,50 Std, 0,25, 0,50	37
OM 902.913, OM 902.930	6374	6	AXOR 2 1823	102,00	180 100 0010 181 100 0011	Std, 0,25, 0,50 Std, 0,25, 0,50	37
OM 900.911, OM 900.917	4249	4	ATEGO 2 712, 713 ATEGO 2 812, 813	102,00	180 100 0010 181 100 0011	Std, 0,25, 0,50 Std, 0,25, 0,50	37
OM 926.910	7201	6	TOURO (O 500) O 500 R	106,00	180 100 0010 181 100 0011	Std, 0,25, 0,50 Std, 0,25, 0,50	37
OM 926.913	7201	6	AXOR 2 2633 K, AXOR 2 1833 A	106,00	180 100 0010 181 100 0011	Std, 0,25, 0,50 Std, 0,25, 0,50	37
OM 926.917	7201	6	AXOR 2 1833 AK	106,00	180 100 0010 181 100 0011	Std, 0,25, 0,50 Std, 0,25, 0,50	37
OM 926.919	7201	6	AXOR 2 2633	106,00	180 100 0010 181 100 0011	Std, 0,25, 0,50 Std, 0,25, 0,50	37
OM 926.921	7201	6	ECONIC 2633 L, AXOR 2 2533, AXOR 2 1933 S	106,00	180 100 0010 181 100 0011	Std, 0,25, 0,50 Std, 0,25, 0,50	37
OM 925.920	7201	6	ATEGO 2 929, 929 L, ATEGO 2 926, 926 L, ATEGO 2 924, 924 L, ATEGO 2 829, 829 L, ATEGO 2 826, 826 L, ATEGO 2 824, 824 L, ATEGO 2 1529, 1529 L, ATEGO 2 1526, 1526 L, ATEGO 2 1524, 1524 L, ATEGO 2 1329, 1329 L, ATEGO 2 1326, 1326 L, ATEGO 2 1324, 1324 L, ATEGO 2 1229, 1229 L, ATEGO 2 1226, 1226 L, ATEGO 2 1224, 1224 L, ATEGO 2 1029, 1029 L, ATEGO 2 1026, 1026 L, ATEGO 2 1024, 1024 L	106,00	180 100 0010 181 100 0011	Std, 0,25, 0,50 Std, 0,25, 0,50	37
OM 924.916, OM 924.923	4801	4	UNIMOG U 4000, UNIMOG U 5000	106,00	180 100 0010 181 100 0011	Std, 0,25, 0,50 Std, 0,25, 0,50	37
OM401.900-001, OM401.900-000, OM401.900-400, OM401.905-909, OM401.912-919, OM401.921-923, OM401.925-928	9572	6	O 303, Series 1019, Series 1219, Series 1419, Series 1619, Series 1719, Series 2219	125,00	180 100 0001 180 100 0002 181 100 0002	Std, 0,25, 0,50, 0,75, 1,00 Std, 0,25, 0,50, 0,75, 1,00 Std, 0,25, 0,50, 0,75, 1,00	38
OM402.900, OM402.905-907, OM402.910-914, OM402.916-917, OM402.919, OM402.921, OM402.923-928	12760	8	O 303, Series 1424, Series 1624, Series 1626, Series 1926, Series 2026, Series 2224, Series 2226, Series 2626	125,00	180 100 0001 180 100 0002 181 100 0002	Std, 0,25, 0,50, 0,75, 1,00 Std, 0,25, 0,50, 0,75, 1,00 Std, 0,25, 0,50, 0,75, 1,00	38
OM403.900, OM403.905-906, OM403.910-000, OM403.911-000, OM403.915-919, OM403.930-935	15960	10	Series 1632, Series 1932, Series 2232, Series 2632, Series 3332	125,00	180 100 0001 180 100 0002 181 100 0002	Std, 0,25, 0,50, 0,75, 1,00 Std, 0,25, 0,50, 0,75, 1,00 Std, 0,25, 0,50, 0,75, 1,00	38
OM404.900-000	19140	12		125,00	180 100 0001 180 100 0002 181 100 0002	Std, 0,25, 0,50, 0,75, 1,00 Std, 0,25, 0,50, 0,75, 1,00 Std, 0,25, 0,50, 0,75, 1,00	38











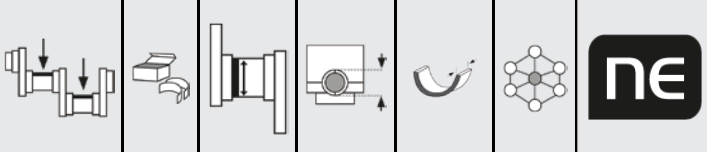













	ccm						Pos.
OM401 901-904, 970, 972-981, 984-991, 993-994	9572	6	.	125,00	180 100 0001 180 100 0002 181 100 0010	Std, 0,25, 0,50, 0,75, 1,00 Std, 0,25, 0,50, 0,75, 1,00 Std, 0,25, 0,50	39
OM402 970-973, 975, 977-978, 980-990, 995-996	12760	8	.	125,00	180 100 0001 180 100 0002 181 100 0009	Std, 0,25, 0,50, 0,75, 1,00 Std, 0,25, 0,50, 0,75, 1,00 Std, 0,25, 0,50, 0,75	40
OM401.901-001, OM401.924	10456	6	Series 1019, Series 1219, Series 1419, Series 1619, Series 1719, Series 2219	125,00	180 100 0001 180 100 0002 181 100 0002	Std, 0,25, 0,50, 0,75, 1,00 Std, 0,25, 0,50, 0,75, 1,00 Std, 0,25, 0,50, 0,75, 1,00	38
OM402.901-000	13941	8		125,00	180 100 0001 180 100 0002 181 100 0002	Std, 0,25, 0,50, 0,75, 1,00 Std, 0,25, 0,50, 0,75, 1,00 Std, 0,25, 0,50, 0,75, 1,00	38
OM404.901-400, OM404.901-000, OM404.918	20911	12		125,00	180 100 0001 180 100 0002 181 100 0002	Std, 0,25, 0,50, 0,75, 1,00 Std, 0,25, 0,50, 0,75, 1,00 Std, 0,25, 0,50, 0,75, 1,00	38
OM421.900, OM421.905-.910	10965	6		128,00	180 100 0001 180 100 0002 181 100 0002	Std, 0,25, 0,50, 0,75, 1,00 Std, 0,25, 0,50, 0,75, 1,00 Std, 0,25, 0,50, 0,75, 1,00	38
OM422.900-000, OM422.905-.923	14618	8		128,00	180 100 0001 180 100 0002 181 100 0002	Std, 0,25, 0,50, 0,75, 1,00 Std, 0,25, 0,50, 0,75, 1,00 Std, 0,25, 0,50, 0,75, 1,00	38
OM424.900-000	21930	12		128,00	180 100 0001 180 100 0002 181 100 0002	Std, 0,25, 0,50, 0,75, 1,00 Std, 0,25, 0,50, 0,75, 1,00 Std, 0,25, 0,50, 0,75, 1,00	38
OM421 901-410, 901-400, 951, 901-500, 901-510	10965	6	.	128,00	180 100 0001 180 100 0002 181 100 0009	Std, 0,25, 0,50, 0,75, 1,00 Std, 0,25, 0,50, 0,75, 1,00 Std, 0,25, 0,50, 0,75	40
OM441 901-400, 901-500, 901-505, 901-507, 901-520, 951, 981-983, 901-504, 980, 986-999, 950, 953, 955, 960-962, 985, 920-927, 929-931, 933-941	10965	6	.	128,00	180 100 0001 180 100 0002 181 100 0010	Std, 0,25, 0,50, 0,75, 1,00 Std, 0,25, 0,50, 0,75, 1,00 Std, 0,25, 0,50	39
OM422 910-410, 951-959, 963, 901-500, OM440 940-942, 945, 970-973, 975-976, 978-979, OM442 901-404, 977-978, 901-520, 941-946, 950, 952, 954-955, 957-968, 971-972, 976, OM446 924-931, 934, 938	14618	8	.	128,00	180 100 0001 180 100 0002 181 100 0009	Std, 0,25, 0,50, 0,75, 1,00 Std, 0,25, 0,50, 0,75, 1,00 Std, 0,25, 0,50, 0,75	40
OM423 905-909, 901-400, 901-500, 901-510, 950-951, OM443 901-500, 901-504, 940, 980	18273	10	.	128,00	180 100 0001 180 100 0002 181 100 0009	Std, 0,25, 0,50, 0,75, 1,00 Std, 0,25, 0,50, 0,75, 1,00 Std, 0,25, 0,50, 0,75	40
OM424 901-400, 901-500, 901-510	21930	12	.	128,00	180 100 0001 180 100 0002 181 100 0009	Std, 0,25, 0,50, 0,75, 1,00 Std, 0,25, 0,50, 0,75, 1,00 Std, 0,25, 0,50, 0,75	40
OM355	11581	6	O 302, O 317, Series 1620, Series 1621, Series 1624, Series 1921, Series 1923, Series 1924, Series 1928, Series 1929	128,00	180 100 0003 181 100 0003	Std, 0,25, 0,50, 0,75, 1,00 Std, 0,25, 0,50, 0,75, 1,00	41
OM447 968, 969-501, 969-502, 969-503	11970	6	.	128,00	180 031 0001 181 031 0004 183 100 0001	Std, 0,25, 0,50, 0,75, 1,00 Std, 0,25, 0,50, 0,75, 1,00 Std	42
OM427 900, 901, 905, 910-911, 902-500, 902-400, 903-600, 950-952	11970	6	.	128,00	180 031 0001 181 031 0001 183 100 0001	Std, 0,25, 0,50, 0,75, 1,00 Std, 0,25, 0,50, 0,75, 1,00 Std	43
OM 457.: 914/915/916/917/918/919 920/922/923/924/925/926/927 928/929 931/932/933/934/935/936/937 938/939/940/941/942/943/944 945/946/947/949 955/956/958/960/962/984	11967	6	ATRON, AXOR, AXOR 2 CITARO, CONECTO TOURISMO, TOURO TRAVEGO	128,00	181 100 0013	Std	44
OM441.900-004, OM441.900-000, OM441.905-.909, OM441.911-.927, OM441.932-.933	11309	6		130,00	180 100 0001 180 100 0002 181 100 0002	Std, 0,25, 0,50, 0,75, 1,00 Std, 0,25, 0,50, 0,75, 1,00 Std, 0,25, 0,50, 0,75, 1,00	38
OM442.900-000, OM442.900-004, OM442.905-.911, OM442.914-.935, OM442.939	15080	8		130,00	180 100 0001 180 100 0002 181 100 0002	Std, 0,25, 0,50, 0,75, 1,00 Std, 0,25, 0,50, 0,75, 1,00 Std, 0,25, 0,50, 0,75, 1,00	38
OM440 907, 909	15080	8	.	130,00	180 100 0001 180 100 0002 181 100 0009	Std, 0,25, 0,50, 0,75, 1,00 Std, 0,25, 0,50, 0,75, 1,00 Std, 0,25, 0,50, 0,75	40
OM443 900, 905	18848	10	.	130,00	180 100 0001 180 100 0002 181 100 0009	Std, 0,25, 0,50, 0,75, 1,00 Std, 0,25, 0,50, 0,75, 1,00 Std, 0,25, 0,50, 0,75	40
OM541	11946	6		130,00	180 100 0007 181 100 0008 182 100 0002	Std Std Std	45













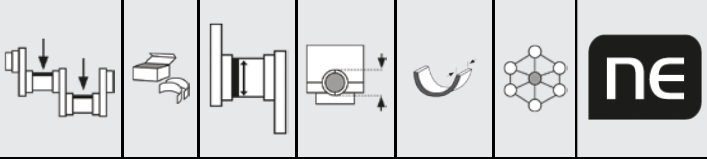









Globally reliable

MERCEDES BENZ

	ccm						Pos.
OM542	15928	8		130,00	180 100 0007 181 100 0005 181 100 0006 182 100 0002	Std Std Std Std	46
OM 471.900, OM 471.902, OM 471.905, OM 471.906, OM 471.909, OM 471.922, OM 471.926	12809	6	ACTROS MP4 / MP5, ANTOS, AROCS, Series 500 (Setra) Series 400 (Setra)	132,00	180 100 0012 181 100 0014 182 100 0003	Std, 0,25, 0,50, 0,75 Std, 0,25, 0,50, 0,75 Std	47











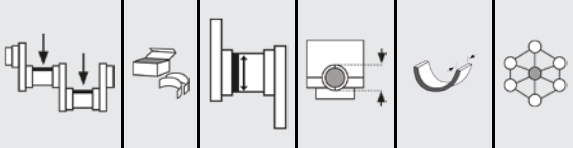





















							Set Composition / QTY																
1 63,50																							
MB/HL 1, 2, 3, 4	4 Pairs	44,950 44,965	51,000 51,019	16,000	SAL	180 110 0001 00 15 21	4		4														
CB/PL 1, 2, 3	3 Pairs	37,940 37,965	41,600 41,616	17,000	S3S	181 110 0002 00 15 21	6																
TW/A 1	2 Halves	52,500 52,750	68,250 68,500		SAL	182 110 0001 00	2																
2 65,50																							
MB/HL 1, 2, 3, 4	4 Pairs	44,950 44,965	51,000 51,019	16,000	S3S	180 110 0002 00 15 21	4		4														
CB/PL 1, 2, 3	3 Pairs	39,940 39,965	43,600 43,616	17,000	S3S	181 110 0003 00 15 21	3		3														
TW/A 1	2 Halves	52,500 52,750	68,250 68,500		SAL	182 110 0001 00	2																
3 72,00																							
MB/HL 1, 2, 3, 4	4 Pairs	46,000	50,000	17,000	SAL	180 110 0003 00 15 21	4		4														
CB/PL 1, 2, 3	3 Pairs	40,000	43,000	14,600	SAL	181 110 0001 00 15 21	6																
TW/A 1	2 Halves	52,500 52,750	67,350 67,600		SAL	182 110 0002 00	2																
4 72,20																							
MB/HL 1, 2, 3, 4	4 Pairs	1,000	1,000	16,050	SAL	180 038 0017 00 15 21	4		4														
CB/PL 1, 2, 3	3 Pairs	3,000	3,000	17,000	SAL	181 038 0022 00 15 21	6																
TW/A 1	2 Halves	54,900 55,100	73,900 74,000		SAL	182 038 0008 00	2																
5 82,00																							
MB/HL 1, 2, 3, 4, 5	5 Pairs	54,940 54,965	59,000 59,019	20,000	SAL	180 010 0012 00 15	5		5														
CB/PL 1, 2, 3, 4	4 Pairs	47,941 47,965	51,600 51,619	20,000	S3S	181 010 0017 00 15	8																
TW/A 1	4 Halves	61,250	76,750		SAL	182 010 0003 00	2		2														
6 82,00																							
MB/HL 1, 2, 3, 4	4 Pairs	54,940 54,965	59,000 59,019	19,000	Nefrox	180 010 0022 00																	
MB/HL 5	1 Pair	54,940 54,965	59,000 59,019	24,430	Nefrox																		
CB/PL 1, 2, 3, 4	4 Pairs	51,935 51,950	55,600 55,612	19,500	SPVD	181 010 0022 00	4		4														

										Set Composition / QTY										
7	82,00																			
CB/PL 1, 2, 3, 4	4 Pairs	51,935 51,950	55,600 55,612	19,500	SPVD	181 010 0022 00	4		4											
8	82,00																			
CB/PL 1, 2, 3, 4, 5, 6	6 Pairs	51,935 51,950	55,600 55,612	19,500	SPVD	181 010 0023 00	6		6											
9	82,90																			
MB/HL 1, 2, 3, 4, 5, 6, 7	7 Pairs	57,950 57,965	62,500 62,519	17,500	SAL	180 010 0005 00	7		7											
CB/PL 1, 2, 3, 4, 5, 6	6 Pairs	47,950 47,965	51,600 51,619	21,800	S3S	181 010 0010 00	12													
TW/A 1	4 Halves	65,800 66,050	80,750 81,000		SAL	182 010 0002 00	8		2											
10	83,00																			
MB/HL 1, 2, 3, 4, 5	5 Pairs	54,950 54,975	59,000 59,019	20,000	SAL	180 010 0016 00	15		5											
TW/A 1	4 Halves	61,250	76,750		SAL	182 010 0003 00	8		2											
11	83,00																			
MB/HL 1	1 Pair	59,940 59,965	64,000 64,019	20,500	SPVD	180 010 0014 00	15		1											
MB/HL 1	1 Pair	59,940 59,965	64,000 64,019	26,240	SPVD	180 010 0015 00	15		1											
CB/PL 1	1 Pair	51,940 51,965	55,600 55,614	20,500	SPVD	181 010 0001 00	15		1											
12	83,00																			
MB/HL 1, 2, 3, 4	4 Pairs	75,940 75,965	80,500 80,522	23,000	SPVD	180 010 0021 00	15		4											
CB/PL 1, 2, 3, 4, 5, 6	6 Pairs	63,940 63,965	67,600 67,614	16,800	SPVD	181 010 0021 00	15		6											
13	83,20																			
MB/HL 1, 2, 3, 4	4 Pairs	63,940 63,965	68,500 68,519	19,000	SAL	180 010 0006 00	14		4											
CB/PL 1, 2, 3, 4, 5, 6	6 Pairs	51,940 51,965	55,600 55,614	19,600	S3S	181 010 0011 00	14		6											
14	85,30																			
MB/HL 1, 2, 3, 4, 5	5 Pairs	57,950 57,965	62,500 62,519	17,500	SAL	180 010 0001 00	15		5											
CB/PL 1, 2, 3, 4	4 Pairs	47,950 47,965	51,600 51,619	21,800	S3S	181 010 0007 00	15		8											
TW/A 1	4 Halves	65,800 66,050	80,750 81,000		SAL	182 010 0002 00	8		2											
Bush/PB 1, 2, 3, 4	4 Pairs	21,995 22,000	24,500 24,521	21,900	SL	184 010 0002 99														

							Set Composition / QTY									
15 87,00																
MB/HL 1, 2, 3, 4	4 Pairs	69,955 69,965	74,500 74,519	27,000	S3S	180 010 0004 00 15	4		4		2					
MB/HL 5	1 Pair	69,955 69,965	74,500 74,519	33,900	S3S	21 26										
CB/PL 1, 2, 3, 4	4 Pairs	51,955 51,965	55,600 55,619	26,000	S3S	181 010 0008 00 15 21 26	8									
CB/PL 1, 2, 3, 4	4 Pairs	51,955 51,965	55,600 55,619	26,000	S3S	181 010 0018 00 15 21 26										
Bush/PB 1, 2, 3, 4	4 Pairs	26,000	29,000 29,021	31,800	SL	184 010 0003 99										
16 87,00																
MB/HL 1, 2, 3, 4, 5	5 Pairs	57,950 57,965	62,500 62,519	17,500	SAL	180 010 0001 00 15 21 26	5		5							
CB/PL 1, 2, 3, 4	4 Pairs	47,950 47,965	51,600 51,619	21,800	SAL	181 010 0004 00 15 21 26	4		4							
CB/PL 1	1 Pair	47,950 47,965	51,600 51,619	21,800	SSI	181 010 0009 00 15 21	1		1							
TW/A 1	4 Halves	65,800 66,050	80,750 81,000		SAL	182 010 0002 00 08 14	2		2							
Bush/PB 1, 2, 3, 4	4 Pairs	25,995 26,000	28,500 28,521	21,900	SR	184 010 0004 99										
17 87,00																
MB/HL 1, 2, 3, 4, 5, 6	6 Pairs	57,950 57,965	62,500 62,519	17,500	SAL	180 010 0008 00 15 21 26	6		5							
CB/PL 1	1 Pair	47,950 47,965	51,600 51,619	21,800	S4S	181 010 0002 00 15 21										
CB/PL 1	1 Pair	47,950 47,965	51,600 51,619	21,800	SPVD	181 010 0013 00 15 21										
TW/A 1	4 Halves	65,800 66,050	80,750 81,000		SAL	182 010 0002 00 08 14	2		2							
18 87,00																
MB/HL 1, 2, 3, 4, 5, 6, 7	7 Pairs	57,950 57,965	62,500 62,519	17,500	SAL	180 010 0005 00 15 21	7		7							
CB/PL 1	1 Pair	47,950 47,965	51,600 51,619	21,800	S4S	181 010 0002 00 15 21										
CB/PL 1	1 Pair	47,950 47,965	51,600 51,619	21,800	SPVD	181 010 0013 00 15 21										
TW/A 1	4 Halves	65,800 66,050	80,750 81,000		SAL	182 010 0002 00 08 14	2		2							











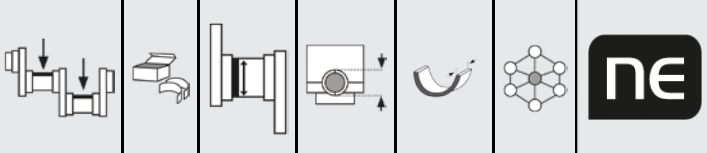















							Set Composition / QTY														
19 87,00																					
MB/HL 1, 2, 3, 4, 5	5 Pairs	57,950 57,965	62,500 62,519	17,500	SAL	180 010 0001 00 15 21 26	5		5												
CB/PL 1, 2, 3, 4	4 Pairs	47,950 47,965	51,600 51,619	21,800	SAL	181 010 0004 00 15 21 26	4		4												
CB/PL 1	1 Pair	47,950 47,965	51,600 51,619	21,800	SSI	181 010 0009 00 15 21	1		1												
TW/A 1	4 Halves	65,800 66,050	80,750 81,000		SAL	182 010 0002 00 08 14	2		2												
20 87,00																					
MB/HL 1, 2, 3, 4, 5	5 Pairs	57,950 57,965	62,500 62,519	17,500	SAL	180 010 0001 00 15 21 26	5		5												
CB/PL 1	1 Pair	47,950 47,965	51,600 51,619	21,800	SSI	181 010 0009 00 15 21	1		1												
TW/A 1	4 Halves	65,800 66,050	80,750 81,000		SAL	182 010 0002 00 08 14	2		2												
21 87,00																					
MB/HL 1, 2, 3, 4, 5, 6	6 Pairs	57,950 57,965	62,500 62,519	17,500	SAL	180 010 0008 00 15 21 26	6		5												
CB/PL 1, 2, 3, 4, 5	5 Pairs	47,950 47,965	51,600 51,619	21,800	SAL	181 010 0015 00 15 21 26	5		5												
TW/A 1	4 Halves	65,800 66,050	80,750 81,000		SAL	182 010 0002 00 08 14	2		2												
22 88,00																					
MB/HL 1	1 Pair	57,950 57,965	62,500 62,519	17,500	SPVD	180 010 0009 00 15 21	1		1												
MB/HL 1	1 Pair	57,940 57,965	62,500 62,519	17,500	S4S	180 010 0013 00 15 21															
CB/PL 1	1 Pair	47,950 47,965	51,600 51,619	21,800	S4S	181 010 0003 00 15 21															
CB/PL 1	1 Pair	47,950 47,965	51,600 51,619	21,800	SPVD	181 010 0014 00 15 21	1		1												
TW/A 1	4 Halves	65,800 66,050	80,750 81,000		SAL	182 010 0002 00 08 14	2		2												
Bush/PB 1, 2, 3, 4	4 Pairs	30,000	32,500 32,525	21,900	SR	184 010 0005 99															

 							Set Composition / QTY														
23 88,00																					
MB/HL 1	1 Pair	57,950 57,965	62,500 62,519	17,500	SPVD	180 010 0009 00 15 21	1		1												
MB/HL 1	1 Pair	57,940 57,965	62,500 62,519	17,500	S4S	180 010 0013 00 15 21															
CB/PL 1	1 Pair	47,950 47,965	51,600 51,619	21,800	S4S	181 010 0003 00 15 21															
CB/PL 1	1 Pair	47,950 47,965	51,600 51,619	21,800	SPVD	181 010 0014 00 15 21	1		1												
TW/A 1	4 Halves	65,800 66,050	80,750 81,000		SAL	182 010 0002 00 08 14	2		2												
24 88,00																					
MB/HL 1, 2, 3	3 Pairs	63,945 63,965	68,500 68,519	20,600	SAL	180 010 0019 00 15 21	3		3		1		1								
MB/HL 4	1 Pair	63,945 63,965	68,500 68,519	24,000	SAL	180 010 0019 26	21														
CB/PL 1, 2, 3, 4, 5, 6	6 Pairs	51,945 51,965	55,600 55,614	19,600	S3S	181 010 0019 00 15 21 26	6		6												
25 89,00																					
MB/HL 1, 2, 3, 4, 5	5 Pairs	57,950 57,965	62,500 62,519	17,500	SAL	180 010 0001 00 15 21 26	5		5												
CB/PL 1, 2, 3, 4	4 Pairs	47,955 47,965	51,600 51,619	22,000	S3S	181 010 0006 00 15 21 26 29	4		4												
CB/PL 1, 2, 3, 4	4 Pairs	47,950 47,965	51,600 51,619	21,800	S3S	181 010 0007 00 15 21 26	8														
TW/A 1	4 Halves	65,500 65,750	80,750 81,000		SAL	182 010 0001 00	2		2												
TW/A 1	4 Halves	65,800 66,050	80,750 81,000		SAL	182 010 0002 00 08 14	2		2												
Bush/PB 1, 2, 3, 4	4 Pairs	23,996 24,000	27,000 27,021	27,600	SL	184 010 0001 99															
Bush/PB 1, 2, 3, 4	4 Pairs	21,995 22,000	24,500 24,521	21,900	SL	184 010 0002 99															
26 89,00																					
MB/HL 1, 2, 3, 4, 5	5 Pairs	57,950 57,965	62,500 62,519	21,400	SAL	180 010 0003 00 15 21 26 29	5		5												
CB/PL 1, 2, 3, 4	4 Pairs	47,955 47,965	51,600 51,619	22,000	S3S	181 010 0006 00 15 21 26 29	4		4												
CB/PL 1, 2, 3, 4	4 Pairs	47,950 47,965	51,600 51,619	21,800	S3S	181 010 0007 00 15 21 26	8														
TW/A 1	4 Halves	65,500 65,750	80,750 81,000		SAL	182 010 0001 00	2		2												
TW/A 1	4 Halves	65,800 66,050	80,750 81,000		SAL	182 010 0002 00 08 14	2		2												





							Set Composition / QTY													
Bush/PB 1, 2, 3, 4	4 Pairs	23,996 24,000	27,000 27,021	27,600	SL	184 010 0001 99														
Bush/PB 1, 2, 3, 4	4 Pairs	21,995 22,000	24,500 24,521	21,900	SL	184 010 0002 99														
27 89,00																				
MB/HL 1, 2, 3, 4, 5	5 Pairs	57,950 57,965	62,500 62,519	17,500	SAL	180 010 0001 00 15 21 26	5		5											
MB/HL 1, 2, 3, 4, 5	5 Pairs	57,950 57,965	62,500 62,519	21,400	SAL	180 010 0003 00 15 21 26 29	5		5											
CB/PL 1, 2, 3, 4	4 Pairs	47,955 47,965	51,600 51,619	22,000	S3S	181 010 0006 00 15 21 26 29	4		4											
CB/PL 1, 2, 3, 4	4 Pairs	47,950 47,965	51,600 51,619	21,800	S3S	181 010 0007 00 15 21 26	8													
TW/A 1	4 Halves	65,500 65,750	80,750 81,000		SAL	182 010 0001 00	2		2											
TW/A 1	4 Halves	65,800 66,050	80,750 81,000		SAL	182 010 0002 00 08 14	2		2											
Bush/PB 1, 2, 3, 4	4 Pairs	23,996 24,000	27,000 27,021	27,600	SL	184 010 0001 99														
Bush/PB 1, 2, 3, 4	4 Pairs	21,995 22,000	24,500 24,521	21,900	SL	184 010 0002 99														
28 89,00																				
MB/HL 1, 2, 3, 4, 5	5 Pairs	57,950 57,965	62,500 62,519	17,500	SAL	180 010 0001 00 15 21 26	5		5											
CB/PL 1	1 Pair	47,950 47,965	51,600 51,619	21,800	SSI	181 010 0009 00 15 21	1		1											
TW/A 1	4 Halves	65,800 66,050	80,750 81,000		SAL	182 010 0002 00 08 14	2		2											
Bush/PB 1, 2, 3, 4	4 Pairs	25,995 26,000	28,500 28,521	21,900	SR	184 010 0004 99														
29 89,00																				
MB/HL 1, 2, 3, 4, 5	5 Pairs	57,950 57,965	62,500 62,519	17,500	SAL	180 010 0001 00 15 21 26	5		5											
CB/PL 1	1 Pair	47,950 47,965	51,600 51,619	21,800	S4S	181 010 0002 00 15 21														
CB/PL 1	1 Pair	47,950 47,965	51,600 51,619	21,800	SPVD	181 010 0013 00 15 21														
TW/A 1	4 Halves	65,800 66,050	80,750 81,000		SAL	182 010 0002 00 08 14	2		2											

							Set Composition / QTY													
30	89,00																			
MB/HL 1, 2, 3, 4, 5, 6	6 Pairs	57,950 57,965	62,500 62,519	17,500	SAL	180 010 0008 00 15 21 26	6		5											
MB/HL 1	1 Pair	57,950 57,965	62,500 62,519	17,500	SPVD	180 010 0009 00 15 21	1		1											
MB/HL 1	1 Pair	57,940 57,965	62,500 62,519	17,500	S4S	180 010 0013 00 15 21														
CB/PL 1	1 Pair	47,950 47,965	51,600 51,619	21,800	S4S	181 010 0002 00 15 21														
CB/PL 1	1 Pair	47,950 47,965	51,600 51,619	21,800	SPVD	181 010 0013 00 15 21														
TW/A 1	4 Halves	65,800 66,050	80,750 81,000		SAL	182 010 0002 00 08 14	2		2											
31	89,00																			
MB/HL 1, 2, 3, 4, 5, 6	6 Pairs	57,950 57,965	62,500 62,519	17,500	SAL	180 010 0008 00 15 21 26	6		5											
CB/PL 1	1 Pair	47,950 47,965	51,600 51,619	21,800	SSI	181 010 0009 00 15 21	1		1											
TW/A 1	4 Halves	65,800 66,050	80,750 81,000		SAL	182 010 0002 00 08 14	2		2											
32	89,90																			
MB/HL 1, 2, 3, 4, 5	5 Pairs	63,940 63,965	68,500 68,519	19,000	SAL	180 010 0007 00 14	5		5											
CB/PL 1, 2, 3, 4, 5, 6, 7, 8	8 Pairs	51,940 51,965	55,600 55,614	19,600	S3S	181 010 0012 00 14	8		8											
33	90,90																			
MB/HL 1, 2, 3, 4, 5, 6	6 Pairs	69,955 69,965	74,500 74,519	27,000	SAL	180 010 0011 00 15 21 26	5		5		2									
CB/PL 1, 2, 3, 4, 5	5 Pairs	51,955 51,965	55,600 55,619	26,000	SAL	181 010 0016 00 15 21	10													
34	91,00																			
MB/HL 1, 2, 3, 4, 5	5 Pairs	69,955 69,965	74,500 74,519	27,000	SAL	180 010 0002 00 15 21 26	4		4		2									
CB/PL 1, 2, 3, 4	4 Pairs	51,955 51,965	55,600 55,619	26,000	SAL	181 010 0005 00 15 21 26	8													

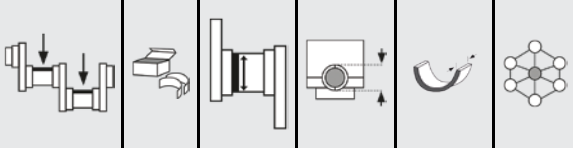

							Set Composition / QTY									
35 97,50																
MB/HL 1, 2, 3, 4, 5, 6	6 Pairs	87,990 88,010	93,000 93,022	24,100	S3S	180 010 0010 00 15	6		6		1		1			
MB/HL 7	1 Pair	87,990 88,010	93,000 93,022	31,810	S3S											
CB/PL 1, 2, 3, 4, 5, 6	6 Pairs	59,990 60,015	65,000 65,019	29,400	S3S	181 100 0007 00 15	12									
36 98,00																
MB/HL 1, 2, 3, 4	4 Pairs	63,945 63,965	68,500 68,519	20,600	SAL	180 010 0020 00 15	4		4		1		1			
MB/HL 5	1 Pair	63,945 63,965	68,500 68,519	24,000	SAL											
CB/PL 1, 2, 3, 4, 5, 6, 7, 8	8 Pairs	51,945 51,965	55,600 55,614	19,600	S3S	181 010 0020 00 15	8		8							
37 102,00																
MB/HL 1	1 Pair	85,990 86,010	91,000 91,022	23,300	S3S	180 100 0010 00 15	1		1							
CB/PL 1	1 Pair	69,995 70,015	75,000 75,019	28,300	SPVD	181 100 0011 00 15	1		1							
38 125,00																
MB/HL 1	1 Pair	103,980 104,000	111,000 111,022	30,500	S3S	180 100 0001 00 15	1		1							
MB/HL 1	1 Pair	103,980 104,000	111,000 111,022	37,810	S3S	180 100 0002 00 15	1		1							
CB/PL 1	1 Pair	89,980 90,000	95,000 95,022	31,000	S3S	181 100 0002 00 15	2									
39 125,00																
MB/HL 1	1 Pair	103,980 104,000	111,000 111,022	30,500	S3S	180 100 0001 00 15	1		1							
MB/HL 1	1 Pair	103,980 104,000	111,000 111,022	37,810	S3S	180 100 0002 00 15	1		1							
CB/PL 1	1 Pair	89,980 90,000	95,000 95,022	26,700	S4S	181 100 0010 00 15										
40 125,00																
MB/HL 1	1 Pair	103,980 104,000	111,000 111,022	30,500	S3S	180 100 0001 00 15	1		1							
MB/HL 1	1 Pair	103,980 104,000	111,000 111,022	37,810	S3S	180 100 0002 00 15	1		1							
CB/PL 1	1 Pair	89,980 90,000	95,000 95,022	31,000	S4S	181 100 0009 00 15										

 							Set Composition / QTY														
41 128,00																					
MB/HL 1, 2, 3, 5, 6	5 Pairs	94,980 95,000	100,000 100,022	35,150	S3S	180 100 0003 00	15	5		5		1		1		1					
MB/HL 4	1 Pair	94,980 95,000	100,000 100,022	64,800	S3S		21														
MB/HL 7	1 Pair	94,980 95,000	102,000 102,022	52,150	S3S		29														
CB/PL 1, 2, 3, 4, 5, 6	6 Pairs	77,980 78,000	83,000 83,022	41,750	S3S	181 100 0003 00	15	12													
42 128,00																					
MB/HL 1, 2, 3, 4, 5, 6	6 Pairs	103,980 104,000	111,000 111,022	36,000	S3S	180 031 0001 00	15	6		6		1		1							
MB/HL 7	1 Pair	103,980 104,000	111,000 111,022	45,810	S3S		21														
CB/PL 1	1 Pair	89,980 90,000	95,000 95,022	36,200	S4S	181 031 0004 00	15														
Cbush/NWL 1	1 Pair	69,910 69,940	75,000 75,030	36,000	SAL	183 100 0001 00	00														
Cbush/NWL 2, 3, 4, 5, 6	5 Pairs	69,910 69,940	75,000 75,030	28,000	SAL																
Cbush/NWL 7	1 Pair	69,910 69,940	76,000 76,030	39,000	SAL																
43 128,00																					
MB/HL 1, 2, 3, 4, 5, 6	6 Pairs	103,980 104,000	111,000 111,022	36,000	S3S	180 031 0001 00	15	6		6		1		1							
MB/HL 7	1 Pair	103,980 104,000	111,000 111,022	45,810	S3S		21														
CB/PL 1, 2, 3, 4, 5, 6	6 Pairs	89,980 90,000	95,000 95,022	36,200	S3S	181 031 0001 00	15	12													
Cbush/NWL 1	1 Pair	69,910 69,940	75,000 75,030	36,000	SAL	183 100 0001 00	00														
Cbush/NWL 2, 3, 4, 5, 6	5 Pairs	69,910 69,940	75,000 75,030	28,000	SAL																
Cbush/NWL 7	1 Pair	69,910 69,940	76,000 76,030	39,000	SAL																
44 128,00																					
CB/PL 1, 2, 3, 4, 5, 6	6 Pairs	89,980 90,000	95,000 95,022	36,200	SPVD	181 100 0013 00															
45 130,00																					
MB/HL 1	1 Pair	107,980 108,000	115,000 115,022	33,500	S4S	180 100 0007 00															
CB/PL 1	1 Pair	93,980 94,000	99,000 99,022	28,600	S4S	181 100 0008 00															
TW/A 1	4 Halves	117,300	139,000		AL	182 100 0002 00															









Globally reliable

MERCEDES BENZ



46	130,00																		
MB/HL 1	1 Pair	107,980 108,000	115,000 115,022	33,500	S4S	180 100 0007 00													
CB/PL 1	1 Pair	93,980 94,000	99,000 99,022	34,400	S4S	181 100 0005 00													
CB/PL 1	1 Pair	93,980 94,000	99,000 99,022	34,400	S4S	181 100 0006 00													
TW/A 1	4 Halves	117,300	139,000		AL	182 100 0002 00													







47	132,00																		
MB/HL 1	1 Pair	114,000 114,020	121,000 121,022	36,000		180 100 0012 00 15 21 26	1		1										
CB/PL 1	1 Pair	94,978 95,000	100,000 100,022	36,300		181 100 0014 00 15 21 26	1		1										
TW/A 1	4 Halves	126,000 126,350	151,000 151,065		SAL	182 100 0003 00													





















	ccm						Pos.
G11B	1244	4	Lancer, Mirage, SAGA 7/77-2/85	69,50	180 088 0005 181 088 0006 181 088 0007	Std, 0,25, 0,50, 0,75, 1,00 Std, 0,25, 0,50 Std, 0,25, 0,50, 0,75, 1,00	1
4G11	1244	4	Lancer, Mirage, SAGA 4/78-12/81	69,50	180 088 0005 181 088 0006 181 088 0007	Std, 0,25, 0,50, 0,75, 1,00 Std, 0,25, 0,50 Std, 0,25, 0,50, 0,75, 1,00	1
G13B	1298	4	Lancer, Mirage, SAGA 10/83-91	71,00	180 088 0005 181 088 0006 181 088 0007	Std, 0,25, 0,50, 0,75, 1,00 Std, 0,25, 0,50 Std, 0,25, 0,50, 0,75, 1,00	1
4G13	1298	4	Lancer, Mirage, SAGA 5/86-	71,00	180 088 0005 181 088 0006 181 088 0007	Std, 0,25, 0,50, 0,75, 1,00 Std, 0,25, 0,50 Std, 0,25, 0,50, 0,75, 1,00	1
4G36	1238	4	Lancer, Galant, Mirage, Delica 11/75-2/79	73,00	180 088 0007 181 088 0008	Std, 0,25, 0,50, 0,75, 1,00, 1,25, 1,50 Std, 0,25, 0,50, 0,75, 1,00, 1,25, 1,50	2
4G30	1289	4	Lancer, Galant, Mirage, Delica 11/69-73	73,00	180 088 0007 181 088 0008	Std, 0,25, 0,50, 0,75, 1,00, 1,25, 1,50 Std, 0,25, 0,50, 0,75, 1,00, 1,25, 1,50	2
G33B	1439	4	Lancer, Galant, Mirage, Delica 7/77-	73,00	180 088 0007 181 088 0008	Std, 0,25, 0,50, 0,75, 1,00, 1,25, 1,50 Std, 0,25, 0,50, 0,75, 1,00, 1,25, 1,50	2
4G33	1439	4	Lancer, Galant, Mirage, Delica 8/71-	73,00	180 088 0007 181 088 0008	Std, 0,25, 0,50, 0,75, 1,00, 1,25, 1,50 Std, 0,25, 0,50, 0,75, 1,00, 1,25, 1,50	2
G12B	1410	4	Lancer, Mirage, SAGA 2/78-5/88	74,00	180 088 0005 181 088 0006 181 088 0007	Std, 0,25, 0,50, 0,75, 1,00 Std, 0,25, 0,50 Std, 0,25, 0,50, 0,75, 1,00	1
4G12	1410	4	Lancer, Mirage, SAGA 3/76-12/81	74,00	180 088 0005 181 088 0006 181 088 0007	Std, 0,25, 0,50, 0,75, 1,00 Std, 0,25, 0,50 Std, 0,25, 0,50, 0,75, 1,00	1
G31B	1499	4	Lancer, Galant, Mirage, Delica 4/86-6/88	74,50	180 088 0007 181 088 0008	Std, 0,25, 0,50, 0,75, 1,00, 1,25, 1,50 Std, 0,25, 0,50, 0,75, 1,00, 1,25, 1,50	2
4G31	1499	4	Lancer, Galant, Mirage, Delica 11/69-74	74,50	180 088 0007 181 088 0008	Std, 0,25, 0,50, 0,75, 1,00, 1,25, 1,50 Std, 0,25, 0,50, 0,75, 1,00, 1,25, 1,50	2
6G71	1998	6	Diamante, Galant, Debonair 7/86-	74,70	180 088 0009 181 088 0011 182 088 0017	Std, 0,25, 0,50, 0,75, 1,00 Std, 0,25, 0,50 Std	3
G15B	1468	4	Lancer, Mirage, SAGA 10/83-92	75,50	180 088 0005 181 088 0006 181 088 0007	Std, 0,25, 0,50, 0,75, 1,00 Std, 0,25, 0,50 Std, 0,25, 0,50, 0,75, 1,00	1
4G15	1468	4	Lancer, Mirage, SAGA 10/86-	75,50	180 088 0005 181 088 0006 181 088 0007	Std, 0,25, 0,50, 0,75, 1,00 Std, 0,25, 0,50 Std, 0,25, 0,50, 0,75, 1,00	1
G32B	1597	4	Lancer, Galant, Mirage, Delica 6/77-	76,90	180 088 0007 181 088 0008	Std, 0,25, 0,50, 0,75, 1,00, 1,25, 1,50 Std, 0,25, 0,50, 0,75, 1,00, 1,25, 1,50	2
4G32	1597	4	Lancer, Galant, Mirage, Delica 10/70-	76,90	180 088 0007 181 088 0008	Std, 0,25, 0,50, 0,75, 1,00, 1,25, 1,50 Std, 0,25, 0,50, 0,75, 1,00, 1,25, 1,50	2
4G91	1496	4	Mirage, Galant, WIRA 8/91-	78,40	180 088 0003 181 088 0004 182 088 0016	Std, 0,25, 0,50, 0,75 Std, 0,25, 0,50, 0,75 Std	4
4G35	1686	4	Lancer, Galant, Mirage, Delica 2/72-5/77	79,00	180 088 0007 181 088 0008	Std, 0,25, 0,50, 0,75, 1,00, 1,25, 1,50 Std, 0,25, 0,50, 0,75, 1,00, 1,25, 1,50	2
G37B	1755	4	Lancer, Galant, Mirage, Delica 8/83-	80,60	180 088 0007 181 088 0008	Std, 0,25, 0,50, 0,75, 1,00, 1,25, 1,50 Std, 0,25, 0,50, 0,75, 1,00, 1,25, 1,50	2
4G37	1755	4	Lancer, Galant, Mirage, Delica 6/86-	80,60	180 088 0007 181 088 0008	Std, 0,25, 0,50, 0,75, 1,00, 1,25, 1,50 Std, 0,25, 0,50, 0,75, 1,00, 1,25, 1,50	2
G62B	1795	4	Lancer, Galant, Mirage, Delica 5/79-8/89	80,60	180 088 0007 181 088 0008	Std, 0,25, 0,50, 0,75, 1,00, 1,25, 1,50 Std, 0,25, 0,50, 0,75, 1,00, 1,25, 1,50	2
4G62	1795	4	Lancer, Galant, Mirage, Delica 78-2/88	80,60	180 088 0007 181 088 0008	Std, 0,25, 0,50, 0,75, 1,00, 1,25, 1,50 Std, 0,25, 0,50, 0,75, 1,00, 1,25, 1,50	2
4D65	1795	4	Galant, Mirage 3/83-9/91	80,60	180 088 0007 181 088 0008	Std, 0,25, 0,50, 0,75, 1,00, 1,25, 1,50 Std, 0,25, 0,50, 0,75, 1,00, 1,25, 1,50	2
4G92	1755	4	Mirage, Libero 8/91-	81,00	180 088 0003 181 088 0005 182 088 0016	Std, 0,25, 0,50, 0,75 Std, 0,25 Std	6
4G92	1755	4	Mirage 8/91-	81,00	181 088 0005 182 088 0016	Std, 0,25 Std	7
4G93	1834	4	Mirage, Galant, WIRA 5/91-	81,00	180 088 0003 181 088 0004 182 088 0016	Std, 0,25, 0,50, 0,75 Std, 0,25, 0,50, 0,75 Std	4
4G93	1834	4	Mirage, Libero 8/91-	81,00	180 088 0003 181 088 0005 182 088 0016	Std, 0,25, 0,50, 0,75 Std, 0,25 Std	6
G51B	1855	4	Galant 11/77-2/78	81,00	180 088 0006 181 088 0009	Std, 0,25, 0,50, 0,75, 1,00 Std, 0,25, 0,50, 0,75, 1,00	5
4G51	1855	4	Galant 6/73-2/78	81,00	180 088 0006 181 088 0009	Std, 0,25, 0,50, 0,75, 1,00 Std, 0,25, 0,50, 0,75, 1,00	5
G52B	1995	4	Galant 11/77-7/78	84,00	180 088 0006 181 088 0009	Std, 0,25, 0,50, 0,75, 1,00 Std, 0,25, 0,50, 0,75, 1,00	5
4G52	1995	4	Galant 8/72-7/78	84,00	180 088 0006 181 088 0009	Std, 0,25, 0,50, 0,75, 1,00 Std, 0,25, 0,50, 0,75, 1,00	5
G63B	1997	4	Lancer, Galant, Mirage, Delica 2/80-7/90	85,00	180 088 0007 181 088 0008	Std, 0,25, 0,50, 0,75, 1,00, 1,25, 1,50 Std, 0,25, 0,50, 0,75, 1,00, 1,25, 1,50	2
4G63	1997	4	Lancer, Galant, Mirage, Delica 4/80-5/92	85,00	180 088 0007 181 088 0008	Std, 0,25, 0,50, 0,75, 1,00, 1,25, 1,50 Std, 0,25, 0,50, 0,75, 1,00, 1,25, 1,50	2



MITSUBISHI

Globally reliable

	ccm						Pos.
4G63	1997	4	Galant, Delica, Pajero, Perdona 2/92-	85,00	180 088 0008 180 088 0013 181 088 0010 182 088 0021	Std, 0,25, 0,50, 0,75, 1,00 Std, 0,25, 0,50, 0,75, 1,00 Std, 0,25, 0,50, 0,75, 1,00 Std	8
G64	2350	4	Lancer, Galant, Mirage, Delica 10/86-8/89	86,50	180 088 0007 181 088 0008	Std, 0,25, 0,50, 0,75, 1,00, 1,25, 1,50 Std, 0,25, 0,50, 0,75, 1,00, 1,25, 1,50	2
4G64	2350	4	Lancer, Galant, Mirage, Delica 10/86-	86,50	180 088 0007 181 088 0008	Std, 0,25, 0,50, 0,75, 1,00, 1,25, 1,50 Std, 0,25, 0,50, 0,75, 1,00, 1,25, 1,50	2
4G53	2384	4	Galant 5/73-7/78	88,00	180 088 0006 181 088 0009	Std, 0,25, 0,50, 0,75, 1,00 Std, 0,25, 0,50, 0,75, 1,00	5
6G72	2972	6	Diamante, Galant, Debonair 7/86-7/92	91,10	180 088 0009 181 088 0013 182 088 0017	Std, 0,25, 0,50, 0,75, 1,00 Std, 0,25, 0,50, 0,75, 1,00 Std	10
4D55	2346	4	Delica, Pajero, Galant 2/80-3/86	91,10	180 088 0006 180 088 0012 181 088 0009 182 088 0022	Std, 0,25, 0,50, 0,75, 1,00 Std, 0,25, 0,50, 0,75, 1,00 Std, 0,25, 0,50, 0,75, 1,00 Std, 0,25	9
4D56, 4D56-T	2476	4	Delica, Pajero, Galant 4/86-	91,10	180 088 0006 180 088 0012 181 088 0009 182 088 0022	Std, 0,25, 0,50, 0,75, 1,00 Std, 0,25, 0,50, 0,75, 1,00 Std, 0,25, 0,50, 0,75, 1,00 Std, 0,25	9
4G54	2555	4	Galant 11/75-7/78	91,10	180 088 0006 181 088 0009	Std, 0,25, 0,50, 0,75, 1,00 Std, 0,25, 0,50, 0,75, 1,00	5
6G74	3496	6	Debonair	93,00	180 088 0010 181 088 0012 182 088 0019	Std, 0,25, 0,50, 0,75, 1,00 Std, 0,25, 0,50, 0,75, 1,00 Std, 0,25	11
4M40	2835	4	Delica, Pajero	95,00	180 088 0011 181 088 0014 182 088 0020	Std, 0,25, 0,50, 0,75 Std, 0,25, 0,50, 0,75 Std	12
4D30	3298	4	11/1978-	100,00	180 088 0001 181 088 0001 181 088 0017 181 088 0018 182 088 0002 182 088 0003	Std, 0,25, 0,50, 0,75 Std, 0,25, 0,50, 0,75 Std, 0,25, 0,50 Std, 0,25, 0,50 Std Std	13
4D31	3298	4	10/82-8/91	100,00	180 088 0001 181 088 0001 181 088 0017 181 088 0018 182 088 0002 182 088 0003	Std, 0,25, 0,50, 0,75 Std, 0,25, 0,50, 0,75 Std, 0,25, 0,50 Std, 0,25, 0,50 Std Std	13
4D31-T	3298	4	10/82-9/89	100,00	180 088 0001 181 088 0001 181 088 0017 181 088 0018 182 088 0002 182 088 0003	Std, 0,25, 0,50, 0,75 Std, 0,25, 0,50, 0,75 Std, 0,25, 0,50 Std, 0,25, 0,50 Std Std	13
4D32	3567	4	9/89-	104,00	180 088 0001 181 088 0001 181 088 0017 181 088 0018 182 088 0002 182 088 0003	Std, 0,25, 0,50, 0,75 Std, 0,25, 0,50, 0,75 Std, 0,25, 0,50 Std, 0,25, 0,50 Std Std	13
4D36	3567	4	.	104,00	180 088 0001 181 088 0001 181 088 0017 181 088 0018 182 088 0002 182 088 0003	Std, 0,25, 0,50, 0,75 Std, 0,25, 0,50, 0,75 Std, 0,25, 0,50 Std, 0,25, 0,50 Std Std	13
4D34	3907	4	8/91-8/91	104,00	180 088 0001 181 088 0001 181 088 0017 181 088 0018 182 088 0002 182 088 0003	Std, 0,25, 0,50, 0,75 Std, 0,25, 0,50, 0,75 Std, 0,25, 0,50 Std, 0,25, 0,50 Std Std	13
4D34-T	3907	4	9/89-	104,00	180 088 0001 181 088 0001 181 088 0017 181 088 0018 182 088 0002 182 088 0003	Std, 0,25, 0,50, 0,75 Std, 0,25, 0,50, 0,75 Std, 0,25, 0,50 Std, 0,25, 0,50 Std Std	13
4D33	4214	4	9/89-	108,00	180 088 0001 181 088 0001 181 088 0017 181 088 0018 182 088 0002 182 088 0003	Std, 0,25, 0,50, 0,75 Std, 0,25, 0,50, 0,75 Std, 0,25, 0,50 Std, 0,25, 0,50 Std Std	13

							Set Composition / QTY									
1 69,50																
MB/HL 1, 2, 4, 5	4 Pairs	48,000	52,000	19,130	SAL	180 088 0005 00	4		4		2					
MB/HL 3	1 Pair	48,000	52,000	23,950	SAL		21									
							26									
							29									
CB/PL 1, 2, 3, 4	4 Pairs	42,000	45,000	17,630	SAL	181 088 0006 00	8									
							15									
							21									
							29									
CB/PL 1, 2, 3, 4	4 Pairs	42,000	45,000	15,630	SAL	181 088 0007 00	8									
							15									
							21									
							26									
							29									
2 73,00																
MB/HL 1, 2, 4, 5	4 Pairs	57,000	61,000	23,130	SAL	180 088 0007 00	4		4		2					
							15									
							21									
							26									
							29									
							31									
							33									
CB/PL 1, 2, 3, 4	4 Pairs	45,000	48,000	23,630	SAL	181 088 0008 00	8									
							15									
							21									
							26									
							29									
							31									
							33									
3 74,70																
MB/HL 1, 2, 3, 4	4 Pairs	60,000	64,000	18,130	SAL	180 088 0009 00	4		4							
							15									
							21									
							26									
							29									
CB/PL 1, 2, 3, 4, 5, 6	6 Pairs	45,000	48,000	15,500	SAL	181 088 0011 00										
							15									
							21									
							29									
TW/A 1	4 Halves	66,250	77,700		SAL	182 088 0017 00	2		2							
							15									
							21									
							29									
4 78,40																
MB/HL 1, 2, 3, 4, 5	5 Pairs	50,000	54,000	19,130	SAL	180 088 0003 00	5		5							
							15									
							21									
							26									
CB/PL 1, 2, 3, 4	4 Pairs	45,000	48,000	16,800	SAL	181 088 0004 00	8									
							15									
							21									
							26									
TW/A 1	2 Halves	56,250	75,400		SAL	182 088 0016 00										
5 81,00																
MB/HL 1, 2, 4, 5	4 Pairs	66,000	70,000	25,130	SAL	180 088 0006 00	4		4		1		1			
							15									
							21									
							26									
							29									
MB/HL 3	1 Pair	66,000	70,000	30,950	SAL											
							21									
							26									
							29									
CB/PL 1, 2, 3, 4	4 Pairs	53,000	56,007	25,130	SAL	181 088 0009 00	8									
							15									
							21									
							26									
							29									







MITSUBISHI







Globally reliable







							Set Composition / QTY								
6 81,00															
MB/HL 1, 2, 3, 4, 5	5 Pairs	50,000	54,000	19,130	SAL	180 088 0003 00 15 21 26	5		5						
CB/PL 1, 2, 3, 4	4 Pairs	45,000	48,000	16,800	S3S	181 088 0005 00 15	8								
TW/A 1	2 Halves	56,250	75,400		SAL	182 088 0016 00									
7 81,00															
CB/PL 1, 2, 3, 4	4 Pairs	45,000	48,000	16,800	S3S	181 088 0005 00 15	8								
TW/A 1	2 Halves	56,250	75,400		SAL	182 088 0016 00									
8 85,00															
MB/HL 1, 2, 4, 5	4 Pairs	57,000	61,000	20,630	SAL	180 088 0008 00 15	4		4		2				
MB/HL 3	1 Pair	57,000	61,000	25,450	SAL	21 26 29									
MB/HL 1, 2, 3, 4, 5	5 Pairs	57,000	61,000	20,630	SAL	180 088 0013 00 15 21 26 29	5		5						
CB/PL 1, 2, 3, 4	4 Pairs	45,000	48,000	21,230	SAL	181 088 0010 00 15 21 26 29	8								
TW/A 1	2 Halves	63,000	80,870		SAL	182 088 0021 00	2								
9 91,10															
MB/HL 1, 2, 4, 5	4 Pairs	66,000	70,000	25,130	SAL	180 088 0006 00 15	4		4		1		1		
MB/HL 3	1 Pair	66,000	70,000	30,950	SAL	21 26 29									
MB/HL 1, 2, 3, 4, 5	5 Pairs	66,000	70,000	25,130	SAL	180 088 0012 00 15 21 26 29	5		5						
CB/PL 1, 2, 3, 4	4 Pairs	53,000	56,007	25,130	SAL	181 088 0009 00 15 21 26 29	8								
TW/A 1	2 Halves	72,250	89,750		SAL	182 088 0022 00 15	2								
10 91,10															
MB/HL 1, 2, 3, 4	4 Pairs	60,000	64,000	18,130	SAL	180 088 0009 00 15 21 26 29	4		4						
CB/PL 1, 2, 3, 4, 5, 6	6 Pairs	50,000	53,000	15,500	SAL	181 088 0013 00 15 21 26 29	12								
TW/A 1	4 Halves	66,250	77,700		SAL	182 088 0017 00	2		2						









Set Composition / QTY

11	93,00																		
MB/HL 1, 2, 3, 4	4 Pairs	64,000	68,000	17,130	S3S	180 088 0010 00	15 21 26 29	4		4									
CB/PL 1, 2, 3, 4, 5, 6	6 Pairs	55,000	58,000	15,500	S3S	181 088 0012 00	15 21 26 29	12											
TW/A 1	2 Halves	70,250	94,700		SAL	182 088 0019 00	15	2											













12	95,00																		
MB/HL 1, 2, 3, 4, 5	5 Pairs	67,988	72,000	22,130	S3S	180 088 0011 00	15 21 26	5		4		1							
CB/PL 1, 2, 3, 4	4 Pairs	53,988	58,000	27,630	S3S	181 088 0014 00	15 21 26	4		4									
TW/A 1	4 Halves	76,250	94,700		SAL	182 088 0020 00		2		2									

13	100,00																		
MB/HL 1, 2, 3, 4, 5	5 Pairs	77,960	82,000	27,130	S3S	180 088 0001 00	15 21 26	5		5									
CB/PL 1, 2, 3, 4	4 Pairs	59,965	64,000	33,130	S3S	181 088 0001 00	15 21 26	4		4									
CB/PL 1, 2, 3, 4	4 Pairs	59,965	64,000	33,130	S3S	181 088 0017 00	15 21												
CB/PL 1, 2, 3, 4	4 Pairs	64,960	69,000	33,130	S3S	181 088 0018 00	15 21												
TW/A 1	3 Halves	83,250	104,000		SL	182 088 0002 00		3											
TW/A 1	3 Halves	83,250	110,000		SL	182 088 0003 00		3											

	ccm						Pos.
KD 110,5-2	1336	2	.	90,00	180 032 0001 180 032 0002 181 032 0001	Std, 0,25, 0,50, 0,75 Std, 0,25, 0,50, 0,75 Std, 0,25, 0,50, 0,75	1
KD 110,5-3	2004	3	.	90,00	180 032 0001 180 032 0002 181 032 0001	Std, 0,25, 0,50, 0,75 Std, 0,25, 0,50, 0,75 Std, 0,25, 0,50, 0,75	1
KD 110,5-4	2670	4	.	90,00	180 032 0001 180 032 0002 181 032 0001	Std, 0,25, 0,50, 0,75 Std, 0,25, 0,50, 0,75 Std, 0,25, 0,50, 0,75	1
KD 110,5-6	4010	6	.	90,00	180 032 0001 180 032 0002 181 032 0001	Std, 0,25, 0,50, 0,75 Std, 0,25, 0,50, 0,75 Std, 0,25, 0,50, 0,75	1
AKD 1105-2, D208-2, D225-2, D308-2, KD 1105-2	1490	2	.	95,00	180 032 0001 180 032 0002 181 032 0001	Std, 0,25, 0,50, 0,75 Std, 0,25, 0,50, 0,75 Std, 0,25, 0,50, 0,75	1
D208-3, D308-3	2235	3	.	95,00	180 032 0001 180 032 0002 181 032 0001	Std, 0,25, 0,50, 0,75 Std, 0,25, 0,50, 0,75 Std, 0,25, 0,50, 0,75	1
D208-4, D308-4	2976	4	.	95,00	180 032 0001 180 032 0002 181 032 0001	Std, 0,25, 0,50, 0,75 Std, 0,25, 0,50, 0,75 Std, 0,25, 0,50, 0,75	1
D208-6, D308-6	4470	6	.	95,00	180 032 0001 180 032 0002 181 032 0001	Std, 0,25, 0,50, 0,75 Std, 0,25, 0,50, 0,75 Std, 0,25, 0,50, 0,75	1
D225-2, D325-2	1700	2	.	95,00	180 032 0001 180 032 0002 181 032 0001	Std, 0,25, 0,50, 0,75 Std, 0,25, 0,50, 0,75 Std, 0,25, 0,50, 0,75	1
D225-3, D325-3, D925L	2550	3	.	95,00	180 032 0001 180 032 0002 181 032 0001	Std, 0,25, 0,50, 0,75 Std, 0,25, 0,50, 0,75 Std, 0,25, 0,50, 0,75	1
D225-4, D325-4	3402	4	.	95,00	180 032 0001 180 032 0002 181 032 0001	Std, 0,25, 0,50, 0,75 Std, 0,25, 0,50, 0,75 Std, 0,25, 0,50, 0,75	1
D225-6, D325-6	5100	6	.	95,00	180 032 0001 180 032 0002 181 032 0001	Std, 0,25, 0,50, 0,75 Std, 0,25, 0,50, 0,75 Std, 0,25, 0,50, 0,75	1
D227-2, D327-2	1885	2	.	100,00	180 032 0001 180 032 0002 181 032 0001	Std, 0,25, 0,50, 0,75 Std, 0,25, 0,50, 0,75 Std, 0,25, 0,50, 0,75	1
D227-3, D327-3	2827	3	.	100,00	180 032 0001 180 032 0002 181 032 0001	Std, 0,25, 0,50, 0,75 Std, 0,25, 0,50, 0,75 Std, 0,25, 0,50, 0,75	1
D227-4, D327-4	3768	4	.	100,00	180 032 0001 180 032 0002 181 032 0001	Std, 0,25, 0,50, 0,75 Std, 0,25, 0,50, 0,75 Std, 0,25, 0,50, 0,75	1
D227-6, D327-6	5654	6	.	100,00	180 032 0001 180 032 0002 181 032 0001	Std, 0,25, 0,50, 0,75 Std, 0,25, 0,50, 0,75 Std, 0,25, 0,50, 0,75	1
D226B-2	2080	2	.	105,00	180 032 0003 181 032 0002 182 032 0001	Std, 0,25, 0,50 Std, 0,25, 0,50 Std	2
D226-2, D916-2	2080	2	.	105,00	180 032 0001 180 032 0002 181 032 0001	Std, 0,25, 0,50, 0,75 Std, 0,25, 0,50, 0,75 Std, 0,25, 0,50, 0,75	1
D226B-3, TD226B-3	3120	3	.	105,00	180 032 0003 181 032 0002 182 032 0001	Std, 0,25, 0,50 Std, 0,25, 0,50 Std	2
D226-3, D916-3	3120	3	.	105,00	180 032 0001 180 032 0002 181 032 0001	Std, 0,25, 0,50, 0,75 Std, 0,25, 0,50, 0,75 Std, 0,25, 0,50, 0,75	1
D226B-4, TD226B-4, TD226-4	4154	4	.	105,00	180 032 0003 181 032 0002 182 032 0001	Std, 0,25, 0,50 Std, 0,25, 0,50 Std	2
D226-4, D916-4	4154	4	.	105,00	180 032 0001 180 032 0002 181 032 0001	Std, 0,25, 0,50, 0,75 Std, 0,25, 0,50, 0,75 Std, 0,25, 0,50, 0,75	1
D226B-6, TD226B-6, TD226-6, TD226-6	6234	6	.	105,00	180 032 0003 181 032 0002 182 032 0001	Std, 0,25, 0,50 Std, 0,25, 0,50 Std	2
D226-6, D916-6	6234	6	.	105,00	180 032 0001 180 032 0002 181 032 0001	Std, 0,25, 0,50, 0,75 Std, 0,25, 0,50, 0,75 Std, 0,25, 0,50, 0,75	1









Set Composition / QTY







1		90,00																
MB/HL 1	1 Pair	64,951 64,970	71,000 71,019	28,000	S3S	180 032 0001 00 15 21 26	1		1									
MB/HL 1	1 Pair	64,951 64,970	71,000 71,019	35,880	S3S	180 032 0002 00 15 21 26	1		1									
CB/PL 1	1 Pair	57,950 57,970	62,000 62,019	27,100	S3S	181 032 0001 00 15 21 26	1		1									
2		105,00																
MB/HL 1	1 Pair	69,951 69,970	75,000 75,019	28,000	S3S	180 032 0003 00 15 21	1		1									
CB/PL 1	1 Pair	62,950 62,970	67,000 67,019	27,100	S3S	181 032 0002 00 15 21	1		1									
TW/A 1	4 Halves	79,000	95,200		SAL	182 032 0001 00	2		2									



NISSAN

Globally reliable







	ccm						Pos.
MA09	930	4	March 8/88-1/92	66,00	180 089 0007 181 089 0009 182 089 0002	Std, 0,25, 0,50, 0,75 Std, 0,25, 0,50, 0,75 Std	1
MA10	987	4	March 9/1982-	68,00	180 089 0007 181 089 0009 182 089 0002	Std, 0,25, 0,50, 0,75 Std, 0,25, 0,50, 0,75 Std	1
GA13	1295	4	Sunny 1/1990-	71,00	180 089 0006 181 089 0008 182 089 0001	Std, 0,25, 0,50, 0,75, 1,00 Std, 0,25, 0,50, 0,75, 1,00 Std	2
H4B 408, HR09DET	898	3	MICRA V 0.9 IG-T	72,20	180 038 0017 181 038 0022 182 038 0008	Std, 0,25, 0,50 Std, 0,25, 0,50 Std	3
E10	988	4	Sunny, Pulsar 3/81-2/91	73,00	180 089 0005 181 089 0006	Std, 0,25, 0,50 Std, 0,25, 0,50	4
J/J13	1299	4	Bluebird, Truck 10/69-11/75	73,00	180 089 0010 181 089 0004 182 089 0010	Std, 0,25, 0,50 Std, 0,25, 0,50, 0,75 Std	5
GA14	1392	4	Sunny 9/88-10/90	73,60	180 089 0006 181 089 0008 182 089 0001	Std, 0,25, 0,50, 0,75, 1,00 Std, 0,25, 0,50, 0,75, 1,00 Std	2
GA15	1497	4	Sunny 8/87-	73,60	180 089 0006 181 089 0008 182 089 0001	Std, 0,25, 0,50, 0,75, 1,00 Std, 0,25, 0,50, 0,75, 1,00 Std	2
E13	1270	4	Sunny, Pulsar 10/81-2/91	76,00	180 089 0005 181 089 0006	Std, 0,25, 0,50 Std, 0,25, 0,50	4
VQ20	1995	6	Cefiro, Cedric, Skyline, Stagea, Fairlady Z, Fuga, Murano, Elgrand	76,00	180 089 0020 181 089 0025 181 089 0027 181 089 0033 182 089 0006	Std, 0,25, 0,50 Std, 0,25, 0,50 Std, 0,25, 0,50 Std, 0,25, 0,50 Std	18
E15	1487	4	Sunny, Pulsar 3/81-2/91	76,00	180 089 0005 181 089 0006	Std, 0,25, 0,50 Std, 0,25, 0,50	4
E15-T	1487	4	Sunny, Pulsar 9/82-9/87	76,00	180 089 0005 181 089 0006	Std, 0,25, 0,50 Std, 0,25, 0,50	4
E16	1597	4	Sunny, Pulsar 5/83-8/88	76,00	180 089 0005 181 089 0006	Std, 0,25, 0,50 Std, 0,25, 0,50	4
GA16	1596	4	Sunny 5/86-	76,00	180 089 0006 181 089 0008 182 089 0001	Std, 0,25, 0,50, 0,75, 1,00 Std, 0,25, 0,50, 0,75, 1,00 Std	2
L20	1998	6	Cedric 1966-5/87	78,00	180 089 0001 181 089 0001	Std, 0,25, 0,50 Std, 0,25, 0,50	7
L20A	1998	6	Cedric, Laurel 6/81-5/87	78,00	180 089 0001 181 089 0002	Std, 0,25, 0,50 Std, 0,25, 0,50	8
RB20D	1998	6	Cefiro 8/1985-	78,00	180 089 0002 181 089 0012	Std, 0,25, 0,50 Std, 0,25	9
RB20	1998	6	Cefiro, Crew 10/1984-	78,00	180 089 0002 181 089 0003	Std, 0,25, 0,50 Std, 0,25	10
VG20	1998	6	Cedric, Gloria 6/83-10/86	78,00	180 089 0008 181 089 0010	Std, 0,25, 0,50 Std	11
VG20	1998	6	Cedric, Gloria 10/86-	78,00	180 089 0009 181 089 0010 181 089 0011	Std, 0,25, 0,50 Std Std, 0,25, 0,50	12
VG20D	1998	6	Cedric, Gloria 6/87-6/91	78,00	181 089 0012	Std, 0,25	13
J15	1483	4	Bluebird, Truck 3/70-8/79	78,00	180 089 0010 181 089 0004 182 089 0010	Std, 0,25, 0,50 Std, 0,25, 0,50, 0,75 Std	5
J16	1567	4	Bluebird, Truck 8/72-8/85	78,00	180 089 0010 181 089 0004 182 089 0010	Std, 0,25, 0,50 Std, 0,25, 0,50, 0,75 Std	5
CA16	1598	4	Bluebird, Stanza, Auster, Preirie 10/79-9/91	78,00	180 089 0012 181 089 0007 181 089 0016	Std, 0,25, 0,50 Std, 0,25, 0,50 Std, 0,25	6
R9M.413, R9M.452	1598	4	NV300 1.6 dci, QASHQAI 1.6 dCi, X-TRAIL 1.6 dCi	80,00	180 038 0015 181 038 0020 182 815 0006	Std, 0,25, 0,50 Std, 0,25, 0,50 Std	14
CD17	1680	4	Sunny, Pulsar, Langrey 10/1982-	80,00	180 089 0012 181 089 0007 181 089 0016	Std, 0,25, 0,50 Std, 0,25, 0,50 Std, 0,25	6
SR18	1838	4	Bluebird, Silvia, R'nessa, Primera, Avenir	82,50	180 089 0021 181 089 0026 182 089 0007	Std, 0,25, 0,50, 0,75, 1,00 Std, 0,25, 0,50 Std	15
L24	2393	6	Cedric 10/71-6/87	83,00	180 089 0001 181 089 0001	Std, 0,25, 0,50 Std, 0,25, 0,50	7
L26	2565	6	Cedric 1/71-6/78	83,00	180 089 0001 181 089 0001	Std, 0,25, 0,50 Std, 0,25, 0,50	7
CA18	1809	4	Bluebird, Stanza, Auster, Preirie 6/1981-	83,00	180 089 0012 181 089 0007 181 089 0016	Std, 0,25, 0,50 Std, 0,25, 0,50 Std, 0,25	6
M9R.630, M9R.780, M9R.782	1995	4	PRIMASTAR 2.0 dCi 90, 115, 120	84,00	180 038 0014 181 038 0019 182 038 0007	Std, 0,25, 0,50 Std, 0,25, 0,50 Std	16
LD28	2792	6	Skyline, Cedric 10/79-10/86	84,50	180 089 0001 181 089 0001	Std, 0,25, 0,50 Std, 0,25, 0,50	7











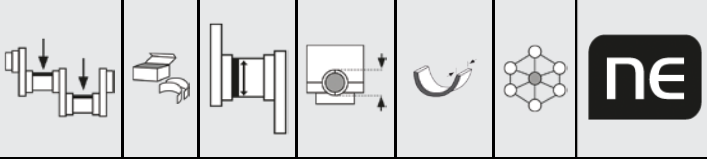









	ccm						Pos.
CA20	1973	4	Bluebird, Stanza, Auster, Preirie 6/1981-	84,50	180 089 0012 181 089 0007 181 089 0016	Std, 0,25, 0,50 Std, 0,25, 0,50 Std, 0,25	6
CD20	1973	4	5/1990-	84,50	180 089 0012 181 089 0017	Std, 0,25, 0,50 Std, 0,25	17
CD20-T	1973	4	6/1991-	84,50	180 089 0012 181 089 0017	Std, 0,25, 0,50 Std, 0,25	17
VQ25	2495	6	Cefiro, Cedric, Skyline, Stagea, Fairlady Z, Fuga, Murano, Elgrand	85,00	180 089 0020 181 089 0025 181 089 0027 181 089 0033 182 089 0006	Std, 0,25, 0,50 Std, 0,25, 0,50 Std, 0,25, 0,50 Std, 0,25, 0,50 Std	18
RD28	2825	6	Laurel, Safari 6/1983-	85,00	180 089 0013 181 089 0018	Std, 0,25, 0,50 Std, 0,25, 0,50	21
Z20	1952	4	Silvia, Laurel, Bluebird 11/1975-	85,00	180 089 0003 181 089 0005	Std, 0,25, 0,50 Std, 0,25, 0,50	19
L20B	1952	4	Truck 1974-4/80	85,00	180 089 0003 181 089 0005	Std, 0,25, 0,50 Std, 0,25, 0,50	19
LD20	1952	4	Skyline, Bluebird, Laurel, Vanette 4/78-9/83	85,00	180 089 0003 181 089 0005	Std, 0,25, 0,50 Std, 0,25, 0,50	19
LD20	1952	4	Skyline, Bluebird, Laurel, Vanette 10/1983-	85,00	180 089 0014 181 089 0005	Std, 0,25, 0,50 Std, 0,25, 0,50	20
M9T.670, M9T.672, M9T.676, M9T.678, M9T.680, M9T.686, M9T.690, M9T.692, M9T.694, M9T.696, M9T.698, M9T.870, M9T.880, M9T.896	2299	4	NV400 2.3 dCi Power Version 100, 110, 125, 140, 145, 150	85,00	180 038 0013 181 038 0018 182 038 0007	Std, 0,25, 0,50 Std, 0,25, 0,50 Std	22
RB25	2498	6	Skyline, Laurel, Stagea 8/1991-	86,00	180 089 0002	Std, 0,25, 0,50	23
RB30	2962	6	Skyline 8/85-8/88	86,00	180 089 0002 181 089 0014	Std, 0,25, 0,50 Std, 0,25, 0,50	24
SR20	1998	4	Bluebird, Silvia, R'hessa, Primera, Avenir	86,00	180 089 0021 181 089 0026 182 089 0007	Std, 0,25, 0,50, 0,75, 1,00 Std, 0,25, 0,50 Std	15
VG30	2960	6	Fairlady Z, Cedric 6/83-4/87	87,00	180 089 0009 181 089 0014	Std, 0,25, 0,50 Std, 0,25, 0,50	25
VG30	2960	6	Fairlady Z, Cedric 4/1987-	87,00	180 089 0009 181 089 0014	Std, 0,25, 0,50 Std, 0,25, 0,50	25
VG30D	2960	6	Fairlady Z, Cedric 2/1986-	87,00	181 089 0015	Std, 0,25, 0,50	26
Z22	2187	4	Silvia, Laurel, Bluebird 8/1982-	87,00	180 089 0003 181 089 0005	Std, 0,25, 0,50 Std, 0,25, 0,50	19
QR20	1998	4	Primera, Presage, X-Trail	89,00	180 089 0023 181 089 0028 182 089 0008 184 089 0004	Std, 0,25, 0,50, 0,75, 1,00 Std, 0,25, 0,50, 0,75, 1,00 Std Std	30
TD23	2289	4	6/1986-	89,00	180 089 0016 181 089 0020 182 089 0003	Std, 0,25, 0,50, 0,75 Std, 0,25, 0,50 Std, 0,20	28
Z24	2389	4	Silvia, Laurel, Bluebird 8/1983-	89,00	180 089 0003 181 089 0005	Std, 0,25, 0,50 Std, 0,25, 0,50	19
YD25	2488	4	1999-	89,00	180 089 0024 181 089 0029 182 089 0009	Std, 0,25, 0,50 Std, 0,25, 0,50 Std	27
TD25	2494	4	8/1986-	89,00	180 089 0016 181 089 0021 182 089 0003	Std, 0,25, 0,50, 0,75 Std, 0,25, 0,50, 0,75 Std, 0,20	29
QR25	2488	4	Primera, Presage, X-Trail	89,00	180 089 0023 181 089 0028 182 089 0008 184 089 0004	Std, 0,25, 0,50, 0,75, 1,00 Std, 0,25, 0,50, 0,75, 1,00 Std Std	30
VQ30	2987	6	Cefiro, Cedric, Skyline, Stagea, Fairlady Z, Fuga, Murano, Elgrand	93,00	180 089 0020 181 089 0025 181 089 0027 181 089 0033 182 089 0006	Std, 0,25, 0,50 Std, 0,25, 0,50 Std, 0,25, 0,50 Std, 0,25, 0,50 Std	18
VQ35	3498	6	Cefiro, Cedric, Skyline, Stagea, Fairlady Z, Fuga, Murano, Elgrand	95,50	180 089 0020 181 089 0025 181 089 0027 181 089 0033 182 089 0006	Std, 0,25, 0,50 Std, 0,25, 0,50 Std, 0,25, 0,50 Std, 0,25, 0,50 Std	18
L28	2753	6	Cedric 6/1975-	96,00	180 089 0001 181 089 0001	Std, 0,25, 0,50 Std, 0,25, 0,50	7
TD27	2663	4	6/1986-	96,00	180 089 0016 181 089 0021 182 089 0003	Std, 0,25, 0,50, 0,75 Std, 0,25, 0,50, 0,75 Std, 0,20	29
TD27-T	2663	4	10/1988-	96,00	180 089 0016 181 089 0021 182 089 0003	Std, 0,25, 0,50, 0,75 Std, 0,25, 0,50, 0,75 Std, 0,20	29
TD42	4169	6	10/1987-	96,00	180 089 0017 181 089 0022 182 089 0003	Std, 0,25, 0,50 Std, 0,25, 0,50 Std, 0,20	32
TB42	4169	6	Safari 10/1987-	96,00	180 089 0011 181 089 0013	Std, 0,25, 0,50 Std, 0,25, 0,50	33



Globally reliable

NISSAN

	ccm						Pos.
BD30	2953	4	5/89-10/91	96,00	180 089 0016 181 089 0032 182 089 0003	Std, 0,25, 0,50, 0,75 Std, 0,25, 0,50 Std, 0,20	31
ZD30, ZD30Ti	2953	4	TERRANO II 3.0 Di, PATROL 3.0 DTi	96,00	180 089 0025 181 089 0030	Std, 0,25 Std, 0,25, 0,50, 0,75	34
QD32	3153	4	Atlas 10	99,20	180 089 0016 181 089 0032 182 089 0003	Std, 0,25, 0,50, 0,75 Std, 0,25, 0,50 Std, 0,20	31











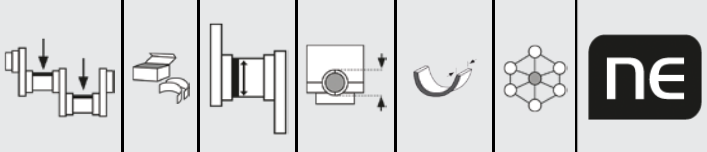









							Set Composition / QTY															
1 66,00																						
MB/HL 1, 2, 3, 4, 5	5 Pairs	54,955	49,000	17,100	SAL	180 089 0007 00 15 21 26	5		5													
CB/PL 1, 2, 3, 4	4 Pairs	39,974	43,000	15,130	SAL	181 089 0009 00 15 21 26	8															
TW/A 1	2 Halves	51,250	60,000		SAL	182 089 0002 00	2															
2 71,00																						
MB/HL 1, 2, 3, 4, 5	5 Pairs	49,964	53,644	17,100	SAL	180 089 0006 00 15 21 26 29	5		5													
CB/PL 1, 2, 3, 4	4 Pairs	39,974	43,000	17,100	SAL	181 089 0008 00 15 21 26 29	8															
TW/A 1	2 Halves	56,250	71,000		SAL	182 089 0001 00	2															
3 72,20																						
MB/HL 1, 2, 3, 4	4 Pairs	1,000	1,000	16,050	SAL	180 038 0017 00 15 21	4		4													
CB/PL 1, 2, 3	3 Pairs	3,000	3,000	17,000	SAL	181 038 0022 00 15 21	6															
TW/A 1	2 Halves	54,900 55,100	73,900 74,000		SAL	182 038 0008 00	2															
4 73,00																						
MB/HL 1, 5	2 Pairs	49,964	53,641	22,100	SAL	180 089 0005 00 15 21	4		4		2											
MB/HL 2, 4	2 Pairs	49,964	53,641	18,100	SAL																	
MB/HL 3	1 Pair	49,964	53,641	26,950	SAL																	
CB/PL 1, 2, 3, 4	4 Pairs	39,974	43,000	17,130	S3S	181 089 0006 00 15 21	8															
5 73,00																						
MB/HL 1, 2, 3	3 Pairs	50,825	54,508	28,100	S3S	180 089 0010 00 15 21	6															
CB/PL 1, 2, 3, 4	4 Pairs	47,650	51,333	22,100	S3S	181 089 0004 00 15 21 26	8															
TW/A 1	4 Halves	56,550	69,700		SL	182 089 0010 00	2		2													



NISSAN

Globally reliable

							Set Composition / QTY													
6	78,00																			
MB/HL 1, 2, 4, 5	4 Pairs	52,957	56,654	20,100	SAL	180 089 0012 00 15	4		4		1		1							
MB/HL 3	1 Pair	52,957	56,654	27,950	SAL	21														
CB/PL 1, 2, 3, 4	4 Pairs	44,974	48,000	18,600	SAL	181 089 0007 00 15	8													
CB/PL 1, 2, 3, 4	4 Pairs	44,974	48,000	18,600	SAL	181 089 0016 00 15	8													
7	78,00																			
MB/HL 1, 7	2 Pairs	54,955	58,660	26,100	S3S	180 089 0001 00 15														
MB/HL 2, 3, 5, 6	4 Pairs	54,955	58,660	24,100	S3S	21														
MB/HL 4	1 Pair	54,955	58,660	31,950	S3S															
CB/PL 1, 2, 3, 4, 5, 6	6 Pairs	49,970	53,000	22,100	S3S	181 089 0001 00 15	12													
8	78,00																			
MB/HL 1, 7	2 Pairs	54,955	58,660	26,100	S3S	180 089 0001 00 15														
MB/HL 2, 3, 5, 6	4 Pairs	54,955	58,660	24,100	S3S	21														
MB/HL 4	1 Pair	54,955	58,660	31,950	S3S															
CB/PL 1, 2, 3, 4, 5, 6	6 Pairs	44,974	48,000	18,600	SAL	181 089 0002 00 15	12													
9	78,00																			
MB/HL 1, 2, 3, 5, 6, 7	6 Pairs	54,975	58,645	19,100	SAL	180 089 0002 00 15														
MB/HL 4	1 Pair	54,975	58,645	26,950	SAL	21														
CB/PL 1, 2, 3, 4, 5, 6	6 Pairs	44,974	48,000	18,600	SAL	181 089 0012 00 15														
10	78,00																			
MB/HL 1, 2, 3, 5, 6, 7	6 Pairs	54,975	58,645	19,100	SAL	180 089 0002 00 15														
MB/HL 4	1 Pair	54,975	58,645	26,950	SAL	21														
CB/PL 1, 2, 3, 4, 5, 6	6 Pairs	41,974	45,000	16,100	SAL	181 089 0003 00 15														
11	78,00																			
MB/HL 1	1 Pair	52,975	56,645	25,600	S3S	180 089 0008 00 15														
MB/HL 2, 3	2 Pairs	52,975	56,645	19,100	S3S	21														
MB/HL 4	1 Pair	52,975	56,645	28,850	S3S															
CB/PL 1, 2, 3, 4, 5, 6	6 Pairs	44,974	48,000	15,100	SAL	181 089 0010 00														







							Set Composition / QTY														
12	78,00																				
MB/HL 1	1 Pair	62,975	66,645	22,600	SAL	180 089 0009 00															
MB/HL 2, 3	2 Pairs	62,975	66,645	19,100	SAL	15 21															
MB/HL 4	1 Pair	62,975	66,645	28,850	SAL																
CB/PL 1, 2, 3, 4, 5, 6	6 Pairs	44,974	48,000	15,100	SAL	181 089 0010 00															
CB/PL 1, 2, 3, 4, 5, 6	6 Pairs	44,974	48,000	17,100	SAL	181 089 0011 00															
						15 21															
13	78,00																				
CB/PL 1, 2, 3, 4, 5, 6	6 Pairs	44,974	48,000	18,600	SAL	181 089 0012 00															
						15															
14	80,00																				
MB/HL 1, 2, 3, 4, 5	5 Pairs	51,500	55,500	17,250	SSI	180 038 0015 00	5		5												
						15 21															
CB/PL 1, 2, 3, 4	4 Pairs	48,000 48,018	51,600 51,618	20,700	Nefrox	181 038 0020 00	4		4												
						15 21															
TW/A 1	2 Halves	58,050	80,250		SAL	182 815 0006 00	2														
15	82,50																				
MB/HL 1, 2, 3, 4, 5	5 Pairs	54,980	58,944	19,100	S3S	180 089 0021 00	5		5												
						15 21 26 29															
CB/PL 1, 2, 3, 4	4 Pairs	47,974	51,000	17,100	S3S	181 089 0026 00	8														
						15 21															
TW/A 1	2 Halves	61,750	83,250		SAL	182 089 0007 00	2														
16	84,00																				
MB/HL 1, 2	2 Pairs	55,985 56,005	59,998 60,011	17,200	S32S	180 038 0014 00	5		5												
						15 21															
MB/HL 3, 4, 5	3 Pairs	55,985 56,005	59,998 60,011	19,500	S32S																
						21															
CB/PL 1, 2	2 Pairs	52,000 52,018	55,580 55,596	19,500	Nefrox	181 038 0019 00	4		4												
						15															
CB/PL 3, 4	2 Pairs	52,000 52,018	55,580 55,596	18,500	Nefrox		21														
TW/A 1	2 Halves	65,600 65,850	84,000 84,250		SAL	182 038 0007 00	2														
17	84,50																				
MB/HL 1, 2, 4, 5	4 Pairs	52,957	56,654	20,100	SAL	180 089 0012 00	4		4		1		1								
						15 21															
MB/HL 3	1 Pair	52,957	56,654	27,950	SAL																
						21															
CB/PL 1, 2, 3, 4	4 Pairs	49,974	53,000	20,100	SAL	181 089 0017 00	8														
						15															

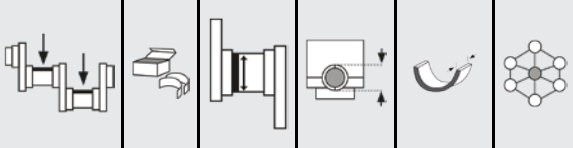

NISSAN

Globally reliable

							NE		Set Composition / QTY											
18		85,00																		
MB/HL 1, 2, 3, 4	4 Pairs	59,975	63,993	20,100	S3S	180 089 0020 00 15 21	4		4											
CB/PL 1, 2, 3, 4, 5, 6	6 Pairs	44,974	48,000	17,100	S3S	181 089 0025 00 15 21	12													
CB/PL 1, 2, 3, 4, 5, 6	6 Pairs	51,974	55,000	17,100	S3S	181 089 0027 00 15 21	12													
CB/PL 1, 2, 3, 4, 5, 6	6 Pairs	49,974	53,000	17,100	S3S	181 089 0033 00 15 21														
TW/A 1	4 Halves	66,750	79,250		SAL	182 089 0006 00	2		2											
19		85,00																		
MB/HL 1, 5	2 Pairs	59,955	63,645	26,130	S3S	180 089 0003 00 15	2		2		1		1		2					
MB/HL 2, 4	2 Pairs	59,955	63,645	24,130	S3S	21														
MB/HL 3	1 Pair	59,955	63,645	31,950	S3S															
CB/PL 1, 2, 3, 4	4 Pairs	49,970	53,000	22,100	S3S	181 089 0005 00 15 21	8													
20		85,00																		
MB/HL 1, 2, 4, 5	4 Pairs	59,955	63,645	22,100	S3S	180 089 0014 00 15														
MB/HL 3	1 Pair	59,955	63,645	31,950	S3S	21														
CB/PL 1, 2, 3, 4	4 Pairs	49,970	53,000	22,100	S3S	181 089 0005 00 15 21	8													
21		85,00																		
MB/HL 1, 2, 3, 5, 6, 7	6 Pairs	54,975	58,645	19,900	SAL	180 089 0013 00 15	6		6		1		1							
MB/HL 4	1 Pair	54,975	58,645	26,950	SAL	21														
CB/PL 1, 2, 3, 4, 5, 6	6 Pairs	49,974	53,000	20,100	SAL	181 089 0018 00 15 21	8													
22		85,00																		
MB/HL 1, 2	2 Pairs	59,985 60,005	63,998 64,011	17,200	SAL	180 038 0013 00 15	5		5											
MB/HL 3, 4, 5	3 Pairs	59,985 60,005	63,998 64,011	19,300	SAL	21														
CB/PL 1, 2, 3, 4	4 Pairs	53,000 53,020	56,587 56,606	19,000	SPVD	181 038 0018 00 15 21	4		4											
TW/A 1	2 Halves	65,600 65,850	84,000 84,250		SAL	182 038 0007 00	2													







 							Set Composition / QTY													
23	86,00																			
MB/HL 1, 2, 3, 5, 6, 7	6 Pairs	54,975	58,645	19,100	SAL	180 089 0002 00	15													
MB/HL 4	1 Pair	54,975	58,645	26,950	SAL		21													
24	86,00																			
MB/HL 1, 2, 3, 5, 6, 7	6 Pairs	54,975	58,645	19,100	SAL	180 089 0002 00	15													
MB/HL 4	1 Pair	54,975	58,645	26,950	SAL		21													
CB/PL 1, 2, 3, 4, 5, 6	6 Pairs	49,974	53,000	17,100	SAL	181 089 0014 00	15													
							21													
25	87,00																			
MB/HL 1	1 Pair	62,975	66,645	22,600	SAL	180 089 0009 00	15													
MB/HL 2, 3	2 Pairs	62,975	66,645	19,100	SAL		21													
MB/HL 4	1 Pair	62,975	66,645	28,850	SAL															
CB/PL 1, 2, 3, 4, 5, 6	6 Pairs	49,974	53,000	17,100	SAL	181 089 0014 00	15													
							21													
26	87,00																			
CB/PL 1, 2, 3, 4, 5, 6	6 Pairs	49,974	53,000	17,100	S3S	181 089 0015 00	15													
							21													
27	89,00																			
MB/HL 1, 2, 3, 4, 5	5 Pairs	62,975	66,654	20,100	SSI	180 089 0024 00	15	5		5										
							21													
CB/PL 1, 2, 3, 4	4 Pairs	51,974	55,000	23,100	S3S	181 089 0029 00	15	8												
							21													
TW/A 1	2 Halves	69,750	88,250		SAL	182 089 0009 00		2												
28	89,00																			
MB/HL 1, 2, 3, 4, 5	5 Pairs	70,920	74,981	26,000	S3S	180 089 0016 00	15	5		5										
							21													
							26													
CB/PL 1, 2, 3, 4	4 Pairs	52,926	55,987	26,100	S3S	181 089 0020 00	15	8												
							21													
TW/A 1	4 Halves	78,850	93,800		SAL	182 089 0003 00	14	2		2										
29	89,00																			
MB/HL 1, 2, 3, 4, 5	5 Pairs	70,920	74,981	26,000	S3S	180 089 0016 00	15	5		5										
							21													
							26													
CB/PL 1, 2, 3, 4	4 Pairs	56,926	59,987	26,100	S3S	181 089 0021 00	15	8												
							21													
							26													
TW/A 1	4 Halves	78,850	93,800		SAL	182 089 0003 00	14	2		2										



NISSAN

Globally reliable







							Set Composition / QTY												
30	89,00																		
MB/HL 1, 2, 4, 5	4 Pairs	54,979	58,944	20,100	SAL	180 089 0023 00	4		5		1								
MB/HL 3	1 Pair	54,979	58,944	23,550	SAL		21												
							26												
							29												
CB/PL 1, 2, 3, 4	4 Pairs	44,974	48,000	19,100	SAL	181 089 0028 00	8												
							15												
							21												
							26												
							29												
TW/A 1	4 Halves	59,270	83,250		S3S	182 089 0008 00	2		2										
Bush/PB 1, 2, 3, 4	4 Pairs	20,001	22,000	22,800	SL	184 089 0004 00													
31	96,00																		
MB/HL 1, 2, 3, 4, 5	5 Pairs	70,920	74,981	26,000	S3S	180 089 0016 00	5		5										
							15												
							21												
							26												
CB/PL 1, 2, 3, 4	4 Pairs	56,925	59,913	26,100	S3S	181 089 0032 00	4		4										
							15												
							21												
TW/A 1	4 Halves	78,850	93,800		SAL	182 089 0003 00	2		2										
32	96,00																		
MB/HL 1, 2, 3, 4, 5, 6, 7	7 Pairs	70,920	74,981	26,000	S3S	180 089 0017 00	7		7										
							15												
							21												
CB/PL 1, 2, 3, 4, 5, 6	6 Pairs	56,926	59,987	26,100	S3S	181 089 0022 00	12												
							15												
							21												
TW/A 1	4 Halves	78,850	93,800		SAL	182 089 0003 00	2		2										
33	96,00																		
MB/HL 1, 2, 3, 4, 5, 7	6 Pairs	70,920	75,000	26,000	SAL	180 089 0011 00	6		6		1		1						
							15												
							21												
MB/HL 6	1 Pair	70,920	75,000	31,950	SAL														
CB/PL 1, 2, 3, 4, 5, 6	6 Pairs	56,926	60,000	26,100	SAL	181 089 0013 00	12												
							15												
							21												
34	96,00																		
MB/HL 1, 2, 3, 4, 5	5 Pairs	70,910	74,981	26,000	SAL	180 089 0025 00	5		5										
		70,920	75,000				15												
CB/PL 1, 2, 3, 4	4 Pairs	56,916	59,987	26,100	SAL	181 089 0030 00	8												
		56,926	60,000				15												
							21												
							26												







	ccm						Pos.
Z 13 DTJ, Z 13 DTH, Z 13 DT	1248	4	MERIVA 1.3 CDTI, COMBO 1.3 CDTI 16V, CORSA D 1.3 CDTI, ASTRA H 1.3 CDTI, AGILA (A) 1.3 CDTI, CORSA C 1.3 CDTI, TIGRA TwinTop 1.3 CDTI	69,60	180 035 0007 181 035 0010	Std, 0,25, 0,50 Std, 0,25, 0,50	1
12 NZ, C12 NZ, X12 SZ	1195	4	Combo 1.2i, Corsa 1.2i	72,00	180 035 0001 181 035 0001	Std, 0,25, 0,50, 0,75, 1,00 Std, 0,25, 0,50, 0,75, 1,00	2
X12 XE, Z12 XE	1199	4	Agila 1.2i 16V, Corsa 1.2i 16V, Astra 1.2i 16V	72,50	180 035 0004 181 035 0004	Std, 0,25, 0,50 Std, 0,25, 0,50	4
X10 XE, Z10 XE	973	4	Agila 1.0i 12V, Corsa 1.0i 12V	72,50	180 035 0003 181 035 0003	Std, 0,25, 0,50 Std, 0,25, 0,50	3
13N, 13NB, 13S, 13SB, C13N	1297	4	Ascona 1.3, Corsa 1.3, Kadett 1.3, Manta 1.3	75,00	180 035 0001 181 035 0001	Std, 0,25, 0,50, 0,75, 1,00 Std, 0,25, 0,50, 0,75, 1,00	2
D 15 DT (DV5RD)	1499	4	COMBO Tour / Life 1.5 D GRANDLAND X 1.5 D CROSSLAND X / CROSSLAND 1.5 D CORSA F 1.5 D	75,00	180 037 0015 181 037 0023 182 051 0001	Std, 0,25, 0,50 Std, 0,25, 0,50 Std	5
D 15 DT (DV5RUCD)	1499	4	ZAFIRA LIFE 1.5 D VIVARO C 1.5 D	75,00	180 037 0015 181 037 0023 182 051 0001	Std, 0,25, 0,50 Std, 0,25, 0,50 Std	5
D 15 DTH (DV5RC)	1499	4	GRANDLAND X 1.5 Turbo D, COMBO Tour / Life 1.5 D GRANDLAND X Van 1.5 D	75,00	180 037 0015 181 037 0023 182 051 0001	Std, 0,25, 0,50 Std, 0,25, 0,50 Std	5
D 15 DTH (DV5RUC)	1499	4	ZAFIRA LIFE 1.5 D, VIVARO C .5 D	75,00	180 037 0015 181 037 0023 182 051 0001	Std, 0,25, 0,50 Std, 0,25, 0,50 Std	5
D 15 DTL (DV5RE)	1499	4	COMBO Tour / Life 1.5 D	75,00	180 037 0015 181 037 0023 182 051 0001	Std, 0,25, 0,50 Std, 0,25, 0,50 Std	5
15 D	1487	4	Corsa 1.5 D	76,00	180 079 0006 180 079 0007 181 079 0006 182 079 0004	Std, 0,25 Std, 0,25, 0,50, 0,75 Std, 0,25, 0,50, 0,75 Std	6
15 TD	1487	4	Corsa 1.5 TD, Kadett 1.5 TD	76,00	180 079 0007 181 079 0006 182 079 0004	Std, 0,25, 0,50, 0,75 Std, 0,25, 0,50, 0,75 Std	7
14 NV, 14 SE, C14 NZ, C14 SE, C14 SEL, X14 NZ, X14 SZ, X14 XE, Z14 XE	1389	4	Astra 1.4i, Astra 1.4i 16V, Combo 1.4i, Combo 1.4i 16V, Corsa 1.4i, Corsa 1.4i 16V, Kadett 1.4, Kadett 1.4i, Tigra 1.4i 16V, Vectra 1.4	77,60	180 035 0001 181 035 0001	Std, 0,25, 0,50, 0,75, 1,00 Std, 0,25, 0,50, 0,75, 1,00	2
12 ST	1196	4	Corsa 1.2, Kadett 1.2	77,80	180 035 0001 181 035 0001	Std, 0,25, 0,50, 0,75, 1,00 Std, 0,25, 0,50, 0,75, 1,00	2
16 NZR, 16 SV, C16 LZ, C16 NZ, C16 SE, C16 SEL, C16 XE, E16 NZ, E16 SE, X16 SZ, X16 SZR, X16 XE, X16 XEL, Y16 XE, Z16 SE, Z16 XE, Z16 XEP, Z16 YNG	1598	4	Ascona 1.6i, Astra 1.6i, Astra 1.6i 16V, Combo 1.6i, Corsa 1.6i, Corsa 1.6i 16V, Kadett 1.6i, Meriva 1.6i 16V, Tigra 1.6i 16V, Vectra 1.6i, Vectra 1.6i 16V, Zafira 1.6i 16V	79,00	180 035 0001 181 035 0001	Std, 0,25, 0,50, 0,75, 1,00 Std, 0,25, 0,50, 0,75, 1,00	2
17 D(4EE1), 17 TD, X17 D	1686	4	Combo 1.7 D, Corsa 1.7 D, Kadett 1.7 D	79,00	180 079 0007 181 079 0006 182 079 0005	Std, 0,25, 0,50, 0,75 Std, 0,25, 0,50, 0,75 Std	8
16 D, 16 DA	1598	4	Ascona 1.6 D, Kadett 1.6 D	80,00	180 035 0002 181 035 0002 181 035 0005	Std, 0,25, 0,50, 0,75, 1,00 Std, 0,25, 0,50, 0,75, 1,00 Std, 0,25, 0,50, 0,75, 1,00	9
16 N, 16 SH	1598	4	Ascona 1.6, Manta 1.6	80,00	180 035 0002 181 035 0002 181 035 0005	Std, 0,25, 0,50, 0,75, 1,00 Std, 0,25, 0,50, 0,75, 1,00 Std, 0,25, 0,50, 0,75, 1,00	9
R9M.408, R9M.413, R9M.450, R9M.452	1598	4	VIVARO B 1.6 CDTI	80,00	180 038 0015 181 038 0020 182 815 0006	Std, 0,25, 0,50 Std, 0,25, 0,50 Std	13
M51 D25WA (E34/E36)	2498	6	Omega 2.5TD	80,00	180 007 0001 181 035 0012	Std, 0,25, 0,50, 0,75, 1,00 Std, 0,25, 0,50	12
F8Q 600, F9Q 760, F9Q 762, F9Q 770, F9Q 772, F9Q 774	1870	4	Arena 1.9 D, Movano 1.9 DTI, Vivaro 1.9 DI, Vivaro 1.9 DTI	80,00	180 038 0003 181 038 0003 182 038 0002	Std, 0,25, 0,50, 0,75 Std, 0,25, 0,50, 0,75 Std	10
F8Q 606	1870	4	Arena 1.9 D	80,00	180 038 0002 180 038 0003 181 038 0002 181 038 0003 182 038 0002	Std, 0,25, 0,50, 0,75 Std, 0,25, 0,50, 0,75 Std, 0,25, 0,50, 0,75 Std, 0,25, 0,50, 0,75 Std	11
X18 XE1, Z18 XE, Z18 XEL	1796	4	Astra 1.8i 16V, Corsa 1.8i 16V, Signum 1.8i 16V, Tigra 1.8i 16V, Vectra 1.8i 16V, Zafira 1.8i 16V	80,50	180 035 0001 181 035 0001	Std, 0,25, 0,50, 0,75, 1,00 Std, 0,25, 0,50, 0,75, 1,00	2
C25 XE, X25 XE	2498	6	Omega, Omega Break, Vectra, Vectra Break	81,60	180 035 0006 181 035 0008	Std, 0,25, 0,50, 0,75 Std, 0,25, 0,50, 0,75	14
C18 XE, X18 XE	1796	4	Astra 1.8i 16V, Vectra 1.8i 16V	81,60	180 035 0002 181 035 0002	Std, 0,25, 0,50, 0,75, 1,00 Std, 0,25, 0,50, 0,75, 1,00	15
17 D, 17 DR	1699	4	Astra 1.7 D, Kadett 1.7 D, Vectra 1.7 D	82,50	180 035 0002 181 035 0002	Std, 0,25, 0,50, 0,75, 1,00 Std, 0,25, 0,50, 0,75, 1,00	15
F4R 720	1998	4	Vivaro 2.0i 16V	82,70	180 038 0003 181 038 0003 182 038 0002	Std, 0,25, 0,50, 0,75 Std, 0,25, 0,50, 0,75 Std	10



OPEL

Globally reliable

	ccm						Pos.
A 20 DTH	1956	4	ASTRA J 2.0 CDTI	83,00	180 035 0009 181 035 0014 182 035 0001	Std. .010, .020 Std. .010, .020 Std. .005	16
A 20 DTH	1956	4	CASCADA 2.0 CDTI	83,00	180 035 0009 181 035 0014 182 035 0001	Std. .010, .020 Std. .010, .020 Std. .005	16
A 20 DTH	1956	4	INSIGNIA 2.0 CDTI	83,00	180 035 0009 181 035 0014 182 035 0001	Std. .010, .020 Std. .010, .020 Std. .005	16
A 20 DTH	1956	4	ZAFIRA C 2.0 CDTI	83,00	180 035 0009 181 035 0014 182 035 0001	Std. .010, .020 Std. .010, .020 Std. .005	16
A 20 DTH Main Bearing Outside Oversize + 1,00 mm	1956	4	ASTRA J 2.0 CDTI	83,00	180 035 0011 181 035 0014 182 035 0001	Std. .010, .020 Std. .010, .020 Std. .005	17
A 20 DTH Main Bearing Outside Oversize + 1,00 mm	1956	4	CASCADA 2.0 CDTI	83,00	180 035 0011 181 035 0014 182 035 0001	Std. .010, .020 Std. .010, .020 Std. .005	17
A 20 DTH Main Bearing Outside Oversize + 1,00 mm	1956	4	INSIGNIA 2.0 CDTI	83,00	180 035 0011 181 035 0014 182 035 0001	Std. .010, .020 Std. .010, .020 Std. .005	17
A 20 DTH Main Bearing Outside Oversize + 1,00 mm	1956	4	ZAFIRA C 2.0 CDTI	83,00	180 035 0011 181 035 0014 182 035 0001	Std. .010, .020 Std. .010, .020 Std. .005	17
A 20 DTR Main Bearing Outside Oversize + 1,00 mm	1956	4	ZAIRA TOURER C 2.0 BitURBO CDTI	83,00	180 035 0011 181 035 0014 182 035 0001	Std. .010, .020 Std. .010, .020 Std. .005	17
A 20 DTR Main Bearing Outside Oversize + 1,00 mm	1956	4	ASTRA J 2.0 BitURBO CDTI	83,00	180 035 0011 181 035 0014 182 035 0001	Std. .010, .020 Std. .010, .020 Std. .005	17
A 20 DTL Main Bearing Outside Oversize + 1,00 mm	1956	4	ZAFIRA TOURER C 2.0 CDTI	83,00	180 035 0011 181 035 0014 182 035 0001	Std. .010, .020 Std. .010, .020 Std. .005	17
A 20 DTR Main Bearing Outside Oversize + 1,00 mm	1956	4	CASCADA 2.0 CDTI	83,00	180 035 0011 181 035 0014 182 035 0001	Std. .010, .020 Std. .010, .020 Std. .005	17
A 20 DT, Y 20 DTJ, Z 20 DTJ, Main Bearing Outside Oversize + 1,00 mm	1956	4	ZAFIRA TOURER C 2.0 CDTI	83,00	180 035 0011 181 035 0014 182 035 0001	Std. .010, .020 Std. .010, .020 Std. .005	17
A 20 DTC, A 20 DTL, A 20 DTJ, A 20 DT, A 20 DTR, A 20 DTE, Main Bearing Outside Oversize + 1,00 mm	1956	4	INSIGNIA 2.0 CDTI	83,00	180 035 0011 181 035 0014 182 035 0001	Std. .010, .020 Std. .010, .020 Std. .005	17
A 20 DTR	1956	4	ZAFIRA TOURER C 2.0 BitURbo CDTI	83,00	180 035 0009 181 035 0014 182 035 0001	Std. .010, .020 Std. .010, .020 Std. .005	16
A 20 DTR	1956	4	ASTRA J 2.0 BitURbo CDTI	83,00	180 035 0009 181 035 0014 182 035 0001	Std. .010, .020 Std. .010, .020 Std. .005	16
A 20 DT, Y 20 DTJ, Z 20 DTJ	1956	4	ZAFIRA TOURER C 2.0 CDTI	83,00	180 035 0009 181 035 0014 182 035 0001	Std. .010, .020 Std. .010, .020 Std. .005	16
A 20 DTL	1956	4	ZAFIRA TOURER C 2.0 CDTI	83,00	180 035 0009 181 035 0014 182 035 0001	Std. .010, .020 Std. .010, .020 Std. .005	16
A 20 DTR	1956	4	CASCADA 2.0 CDTI	83,00	180 035 0009 181 035 0014 182 035 0001	Std. .010, .020 Std. .010, .020 Std. .005	16
A 20 DTC, A 20 DTL, A 20 DTJ, A 20 DT, A 20 DTR A 20 DTE,	1956	4	INSIGNIA 2.0 CDTI	83,00	180 035 0009 181 035 0014 182 035 0001	Std. .010, .020 Std. .010, .020 Std. .005	16
B 20 DTH	1956	4	ANTARA 2.0 CDTI, CASCADA 2.0 CDTI, INSIGNIA 2.0 CDTI, ZAFIRA TOURER C 2.0 CDTI	83,00	181 035 0014 182 035 0001	Std. .010, .020 Std. .005	18
A 20 DTH Main Bearing Outside Oversize + 0,50 mm	1956	4	ASTRA J 2.0 CDTI	83,00	180 035 0010 181 035 0014 182 035 0001	Std. .010, .020 Std. .010, .020 Std. .005	19
A 20 DTH Main Bearing Outside Oversize + 0,50 mm	1956	4	CASCADA 2.0 CDTI	83,00	180 035 0010 181 035 0014 182 035 0001	Std. .010, .020 Std. .010, .020 Std. .005	19
A 20 DTH Main Bearing Outside Oversize + 0,50 mm	1956	4	INSIGNIA 2.0 CDTI	83,00	180 035 0010 181 035 0014 182 035 0001	Std. .010, .020 Std. .010, .020 Std. .005	19
A 20 DTH Main Bearing Outside Oversize + 0,50 mm	1956	4	ZAFIRA C 2.0 CDTI	83,00	180 035 0010 181 035 0014 182 035 0001	Std. .010, .020 Std. .010, .020 Std. .005	19











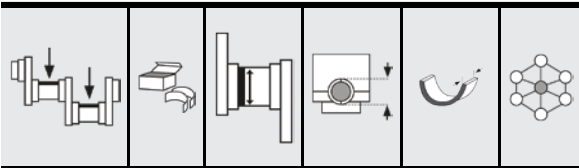













	ccm						Pos.
A 20 DTR Main Bearing Outside Oversize + 0,50 mm	1956	4	ZAFIRA TOURER C 2.0 BiTurbo CDTI	83,00	180 035 0010 181 035 0014 182 035 0001	Std. .010, .020 Std. .010, .020 Std. .005	19
A 20 DTR Main Bearing Outside Oversize + 0,50 mm	1956	4	ASTRA J 2.0 BiTurbo CDTI	83,00	180 035 0010 181 035 0014 182 035 0001	Std. .010, .020 Std. .010, .020 Std. .005	19
A 20 DTL Main Bearing Outside Oversize + 0,50 mm	1956	4	ZAFIRA TOURER C 2.0 CDTI	83,00	180 035 0010 181 035 0014 182 035 0001	Std. .010, .020 Std. .010, .020 Std. .005	19
A 20 DTR Main Bearing Outside Oversize + 0,50 mm	1956	4	CASCADA 2.0 CDTI	83,00	180 035 0010 181 035 0014 182 035 0001	Std. .010, .020 Std. .010, .020 Std. .005	19
A 20 DT, Y 20 DTJ, Z 20 DTJ, Main Bearing Outside Oversize + 0,50 mm	1956	4	ZAFIRA TOURER C 2.0 CDTI	83,00	180 035 0010 181 035 0014 182 035 0001	Std. .010, .020 Std. .010, .020 Std. .005	19
A 20 DTC, A 20 DTL, A 20 DTJ, A 20 DT, A 20 DTR, A 20 DTE, Main Bearing Outside Oversize + 0,50 mm	1956	4	INSIGNIA 2.0 CDTI	83,00	180 035 0010 181 035 0014 182 035 0001	Std. .010, .020 Std. .010, .020 Std. .005	19
M9R.630, M9R.692, M9R.780, M9R.782, M9R.784, M9R.786, M9R.788	1995	4	VIVARO A 2.0 CDTI	84,00	180 038 0014 181 038 0019 182 038 0007	Std. 0,25, 0,50 Std. 0,25, 0,50 Std	21
X 22 DTH, Y 22 DTH, Y 22 DTR	2171	4	Frontera B 2.2 DTI 16V, Sintra 2.2 TDI 16V, Astra G 2.2 DTI 16V, Signum 2.2 DTI 16V, Vectra B 2.2 DTI 16V, Vectra C 2.2 DTI 16V, Zafira A 2.2 DTI 16V	84,00	180 035 0008 181 035 0013	Std. 0,25, 0,50 Std. 0,25	20
18 E, 18 N, 18 S, 18 SE, C18 NE, C18 NZ	1796	4	Ascona 1.8i, Astra 1.8i, Kadett 1.8i, Manta 1.8, Rekord 1.8, Vectra 1.8i	84,80	180 035 0002 181 035 0002 181 035 0005	Std. 0,25, 0,50, 0,75, 1,00 Std. 0,25, 0,50, 0,75, 1,00 Std. 0,25, 0,50, 0,75, 1,00	9
18 NV, 18 SEH, 18 SV, E18 NV, E18 NVR, S18 NV	1796	4	Ascona 1.8, Kadett 1.8, Omega 1.8, Omega 1.8i, Vectra 1.8	84,80	180 035 0002 181 035 0002	Std. 0,25, 0,50, 0,75, 1,00 Std. 0,25, 0,50, 0,75, 1,00	15
M9T 670, M9T 672, M9T 676, M9T 678, M9T 680, M9T 686, M9T 690, M9T 692, M9T 694, M9T 696, M9T 698, M9T 870, M9T 876, M9T 880	2299	4	MOVANO B 2.3 CDTI Power Version 100, 110, 125, 140, 145, 150	85,00	180 038 0013 181 038 0018 182 038 0007	Std. 0,25, 0,50 Std. 0,25, 0,50 Std	22
X30 XE	2962	6	Omega, Omega Break, Sintra	86,00	180 035 0002 181 035 0009	Std. 0,25, 0,50, 0,75, 1,00 Std. 0,25, 0,50	23
20 SE, 20 SEH, 20 XE, C20 LET, C20 NE, C20 XE, X20 SE, X20 XEV	1998	4	Ascona 2.0i, Astra 2.0i, Astra 2.0i 16V, Calibra 2.0i, Calibra 2.0i 16V, Frontera 2.0i, Frontera 2.0i 16V, Kadett 2.0i, Kadett 2.0i 16V, Omega 2.0i, Omega 2.0i 16V, Vectra 2.0i, Vectra 2.0i 16V	86,00	180 035 0002 181 035 0002 181 035 0007	Std. 0,25, 0,50, 0,75, 1,00 Std. 0,25, 0,50, 0,75, 1,00 Std. 0,25, 0,50, 0,75	24
X22 SE	2198	4	Frontera 2.2i 16V, Sintra 2.2i 16V	86,00	180 035 0002 181 035 0002 181 035 0007	Std. 0,25, 0,50, 0,75, 1,00 Std. 0,25, 0,50, 0,75, 1,00 Std. 0,25, 0,50, 0,75	24
X22 XE	2198	4	Frontera 2.2i 16V	86,00	180 035 0002 180 035 0005 181 035 0006	Std. 0,25, 0,50, 0,75, 1,00 Std. 0,25, 0,50 Std. 0,25, 0,50, 0,75	25
Y22 XE, Z22 XE	2198	4	Omega 2.2i 16V	86,00	180 035 0005 181 035 0006	Std. 0,25, 0,50 Std. 0,25, 0,50, 0,75	26
4ZC1	1995	4	Euromidi 2.0	88,00	180 079 0014 181 079 0013 182 079 0010	Std. 0,25, 0,50 Std. 0,25, 0,50 Std	27
4ZD1	2255	4	Campo 2.3	89,50	180 079 0014 181 079 0013 182 079 0010	Std. 0,25, 0,50 Std. 0,25, 0,50 Std	27
S8U 780, S8U 782	2445	4	Arena 2.5 D	93,00	180 020 0003 181 020 0012	Std. .010, .020, .030 Std. .010, .020, .030	29
4JA1	2499	4	Campo 2.5 D,	93,00	180 079 0011 181 079 0009 182 079 0007	Std. 0,25, 0,50, 0,75 Std. 0,25, 0,50, 0,75 Std. 0,25	28
S8U 758	2499	4	Arena 2.5 D	93,00	180 020 0003 181 020 0012	Std. .010, .020, .030 Std. .010, .020, .030	29
S9W 700, S9W 702	2799	4	Movano 2.8 DTI	94,40	180 020 0003 181 020 0012	Std. .010, .020, .030 Std. .010, .020, .030	29
20 E	1979	4	Ascona 2.0i, Kadett 2.0i	95,00	180 035 0002 181 035 0002 181 035 0007	Std. 0,25, 0,50, 0,75, 1,00 Std. 0,25, 0,50, 0,75, 1,00 Std. 0,25, 0,50, 0,75	24
4JG2-T, 4JG2-TC	3059	4	Campo 3.1 TD	95,40	180 079 0012 181 079 0009 182 079 0008	Std. 0,25, 0,50, 0,75 Std. 0,25, 0,50, 0,75 Std. 0,25	30











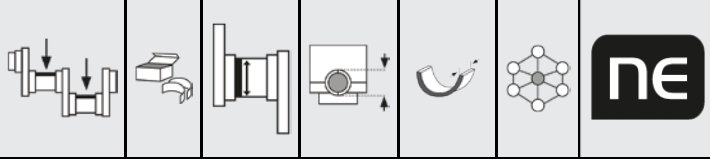





























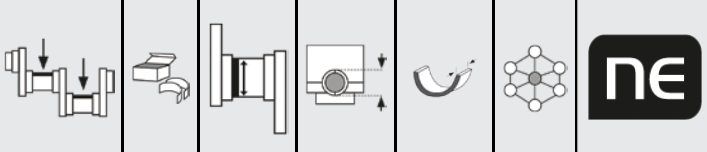















OPEL











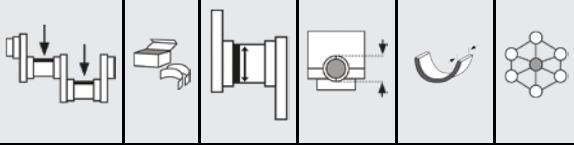









Globally reliable

									Set Composition / QTY												
1											69,60										
MB/HL 1, 2, 4, 5	4 Pairs	50,982 51,000	54,710 54,722	19,000	SAL	180 035 0007 00 15	5		4		1										
MB/HL 3	1 Pair	50,982 51,000	54,710 54,722	23,950	SAL		21														
CB/PL 1, 2, 3, 4	4 Pairs	42,582 42,600	45,734 45,744	20,000	SAL	181 035 0010 00 15	4		4												
2											72,00										
MB/HL 1, 2, 3, 4, 5	5 Pairs	54,972 54,985	59,000 59,013	19,500	SAL	180 035 0001 00 15	8		2												
CB/PL 1, 2, 3, 4	4 Pairs	42,971 42,987	46,000 46,012	16,600	SAL	181 035 0001 00 15	8														
3											72,50										
MB/HL 1, 2, 3	3 Pairs	49,984 49,997	54,000 54,013	17,100	SAL	180 035 0003 00 15	6		2												
MB/HL 4	1 Pair	49,984 49,997	54,000 54,013	22,900	SAL		21														
CB/PL 1, 2, 3	3 Pairs	42,971 42,987	46,000 46,012	13,200	SAL	181 035 0003 00 15	6														
4											72,50										
MB/HL 1, 2, 3, 4	4 Pairs	49,984 49,997	54,000 54,013	17,100	SAL	180 035 0004 00 15	8		2												
MB/HL 5	1 Pair	49,984 49,997	54,000 54,013	22,900	SAL		21														
CB/PL 1, 2, 3, 4	4 Pairs	42,971 42,987	46,000 46,012	13,200	SAL	181 035 0004 00 15	8														
5											75,00										
MB/HL 1, 2, 3, 4, 5	5 Pairs	1,000 2,000	3,000 4,000	19,900	SAL	180 037 0015 00 15															
CB/PL 1, 2, 3, 4	4 Pairs	44,350 44,366	48,000 48,018	17,100	SPVD	181 037 0023 00 15	8														
TW/A 1	2 Halves	55,200 55,480	71,350 71,700		SAL	182 051 0001 00	2														
6											76,00										
MB/HL 1, 2, 3, 4, 5	5 Pairs	47,938	51,976	15,530	SAL	180 079 0006 00 15															
MB/HL 1, 2, 3, 4, 5	5 Pairs	51,938	55,976	15,530	SAL	180 079 0007 00 15	5		5												
CB/PL 1, 2, 3, 4	4 Pairs	45,945	48,982	16,830	SAL	181 079 0006 00 15	8														
TW/A 1	2 Halves	59,000	69,950		SAL	182 079 0004 00															





							Set Composition / QTY														
7	76,00																				
MB/HL 1, 2, 3, 4, 5	5 Pairs	51,938	55,976	15,530	SAL	180 079 0007 00 15 21 26	5		5												
CB/PL 1, 2, 3, 4	4 Pairs	45,945	48,982	16,830	SAL	181 079 0006 00 15 21 26	8														
TW/A 1	2 Halves	59,000	69,950		SAL	182 079 0004 00															
8	79,00																				
MB/HL 1, 2, 3, 4, 5	5 Pairs	51,938	55,976	15,530	SAL	180 079 0007 00 15 21 26	5		5												
CB/PL 1, 2, 3, 4	4 Pairs	45,945	48,982	16,830	SAL	181 079 0006 00 15 21 26	8														
TW/A 1	2 Halves	59,000	73,700		SAL	182 079 0005 00	2														
9	80,00																				
MB/HL 1, 2, 3, 4	4 Pairs	57,982 57,995	62,000 62,013	19,500	SAL	180 035 0002 00 15 21 26 29	8		2												
MB/HL 5	1 Pair	57,982 57,995	62,000 62,013	25,900	SAL																
CB/PL 1, 2, 3, 4	4 Pairs	48,971 48,987	52,000 52,012	19,300	S3S	181 035 0002 00 15 21 26 29	4		4												
CB/PL 1, 2, 3, 4	4 Pairs	48,971 48,987	52,000 52,012	19,300	S3S	181 035 0005 00 15 21 26 29	8														
10	80,00																				
MB/HL 1, 2, 3, 4, 5	5 Pairs	54,785 54,795	58,731 58,744	18,500	S32S	180 038 0003 00 15 21 26	5		5												
CB/PL 1, 2, 3, 4	4 Pairs	48,000 48,020	51,587 51,600	20,500	SAL	181 038 0003 00 15 21 26	8														
TW/A 1	2 Halves	60,500 60,750	79,750 80,000		SAL	182 038 0002 00	2														
11	80,00																				
MB/HL 1, 2, 3, 4, 5	5 Pairs	54,785 54,795	58,731 58,744	18,500	SAL	180 038 0002 00 15 21 26	5		5												
MB/HL 1, 2, 3, 4, 5	5 Pairs	54,785 54,795	58,731 58,744	18,500	S32S	180 038 0003 00 15 21 26	5		5												
CB/PL 1, 2, 3, 4	4 Pairs	48,000 48,020	51,587 51,600	20,500	SAL	181 038 0002 00 15 21 26	8														
CB/PL 1, 2, 3, 4	4 Pairs	48,000 48,020	51,587 51,600	20,500	SAL	181 038 0003 00 15 21 26	8														
TW/A 1	2 Halves	60,500 60,750	79,750 80,000		SAL	182 038 0002 00	2														





							Set Composition / QTY														
12 80,00																					
MB/HL 1, 2, 3, 4, 5, 6	6 Pairs	59,971 59,990	65,000 65,019	20,000	SAL	180 007 0001 00 15	6		6		1		1								
MB/HL 7	1 Pair	59,971 59,990	65,000 65,019	24,940	SAL																
CB/PL 1, 2, 3, 4, 5, 6	6 Pairs	44,975 44,991	48,000 48,016	18,000	S4S	181 035 0012 00 15 21															
13 80,00																					
MB/HL 1, 2, 3, 4, 5	5 Pairs	51,500	55,500	17,250	SSI	180 038 0015 00 15 21	5		5												
CB/PL 1, 2, 3, 4	4 Pairs	48,000 48,018	51,600 51,618	20,700	Nefrox	181 038 0020 00 15 21	4		4												
TW/A 1	2 Halves	58,050	80,250		SAL	182 815 0006 00	2														
14 81,60																					
MB/HL 1	1 Pair	68,000 68,013	72,000 72,013	20,100	SAL	180 035 0006 00 15	2		2		2		2								
MB/HL 2, 3	2 Pairs	68,000 68,013	72,000 72,013	17,000	SAL																
MB/HL 4	1 Pair	68,000 68,013	72,000 72,013	24,500	SAL																
CB/PL 1, 2, 3, 4, 5, 6	6 Pairs	48,971 48,987	52,000 52,012	16,300	SAL	181 035 0008 00 15 21 26	12														
15 81,60																					
MB/HL 1, 2, 3, 4	4 Pairs	57,982 57,995	62,000 62,013	19,500	SAL	180 035 0002 00 15	8		2												
MB/HL 5	1 Pair	57,982 57,995	62,000 62,013	25,900	SAL																
CB/PL 1, 2, 3, 4	4 Pairs	48,971 48,987	52,000 52,012	19,300	S3S	181 035 0002 00 15 21 26 29	4		4												
16 83,00																					
MB/HL 1, 2, 3, 4, 5	5 Pairs	60,034	63,718	20,750	SAL	180 035 0009 00 16 22	5		5												
CB/PL 1, 2, 3, 4	4 Pairs	50,844 50,860	53,950 53,966	19,500	Nefrox	181 035 0014 00 16 22	4		4												
TW/A 1	2 Halves	68,040	82,670		SAL	182 035 0001 00 11	2														
17 83,00																					
MB/HL 1, 2, 3, 4, 5	5 Pairs	60,034	64,218	20,750	SAL	180 035 0011 00 16 22	5		5												
CB/PL 1, 2, 3, 4	4 Pairs	50,844 50,860	53,950 53,966	19,500	Nefrox	181 035 0014 00 16 22	4		4												
TW/A 1	2 Halves	68,040	82,670		SAL	182 035 0001 00 11	2														

							Set Composition / QTY																
18 83,00																							
CB/PL 1, 2, 3, 4	4 Pairs	50,844 50,860	53,950 53,966	19,500	Nefrox	181 035 0014 00 16 22	4		4														
TW/A 1	2 Halves	68,040	82,670		SAL	182 035 0001 00 11	2																
19 83,00																							
MB/HL 1, 2, 3, 4, 5	5 Pairs	60,034	64,218	20,750	SAL	180 035 0010 00 16 22	5		5														
CB/PL 1, 2, 3, 4	4 Pairs	50,844 50,860	53,950 53,966	19,500	Nefrox	181 035 0014 00 16 22	4		4														
TW/A 1	2 Halves	68,040	82,670		SAL	182 035 0001 00 11	2																
20 84,00																							
MB/HL 1, 2, 4, 5	4 Pairs	67,980 67,996	72,000 72,013	19,500	SAL	180 035 0008 00 15	4		4		1		1										
MB/HL 3	1 Pair	67,980 67,996	72,000 72,013	25,900	SAL	21																	
CB/PL 1, 2, 3, 4	4 Pairs	48,971 48,990	52,000 52,012	20,300	S4S	181 035 0013 00 15																	
21 84,00																							
MB/HL 1, 2	2 Pairs	55,985 56,005	59,998 60,011	17,200	S32S	180 038 0014 00 15	5		5														
MB/HL 3, 4, 5	3 Pairs	55,985 56,005	59,998 60,011	19,500	S32S	21																	
CB/PL 1, 2	2 Pairs	52,000 52,018	55,580 55,596	19,500	Nefrox	181 038 0019 00 15	4		4														
CB/PL 3, 4	2 Pairs	52,000 52,018	55,580 55,596	18,500	Nefrox	21																	
TW/A 1	2 Halves	65,600 65,850	84,000 84,250		SAL	182 038 0007 00	2																
22 85,00																							
MB/HL 1, 2	2 Pairs	59,985 60,005	63,998 64,011	17,200	SAL	180 038 0013 00 15	5		5														
MB/HL 3, 4, 5	3 Pairs	59,985 60,005	63,998 64,011	19,300	SAL	21																	
CB/PL 1, 2, 3, 4	4 Pairs	53,000 53,020	56,587 56,606	19,000	SPVD	181 038 0018 00 15 21	4		4														
TW/A 1	2 Halves	65,600 65,850	84,000 84,250		SAL	182 038 0007 00	2																
23 86,00																							
MB/HL 1, 2, 3, 4	4 Pairs	57,982 57,995	62,000 62,013	19,500	SAL	180 035 0002 00 15	8		2														
MB/HL 5	1 Pair	57,982 57,995	62,000 62,013	25,900	SAL	21 26 29																	
CB/PL 1, 2, 3, 4, 5, 6	6 Pairs	53,971 53,990	57,000 57,012	16,300	SAL	181 035 0009 00 15 21	12																

 							Set Composition / QTY															
24 86,00																						
MB/HL 1, 2, 3, 4	4 Pairs	57,982 57,995	62,000 62,013	19,500	SAL	180 035 0002 00	8		2													
MB/HL 5	1 Pair	57,982 57,995	62,000 62,013	25,900	SAL		15 21 26 29															
CB/PL 1, 2, 3, 4	4 Pairs	48,971 48,987	52,000 52,012	19,300	S3S	181 035 0002 00	4		4													
CB/PL 1, 2, 3, 4	4 Pairs	48,971 48,987	52,000 52,012	20,300	S3S	181 035 0007 00	4		4													
25 86,00																						
MB/HL 1, 2, 3, 4	4 Pairs	57,982 57,995	62,000 62,013	19,500	SAL	180 035 0002 00	8		2													
MB/HL 5	1 Pair	57,982 57,995	62,000 62,013	25,900	SAL		15 21 26 29															
MB/HL 1, 2, 3, 4	4 Pairs	57,974 57,995	62,000 62,013	19,500	SAL	180 035 0005 00	8		2													
MB/HL 5	1 Pair	57,974 57,995	62,000 62,013	25,900	SAL		15															
CB/PL 1, 2, 3, 4	4 Pairs	48,971 48,987	52,000 52,012	19,300	S3S	181 035 0006 00	8															
26 86,00																						
MB/HL 1, 2, 3, 4	4 Pairs	57,974 57,995	62,000 62,013	19,500	SAL	180 035 0005 00	8		2													
MB/HL 5	1 Pair	57,974 57,995	62,000 62,013	25,900	SAL		15															
CB/PL 1, 2, 3, 4	4 Pairs	48,971 48,987	52,000 52,012	19,300	S3S	181 035 0006 00	8															
27 88,00																						
MB/HL 1, 2, 3, 4, 5	5 Pairs	55,932	59,980	21,860	SAL	180 079 0014 00																
CB/PL 1, 2, 3, 4	4 Pairs	48,940	51,985	21,630	SAL	181 079 0013 00																
TW/A 1	2 Halves	64,000	80,200		SAL	182 079 0010 00																
28 93,00																						
MB/HL 1, 2, 3, 4, 5	5 Pairs	59,932	64,000	23,030	SAL	180 079 0011 00	5		5													
CB/PL 1, 2, 3, 4	4 Pairs	52,930	56,000	25,830	SAL	181 079 0009 00	8															
TW/A 1	2 Halves	73,050	86,950		SAL	182 079 0007 00	2															









29	93,00																	
MB/HL 1, 2, 3, 4	4 Pairs	76,187 76,200	80,586 80,607	24,990	S3S	180 020 0003 00 16	1		1		4		4					
MB/HL 5	1 Pair	76,187 76,200	80,586 80,607	31,950	S3S		22 27											
CB/PL 1, 2, 3, 4	4 Pairs	56,520 56,535	60,333 60,345	24,700	S3S	181 020 0012 00 16 22 27	8											





















30	95,40																	
MB/HL 1, 2, 3, 4, 5	5 Pairs	69,932	74,000	23,030	SAL	180 079 0012 00 15 21 26	5		5									
CB/PL 1, 2, 3, 4	4 Pairs	52,930	56,000	25,830	SAL	181 079 0009 00 15 21 26	8											
TW/A 1	2 Halves	78,050	92,950		SAL	182 079 0008 00 15	2											



PERKINS

Globally reliable







	ccm						Pos.
3.152, AD3.152, T3.152.4	2500	3		91,49	180 036 0003 181 036 0003 182 036 0001	Std. .010, .020, .030, .040, .050, .060 Std. .010, .020, .030, .040, .050, .060 Std	1
4.203, AD4.203, D4.203, G4.203	3300	4		91,49	180 036 0001 181 036 0001 182 036 0001	Std. .010, .020, .030, .040, .050, .060 Std. .010, .020, .030, .040, .050, .060 Std	2
4.212, A4.212, G4.212	3470	4		98,48	180 036 0002 181 036 0002 182 036 0002	Std. 0,25, 0,50, 0,75, 1,00, 1,25, 1,50 Std. 0,25, 0,50, 0,75, 1,00, 1,25, 1,50 Std. .010, .005	3
4.236, A4.236, C4.236, G4.236	3866	4		98,48	180 036 0002 181 036 0002 182 036 0002	Std. 0,25, 0,50, 0,75, 1,00, 1,25, 1,50 Std. 0,25, 0,50, 0,75, 1,00, 1,25, 1,50 Std. .010, .005	3
C4.40	3990	4		100,00	180 036 0002 181 036 0002 182 036 0002	Std. 0,25, 0,50, 0,75, 1,00, 1,25, 1,50 Std. 0,25, 0,50, 0,75, 1,00, 1,25, 1,50 Std. .010, .005	3
4.248, A4.248	4065	4		101,05	180 036 0002 181 036 0002 182 036 0002	Std. 0,25, 0,50, 0,75, 1,00, 1,25, 1,50 Std. 0,25, 0,50, 0,75, 1,00, 1,25, 1,50 Std. .010, .005	3







							Set Composition / QTY									
1 91,49																
MB/HL 1	1 Pair	69,812 69,825	74,079 74,092	32,360	SAL	180 036 0003 00	4		2		1		1			
MB/HL 2	1 Pair	69,812 69,825	74,079 74,092	39,170	SAL		22									
MB/HL 3, 4	2 Pairs	69,812 69,825	74,079 74,092	23,800	SAL		30 32 34									
CB/PL 1, 2, 3	3 Pairs	57,112 57,125	60,833 60,846	30,230	SAL	181 036 0003 00	6									
TW/A 1	4 Halves	77,343 77,597	90,221 90,475		SAL	182 036 0001 00	2		2							
2 91,49																
MB/HL 1	1 Pair	69,812 69,825	74,079 74,092	32,360	SAL	180 036 0001 00	4		4		1		1			
MB/HL 2, 3	2 Pairs	69,812 69,825	74,079 74,092	39,170	SAL		22 27									
MB/HL 4, 5	2 Pairs	69,812 69,825	74,079 74,092	23,800	SAL		30 32 34									
CB/PL 1, 2, 3, 4	4 Pairs	57,112 57,125	60,833 60,846	30,230	SAL	181 036 0001 00	8									
TW/A 1	4 Halves	77,343 77,597	90,221 90,475		SAL	182 036 0001 00	2		2							
3 98,48																
MB/HL 1, 2, 3, 4	4 Pairs	76,162 76,175	80,416 80,442	31,880	SAL	180 036 0002 00	1		1		4		4			
MB/HL 5	1 Pair	76,162 76,175	80,416 80,442	36,700	SAL		21 26 29 31 33									
CB/PL 1, 2, 3, 4	4 Pairs	63,475 63,487	67,208 67,221	31,880	SAL	181 036 0002 00	8									
TW/A 1	4 Halves	86,868 87,122	103,840 104,090		SAL	182 036 0002 00	2		2							



PEUGEOT

Globally reliable







	ccm						Pos.
1KR-FE	998	3	108 1.0 VTi	71,00	180 096 0032 181 096 0042 182 096 0030	Std, 0,25, 0,50, 0,75 Std, 0,25, 0,50, 0,75 Std	1
HDY, HDZ, TU 1, TU 1K, TU 1M, TU 1MZ	1124	4	106 1.1, 106 1.1i, 205 1.1, 205 1.1i, Partner 1.1i	72,00	180 037 0001 181 037 0001 182 037 0001	Std, 0,30, 0,50, 0,80 Std, 0,30, 0,50 Std, 0,10, 0,20	2
TU 1JP	1124	4	106 1.1i, 206 1.1i, Partner 1.1i	72,00	180 037 0001 181 037 0002 182 037 0001	Std, 0,30, 0,50, 0,80 Std, 0,30, 0,50, 0,80 Std, 0,10, 0,20	3
8HT (DV4TD)	1398	4	107 1.4 HDi	73,70	180 051 0001 181 037 0015 182 051 0001	Std, 0,25, 0,30, 0,50, 0,80 Std, 0,30, 0,50 Std	4
8HS (DV4TED)	1398	4	BIPPER 1.4 HDi, BIPPER Tepee 1.4 HDi	73,70	180 051 0001 181 037 0015 182 051 0001	Std, 0,25, 0,30, 0,50, 0,80 Std, 0,30, 0,50 Std	4
8HX (DV4TD), 8HZ (DV4TD)	1398	4	1007 1.4 HDi, 307 1.4 HDi, 206 1.4 HDi eco 70	73,70	180 051 0001 181 037 0015 182 051 0001	Std, 0,25, 0,30, 0,50, 0,80 Std, 0,30, 0,50 Std	4
8HP (DV4C), 8HR (DV4C)	1398	4	208 1.4 HDi	73,70	180 051 0001 181 037 0015 182 051 0001	Std, 0,25, 0,30, 0,50, 0,80 Std, 0,30, 0,50 Std	4
8HR (DV4C), 8HZ (DV4TD)	1398	4	207 1.4 HDi	73,70	180 051 0001 181 037 0015 182 051 0001	Std, 0,25, 0,30, 0,50, 0,80 Std, 0,30, 0,50 Std	4
TU 2J2/Z, TU 2JA.4A	1294	4	106 1.3i, 205 1.3	75,00	180 037 0001 181 037 0001 182 037 0001	Std, 0,30, 0,50, 0,80 Std, 0,30, 0,50 Std, 0,10, 0,20	2
ET3 J4	1361	4	206 1.4i 16V, 207 1.4i 16V, 307 1.4i 16V	75,00	180 037 0001 181 037 0002 182 037 0001	Std, 0,30, 0,50, 0,80 Std, 0,30, 0,50, 0,80 Std, 0,10, 0,20	3
TU 3, TU 3.2, TU 3.2/K, TU 3A, TU 3A/K, TU 3K.1A, TU 3M, TU 3MC, TU 3S	1361	4	106 1.4, 106 1.4i, 205 1.4, 205 1.4i, 306 1.4, 306 1.4i, 309 1.4, 309 1.4i, 4051.4, 405 1.4i, Partner 1.4i	75,00	180 037 0001 181 037 0001 182 037 0001	Std, 0,30, 0,50, 0,80 Std, 0,30, 0,50 Std, 0,10, 0,20	2
TU 3F2K, TU 3FJ2, TU 3FM, TU 3FM2K	1361	4	106 1.4, 106 1.4i, 205 1.4i, 309 1.4i, 405 1.4i	75,00	180 037 0002 181 037 0001 182 037 0001	Std, 0,30, 0,50 Std, 0,30, 0,50 Std, 0,10, 0,20	5
TU 3JP	1361	4	106 1.4i, 205 1.4i, 206 1.4i, 306 1.4i, 307 1.4i, Partner 1.4i	75,00	180 037 0001 181 037 0002 181 037 0003 182 037 0001	Std, 0,30, 0,50, 0,80 Std, 0,30, 0,50, 0,80 Std, 0,30, 0,50 Std, 0,10, 0,20	6
TUD 3Y	1361	4	106 1.4 D	75,00	180 037 0001 181 037 0003 182 037 0001	Std, 0,30, 0,50, 0,80 Std, 0,30, 0,50 Std, 0,10, 0,20	7
YHR (DV5RUCd), YHS (DV5RCE), YHV (DV5RUC), YHW (DV5RE), YHX (DV5RC), YHY (DV5RD), YHZ (DV5RC)	1499	4	301 1.5 BlueHDI 100, 2008 I 1.5 BlueHDI 100/120, 2008 II 1.5 BlueHDI 100/110/130, 208 I + II 1.5 BlueHDI 100/130, 3008 1.5 BlueHDI 130, 308 II 1.5 BlueHDI 100/130, 5008 II 1.5 BlueHDI 130, 508 II 1.5 BlueHDI 130, EXPERT 1.5 BlueHDI 100/120, PARTNER 1.5 BlueHDI 75/100/130, RIFTER 1.5 BlueHDI 75/100/130, TRAVELLER 1.5 BlueHDI 100/120	75,00	180 037 0015 181 037 0023 182 051 0001	Std, 0,25, 0,50 Std, 0,25, 0,50 Std	9
HMT (EB2D), HMZ (EB2F)	1199	3	108 1.2	75,00	180 037 0013 181 037 0020 182 037 0005	Std, 0,30, 0,50, 0,80, 1,00 Std, 0,30, 0,50, 0,80, 1,00 Std	8
HMY (EB2M), EB2F	1199	3	301 1.2 VTi 72, 301 1.2 VTi 82	75,00	180 037 0013 181 037 0020 182 037 0005	Std, 0,30, 0,50, 0,80, 1,00 Std, 0,30, 0,50, 0,80, 1,00 Std	8
HNY (EB2DTS)	1199	3	3008 1.2, 5008 1.2	75,00	180 037 0013 181 037 0020 182 037 0005	Std, 0,30, 0,50, 0,80, 1,00 Std, 0,30, 0,50, 0,80, 1,00 Std	8
HNV (EB2DTM), HNZ (EB2DT)	1199	3	PARTNER Tepee 1.2 THP	75,00	180 037 0013 181 037 0020 182 037 0005	Std, 0,30, 0,50, 0,80, 1,00 Std, 0,30, 0,50, 0,80, 1,00 Std	8
HMZ (EB2F), HNZ (EB2DT), HNY (EB2DTS)	1199	3	2008 1.2 VTi, 2008 1.2 THP 110, 2008 1.2 THP 130	75,00	180 037 0013 181 037 0020 182 037 0005	Std, 0,30, 0,50, 0,80, 1,00 Std, 0,30, 0,50, 0,80, 1,00 Std	8
HMZ (EB2F), HNZ (EB2DT), HNY (EB2DTS)	1199	3	308 II 1.2 VTi 72, 308 II 1.2 THP 110, 308 II 1.2 THP 130	75,00	180 037 0013 181 037 0020 182 037 0005	Std, 0,30, 0,50, 0,80, 1,00 Std, 0,30, 0,50, 0,80, 1,00 Std	8
HMZ (EB2F), HNZ (EB2DT)	1199	3	208 1.2, 208 1.2 THP	75,00	180 037 0013 181 037 0020 182 037 0005	Std, 0,30, 0,50, 0,80, 1,00 Std, 0,30, 0,50, 0,80, 1,00 Std	8
TUD5	1527	4	106 1.5D	77,00	180 037 0002 181 037 0012	Std, 0,30, 0,50 Std, 0,30, 0,50	10
5FS (EP6C) From Orga No. 1323488	1598	4	2008 1.6 VTi	77,00	180 037 0014 181 037 0022 182 037 0006	Std, 0,30, 0,50, 0,80 Std, 0,30, 0,50 Std	12
5FS (EP6C)	1598	4	207 1.6 16V VTi, 207 CC 1.6 16V, 208 1.6, 3008 1.6 VTi,	77,00	180 037 0014 181 037 0022 182 037 0006	Std, 0,30, 0,50, 0,80 Std, 0,30, 0,50 Std	12











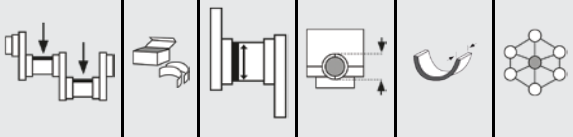













	ccm						Pos.
EP6CDTX	1598	4	RCZ 1.6 16V	77,00	180 037 0014 181 037 0022 182 037 0006	Std, 0,30, 0,50, 0,80 Std, 0,30, 0,50 Std	12
EP6CDT	1598	4	RCZ 1.6 16V, 508 1.6 THP	77,00	180 037 0014 181 037 0022 182 037 0006	Std, 0,30, 0,50, 0,80 Std, 0,30, 0,50 Std	12
5FK (EP6CB)	1598	4	PARTNER Tepee 1.6, PARTNER 1.6, RANCH 1.6	77,00	180 037 0014 181 037 0022 182 037 0006	Std, 0,30, 0,50, 0,80 Std, 0,30, 0,50 Std	12
5FS (EP6C)	1598	4	PARTNER Tepee 1.6, 508 1.6 VTi	77,00	180 037 0014 181 037 0022 182 037 0006	Std, 0,30, 0,50, 0,80 Std, 0,30, 0,50 Std	12
5FH (EP6C)	1598	4	508 1.6 VTi	77,00	180 037 0014 181 037 0022 182 037 0006	Std, 0,30, 0,50, 0,80 Std, 0,30, 0,50 Std	12
5FY (EP6DTS)	1598	4	308 1.6 16V, 207 1.6 16V RC	77,00	180 037 0014 181 037 0021 182 037 0006	Std, 0,30, 0,50, 0,80 Std, 0,30, 0,50, 0,80 Std	11
5FR (EP6DT)	1598	4	207 CC 1.6 16V Turbo	77,00	180 037 0014 181 037 0021 182 037 0006	Std, 0,30, 0,50, 0,80 Std, 0,30, 0,50, 0,80 Std	11
5FT (EP6DT)	1598	4	308 CC 1.6 16V, 308 1.6 16V	77,00	180 037 0014 181 037 0021 182 037 0006	Std, 0,30, 0,50, 0,80 Std, 0,30, 0,50, 0,80 Std	11
5FX (EP6DT)	1598	4	308 CC 1.6 16V, 308 1.6 16V, 3008 1.6 THP, 207 CC 1.6 16V Turbo, 207 1.6 16V Turbo	77,00	180 037 0014 181 037 0021 182 037 0006	Std, 0,30, 0,50, 0,80 Std, 0,30, 0,50, 0,80 Std	11
5FW (EP6)	1598	4	5008 1.6 16V, 308 1.6 16V, 308 CC 1.6 16V, 3008 1.6 VTi, 207 CC 1.6 16V, 207 1.6 16V VTi	77,00	180 037 0014 181 037 0021 182 037 0006	Std, 0,30, 0,50, 0,80 Std, 0,30, 0,50, 0,80 Std	11
5FU (EP6CDTX)	1598	4	208 1.6 GTi	77,00	180 037 0014 181 037 0022 182 037 0006	Std, 0,30, 0,50, 0,80 Std, 0,30, 0,50 Std	12
5GZ (EP6FDT)	1598	4	3008 SUV 1.6 THP 165, 3008 1.6 Turbo, 3008 1.6 Griffes Turbo	77,00	180 037 0014 181 037 0022 182 037 0006	Std, 0,30, 0,50, 0,80 Std, 0,30, 0,50 Std	12
5FV (EP6CDT)	1598	4	3008 1.6 THP	77,00	180 037 0014 181 037 0022 182 037 0006	Std, 0,30, 0,50, 0,80 Std, 0,30, 0,50 Std	12
XR5S,XR5,XR5A	1472	4	305 I 1.5i,305 II 1.5i	78,00	180 037 0010 181 037 0001	Std, 0,30, 0,50, 0,80 Std, 0,30, 0,50	13
TU 5J2, TU 5J4, TU 5JP	1587	4	106 1.6i, 106 1.6i 16V, 206 1.6i, 306 1.6i	78,50	180 037 0002 181 037 0001 181 037 0003 182 037 0001	Std, 0,30, 0,50 Std, 0,30, 0,50 Std, 0,30, 0,50 Std, 0,10, 0,20	14
TU 5JP4	1587	4	206 1.6i 16V, 307 1.6i 16V, 307 CC 1.6i 16V, 308 1.6i 16V, Partner 1.6i 16V	78,50	180 037 0002 181 037 0003 182 037 0001	Std, 0,30, 0,50 Std, 0,30, 0,50 Std, 0,10, 0,20	15
XUD7	1769	4	205 1.8 D, 305 1.8 D, 306 1.8 D, 309 1.8 D, 405 1.8 D, Partner 1.8 D	80,00	180 037 0003 181 037 0004 182 037 0002	Std, 0,30, 0,50, 0,80 Std, 0,30, 0,50, 0,80 Std, 0,30, 0,50, 0,10, 0,20	16
XUD7 T, XUD7 TE, XUD7 TEY	1769	4	205 1.8 TD, 309 1.8 TD, 405 1.8 TD	80,00	180 037 0003 181 037 0005	Std, 0,30, 0,50, 0,80 Std, 0,30, 0,50	17
DW8, DW8 B, XUD9 AY	1868	4	206 1.9 D, 306 1.9 D, Expert 1.9 D, Partner 1.9 D	82,20	180 037 0003 181 037 0004 182 037 0002	Std, 0,30, 0,50, 0,80 Std, 0,30, 0,50, 0,80 Std, 0,30, 0,50, 0,10, 0,20	16
EW7 J4	1749	4	406 1.8 16V, 807 1.8 16V	82,70	180 037 0007 181 037 0008 182 037 0004	Std, 0,30, 0,50, 0,80, 1,00 Std, 0,30, 0,50, 0,80 Std	18
XU 51C/K	1581	4	205 1.6, 305 1.6, 309 1.6, 405 1.6	83,00	180 037 0004 181 037 0006 182 037 0002	Std, 0,30, 0,50, 0,80 Std, 0,30, 0,50, 0,80 Std, 0,30, 0,50, 0,10, 0,20	19
XU 52C, XU 5JP, XU 5M, XU 5M2Z, XU 5M3Z	1581	4	205 1.6i, 309 1.6i, 405 1.6i	83,00	180 037 0004 181 037 0006 182 037 0002	Std, 0,30, 0,50, 0,80 Std, 0,30, 0,50, 0,80 Std, 0,30, 0,50, 0,10, 0,20	19
XU 52C, XU 5S	1581	4	305 1.6, 309 1.6i, 405 1.6i	83,00	180 037 0004 181 037 0006 182 037 0002	Std, 0,30, 0,50, 0,80 Std, 0,30, 0,50, 0,80 Std, 0,30, 0,50, 0,10, 0,20	19
XU 7JB, XU 7JP, XU 7JP4, XU 7JPZ	1762	4	306 1.8i, 306 1.8i 16V, 405 1.8i, 406 1.8i, 406 1.8i 16V, 806 1.8i, Expert 1.8i	83,00	180 037 0004 181 037 0008 182 037 0002	Std, 0,30, 0,50, 0,80 Std, 0,30, 0,50, 0,80 Std, 0,30, 0,50, 0,10, 0,20	20
XU 92C, XU 9S	1905	4	205 1.9i, 305 1.9i, 309 1.9i, 405 1.9i	83,00	180 037 0004 181 037 0007 182 037 0002	Std, 0,30, 0,50, 0,80 Std, 0,30, 0,50 Std, 0,30, 0,50, 0,10, 0,20	21
XUD 9, XUD 9A, XUD 9AU, XUD 9B, XUD 9K, XUD 9Y	1905	4	205 1.9 D, 305 1.9 D, 306 1.9 D, 309 1.9 D, 405 1.9 D, Boxer 1.9 D, Expert 1.9 D, J5 1.9 D, Partner 1.9 D	83,00	180 037 0003 181 037 0004 182 037 0002	Std, 0,30, 0,50, 0,80 Std, 0,30, 0,50, 0,80 Std, 0,30, 0,50, 0,10, 0,20	16













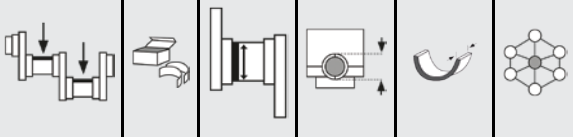













PEUGEOT

Globally reliable

	ccm						Pos.
XUD 9ATF, XUD 9BSD, XUD 9BTF, XUD 9SD, XUD 9SE, XUD 9TE, XUD 9TF, XUD 9UTF	1905	4	306 1.9 TD, 405 1.9 TD, 406 1.9 TD, 806 1.9 TD, Boxer 1.9 TD, Expert 1.9 TD	83,00	180 037 0003 181 037 0005 181 037 0011	Std, 0,30, 0,50, 0,80 Std, 0,30, 0,50 Std, 0,30, 0,50, 0,80	22
XC7, XC7 P	1618	4	404 1.6, 504 1.6, J7 1.6, J9 1.6	84,00	180 037 0005 180 037 0006 181 037 0010 182 037 0003	Std, 0,30, 0,50, 0,80, 1,00 Std, 0,30, 0,50, 0,80, 1,00 Std, 0,30, 0,50, 0,80, 1,00 Std, 0,30, 0,50, 0,80, 0,10, 0,20	23
XM 7, XM 7A	1796	4	504 1.8, 505 1.8, J7 1.8	84,00	180 037 0005 180 037 0006 181 037 0010 182 037 0003	Std, 0,30, 0,50, 0,80, 1,00 Std, 0,30, 0,50, 0,80, 1,00 Std, 0,30, 0,50, 0,80, 1,00 Std, 0,30, 0,50, 0,80, 0,10, 0,20	23
XM 7P	1796	4	504 1.8, J7 1.8	84,00	180 037 0005 181 037 0010 182 037 0003	Std, 0,30, 0,50, 0,80, 1,00 Std, 0,30, 0,50, 0,80, 1,00 Std, 0,30, 0,50, 0,80, 0,10, 0,20	24
XM 7T	1796	4	505 1.8, J5 1.8	84,00	180 037 0006 181 037 0010 182 037 0003	Std, 0,30, 0,50, 0,80, 1,00 Std, 0,30, 0,50, 0,80, 1,00 Std, 0,30, 0,50, 0,80, 0,10, 0,20	25
EW10 D, EW10 J4	1997	4	206 2.0 16V, 307 2.0i 16V, 406 2.0 16V, 406 2.0 16V Hpi, 607 2.0i 16V, 806 2.0i 16V, 807 2.0 16V, Expert 2.0i 16V	85,00	180 037 0007 181 037 0008 182 037 0004	Std, 0,30, 0,50, 0,80, 1,00 Std, 0,30, 0,50, 0,80 Std	18
DW10	1997	4	Boxer II 2.0 HDi, Partner 2.0 HDi, 206 2.0 HDi, 306 2.0 HDi, 307 2.0 HDi, 406 2.0 HDi, Expert 2.0 HDi 16V, 307 CC 2.0 HDi 16V, 307 2.0 HDi 16V, 308 2.0 HDi 16V, 407 2.0 HDi 16V, 607 2.0 HDi 16V, 807 2.0 HDi 16V	85,00	180 037 0003 181 037 0019 182 037 0002	Std, 0,30, 0,50, 0,80 Std, 0,30, 0,50 Std, 0,30, 0,50, 0,10, 0,20	26
DW12	2179	4	407 2.2 HDi Biturbo 16V, 607 2.2 HDi Biturbo 16V, 807 2.2 HDi Biturbo 16V, 4007 2.2 HDi 16V, Boxer II 2.2 HDi 16V, 406 2.2 HDi 16V, 807 2.2 HDi 16V	85,00	180 037 0003 181 037 0019 182 037 0002	Std, 0,30, 0,50, 0,80 Std, 0,30, 0,50 Std, 0,30, 0,50, 0,10, 0,20	26
RFV	1998	4	306 2.0i 16V	86,00	180 037 0003 181 037 0007	Std, 0,30, 0,50, 0,80 Std, 0,30, 0,50	27
XU10 2C, XU10 MZ, XU10 J2, XU10 J4	1998	4	306 2.0i, 306 2.0i 16V, 405 2.0i, 405 2.0i 16V, 405 2.0i Turbo 16V, 406 2.0i 16V, 406 2.0i Turbo, 605 2.0i, 605 2.0i 16V, 605 2.0i Turbo, 606 2.0i, 606 2.0i 16V, 606 2.0i Turbo, Boxer 2.0i	86,00	180 037 0003 181 037 0007 181 037 0009	Std, 0,30, 0,50, 0,80 Std, 0,30, 0,50 Std, 0,30, 0,50	28
4HV (P22DTE)	2198	4	BOXER 2.2 HDi 100	86,00	180 021 0009 181 021 0011	Std, 0,25, 0,50 Std, 0,25, 0,50	29
4HG (P22DTE)	2198	4	BOXER 2.2 HDi 110	86,00	180 021 0009 181 021 0011	Std, 0,25, 0,50 Std, 0,25, 0,50	29
4HU (P22DTE)	2198	4	BOXER 2.2 HDi 120	86,00	180 021 0009 181 021 0011	Std, 0,25, 0,50 Std, 0,25, 0,50	29
4HH (P22DTE)	2198	4	BOXER 2.2 HDi 130	86,00	180 021 0009 181 021 0011	Std, 0,25, 0,50 Std, 0,25, 0,50	29
4HJ (P22DTE)	2198	4	BOXER 2.2 HDi 150	86,00	180 021 0009 181 021 0011	Std, 0,25, 0,50 Std, 0,25, 0,50	29
XN1, XN1P, XN2, XN6	1971	4	504 2.0, 504 2.0i, 505 2.0, 505 2.0i, J9 2.0	88,00	180 037 0005 180 037 0006 181 037 0010 182 037 0003	Std, 0,30, 0,50, 0,80, 1,00 Std, 0,30, 0,50, 0,80, 1,00 Std, 0,30, 0,50, 0,80, 1,00 Std, 0,30, 0,50, 0,80, 0,10, 0,20	23
XN1A, XN1T, XN1TA	1971	4	505 2.0, J5 2.0, J9 2.0	88,00	180 037 0006 181 037 0010 182 037 0003	Std, 0,30, 0,50, 0,80, 1,00 Std, 0,30, 0,50, 0,80, 1,00 Std, 0,30, 0,50, 0,80, 0,10, 0,20	25
DJ5	2446	4	Boxer 2.5D	92,00	180 037 0011 181 037 0016	Std, 0,30, 0,50, 0,80, 1,00 Std, 0,30, 0,50, 0,80, 1,00	30
DJ5T	2446	4	Boxer 2.5TD	92,00	180 037 0012 181 037 0017	Std, 0,30, 0,50, 0,80, 1,00 Std, 0,30, 0,50, 0,80, 1,00	31
CRD93 (U25 651/661)	2498	4	J5 2.5D	93,00	180 037 0008 181 037 0013	Std, 0,25, 0,50, 0,75 Std, 0,25, 0,50, 0,75	32
XD3T, XD3TE, XD3, XD3P	2497	4	505 2.5D, 505 2.5 TD, 604 2.5 TD, J9 2.5D, Ssangyong Korando 2.5TD	94,00	180 037 0009 181 037 0014	Std, 0,30, 0,50, 0,80 Std, 0,30, 0,50, 0,80	33
F1CE0481D (F30DT), F1CE3481E (F30DTE), F1CE3481N (F30DTE)	2999	4	BOXER 3.0 HDi	95,80	180 121 0016 181 121 0017	Std, 0,25, 0,50, 0,75 Std, 0,25, 0,50, 0,75	34

 							Set Composition / QTY													
1 71,00																				
MB/HL 1, 2, 3, 4	4 Pairs	44,000	48,000	14,900	SAL	180 096 0032 00 15 21 26	4		4											
CB/PL 1, 2, 3	3 Pairs	40,000	43,000	13,500	SAL	181 096 0042 00 15 21 26	6													
TW/A 1	2 Halves	52,000	63,000		SAL	182 096 0030 00	2													
2 72,00																				
MB/HL 1, 2, 3, 4, 5	5 Pairs	49,965 49,981	53,655 53,674	17,290	SAL	180 037 0001 00 17 21 28	4		6											
CB/PL 1, 2, 3, 4	4 Pairs	44,975 44,991	48,655 48,671	19,750	SAL	181 037 0001 00 17 21	8													
TW/A 1	2 Halves	55,250 55,500	71,450 71,700		S3S	182 037 0001 00 08 14	2													
3 72,00																				
MB/HL 1, 2, 3, 4, 5	5 Pairs	49,965 49,981	53,655 53,674	17,290	SAL	180 037 0001 00 17 21 28	4		6											
CB/PL 1, 2, 3, 4	4 Pairs	44,975 44,991	48,655 48,671	19,750	SAL	181 037 0002 00 17 21 28	4		4											
TW/A 1	2 Halves	55,250 55,500	71,450 71,700		S3S	182 037 0001 00 08 14	2													
4 73,70																				
MB/HL 1, 2, 3, 4, 5	5 Pairs	49,962 49,981	53,655 53,674	19,900	SAL	180 051 0001 00 15 17 21 28	5		5											
CB/PL 1, 2, 3, 4	4 Pairs	44,975 44,991	48,655 48,671	17,050	S4S	181 037 0015 00 17 21	4		4											
TW/A 1	2 Halves	55,200 55,480	71,350 71,700		SAL	182 051 0001 00	2													
5 75,00																				
MB/HL 1, 2, 3, 4, 5	5 Pairs	49,965 49,984	53,712 53,731	17,300	SAL	180 037 0002 00 17 21	4		6											
CB/PL 1, 2, 3, 4	4 Pairs	44,975 44,991	48,655 48,671	19,750	SAL	181 037 0001 00 17 21	8													
TW/A 1	2 Halves	55,250 55,500	71,450 71,700		S3S	182 037 0001 00 08 14	2													

									Set Composition / QTY									
6	75,00																	
MB/HL 1, 2, 3, 4, 5	5 Pairs	49,965 49,981	53,655 53,674	17,290	SAL	180 037 0001 00 17 21 28	4		6									
CB/PL 1, 2, 3, 4	4 Pairs	44,975 44,991	48,655 48,671	19,750	SAL	181 037 0002 00 17 21 28	4		4									
CB/PL 1, 2, 3, 4	4 Pairs	44,975 44,991	48,655 48,671	19,750	SAL	181 037 0003 00 17 21	4		4									
TW/A 1	2 Halves	55,250 55,500	71,450 71,700		S3S	182 037 0001 00 08 14	2											
7	75,00																	
MB/HL 1, 2, 3, 4, 5	5 Pairs	49,965 49,981	53,655 53,674	17,290	SAL	180 037 0001 00 17 21 28	4		6									
CB/PL 1, 2, 3, 4	4 Pairs	44,975 44,991	48,655 48,671	19,750	SAL	181 037 0003 00 17 21	4		4									
TW/A 1	2 Halves	55,250 55,500	71,450 71,700		S3S	182 037 0001 00 08 14	2											
8	75,00																	
MB/HL 1, 2, 3, 4	4 Pairs	41,984 42,000	45,600 45,619	16,100	SAL	180 037 0013 00 17 21 28 29	2		2		4							
CB/PL 1, 2, 3	3 Pairs	41,984 42,000	45,000 45,016	16,000	SAL	181 037 0020 00 17 21 28 29	6											
TW/A 1	2 Halves	47,800	65,000		SAL	182 037 0005 00	2											
9	75,00																	
MB/HL 1, 2, 3, 4, 5	5 Pairs	1,000 2,000	3,000 4,000	19,900	SAL	180 037 0015 00 15 21												
CB/PL 1, 2, 3, 4	4 Pairs	44,350 44,366	48,000 48,018	17,100	SPVD	181 037 0023 00 15 21	8											
TW/A 1	2 Halves	55,200 55,480	71,350 71,700		SAL	182 051 0001 00	2											
10	77,00																	
MB/HL 1, 2, 3, 4, 5	5 Pairs	49,965 49,984	53,712 53,731	17,300	SAL	180 037 0002 00 17 21	4		6									
CB/PL 1, 2, 3, 4	4 Pairs	44,975 44,991	48,655 48,671	17,300	SAL	181 037 0012 00 17 21	8											

 							Set Composition / QTY													
11 77,00																				
MB/HL 1, 2, 3, 4, 5	5 Pairs	45,024	48,674	17,900	SSI	180 037 0014 00 17 21 28	5		5											
CB/PL 1, 2, 3, 4	4 Pairs	45,000	48,000	19,700	SSI	181 037 0021 00 17 21 28	8													
TW/A 1	2 Halves	50,500 50,750	70,000 70,250		SAL	182 037 0006 00	2													
12 77,00																				
MB/HL 1, 2, 3, 4, 5	5 Pairs	45,024	48,674	17,900	SSI	180 037 0014 00 17 21 28	5		5											
CB/PL 1, 2, 3, 4	4 Pairs	44,975 44,991	48,000 48,019	19,700	S32S	181 037 0022 00 17 21	4		4											
TW/A 1	2 Halves	50,500 50,750	70,000 70,250		SAL	182 037 0006 00	2													
13 78,00																				
MB/HL 1, 2, 3, 4, 5	5 Pairs	53,036 53,046	56,822 56,832	19,290	SAL	180 037 0010 00 17 21 28	5		5											
CB/PL 1, 2, 3, 4	4 Pairs	44,975 44,991	48,655 48,671	19,750	SAL	181 037 0001 00 17 21	8													
14 78,50																				
MB/HL 1, 2, 3, 4, 5	5 Pairs	49,965 49,984	53,712 53,731	17,300	SAL	180 037 0002 00 17 21	4		6											
CB/PL 1, 2, 3, 4	4 Pairs	44,975 44,991	48,655 48,671	19,750	SAL	181 037 0001 00 17 21	8													
CB/PL 1, 2, 3, 4	4 Pairs	44,975 44,991	48,655 48,671	19,750	SAL	181 037 0003 00 17 21	4		4											
TW/A 1	2 Halves	55,250 55,500	71,450 71,700		S3S	182 037 0001 00 08 14	2													
15 78,50																				
MB/HL 1, 2, 3, 4, 5	5 Pairs	49,965 49,984	53,712 53,731	17,300	SAL	180 037 0002 00 17 21	4		6											
CB/PL 1, 2, 3, 4	4 Pairs	44,975 44,991	48,655 48,671	19,750	SAL	181 037 0003 00 17 21	4		4											
TW/A 1	2 Halves	55,250 55,500	71,450 71,700		S3S	182 037 0001 00 08 14	2													



PEUGEOT





Globally reliable

							Set Composition / QTY															
16 80,00																						
MB/HL 1, 2, 3, 4, 5	5 Pairs	59,981 60,000	63,731 63,750	20,290	SAL	180 037 0003 00	5		5													
						17																
						21																
						28																
CB/PL 1, 2, 3, 4	4 Pairs	49,984 50,000	53,695 53,708	20,050	SAL	181 037 0004 00	8															
						17																
						21																
						28																
TW/A 1	4 Halves	67,050 67,300	83,050 83,300		S3S	182 037 0002 00	2		2													
						17																
						21																
						08																
						14																
17 80,00																						
MB/HL 1, 2, 3, 4, 5	5 Pairs	59,981 60,000	63,731 63,750	20,290	SAL	180 037 0003 00	5		5													
						17																
						21																
						28																
CB/PL 1, 2, 3, 4	4 Pairs	49,984 50,000	53,695 53,708	19,800	S3S	181 037 0005 00	8															
						17																
						21																
						28																
18 82,70																						
MB/HL 1, 2, 3, 4, 5	5 Pairs	59,981 60,000	63,708 63,727	21,000	SAL	180 037 0007 00	5		5													
						17																
						21																
						28																
						29																
CB/PL 1, 2, 3, 4	4 Pairs	44,975 44,991	48,655 48,671	22,750	SAL	181 037 0008 00	8															
						17																
						21																
						28																
TW/A 1	2 Halves	67,050 67,300	83,050 83,300		SAL	182 037 0004 00	2															
						17																
						21																
						28																
19 83,00																						
MB/HL 1, 2, 3, 4, 5	5 Pairs	59,990 60,000	63,718 63,727	20,290	SAL	180 037 0004 00	5		5													
						17																
						21																
						28																
CB/PL 1, 2, 3, 4	4 Pairs	44,975 44,991	48,655 48,671	20,250	SAL	181 037 0006 00	8															
						17																
						21																
						28																
TW/A 1	4 Halves	67,050 67,300	83,050 83,300		S3S	182 037 0002 00	2		2													
						17																
						21																
						08																
						14																
20 83,00																						
MB/HL 1, 2, 3, 4, 5	5 Pairs	59,990 60,000	63,718 63,727	20,290	SAL	180 037 0004 00	5		5													
						17																
						21																
						28																
CB/PL 1, 2, 3, 4	4 Pairs	44,975 44,991	48,655 48,671	22,750	SAL	181 037 0008 00	8															
						17																
						21																
						28																
TW/A 1	4 Halves	67,050 67,300	83,050 83,300		S3S	182 037 0002 00	2		2													
						17																
						21																
						08																
						14																







Set Composition / QTY













21 83,00

MB/HL 1, 2, 3, 4, 5	5 Pairs	59,990 60,000	63,718 63,727	20,290	SAL	180 037 0004 00 17 21 28	5		5										
CB/PL 1, 2, 3, 4	4 Pairs	49,984 50,000	53,695 53,708	20,250	SAL	181 037 0007 00 17 21	8												
TW/A 1	4 Halves	67,050 67,300	83,050 83,300		S3S	182 037 0002 00 17 21 08 14	2		2										







22 83,00

MB/HL 1, 2, 3, 4, 5	5 Pairs	59,981 60,000	63,731 63,750	20,290	SAL	180 037 0003 00 17 21 28	5		5											
CB/PL 1, 2, 3, 4	4 Pairs	49,984 50,000	53,695 53,708	19,800	S3S	181 037 0005 00 17 21	8													
CB/PL 1, 2, 3, 4	4 Pairs	49,984 50,000	53,695 53,708	20,000	S3S	181 037 0011 00 17 21 28	4		4											

23 84,00

MB/HL 1	1 Pair	59,401 59,416	63,227 63,246	29,500	SAL	180 037 0005 00 17	2		2		2		2		2						
MB/HL 2	1 Pair	58,548 58,573	62,384 62,403	21,500	SAL	21 28															
MB/HL 3	1 Pair	57,174 57,189	61,000 61,019	29,500	SAL	29															
MB/HL 4	1 Pair	56,140 56,165	59,976 59,995	21,500	SAL																
MB/HL 5	1 Pair	54,905 54,920	58,731 58,750	29,400	SAL																
MB/HL 1	1 Pair	59,401 59,416	63,227 63,246	29,500	SAL	180 037 0006 00 17	1		1		1		1		1						
MB/HL 2	1 Pair	58,548 58,573	62,384 62,403	21,500	SAL	21 28															
MB/HL 3	1 Pair	57,174 57,189	61,000 61,019	29,500	SAL	29															
MB/HL 4	1 Pair	56,140 56,165	59,976 59,995	21,500	SAL																
MB/HL 5	1 Pair	54,905 54,920	58,731 58,750	29,400	SAL																
CB/PL 1, 2, 3, 4	4 Pairs	49,975 49,991	53,655 53,674	23,400	SAL	181 037 0010 00 17 21 28 29	8														
TW/A 1	4 Halves	61,400 61,650	72,550 72,800		S3S	182 037 0003 00 17 21 28 08 14	2		2												

24 84,00











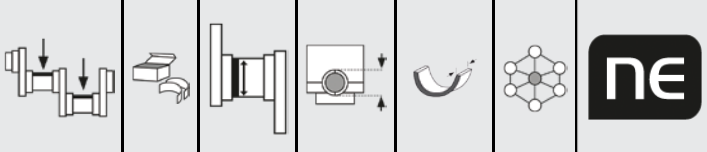





















MB/HL 1	1 Pair	59,401 59,416	63,227 63,246	29,500	SAL	180 037 0005 00 17	2		2		2		2		2						
MB/HL 2	1 Pair	58,548 58,573	62,384 62,403	21,500	SAL	21 28															
MB/HL 3	1 Pair	57,174 57,189	61,000 61,019	29,500	SAL	29															
MB/HL 4	1 Pair	56,140 56,165	59,976 59,995	21,500	SAL																
MB/HL 5	1 Pair	54,905 54,920	58,731 58,750	29,400	SAL																
CB/PL 1, 2, 3, 4	4 Pairs	49,975 49,991	53,655 53,674	23,400	SAL	181 037 0010 00 17 21 28 29	8														



PEUGEOT

Globally reliable







						NE		Set Composition / QTY													
TW/A 1	4 Halves	61,400 61,650	72,550 72,800		S3S	182 037 0003 00		2		2											
25	84,00																				
MB/HL 1	1 Pair	59,401 59,416	63,227 63,246	29,500	SAL	180 037 0006 00		1		1		1		1		1					
MB/HL 2	1 Pair	58,548 58,573	62,384 62,403	21,500	SAL			21		28											
MB/HL 3	1 Pair	57,174 57,189	61,000 61,019	29,500	SAL			29													
MB/HL 4	1 Pair	56,140 56,165	59,976 59,995	21,500	SAL																
MB/HL 5	1 Pair	54,905 54,920	58,731 58,750	29,400	SAL																
CB/PL 1, 2, 3, 4	4 Pairs	49,975 49,991	53,655 53,674	23,400	SAL	181 037 0010 00		8													
TW/A 1	4 Halves	61,400 61,650	72,550 72,800		S3S	182 037 0003 00		2		2											
26	85,00																				
MB/HL 1, 2, 3, 4, 5	5 Pairs	59,981 60,000	63,731 63,750	20,290	SAL	180 037 0003 00		5		5											
CB/PL 1, 2, 3, 4	4 Pairs	49,984 50,000	53,695 53,708	20,000	S4S	181 037 0019 00		17		21											
TW/A 1	4 Halves	67,050 67,300	83,050 83,300		S3S	182 037 0002 00		2		2											
27	86,00																				
MB/HL 1, 2, 3, 4, 5	5 Pairs	59,981 60,000	63,731 63,750	20,290	SAL	180 037 0003 00		5		5											
CB/PL 1, 2, 3, 4	4 Pairs	49,984 50,000	53,695 53,708	20,250	SAL	181 037 0007 00		8													
28	86,00																				
MB/HL 1, 2, 3, 4, 5	5 Pairs	59,981 60,000	63,731 63,750	20,290	SAL	180 037 0003 00		5		5											
CB/PL 1, 2, 3, 4	4 Pairs	49,984 50,000	53,695 53,708	20,250	SAL	181 037 0007 00		8													
CB/PL 1, 2, 3, 4	4 Pairs	49,984 50,000	53,695 53,708	20,250	SAL	181 037 0009 00		8													







						Set Composition / QTY																
29 86,00						MB/HL 1, 2	2 Pairs	65,020	69,520	23,400	SSI	180 021 0009 00 15	4		1		3		1		1	
						MB/HL 3	1 Pair	65,020	69,520	24,200	SSI	21										
						MB/HL 4	1 Pair	65,020	69,520	29,000	SSI											
						MB/HL 5	1 Pair	70,020	74,520	19,700	SSI											
						CB/PL 1, 2	2 Pairs	53,000	56,000	23,300	SSI	181 021 0011 00 15	4		4							
						CB/PL 3, 4	2 Pairs	53,000	56,000	24,500	SSI	21										
30 92,00						MB/HL 1, 2, 4, 5	4 Pairs	63,980 63,998	68,689 68,707	21,500	SAL	180 037 0011 00 17	4		4		1		1			
						MB/HL 3	1 Pair	63,980 63,998	68,689 68,707	27,510	SAL	21 28 29										
						CB/PL 1, 2, 3, 4	4 Pairs	53,980 53,998	57,673 57,694	22,650	SAL	181 037 0016 00 17 21 28 29	8									
31 92,00						MB/HL 1, 2, 4, 5	4 Pairs	63,980 63,998	68,689 68,707	21,500	SAL	180 037 0012 00 17	4		4		1		1			
						MB/HL 3	1 Pair	63,980 63,998	68,689 68,707	27,000	SAL	21 28 29										
						CB/PL 1, 2, 3, 4	4 Pairs	53,980 53,998	57,673 57,694	22,650	S3S	181 037 0017 00 17 21 28 29	8									
32 93,00						MB/HL 1, 2, 3, 4, 5	5 Pairs	67,035 67,050	71,695 71,705	28,700	SAL	180 037 0008 00 15 21 26	10									
						CB/PL 1, 2, 3, 4	4 Pairs	53,990 54,005	57,675 57,685	24,500	SAL	181 037 0013 00 15 21 26	4		4							
33 94,00						MB/HL 1, 3, 5	3 Pairs	59,994 60,021	63,737 63,750	30,000	SAL	180 037 0009 00 17	2		2		3		3			
						MB/HL 2, 4	2 Pairs	59,994 60,021	63,737 63,750	24,000	SAL	21 28										
						CB/PL 1, 2, 3, 4	4 Pairs	54,994 55,021	58,737 58,750	29,000	SAL	181 037 0014 00 17 21 28	8									
34 95,80						MB/HL 1, 2, 3, 4, 5	5 Pairs	1,000	1,000	1,000	SAL	180 121 0016 00 15 21 26	1		4		3		1		1	
						CB/PL 1, 2, 3, 4	4 Pairs	64,015 64,038	67,833 67,848	26,800	S3S	181 121 0017 00 15 21 26	4		4							



RENAULT

Globally reliable

	ccm						Pos.
C1C	956	4	Express 1.0, R4 1.0	65,00	180 038 0006 181 038 0014 182 038 0005	Std, 0,25, 0,50, 0,75, 1,00 Std, 0,25, 0,50, 0,75 Std, 0,05, 0,10	1
D4F 704/706/712	1149	4	Clio 1.2 16V, Modus 1.2 16V, Twingo 1.2 16V	69,00	180 038 0010 181 038 0013	Std Std, 0,25, 0,50, 0,75	2
D7F, D7D	1149	4	Clio 1.1, Kangoo 1.1, Twingo 1.1i	69,00	180 038 0009 180 038 0010 181 038 0012 181 038 0013	Std, 0,25, 0,50, 0,75 Std Std, 0,25, 0,50, 0,75 Std, 0,25, 0,50, 0,75	3
C1E	1108	4	Clio 1.1, Estafette 1.1, Express 1.1, R5 1.1, R9 1.1, R11 1.1, Rapid 1.1	70,00	180 038 0006 181 038 0014 182 038 0005	Std, 0,25, 0,50, 0,75, 1,00 Std, 0,25, 0,50, 0,75 Std, 0,05, 0,10	1
C1G	1237	4	R5 1.2, R9 1.2, R11 1.2, R19 1.2, Rapid 1.2	71,50	180 038 0006 181 038 0008	Std, 0,25, 0,50, 0,75, 1,00 Std, 0,25, 0,50, 0,75, 1,00	4
H5F.400, H5F.402, H5F.404, H5F.403, H5F.408, H5F.412, H5F.410, H5F.405	1197	4	CAPTUR I 1.2 Tce, CLIO IV 1.2 Tce, DOKKER 1.2 Tce, DUSTER 1.2 Tce, GRAND SCÉNIC III + IV 1.2 Tce, KADJAR 1.2 Tce, GRAND KANGOO II 1.2 Tce, LODGY 1.2 Tce, MEGANE CC 1.2 Tce, MEGANE III 1.2 Tce, MEGANE IV GRAND COUPE 1.2 Tce, SCÉNIC III + IV 1.2 Tce	72,20	180 038 0016 181 038 0021 182 038 0008	Std, 0,25, 0,50 Std, 0,25, 0,50 Std	5
H4B.400, H4B.401, H4B.408, H4B.410, H4B.409, H4B.405, H4B.451, H4B.453 H4B.412	898	3	CLIO IV 0.9 TCe 90, CAPTUR I 0.9 TCe 90, TWINGO III 0.9 TCe 90, THALIA III / SYMBOL 0.9 TCe 90, SANDERO / STEPWAY II 0.9 TCe 90	72,20	180 038 0017 181 038 0022 182 038 0008	Std, 0,25, 0,50 Std, 0,25, 0,50 Std	6
810.19, 810.25, 810.26, 810.29	1289	4	R5 1.3	73,00	180 038 0006 181 038 0008	Std, 0,25, 0,50, 0,75, 1,00 Std, 0,25, 0,50, 0,75, 1,00	4
C3G	1239	4	Clio 1.2i, Express 1.2i, Rapid 1.2i	74,00	180 038 0006 181 038 0014 182 038 0005	Std, 0,25, 0,50, 0,75, 1,00 Std, 0,25, 0,50, 0,75 Std, 0,05, 0,10	1
E5F 710/716, E7F 700/704/706/708/750	1171	4	Clio 1.2, Express 1.2	75,80	180 038 0006 181 038 0008	Std, 0,25, 0,50, 0,75, 1,00 Std, 0,25, 0,50, 0,75, 1,00	4
E6J 700/701, E7J	1390	4	Clio 1.4, Clio 1.4i, Express 1.4i, Kangoo 1.4i, Megane 1.4i, R19 1.4, R19 1.4i, Rapid 1.4i	75,80	180 038 0006 181 038 0008	Std, 0,25, 0,50, 0,75, 1,00 Std, 0,25, 0,50, 0,75, 1,00	4
840 725, 847 700/701/720, C1J, C2J, C3J	1397	4	R5 1.4, R9 1.4, R11 1.4, R21 1.4, Trafic 1.4	76,00	180 038 0006 181 038 0008	Std, 0,25, 0,50, 0,75, 1,00 Std, 0,25, 0,50, 0,75, 1,00	4
K9K	1461	4	Clio 1.5 TD Dci, Kangoo 1.5 TD Dci, Megane 1.5 TD Dci, Modus 1.5 TD Dci, Scenic 1.5 TD Dci	76,00	180 038 0001 181 038 0001 182 038 0001	Std, 0,25, 0,50, 0,75 Std, 0,25, 0,50, 0,75 Std	7
C2L 714/717	1565	4	R21 1.6	77,00	180 038 0006 181 038 0008	Std, 0,25, 0,50, 0,75, 1,00 Std, 0,25, 0,50, 0,75, 1,00	4
F8M	1596	4	Express 1.6 D, R5 1.6 D, R9 1.6 D, R11 1.6 D, Rapid 1.6 D	78,00	180 038 0002 181 038 0002 182 038 0002	Std, 0,25, 0,50, 0,75 Std, 0,25, 0,50, 0,75 Std	8
K4J	1390	4	Clio 1.4i 16V, Megane 1.4i 16V, Modus 1.4i 16V, Scenic 1.4i 16V, Symbol 1.4i 16V, Thalia 1.4i 16V	79,50	180 038 0007 181 038 0008 181 038 0009 182 038 0001	Std, 0,25, 0,50, 0,75 Std, 0,25, 0,50, 0,75, 1,00 Std, 0,25, 0,50, 0,75 Std	9
K4M, K7M	1598	4	Clio 1.6i, Clio 1.6i 16V, Kangoo 1.6i 16V, Laguna 1.6i 16V, Megane 1.6i, Megane 1.6i 16V, Modus 1.6i 16V, Scenic 1.6i, Scenic 1.6i 16V, Symbol 1.6i, Thalia 1.6i	79,50	180 038 0007 181 038 0008 181 038 0009 182 038 0001	Std, 0,25, 0,50, 0,75 Std, 0,25, 0,50, 0,75, 1,00 Std, 0,25, 0,50, 0,75 Std	9
R9M.402, R9M.404, R9M.408, R9M.409, R9M.413, R9M.414, R9M.450, R9M.452 R9M.453	1598	4	ESPACE V 1.6 dCi, FLUENCE 1.6 dCi, GRAND SCÉNIC III + IV 1.6 dCi, KADJAR 1.6 dCi, KOLEOS II 1.6 dCi, MEGANE CC 1.6 dCi, MEGANE III + IV 1.6 dCi, SCÉNIC III + IV 1.6 dCi, TALISMAN 1.6 dCi, TRAFIC III 1.6 dCi	80,00	180 038 0015 181 038 0020 182 815 0006	Std, 0,25, 0,50 Std, 0,25, 0,50 Std	12
F8Q 600/622/630/648/662/680/682/684 F9Q 680/710/716/717/718/722/730/731	1870	4	Clio 1.9 D, Clio 1.9 Dti, Espace 1.9 Dti, Espace 1.9 Dci, Kangoo 1.9 D, Kangoo 1.9 Dci, Kangoo 1.9 Dti, Laguna 1.9 Dci, Laguna 1.9 Dti, Master 1.9 Dci, Master Dti, Megane 1.9 D, Megane 1.9 Dci, Megane 1.9 Dti, Rapid 1.9 D, Scenic 1.9 D, Scenic 1.9 Dci, Scenic 1.9 Dti	80,00	180 038 0003 181 038 0003 181 038 0015 182 038 0002	Std, 0,25, 0,50, 0,75 Std, 0,25, 0,50, 0,75 Std, 0,25, 0,50 Std	10
F8Q 606/610/620/624/632/644/646/672	1870	4	Clio 1.9 D, Express 1.9 D, Kangoo 1.9 D, Megane 1.9 D, Megane 1.9 TD, R19 1.9 D, R19 1.9 TD, R21 1.9 D, R21 1.9 TD, Rapid 1.9 D, Scenic 1.9 TD	80,00	180 038 0002 180 038 0003 181 038 0002 181 038 0003 181 038 0015 182 038 0002	Std, 0,25, 0,50, 0,75 Std, 0,25, 0,50, 0,75 Std, 0,25, 0,50, 0,75 Std, 0,25, 0,50, 0,75 Std, 0,25, 0,50 Std	11
F8Q 640/678/706/714/742/744	1870	4	Clio 1.9 D, R19 1.9 D, Rapid 1.9 D	80,00	180 038 0002 181 038 0002 182 038 0002	Std, 0,25, 0,50, 0,75 Std, 0,25, 0,50, 0,75 Std	8
F1N, F2N, F2R, F3N	1721	4	Clio 1.7, R5 1.7, R5 1.7i, R9 1.7, R9 1.7i, R11 1.7, R11 1.7i, R19 1.7, R19 1.7i, R21 1.7, R21 1.7i, Trafic 1.7	81,00	180 038 0002 181 038 0002 182 038 0002	Std, 0,25, 0,50, 0,75 Std, 0,25, 0,50, 0,75 Std	8











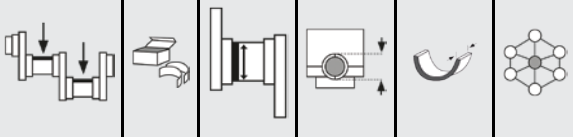













	ccm						Pos.
F7P 700/704	1764	4	R19 1.8i 16V	82,00	180 038 0002 181 038 0002 182 038 0002	Std, 0,25, 0,50, 0,75 Std, 0,25, 0,50, 0,75 Std	8
F3P 720/724/754/755/758	1783	4	Clio 1.8i, Laguna 1.8i, R19 1.8i	82,70	180 038 0002 180 038 0003 181 038 0002 181 038 0003 182 038 0002	Std, 0,25, 0,50, 0,75 Std, 0,25, 0,50, 0,75 Std, 0,25, 0,50, 0,75 Std, 0,25, 0,50, 0,75 Std	13
F3P 674/678/704/705/710/714	1794	4	Clio 1.8i, Laguna 1.8i, R19 1.8i	82,70	180 038 0002 180 038 0003 181 038 0002 181 038 0003 182 038 0002	Std, 0,25, 0,50, 0,75 Std, 0,25, 0,50, 0,75 Std, 0,25, 0,50, 0,75 Std, 0,25, 0,50, 0,75 Std	13
F3P 700/706/707/708/712/760/764/765 F7P 720/722	1794	4	Clio 1.8i, Clio 1.8i 16V, R19 1.8i	82,70	180 038 0002 181 038 0002 182 038 0002	Std, 0,25, 0,50, 0,75 Std, 0,25, 0,50, 0,75 Std	8
F3R 722/723/728/729/742/751/768/769 F7R 700/710/714	1998	4	Clio 2.0i Williams 16V, Espace 2.0, Laguna 2.0i, Megane 2.0i, Megane 2.0i 16V	82,70	180 038 0002 180 038 0003 181 038 0002 181 038 0003 182 038 0002	Std, 0,25, 0,50, 0,75 Std, 0,25, 0,50, 0,75 Std, 0,25, 0,50, 0,75 Std, 0,25, 0,50, 0,75 Std	13
F3R 791/796, F4R 700/701/712/720/722/730/732/740 F5R 700/740	1998	4	Avantime 2.0i Turbo 16V, Clio 2.0i 16V, Espace 2.0i 16V, Espace 2.0i Turbo 16V, Laguna 2.0i 16V, Laguna 2.0i Turbo 16V, Megane 2.0i 16V, Megane 2.0i Turbo 16V, Scenic 2.0i 16V, Scenic 2.0i Turbo 16V, Trafic 2.0i 16V, Vel Satis 2.0i Turbo 16V	82,70	180 038 0003 181 038 0003 182 038 0002	Std, 0,25, 0,50, 0,75 Std, 0,25, 0,50, 0,75 Std	14
M9R.630, M9R.692, M9R.780, M9R.782, M9R.786	1995	4	TRAFIC II 2.0 dCi 90	84,00	180 038 0014 181 038 0019 182 038 0007	Std, 0,25, 0,50 Std, 0,25, 0,50 Std	15
M9T.670, M9T.672, M9T.676, M9T.678, M9T.680, M9T.686, M9T.690, M9T.692, M9T.694, M9T.696, M9T.698, M9T.870 M9T.880, M9T.890, M9T.896, M9T.898,	2298	4	MASTER III 2.3 dCi Power Version 100, 110, 125, 140, 145, 150	85,00	180 038 0013 181 038 0018 182 038 0007	Std, 0,25, 0,50 Std, 0,25, 0,50 Std	16
852 700/710/720/750, J8S 174/330/600/604/620/704/706/711	2068	4	Espace 2.1 TD, Fuego 2.1 TD, Master T28 2.1 D, R18 2.1 D, R18 2.1 TD, R20 2.1 D, R21 2.1 D, R21 2.1 TD, R25 2.1 D, Trafic 2.1 D	86,00	180 038 0004 180 038 0005 181 038 0004 181 038 0005 182 038 0003 182 038 0004	Std, 0,25, 0,50, 0,75 Std, 0,25, 0,50 Std, 0,25, 0,50, 0,75 Std, 0,25, 0,50 Std, 0,05 Std	17
J8S 240/610/612/702/708/714/738/746	2068	4	Espace 2.1 TD, R20 2.1 TD, R21 2.1 TD, R25 2.1 TD, R30 2.1 TD, Safrane 2.1 TD	86,00	180 038 0004 180 038 0005 181 038 0006 182 038 0003 182 038 0004	Std, 0,25, 0,50, 0,75 Std, 0,25, 0,50 Std, 0,25 Std, 0,05 Std	18
G8T	2188	4	Espace, Espace Grand, Laguna, Laguna Nevada, Safrane	87,00	180 038 0008 181 038 0011	Std, 0,25, 0,50, 0,75 Std	19
G9T, G9U	2188	4	Avantime, Espace, Espace Grand, Laguna, Master, Master Combi, Master Minibus, Velsatis, Trafic	87,00	180 038 0008 181 038 0010	Std, 0,25, 0,50, 0,75 Std, 0,25, 0,50	20
829.01, 829.710, J5R 716, J6R 234/236/706/707/711/734, J7R 720/722/732/750/752	1995	4	Espace 2.0, Fuego 2.0, R18 2.0, R20 2.0, R21 2.0i, R21 2.0i 16V, R21 2.0i Turbo, R25 2.0, R25 2.0i, R25 2.0i 12V, Trafic 2.0	88,00	180 038 0004 180 038 0005 181 038 0007 182 038 0003 182 038 0004	Std, 0,25, 0,50, 0,75 Std, 0,25, 0,50 Std, 0,25, 0,50, 0,75 Std, 0,05 Std	21
851 700	2165	4	R20 2.2	88,00	180 038 0004 180 038 0005 181 038 0004 181 038 0005 181 038 0006 182 038 0003 182 038 0004	Std, 0,25, 0,50, 0,75 Std, 0,25, 0,50 Std, 0,25, 0,50, 0,75 Std, 0,25, 0,50 Std, 0,25 Std, 0,05 Std	22
J6T 790	2165	4	R21 2.2i	88,00	180 038 0004 181 038 0004 182 038 0003	Std, 0,25, 0,50, 0,75 Std, 0,25, 0,50, 0,75 Std, 0,05	23
J7T	2165	4	Espace 2.2i, R21 2.2i, R25 2.2i, Safrane 2.2i, Safrane 2.2i 12V, Trafic 2.2i	88,00	180 038 0005 181 038 0004 181 038 0005 182 038 0004	Std, 0,25, 0,50 Std, 0,25, 0,50, 0,75 Std, 0,25, 0,50 Std	24
8140.21.235, 8140.47.2711, 8140.61.200/235/2300, S8U 720/722/730/731/780/782	2445	4	Master 2.4 D, Master 2.4 TD, Master P28 2.4 D, Master T28 2.4 D, Master T30 2.4 D, Master T35 2.4 D, Trafic 2.4 D	93,00	180 020 0003 181 020 0012	Std, .010, .020, .030 Std, .010, .020, .030	25
8140.07, 8140.27, 8140.47, 8140.67, 8144.97, S8U 700/702/704/714/740/742/750/752	2499	4	Master 2.5 D, Master 2.5 TD, Safrane 2.5 TD, Safrane 2.5 TDE, Trafic 2.5 D	93,00	180 020 0003 181 020 0012	Std, .010, .020, .030 Std, .010, .020, .030	25
8140.43.2620, 8140.43.2629, S9W 700/702	2799	4	Master 2.8 dTi	94,40	180 020 0003 181 020 0012	Std, .010, .020, .030 Std, .010, .020, .030	25



RENAULT

Globally reliable

							Set Composition / QTY								
1 65,00															
MB/HL 1, 2, 3, 4, 5	5 Pairs	54,795 54,805	58,731 58,750	19,500	SAL	180 038 0006 00 15 21 26 29	5		5						
CB/PL 1, 2, 3, 4	4 Pairs	43,964 43,980	47,614 47,625	20,750	SAL	181 038 0014 00 15 21 26	8								
TW/A 1	2 Halves	59,800 60,050	79,800 80,050		SAL	182 038 0005 00 02 08	2								
2 69,00															
MB/HL 1, 2, 3, 4	4 Pairs	43,990 44,010	47,612 47,625	18,800	SAL	180 038 0010 00	4		5		1				
MB/HL 5	1 Pair	43,990 44,010	47,612 47,625	23,900	SAL										
CB/PL 1, 2, 3, 4	4 Pairs	39,984 40,000	43,639 43,650	16,250	SAL	181 038 0013 00 15 21 26	8								
3 69,00															
MB/HL 1, 2, 3, 4	4 Pairs	43,990 44,010	47,612 47,625	18,800	SAL	180 038 0009 00 15	4		5		1				
MB/HL 5	1 Pair	43,990 44,010	47,612 47,625	23,930	SAL	21 26									
MB/HL 1, 2, 3, 4	4 Pairs	43,990 44,010	47,612 47,625	18,800	SAL	180 038 0010 00	4		5		1				
MB/HL 5	1 Pair	43,990 44,010	47,612 47,625	23,900	SAL										
CB/PL 1, 2, 3, 4	4 Pairs	39,984 40,000	43,639 43,650	16,250	SAL	181 038 0012 00 15 21 26	8								
CB/PL 1, 2, 3, 4	4 Pairs	39,984 40,000	43,639 43,650	16,250	SAL	181 038 0013 00 15 21 26	8								
4 71,50															
MB/HL 1, 2, 3, 4, 5	5 Pairs	54,795 54,805	58,731 58,750	19,500	SAL	180 038 0006 00 15 21 26 29	5		5						
CB/PL 1, 2, 3, 4	4 Pairs	43,964 43,980	47,614 47,625	17,750	SAL	181 038 0008 00 15 21 26 29	8								
5 72,20															
MB/HL 1, 2, 3, 4, 5	5 Pairs	1,000	1,000	16,050	SAL	180 038 0016 00 15 21	5		5						
CB/PL 1, 2, 3, 4	4 Pairs	2,000	2,000	17,000	SAL	181 038 0021 00 15 21	8								
TW/A 1	2 Halves	54,900 55,100	73,900 74,000		SAL	182 038 0008 00	2								











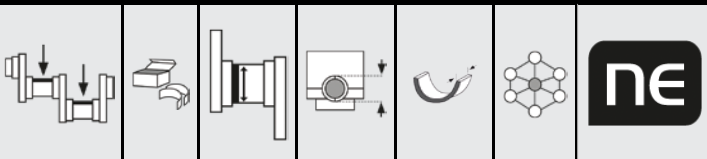















							 		Set Composition / QTY											
6	72,20																			
MB/HL 1, 2, 3, 4	4 Pairs	1,000	1,000	16,050	SAL	180 038 0017 00	4		4											
CB/PL 1, 2, 3	3 Pairs	3,000	3,000	17,000	SAL	181 038 0022 00	6													
TW/A 1	2 Halves	54,900 55,100	73,900 74,000		SAL	182 038 0008 00	2													
7	76,00																			
MB/HL 1, 2, 3, 4, 5	5 Pairs	48,000 48,011	51,935 51,943	19,500	SAL	180 038 0001 00	5		5											
CB/PL 1, 2	2 Pairs	43,960 43,980	47,610 47,628	20,600	S32S	181 038 0001 00	4		4											
CB/PL 3, 4	2 Pairs	43,960 43,980	47,610 47,628	17,600	S32S	21 26														
TW/A 1	2 Halves	52,710 53,210	73,410 73,910		SAL	182 038 0001 00	2													
8	78,00																			
MB/HL 1, 2, 3, 4, 5	5 Pairs	54,785 54,795	58,731 58,744	18,500	SAL	180 038 0002 00	5		5											
CB/PL 1, 2, 3, 4	4 Pairs	48,000 48,020	51,587 51,600	20,500	SAL	181 038 0002 00	8													
TW/A 1	2 Halves	60,500 60,750	79,750 80,000		SAL	182 038 0002 00	2													
9	79,50																			
MB/HL 1, 2, 3, 4, 5	5 Pairs	48,000 48,011	51,935 51,943	19,500	SAL	180 038 0007 00	3		7											
CB/PL 1, 2, 3, 4	4 Pairs	43,964 43,980	47,614 47,625	17,750	SAL	181 038 0008 00	8													
CB/PL 1, 2, 3, 4	4 Pairs	43,960 43,980	47,610 47,628	17,600	SAL	181 038 0009 00	8													
TW/A 1	2 Halves	52,710 53,210	73,410 73,910		SAL	182 038 0001 00	2													
10	80,00																			
MB/HL 1, 2, 3, 4, 5	5 Pairs	54,785 54,795	58,731 58,744	18,500	S32S	180 038 0003 00	5		5											
CB/PL 1, 2, 3, 4	4 Pairs	48,000 48,020	51,587 51,600	20,500	SAL	181 038 0003 00	8													
CB/PL 1, 2, 3, 4	4 Pairs	48,000 48,020	51,587 51,606	20,250	S3S	181 038 0015 00	8													
TW/A 1	2 Halves	60,500 60,750	79,750 80,000		SAL	182 038 0002 00	2													



RENAULT

Globally reliable

								Set Composition / QTY																		
11												80,00														
MB/HL 1, 2, 3, 4, 5	5 Pairs	54,785 54,795	58,731 58,744	18,500	SAL	180 038 0002 00 15 21 26	5		5																	
MB/HL 1, 2, 3, 4, 5	5 Pairs	54,785 54,795	58,731 58,744	18,500	S32S	180 038 0003 00 15 21 26	5		5																	
CB/PL 1, 2, 3, 4	4 Pairs	48,000 48,020	51,587 51,600	20,500	SAL	181 038 0002 00 15 21 26	8																			
CB/PL 1, 2, 3, 4	4 Pairs	48,000 48,020	51,587 51,600	20,500	SAL	181 038 0003 00 15 21 26	8																			
CB/PL 1, 2, 3, 4	4 Pairs	48,000 48,020	51,587 51,606	20,250	S3S	181 038 0015 00 15 21	8																			
TW/A 1	2 Halves	60,500 60,750	79,750 80,000		SAL	182 038 0002 00	2																			
12												80,00														
MB/HL 1, 2, 3, 4, 5	5 Pairs	51,500	55,500	17,250	SSI	180 038 0015 00 15 21	5		5																	
CB/PL 1, 2, 3, 4	4 Pairs	48,000 48,018	51,600 51,618	20,700	Nefrox	181 038 0020 00 15 21	4		4																	
TW/A 1	2 Halves	58,050	80,250		SAL	182 815 0006 00	2																			
13												82,70														
MB/HL 1, 2, 3, 4, 5	5 Pairs	54,785 54,795	58,731 58,744	18,500	SAL	180 038 0002 00 15 21 26	5		5																	
MB/HL 1, 2, 3, 4, 5	5 Pairs	54,785 54,795	58,731 58,744	18,500	S32S	180 038 0003 00 15 21 26	5		5																	
CB/PL 1, 2, 3, 4	4 Pairs	48,000 48,020	51,587 51,600	20,500	SAL	181 038 0002 00 15 21 26	8																			
CB/PL 1, 2, 3, 4	4 Pairs	48,000 48,020	51,587 51,600	20,500	SAL	181 038 0003 00 15 21 26	8																			
TW/A 1	2 Halves	60,500 60,750	79,750 80,000		SAL	182 038 0002 00	2																			
14												82,70														
MB/HL 1, 2, 3, 4, 5	5 Pairs	54,785 54,795	58,731 58,744	18,500	S32S	180 038 0003 00 15 21 26	5		5																	
CB/PL 1, 2, 3, 4	4 Pairs	48,000 48,020	51,587 51,600	20,500	SAL	181 038 0003 00 15 21 26	8																			
TW/A 1	2 Halves	60,500 60,750	79,750 80,000		SAL	182 038 0002 00	2																			











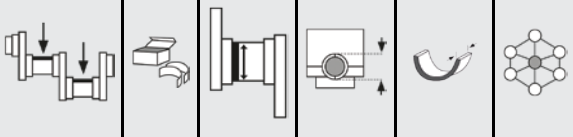







							Set Composition / QTY															
15 84,00																						
MB/HL 1, 2	2 Pairs	55,985 56,005	59,998 60,011	17,200	S32S	180 038 0014 00	15	5		5												
MB/HL 3, 4, 5	3 Pairs	55,985 56,005	59,998 60,011	19,500	S32S		21															
CB/PL 1, 2	2 Pairs	52,000 52,018	55,580 55,596	19,500	Nefrox	181 038 0019 00	15	4		4												
CB/PL 3, 4	2 Pairs	52,000 52,018	55,580 55,596	18,500	Nefrox		21															
TW/A 1	2 Halves	65,600 65,850	84,000 84,250		SAL	182 038 0007 00		2														
16 85,00																						
MB/HL 1, 2	2 Pairs	59,985 60,005	63,998 64,011	17,200	SAL	180 038 0013 00	15	5		5												
MB/HL 3, 4, 5	3 Pairs	59,985 60,005	63,998 64,011	19,300	SAL		21															
CB/PL 1, 2, 3, 4	4 Pairs	53,000 53,020	56,587 56,606	19,000	SPVD	181 038 0018 00	15 21	4		4												
TW/A 1	2 Halves	65,600 65,850	84,000 84,250		SAL	182 038 0007 00		2														
17 86,00																						
MB/HL 1, 2, 3, 4, 5	5 Pairs	62,873 62,892	66,668 66,687	23,500	SAL	180 038 0004 00	15 21 26	10														
MB/HL 1, 2, 3, 4, 5	5 Pairs	62,873 62,892	66,668 66,687	23,500	SAL	180 038 0005 00	15 21	5		5												
CB/PL 1, 2, 3, 4	4 Pairs	56,267 56,286	60,000 60,019	20,750	SAL	181 038 0004 00	15 21 26	4		4												
CB/PL 1, 2, 3, 4	4 Pairs	56,267 56,286	60,000 60,019	20,750	SAL	181 038 0005 00	15 21	4		4												
TW/A 1	2 Halves	71,200 71,450	87,840 88,090		SAL	182 038 0003 00	02	2														
TW/A 1	2 Halves	71,200 71,450	87,840 88,090		SAL	182 038 0004 00		2														
18 86,00																						
MB/HL 1, 2, 3, 4, 5	5 Pairs	62,873 62,892	66,668 66,687	23,500	SAL	180 038 0004 00	15 21 26	10														
MB/HL 1, 2, 3, 4, 5	5 Pairs	62,873 62,892	66,668 66,687	23,500	SAL	180 038 0005 00	15 21	5		5												
CB/PL 1, 2, 3, 4	4 Pairs	56,267 56,286	60,000 60,019	20,750	SAL	181 038 0006 00	15	4		4												
TW/A 1	2 Halves	71,200 71,450	87,840 88,090		SAL	182 038 0003 00	02	2														
TW/A 1	2 Halves	71,200 71,450	87,840 88,090		SAL	182 038 0004 00		2														



















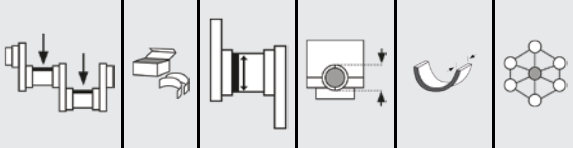

















RENAULT











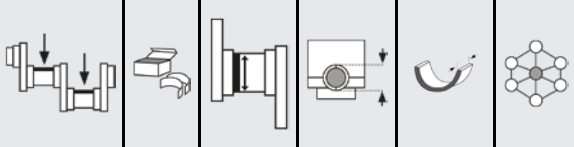



















Globally reliable











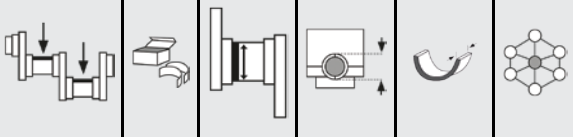













							Set Composition / QTY														
19	87,00																				
MB/HL 1, 2, 3, 4, 5	5 Pairs	57,981 58,001	61,669 61,681	20,990	SSI	180 038 0008 00 15 21 26	5		5												
CB/PL 1, 2, 3, 4	4 Pairs	47,976 47,991	51,613 51,626	20,650	SSI	181 038 0011 00	8														
20	87,00																				
MB/HL 1, 2, 3, 4, 5	5 Pairs	57,981 58,001	61,669 61,681	20,990	SSI	180 038 0008 00 15 21 26	5		5												
CB/PL 1, 2, 3, 4	4 Pairs	52,972 52,989	56,586 56,606	20,650	S32S	181 038 0010 00 15 21	4		4												
21	88,00																				
MB/HL 1, 2, 3, 4, 5	5 Pairs	62,873 62,892	66,668 66,687	23,500	SAL	180 038 0004 00 15 21 26	10														
MB/HL 1, 2, 3, 4, 5	5 Pairs	62,873 62,892	66,668 66,687	23,500	SAL	180 038 0005 00 15 21	5		5												
CB/PL 1, 2, 3, 4	4 Pairs	52,267 52,286	56,000 56,019	18,750	SAL	181 038 0007 00 15 21 26	4		4												
TW/A 1	2 Halves	71,200 71,450	87,840 88,090		SAL	182 038 0003 00 02	2														
TW/A 1	2 Halves	71,200 71,450	87,840 88,090		SAL	182 038 0004 00	2														
22	88,00																				
MB/HL 1, 2, 3, 4, 5	5 Pairs	62,873 62,892	66,668 66,687	23,500	SAL	180 038 0004 00 15 21 26	10														
MB/HL 1, 2, 3, 4, 5	5 Pairs	62,873 62,892	66,668 66,687	23,500	SAL	180 038 0005 00 15 21	5		5												
CB/PL 1, 2, 3, 4	4 Pairs	56,267 56,286	60,000 60,019	20,750	SAL	181 038 0004 00 15 21 26	4		4												
CB/PL 1, 2, 3, 4	4 Pairs	56,267 56,286	60,000 60,019	20,750	SAL	181 038 0005 00 15 21	4		4												
CB/PL 1, 2, 3, 4	4 Pairs	56,267 56,286	60,000 60,019	20,750	SAL	181 038 0006 00 15	4		4												
TW/A 1	2 Halves	71,200 71,450	87,840 88,090		SAL	182 038 0003 00 02	2														
TW/A 1	2 Halves	71,200 71,450	87,840 88,090		SAL	182 038 0004 00	2														

							 		Set Composition / QTY														
23 88,00																							
MB/HL 1, 2, 3, 4, 5	5 Pairs	62,873 62,892	66,668 66,687	23,500	SAL	180 038 0004 00 15 21 26	10																
CB/PL 1, 2, 3, 4	4 Pairs	56,267 56,286	60,000 60,019	20,750	SAL	181 038 0004 00 15 21 26	4		4														
TW/A 1	2 Halves	71,200 71,450	87,840 88,090		SAL	182 038 0003 00 02	2																
24 88,00																							
MB/HL 1, 2, 3, 4, 5	5 Pairs	62,873 62,892	66,668 66,687	23,500	SAL	180 038 0005 00 15 21	5		5														
CB/PL 1, 2, 3, 4	4 Pairs	56,267 56,286	60,000 60,019	20,750	SAL	181 038 0004 00 15 21 26	4		4														
CB/PL 1, 2, 3, 4	4 Pairs	56,267 56,286	60,000 60,019	20,750	SAL	181 038 0005 00 15 21	4		4														
TW/A 1	2 Halves	71,200 71,450	87,840 88,090		SAL	182 038 0004 00	2																
25 93,00																							
MB/HL 1, 2, 3, 4	4 Pairs	76,187 76,200	80,586 80,607	24,990	S3S	180 020 0003 00 16	1		1		4		4										
MB/HL 5	1 Pair	76,187 76,200	80,586 80,607	31,950	S3S	22 27																	
CB/PL 1, 2, 3, 4	4 Pairs	56,520 56,535	60,333 60,345	24,700	S3S	181 020 0012 00 16 22 27	8																

	ccm						Pos.
712	3317	4	SB2, SG2, SG3, TP3	98,00	180 040 0006 181 040 0008 182 040 0004	Std, 0,25, 0,50, 0,75 Std, 0,25, 0,50 Std	1
597	5278	6	.	100,00	180 040 0005 181 040 0009 182 040 0005	Std, 0,25, 0,50, 0,75, 1,00 Std, 0,25 Std	2
720	3596	4	JK60, JK65, JK75, JN85, S90, S40, SG4	102,00	180 040 0006 181 040 0008 182 040 0004	Std, 0,25, 0,50, 0,75 Std, 0,25, 0,50 Std	1
MIDR 06.02.12 D, MIDS 06.02.12, MIDS 06.02.12 B/C/D	5490	6	.	102,00	180 040 0001 180 040 0005 181 040 0001 182 040 0005	Std, 0,25, 0,50 Std, 0,25, 0,50, 0,75, 1,00 Std, 0,25, 0,50 Std	3
MIDR 06.02.26 H/Q/U/W/X	5490	6	.	102,00	180 040 0001 181 040 0001 182 040 0001	Std, 0,25, 0,50 Std, 0,25, 0,50 Std	4
797 20/21/23/26, 798-10	5490	6	.	102,00	180 040 0005 181 040 0009 182 040 0005	Std, 0,25, 0,50, 0,75, 1,00 Std, 0,25 Std	2
MIDR 06.02.26 D	6170	6	.	102,00	180 040 0001 181 040 0001 182 040 0001	Std, 0,25, 0,50 Std, 0,25, 0,50 Std	4
DXi5 160 Euro4, DXi5 190 Euro4, DXi5 220 Euro4	4761	4	Midlum 160 04.2006- Midlum 190 04.2006- Midlum 220 04.2006-	108,00	180 059 0010 181 059 0016 182 059 0008	Std, 0,25, 0,50 Std, 0,25, 0,50 Std	5
DXi7 240 Euro4, DXi7 280 Euro4, DXi7 320 Euro4	7146	6	Lander 240 03.2005- Midlum 240 04.2006- Premium 240 03.2005- Lander 280 03.2005- Midlum 280 04.2006- Premium 280 03.2005- Lander 320 03.2005- Premium 320 03.2005-	108,00	180 059 0010 181 059 0016 182 059 0008	Std, 0,25, 0,50 Std, 0,25, 0,50 Std	5
MID/MIDR/MIDS/MIP/MIPS/MIS 06.20.30	8820	6	C190, C210, CLR220, G190, G200, G210, G230, GB191, GB231, GC190, GC191, GC230, GC231, GF191, GF230, GF231, GFC231, GLR190, GLR210, GLR230, GR190, GR191, GR230, GR231, GRH235, PR10, PR12, PR14, PR100, PR770, PR950, TB191, TB231, TF230	120,00	180 040 0003 180 040 0004 181 040 0006 182 040 0002	Std, 0,25 Std, 0,25, 0,50 Std, 0,25, 0,50, 0,75, 1,00 Std	7
M620, MDZ23, MH620	9500	6	.	120,00	180 040 0002 181 040 0010 182 040 0003	Std, 0,25, 0,50, 0,75, 1,00 Std, 0,25, 0,50, 0,75, 1,00 Std	8
MIPS 06.20.45, MIDR 06.20.45, MIDS 06.20.45, MIPR 06.20.45	9840	6	Agora Citybus, Ares 300, Kerax 260, Kerax 300, Kerax 340, Maxter 300, Maxter 340, PER180, Premium 260, Premium 300, Premium 340	120,00	180 040 0003 180 040 0004 181 040 0003 181 040 0004 181 040 0005 182 040 0002	Std, 0,25 Std, 0,25, 0,50 Std, 0,25, 0,50 Std, 0,25, 0,50, 0,75, 1,00 Std, 0,25, 0,50 Std	6
DXi11 330 Euro3, DXi11 370 Euro4/5, DXi11 380 Euro3, DXi11 410 Euro4/5, DXi11 440 Euro3, DXi11 450 Euro4/5	10800	6	Kerax 370 03.2005- Lander 370 Premium 370	123,00	180 059 0008 181 059 0014	Std, 0,25, 0,50 Std, 0,25, 0,50	10
MIDR 06.23.56	11116	6	.	123,00	180 040 0003 180 040 0004 181 040 0003 181 040 0004 181 040 0005 182 040 0002	Std, 0,25 Std, 0,25, 0,50 Std, 0,25, 0,50 Std, 0,25, 0,50, 0,75, 1,00 Std, 0,25, 0,50 Std	6
DCi 11 B (Euro 2), DCi 11 C (Euro 3), DCi 11 E (Euro 3), DCi 11 G (Euro 3)	11100	6	Kerax 420 01.2001-04.2006 Lander 420 Premium 420 01.2001-04.2006 Midlum 180 07.2001-04.2006 Kerax 370 01.2001-04.2006 Lander 370 Premium 370 01.2000-04.2006 Kerax 320 01.2001-04.2006 Premium 320 01.2000-04.2006 Kerax 270 01.2001-04.2006 Premium 270 01.2001-	123,00	180 040 0007 181 040 0011 182 040 0006	Std, 0,25, 0,50 Std, 0,25, 0,50 Std	9
DXi 12 440 Euro3, DXi 12 480 Euro3	12100	6	Magnum AE 440 03.2005- Magnum AE 480 03.2005-	131,00	180 059 0009 181 059 0009 182 059 0004	Std, 0,25, 0,50 Std, 0,25, 0,50 Std, 0,10, 0,20	11
DXi13 440 Euro4/5, DXi 13 460 Euro4/5, DXi 13 480 Euro4/5, DXi 13 500 Euro4/5, DXi 13 520 Euro4/5	12800	6	Magnum AE 440 03.2009- Kerax 460 Magnum AE 460 03.2009- Kerax 480 Magnum AE 480 03.2009- Kerax 520 Magnum AE 520 08.2009-	131,00	180 059 0009 181 059 0013 181 059 0015 182 059 0004	Std, 0,25, 0,50 Std, 0,25, 0,50 Std, 0,25, 0,50 Std, 0,10, 0,20	12
MIDR 06.35.40, MIDS 06.35.40	12000	6	Magnum AE380, Magnum AE385, Magnum AE420, R340, R350, R357, R365, R380, R385, R420, R TS	135,00	180 040 0002 181 040 0002 181 040 0007 181 040 0010 182 040 0003	Std, 0,25, 0,50, 0,75, 1,00 Std, 0,25, 0,50, 0,75, 1,00 Std, 0,25, 0,50, 0,75, 1,00 Std, 0,25, 0,50, 0,75, 1,00 Std	13

 						Set Composition / QTY															
1	98,00																				
MB/HL 1, 3, 5	3 Pairs	73,962 73,975	78,691 78,710	35,340	S3S	180 040 0006 00 15	2		2		3		3								
MB/HL 2, 4	2 Pairs	73,962 73,975	78,691 78,710	26,300	S3S	21 26															
CB/PL 1, 2, 3, 4	4 Pairs	60,261 60,274	63,995 64,008	30,380	S3S	181 040 0008 00 15 21	2														
TW/A 1	4 Halves	83,750 84,000	99,650 99,900		S3S	182 040 0004 00	2		2												
2	100,00																				
MB/HL 1, 2, 3, 4, 5, 6, 7	7 Pairs	70,002 70,021	74,000 74,018	29,000	S3S	180 040 0005 00 15 21 26 29	7		7												
CB/PL 1, 2, 3, 4, 5, 6	6 Pairs	64,981 65,000	68,701 68,720	30,380	S3S	181 040 0009 00 15	12														
TW/A 1	4 Halves	77,650 77,900	94,950 95,200		S3S	182 040 0005 00															
3	102,00																				
MB/HL 1, 2, 3, 4, 5, 6, 7	7 Pairs	76,002 76,021	80,000 80,019	28,000	S3S	180 040 0001 00 15 21	7		7												
MB/HL 1, 2, 3, 4, 5, 6, 7	7 Pairs	70,002 70,021	74,000 74,018	29,000	S3S	180 040 0005 00 15 21 26 29	7		7												
CB/PL 1, 2, 3, 4, 5, 6	6 Pairs	64,981 65,000	68,701 68,720	31,150	S3S	181 040 0001 00 15 21	12														
TW/A 1	4 Halves	77,650 77,900	94,950 95,200		S3S	182 040 0005 00															
4	102,00																				
MB/HL 1, 2, 3, 4, 5, 6, 7	7 Pairs	76,002 76,021	80,000 80,019	28,000	S3S	180 040 0001 00 15 21	7		7												
CB/PL 1, 2, 3, 4, 5, 6	6 Pairs	64,981 65,000	68,701 68,720	31,150	S3S	181 040 0001 00 15 21	12														
TW/A 1	4 Halves	85,100 85,350	107,600 107,850		SR	182 040 0001 00	2		2												
5	108,00																				
MB/HL 1	1 Pair	84,980 85,000	90,500 90,520	26,500	S3S	180 059 0010 00 15 21	1		1												
CB/PL 1	1 Pair	74,980 75,000	80,000 80,020	29,200	SPVD	181 059 0016 00 15 21	1		1												
TW/A 1	4 Halves	91,400	114,000		SAL	182 059 0008 00	2		2												







 							Set Composition / QTY														
6 120,00																					
MB/HL 1, 2, 3, 4, 5, 6, 7	7 Pairs	95,966 95,988	102,000 102,022	34,000	S3S	180 040 0003 00 15	7		7												
MB/HL 1, 2, 3, 4, 5, 6, 7	7 Pairs	95,966 95,988	102,000 102,022	34,000	S3S	180 040 0004 00 15 21	7		7												
CB/PL 1	1 Pair	76,960 76,980	82,000 82,022	40,900	S3S	181 040 0003 00 15 21	12														
CB/PL 1	1 Pair	76,960 76,980	82,000 82,022	40,900	S3S	181 040 0004 00 15 21 26 29	2														
CB/PL 1, 2, 3, 4, 5, 6	6 Pairs	76,960 76,980	82,000 82,022	40,900	S3S	181 040 0005 00 15 21	6		6												
TW/A 1	4 Halves	108,000 108,250	131,750 132,000		S3S	182 040 0002 00	2		2												
7 120,00																					
MB/HL 1, 2, 3, 4, 5, 6, 7	7 Pairs	95,966 95,988	102,000 102,022	34,000	S3S	180 040 0003 00 15	7		7												
MB/HL 1, 2, 3, 4, 5, 6, 7	7 Pairs	95,966 95,988	102,000 102,022	34,000	S3S	180 040 0004 00 15 21	7		7												
CB/PL 1, 2, 3, 4, 5, 6	6 Pairs	71,960 71,980	76,000 76,020	39,300	S3S	181 040 0006 00 15 21 26 29	12														
TW/A 1	4 Halves	108,000 108,250	131,750 132,000		S3S	182 040 0002 00	2		2												
8 120,00																					
MB/HL 1, 4, 7	3 Pairs	89,940 89,960	96,000 96,027	63,620	S3S	180 040 0002 00 15	4		4		3		3								
MB/HL 2, 3, 5, 6	4 Pairs	89,940 89,960	96,000 96,027	40,250	S3S	21 26 29															
CB/PL 1	1 Pair	83,960 83,980	90,000 90,020	45,000	S3S	181 040 0010 00 15 21 26 29	2														
TW/A 1	4 Halves	100,500 100,750	121,670 121,920		S3S	182 040 0003 00	2														
9 123,00																					
MB/HL 1, 2, 3, 4, 5, 6, 7	7 Pairs	101,966 101,998	108,000 108,022	33,000	S3S	180 040 0007 00 15 21	7		7												
CB/PL 1, 2, 3, 4, 5, 6	6 Pairs	76,960 76,980	82,000 82,022	40,900	S3S	181 040 0011 00 15 21	6		6												
TW/A 1	4 Halves	114,000 114,250	137,750 138,000		S3S	182 040 0006 00	2		2												











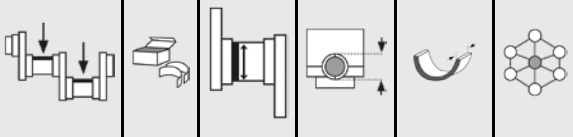















 							Set Composition / QTY													
10 123,00																				
MB/HL 1, 2, 3, 4, 5, 6, 7	7 Pairs	107,978 108,000	113,040 113,065	32,200	S3S	180 059 0008 00 15 21	7		7											
CB/PL 1, 2, 3, 4, 5, 6	6 Pairs	85,978 86,000	90,835 90,850	45,100	S3S	181 059 0014 00 15 21	6		6											
11 131,00																				
MB/HL 1, 2, 3, 4, 5, 6, 7	7 Pairs	107,978 108,000	113,040 113,065	37,800	S3S	180 059 0009 00 15 21	7		7											
CB/PL 1, 2, 3, 4, 5, 6	6 Pairs	91,978 92,000	96,835 96,850	49,100	S3S	181 059 0009 00 15 21	12													
TW/A 1	4 Halves	116,660 117,090	139,680 139,930		S3S	182 059 0004 00 08 14	4													
12 131,00																				
MB/HL 1, 2, 3, 4, 5, 6, 7	7 Pairs	107,978 108,000	113,040 113,065	37,800	S3S	180 059 0009 00 15 21	7		7											
CB/PL 1, 2, 3, 4, 5, 6	6 Pairs	98,978 99,000	103,835 103,850	48,850	S3S	181 059 0013 00 15 21	12													
CB/PL 1, 2, 3, 4, 5, 6	6 Pairs	98,978 99,000	103,835 103,850	48,850	S32S	181 059 0015 00 15 21	6		6											
TW/A 1	4 Halves	116,660 117,090	139,680 139,930		S3S	182 059 0004 00 08 14	4													
13 135,00																				
MB/HL 1, 4, 7	3 Pairs	89,940 89,960	96,000 96,027	63,620	S3S	180 040 0002 00 15	4		4		3		3							
MB/HL 2, 3, 5, 6	4 Pairs	89,940 89,960	96,000 96,027	40,250	S3S	21 26 29														
CB/PL 1, 2, 3, 4, 5, 6	6 Pairs	83,960 83,980	90,000 90,020	45,000	S3S	181 040 0002 00 15 21 26 29	12													
CB/PL 1	1 Pair	83,960 83,980	90,000 90,020	40,000	S3S	181 040 0007 00 15 21 26 29	2													
CB/PL 1	1 Pair	83,960 83,980	90,000 90,020	45,000	S3S	181 040 0010 00 15 21 26 29	2													
TW/A 1	4 Halves	100,500 100,750	121,670 121,920		S3S	182 040 0003 00	2													



SAAB

Globally reliable

	ccm						Pos.
Z18 XE	1796	4	9-3 1.8i 16V	80,50	180 035 0001 181 035 0001	Std, 0,25, 0,50, 0,75, 1,00 Std, 0,25, 0,50, 0,75, 1,00	1
Z19DTJ, 182B9.000, 186A8.000, 192A1.000, 937A2.000	1910	4	9-3 1.9 TiD 8V	82,00	180 020 0005 181 020 0011 182 020 0001	Std, 0,25 Std, .010 Std	2
Z19 DTH, 937A5.000, 939A1.000	1910	4	9-3 1.9 TiD, 9-3 1.9 TiD 16V, 9-5 1.9 TiD	82,00	180 020 0006 181 020 0009 182 020 0001	Std, .010, .020, .030 Std, .010, .020, .030 Std	3
A 20 DT, A 20 DTR, Main Bearng Outside Oversize + 1,00 mm	1956	4	9-5 2.0 TiD, TTiD	83,00	180 035 0011 181 035 0014 182 035 0001	Std, .010, .020 Std, .010, .020 Std, .005	4
A 20 DTH	1956	4	9-5 2.0 TiD	83,00	180 035 0009 181 035 0014 182 035 0001	Std, .010, .020 Std, .010, .020 Std, .005	5
A 20 DTR	1956	4	9-5 2.0 TTiD	83,00	180 035 0009 181 035 0014 182 035 0001	Std, .010, .020 Std, .010, .020 Std, .005	5
A 20 DT	1956	4	9-5 2.0 TiD	83,00	180 035 0009 181 035 0014 182 035 0001	Std, .010, .020 Std, .010, .020 Std, .005	5
A 20 DTH Main Bearing Outside Oversize + 0,50 mm	1956	4	9-5 2.0 TiD	83,00	180 035 0010 181 035 0014 182 035 0001	Std, .010, .020 Std, .010, .020 Std, .005	6
A 20 DT, A 20 DTR, Main Bearing Outside Oversize + 0,50 mm	1956	4	9-5 2.0 TiD, TTiD	83,00	180 035 0010 181 035 0014 182 035 0001	Std, .010, .020 Std, .010, .020 Std, .005	6
X 22 DTH, Y 22 DTH	2171	4	9-3 2.2 TiD 16V	84,00	180 035 0008 181 035 0013	Std, 0,25, 0,50 Std, 0,25	7
B20, B202I, B202SI, B202XL, B204I, B204L, B20C, B20E, B234I	1985	4	900 2.0, 900 2.0 16V, 900 2.0 16V, 9000 2.0 16V, 9-3 2.0i, 9-3 2.0 16V Turbo	90,00	180 039 0002 181 039 0001 182 039 0002	Std, 0,25 Std, 0,25, 0,50 Std	8
B234, B234E, B234L, B235R	2290	4	900 2.3 16V Turbo, 9000 2.3, 9000 2.3-16, 9000 CD/CS/S/SE 2.3 16V Turbo	90,00	180 039 0001 181 039 0001 182 039 0001	Std, 0,25, 0,50 Std, 0,25, 0,50 Std	9





							 		Set Composition / QTY														
1 80,50							MB/HL 1, 2, 3, 4, 5	5 Pairs	54,972 54,985	59,000 59,013	19,500	SAL	180 035 0001 00 15 21 26 29	8		2							
							CB/PL 1, 2, 3, 4	4 Pairs	42,971 42,987	46,000 46,012	16,600	SAL	181 035 0001 00 15 21 26 29	8									
2 82,00							MB/HL 1, 2, 3, 4, 5	5 Pairs	59,586 60,000	63,705 63,718	20,750	S3S	180 020 0005 00 15	10									
							CB/PL 1, 2, 3, 4	4 Pairs	50,787 50,805	53,901 53,913	19,500	S3S	181 020 0011 00 16	8									
							TW/A 1	2 Halves	67,785 68,040	82,425 82,677		SAL	182 020 0001 00	2									
3 82,00							MB/HL 1, 2, 3, 4, 5	5 Pairs	59,986 60,000	63,705 63,718	20,750	SSI	180 020 0006 00 16 22 27	5		5							
							CB/PL 1, 2, 3, 4	4 Pairs	50,787 50,805	53,901 53,913	19,500	S3S	181 020 0009 00 16 22 27	8									
							TW/A 1	2 Halves	67,785 68,040	82,425 82,677		SAL	182 020 0001 00	2									
4 83,00							MB/HL 1, 2, 3, 4, 5	5 Pairs	60,034	64,218	20,750	SAL	180 035 0011 00 16 22	5		5							
							CB/PL 1, 2, 3, 4	4 Pairs	50,844 50,860	53,950 53,966	19,500	Nefrox	181 035 0014 00 16 22	4		4							
							TW/A 1	2 Halves	68,040	82,670		SAL	182 035 0001 00 11	2									
5 83,00							MB/HL 1, 2, 3, 4, 5	5 Pairs	60,034	63,718	20,750	SAL	180 035 0009 00 16 22	5		5							
							CB/PL 1, 2, 3, 4	4 Pairs	50,844 50,860	53,950 53,966	19,500	Nefrox	181 035 0014 00 16 22	4		4							
							TW/A 1	2 Halves	68,040	82,670		SAL	182 035 0001 00 11	2									
6 83,00							MB/HL 1, 2, 3, 4, 5	5 Pairs	60,034	64,218	20,750	SAL	180 035 0010 00 16 22	5		5							
							CB/PL 1, 2, 3, 4	4 Pairs	50,844 50,860	53,950 53,966	19,500	Nefrox	181 035 0014 00 16 22	4		4							
							TW/A 1	2 Halves	68,040	82,670		SAL	182 035 0001 00 11	2									



SAAB

Globally reliable







							Set Composition / QTY														
7	84,00																				
MB/HL 1, 2, 4, 5	4 Pairs	67,980 67,996	72,000 72,013	19,500	SAL	180 035 0008 00 15	4		4		1		1								
MB/HL 3	1 Pair	67,980 67,996	72,000 72,013	25,900	SAL	21															
CB/PL 1, 2, 3, 4	4 Pairs	48,971 48,990	52,000 52,012	20,300	S4S	181 035 0013 00 15															
8	90,00																				
MB/HL 1, 2, 3, 4, 5	5 Pairs	57,981 58,000	62,000 62,019	21,500	S3S	180 039 0002 00 15	10														
CB/PL 1, 2, 3, 4	4 Pairs	51,981 52,000	56,000 56,019	20,250	S3S	181 039 0001 00 15 21	8														
TW/A 1	2 Halves	66,000	81,810		S3S	182 039 0002 00	2														
9	90,00																				
MB/HL 1, 2, 3, 4, 5	5 Pairs	57,981 58,000	62,000 62,019	21,500	S3S	180 039 0001 00 15 21	10														
CB/PL 1, 2, 3, 4	4 Pairs	51,981 52,000	56,000 56,019	20,250	S3S	181 039 0001 00 15 21	8														
TW/A 1	2 Halves	62,025	81,900		SAL	182 039 0001 00	2														











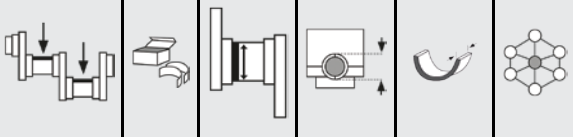



	ccm					Pos.
D8, DN8, DS8, DSi8	7800	6		115,00	180 139 0004 Std, 0,25, 0,50, 0,75, 1,00 181 139 0004 Std, 0,25, 0,50, 0,75, 1,00 182 139 0002 Std	1
DN9, DS9, DSC9 01/02/03/05/06/07/08/09	8476	6		115,00	180 139 0001 Std, 0,25, 0,50 180 139 0006 Std, 0,25, 0,50 181 139 0001 Std, 0,25, 0,50, 0,75, 1,00 182 139 0001 Std 182 139 0005 Std 183 139 0001 Std 184 139 0001 Semi	2
D9A, DC9, DSC9 10/11/12/13/15	8974	6		115,00	180 139 0001 Std, 0,25, 0,50 180 139 0006 Std, 0,25, 0,50 181 139 0001 Std, 0,25, 0,50, 0,75, 1,00 182 139 0001 Std 182 139 0005 Std 183 139 0001 Std 184 139 0001 Semi	2
D10, DS10	10260	6		127,00	180 139 0002 Std, 0,25, 0,50, 0,75, 1,00 181 139 0002 Std, 0,25, 0,50, 0,75, 1,00 182 139 0003 Std, 0,12, 0,20 183 139 0002 Semi 184 139 0002 Semi	3
D14, DS14, DSC14, DSi14	14181	8		127,00	180 139 0003 Std, 0,25, 0,50, 0,75, 1,00 181 139 0003 Std, 0,25, 0,50, 0,75, 1,00 182 139 0003 Std, 0,12, 0,20 183 139 0004 Std	5
D11, DN11, DS11, DSC11, DTC11	11022	6		127,00	180 139 0002 Std, 0,25, 0,50, 0,75, 1,00 181 139 0002 Std, 0,25, 0,50, 0,75, 1,00 182 139 0003 Std, 0,12, 0,20 183 139 0002 Semi 184 139 0002 Semi	3
DC12, DSC12, DT12	11716	6		127,00	180 139 0005 Std, 0,25, 0,50 181 139 0005 Std, 0,25, 0,50 182 139 0004 Std 183 139 0003 Std 184 139 0003 Semi	4
DT12	11716	6	124 P 09.2000- 124 R 09.2000- 124 T 03.1995-09.2004 Irizar PB 00.2007- PB GT 13.9 09.2006- R 470 04.2004-09.2006 G 470 10.2007- P 470 09.2004-08.2005 R 470 04.2004-09.2006 T 470 09.2004-10.2005 124 P 09.1995-09.2004 124 R 09.1995-09.2004 124 T 03.1995-09.2004 P 420 09.2004- R 420 02.2004- T 420 09.2004-10.2005 G 420 10.2006- OmniCity 02.2004- PB GT 13.9 09.2006-	127,00	180 139 0007 Std, 0,25, 0,50 181 139 0005 Std, 0,25, 0,50 182 139 0004 Std	6
DC16	15600	8	164 R 04.2000- 164 T 04.2000- R 580 04.2004-09.2006 T 580 09.2004-10.2005 R 500 03.2004- R 560 02.2006- R 620 02.2006-	127,00	180 139 0007 Std, 0,25, 0,50 181 139 0006 Std, 0,25, 0,50 182 139 0004 Std	7
DC 13.05	12700	6	IRIZAR PB, P,G,R,T - series P 400, OMNIEXPRESS, IRIZAR CENTURY, K - series, K 400 EB, K 400 IB	130,00	180 139 0007 Std, 0,25, 0,50 181 139 0008 Std, 0,25, 0,50 182 139 0004 Std	8
DC 13.147	12742	6	P,G,R,T - series R 450	130,00	180 139 0007 Std, 0,25, 0,50 181 139 0008 Std, 0,25, 0,50 182 139 0004 Std	8
DC 13.125	12700	6	P,G,R,T - series G 490, R 490, TOURING HD 121, INTERLINK HD 490, LD 490, MD 490	130,00	180 139 0007 Std, 0,25, 0,50 181 139 0008 Std, 0,25, 0,50 182 139 0004 Std	8
DC 13.124	12700	6	P,G,R,T - series G 450, P 450, R 450 TOURING HD 121 INTERLINK HD 450, LD 450, MD 450	130,00	180 139 0007 Std, 0,25, 0,50 181 139 0008 Std, 0,25, 0,50 182 139 0004 Std	8
DC 13.116	12700	6	P,G,R,T - series P 370	130,00	180 139 0007 Std, 0,25, 0,50 181 139 0008 Std, 0,25, 0,50 182 139 0004 Std	8
DC 13.115	12700	6	P,G,R,T - series G 410, P 410, R410, TOURING HD 121 INTERLINK HD 410, LD 410, MD 410	130,00	180 139 0007 Std, 0,25, 0,50 181 139 0008 Std, 0,25, 0,50 182 139 0004 Std	8
DC 13.06	12700	6	P,G,R,T - series P 360	130,00	180 139 0007 Std, 0,25, 0,50 181 139 0008 Std, 0,25, 0,50 182 139 0004 Std	8
DC 13.114	12700	6	F - series F 360 K - series K 360 IB	130,00	180 139 0007 Std, 0,25, 0,50 181 139 0008 Std, 0,25, 0,50 182 139 0004 Std	8



SCANIA

Globally reliable

	ccm						Pos.
DC 13.113	12700	6	K - series K 400 IB	130,00	180 139 0007 181 139 0008 182 139 0004	Std, 0,25, 0,50 Std, 0,25, 0,50 Std	8
DC 13.111	12700	6	P,G,R,T - series G 480	130,00	180 139 0007 181 139 0008 182 139 0004	Std, 0,25, 0,50 Std, 0,25, 0,50 Std	8
DC 13.107	12700	6	K - series K 410 IB	130,00	180 139 0007 181 139 0008 182 139 0004	Std, 0,25, 0,50 Std, 0,25, 0,50 Std	8
DC 13.05, DC 13.06, DC 13.07, DC 13.10	12700	6	P,G,R,T - series G 400, P 400, R 400 G 360, P 360, R 360 G 480, R 480, P 480	130,00	180 139 0007 181 139 0008 182 139 0004	Std, 0,25, 0,50 Std, 0,25, 0,50 Std	8
DC 13.108, DC 13.114	12742	6	K - series K 360 IB P,G,R,T - series G 450, P 450, R 450 G 440, R 440	130,00	180 139 0007 181 139 0008 182 139 0004	Std, 0,25, 0,50 Std, 0,25, 0,50 Std	8
DC 13.10, DC 13.109, DC 13.112, DC 13.121, DC 13.124, DC 13.147	12742	6	P,G,R,T - series G 450, P 450, R 450, G 440, R 440 K - series K 360 IB	130,00	180 139 0007 181 139 0008 182 139 0004	Std, 0,25, 0,50 Std, 0,25, 0,50 Std	8





 							Set Composition / QTY													
1 115,00																				
MB/HL 1, 2, 3, 4, 5, 6, 7	7 Pairs	84,978 85,001	89,397 89,420	32,000	S3S	180 139 0004 00	15 21 26 29	14												
CB/PL 1, 2, 3, 4, 5, 6	6 Pairs	74,980 74,998	78,701 78,719	42,160	S3S	181 139 0004 00	15 21 26 29	12												
TW/A 1	4 Halves	94,615 94,869	112,877 113,131		S3S	182 139 0002 00														
2 115,00																				
MB/HL 1, 2, 3, 4, 5, 6, 7	7 Pairs	89,978 90,000	94,200 94,222	35,500	S3S	180 139 0001 00	15 21	7		7										
MB/HL 1, 2, 3, 4, 5, 6, 7	7 Pairs	94,978 95,000	99,200 99,222	35,400	S3S	180 139 0006 00	15 21	7		7										
CB/PL 1, 2, 3, 4, 5, 6	6 Pairs	79,978 80,000	84,230 84,252	42,250	S3S	181 139 0001 00	15 21 26 29	12												
TW/A 1	4 Halves	100,650 101,000	125,100 125,500		S3S	182 139 0001 00		4												
TW/A 1	4 Halves	105,650 106,000	130,000 130,350		SR	182 139 0005 00														
Cbush/NWL 1, 2, 3, 4, 5, 6, 7	7 Pairs	66,930 66,950	71,000 71,030	35,000	SR	183 139 0001 00														
Bush/PB 1, 2, 3	3 Pairs	49,995 50,000	53,800 53,830	24,100	SR	184 139 0001 99														
Bush/PB 4, 5, 6	3 Pairs	49,995 50,000	53,800 53,830	43,500	SR															
3 127,00																				
MB/HL 1, 2, 3, 4, 5, 6	6 Pairs	101,597 101,620	106,260 106,286	35,710	S3S	180 139 0002 00	15	12		2										
MB/HL 7	1 Pair	101,597 101,620	106,260 106,286	43,740	S3S		21 26 29													
CB/PL 1, 2, 3, 4, 5, 6	6 Pairs	84,234 84,254	88,483 88,503	47,750	S3S	181 139 0002 00	15 21 26 29	12												
TW/A 1	4 Halves	112,649 113,030	132,512 132,893		S3S	182 139 0003 00	09 14	4												
Cbush/NWL 1	1 Pair	68,136 68,155	71,438 71,488	35,310	SR	183 139 0002 99														
Cbush/NWL 2, 3	2 Pairs	68,136 68,155	71,438 71,488	30,400	SR															
Cbush/NWL 4	1 Pair	59,951 59,970	63,475 63,525	30,400	SR															
Bush/PB 1, 2, 3	3 Pairs	49,995 50,000	53,800 53,830	30,100	SR	184 139 0002 99														
Bush/PB 4, 5, 6	3 Pairs	49,995 50,000	53,800 53,830	49,300	SR															











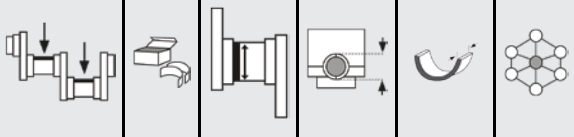

SCANIA

Globally reliable

							Set Composition / QTY															
4	127,00																					
MB/HL 1, 2, 3, 4, 5, 6, 7	7 Pairs	107,978 108,000	112,200 112,222	34,300	S3S	180 139 0005 00 15 21	7		7													
CB/PL 1, 2, 3, 4, 5, 6	6 Pairs	86,978 87,000	91,230 91,252	45,200	S3S	181 139 0005 00 15 21	12															
TW/A 1	4 Halves	118,650 119,050	143,700 144,100		SR	182 139 0004 00	4															
Cbush/NWL 1, 2, 3, 4, 5, 6, 7	7 Pairs	84,930 84,950	89,000 89,035	35,000	SR	183 139 0003 00																
Bush/PB 1, 2, 3	3 Pairs	53,995 54,000	57,800 57,830	26,100	SR	184 139 0003 99																
Bush/PB 4, 5, 6	3 Pairs	53,995 54,000	57,800 57,830	48,260	SR																	
5	127,00																					
MB/HL 1, 2, 3, 4, 5	5 Pairs	101,575 101,620	106,261 106,284	40,000	S3S	180 139 0003 00 15 21 26 29	10															
CB/PL 1, 2, 3, 4, 5, 6, 7, 8	8 Pairs	89,978 90,000	94,000 94,022	40,990	S3S	181 139 0003 00 15 21 26 29	8		8													
TW/A 1	4 Halves	112,649 113,030	132,512 132,893		S3S	182 139 0003 00 09 14	4															
Cbush/NWL 1, 2, 3, 4, 5, 6	6 Pairs	68,951 68,970	73,000 73,030	30,000	SR	183 139 0004 00																
6	127,00																					
MB/HL 1	1 Pair	107,978 108,000	112,200 112,222	34,400	S3S	180 139 0007 00 15 21	1		1													
CB/PL 1, 2, 3, 4, 5, 6	6 Pairs	86,978 87,000	91,230 91,252	45,200	S3S	181 139 0005 00 15 21	12															
TW/A 1	4 Halves	118,650 119,050	143,700 144,100		SR	182 139 0004 00	4															
7	127,00																					
MB/HL 1	1 Pair	107,978 108,000	112,200 112,222	34,400	S3S	180 139 0007 00 15 21	1		1													
CB/PL 1, 2, 3, 4, 5, 6, 7, 8	8 Pairs	92,978 93,000	97,230 97,252	40,350	S3S	181 139 0006 00 15 21	16															
TW/A 1	4 Halves	118,650 119,050	143,700 144,100		SR	182 139 0004 00	4															
8	130,00																					
MB/HL 1	1 Pair	107,978 108,000	112,200 112,222	34,400	S3S	180 139 0007 00 15 21	1		1													
CB/PL 1, 2, 3, 4, 5, 6	6 Pairs	92,978 93,000	97,230 97,252	43,000	S3S	181 139 0008 00 15 21	12															
TW/A 1	4 Halves	118,650 119,050	143,700 144,100		SR	182 139 0004 00	4															

	ccm				Pos.
AZQ, BME	1198	3 IBIZA IV (6L1) 1.2 CORDOBA (6L2) 1.2	76,50	180 050 0022 181 050 0024 Std, 0,25 Std, 0,25	1

  Set Composition / QTY										
1	76,50									
MB/HL 1, 2, 3, 4	4 Pairs	47,960 47,980	55,000 55,016	18,500	SSI	180 050 0022 00 15	4		4	
CB/PL 1, 2, 3	3 Pairs	41,975 41,990	45,000 45,012	15,000	SSI	181 050 0024 00 15	6			

	ccm					Pos.	
781.135, 781.136	1289	4	Favorit 1.3, Favorit 1.3i, Felicia 1.3i, Forman 1.3, Rapid 1.3	75,50	180 153 0001 181 153 0001 182 153 0001	Std, 0,25, 0,50, 0,75 Std, 0,25, 0,50, 0,75 Std, 0,25	1
AZQ, BME	1198	3	FABIA Stufenheck (6Y3) 1.2, FABIA Praktik 1.2, FABIA Combi (6Y5) 1.2, FABIA (6Y2) 1.2	76,50	180 050 0022 181 050 0024	Std, 0,25 Std, 0,25	2



















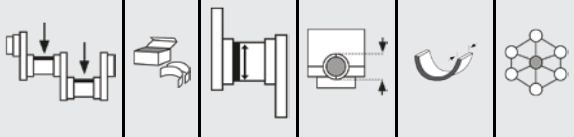













SKODA

Globally reliable







1		75,50																
MB/HL 1, 2, 3	3 Pairs	59,971 59,990	65,000 65,016	24,000	SAL	180 153 0001 00 15 21 26	3		3									
CB/PL 1, 2, 3, 4	4 Pairs	44,975 44,991	48,000 48,011	22,000	SAL	181 153 0001 00 15 21 26	8											
TW/A 1	2 Halves	65,000 65,250	74,750 75,000		SAL	182 153 0001 00 15												
2		76,50																
MB/HL 1, 2, 3, 4	4 Pairs	47,960 47,980	55,000 55,016	18,500	SSI	180 050 0022 00 15	4		4									
CB/PL 1, 2, 3	3 Pairs	41,975 41,990	45,000 45,012	15,000	SSI	181 050 0024 00 15	6											





	ccm						Pos.
WD406	2660	4	Diesel-Tractor 2.66l	92,00	180 055 0002 181 055 0002 182 055 0002	Std, 0,25, 0,50, 0,75, 1,00 Std, 0,25, 0,50, 0,75, 1,00 Std, 0,25, 0,50	1
WD306 WD307	2260	3	Models 190, 540, 545, Plus-Series Steyr 40, Diesel-Tractor 2.26l	98,00	180 055 0002 181 055 0002 182 055 0002	Std, 0,25, 0,50, 0,75, 1,00 Std, 0,25, 0,50, 0,75, 1,00 Std, 0,25, 0,50	1
WD407	3020	4	Diesel-Tractor 3.02l	98,00	180 055 0002 181 055 0002 182 055 0002	Std, 0,25, 0,50, 0,75, 1,00 Std, 0,25, 0,50, 0,75, 1,00 Std, 0,25, 0,50	1
WD308	2360	3	Plus-Series Steyr 40, Diesel-Tractor 2.36l	100,00	180 055 0002 181 055 0002 182 055 0002	Std, 0,25, 0,50, 0,75, 1,00 Std, 0,25, 0,50, 0,75, 1,00 Std, 0,25, 0,50	1
WD408	3140	4	Diesel-Tractor 3.14l	100,00	180 055 0002 181 055 0002 182 055 0002	Std, 0,25, 0,50, 0,75, 1,00 Std, 0,25, 0,50, 0,75, 1,00 Std, 0,25, 0,50	1
WD311.40, B311.41, 311.44	2600	3	Tractors 8055, 8055a, 8060, 8060a,	100,00	180 055 0003 181 055 0001 182 055 0001	Std, 0,25, 0,50, 0,75, 1,00 Std, 0,25, 0,50 Std, 0,25	2
WD411.41, WD411.42, WD411.85, WD411.86	3460	4	Tractors 8070, 8070a, 8080, 8080a	100,00	180 055 0003 181 055 0001 182 055 0001	Std, 0,25, 0,50, 0,75, 1,00 Std, 0,25, 0,50 Std, 0,25	2
WD611.40, WD611.85	5180	6	Tractors 8100, 8100a, 8120, 8120a	100,00	180 055 0003 181 055 0001 182 055 0001	Std, 0,25, 0,50, 0,75, 1,00 Std, 0,25, 0,50 Std, 0,25	2
WD410	3983	4		105,00	180 055 0001 181 055 0001 182 055 0001	Std, 0,25, 0,50, 0,75 Std, 0,25, 0,50 Std, 0,25	3
WD609	5975	6		105,00	180 055 0001 181 055 0001 182 055 0001	Std, 0,25, 0,50, 0,75 Std, 0,25, 0,50 Std, 0,25	3
WD412	4936	4		108,00	180 055 0001 181 055 0001 182 055 0001	Std, 0,25, 0,50, 0,75 Std, 0,25, 0,50 Std, 0,25	3
WD610	9695	6		108,00	180 055 0001 181 055 0001 182 055 0001	Std, 0,25, 0,50, 0,75 Std, 0,25, 0,50 Std, 0,25	3
WD612	6600	6	Truck 591, 592, 691, 692, 791, 791 4x4, Tractor 8140, 8150	108,00	180 055 0004 181 055 0001	Std, 0,25, 0,50, 0,75, 1,00 Std, 0,25, 0,50	4
WD612 (Turbo)	6600	6	Truck 8160, Truck 790, 791, 891, 692, 792, 892	108,00	180 055 0004 181 055 0003	Std, 0,25, 0,50, 0,75, 1,00 Std, 0,25, 0,50, 0,75, 1,00	5
WD615	9700	6	Diesel Trucks Models 991, 991 4x4	126,00	180 055 0005 181 055 0004 181 055 0005	Std, 0,25, 0,50, 0,75, 1,00 Std, 1,00 Std, 0,25, 0,50, 0,75, 1,00	6
WD615 Turbo	9700	6	Truck 1291, 1491, 2891, 1291 4x4, 1491 6x6, 1891	126,00	180 055 0005 181 055 0004 181 055 0006	Std, 0,25, 0,50, 0,75, 1,00 Std, 1,00 Std, 0,25, 0,50, 0,75, 1,00	7
WD815.00	12000	8	Truck 1290, 1291, 1490, 1491	126,00	180 055 0005 181 055 0004	Std, 0,25, 0,50, 0,75, 1,00 Std, 1,00	8
WD815.60 Turbo	12000	8	Truck 1290, 1291, 1491, 1891, 2891	126,00	180 055 0005 181 055 0004 181 055 0006	Std, 0,25, 0,50, 0,75, 1,00 Std, 1,00 Std, 0,25, 0,50, 0,75, 1,00	7



 							Set Composition / QTY														
1 98,00																					
MB/HL 1	1 Pair	64,971 64,990	71,000 71,030	27,500	SSI	180 055 0002 00 15 21 26 29	1		1												
CB/PL 1	1 Pair	59,971 59,990	65,000 65,019	25,000	SSI	181 055 0002 00 15 21 26 29	2														
TW/A 1	4 Halves	75,700	92,700		SAL	182 055 0002 00 15 21	2		2												
2 100,00																					
MB/HL 1	1 Pair	74,974 74,990	81,000 81,035	26,500	SSI	180 055 0003 00 15 21 26 29	1		1												
CB/PL 1	1 Pair	65,951 65,970	71,000 71,019	28,000	S3S	181 055 0001 00 15 21	2														
TW/A 1	2 Halves	85,700	101,700		SAL	182 055 0001 00 15	1		1												
3 105,00																					
MB/HL 1	1 Pair	74,951 74,970	82,000 82,035	30,500	SSI	180 055 0001 00 15 21 26	1		1												
CB/PL 1	1 Pair	65,951 65,970	71,000 71,019	28,000	S3S	181 055 0001 00 15 21	2														
TW/A 1	2 Halves	85,700	101,700		SAL	182 055 0001 00 15	1		1												
4 108,00																					
MB/HL 1	1 Pair	79,951 79,970	87,000 87,022	29,500	SSI	180 055 0004 00 15 21 26 29	1		1												
CB/PL 1	1 Pair	65,951 65,970	71,000 71,019	28,000	S3S	181 055 0001 00 15 21	2														
5 108,00																					
MB/HL 1	1 Pair	79,951 79,970	87,000 87,022	29,500	SSI	180 055 0004 00 15 21 26 29	1		1												
CB/PL 1	1 Pair	65,951 65,970	71,000 71,019	28,000	RIL	181 055 0003 00 15 21 26 29	1		1												



















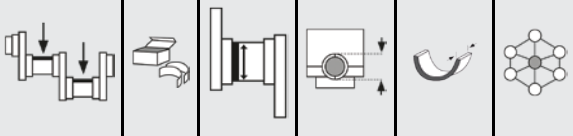







Set Composition / QTY

6	126,00																	
MB/HL 1	1 Pair	99,978 100,000	108,000 108,220	35,000	SSI	180 055 0005 00 15 21 26 29	1		1									
CB/PL 1	1 Pair	81,978 82,000	88,000 88,022	35,000	S3S	181 055 0004 00 29	2											
CB/PL 1	1 Pair	81,978 82,000	88,000 88,022	35,000	S3S	181 055 0005 00 15 21 26 29	2											

7	126,00																	
MB/HL 1	1 Pair	99,978 100,000	108,000 108,220	35,000	SSI	180 055 0005 00 15 21 26 29	1		1									
CB/PL 1	1 Pair	81,978 82,000	88,000 88,022	35,000	S3S	181 055 0004 00 29	2											
CB/PL 1	1 Pair	81,978 82,000	88,000 88,022	35,000	RIL	181 055 0006 00 15 21 26 29	1		1									

8	126,00																	
MB/HL 1	1 Pair	99,978 100,000	108,000 108,220	35,000	SSI	180 055 0005 00 15 21 26 29	1		1									
CB/PL 1	1 Pair	81,978 82,000	88,000 88,022	35,000	S3S	181 055 0004 00 29	2											

	ccm						Pos.
EN07	658	4	Pleo, R1, R2	56,00	180 092 0001 181 092 0001 182 092 0001	Std, 0,25, 0,50 Std, 0,25, 0,50 Std	1
1KR-FE	998	3	JUSTY IV 1.0	71,00	180 096 0032 181 096 0042 182 096 0030	Std, 0,25, 0,50, 0,75 Std, 0,25, 0,50, 0,75 Std	2
EF10	997	3	Justy, Domingo 10/1983-	78,00	180 092 0005 181 092 0007	Std, 0,25, 0,50 Std, 0,25	3
M15A	1490	4	JUSTY III (G3X) 1.5 AWD	78,00	180 094 0008 181 094 0009 182 094 0004	Std, 0,25, 0,50 Std, 0,25, 0,50 Std	5
EF12	1189	3	Justy, Domingo 10/1985-	78,00	180 092 0005 181 092 0008	Std, 0,25, 0,50 Std, 0,25, 0,50	4
EA64	1176	4	Leone 10/78-9/79	79,00	180 092 0003 181 092 0005 184 092 0001	Std, 0,25, 0,50 Std, 0,25, 0,50 Std	6
EA65	1298	4	Leone 10/79-10/89	83,00	180 092 0003 181 092 0005 184 092 0001	Std, 0,25, 0,50 Std, 0,25, 0,50 Std	6
EA63	1361	4	Leone 10/78-9/79	85,00	180 092 0003 181 092 0005 184 092 0001	Std, 0,25, 0,50 Std, 0,25, 0,50 Std	6
EJ15	1493	4	Impreza	85,00	180 092 0002 181 092 0003	Std, 0,25, 0,50 Std	7
EJ16	1597	4	Impreza	87,90	180 092 0002 181 092 0003	Std, 0,25, 0,50 Std	7
EJ18	1820	4	Legacy	87,90	180 092 0002 181 092 0004	Std, 0,25, 0,50 Std, 0,25, 0,50	8
EA71	1595	4	Leone 10/1978-	92,00	180 092 0003 181 092 0005 184 092 0001	Std, 0,25, 0,50 Std, 0,25, 0,50 Std	6
EA81	1781	4	Leone 6/79-10/84	92,00	180 092 0004 181 092 0005 184 092 0001	Std, 0,25 Std, 0,25, 0,50 Std	9
EA81-T	1781	4	Leone 8/82-10/84	92,00	180 092 0004 181 092 0005 184 092 0001	Std, 0,25 Std, 0,25, 0,50 Std	9
EA82	1781	4	Leone 6/84-	92,00	180 092 0004 181 092 0005 184 092 0001	Std, 0,25 Std, 0,25, 0,50 Std	9
EA82	1781	4	Leone 6/1984-	92,00	180 092 0004 181 092 0006 184 092 0001	Std, 0,25 Std, 0,25 Std	10
EA82-T	1781	4	Leone 6/84-8/91	92,00	180 092 0004 181 092 0006 184 092 0001	Std, 0,25 Std, 0,25 Std	10
ER27	2672	6	Arcyone 7/87-9/91	92,00	180 092 0006 181 092 0009	Std, 0,25 Std, 0,25	11
EJ20	1994	4	Legacy	92,00	180 092 0002 181 092 0004	Std, 0,25, 0,50 Std, 0,25, 0,50	8







 							Set Composition / QTY														
1 56,00																					
MB/HL 1, 2, 3, 4, 5	5 Pairs	41,985	45,000	14,100	S3S	180 092 0001 00 15 21	10														
CB/PL 1, 2, 3, 4	4 Pairs	31,000	34,000	13,500	S3S	181 092 0001 00 15 21	8														
TW/A 1	4 Halves	47,250	57,650		SAL	182 092 0001 00	2		2												
2 71,00																					
MB/HL 1, 2, 3, 4	4 Pairs	44,000	48,000	14,900	SAL	180 096 0032 00 15 21 26	4		4												
CB/PL 1, 2, 3	3 Pairs	40,000	43,000	13,500	SAL	181 096 0042 00 15 21 26	6														
TW/A 1	2 Halves	52,000	63,000		SAL	182 096 0030 00	2														
3 78,00																					
MB/HL 1, 3, 4	3 Pairs	41,980	45,000	20,130	S3S	180 092 0005 00 15 21															
MB/HL 2	1 Pair	41,980	45,000	24,960	S3S	180 092 0005 00 15 21															
CB/PL 1, 2, 3	3 Pairs	42,000	45,000	15,130	S3S	181 092 0007 00 15															
4 78,00																					
MB/HL 1, 3, 4	3 Pairs	41,980	45,000	20,130	S3S	180 092 0005 00 15 21															
MB/HL 2	1 Pair	41,980	45,000	24,960	S3S	180 092 0005 00 15 21															
CB/PL 1, 2, 3	3 Pairs	42,000	45,000	15,130	S3S	181 092 0008 00 15 21	6														
5 78,00																					
MB/HL 1, 2, 3, 4, 5	5 Pairs	52,000	56,000	18,000	SAL	180 094 0008 00 15 21	5		5												
CB/PL 1, 2, 3, 4	4 Pairs	42,000	45,000	18,000	SAL	181 094 0009 00 15 21	8														
TW/A 1	2 Halves	59,250	75,000		SAL	182 094 0004 00	2														
6 85,00																					
MB/HL 1, 3	2 Pairs	49,960	53,987	21,130	SAL	180 092 0003 00 15	4		2												
MB/HL 2	1 Pair	49,960	53,987	25,960	SAL	180 092 0003 00 15	21														
CB/PL 1, 2, 3, 4	4 Pairs	45,000	48,000	13,630	SAL	181 092 0005 00 15 21	8														
Bush/PB 1, 2, 3, 4	4 Pairs	21,000	23,000	19,400	SL	184 092 0001 00															



SUBARU

Globally reliable

							Set Composition / QTY													
7	85,00																			
MB/HL 1, 2, 3, 4	4 Pairs	60,000	64,000	15,130	SAL	180 092 0002 00 15	4		4		2									
MB/HL 5	1 Pair	60,000	64,000	22,940	SAL	21														
CB/PL 1, 2, 3, 4	4 Pairs	48,000	51,000	15,630	SAL	181 092 0003 00	8													
8	87,90																			
MB/HL 1, 2, 3, 4	4 Pairs	60,000	64,000	15,130	SAL	180 092 0002 00 15	4		4		2									
MB/HL 5	1 Pair	60,000	64,000	22,940	SAL	21														
CB/PL 1, 2, 3, 4	4 Pairs	52,000	55,000	16,630	SAL	181 092 0004 00 15 21	8													
9	92,00																			
MB/HL 1, 3	2 Pairs	54,965	59,000	21,130	SAL	180 092 0004 00 15														
MB/HL 2	1 Pair	54,965	59,000	25,960	SAL															
CB/PL 1, 2, 3, 4	4 Pairs	45,000	48,000	13,630	SAL	181 092 0005 00 15 21	8													
Bush/PB 1, 2, 3, 4	4 Pairs	21,000	23,000	19,400	SL	184 092 0001 00														
10	92,00																			
MB/HL 1, 3	2 Pairs	54,965	59,000	21,130	SAL	180 092 0004 00 15														
MB/HL 2	1 Pair	54,965	59,000	25,960	SAL															
CB/PL 1, 2, 3, 4	4 Pairs	45,005	48,000	14,630	SAL	181 092 0006 00 15														
Bush/PB 1, 2, 3, 4	4 Pairs	21,000	23,000	19,400	SL	184 092 0001 00														
11	92,00																			
MB/HL 1, 3, 4	3 Pairs	54,965	59,000	21,130	SAL	180 092 0006 00 15														
MB/HL 2	1 Pair	54,965	59,000	24,960	SAL															
CB/PL 1, 2, 3, 4, 5, 6	6 Pairs	45,005	48,000	14,630	SAL	181 092 0009 00 15														











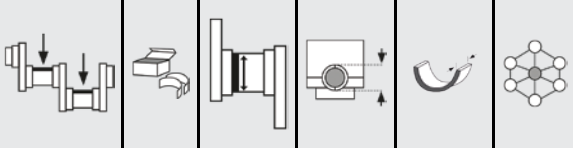









	ccm						Pos.
F5A	543	3	Fronte, Carry, Cervo 5/79-2/90	62,00	180 094 0001 182 094 0001	Std, 0,25, 0,50 Std	1
F5A-T	543	3	Fronte, Carry 5/79-9/89	62,00	180 094 0001 181 094 0001 182 094 0001	Std, 0,25, 0,50 Std, 0,25, 0,50, 0,75, 1,00 Std	2
F5B	543	3	1988-	62,00	180 094 0001 182 094 0001	Std, 0,25, 0,50 Std	1
F8A	797	4	Jimny, Alto 12/79-9/88	62,00	180 094 0002 181 094 0003 182 094 0002	Std, 0,25, 0,50, 0,75, 1,00 Std, 0,25, 0,50, 0,75, 1,00 Std	3
F6A	657	3	.	65,00	180 094 0007 181 094 0008	Std, 0,25, 0,50, 0,75 Std, 0,25, 0,50, 0,75	4
F10A	970	4	Jimny, Alto 8/82-7/91	65,50	180 094 0002 181 094 0003 182 094 0002	Std, 0,25, 0,50, 0,75, 1,00 Std, 0,25, 0,50, 0,75, 1,00 Std	3
K10B	998	3	ALTO 1.0	73,00	180 094 0003 181 094 0010	Std, 0,25, 0,50, 0,75, 1,00 Std, 0,25, 0,50, 0,75, 1,00	5
8HY	1398	4	LIANA 1.4 DDiS, ESCUDO 1.4 DDiS	73,70	180 051 0001 181 037 0015 182 051 0001	Std, 0,25, 0,30, 0,50, 0,80 Std, 0,30, 0,50 Std	6
G13B	1298	4	Cultus 8/1984-	74,00	180 094 0004 181 094 0005 182 094 0003	Std, 0,25, 0,50, 0,75, 1,00 Std, 0,25, 0,50, 0,75, 1,00 Std	8
G13BA	1298	4	Cultus 9/1988-	74,00	180 094 0004 181 094 0005 182 094 0003	Std, 0,25, 0,50, 0,75, 1,00 Std, 0,25, 0,50, 0,75, 1,00 Std	8
G13B	1298	4	Cultus 8/1984-	74,00	180 094 0004 181 094 0007 182 094 0003	Std, 0,25, 0,50, 0,75, 1,00 Std Std	9
G10	993	3	Fronte 10/83-7/91	74,00	180 094 0003 181 094 0004 182 094 0003	Std, 0,25, 0,50, 0,75, 1,00 Std Std	7
G10-T	993	3	Fronte 5/1984-9/88	74,00	180 094 0003 181 094 0004 182 094 0003	Std, 0,25, 0,50, 0,75, 1,00 Std Std	7
G13A	1324	4	Cultus 8/84-9/88	74,00	180 094 0004 181 094 0005 182 094 0003	Std, 0,25, 0,50, 0,75, 1,00 Std, 0,25, 0,50, 0,75, 1,00 Std	8
G15A	1493	4	Escude, Cultus 7/1991-	75,00	180 094 0005 181 094 0006 182 094 0004	Std, 0,25, 0,50 Std, 0,25, 0,50 Std	10
G16A	1590	4	Escude, Cultus 5/1988-	75,00	180 094 0005 181 094 0006 182 094 0004	Std, 0,25, 0,50 Std, 0,25, 0,50 Std	10
G16B	1590	4	Escude, Cultus 8/1991-	75,00	180 094 0005 181 094 0006 182 094 0004	Std, 0,25, 0,50 Std, 0,25, 0,50 Std	10
M15A	1490	4	IGNIS 1.5, SX4 1.5, SWIFT 1.5, LIANA 1.5,	78,00	180 094 0008 181 094 0009 182 094 0004	Std, 0,25, 0,50 Std, 0,25, 0,50 Std	11
M16A	1586	4	VITARA 1.6, SX4 1.6, SWIFT 1.6., LIANA 1.6, GRAND VITARA 1.6	78,00	180 094 0008 181 094 0009 182 094 0004	Std, 0,25, 0,50 Std, 0,25, 0,50 Std	11
F8B	796	3	Alto 12/79-7/91	79,60	180 094 0006 181 094 0001 182 094 0002	Std, 0,25, 0,50, 0,75, 1,00 Std, 0,25, 0,50, 0,75, 1,00 Std	12
M18A	1796	4	LIANA 1.8, AERIO 1.8	83,00	180 094 0008 181 094 0009 182 094 0004	Std, 0,25, 0,50 Std, 0,25, 0,50 Std	11



SUZUKI

Globally reliable

							Set Composition / QTY													
1 62,00																				
MB/HL 1, 2, 3, 4	4 Pairs	40,000	44,000	17,130	SAL	180 094 0001 00 15 21														
TW/A 1	2 Halves	47,250	63,000		SAL	182 094 0001 00														
2 62,00																				
MB/HL 1, 2, 3, 4	4 Pairs	40,000	44,000	17,130	SAL	180 094 0001 00 15 21														
CB/PL 1, 2, 3	3 Pairs	38,000	41,000	18,100	SAL	181 094 0001 00 15 21 26 29	6													
TW/A 1	2 Halves	47,250	63,000		SAL	182 094 0001 00														
3 62,00																				
MB/HL 1, 2, 3, 4, 5	5 Pairs	50,000	54,000	20,100	SAL	180 094 0002 00 15 21 26 29	10													
CB/PL 1, 2, 3, 4	4 Pairs	38,000	41,000	18,100	SAL	181 094 0003 00 15 21 26 29	8													
TW/A 1	2 Halves	57,250	73,000		SAL	182 094 0002 00	2													
4 65,00																				
MB/HL 1, 2, 3, 4	4 Pairs	44,000	48,000	17,100	SAL	180 094 0007 00 15 21 26	8													
CB/PL 1, 2, 3	3 Pairs	35,980	39,010	16,100	SAL	181 094 0008 00 15 21 26	6													
5 73,00																				
MB/HL 1, 2, 3, 4	4 Pairs	45,000	49,000	18,100	SAL	180 094 0003 00 15 21 26 29	4		4											
CB/PL 1, 2, 3	3 Pairs	41,020	44,224	16,000	SAL	181 094 0010 00 15 21 26 29	6													
6 73,70																				
MB/HL 1, 2, 3, 4, 5	5 Pairs	49,962 49,981	53,655 53,674	19,900	SAL	180 051 0001 00 15 17 21 28	5		5											
CB/PL 1, 2, 3, 4	4 Pairs	44,975 44,991	48,665 48,671	17,050	S4S	181 037 0015 00 17 21	4		4											
TW/A 1	2 Halves	55,200 55,480	71,350 71,700		SAL	182 051 0001 00	2													

 							Set Composition / QTY									
7 74,00																
MB/HL 1, 2, 3, 4	4 Pairs	45,000	49,000	18,100	SAL	180 094 0003 00	15 21 26 29	4		4						
CB/PL 1, 2, 3	3 Pairs	42,000	45,000	18,100	SAL	181 094 0004 00		6								
TW/A 1	2 Halves	52,250	68,000		SAL	182 094 0003 00		2								
8 74,00																
MB/HL 1, 2, 3, 4, 5	5 Pairs	45,000	49,000	18,100	SAL	180 094 0004 00	15 21 26 29	5		5						
CB/PL 1, 2, 3, 4	4 Pairs	42,000	45,000	18,100	SAL	181 094 0005 00	15 21 26 29	8								
TW/A 1	2 Halves	52,250	68,000		SAL	182 094 0003 00		2								
9 74,00																
MB/HL 1, 2, 3, 4, 5	5 Pairs	45,000	49,000	18,100	SAL	180 094 0004 00	15 21 26 29	5		5						
CB/PL 1, 2, 3, 4	4 Pairs	42,000	45,000	18,100	S3S	181 094 0007 00										
TW/A 1	2 Halves	52,250	68,000		SAL	182 094 0003 00		2								
10 75,00																
MB/HL 1, 2, 3, 4, 5	5 Pairs	52,000	56,000	18,100	SAL	180 094 0005 00	15 21	5		5						
CB/PL 1, 2, 3, 4	4 Pairs	44,000	47,000	18,100	SAL	181 094 0006 00	15 21	8								
TW/A 1	2 Halves	59,250	75,000		SAL	182 094 0004 00		2								
11 78,00																
MB/HL 1, 2, 3, 4, 5	5 Pairs	52,000	56,000	18,000	SAL	180 094 0008 00	15 21	5		5						
CB/PL 1, 2, 3, 4	4 Pairs	42,000	45,000	18,000	SAL	181 094 0009 00	15 21	8								
TW/A 1	2 Halves	59,250	75,000		SAL	182 094 0004 00		2								









SUZUKI

Globally reliable



Set Composition / QTY







12		79,60																	
MB/HL 1, 2, 3, 4	4 Pairs	50,000	54,000	17,100	SAL	180 094 0006 00	15	8											
							21												
							26												
							29												
CB/PL 1, 2, 3	3 Pairs	38,000	41,000	18,100	SAL	181 094 0001 00	15	6											
							21												
							26												
							29												
TW/A 1	2 Halves	57,250	73,000		SAL	182 094 0002 00		2											







	ccm						Pos.
1SZ-FE	998	4	YARIS 1.0, VITZ 1.0	69,00	180 070 0008 180 096 0035 181 096 0047 182 070 0001	Std, 0,25, 0,50 Std, 0,25, 0,50, 0,75 Std, 0,25, 0,50, 0,75 Std	1
1E	999	4	Starlet, Tercel 10/1984-	70,50	180 096 0006 181 096 0013 182 096 0012	Std, 0,25, 0,50, 0,75 Std, 0,25, 0,50, 0,75 Std, 0,25	2
1KR-FE	998	3	AYGO 1.0, BELTA 1.0, IQ 1.0, PASSO 1.0, VITZ 1.0, YARIS 1.0,	71,00	180 096 0032 181 096 0042 182 096 0030	Std, 0,25, 0,50, 0,75 Std, 0,25, 0,50, 0,75 Std	3
2K	993	4	Starlet, Townace, Corolla, Liteace 8/82-9/86	72,00	180 096 0001 181 096 0006 181 096 0007 182 096 0007	Std, 0,25, 0,50 Std, 0,25, 0,50 Std, 0,25, 0,50 Std	4
2E	1295	4	Starlet, Tercel 10/1984-	73,00	180 096 0006 181 096 0013 182 096 0012	Std, 0,25, 0,50, 0,75 Std, 0,25, 0,50, 0,75 Std, 0,25	2
1N / 1N-T	1453	4	Starlet, Prius, Corolla 12/1986-	74,00	180 096 0013 181 096 0022 182 096 0007 184 096 0001	Std, 0,25, 0,50 Std, 0,25, 0,50 Std Std	5
3K	1166	4	Starlet, Townace, Corolla, Liteace 8/82-10/83	75,00	180 096 0001 181 096 0006 181 096 0007 182 096 0007	Std, 0,25, 0,50 Std, 0,25, 0,50 Std, 0,25, 0,50 Std	4
4K	1290	4	Starlet, Townace, Corolla, Liteace 8/82-8/90	75,00	180 096 0001 181 096 0006 181 096 0007 182 096 0007	Std, 0,25, 0,50 Std, 0,25, 0,50 Std, 0,25, 0,50 Std	4
2NZ-FE	1298	4	Funcargo, Ist, Porte, Raum, Ractis, Vios, Yaris	75,00	180 096 0027 181 096 0037 182 096 0028	Std, 0,25 Std, 0,25, 0,50, 0,75 Std	7
M	1988	6	Cressida 10/84-8/89	75,00	180 096 0024 181 096 0004 182 096 0005	Std, 0,25 Std, 0,25, 0,50 Std	6
1NZ-FE	1496	4	Funcargo, Ist, Porte, Raum, Ractis, Vios, Yaris 1.5	75,00	180 096 0027 181 096 0037 182 096 0028	Std, 0,25 Std, 0,25, 0,50, 0,75 Std	7
5WZ-HV (DV5RUC), 5WZ-TV (DV5RUCD), DV5RC, DV5RD, DV5RE	1499	4	PROACE 1.5 D-4D 75/100/130	75,00	180 037 0015 181 037 0023	Std, 0,25, 0,50 Std, 0,25, 0,50	8
2A	1295	4	Tercel, Carina 1/83-7/83	76,00	180 096 0025 181 096 0001 182 096 0003	Std, 0,25, 0,50 Std Std	9
2A	1295	4	Corolla, Corona 7/83-5/85	76,00	180 096 0025 181 096 0002 182 096 0003	Std, 0,25, 0,50 Std, 0,25, 0,50 Std	10
3A	1452	4	Tercel, Carina 1/83-10/83	77,50	180 096 0025 181 096 0001 182 096 0003	Std, 0,25, 0,50 Std Std	9
3A	1452	4	Corolla, Corona 10/83-9/90	77,50	180 096 0025 181 096 0002 182 096 0003	Std, 0,25, 0,50 Std, 0,25, 0,50 Std	10
1VZ-FE	1992	6	Camry	78,00	180 096 0010 181 096 0017 182 096 0017	Std, 0,25, 0,50 Std, 0,25, 0,50 Std	11
5A	1498	4	Corolla, Corona 5/1987-	78,70	180 096 0025 181 096 0002 182 096 0003	Std, 0,25, 0,50 Std, 0,25, 0,50 Std	10
3ZZ-FE	1598	4	Corolla 1.6	79,00	180 096 0026 181 096 0035 182 096 0028	Std, 0,25, 0,50, 0,75 Std, 0,25, 0,50, 0,75 Std	12
1ZZ-FE	1794	4	ALLION 1.8, COROLLA 1.8, PREMIO 1.8	79,00	180 096 0026 181 096 0035 182 096 0028	Std, 0,25, 0,50, 0,75 Std, 0,25, 0,50, 0,75 Std	12
5K	1486	4	Starlet, Townace, Corolla, Liteace 9/1985-	80,50	180 096 0001 181 096 0006 181 096 0007 182 096 0007	Std, 0,25, 0,50 Std, 0,25, 0,50 Std, 0,25, 0,50 Std	4
1S	1832	4	Celica, Camry, Carina 3/82-8/88	80,50	180 096 0005 181 096 0011 182 096 0011	Std, 0,25, 0,50 Std, 0,25, 0,50 Std	13
4A	1587	4	Tercel, Carina 1/83-7/83	81,00	180 096 0025 181 096 0001 182 096 0003	Std, 0,25, 0,50 Std Std	9
4A	1587	4	Corolla, Corona 10/1983-	81,00	180 096 0025 181 096 0002 182 096 0003	Std, 0,25, 0,50 Std, 0,25, 0,50 Std	10
4A-GZE	1587	4	5/1987-	81,00	180 096 0025 182 096 0003	Std, 0,25, 0,50 Std	14



TOYOTA

Globally reliable







	ccm						Pos.
1CD-FTV	1995	4	COROLLA 2.0 D-4D, AVENSIS 2.0 D-4D, RAV 4 II 2.0 D-4D	82,20	180 096 0023 182 096 0019	Std, 0,25, 0,50, 0,75 Std	15
4S	1838	4	Ipsum 4/1987-	82,50	180 096 0005 181 096 0011 182 096 0011	Std, 0,25, 0,50 Std, 0,25, 0,50 Std	13
5M	2759	6	8/84-8/90	83,00	180 096 0024 181 096 0020 182 096 0005	Std, 0,25 Std, 0,25, 0,50 Std	16
1C	1839	4	Corona 1/82-8/85	83,00	180 096 0012 181 096 0021 182 096 0019	Std, 0,25, 0,50, 0,75 Std, 0,25, 0,50 Std	17
1C	1839	4	Corona, Camry 8/85-8/90	83,00	180 096 0012 181 096 0021 182 096 0019	Std, 0,25, 0,50, 0,75 Std, 0,25, 0,50 Std	17
1C	1839	4	Corona 8/90-10/91	83,00	180 096 0012 181 096 0021 181 096 0036 182 096 0019	Std, 0,25, 0,50, 0,75 Std, 0,25, 0,50 Std, 0,25, 0,50, 0,75 Std	18
6M	2954	6	8/84-8/87	83,00	180 096 0024 181 096 0020 182 096 0005	Std, 0,25 Std, 0,25, 0,50 Std	16
7M	2954	6	1/1986-	83,00	180 096 0024 181 096 0020 182 096 0005	Std, 0,25 Std, 0,25, 0,50 Std	16
21R	1972	4	3/82-8/84	84,00	180 096 0003 182 096 0008	Std, 0,25, 0,50, 0,75, 1,00 Std	28
21R	1972	4	8/84-8/88	84,00	180 096 0003 182 096 0009	Std, 0,25, 0,50, 0,75, 1,00 Std	19
2S	1995	4	Celica, Camry, Carina 8/82-8/86	84,00	180 096 0005 181 096 0011 182 096 0011	Std, 0,25, 0,50 Std, 0,25, 0,50 Std	13
1Y	1626	4	Liteace, Townace, Hilux 10/82-8/88	86,00	180 096 0002 181 096 0008 182 096 0011	Std, 0,25, 0,50, 0,75, 1,00, 1,25, 1,50 Std, 0,25, 0,50, 0,75, 1,00, 1,25, 1,50 Std	23
2Y	1812	4	Liteace, Townace, Hilux 12/1982-	86,00	180 096 0002 181 096 0008 182 096 0011	Std, 0,25, 0,50, 0,75, 1,00, 1,25, 1,50 Std, 0,25, 0,50, 0,75, 1,00, 1,25, 1,50 Std	23
2C	1974	4	Corona 11/1982-	86,00	180 096 0012 181 096 0021 182 096 0019	Std, 0,25, 0,50, 0,75 Std, 0,25, 0,50 Std	17
2C	1974	4	Corona, Camry 8/85-8/90	86,00	180 096 0012 181 096 0021 182 096 0019	Std, 0,25, 0,50, 0,75 Std, 0,25, 0,50 Std	17
2C	1974	4	Corona 8/1985-	86,00	180 096 0012 181 096 0021 181 096 0036 182 096 0019	Std, 0,25, 0,50, 0,75 Std, 0,25, 0,50 Std, 0,25, 0,50, 0,75 Std	18
1AZ-FE	1998	4	2000-	86,00	180 096 0030 181 096 0039	Std, 0,25, 0,50 Std, 0,25, 0,50	20
1RZ	1989	4	Hiace, Land Cruiser 8/89-	86,00	180 096 0004 181 096 0010 182 096 0010	Std, 0,25, 0,50 Std, 0,25, 0,50 Std, 0,25	48
3S	1998	4	Celica, Camry, Carina 6/84-8/86	86,00	180 096 0005 181 096 0011 182 096 0011	Std, 0,25, 0,50 Std, 0,25, 0,50 Std	13
3S	1998	4	Ipsum 8/86-7/90	86,00	180 096 0005 181 096 0011 182 096 0011	Std, 0,25, 0,50 Std, 0,25, 0,50 Std	13
3S	1998	4	Ipsum, Townace, Liteace 8/1986-	86,00	180 096 0005 182 096 0011	Std, 0,25, 0,50 Std	21
1TR-FE	1998	4	Innova, Hilux	86,00	180 096 0028 181 096 0045 182 096 0029	Std, 0,25, 0,50, 0,75 Std, 0,25, 0,50 Std	22
3Y	1998	4	Liteace, Townace, Hilux 12/1982-	86,00	180 096 0002 181 096 0008 182 096 0011	Std, 0,25, 0,50, 0,75, 1,00, 1,25, 1,50 Std, 0,25, 0,50, 0,75, 1,00, 1,25, 1,50 Std	23
3C	2184	4	Corona 5/1990-	86,00	180 096 0012 181 096 0021 181 096 0036 182 096 0019	Std, 0,25, 0,50, 0,75 Std, 0,25, 0,50 Std, 0,25, 0,50, 0,75 Std	18
5S	2164	4	Ipsum, Townace, Liteace	87,00	180 096 0005 182 096 0011	Std, 0,25, 0,50 Std	21
4VZ-FE	2496	6	Camry	87,50	180 096 0010 181 096 0019 182 096 0017	Std, 0,25, 0,50 Std, 0,25, 0,50 Std	24
3VZ-FE	2959	6	Septer	87,50	180 096 0010 181 096 0019 182 096 0017	Std, 0,25, 0,50 Std, 0,25, 0,50 Std	24
3VZ-E	2959	6	Hilux	87,50	180 096 0011 181 096 0018 182 096 0017	Std, 0,25, 0,50 0,50 Std	25







	ccm						Pos.
H	3576	6	Dyna, Forklift, Coaster 2/69-8/80	88,00	180 096 0020 181 096 0044 182 096 0023	Std, 0,25, 0,50 Std, 0,25, 0,50 Std	26
2J	2481	4	Dyna, Toyoace 11/75-9/91	88,00	180 096 0019 181 096 0028 182 096 0023 184 096 0003	Std Std, 0,25, 0,50 Std Std	27
2J-T	2481	4	Dyna, Toyoace 5/1982-	88,00	180 096 0019 181 096 0028 182 096 0023 184 096 0003	Std Std, 0,25, 0,50 Std Std	27
20R	2189	4	3/82-4/82	88,50	180 096 0003 182 096 0008	Std, 0,25, 0,50, 0,75, 1,00 Std	28
2AZ-FE	2362	4		88,50	180 096 0030 181 096 0039	Std, 0,25, 0,50 Std, 0,25, 0,50	20
L	2188	4	Crown, Hilux, Toyoace 10/77-2/82	90,00	181 096 0024 182 096 0021 183 096 0005 184 096 0003	Std, 0,25, 0,50 Std, 0,25 Std Std	30
L	2188	4	2/82-4/83	90,00	181 096 0025 182 096 0021 183 096 0005 184 096 0003	Std, 0,25, 0,50, 0,75, 1,00 Std, 0,25 Std Std	31
L	2188	4	4/83-8/88	90,00	180 096 0016 181 096 0025 182 096 0021 183 096 0005 184 096 0003	Std, 0,25, 0,50, 0,75 Std, 0,25, 0,50, 0,75, 1,00 Std, 0,25 Std Std	32
F	3878	6	Land Cruiser 9/73-9/75	90,00	180 096 0007 181 096 0014	Std, 0,25, 0,50 Std, 0,25, 0,50	29
4Y	2237	4	Liteace, Townace, Hilux 8/1986-	91,00	180 096 0002 181 096 0008 182 096 0011	Std, 0,25, 0,50, 0,75, 1,00, 1,25, 1,50 Std, 0,25, 0,50, 0,75, 1,00, 1,25, 1,50 Std	23
2H	3980	6	Dyna, Forklift, Coaster 11/79-4/82	91,00	180 096 0020 181 096 0044 182 096 0023	Std, 0,25, 0,50 Std, 0,25, 0,50 Std	26
2H	3980	6	Dyna, Coaster, Land Cruiser 4/82-10/85	91,00	180 096 0020 181 096 0029 181 096 0044 182 096 0023	Std, 0,25, 0,50 Std, 0,25, 0,50 Std, 0,25, 0,50 Std	33
2H	3980	6	Dyna, Coaster, Land Cruiser 10/85-9/91	91,00	180 096 0020 181 096 0029 182 096 0024	Std, 0,25, 0,50 Std, 0,25, 0,50 Std	34
12H-T	3980	6	Coaster, Land Cruiser 10/85-9/87	91,00	180 096 0020 181 096 0029 182 096 0024	Std, 0,25, 0,50 Std, 0,25, 0,50 Std	34
22R	2366	4	3/82-8/84	92,00	180 096 0003 182 096 0008	Std, 0,25, 0,50, 0,75, 1,00 Std	28
22R	2366	4	8/1984-	92,00	180 096 0003 182 096 0009	Std, 0,25, 0,50, 0,75, 1,00 Std	19
2L	2446	4	2/82-8/83	92,00	181 096 0025 182 096 0021 183 096 0005 184 096 0003	Std, 0,25, 0,50, 0,75, 1,00 Std, 0,25 Std Std	31
2L / 2L-T	2446	4	8/82-8/83	92,00	181 096 0026 182 096 0021 183 096 0005	Std, 0,25, 0,50, 0,75 Std, 0,25 Std	35
2 L	2446	4	8/83-7/88	92,00	180 096 0016 181 096 0025 182 096 0021 183 096 0005 184 096 0003	Std, 0,25, 0,50, 0,75 Std, 0,25, 0,50, 0,75, 1,00 Std, 0,25 Std Std	32
2L	2446	4	8/1990-	92,00	180 096 0016 181 096 0025 182 096 0021 183 096 0002	Std, 0,25, 0,50, 0,75 Std, 0,25, 0,50, 0,75, 1,00 Std, 0,25 Std	36
2L-T	2446	4	8/83-8/88	92,00	180 096 0016 181 096 0026 182 096 0021 183 096 0005	Std, 0,25, 0,50, 0,75 Std, 0,25, 0,50, 0,75 Std, 0,25 Std	37
2L-T	2446	4	8/1988-	92,00	180 096 0016 181 096 0026 182 096 0021 183 096 0002 184 096 0002	Std, 0,25, 0,50, 0,75 Std, 0,25, 0,50, 0,75 Std, 0,25 Std Std	38
2KD-FTV	2494	4	Land Cruiser Prado, Hiace Van, Regiusace Van, Innova, Fortuner	92,00	180 096 0023 181 096 0034 182 096 0026	Std, 0,25, 0,50, 0,75 Std, 0,25, 0,50, 0,75 Std	50
5P	2771	4	Dyna, Toyoace 11/75-10/85	93,00	180 096 0019 181 096 0028 182 096 0023 184 096 0003	Std Std, 0,25, 0,50 Std Std	27
5VZ-FE	3378	6	4Runner, T100, Tacoma 3.4 i	93,50	180 096 0034 181 096 0046	Std, 0,25, 0,50, 0,75, 1,00 Std, 0,25, 0,50, 0,75, 1,00	39



TOYOTA

Globally reliable

	ccm						Pos.
1UR-FE	4608	8	LAND CRUISER 4.6 V8, TUNDRA 4.6 V8	94,00	180 096 0037 181 096 0052	Std Std	43
3F	3955	6	Land Cruiser 1984-	94,00	181 096 0015 182 096 0015	Std, 0,25, 0,50 Std	40
1GR-FE	3956	6	TUNDRA Pick-up 4.0, LAND CRUISER PRADO 4.0, FORTUNER 4.0, 4 RUNNER 4.0, HILUX 4.0	94,00	180 096 0033 181 096 0043 182 096 0031	Std, 0,25, 0,50, 0,75 Std, 0,25, 0,50, 0,75 Std	44
1H-Z	4163	6	1/1990-	94,00	180 096 0014 181 096 0023 182 096 0020	Std, 0,25, 0,50, 0,75 Std, 0,25, 0,50, 0,75 Std	41
1HD	4163	6	1/1990-	94,00	180 096 0014 181 096 0023 182 096 0020	Std, 0,25, 0,50, 0,75 Std, 0,25, 0,50, 0,75 Std	41
2F	4230	6	Land Cruiser 4/75-11/84	94,00	180 096 0007 181 096 0014	Std, 0,25, 0,50 Std, 0,25, 0,50	29
3UR-FE	5663	8	Tundra 5.7, Land Cruiser 5.7	94,00	180 096 0037 181 096 0050	Std Std	42
2TZ-FE	2438	4	Carina, Celica, Corolla 1990-	95,00	180 096 0004 181 096 0010 182 096 0010	Std, 0,25, 0,50 Std, 0,25, 0,50 Std, 0,25	48
2RZ	2438	4	Hiace, Land Cruiser 8/89-	95,00	180 096 0004 181 096 0010 182 096 0010	Std, 0,25, 0,50 Std, 0,25, 0,50 Std, 0,25	48
2TR-FE	2693	4	Land Cruiser Prado, Hilux, Fortuner	95,00	180 096 0028 181 096 0038 182 096 0029	Std, 0,25, 0,50, 0,75 Std, 0,25, 0,50 Std	49
B	2977	4	Dyna, Coaster 2/72-9/84	95,00	180 096 0021 181 096 0030 184 096 0004	Std, 0,25, 0,50, 0,75 Std, 0,25, 0,50, 0,75 Std	45
B	2977	4	Dyna, Coaster 4/84-	95,00	180 096 0022 181 096 0030 181 096 0032 184 096 0004	Std, 0,25, 0,50 Std, 0,25, 0,50, 0,75 Std, 0,25, 0,50 Std	46
11B	2977	4	8/1988-	95,00	180 096 0022 181 096 0033 183 096 0004	Std, 0,25, 0,50 Std, 0,25, 0,50 Std	55
11B	2977	4	1/85-6/86	95,00	180 096 0022 181 096 0031	Std, 0,25, 0,50 Std, 0,25, 0,50	54
11B	2977	4	6/86-8/88	95,00	180 096 0022 181 096 0031 183 096 0003	Std, 0,25, 0,50 Std, 0,25, 0,50 Std	47
3 L	2779	4	8/1988-	96,00	180 096 0016 181 096 0026 182 096 0021 183 096 0002 184 096 0002	Std, 0,25, 0,50, 0,75 Std, 0,25, 0,50, 0,75 Std, 0,25 Std Std	38
1Z	2953	4	1990-	96,00	180 096 0017 181 096 0027 182 096 0022	Std, 0,25, 0,50 Std, 0,25, 0,50 Std	51
11Z	4429	6	1990-	96,00	180 096 0018 181 096 0029 182 096 0022	Std, 0,25, 0,50 Std, 0,25, 0,50 Std	52
1KD-FTV	2982	4	Land Cruiser Prado, Hiace Van, Regiusace Van, Innova, Fortuner	96,00	180 096 0023 181 096 0034 182 096 0026	Std, 0,25, 0,50, 0,75 Std, 0,25, 0,50, 0,75 Std	50
1KZ-TE	2982	4	Hiace, Land Cruiser, Hiluxsurf	96,00	180 096 0023 181 096 0034 182 096 0026	Std, 0,25, 0,50, 0,75 Std, 0,25, 0,50, 0,75 Std	50
2B	3168	4	Dyna, Coaster 1/77-10/82	98,00	180 096 0021 181 096 0030 184 096 0004	Std, 0,25, 0,50, 0,75 Std, 0,25, 0,50, 0,75 Std	45
3B	3431	4	8/80-9/84	98,00	180 096 0021 181 096 0031	Std, 0,25, 0,50, 0,75 Std, 0,25, 0,50	53
3B	3431	4	8/84-8/88	98,00	180 096 0022 181 096 0031	Std, 0,25, 0,50 Std, 0,25, 0,50	54
3B	3431	4	8/1988-	98,00	180 096 0022 181 096 0033 183 096 0004	Std, 0,25, 0,50 Std, 0,25, 0,50 Std	55
1FZ-FE	4476	6	Land Cruiser	100,00	180 096 0009 181 096 0016 182 096 0016	Std, 0,25, 0,50 Std, 0,25, 0,50, 0,75 Std, 0,25	56
13B	3431	4	9/84-6/86	102,00	180 096 0022 181 096 0031	Std, 0,25, 0,50 Std, 0,25, 0,50	54
13B	3431	4	6/86-8/88	102,00	180 096 0022 181 096 0031 183 096 0003	Std, 0,25, 0,50 Std, 0,25, 0,50 Std	47
13B-T	3431	4	9/84-4/88	102,00	180 096 0022 181 096 0031	Std, 0,25, 0,50 Std, 0,25, 0,50	54
13B-T	3431	4	4/88-3/89	102,00	180 096 0022 181 096 0033	Std, 0,25, 0,50 Std, 0,25, 0,50	57











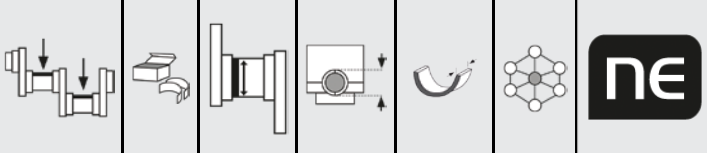







	ccm						Pos.
13B-T	3431	4	3/89-1/90	102,00	180 096 0022 181 096 0033 183 096 0004	Std, 0,25, 0,50 Std, 0,25, 0,50 Std	55
14B	3660	4	8/1988-	102,00	180 096 0022 181 096 0033 183 096 0004	Std, 0,25, 0,50 Std, 0,25, 0,50 Std	55
14B-T	3660	4	10/1989-	102,00	180 096 0022 181 096 0033 183 096 0004	Std, 0,25, 0,50 Std, 0,25, 0,50 Std	55
1W	4009	4	1983-	104,00	180 751 0005 181 751 0006 182 751 0001	Std, 0,25, 0,50 Std, 0,25, 0,50 Std	58



TOYOTA

Globally reliable

									Set Composition / QTY														
1 69,00																							
MB/HL 1, 2, 3, 4, 5	5 Pairs	46,000	50,000	14,900	SAL	180 070 0008 00	5		5														
						15 21																	
MB/HL 1, 2, 3, 4, 5	5 Pairs	45,990 46,000	50,000 50,016	15,000	SAL	180 096 0035 00	5		5														
						15 21 26																	
CB/PL 1, 2, 3, 4	4 Pairs	34,990 35,000	38,000 38,016	13,300	SAL	181 096 0047 00	8																
						15 21 26																	
TW/A 1	2 Halves	52,250	63,000		SAL	182 070 0001 00	2																
2 70,50																							
MB/HL 1, 2, 3, 4, 5	5 Pairs	47,000	51,022	16,000	SAL	180 096 0006 00	5		5														
						15 21 26																	
CB/PL 1, 2, 3, 4	4 Pairs	40,000	43,000	15,100	SAL	181 096 0013 00	8																
						15 21 26																	
TW/A 1	4 Halves	52,750	64,500		SAL	182 096 0012 00	2		2														
						15																	
3 71,00																							
MB/HL 1, 2, 3, 4	4 Pairs	44,000	48,000	14,900	SAL	180 096 0032 00	4		4														
						15 21 26																	
CB/PL 1, 2, 3	3 Pairs	40,000	43,000	13,500	SAL	181 096 0042 00	6																
						15 21 26																	
TW/A 1	2 Halves	52,000	63,000		SAL	182 096 0030 00	2																
4 72,00																							
MB/HL 1, 2, 3, 4, 5	5 Pairs	50,000	54,004	20,900	SAL	180 096 0001 00	5		5														
						15 21																	
CB/PL 1, 2, 3, 4	4 Pairs	42,000	45,000	18,900	SAL	181 096 0006 00	8																
						15 21																	
CB/PL 1, 2, 3, 4	4 Pairs	48,000	51,000	17,100	SAL	181 096 0007 00																	
						15 21																	
TW/A 1	4 Halves	55,250	68,000		SAL	182 096 0007 00	2		2														
5 74,00																							
MB/HL 1, 2, 3, 4, 5	5 Pairs	50,000	54,036	18,000	SAL	180 096 0013 00	5		5														
						15 21																	
CB/PL 1, 2, 3, 4	4 Pairs	44,000	47,014	17,900	SAL	181 096 0022 00	8																
						15 21																	
TW/A 1	4 Halves	55,250	68,000		SAL	182 096 0007 00	2		2														
Bush/PB 1, 2, 3, 4	4 Pairs	23,500	26,500	23,500	SL	184 096 0001 00																	

							Set Composition / QTY													
6	75,00																			
	MB/HL 1	1 Pair	60,000	64,022	25,130	S3S	180 096 0024 00 15													
	MB/HL 2, 3, 4, 5, 6, 7	6 Pairs	60,000	64,022	22,130	S3S														
	CB/PL 1, 2, 3, 4, 5, 6	6 Pairs	52,000	55,015	20,000	S3S	181 096 0004 00 15 21													
	TW/A 1	4 Halves	66,250	80,000		SAL	182 096 0005 00	2		2										
7	75,00																			
	MB/HL 1, 2, 3, 4, 5	5 Pairs	46,000	50,000	16,100	SAL	180 096 0027 00 15	5		5										
	CB/PL 1, 2, 3, 4	4 Pairs	40,000	43,000	13,600	SAL	181 096 0037 00 15 21 26	8												
	TW/A 1	2 Halves	53,750	69,750		SAL	182 096 0028 00	2												
8	75,00																			
	MB/HL 1, 2, 3, 4, 5	5 Pairs	1,000 2,000	3,000 4,000	19,900	SAL	180 037 0015 00 15 21													
	CB/PL 1, 2, 3, 4	4 Pairs	44,350 44,366	48,000 48,018	17,100	SPVD	181 037 0023 00 15 21	8												
9	76,00																			
	MB/HL 1, 2, 3, 4, 5	5 Pairs	48,000	52,020	19,900	SAL	180 096 0025 00 15 21	5		5										
	CB/PL 1, 2, 3, 4	4 Pairs	40,000	43,000	17,100	SAL	181 096 0001 00	8												
	TW/A 1	4 Halves	53,750	66,000		SAL	182 096 0003 00	2		2										
10	76,00																			
	MB/HL 1, 2, 3, 4, 5	5 Pairs	48,000	52,020	19,900	SAL	180 096 0025 00 15 21	5		5										
	CB/PL 1, 2, 3, 4	4 Pairs	40,000	43,000	17,100	SAL	181 096 0002 00 15 21	8												
	TW/A 1	4 Halves	53,750	66,000		SAL	182 096 0003 00	2		2										
11	78,00																			
	MB/HL 1	1 Pair	64,000	68,010	22,000	S3S	180 096 0010 00 15													
	MB/HL 2, 3, 4	3 Pairs	64,000	68,010	19,900	S3S	21													
	CB/PL 1, 2, 3, 4, 5, 6	6 Pairs	48,000	51,000	16,950	S3S	181 096 0017 00 15 21													
	TW/A 1	4 Halves	71,250	86,500		SAL	182 096 0017 00													



TOYOTA

Globally reliable

						NE		Set Composition / QTY															
12 79,00																							
MB/HL 1, 2, 3, 4, 5	5 Pairs	48,000	52,000	17,000	SAL	180 096 0026 00	15 21 26	5		5													
CB/PL 1, 2, 3, 4	4 Pairs	44,000	47,000	15,600	SAL	181 096 0035 00	15 21 26	8															
TW/A 1	2 Halves	53,750	69,750		SAL	182 096 0028 00		2															
13 80,50																							
MB/HL 1, 2, 4, 5	4 Pairs	55,000	59,020	19,200	SAL	180 096 0005 00	15 21	4		4		1		1									
MB/HL 3	1 Pair	55,000	59,020	23,000	SAL																		
CB/PL 1, 2, 3, 4	4 Pairs	48,000	51,000	20,500	SAL	181 096 0011 00	15 21	8															
TW/A 1	4 Halves	64,300	76,000		SAL	182 096 0011 00		2		2													
14 81,00																							
MB/HL 1, 2, 3, 4, 5	5 Pairs	48,000	52,020	19,900	SAL	180 096 0025 00	15 21	5		5													
TW/A 1	4 Halves	53,750	66,000		SAL	182 096 0003 00		2		2													
15 82,20																							
MB/HL 1, 2, 3, 4, 5	5 Pairs	70,000	75,000	23,800	SAL	180 096 0023 00	15 21 26	5		5													
TW/A 1	4 Halves	63,250	76,800		SAL	182 096 0019 00		2		2													
16 83,00																							
MB/HL 1	1 Pair	60,000	64,022	25,130	S3S	180 096 0024 00	15																
MB/HL 2, 3, 4, 5, 6, 7	6 Pairs	60,000	64,022	22,130	S3S																		
CB/PL 1, 2, 3, 4, 5, 6	6 Pairs	52,000	55,015	20,000	S3S	181 096 0020 00	15 21																
TW/A 1	4 Halves	66,250	80,000		SAL	182 096 0005 00		2		2													
17 83,00																							
MB/HL 1, 2, 3, 4, 5	5 Pairs	57,000	61,000	20,000	SAL	180 096 0012 00	15 21 26	5		5													
CB/PL 1, 2, 3, 4	4 Pairs	50,500	53,500	23,100	SAL	181 096 0021 00	15 21	8															
TW/A 1	4 Halves	63,250	76,800		SAL	182 096 0019 00		2		2													



















						NE		Set Composition / QTY												
18		83,00																		
MB/HL 1, 2, 3, 4, 5	5 Pairs	57,000	61,000	20,000	SAL	180 096 0012 00	15 21 26	5		5										
CB/PL 1, 2, 3, 4	4 Pairs	50,500	53,500	23,100	SAL	181 096 0021 00	15 21	8												
CB/PL 1, 2, 3, 4	4 Pairs	50,500	53,500	23,100	SAL	181 096 0036 00	15 21 26	8												
TW/A 1	4 Halves	63,250	76,800		SAL	182 096 0019 00		2		2										
19		84,00																		
MB/HL 1, 2, 3, 4, 5	5 Pairs	59,990	64,004	22,000	S3S	180 096 0003 00	15 21 26 29													
TW/A 1	4 Halves	66,250	80,000		SAL	182 096 0009 00		2		2										
20		86,00																		
MB/HL 1, 2, 3, 4, 5	5 Pairs	55,000	59,000	16,900	SAL	180 096 0030 00	15 21	5		5										
CB/PL 1, 2, 3, 4	4 Pairs	48,000	51,000	15,500	SAL	181 096 0039 00	15 21	8												
21		86,00																		
MB/HL 1, 2, 4, 5	4 Pairs	55,000	59,020	19,200	SAL	180 096 0005 00	15	4		4		1		1						
MB/HL 3	1 Pair	55,000	59,020	23,000	SAL	21														
TW/A 1	4 Halves	64,300	76,000		SAL	182 096 0011 00		2		2										
22		86,00																		
MB/HL 1, 2, 4, 5	4 Pairs	60,000	64,004	21,000	SAL	180 096 0028 00	15	5		5										
MB/HL 3	1 Pair	59,994	64,004	21,000	SAL	21 26														
CB/PL 1, 2, 3, 4	4 Pairs	53,000	56,000	15,600	SAL	181 096 0045 00	15 21													
TW/A 1	4 Halves	66,000 66,250	81,000		SAL	182 096 0029 00		2		2										
23		86,00																		
MB/HL 1, 2, 3, 4, 5	5 Pairs	58,000	62,000	20,930	SAL	180 096 0002 00	15 21 26 29 31 33	5		5										
CB/PL 1, 2, 3, 4	4 Pairs	48,000	51,000	19,900	SAL	181 096 0008 00	15 21 26 29 31 33	8												
TW/A 1	4 Halves	64,300	76,000		SAL	182 096 0011 00		2		2										



TOYOTA

Globally reliable

							Set Composition / QTY													
24 87,50																				
MB/HL 1	1 Pair	64,000	68,010	22,000	S3S	180 096 0010 00														
MB/HL 2, 3, 4	3 Pairs	64,000	68,010	19,900	S3S	15 21														
CB/PL 1, 2, 3, 4, 5, 6	6 Pairs	55,000	58,000	16,950	S3S	181 096 0019 00														
						15 21														
TW/A 1	4 Halves	71,250	86,500		SAL	182 096 0017 00														
25 87,50																				
MB/HL 1	1 Pair	64,000	68,010	22,000	SAL	180 096 0011 00														
MB/HL 2, 3, 4	3 Pairs	64,000	68,010	19,900	SAL	15 21														
CB/PL 1, 2, 3, 4, 5, 6	6 Pairs	55,000	58,000	16,950	SAL	181 096 0018 21														
TW/A 1	4 Halves	71,250	86,500		SAL	182 096 0017 00														
26 88,00																				
MB/HL 1, 2, 3, 5, 6, 7	6 Pairs	70,000	74,002	22,600	SAL	180 096 0020 00	12		2											
						15														
MB/HL 4	1 Pair	70,000	74,002	29,600	SAL	21														
CB/PL 1, 2, 3, 4, 5, 6	6 Pairs	55,000	58,000	27,600	SAL	181 096 0044 00	12													
						15 21														
TW/A 1	4 Halves	76,250	90,000		SAL	182 096 0023 00	2		2											
27 88,00																				
MB/HL 1, 2, 4, 5	4 Pairs	70,000	74,000	22,600	SAL	180 096 0019 00														
MB/HL 3	1 Pair	70,000	74,000	29,600	SAL															
CB/PL 1, 2, 3, 4	4 Pairs	55,000	58,000	27,600	SAL	181 096 0028 00														
						15 21														
TW/A 1	4 Halves	76,250	90,000		SAL	182 096 0023 00	2		2											
Bush/PB 1, 2, 3, 4	4 Pairs	27,000	30,000	30,500	SL	184 096 0003 00														
28 88,50																				
MB/HL 1, 2, 3, 4, 5	5 Pairs	59,990	64,004	22,000	S3S	180 096 0003 00														
						15 21 26 29														
TW/A 1	4 Halves	66,250	80,000		SAL	182 096 0008 00	2		2											
29 90,00																				
MB/HL 1	1 Pair	66,990	72,010	32,150	SAL	180 096 0007 00	2		2		1		1		1		1			
						15														
MB/HL 2	1 Pair	68,490	73,510	30,150	SAL	21														
MB/HL 3	1 Pair	69,990	75,010	35,940	SAL															
MB/HL 4	1 Pair	71,490	76,510	40,150	SAL															
CB/PL 1, 2, 3, 4, 5, 6	6 Pairs	54,000	56,800	31,850	SAL	181 096 0014 00	12													
						15 21														

									Set Composition / QTY										
30 90,00																			
CB/PL 1, 2, 3, 4	4 Pairs	53,000	56,000	26,000	SAL	181 096 0024 00 15 21	8												
TW/A 1	4 Halves	70,250	81,800		SAL	182 096 0021 00 15	2		2										
Cbush/NWL 1, 2	2 Pairs	34,985	38,015	28,040	SAL	183 096 0005 00													
Cbush/NWL 3, 4, 5, 6	4 Pairs	34,985	38,015	20,030	SAL														
Bush/PB 1, 2, 3, 4	4 Pairs	27,000	30,000	30,500	SL	184 096 0003 00													
31 90,00																			
CB/PL 1, 2, 3, 4	4 Pairs	53,000	56,000	26,000	SAL	181 096 0025 00 15 21 26 29	8												
TW/A 1	4 Halves	70,250	81,800		SAL	182 096 0021 00 15	2		2										
Cbush/NWL 1, 2	2 Pairs	34,985	38,015	28,040	SAL	183 096 0005 00													
Cbush/NWL 3, 4, 5, 6	4 Pairs	34,985	38,015	20,030	SAL														
Bush/PB 1, 2, 3, 4	4 Pairs	27,000	30,000	30,500	SL	184 096 0003 00													
32 90,00																			
MB/HL 1, 2, 3, 4, 5	5 Pairs	62,000	66,000	27,600	SAL	180 096 0016 00 15 21 26	5		5										
CB/PL 1, 2, 3, 4	4 Pairs	53,000	56,000	26,000	SAL	181 096 0025 00 15 21 26 29	8												
TW/A 1	4 Halves	70,250	81,800		SAL	182 096 0021 00 15	2		2										
Cbush/NWL 1, 2	2 Pairs	34,985	38,015	28,040	SAL	183 096 0005 00													
Cbush/NWL 3, 4, 5, 6	4 Pairs	34,985	38,015	20,030	SAL														
Bush/PB 1, 2, 3, 4	4 Pairs	27,000	30,000	30,500	SL	184 096 0003 00													
33 91,00																			
MB/HL 1, 2, 3, 5, 6, 7	6 Pairs	70,000	74,002	22,600	SAL	180 096 0020 00 15	12		2										
MB/HL 4	1 Pair	70,000	74,002	29,600	SAL	21													
CB/PL 1, 2, 3, 4, 5, 6	6 Pairs	55,000	58,000	25,600	SAL	181 096 0029 00 15 21	12												
CB/PL 1, 2, 3, 4, 5, 6	6 Pairs	55,000	58,000	27,600	SAL	181 096 0044 00 15 21	12												
TW/A 1	4 Halves	76,250	90,000		SAL	182 096 0023 00	2		2										



TOYOTA

Globally reliable

							Set Composition / QTY														
34 91,00																					
MB/HL 1, 2, 3, 5, 6, 7	6 Pairs	70,000	74,002	22,600	SAL	180 096 0020 00	15	12		2											
MB/HL 4	1 Pair	70,000	74,002	29,600	SAL		21														
CB/PL 1, 2, 3, 4, 5, 6	6 Pairs	55,000	58,000	25,600	SAL	181 096 0029 00	15	12													
TW/A 1	4 Halves	76,250	90,000		SAL	182 096 0024 00	00	2		2											
35 92,00																					
CB/PL 1, 2, 3, 4	4 Pairs	55,000	58,000	26,000	SAL	181 096 0026 00	15	8													
TW/A 1	4 Halves	70,250	81,800		SAL	182 096 0021 00	15	2		2											
Cbush/NWL 1, 2	2 Pairs	34,985	38,015	28,040	SAL	183 096 0005 00	00														
Cbush/NWL 3, 4, 5, 6	4 Pairs	34,985	38,015	20,030	SAL																
36 92,00																					
MB/HL 1, 2, 3, 4, 5	5 Pairs	62,000	66,000	27,600	SAL	180 096 0016 00	15	5		5											
CB/PL 1, 2, 3, 4	4 Pairs	53,000	56,000	26,000	SAL	181 096 0025 00	15	8													
TW/A 1	4 Halves	70,250	81,800		SAL	182 096 0021 00	15	2		2											
Half 1, 2	2 Pairs	34,975	38,015	32,620	SAL	183 096 0002 00	00														
Half 3, 4, 5	3 Pairs	27,975	31,015	17,430	SAL																
37 92,00																					
MB/HL 1, 2, 3, 4, 5	5 Pairs	62,000	66,000	27,600	SAL	180 096 0016 00	15	5		5											
CB/PL 1, 2, 3, 4	4 Pairs	55,000	58,000	26,000	SAL	181 096 0026 00	15	8													
TW/A 1	4 Halves	70,250	81,800		SAL	182 096 0021 00	15	2		2											
Cbush/NWL 1, 2	2 Pairs	34,985	38,015	28,040	SAL	183 096 0005 00	00														
Cbush/NWL 3, 4, 5, 6	4 Pairs	34,985	38,015	20,030	SAL																

						Set Composition / QTY																
38 92,00						MB/HL 1, 2, 3, 4, 5	5 Pairs	62,000	66,000	27,600	SAL	180 096 0016 00 15 21 26	5		5							
						CB/PL 1, 2, 3, 4	4 Pairs	55,000	58,000	26,000	SAL	181 096 0026 00 15 21 26	8									
						TW/A 1	4 Halves	70,250	81,800		SAL	182 096 0021 00 15	2		2							
						Half 1, 2	2 Pairs	34,975	38,015	32,620	SAL	183 096 0002 00										
						Half 3, 4, 5	3 Pairs	27,975	31,015	17,430	SAL											
						Bush/PB 1, 2	2 Pairs	29,000	32,000	23,000	SL	184 096 0002 00										
						Bush/PB 3, 4	2 Pairs	29,000	32,000	31,000	SL											
39 93,50						MB/HL 1	1 Pair	63,985 64,000	68,011 68,029	22,000		180 096 0034 00 15	1		1		3		3			
						MB/HL 2, 3, 4	3 Pairs	63,985 64,000	68,011 68,029	20,000		21 26 29										
						CB/PL 1, 2, 3, 4, 5, 6	6 Pairs	54,986 55,001	58,001 58,024	16,800		181 096 0046 00 15 21 26 29	12									
40 94,00						CB/PL 1, 2, 3, 4, 5, 6	6 Pairs	53,000	56,000	22,000	SAL	181 096 0015 00 15 21	12									
						TW/A 1	4 Halves	78,250	91,000		SAL	182 096 0015 00										
41 94,00						MB/HL 1, 2, 3, 4, 5, 6, 7	7 Pairs	66,990	71,000	22,100	SAL	180 096 0014 00 15 21 26	7		7							
						CB/PL 1, 2, 3, 4, 5, 6	6 Pairs	59,000	62,014	23,600	SAL	181 096 0023 00 15 21 26	12									
						TW/A 1	4 Halves	74,250	85,750		SAL	182 096 0020 00	2		2							
42 94,00						MB/HL 1, 2, 3, 4, 5	5 Pairs	1,000	1,000	1,000		180 096 0037 00										
						CB/PL 1, 2, 3, 4, 5, 6, 7, 8	8 Pairs	1,000 52,980	1,000 59,020	17,000	SAL	181 096 0050 00										
43 94,00						MB/HL 1, 2, 3, 4, 5	5 Pairs	1,000	1,000	1,000		180 096 0037 00										
						CB/PL 1, 2, 3, 4, 5, 6, 7, 8	8 Pairs	52,980	56,020	17,000	SAL	181 096 0052 00										



TOYOTA

Globally reliable

								Set Composition / QTY												
44 94,00																				
MB/HL 1, 2	2 Pairs	72,000	77,000	19,000	SAL	180 096 0033 00 15	2		2		2		2							
MB/HL 3, 4	2 Pairs	72,000	77,000	22,300	SAL	21 26														
CB/PL 1, 2, 3, 4, 5, 6	6 Pairs	56,000	59,000	14,500	SAL	181 096 0043 00 15	12													
TW/A 1	4 Halves	79,500	96,500		SAL	182 096 0031 00	2		2											
45 95,00																				
MB/HL 1, 2, 4, 5	4 Pairs	70,000	75,000	26,900	SAL	180 096 0021 00 15	8		2											
MB/HL 3	1 Pair	70,000	75,000	33,930	SAL	21 26														
CB/PL 1, 2, 3, 4	4 Pairs	59,000	62,000	30,000	SAL	181 096 0030 00 15	8													
Bush/PB 1, 2, 3, 4	4 Pairs	29,010	33,000	32,000	SL	184 096 0004 00														
46 95,00																				
MB/HL 1, 2, 3, 4, 5	5 Pairs	70,000	75,000	26,900	SAL	180 096 0022 00 15	5		5											
CB/PL 1, 2, 3, 4	4 Pairs	59,000	62,000	30,000	SAL	181 096 0030 00 15	8													
CB/PL 1, 2, 3, 4	4 Pairs	59,000	62,000	30,000	SAL	181 096 0032 00 15	8													
Bush/PB 1, 2, 3, 4	4 Pairs	29,010	33,000	32,000	SL	184 096 0004 00														
47 95,00																				
MB/HL 1, 2, 3, 4, 5	5 Pairs	70,000	75,000	26,900	SAL	180 096 0022 00 15	5		5											
CB/PL 1, 2, 3, 4	4 Pairs	61,000	64,000	30,000	SAL	181 096 0031 00 15	8													
Cbush/NWL 1	1 Pair	53,475	57,500	20,000	SL	183 096 0003 00														
Cbush/NWL 2	1 Pair	53,225	57,250	20,000	SL															
Cbush/NWL 3	1 Pair	52,975	56,000	20,000	SL															
Cbush/NWL 4	1 Pair	52,725	56,000	20,000	SL															
Cbush/NWL 5	1 Pair	52,475	56,250	20,000	SL															
48 95,00																				
MB/HL 1, 5	2 Pairs	59,995	64,000	25,000	SAL	180 096 0004 00 15	3		3		2		2							
MB/HL 2, 3, 4	3 Pairs	59,995	64,000	23,000	SAL	21														
CB/PL 1, 2, 3, 4	4 Pairs	53,000	56,000	19,700	SAL	181 096 0010 00 15	8													
TW/A 1	4 Halves	65,250	89,700		SAL	182 096 0010 00 15														







									Set Composition / QTY													
49	95,00																					
MB/HL 1, 2, 4, 5	4 Pairs	60,000	64,004	21,000	SAL	180 096 0028 00	5		5													
MB/HL 3	1 Pair	59,994	64,004	21,000	SAL	21 26																
CB/PL 1, 2, 3, 4	4 Pairs	53,002	56,000	15,600	SAL	181 096 0038 00	8															
TW/A 1	4 Halves	66,000 66,250	81,000		SAL	182 096 0029 00	2		2													
50	96,00																					
MB/HL 1, 2, 3, 4, 5	5 Pairs	70,000	75,000	23,800	SAL	180 096 0023 00	5		5													
CB/PL 1, 2, 3, 4	4 Pairs	59,000	62,014	24,600	SAL	181 096 0034 00	8															
TW/A 1	4 Halves	76,250	90,920		SAL	182 096 0026 00	2		2													
51	96,00																					
MB/HL 1, 2, 3, 4, 5	5 Pairs	74,000	78,000	25,600	SAL	180 096 0017 00	15 21															
CB/PL 1, 2, 3, 4	4 Pairs	55,000	58,000	25,600	SAL	181 096 0027 00	15 21															
TW/A 1	4 Halves	82,250	95,750		SAL	182 096 0022 00																
52	96,00																					
MB/HL 1, 2, 3, 4, 5, 6, 7	7 Pairs	74,000	78,000	25,600	SAL	180 096 0018 00	15 21															
CB/PL 1, 2, 3, 4, 5, 6	6 Pairs	55,000	58,000	25,600	SAL	181 096 0029 00	12															
TW/A 1	4 Halves	82,250	95,750		SAL	182 096 0022 00																
53	98,00																					
MB/HL 1, 2, 4, 5	4 Pairs	70,000	75,000	26,900	SAL	180 096 0021 00	8		2													
MB/HL 3	1 Pair	70,000	75,000	33,930	SAL	21 26																
CB/PL 1, 2, 3, 4	4 Pairs	61,000	64,000	30,000	SAL	181 096 0031 00	8															
54	98,00																					
MB/HL 1, 2, 3, 4, 5	5 Pairs	70,000	75,000	26,900	SAL	180 096 0022 00	5		5													
CB/PL 1, 2, 3, 4	4 Pairs	61,000	64,000	30,000	SAL	181 096 0031 00	8															



TOYOTA

Globally reliable







									Set Composition / QTY													
55 98,00																						
MB/HL 1, 2, 3, 4, 5	5 Pairs	70,000	75,000	26,900	SAL	180 096 0022 00 15 21	5		5													
CB/PL 1, 2, 3, 4	4 Pairs	61,000	64,000	30,000	SAL	181 096 0033 00 15 21	8															
Cbush/NWL 1	1 Pair	53,475	57,500	20,000	SL	183 096 0004 00																
Cbush/NWL 2	1 Pair	53,225	57,250	20,000	SL																	
Cbush/NWL 3	1 Pair	52,975	57,000	20,000	SL																	
Cbush/NWL 4	1 Pair	52,725	57,000	20,000	SL																	
Cbush/NWL 5	1 Pair	52,475	57,250	20,000	SL																	
56 100,00																						
MB/HL 1, 2, 3, 4, 5, 6, 7	7 Pairs	69,000	74,026	23,300	SAL	180 096 0009 00 15 21	7		7													
CB/PL 1, 2, 3, 4, 5, 6	6 Pairs	57,000	60,526	21,400	SAL	181 096 0016 00 15 21 26	12															
TW/A 1	4 Halves	75,250	93,750		SAL	182 096 0016 00 15	2		2													
57 102,00																						
MB/HL 1, 2, 3, 4, 5	5 Pairs	70,000	75,000	26,900	SAL	180 096 0022 00 15 21	5		5													
CB/PL 1, 2, 3, 4	4 Pairs	61,000	64,000	30,000	SAL	181 096 0033 00 15 21	8															
58 104,00																						
MB/HL 1, 2, 3, 4, 5	5 Pairs	72,960	78,000	25,130	S3S	180 751 0005 00 15 21	10															
CB/PL 1, 2, 3, 4	4 Pairs	61,960	65,985	28,130	S3S	181 751 0006 00 15 21	4		4													
TW/A 1	4 Halves	82,250	98,900		S3S	182 751 0001 00	2		2													







	ccm						Pos.
HE	771	4	Polo 0.8l	64,50	180 050 0001 180 050 0006 180 050 0008 181 050 0010 183 050 0001 183 050 0002 184 050 0002	Std, 0,25, 0,50, 0,75, 1,00 Std, 0,25, 0,50 Std, 0,25, 0,50 Std, 0,25, 0,50, 0,75 Std, Semi Std, Semi Semi	1
AER, ALL	999	4	Lupo 1.0i, Polo 1.0i	67,10	180 050 0004 181 050 0004 182 050 0001 184 050 0003 184 050 0004	Std, 0,25, 0,50 Std, 0,25, 0,50 Std Semi Semi	2
ALD, ANV, ATE, AUC	999	4	Lupo 1.0i, Polo 1.0i	67,10	180 050 0004 181 050 0004 182 050 0001 184 050 0004	Std, 0,25, 0,50 Std, 0,25, 0,50 Std Semi	3
AHT	999	4	Lupo 1.0i	67,10	180 153 0001 181 050 0004 184 050 0003	Std, 0,25, 0,50, 0,75 Std, 0,25, 0,50 Semi	4
HA	895	4	Derby 0.9, Polo 0.9	69,50	180 050 0001 180 050 0006 180 050 0008 181 050 0010 183 050 0001 183 050 0002 184 050 0002	Std, 0,25, 0,50, 0,75, 1,00 Std, 0,25, 0,50 Std, 0,25, 0,50 Std, 0,25, 0,50, 0,75 Std, Semi Std, Semi Semi	1
361, FA, FJ, GG, HB, HC	1093	4	Derby 1.1, Golf 1.1, Jetta 1.1, Polo 1.1, Scirocco 1.1	69,50	180 050 0001 180 050 0006 180 050 0008 181 050 0010 183 050 0001 183 050 0002 184 050 0002	Std, 0,25, 0,50, 0,75, 1,00 Std, 0,25, 0,50 Std, 0,25, 0,50 Std, 0,25, 0,50, 0,75 Std, Semi Std, Semi Semi	1
GL, GN	1043	4	Derby 1.0i, Golf 1.0, Polo 1.0i	75,00	180 050 0006 181 050 0010 183 050 0001 183 050 0002 184 050 0002	Std, 0,25, 0,50 Std, 0,25, 0,50, 0,75 Std, Semi Std, Semi Semi	7
AAK, AAU, ACM, AEV, HZ	1043	4	Golf 1.05, Jetta 1.05, Polo 1.05, Polo 1.05i	75,00	180 050 0005 181 050 0010 182 050 0002 183 050 0001 183 050 0002 184 050 0002	Std, 0,25, 0,50 Std, 0,25, 0,50, 0,75 Std, 0,25, 0,50, 0,20 Std, Semi Std, Semi Semi	9
EU	1272	4	Passat 1.3	75,00	180 050 0001 180 050 0008 181 050 0001 183 050 0001 183 050 0002	Std, 0,25, 0,50, 0,75, 1,00 Std, 0,25, 0,50 Std, 0,25, 0,50, 0,75, 1,00 Std, Semi Std, Semi	6
FY, FZ, GF, GT, HH, HJ, HK, HW, MH, NU	1272	4	Derby 1.3, Golf 1.3, Jetta 1.3, Passat 1.3, Polo 1.3, Quantum 1.3, Santana 1.3, Scirocco 1.3	75,00	180 050 0006 181 050 0010 183 050 0001 183 050 0002 184 050 0002	Std, 0,25, 0,50 Std, 0,25, 0,50, 0,75 Std, Semi Std, Semi Semi	7
GS	1272	4	Jetta 1.3	75,00	180 050 0006 180 050 0008 181 050 0010 183 050 0001 183 050 0002 184 050 0002	Std, 0,25, 0,50 Std, 0,25, 0,50 Std, 0,25, 0,50, 0,75 Std, Semi Std, Semi Semi	8
2G, 3F, AAV, GK, NZ	1272	4	Derby 1.3i, Golf 1.3, Golf 1.3i, Jetta 1.3i, Polo 1.3, Polo 1.3i	75,00	180 050 0005 181 050 0010 182 050 0002 183 050 0001 183 050 0002 184 050 0002	Std, 0,25, 0,50 Std, 0,25, 0,50, 0,75 Std, 0,25, 0,50, 0,20 Std, Semi Std, Semi Semi	9
MN	1272	4	Polo 1.3 D	75,00	180 050 0005 180 050 0006 181 050 0010 182 050 0002 183 050 0001 183 050 0002 184 050 0002	Std, 0,25, 0,50 Std, 0,25, 0,50 Std, 0,25, 0,50, 0,75 Std, 0,25, 0,50, 0,20 Std, Semi Std, Semi Semi	10
PY	1272	4	Polo 1.3i G40	75,00	180 050 0005 180 050 0006 181 050 0010 182 050 0002 183 050 0001 183 050 0002 184 050 0002	Std, 0,25, 0,50 Std, 0,25, 0,50 Std, 0,25, 0,50, 0,75 Std, 0,25, 0,50, 0,20 Std, Semi Std, Semi Semi	10
EP	1297	4	Passat 1.3, Santana 1.3	75,00	180 050 0001 180 050 0008 181 050 0001 183 050 0001 183 050 0002	Std, 0,25, 0,50, 0,75, 1,00 Std, 0,25, 0,50 Std, 0,25, 0,50, 0,75, 1,00 Std, Semi Std, Semi	6
ABD	1391	4	Golf 1.4i, Vento 1.4i	75,00	180 050 0005 181 050 0010 182 050 0002 184 050 0003	Std, 0,25, 0,50 Std, 0,25, 0,50, 0,75 Std, 0,25, 0,50, 0,20 Semi	5



VOLKSWAGEN

Globally reliable







	ccm						Pos.
1W	1398	4	Polo 1.4 D	75,00	180 050 0005 181 050 0010 182 050 0002 183 050 0001 183 050 0002 184 050 0002	Std, 0,25, 0,50 Std, 0,25, 0,50, 0,75 Std, 0,25, 0,50, 0,20 Std, Semi Std, Semi Semi	9
ADX	1296	4	Polo 1.3i	76,50	180 050 0005 181 050 0002 182 050 0002 184 050 0003	Std, 0,25, 0,50 Std, 0,25, 0,50, 0,75 Std, 0,25, 0,50, 0,20 Semi	12
AEX	1390	4	Caddy 1.4i, Golf 1.4i, Polo 1.4i, Vento 1.4i	76,50	180 050 0005 181 050 0002 182 050 0002 184 050 0003	Std, 0,25, 0,50 Std, 0,25, 0,50, 0,75 Std, 0,25, 0,50, 0,20 Semi	12
AFH	1390	4	Polo 1.4i 16V	76,50	180 050 0004 180 050 0013 181 050 0002 182 050 0002 184 050 0003 184 050 0004	Std, 0,25, 0,50 Std, 0,25, 0,50, 1,00 Std, 0,25, 0,50, 0,75 Std, 0,25, 0,50, 0,20 Semi Semi	14
AFK, AHW, AKK, AKP, AKQ, ANW, APE, AQQ, AUA, AUB, AUD, AXP, BBY, BBZ, BCA, BKY	1390	4	Bora 1.4i 16V, Caddy 1.4i, Caddy 1.4i 16V, Golf 1.4i 16V, Jetta 1.4i 16V, Lupo 1.4i, Lupo 1.4i 16V, New Beetle 1.4i 16V, Polo 1.4i, Polo 1.4i 16V, Polocross 1.4i 16V	76,50	180 050 0004 181 050 0002 182 050 0001 184 050 0004	Std, 0,25, 0,50 Std, 0,25, 0,50, 0,75 Std Semi	15
AKV, APQ	1390	4	Caddy 1.4i, Golf 1.4i, Polo 1.4i	76,50	180 050 0004 180 050 0005 181 050 0002 182 050 0002 184 050 0003 184 050 0004	Std, 0,25, 0,50 Std, 0,25, 0,50 Std, 0,25, 0,50, 0,75 Std, 0,25, 0,50, 0,20 Semi Semi	17
ANX	1390	4	Polo 1.4i	76,50	180 050 0004 180 050 0005 181 050 0002 182 050 0002 184 050 0003	Std, 0,25, 0,50 Std, 0,25, 0,50 Std, 0,25, 0,50, 0,75 Std, 0,25, 0,50, 0,20 Semi	18
AXU	1390	4	Polo 1.4 FSI 16V	76,50	180 050 0005 181 050 0013 182 050 0002 183 050 0001 183 050 0002 184 050 0004	Std, 0,25, 0,50 Std, 0,25, 0,50 Std, 0,25, 0,50, 0,20 Std, Semi Std, Semi Semi	20
BLG, BLN, BMY, BUD	1390	4	Golf 1.4 FSI 16V, Golf 1.4 TSI 16V, Jetta 1.4 TSI 16V, Polo 1.4 FSI 16V, Polocross 1.4 FSI 16V, Touran 1.4 TSI 16V	76,50	180 050 0004 181 050 0005 182 050 0002 184 050 0004	Std, 0,25, 0,50 Std, 0,25, 0,50 Std, 0,25, 0,50, 0,20 Semi	22
FH, FK	1471	4	Golf 1.5, Passat 1.5, Scirocco 1.5	76,50	180 050 0001 180 050 0008 181 050 0010 183 050 0001 183 050 0002	Std, 0,25, 0,50, 0,75, 1,00 Std, 0,25, 0,50 Std, 0,25, 0,50, 0,75 Std, Semi Std, Semi	23
682	1471	4		76,50	180 050 0001 180 050 0008 181 050 0009 183 050 0001 183 050 0002	Std, 0,25, 0,50, 0,75, 1,00 Std, 0,25, 0,50 Std, 0,25, 0,50, 0,75 Std, Semi Std, Semi	25
1V, ME, MF, RA, SB	1588	4	Caddy 1.6 D, Golf 1.6 D, Golf 1.6 TD, Jetta 1.6 D, Jetta 1.6 TD, Passat 1.6 TD	76,50	180 050 0007 180 050 0013 181 050 0009 182 050 0002 184 050 0005	Std, 0,25, 0,50 Std, 0,25, 0,50, 1,00 Std, 0,25, 0,50, 0,75 Std, 0,25, 0,50, 0,20 Semi	24
685, JK, JP, JR, JX	1588	4	Caddy 1.6 D, Golf 1.6 D, Jetta 1.6 D, Jetta 1.6 TD, Passat 1.6 D, Pickup 1.6 D, Santana 1.6 D, Transporter T3 1.6 D, Vanagon 1.6 D	76,50	180 050 0001 180 050 0007 180 050 0013 181 050 0009 182 050 0002 184 050 0005	Std, 0,25, 0,50, 0,75, 1,00 Std, 0,25, 0,50 Std, 0,25, 0,50, 1,00 Std, 0,25, 0,50, 0,75 Std, 0,25, 0,50, 0,20 Semi	26
ADK	1588	4		76,50	180 050 0013 181 050 0009 182 050 0002 184 050 0005	Std, 0,25, 0,50, 1,00 Std, 0,25, 0,50, 0,75 Std, 0,25, 0,50, 0,20 Semi	27
CR, CS, CY	1588	4	Golf 1.6 D, Jetta 1.6 D, Jetta 1.6 TD, Quantum 1.6 D, Quantum 1.6 TD, Rabbit 1.6 D, Rabbit 1.6 TD, Santana 1.6 D, Santana 1.6 TD, Transporter T2 1.6 D, Vanagon 1.6 D	76,50	180 050 0001 181 050 0009 184 050 0005	Std, 0,25, 0,50, 0,75, 1,00 Std, 0,25, 0,50, 0,75 Semi	28
ANY, AYZ	1191	3	Lupo 1.2TDI 3L	76,50	181 050 0021	Std, 0,25, 0,50	29
ALM	1598	4	Polo 1.6i	76,50	180 050 0004 181 050 0002 182 050 0002 184 050 0004	Std, 0,25, 0,50 Std, 0,25, 0,50, 0,75 Std, 0,25, 0,50, 0,20 Semi	11
ABU, AEA	1598	4	Golf 1.6i, Polo 1.6i, Vento 1.6i	76,50	180 050 0005 181 050 0002 182 050 0002 184 050 0003	Std, 0,25, 0,50 Std, 0,25, 0,50, 0,75 Std, 0,25, 0,50, 0,20 Semi	12







	ccm						Pos.
AEE	1598	4	Caddy 1.6i, Golf 1.6i	76,50	180 050 0004 180 050 0005 180 050 0013 181 050 0002 182 050 0002 184 050 0003 184 050 0004	Std, 0,25, 0,50 Std, 0,25, 0,50 Std, 0,25, 0,50, 1,00 Std, 0,25, 0,50, 0,75 Std, 0,25, 0,50, 0,20 Semi Semi	13
AHS	1598	4	Polo 1.6i	76,50	180 050 0004 180 050 0013 181 050 0002 182 050 0002 184 050 0003 184 050 0004	Std, 0,25, 0,50 Std, 0,25, 0,50, 1,00 Std, 0,25, 0,50, 0,75 Std, 0,25, 0,50, 0,20 Semi Semi	14
AJV	1598	4	Polo 1.6i 16V	76,50	180 050 0004 181 050 0002 181 050 0011 182 050 0002 184 050 0004	Std, 0,25, 0,50 Std, 0,25, 0,50, 0,75 Std, 0,25, 0,50, 0,75 Std, 0,25, 0,50, 0,20 Semi	16
ARC, ATN, AUS, AVY, AZD, BCB	1598	4	Bora 1.6i 16V, Golf 1.6i 16V, Lupo 1.6i 16V, Polo 1.6i 16V	76,50	180 050 0004 181 050 0011 182 050 0002 184 050 0004	Std, 0,25, 0,50 Std, 0,25, 0,50, 0,75 Std, 0,25, 0,50, 0,20 Semi	19
BAD	1598	4	Bora 1.6 FSI 16V, Golf 1.6 FSI 16V	76,50	180 050 0004 181 050 0013 182 050 0002 184 050 0004	Std, 0,25, 0,50 Std, 0,25, 0,50 Std, 0,25, 0,50, 0,20 Semi	21
BLF, BLP, BTS	1598	4	Eos 1.6 FSI 16V, Golf 1.6 FSI 16V, Passat 1.6 FSI 16V, Touran 1.6 FSI 16V	76,50	180 050 0004 181 050 0005 182 050 0002 184 050 0004	Std, 0,25, 0,50 Std, 0,25, 0,50 Std, 0,25, 0,50, 0,20 Semi	22
AZQ, BME	1198	3	POLO (9N_) 1.2 12V	76,50	180 050 0022 181 050 0024	Std, 0,25 Std, 0,25	30
AMF, BAY	1422	3	Arosa 1.4TDI, Lupo 1.4TDI, Polo 1.4TDI	76,50	181 050 0021	Std, 0,25, 0,50	29
AKU	1716	4	Lupo 1.7 SDI, Polo 1.7 SDI	79,50	180 050 0013 181 050 0009 182 050 0002 184 050 0007	Std, 0,25, 0,50, 1,00 Std, 0,25, 0,50, 0,75 Std, 0,25, 0,50, 0,20 Semi	34
AHB, AHG, AKW	1716	4	Caddy 1.7 SDI, Polo 1.7 SDI	79,50	180 050 0013 181 050 0009 182 050 0002 184 050 0007	Std, 0,25, 0,50, 1,00 Std, 0,25, 0,50, 0,75 Std, 0,25, 0,50, 0,20 Semi	34
KY	1716	4	Campmobil 1.7 D	79,50	180 050 0001 180 050 0007 180 050 0013 181 050 0009 182 050 0002 184 050 0005	Std, 0,25, 0,50, 0,75, 1,00 Std, 0,25, 0,50 Std, 0,25, 0,50, 1,00 Std, 0,25, 0,50, 0,75 Std, 0,25, 0,50, 0,20 Semi	26
1X, 1Y	1896	4	Caddy 1.9 D, California 1.9 D, Golf 1.9 D, Parati 1.9 D, Passat 1.9 D, Polo 1.9 D, Saveiro 1.9 D, Transporter T4 1.9 D, Vento 1.9 D	79,50	180 050 0007 180 050 0013 181 050 0009 182 050 0002 184 050 0007	Std, 0,25, 0,50 Std, 0,25, 0,50, 1,00 Std, 0,25, 0,50, 0,75 Std, 0,25, 0,50, 0,20 Semi	31
1Z, AAZ, ABL, AGR, AHH, AHU, ALE, ALH	1896	4	Bora 1.9 TDI, Caddy 1.9 TDI, California 1.9 TDI, Golf 1.9 TDI, Jetta 1.9 TDI, New Beetle 1.9 TDI, Passat 1.9 TDI, Polo 1.9 TDI, Transporter 1.9 TDI, Vento 1.9 TDI	79,50	180 050 0007 180 050 0013 181 050 0012 182 050 0002 183 050 0001 183 050 0002 184 050 0006	Std, 0,25, 0,50 Std, 0,25, 0,50, 1,00 Std, 0,25, 0,50, 0,75 Std, 0,25, 0,50, 0,20 Std, Semi Std, Semi Semi	32
ADE, AFD, ARD, AVM, BEQ, BEU, BJC, BXT	1896	4		79,50	180 050 0013 181 050 0012 182 050 0002 184 050 0006	Std, 0,25, 0,50, 1,00 Std, 0,25, 0,50, 0,75 Std, 0,25, 0,50, 0,20 Semi	33
ADG, ANC, AQM, ASY, AYQ, BGL, BGM	1896	4	Bora SDI, Golf 1.9 SDI, Polo 1.9 SDI	79,50	180 050 0013 181 050 0009 182 050 0002 184 050 0007	Std, 0,25, 0,50, 1,00 Std, 0,25, 0,50, 0,75 Std, 0,25, 0,50, 0,20 Semi	34
AEF	1896	4	Caddy 1.9 D, Polo 1.9 D	79,50	180 050 0013 181 050 0009 182 050 0002 184 050 0007	Std, 0,25, 0,50, 1,00 Std, 0,25, 0,50, 0,75 Std, 0,25, 0,50, 0,20 Semi	34
AEY, AGD, ASX	1896	4	Caddy 1.9 SDI, Golf 1.9 SDI, Polo 1.9 SDI, Vento 1.9 SDI	79,50	180 050 0013 181 050 0012 182 050 0002 184 050 0006	Std, 0,25, 0,50, 1,00 Std, 0,25, 0,50, 0,75 Std, 0,25, 0,50, 0,20 Semi	33
AGP	1896	4	Bora 1.9 SDI, Golf 1.9 SDI, Polo 1.9 SDI	79,50	180 050 0013 181 050 0009 181 050 0012 182 050 0002 184 050 0006 184 050 0007	Std, 0,25, 0,50, 1,00 Std, 0,25, 0,50, 0,75 Std, 0,25, 0,50, 0,75 Std, 0,25, 0,50, 0,20 Semi Semi	35
BLS, BXE	1896	4	Caddy III 1.9TDI, Golf V 1.9TDI, Jetta III 1.9TDI, Passat 1.9TDI, Touran 1.9TDI	79,50	180 050 0015 181 050 0022 182 050 0002	Std, 0,25, 0,50, 0,75 Std, 0,25, 0,50 Std, 0,25, 0,50, 0,20	36
ARL	1896	4	Bora 1.9TDI, Golf IV 1.9TDI	79,50	180 050 0015 181 050 0019 183 050 0003	Std, 0,25, 0,50, 0,75 Std, 0,25, 0,50 Std	37



VOLKSWAGEN

Globally reliable







	ccm						Pos.
AFN, ASV, AVG	1896	4	Bora 1.9TDI, Golf IV 1.9TDI, Passat 1.9TDI, Polo 1.9TDI, Sharan 1.9TDI	79,50	180 050 0007 180 050 0013 181 050 0017 182 050 0002 184 050 0006	Std, 0,25, 0,50 Std, 0,25, 0,50, 1,00 Std, 0,25 Std, 0,25, 0,50, 0,20 Semi	38
AHF	1896	4	Bora 1.9TDI, Golf IV 1.9TDI	79,50	180 050 0013 181 050 0017 182 050 0002 183 050 0001 183 050 0002 184 050 0006	Std, 0,25, 0,50, 1,00 Std, 0,25 Std, 0,25, 0,50, 0,20 Std, Semi Std, Semi Semi	39
AJM, ATJ, AUY, BVK	1896	4	Bora 1.9TDI, Golf IV 1.9TDI, Passat 1.9TDI, Sharan 1.9TDI	79,50	180 050 0013 181 050 0022 182 050 0002	Std, 0,25, 0,50, 1,00 Std, 0,25, 0,50 Std, 0,25, 0,50, 0,20	40
ANU	1896	4	Sharan 1.9TDI	79,50	180 050 0007 180 050 0013 181 050 0022 182 050 0002 183 050 0001 183 050 0002	Std, 0,25, 0,50 Std, 0,25, 0,50, 1,00 Std, 0,25, 0,50 Std, 0,25, 0,50, 0,20 Std, Semi Std, Semi	41
ARL, ASZ, AXB, AXC, BLT, BRR, BRS, BTB	1896	4	Bora 1.9TDI, Golf IV 1.9TDI, Polo 1.9TDI, Sharan 1.9TDI	79,50	180 050 0015 181 050 0019 182 050 0002 183 050 0003	Std, 0,25, 0,50, 0,75 Std, 0,25, 0,50 Std, 0,25, 0,50, 0,20 Std	42
AXR, AVQ, BEW, BJB, BKC, BLS, BMT, BRU, BSU, BXE, BXF, BXJ	1896	4	Bora 1.9TDI, Caddy 1.9TDI, Golf IV 1.9TDI, Golf V 1.9TDI, Polo 1.9TDI, Polocross 1.9TDI, Passat 1.9TDI, New Beetle 1.9TDI	79,50	180 050 0015 181 050 0022 182 050 0002 183 050 0003	Std, 0,25, 0,50, 0,75 Std, 0,25, 0,50 Std, 0,25, 0,50, 0,20 Std	43
ATD, BSW	1896	4	Bora 1.9TDI, Golf IV 1.9TDI, New Beetle 1.9TDI, Polo 1.9TDI, Polocross 1.9TDI	79,50	180 050 0013 181 050 0022 182 050 0002 183 050 0003	Std, 0,25, 0,50, 1,00 Std, 0,25, 0,50 Std, 0,25, 0,50, 0,20 Std	44
AVB	1896	4	Passat 1.9TDI	79,50	180 050 0013 181 050 0022 182 050 0002 183 050 0003 184 050 0006	Std, 0,25, 0,50, 1,00 Std, 0,25, 0,50 Std, 0,25, 0,50, 0,20 Std Semi	45
AVF, AWX	1896	4	Passat 1.9TDI	79,50	180 050 0015 181 050 0019 182 050 0002 183 050 0003 184 050 0006	Std, 0,25, 0,50, 0,75 Std, 0,25, 0,50 Std, 0,25, 0,50, 0,20 Std Semi	46
1F, ABN	1595	4	Caddy 1.6, Caddy 1.6i, Golf 1.6i, Jetta 1.6i, Passat 1.6i, Polo 1.6i	81,00	180 050 0014 181 050 0001 182 050 0002 183 050 0001 183 050 0002 184 050 0008	Std, 0,25, 0,50, 0,75, 1,00 Std, 0,25, 0,50, 0,75, 1,00 Std, 0,25, 0,50, 0,20 Std, Semi Std, Semi Semi	47
ADP, AEK	1595	4	Golf 1.6i, Passat 1.6i, Vento 1.6i	81,00	180 050 0014 181 050 0001 182 050 0002 184 050 0008	Std, 0,25, 0,50, 0,75, 1,00 Std, 0,25, 0,50, 0,75, 1,00 Std, 0,25, 0,50, 0,20 Semi	50
AEH, AKL, APF, AUR, AWH	1595	4	Bora 1.6i, Golf 1.6i, New Beetle 1.6i, Polo 1.6i	81,00	180 050 0009 181 050 0001 182 050 0001 184 050 0008	Std, 0,25, 0,50 Std, 0,25, 0,50, 0,75, 1,00 Std Semi	53
AFT	1595	4	Golf 1.6i, Passat 1.6i, Polo 1.6i, Vento 1.6i	81,00	180 050 0009 180 050 0013 180 050 0014 181 050 0001 182 050 0002 183 050 0001 183 050 0002 184 050 0008	Std, 0,25, 0,50 Std, 0,25, 0,50, 1,00 Std, 0,25, 0,50, 0,75, 1,00 Std, 0,25, 0,50, 0,75, 1,00 Std, 0,25, 0,50, 0,20 Std, Semi Std, Semi Semi	54
AKS	1595	4	Golf 1.6i, Vento 1.6i	81,00	180 050 0009 180 050 0013 180 050 0014 181 050 0001 182 050 0002 184 050 0008	Std, 0,25, 0,50 Std, 0,25, 0,50, 1,00 Std, 0,25, 0,50, 0,75, 1,00 Std, 0,25, 0,50, 0,75, 1,00 Std, 0,25, 0,50, 0,20 Semi	55
AHL, ARM	1595	4	Passat 1.6, Passat 1.6i,	81,00	180 050 0003 180 050 0009 181 050 0001 181 050 0003 182 050 0001 182 050 0003 184 050 0008	Std, 0,25, 0,50, 0,75 Std, 0,25, 0,50 Std, 0,25, 0,50, 0,75, 1,00 Std, 0,25, 0,50, 0,75 Std Std Std Semi	57
ALZ, ANA, AVU, AYD, BFQ, BFS, BGU, BSE, BSF	1595	4	Bora 1.6i, Caddy 1.6i, Golf 1.6i, Jetta 1.6i, New Beetle 1.6i, Passat 1.6i, Touran 1.6i	81,00	180 050 0003 181 050 0003 182 050 0003	Std, 0,25, 0,50, 0,75 Std, 0,25, 0,50, 0,75 Std	58
DT, EZA, HM, HN, JU, PN, RE, RL	1595	4	Caddy 1.6, Golf 1.6i, Jetta 1.6, Jetta 1.6i, Passat 1.6, Passat 1.6i, Santana 1.6, Scirocco 1.6	81,00	180 050 0001 180 050 0008 180 050 0014 181 050 0001 182 050 0002 183 050 0001 183 050 0002	Std, 0,25, 0,50, 0,75, 1,00 Std, 0,25, 0,50 Std, 0,25, 0,50, 0,75, 1,00 Std, 0,25, 0,50, 0,75, 1,00 Std, 0,25, 0,50, 0,20 Std, Semi Std, Semi	63







	ccm						Pos.
EW, EZ	1595	4	Caddy 1.6i, Golf 1.6i, Jetta 1.6i, Scirocco 1.6i	81,00	180 050 0001 180 050 0008 180 050 0014 181 050 0001 182 050 0002 183 050 0001 183 050 0002 184 050 0008	Std, 0,25, 0,50, 0,75, 1,00 Std, 0,25, 0,50 Std, 0,25, 0,50, 0,75, 1,00 Std, 0,25, 0,50, 0,75, 1,00 Std, 0,25, 0,50, 0,20 Std, Semi Std, Semi Semi	65
PP	1595	4	Passat 1.6	81,00	180 050 0014 181 050 0001 182 050 0002 183 050 0001 183 050 0002	Std, 0,25, 0,50, 0,75, 1,00 Std, 0,25, 0,50, 0,75, 1,00 Std, 0,25, 0,50, 0,20 Std, Semi Std, Semi	66
RF	1595	4	Golf 1.6, Jetta 1.6, Passat 1.6	81,00	180 050 0014 181 050 0001 182 050 0002 184 050 0008	Std, 0,25, 0,50, 0,75, 1,00 Std, 0,25, 0,50, 0,75, 1,00 Std, 0,25, 0,50, 0,20 Semi	50
ABS	1781	4	Derby 1.8i, Golf 1.8i, Passat 1.8i, Vento 1.8i	81,00	180 050 0014 181 050 0001 182 050 0002 183 050 0001 183 050 0002 184 050 0008	Std, 0,25, 0,50, 0,75, 1,00 Std, 0,25, 0,50, 0,75, 1,00 Std, 0,25, 0,50, 0,20 Std, Semi Std, Semi Semi	47
1P, PB, PF, RV	1781	4	Golf 1.8i, Jetta 1.8i, Passat 1.8i	81,00	180 050 0014 181 050 0001 182 050 0002 183 050 0001 183 050 0002 184 050 0008	Std, 0,25, 0,50, 0,75, 1,00 Std, 0,25, 0,50, 0,75, 1,00 Std, 0,25, 0,50, 0,20 Std, Semi Std, Semi Semi	47
AAM, ANN, ANP	1781	4	Golf 1.8i, Jetta 1.8i, Vento 1.8i, Passat 1.8i	81,00	180 050 0009 180 050 0014 181 050 0001 182 050 0002 184 050 0008	Std, 0,25, 0,50 Std, 0,25, 0,50, 0,75, 1,00 Std, 0,25, 0,50, 0,75, 1,00 Std, 0,25, 0,50, 0,20 Semi	49
ACC, ADF, AJH	1781	4	Golf 1.8i, Sharan 1.8i Turbo 20V	81,00	180 050 0014 181 050 0001 182 050 0002 184 050 0008	Std, 0,25, 0,50, 0,75, 1,00 Std, 0,25, 0,50, 0,75, 1,00 Std, 0,25, 0,50, 0,20 Semi	50
ADR	1781	4	Passat 1.8i 20V	81,00	180 050 0013 180 050 0014 181 050 0001 182 050 0002 184 050 0008	Std, 0,25, 0,50, 1,00 Std, 0,25, 0,50, 0,75, 1,00 Std, 0,25, 0,50, 0,75, 1,00 Std, 0,25, 0,50, 0,20 Semi	51
ADZ	1781	4	Derby 1.8i, Golf 1.8i, Passat 1.8i, Vento 1.8i	81,00	180 050 0009 180 050 0014 181 050 0001 182 050 0002 183 050 0001 183 050 0002 184 050 0008	Std, 0,25, 0,50 Std, 0,25, 0,50, 0,75, 1,00 Std, 0,25, 0,50, 0,75, 1,00 Std, 0,25, 0,50, 0,20 Std, Semi Std, Semi Semi	52
AFY	1781	4	Passat 1.8i 20V	81,00	180 050 0009 180 050 0013 180 050 0014 181 050 0001 182 050 0002 184 050 0008	Std, 0,25, 0,50 Std, 0,25, 0,50, 1,00 Std, 0,25, 0,50, 0,75, 1,00 Std, 0,25, 0,50, 0,75, 1,00 Std, 0,25, 0,50, 0,20 Semi	55
AGN, APT, ARG, AWC	1781	4	Bora 1.8i 16V, Golf 1.8i 16V, Passat 1.8i 20V, Sharan 1.8i Turbo 20V	81,00	180 050 0009 181 050 0001 182 050 0002 184 050 0008	Std, 0,25, 0,50 Std, 0,25, 0,50, 0,75, 1,00 Std, 0,25, 0,50, 0,20 Semi	56
APH, AVC	1781	4	New Beetle 1.8i T 20V	81,00	180 050 0013 181 050 0001 182 050 0002 184 050 0008	Std, 0,25, 0,50, 1,00 Std, 0,25, 0,50, 0,75, 1,00 Std, 0,25, 0,50, 0,20 Semi	59
ARX, AWP, AWU, AWW, BBU, BJX, BKF	1781	4	Bora 1.8i Turbo 20V, Jetta 1.8i Turbo 20V, New Beetle 1.8i T 20V, Polo 1.8i Turbo 20V	81,00	180 050 0009 181 050 0011 182 050 0002	Std, 0,25, 0,50 Std, 0,25, 0,50, 0,75 Std, 0,25, 0,50, 0,20	60
AUM, AUQ	1781	4	Bora 1.8i Turbo 20V	81,00	180 050 0009 181 050 0011 182 050 0002 184 050 0008	Std, 0,25, 0,50 Std, 0,25, 0,50, 0,75 Std, 0,25, 0,50, 0,20 Semi	61
AWM, AWT	1781	4	Passat 1.8i Turbo 20V	81,00	180 050 0009 181 050 0011 182 050 0002 184 050 0008	Std, 0,25, 0,50 Std, 0,25, 0,50, 0,75 Std, 0,25, 0,50, 0,20 Semi	61
DS, DZ, JN, JV	1781	4	Passat 1.8, Santana 1.8	81,00	180 050 0008 180 050 0014 181 050 0001 182 050 0002 183 050 0001 183 050 0002	Std, 0,25, 0,50 Std, 0,25, 0,50, 0,75, 1,00 Std, 0,25, 0,50, 0,75, 1,00 Std, 0,25, 0,50, 0,20 Std, Semi Std, Semi	62
DX, EV, EX, GU, GX, JH, KR, PL, RG, RH, RP	1781	4	Corrado 1.8i 16V, Golf 1.8, Golf 1.8i, Golf 1.8i 16V, Jetta 1.8, Jetta 1.8i, Jetta 1.8i 16V, Passat 1.8i, Passat 1.8i 16V, Rabbit 1.8i, Scirocco 1.8i, Scirocco 1.8i 16V	81,00	180 050 0008 180 050 0014 181 050 0001 182 050 0002 183 050 0001 183 050 0002 184 050 0008	Std, 0,25, 0,50 Std, 0,25, 0,50, 0,75, 1,00 Std, 0,25, 0,50, 0,75, 1,00 Std, 0,25, 0,50, 0,20 Std, Semi Std, Semi Semi	64



Globally reliable

VOLKSWAGEN

	ccm						Pos.
AEB	1781	4	Passat 1.8i Turbo 20V	81,00	180 050 0014 181 050 0015 182 050 0002 184 050 0008	Std, 0,25, 0,50, 0,75, 1,00 Std Std, 0,25, 0,50, 0,20 Semi	69
AGU, APU, ARZ	1781	4	Golf IV 1.8i Turbo 20V, Passat 1.8i Turbo 20V	81,00	180 050 0009 181 050 0015 182 050 0002 184 050 0008	Std, 0,25, 0,50 Std Std, 0,25, 0,50, 0,20 Semi	70
ANB	1781	4	Passat 1.8i Turbo 20V	81,00	180 050 0009 181 050 0001 181 050 0015 182 050 0002 184 050 0008	Std, 0,25, 0,50 Std, 0,25, 0,50, 0,75, 1,00 Std Std, 0,25, 0,50, 0,20 Semi	71
AGZ, AQN, AZX	2324	5	Bora 2.3i 20V, Bora 2.3i 25V, Golf 2.3i 20V, Golf 2.3i 25V, Passat 2.3i 20V	81,00	180 050 0010 181 050 0006	Std, 0,25 Std, 0,25, 0,50	67
AAA, AES, AMV, AQP, AUE, AYL, BDE	2792	6	California 2.8i, EuroVan 2.8i, Golf VR6 2.8i 24V, Jetta VR6 2.8i, Passat VR6 2.8i, Sharan VR6 2.8i, Sharan 2.8i 24V, Transporter T4 2.8i	81,00	180 050 0011 181 050 0007	Std, 0,25, 0,50 Std, 0,25, 0,50	68
AAC	1998	4	California 2.0i, Transporter T4 2.0i	81,00	180 050 0014 181 050 0001 182 050 0002 184 050 0007	Std, 0,25, 0,50, 0,75, 1,00 Std, 0,25, 0,50, 0,75, 1,00 Std, 0,25, 0,50, 0,20 Semi	48
AZV, BGW, BKD, BKP, BMA, BMM, BMN, BMP, BMR, BVD, BVE	1968	4	Caddy III 2.0TDI, Eos 2.0TDI, Golf V 2.0TDI, Golf V 2.0TDI 16V, Jetta III 2.0TDI, Jetta III 2.0TDI 16V, Passat 2.0TDI, Passat 2.0TDI 16V, Passat Variant 2.0TDI, Passat Variant 2.0TDI 16V, Touran 2.0TDI, Touran 2.0TDI 16V	81,00	180 050 0015 181 050 0019 183 050 0003	Std, 0,25, 0,50, 0,75 Std, 0,25, 0,50 Std	37
AZV, BKD, BKP, BMA, BMR, BUZ, BVE, BWV	1968	4	Golf V 2.0TDI 16V, Passat 2.0TDI 16V, Touran 2.0TDI 16V	81,00	180 050 0015 181 050 0019 182 050 0002	Std, 0,25, 0,50, 0,75 Std, 0,25, 0,50 Std, 0,25, 0,50, 0,20	72
BDJ, BDK, BST	1968	4	Golf V 2.0 SDI	81,00	180 050 0015 181 050 0022 182 050 0002	Std, 0,25, 0,50, 0,75 Std, 0,25, 0,50 Std, 0,25, 0,50, 0,20	36
BGW, BHW	1968	4	Passat 2.0TDI	81,00	180 050 0015 181 050 0019 182 050 0002 184 050 0006	Std, 0,25, 0,50, 0,75 Std, 0,25, 0,50 Std, 0,25, 0,50, 0,20 Semi	73
BMM, BMN, BMP, BRT, BVH	1968	4	Caddy 2.0TDI 16V, Golf V 2.0TDI 16V, Jetta 2.0TDI 16V, Passat 2.0TDI 16V, Sharan 2.0TDI 16V, Touran 2.0TDI 16V	81,00	180 050 0015 181 050 0019 182 050 0002	Std, 0,25, 0,50, 0,75 Std, 0,25, 0,50 Std, 0,25, 0,50, 0,20	72
ACV, AGX, AHD, AHY, AJT, ANJ, APA, AUF, AVR, AXG, AXL, AYC, AYY, BBE, BBF	2461	5	California 2.5TDI, LT28 TDI, LT35 TDI, LT46 TDI, Transporter T4 2.5TDI	81,00	180 050 0017 181 050 0018 182 050 0005	Std, 0,25, 0,50 Std, 0,25, 0,50 Std	74
AXD, AXE, BAC, BLJ, BLK, BNZ, BPC, BPD, BPE	2461	5	Multivan V 2.5 TDI, Multivan V 2.5 TDI 4motion, Touareg 2.5 R5 TDI, Transporter V 2.5 TDI, Transporter V 2.5 TDI 4motion	81,00	180 050 0021 181 050 0020	Std, 0,25, 0,50 Std, 0,25, 0,50	75
ABV	2861	6	Corrado VR6 2.9i, Golf VR6 2.9i, Passat VR6 2.9i	82,00	180 050 0011 181 050 0007	Std, 0,25, 0,50 Std, 0,25, 0,50	68
ACK, AGE, ALG, AMX, APR, AQD, ATQ, ATX, BBG	2771	6	Passat 2.8i 30V	82,50	180 050 0012 181 050 0008 182 050 0004	Std, 0,25, 0,50 Std, 0,25, 0,50 Std	82
2E, ABF, ADY	1984	4	Corrado 2.0i, Golf 2.0i, Passat 2.0i, Passat 2.0i 16V, Sharan 2.0i, Vento 2.0i	82,50	180 050 0014 181 050 0001 182 050 0002 183 050 0001 183 050 0002	Std, 0,25, 0,50, 0,75, 1,00 Std, 0,25, 0,50, 0,75, 1,00 Std, 0,25, 0,50, 0,20 Std, Semi Std, Semi	66
9A	1984	4	Corrado 2.0i 16V, Golf 2.0i 16V, Passat 2.0i 16V	82,50	180 050 0014 181 050 0001 182 050 0002 183 050 0001 183 050 0002 184 050 0008	Std, 0,25, 0,50, 0,75, 1,00 Std, 0,25, 0,50, 0,75, 1,00 Std, 0,25, 0,50, 0,20 Std, Semi Std, Semi Semi	47
AEG, APK, AQY, ASU, AUZ, AVA	1984	4	Bora 2.0i, Golf 2.0i, Jetta 2.0i, New Beetle 2.0i, Passat 2.0i	82,50	180 050 0009 181 050 0001 182 050 0002 184 050 0008	Std, 0,25, 0,50 Std, 0,25, 0,50, 0,75, 1,00 Std, 0,25, 0,50, 0,20 Semi	56
AEP	1984	4	Golf 2.0i, Passat 2.0i, Vento 2.0i	82,50	180 050 0014 181 050 0001 182 050 0002	Std, 0,25, 0,50, 0,75, 1,00 Std, 0,25, 0,50, 0,75, 1,00 Std, 0,25, 0,50, 0,20	76
AGG	1984	4	Golf 2.0i, Passat 2.0i, Vento 2.0i	82,50	180 050 0009 180 050 0013 180 050 0014 181 050 0001 182 050 0002 183 050 0001 183 050 0002	Std, 0,25, 0,50 Std, 0,25, 0,50, 1,00 Std, 0,25, 0,50, 0,75, 1,00 Std, 0,25, 0,50, 0,75, 1,00 Std, 0,25, 0,50, 0,20 Std, Semi Std, Semi	77
AKR	1984	4	Golf 2.0i, Vento 2.0i	82,50	180 050 0009 180 050 0013 180 050 0014 181 050 0001 182 050 0002	Std, 0,25, 0,50 Std, 0,25, 0,50, 1,00 Std, 0,25, 0,50, 0,75, 1,00 Std, 0,25, 0,50, 0,75, 1,00 Std, 0,25, 0,50, 0,20	78
ALT, AXX, BPY, BVX, BWA	1984	4	Bora 2.0 TFSI 16V, Eos 2.0 TFSI 16V, Golf 2.0 FSI 16V, Golf 2.0 TFSI 16V, Jetta 2.0 TFSI 16V, Passat 2.0 FSI 16V, Passat 2.0 TFSI 16V	82,50	180 050 0009 181 050 0011 182 050 0001	Std, 0,25, 0,50 Std, 0,25, 0,50, 0,75 Std	79











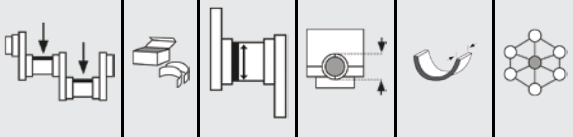













	ccm						Pos.
ATM, AZG, AZH, AZJ, AZM, BDC, BEH, BEJ, BER, BEV, BGD, BHP, BSX	1984	4	Bora 2.0i, Golf 2.0i, Jetta 2.0i, New Beetle 2.0i, Passat 2.0i	82,50	180 050 0009 181 050 0011 182 050 0002	Std, 0,25, 0,50 Std, 0,25, 0,50, 0,75 Std, 0,25, 0,50, 0,20	60
AWF	1984	4	Golf 2.0i	82,50	180 050 0009 181 050 0001 182 050 0002	Std, 0,25, 0,50 Std, 0,25, 0,50, 0,75, 1,00 Std, 0,25, 0,50, 0,20	80
AXA	1984	4	Multivan T5 2.0i, Transporter T5 2.0i	82,50	180 050 0009 181 050 0001 181 050 0011 182 050 0002 183 050 0001 183 050 0002 184 050 0008	Std, 0,25, 0,50 Std, 0,25, 0,50, 0,75, 1,00 Std, 0,25, 0,50, 0,75 Std, 0,25, 0,50, 0,20 Std, Semi Std, Semi Semi	81
AXW, BLR, BLX, BLY, BVY, BVZ	1984	4	Eos 2.0 FSI 16V, Golf 2.0 FSI 16V, Jetta 2.0 FSI 16V, Passat 2.0 FSI 16V, Touran 2.0 FSI 16V	82,50	180 050 0009 181 050 0011 182 050 0001	Std, 0,25, 0,50 Std, 0,25, 0,50, 0,75 Std	79
AXJ, AYT, AZZ, BAA, BDL, BFH, BKJ, BKK, BKL, BMF, BML, BMV, BMX, BRJ, BRK, BUB	3189	6	Eos 3.2i 24V, Golf 3.2i 24V, New Beetle 3.2i 24V, Phaeton VR6 3.2i 24V, Touareg 3.2i 24V, Transporter T5 3.2i 24V	84,00	180 050 0011 181 050 0007	Std, 0,25, 0,50 Std, 0,25, 0,50	68
AXZ	3168	6	Passat 3.2 FSI 24V	89,00	180 050 0011 181 050 0007	Std, 0,25, 0,50 Std, 0,25, 0,50	68
BHK, BLV	3597	6	Passat 3.6 FSI 24V, Touareg 3.6 FSI 24V	89,00	180 050 0011 181 050 0007	Std, 0,25, 0,50 Std, 0,25, 0,50	68
AWG	1984	4		92,50	180 050 0009 181 050 0001 182 050 0002	Std, 0,25, 0,50 Std, 0,25, 0,50, 0,75, 1,00 Std, 0,25, 0,50, 0,20	80



VOLKSWAGEN











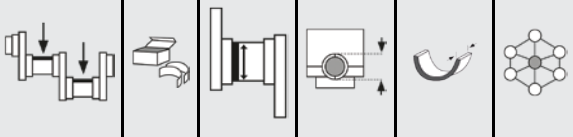

















Globally reliable











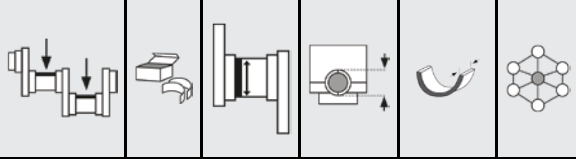













							Set Composition / QTY															
1 64,50																						
MB/HL 1, 2, 3, 4	4 Pairs	53,958 53,978	59,000 59,019	18,500	SAL	180 050 0001 00 15	4		4		1		1									
MB/HL 5	1 Pair	53,958 53,978	59,000 59,019	24,930	SAL		21 26 29															
MB/HL 1, 2, 3, 4	4 Pairs	53,958 53,978	59,000 59,019	18,500	SAL	180 050 0006 00 15	8		2													
MB/HL 5	1 Pair	53,958 53,978	59,000 59,019	24,930	SAL		21															
MB/HL 1, 2, 3, 4	4 Pairs	53,958 53,978	59,000 59,019	18,500	S3S	180 050 0008 00 15	5		3		1		1									
MB/HL 5	1 Pair	53,958 53,978	59,000 59,019	24,930	S3S		21															
CB/PL 1, 2, 3, 4	4 Pairs	41,955 41,970	45,000 45,016	18,000	S3S	181 050 0010 00 15 21 26	8															
Cbush/NWL 1	1 Pair	42,959 42,975	46,000 46,025	15,000	SAL	183 050 0001 00 99																
Cbush/NWL 1	1 Pair	41,959 41,975	45,000	15,000	SAL	183 050 0002 00 99																
Bush/PB 1, 2, 3, 4	4 Pairs	20,000	23,000 23,052	24,000	SL	184 050 0002 99																
2 67,10																						
MB/HL 1, 2, 3, 4, 5	5 Pairs	53,963 53,978	59,000 59,019	18,500	SAL	180 050 0004 00 15 21	5		5													
CB/PL 1, 2, 3, 4	4 Pairs	41,965 41,980	45,000 45,012	18,500	SAL	181 050 0004 00 15 21	8															
TW/A 1	2 Halves	59,500 59,750	71,550 71,800		SAL	182 050 0001 00	2															
Bush/PB 1, 2, 3, 4	4 Pairs	17,000	20,000 20,052	20,300	SL	184 050 0003 99																
Bush/PB 1, 2, 3, 4	4 Pairs	17,000	20,000 20,033	20,500	SL	184 050 0004 99																
3 67,10																						
MB/HL 1, 2, 3, 4, 5	5 Pairs	53,963 53,978	59,000 59,019	18,500	SAL	180 050 0004 00 15 21	5		5													
CB/PL 1, 2, 3, 4	4 Pairs	41,965 41,980	45,000 45,012	18,500	SAL	181 050 0004 00 15 21	8															
TW/A 1	2 Halves	59,500 59,750	71,550 71,800		SAL	182 050 0001 00	2															
Bush/PB 1, 2, 3, 4	4 Pairs	17,000	20,000 20,033	20,500	SL	184 050 0004 99																
4 67,10																						
MB/HL 1, 2, 3	3 Pairs	59,971 59,990	65,000 65,016	24,000	SAL	180 153 0001 00 15 21 26	3		3													
CB/PL 1, 2, 3, 4	4 Pairs	41,965 41,980	45,000 45,012	18,500	SAL	181 050 0004 00 15 21	8															
Bush/PB 1, 2, 3, 4	4 Pairs	17,000	20,000 20,052	20,300	SL	184 050 0003 99																











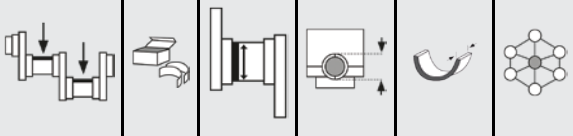

















 							Set Composition / QTY														
5 75,00																					
MB/HL 1, 2, 3, 4, 5	5 Pairs	53,958 53,978	59,000 59,019	18,500	SAL	180 050 0005 00 15 21	10														
CB/PL 1, 2, 3, 4	4 Pairs	41,955 41,970	45,000 45,016	18,000	S3S	181 050 0010 00 15 21 26	8														
TW/A 1	4 Halves	59,500 59,750	72,950 73,200		SAL	182 050 0002 00 15 21 14	2		2												
Bush/PB 1, 2, 3, 4	4 Pairs	17,000	20,000 20,052	20,300	SL	184 050 0003 99															
6 75,00																					
MB/HL 1, 2, 3, 4	4 Pairs	53,958 53,978	59,000 59,019	18,500	SAL	180 050 0001 00 15	4		4		1		1								
MB/HL 5	1 Pair	53,958 53,978	59,000 59,019	24,930	SAL	21 26 29															
MB/HL 1, 2, 3, 4	4 Pairs	53,958 53,978	59,000 59,019	18,500	S3S	180 050 0008 00 15	5		3		1		1								
MB/HL 5	1 Pair	53,958 53,978	59,000 59,019	24,930	S3S	21															
CB/PL 1, 2, 3, 4	4 Pairs	47,758 47,778	50,600 50,612	19,000	S3S	181 050 0001 00 15 21 26 29	8														
Cbush/NWL 1	1 Pair	42,959 42,975	46,000 46,025	15,000	SAL	183 050 0001 00 99															
Cbush/NWL 1	1 Pair	41,959 41,975	45,000	15,000	SAL	183 050 0002 00 99															
7 75,00																					
MB/HL 1, 2, 3, 4	4 Pairs	53,958 53,978	59,000 59,019	18,500	SAL	180 050 0006 00 15	8		2												
MB/HL 5	1 Pair	53,958 53,978	59,000 59,019	24,930	SAL	21															
CB/PL 1, 2, 3, 4	4 Pairs	41,955 41,970	45,000 45,016	18,000	S3S	181 050 0010 00 15 21 26	8														
Cbush/NWL 1	1 Pair	42,959 42,975	46,000 46,025	15,000	SAL	183 050 0001 00 99															
Cbush/NWL 1	1 Pair	41,959 41,975	45,000	15,000	SAL	183 050 0002 00 99															
Bush/PB 1, 2, 3, 4	4 Pairs	20,000	23,000 23,052	24,000	SL	184 050 0002 99															
8 75,00																					
MB/HL 1, 2, 3, 4	4 Pairs	53,958 53,978	59,000 59,019	18,500	SAL	180 050 0006 00 15	8		2												
MB/HL 5	1 Pair	53,958 53,978	59,000 59,019	24,930	SAL	21															
MB/HL 1, 2, 3, 4	4 Pairs	53,958 53,978	59,000 59,019	18,500	S3S	180 050 0008 00 15	5		3		1		1								
MB/HL 5	1 Pair	53,958 53,978	59,000 59,019	24,930	S3S	21															
CB/PL 1, 2, 3, 4	4 Pairs	41,955 41,970	45,000 45,016	18,000	S3S	181 050 0010 00 15 21 26	8														
Cbush/NWL 1	1 Pair	42,959 42,975	46,000 46,025	15,000	SAL	183 050 0001 00 99															
Cbush/NWL 1	1 Pair	41,959 41,975	45,000	15,000	SAL	183 050 0002 00 99															
Bush/PB 1, 2, 3, 4	4 Pairs	20,000	23,000 23,052	24,000	SL	184 050 0002 99															



									Set Composition / QTY												
9	75,00																				
MB/HL 1, 2, 3, 4, 5	5 Pairs	53,958 53,978	59,000 59,019	18,500	SAL	180 050 0005 00 15 21	10														
CB/PL 1, 2, 3, 4	4 Pairs	41,955 41,970	45,000 45,016	18,000	S3S	181 050 0010 00 15 21 26	8														
TW/A 1	4 Halves	59,500 59,750	72,950 73,200		SAL	182 050 0002 00 15 21 14	2		2												
Cbush/NWL 1	1 Pair	42,959 42,975	46,000 46,025	15,000	SAL	183 050 0001 00 99															
Cbush/NWL 1	1 Pair	41,959 41,975	45,000	15,000	SAL	183 050 0002 00 99															
Bush/PB 1, 2, 3, 4	4 Pairs	20,000	23,000 23,052	24,000	SL	184 050 0002 99															
10	75,00																				
MB/HL 1, 2, 3, 4, 5	5 Pairs	53,958 53,978	59,000 59,019	18,500	SAL	180 050 0005 00 15 21	10														
MB/HL 1, 2, 3, 4	4 Pairs	53,958 53,978	59,000 59,019	18,500	SAL	180 050 0006 00 15	8		2												
MB/HL 5	1 Pair	53,958 53,978	59,000 59,019	24,930	SAL	21															
CB/PL 1, 2, 3, 4	4 Pairs	41,955 41,970	45,000 45,016	18,000	S3S	181 050 0010 00 15 21 26	8														
TW/A 1	4 Halves	59,500 59,750	72,950 73,200		SAL	182 050 0002 00 15 21 14	2		2												
Cbush/NWL 1	1 Pair	42,959 42,975	46,000 46,025	15,000	SAL	183 050 0001 00 99															
Cbush/NWL 1	1 Pair	41,959 41,975	45,000	15,000	SAL	183 050 0002 00 99															
Bush/PB 1, 2, 3, 4	4 Pairs	20,000	23,000 23,052	24,000	SL	184 050 0002 99															
11	76,50																				
MB/HL 1, 2, 3, 4, 5	5 Pairs	53,963 53,978	59,000 59,019	18,500	SAL	180 050 0004 00 15 21	5		5												
CB/PL 1, 2, 3, 4	4 Pairs	47,763 47,778	50,600 50,612	18,500	SAL	181 050 0002 00 15 21 26	8														
TW/A 1	4 Halves	59,500 59,750	72,950 73,200		SAL	182 050 0002 00 15 21 14	2		2												
Bush/PB 1, 2, 3, 4	4 Pairs	17,000	20,000 20,033	20,500	SL	184 050 0004 99															
12	76,50																				
MB/HL 1, 2, 3, 4, 5	5 Pairs	53,958 53,978	59,000 59,019	18,500	SAL	180 050 0005 00 15 21	10														
CB/PL 1, 2, 3, 4	4 Pairs	47,763 47,778	50,600 50,612	18,500	SAL	181 050 0002 00 15 21 26	8														
TW/A 1	4 Halves	59,500 59,750	72,950 73,200		SAL	182 050 0002 00 15 21 14	2		2												
Bush/PB 1, 2, 3, 4	4 Pairs	17,000	20,000 20,052	20,300	SL	184 050 0003 99															











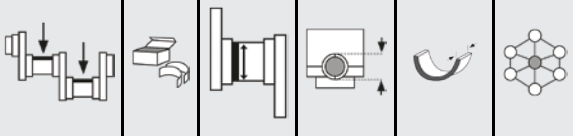













 							Set Composition / QTY															
13 76,50																						
MB/HL 1, 2, 3, 4, 5	5 Pairs	53,963 53,978	59,000 59,019	18,500	SAL	180 050 0004 00 15 21	5		5													
MB/HL 1, 2, 3, 4, 5	5 Pairs	53,958 53,978	59,000 59,019	18,500	SAL	180 050 0005 00 15 21	10															
MB/HL 1, 2, 3, 4, 5	5 Pairs	53,958 53,978	59,000 59,019	18,500	SAL	180 050 0013 00 15 21 29	5		5													
CB/PL 1, 2, 3, 4	4 Pairs	47,763 47,778	50,600 50,612	18,500	SAL	181 050 0002 00 15 21 26	8															
TW/A 1	4 Halves	59,500 59,750	72,950 73,200		SAL	182 050 0002 00 15 21 14	2		2													
Bush/PB 1, 2, 3, 4	4 Pairs	17,000	20,000 20,052	20,300	SL	184 050 0003 99																
Bush/PB 1, 2, 3, 4	4 Pairs	17,000	20,000 20,033	20,500	SL	184 050 0004 99																
14 76,50																						
MB/HL 1, 2, 3, 4, 5	5 Pairs	53,963 53,978	59,000 59,019	18,500	SAL	180 050 0004 00 15 21	5		5													
MB/HL 1, 2, 3, 4, 5	5 Pairs	53,958 53,978	59,000 59,019	18,500	SAL	180 050 0013 00 15 21 29	5		5													
CB/PL 1, 2, 3, 4	4 Pairs	47,763 47,778	50,600 50,612	18,500	SAL	181 050 0002 00 15 21 26	8															
TW/A 1	4 Halves	59,500 59,750	72,950 73,200		SAL	182 050 0002 00 15 21 14	2		2													
Bush/PB 1, 2, 3, 4	4 Pairs	17,000	20,000 20,052	20,300	SL	184 050 0003 99																
Bush/PB 1, 2, 3, 4	4 Pairs	17,000	20,000 20,033	20,500	SL	184 050 0004 99																
15 76,50																						
MB/HL 1, 2, 3, 4, 5	5 Pairs	53,963 53,978	59,000 59,019	18,500	SAL	180 050 0004 00 15 21	5		5													
CB/PL 1, 2, 3, 4	4 Pairs	47,763 47,778	50,600 50,612	18,500	SAL	181 050 0002 00 15 21 26	8															
TW/A 1	2 Halves	59,500 59,750	71,550 71,800		SAL	182 050 0001 00	2															
Bush/PB 1, 2, 3, 4	4 Pairs	17,000	20,000 20,033	20,500	SL	184 050 0004 99																
16 76,50																						
MB/HL 1, 2, 3, 4, 5	5 Pairs	53,963 53,978	59,000 59,019	18,500	SAL	180 050 0004 00 15 21	5		5													
CB/PL 1, 2, 3, 4	4 Pairs	47,763 47,778	50,600 50,612	18,500	SAL	181 050 0002 00 15 21 26	8															
CB/PL 1, 2, 3, 4	4 Pairs	47,763 47,778	50,600 50,612	18,500	S32S	181 050 0011 00 15 21 26	4		4													
TW/A 1	4 Halves	59,500 59,750	72,950 73,200		SAL	182 050 0002 00 15 21 14	2		2													
Bush/PB 1, 2, 3, 4	4 Pairs	17,000	20,000 20,033	20,500	SL	184 050 0004 99																

 							Set Composition / QTY														
17	76,50																				
MB/HL 1, 2, 3, 4, 5	5 Pairs	53,963 53,978	59,000 59,019	18,500	SAL	180 050 0004 00 15 21	5		5												
MB/HL 1, 2, 3, 4, 5	5 Pairs	53,958 53,978	59,000 59,019	18,500	SAL	180 050 0005 00 15 21	10														
CB/PL 1, 2, 3, 4	4 Pairs	47,763 47,778	50,600 50,612	18,500	SAL	181 050 0002 00 15 21 26	8														
TW/A 1	4 Halves	59,500 59,750	72,950 73,200		SAL	182 050 0002 00 15 21 14	2		2												
Bush/PB 1, 2, 3, 4	4 Pairs	17,000	20,000 20,052	20,300	SL	184 050 0003 99															
Bush/PB 1, 2, 3, 4	4 Pairs	17,000	20,000 20,033	20,500	SL	184 050 0004 99															
18	76,50																				
MB/HL 1, 2, 3, 4, 5	5 Pairs	53,963 53,978	59,000 59,019	18,500	SAL	180 050 0004 00 15 21	5		5												
MB/HL 1, 2, 3, 4, 5	5 Pairs	53,958 53,978	59,000 59,019	18,500	SAL	180 050 0005 00 15 21	10														
CB/PL 1, 2, 3, 4	4 Pairs	47,763 47,778	50,600 50,612	18,500	SAL	181 050 0002 00 15 21 26	8														
TW/A 1	4 Halves	59,500 59,750	72,950 73,200		SAL	182 050 0002 00 15 21 14	2		2												
Bush/PB 1, 2, 3, 4	4 Pairs	17,000	20,000 20,052	20,300	SL	184 050 0003 99															
19	76,50																				
MB/HL 1, 2, 3, 4, 5	5 Pairs	53,963 53,978	59,000 59,019	18,500	SAL	180 050 0004 00 15 21	5		5												
CB/PL 1, 2, 3, 4	4 Pairs	47,763 47,778	50,600 50,612	18,500	S32S	181 050 0011 00 15 21 26	4		4												
TW/A 1	4 Halves	59,500 59,750	72,950 73,200		SAL	182 050 0002 00 15 21 14	2		2												
Bush/PB 1, 2, 3, 4	4 Pairs	17,000	20,000 20,033	20,500	SL	184 050 0004 99															
20	76,50																				
MB/HL 1, 2, 3, 4, 5	5 Pairs	53,958 53,978	59,000 59,019	18,500	SAL	180 050 0005 00 15 21	10														
CB/PL 1, 2, 3, 4	4 Pairs	47,763 47,778	50,600 50,612	17,200	S32S	181 050 0013 00 15 21	4		4												
TW/A 1	4 Halves	59,500 59,750	72,950 73,200		SAL	182 050 0002 00 15 21 14	2		2												
Cbush/NWL 1	1 Pair	42,959 42,975	46,000 46,025	15,000	SAL	183 050 0001 00 99															
Cbush/NWL 1	1 Pair	41,959 41,975	45,000	15,000	SAL	183 050 0002 00 99															
Bush/PB 1, 2, 3, 4	4 Pairs	17,000	20,000 20,033	20,500	SL	184 050 0004 99															

							 		Set Composition / QTY													
21		76,50																				
MB/HL 1, 2, 3, 4, 5	5 Pairs	53,963 53,978	59,000 59,019	18,500	SAL	180 050 0004 00 15 21	5		5													
CB/PL 1, 2, 3, 4	4 Pairs	47,763 47,778	50,600 50,612	17,200	S32S	181 050 0013 00 15 21	4		4													
TW/A 1	4 Halves	59,500 59,750	72,950 73,200		SAL	182 050 0002 00 15 21 14	2		2													
Bush/PB 1, 2, 3, 4	4 Pairs	17,000	20,000 20,033	20,500	SL	184 050 0004 99																
22		76,50																				
MB/HL 1, 2, 3, 4, 5	5 Pairs	53,963 53,978	59,000 59,019	18,500	SAL	180 050 0004 00 15 21	5		5													
CB/PL 1, 2, 3, 4	4 Pairs	47,763 47,778	50,600 50,612	17,200	SAL	181 050 0005 00 15 21	8															
TW/A 1	4 Halves	59,500 59,750	72,950 73,200		SAL	182 050 0002 00 15 21 14	2		2													
Bush/PB 1, 2, 3, 4	4 Pairs	17,000	20,000 20,033	20,500	SL	184 050 0004 99																
23		76,50																				
MB/HL 1, 2, 3, 4	4 Pairs	53,958 53,978	59,000 59,019	18,500	SAL	180 050 0001 00 15	4		4		1		1									
MB/HL 5	1 Pair	53,958 53,978	59,000 59,019	24,930	SAL	21 26 29																
MB/HL 1, 2, 3, 4	4 Pairs	53,958 53,978	59,000 59,019	18,500	S3S	180 050 0008 00 15	5		3		1		1									
MB/HL 5	1 Pair	53,958 53,978	59,000 59,019	24,930	S3S	21																
CB/PL 1, 2, 3, 4	4 Pairs	41,955 41,970	45,000 45,016	18,000	S3S	181 050 0010 00 15 21 26	8															
Cbush/NWL 1	1 Pair	42,959 42,975	46,000 46,025	15,000	SAL	183 050 0001 00 99																
Cbush/NWL 1	1 Pair	41,959 41,975	45,000	15,000	SAL	183 050 0002 00 99																
24		76,50																				
MB/HL 1, 2, 3, 4, 5	5 Pairs	53,958 53,978	59,000 59,019	18,500	S3S	180 050 0007 00 15 21	5		5													
MB/HL 1, 2, 3, 4, 5	5 Pairs	53,958 53,978	59,000 59,019	18,500	SAL	180 050 0013 00 15 21 29	5		5													
CB/PL 1, 2, 3, 4	4 Pairs	47,758 47,778	50,600 50,619	19,000	S3S	181 050 0009 00 15 21 26	8															
TW/A 1	4 Halves	59,500 59,750	72,950 73,200		SAL	182 050 0002 00 15 21 14	2		2													
Bush/PB 1, 2, 3, 4	4 Pairs	24,000	27,000 27,052	25,000	SL	184 050 0005 99																





							Set Composition / QTY									
25 76,50																
MB/HL 1, 2, 3, 4	4 Pairs	53,958 53,978	59,000 59,019	18,500	SAL	180 050 0001 00 15	4		4		1		1			
MB/HL 5	1 Pair	53,958 53,978	59,000 59,019	24,930	SAL	21 26 29										
MB/HL 1, 2, 3, 4	4 Pairs	53,958 53,978	59,000 59,019	18,500	S3S	180 050 0008 00 15	5		3		1		1			
MB/HL 5	1 Pair	53,958 53,978	59,000 59,019	24,930	S3S	21										
CB/PL 1, 2, 3, 4	4 Pairs	47,758 47,778	50,600 50,619	19,000	S3S	181 050 0009 00 15 21 26	8									
Cbush/NWL 1	1 Pair	42,959 42,975	46,000 46,025	15,000	SAL	183 050 0001 00 99										
Cbush/NWL 1	1 Pair	41,959 41,975	45,000	15,000	SAL	183 050 0002 00 99										
26 76,50																
MB/HL 1, 2, 3, 4	4 Pairs	53,958 53,978	59,000 59,019	18,500	SAL	180 050 0001 00 15	4		4		1		1			
MB/HL 5	1 Pair	53,958 53,978	59,000 59,019	24,930	SAL	21 26 29										
MB/HL 1, 2, 3, 4, 5	5 Pairs	53,958 53,978	59,000 59,019	18,500	S3S	180 050 0007 00 15 21	5		5							
MB/HL 1, 2, 3, 4, 5	5 Pairs	53,958 53,978	59,000 59,019	18,500	SAL	180 050 0013 00 15 21 29	5		5							
CB/PL 1, 2, 3, 4	4 Pairs	47,758 47,778	50,600 50,619	19,000	S3S	181 050 0009 00 15 21 26	8									
TW/A 1	4 Halves	59,500 59,750	72,950 73,200		SAL	182 050 0002 00 15 21 14	2		2							
Bush/PB 1, 2, 3, 4	4 Pairs	24,000	27,000 27,052	25,000	SL	184 050 0005 99										
27 76,50																
MB/HL 1, 2, 3, 4, 5	5 Pairs	53,958 53,978	59,000 59,019	18,500	SAL	180 050 0013 00 15 21 29	5		5							
CB/PL 1, 2, 3, 4	4 Pairs	47,758 47,778	50,600 50,619	19,000	S3S	181 050 0009 00 15 21 26	8									
TW/A 1	4 Halves	59,500 59,750	72,950 73,200		SAL	182 050 0002 00 15 21 14	2		2							
Bush/PB 1, 2, 3, 4	4 Pairs	24,000	27,000 27,052	25,000	SL	184 050 0005 99										
28 76,50																
MB/HL 1, 2, 3, 4	4 Pairs	53,958 53,978	59,000 59,019	18,500	SAL	180 050 0001 00 15	4		4		1		1			
MB/HL 5	1 Pair	53,958 53,978	59,000 59,019	24,930	SAL	21 26 29										
CB/PL 1, 2, 3, 4	4 Pairs	47,758 47,778	50,600 50,619	19,000	S3S	181 050 0009 00 15 21 26	8									
Bush/PB 1, 2, 3, 4	4 Pairs	24,000	27,000 27,052	25,000	SL	184 050 0005 99										

 							Set Composition / QTY														
29	76,50																				
CB/PL 1, 2, 3	3 Pairs	47,758 47,778	50,600 50,612	20,000	S4S	181 050 0021 00 15 21															
30	76,50																				
MB/HL 1, 2, 3, 4	4 Pairs	47,960 47,980	55,000 55,016	18,500	SSI	180 050 0022 00 15	4		4												
CB/PL 1, 2, 3	3 Pairs	41,975 41,990	45,000 45,012	15,000	SSI	181 050 0024 00 15	6														
31	79,50																				
MB/HL 1, 2, 3, 4, 5	5 Pairs	53,958 53,978	59,000 59,019	18,500	S3S	180 050 0007 00 15 21	5		5												
MB/HL 1, 2, 3, 4, 5	5 Pairs	53,958 53,978	59,000 59,019	18,500	SAL	180 050 0013 00 15 21 29	5		5												
CB/PL 1, 2, 3, 4	4 Pairs	47,758 47,778	50,600 50,619	19,000	S3S	181 050 0009 00 15 21 26	8														
TW/A 1	4 Halves	59,500 59,750	72,950 73,200		SAL	182 050 0002 00 15 21 14	2		2												
Bush/PB 1, 2, 3, 4	4 Pairs	24,000	27,000 27,052	25,000	SL	184 050 0007 99															
32	79,50																				
MB/HL 1, 2, 3, 4, 5	5 Pairs	53,958 53,978	59,000 59,019	18,500	S3S	180 050 0007 00 15 21	5		5												
MB/HL 1, 2, 3, 4, 5	5 Pairs	53,958 53,978	59,000 59,019	18,500	SAL	180 050 0013 00 15 21 29	5		5												
CB/PL 1, 2, 3, 4	4 Pairs	47,758 47,778	50,600 50,619	20,000	S3S	181 050 0012 00 15 21 26	8														
TW/A 1	4 Halves	59,500 59,750	72,950 73,200		SAL	182 050 0002 00 15 21 14	2		2												
Cbush/NWL 1	1 Pair	42,959 42,975	46,000 46,025	15,000	SAL	183 050 0001 00 99															
Cbush/NWL 1	1 Pair	41,959 41,975	45,000	15,000	SAL	183 050 0002 00 99															
Bush/PB 1, 2, 3, 4	4 Pairs	26,000	29,000 29,052	25,000	SL	184 050 0006 99															
33	79,50																				
MB/HL 1, 2, 3, 4, 5	5 Pairs	53,958 53,978	59,000 59,019	18,500	SAL	180 050 0013 00 15 21 29	5		5												
CB/PL 1, 2, 3, 4	4 Pairs	47,758 47,778	50,600 50,619	20,000	S3S	181 050 0012 00 15 21 26	8														
TW/A 1	4 Halves	59,500 59,750	72,950 73,200		SAL	182 050 0002 00 15 21 14	2		2												
Bush/PB 1, 2, 3, 4	4 Pairs	26,000	29,000 29,052	25,000	SL	184 050 0006 99															

							Set Composition / QTY																
34	79,50																						
MB/HL 1, 2, 3, 4, 5	5 Pairs	53,958 53,978	59,000 59,019	18,500	SAL	180 050 0013 00 15 21 29	5		5														
CB/PL 1, 2, 3, 4	4 Pairs	47,758 47,778	50,600 50,619	19,000	S3S	181 050 0009 00 15 21 26	8																
TW/A 1	4 Halves	59,500 59,750	72,950 73,200		SAL	182 050 0002 00 15 21 14	2		2														
Bush/PB 1, 2, 3, 4	4 Pairs	24,000	27,000 27,052	25,000	SL	184 050 0007 99																	
35	79,50																						
MB/HL 1, 2, 3, 4, 5	5 Pairs	53,958 53,978	59,000 59,019	18,500	SAL	180 050 0013 00 15 21 29	5		5														
CB/PL 1, 2, 3, 4	4 Pairs	47,758 47,778	50,600 50,619	19,000	S3S	181 050 0009 00 15 21 26	8																
CB/PL 1, 2, 3, 4	4 Pairs	47,758 47,778	50,600 50,619	20,000	S3S	181 050 0012 00 15 21 26	8																
TW/A 1	4 Halves	59,500 59,750	72,950 73,200		SAL	182 050 0002 00 15 21 14	2		2														
Bush/PB 1, 2, 3, 4	4 Pairs	26,000	29,000 29,052	25,000	SL	184 050 0006 99																	
Bush/PB 1, 2, 3, 4	4 Pairs	24,000	27,000 27,052	25,000	SL	184 050 0007 99																	
36	79,50																						
MB/HL 1, 2, 3, 4, 5	5 Pairs	53,958 53,978	59,000 59,012	18,500	S3S	180 050 0015 00 15 21 26	5		5														
CB/PL 1, 2, 3, 4	4 Pairs	47,758 47,778	50,600 50,612	20,000	S4S	181 050 0022 00 15 21																	
TW/A 1	4 Halves	59,500 59,750	72,950 73,200		SAL	182 050 0002 00 15 21 14	2		2														
37	79,50																						
MB/HL 1, 2, 3, 4, 5	5 Pairs	53,958 53,978	59,000 59,012	18,500	S3S	180 050 0015 00 15 21 26	5		5														
CB/PL 1, 2, 3, 4	4 Pairs	50,858 50,878	53,700 53,712	20,400	S4S	181 050 0019 00 15 21																	
Cbush/NWL 1, 2, 3, 4, 5	5 Pairs	28,939 28,960	32,000 32,025	25,000	S3S	183 050 0003 00																	
38	79,50																						
MB/HL 1, 2, 3, 4, 5	5 Pairs	53,958 53,978	59,000 59,019	18,500	S3S	180 050 0007 00 15 21	5		5														
MB/HL 1, 2, 3, 4, 5	5 Pairs	53,958 53,978	59,000 59,019	18,500	SAL	180 050 0013 00 15 21 29	5		5														
CB/PL 1, 2, 3, 4	4 Pairs	47,758 47,778	50,600 50,612	20,000	S4S	181 050 0017 00 15																	
TW/A 1	4 Halves	59,500 59,750	72,950 73,200		SAL	182 050 0002 00 15 21 14	2		2														
Bush/PB 1, 2, 3, 4	4 Pairs	26,000	29,000 29,052	25,000	SL	184 050 0006 99																	











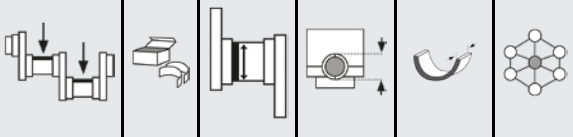















Set Composition / QTY

39		79,50																		
MB/HL 1, 2, 3, 4, 5	5 Pairs	53,958 53,978	59,000 59,019	18,500	SAL	180 050 0013 00 15 21 29	5		5											
CB/PL 1, 2, 3, 4	4 Pairs	47,758 47,778	50,600 50,612	20,000	S4S	181 050 0017 00 15														
TW/A 1	4 Halves	59,500 59,750	72,950 73,200		SAL	182 050 0002 00 15 21 14	2		2											
Cbush/NWL 1	1 Pair	42,959 42,975	46,000 46,025	15,000	SAL	183 050 0001 00 99														
Cbush/NWL 1	1 Pair	41,959 41,975	45,000	15,000	SAL	183 050 0002 00 99														
Bush/PB 1, 2, 3, 4	4 Pairs	26,000	29,000 29,052	25,000	SL	184 050 0006 99														
40		79,50																		
MB/HL 1, 2, 3, 4, 5	5 Pairs	53,958 53,978	59,000 59,019	18,500	SAL	180 050 0013 00 15 21 29	5		5											
CB/PL 1, 2, 3, 4	4 Pairs	47,758 47,778	50,600 50,612	20,000	S4S	181 050 0022 00 15 21														
TW/A 1	4 Halves	59,500 59,750	72,950 73,200		SAL	182 050 0002 00 15 21 14	2		2											
41		79,50																		
MB/HL 1, 2, 3, 4, 5	5 Pairs	53,958 53,978	59,000 59,019	18,500	S3S	180 050 0007 00 15 21	5		5											
MB/HL 1, 2, 3, 4, 5	5 Pairs	53,958 53,978	59,000 59,019	18,500	SAL	180 050 0013 00 15 21 29	5		5											
CB/PL 1, 2, 3, 4	4 Pairs	47,758 47,778	50,600 50,612	20,000	S4S	181 050 0022 00 15 21														
TW/A 1	4 Halves	59,500 59,750	72,950 73,200		SAL	182 050 0002 00 15 21 14	2		2											
Cbush/NWL 1	1 Pair	42,959 42,975	46,000 46,025	15,000	SAL	183 050 0001 00 99														
Cbush/NWL 1	1 Pair	41,959 41,975	45,000	15,000	SAL	183 050 0002 00 99														
42		79,50																		
MB/HL 1, 2, 3, 4, 5	5 Pairs	53,958 53,978	59,000 59,012	18,500	S3S	180 050 0015 00 15 21 26	5		5											
CB/PL 1, 2, 3, 4	4 Pairs	50,858 50,878	53,700 53,712	20,400	S4S	181 050 0019 00 15 21														
TW/A 1	4 Halves	59,500 59,750	72,950 73,200		SAL	182 050 0002 00 15 21 14	2		2											
Cbush/NWL 1, 2, 3, 4, 5	5 Pairs	28,939 28,960	32,000 32,025	25,000	S3S	183 050 0003 00														



							Set Composition / QTY																
43 79,50																							
MB/HL 1, 2, 3, 4, 5	5 Pairs	53,958 53,978	59,000 59,012	18,500	S3S	180 050 0015 00 15 21 26	5		5														
CB/PL 1, 2, 3, 4	4 Pairs	47,758 47,778	50,600 50,612	20,000	S4S	181 050 0022 00 15 21																	
TW/A 1	4 Halves	59,500 59,750	72,950 73,200		SAL	182 050 0002 00 15 21 14	2		2														
Cbush/NWL 1, 2, 3, 4, 5	5 Pairs	28,939 28,960	32,000 32,025	25,000	S3S	183 050 0003 00																	
44 79,50																							
MB/HL 1, 2, 3, 4, 5	5 Pairs	53,958 53,978	59,000 59,019	18,500	SAL	180 050 0013 00 15 21 29	5		5														
CB/PL 1, 2, 3, 4	4 Pairs	47,758 47,778	50,600 50,612	20,000	S4S	181 050 0022 00 15 21																	
TW/A 1	4 Halves	59,500 59,750	72,950 73,200		SAL	182 050 0002 00 15 21 14	2		2														
Cbush/NWL 1, 2, 3, 4, 5	5 Pairs	28,939 28,960	32,000 32,025	25,000	S3S	183 050 0003 00																	
45 79,50																							
MB/HL 1, 2, 3, 4, 5	5 Pairs	53,958 53,978	59,000 59,019	18,500	SAL	180 050 0013 00 15 21 29	5		5														
CB/PL 1, 2, 3, 4	4 Pairs	47,758 47,778	50,600 50,612	20,000	S4S	181 050 0022 00 15 21																	
TW/A 1	4 Halves	59,500 59,750	72,950 73,200		SAL	182 050 0002 00 15 21 14	2		2														
Cbush/NWL 1, 2, 3, 4, 5	5 Pairs	28,939 28,960	32,000 32,025	25,000	S3S	183 050 0003 00																	
Bush/PB 1, 2, 3, 4	4 Pairs	26,000	29,000 29,052	25,000	SL	184 050 0006 99																	
46 79,50																							
MB/HL 1, 2, 3, 4, 5	5 Pairs	53,958 53,978	59,000 59,012	18,500	S3S	180 050 0015 00 15 21 26	5		5														
CB/PL 1, 2, 3, 4	4 Pairs	50,858 50,878	53,700 53,712	20,400	S4S	181 050 0019 00 15 21																	
TW/A 1	4 Halves	59,500 59,750	72,950 73,200		SAL	182 050 0002 00 15 21 14	2		2														
Cbush/NWL 1, 2, 3, 4, 5	5 Pairs	28,939 28,960	32,000 32,025	25,000	S3S	183 050 0003 00																	
Bush/PB 1, 2, 3, 4	4 Pairs	26,000	29,000 29,052	25,000	SL	184 050 0006 99																	











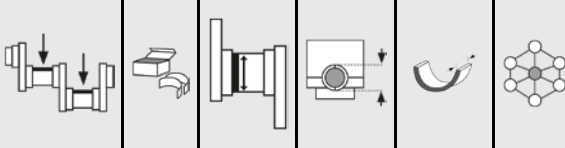















 							Set Composition / QTY															
47 81,00																						
MB/HL 1, 2, 3, 4, 5	5 Pairs	53,958 53,978	59,000 59,019	18,500	SAL	180 050 0014 00	15 21 26 29	6		4												
CB/PL 1, 2, 3, 4	4 Pairs	47,758 47,778	50,600 50,612	19,000	S3S	181 050 0001 00	15 21 26 29	8														
TW/A 1	4 Halves	59,500 59,750	72,950 73,200		SAL	182 050 0002 00	15 21 14	2		2												
Cbush/NWL 1	1 Pair	42,959 42,975	46,000 46,025	15,000	SAL	183 050 0001 00	99															
Cbush/NWL 1	1 Pair	41,959 41,975	45,000	15,000	SAL	183 050 0002 00	99															
Bush/PB 1, 2, 3, 4	4 Pairs	20,000	23,000 23,021	25,000	SL	184 050 0008 99																
48 81,00																						
MB/HL 1, 2, 3, 4, 5	5 Pairs	53,958 53,978	59,000 59,019	18,500	SAL	180 050 0014 00	15 21 26 29	6		4												
CB/PL 1, 2, 3, 4	4 Pairs	47,758 47,778	50,600 50,612	19,000	S3S	181 050 0001 00	15 21 26 29	8														
TW/A 1	4 Halves	59,500 59,750	72,950 73,200		SAL	182 050 0002 00	15 21 14	2		2												
Bush/PB 1, 2, 3, 4	4 Pairs	24,000	27,000 27,052	25,000	SL	184 050 0007 99																
49 81,00																						
MB/HL 1, 2, 3, 4, 5	5 Pairs	53,963 53,983	59,000 59,010	18,500	SAL	180 050 0009 00	15 21	5		5												
MB/HL 1, 2, 3, 4, 5	5 Pairs	53,958 53,978	59,000 59,019	18,500	SAL	180 050 0014 00	15 21 26 29	6		4												
CB/PL 1, 2, 3, 4	4 Pairs	47,758 47,778	50,600 50,612	19,000	S3S	181 050 0001 00	15 21 26 29	8														
TW/A 1	4 Halves	59,500 59,750	72,950 73,200		SAL	182 050 0002 00	15 21 14	2		2												
Bush/PB 1, 2, 3, 4	4 Pairs	20,000	23,000 23,021	25,000	SL	184 050 0008 99																
50 81,00																						
MB/HL 1, 2, 3, 4, 5	5 Pairs	53,958 53,978	59,000 59,019	18,500	SAL	180 050 0014 00	15 21 26 29	6		4												
CB/PL 1, 2, 3, 4	4 Pairs	47,758 47,778	50,600 50,612	19,000	S3S	181 050 0001 00	15 21 26 29	8														
TW/A 1	4 Halves	59,500 59,750	72,950 73,200		SAL	182 050 0002 00	15 21 14	2		2												
Bush/PB 1, 2, 3, 4	4 Pairs	20,000	23,000 23,021	25,000	SL	184 050 0008 99																











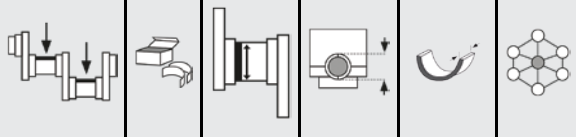

































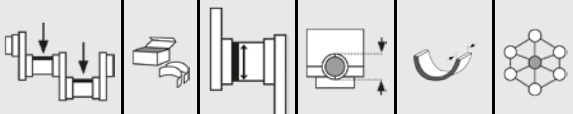























VOLKSWAGEN











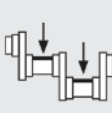

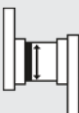
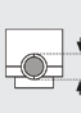











Globally reliable











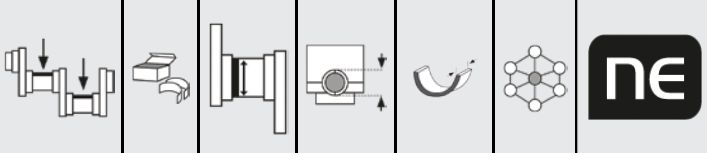











							Set Composition / QTY													
51	81,00																			
MB/HL 1, 2, 3, 4, 5	5 Pairs	53,958 53,978	59,000 59,019	18,500	SAL	180 050 0013 00 15 21 29	5		5											
MB/HL 1, 2, 3, 4, 5	5 Pairs	53,958 53,978	59,000 59,019	18,500	SAL	180 050 0014 00 15 21 26 29	6		4											
CB/PL 1, 2, 3, 4	4 Pairs	47,758 47,778	50,600 50,612	19,000	S3S	181 050 0001 00 15 21 26 29	8													
TW/A 1	4 Halves	59,500 59,750	72,950 73,200		SAL	182 050 0002 00 15 21 14	2		2											
Bush/PB 1, 2, 3, 4	4 Pairs	20,000	23,000 23,021	25,000	SL	184 050 0008 99														
52	81,00																			
MB/HL 1, 2, 3, 4, 5	5 Pairs	53,963 53,983	59,000 59,010	18,500	SAL	180 050 0009 00 15 21	5		5											
MB/HL 1, 2, 3, 4, 5	5 Pairs	53,958 53,978	59,000 59,019	18,500	SAL	180 050 0014 00 15 21 26 29	6		4											
CB/PL 1, 2, 3, 4	4 Pairs	47,758 47,778	50,600 50,612	19,000	S3S	181 050 0001 00 15 21 26 29	8													
TW/A 1	4 Halves	59,500 59,750	72,950 73,200		SAL	182 050 0002 00 15 21 14	2		2											
Cbush/NWL 1	1 Pair	42,959 42,975	46,000 46,025	15,000	SAL	183 050 0001 00 99														
Cbush/NWL 1	1 Pair	41,959 41,975	45,000	15,000	SAL	183 050 0002 00 99														
Bush/PB 1, 2, 3, 4	4 Pairs	20,000	23,000 23,021	25,000	SL	184 050 0008 99														
53	81,00																			
MB/HL 1, 2, 3, 4, 5	5 Pairs	53,963 53,983	59,000 59,010	18,500	SAL	180 050 0009 00 15 21	5		5											
CB/PL 1, 2, 3, 4	4 Pairs	47,758 47,778	50,600 50,612	19,000	S3S	181 050 0001 00 15 21 26 29	8													
TW/A 1	2 Halves	59,500 59,750	71,550 71,800		SAL	182 050 0001 00	2													
Bush/PB 1, 2, 3, 4	4 Pairs	20,000	23,000 23,021	25,000	SL	184 050 0008 99														
54	81,00																			
MB/HL 1, 2, 3, 4, 5	5 Pairs	53,963 53,983	59,000 59,010	18,500	SAL	180 050 0009 00 15 21	5		5											
MB/HL 1, 2, 3, 4, 5	5 Pairs	53,958 53,978	59,000 59,019	18,500	SAL	180 050 0013 00 15 21 29	5		5											
MB/HL 1, 2, 3, 4, 5	5 Pairs	53,958 53,978	59,000 59,019	18,500	SAL	180 050 0014 00 15 21 26 29	6		4											
CB/PL 1, 2, 3, 4	4 Pairs	47,758 47,778	50,600 50,612	19,000	S3S	181 050 0001 00 15 21 26 29	8													

							Set Composition / QTY														
TW/A 1	4 Halves	59,500 59,750	72,950 73,200		SAL	182 050 0002 00	2		2												
Cbush/NWL 1	1 Pair	42,959 42,975	46,000 46,025	15,000	SAL	183 050 0001 00															
Cbush/NWL 1	1 Pair	41,959 41,975	45,000	15,000	SAL	183 050 0002 00															
Bush/PB 1, 2, 3, 4	4 Pairs	20,000	23,000 23,021	25,000	SL	184 050 0008 99															
55 81,00																					
MB/HL 1, 2, 3, 4, 5	5 Pairs	53,963 53,983	59,000 59,010	18,500	SAL	180 050 0009 00	5		5												
MB/HL 1, 2, 3, 4, 5	5 Pairs	53,958 53,978	59,000 59,019	18,500	SAL	180 050 0013 00	5		5												
MB/HL 1, 2, 3, 4, 5	5 Pairs	53,958 53,978	59,000 59,019	18,500	SAL	180 050 0014 00	6		4												
CB/PL 1, 2, 3, 4	4 Pairs	47,758 47,778	50,600 50,612	19,000	S3S	181 050 0001 00	8														
TW/A 1	4 Halves	59,500 59,750	72,950 73,200		SAL	182 050 0002 00	2		2												
Bush/PB 1, 2, 3, 4	4 Pairs	20,000	23,000 23,021	25,000	SL	184 050 0008 99															
56 81,00																					
MB/HL 1, 2, 3, 4, 5	5 Pairs	53,963 53,983	59,000 59,010	18,500	SAL	180 050 0009 00	5		5												
CB/PL 1, 2, 3, 4	4 Pairs	47,758 47,778	50,600 50,612	19,000	S3S	181 050 0001 00	8														
TW/A 1	4 Halves	59,500 59,750	72,950 73,200		SAL	182 050 0002 00	2		2												
Bush/PB 1, 2, 3, 4	4 Pairs	20,000	23,000 23,021	25,000	SL	184 050 0008 99															
57 81,00																					
MB/HL 1, 2, 3, 4, 5	5 Pairs	47,958 47,978	53,000 53,010	18,500	SAL	180 050 0003 00	5		5												
MB/HL 1, 2, 3, 4, 5	5 Pairs	53,963 53,983	59,000 59,010	18,500	SAL	180 050 0009 00	5		5												
CB/PL 1, 2, 3, 4	4 Pairs	47,758 47,778	50,600 50,612	19,000	S3S	181 050 0001 00	8														
CB/PL 1, 2, 3, 4	4 Pairs	41,965 41,980	45,000 45,016	19,000	S3S	181 050 0003 00	4		4												
TW/A 1	2 Halves	59,500 59,750	71,550 71,800		SAL	182 050 0001 00	2														
TW/A 1	2 Halves	53,500 53,750	65,550 65,800		SAL	182 050 0003 00	2														
Bush/PB 1, 2, 3, 4	4 Pairs	20,000	23,000 23,021	25,000	SL	184 050 0008 99															

 							Set Composition / QTY												
58 81,00																			
MB/HL 1, 2, 3, 4, 5	5 Pairs	47,958 47,978	53,000 53,010	18,500	SAL	180 050 0003 00	15 21 26	5		5									
CB/PL 1, 2, 3, 4	4 Pairs	41,965 41,980	45,000 45,016	19,000	S3S	181 050 0003 00	15 21 26	4		4									
TW/A 1	2 Halves	53,500 53,750	65,550 65,800		SAL	182 050 0003 00		2											
59 81,00																			
MB/HL 1, 2, 3, 4, 5	5 Pairs	53,958 53,978	59,000 59,019	18,500	SAL	180 050 0013 00	15 21 29	5		5									
CB/PL 1, 2, 3, 4	4 Pairs	47,758 47,778	50,600 50,612	19,000	S3S	181 050 0001 00	15 21 26 29	8											
TW/A 1	4 Halves	59,500 59,750	72,950 73,200		SAL	182 050 0002 00	15 21 14	2		2									
Bush/PB 1, 2, 3, 4	4 Pairs	20,000	23,000 23,021	25,000	SL	184 050 0008 99													
60 81,00																			
MB/HL 1, 2, 3, 4, 5	5 Pairs	53,963 53,983	59,000 59,010	18,500	SAL	180 050 0009 00	15 21	5		5									
CB/PL 1, 2, 3, 4	4 Pairs	47,763 47,778	50,600 50,612	18,500	S32S	181 050 0011 00	15 21 26	4		4									
TW/A 1	4 Halves	59,500 59,750	72,950 73,200		SAL	182 050 0002 00	15 21 14	2		2									
61 81,00																			
MB/HL 1, 2, 3, 4, 5	5 Pairs	53,963 53,983	59,000 59,010	18,500	SAL	180 050 0009 00	15 21	5		5									
CB/PL 1, 2, 3, 4	4 Pairs	47,763 47,778	50,600 50,612	18,500	S32S	181 050 0011 00	15 21 26	4		4									
TW/A 1	4 Halves	59,500 59,750	72,950 73,200		SAL	182 050 0002 00	15 21 14	2		2									
Bush/PB 1, 2, 3, 4	4 Pairs	20,000	23,000 23,021	25,000	SL	184 050 0008 99													
62 81,00																			
MB/HL 1, 2, 3, 4	4 Pairs	53,958 53,978	59,000 59,019	18,500	S3S	180 050 0008 00	15	5		3		1		1					
MB/HL 5	1 Pair	53,958 53,978	59,000 59,019	24,930	S3S	21													
MB/HL 1, 2, 3, 4, 5	5 Pairs	53,958 53,978	59,000 59,019	18,500	SAL	180 050 0014 00	15 21 26 29	6		4									
CB/PL 1, 2, 3, 4	4 Pairs	47,758 47,778	50,600 50,612	19,000	S3S	181 050 0001 00	15 21 26 29	8											
TW/A 1	4 Halves	59,500 59,750	72,950 73,200		SAL	182 050 0002 00	15 21 14	2		2									
Cbush/NWL 1	1 Pair	42,959 42,975	46,000 46,025	15,000	SAL	183 050 0001 00	99												











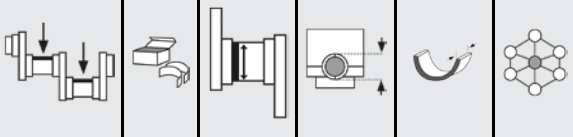













 							Set Composition / QTY													
Cbush/NWL 1	1 Pair	41,959 41,975	45,000	15,000	SAL	183 050 0002 00 99														
63	81,00																			
MB/HL 1, 2, 3, 4	4 Pairs	53,958 53,978	59,000 59,019	18,500	SAL	180 050 0001 00 15	4		4		1		1							
MB/HL 5	1 Pair	53,958 53,978	59,000 59,019	24,930	SAL	21 26 29														
MB/HL 1, 2, 3, 4	4 Pairs	53,958 53,978	59,000 59,019	18,500	S3S	180 050 0008 00 15	5		3		1		1							
MB/HL 5	1 Pair	53,958 53,978	59,000 59,019	24,930	S3S	21														
MB/HL 1, 2, 3, 4, 5	5 Pairs	53,958 53,978	59,000 59,019	18,500	SAL	180 050 0014 00 15 21 26 29	6		4											
CB/PL 1, 2, 3, 4	4 Pairs	47,758 47,778	50,600 50,612	19,000	S3S	181 050 0001 00 15 21 26 29	8													
TW/A 1	4 Halves	59,500 59,750	72,950 73,200		SAL	182 050 0002 00 15 21 14	2		2											
Cbush/NWL 1	1 Pair	42,959 42,975	46,000 46,025	15,000	SAL	183 050 0001 00 99														
Cbush/NWL 1	1 Pair	41,959 41,975	45,000	15,000	SAL	183 050 0002 00 99														
64	81,00																			
MB/HL 1, 2, 3, 4	4 Pairs	53,958 53,978	59,000 59,019	18,500	S3S	180 050 0008 00 15	5		3		1		1							
MB/HL 5	1 Pair	53,958 53,978	59,000 59,019	24,930	S3S	21														
MB/HL 1, 2, 3, 4, 5	5 Pairs	53,958 53,978	59,000 59,019	18,500	SAL	180 050 0014 00 15 21 26 29	6		4											
CB/PL 1, 2, 3, 4	4 Pairs	47,758 47,778	50,600 50,612	19,000	S3S	181 050 0001 00 15 21 26 29	8													
TW/A 1	4 Halves	59,500 59,750	72,950 73,200		SAL	182 050 0002 00 15 21 14	2		2											
Cbush/NWL 1	1 Pair	42,959 42,975	46,000 46,025	15,000	SAL	183 050 0001 00 99														
Cbush/NWL 1	1 Pair	41,959 41,975	45,000	15,000	SAL	183 050 0002 00 99														
Bush/PB 1, 2, 3, 4	4 Pairs	20,000	23,000 23,021	25,000	SL	184 050 0008 99														
65	81,00																			
MB/HL 1, 2, 3, 4	4 Pairs	53,958 53,978	59,000 59,019	18,500	SAL	180 050 0001 00 15	4		4		1		1							
MB/HL 5	1 Pair	53,958 53,978	59,000 59,019	24,930	SAL	21 26 29														
MB/HL 1, 2, 3, 4	4 Pairs	53,958 53,978	59,000 59,019	18,500	S3S	180 050 0008 00 15	5		3		1		1							
MB/HL 5	1 Pair	53,958 53,978	59,000 59,019	24,930	S3S	21														
MB/HL 1, 2, 3, 4, 5	5 Pairs	53,958 53,978	59,000 59,019	18,500	SAL	180 050 0014 00 15 21 26 29	6		4											

							Set Composition / QTY													
CB/PL 1, 2, 3, 4	4 Pairs	47,758 47,778	50,600 50,612	19,000	S3S	181 050 0001 00	15 21 26 29	8												
TW/A 1	4 Halves	59,500 59,750	72,950 73,200		SAL	182 050 0002 00	15 21 14	2		2										
Cbush/NWL 1	1 Pair	42,959 42,975	46,000 46,025	15,000	SAL	183 050 0001 00	99													
Cbush/NWL 1	1 Pair	41,959 41,975	45,000	15,000	SAL	183 050 0002 00	99													
Bush/PB 1, 2, 3, 4	4 Pairs	20,000	23,000 23,021	25,000	SL	184 050 0008 99														
66 81,00																				
MB/HL 1, 2, 3, 4, 5	5 Pairs	53,958 53,978	59,000 59,019	18,500	SAL	180 050 0014 00	15 21 26 29	6		4										
CB/PL 1, 2, 3, 4	4 Pairs	47,758 47,778	50,600 50,612	19,000	S3S	181 050 0001 00	15 21 26 29	8												
TW/A 1	4 Halves	59,500 59,750	72,950 73,200		SAL	182 050 0002 00	15 21 14	2		2										
Cbush/NWL 1	1 Pair	42,959 42,975	46,000 46,025	15,000	SAL	183 050 0001 00	99													
Cbush/NWL 1	1 Pair	41,959 41,975	45,000	15,000	SAL	183 050 0002 00	99													
67 81,00																				
MB/HL 1, 2, 3, 4, 5, 6	6 Pairs	59,958 59,978	65,000 65,010	17,000	SAL	180 050 0010 00	15	5		5										
CB/PL 1, 2, 3, 4, 5	5 Pairs	53,958 53,978	56,800 56,819	17,000	SAL	181 050 0006 00	15 21	10												
68 81,00																				
MB/HL 1, 2, 3, 4, 5, 6, 7	7 Pairs	59,958 59,978	65,000 65,010	17,000	SAL	180 050 0011 00	15 21	7		7										
CB/PL 1, 2, 3, 4, 5, 6	6 Pairs	53,958 53,978	56,800 56,819	17,000	SAL	181 050 0007 00	15 21	12												
69 81,00																				
MB/HL 1, 2, 3, 4, 5	5 Pairs	53,958 53,978	59,000 59,019	18,500	SAL	180 050 0014 00	15 21 26 29	6		4										
CB/PL 1, 2, 3, 4	4 Pairs	47,758 47,778	50,600 50,612	19,000	S4S	181 050 0015 00														
TW/A 1	4 Halves	59,500 59,750	72,950 73,200		SAL	182 050 0002 00	15 21 14	2		2										
Bush/PB 1, 2, 3, 4	4 Pairs	20,000	23,000 23,021	25,000	SL	184 050 0008 99														

							Set Composition / QTY														
70	81,00																				
MB/HL 1, 2, 3, 4, 5	5 Pairs	53,963 53,983	59,000 59,010	18,500	SAL	180 050 0009 00 15 21	5		5												
CB/PL 1, 2, 3, 4	4 Pairs	47,758 47,778	50,600 50,612	19,000	S4S	181 050 0015 00															
TW/A 1	4 Halves	59,500 59,750	72,950 73,200		SAL	182 050 0002 00 15 21 14	2		2												
Bush/PB 1, 2, 3, 4	4 Pairs	20,000	23,000 23,021	25,000	SL	184 050 0008 99															
71	81,00																				
MB/HL 1, 2, 3, 4, 5	5 Pairs	53,963 53,983	59,000 59,010	18,500	SAL	180 050 0009 00 15 21	5		5												
CB/PL 1, 2, 3, 4	4 Pairs	47,758 47,778	50,600 50,612	19,000	S3S	181 050 0001 00 15 21 26 29	8														
CB/PL 1, 2, 3, 4	4 Pairs	47,758 47,778	50,600 50,612	19,000	S4S	181 050 0015 00															
TW/A 1	4 Halves	59,500 59,750	72,950 73,200		SAL	182 050 0002 00 15 21 14	2		2												
Bush/PB 1, 2, 3, 4	4 Pairs	20,000	23,000 23,021	25,000	SL	184 050 0008 99															
72	81,00																				
MB/HL 1, 2, 3, 4, 5	5 Pairs	53,958 53,978	59,000 59,012	18,500	S3S	180 050 0015 00 15 21 26	5		5												
CB/PL 1, 2, 3, 4	4 Pairs	50,858 50,878	53,700 53,712	20,400	S4S	181 050 0019 00 15 21															
TW/A 1	4 Halves	59,500 59,750	72,950 73,200		SAL	182 050 0002 00 15 21 14	2		2												
73	81,00																				
MB/HL 1, 2, 3, 4, 5	5 Pairs	53,958 53,978	59,000 59,012	18,500	S3S	180 050 0015 00 15 21 26	5		5												
CB/PL 1, 2, 3, 4	4 Pairs	50,858 50,878	53,700 53,712	20,400	S4S	181 050 0019 00 15 21															
TW/A 1	4 Halves	59,500 59,750	72,950 73,200		SAL	182 050 0002 00 15 21 14	2		2												
Bush/PB 1, 2, 3, 4	4 Pairs	26,000	29,000 29,052	25,000	SL	184 050 0006 99															
74	81,00																				
MB/HL 1, 2, 3, 4, 5, 6	6 Pairs	57,958 57,978	63,000 63,019	18,500	S3S	180 050 0017 00 15 21	6		6												
CB/PL 1, 2, 3, 4, 5	5 Pairs	47,758 47,778	50,600 50,612	20,000	S4S	181 050 0018 00 15 21															
TW/A 1	4 Halves	63,500 63,750	76,950 77,200		SAL	182 050 0005 00	2		2												









							Set Composition / QTY														
75 81,00																					
MB/HL 1, 2, 3, 4, 5, 6	6 Pairs	57,963 57,978	64,000 64,010	18,500	SAL	180 050 0021 00 15 21	6		6												
CB/PL 1, 2, 3, 4, 5	5 Pairs	50,858 50,878	53,700 53,712	20,400	S4S	181 050 0020 00 15 21	10														
76 82,50																					
MB/HL 1, 2, 3, 4, 5	5 Pairs	53,958 53,978	59,000 59,019	18,500	SAL	180 050 0014 00 15 21 26 29	6		4												
CB/PL 1, 2, 3, 4	4 Pairs	47,758 47,778	50,600 50,612	19,000	S3S	181 050 0001 00 15 21 26 29	8														
TW/A 1	4 Halves	59,500 59,750	72,950 73,200		SAL	182 050 0002 00 15 21 14	2		2												
77 82,50																					
MB/HL 1, 2, 3, 4, 5	5 Pairs	53,963 53,983	59,000 59,010	18,500	SAL	180 050 0009 00 15 21	5		5												
MB/HL 1, 2, 3, 4, 5	5 Pairs	53,958 53,978	59,000 59,019	18,500	SAL	180 050 0013 00 15 21 29	5		5												
MB/HL 1, 2, 3, 4, 5	5 Pairs	53,958 53,978	59,000 59,019	18,500	SAL	180 050 0014 00 15 21 26 29	6		4												
CB/PL 1, 2, 3, 4	4 Pairs	47,758 47,778	50,600 50,612	19,000	S3S	181 050 0001 00 15 21 26 29	8														
TW/A 1	4 Halves	59,500 59,750	72,950 73,200		SAL	182 050 0002 00 15 21 14	2		2												
Cbush/NWL 1	1 Pair	42,959 42,975	46,000 46,025	15,000	SAL	183 050 0001 00 99															
Cbush/NWL 1	1 Pair	41,959 41,975	45,000	15,000	SAL	183 050 0002 00 99															
78 82,50																					
MB/HL 1, 2, 3, 4, 5	5 Pairs	53,963 53,983	59,000 59,010	18,500	SAL	180 050 0009 00 15 21	5		5												
MB/HL 1, 2, 3, 4, 5	5 Pairs	53,958 53,978	59,000 59,019	18,500	SAL	180 050 0013 00 15 21 29	5		5												
MB/HL 1, 2, 3, 4, 5	5 Pairs	53,958 53,978	59,000 59,019	18,500	SAL	180 050 0014 00 15 21 26 29	6		4												
CB/PL 1, 2, 3, 4	4 Pairs	47,758 47,778	50,600 50,612	19,000	S3S	181 050 0001 00 15 21 26 29	8														
TW/A 1	4 Halves	59,500 59,750	72,950 73,200		SAL	182 050 0002 00 15 21 14	2		2												







 							Set Composition / QTY														
79	82,50																				
MB/HL 1, 2, 3, 4, 5	5 Pairs	53,963 53,983	59,000 59,010	18,500	SAL	180 050 0009 00 15 21	5		5												
CB/PL 1, 2, 3, 4	4 Pairs	47,763 47,778	50,600 50,612	18,500	S32S	181 050 0011 00 15 21 26	4		4												
TW/A 1	2 Halves	59,500 59,750	71,550 71,800		SAL	182 050 0001 00	2														
80	82,50																				
MB/HL 1, 2, 3, 4, 5	5 Pairs	53,963 53,983	59,000 59,010	18,500	SAL	180 050 0009 00 15 21	5		5												
CB/PL 1, 2, 3, 4	4 Pairs	47,758 47,778	50,600 50,612	19,000	S3S	181 050 0001 00 15 21 26 29	8														
TW/A 1	4 Halves	59,500 59,750	72,950 73,200		SAL	182 050 0002 00 15 21 14	2		2												
81	82,50																				
MB/HL 1, 2, 3, 4, 5	5 Pairs	53,963 53,983	59,000 59,010	18,500	SAL	180 050 0009 00 15 21	5		5												
CB/PL 1, 2, 3, 4	4 Pairs	47,758 47,778	50,600 50,612	19,000	S3S	181 050 0001 00 15 21 26 29	8														
CB/PL 1, 2, 3, 4	4 Pairs	47,763 47,778	50,600 50,612	18,500	S32S	181 050 0011 00 15 21 26	4		4												
TW/A 1	4 Halves	59,500 59,750	72,950 73,200		SAL	182 050 0002 00 15 21 14	2		2												
Cbush/NWL 1	1 Pair	42,959 42,975	46,000 46,025	15,000	SAL	183 050 0001 00 99															
Cbush/NWL 1	1 Pair	41,959 41,975	45,000	15,000	SAL	183 050 0002 00 99															
Bush/PB 1, 2, 3, 4	4 Pairs	20,000	23,000 23,021	25,000	SL	184 050 0008 99															
82	82,50																				
MB/HL 1, 2, 3, 4	4 Pairs	64,959 64,978	70,000 70,019	18,500	S3S	180 050 0012 00 15 21	4		4												
CB/PL 1, 2, 3, 4, 5, 6	6 Pairs	53,958 53,978	57,600 57,612	17,000	S3S	181 050 0008 00 15 21	12														
TW/A 1	4 Halves	70,500 70,750	84,650 84,900		SAL	182 050 0004 00	2		2												



VOLVO

Globally reliable

	ccm						Pos.
D4164T (DV6 TED4)	1560	4	C30 1.6 Hdi 16V, S40 1.6 Hdi 16V, V50 1.6 Hdi 16V	75,00	180 051 0001 181 051 0001 182 051 0001	Std, 0,25, 0,30, 0,50, 0,80 Std, 0,25, 0,30, 0,50, 0,80 Std	1
D16, F8M 700	1596	4	340 1.6 D, 343 1.6 D, 345 1.6 D	78,00	180 038 0002 180 038 0003 181 038 0002 181 038 0003 182 038 0002	Std, 0,25, 0,50, 0,75 Std, 0,25, 0,50, 0,75 Std, 0,25, 0,50, 0,75 Std, 0,25, 0,50, 0,75 Std	2
D4192T	1870	4	S40 1.9 TD, V40 1.9 TD	80,00	180 038 0002 180 038 0003 181 038 0002 181 038 0003 182 038 0002	Std, 0,25, 0,50, 0,75 Std, 0,25, 0,50, 0,75 Std, 0,25, 0,50, 0,75 Std, 0,25, 0,50, 0,75 Std	2
D4172T	1870	4	440 1.9 TD, 460 1.9 TD	80,00	180 038 0003 181 038 0002 181 038 0003 182 038 0002	Std, 0,25, 0,50, 0,75 Std, 0,25, 0,50, 0,75 Std, 0,25, 0,50, 0,75 Std	3
B4164S	1587	4	S40 1.6 16V, V40 1.6 16V	81,00	180 051 0002 181 051 0002	Std, 0,25 Std, 0,25, 0,50	4
B5202FS, B5204T	1984	4	850 2.0 10V, 850 2.0 10V Turbo, S60 2.0 10V Turbo, S70 2.0 10V, V60 2.0 10V Turbo, V70 2.0 10V, V70 2.0 10V Turbo	81,00	180 051 0003 181 051 0003	Std, 0,25, 0,50 Std, 0,25, 0,50	5
B4184SJ/SM, B4194T	1834	4	S40 1.8 16V, V40 1.8 16V, V40 1.8 16V Turbo	81,00	180 051 0002 181 051 0002	Std, 0,25 Std, 0,25, 0,50	4
B5234FT, B5234T	2319	5	850 2.3i 20V Turbo, C70 2.3 Turbo, S60 2.3i 20V Turbo, S70 2.3i Turbo, S70 2.3i 20V Turbo, V60 2.3i 20V Turbo, V70 2.3i 20V Turbo	81,00	180 051 0003 181 051 0003	Std, 0,25, 0,50 Std, 0,25, 0,50	5
B5244T5	2401	5	S60 T5 2.4 Turbo, V70 T5 2.4 Turbo	81,00	180 051 0003 181 051 0003	Std, 0,25, 0,50 Std, 0,25, 0,50	5
B18U	1794	4	440, 460	82,70	180 038 0002 181 038 0002 182 038 0002	Std, 0,25, 0,50, 0,75 Std, 0,25, 0,50, 0,75 Std	6
B20F	1998	4	440 2.0, 460 2.0, 480 2.0	82,70	180 038 0002 181 038 0002 182 038 0002	Std, 0,25, 0,50, 0,75 Std, 0,25, 0,50, 0,75 Std	6
B4204S, B4204T	1948	4	S40 2.0 16V, V40 2.0 16V	83,00	180 051 0002 181 051 0002	Std, 0,25 Std, 0,25, 0,50	4
B5244S, B5252, B5252S, B5254FS, B5254FT, B5254S, B5254T	2435	5	850 2.4i Turbo 20V, 850 2.4i 20V, C70 2.4 20V, C70 2.4 Turbo 20V, S60 2.4, S70 2.4 10V, S70 2.4 20V, S70 2.4 Turbo 20V, V50 2.4, V70 2.4, V70 2.4 20V, V70 2.4 Turbo 20V	83,00	180 051 0003 181 051 0003	Std, 0,25, 0,50 Std, 0,25, 0,50	5
B5254T4	2521	5	S80 2.5 20V	83,00	180 051 0003 181 051 0003	Std, 0,25, 0,50 Std, 0,25, 0,50	5
D4204T, D4204T2	1998	4	C30 2.0 TD 16V, C70 2.0 TD 16V, S40 2.0 TDi 16V, S80 2.0 TD 16V, V50 2.0 TDi 16V, V70 II 2.0 TD 16V	85,00	180 037 0003 181 037 0019 182 037 0002	Std, 0,30, 0,50, 0,80 Std, 0,30, 0,50 Std, 0,30, 0,50, 0,10, 0,20	7
B19ET, B20, B19A	1986	4	240 2.0 Turbo, 242 2.0, 242 2.0 Turbo, 244 2.0, 245 2.0, 260 2.0 Turbo, 340 2.0, 360 2.0	88,90	180 051 0004 181 051 0004	Std, .010, .020, .030 Std, 0,25, 0,50	8
B200E, B200FG, B200ET, B200F, B200FT, B200K, B204E, B204FT	1986	4	240 2.0, 340 2.0, 360 2.0, 740 2.0, 740 2.0 16V, 740 2.0 Turbo, 760 2.0, 760 2.0 16V, 760 2.0 Turbo, 780 2.0 16V Turbo, 940 2.0, 940 2.0 16V, 940 2.0 16V Turbo, 960 2.0 16V, 960 2.0 16V Turbo	88,90	180 051 0005 180 051 0006 181 051 0005 182 051 0002	Std, 0,25, 0,50 Std, 0,25 Std, 0,25, 0,50, 0,75 Std	9
B21A, B21E	2127	4	240 2.1, 242 2.1, 244 2.1, 245 2.1	92,00	180 051 0004 181 051 0004	Std, .010, .020, .030 Std, 0,25, 0,50	8
B200, B204GT	2126	4	240 2.1	92,00	180 051 0005 180 051 0006 181 051 0005 182 051 0002	Std, 0,25, 0,50 Std, 0,25 Std, 0,25, 0,50, 0,75 Std	9
D50, TD50	5100	6		95,25	180 059 0001 181 059 0001 181 059 0002 182 059 0001	Std, 0,25, 0,50, 0,75, 1,00 Std, 0,25, 0,50, 0,75, 1,00 Std, 0,25, 0,50, 0,75, 1,00 Std	10
B23E, B23ET	2316	4	240 2.3, 740 2.3, 740 2.3 Turbo, 760 2.3 Turbo	96,00	180 051 0004 181 051 0004	Std, .010, .020, .030 Std, 0,25, 0,50	8
B230A, B230E, B230ET, B230F, B230FB, B230FD, B230FS, B230FT, B230K, B234F	2316	4	240 2.3, 740 2.3, 740 2.3 16V, 740 2.3 Turbo, 760 2.3, 760 2.3 Turbo, 940 2.3, 940 2.3 16V, 940 2.3 Turbo, 960 2.3, 960 2.3 Turbo	96,00	180 051 0005 180 051 0006 181 051 0005 182 051 0002	Std, 0,25, 0,50 Std, 0,25 Std, 0,25, 0,50, 0,75 Std	9
D60, TD60, TD61, TD63	5480	6		98,43	180 059 0001 181 059 0001 181 059 0002 182 059 0001	Std, 0,25, 0,50, 0,75, 1,00 Std, 0,25, 0,50, 0,75, 1,00 Std, 0,25, 0,50, 0,75, 1,00 Std	10
TAMD61	5480	6		98,43	180 059 0001 181 059 0001 181 059 0002	Std, 0,25, 0,50, 0,75, 1,00 Std, 0,25, 0,50, 0,75, 1,00 Std, 0,25, 0,50, 0,75, 1,00	11
D7 Euro 2 A230, A260, A285, B230, B260	6700	6		104,78	180 059 0006 181 059 0010 182 051 0003	Std, .010, .020 Std, .010, .020 Std	12
D70, MD70, TAMD70, TAMD71, TD70, TD71, TD73, TDF71	6700	6		104,78	180 059 0002 181 059 0003 181 059 0004 182 059 0002	Std, 0,25, 0,50, 0,75, 1,00 Std, 0,25, 0,50, 0,75, 1,00 Std, 0,25, 0,50, 0,75 Std	13

	ccm						Pos.
D7 Euro 2 C215, C250, C275, C290, C310	7300	6		107,00	180 059 0006 181 059 0010 182 051 0003	Std, .010, .020 Std, .010, .020 Std	12
D7 Euro 4/5 E240, E280, E320	7146	6		108,00	180 059 0006 181 059 0010 182 051 0003	Std, .010, .020 Std, .010, .020 Std	12
D7D EAE 2	7146	6	Industriemotor	108,00	180 015 0008 181 015 0007 181 015 0008 183 015 0002 184 015 0003	Std, 0,25, 0,50, 0,75 Std, 0,25, 0,50, 0,75 Std, 0,25, 0,50, 0,75, 1,00 Std Semi	14
D7E Euro4/5, D7F Euro4/5	7146	6	FE 260 04.2009- FE 300 04.2009- FE 340 04.2009-	108,00	180 059 0010 181 059 0016 182 059 0008	Std, 0,25, 0,50 Std, 0,25, 0,50 Std	15
D9 Euro 3 A260, A300, A340, A380 - D9 Euro 4/5 B260, B300, B310, B340, B360, B380	9364	6		120,00	180 059 0008 181 059 0012 182 059 0007	Std, 0,25, 0,50 Std, 0,25, 0,50 Std	16
D100, HD100, MD100, TD100, TD101, TD102, TD103, THD100, THD101, THD102, THD103, THD104, TMD100	9600	6		120,65	180 059 0003 181 059 0005 181 059 0006 182 059 0003	Std, 0,25, 0,50, 0,75, 1,00 Std, 0,25, 0,50, 0,75, 1,00 Std, 0,25, 0,50, 0,75, 1,00 Std	17
D11B 390 Euro4/5, D11B 430	10800	6	.	123,00	180 059 0008 181 059 0014	Std, 0,25, 0,50 Std, 0,25, 0,50	18
D120, TD120	12000	6		130,18	180 059 0004 181 059 0007 181 059 0008 182 059 0004	Std, 0,25, 0,50, 0,75, 1,00 Std, 0,25, 0,75, 1,00 Std, 0,25, 0,50, 0,75, 1,00 Std, 0,10, 0,20	19
TAMD120, TD120, TMD120	12000	6		130,18	180 059 0004 181 059 0007 182 059 0004	Std, 0,25, 0,50, 0,75, 1,00 Std, 0,25, 0,75, 1,00 Std, 0,10, 0,20	20
TAMD121, TD121	12000	6		130,18	180 059 0004 181 059 0007 181 059 0008 182 059 0004	Std, 0,25, 0,50, 0,75, 1,00 Std, 0,25, 0,75, 1,00 Std, 0,25, 0,50, 0,75, 1,00 Std, 0,10, 0,20	19
TAMD122, TD121, TD122, TD123, TID121, TMD121, TMD122, TD 101*, TD 102*, TD 121*, TD 122*	12000	6	B 12, F 10/260, F 12/290, FL 10/280, N 10/250, N 12/290, NL 10/260	130,18	180 059 0004 181 059 0008 182 059 0004 183 059 0001	Std, 0,25, 0,50, 0,75, 1,00 Std, 0,25, 0,50, 0,75, 1,00 Std, 0,10, 0,20 Std	21
D12A Euro 2, D12C Euro 3, D12D Euro 3	12130	6	B 12 10.1995- FH 12-340 08.1993-08.1998 FH 12-380 08.1993-08.1998 FL 12-380 09.1995-10.1998 FH 12-340 08.1998-03.2002 FM 12-340 08.1998-01.2002 NH 12-460 07.1999- FH 12-500 09.2001-	131,00	180 059 0005 181 059 0009 182 059 0004	Std, 0,25, 0,50 Std, 0,25, 0,50 Std, 0,10, 0,20	22
D13A Euro5, D13B Euro4/Euro5	12100	6	FH 400 09.2005- FM 400 09.2007- FH 440 09.2005- FM 440 09.2007- FH 480 09.2005- FM 480 09.2007- FH 520 09.2005- FH 500 09.2007-	131,00	180 059 0009 181 059 0013 181 059 0015 182 059 0004	Std, 0,25, 0,50 Std, 0,25, 0,50 Std, 0,25, 0,50 Std, 0,10, 0,20	23
D16A Euro 2, D16C 550 Euro 3, D16C 610 Euro 3, D16E 540 Euro 4, D16E 580 Euro 4, D16E 660 Euro 4	16120	6	FH 16-470 08.1993-12.1999 FH 16-520 08.1993-12.1999 FH 16-550 01.2003- FH 16-610 01.2003- FH 16-580 02.2006- FH 16-660 02.2006-	144,00	180 059 0007 181 059 0017 182 059 0006	Std, 0,25, 0,50 Std, 0,25, 0,50 Std	24
TD162	16120	6		144,00	180 059 0007 181 059 0011 182 059 0006	Std, 0,25, 0,50 Std, 0,25, 0,50 Std	25



VOLVO

Globally reliable

							Set Composition / QTY								
1 75,00															
MB/HL 1, 2, 3, 4, 5	5 Pairs	49,962 49,981	53,655 53,674	19,900	SAL	180 051 0001 00 15 17 21 28	5		5						
CB/PL 1, 2, 3, 4	4 Pairs	46,975 46,991	50,655 50,674	17,000	S3S	181 051 0001 00 15 17 21 28	8								
TW/A 1	2 Halves	55,200 55,480	71,350 71,700		SAL	182 051 0001 00	2								
2 78,00															
MB/HL 1, 2, 3, 4, 5	5 Pairs	54,785 54,795	58,731 58,744	18,500	SAL	180 038 0002 00 15 21 26	5		5						
MB/HL 1, 2, 3, 4, 5	5 Pairs	54,785 54,795	58,731 58,744	18,500	S32S	180 038 0003 00 15 21 26	5		5						
CB/PL 1, 2, 3, 4	4 Pairs	48,000 48,020	51,587 51,600	20,500	SAL	181 038 0002 00 15 21 26	8								
CB/PL 1, 2, 3, 4	4 Pairs	48,000 48,020	51,587 51,600	20,500	SAL	181 038 0003 00 15 21 26	8								
TW/A 1	2 Halves	60,500 60,750	79,750 80,000		SAL	182 038 0002 00	2								
3 80,00															
MB/HL 1, 2, 3, 4, 5	5 Pairs	54,785 54,795	58,731 58,744	18,500	S32S	180 038 0003 00 15 21 26	5		5						
CB/PL 1, 2, 3, 4	4 Pairs	48,000 48,020	51,587 51,600	20,500	SAL	181 038 0002 00 15 21 26	8								
CB/PL 1, 2, 3, 4	4 Pairs	48,000 48,020	51,587 51,600	20,500	SAL	181 038 0003 00 15 21 26	8								
TW/A 1	2 Halves	60,500 60,750	79,750 80,000		SAL	182 038 0002 00	2								
4 81,00															
MB/HL 1, 2, 3, 4	4 Pairs	64,987 65,000	69,000 69,014	19,600	SSI	180 051 0002 00 15	4		4		1		1		
MB/HL 5	1 Pair	64,987 65,000	69,000 69,014	25,880	SSI										
CB/PL 1, 2, 3, 4	4 Pairs	49,984 50,000	53,000 53,013	19,500	S3S	181 051 0002 00 15 21	8								
5 81,00															
MB/HL 1, 2, 3, 4, 5	5 Pairs	64,987 65,000	69,000 69,014	19,600	SAL	180 051 0003 00 15	5		5		1		1		
MB/HL 6	1 Pair	64,987 65,000	69,000 69,014	25,880	SAL	21									
CB/PL 1, 2, 3, 4, 5	5 Pairs	49,984 50,000	53,000 53,013	19,500	S3S	181 051 0003 00 15 21	10								











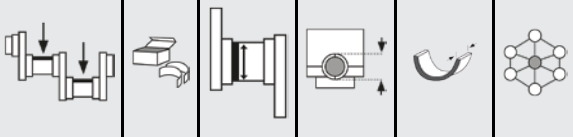













							Set Composition / QTY										
6 82,70																	
MB/HL 1, 2, 3, 4, 5	5 Pairs	54,785 54,795	58,731 58,744	18,500	SAL	180 038 0002 00 15 21 26	5	5									
CB/PL 1, 2, 3, 4	4 Pairs	48,000 48,020	51,587 51,600	20,500	SAL	181 038 0002 00 15 21 26	8										
TW/A 1	2 Halves	60,500 60,750	79,750 80,000		SAL	182 038 0002 00	2										
7 85,00																	
MB/HL 1, 2, 3, 4, 5	5 Pairs	59,981 60,000	63,731 63,750	20,290	SAL	180 037 0003 00 17 21 28	5	5									
CB/PL 1, 2, 3, 4	4 Pairs	49,984 50,000	53,695 53,708	20,000	S4S	181 037 0019 00 17 21											
TW/A 1	4 Halves	67,050 67,300	83,050 83,300		S3S	182 037 0002 00 17 21 08 14	2	2									
8 88,90																	
MB/HL 1, 2, 3, 4	4 Pairs	63,442 63,464	67,462 67,488	28,200	S3S	180 051 0004 00 16	8	2									
MB/HL 5	1 Pair	63,442 63,464	67,462 67,488	38,913	S3S	22 27											
CB/PL 1, 2, 3, 4	4 Pairs	53,987 54,000	58,000 58,013	24,000	S3S	181 051 0004 00 15 21	8										
9 88,90																	
MB/HL 1, 2, 3, 4, 5	5 Pairs	54,987 55,000	59,000 59,019	21,000	SAL	180 051 0005 00 15 21	5	5									
MB/HL 1, 2, 3, 4	4 Pairs	62,987 63,000	67,000 67,019	21,000	SAL	180 051 0006 00 15	4	4	1	1							
MB/HL 5	1 Pair	62,987 63,000	67,000 67,019	35,380	SAL												
CB/PL 1, 2, 3, 4	4 Pairs	48,985 49,005	52,000 52,013	24,000	S3S	181 051 0005 00 15 21 26	8										
TW/A 1	2 Halves	61,250	76,000		SAL	182 051 0002 00	1	1									
10 95,25																	
MB/HL 1, 2, 3, 4, 5, 6, 7	7 Pairs	76,149 76,162	81,051 81,077	27,940	S3S	180 059 0001 00 15 21 26 29	7	7									
CB/PL 1, 2, 3, 4, 5, 6	6 Pairs	63,449 63,461	67,322 67,335	33,780	S3S	181 059 0001 00 15 21 26 29	12										
CB/PL 1, 2, 3, 4, 5, 6	6 Pairs	63,449 63,462	67,323 67,336	34,600	S3S	181 059 0002 00 15 21 26 29	12										
TW/A 1	4 Halves	85,090 85,344	104,394 104,648		S3S	182 059 0001 00	4										



VOLVO

Globally reliable

							Set Composition / QTY														
11 98,43																					
MB/HL 1, 2, 3, 4, 5, 6, 7	7 Pairs	76,149 76,162	81,051 81,077	27,940	S3S	180 059 0001 00 15 21 26 29	7		7												
CB/PL 1, 2, 3, 4, 5, 6	6 Pairs	63,449 63,461	67,322 67,335	33,780	S3S	181 059 0001 00 15 21 26 29	12														
CB/PL 1, 2, 3, 4, 5, 6	6 Pairs	63,449 63,462	67,323 67,336	34,600	S3S	181 059 0002 00 15 21 26 29	12														
12 104,78																					
MB/HL 1, 2, 3, 4, 5, 6, 7	7 Pairs	90,528 90,550	96,483 96,508	30,400	S3S	180 059 0006 00 16 22	7		7												
CB/PL 1, 2, 3, 4, 5, 6	6 Pairs	73,831 73,850	77,740 77,753	37,000	S3S	181 059 0010 00 16 22	12														
TW/A 1	4 Halves	98,280 98,530	120,480 120,730		S3S	182 051 0003 00	4														
13 104,78																					
MB/HL 1, 2, 3, 4, 5, 6, 7	7 Pairs	82,535 82,550	88,483 88,504	30,610	S3S	180 059 0002 00 15 21 26 29	7		7												
CB/PL 1, 2, 3, 4, 5, 6	6 Pairs	69,839 69,850	73,733 73,753	37,160	S3S	181 059 0003 00 15 21 26 29	12														
CB/PL 1, 2, 3, 4, 5, 6	6 Pairs	69,837 69,850	73,738 73,754	36,910	S3S	181 059 0004 00 15 21 26	12														
TW/A 1	4 Halves	90,145 90,399	112,573 112,827		S3S	182 059 0002 00	4														
14 108,00																					
MB/HL 1	1 Pair	84,980 85,000	90,500 90,520	31,000	SAL	180 015 0008 00 15 21 26	2														
CB/PL 1	1 Pair	67,980 68,000	72,500 72,520	30,000	S3S	181 015 0007 00 15 21 26	2														
CB/PL 1	1 Pair	67,980 68,000	72,500 72,520	30,000	S3S	181 015 0008 00 15 21 26 29	1		1												
Cbush/NWL 1, 2, 3	3 Pairs	64,930 64,950	69,000 69,030	22,000	SR	183 015 0002 00															
Cbush/NWL 4, 5, 6, 7	4 Pairs	64,930 64,950	69,000 69,030	27,000	SR																
Bush/PB 1, 2	2 Pairs	41,994 42,000	45,500 45,520	29,800	SR	184 015 0003 99															

 							Set Composition / QTY															
15 108,00																						
MB/HL 1	1 Pair	84,980 85,000	90,500 90,520	26,500	S3S	180 059 0010 00 15 21	1		1													
CB/PL 1	1 Pair	74,980 75,000	80,000 80,020	29,200	SPVD	181 059 0016 00 15 21	1		1													
TW/A 1	4 Halves	91,400	114,000		SAL	182 059 0008 00	2		2													
16 120,00																						
MB/HL 1, 2, 3, 4, 5, 6, 7	7 Pairs	107,978 108,000	113,040 113,065	32,200	S3S	180 059 0008 00 15 21	7		7													
CB/PL 1, 2, 3, 4, 5, 6	6 Pairs	87,987 88,000	92,835 92,850	45,100	S3S	181 059 0012 00 15 21	12															
TW/A 1	4 Halves	116,600 117,100	139,550 139,900		S3S	182 059 0007 00																
17 120,65																						
MB/HL 1, 2, 3, 4, 5, 6, 7	7 Pairs	99,977 100,000	105,004 105,065	37,340	S3S	180 059 0003 00 15 21 26 29	7		7													
CB/PL 1, 2, 3, 4, 5, 6	6 Pairs	86,001 86,017	90,914 90,339	45,470	S3S	181 059 0005 00 15 21 26 29	12															
CB/PL 1, 2, 3, 4, 5, 6	6 Pairs	86,003 86,018	90,925 90,940	45,720	S3S	181 059 0006 00 15 21 26 29	12															
TW/A 1	4 Halves	108,458 108,712	131,674 131,928		S3S	182 059 0003 00	4															
18 123,00																						
MB/HL 1, 2, 3, 4, 5, 6, 7	7 Pairs	107,978 108,000	113,040 113,065	32,200	S3S	180 059 0008 00 15 21	7		7													
CB/PL 1, 2, 3, 4, 5, 6	6 Pairs	85,978 86,000	90,835 90,850	45,100	S3S	181 059 0014 00 15 21	6		6													
19 130,18																						
MB/HL 1, 2, 3, 4, 5, 6, 7	7 Pairs	107,915 107,937	113,040 113,065	37,080	S3S	180 059 0004 00 15 21 26 29	7		7													
CB/PL 1, 2, 3, 4, 5, 6	6 Pairs	92,027 92,042	96,837 96,850	45,970	S3S	181 059 0007 00 15 26 29	12															
CB/PL 1, 2, 3, 4, 5, 6	6 Pairs	92,025 92,043	96,835 96,850	46,230	S3S	181 059 0008 00 15 21 26 29	12															
TW/A 1	4 Halves	116,660 117,090	139,680 139,930		S3S	182 059 0004 00 08 14	4															







VOLVO





Globally reliable

							Set Composition / QTY														
20 130,18																					
MB/HL 1, 2, 3, 4, 5, 6, 7	7 Pairs	107,915 107,937	113,040 113,065	37,080	S3S	180 059 0004 00	15 21 26 29	7		7											
CB/PL 1, 2, 3, 4, 5, 6	6 Pairs	92,027 92,042	96,837 96,850	45,970	S3S	181 059 0007 00	15 26 29	12													
TW/A 1	4 Halves	116,660 117,090	139,680 139,930		S3S	182 059 0004 00	08 14	4													
21 130,18																					
MB/HL 1, 2, 3, 4, 5, 6, 7	7 Pairs	107,915 107,937	113,040 113,065	37,080	S3S	180 059 0004 00	15 21 26 29	7		7											
CB/PL 1, 2, 3, 4, 5, 6	6 Pairs	92,025 92,043	96,835 96,850	46,230	S3S	181 059 0008 00	15 21 26 29	12													
TW/A 1	4 Halves	116,660 117,090	139,680 139,930		S3S	182 059 0004 00	08 14	4													
Cbush/NWL 1	1 Pair	56,296 56,310	59,525 59,550	25,650	SAL	183 059 0001 00															
Cbush/NWL 2	1 Pair	60,271 60,290	63,500 63,525	25,650	SAL																
Cbush/NWL 3	1 Pair	61,058 61,077	64,287 64,313	25,650	SAL																
Cbush/NWL 4	1 Pair	63,446 63,465	66,675 66,700	25,650	SAL																
Cbush/NWL 5	1 Pair	64,233 64,252	67,462 67,487	25,650	SAL																
Cbush/NWL 6	1 Pair	66,621 66,640	69,850 69,875	25,650	SAL																
Cbush/NWL 7	1 Pair	68,996 69,015	72,225 72,250	33,600	SAL																
22 131,00																					
MB/HL 1, 2, 3, 4, 5, 6, 7	7 Pairs	107,987 108,000	113,040 113,065	37,700	S3S	180 059 0005 00	15 21														
CB/PL 1, 2, 3, 4, 5, 6	6 Pairs	91,978 92,000	96,835 96,850	49,100	S3S	181 059 0009 00	15 21	12													
TW/A 1	4 Halves	116,660 117,090	139,680 139,930		S3S	182 059 0004 00	08 14	4													
23 131,00																					
MB/HL 1, 2, 3, 4, 5, 6, 7	7 Pairs	107,978 108,000	113,040 113,065	37,800	S3S	180 059 0009 00	15 21	7		7											
CB/PL 1, 2, 3, 4, 5, 6	6 Pairs	98,978 99,000	103,835 103,850	48,850	S3S	181 059 0013 00	15 21	12													
CB/PL 1, 2, 3, 4, 5, 6	6 Pairs	98,978 99,000	103,835 103,850	48,850	S32S	181 059 0015 00	15 21	6		6											
TW/A 1	4 Halves	116,660 117,090	139,680 139,930		S3S	182 059 0004 00	08 14	4													



Set Composition / QTY

24	144,00																	
MB/HL 1, 2, 3, 4, 5, 6, 7	7 Pairs	117,978 118,000	123,110 123,135	38,500	S3S	180 059 0007 00 15 21	7		7									
CB/PL 1, 2, 3, 4, 5, 6	6 Pairs	111,978 112,000	116,972 116,987	46,550	S3S	181 059 0017 00 15 21	12											
TW/A 1	4 Halves	129,300 129,800	151,400 151,900		S3S	182 059 0006 00	4											

25	144,00																	
MB/HL 1, 2, 3, 4, 5, 6, 7	7 Pairs	117,978 118,000	123,110 123,135	38,500	S3S	180 059 0007 00 15 21	7		7									
CB/PL 1, 2, 3, 4, 5, 6	6 Pairs	99,988 100,000	104,792 104,807	46,450	S3S	181 059 0011 00 15 21	12											
TW/A 1	4 Halves	129,300 129,800	151,400 151,900		S3S	182 059 0006 00	4											

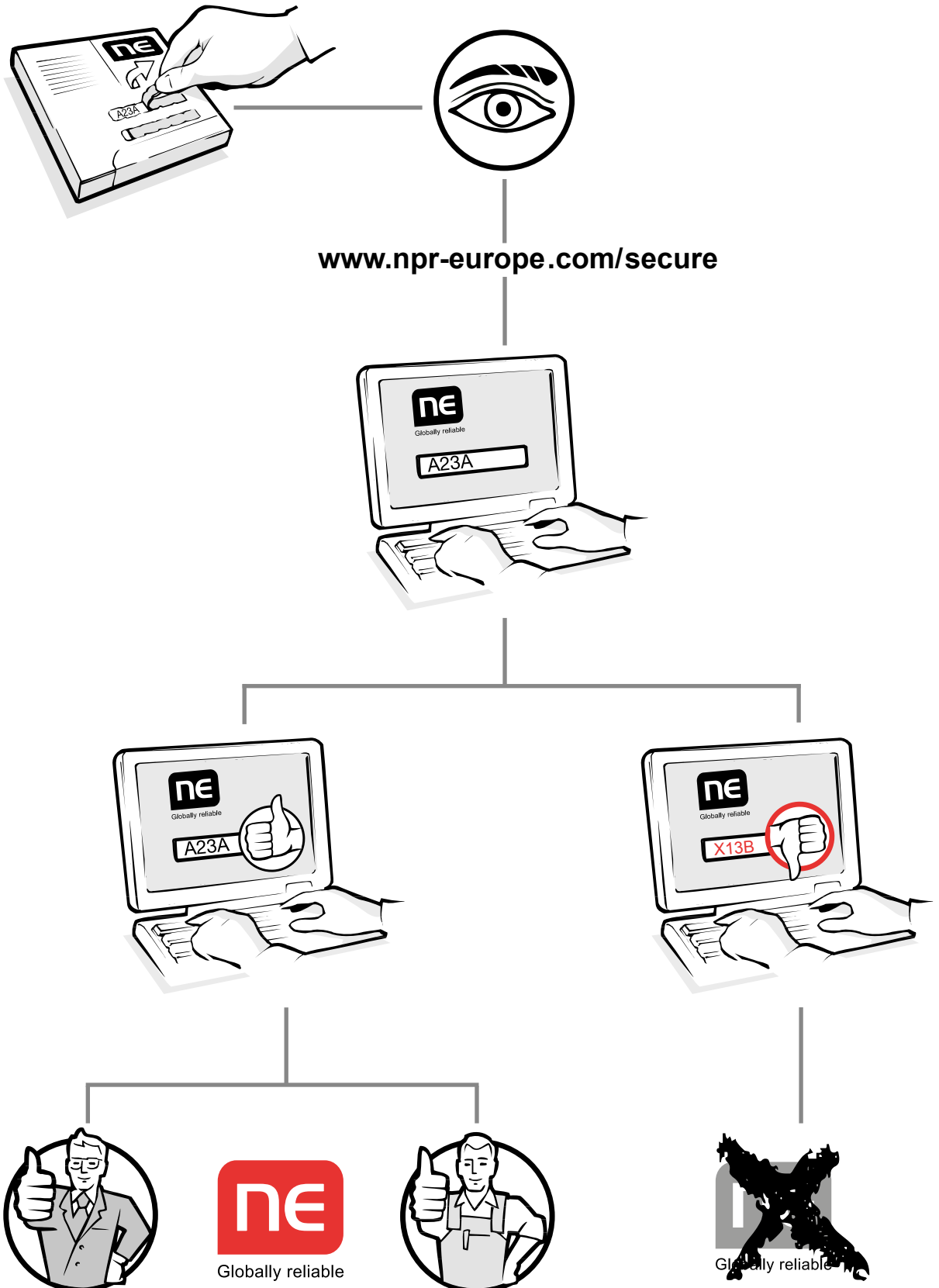

GENERAL TERMS AND CONDITIONS OF NPR OF EUROPE GMBH

General Terms and Conditions of NPR of Europe GmbH (hereinafter referred to as "NE"), Siemensstr. 56, 70825 Korntal-Münchingen
Verkaufs- und Lieferbedingungen

Terms and Conditions of Sale and Delivery
as at 07/2007

1. Scope

(1) The following conditions of sale apply for all Contracts concluded between NE and the Purchaser regarding the delivery of goods. They shall also apply to all future commercial relations even if they have not been expressly agreed. General terms and conditions of the purchaser do not apply to NE, even if this are not contradicted by NE.

(2) All agreements reached between NE and the purchaser in connection with the purchase contracts, are in the purchase contract, these conditions and the order confirmation put in writing by NE.

2. Offers and conclusion of the contract

(1) Offers on the part of NE are subject to change and non-binding, even for repeat orders, unless NE has expressly indicated this as binding in writing.

(2) If the order should qualify as an offer in accordance with § 145 of the BGB [German Civil Code] then NE shall be permitted to accept this within two weeks, through consignment of an order confirmation, or by sending the ordered goods to the purchaser within this time period.

(3) Dimensions, weights, figures, diagrams and other data relating to non-binding offers by NE remain the property of NE and are only approximately decisive, insofar as they have not been expressly indicated as binding by NE.

3. Prices, terms and conditions of payment

(1) If the agreed delivery time should exceed a period of four months from the conclusion of the Contract, or the delivery is delayed for more than four months from the conclusion of the Contract for reasons attributed to the purchaser alone or which come within his sphere of risk, then NE is entitled to charge the current price on the day of delivery. If the increase in price amounts to more than 5% of the named purchase price, then the purchaser is entitled to withdraw from the Contract. This right to withdraw does not apply if the purchaser fails to administrate it within a period of two weeks, beginning with the date of the notification of the new price.

(2) The prices apply "ex-warehouse" insofar as no deviating agreement with the purchaser has been made in addition to the VAT rate at the time of the invoicing. Packaging costs are not included in the price.

(3) Unless otherwise agreed in writing with the

purchaser, the purchase price shall be payable by the purchaser immediately following the invoice date, without delay and following deductions. Payments made by the purchaser shall be credited first of all to their previous debts, irrespective of any deviating provisions. Where costs and interest have already arisen, we are entitled to credit a payment first to the costs, then to the interest and finally to the principal amount.

(4) If a cash deduction is agreed in writing, then no other payable claims can be made against the purchaser.

(5) The acceptance of exchanges or cheques shall only be completed on account; the cost of discounting and inclusion shall be borne by the purchaser. Following acceptance of the exchange, NE is entitled to return the exchange, in case acceptance is refused by the State Central Bank.

(6) If, following the order confirmation, NE should become aware of facts which raise reasonable doubt regarding the purchaser's ability to meet financial obligations, NE is entitled to request the full payment or a corresponding security deposit prior to delivery, and also to withdraw from the Contract if the payment deadline is not adhered to. Besides a delay in payment as outlined above, corresponding information from a bank, credit agency or a company involved in commercial relations with the purchaser, referring in particular to the careful nature of a prudent businessman, may be considered as evidence of a significant decline in wealth. If delivery has already taken place, invoiced amounts shall be considered payable immediately, regardless of agreed payment conditions, and where appropriate on return of acceptances.

(7) Should the purchaser make a delayed payment, NE is entitled to request interest at 8% above the current basic interest rate of the European Central Bank (ECB) at the relevant point in time. NE reserves the right to demonstrate evidence of greater losses.

(8) The purchaser is only entitled to compensation if the counterclaims are found to be legally binding, recognised by NE or indisputable, even if notifications of defects or counterclaims are asserted. The Purchaser is only authorised to exercise a right of retention insofar as his counterclaim is based on the same contractual relationship.

(9) At the refusal of the Purchaser to pay or where a payment deadline has not been met, NE is entitled to fully or partly withdraw from the Contract and request compensation for damages.

4. Delivery and service time; Force Majeure

(1) Delivery deadlines or periods which have not been expressly agreed as binding shall simply represent information that is without obligation.

GENERAL TERMS AND CONDITIONS OF NPR OF EUROPE GMBH

(2) Part-deliveries are acceptable, insofar as the Purchaser is not put at an unreasonable disadvantage.

(3) NE reserves the right to claim 10% of any excess deliveries and short deliveries.

(4) If dispatch is delayed at the Purchaser's request, NE shall store the respective items at the purchaser's expense and risk.

(5) The delivery period may be extended in the case of Force Majeure, strike, blameless incapacity and adverse weather conditions during the period of delay.

5. Delay in Delivery

(1) Where NE is culpable of not adhering to an expressly agreed deadline or is delayed for other reasons, the Purchaser shall arrange to guarantee NE a suitable grace period beginning from the first day of delay. Where this grace period has elapsed without delivery, the Purchaser is entitled to withdraw from the Contract.

(2) NE is liable according to legal requirements, insofar as the delay in delivery depends on an intentionally assigned or grossly negligent breach of contract. NE shall assign responsibility to its representatives or vicarious agents. If this should not be the case, liability for damages shall be limited to foreseeable damage considered typical for the contract. According to loyalty and good faith, economic circumstances, type, scope and duration of the commercial relationship shall be carefully considered in favour of NE regarding the amount of compensation.

(3) If the delay in delivery represented by NE rests on the culpable breach of a significant contractual obligation, NE is liable according to legal provisions; whereby its liability is limited to foreseeable damage considered typical for the Contract.

(4) Further legal claims and rights of the Purchaser remain unaffected by a delay in delivery on the part of NE.

6. Transfer of risk, shipping and packaging, withdrawal

(1) Unless otherwise specified on the order confirmation, all deliveries are made "ex warehouse". Shipment and dispatch shall not be insured; this is at the Purchaser's own risk. This applies equally to return deliveries. NE endeavours to consider the interests of the Purchaser with respect to the type of shipping. Any additional costs which this may entail shall be borne by the Purchaser, even in the case of "free delivery" of agreed freight.

(2) If dispatch is delayed at the Purchaser's request or through fault on the part of the latter, the Vendor shall store the respective items at the purchaser's expense and risk. In this case, the advertisement of readiness for dispatch is equal to that of shipping.

(3) Transport packing and other convenience packaging shall not be withdrawn.

(4) A withdrawal of individual rings to be distributed in the aftermarket is excluded.

7. Guarantee, liability

(1) The Purchaser shall inspect the received goods for completeness, damage during transit, apparent defects, quality and its subsequent characteristics. The Purchaser shall notify NE immediately and in writing of any apparent defects within an acceptable period of the transaction. NE assumes no guarantee for rectifying apparent defects for which a claim is not immediately made in writing by the Purchaser.

(2) Provided that there is a defect evident in the goods for which NE may be held responsible, and provided a claim is made against it in due time by the Purchaser, NE shall, with the exclusion of the rights of the Subsidiary of NIPPON PISTON RING CO., LTD Purchaser, withdraw from the Contract or reduce the purchase price in the interests of supplementary performance, unless NE is entitled to refusal of subsequent performance on legal grounds. The Purchaser shall guarantee to provide NE with an appropriate deadline for the rectification of each individual defect in the interests of subsequent performance.

(3) Subsequent performance can be implemented, according to the wishes of NE, either through rectification of the defect or the delivery of replacement goods. NE is entitled to refuse subsequent performance chosen by the Purchaser if it is associated with disproportionate costs. During subsequent performance, a reduction in the purchase price or withdrawal from the Contract are excluded by the Purchaser. Subsequent improvement is considered to have failed following the second unsuccessful attempt. Where subsequent performance has failed or where NE has refused it altogether, the Purchaser can, if he chooses, further decrease the purchase price (reduction) or declare his withdrawal from the Contract.

(4) In the case of subsequent performance, NE bears all necessary expenses for the purposes of rectifying defects, in particular transport and labour costs. This only applies insofar as the expenses do not increase because the delivery item was brought to a location other than the place of performance.

(5) Warranty claims made by the Purchaser are not deemed valid if the defect can be attributed to a breach of operating, maintenance or installation instructions, or inappropriate processing or use by the Purchaser or a third party.

(6) Claims made by the Purchaser for material defects shall be time-barred for 24 months following the transfer of risk, according to legal provisions.

GENERAL TERMS AND CONDITIONS OF NPR OF EUROPE GMBH

(7) The Purchaser may only validate damages claims for the defect based on the following conditions if subsequent performance has failed or if NE refuses subsequent performance. The right of the Purchaser to assert additional damages claims regarding the following conditions remains unaffected.

(8) NE is only liable according to legal provisions insofar as damages claims which can be attributed to fraud, deliberate intent, or gross negligence by NE are asserted by the Purchaser. If no deliberate intent by NE to breach the terms of the Contract is apparent, liability is limited to foreseeable damage considered typical for the Contract. NE is furthermore liable according to legal provisions insofar as it culpably violates an essential contractual obligation. In this case, liability is limited to foreseeable damage considered typical for the Contract. Continual liability for damages not mentioned in the above provisions shall not be accepted irrespective of the legal nature of the asserted claim.

(9) Damage claims arising from culpable injury to life, limb or health, from the acquisition of warranties or on the grounds of the mandatory provisions of the Produkthaftungsgesetz [German Product Liability Act], remain unchanged by the preceding provisions.

(10) Insofar as liability for damages caused by NE is excluded or limited, this shall also apply to the personal liability of its employees, representatives and vicarious agents.

8. Retention of title

(1) NE reserves ownership of the Goods up to receipt of all payments from commercial relations with the Purchaser.

(2) The Purchaser shall notify NE of all third party involvement immediately and in writing, in particular law enforcement procedures and other restrictions to ownership. The Purchaser shall replace all damages and costs for NE arising from a breach of this liability, using necessary intervention measures against the involvement of third parties.

(3) The Purchaser may not pledge or assign as security the items delivered hereunder. In the case of pledging, appropriation or other use by a third party, NE shall be notified immediately. Enforcement officers and third parties shall

(4) Should the Purchaser breach the terms of the Contract, notably in the case of a delay in payment, NE shall be entitled to request a reduction in the deadline. A previous withdrawal from the Contract is not required for a demand for reduction. Any transport costs resulting from this shall be borne by the Purchaser.

(5) Should retention of title be asserted on the part of NE or a pledge implemented for the delivered items, this shall not be considered a withdrawal from the Contract.

(6) The Purchaser is entitled to redistribute the items for delivery as part of routine business activities. The Purchaser has already assigned all receivables arising from redistribution to the Purchaser and independent of whether or not the items for delivery were altered during redistribution, to NE, to the sum of the purchase price agreed between NE and the Purchaser and including VAT. The Purchaser is entitled to collect these receivables following transfer. NE undertakes not to collect the receivables provided that the Purchaser properly complies with his payment obligations and is not in arrears with payment. If this is indeed the case, NE can request the disclosure of all necessary information for collection.

(7) Processing of goods by the Purchaser shall always be undertaken for NE. If the goods are processed alongside other items not belonging to NE, NE shall acquire joint ownership of the new items in the ratio of the value of the delivered goods to the value of the other items at the time of processing.

9. Final provisions, applicable law

(1) Unless otherwise agreed, the the place of business is the NE delivery location.

(2) If the Purchaser is a businessman, the place of jurisdiction is the court responsible for the NE place of business. However, NE is entitled to take action against the Purchaser at its general place of jurisdiction. The court of jurisdiction shall be the same if the Purchaser has no general domestic court of jurisdiction, relocates their place of residence or normal home abroad on conclusion of the Contract, or their place of residence or normal home is unknown at the time that the claim is made.

(3) The Purchaser is not entitled to assign claims from the purchase contract without the consent of NE.



Globally reliable

LAGERSCHALEN
COUSSINETS
COJINETES



Globally reliable

NPR of Europe GmbH
Siemensstraße 56
70825 Korntal-
Münchingen
Germany
www.npr-europe.com

B5/1