



LED WATTAGE CHART

	32L	48L	64L
700 milliamps	71w	104w	136w
1050 milliamps	106w	156w	205w

FORM AND FUNCTION

- Sleek, low profile housing
- Engineered for optimum thermal management
- Low depreciation rate
- Optical system designed for:
 - Parking Lots
 - Commercial Applications

CONSTRUCTION

- Die Formed heavy duty Aluminum
- Corrosion resistant external hardware
- One-piece silicone gasket ensures IP-65 seal for electronics compartment
- Two-piece silicone Micro Optic system ensures IP-67 level seal around each PCB

BUY AMERICAN

To ensure the latest BAA/TAA/BABA Standards are being met, please select BAA, TAA, or BABA in the options section. Please contact the factory before placing an order for any NLS products requesting BAA (Buy American Act), TAA (Trade American Act), or BABA (Build America, Buy America).



Project Name:

Type:

VSR-1 ORDERING GUIDE

Cat#	Light Dist.	# of LEDs	Milliamps	Kelvin	Volts
Value Series Round 1 (VSR-1)	Type 2 (T2)	32 (32L)	700 (7)	Amber 586-600nM (AMBER) ⑤ ⑥	120-277 (UNV)
	Type 3 (T3)	48 (48L)	1050 (1)	2700K, 70 CRI (27K7) ⑤	347-480 (HV)
	Type 4 (T4)	64 (64L)		2700K, 80 CRI (27K8) ① ⑤	
	Type 5 (T5)			3000K, 70 CRI (30K7) ⑤	
				3000K, 80 CRI (30K8) ① ⑤	
				3500K, 80 CRI (35K8)	
				4000K, 70 CRI (40K7)	
				4000K, 80 CRI (40K8) ①	
				5000K, 70 CRI (50K7)	
				5000K, 80 CRI (50K8) ①	

Mounting	Color	Controls Options	Options
Direct Pole 6" Arm Single D180 (DPS6) ②	Bronze Textured (BRZ)	Nema 7-Pin Receptacle (PE7)	Bird Spikes (BS)
Direct Pole 10" Arm D90, T90, T120, Quad (DPS10) ②	White Textured (WHT)	Photocell + Receptacle (PCR)	Marine Grade Finish (MGF)
Wall Mount (WM) ③	Smooth White Gloss (SWT)	Receptacle + Shorting Cap (PER)	Quick Mount Bracket (QMB)
	Silver Metallic (SVR)	FSP-211 with Motion Sensor 8' + Below Heights (FSP-8) ④	Retrofit Mount Bracket (RQMB)
	Black Textured (BLK)	9'-20' Heights (FSP-20) ④	Round Pole Adaptor 3'-4" Pole (RPA4)
	Smooth Black Gloss (SBK)	21'-40' Heights (FSP-40) ④	Round Pole Adaptor 5"-6" Pole (RPA5)
	Graphite Textured (GPH)	Custom Controls Integration (CCI) ⑤	Rotated Optic Left (ROL)
	Grey Textured (GRY)	Button Type Photocell (PC) ④	Rotated Optic Right (ROR)
	Green Textured (GRN)		Automotive House Side Shield (AHS)
	Hunter Green Textured (HGN)		House Side Shield (HSS)
	Custom (CS)		Buy American (BAA) ⑥
			Trade American (TAA) ⑥
			Build America Buy American (BABA) ⑥

Notes:

- ① Consult Factory for Lead Time. Consult Factory for 90 CRI Requests.
- ② For Round Pole Specify RPA4 or RPA5
- ③ Includes 6" Bolt On Arm
- ④ Universal Voltage 120-277
- ⑤ 3000K or lower, with fixed mounting options only, must be selected to meet International Dark-Sky Association certification.
- ⑥ Please contact Factory for Custom Control Integration requests (nLight, NX, WaveLinx, Crestron, DMX/RDM, Synapse, Casambi, Dali II, Avi-On, or other control systems)
- ⑦ Turtle Safe
- ⑧ Consult factory for all BAA/TAA/BABA requests



701 Kingshill Place, Carson, CA 90746
Call Us Today (310) 341-2037

nlsighting.com

PRODUCT SPECIFICATIONS

ELECTRICAL

- 120-277 Volts (UNV) or 347-480 Volts (HV)
- 0-10V dimming driver
- Driver power factor at maximum load is $\geq .95$, THD maximum load is 15%
- LED Drivers Ambient Temp. Min is -40°C and Ambient Temp. Max ranges from 50°C to 55°C and, in some cases, even higher. Consult the factory for revalidation by providing the fixture catalog string before quoting and specifying it.
- All internal wiring UL certified for 600 VAC and 105°C
- All drivers, controls, and sensors housed in enclosed IP-65 compartment
- CRI 70, 80 or 90
- Color temperatures: Amber, 2700K, 3000K, 3500K, 4000K, 5000K
- Surge Protection: 20KA supplies as standard.

OPTIONS

- **BIRD SPIKES (BS)**—Offers effective and humane deterrent for larger bird species and provides cost-effective long-term solution to nuisance bird infestations and protect your property.
- **MARINE GRADE FINISH (MGF)**—A multi-step process creating protective finishing coat against harsh environments.
 - Chemically washed in a 5 stage cleaning system.
 - Pre-baked
 - Powder coated 3-5 mils of Zinc Rich Super Durable Polyester Primer.
 - 1-2 feet inside pole coverage top and bottom.
 - Oven Baked.
 - Finished Powder Coating of Super Durable Polyester Powder Coat 3-5 mil thickness.
- **SHIELDS (HSS, AHS)**—House Side Shield (HSS) is designed for full property line cut-off. Automotive House Side Shield (AHS) is a single-sided shield allowing partial cut-off on either side or front of luminaire.
- **ROUND POLE ADAPTER (RPA)**— When using round poles, specify Round Pole Adapter (RPA). Specify RPA4 when installing on 3"-4" round poles, and RPA5 when installing on 5"-6" round poles.

CONTROLS

- **FSP-211 (FSP-X)**—Passive infrared (PIR) sensor providing multi-level control based on motion/daylight contribution.
 - All control parameters adjustable via wireless configuration remote storing and transmitting sensor profiles.
 - FSP-20 mounting heights 9-20 feet
 - FSP-40 mounting heights 21-40 feet.
 - Includes 5 dimming event cycles, 0-10V dimming with motion sensing, re-programmable in the field.
 - FSIR-100 commissioning remote is required to change sensor settings. Please contact factory for ordering.
- **NEMA 7-PIN RECEPTACLE (PE7)**—An ANSI C136.41-2013 receptacle provides electrical and mechanical interconnection between photo control cell and luminaire. Dimming receptacle available two or four dimming contacts supports 0-10 VDC dimming methods or Digital Addressable Lighting Interface (DALI), providing reliable power interconnect.
- Controls Agnostic: Please contact factory for your preferred controls option. (nLight, NX, WaveLinx, Crestron, DMX/RDM, Synapse, Casambi, DALI II, Avi-On, or other control systems)

OPTICS

Silicone optics high photothermal stability and light output provides higher powered LEDs with minimized lumen depreciation LED life. UV and thermal stability with scratch resistance increases exterior application durability.

- IES Types

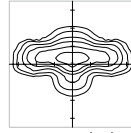

TYPE II (T2)

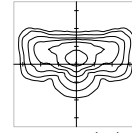

TYPE III (T3)

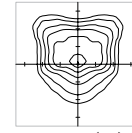

TYPE IV (T4)

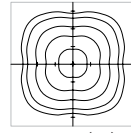

TYPE V (T5)

FINISH

- 5 mils electrostatic powder coat.
- NLS' standard high-quality finishes prevent corrosion protects against extreme environmental conditions

WARRANTY

Five-year limited warranty for drivers and LEDs.

LISTINGS

- Certified to UL 1598
- CSA C22.2 No. 250.0
- IP65/ IP67 Rated
- Dark Sky Approved
- IK10 Rated

BUY AMERICAN OPTION

While all of the NLS Lighting products listed in this document qualify for the Buy America(n) Act of 1933, we reserve the right to change our listings without notice.

The information provided above is for general informational purposes only. We encourage you to consult legal professionals for advice particular to your projects concerning BAA, TAA, BABA or Buy America.

Additional NLS Products that meet BAA, TAA standards can be found at the following link:

<https://nlsighting.com/buy-american/>



The information and specifications on this document are subject to change without any notification. All values are design, nominal, typical or prorated values when measured under internal and external laboratory conditions.



701 Kingshill Place, Carson, CA 90746
Call Us Today (310) 341-2037

nlsighting.com

PRODUCT SPECIFICATIONS

LUMENS

PART NUMBER	T2	LM/W	BUG	T3 HSS	LM/W	BUG	T3	LM/W	BUG	T4 AHS	LM/W	T4 HSS	LM/W	BUG	T4	LM/W	BUG	T5	LM/W	BUG	Watts
VSR-1-32L-7-30K7	7427	105	B2-U0-G2	4118	58	B0-U0-G1	7881	111	B2-U0-G2	5112	72	4047	57	B0-U0-G1	7896	111	B2-U0-G2	8236	116	B3-U0-G2	71
VSR-1-32L-7-40K7	7991	113	B2-U0-G2	4402	62	B0-U0-G1	8480	119	B2-U0-G2	5396	76	4331	61	B0-U0-G2	8496	120	B2-U0-G2	8875	125	B3-U0-G2	71
VSR-1-32L-7-50K7	8169	115	B2-U0-G2	4686	66	B0-U0-G1	8669	122	B2-U0-G2	5680	80	4615	65	B0-U0-G2	8685	122	B2-U0-G2	9088	128	B3-U0-G2	71
VSR-1-32L-1-30K7	11088	105	B2-U0-G2	6148	58	B0-U0-G2	10812	102	B2-U0-G2	7632	72	6042	57	B0-U0-G2	10715	101	B2-U0-G2	11130	105	B4-U0-G2	106
VSR-1-32L-1-40K7	11930	113	B2-U0-G2	6572	62	B0-U0-G2	11634	110	B2-U0-G2	8056	76	6466	61	B0-U0-G2	11529	109	B2-U0-G2	11978	113	B4-U0-G2	106
VSR-1-32L-1-50K7	12196	115	B2-U0-G2	6996	66	B0-U0-G2	11893	112	B2-U0-G2	8480	80	6890	65	B0-U0-G2	11787	111	B2-U0-G2	12296	116	B4-U0-G2	106
VSR-1-48L-7-30K7	11844	114	B2-U0-G2	6032	58	B0-U0-G2	11544	111	B2-U0-G2	7488	72	5928	57	B0-U0-G2	11648	112	B2-U0-G2	12068	116	B4-U0-G2	104
VSR-1-48L-7-40K7	12744	123	B2-U0-G2	6448	62	B0-U0-G2	12421	119	B2-U0-G2	7904	76	6344	61	B0-U0-G2	12444	120	B2-U0-G2	12985	125	B4-U0-G2	104
VSR-1-48L-7-50K7	13028	125	B2-U0-G2	6864	66	B0-U0-G2	12698	122	B2-U0-G2	8320	80	6760	65	B0-U0-G2	12792	123	B2-U0-G2	13275	128	B4-U0-G2	104
VSR-1-48L-1-30K7	16318	105	B3-U0-G3	9048	58	B0-U0-G2	15912	102	B3-U0-G3	11232	72	8892	57	B1-U0-G2	15769	101	B3-U0-G3	16455	105	B4-U0-G2	156
VSR-1-48L-1-40K7	17558	113	B3-U0-G3	9672	62	B0-U0-G2	17121	110	B3-U0-G3	11856	76	9516	61	B1-U0-G2	16968	109	B3-U0-G3	17705	113	B4-U0-G2	156
VSR-1-48L-1-50K7	17950	115	B3-U0-G3	10296	66	B1-U0-G2	17503	112	B3-U0-G3	12480	80	10140	65	B1-U0-G2	17346	111	B3-U0-G3	18100	116	B4-U0-G2	156
VSR-1-64L-7-30K7	15488	114	B3-U0-G3	7888	58	B0-U0-G2	15096	111	B2-U0-G2	9792	72	7752	57	B0-U0-G2	15124	111	B3-U0-G3	15781	116	B4-U0-G2	136
VSR-1-64L-7-40K7	16665	123	B3-U0-G3	8432	62	B0-U0-G2	16243	119	B2-U0-G2	10336	76	8296	61	B0-U0-G2	16273	120	B3-U0-G3	16981	125	B4-U0-G2	136
VSR-1-64L-7-50K7	17037	125	B3-U0-G3	8976	66	B0-U0-G2	16606	122	B2-U0-G2	10880	80	8840	65	B1-U0-G2	16728	123	B3-U0-G3	17359	128	B4-U0-G2	136
VSR-1-64L-1-30K7	21443	105	B3-U0-G3	11890	58	B1-U0-G2	20910	102	B3-U0-G3	14760	72	11685	57	B1-U0-G2	20722	101	B3-U0-G3	21623	105	B5-U0-G3	205
VSR-1-64L-1-40K7	23073	113	B3-U0-G3	12710	62	B1-U0-G2	22499	110	B3-U0-G3	15580	76	12505	61	B1-U0-G2	22297	109	B3-U0-G3	23267	113	B5-U0-G3	205
VSR-1-64L-1-50K7	23588	115	B3-U0-G3	13530	66	B1-U0-G2	23001	112	B3-U0-G3	16400	80	13325	65	B1-U0-G3	22795	111	B3-U0-G4	23785	116	B5-U0-G3	205

Lumen Maintenance Data

Ambient Temperature	Drive Current	L90 Hours*	L70 Hours**	30,000 Hours*	50,000 Hours*	60,000 Hours*	100,000 Hours**
25°C	Up to 700mA	58,000	173,000	95.7%	91.6%	89.6%	82.1%
	1050mA	38,000	96,000	93.0%	85.4%	81.8%	68.8%

*Reported extrapolations per IESNA TM-21 **Projected extrapolations per IESNA TM-21

LED KELVIN RANGE

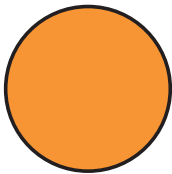

AMBER
585-600 nm

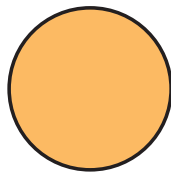

2700K 70 CRI

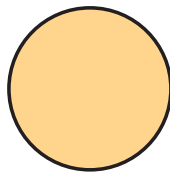

3000K 70 CRI

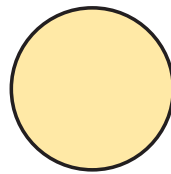

3500K 80 CRI

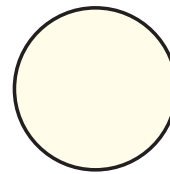

4000K 70 CRI

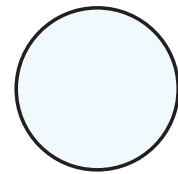

5000K 70 CRI

Color	Dominant or Peak Wavelength Range (nm)	
	Minimum	Maximum
Amber	585	600

PRODUCT SPECIFICATIONS

DIMENSION	VSR-1
A	17 in.
B	6 in.
Weight	15 lbs

EPA

EPA	SGL	D90	D180	T90	T120	QD
VSR-1	.33	.66	.66	1.0	1.0	1.32

DPX ARM LENGTH

DPX ARM LENGTH	SGL	D90	D180	T90	T120	QD
VSR-1	6"	20"	6"	10"	10"	10"

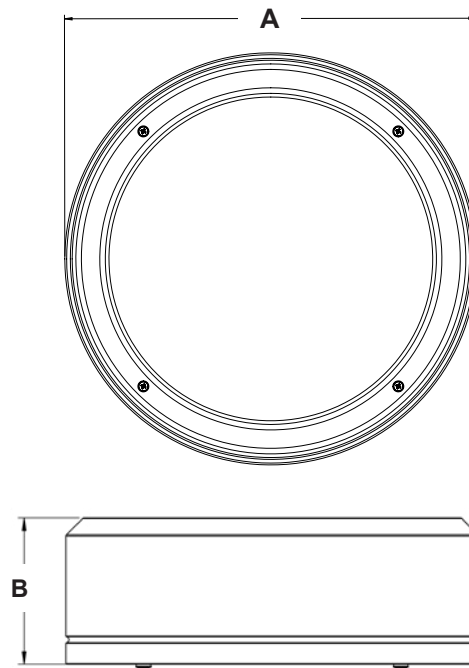

OPTICAL CONFIGURATIONS

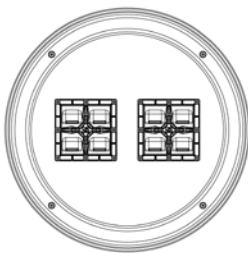

VSR-1 / 32L

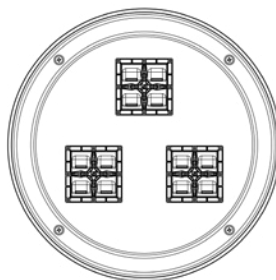

VSR-1 / 48L

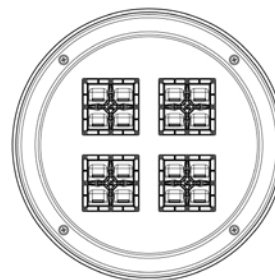

VSR-1 / 64L

PRODUCT SPECIFICATIONS

DIRECT POLE MOUNT(DPX)

Standard mounting arm is extruded aluminum in lengths of 6" and 10"

*Arm lengths may vary depending on configuration

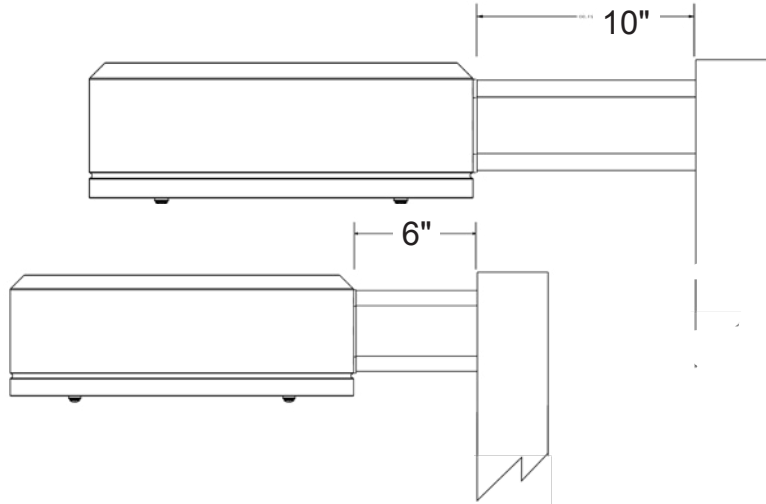

WALL MOUNT (WM)

Cast Aluminum Plate for direct wall mount.
3" extruded aluminum arm mounts directly to a cast wall mount box.

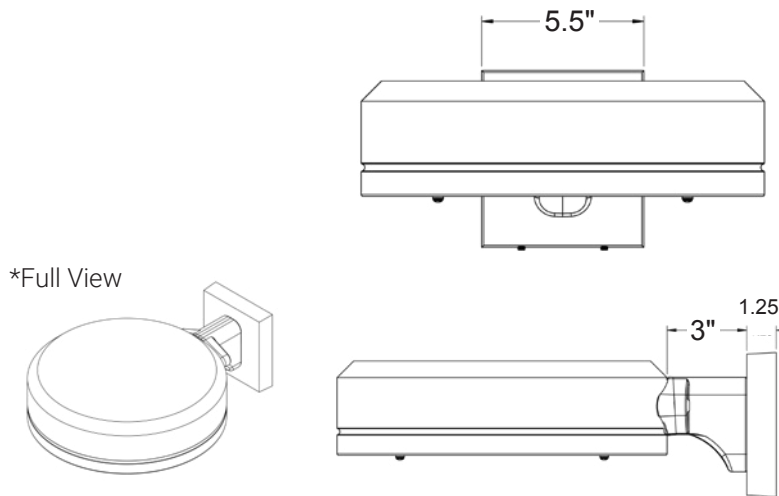

PRODUCT SPECIFICATIONS

Optional Cast Aluminum Bracket designed for quick mounting on Direct Square or Round Poles. Cleat mounts directly to pole for easily hung fixtures.

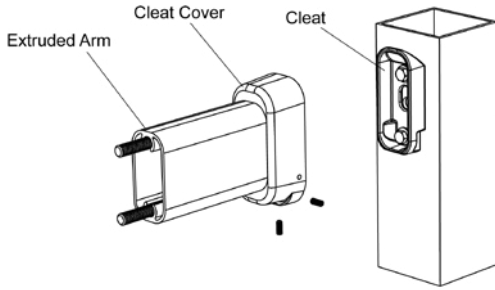

**QUICK MOUNT BRACKET (QMB)
DIRECT POLE (DP6/DP10)**

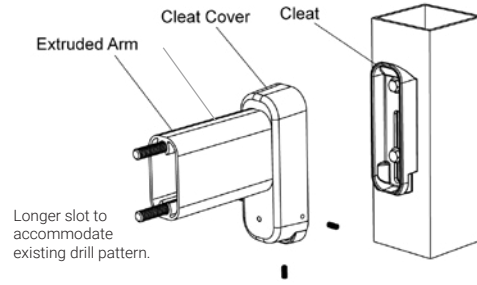
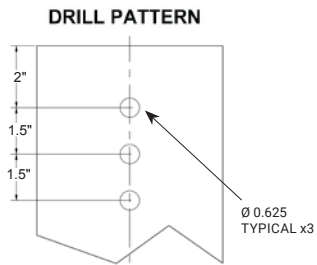

RETROFIT QUICK MOUNT BRACKET (RQMB)

RQMB DRILL PATTERN

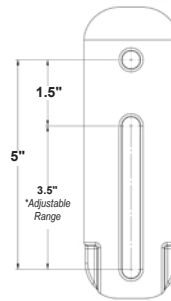

HOUSE SIDE SHIELD

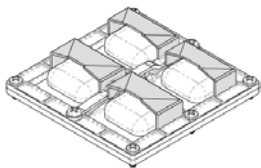

AUTOMOTIVE HOUSE SIDE SHIELD

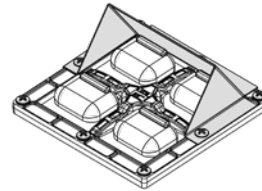

RPA4 / RPA5

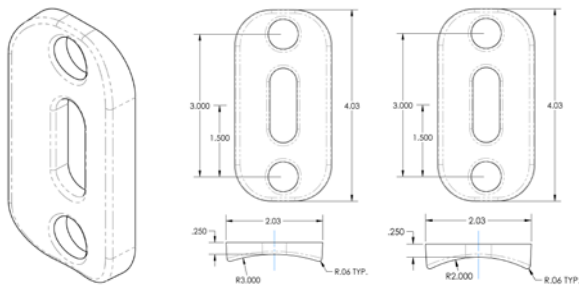

FSP-211

