



**Red Hat**

# Red Hat Certified Cloud & Service Provider Program

***SKU Guide***

October 2020

Version 1.32

# Table of Contents

DISCLAIMER	1
1. INTRODUCTION	2
2. RELEASE NOTES	3
2.1. NEW OFFERINGS	3
2.2. CHANGES & UPDATES	3
3. CCSP PROGRAM OVERVIEW	4
4. CCSP SOFTWARE SUBSCRIPTIONS	5
4.1. CCSP PROGRAM SUBSCRIPTIONS	5
4.2. PARTNER INFRASTRUCTURE SOFTWARE SUBSCRIPTIONS	5
4.3. END USER SOFTWARE SUBSCRIPTIONS	5
5. CCSP PROGRAM PARTICIPATION AND ENABLEMENT SKUS	7
6. CCSP PRODUCT SKUS AND USE CASES	8
6.1. INFRASTRUCTURE PRODUCTS	8
6.1.1. RED HAT ENTERPRISE LINUX	8
6.1.2. RED HAT ENTERPRISE LINUX ADD-ONS	12
6.1.3. RED HAT ENTERPRISE LINUX FOR POWER	18
6.1.4. RED HAT ENTERPRISE LINUX FOR Z SYSTEMS	22
6.1.5. RED HAT ENTERPRISE LINUX FOR Z SYSTEMS EXTENDED LIFE CYCLE SUPPORT ADD-ON	24
6.1.6. RED HAT ENTERPRISE LINUX FOR IBM SYSTEM Z AND LINUXONE WITH COMPREHENSIVE ADD-ONS	25
6.1.7. RED HAT OPENSTACK PLATFORM	27
6.1.8. RED HAT OPENSTACK PLATFORM EXTENDED LIFE CYCLE SUPPORT ADD-ON	30
6.1.9. RED HAT VIRTUALIZATION	31
6.1.10. RED HAT VIRTUALIZATION FOR IBM POWER	33
6.2. CLOUD-NATIVE APPLICATION PLATFORMS, APPLICATION DEVELOPMENT, AND MIDDLEWARE	35
6.2.1. RED HAT OPENSIFT CONTAINER PLATFORM	35
6.2.2. RED HAT OPENSIFT CONTAINER PLATFORM FOR POWER	39
6.2.3. RED HAT OPENSIFT CONTAINER PLATFORM BUNDLES	43
6.2.4. RED HAT MIDDLEWARE	46
6.2.5. RED HAT MIDDLEWARE EXTENDED LIFE CYCLE SUPPORT ADD-ONS	53
6.2.6. RED HAT MIDDLEWARE BUNDLES	59
6.2.7. RED HAT 3SCALE API MANAGEMENT	64
6.2.8. RED HAT BUILD OF OPENJDK	67
6.3. MANAGEMENT AND AUTOMATION	69
6.3.1. RED HAT ANSIBLE AUTOMATION PLATFORM	69
6.3.2. RED HAT SMART MANAGEMENT FOR SERVICE PROVIDERS	71
6.4. CLOUD STORAGE	74
6.4.1. RED HAT GLUSTER STORAGE	74
6.4.2. RED HAT CEPH STORAGE	77
6.4.3. RED HAT OPENSIFT CONTAINER STORAGE	83
6.4.4. RED HAT OPENSIFT CONTAINER STORAGE FOR SHARING EXTERNAL STORAGE ADD-ON	87
6.5. SAP	91
6.5.1. RED HAT ENTERPRISE LINUX FOR SAP APPLICATIONS	91
6.5.2. RED HAT ENTERPRISE LINUX FOR SAP APPLICATIONS FOR POWER	94
6.5.3. RED HAT ENTERPRISE LINUX FOR SAP WITH HA & UPDATE SERVICES	96
6.5.4. RED HAT ENTERPRISE LINUX FOR SAP WITH HA & UPDATE SERVICES FOR POWER	100
APPENDIX A: CCSP TERMS AND DEFINITIONS	104
ABOUT RED HAT	107

## Disclaimer

This guide provides important information about the Red Hat Certified Cloud and Service Provider (CCSP) program. The terms that govern the CCSP program are contained in the CCSP Partner Agreement and CCSP program appendix (the "agreement") entered into between Red Hat and each partner participating in the CCSP program (the "service provider" or "CCSP partner"). All terms not otherwise defined herein shall have the meaning set forth in the agreement.

All CCSP partners can access the current version of this guide on the [Red Hat Partner Connect](#).

CCSP program benefits and requirements are applied based on where the CCSP is located, and there may be some region specific benefits or requirements not covered here. Your CCSP Program Manager can provide additional details if needed.

To the extent that this guide has been translated into any language other than English, the English version of the guide will prevail over any inconsistencies with a non-English version of the guide.

# 1. Introduction

The purpose of this guide is to help Red Hat partners understand the Red Hat product offerings available in the Red Hat Certified Cloud and Service Provider program and the SKUs associated with those offerings. The use cases contained in the guide attempt to show standard deployment examples with appropriate SKU mappings; they are not designed to cover every possible deployment option. CCSP partners that have more complex requirements should work with their Red Hat partner account team to better understand how to build, deploy, and manage end-customer offerings based upon Red Hat products.

See the other Red Hat Certified Cloud and Service Provider program documents for more details about the Red Hat Certified Cloud and Service Provider program, along with specific business and technical requirements for all CCSP partners:

- The *CCSP Program Guide* contains important program information, including partner enrollment, partner levels and benefits, membership requirements, and business requirements.
- The *CCSP Technical and Operations Guide (ToR)* contains important technical requirements for each of the CCSP product offerings, including deployment options, pricing terms, staffing and training information, and support models

## 2. Release Notes

The following is a summary of the changes made to the SKU Guide for the October 1st, 2020 release. All new SKUs are highlighted in **Blue** inside the billing SKU tables.

### 2.1. New Offerings

- [Red Hat OpenShift Container Storage for Sharing External Storage Add-on](#)
- [Red Hat OpenShift Container Platform Bundles](#)

### 2.2. Changes & Updates

#### [Red Hat Virtualization](#)

- New Full support SKUs to go along with the existing Diagnostic support SKUs

#### [Red Hat Enterprise Linux for Power](#)

- New Dedicated (Full & Diagnostic) Hourly SKUs to go along with the existing Dedicated Monthly, Yearly, and 3-year SKUs
- New Multi-tenant (Full & Diagnostic, Scale Out & Enterprise) SKUs to go along with the existing Dedicated SKUs

#### [Red Hat Enterprise Linux for SAP with HA & Update Services for Power](#)

- New Dedicated (Full & Diagnostic) Hourly SKUs to go along with the existing Dedicated Monthly, Yearly, and 3-year SKUs
- New Multi-tenant (Full & Diagnostic, Scale Out & Enterprise) SKUs to go along with the existing Dedicated SKUs

#### [Red Hat OpenShift Container Storage](#)

- New use case examples for internal and external modes

## 3. CCSP Program Overview

The Red Hat Certified Cloud and Service Provider program allows cloud, hosting, system integrator, and managed service providers to host and resell certified Red Hat offerings on-demand through multi-tenant, dedicated, and managed models.

### A CCSP partner receives:

- Flexible pricing aligned to the way a provider charges its customers, with:
  - Pay-as-you-go hourly, monthly, and yearly models with monthly billing in arrears
  - Consistency between on-demand and dedicated service models
  - Streamlined procurement of Red Hat subscriptions
- Premium (24x7) Red Hat support for all infrastructure components purchased from Red Hat
- Red Hat-certified offerings for resale with SKUs built specifically for CCSP partners
- Systems management solutions to manage Red Hat cloud offerings, including:
  - Red Hat Update Infrastructure (RHUI): in-cloud management and update services built for on-demand consumption and dynamic scale
  - Red Hat Satellite: a full-featured, active management solution for managed-service environments
- Joint customer issue resolution with Red Hat Global Support Services
- A compliant way to offer Red Hat solutions in the cloud or as a managed service
- Alignment with Red Hat field compensation, fostering joint sales engagements
- Access to thousands of certified Red Hat Enterprise Linux ISV applications for deployment in cloud environments
- Red Hat branding and promotion as a Red Hat Certified Cloud and Service Provider partner

## 4. CCSP Software Subscriptions

All CCSP partners will have access to Red Hat software made available through a special set of software subscriptions. These software subscriptions are provided to partners for a variety of reasons including: building and managing an infrastructure, implementing a Red Hat update service, and re-selling Red Hat software to their end-customers.

The three types of software subscriptions in the Red Hat Certified Cloud and Service Provider program are:

- CCSP program subscriptions
- Partner Infrastructure software subscriptions
- End User software subscriptions

CCSP Program and Partner Infrastructure subscriptions are provided to all CCSP partners free of charge and are used to designate the partner's support level (Full or Diagnostic) and to enable the partner to get up and running. CCSP partners purchase End User software subscriptions directly from Red Hat or from an authorized CCSP Distributor. End User software subscription pricing and terms are set in the CCSP Price Book for CCSP partners purchasing directly from Red Hat. Partners purchasing from a Distributor must check with their distributor for pricing and terms.

### 4.1. CCSP Program Subscriptions

CCSP program subscriptions are Red Hat product entitlements to be used by a CCSP partner to implement an update service, either Red Hat Update Infrastructure (RHUI) or Red Hat Satellite, and for errata and patch management.

CCSP program subscriptions are also used to create images of Red Hat software to be used by the CCSPs end customers.

### 4.2. Partner Infrastructure Software Subscriptions

CCSP partner infrastructure software subscriptions are used by the CCSP partner to build and operate infrastructure that is not directly exposed to the end customers but is crucial to a cost-effective, enterprise cloud environment. Partner infrastructure software subscriptions are offered under business terms that typically mirror the provider's business model and permit scaling with customer demand.

All CCSP partners must deploy Red Hat products on a Red Hat-supported hypervisor. Review a list of [all supported hypervisors](#) on the Red Hat Customer Portal. In addition, all CCSP partners must deploy an infrastructure on Red Hat certified hardware.

Visit the Red Hat Customer Portal for a [current list of certified hardware](#).

### 4.3. End User Software Subscriptions

The CCSP program gives a partner the right to host and resell Red Hat subscriptions to end customers on the partner's cloud or service. The end customer software subscriptions can be sold as multi-tenant or dedicated user models, as described below.

- **Multi-tenant platform** pricing is used when a partner has multiple end customers running virtual guests on a

server. The size of the virtual guest (small or large) is based on the number of physical cores, or any portion thereof, that is allocated to the virtual guest. VMs are defined as large when there are five or more physical cores (pCores) allocated, while small instances are VMs with four or fewer pCores allocated.

- **Dedicated user** pricing may apply when it is used for software subscriptions sold on a single system or VM that is dedicated to no more than one end customer for the term of the software subscription.

Subscription	Description	Support	Term
CCSP Program subscriptions	To create images of Red Hat software for end-customer software subscriptions. To perform errata and patch management and create images for end-customer subscription offerings.	Premium (24x7x365 from Red Hat to the CCSP partner)	2 years (no cost to the CCSP partner)
Partner Infrastructure software subscriptions	Used by the CCSP partner for its infrastructure, including clouds, and to host customers.	Premium	Monthly
End User software subscriptions	To be used on a CCSP's service end customers	Full or Diagnostic	Hourly, Monthly, Yearly

**Table 1. CCSP Software Subscription Summary**

More details about the CCSP software subscriptions can be found in the *Global Certified Cloud and Service Provider Appendix 2*.



## 5. CCSP Program Participation and Enablement SKUs

These SKUs are delivered through the CCSP Program and Partner Infrastructure Software subscriptions made available free of charge to all CCSP partners. These SKUs are automatically placed in the CCSP partner's account after the CCSP contract has been signed.

SKU	Description	Term
<b>Participation</b>		
MCT3252	Red Hat Certified Cloud and Service Provider Subscription with <b>Full</b> Support	2 Years
MCT3253	Red Hat Certified Cloud and Service Provider Subscription with <b>Diagnostic</b> Support	2 Years
<b>Enablement</b>		
RC1116415	Red Hat Update Infrastructure (RHUI) and Red Hat Enterprise Linux Add-Ons for providers	2 Years
RC0305160	Red Hat Satellite for Red Hat Certified Cloud and Service Providers  (requires purchase of Smart Mgmt Software Subscription for each unit being managed)	2 Years
RC1257407	Red Hat Satellite Add-Ons for providers	2 Years
MCT2955	Red Hat CloudForms for providers	2 Years
MCT2968	Red Hat OpenStack Platform for providers	2 Years
MCT3009	Red Hat OpenShift Container Platform for providers	2 Years
RV0130225	Red Hat Virtualization for providers	2 Years
MCT3153	Red Hat JBoss Middleware for providers	2 Years
RH00731	Red Hat Enterprise Linux for providers (via RHUI)	2 Years

*Table 2. Program Participation and Enablement SKUs*



These SKUs are valid for the length of the CCSP contract with an initial SKU term length of 2 years, followed by automatic yearly renewals.

## 6. CCSP Product SKUs and Use Cases

The following pages contain details about the product billing SKUs and typical use cases for all of the Red Hat products available through the Red Hat Certified Cloud and Service Provider program.

CCSP partners can re-sell these SKUs to their end-customers or use these SKUs to build offerings consumed by their end customers. These SKUs are used for the monthly billing reports required by Red Hat. CCSP partners purchasing directly from Red Hat can find SKU pricing details in the current CCSP Price Book.

### 6.1. Infrastructure Products

#### 6.1.1. Red Hat Enterprise Linux

##### 6.1.1.1. Billing SKUs

SKU	Description	Term	Unit of Measure
<b>Dedicated</b>			
RH00232HR	Red Hat Enterprise Linux Server, Full Support (Physical or Virtual Nodes, Dedicated, Hourly)	HOUR	Physical or Virtual Node
RH00236HR	Red Hat Enterprise Linux Server, Diagnostic Support (Physical or Virtual Nodes, Dedicated, Hourly)	HOUR	Physical or Virtual Node
RH00232	Red Hat Enterprise Linux Server for Service Providers, Full Support (Physical or Virtual Nodes, Dedicated, Yearly)	ANNUAL	Socket-Pair
RH00232F3	Red Hat Enterprise Linux Server for Service Providers, Full Support (Physical or Virtual Nodes, Dedicated, 3 Years)	3 - Year	Socket-Pair
RH00233	Red Hat Enterprise Linux Server for Virtual Datacenters for Service Providers, Full Support (Dedicated, Yearly)	ANNUAL	Socket-Pair
RH00233F3	Red Hat Enterprise Linux Server for Virtual Datacenters for Service Providers, Full Support (Dedicated, 3 Years)	3 - Year	Socket-Pair
RH00234	Red Hat Enterprise Linux Server for Service Providers, Full Support (Physical or Virtual Nodes, Dedicated, Monthly)	MONTH	Socket-Pair
RH00235	Red Hat Enterprise Linux Server for Virtual Datacenters for Service Providers, Full Support (Dedicated, Monthly)	MONTH	Socket-Pair
RH00236	Red Hat Enterprise Linux Server for Service Providers, Diagnostic Support (Physical or Virtual Nodes, Dedicated, Yearly)	ANNUAL	Socket-Pair
RH00236F3	Red Hat Enterprise Linux Server for Service Providers, Diagnostic Support (Physical or Virtual Nodes, Dedicated, 3 Years)	3 - Year	Socket-Pair
RH00237	Red Hat Enterprise Linux Server for Virtual Datacenters for Service Providers, Diagnostic Support (Dedicated, Yearly)	ANNUAL	Socket-Pair

SKU	Description	Term	Unit of Measure
RH00237F3	Red Hat Enterprise Linux Server for Virtual Datacenters for Service Providers, Diagnostic Support (Dedicated, 3 Years)	3 - Year	Socket-Pair
RH00238	Red Hat Enterprise Linux Server for Service Providers, Diagnostic Support (Physical or Virtual Nodes, Dedicated, Monthly)	MONTH	Socket-Pair
RH00239	Red Hat Enterprise Linux Server for Virtual Datacenters for Service Providers, Diagnostic Support (Dedicated, Monthly)	MONTH	Socket-Pair
<b>Multi-tenant</b>			
MCT2559	Red Hat Enterprise Linux Server, Full Support (Small Virtual Guest, Multi-Tenant, Yearly)	ANNUAL	Virtual Guest
MCT2559F3	Red Hat Enterprise Linux Server, Full Support (Small Virtual Guest, Multi-Tenant, 3 Years)	3 - Year	Virtual Guest
MCT2560	Red Hat Enterprise Linux Server, Full Support (Large Virtual Guest, Multi-Tenant, Yearly)	ANNUAL	Virtual Guest
MCT2560F3	Red Hat Enterprise Linux Server, Full Support (Large Virtual Guest, Multi-Tenant, 3 Years)	3 - Year	Virtual Guest
MCT2561	Red Hat Enterprise Linux Server, Full Support (Small Virtual Guest, Multi-Tenant, Monthly)	MONTH	Virtual Guest
MCT2562	Red Hat Enterprise Linux Server, Full Support (Large Virtual Guest, Multi-Tenant, Monthly)	MONTH	Virtual Guest
MCT2563	Red Hat Enterprise Linux Server, Full Support (Small Virtual Guest, Multi-Tenant, Hourly)	HOUR	Virtual Guest
MCT2564	Red Hat Enterprise Linux Server, Full Support (Large Virtual Guest, Multi-Tenant, Hourly)	HOUR	Virtual Guest
MCT2565	Red Hat Enterprise Linux Server, Diagnostic Support (Small Virtual Guest, Multi-Tenant, Yearly)	ANNUAL	Virtual Guest
MCT2565F3	Red Hat Enterprise Linux Server, Diagnostic Support (Small Virtual Guest, Multi-Tenant, 3 Years)	3 - Year	Virtual Guest
MCT2566	Red Hat Enterprise Linux Server, Diagnostic Support (Large Virtual Guest, Multi-Tenant, Yearly)	ANNUAL	Virtual Guest
MCT2566F3	Red Hat Enterprise Linux Server, Diagnostic Support (Large Virtual Guest, Multi-Tenant, 3 Years)	3 - Year	Virtual Guest
MCT2567	Red Hat Enterprise Linux Server, Diagnostic Support (Small Virtual Guest, Multi-Tenant, Monthly)	MONTH	Virtual Guest
MCT2568	Red Hat Enterprise Linux Server, Diagnostic Support (Large Virtual Guest, Multi-Tenant, Monthly)	MONTH	Virtual Guest

SKU	Description	Term	Unit of Measure
MCT2569	Red Hat Enterprise Linux Server, Diagnostic Support (Small Virtual Guest, Multi-Tenant, Hourly)	HOUR	Virtual Guest
MCT2570	Red Hat Enterprise Linux Server, Diagnostic Support (Large Virtual Guest, Multi-Tenant, Hourly)	HOUR	Virtual Guest

**Table 3. Red Hat Enterprise Linux Billing SKU Details**

**Notes:** \* The RHEL Physical/Virtual SKUs allow entitlements for either 1 physical system or 2 virtual guests.

### 6.1.1.2. Red Hat Enterprise Linux Use Case Examples

#### Example 1

RHEL VMs dedicated to a single customer sharing a 4 socket server.

- **Graphic A:** CCSP is allowed unlimited RHEL VMs on this server by using 2X RH00235 SKUs

#### Example 2

A 4 socket server supporting multiple customers with multiple RHEL VMs.

- **Graphic B:** Required SKUs vary depending upon size of RHEL VM (small  $\Leftarrow$  4 cores, large  $>$  4 cores) and billing term (hour, month, year, 3-year).

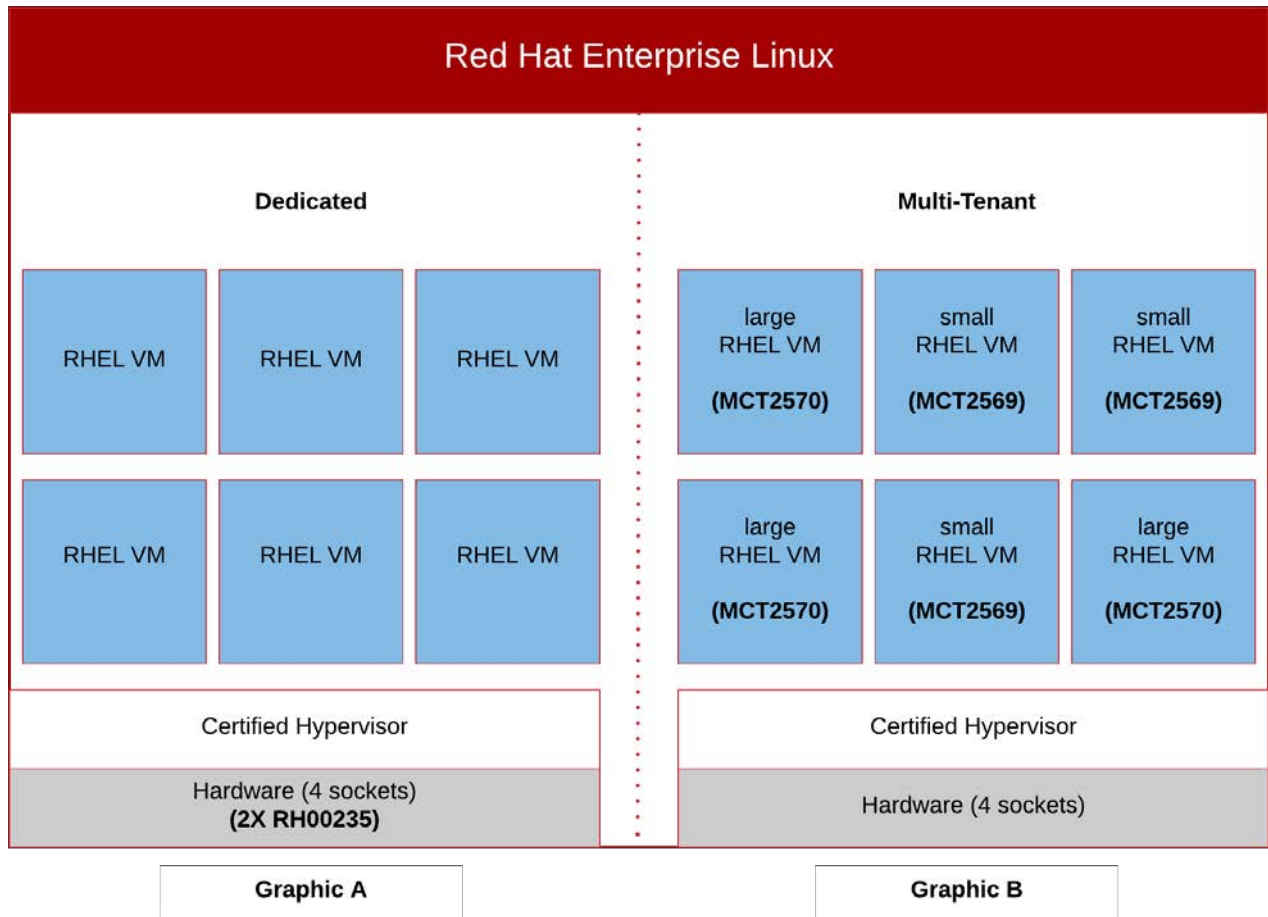

**Figure 1. Red Hat Enterprise Linux Use Cases**

## 6.1.2. Red Hat Enterprise Linux Add-Ons

### 6.1.2.1. Red Hat Enterprise Linux High Availability Add-On Billing SKUs

SKU	Description	Term	Unit of Measure
<b>Dedicated</b>			
RH00385	Red Hat Enterprise Linux, High Availability Add-On, Layered Support (Physical or Virtual Nodes, Dedicated, Yearly)	ANNUAL	Socket-Pair
RH00385MO	Red Hat Enterprise Linux, High Availability Add-On, Layered Support (Physical or Virtual Nodes, Dedicated, Monthly)	MONTH	Socket-Pair
RH00385F3	Red Hat Enterprise Linux, High Availability Add-On, Layered Support (Physical or Virtual Nodes, Dedicated, 3 Years)	3 - Year	Socket-Pair
RH00386	Red Hat Enterprise Linux, High Availability Add-On, Layered Support (Unlimited Virtual Guests, Dedicated, Yearly)	ANNUAL	Socket-Pair
RH00386MO	Red Hat Enterprise Linux, High Availability Add-On, Layered Support (Unlimited Virtual Guests, Dedicated, Monthly)	MONTH	Socket-Pair
RH00386F3	Red Hat Enterprise Linux, High Availability Add-On, Layered Support (Unlimited Virtual Guests, Dedicated, 3 Years)	3 - Year	Socket-Pair
<b>Multi-Tenant</b>			
MCT2910HR	Red Hat Enterprise Linux, High Availability Add-On, Layered Support (Virtual Guest, Multi-Tenant, Hourly)	HOUR	Virtual Guest
MCT2910	Red Hat Enterprise Linux, High Availability Add-On, Layered Support (Virtual Guest, Multi-Tenant, Yearly)	ANNUAL	Virtual Guest
MCT2910F3	Red Hat Enterprise Linux, High Availability Add-On, Layered Support (Virtual Guest, Multi-Tenant, 3 Years)	3 - Year	Virtual Guest
MCT2912	Red Hat Enterprise Linux, High Availability Add-On, Layered Support (Virtual Guest, Multi-Tenant, Monthly)	MONTH	Virtual Guest

**Table 4. Red Hat Enterprise Linux High Availability Add-On Billing SKU Details**

### 6.1.2.2. Red Hat Enterprise Linux Load Balancer Add-On Billing SKUs

SKU	Description	Term	Unit of Measure
<b>Dedicated</b>			

SKU	Description	Term	Unit of Measure
RH00390	Red Hat Enterprise Linux, Load Balancer Add-On, Layered Support (Physical or Virtual Nodes, Dedicated, Yearly)	ANNUAL	Socket-Pair
RH00390MO	Red Hat Enterprise Linux, Load Balancer Add-On, Layered Support (Physical or Virtual Nodes, Dedicated, Monthly)	MONTH	Socket-Pair
RH00390F3	Red Hat Enterprise Linux, Load Balancer Add-On, Layered Support (Physical or Virtual Nodes, Dedicated, 3 Years)	3 - Year	Socket-Pair
<b>Multi-Tenant</b>			
MCT2913HR	Red Hat Enterprise Linux, Load Balancer Add-On, Layered Support (Virtual Guest, Multi-Tenant, Hourly)	HOURLY	Virtual Guest
MCT2913	Red Hat Enterprise Linux, Load Balancer Add-On, Layered Support (Virtual Guest, Multi-Tenant, Yearly)	ANNUAL	Virtual Guest
MCT2913F3	Red Hat Enterprise Linux, Load Balancer Add-On, Layered Support (Virtual Guest, Multi-Tenant, 3 Years)	3 - Year	Virtual Guest
MCT2915	Red Hat Enterprise Linux, Load Balancer Add-On, Layered Support (Virtual Guest, Multi-Tenant, Monthly)	MONTH	Virtual Guest

**Table 5. Red Hat Enterprise Linux Load Balancer Add-On Billing SKU Details**

### 6.1.2.3. Red Hat Enterprise Linux Resilient Storage Add-On Billing SKUs

SKU	Description	Term	Unit of Measure
<b>Dedicated</b>			
RH00387	Red Hat Enterprise Linux, Resilient Storage Add-On, Layered Support (Physical or Virtual Nodes, Dedicated, Yearly)	ANNUAL	Socket-Pair
RH00387MO	Red Hat Enterprise Linux, Resilient Storage Add-On, Layered Support (Physical or Virtual Nodes, Dedicated, Monthly)	MONTH	Socket-Pair
RH00387F3	Red Hat Enterprise Linux, Resilient Storage Add-On, Layered Support (Physical or Virtual Nodes, Dedicated, 3 Years)	3 - Year	Socket-Pair
RH00388	Red Hat Enterprise Linux, Resilient Storage Add-On, Layered Support (Unlimited Virtual Guests, Dedicated, Yearly)	ANNUAL	Socket-Pair

SKU	Description	Term	Unit of Measure
RH00388MO	Red Hat Enterprise Linux, Resilient Storage Add-On, Layered Support (Unlimited Virtual Guests, Dedicated, Monthly)	MONTH	Socket-Pair
RH00388F3	Red Hat Enterprise Linux, Resilient Storage Add-On, Layered Support (Unlimited Virtual Guests, Dedicated, 3 Years)	3 - Year	Socket-Pair
<b>Multi-Tenant</b>			
MCT2916HR	Red Hat Enterprise Linux, Resilient Storage Add-On, Layered Support (Virtual Guest, Multi-Tenant, Hourly)	HOUR	Virtual Guest
MCT2916	Red Hat Enterprise Linux, Resilient Storage Add-On, Layered Support (Virtual Guest, Multi-Tenant, Yearly)	ANNUAL	Virtual Guest
MCT2916F3	Red Hat Enterprise Linux, Resilient Storage Add-On, Layered Support (Virtual Guest, Multi-Tenant, 3 Years)	3 - Year	Virtual Guest
MCT2918	Red Hat Enterprise Linux, Resilient Storage Add-On, Layered Support (Virtual Guest, Multi-Tenant, Monthly)	MONTH	Virtual Guest

**Table 6. Red Hat Enterprise Linux Resilient Storage Add-On Billing SKU Details**

#### 6.1.2.4. Red Hat Enterprise Linux Scalable File System Add-On Billing SKUs

SKU	Description	Term	Unit of Measure
<b>Dedicated</b>			
RH00389	Red Hat Enterprise Linux, Scalable File System Add-On, Layered Support (Physical or Virtual Nodes, Dedicated, Yearly)	ANNUAL	Socket-Pair
RH00389MO	Red Hat Enterprise Linux, Scalable File System Add-On, Layered Support (Physical or Virtual Nodes, Dedicated, Monthly)	MONTH	Socket-Pair
RH00389F3	Red Hat Enterprise Linux, Scalable File System Add-On, Layered Support (Physical or Virtual Nodes, Dedicated, 3 Years)	3 - Year	Socket-Pair
<b>Multi-Tenant</b>			
MCT2908HR	Red Hat Enterprise Linux, Scalable File System Add-On, Layered Support (Virtual Guest, Multi-Tenant, Hourly)	HOUR	Virtual Guest
MCT2908	Red Hat Enterprise Linux, Scalable File System Add-On, Layered Support (Virtual Guest, Multi-Tenant, Yearly)	ANNUAL	Virtual Guest



SKU	Description	Term	Unit of Measure
MCT2908F3	Red Hat Enterprise Linux, Scalable File System Add-On, Layered Support (Virtual Guest, Multi-Tenant, 3 Years)	3 - Year	Virtual Guest
MCT2909	Red Hat Enterprise Linux, Scalable File System Add-On, Layered Support (Virtual Guest, Multi-Tenant, Monthly)	MONTH	Virtual Guest

**Table 7. Red Hat Enterprise Linux Scalable File System Add-On Billing SKU Details**

### 6.1.2.5. Red Hat Enterprise Linux Extended Life Cycle Support Add-On Billing SKUs

SKU	Description	Term	Unit of Measure
<b>Dedicated</b>			
RH00777HR	Red Hat Enterprise Linux, Extended Life Cycle Support Add-On, Layered Support (Physical or Virtual Nodes, Dedicated, Yearly)	HOURL	Physical Node or Virtual Node
RH00777	Red Hat Enterprise Linux, Extended Life Cycle Support Add-On, Layered Support (Physical or Virtual Nodes, Dedicated, Yearly)	ANNUAL	Socket-Pair
RH00360	Red Hat Enterprise Linux, Extended Life Cycle Support Add-On, Layered Support (Physical or Virtual Nodes, Dedicated, Monthly)	MONTH	Socket-Pair
RH00778HR	Red Hat Enterprise Linux, Extended Life Cycle Support Add-On, Layered Support (Unlimited Virtual Guests, Dedicated, Yearly)	HOURL	Virtual Guest
RH00778	Red Hat Enterprise Linux, Extended Life Cycle Support Add-On, Layered Support (Unlimited Virtual Guests, Dedicated, Yearly)	ANNUAL	Socket-Pair
RH00361	Red Hat Enterprise Linux, Extended Life Cycle Support Add-On, Layered Support (Unlimited Virtual Guests, Dedicated, Monthly)	MONTH	Socket-Pair
<b>Multi-Tenant</b>			
MCT3574	Red Hat Enterprise Linux, Extended Life Cycle Support Add-On, Layered Support (Small Virtual Guest, Multi-Tenant, Yearly)	ANNUAL	Virtual Guest
MCT3574MO	Red Hat Enterprise Linux, Extended Life Cycle Support Add-On, Layered Support (Small Virtual Guest, Multi-Tenant, Monthly)	MONTH	Virtual Guest
MCT3574HR	Red Hat Enterprise Linux, Extended Life Cycle Support Add-On, Layered Support (Small Virtual Guest, Multi-Tenant Hourly)	HOURL	Virtual Guest

SKU	Description	Term	Unit of Measure
MCT3575	Red Hat Enterprise Linux, Extended Life Cycle Support Add-On, Layered Support (Large Virtual Guest, Multi-Tenant, Yearly)	ANNUAL	Virtual Guest
MCT3575MO	Red Hat Enterprise Linux, Extended Life Cycle Support Add-On, Layered Support (Large Virtual Guest, Multi-Tenant, Monthly)	MONTH	Virtual Guest
MCT3575HR	Red Hat Enterprise Linux, Extended Life Cycle Support Add-On, Layered Support (Large Virtual Guest, Multi-Tenant, Hourly)	HOUR	Virtual Guest

**Table 8. Extended Life Cycle Support Add-On Billing SKU Details**

### 6.1.2.6. Red Hat Enterprise Linux Extended Life Cycle Support Add-On Use Case Examples

Red Hat offers a variety of optional Red Hat Enterprise Linux Add-Ons that enhance and extend the features of Red Hat Enterprise Linux.

The following Red Hat Enterprise Linux Add-Ons are available in the Red Hat Certified Cloud and Service Provider program:

- Red Hat Enterprise Linux High Availability Add-On
- Red Hat Enterprise Linux Load Balancer Add-On
- Red Hat Enterprise Linux Resilient Storage Add-On
- Red Hat Enterprise Linux Scalable File System Add-On
- Extended Life Cycle Support Add-On



The Red Hat Enterprise Linux Add-Ons have similar deployment use cases, and there are Dedicated and Multi-Tenant SKUs available for all. The use cases below are designed to represent any/all Red Hat Enterprise Linux Add-Ons. Only the SKUs will change from Add-On to Add-On.

#### Example 1

- **Graphic A:** Socket-pair dedicated to a single customer with a single VM
  - Customer A using Red Hat Enterprise Linux High Availability Add-On yearly subscription

#### Example 2

- **Graphic B:** Socket-pair dedicated to a single customer with multiple VMs
  - Customer B using Red Hat Enterprise Linux Load Balancer Add-On monthly subscription

#### Example 3

- **Graphic C:** Socket-pair supporting multiple customers
  - Customer C using Red Hat Enterprise Linux Scalable File System Add-On hourly subscription
  - Customer D using Red Hat Enterprise Linux Resilient Storage Add-On yearly subscription
  - Customer E using Red Hat Enterprise Linux High Availability Add-On 3 year subscription

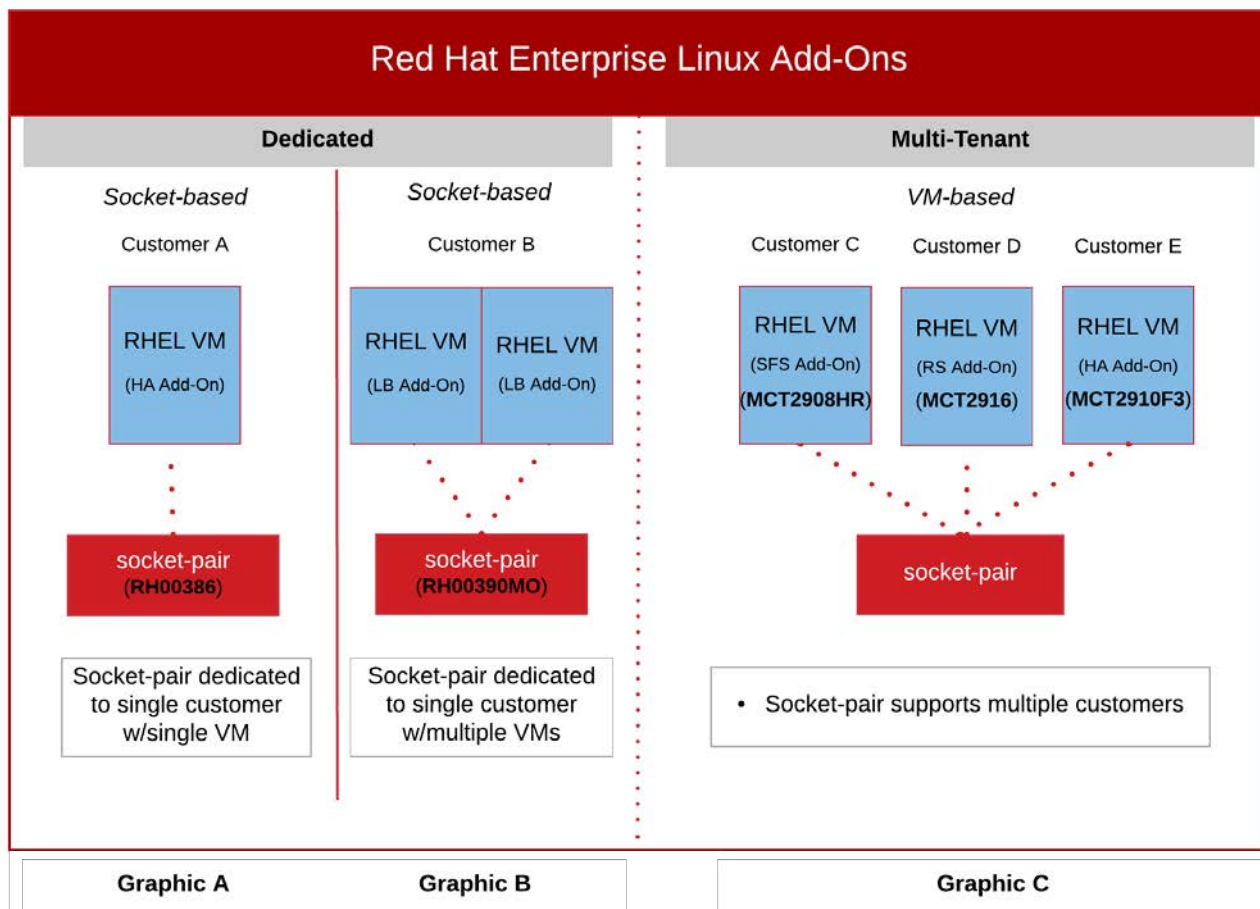

Figure 2. Red Hat Enterprise Linux Add-Ons Use Cases

## 6.1.3. Red Hat Enterprise Linux for Power

### 6.1.3.1. Billing SKUs

SKU	Description	Term	Unit of Measure
<b>Dedicated</b>			
<b>RH01944HR</b>	<b>Red Hat Enterprise Linux for Power, LE, Full Support (4 Cores, Up to 4 LPARs, Dedicated, Hourly)</b>	<b>HOURL</b>	<b>Physical Node or Virtual Node</b>
<b>RH01944MO</b>	Red Hat Enterprise Linux for Power, LE, Full Support (4 Cores, Up to 4 LPARs, Dedicated, Monthly)	MONTH	Physical Node or Virtual Node
<b>RH01944</b>	Red Hat Enterprise Linux for Power, LE, Full Support (4 Cores, Up to 4 LPARs, Dedicated, Yearly)	ANNUAL	Physical Node or Virtual Node
<b>RH01944F3</b>	Red Hat Enterprise Linux for Power, LE, Full Support (4 Cores, Up to 4 LPARs, Dedicated, 3 Years)	3 - Year	Physical Node or Virtual Node
<b>RH01945HR</b>	<b>Red Hat Enterprise Linux for Power, LE, Diagnostic Support (4 Cores, Up to 4 LPARs, Dedicated, Hourly)</b>	<b>HOURL</b>	<b>Physical Node or Virtual Node</b>
<b>RH01945MO</b>	Red Hat Enterprise Linux for Power, LE, Diagnostic Support (4 Cores, Up to 4 LPARs, Dedicated, Monthly)	MONTH	Physical Node or Virtual Node
<b>RH01945</b>	Red Hat Enterprise Linux for Power, LE, Diagnostic Support (4 Cores, Up to 4 LPARs, Dedicated, Yearly)	ANNUAL	Physical Node or Virtual Node
<b>RH01945F3</b>	Red Hat Enterprise Linux for Power, LE, Diagnostic Support (4 Cores, Up to 4 LPARs, Dedicated, 3 Years)	3 - Year	Physical Node or Virtual Node
<b>Multi-Tenant</b>			
<b>RH02224HR</b>	<b>Red Hat Enterprise Linux for Power, LE, Full Support (1 Core, Scale out, Multi-tenant, Hourly)</b>	<b>HOURL</b>	<b>Physical Node or Virtual Node</b>
<b>RH02224MO</b>	<b>Red Hat Enterprise Linux for Power, LE, Full Support (1 Core, Scale out, Multi-tenant, Monthly)</b>	<b>MONTH</b>	<b>Physical Node or Virtual Node</b>
<b>RH02224</b>	<b>Red Hat Enterprise Linux for Power, LE, Full Support (1 Core, Scale out, Multi-tenant, Yearly)</b>	<b>ANNUAL</b>	<b>Physical Node or Virtual Node</b>

SKU	Description	Term	Unit of Measure
RH02224F3	Red Hat Enterprise Linux for Power, LE, Full Support (1 Core, Scale out, Multi-tenant, 3 Years)	3 - Year	Physical Node or Virtual Node
RH02223HR	Red Hat Enterprise Linux for Power, LE, Diagnostic Support (1 Core, Scale out, Multi-tenant, Hourly)	HOUR	Physical Node or Virtual Node
RH02223MO	Red Hat Enterprise Linux for Power, LE, Diagnostic Support (1 Core, Scale out, Multi-tenant, Monthly)	MONTH	Physical Node or Virtual Node
RH02223	Red Hat Enterprise Linux for Power, LE, Diagnostic Support (1 Core, Scale out, Multi-tenant, Yearly)	ANNUAL	Physical Node or Virtual Node
RH02223F3	Red Hat Enterprise Linux for Power, LE, Diagnostic Support (1 Core, Scale out, Multi-tenant, 3 Years)	3 - Year	Physical Node or Virtual Node
RH02230HR	Red Hat Enterprise Linux for Power, LE, Full Support (1 Core, Enterprise, Multi-tenant, Hourly)	HOUR	Physical Node or Virtual Node
RH02230MO	Red Hat Enterprise Linux for Power, LE, Full Support (1 Core, Enterprise, Multi-tenant, Monthly)	MONTH	Physical Node or Virtual Node
RH02230	Red Hat Enterprise Linux for Power, LE, Full Support (1 Core, Enterprise, Multi-tenant, Yearly)	ANNUAL	Physical Node or Virtual Node
RH02230F3	Red Hat Enterprise Linux for Power, LE, Full Support (1 Core, Enterprise, Multi-tenant, 3 Years)	3 - Year	Physical Node or Virtual Node
RH02229HR	Red Hat Enterprise Linux for Power, LE, Diagnostic Support (1 Core, Enterprise, Multi-tenant, Hourly)	HOUR	Physical Node or Virtual Node
RH02229MO	Red Hat Enterprise Linux for Power, LE, Diagnostic Support (1 Core, Enterprise, Multi-tenant, Monthly)	MONTH	Physical Node or Virtual Node
RH02229	Red Hat Enterprise Linux for Power, LE, Diagnostic Support (1 Core, Enterprise, Multi-tenant, Yearly)	ANNUAL	Physical Node or Virtual Node
RH02229F3	Red Hat Enterprise Linux for Power, LE, Diagnostic Support (1 Core, Enterprise, Multi-tenant, 3 Years)	3 - Year	Physical Node or Virtual Node

## Table 9. Red Hat Enterprise Linux for Power Billing SKU Details

### Notes:

- New terminology:
  - Multi-tenant Scale out = Small Instance (1-4 vCPUs)
  - Multi-tenant Enterprise = Large instance (> 4 vCPUs)

### 6.1.3.2. Red Hat Enterprise Linux for Power Use Case Examples

#### Example 1

12 Red Hat Enterprise Linux virtual nodes on IBM Power hardware dedicated to a single customer.

- A provider has a IBM Power8 server with a total of 6 cores (2 General Purpose cores and 4 IFL cores) dedicated to a single customer. The customer wants to run 12 RHEL virtual nodes (LPARs), with annual pricing. The provider will run the customer's RHEL virtual nodes using the 4 IFL cores in order to take advantage of the lower-cost IFL core licensing offered by IBM.
  - To determine the Red Hat Enterprise Linux for Power SKU quantity:
    - 1x RH01945 SKUs will cover up to 4 cores or 4 virtual nodes
    - 2x RH01945 SKUs to cover the remaining 8 RHEL virtual nodes
    - Total quantity of RH01945 SKUs = 3

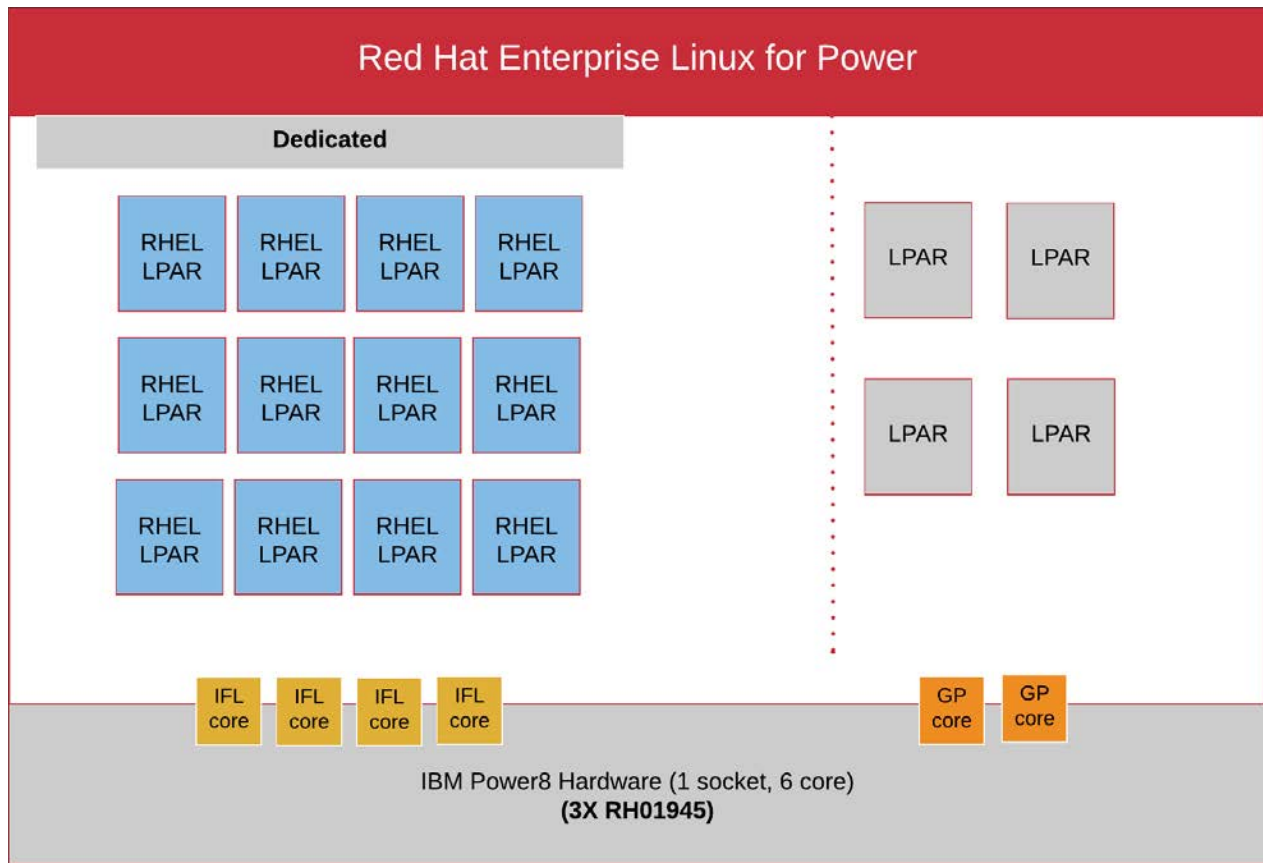

**Figure 3. Red Hat Enterprise Linux for Power Use Cases**

**Notes:**

- In this case, PowerVM is not considered to be a hypervisor. The RHEL systems are running on PowerVM LPARs. Red Hat Virtualization for Power is the only supported virtualization solution for IBM Power Systems
- RHEL for Power SKUs can be stacked in order to entitle larger Power hardware capable of running many
- Customers are allowed to run RHEL LPARs on General Purpose (GP) cores if they prefer but they are more expensive to license with IBM than IFL cores
- Big-endian (BE) SKUs are not currently available in the CCSP program, which effectively limits support to IBM Power8 hardware
- **IFL-based RHEL for Power SKUs have been retired from CCSP as of March 1st, 2019**

## 6.1.4. Red Hat Enterprise Linux for z Systems

### 6.1.4.1. Billing SKUs

SKU	Description	Term	Unit of Measure
<b>Dedicated</b>			
<b>RH00629</b>	Red Hat Enterprise Linux for z Systems, Full Support (IFL, Dedicated, Yearly)	ANNUAL	IFL
<b>RH00629MO</b>	Red Hat Enterprise Linux for z Systems, Full Support (IFL, Dedicated, Monthly)	MONTH	IFL
<b>RH00628</b>	Red Hat Enterprise Linux for z Systems, Diagnostic Support (IFL, Dedicated, Yearly)	ANNUAL	IFL
<b>RH00628MO</b>	Red Hat Enterprise Linux for z Systems, Diagnostic Support (IFL, Dedicated, Monthly)	MONTH	IFL

*Table 10. Red Hat Enterprise Linux for z Systems Billing SKU Details*

### 6.1.4.2. Red Hat Enterprise Linux for z Systems Use Case Examples

#### Example 1

12 Red Hat Enterprise Linux LPARs running on an IBM z Systems hardware dedicated to a single customer.

- One Red Hat Enterprise Linux z Systems SKU includes enough entitlements to support up to 100 Red Hat Enterprise Linux LPARs on a single IFL.
  - **Total quantity of RH00628MO SKUs = 1**



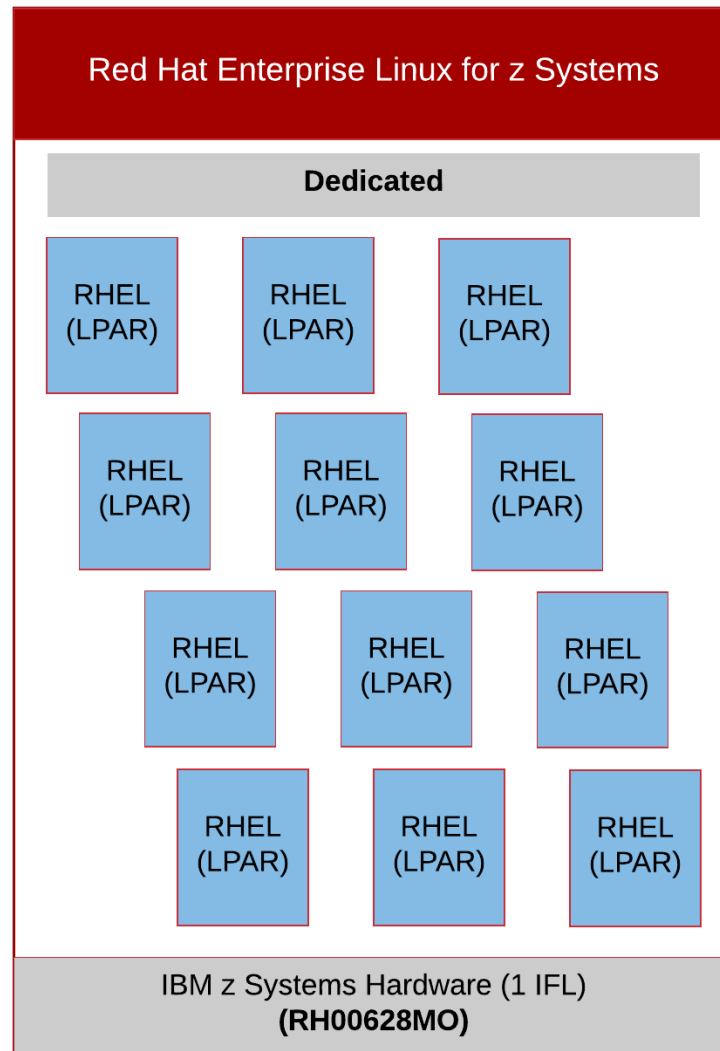

Figure 4. Red Hat Enterprise Linux z Systems Use Cases

## 6.1.5. Red Hat Enterprise Linux for z Systems Extended Life Cycle Support Add-On

### 6.1.5.1. Billing SKUs

SKU	Description	Term	Unit of Measure
<b>Dedicated</b>			
<b>RH00776</b>	Red Hat Enterprise Linux for z Systems, Extended Life Cycle Support Add-On , Layered Support (IFL, Dedicated, Yearly)	ANNUAL	IFL
<b>RH00776MO</b>	Red Hat Enterprise Linux for z Systems, Extended Life Cycle Support Add-On, Layered Support (IFL, Dedicated, Monthly)	MONTH	IFL

**Table 11. Red Hat Enterprise Linux for z Systems Extended Life Cycle Support Add-On Billing SKU Details**

## 6.1.6. Red Hat Enterprise Linux for IBM System Z and LinuxOne with Comprehensive Add-Ons

### 6.1.6.1. Billing SKUs

SKU	Description	Term	Unit of Measure
<b>Dedicated</b>			
<b>RH02214MO</b>	Red Hat Enterprise Linux for IBM System Z and LinuxOne with Comprehensive Add-Ons, Diagnostic Support (IFL, Dedicated, Monthly)	MONTH	IFL
<b>RH02214</b>	Red Hat Enterprise Linux for IBM System Z and LinuxOne with Comprehensive Add-Ons, Diagnostic Support (IFL, Dedicated, Yearly)	ANNUAL	IFL
<b>RH02214F3</b>	Red Hat Enterprise Linux for IBM System Z and LinuxOne with Comprehensive Add-Ons, Diagnostic Support (IFL, Dedicated, Yearly)	3-YEAR	IFL
<b>RH02215MO</b>	Red Hat Enterprise Linux for IBM System Z and LinuxOne with Comprehensive Add-Ons, Full Support (IFL, Dedicated, Monthly)	MONTH	IFL
<b>RH02215</b>	Red Hat Enterprise Linux for IBM System Z and LinuxOne with Comprehensive Add-Ons, Full Support (IFL, Dedicated, Yearly)	ANNUAL	IFL
<b>RH02215F3</b>	Red Hat Enterprise Linux for IBM System Z and LinuxOne with Comprehensive Add-Ons, Full Support (IFL, Dedicated, 3 Year)	3-YEAR	IFL

**Table 12. Red Hat Enterprise Linux for IBM System Z and LinuxOne with Comprehensive Add-Ons Billing SKU Details**

#### Notes:

- All SKUs provide an "unlimited" number of VMs on a single IBM System z (practical VM limit is 100/IFL)
- All SKUs include the following software:
  - RHEL for IBM System z
  - RHEL Extended Update Support Add-on
  - RHEL High Availability Add-on



RHEL Smart Management Add-on **is not** included with this offering.

### 6.1.6.2. Red Hat Enterprise Linux for IBM System Z and LinuxOne with Comprehensive Add-Ons Use Case Examples

#### Example 1

12 Red Hat Enterprise Linux VMs running on an IBM mainframe (ex. IBM z15 or LinuxONE III) dedicated to a single customer with monthly pricing.

- One Red Hat Enterprise Linux for IBM System Z and LinuxOne with Comprehensive Add-Ons SKU includes enough entitlements to support up to 100 Red Hat Enterprise Linux VMs on a single IFL.
  - **Total quantity of RH02214MO SKUs reported = 1**

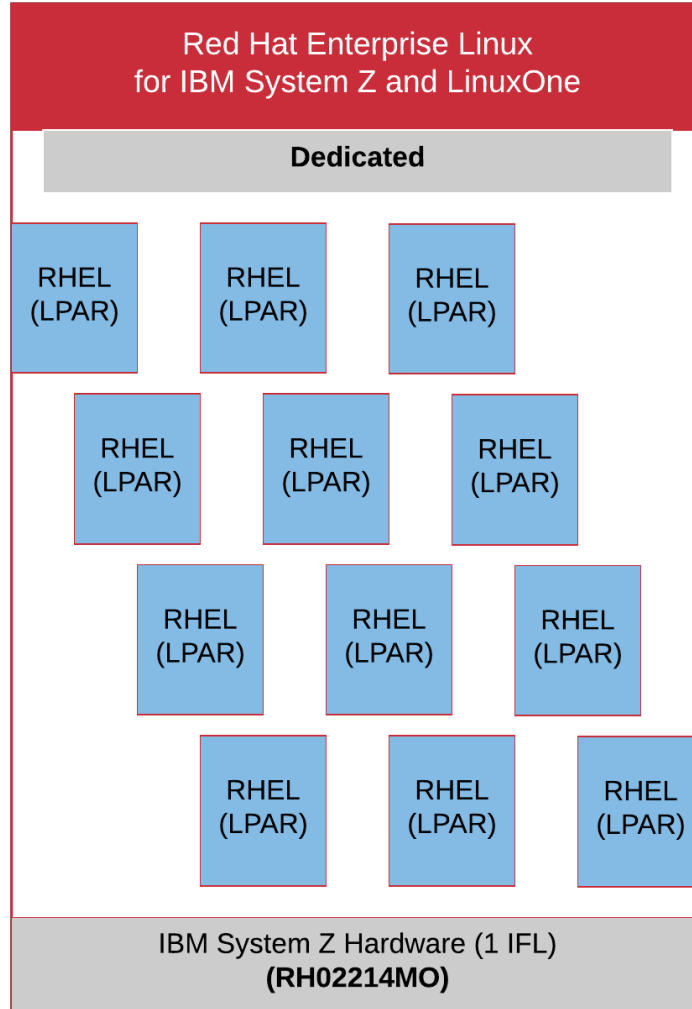

**Figure 5. Red Hat Enterprise Linux for IBM System Z and LinuxOne with Comprehensive Add-Ons Use Cases**

## 6.1.7. Red Hat OpenStack Platform

### 6.1.7.1. Billing SKUs

SKU	Description	Term	Unit of Measure
<b>Dedicated</b>			
MCT2963	Red Hat OpenStack Platform, Diagnostic Support (Dedicated, Yearly)	ANNUAL	Socket-Pair
MCT2963F3	Red Hat OpenStack Platform, Diagnostic Support (Dedicated, 3 Years)	3 - Year	Socket-Pair
MCT2964	Red Hat OpenStack Platform, Diagnostic Support (Dedicated, Monthly)	MONTH	Socket-Pair
MCT2965	Red Hat OpenStack Platform, (without Guest OS), Diagnostic Support (Dedicated, Yearly)	ANNUAL	Socket-Pair
MCT2965F3	Red Hat OpenStack Platform, (without Guest OS), Diagnostic Support (Dedicated, 3 Years)	3 - Year	Socket-Pair
MCT2966	Red Hat OpenStack Platform, (without Guest OS), Diagnostic Support (Dedicated, Monthly)	MONTH	Socket-Pair
<b>Multi-Tenant</b>			
MCT2967	Red Hat OpenStack Platform, (without Guest OS), Diagnostic Support (Multi-Tenant, Monthly)	MONTH	Socket
MCT3577	Red Hat OpenStack Platform (without Guest OS), Diagnostic Support (Multi-Tenant, Yearly)	ANNUAL	Socket

**Table 13. Red Hat OpenStack Platform Billing SKU Details**

### 6.1.7.2. Red Hat OpenStack Platform Use Case Examples

#### Example 1

- **Graphic A** Red Hat OpenStack Platform infrastructure dedicated to a single customer using non-Red Hat Enterprise Linux guests.
- **Graphic B** Red Hat OpenStack Platform infrastructure dedicated to a single customer using unlimited Red Hat Enterprise Linux guests.

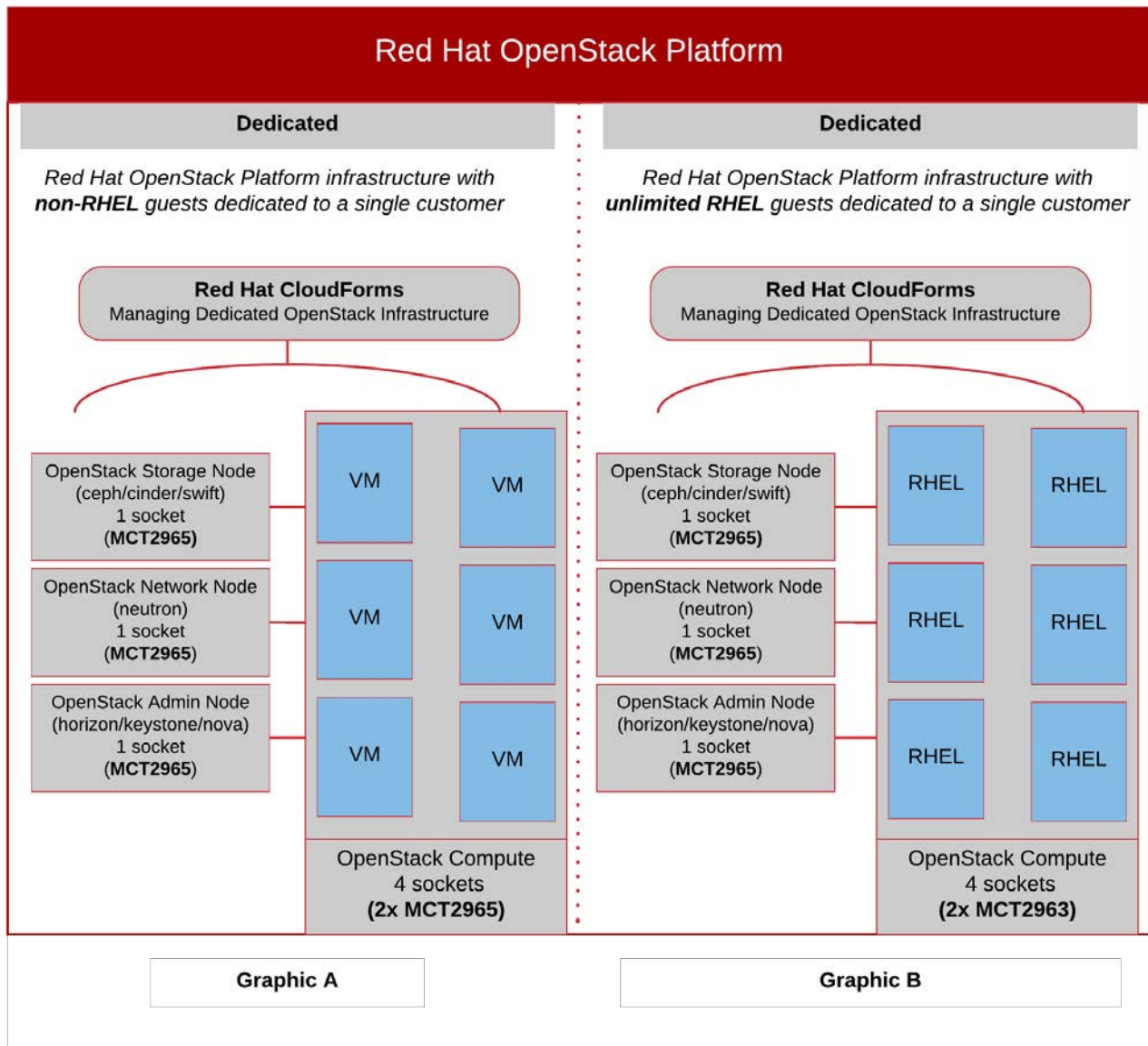

Figure 6. Red Hat OpenStack Platform Use Cases

Example 2

- **Graphic C** Red Hat OpenStack Platform infrastructure dedicated to a single customer. using non-Red Hat Enterprise Linux The OpenStack controller nodes will run as VMs on Red Hat Virtualization.
- **Graphic D** A public cloud built on Red Hat OpenStack Platform. Customers are responsible for obtaining their own Red Hat Enterprise Linux subscriptions.

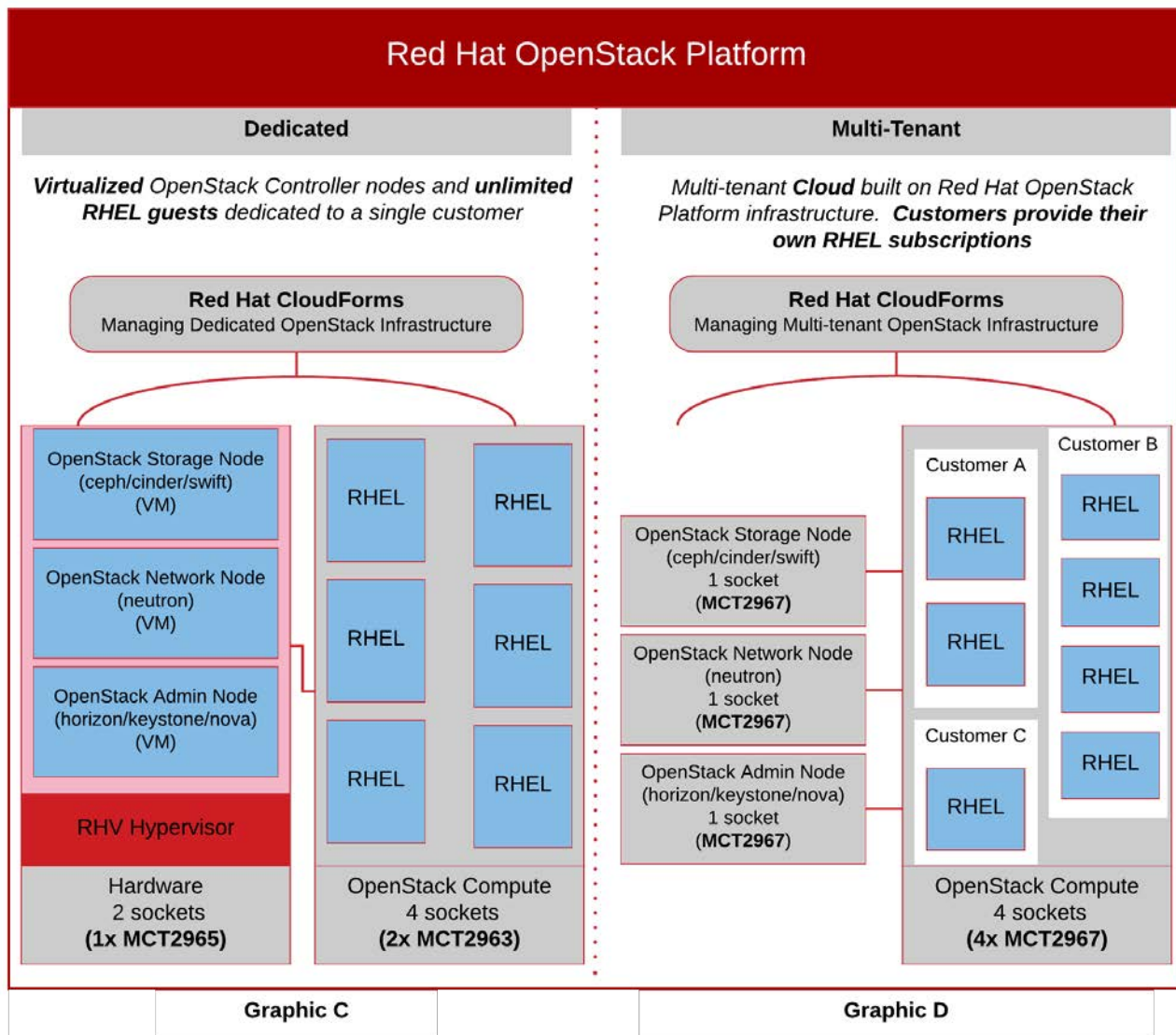

Figure 7. Red Hat OpenStack Platform Use Cases

## 6.1.8. Red Hat OpenStack Platform Extended Life Cycle Support Add-On

### 6.1.8.1. Billing SKUs

SKU	Description	Term	Unit of Measure
<b>Dedicated</b>			
<b>RH01888MO</b>	Red Hat OpenStack Platform, Extended Life Cycle Support Add-On, Layered Support (Socket-Pair, Dedicated, Monthly)	MONTH	Socket-Pair
<b>RH01888</b>	Red Hat OpenStack Platform, Extended Life Cycle Support Add-On, Layered Support (Socket-Pair, Dedicated, Yearly)	ANNUAL	Socket-Pair
<b>Multi-Tenant</b>			
<b>RH01889MO</b>	Red Hat OpenStack Platform, Extended Life Cycle Support Add-On, Layered Support (1 Socket, Multi-Tenant, Monthly)	MONTH	Socket
<b>RH01889</b>	Red Hat OpenStack Platform, Extended Life Cycle Support Add-On, Layered Support (1 Socket, Multi-Tenant, Yearly)	ANNUAL	Socket

**Table 14. Red Hat OpenStack Platform ELS Add-On Billing SKU Details**



## 6.1.9. Red Hat Virtualization

### 6.1.9.1. Billing SKUs

SKU	Description	Term	Unit of Measure
<b>Dedicated</b>			
RV00078MO	Red Hat Virtualization, Diagnostic Support (Socket-Pair, Dedicated, Monthly)	MONTH	Socket-Pair
RV00078	Red Hat Virtualization, Diagnostic Support (Socket-Pair, Dedicated, Yearly)	ANNUAL	Socket-Pair
RV00078F3	Red Hat Virtualization, Diagnostic Support (Socket-Pair, Dedicated, 3 Years)	3 - Year	Socket-Pair
MCT3958MO	<b>Red Hat Virtualization, Full Support (Socket-Pair, Dedicated, Monthly)</b>	<b>MONTH</b>	<b>Socket-Pair</b>
MCT3958	<b>Red Hat Virtualization, Full Support (Socket-Pair, Dedicated, Yearly)</b>	<b>ANNUAL</b>	<b>Socket-Pair</b>
MCT3958F3	<b>Red Hat Virtualization, Full Support (Socket-Pair, Dedicated, 3 Years)</b>	<b>3 - Year</b>	<b>Socket-Pair</b>
<b>Multi-Tenant</b>			
MCT2674	Red Hat Virtualization for Service Providers, Full Support (1 Socket, Multi-Tenant, Monthly)	MONTH	Socket

*Table 15. Red Hat Virtualization Billing SKU Details*

### 6.1.9.2. Red Hat Virtualization Use Case Examples

#### Example 1

CCSP partner offering VMs on Red Hat Virtualization dedicated to a single customer.

- Customer provides guest OS subscription or license
- Red Hat Virtualization Manager subscription is included but Red Hat Enterprise Linux OS subscription for Red Hat Virtualization Manager is **not**.

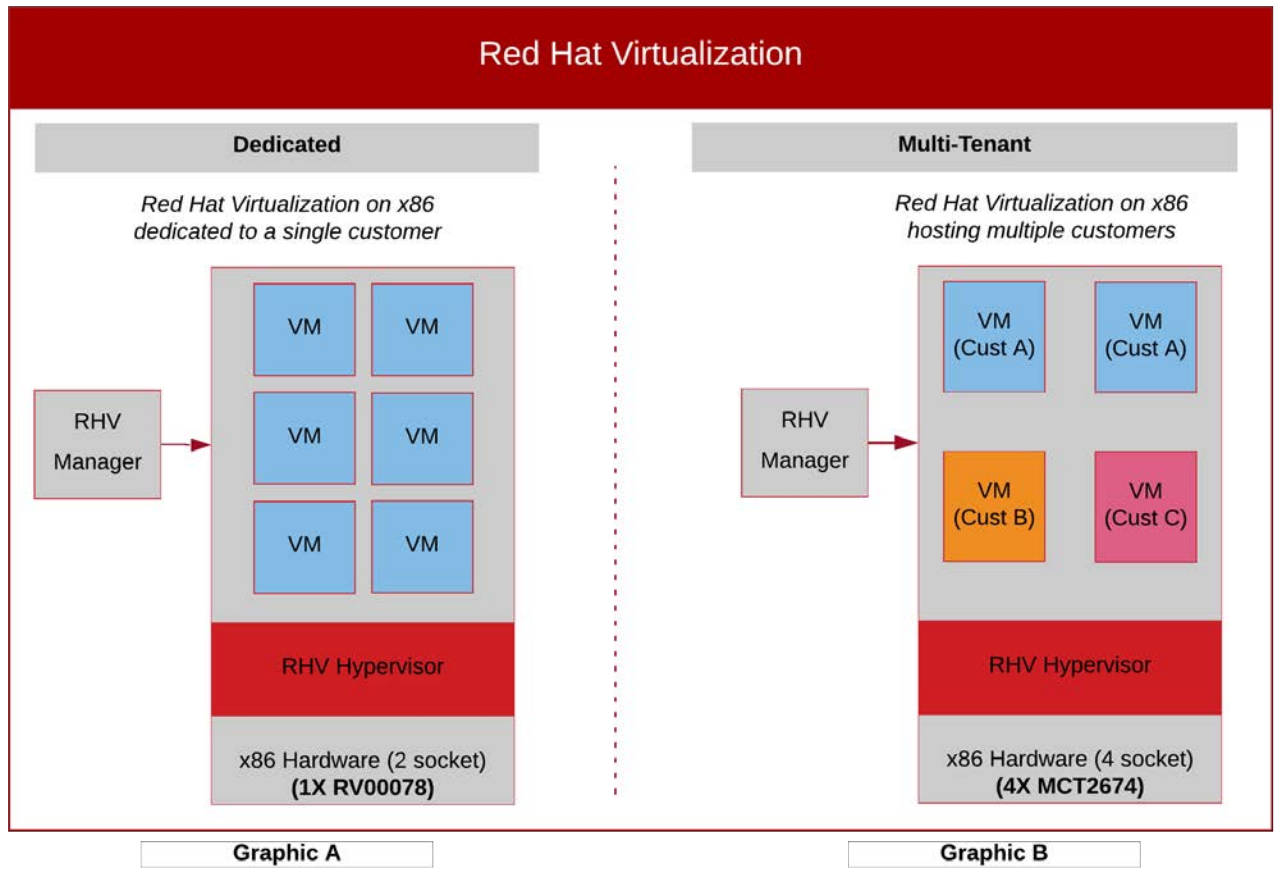

Figure 8. Red Hat Virtualization Use Case Example 1

## 6.1.10. Red Hat Virtualization for IBM Power

### 6.1.10.1. Billing SKUs

SKU	Description	Term	Unit of Measure
<b>Dedicated</b>			
<b>RH00627</b>	Red Hat Virtualization for IBM Power, Full Support (Socket-Pair, Dedicated, Yearly)	ANNUAL	Socket-Pair
<b>RH00627MO</b>	Red Hat Virtualization for IBM Power, Full Support (Socket-Pair, Dedicated, Monthly)	MONTH	Socket-Pair
<b>RH00627F3</b>	Red Hat Virtualization for IBM Power, Full Support (Socket-Pair, Dedicated, 3 Years)	3 - Year	Socket-Pair
<b>RH00626</b>	Red Hat Virtualization for IBM Power, Diagnostic Support (Socket-Pair, Dedicated, Yearly)	ANNUAL	Socket-Pair
<b>RH00626MO</b>	Red Hat Virtualization for IBM Power, Diagnostic Support (Socket-Pair, Dedicated, Monthly)	MONTH	Socket-Pair
<b>RH00626F3</b>	Red Hat Virtualization for IBM Power, Diagnostic Support (Socket-Pair, Dedicated, 3 Years)	3 - Year	Socket-Pair

**Table 16. Red Hat Virtualization for IBM Power Billing SKU Details**

### 6.1.10.2. Red Hat Virtualization for IBM Power Use Case Examples

#### Example 1

CCSP partner using Red Hat Virtualization on IBM Power hardware to host VMs dedicated to a single customer.

- Customer provides guest OS subscription or license
- Red Hat Virtualization Manager subscription is included but Red Hat Enterprise Linux OS subscription for Red Hat Virtualization Manager is **not**.

# Red Hat Virtualization for IBM Power

**Dedicated**

*Red Hat Virtualization on Power dedicated to a single customer*

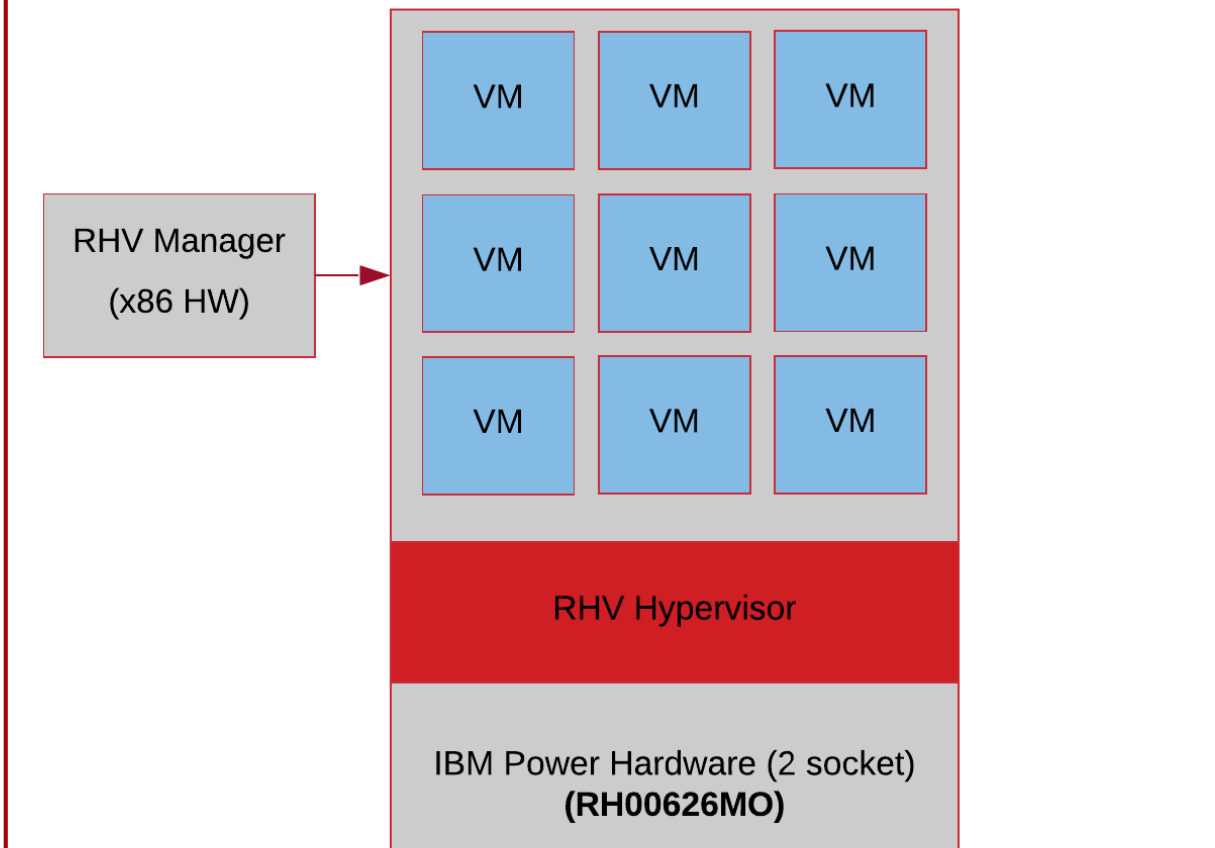

Figure 9. Red Hat Virtualization for IBM Power Use Case Example 1

## 6.2. Cloud-native Application Platforms, Application Development, and Middleware

### 6.2.1. Red Hat OpenShift Container Platform

#### 6.2.1.1. Billing SKUs

SKU	Description	Term	Unit of Measure
<b>Dedicated &amp; Multi-Tenant</b>			
MW01240HR	Red Hat OpenShift Container Platform, Diagnostic Support (2 Cores or 4 vCPUs, Hourly)	HOUR	Virtual Guest
MCT3016	Red Hat OpenShift Container Platform, Diagnostic Support (2 Cores or 4 vCPUs, Monthly)	MONTH	Virtual Guest
MW00472	Red Hat OpenShift Container Platform, Diagnostic Support (2 Cores or 4 vCPUs, Yearly)	ANNUAL	Virtual Guest
MW00472F3	Red Hat OpenShift Container Platform, Diagnostic Support (2 Cores or 4 vCPUs, 3 Years)	3 - Year	Virtual Guest
MW01241HR	Red Hat OpenShift Container Platform, Full Support (2 Cores or 4 vCPUs, Hourly)	HOUR	Virtual Guest
MW00226	Red Hat OpenShift Container Platform, Full Support (2 Cores or 4 vCPUs, Yearly)	ANNUAL	Virtual Guest
MW00226MO	Red Hat OpenShift Container Platform, Full Support (2 Cores or 4 vCPUs, Monthly)	MONTH	Virtual Guest
MW00226F3	Red Hat OpenShift Container Platform, Full Support (2 Cores or 4 vCPUs, 3 Years)	3 - Year	Virtual Guest

**Table 17. Red Hat OpenShift Container Platform Billing SKU Details**

#### Notes:

- OpenShift SKUs are stackable if necessary to cover larger hosts/VMs.
- 2 Core SKUs can't be split. OpenShift nodes consume in 2-core units even when used on single core systems.
- OpenShift SKUs are **only required for Application/Worker Nodes**. Master & Infrastructure Nodes are no-cost components.
  - Infrastructure Nodes may only host the following components: Registry, Router, Metrics Aggregation, Logging Aggregation, CloudForms.
- Each OpenShift subscription includes the base OS (RHEL or CoreOS) entitlements.
- Cores vs. vCPUs & Hyper-threading
  - Virtual Machines use virtualized CPUs (vCPUs)
  - OpenShift core to vCPU equivalency

- 1 core = 1 vCPU for when Hyper-threading is **not** enabled
- 1 core = 2 vCPU when Hyper-threading is enabled
- Ex. A VM where Hyper-threading is not enabled - A single 2 Core OpenShift SKU will cover 2 vCPUs
- Ex. A VM where Hyper-threading is enabled - A single 2 Core OpenShift SKU will cover 4 vCPUs
- To determine whether a system supports Hyper-threading, visit <https://access.redhat.com/solutions/7714>

### 6.2.1.2. Red Hat OpenShift Container Platform Use Case Examples

#### Example 1

- **Graphic A** Virtualized Red Hat OpenShift Container Platform infrastructure with 3 Master nodes (HA config) and 2 Infrastructure nodes dedicated to a single customer with **annual subscription pricing**.
  - 3 VMs (not hyper-threaded) for the OpenShift Application nodes consumed by Customer A
    - App node 1: 1 vCPU = 1x MW00472
    - App node 2: 4 vCPU = 2x MW00472
    - App node 3: 6 vCPU = 3x MW00472
      - Total OpenShift consumption reported = 6x MW00472

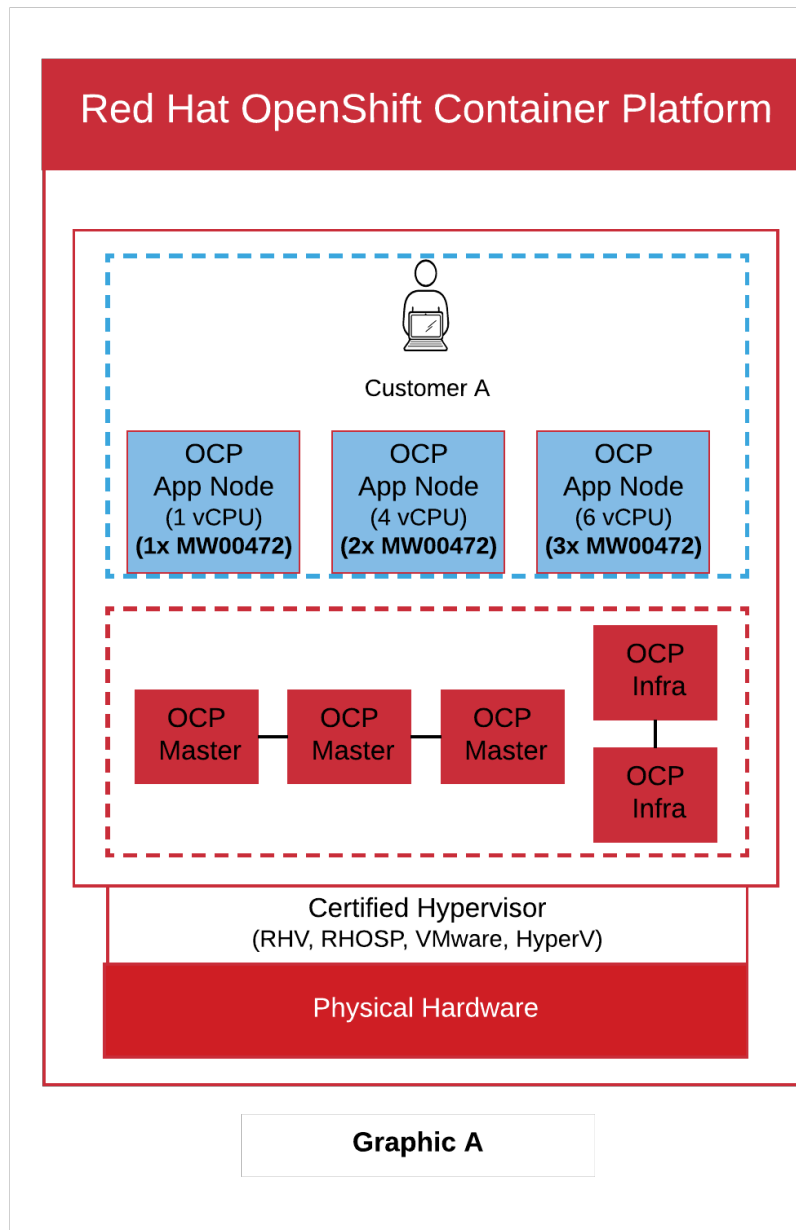

Figure 10. Red Hat OpenShift Container Platform Dedicated Use Case Example

## Example 2

- **Graphic B** Virtualized Red Hat OpenShift Container Platform infrastructure 3 Master nodes (HA config) and 2 Infrastructure nodes supporting multiple customers with **monthly subscription pricing**.
  - 2 VMs (not hyper-threaded) for the OpenShift Application nodes consumed by Customer B
    - App node 1: 2 vCPU = 1x MCT3016
    - App node 2: 2 vCPU = 1x MCT3016
      - Total OpenShift consumption reported = 2x MCT3016
  - 3 VMs (hyper-threaded) for the OpenShift Application nodes consumed by Customer C

- App node 1: 8 vCPU = 2x MCT3016
- App node 2: 8 vCPU = 2x MCT3016
- App node 3: 8 vCPU = 2x MCT3016
- Total OpenShift consumption reported = 6x MCT3016

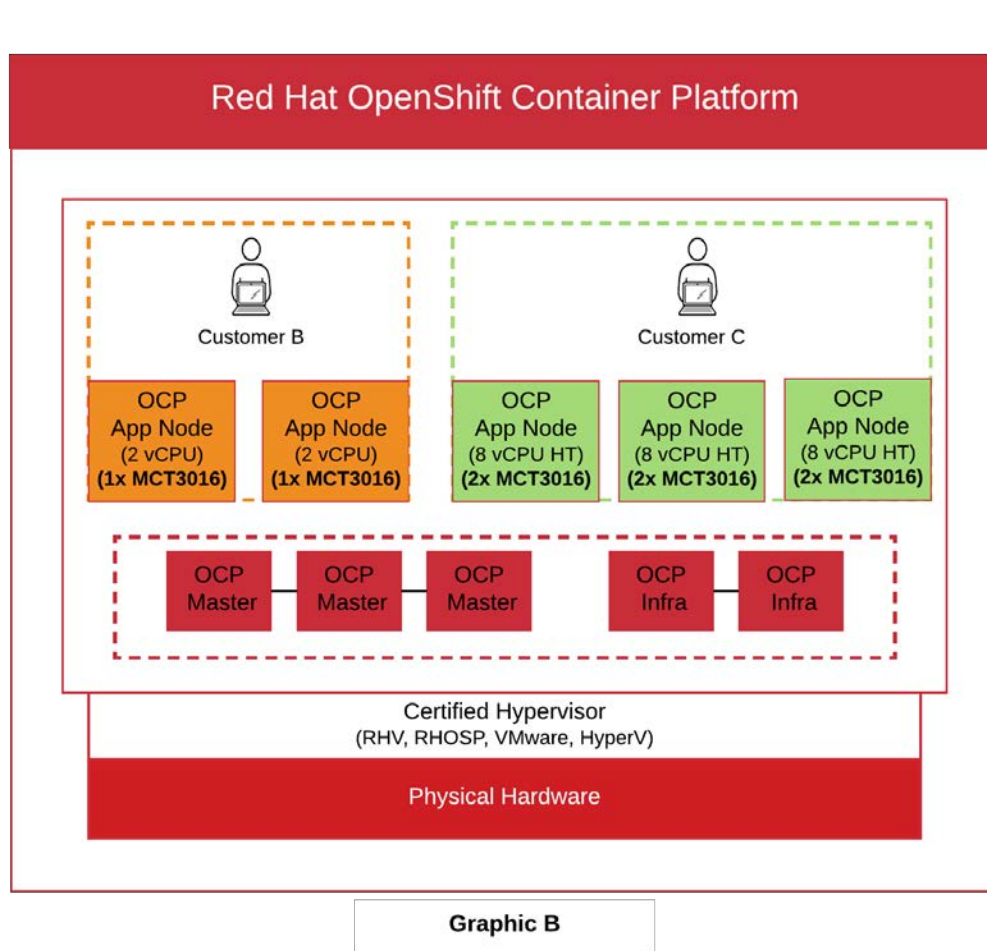

Figure 11. Red Hat OpenShift Container Platform Multi-tenant Use Case Example



## 6.2.2. Red Hat OpenShift Container Platform for Power

### 6.2.2.1. Billing SKUs

SKU	Description	Term	Unit of Measure
<b>Dedicated &amp; Multi-Tenant</b>			
<b>MW01230</b>	Red Hat OpenShift Container Platform for Power, Diagnostic Support (2 cores or 4 vCPUs, Yearly)	ANNUAL	Virtual Guest
<b>MW01230F3</b>	Red Hat OpenShift Container Platform for Power, Diagnostic Support (2 cores or 4 vCPUs, 3 Year)	3-YEAR	Virtual Guest
<b>MW01230MO</b>	Red Hat OpenShift Container Platform for Power, Diagnostic Support (2 cores or 4 vCPUs, Monthly)	MONTH	Virtual Guest
<b>MW01233</b>	Red Hat OpenShift Container Platform for Power, Full Support (2 cores or 4 vCPUs, Yearly)	ANNUAL	Virtual Guest
<b>MW01233F3</b>	Red Hat OpenShift Container Platform for Power, Full Support (2 cores or 4 vCPUs, 3 Year)	3-YEAR	Virtual Guest
<b>MW01233MO</b>	Red Hat OpenShift Container Platform for Power, Full Support (2 cores or 4 vCPUs, Monthly)	MONTH	Virtual Guest

**Table 18. Red Hat OpenShift Container Platform for Power Billing SKU Details**

#### Notes:

- Red Hat OpenShift Container Platform for Power is only available for IBM Power LE (little endian) systems.
- OpenShift SKUs are stackable if necessary to cover larger hosts/VMs.
- 2 Core SKUs can't be split. OpenShift nodes consume in 2-core units even when used on single core systems.
- OpenShift SKUs are **only required for Application/Worker Nodes**. Master & Infrastructure Nodes are no-cost components.
  - Infrastructure Nodes may only host the following components: Registry, Router, Metrics Aggregation, Logging Aggregation, CloudForms.
- Each OpenShift subscription includes the base OS (RHEL or CoreOS) entitlements.
- OpenShift v3 supports RH Satellite or Subscription Manager
- OpenShift v4 subscription accounting (OCM/Sub Watch) does not work with IBM Power 8 & 9 hardware. Core usage will need to be tracked manually.
- Counting cores on IBM Power Systems
  - Rules can vary depending upon the hardware being used and the processor virtualization configuration but in general, a single 2-core Red Hat OpenShift Container Platform for Power SKU will cover 2 LPAR Virtual Processors (VPs).
  - Power Systems Virtual Processors (VPs) are essentially the same as x86 vCPUs.
    - Ex. IBM Power9 E950 server with 4 sockets/12 physical cores, total 48 physical cores shared across 3 LPARs.

- LPAR1: OCP worker node with 6 Virtual Processors = 3 (2-core) OCP for Power SKUs.
- LPAR2: OCP worker node with 24 Virtual Processors = 12 (2-core) OCP for Power SKUs.
- LPAR3: OCP worker node with 4 Virtual Processors = 2 (2-core) OCP for Power SKUs.

### 6.2.2.2. Red Hat OpenShift Container Platform for Power Use Case Examples

#### Example 1

- **Graphic A** Red Hat OpenShift Container Platform for Power on IBM Power Systems hardware with 3 Master nodes (HA config) and 3 App/Worker nodes dedicated to a single customer with **annual subscription pricing**.
  - 3 VMs for the OpenShift Application nodes consumed by Customer A
    - App node 1: 4 VPs/vCPUs = 2x MW01230
    - App node 2: 4 VPs/vCPUs = 2x MW01230
    - App node 3: 8 VPs/vCPUs = 4x MW01230
      - Total OpenShift consumption reported = 8x MW01230

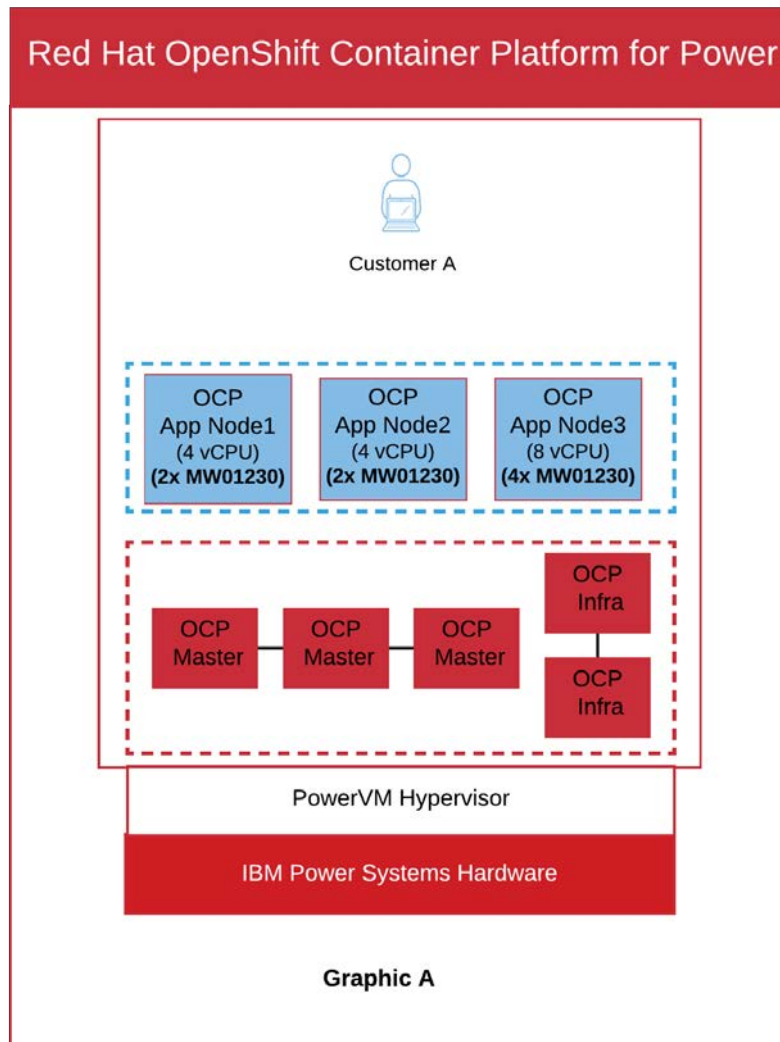

Figure 12. Red Hat OpenShift Container Platform for Power Dedicated Use Case Example

## Example 2

- **Graphic B** Red Hat OpenShift Container Platform for Power on IBM Power Systems hardware with 3 Master nodes (HA config) and 2 Infrastructure nodes supporting multiple customers with **mixed subscription pricing**.
  - 2 App/Worker nodes consumed by Customer B
    - App node 1: 2 VPs/vCPUs = 1x MW01230MO
    - App node 2: 2 VPs/vCPUs = 1x MW01230MO
      - Total OpenShift consumption reported = 2x MM01230MO
  - 3 App/Worker nodes consumed by Customer C
    - App node 1: 8 VPs/vCPUs = 4x MW01230
    - App node 2: 8 VPs/vCPUs = 4x MW01230

- App node 3: 8 VPs/vCPUs = 4x MW01230
  - Total OpenShift consumption reported = 12x MW01230

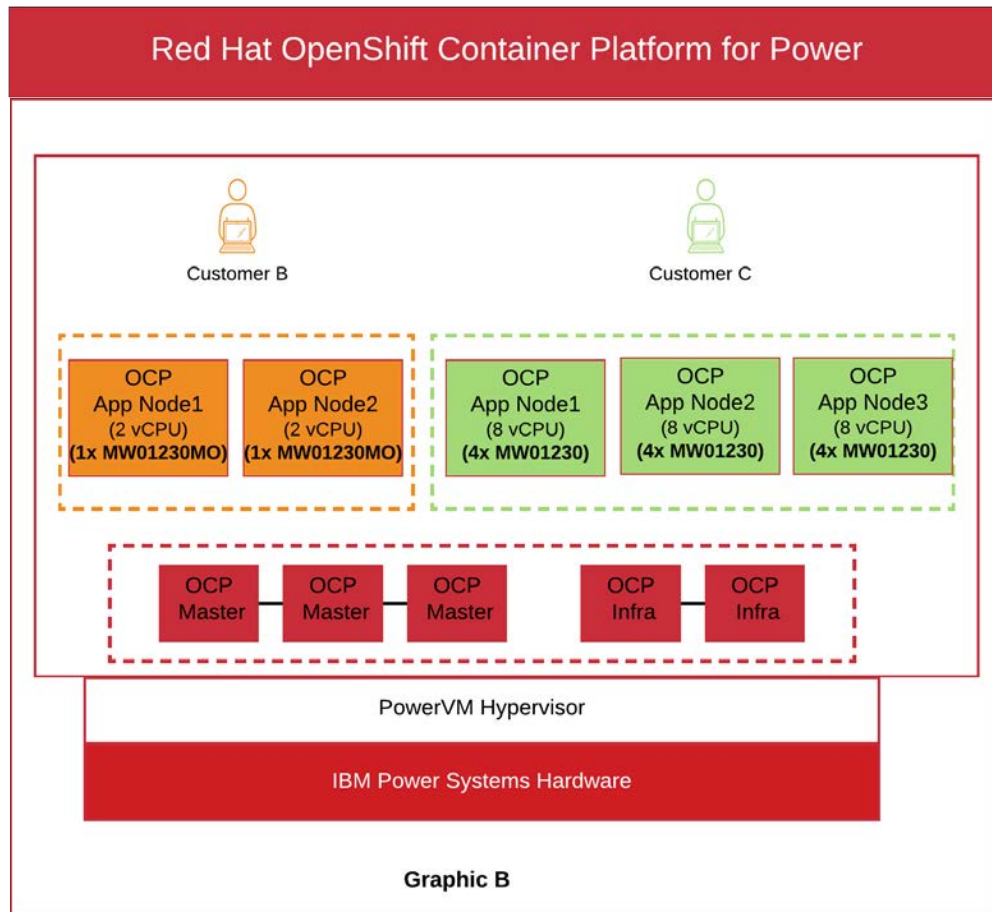

Figure 13. Red Hat OpenShift Container Platform for Power Multi-tenant Use Case Example

## 6.2.3. Red Hat OpenShift Container Platform Bundles

### 6.2.3.1. Billing SKUs

SKU	Description	Term	Unit of Measure
<b>Dedicated &amp; Multi-Tenant</b>			
MW01305	Red Hat OpenShift Container Platform with Runtimes and Red Hat OpenShift Container Storage, Full Support (2 Cores or 4 vCPUs, Yearly)	ANNUAL	Core Band or vCPU
MW01306	Red Hat OpenShift Container Platform with Runtimes and Red Hat OpenShift Container Storage, Full Support (16 Cores or 32 vCPUs, Yearly)	ANNUAL	Core Band or vCPU
MW01307	Red Hat OpenShift Container Platform with Runtimes and Red Hat OpenShift Container Storage, Full Support (64 Cores or 128 vCPUs, Yearly)	ANNUAL	Core Band or vCPU
MW01305F3	Red Hat OpenShift Container Platform with Runtimes and Red Hat OpenShift Container Storage, Full Support (2 Cores or 4 vCPUs, 3 Years)	3 - Year	Core Band or vCPU
MW01306F3	Red Hat OpenShift Container Platform with Runtimes and Red Hat OpenShift Container Storage, Full Support (16 Cores or 32 vCPUs, 3 Years)	3 - Year	Core Band or vCPU
MW01307F3	Red Hat OpenShift Container Platform with Runtimes and Red Hat OpenShift Container Storage, Full Support (64 Cores or 128 vCPUs, 3 Years)	3 - Year	Core Band or vCPU

*Table 19. Red Hat OpenShift Container Platform with Runtimes and Red Hat OpenShift Container Storage Billing SKU Details*

SKU	Description	Term	Unit of Measure
<b>Dedicated &amp; Multi-Tenant</b>			
MW01299	Red Hat OpenShift Container Platform with Integration and Red Hat OpenShift Container Storage, Full Support (2 Cores or 4 vCPUs, Yearly)	ANNUAL	Core Band or vCPU
MW01300	Red Hat OpenShift Container Platform with Integration and Red Hat OpenShift Container Storage, Full Support (16 Cores or 32 vCPUs, Yearly)	ANNUAL	Core Band or vCPU
MW01301	Red Hat OpenShift Container Platform with Integration and Red Hat OpenShift Container Storage, Full Support (64 Cores or 128 vCPUs, Yearly)	ANNUAL	Core Band or vCPU

SKU	Description	Term	Unit of Measure
MW01299F3	Red Hat OpenShift Container Platform with Integration and Red Hat OpenShift Container Storage, Full Support (2 Cores or 4 vCPUs, 3 Years)	3 - Year	Core Band or vCPU
MW01300F3	Red Hat OpenShift Container Platform with Integration and Red Hat OpenShift Container Storage, Full Support (16 Cores or 32 vCPUs, 3 Years)	3 - Year	Core Band or vCPU
MW01301F3	Red Hat OpenShift Container Platform with Integration and Red Hat OpenShift Container Storage, Full Support (64 Cores or 128 vCPUs, 3 Years)	3 - Year	Core Band or vCPU

*Table 20. Red Hat OpenShift Container Platform with Integration and Red Hat OpenShift Container Storage Billing SKU Details*

SKU	Description	Term	Unit of Measure
<b>Dedicated &amp; Multi-Tenant</b>			
MW01296	Red Hat OpenShift Container Platform with Process Automation and Red Hat OpenShift Container Storage, Full Support (2 Cores or 4 vCPUs, Yearly)	ANNUAL	Core Band or vCPU
MW01297	Red Hat OpenShift Container Platform with Process Automation and Red Hat OpenShift Container Storage, Full Support (16 Cores or 32 vCPUs, Yearly)	ANNUAL	Core Band or vCPU
MW01298	Red Hat OpenShift Container Platform with Process Automation and Red Hat OpenShift Container Storage, Full Support (64 Cores or 128 vCPUs, Yearly)	ANNUAL	Core Band or vCPU
MW01296F3	Red Hat OpenShift Container Platform with Process Automation and Red Hat OpenShift Container Storage, Full Support (2 Cores or 4 vCPUs, 3 Years)	3 - Year	Core Band or vCPU
MW01297F3	Red Hat OpenShift Container Platform with Process Automation and Red Hat OpenShift Container Storage, Full Support (16 Cores or 32 vCPUs, 3 Years)	3 - Year	Core Band or vCPU
MW01298F3	Red Hat OpenShift Container Platform with Process Automation and Red Hat OpenShift Container Storage, Full Support (64 Cores or 128 vCPUs, 3 Years)	3 - Year	Core Band or vCPU

*Table 21. Red Hat OpenShift Container Platform with Process Automation and Red Hat OpenShift Container Storage Billing SKU Details*

SKU	Description	Term	Unit of Measure
<b>Dedicated &amp; Multi-Tenant</b>			
MW01302	Red Hat OpenShift Container Platform with Middleware Portfolio and Red Hat OpenShift Container Storage, Full Support (2 Cores or 4 vCPUs, Yearly)	ANNUAL	Core Band or vCPU
MW01303	Red Hat OpenShift Container Platform with Middleware Portfolio and Red Hat OpenShift Container Storage, Full Support (16 Cores or 32 vCPUs, Yearly)	ANNUAL	Core Band or vCPU
MW01304	Red Hat OpenShift Container Platform with Middleware Portfolio and Red Hat OpenShift Container Storage, Full Support (64 Cores or 128 vCPUs, Yearly)	ANNUAL	Core Band or vCPU
MW01302F3	Red Hat OpenShift Container Platform with Middleware Portfolio and Red Hat OpenShift Container Storage, Full Support (2 Cores or 4 vCPUs, 3 Years)	3 - Year	Core Band or vCPU
MW01303F3	Red Hat OpenShift Container Platform with Middleware Portfolio and Red Hat OpenShift Container Storage, Full Support (16 Cores or 32 vCPUs, 3 Years)	3 - Year	Core Band or vCPU
MW01304F3	Red Hat OpenShift Container Platform with Middleware Portfolio and Red Hat OpenShift Container Storage, Full Support (64 Cores or 128 vCPUs, 3 Years)	3 - Year	Core Band or vCPU

**Table 22. Red Hat OpenShift Container Platform with Middleware Portfolio and Red Hat OpenShift Container Storage Billing SKU Details**

Notes:

## 6.2.4. Red Hat Middleware

### 6.2.4.1. Billing SKUs

SKU	Description	Term	Unit of Measure
<b>Dedicated &amp; Multi-Tenant</b>			
MW00229MO	Red Hat JBoss Enterprise Application Platform, Full Support (2 Cores or 4 vCPUs, Monthly)	MONTH	Core Band or vCPU
MW00229	Red Hat JBoss Enterprise Application Platform, Full Support (2 Cores or 4 vCPUs, Yearly)	ANNUAL	Core Band or vCPU
MW00475HR	Red Hat JBoss Enterprise Application Platform, Full Support (1 Core or 2 vCPUs, Hourly)	HOURLY	Core Band or vCPU
MW00473MO	Red Hat JBoss Enterprise Application Platform, Full Support (1 Core or 2 vCPUs, Monthly)	MONTH	Core Band or vCPU
MW00229F3	Red Hat JBoss Enterprise Application Platform, Full Support (2 Cores or 4 vCPUs, 3 Years)	3 - Year	Core Band or vCPU
MCT2774F3	Red Hat JBoss Enterprise Application Platform, Full Support (4 Cores or 8 vCPUs, 3 Years)	3 - Year	Core Band or vCPU
MW00723	Red Hat JBoss Enterprise Application Platform, Full Support (16 Cores or 32 vCPUs, Yearly)	ANNUAL	Core Band or vCPU
MCT2774	Red Hat JBoss Enterprise Application Platform, Full Support (4 Cores or 8 vCPUs, Yearly)	ANNUAL	Core Band or vCPU
MCT3144F3	Red Hat JBoss Enterprise Application Platform, Full Support (16 Cores or 32 vCPUs, 3 Years)	3 - Year	Core Band or vCPU
MCT3145	Red Hat JBoss Enterprise Application Platform, Full Support (64 Cores or 128 vCPUs, Yearly)	ANNUAL	Core Band or vCPU
MCT3145F3	Red Hat JBoss Enterprise Application Platform, Full Support (64 Cores or 128 vCPUs, 3 Years)	3 - Year	Core Band or vCPU

*Table 23. Red Hat JBoss Enterprise Application Platform Billing SKU Details*

SKU	Description	Term	Unit of Measure
<b>Dedicated &amp; Multi-Tenant</b>			
MW00479HR	Red Hat JBoss Web Server, Full Support (1 Core or 2 vCPUs, Hourly)	HOURLY	Core Band or vCPU



SKU	Description	Term	Unit of Measure
MW00477MO	Red Hat JBoss Web Server, Full Support (1 Core or 2 vCPUs, Monthly)	MONTH	Core Band or vCPU
MW00728	Red Hat JBoss Web Server, Full Support (2 Cores or 4 vCPUs, Yearly)	ANNUAL	Core Band or vCPU
MW00728F3	Red Hat JBoss Web Server, Full Support (2 Cores or 4 vCPUs, 3 Years)	3 - Year	Core Band or vCPU
MCT2786F3	Red Hat JBoss Web Server, Full Support (4 Cores or 8 vCPUs, 3 Years)	3 - Year	Core Band or vCPU
MCT3151	Red Hat JBoss Web Server, Full Support (16 Cores or 32 vCPUs, Yearly)	ANNUAL	Core Band or vCPU
MCT2786	Red Hat JBoss Web Server, Full Support (4 Cores or 8 vCPUs, Yearly)	ANNUAL	Core Band or vCPU
MCT3151F3	Red Hat JBoss Web Server, Full Support (16 Cores or 32 vCPUs, 3 Years)	3 - Year	Core Band or vCPU
MCT3152	Red Hat JBoss Web Server, Full Support (64 Cores or 128 vCPUs, Yearly)	ANNUAL	Core Band or vCPU
MCT3152F3	Red Hat JBoss Web Server, Full Support (64 Cores or 128 vCPUs, 3 Years)	3 - Year	Core Band or vCPU

**Table 24. Red Hat JBoss Web Server Billing SKU Details**

SKU	Description	Term	Unit of Measure
<b>Dedicated &amp; Multi-Tenant</b>			
MW00233MO	Red Hat Fuse, Full Support (2 Cores or 4 vCPUs, Monthly)	MONTH	Core Band or vCPU
MW00233	Red Hat Fuse, Full Support (2 Cores or 4 vCPUs, Yearly)	ANNUAL	Core Band or vCPU
MW00233F3	Red Hat Fuse, Full Support (2 Cores or 4 vCPUs, 3 Years)	3 - Year	Core Band or vCPU
MW00491HR	Red Hat Fuse, Full Support (1 Core or 2 vCPUs, Hourly)	HOUR	Core Band or vCPU
MW00489MO	Red Hat Fuse, Full Support (1 Core or 2 vCPUs, Monthly)	MONTH	Core Band or vCPU

SKU	Description	Term	Unit of Measure
MCT3149F3	Red Hat Fuse, Full Support (4 Cores or 8 vCPUs, 3 Years)	3 - Year	Core Band or vCPU
MCT3148	Red Hat Fuse, Full Support (16 Cores or 32 vCPUs, Yearly)	ANNUAL	Core Band or vCPU
MCT3149	Red Hat Fuse, Full Support (4 Cores or 8 vCPUs, Yearly)	ANNUAL	Core Band or vCPU
MCT3148F3	Red Hat Fuse, Full Support (16 Cores or 32 vCPUs, 3 Years)	3 - Year	Core Band or vCPU
MCT3150	Red Hat Fuse, Full Support (64 Cores or 128 vCPUs, Yearly)	ANNUAL	Core Band or vCPU
MCT3150F3	Red Hat Fuse, Full Support (64 Cores or 128 vCPUs, 3 Years)	3 - Year	Core Band or vCPU

**Table 25. Red Hat Fuse Billing SKU Details**

SKU	Description	Term	Unit of Measure
<b>Dedicated &amp; Multi-Tenant</b>			
MW00231MO	Red Hat Data Grid, Full Support (2 Cores or 4 vCPUs, Monthly)	MONTH	Core Band or vCPU
MW00231	Red Hat Data Grid, Full Support (2 Cores or 4 vCPUs, Yearly)	ANNUAL	Core Band or vCPU
MW00231F3	Red Hat Data Grid, Full Support (2 Cores or 4 vCPUs, 3 Years)	3 - Year	Core Band or vCPU
MW00483HR	Red Hat Data Grid, Full Support (1 Core or 2 vCPUs, Hourly)	HOUR	Core Band or vCPU
MW00481MO	Red Hat Data Grid, Full Support (1 Core or 2 vCPUs, Monthly)	MONTH	Core Band or vCPU
MCT2804F3	Red Hat Data Grid, Full Support (4 Cores or 8 vCPUs, 3 Years)	3 - Year	Core Band or vCPU
MCT3140	Red Hat Data Grid, Full Support, (16 Cores or 32 vCPUs, Yearly)	ANNUAL	Core Band or vCPU
MCT2804	Red Hat Data Grid, Full Support (4 Cores or 8 vCPUs, Yearly)	ANNUAL	Core Band or vCPU

SKU	Description	Term	Unit of Measure
MCT3140F3	Red Hat Data Grid, Full Support, (16 Cores or 32 vCPUs, 3 Years)	3 - Year	Core Band or vCPU
MCT3141	Red Hat Data Grid, Full Support, (64 Cores or 128 vCPUs, Yearly)	ANNUAL	Core Band or vCPU
MCT3141F3	Red Hat Data Grid, Full Support, (64 Cores or 128 vCPUs, 3 Years)	3 - Year	Core Band or vCPU

**Table 26. Red Hat Data Grid Billing SKU Details**

SKU	Description	Term	Unit of Measure
<b>Dedicated &amp; Multi-Tenant</b>			
MW00235MO	Red Hat AMQ, Full Support (2 Cores or 4 vCPUs, Monthly)	MONTH	Core Band or vCPU
MW00235	Red Hat AMQ, Full Support (2 Cores or 4 vCPUs, Yearly)	ANNUAL	Core Band or vCPU
MW00235F3	Red Hat AMQ, Full Support (2 Cores or 4 vCPUs, 3 Years)	3 - Year	Core Band or vCPU
MW00487HR	Red Hat AMQ, Full Support (1 Core or 2 vCPUs, Hourly)	HOUR	Core Band or vCPU
MW00485MO	Red Hat AMQ, Full Support (1 Core or 2 vCPUs, Monthly)	MONTH	Core Band or vCPU
MCT3074F3	Red Hat AMQ, Full Support (4 Cores or 8 vCPUs, 3 Years)	3 - Year	Core Band or vCPU
MCT3134	Red Hat AMQ, Full Support (16 Cores or 32 vCPUs, Yearly)	ANNUAL	Core Band or vCPU
MCT3074	Red Hat AMQ, Full Support (4 Cores or 8 vCPUs, Yearly)	ANNUAL	Core Band or vCPU
MCT3134F3	Red Hat AMQ, Full Support (16 Cores or 32 vCPUs, 3 Years)	3 - Year	Core Band or vCPU
MCT3135	Red Hat AMQ, Full Support (64 Cores or 128 vCPUs, Yearly)	ANNUAL	Core Band or vCPU
MCT3135F3	Red Hat AMQ, Full Support (64 Cores or 128 vCPUs, 3 Years)	3 - Year	Core Band or vCPU

**Table 27. Red Hat AMQ Billing SKU Details**

SKU	Description	Term	Unit of Measure
<b>Dedicated &amp; Multi-Tenant</b>			
MW00237MO	Red Hat Decision Manager, Full Support (2 Cores or 4 vCPUs, Monthly)	MONTH	Core Band or vCPU
MW00237	Red Hat Decision Manager, Full Support (2 Cores or 4 vCPUs, Yearly)	ANNUAL	Core Band or vCPU
MW00237F3	Red Hat Decision Manager, Full Support (2 Cores, 3 Years)	3 - Year	Core Band or vCPU
MW00495HR	Red Hat Decision Manager, Full Support (1 Core or 2 vCPUs, Hourly)	HOUR	Core Band or vCPU
MW00493MO	Red Hat Decision Manager, Full Support (1 Core or 2 vCPUs, Monthly)	MONTH	Core Band or vCPU
MCT2810F3	Red Hat Decision Manager, Full Support (4 Cores or 8 vCPUs, 3 Years)	3 - Year	Core Band or vCPU
MCT3138	Red Hat Decision Manager, Full Support (16 cores or 32 vCPUs, Yearly)	ANNUAL	Core Band or vCPU
MCT2810	Red Hat Decision Manager, Full Support (4 Cores or 8 vCPUs, Yearly)	ANNUAL	Core Band or vCPU
MCT3138F3	Red Hat Decision Manager Full Support (16 cores or 32 vCPUs, 3 Years)	3 - Year	Core Band or vCPU
MCT3139	Red Hat Decision Manager, Full Support (64 Cores or 128 vCPUs, Yearly)	ANNUAL	Core Band or vCPU
MCT3139F3	Red Hat Decision Manager, Full Support (64 Cores or 128 vCPUs, 3 Years)	3 - Year	Core Band or vCPU

**Table 28. Red Hat Decision Manager Billing SKU Details**

SKU	Description	Term	Unit of Measure
<b>Dedicated &amp; Multi-Tenant</b>			
MW00239MO	Red Hat Process Automation Manager, Full Support (2 Cores or 4 vCPUs, Monthly)	MONTH	Core Band or vCPU

SKU	Description	Term	Unit of Measure
MW00239	Red Hat Process Automation Manager, Full Support (2 Cores or 4 vCPUs, Yearly)	ANNUAL	Core Band or vCPU
MW00239F3	Red Hat Process Automation Manager, Full Support (2 Cores or 4 vCPUs, 3 Years)	3 - Year	Core Band or vCPU
MW00499HR	Red Hat Process Automation Manager, Full Support (1 Core or 2 vCPUs, Hourly)	HOURLY	Core Band or vCPU
MW00497MO	Red Hat Process Automation Manager, Full Support (1 Core or 2 vCPUs, Monthly)	MONTH	Core Band or vCPU
MCT3038F3	Red Hat Process Automation Manager, Full Support (4 Cores or 8 vCPUs, 3 Years)	3 - Year	Core Band or vCPU
MCT3136	Red Hat Process Automation Manager, Full Support (16 Cores or 32 vCPUs, Yearly)	ANNUAL	Core Band or vCPU
MCT3038	Red Hat Process Automation Manager, Full Support (4 Cores or 8 vCPUs, Yearly)	ANNUAL	Core Band or vCPU
MCT3136F3	Red Hat Process Automation Manager, Full Support (16 Cores or 32 vCPUs, 3 Years)	3 - Year	Core Band or vCPU
MCT3137	Red Hat Process Automation Manager, Full Support (64 Cores or 128 vCPUs, Yearly)	ANNUAL	Core Band or vCPU
MCT3137F3	Red Hat Process Automation Manager, Full Support (64 Cores or 128 vCPUs, 3 Years)	3 - Year	Core Band or vCPU

**Table 29. Red Hat Process Automation Manager Billing SKU Details**

### 6.2.4.2. Red Hat Middleware Use Case Examples

#### Example 1

Red Hat Middleware Term and Core metering options.

Red Hat Middleware Metering Options						
		1 Core or 2 vCPU	2 Core or 4 vCPU	4 Core or 8 vCPU	16 Core or 32 vCPU	64 Core or 128 vCPU
Term	Hour	Y	N/A	N/A	N/A	N/A
	Month	Y	Y	N/A	N/A	N/A
	Annual	N/A	Y	Y	Y	Y
	3-Year	N/A	Y	Y	Y	Y

Figure 14. Red Hat Middleware Term & Core Metering Options

## 6.2.5. Red Hat Middleware Extended Life Cycle Support Add-Ons

### 6.2.5.1. Billing SKUs

SKU	Description	Term	Unit of Measure
<b>Dedicated</b>			
<b>MW00261</b>	Red Hat JBoss Enterprise Application Platform Extended Life Cycle Support Add-On, Layered Support (4 Cores or 8 vCPUs, Yearly)	ANNUAL	Core Band or vCPU
<b>MW00262</b>	Red Hat JBoss Enterprise Application Platform Extended Life Cycle Support Add-On, Layered Support (64 Cores or 128 vCPUs, Yearly)	ANNUAL	Core Band or vCPU
<b>MW00474MO</b>	Red Hat JBoss Enterprise Application Platform Extended Life Cycle Support Add-On, Layered Support (1 Core or 2 vCPUs, Monthly)	MONTH	Core Band or vCPU
<b>MW00476HR</b>	Red Hat JBoss Enterprise Application Platform Extended Life Cycle Support Add-On, Layered Support (1 Core or 2 vCPUs, Hourly)	HOUR	Core Band or vCPU
<b>MW00762</b>	Red Hat JBoss Enterprise Application Platform Extended Life Cycle Support Add-On, Layered Support (2 Cores or 4vCPUs, Yearly)	ANNUAL	Core Band or vCPU
<b>MW00762F3</b>	Red Hat JBoss Enterprise Application Platform Extended Life Cycle Support Add-On, Layered Support (2 Cores or 4vCPUs, 3 Years)	3 - Year	Core Band or vCPU
<b>MW00261F3</b>	Red Hat JBoss Enterprise Application Platform Extended Life Cycle Support Add-On, Layered Support (4 Cores or 8 vCPUs, 3 Years)	3 - Year	Core Band or vCPU
<b>MW00765</b>	Red Hat JBoss Enterprise Application Platform Extended Life Cycle Support Add-On, Layered Support (16 Cores or 32 vCPUs, Yearly)	ANNUAL	Core Band or vCPU
<b>MW00765F3</b>	Red Hat JBoss Enterprise Application Platform Extended Life Cycle Support Add-On, Layered Support (16 Cores or 32 vCPUs, 3 Years)	3 - Year	Core Band or vCPU
<b>MW00262F3</b>	Red Hat JBoss Enterprise Application Platform Extended Life Cycle Support Add-On, Layered Support (64 Cores or 128 vCPUs, 3 Years)	3 - Year	Core Band or vCPU

**Table 30. Red Hat JBoss Enterprise Application Platform Extended Life Cycle Support Add-On Billing SKU Details**

SKU	Description	Term	Unit of Measure
<b>Dedicated</b>			
MW00264	Red Hat JBoss Web Server Extended Life Cycle Support Add-On, Layered Support (4 Cores or 8 vCPUs, Yearly)	ANNUAL	Core Band or vCPU
MW00265	Red Hat JBoss Web Server Extended Life Cycle Support Add-On, Layered Support (64 Cores or 128 vCPUs, Yearly)	ANNUAL	Core Band or vCPU
MW00478MO	Red Hat JBoss Web Server Extended Life Cycle Support Add-On, Layered Support (1 Core or 2 vCPUs, Monthly)	MONTH	Core Band or vCPU
MW00480HR	Red Hat JBoss Web Server Extended Life Cycle Support Add-On, Layered Support (1 Core or 2 vCPUs, Hourly)	HOURLY	Core Band or vCPU
MW00768	Red Hat JBoss Web Server Extended Life Cycle Support Add-On, Layered Support (2 Core or 4 vCPUs, Yearly)	ANNUAL	Core Band or vCPU
MW00768F3	Red Hat JBoss Web Server Extended Life Cycle Support Add-On, Layered Support (2 Core or 4 vCPUs, 3 Years)	3 - Year	Core Band or vCPU
MW00264F3	Red Hat JBoss Web Server Extended Life Cycle Support Add-On, Layered Support (4 Cores or 8 vCPUs, 3 Years)	3 - Year	Core Band or vCPU
MW00771	Red Hat JBoss Web Server Extended Life Cycle Support Add-On, Layered Support (16 Cores or 32 vCPUs, Yearly)	ANNUAL	Core Band or vCPU
MW00771F3	Red Hat JBoss Web Server Extended Life Cycle Support Add-On, Layered Support (16 Cores or 32 vCPUs, 3 Years)	3 - Year	Core Band or vCPU
MW00265F3	Red Hat JBoss Web Server Extended Life Cycle Support Add-On, Layered Support (64 Cores or 128 vCPUs, 3 Years)	3 - Year	Core Band or vCPU

**Table 31. Red Hat JBoss Web Server Extended Life Cycle Support Add-On Billing SKU Details**

SKU	Description	Term	Unit of Measure
<b>Dedicated</b>			
MW00253	Red Hat Fuse Extended Life Cycle Support Add-On, Layered Support (4 Cores or 8 vCPUs, Yearly)	ANNUAL	Core Band or vCPU



SKU	Description	Term	Unit of Measure
MW00254	Red Hat Fuse Extended Life Cycle Support Add-On, Layered Support (64 Cores or 128 vCPUs, Yearly)	ANNUAL	Core Band or vCPU
MW00490MO	Red Hat Fuse Extended Life Cycle Support Add-On, Layered Support (1 Core or 2 vCPUs, Monthly)	MONTH	Core Band or vCPU
MW00492HR	Red Hat Fuse Extended Life Cycle Support Add-On, Layered Support (1 Core or 2 vCPUs, Hourly)	HOURLY	Core Band or vCPU
MW00744	Red Hat Fuse Extended Life Cycle Support Add-On, Layered Support (2 Cores or 4 vCPUs, Yearly)	ANNUAL	Core Band or vCPU
MW00744F3	Red Hat Fuse Extended Lifecycle Support Add-On, Layered Support (2 cores or 4 vCPUs, 3 Year)	3 - Year	Core Band or vCPU
MW00253F3	Red Hat Fuse Extended Life Cycle Support Add-On, Layered Support (4 Cores or 8 vCPUs, 3 Years)	3 - Year	Core Band or vCPU
MW00747	Red Hat Fuse Extended Life Cycle Support Add-On, Layered Support (16 Cores or 32 vCPUs, Yearly)	ANNUAL	Core Band or vCPU
MW00747F3	Red Hat Fuse Extended Life Cycle Support Add-On, Layered Support (16 Cores or 32 vCPUs, 3 Years)	3 - Year	Core Band or vCPU
MW00254F3	Red Hat Fuse Extended Life Cycle Support Add-On, Layered Support (64 Cores or 128 vCPUs, 3 Years)	3 - Year	Core Band or vCPU

**Table 32. Red Hat Fuse Extended Life Cycle Support Add-On Billing SKU Details**

SKU	Description	Term	Unit of Measure
<b>Dedicated</b>			
MW00259	Red Hat Data Grid Extended Life Cycle Support Add-On, Layered Support (4 Cores or 8 vCPUs, Yearly)	ANNUAL	Core Band or vCPU
MW00260	Red Hat Data Grid Extended Life Cycle Support Add-On, Layered Support, (64 Cores or 128 vCPUs, Yearly)	ANNUAL	Core Band or vCPU
MW00482MO	Red Hat Data Grid Extended Life Cycle Support Add-On, Layered Support (1 Core or 2 vCPUs, Monthly)	MONTH	Core Band or vCPU
MW00484HR	Red Hat Data Grid Extended Life Cycle Support Add-On, Layered Support (1 Core or 2 vCPUs, Hourly)	HOURLY	Core Band or vCPU
MW00756	Red Hat Data Grid Extended Life Cycle Support Add-On, Layered Support (2 Cores or 4 vCPUs, Yearly)	ANNUAL	Core Band or vCPU
MW00756F3	Red Hat Data Grid Extended Life Cycle Support Add-On, Layered Support (2 Cores or 4 vCPUs, 3 Years)	3 - Year	Core Band or vCPU

SKU	Description	Term	Unit of Measure
MW00259F3	Red Hat Data Grid Extended Life Cycle Support Add-On, Layered Support (4 Cores or 8 vCPUs, 3 Years)	3 - Year	Core Band or vCPU
MW00759	Red Hat Data Grid Extended Life Cycle Support Add-On, Layered Support (16 Cores or 32 vCPUs, Yearly)	ANNUAL	Core Band or vCPU
MW00759F3	Red Hat Data Grid Extended Life Cycle Support Add-On, Layered Support (16 Cores or 32 vCPUs, 3 Years)	3 - Year	Core Band or vCPU
MW00260F3	Red Hat Data Grid Extended Life Cycle Support Add-On, Layered Support, (64 Cores or 128 vCPUs, 3 Years)	3 - Year	Core Band or vCPU

**Table 33. Red Hat Data Grid Extended Life Cycle Support Add-On Billing SKU Details**

SKU	Description	Term	Unit of Measure
<b>Dedicated</b>			
MW00255	Red Hat AMQ Extended Life Cycle Support Add-On, Layered Support (4 Cores or 8 vCPUs, Yearly)	ANNUAL	Core Band or vCPU
MW00256	Red Hat AMQ Extended Life Cycle Support Add-On, Layered Support (64 Cores or 128 vCPUs, Yearly)	ANNUAL	Core Band or vCPU
MW00486MO	Red Hat AMQ Extended Life Cycle Support Add-On, Layered Support (1 Core or 2 vCPUs, Monthly)	MONTH	Core Band or vCPU
MW00488HR	Red Hat AMQ Extended Life Cycle Support Add-On, Layered Support (1 Core or 2 vCPUs, Hourly)	HOUR	Core Band or vCPU
MW00750	Red Hat AMQ Extended Life Cycle Support Add-On, Layered Support (2 Cores or 4 vCPUs, Yearly)	ANNUAL	Core Band or vCPU
MW00750F3	Red Hat AMQ Extended Life Cycle Support Add-On, Layered Support (2 Cores or 4 vCPUs, 3 Years)	3 - Year	Core Band or vCPU
MW00255F3	Red Hat AMQ Extended Life Cycle Support Add-On, Layered Support (4 Cores or 8 vCPUs, 3 Years)	3 - Year	Core Band or vCPU
MW00753	Red Hat AMQ Extended Life Cycle Support Add-On, Layered Support (16 Cores or 32 vCPUs, Yearly)	ANNUAL	Core Band or vCPU
MW00753F3	Red Hat AMQ Extended Life Cycle Support Add-On, Layered Support (16 Cores or 32 vCPUs, 3 Years)	3 - Year	Core Band or vCPU
MW00256F3	Red Hat AMQ Extended Life Cycle Support Add-On, Layered Support (64 Cores or 128 vCPUs, 3 Years)	3 - Year	Core Band or vCPU

**Table 34. Red Hat AMQ Extended Life Cycle Support Add-On Billing SKU Details**

SKU	Description	Term	Unit of Measure
<b>Dedicated</b>			
MW00249	Red Hat Decision Manager Extended Life Cycle Support Add-On, Layered Support (4 Cores or 8 vCPUs, Yearly)	ANNUAL	Core Band or vCPU
MW00250	Red Hat Decision Manager Extended Life Cycle Support Add-On, Layered Support (64 Cores or 128 vCPUs, Yearly)	ANNUAL	Core Band or vCPU
MW00494MO	Red Hat Decision Manager Extended Life Cycle Support Add-On, Layered Support (1 Core or 2 vCPUs, Monthly)	MONTH	Core Band or vCPU
MW00496HR	Red Hat Decision Manager Extended Life Cycle Support Add-On, Layered Support (1 Core or 2 vCPUs, Hourly)	HOURLY	Core Band or vCPU
MW00732	Red Hat Decision Manager Extended Life Cycle Support Add-On, Layered Support (2 Cores or 4 vCPUs, Yearly)	ANNUAL	Core Band or vCPU
MW00732F3	Red Hat Decision Manager Extended Lifecycle Support Add-On, Layered Support (2 cores or 4 vCPUs, 3 Year)	3 - Year	Core Band or vCPU
MW00249F3	Red Hat Decision Manager Extended Life Cycle Support Add-On, Layered Support (4 Cores or 8 vCPUs, 3 Years)	3 - Year	Core Band or vCPU
MW00735	Red Hat Decision Manager Extended Life Cycle Support Add-On, Layered Support (16 Cores or 32 vCPUs, Yearly)	ANNUAL	Core Band or vCPU
MW00735F3	Red Hat Decision Manager Extended Life Cycle Support Add-On, Layered Support (16 Cores or 32 vCPUs, 3 Years)	3 - Year	Core Band or vCPU
MW00250F3	Red Hat Decision Manager Extended Life Cycle Support Add-On, Layered Support (64 Cores or 128 vCPUs, 3 Years)	3 - Year	Core Band or vCPU

**Table 35. Red Hat Decision Manager Extended Life Cycle Support Add-On Billing SKU Details**

SKU	Description	Term	Unit of Measure
<b>Dedicated</b>			
MW00251	Red Hat Process Automation Manager Extended Life Cycle Support Add-On, Layered Support (4 Cores or 8 vCPUs, Yearly)	ANNUAL	Core Band or vCPU
MW00252	Red Hat Process Automation Manager Extended Life Cycle Support Add-On, Layered Support (64 Cores or 128 vCPUs, Yearly)	ANNUAL	Core Band or vCPU

SKU	Description	Term	Unit of Measure
MW00498MO	Red Hat Process Automation Manager Extended Life Cycle Support Add-On, Layered Support (1 Core or 2 vCPUs, Monthly)	MONTH	Core Band or vCPU
MW00500HR	Red Hat Process Automation Manager Extended Life Cycle Support Add-On, Layered Support (1 Core or 2 vCPUs, Hourly)	HOURLY	Core Band or vCPU
MW00738	Red Hat Process Automation Manager Extended Life Cycle Support Add-On, Layered Support (2 Cores or 4 vCPUs, Yearly)	ANNUAL	Core Band or vCPU
MW00738F3	Red Hat Process Automation Manager Extended Lifecycle Support Add-On, Layered Support (2 cores or 4 vCPUs, 3 Year)	3 - Year	Core Band or vCPU
MW00251F3	Red Hat Process Automation Manager Extended Life Cycle Support Add-On, Layered Support (4 Cores or 8 vCPUs, 3 Years)	3 - Year	Core Band or vCPU
MW00741	Red Hat Process Automation Manager Extended Life Cycle Support Add-On, Layered Support (16 Cores or 32 vCPUs, Yearly)	ANNUAL	Core Band or vCPU
MW00741F3	Red Hat Process Automation Manager Extended Life Cycle Support Add-On, Layered Support (16 Cores or 32 vCPUs, 3 Years)	3 - Year	Core Band or vCPU
MW00252F3	Red Hat Process Automation Manager Extended Life Cycle Support Add-On, Layered Support (64 Cores or 128 vCPUs, 3 Years)	3 - Year	Core Band or vCPU

**Table 36. Red Hat Process Automation Manager Extended Life Cycle Support Add-On Billing SKU Details**

## 6.2.6. Red Hat Middleware Bundles

### 6.2.6.1. Billing SKUs

SKU	Description	Term	Unit of Measure
<b>Dedicated &amp; Multi-Tenant</b>			
MW00667	Red Hat Runtimes, Full Support (2 cores or 4 vCPUs, Yearly)	Annual	Core Band or vCPU
MW00667F3	Red Hat Runtimes, Full Support (2 cores or 4 vCPUs, 3 Year)	3 - Year	Core Band or vCPU
MW00668	Red Hat Runtimes, Full Support (16 cores or 32 vCPUs, Yearly)	Annual	Core Band or vCPU
MW00668F3	Red Hat Runtimes, Full Support (16 cores or 32 vCPUs, 3 Year)	3 - Year	Core Band or vCPU
MW00669	Red Hat Runtimes, Full Support (64 cores or 128 vCPUs, Yearly)	Annual	Core Band or vCPU
MW00669F3	Red Hat Runtimes, Full Support (64 cores or 128 vCPUs, 3 Year)	3 - Year	Core Band or vCPU
MW00774HR	Red Hat Runtimes, Full Support (1 Core or 2 vCPUs, Hourly, Billing)	HOURLY	Core Band or vCPU
MW00775MO	Red Hat Runtimes, Full Support (1 Core or 2 vCPUs, Monthly, Billing)	MONTH	Core Band or vCPU

*Table 37. Red Hat Runtimes Billing SKU Details*

SKU	Description	Term	Unit of Measure
<b>Dedicated &amp; Multi-Tenant</b>			
MW00670	Red Hat Integration, Full Support (2 Cores or 4 vCPUs, Yearly)	Annual	Core Band or vCPU
MW00670F3	Red Hat Integration, Full Support (2 Cores or 4 vCPUs, 3 Year)	3 - Year	Core Band or vCPU
MW00671	Red Hat Integration, Full Support (16 Cores or 32 vCPUs, Yearly)	Annual	Core Band or vCPU
MW00671F3	Red Hat Integration, Full Support (16 Cores or 32 vCPUs, 3 Year)	3 - Year	Core Band or vCPU

SKU	Description	Term	Unit of Measure
MW00672	Red Hat Integration, Full Support (64 Cores or 128 vCPUs, Yearly)	Annual	Core Band or vCPU
MW00672F3	Red Hat Integration, Full Support (64 Cores or 128 vCPUs, 3 Year)	3 - Year	Core Band or vCPU
MW00776HR	Red Hat Integration, Full Support (1 Core or 2 vCPUs, Hourly, Billing)	HOUR	Core Band or vCPU
MW00777MO	Red Hat Integration, Full Support (1 Core or 2 vCPUs, Monthly, Billing)	MONTH	Core Band or vCPU

**Table 38. Red Hat Integration Billing SKU Details**

SKU	Description	Term	Unit of Measure
<b>Dedicated &amp; Multi-Tenant</b>			
MW00673	Red Hat Process Automation, Full Support (2 Cores or 4 vCPUs, Yearly)	Annual	Core Band
MW00673F3	Red Hat Process Automation, Full Support (2 Cores or 4 vCPUs, 3 Year)	3 - Year	Core Band
MW00674	Red Hat Process Automation, Full Support (16 Cores or 32 vCPUs, Yearly)	Annual	Core Band
MW00674F3	Red Hat Process Automation, Full Support (16 Cores or 32 vCPUs, 3 Year)	3 - Year	Core Band
MW00675	Red Hat Process Automation, Full Support (64 Cores or 128 vCPUs, Yearly)	\$Annual	Core Band
MW00675F3	Red Hat Process Automation, Full Support (64 Cores or 128 vCPUs, 3 Year)	3 - Year	Core Band
MW00778HR	Red Hat Process Automation, Full Support (1 Core or 2 vCPUs, Hourly, Billing)	HOUR	Core Band or vCPU
MW00779MO	Red Hat Process Automation, Full Support (1 Core or 2 vCPUs, Monthly, Billing)	MONTH	Core Band or vCPU

**Table 39. Red Hat Process Automation Billing SKU Details**

SKU	Description	Term	Unit of Measure
<b>Dedicated &amp; Multi-Tenant</b>			
MW00676	Red Hat Middleware Portfolio, Full Support (2 cores or 4 vCPUs, Yearly)	Annual	Core Band
MW00676F3	Red Hat Middleware Portfolio, Full Support (2 cores or 4 vCPUs, 3 Year)	3 - Year	Core Band
MW00677	Red Hat Middleware Portfolio, Full Support (16 cores or 32 vCPUs, Yearly)	Annual	Core Band
MW00677F3	Red Hat Middleware Portfolio, Full Support (16 cores or 32 vCPUs, 3 Year)	3 - Year	Core Band
MW00678	Red Hat Middleware Portfolio, Full Support (64 cores or 128 vCPUs, Yearly)	Annual	Core Band
MW00678F3	Red Hat Middleware Portfolio, Full Support (64 cores or 128 vCPUs, 3 Year)	3 - Year	Core Band
MW00780HR	Red Hat Middleware Portfolio, Full Support (1 Core or 2 vCPUs, Hourly, Billing)	HOURLY	Core Band or vCPU
MW00781MO	Red Hat Middleware Portfolio, Full Support (1 Core or 2 vCPUs, Monthly, Billing)	MONTH	Core Band or vCPU

**Table 40. Red Hat Middleware Portfolio Billing SKU Details**

SKU	Description	Term	Unit of Measure
<b>Dedicated &amp; Multi-Tenant</b>			
MW00679	Red Hat OpenShift Container Platform with Runtimes, Full Support (2 Cores or 4 vCPUs, Yearly)	Annual	Core Band
MW00679F3	Red Hat OpenShift Container Platform with Runtimes, Full Support (2 Cores or 4 vCPUs, 3 Year)	3 - Year	Core Band
MW00680	Red Hat OpenShift Container Platform with Runtimes, Full Support (16 Cores or 32 vCPUs, Yearly)	Annual	Core Band
MW00680F3	Red Hat OpenShift Container Platform with Runtimes, Full Support (16 Cores or 32 vCPUs, 3 Year)	3 - Year	Core Band
MW00681	Red Hat OpenShift Container Platform with Runtimes, Full Support (64 Cores or 128 vCPUs, Yearly)	Annual	Core Band

SKU	Description	Term	Unit of Measure
MW00681F3	Red Hat OpenShift Container Platform with Runtimes, Full Support (64 Cores or 128 vCPUs, 3 Year)	3 - Year	Core Band

**Table 41. Red Hat OpenShift Container Platform with Runtimes Billing SKU Details**

SKU	Description	Term	Unit of Measure
<b>Dedicated &amp; Multi-Tenant</b>			
MW00682	Red Hat OpenShift Container Platform with Integration, Full Support (2 Cores or 4 vCPUs, Yearly)	Annual	Core Band
MW00682F3	Red Hat OpenShift Container Platform with Integration, Full Support (2 Cores or 4 vCPUs, 3 Year)	3 - Year	Core Band
MW00683	Red Hat OpenShift Container Platform with Integration, Full Support (16 Cores or 32 vCPUs, Yearly)	Annual	Core Band
MW00683F3	Red Hat OpenShift Container Platform with Integration, Full Support (16 Cores or 32 vCPUs, 3 Year)	3 - Year	Core Band
MW00684	Red Hat OpenShift Container Platform with Integration, Full Support (64 Cores or 128 vCPUs, Yearly)	Annual	Core Band
MW00684F3	Red Hat OpenShift Container Platform with Integration, Full Support (64 Cores or 128 vCPUs, 3 Year)	3 - Year	Core Band

**Table 42. Red Hat OpenShift Container Platform with Integration Billing SKU Details**

SKU	Description	Term	Unit of Measure
<b>Dedicated &amp; Multi-Tenant</b>			
MW00685	Red Hat OpenShift Container Platform with Automation, Full Support (2 Cores or 4 vCPUs, Yearly)	Annual	Core Band
MW00685F3	Red Hat OpenShift Container Platform with Automation, Full Support (2 Cores or 4 vCPUs, 3 Year)	3 - Year	Core Band
MW00686	Red Hat OpenShift Container Platform with Automation, Full Support (16 Cores or 32 vCPUs, Yearly)	Annual	Core Band



SKU	Description	Term	Unit of Measure
MW00686F3	Red Hat OpenShift Container Platform with Automation, Full Support (16 Cores or 32 vCPUs, 3 Year)	3 - Year	Core Band
MW00687	Red Hat OpenShift Container Platform with Automation, Full Support (64 Cores or 128 vCPUs, Yearly)	Annual	Core Band
MW00687F3	Red Hat OpenShift Container Platform with Automation, Full Support (64 Cores or 128 vCPUs, 3 Year)	3 - Year	Core Band

**Table 43. Red Hat OpenShift Container Platform with Process Automation Billing SKU Details**

SKU	Description	Term	Unit of Measure
<b>Dedicated &amp; Multi-Tenant</b>			
MW00688	Red Hat OpenShift Container Platform with Middleware Portfolio, Full Support (2 Cores or 4 vCPUs, Yearly)	Annual	Core Band
MW00688F3	Red Hat OpenShift Container Platform with Middleware Portfolio, Full Support (2 Cores or 4 vCPUs, 3 Year)	3 - Year	Core Band
MW00689	Red Hat OpenShift Container Platform with Middleware Portfolio, Full Support (16 Cores or 32 vCPUs, Yearly)	Annual	Core Band
MW00689F3	Red Hat OpenShift Container Platform with Middleware Portfolio, Full Support (16 Cores or 32 vCPUs, 3 Year)	3 - Year	Core Band
MW00690	Red Hat OpenShift Container Platform with Middleware Portfolio, Full Support (64 Cores or 128 vCPUs, Yearly)	Annual	Core Band
MW00690F3	Red Hat OpenShift Container Platform with Middleware Portfolio, Full Support (64 Cores or 128 vCPUs, 3 Year)	3 - Year	Core Band

**Table 44. Red Hat OpenShift Container Platform with Middleware Portfolio Billing SKU Details**

**Notes:**

- When purchased with OpenShift, the bundle provides one pool of cores for OpenShift and a separate, equal pool of cores for Middleware.
- Each “Core” is an entitlement to run any of the eligible products
  - ex. 64 cores of MW Portfolio = 64 total MW cores; **not** 64 cores of each product
  - ex. 64 cores of MW+OpenShift = 64 total MW cores + 64 OpenShift cores

## 6.2.7. Red Hat 3scale API Management

### 6.2.7.1. Billing SKUs

SKU	Description	Term	Unit of Measure
<b>Dedicated &amp; Multi-Tenant</b>			
MW00554	Red Hat 3scale API Management, Full Support (64 Cores or 128 vCPUs, Yearly)	ANNUAL	Core Band or vCPU
MW00554F3	Red Hat 3scale API Management, Full Support (64 Cores or 128 vCPUs, 3 Years)	3 - Year	Core Band or vCPU
MW00555F3	Red Hat 3scale API Management, Full Support (16 Cores or 32 vCPUs, 3 Years)	3 - Year	Core Band or vCPU
MW00556	Red Hat 3scale API Management, Full Support (4 Cores or 8 vCPUs, Yearly)	ANNUAL	Core Band or vCPU
MW00557MO	Red Hat 3scale API Management, Full Support (1 Core or 2 vCPUs, Monthly)	MONTH	Core Band or vCPU
MW00557HR	Red Hat 3scale API Management, Full Support (1 Core or 2 vCPUs, Hourly)	HOURLY	Core Band or vCPU
MW00724	Red Hat 3scale API Management, Full Support (2 Cores or 4 vCPUs, Yearly)	ANNUAL	Core Band or vCPU
MW00724F3	Red Hat 3scale API Management, Full Support (2 Cores or 4 vCPUs, 3 Years)	3 - Year	Core Band or vCPU
MW00556F3	Red Hat 3scale API Management, Full Support (4 Cores or 8 vCPUs, 3 Years)	3 - Year	Core Band or vCPU
MW00727	Red Hat 3scale API Management, Full Support (16 Cores or 32 vCPUs, Yearly)	ANNUAL	Core Band or vCPU

**Table 45. Red Hat 3scale API Management Billing SKU Details**

#### Notes:

- When running 3scale on OpenShift, 3scale nodes require a sufficient quantity of 3scale and OpenShift SKUs to cover the core/vCPU count of the OpenShift Application node running the 3scale software.
- Refer to the OpenShift [OpenShift Notes](#) for information about SKU stacking, vCPU equivalency, and no-cost OpenShift components.

### 6.2.7.2. Red Hat 3scale API Management Use Case Examples

#### Example 1

- **Graphic A** A 3scale API Management environment running on a virtualized Red Hat OpenShift Container Platform infrastructure dedicated to a single customer with **annual subscription pricing**. The customer API

Management environment will require **both 3scale and OpenShift** SKUs.

- 3 VMs (hyper-threaded) for the 3scale API Management environment consumed by Customer A
  - API vm 1: 8 vCPU = 1x MW00556 and 4x MW00472
  - API vm 2: 8 vCPU = 1x MW00556 and 4x MW00472
  - API vm 3: 16 vCPU = 2x MW00556 and 8x MW00472
    - Total consumption reported = 6x MW00556 (3scale) and 16x MW00472 (OpenShift)

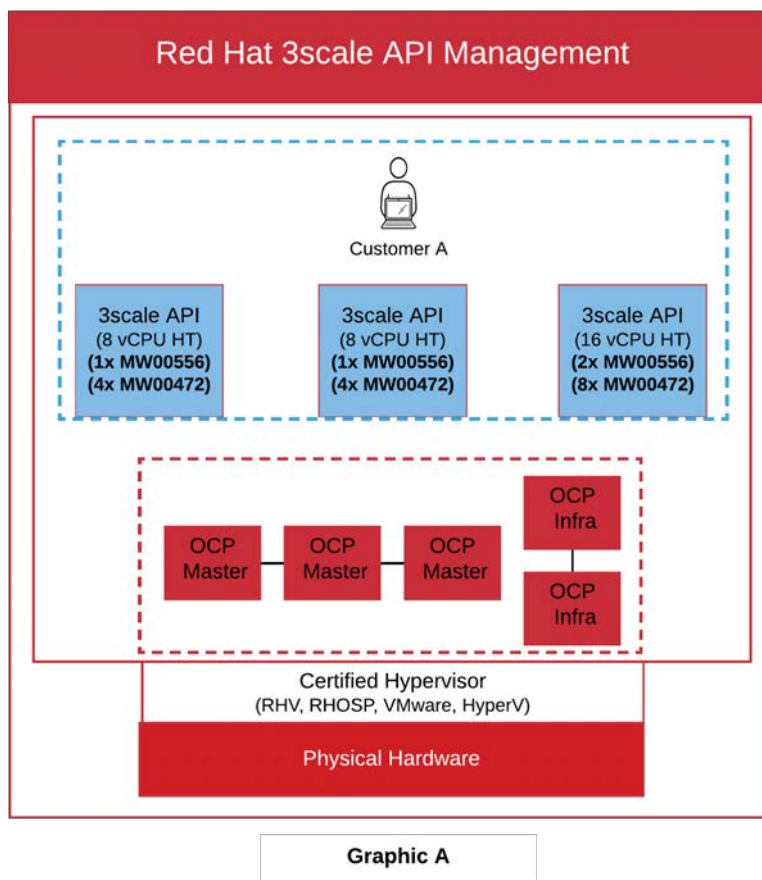
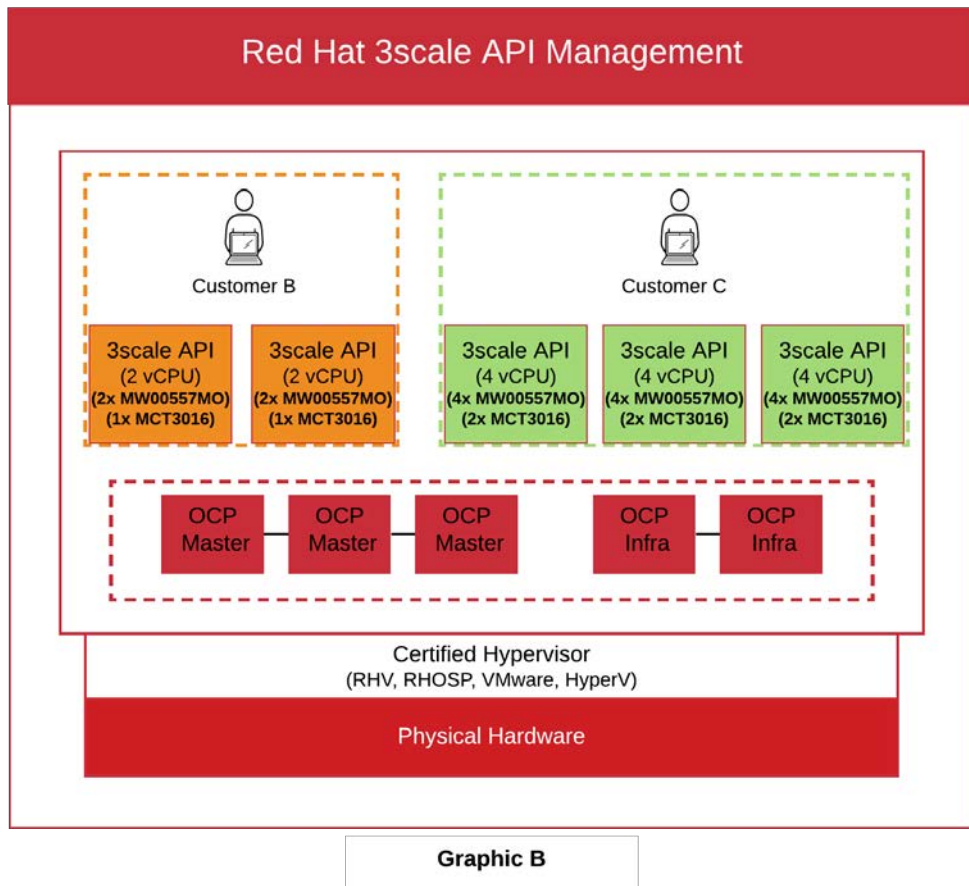

**Figure 15. Red Hat 3scale API Management Dedicated Use Case Example**

### Example 2

- **Graphic B** A 3scale API Management environment running on a virtualized Red Hat OpenShift Container Platform infrastructure supporting multiple customers with **monthly subscription pricing**. The customer API Management environment will require **both 3scale and OpenShift** SKUs.
  - 2 VMs (not hyper-threaded) for the 3scale API Management environment consumed by Customer B
    - API vm 1: 2 vCPU = 2x MW00557MO and 1x MCT3016
    - API vm 2: 2 vCPU = 2x MW00557MO and 1x MCT3016

- Total consumption reported = 4x MW00557MO (3scale) and 2x MCT3016 (OpenShift)
- 3 VMs (not hyper-threaded) for the 3scale API Management environment consumed by Customer C
  - API vm 1: 4 vCPU = 4x MW00557MO and 2x MCT3016
  - API vm 2: 4 vCPU = 4x MW00557MO and 2x MCT3016
  - API vm 3: 4 vCPU = 4x MW00557MO and 2x MCT3016
    - Total consumption reported = 12x MW00557MO (3scale) and 6x MCT3016 (OpenShift)



**Figure 16. Red Hat 3scale API Management Multi-tenant Use Case Example**

## 6.2.8. Red Hat build of OpenJDK

### 6.2.8.1. Billing SKUs

SKU	Description	Term	Unit of Measure
<b>Dedicated &amp; Multi-Tenant</b>			
<b>For Servers</b>			
MW01210	Red Hat build of OpenJDK for Servers, Full Support (10 Cores or 20 vCPUs, Yearly)	ANNUAL	Core Band
MW01211	Red Hat build of OpenJDK for Servers, Full Support (200 Cores or 400 vCPUs, Yearly)	ANNUAL	Core Band
MW01212	Red Hat build of OpenJDK for Servers, Full Support (2,000 Cores or 4,000 vCPUs, Yearly)	ANNUAL	Core Band
MW01213	Red Hat build of OpenJDK for Servers, Full Support (Unlimited Cores or vCPUs, Yearly)	ANNUAL	Core Band
MW01210F3	Red Hat build of OpenJDK for Servers, Full Support (10 Cores or 20 vCPUs, 3 Year)	3 - Year	Core Band
MW01211F3	Red Hat build of OpenJDK for Servers, Full Support (200 Cores or 400 vCPUs, 3 Year)	3 - Year	Core Band
MW01212F3	Red Hat build of OpenJDK for Servers, Full Support (2,000 Cores or 4,000 vCPUs, 3 Year)	3 - Year	Core Band
MW01213F3	Red Hat build of OpenJDK for Servers, Full Support (Unlimited Cores or vCPUs, 3 Year)	3 - Year	Core Band
MW01218MO	Red Hat build of OpenJDK for Servers, Full Support (1 Core or 2 vCPUs, Monthly)	MONTH	Core Band
MW01218HR	Red Hat build of OpenJDK for Servers, Full Support (1 Core or 2 vCPUs, Hourly)	HOUR	Core Band
<b>For Workstations</b>			
MW01220	Red Hat build of OpenJDK for Workstations, Full Support (50 Clients, Yearly)	ANNUAL	Physical Node
MW01221	Red Hat build of OpenJDK for Workstations, Full Support (1,000 Clients, Yearly)	ANNUAL	Physical Node
MW01222	Red Hat build of OpenJDK for Workstations, Full Support (10,000 Clients, Yearly)	ANNUAL	Physical Node
MW01223	Red Hat build of OpenJDK for Workstations, Full Support (Unlimited Clients, Yearly)	ANNUAL	Physical Node
MW01220F3	Red Hat build of OpenJDK for Workstations, Full Support (50 Clients, 3 Year)	3 - Year	Physical Node

SKU	Description	Term	Unit of Measure
MW01221F3	Red Hat build of OpenJDK for Workstations, Full Support (1,000 Clients, 3 Year)	3 - Year	Physical Node
MW01222F3	Red Hat build of OpenJDK for Workstations, Full Support (10,000 Clients, 3 Year)	3 - Year	Physical Node
MW01223F3	Red Hat build of OpenJDK for Workstations, Full Support (Unlimited Clients, 3 Year)	3 - Year	Physical Node
MW01228MO	Red Hat build of OpenJDK for Workstations, Full Support (1 Client, Monthly)	MONTH	Physical Node
MW01229HR	Red Hat build of OpenJDK for Workstations, Full Support (1 Client, Hourly)	HOUR	Physical Node

**Table 46. Red Hat build of OpenJDK Billing SKU Details**

**Notes:**

- Entitlements for Java workloads on OpenJDK are included in a Red Hat Enterprise Linux subscription.
- Red Hat Middleware subscriptions include OpenJDK entitlements for Windows when used with Red Hat Middleware.
- For other Java workloads on Windows (non-Red Hat Middleware), an additional subscription for OpenJDK on Windows is required.

## 6.3. Management and Automation

### 6.3.1. Red Hat Ansible Automation Platform

#### 6.3.1.1. Billing SKUs

SKU	Description	Term	Unit of Measure
MCT3752MO	Red Hat Ansible Automation Platform, Full Support (1 Managed Node, Dedicated, Monthly)	MONTH	Managed Node
MCT3752	Red Hat Ansible Automation Platform, Full Support (1 Managed Node, Dedicated, Yearly)	ANNUAL	Managed Node
MCT3752F3	Red Hat Ansible Automation Platform, Full Support (1 Managed Node, Dedicated, 3 Years)	3 – YEAR	Managed Node

**Table 47. Red Hat Ansible Automation Platform Billing SKU Details**

#### Notes:

- Red Hat Ansible Automation Platform is a consolidated offering that includes both Red Hat Ansible Tower and Red Hat Ansible Engine.
- Ansible software repositories are made available via the CCSP *Red Hat Satellite - Add-Ons for Providers (RC1257407)* Enablement SKU.
- Use of Red Hat Ansible Automation Platform requires a license key. To request a license key, please contact your Red Hat partner account manager.
- Partners own the Ansible subscriptions and operate all of the Ansible components. Ansible is not visible to, or used by, partner's end-customers.
- Ansible components can be used to manage partner systems and/or end-customer systems.

#### 6.3.1.2. Red Hat Ansible Automation Platform Use Case Examples

CCSP partners can use Red Hat Ansible Automation Platform to automate configuration and management tasks within their infrastructures. Red Hat Ansible Automation Platform helps partners scale their operations efficiently while minimizing the potential for costly errors caused by manual processes.

##### Use Case Example 1

- **Graphic A** CCSP partner using Red Hat Ansible Automation Platform (with Full support and yearly pricing) to manage RHEL and non-RHEL systems. Managed systems running RHEL require entitlements for **both Ansible Automation and RHEL**.
  - Managed environment includes:
    - 1 Ansible Tower management server running on RHEL. Requires 1x RH00232 (RHEL).
    - 1 RHEL managed node. Requires 1x MCT3752 (Ansible Automation) and 1x RH00232 (RHEL).
    - 2 non-RHEL OS managed nodes. Requires 2x MCT3752 (Ansible Automation).

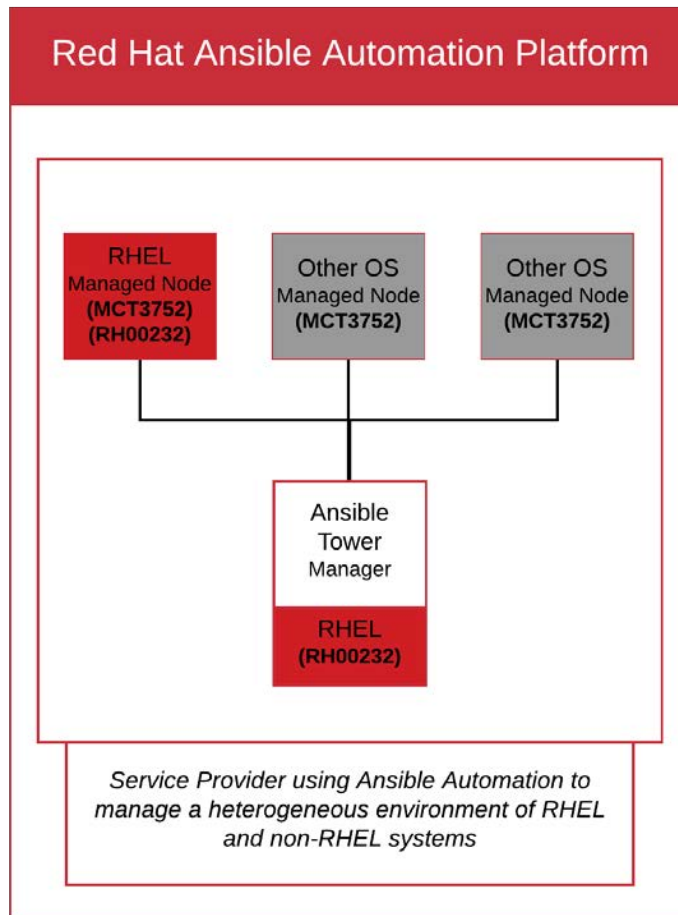

**Graphic A**

**Figure 17. Example 1**



## 6.3.2. Red Hat Smart Management for Service Providers

### 6.3.2.1. Billing SKUs

SKU	Description	Term	Unit of Measure
<b>Dedicated</b>			
MCT3024	Smart Management for Service Providers, Annual Bill Only	ANNUAL	Socket-Pair
MCT3025	Smart Management for Service Providers, Monthly Bill Only	MONTH	Socket-Pair
<b>Multi-tenant</b>			
MCT3026	Smart Management for Service Providers, Annual Bill Only	ANNUAL	System
MCT3027	Smart Management for Service Providers, Monthly Bill Only	MONTH	System

*Table 48. Red Hat Smart Management for Service Providers Billing SKU Details*

### 6.3.2.2. Red Hat Smart Management for Service Providers Use Case Examples

#### Example 1

CCSP partner using Red Hat Smart Management for Service Providers to manage, control, and provide Red Hat software updates to their end-customers who are using Red Hat Enterprise Linux in Dedicated and Multi-Tenant environments.

**Graphic A** Using Red Hat Smart Management for Service Providers to manage multiple customers in an infrastructure that includes both physical and virtualized hardware.

- Managing a physical 2 socket server dedicated to a single customer (**Customer A**) = 1x MCT3024
- Managing a Red Hat certified hypervisor with 4 sockets dedicated to a single customer running RHEL VMs (**Customer B**) = 2x MCT3024
- Managing 4 RHEL VMs dedicated to a single customer running on a Red Hat certified hypervisor (**Customer C**) = 4x MCT3026

**Total Smart Management consumption reported** = 3x MCT3024 and 4x MCT3026

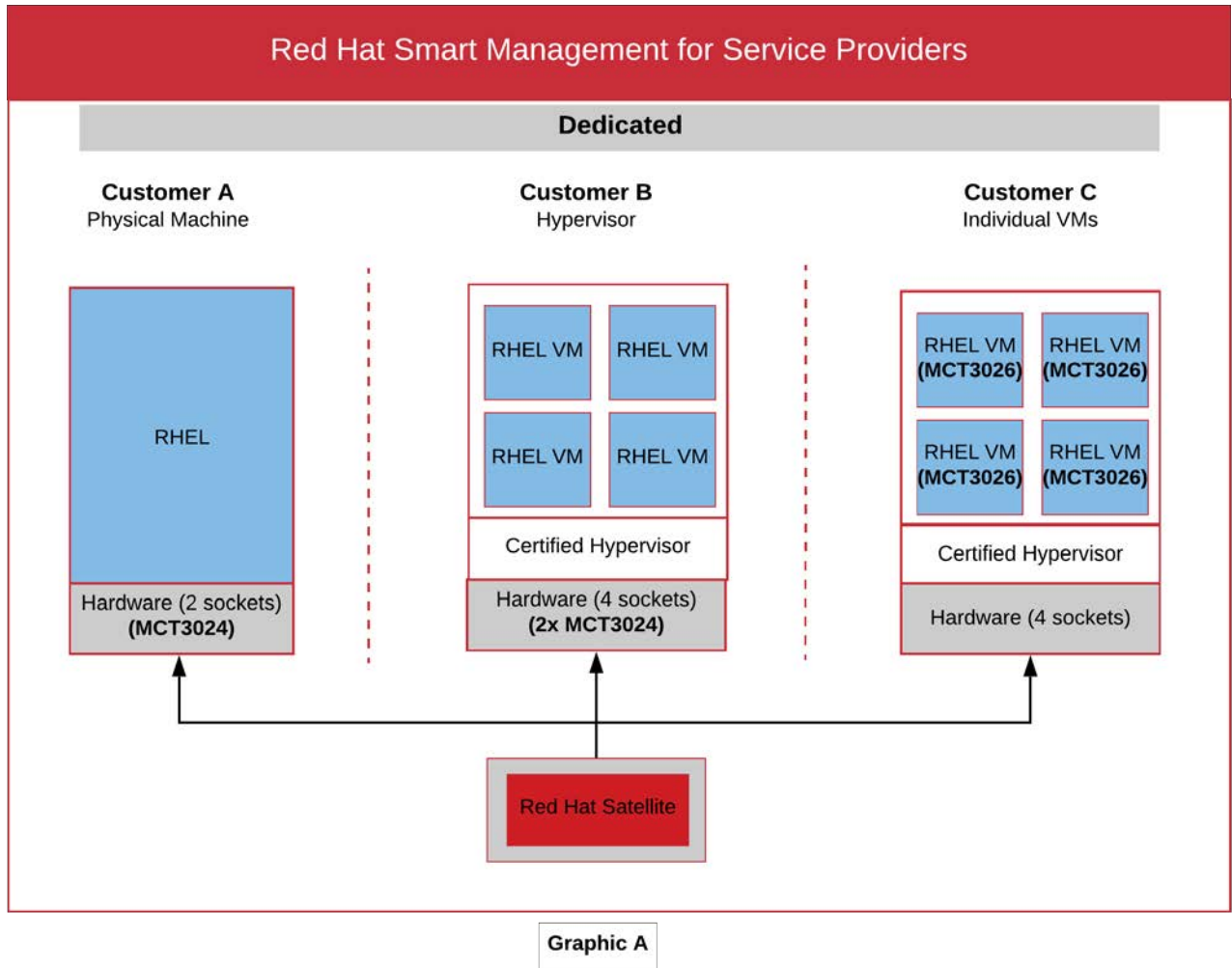

**Figure 18. Red Hat Smart Management for Service Providers Use Case Example 1**

**Example 2**

**Graphic B** Managing RHEL VMs used by multiple customers running on a Red Hat certified hypervisor.

- 2 RHEL VMs with monthly billing for **(Customer A)** = 2x MCT3027
- 1 RHEL VM with annual billing for **(Customer B)** = 1x MCT3026
- 3 RHEL VMs with monthly billing for **(Customer C)** = 3x MCT3027

**Total Smart Management consumption reported** = 1x MCT3026 and 5x MCT3027

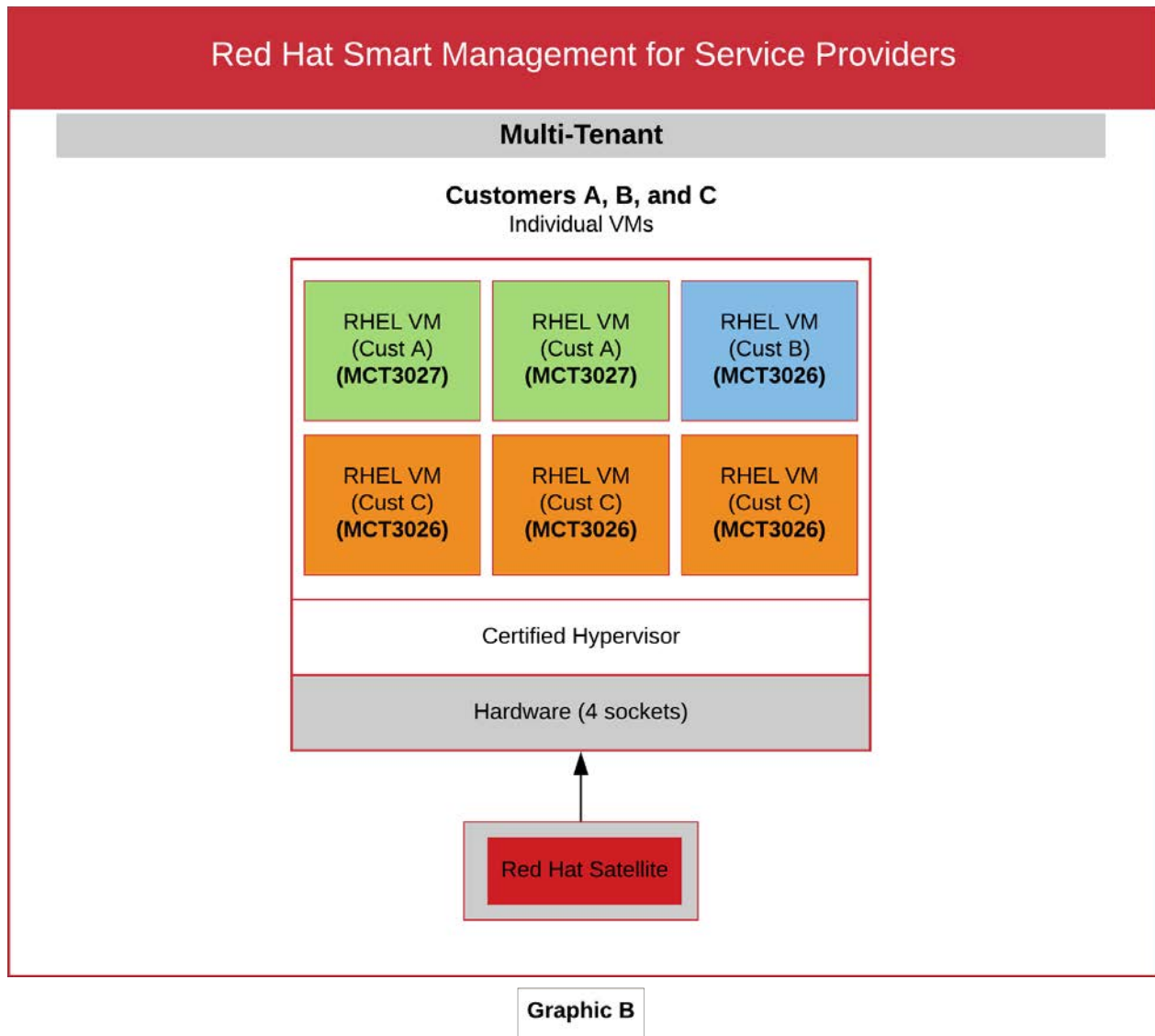

Figure 19. Red Hat Smart Management for Service Providers Use Case Example 2

## 6.4. Cloud Storage

### 6.4.1. Red Hat Gluster Storage

#### 6.4.1.1. Billing SKUs

SKU	Description	Term	Unit of Measure
<b>Dedicated</b>			
RS00100MO	Red Hat Gluster Storage, Diagnostic Support (Physical Node, Monthly)	MONTH	Physical Node
<b>Multi-Tenant</b>			
RS00098MO	Red Hat Gluster Storage, Diagnostic Support (100GB Pack - Raw Used, Shared, Monthly)	MONTH	RAW STORAGE USED

*Table 49. Red Hat Gluster Storage Billing SKU Details*

#### 6.4.1.2. Red Hat Gluster Storage Use Case Examples

##### Example 1

- **Graphic A** CCSP partner offering a dedicated Gluster storage cluster to a single customer

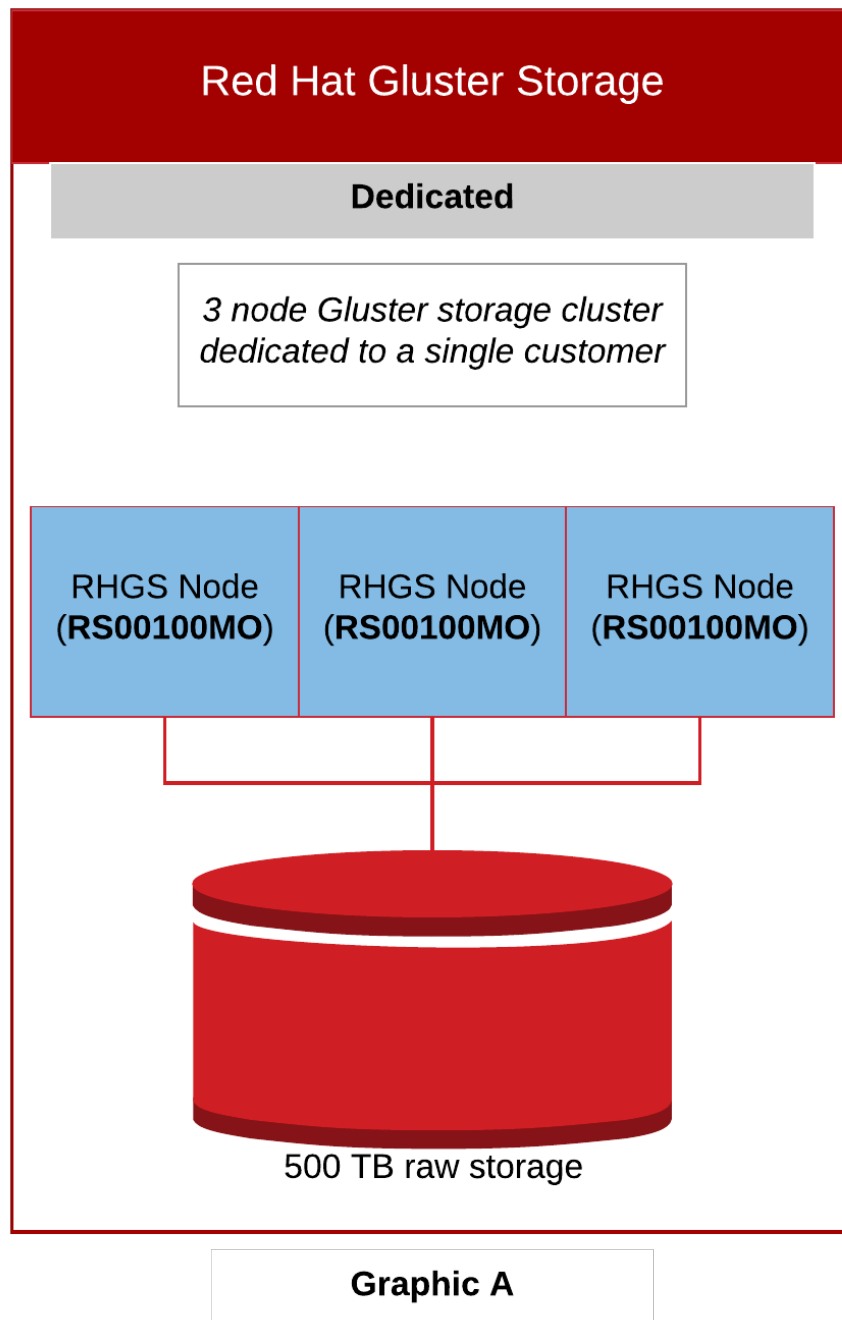
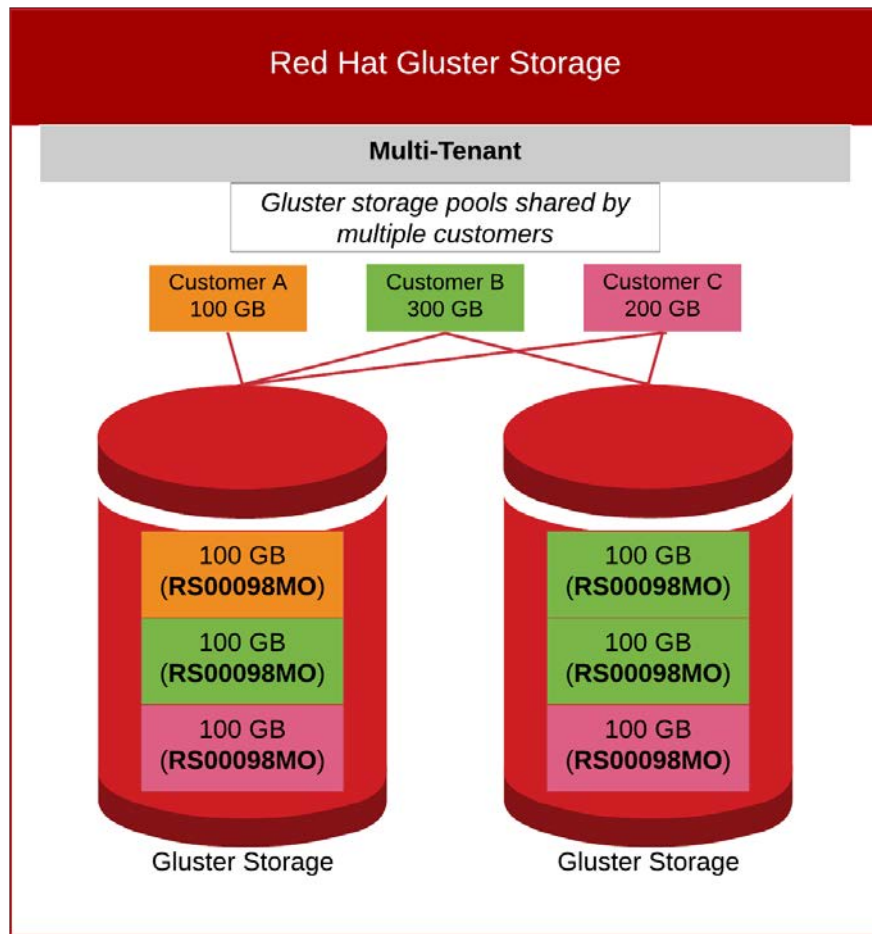

Figure 20. Red Hat Gluster Storage Use Case Example 1

#### Example 2

- **Graphic B** CCSP partner offering a shared Gluster storage cluster to multiple customers



Graphic B

Figure 21. Red Hat Gluster Storage Use Case Example 2

## 6.4.2. Red Hat Ceph Storage

### 6.4.2.1. Billing SKUs

SKU	Description	Term	Unit of Measure
<b>Dedicated</b>			
RS00090MO	Red Hat Ceph Storage, Diagnostic Support (Up to 256TB, Monthly)	MONTH	STORAGE BAND
RS00091MO	Red Hat Ceph Storage, Diagnostic Support (Up to 512TB, Monthly)	MONTH	STORAGE BAND
RS00092MO	Red Hat Ceph Storage, Diagnostic Support (Up to 1PB, Monthly)	MONTH	STORAGE BAND
RS00093MO	Red Hat Ceph Storage, Diagnostic Support (Up to 2PB, Monthly)	MONTH	STORAGE BAND
RS00094MO	Red Hat Ceph Storage, Diagnostic Support (Up to 3PB, Monthly)	MONTH	STORAGE BAND
RS00095MO	Red Hat Ceph Storage, Diagnostic Support (Up to 4PB, Monthly)	MONTH	STORAGE BAND
RS00096MO	Red Hat Ceph Storage, Diagnostic Support (Up to 5PB, Monthly)	MONTH	STORAGE BAND
<b>Multi-Tenant</b>			
RS00099MO	Red Hat Ceph Storage, Diagnostic Support (100GB Pack - Raw Used, Shared, Monthly)	MONTH	RAW STORAGE USED

**Table 50. General Purpose < 1PB Ceph Billing SKU Details**

SKU	Description	Term	Unit of Measure
<b>Dedicated &amp; Multi-Tenant</b>			
RS00291	Red Hat Ceph Storage, Diagnostic Support (Up to 1PB, Usable Storage, Yearly)	ANNUAL	STORAGE BAND
RS00291MO	Red Hat Ceph Storage, Diagnostic Support (Up to 1PB, Usable Storage, Monthly)	MONTH	STORAGE BAND
RS00292	Red Hat Ceph Storage, Diagnostic Support (Up to 1.2 PB, Usable Storage, Yearly)	ANNUAL	STORAGE BAND
RS00292MO	Red Hat Ceph Storage, Diagnostic Support (Up to 1.2 PB, Usable Storage, Monthly)	MONTH	STORAGE BAND
RS00293	Red Hat Ceph Storage, Diagnostic Support (Up to 1.4 PB, Usable Storage, Yearly)	ANNUAL	STORAGE BAND

SKU	Description	Term	Unit of Measure
RS00293MO	Red Hat Ceph Storage, Diagnostic Support (Up to 1.4 PB, Usable Storage, Monthly)	MONTH	STORAGE BAND
RS00294	Red Hat Ceph Storage, Diagnostic Support (Up to 1.6 PB, Usable Storage, Yearly)	ANNUAL	STORAGE BAND
RS00294MO	Red Hat Ceph Storage, Diagnostic Support (Up to 1.6 PB, Usable Storage, Monthly)	MONTH	STORAGE BAND
RS00295	Red Hat Ceph Storage, Diagnostic Support (Up to 1.8 PB, Usable Storage, Yearly)	ANNUAL	STORAGE BAND
RS00295MO	Red Hat Ceph Storage, Diagnostic Support (Up to 1.8 PB, Usable Storage, Monthly)	MONTH	STORAGE BAND
RS00296	Red Hat Ceph Storage, Full Support (Up to 1PB, Usable Storage, Yearly)	ANNUAL	STORAGE BAND
RS00296MO	Red Hat Ceph Storage, Full Support (Up to 1PB, Usable Storage, Monthly)	MONTH	STORAGE BAND
RS00297	Red Hat Ceph Storage, Full Support (Up to 1.2 PB, Usable Storage, Yearly)	ANNUAL	STORAGE BAND
RS00297MO	Red Hat Ceph Storage, Full Support (Up to 1.2 PB, Usable Storage, Monthly)	MONTH	STORAGE BAND
RS00298	Red Hat Ceph Storage, Full Support (Up to 1.4 PB, Usable Storage, Yearly)	ANNUAL	STORAGE BAND
RS00298MO	Red Hat Ceph Storage, Full Support (Up to 1.4 PB, Usable Storage, Monthly)	MONTH	STORAGE BAND
RS00299	Red Hat Ceph Storage, Full Support (Up to 1.6 PB, Usable Storage, Yearly)	ANNUAL	STORAGE BAND
RS00299MO	Red Hat Ceph Storage, Full Support (Up to 1.6 PB, Usable Storage, Monthly)	MONTH	STORAGE BAND
RS00300	Red Hat Ceph Storage, Full Support (Up to 1.8 PB, Usable Storage, Yearly)	ANNUAL	STORAGE BAND
RS00300MO	Red Hat Ceph Storage, Full Support (Up to 1.8 PB, Usable Storage, Monthly)	MONTH	STORAGE BAND

**Table 51. General Purpose 1 PB minimum Ceph Billing SKU Details**

SKU	Description	Term	Unit of Measure
RS00281	Red Hat Ceph Storage (Object storage only, backup and archival use only), Diagnostic Support (Up to 5 PB, Raw Storage, Yearly)	ANNUAL	STORAGE BAND



SKU	Description	Term	Unit of Measure
RS00281MO	Red Hat Ceph Storage (Object storage only, backup and archival use only), Diagnostic Support (Up to 5 PB, Raw Storage, Monthly)	MONTH	STORAGE BAND
RS00282	Red Hat Ceph Storage (Object storage only, backup and archival use only), Diagnostic Support (Up to 6 PB, Raw Storage, Yearly)	ANNUAL	STORAGE BAND
RS00282MO	Red Hat Ceph Storage (Object storage only, backup and archival use only), Diagnostic Support (Up to 6 PB, Raw Storage, Monthly)	MONTH	STORAGE BAND
RS00283	Red Hat Ceph Storage (Object storage only, backup and archival use only), Diagnostic Support (Up to 7 PB, Raw Storage, Yearly)	ANNUAL	STORAGE BAND
RS00283MO	Red Hat Ceph Storage (Object storage only, backup and archival use only), Diagnostic Support (Up to 7 PB, Raw Storage, Monthly)	MONTH	STORAGE BAND
RS00284	Red Hat Ceph Storage (Object storage only, backup and archival use only), Diagnostic Support (Up to 8 PB, Raw Storage, Yearly)	ANNUAL	STORAGE BAND
RS00284MO	Red Hat Ceph Storage (Object storage only, backup and archival use only), Diagnostic Support (Up to 8 PB, Raw Storage, Monthly)	MONTH	STORAGE BAND
RS00285	Red Hat Ceph Storage (Object storage only, backup and archival use only), Diagnostic Support (Up to 9 PB, Raw Storage, Yearly)	ANNUAL	STORAGE BAND
RS00285MO	Red Hat Ceph Storage (Object storage only, backup and archival use only), Diagnostic Support (Up to 9 PB, Raw Storage, Monthly)	MONTH	STORAGE BAND
RS00286	Red Hat Ceph Storage (Object storage only, backup and archival use only), Full Support (Up to 5 PB, Raw Storage, Yearly)	ANNUAL	STORAGE BAND
RS00286MO	Red Hat Ceph Storage (Object storage only, backup and archival use only), Full Support (Up to 5 PB, Raw Storage, Monthly)	MONTH	STORAGE BAND
RS00287	Red Hat Ceph Storage (Object storage only, backup and archival use only), Full Support (Up to 6 PB, Raw Storage, Yearly)	ANNUAL	STORAGE BAND
RS00287MO	Red Hat Ceph Storage (Object storage only, backup and archival use only), Full Support (Up to 6 PB, Raw Storage, Monthly)	MONTH	STORAGE BAND

SKU	Description	Term	Unit of Measure
RS00288	Red Hat Ceph Storage (Object storage only, backup and archival use only), Full Support (Up to 7 PB, Raw Storage, Yearly)	ANNUAL	STORAGE BAND
RS00288MO	Red Hat Ceph Storage (Object storage only, backup and archival use only), Full Support (Up to 7 PB, Raw Storage, Monthly)	MONTH	STORAGE BAND
RS00289	Red Hat Ceph Storage (Object storage only, backup and archival use only), Full Support (Up to 8 PB, Raw Storage, Yearly)	ANNUAL	STORAGE BAND
RS00289MO	Red Hat Ceph Storage (Object storage only, backup and archival use only), Full Support (Up to 8 PB, Raw Storage, Monthly)	MONTH	STORAGE BAND
RS00290	Red Hat Ceph Storage (Object storage only, backup and archival use only), Full Support (Up to 9 PB, Raw Storage, Yearly)	ANNUAL	STORAGE BAND
RS00290MO	Red Hat Ceph Storage (Object storage only, backup and archival use only), Full Support (Up to 9 PB, Raw Storage, Monthly)	MONTH	STORAGE BAND

**Table 52. Backup/Archive Object Only 5 PB minimum Ceph Billing SKU Details**

#### 6.4.2.2. Red Hat Ceph Storage Use Case Examples

**Notes:**

- Red Hat Ceph Storage pricing is based on the amount of storage being managed (raw storage capacity, usable storage capacity, raw storage used). There is no cost for the Ceph servers that makeup the storage cluster.
- Conversion from PB or TB to GB is done at a decimal basis (1PB = 1000TB, 1TB = 1000GB).
- Partners needing less than 1 PB of Ceph storage should use the older (RH00090MO-RH00096MO & RS00099MO) SKUs.
- For Storage as a Service and general storage service use cases
  - Storing **any type of data** (file, block, object) from any type of storage (NAS, SAN, HCI, etc) is allowed.
  - Storage consumption is measured based upon Usable Storage Capacity.
  - Minimum commitment is 1 PB for 1 Year.
- For Backup/Archive service use cases
  - Storing **ONLY S3 object data** (no file or block) from backup applications (Spectrum Protect, Netbackup, Commvault, Veeam, etc) is allowed.
  - Storage consumption is measured based upon Raw Storage Capacity.
  - The Backup Storage as Service Ceph Cluster capacity cannot be used for any other purpose or applications.
  - Minimum commitment is 5 PB for 1 Year

### Example 1 - General Storage Service

CCSP partner offering a dedicated Ceph storage cluster to a single customer with annual pricing

- **Graphic A** Partner providing 2PB of Ceph usable storage capacity for general Storage as as Service use cases, dedicated to a single customer (customer A).
  - Red Hat Ceph Storage consumption reported = 2x RS00296

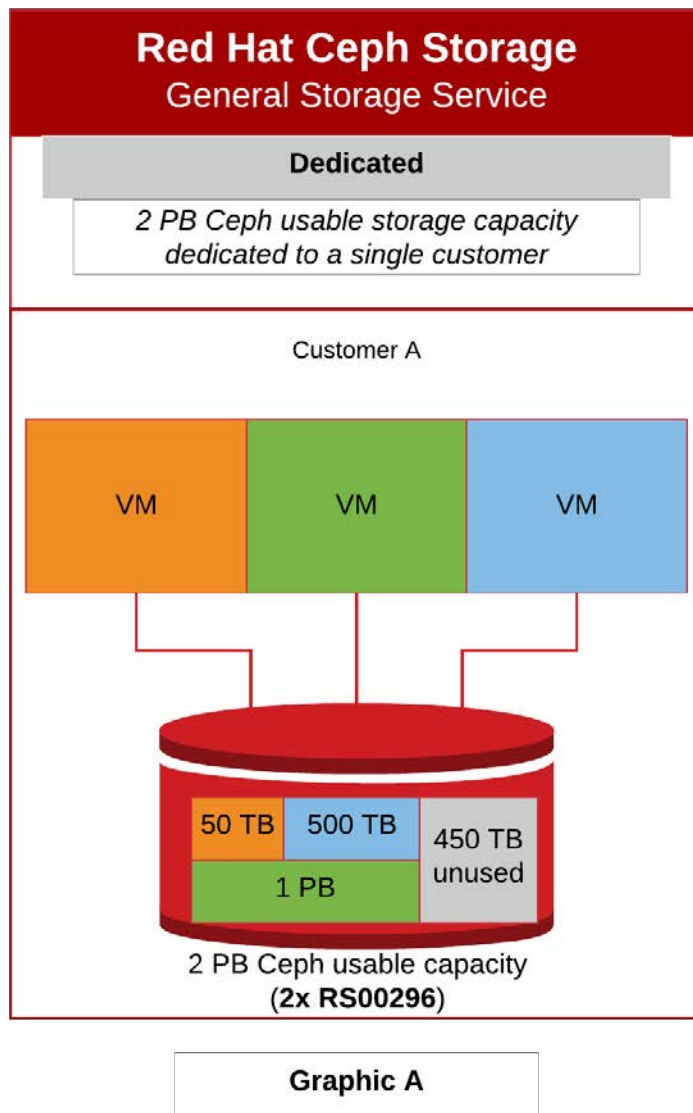

Figure 22. Red Hat Ceph Storage General Storage Service Use Case Example 1

### Example 2 - Backup/Archive Service using only Object data

CCSP partner offering Backup/Archive service to multiple customers with monthly pricing.

• **Graphic B** Partner would report:

- 1 PB raw storage capacity for Customer A
- 3 PB raw storage capacity for Customer B
- 4 PB raw storage capacity for Customer C
  - Total raw storage capacity = 8 PB
  - Red Hat Ceph Storage consumption reported = 1x RS00284MO

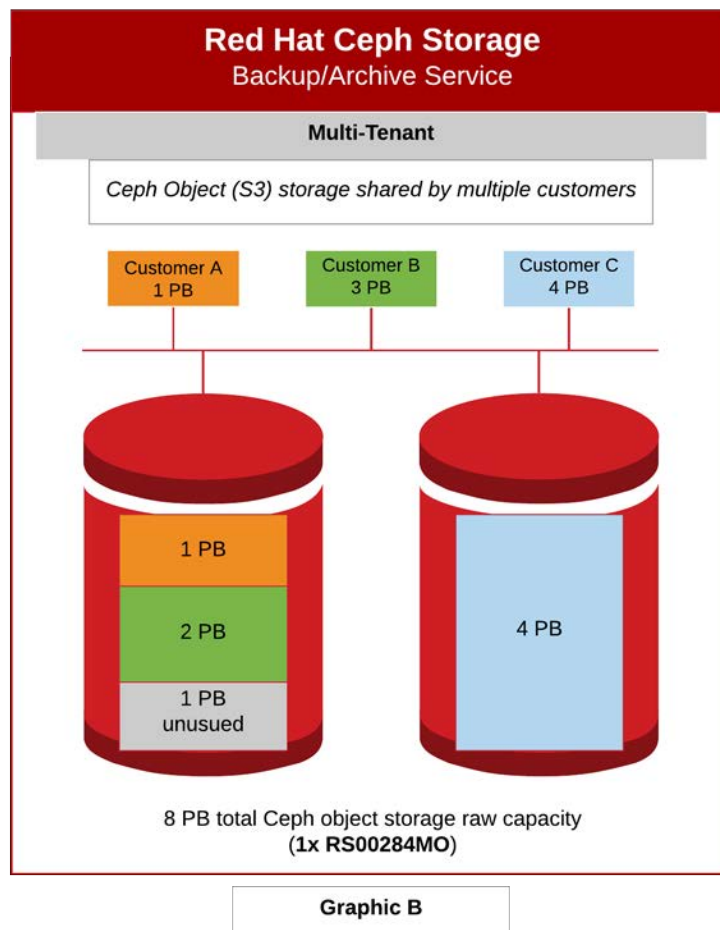

Figure 23. Red Hat Ceph Storage Backup/Archive Service Use Case Example 2

## 6.4.3. Red Hat OpenShift Container Storage

### 6.4.3.1. Billing SKUs

SKU	Description	Term	Unit of Measure
<b>Dedicated &amp; Multi-Tenant</b>			
RS00279HR	Red Hat OpenShift Container Storage, Diagnostic Support (2 Cores, Hourly)	HOUR	Core Band
RS00190MO	Red Hat OpenShift Container Storage, Diagnostic Support (2 Cores, Monthly)	MONTH	Core Band
RS00207	Red Hat OpenShift Container Storage, Diagnostic Support (2 Cores, Yearly)	ANNUAL	Core Band
RS00208F3	Red Hat OpenShift Container Storage, Diagnostic Support (2 Cores, 3 Years)	3 - YEAR	Core Band
RS00206MO	Red Hat OpenShift Container Storage, Full Support (2 Cores, Monthly)	MONTH	Core Band
RS00191	Red Hat OpenShift Container Storage, Full Support (2 Cores, Yearly)	ANNUAL	Core Band
RS00191F3	Red Hat OpenShift Container Storage, Full Support (2 Cores, 3 Years)	3 - YEAR	Core Band
RS00280HR	Red Hat OpenShift Container Storage, Full Support (2 Cores, Hourly)	HOUR	Core Band

**Table 53. Red Hat OpenShift Container Storage Billing SKU Details**

#### Notes:

- Red Hat OpenShift Container Storage 4
  - OCS 4.x is built on a new technology stack that includes Red Hat Ceph Storage, the Rook.io Operator, and NooBaa's Multi-Cloud Object Gateway technology.
  - OpenShift Nodes that run other workloads in addition to storage workloads require both Red Hat OpenShift Container Storage and Red Hat OpenShift Container Platform subscriptions.
  - OCS Internal/Converged Mode
    - OCS is deployed inside the OpenShift cluster
    - OpenShift worker nodes can be dedicated to OCS or shared with applications
    - Optimized for simplicity of management
  - OCS External/Independent Mode (only available with OCS v4.5 and higher)
    - OCS is deployed outside the OpenShift cluster
    - External storage cluster can be OCS or Red Hat Ceph Storage (see Red Hat OpenShift Container Storage for Sharing External Storage Add-on details)
    - Optimized for shared storage across multiple Red Hat OpenShift Container Platform clusters.

### 6.4.3.2. Red Hat OpenShift Container Storage Use Case Examples



In addition to the required Red Hat OpenShift Container Storage subscriptions, the required Red Hat OpenShift Container Platform subscriptions are not depicted in these examples.

#### Example 1

Red Hat OpenShift Container Storage (Internal Mode) deployed on top of Red Hat OpenShift Container Platform providing **persistent storage to a single OpenShift worker node** hosting applications dedicated to a single customer with **monthly pricing**.

- 1 OpenShift worker node with access to OCS persistent storage hosting a single customer's applications
  - OCP node: 2 Cores or 4 vCPU = 1x RS00190MO
  - Total Red Hat OpenShift Container Storage consumption reported = 1x RS00190MO

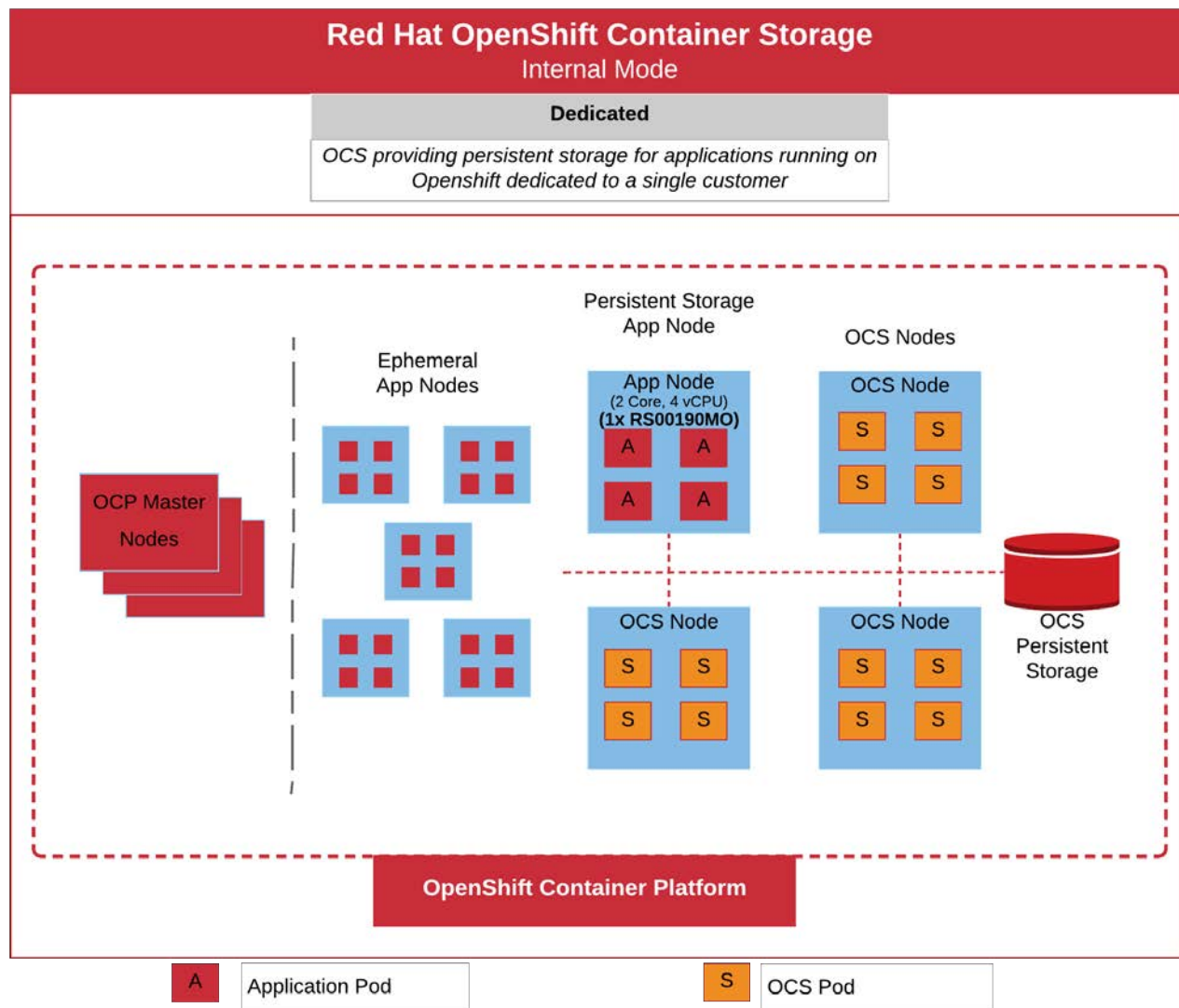

Figure 24. Red Hat OpenShift Container Storage Dedicated Use Case Example

### Example 2

Red Hat OpenShift Container Storage (External Mode) deployed outside of Red Hat OpenShift Container Platform providing **persistent storage to a single OpenShift cluster** with multiple worker nodes hosting applications for multiple customers with **hourly pricing**.

- External OCS storage cluster providing persistent storage to 2 OpenShift worker nodes hosting multiple customer applications.
  - OCP node 1: 2 Cores or 4 vCPU = 1x RS00279HR
  - OCP node 2: 8 Cores or 16 vCPU = 4x RS00279HR
  - Total Red Hat OpenShift Container Storage consumption reported = 5x RS00279HR

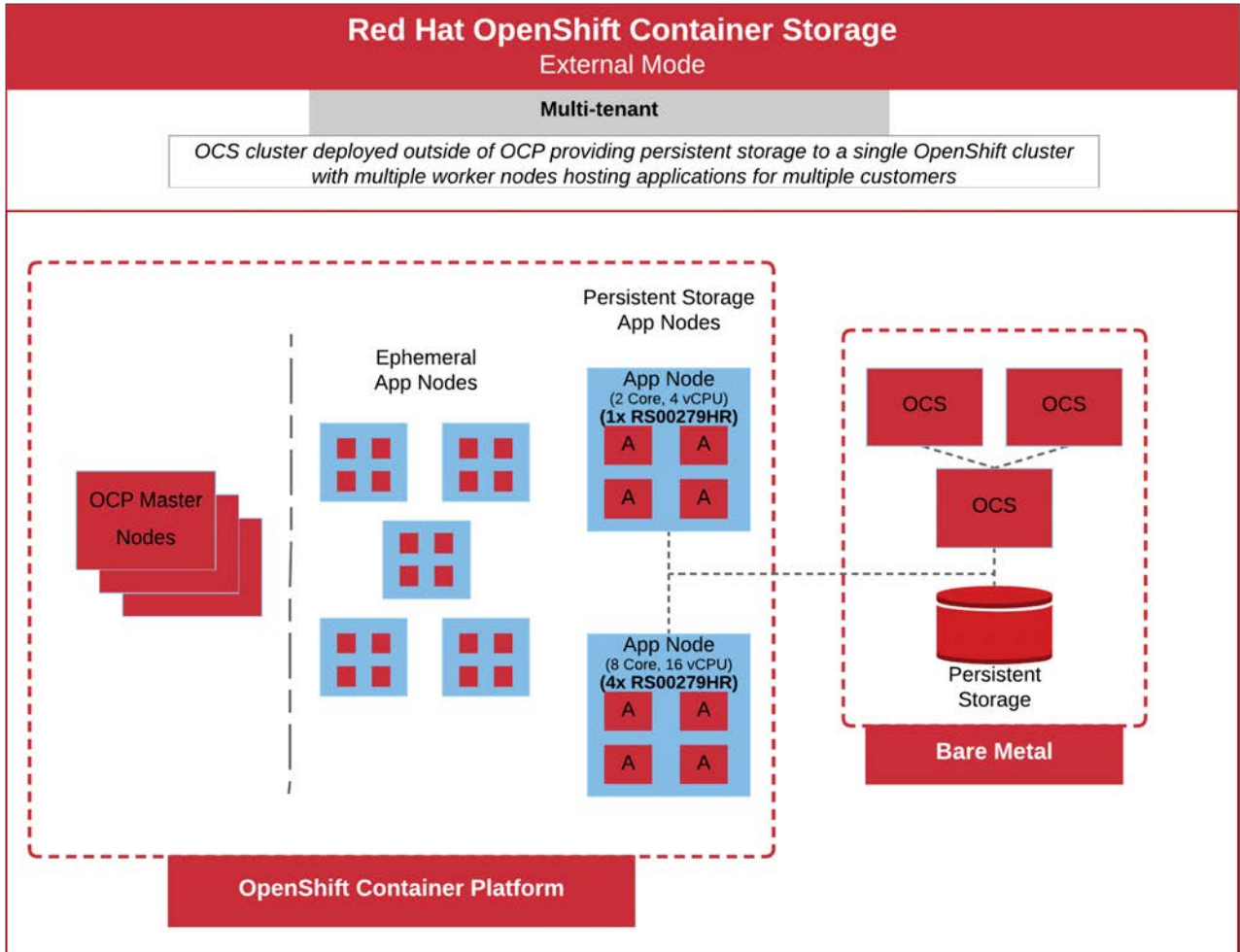

Figure 25. Red Hat OpenShift Container Storage Multi-tenant Use Case Example



## 6.4.4. Red Hat OpenShift Container Storage for Sharing External Storage Add-on

### 6.4.4.1. Billing SKUs

SKU	Description	Term	Unit of Measure
<b>Dedicated &amp; Multi-Tenant</b>			
RS00309HR	Red Hat OpenShift Container Storage add-on for Sharing External Storage, Diagnostic Support (2 Cores, Hourly)	HOUR	Physical Node or Virtual Node
RS00309MO	Red Hat OpenShift Container Storage add-on for Sharing External Storage, Diagnostic Support (2 Cores, Monthly)	MONTH	Physical Node or Virtual Node
RS00309	Red Hat OpenShift Container Storage add-on for Sharing External Storage, Diagnostic Support (2 Cores, Yearly)	ANNUAL	Physical Node or Virtual Node
RS00309F3	Red Hat OpenShift Container Storage add-on for Sharing External Storage, Diagnostic Support (2 Cores, 3 Years)	3 - Year	Physical Node or Virtual Node
RS00310HR	Red Hat OpenShift Container Storage add-on for Sharing External Storage, Full Support (2 Cores, Hourly)	HOUR	Physical Node or Virtual Node
RS00310MO	Red Hat OpenShift Container Storage add-on for Sharing External Storage, Full Support (2 Cores, Monthly)	MONTH	Physical Node or Virtual Node
RS00310	Red Hat OpenShift Container Storage add-on for Sharing External Storage, Full Support (2 Cores, Yearly)	ANNUAL	Physical Node or Virtual Node
RS00310F3	Red Hat OpenShift Container Storage add-on for Sharing External Storage, Full Support (2 Cores, 3 Years)	3 - Year	Physical Node or Virtual Node

Table 54. Red Hat OpenShift Container Storage for Sharing External Storage Add-on Billing SKU Details

#### Notes:

- Red Hat OpenShift Container Storage for Sharing External Storage Add-on SKUs are **required** for worker nodes in **new** OpenShift clusters that need access to the RHCS or shared OCS external clusters.
- Red Hat OpenShift Container Storage for Sharing External Storage Add-on SKUs are **not required** for the **original** OpenShift cluster worker nodes that were deployed at the same time as the OCS external cluster.

### 6.4.4.2. Red Hat OpenShift Container Storage for Sharing External Storage Add-on Use Case Examples



In addition to the required Red Hat OpenShift Container Storage for Sharing External Storage Add-on subscriptions, the required Red Hat OpenShift Container Storage and Red Hat OpenShift Container Platform subscriptions are not depicted in these examples.

### Example 1

Existing Red Hat Ceph Storage cluster providing persistent storage to **multiple OpenShift worker nodes** hosting applications for multiple customers with **Hourly pricing**.

- External Ceph storage cluster providing persistent storage to 2 OpenShift worker nodes hosting multiple customer applications.
  - OCP node 1: 2 Cores or 4 vCPU = 1x RS00309HR
  - OCP node 2: 8 Cores or 16 vCPU = 4x RS00309HR
  - Total Red Hat OpenShift Container Storage for Sharing External Storage Add-on consumption reported = 5x RS00309HR

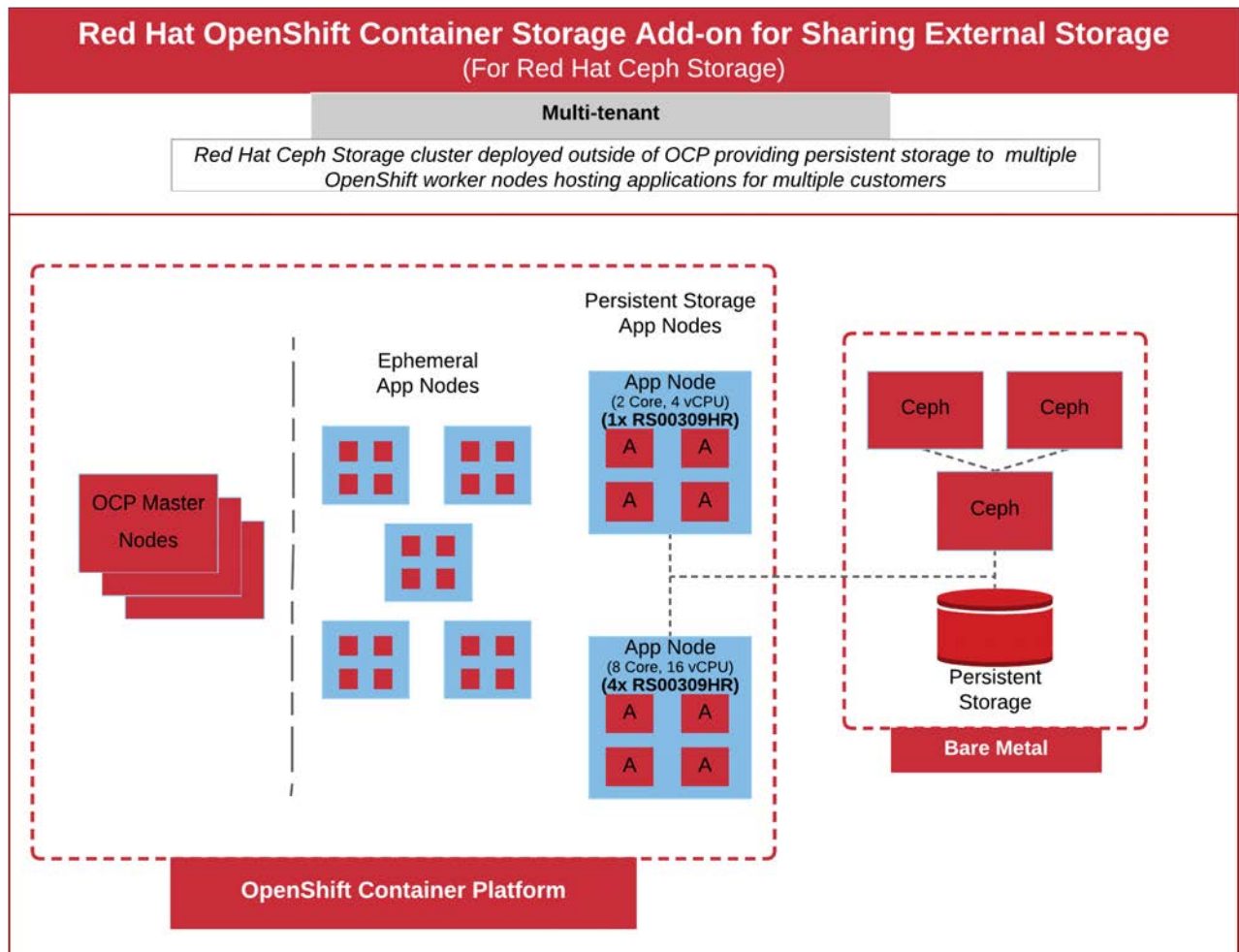

Figure 26. Red Hat OpenShift Container Storage for Sharing External Storage Add-on Multi-tenant Use Case Example

## Example 2

Existing Red Hat OpenShift Container Storage cluster deployed outside of Red Hat OpenShift Container Platform providing persistent storage to multiple (1 existing and 2 new) OpenShift worker nodes across multiple OpenShift clusters hosting applications for multiple customers with **Hourly pricing**.

- External OCS storage cluster providing persistent storage to 5 OpenShift worker nodes across 3 OpenShift clusters. OCS Add-on SKUs only required for the worker nodes in the **new** OCP clusters.
  - New OCP Cluster 1
    - OCP node 1: 2 Cores or 4 vCPU = 1x RS00309HR
    - OCP node 2: 2 Cores or 4 vCPU = 1x RS00309HR
  - New OCP Cluster 2
    - OCP node 1: 8 Cores or 16 vCPU = 4x RS00309HR
  - Total Red Hat OpenShift Container Storage for Sharing External Storage Add-on consumption reported = 6x RS00309HR

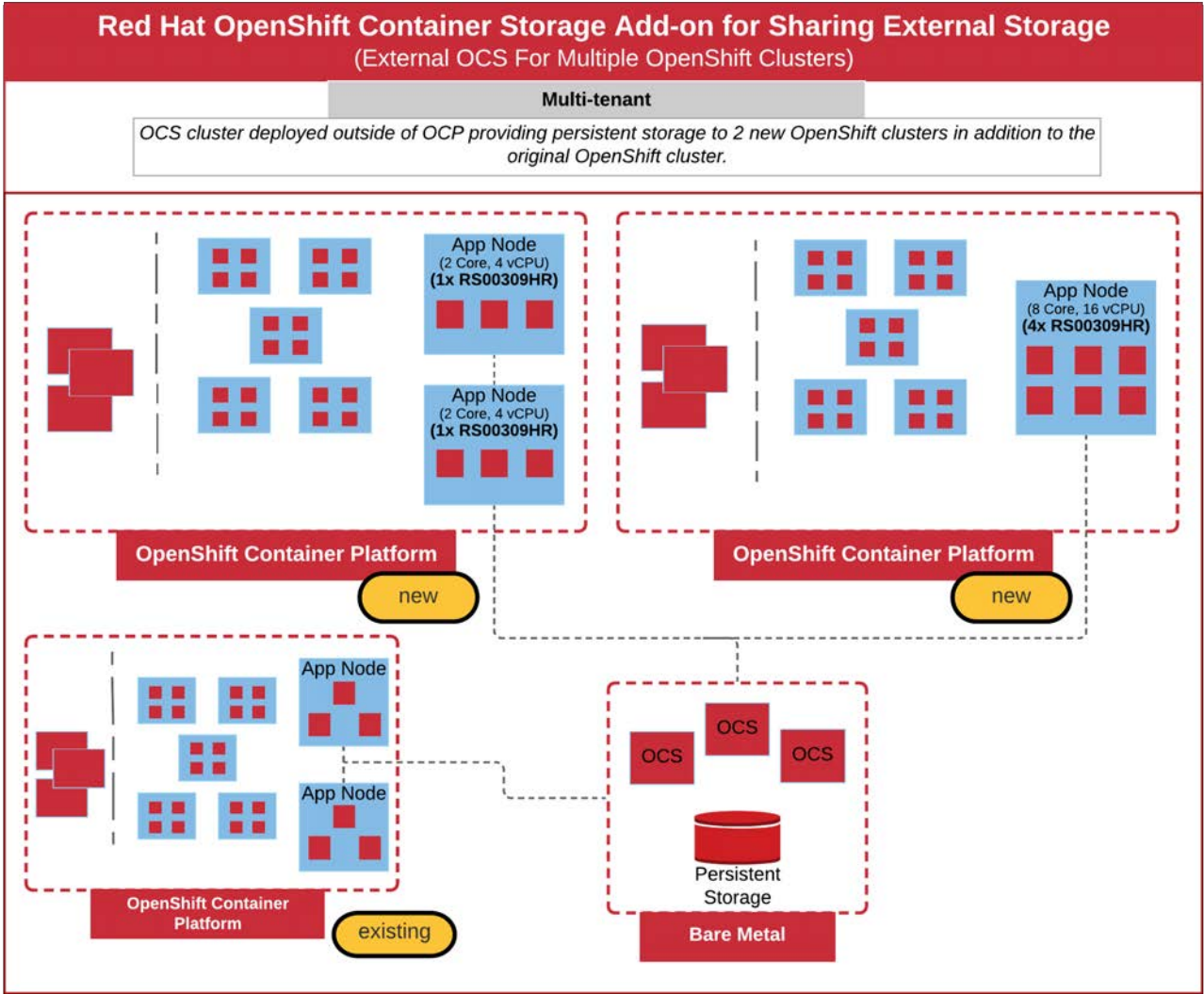

Figure 27. Red Hat OpenShift Container Storage for Sharing External Storage Add-on Multi-tenant Use Case Example

## 6.5. SAP

### 6.5.1. Red Hat Enterprise Linux for SAP Applications

#### 6.5.1.1. Billing SKUs

SKU	Description	Term	Unit of Measure
<b>Dedicated</b>			
<b>RH00538</b>	Red Hat Enterprise Linux for SAP Applications for Service Providers, Full Support (Physical or Virtual Nodes, Dedicated, Yearly)	ANNUAL	Socket-Pair
<b>RH00538MO</b>	Red Hat Enterprise Linux for SAP Applications for Service Providers, Full Support (Physical or Virtual Nodes, Dedicated, Monthly)	MONTH	Socket-Pair
<b>RH00538F3</b>	Red Hat Enterprise Linux for SAP Applications for Service Providers, Full Support (Physical or Virtual Nodes, Dedicated, 3 Years)	3 - Year	Socket-Pair
<b>RH00539</b>	Red Hat Enterprise Linux for Virtual Datacenters for SAP Applications for Service Providers, Full Support (Dedicated, Yearly)	ANNUAL	Socket-Pair
<b>RH00539MO</b>	Red Hat Enterprise Linux for Virtual Datacenters for SAP Applications for Service Providers, Full Support (Dedicated, Monthly)	MONTH	Socket-Pair
<b>RH00539F3</b>	Red Hat Enterprise Linux for Virtual Datacenters for SAP Applications for Service Providers, Full Support (Dedicated, 3 Years)	3 - Year	Socket-Pair
<b>RH00536</b>	Red Hat Enterprise Linux for SAP Applications for Service Providers, Diagnostic Support (Physical or Virtual Nodes, Dedicated, Yearly)	ANNUAL	Socket-Pair
<b>RH00536MO</b>	Red Hat Enterprise Linux for SAP Applications for Service Providers, Diagnostic Support (Physical or Virtual Nodes, Dedicated, Monthly)	MONTH	Socket-Pair
<b>RH00536F3</b>	Red Hat Enterprise Linux for SAP Applications for Service Providers, Diagnostic Support (Physical or Virtual Nodes, Dedicated, 3 Years)	3 - Year	Socket-Pair
<b>RH00537</b>	Red Hat Enterprise Linux for Virtual Datacenters for SAP Applications for Service Providers, Diagnostic Support (Dedicated, Yearly)	ANNUAL	Socket-Pair
<b>RH00537MO</b>	Red Hat Enterprise Linux for Virtual Datacenters for SAP Applications for Service Providers, Diagnostic Support (Dedicated, Monthly)	MONTH	Socket-Pair

SKU	Description	Term	Unit of Measure
RH00537F3	Red Hat Enterprise Linux for Virtual Datacenters for SAP Applications for Service Providers, Diagnostic Support (Dedicated, 3 Years)	3 - Year	Socket-Pair
<b>Multi-Tenant</b>			
RH00622	Red Hat Enterprise Linux for SAP Applications, Diagnostic Support (Large Virtual Guest, Multi-Tenant, Yearly)	ANNUAL	Virtual Guest
RH00623	Red Hat Enterprise Linux for SAP Applications, Diagnostic Support (Small Virtual Guest, Multi-Tenant, Yearly)	ANNUAL	Virtual Guest
RH00622MO	Red Hat Enterprise Linux for SAP Applications, Diagnostic Support (Large Virtual Guest, Multi-Tenant, Monthly)	MONTH	Virtual Guest
RH00623MO	Red Hat Enterprise Linux for SAP Applications, Diagnostic Support (Small Virtual Guest, Multi-Tenant, Monthly)	MONTH	Virtual Guest
RH00622HR	Red Hat Enterprise Linux for SAP Applications, Diagnostic Support (Large Virtual Guest, Multi-Tenant, Hourly)	HOUR	Virtual Guest
RH00623HR	Red Hat Enterprise Linux for SAP Applications, Diagnostic Support (Small Virtual Guest, Multi-Tenant, Hourly)	HOUR	Virtual Guest

**Table 55. Red Hat Enterprise Linux for SAP Applications Billing SKU Details**

### 6.5.1.2. Red Hat Enterprise Linux for SAP Applications Use Case Examples

#### Example 1

CCSP partner offering Red Hat Enterprise Linux for SAP Applications in both dedicated and multi-tenant environments.

- **Graphic A** Dedicated Red Hat Enterprise Linux for SAP Applications environment with unlimited Red Hat Enterprise Linux VMs for Customer A
- **Graphic B** Red Hat Enterprise Linux for SAP Applications infrastructure shared by multiple customers:
  - 3 large Red Hat Enterprise Linux VMs for Customer B
  - 4 small Red Hat Enterprise Linux VMs for Customer C

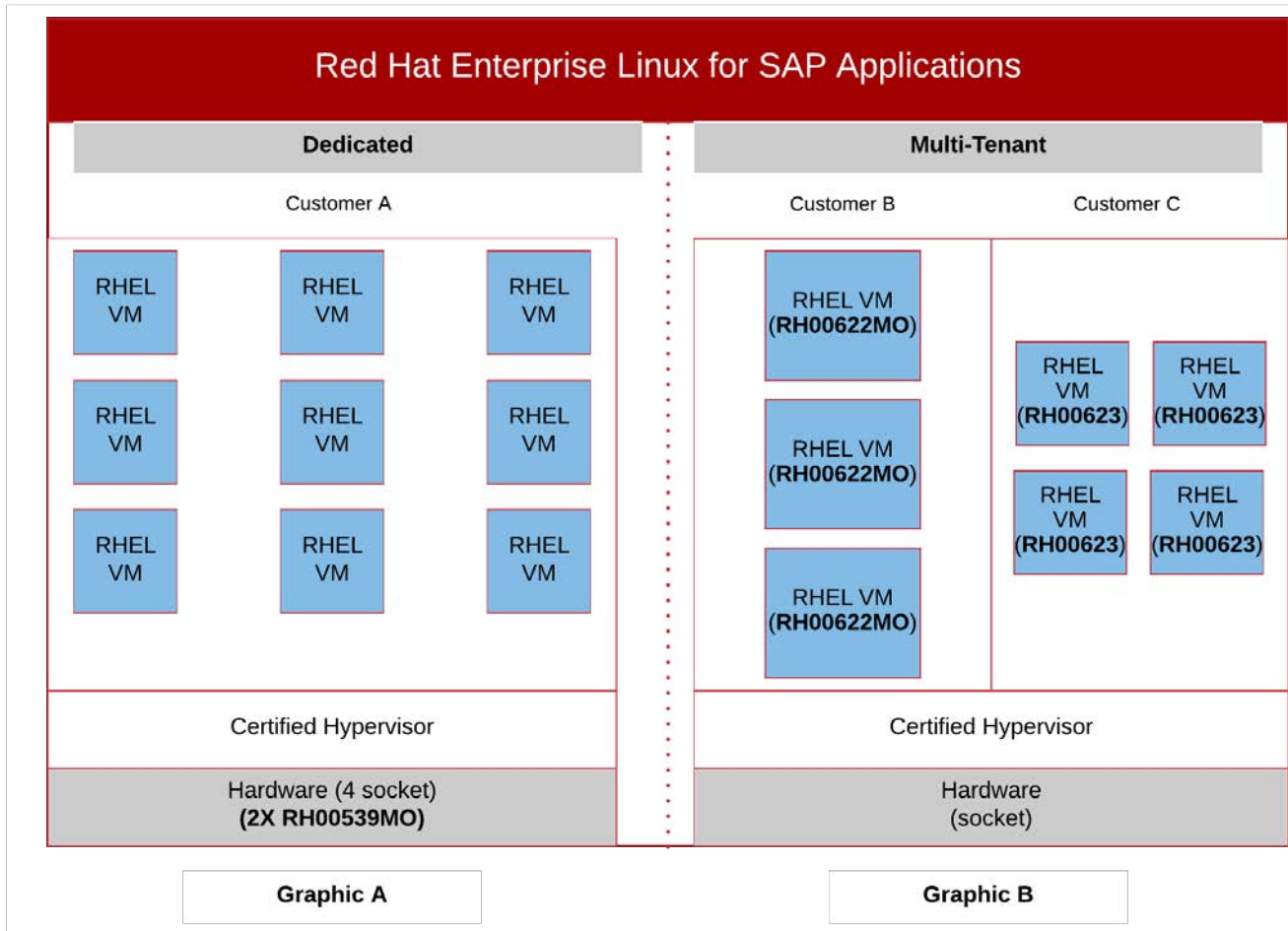

Figure 28. Red Hat Enterprise Linux for SAP Applications Use Case Example 1

## 6.5.2. Red Hat Enterprise Linux for SAP Applications for Power

### 6.5.2.1. Billing SKUs

SKU	Description	Term	Unit of Measure
<b>Dedicated</b>			
<b>RH01947F3</b>	Red Hat Enterprise Linux for SAP Applications for Power, LE, Diagnostic Support (4 Cores, Up to 4 LPARs, Dedicated, 3 Years)	3 - Year	Physical Node or Virtual Node
<b>RH01947</b>	Red Hat Enterprise Linux for SAP Applications for Power, LE, Diagnostic Support (4 Cores, Up to 4 LPARs, Dedicated, Yearly)	ANNUAL	Physical Node or Virtual Node
<b>RH01947MO</b>	Red Hat Enterprise Linux for SAP Applications for Power, LE, Diagnostic Support (4 Cores, Up to 4 LPARs, Dedicated, Monthly)	MONTH	Physical Node or Virtual Node
<b>RH01948F3</b>	Red Hat Enterprise Linux for SAP Applications for Power, LE, Full Support (4 Cores, Up to 4 LPARs, Dedicated, 3 Years)	3 - Year	Physical Node or Virtual Node
<b>RH01948</b>	Red Hat Enterprise Linux for SAP Applications for Power, LE, Full Support (4 Cores, Up to 4 LPARs, Dedicated, Yearly)	ANNUAL	Physical Node or Virtual Node
<b>RH01948MO</b>	Red Hat Enterprise Linux for SAP Applications for Power, LE, Full Support (4 Cores, Up to 4 LPARs, Dedicated, Monthly)	MONTH	Physical Node or Virtual Node

**Table 56. Red Hat Enterprise Linux for SAP Applications for Power Billing SKU Details**

#### Notes:

- Red Hat Enterprise Linux for SAP Applications for Power in the CCSP program is only available for IBM Power LE hardware

### 6.5.2.2. Red Hat Enterprise Linux for SAP Applications for Power Use Case Examples

#### Example 1

CCSP partner offering Red Hat Enterprise Linux for SAP Applications for Power in dedicated environments.

- Red Hat Enterprise Linux for SAP Applications for Power environment dedicated to a single customer running 6 RHEL LPARs across 4 IFL cores with Monthly pricing.



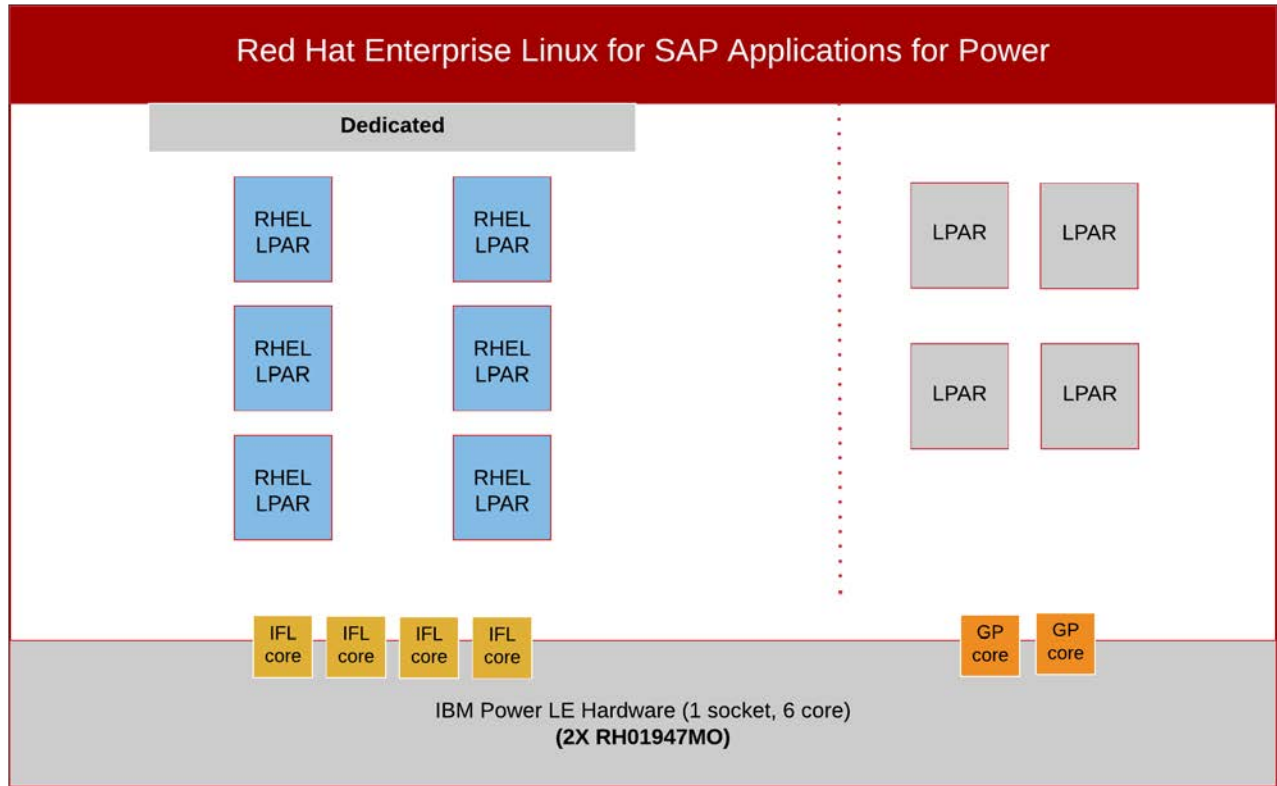

*Figure 29. Red Hat Enterprise Linux for SAP Applications for Power Use Case Example 1*

## 6.5.3. Red Hat Enterprise Linux for SAP with HA & Update Services

### 6.5.3.1. Billing SKUs

SKU	Description	Term	Unit of Measure
<b>Dedicated</b>			
<b>RH01894MO</b>	Red Hat Enterprise Linux for SAP with High Availability and Update Services, Full Support (Physical or Virtual Nodes, Dedicated, Monthly)	MONTH	Socket-Pair
<b>RH01894</b>	Red Hat Enterprise Linux for SAP with High Availability and Update Services, Full Support (Physical or Virtual Nodes, Dedicated, Yearly)"	ANNUAL	Socket-Pair
<b>RH01894F3</b>	Red Hat Enterprise Linux for SAP with High Availability and Update Services, Full Support (Physical or Virtual Nodes, Dedicated, 3 Years)	3 - Year	Socket-Pair
<b>RH01895MO</b>	Red Hat Enterprise Linux for Virtual Datacenters for SAP with High Availability and Update Services, Full Support (Dedicated, Monthly)	MONTH	Socket-Pair
<b>RH01895</b>	Red Hat Enterprise Linux for Virtual Datacenters for SAP with High Availability and Update Services, Full Support (Dedicated, Yearly)	ANNUAL	Socket-Pair
<b>RH01895F3</b>	Red Hat Enterprise Linux for Virtual Datacenters for SAP with High Availability and Update Services, Full Support (Dedicated, 3 Years)	3 - Year	Socket-Pair
<b>RH01896MO</b>	Red Hat Enterprise Linux for SAP with High Availability and Update Services, Diagnostic Support (Physical or Virtual Nodes, Dedicated, Monthly)	MONTH	Socket-Pair
<b>RH01896</b>	Red Hat Enterprise Linux for SAP with High Availability and Update Services, Diagnostic Support (Physical or Virtual Nodes, Dedicated, Yearly)	ANNUAL	Socket-Pair
<b>RH01896F3</b>	Red Hat Enterprise Linux for SAP with High Availability and Update Services, Diagnostic Support (Physical or Virtual Nodes, Dedicated, 3 Years)	3 - Year	Socket-Pair
<b>RH01897MO</b>	Red Hat Enterprise Linux for Virtual Datacenters for SAP with High Availability and Update Services, Diagnostic Support (Dedicated, Monthly)	MONTH	Socket-Pair
<b>RH01897</b>	Red Hat Enterprise Linux for Virtual Datacenters for SAP with High Availability and Update Services, Diagnostic Support (Dedicated, Yearly)	ANNUAL	Socket-Pair
<b>RH01897F3</b>	Red Hat Enterprise Linux for Virtual Datacenters for SAP with High Availability and Update Services, Diagnostic Support (Dedicated, 3 Years)	3 - Year	Socket-Pair

SKU	Description	Term	Unit of Measure
<b>Multi-Tenant</b>			
<b>RH00806HR</b>	Red Hat Enterprise Linux for SAP with High Availability and Update Services, Full Support (Large Virtual Guest, Multi-Tenant, Hourly)	HOUR	Virtual Guest
<b>RH00806MO</b>	Red Hat Enterprise Linux for SAP with High Availability and Update Services, Full Support (Large Virtual Guest, Multi-Tenant, Monthly)	MONTH	Virtual Guest
<b>RH00806</b>	Red Hat Enterprise Linux for SAP with High Availability and Update Services, Full Support (Large Virtual Guest, Multi-Tenant, Yearly)	ANNUAL	Virtual Guest
<b>RH00806F3</b>	Red Hat Enterprise Linux for SAP with High Availability and Update Services, Full Support (Large Virtual Guest, Multi-Tenant, 3 Years)	3 - Year	Virtual Guest
<b>RH00807HR</b>	Red Hat Enterprise Linux for SAP with High Availability and Update Services, Full Support (Small Virtual Guest, Multi-Tenant, Hourly)	HOUR	Virtual Guest
<b>RH00807MO</b>	Red Hat Enterprise Linux for SAP with High Availability and Update Services, Full Support (Small Virtual Guest, Multi-Tenant, Monthly)	MONTH	Virtual Guest
<b>RH00807</b>	Red Hat Enterprise Linux for SAP with High Availability and Update Services, Full Support (Small Virtual Guest, Multi-Tenant, Yearly)	ANNUAL	Virtual Guest
<b>RH00807F3</b>	Red Hat Enterprise Linux for SAP with High Availability and Update Services, Full Support (Small Virtual Guest, Multi-Tenant, 3 Years)	3 - Year	Virtual Guest
<b>RH00808HR</b>	Red Hat Enterprise Linux for SAP with High Availability and Update Services, Diagnostic Support (Large Virtual Guest, Multi-Tenant, Hourly)	HOUR	Virtual Guest
<b>RH00808MO</b>	Red Hat Enterprise Linux for SAP with High Availability and Update Services, Diagnostic Support (Large Virtual Guest, Multi-Tenant, Monthly)	MONTH	Virtual Guest
<b>RH00808</b>	Red Hat Enterprise Linux for SAP with High Availability and Update Services, Diagnostic Support (Large Virtual Guest, Multi-Tenant, Yearly)	ANNUAL	Virtual Guest
<b>RH00808F3</b>	Red Hat Enterprise Linux for SAP with High Availability and Update Services, Diagnostic Support (Large Virtual Guest, Multi-Tenant, 3 Years)	3 - Year	Virtual Guest
<b>RH00809HR</b>	Red Hat Enterprise Linux for SAP with High Availability and Update Services, Diagnostic Support (Small Virtual Guest, Multi-Tenant, Hourly)	HOUR	Virtual Guest

SKU	Description	Term	Unit of Measure
RH00809MO	Red Hat Enterprise Linux for SAP with High Availability and Update Services, Diagnostic Support (Small Virtual Guest, Multi-Tenant, Monthly)	MONTH	Virtual Guest
RH00809	Red Hat Enterprise Linux for SAP with High Availability and Update Services, Diagnostic Support (Small Virtual Guest, Multi-Tenant, Yearly)	ANNUAL	Virtual Guest
RH00809F3	Red Hat Enterprise Linux for SAP with High Availability and Update Services, Diagnostic Support (Small Virtual Guest, Multi-Tenant, 3 Years)	3 - Year	Virtual Guest

**Table 57. Red Hat Enterprise Linux for SAP with HA and Update Services Billing SKU Details**

### 6.5.3.2. Red Hat Enterprise Linux for SAP with HA and Update Services Use Case Examples

#### Example 1

CCSP partner offering Red Hat Enterprise Linux for SAP with HA and Update Services in both dedicated and multi-tenant environments.

- **Graphic A** Dedicated Red Hat Enterprise Linux for SAP with HA and Update Services environment with unlimited Red Hat Enterprise Linux VMs for Customer A
- **Graphic B** Red Hat Enterprise Linux for SAP with HA and Update Services infrastructure shared by multiple customers:
  - 6 small Red Hat Enterprise Linux VMs for Customer B
  - 3 large Red Hat Enterprise Linux VMs for Customer C

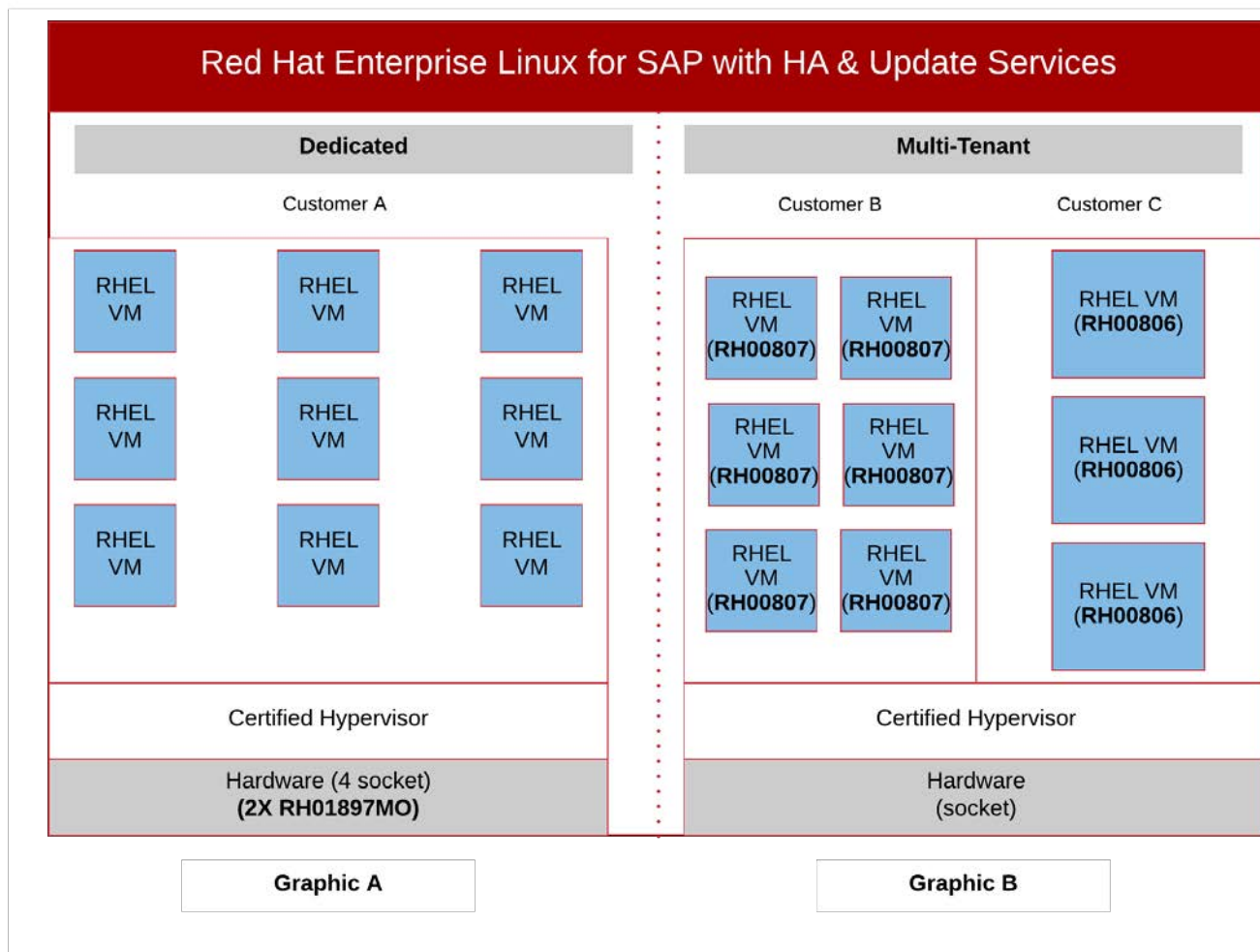

Figure 30. Red Hat Enterprise Linux for SAP with HA and Update Services Use Case Example 1

## 6.5.4. Red Hat Enterprise Linux for SAP with HA & Update Services for Power

### 6.5.4.1. Billing SKUs

SKU	Description	Term	Unit of Measure
<b>Dedicated</b>			
<b>RH01909HR</b>	<b>Red Hat Enterprise Linux for SAP with High Availability and Update Services for Power, LE, Diagnostic Support (4 Cores, Up to 4 LPARs, Dedicated, Hourly)</b>	<b>HOURLY</b>	<b>Physical Node or Virtual Node</b>
<b>RH01909MO</b>	Red Hat Enterprise Linux for SAP with High Availability and Update Services for Power, LE, Diagnostic Support (4 Cores, Up to 4 LPARs, Dedicated, Monthly)	MONTH	Physical Node or Virtual Node
<b>RH01909</b>	Red Hat Enterprise Linux for SAP with High Availability and Update Services for Power, LE, Diagnostic Support (4 Cores, Up to 4 LPARs, Dedicated, Yearly)	ANNUAL	Physical Node or Virtual Node
<b>RH01909F3</b>	Red Hat Enterprise Linux for SAP with High Availability and Update Services for Power, LE, Diagnostic Support (4 Cores, Up to 4 LPARs, Dedicated, 3 Years)	3 - Year	Physical Node or Virtual Node
<b>RH01946HR</b>	<b>Red Hat Enterprise Linux for SAP with High Availability and Update Services for Power, LE, Full Support (4 Cores, Up to 4 LPARs, Dedicated, Hourly)</b>	<b>HOURLY</b>	<b>Physical Node or Virtual Node</b>
<b>RH01946MO</b>	Red Hat Enterprise Linux for SAP with High Availability and Update Services for Power, LE, Full Support (4 Cores, Up to 4 LPARs, Dedicated, Monthly)	MONTH	Physical Node or Virtual Node
<b>RH01946</b>	Red Hat Enterprise Linux for SAP with High Availability and Update Services for Power, LE, Full Support (4 Cores, Up to 4 LPARs, Dedicated, Yearly)	ANNUAL	Physical Node or Virtual Node
<b>RH01946F3</b>	Red Hat Enterprise Linux for SAP with High Availability and Update Services for Power, LE, Full Support (4 Cores, Up to 4 LPARs, Dedicated, 3 Years)	3 - Year	Physical Node or Virtual Node
<b>Multi-Tenant</b>			
<b>RH02225HR</b>	<b>Red Hat Enterprise Linux for SAP with High Availability and Update Services for Power, LE, Full Support (1 Core, Scale out, Multi-tenant, Hourly)</b>	<b>HOURLY</b>	<b>Physical Node or Virtual Node</b>
<b>RH02225MO</b>	<b>Red Hat Enterprise Linux for SAP with High Availability and Update Services for Power, LE, Full Support (1 Core, Scale Out, Multi-tenant, Monthly)</b>	<b>MONTH</b>	<b>Physical Node or Virtual Node</b>
<b>RH02225</b>	<b>Red Hat Enterprise Linux for SAP with High Availability and Update Services for Power, LE, Full Support (1 Core, Scale Out Multi-tenant, Yearly)</b>	<b>ANNUAL</b>	<b>Physical Node or Virtual Node</b>

SKU	Description	Term	Unit of Measure
RH02225F3	Red Hat Enterprise Linux for SAP with High Availability and Update Services for Power, LE, Full Support (1 Core, Scale Out, Multi-tenant, 3 Years)	3 - Year	Physical Node or Virtual Node
RH02226HR	Red Hat Enterprise Linux for SAP with High Availability and Update Services for Power, LE, Diagnostic Support (1 Core, Scale out, Multi-tenant, Hourly)	HOUR	Physical Node or Virtual Node
RH02226MO	Red Hat Enterprise Linux for SAP with High Availability and Update Services for Power, LE, Diagnostic Support (1 Core, Scale Out, Multi-tenant, Monthly)	MONTH	Physical Node or Virtual Node
RH02226	Red Hat Enterprise Linux for SAP with High Availability and Update Services for Power, LE, Diagnostic Support (1 Core, Scale Out Multi-tenant, Yearly)	ANNUAL	Physical Node or Virtual Node
RH02226F3	Red Hat Enterprise Linux for SAP with High Availability and Update Services for Power, LE, Diagnostic Support (1 Core, Scale Out, Multi-tenant, 3 Years)	3 - Year	Physical Node or Virtual Node
RH02227HR	Red Hat Enterprise Linux for SAP with High Availability and Update Services for Power, LE, Full Support (1 Core, Enterprise, Multi-tenant, Hourly)	HOUR	Physical Node or Virtual Node
RH02227MO	Red Hat Enterprise Linux for SAP with High Availability and Update Services for Power, LE, Full Support (1 Core, Enterprise Multi-tenant, Monthly)	MONTH	Physical Node or Virtual Node
RH02227	Red Hat Enterprise Linux for SAP with High Availability and Update Services for Power, LE, Full Support (1 Core, Enterprise Multi-tenant, Yearly)	ANNUAL	Physical Node or Virtual Node
RH02227F3	Red Hat Enterprise Linux for SAP with High Availability and Update Services for Power, LE, Full Support (1 Core, Enterprise, Multi-tenant, 3 Years)	3 - Year	Physical Node or Virtual Node
RH02228HR	Red Hat Enterprise Linux for SAP with High Availability and Update Services for Power, LE, Diagnostic Support (1 Core, Enterprise, Multi-tenant, Hourly)	HOUR	Physical Node or Virtual Node
RH02228MO	Red Hat Enterprise Linux for SAP with High Availability and Update Services for Power, LE, Diagnostic Support (1 Core, Enterprise, Multi-tenant, Monthly)	MONTH	Physical Node or Virtual Node

SKU	Description	Term	Unit of Measure
RH02228	Red Hat Enterprise Linux for SAP with High Availability and Update Services for Power, LE, Diagnostic Support (1 Core, Enterprise Multi-tenant, Yearly)	ANNUAL	Physical Node or Virtual Node
RH02228F3	Red Hat Enterprise Linux for SAP with High Availability and Update Services for Power, LE, Diagnostic Support (1 Core, Enterprise, Multi-tenant, 3 Years)	3 - Year	Physical Node or Virtual Node

**Table 58. Red Hat Enterprise Linux for SAP with HA & Update Services for Power Billing SKU Details**

**Notes:**

- New terminology:
  - Multi-tenant Scale out = Small Instance (1-4 vCPUs)
  - Multi-tenant Enterprise = Large instance (>4 vCPUs)
- Red Hat Enterprise Linux for SAP with HA & Update Services for Power in the CCSP program is only available for IBM Power LE hardware

**6.5.4.2. Red Hat Enterprise Linux for SAP with HA & Update Services for Power Use Case Examples**

**Example 1**

CCSP partner offering Red Hat Enterprise Linux for SAP with HA & Update Services for Power in dedicated environments.

- Red Hat Enterprise Linux for SAP with HA & Update Services for Power environment dedicated to a single customer running 12 RHEL LPARs across 4 IFL cores with Annual pricing.



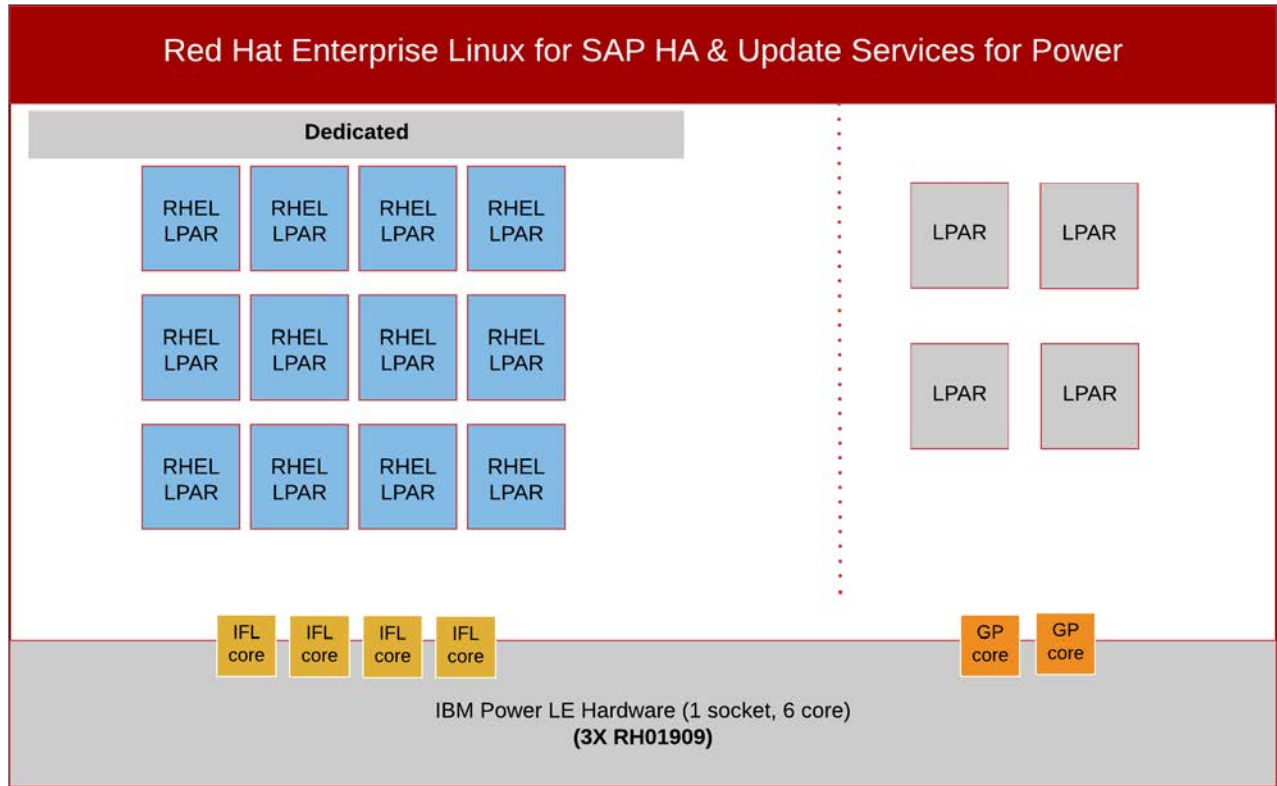

**Figure 31. Red Hat Enterprise Linux for SAP with HA & Update Services for Power Use Case Example 1**

# Appendix A: CCSP Terms and Definitions

This table contains important terms and definitions related to the CCSP program.

Term	Definition
<b>Business Terms</b>	
<b>Multi-tenant</b>	Multi-tenant offerings are designed for CCSP end-customer offerings that have software isolation of customer apps and data but the infrastructure used to host the offering is shared between multiple customers. Multi-tenant offerings are typically measured by virtual elements like Virtual Guests rather than physical elements like sockets or socket-pairs.
<b>Dedicated</b>	Dedicated offerings are designed for CCSP end-customer offerings that have servers dedicated to a single customer, where the hardware is not shared with other customers. Hypervisors dedicated to a single customer can fall in this category. Dedicated offerings are typically measured by sockets or socket-pairs.
<b>Partner Service</b>	A partner service is an offering that the partner implements at an end user location with the following additional terms: (a) only Dedicated System End User Software Subscriptions and pricing are eligible for this type of Partner Service; (b) Partner is responsible for the procurement of all associated hardware and all other obligations associated with implementing the Partner Service; and (c) the End User Software Subscriptions may only be resold by the partner to its end users and not to the end user's customers or partners unless those entities have their own Partner Service onsite installation.
<b>Sell-to</b>	Sell-to is a CCSP business model where the CCSP partner uses Red Hat software to build, run, and/or manage offerings for their end customers.
<b>Sell-through</b>	Sell-through is a CCSP business model where the CCSP partner makes Red Hat software available to their end customers.
<b>Software</b>	Software is the Red Hat-branded software made available under the CCSP program, including all updates, that are delivered by Red Hat, in either binary or source code form or recompiled from source files that are obtained from Red Hat.
<b>CCSP program subscriptions</b>	CCSP program subscriptions are entitlements to software subscriptions for the partner to implement an update service in the Partner Service and provide access to Red Hat software that allows a partner to create images for end user(s) software subscriptions.

Term	Definition
<b>End user software subscriptions</b>	End user software subscriptions are subscriptions consumed by the end users in the Partner Service.
<b>Updates</b>	An update is software that can include software fixes, updates, upgrades, additions, corrections, modifications, and security advisories delivered by Red Hat when and if available.
<b>Software maintenance</b>	Software maintenance is the delivery of software updates.
<b>Errata</b>	Red Hat errata are package updates, bug fixes, and security patches for Red Hat products that have been tested and approved by Red Hat.
<b>Technical Terms</b>	
<b>Socket</b>	A socket is a physical connection that contains a central processing unit or other integrated circuit that executes instructions provided by the software.
<b>Socket-pair</b>	A socket-pair is two (2) sockets on a physical system.
<b>Core</b>	A core is a physical processing core located in a CPU or a virtual processing core within a virtual machine or supporting a container. In each case, a core contains or executes the software running for production purposes.
<b>Core Band</b>	A group of processing cores, i.e. 2,4,16 or 64.
<b>Virtual CPU (vCPU)</b>	A physical (x86) processor, in whole or in part, which is assigned to a virtual machine or container.
<b>Virtual Processor (VP)</b>	A physical IBM Power Systems processor, in whole or in part, which is assigned to an LPAR and presented to the operating systems as a Virtual Processor.
<b>Simultaneous Multithreading (SMT)</b>	The ability of IBM Power Systems servers to enable a single physical processor core to simultaneously dispatch instructions from more than one hardware thread context. With SMT, each processor core can present multiple hardware threads allowing more instructions to run at the same time.
<b>Hyper-threading (HT)</b>	Intel's proprietary implementation of Simultaneous Multithreading technology.

Term	Definition
<b>System</b>	A system is a physical or virtual system on which a user installs or execute all or a portion of the software. It includes, without limitation, a server, work station, laptop, virtual machine, container, blade, node, partition, appliance or engine, as applicable.
<b>Virtual Machine/Guest/Node</b>	A virtual machine/guest/node is an instance of the software that is executed or installed on a system that is a virtual machine or container.
<b>Physical Node</b>	A physical system which contains or executes all or a portion of the Software including, without limitation, a server, work station, laptop, blade or other physical system, as applicable.
<b>Managed Node</b>	A Node managed by the Software. "Node" means a Virtual Node, Physical Node or other instance of software.
<b>Usable Storage Capacity</b>	A measure of storage capacity equal to all storage space available <i>after</i> Data Protection schemes such as Replication or Erasure Coding.
<b>Raw Storage Capacity</b>	A measure of storage capacity equal to all physical storage visible and managed by Red Hat Storage.
<b>External Mode</b>	<b>When an Red Hat OpenShift Container Storage cluster is separate from the Red Hat OpenShift Container Platform cluster where storage consuming applications are running.</b>

**Table 59. CCSP Terms and Definitions**

# About Red Hat

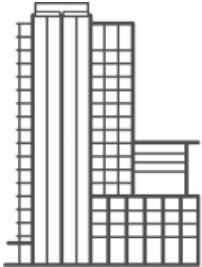

Red Hat is the world's leading provider of enterprise open source software solutions, using a community-powered approach to deliver reliable and high-performing Linux, hybrid cloud, container, and Kubernetes technologies. Red Hat helps customers integrate new and existing IT applications, develop cloud-native applications, standardize on our industry-leading operating system, and automate, secure, and manage complex environments. Award-winning support, training, and consulting services make Red Hat a trusted adviser to the Fortune 500. As a strategic partner to cloud providers, system integrators, application vendors, customers, and open source communities, Red Hat can help organizations prepare for the digital future.

---

North America	Europe, Middle East, and Africa	Asia Pacific	Latin America
1 888 REDHAT1	00800 7334 2835	+65 6490 4200	+54 11 4329 7300
<a href="http://www.redhat.com">www.redhat.com</a>	<a href="mailto:europa@redhat.com">europa@redhat.com</a>	<a href="mailto:apac@redhat.com">apac@redhat.com</a>	<a href="mailto:info-latam@redhat.com">info-latam@redhat.com</a>

---

Copyright © 2019 Red Hat, Inc. Red Hat, Red Hat Enterprise Linux, the Red Hat logo, and JBoss are trademarks or registered trademarks of Red Hat, Inc. or its subsidiaries in the United States and other countries. Linux® is the registered trademark of Linus Torvalds in the U.S. and other countries.

All other trademarks referenced herein are the property of their respective owners.

The information contained herein is subject to change without notice. Red Hat, Inc. shall not be liable for technical or editorial errors or omissions contained herein.

Distribution of modified versions of this document is prohibited without the explicit permission of Red Hat Inc.