

AGENDA

**SPECIAL MEETING
CABLE COMMUNICATIONS ADVISORY BOARD
New Ulm, Minnesota
City Hall Council Chambers**

Thursday, December 14, 2017 – 5:15 p.m.

1. APPROVAL OF MINUTES.
2. COMMUNITY CABLE ACCESS COORDINATOR ADMINISTRATIVE REPORT.
3. OLD BUSINESS.
 - a. Consider revised Lease Agreement with the City of New Ulm.
 - b. Consider approval of the 90% design from MoreCom for the Council Chambers High Definition Upgrade.
4. NEW BUSINESS.
 - a. Consider approval of bid for purchase of High Definition Studio Upgrade Equipment.
 - b. Consider request to use up to \$20,000 of the 2017 budget for the purchase of an upgraded High Definition Content Server.
5. BOARD MEMBER COMMENTS.
6. ADJOURNMENT.

City of New Ulm
Request for Cable Communications Advisory Board Action

Meeting Date:	December 14, 2017	Agenda Item Number:	1.
Agenda Section:	Approval of Minutes	Originating Department:	NUCAT
Resolution:	N/A	Prepared By:	Community Cable Access Coordinator
Number of Attachments:	2	Presented By:	Community Cable Access Coordinator
Item:	Approval of Minutes from the Cable Communications Advisory Board Regular Meeting held on July 20, 2017 and Special Meeting held on September 13, 2017.		

Staff Proposed Action:

Motion by _____, second by _____, approving the Minutes from the Cable Communications Advisory Board Regular Meeting held on July 20, 2017 and Special Meeting held on September 13, 2017.

Overview:

N/A

Primary Issues/Alternatives to Consider:

N/A

Budgetary/Fiscal Issues:

N/A

Attachments:

- July 20, 2017 Regular Meeting Minutes
- September 13, 2017 Special Meeting Minutes

MINUTES

**REGULAR MEETING
CABLE COMMUNICATIONS ADVISORY BOARD
New Ulm, Minnesota**

**Thursday, July 20, 2017 – 5:00 p.m.
City Hall Council Chambers**

Board Members Present: Denise Fischer, Tom Groebner, Les Schultz.

Board Members Absent: Jack Beranek, Linda Heine.

1. APPROVAL OF MINUTES

Motion by: Fischer Second by: Groebner Motion Passed.

2. COMMUNITY CABLE ACCESS COORDINATOR ADMINISTRATIVE REPORT

Coordinator Steve Sherman reviewed the NUCAT Administrative Activities Report.

Motion by: Groebner Second by: Fischer Motion Passed.

3. OLD BUSINESS

A. Received update regarding the extension of the Building Sharing Agreement with the New Ulm Public Library.

Received update on the terms of the extension of the Building Sharing Agreement between New Ulm Community Access Television and New Ulm Public Library.

Authorized staff to submit change to 3-year agreement and 120 day opt out.

Motion by: Groebner Second by: Fischer Motion Passed.

B. Received update regarding City Hall Council Chambers Electronic Equipment.

Received update on progress regarding upgrades to the City Hall Council Chambers audio visual equipment.

Motion by: Groebner Second by: Fischer Motion Passed.

4. NEW BUSINESS - no discussion

5. BOARD MEMBER COMMENTS – no discussion

6. ADJOURNMENT

Motion by: Groebner Second by: Fischer Motion Passed.

MINUTES

**SPECIAL MEETING
CABLE COMMUNICATIONS ADVISORY BOARD
New Ulm, Minnesota**

**Wednesday, September 13, 2017 – 5:15 p.m.
City Hall Council Chambers**

Board Members Present: Denise Fischer, Tom Groebner, Linda Heine, Les Schultz.

Board Members Absent: Jack Beranek.

1. OLD BUSINESS

A. Received update regarding Cable Franchise Agreement.

Steven Sherman provided update on the time table for the Cable Franchise Agreement.

Motion by: Heine Second by: Groebner Motion Passed.

2. NEW BUSINESS

A. Consider proposals from Audio Visual Technical Consultants to prepare bidding documents required for the High Definition upgrade process.

Steven Sherman's recommendation was MoreCom.

Motion by: Groebner Second by: Heine Motion Passed.

3. BOARD MEMBER COMMENTS – no discussion

4. ADJOURNMENT

Motion by: Groebner Second by: Fischer Motion Passed.

City of New Ulm

Request for Cable Communications Advisory Board Action

Meeting Date:	December 14, 2017	Agenda Item Number:	2.
Agenda Section:	Community Cable Access Coordinator Admin Report	Originating Department:	NUCAT
Resolution:	N/A	Prepared By:	Community Cable Access Coordinator
Number of Attachments:	1	Presented By:	Community Cable Access Coordinator
Item:	Receive report regarding NUCAT Administrative Activities.		

Staff Proposed Action:

Motion by _____, second by _____, accepting report on NUCAT Administrative Activities.

Overview:

Community Cable Access Coordinator Administrative Report

Primary Issues/Alternatives to Consider:

N/A

Budgetary/Fiscal Issues:

N/A

Attachments:

Administrative Report - 3rd Quarter 2017

COMMUNITY CABLE ACCESS COORDINATOR ADMINISTRATIVE REPORT
3rd Quarter 2017

July

Monthly government segments encompassed City Council, Public Utilities Commission, District 88 School Board, Advisory and Commission meetings.

Staff, studio and volunteer productions, editing and training included: City Council (Live Council Chambers); Checking in with the New Ulm Public Library (on location); Preach the Word with Jim Colebank (Volunteer Studio); Concerts in the Park- Lonny Carpenter Band (on location); WWI Speaker Series with Kathryn Goetz (on location); Bavarian Blast- Squeezebox with Mollie B (on location); Bavarian Blast Parade (Live); Curb Stop GPS Location PSA; Concerts in the Park- Ken & Ken Show (on location); Public Utilities Commission (Live Council Chambers); Independent School District 88 School Board (Live); and Concerts in the Park- Schell's Hobo Band (on location).

There are six weekly church submissions from the community as well.

Community Volunteer/Student Training and Education: two hours

August

Monthly government segments encompassed all City Council, Public Utilities Commission, Brown County Board of Commissioners, District 88 School Board, Advisory and Commission meetings.

Staff, studio, and volunteer productions, editing, and training included: Checking In with the New Ulm Public Library (On Location); City Council (LIVE Council Chambers); New Ulm Public Library Presents How Soundtracks are Made and Why They Affect Us with Peter Michael von der Nahmer (NUCAT Studio); Park and Recreation Department Update (On Location); Preach the Word with Jim Colebank (Volunteer Studio); Concerts in the Park with Larry Mages and the Mages Family Band, DD & Rosco, Molly and Sunny Boy, and Sleepy Eye Area Concertina Club (all On Location); Off the Shelves featuring The Jeremy Poland Band (On Location); Public Utilities Commission (LIVE Council Chambers); Musical Tales Concerto with Peter Michael von der Nahmer (On Location); and New Ulm Chamber of Commerce Hot Topics: Immigration & Economic Development (On Location).

Brown County Historical Society presented the following: Tipi Life and Buffalo Trunk (NUCAT Studio); And More on the Dakota War (On Location); US-Dakota Relations Prior to the War (On Location); The Dakota People Then and Now (NUCAT Studio); and The Last and the Last (On Location).

There are six weekly church submissions from the community as well.

Volunteer Training Hours: three hours

DVD Sales: \$85

September

Monthly government segments encompassed all City Council, Public Utilities Commission, Brown County Board of Commissioners, District 88 School Board, Advisory and Commission meetings.

Staff, studio, and volunteer productions, editing, and training included: Brown County Board of Commissioners (staff on location); New Ulm City Council (Live Council Chambers and New Ulm Middle School); Off the Shelves featuring Hanna Cesario (staff on location); Preach the Word with Jim Colebank (Volunteer Studio); New Ulm Public Library Presents Noon Tunes with The Singing Cowgirl (staff on location); Civil War Round Table with Denny Warta (staff studio); Something Artsy-Oktoberfest Edition (volunteer on location); Hockey-New Ulm Steel (staff on location); The Process with Jason Jaspersen-Episode 1 (staff on location); Public Utilities Commission (Live New Ulm Middle School); ISD 88 School Board (Live New Ulm Middle School); Checking In with the New Ulm Public Library - October (staff on location); New Ulm Park and Recreation Program Update - October (staff on location); and ISD 88 2017 Hall of Fame (staff on location).

There are six weekly church submissions from the community as well.

Volunteer/Student Training Hours: two hours

DVD Sales: \$145

City of New Ulm

Request for Cable Communications Advisory Board Action

Meeting Date:	December 14, 2017	Agenda Item Number:	3. a.
Agenda Section:	Old Business	Originating Department:	New Ulm Public Library
Resolution:	N/A	Prepared By:	Steven Sherman
Number of Attachments:	1	Presented By:	Steven Sherman
Item:	Consider revised Lease Agreement with the City of New Ulm.		

Staff Proposed Action:

Motion by _____, second by _____, to recommend the Lease Agreement for space in the New Ulm Public Library be accepted by the City Council.

Overview:

The lease arrangement between NUCAT and the Library had expired. After a discussion between the Community Cable Access Coordinator and the Library Director, adjustments were made to the original draft and presented in this version.

Primary Issues/Alternatives to Consider:

The Lease Agreement is set to begin January 1st.

Budgetary/Fiscal Issues:

The rent amount has not changed and will not affect the budget.

Attachments:

Lease Agreement

LEASE AGREEMENT

AGREEMENT made this ____ day of _____, 2017, by and between the City of New Ulm, Minnesota, a municipal corporation (hereinafter "City") and New Ulm Community Access Television (hereinafter "NUCAT").

RECITALS:

- A. City owns and operates a public library building located at 17 North Broadway Street, New Ulm, Minnesota.
- B. NUCAT requires space in the library for an office.
- C. City and NUCAT agree that space will be leased by City to NUCAT in the library building, under the terms and conditions set forth below.

NOW, THEREFORE, for good and valuable consideration, including the mutual covenants contained herein, it is hereby agreed by and between the undersigned as follows:

1. **Premises.** City hereby rents to NUCAT, and NUCAT rents from City, approximately 480 square feet in the basement level of the library building, adjacent to the Library Meeting Room together with an additional 81 square feet for storage and server space (hereinafter "the Premises"). The Premises may be used by NUCAT for an office and for the storage of cable equipment and other materials used in its operations. NUCAT may also use, on occasion and with the consent of Library Administration, the Library Meeting Room as a studio. No equipment may be stored in the Library Meeting

Room or at any other locations at the Library without the authorization of the library director.

2. **Term.** This lease shall commence on January 1, 2018, and shall continue for a period of 36 months thereafter.

3. **Rent.** NUCAT shall pay to City \$6.25 per square foot per year for rent, to be in the total amount of \$3,506.25 to be paid in one payment on or before April 30, 2018, and on or before April 30 of each year thereafter throughout the entire term of this lease. In addition, NUCAT shall pay to City 1.7% of the Library's annual budgeted amount for utilities. That information shall be provided by City to NUCAT and shall be added to the base rent to be paid on the date set forth above.

NUCAT may use the Library Meeting Room as a studio for up to four times, totaling 16 hours, weekly without charge. Any use of the Library Meeting Room by NUCAT in excess of 16 hours per week will be billed at the then-prevailing Meeting Room rental rate.

4. **Conditions of Use.** NUCAT's use of the Library Meeting Room for recording purposes shall be coordinated with library administration. The employees and representatives of NUCAT will at all times respect the peace and quiet of a library setting and whenever possible will schedule recordings at times that will be most conducive to the library's regular operations. NUCAT or other City staff shall be present at all times when the NUCAT facility is open to the public. The only NUCAT representative provided with, or authorized to have a key to the Library building will be the NUCAT director or other designated City staff.

5. **Garbage.** NUCAT may make use of the garbage facilities available to the library from the deposit of its own garbage or recyclables.

6. **Insurance.** City has no obligation to insure the property of NUCAT for any loss as a result of fire, windstorm or other cause.

7. **Termination.** Either party of this agreement may terminate this lease by providing a written notice to the other, within 120 days of the date of the proposed termination.

CITY OF NEW ULM

NEW ULM COMMUNITY ACCESS
TELEVISION

By _____
Brian Gramentz
City Manager

By _____
Steven Sherman
Community Cable Access
Coordinator

**City of New Ulm
Request for Cable Communications Advisory Board Action**

Meeting Date:	December 14, 2017	Agenda Item Number:	3. b.
Agenda Section:	Old Business	Originating Department:	NUCAT
Resolution:	N/A	Prepared By:	Steven Sherman
Number of Attachments:	2	Presented By:	Steven Sherman
Item:	Consider approval of the 90% design from MoreCom for the Council Chambers High Definition Upgrade.		

Staff Proposed Action:

Motion by _____, second by _____ to recommend approval of the 90% design from MoreCom for the Council Chamber High Definition Upgrade.

Overview:

The Audio Visual consultant hired to prepare the design for the Council Chambers High Definition Upgrade has provided 90% design to be reviewed for a red line pass. If accepted, the consultant will complete the design and will put out a call for bids to audio visual integrators.

Primary Issues/Alternatives to Consider:

The cost is a little higher than expected. Staff recommends discussing cheaper alternatives on several of the equipment options with MoreCom before sending out for bids.

Budgetary/Fiscal Issues:

\$65,000 has been budgeted for this equipment and installation phase of this project for 2018. Initial estimate received is \$5,000 higher.

Attachments:

- Design Drawings
- Bill of Materials



City of New Ulm Council Chambers Technology Upgrades

90% Drawings

Consultants Project ID: 17142



City of New Ulm
100 North Broadway
New Ulm, MN 56073
ci.new-ulm.mn.us

Council Chambers Technology Upgrades
Title Sheet

Sheet Index			Sheet Numbering	Project Location						
<p>Section 00: General Information 01 Title Sheet 20 Legend: Technology Power 30 Legend: Audio 40 Legend: Video 70 Legend: Networks</p> <p>Section 100: Architectural 111 Floor Plan 112 Ceiling Plan 182 Racks Details</p> <p>Section 200: Technology Power 211 Tech Power Conditioning 222 Tech Power Rack Distribution 223 Tech Power Lectern Distribution</p>	<p>Section 300: Audio</p> <p>Section 400: Video 411 Presentation Sources 415 Presentation Distribution 422 Cameras 432 Broadcast Switching – TriCaster Mini AE 452 Program Distribution 471 Automated Playback</p> <p>Section 500: Control 500-509 Control Symbols 511 Control Schematic 521 – 533 Touch Panel Pages</p>	<p>Section 600: Radio Frequency</p> <p>Section 700: Networks</p> <p>Section 800: Information Systems</p> <p>Section 900: Schedules 901 Bill of Material Sheet 1 of 2 902 Bill of Material Sheet 2 of 2</p>	<table border="1"> <tr> <td>1.</td> <td>00</td> </tr> <tr> <td colspan="2" style="text-align: center;">Revision</td> </tr> <tr> <td colspan="2" style="text-align: center;">Sheet Number</td> </tr> </table>	1.	00	Revision		Sheet Number		<p>City of New Ulm 100 North Broadway New Ulm, MN 56073 ci.new-ulm.mn.us</p>
1.	00									
Revision										
Sheet Number										

Sheet Size: 11 x 17
Scale: NO SCALE
Date: 12-12-2017
Sheet Number: 1.00

#2 Technology Ground Wire
Southwire, 25083202
#2 AWG stranded, copper THHN wire with green jacket

#10 Technology Ground Wire
Southwire, 22068225
#10 AWG stranded, copper, THHN wire with green jacket

Schematic Symbol of Power Cords and Cables

Power Cables

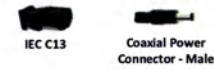

Power Connectors



Power Adapters and/or Converters
Adapter and/or converter use is strictly prohibited unless shown/specified within MoreCom's schematic drawings.
Adapter(s) and/or converter(s) may be used if written approval is received from the consultant prior to installation.
Adapters and/or converters used must be the make/model specified herein.

Audio Left
 Belden: 8451 010U1000 (PVC)
 Belden: 88451 0101000 (Plenum)

Audio Right
 Belden: 8451 (PVC)
 Belden: 88451 (Plenum)

Speaker
 Belden, 5200UE 008U1000 (PVC)
 Belden, 6200UE 008U1000 (Plenum)

Audio Cables

 RCA Male Cable Connectors
 Neutrik, NF2C-B2, 35HDNAU

 RCA Female Cable Connectors
 Switchcraft, 3503X

 3.5MM, TRS Male Cable Connector
 Switchcraft, 35HDNAU

 1/4" TRS Male Cable Connector
 Neutrik, NP3X-BAG

 XLR Male Cable Connector
 Neutrik, NC3MXL1-BAG-w/o-D

 XLR Female Cable Connector
 Neutrik, NC3FXL1-BAG-w/o-D

 SpeakON Cable Connector
 Neutrik, NL4FX

 Spade Connector
 Panduit, PV14-8FX-C

 Phoenix 2-Pole Connector
 Phoenix Contact, 1840366

 Phoenix 3-Pole Connector
 Phoenix Contact, 1840379

 Phoenix 4-Pole Connector
 Phoenix Contact, 1840382

 Phoenix 5-Pole Connector
 Phoenix Contact, 1840395

 Phoenix 6-Pole Connector
 Phoenix Contact, 1840405

 Phoenix 8-Pole Connector
 Phoenix Contact, 1840421

Audio Connectors

 Adapter: RCA Female to RCA Female
 Comprehensive, PJ-BL



 Adapter: 1/4" TS Male to RCA Female
 Comprehensive, SPP-PJ



 Adapter: XLR Female to 1/4" TRS Female
 Neutrik, NA3FJ

 Adapter: XLR Male to 1/4" TRS Female
 Neutrik, NA3MJ

 Adapter: 1/4" TRS Male to XLR Female
 Neutrik, NA3FP

 Adapter: 1/4" TRS Male to XLR Male
 Neutrik, NA3MP

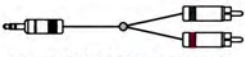
 Adapter: 1/8" Male TRS to Dual RCA Female
 Cables To Go, 40422

 Adapter: 1/8" Male TRS to Dual RCA Male
 Cables To Go, 40421

Audio Adapters
 Adapter use is strictly prohibited unless shown/specified within MoreCom's
 schematic drawings.
 Adapter(s) may be used if written approval is received from the consultant prior to
 installation.
 Adapters used must be the make/model specified herein.

Video Cables

Composite Video
 Belden: 8241 010U1000 (PVC)
 Belden: 88241 0101000 (Plenum)

RGBHV Cable
 Extron, 22-020-03 (PVC)
 Extron, 22-103-03 (Plenum)

VGA Cable
 (contractor to determine length for installation)
 Three Feet (3'): Extron, 26-238-14, (PVC)
 Six Feet (6'): Extron, 26-238-01, (PVC)
 Thirty Five Feet (35'): Extron, 26-238-17, (PVC)
 Fifty Feet (50'): Extron, 26-238-18, (PVC)
 One Hundred Feet (100'): Extron, 26-238-20, (PVC)



VGA Breakout Cable
 Extron, SYM BNCM/25, 26-533-04

Component/RGB Cable
 Extron, 22-020-03 (PVC)
 Extron, 22-103-03 (Plenum)
 Ignore Yellow and Black



Component Breakout Cable
 Extron, SYM BNCM/25, 26-533-04
 Note: Ignore Yellow and Black



HDMI Cable
 (contractor to determine length for installation)
 Three Feet (3'): Extron, 26-650-03, (PVC)
 Six Feet (6'): Extron, 26-650-06, (PVC)
 Twelve Feet (12'): Extron, 26-650-12, (PVC)
 Twenty Five Feet (25'): Extron, 26-650-25, (PVC)
 Thirty Five Feet (35'): Extron, 26-650-35, (PVC)
 Fifty Feet (50'): Extron, 26-650-50, (PVC)
 Seventy Five Feet (75'): Extron, 26-650-75, (PVC)
 One Hundred Feet (100'): Extron, 26-238-20, (PVC)

Video Connectors



BNC - RG59
 Amphenol, 31-71008-RFX



RCA Male Cable Connector
 Switchcraft, 3502A



RGBHV Mini-Hi-Res BNC
 Extron, 100-250-0, BNC Connectors
 Extron, 70-089-01, Red Strain Reliefs
 Extron, 70-089-02, Green Strain Reliefs
 Extron, 70-089-03, Blue Strain Reliefs
 Extron, 70-089-04, Yellow Strain Reliefs
 Extron, 70-089-05, Black Strain Reliefs



BNC Terminator
 Vittek, VT-Terminator

Video Adapters

Adapter use is strictly prohibited unless shown/specified within MoreCom's schematic drawings.
 Adapter use may be used if written approval is received from the consultant prior to installation.
 Adapters used must be the make/model specified herein.



Adapter: RCA Male to BNC Female
 Extron, BNCF-RCAM/10, 100-226-01



Adapter: RCA Male to BNC Female
 Extron, RCAF-BNCF/10, 100-229-01



Adapter: BNC female to BNC Female
 Comprehensive, B-BL



Adapter: BNC Male to "F" Female
 Comprehensive, FJ-BP



Adapter: "F" Male to BNC Female
 Comprehensive, FP-BJ



Adapter: RCA Male to "F" Female
 Comprehensive, PP-FJ



Adapter: DVI Male to HDMI Female
 Cablelra, ZA5600FM



VicTsing, Gold-Plated 1080P HDMI to VGA Cable Adapter

Network Cables

Ethernet CAT5e
 Belden, 1583A 0061000 (PVC)
 Belden, 1533P D151000 (Plenum)
 Belden, 7997A 0101000 (Direct Bury)

Ethernet CAT6
 Belden DataTwist 4800 UTP Cable (600Mhz)
 Belden, 4812 006A1000 (Riser)
 Belden: 4813 D15A1000 (Plenum)

Ethernet 25-Pair CAT5e
 Bertek, 10061456 (PVC)

Single Mode Fiber Optic Cable: OS2
 Verify Strand Count
 Belden: B9W231 (PVC)
 Belden: B9W241 (Plenum)
 Corning Altos Series: 048EUC-T4101F20 (Direct Bury)

Multi-Mode Fiber Optic Cable: OM1
 Verify Strand Count
 Belden: B9B240 (PVC)
 Belden: B9W241 (Plenum)
 Corning Altos Series: 012K-T4130F20 (Direct Bury)

Single Mode Fiber Optic Patch Cable: OS2 9/125
 LC to LC UPC Duplex Plenum
 Verify Length Required
 Fiber Store SM-LCU-LCU-DX-FS-___M-OFNP

Network Connectors

CAT5e, 8P8C Modular Plug
 Comprehensive, RJ45P

CAT6, 8P8C Modular Plug
 Platinum Tools, 100010C

6P4C Modular Plug
 Comprehensive, RJ11P

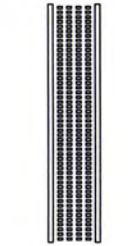

66 Block: 25-Pair
 Siemens, S66M1-25
 Bridge Clips
 Siemens, SA1-SS-(100)
 Stand Off Bracket
 Siemens, S88-10

Splice Protection Sleeve
 Tyco Electronics, SMOUV-1120-01

Council Chambers Technology Upgrades
Council Chambers Floor Plan

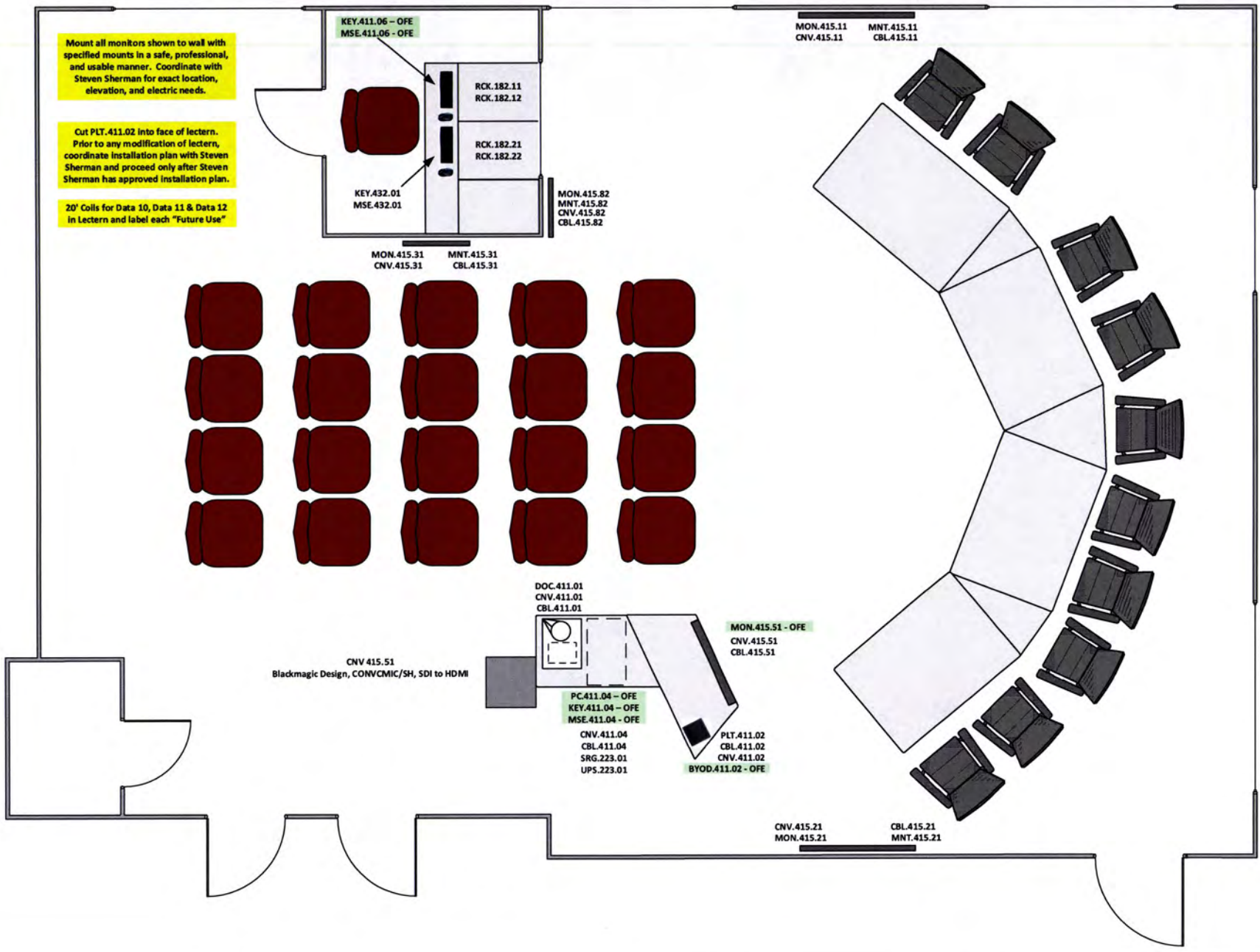

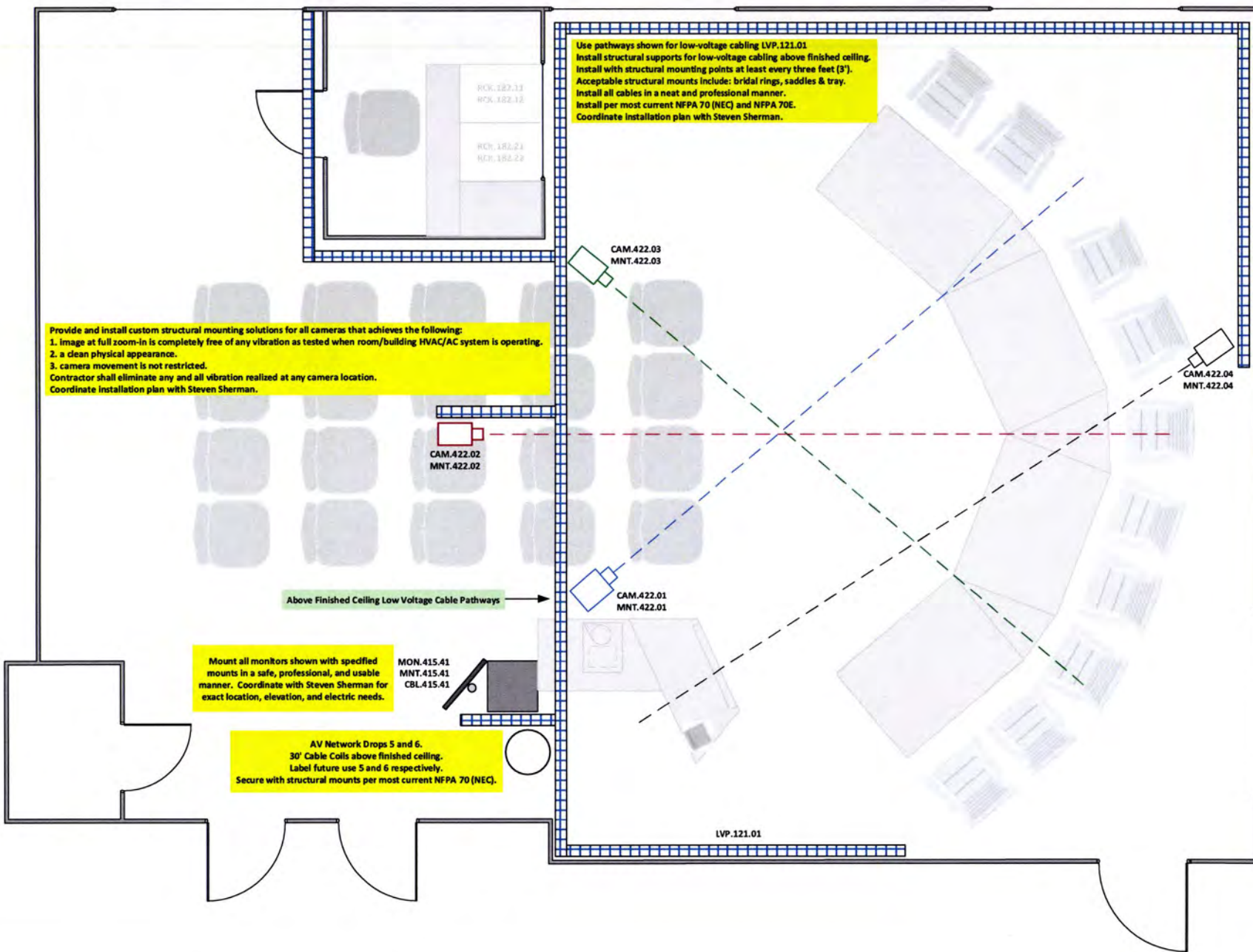

Council Chambers Technology Upgrades
Council Chambers Ceiling Plan

CMT.182.117
 Custom, Mounting Solution
 Mount CNV.415.81 behind monitor.

CNV.415.81
 Blackmagic Design, CONVCMIC/SH
 CBL.415.81
 Cables to Go, 42517
 MON.415.81
 AOC, I2269VW



MON.432.21,
 AOC, I2269VW
 CBL.432.22, Cables to Go, 42517

OLS.221.11
 Middle Atlantic
 PD-8155C-NS
 CNV.452.32
 Blackmagic Design, CONVCMIC/HS
 Mount CNV.452.32 behind scopes.
 CMT.182.116
 Custom, Mounting Solution
 Install outlet strip OLS.211.11
 vertically in rear of rack on left side
 CMT.182.115
 Custom, Mounting Solution

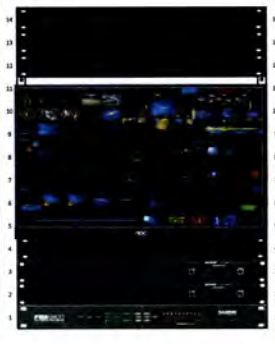

MON.452.31
 Blackmagic Design, SMTWSCOPEDUO4K2
 MON.432.31
 AOC, I2269VW
 CBL.432.31
 Cables to Go, 26942
 RKA.182.214
 Middle Atlantic, EB1
 RKA.182.213
 Middle Atlantic, EB1
 RKA.182.212
 Middle Atlantic, EB1
 MON.432.32,
 AOC, I2269VW
 CBL.432.32
 Cables to Go, 26942
 OLS.222.11
 Middle Atlantic
 PD-8155C-NS
 CMT.182.215
 Custom, Mounting Solution
 Install outlet strip OLS.211.21
 vertically in rear of rack on left side

RCK.182.11
 OFE - Winsted

RCK.182.21
 OFE - Winsted

RKA.182.01, Middle Atlantic, HWS00
 RKA.182.02, RackGold, LYSB01G2I8M8A-CMPTRACCS
 RKA.182.03, RackGold, LYSB01G2I8M8A-CMPTRACCS
 RKA.182.04, Middle Atlantic, LBP-1R
 RKA.182.05, Panduit, TTR-75RO
 RKA.182.06, Panduit, G2X4LG6
 RKA.182.06, Panduit, G2X4LG6

OLS.221.12
 Middle Atlantic
 PD-8155C-NS
 RKA.182.124
 Middle Atlantic, EB1
 RKA.182.123
 Middle Atlantic, EB1
 SEG.422.01
 NewTek, FG-000874-R001
 CBL.411.06
 Cables to Go, 54327
 RKA.182.121
 Middle Atlantic, EB1
 UPS.211.01
 Eaton, SP1500RT
 SFT.432.01, NewTek, FG-001090-R001
 ATT.422.01, Fiber Store, 48526
 TRX.422.01, Fiber Store, 13262
 NPP.422.01
 Panduit, DP24688ZTGY
 NSW.422.01
 Hewlett Packard Enterprise, J1384A
 CNV.411.06
 Blackmagic Design, CONVCMIC/HS
 PC.411.06, OFE
 RKA.182.122
 Middle Atlantic, U2V
 SRG.211.01
 SurgeX, SX1120-RT



SNC.411.13, Blackmagic Design, CONVMSYNC
 CNV.415.01, Blackmagic Design, CONVMSDIDA
 CNV.432.01, Blackmagic Design, CONVCMIC/SH
 CBL.432.01, Cables to Go, 50612
 CNV.432.21, Blackmagic Design, CONVCMIC/HS
 CBL.432.21, Cables to Go, 50612
 RKA.182.228, Middle Atlantic, U2V
 CMT.182.229, Custom, Mounting Solution
 RKA.182.227
 Middle Atlantic, EB1
 RKA.182.225
 Middle Atlantic, EB1
 RKA.182.224
 Middle Atlantic, EB1
 RKA.182.221
 Middle Atlantic, EB1
 VDA.452.41, OFE
 Kramer, VM-SARIII
 RKA.182.223
 Middle Atlantic, EB1
 CNV.452.11, Blackmagic Design, CONVMSDIDA
 CNV.452.31, Blackmagic Design, CONVMSASA
 CNV.452.41, Blackmagic Design, CONVMSASA
 RKA.182.226, Middle Atlantic, U2V
 CMT.182.230, Custom, Mounting Solution
 OLS.222.22
 Middle Atlantic
 PD-8155C-NS
 CMT.182.231
 Custom, Mounting Solution
 MOD.452.41 - OFE
 Scientific Atlanta

RCK.182.12
 OFE - Winsted

RCK.182.22
 OFE - Winsted

Install outlet strip
 OLS.211.12 vertically in
 rear of rack on left side
 CMT.182.125
 Custom, Mounting Solution

Install outlet strips OLS.211.22 and OLS.221.23
 vertically in rear of rack on left side

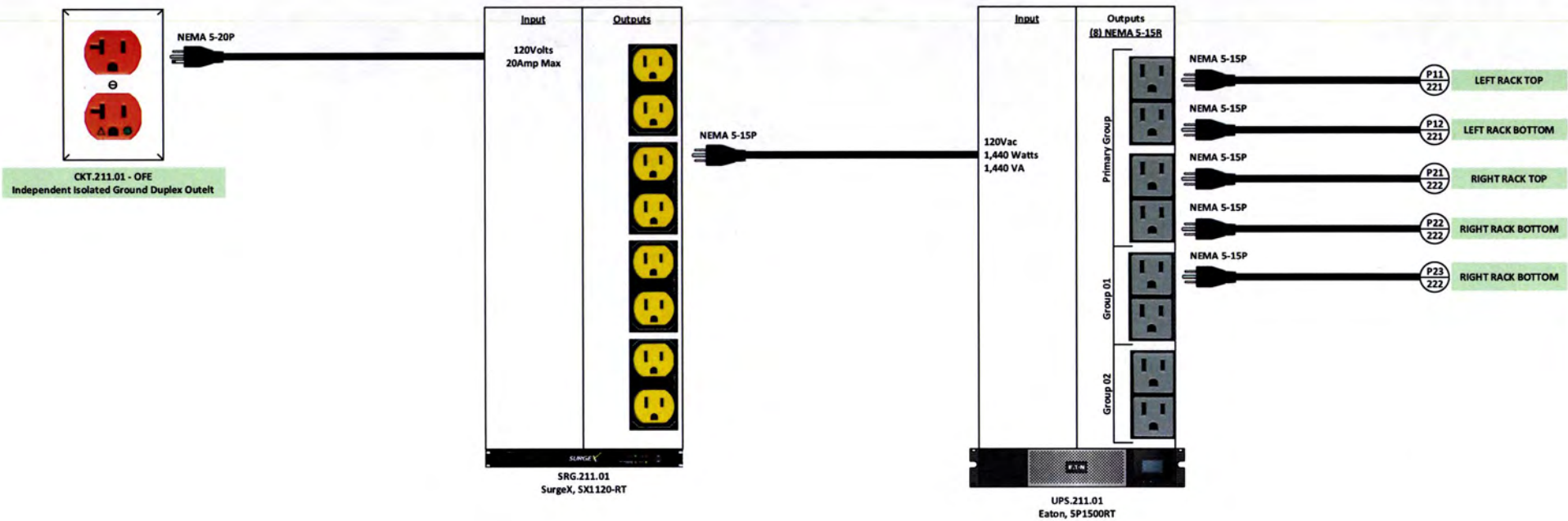

CKT.211.01 - OFE
Independent Isolated Ground Duplex Outelt

SRG.211.01
SurgeX, SX1120-RT

UPS.211.01
Eaton, SP1500RT

UPS P11 211

OLS.221.11
Middle Atlantic
PD-8155C-NS



Presentation Monitor

MON.415.81
AOC, I2269VW



Tricaster MultiView

MON.432.31
AOC, I2269VW



SWT.411.31
Blackmagic Design, VHUBSMTCS6G1212

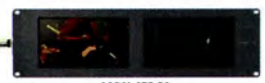

MON.452.31
Blackmagic Design, SMTWScopeDUO4K2

REC.452.31 - OFE
MAGNAVOX, DVD RECORDER

UPS P12 211

OLS.221.12
Middle Atlantic
PD-8155C-NS



NSW.422.01
Hewlett Packard Enterprise, J1384A



CNV.411.06
Blackmagic Design, CONVCMIC/HS



SEG.422.01
NewTek, FG-000874-R001



PC.411.06, OFE

MoreCom
7600 Boone Avenue North
Minneapolis, MN 55428
morecom.com

City of New Ulm
100 North Broadway
New Ulm, MN 56073
ci.new-ulm.mn.us

Council Chambers Technology Upgrades Technology Power: Left Rack

Sheet Size:
11 x 17

Scale:
NO SCALE

Date:
12-12-2017

Sheet Number:
221.00

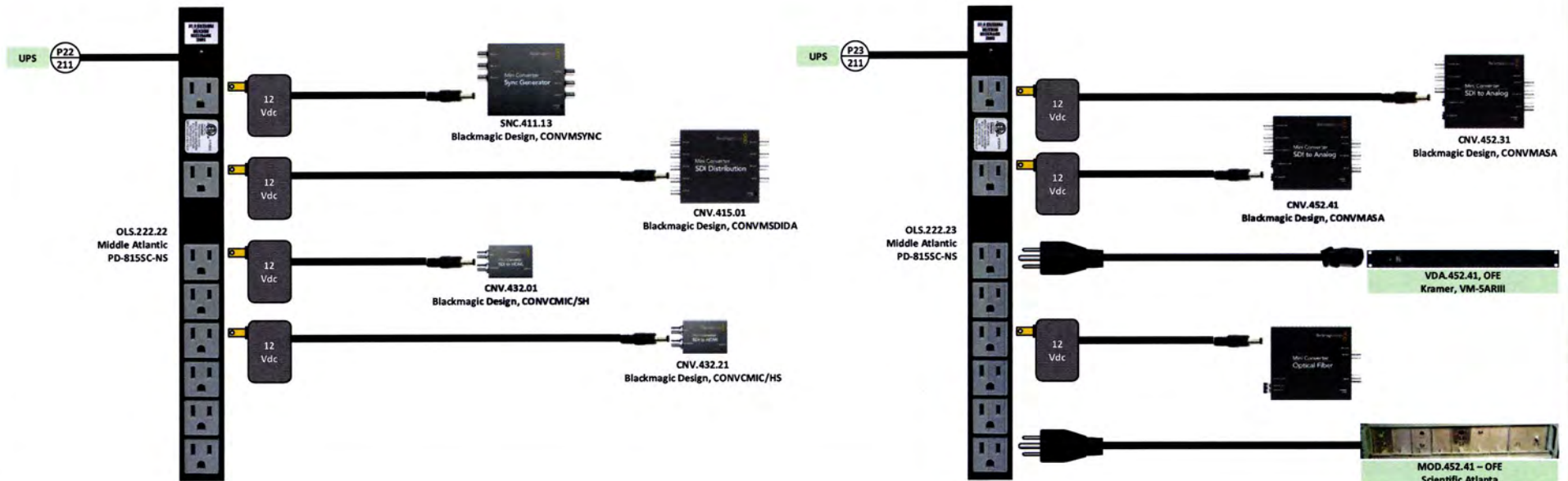
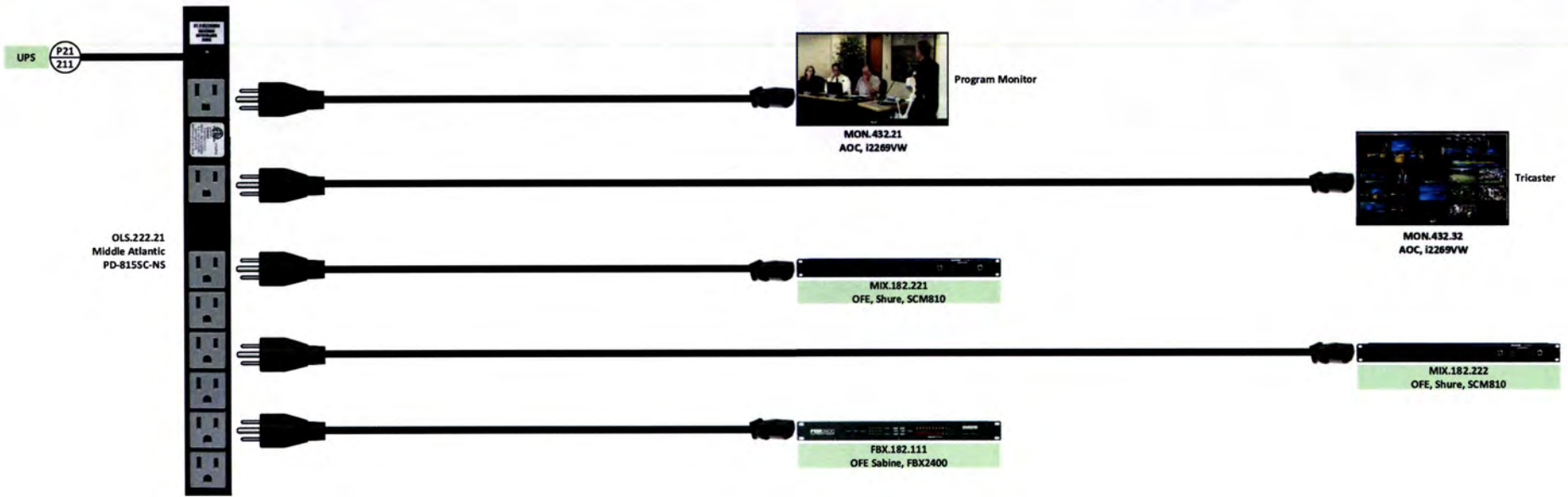

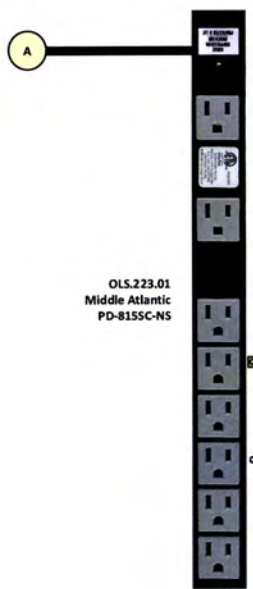
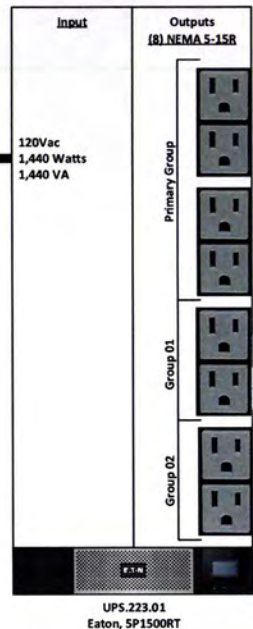
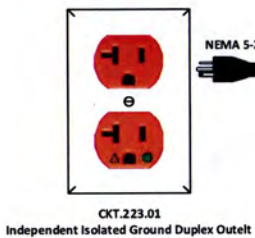

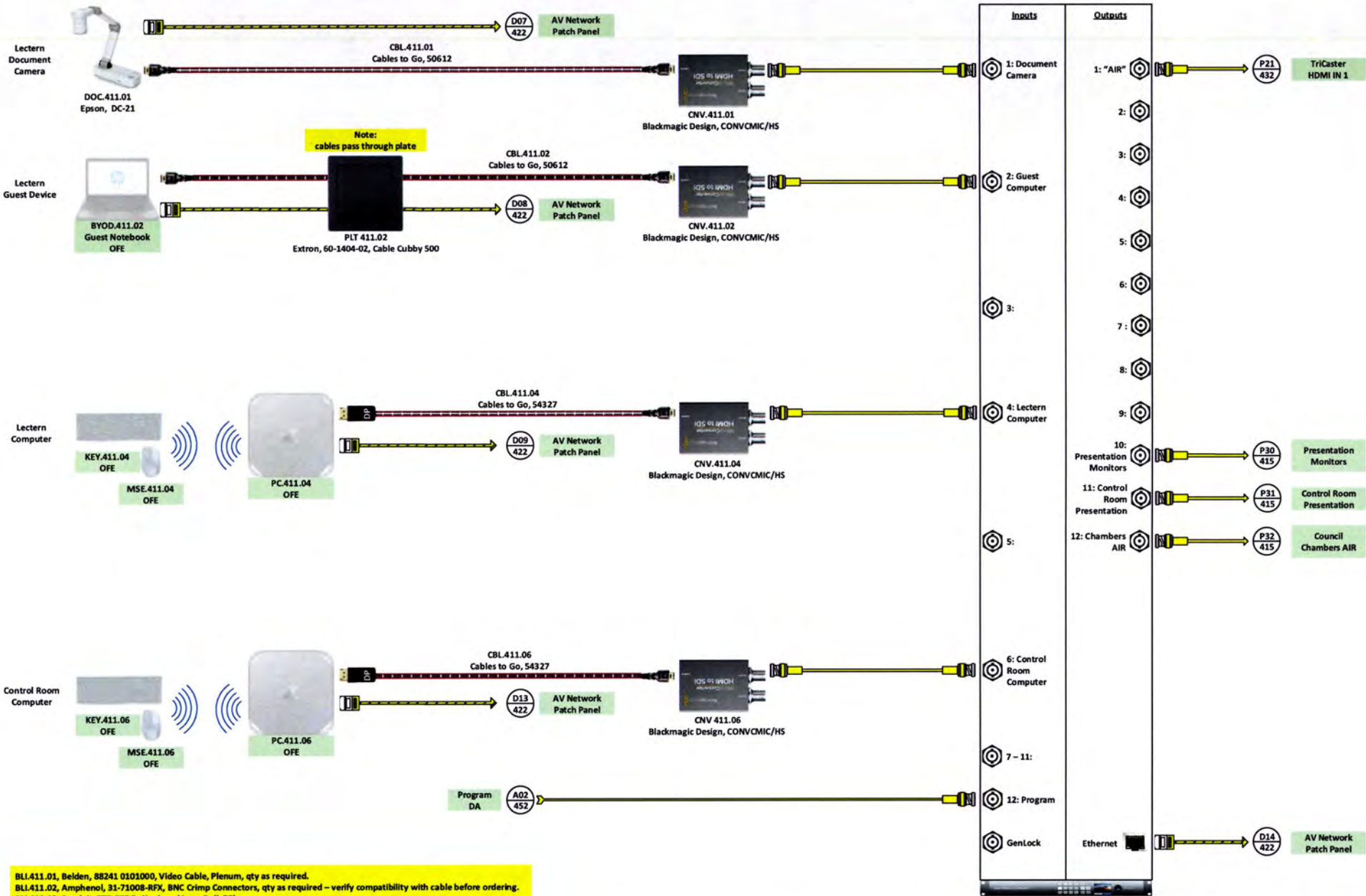

BLI.411.01, Belden, 88241 0101000, Video Cable, Plenum, qty as required.
 BLI.411.02, Amphenol, 31-71009-RFX, BNC Crimp Connectors, qty as required - verify compatibility with cable before ordering.
 BLI.411.03, Panduit, TTR-75RO, Hook and Loop Roll, 75'

SWT.411.31
 Black Magic Design, VHUBSMTC56G1212, Smart Videohub CleanSwitch 12x12

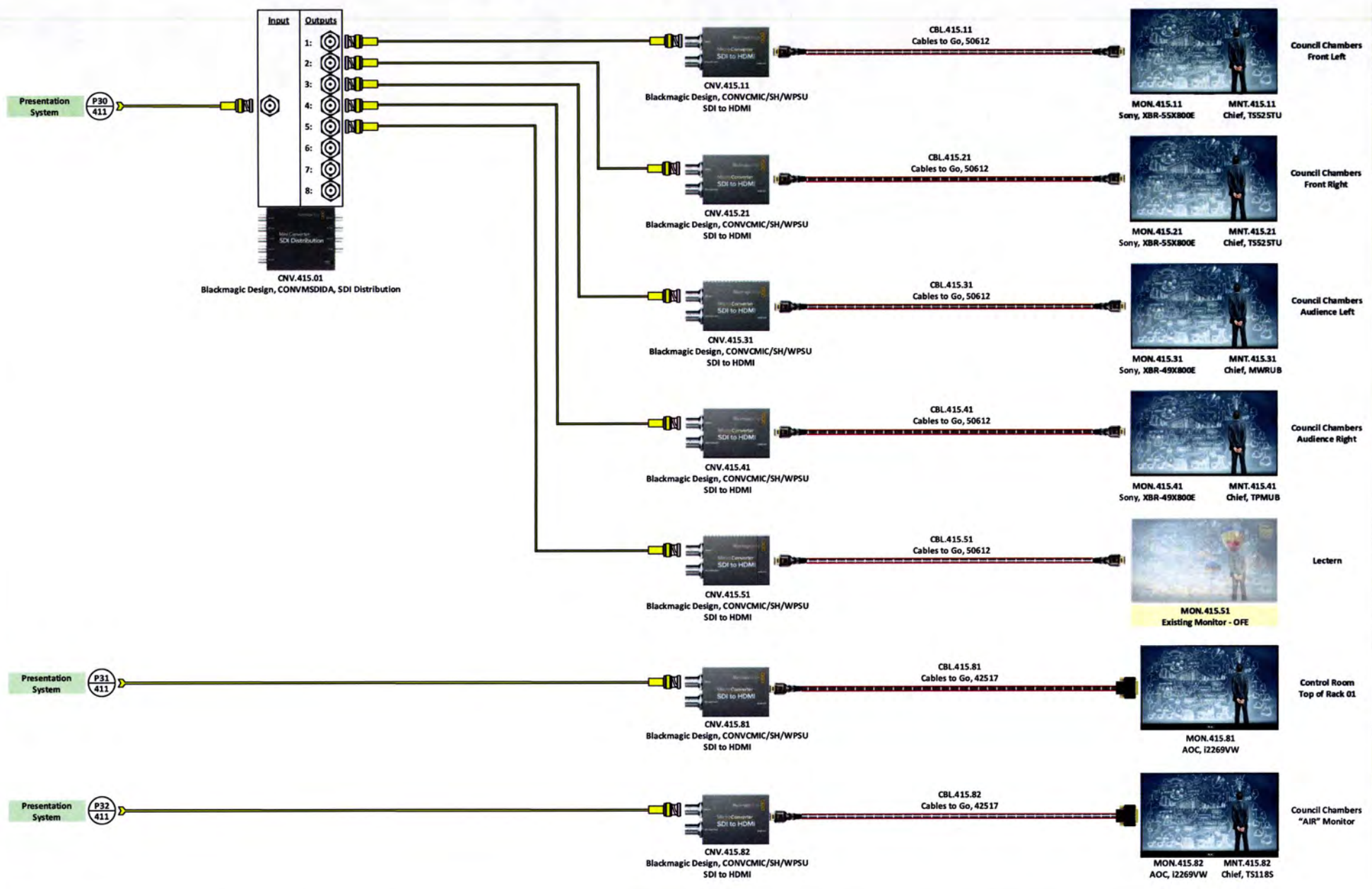

Council Chambers Technology Upgrades Presentation Distribution

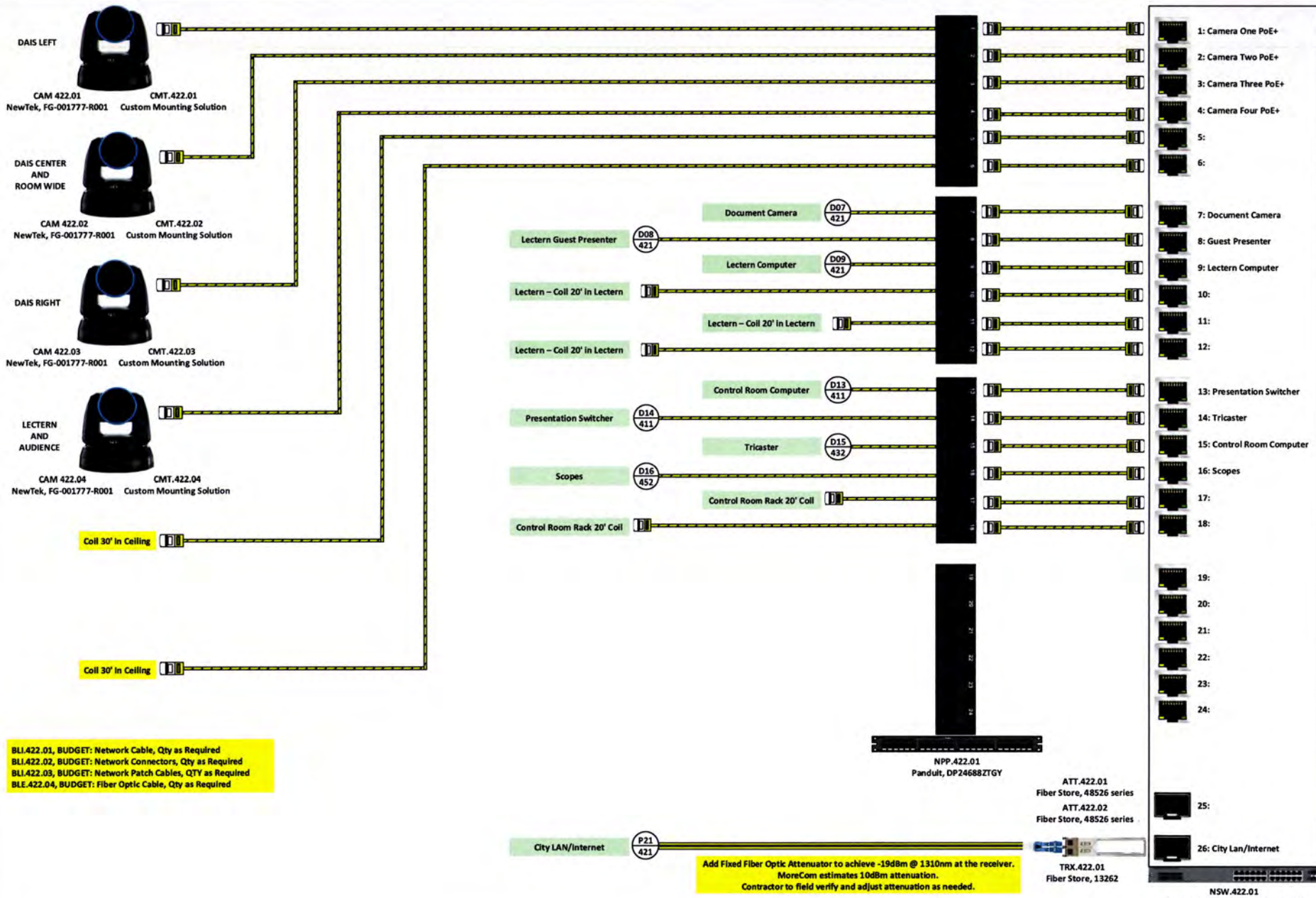

BLI.422.01, BUDGET: Network Cable, Qty as Required
 BLI.422.02, BUDGET: Network Connectors, Qty as Required
 BLI.422.03, BUDGET: Network Patch Cables, QTY as Required
 BLE.422.04, BUDGET: Fiber Optic Cable, Qty as Required

Add Fixed Fiber Optic Attenuator to achieve -19dBm @ 1310nm at the receiver.
 MoreCom estimates 10dBm attenuation.
 Contractor to field verify and adjust attenuation as needed.

ATT.422.01
 Fiber Store, 48526 series
 ATT.422.02
 Fiber Store, 48526 series
 TRX.422.01
 Fiber Store, 13262

- 1: Camera One PoE+
- 2: Camera Two PoE+
- 3: Camera Three PoE+
- 4: Camera Four PoE+
- 5:
- 6:
- 7: Document Camera
- 8: Guest Presenter
- 9: Lectern Computer
- 10:
- 11:
- 12:
- 13: Presentation Switcher
- 14: Tricaster
- 15: Control Room Computer
- 16: Scopes
- 17:
- 18:
- 19:
- 20:
- 21:
- 22:
- 23:
- 24:
- 25:
- 26: City Lan/Internet

NSW.422.01
 Hewlett Packard Enterprise, J1384A,
 1920S 24G 25FP Ppoe+ 185W

P21
451



CBL.432.01
Cables to Go, 50612

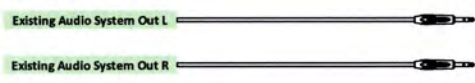
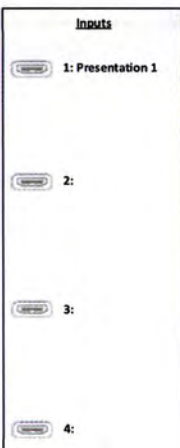

D15
427

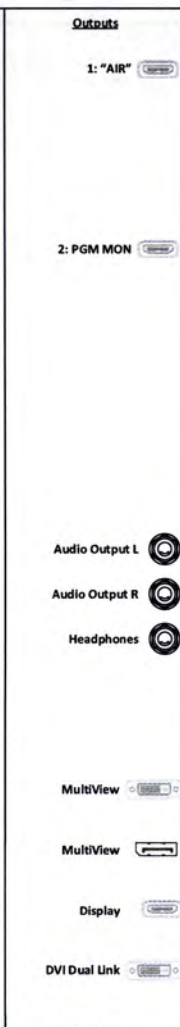
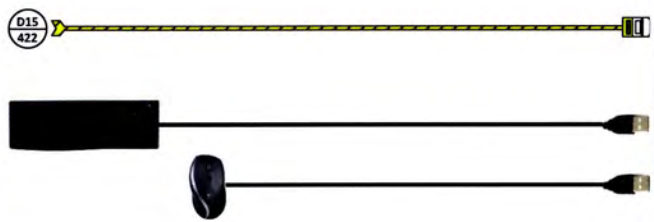

CBL.432.11
Cables to Go, 50612



A01
431



CBL.432.21
Cables to Go, 42517

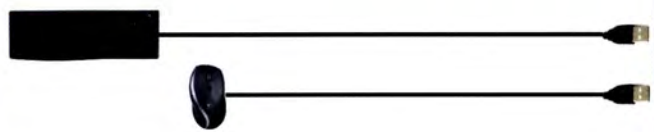

CBL.432.31
Cables to Go, 26942



CBL.432.32
Cables to Go, 26942



SFT.432.01
NewTek, FG-001090-R001, TriCaster Advanced Edition
Software for TriCaster Mini HDMI Switchers

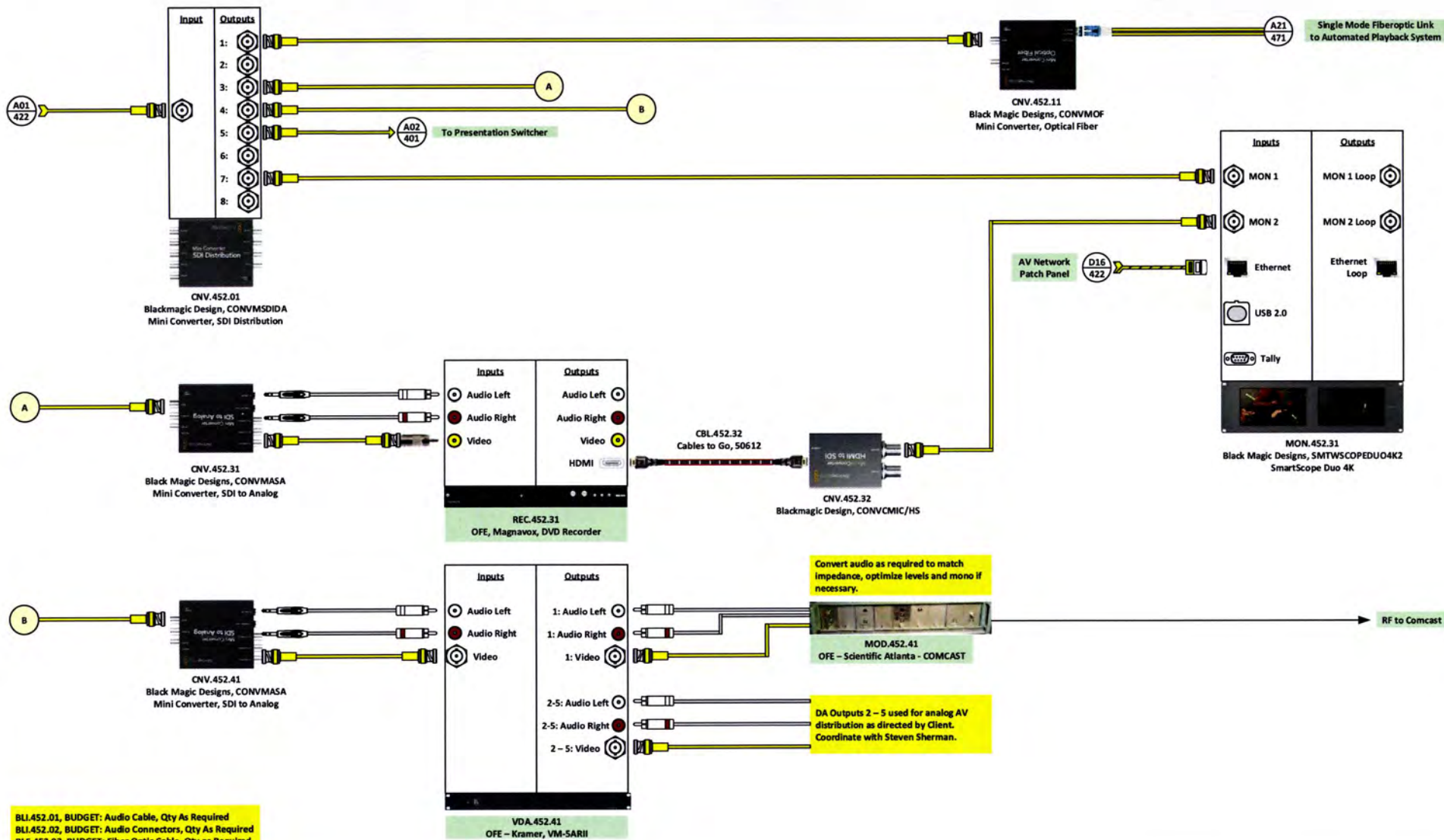

BLI.452.01, BUDGET: Audio Cable, Qty As Required
 BLI.452.02, BUDGET: Audio Connectors, Qty As Required
 BLE.452.03, BUDGET: Fiber Optic Cable, Qty as Required

THE CITY HAS SEVERAL STRANDS OF FIBER CONNECTING THE CITY HALL TO THE CABLE TV HEAD-END. COORDINATE WITH STEVEN SHERMAN FOR ACCESS TO AT LEAST ONE STRAND FOR VIDEO USE.



THERE IS NO POWER DRAWING FOR CNV.471.01. POWER WITH AVAILABLE OUTLETS IN THE RACK WITH TIGHTROPE MEDIA SYSTEMS APB.471.01

THIS DESIGN ASSUMES THE EXISTING CABLE CAST SYSTEM IS UPGRADABLE OR CAPABLE OF ACCEPTING HD-SDI VIDEO. ADDITIONAL CONVERTER MAY BE REQUIRED TO CONVERT FROM SDI TO ANALOG IF TIGHTROPE IS NOT CAPABLE. PLEASE COORDINATE WITH STEVEN SHERMAN.

BLE.471.01, BUDGET: Fiber Optic Cable, Qty as Required

Line	SHEET	PROJECT ID	MAKE	MODEL	DESCRIPTION	Unit	Total
1	111	LVP.121.01	BUDGET	LINE ITEM	Low-voltage structural supports and hardware as required by NEC using pathways shown	\$ 500.00	\$ 500.00
2	182	RKA.182.01	MIDDLE ATLANTIC	HW500	RACK SCREWS	\$ 183.00	\$ 683.00
3	182	RKA.182.02	RACK GOLD	LYS801G218MBA-CMPTRACCS	RACK CLIPS	\$ 30.00	\$ 713.00
4	182	RKA.182.03	RACK GOLD	LYS801G218MBA-CMPTRACCS	RACK CLIPS	\$ 30.00	\$ 743.00
5	182	RKA.182.04	MIDDLE ATLANTIC	LBP-1R	LACER BARS, HORIZONTAL, PACK OF TEN	\$ 75.00	\$ 818.00
6	182	RKA.182.05	PANDUIT	TTR-75RO	HOOK AND LOOP ROLL, 75'	\$ 80.00	\$ 898.00
7	182	RKA.182.06	PANDUIT	G2X4LG6	SLOTTED DUCT, 2" W X 4" H X 6' LONG, PVC, LIGHT GRAY	\$ 500.00	\$ 1,398.00
8	182	RKA.182.07	PANDUIT	C2LG6	DUCT COVER, 2" W X 6' LONG, PVC, LIGHT GRAY	\$ 100.00	\$ 1,498.00
9	182	RKA.182.112	MIDDLE ATLANTIC	EB1	BLANK RACK PANEL, 1RU	\$ 8.00	\$ 1,506.00
10	182	RKA.182.113	MIDDLE ATLANTIC	RC-2	RACK SHELF, CLAMPING, 2RU	\$ 25.00	\$ 1,531.00
11	182	CMT.182.114	CUSTOM	CUSTOM	CUSTOM MOUNTING SOLUTION	\$ 25.00	\$ 1,556.00
12	182	CMT.182.115	CUSTOM	CUSTOM	CUSTOM MOUNTING SOLUTION	\$ 25.00	\$ 1,581.00
13	182	CMT.182.116	CUSTOM	CUSTOM	CUSTOM MOUNTING SOLUTION	\$ 25.00	\$ 1,606.00
14	182	CMT.182.117	CUSTOM	CUSTOM	CUSTOM MOUNTING SOLUTION	\$ 25.00	\$ 1,631.00
15	182	RKA.182.121	MIDDLE ATLANTIC	EB1	BLANK RACK PANEL, 1RU	\$ 8.00	\$ 1,639.00
16	182	RKA.182.122	MIDDLE ATLANTIC	UZV	RACK SHELF, VENTED, 2RU	\$ 75.00	\$ 1,714.00
17	182	RKA.182.123	MIDDLE ATLANTIC	EB1	BLANK RACK PANEL, 1RU	\$ 8.00	\$ 1,722.00
18	182	RKA.182.124	MIDDLE ATLANTIC	EB1	BLANK RACK PANEL, 1RU	\$ 8.00	\$ 1,730.00
19	182	CMT.182.125	CUSTOM	CUSTOM	CUSTOM MOUNTING SOLUTION	\$ 75.00	\$ 1,805.00
20	182	RKA.182.211	MIDDLE ATLANTIC	EB1	BLANK RACK PANEL, 1RU	\$ 8.00	\$ 1,813.00
21	182	RKA.182.212	MIDDLE ATLANTIC	EB1	BLANK RACK PANEL, 1RU	\$ 8.00	\$ 1,821.00
22	182	RKA.182.213	MIDDLE ATLANTIC	EB1	BLANK RACK PANEL, 1RU	\$ 8.00	\$ 1,829.00
23	182	RKA.182.214	MIDDLE ATLANTIC	EB1	BLANK RACK PANEL, 1RU	\$ 8.00	\$ 1,837.00
24	182	CMT.182.215	CUSTOM	CUSTOM	CUSTOM MOUNTING SOLUTION	\$ 75.00	\$ 1,912.00
25	182	RKA.182.221	MIDDLE ATLANTIC	EB1	BLANK RACK PANEL, 1RU	\$ 8.00	\$ 1,920.00
26	182	RKA.182.222	MIDDLE ATLANTIC	UZV	RACK SHELF, VENTED, 2RU	\$ 75.00	\$ 1,995.00
27	182	RKA.182.223	MIDDLE ATLANTIC	EB1	BLANK RACK PANEL, 1RU	\$ 8.00	\$ 2,003.00
28	182	RKA.182.224	MIDDLE ATLANTIC	EB1	BLANK RACK PANEL, 1RU	\$ 8.00	\$ 2,011.00
29	182	RKA.182.225	MIDDLE ATLANTIC	EB1	BLANK RACK PANEL, 1RU	\$ 8.00	\$ 2,019.00
30	182	RKA.182.226	MIDDLE ATLANTIC	UZV	RACK SHELF, VENTED, 2RU	\$ 75.00	\$ 2,094.00
31	182	RKA.182.227	MIDDLE ATLANTIC	EB1	BLANK RACK PANEL, 1RU	\$ 8.00	\$ 2,102.00
32	182	RKA.182.228	MIDDLE ATLANTIC	UZV	RACK SHELF, VENTED, 2RU	\$ 75.00	\$ 2,177.00
33	182	CMT.182.229	CUSTOM	CUSTOM	CUSTOM MOUNTING SOLUTION	\$ 75.00	\$ 2,252.00
34	182	CMT.182.230	CUSTOM	CUSTOM	CUSTOM MOUNTING SOLUTION	\$ 75.00	\$ 2,327.00
35	182	CMT.182.231	CUSTOM	CUSTOM	CUSTOM MOUNTING SOLUTION	\$ 75.00	\$ 2,402.00
36	182	CMT.182.232	CUSTOM	CUSTOM	CUSTOM MOUNTING SOLUTION	\$ 75.00	\$ 2,477.00
37	211	CKT.211.01	OFE	OFE	OWNER FURNISHED EQUIPMENT: ELECTRIC CIRCUIT	\$ -	\$ 2,477.00
38	211	SRG.211.01	SURGEX	SK1120-RT	SURGE PROTECTOR, ACTIVE, 120VAC, 20AMPS	\$ 700.00	\$ 3,177.00
39	211	UPS.211.01	EATON	SP1500RT	UPS, 1500VA, 2RU	\$ 700.00	\$ 3,877.00
40	221	OLS.221.11	MIDDLE ATLANTIC	PD-815SC-NS	OUTLET STRIP, 15AMPS, HIGH-DENSITY, SLIM, NO SURGE	\$ 100.00	\$ 3,977.00
41	221	OLS.221.12	MIDDLE ATLANTIC	PD-815SC-NS	OUTLET STRIP, 15AMPS, HIGH-DENSITY, SLIM, NO SURGE	\$ 100.00	\$ 4,077.00
42	222	OLS.222.21	MIDDLE ATLANTIC	PD-815SC-NS	OUTLET STRIP, 15AMPS, HIGH-DENSITY, SLIM, NO SURGE	\$ 100.00	\$ 4,177.00
43	222	OLS.222.22	MIDDLE ATLANTIC	PD-815SC-NS	OUTLET STRIP, 15AMPS, HIGH-DENSITY, SLIM, NO SURGE	\$ 100.00	\$ 4,277.00
44	222	OLS.222.23	MIDDLE ATLANTIC	PD-815SC-NS	OUTLET STRIP, 15AMPS, HIGH-DENSITY, SLIM, NO SURGE	\$ 100.00	\$ 4,377.00
45	223	CKT.223.01	OFE	OFE	OWNER FURNISHED EQUIPMENT: ELECTRIC CIRCUIT	\$ -	\$ 4,377.00
46	223	SRG.223.01	SURGEX	SA-20	SURGE PROTECTOR, ACTIVE, 120VAC, 20AMPS	\$ 420.00	\$ 4,797.00
47	223	UPS.223.01	EATON	SP1500RT	UPS, 1500VA, 2RU	\$ 700.00	\$ 5,497.00
48	223	OLS.223.01	MIDDLE ATLANTIC	PD-815SC-NS	OUTLET STRIP, 15AMPS, HIGH-DENSITY, SLIM, NO SURGE	\$ 100.00	\$ 5,597.00
49	411	DOC.411.01	EPSON	DC-21	DOCUMENT CAMERA, DESK	\$ 560.00	\$ 6,157.00
50	411	CBL.411.01	CABLES TO GO	50612	CABLE, HDMI MALE TO HDMI MALE, 15'	\$ 23.00	\$ 6,180.00
51	411	CNV.411.01	BLACKMAGIC DESIGN	CONVCMIC/HS	CONVERTER, HDMI TO SDI, MICRO CONVERTER	\$ 55.00	\$ 6,235.00
52	411	BYOD.411.02	OFE	OFE	OWNER FURNISHED EQUIPMENT: LAPTOP BY END-USERS - BRING YOUR OWN DEVICE	\$ -	\$ 6,235.00
53	411	PLT.411.02	EXTRON	60-1404-02	PLATE, RECESSED, CABLE CUBBY 500, BLACK, WITH US AC POWER MODULE, CABLE PASS	\$ 600.00	\$ 6,835.00
54	411	CBL.411.02	CABLES TO GO	50612	CABLE, HDMI MALE TO HDMI MALE, 15'	\$ 23.00	\$ 6,858.00
55	411	CNV.411.02	BLACKMAGIC DESIGN	CONVCMIC/HS	CONVERTER, HDMI TO SDI, MICRO CONVERTER	\$ 55.00	\$ 6,913.00
56	411	KEY.411.04	OFE	OFE	OWNER FURNISHED EQUIPMENT: KEYBOARD	\$ -	\$ 6,913.00
57	411	MSE.411.04	OFE	OFE	OWNER FURNISHED EQUIPMENT: MOUSE	\$ -	\$ 6,913.00
58	411	PC.411.04	OFE	OFE	OWNER FURNISHED EQUIPMENT: COMPUTER	\$ -	\$ 6,913.00
59	411	CBL.411.04	CABLES TO GO	54327	CABLE, DISPLAY PORT TO HDMI, 10'	\$ 34.00	\$ 6,947.00
60	411	CNV.411.04	BLACKMAGIC DESIGN	CONVCMIC/HS	CONVERTER, HDMI TO SDI, MICRO CONVERTER	\$ 55.00	\$ 7,002.00
61	411	KEY.411.06	OFE	OFE	OWNER FURNISHED EQUIPMENT: KEYBOARD	\$ -	\$ 7,002.00
62	411	MSE.411.06	OFE	OFE	OWNER FURNISHED EQUIPMENT: MOUSE	\$ -	\$ 7,002.00
63	411	PC.411.06	OFE	OFE	OWNER FURNISHED EQUIPMENT: COMPUTER	\$ -	\$ 7,002.00
64	411	CBL.411.06	CABLES TO GO	54327	CABLE, DISPLAY PORT TO HDMI, 10'	\$ 34.00	\$ 7,036.00
65	411	CNV.411.06	BLACKMAGIC DESIGN	CONVCMIC/HS	CONVERTER, HDMI TO SDI, MICRO CONVERTER	\$ 55.00	\$ 7,091.00
66	411	SWT.411.31	BLACKMAGIC DESIGN	VHUBSMTCS6G1212	SWITCHER, MATRIX, 12X12, SDI, SMART VIDEOHUB CLEAN SWITCH 12X12	\$ 1,495.00	\$ 8,586.00
67	411	BLI.411.01	BELDEN	88241 0101000	BUDGET: VIDEO CABLE, BELDEN, 88241 0101000 - QTY AS REQUIRED	\$ 1,800.00	\$ 10,386.00
68	411	BLI.411.02	AMPHENOL	31-71008-RFX	BUDGET: BNC CONNECTORS - QTY AS REQUIRED	\$ 150.00	\$ 10,536.00
69	411	BLI.411.02	PANDUIT	TTR-75RO	HOOK AND LOOP ROLL, 75'	\$ 80.00	\$ 10,616.00
70	415	CNV.415.01	BLACKMAGIC DESIGN	CONVMSDIDA	DISTRIBUTION AMPLIFIER, SDI, 1X8, MINI CONVERTER, SDI DISTRIBUTION	\$ 195.00	\$ 10,811.00
71	415	CNV.415.11	BLACKMAGIC DESIGN	CONVCMIC/SH/WPSU	CONVERTER, SDI TO HDMI, MICRO CONVERTER, WITH POWER SUPPLY	\$ 59.00	\$ 10,870.00
72	415	CBL.415.11	CABLES TO GO	50612	CABLE, HDMI MALE TO HDMI MALE, 15'	\$ 23.00	\$ 10,893.00
73	415	MON.415.11	SONY	XBR-55X800E	MONITOR, 55" LED	\$ 800.00	\$ 11,693.00
74	415	MNT.415.11	CHIEF MFG	TSS25TU	MOUNT, WALL, DUAL ARM WALL MOUNT, THINSTALL, UNIVERSAL, BLACK, 37" TO 58" DISPLAYS	\$ 436.00	\$ 12,129.00
75	415	CNV.415.21	BLACKMAGIC DESIGN	CONVCMIC/SH/WPSU	CONVERTER, SDI TO HDMI, MICRO CONVERTER, WITH POWER SUPPLY	\$ 59.00	\$ 12,188.00
76	415	CBL.415.21	CABLES TO GO	50612	CABLE, HDMI MALE TO HDMI MALE, 15'	\$ 23.00	\$ 12,211.00
77	415	MON.415.21	SONY	XBR-55X800E	MONITOR, 55" LED	\$ 800.00	\$ 13,011.00

Sheet Number: 901.00
Date: 12-12-2017
Scale: NO SCALE
Sheet Size: 11 x 17

Council Chambers Technology Upgrades Bill of Material Sheet 1 of 2

 City of New Ulm
100 North Broadway
New Ulm, MN 56073
cl.new-ulm.mn.us

 **MoreCom**
7600 Boone Avenue North
Minneapolis, MN 55428
morecom.com

Line	SHEET	PROJECT ID	MAKE	MODEL	DESCRIPTION	Unit	Total
78	415	MNT.415.21	CHIEF MFG	T5525TU	MOUNT, WALL, DUAL ARM WALL MOUNT, THINSTALL, UNIVERSAL, BLACK, 37" TO 58" DISPLAYS	\$ 436.00	\$13,447.00
79	415	CNV.415.31	BLACKMAGIC DESIGN	CONVCMIC/SH/WPSU	CONVERTER, SDI TO HDMI, MOCRO CONVERTER, WITH POWER SUPPLY	\$ 59.00	\$13,506.00
80	415	CBL.415.31	CABLES TO GO	50612	CABLE, HDMI MALE TO HDMI MALE, 15'	\$ 23.00	\$13,529.00
81	415	MON.415.31	SONY	XBR-49X800E	MONITOR, 49" LED	\$ 700.00	\$14,229.00
82	415	MNT.415.31	CHIEF MFG	MWRUB	MOUNT, WALL, SINGLE ARM, UNIVERSAL SWING ARM MOUNT, BLACK, 30" TO 55" DISPLAYS	\$ 419.00	\$14,648.00
83	415	CNV.415.41	BLACKMAGIC DESIGN	CONVCMIC/SH/WPSU	CONVERTER, SDI TO HDMI, MOCRO CONVERTER, WITH POWER SUPPLY	\$ 59.00	\$14,707.00
84	451	CBL.415.41	CABLES TO GO	50612	CABLE, HDMI MALE TO HDMI MALE, 15'	\$ 23.00	\$14,730.00
85	415	MON.415.41	SONY	XBR-49X800E	MONITOR, 49" LED	\$ 700.00	\$15,430.00
86	415	MNT.415.41	CHIEF MFG	MWRUB	MOUNT, WALL, SINGLE ARM, UNIVERSAL SWING ARM MOUNT, BLACK, 30" TO 55" DISPLAYS	\$ 419.00	\$15,849.00
87	415	CNV.415.51	BLACKMAGIC DESIGN	CONVCMIC/SH/WPSU	CONVERTER, SDI TO HDMI, MOCRO CONVERTER, WITH POWER SUPPLY	\$ 59.00	\$15,908.00
88	451	CBL.415.51	CABLES TO GO	50612	CABLE, HDMI MALE TO HDMI MALE, 15'	\$ 23.00	\$15,931.00
89	415	MON.415.51	OFE	OFE	OWNER FURNISHED EQUIPMENT: MONITOR, LECTERN	\$ -	\$15,931.00
90	415	CNV.415.81	BLACKMAGIC DESIGN	CONVCMIC/SH/WPSU	CONVERTER, SDI TO HDMI, MOCRO CONVERTER, WITH POWER SUPPLY	\$ 59.00	\$15,990.00
91	451	CBL.415.81	CABLES TO GO	42517	CABLE, HDMI MALE TO DVI MALE, 3-METERS	\$ 18.00	\$16,008.00
92	415	MON.415.81	AOC	i2269VW	MONITOR, 22" LCD	\$ 100.00	\$16,108.00
93	415	CNV.415.82	BLACKMAGIC DESIGN	CONVCMIC/SH/WPSU	CONVERTER, SDI TO HDMI, MOCRO CONVERTER, WITH POWER SUPPLY	\$ 59.00	\$16,167.00
94	415	CBL.415.82	CABLES TO GO	42517	CABLE, HDMI MALE TO DVI MALE, 3-METERS	\$ 18.00	\$16,185.00
95	415	MON.415.82	AOC	i2269VW	MONITOR, 22" LCD	\$ 100.00	\$16,285.00
96	422	CAM.422.01	NEWTEK	FG-001777-R01	CAMERA, NDIHX-PTZ1, PTZF, NDI, SDI, HDMI, POE+	\$ 2,700.00	\$18,985.00
97	422	CMT.422.01	CUSTOM	CUSTOM	CUSTOM MOUNTING SOLUTION	\$ 75.00	\$19,060.00
98	422	CAM.422.02	NEWTEK	FG-001777-R01	CAMERA, NDIHX-PTZ1, PTZF, NDI, SDI, HDMI, POE+	\$ 2,700.00	\$21,760.00
99	422	CMT.422.02	CUSTOM	CUSTOM	CUSTOM MOUNTING SOLUTION	\$ 75.00	\$21,835.00
100	422	CAM.422.03	NEWTEK	FG-001777-R01	CAMERA, NDIHX-PTZ1, PTZF, NDI, SDI, HDMI, POE+	\$ 2,700.00	\$24,535.00
101	422	CMT.422.03	CUSTOM	CUSTOM	CUSTOM MOUNTING SOLUTION	\$ 75.00	\$24,610.00
102	422	CAM.422.04	NEWTEK	FG-001777-R01	CAMERA, NDIHX-PTZ1, PTZF, NDI, SDI, HDMI, POE+	\$ 2,700.00	\$27,310.00
103	422	CMT.422.04	CUSTOM	CUSTOM	CUSTOM MOUNTING SOLUTION	\$ 75.00	\$27,385.00
104	422	NPP.422.01	PANDUIT	DP24688ZTGY	PATCH PANEL, CAT6, 24-PORT	\$ 399.00	\$27,784.00
105	422	NSW.422.01	HEWLETT PACKARD ENTERPRISE	JL384A	SWITCH, NETWORK, 1920S, GIGABIT, 24-PORT, 2SFP, PPOE+, 185WATTS	\$ 478.00	\$28,262.00
106	422	TRX.422.01	FIBER STORE	13262	TRANSCEIVER, 1000BASE-LX-SFP, 1310NM, 10KM	\$ 50.00	\$28,312.00
107	422	ATT.422.01	FIBER STORE	48526	ATTENUATOR, 10DB, FIBER OPTIC, LC/UPC, SINGLEMODE, FIXED, MALE-FEMALE	\$ 25.00	\$28,337.00
108	422	ATT.422.02	FIBER STORE	48526	ATTENUATOR, 10DB, FIBER OPTIC, LC/UPC, SINGLEMODE, FIXED, MALE-FEMALE	\$ 25.00	\$28,362.00
109	422	BLI.422.01	BELDEN	4813 D15A1000	BUDGET: CAT6 CABLE, 600MHZ RATED, PLENUM, QTY AS REQUIRED	\$ 2,000.00	\$30,362.00
110	422	BLI.422.02	PLATINUM TOOLS	100010C	BUDGET: CAT6 CONNECTORS, QTY AS REQUIRED	\$ 100.00	\$30,462.00
111	422	BLI.422.03	CABLES TO GO	791	BUDGET: CAT6 PATCH CORDS, QTY AS REQUIRED	\$ 50.00	\$30,512.00
112	422	BLI.422.04	FIBER STORE	SM-LCU-LCU-DX-FS-__M-OFNP	BUDGET: FIBER OPTIC CABLE, OS2 9/125, LC/UPC TO LC/UPC DUPLEX, SINGLEMODE, QTY AS REQUIRED	\$ 500.00	\$31,012.00
113	432	CNV.432.01	BLACKMAGIC DESIGN	CONVCMIC/SH/WPSU	CONVERTER, SDI TO HDMI, MOCRO CONVERTER, WITH POWER SUPPLY	\$ 59.00	\$31,071.00
114	432	CBL.432.01	CABLES TO GO	50612	CABLE, HDMI MALE TO HDMI MALE, 15'	\$ 23.00	\$31,094.00
115	432	SEG.432.01	NEWTEK	FG-000874-R001	SWITCHER, SEG, TRICASTER, MINI HD-4, HDMI, NDI	\$ 5,995.00	\$37,089.00
116	432	SFT.432.01	NEWTEK	FG-001090-R001	SOFTWARE, TRICASTER ADVANCED EDITION, FOR TRICASTER MINI HDMI SWITCHERS	\$ 1,995.00	\$39,084.00
117	432	CBL.432.11	CABLES TO GO	50612	CABLE, HDMI MALE TO HDMI MALE, 15'	\$ 23.00	\$39,107.00
118	432	CNV.432.11	BLACKMAGIC DESIGN	CONVCMIC/HS	CONVERTER, HDMI TO SDI, MICRO CONVERTER	\$ 55.00	\$39,162.00
119	432	CBL.432.21	CABLES TO GO	42517	CABLE, HDMI MALE TO DVI MALE, 3-METERS	\$ 18.00	\$39,180.00
120	432	MON.432.21	AOC	i2269VW	MONITOR, 22" LCD	\$ 100.00	\$39,280.00
121	432	CBL.432.31	CABLES TO GO	26942	CABLE, DVI-D MALE TO MALE, 3-METERS	\$ 22.00	\$39,302.00
122	432	MON.432.31	AOC	i2269VW	MONITOR, 22" LCD	\$ 100.00	\$39,402.00
123	432	CBL.432.32	CABLES TO GO	26942	CABLE, DVI-D MALE TO MALE, 3-METERS	\$ 22.00	\$39,424.00
124	432	MON.432.32	AOC	i2269VW	MONITOR, 22" LCD	\$ 100.00	\$39,524.00
125	452	CNV.452.01	BLACKMAGIC DESIGN	CONVMSDIDA	DISTRIBUTION AMPLIFIER, SDI, 1X8, MINI CONVERTER, SDI DISTRIBUTION	\$ 195.00	\$39,719.00
126	452	CNV.452.11	BLACKMAGIC DESIGN	CONVMOF	CONVERTER, SDI TO SINGLEMODE FIBER, MINI CONVERTER, OPTICAL FIBER	\$ 495.00	\$40,214.00
127	452	MON.542.31	BLACKMAGIC DESIGN	SMTWSCOPEDUO4K2	SCOPE, SMARTSCOPE DUO4K, WAVEFORM, VECTOR, AUDIO PHASE & LEVEL, HISTORYGRAM	\$ 795.00	\$41,009.00
128	452	CNV.542.31	BLACKMAGIC DESIGN	CONVMASA	CONVERTER, SDI TO ANALOG, MINI CONVERTER	\$ 195.00	\$41,204.00
129	452	REC.452.31	OFE	OFE	OWNER FURNISHED EQUIPMENT, DVD RECORDER, MAGNAVOX	\$ -	\$41,204.00
130	452	CBL.452.32	CABLES TO GO	50612	CABLE, HDMI MALE TO HDMI MALE, 15'	\$ 23.00	\$41,227.00
131	452	CNV.452.32	BLACKMAGIC DESIGN	CONVCMIC/HS	CONVERTER, HDMI TO SDI, MICRO CONVERTER	\$ 55.00	\$41,282.00
132	452	CNV.542.41	BLACKMAGIC DESIGN	CONVMASA	CONVERTER, SDI TO ANALOG, MINI CONVERTER	\$ 195.00	\$41,477.00
133	452	VDA.452.41	OFE	OFE	OWNER FURNISHED EQUIPMENT: KRAMER, VM-SARII, AV DIST. AMPLIFIER 1X5	\$ -	\$41,477.00
134	452	MOD.452.41	OFE	OFE	OWNER FURNISHED EQUIPMENT: SCIENTIFIC ATLANTA, MODULATOR - COMCAST	\$ -	\$41,477.00
135	452	BLI.452.01	BUDGET	LINE ITEM	BUDGET: AUDIO CABLES, QTY AS REQUIRED	\$ 50.00	\$41,527.00
136	452	BLI.452.02	BUDGET	LINE ITEM	BUDGET: AUDIO CONNECTORS, QTY AS REQUIRED	\$ 50.00	\$41,577.00
137	452	BLI.452.03	FIBER STORE	SM-LCU-LCU-DX-FS-__M-OFNP	BUDGET: FIBER OPTIC CABLE, OS2 9/125, LC/UPC TO LC/UPC DUPLEX, SINGLEMODE, QTY AS REQUIRED	\$ 500.00	\$42,077.00
138	471	CNV.471.01	BLACKMAGIC DESIGN	CONVMOF	CONVERTER, SDI TO SINGLEMODE FIBER, MINI CONVERTER, OPTICAL FIBER	\$ 495.00	\$42,572.00
139	471	BLI.471.01	FIBER STORE	SM-LCU-LCU-DX-FS-__M-OFNP	BUDGET: FIBER OPTIC CABLE, OS2 9/125, LC/UPC TO LC/UPC DUPLEX, SINGLEMODE, QTY AS REQUIRED	\$ 100.00	\$42,672.00
140	901	BLI.901.01	BUDGET	LINE ITEM	FREIGHT	\$ 800.00	\$43,472.00
141					TOTAL ESTIMATED GOODS:	\$ 43,472.00	
142							
143	901	BLI.901.11	LABOR	DEMO	REMOVE CONTROL ROOM CABLING - STRIP RACK AND LECTERN TO BARE BONES AND START OVER -	\$ 1,200.00	\$44,672.00
144	901	BLI.901.12	LABOR	ROUGH-IN	CABLE PULLS, RACK MOUNTING EQUIPMENT, MOUNTING MONITORS	\$ 6,500.00	\$51,172.00
145	901	BLI.901.13	LABOR	TERMINATION	TERMINATE ALL CABLES	\$ 4,500.00	\$55,672.00
146	901	BLI.901.14	LABOR	TESTING	TESTING AND VERIFYING SIGNALS	\$ 500.00	\$56,172.00
147	901	BLI.901.15	LABOR	CALIBRATION	CALIBRATE SYSTEM FOR OPTIMAL USE	\$ 500.00	\$56,672.00
148					TOTAL ESTIMATED SERVICES:	\$ 13,200.00	
149					PROJECT SUBTOTAL:	\$ 56,672.00	
150	901	BLI.901.21	BUDGET	10% CONTINGENCY	BUDGET: 15% CONTINGENCY FOR CHANGE ORDERS AND UNEXPECTED ISSUES	\$ 8,500.80	\$65,172.80
151					TOTAL PROJECT ESTIMATE:	\$65,172.80	

Sheet Size: 11 x 17
 Scale: NO SCALE
 Date: 12-12-2017
 Sheet Number: 902.00

Council Chambers Technology Upgrades

Bill of Material Sheet 2 of 2

 City of New Ulm
 100 North Broadway
 New Ulm, MN 56073
 ci.new-ulm.mn.us

 **More Com**
 7600 Boone Avenue North
 Minneapolis, MN 55428
 morecom.com

Line	SHEET	PROJECT ID	MAKE	MODEL	DESCRIPTION	Unit	Total
1	111	LVP.121.01	BUDGET	LINE ITEM	Low-voltage structural supports and hardware as required by NEC using pathways shown	\$ 500.00	\$ 500.00
2	182	RKA.182.01	MIDDLE ATLANTIC	HW500	RACK SCREWS	\$ 183.00	\$ 683.00
3	182	RKA.182.02	RACK GOLD	LYSB01G218M8A-CMPTRACCS	RACK CLIPS	\$ 30.00	\$ 713.00
4	182	RKA.182.03	RACK GOLD	LYSB01G218M8A-CMPTRACCS	RACK CLIPS	\$ 30.00	\$ 743.00
5	182	RKA.182.04	MIDDLE ATLANTIC	LBP-1R	LACER BARS, HORIZONTAL, PACK OF TEN	\$ 75.00	\$ 818.00
6	182	RKA.182.05	PANDUIT	TTR-75RO	HOOK AND LOOP ROLL, 75'	\$ 80.00	\$ 898.00
7	182	RKA.182.06	PANDUIT	G2X4LG6	SLOTTED DUCT, 2" W X 4" H X 6' LONG, PVC, LIGHT GRAY	\$ 500.00	\$ 1,398.00
8	182	RKA.182.07	PANDUIT	C2LG6	DUCT COVER, 2" W X 6' LONG, PVC, LIGHT GRAY	\$ 100.00	\$ 1,498.00
9	182	RKA.182.112	MIDDLE ATLANTIC	EB1	BLANK RACK PANEL, 1RU	\$ 8.00	\$ 1,506.00
10	182	RKA.182.113	MIDDLE ATLANTIC	RC-2	RACK SHELF, CLAMPING, 2RU	\$ 25.00	\$ 1,531.00
11	182	CMT.182.114	CUSTOM	CUSTOM	CUSTOM MOUNTING SOLUTION	\$ 25.00	\$ 1,556.00
12	182	CMT.182.115	CUSTOM	CUSTOM	CUSTOM MOUNTING SOLUTION	\$ 25.00	\$ 1,581.00
13	182	CMT.182.116	CUSTOM	CUSTOM	CUSTOM MOUNTING SOLUTION	\$ 25.00	\$ 1,606.00
14	182	CMT.182.117	CUSTOM	CUSTOM	CUSTOM MOUNTING SOLUTION	\$ 25.00	\$ 1,631.00
15	182	RKA.182.121	MIDDLE ATLANTIC	EB1	BLANK RACK PANEL, 1RU	\$ 8.00	\$ 1,639.00
16	182	RKA.182.122	MIDDLE ATLANTIC	U2V	RACK SHELF, VENTED, 2RU	\$ 75.00	\$ 1,714.00
17	182	RKA.182.123	MIDDLE ATLANTIC	EB1	BLANK RACK PANEL, 1RU	\$ 8.00	\$ 1,722.00
18	182	RKA.182.124	MIDDLE ATLANTIC	EB1	BLANK RACK PANEL, 1RU	\$ 8.00	\$ 1,730.00
19	182	CMT.182.125	CUSTOM	CUSTOM	CUSTOM MOUNTING SOLUTION	\$ 75.00	\$ 1,805.00
20	182	RKA.182.211	MIDDLE ATLANTIC	EB1	BLANK RACK PANEL, 1RU	\$ 8.00	\$ 1,813.00
21	182	RKA.182.212	MIDDLE ATLANTIC	EB1	BLANK RACK PANEL, 1RU	\$ 8.00	\$ 1,821.00
22	182	RKA.182.213	MIDDLE ATLANTIC	EB1	BLANK RACK PANEL, 1RU	\$ 8.00	\$ 1,829.00
23	182	RKA.182.214	MIDDLE ATLANTIC	EB1	BLANK RACK PANEL, 1RU	\$ 8.00	\$ 1,837.00
24	182	CMT.182.215	CUSTOM	CUSTOM	CUSTOM MOUNTING SOLUTION	\$ 75.00	\$ 1,912.00
25	182	RKA.182.221	MIDDLE ATLANTIC	EB1	BLANK RACK PANEL, 1RU	\$ 8.00	\$ 1,920.00
26	182	RKA.182.222	MIDDLE ATLANTIC	U2V	RACK SHELF, VENTED, 2RU	\$ 75.00	\$ 1,995.00
27	182	RKA.182.223	MIDDLE ATLANTIC	EB1	BLANK RACK PANEL, 1RU	\$ 8.00	\$ 2,003.00
28	182	RKA.182.224	MIDDLE ATLANTIC	EB1	BLANK RACK PANEL, 1RU	\$ 8.00	\$ 2,011.00
29	182	RKA.182.225	MIDDLE ATLANTIC	EB1	BLANK RACK PANEL, 1RU	\$ 8.00	\$ 2,019.00
30	182	RKA.182.226	MIDDLE ATLANTIC	U2V	RACK SHELF, VENTED, 2RU	\$ 75.00	\$ 2,094.00
31	182	RKA.182.227	MIDDLE ATLANTIC	EB1	BLANK RACK PANEL, 1RU	\$ 8.00	\$ 2,102.00
32	182	RKA.182.228	MIDDLE ATLANTIC	U2V	RACK SHELF, VENTED, 2RU	\$ 75.00	\$ 2,177.00
33	182	CMT.182.229	CUSTOM	CUSTOM	CUSTOM MOUNTING SOLUTION	\$ 75.00	\$ 2,252.00
34	182	CMT.182.230	CUSTOM	CUSTOM	CUSTOM MOUNTING SOLUTION	\$ 75.00	\$ 2,327.00
35	182	CMT.182.231	CUSTOM	CUSTOM	CUSTOM MOUNTING SOLUTION	\$ 75.00	\$ 2,402.00

36	182	CMT.182.232	CUSTOM	CUSTOM	CUSTOM MOUNTING SOLUTION	\$ 75.00	\$ 2,477.00
37	211	CKT.211.01	OFE	OFE	OWNER FURNISHED EQUIPMENT: ELECTRIC CIRCUIT	\$ -	\$ 2,477.00
38	211	SRG.211.01	SURGEX	SX1120-RT	SURGE PROTECTOR, ACTIVE, 120VAC, 20AMPS	\$ 700.00	\$ 3,177.00
39	211	UPS.211.01	EATON	5P1500RT	UPS, 1500VA, 2RU	\$ 700.00	\$ 3,877.00
40	221	OLS.221.11	MIDDLE ATLANTIC	PD-815SC-NS	OUTLET STRIP, 15AMPS, HIGH-DENSITY, SLIM, NO SURGE	\$ 100.00	\$ 3,977.00
41	221	OLS.221.12	MIDDLE ATLANTIC	PD-815SC-NS	OUTLET STRIP, 15AMPS, HIGH-DENSITY, SLIM, NO SURGE	\$ 100.00	\$ 4,077.00
42	222	OLS.222.21	MIDDLE ATLANTIC	PD-815SC-NS	OUTLET STRIP, 15AMPS, HIGH-DENSITY, SLIM, NO SURGE	\$ 100.00	\$ 4,177.00
43	222	OLS.222.22	MIDDLE ATLANTIC	PD-815SC-NS	OUTLET STRIP, 15AMPS, HIGH-DENSITY, SLIM, NO SURGE	\$ 100.00	\$ 4,277.00
44	222	OLS.222.23	MIDDLE ATLANTIC	PD-815SC-NS	OUTLET STRIP, 15AMPS, HIGH-DENSITY, SLIM, NO SURGE	\$ 100.00	\$ 4,377.00
45	223	CKT.223.01	OFE	OFE	OWNER FURNISHED EQUIPMENT: ELECTRIC CIRCUIT	\$ -	\$ 4,377.00
46	223	SRG.223.01	SURGEX	SA-20	SURGE PROTECTOR, ACTIVE, 120VAC, 20AMPS	\$ 420.00	\$ 4,797.00
47	223	UPS.223.01	EATON	5P1500RT	UPS, 1500VA, 2RU	\$ 700.00	\$ 5,497.00
48	223	OLS.223.01	MIDDLE ATLANTIC	PD-815SC-NS	OUTLET STRIP, 15AMPS, HIGH-DENSITY, SLIM, NO SURGE	\$ 100.00	\$ 5,597.00
49	411	DOC.411.01	EPSON	DC-21	DOCUMENT CAMERA, DESK	\$ 560.00	\$ 6,157.00
50	411	CBL.411.01	CABLES TO GO	50612	CABLE, HDMI MALE TO HDMI MALE, 15'	\$ 23.00	\$ 6,180.00
51	411	CNV.411.01	BLACKMAGIC DESIGN	CONVCMIC/HS	CONVERTER, HDMI TO SDI, MICRO CONVERTER	\$ 55.00	\$ 6,235.00
52	411	BYOD.411.02	OFE	OFE	OWNER FURNISHED EQUIPMENT: LAPTOP BY END-USERS - BRING YOUR OWN DEVICE	\$ -	\$ 6,235.00
53	411	PLT.411.02	EXTRON	60-1404-02	PLATE, RECESSED, CABLE CUBBY 500, BLACK, WITH US AC POWER MODULE, CABLE PASS	\$ 600.00	\$ 6,835.00
54	411	CBL.411.02	CABLES TO GO	50612	CABLE, HDMI MALE TO HDMI MALE, 15'	\$ 23.00	\$ 6,858.00
55	411	CNV.411.02	BLACKMAGIC DESIGN	CONVCMIC/HS	CONVERTER, HDMI TO SDI, MICRO CONVERTER	\$ 55.00	\$ 6,913.00
56	411	KEY.411.04	OFE	OFE	OWNER FURNISHED EQUIPMENT: KEYBOARD	\$ -	\$ 6,913.00
57	411	MSE.411.04	OFE	OFE	OWNER FURNISHED EQUIPMENT: MOUSE	\$ -	\$ 6,913.00
58	411	PC.411.04	OFE	OFE	OWNER FURNISHED EQUIPMENT: COMPUTER	\$ -	\$ 6,913.00
59	411	CBL.411.04	CABLES TO GO	54327	CABLE, DISPLAY PORT TO HDMI, 10'	\$ 34.00	\$ 6,947.00
60	411	CNV.411.04	BLACKMAGIC DESIGN	CONVCMIC/HS	CONVERTER, HDMI TO SDI, MICRO CONVERTER	\$ 55.00	\$ 7,002.00
61	411	KEY.411.06	OFE	OFE	OWNER FURNISHED EQUIPMENT: KEYBOARD	\$ -	\$ 7,002.00
62	411	MSE.411.06	OFE	OFE	OWNER FURNISHED EQUIPMENT: MOUSE	\$ -	\$ 7,002.00
63	411	PC.411.06	OFE	OFE	OWNER FURNISHED EQUIPMENT: COMPUTER	\$ -	\$ 7,002.00
64	411	CBL.411.06	CABLES TO GO	54327	CABLE, DISPLAY PORT TO HDMI, 10'	\$ 34.00	\$ 7,036.00
65	411	CNV.411.06	BLACKMAGIC DESIGN	CONVCMIC/HS	CONVERTER, HDMI TO SDI, MICRO CONVERTER	\$ 55.00	\$ 7,091.00
66	411	SWT.411.31	BLACKMAGIC DESIGN	VHUBSMTCS6G1212	SWITCHER, MATRIX, 12X12, SDI, SMART VIDEOHUB CLEAN SWITCH 12X12	\$ 1,495.00	\$ 8,586.00
67	411	BLI.411.01	BELDEN	88241 0101000	BUDGET: VIDEO CABLE, BELDEN, 88241 0101000 - QTY AS REQUIRED	\$ 1,800.00	\$ 10,386.00
68	411	BLI.411.02	AMPHENOL	31-71008-RFX	BUDGET: BNC CONNECTORS - QTY AS REQUIRED	\$ 150.00	\$ 10,536.00
69	411	BLI.411.02	PANDUIT	TTR-75RO	HOOK AND LOOP ROLL, 75'	\$ 80.00	\$ 10,616.00

70	415	CNV.415.01	BLACKMAGIC DESIGN	CONVMSDIDA	DISTRIBUTION AMPLIFIER, SDI, 1X8, MINI CONVERTER, SDI DISTRIBUTION	\$ 195.00	\$ 10,811.00
71	415	CNV.415.11	BLACKMAGIC DESIGN	CONVCMIC/SH/WPSU	CONVERTER, SDI TO HDMI, MOCRO CONVERTER, WITH POWER SUPPLY	\$ 59.00	\$ 10,870.00
72	415	CBL.415.11	CABLES TO GO	50612	CABLE, HDMI MALE TO HDMI MALE, 15'	\$ 23.00	\$ 10,893.00
73	415	MON.415.11	SONY	XBR-55X800E	MONITOR, 55" LED	\$ 800.00	\$ 11,693.00
74	415	MNT.415.11	CHIEF MFG	TSS25TU	MOUNT, WALL, DUAL ARM WALL MOUNT, THINSTALL, UNIVERSAL, BLACK, 37" TO 58" DISPLAYS	\$ 436.00	\$ 12,129.00
75	415	CNV.415.21	BLACKMAGIC DESIGN	CONVCMIC/SH/WPSU	CONVERTER, SDI TO HDMI, MOCRO CONVERTER, WITH POWER SUPPLY	\$ 59.00	\$ 12,188.00
76	415	CBL.415.21	CABLES TO GO	50612	CABLE, HDMI MALE TO HDMI MALE, 15'	\$ 23.00	\$ 12,211.00
77	415	MON.415.21	SONY	XBR-55X800E	MONITOR, 55" LED	\$ 800.00	\$ 13,011.00
78	415	MNT.415.21	CHIEF MFG	TSS25TU	MOUNT, WALL, DUAL ARM WALL MOUNT, THINSTALL, UNIVERSAL, BLACK, 37" TO 58" DISPLAYS	\$ 436.00	\$ 13,447.00
79	415	CNV.415.31	BLACKMAGIC DESIGN	CONVCMIC/SH/WPSU	CONVERTER, SDI TO HDMI, MOCRO CONVERTER, WITH POWER SUPPLY	\$ 59.00	\$ 13,506.00
80	415	CBL.415.31	CABLES TO GO	50612	CABLE, HDMI MALE TO HDMI MALE, 15'	\$ 23.00	\$ 13,529.00
81	415	MON.415.31	SONY	XBR-49X800E	MONITOR, 49" LED	\$ 700.00	\$ 14,229.00
82	415	MNT.415.31	CHIEF MFG	MWRUB	MOUNT, WALL, SINGLE ARM, UNIVERSAL SWING ARM MOUNT, BLACK, 30" TO 55" DISPLAYS	\$ 419.00	\$ 14,648.00
83	415	CNV.415.41	BLACKMAGIC DESIGN	CONVCMIC/SH/WPSU	CONVERTER, SDI TO HDMI, MOCRO CONVERTER, WITH POWER SUPPLY	\$ 59.00	\$ 14,707.00
84	451	CBL.415.41	CABLES TO GO	50612	CABLE, HDMI MALE TO HDMI MALE, 15'	\$ 23.00	\$ 14,730.00
85	415	MON.415.41	SONY	XBR-49X800E	MONITOR, 49" LED	\$ 700.00	\$ 15,430.00
86	415	MNT.415.41	CHIEF MFG	MWRUB	MOUNT, WALL, SINGLE ARM, UNIVERSAL SWING ARM MOUNT, BLACK, 30" TO 55" DISPLAYS	\$ 419.00	\$ 15,849.00
87	415	CNV.415.51	BLACKMAGIC DESIGN	CONVCMIC/SH/WPSU	CONVERTER, SDI TO HDMI, MOCRO CONVERTER, WITH POWER SUPPLY	\$ 59.00	\$ 15,908.00
88	451	CBL.415.51	CABLES TO GO	50612	CABLE, HDMI MALE TO HDMI MALE, 15'	\$ 23.00	\$ 15,931.00
89	415	MON.415.51	OFE	OFE	OWNER FURNISHED EQUIPMENT: MONITOR, LECTERN	\$ -	\$ 15,931.00
90	415	CNV.415.81	BLACKMAGIC DESIGN	CONVCMIC/SH/WPSU	CONVERTER, SDI TO HDMI, MOCRO CONVERTER, WITH POWER SUPPLY	\$ 59.00	\$ 15,990.00
91	451	CBL.415.81	CABLES TO GO	42517	CABLE, HDMI MALE TO DVI MALE, 3-METERS	\$ 18.00	\$ 16,008.00
92	415	MON.415.81	AOC	i2269VW	MONITOR, 22" LCD	\$ 100.00	\$ 16,108.00
93	415	CNV.415.82	BLACKMAGIC DESIGN	CONVCMIC/SH/WPSU	CONVERTER, SDI TO HDMI, MOCRO CONVERTER, WITH POWER SUPPLY	\$ 59.00	\$ 16,167.00
94	415	CBL.415.82	CABLES TO GO	42517	CABLE, HDMI MALE TO DVI MALE, 3-METERS	\$ 18.00	\$ 16,185.00
95	415	MON.415.82	AOC	i2269VW	MONITOR, 22" LCD	\$ 100.00	\$ 16,285.00
96	422	CAM.422.01	NEWTEK	FG-001777-R01	CAMERA, NDIHX-PTZ1, PTZF, NDI, SDI, HDMI, POE+	\$ 2,700.00	\$ 18,985.00
97	422	CMT.422.01	CUSTOM	CUSTOM	CUSTOM MOUNTING SOLUTION	\$ 75.00	\$ 19,060.00
98	422	CAM.422.02	NEWTEK	FG-001777-R01	CAMERA, NDIHX-PTZ1, PTZF, NDI, SDI, HDMI, POE+	\$ 2,700.00	\$ 21,760.00
99	422	CMT.422.02	CUSTOM	CUSTOM	CUSTOM MOUNTING SOLUTION	\$ 75.00	\$ 21,835.00
100	422	CAM.422.03	NEWTEK	FG-001777-R01	CAMERA, NDIHX-PTZ1, PTZF, NDI, SDI, HDMI, POE+	\$ 2,700.00	\$ 24,535.00
101	422	CMT.422.03	CUSTOM	CUSTOM	CUSTOM MOUNTING SOLUTION	\$ 75.00	\$ 24,610.00
102	422	CAM.422.04	NEWTEK	FG-001777-R01	CAMERA, NDIHX-PTZ1, PTZF, NDI, SDI, HDMI, POE+	\$ 2,700.00	\$ 27,310.00
103	422	CMT.422.04	CUSTOM	CUSTOM	CUSTOM MOUNTING SOLUTION	\$ 75.00	\$ 27,385.00

104	422	NPP.422.01	PANDUIT	DP24688ZTGY	PATCH PANEL, CAT6, 24-PORT	\$ 399.00	\$ 27,784.00
105	422	NSW.422.01	HEWLETT PACKARD ENTERPIRS	JL384A	SWITCH, NETWORK, 1920S, GIGABIT, 24-PORT, 2SFP, PPOE+, 185WATTS	\$ 478.00	\$ 28,262.00
106	422	TRX.422.01	FIBER STORE	13262	TRANSCEIVER, 1000BASE-LX-SFP, 1310NM, 10KM	\$ 50.00	\$ 28,312.00
107	422	ATT.422.01	FIBER STORE	48526	ATTENUATOR, 10DB, FIBER OPTIC, LC/UPC, SINGLEMODE, FIXED, MALE-FEMALE	\$ 25.00	\$ 28,337.00
108	422	ATT.422.02	FIBER STORE	48526	ATTENUATOR, 10DB, FIBER OPTIC, LC/UPC, SINGLEMODE, FIXED, MALE-FEMALE	\$ 25.00	\$ 28,362.00
109	422	BLI.422.01	BELDEN	4813 D15A1000	BUDGET: CAT6 CABLE, 600MHZ RATED, PLENUM, QTY AS REQUIRED	\$ 2,000.00	\$ 30,362.00
110	422	BLI.422.02	PLATINUM TOOLS	100010C	BUDGET: CAT6 CONNECTORS, QTY AS REQUIRED	\$ 100.00	\$ 30,462.00
111	422	BLI.422.03	CABLES TO GO	791	BUDGET: CAT6 PATCH CORDS, QTY AS REQUIRED	\$ 50.00	\$ 30,512.00
112	422	BLI.422.04	FIBER STORE	SM-LCU-LCU-DX-FS-__M-OFNP	BUDGET: FIBER OPTIC CABLE, OS2 9/125, LC/UPC TO LC/UPC DUPLEX, SINGLEMODE, QTY AS REQUIRED	\$ 500.00	\$ 31,012.00
113	432	CNV.432.01	BLACKMAGIC DESIGN	CONVCMIC/SH/WPSU	CONVERTER, SDI TO HDMI, MOCRO CONVERTER, WITH POWER SUPPLY	\$ 59.00	\$ 31,071.00
114	432	CBL.432.01	CABLES TO GO	50612	CABLE, HDMI MALE TO HDMI MALE, 15'	\$ 23.00	\$ 31,094.00
115	432	SEG.432.01	NEWTEK	FG-000874-R001	SWITCHER, SEG, TRICASTER, MINI HD-4, HDMI, NDI	\$ 5,995.00	\$ 37,089.00
116	432	SFT.432.01	NEWTEK	FG-001090-R001	SOFTWARE, TRICASTER ADVANCED EDITION, FOR TRICASTER MINI HDMI SWITCHERS	\$ 1,995.00	\$ 39,084.00
117	432	CBL.432.11	CABLES TO GO	50612	CABLE, HDMI MALE TO HDMI MALE, 15'	\$ 23.00	\$ 39,107.00
118	432	CNV.432.11	BLACKMAGIC DESIGN	CONVCMIC/HS	CONVERTER, HDMI TO SDI, MICRO CONVERTER	\$ 55.00	\$ 39,162.00
119	432	CBL.432.21	CABLES TO GO	42517	CABLE, HDMI MALE TO DVI MALE, 3-METERS	\$ 18.00	\$ 39,180.00
120	432	MON.432.21	AOC	i2269VW	MONITOR, 22" LCD	\$ 100.00	\$ 39,280.00
121	432	CBL.432.31	CABLES TO GO	26942	CABLE, DVI-D MALE TO MALE, 3-METERS	\$ 22.00	\$ 39,302.00
122	432	MON.432.31	AOC	i2269VW	MONITOR, 22" LCD	\$ 100.00	\$ 39,402.00
123	432	CBL.432.32	CABLES TO GO	26942	CABLE, DVI-D MALE TO MALE, 3-METERS	\$ 22.00	\$ 39,424.00
124	432	MON.432.32	AOC	i2269VW	MONITOR, 22" LCD	\$ 100.00	\$ 39,524.00
125	452	CNV.452.01	BLACKMAGIC DESIGN	CONVMSDIDA	DISTRIBUTION AMPLIIFER, SDI, 1X8, MINI CONVERTER, SDI DISTRIBUTION	\$ 195.00	\$ 39,719.00
126	452	CNV.452.11	BLACKMAGIC DESIGN	CONVMOF	CONVERTER, SDI TO SINGLEMODE FIBER, MINI CONVERTER, OPTICAL FIBER	\$ 495.00	\$ 40,214.00
127	452	MON.542.31	BLACKMAGIC DESIGN	SMTWSCOPEDUO4K2	SCOPE, SMARTSCOPE DUO4K, WAVEFORM, VECTOR, AUDIO PHASE & LEVEL, HISTORYGRAM	\$ 795.00	\$ 41,009.00
128	452	CNV.542.31	BLACKMAGIC DESIGN	CONVMASA	CONVERTER, SDI TO ANALOG, MINI CONVERTER	\$ 195.00	\$ 41,204.00
129	452	REC.452.31	OFE	OFE	OWNER FURNISHED EQUIPMENT, DVD RECORDER, MAGNAVOX	\$ -	\$ 41,204.00
130	452	CBL.452.32	CABLES TO GO	50612	CABLE, HDMI MALE TO HDMI MALE, 15'	\$ 23.00	\$ 41,227.00
131	452	CNV.452.32	BLACKMAGIC DESIGN	CONVCMIC/HS	CONVERTER, HDMI TO SDI, MICRO CONVERTER	\$ 55.00	\$ 41,282.00
132	452	CNV.542.41	BLACKMAGIC DESIGN	CONVMASA	CONVERTER, SDI TO ANALOG, MINI CONVERTER	\$ 195.00	\$ 41,477.00
133	452	VDA.452.41	OFE	OFE	OWNER FURNISHED EQUIPMENT: KRAMER, VM-SARII, AV DIST. AMPLIFIER 1X5	\$ -	\$ 41,477.00
134	452	MOD.452.41	OFE	OFE	OWNER FURNISHED EQUIPMENT: SCIENTIFIC ATLANA, MODULATOR - COMCAST	\$ -	\$ 41,477.00
135	452	BLI.452.01	BUDGET	LINE ITEM	BUDGET: AUDIO CABLES, QTY AS REQUIRED	\$ 50.00	\$ 41,527.00
136	452	BLI.452.02	BUDGET	LINE ITEM	BUDGET: AUDIO CONNECTORS, QTY AS REQUIRED	\$ 50.00	\$ 41,577.00
137	452	BLI.452.03	FIBER STORE	SM-LCU-LCU-DX-FS-__M-OFNP	BUDGET: FIBER OPTIC CABLE, OS2 9/125, LC/UPC TO LC/UPC DUPLEX, SINGLEMODE, QTY AS REQUIRED	\$ 500.00	\$ 42,077.00

138	471	CNV.471.01	BLACKMAGIC DESIGN	CONVMOF	CONVERTER, SDI TO SINGLEMODE FIBER, MINI CONVERTER, OPTICAL FIBER	\$ 495.00	\$ 42,572.00
139	471	BLI.471.01	FIBER STORE	SM-LCU-LCU-DX-FS-__M-OFNP	BUDGET: FIBER OPTIC CABLE, OS2 9/125, LC/UPC TO LC/UPC DUPLEX, SINGLEMODE, QTY AS REQUIRED	\$ 100.00	\$ 42,672.00
140	901	BLI.901.01	BUDGET	LINE ITEM	FREIGHT	\$ 800.00	\$ 43,472.00
141					TOTAL ESTIMATED GOODS:	\$ 43,472.00	
142							
143	901	BLI.901.11	LABOR	DEMO	REMOVE CONTROL ROOM CABLING - STRIP RACK AND LECTERN TO BARE BONES AND START OVER -	\$ 1,200.00	\$ 44,672.00
144	901	BLI.901.12	LABOR	ROUGH-IN	CABLE PULLS, RACK MOUNTING EQUIPMENT, MOUNTING MONITORS	\$ 6,500.00	\$ 51,172.00
145	901	BLI.901.13	LABOR	TERMINATION	TERMINATE ALL CABLES	\$ 4,500.00	\$ 55,672.00
146	901	BLI.901.14	LABOR	TESTING	TESTING AND VERIFYING SIGNALS	\$ 500.00	\$ 56,172.00
147	901	BLI.901.15	LABOR	CALIBRATION	CALIBRATE SYSTEM FOR OPTIMAL USE	\$ 500.00	\$ 56,672.00
148					TOTAL ESTIMATED SERVICES:	\$ 13,200.00	
149					PROJECT SUBTOTAL:	\$ 56,672.00	
150	901	BLI.901.21	BUDGET	10% CONTINGENCY	BUDGET: 15% CONTINGENCY FOR CHANGE ORDERS AND UNEXPECTED ISSUES	\$ 8,500.80	\$ 65,172.80
151					TOTAL PROJECT ESTIMATE:	\$ 65,172.80	

City of New Ulm
Request for Cable Communications Advisory Board Action

Meeting Date:	December 14, 2017	Agenda Item Number:	4. a.
Agenda Section:	New Business	Originating Department:	NUCAT
Resolution:	N/A	Prepared By:	Mike McMahon Production Technician
Number of Attachments:	3	Presented By:	Mike McMahon Production Technician
Item:	Consider approval of bid for purchase of High Definition Studio Upgrade Equipment.		

Staff Proposed Action:

Motion by _____, second by _____, to accept the quote from B&H or Adorama for the High Definition Studio Upgrade Equipment.

Overview:

The cable access studio requires an update to High Definition. NUCAT staff have prepared the design for review with quotes for equipment from B&H and Adorama.

Primary Issues/Alternatives to Consider:

N/A

Budgetary/Fiscal Issues:

\$25,000 has been budgeted for the purchase of equipment.

Attachments:

- Design Presentation
- B&H Quote
- Adorama Quote

PART II

STUDIO UPDATES

Inputs



SDI

HDMI

USB

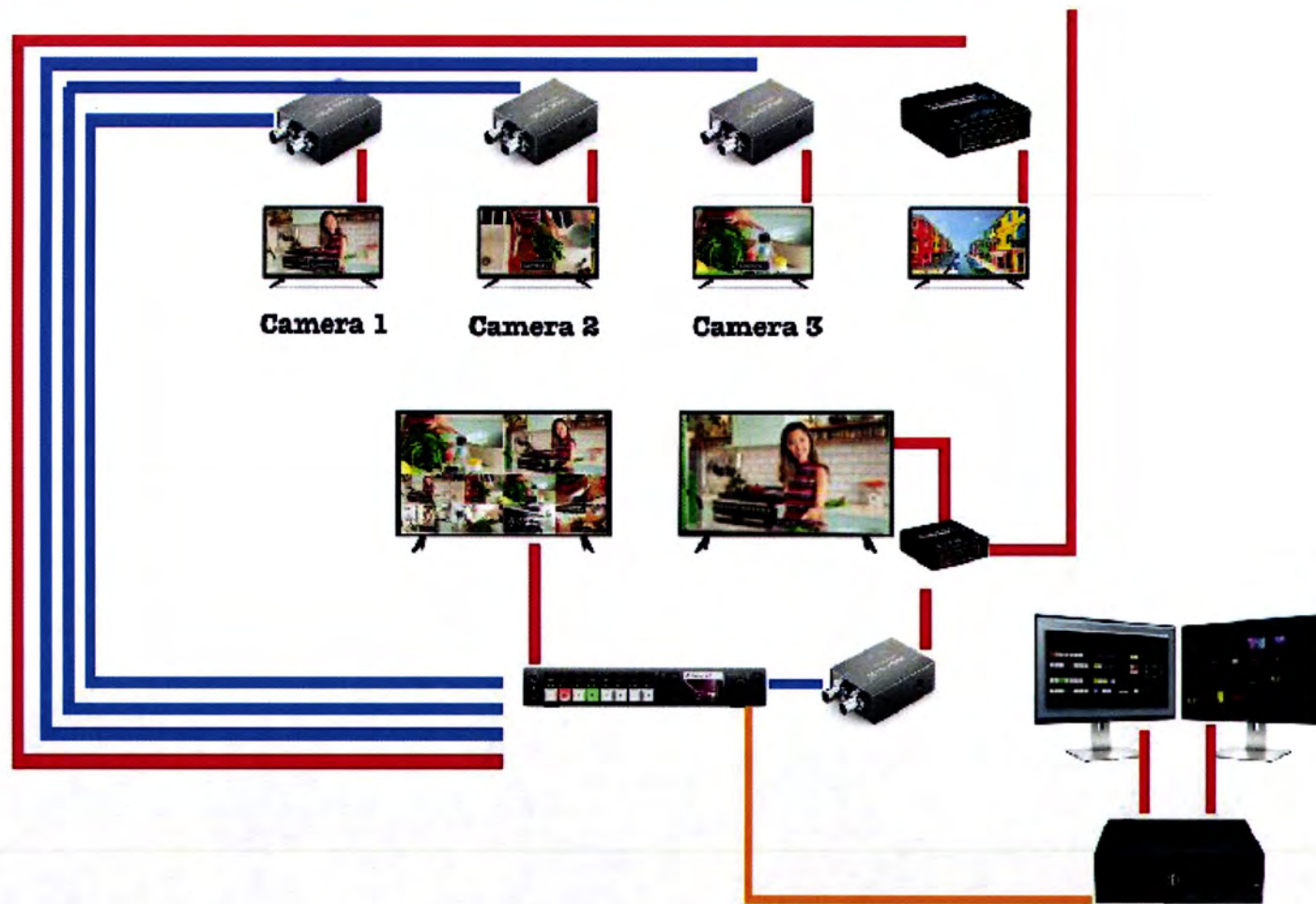



HD STUDIO SWITCHER

- INDUSTRY STANDARD OUTPUT
- LOW PRICE POINT
- EXPANSION READY
- HD CAMERA
- COMPUTER CONTROL



BLACKMAGIC CAMERAS

- INDUSTRY LEADER
- RELIABILITY
- HIGH QUALITY
- LOW PRICE POINT
- INTERCHANABLE LENSES
- COMPATIBLE WITH EXISTING EQUIPMENT.



Before

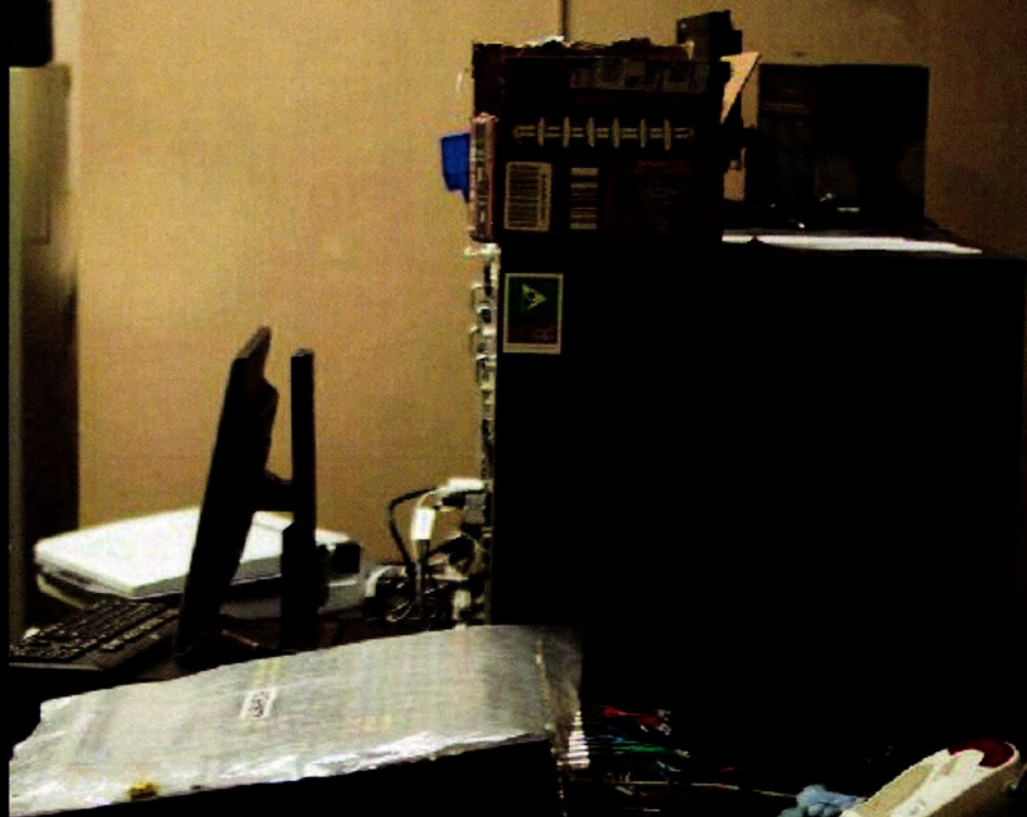



After





Government, Education, and Corporate Department

For Pricing Requests, Purchase Orders, and Customer Service:

Phone: **800-947-8003**
212-239-7503

Fax: **800-858-5517**
212-239-7759

Email: Education: emailbids@bhphoto.com
Corporate: corporatesales@bhphoto.com

Federal Government: gsa@bhphoto.com
State and Local: biddept@bhphoto.com

The Professional's Source

420 Ninth Avenue, New York City, NY 10001 • www.bhphotovideo.com

Prices Are Valid Until:

12/13/17

Bid No.: 707039190

Sold To:

City Of New Ulm
100 N Broadway St Ste 1
Attn: Steven Sherman
NEW ULM, MN 56073

Ship To:

City Of New Ulm
100 North Broadway
NEW ULM, MN 56073

Bill Phone: (507)359-8290
Fax Phone: (507)359-9752

(507)359-8233

Date	Customer Code	Terms	Salesperson	Ship Via
11/27/17	41941585	N/A	4C3	STANDARD
Qty Ord	Item Description	SKU# MFR#	Item Price	Amount
1	BLACKMAGIC URSA MINI PRO 4.6K CAM w/EF LENS MOUNT/REG	BLURSAMPRO (CINEURSAMUPR)	5,149.00	5,149.00
1	BLACKMAGIC V-MOUNT BUNDLE w/BATS/VM PLATE/CHARGER/REG	BLUMPROVMNT (UMPROVMOUNT)	749.00	749.00
	Free item when purchased with BLURSAMPRO			-749.00
1	ANTON-BAUER 2/DIGI 90 LITH BATT 14.4/CHRGR/GM PLA/REG	ANDIG90GMCK (BDLPLVITEC1)	1,179.00	1,179.00
	CONSISTS OF:			
	2 ANTON-BAUER DIGI 90 LITHIUM ION DIGI BATTERY 14.4V/REG	ANDIG90GM (86750082)		
	1 ANTON-BAUER DUAL SIMULTANEOUS 2 POS POWERCHARGER/REG	ANPERFDUAL (84750120)		
	1 ANTON-BAUER QRC-BM URSA GOLD MOUNT/REG	ANQRCBMURS (83750201)		
2	TRANSCEND CFAST 2.0 CFX650 FLASH MEMRY CRD-256GB/REG	TRCFX650256G (TS258GCFX650)	457.95	915.90

Continued on Next Page ...



Government, Education, and Corporate Department
For Pricing Requests, Purchase Orders, and Customer Service:

Phone: **800-947-8003**
212-239-7503

Fax: **800-858-5517**
212-239-7759

Email: Education: emailbids@bhphoto.com Federal Government: gsa@bhphoto.com
Corporate: corporatesales@bhphoto.com State and Local: biddept@bhphoto.com

The Professional's Source

420 Ninth Avenue, New York City, NY 10001 • www.bhphotovideo.com

Federal ID#: 19-2780071

Bid No.: 707039190

Date	Customer Code	Terms	Salesperson	Ship Via
11/27/17	41941585	N/A	Slsm	STANDARD

Qty	Ord	Item Description	SKU# MFR#	Item Price	Amount
1		CANON COMPACT-SERVO 18-80MM T4.4 EF/REG <i>This Is A Special Order Item, And Is Not Returnable.</i> Price After \$300.00 Instant Rebate Exp. 12/31/17	CAE1880EF (1714C002)	4,925.00	4,925.00
1		CANON ZOOM GRIP ZSG-C10/REG <i>This Is A Special Order Item, And Is Not Returnable.</i> Free item when purchased with CAE1880EF	CAZSGC10 (1715C002)	474.05	474.05 -474.05
2		BLACKMAGIC BLACKMAGIC STUDIO CAMERA 4K 2/REG	BLSTUDCAM4K (NSTUDMFTUHD2)	1,499.00	2,998.00
2		MTF B4 2/3" TO SUPER16 MICRO FOUR THIRDS/REG	MTB4S16M43 (MTB4S16M43)	2,395.00	4,790.00
1		BLACK-MAGIC ATEM TELEVISION STUDIO HD SWITCHER/REG	BLATSHD (SWATEMTVSTUH)	859.00	859.00
4		HITACHI ALPHA SERIES 22"-CLASS FHD LED HDTV/REG	HI22E30 (22E30)	112.00	448.00
2		VIZIO D-SERIES 32" CLASS LED SMART TV/REG	VID32FE1 (D32FE1)	198.00	396.00
4		PEERLESS ARTICULATING WALL MOUNT f/29" MONITORS/REG	PELCW620AN (LCW620ANEW)	86.00	344.00
2		PEERLESS UNIVRSL TILTNG WALL MNT f/32-50" DSPLY/REG	PEETTMUN (ETTMUNEW)	29.99	59.98

Continued on Next Page ...



Government, Education, and Corporate Department

For Pricing Requests, Purchase Orders, and Customer Service:

Phone: **800-947-8003**
212-239-7503

Fax: **800-858-5517**
212-239-7759

Email: Education: emailbids@bhphoto.com Federal Government: gsa@bhphoto.com
Corporate: corporatesales@bhphoto.com State and Local: biddept@bhphoto.com

The Professional's Source

420 Ninth Avenue, New York City, NY 10001 • www.bhphotovideo.com

Federal ID#: 19-2768071

Bid No.: 707039190

Date	Customer Code	Terms	Salesperson	Ship Via
11/27/17	41941585	N/A	Slsm	STANDARD

Qty	Ord	Item Description	SKU# MFR#	Item Price	Amount
1		MOUNT-IT! DUAL ARM STAND 1/UP TO 27" MONITRS-BLK/REG	MOMI792 (MI792)	72.51	72.51
3		NTW HI-SPEED HDMI w/ETHERNET CH/26AWG/50'/REG	NTHSHDMI2650 (NHDMM405026C)	30.00	90.00
1		COMPREHENSIVE-C HDMI WALLPLATE 1-PORT PIGTAIL/REG	COWPHM1PT (WPHM1PT)	14.00	14.00
1		EPSON HOME CINEMA 1060 PRJCTR-1080P/3100LMNS/REG	EPHC1060P (V11H849020)	499.99	499.99
1		PEERLESS PRG-UNV UNIVERSAL PROJECTOR MOUNT/BLK/REG	PEPRGUNV (PRGUNV)	92.95	92.95
6		PEARSTONE STND SERS CABLE/BNC to BNC (SDI) - 10'/REG	PESBBSDI10 (SDI1010)	9.99	59.94
3		PEARSTONE STND SERS CABLE/BNC to BNC (SDI) - 75'/REG	PESBBSDI75 (SDI1075)	34.95	104.85
1		KANEXPRO 4K HDMI 2-PORT SLIM SPLITTER/REG	KASPHD1X24K (SPHD1X24K)	37.99	37.99
4		BLACK-MAGIC MICRO CONVRTR-HDMI TO SDI w/PWR SUPPL/REG	BLMCHDMISDI (CONVMICHSPS)	49.00	196.00

Continued on Next Page ...



Government, Education, and Corporate Department
For Pricing Requests, Purchase Orders, and Customer Service:

Phone: **800-947-8003**
212-239-7503

Fax: **800-858-5517**
212-239-7759

Email: Education: emailbids@bhphoto.com
Corporate: corporatesales@bhphoto.com

Federal Government: gsa@bhphoto.com
State and Local: biddept@bhphoto.com

The Professional's Source

420 Ninth Avenue, New York City, NY 10001 • www.bhphotovideo.com

Federal ID#: 13-2768071

Bid No.: 707039190

Date	Customer Code	Terms	Salesperson	Ship Via
11/27/17	41941585	N/A	Slsm	STANDARD

Qty	Ord	Item Description	SKU# MFR#	Item Price	Amount
<p>PLEASE NOTE: -----</p> <p>**** Please reference your BID number on all PO's ****</p> <p>Certain items may be enforced by vendor to sell at the vendor-imposed price posted at the time of order.</p>					

Payment Type - NO PAYMENT TYPE SELECTED	- Amount	Sub-Total: 23,232.11
		Shipping: Free STND
		Total: 23,232.11

BNH_quote



42 West 18th Street
 New York NY 10011
www.adorama.com
info@adorama.com

888-582-2500

QUOTE



1727161

12/04/2017

BILLING ADDRESS:

NEW ULM COMMUNITY ACCESS TELEV
 Att: ACCOUNTS PAYABLE
 100 N. BROADWAY ST
 NEW ULM, MN 56073 USA
 (507) 359-8233

SHIPPING ADDRESS:

NEW ULM COMMUNITY ACCESS TELEV
 Att: ACCOUNTS PAYABLE
 100 N. BROADWAY ST
 NEW ULM, MN 56073 USA
 (507) 359-8233

Customer No: 9741605
 Customer PO: quote
 Terms:

Any item/s showing as "back-order"?
 An item listed as "back-order" is on order with the supplier and is temporarily out of stock. These items will ship soon. Most backordered items ship within ten business days. We never charge additional shipping as a result of a back-order. Please feel free to contact us for additional information at www.adorama.com/email.

Note: Please be prudent when throwing away packaging material or boxes. It is possible to miss some contents. Checking off contents against the packing list is always a good idea. If something is indeed missing please make a claim within five days to be compliant with our policies.

SKU#	Item	Qty	Price	Total
BMCIEURUPRO	BLACKMAGIC URSA MINI PRO EF	1	5,099.73	5,099.73
Mfg Item#: CINEURSAMUPRO46K				
ABDIGITAL90A	ANTNBR GLD MNT DGTL 90 BAT 14.4V 93WH A	1	557.97	557.97
Above Item is a Kit and Consists of the Following Items:				
ABDIGITAL90	ANTNBR GOLD MNT DIGTL 90 BAT 14.4V 93WH	2		
Mfg Item#: 8675-0092				
BMCINEURVBGD	BLACKMAGC DESIGN URSA GOLD BATTERY PLATE	1		
Mfg Item#: CINEURVBATTGOLD				
End of Kit Item (Prices are for Kit Only)				
ABBCTT70	ANTON BAUER TANDEM 70 BATT CHR 70W	1	487.13	487.13
Mfg Item#: 8475-0067				
ILXCF35256	LEXAR 256GB CFAST 3500X(BLKMAGIC,CANON)	2	516.33	1,032.66
Mfg Item#: LC256CRBNA3500				
CACSER1880MM	ANON** COMPACT-SERVO 18-80MM T4.4 EF	1	4,925.00	4,925.00
Mfg Item#: 1714C002				
BMCINSMFUHD2	BLACKMAGIC STUDIO CAMERA 4K 2	2	1,442.36	2,884.72
Mfg Item#: CINSTUDMFT/UHD2				
MTFB4S16M43	MTF SRVCS B4 TO SUPR16 MICRO 4/3RD ADP	2	2,075.27	4,150.54
Mfg Item#: MTB4S16M43				
BMSWATEMTVST	BLACKMAGIC ATEM TELEVISION STUDIO HD	1	845.05	845.05
Mfg Item#: SWATEMTVSTU/HD				
SSGS22F350FH	SAMSUNG SF350 22" FULL HD MONITOR	4	120.72	482.88
Mfg Item#: S22F350				
LOT32MP58HQP	LG IPS 32MP58HQ-P 32" SCRNLIT LED-LIT MON	2	201.74	403.48
Mfg Item#: 32MP58HQ-P				

We want to buy your used photo equipment:
 In the last year alone, Adorama spent millions buying 35mm, medium / large-format, scopes, video and digital equipment. Our satisfied customers happily cashed in or traded their equipment and enjoyed our above market value payout. Adorama pays top dollar for individual items, rare pieces, collections and estates. For more information, call 1-800-223-2500 or visit us at www.adorama.com/sell and use our online quoting system.

No Hassle Return Policy:
 We want you to be completely happy with your purchase from Adorama. Please see the general Return/Exchange guidelines and policy posted on our website at www.adorama.com/policy.



We pay top dollar for your used photo & video equipment

To find out the value of your equipment:
 online adorama.com/sell by phone 800-223-2500 bring it 42 W 18 St NYC

Ship Via: UPS Ground Delivery

Salesman 00940 - EliavL

Printed By: ELIAVL 12/04/17 11:12 AM



42 West 18th Street
 New York NY 10011
www.adorama.com
info@adorama.com

888-582-2500

QUOTE



1727161

12/04/2017

BILLING ADDRESS:

NEW ULM COMMUNITY ACCESS TELEV
 At: ACCOUNTS PAYABLE
 100 N. BROADWAY ST
 NEW ULM, MN 56073 USA
 (507) 359-8233

SHIPPING ADDRESS:

NEW ULM COMMUNITY ACCESS TELEV
 At: ACCOUNTS PAYABLE
 100 N. BROADWAY ST
 NEW ULM, MN 56073 USA
 (507) 359-8233

Customer No: 9741605
 Customer PO: quote
 Terms:

Any item/s showing as "back-order"?

An item listed as "back-order" is on order with the supplier and is temporarily out of stock. These items will ship soon. Most backordered items ship within ten business days. We never charge additional shipping as a result of a back-order. Please feel free to contact us for additional information at www.adorama.com/email.

Note: Please be prudent when throwing away packaging material or boxes. It is possible to miss some contents. Checking off contents against the packing list is always a good idea. If something is indeed missing please make a claim within five days to be compliant with our policies.

We want to buy your used photo equipment:

In the last year alone, Adorama spent millions buying 35mm, medium / large-format, scopes, video and digital equipment. Our satisfied customers happily cashed in or traded their equipment and enjoyed our above market value payout. Adorama pays top dollar for individual items, rare pieces, collections and estates. For more information, call 1-800-223-2500 or visit us at www.adorama.com/sell and use our online quoting system.

No Hassle Return Policy:

We want you to be completely happy with your purchase from Adorama. Please see the general Return/Exchange guidelines and policy posted on our website at www.adorama.com/policy.

SKU#	Item	Qty	Price	Total
LOT24MP59GP	LG 24" FULL HD IPS MONITOR W/ FREESYNC	2	154.37	308.74
Mfg Item#: 24MP59G-P				
PEESA730P	PEERLS SA730P SMRTMNT UNV ARTICULATNG MT	4	50.55	202.20
Mfg Item#: SA730P				
PEETUTMU	PEERLESS ULTRATHIN TILT - 32-46" MOUNT	2	19.15	38.30
Mfg Item#: ETUTMU				
STARMBARDUO	STARTECH DUAL MONITOR CROSSBAR STAND	1	84.26	84.26
Mfg Item#: ARMBARDUO				
STHDMM50	STARTECH 50'HISPEED HDMI CABL HDMI-M/M	3	46.81	140.43
Mfg Item#: HDMM50				
CVWP1785EPKI	COMP 1GNG WLP-KYDEX IVORY-HDMI F(1)-PT	1	29.11	29.11
Mfg Item#: WP-1785-E-P-KI				
PEEPRGUNV	PEERLESS PRG-UNVIERSAL PG PROJCT MT BLK	1	83.32	83.32
Mfg Item#: PRG-UNV				
TCCBCB10BK	TECNC BNC TO BNC VIDEO CABLE 10' BLACK	6	14.47	86.82
Mfg Item#: CB-CB-10-BK				
LD4855RBK075	LAIRD DIG CNMA BNC-BNC SL RG59 75'CBL,B	3	61.16	183.48
Mfg Item#: 4855R-B-B-BK-075				
AVNSFHD102B	AVINAIR SF PRO 1*2 HDMI SPLITTER/4K,2K	2	41.70	83.40
Mfg Item#: AV-SF-HD102B				
BMMICSTH	BLACK MAGIC MICRO CONVERTER SDI-TO-HDMI	4	50.24	200.96
Mfg Item#: CONVCMIC/SH/WPSU				



We pay top dollar for your used photo & video equipment

To find out the value of your equipment:
 online adorama.com/sell by phone 800-223-2500 bring it 42 W 18 St NYC

Ship Via: UPS Ground Delivery

Salesman 00940 - EliavL

Printed By: ELIAVL 12/04/17 11:12 AM



42 West 18th Street
New York NY 10011
www.adorama.com
info@adorama.com

888-582-2500

QUOTE



1727161

12/04/2017

BILLING ADDRESS:

NEW ULM COMMUNITY ACCESS TELEV
Att: ACCOUNTS PAYABLE
100 N. BROADWAY ST
NEW ULM, MN 56073 USA
(507) 359-8233

SHIPPING ADDRESS:

NEW ULM COMMUNITY ACCESS TELEV
Att: ACCOUNTS PAYABLE
100 N. BROADWAY ST
NEW ULM, MN 56073 USA
(507) 359-8233

Customer No: 9741605

Customer PO: quote

Terms:

Any item/s showing as "back-order"?

An item listed as "back-order" is on order with the supplier and is temporarily out of stock. These items will ship soon. Most backordered items ship within ten business days. We never charge additional shipping as a result of a back-order. Please feel free to contact us for additional information at www.adorama.com/email.

Note: Please be prudent when throwing away packaging material or boxes. It is possible to miss some contents. Checking off contents against the packing list is always a good idea. If something is indeed missing please make a claim within five days to be compliant with our policies.

SKU#	Item	Qty	Price	Total
------	------	-----	-------	-------

Thank you for your order.

This quote was prepared by your sales representative,
Levy, Eliav.

To place order or for any help, call
Levy, Eliav

at (888) 582-2500 or email at eliavl@adorama.com

To email Customer Service please go to www.adorama.com/email

Sub Total:	22310.18
Shipping:	.00
Tax:	.00
Quote Total:	22310.18

We want to buy your used photo equipment:

In the last year alone, Adorama spent millions buying 35mm, medium / large-format, scopes, video and digital equipment. Our satisfied customers happily cashed in or traded their equipment and enjoyed our above market value payout. Adorama pays top dollar for individual items, rare pieces, collections and estates. For more information, call 1-800-223-2500 or visit us at www.adorama.com/sell and use our online quoting system.

No Hassle Return Policy:

We want you to be completely happy with your purchase from Adorama. Please see the general Return/Exchange guidelines and policy posted on our website at www.adorama.com/policy.



We pay top dollar for your used photo & video equipment

To find out the value of your equipment:

online	by phone	bring it
adorama.com/sell	800-223-2500	42 W 18 St NYC

Ship Via: UPS Ground Delivery

Salesman 00940 - Eliavl

Printed By: ELIAVL 12/04/17 11:12 AM

City of New Ulm
Request for Cable Communications Advisory Board Action

Meeting Date:	December 14, 2017	Agenda Item Number:	4. b.
Agenda Section:	New Business	Originating Department:	NUCAT
Resolution:	N/A	Prepared By:	Steven Sherman
Number of Attachments:	N/A	Presented By:	Steven Sherman
Item:	Consider request to use up to \$20,000 of the 2017 budget for the purchase of an upgraded High Definition Content Server.		

Staff Proposed Action:

Motion by _____, second by _____, to use up to \$20,000 of the 2017 budget for the purchase of an upgraded High Definition Content Server.

Overview:

NUCAT will be transitioning to a High Definition channel early in 2018. The current content server needs to be replaced to be compliant with high definition video. NUCAT requests that \$20,000 of the 2017 budget be used to pay for this purchase.

Primary Issues/Alternatives to Consider:

The current content server was purchased in 2013. It is only able to present Standard Definition video content. With the upcoming upgrade to a High Definition channel, a new content server will need to be purchased.

Budgetary/Fiscal Issues:

The 2018 budget will not be able to accommodate this purchase. If the purchase can be completed during 2017, staff would like to use 2017 funds. If unable to complete purchase by the end of year, staff requests a carryover of \$20,000 to the 2018 Budget.

Attachments:

N/A