

PB94-181765



**Seismic Vulnerability of Equipment in Critical Facilities:
Life-Safety and Operational Consequences**

by

K. Porter¹, G.S. Johnson², M.M. Zadeh², C.R. Scawthorn³, and S.J. Eder⁴

November 24, 1993

Technical Report NCEER-93-0022

NCEER Project Numbers 91-6211 and 91-3212

NSF Master Contract Number BCS 90-25010

and

NYSSTF Grant Number NEC-91029

- 1 Project Engineer, EQE International
- 2 Technical Managers, EQE International
- 3 Vice President, EQE International
- 4 Regional Manager, EQE International

NATIONAL CENTER FOR EARTHQUAKE ENGINEERING RESEARCH
State University of New York at Buffalo
Red Jacket Quadrangle, Buffalo, NY 14261

REPRODUCED BY
U.S. DEPARTMENT OF COMMERCE
NATIONAL TECHNICAL
INFORMATION SERVICE
SPRINGFIELD, VA 22161

PREFACE

The National Center for Earthquake Engineering Research (NCEER) was established to expand and disseminate knowledge about earthquakes, improve earthquake-resistant design, and implement seismic hazard mitigation procedures to minimize loss of lives and property. The emphasis is on structures in the eastern and central United States and lifelines throughout the country that are found in zones of low, moderate, and high seismicity.

NCEER's research and implementation plan in years six through ten (1991-1996) comprises four interlocked elements, as shown in the figure below. Element I, Basic Research, is carried out to support projects in the Applied Research area. Element II, Applied Research, is the major focus of work for years six through ten. Element III, Demonstration Projects, have been planned to support Applied Research projects, and will be either case studies or regional studies. Element IV, Implementation, will result from activity in the four Applied Research projects, and from Demonstration Projects.

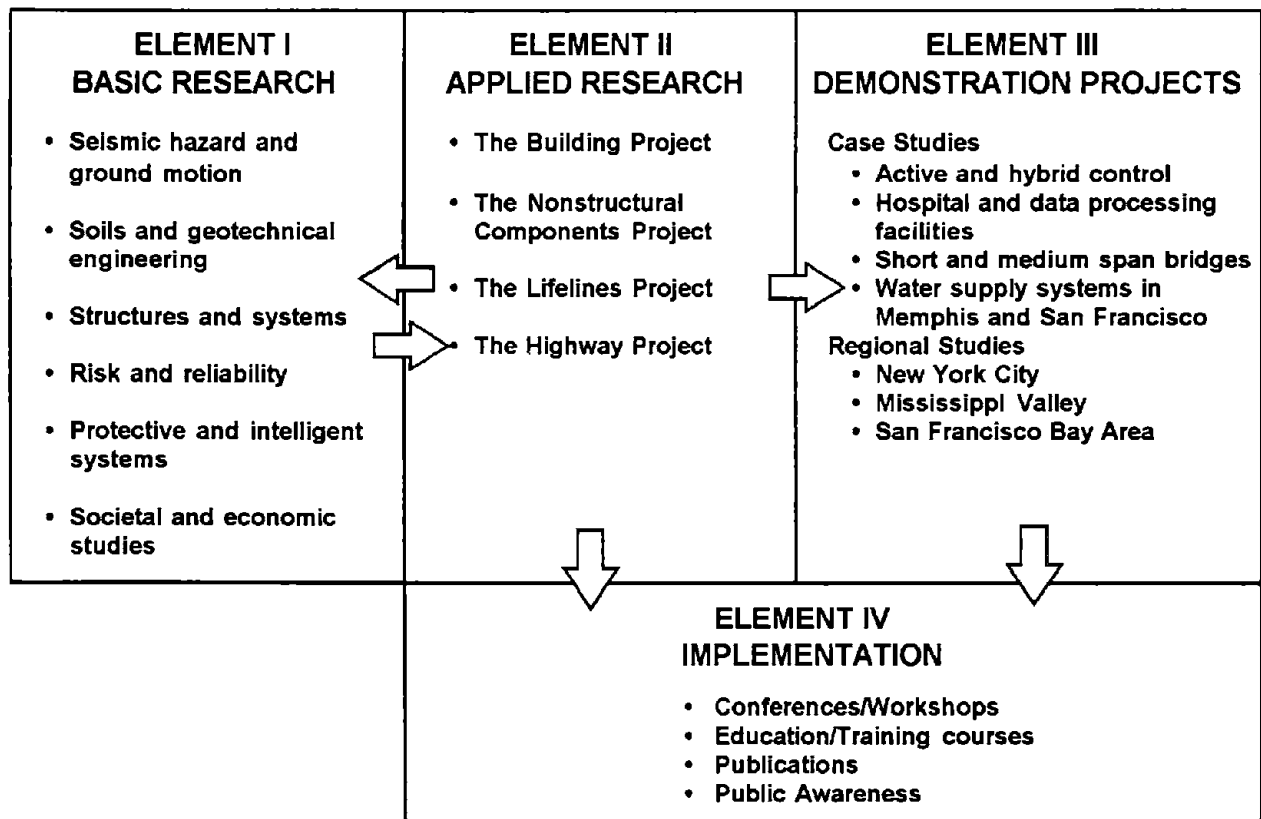

Research tasks in the **Nonstructural Components Project** focus on analytical and experimental investigations of seismic behavior of secondary systems, investigating hazard mitigation through optimization and protection, and developing rational criteria and procedures for seismic design and performance evaluation. Specifically, tasks are being performed to: (1) provide a risk analysis of a selected group of nonstructural elements; (2) improve simplified analysis so that research results can be readily used by practicing engineers; (3) protect sensitive equipment and critical subsystems using passive, active or hybrid systems; and (4) develop design and performance evaluation guidelines.

The end product of the **Nonstructural Components Project** will be a set of simple guidelines for design, performance evaluation, support design, and protection and mitigation measures in the form of handbooks or computer codes, and software and hardware associated with innovative protection technology.

The **risk and reliability program** constitutes one of the important areas of research in the **Nonstructural Components Project**. The program is concerned with reducing the uncertainty in current models which characterize and predict seismically induced ground motion, and resulting structural damage and system unserviceability. The goal of the program is to provide analytical and empirical procedures to bridge the gap between traditional earthquake engineering and socioeconomic considerations for the most cost-effective seismic hazard mitigation. Among others, the following tasks are being carried out:

1. Study seismic damage and develop fragility curves for existing structures.
2. Develop retrofit and strengthening strategies.
3. Develop intelligent structures using high-tech and traditional sensors for on-line and real-time diagnoses of structural integrity under seismic excitation.
4. Improve and promote damage-control design for new structures.
5. Study critical code issues and assist code groups to upgrade seismic design code.
6. Investigate the integrity of nonstructural systems under seismic conditions.

Seismic vulnerability of equipment in critical facilities is one of the research thrusts of NCEER's project on nonstructural components. The objective is to develop a methodology to assess and improve the reliability of critical equipment systems in a seismic environment. The first phase of this work includes the construction of risk tables and the development of equipment performance data bases based on compilation of data on the morphology and history of a selected group of equipment systems. This report presents results of this phase of the study for four representative facility types and six key systems.

ABSTRACT

This study is part of a multi-year program aimed toward reducing earthquake risk for critical facility equipment and components. The program goal is to determine which equipment components are critical to life safety and normal operations, and how equipment systems have performed in past earthquakes. This report represents the first program phase, in which equipment data were collected and reviewed in the context of four sample facility types and six equipment systems. Subsequent program phases will: (i) develop a simplified method to assess and improve the reliability of equipment systems, (ii) apply the methodology to example building and component inventories, and (iii) disseminate component fragility and system reliability models in a format that can be used by code-writing bodies, emergency-response facility owners, and operators of economically valuable facilities.

In compiling equipment data, engineers reviewed example high-rise office buildings, telephone central offices, data processing centers, and hospitals to determine how each facility relies on various equipment systems and components for life safety and normal operations. For each major system (e.g., fire response, emergency power, uninterruptible power supply [UPS], HVAC, etc.), logic diagrams were developed. The logic diagrams indicate how system functionality is affected by failure of individual components.

All of the facilities studied rely on similar systems and components for life safety. These systems generally have backups for protection against isolated component failures. For normal operations, the number and extent of backups and safeguards varies substantially, reflecting the varying financial costs or social consequences of operational failure.

Several key equipment systems were also selected for a detailed investigation of their performance in past earthquakes, to document observed vulnerabilities of typical components and the demonstrated effects of those vulnerabilities on system functionality. Systems reviewed were UPS, standby and emergency power generation, fire detection and alarm, fire suppression, air conditioning, and power distribution.

The observed performance of equipment systems in past earthquakes demonstrates that equipment attributes that lead to poor performance during moderate and large earthquakes can be identified, avoided in new construction, and eliminated from existing facilities. Vulnerabilities are typically dependent on details of construction or system configuration; susceptibility to damage is not necessarily a function of ground motion amplitude.

The findings of this report represent much of the basis for engineering and economic analysis to determine quantitatively the overall societal risk posed by seismically vulnerable equipment. They also form the basis for the development of empirical guidelines for the design of new equipment systems and the performance evaluation of existing systems.

CONTENTS

	<u>Page</u>
1. INTRODUCTION	1-1
1.1 Background	1-1
1.2 Objectives and Scope of Work	1-2
1.3 Organization of Report	1-3
2. SUMMARY AND CONCLUSIONS	2-1
2.1 Equipment in Critical Facilities	2-1
2.1.1 High-Rise Office Building	2-2
2.1.2 Telephone Central Office	2-2
2.1.3 Data Processing Center	2-3
2.1.4 Hospital	2-3
2.2 Seismic Performance of Key Equipment Systems	2-3
2.2.1 Uninterruptible Power Supply (UPS).....	2-4
2.2.2 Emergency Power Generation	2-4
2.2.3 Fire Detection and Alarm	2-5
2.2.4 Fire Suppression.....	2-5
2.2.5 Air Conditioning	2-5
2.2.6 Power Distribution.....	2-5
2.3 Conclusions.....	2-6
3. EQUIPMENT IN CRITICAL FACILITIES	3-1
3.1 General.....	3-1
3.2 High-Rise Office Building	3-5
3.2.1 San Francisco High-Rise Office Building	3-5
3.2.2 Performance of San Francisco High-Rise in Loma Prieta...	3-5
3.2.3 San Francisco High-Rise Components	3-5
3.2.4 San Francisco High-Rise Normal Operations Systems.....	3-6
3.2.5 San Francisco High-Rise Life-Safety Systems.....	3-6
3.2.6 Los Angeles High-Rise Office Building	3-8
3.2.7 Comparison of SF and LA High-Rise Office Buildings	3-8
3.2.8 Conclusions Regarding High-Rise Office Buildings.....	3-9
3.3 Telephone Central Office.....	3-32

CONTENTS (Cont.)

	<u>Page</u>
3.3.1 Example Central Offices	3-32
3.3.2 Performance of Sample COs in Recent Large Earthquakes	3-32
3.3.3 CO Components.....	3-33
3.3.4 CO Life-Safety Systems	3-33
3.3.5 CO Telecommunications Equipment.....	3-34
3.3.6 CO Building Support Equipment	3-36
3.3.7 Conclusions Regarding Sample Central Offices.....	3-38
3.4 Data Processing Center.....	3-53
3.4.1 Example Data Processing Centers.....	3-53
3.4.2 Performance of Data Processing Centers in the October 1989 Loma Prieta Earthquake.....	3-53
3.4.3 Data Center Components	3-54
3.4.4 Data Center Life-Safety Systems.....	3-54
3.4.5 Data Center Data Processing Equipment.....	3-56
3.4.6 Data Center Building Support Equipment	3-57
3.4.7 Conclusions Regarding Sample Data Centers	3-61
3.5 Hospital	3-78
3.5.1 Example Hospital.....	3-78
3.5.2 Hospital Performance in Loma Prieta Earthquake	3-78
3.5.3 Hospital Components.....	3-79
3.5.4 Hospital Life-Safety Systems	3-79
3.5.5 Hospital Normal Operation Systems.....	3-80
3.5.6 Conclusions Regarding Sample Hospital	3-81
4. PERFORMANCE OF KEY SYSTEMS IN PAST EARTHQUAKES	4-1
4.1 Background	4-1
4.2 Systems Reviewed	4-3
4.3 Uninterruptible Power Supply (UPS).....	4-4
4.3.1 Description of UPS Systems	4-4
4.3.2 Seismic Performance of UPS Systems	4-6
4.3.3 Description of Instances of Damage	4-6
4.4 Standby and Emergency Power Generation	4-15

CONTENTS (Cont.)

	<u>Page</u>
4.4.1 Description of Power Generation System	4-15
4.4.2 Seismic Performance of Emergency Power Generation Systems	4-16
4.4.3 Description of Instances of Damage	4-17
4.5 Fire Detection and Alarm.....	4-26
4.5.1 Description of Fire Detection and Alarm Systems	4-26
4.5.2 Seismic Performance of Fire Detection and Alarm Systems	4-29
4.5.2 Description of Instances of Damage	4-30
4.6 Fire Suppression	4-44
4.6.1 Description of Fire Suppression Systems.....	4-44
4.6.2 Seismic Performance of Fire Suppression Systems	4-46
4.6.3 Specific Instances of Damage to Fire Suppression Systems	4-46
4.7 Air Conditioning	4-53
4.7.1 Description of Central Chilled Water Systems	4-53
4.7.2 Description of Air Conditioning Distribution Systems	4-59
4.7.3 Seismic Performance of Chilled Water Systems.....	4-62
4.7.4 Seismic Performance of Air Conditioning Distribution Systems	4-63
4.7.5 Specific Instances of Damage to Chilled Water Systems .	4-64
4.7.6 Specific Instances of Damage to Air Conditioning Distribution Systems.....	4-67
4.8 Power Distribution Systems in Commercial and Industrial Facilities.....	4-90
4.8.1 Description of Power Distribution Systems	4-90
4.8.2 Seismic Performance of Power Distribution Systems	4-95
4.8.3 Specific Instances of Damage to Power Distribution Systems	4-96

APPENDICES

- A. Earthquakes and Sites Included in Earthquake Performance Investigation
- B. Data Base of UPS Systems
- C. Data Base of Engine-Generator Systems
- D. Data Base of Air Conditioning Systems
- E. Data Base of Power Distribution Systems in Commercial and Industrial Facilities

TABLES

	<u>Page</u>
2-1 Component Criticality	2-7
2-2 Summary of Vulnerabilities of Key Equipment Systems.....	2-11

FIGURES

2-1 Data Processing Center Life-Safety System	2-15
3-1 Example logic tree for data processing center components	3-3
3-2 Data processing center life-safety systems.....	3-4
3-3 SF high-rise building use dependencies	3-10
3-4 SF high-rise building normal operation systems	3-11
3-5 SF high-rise building life-safety systems.....	3-12
3-6 HVAC system example of dependencies for SF high-rise normal operation system.....	3-13
3-7 SF high-rise fire detection and alarm systems	3-14
3-8 SF high-rise fire suppression systems	3-15
3-9 SF high-rise building smoke purge system	3-16
3-10 SF high-rise building gas shut-off system	3-17
3-11 SF high-rise building elevator safety system	3-18
3-12 SF high-rise building evacuation/egress system.....	3-19
3-13 SF high-rise building old emergency power generator system.....	3-20
3-14 SF high-rise new emergency power generator system.....	3-21
3-15 LA high-rise building use dependencies	3-22
3-16 LA high-rise building normal operation systems.....	3-23
3-17 LA high-rise building life-safety systems	3-24

FIGURES (Cont.)

	<u>Page</u>
3-18 HVAC system example of dependencies for LA high-rise normal operation system.....	3-25
3-19 LA high-rise fire detection and alarm systems.....	3-26
3-20 LA high-rise fire suppression systems.....	3-27
3-21 LA high-rise building life smoke purge system.....	3-28
3-22 LA high-rise building elevator safety system.....	3-29
3-23 LA high-rise building evacuation/egress system.....	3-30
3-24 LA high-rise emergency power generator system.....	3-31
3-25 Central office components.....	3-39
3-26 Central office life-safety systems.....	3-40
3-27 Central office fire detection and alarm.....	3-41
3-28 Central office active fire suppression systems.....	3-42
3-29 Central office gas shut-off.....	3-43
3-30 Central office elevator stopping system.....	3-44
3-31 Central office telecommunications equipment.....	3-45
3-32 Central office building support systems.....	3-46
3-33 Central office electric power.....	3-47
3-34 Central office uninterruptible power supply.....	3-48
3-35 Central office backup generator system.....	3-49
3-36 Central office HVAC.....	3-50
3-37 Central office HVAC control equipment.....	3-51
3-38 Central office plumbing.....	3-52
3-39 Data processing center components.....	3-62
3-40 Data processing center life-safety systems.....	3-63
3-41 Data processing center fire detection and alarm systems.....	3-64
3-42 Data processing center active fire suppression.....	3-65
3-43 Data processing center sprinkler systems.....	3-66
3-44 Data processing center life-safety elevator safety system.....	3-67
3-45 Data processing center equipment.....	3-68
3-46 Data processing center building support systems.....	3-69
3-47 Data processing center electric power.....	3-70
3-48 Data processing center uninterruptible power supply (UPS).....	3-71
3-49 Data processing center emergency generator system.....	3-72

FIGURES (Cont.)

		<u>Page</u>
3-50	Data processing center telecommunications	3-73
3-51	Data processing center HVAC and equipment cooling	3-74
3-52	Data processing center central HVAC	3-75
3-53	Data processing center HVAC control equipment	3-76
3-54	Data processing center plumbing	3-77
3-55	SF area hospital use dependencies	3-82
3-56	SF area hospital life-safety systems.....	3-83
3-57	SF area hospital - fire response system.....	3-84
3-58	SF area hospital - communication system.....	3-85
3-59	SF Area Hospital Normal Operations Systems.....	3-86
3-60	SF Area Hospital Electrical Systems	3-87
3-61	SF Area Hospital - Water Supply System	3-88
3-62	SF Area Hospital - Medical Gases System	3-89
3-63	SF Area Hospital - Computer System.....	3-90
4-1	The uninterruptible power system.	4-10
4-2	Stationary battery rack configurations.	4-11
4-3	At a substation affected by the 1987 Whittier Earthquake, the battery charger was tripped by the actuation of a molded case circuit breaker in the associated distribution panel.	4-12
4-4	Several of the lead selenium flat plate batteries in the upper shelf of the wooden two-tier rack suffered dislodged anode plates and loss of supply voltage due to banging of batteries during the 1987 New Zealand Earthquake.	4-13
4-5	Batteries from a hydroelectric plant, affected by the 1986 Chalfant Valley Earthquake shifted up to 1/2 inch in their rack but continued to function properly.....	4-14
4-6	One of the 30-kW Onan diesel generators mounted on the roof of the building failed to start due to a faulty relay in its local control panel mounted to the adjacent wall. The equipment was affected by the 1987 Whittier Earthquake. Ground motion at the site is estimated to be 0.40g, with a duration in excess of 3 seconds.	4-21

FIGURES (Cont.)

	<u>Page</u>
4-7 The diesel generator at this site did not respond to a manual start following the 1991 Costa Rica Earthquake (measured PGA of 0.12g). Inspection by a utility technician the day following the earthquake revealed a broken wire at the terminal connection serving the solenoid valve that controls oil flow to the Woodward governor.....	4-22
4-8 One of the 75-kW diesel generators mounted on the roof of a commercial building shifted laterally during the 1987 Whittier Earthquake, buckling its spring isolation mounts. Shifting of the unit broke the coupling of the exhaust pipe to the muffler mounted atop the diesel. The ground motion is estimated to be 0.40g.	4-23
4-9 In the 1991 Costa Rica Earthquake, a fuel line that was routed along the concrete foundation mats of some of the diesels from nearby day tanks suffered breaks in its branch lines due to differential displacement imposed by settlement and soil spreading beneath the concrete mats.	4-24
4-10 This diesel generator suffered severe shaft misalignment following the 1991 Costa Rica Earthquake. The misalignment was caused by differential settlement between the diesel foundation and the plant base mat (which supports the front of the generator drive shaft).....	4-25
4-11 A fire control station at a small manufacturing facility. This control station experienced 0.35g during the 1989 Loma Prieta Earthquake and experienced no malfunction or damage.....	4-34
4-12 A fire control station mounted to an interior wall at a university which was affected by the 1989 Loma Prieta Earthquake. The control station functioned properly during the earthquake.	4-35
4-13 Fire communications panels at a university medical facility affected by the 1989 Loma Prieta Earthquake (0.25g). These communications panels relay data from the detectors to the fire department and were not affected by the earthquake.....	4-35

FIGURES (Cont.)

	<u>Page</u>
4-14 A wall mounted fire control unit at a large cement factory. This unit experienced the 1989 Loma Prieta Earthquake (0.25g) with no reported damage or equipment malfunction.	4-36
4-15 A wall mounted fire communications panel at a university medical facility. The panel was affected by the 1989 Loma Prieta Earthquake (0.25g) but was not damaged.	4-36
4-16 Wall mounted fire communications panel in the basement of a university medical facility affected by the 1989 Loma Prieta Earthquake (0.25g). The panel operated properly during the earthquake.....	4-37
4-17 Fire alarm panel at a large university medical facility affected by the 1989 Loma Prieta Earthquake (0.25g). The alarm panel is mounted to an interior wall. There was no reported damage or equipment malfunction as a result of the earthquake.	4-37
4-18 Examples of typical fire life safety system peripheral equipment (A) a speaker, (B) an alarm bell, and (C) a fire pull station.	4-38
4-19 At a data processing facility, affected by the 1987 Whittier Earthquake, property losses occurred due to the actuation of the preaction automatic sprinkler system. Postulated causes of the system actuation included either dust-induced smoke detector actuation, or detector malfunction.....	4-39
4-20 a) A fire pull station mounted to an interior wall at a university medical facility which experienced around 0.25g during the 1989 Loma Prieta Earthquake. This pull station is typical of several other pull stations at this facility which alarmed during the earthquake due to the inadvertent actuation of the mercury switch within the device. b) A fire pull station at a board mill which was affected by the 1987 New Zealand Earthquake (estimated 0.25g). This explosion-proof fire pull station is mounted to a concrete-block wall and experienced no seismic effects or damage from the earthquake.	4-40

FIGURES (Cont.)

	<u>Page</u>
4-21 A typical fire pull station which operates using a mercury switch. These pull stations actuated in several of the buildings at a large university and its associated medical facility during the 1989 Loma Prieta Earthquake (estimated 0.25g).....	4-41
4-22 This conduit, located in a heavy industrial facility, pulled apart at couplings due to relative motion of two sections of the control panel and between the panel and the wall.....	4-42
4-23 At a cogeneration plant affected by the 1992 Cape Mendocino Earthquake, tubes connected to a pressure top crimped when the suspended boiler swung, causing significant differential lateral displacement with the boiler support structure at this elevation..	4-43
4-24 At a paper mill, affected by the 1987 New Zealand Earthquake, an entire section of the sprinkler piping system collapsed during the earthquake. The cause for the collapse appeared to be a poor support design in which rod hanger supports were eccentrically hung from straps on the bottom flange of a wide-flanged beam. They pried off of the beam flange.....	4-50
4-25 At a small manufacturing plant, located in the epicentral area of the 1989 Loma Prieta Earthquake, threaded couplings in fire sprinkler lines cracked in two locations during the event.	4-51
4-26 At a food dehydration and packaging plant, affected by the 1989 Loma Prieta Earthquake, sprinkler lines cracked at threaded couplings at two locations. Cracked couplings occurred where a short vertical connection spanned between two long perpendicular pipe runs.	4-51
4-27 At a disk drive assembly plant, located in the epicentral area of the 1989 Loma Prieta Earthquake, seven sprinkler heads on flexible rod-hung pipe broke due to impact with adjacent wood ceiling beams.	4-52
4-28 Fallen fire extinguisher at a paper mill. Estimated PGA of 0.50g during the 1987 New Zealand Earthquake.....	4-52

FIGURES (Cont.)

	<u>Page</u>
4-29 These chillers, located at two data processing facilities, affected by the 1987 Whittier Earthquake, shifted sufficiently on their vibration isolators to fracture attached piping, and render the units inoperable.	4-72
4-30 These chillers, located at a processing facility, affected by the 1987 Whittier Earthquake, shifted off their spring-type vibration isolators. The units remained operable during and following the earthquake.	4-73
4-31 One of eight pad-mounted refrigerant compressors located at a large office complex, affected by the 1989 Loma Prieta Earthquake, that rolled off its isolation mounts. The units were undamaged and operational once they were re-mounted. Attached piping had sufficient flexibility to accommodate the displacement.	4-73
4-32 This horizontal pump in the penthouse of a data processing facility, affected by the 1987 Whittier Earthquake, dislodged from its vibration isolation mounts. The pump remained functional, in spite of the anchorage damage.....	4-74
4-33 This pump mounted on vibration isolators with seismic stops, located at a second data processing facility affected by the 1987 Whittier Earthquake, showed evidence of movement. Some of the bolts anchoring the seismic stops showed evidence of minor prying; however, the pump continued to operate.....	4-74
4-34 This chilled water pump at a data processing facility, affected by the 1987 Whittier Earthquake, sustained a cracked casing. The damage was apparently caused by seismic anchor movement. A chiller that was rigidly connected to the pump through piping moved six inches during the earthquake.....	4-75
4-35 At a power plant, affected by the 1979 Imperial Valley Earthquake, the cast-iron yoke of a diaphragm-operated valve cracked, due to the repeated impact of its diaphragm housing with an adjacent steel column. The arrow points to the repair at the location of the damage..	4-75

FIGURES (Cont.)

	<u>Page</u>
4-36 One of two diaphragm-operated valves at a power plant, affected by the 1985 Chile Earthquake, that were damaged due to the impact of their cast-steel yokes with an adjacent handrail approximately 10 inches away. On one operator, the connecting service air line broke, due to insufficient slack to accommodate the displacement of the operator.....	4-76
4-37 This chilled water line located at a navy base hangar, affected by the 1986 Alaska Earthquake, sustained damage when a Victaulic coupling broke. The mechanical coupling could not accommodate the lateral loads caused by the differential displacement of its supports.	4-76
4-38 At a navy base, affected by the 1992 Cape Mendocino Earthquake, PVC chilled water piping attached to an air handler broke. The equipment was supported on vibration isolators that moved differentially from the pipe supports, causing the pipe to break.....	4-77
4-39 Two of three data processing facilities, affected by the 1987 Whittier Earthquake, where movement of piping damaged wall penetrations. The pipes were undamaged in all cases.	4-78
4-40 This forced-draft evaporative cooler at a data processing facility, affected by the 1987 Whittier Earthquake, shifted off its vibration isolators. The unit remained operable in site of its anchorage damage.	4-79
4-41 These evaporative coolers located at a telephone facility shifted off their vibration isolators during the 1987 Whittier Earthquake.....	4-79
4-42 Eccentric connections damaged in cooling towers at a cogeneration plant in the 1992 Cape Mendocino Earthquake. Photo on left is an identical undamaged connection.	4-80
4-43 Two examples of damage to fans on vibration isolators occurred at a large electrical substation, affected by the 1971 San Fernando Earthquake. In one case, a centrifugal fan located in the third floor HVAC room, broke its cast-iron isolation mounts. In the second case, one of six frame-mounted fans, in the basement, broke its spring isolators.	4-81

FIGURES (Cont.)

	<u>Page</u>
4-44 This fan, located in the penthouse at a data processing facility, affected by the 1987 Whittier Earthquake, was knocked from its non-seismically designed vibration isolation mounts. Not the torn duct connection.	4-82
4-45 This roof-mounted HVAC fan located at a large office complex, affected by the 1989 Loma Prieta Earthquake, shifted on its rubber isolation mounts. The fan was otherwise undamaged and operable.	4-82
4-46 Most of the 48 air handling units located on the second floor of a large electrical substation, affected by the 1971 San Fernando Earthquake, were shaken from their isolation mounts. The mountings were not designed to accommodate seismic loads. On five of the units, the movement was sufficient to damage attached piping and ducts.	4-83
4-47 These forced-draft fans associated with the plant's boilers at a steel mill, affected by the 1985 Mexico Earthquake, suffered shaft misalignment. The boilers are tied to the fan housings through a large, heavy, rigidly attached duct system. The boilers shifted during the earthquake, pulling the duct, which in turn, pulled on and caused a misalignment of the fans.	4-83
4-48 At a manufacturing facility, affected by the 1989 Loma Prieta Earthquake, a fan motor, mounted external to the air handler, sheared its anchor bolts. The cause appears to be differential flexure between the fan impeller (connected to the motor through the drive shaft) and the steel frame supporting the motor.	4-84
4-49 This in-line vane-axial fan at a small manufacturing facility, affected by the 1989 Loma Prieta Earthquake, tore the elastic bellows connecting the fan enclosure to the HVAC ducts. The fan enclosure did not fall and was otherwise undamaged.	4-84
4-50 At a paper mill, affected by the 1987 New Zealand Earthquake, a section of rod-hung duct fell from its supports (Note new joint, shown as a light patch). The circular duct was fastened with riveted joints that pulled apart during the earthquake. Inspection of the fallen section of duct revealed severe corrosion at the riveted joint.	4-85

FIGURES (Cont.)

		<u>Page</u>
4-51	At a small electronics manufacturing facility, affected by the 1984 Morgan Hill Earthquake, a cantilevered, vertical section of HVAC duct broke from its horizontal header and fell.	4-86
4-52	At a small electronics manufacturing facility, affected by the 1984 Morgan Hill Earthquake, a branch line tore at a wall penetration due to flexible header motion.....	4-87
4-53	At a small manufacturing facility affected by the 1989 Loma Prieta Earthquake, a section of HVAC ducting fell to the floor when a strap broke at the duct connection and the attached section pulled free of its joints. Joints are lap fit, with no rivets or bolts.....	4-87
4-54	This a cantilevered duct section at a chemical plant severed and fell during the 1985 Mexico Earthquake. The duct was not positively attached to its rod-hung trapeze supports. Seismically induced uplift of the duct allowed the support to swing out from under the duct. The duct connections could not support the cantilevered weight and severed.....	4-88
4-55	At a data processing center in the 1987 Whittier Earthquake, a duct deformed at the joints of an angled offset section.....	4-88
4-56	At a telecommunication building in the 1989 Loma Prieta Earthquake, a vertical cantilevered section of duct fell to the floor with its attached diffuser.	4-89
4-57	The construction of a typical section of a motor control center.....	4-102
4-58	Primary components of a typical low voltage switchgear assembly.	4-103
4-59	A typical medium voltage switchgear assembly, and the primary components of an individual metal-clad section.....	4-104
4-60	Basic components of a typical distribution panel.	4-105
4-61	Two of the four MCCs at a pumping plant, affected by the 1983 sequence of earthquakes in Coalinga. All four MCCs were inadequately anchored and slid during the earthquake. Note the conduit in the upper photograph, which acted as an inadvertent restraint for the MCC, moved and damaged the ceiling.	4-106

FIGURES (Cont.)

	<u>Page</u>
4-62 This MCC at a water treatment plant, affected by the 1983 sequence of earthquakes in Coalinga was inadequately anchored and slid during the earthquake. The motor controllers were undamaged.	4-107
4-63 This unanchored MCC, at a water treatment plant slid approximately 3 inches during the 1983 sequence of earthquakes in Coalinga, but was not damaged.	4-107
4-64 This roof-mounted MCC at a manufacturing facility, affected by the 1989 Loma Prieta Earthquake, pulled its anchorage. The anchorage design of the two-section unit used 3/8-inch lag bolts into wood.	4-108
4-65 This three-section DC switchboard at a bank computer facility, which experienced an estimated a peak ground acceleration (PGA) of 0.40g, during the 1987 Whittier Earthquake, broke its anchorage and shifted several inches.	4-108
4-66 One of two free-standing switchgear assemblies at a brick extraction plant, affected by the 1989 Loma Prieta Earthquake, that shifted about one inch. It appears that overhead conduit provided some restraining effect.	4-109
4-67 This assembly of 4.16 kV switchgear, located in the control building of a pumping plant sheared its anchor bolts and slid during the 1983 Coalinga Earthquake.	4-109
4-68 This assembly containing the substation transformer and attached 4.16 kV switchgear located at a water treatment plant, affected by the 1983 Coalinga Earthquake, slipped from its anchor clips and slid about two inches. This movement cracked a short section of plastic conduit running between the assembly and its concrete pad. ..	4-110
4-69 One of two transformers at a pumping plant that slid during the 1983 sequence of earthquakes in Coalinga.	4-110
4-70 This unanchored oil-filled transformer at a paper mill, affected by the 1987 New Zealand Earthquake, an slid several inches. The unit was reported as operable when power was restored.	4-111

FIGURES (Cont.)

	<u>Page</u>
4-71 These three unanchored oil-filled transformers at a computer facility, affected by the 1987 Whittier Earthquake, shifted slightly. The units were undamaged when the facility reenergized about 24 hours after the main shock.....	4-111
4-72 These rail-mounted unit substation transformers at a steel mill, affected by the 1985 Mexico Earthquake, fractured the bolts on their rail blocks and shifted during the earthquake.	4-112
4-73 These MCCs at a chemical plant, affected by the 1985 Mexico Earthquake, sustained damage due both to inadequate anchorage and structural damage to the cabinet.	4-112
4-74 Several slide-mounted motor controllers in this MCC at a paper mill, affected by the 1987 New Zealand Earthquake slid forward from the front face of the MCC, but did not fall to the floor. When pushed back into position, the motor controllers remained functional.....	4-113
4-75 At a distillery, affected by the 1987 New Zealand Earthquake, there were some reports of earthquake-induced distortion to the MCC frame which resulted in difficulty in opening the controller doors and in removing the controllers.	4-113
4-76 One of two dry-type distribution transformers located at a bank computer facility, which was damaged during the 1987 Whittier Earthquake. During the earthquake, the channel supporting the internal core-coil assembly deformed to the extent that the core-coil impacted and damaged the enclosure siding. Note that the frame shown in the photograph is a post-earthquake modification.....	4-114
4-77 The foundation pad for this distribution transformer at a petrochemical facility, was damaged by the 1983 Coalinga Earthquake. An earthquake-induced crack broke the ground near the corner of the transformer's foundation pad.	4-114
4-78 This low voltage switchgear assembly at a chemical plant, was damaged by the 1985 Mexico Earthquake. Damage to the switchgear occurred in the fiberglass supports of vertical bus bars, mounted in the rear of each section behind the draw-out circuit breakers.	4-115

FIGURES (Cont.)

	<u>Page</u>
4-79 At one of the canal pumping stations, affected by the 1983 Coalinga Earthquake, the 2400-volt switchgear could not be reenergized when the circuit breakers were reset. Subsequent investigation revealed that one of the three fuses (shown) used for switchgear surge protection had dislodged from its clamps sufficiently to lose electrical contact.	4-115
4-80 This unanchored, oil-filled transformer at a steel mill, suffered an internal short circuit during the 1985 Mexico Earthquake. Apparently, a ground fault occurred in an internal bus connection of the transformer, burning windings in one coil.	4-116
4-81 One of six distribution panels at a paper mill damaged by the 1987 New Zealand Earthquake. Apparently, the internal bus bars were not positively attached, such that the loose bus bars contacted and shorted the unit during the earthquake.	4-116
4-82 This distribution panel at a computer facility, which experienced a PGA in excess of 0.40g during the 1987 Whittier Earthquake, was damaged when its cables were disconnected. During the earthquake, the cables were pulled from their connections, resulting in damage to the bus bars and the lug assembly.	4-117
4-83 This three-section MCC is located at a computer facility, which experienced an estimated PGA of 0.40g during the 1987 Whittier Earthquake. During the earthquake, the MCC impacted the adjacent wall board. The unit was not damaged by the earthquake.	4-117
4-84 This unclad transformer at a steel mill, affected by the 1985 Mexico Earthquake, was hit by a light fixture. The transformer is enclosed in a mesh fence but is otherwise unclad to allow natural air cooling. ...	4-118
4-85 One two 480-volt substations at a manufacturing plant, affected by the Loma Prieta Earthquake. These units were sprayed with water when an overhead sprinkler broke. Each substation included two transformers. Both unit substations were disassembled, dried out, and reassembled, prior to repowering three days after the earthquake....	4-118

SECTION 1

INTRODUCTION

This section describes the objectives and scope of work for this study, and the organization of the report. The seismic reliability of equipment systems is a matter of significant economic and life-safety consequence. This study is part of a multi-year program aimed toward reducing earthquake risk for critical facility equipment and components. Program phases are as follows: (i) collect data on the layout, use, and past seismic performance of equipment systems, (ii) develop a simplified methodology to assess equipment fragility and improve system reliability, (iii) provide example applications illustrating the methodology, and (iv) disseminate the methodology in a format that can be used by code-writing bodies, emergency-response facility owners, and operators of valuable facilities. The present study represents the first program phase: data collection.

1.1 Background

While earthquake safety and survivability of buildings have received a great deal of attention in recent years, both to improve life-safety, and more recently to improve their post-earthquake usability, less effort has been devoted to the seismic reliability of equipment within those buildings. Most facilities depend as heavily on their equipment as on their architectural and structural features, so earthquake-induced failure of equipment can and has impaired facilities' operability, life-safety features, or both. The seismic reliability of facility equipment is therefore a matter of significant economic and life-safety consequence.

The present study represents the first phase in a multi-year program to develop and disseminate a methodology for engineers without seismic expertise to assess and improve the reliability of equipment systems. It is anticipated that code-writing bodies will be able to apply the methodology in the development of building codes, and owners of critical facilities will be able to use the results to assess and improve the reliability of their equipment systems. Steps to accomplish the goals of the program include the following:

1. Compile data on the morphology and history of equipment systems. Examine sample facility types and equipment systems. Incorporate these data into risk tables and equipment performance data bases.
2. Formalize generic fragility assessment procedures (FAPs) to assess fragility of all critical equipment. Apply prototype FAPs to critical equipment data bases.

3. On the basis of prototype FAPs, develop a prototype critical system reliability assessment methodology (CSRAM) for estimating casualties and economic losses due to equipment damage.
4. As an example application, assess at a regional level the reliability of all equipment systems affected by selected scenario earthquakes. Estimate the inventory of population at risk, buildings, equipment systems, and equipment components. Develop scenario earthquakes for seismic regions. Apply the prototype CSRAM to inventory estimates. Characterize loss estimates by facility type, system, component, etc.
5. Develop guidelines for judging or improving critical equipment reliability. Prepare a user's guide for use by engineers without seismic expertise. Field test user's guide and CSRAM.
6. Perform pilot dissemination of user's guide, providing training in its application.

This report presents the results of task 1 noted above: the compilation of data on equipment systems and their performance. Ideally, the data would include numerous observations of the performance of all types of equipment systems found in all common types of facilities. From such data, system reliabilities could be calculated directly, without the need for intermediate steps. Unfortunately, this is impractical because of the almost unlimited combinations of facility types, equipment components, system layouts, installation quality, and maintenance of quality. However, it is possible to select a few representative facility types, examine their equipment systems, and draw general conclusions regarding equipment function and seismic reliability. These generalizations may then be applied to other facilities.

It is also possible to select a few important equipment systems, investigate their historical seismic performance, and draw general conclusions regarding the identification and classification of equipment vulnerabilities. These conclusions may then be applied to other equipment systems.

1.2 Objectives and Scope of Work

In this study, generalizations regarding equipment function and seismic reliability are developed by reviewing the major components, criticality for life-safety and normal operations, and system dependencies of four important facility types:

- High-rise office buildings
- Telephone central offices

- Data processing centers
- Hospitals

Sample sites of each facility type are selected which, as a matter of interest, have recently experienced significant earthquake motion. At each facility, equipment systems are reviewed, identifying the criticality for life-safety and normal operations. The equipment components of each system are identified, and any system backups are noted, should a given equipment component fail in an earthquake. From this, equipment components are tabulated according to their presence, their criticality, and their redundancies in the example facilities.

Generalizations regarding equipment vulnerabilities are developed by examining in detail the historic seismic performance of six key equipment systems:

- Uninterruptible power supply (UPS)
- Standby and emergency power generation
- Fire detection
- Fire suppression
- Air conditioning
- Power distribution

Investigations from past earthquakes are used to identify seismic vulnerabilities of specific types of equipment in these systems. Detailed data are gathered on important equipment attributes and seismic demand parameters on key systems. Data bases are developed to quantify these attributes for specific equipment categories.

1.3 Organization of Report

This section has introduced the study objectives and scope of work. Section 2 summarizes findings and presents conclusions. Section 3 provides detailed observations made at the sample facilities, and section 4 describes in detail observed seismic performance of components in the key equipment systems. At the beginning of each section, a brief abstract of that section is presented.

Appendix A contains a list of sites from more than 20 earthquakes where significant amounts of detailed equipment data have been collected and collated. Appendices B through E contain data bases of equipment parameters and equipment performance for key equipment systems.

SECTION 2

SUMMARY AND CONCLUSIONS

This section presents a summary of the findings and the conclusions for this study. All of the critical facilities studied (high-rise office buildings, telephone central offices, data processing centers, and hospitals) rely on similar equipment systems and components for life-safety, generally with backups for protection should any component fail. For normal operations, the number and extent of backups and safeguards varied substantially, reflecting the financial costs or social consequences of operational failure. This is summarized in Table 2-1.

The study of the seismic performance of key equipment systems (uninterruptible power supply, emergency power generation, fire detection, fire suppression, air conditioning, and power distribution), summarized in Table 2-2, demonstrates that equipment attributes leading to poor performance in earthquakes can be identified and avoided and can be eliminated from existing facilities. The study also shows that equipment failures in moderate and large earthquakes are typically dependent on details of construction and equipment configurations; they are typically not a function of ground motion amplitude. Detailed equipment performance data, such as those compiled for this study, can be used to develop empirical criteria for new design. Because equipment performance data demonstrate failure probability of a random sample, these data can also be used to assist in damage prediction models, statistical evaluations, fragility modelling, and probabilistic risk assessments.

This study forms much of the basis for answering several important questions on the costs and benefits of improving equipment seismic reliability, the priorities for addressing reliability, and the methods for increasing reliability of new systems designs and assessment of existing systems.

2.1 Equipment in Critical Facilities

The four sample facility types reviewed (high-rise office building, telephone central office, data processing center, and hospital) contain much of the range of systems and equipment required for life-safety by most commercial and lifeline facilities.

For each facility, equipment and systems are characterized in terms of the operational use served: life-safety or normal operations. Life-safety as used here refers only to the safe evacuation of occupants in emergencies.

The use and criticality of facility components and lifeline services are illustrated in logic diagrams such as shown in Figure 2-1. These diagrams are constructed for each major system at each facility type (found in Section 3). The diagrams illustrate system dependencies and redundancies and identify basic components on which each system relies. By following the entire sequence of logic trees, the basic components can be determined and seismic reliability may be discussed and evaluated.

Table 2-1 summarizes criticality of those basic components for each of the facility types. The table identifies which components are present, which are critical for life-safety and normal facility function, and whether other components or systems provide backup should a given component fail during an earthquake.

Although the same key equipment systems are present in all four facility types, the number and extent of backups and safeguards varies substantially, reflecting the cost or consequences of operational failure. Where those costs are lowest, backups generally serve only life-safety purposes, and the likelihood of operational shutdown and business interruption is higher. In contrast, where consequences of shutdown are higher, the likelihood of operational shutdown is lower due to the use of backup systems that serve normal operating equipment.

The following sections summarize several of the key findings for each of the facility types.

2.1.1 High-Rise Office Building

In the two high-rise office buildings visited, it was found that equipment critical to normal operations generally lack backups. In contrast, life-safety systems have redundancy safeguarding them from utility failure or equipment damage. For example, safeguards for fire detection, alarm, and suppression include on-site water supply, an on-site generator, batteries to run the Fire Communications Center (FCC), diesel-powered fire pumps, and hand-held fire extinguishers. Elevator safety and gas shutoff are similarly protected. Note that backup equipment does not provide for normal operations after utility failure. For example, on-site generators do not power air conditioning, lighting, or tenant electric service. On-site water is not available for air conditioning or tenant uses.

2.1.2 Telephone Central Office

In the two central offices (COs) visited, it was found that power is the only utility critical to normal operations (i.e. telephone switching) and is provided with backup. As a consequence, COs can operate in the event of off-site utility failure such as commercial power failure. On-site uninterruptible power supply (UPS) and generators are capable of providing continuous electric power. Electronic switching equipment can operate for limited duration without continuous air conditioning, reducing the need for off-site water service.

Fire suppression equipment does not require water: at the example facilities, only hand-held fire extinguishers and total-flooding-gaseous systems are present because of the sensitivity of switching equipment to water. These backups and safeguards are in place because of the public-safety and economic consequences of telephone service failure.

2.1.3 Data Processing Center

In the three sample facilities visited, it was found that backup systems exist to provide for continuous power and water service both for life-safety purposes and data processing. The redundancy of systems required for normal operations reflects the high economic cost of service interruption. On-site UPS provides for uninterrupted power to computers. During extended commercial power failures, multiple engine generators with several days' supply of fuel can provide power to computers, air conditioning equipment (for computer cooling), and telecommunications equipment. On-site water supports both firefighting and air conditioning needs. Fire detection and suppression systems are especially elaborate in computer areas, which are provided with three redundant suppression systems: preaction water spray (PWS), total-flooding-gaseous (halon), and hand-held fire extinguishers. Several safeguards mitigate the potential for accidental release of water onto computers. Sprinkler lines in computer areas are normally dry, and are charged with water only when fire is indicated by more than one detector. Water is released only from sprinkler heads whose fusible link is melted by heat. It is illustrative of the extent to which data centers are independent of off-site utilities to note that the data centers are equipped with portable toilets, reducing demand both for water and sewer service.

2.1.4 Hospital

One sample hospital was visited. Because of the vital role hospitals play in post-disaster situations, virtually all utilities are critical. The hospital thus has backup provisions for water, power and telecommunications service. It should be noted that no on-site backup water supply is maintained at the sample facility; off-site service is provided from two independent sources through independent service connections, and the hospital is capable of tapping water from a water main three blocks away within 24 hours. On-site generators and fuel supplies can provide power for up to three days without resupply. Telecommunications are especially important, and are therefore provided by six independent systems.

2.2 Seismic Performance of Key Equipment Systems

The historical seismic performance of six key equipment systems is evaluated and observed vulnerabilities are summarized. Those systems are critical for life-safety or normal operations for most or all of the sample facilities visited, and include the following:

uninterruptible power supply (UPS), standby and emergency power generation, fire detection and alarm, fire suppression, air conditioning, and power distribution.

The observed vulnerabilities are summarized in Table 2-2. In that table, vulnerabilities for a particular system are grouped either by system component or by common failure mode. Several of the key findings for each equipment system are summarized in the following sections. The following general conclusions result from this study:

- Equipment attributes leading to poor performance in earthquakes can be identified and avoided and can be eliminated from existing facilities.
- Equipment failures in moderate and large earthquakes are typically dependent on details of construction and equipment configurations; they are typically not a function of ground motion amplitude.
- Performance data can be used to develop empirical criteria for new design.
- Equipment performance data demonstrate failure probability of a random sample. These data can be used to assist in damage prediction models, statistical evaluations, fragility modelling, and probabilistic risk assessments.

2.2.1 Uninterruptible Power Supply (UPS)

The UPS system seismic performance study addresses battery chargers, inverters, and batteries. By far the most vulnerable component is the battery system. Batteries have failed from numerous causes including: overturning of the batteries due to lack of wraparound bracing or structural inadequacy of the rack; impact of adjacent batteries; and falling of objects or structures onto batteries.

2.2.2 Emergency Power Generation

The emergency power generation seismic performance study focuses on the engine-generator system. The most common source of emergency power generation system malfunction shown to occur in past earthquakes is associated with relay actuation or damage of some kind. This includes relay damage, temporary seismic induced transients, or other spurious actuation of relays. Various types of damage have also occurred due to failure of vibration isolator supports. Other damage has been related to differential settlement, such as between separate engine and generator base support skids and foundations.

2.2.3 Fire Detection and Alarm

The fire detection seismic performance study addresses detectors, circuitry, control panels, speakers, alarms, and pull stations. Most of the vulnerabilities are related to control panels which were not necessarily part of the fire protection systems. However, many types of control panels are included in this study, as their identified vulnerabilities are considered applicable to fire detection related control panels. Key vulnerabilities of control panels include anchorage failure, relay chatter, and damage from spatial interaction effects. Similarly, vulnerabilities to conduit and tubing from other systems are considered appropriate. The key concern for conduit and tubing is failure due to seismic induced differential displacement of support points.

2.2.4 Fire Suppression

The primary vulnerabilities in fire suppression systems have been associated with damage to sprinkler heads due to impact with structural members or breaking of pipes. Failure of fire piping has occurred through causes such as poor support details inducing unzipping of the system, small branch lines acting as anchors for flexible large headers and failing, and failure due to excessive differential displacement of connected flexible systems.

2.2.5 Air Conditioning

The air conditioning system seismic performance study addresses the chilled water system, and the distribution system (fans, air handlers, and ducts). The most common failures were due to failure of vibration isolator supports. The excessive displacement that results from failure of vibration isolator supports often breaks attached piping and ducting. Non-ductile chilled water piping (PVC, or Victaulic-type connections) has also been damaged.

2.2.6 Power Distribution

The power distribution seismic performance study focuses on Motor Control Centers (MCCs), switchgear, distribution panels, and transformers. The primary vulnerabilities demonstrated were inadequate anchorage of cabinets allowing excessive displacement, along with various electrical faults. A number of systems have also been shut down due to the spurious actuation of electromechanical relays in switchgear.

2.3 Conclusions

Overall seismic risk posed by equipment, whether to life-safety or economic vitality, may be seen as a combination of three factors:

- **Criticality:** the extent to which each facility relies on a system and the equipment components of that system for life-safety or normal operations.
- **Vulnerability:** the level of damage that the component will be expected to experience due to earthquake motion.
- **Commonality:** the number and operational value of facilities that rely on the equipment.

This study examines these items in a qualitative fashion for the four representative facility types and six key systems. However, the findings of this study are directly applicable to systems in any commercial, industrial, or government facility. A full quantitative analysis of the casualty or dollar risk may be performed using much of the data presented in this report. The logic tree diagrams of section 3 may form the basis of formal fault tree analyses to estimate probability of single facility failures due to equipment damage, with basic-event probabilities drawn in part from section 4 of this report. Economic census data may be used to estimate the number and value of each type of facility whose failure probability is estimated. Economic models such as the input-output model may be used to estimate the potential cost of facility failures. This study therefore forms much of the basis for answering the following important questions:

1. What is the potential cost to society of equipment-related facility failures in future large earthquakes?
2. What are the costs and benefits of improving equipment seismic reliability, and which components should be addressed first?
3. What guidance can be provided for the design of new life-safety and operational equipment systems to increase a facility's overall seismic reliability?
4. What are the bases for assessing the seismic reliability of existing equipment systems in critical facilities?

Table 2-1 (Page 1 of 4)
COMPONENT CRITICALITY

Equipment Identification			Highrise Office		Central Office		Data Center		Hospital	
Component Name	Key System	Use	Life Safety	Normal Operation	Life Safety	Normal Operation	Life Safety	Normal Operation	Life Safety	Normal Operation
Raised access floors		Computers					0	2		
Mainframes		Computers					0	2	0	2
Mini/microcomputers		Computers					0	2	1	2
Tape drives		Computers			0	2	0	2		
Disk drives		Computers					0	2		
Tape storage racks		Computers					0	2		
Disk storage racks		Computers					0	2		
Printers		Computers					0	2		
Document handling equipment		Computers					0	2		
Communications cable		Computers					0	2		
Communications control eqt		Computers					0	2		
Fuel supply tanks	Engine Generator	Electrical	1	0	0	1	0	1	0	1
Automatic fuel shutoff valve	Engine Generator	Electrical	2	0	0	1				
Electric fuel pumps	Engine Generator	Electrical	1	0	0	1	0	1	0	1
Diesel fuel pumps	Engine Generator	Electrical	1	0			0	1		
Backup generators	Engine Generator	Electrical	1	0	0	1	0	1	0	1
Generator control equipment	Engine Generator	Electrical	1	0	0	1	0	1		
Day tank	Engine Generator	Electrical	1	0	0	1	0	1		
Emergency generator battery unit	Engine Generator	Electrical	1	0					0	1
Power transfer equipment	UPS	Electrical			0	1	0	1	0	1
Rectifiers/chargers	UPS	Electrical			0	1	0	1		
Batteries	UPS	Electrical			0	1	0	1	0	1
Inverters	UPS	Electrical			0	1	0	1		
Substations		Electrical			0	2	0	2		
Distribution panels		Electrical			0	2	0	2		
Motor generators		Electrical					0	2		
Power conditioners		Electrical			0	2	0	2		
Switchgear		Electrical			0	1	0	1	0	1
Conduit		Electrical	1	2	0	2	0	2	0	2
Power cable		Electrical	0	2	0	2	0	2	0	2
Motor control center (MCC)		Electrical	1	0	0	2			0	2
Switchgear		Electrical	1	0	0	2	0	2	0	2
Transformers		Electrical			0	2	0	2	0	1
Starter motors		Electrical	1	0	0	1	0	1		

2-7

* = presence varies by facility
 0 = not critical
 1 = critical, redundant
 2 = critical, non-redundant
 blank = not at sample sites

Note: Hospital life safety refers to safe evacuation to temporary site

Table 2-1 (Page 2 of 4)
COMPONENT CRITICALITY

Equipment Identification			Highrise Office		Central Office		Data Center		Hospital	
Component Name	Key System	Use	Life Safety	Normal Operation	Life Safety	Normal Operation	Life Safety	Normal Operation	Life Safety	Normal Operation
Stairway emergency lighting		Electrical	2	0	2	0	2	0	2	0
Interior lighting fixtures		Electrical	0	2	0	0	0	2	0	2
Temporary lights		Electrical							2	0
Fuel piping		Electrical	1	0	0	1	0	1	0	1
55 gallon (fuel) drums		Electrical	1	0						
Off-site power		Electrical	1	2	0	1	0	2	1	1
Portable generators		Electrical							2	0
Elevators		Elevator	0	2	0	0	0	2	0	2
Elevator derailment detector		Elevator	1	0	1	0	1	0	1	0
Elevator ring-and-string		Elevator	1	0	1	0	1	0	1	0
Fire alarm manual pull stations	Fire Detection & Alarm	Fire	1	0	1	0	1	0		
AS alarm valve	Fire Detection & Alarm	Fire	1	0			1	0		
PWS smoke detectors wiring	Fire Detection & Alarm	Fire					1	0		
FCC panel	Fire Detection & Alarm	Fire	2	0	2	0	2	0	2	0
Fire alarm indicating devices	Fire Detection & Alarm	Fire	2	0	2	0	2	0	2	0
Remote fire alarm monitors	Fire Detection & Alarm	Fire			2	0			2	0
Heat detectors	Fire Detection & Alarm	Fire	1	0	1	0			2	0
Sprinkler flow sensors	Fire Detection & Alarm	Fire	1	0	1	0	1	0	2	0
Spot or area smoke detectors	Fire Detection & Alarm	Fire	1	0	1	0	1	0	2	0
Line smoke detectors	Fire Detection & Alarm	Fire			1	0				
Plenum smoke detectors	Fire Detection & Alarm	Fire	1	0	1	0	1	0		
On-site fire water supply	Fire Suppression	Fire	1	0			1	0		
Total flooding gas system	Fire Suppression	Fire			1	0	1	0		
Hand fire extinguishers	Fire Suppression	Fire	1	0	1	0	1	0	2	0
Hose stations	Fire Suppression	Fire			1	0				
Electric fire pumps	Fire Suppression	Fire	1*	0			1	0		
Diesel fire pumps	Fire Suppression	Fire	1*	0			1	0		
Fusible link sprinkler heads	Fire Suppression	Fire	2	0			1	0	2	0
Preaction fire water valves	Fire Suppression	Fire					1	0		
Air duct fire & smoke dampers	Fire Suppression	Fire			2	0	2	0		
Fire water risers	Fire Suppression	Fire	2	0			1	0	2	0
Fire water cross mains	Fire Suppression	Fire	2	0			1	0	2	0
Fire water branch lines	Fire Suppression	Fire	2	0			1	0	2	0
Off-site fire water supply		Fire	1	0			1	0	1	0

* = presence varies by facility

0 = not critical

1 = critical, redundant

2 = critical, non-redundant

blank = not at sample sites

Note: Hospital life safety refers to safe evacuation to temporary site

Table 2-1 (Page 3 of 4)
COMPONENT CRITICALITY

Equipment Identification			Highrise Office		Central Office		Data Center		Hospital	
Component Name	Key System	Use	Life Safety	Normal Operation	Life Safety	Normal Operation	Life Safety	Normal Operation	Life Safety	Normal Operation
Food service appliances		Food							0	2
Kitchen equipment		Food							0	2
Gas shutoff valve		HVAC	2	0	2	0	2	0	2	0
Ductwork	Air conditioning	HVAC	0	2	0	2	0	2	0	2
Chillers	Air conditioning	HVAC	0	2	0	2	0	2	0	2
Cooling towers	Air conditioning	HVAC	0	2	0	2	0	2	0	2
Fans	Air conditioning	HVAC	0	2	0	2	0	2	0	2
Pneumatic HVAC control system	Air conditioning	HVAC	0	2	0	2	0	2	0	2
Electric HVAC control system	Air conditioning	HVAC								
Chilled water distribution	Air conditioning	HVAC					0	2		
Boilers		HVAC	0	2	0	0*	0	2	0	2
Heat exchangers		HVAC	0	2	0	0*	0	2	0	2
EAC units		HVAC					0	2		
Gas lines		HVAC	0	2	0	0*	0	2	0	2
Laboratory equipment		Medical							2	2
Blood bank refrigerators		Medical							0	2
Incubators		Medical							2	2
Sterilizers		Medical							2	2
Surgical lights		Medical							2	2
Sanitizers		Medical							2	2
X-ray equipment		Medical							2	2
Liquid oxygen tank		Medical							1	1
Oxygen coils		Medical							1	1
Oxygen supply line		Medical							1	1
Nitrous oxide tank		Medical							1	1
Nitrous oxide supply line		Medical							1	1
Backup oxygen units		Medical							1	1
Backup nitrous oxide units		Medical							1	1
Portable toilets		Sewer					0	1		
Wastewater piping		Sewer	0	2	0	0	0	1	0	2
Sewer service		Sewer	0	2	0	0	0	1	0	2
Storm drain		Sewer	0	2					0	2
Cabletrays		Telecom			0	2	0	2		
Telephone cable		Telecom	0	2	0	2	0	2	0	2

2-9

* = presence varies by facility

0 = not critical

1 = critical, redundant

2 = critical, non-redundant

blank = not at sample sites

Note: Hospital life safety refers to safe evacuation to temporary site

Table 2-1 (Page 4 of 4)
COMPONENT CRITICALITY

Equipment Identification			Highrise Office		Central Office		Data Center		Hospital	
Component Name	Key System	Use	Life Safety	Normal Operation	Life Safety	Normal Operation	Life Safety	Normal Operation	Life Safety	Normal Operation
Cable entrance facility		Telecom			0	2	0	2		
Main distribution frame		Telecom			0	2				
Microwave antenna		Telecom			0	2				
Microwave antenna tower		Telecom			0	2				
Microwave signal equipment		Telecom			0	2				
Multiplexers		Telecom			0	2	0	2		
Switching equipment		Telecom			0	2	0	2		
Equipment monitors		Telecom			0	2				
PBX system		Telecom							2	2
CB radio		Telecom							2	2
Ham radio		Telecom							2	2
Cellular phones		Telecom							2	2
Walkie talkies		Telecom							2	2
Telephone service		Telecom							2	2
On-site domestic water supply		Water					0	1		
Plumbing fixtures		Water	0	2	0	0	0	1	0	2
Domestic water pumps		Water	0	2	0	2	0	2	2	2
Fresh water piping		Water	0	2	0	2	0	2	1	2
Off-site domestic water supply		Water	0	2	0	2	0	1	1	1

2-10

* = presence varies by facility
 0 = not critical
 1 = critical, redundant
 2 = critical, non-redundant
 blank = not at sample sites

Note: Hospital life safety refers to safe evacuation to temporary site

Table 2-2 (Page 1 of 4)
SUMMARY OF VULNERABILITIES OF KEY EQUIPMENT SYSTEMS

System	Typical Components Reviewed	Observed Vulnerabilities	
UPS	Charger/Rectifier Inverter Battery	Battery Chargers / Rectifiers Inverters Batteries	<ul style="list-style-type: none"> • Tripping due to actuation of circuit breaker in associated distribution panel (impact of panel with wall) • Blown fuses • Power surge burned out capacitors after cabinet broke anchorage and slid 12" • Overturning due to lack of wraparound bracing • Overturning due to structural failure of rack • Overturning due to inadequate anchorage of rack • Breaking of electrical contact due to impact of adjacent batteries (lack of spacers) • Failure due to collapse of masonry wall onto batteries (seismic interaction)
Standby and Emergency Power Generation	Generator Engine Control Panel	Control System Malfunction Vibration Isolators Differential Settlement /Motion	<ul style="list-style-type: none"> • Unit malfunction due to relay damage (e.g., circuit breaker trip) • Unit malfunction due to relay damage from temporary seismic induced transients (e.g. liquid sloshing, dynamic liquid pressure, or vibration) • Relay damage or other control system damage due to overcurrent surges • Inability to stabilize generator due to misadjustment of voltage regulator • Spurious actuation of protective relays • Breaking of piping connections due to shifting of diesel after failure of vibration isolator • Damage to exhaust systems due to movement of diesel after failure of vibration isolator • Misalignment of shaft and bearing damage due to soil settlement (engine and generator on separate skids) • Breaking of attached piping due to settlement and spreading

Table 2-2 (Page 2 of 4)
SUMMARY OF VULNERABILITIES OF KEY EQUIPMENT SYSTEMS

System	Typical Components Reviewed	Observed Vulnerabilities	
Fire Detection and Alarm	Detectors Control Panels Speakers Alarm Pull Stations Conduit/Tubing (Circuitry)	<p>Detectors</p> <p>Control Panels (Including non-fire detection systems)</p> <p>Alarms, Speakers, and Pull Stations</p> <p>Circuitry (Including non-fire detection systems)</p>	<ul style="list-style-type: none"> • Inadvertent actuation of smoke detectors by dust in an earthquake. • Actuation of water flow detectors by breaks in fire protection piping. • Malfunction of system due to spurious actuation of relays mounted in control panels. • Damage to panel due to inadequate anchorage. • Burned coil in a control panel meter due to current surge. • Broken filaments in control panel indicator lights. • Damage to relays due to internal short circuit. • Damage to slide-in electrical controllers and recorders in control panels, after components slid out and fell to floor. • Damage to inadequately anchored speakers. • Alarms inadvertently actuating due to sloshing of mercury in switches. • Damage to conduit and tubing (not necessarily in fire system) due to inadequate flexibility of conduit/tubing at structural joints. • Damage to conduit and tubing (not necessarily in fire system) due to movement of attached unanchored or flexible equipment. • Damage to conduit and tubing (not necessarily in fire system) at transition between rigid and rod-hung support systems due to inadequate flexibility.
Fire Suppression	Piping Sprinkler Heads Pumps Valves	<p>Piping</p> <p>Sprinkler Heads</p> <p>Pumps</p> <p>Valves</p>	<ul style="list-style-type: none"> • Collapse of the system due to unzipping of supports (poor support details, such as eccentrically loaded supports or short rod hangers, used throughout the system). • Damage due to structural failure or large structural displacements. • Damage where small piping acts as rigid anchor for flexible larger piping. • Damage due to differential displacement of flexible systems. • Breaking of sprinkler heads due to impact with structural members. • Damage to sprinkler heads attached to collapsed suspended ceilings. • Damage due to large displacement of attached unanchored equipment or tanks. • Damage due to differential ground settlement. • Fracturing of yokes due to impact with adjacent steel.

Table 2-2 (Page 3 of 4)
SUMMARY OF VULNERABILITIES OF KEY EQUIPMENT SYSTEMS

System	Typical Components Reviewed	Observed Vulnerabilities	
Air Conditioning	<p><u>Chilled Water</u> Chillers Pumps Valves Piping Cooling Towers/ Evaporative Coolers</p> <p><u>Distribution</u> Fans Air Handlers HVAC Ducts</p>	<p>CHILLED WATER</p> <p>Chillers</p> <p>Pumps</p> <p>Valves</p> <p>Piping</p> <p>Evaporative Coolers/ Cooling Towers</p> <p>DISTRIBUTION Fans and Air Handlers</p> <p>HVAC Ducting</p>	<ul style="list-style-type: none"> • Breaking of attached piping due to failure of vibration isolator supports. • Breaking of piping connections due to differential settlement. • Pump damage due to large movement of piping. • Malfunction due to rigidly attached tubing disconnecting when the valve moved. • Broken yokes from impact with structural members. • Breaking of mechanical (Victaulic-type) couplings. • Damage to piping due to differential displacement of support points. • Non-ductile piping (e.g. PVC) cracked due to movement of piping, supports, or attached equipment. • Piping cracked at location of old weld repair. • Damage to evaporative coolers due to failure of vibration isolators. • Structural damage to deteriorated wood cooling towers. • Structural damage to cooling towers with eccentric beam connections. • Damage due to failed vibration isolation supports. • Damage due to differential displacements (e.g. fan and motor on different foundations or movement of equipment attached by rigid piping or ducting). • Damage to flexible bellows from movement of air handlers, fans, or attached ducts. • Falling of duct due to corrosion failure. • Falling of cantilevered duct sections due to high inertial loading causing high reaction forces at relatively weak connections (e.g. riveted lap joints and simple friction connections). • Falling of cantilevered ducts where flexible headers developed high stresses in short duct segments not flexible enough to accommodate the motion. • Falling of cantilevered ducts which are not tied down to their supports. • Falling of ducts due to failure of suspended ceilings. • Shearing and opening of joints and falling of light gage circular duct with riveted lap joints subject to high bending strains in very flexible systems.

Table 2-2 (Page 4 of 4)
SUMMARY OF VULNERABILITIES OF KEY EQUIPMENT SYSTEMS

System	Typical Components Reviewed	Observed Vulnerabilities	
Power Distribution	MCC Switchgear Distribution Panel Transformer	Anchorage	<ul style="list-style-type: none"> • Damage to power distribution components due to sliding or overturning of unanchored or inadequately anchored equipment.
		Structural Damage	<ul style="list-style-type: none"> • Structural failure of cabinets and anchorage due to excessive inertial loads. • Damage to switchgear busbars due to differential settlement.
		Internal Damage	<ul style="list-style-type: none"> • Damage to fiberglass bus bar supports in a low voltage switchgear due to inertial loading. • Dislodging of fuses in switchgear. • Ground faults in transformers due to loss of insulation from vibration. • Short circuit in distribution panel due to loose bus bars. • Disconnection of attached cables to distribution panel.
		Interaction	<ul style="list-style-type: none"> • Impact of falling objects on power distribution equipment.
		Water Spray	<ul style="list-style-type: none"> • Forced shutdown of unit substations due to water spray from broken overhead sprinklers.
		Relay Actuation	<ul style="list-style-type: none"> • Shutdown of system due to actuation of electromechanical relays in switchgear. • Shutdown of system due to actuation of molded case circuit breakers.

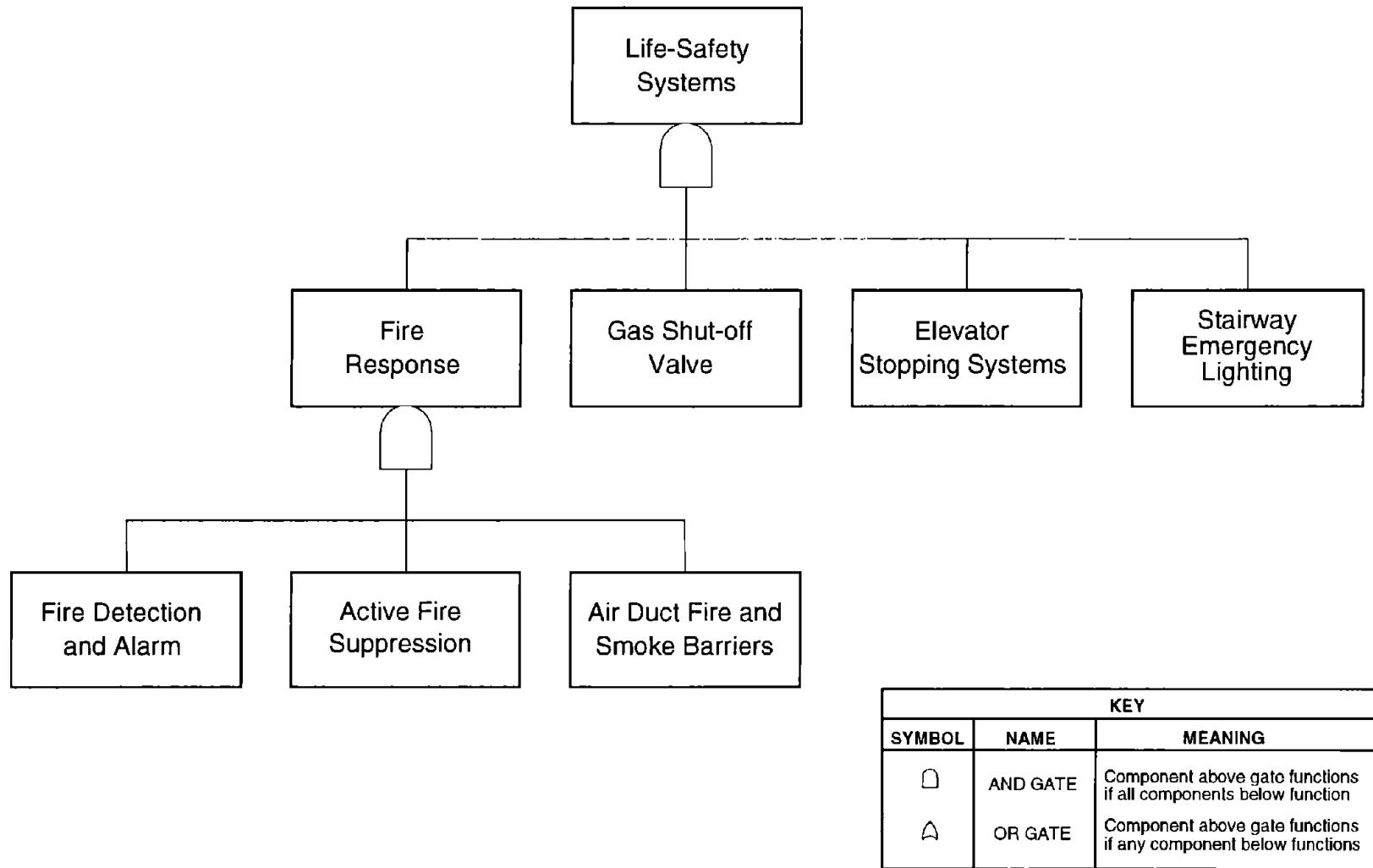

KEY		
SYMBOL	NAME	MEANING
⌋	AND GATE	Component above gate functions if all components below function
⌋	OR GATE	Component above gate functions if any component below functions

Figure 2-1: Data processing center life-safety system

SECTION 3 EQUIPMENT IN CRITICAL FACILITIES

This section examines in detail the equipment systems, functions, and system dependencies of four representative facility types: high-rise office buildings, telephone central offices, data processing centers, and hospitals. Logic diagrams of life-safety systems are presented for each example facility type, identifying critical components and describing backup systems.

The following are some of the key findings: High-rise office building: Equipment critical to normal operations generally lack backups; life-safety equipment has redundancy, such as backup power and on-site water. On-site generators do not power air conditioning, lighting, or tenant electric service. On-site water is not available for air conditioning or tenant uses. Telephone central office: Equipment critical to telephone switching is provided with backup power, and is designed to operate for limited duration without continuous air conditioning, reducing the need for off-site water service. Data processing center: Backup systems exist to provide for continuous power and water service both for life-safety and data processing. On-site power and water supplies provide several days' continuous operation of computers in the event of utility failure. Three fire suppression systems are provided in computer areas. Hospital: Because of the importance of the hospital many normal operation systems are provided with backups. No on-site water supply is maintained at the example facility; off-site service is provided from two independent sources and a third source is available within 24 hours by tapping into a water main three blocks away. On-site generators and fuel supplies can provide power for up to three days without resupply. Telecommunications are especially important, with six independent systems.

3.1 General

In the following sections, organized by facility type, fixed features and equipment are broken out in terms of their function and the system that they serve. To the extent possible, equipment components are also classified in terms of operational mode. Operational modes include the following:

1. **Life-safety.** A component is essential for life-safety if its failure will result in a condition where lives are in imminent danger or are not sufficiently protected from potential danger as judged by prevailing standards. In the case of hospitals, *life-safety* implies only the safe evacuation of building occupants.
2. **Normal building operations.** This includes all other functions.

The diagrams referred to in this section are a type of logic tree that depicts facility components and lifeline services and the functional relationships between them. The box at the top of the tree represents all the fixed components and the lifelines on which they rely. The top component is connected via lines and a logic symbol to more basic components on which it relies. In the example in Figure 3-1, the top component is "Data Processing Center", which is comprised of structural elements, architectural elements, and equipment. These three more basic components are connected to the top component by an "and" gate. At each branching of the logic tree there is either an "and" gate or an "or" gate. An "and" gate means that the upper component can only continue to provide its proper function only if all of the lower components connected to it are also functional. An "or" gate means the upper component functions if any one of the lower components functions.

The lower components in the logic tree are in turn further broken down into contributing components according to the same scheme. For example, in Figure 3-2, life-safety equipment systems are further broken down into fire response, gas shut-off, elevator stopping, and stairway emergency lighting.

At the bottom of the logic tree are "basic components." These represent individual pieces of equipment such as "gas shut-off valve." If one knows about whether each basic component is functional, one can determine whether the top component (and every intermediate component) is functional by applying the logic indicated by the "and" and "or" gates.

Note that, since this study is intended to focus on a facility's equipment, human factors are excluded from the text and accompanying logic trees. That is, neither procedures nor human errors are represented.

KEY		
SYMBOL	NAME	MEANING
⌋	AND GATE	Component above gate functions if all components below function
⌋	OR GATE	Component above gate functions if any component below functions

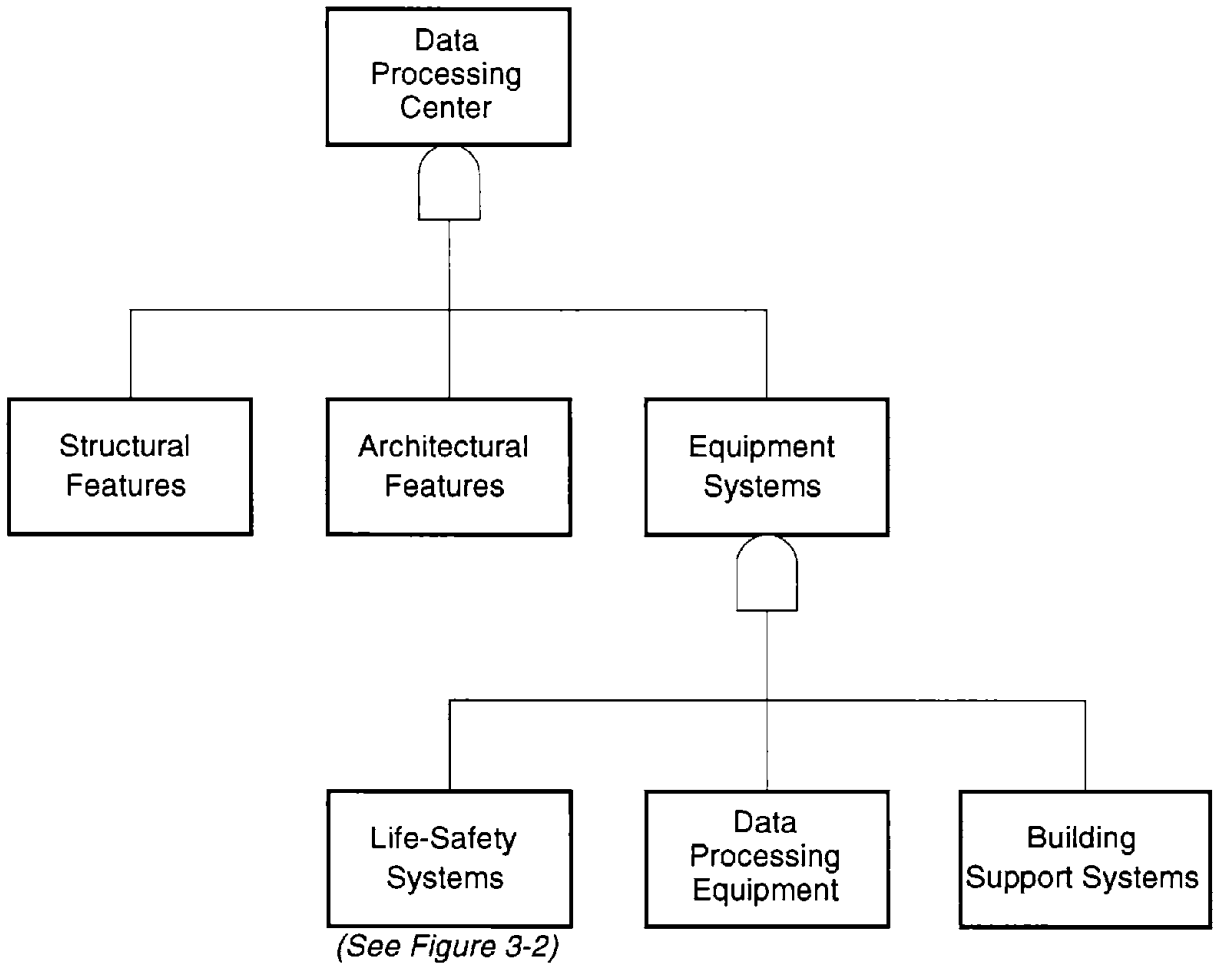
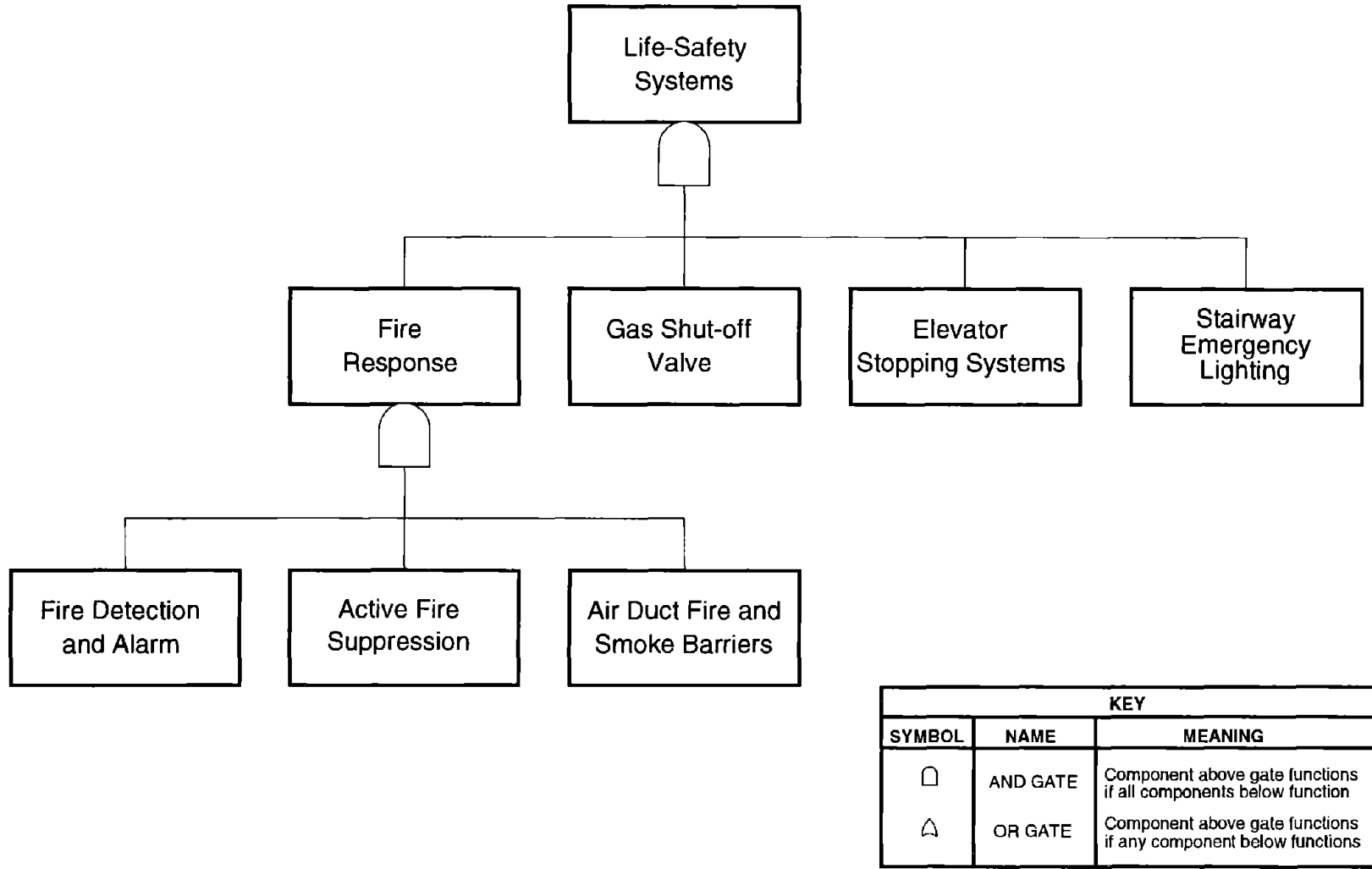

Figure 3-1: Example logic tree for data processing center components



KEY		
SYMBOL	NAME	MEANING
□	AND GATE	Component above gate functions if all components below function
△	OR GATE	Component above gate functions if any component below functions

Figure 3-2: Data Center Life-safety Systems

3.2 High-Rise Office Building

3.2.1 San Francisco High-Rise Office Building

A typical high-rise building in San Francisco was studied to understand the primary building equipment systems and to identify essential systems and components for life-safety and normal building occupancy. The building reviewed is a 44-story, 1960s vintage, steel-frame structure located in the San Francisco Financial District. Information was collected by interviewing the building stationary engineer and by walkdowns. The building stationary engineer proved to be a valuable source of information, since he has worked in the building for about 10 years and was instrumental in the response of the facility to the October 1989 Loma Prieta earthquake.

3.2.2 Performance of San Francisco High-Rise in Loma Prieta

The building and its systems and components performed well during the earthquake and sustained no significant damage. The building was re-occupied within two days after the event. Activities undertaken at the facility prior to re-occupancy included inspection, clean-up, and minor repair. The most notable seismic effects included fallen ceiling tiles and asbestos insulation, damage to the exterior facade (from an adjacent building) falling through a skylight on an annex roof, and isolated out-of-plumb doors.

After the Loma Prieta earthquake, much of the critical equipment was seismically upgraded. All critical electrical distribution system cabinets were anchored. Snubbers were added to many larger mechanical equipment items that were vertically spring isolated. Seismic restraints on start battery racks and fuel day tanks were also added. On several floors where new tenants have moved in since the earthquake, additional seismic restraints were added to the fire-protection sprinkler piping.

3.2.3 San Francisco High-Rise Components

Building systems required for occupancy are illustrated in Figure 3-3. As shown, the ability to house tenants is dependent on the building structure, its architectural features, normal building operation systems, and what is formally termed building life-safety systems. The building normal operation systems and life-safety systems are shown in Figures 3-4 and 3-5, respectively.

3.2.4 San Francisco High-Rise Normal Operation Systems

Building normal operation systems include those required to support typical tenant needs. These include lighting and tenant electrical power supply, HVAC, domestic water, sewage discharge and storm drain, telephone and communications, and elevator service. None of these systems are considered critical to life-safety from the standpoint of functionality; normal building code provisions address the concern of potential life-safety hazards posed by the overturning or falling of these items. The systems are relatively complex, and are considered important from the business interruption (financial loss) perspective as they are necessary for occupancy.

HVAC. As an example, Figure 3-6 provides a partial system diagram of the heating, ventilation, and air conditioning (HVAC) system. HVAC is dependent on many components and other systems such as electric power, compressed air, and heating and cooling functions. Note that the new emergency power supply was added to drive building air compressors following the Loma Prieta earthquake. Although compressors are not critical, they supply compressed air to the building's pneumatic control system, which is considered by the stationary engineer to be the "heart of the building system."

In other high-rise buildings, HVAC and compressed air may be a critical life-safety system. This is because some buildings utilize HVAC as part of the smoke purge system. Since much of the pneumatic control system for the building ventilation system is plastic tubing, it will likely melt during a fire and thus cannot be relied on.

3.2.5 San Francisco High-Rise Life-Safety Systems

As shown in Figure 3-5, building critical life-safety systems consist of fire response systems, smoke purge, main gas shut-off, elevator safety, and building egress. In addition, an emergency response services group is on standby to respond to emergency situations.

Fire response. According to the stationary engineer, the most critical system is fire response. The fire response consists of the detection and alarm system, and fire suppression system. These fire response systems are shown in Figures 3-7 and 3-8.

The main elements of the fire detection and alarm system, shown in Figure 3-7, are the detectors, the Fire Communications Center (FCC) panel and the speakers and alarms throughout the tenanted areas of the building. The FCC panel is located on the ground floor and is the critical focal point for the entire detection and alarm system. It receives signals from all detection systems including area smoke detectors, plenum smoke detectors, the tenant floor fire alarm pull stations, and the flow sensors on the fire protection sprinkler piping. The FCC panel provides the electric power to these detectors, alarms and speakers, and serves as the central control station for fire-fighting crews in the event of a fire.

The FCC panel receives backup power by the "old" 175 KW emergency generator. It has a small internal battery to handle detection device loads for four hours and to sound alarms for five minutes.

The fire suppression system is shown in Figure 3-8. It includes an on-site water supply, firewater pumps, and all of the fire protection piping. Note that the system had two major upgrades following the Loma Prieta earthquake. These include addition of a back-up water supply and "new" emergency generator service (1000 KW) to supply electric power to the two large main fire water pumps.

The older backup diesel-driven fire water pump is supplied with fuel from a small day tank. The day tank must be refilled from 55-gallon drums. The firewater pumps are located in the basement.

Smoke purge. The smoke purge system is relatively simple and is shown in Figure 3-9. With an alarm from the FCC panel, fire fighters enter floors above the fire and break windows to allow smoke to exit the building rather than infiltrate upper stories.

Gas shut-off. The building includes a restaurant on the lower floor. This is supplied by a main gas line. As shown in Figure 3-10, this line has a main gas shut-off life-safety system. The solenoid valve cuts off the gas supply if any of three events occur: a signal of fire from the FCC panel; a signal from a motion sensor (seismic) trigger; or loss of normal building power.

Elevator stopping. All of the building elevators have a life-safety system to cause them to stop at the nearest floor in the event of earthquake, derailment, or loss of normal building power. The earthquake detector consists of the simplified "ring and string" system (Figure 3-11).

Evacuation and egress. Life-safety systems for building evacuation and egress are shown in Figure 3-11. These systems consist of emergency lighting (including exit signs), the ability to announce messages to tenants on selected floors through the FCC panel by fire-fighting crews, and the elevators. Note that after the Loma Prieta earthquake, additional emergency elevator service was provided via an upgrade of the new 1000 KW emergency generator. This enabled quicker access to floors than just the one freight elevator.

Generators. Figures 3-13 and 3-14 show the old and new emergency generator systems, respectively. The old 175 KW generator is located on the top floor of the building, and receives fuel via 55-gallon drums (transported up through the freight elevator). Two full spare drums (noted to be unrestrained during the walkdown) are located adjacent to the day tank. The new 1000-KW emergency generator is located on the second floor. The large day tank can be filled by pumping from fuel trucks at street level.

3.2.6 Los Angeles High-Rise Office Building

A typical, modern high-rise building in Los Angeles (Irvine, CA) was reviewed to determine the commonality between systems in high-rise buildings located in different geographic areas and of varying vintages. The Los Angeles-area building is an 18-story, late-1980s, steel moment-frame structure located in Irvine, California, adjacent to John Wayne Airport. Information was collected through walkdowns and interviews with the building engineer.

The building systems for the Los Angeles high-rise are shown in Figures 3-15 through 3-17. The systems are presented in the same order as those previously shown for the San Francisco high-rise.

3.2.7 Comparison of SF and LA High-Rise Office Buildings

Overall, normal operating systems and life-safety systems for the Los Angeles high-rise were similar to those identified for the San Francisco high-rise. A brief discussion of system differences follows.

HVAC. HVAC systems for the Los Angeles and San Francisco buildings have generally similar configurations as shown in Figures 3-6 and 3-18, respectively. Both systems are dependent on pneumatic controls using Teflon coated tubing. However, air compressors for the Los Angeles high-rise are not connected into emergency power. This is because the damper control system used under normal operating conditions are not required for fire safety or smoke purge operations.

Fire detection and alarm. Fire detection and alarm systems shown in Figures 3-7 and 3-19 are virtually identical. The only minor difference between the systems is that the Los Angeles building has heat detectors located in the boiler and trash rooms.

Fire suppression. Although the fire-suppression systems are generally similar (Figures 3-8 and 3-20), there are two noteworthy differences, one major and one minor. First, the San Francisco high-rise has two redundant fire pump systems: an electric firewater pump system and a direct diesel firewater pump system. This redundancy will enhance the reliability of the fire suppression system of the San Francisco high-rise.

Second, the firewater supply system for the Los Angeles high-rise draws city water through the 20,000 gallon underground storage tank. In the San Francisco building, water is drawn from either the city mains or a 20,000 gallon tank. This difference is considered minor.

Smoke purge. The smoke purge systems (Figures 3-9 and 3-21) for the two buildings contained one significant difference: the San Francisco high-rise did not require positive pressurization of the stairwells to prevent smoke infiltration. This is probably because of the age of this building.

Gas shut-off. Gas shut-off systems for the two high-rises were surprisingly different. The San Francisco building (Figure 3-10) has several control systems for turning off gas to the building during abnormal conditions. However, the Los Angeles high-rise has no apparent safety systems for turning off gas flow. Safety devices for turning off gas flow to commercial office buildings apparently are not required by current local codes, although this requirement is under discussion.



Elevator safety. Elevator safety systems are similar (Figures 3-11 and 3-22). The elevator safety system for the Los Angeles high-rise actuates upon a signal from a counterweight derailment detector, loss of building power, or loss of signal from the elevator controller. The San Francisco office building also has a ring-and-string earthquake detection system. According to the building engineer at the Los Angeles high-rise, the ring and string system is no longer required.

3.2.8 Conclusions Regarding High-Rise Office Buildings

It was found that equipment critical to life-safety had redundancy, but that backup systems were not present to allow for continued tenant occupancy following utility failure. Life-safety backups included on-site generators, on-site fire-fighting water, and redundant systems for fire detection, alarm, and suppression, elevator safety, and gas shut-off. On-site generators did not power air conditioning, lighting, or tenant electric service, nor was on-site firefighting water available for air conditioning or tenant uses. This may reflect the relatively low cost to building owners of temporary building shutdown.

Normal operating and life-safety systems for both the San Francisco and Los Angeles high-rises are similar. Although selected systems had some differences, major system functions and components were generally the same even though the buildings were constructed 30 years apart.

The emergency power generation system appears to be the most critical, since many life-safety systems depend upon it. Assuming normal building power is unavailable, failure of the emergency power system due to direct damage or an electrical fault will result in failure of many life-safety systems.

KEY		
SYMBOL	NAME	MEANING
	AND GATE	Component above gate functions if all components below function
	OR GATE	Component above gate functions if any component below functions

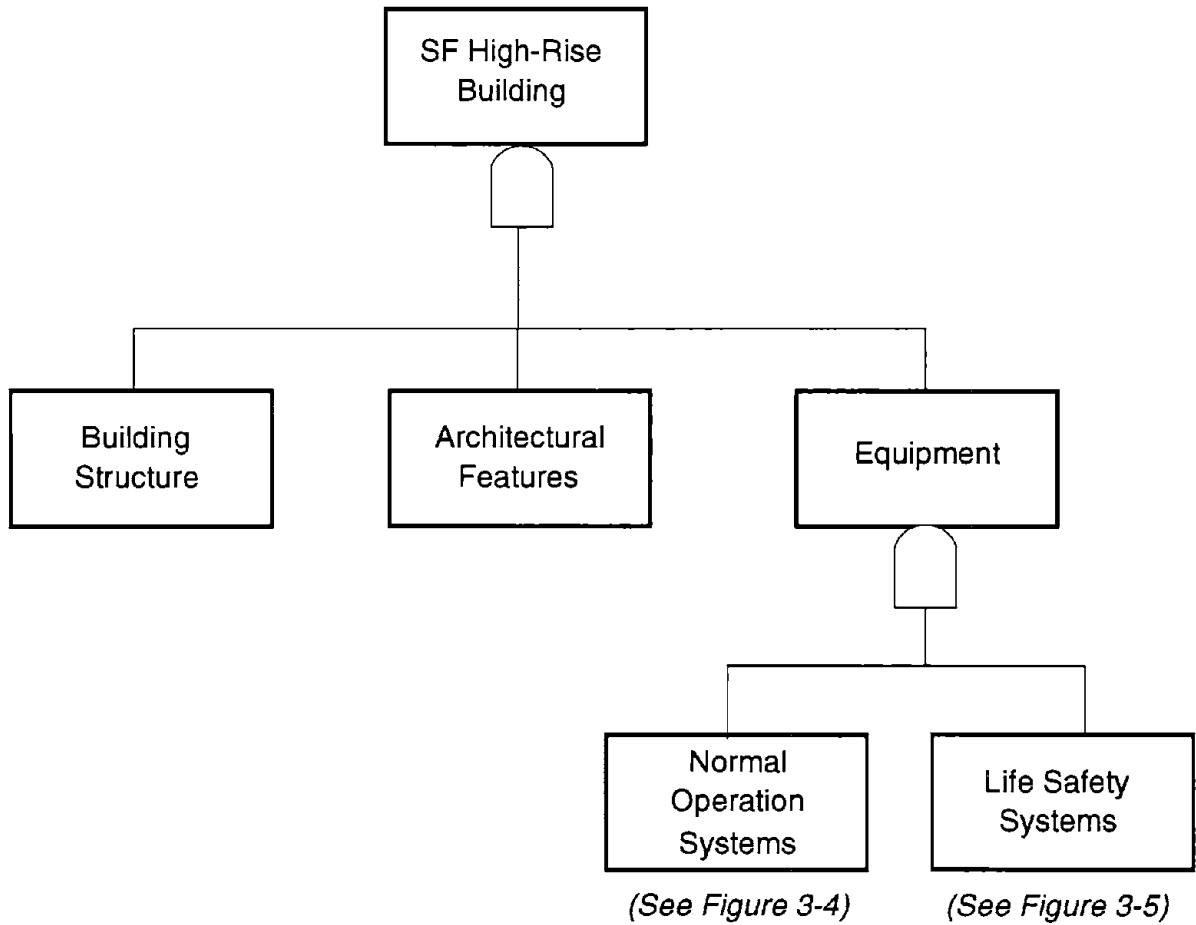

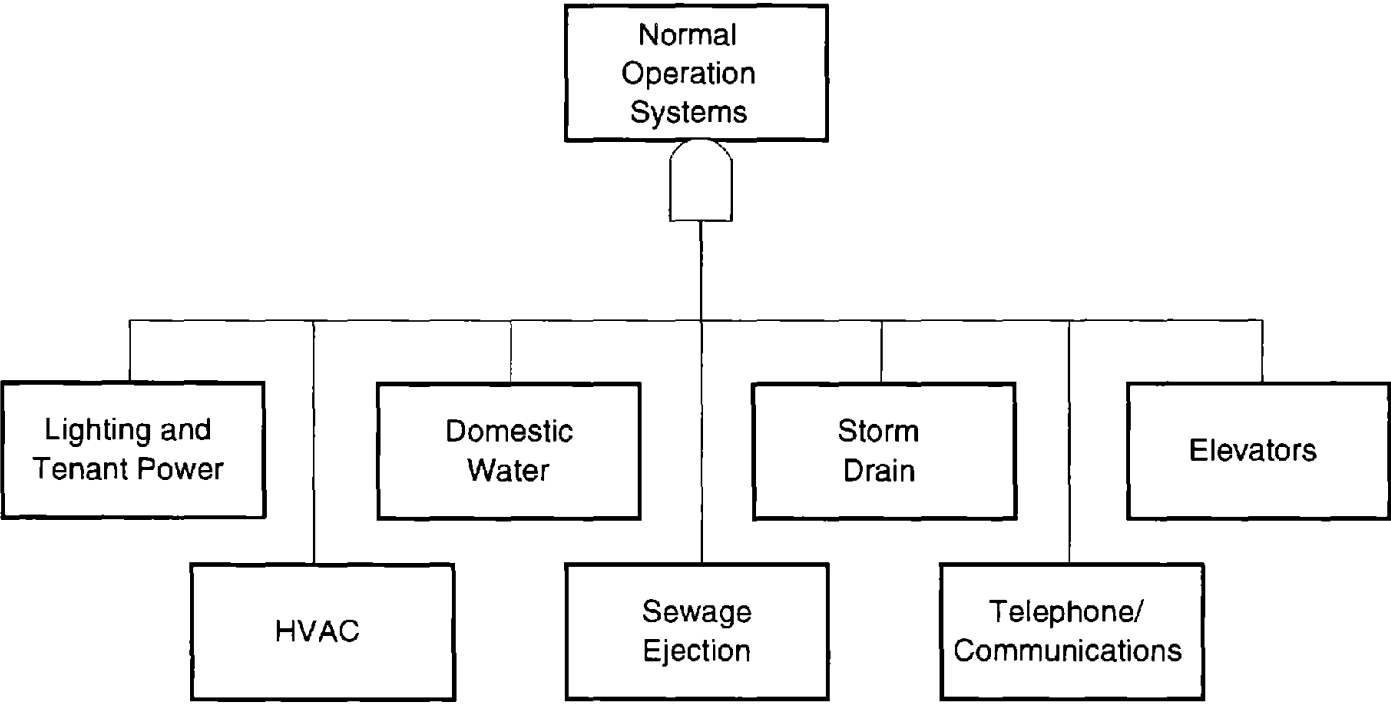



Figure 3-3: SF high-rise building use dependencies

KEY		
SYMBOL	NAME	MEANING
	AND GATE	Component above gate functions if all components below function
	OR GATE	Component above gate functions if any component below functions



(See Figure 3-6)

Figure 3-4: SF high-rise building normal operation systems

KEY		
SYMBOL	NAME	MEANING
	AND GATE	Component above gate functions if all components below function
	OR GATE	Component above gate functions if any component below functions

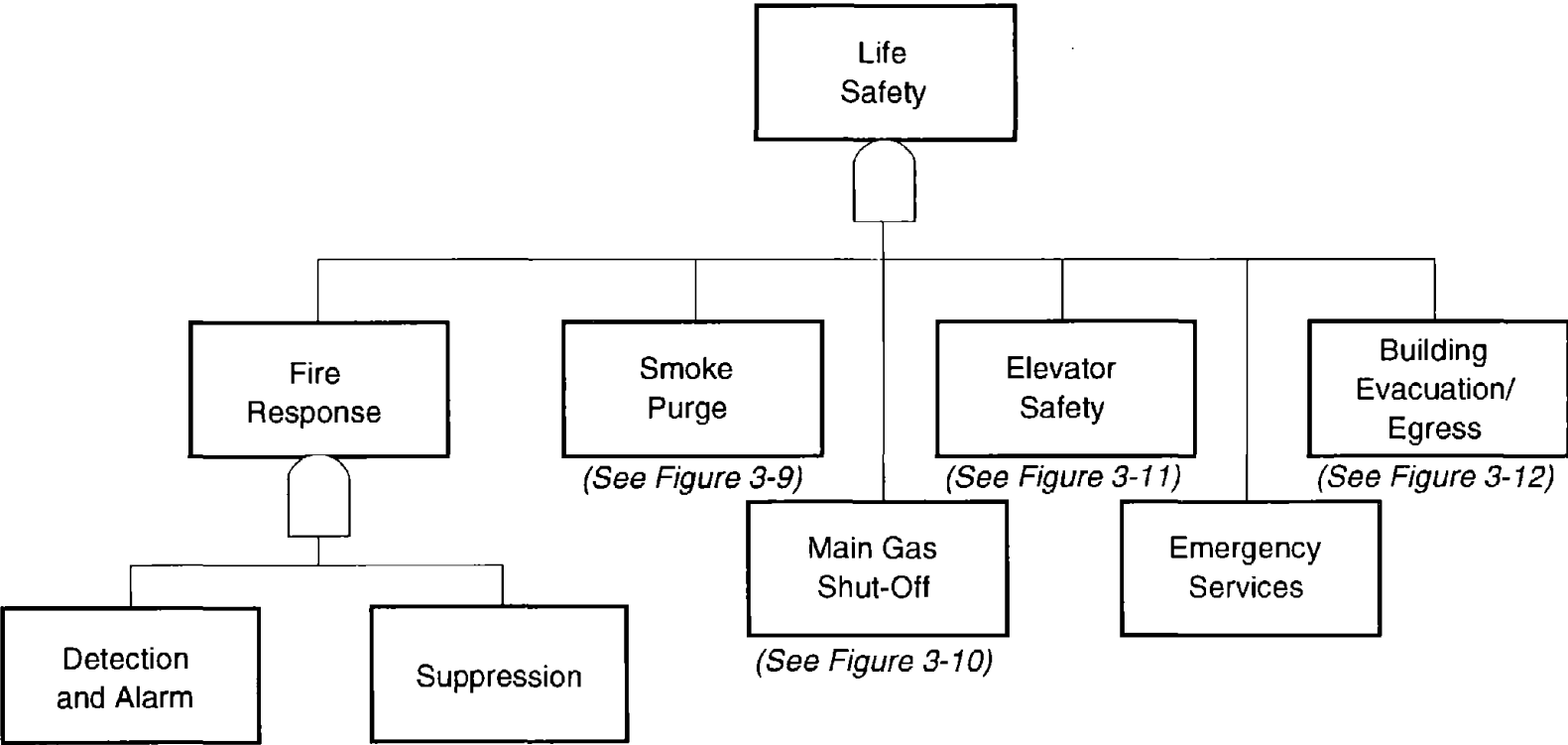

3-12

Figure 3-5: SF high-rise building life-safety systems

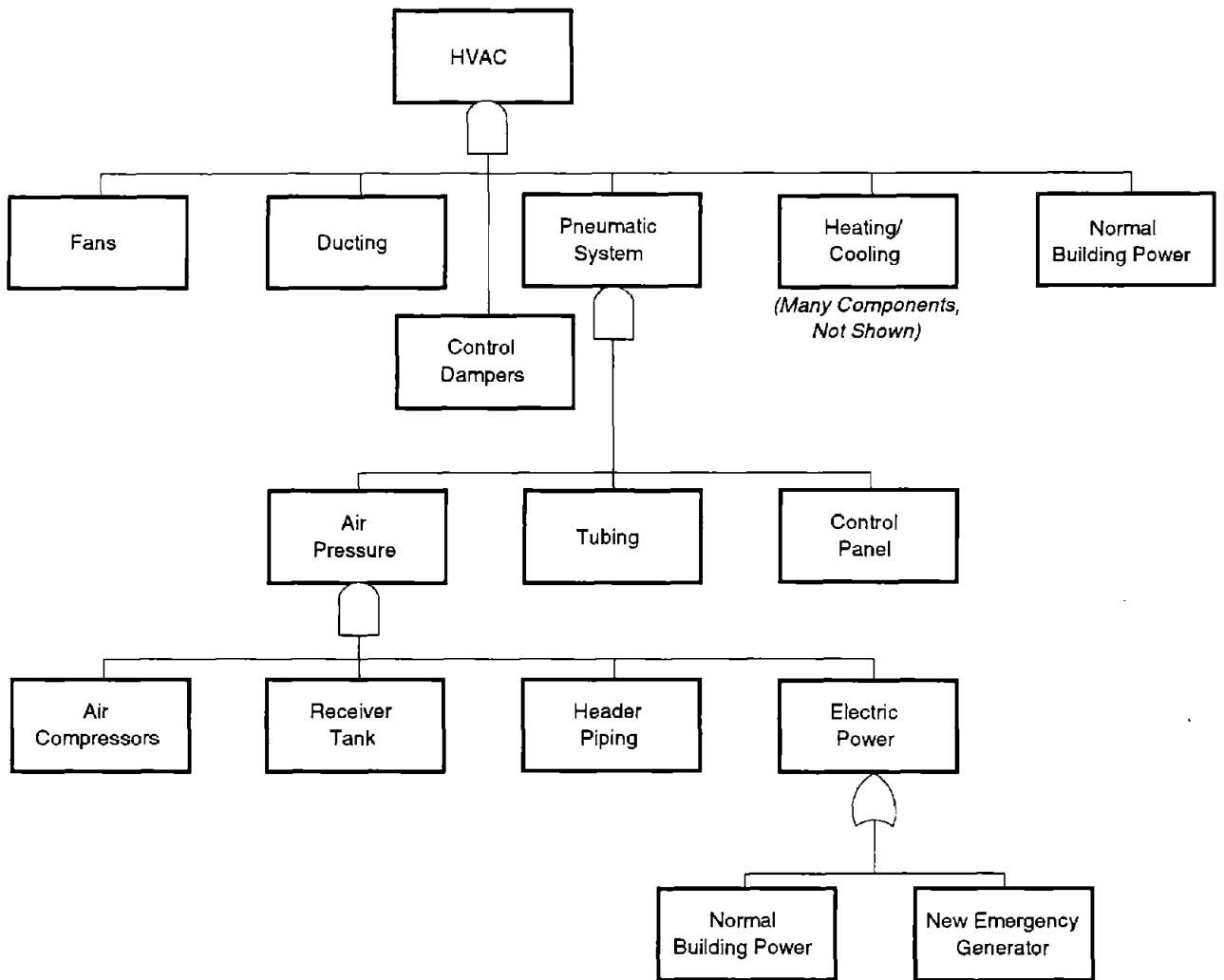



KEY		
SYMBOL	NAME	MEANING
	AND GATE	Component above gate functions if all components below function
	OR GATE	Component above gate functions if any component below functions

Figure 3-6: HVAC system example of dependencies for SF high-rise normal operation system

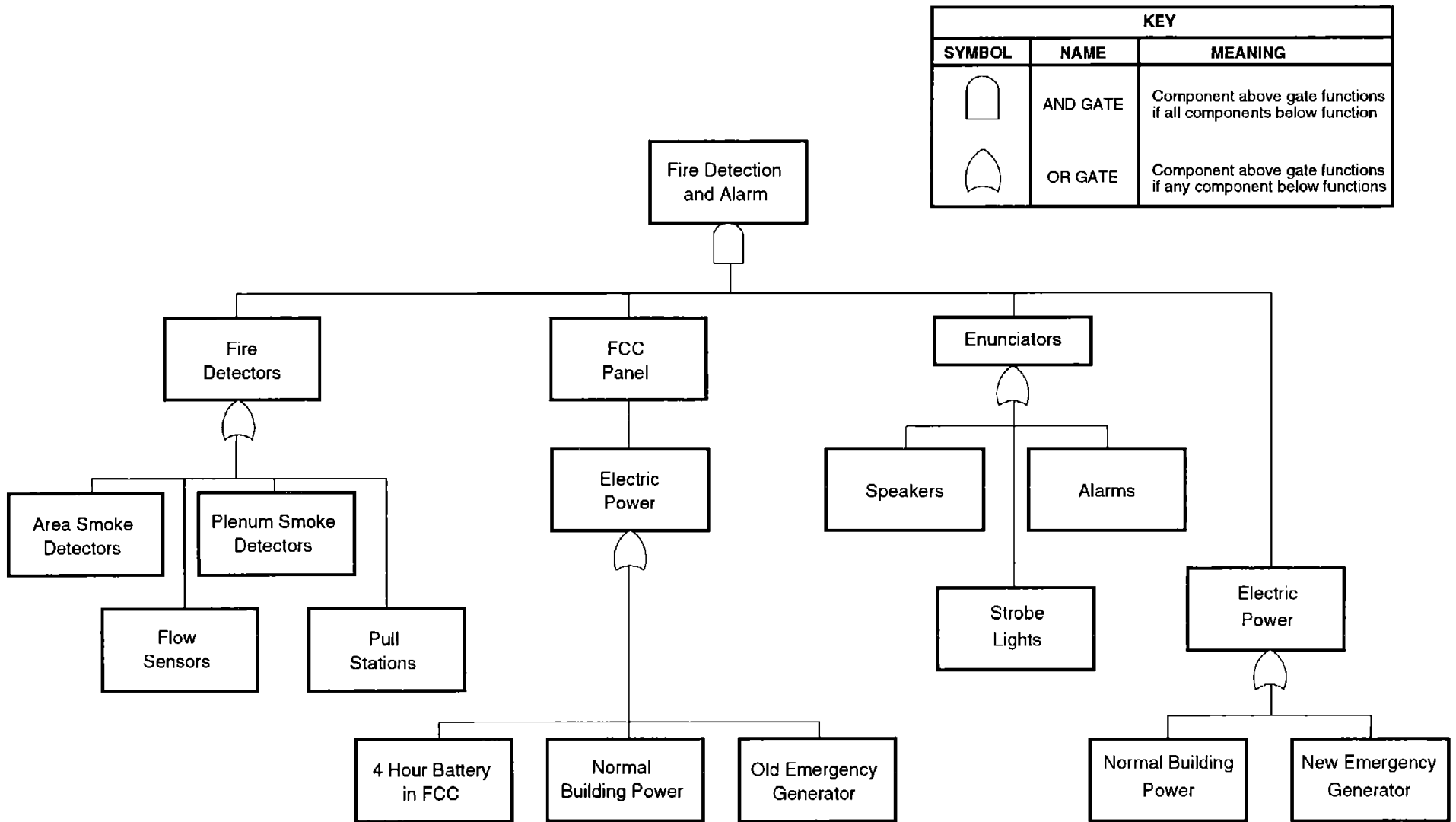



Figure 3-7: SF high-rise fire detection and alarm systems

KEY		
SYMBOL	NAME	MEANING
	AND GATE	Component above gate functions if all components below function
	OR GATE	Component above gate functions if any component below functions

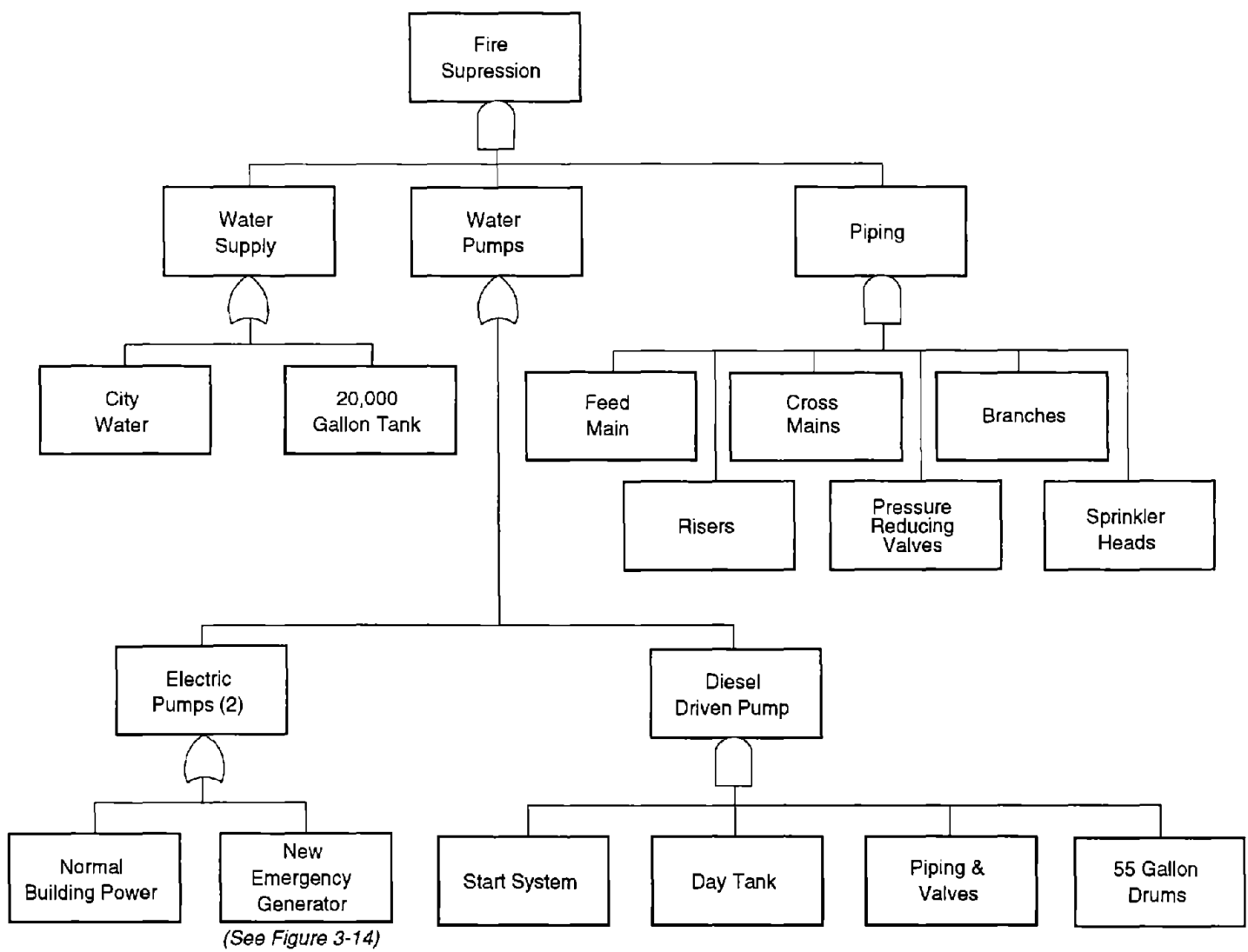



Figure 3-8: SF high-rise fire suppression systems

KEY		
SYMBOL	NAME	MEANING
	AND GATE	Component above gate functions if all components below function
	OR GATE	Component above gate functions if any component below functions

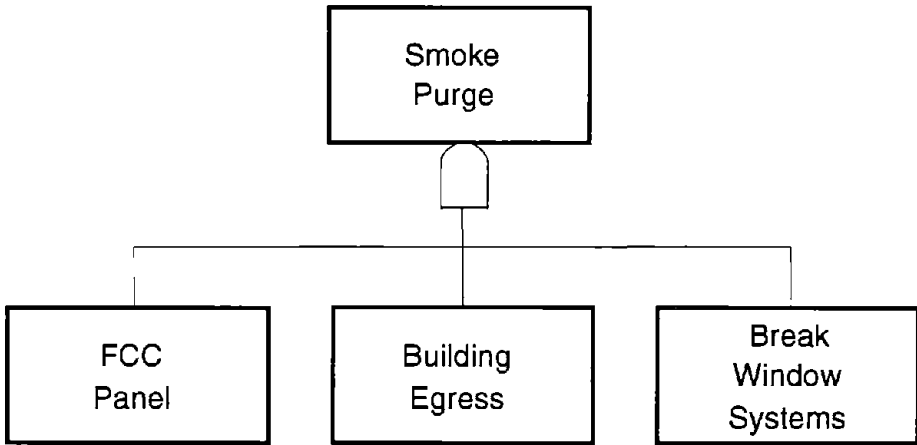



Figure 3-9: SF high-rise building smoke purge system

KEY		
SYMBOL	NAME	MEANING
	AND GATE	Component above gate functions if all components below function
	OR GATE	Component above gate functions if any component below functions

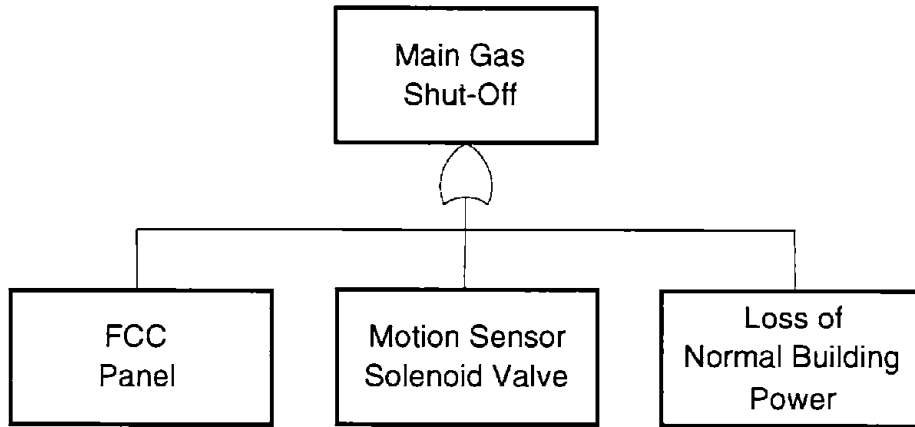



Figure 3-10: SF high rise building gas shut-off system

KEY		
SYMBOL	NAME	MEANING
	AND GATE	Component above gate functions if all components below function
	OR GATE	Component above gate functions if any component below functions

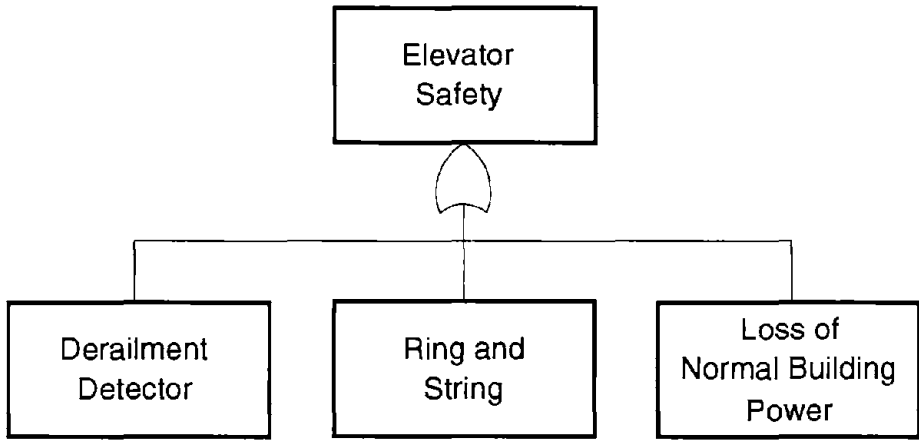

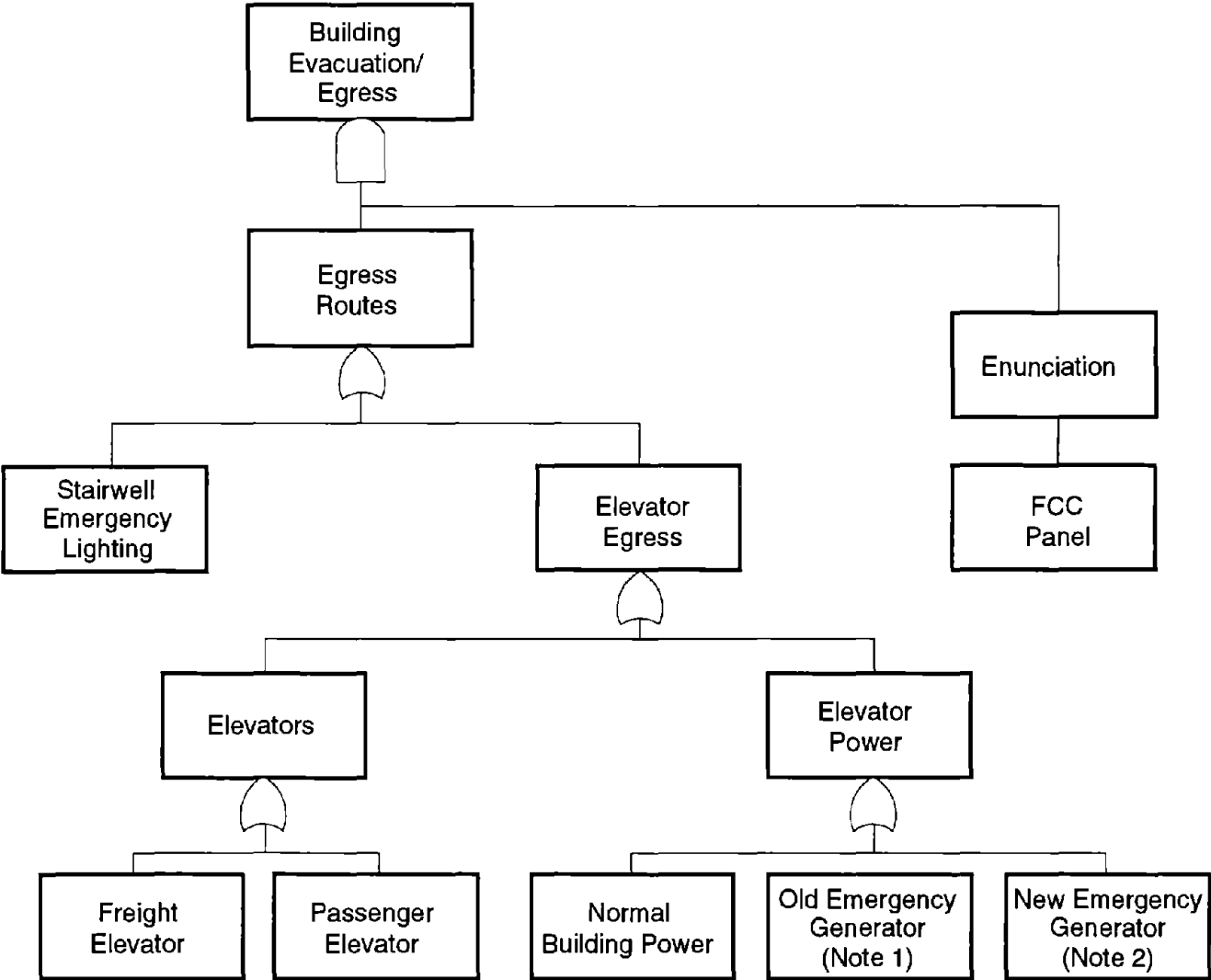

Figure 3-11: SF high-rise building elevator safety system

KEY		
SYMBOL	NAME	MEANING
	AND GATE	Component above gate functions if all components below function
	OR GATE	Component above gate functions if any component below functions



Note 1: Old generator powers freight elevator
 Note 2: New generator powers passenger elevator

Figure 3-12: SF high-rise building evacuation/egress system

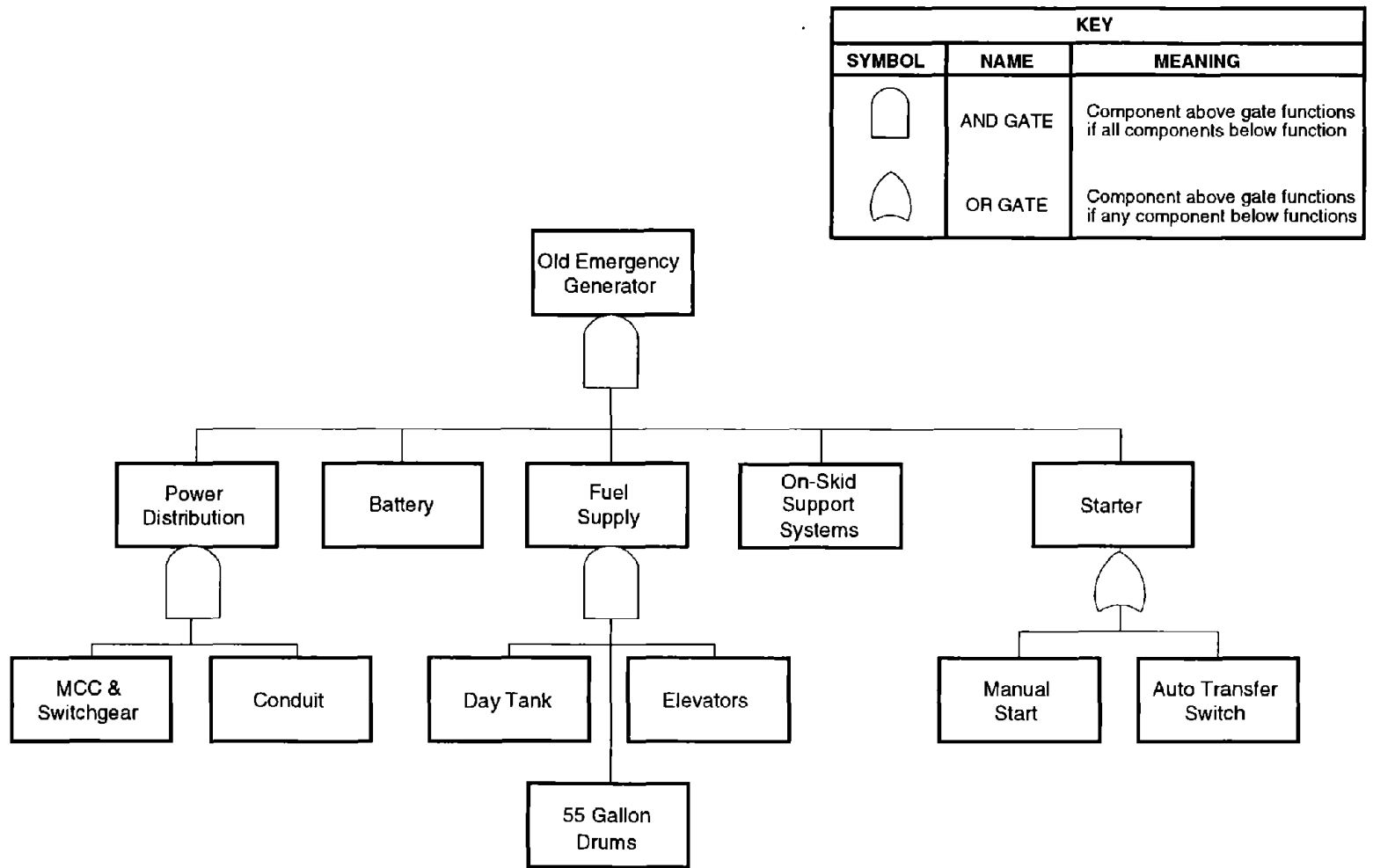



Figure 3-13: SF high-rise old emergency power generator system

KEY		
SYMBOL	NAME	MEANING
	AND GATE	Component above gate functions if all components below function
	OR GATE	Component above gate functions if any component below functions

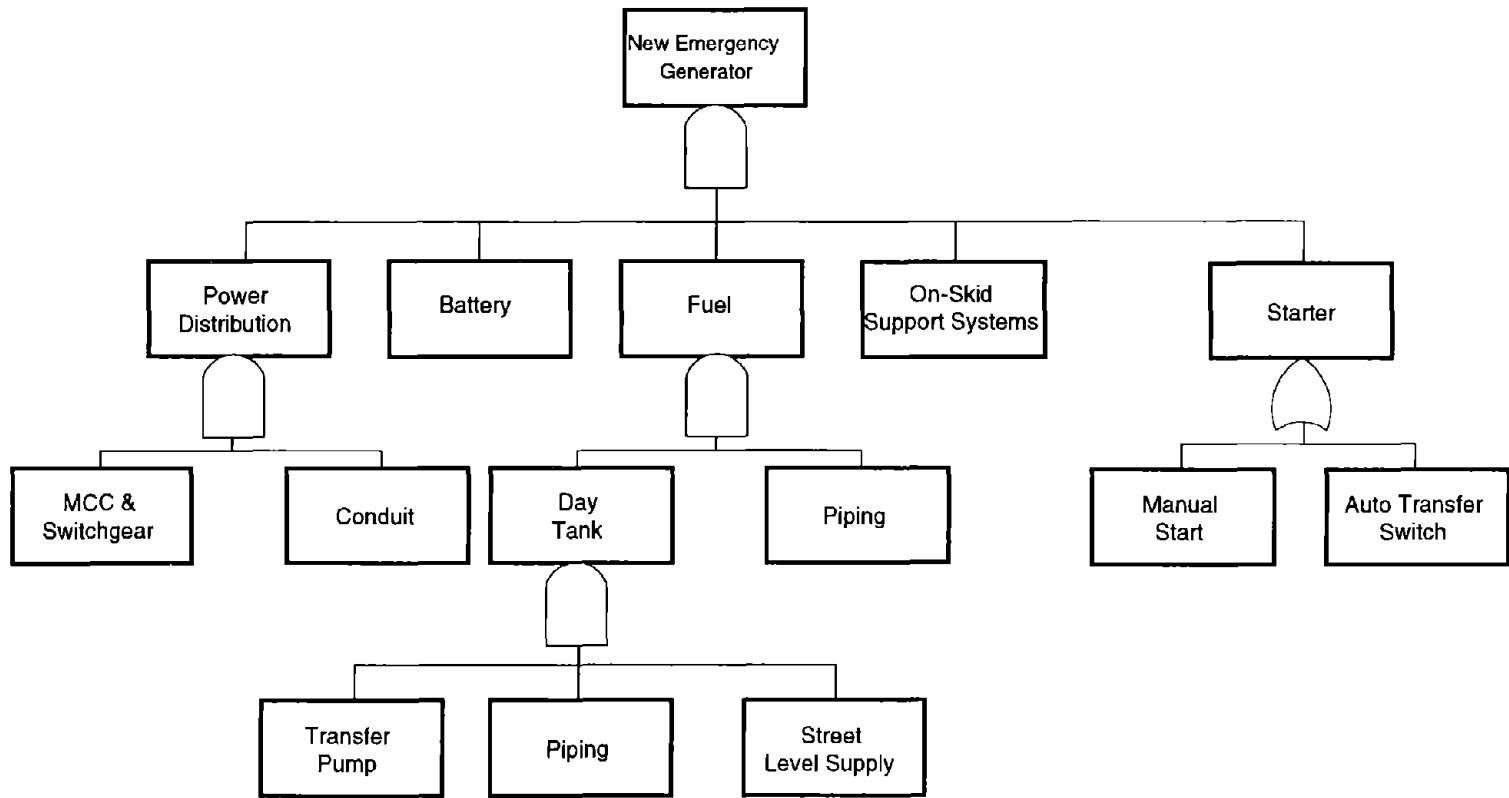



Figure 3-14: SF high-rise new emergency power generator system

KEY		
SYMBOL	NAME	MEANING
	AND GATE	Component above gate functions if all components below function
	OR GATE	Component above gate functions if any component below functions

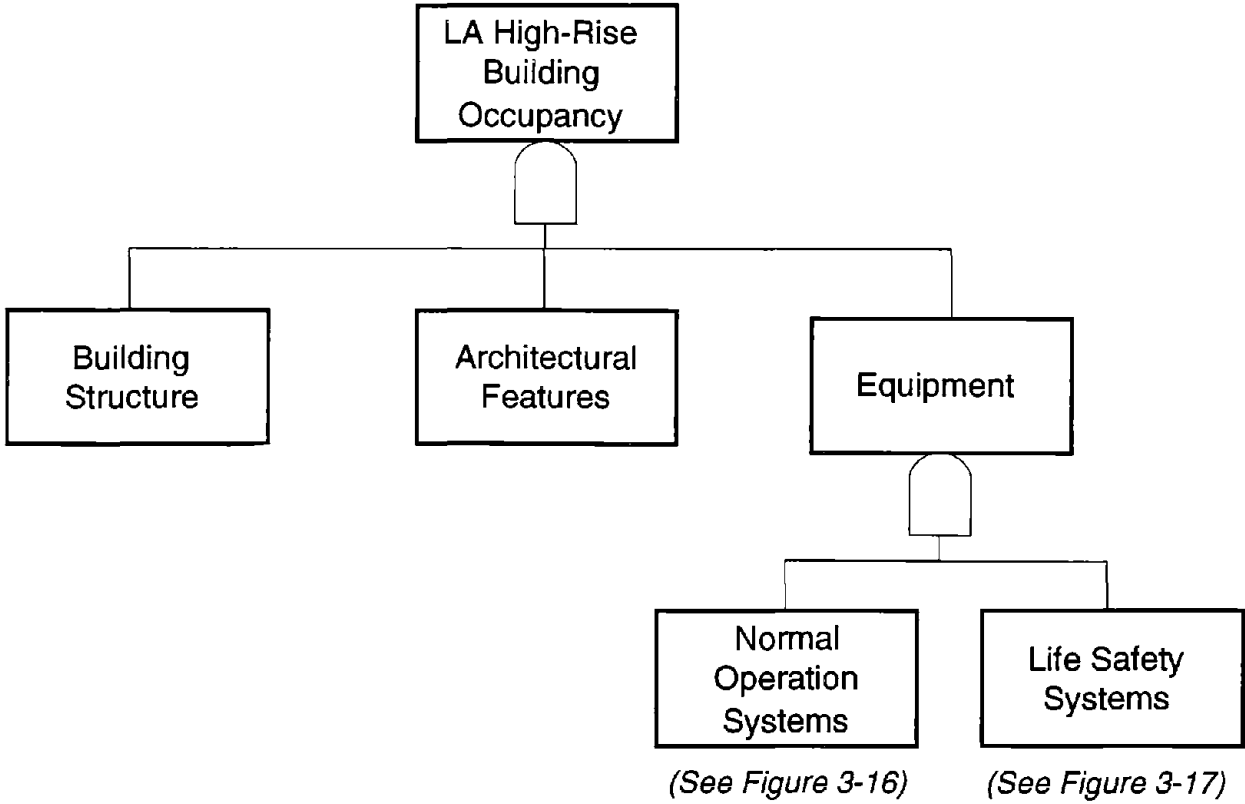

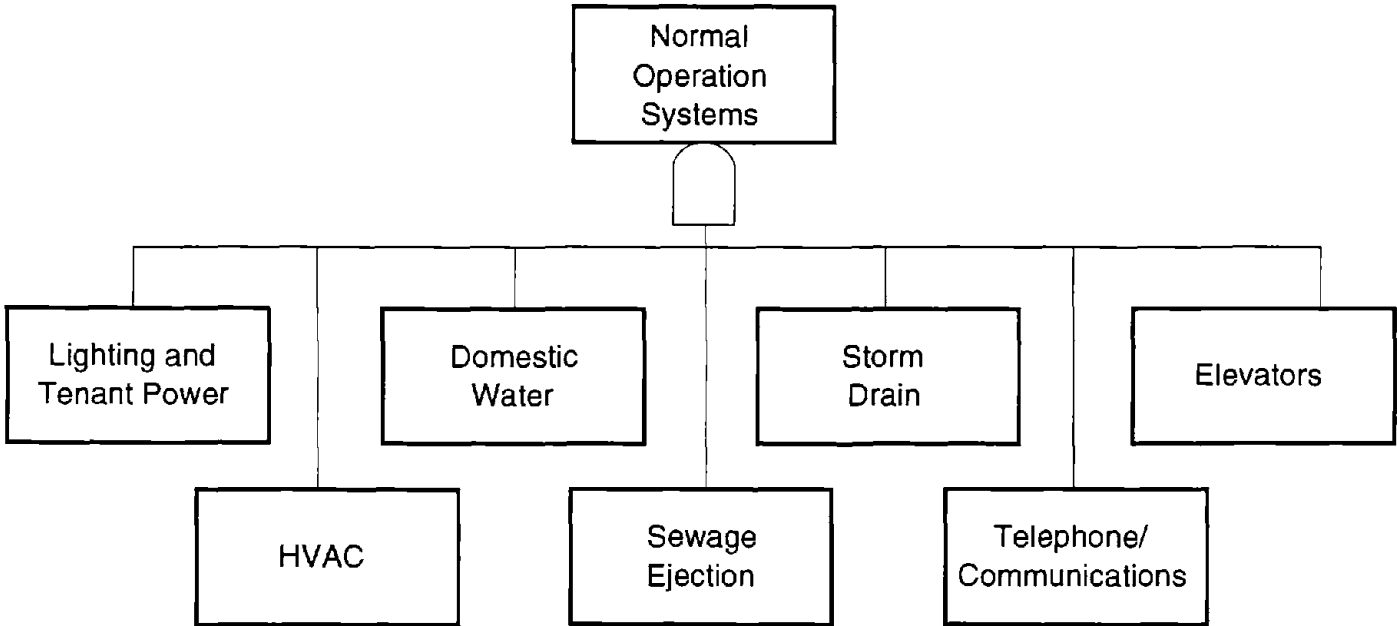

Figure 3-15: LA high-rise building use dependencies

KEY		
SYMBOL	NAME	MEANING
	AND GATE	Component above gate functions if all components below function
	OR GATE	Component above gate functions if any component below functions



(See Figure 3-18)

Figure 3-16: LA high-rise building normal operation systems

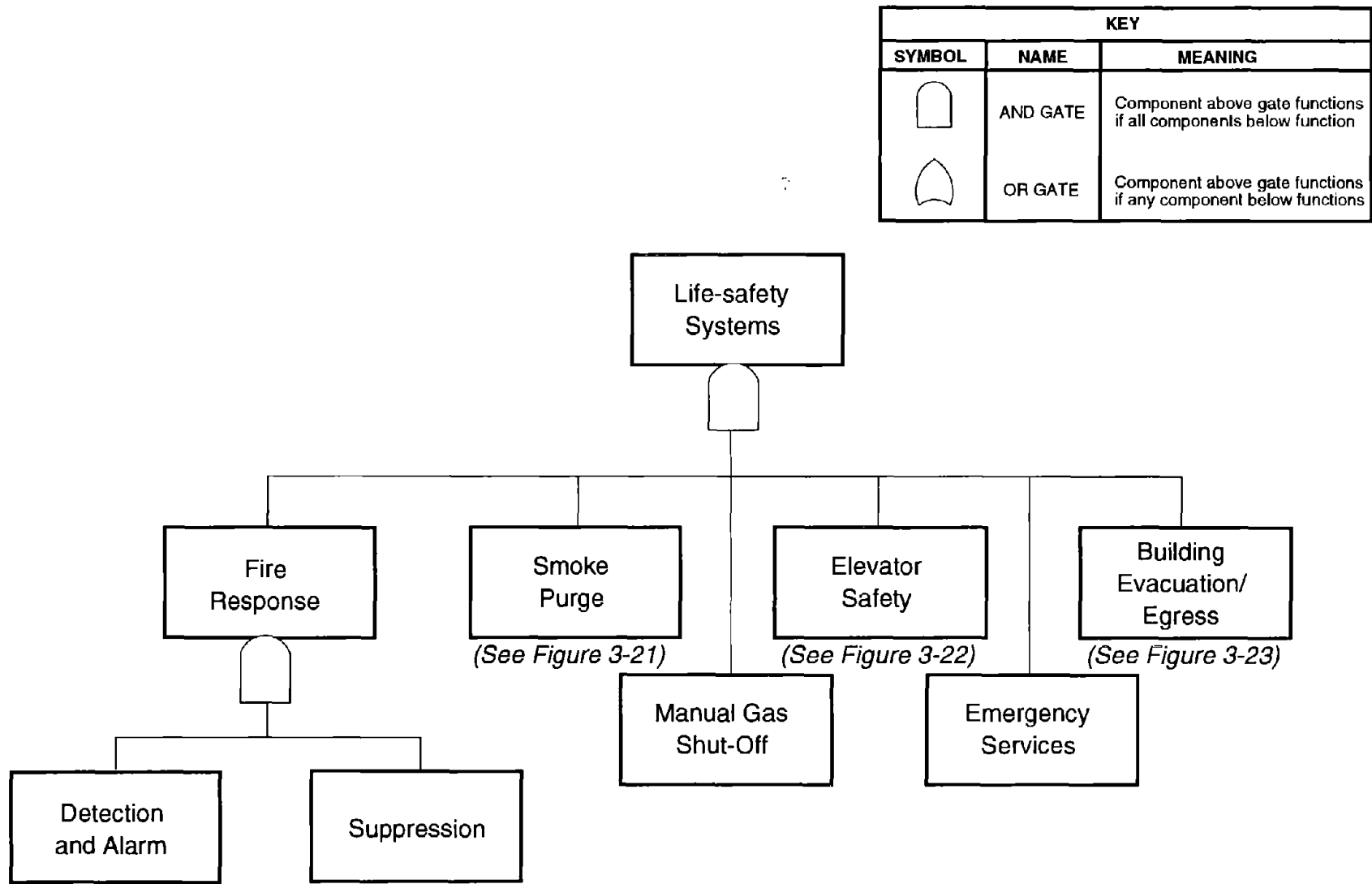

Figure 3-17: LA high-rise building life-safety systems

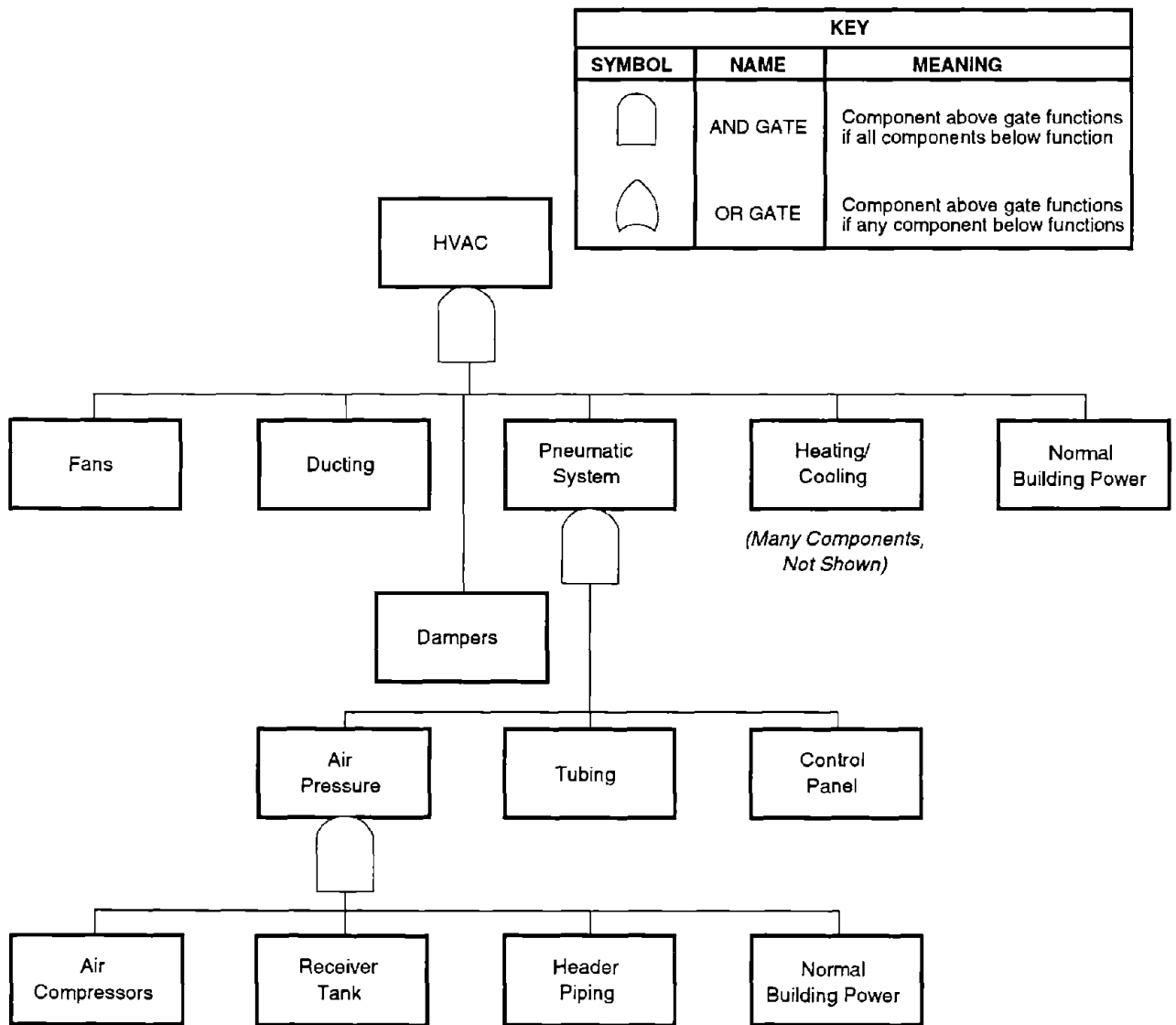

Figure 3-18: HVAC system example of dependencies for LA high-rise normal operation system

3-26

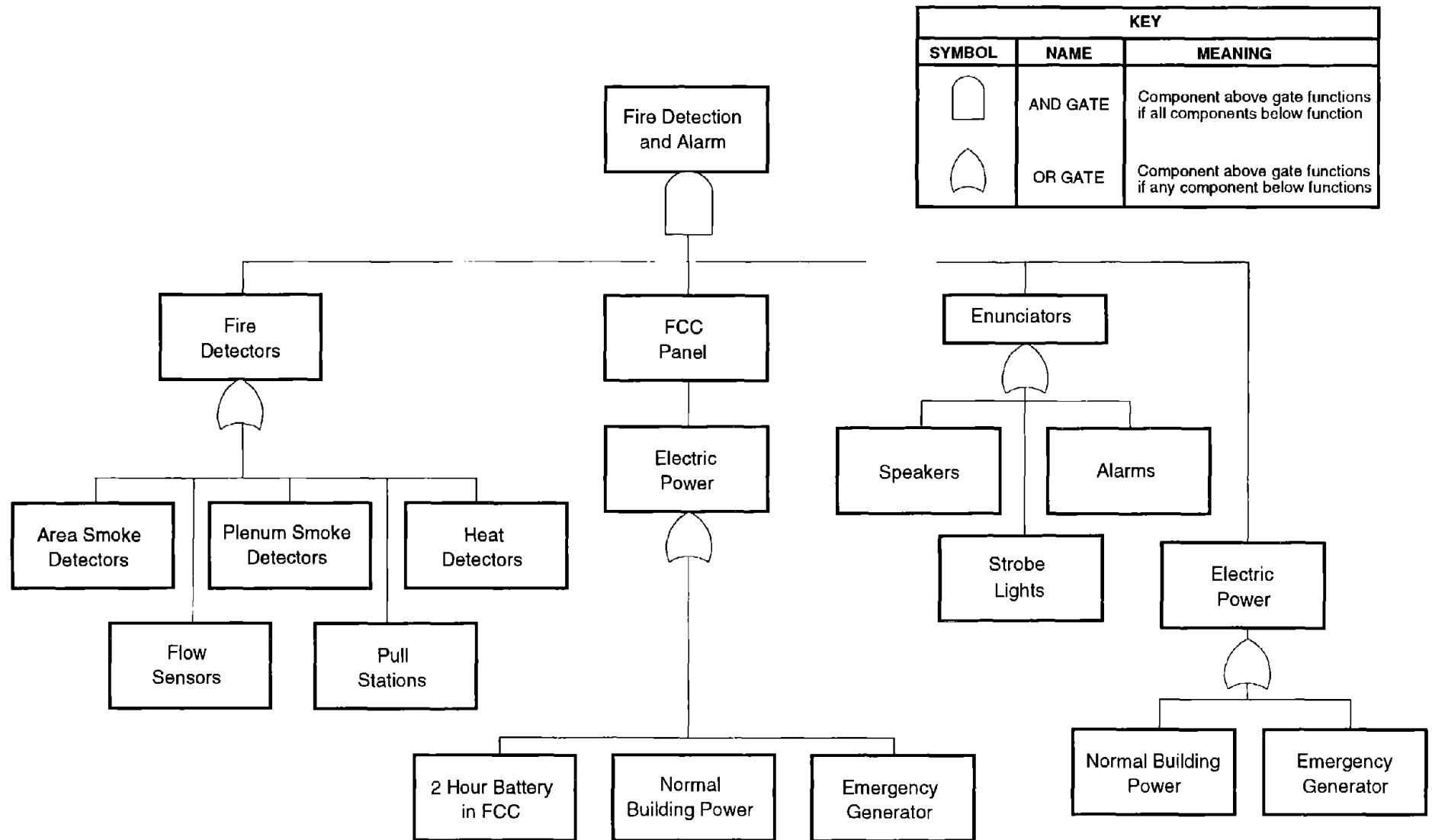

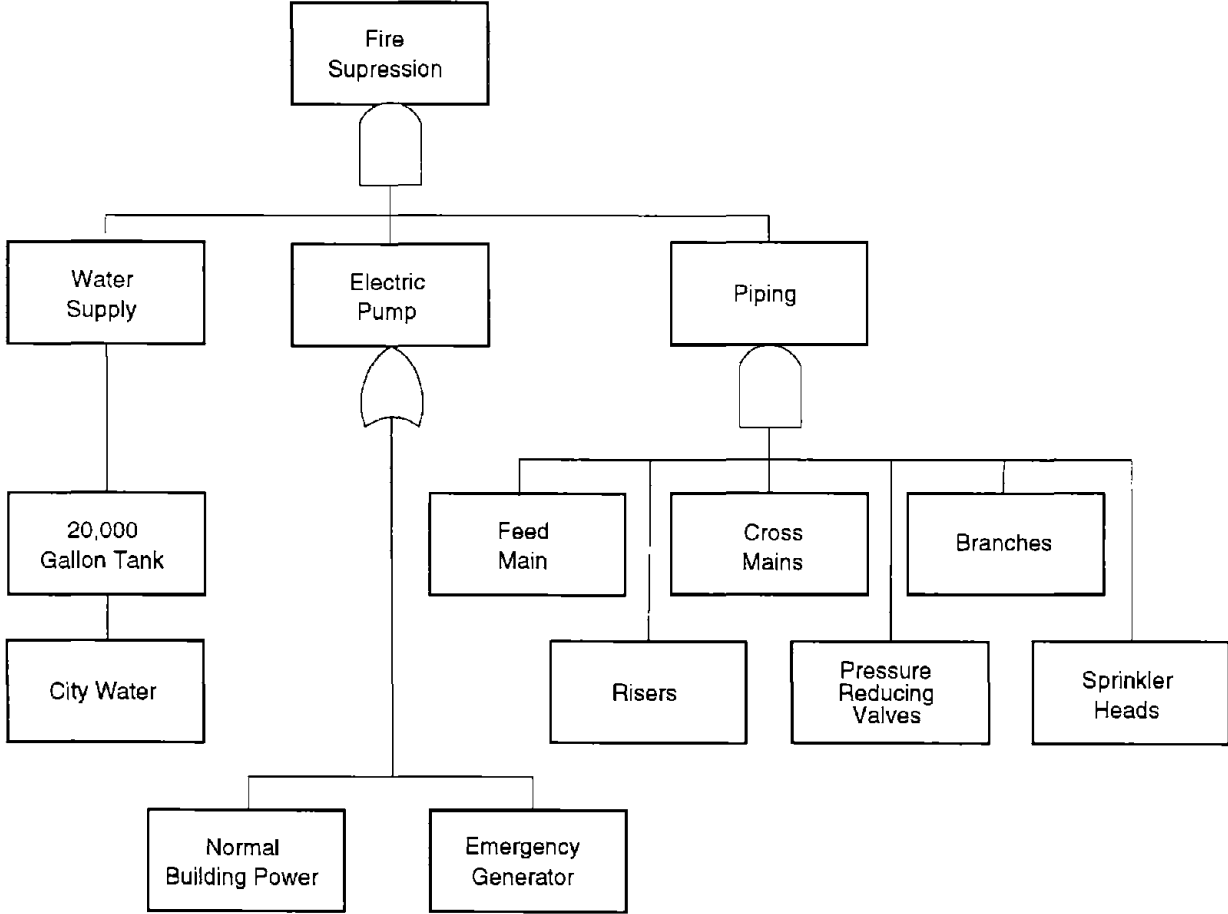



Figure 3-19: LA high-rise fire detection and alarm systems

KEY		
SYMBOL	NAME	MEANING
	AND GATE	Component above gate functions if all components below function
	OR GATE	Component above gate functions if any component below functions



(See Figure 3-24)

Figure 3-20: LA high-rise fire suppression systems

KEY		
SYMBOL	NAME	MEANING
	AND GATE	Component above gate functions if all components below function
	OR GATE	Component above gate functions if any component below functions

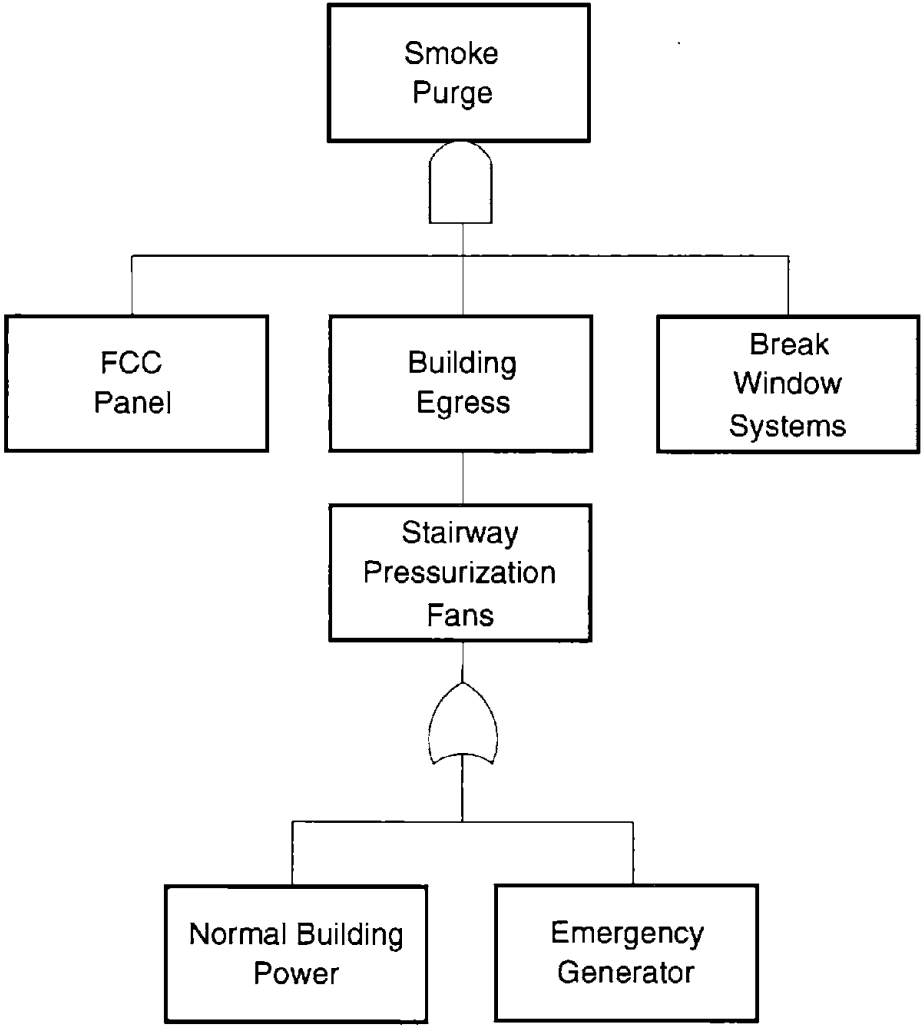



Figure 3-21: LA high-rise building life smoke purge system

KEY		
SYMBOL	NAME	MEANING
	AND GATE	Component above gate functions if all components below function
	OR GATE	Component above gate functions if any component below functions

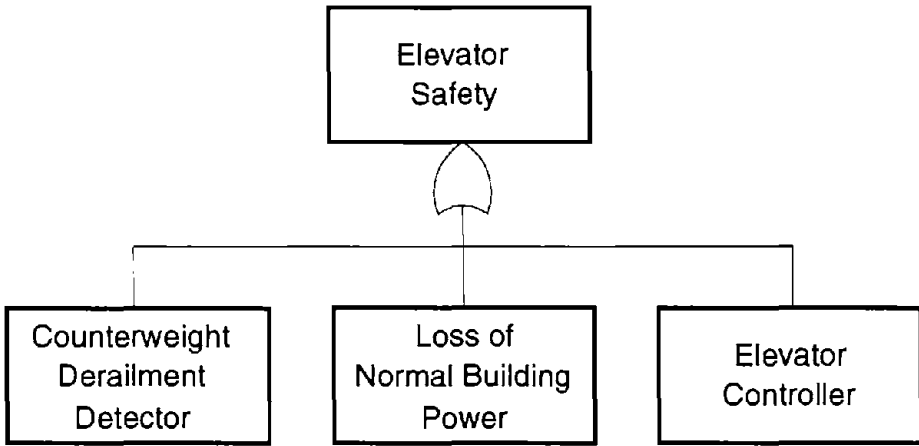



Figure 3-22: LA high-rise building elevator safety system

KEY		
SYMBOL	NAME	MEANING
	AND GATE	Component above gate functions if all components below function
	OR GATE	Component above gate functions if any component below functions

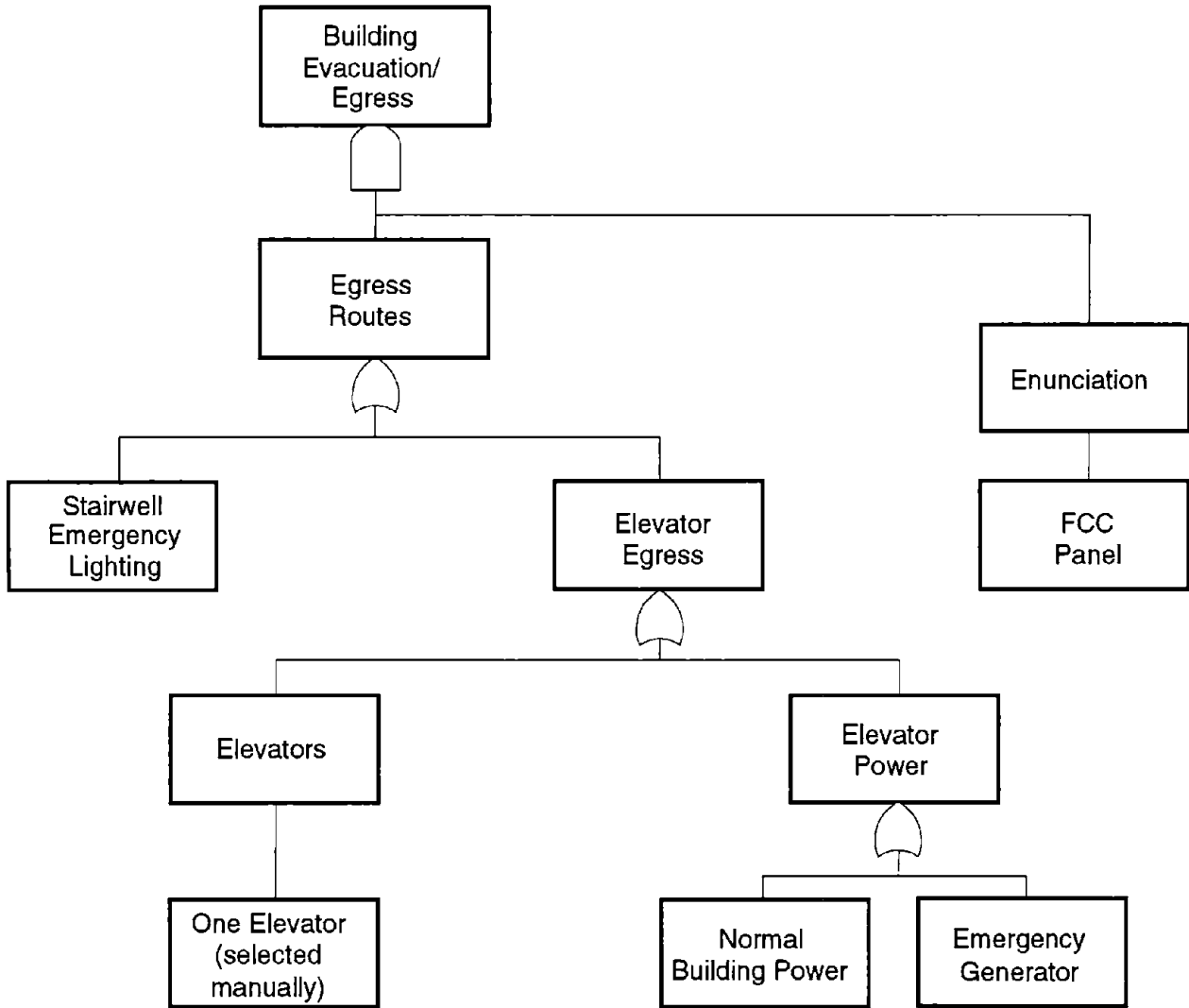

Figure 3-23: LA high-rise building evacuation/egress system

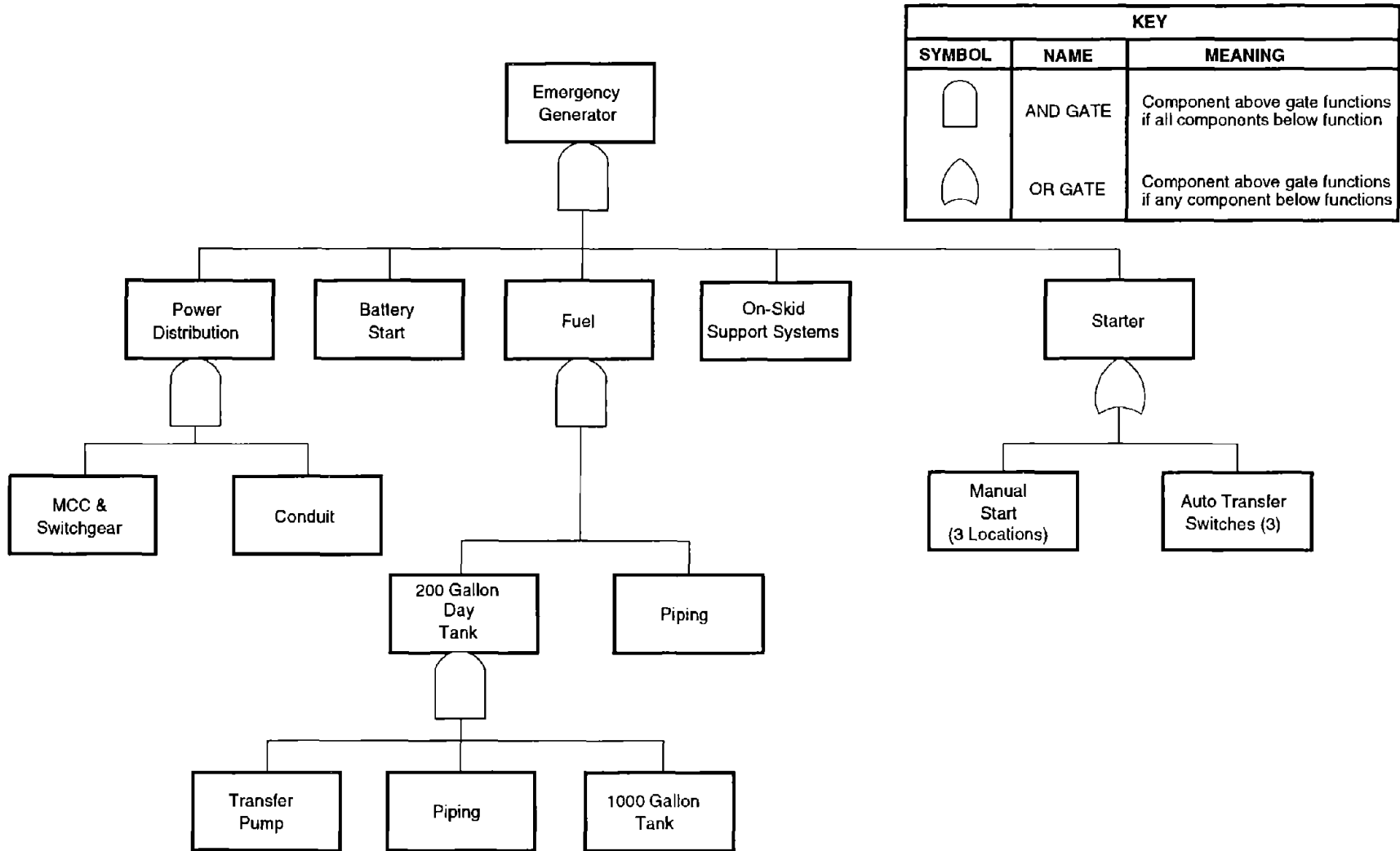

Figure 3-24: LA high-rise emergency power generator system

3.3 Telephone Central Office

3.3.1 Example Central Offices

The first Central Office (CO) reviewed (called Example 1 hereafter) is a low-rise, 1960s-vintage building whose structural system is reinforced concrete shear wall with moment-resisting frames. The CO is located within 40 miles of the epicenter of a major recent earthquake. The second CO (Example 2) is located less than 10 miles from the epicenter of a major recent earthquake. This low-rise CO was constructed incrementally between the 1960s and 1980s. Its structural system is to a large extent a nonductile reinforced concrete distributed moment frame. Note that, for the purposes of this report, "low-rise" refers to a building of 1 to 3 stories in height, excluding basement.

3.3.2 Performance of Sample COs in Recent Large Earthquakes

Building data on the example COs were collected from walkdowns performed in the company of building engineers and facility managers. The engineers and facility managers had been present at the buildings during the earthquakes, and were able to provide valuable insight into the seismic performance of primary and backup equipment.

Only Example 2 experienced significant problems due to the earthquake. The facility experienced equipment and architectural damage, as well as some lifeline interruption, but continued to operate without significant service interruption.

Extensive seismic bracing of equipment had been performed prior to the earthquake, to varying degrees of efficacy. No damage to switching equipment or its anchorage was reported. A few instances of electronic card contact problems were reported, but most of these were corrected by the system operator using system software controls. A few boards required manual re-racking to restore function.

Battery racks, which were unbraced and contained no battery cell spacers, walked and were damaged. The uninterruptible power supply (UPS) system continued to operate, however. Overhead grillage anchored to nonstructural walls broke away and pounded against the wall. A shaft of a rooftop air handling unit was bent, its bearings damaged. An unanchored boiler mounted on the roof slid, but was undamaged.

Architectural damage included widespread cracking of stud-and-stucco walls, especially at the corners of windows, doorways, and other openings. There was some localized collapse of suspended ceiling tiles in an office area.

The facility experienced limited lifeline failure. Off-site electric service was interrupted for approximately one hour. On-site power was available during the service interruption. Gas service was automatically shut off by a valve equipped with a motion sensor.

3.3.3 CO Components

In general, a CO is comprised of three elements, as depicted in Figure 3-25: structural features, architectural features, and equipment systems. Structural features are those that support the building and prevent collapse. Architectural features include those elements that make a building habitable and comfortable, but whose failure does not reduce the building's capacity to carry weight. Equipment systems include mechanical, electrical, and plumbing features that make a building operational. In Figure 3-25, equipment has been broken out into life-safety, telecommunications, and building support systems. The latter two serve normal operations.

3.3.4 CO Life-Safety Systems

Components necessary for life-safety are depicted in Figure 3-26. In summary, they include fire detection and alarm, fire suppression, fire and smoke barriers in ductwork, gas shut-off, and stairway emergency lighting. In multi-story COs, elevator stopping systems are considered a life-safety issue. Example 1 contained an elevator.

Aside from structural and architectural collapse hazards, fire typically poses the most serious risk to life-safety after an earthquake. Telecommunications facilities contain a variety of ignition sources and flammable materials. Some of these materials, when burned, produce toxic and corrosive products of combustion and smoke. The burning of PVC conduit produces gas that, when combined with moisture in the air, produces hydrochloric acid, a highly toxic material. Fire detection, alarm, and suppression systems are therefore critical.

Fire detection and alarm. The main element and focal point of fire detection and alarm is the fire alarm panel. The fire alarm panel is typically located near the main entrance to the CO. Its purpose is to enunciate the area of the CO in which fire has been detected. The fire alarm panel receives signals from a variety of smoke and heat detectors, sprinkler flow sensors, and fire alarm pull boxes. When a CO is unoccupied, fire alarms are monitored remotely from another CO via dedicated telephone lines. Figure 3-27 depicts the fire detection and alarm system in detail.

Smoke detection devices include spot detectors, line detectors, and HVAC duct smoke detectors. Spot detectors resemble home smoke detectors, in that they sample air at a single spot. Line detectors are long pipes that draw air from a larger area to a central

smoke detection device. Fire alarm indicating devices alert building occupants of a fire with audible alarms and strobe lights.

Fire suppression. Figure 3-28 shows the active fire suppression system in detail. COs may contain a variety of automatic and manual suppression systems. Automatic systems include automatic sprinklers (AS), preaction sprinkler systems, and total flooding gaseous systems. Manual systems include hand extinguishers and hose stations. The example COs contain only total flooding gaseous systems and hand extinguishers.

Total-flooding-gaseous systems use halon as the preferred gas, as it is non-conducting and requires no cleanup. A recent international agreement results in the phasing-out of halon because it is a chloroflourocarbon (CFC). A substitute gas is currently being developed. The total-flooding-gaseous systems in the example COs comprise tanks of halon connected to smoke and heat detection systems.

The primary type of manual suppression available in CO is hand extinguishers. At the example COs, hand extinguishers in switching areas are charged with halon; extinguishers in other spaces are charged with CO₂. Hose stations are present in some COs, depending on the operating company, but were not observed in the example facilities.

Fire and smoke barriers in ductwork. Air ducts crossing fire-rated partitions are fitted with dampers that shut when heat melts a fusible link. These are termed "fire dampers," and are designed to provide a fire-rated barrier equal to the fire rating of the partition. Fire dampers are not designed to seal the duct against smoke. Recently, CO managers have begun to install smoke detectors in ductwork that activate smoke dampers. These dampers, typically located downstream of fire dampers, seal the duct against smoke.

Gas shut-off. Gas may be shut off manually or automatically, as shown in Figure 3-29. Automatic safety valves close the gas supply following either a signal from the fire alarm panel, triggering of the motion (seismic) sensor, or loss of building power. This occurs in the Example 2 Central Office, as noted above.

Elevator safety. The elevator stopping system is shown in Figure 3-30. Elevators automatically stop in the event of earthquake, derailment, or loss of off-site power.

3.3.5 CO Telecommunications Equipment

Equipment required to continue telecommunications service includes switching equipment, cable handling systems, electric power, computer facilities, and HVAC. Operational equipment includes the cable entrance facility (CEF), main distribution frame (MDF), cables in cable trays, microwave systems, multiplexing equipment, electromechanical or electronic switching equipment, terminals (called remote alarms) for monitoring electronic switching equipment and building alarms, and billing tape drives (Figure 3-31).

Cable entrance facility (CEF). Cable trunks, each containing 2,000 to 5,000 copper single-pair telephone wires or a single fiber optic cable, enter the CO in a below-grade CEF. Trunks containing copper wire are typically 4 inches in diameter, and are typically charged with nitrogen or dry air to exclude moisture. Fiber optic lines are enclosed in a 1-inch diameter cable. In addition to cables, the CEF also contains an air dryer, smoke detection equipment, and gas detection equipment, and may contain water detectors and a form of automatic fire protection such as sprinklers.

Main distribution frame and cable trays. The CEF represents the control point of the cables entering the facility. The wires within the cables are routed to the switching equipment on a lightweight steel frame called a main distribution frame (MDF). The MDF is typically 5 feet wide, 15 feet high, and may extend several hundred feet. Smaller numbers of cables may be carried between equipment in overhead racks or trays, which are rod-hung from the floor or roof diaphragm above.

Microwave systems. Some COs are linked to other exchanges by microwave. Example 1 maintains a microwave network link. The microwave system is comprised of a rooftop dish antenna, steel-frame tower, wave guide, and microwave equipment to translate the microwave signal to an electronic signal.

Multiplexing equipment. Multiplexers perform a variety of functions depending on the application, but basically they are used to combine multiple distinct signals (called channels), for transmission on the same line. In the example facilities, multiplexing equipment takes the form of numerous tall and slender rack-mounted devices anchored at the floor and attached to an overhead horizontal steel grid, which in turn is braced to the roof diaphragm.

Switching equipment. Switching equipment may be either electromechanical or electronic. Electromechanical systems are the older of the two basic types and are rapidly being replaced. Remaining typical electromechanical switching devices is the crossbar switch. This is a tall, heavy, rack-mounted device. The predominant equipment today is the electronic switching device. This equipment is sometimes referred to as an electronic switching system (ESS), which is a product of AT&T, or DMS, which is a product of Northern Telecom. An ESS or DMS is essentially a mainframe computer containing one or multiple CPUs. Both example facilities are equipped with electronic switching equipment only; neither has electromechanical switches. Example 2, for instance, uses Automatic Electronic GTD5 devices that employ Intel 8088 CPUs running at 12 MHz clock speed.

Electronic switching devices may be in cabinets or on open racks. The majority of this equipment is open on at least one side. Both example facilities use rack-mounted devices. Most electronic switching devices in use today handle between 10,000 and 30,000 lines, although larger and smaller devices are in use to a significant extent. All electronic

switching equipment at the example facilities are anchored to the floor and braced by the overhead grid system.

Equipment monitoring terminals and billing tape drives. Peripherally attached to electronic switching equipment are monitoring terminals and billing tape drives. Terminals are located in the CO or at a remote monitoring station and provide the means for communicating with electronic switching equipment. These terminals typically comprise a keyboard, monitor, and printer. Electronic switching equipment records data on toll call destination and duration on magnetic tape storage devices called tape drives. Note that billing tape drives are not essential to telecommunication switching operations.

3.3.6 CO Building Support Equipment

As shown in Figure 3-32, the systems that support telecommunications switching and other normal building functions include the following:

- Electric power
- Heating, ventilation, and air conditioning (HVAC)
- Raised access floors
- Plumbing

Telecommunications equipment relies on electric power and equipment cooling to continue operating. In addition, some COs have raised access floors in switching areas; the raised flooring may therefore be considered critical to switching operations, since its collapse can damage switching equipment or cable. Other building support services are less critical to telecommunications switching.

Electric power. The main components of electric power service (Figure 3-33) are power supply and power distribution. Three sources of electric power supply are available at COs: the local commercial utility, and two on-site backup systems. On-site systems include the uninterruptible power supply (UPS) and backup generators. In the event of service interruption from the local utility, backup generators can supply the power demand for the entire CO. On-site fuel supplies at the example COs are adequate for 72 hours of operation. UPS batteries supplies power only to switching equipment, and can supply power for approximately 4 hours.

UPS. Off-site electric power is fed to a rectifier, which converts it to DC. The DC power is fed to banks of batteries (the UPS system, Figure 3-34), constantly charging them. Power flows from the batteries directly to telephone equipment that requires DC power. The batteries also supply DC power to converters that derive other voltages to accommodate individual system needs. Depending on the size and power demand of the CO, dozens of batteries in multiple racks may be required.

Backup generators. In the event of commercial power failure, on-site generators can provide AC power adequate to carry the entire building load. Generators also provide AC power to rectifiers to charge UPS batteries or power DC-driven telephone equipment. Figure 3-35 depicts the backup generator system. Generators may be diesel or gas-turbine sets. Their primary elements are generators, starter motors, fuel lines, fuel tanks, fuel pumps, and control equipment. Smaller facilities with lesser power demands may have self-contained generator units mounted on concrete pads outside of the facility, containing all necessary equipment.

Power distribution equipment. Power distribution requires transformers, substations, switchgear, distribution panels, power switching centers, automatic transfer switches, manual transfer switches, motor control centers, power conditioners, and conduit or bus duct. In the example facilities, conduit is used exclusively, and is carried in overhead, rod-hung racks or in trays on the braced overhead grid. All power cable in a CO is run through metal conduit as a fire-safety precaution.

HVAC. Many of the electronic devices in a CO produce large amounts of waste heat, and can be affected if allowed to operate for extended periods without cooling. For this reason, HVAC is considered critical to telecommunications switching. HVAC, as depicted in Figure 3-36, performs three functions: air heating, ventilation, and air cooling. Air heating is rare in COs in mild climates; residual heat from switching equipment typically provides necessary environmental heating needs for occupied COs. Nonetheless, Example 2 does contain heating equipment, comprising gas lines, a boiler, and heat exchanger. Gas shut-off equipment is considered a life-safety component, as discussed above. The ventilation system is comprised of fans, ductwork, and dampers, which act like valves to stop or control volumetric flow of air. Air conditioning equipment varies by facility size. Small facilities may use packaged air conditioning units that operate much like home air conditioning units. Large air conditioning systems use ammonia in a closed-loop system. Evaporation of water flowing over coils carries away heat, condensing the ammonia. The ammonia is then pumped into coils in the chillers. Air flowing over the chiller coils becomes cool and is pumped by fans into the ventilation system as needed.

A control system detects temperature, regulates damper positions, and controls heating and air conditioning operations. A pneumatic control system, shown in Figure 3-37, includes compressors, pneumatic piping, a receiver tank (plenum), control panel, and pneumatic actuators attached to duct dampers.

Note that, to a limited extent, HVAC may be considered a life-safety component. Small amounts of hydrogen are produced when older, so-called "rectangular" batteries in the are charged. Hydrogen gas represents an explosion hazard if allowed to accumulate. For this reason, battery rooms undergo numerous air changes per hour and are equipped with gas

detection equipment. Newer "cylindrical" batteries are sealed and do not produce hydrogen when charged. Both example facilities employ rectangular batteries in their UPS systems.

Raised access floors. Electronic switching areas may have raised access floors, that is, flooring panels mounted on 6- to 30-inch pedestals that stand on the structural floor diaphragm. The space between the floor diaphragm and the raised access floor is used for power conduit, computer communications cable, chilled water hose, and so on. Access flooring can be particularly vulnerable to seismic damage. However, neither of the example facilities visited were observed to contain raised flooring.

Plumbing. As shown in Figure 3-38, plumbing in a CO requires a supply of domestic water, water pumps, piping, sinks, drinking fountains, restroom fixtures, and waste water piping and sewer service. Note that, in large COs with water-cooled condensers, off-site domestic water supply is critical for continued HVAC functionality, which in turn is critical for telecommunications switching.

3.3.7 Conclusions Regarding Sample Central Offices

In contrast to equipment in high-rise office buildings, CO equipment systems critical to normal operations were provided with significant backups. In consequence, COs can operate in the event of off-site utility failure such as commercial power failure or off-site water service interruption. On-site uninterruptible power supply (UPS) and generators were capable of providing continuous electric power. Electronic switching equipment could operate for limited duration without continuous air conditioning, reducing the need for off-site water service. In addition, fire suppression equipment did not require water: at the example facilities, only hand extinguishers and total-flooding-gaseous systems were present because of the sensitivity of switching equipment to water. These backups and safeguards were in place because life-safety systems also had substantial redundancy. Six separate systems were available for fire detection, and two for fire suppression. The ability of COs to operate independently of off-site utilities reflects the public-safety and economic costs of telephone service failure. That is, since the cost of downtime is high, CO owners reduce the probability of downtime with equipment backups.

KEY		
SYMBOL	NAME	MEANING
□	AND GATE	Component above gate functions if all components below function
△	OR GATE	Component above gate functions if any component below functions

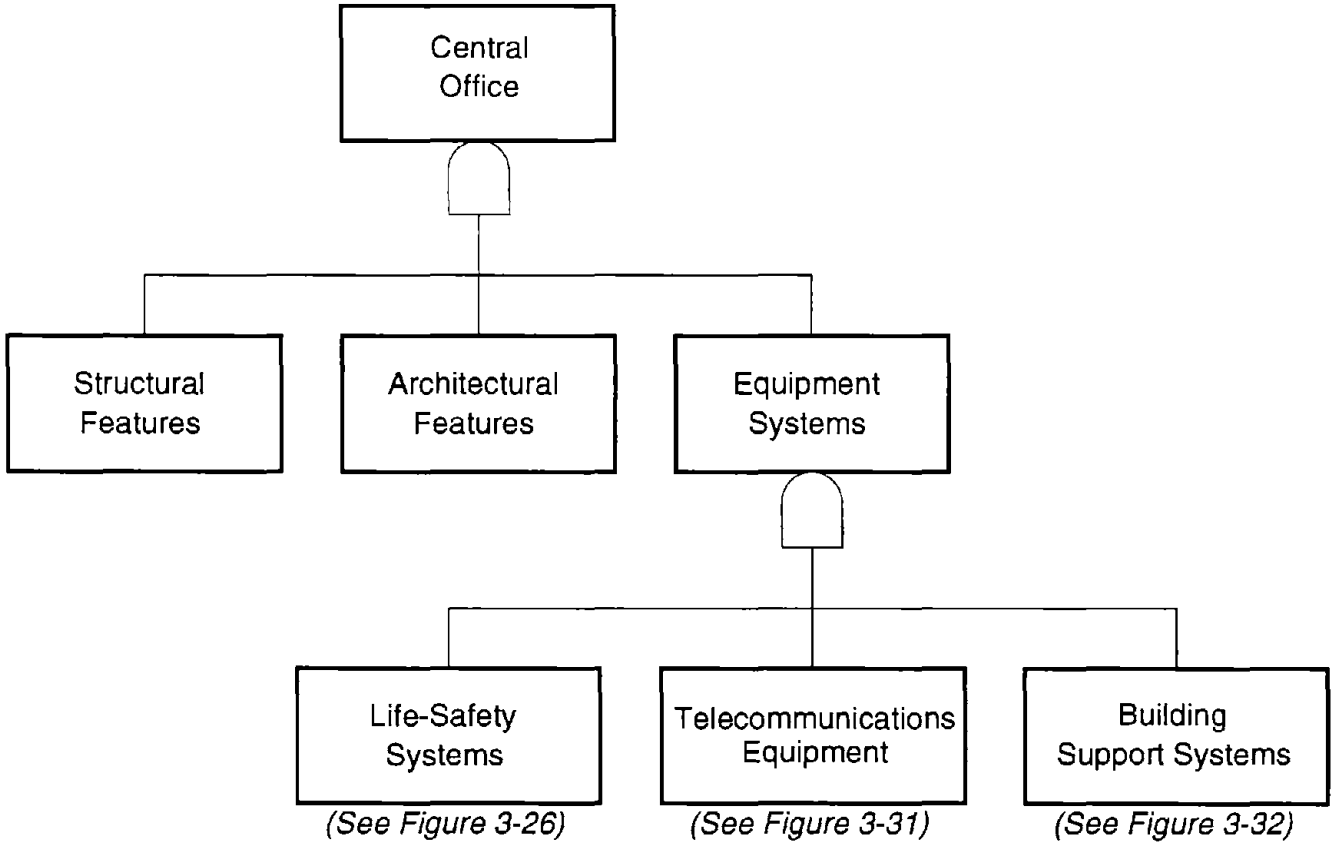

Figure 3-25: Central office components

KEY		
SYMBOL	NAME	MEANING
⌋	AND GATE	Component above gate functions if all components below function
⌋	OR GATE	Component above gate functions if any component below functions

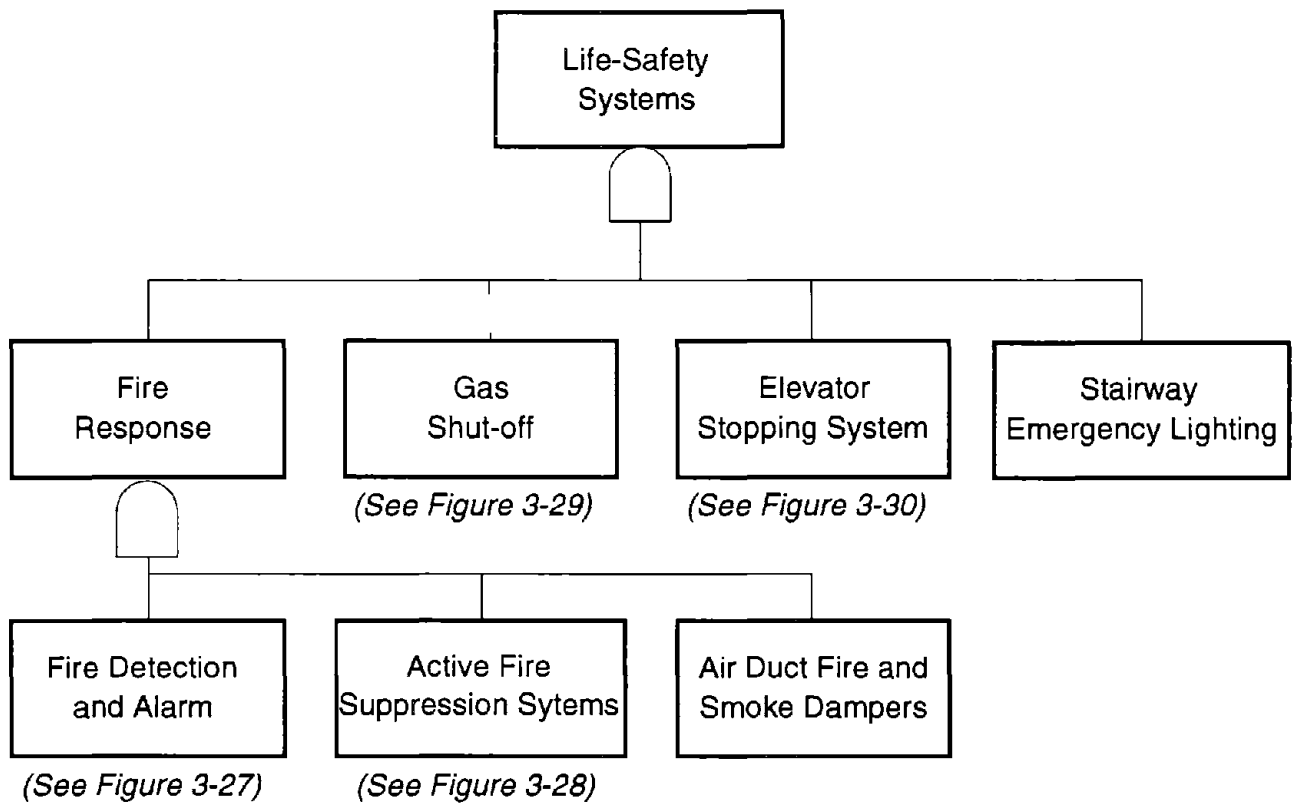

Figure 3-26: Central office life-safety systems

KEY		
SYMBOL	NAME	MEANING
⌋	AND GATE	Component above gate functions if all components below function
⌋	OR GATE	Component above gate functions if any component below functions

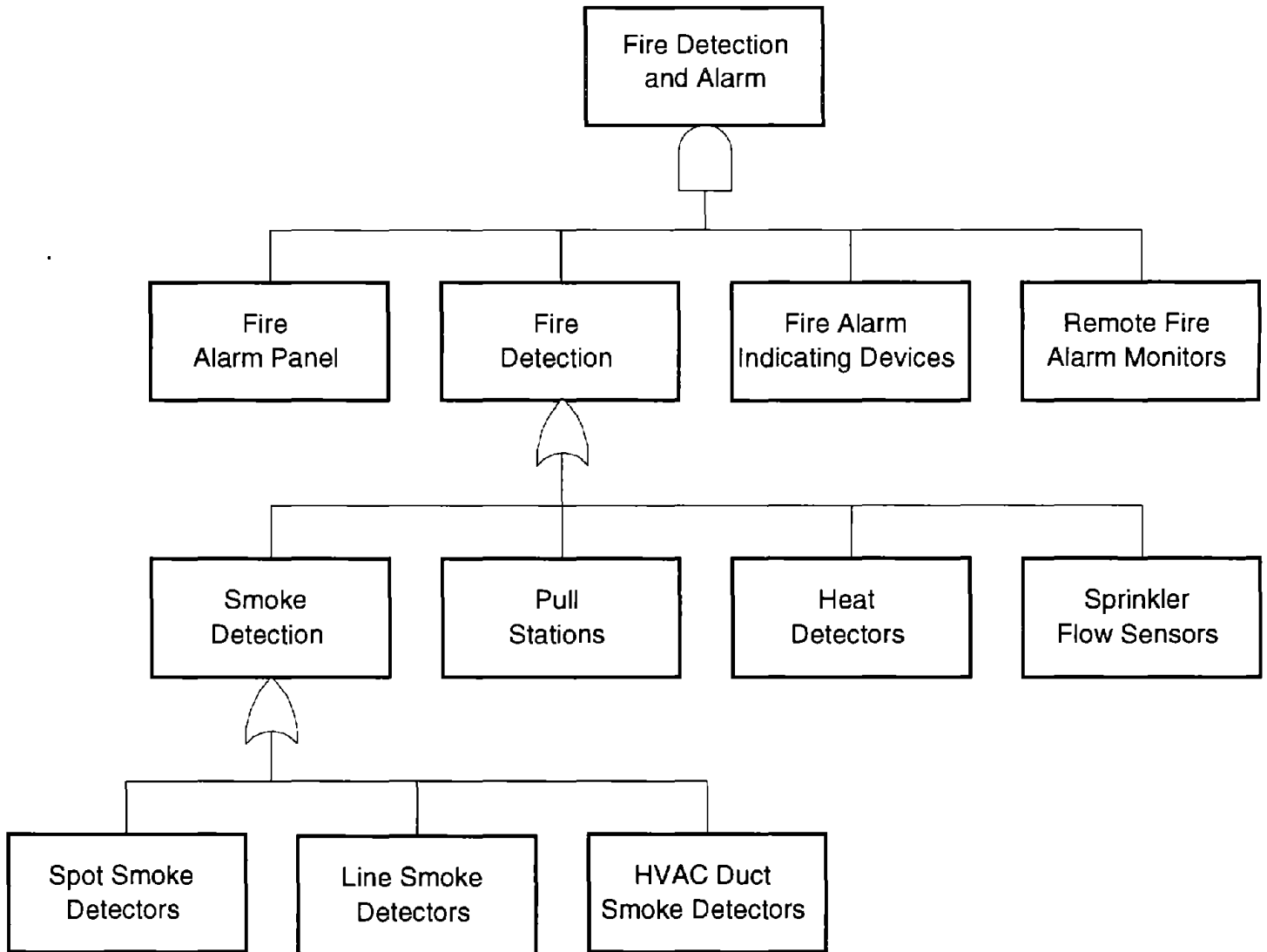
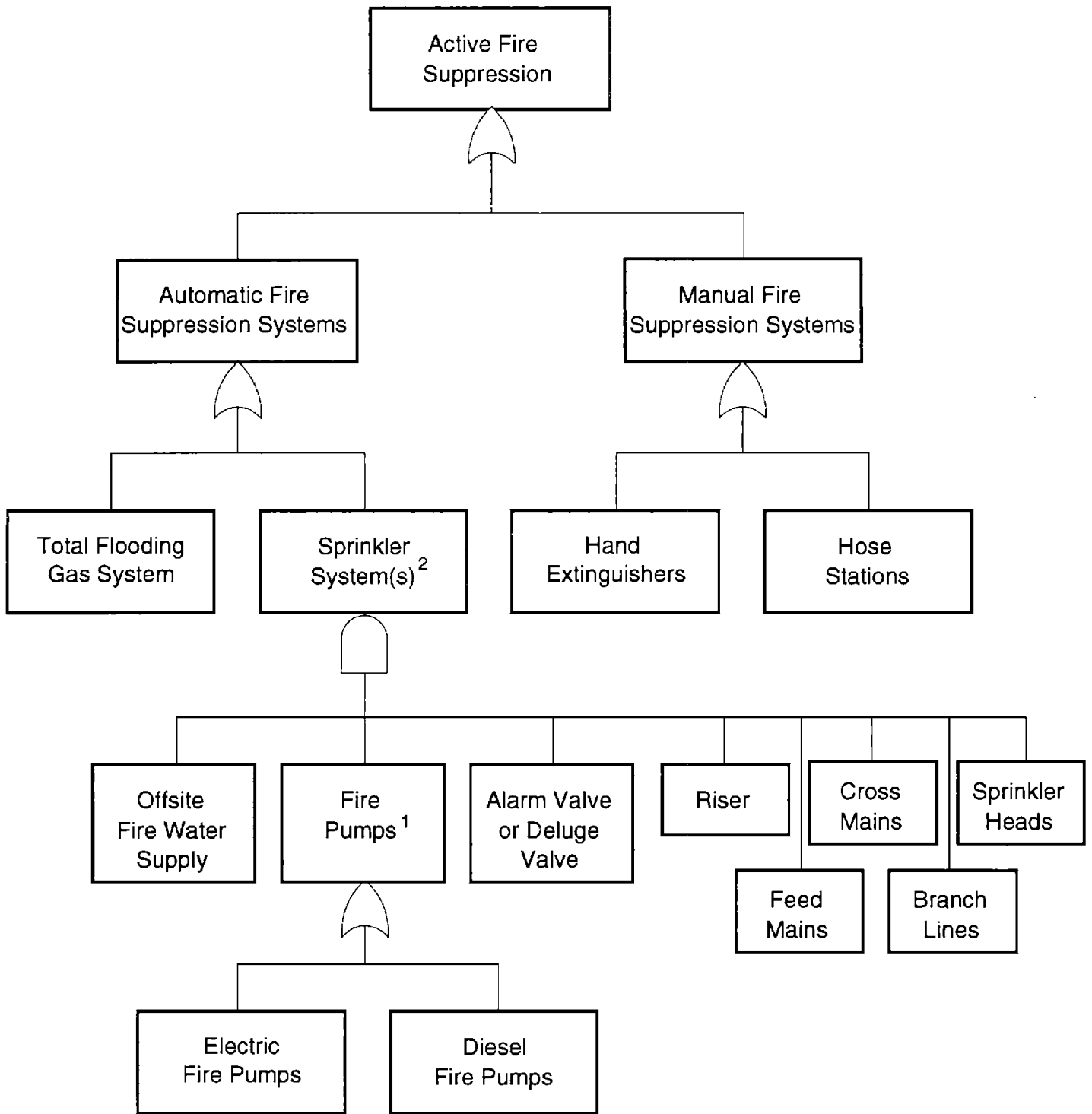

Figure 3-27: Central office fire detection and alarm



¹ Presence of fire pumps depends on building height, sprinkler system design, and local water supply pressure.

² Presence of sprinkler systems varies between carriers and COs.

KEY		
SYMBOL	NAME	MEANING
□	AND GATE	Component above gate functions if all components below function
∧	OR GATE	Component above gate functions if any component below functions

Figure 3-28: Central office active fire suppression systems

KEY		
SYMBOL	NAME	MEANING
□	AND GATE	Component above gate functions if all components below function
∧	OR GATE	Component above gate functions if any component below functions

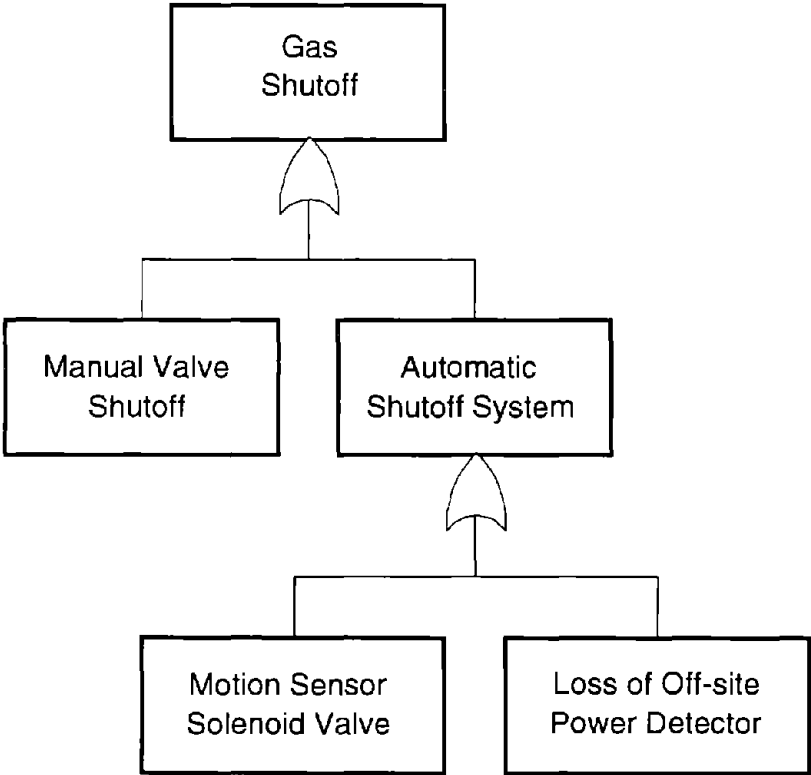

Figure 3-29: Central office gas shut-off

KEY		
SYMBOL	NAME	MEANING
□	AND GATE	Component above gate functions if all components below function
∧	OR GATE	Component above gate functions if any component below functions

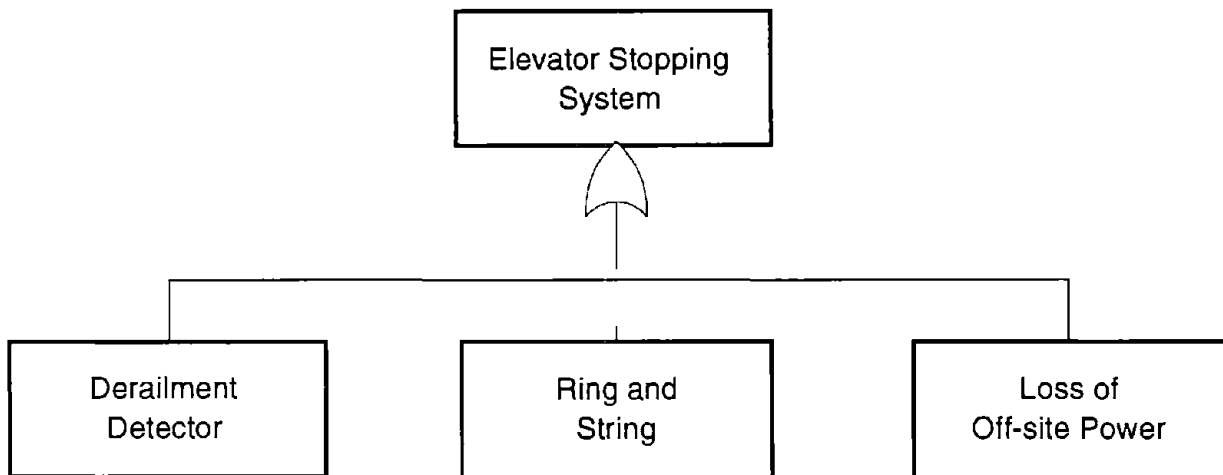
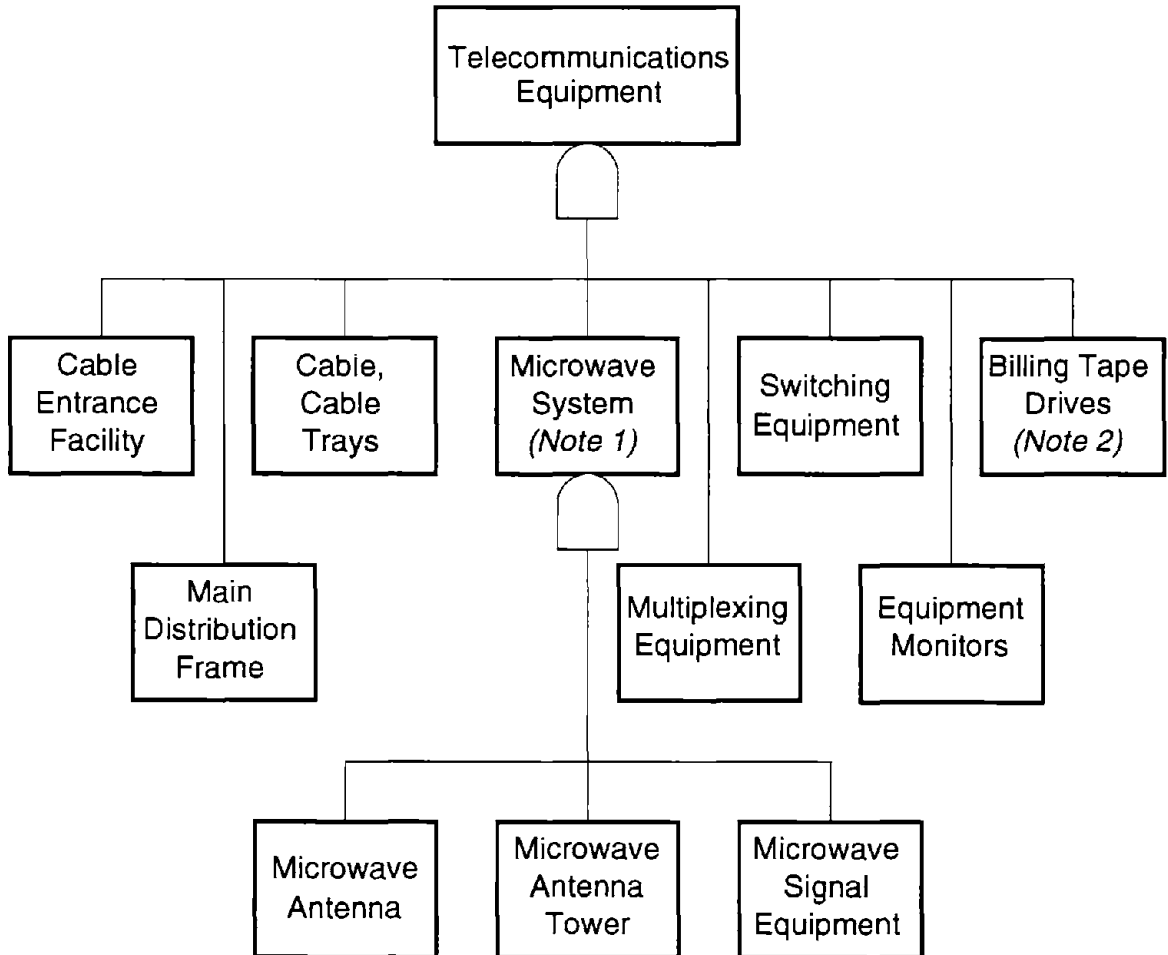

Figure 3-30: Central office elevator stopping system

KEY		
SYMBOL	NAME	MEANING
□	AND GATE	Component above gate functions if all components below function
△	OR GATE	Component above gate functions if any component below functions



Notes:

- 1: Presence of microwave systems varies by CO.*
- 2: Billing tape drives are not critical for switching function.*

Figure 3-31: Central office telecommunications equipment

KEY		
SYMBOL	NAME	MEANING
□	AND GATE	Component above gate functions if all components below function
△	OR GATE	Component above gate functions if any component below functions

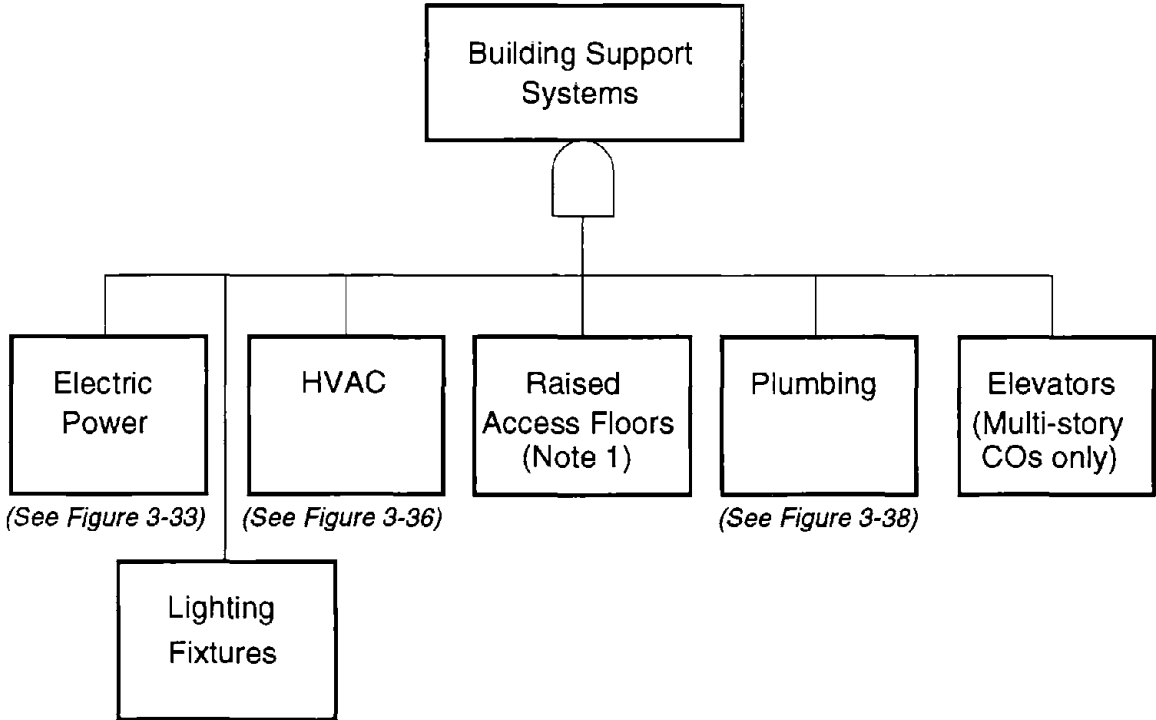

NOTES:

- 1: Presence of raised access floors varies by CO.

Figure 3-32: Central office building support systems

KEY		
SYMBOL	NAME	MEANING
⊓	AND GATE	Component above gate functions if all components below function
⊔	OR GATE	Component above gate functions if any component below functions

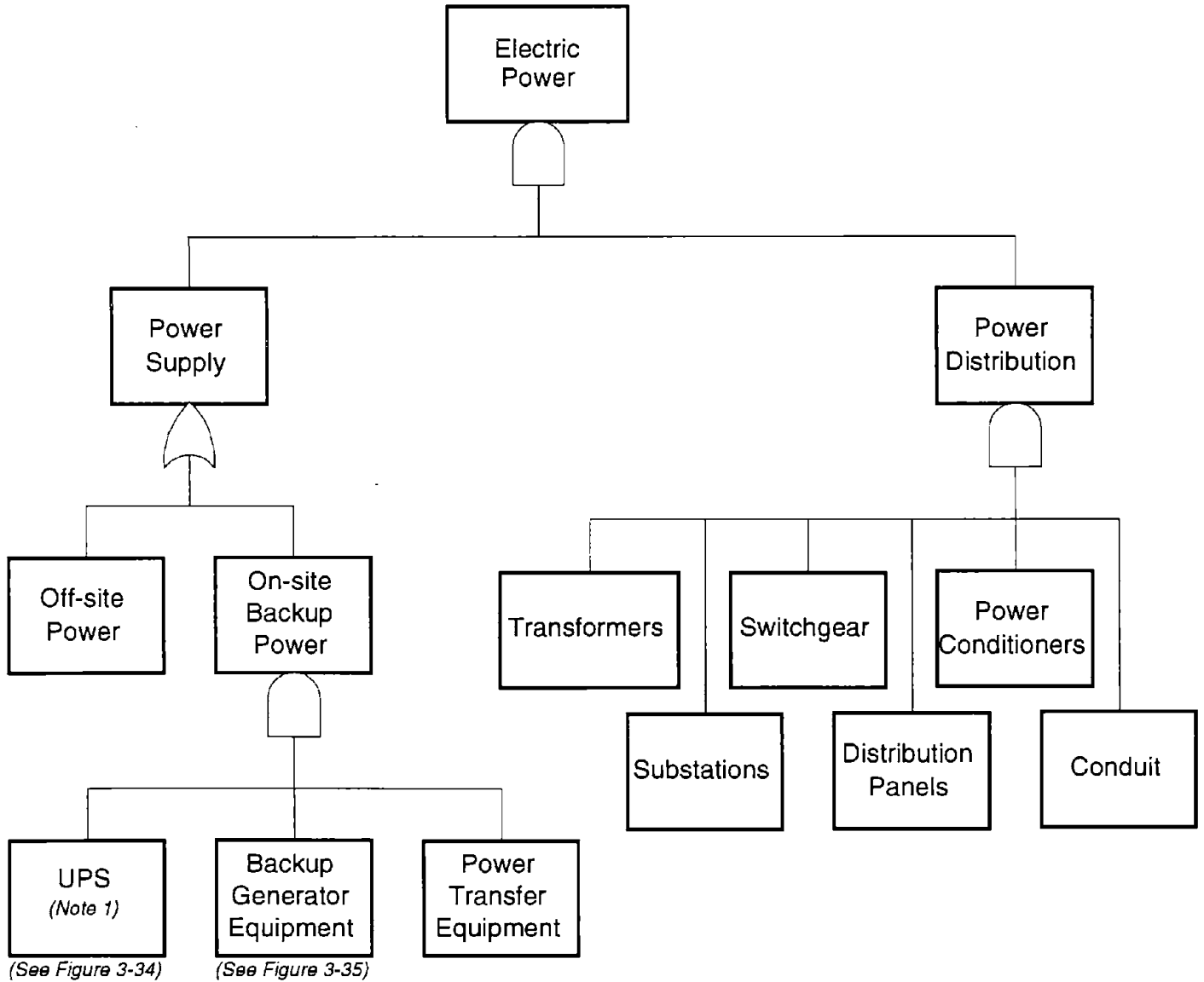

Notes:

1: UPS used only for telecommunications equipment.

Figure 3-33: Central office electric power

KEY		
SYMBOL	NAME	MEANING
⌋	AND GATE	Component above gate functions if all components below function
⌋	OR GATE	Component above gate functions if any component below functions

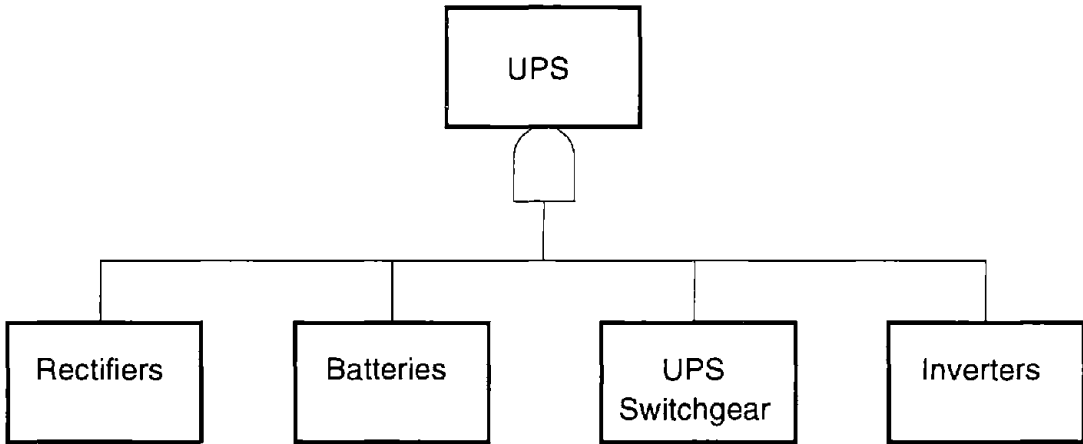
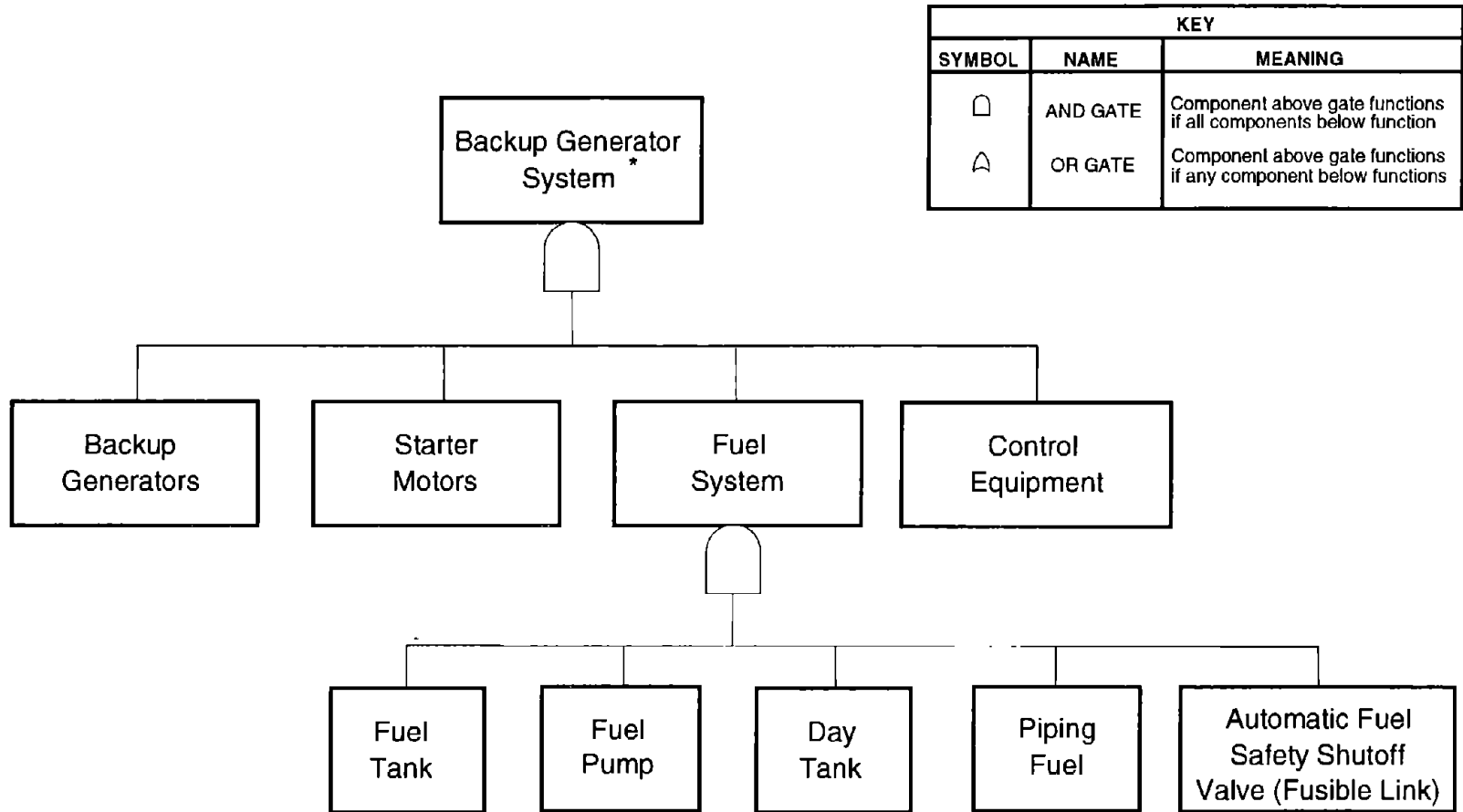

Figure 3-34: Central office uninterruptible power supply



* Smaller facilities may have packaged generator units

Figure 3-35: Central office backup generator system

KEY		
SYMBOL	NAME	MEANING
⌋	AND GATE	Component above gate functions if all components below function
⌋	OR GATE	Component above gate functions if any component below functions

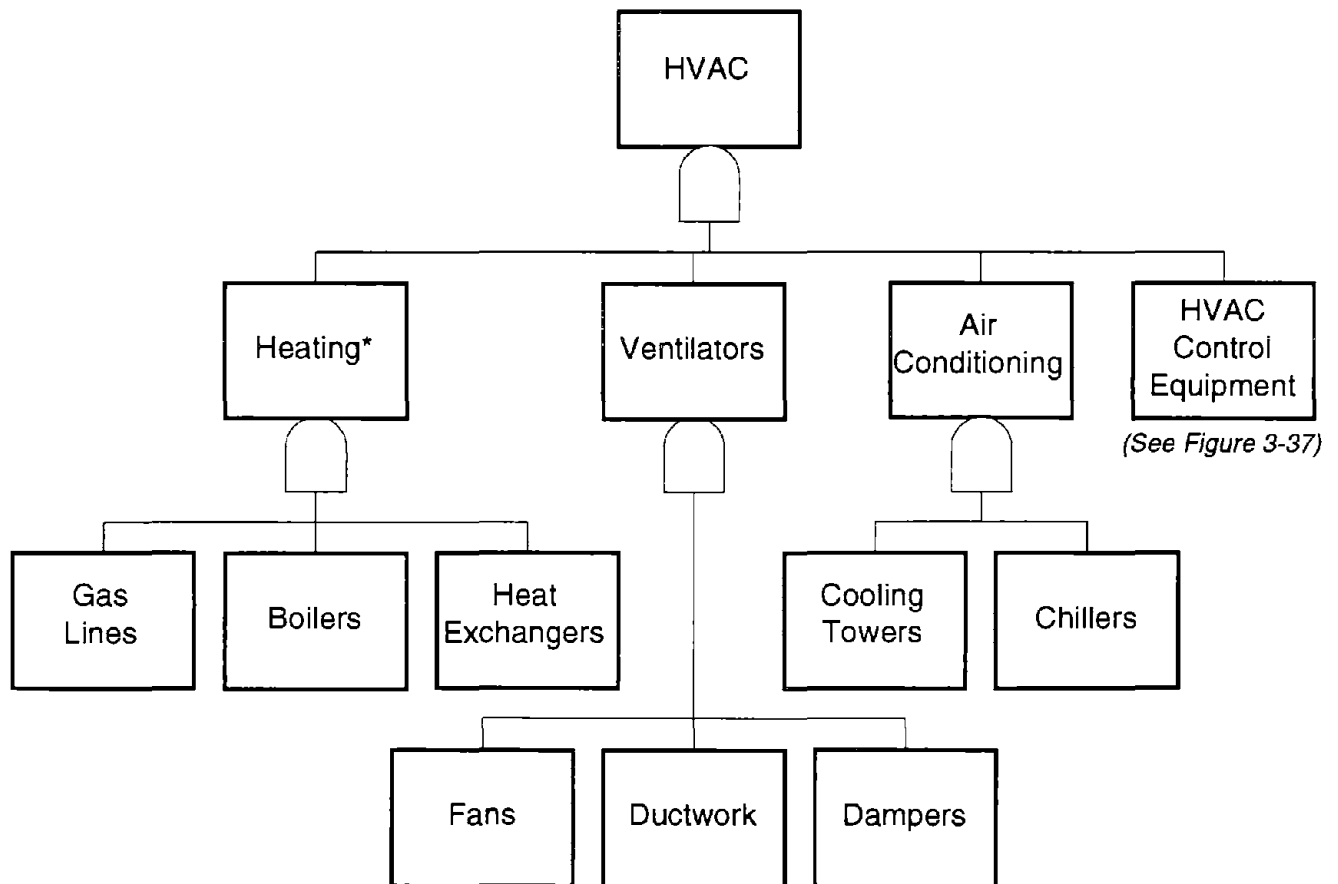

* Heating equipment may or may not be critical, depending on climate

Figure 3-36: Central office HVAC

KEY		
SYMBOL	NAME	MEANING
⊓	AND GATE	Component above gate functions if all components below function
⊔	OR GATE	Component above gate functions if any component below functions

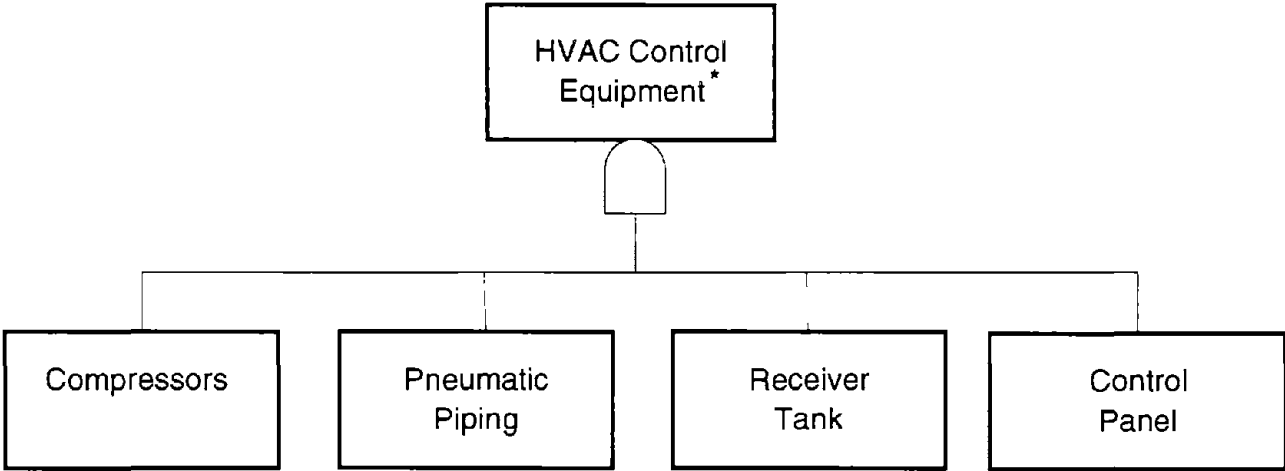

* Pneumatic system depicted here. Electric systems also exist.

Figure 3-37: Central office HVAC control equipment

KEY		
SYMBOL	NAME	MEANING
⌋	AND GATE	Component above gate functions if all components below function
⌋	OR GATE	Component above gate functions if any component below functions

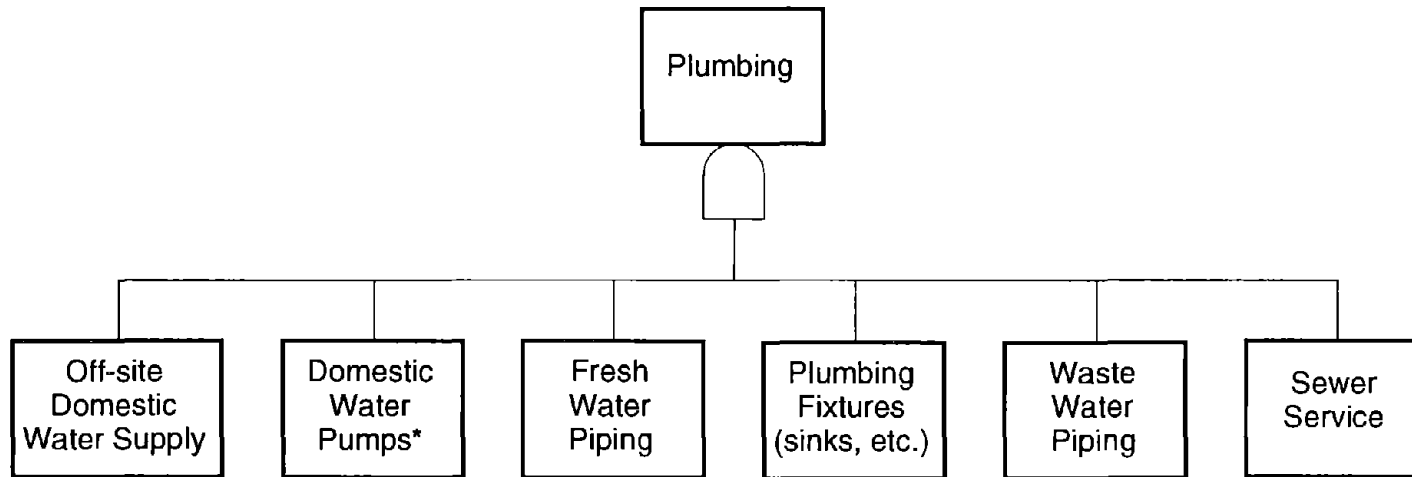

* Presence of domestic water pumps depends on building height, water supply pressure, etc.

Figure 3-38: Central office plumbing

3.4 Data Processing Center

3.4.1 Example Data Processing Centers

Three facilities were visited: two in the San Francisco Bay area, and one in the Los Angeles area. The first San Francisco-area data center reviewed is a high-rise, 1970s-vintage distributed steel moment-frame building located within 10 miles of two major faults. The second data center in the San Francisco Bay area is a mid-rise, 1980s-vintage perimeter steel moment-frame building. The third data center, located in the Los Angeles area, is a high-rise distributed steel moment-frame building, designed in the 1970s. For the purposes of this report, "mid-rise" is defined as 4 to 7 stories; "high-rise" is defined as 8 or more stories. A perimeter steel moment-frame building resists lateral forces with beams and columns connected rigidly together at the exterior walls. Interior beams and columns in this type of structure carry only vertical loads, that is, they resist gravity but not earthquake or wind loads. A distributed steel moment-frame building, in contrast, has rigidly connected beams and columns in the interior of the building as well as at the perimeter. Thus, the interior frames resist lateral forces as well as gravity loads.

Data regarding the three example facilities were collected from architectural, structural, mechanical and electrical design drawings provided by the building owner. In addition, walkdowns were performed in the company of building stationary engineers and facility managers. The stationary engineers and facility managers at the two San Francisco Bay area data centers had been present at the buildings during the October 1989 Loma Prieta earthquake, and were able to provide valuable insight into the seismic performance of primary and backup equipment.

3.4.2 Performance of Data Processing Centers in the October 1989 Loma Prieta Earthquake

Only the high-rise San Francisco Bay area data center is reported to have had a problem in the Loma Prieta earthquake. The building structural and architectural elements performed well in the earthquake, with minimal damage aside from contents falling from shelves, etc. There was no need for building evacuation. The only significant problem reported was associated with electric power, when both the commercial utility and one of the backup power systems failed.

Commercial electric power was lost in much of the San Francisco Bay area following the earthquake. Backup generators at the affected data center started automatically, but a failure of controller equipment resulted in the failure of basement-floor fuel pumps to resupply generator day tanks. The generators ran until the day tanks emptied. The control failure was attributed to a microprocessor that controls pump operation. The

microprocessor has a "power-up-reset" circuit, which initializes a control program. The circuit keeps the microprocessor in a "clear" mode until backup power is fully available, at which point the microprocessor initiates its control program. The "clear" mode refers to the position of an electronic pointer that instructs the microprocessor on where in its memory the first command of the control program resides. Data center officials believe that commercial electric power was interrupted and momentarily restored twice before it was finally lost. In consequence, they believe, the microprocessor experienced a sequence of power loss, then power restored, then power loss, then power restored, which caused the electronic pointer to move and fail to instruct the microprocessor of the correct initial memory position for the control program. The shift in the memory position pointer confused the proper operation of the control equipment. Engineers faced with the failure of the fuel pumps essentially rebooted the control computer and it proceeded to operate normally.

Data center officials have been unable to duplicate the failure, and since have replaced the control equipment with a standard, battery-supplied Siemens programmable controller. The new controller has EPROM, that is, an electronic programmable read-only memory, which can load the control program into the controller after restoration of power, even if the backup battery fails to maintain microprocessor memory power. In addition, data center managers have installed equipment that enables building engineers to control backup power equipment manually, either locally or remotely, through equipment in the building central control room.

3.4.3 Data Center Components

A data center is comprised of the same basic elements as the other facility types, as depicted in Figure 3-39: structural features, architectural features, and equipment systems. In Figure 3-39, equipment has been broken out into life-safety, data processing, and building support systems, which are detailed below. The latter two types of equipment support normal building operations.

3.4.4 Data Center Life-Safety Systems

Components of life-safety systems are depicted in Figure 3-40. In summary, they include fire detection and alarm, active fire suppression, fire and smoke barriers in ductwork (i.e., passive fire suppression), gas shut-off, elevator stopping systems, and stairway emergency lighting.

Fire detection and alarm. As with other buildings discussed above, the main element and focal point of fire detection and alarm is the Fire Communications Center (FCC) panel. It receives signals from a variety of smoke detectors, fire alarm pull boxes, and sprinkler flow sensors. The FCC panel is redundantly powered by building power and its own backup

battery. Fire alarm indicating devices located throughout the building contain loudspeakers and strobe lights to alert building occupants of a fire. These devices are controlled by and powered through the FCC panel. Figure 3-41 depicts the fire detection and alarm system in detail.

Fire suppression. Figure 3-42 shows the active fire suppression system in detail. Its main components are halon systems, fire water systems, and fire extinguishers. The type and number of fire suppression systems varies throughout the example facilities. All areas have fire extinguishers and a sprinkler system. Computer areas are also protected by halon systems.

A halon system is comprised of tanks of halon gas connected to area smoke detectors. Halon gas is used because it extinguishes fires without damaging electronic equipment or asphyxiating building occupants. The gas is automatically released upon a signal from two or more smoke detectors in adjacent areas. Halon systems are present in all three example data centers.

Fire water systems are comprised of four components: fire water supply, fire water pumps, fire water risers, and a sprinkler system. Fire water may be supplied either from off-site fire water service or from on-site tanks used exclusively for fire water. Water pressure is supplied either from electric fire water pumps or from backup diesel fire water pumps.

As shown in Figure 3-43, two different sprinkler systems are used in the example data centers: automatic sprinklers (AS) and preaction water spray (PWS) systems. Non-computer areas have ordinary AS systems; computer areas are protected by preaction water spray systems. In an AS system, water is released from a sprinkler head when the fusible link on the head melts. An AS system is comprised of headers, branches, and sprinkler heads. A preaction water spray systems is essentially an AS system with several safeguards to prevent accidental release of water. Sprinkler branch lines in a preaction system are typically dry, i.e., they contain only air, which is sometimes pressurized. Thus, shaking damage to sprinkler lines or heads cannot by itself cause a release of water onto computer equipment. Upon detection of a fire, a deluge valve near the riser is opened to allow water into the sprinkler headers. Operation of the deluge valve may require a signal from more than one smoke detector. After a deluge valve is opened, water is released only when heat melts the fusible link on a sprinkler head. If the sprinkler line is charged with pressurized air, this must be released first, before water enters the line.

Gas shut-off. Gas service to the data centers incorporates a safety valve that can automatically shut off the gas supply when one of three events occur: it receives a signal from the FCC panel, its motion (seismic) sensor is triggered, or building power is lost.

Elevator stopping system. Elevator stopping equipment is shown in Figure 3-44. Elevators automatically stop in the event of earthquake, derailment, or loss of off-site power. The simple ring-and-string system signals the elevator that an earthquake has occurred.

3.4.5 Data Center Data Processing Equipment

The central component of data centers is the data processing equipment itself, depicted in Figure 3-45. This equipment typically is comprised of the following, each of which is described below.

- Mainframes
- Storage devices
- Mass storage facilities
- High speed printers
- Document handling equipment
- Communications equipment and cables

Mainframes are typically cabinets of various sizes and heights, mounted on leveling pads or casters, and frequently arranged in small clusters. They perform data manipulation. *Storage devices* include tape drives, tape drive controllers, disk drives, and disk drive controllers. This equipment is used to store data and programs for ready access by computers. The devices are analogous to the floppy disk drive in a typical desktop computer. The storage media are removable. In the case of a desktop computer, the storage media are the 3.5- or 5.25-inch floppy diskettes. For mainframe computers, the media are large tape reels or large removable disks.

The tapes or disks are kept for long-term storage in *mass storage facilities* such as tape racks or disk files. The desktop analog of mass storage facilities are diskette file boxes. The example data centers have numerous tall, generally unbraced tape racks.

Documents are produced using *high speed printers* governed by *printer controllers*. In a desktop computer system, the printer controller is incorporated in the printer itself; in a data processing center, a separate unit is used. *Document handling equipment* is used to fold the printed documents, put them in envelopes, and so on.

Connecting all the above equipment together are *communications cables*. In computer areas, these cables are typically routed beneath raised access floors and enter computer cabinets from below. In telecommunications areas, cable is routed in overhead cable trays. Signals between computer components are managed by *communications controllers*.

3.4.6 Data Center Building Support Equipment

As shown in Figure 3-46, the systems that support data processing and other normal building functions include the following:

- Electric power
- Telecommunications
- Heating, ventilation, and air conditioning (HVAC), and equipment cooling
- Equipment cooling
- Plumbing
- Elevators
- Raised access floors

Data processing equipment relies on electric power and equipment cooling to continue operating. Telecommunications equipment is critical to maintain the flow of data between outside sources and the data center. In addition, raised access floors may be considered critical to data processing, since the collapse of raised access floors can damage data processing equipment or underfloor services such as chilled water conduit.

Different levels of reliability are required from these components and their subcomponents to ensure uninterrupted data processing. Many of them must remain functional even during the earthquake shaking to ensure that no data are lost. These include telecommunications equipment, raised access flooring, and portions of electric power systems (namely uninterruptible power supply and electric power conditioning and distribution). Other components, namely equipment cooling and emergency generators (which are part of the electric power system), must be operational within a few minutes following the earthquake. Each of these components is discussed in the following sections.

Electric power. Electric power supply to data processing equipment must be continuous to avoid loss of data. Interruption of power for even one AC cycle can cause data loss. Furthermore, voltage must be carefully controlled, as voltage spikes can damage sensitive electronic equipment. Protecting against these hazards requires an elaborate and highly reliable system of backup power, as well as equipment that can transfer the source of power smoothly from commercial power to on-site sources. These on-site sources are the uninterruptible power supply (UPS, a battery-driven system) and on-site backup electric generators. They must be capable of supplying electric power for several days until off-site electric power is restored.

The fuel pump failure at the high-rise San Francisco Bay area data center illustrates the highly complex nature of ensuring continuous operation when commercial lifelines can fail. The main components of electric power are power supply and power distribution, as shown in Figure 3-47.

UPS systems. UPS systems (depicted in Figure 3-48) include rectifiers, batteries in battery racks, inverters, and switchgear. Rectifiers convert AC power to DC, to charge batteries. The batteries, in turn, supply raw DC power, which may be converted back to AC by banks of inverters. Normally, automatic switchgear transfers the power source the UPS system, but this can also be performed manually. Batteries may be recharged from either commercial or backup generator power.

The example data centers maintain a variety of UPS systems. The high-rise San Francisco Bay area data center maintains two UPS systems: one manufactured by Teledyne and one by Exide. The other two data centers maintain Exide systems: two systems in the mid-rise San Francisco Bay area data center and one in the Los Angeles data center.

UPS systems at the example data centers are capable of supplying electric power to critical data processing equipment only briefly, but long enough to power up on-site backup generators, which can supply electric power as long as fuel is available.

Emergency generators. Emergency generator systems are depicted in Figure 3-49. One of the San Francisco Bay area data centers has four 3.5-megawatt-rated packaged turbine generators; in practice, they deliver somewhat less power on sustained demand, and are required to supply power only to data processing equipment, life-safety equipment, and critical HVAC equipment. The second San Francisco Bay area data center maintains seven diesel generators, capable of supplying a total of 9.8 megawatts of power. The Los Angeles data center maintains three turbine generators. Minimal redundancy is available. Typically, only one generator may be off-line without reducing available backup power below the minimum requirement.

The generators power up automatically on loss of commercial power. Load-sensing relays in control equipment allow for a 3-second delay between loss of commercial power and triggering generator start-up. Fuel is supplied to generators from nearby day tanks. Day tanks provide only a brief supply of fuel. Electric and diesel fuel pumps resupply the day tanks from large capacity storage tanks. Buried tanks store enough fuel for several days' continuous operation of generators. The number and capacity of fuel storage tanks varies from site to site.

Power distribution. Power distribution relies on a variety of stepdown transformers, substations, switchgear, distribution panels, power switching centers, automatic transfer switches, manual transfer switches, and motor control centers. Power is transmitted through conduit or bus duct.

Power is received from the commercial supplier at 12 to 21 kV, depending on location. Stepdown transformers reduce the voltage to an intermediate level for routing through the data center. Larger mechanical equipment is supplied at these intermediate voltages (e.g., fans, chillers, supplied at 480 volts). Electrical switchgear, motor control centers, distribution panels, and transformers in the example data centers are all standard equipment that might be found in any large building. Power conditioners located in the data processing areas step voltage down to 208 and 120-volt levels, and clean it up for use by computers by controlling voltage.

Electric power at one of the example data centers is routed to equipment through rigid bus ducts, rather than conduit in cable trays. The use of bus ducts is not universal, but was observed to be extensive at this site. Rigid bus duct conducts power through rigid bars bolted within the sheet metal duct. The bus duct is rod-hung from ceilings with occasional diagonal bracing.

Telecommunications. Raw data may be delivered to the data centers on paper or in electronic format on tapes, disks, or by telephone. Much of the electronic data processed at the example facilities was sent by telephone. This requires the use of telecommunications equipment including modem cabinets, cable, multiplexers, and telephone switching equipment, as shown in Figure 3-50.

Modems translate analog telephone signals to digital computer signals, the same way that modems for desktop computers do. Because of the intense telecommunications usage by the example data centers, the telecommunications equipment in them resembles that of a small telephone exchange. The facilities include a cable entrance facility (CEF), multiplexing/demultiplexing equipment, switching equipment, cable and cable trays.

CEF, cable, and cable trays. Telecommunications cable (copper wire and fiber optic cable) enters the data centers in a below-ground CEF. The CEF represents the control point of the cables entering the facility. The wires within the cables are routed into the switching equipment area in overhead racks or trays, which are rod-hung from the floor diaphragm above.

Multiplexing/demultiplexing equipment. A large number of multiplexed circuits enter the example data centers. Multiplexing refers to the combination of many circuits (a circuit being one individual telephone conversation or its computer equivalent) on a single cable. Copper and fiber optic cable are both used at the sample data centers to carry multiplexed voice and data signals between facilities. Multiplexers perform a variety of functions depending on the application, but basically they are used to combine or separate the distinct circuits on the multiplexed signals. In the example data centers, multiplexing equipment takes the form of tall rack-mounted devices.

Switching equipment and controlling computers. The example data centers have switching equipment similar to that of a small commercial telephone exchange. This equipment connects telephone lines within the data center to each other and to outside lines. Electronic switching equipment is essentially a mainframe computer containing one or multiple CPUs.

HVAC and equipment cooling. Data processing equipment generates large amounts of waste heat that must be eliminated to prevent equipment failure. Stationary engineers at the example data centers indicate that computer operation would fail within 15 minutes of cooling failure. As shown in Figure 3-51, there are three systems that provide HVAC and equipment cooling:

- Central heating, ventilation and air conditioning (HVAC) system
- Chilled water
- Local environmental air conditioning (EAC) units

Central HVAC. Central HVAC, depicted in Figure 3-52, performs three functions: air heating, ventilation, and air cooling. Air heating requires heat exchangers and gas-fueled boilers. Note that air heating is not critical for data processing at the example data centers; residual heat from computer equipment typically provides all necessary environmental air heating needs for computer areas.

The ventilation system is comprised of fans and ductwork, while air conditioning requires chillers and cooling towers. A coolant, typically ammonia, is circulated in a closed loop from coils in the cooling tower, where it is cooled by the evaporation of water, to coils in the chillers, where the ammonia, in turn, cools air or water. In addition, water is continually lost in the cooling towers, and must be replaced. Water supply is discussed in a following section.

A pneumatic control system adjusts the position of duct dampers to direct the flow of cooled or heated air through ductwork. The pneumatic control system, shown in Figure 3-53, includes compressors, pneumatic piping, a receiver tank (plenum), and a control panel. In other facilities, the control equipment may be electric rather than pneumatic.

Chilled water and EAC units. As mentioned above, some mainframe equipment requires a supply of chilled water. This is supplied from the chillers by distribution piping and hose routed beneath raised access floors. Chilled water is also used by EAC units to cool air.

Plumbing. As shown in Figure 3-54, plumbing in a data center requires a supply of domestic water, water pumps, piping, sinks, drinking fountains, restroom fixtures, and waste water piping and sewer service. Note that domestic water supply is critical for continued HVAC and equipment cooling, which in turn are critical for data processing. For this reason, the example data centers all maintain on-site tanks of domestic water that are

separate from the on-site firefighting water supply. In the event of need, on-site domestic water supply may be strictly rationed to critical uses.

Raised access floors. Computer rooms typically have raised access floors, that is, flooring panels mounted on 6- to 30-inch pedestals that stand on the structural floor diaphragm. The space between the floor diaphragm and the raised access floor is used for power conduit, computer communications cable, chilled water hose, and so on. Access flooring can be particularly vulnerable to seismic damage. Collapse of access flooring can damage computer equipment, cooling systems, and power and communications cable.

3.4.7 Conclusions Regarding Sample Data Centers

Backup systems exist to provide for continuous power and water service both for life-safety and data processing. On-site UPS provides for uninterrupted power to computers. During extended commercial power failures, multiple engine generators with several days' supply of fuel can provide power to computers, air conditioning equipment (for computer cooling), and telecommunications equipment. Substantial supplies of on-site water support both firefighting and air conditioning needs. Fire detection and suppression systems are especially elaborate in computer areas, which are provided with three redundant suppression systems: preaction water spray (PWS), total-flooding-gaseous (halon), and hand extinguishers. Several safeguards mitigate the potential for accidental release of water onto computers. Sprinkler lines in computer areas are normally dry, and are charged with water only when fire is indicated by more than one detector. Water is released only from sprinkler heads whose fusible link is melted by heat. It is illustrative of the extent to which data centers are independent of off-site utilities to note that the data centers were equipped with portable toilets, reducing demand both for water and sewer service. The backups for normal operations equipment reflect the high economic cost to the data center owner of service interruption.

KEY		
SYMBOL	NAME	MEANING
⊓	AND GATE	Component above gate functions if all components below function
⊔	OR GATE	Component above gate functions if any component below functions

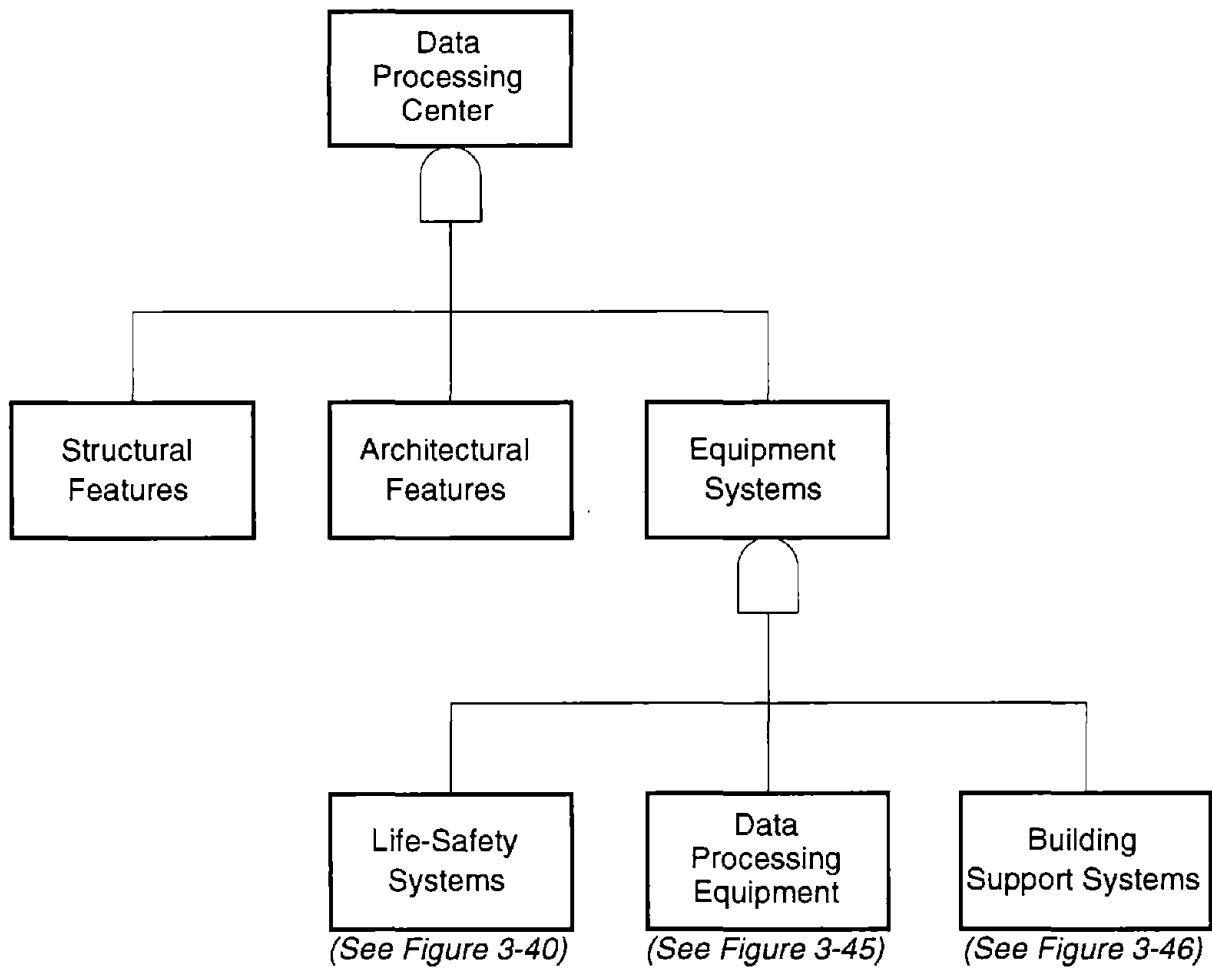

Figure 3-39: Data processing center components

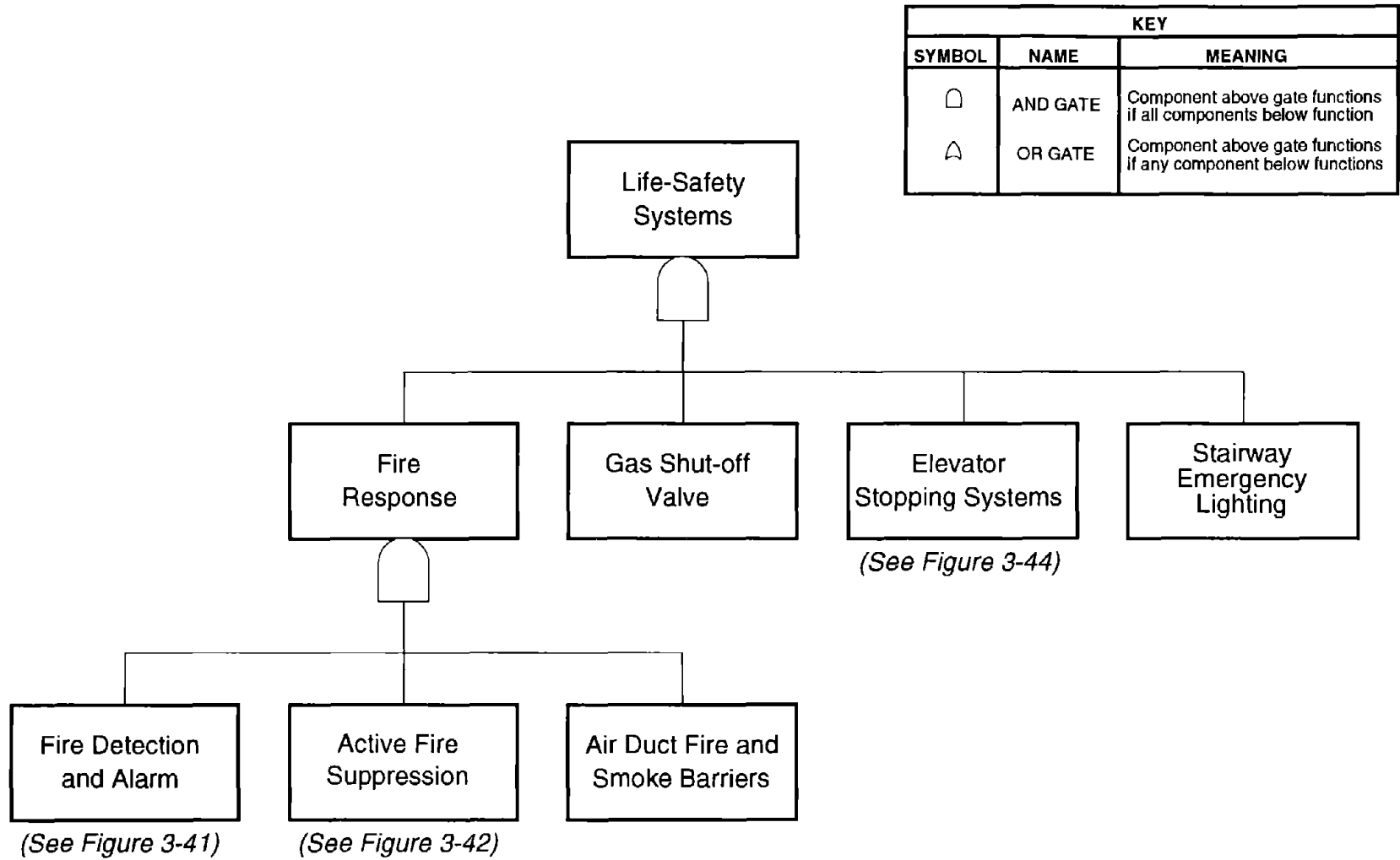

Figure 3-40: Data processing life-safety systems

KEY		
SYMBOL	NAME	MEANING
□	AND GATE	Component above gate functions if all components below function
△	OR GATE	Component above gate functions if any component below functions

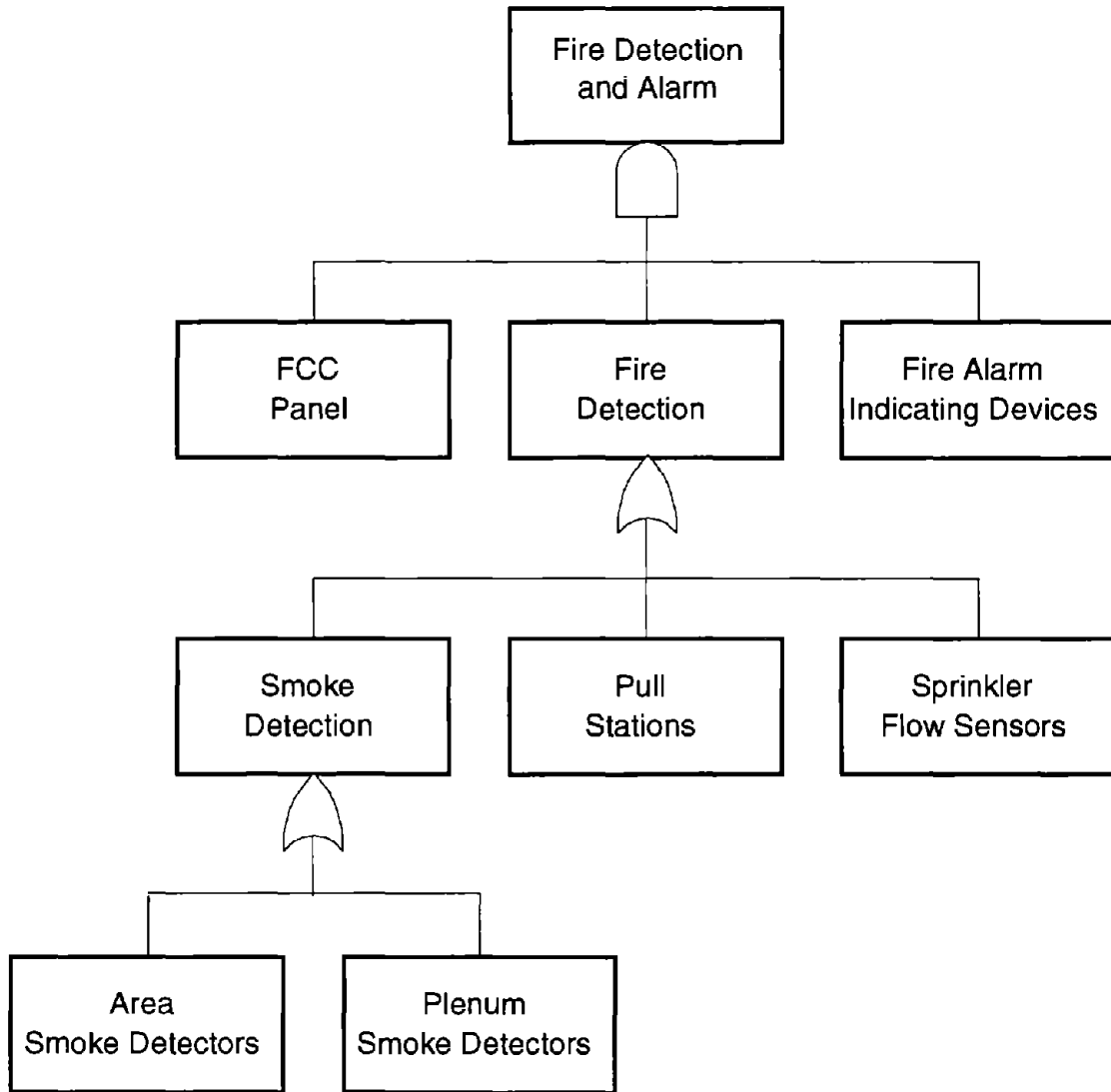

Figure 3-41: Data processing center fire detection and alarm systems

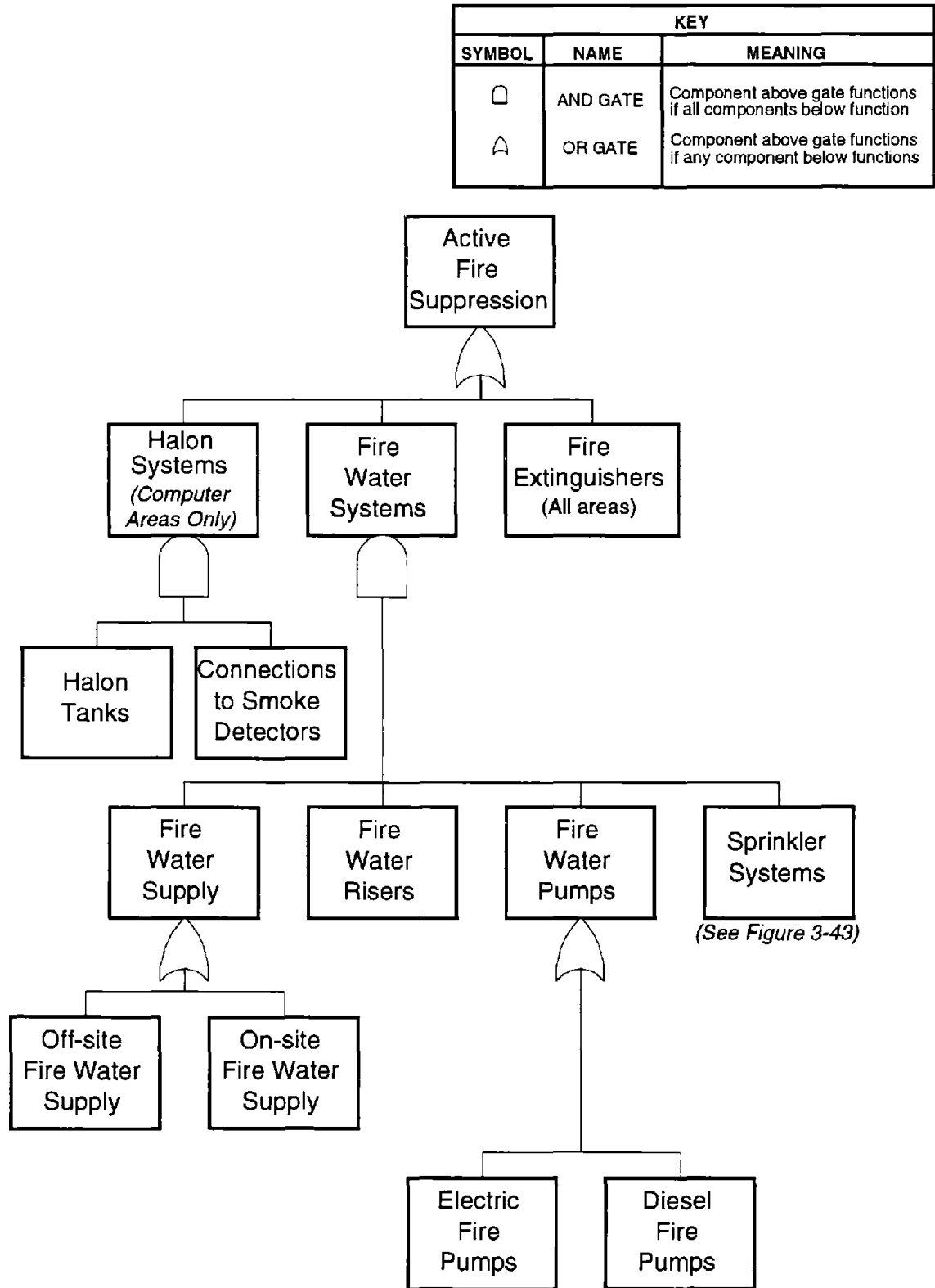

Figure 3-42: Data processing center active fire suppression

KEY		
SYMBOL	NAME	MEANING
⊓	AND GATE	Component above gate functions if all components below function
⊔	OR GATE	Component above gate functions if any component below functions

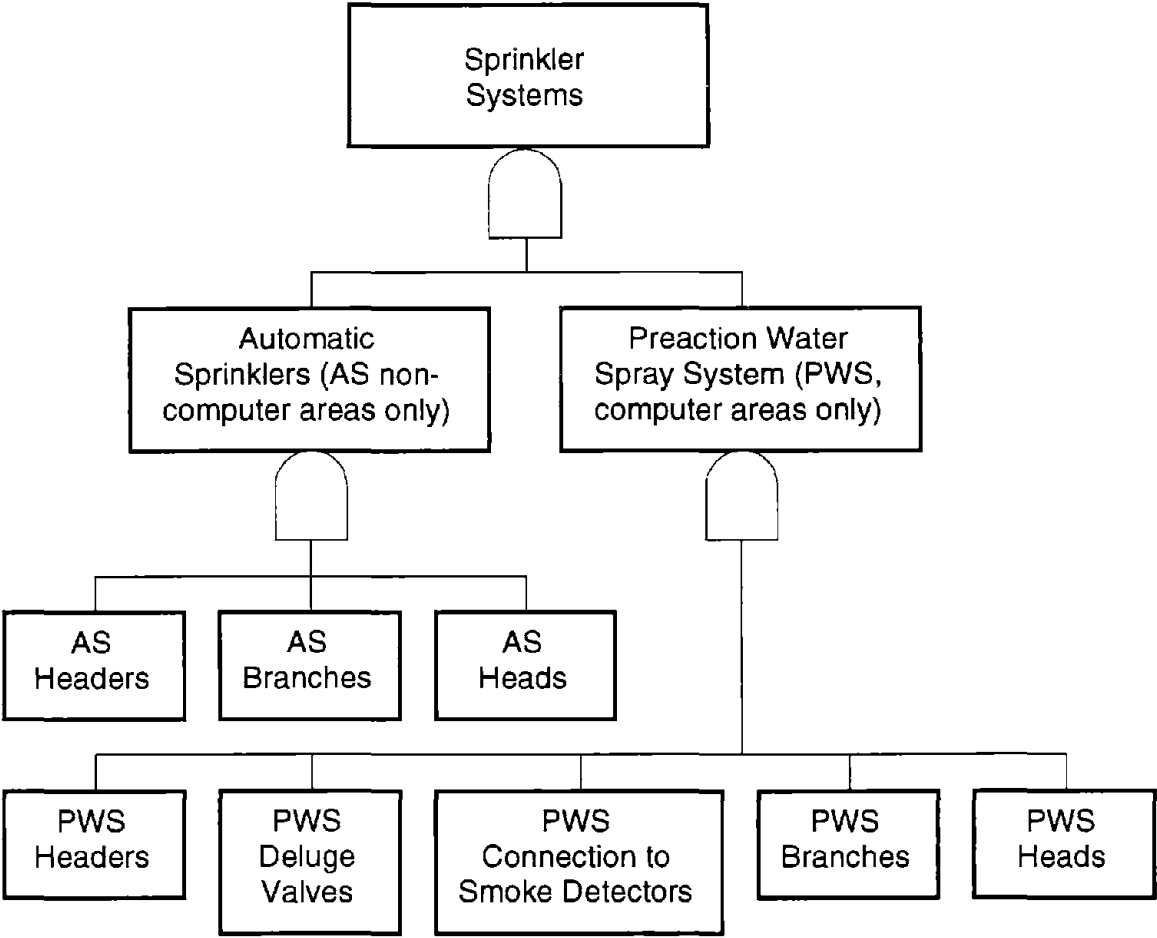

Figure 3-43: Data processing center sprinkler systems

KEY		
SYMBOL	NAME	MEANING
⊓	AND GATE	Component above gate functions if all components below function
⊔	OR GATE	Component above gate functions if any component below functions

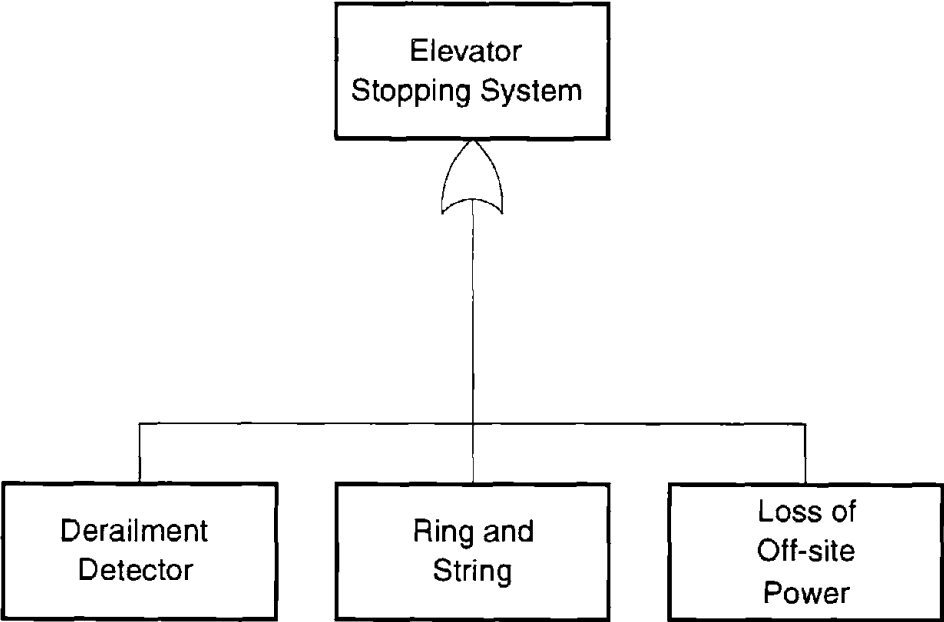

Figure 3-44: Data processing center life-safety elevator safety system

KEY		
SYMBOL	NAME	MEANING
⊓	AND GATE	Component above gate functions if all components below function
⊔	OR GATE	Component above gate functions if any component below functions

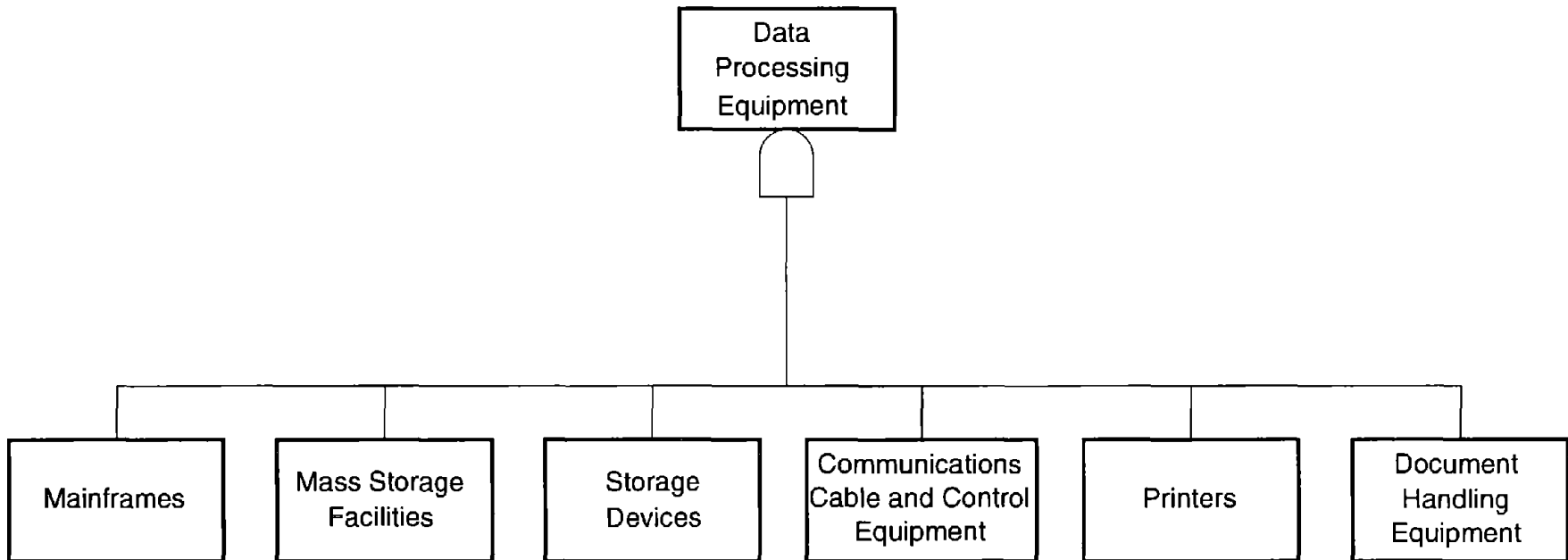

Figure 3-45: Data processing center equipment

KEY		
SYMBOL	NAME	MEANING
⌋	AND GATE	Component above gate functions if all components below function
⌋	OR GATE	Component above gate functions if any component below functions

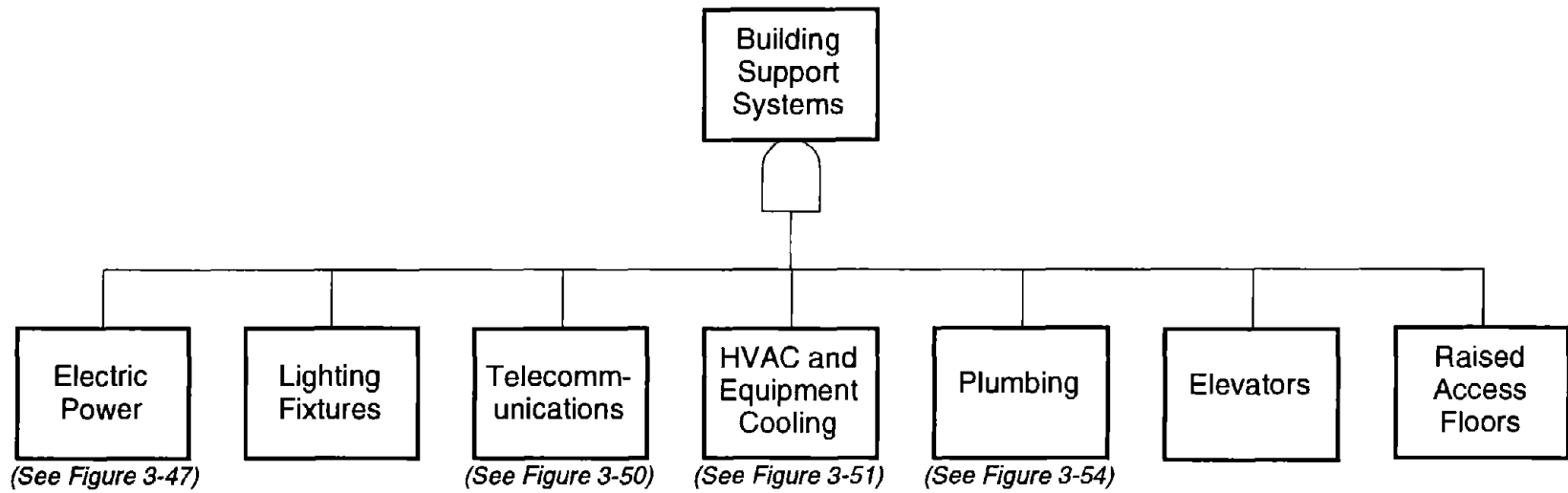
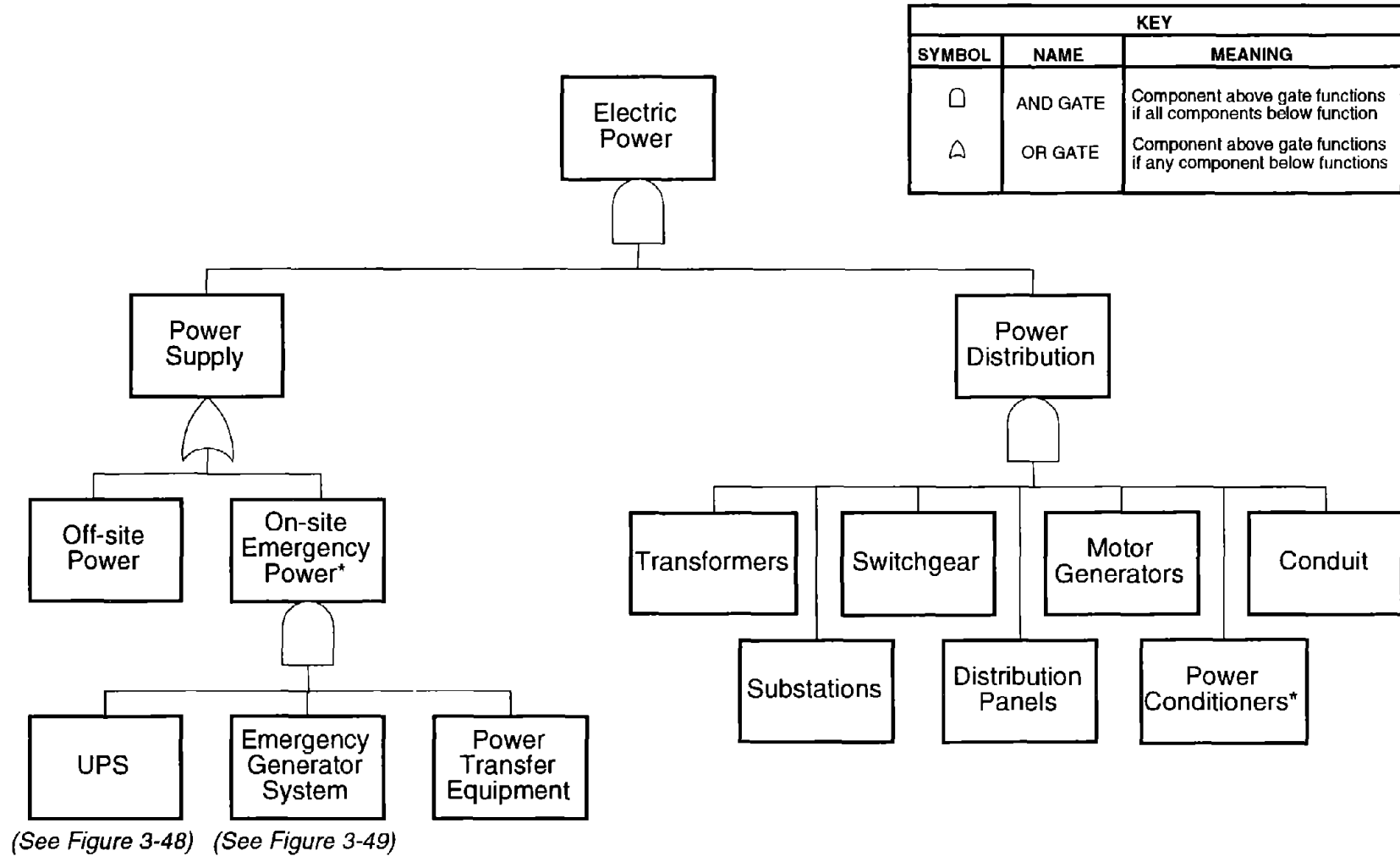

Figure 3-46: Data processing center building support systems



(See Figure 3-48) (See Figure 3-49)

* used only for data processing

Figure 3-47: Data processing center electric power

KEY		
SYMBOL	NAME	MEANING
⊓	AND GATE	Component above gate functions if all components below function
⊔	OR GATE	Component above gate functions if any component below functions

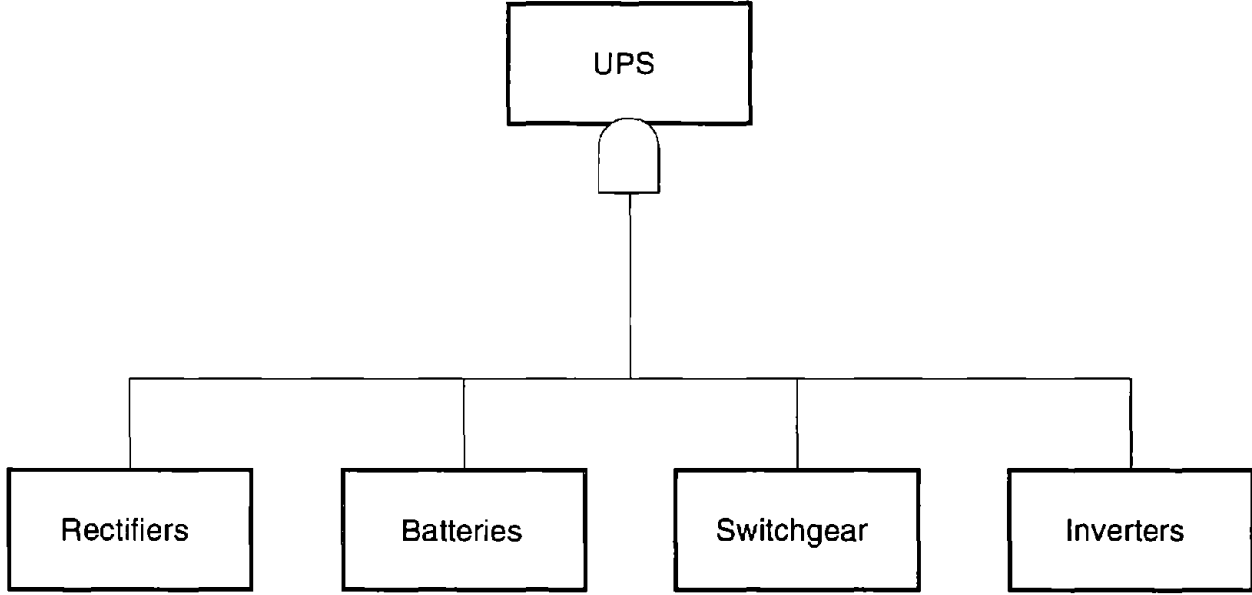

Figure 3-48: Data processing center uninterruptible power supply (UPS)

KEY		
SYMBOL	NAME	MEANING
⌋	AND GATE	Component above gate functions if all components below function
⌋	OR GATE	Component above gate functions if any component below functions

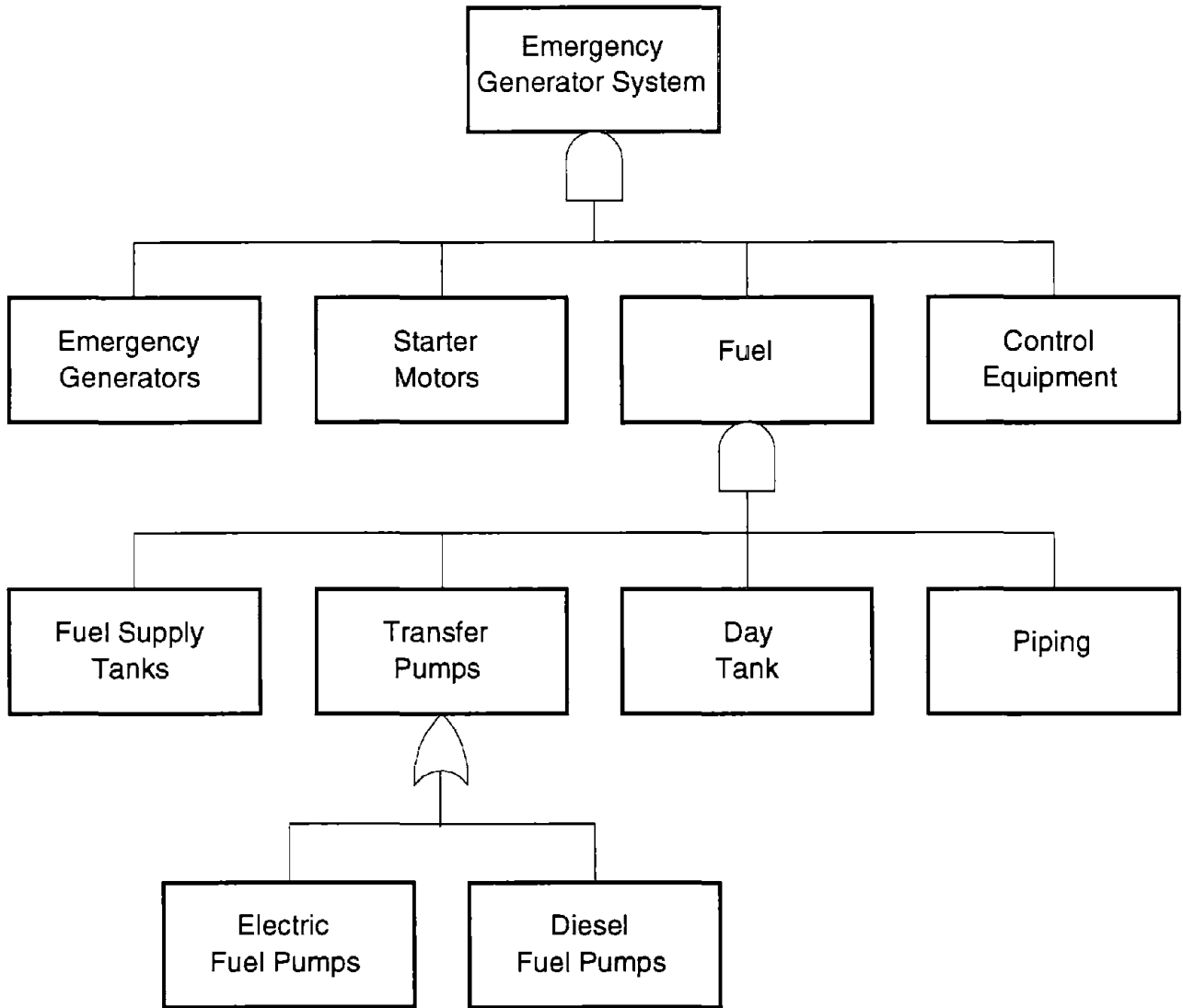

Figure 3-49: Data processing center emergency generator system

KEY		
SYMBOL	NAME	MEANING
□	AND GATE	Component above gate functions if all components below function
△	OR GATE	Component above gate functions if any component below functions

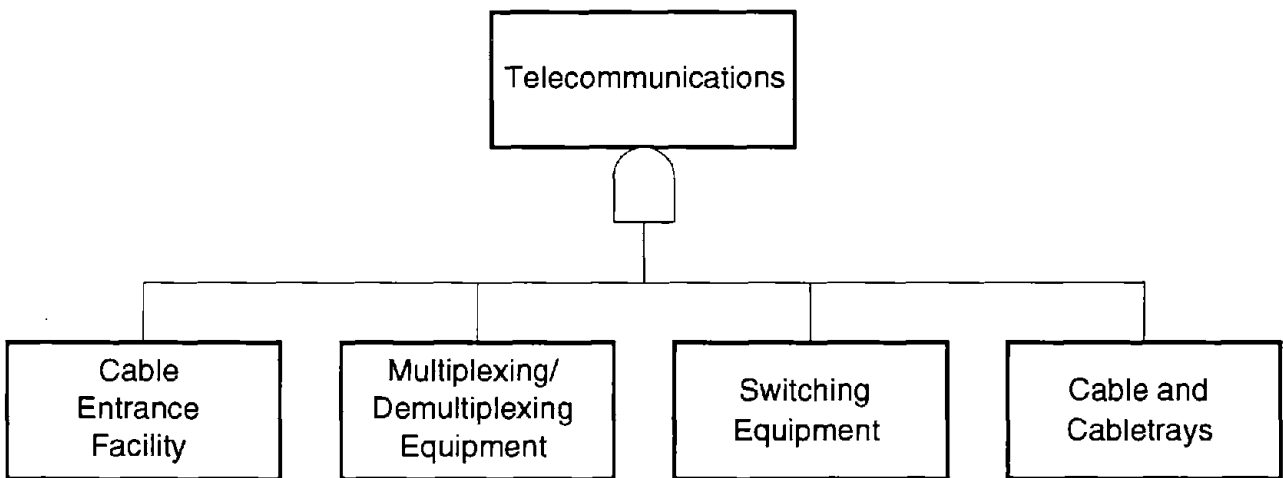

Figure 3-50: Data processing center telecommunications

KEY		
SYMBOL	NAME	MEANING
□	AND GATE	Component above gate functions if all components below function
△	OR GATE	Component above gate functions if any component below functions

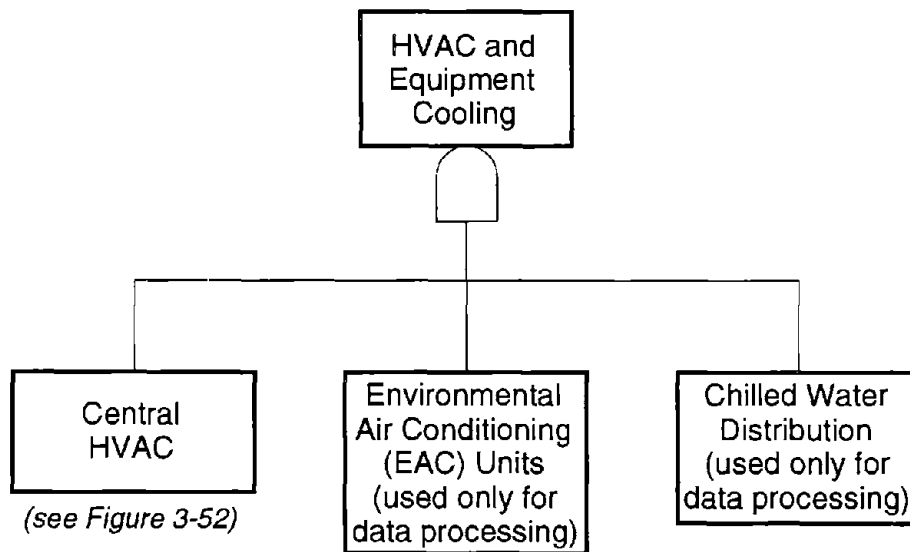
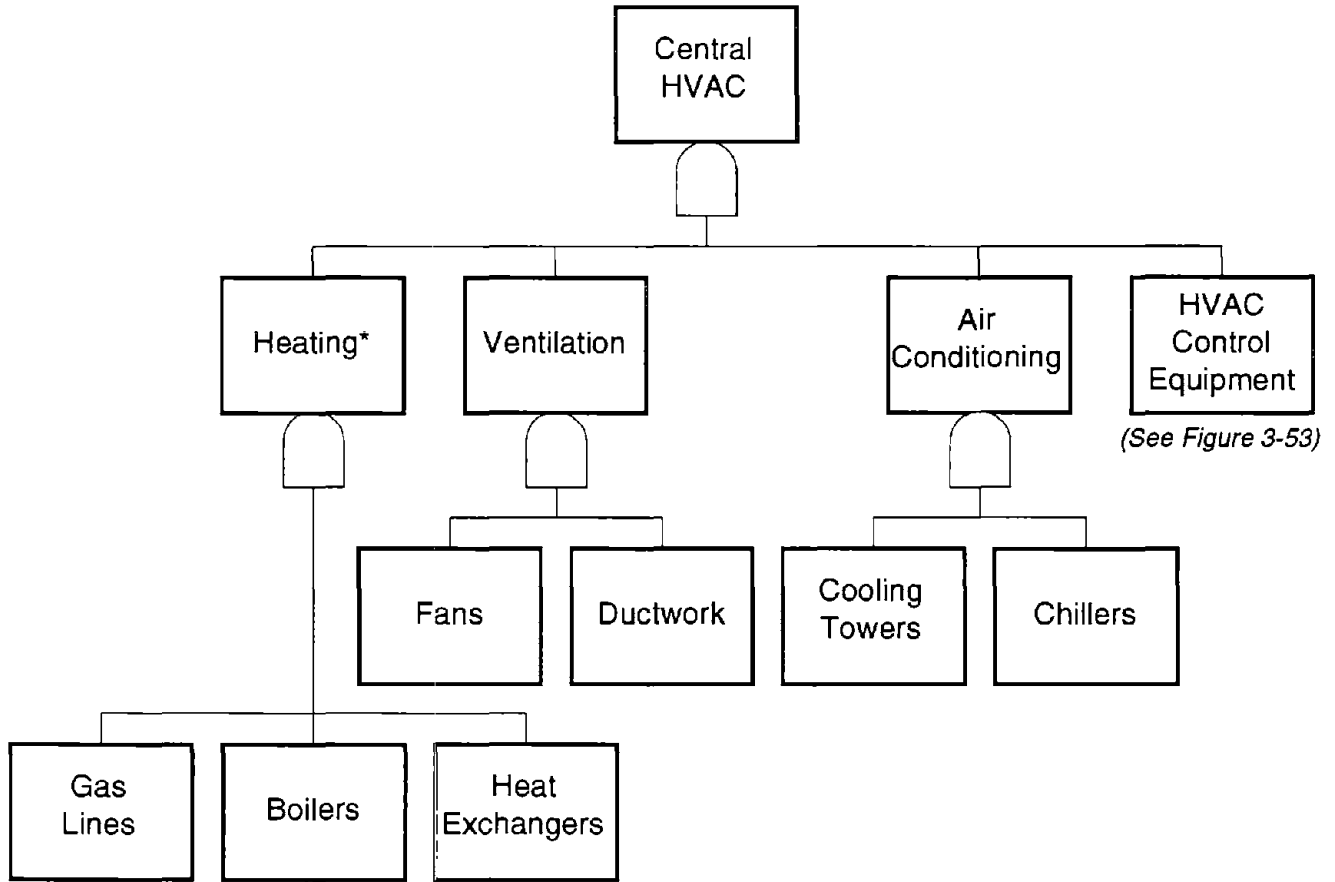

Figure 3-51: Data processing center HVAC and equipment cooling

KEY		
SYMBOL	NAME	MEANING
⌋	AND GATE	Component above gate functions if all components below function
⌋	OR GATE	Component above gate functions if any component below functions



* Heating equipment is not critical for data processing

Figure 3-52: Data processing center central HVAC

KEY		
SYMBOL	NAME	MEANING
⊓	AND GATE	Component above gate functions if all components below function
⊔	OR GATE	Component above gate functions if any component below functions

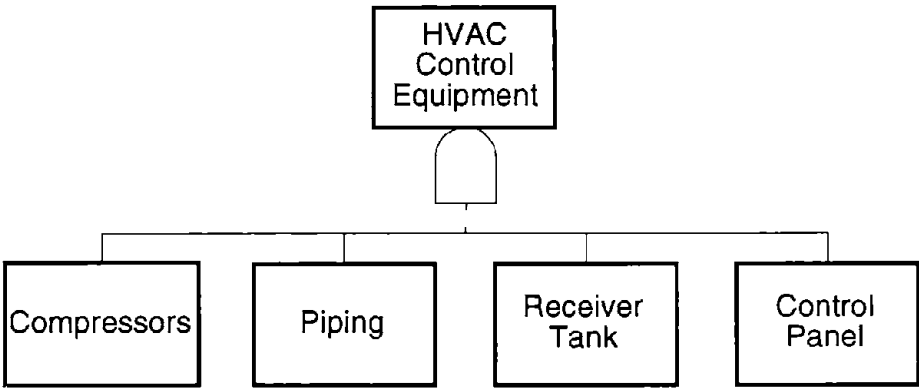

Figure 3-53: Data processing HVAC control equipment

KEY		
SYMBOL	NAME	MEANING
□	AND GATE	Component above gate functions if all components below function
∪	OR GATE	Component above gate functions if any component below functions

3-77

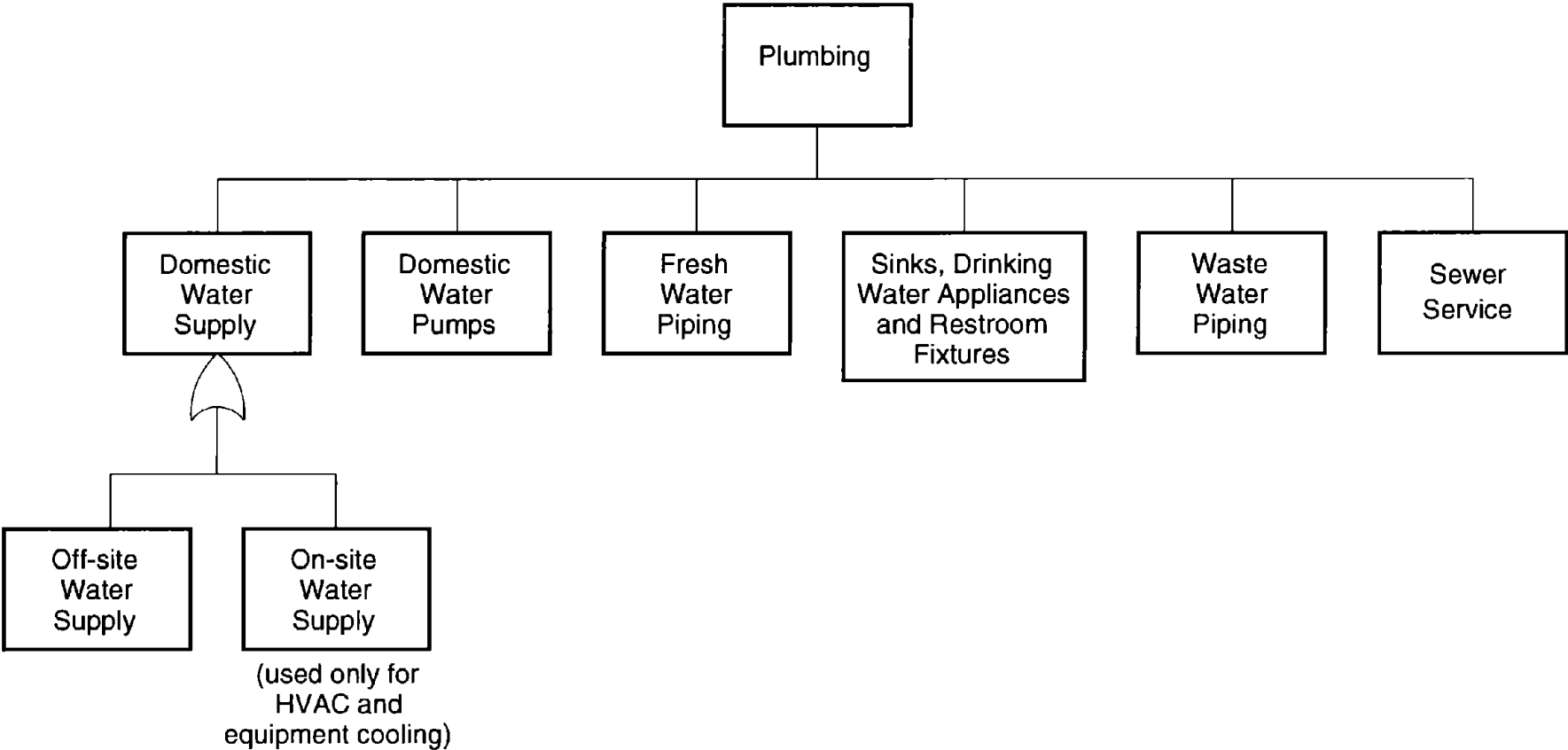

Figure 3-54: Data processing center plumbing

3.5 Hospital

3.5.1 Example Hospital

A typical hospital in the San Francisco area was studied to understand the primary equipment systems and to identify essential systems and components. The hospital includes three structures: two patient care wings and a service building. The patient care wings are a reinforced-concrete structure built in 1968, and a steel-frame structure built in 1975. The service building was constructed in 1958. The largest of the buildings is six stories high. The hospital could be expected to average approximately 300 patients (not including outpatients) at any time.

Information was collected by interviewing the head of engineering for the hospital, and by walking down the hospital equipment. The head of engineering proved to be especially valuable, as it became apparent that the hospital is seriously concerned about earthquake safety and has taken several steps to address perceived weaknesses. For example, the hospital is in the process of securing all computer equipment to the desks, so that it will not slide to the floor and be damaged, and hopefully will remain functional following an earthquake.

Hospital personnel also actively participate in county emergency planning groups and perform drills to prepare for an earthquake. These are primarily paper drills, meaning that people do not physically act out the drill, but they nonetheless address realistic situations that may be encountered. The example posed to us was that of a visible cloud of yellow gas rising from a nearby facility.

3.5.2 Hospital Performance in Loma Prieta Earthquake

The head of engineering was home at the time of the 1989 Loma Prieta earthquake. He immediately went to the hospital and arrived approximately 15 minutes after the earthquake.

The building and its systems and components performed well during the earthquake and sustained no significant damage. The newer steel frame building experienced cracks in plaster and popping out of expansion joints. The buildings were inspected by structural engineers from the California Office of Statewide Health Planning and Development (OSHPD) very shortly after the earthquake. The hospital was not evacuated.

3.5.3 Hospital Components

Like the three foregoing facility types, a hospital may be considered to comprise structural, architectural, and equipment components, as shown in Figure 3-55. Equipment may be further broken out into life-safety and normal operations components. Unlike the three foregoing types, the definition of life-safety systems for hospitals is somewhat problematic. In the event of an earthquake, and depending on the earthquake's size, location, effects, and the damage to the facility, the hospital may either be required for occupancy of existing patients and emergency treatment, or it may be evacuated and relocated to temporary facilities, in this case a park across the street. Considered in the same light, telephone switching at COs serve a life-safety function, as they provide communications for emergency responders. For consistency and simplicity, *life-safety* for hospitals has been defined in its strictest sense: the safe evacuation of building occupants; all other functions are termed *normal operations* herein, even though most serve a life-safety purpose. Note however, that life-safety in this case must include the ability to continue to provide emergency health care to patients at the temporary site -- in this case, a park across the street.

3.5.4 Hospital Life-Safety Systems

Hospital life-safety components are illustrated in Figure 3-56. As with other facility types, basic life-safety equipment includes fire response components, elevator safety systems, stairway emergency lighting, and gas shut-off. However, several additional components are required to provide emergency health care to patients at the temporary site, including portable generators, communications, temporary lights, and pumps.

Fire response. Fire detection, alarm, and suppression components are illustrated in Figure 3-57. The fire protection system is a simplex system, utilizing smoke detectors that set off alarms, as well as heat detectors in critical areas, such as over surgery, which activate flow switches in the lines. The sprinkler system is a charged wet system. There are two main differences between the hospital's fire response system and that of the other facility types: alarm connection to the fire department, and lack of on-site water supply. Activation of either smoke or heat detectors causes automatic notification to the fire department. Once a fire has been detected however, somewhat less redundancy exists for suppression, since no on-site supply of firefighting water is available. Sprinkler lines rely on the public water utility for supply.

Communications. Communications are critical for the hospital, for emergencies and for normal operations. Figure 3-58 shows the various systems that are used, any of which would be used in an emergency such as an earthquake.

Gas shut-off. Unlike other sample facilities discussed here, gas shut-off at the sample hospital relies solely on trained staff to close gas valves manually. The main gas shut-off is a manual valve outside the boiler plant. The hospital is staffed by trained personnel 24 hours a day, who are expected to be able to shut off the gas supply if necessary. Neither loss of building power nor strong ground motion will shut off gas.

3.5.5 Hospital Normal Operation Systems

As shown in Figure 3-59, building normal operation systems include those required to support normal patient care. These include lighting and electrical power supply, HVAC, heating, domestic water, sewage discharge, computer systems, food services, telephone and communications, and elevator services. Although most of these systems are also considered critical to life-safety from the standpoint of functionality, normal building code provisions address only the concern of potential life-safety (i.e., falling) hazards posed by these items. State requirements for hospitals address specific functionality concerns. For example, because the diesel generators are required to be operated 1/2 hour each week, they are fired up and power the entire hospital between 7:30 and 8:00 every Friday morning.

The hospital tends to have backup systems for many of its non-critical operations as well as life-safety systems. For example, should the sewage system fail, there are plastic bags stationed throughout the hospital for waste disposal, with specified locations for temporary waste storage.

The hospital also relies on external sources for backup to some systems. For example, the blood bank three blocks away is assumed to be available in case blood is needed to treat patients after an earthquake. Food services usually maintain a 24-hour supply of food, after which external sources are required.

Electric power. Electric power is the most important utility required by the hospital. Figure 3-60 shows the dependencies for the electric power system. When power is lost from the main grid, a load transfer switch activates the diesel generators within 8 seconds. The hospital contains five diesels: one 1100 kW, two at 600 kW, one at 650 kW, and one at 125 kW. The 20,000 gallon diesel tank contains sufficient fuel for 3 days of power, 2 days if boilers are operating.

Water. Figure 3-61 shows the water system dependencies. This system is considered by the head engineer to be the second most important utility for the hospital. It is necessary to drive the boilers and for cleaning of equipment. The hospital is supplied by two lines from different reservoirs. They also have the ability to tap into a utility line 3 blocks away within 24 hours, using fire hoses to get a critical amount of water. The hospital has no water storage tanks or pumps.



Medical gases. Figure 3-62 shows the system dependencies for the medical gas supply system. These gases are required to be available at any time for surgery, for normal operation or after an earthquake. The systems are supplied by tanks, as well as individual canisters throughout the hospital.

Computers. Figure 3-63 shows the dependencies for another critical system, the computer systems. These systems are critical for monitoring patients in intensive care or coronary care, for surgery, for the fire alarm system, and for X-rays. Besides the normal building power and emergency diesels, there are several UPS units throughout the hospital to keep the computer systems operating at all times.

3.5.6 Conclusions Regarding Sample Hospital

Because of the vital role hospitals play in post-disaster situations, virtually all utilities are critical, and the distinction between life-safety and normal operations is problematic. In any case, the societal cost of service failure is very high for hospitals, and substantial efforts are made to mitigate as much as possible the potential for downtime due to utility failure. The sample hospital is therefore provided with backups for water, power and telecommunications service. No on-site water supply is maintained at the sample facility; off-site service is provided from two independent sources through independent service connections, and the hospital is capable of tapping water from a main three blocks away within 24 hours. On-site generators and fuel supplies can provide power for up to three days without resupply. Telecommunications are especially important, and are therefore provided by six independent systems.

It should be noted that an earthquake is one of many threats for which the hospital staff must be prepared. Another example given to us is bomb threats, as a bomb has in the past been found and defused on the premises. This hospital has taken a proactive approach to preparing for an earthquake, with contingency planning, backup systems, and investment in modifications to prevent or mitigate losses due to an earthquake.

KEY		
SYMBOL	NAME	MEANING
	AND GATE	Component above gate functions if all components below function
	OR GATE	Component above gate functions if any component below functions

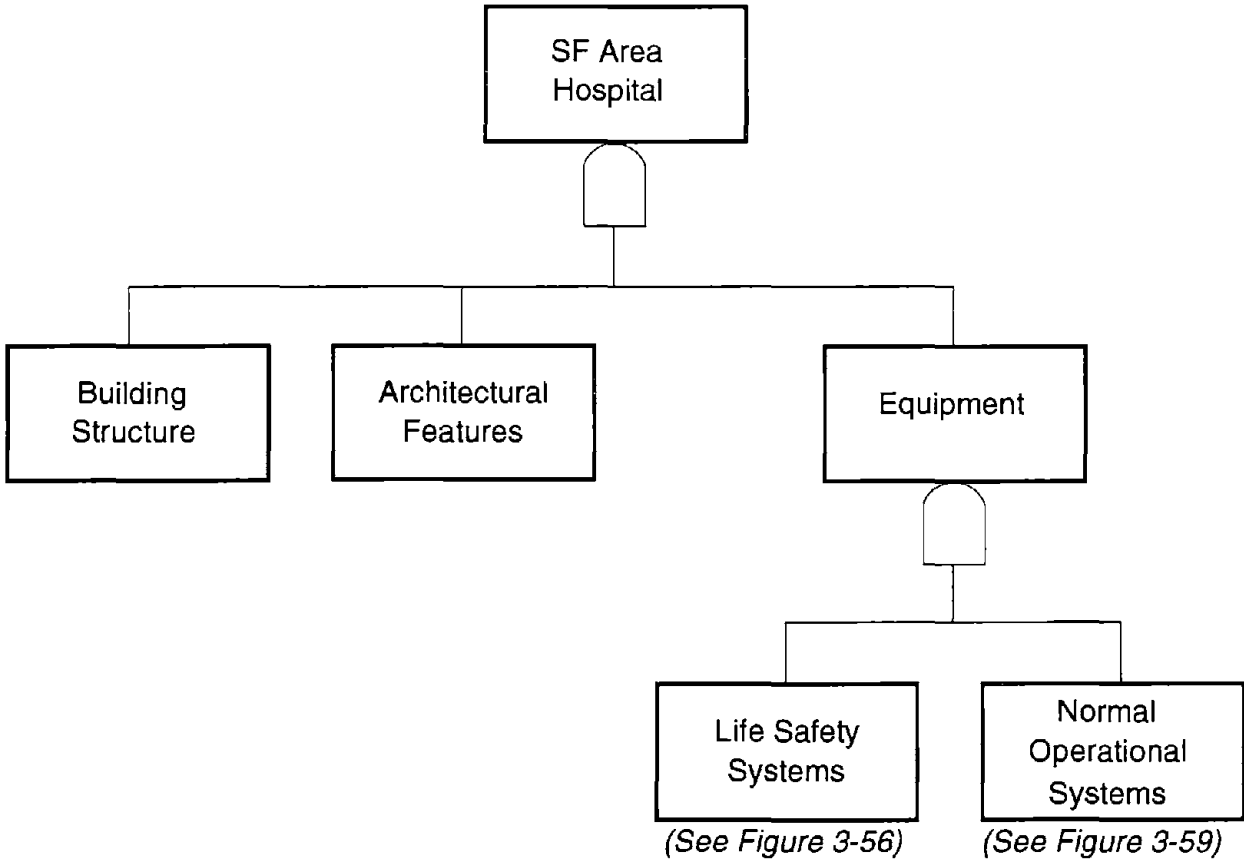



Figure 3-55: SF area hospital use dependencies

KEY		
SYMBOL	NAME	MEANING
	AND GATE	Component above gate functions if all components below function
	OR GATE	Component above gate functions if any component below functions

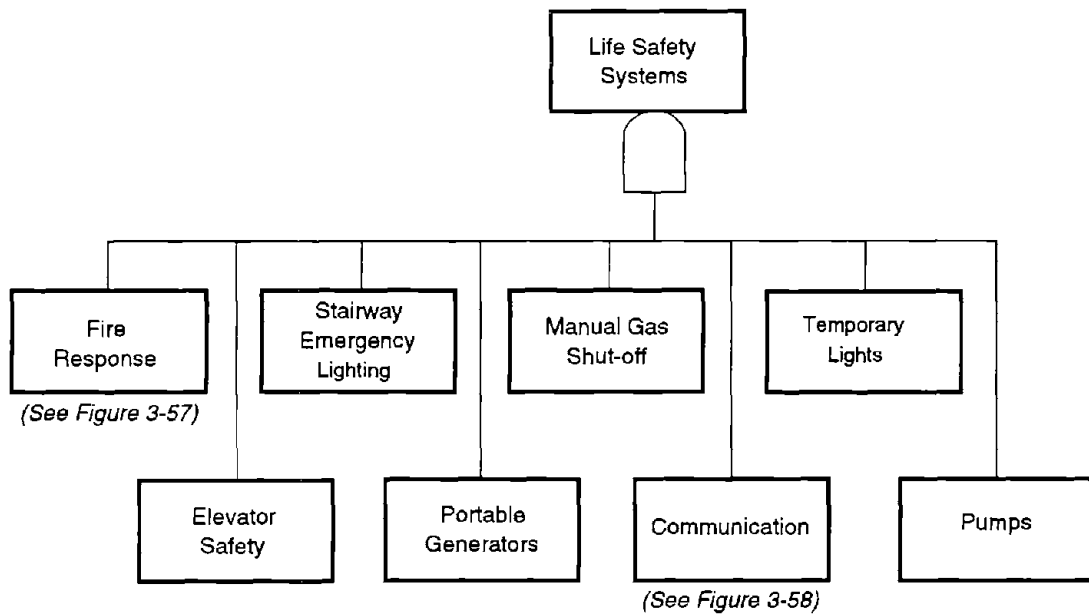

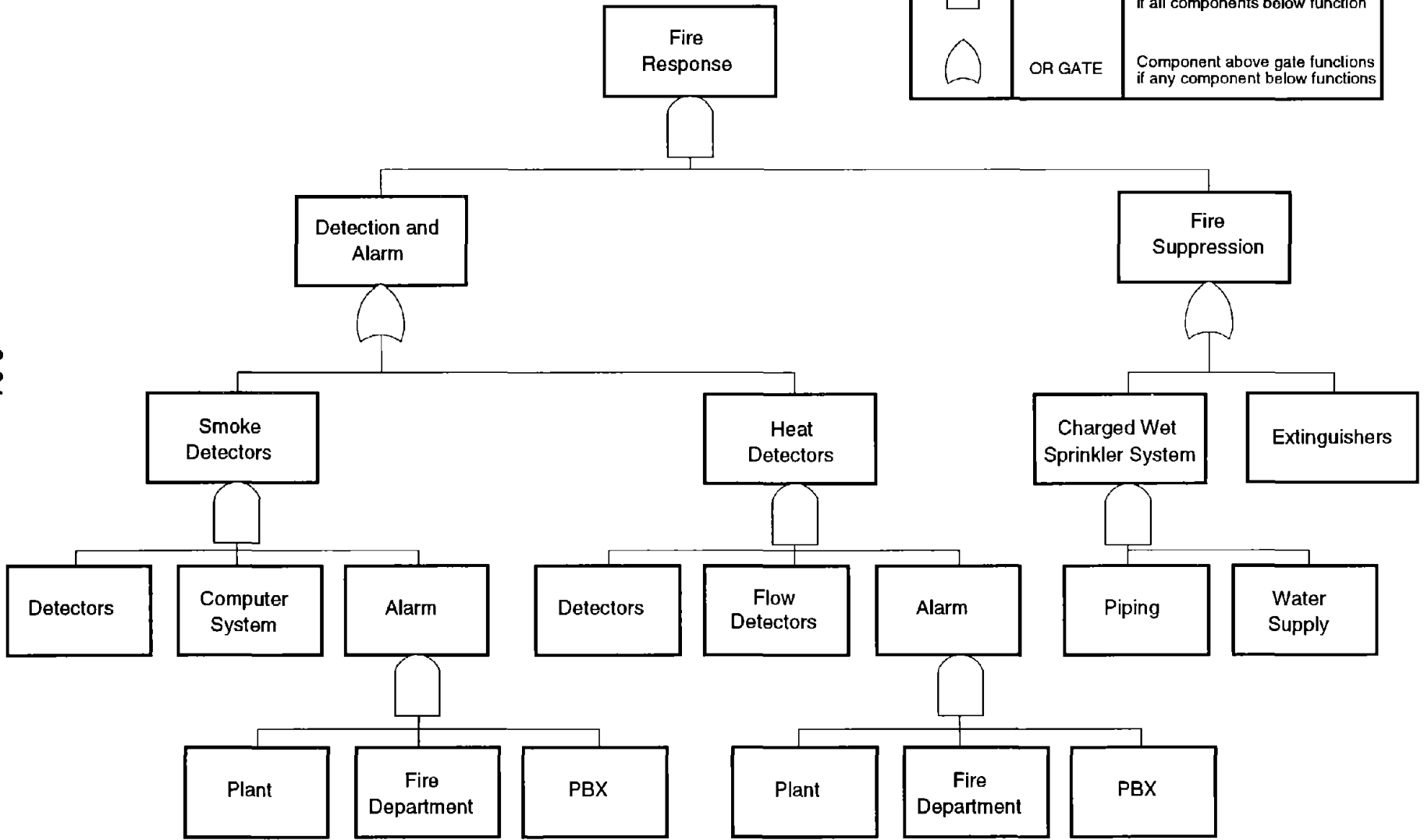

Figure 3-56: SF area hospital life-safety systems

KEY		
SYMBOL	NAME	MEANING
	AND GATE	Component above gate functions if all components below function
	OR GATE	Component above gate functions if any component below functions



3-84

Figure 3-57: SF area hospital - fire response system

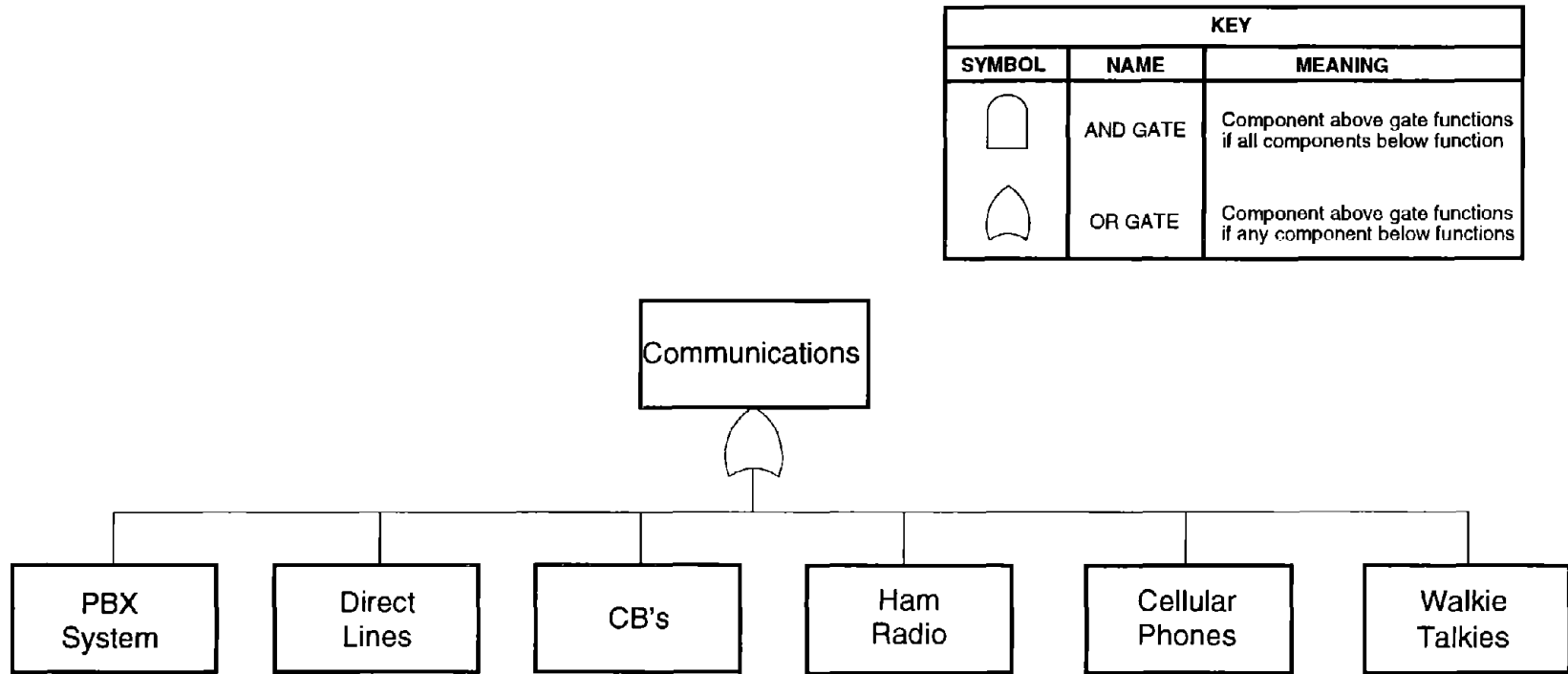

Figure 3-58: SF area hospital - communication system

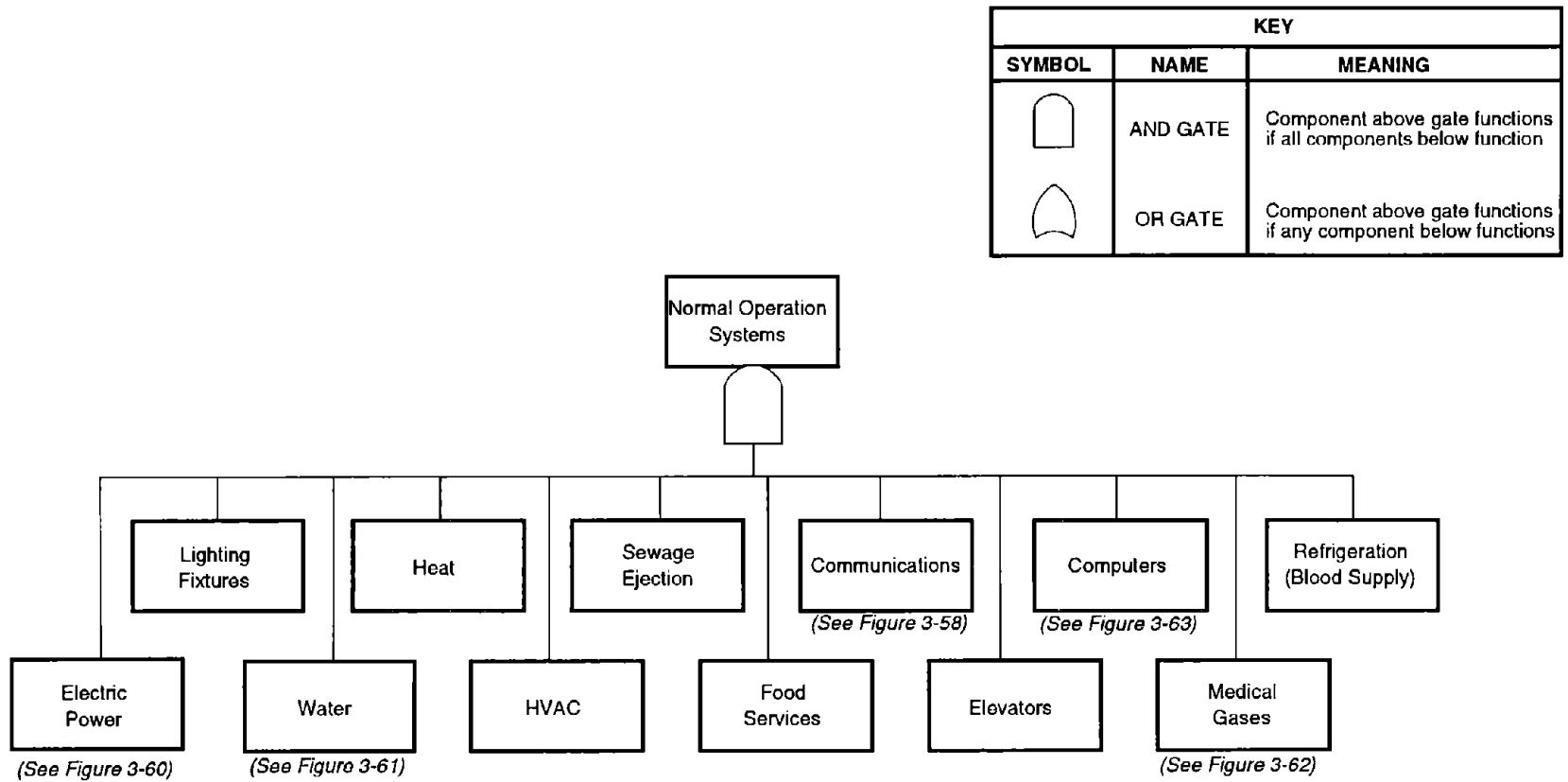

Figure 3-59: SF area hospital normal operation systems

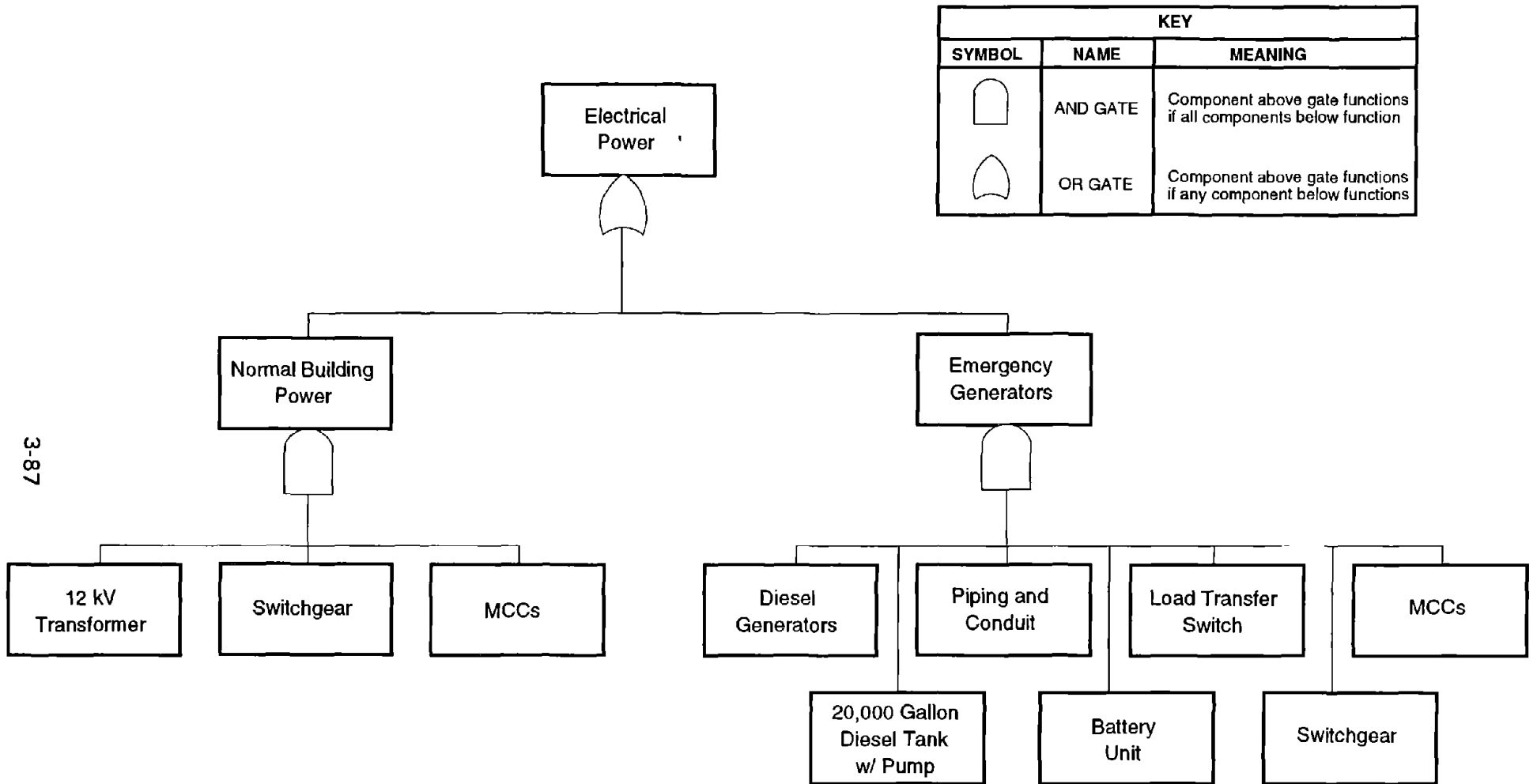



Figure 3-60: SF area hospital electrical systems

KEY		
SYMBOL	NAME	MEANING
	AND GATE	Component above gate functions if all components below function
	OR GATE	Component above gate functions if any component below functions

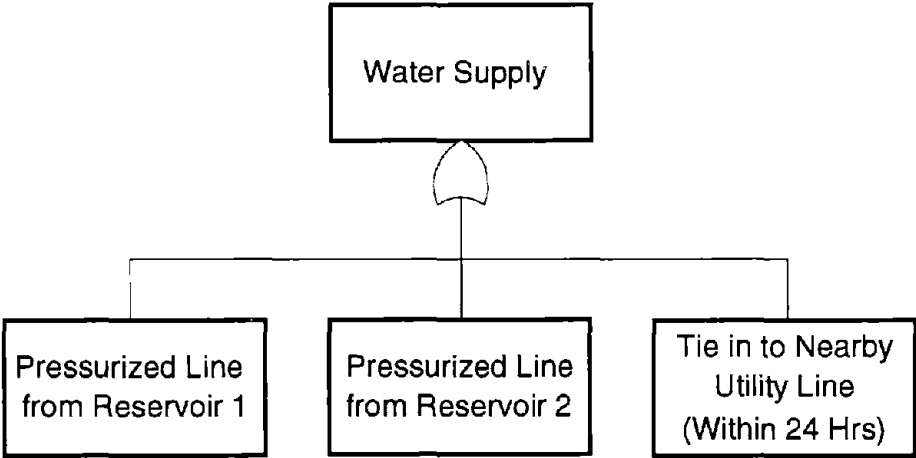

Figure 3-61: SF area hospital - water supply system

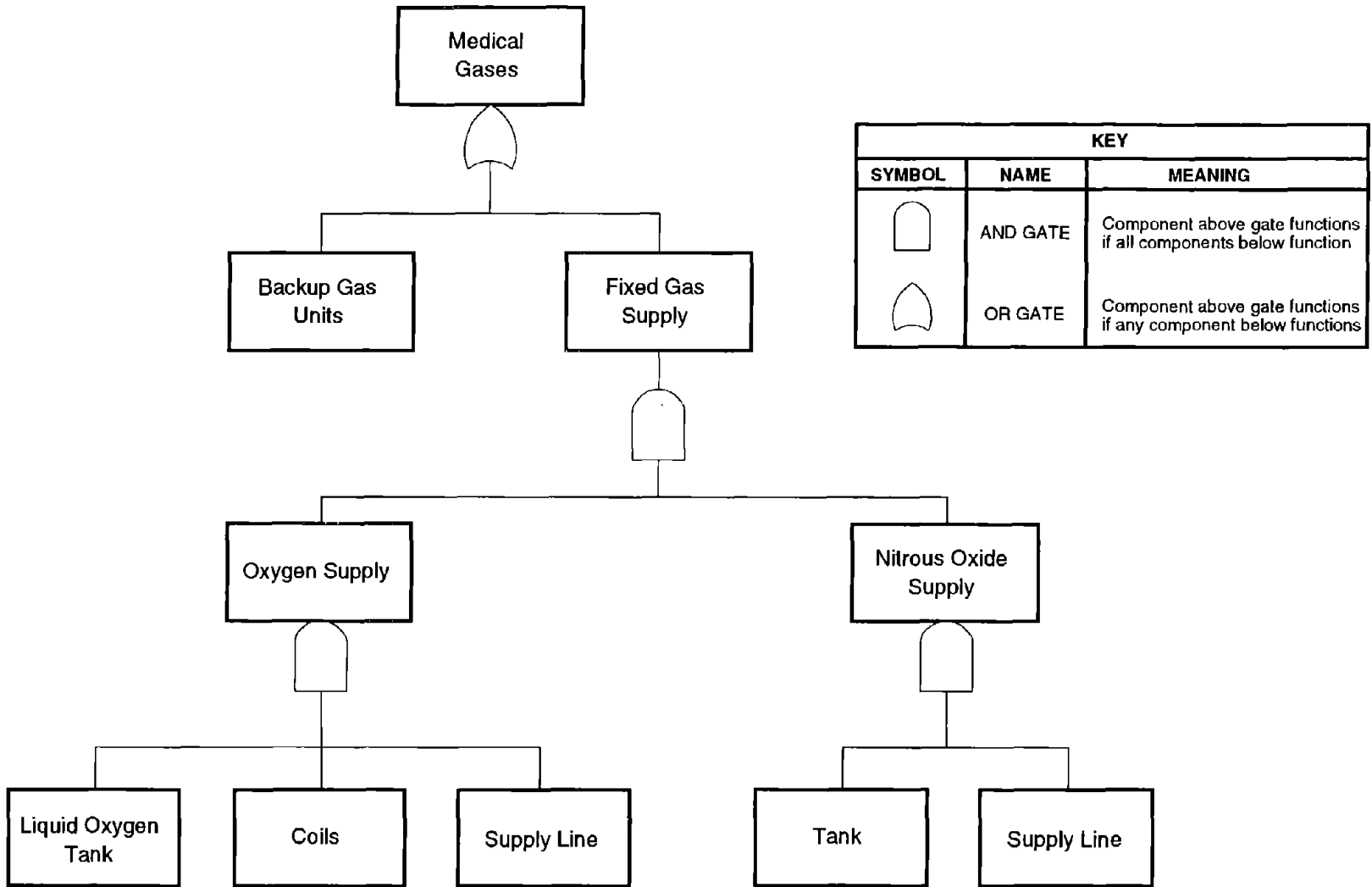



Figure 3-62: SF area hospital - medical gases system

KEY		
SYMBOL	NAME	MEANING
	AND GATE	Component above gate functions if all components below function
	OR GATE	Component above gate functions if any component below functions

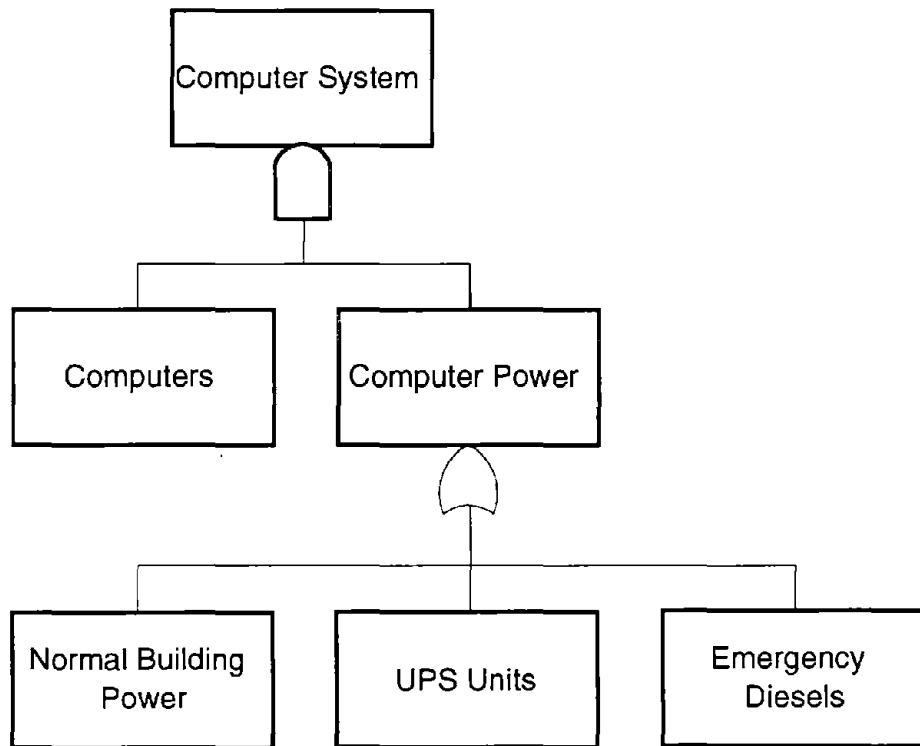

Figure 3-63: SF area hospital - computer system

SECTION 4

PERFORMANCE OF KEY SYSTEMS IN PAST EARTHQUAKES

This section examines the seismic performance of several systems that are important for life-safety or for normal operation in many types of facilities: uninterruptible power supply (UPS), standby and emergency power generation (focussing on engine-generators), fire detection and alarm, fire suppression, air conditioning, and power distribution. Typical components of each system are described and seismic vulnerabilities which have been observed in past earthquakes are discussed for these systems and their components. Specific instances of damage are described which illustrate these vulnerabilities.

Some of the key vulnerabilities can be summarized as follows: UPS: Battery damage due to identifiable attributes. Power Generation: Control system malfunction due to effects of relay chatter. Fire detection and alarm: Inadvertant alarm actuation due to limited identifiable sources. Fire suppression: Breaking of sprinkler heads and piping due to various specific causes. Air conditioning: Damage to vibration isolator mounted equipment. Power distribution: Damage to unanchored or inadequately anchored electrical cabinets.

4.1 Background

Considerable research has been recently conducted for the investigation of earthquakes which have occurred throughout the world over the last two decades. One major focus of these investigations has been the performance of equipment in strong motion earthquakes. The primary driving force behind that research has been the need in the nuclear industry for methods of seismic qualification of equipment in nuclear plants that were built before specific seismic requirements existed. Because most of the electrical and mechanical equipment in nuclear plants is also common to other industrial facilities, the types of facilities investigated for seismic performance have been diverse and extensive, including:

- Power plants
- Electric distribution stations
- Petrochemical facilities
- Water treatment and pumping stations
- Manufacturing facilities
- Large industrial facilities
- Commercial facilities
- Hospitals
- Other facilities where access was made available

Information on each facility has been collected from several sources, including the following:

- **Interviews with the facility management and operating personnel.** These often provide the most reliable and detailed information on the effects of the earthquake at each facility.
- **Facility damage surveys.** Where possible, facilities were surveyed immediately following the earthquake, so that damage could be observed prior to repairs. Additional surveys were taken at many sites in order to collect detailed data on undamaged installations.
- **Facility operating logs.** The operating logs list problems in system operation associated with the earthquake, and usually tabulate earthquake damage to the facility. Operating logs also provide the amount of time the facility may have been out of operation following the earthquake, and any problems encountered in restarting and running the facility.
- **Facility inspection reports.** Facility management often produces a detailed inspection report summarizing the effects of the earthquake. The report also normally describes causes of any system malfunctions.
- **Additional data collection.** These include seismic and other design criteria, data books, and design drawings of structures, mechanical and electrical systems.

The research on facility performance during earthquakes focuses on collecting all of the information that is available on damage or adverse effects of any kind caused by the earthquake. Of secondary importance is detailed information on systems and equipment that were undamaged in the earthquake. Because of the time involved in gathering these data and the cooperation required from each facility, often incorporating multiple visits to the site, the inventories and details on undamaged equipment by nature tend to vary in completeness from facility to facility.

The ongoing research to date includes hundreds of sites in over 30 earthquakes. Appendix A identifies sites from more than 20 earthquakes, where significant amounts of detailed equipment data have been collected and collated. Although it is virtually impossible to know of all damage from an earthquake, or all of the success data, the vast amount of data leads to several important conclusions regarding seismic performance of equipment, including the following:

- Common sources of seismic damage or adverse effects to facilities and equipment.
- Thresholds of seismic motion corresponding to various types of seismic damage.
- Types of damage that are not sensitive to acceleration levels.
- Standards in equipment construction and installation which ensure the ability to withstand anticipated seismic loads.

4.2 Systems Reviewed

Sections 4.3 through 4.8 of the report document the review of the performance of several key building systems in strong motion earthquakes. Systems were chosen that have been identified as critical for life safety or for normal operation of the facilities reviewed in Section 3. The systems covered are:

- Uninterruptible Power Supply (UPS)
- Standby and Emergency Power Generation (focussing on the generators)
- Fire Detection and Alarm
- Fire Suppression
- Air Conditioning
- Power Distribution

Each of the systems is defined in terms of its function and components. Vulnerabilities are discussed which have been identified in past earthquakes. For several of the systems, databases have been compiled which contain detailed data on systems and components which have experienced strong motion earthquakes, both damaged and undamaged. These databases are contained in Appendices B through E.

4.3 Uninterruptible Power Supply (UPS)

The electric power supply to any data processing equipment must be continuous, as interruption of power for even one AC cycle can cause data loss. Furthermore, voltage must be carefully controlled, as voltage spikes can damage sensitive equipment. Because of the common use of computers to control critical system functions, many facilities require a highly reliable source of backup power and equipment that can transfer the source of power smoothly from commercial power to on-site sources. These on-site sources are the uninterruptible power supply (UPS) and the on-site backup generators. The UPS system must typically be capable of supplying electric power to critical equipment only briefly, but long enough to power up the generators, which then must be able to supply power as long as fuel is available, possibly for several days until off-site electric power is restored.

4.3.1 Description of UPS Systems

UPS systems consist of four major components: the battery charger/rectifier, the batteries, the static inverter, and the static transfer switch. These components perform the following functions:

- Eliminate power line noise/voltage transients,
- Provide voltage regulation,
- Protect against frequency variations and provide frequency conversion if required,
- Provide an uninterruptible source of power during power outages.

As shown in Figure 4-1, incoming AC power is converted to DC by the battery charger/rectifier, then reconverted back to AC by the static inverter. This conversion/reconversion ensures the output power will be free from transients and voltage fluctuations. Upon loss of offsite AC power, the battery supplies DC power to the inverter for continued operation. The batteries will continue to supply AC power through the inverter until the bypass source (emergency generators) come on-line or commercial off-site AC power is restored.

- **Battery chargers** use **rectifiers** as the primary component to produce direct current by means of an alternating voltage. Most modern battery chargers are built with solid-state rectifiers consisting of semiconductors of selenium, germanium, or silicon diodes. Other primary components of battery chargers include solid-state diodes, transformer coils, capacitors, electronic filters, and resistors. The internal components are normally bolted either to the rear panel or

walls of the cabinet, or to interior panels or steel frames mounted within the cabinet. The primary components are usually protected from electrical faults by molded case circuit breakers and fuses.

- **Batteries** are a group of electro-chemical cells interconnected to supply a specified voltage of DC power. The electrode elements are the key components of the battery system. Each plate consists of a rigid lead alloy grid that provides physical support for relatively porous, active materials. Reaction of the electrolyte and active materials creates a current flow when a load is imposed on the cell.

Batteries are typically mounted on a rack specifically constructed for this purpose. These battery racks are normally frames of steel channels, angles, and struts that support the batteries above the floor. Racks can be multi-rowed, multi-tiered, or multi-stepped (see Figure 4-2).

- **Static inverters** perform the opposite function of battery chargers/rectifiers; they change DC power into AC. The primary components of an inverter are similar to those of a battery charger except that inverters use a solid-state thyristor (or silicon controlled rectifier) instead of a diode, and have a commutation control circuit which activates the thyristor in converting DC voltage into positive and negative half-cycles.
- **Static Transfer Switches** are essential tripping devices which trip upon detecting an electrical fault in their control circuitry. Static transfer switches are often found as components of a switchgear or a motor control center (MCC), and may be found in a stand alone cabinet.

Floor mounted battery chargers and static inverters are typically anchored through base channels. Holes are provided in the bottom flange of the base channel for embedded bolts or expansion anchors into the concrete floor. Alternately, the cabinet may be welded to embedded steel, either by puddle welds through the bolt holes or tack welds along the periphery of the base channel.

Wall- or rack-mounted units are normally anchored by bolts through the back panel of the cabinet. If the unit is attached directly to a concrete wall, expansion anchors are normally used. Rack-mounted units are typically anchored by threaded connections such as the manufacturers standard spring-supported nut into a Unistrut member.

Battery racks are typically secured to the floor with concrete expansion anchors. The bolt pattern and sizes are usually specified by the battery manufacturer, depending on the

application and the facility location. Typical anchorage of battery racks utilizes two 1/2-inch expansion anchors per battery rack support.

4.3.2 Seismic Performance of UPS Systems

Batteries have clearly been demonstrated to be the most vulnerable component of the UPS system. Several types of damage have caused failure of UPS systems, and several other instances of damage to batteries have occurred that have not affected the functionality of the system, but have been documented. Note that static transfer switches are not discussed explicitly, as they are often a component of MCCs or switchgear. The vulnerabilities of MCCs and switchgear are presented as part of the power distribution system, in Section 4.8 of the report.

The observed vulnerabilities of the UPS system are as follows:

Battery Chargers / Rectifiers	Tripping due to actuation of circuit breaker in associated distribution panel (impact of panel with wall)
Inverters	Blown fuses Power surge burned out capacitors after cabinet broke anchorage and slid 12"
Batteries	Overturning due to lack of wraparound bracing Overturning due to structural failure of rack Overturning due to inadequate anchorage of rack Breaking of electrical contact due to impact of adjacent batteries (lack of spacers) Failure due to collapse of masonry wall onto batteries (seismic interaction)

4.3.3 Description of Instances of Damage

This section describes several specific instances of damage leading to the observations on vulnerabilities presented above. Also presented are several instances of "seismic effects", where local damage to components was documented that did not affect the functionality of the UPS for these facilities.

Battery Chargers / Rectifiers

- During the 1987 Whittier Earthquake, at a substation which experienced an estimated PGA of 0.20g, a battery charger was tripped by the actuation of a molded case, branch circuit breaker in the associated distribution panel. The breaker actuation appears to be the result of impact of the panel with the wall (Figure 4-3).

Inverters

- At a data processing center, which experienced an estimated PGA in excess of 0.30g during the 1987 Whittier Earthquake, the inverter in one UPS unit sustained five blown fuses following the earthquake, causing a loss of emergency power to the facility. The system requires three units to maintain full power. At the time of the earthquake, one of the four UPS units was down for maintenance; the remaining three units were operating to supply AC power to the facility.

The facility engineer and the manufacturer suggested three possible explanations for the damage. When off-site power is lost, emergency DC power is supplied by batteries. If one of the cells is not functional, certain fuses within the UPS will blow in order to protect the more valuable subcomponents. Another potential explanation is that power surges occurred prior to the loss of off-site power, which could blow fuses in the unit. The third explanation given is that the UPS unit contained faulty fuses or other subcomponents.

- At a computer facility, which experienced an estimated PGA of 0.40g during the 1987 Whittier Earthquake, two UPS units sheared their anchorage and slid about 12 inches during the earthquake. The cabinets were observed to have poor anchorage-concrete pad edge distance. When power was restored, a momentary surge in the incoming current to the UPS burned out several capacitors in the inverters. The exact nature of the disturbance in the power supply was not determined.
- At a data processing facility, the inverter of an Emerson "Acu-Power" UPS pulled or sheared all of its anchor bolts. The unit was anchored with 3/8-inch shell type expansion anchors. The UPS was not damaged, in spite of a PGA in excess of 0.40g measured nearby.

Batteries

- At a pumping facility affected by the 1983 Coalinga Earthquake, a small battery rack had no wraparound bracing and the batteries overturned. The plant UPS system was lost as a result of this damage.
- Similar damage occurred at a substation affected by the 1986 San Salvador Earthquake where five unrestrained batteries fell off their racks and were damaged. In addition, spacers were not provided between the cells and during the earthquake, other batteries shifted, distorting but not damaging busbars.
- A battery rack was damaged at a sanatorium during the 1971 San Fernando Earthquake. The battery rack included restraining bracing; however, the bracing was attached to the adjacent wall through a weak anchorage. Damage to this anchorage caused the battery rack to overturn.
- At a telephone switching station, affected by the 1990 Central Luzon, Philippines Earthquake, a two-tier battery rack pulled its expansion anchors and overturned. The rack was reportedly anchored with small, lead sleeve expansion bolts.
- At another telephone switching station, affected by the 1990 Central Luzon, Philippines Earthquake, 11 out of 24 batteries on a two-tier rack were reported to have internal damage. The rack was a two-tier Unistrut assembly with wraparound bracing, but with no foam spacers between the batteries. Apparently, impact of the batteries against the rack or the reaction of lateral loads through the busbar connections dislodged plates within the battery jars. The plates dislodged from their connections with the battery terminals, breaking electrical contact.
- Five cells on a substation two-tier battery rack would not operate following the 1987 New Zealand Earthquake. The cells were Chloride, flat plate batteries and weighed about 40 pounds each (Figure 4-4). Gaps between the individual cells allowed the cells to rock and pound during the earthquake. Loss of voltage was caused by the dislodging of the positive plates within the battery jars. It should be noted that the manufacturer attributed the damage to deterioration with age; the batteries were eight years old at the time of the earthquake.

- At a hydroelectric plant affected by the 1985 Chile Earthquake, there were two instances of differential rocking between batteries causing a flexible bus strap to buckle on the upper tier of a two-tier rack. The operability of the batteries was not impaired. The rack contained small spacers between batteries, but the spacers slipped out during the earthquake, allowing the batteries to impact each other.
- At a privately owned hydroelectric plant affected by the 1986 Chalfant Valley Earthquake, unrestrained lead calcium cells shifted up to 1/2 inch in their rack (Figure 4-5). The battery rack had no spacers between the cells and no wraparound bracing to prevent movement of the battery cells. The owner/operator reported that the batteries were undamaged in spite of their movement.
- Other instances of distorted busbars and battery interaction caused by lack of or insufficient spacers occurred during the Chile and North Palm Springs earthquakes. In all cases, the batteries remained functional following the earthquake.
- An unreinforced clay tile masonry wall collapsed on a rack of batteries during the 1985 Mexico Earthquake. The batteries were part of the UPS at a steel mill's administrative building.
- In addition to the above mentioned instances of damage, at an energy facility, affected by the 1987 Whittier Earthquake, several battery cells in an inverter were found to be defective when the UPS failed to provide emergency power to the control room following the earthquake. Plant management believed that the cells had gone bad before the earthquake.

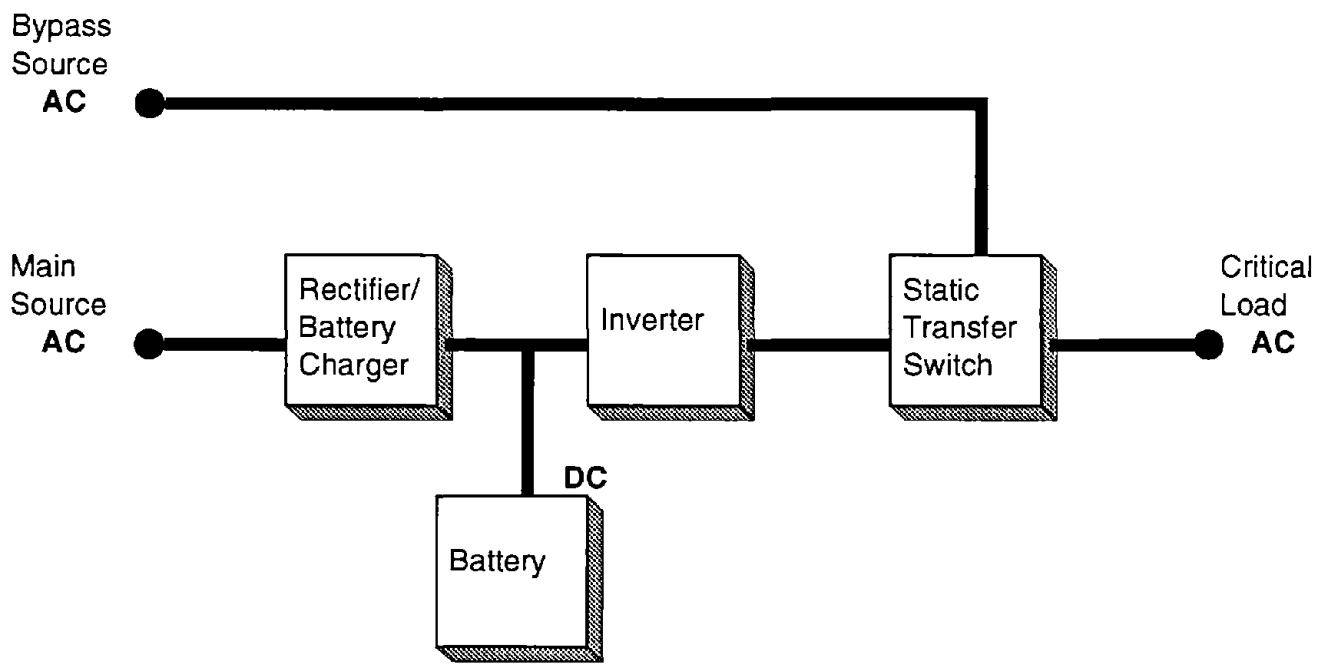

Figure 4-1: The uninterruptible power system. (Courtesy of Emerson Electric Company).

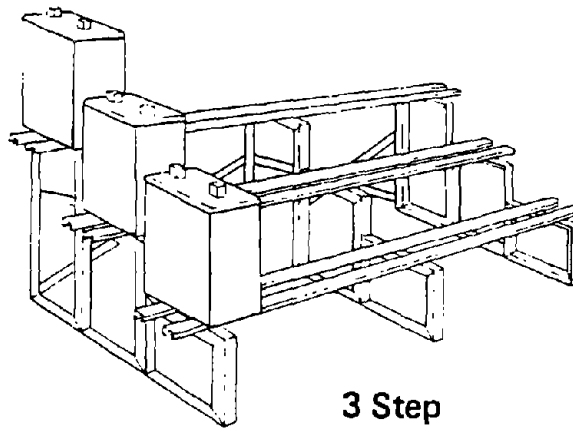
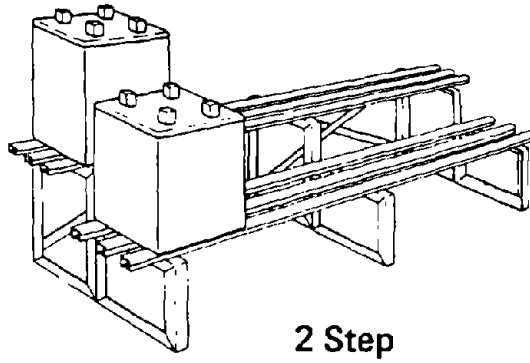
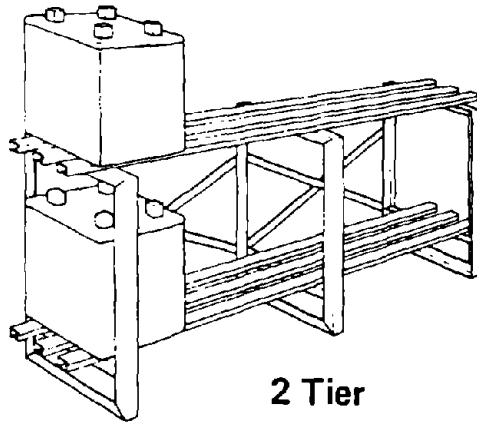

Figure 4-2: Stationary battery rack configurations.

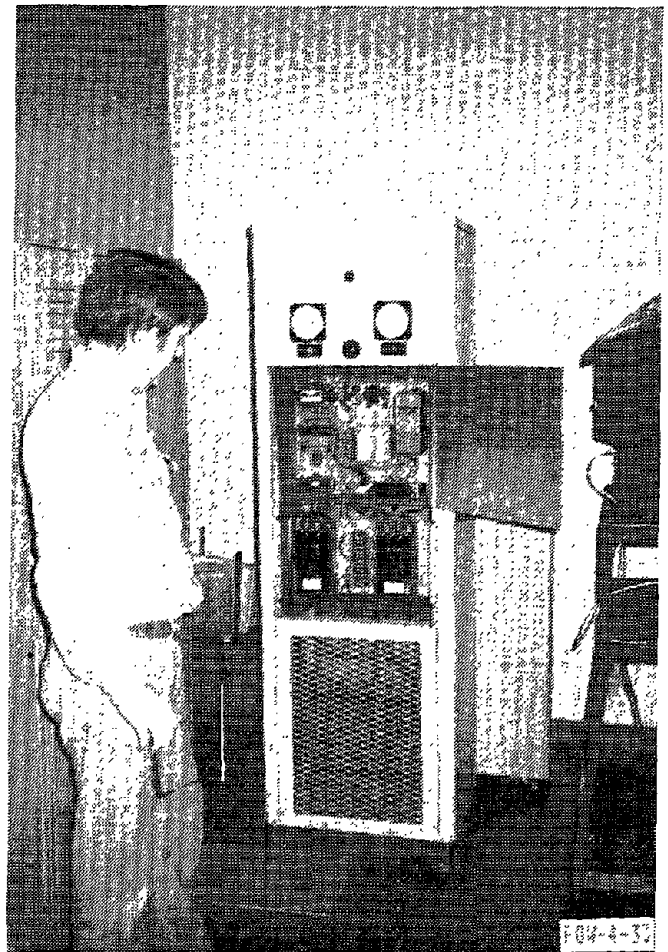
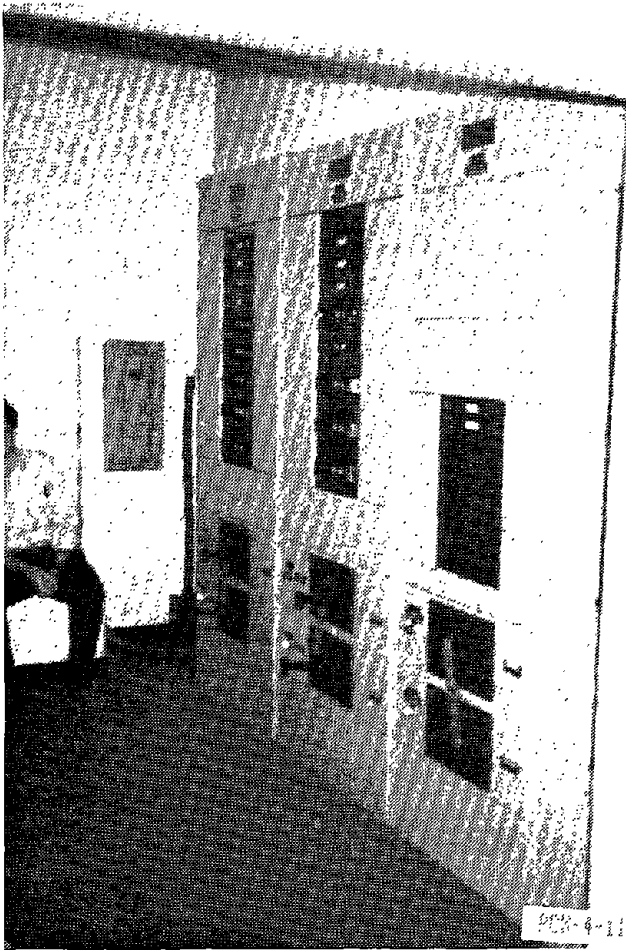

Figure 4-3: At a substation affected by the 1987 Whittier Earthquake, the battery charger (lower photograph) was tripped by the actuation of a molded case circuit breaker in the associated distribution panel (upper photograph).

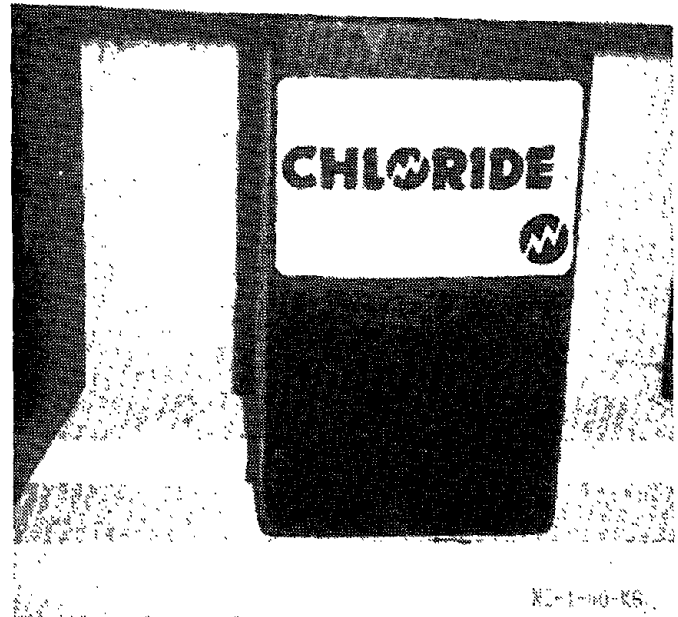
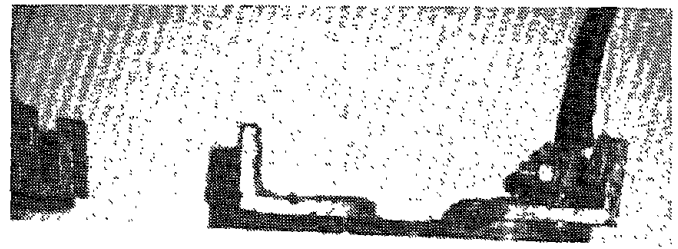
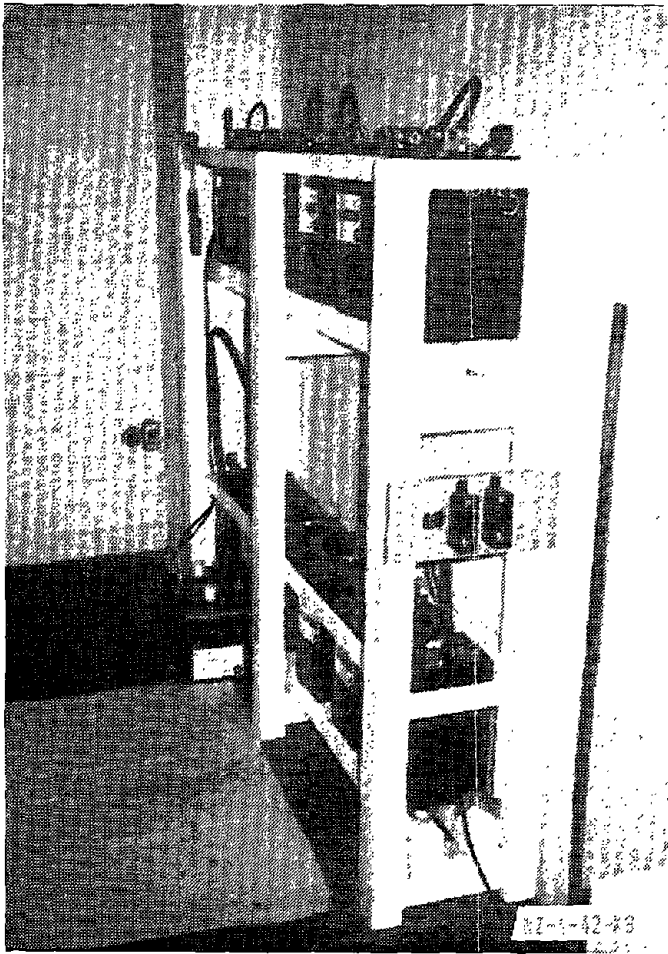

Figure 4-4: Several of the lead selenium flat plate batteries in the upper shelf of the wooden two-tier rack suffered dislodged anode plates and loss of supply voltage due to banging of batteries during the 1987 New Zealand Earthquake.

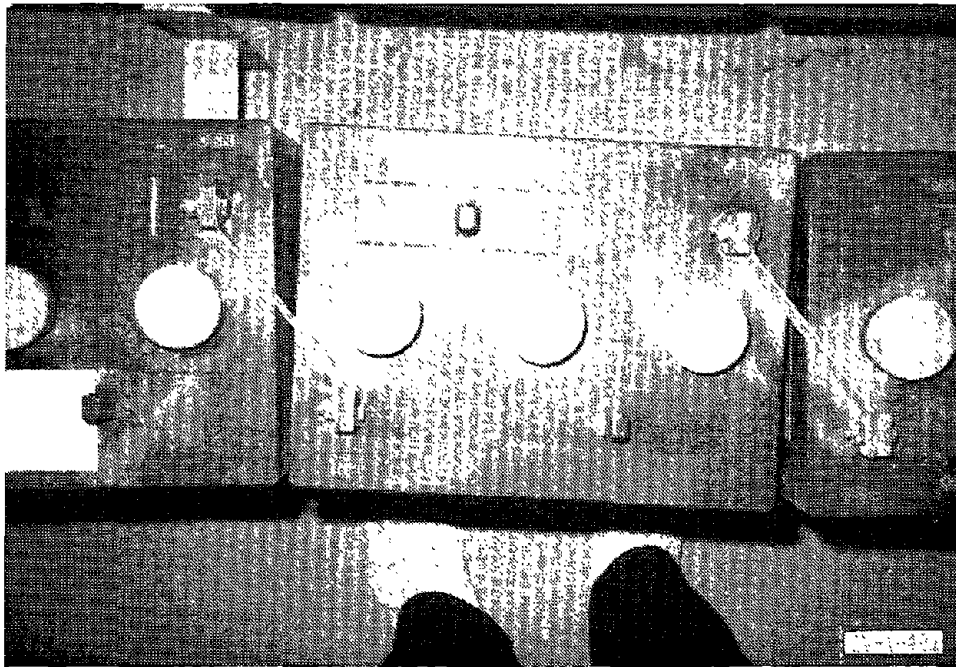

Figure 4-5: Batteries from a hydroelectric plant, affected by the 1986 Chalfant Valley Earthquake shifted up to 1/2 inch in their rack but continued to function properly.

4.4 Standby and Emergency Power Generation

Standby and emergency power generation systems are required to provide bulk AC power for life-safety systems and for normal operation of facilities after an earthquake. Upon failure or outage of the normal source, the engine generator provides reliable electric power, of acceptable quality and quantity, within a specified time for the operation of equipment. This section discusses seismic performance of those systems, focussing on the engine-generators.

4.4.1 Description of Power Generation System

Standby and emergency power engine-generators rely on three major equipment items: the generator, the reciprocating-piston engine, and the local control and instrumentation panel. A description of each of these component follows.

Generators are typically the brushless rotating-field type with either a rotating rectifier exciter, or a solid-state exciter and voltage regulator. Generator capacity is measured in kilovolt-amperes (kVA) or kilowatts (kW).

Reciprocating-piston engines are the most common driver for standby and emergency power generators. Piston engines are normally diesel-fueled, although engines that operate on alternate fuels, such as natural gas or oil, are common in facilities which process these fuels. Gas turbines are sometimes used as drivers and are fueled by diesel oil, gasoline or kerosene.

Engine-generators normally include the piston engine and generator in a direct shaft connection, bolted to a common steel skid. The engine-generator system includes peripheral components for cooling, heating, starting and monitoring operation, as well as supplying fuel, lubrication, and air. The diesel engine typically includes the following sub-components:

- **Fuel supply system.** The fuel supply system includes the strainers, filters, piping, and fuel pump.
- **Lubrication system.** The diesel engine lubrication system includes piping, filters, and the oil pump.
- **Cooling system.** This system includes a radiator and fan unit or a heat exchanger mounted to the engine block or supporting skid.
- **Heater.** Electric jacket-water heaters are commonly installed to maintain the water temperature in order to facilitate starting.

- **Air intake system.** This system includes the ducting, fans, and filters necessary to make clean air available to the engine.
- **Exhaust system.** The exhaust system includes a muffler and exhaust piping or ducting to direct away the exhaust. There is generally an expansion joint in the ducting to absorb operating vibrations and thermal expansion.
- **Starting system.** Medium and large engines generally rely on compressed air for starting. Air in the receiver tank powers air motors driving the crankshaft through a gear linkage, or the air can go directly to the cylinders in large diesels. Battery-driven electric motors are sometimes used on smaller capacity systems.

Local control and instrument panel. The local engine control panel contains gauges and controls designed to monitor conditions such as low oil pressure, engine overheat, engine overspeed, and generator overload.

Other freestanding **peripheral equipment** that supports the operation of the engine-generator would typically include a local fuel (day) tank with its supply pump, an air compressor, and plenum tanks for the engine pneumatic starting system, switchgear cabinets (which can include an automatic transfer switch), and a control panel for the generator.

The components of engine-generators are typically bolted either to the engine block or to the supporting skid. The skid also supports peripheral attachments such as conduit, piping, and a local control and instrumentation panel. The skid is normally anchored to the supporting concrete foundation with cast-in-place bolts through bolt holes in the skid base channel.

Engine-generator units are sometimes supported on isolation mounts. These mounts are used to provide vibration isolation between the generator base and the supporting building structure (Figure 4-6).

4.4.2 Seismic Performance of Emergency Power Generation Systems

The most common vulnerability to these systems is associated with malfunction of control systems, causing engine-generators to stop or fail to start. Another area of vulnerability that has been identified is associated with failure of vibration isolators. These isolators are often not designed for seismic loads and can result in large movement of the generator, damaging attached components. The third area of vulnerability is associated with failures due to differential settlement or motion between separate structural systems, such as an engine and generator on separate slabs. The following list summarizes and categorizes the observed vulnerabilities:

Control System Malfunction	<p>Unit malfunction due to relay damage (e.g., circuit breaker trip)</p> <p>Unit malfunction due to relay damage from temporary seismic induced transients (e.g. liquid sloshing, dynamic liquid pressure, or vibration)</p> <p>Relay damage or other control system damage due to overcurrent surges</p> <p>Inability to stabilize generator due to misadjustment of voltage regulator</p> <p>Spurious actuation of protective relays</p>
Vibration Isolators	<p>Breaking of piping connections due to shifting of diesel after failure of vibration isolator</p> <p>Damage to exhaust systems due to movement of diesel after failure of vibration isolator</p>
Differential Settlement / Motion	<p>Misalignment of shaft and bearing damage due to soil settlement (engine and generator on separate skids)</p> <p>Breaking of attached piping due to settlement and spreading</p>

4.4.3 Description of Instances of Damage

This section presents several specific instances of damage related to the vulnerabilities listed above. Also presented are instances of "seismic effects", where local damage to components was documented but did not affect the power generation capability for these facilities. The damage is organized according to the general category of vulnerabilities presented above, with miscellaneous "seismic effects" described under the heading "Other Seismic Effects".

Control Systems

- One 30-kW Onan diesel generator mounted on the roof of a three-story building failed to start because of a damaged relay in its local control panel (Figure 4-6). The panel was mounted to a wall adjacent to the diesel. The facility maintenance personnel reported that an electrical contractor had discovered the faulty relay following the earthquake and replaced it. The cause of the relay failure, whether

due to an electrical fault or vibration damage, was never determined. It was speculated that the faulty relay was a pre-existing condition that was discovered when the diesel attempted to start during the earthquake; however, the diesel generators at the site are tested periodically, and this particular unit was operable when tested a few weeks prior to the earthquake.

- A 200-kW General Motors diesel engine at a large power facility did not respond to a manual start following the earthquake. Inspection by a utility technician the day following the earthquake revealed a broken wire at the terminal connection serving the solenoid valve that controls oil flow to the Woodward governor (Figure 4-7). The technician described the wire connection as having "burned". This may have been a result of an overcurrent surge or a disconnect due to vibration.
- At a large power facility, five out of a total of eight diesel generators ranging between 1750- and 2500-kW shut down due to various automatic trips such as excessive vibration.
- One of three 2500-kW General Motors Allison gas turbine generators at a telephone switching station would not start following the earthquake. The unit could not stabilize at operating speed due to a voltage regulator in the generator control panel that was out of adjustment. Once the regulator was readjusted, the unit started and operated without problems.
- The 5000-kVA emergency diesel generator at an oil refinery started during the earthquake, but tripped off-line due to protective relay actuation. The relay was reset and the diesel operated properly.
- One of the three 40000-kW gas turbine generators at a power plant was operating at the time of the earthquake. The GE "Speedtronic" computer control system shut the operating unit down during the earthquake, most likely upon detection of excessive vibration, according to the operators. Blackout of the local 34.5-kilovolt (kV) distribution system made restart of the turbine and diesel generators a low priority immediately following the earthquake. In the meantime, the gas turbines were checked for signs of damage including possible shaft misalignment. Finding no apparent damage, a restart attempt was made the day after the earthquake in the two units that had not been in operation. It was discovered that the Speedtronic control had

tripped various alarms within its control logic that required resetting prior to allowing gas turbine restart.

Vibration Isolators and Other Anchorage Related Damage

- At a commercial facility, one of the two 75-kW emergency diesel generators mounted on the roof of the three-story building was supported on spring vibration isolators. The vibration isolators buckled during the earthquake as the unit shifted to one side (Figure 4-8). Shifting of the diesel broke a flexible coupling on the exhaust discharge pipe attached to the muffler.
- One of the two 650-kW gas turbine generators at a telephone switching facility pulled its anchor bolts and slid about two inches. The unit was anchored with two 1/2-inch expansion anchors at each of the four corners of the gas turbine enclosure. The unit remained operable in spite of its anchorage damage.
- Four 660-kW Waukesha diesel generators at a data processing center are supported on vibration isolators equipped with seismic bumpers mounted next to the base channel of the skid. Impact of the diesel skid against the bumpers during the earthquake was sufficient to loosen several of the 1/2-inch expansion anchors securing the bumpers to the floor.
- Three 8000-kW Pielstick diesel engines with Nishibu generators at a power plant were found to operate with excessive vibration when tested following the earthquake. The vibration was corrected by tightening anchor bolts to the concrete pedestal.

Differential Displacement / Settlement

- Several of the General Motors and Nordberg diesel generators, ranging in size from 1750- to 2500-kW, shut down at a power plant as fuel and water lines routed along the concrete foundation mats from nearby day tanks suffered breaks in branch lines due to differential displacement imposed by settlement and soil spreading beneath the concrete mats (Figure 4-9). In one case, differential settlement between the diesel foundation and the plant base mat (which supports the front of the generator drive shaft) caused severe shaft misalignment requiring the unit to be extensively overhauled following the earthquake (Figure 4-10).

- An outboard pillow-block bearing on a 3 megawatts (MW) Copper-Bessimer diesel engine and Ideal Electric generator was damaged several days after the earthquake. The diesel engine and generator are mounted on different bases. During the earthquake or one of the major aftershocks, differential displacement caused a misalignment in the shaft, which damaged the bearing. Tolerance for the shaft is 0.003 inch.

Other Seismic Effects

- The 145-kVA Onan generator in a power plant was manually started following the earthquake to provide emergency AC power supply to the nearby 500-kV control house. The generator operated for two hours until its fuel supply was exhausted in the day tank. The fuel pump for resupply of the day tank is AC powered and not connected to the diesel generator, so the tank could not be replenished.
- The exhaust system for four 660-kW Waukesha diesel generators includes a muffler and discharge duct supported above the diesel on spring hangers with diagonal cable restraints. On one unit, swaying of the muffler during the earthquake partially dislodged the slip-on connection of the exhaust muffler to the engine block. This breach in the exhaust ducting leaked fumes into the diesel room. Since the air intake to each diesel draws from the ambient air, it is possible that prolonged leakage of exhaust fumes would have choked the diesel. However, the diesels were purposely shut off shortly after the earthquake to stop the supply of emergency power, as broken fire sprinklers were spraying electrical equipment within the facility's processing areas.
- A rod-hung exhaust duct disconnected from its attachment to an 8000-kW Pielstick diesel engine during the earthquake. The disconnected duct did not affect the operability of the diesel.
- A telephone switching facility contains two 650-kW gas turbine generators. When off-site power was lost at the site following the earthquake, an attempt was made to start the turbine generators. One turbine could not be started because of apparent mechanical problems that had plagued the unit prior to the earthquake. The remaining turbine generator was started and operated for about 1-1/2 hours. The unit was eventually shut off due to overheating. The source of the overheating was never definitively determined, although it may have been due to damage to the bearing.

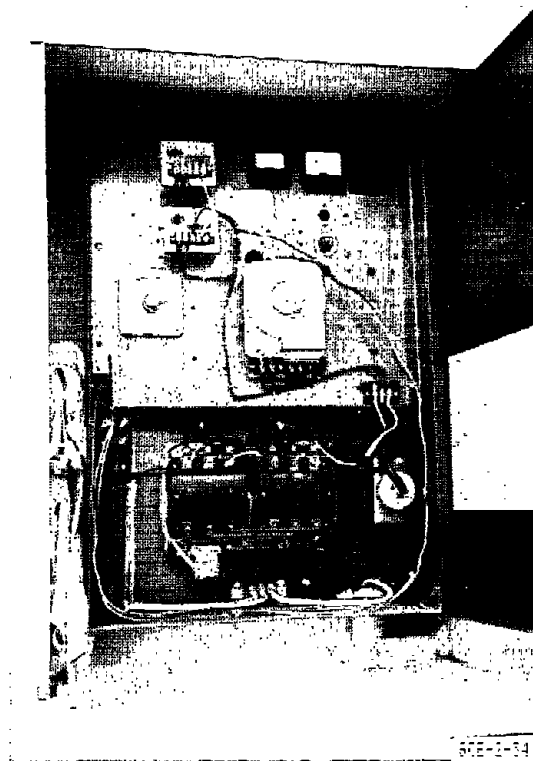
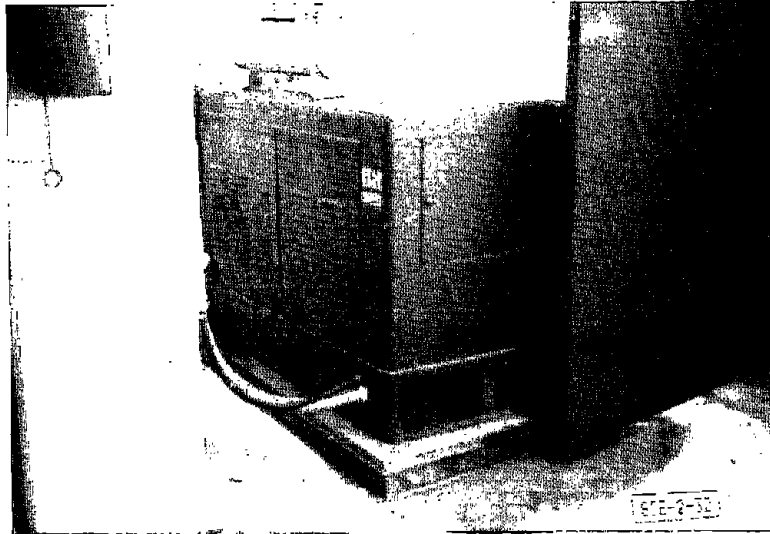

Figure 4-6: One of the 30-kW Onan diesel generators mounted on the roof of the building failed to start due to a faulty relay in its local control panel mounted to the adjacent wall (lower photograph). The equipment was affected by the 1987 Whittier Earthquake. Ground motion at the site is estimated to be 0.40g, with a duration in excess of 3 seconds.

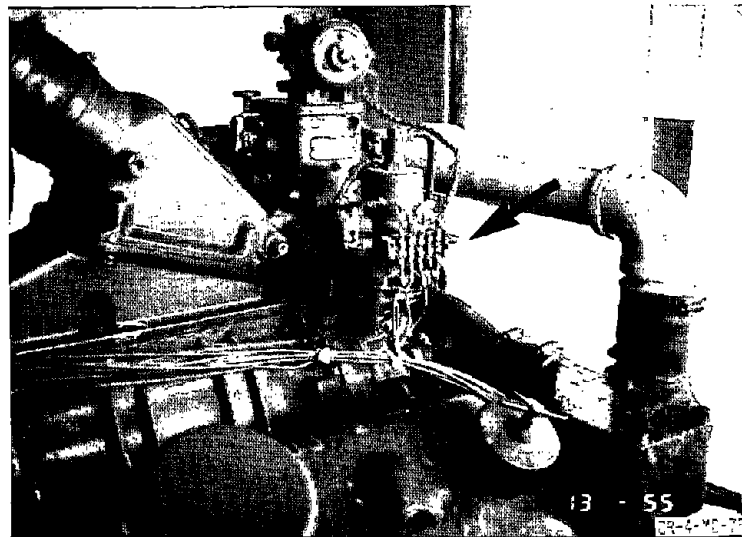
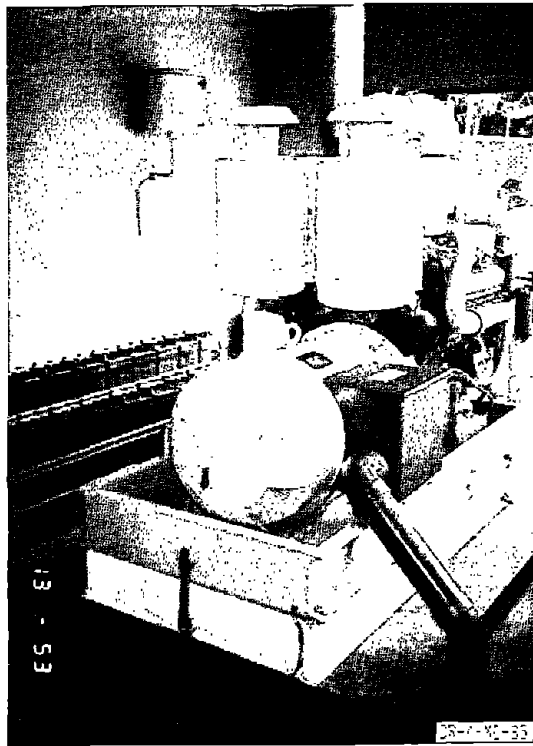

Figure 4-7: The diesel generator at this site did not respond to a manual start following the 1991 Costa Rica Earthquake (measured PGA of 0.12g). Inspection by a utility technician the day following the earthquake revealed a broken wire at the terminal connection serving the solenoid valve (arrow, lower photograph) that controls oil flow to the Woodward governor.

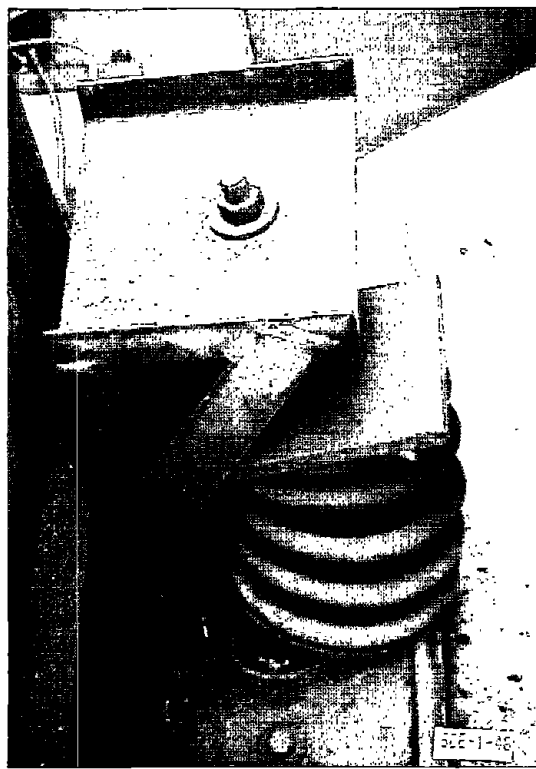
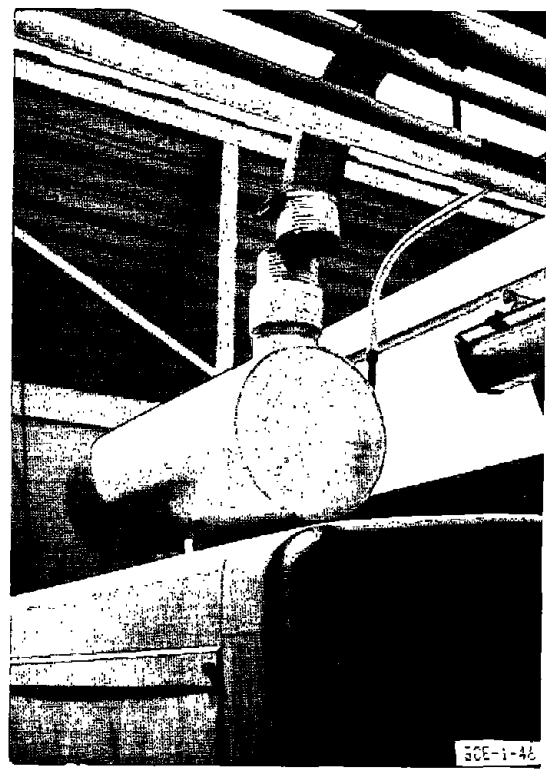
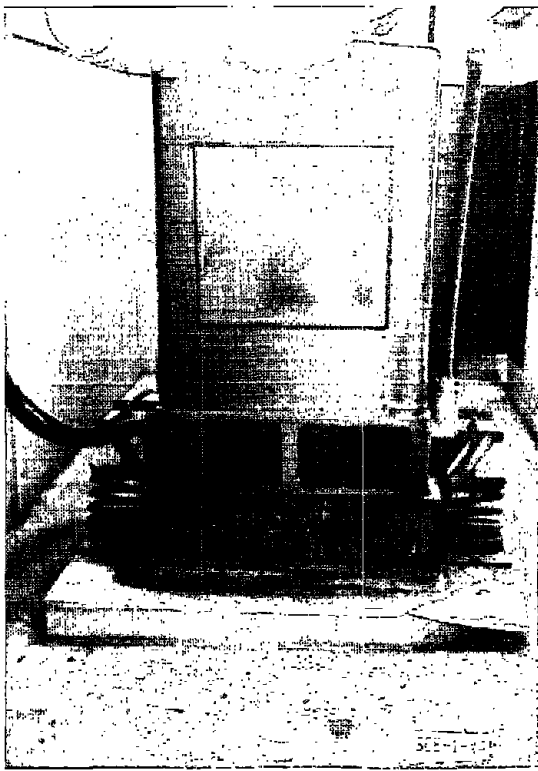

Figure 4-8: One of the 75-kW diesel generators mounted on the roof of a commercial building shifted laterally during the 1987 Whittier Earthquake, buckling its spring isolation mounts (lower photograph). Shifting of the unit broke the coupling of the exhaust pipe to the muffler mounted atop the diesel (upper right photograph). The ground motion is estimated to be 0.40g.



Figure 4-9: In the 1991 Costa Rica Earthquake, a fuel line that was routed along the concrete foundation mats of some of the diesels from nearby day tanks suffered breaks in its branch lines due to differential displacement imposed by settlement and soil spreading beneath the concrete mats.

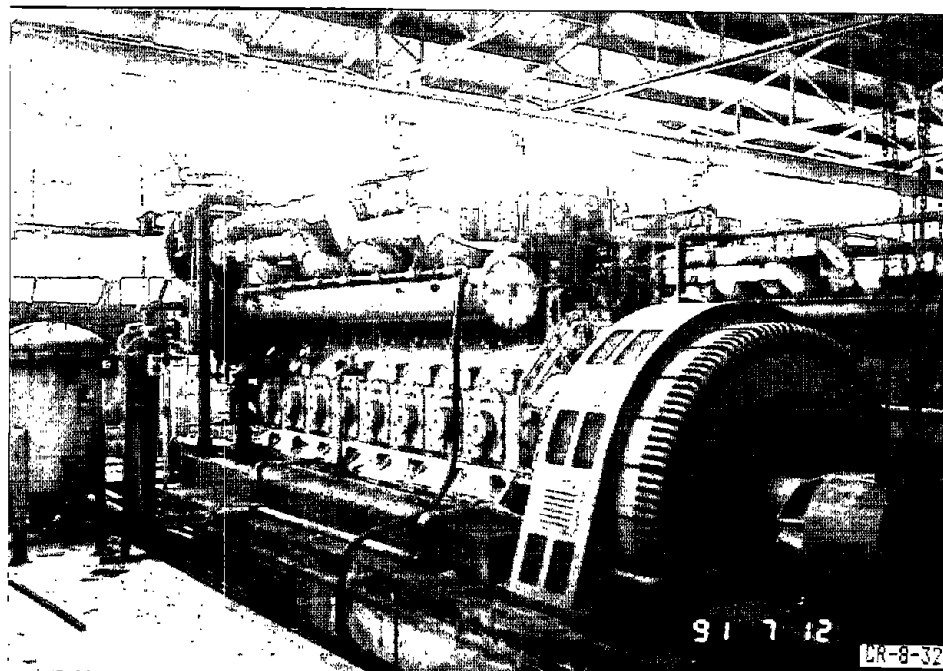

Figure 4-10: This diesel generator suffered severe shaft misalignment following the 1991 Costa Rica Earthquake. The misalignment was caused by differential settlement between the diesel foundation and the plant base mat (which supports the front of the generator drive shaft).

4.5 Fire Detection and Alarm

A fire detection and alarm system is designed to detect the incipient stage of a fire so as to provide sufficient time for evacuation by building occupants. The critical nature of this life-safety system requires that it be on an emergency power supply in the event commercial power is lost.

4.5.1 Description of Fire Detection and Alarm Systems

The primary components of fire detection and alarm systems are typically as follows:

- Control panels
- Detectors
- Alarms, speakers, and pull stations
- Circuitry

4.5.1.1 Control Panels

The Fire Communications Center (FCC) panel is typically the focal point for the entire fire detection and alarm system. The panel is an instrumentation and control panel which receives the fire detection signals from detectors and fire alarm pull boxes throughout the building. The signal will either be re-transmitted or converted into an audible and visible alarm to alert occupants. In addition to main control panels, local control and instrumentation panels are sometimes distributed throughout the facilities, close to the systems they monitor.

Typical components of the control panels include the following:

- Switches, push buttons, and panel lights
- Indicators and annunciators
- Relays
- Controllers
- Solid-state circuit boards
- Power supplies
- Tubing, wiring, and terminal blocks

Control panels are most commonly wall mounted in sheet metal enclosures. The cabinet enclosures normally consist of steel angles or channels welded together, with sheet metal siding attached by spot welds. FCC panels often contain 24 hours of battery back-up in the bottom of the cabinet.

The wall-mounted cabinets are typically anchored with expansion bolts directly into concrete walls, or with bolts to Unistrut members anchored to the wall with expansion bolts.

In general, control panel components are either bolted to interior panels or framing, or attached to the front or rear face of the cabinet through penetrations in the sheet metal. Electronic components are often bolted to internal frames or racks of light steel angles.

Several examples of fire control panels that experienced the 1989 Loma Prieta Earthquake with no malfunction or damage are shown in Figures 4-11 to 4-17.

4.5.1.2 Detectors

Detectors are a basic and critical portion of the detection system. Four typical types of detectors are the following:

- Thermal detectors
- Flame detectors
- Smoke detectors/products of combustion detectors
- Water flow detectors

Thermal detectors may be of three general types: fixed temperature detectors, rate of rise detectors, and rate compensated detectors.

- **Fixed temperature detectors** consist of a disc with two layers of nickel-iron alloy of differing thermal expansion coefficients. When an overheat condition occurs anywhere along the detection elements, the resistance of the inorganic eutectic salt within the sensing element drops, causing a current flow between the nickel conductor and the inconel outer tubing. The control panel senses this current flow and activates an alarm with visible or audible signals.
- **Rate of rise detectors** operate when the fire plume raises the air temperature within a chamber at a rate above a certain threshold of operation. The air within the chamber is heated, expands in volume, and moves the diaphragm upward until it makes contact with the adjustment screw. This completes the circuit and initiates the signal transmission back to the control panel.
- **Rate compensated detectors** are similar to rate-of-rise, but are capable of detecting varying rates of temperature change. A rapid increase in the air temperature causes the shell to heat and expand. The contact

points contact each other and the circuit closes, transmitting a signal to the control panel.

Flame detectors are designed to respond to the optical radiant energy generated by the diffusion flame combustion process (the illumination intensity and the frequency of flame modulation). There are two general types of flame detectors now in use: ultraviolet detectors and infrared detectors. The sensing element in a flame detector may be a photoelectric cell, a photoconductive cell, or a gas-filled electronic tube, which reacts when subjected to optical radiation.

Smoke detectors and products of combustion detectors respond to the visible and invisible products of combustion (i.e., unconsumed carbon and carbon-rich particles or solid particles smaller than approximately five microns, various gases, and ions). Underwriters' Laboratories classifies smoke detectors, regardless of their design, as photoelectric detectors or ionization-type combustion product detectors.

- **Photoelectric detectors** rely on the intensity of the light beam received in the photoelectric cell for fire detection. When the light beam intensity is reduced by visible smoke particles drawn into the detector chamber, an unbalanced condition in the electrical circuit to the photoelectric cell ensues, which activates the detector.
- **Ionization-type combustion products detectors** detect both the visible and invisible particle matter generated by the fire. The oxygen and nitrogen molecules of the air in the chamber are ionized by alpha particles from a radioactive source. The ionized pairs move toward the electrodes of the opposite sign when electrical voltage is applied, and a minute electrical current flow is established across the sampling chamber. Combustion particles, as they enter the chamber, attach to the ions. The combustion particles have a greater mass and thus reduce the mobility of the ions, which reduces the electrical current flow across the sampling chamber. This reduction in electrical current flow initiates the detector signal.

Water flow detectors are used in wet-type automatic sprinkler systems, where piping is always charged with water. These detectors are mechanical in which a paddle inserted into the sprinkler piping moves upon water flow, causing an electrical circuit to close, or pneumatic, in which a sensor detects a change in water pressure upon operation of a sprinkler head.

4.5.1.3 Alarms, Speakers, and Pull Stations

Alarms, speakers, and pull stations are peripheral fire life-safety equipment which are used to either visually or audibly alert occupants of the building or the fire department to the existing fire danger.

Speakers and alarms are generally ceiling- or wall-mounted devices which alert and instruct the occupants of a building in the event of a fire. They may be either automatic or manual notification devices.

Fire pull stations are typically wall-mounted switches that are used to alert occupants of the building or facility in the event of a fire. Fire pull stations are notification devices and require human action at the time of the fire.

Examples of typical equipment are shown in Figure 4-18.

4.5.1.4 Circuitry

The term "circuitry" refers to the electrical or pneumatic circuit which connects the detection component to the FCC panel. Circuits either transmit an electrical signal, initiate an alarm when a circuit is broken, or under a negative pressure, carry products of combustion to a detector which initiates a separate signal to a control panel.

A circuit may be an electrical circuit, usually of low voltage, although some systems, primarily the smoke and flame detectors, require 115-volt wiring. The circuit may also be a pneumatic system involving 0.31- to 0.16-centimeter open-ended tubing, which draws samples to a monitoring products of combustion detector. Heat actuating devices which rely on the closing of an electrical circuit by expansion of air in a detector directly exposed to a flaming fire also exist, although this system is considered old technology and thus is relatively scarce.

Finger clamps are widely employed to anchor both conduit and tubing to ceilings and walls. Conduit and tubing can also be rod-hung or anchored to Unistrut channels mounted on the wall or ceiling by Unistrut clamps.

4.5.2 Seismic Performance of Fire Detection and Alarm Systems

This section discusses the performance of fire detection and alarm systems and their components in past earthquakes. Because some of the components, such as control panels and circuitry, are not unique to fire systems, we have also included discussion of the performance of this type of equipment in other applications, where vulnerabilities exhibited in those applications could be relevant to the application for fire detection and alarm systems.

The following list summarizes the observed vulnerabilities:

Detectors	<p>Inadvertent actuation of smoke detectors by dust in an earthquake.</p> <p>Actuation of water flow detectors by breaks in fire protection piping.</p>
Control Panels (including non-fire detection systems)	<p>Malfunction of system due to spurious actuation of relays mounted in control panels.</p> <p>Damage to panel due to inadequate anchorage.</p> <p>Burned coil in a control panel meter due to current surge.</p> <p>Broken filaments in control panel indicator lights.</p> <p>Damage to relays due to internal short circuit.</p> <p>Damage to slide-in electrical controllers and recorders in control panels, after components slid out and fell to floor.</p>
Alarms, Speakers, and Pull Stations	<p>Damage to inadequately anchored speakers.</p> <p>Alarms inadvertently actuating due to sloshing of mercury in switches.</p>
Circuitry (including non-fire detection systems)	<p>Damage to conduit and tubing (not necessarily in fire system) due to inadequate flexibility of conduit/tubing at structural joints.</p> <p>Damage to conduit and tubing (not necessarily in fire system) due to movement of attached unanchored or flexible equipment.</p> <p>Damage to conduit and tubing (not necessarily in fire system) at transition between rigid and rod-hung support systems due to inadequate flexibility.</p>

4.5.3 Description of Instances of Damage

This section describes several specific instances of damage leading to observations on vulnerabilities presented above. Also presented are several instances of "seismic effects", where local damage to components was documented that did not affect functionality of the

fire detection system or other designated use. As discussed above, this section also includes applications other than fire detection systems, where the damage could also be expected to be possible in fire detection systems.

Detectors

- At a data processing facility affected by the 1987 Whittier Earthquake, major losses occurred due to the actuation of the fire suppression system. The building contains a preaction fire sprinkler system, which requires signals from ceiling-mounted smoke detectors to actuate. During the earthquake, the system actuated and the main deluge valve opened, spraying water from broken fire sprinklers and pipes throughout the office areas (Figure 4-19). Postulated causes of the system actuation included (1) the smoke detectors caused actuation upon sensing dust suspended in the air from falling debris, or (2) detectors malfunctioned due to collapse of the suspended ceilings.
- Another instance of detector actuation occurred in Sunnyvale during the 1989 Loma Prieta Earthquake. The fire department reported several instances of broken pipes in fire protection systems actuating water flow detectors during the earthquake.

Control Panels

- Spurious actuation of relays in control panels or relay racks has occurred at several power facilities and refineries in past earthquakes. This includes the Valley Steam Plant, Burbank Power Plant, Concon Refinery, San Isidro Substation, San Sebastian Substation, El Infiernillo Hydroelectric Plant, and La Villita Hydroelectric Plant.
- Lack of anchorage or inadequate anchorage has caused several instances of damage or "seismic effects" to control panels in past earthquakes. Facilities include the Union Oil Butane Plant, Main Oil Pumping Plant, Las Ventanas Power Plant, San Isidro Substation, Kawerau Substation, Edgecumbe Substation, Whakatane Board Mills, Anchorage Municipal Light and Power Plant, Elmendorf Air Force Base, Inanghua Substation, Olive View Hospital, Guatel Building, and the Lawrence Livermore National Laboratory.
- A control panel in a water treatment plant contained a meter which was inoperable following the main shock. Dismantling of the meter revealed a burned coil inside. The burned coil was apparently caused

by an electrical fault, most likely a current surge during the earthquake before the loss of offsite power. The electrical fault was speculated to have resulted from an internal short circuit in the meter, a surge in the circuit supplying the meter, or a surge in the plant's power supply from its 4160-volt substation.

- In a factory affected by the 1985 Chile Earthquake, a few 1-inch diameter indicator lights in control panels had to be replaced because of broken filaments.
- In a hydroelectric plant affected by the 1985 Chile Earthquake, three relays suffered an internal short circuit when a spring in the electric monitoring circuit vibrated, detached, touched ground, and burned.
- Slide-in electrical components have slid out of control panels at several sites, in some instances falling to the floor, and in some cases not suffering permanent damage. Facilities include the Main Oil Pumping Plant, the Coalinga Water Treatment Plant, the Union Oil Butane Plant, the Concon Petroleum Refinery, the SICARTSA Steel Mill,, and the Caxton Paper Mill.

Alarms, Speakers, and Pull Stations

- One incident of inadequately anchored speaker damage occurred at a telephone facility affected by the 1987 Whittier Earthquake. In this case, the anchor bolts holding a speaker into a sheetrock wall failed, leaving the speaker hanging by its cabling.
- An incident of reported spurious actuation of mercury switches occurred at a university and its associated hospital in the 1989 Loma Prieta Earthquake. In that earthquake, fire pull stations throughout the site inadvertently activated alarms during the earthquake. It was determined that the seismically induced lateral motion caused mercury in the switches to close contacts, causing the pull stations to trigger alarms (Figures 4-20 and 4-21).

Circuitry (not necessarily fire system lines)

- An example of conduit damage is shown in Figure 4-22, from a heavy industrial facility affected by the 1985 Mexico Earthquake. The conduit pulled apart due to the relative motion of two sections of the control panel and between the panel and the wall.

- Tubing attached to a chemical analyzer rack was disconnected at a fitting at a petrochemical facility affected by the 1983 Coalinga Earthquake. The rack was very flexible and the tubing was routed to a rigid column as it exited the rack. During the earthquake, the flexible rack and the rigid tubing support moved differentially, disconnecting the tubing at a fitting.
- At a large power plant facility affected by the 1979 Imperial Valley Earthquake, a diaphragm-operated valve was inoperable following the earthquake due to a disconnected air line. The air line tubing was rigidly supported on an adjacent handrail. The cause of the seismic effect was differential movement between the flexibly supported valve operator and the rigid tubing attachment.
- An example of tube crimping from a cogeneration plant in the 1992 Cape Mendocino Earthquake is shown in Figure 4-23. Several tubes connected to pressure tops spanning from the boiler support structure to the boiler, which is suspended from the top of the support structure, were crimped due to very large displacements of the boiler relative to the support structure at this elevation.

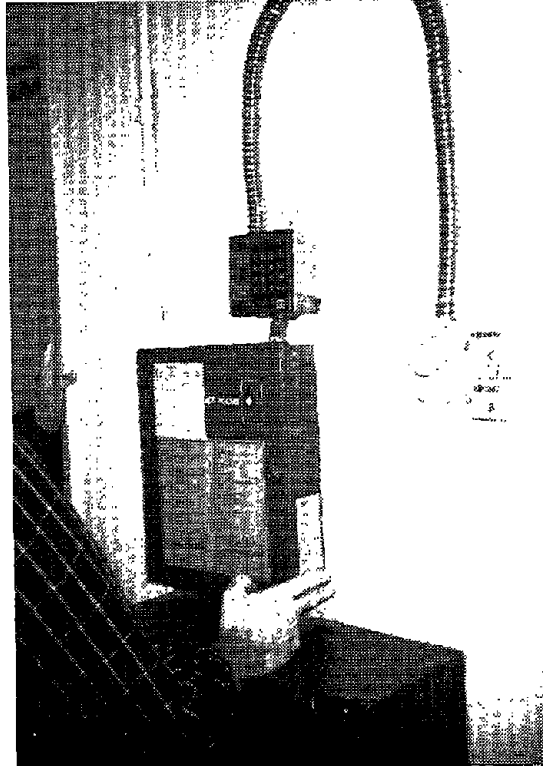

Figure 4-11: A fire control station at a small manufacturing facility. This control station experienced 0.35g during the 1989 Loma Prieta Earthquake and experienced no malfunction or damage.

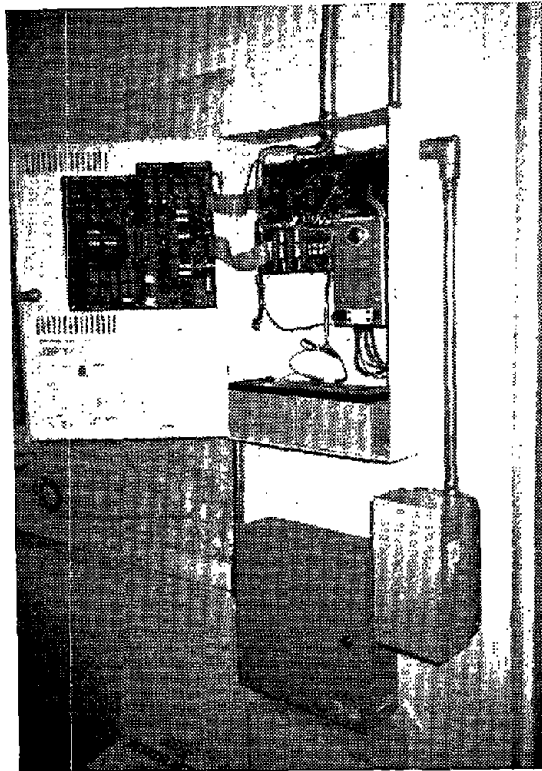

Figure 4-12: A fire control station mounted to an interior wall at a university which was affected by the 1989 Loma Prieta Earthquake. The control station functioned properly during the earthquake.

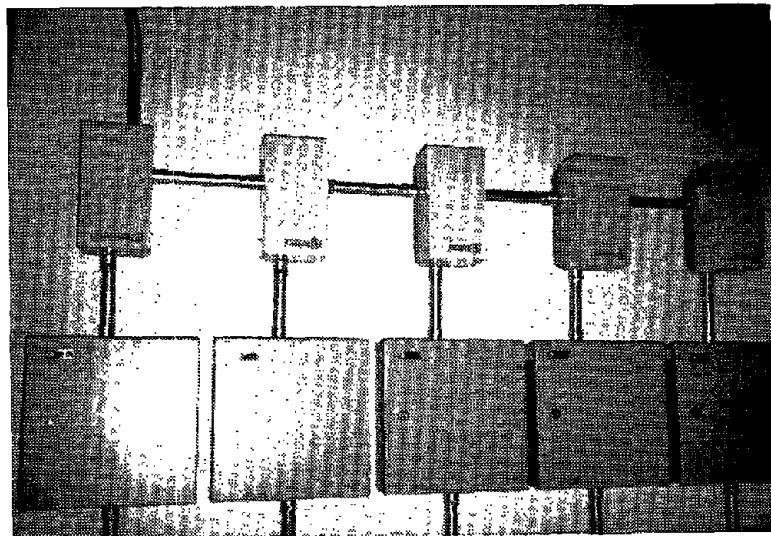

Figure 4-13: Fire communications panels at a university medical facility affected by the 1989 Loma Prieta Earthquake (0.25g). These communications panels relay data from the detectors to the fire department and were not affected by the earthquake.

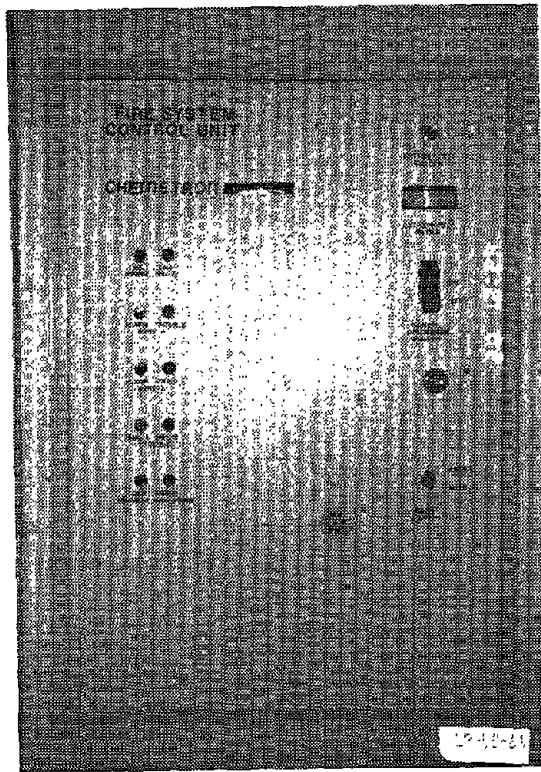

Figure 4-14: A wall mounted fire control unit at a large cement factory. This unit experienced the 1989 Loma Prieta Earthquake (0.25g) with no reported damage or equipment malfunction.

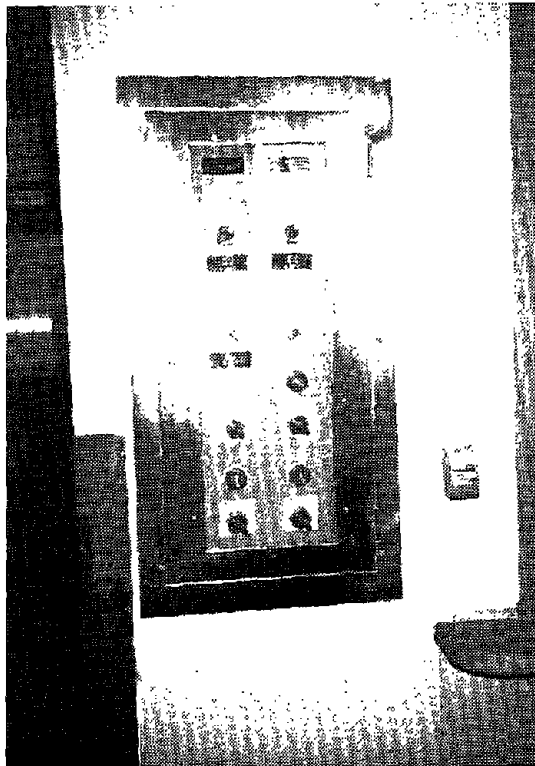

Figure 4-15: A wall mounted fire communications panel at a university medical facility. The panel was affected by the 1989 Loma Prieta Earthquake (0.25g) but was not damaged.

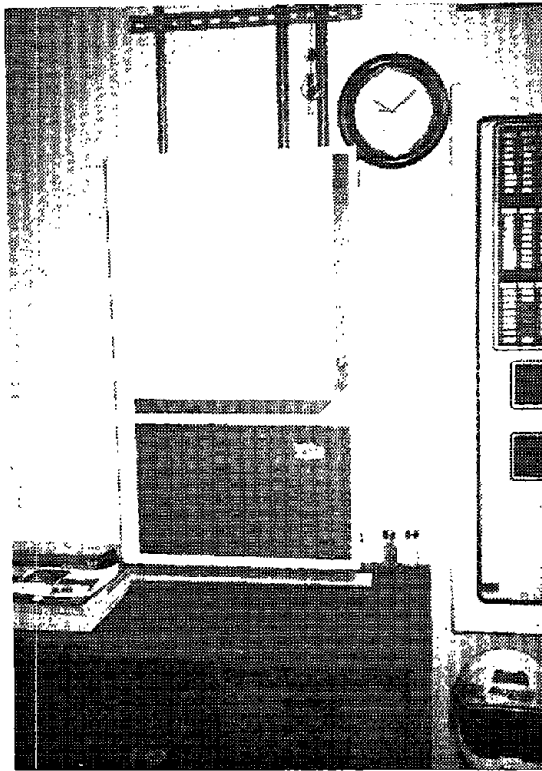

Figure 4-16: Wall mounted fire communications panel in the basement of a university medical facility affected by the 1989 Loma Prieta Earthquake (0.25g). The panel operated properly during the earthquake.

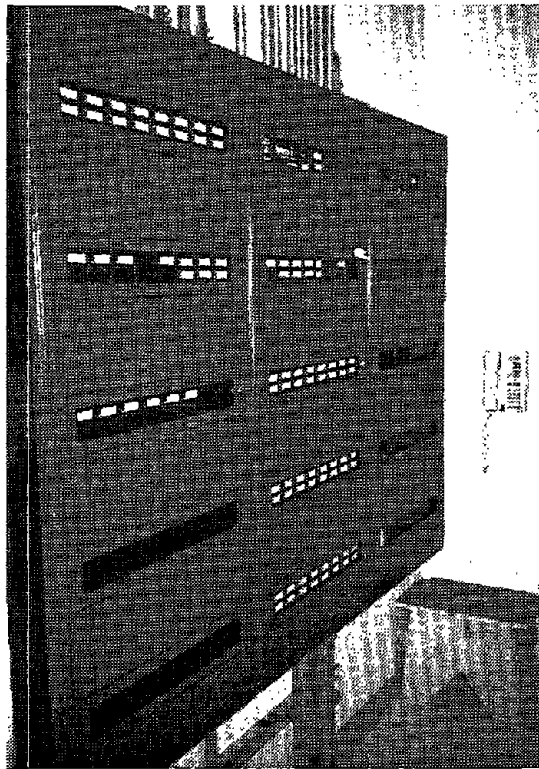
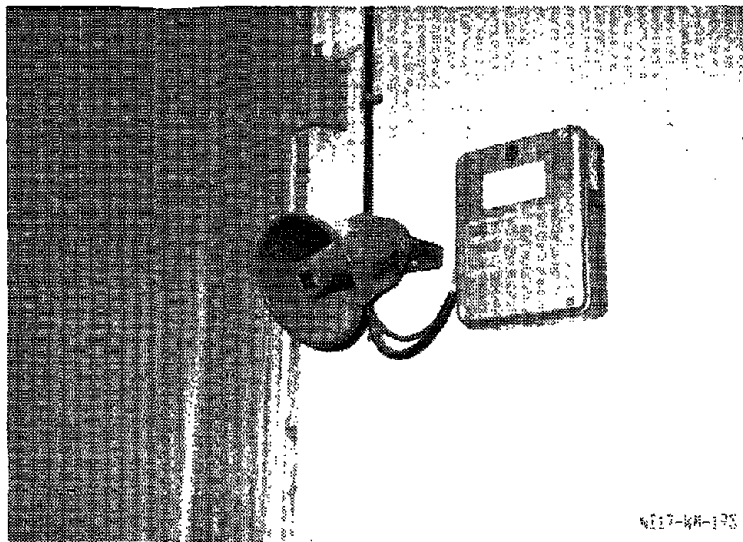
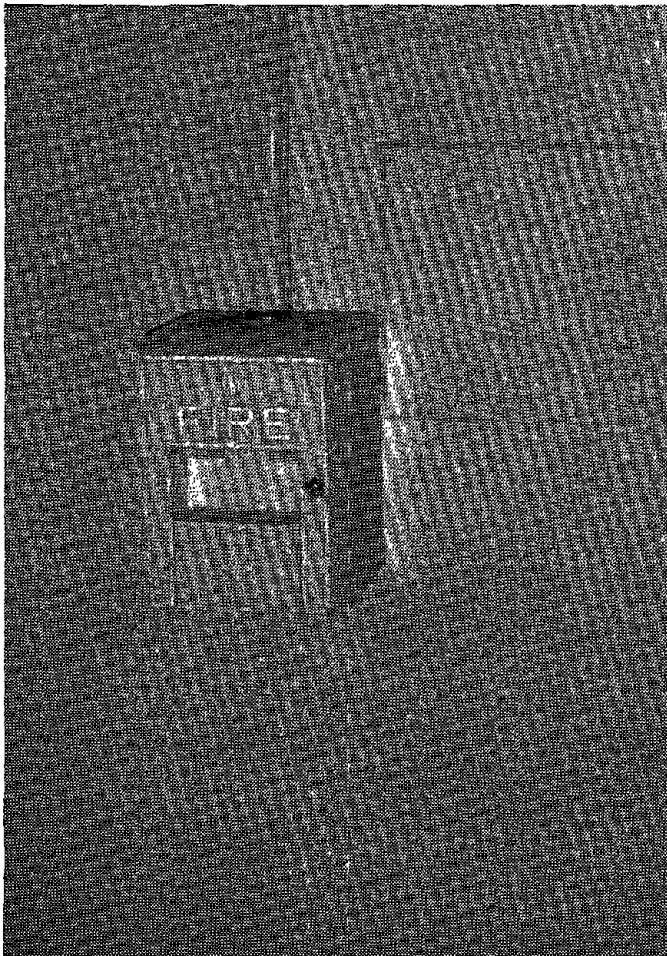

Figure 4-17: Fire alarm panel at a large university medical facility affected by the 1989 Loma Prieta Earthquake (0.25g). The alarm panel is mounted to an interior wall. There was no reported damage or equipment malfunction as a result of the earthquake.



(A) Speaker



(C) A fire-pull station

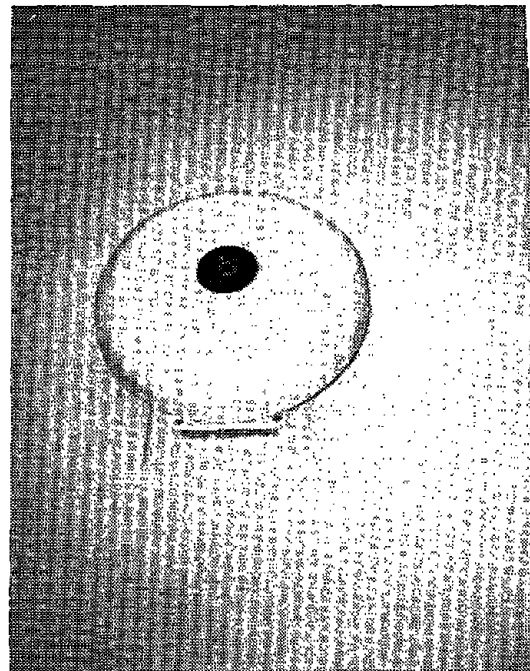

(B) An alarm bell

Figure 4-18: Examples of typical fire life safety system peripheral equipment: (A) a speaker, (B) an alarm bell, and (C) a fire pull station.

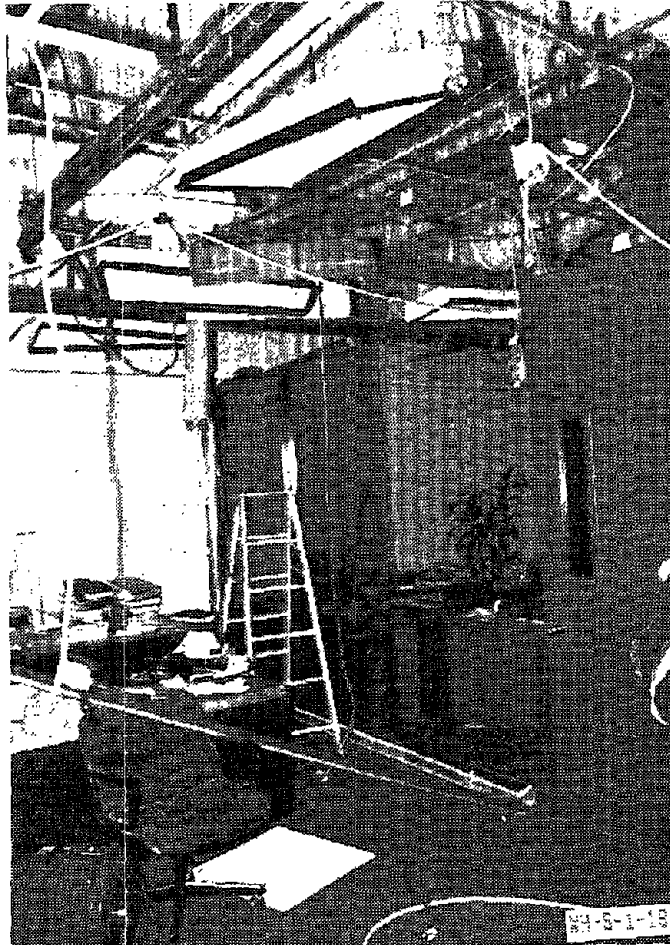

Figure 4-19: At a data processing facility, affected by the 1987 Whittier Earthquake, property losses occurred due to the actuation of the preaction automatic sprinkler system. Postulated causes of the system actuation included either dust-induced smoke detector actuation, or detector malfunction.

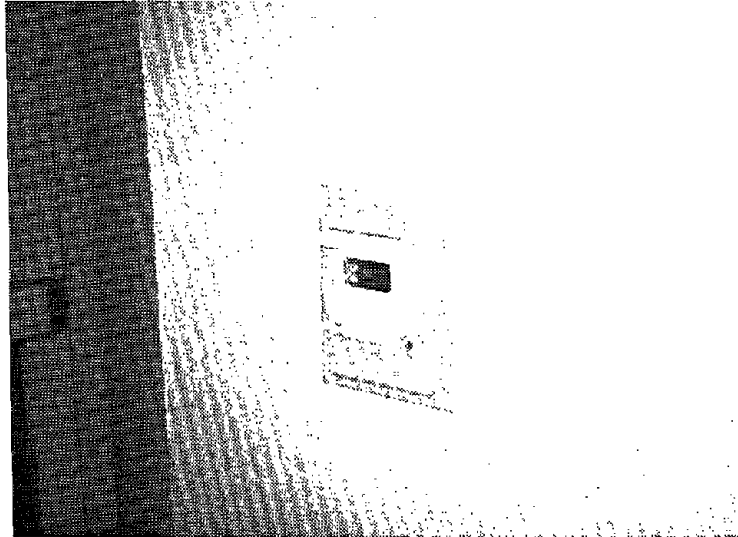

Figure 4-20a: A fire pull station mounted to an interior wall at a university medical facility which experienced around 0.25g during the 1989 Loma Prieta Earthquake. This pull station is typical of several other pull stations at this facility which alarmed during the earthquake due to the inadvertent actuation of the mercury switch within the device.



Figure 4-20b: A fire pull station at a board mill which was affected by the 1987 New Zealand Earthquake (estimated 0.25g). This explosion-proof fire pull station is mounted to a concrete-block wall and experienced no seismic effects or damage from the earthquake.

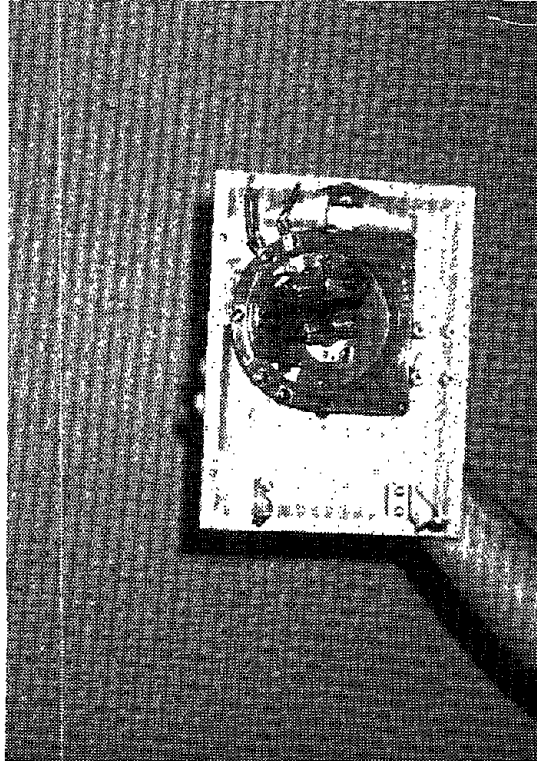

Figure 4-21: A typical fire pull station which operates using a mercury switch. These pull stations actuated in several of the buildings at a large university and its associated medical facility during the 1989 Loma Prieta Earthquake (estimated 0.25g).

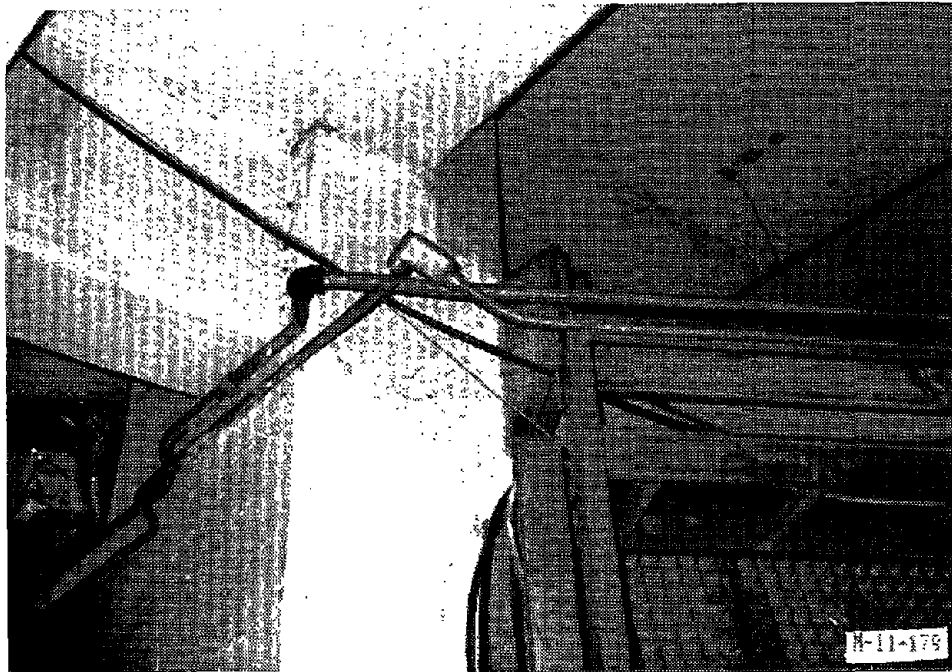
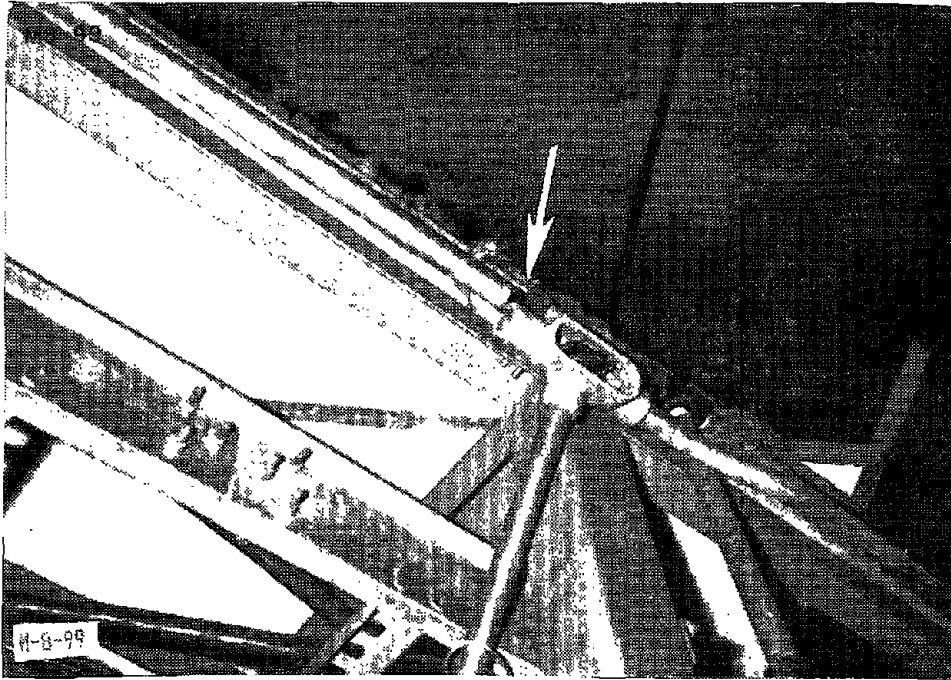

Figure 4-22: This conduit, located in a heavy industrial facility, pulled apart at couplings due to relative motion of two sections of the control panel (top photograph) and between the panel and the wall (bottom photograph).

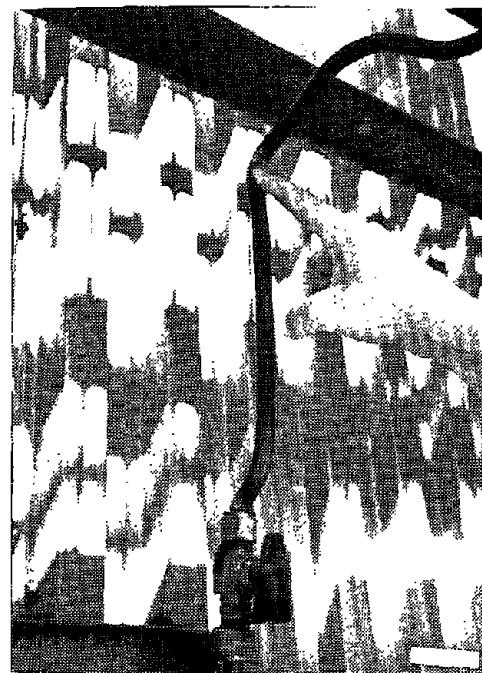

Figure 4-23: At a cogeneration plant affected by the 1992 Cape Mendocino Earthquake, tubes connected to a pressure top crimped when the suspended boiler swung, causing significant differential lateral displacement with the boiler support structure at this elevation

4.6 Fire Suppression

Fire suppression systems are designed to extinguish or contain fires, protecting people and property from fire damage. Because fire suppression is considered to be a critical life-safety function at virtually any facility, there is typically some degree of redundancy available.

4.6.1 Description of Fire Suppression Systems

A fire suppression system for a building or facility is usually comprised of one or more automatic or manual suppression systems. These systems are designed to deliver either water or gaseous extinguishing agents at a particular discharge rate to combat a design fire.

Automatic fire water systems typically consist of the fire water supply; waterflow controlling devices, or valves; a fire water pump, if needed; distribution piping; and a sprinkler system consisting of sprinkler heads and branch piping.

Automatic gaseous systems, used where water might damage electrical equipment, might consist of tanks of gas connected to specially designed discharge nozzles and activated by smoke or heat detectors.

Manual systems would include fire extinguishers of various types and indoor fire hose stations.

4.6.1.1 Automatic Fire Water Sprinkler Systems

Automatic fire water sprinklers are devices for automatically delivering water to a fire at sufficient density to control the fire. The water is supplied to the sprinklers through a system of piping, ordinarily suspended from the ceiling, with the sprinklers placed at intervals along branching pipes. The orifice of the automatic sprinkler is normally closed by a disk or cap held in place by a temperature-sensitive link or glass bulb. There are five major classifications of automatic fire water sprinkler systems:

- **Wet-pipe Systems.** These systems employ automatic sprinklers attached to a piping system that contains water under pressure at all times. When a fire occurs, individual sprinklers are actuated by the heat, and water discharges from the sprinklers immediately.
- **Dry-pipe Systems.** These systems have automatic sprinklers attached to piping that contains air or nitrogen under pressure. When a sprinkler is opened by heat from a fire, the pressure is reduced to the point where water pressure on the supply side of the dry-pipe valve

can force open the valve. Then water flows into system piping to be discharged from opened sprinklers.

- **Preaction Systems.** These are systems in which there is air in the piping that may or may not be under pressure. When a fire occurs, a supplementary fire-detecting device in the protected area is actuated. This opens a water control valve which permits water to flow into the piping system before a sprinkler is activated. When sprinklers are subsequently opened by the heat of the fire, water flows through the sprinklers immediately, as it does in a wet-pipe system.
- **Combined Dry-pipe and Preaction Systems.** These include the essential features of both types of systems. The piping system contains air under pressure. A supplementary heat-detecting device opens the water control valve and an air exhauster at the end of the unheated feed main. The system then fills with water and operates as a wet-pipe system. If the supplementary heat-detecting system should fail, the system will operate as a conventional dry-pipe system.
- **Deluge Systems.** In these systems, all sprinklers are open at all times. When heat from a fire actuates the fire-detecting device, the deluge valve opens and water flows to, and is discharged from, all the sprinklers on the piping system, thus deluging the protected areas.

4.6.1.2 Automatic Gaseous Systems

Gaseous systems, such as halon, are typically used in areas where sensitive electrical equipment could be damaged by water spraying. The halon system often consists of halon tanks connected to smoke or heat detectors. The gas is automatically released upon a signal from a specified number of detectors. Although halon is the most common gas found, as it is non-conducting and requires no cleanup, the use of halon is being phased out because it is a chlorofluorocarbon (CFC). Other gases such as carbon dioxide may be used as an extinguishing agent by reducing the oxygen content of the atmosphere by dilution to a point where the atmosphere will no longer support combustion.

4.6.1.3 Manual Systems

Fire extinguishers and hose systems provide a means of manual fire fighting operations. Standpipe systems may serve as a backup for, and complement to, sprinklers. Extinguishers will most likely deliver water under pressure, but may include carbon dioxide, halon, or foam, depending on the combustibles present.

4.6.2 Seismic Performance of Fire Suppression Systems

This section lists the observed vulnerabilities to fire suppression systems as evidenced by past earthquakes. The most vulnerable components appear to be rod-hung fire protection piping and sprinkler heads. As several of the components, such as pumps and valves, are not unique to fire suppression systems, vulnerabilities to these components are also included which have been observed in other systems but would also be a consideration for fire suppression systems.

The following list summarizes the observed vulnerabilities:

Piping	<p>Collapse of the system due to unzipping of supports (poor support details, such as eccentrically loaded supports or short rod hangers, used throughout the system).</p> <p>Damage due to structural failure or large structural displacements.</p> <p>Damage where small piping acts as rigid anchor for flexible larger piping.</p> <p>Damage due to differential displacement of flexible systems.</p>
Sprinkler Heads	<p>Breaking of sprinkler heads due to impact with structural members.</p> <p>Damage to sprinkler heads attached to collapsed suspended ceilings.</p>
Pumps	<p>Damage due to large displacement of attached unanchored equipment or tanks.</p> <p>Damage due to differential ground settlement.</p>
Valves	<p>Fracturing of yokes due to impact with adjacent steel.</p>

4.6.3 Specific Instances of Damage to Fire Suppression Systems

This section describes several specific instances of damage to fire suppression systems resulting in the description of vulnerabilities given above. Also described are instances of "seismic effects", where local damage was identified, but the system did not malfunction or fail.

Fire Protection Piping

- At a paper mill affected by the 1987 New Zealand Earthquake, an entire section of sprinkler piping collapsed during the earthquake. All of the rod hanger supports for the piping were attached eccentrically to metal straps on the bottom flange of the ceiling beams (Figure 4-24). During the earthquake, the straps pried off of the beam flanges, losing the vertical support. Because the same detail was used throughout the system, each identical support failed, and the system unzipped, falling to the floor.
- At a data processing center, located in the epicentral area of the 1987 Whittier Earthquake, a section of firewater piping in the parking structure sagged when it pulled several rod supports from the concrete slab above. The attachment of the failed piping supports was found to consist of "shot-in" concrete nails.
- At a second data processing facility, affected by the 1987 Whittier Earthquake, fire sprinkler piping was ruptured at several locations within the building, creating water leaks. In most cases, the breaks seemed to be caused by collapsing ceilings dragging down sections of piping.
- At a third data processing facility, affected by the 1987 Whittier Earthquake, firewater piping broke at several locations on the fourth floor of the building. The breaks typically occurred where a long run of 4-inch header was restrained longitudinally only by the 2-inch branch lines that feed the individual ceiling-mounted sprinklers.
- At a small manufacturing plant, located in the epicentral area of the 1989 Loma Prieta Earthquake, threaded couplings in fire sprinkler lines cracked in two locations during the event (Figure 4-25). Cracking in the sprinkler line coupling may have been aggravated by impact from adjacent rod-hung piping and ducts in this very congested area of the ceiling.
- At a disk drive assembly plant, located in the epicentral area of the 1989 Loma Prieta Earthquake, threaded couplings in fire sprinkler lines cracked in two locations during the event. At both locations, cracking occurred in short interconnections between long, horizontal runs of rod-hung pipe.

- At a food dehydration and packaging plant, affected by the 1989 Loma Prieta Earthquake, sprinkler lines cracked at threaded couplings at two locations. Cracked couplings occurred where a short vertical connection spanned between two long perpendicular pipe runs. It was apparent that the interconnecting pipe cracked while resisting differential movement between the two long runs of sprinkler piping (Figure 4-26).

- At an eight-building office complex, affected by the 1989 Loma Prieta Earthquake, water leaks occurred in one location of the fire suppression system. Over a second-floor corridor, a threaded coupling cracked at the junction of a 1-1/4-inch riser with a 4-inch main fire suppression header. The failure was probably aggravated by impact from an adjacent section of sheet metal ducting.

- At a refractory, affected by the 1989 Loma Prieta Earthquake, a 4-inch steel firewater line failed. The line is rod hung from the wooden ceiling beams of the steel-frame high-bay structure. A long east-west run of piping is interrupted by a short length of vertical riser, which then branches into a long north-south run. The short vertical section of piping was formed to try to coordinate sway of the east-west run with the north-south run. The resulting loads cracked the threaded elbows at the top and bottom of the riser.

Sprinkler Heads

- At a data processing facility, affected by the 1987 Whittier Earthquake, several sprinkler heads sheared off where threaded couplings to branch lines provided the primary restraint against longitudinal displacement of a long run of 4-inch header.

- At a second data processing facility, affected by the 1987 Whittier Earthquake, a flexible run of fire suppression piping, near a building expansion joint, bounced against the ceiling wallboard, breaking off several sprinkler heads upon impact.

- At a disk drive assembly plant, located in the epicentral area of the 1989 Loma Prieta Earthquake, seven sprinkler heads on flexible rod-hung pipe broke due to impact with adjacent wood ceiling beams. The building includes a total of over 1000 ceiling-mounted sprinklers (Figure 4-27).

Valves

- At a power plant, affected by the 1979 Imperial Valley Earthquake, the yoke of a cast-iron diaphragm-operated valve fractured when the diaphragm housing repeatedly struck an adjacent structural steel beam.
- At a power plant affected by the 1985 Chile Earthquake, two air-operated valves on flexible piping sustained broken yokes when the pipe swung into an adjacent handrail.

Pumps (including non-fire suppression system pumps)

- At a chemical plant, affected by the 1985 Mexico Earthquake, about 20 horizontal pumps were damaged by differential displacement caused by ground settlement. Pumps on individual spread footings settled as much as 12 inches, severing connections to pipes which had adjacent supports on a pile supported building which did not settle.
- At a computer facility affected by the 1987 Whittier Earthquake, a horizontal pump sustained a broken casing. The pump was rigidly connected through piping to an unanchored chiller. The pump damage was attributed to excessive loads transmitted to the casing when the chiller moved about six inches.
- At two other computer facilities affected by the 1987 Whittier Earthquake, horizontal pumps sustained damage when they were dislodged from their poorly designed vibration isolators.

Manual Systems

- There are several instances of fire extinguishers falling to the floor during earthquakes (Figure 4-28). It is not known whether any of these incidents resulted in damage to the extinguishers such that they would not operate.

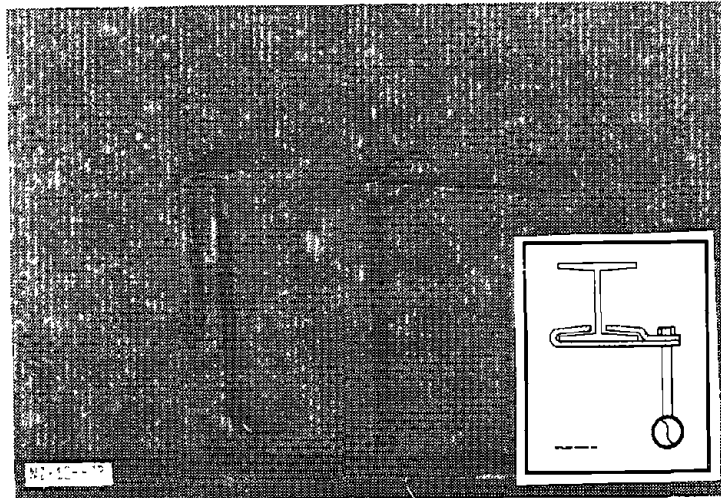

Figure 4-24: At a paper mill, affected by the 1987 New Zealand Earthquake, an entire section of the sprinkler piping system collapsed during the earthquake. The cause for the collapse appeared to be a poor support design in which rod hanger supports were eccentrically hung from straps on the bottom flange of a wide-flanged beam. They pried off of the beam flange.

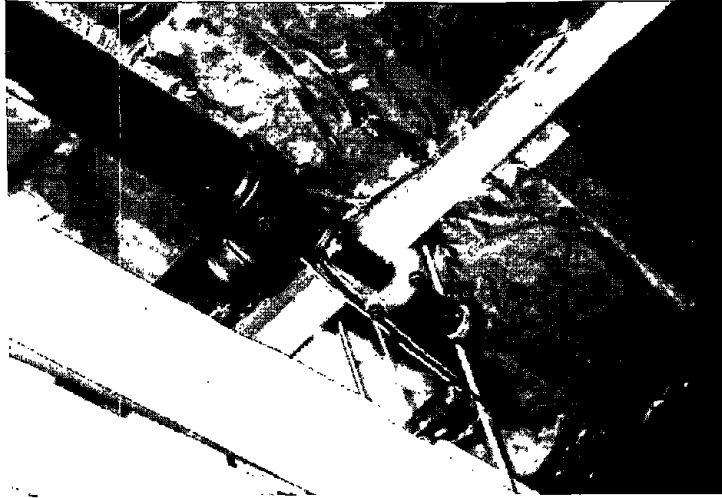

Figure 4-25: At a small manufacturing plant, located in the epicentral area of the 1989 Loma Prieta Earthquake, threaded couplings in fire sprinkler lines cracked in two locations during the event.

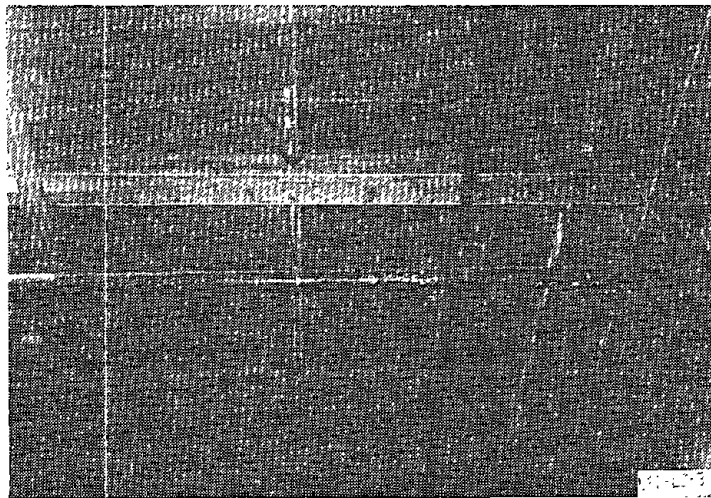

Figure 4-26: At a food dehydration and packaging plant, affected by the 1989 Loma Prieta Earthquake, sprinkler lines cracked at threaded couplings at two locations. Cracked couplings occurred where a short vertical connection spanned between two long perpendicular pipe runs.

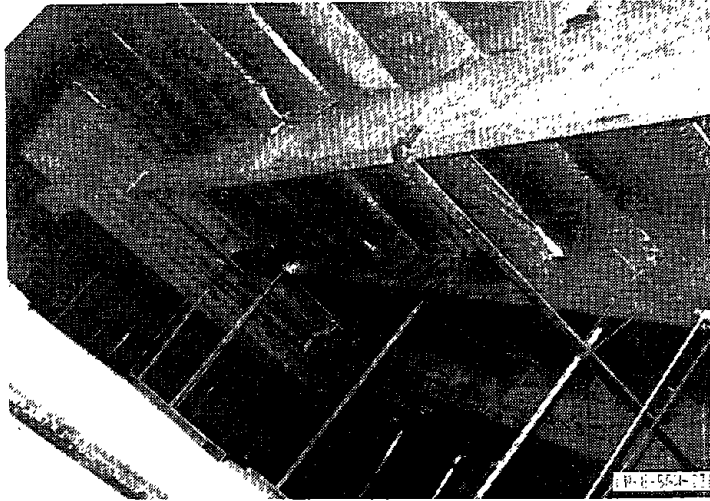

Figure 4-27: At a disk drive assembly plant, located in the epicentral area of the 1989 Loma Prieta Earthquake, seven sprinkler heads on flexible rod-hung pipe broke due to impact with adjacent wood ceiling beams.

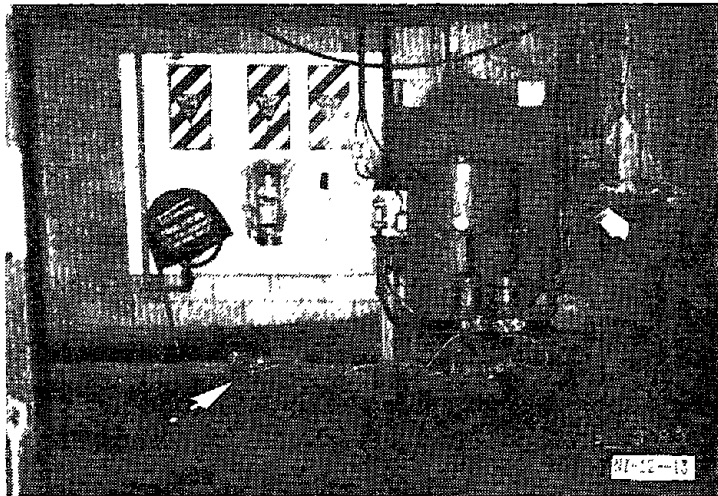

Figure 4-28: Fallen fire extinguisher at a paper mill. Estimated PGA of 0.50g during the 1987 New Zealand Earthquake.

4.7 Air Conditioning

Air conditioning systems are typically not considered as essential to life safety; however, they are typically critical for continued operation of a facility, particularly with regard to the computer systems. With the increased use of computers to control normal building functions in almost every type of facility, the air conditioning system has increasing criticality.

In this study, we have divided the air conditioning system into two major subsystems:

- Central Chilled Water System
- Air Conditioning Distribution System

These subsystems are treated separately in the following sections of the report.

4.7.1 Description of Central Chilled Water Systems

The central chilled water system, as defined here, is responsible for chilling and transporting water to the various areas of a facility where it will be used. Equipment that uses chilled water to maintain temperature in critical areas of a facility, such as air handlers and fans, are discussed with the air conditioning distribution system.

Chilled water systems can range in complexity from a very simple system which uses municipal water to complex systems using recycled facility water. In general, a facility's chilled water system includes either an evaporative cooler or a chiller to actually cool the water and peripherals (i.e., pumps, valves, and piping) used to transport the chilled water throughout the facility. Large facilities normally employ an evaporative cooling tower as an ultimate heat sink to cool recycled water from other facility systems.

The primary components of a chilled water system are the following:

- Chillers
- Pumps
- Valves
- Piping
- Evaporative coolers/Cooling towers

4.7.1.1 Chillers

Chillers are the primary component in the chilled water, centralized HVAC systems found in large commercial and industrial facilities. The basic components of a chiller include a compressor, a condenser, an evaporator, and a control and instrumentation panel. Each component is described briefly below.

- **Compressors** draw the vaporized refrigerant from the evaporator and force it into the condenser. The compressor may be either a kinetic (centrifugal) or a positive displacement (reciprocating-piston) type. Centrifugal compressors are more common in larger capacity units.
- **Condensers** are heat exchangers which reduce the refrigerant from a vapor to a liquid state. Chiller condensers are usually shell and tube-type heat exchangers, with refrigerant on the shell side.
- **Evaporators** (coolers) are tube bundles over which refrigerant is sprayed and evaporated, the inverse function of the condenser. Evaporator tubes can have either finned or plain surfaces. Basic types of evaporators include flooded type evaporators (which operate practically full of liquid refrigerant) and dry-expansion units (which operate with very small amounts of liquid refrigerant in the evaporator).
- **Control panels** provide local chiller system monitoring and control functions. Typical components include: oil level switches/gauges, temperature switches/gauges, pressure switches/gauges, undervoltage and phase protection relays, and compressor motor circuit breakers.

Chiller components may be arranged in a variety of configurations. Typically the evaporator and condenser are mounted in a stacked configuration, one above the other, with the compressor and the control panel mounted on the side. Variations of this arrangement include the side-by-side configuration, with the compressor usually mounted above the condenser and evaporator, or a configuration with all components mounted side by side on the skid. Components are usually bolted to a supporting steel skid, which is, in turn, bolted to a concrete pad. Attachments to chillers include piping for routing cooling water or refrigerant to the unit, electrical conduit, and instrumentation and control lines.

4.7.1.2 Pumps

In general, horizontal, single-stage, centrifugal pumps are used in chilled water systems. Centrifugal pumps move fluid using the kinetic energy of a rotating impeller; fluid is forced in the radial direction by centrifugal force.

Single-stage centrifugal pumps are used in applications that require a high fluid flow rate at a relatively low differential pressure. They include a single impeller that moves fluid primarily by centrifugal force. The suction port is normally mounted along or near the impeller axis, and the discharge port is mounted near the periphery.

The single stage centrifugal pumps in chilled water systems are usually powered by electric motors with the pump and motor sharing the same shaft through a close-coupled connection. Small, single-stage pumps sometimes mount the motor and impeller within the same casing.

4.7.1.3 Valves

Remote operated valves allow fluid flow in chilled water systems to be controlled from a central control panel. Remote-operated valves are generally categorized as either actuated by fluid devices (e.g., diaphragm-operated and piston-operated valves) or by electric devices (such as motors or solenoids).

- **Diaphragm-Actuated Air-Operated Valves (AOVs).** The most common type of fluid-operated valve is a diaphragm-operated pneumatic valve. The primary components of a diaphragm-operated valve are discussed below.

The *bell housing* contains a *diaphragm* (usually a thin, steel membrane) which forms a pressure barrier between the top and bottom sections of the housing.

The position of the *actuator rod* (or *valve stem*) is controlled by the differential pressure across the diaphragm. The actuator rod position, in turn, controls the position of the valve.

A *cast-iron* or *steel yoke* supports the bell housing and connects it to the valve body. The actuator rod is typically threaded through the yoke.

The air pressure on the actuator diaphragm is controlled by a *pneumatic relay* or *positioner*, which is often mounted directly to the operator yoke. This relay regulates the pressure of service air to the

actuator diaphragm and hence, the valve position. In older plants with pneumatic control systems, the valve control relay receives its signal from an instrument air system. Power plants with electronic control systems control pneumatic valve operators through solenoid valves that regulate the air pressure to the diaphragm.

The *valve*, which is actuated by a diaphragm-operator, may be of any type, size, or orientation.

- **Piston-Actuated AOVs.** Piston-operated valves are similar to diaphragm-operated valves, with a piston replacing the diaphragm as the valve actuator. The primary components of a piston-operated valve (where they differ from diaphragm-operated valve components) are discussed below.

The *cylinder* contains a *piston* which actuates the valve.

The piston acts in opposition to a *spring* to control the position of the valve.

Fluid-operators are typically cantilevered either above, or to the side of the valves they serve. The length from the cantilevered actuator to the valve body is typically 1 to 4 feet, depending on the size of the valve, with operator weights ranging up to several hundred pounds. Depending on the manufacturer, the valve and actuator can form a continuous body, or the actuator can be attached to the valve through a flanged, threaded, or ring clamp connection. The size of the valve operator depends on the size of the valve and other parameters (i.e., the pressure of the fluid in the pipe).

- **Motor-Operated Valves (MOV).** In modern facilities, electric controls replace the pneumatic controls used throughout the 1950s and 1960s. Similarly, valves are remotely controlled using electric motors rather than pneumatic devices. The primary components of a motor-operated valve are discussed below.

The *electric drive motor* typically operates at 240/480 volts and is a 3-phase, 60-cycle unit.

The *gear box* includes the gears which link the valve actuation to the drive motor shaft.

The complexity of the *control system* (or control box) included within a motor operator depends on its vintage and application. Local controls typically include a relay for actuating the primary circuit to the motor, and torque and limit switches for coordinating the drive motor and the valve position. Typically, the motor controller for the valve is mounted remotely in a motor control center; however, modern valve operators may have a local motor controller built into the operator housing, rather than in a remote motor control center.

The *valve actuator shaft* is typically threaded through the *steel support frame* or *yoke*.

The valve, which is actuated by a motor-operator, may be of any type, size, or orientation.

Motor-operators may be mounted in any position (e.g., cantilevered vertically above, below, or to the side of the valve). In some cases, the operator and yoke form a double cantilever; the operator is offset to one side of the yoke, which is cantilevered from the valve. The yoke, which connects the operator to the valve body, may take the form of a steel pipe enclosing the actuator shaft or a frame of welded beams. The attachments of the motor-gearbox to the yoke and the yoke to the valve are typically bolted flange connections, threaded connections, or ring clamps.

- **Solenoid-Operated Valves.** Solenoid operators are smaller and lighter than motor operators and have lower power requirements and a faster response time. Solenoid-operated valves are actuated by passing an electrical current through a coil, thereby creating a magnetic field which opens or closes the valve.

Solenoid operators are generally more compact than motor operators, presenting less of a cantilevered mass supported from the valve body. In addition, solenoid-operated valves are typically mounted on smaller diameter lines than MOVs.

4.7.1.4 Piping

A major component of the cooling water system is the piping, which is responsible for transporting the water from the cooling devices throughout the facility to the critical areas.

Typical piping serving chilled water systems presents a wide variety of configurations. Piping is most often steel, but can also include poly-vinyl chloride (PVC), copper, or cast

iron. Steel piping is most often welded or flanged, but some systems include sections of threaded piping or piping connected by mechanical couplings, such as the Victaulic style connection. Chilled or heated water piping is normally wrapped in thermal insulation.

Unless special provisions are made by the operating facility, piping support for chilled water systems need not consider seismic loads. Piping is typically rod hung from ceilings, either individually or in multiple runs supported on suspended trapeze hangers. Piping runs for HVAC systems are often very flexible. In known regions of high seismicity, careful building utility designers will provide some means of lateral bracing for rod-hung piping systems.

Piping systems normally include periodic taps for instrumentation, such as pressure gages, thermal resistance detectors (TRDs) or thermometers. Instrument taps are typically small tubing connections threaded directly through penetrations into the piping. Other components normally considered part of the piping system include hand valves and check valves. Valve supporting remote controlled actuators have been discussed in a section above.

4.7.1.5 Evaporative Coolers and Cooling Towers

Evaporative cooling towers are the ultimate heat sink for most chilled water systems. Circulating water within a building facility is routed through an evaporative cooling tower to discard heat to atmosphere. Cooling towers must therefore be located outdoors, either on a building roof or utility mat adjacent to the building.

Evaporative cooling towers are typically large, steel-frame structures with an exterior cladding or lightweight sheet metal. Water is pumped to the top of the cooling tower and trickles down through a series of baffles, being cooled by a forced updraft of ambient air during its descent. Fans are placed at the top or the bottom of the tower to force air circulation.

Cooling towers are frequently supported on spring isolation mounts to damp out vibration from the operating fans.

An alternative design is the coil type water-to-air heat exchanger. Rather than cooling the water by evaporation to a forced air flow, dry air is forced past finned tubing containing the circulating water (the coil unit). Like evaporative cooling towers, coil heat exchangers typically include propeller fans at the base of the coil assembly to force the air flow past the finned water tubes. Coil heat exchangers are typically smaller than evaporative cooling towers.

4.7.2 Description of Air Conditioning Distribution Systems

The air conditioning distribution system, as defined here, uses chilled or heated water to maintain temperature in critical areas of a facility. This section describes equipment distributed throughout a building for the purpose of exchanging heat between the chilled (or heated) water and the internal air.

Distribution systems can range in complexity from a very simple system which use window-mounted air conditioners, to complex systems using multi-stage filters in air handling units. In general, the primary components of an HVAC system are the following:

- Fans
- Air handling units
- Heating, Ventilation, and Air Conditioning (HVAC) ducts

4.7.2.1 Fans

Industrial HVAC fans are divided into two general classes: axial and centrifugal.

Axial Fans. Axial fans are used in relatively low pressure applications such as building HVAC systems or cooling towers. The two major types of axial fans are:

- Propeller fans
- Vane-axial fans

Propeller fans consist of two or more blades assembled on a central shaft and revolving within a narrow mounting-ring. Propeller fans move air (without developing significant pressure) simply by the angle of attack of the propeller blades. Propeller fans are often mounted to a wall or ceiling and are typically used for general ventilation or makeup air applications.

Vane-axial fans have an impeller wheel, typically with four to eight blades, mounted to a central shaft within a cylindrical casing. Vane-axial fans are generally used in higher pressure, higher flow applications than propeller fans. Vane-axial fans include a set of guide vanes mounted either before or after the impeller that streamline the air flow for greater efficiency. The vanes convert much of the kinetic energy imparted to the air stream from the impeller into increased air pressure, so that vane-axial fans can operate at differential pressures of up to 12 inches of water.

A variation of vane-axial design are tube-axial fans, which include the higher pressure impeller wheel mounted within a cylindrical casing, but without the provision of vanes.

Certain axial fan designs include multiple impellers for increased pressure boost. Axial-flow fans are normally mounted inside cylindrical ducting, supported by radial struts running from the duct wall to the duct centerline. Electric drive motors are usually mounted along the duct centerline immediately upstream of the impeller. The impeller and drive shaft are normally cantilevered from the motor. Alternate designs mount the motor on the outside of the duct with a belt connection between the motor and the impeller drive shaft. Belt connections allow the fan and motor to operate at different speeds.

Centrifugal Fans. Centrifugal fans are divided into three major categories depending upon the position of their blades. The three blade positions are:

- Forward-curved
- Radial
- Backward-inclined

Forward-curved centrifugals (also called squirrel-cage fans) have blades inclined toward the direction of rotation at the tip. These fans produce high flow volumes at low static pressures and are the most widely used centrifugal fans for general ventilation and packaged HVAC equipment.

Radial-blade centrifugals have their blades positioned on the radii extending from their axis of rotation. These radial designs are the simplest and least efficient type of centrifugal fan.

Backward-inclined fans are the third type of centrifugal fan and have their blades inclined opposite to the direction of rotation at the tip.

Centrifugal fans typically have a cylindrical intake duct centered on the fan shaft and a square discharge duct directed tangentially from the periphery of the fan. A variation of the centrifugal fan is the tubular centrifugal fan which redirects the discharged air in the axial direction. As with axial-flow fans, centrifugal fans can have the electrical drive motor mounted either directly on the fan shaft, or outside of the fan casing with a belt drive to the fan. The impeller and drive shaft may have either a single-point support, where they are cantilevered from the motor, or a two-point support, where the shaft is supported both at the motor and at an end bearing.

4.7.2.2 Air Handling Units

Air handlers are sheet metal enclosures containing (as a minimum) a fan and a heat exchanger, for the purpose of heating, dehumidifying or chilling air, and distributing it to areas within a building, usually through a duct system. Small capacity, simple air handlers are often referred to as fan-coil units. Additional components such as filters, air-mixing

boxes, and dampers are included in more elaborate air handlers. A brief description of air handler components is included below.

- **Fans** produce air flow across the coil for heat transfer. Air handlers normally use a centrifugal fan, with either a direct drive motor or are belt-driven by an external motor.
- **Coils** act as heat exchangers in an air handler. Cooling coils are rectangular arrays of tubing (typically 1/2 inch in diameter) with fins attached to improve the heat transfer efficiency. The coils are typically copper, with copper or aluminum fins.
- **Filters** are included to improve the quality of the distributed air. The filters are either a strainer type (typically containing a replaceable sheet of cellulose, glass fibers, cotton batting, wool felt, or synthetic material), or the electronic type (the filter ionizes the particles in the airstream with an electric charge and captures them on a charged plate). Filters are typically mounted in steel frames which are bolted together as part of a modular system.
- **Mixing Boxes** are used as a plenum for combining two airstreams (such as outside air and return air) before channeling the resulting blend into the unit.
- **Dampers** are rotating flaps provided in the inlet or outlet sides of the air handler to control the flow of air into or out of the fan.

Air handlers are typically classified as being either a draw-through or a blow-through type. Draw-through air handlers have the heat exchanger (coil) upstream of the fan, whereas the blow-through design locates the coil downstream.

Air handler enclosures normally consist of sheet metal welded to a framework of steel angles or channels. Typical enclosures range in size from 2 feet to over 10 feet on edge, with weights ranging from 200 to 10,000 pounds. Large components, such as fans and coils, are typically bolted to internal frames which are welded to the enclosure framing. Fans may be located in a variety of orientations with respect to the coil unit.

Air handlers typically include a system of attached ducts, which provides for the intake and discharge of air. Additional attachments to air handlers include piping for cooling water or refrigerant, electrical conduit, and instrumentation lines.

4.7.2.3 HVAC Ducts

The last component of the HVAC system discussed here is the ducting, which is responsible for transporting the cooled air from the fan/AHU throughout the facility to the critical areas.

HVAC ducting is found in a range of designs. The most common are sheet metal ducts of rectangular or circular cross section. Sheet metal ducting is typically suspended from ceilings by metal straps or rod-hung trapeze supports. Design of the ducting often follows standards of the Sheet Metal And Air Conditioning Contractors National Association (SMACNA). Duct connections may be companion angle or riveted lap joints.

Smaller sections of HVAC ducting, near the outer reaches of the air flow system, are sometimes routed through suspended ceilings. In some cases, the ducting is no more than a lightweight segmented plastic tube that rests atop the T-bar framing of a suspended ceiling. Suspended ceiling ducting typically terminates in steel diffuser panels, placed within the T-bar framing in the same manner as an acoustic ceiling panel. These metal diffusers are sometimes not separately attached (by cable) to the slab above, and can therefore dislodge from the T-bar framing under earthquake-induced sway.

4.7.3 Seismic Performance of Chilled Water Systems

This section describes the observed vulnerabilities for the components of chilled water systems.

Chillers	Breaking of attached piping due to failure of vibration isolator supports.
Pumps	Breaking of piping connections due to differential settlement. Pump damage due to large movement of piping.
Valves	Malfunction due to rigidly attached tubing disconnecting when the valve moved. Broken yokes from impact with structural members.

Piping

Breaking of mechanical (Victaulic-type) couplings.

Damage to piping due to differential displacement of support points.

Non-ductile piping (e.g. PVC) cracked due to movement of piping, supports, or attached equipment.

Piping cracked at location of old weld repair.

**Evaporative Coolers/
Cooling Towers**

Damage to evaporative coolers due to failure of vibration isolators.

Structural damage to deteriorated wood cooling towers.

Structural damage to cooling towers with eccentric beam connections.

4.7.4 Seismic Performance of Air Conditioning Distribution Systems

This section describes observed vulnerabilities in the components of distribution systems. Fans and Air handling units have shown the same general vulnerabilities and are discussed together.

Fans and Air Handlers

Damage due to failed vibration isolation supports.

Damage due to differential displacements (e.g. fan and motor on different foundations or movement of equipment attached by rigid piping or ducting).

Damage to flexible bellows from movement of air handlers, fans, or attached ducts.

HVAC Ducting

Falling of duct due to corrosion failure.

Falling of cantilevered duct sections due to high inertial loading causing high reaction forces at relatively weak connections (e.g. riveted lap joints and simple friction connections).

Falling of cantilevered ducts where flexible headers developed high stresses in short duct segments not flexible enough to accommodate the motion.

Falling of cantilevered ducts which are not tied down to their supports.

Falling of ducts due to failure of suspended ceilings.

Shearing and opening of joints and falling of light gage circular duct with riveted lap joints subject to high bending strains in very flexible systems.

4.7.5 Specific Instances of Damage to Chilled Water Systems

This section describes specific instances of damage to chilled water system components that have led to the descriptions of observed vulnerabilities presented in Section 4.7.3. Also presented are examples of "seismic effects", where local damage did not lead to malfunction. Note that these examples do not attempt to describe all known instances of damage in earthquakes.

Chillers

- At two data processing facilities, affected by the 1987 Whittier Earthquake, chillers on vibration isolators shifted sufficiently to fracture attached piping, rendering the chillers inoperable (Figure 4-29).
- At a third data processing facility, affected by the 1987 Whittier Earthquake, two chillers shifted off their spring-type vibration isolators. These units remained operable during and following the earthquake (Figure 4-30).
- At a utility headquarters building, affected by the 1987 Whittier Earthquake, one of five chillers on vibration isolators shifted

sufficiently to fracture attached piping, rendering the chillers inoperable.

- At a large office complex, affected by the 1989 Loma Prieta Earthquake, eight pad-mounted refrigerant compressors rolled off their isolation mounts. The units were undamaged and operational once they were re-mounted. Attached piping had sufficient flexibility to accommodate the displacement (Figure 4-31).

Pumps

- At a data processing facility, affected by the 1987 Whittier Earthquake, horizontal pumps in the penthouse were dislodged from their vibration isolation mounts. The pumps appeared to be functional, in spite of the anchorage damage (Figure 4-32).
- At a second data processing facility, affected by the 1987 Whittier Earthquake, horizontal pumps mounted on vibration isolators with seismic stops showed evidence of movement. Some of the bolts anchoring the seismic stops showed evidence of minor prying; however, the pumps continued to operate (Figure 4-33).

Valves

- At a power plant, affected by the 1979 Imperial Valley Earthquake, a diaphragm-operated valve became stuck following the earthquake, when rigid tubing attached to the operator came loose. The rigid 1/4-inch tube did not allow for differential displacement. There was no permanent damage as a result of this incident.
- At a data processing facility, affected by the 1987 Whittier Earthquake, one of four small, chilled water pumps (approximately 10 hp) sustained a cracked casing. The damage was apparently caused by seismic anchor movement. A chiller that was rigidly connected to the pump through piping moved six inches during the earthquake (Figure 4-34).
- At a power plant, affected by the 1979 Imperial Valley Earthquake, the cast-iron yoke of a diaphragm-operated valve cracked, due to the repeated impact of its diaphragm housing with an adjacent steel column (Figure 4-35).

- At a power plant, affected by the 1985 Chile Earthquake, two diaphragm-operated valves were damaged due to the impact of their cast-steel yokes with an adjacent handrail approximately 10 inches away. On one operator, the connecting service air line broke, due to insufficient slack to accommodate the displacement of the operator (Figure 4-36).

Piping

- At a navy base hangar, affected by the 1986 Alaska Earthquake, a chilled water line sustained damage when a Victaulic coupling broke. The mechanical coupling could not accommodate the lateral loads caused by the differential displacement of its supports (Figure 4-37).
- At a manufacturing plant, affected by the 1989 Loma Prieta Earthquake, a roof-mounted, PVC, chilled water line sustained several cracks caused by the pipe's inability to accommodate the differential displacement loads on its supports.
- At a power plant, affected by the 1991 Costa Rica Earthquake, a PVC pipe fractured due to settlement of the base slab supporting it. The pipe could not accommodate the differential settlement of its supports.
- At a navy base, affected by the 1992 Cape Mendocino Earthquake, PVC chilled water piping attached to an air handler broke. The equipment was supported on vibration isolators that moved differentially from the pipe supports, causing the pipe to break (Figure 4-38).
- At three data processing facilities, affected by the 1987 Whittier Earthquake, movement of piping damaged wall penetrations. The pipes were undamaged in all cases (Figure 4-39).
- At a power plant, affected by the 1979 Imperial Valley Earthquake, cooling water lines cracked at the location of an old weld repair.

Evaporative Coolers/Cooling Towers

- At a data processing facility, affected by the 1987 Whittier Earthquake, a forced-draft evaporative cooler shifted off its vibration isolators. The unit remained operable in site of its anchorage damage (Figure 4-40).

- At a telephone facility, affected by the 1987 Whittier Earthquake, evaporative coolers shifted off their vibration isolators (Figure 4-41).
- At a small manufacturing facility, affected by the 1989 Loma Prieta Earthquake, an evaporative cooler rotated and dislodged from its isolation mounts. The attached piping remained intact and the cooler was operable once it was remounted.
- At a petrochemical facility, affected by the 1983 Coalinga Earthquake, a large wooden cooling tower sustained internal damage to beams and columns. Operators noted that the tower is constantly undergoing repairs due to the corrosive nature of the water flowing through the tower.
- At a cogeneration plant experiencing the 1992 Cape Mendocino Earthquake, a cooling tower was structurally damaged in several locations due to a joint detail where the diagonal beams were eccentric to the joint (Figure 4-42).

4.7.6 Specific Instances of Damage to Air Conditioning Distribution Systems

This section describes specific instances of damage to fans, air handlers, and HVAC ducts that have led to the observed vulnerabilities described in Section 4.7.4. Also included are descriptions of instances of "seismic effects", where local damage was noted that did not affect the function of the system.

Fans and Air Handlers

- At a large electrical substation, affected by the 1971 San Fernando Earthquake, a centrifugal fan located in the third floor HVAC room, broke its cast-iron isolation mounts. The isolation mounts were not designed to accommodate lateral loads. At the same facility one of six frame-mounted fans, in the basement, broke its spring isolator (Figure 4-43).
- At two data processing facilities, affected by the 1987 Whittier Earthquake, fans in the penthouses were knocked from their non-seismically designed vibration isolation mounts (Figure 4-44).
- At a large office complex, affected by the 1989 Loma Prieta Earthquake, a roof-mounted HVAC fan shifted on its rubber isolation

mounts. The fan was otherwise undamaged and operable (Figure 4-45).

- At a utility headquarters building, affected by the 1987 Whittier Earthquake, fans supported on vibration isolators fell off of their supports.
- At a small manufacturing facility, affected by the 1989 Loma Prieta Earthquake, two centrifugal fans in the penthouse dislodged from their isolation mounts. The units were otherwise undamaged and were operable once they were remounted.
- At a large electrical substation, affected by the 1971 San Fernando Earthquake, most of the 48 air handling units on the second floor of the station building were shaken from their isolation mounts. The mountings were not designed to accommodate seismic loads. On five of the units, the movement was sufficient to damage attached piping and ducts (Figure 4-46).
- At a data processing facility, affected by the 1987 Whittier Earthquake, air handlers in the penthouse were dislodged from their vibration isolation mounts.
- At a manufacturing plant, affected by the 1989 Loma Prieta Earthquake, sheet metal ducting near four roof-mounted air handlers was reported to have pulled apart at several seams. This may have been aggravated by rocking of the air handlers on their isolation mounts. The insulated PVC water lines serving the air handlers were reported to have fractured in four different locations on the roof. The air handlers themselves were reported as undamaged by the earthquake. Additional air handler damage at the facility occurred when six unanchored air conditioning units shifted several inches exposing duct penetrations. Conduit attached to the units was pulled apart by the imposed displacement.
- At a large office complex, affected by the 1989 Loma Prieta Earthquake, two sheet-metal enclosed air handlers rolled off their isolation mounts. Attached water lines appeared to have sufficient flexibility such that there were no reports of water leaks. The air handlers were undamaged and operational once they were remounted.
- At a steel mill, affected by the 1985 Mexico Earthquake, the forced-draft fans associated with the plant's boilers suffered shaft

misalignment. The boilers are tied to the fan housings through a large, heavy, rigidly attached duct system. The boilers shifted during the earthquake, pulling the duct, which in turn, pulled on and caused a misalignment of the fans (Figure 4-47).

- At a chemical plant, affected by the 1985 Mexico Earthquake, three forced-draft fans suffered shaft misalignments. The misalignments were apparently caused by differential ground settlement at the site (at some places, as much as 12 inches). In at least one case, the misalignment was sufficient for the impeller to impinge on the fan housing.
- At a power plant, affected by the 1987 Superstition Hills Earthquake, all four direct drive, forced-draft fans suffered misalignments ranging from 0.003 to 0.011 inches. The fans are attached to a pendulum-supported boiler through a duct system. It appears that seismic loads transferred from the boiler, through the flexible duct system to the fan housing, caused the fans' misalignment.
- At a utility headquarters building, affected by the 1987 Whittier Earthquake, two rod-supported air handlers swayed sufficiently to break attached 1-inch water lines.
- At a manufacturing facility, affected by the 1989 Loma Prieta Earthquake, a fan motor, mounted external to the air handler, sheared its anchor bolts. The cause appears to be differential flexure between the fan impeller (connected to the motor through the drive shaft) and the steel frame supporting the motor (Figure 4-48).
- At a data processing facility, affected by the 1989 Loma Prieta Earthquake, a threaded water line within the mechanical penthouse air handler was reported to have cracked at the attachment to one of the water coils. It appears that there was insufficient flexibility in the water line to accommodate displacement between the spring-mounted air handler and the relatively stiff water lines outside the assembly.
- At a small manufacturing facility, affected by the 1989 Loma Prieta Earthquake, an in-line vane-axial fan tore the elastic bellows connecting the fan enclosure to the HVAC ducts. The fan enclosure did not fall and was otherwise undamaged (Figure 4-49). Similar damage occurred at a data processing facility in the same epicentral area.

HVAC Ducting

- At a paper mill, affected by the 1987 New Zealand Earthquake, a section of rod-hung duct fell from its supports. The circular duct was fastened with riveted joints that pulled apart during the earthquake. Inspection of the fallen section of duct revealed severe corrosion at the riveted joint (Figure 4-50).
- At a small electronics manufacturing facility, affected by the 1984 Morgan Hill Earthquake, a cantilevered, vertical section of HVAC duct broke from its horizontal header and fell (Figure 4-51). The round duct was constructed of riveted lap joints, which failed under the cantilever's inertial loads. A split was also noted in another section of HVAC ducting.
- At the same facility, another section of duct split a seam where a branch line entered a wall penetration (Figure 4-52). The damaged section was approximately ten inches in diameter, branching off an estimated twenty inch diameter header. The seam pulled apart near the wall, approximately four feet from the branch point. The branch apparently was not flexible enough to accommodate the header motion, and the seam was too weak to resist the imposed differential displacement.
- At a small manufacturing facility, affected by the 1989 Loma Prieta Earthquake, a section of HVAC ducting broke and fell to the floor. The circular duct is lap jointed (without rivets or bolts) and hung from the ceiling with sheet metal straps. During the earthquake, a portion of the duct fell to the floor when a strap broke at the duct connection and the attached section pulled free of its joints (Figure 4-53).
- At a chemical plant, affected by the 1985 Mexico Earthquake, a cantilevered duct section severed and fell. The duct was not positively attached to its rod-hung trapeze supports. Seismically induced uplift of the duct allowed the support to swing out from under the duct. The duct could not support the cantilevered weight and severed at a connection (Figure 4-54).
- At a data processing center in the 1987 Whittier Earthquake, a duct above the battery racks deformed at the joints of an angled offset section (Figure 4-55).

- At a communications building in Watsonville in the 1989 Loma Prieta Earthquake, a vertical cantilevered section of duct fell to the floor with its attached diffuser (Figure 4-56).

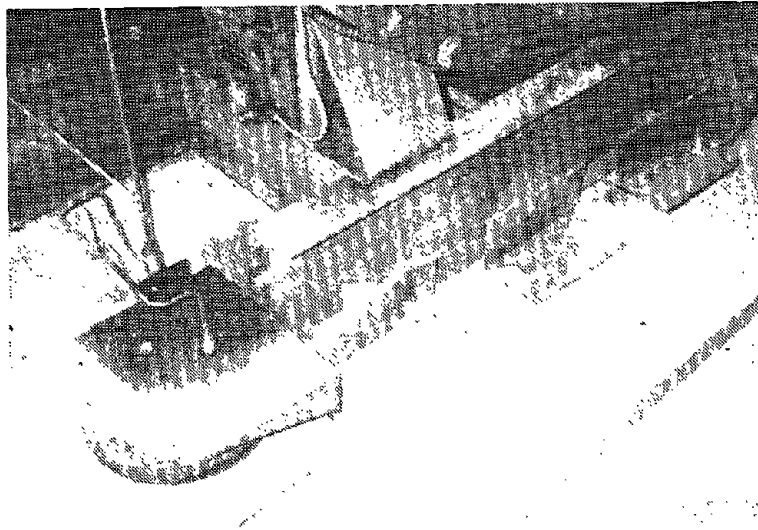

Figure 4-29: These chillers, located at two data processing facilities, affected by the 1987 Whittier Earthquake, shifted sufficiently on their vibration isolators to fracture attached piping, and render the units inoperable.

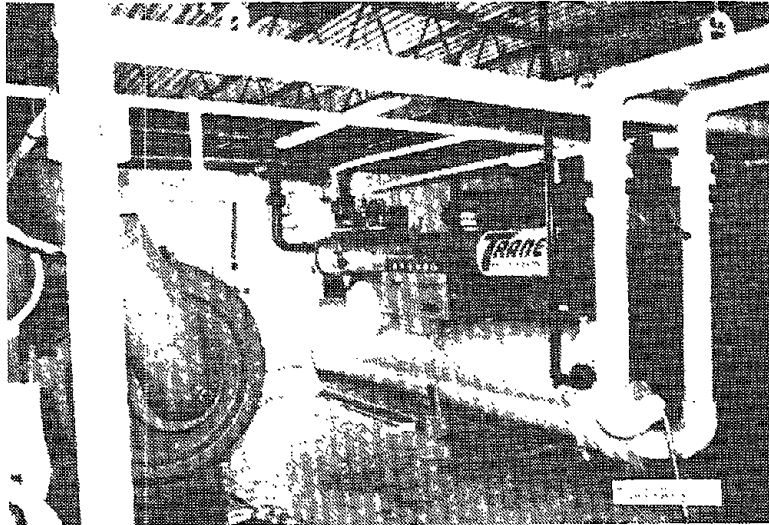

Figure 4-30: These chillers, located at a processing facility, affected by the 1987 Whittier Earthquake, shifted off their spring-type vibration isolators. The units remained operable during and following the earthquake.

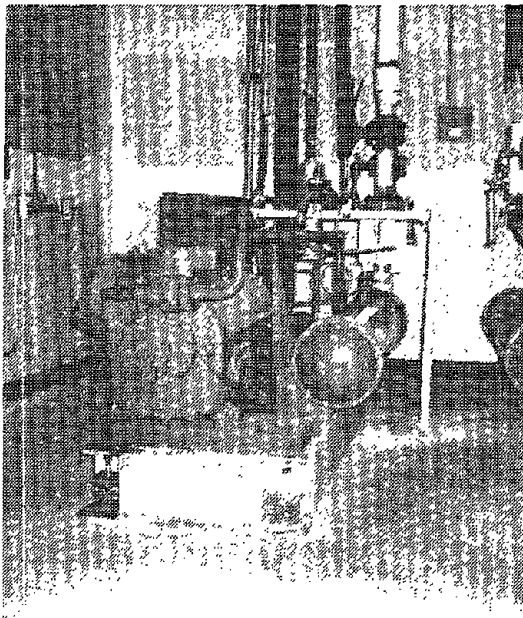

Figure 4-31: One of eight pad-mounted refrigerant compressors located at a large office complex, affected by the 1989 Loma Prieta Earthquake, that rolled off its isolation mounts. The units were undamaged and operational once they were re-mounted. Attached piping had sufficient flexibility to accommodate the displacement.

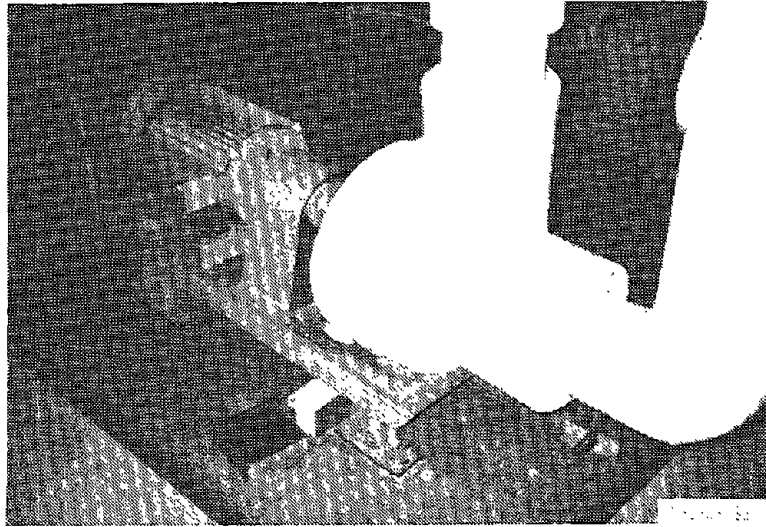

Figure 4-32: This horizontal pump in the penthouse of a data processing facility, affected by the 1987 Whittier Earthquake, dislodged from its vibration isolation mounts. The pump remained functional, in spite of the anchorage damage.

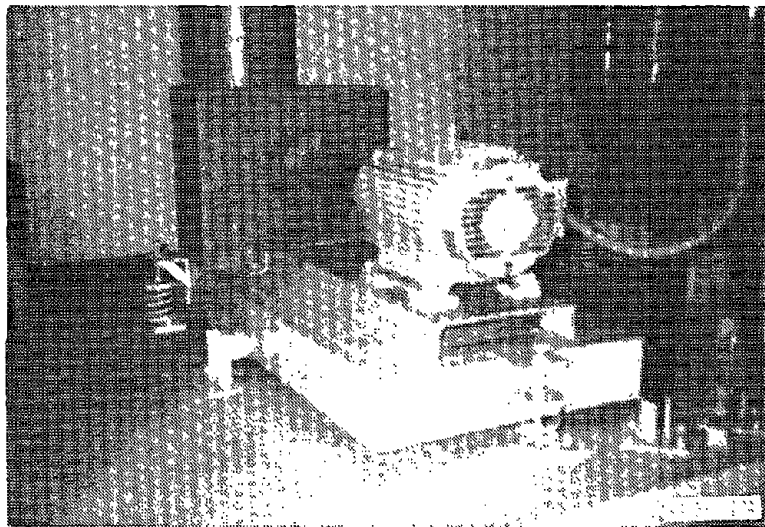

Figure 4-33: This pump mounted on vibration isolators with seismic stops, located at a second data processing facility affected by the 1987 Whittier Earthquake, showed evidence of movement. Some of the bolts anchoring the seismic stops showed evidence of minor prying; however, the pump continued to operate.

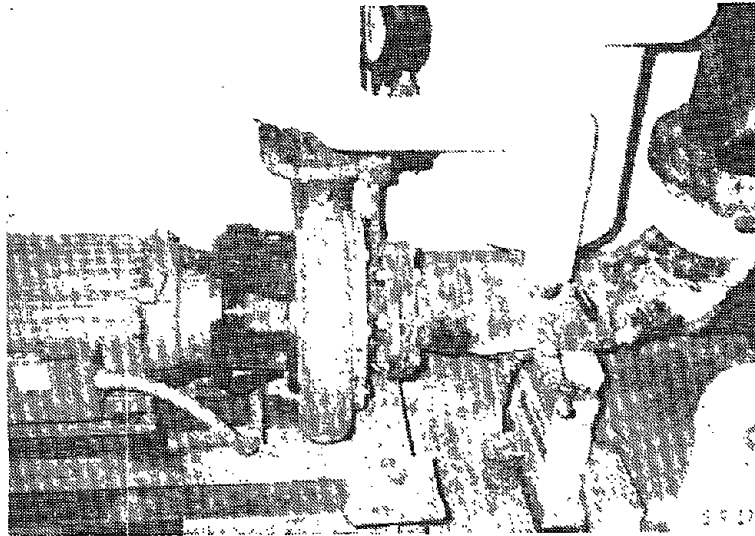

Figure 4-34: This chilled water pump at a data processing facility, affected by the 1987 Whittier Earthquake, sustained a cracked casing. The damage was apparently caused by seismic anchor movement. A chiller that was rigidly connected to the pump through piping moved six inches during the earthquake.

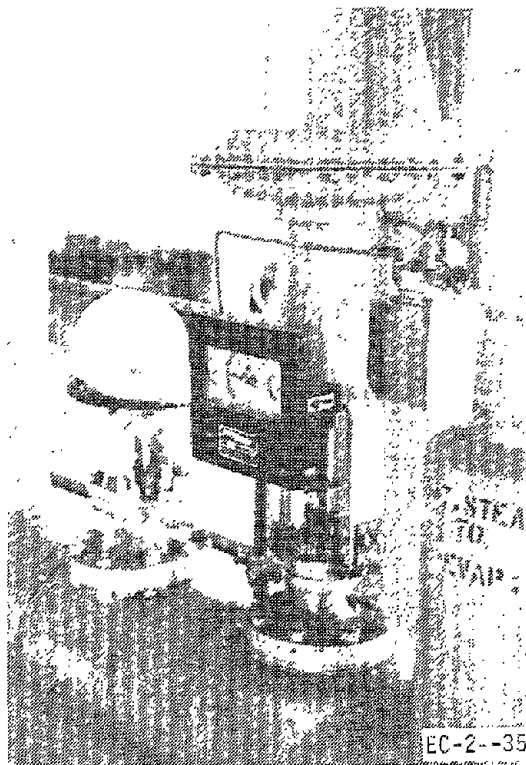

Figure 4-35: At a power plant, affected by the 1979 Imperial Valley Earthquake, the cast-iron yoke of a diaphragm-operated valve cracked, due to the repeated impact of its diaphragm housing with an adjacent steel column. The arrow points to the repair at the location of the damage.

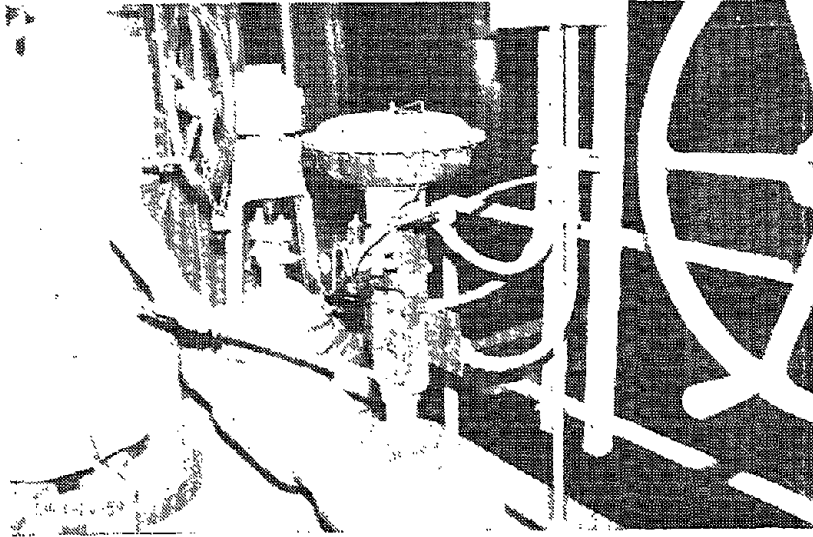

Figure 4-36: One of two diaphragm-operated valves at a power plant, affected by the 1985 Chile Earthquake, that were damaged due to the impact of their cast-steel yokes with an adjacent handrail approximately 10 inches away. On one operator, the connecting service air line broke, due to insufficient slack to accommodate the displacement of the operator.

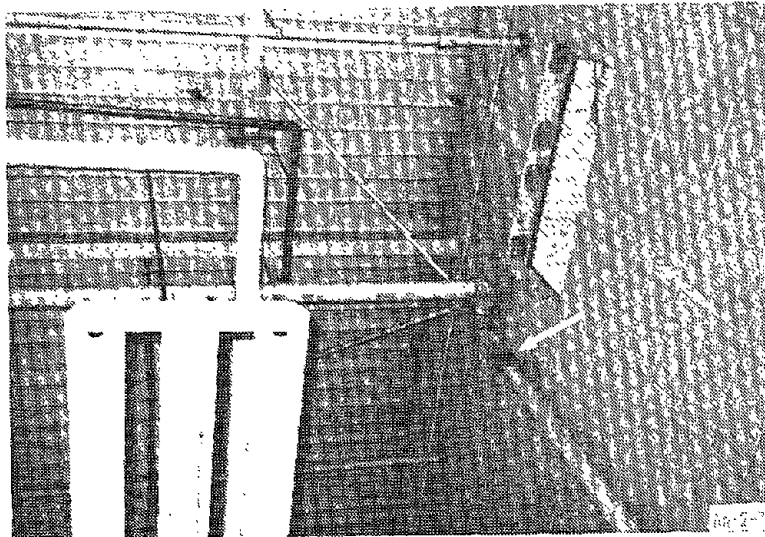

Figure 4-37: This chilled water line located at a navy base hangar, affected by the 1986 Alaska Earthquake, sustained damage when a Victaulic coupling broke. The mechanical coupling could not accommodate the lateral loads caused by the differential displacement of its supports.

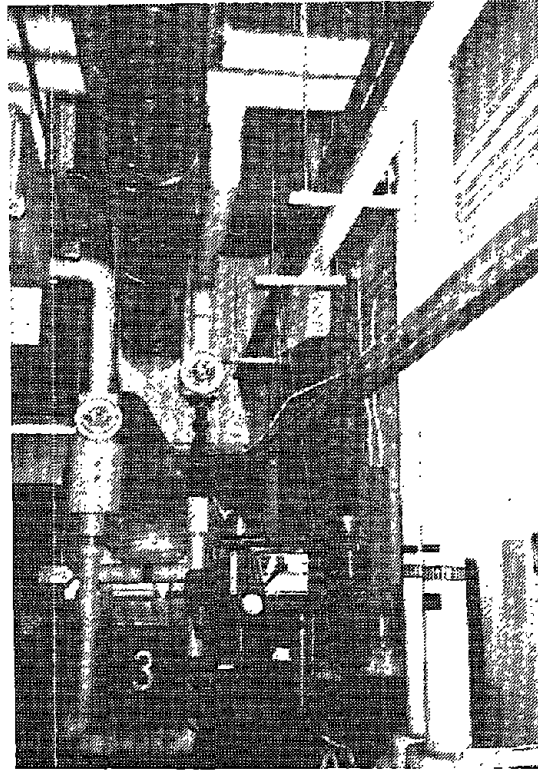

Figure 4-38: At a navy base, affected by the 1992 Cape Mendocino Earthquake, PVC chilled water piping attached to an air handler broke. The equipment was supported on vibration isolators that moved differentially from the pipe supports, causing the pipe to break.

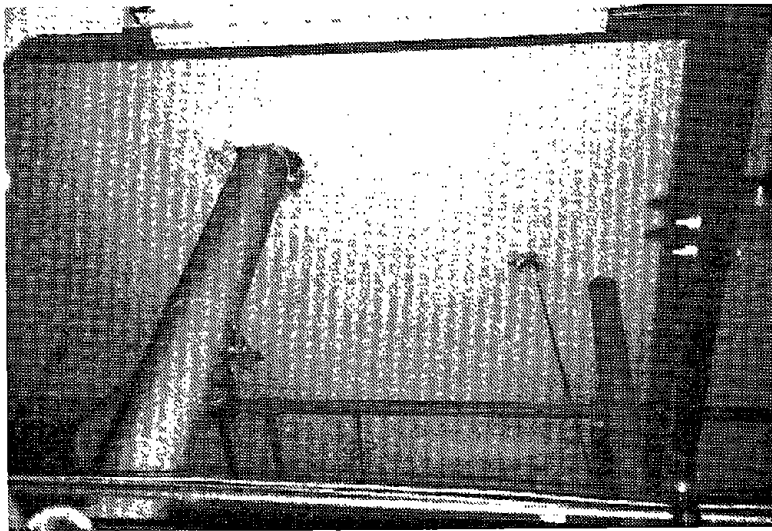
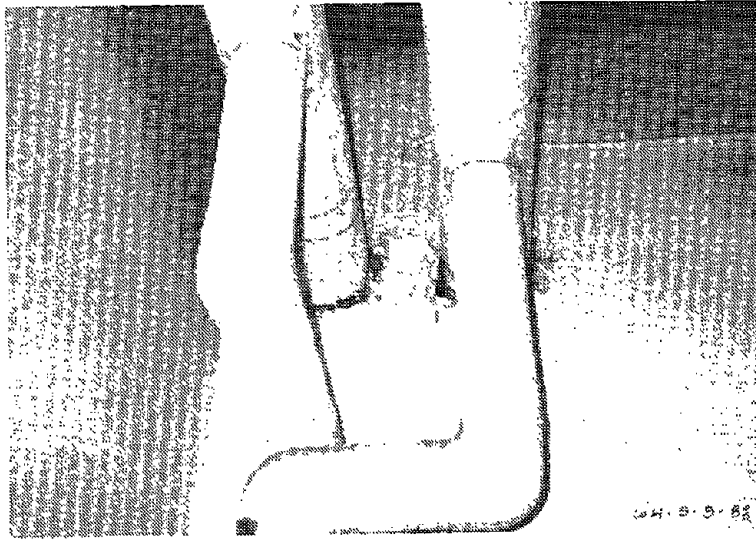

Figure 4-39: Two of three data processing facilities, affected by the 1987 Whittier Earthquake, where movement of piping damaged wall penetrations. The pipes were undamaged in all cases.

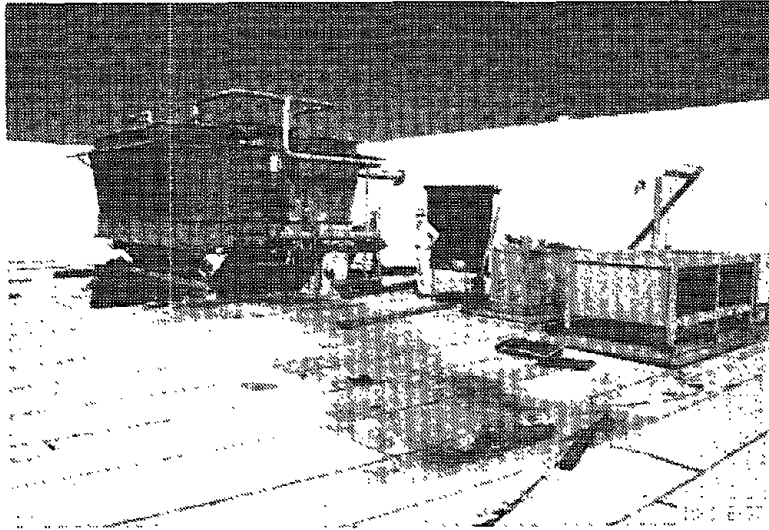

Figure 4-40: This forced-draft evaporative cooler at a data processing facility, affected by the 1987 Whittier Earthquake, shifted off its vibration isolators. The unit remained operable in spite of its anchorage damage.

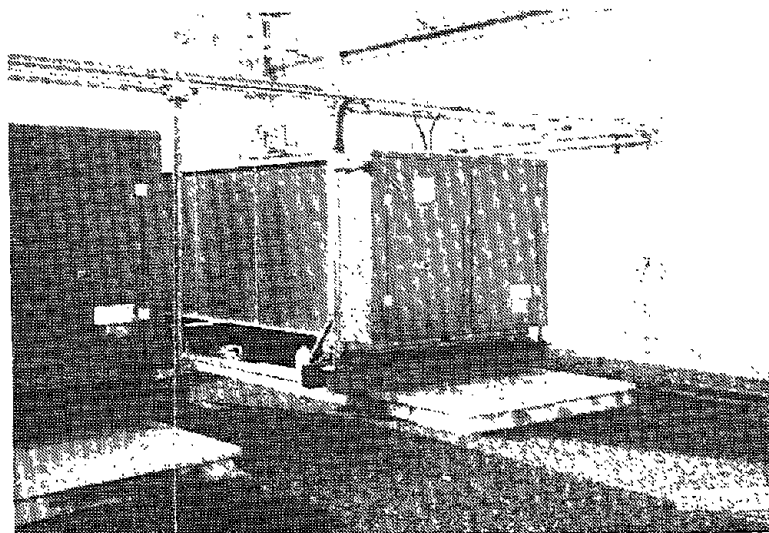

Figure 4-41: These evaporative coolers located at a telephone facility shifted off their vibration isolators during the 1987 Whittier Earthquake.

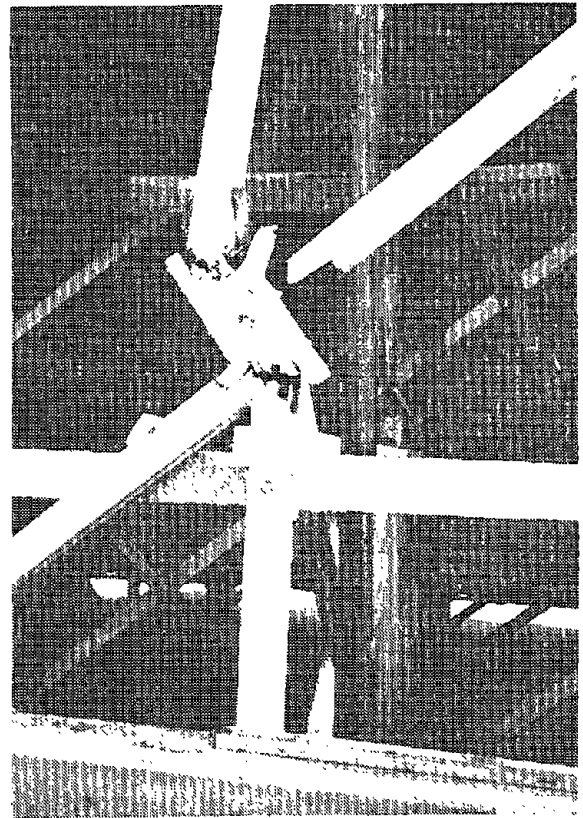
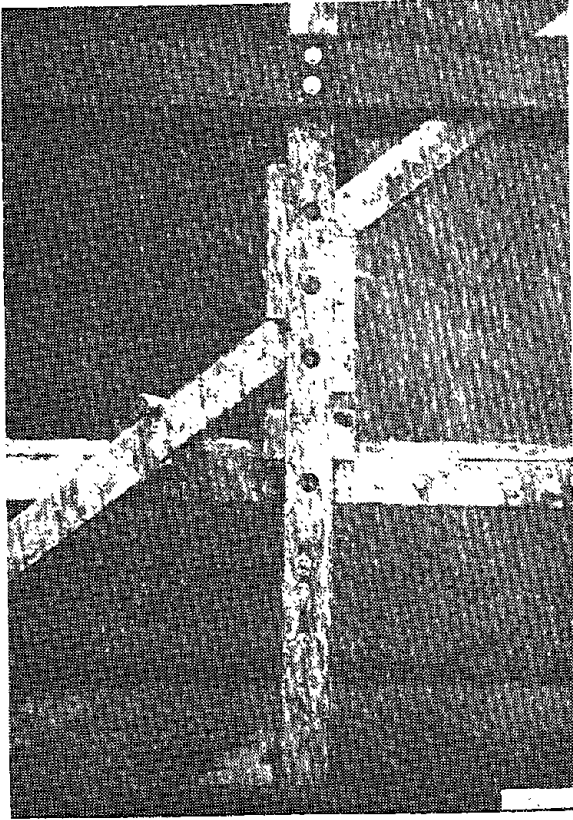

Figure 4-42: Eccentric connections damaged in cooling towers at a cogeneration plant in the 1992 Cape Mendocino Earthquake. Photo on left is an identical undamaged connection.

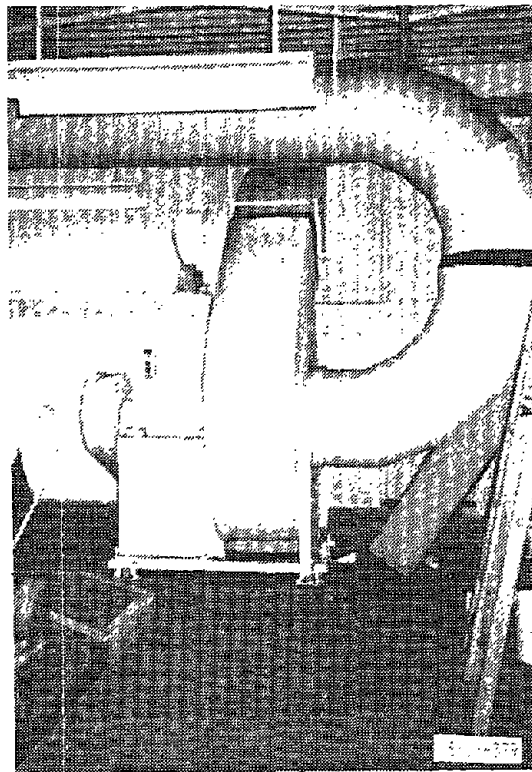
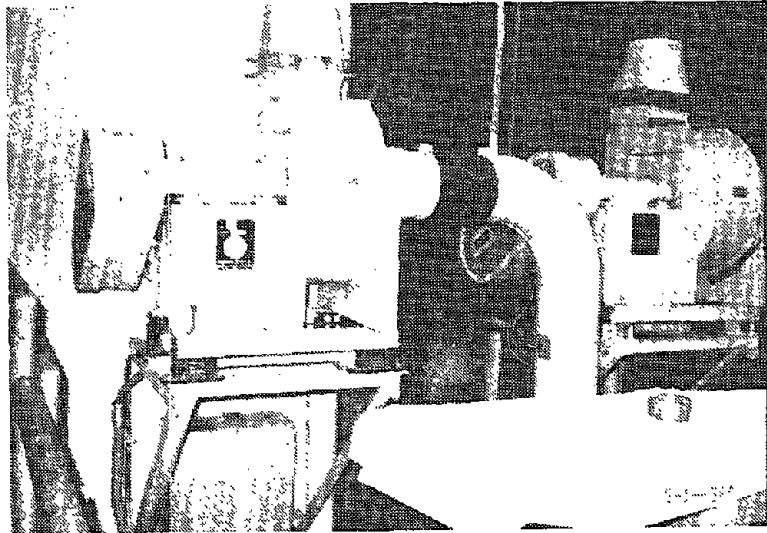

Figure 4-43: Two examples of damage to fans on vibration isolators occurred at a large electrical substation, affected by the 1971 San Fernando Earthquake. In one case, a centrifugal fan located in the third floor HVAC room, broke its cast-iron isolation mounts. In the second case, one of six frame-mounted fans, in the basement, broke its spring isolators.



Figure 4-44: This fan, located in the penthouse at a data processing facility, affected by the 1987 Whittier Earthquake, was knocked from its non-seismically designed vibration isolation mounts. Not the torn duct connection.



Figure 4-45: This roof-mounted HVAC fan located at a large office complex, affected by the 1989 Loma Prieta Earthquake, shifted on its rubber isolation mounts. The fan was otherwise undamaged and operable.

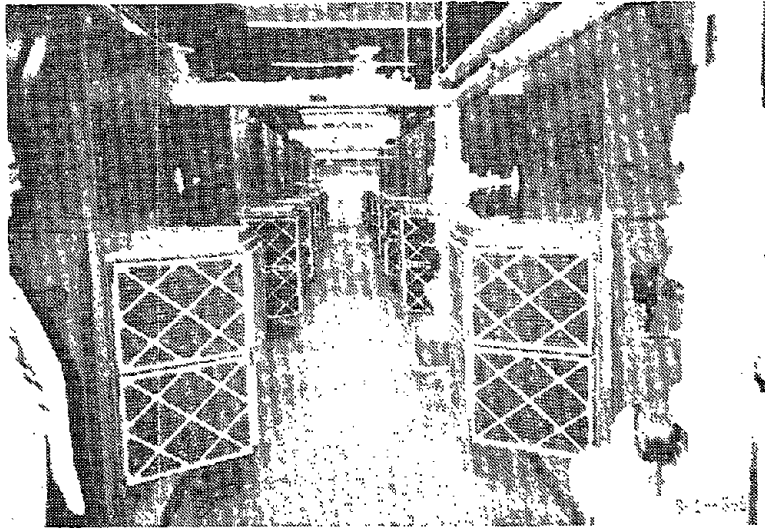

Figure 4-46: Most of the 48 air handling units located on the second floor of a large electrical substation, affected by the 1971 San Fernando Earthquake, were shaken from their isolation mounts. The mountings were not designed to accommodate seismic loads. On five of the units, the movement was sufficient to damage attached piping and ducts.

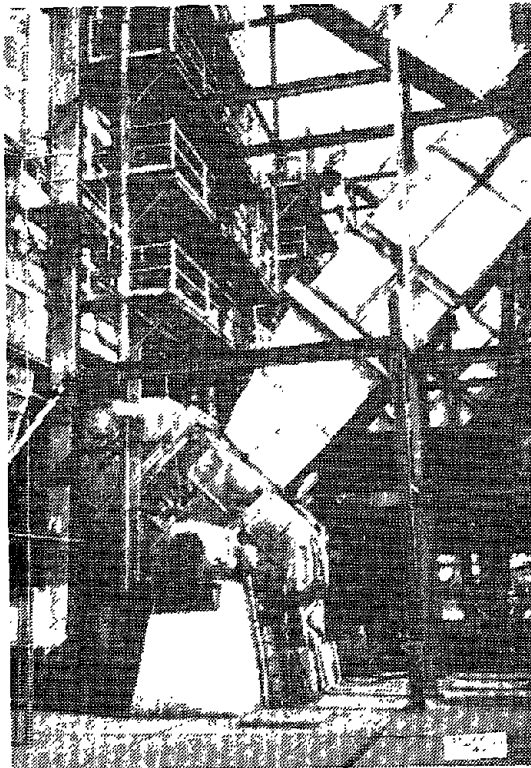

Figure 4-47: These forced-draft fans associated with the plant's boilers at a steel mill, affected by the 1985 Mexico Earthquake, suffered shaft misalignment. The boilers are tied to the fan housings through a large, heavy, rigidly attached duct system. The boilers shifted during the earthquake, pulling the duct, which in turn, pulled on and caused a misalignment of the fans.

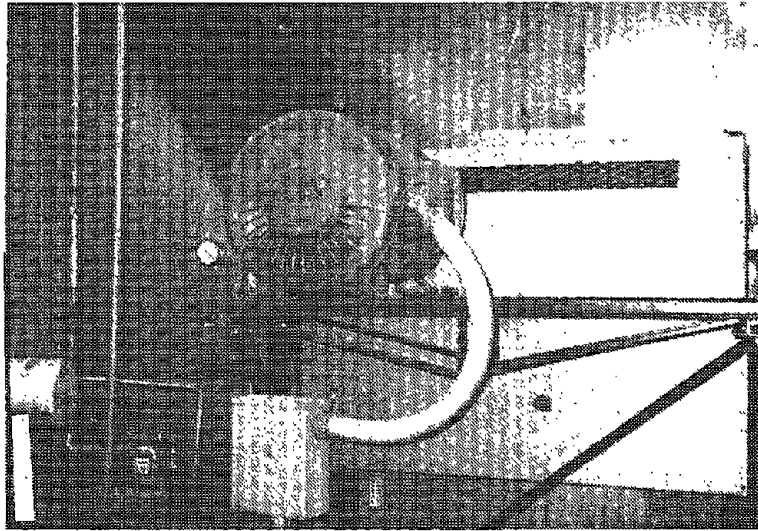

Figure 4-48: At a manufacturing facility, affected by the 1989 Loma Prieta Earthquake, a fan motor, mounted external to the air handler, sheared its anchor bolts. The cause appears to be differential flexure between the fan impeller (connected to the motor through the drive shaft) and the steel frame supporting the motor.

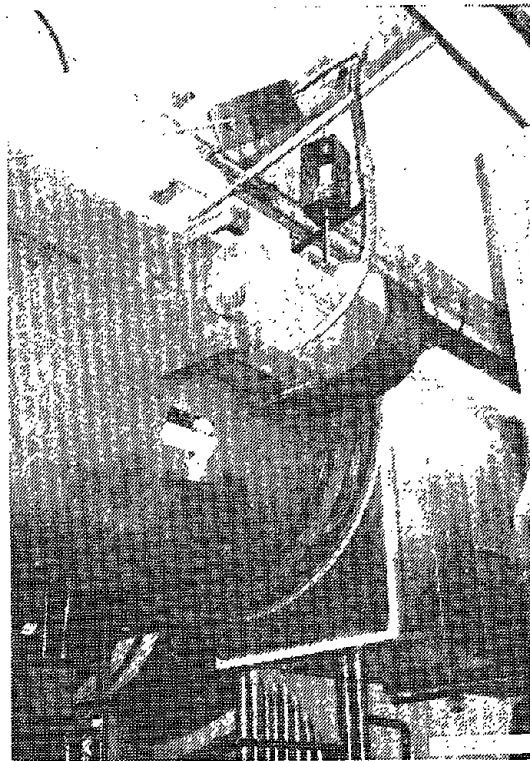

Figure 4-49: This in-line vane-axial fan at a small manufacturing facility, affected by the 1989 Loma Prieta Earthquake, tore the elastic bellows connecting the fan enclosure to the HVAC ducts. The fan enclosure did not fall and was otherwise undamaged.

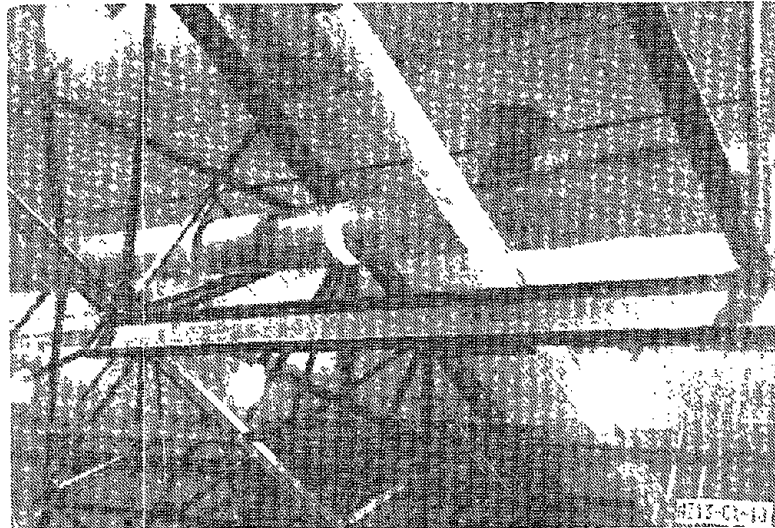

Figure 4-50: At a paper mill, affected by the 1987 New Zealand Earthquake, a section of rod-hung duct fell from its supports (Note new joint, shown as a light patch). The circular duct was fastened with riveted joints that pulled apart during the earthquake. Inspection of the fallen section of duct revealed severe corrosion at the riveted joint.

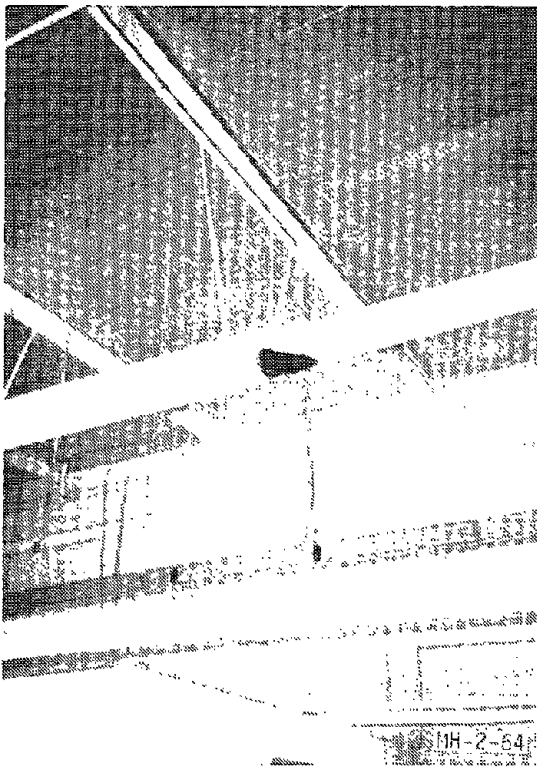
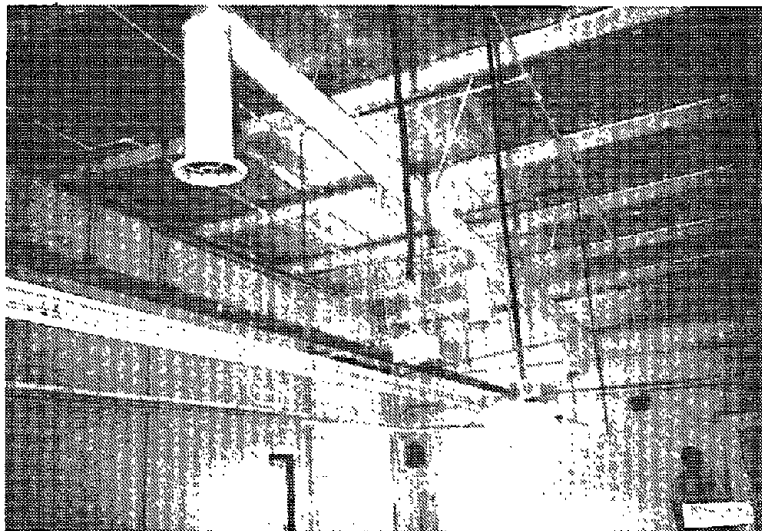

Figure 4-51: At a small electronics manufacturing facility, affected by the 1984 Morgan Hill Earthquake, a cantilevered, vertical section of HVAC duct broke from its horizontal header and fell.

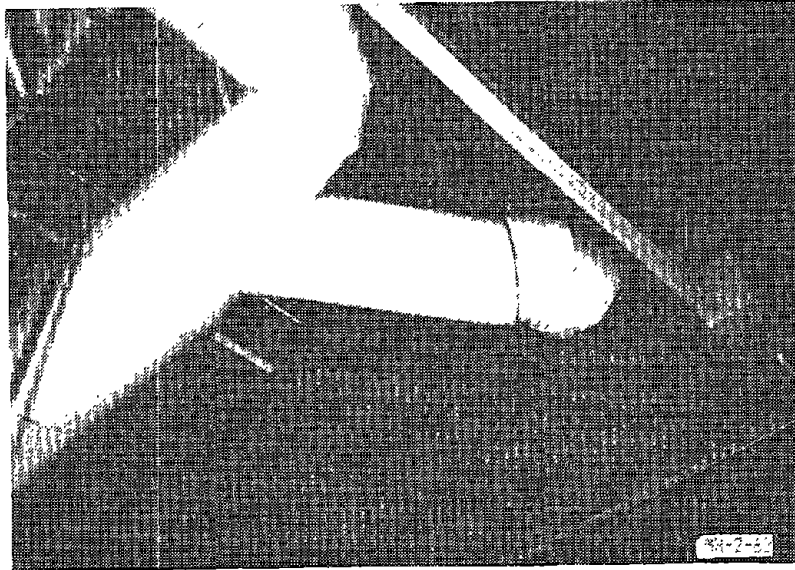

Figure 4-52: At a small electronics manufacturing facility, affected by the 1984 Morgan Hill Earthquake, a branch line tore at a wall penetration due to flexible header motion.

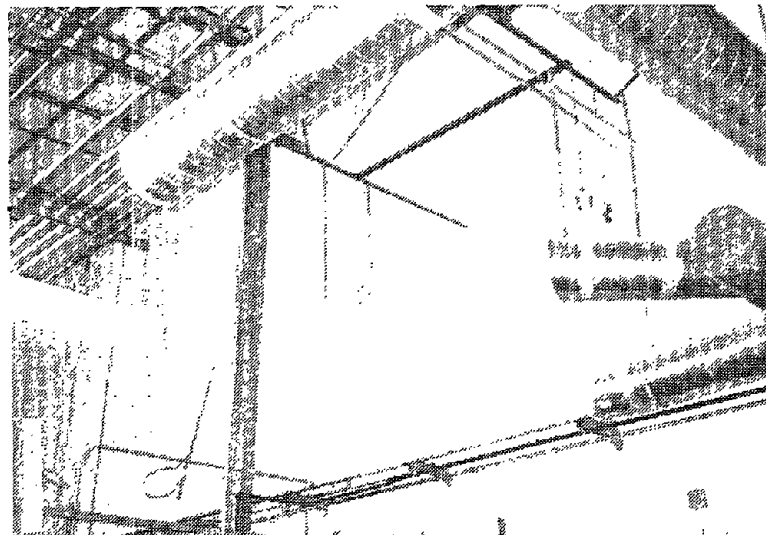

Figure 4-53: At a small manufacturing facility affected by the 1989 Loma Prieta Earthquake, a section of HVAC ducting fell to the floor when a strap broke at the duct connection and the attached section pulled free of its joints. Joints are lap fit, with no rivets or bolts.

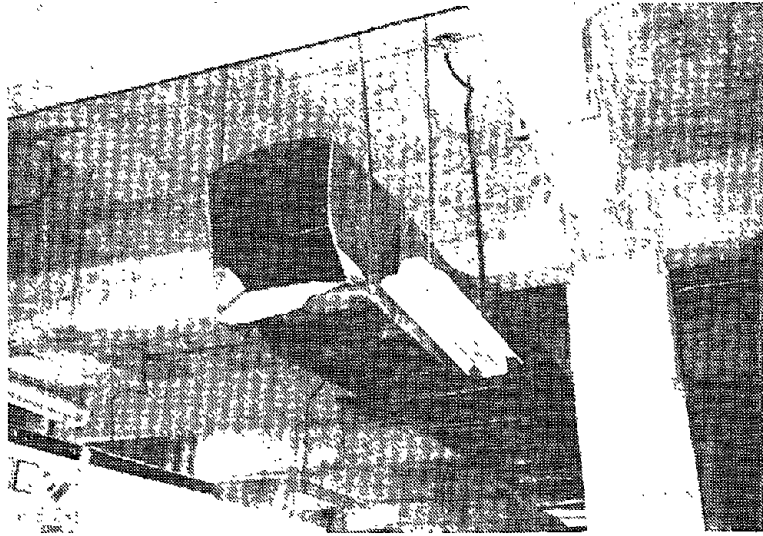

Figure 4-54: This a cantilevered duct section at a chemical plant severed and fell during the 1985 Mexico Earthquake. The duct was not positively attached to its rod-hung trapeze supports. Seismically induced uplift of the duct allowed the support to swing out from under the duct. The duct connections could not support the cantilevered weight and severed.

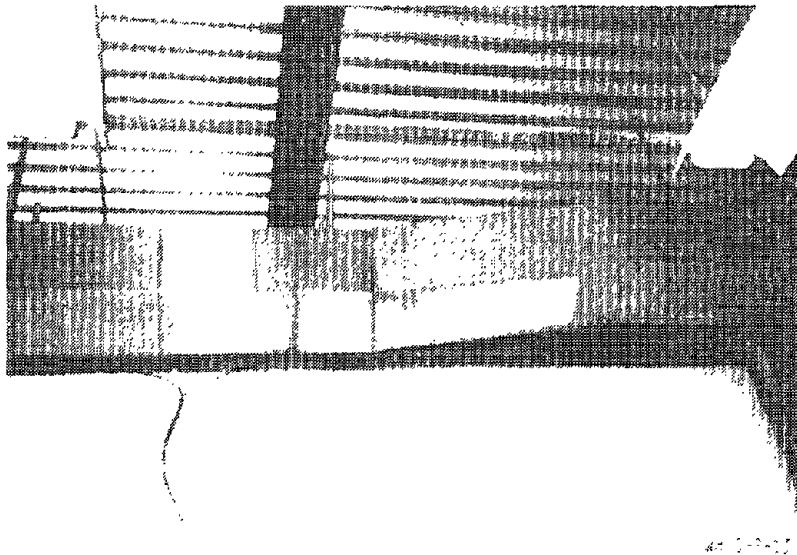

Figure 4-55: At a data processing center in the 1987 Whittier Earthquake, a duct deformed at the joints of an angled offset section.

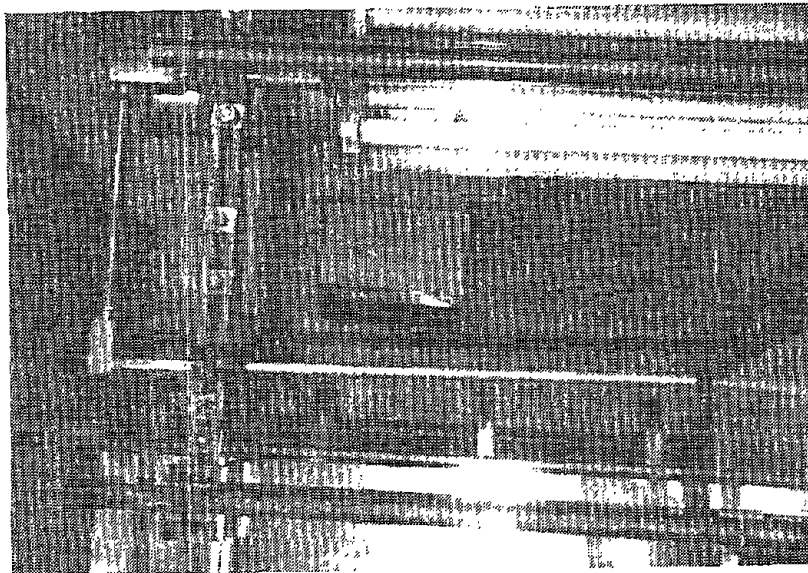
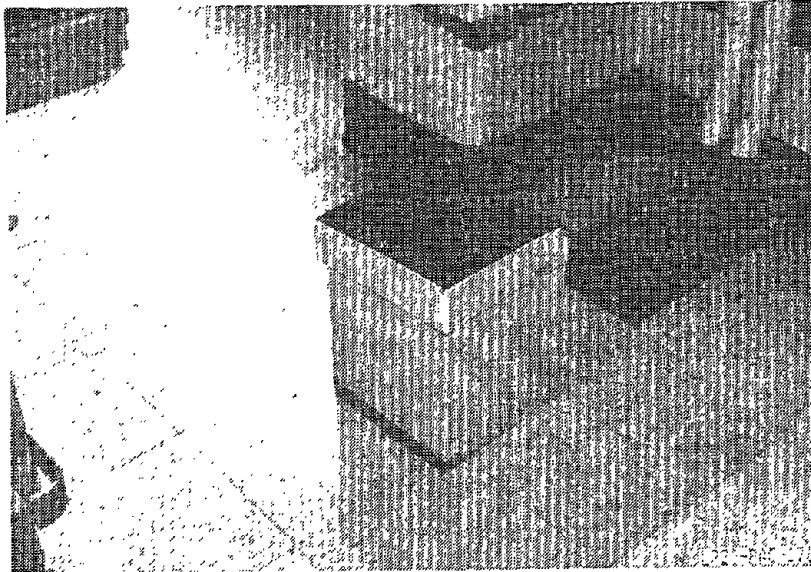

Figure 4-56: At a telecommunication building in the 1989 Loma Prieta Earthquake, a vertical cantilevered section of duct fell to the floor with its attached diffuser.

4.8 Power Distribution Systems in Commercial and Industrial Facilities

In the context of this study, power distribution systems are responsible for transmitting the power generated by the diesel generator and UPS systems to the critical building equipment. In general, the power distribution system is involved in stepping down AC power to operating voltage levels and for monitoring (protecting) power for motors on critical equipment items such as pumps, fans, and motor-operated valves.

4.8.1 Description of Power Distribution Systems

The five major components of the power distribution system are motor control centers, low and medium voltage switchgear, distribution panels, and transformers. In addition, conduit and automatic transfer switches play an important role in carrying power between components and in bringing power to and from the system. Each of the five major components is discussed below.

4.8.1.1 Motor Control Centers (MCCs)

Motor Control Centers (MCCs) provide control and electrical fault protection systems for motors powered at 600 volts or less (typically 480 volts). Motor controllers are mounted in sheet metal cubicles. They are typically assembled into stacks, which are lined up side-by-side and bolted together to form a motor control center (Figure 4-57). Alternately, individual motor controller cubicles may be attached to racks, walls, or even the equipment they serve.

Individual motor controllers are normally mounted in a sheet metal box that can be removed from its cubicle in the motor control center. The individual components of the motor controller are attached to the walls and rear face of the box with small screws. A motor controller typically includes a molded-case circuit breaker or disconnect switch, magnetic contactors, a control transformer, fuses, push buttons, and pilot lights.

Each section of an MCC is a sheet metal enclosure, usually reinforced at its corners by overlapping sheet metal bends, or by a framework of steel angles. The front of the section contains the stack of motor controller cubicles, while the rear is a closed compartment containing vertical bus bars that tie the primary circuit into the clip connections at the rear of each cubicle. A vertical raceway or "gutter" is often provided along one side of each section to carry control circuit wiring.

Motor control centers may be either single- or double-sided. Double-sided MCCs have controller cubicles on both the front and rear face of the cabinet, with the vertical bus bars routed through a center compartment between the front and rear stacks of controller cubicles.

Motor control centers may be either free-standing units or form part of a more complex assembly. In many cases, MCCs are included in an assembly with switchgear, distribution panels, and/or transformers.

MCC cabinet dimensions are generally standardized. Most MCC sections are 20 to 24 inches wide, and 90 inches tall. The depth of each section varies from 12 to 24 inches, with double-sided sections usually having depths of 20 or 24 inches. The weight of each section ranges from 500 to 800 pounds.

MCC Equipment Anchorage. Free-standing motor control centers are supported on base channels that include the attachment points for anchorage to the floor. Bolt holes are provided in the base channel for anchor bolts. Most motor control centers are anchored by expansion bolts ranging from 3/8 to 5/8 inch. If the MCC is mounted on a concrete pad, cast-in-place bolts may anchor the cabinet. Alternately, the base channel may be spot welded to plates embedded in the concrete floor.

Wall- or rack-mounted cubicles are anchored with bolts either through the rear wall of the cubicle or through mounting brackets. Unistrut is often used in rack supports or as the wall attachment. Alternately, the cubicle may be anchored by expansion bolts directly into a concrete wall.

4.8.1.2 Low Voltage Switchgear

Low voltage switchgear provide electrical fault protection circuit breakers for systems powered at 600 volts or less (typically 480 volts). The circuit breakers are mounted in sheet metal cubicles which are typically assembled in vertical stacks. The vertical sections are bolted together, side-by-side, to form a switchgear assembly. Low voltage switchgear assemblies consist of one or more circuit breakers, and associated control relays and instrumentation mounted in a sheet metal enclosure (Figure 4-58).

Low voltage circuit breakers carry currents ranging from 200 to 4000 amperes. The power circuit protected by an individual breaker may serve a single motor, or it may feed power to a motor control center or distribution panel where the power is distributed into secondary circuits.

Most low voltage circuit breakers are the draw-out type. They are mounted on a rail support system that allows them to be disconnected from their primary contacts at the rear, and drawn forward out of their sheet metal enclosure for maintenance. While in operation, the circuit breaker clamps to bus bars in the rear of the switchgear assembly. Additional positive attachment of the breaker to its enclosure is made by a mechanical jack or racking mechanism which slides the breaker in or out of operating position.

Circuit breakers typically include spring-actuated electric contacts, a closing solenoid, tripping devices (either overcurrent trip devices, undervoltage trip devices, or a shunt trip device), fuses, and auxiliary switches.

Circuit breakers are sized according to the current they carry. Overall circuit breaker cubicle dimensions range from 20 to 30 inches. The weight of individual circuit breakers ranges from 150 to 500 pounds.

Low voltage switchgear assemblies normally include at least one cubicle that serves as a metering compartment. This compartment typically contains ammeters, voltmeters, protective relays, and instrument transformers mounted through cutouts on the cubicle door or to the inner walls of the cubicle.

Low Voltage Switchgear Equipment Anchorage. Switchgear assemblies are typically anchored through bolt holes provided in the base channel of their interior framing. The assemblies are typically anchored with either expansion bolts, cast-in-place bolts embedded in the concrete pad supporting the assembly, or puddle welds to base plates embedded in the concrete floor.

4.8.1.3 Medium Voltage Switchgear

Medium voltage switchgear provide electrical switching and fault protection circuit breakers for systems powered between 2400 and 13,800 volts. Medium voltage switchgear assemblies consist of one or more circuit breakers and associated control relays and instrumentation mounted in a sheet metal enclosure. Medium voltage circuit breakers are mounted in sheet metal cabinets which are bolted together, side-by-side, to form a switchgear assembly (Figure 4-59). A medium voltage circuit breaker may serve a single large motor, or it may feed power to a unit substation transformer which steps power down to the 480 volt level to supply a low voltage switchgear assembly.

Draw-out, air-magnetic circuit breakers are the basic component of metal-clad switchgear found in most modern power plant and industrial applications. Metal-clad switchgear is a subset of medium voltage switchgear, where each circuit breaker is enclosed in a separate sheet metal compartment. These sheet metal enclosures isolate each circuit breaker from adjacent breakers, to limit the propagation of damage from an electrical fault.

Draw-out, air-magnetic circuit breakers are mounted on rollers to allow them to be wheeled in and out of their individual sheet metal enclosures. There are two general types of draw-out circuit breakers: the horizontally-racked model and the vertically-racked model.

The horizontally-racked model has clamping bus connections at its rear. It is racked into operating position by a mechanical jack (often consisting of a threaded bar) that rolls the circuit breaker into contact with the bus connections at the rear of its enclosure and

secures it in place. The weight of the circuit breaker rests on the floor of its sheet metal enclosure.

Vertically-racked circuit breakers roll into position within their enclosure and are then engaged by a jack built into the walls of the enclosure. The jack lifts the circuit breaker several inches above the floor, until the clamping connections atop the circuit breaker contact the bus connections at the top of the enclosure. The weight of the circuit breaker is then supported on the framework of the sheet metal enclosure. A vertically-racked breaker, mounted off the floor in its operating position, is shown in Figure 4-59 (lower photograph).

Air-magnetic circuit breakers normally include spring-actuated contacts, tripping devices, auxiliary switches, fuses.

Medium voltage circuit breakers are often integrated into unit substations that may include a transformer (typically 4160/480 volt), a set of low voltage switchgear, or a distribution switchboard.

Medium Voltage Switchgear Equipment Anchorage. Switchgear assemblies are typically anchored using bolt holes provided in the base channel of their interior framing. They are typically anchored with either expansion bolts, cast-in-place bolts embedded in a concrete supporting pad, or puddle welds to steel base plates embedded in the concrete floor.

4.8.1.4 Distribution Panels

Distribution panels are assemblies of molded case circuit breakers or fused switches mounted in sheet metal cabinets (Figure 4-60). Their function is similar to motor control centers and low voltage switchgear: to distribute low voltage AC or DC power from a main circuit to branch circuits, and to provide overcurrent protection. Distribution panels typically serve AC power systems ranging up to 600 volts and DC power systems ranging up to 250 volts. Distribution panels includes panelboards and switchboards.

Distribution panels contain circuit breakers or fusible switches mounted in vertical stacks. A main circuit breaker typically controls power entering the cabinet and provides overcurrent protection to the assembly of branch circuit breakers. The branch circuit breakers are usually mounted in one or two columns either above or below the main breaker. Two types of distribution panels are found in power plant electrical systems: switchboards and panelboards. Although switchboards and panelboards perform the same function, they differ in construction and application. Switchboards are typically floor-mounted assemblies, while panelboards are usually wall-mounted. Switchboards usually distribute larger quantities of power than panelboards.

Distribution Panel Equipment Anchorage. Distribution panel enclosures are typically anchored through mounting holes provided in the cabinet frame. Free-standing switchboards are anchored using either concrete expansion anchors routed through bolt holes in the cabinet frame, or by welding the base frame members to steel plates embedded in the concrete floor. Wall-mounted panelboards can be either bolted directly to the wall using expansion anchors, or bolted to a Unistrut frame which is anchored to the wall. Connecting conduit is typically attached to the wall using Unistrut brackets, clamps, and wall anchors.

4.8.1.5 Transformers

Transformers included in power distribution systems are the unit substation type, typically 4160/480 volts, and the distribution type, typically 480/120 volts, of both liquid- and air-cooled transformers.

Unit substation transformers typically have primary voltages of 2400 to 4160 volts, and secondary voltages of 480 volts. These transformers are usually categorized as secondary unit substation transformers. They receive their input from primary unit substation transformers that step voltage down from transmission line levels to the 2400 to 4160 volt level.

Unit substation transformers may be either liquid- or air-cooled. Liquid-cooled units typically consist of a rectangular steel tank filled with oil or a similar insulating fluid. The transformer coils are submerged in a liquid bath which provides cooling and insulation within the steel tank casing. Most liquid-filled transformers have one or more radiator coils attached to the side of the transformer to provide sufficient surface area for cooling.

Air-cooled or dry-type unit substation transformers are similar in size and construction to liquid-cooled units, except the transformer coils are mounted in a ventilated steel enclosure, rather than a liquid bath. Most air-cooled transformers rely on natural convection cooling through the louvered or perforated sections of their casings. Larger air-cooled unit substation transformers may have small fans mounted in their enclosures for forced air cooling.

The casings of both liquid-cooled and air-cooled unit substation transformers have typical overall dimensions of 60 to 100 inches in height, and 40 to 100 inches in width and depth. The weights of these units range from 2,000 to 15,000 pounds, depending on their power output. Transformer capacity is measured in kilovolt-amperes (kVA), with capacities typically ranging from 100 to 3000 kVA.

Unit Substation Transformer Anchorage. Normally, unit substation transformers are supported on a concrete pad. Typical anchorage uses bolts embedded in the concrete pad and routed through bolt holes provided in the base channel of the

transformer casing. In some cases, transformers are anchored using clips that are held down using expansion anchors into a concrete pad.

Distribution transformers typically have primary voltages of 480 volts stepping down to secondary voltages of 120 to 240 volts. This type of transformer is almost always air-cooled, although a few examples of liquid-cooled distribution transformers are found in older facilities. The construction of distribution transformers is essentially the same as that of unit substation transformers, except for a difference in size. Air-cooled distribution transformers may be either ventilated or encapsulated. The larger units are usually ventilated, with the cooling of coils accomplished by natural air convection through vents in the transformer casing. Encapsulated units are also cooled by natural convection, but depend on sufficient heat transfer between the enclosed atmosphere surrounding the coils and the casing wall.

Sizes of distribution transformers range from small wall-mounted units, with overall dimensions of about 10 inches in height, width, and depth, and weights of 50 to 100 pounds. to larger units, that are typically floor-mounted with dimensions ranging up to the size of unit substation transformers and weights ranging up to 5000 pounds.

Distribution Transformer Anchorage. Distribution transformers are usually anchored by bolts through a base channel or mounting brackets into the supporting floor, steel frame, or wall. Expansion anchors are often used, due to the relatively light weight of most distribution transformers.

4.8.2 Seismic Performance of Power Distribution Systems

This section describes the observed seismic vulnerabilities in power distribution systems. These vulnerabilities have been categorized as one of several general types. Note that for this system, the vulnerabilities have not been grouped according to component, as they have been in previous sections, where those systems have been defined to include more diverse mechanical equipment, electrical equipment, and piping.

It should also be noted that, as discussed in Section 4.8.3, the observed vulnerabilities have most often resulted in local damage to the equipment which has not affected functionality of the system.

Observed seismic vulnerabilities for power distribution systems are as follows:

Anchorage	Damage to power distribution components due to sliding or overturning of unanchored or inadequately anchored equipment.
------------------	---

Structural Damage	Structural failure of cabinets and anchorage due to excessive inertial loads.
	Damage to switchgear busbars due to differential settlement.
Internal Damage	Damage to fiberglass bus bar supports in a low voltage switchgear due to inertial loading.
	Dislodging of fuses in switchgear.
	Ground faults in transformers due to loss of insulation from vibration.
	Short circuit in distribution panel due to loose bus bars.
	Disconnection of attached cables to distribution panel.
Interaction	Impact of falling objects on power distribution equipment.
Water Spray	Forced shutdown of unit substations due to water spray from broken overhead sprinklers.
Relay Actuation	Shutdown of system due to actuation of electromechanical relays in switchgear.
	Shutdown of system due to actuation of molded case circuit breakers.

4.8.3 Specific Instances of Damage to Power Distribution Systems

This section describes instances of seismic damage that have led to the observed vulnerabilities described above. Note that most of the incidents described would be classified as "seismic effects", where local damage was noted, but the equipment was not damaged enough to affect functionality of the system.

Anchorage

At a pumping plant, affected by the 1983 sequence of earthquakes in Coalinga, all four MCCs slid during the earthquake (Figure 4-61). In all cases the motor controllers were undamaged.

At a water treatment plant, affected by the 1983 sequence of earthquakes in Coalinga, two MCCs slid (Figure 4-62). The motor controllers were undamaged.

At a second water treatment plant, affected by the 1983 sequence of earthquakes in Coalinga, an unanchored MCC slid approximately 3 inches during the earthquake, but was not damaged (Figure 4-63).

At a steel mill, affected by the 1985 Mexico Earthquake, rocking of one MCC broke several tack welds that anchored the cabinet to embedded steel in the floor. The cabinet did not overturn, and motor controllers were undamaged.

At a manufacturing facility, affected by the 1989 Loma Prieta Earthquake, a roof-mounted MCC pulled its anchorage (Figure 4-64). The MCC is housed in an outdoor enclosure supported on wooden boards. The anchorage design of the two-section unit used 3/8-inch lag bolts into the wood, one in each corner of the unit. It appears that, due to inaccessibility to the rear of the enclosure, only the front base channel of the enclosure was anchored.

At a bank computer facility, which experienced an estimated a peak ground acceleration (PGA) of 0.40g, during the 1987 Whittier Earthquake, a three-section DC switchboard broke its anchorage and shifted several inches (Figure 4-65). The switchboard controls DC output from the battery racks; therefore all switches and breakers were likely closed at the time of the earthquake and any interruption in DC current would have been noted. It can therefore be assumed that the switchboard was undamaged by the earthquake.

At a brick extraction plant, affected by the 1989 Loma Prieta Earthquake, one of two free-standing switchgear assemblies shifted about one inch (Figure 4-66). Although the unit was not anchored, it appears that overhead conduit provided some restraining effect. Operators indicated that the unit's operability was not affected by the earthquake.

At a pumping plant, affected by the 1983 Coalinga Earthquake, one assembly of 4.16 kV switchgear, located in the control building, sheared its anchor bolts and slid (Figure 4-67). Sliding of the assembly stopped when the bottom framing channel impacted a conduit flange embedded in the floor. At the same facility, a 2.4 kV assembly, mounted in an outdoor enclosure, slipped from its anchor clips and slid one inch.

At a water treatment plant, affected by the 1983 Coalinga Earthquake, an assembly containing the substation transformer and attached 4.16 kV switchgear slipped from its anchor clips and slid about two inches (Figure 4-68). This movement cracked a short section of plastic conduit running between the assembly and its concrete pad. Neither the electrical connections in the conduit nor the switchgear assembly were damaged.

At a pumping plant, two transformers slid during the 1983 sequence of earthquakes in Coalinga (Figure 4-69). In one case, anchorage consisted of four small clips acting as sliding restraints. The clips were not sufficient to restrain the 5,000 pound transformer; the unit slid up to three inches. Several months later, a short circuit developed in one

transformer. This damage was attributed to a break in the short section of conduit routed beneath the transformer into the concrete pad.

At a computer facility, which experienced an estimated PGA of 0.25g during the 1986 Alaska Earthquake, two unanchored dry-type transformers (one unit substation, one distribution) slid about 1/2 inch. The units were not damaged.

At a bank computer facility, affected by the 1987 Whittier Earthquake, an unanchored transformer slid about 1 inch, but was not damaged.

At a paper mill, affected by the 1987 New Zealand Earthquake, an unanchored oil-filled transformer slid several inches (Figure 4-70). The unit was reported as operable when power was restored.

At a computer facility, affected by the 1987 Whittier Earthquake, three unanchored oil-filled transformers shifted slightly (Figure 4-71). The units were undamaged when the facility reenergized about 24 hours after the main shock.

At a water treatment plant, affected by the 1985 Chile Earthquake, an unanchored, spare oil-filled transformer slid over eight inches. Operators reported that the unit was undamaged by the earthquake.

At a steel mill, affected by the 1985 Mexico Earthquake, about seven of two dozen rail-mounted unit substation transformers fractured the bolts on their rail blocks and shifted during the earthquake (Figure 4-72). The transformers were reported to be otherwise undamaged.

Structural Damage

At a chemical plant, affected by the 1985 Mexico Earthquake, several motor control centers were damaged (Figure 4-73). During the earthquake, three of the twelve assemblies, located in one heavily damaged building, pulled their anchorage and overturned, causing minor damage to push buttons and switches on the front faces of the cabinets. Some of the MCCs that remained upright experienced permanent deformation in their cabinet structures. The shear deformation in the assembly structures was sufficient to lodge some of the removable motor control units into their drawers so that they could not be pulled out of the cabinet easily. Once extracted, the motor controller cubicles themselves showed deformation and buckling in the sheet metal. In some cubicles, the deformation was sufficient to crack the insulated casings of internal components such as contactors.

At a paper mill, affected by the 1987 New Zealand Earthquake, several slide-mounted motor controllers slid forward from the front face of the MCC, but did not fall to the floor (Figure 4-74). When pushed back into position, the motor controllers remained functional.

At a distillery, affected by the 1987 New Zealand Earthquake, there were some reports of earthquake-induced distortion to the MCC frame which resulted in difficulty in opening the controller doors and in removing the controllers (Figure 4-75). This frame damage did not affect the function of the MCC.

At a chemical plant substation, affected by the 1985 Mexico Earthquake, a 13.8 kV switchgear required repair following the event. During the earthquake, sections of the switchgear floor slab settled differentially as much as three inches, creating tension and shear in the continuous horizontal busbars. Technicians reported that some connections in the busbar compartment had to be repaired following the earthquake.

At a college, which experienced an estimated PGA of 0.30g during the 1989 Loma Prieta Earthquake, a minor leak was discovered in the power supply transformer of a unit substation. The leak occurred at the connection between the bus duct and the disconnect switch enclosure. Operation of the transformer was not affected.

At a bank computer facility, which experienced a PGA in excess of 0.40g during the 1987 Whittier Earthquake, two dry-type distribution transformers, located on the third and fourth floors of the building, suffered damage (Figure 4-76). The internal core-coil assembly was bolted to the base of a lightweight inverted channel inside the enclosure. During the earthquake, the channel deformed to the extent that the core-coil impacted and damaged the enclosure siding. Both units functioned through the earthquake, but were taken out of service following the event, due to excessive noise.

Similar damage occurred at another computer facility, which experienced an estimated PGA of 0.40g during the 1987 Whittier Earthquake. Following the earthquake, a small dry-type distribution transformer required replacement. The 75 kVA unit was operational following the earthquake, but was unusually noisy. An inspection of the transformer internals revealed that the bolts holding the support frame for the core assembly had loosened. In addition, the frame and coils were distorted.

At a petrochemical facility, affected by the 1983 Coalinga Earthquake, the foundation pad for a distribution transformer was damaged (Figure 4-77). An earthquake-induced crack broke the ground near the corner of the transformer's foundation pad, causing damage to the concrete which required replacement. The transformer's operability was not affected by the earthquake.

Internal Damage

At a chemical plant, affected by the 1985 Mexico Earthquake, a low voltage switchgear assembly was damaged inside a heavily damaged two-story building (Figure 4-78). Damage to the switchgear occurred in the fiberglass supports of vertical bus bars, mounted in the rear of each section behind the draw-out circuit breakers. The cause of the cracks in the bus bars supports was apparently deformation of the switchgear cabinet structure during the earthquake.

At one of the canal pumping stations, affected by the 1983 Coalinga Earthquake, the 2400-volt switchgear could not be reenergized when the circuit breakers were reset. Subsequent investigation revealed that one of the three fuses used for switchgear surge protection had dislodged from its clamps sufficiently to lose electrical contact (Figure 4-79). The fuse did not dislodge totally and did not fall to the floor of the cabinet. Pushing the fuse back into place allowed restoration of power to the station.

At a steel mill, affected by the 1985 Mexico Earthquake, an unanchored, oil-filled transformer suffered an internal short circuit (Figure 4-80). According to facility engineers, a ground fault occurred in an internal bus connection of the transformer, burning windings in one coil. Detailed investigations of the failure revealed that the ground fault was caused by a loss of insulation between a live and a grounded bus connection. Within this particular model of transformer, adjacent bus connections are insulated by paper strips inserted between the bus bars. The paper insulation is held in place by friction only, and therefore tends to slip out of position under vibration or slight distortion of the bus bars.

At a paper mill, a wall-mounted distribution panel suffered an internal short circuit during the 1987 New Zealand Earthquake (Figure 4-81). Apparently, the internal bus bars were not positively attached. During the earthquake, the loose bus bars contacted and shorted the unit. Plant operators suspected a factory defective unit, since the unit was one of six new, identical units and the other panels were not damaged.

At a computer facility, which experienced a PGA in excess of 0.40g during the 1987 Whittier Earthquake, a distribution panel was damaged when its cables were disconnected (Figure 4-82). The panel is anchored with 1/2-inch bolts and is located on the ground floor of the main building. The distribution panel's power cables are attached to the internal bus bars through a lug assembly. The cables run from the lug assembly through the base of the panel into a conduit system buried in the ground. The conduit system provides an electrical connection between the main building and an adjacent building. There is virtually no slack in the cables as they enter the conduit. During the earthquake, the cables were pulled from their connections, resulting in damage to the bus bars and the lug assembly. It appears that the differential movement between the two buildings pulled the cable sufficiently to disconnect them from the distribution panel. Other components of the panel were undamaged.

Interaction

At a computer facility, which experienced an estimated PGA of 0.40g during the 1987 Whittier Earthquake, a three-section MCC impacted the adjacent wall board during the earthquake (Figure 4-83). The unit was not damaged by the earthquake.

At a pumping plant, affected by the 1985 Chile Earthquake, the porcelain base of a low voltage circuit breaker fractured when the cabinet impacted a structural column nearby.

At a steel mill, affected by the 1985 Mexico Earthquake, an unclad transformer was hit by a light fixture (Figure 4-84). The transformer is enclosed in a mesh fence but is otherwise unclad to allow natural air cooling. The transformer is located in a room where most of the light fixtures fell during the earthquake. It was reported that one light fixture hit the exposed transformer coils. The transformer was reported as undamaged following the earthquake.

Spray

At a manufacturing plant, affected by the Loma Prieta Earthquake, two 480-volt substations were sprayed with water when an overhead sprinkler broke (Figure 4-85). Each substation included two transformers. Both unit substations were disassembled, dried out, and reassembled, prior to repowering three days after the earthquake.

Relay Actuation

There have been several instances of system shutdown due to actuation of electromechanical relays or molded case circuit breakers. Although the cause of the relay actuation can generally not be determined, potential causes have included electrical fluctuations (i.e. protective relays performing their design function), actuation due to equipment vibration, and equipment due to equipment impact loads (e.g. cabinets pounding).

Courtesy Siemens-Allis

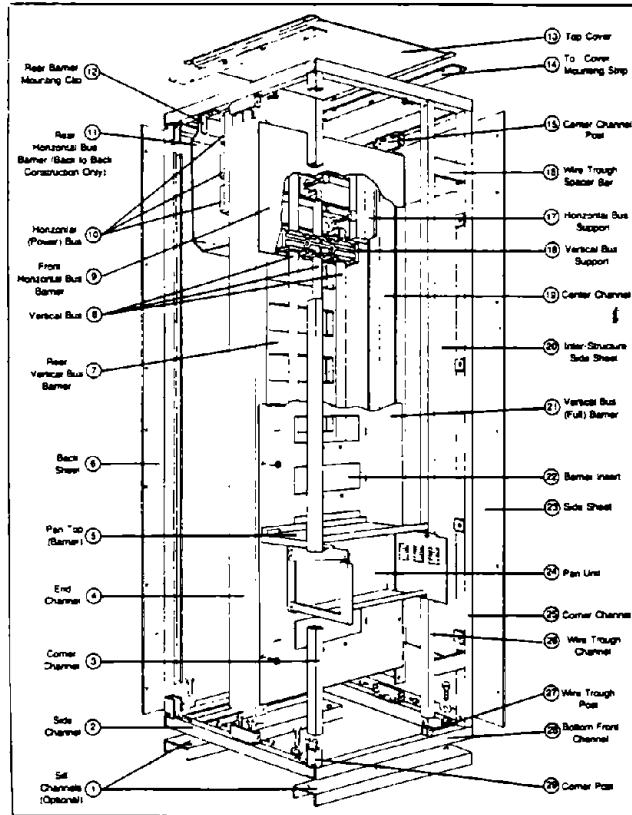
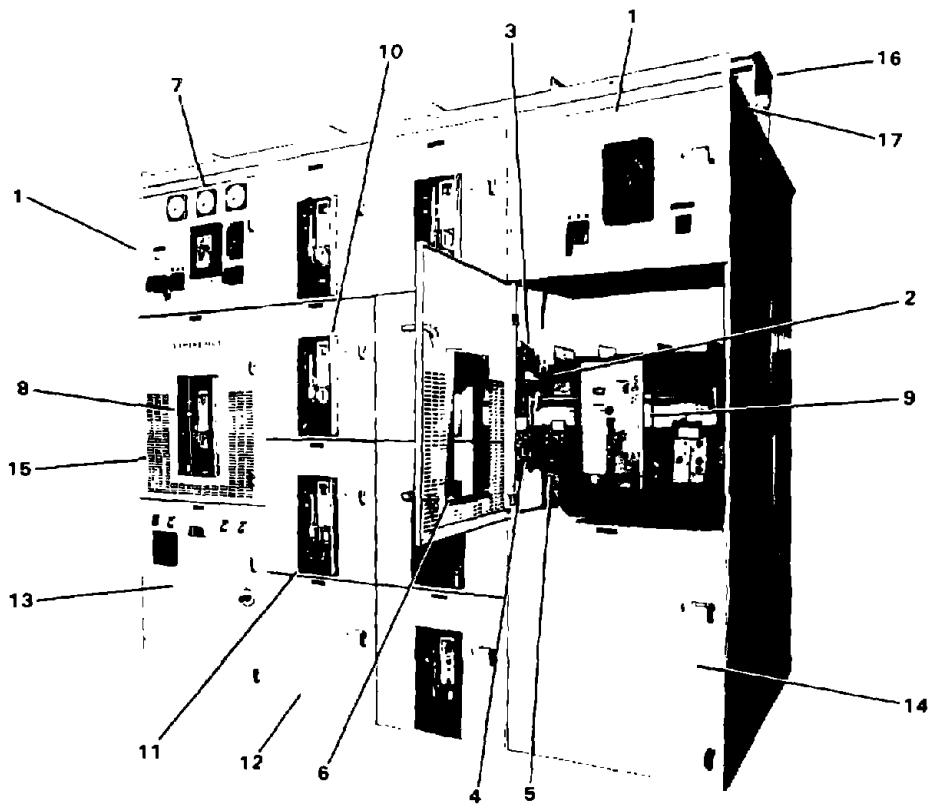

Figure 4-57: The construction of a typical section of a motor control center.

- 1 Meter and Auxiliary Compartment (Page 9)
- 2 Control Wiring (Page 9)
- 3 Control Circuit Fuses (Page 6)
- 4 Telescopic Breaker Drawout Rails (Page 6)
- 5 Stationary Secondary Disconnects (Page 5)
- 6 Breaker Escutcheon Opening
- 7 Indicating Instruments
- 8 RL-3200 Electrically Operated Breaker in Connected Position
- 9 RL-3200 Electrically Operated Breaker in Test Position
- 10 RL-1600 Manually Operated Breaker in Connected Position
- 11 RL-800 Manually Operated Breaker in Connected Position
- 12 Future Breaker Compartment (Page 6)
- 13 Auxiliary Compartment
- 14 Blank Compartment
- 15 Ventilation Openings (RL-2000, RL-3200 and RL-4000)
- 16 Ventilation and Lifting Structure
- 17 Interunit Wiring Trough



Courtesy Siemens-Allis Corporation

Figure 4-58: Primary components of a typical low voltage switchgear assembly.

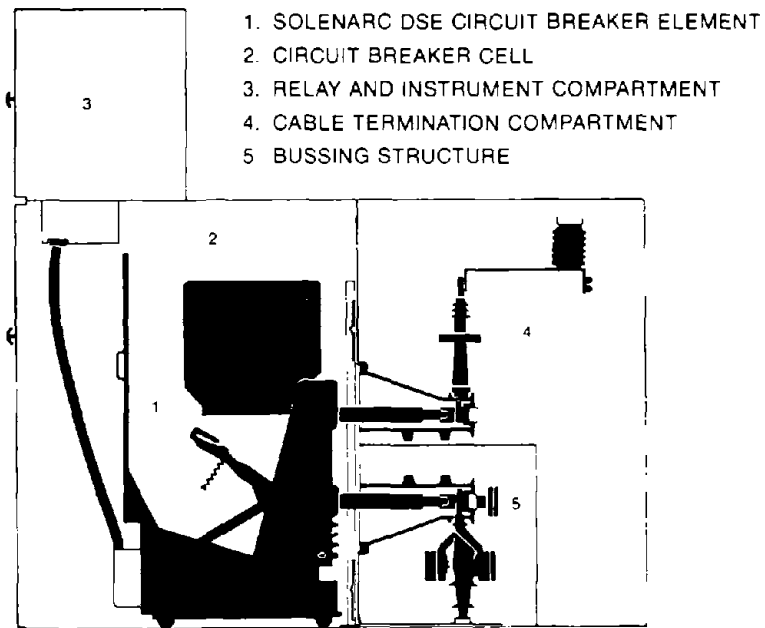
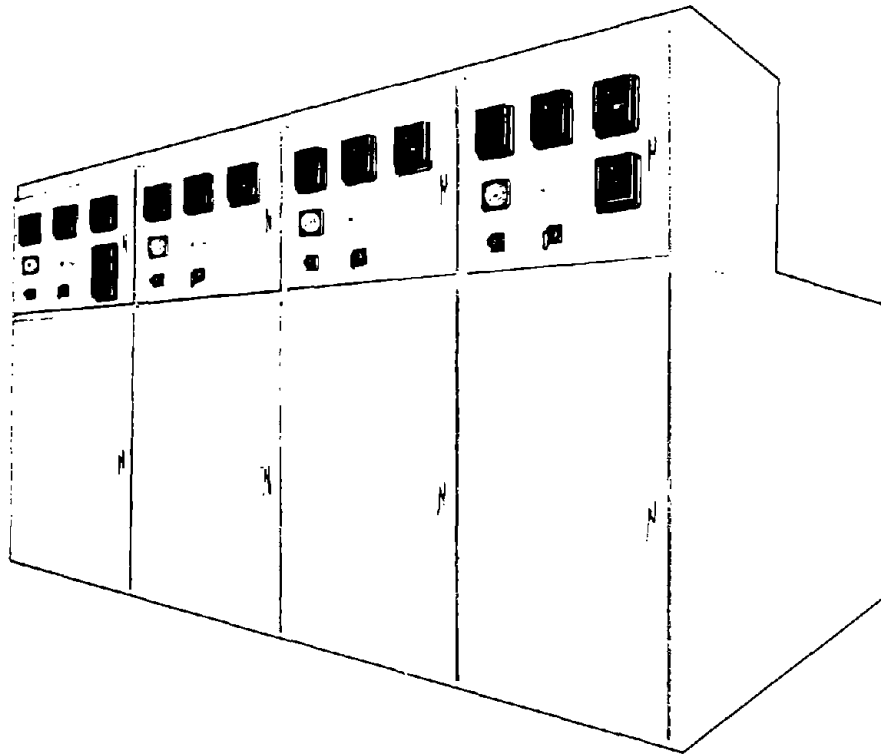

Courtesy Square D Corporation

Figure 4-59: A typical medium voltage switchgear assembly, and the primary components of an individual metal-clad section.

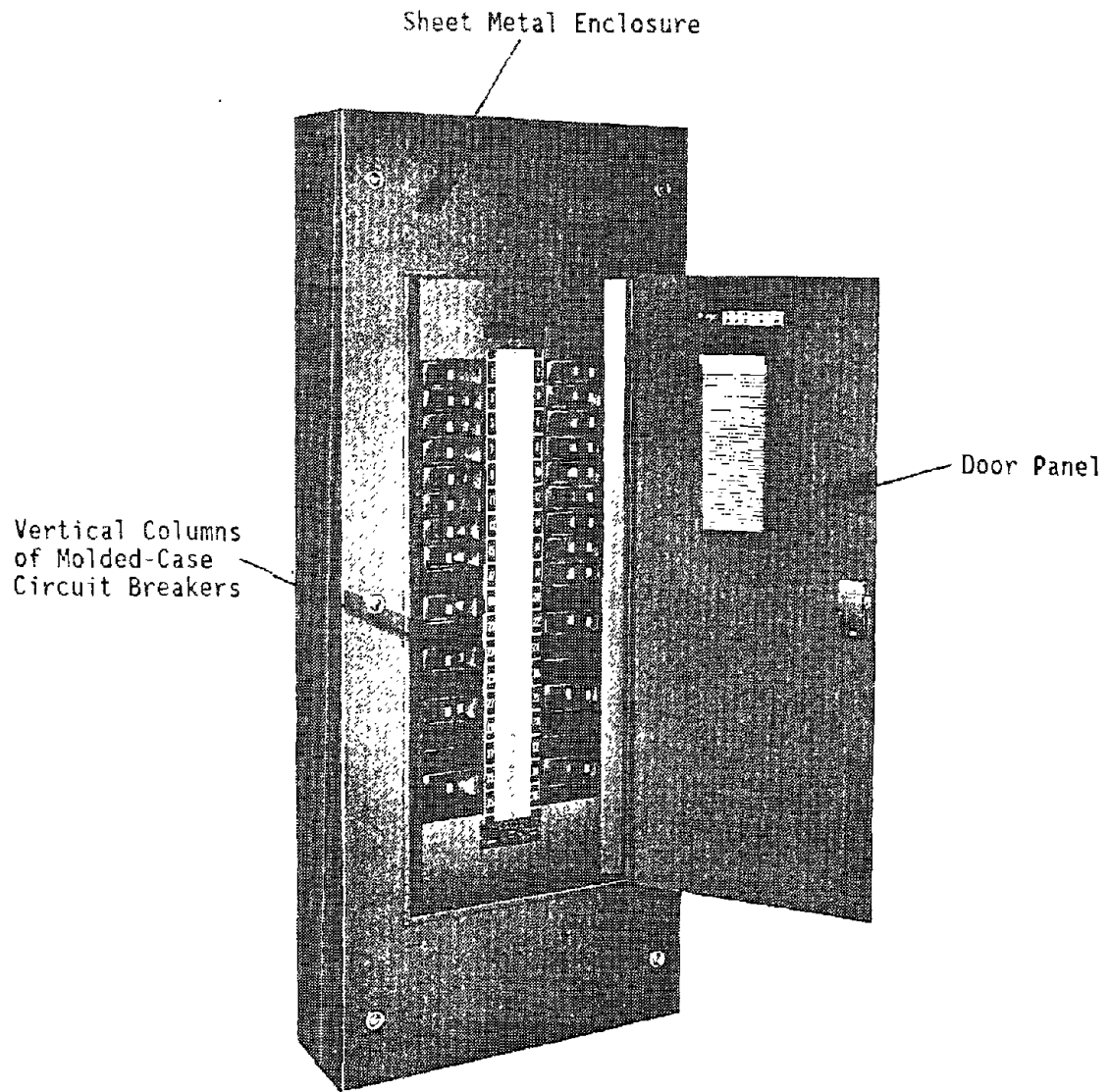

Courtesy Federal Pacific Company

Figure 4-60: Basic components of a typical distribution panel.

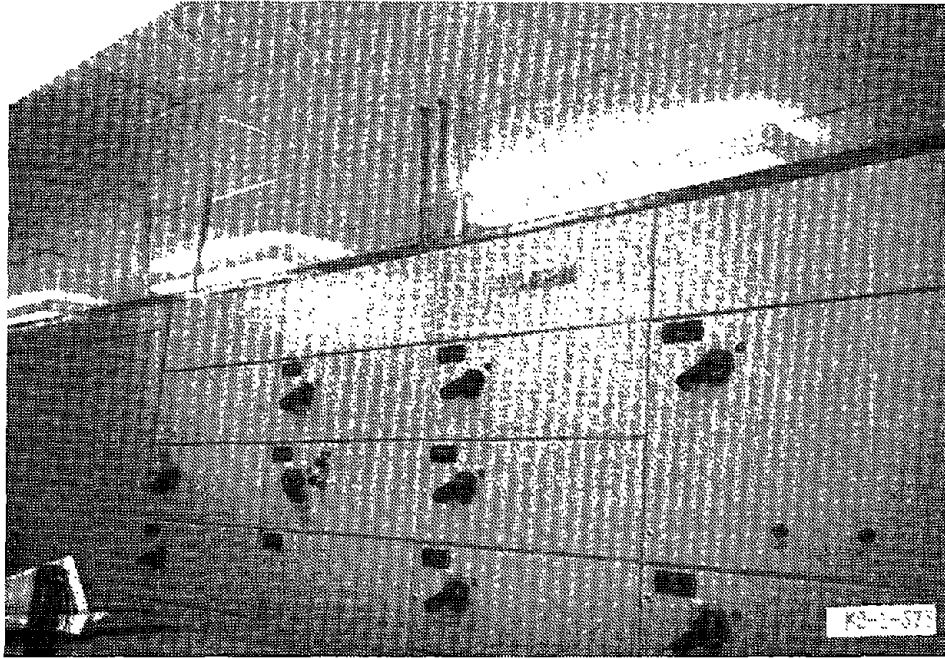

Figure 4-61: Two of the four MCCs at a pumping plant, affected by the 1983 sequence of earthquakes in Coalinga. All four MCCs were inadequately anchored and slid during the earthquake. Note the conduit in the upper photograph, which acted as an inadvertent restraint for the MCC, moved and damaged the ceiling.



Figure 4-62: This MCC at a water treatment plant, affected by the 1983 sequence of earthquakes in Coalinga was inadequately anchored and slid during the earthquake. The motor controllers were undamaged.

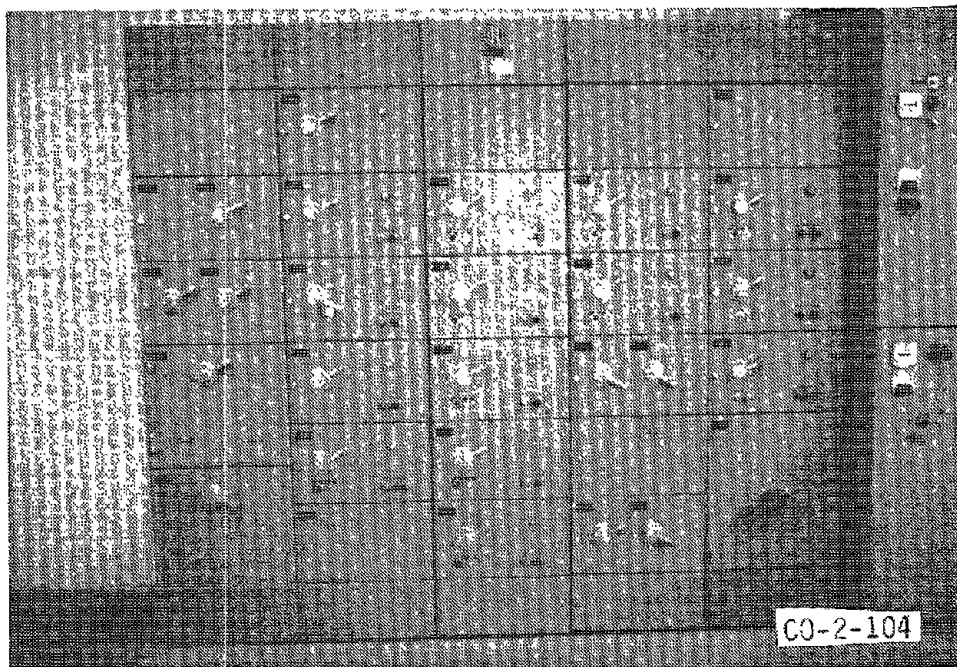

Figure 4-63: This unanchored MCC, at a water treatment plant slid approximately 3 inches during the 1983 sequence of earthquakes in Coalinga, but was not damaged.



Figure 4-64: This roof-mounted MCC at a manufacturing facility, affected by the 1989 Loma Prieta Earthquake, pulled its anchorage. The anchorage design of the two-section unit used 3/8-inch lag bolts into wood.

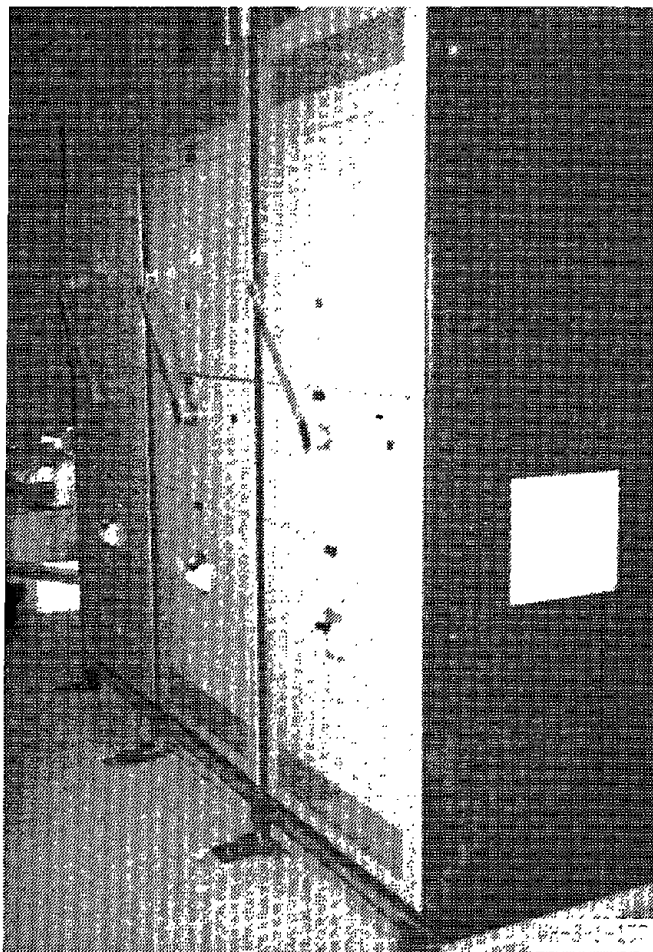

Figure 4-65: This three-section DC switchboard at a bank computer facility, which experienced an estimated peak ground acceleration (PGA) of 0.40g, during the 1987 Whittier Earthquake, broke its anchorage and shifted several inches.

Figure 4-66: One of two free-standing switchgear assemblies at a brick extraction plant, affected by the 1989 Loma Prieta Earthquake, that shifted about one inch. It appears that overhead conduit provided some restraining effect.

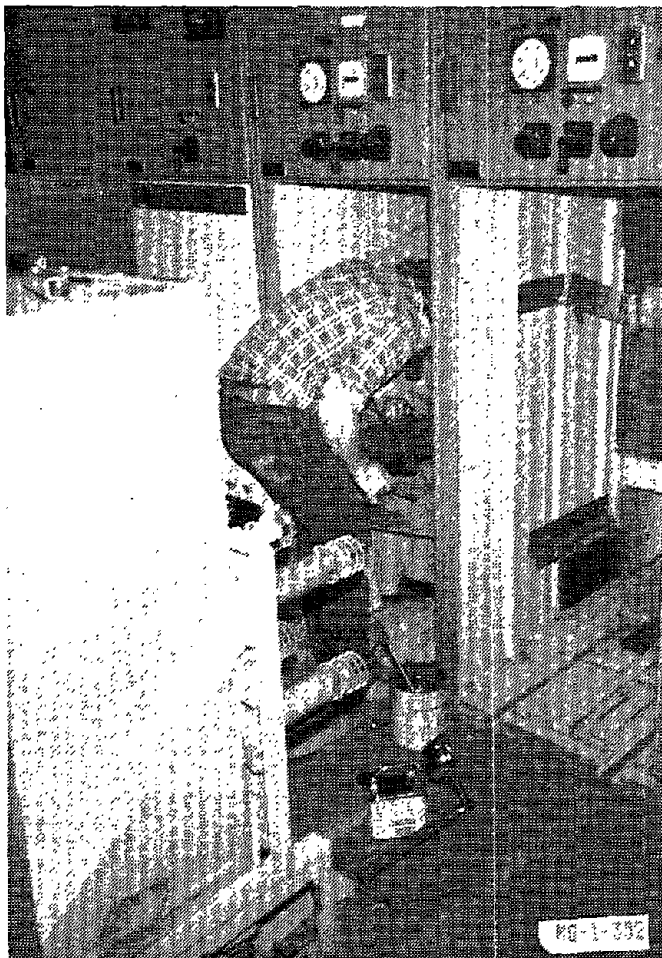
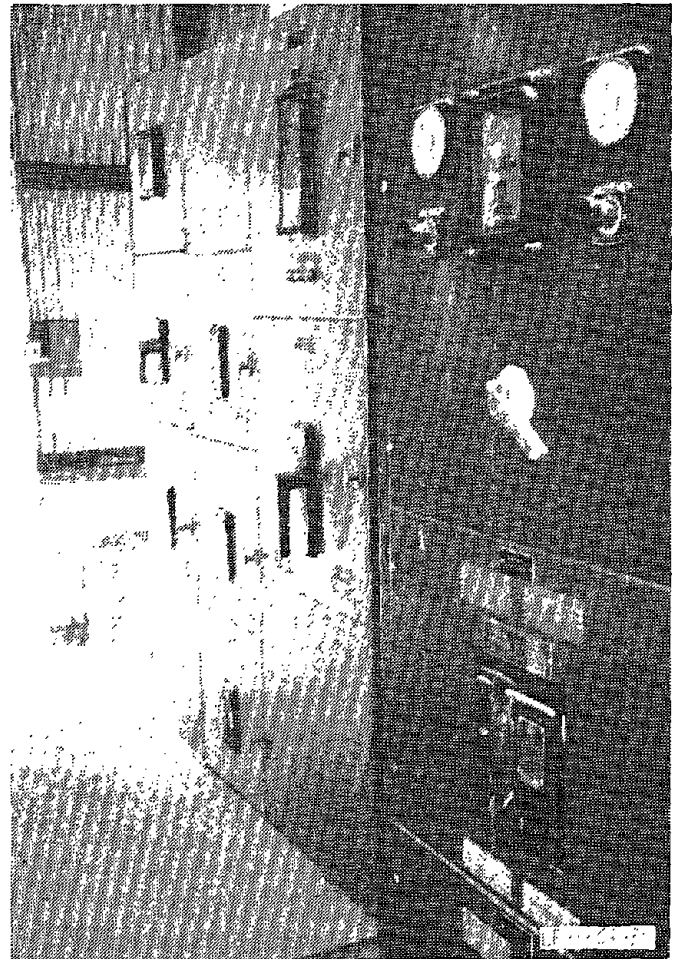

Figure 4.-67: This assembly of 4.16 kV switchgear, located in the control building of a pumping plant sheared its anchor bolts and slid during the 1983 Coalinga Earthquake.

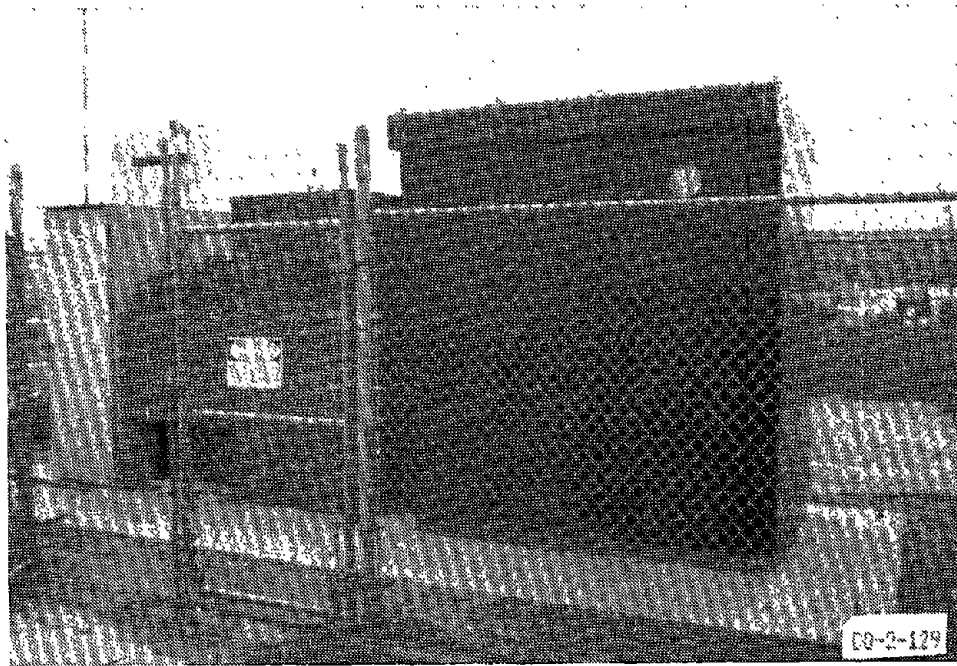

Figure 4-68: This assembly containing the substation transformer and attached 4.16 kV switchgear located at a water treatment plant, affected by the 1983 Coalinga Earthquake, slipped from its anchor clips and slid about two inches. This movement cracked a short section of plastic conduit running between the assembly and its concrete pad.

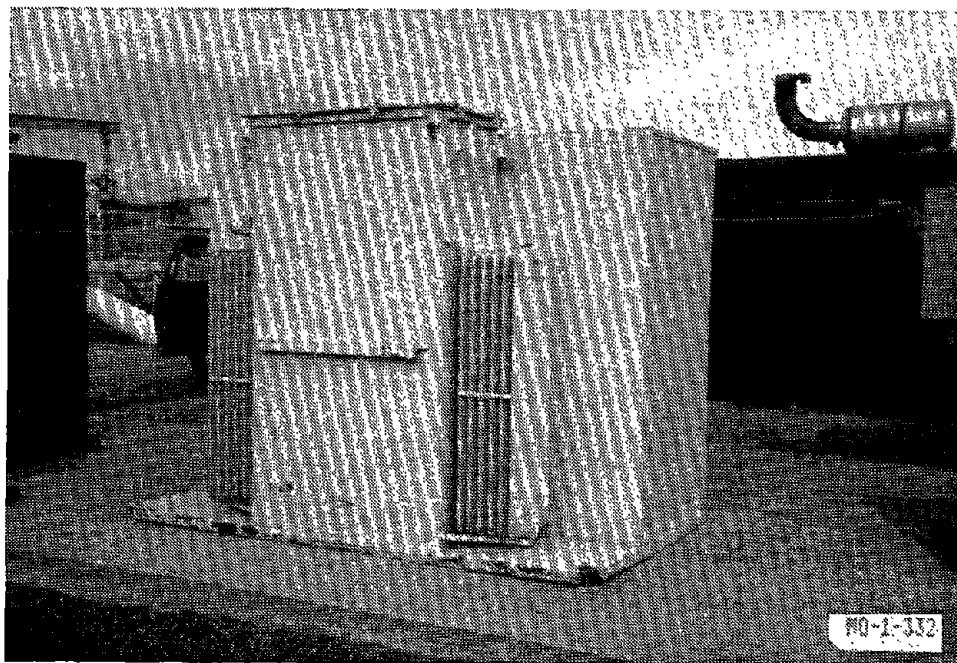

Figure 4-69: One of two transformers at a pumping plant that slid during the 1983 sequence of earthquakes in Coalinga.

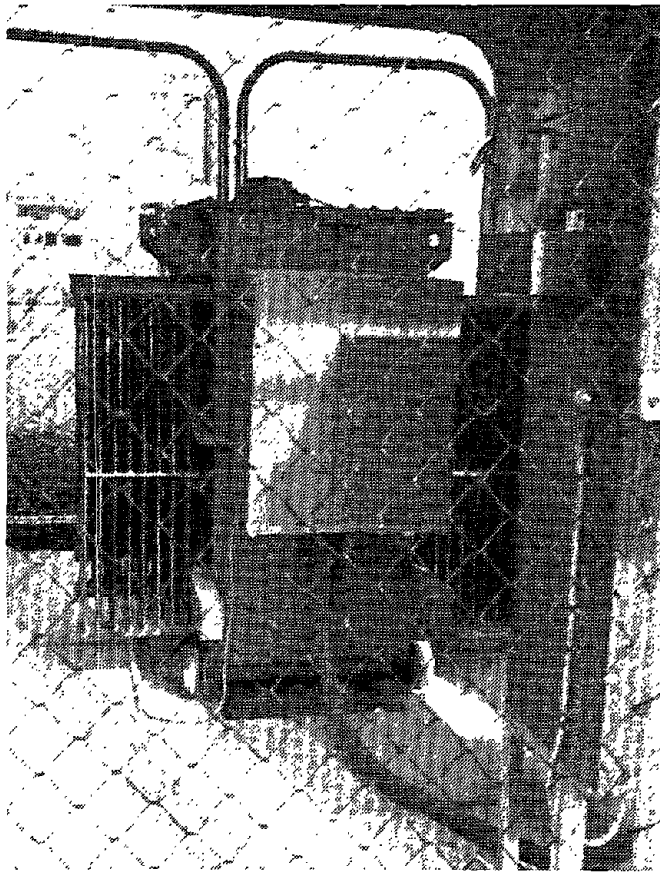

Figure 4-70: This unanchored oil-filled transformer at a paper mill, affected by the 1987 New Zealand Earthquake, slid several inches. The unit was reported as operable when power was restored.

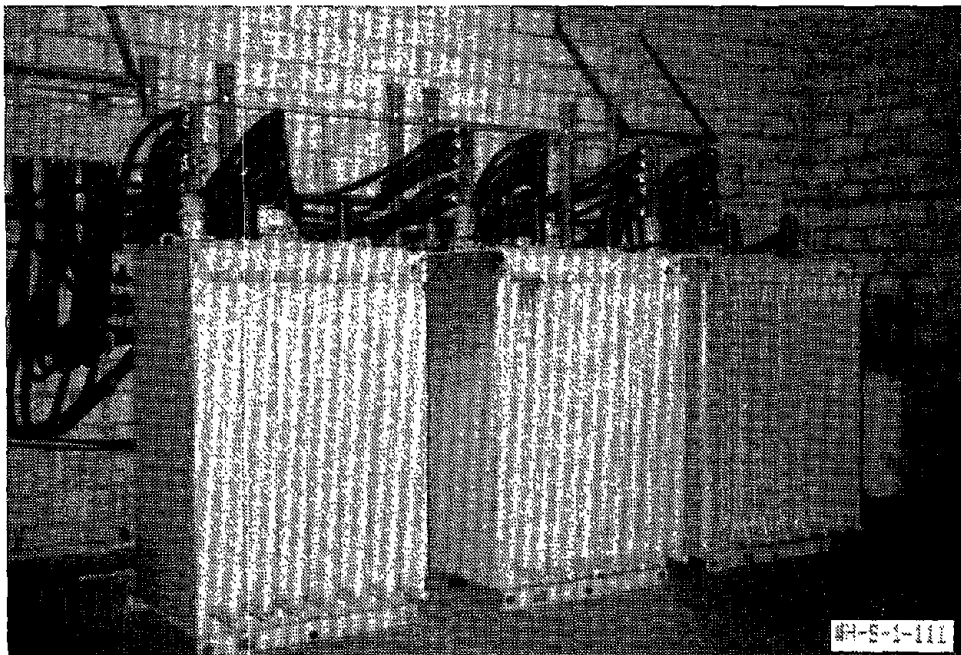

Figure 4-71: These three unanchored oil-filled transformers at a computer facility, affected by the 1987 Whittier Earthquake, shifted slightly. The units were undamaged when the facility reenergized about 24 hours after the main shock.

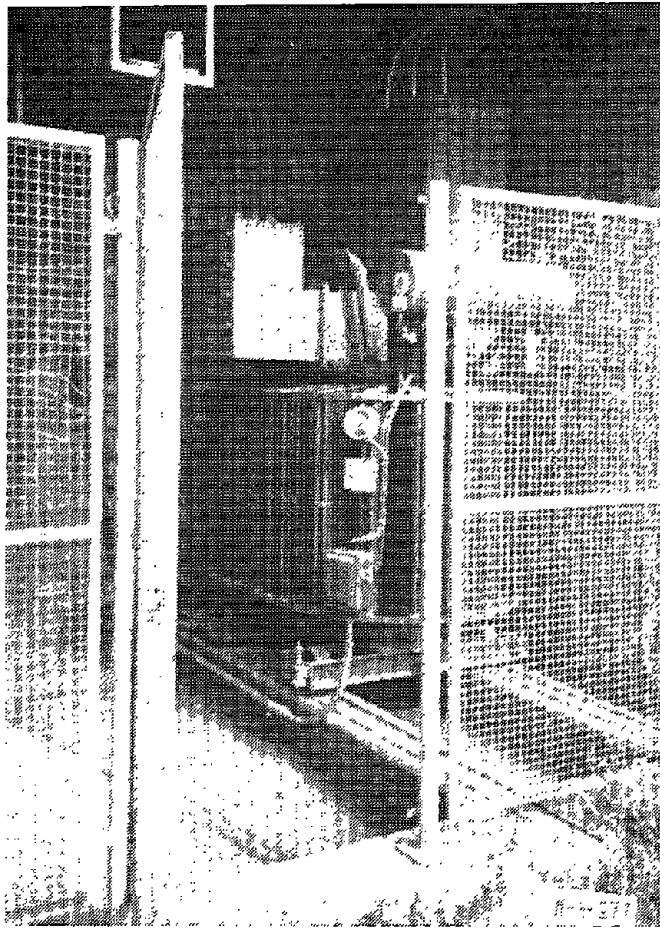

Figure 4-72: These rail-mounted unit substation transformers at a steel mill, affected by the 1985 Mexico Earthquake, fractured the bolts on their rail blocks and shifted during the earthquake.

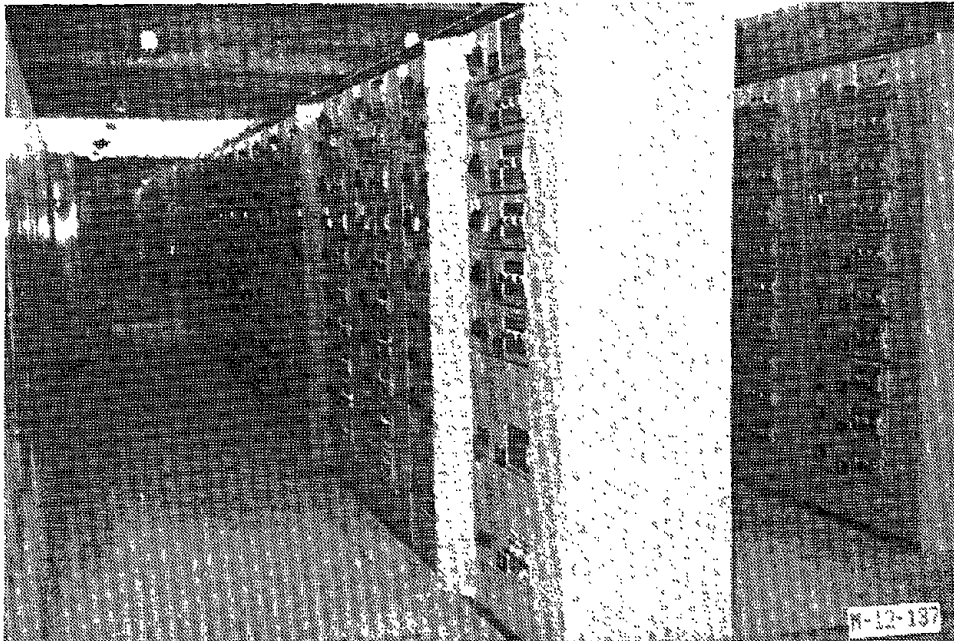

Figure 4-73: These MCCs at a chemical plant, affected by the 1985 Mexico Earthquake, sustained damage due both to inadequate anchorage and structural damage to the cabinet.

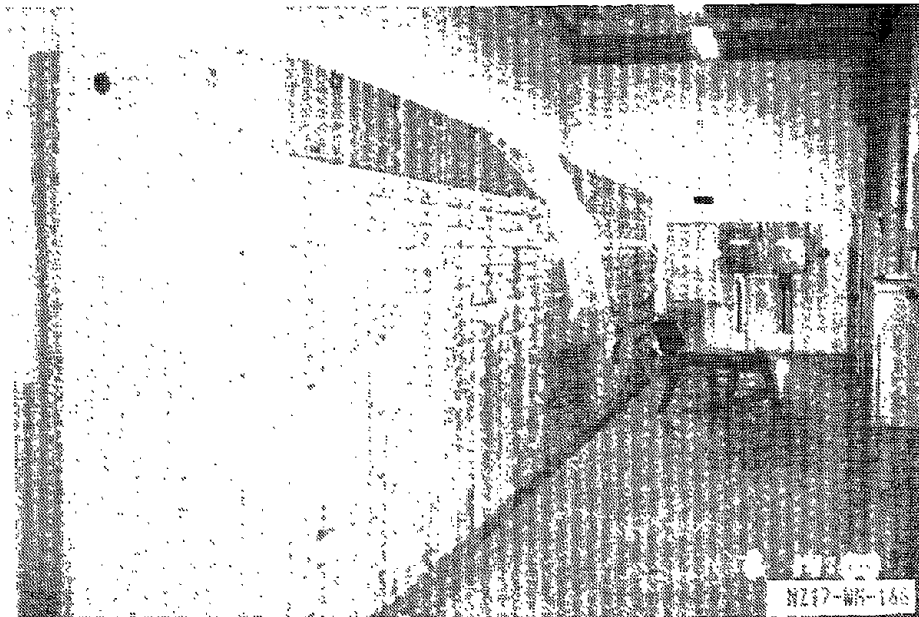

Figure 4-74: Several slide-mounted motor controllers in this MCC at a paper mill, affected by the 1987 New Zealand Earthquake slid forward from the front face of the MCC, but did not fall to the floor. When pushed back into position, the motor controllers remained functional.



Figure 4-75: At a distillery, affected by the 1987 New Zealand Earthquake, there were some reports of earthquake-induced distortion to the MCC frame which resulted in difficulty in opening the controller doors and in removing the controllers.

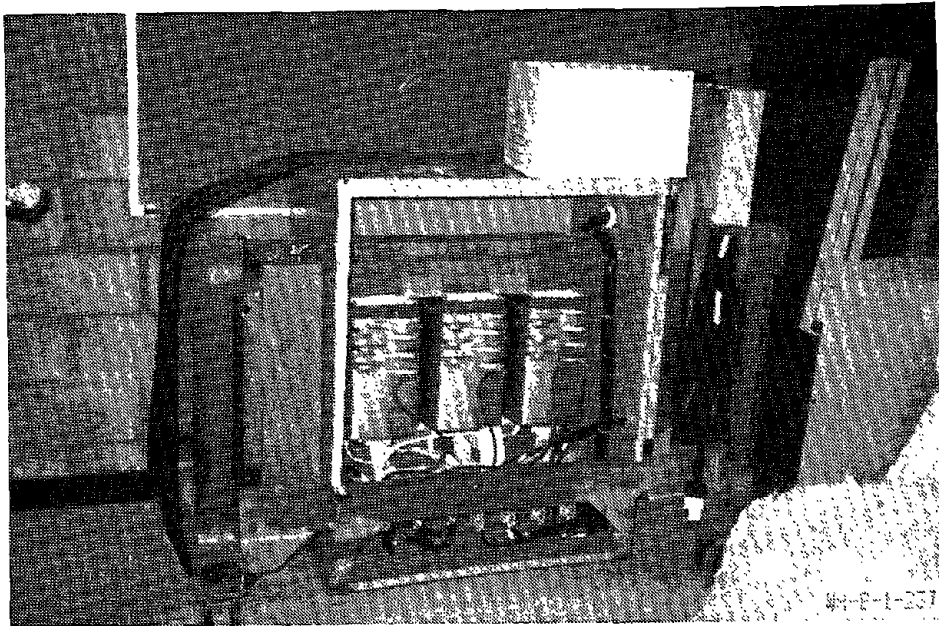

Figure 4-76: One of two dry-type distribution transformers located at a bank computer facility, which was damaged during the 1987 Whittier Earthquake. During the earthquake, the channel supporting the internal core-coil assembly deformed to the extent that the core-coil impacted and damaged the enclosure siding. Note that the frame shown in the photograph is a post-earthquake modification.

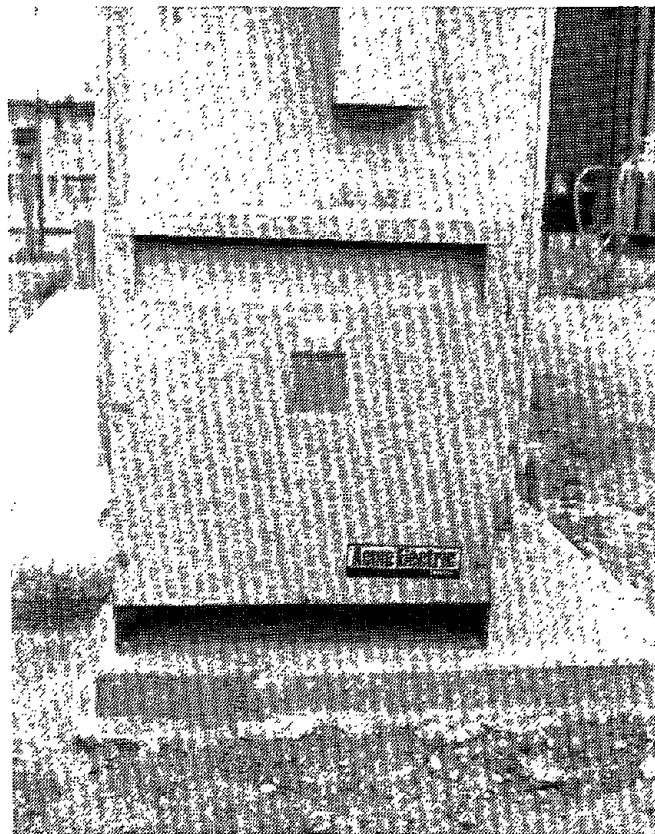

Figure 4-77: The foundation pad for this distribution transformer at a petrochemical facility, was damaged by the 1983 Coalinga Earthquake. An earthquake-induced crack broke the ground near the corner of the transformer's foundation pad.

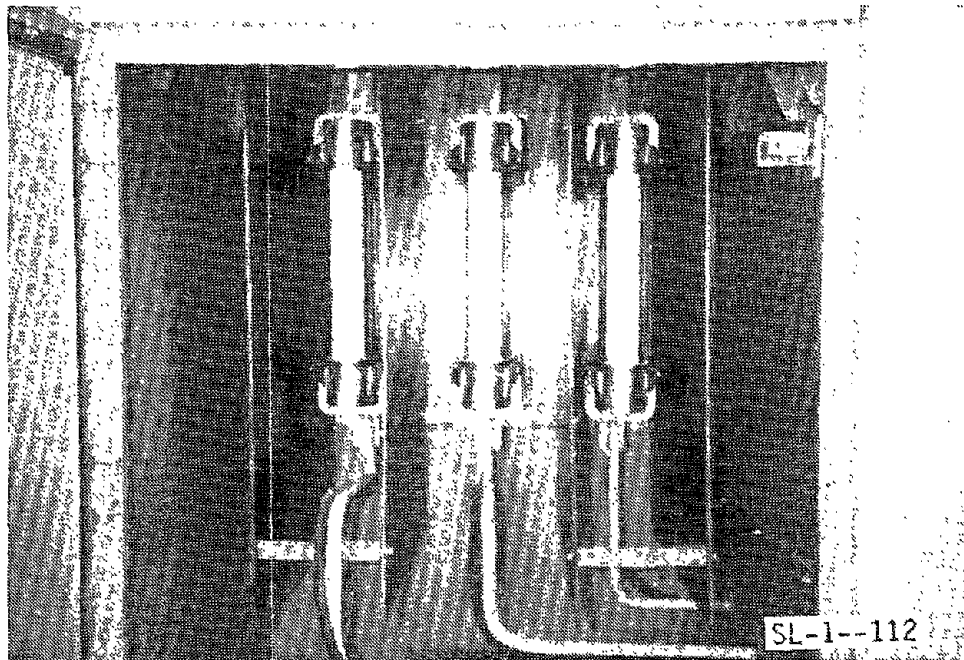

Figure 4-78: This low voltage switchgear assembly at a chemical plant, was damaged by the 1985 Mexico Earthquake. Damage to the switchgear occurred in the fiberglass supports of vertical bus bars, mounted in the rear of each section behind the draw-out circuit breakers.

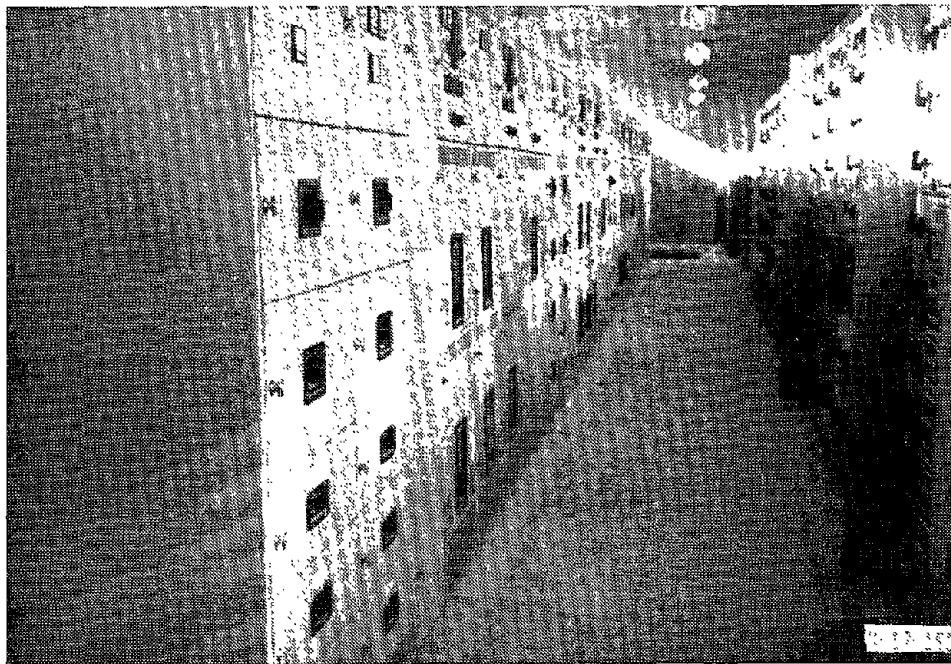

Figure 4-79: At one of the canal pumping stations, affected by the 1983 Coalinga Earthquake, the 2400-volt switchgear could not be reenergized when the circuit breakers were reset. Subsequent investigation revealed that one of the three fuses (shown) used for switchgear surge protection had dislodged from its clamps sufficiently to lose electrical contact.

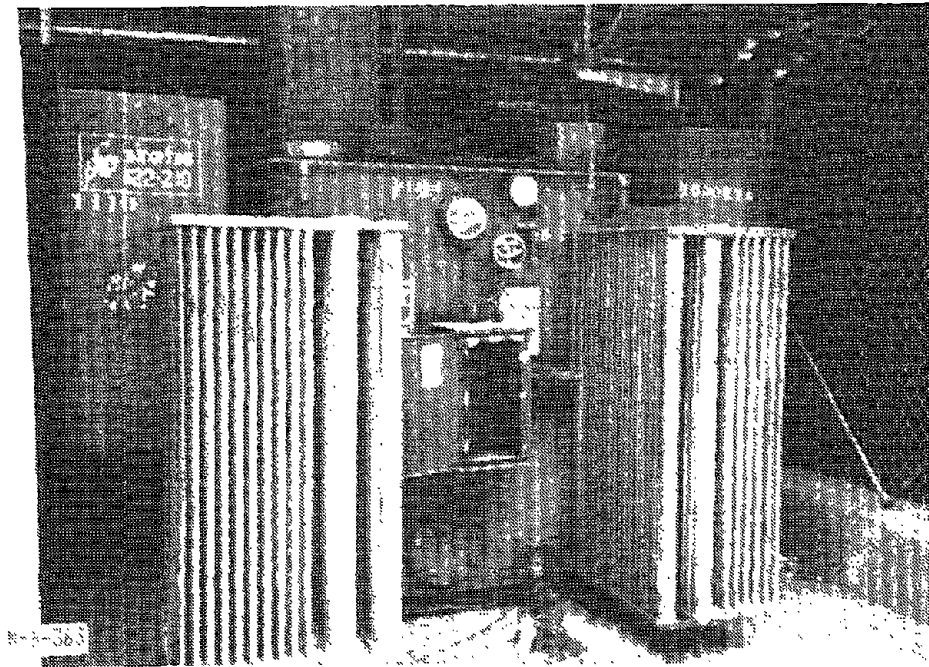

Figure 4-80: This unanchored, oil-filled transformer at a steel mill, suffered an internal short circuit during the 1985 Mexico Earthquake. Apparently, a ground fault occurred in an internal bus connection of the transformer, burning windings in one coil.

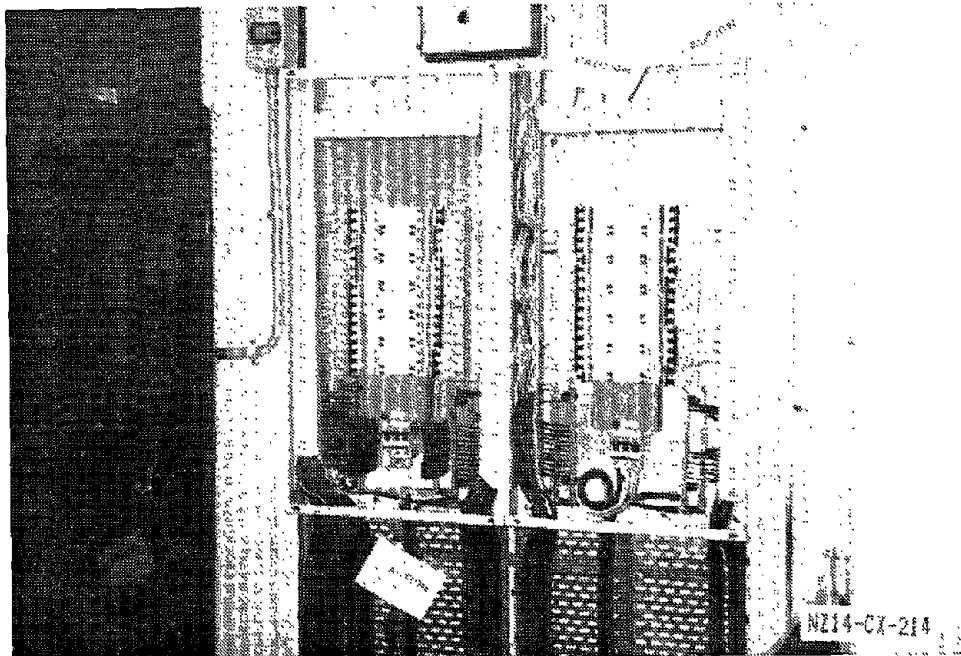

Figure 4-81: One of six distribution panels at a paper mill damaged by the 1987 New Zealand Earthquake. Apparently, the internal bus bars were not positively attached, such that the loose bus bars contacted and shorted the unit during the earthquake.

Figure 4-82: This distribution panel at a computer facility, which experienced a PGA in excess of 0.40g during the 1987 Whittier Earthquake, was damaged when its cables were disconnected. During the earthquake, the cables were pulled from their connections, resulting in damage to the bus bars and the lug assembly.

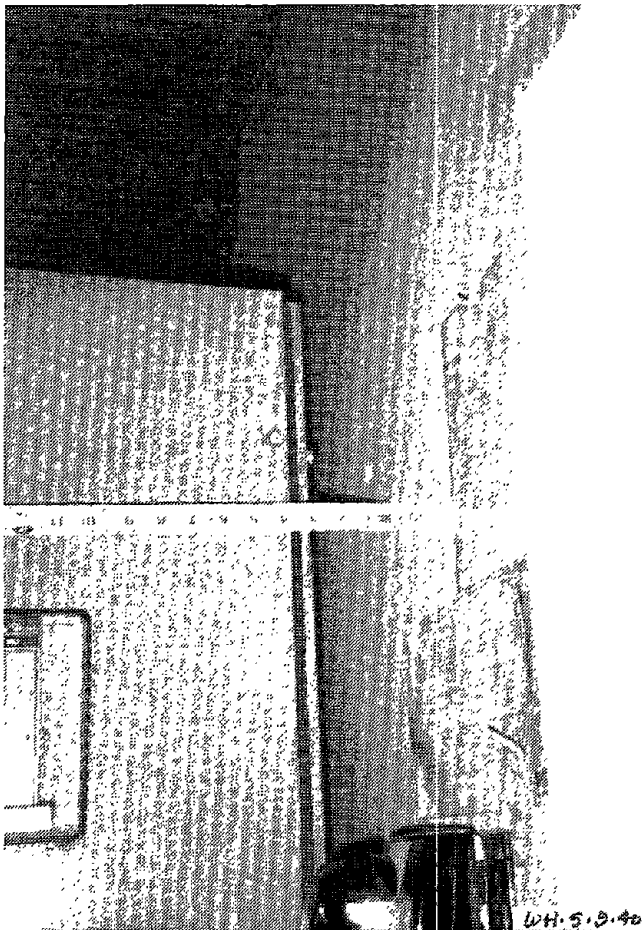
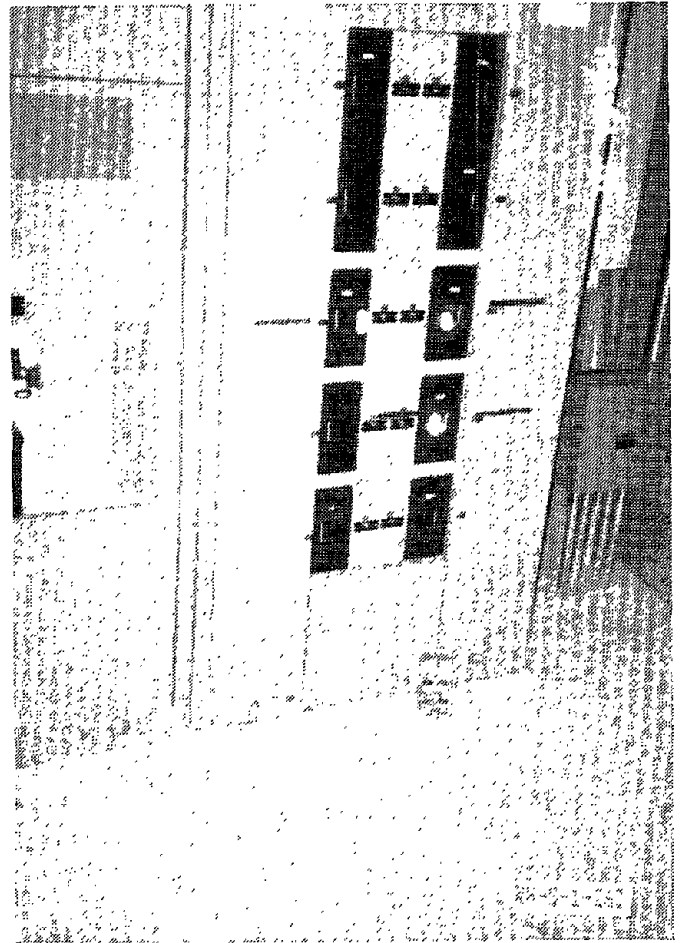

Figure 4-83: This three-section MCC is located at a computer facility, which experienced an estimated PGA of 0.40g during the 1987 Whittier Earthquake. During the earthquake, the MCC impacted the adjacent wall board. The unit was not damaged by the earthquake.

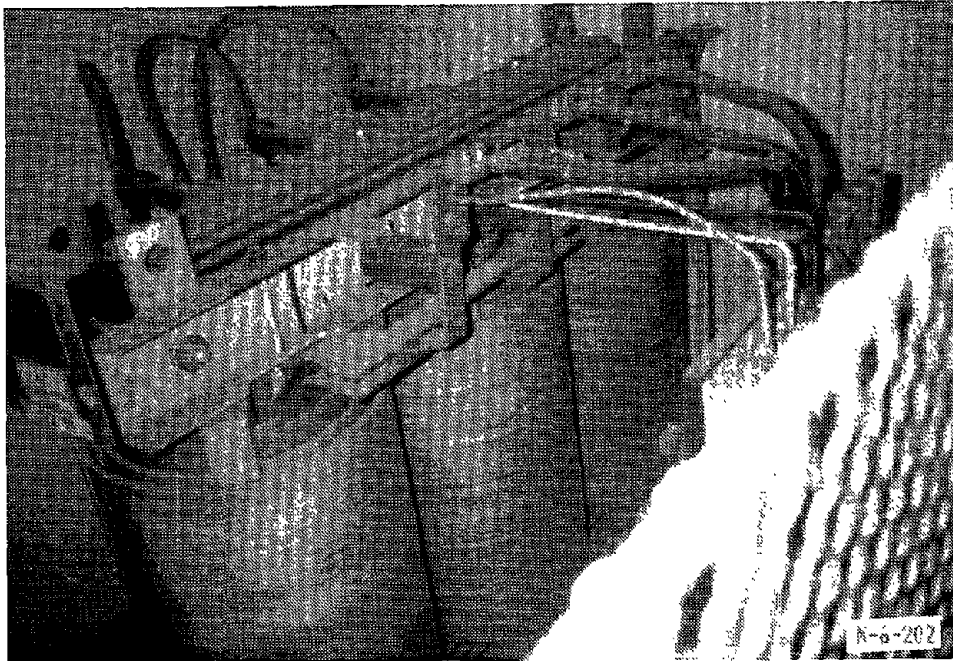

Figure 4-84: This unclad transformer at a steel mill, affected by the 1985 Mexico Earthquake, was hit by a light fixture. The transformer is enclosed in a mesh fence but is otherwise unclad to allow natural air cooling.



Figure 4-85: One two 480-volt substations at a manufacturing plant, affected by the Loma Prieta Earthquake. These units were sprayed with water when an overhead sprinkler broke. Each substation included two transformers. Both unit substations were disassembled, dried out, and reassembled, prior to repowering three days after the earthquake.

APPENDIX A

EARTHQUAKES AND SITES INCLUDED IN EARTHQUAKE PERFORMANCE INVESTIGATION

APPENDIX A
EARTHQUAKES AND SITES INCLUDED IN
EARTHQUAKE PERFORMANCE INVESTIGATION

The earthquake performance studies included in this project are based on investigations of dozens of strong-motion earthquakes which have occurred over the last two decades. This ongoing research includes hundreds of sites, covering a wide range of commercial, industrial, and government facilities.

Table A-1 gives a partial list of earthquakes and sites where a significant amount of equipment performance data have been gathered and collated. The table describes the earthquakes and the facilities and gives an estimate of the peak ground acceleration (PGA) experienced at each site.

Table A-1

PARTIAL LIST OF EARTHQUAKE SITES INCLUDED IN EQUIPMENT PERFORMANCE INVESTIGATION

<u>Earthquake (Magnitude)</u>	<u>Facility</u>	<u>Type of Facility</u>	<u>Estimated Peak Ground Acceleration (g)**</u>
San Fernando, CA Earthquake 1971 (M6.5)	Sylmar Converter Station	Large electrical substation	0.50-0.75
	Rinaldi Receiving Station	Large electrical substation	0.50-0.75
	Valley Steam Plant	Four-unit gas-fired power plant	0.40
	Burbank Power Plant	Six-unit gas-fired power plant	0.30
	Glendale Power Plant	Five-unit gas-fired power plant	0.30
	Pasadena Power Plant	Five-unit gas-fired power plant	0.20
Point Mugu, CA Earthquake 1973 (M5.7)	Ormond Beach Power Plant	Large two-unit oil-fired power plant	0.20
Ferndale, CA Earthquake 1975 (M5.5)	Humboldt Bay Power Plant	Two gas-fired units, one nuclear unit	0.30*
Santa Barbara, CA Earthquake 1978 (M5.7)	Goleta Substation	Electrical substation	0.26*
Imperial Valley, CA Earthquake 1979 (M6.6)	El Centro Steam Plant	Four-unit gas-fired power plant	0.42*
	Drop IV Hydro. Plant	Two-unit hydroelectric plant	0.30

* Ground acceleration measured by an instrument at the site

** Average of two horizontal components

Table A-1 (Page 2 of 11)

PARTIAL LIST OF EARTHQUAKE SITES INCLUDED IN EQUIPMENT PERFORMANCE INVESTIGATION

<u>Earthquake (Magnitude)</u>	<u>Facility</u>	<u>Type of Facility</u>	<u>Estimated Peak Ground Acceleration (g)**</u>
Humboldt, CA Earthquake 1980 (M7.0)	Humboldt Bay Power Plant	Two gas-fired units one nuclear unit	0.25
Coalinga, CA Earthquake 1983 (M6.7)	Main Oil Pumping Plant	Pumping station feeding oil pipeline from Coalinga area	0.60
	Union Oil Butane Plant	Petrochemical facility to extract butane and propane from well waste gas	0.60
	Shell Water Treatment Plant	Petrochemical facility to demineralize water prior to steam injection into oil wells	0.60
	Coalinga Water Treatment Plant	Potable water purification facility	0.60
	Coalinga Substation No.2	Electrical substation	0.60
	Shell Tank Farm No.29	Oil storage tank farm	0.60
	Pleasant Valley Pumping Plant	Pumping station to supply water from the San Luis Canal to the Coalinga Canal	0.56*
	San Luis Canal Pumping Stations (29)	Agricultural pumping stations taking water from the San Luis Canal	0.20-0.60
	Gates Substation	Large electrical substation	0.25
Kettleman Compressor Station	Natural gas pipeline booster station	0.20	

* Ground acceleration measured by an instrument at the site
 ** Average of two horizontal components

Table A-1 (Page 3 of 11)

PARTIAL LIST OF EARTHQUAKE SITES INCLUDED IN EQUIPMENT PERFORMANCE INVESTIGATION

<u>Earthquake (Magnitude)</u>	<u>Facility</u>	<u>Type of Facility</u>	<u>Estimated Peak Ground Acceleration (g)**</u>
Morgan Hill, CA Earthquake 1984 (M6.2)	United Tech. Chemical Plant	Large research facility for missile systems development	0.50
	IBM/Santa Teresa Facility	Large computer facility for software development	0.37*
	San Martin Winery	Winery	0.35
	Wiltron Electronics Plant	Electronics manufacturing facility	0.35
	Metcalf Substation	Large electrical substation	0.40
	Evergreen Community College	Large college complex with self-contained HVAC power plant	0.20
Chile Earthquake 1985 (M7.8)	Mirassou Winery	Winery	0.20
	Bata Shoe Factory	Four-building factory and tannery	0.64
	San Isidro Substation	Electrical substation	0.58*
	Llolleo Water Pumping Plant	Water pumping station	0.55
	Terquim Tank Farm	Oil/acetate/acid storage tank farm	0.55
	Vicuna Hospital	Four-story hospital	0.55

* Ground acceleration measured by an instrument at the site

** Average of two horizontal components

Table A-1 (Page 4 of 11)

PARTIAL LIST OF EARTHQUAKE SITES INCLUDED IN EQUIPMENT PERFORMANCE INVESTIGATION

<u>Earthquake (Magnitude)</u>	<u>Facility</u>	<u>Type of Facility</u>	<u>Estimated Peak Ground Acceleration (g) **</u>
Chile Earthquake 1985 (Cont.)	Rapel Hydroelectric Plant	Five-unit hydroelectric plant	0.40*
	San Sebastian Substation	Electrical substation	0.35
	Concon Petroleum Refinery	Petrochemical facility producing fuel oil, asphalt, gasoline, and other petroleum products	0.30
	Oxiquim Chemical Plant	Chemical facility producing various chemicals, including feed stock for paint ingredients	0.30
	Concon Water Pumping Station	Water pumping station	0.30
	Renca Power Plant	Two-unit coal-fired power plant	0.30
	Laguna Verde Power Plant	Two-unit coal-fired peaking plant	0.25
	Las Ventanas Copper Refinery	Copper refinery/foundry/power plant	0.25
	Las Ventanas Power Plant	Two-unit gas-fired power plant	0.25*
	San Cristobal Substation	Electrical substation	0.25
	Las Condes Hospital	Four-story hospital	0.20

* Ground acceleration measured by an instrument at the site
 ** Average of two horizontal components

Table A-1 (Page 5 of 11)

PARTIAL LIST OF EARTHQUAKE SITES INCLUDED IN EQUIPMENT PERFORMANCE INVESTIGATION

Earthquake (Magnitude)	Facility	Type of Facility	Estimated Peak Ground Acceleration (g)**
Mexico Earthquake 1985 (M8.1)	Infiernillo Dam	Six-unit hydroelectric plant	0.15
	La Villita Power Plant	Four-unit hydroelectric plant	0.14
	SICARTSA Steel Mill	Large, modern steel mill	0.25-0.50
	Fertimex Fertilizer Plant	Fertilizer plant	0.25-0.50
Adak, Alaska Earthquake 1986 (M7.5)	Adak Naval Base	Diesel-electric power plants, electrical substations, sewage lift stations, water treatment plant, steam plants	0.25
North Palm Springs, CA Earthquake 1986 (M6.0)	Devers Substation	Large electrical distribution substation	0.85*
	Whitewater Hydro. Plant	Small hydroelectric power plant	0.50
Chalfant Valley, CA Earthquake 1986 (M6.0)	Control Gorge Hydro Plant	Two-unit hydroelectric plant	0.25
	Hi-Head Hydro Plant	Small one-unit unmanned hydroelectric plant	0.25
San Salvador Earthquake 1986 (M5.4)	Soyapango Substation	Electrical substation	0.50
	San Antonio Substation	Electrical substation	0.40
Cerro Prieto, Mexico Earthquake 1987 (M5.4)	Power Plant 1	Geothermal power plant	0.20-0.30
	Power Plant 3	Geothermal power plant	0.20-0.30

* Ground acceleration measured by an instrument at the site

** Average of two horizontal components

Table A-1 (Page 6 of 11)

PARTIAL LIST OF EARTHQUAKE SITES INCLUDED IN EQUIPMENT PERFORMANCE INVESTIGATION

<u>Earthquake (Magnitude)</u>	<u>Facility</u>	<u>Type of Facility</u>	<u>Estimated Peak Ground Acceleration (g) **</u>
Bay of Plenty, New Zealand Earthquake 1987 (M6.25)	Edgecumbe Substation	230/115 kV substation	0.50-1.0
	New Zealand Distillery	Liquor distillery	0.50-1.0
	Caxton Paper Mill	Paper and pulp mill	0.40-0.55
	Kawerau Substation	230/115 kV substation	0.40-0.55
	Whakatane Board Mill	Paper mill producing cardboard	0.25
	Matahina Dam	Two-unit hydroelectric plant	0.26*
Whittier, CA Earthquake 1987 (M5.9)	Olinda Substation	Electrical substation	0.65*
	SCE Central Dispatch Headquarters	Data Processing Center	0.56*
	SCE Headquarters	Large office complex	0.42*
	California Federal Bank Facility	Data processing facility	0.40
	Ticor Facility	Data processing facility	0.40
	Mesa Substation	Electrical substation	0.35
	Sanwa Bank Facility	Data processing facility	0.40
	Alhambra Telephone Station	Three-story concrete-frame building	0.40

* Ground acceleration measured by an instrument at the site

** Average of two horizontal components

Table A-1 (Page 7 of 11)

PARTIAL LIST OF EARTHQUAKE SITES INCLUDED IN EQUIPMENT PERFORMANCE INVESTIGATION

Earthquake (Magnitude)	Facility	Type of Facility	Estimated Peak Ground Acceleration (g) **
Whittier, CA Earthquake (Cont.)	Rosemead Telephone Station	Two-story steel-frame building	0.40
	Central Telephone Station	Three steel-frame high-rise buildings	0.15
	Wells Fargo Bank Facility	Data processing facility	0.30
	Center Substation	Electrical Substation	0.30
	Lighthype Substation	Electrical Substation	0.26*
	Del Amo Substation	Electrical Substation	0.20
	Pasadena Power Plant	Five-unit gas-fired power plant	0.25
	Glendale Power Plant	Five-unit gas-fired power plant	0.20g
	Commerce Refuse- to-Energy Plant	One-unit gas-fired power plant	0.30
Superstition Hills (El Centro), CA 1987 (M6.3)	Mesquite Lake Resource Recovery Plant	16 MW gas-fired power plant	0.20
	El Centro Steam Plant	Four-unit gas-fired power plant	0.26*

* Ground acceleration measured by an instrument at the site
 ** Average of two horizontal components

Table A-1 (Page 8 of 11)

PARTIAL LIST OF EARTHQUAKE SITES INCLUDED IN EQUIPMENT PERFORMANCE INVESTIGATION

<u>Earthquake (Magnitude)</u>	<u>Facility</u>	<u>Type of Facility</u>	<u>Estimated Peak Ground Acceleration (g)**</u>
Loma Prieta Earthquake 1989 (M7.1)	Moss Landing Power Plant	Seven-unit gas-fired power plant	0.30
	Gilroy Energy Cogen Plant	One-unit combined gas turbine and steam turbine plant	0.32
	Cardinal Cogen Plant	One-unit combined gas turbine and steam turbine plant	0.25
	UCSC Cogen Plant	One-unit diesel cogeneration plant	0.40
	Hunter's Point Plant	Three-unit gas-fired power plant	0.15
	Portrero Plant	One-unit gas-fired plant	0.15
	Metcalf Substation	500 kV substation	0.30
	San Mateo Substation	230 kV substation	0.20
	Monte Vista Substation	230 kV substation	0.20
	National Refractory	Large brick & magnesia extraction plant	0.30
	Green Giant Foods	Concrete tilt-up food processing plant	0.33
	Watsonville Wastewater Treatment	Sewage treatment plant	0.40
Santa Cruz Telephone Station	Three-story concrete shear wall switching station	0.50	

* Ground acceleration measured by an instrument at the site
 ** Average of two horizontal components

Table A-1 (Page 9 of 11)

PARTIAL LIST OF EARTHQUAKE SITES INCLUDED IN EQUIPMENT PERFORMANCE INVESTIGATION

<u>Earthquake (Magnitude)</u>	<u>Facility</u>	<u>Type of Facility</u>	<u>Estimated Peak Ground Acceleration (g)**</u>
Loma Prieta Earthquake (Cont.)	Watsonville Telephone Station	Four-story concrete shear wall switching station	0.33*
	Seagate Technology Watsonville	Concrete tilt-up manufacturing facility	0.40
	Santa Cruz Water Treatment	Potable water purification facility	0.40
	Soquel Water District Headquarters	One-story wood-frame office complex with small pumping station & storage tanks	0.50
	Lipton Foods	Concrete tilt-up food processing and packaging facility	0.30
	Lone Star Cement	Large cement factory	0.25
	Watkins-Johnson Instruments	One-, two-, and three-story concrete & steel-frame buildings for light manufacturing	0.35
	Rinconada Water Treatment Plant	Potable water processing facility	0.30
	IBM/Santa Teresa Facility	Steel-frame high-rise complex for software development	0.20
	EPRl Headquarters	Two- and three-story concrete-frame office	0.25
San Martin Winery	Winery	0.30	

* Ground acceleration measured by an instrument at the site
 ** Average of two horizontal components

Table A-1 (Page 10 of 11)

PARTIAL LIST OF EARTHQUAKE SITES INCLUDED IN EQUIPMENT PERFORMANCE INVESTIGATION

Earthquake (Magnitude)	Facility	Type of Facility	Estimated Peak Ground Acceleration (g)**
Central Luzon Philippines Earthquake 1990 (M7.7)	Baguio Telephone	Telephone switching station	--
	Cabanatuan Substation	230 kV	--
	La Trinidad Substation	230 kV	--
	San Manuel Substation	230 kV	--
	Moog Manufacturing Plant	Manufacturing plant	--
Valle de Estrella, Costa Rica Earthquake 1991 (M7.4)	Bomba Water Treatment Plant		--
	Cachi Dam	1,000 MW hydroelectric plant	0.12*
	Changuinola Power Plant	Diesel power plant	--
	Limon Telephone	Telephone switching station	--
	Moin Power Plant	140 MW thermoelectric power plant	--
	RECOPE Refinery	Oil refinery	

* Ground acceleration measured by an instrument at the site

** Average of two horizontal components

Table A-1 (Page 11 of 11)

PARTIAL LIST OF EARTHQUAKE SITES INCLUDED IN EQUIPMENT PERFORMANCE INVESTIGATION

<u>Earthquake (Magnitude)</u>	<u>Facility</u>	<u>Type of Facility</u>	<u>Estimated Peak Ground Acceleration (g)**</u>
Sierra Madre, California Earthquake 1991 (M5.8)	Pasadena Power Plant	Five-unit gas-fired power plant	0.20g
	Goodrich Substation	230 kV substation	0.30g
Cape Mendocino, California Earthquake 1992 (M7.0)	PALCO Co-generation Plant	Two-unit power plant	0.50
	Humboldt Bay Power Plant	Two gas-fired units, one nuclear unit	--
	Centerville Beach Station	Naval facility	0.40*
Landers and Big Bear, California Earthquake 1992 (M7.4)	Cool Water Generation Plant	Four-unit power plant two gas/oil-fired and two combined cycle units	0.35*
	Mitsubishi Cement Plant	Cement plant	--
	LUZ Projects	Solar electric generating station	0.35

* Ground acceleration measured by an instrument at the site

** Average of two horizontal components

APPENDIX B

DATA BASE OF UPS SYSTEMS

APPENDIX B DATA BASE OF UPS SYSTEMS

For this project, a data base has been compiled of detailed data on 93 UPS systems which have experienced large motion earthquakes. Sites were generally selected where detailed data have been compiled on batteries. Information on the UPS systems reviewed is summarized in Tables B-1 through B-5. The tables are grouped into the following categories:

- UPS Systems Data
- Charger/Inverter Equipment Details
- Charger/Inverter Anchorage Details
- Battery Racks - Equipment and Anchorage Details
- UPS Systems Seismic Demand

UPS SYSTEMS DATA

Table B-1 presents an overview of information on the earthquake and site and main components of the uninterruptible power supply system. This table indicates whether damage occurred to either the battery charger, inverter or battery.

Blank spaces in this table, as well as the other tables in this section, indicate one of the following:

- If the damage column is also blank, that component was not present.
- If the damage column had a "yes" or "no", the specific data indicated in that column were not available for that equipment item.

Photo codes correspond to the photographs at the end of this section. Those photos are arranged in alphabetical order, according to the first letters of the code.

CHARGER/INVERTER EQUIPMENT DETAILS

Table B-2 presents information on equipment manufacturer, model number, power rating, and cabinet dimensions of the battery chargers, inverters, and UPS units in the systems reviewed. There are a variety of manufacturers represented, providing a wide range of input and output voltages. Cabinet sizes for battery chargers and inverters range from small wall-mounted units (10" wide x 20" deep x 20" high) to large free-standing units (108" wide x 36" deep x 78" high).

CHARGER/INVERTER ANCHORAGE DETAILS

Table B-3 presents anchorage information on the battery chargers and static inverters reviewed. There are examples of both unanchored and anchored units, as well as floor-mounted and wall-mounted cabinets. Typically, cabinets are anchored using expansion anchors or welds to steel embeds.

BATTERY RACKS - EQUIPMENT AND ANCHORAGE DETAILS

Table B-4 presents the manufacturers, battery types, rack configurations and anchorage details for batteries reviewed. Most major manufacturers of batteries are represented, as well as some lesser-known, international manufacturers. The batteries reviewed are mostly lead acid type which are housed on a variety of rack configurations. There are many examples of well anchored racks as well as unanchored racks. Typically, racks are anchored using expansion anchors.

UPS SYSTEMS SEISMIC DEMAND

Table B-5 presents information on peak ground acceleration (PGA) experienced by the uninterruptible power supply systems, duration of earthquake, soil type and site and earthquake which affected each UPS system.

The PGA is the average of the two free-field horizontal components. PGAs for the sites reviewed have either been measured or estimated based on the nearest record. The UPS systems reviewed experienced PGAs from 0.10g to 0.85g.

The duration of the earthquake is considered to be that length of time for which the ground acceleration exceeds 0.10g in the epicentral area. The UPS systems

reviewed experienced earthquakes with strong-motion durations ranging from 3 to about 50 seconds.

The facilities are defined in the table as founded on stiff soil when the shear wave velocity of soil is greater than 3500 to 4000 feet per second. Below those values, the facilities are defined as founded on soft soil. The facilities housing the UPS systems reviewed are located on a variety of soil types (i.e., sand, alluvium, marine sediment, poor clay, limestone, rock, etc.).

Table B-1 (Page 1 of 3)
UPS SYSTEMS DATA

Earthquake	Site	UPS Type	UPS Manufacturer	Damage	Battery Manufacturer	Battery Damage	Bat. Photo I.D.	
	ADAK	ANTENNA	UPS	TELEDYNE	NO	EXIDE	NO	AA-1-345
	ADAK	BIRCHWOOD	CHARGER	GENERAL	NO	NIFE	NO	AA-1-326
	ADAK	ZETO POINT	INVERTER	EXIDE	NO	EXIDE	NO	AA-1-374
	ADAK	POWER PLANT	-	-	-	GOULD	NO	AA-1-139
	ADAK	POWER PLANT	-	-	-	C&D	NO	AA-1-250
	ADAK	TELEPHONE	-	-	-	C&D	NO	AA-1-283
	ADAK	TRANSMITTER	-	-	-	C&D	NO	AA-1-464
	CHALFANT	HI-HEAD	CHARGER	EXIDE	NO	EXIDE	YES	CV-1403
	CHILE	RAPEL	INVERTER	AIR	NO	-	YES	CH-2-RA-111
	CHILE	RAPEL	INVERTER	AEG	NO	-	YES	CH-2-RA-111
	CHILE	RENCA POWER	-	-	-	EXIDE	NO	CH-2-RE-251
	COALINGA	GETTY OIL	INVERTER	EXIDE	NO	-	-	MO-1-533
	COALINGA	GETTY OIL	CHARGER	POWER	NO	EXIDE	NO	MO-1-394
	COALINGA	GETTY OIL	CHARGER	WARREN	NO	NIFE	NO	MO-2-43
	COALINGA	PLEASANT	CHARGER	EXIDE	NO	EXIDE	NO	PV-1-148
	COALINGA	UNION OIL	CHARGER	NIFE	NO	-	-	-
	COALINGA	GETTY OIL	-	-	-	-	YES	MO-1-53
	COALINGA	KETTLEMAN	-	-	-	EXIDE	NO	KT-1-276
	COALINGA	UNION OIL	-	-	-	NIFE	NO	UO-3-61
	COSTA RICA	LIMON	CHARGER	LORAIN	NO	YOUASA,	NO	CR-2-TL-94
	FERNDALE	HUMBOLDT	CHARGER	POWER GUARD	NO	CATERPILLER	NO	HB-2-230
	FERNDALE	HUMBOLDT	CHARGER	C&D	NO	C&D	NO	HB-2-258
	FERNDALE	HUMBOLDT	CHARGER	EXIDE	NO	C&D	NO	HB-3-118
	FERNDALE	HUMBOLDT	-	-	-	EXIDE	NO	HB-3-118
	IMPERIAL	DROP IV	CHARGER	EXIDE	NO	EXIDE	NO	D4-23
	IMPERIAL	EL CENTRO	CHARGER	C&D	NO	GOULD	NO	EC-1-167
	IMPERIAL	EL CENTRO	CHARGER	AUTOREG	NO	EXIDE	NO	EC-5-70
	LOMA PRIETA	EPRI	INVERTER	EXIDE	NO	POWER	NO	LP-8-EPRI-1
	LOMA PRIETA	GILROY	CHARGER	RATELCO	NO	C&D	NO	LP-GCO-250
	LOMA PRIETA	GILROY	CHARGER	SOLID STATE	NO	C&D	NO	LP-GCO-250
	LOMA PRIETA	GILROY	INVERTER	SOLID STATE	NO	C&D	NO	LP-GCO-250
	LOMA PRIETA	LIPTON FOOD	UPS	BEST POWER	NO	-	-	-
	LOMA PRIETA	UCSC	CHARGER	LA MARCHE	NO	-	NO	LP-UCSC-17
	LOMA PRIETA	CARDINAL	-	-	-	C&D	NO	LP-11-CLG-2
	LOMA PRIETA	PAC BELL	-	-	-	C&D	NO	LP-SCPB-23
	LOMA PRIETA	PAC BELL	-	-	-	DELCO	NO	LP-SCPB-56
	MEXICO	LA VILLITA	CHARGER	EXIDE	NO	EXIDE	NO	M-2-160
	MEXICO	SICARTSA	INVERTER	LORIAN	NO	NIFE &	YES	M-6-485
	MEXICO	LA VILLITA	-	-	-	EXIDE	NO	M-2-80
	MEXICO	SICARTSA	-	-	-	NIFE	NO	M-6-191
	MORGAN HILL	METCALF	CHARGER	WESTINGHOUS	NO	EXIDE	NO	MH-2-115

B-4

Table B-1 (Page 2 of 3)
UPS SYSTEMS DATA

Earthquake	Site	UPS Type	UPS Manufacturer	Damage	Battery Manufacturer	Battery Damage	Bat. Photo I.D.
MORGAN HILL	METCALF	CHARGER	EXIDE	NO	EXIDE	NO	MH-2-111
MORGAN HILL	METCALF	-	-	-	EXIDE	NO	MH-2-114
N. PALM	DEVERS	CHARGER	FAN STEEL	NO	EXIDE	YES	PS-2-63
N. PALM	DEVERS	INVERTER	ELGAR ONAN	NO	EXIDE	YES	PS-2-63
N. PALM	DEVERS	CHARGER	C&D RATELCO	NO	EXIDE	NO	PS-2-111
N. PALM	WHITEWATER	CHARGER	RATELCO	NO	C&D	YES	PS-2-306
NEW ZEALAND	EDGE CUMBE	CHARGER	PRODELTO	NO	CHLORIDE	NO	NZ-3-105-ES
NEW ZEALAND	EDGE CUMBE	CHARGER	WESTINGHOUSE	NO	-	-	-
NEW ZEALAND	NEW ZEALAND	CHARGER	SAFE	NO	-	-	-
NEW ZEALAND	EDGE CUMBE	-	-	-	LUCAS	NO	NZ-3-101-ES
NEW ZEALAND	EDGE CUMBE	-	-	-	CHLORIDE	NO	NZ-3-151-ES
NEW ZEALAND	KAWERAU	-	-	-	CHLORIDE	YES	NZ-1-41-KS
NEW ZEALAND	KAWERAU	-	-	-	CHLORIDE	NO	NZ-7-KS-21
NEW ZEALAND	MATAHINA	-	-	-	CHLORIDE,	NO	NZ-2-320-MD
NEW ZEALAND	MATAHINA	-	-	-	LUCAS	NO	NZ-2-314-MD
PHILLIPPINE	BAGUIO	-	-	-	C&D	YES	-
PHILLIPPINE	BAGUIO	-	-	-	C&D	YES	-
POINT MUGU	ORMOND	INVERTER	ELGAR	NO	EXIDE	NO	OB-1-50
POINT MUGU	ORMOND	CHARGER	POWER	NO	EXIDE	NO	OB-1-50
POINT MUGU	ORMOND	CHARGER	SOLID STATE	NO	EXIDE	NO	OB-1-50
SAN	GLENDALE	CHARGER	LA MARCHE	NO	EXIDE	NO	G-6-74
SAN	GLENDALE	INVERTER	LA MARCHE	NO	GOULD	NO	G-1-52
SAN	GLENDALE	CHARGER	FAN STEEL	NO	EXIDE	NO	G-1-59
SAN	GLENDALE	INVERTER	SOLID STATE	NO	-	-	-
SAN	GLENDALE	INVERTER	SOLID STATE	NO	GOULD	NO	G-1-52
SAN	RINALDI	CHARGER	C&D	NO	-	-	-
SAN	SYLMAR	CHARGER	POWERTRONIC	NO	YOUSA	NO	S-1-130
SAN	VALLEY	CHARGER	REGCO	NO	ELECTRONIC	NO	VA-1-51
SAN	BURBANK	-	-	-	C&D	NO	B-3-134
SAN	OLIVE	-	-	-	EXIDE	NO	B-3-35
SAN	SOYOPANGO	-	-	-	EXIDE	YES	580-05-047
SUPERSTITIO	EL CENTRO	CHARGER	COMPUTER	NO	-	-	-
SUPERSTITIO	MESQUITE	INVERTER	HDR POWER	NO	-	-	-
WHITTIER	CAL-FED	INVERTER	EMERSON	YES	C&D	NO	WH-S-1-131
WHITTIER	COMMERCE	INVERTER	COMPUTER	NO	-	UNKNW	-
WHITTIER	DEL AMO	CHARGER	-	YES	C&D	YES	POW-4-9
WHITTIER	MESA	CHARGER	EXIDE	NO	EXIDE	NO	POW-2-47
WHITTIER	PUENTE	INVERTER	EMERSON	YES	EMERSON	YES	POW-14-278
WHITTIER	PUENTE	CHARGER	EXIDE	NO	EXIDE	NO	POW-14-198
WHITTIER	SANWA DATA	INVERTER	EMERSON	YES	-	-	-
WHITTIER	SCE	INVERTER	EMERSON	NO	C&D	NO	SCE-2-109
WHITTIER	WELLS FARGO	INVERTER	EMERSON	NO	C&D	NO	WH-S-5-74

B-5

**Table B-1 (Page 3 of 3)
UPS SYSTEMS DATA**

Earthquake	Site	UPS Type	UPS Manufacturer	Damage	Battery Manufacturer	Battery Damage	Bat. Photo I.D.
WHITTIER	WELLS FARGO	INVERTER	EMERSON	YES	C&D	NO	WH-S-5-74
WHITTIER	CENTER	-	-	-	EXIDE	NO	POW-6-3
WHITTIER	LIGHTHYPE	-	-	-	EXIDE	NO	POW-5-37
WHITTIER	LIGHTHYPE	-	-	-	GOULD	NO	POW-5-28
WHITTIER	OLINDA	-	-	-	EXIDE	NO	POW-15-44
WHITTIER	PAC BELL	-	-	-	C&D	NO	POW-16-51
WHITTIER	PAC BELL	-	-	-	EXIDE	NO	POW-16-116
WHITTIER	PAC BELL	-	-	-	C&D	NO	POW-16-114
WHITTIER	SCE	-	-	-	EXIDE	NO	SCE-1-80

**Table B-2 (Page 1 of 2)
CHARGER/INVERTER EQUIPMENT DETAILS**

Site	Equipment Type	Equipment Manufacturer	Model No.	Power Rating		Dimensions		
				Input	Output	D	W	H
ANTENNA	UPS	TELEDYNE	-	200V, 750A	208V, 556A,	30	72	90
BIRCHWOOD	CHARGER	GENERAL	6RW980BN06W	-	240V DC	12	20	24
CAL-FED	INVERTER	EMERSON	5CCB-2000	1663kVA,	2000A AC	48	120	75
COMMERCE	INVERTER	COMPUTER	UNKNOWN	-	-	20	40	60
DEL AMO	CHARGER	-	-	-	UNKNOWN	30	30	60
DEVERS	CHARGER	C&D RATELCO	-	-	130V DC	24	26	68
DEVERS	CHARGER	FAN STEEL	-	240V AC	129V DC,	30	30	50
DEVERS	INVERTER	ELGAR ONAN	103-11-142	-	-	19	55	72
DROP IV	CHARGER	EXIDE	-	480V AC	140V DC,	10	20	20
EDGE CUMBE	CHARGER	PRODELTO	-	24V DC,	230-400V AC	30	36	72
EDGE CUMBE	CHARGER	WESTINGHOUS	TNE 150/20	-	-	15	24	30
EL CENTRO	CHARGER	AUTOREG	-	-	-	14	17	24
EL CENTRO	CHARGER	C&D	ARU-130-E25	480V AC,	132V DC,	14	17	24
EL CENTRO	CHARGER	COMPUTER	-	120V AC,	-	20	36	45
EPRI	INVERTER	EXIDE	3135	-	-	40	120	80
GETTY OIL	CHARGER	POWER	TC-24-9CE	120V AC, 5A	24V DC, 9A	10	20	20
GETTY OIL	CHARGER	WARREN	48TFR-50-S	110VAC	48V DC	20	30	30
GETTY OIL	INVERTER	EXIDE	1205F1-CV	120V AC	140V DC	20	30	50
GILROY	CHARGER	RATELCO	-	-	120V DC	10	30	10
GILROY	CHARGER	SOLID STATE	-	-	-	20	29	57
GILROY	INVERTER	SOLID STATE	-	-	-	36	56	78
GLENDALE	CHARGER	FAN STEEL	3452A	-	-	20	24	30
GLENDALE	CHARGER	LA MARCHE	-	-	-	25	27	57
GLENDALE	INVERTER	SOLID STATE	-	-	-	30	30	50
GLENDALE	INVERTER	SOLID STATE	-	-	-	30	30	90
HI-HEAD	CHARGER	EXIDE	USF52-1-50	240V AC,	-	10	24	30
HUMBOLDT	CHARGER	EXIDE	UR-60-1-12-	120V AC,	140V DC	12	21	26
HUMBOLDT	CHARGER	POWER GUARD	-	-	-	10	30	20
LA VILLITA	CHARGER	EXIDE	-	-	-	30	20	60
LIMON	CHARGER	LORAIN	RHM-200-D50	-	240V DC,	10	20	40
LIPTON FOOD	UPS	BEST POWER	-	-	-	30	30	40
MESA	CHARGER	EXIDE	SCR-130-3-1	-	240V DC	32	24	49
MESQUITE	INVERTER	HDR POWER	-	-	-	30	60	60
METCALF	CHARGER	EXIDE	-	-	-	24	50	50
METCALF	CHARGER	WESTINGHOUS	-	-	-	20	30	30
NEW ZEALAND	CHARGER	SAFE	SLP2	-	-	15	24	50
ORMOND	CHARGER	POWER	-	-	-	40	40	80
ORMOND	CHARGER	SOLID STATE	-	-	-	24	36	60
ORMOND	INVERTER	ELGAR	S02-1	-	-	24	36	60
PLEASANT	CHARGER	EXIDE	USP-130-3-5	480V AC	250V DC	24	32	49
PUENTE	CHARGER	EXIDE	SCRF-130-3-	480V AC	120V DC,	24	42	62

B-7

Table B-2 (Page 2 of 2)
CHARGER/INVERTER EQUIPMENT DETAILS

Site	Equipment Type	Equipment Manufacturer	Model No.	Power Rating		Dimensions		
				Input	Output	D	W	H
PUENTE	INVERTER	EMERSON	AO-503	-	34kW	28	60	78
RAPEL	INVERTER	AEG	-	-	-	30	30	40
RAPEL	INVERTER	AIR	49	-	-	30	30	40
RINALDI	CHARGER	C&D	ARR48A/C3F3	-	115/240V,	12	20	12
SCE	INVERTER	EMERSON	AP-500	-	-	36	72	78
SICARTSA	INVERTER	LORIAN	-	130V DC	120V AC	30	100	90
SYLMAR	CHARGER	POWERTRONIC	ML-629	-	125V DC	24	24	48
UCSC	CHARGER	LA MARCHE	A52C-3K	-	48V	20	30	60
UNION OIL	CHARGER	NIFE	RSECTSV107-	240V AC	24V DC, 55A	20	10	40
VALLEY	CHARGER	REGCO	11-6	460V AC,	250V DC,	20	24	72
WELLS FARGO	INVERTER	EMERSON	92	-	415 Hz	30	70	78
WELLS FARGO	INVERTER	EMERSON	AP-500	-	270kW,	36	108	78
WHITEWATER	CHARGER	RATELCO	-	-	120V DC,	8	16	20
ZETO POINT	INVERTER	EXIDE	208-200T3	280V, 713A	208V, 556A	30	72	90

B-8

**Table B-3 (Page 1 of 2)
CHARGER/INVERTER ANCHORAGE DETAILS**

Site	Equipment Type	Anchorage	Damaged	Photo I.D
	UPS	-	NO	AA-1-337
	CHARGER	UNISTRUT TO WALL	NO	AA-1-322
	INVERTER	(8) 1/2" BOLTS	YES	WH-S-1-155
	INVERTER	-	NO	POW-13-160
	CHARGER	BASE CHANNEL 3/8" BOLTS	YES	POW-4-33
	CHARGER	(4) 3/8" BOLTS	NO	PS-2-113
	CHARGER	(4) 3/8" BOLTS	NO	PS-2-33
	INVERTER	(4) 1/2" BOLTS	NO	PS-2-10
	CHARGER	(4) 1/2" BOLTS	NO	D4-68
	CHARGER	(4) 12mm BOLTS	NO	NZ-7-ES-270
	CHARGER	(4) 3/8" BOLTS TO WALL	NO	NZ16-ES-19
	CHARGER	(4) 3/8" BOLTS TO WALL	NO	EC-12-36
	CHARGER	BOLTED TO FLOOR	NO	-
	CHARGER	UNANCHORED	NO	-
	INVERTER	UNANCHORED	NO	LP-8-EPRI-105
	CHARGER	RACK MOUNTED IN UPS	NO	MO-1-389
	CHARGER	WALL ANCHORED	NO	MO-1-393
	INVERTER	-	NO	MO-1-351
	CHARGER	-	NO	LP-GCO-249
	CHARGER	BOLTED TO UNISTRUT	NO	LP-GCO-256
	INVERTER	-	NO	LP-GCO-248
	CHARGER	BOLTED TO WALL	NO	G-1-384
	CHARGER	UNANCHORED	NO	G-6-286
	INVERTER	BOLTED TO FLOOR	NO	G-6-286
	INVERTER	UNANCHORED	NO	G-1-385
	INVERTER	UNANCHORED	NO	G-6-79
	CHARGER	WALL MOUNTED (6) 1/2"	NO	CV-1-399
	CHARGER	BOLTED TO BLOCK WALL	NO	HB-2-229
	CHARGER	GROUT PAD (4) 5/8" BOLTS	NO	HB-4-26
	CHARGER	WALL MOUNTED 3/8" BOLTS	NO	HB-3-106
	CHARGER	-	NO	M-2-76
	CHARGER	RACK MOUNTED	NO	CR-2-TL-100
	UPS	UNANCHORED	NO	LP2-L5-32
	CHARGER	(4) 1/4" BOLTS TO FLOOR	NO	POW-2-48
	INVERTER	-	NO	SPH-1-294
	CHARGER	-	NO	MH-2-109
	CHARGER	-	NO	MH-2-115
	CHARGER	WALL MOUNTED	NO	NZ-5-ZD-14
	CHARGER	FLOOR MOUNTED	NO	OB-1-49
	CHARGER	FLOOR MOUNTED (4) 5/8"	NO	OB-1-93
	INVERTER	FLOOR MOUNTED (4) 5/8"	NO	OB-1-100

B
9

**Table B-3 (Page 2 of 2)
CHARGER/INVERTER ANCHORAGE DETAILS**

Site	Equipment Type	Anchorage	Damaged	Photo I.D
PLEASANT VALLEY PUMPING	CHARGER	3/8" BOLTS	NO	PV-1-102
PUENTE HILLS LANDFILL	CHARGER	FLOOR MOUNTED 3/8" BOLTS	NO	POW-14-277
PUENTE HILLS LANDFILL	INVERTER	FLOOR MOUNTED 3/8" BOLTS	YES	POW-14-235
RAPEL HYDROELECTRIC	INVERTER	-	NO	CH-2-RA-126
RAPEL HYDROELECTRIC	INVERTER	-	NO	CH-2-RA-134
RINALDI RECEIVING	CHARGER	WALL MOUNTED	NO	OV/R-60
SANWA DATA PROCESSING	INVERTER	FLOOR MOUNTED	YES	WH-S-9-34
SCE ALHAMBRA	INVERTER	-	NO	SCE-2-101
SICARTSA	INVERTER	-	NO	M-6-193
SYLMAR CONVERTER STATION	CHARGER	(4) 1" BOLTS ON FRAME	NO	S-1-102
UCSC COGENERATION PLANT	CHARGER	-	NO	LP-UCSC-15
UNION OIL BUTANE PLANT	CHARGER	IN UNANCHORED CABINET	NO	UO-3-59
VALLEY STEAM PLANT	CHARGER	FLOOR MOUNTED	NO	VA-2-69
WELLS FARGO	INVERTER	(4) 1/2" BOLTS	YES	WH-S-5-67
WELLS FARGO	INVERTER	-	NO	WH-S-5-69
WHITewater HYDROELECTRIC	CHARGER	(6) 1/4" UNISTRUT BOLTS	NO	PS-2-307
ZETO POINT	INVERTER	CHANNELS WITH 5/8" BOLTS	NO	AA-1-368

B-10

**Table B-4 (Page 1 of 3)
BATTERY RACKS - EQUIPMENT AND ANCHORAGE DETAILS**

Site	Battery Manufacturer	Battery Type	Configuration	Anchorage	Damage	Photo I.D.
ANTENNA	EXIDE	CALCIUM FLAT	2-TIER RACK	(2) 3/8"	NO	AA-1-345
BAGUIO	C&D	-	2-TIER	-	YES	-
BAGUIO	C&D	-	2-TIER	EXPANSION	YES	-
BIRCHWOOD	NIFE	-	3-STEP	-	NO	AA-1-326
BURBANK	C&D	CALCIUM FLAT	3-TIER	-	NO	B-3-134
CAL-FED	C&D	LEAD CALCIUM	2-TIER	(2) 1/2"	NO	WH-S-1-131
CARDINAL	C&D	-	3-TIER	(2) 1/2"	NO	LP-11-CLG-2
CENTER	EXIDE	-	2-STEP	(1) 3/8"	NO	POW-6-3
COMMERCE	-	-	-	-	UNKNW	-
DEL AMO	C&D	LEAD CALCIUM	2-TIER	(2) 3/8"	YES	POW-4-9
DEVERS	EXIDE	CALCIUM FLAT	2-STEP	(2) 1/2"	NO	PS-2-111
DEVERS	EXIDE	CALCIUM FLAT	2-STEP	(2) 1/2"	YES	PS-2-63
DEVERS	EXIDE	CALCIUM	2-STEP	(2) 1/2"	YES	PS-2-63
DROP IV	EXIDE	-	2-TIER	-	NO	D4-23
EDGE CUMBE	-	-	-	-	-	-
EDGE CUMBE	CHLORIDE	FLAT PLATE	1-TIER	(2) 1/4"	NO	NZ-3-105-ES
EDGE CUMBE	CHLORIDE	LEAD	2-TIER	(1) 3/8"	NO	NZ-3-151-ES
EDGE CUMBE	LUCAS	-	2-TIER	-	NO	NZ-3-101-ES
EL CENTRO	-	-	-	-	-	-
EL CENTRO	EXIDE	TUBULAR	2-STEP	(2) 3/8"	NO	EC-5-70
EL CENTRO	GOULD	MCX-425	2-STEP	(2) 1/2"	NO	EC-1-167
EPRI	POWER	LEAD ACID	2-TIER	(2) 1/4"	NO	LP-8-EPRI-1
GETTY OIL	-	-	-	-	-	M0-1-533
GETTY OIL	-	STATION	2-STEP	UNANCHORED	YES	MO-1-53
GETTY OIL	EXIDE	-	1-TIER	UNANCHORED	NO	MO-1-394
GETTY OIL	NIFE	NICKEL	2 SHELVES	3/8" BOLTS	NO	MO-2-43
GILROY	C&D	LEAD CALCIUM	2-TIER	(2) 3/8"	NO	LP-GCO-250
GILROY	C&D	LEAD CALCIUM	2-TIER	(2) 3/8"	NO	LP-GCO-250
GLENDALE	-	-	-	-	-	-
GLENDALE	EXIDE	-	2-TIER	(2) 3/8"	NO	G-1-59
GLENDALE	EXIDE	MANCHEX	2-TIER	(2) 3/8"	NO	G-6-74
GLENDALE	GOULD	MANCHEX	2-TIER	(2) 3/8"	NO	G-1-52
GLENDALE	GOULD	MANCHEX	2-TIER	(2) 3/8"	NO	G-1-52
HI-HEAD	EXIDE	CALCIUM FLAT	2-STEP	(2) 1/2"	YES	CV-1-403
HUMBOLDT BAY	C&D	-	2-STEP	WELDED TO	NO	HB-2-258
HUMBOLDT BAY	C&D	-	2-STEP	WELDED TO	NO	HB-3-118
HUMBOLDT BAY	CATERPILLER	-	LOW STEEL	UNANCHORED	NO	HB-2-230
HUMBOLDT BAY	EXIDE	MANCHEX	2-STEP	(2) 1/2"	NO	HB-3-118
KAWERAU	CHLORIDE	LEAD	1-TIER	-	NO	NZ-7-KS-21
KAWERAU	CHLORIDE	LEAD	2-TIER	-	YES	NZ-1-41-KS
KETTLEMAN	EXIDE	MANCHEX	2-STEP	-	NO	KT-1-276

B-11

Table B-4 (Page 2 of 3)
BATTERY RACKS - EQUIPMENT AND ANCHORAGE DETAILS

Site	Battery Manufacturer	Battery Type	Configuration	Anchorage	Damage	Photo I.D.
LA VILLITA	EXIDE	-	2-STEP	UNANCHORED	NO	M-2-80
LA VILLITA	EXIDE	-	2-TIER	UNANCHORED	NO	M-2-160
LIGHTHYPE	EXIDE	LEAD CALCIUM	2-TIER	-	NO	POW-5-37
LIGHTHYPE	GOULD	LEAD CALCIUM	2-STEP	(2) 3/8"	NO	POW-5-28
LIMON	YOUSA, EXIDE	PS-2600, G	1-TIER	(2) 3/8"	NO	CR-2-TL-94
LIPTON FOOD	-	-	-	-	-	-
MATAHINA DAM	CHLORIDE,	363/EPP-33,	1-TIER	(2)	NO	NZ-2-320-MD
MATAHINA DAM	LUCAS	-	2-TIER	WALL	NO	NZ-2-314-MD
MESA	EXIDE	CALCIUM FLAT	2-STEP	(1) 3/8"	NO	POW-2-47
MESQUITE	-	-	-	-	-	-
METCALF	EXIDE	-	2-STEP	-	NO	MH-2-114
METCALF	EXIDE	-	2-TIER	-	NO	MH-2-111
METCALF	EXIDE	-	2-TIER	-	NO	MH-2-115
NEW ZEALAND	-	-	-	-	-	-
OLINDA	EXIDE	-	2-STEP	-	NO	POW-15-44
OLIVE STREET	EXIDE	MANCHEX	2-TIER	-	NO	B-3-35
ORMOND BEACH	EXIDE	-	2-STEP	(2) 5/8"	NO	OB-1-50
PAC BELL	C&D	ANTIMONY	CONCRETE	RESTING ON	NO	POW-16-51
PAC BELL	C&D	ANTIMONY &	CONCRETE	RESTING ON	NO	POW-16-114
PAC BELL	EXIDE	CALCIUM FLAT	2-TIER	BOLTS	NO	POW-16-116
PAC BELL	C&D	LEAD CADMIUM	2-TIER	(3) 1/2"	NO	LP-SCPB-23
PAC BELL	DELCO	HEAVY DUTY	2-TIER	1/2"	NO	LP-SCPB-56
PLEASANT	EXIDE	CALCIUM FLAT	2-STEP	(2) 1/2"	NO	PV-1-148
POWER PLANT	GOULD	PLANTE	3-STEP	UNANCHORED	NO	AA-1-139
POWER PLANT	C&D	LEAD CALCIUM	2-STEP	UNANCHORED	NO	AA-1-250
PUENTE HILLS	EMERSON	-	3 SHELVES	3/8" BOLTS	YES	POW-14-278
PUENTE HILLS	EXIDE	CALCIUM FLAT	2-TIER	UNANCHORED	NO	POW-14-198
RAPEL	-	-	1&2-STEP	(2) 1/2"	YES	CH-2-RA-111
RENCA POWER	EXIDE	-	2-STEP	-	NO	CH-2-RE-251
RINALDI	-	-	-	-	-	-
SANWA DATA	-	-	-	-	-	-
SCE ALHAMBRA	C&D	4LCWC7	2-TIER	(2) 1/2"	NO	SCE-2-109
SCE ROSEMEAD	EXIDE	-	2-TIER	(2) 1/2"	NO	SCE-1-80
SICARTSA	NIFE	-	3-STEP RACK	-	NO	M-6-191
SICARTSA	NIFE &	-	4-STEP	WELDED TO	YES	M-6-485
SOYOPANGO	EXIDE	CALCIUM FLAT	2-STEP	-	YES	580-05-047
SYLMAR	YOUSA	1YP500A,	2&3-STEP	(2)	NO	S-1-130
TELEPHONE	C&D	MINITANK	2-TIER	(2) 1/2"	NO	AA-1-283
TRANSMITTER	C&D	CALCIUM FLAT	2-TIER	(2) 5/8"	NO	AA-1-464
UCSC	-	-	2-TIER	-	NO	LP-UCSC-17
UNION OIL	-	-	-	-	-	-
UNION OIL	NIFE	HIP6-MIN792	STEEL MESH	UNANCHORED	NO	UO-3-61

B-12

Table B-4 (Page 3 of 3)
BATTERY RACKS - EQUIPMENT AND ANCHORAGE DETAILS

Site	Battery Manufacturer	Battery Type	Configuration	Anchorage	Damage	Photo I.D.
VALLEY STEAM	ELECTRONIC	EME-25	2-STEP	1/2" BOLTS	NO	VA-1-51
WELLS FARGO	C&D	-	2-TIER	(2) 1/4"	NO	WH-S-5-74
WHITEWATER	C&D	LEAD CALCIUM	2-STEP	(2) 1/2"	YES	PS-2-306
ZETO POINT	EXIDE	CALCIUM FLAT	2-TIER	(2) 3/8"	NO	AA-1-374

**Table B-5 (Page 1 of 2)
UPS SYSTEMS SEISMIC DEMAND**

Earthquake	Site	Pga	Duration	Soil
ADAK	ANTENNA ARRAY	0.25	25	SOFT
ADAK	BIRCHWOOD SUBSTATION	0.25	25	SOFT
ADAK	POWER PLANT #3	0.25	25	SOFT
ADAK	POWER PLANT #5	0.25	25	SOFT
ADAK	TELEPHONE EXCHANGE	0.25	25	SOFT
ADAK	TRANSMITTER BUILDING	0.25	25	SOFT
ADAK	ZETO POINT	0.25	25	SOFT
CHALFANT	HI-HEAD HYDROELECTRIC PLANT	0.25		-
CHILE	RAPEL HYDROELECTRIC PLANT	0.23	40	SOFT
CHILE	RENCA POWER PLANT	0.30	40	SOFT
COALINGA	GETTY OIL PUMPING PLANT	0.60	10	-
COALINGA	KETTLEMAN COMPRESSOR STATION	0.20	10	-
COALINGA	PLEASANT VALLEY PUMPING PLANT	0.54	10	-
COALINGA	UNION OIL BUTANE PLANT	0.60	10	-
COSTA RICA	LIMON TELEPHONE	-	30	SOFT
FERNDALE	HUMBOLDT BAY POWER PLANT	0.30		SOFT
IMPERIAL VALLEY	DROP IV HYDROELECTRIC PLANT	0.30		SOFT
LOMA PRIETA	CARDINAL COGENERATION PLANT	0.25	12	SOFT
LOMA PRIETA	EPRI HEADQUATERS	0.25	12	STIFF
LOMA PRIETA	GILROY COGENERATION PLANT	0.31	12	SOFT
LOMA PRIETA	LIPTON FOOD PROCESSING PLANT	0.30	12	-
LOMA PRIETA	PAC BELL SANTA CRUZ	0.40	12	SOFT
LOMA PRIETA	UCSC COGENERATION PLANT	0.50	12	STIFF
MEXICO	LA VILLITA POWER PLANT	0.14	50	STIFF
MEXICO	SICARTSA	0.25	50	SOFT
MORGAN HILL	METCALF SUBSTATION	0.30		SOFT
N. PALM SPRINGS	DEVERS SUBSTATION	0.85	10	SOFT
N. PALM SPRINGS	WHITEWATER HYDROELECTRIC PLANT	0.50	10	SOFT
NEW ZEALAND	EDGE CUMBE SUBSTATION	0.50	10	SOFT
NEW ZEALAND	KAWERAU SUBSTATION	0.40	10	SOFT
NEW ZEALAND	MATAHINA DAM	0.27	10	STIFF
NEW ZEALAND	NEW ZEALAND DISTILLERY	0.50	10	SOFT
PHILLIPPINE	BAGUIO TELEPHONE	-		SOFT
POINT MUGU	ORMOND BEACH POWER PLANT	0.20		-
SAN FERNANDO	BURBANK MAGNOLIA STREET	0.30		SOFT
SAN FERNANDO	GLENDALE POWER PLANT	0.25		SOFT
SAN FERNANDO	OLIVE STREET PLANT	0.30		SOFT
SAN FERNANDO	PINALDI RECEIVING STATION	0.50		-
SAN FERNANDO	SYLMAR CONVERTER STATION	0.50		SOFT
SAN FERNANDO	VALLEY STEAM PLANT	0.30		SOFT
SAN SALVADOR	SOYOPANGO SUBSTATION	0.50	5	SOFT

B-14

**Table B-5 (page 2 of 2)
UPS SYSTEMS SEISMIC DEMAND**

Earthquake	Site	Pga	Duration	Soil
SUPERSTITION HILLS	EL CENTRO STEAM PLANT	0.26		STIFF
SUPERSTITION HILLS	MESQUITE LAKE POWER PLANT	0.20		SOFT
WHITTIER	CAL-FED	0.40	3	SOFT
WHITTIER	CENTER SUBSTATION	0.35	3	SOFT
WHITTIER	COMMERCE REFUSE PLANT	0.40	3	UKNWN
WHITTIER	DEL AMO SUBSTATION	0.20	3	SOFT
WHITTIER	LIGHTHYPE SUBSTATION	0.26	3	SOFT
WHITTIER	MESA SUBSTATION	0.40	3	SOFT
WHITTIER	OLINDA SUBSTATION	0.64	3	STIFF
WHITTIER	PAC BELL GRAND CENTRAL	0.20	3	-
WHITTIER	PAC BELL ROSEMEAD	0.40	3	SOFT
WHITTIER	PUENTE HILLS LANDFILL	0.30	3	SOFT
WHITTIER	SANWA DATA PROCESSING CENTER	0.40	3	SOFT
WHITTIER	SCE ALHAMBRA	0.56	3	STIFF
WHITTIER	SCE ROSEMEAD	0.40	3	SOFT
WHITTIER	WELLS FARGO	0.40	3	SOFT

B-15

**PHOTOGRAPHS OF
UPS SYSTEMS REVIEWED**

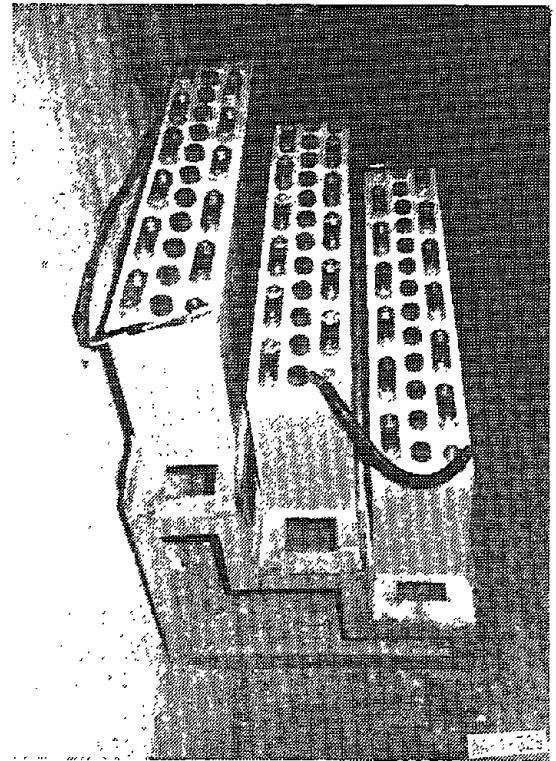
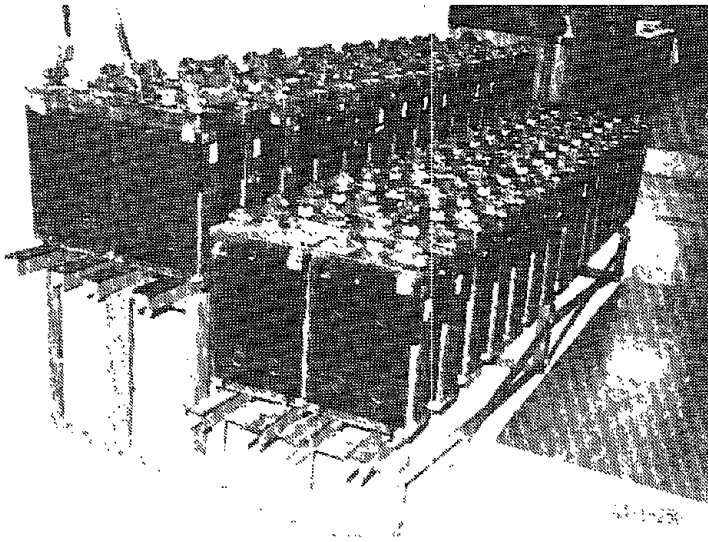
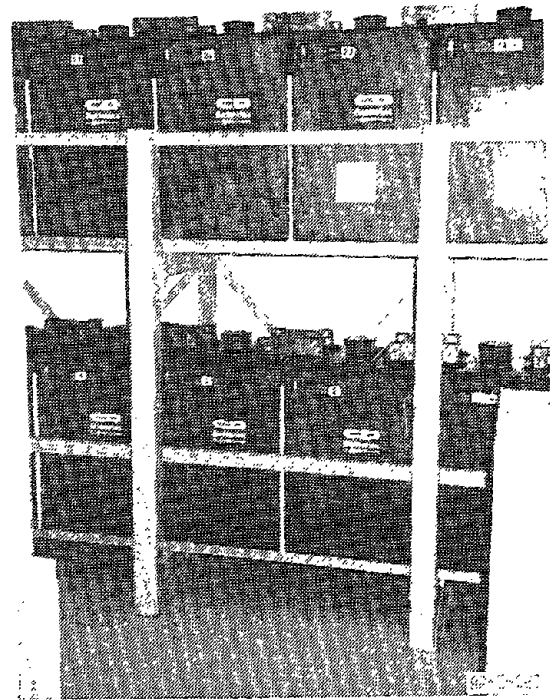
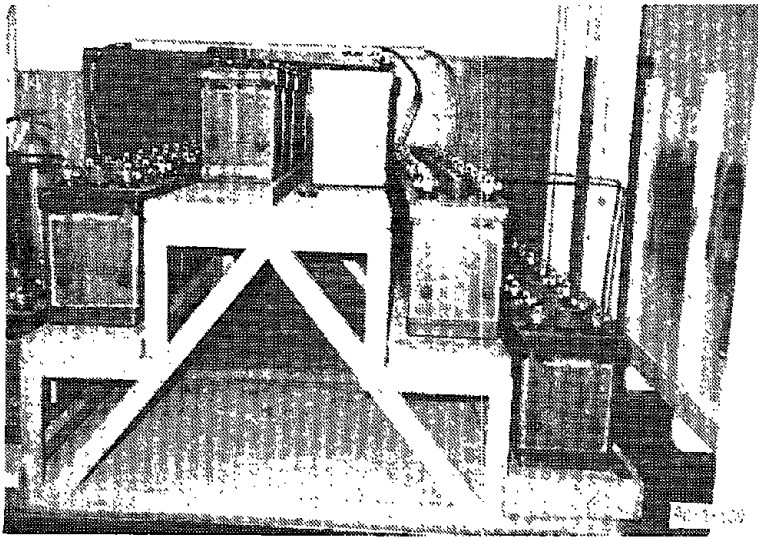

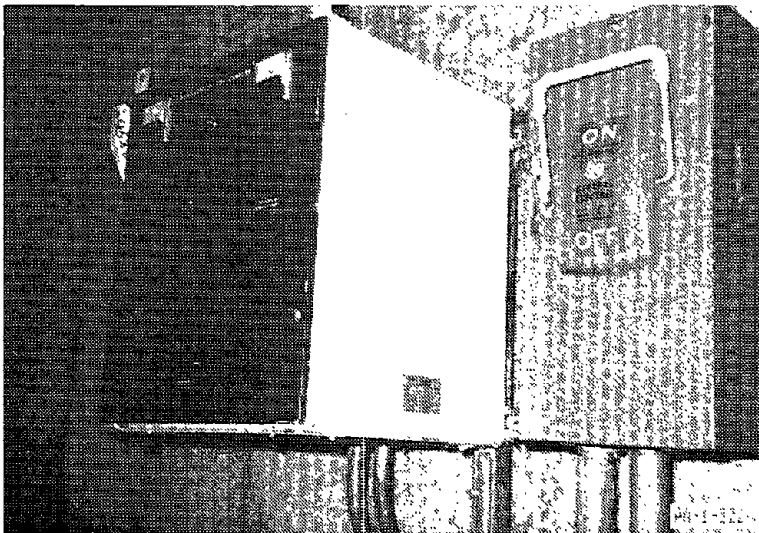
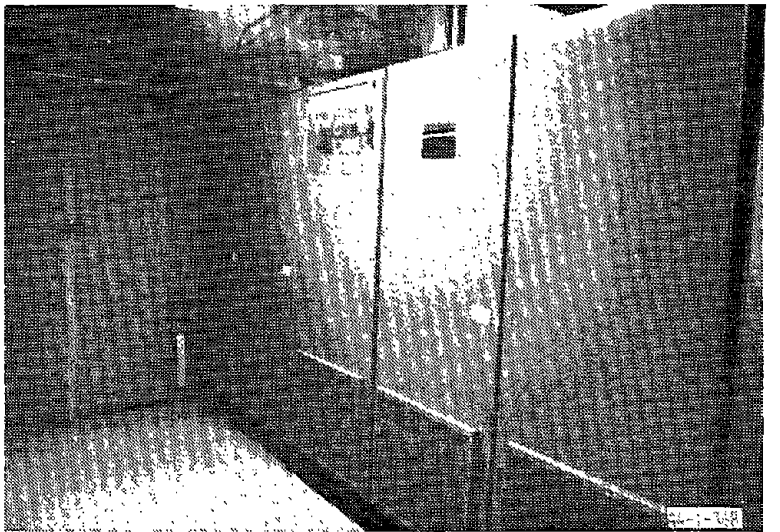
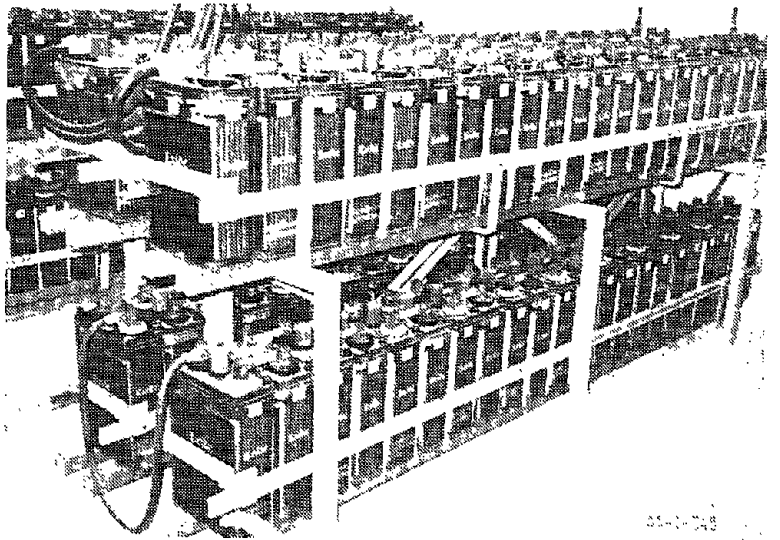
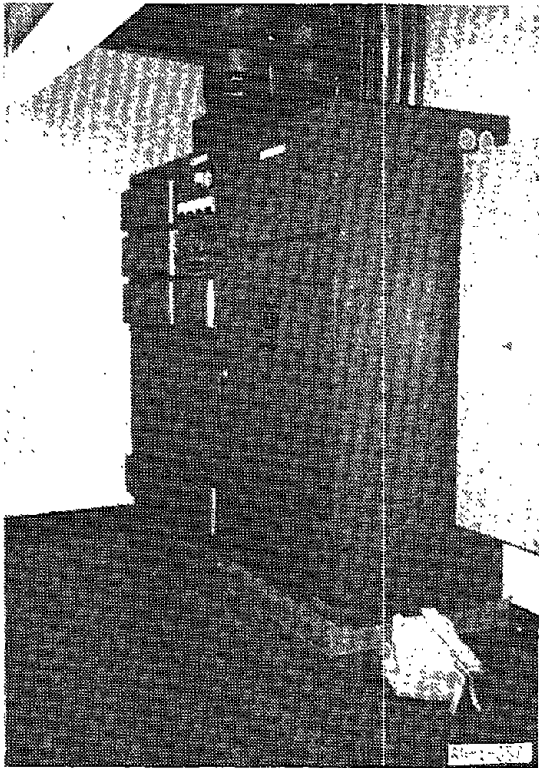

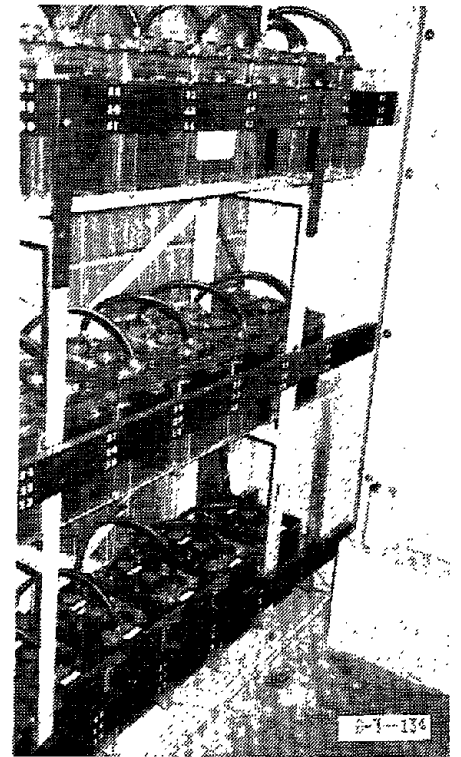
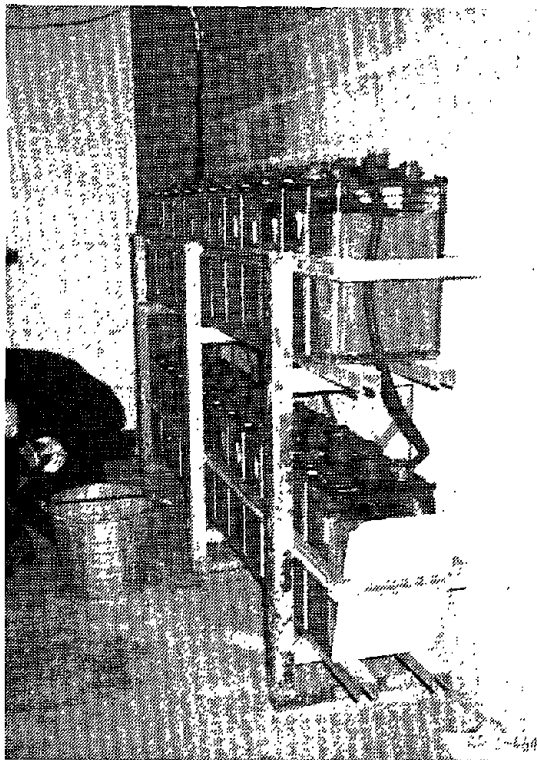
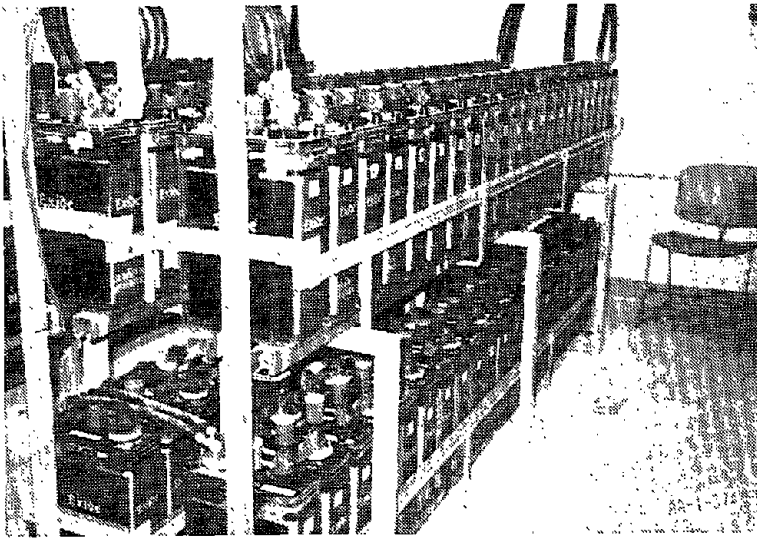

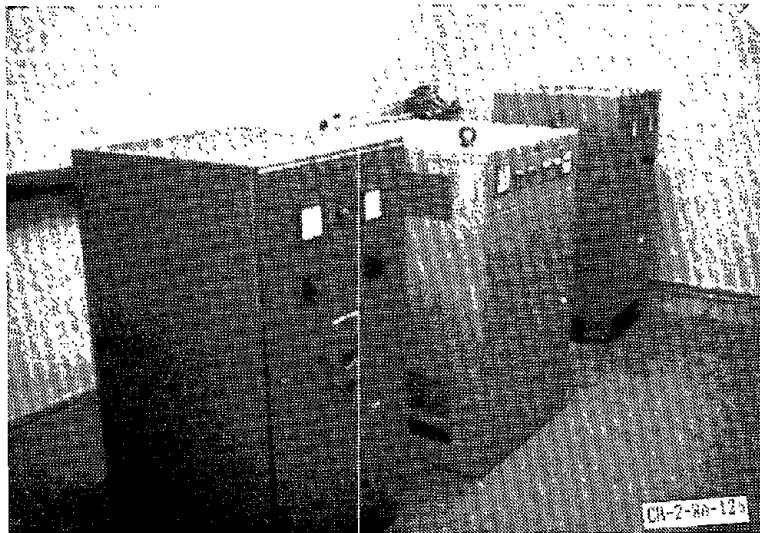
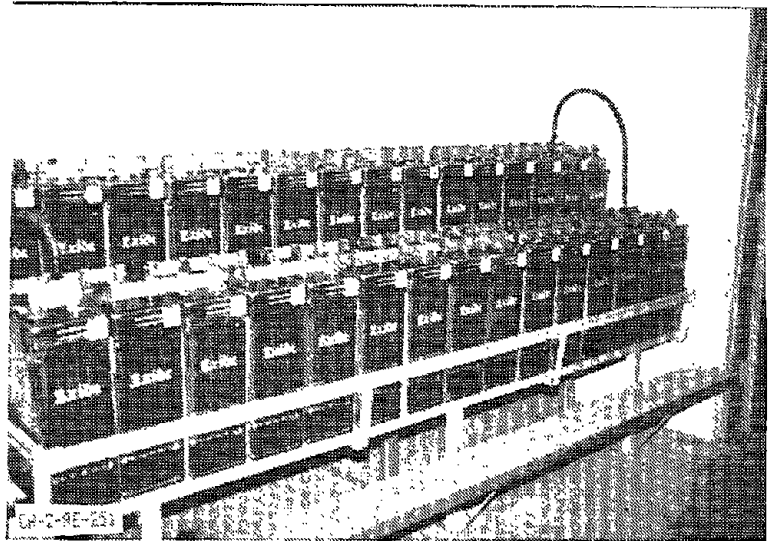
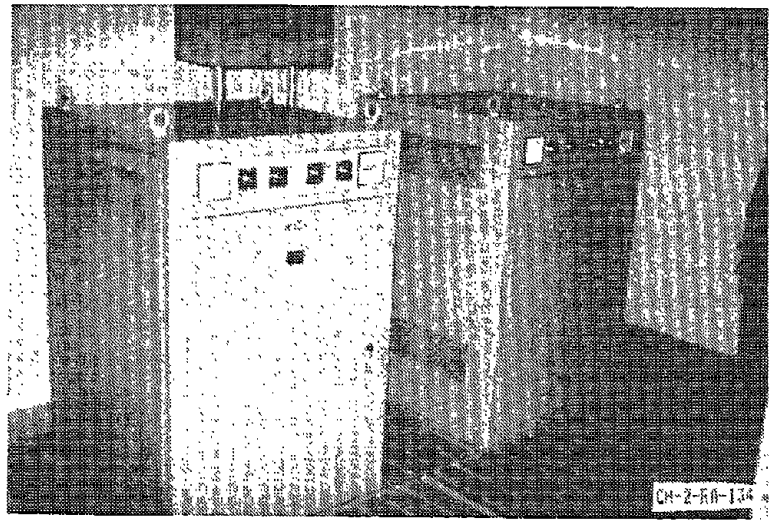
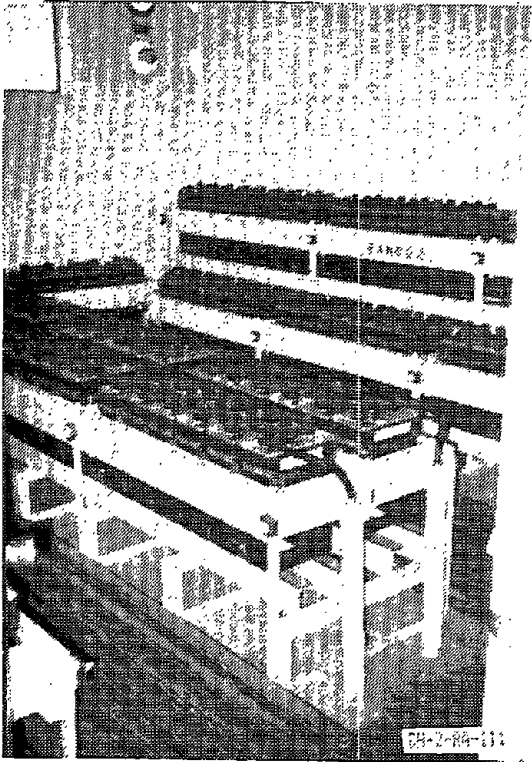

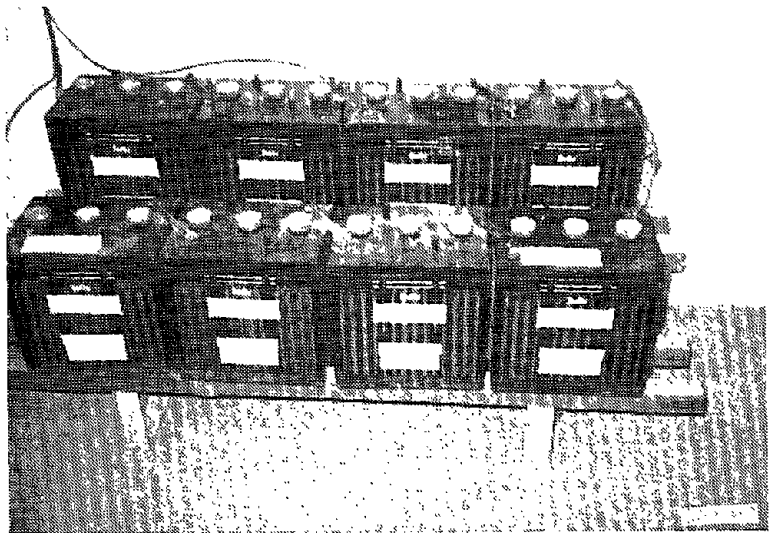
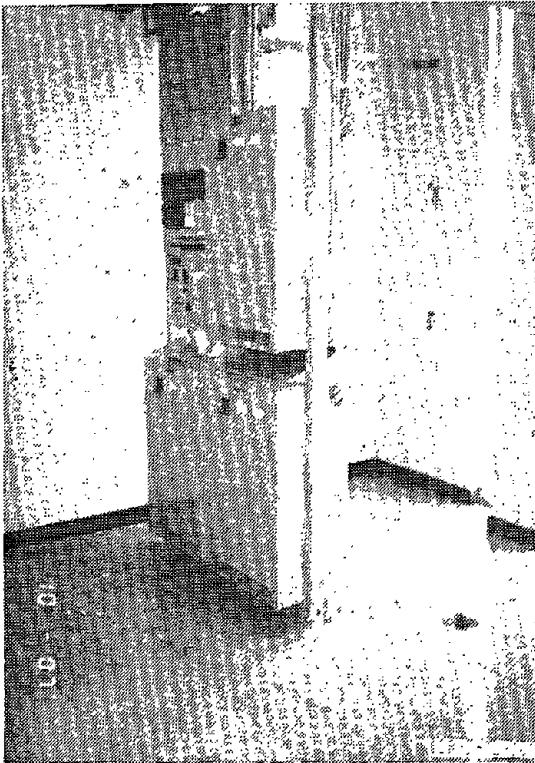
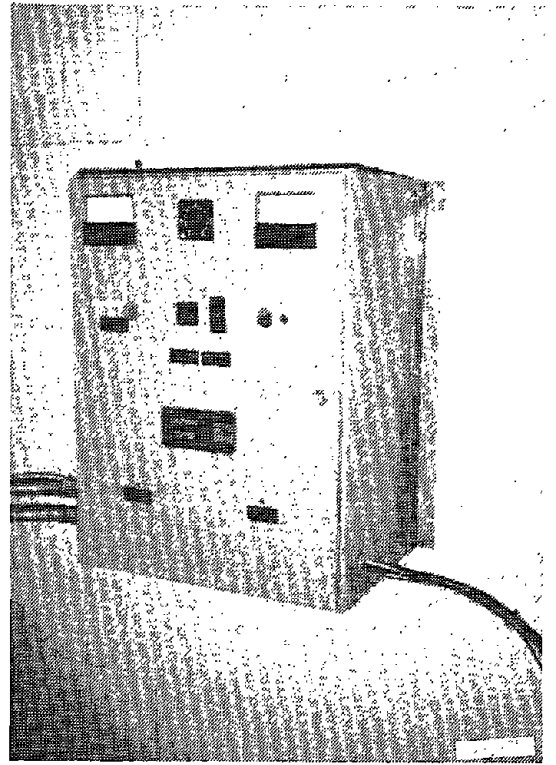
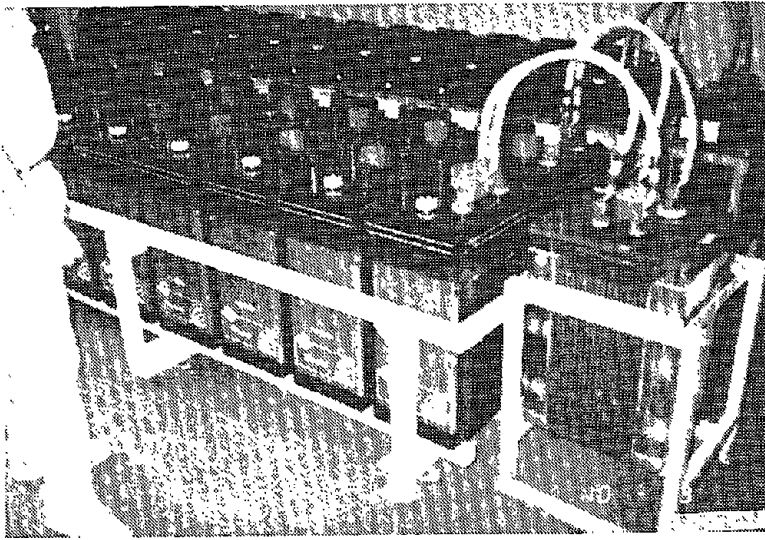

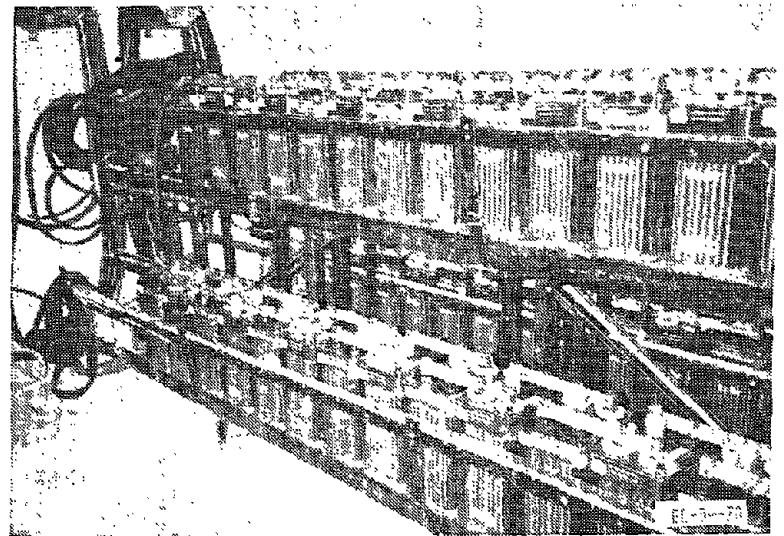
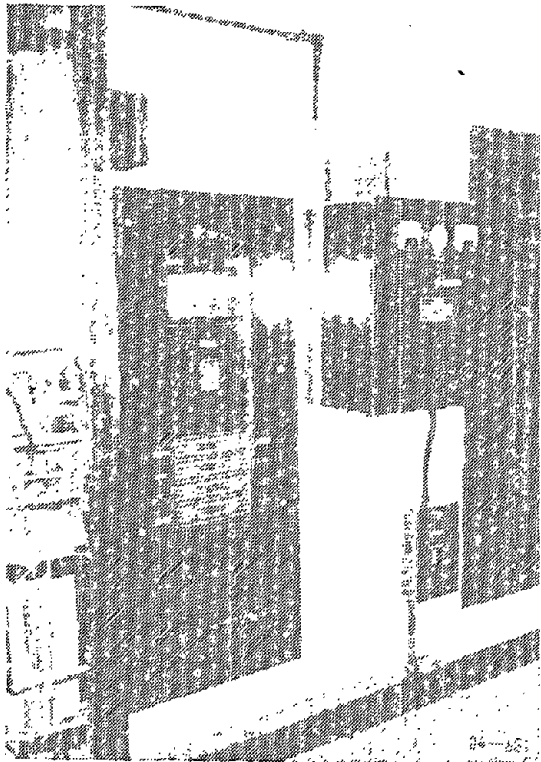
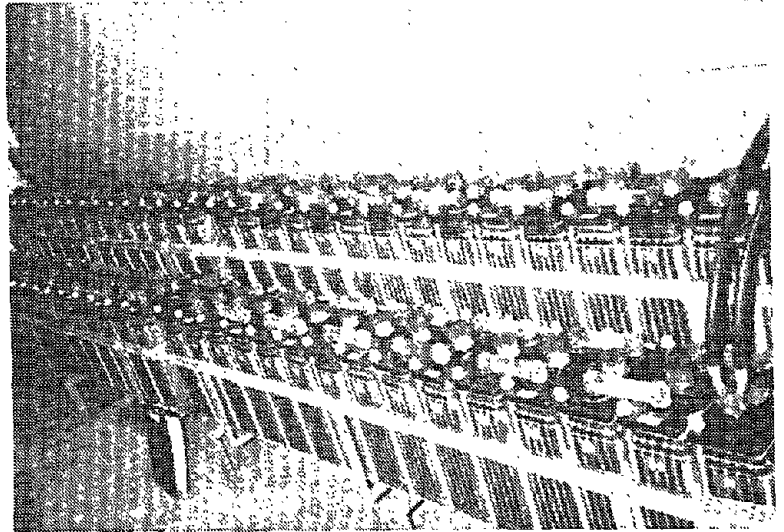
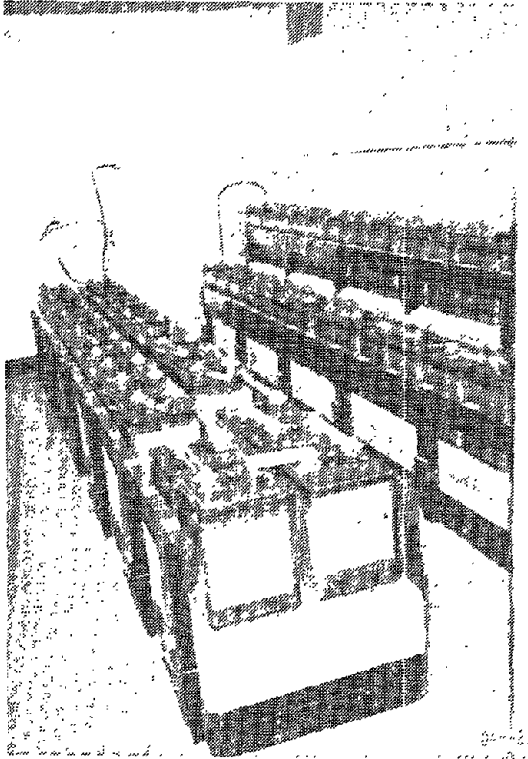

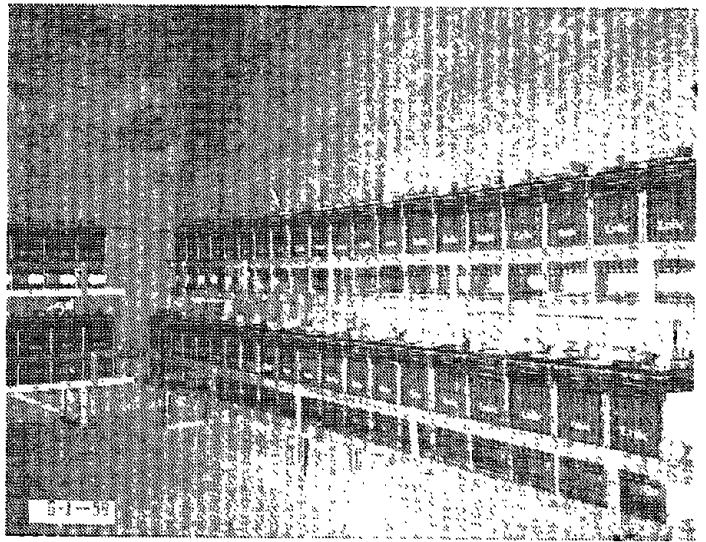
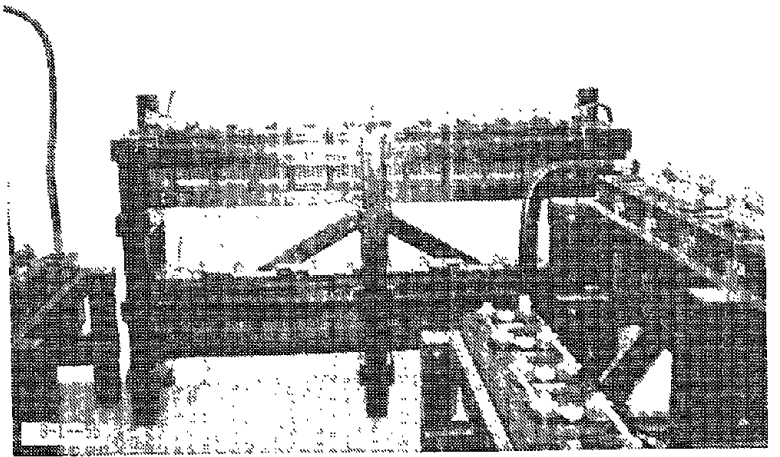
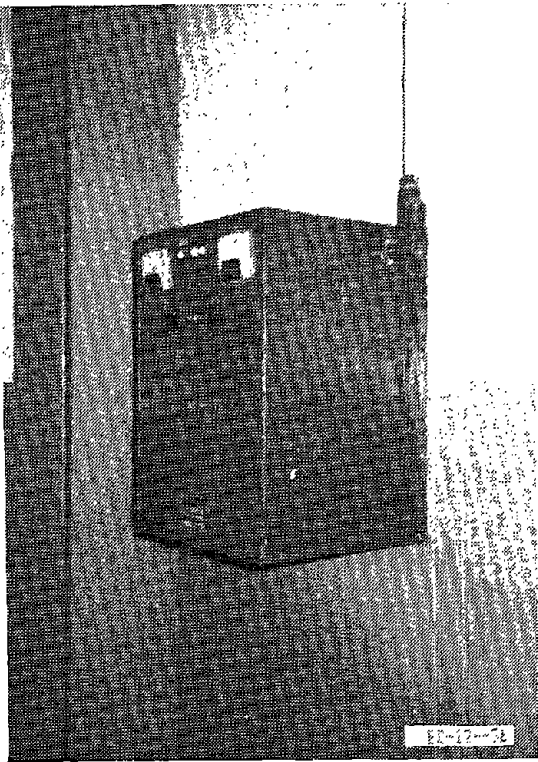

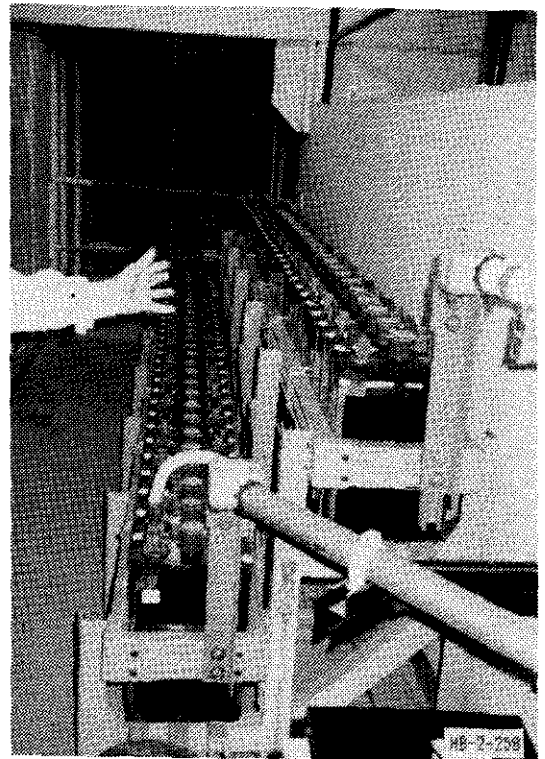
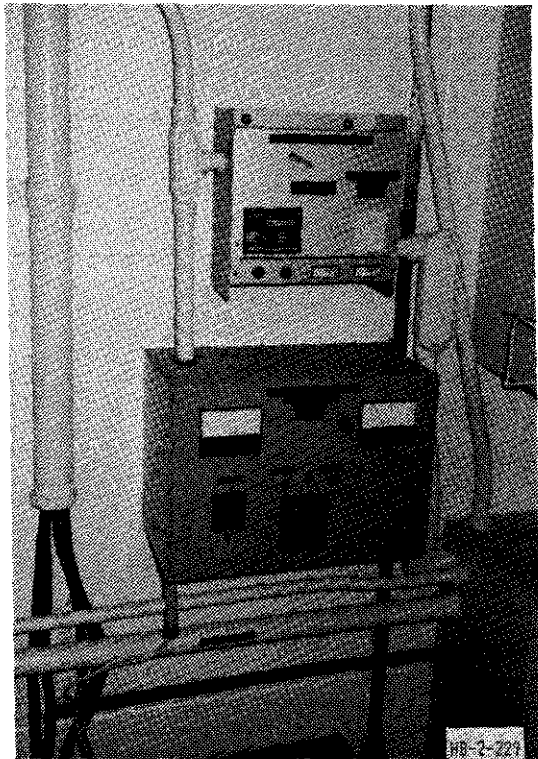
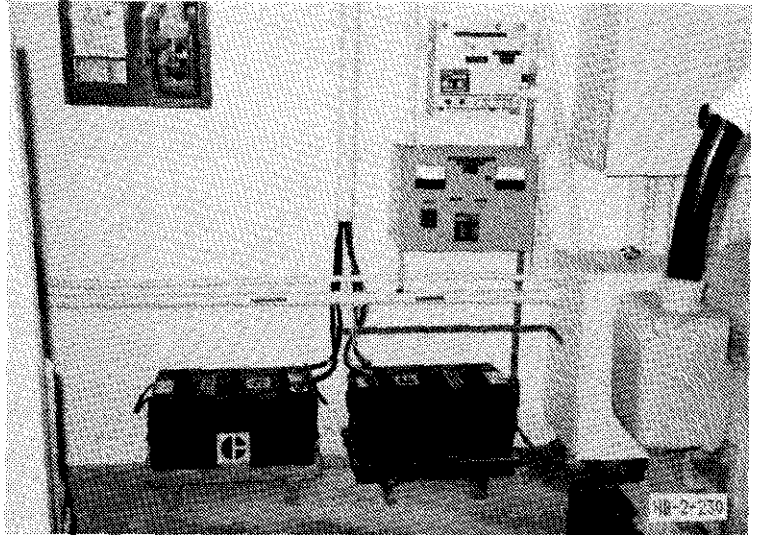
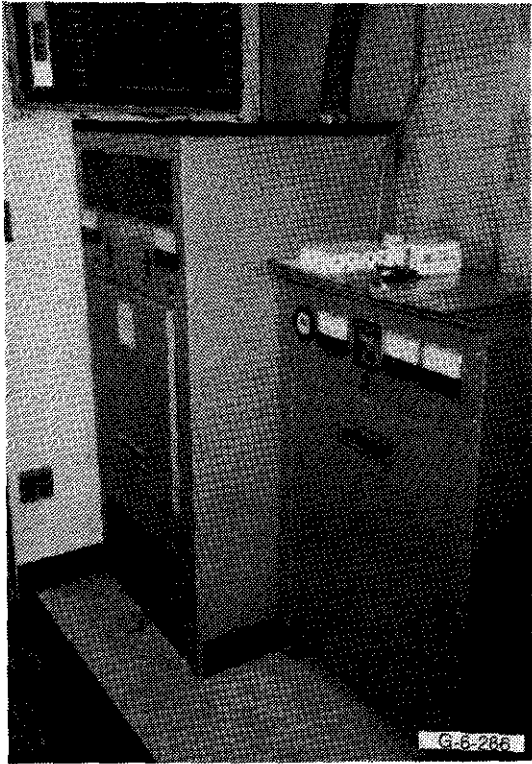

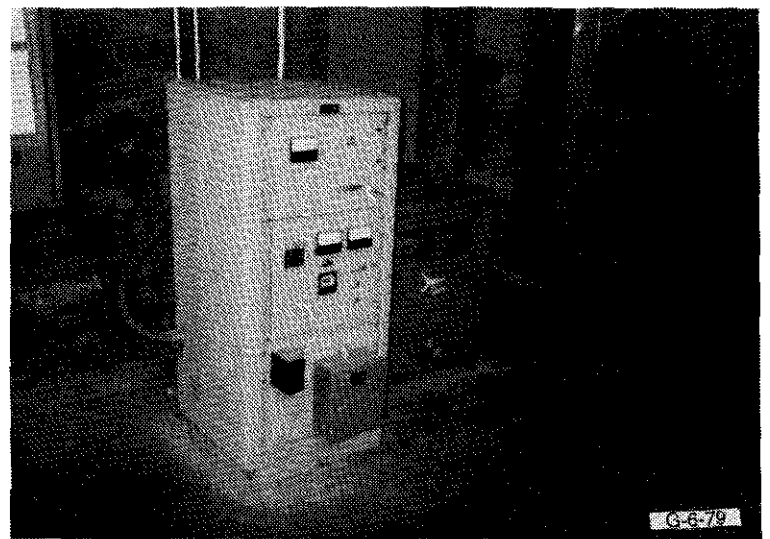
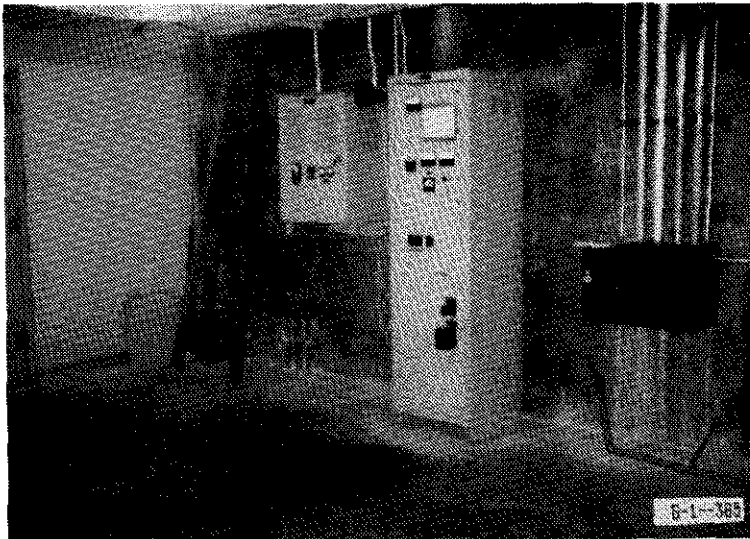
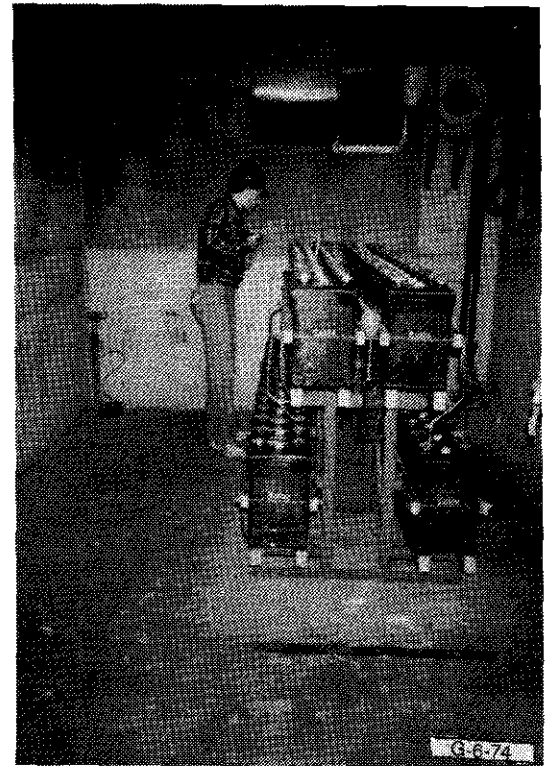
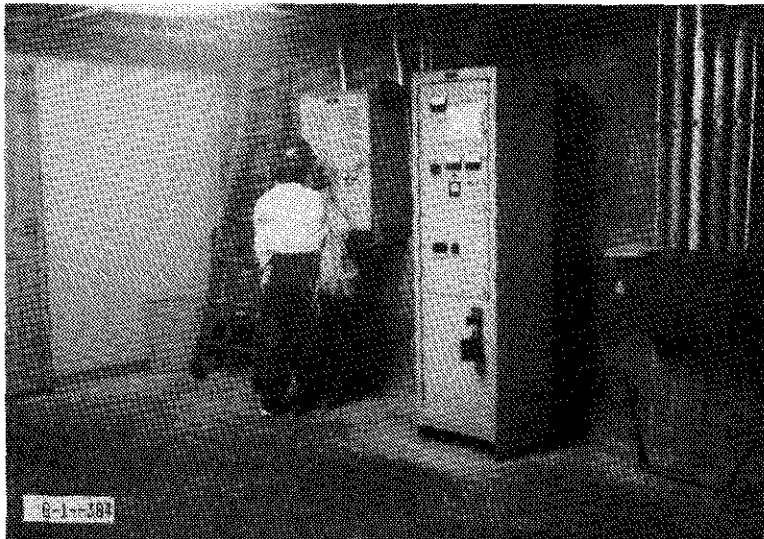

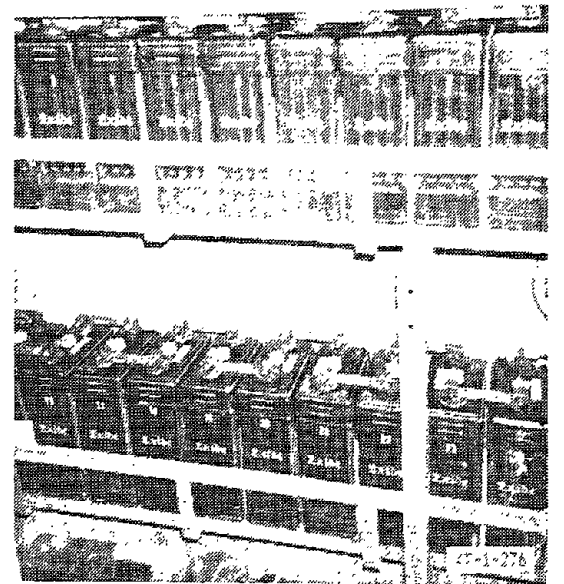
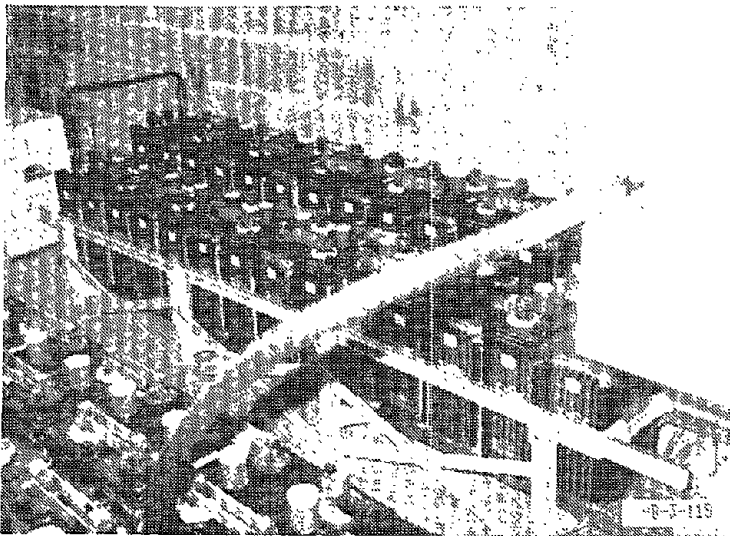
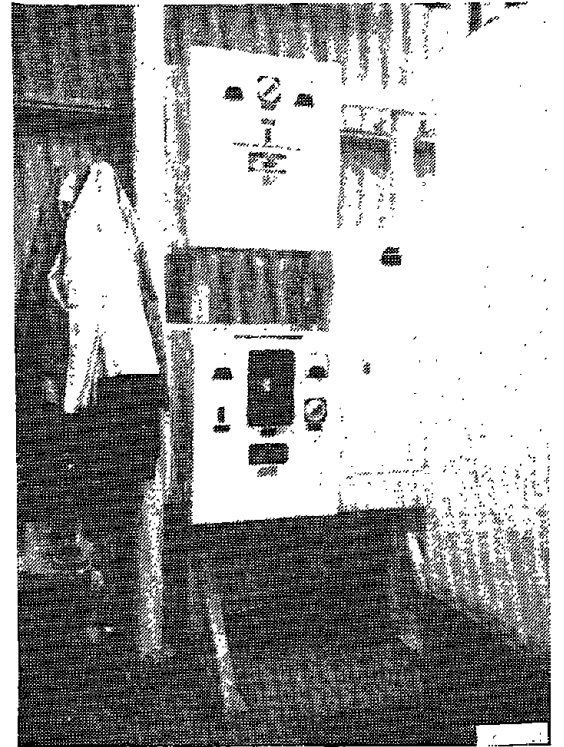
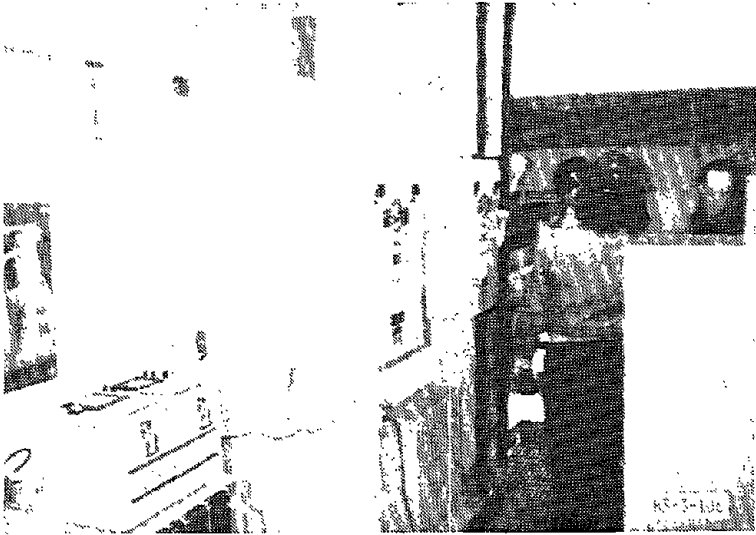

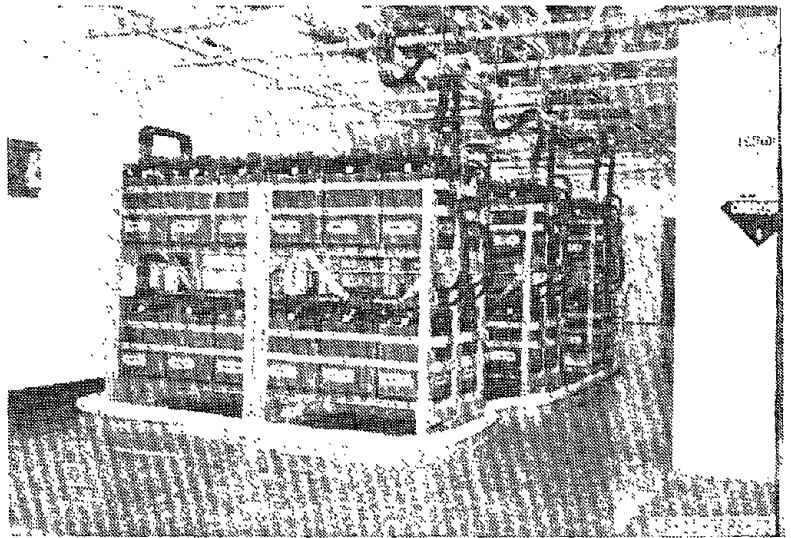
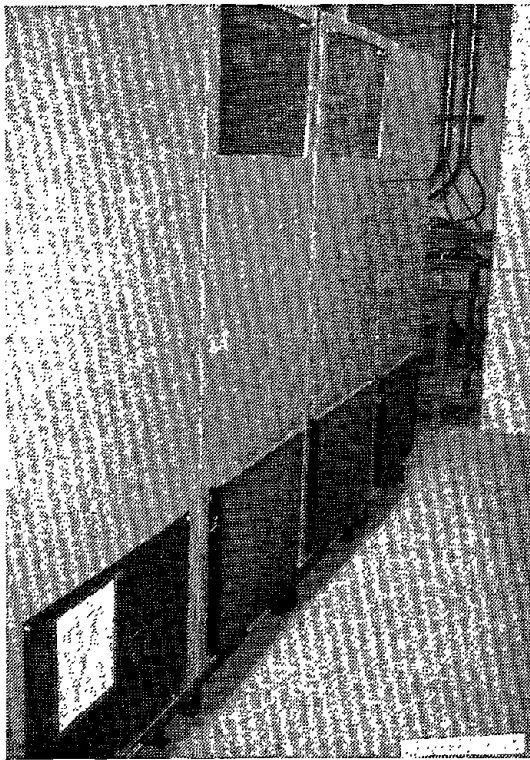
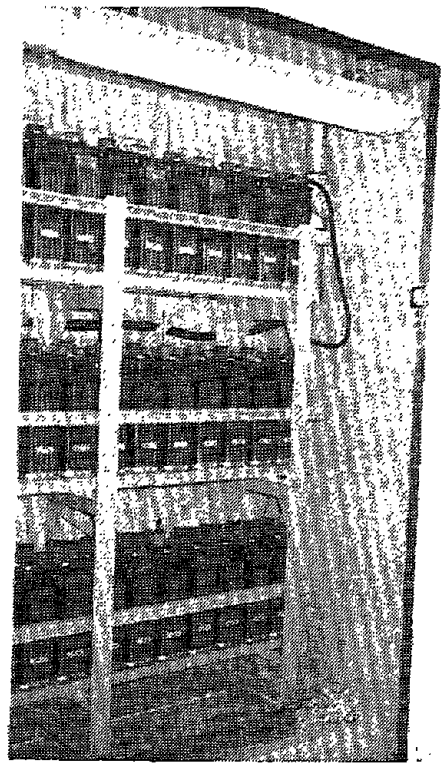
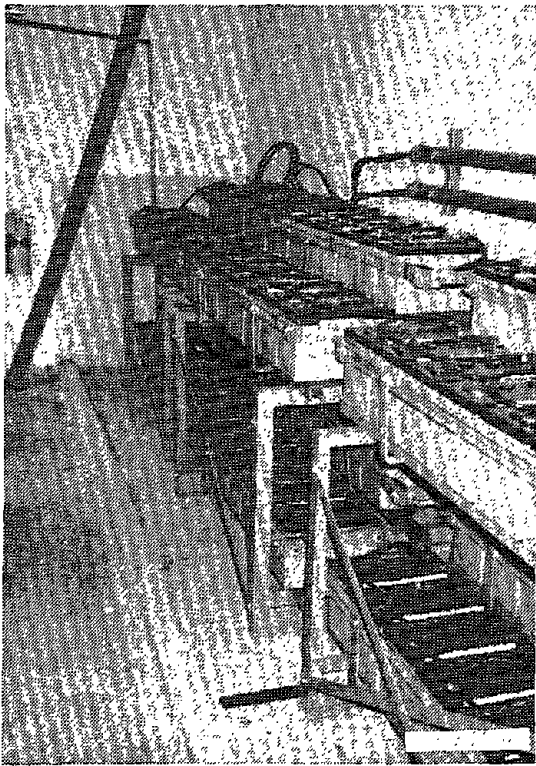

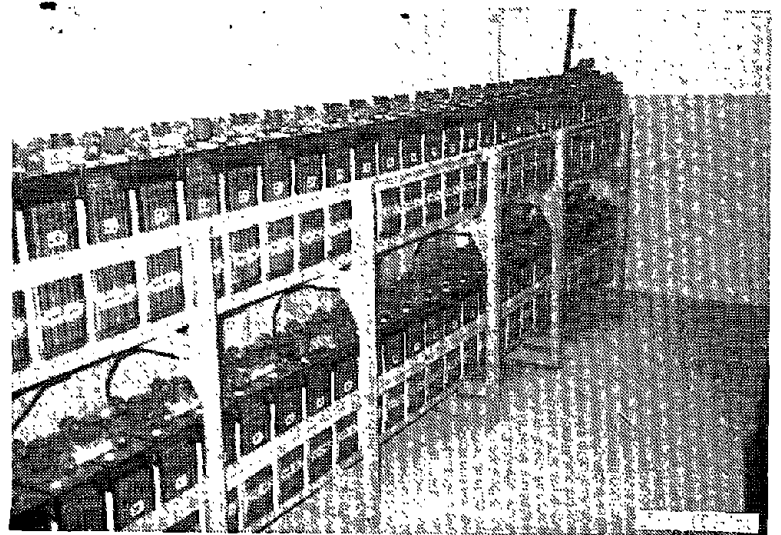
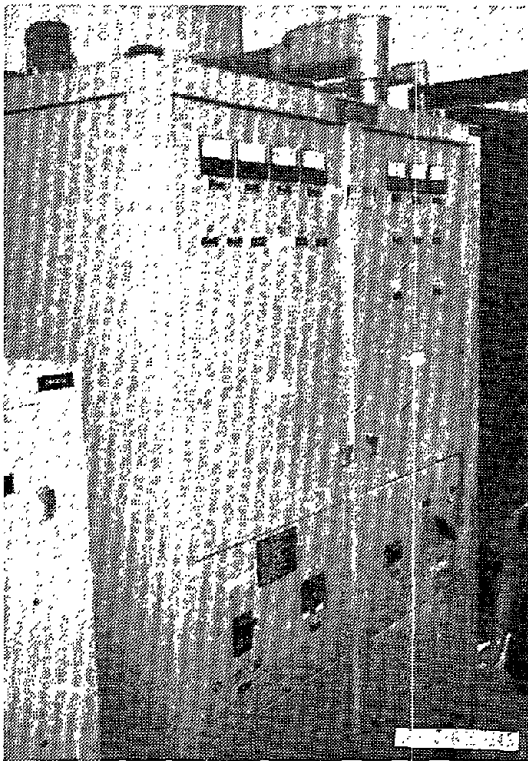
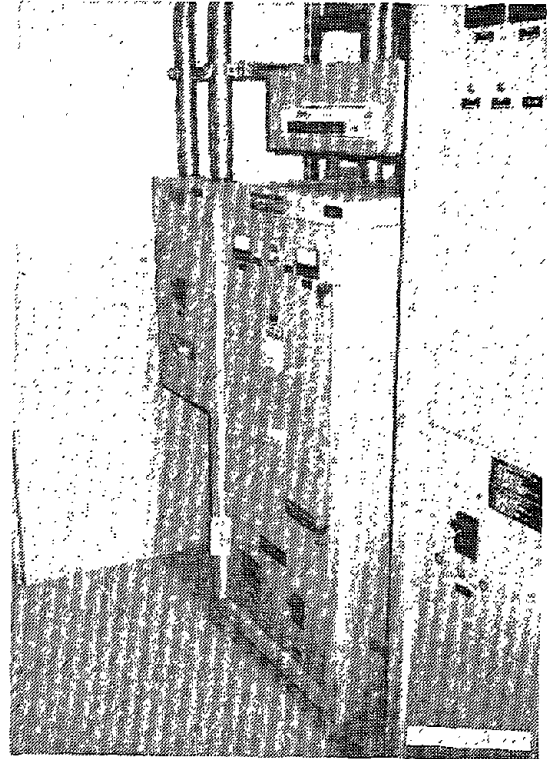
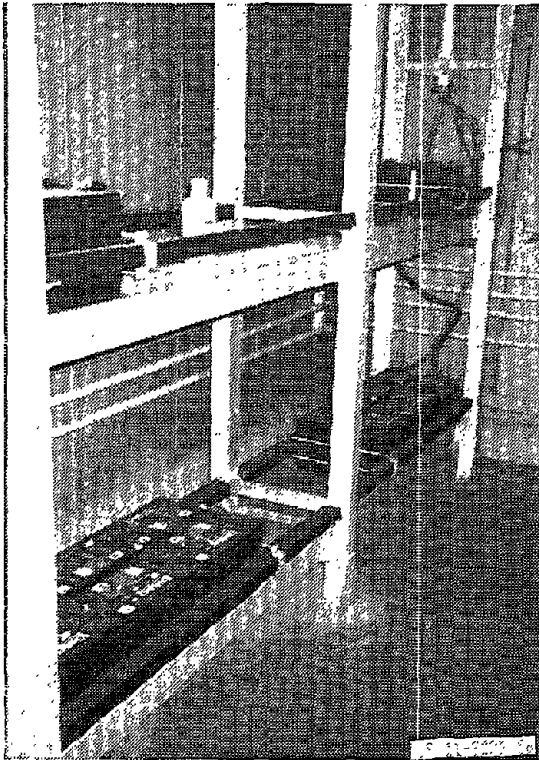

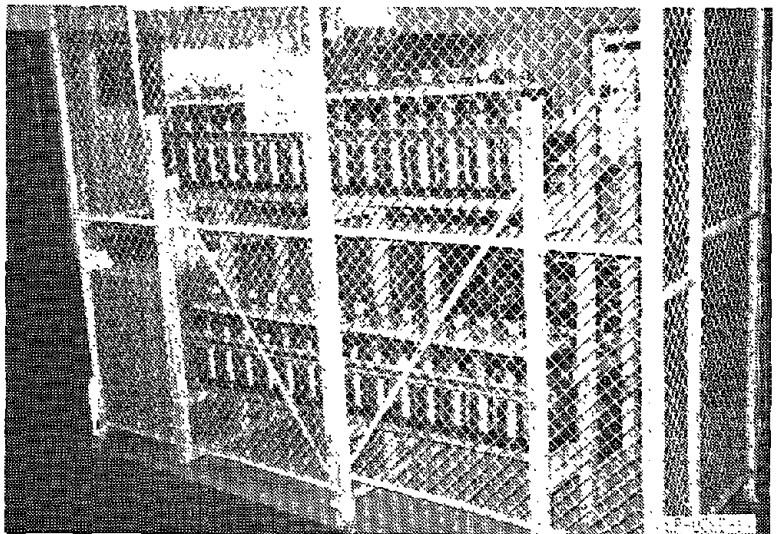
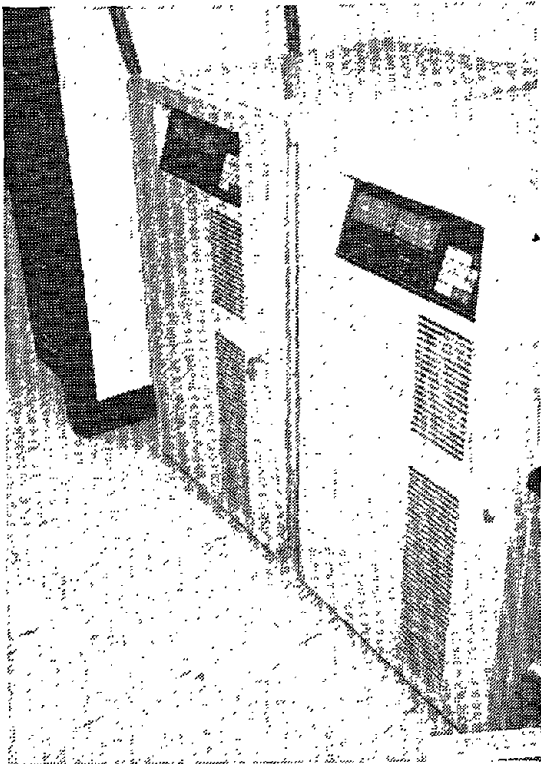
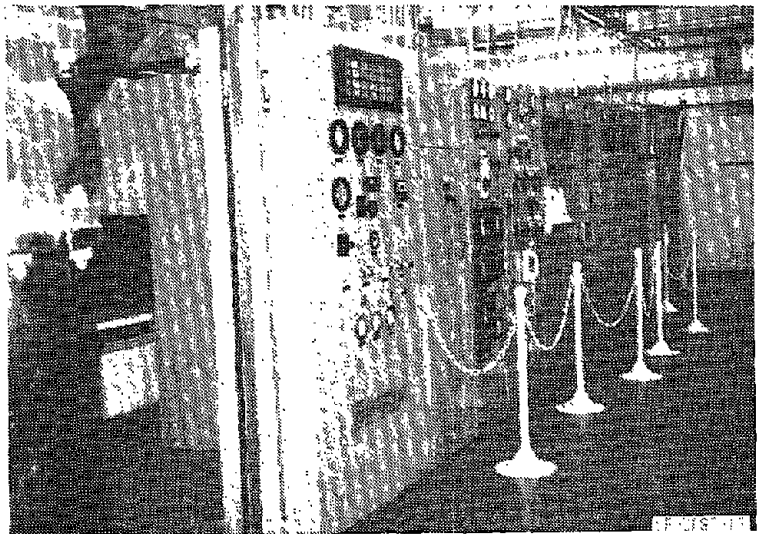
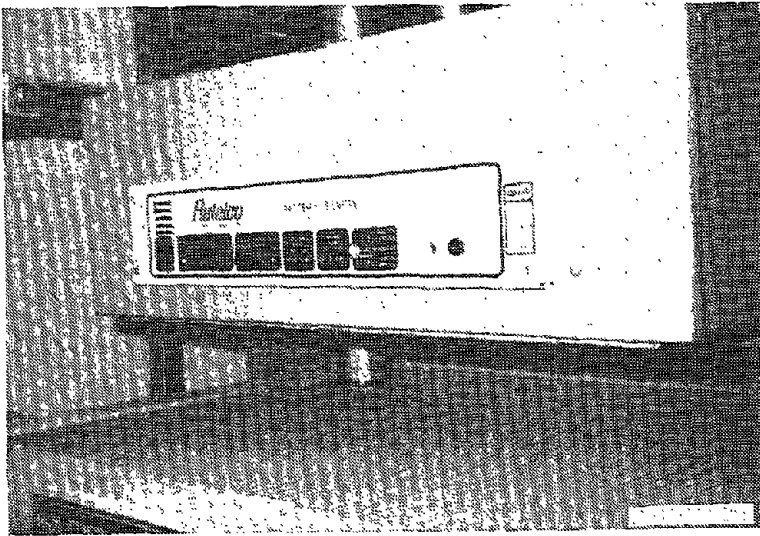

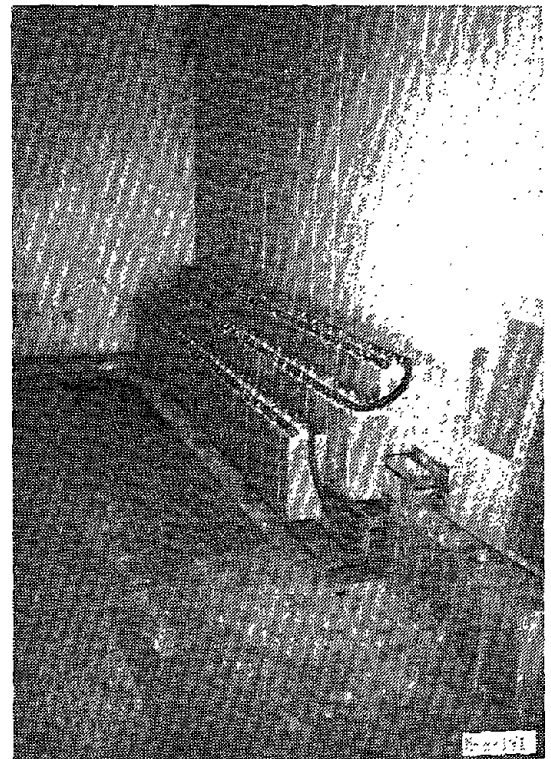
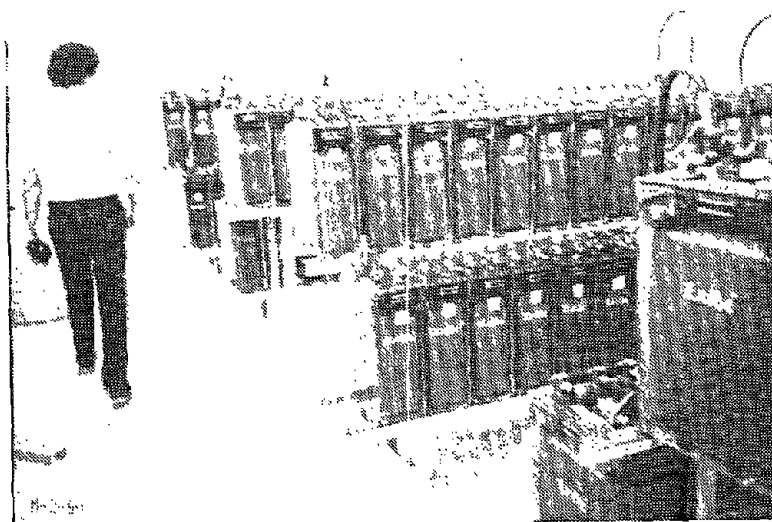
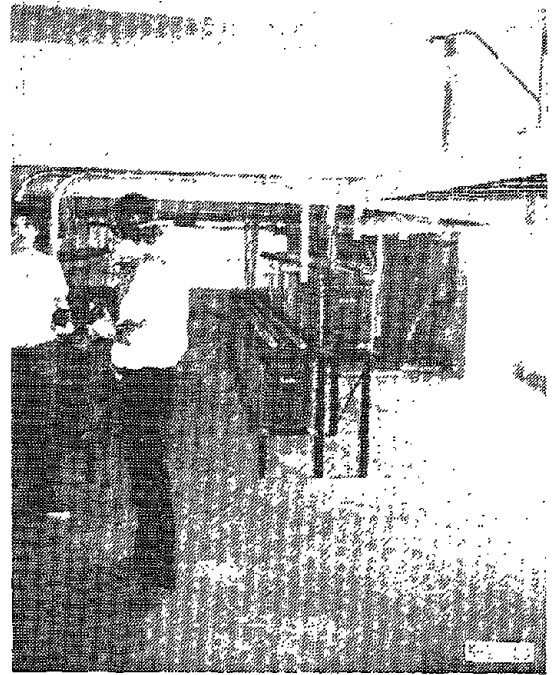
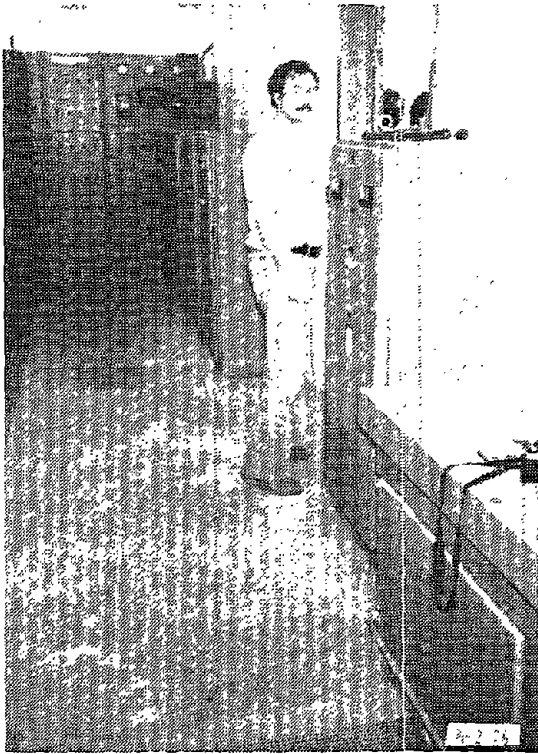

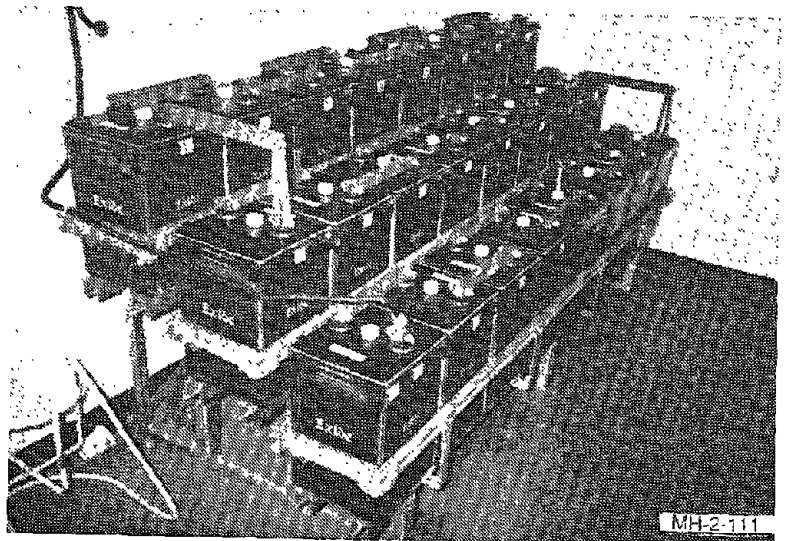
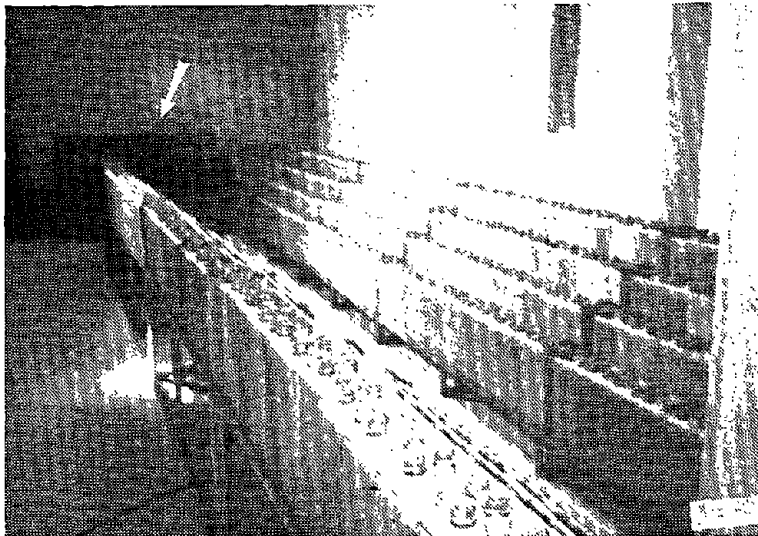
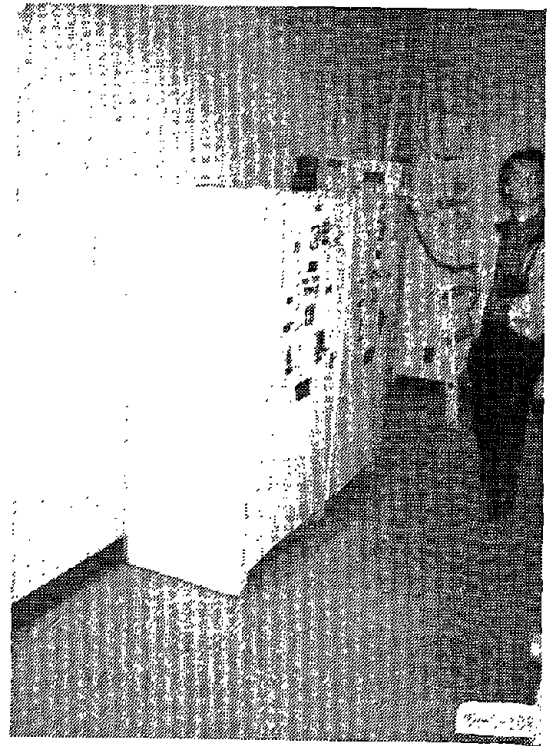
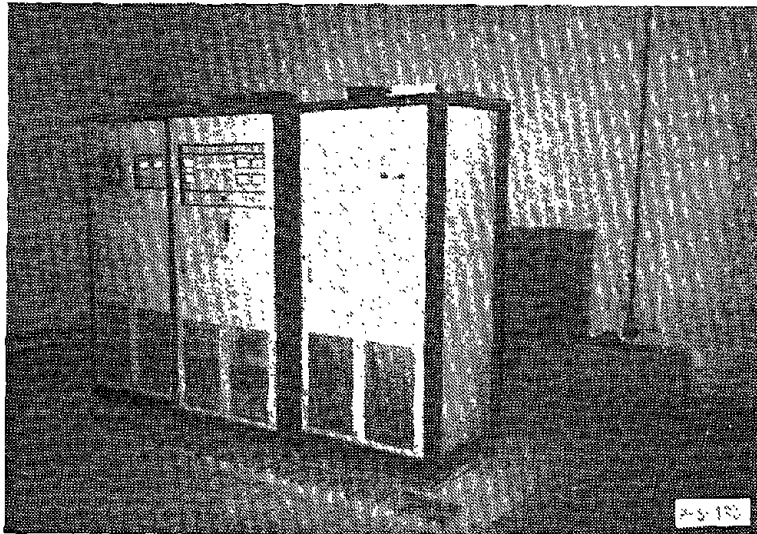

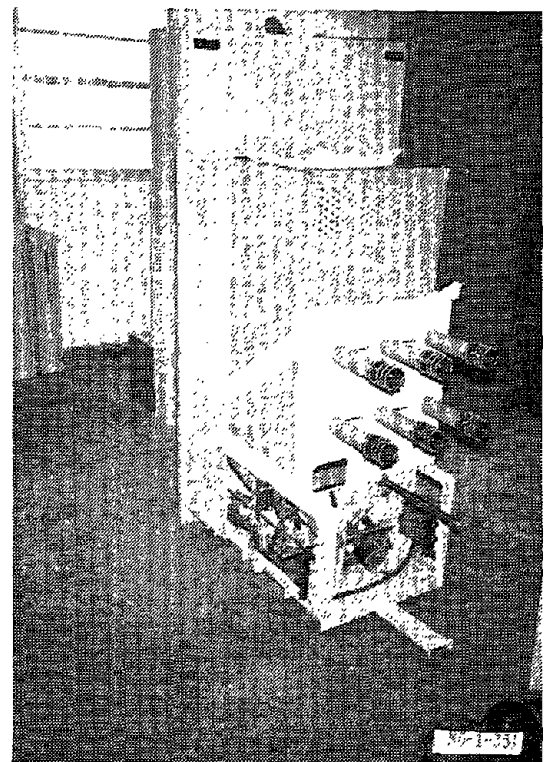
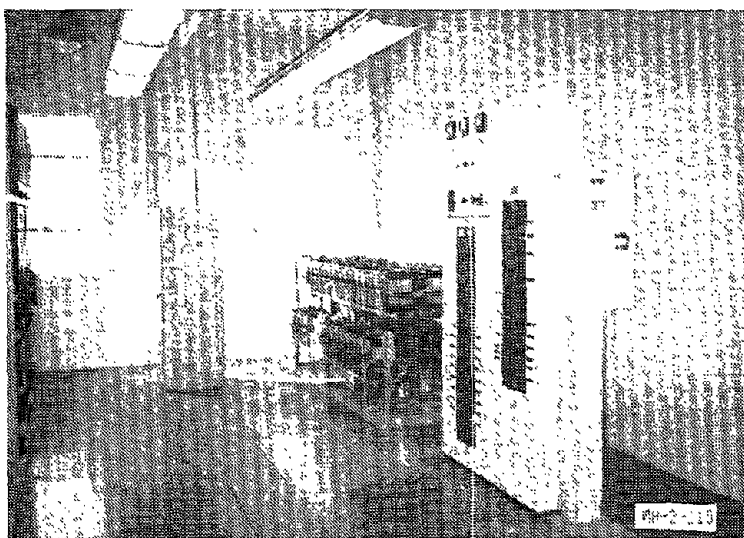
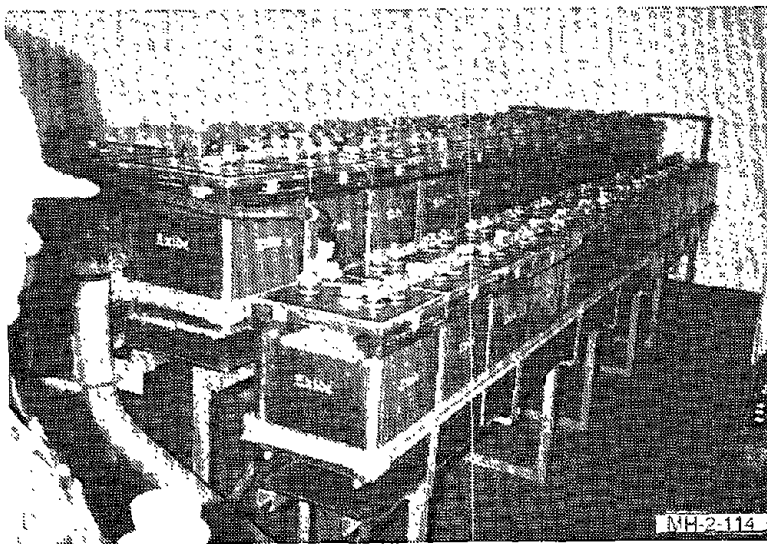
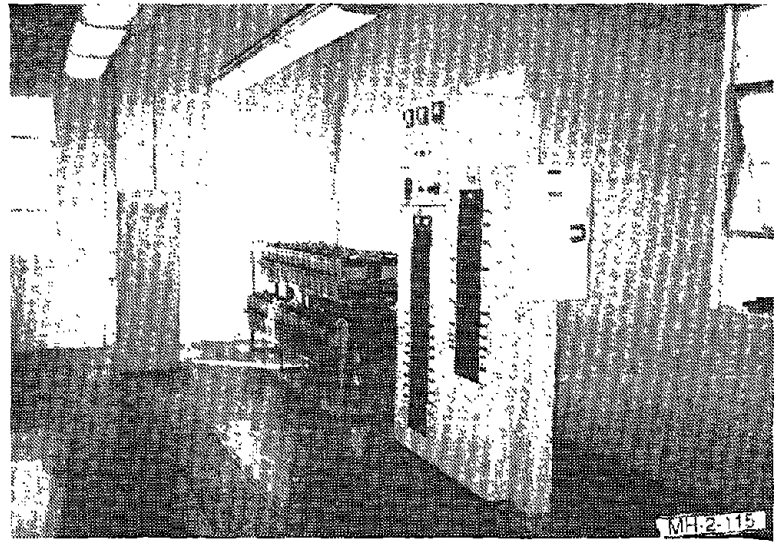

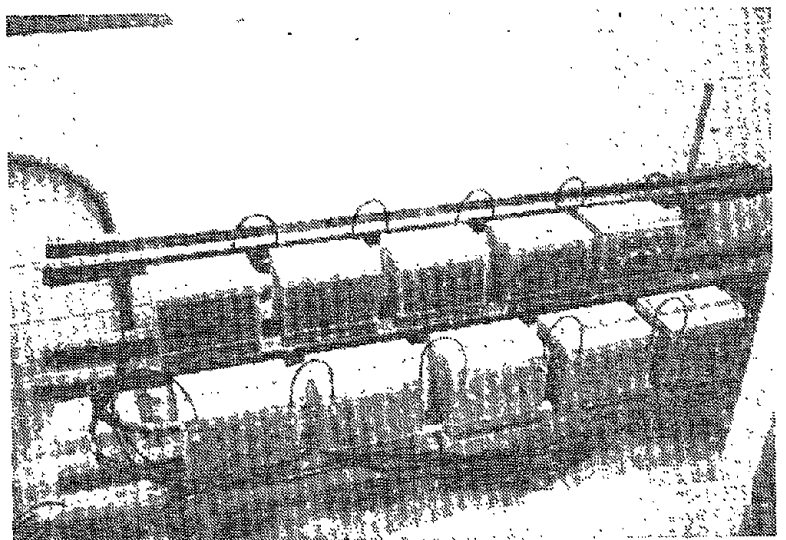
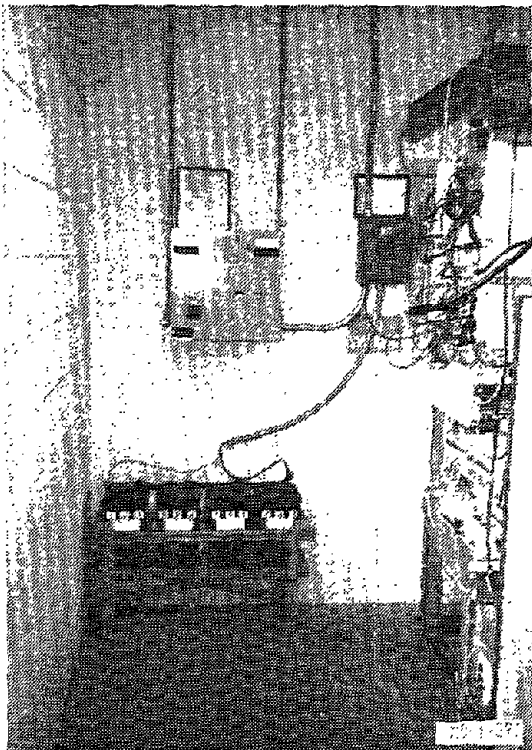
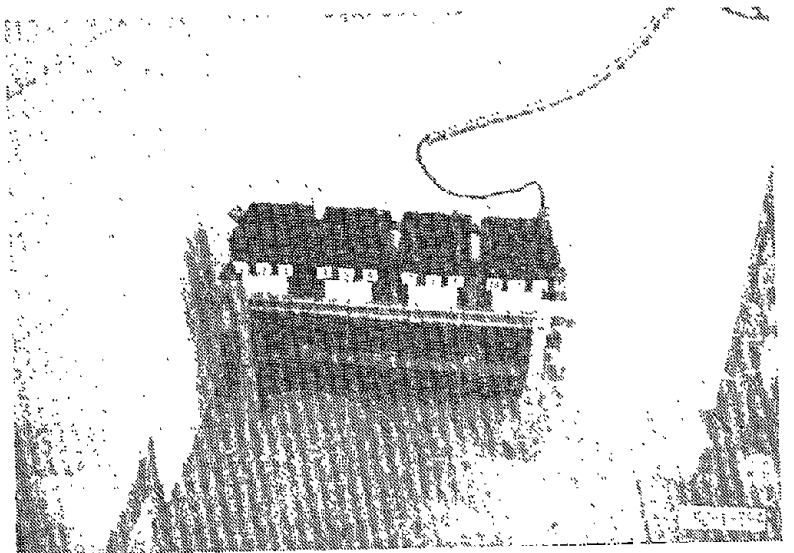
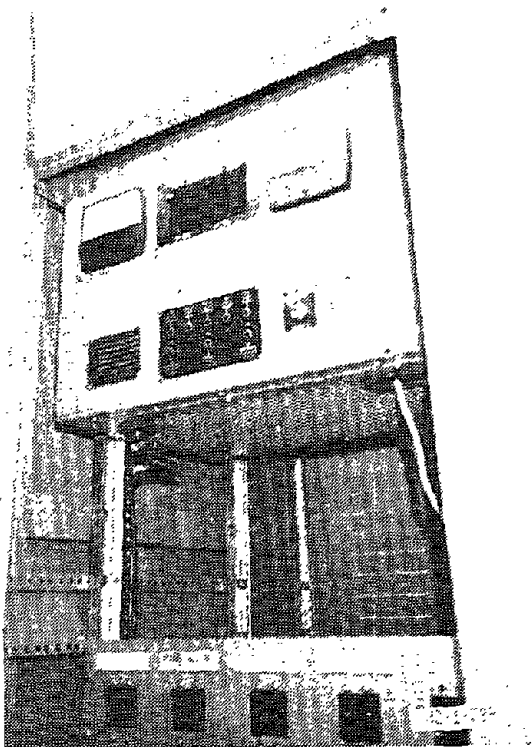

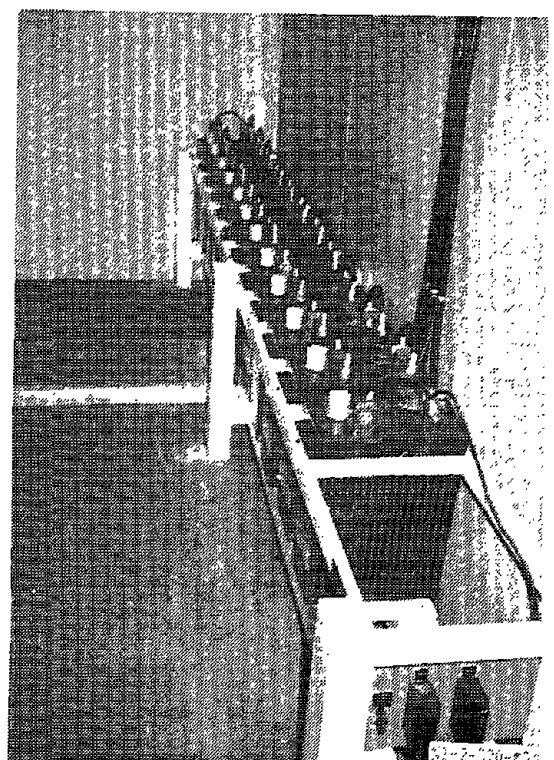
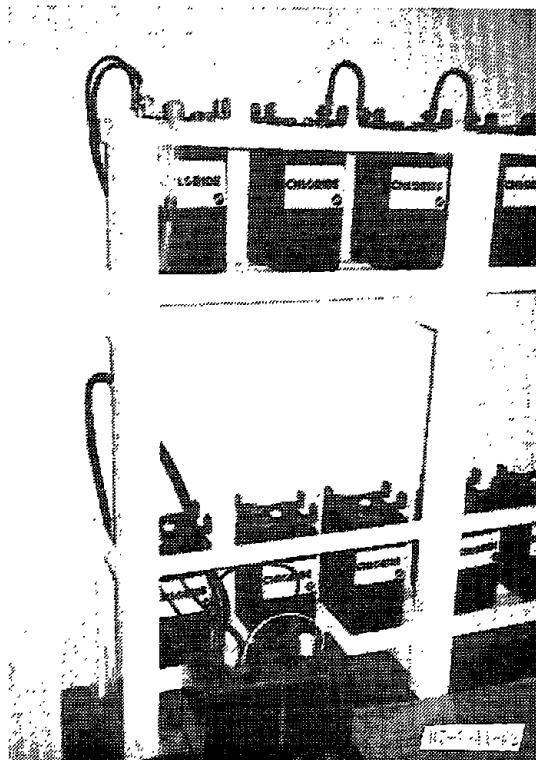
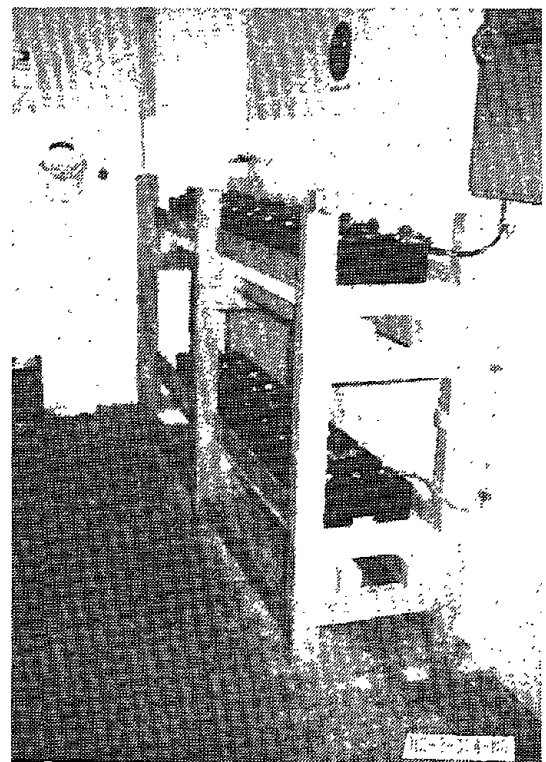

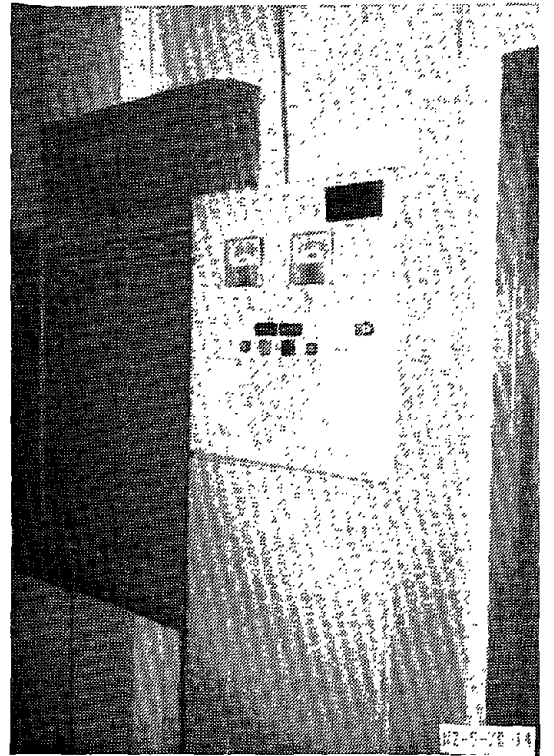
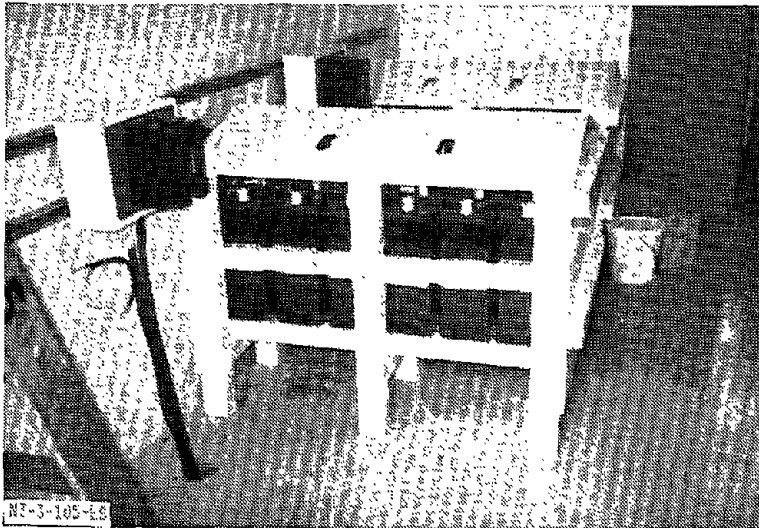
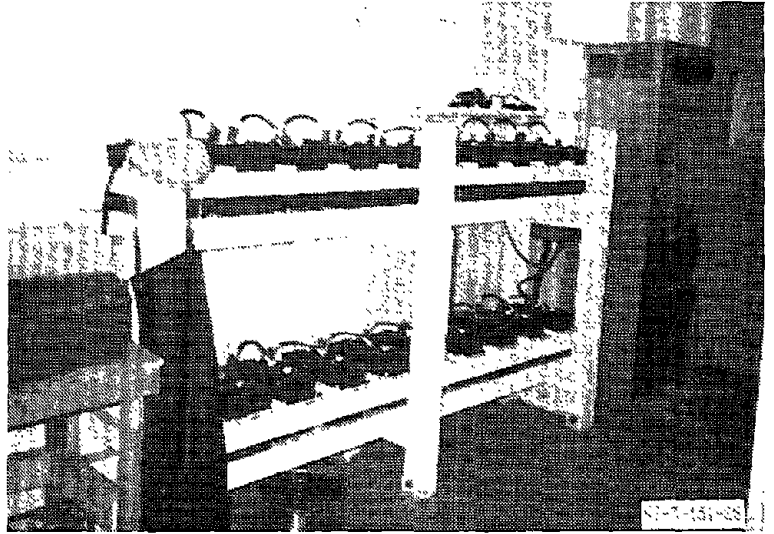

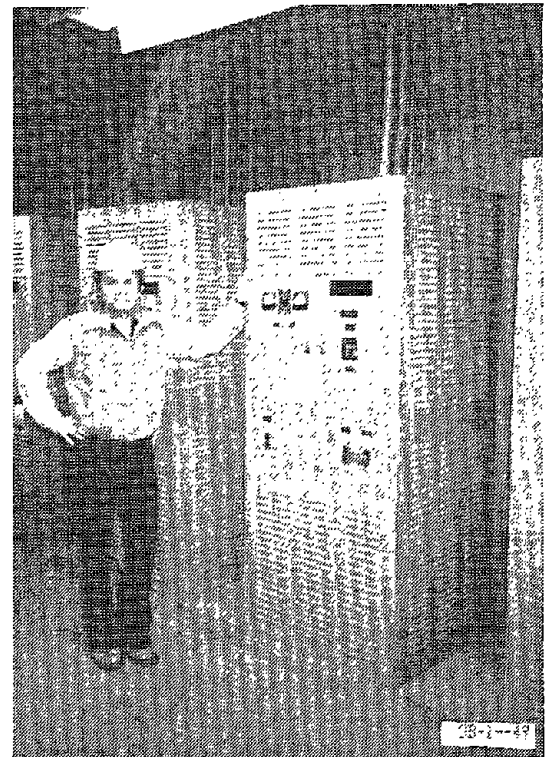
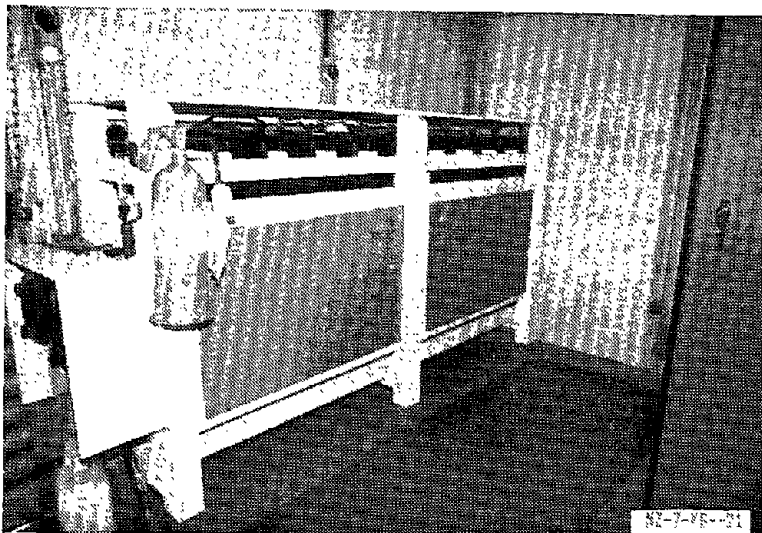
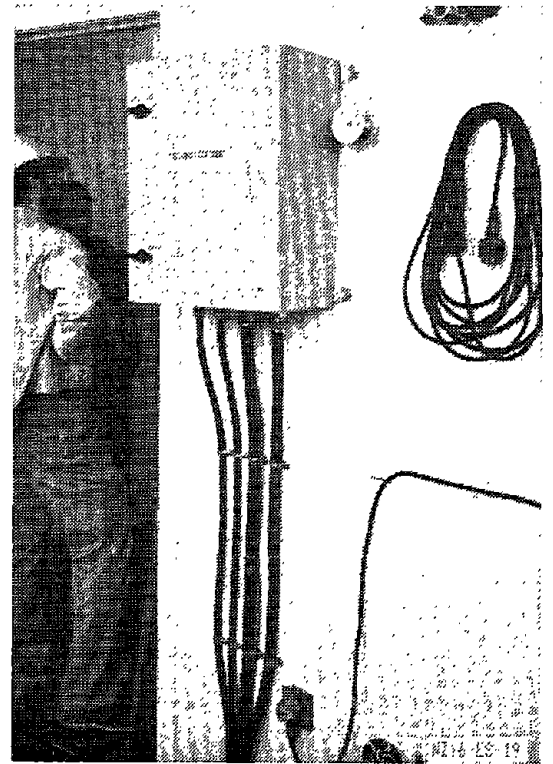

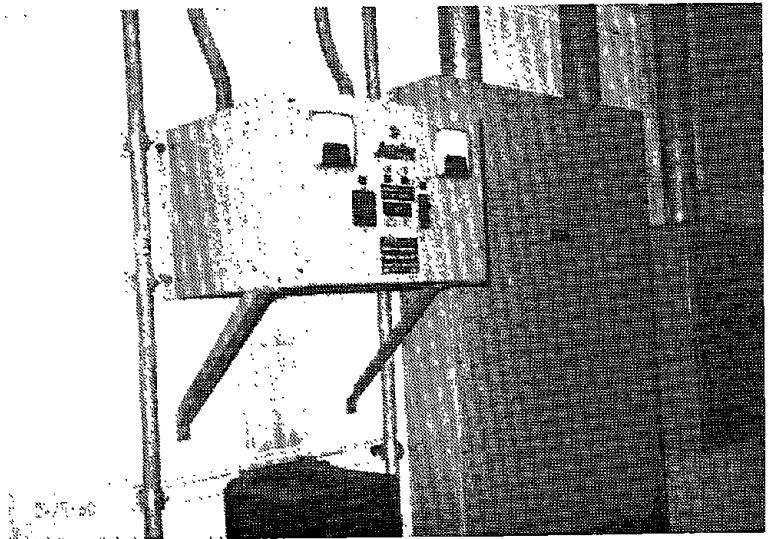
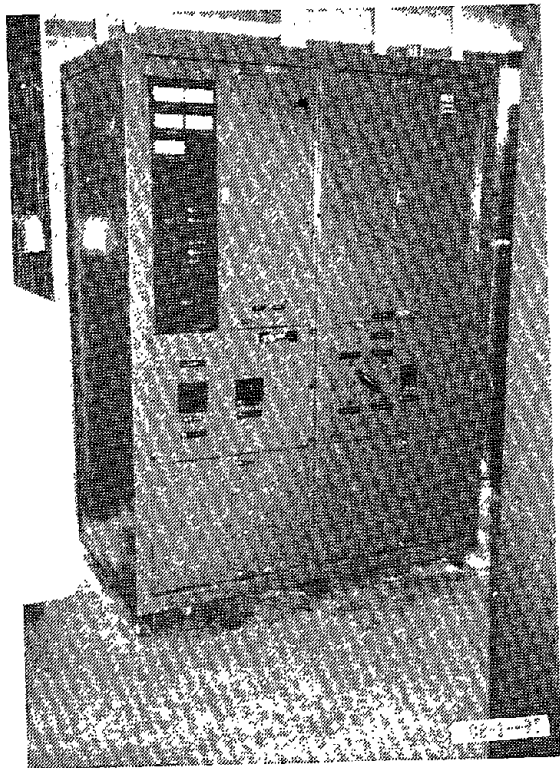
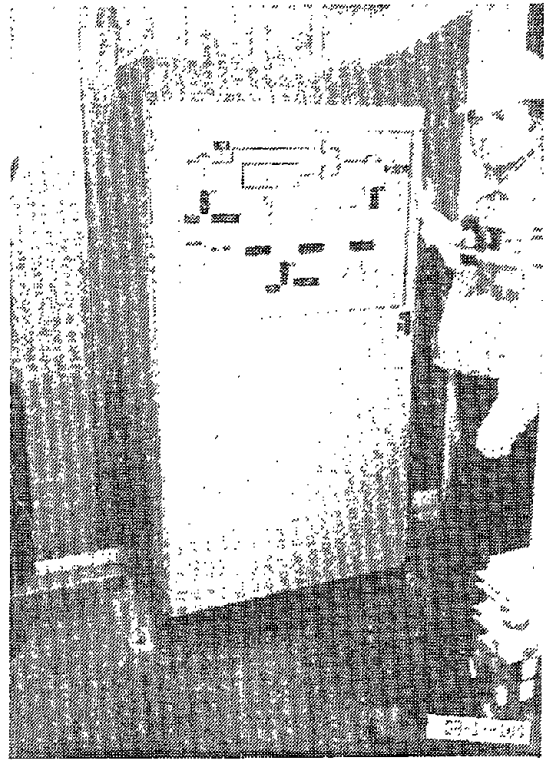

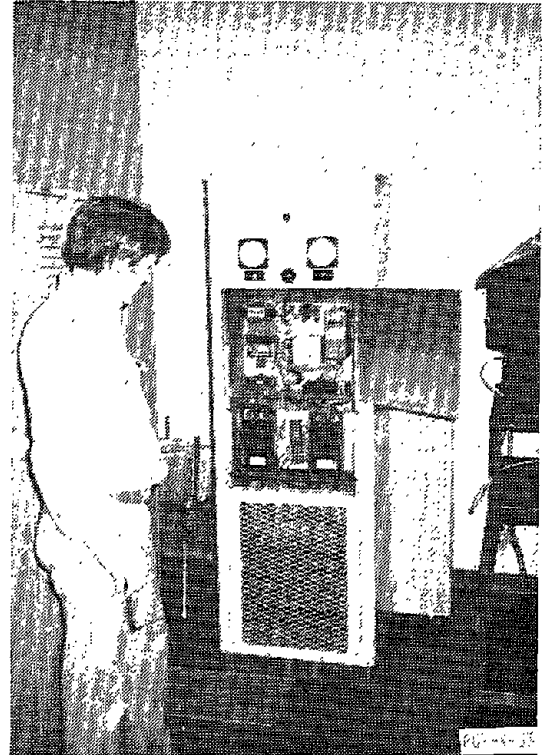
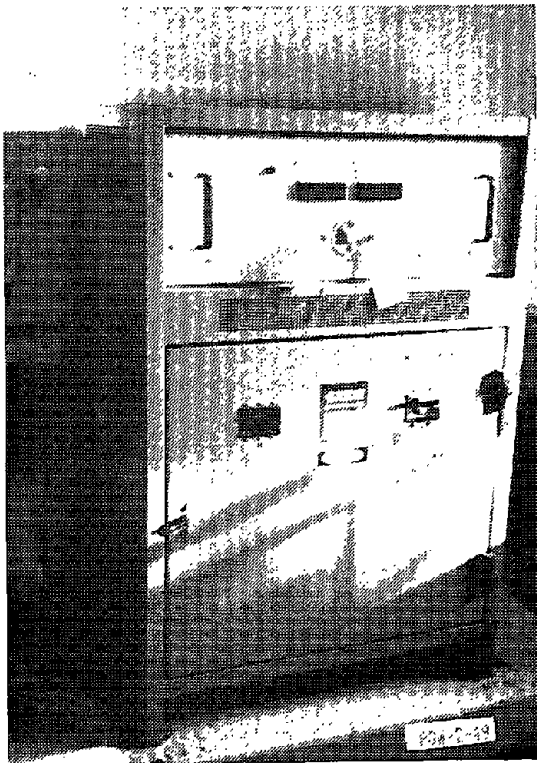
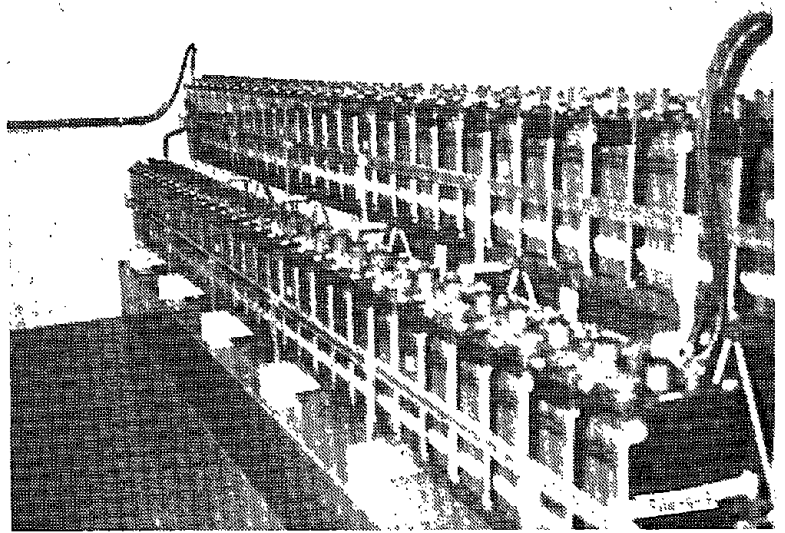
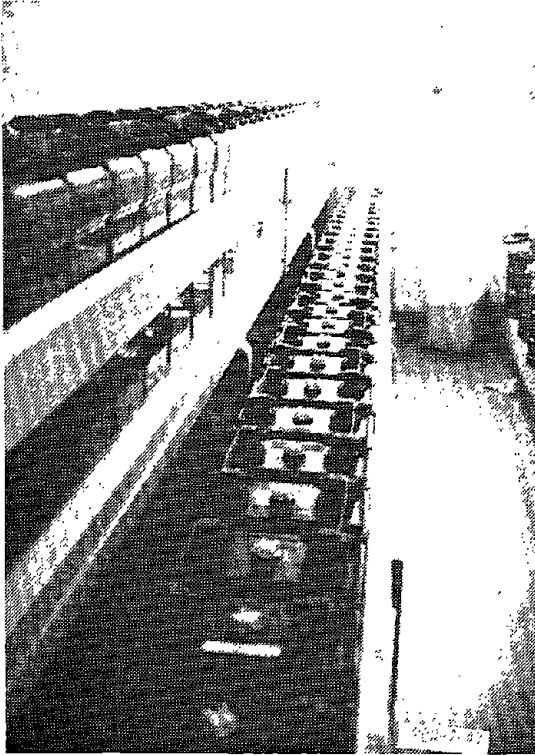

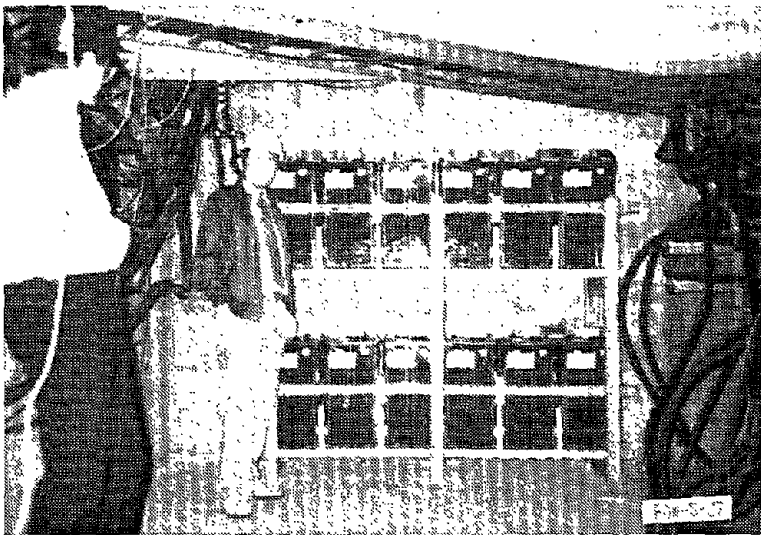
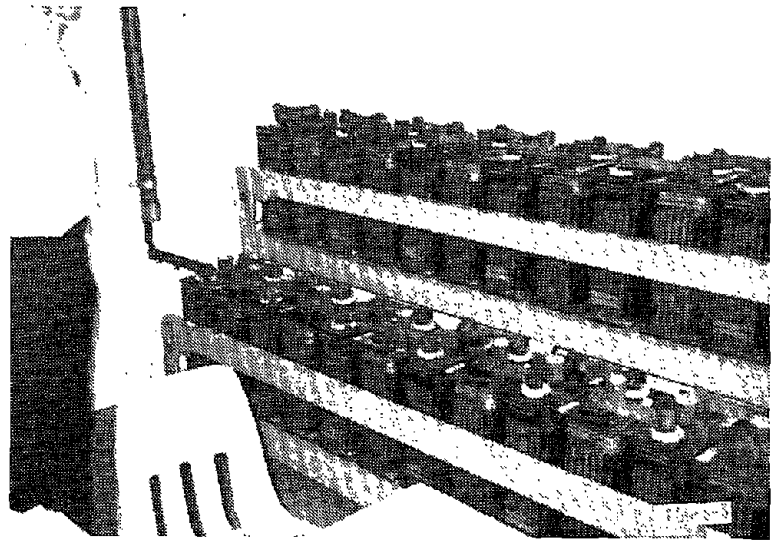
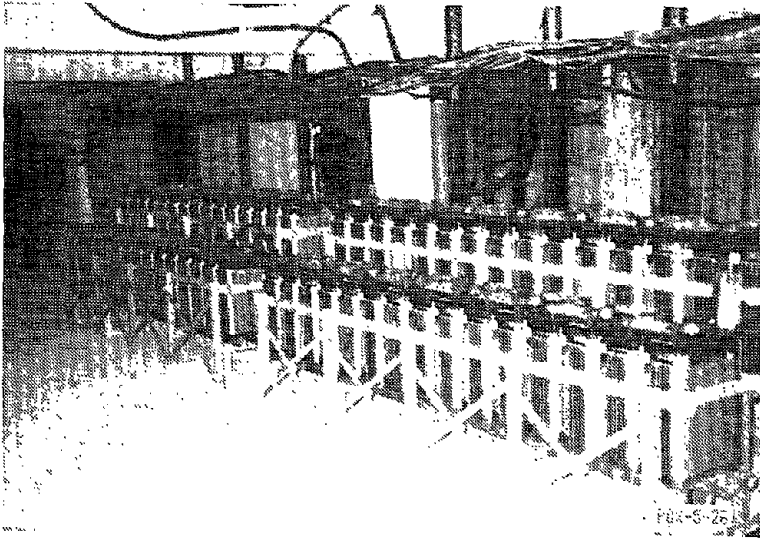

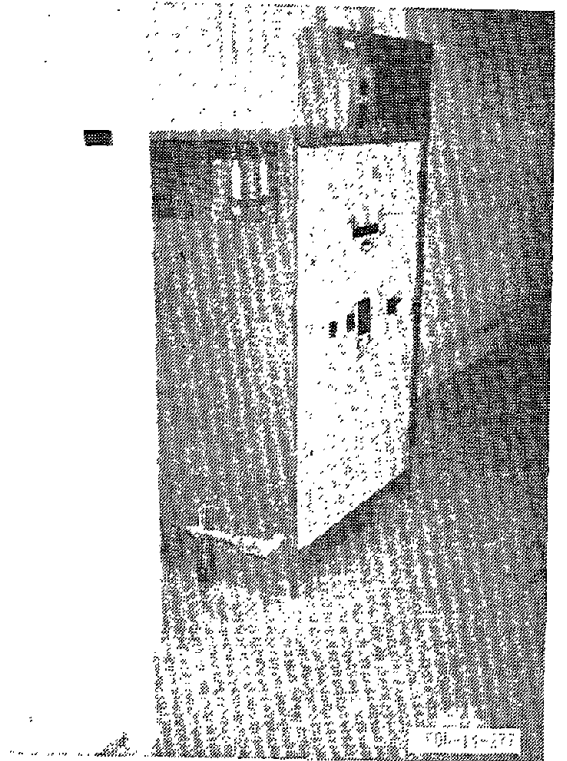
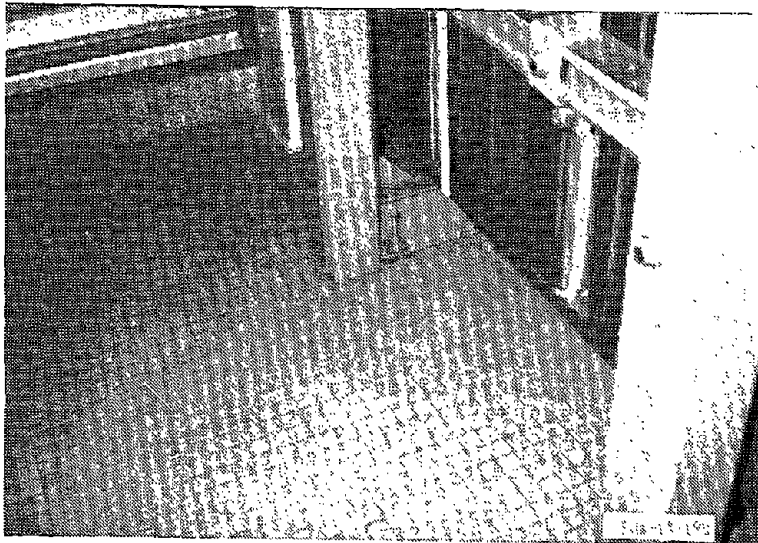
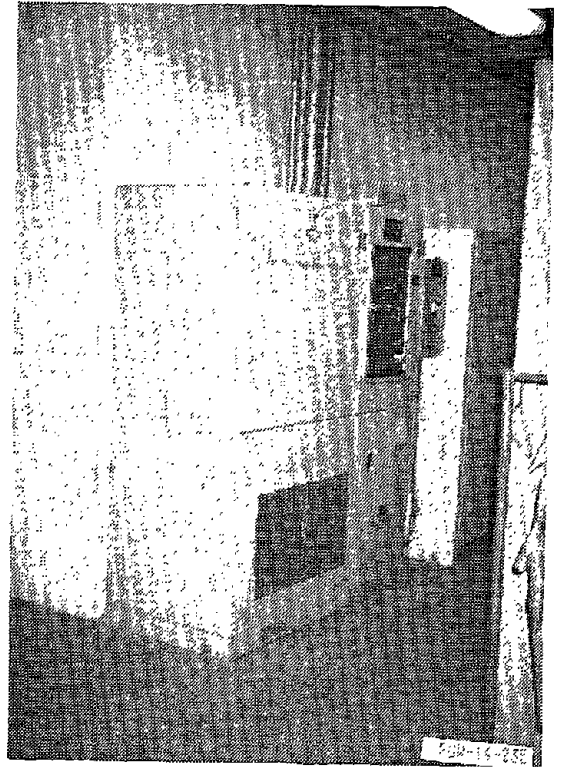
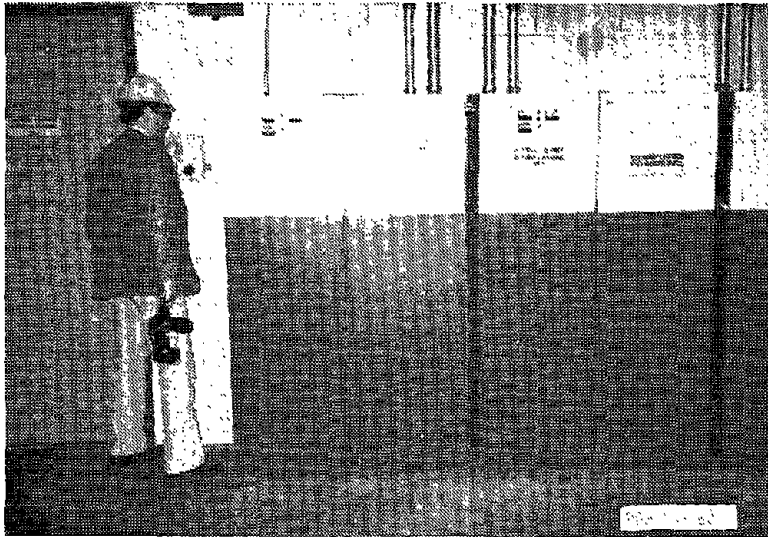

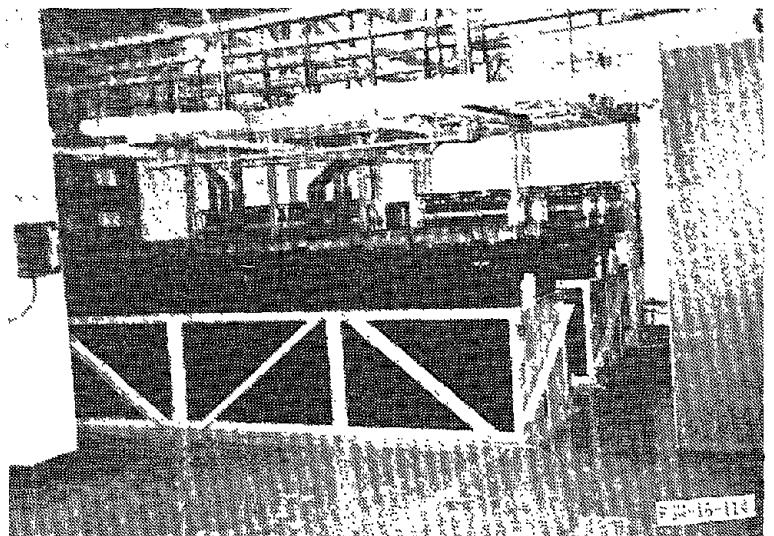
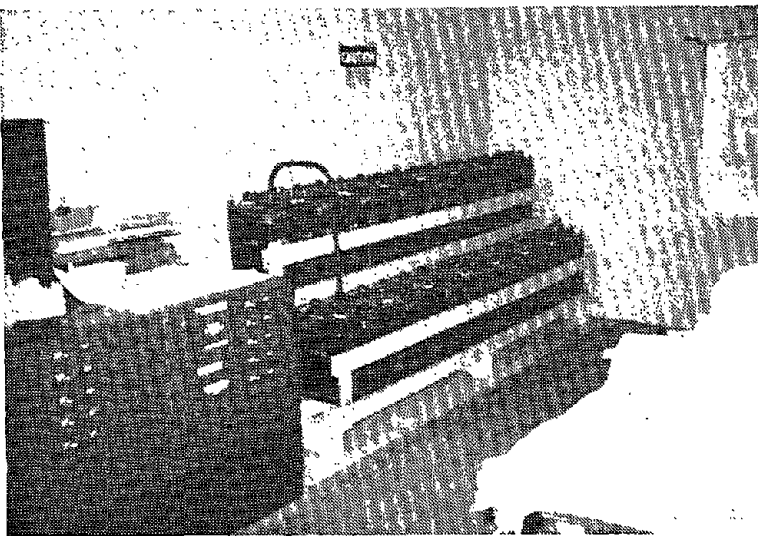
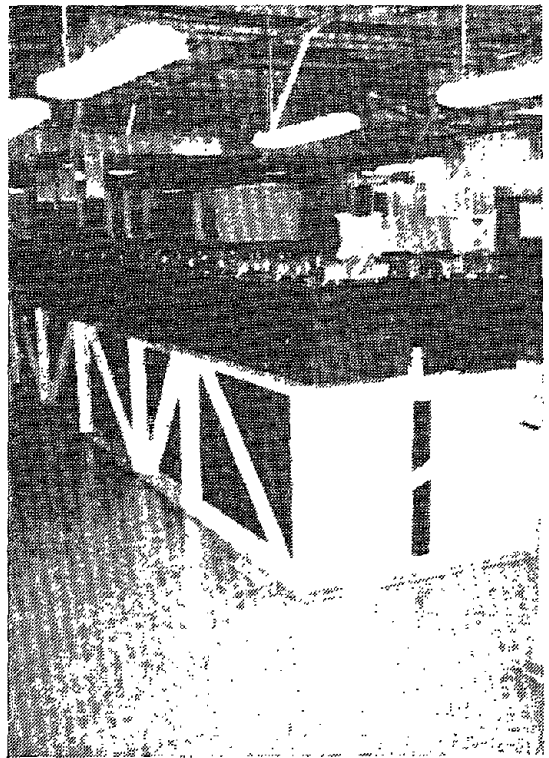
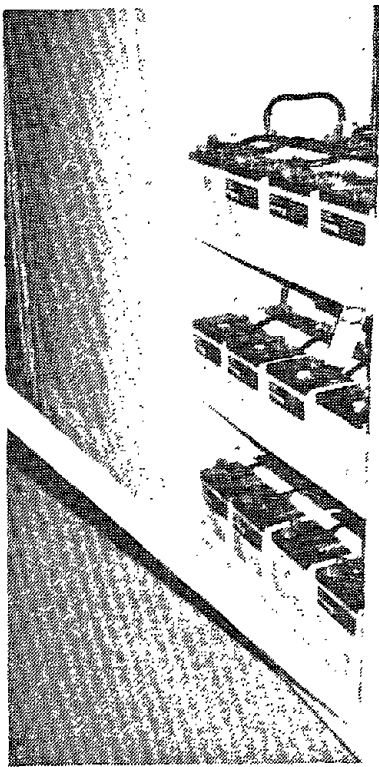

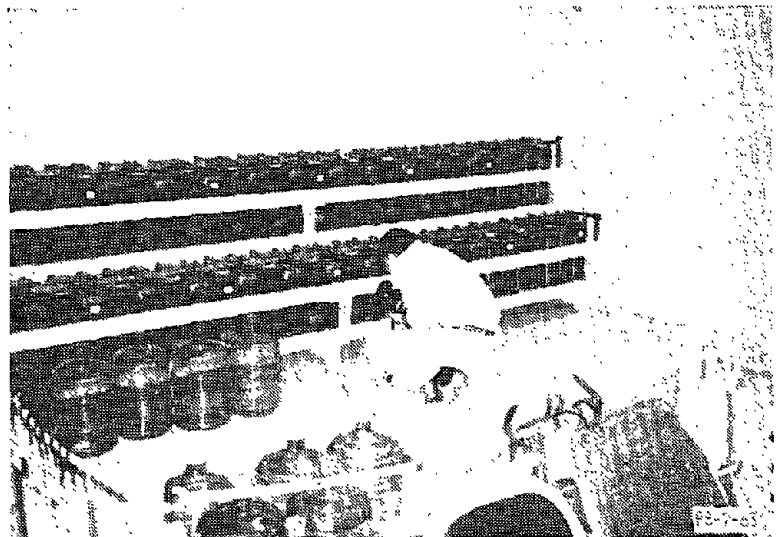
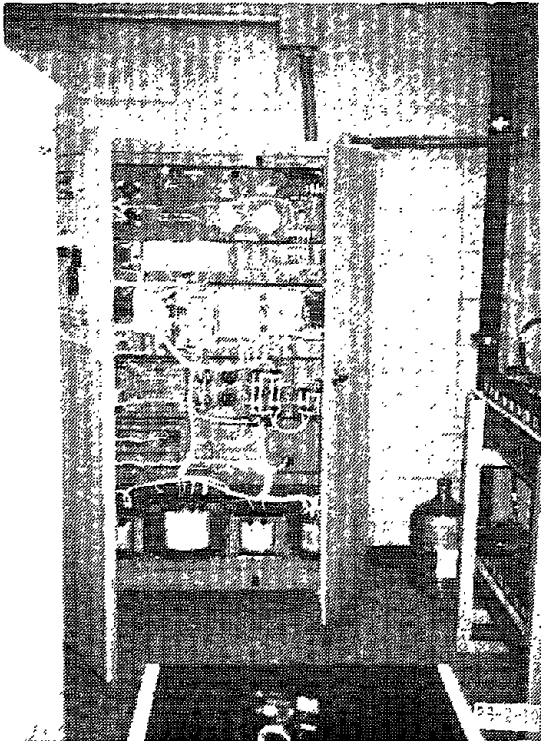
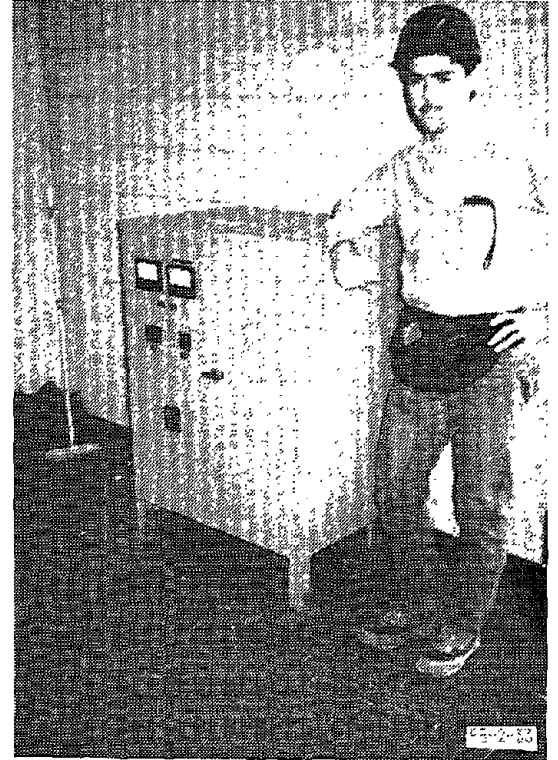

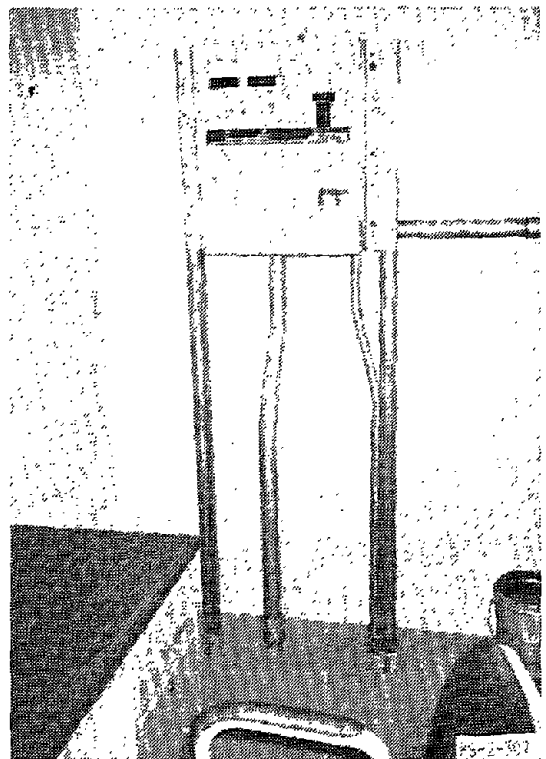
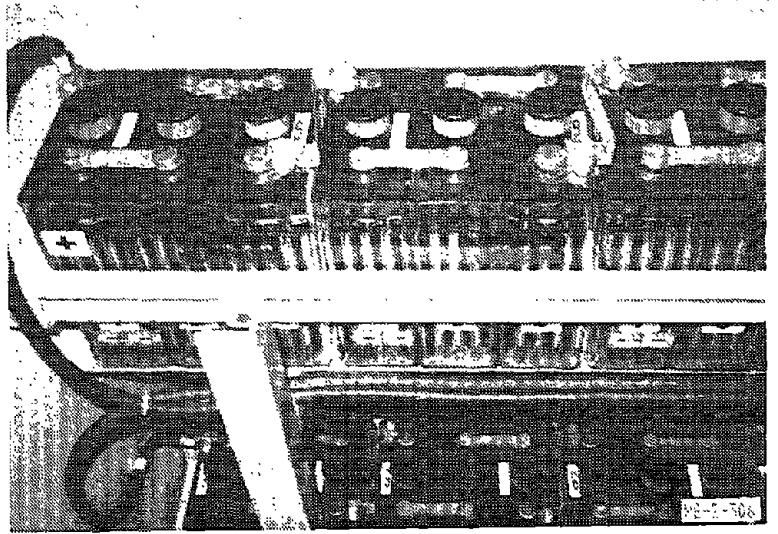
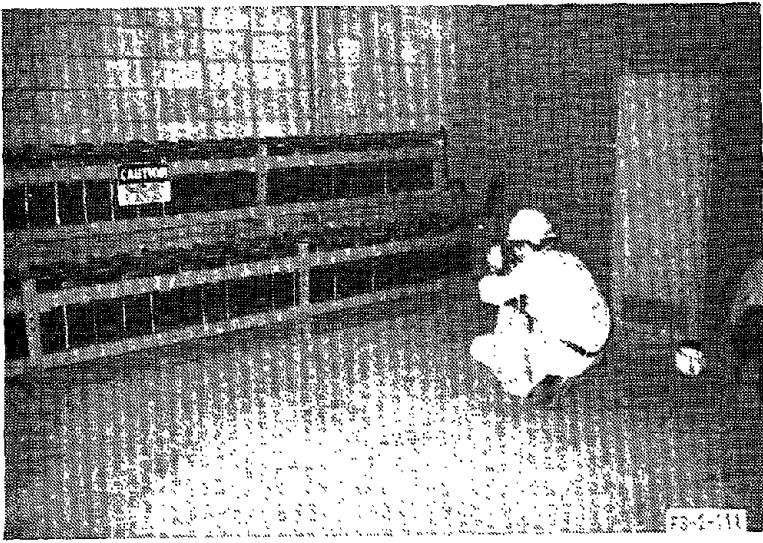

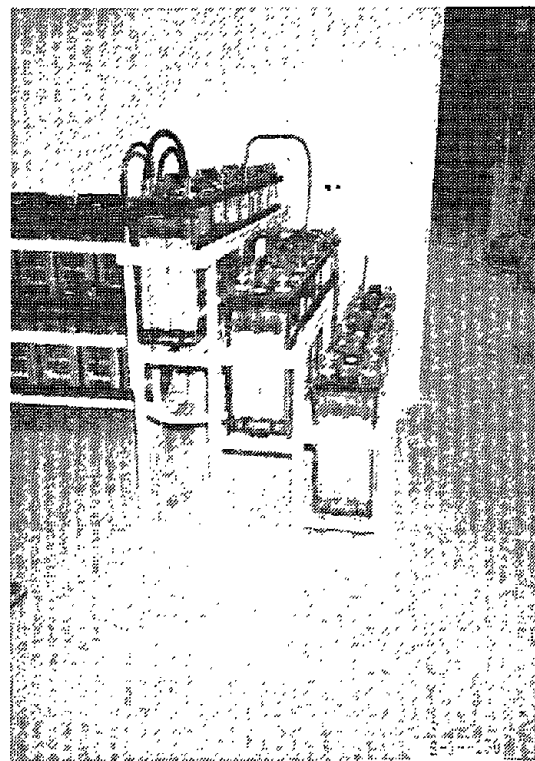
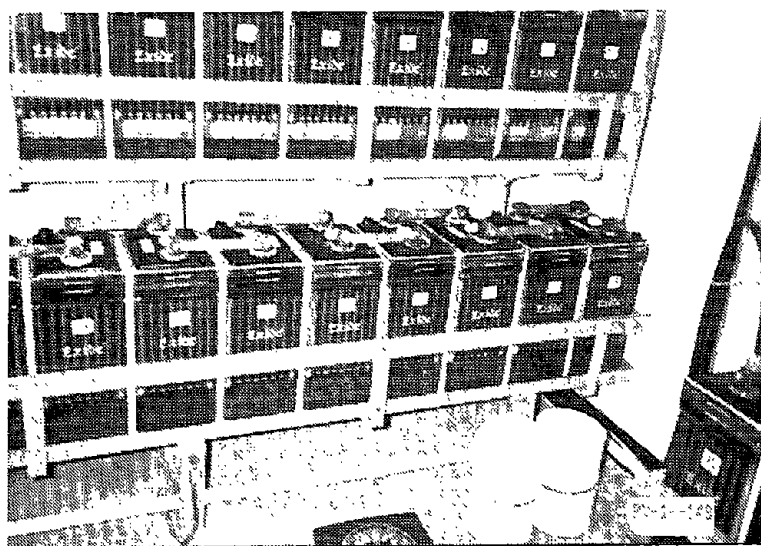
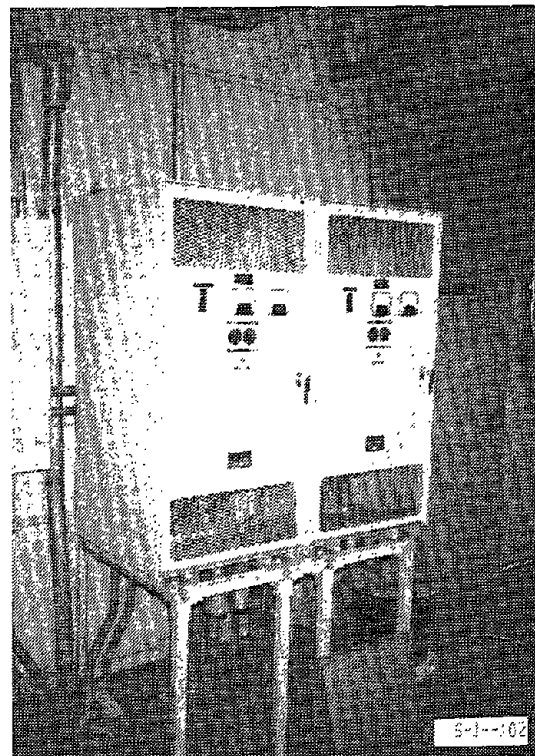
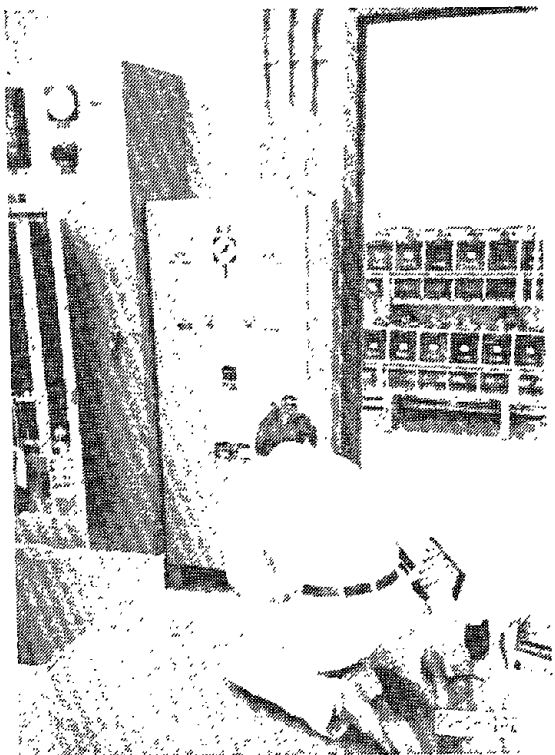

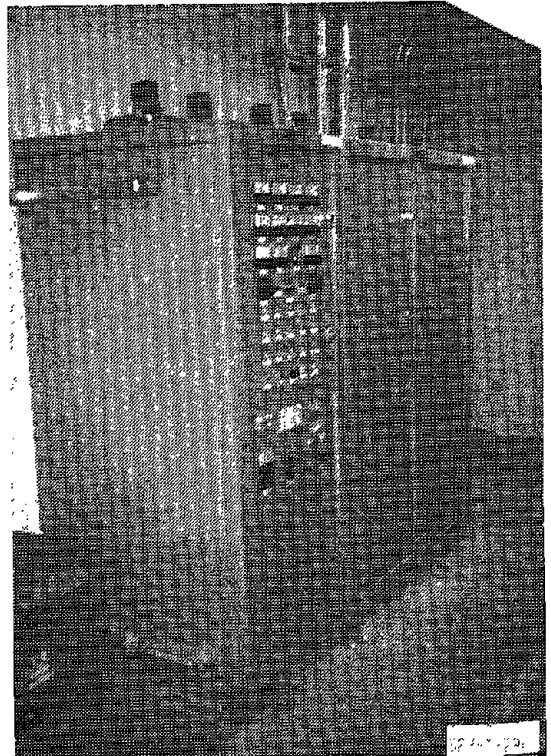
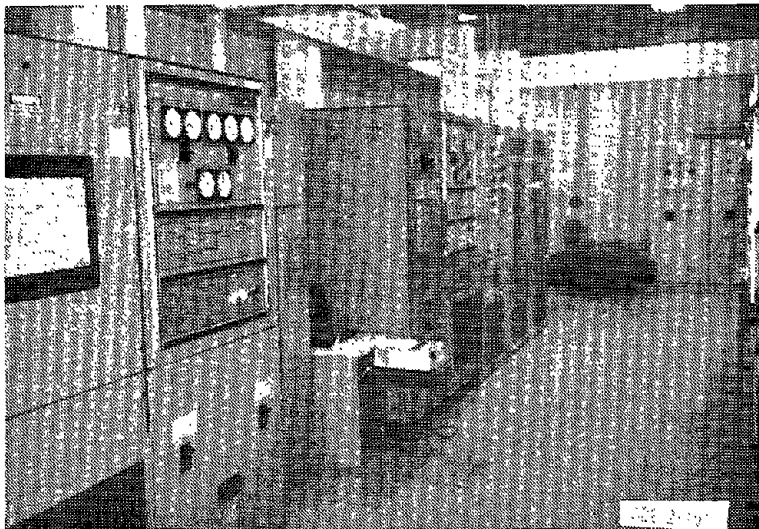
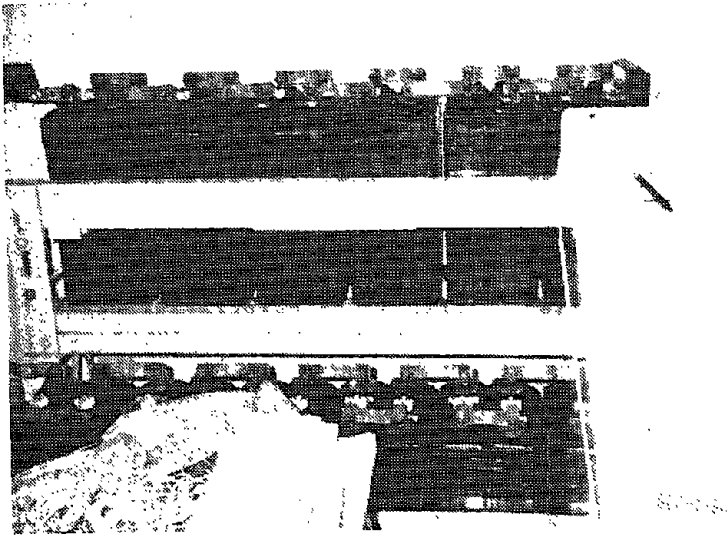

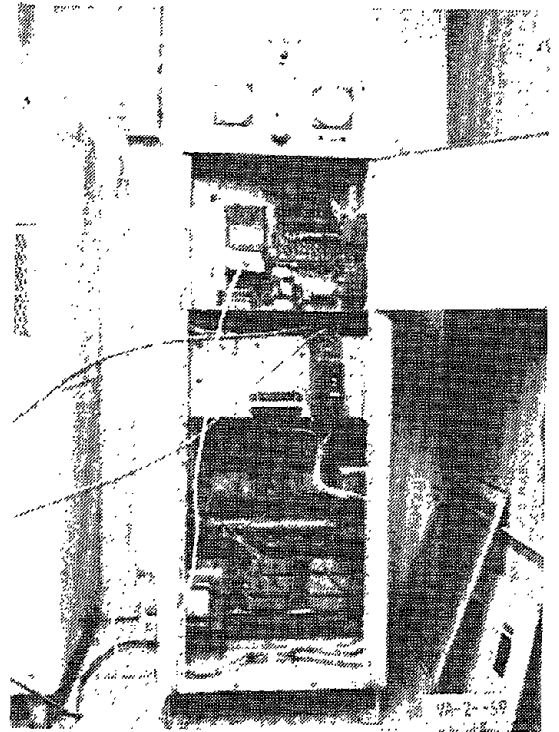
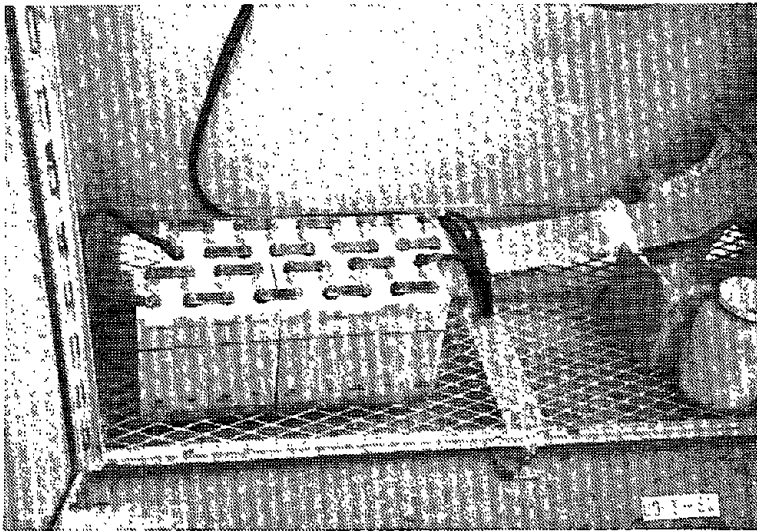
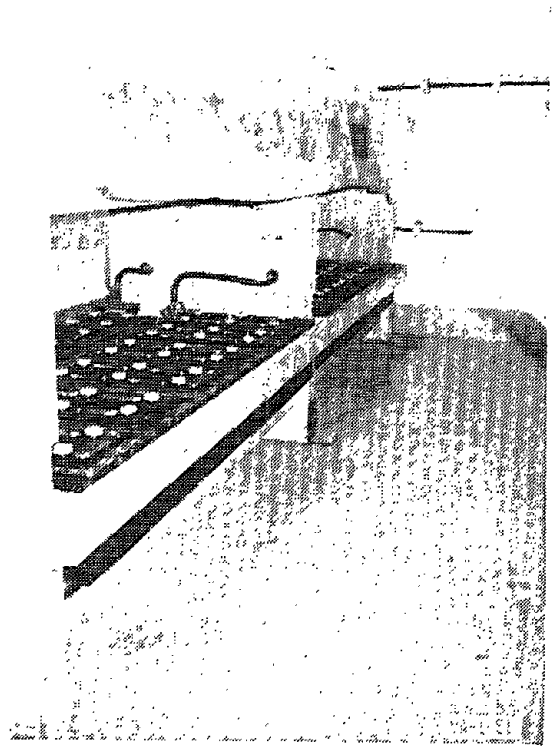
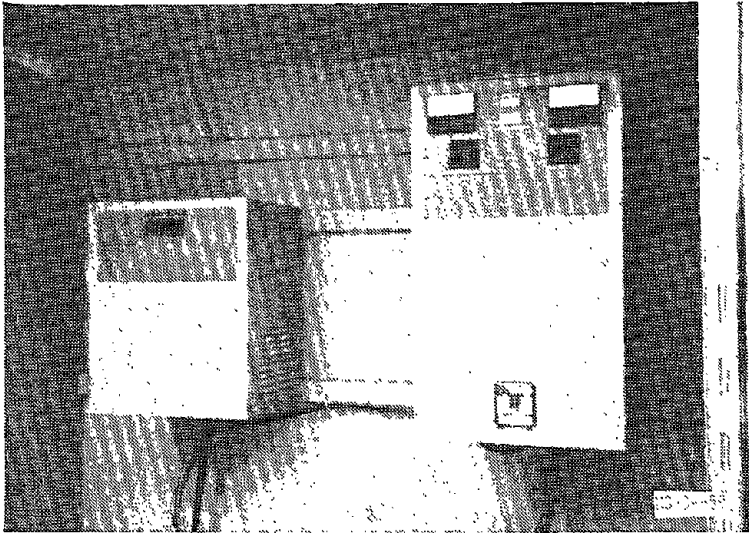

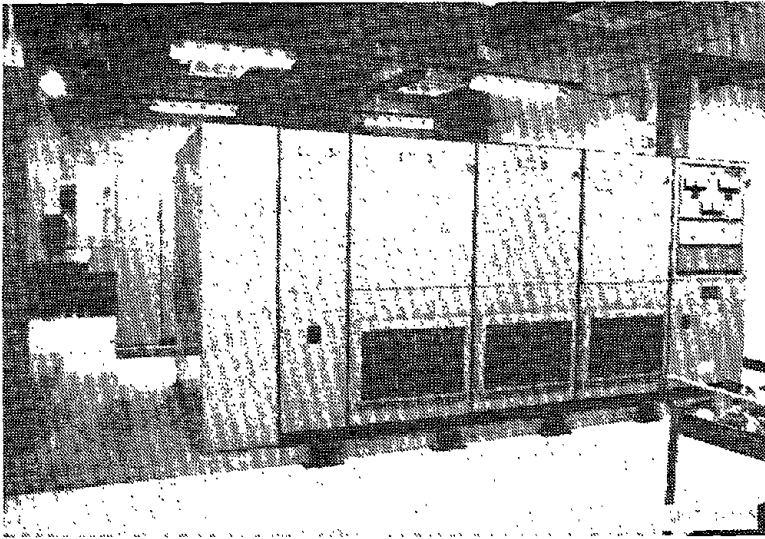
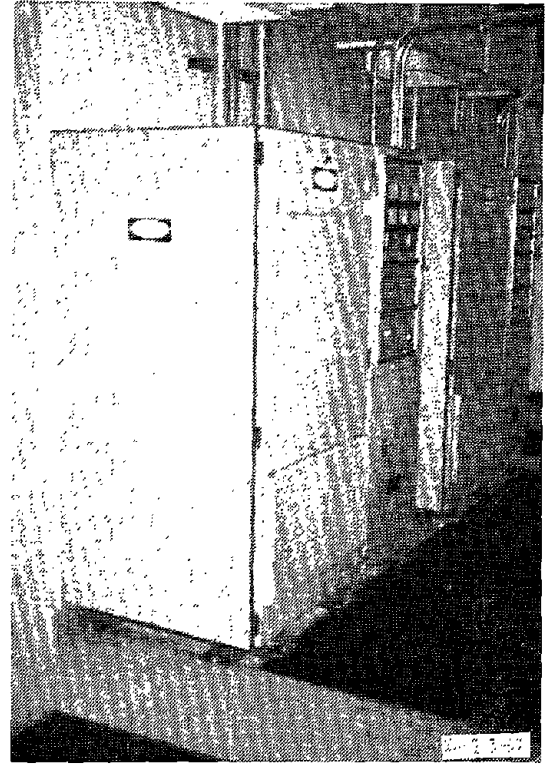
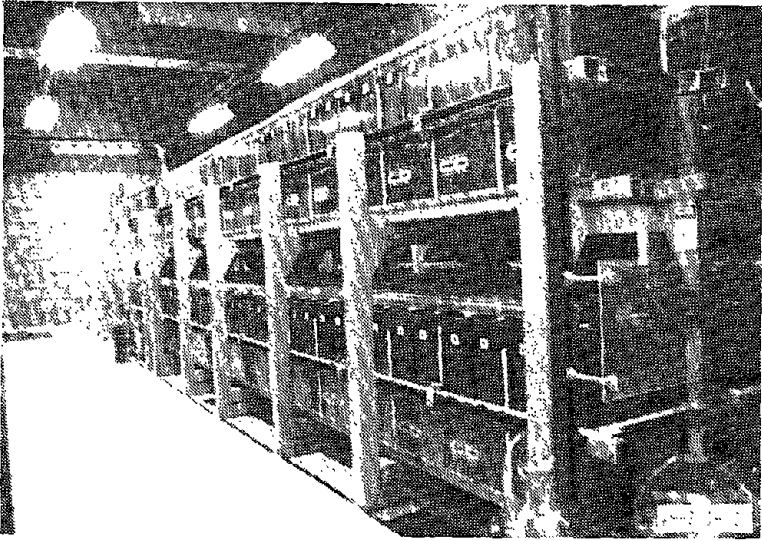

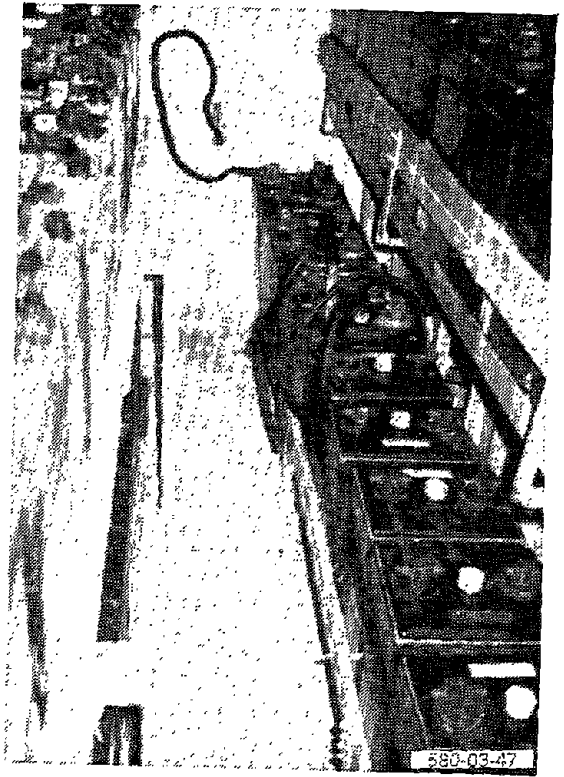
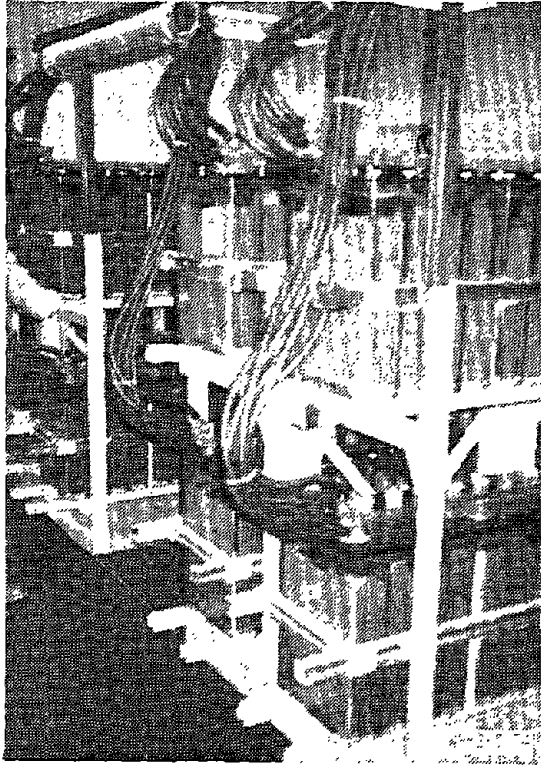

APPENDIX C

DATA BASE OF ENGINE-GENERATOR SYSTEMS

APPENDIX C

DATA BASE OF ENGINE-GENERATOR SYSTEMS

As part of the review of emergency power generation systems, a data base has been compiled of detailed data on 111 engine-generator systems that have experienced strong motion earthquakes. Sites include industrial and power facilities.

Information on the engine-generator systems reviewed is summarized in Tables C-1 through C-3. The tables are grouped into the following categories:

- Equipment Parameters
- Seismic Demand Parameters
- Anchorage Parameters

Blank spaces in any of the tables indicate that the specific information in that column was not collected for that piece of equipment.

EQUIPMENT PARAMETERS

Table C-1 presents information on the kilowatt and kilovolt-amperes of the equipment, manufacturer of the engine and generator, vintage of the equipment (this is presented as the age of the facility unless more detail is available), number of examples, indication of manual or automatic start ability, whether the equipment was damaged in its earthquake, and a photo identification number. This number corresponds to indexes on the photos in the back of this appendix, which are arranged alphabetically according to the first letters of the photo code.

The examples reviewed range in size from 30 to 8000 kW. Most major manufacturers of engine-generators are represented, as well as some lesser known and international manufacturers. Vintages of the engine-generators range from the early 1950s to the 1990s. Numerous examples of engine-generators with automatic start systems are included.

SEISMIC DEMAND PARAMETERS

Table C-2 presents information on peak ground acceleration (PGA) experienced by the engine-generator systems, duration of earthquake, soil type, elevation of equipment relative to grade, indication of equipment damage, and the earthquake which affected each engine-generator system.

The PGA is the average of the two free-field horizontal components. PGAs for sites have either been measured or estimated based on the nearest record. The engine-generators reviewed experienced PGAs from 0.10g to 0.85g.

The duration of the earthquake is considered to be that length of time for which the ground acceleration in the epicentral area exceeds 0.10g. The engine-generators reviewed experienced earthquakes with strong-motion durations ranging from 3 to about 50 seconds.

The facilities are defined in Table C-2 as founded on rock when the shear wave velocity of soil is greater than 3500 to 4000 feet per second. Below those values, the facilities are defined as founded on soil. The facilities housing the engine-generator systems reviewed are located on a variety of soil types (i.e., sand, alluvium, marine sediment, poor clay, limestone, rock, etc.).

ANCHORAGE PARAMETERS

Table C-3 presents information on the engine-generator foundation, type of anchorage, number of anchor bolts, size of anchor bolts, and whether the equipment was damaged in the earthquake.

The engine-generators reviewed have a variety of foundation arrangements including, floor mounted, skid mounted, mounted on concrete pad or steel plate, vibration isolated with spring isolation mounts and elastomeric pads and mounted on the backs of trailers or trucks. Anchorage types include cast-in-place bolts, expansion anchors and a few unanchored examples. Anchor bolt sizes range from 1/2-inch to 1 1/2-inch.

Elevation levels for the engine-generators reviewed range from basement levels to the rooftops of three-story buildings.

**Table C-1 (Page 1 of 2)
EQUIPMENT PARAMETERS**

Site	Kva	Kw	Engine Manufacturer	Generator Manufacturer	Vintage	No.	Manual/Auto	Damage	Photo_id
Adak Naval Base	375	300	Caterpillar	Caterpillar	1960	2		No	AA-1-385
Adak Naval Base	3750	3000	Cooper-Bessimer	Ideal Electric	1965	6		Yes	AA-1-52
Adak Naval Base	125	100	Cummins	Cummins	1960	1		No	AA-1-275
Adak Naval Base	ND	500	Cummins	Kato	1978	2		No	AA-1-356
Adak Naval Base	2500	2000	Fairbanks Morse	Fairbanks Morse	1960	2		No	AA-1-222
Adak Naval Base	57	45	Instrument Lab	Instrument Lab	1960	2		No	AA-2-349
Cachi Dam	250	200	General Motors	General Motors	-	1	Manual	Yes	CR-4-MC-85
California Fede	825	660	Waukesha	Waukesha	1980	4	Automatic	Yes	WH-S-1-145
Cardinal Co-Gen	ND	500	Sterling & Viking	Sterling & Viking	1950	1	Automatic	No	LP-11-CCO-5
Central Telepho	ND	2500	GM Allison	GM Allison	1976	3	Automatic	Yes	POW-16-45
Central Telepho	ND	1000	General Motors	General Motors	1960	1	Automatic	No	POW-16-40
Changuinola Pow	ND	2500	General Motors	General Motors	1960	3		Yes	CR-6-RD-45
Changuinola Pow	2188	1750	Nordberg	Nordberg	1960	5		Yes	CR-7-RH-293
Concon Refinery	5000	-	-	-	-	1	Automatic	Yes	ND
Concon Water Pu	950	-	AEG	AEG	1963	2	Manual	No	CH-2-CC-449
Devers Substati	145	150	Onan	Onan	1983	1	Manual	Yes	PS-1-162
Edgecumbe Subst	8	-	McEvans	McEvans	1960	1	Manual	No	NZ16-ES-53
IBM/Santa Teres	ND	210	Caterpillar	Caterpillar	1977	1	Automatic	No	LP-IBM-146
IBM/Santa Teres	ND	3500	Turbine Power System	Turbine Power System	1977	2	Manual	No	LP-IBM-143
Kettleman Compr	ND	1000	Clark	Clark	1950	8		No	KT-1-234
Kettleman Compr	ND	5000	Cooper-Bessimer	Cooper-Bessimer	-	1		No	KT-1-189
Kettleman Compr	500	400	Copper-Bessimer	General Electric	1950	4		No	KT-1-286
Kettleman Compr	ND	-	Ingersoll-Rand	Ingersoll Rand	1950	4		No	SAMP-EX-632
LLolloe Pumping	140	100	Allis-Chalmers	Allis-Chalmers	-	1	Manual	No	KES-NEER-2
La Villita Powe	750	600	Caterpillar	Caterpillar	1973	1	Manual	No	M-2-187
Las Ventanas Co	250	220	Kato/Caterpillar	Kato/Caterpillar	1960	2	Manual	No	KES-NEER-1
Las Ventanas Co	1050	1000	Siemens	Siemens	1960	1	Automatic	No	CH-2-LCV-547
Limon Telephone	49	39	Allis-Chalmers	Onan	-	1	Automatic	No	CR-2-TL-97
Lipton Foods	50	40	Cummins	Cummins	1987	1	Automatic	No	LP2-LS-40
Matahina Dam	375	400	Elin	Elin	1970	1		No	NZ-2-312-MD
Moin Power Plan	38000	40000	Hitachi	Hitachi	1990	3		Yes	CR-4-IDP-27
Moin Power Plan	ND	8000	Pielstick	Nishibu	1976	3		Yes	CR-4-IDP-2
Moog Manufactur	438	350	Cummins	Cummins	1985	1	Automatic	No	PH2BAG258
National Refrac	250	200	Caterpillar	Caterpillar	-	1	Manual	No	LP-NR-17
Port of Moin	ND	500	Caterpillar	Caterpillar	-	1	Automatic	No	CR-3-PM-29
Rapel Hydroelec	260	200	-	-	1960	1	Manual	No	CH-2-RA-133
Renca Power Pla	350	-	General Motors	General Motors	1962	1		No	KES-NEER-3
Rosemead Teleph	ND	650	-	-	-	2	Manual	Yes	ND
SCE Headquarter	ND	500	Int. Harvester	Int. Harvester	-	1	Automatic	No	SCE-2-105
SCE Headquarter	38	30	Onan	Onan	1970	2	Automatic	Yes	SCE-2-32
SCE Headquarter	93	75	Onan	Onan	1970	1	Automatic	No	SCE-1-44

C-3

**Table C-1 (Page 2 of 2)
EQUIPMENT PARAMETERS**

Site	Kva	Kw	Engine Manufacturer	Generator Manufacturer	Vintage	No.	Manual/Auto	Damage	Photo_id
SCE Headquarter	93	75	Onan	Onan	1970	1	Automatic	Yes	SCE-1-44
Santa Cruz Tele	ND	100	Int. Harvester	Electric Machinery	1960	2	Automatic	Yes	LP-11-SCPB-54
Soquel Water	ND	50	-	-	-	1	Manual	No	LP-SQW-8
Soquel Water	ND	30	Genset	Genset	-	1	Automatic	No	LP-SQW-14
Soquel Water	ND	200	International	Leroy	-	1	Manual	No	LP-SQW-9
UC Santa Cruz	ND	2600	De Laval Ent.	Ideal Electric	-	1		No	LP-USCS-41
Union Oil	ND	1000	Clark	Clark	1952	7		No	UO-1-23
Union Oil	ND	1000	Ingersoll-Rand	Ingersoll-Rand	1952	7		No	UO-3-71
Union Oil	ND	-	Kato	Kato	1981	1		No	UO-1-183
Union Oil	ND	1000	Solar Turbines	Saturn Turbine Corp.	1981	3		No	UO-1-35
Wells Fargo Ban	ND	900	-	-	-	5	Automatic	Yes	WH-S-5-43
Whitewater Hydr	ND	30	Caterpillar	Caterpillar	1970	1	Manual	No	PS-2-338

C-4

**Table C-2
SEISMIC DEMAND PARAMETERS**

Earthquake	Site	Pga	Duration	Soil type
Adak Alaska	Adak Naval Base	0.25	25	Soil
Chile	Concon Refinery	0.30	40	Soil
Chile	Concon Water Pu	0.30	40	Soil
Chile	LLollo Pumping	0.55	40	Soil
Chile	Las Ventanas Co	0.25	40	Soil
Chile	Rapel Hydroelec	0.23	40	Soil
Chile	Renca Power Pla	0.30	40	Soil
Coalinga	Kettleman Compr	0.20	10	Soil
Coalinga	Union Oil	0.60	10	Soil
Costa Rica	Cachi Dam	0.12	30	Rock
Costa Rica	Changuinola Pow	-	30	Soil
Costa Rica	Limon Telephone	-	30	Soil
Costa Rica	Moin Power Plan	-	30	Soil
Costa Rica	Port of Moin	-	30	Rock
Loma Prieta	Cardinal Co-Gen	0.25	12	Soil
Loma Prieta	IBM/Santa Teres	0.37	10	-
Loma Prieta	Lipton Foods	0.30	12	Rock
Loma Prieta	National Refrac	0.30	12	Soil
Loma Prieta	Santa Cruz Tele	0.40	12	Soil
Loma Prieta	Soquel Water	0.45	12	Soil/rock
Loma Prieta	UC Santa Cruz	0.40	12	Rock
Mexico	La Villita Powe	0.14	50	Rock
New Zealand	Edgecumbe Subst	0.50	10	Soil
New Zealand	Matahina Dam	0.27	10	Rock
Palm Springs	Devers Substati	0.85	6	Soil
Palm Springs	Whitewater Hydr	0.55	6	-
Phillipines	Moog Manufactur	-	-	Soil
Whittier	California Fede	0.40	3	Soil
Whittier	Central Telepho	0.20	3	Soil
Whittier	Rosemead Teleph	0.40	3	Soil
Whittier	SCE Headquarter	0.40	3	Soil
Whittier	Wells Fargo Ban	0.35	3	Soil

**Table C-3 (Page 1 of 2)
ANCHORAGE PARAMETERS**

Site	Foundation	Elev	Type	No.	Size
Adak Naval Base	Concrete pedestal	0	Bolts	14	1.25
Adak Naval Base	Isolation supports	0	-	-	-
Adak Naval Base	Isolation supports	0	-	-	-
Adak Naval Base	Steel skid	0	Bolts	6	0.50
Adak Naval Base	Steel skid	0	Bolts	-	0.75
Adak Naval Base	Steel skid	0	Bolts	-	2.00
Cachi Dam	-	0	Cast-in-place bolts	6	0.75
California Federal	Isolation supports	0	Bolts	-	0.63
Cardinal	-	0	-	-	-
Central Telephone	Floor	-20	-	-	-
Central Telephone	Steel skid	-20	Cast-in-place bolts	-	1.00
Changuinola Power	Steel skid	0	Bolts	-	-
Changuinola Power	Steel skid	0	Bolts	-	-
Concon Refinery	-	0	-	-	-
Concon Water Pumping	-	0	-	-	-
Devers Substation	Concrete pad	0	Bolts	-	-
Edgecumbe Substation	Skid mounted	0	Bolts	-	0.63
IBM/Santa Teresa	-	0	-	-	-
IBM/Santa Teresa	Trailer-mounted	-	-	-	-
Kettleman Compressor	-	0	-	-	-
Kettleman Compressor	-	0	-	-	-
Kettleman Compressor	-	0	Bolts	14	1.00
Kettleman Compressor	Basemat	0	Bolts	20	1.25
LLollo Pumping	-	0	Unanchored	-	-
La Villita Power	Concrete pad	0	Cast-in-place bolts	-	0.75
Las Ventanas Copper	Isolation supports	0	-	-	-
Las Ventanas Copper	Skid	0	Bolts	-	-
Limon Telephone	Concrete mat	0	Bolts	-	-
Lipton Foods	-	0	-	-	-
Matahina Dam	Steel floor plate	-20	Bolts	-	-
Moin Power Plant	-	0	-	-	-
Moin Power Plant	Steel skid	0	Bolts	12	1.00
Moog Manufacturing	Concrete pad	0	Bolts	4	0.75
National Refractory	-	0	Cast-in-place bolts	-	1.00
Port of Moin	-	0	-	-	-
Rapel Hydroelectric	Isolation supports	0	-	-	-
Renca Power Plant	Floor	0	Bolts	8	0.50
Rosemead Telephone	-	20	-	-	-
SCE Headquarters	-	0	-	-	-
SCE Headquarters	Concrete pad	60	-	-	-
SCE Headquarters	Floor	60	Unanchored	-	-

C-6

**Table C-3 (Page 2 of 2)
ANCHORAGE PARAMETERS**

Site	Foundation	Elev	Type	No.	Size
SCE Headquarters	Isolation supports	60	-	-	-
Santa Cruz Telephone	-	40	Expansion anchors	8	0.50
Soquel Water	Concrete pad	0	Cast-in-place bolts	-	0.50
Soquel Water	Trailer-mounted	2	-	-	-
Soquel Water	Truck-mounted	3	-	-	-
UC Santa Cruz	Concrete floor	0	Cast-in-place bolts	-	1.00
Union Oil	Concrete pad	0	Bolts	8	1.50
Union Oil	Concrete pedestal	3	Cast-in-place bolts	12	1.00
Union Oil	Concrete pedestal	3	Cast-in-place bolts	12	1.00
Union Oil	Steel skid	0	Cast-in-place bolts	10	0.75
Wells Fargo Bank	-	60	-	-	-
Whitewater	Concrete floor	0	Expansion anchors	4	0.50

C-7

**PHOTOGRAPHS OF ENGINE-
GENERATORS REVIEWED**

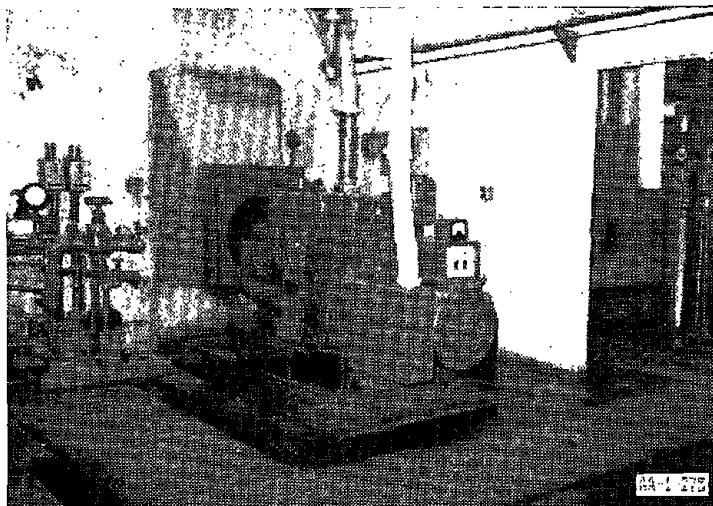
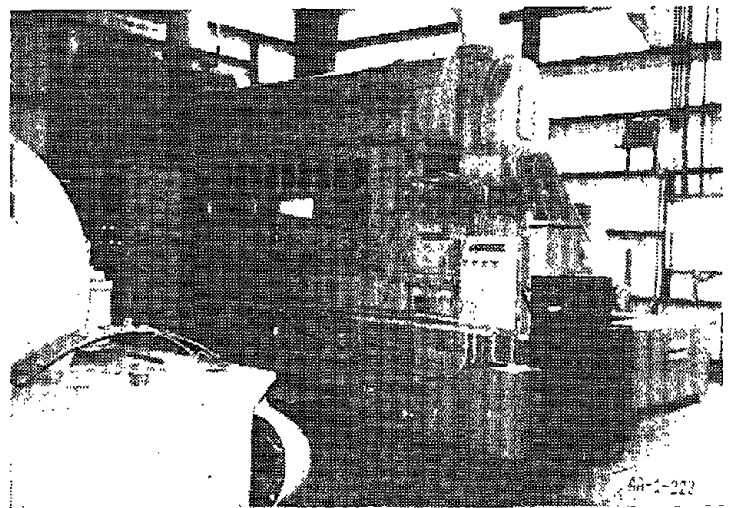
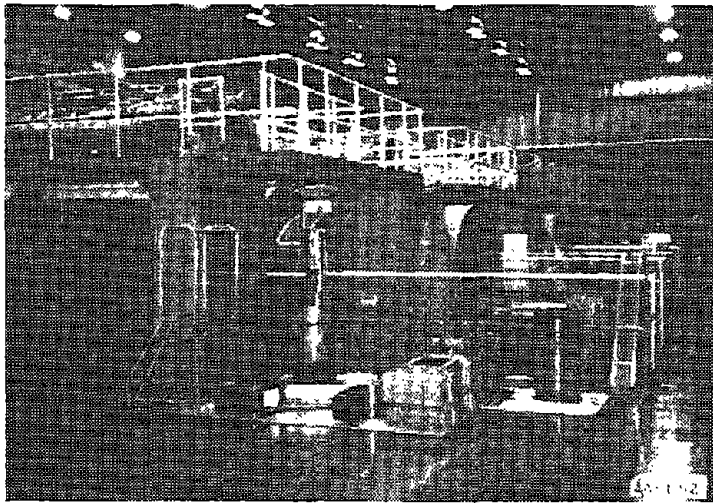

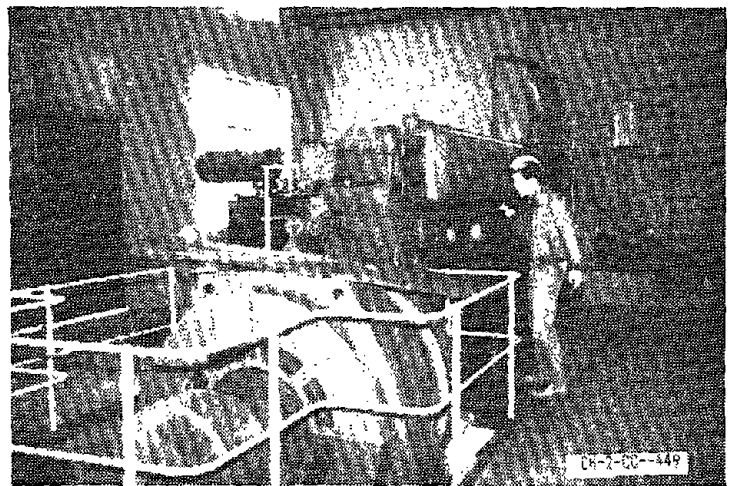
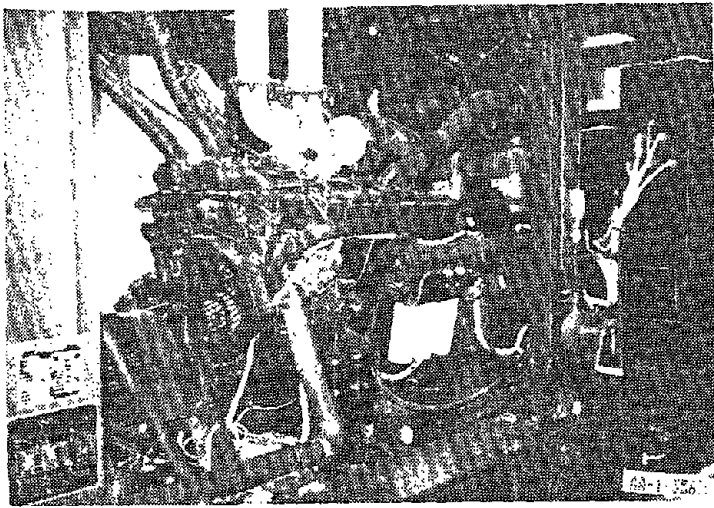
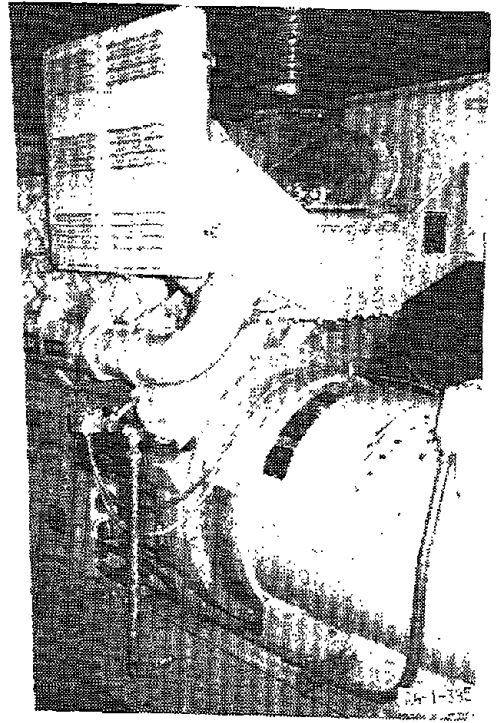

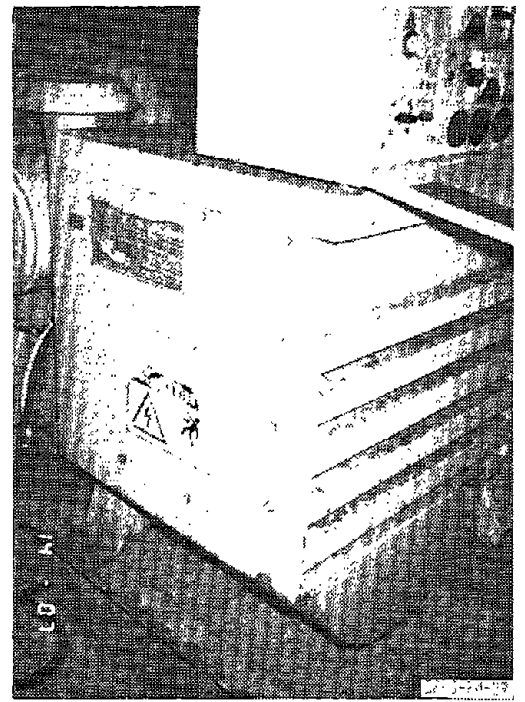
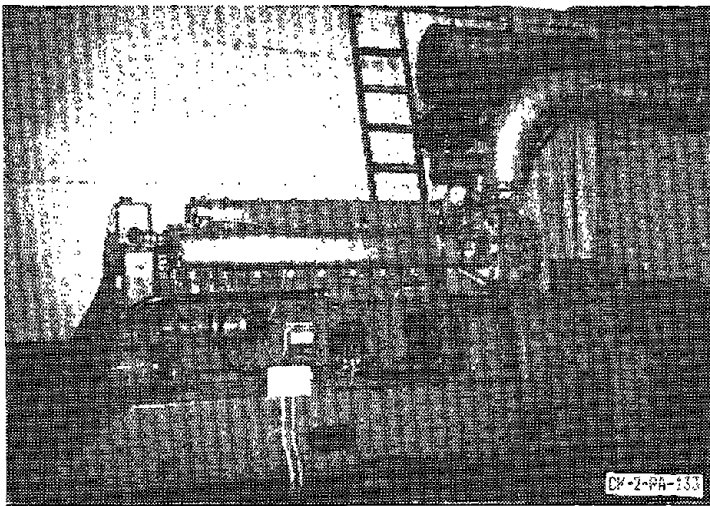
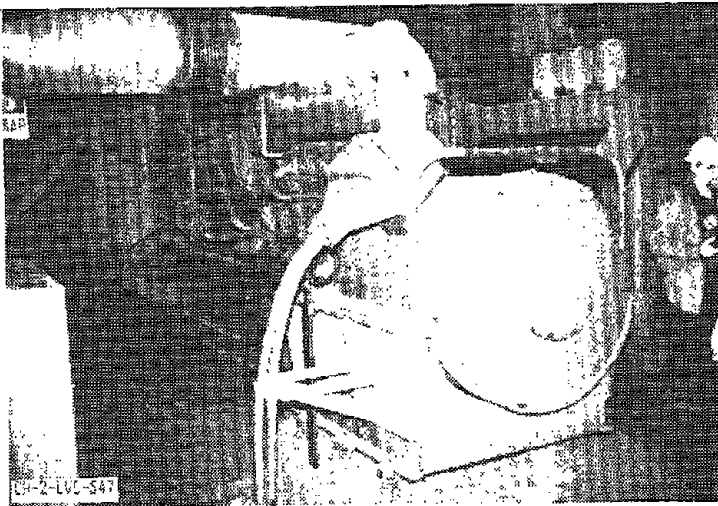
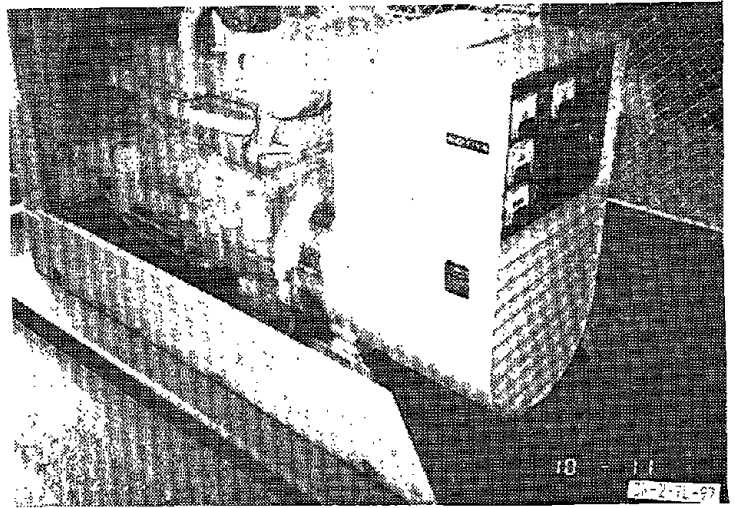

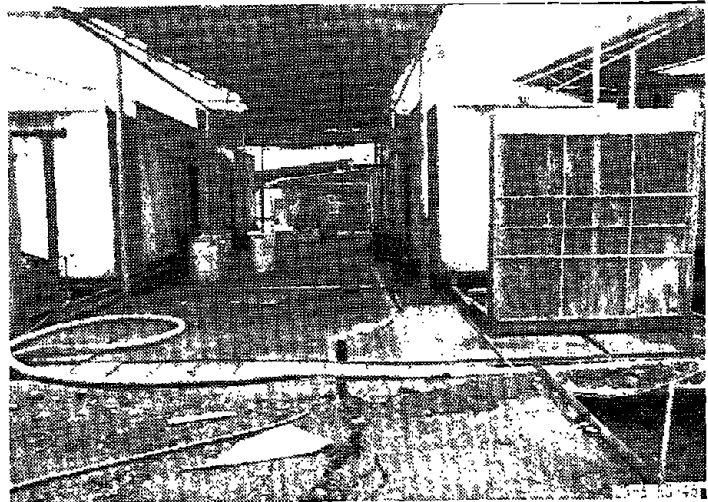
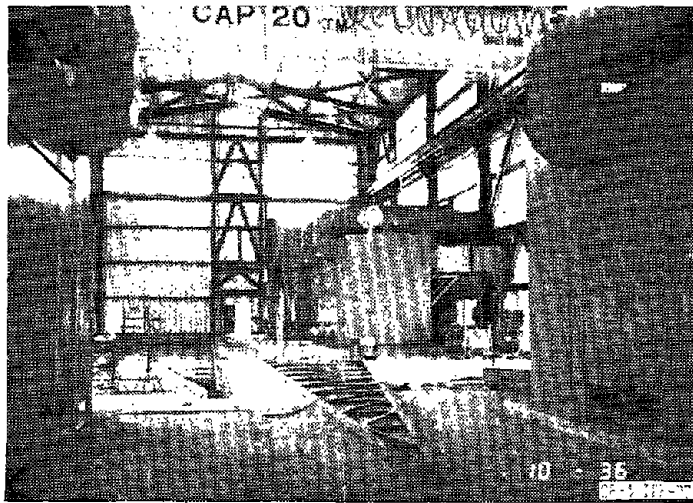
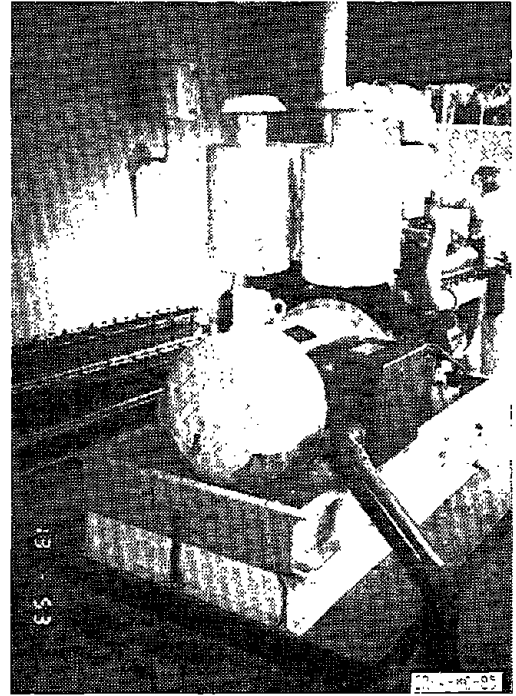
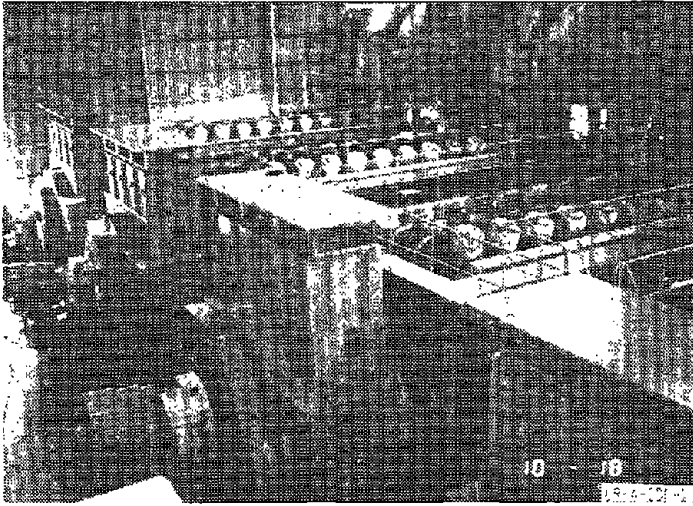

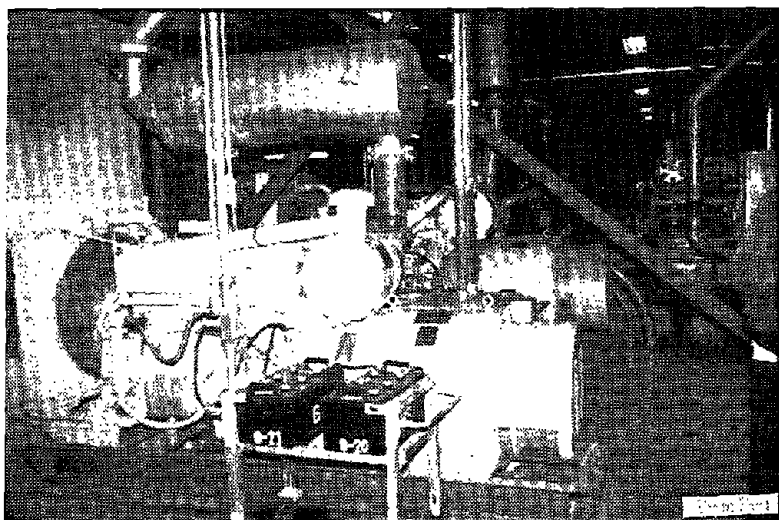
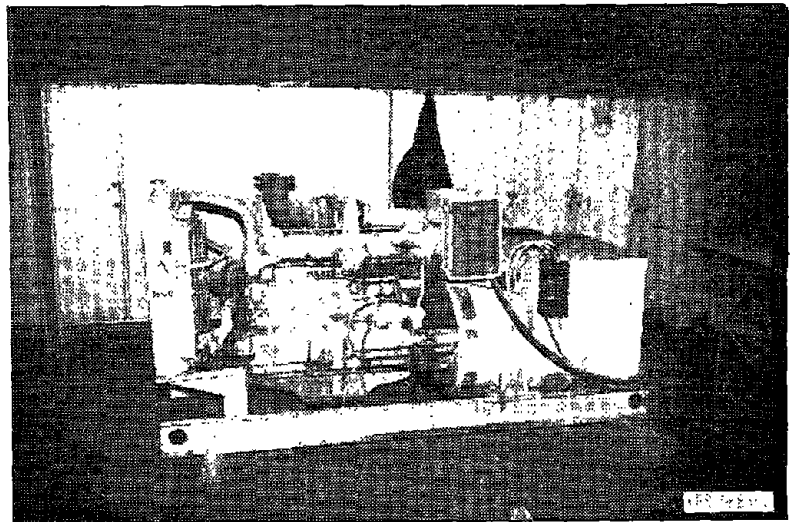
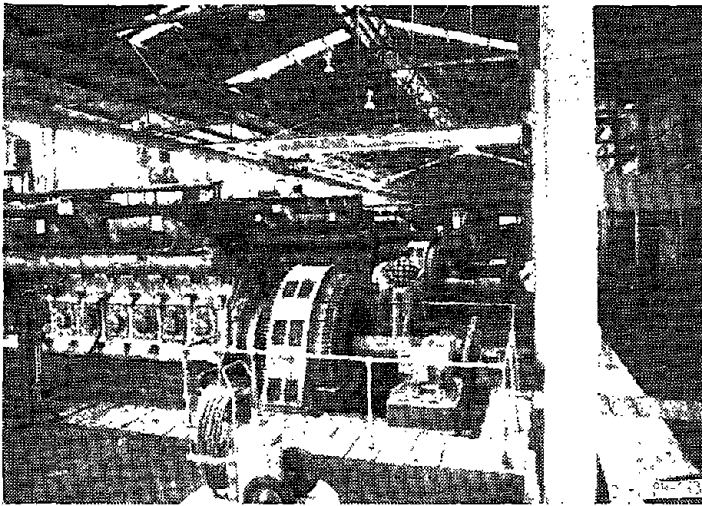

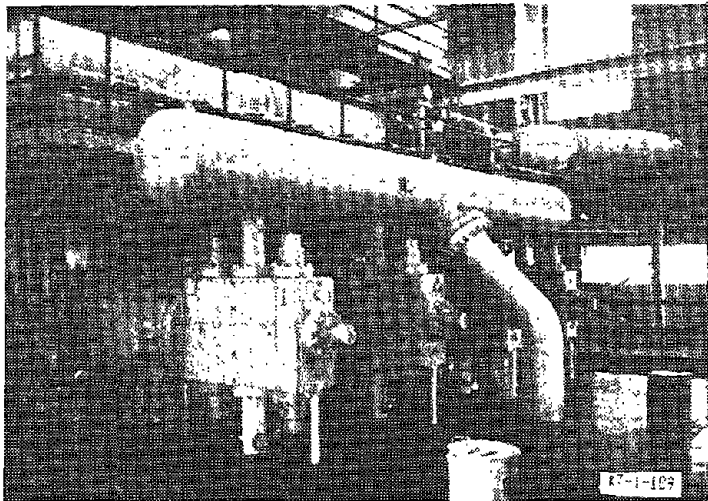
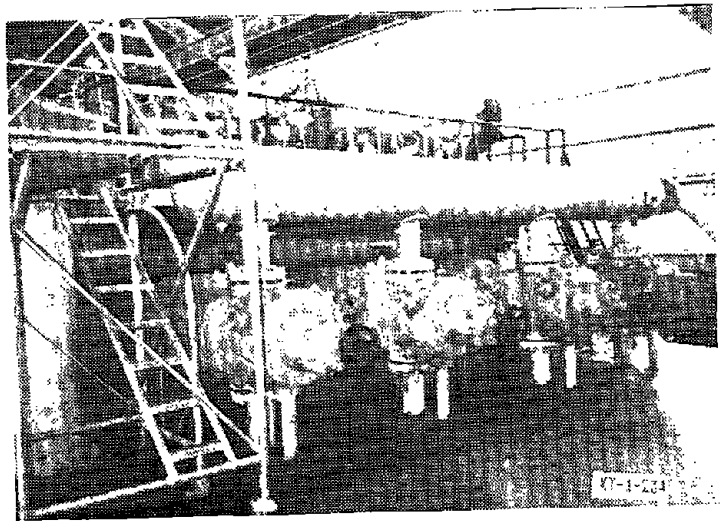

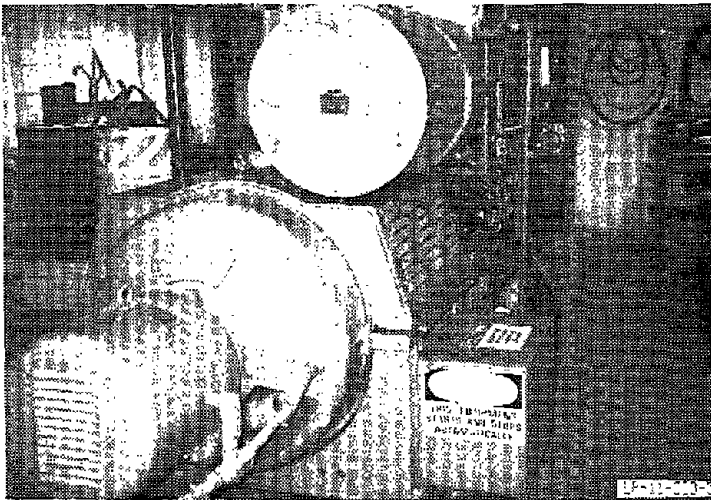
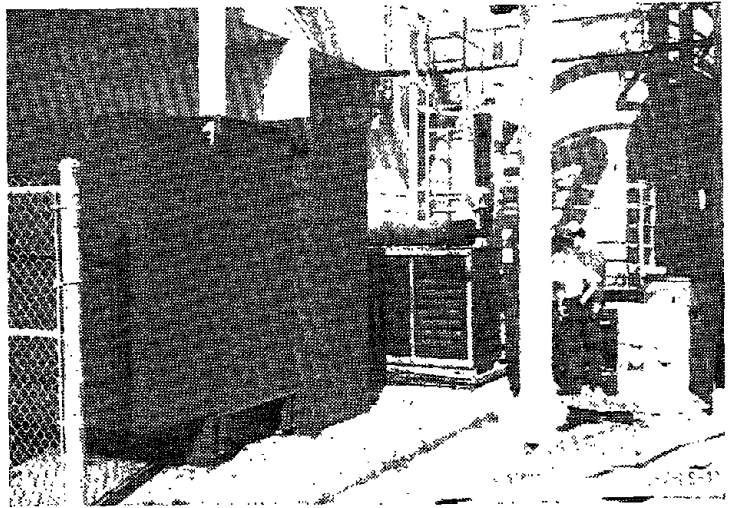
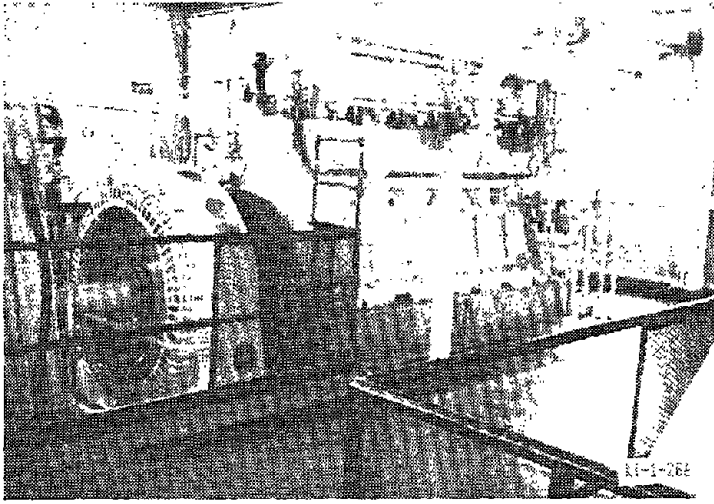

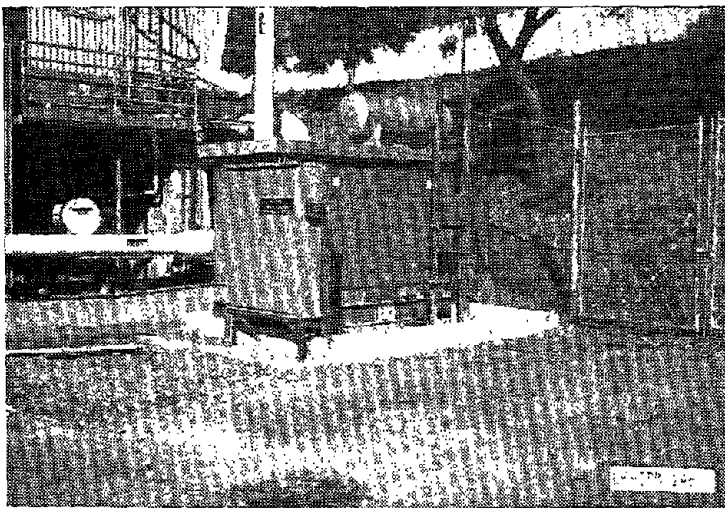
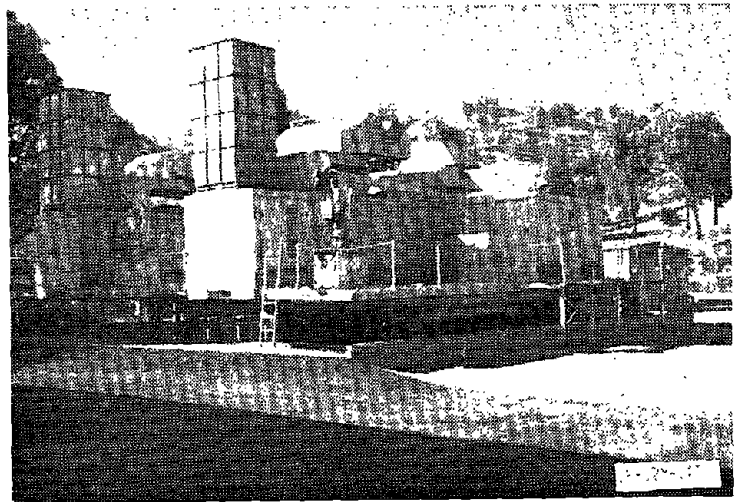
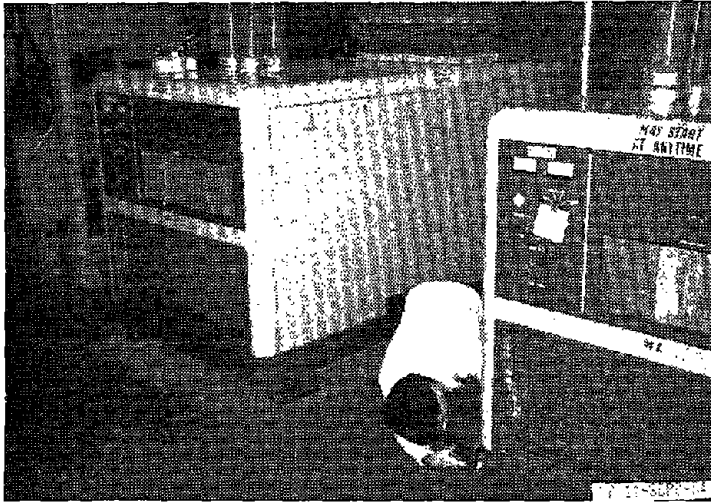

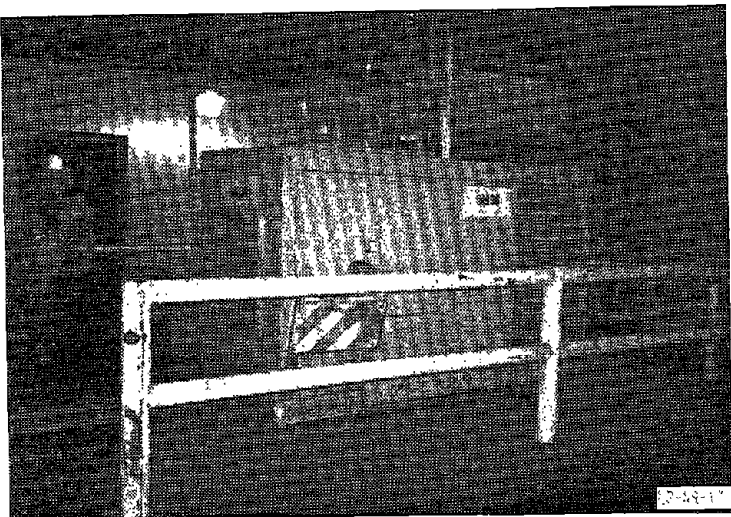

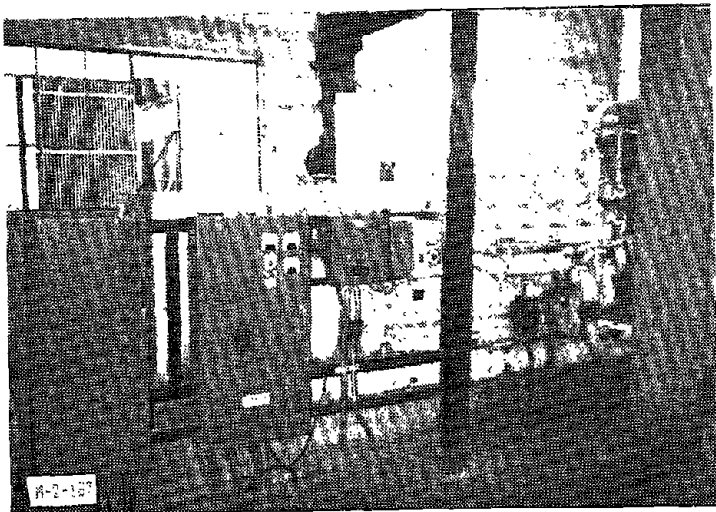
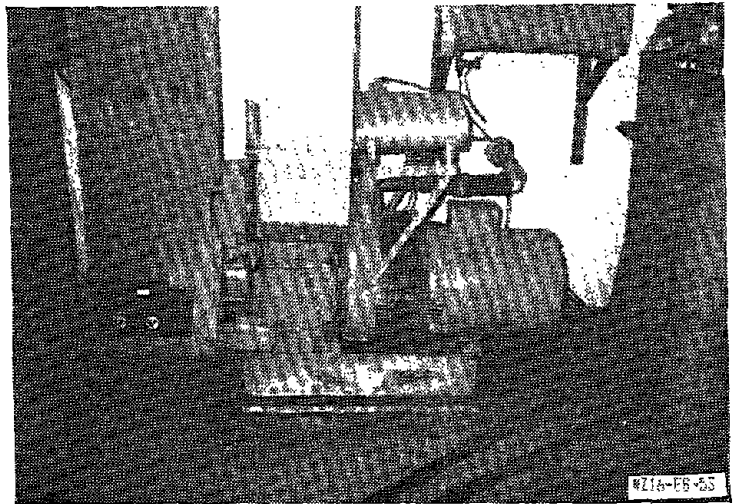
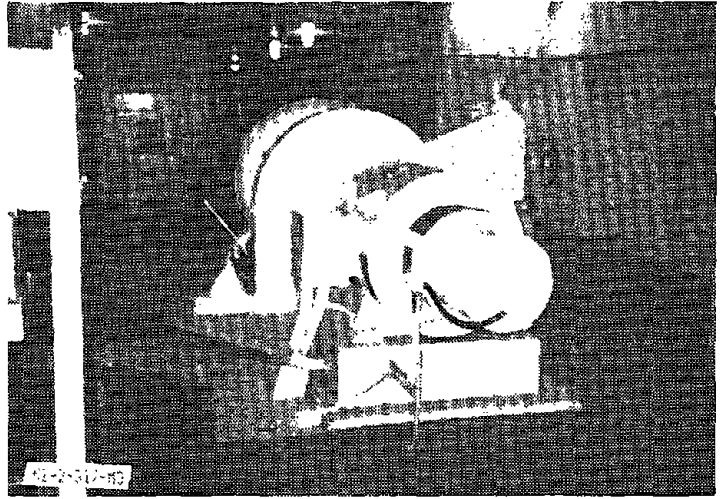
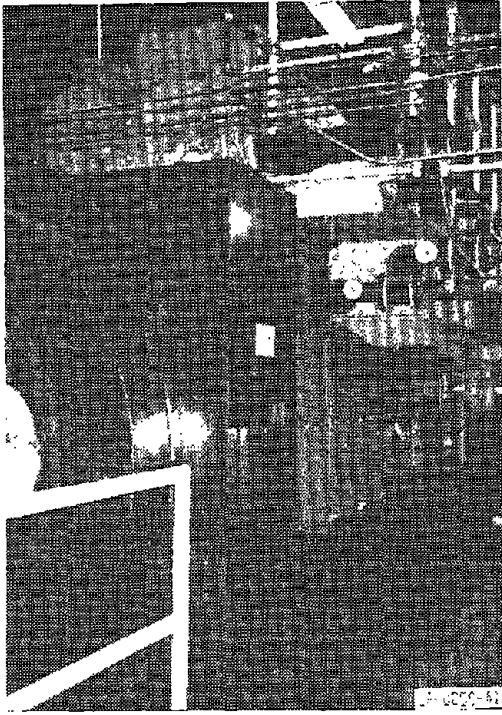

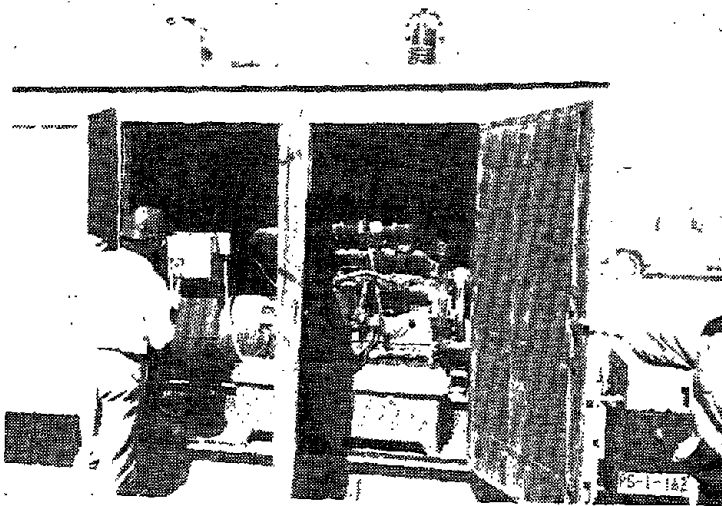
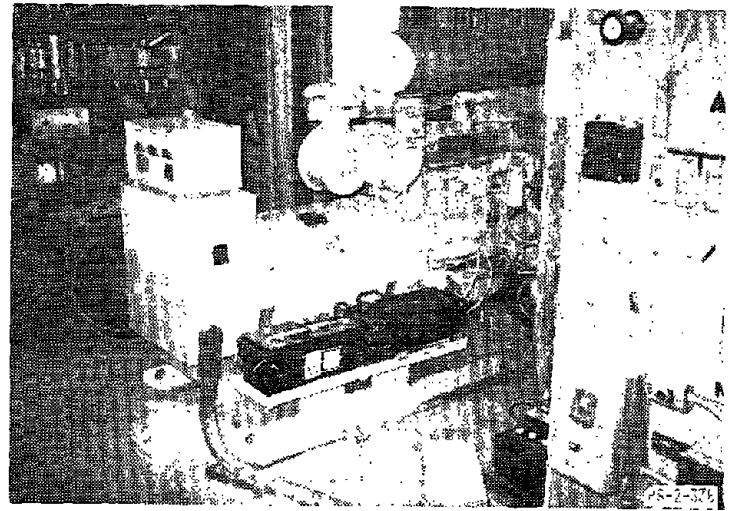
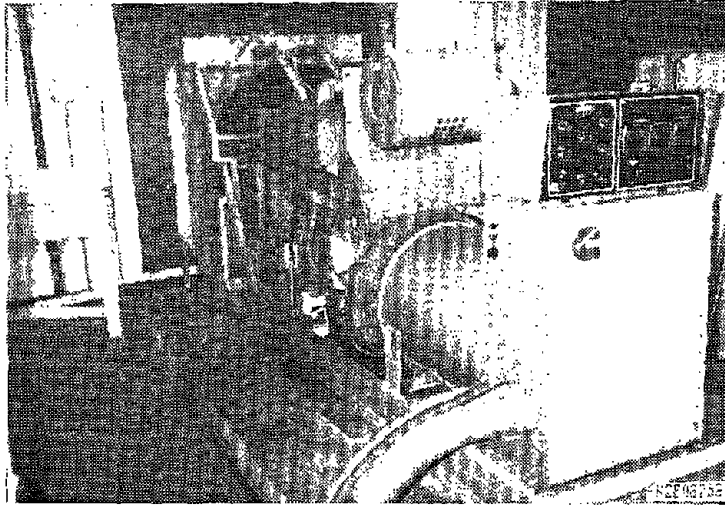

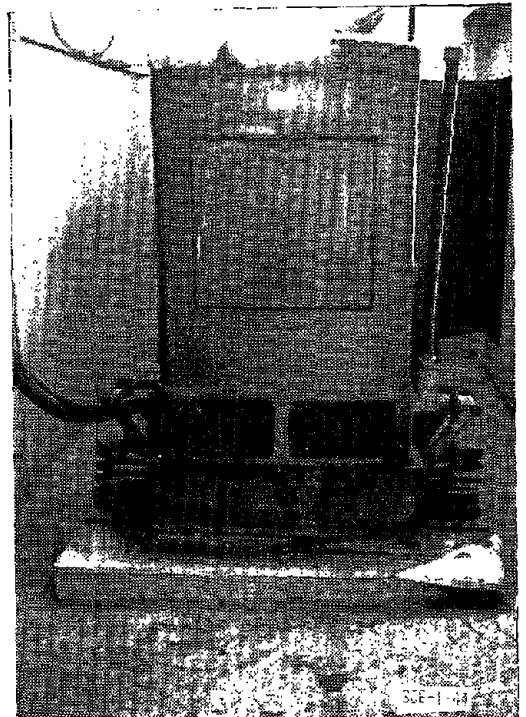
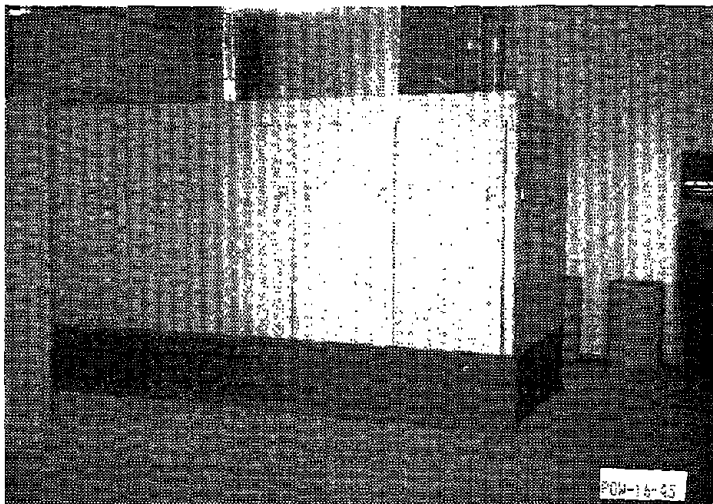
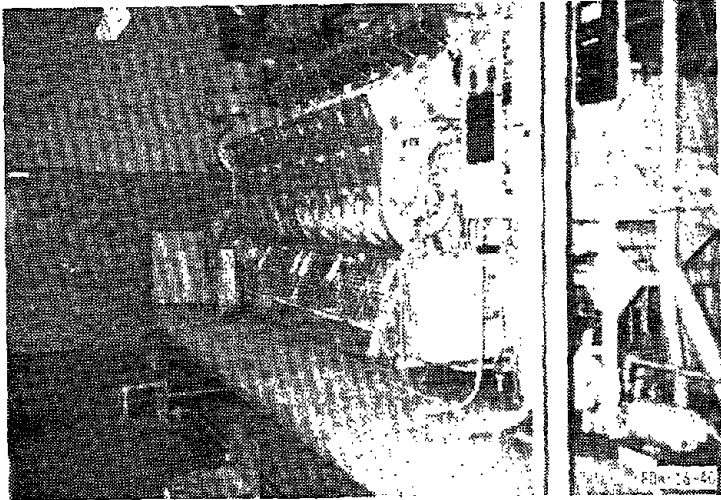
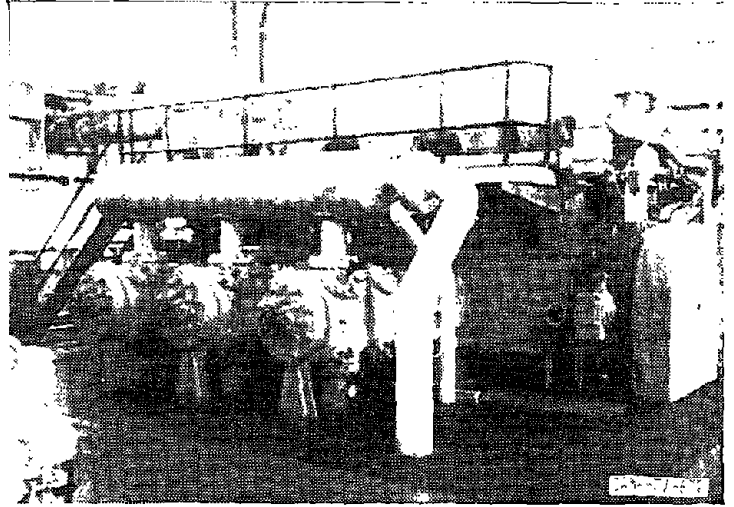

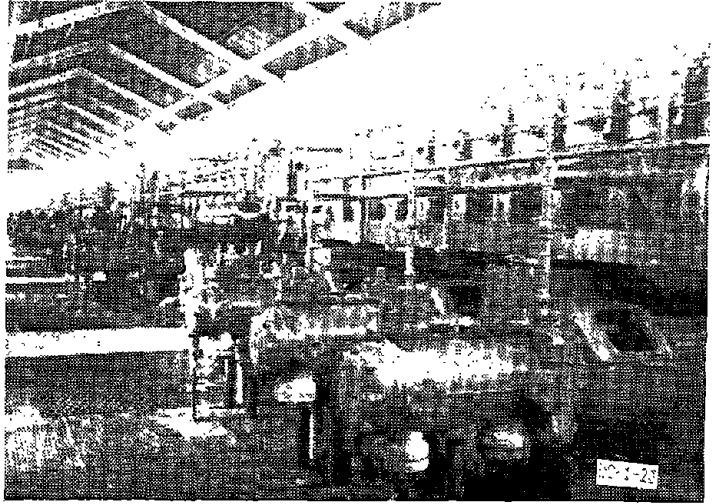
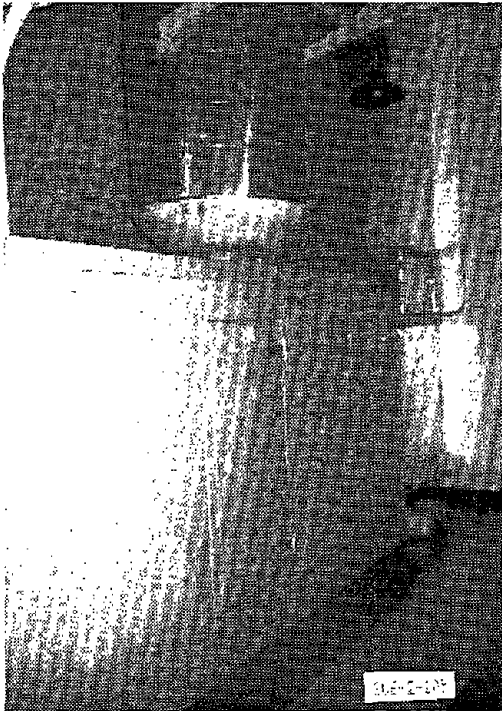
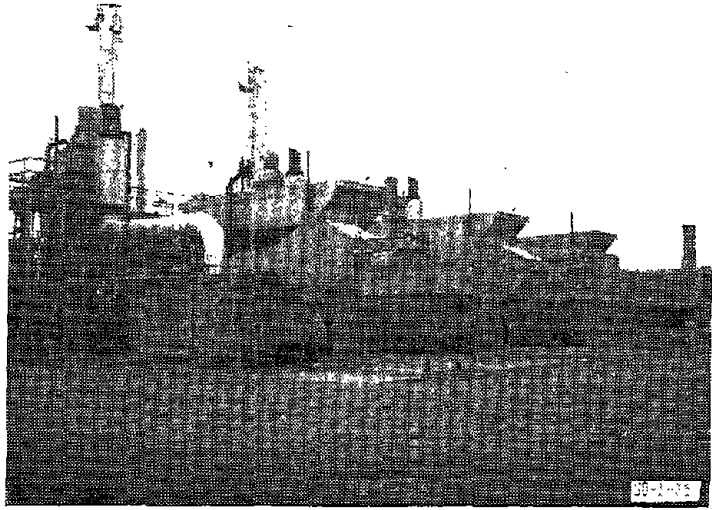
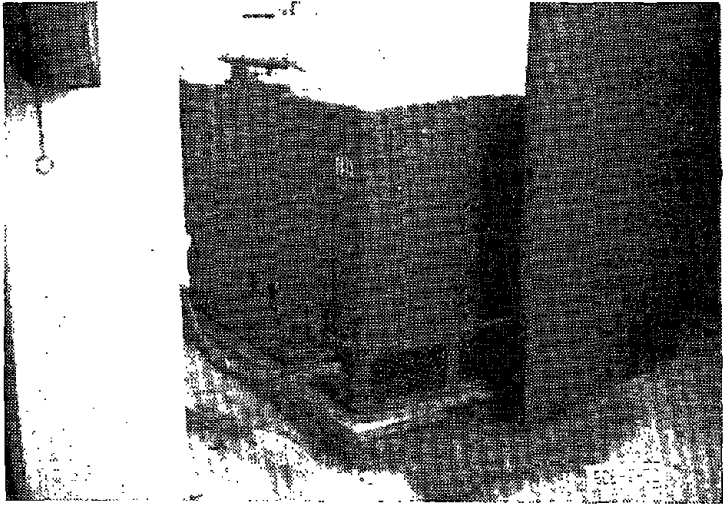

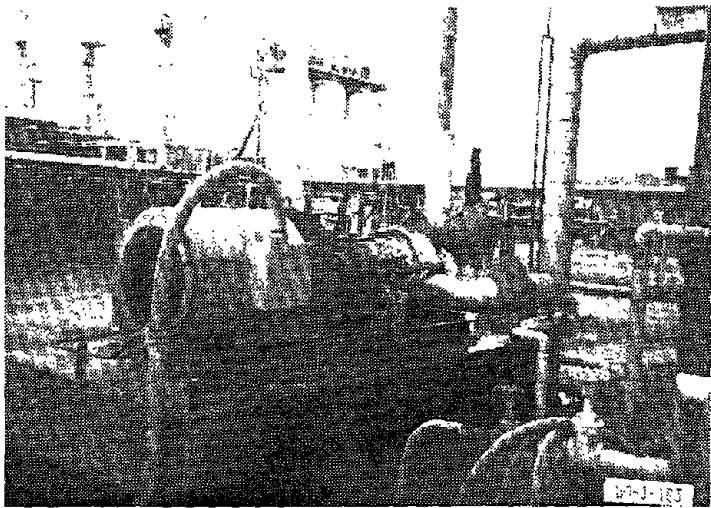
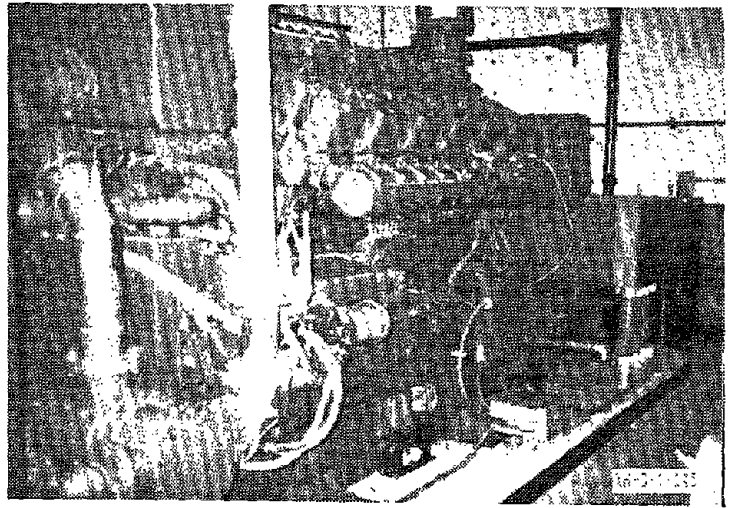
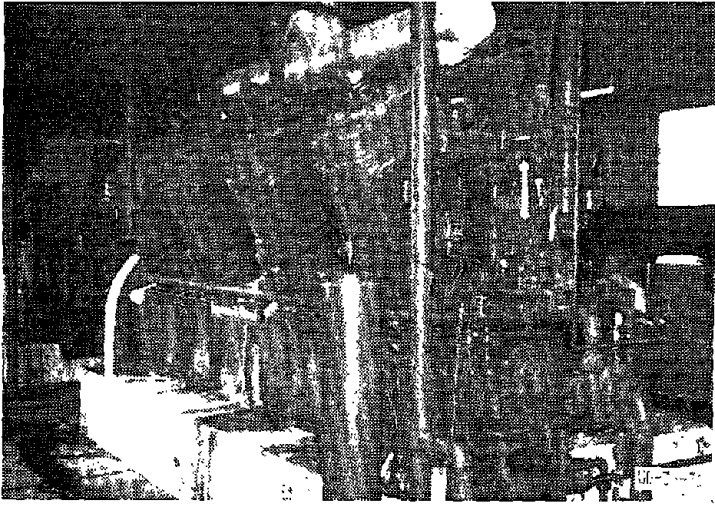

APPENDIX D

DATA BASE OF AIR CONDITIONING SYSTEMS

APPENDIX D

DATA BASE OF AIR CONDITIONING SYSTEMS

For this study, a data base has been compiled of air conditioning systems which have experienced strong motion earthquakes. The data base includes sites where the chilled water system details have been collected and where air handler data have been collected. Most of the data have been gathered from sites in the Whittier and Loma Prieta earthquakes, as the investigation of these earthquakes included more data processing facilities than for other earthquakes, which focussed heavily on power facilities.

Information on the air conditioning systems reviewed is summarized in Tables D-1 through D-7. The tables are grouped into the following categories:

- Air Conditioning System Data
- Chiller Equipment Details
- Air Handler Equipment Details
- Evaporative Cooler Equipment Details
- Pump Equipment Details
- Fan Equipment Details
- Air Conditioning System Seismic Demand

AIR CONDITIONING SYSTEM DATA

Table D-1 presents an overview of information on the earthquake and site and number of components of the air conditioning system including damage to any of the major components. In this table damage is defined as a loss of function in the equipment. Therefore, if an equipment item dismantled from its spring isolators but remained functional, it is considered to be undamaged. Blank spaces where the manufacturers are listed indicate one of the following:

- If the damage column is also blank, that component was not present.
- If the damage column has a "yes" or "no", only the functionality data was collected, but not detailed nameplate data.

CHILLER EQUIPMENT DETAILS

Table D-2 presents information on chiller manufacturer, capacity (in tons of refrigeration), location (above grade) in facility, and anchorage type. A variety of chiller manufacturers are represented, with capacities ranging from 30 to 1000 tons of refrigeration. There is representation for chillers on vibration isolation supports as well as for bolted units.

AIR HANDLER EQUIPMENT DETAILS

Table D-3 presents information on air handler manufacturer, location (above grade) in facility, and anchorage type. A small number of air handler manufacturers are represented; most are supported on some type of vibration isolation supports. As discussed in Section 4.7.4 and 4.7.6, these isolators are one of the main causes of the high proportion of damaged units.

EVAPORATIVE COOLER EQUIPMENT DETAILS

Table D-4 presents information on evaporative cooler manufacturer, location (above grade) in facility, and anchorage type. A small number of evaporative cooler manufacturers are represented; most are supported on some type of vibration isolation supports.

PUMP EQUIPMENT DETAILS

Table D-5 presents information on pump manufacturer, motor size (in hp), location (above grade) in facility, and anchorage type. Note that this table contains only pumps directly associated with HVAC systems. A variety of pumps are represented, with motor sizes ranging from 10 to 50 hp.

FAN EQUIPMENT DETAILS

Table D-6 presents information on fan manufacturer, location (above grade) in facility, and anchorage type. This table includes only fans associated with HVAC systems and excludes boiler fans, such as those found in power plants. A small number of fan manufacturers are represented. Most fans are supported on some type of vibration isolation supports.

AIR CONDITIONING SYSTEMS SEISMIC DEMAND

Table D-7 presents information on peak ground acceleration (PGA) experienced by the air conditioning systems, duration of earthquake, soil type and site and earthquake which affected each air conditioning system.

The PGA is the average of the two free-field horizontal components. PGAs for the sites reviewed have either been measured or estimated based on the nearest record. The air conditioning systems reviewed have experienced PGAs from 0.20g to 0.50g.

The duration of the earthquake is considered to be that length of time for which the ground acceleration in the epicentral area exceeds 0.10g. The air conditioning systems reviewed have experienced earthquakes with strong-motion durations ranging from 5 to about 20 seconds.

The facilities are defined in the table as founded on stiff soil when the shear wave velocity of soil is greater than 3500 to 4000 feet per second. Below those values, the facilities are defined as founded on soft soil. The facilities housing the air conditioning systems reviewed are located on a variety of soil types (i.e., sand, alluvium, marine sediment, poor clay, limestone, rock, etc.).

**Table D-1
AIR CONDITIONING SYSTEM DATA**

EARTHQUAKE	SITE	CHILLER MANUFACTURER	DAMAGE TO CHILLER?	AIR HANDLER MANUFACTURER	DAMAGE TO AIR HANDLER?	EVAP. COOLER MANUFACTURER	DAMAGE TO EVAP. CLR?	PUMP MANUFACTURER	DAMAGE TO PUMP?	FAN MANUFACTURER	DAMAGE TO FAN?
San Fernando	Sylmar Converter Sta	Chrysler	-	American Air	Yes	-	-	-	-	Buffalo Centrif	Dismounts
Morgan Hill	Evergreen College	Chrysler 550	No	-	-	-	-	-	-	-	-
Morgan Hill	Evergreen College	Trane 450 ton	No	-	-	-	-	-	-	-	-
Whittier	California Federal	Carrier 500 t	No	-	-	Baltimore Air	No	No Name Plate 50 hpr (6)	No	-	-
Whittier	Ticor Facility	Trane (2)	Yes	-	-	Baltimore Air	No	-	-	No Name Plate V	Yes
Whittier	Sanwa Bank Facility	ND	Yes	-	-	-	-	No Name Plate 20 hpr (4)	Yes	-	-
Whittier	Wells Fargo	Carrier 350 t	No	-	-	-	-	No Name Plate 20 hpr (10)	No	-	-
Whittier	SCE Headquarters	Carrier 350 t	No	-	Yes	Marley	No	B&G 20 hpr (13)	No	-	-
Whittier	SCE Headquarters	McQuay 600 to	No	-	Yes	-	-	Reliance 30 hpr (2)	No	-	-
Whittier	SCE Headquarters	Carrier 30 to	Yes	-	-	-	-	-	-	-	-
Whittier	SCE Headquarters	ND 5 ton	Yes	-	-	-	-	-	-	-	-
Loma Prieta	IBM/Santa Teresa	Trane 1000 to	No	McQuay (2)	No	-	No	Lincoln 30 hpr (14)	No	American SF Van	Yes
Loma Prieta	IBM/Santa Teresa	ND	-	McQuay	Yes	-	-	-	-	-	-
Loma Prieta	EPRI Headquarters	Trane 200 ton	No	-	Dismount	Baltimore Air	No	-	-	-	Dismount
Loma Prieta	EPRI Headquarters	Trane 40 ton	Dismount	-	-	-	-	-	-	-	-
Loma Prieta	Lipton Foods	York 580 ton	No	-	-	Marley	No	-	No	-	-
Loma Prieta	Lipton Foods	York 125 ton	No	-	-	-	-	-	-	-	-
Loma Prieta	Seagate Technology	Trane 500 ton	No	Carrier Air C	Yes	-	-	-	-	-	-
Loma Prieta	Seagate Technology	ND	-	Page (4)	Yes	-	-	-	-	-	-
Loma Prieta	Watkins Johnson	Trane 300 ton	No	Baltimore Air	Dismount	-	-	-	-	Twin City Vanea	Yes
Loma Prieta	Watkins Johnson	ND	-	-	Yes	-	-	-	-	-	Yes
Loma Prieta	UC Santa Cruz	Carrier	No	Twin City	No	-	-	TACO 10 hpr (8)	No	-	-
Loma Prieta	UC Santa Cruz	-	-	-	-	-	-	Reliance 25 hpr (2)	No	-	-
Cape Mendocino	Centerville Beach	Trane 100 ton	No	Trane	Yes	-	-	Century 15 hpr (2)	No	-	-

D-4

**Table D-2
CHILLER EQUIPMENT DETAILS**

SITE	CHILLER MANUFACTURER	ELEVATION	CHILLER ANCHORAGE	DAMAGE TO CHILLER?
California Federal	Carrier 500 ton (3)	0	Bumped Isolator	No
Centerville Beach	Trane 100 ton	0	-	No
EPRI Headquarters	Trane 200 ton	0	Not Anchored	No
EPRI Headquarters	Trane 40 ton (8)	20	Spring Isolator	Dismount
Evergreen College	Chrysler 550 ton	0	-	No
Evergreen College	Trane 450 ton	0	-	No
IBM/Santa Teresa	Trane 1000 ton (4)	0	Bolts	No
Lipton Foods	York 125 ton	0	Spring Isolator	No
Lipton Foods	York 580 ton	0	Bolts	No
SCE Headquarters	Carrier 30 ton	40	Spring Isolator	Yes
SCE Headquarters	Carrier 350 ton (2)	-20	Bolts	No
SCE Headquarters	McQuay 600 ton (2)	-20	Bolts	No
SCE Headquarters	ND 5 ton	40	-	Yes
Sanwa Bank Facility	ND	40	Bumped Pads	Yes
Seagate Technology	Trane 500 ton (2)	0	Bolts	No
Ticor Facility	Trane (2)	30	Spring Isolator	Yes
UC Santa Cruz	Carrier	0	Bumped Isolator	No
Watkins Johnson	Trane 300 ton	0	Bolts	No
Wells Fargo	Carrier 350 ton (4)	-20	Bumped Isolator	No

D-5

**Table D-3
AIR HANDLER EQUIPMENT DETAILS**

SITE	AIR HANDLER MANUFACTURER	ELEVATION	AIR HANDLER ANCHORAGE	DAMAGE?
Centerville Beach	Trane	0	Spring Isolator	Yes
IBM/Santa Teresa	McQuay (2)	20	Rod-hung	No
IBM/Santa Teresa	McQuay	80	Spring Isolator	Yes
Seagate Technology	Carrier Air	20	Anchors	Yes
Seagate Technology	Page (4)	20	Spring Isolator	Yes
Sylmar Converter Sta	American Air	12	Spring Isolator	Yes
UC Santa Cruz	Twin City	0	Bolts	No
Watkins Johnson	Baltimore Air	20	Spring Isolator	Dismount

**Table D-4
EVAPORATIVE COOLER EQUIPMENT DETAILS**

SITE	MANUFACTURER	ELEVATION	ANCHORAGE	DAMAGE?
California Federal	Baltimore Air	20	Spring Isolator	No
EPRI Headquarters	Baltimore Air	0	-	No
Lipton Foods	Marley	0	Bolts	No
SCE Headquarters	Marley	60	Spring Isolator	No
Ticor Facility	Baltimore Air	20	Spring Isolator	No

D-7

**Table D-5
PUMP EQUIPMENT DETAILS**

SITE	PUMP MANUFACTURER	ELEVATION	PUMP ANCHORAGE	DAMAGE?
California Federal	No Name Plate 50 hpr (6)	0	Bumped Isolator	No
Centerville Beach	Century 15 hpr (2)	0	Bolts	No
IBM/Santa Teresa	Lincoln 30 hpr (14)	0	Bolts	No
SCE Headquarters	B&G 20 hpr (13)	-20	Bolts	No
SCE Headquarters	Reliance 30 hpr (2)	-20	Bolts	No
Sanwa Bank Facility	No Name Plate 20 hpr (4)	40	Bumped Isolator	Yes
UC Santa Cruz	Reliance 25 hpr (2)	0	Bolts	No
UC Santa Cruz	TACO 10 hpr (8)	0	Bumped Isolator	No
Wells Fargo	No Name Plate 20 hpr (10)	0	Bumped Isolator	No

**Table D-6
FAN EQUIPMENT DETAILS**

SITE	FAN MANUFACTURER	ELEVATION	FAN ANCHORAGE	DAMAGE?
EPRI Headquarters		20	Rubber Pads	Dismount
IBM/Santa Teresa	American SF Vaneaxial	80	Spring Hangers	Yes
Sylmar Converter Sta	Buffalo Centrifugal (18)	30	Spring Isolator	Dismounts
Ticor Facility	No Name Plate Vaneaxial	30	Spring Isolator	Yes
Watkins Johnson	-	30	Spring Isolator	Yes
Watkins Johnson	Twin City Vaneaxial	30	Spring Hangers	Yes

**Table D-7
AIR CONDITIONING SYSTEM SEISMIC DEMAND**

EARTHQUAKE	SITE	PGA	DURATION	SOIL
Cape Mendocino	Centerville Beach	0.40	10	Rock
Loma Prieta	EPRI Headquarters	0.20	10	Rock
Loma Prieta	IBM/Santa Teresa	0.20	10	Soil
Loma Prieta	Lipton Foods	0.30	10	Rock
Loma Prieta	Seagate Technology	0.40	10	Soil
Loma Prieta	UC Santa Cruz	0.45	10	Rock
Loma Prieta	Watkins Johnson	0.35	10	Rock
Morgan Hill	Evergreen College	0.20	20	Soil
San Fernando	Sylmar Converter Sta	0.50	15	Soil
Whittier	California Federal	0.40	3	Soil
Whittier	SCE Headquarters	0.40	3	Soil
Whittier	Sanwa Bank Facility	0.40	3	Rock
Whittier	Ticor Facility	0.40	3	Soil
Whittier	Wells Fargo	0.35	3	Soil

D-10

APPENDIX E

DATA BASE OF POWER DISTRIBUTION SYSTEMS IN COMMERCIAL AND INDUSTRIAL FACILITIES

APPENDIX E
DATA BASE OF POWER DISTRIBUTION SYSTEMS IN COMMERCIAL
AND INDUSTRIAL FACILITIES

For this project, a data base has been compiled of power distribution systems in commercial and industrial facilities. Power facilities have been excluded from this data base. In general, a facility has been included where detailed data are available on motor control centers, switchgear, distribution panels, or transformers.

Information on the power distribution systems reviewed is summarized in Tables E-1 through E-7. The tables are grouped into the following categories:

- Power Distribution System Data
- Motor Control Center Equipment Details
- Low Voltage Switchgear Equipment Details
- Medium Voltage Switchgear Equipment Details
- Distribution Panel Equipment Details
- Transformer Equipment Details
- Power Distribution System Seismic Demand

POWER DISTRIBUTION SYSTEM DATA

Table E-1 presents overall information on the earthquake and site, the number of components of the power distribution system, and whether damage occurred to any of the major components.

Note that in this table, as well as in the other tables in this section, components presented on the same line are not necessarily part of the same power distribution system. Input on different lines for a given component is used to differentiate the number of damaged versus undamaged units, or different manufacturers for units within the same facility.

In this table damage is defined as any documented seismic effect, regardless of system functionality. Therefore, if an unanchored equipment item slid during the earthquake and remained functional, it is still considered to be damaged.

MOTOR CONTROL CENTER EQUIPMENT DETAILS

Table E-2 presents information on motor control center manufacturer, model number, location (above grade) in facility, and anchorage type. A variety of MCC manufacturers are represented. Anchorage types include bolts, welds, clamps, and unanchored cabinets.

LOW VOLTAGE SWITCHGEAR EQUIPMENT DETAILS

Table E-3 presents information on low voltage switchgear manufacturer, breaker model, location (above grade) in facility, and anchorage type. A variety of low voltage switchgear manufacturers are represented.

MEDIUM VOLTAGE SWITCHGEAR EQUIPMENT DETAILS

Table E-4 presents information on medium voltage switchgear manufacturer, breaker voltage, location (above grade) in facility, and anchorage type. Medium voltage switchgear are represented from 2.4 kV to 13.8 kV.

DISTRIBUTION PANEL EQUIPMENT DETAILS

Table E-5 presents information on distribution panel manufacturer, whether the panel is a panelboard (P) or a switchboard (S), location (above grade) in facility, and anchorage type. Distribution panels typically have bolted anchorage.

TRANSFORMER EQUIPMENT DETAILS

Table E-6 presents information on transformer manufacturer, capacity (in kVA), whether the unit is a wet or dry type, whether the transformer is a unit substation or distribution transformer, location (above grade) in facility, and anchorage type. A wide diversity of transformers is represented.

POWER DISTRIBUTION SYSTEMS SEISMIC DEMAND

Table E-7 presents information on peak ground acceleration (PGA) experienced by the power distribution systems, duration of earthquake, soil type and site and earthquake which affected each power distribution system.

The PGA is the average of the two free-field horizontal components. PGAs for the sites reviewed have either been measured or estimated based on the nearest record. The power distribution systems reviewed have experienced PGAs from 0.25g to 0.60g.

The duration of the earthquake is considered to be that length of time for which the ground acceleration in the epicentral area exceeds 0.10g. The power distribution systems reviewed have experienced earthquakes with strong-motion durations ranging from 5 to about 50 seconds.

The facilities are defined in the table as founded on stiff soil when the shear wave velocity of soil is greater than 3500 to 4000 feet per second. Below those values, the facilities are defined as founded on soft soil. The facilities housing the power distribution systems reviewed are located on a variety of soil types (i.e., sand, alluvium, marine sediment, poor clay, limestone, rock, etc.).

Table E-1 (Page 1 of 2)
POWER DISTRIBUTION SYSTEM DATA

EARTHQUAKE	SITE	NO. OF MCC's	MCC DAMAGE?	NO. OF LVSG's	LVSG DAMAGE?	NO. OF MVSG's	MVSG DAMAGE?	NO. OF D. PNL's	D. PNL DAMAGE?	NO. OF X-FRMR's	X-FRMR DAMAGE?
Adak	Adak Naval Base	-	-	2	No	-	-	-	-	1	No
Adak	Adak Naval Base	-	-	-	-	4	No	-	-	1	No
Adak	Adak Naval Base	-	-	-	-	-	-	-	-	1	No
Adak	Adak Naval Base	-	-	-	-	-	-	-	-	3	No
Adak	Adak Naval Base	-	-	-	-	-	-	-	-	1	Yes
Adak	Adak Naval Base	-	-	-	-	-	-	-	-	1	Yes
Whittier	California Federal Bank	3	No	4	No	-	-	1	No	2	No
Whittier	California Federal Bank	-	-	1	Yes	-	-	2	No	4	Yes
Whittier	California Federal Bank	-	-	2	No	-	-	1	No	3	Yes
New Zealand	Caxton Paper Mill	3	No	2	No	2	No	4	No	1	No
New Zealand	Caxton Paper Mill	3	No	1	No	-	-	6	Yes	1	Yes
New Zealand	Caxton Paper Mill	2	No	-	-	-	-	-	-	1	No
New Zealand	Caxton Paper Mill	2	No	-	-	-	-	-	-	4	No
New Zealand	Caxton Paper Mill	4	No	-	-	-	-	-	-	-	-
Loma Prieta	EPRI Headquarters	3	No	1	No	-	-	-	-	1	Yes
Mexico	Fertimex Fertilizer Plant	12	Yes	1	Yes	1	Yes	-	-	-	-
Coalinga	Getty Oil	1	Yes	-	-	1	Yes	2	Yes	1	Yes
Coalinga	Getty Oil	2	Yes	-	-	1	Yes	-	-	1	Yes
Coalinga	Getty Oil	1	No	-	-	-	-	-	-	-	-
Morgan Hill	IBM	1	No	1	No	5	No	-	-	1	No
Morgan Hill	IBM	1	No	-	-	-	-	-	-	1	No
Coalinga	Kettleman Compressor Sta.	6	No	1	No	1	No	2	No	1	No
Coalinga	Kettleman Compressor Sta.	1	No	-	-	-	-	-	-	2	No
Loma Prieta	Lipton Foods	2	No	1	No	-	-	-	-	-	-
Loma Prieta	Lipton Foods	1	No	-	-	-	-	-	-	-	-
Loma Prieta	National Refractory	2	No	2	Yes	1	No	-	-	1	No
Loma Prieta	National Refractory	6	No	1	No	1	No	-	-	1	No
Loma Prieta	National Refractory	1	No	-	-	1	No	-	-	1	No
Loma Prieta	National Refractory	1	No	-	-	-	-	-	-	4	No
New Zealand	New Zealand Distillery	1	Yes	-	-	-	-	-	-	-	-
Chile	Oxiquim	1	No	-	-	-	-	-	-	-	-
Coalinga	Pumping Stations	1	No	-	-	1	No	-	-	1	No
Coalinga	Pumping Stations	1	No	-	-	1	No	-	-	-	-
Coalinga	Pumping Stations	1	No	-	-	1	No	-	-	-	-
Coalinga	Pumping Stations	-	-	-	-	1	Yes	-	-	-	-
Whittier	Sanwa Bank	1	Yes	-	-	-	-	-	-	1	Yes
Loma Prieta	SC Telephone Center	-	-	1	No	-	-	-	-	-	-
Whittier	SCE Dispatch Center	-	-	1	No	-	-	-	-	-	-

E-4

Table E-1 (Page 2 of 2)
POWER DISTRIBUTION SYSTEM DATA

EARTHQUAKE	SITE	NO. OF MCC's	MCC DAMAGE?	NO. OF LVSG's	LVSG DAMAGE?	NO. OF MVSG's	MVSG DAMAGE?	NO. OF D. PNL's	D. PNL DAMAGE?	NO. OF X-FRMR's	X-FRMR DAMAGE?
Whittier	SCE Dispatch Center	-	-	1	No	-	-	2	No	-	-
Whittier	SCE Headquarters	3	No	1	No	-	-	-	-	1	No
Loma Prieta	Seagate Technologies	2	No	4	Yes	-	-	-	-	8	Yes
Loma Prieta	Seagate Technologies	-	-	-	-	-	-	-	-	1	No
Loma Prieta	Seagate Technologies	-	-	-	-	-	-	-	-	1	No
Coalinga	Shell Water Treatment	2	Yes	-	-	-	-	-	-	-	-
Coalinga	Shell Water Treatment	4	No	-	-	-	-	-	-	-	-
Mexico	SICARTSA	2	No	10	No	20	No	-	-	1	Yes
Mexico	SICARTSA	1	Yes	-	-	-	-	-	-	20	Yes
Mexico	SICARTSA	-	-	-	-	-	-	-	-	20	Yes
Coalinga	Union Oil	1	No	-	-	-	-	-	-	1	No
Coalinga	Union Oil	-	-	-	-	-	-	-	-	1	No
Coalinga	Union Oil	-	-	-	-	-	-	1	No	1	Yes
Loma Prieta	Watkins-Johnson	2	No	-	-	-	-	1	No	1	No
Loma Prieta	Watkins-Johnson	-	-	-	-	-	-	-	-	1	No
New Zealand	Whakatane Board Mills	1	Yes	1	No	1	No	-	-	-	-
New Zealand	Whakatane	1	No	-	-	-	-	-	-	-	-
Whittier	Wells Fargo Bank	-	-	-	-	-	-	0	-	1	No
Loma Prieta	W. Valley College	-	-	-	-	-	-	-	-	1	Yes

E-5

**Table E-2
MOTOR CONTROL CENTER EQUIPMENT DETAILS**

SITE	MCC MANUFACTURER	MCC MODEL NO.	MCC ELEV.	MCC ANCHORAGE	MCC DAMAGE?
California Federal Bank	General Electric	8000	0	-	No
Caxton Paper Mill	A&G Price	-	-15	3/8" bolts	No
Caxton Paper Mill	ASEA	-	0	3/8" bolts	No
Caxton Paper Mill	General Electric	7700	-15	-	No
Caxton Paper Mill	Turnbull & Jones	-	0	Bolts	No
Caxton Paper Mill	Turnbull & Jones	-	15	Bolts	No
EPRI Headquarters	Industrial	-	20	None	No
Fertimex Fertilizer Plant	CGE	-	20	3/8" bolts	Yes
Getty Oil	Allen-Bradley	-	0	Rack	No
Getty Oil	Furnas	89	0	Clips	Yes
Getty Oil	Nelson-Electric	-	0	Clips	Yes
IBM	Westinghouse	TypeW	0	Welds	No
IBM	Westinghouse	TypeW	70	Clips	No
Kettleman Compressor Sta.	Square-D	-	0	1/2" bolts	No
Kettleman Compressor Sta.	Westinghouse	11300	3	-	No
Lipton Foods	Cutler Hammer	-	0	Bolts	No
Lipton Foods	Square-D	-	0	Bolts	No
National Refractory	Allen-Bradley	-	0	Bolts	No
National Refractory	Allen-Bradley	-	0	Bolts	No
National Refractory	Cutler-Hammer	-	0	-	No
National Refractory	Square-D	-	0	-	No
New Zealand Distillery	ASEA	-	25	Bolts	Yes
Oxiquim	AEG	-	0	Bolts	No
Pumping Stations	General Electric	7700	0	-	No
Pumping Stations	Westinghouse	11300	0	3/8" bolts	No
Pumping Stations	Westinghouse	TypeW	0	3/8" bolts	No
SCE Headquarters	General Electric	8000	-15	-	No
SICARTSA	CGE	-	0	Welds	Yes
SICARTSA	Cutler-Hammer	-	50	-	No
Sanwa Bank	Sylvania	-	0	3/8" bolts	Yes
Seagate Technologies	Westinghouse	5Star	0	-	No
Shell Water Treatment	Westinghouse	-	0	Bolts	No
Shell Water Treatment	Westinghouse	5Star	0	Clamps	Yes
Union Oil	ITE/Gould	-	0	-	No
Watkins-Johnson	General Electric	7700	0	None	No
Whakatane	ASEA	-	0	Bolts	No
Whakatane Board Mills	ASEA	-	15	Bolts	Yes

**Table E-3
LOW VOLTAGE SWITCHGEAR EQUIPMENT DETAILS**

SITE	NO. OF LVSG	LVSG MANUFACTURER	LVSG MODEL NO.	LVSG ELEV.	LVSG ANCHORAGE	LVSG DAMAGE?
Adak Naval Base	2	General Electric	AKD-5	0	-	No
California Federal Bank	1	Emerson	ND	20	-	Yes
California Federal Bank	2	General Electric	ND	20	1/2" bolts	No
California Federal Bank	4	Westinghouse	ND	0	None	No
Caxton Paper Mill	1	Cutler Hammer	ND	0	3/8" bolts	No
Caxton Paper Mill	2	Andrews	ND	0	-	No
EPRI Headquarters	1	General Electric	ND	0	-	No
Fertimex Fertilizer Plant	1	Sace	ND	20	-	Yes
IBM	1	FPE	ND	0	1/2" bolts	No
Kettleman Compressor Sta.	1	Westinghouse	ND	0	-	No
Lipton Foods	1	ITE	ND	0	Brackets	No
National Refractory	1	Siemans-Allis	ND	0	None	No
National Refractory	2	General Electric	AKD-5	0	None	Yes
SC Telephone	1	FPE	ND	0	-	No
SCE Dispatch Center	1	General Electric	ND	0	-	No
SCE Dispatch Center	1	VoltSwitch	ND	0	-	No
SCE Headquarters	1	General Electric	ND	0	-	No
SICARTSA	10	Silco Asgen	ND	20	-	No
Seagate Technologies	4	ITE	ND	0	-	Yes
Whakatane Board Mills	1	GE Canada	ND	0	Bolts	No

E-7

**Table E-4
MEDIUM VOLTAGE SWITCHGEAR EQUIPMENT DETAILS**

SITE	NO. OF MVSG's	MVSG MANUFACTURER	MVSG VOLTAGE	MVSG ELEV.	MVSG ANCHORAGE	MVSG DAMAGE?
Adak Naval Base	4	General Electric	13.8	0	-	No
Caxton Paper Mill	2	Yorkshire	11	-15	1/2" bolts	No
Fertimex Fertilizer	1	Siemens	13.8	0	-	Yes
Getty Oil	1	General Electric	4	0	5/8" bolts	Yes
Getty Oil	1	Nelson Electric	2.4	0	Clamps	Yes
IBM	5	FPE	12	0	1/2" bolts	No
Kettleman Compressor	1	Westinghouse	2.4	3	-	No
National Refractory	1	FPE	13.8	0	Welds	No
National Refractory	1	FPE	2.3	0	-	No
National Refractory	1	General Electric	2.3	0	-	No
Pumping Stations	1	General Electric	2.3	0	-	No
Pumping Stations	1	General Electric	2.4	0	Clamps	No
Pumping Stations	1	Westinghouse	2.3	0	-	No
SICARTSA	20	Silco Asgen	13.8	20	-	No
Whakatane Board	1	Asea	11	0	-	No

E-9

**Table E-5
DISTRIBUTION PANEL EQUIPMENT DETAILS**

SITE	NO. OF DIST. PANEL's	DIST. PANEL MANUFACTURER	SWITCHBOARD/ PANELBOARD	DIST. PANEL ELEVATION	DIST. PANEL ANCHORAGE	DIST. PANEL DAMAGE?
California Federal	1	Benjamin Electric	Sw	20	1/2" bolts	No
California Federal	1	General Electric	Sw	20	1/2" bolts	No
California Federal	2	General Electric	Panel	0	1/4" bolts	No
Caxton Paper Mill	4	Andrews	Sw	-15	Bolts	No
Getty Oil	2	Westinghouse	Panel	0	Clamps	Yes
Kettleman Compressor	2	Westinghouse	Sw	0	1/2" bolts	No
SCE Dispatch Center	2	General Electric	Sw	-15	None	No
Union Oil	1	General Electric	Sw	20	-	No
Watkins-Johnson	1	Sierra	Sw	0	-	No

**Table E-6
TRANSFORMER EQUIPMENT DETAILS**

SITE	TRANSFORMER MANUFACTURER	CAPACITY (kVA)	WET/DRY TRANSFORMER	UNIT SUBSTATION /DISTRIBUTION	TRANSFORMER ELEVATION	TRANSFORMER ANCHORAGE	TRANSFORMER DAMAGE?
Adak Naval Base	FPE	2000	Dry	Unit	0	None	Yes
Adak Naval Base	FPE	40	Dry	Dist.	0	None	Yes
Adak Naval Base	General Electric	300	Wet	Unit	0	None	No
Adak Naval Base	Sierra	300	Wet	Unit	0	Clips	No
Adak Naval Base	Vista	-	Wet	Unit	0	None	No
Adak Naval Base	Westinghouse	-	Dry	Dist.	0	None	No
California Federal Bank	General Electric	112.5	Dry	Dist.	0	3/8" bolts	No
California Federal Bank	General Electric	150	Dry	Dist.	30	3/8" bolts	Yes
California Federal Bank	Westinghouse	-	Wet	Unit	0	None	Yes
Caxton Paper Mill	International	4	Dry	Dist.	0	3/16" bolts	No
Caxton Paper Mill	Long & Crawford	250	Dry	Dist.	0	None	Yes
Caxton Paper Mill	Trotman	-	Dry	Dist.	-15	3/8" bolts	No
Caxton Paper Mill	Xformer Windrs	5	Dry	Dist.	-15	Bolts	No
Getty Oil	Sierra	200	Wet	Unit	0	None	Yes
Getty Oil	Sierra	300	Wet	Unit	0	Clips	Yes
IBM	FPE	2000	Dry	Unit	0	Bolts	No
IBM	Westinghouse	50	Dry	Dist.	0	None	No
Kettleman Compressor Sta.	Gardener	37	Dry	Dist.	0	1/2" bolts	No
Kettleman Compressor Sta.	Square-D	30	Dry	Dist.	0	1/2" bolts	No
National Refractory	General Electric	1500	Wet	Unit	0	None	No
National Refractory	RTE	1120	Wet	Unit	0	None	No
National Refractory	Sylvania	1000	Dry	Unit	0	None	No
National Refractory	Sylvania	50	Dry	Dist.	0	-	No
Pumping Stations	Pacific	225	Wet	Dist.	0	None	No
SCE Headquarters	Zinsco	50	Dry	Dist.	0	Bolts	No
SICARTSA	IEM	2000	Wet	Unit	0	None	Yes
SICARTSA	IEM	2000	Wet	Unit	0	Rails	Yes
Seagate Technologies	Balteau	-	Wet	Unit	0	-	No
Seagate Technologies	Industrial	2000	Dry	Unit	0	-	Yes
Seagate Technologies	Industrial	225	Dry	Dist.	-15	3/8" bolts	No
Union Oil	ACME Electric	30	Dry	Dist.	0	3/8" bolts	Yes
Union Oil	ACME Electric	5	Dry	Dist.	8	Welds	No
Union Oil	ACME Electric	9	Dry	Dist.	0	None	No
W. Valley College	Sierra	-	Wet	Unit	0	None	Yes
Watkins-Johnson	General Electric	300	Dry	Dist.	30	-	No
Watkins-Johnson	International	300	Dry	Dist.	20	3/8" bolts	No
Wells Fargo Bank	MGN	300	Dry	Dist.	-20	None	No

Table E-7 (Page 1 of 2)
POWER DISTRIBUTION SYSTEM SEISMIC DEMAND

EARTHQUAKE	SITE	PGA (g's)	DURATION (sec)	SOIL TYPE
Adak	Adak Naval Base	0.25	25	Soil
Adak	Adak Naval Base	0.25	25	Soil
Adak	Adak Naval Base	0.25	25	Soil
Adak	Adak Naval Base	0.25	25	Soil
Adak	Adak Naval Base	0.25	25	Soil
Adak	Adak Naval Base	0.25	25	Soil
Whittier	California Federal Bank	0.40	3	Soil
Whittier	California Federal Bank	0.40	3	Soil
Whittier	California Federal Bank	0.40	3	Soil
New Zealand	Caxton Paper Mill	0.40	10	Soil
New Zealand	Caxton Paper Mill	0.40	10	Soil
New Zealand	Caxton Paper Mill	0.40	10	Soil
New Zealand	Caxton Paper Mill	0.40	10	Soil
New Zealand	Caxton Paper Mill	0.40	10	Soil
Loma Prieta	EPRI Headquarters	0.25	10	Rock
Mexico	Fertimex Fertilizer Plant	0.25	50	Soil
Coalinga	Getty Oil	0.60	10	Soil
Coalinga	Getty Oil	0.60	10	Soil
Coalinga	Getty Oil	0.60	10	Soil
Morgan Hill	IBM	0.37	20	Soil
Morgan Hill	IBM	0.37	20	Soil
Coalinga	Kettleman Compressor Sta.	0.20	10	Soil
Coalinga	Kettleman Compressor Sta.	0.20	10	Soil
Loma Prieta	Lipton Foods	0.30	10	Rock
Loma Prieta	Lipton Foods	0.30	10	Rock
Loma Prieta	National Refractory	0.30	10	Soil
Loma Prieta	National Refractory	0.30	10	Soil
Loma Prieta	National Refractory	0.30	10	Soil
Loma Prieta	National Refractory	0.30	10	Soil
New Zealand	New Zealand Distillery	0.50	10	Soil
Chile	Oxiquim	0.30	40	Soil
Coalinga	Pumping Stations	0.35	10	Soil
Coalinga	Pumping Stations	0.35	10	Soil
Coalinga	Pumping Stations	0.35	10	Soil
Coalinga	Pumping Stations	0.35	10	Soil

E-11

Table E-7 (Page 2 of 2)
POWER DISTRIBUTION SYSTEM SEISMIC DEMAND

EARTHQUAKE	SITE	PGA (g's)	DURATION (sec)	SOIL TYPE
Whittier	Sanwa Bank	0.40	3	Rock
Loma Prieta	SC Telephone	0.40	10	Soil
Whittier	SCE Dispatch Center	0.56	3	Soil
Whittier	SCE Dispatch Center	0.56	3	Soil
Whittier	SCE Headquarters	0.40	3	Soil
Loma Prieta	Seagate Technologies	0.33	10	Soil
Loma Prieta	Seagate Technologies	0.33	10	Soil
Loma Prieta	Seagate Technologies	0.33	10	Soil
Coalinga	Shell Water Treatment	0.60	10	Soil
Coalinga	Shell Water Treatment	0.60	10	Soil
Mexico	SICARTSA	0.25	50	Soil
Mexico	SICARTSA	0.25	50	Soil
Mexico	SICARTSA	0.25	50	Soil
Coalinga	Union Oil	0.60	10	Soil
Coalinga	Union Oil	0.60	10	Soil
Coalinga	Union Oil	0.60	10	Soil
Loma Prieta	Watkins-Johnson	0.35	10	Rock
Loma Prieta	Watkins-Johnson	0.35	10	Rock
New Zealand	Whakatane Board Mills	0.25	10	Soil
New Zealand	Whakatane	0.25	10	Soil
Whittier	Wells Fargo Bank	0.35	3	Soil
Loma Prieta	W. Valley College	0.30	10	Soil

E-12

**NATIONAL CENTER FOR EARTHQUAKE ENGINEERING RESEARCH
LIST OF TECHNICAL REPORTS**

The National Center for Earthquake Engineering Research (NCEER) publishes technical reports on a variety of subjects related to earthquake engineering written by authors funded through NCEER. These reports are available from both NCEER's Publications Department and the National Technical Information Service (NTIS). Requests for reports should be directed to the Publications Department, National Center for Earthquake Engineering Research, State University of New York at Buffalo, Red Jacket Quadrangle, Buffalo, New York 14261. Reports can also be requested through NTIS, 5285 Port Royal Road, Springfield, Virginia 22161. NTIS accession numbers are shown in parenthesis, if available.

- NCEER-87-0001 "First-Year Program in Research, Education and Technology Transfer," 3/5/87, (PB88-134275).
- NCEER-87-0002 "Experimental Evaluation of Instantaneous Optimal Algorithms for Structural Control," by R.C. Lin, T.T. Soong and A.M. Reinhorn, 4/20/87, (PB88-134341).
- NCEER-87-0003 "Experimentation Using the Earthquake Simulation Facilities at University at Buffalo," by A.M. Reinhorn and R.L. Ketter, to be published.
- NCEER-87-0004 "The System Characteristics and Performance of a Shaking Table," by J.S. Hwang, K.C. Chang and G.C. Lee, 6/1/87, (PB88-134259). This report is available only through NTIS (see address given above).
- NCEER-87-0005 "A Finite Element Formulation for Nonlinear Viscoplastic Material Using a Q Model," by O. Gyebi and G. Dasgupta, 11/2/87, (PB88-213764).
- NCEER-87-0006 "Symbolic Manipulation Program (SMP) - Algebraic Codes for Two and Three Dimensional Finite Element Formulations," by X. Lee and G. Dasgupta, 11/9/87, (PB88-218522).
- NCEER-87-0007 "Instantaneous Optimal Control Laws for Tall Buildings Under Seismic Excitations," by J.N. Yang, A. Akbarpour and P. Ghaemmaghami, 6/10/87, (PB88-134333). This report is only available through NTIS (see address given above).
- NCEER-87-0008 "IDARC: Inelastic Damage Analysis of Reinforced Concrete Frame - Shear-Wall Structures," by Y.J. Park, A.M. Reinhorn and S.K. Kunnath, 7/20/87, (PB88-134325).
- NCEER-87-0009 "Liquefaction Potential for New York State: A Preliminary Report on Sites in Manhattan and Buffalo," by M. Budhu, V. Vijayakumar, R.F. Giese and L. Baumgras, 8/31/87, (PB88-163704). This report is available only through NTIS (see address given above).
- NCEER-87-0010 "Vertical and Torsional Vibration of Foundations in Inhomogeneous Media," by A.S. Veletsos and K.W. Dotson, 6/1/87, (PB88-134291).
- NCEER-87-0011 "Seismic Probabilistic Risk Assessment and Seismic Margins Studies for Nuclear Power Plants," by Howard H.M. Hwang, 6/15/87, (PB88-134267).
- NCEER-87-0012 "Parametric Studies of Frequency Response of Secondary Systems Under Ground-Acceleration Excitations," by Y. Yong and Y.K. Lin, 6/10/87, (PB88-134309).
- NCEER-87-0013 "Frequency Response of Secondary Systems Under Seismic Excitation," by J.A. HoLung, J. Cai and Y.K. Lin, 7/31/87, (PB88-134317).
- NCEER-87-0014 "Modelling Earthquake Ground Motions in Seismically Active Regions Using Parametric Time Series Methods," by G.W. Ellis and A.S. Cakmak, 8/25/87, (PB88-134283).
- NCEER-87-0015 "Detection and Assessment of Seismic Structural Damage," by E. DiPasquale and A.S. Cakmak, 8/25/87, (PB88-163712).

- NCEER-87-0016 "Pipeline Experiment at Parkfield, California," by J. Isenberg and E. Richardson, 9/15/87, (PB88-163720). This report is available only through NTIS (see address given above).
- NCEER-87-0017 "Digital Simulation of Seismic Ground Motion," by M. Shinozuka, G. Deodatis and T. Harada, 8/31/87, (PB88-155197). This report is available only through NTIS (see address given above).
- NCEER-87-0018 "Practical Considerations for Structural Control: System Uncertainty, System Time Delay and Truncation of Small Control Forces," J.N. Yang and A. Akbarpour, 8/10/87, (PB88-163738).
- NCEER-87-0019 "Modal Analysis of Nonclassically Damped Structural Systems Using Canonical Transformation," by J.N. Yang, S. Sarkani and F.X. Long, 9/27/87, (PB88-187851).
- NCEER-87-0020 "A Nonstationary Solution in Random Vibration Theory," by J.R. Red-Horse and P.D. Spanos, 11/3/87, (PB88-163746).
- NCEER-87-0021 "Horizontal Impedances for Radially Inhomogeneous Viscoelastic Soil Layers," by A.S. Veletsos and K.W. Dotson, 10/15/87, (PB88-150859).
- NCEER-87-0022 "Seismic Damage Assessment of Reinforced Concrete Members," by Y.S. Chung, C. Meyer and M. Shinozuka, 10/9/87, (PB88-150867). This report is available only through NTIS (see address given above).
- NCEER-87-0023 "Active Structural Control in Civil Engineering," by T.T. Soong, 11/11/87, (PB88-187778).
- NCEER-87-0024 "Vertical and Torsional Impedances for Radially Inhomogeneous Viscoelastic Soil Layers," by K.W. Dotson and A.S. Veletsos, 12/87, (PB88-187786).
- NCEER-87-0025 "Proceedings from the Symposium on Seismic Hazards, Ground Motions, Soil-Liquefaction and Engineering Practice in Eastern North America," October 20-22, 1987, edited by K.H. Jacob, 12/87, (PB88-188115).
- NCEER-87-0026 "Report on the Whittier-Narrows, California, Earthquake of October 1, 1987," by J. Pantelic and A. Reinhorn, 11/87, (PB88-187752). This report is available only through NTIS (see address given above).
- NCEER-87-0027 "Design of a Modular Program for Transient Nonlinear Analysis of Large 3-D Building Structures," by S. Srivastav and J.F. Abel, 12/30/87, (PB88-187950).
- NCEER-87-0028 "Second-Year Program in Research, Education and Technology Transfer," 3/8/88, (PB88-219480).
- NCEER-88-0001 "Workshop on Seismic Computer Analysis and Design of Buildings With Interactive Graphics," by W. McGuire, J.F. Abel and C.H. Conley, 1/18/88, (PB88-187760).
- NCEER-88-0002 "Optimal Control of Nonlinear Flexible Structures," by J.N. Yang, F.X. Long and D. Wong, 1/22/88, (PB88-213772).
- NCEER-88-0003 "Substructuring Techniques in the Time Domain for Primary-Secondary Structural Systems," by G.D. Manolis and G. Juhn, 2/10/88, (PB88-213780).
- NCEER-88-0004 "Iterative Seismic Analysis of Primary-Secondary Systems," by A. Singhal, L.D. Lutes and P.D. Spanos, 2/23/88, (PB88-213798).
- NCEER-88-0005 "Stochastic Finite Element Expansion for Random Media," by P.D. Spanos and R. Ghanem, 3/14/88, (PB88-213806).

- NCEER-88-0006 "Combining Structural Optimization and Structural Control," by F.Y. Cheng and C.P. Pantelides, 1/10/88, (PB88-213814).
- NCEER-88-0007 "Seismic Performance Assessment of Code-Designed Structures," by H.H-M. Hwang, J-W. Jaw and H-J. Shau, 3/20/88. (PB88-219423).
- NCEER-88-0008 "Reliability Analysis of Code-Designed Structures Under Natural Hazards," by H.H-M. Hwang, H. Ushiba and M. Shinozuka, 2/29/88, (PB88-229471).
- NCEER-88-0009 "Seismic Fragility Analysis of Shear Wall Structures," by J-W Jaw and H.H-M. Hwang, 4/30/88, (PB89-102867).
- NCEER-88-0010 "Base Isolation of a Multi-Story Building Under a Harmonic Ground Motion - A Comparison of Performances of Various Systems," by F-G Fan, G. Ahmadi and I.G. Tadjbakhsh, 5/18/88, (PB89-122238).
- NCEER-88-0011 "Seismic Floor Response Spectra for a Combined System by Green's Functions," by F.M. Lavelle, L.A. Bergman and P.D. Spanos, 5/1/88, (PB89-102875).
- NCEER-88-0012 "A New Solution Technique for Randomly Excited Hysteretic Structures," by G.Q. Cai and Y.K. Lin, 5/16/88, (PB89-102883).
- NCEER-88-0013 "A Study of Radiation Damping and Soil-Structure Interaction Effects in the Centrifuge," by K. Weissman, supervised by J.H. Prevost, 5/24/88, (PB89-144703).
- NCEER-88-0014 "Parameter Identification and Implementation of a Kinematic Plasticity Model for Frictional Soils," by J.H. Prevost and D.V. Griffiths, to be published.
- NCEER-88-0015 "Two- and Three- Dimensional Dynamic Finite Element Analyses of the Long Valley Dam," by D.V. Griffiths and J.H. Prevost, 6/17/88, (PB89-144711).
- NCEER-88-0016 "Damage Assessment of Reinforced Concrete Structures in Eastern United States," by A.M. Reinhorn, M.J. Seidel, S.K. Kunnath and Y.J. Park, 6/15/88, (PB89-122220).
- NCEER-88-0017 "Dynamic Compliance of Vertically Loaded Strip Foundations in Multilayered Viscoelastic Soils," by S. Ahmad and A.S.M. Israil, 6/17/88, (PB89-102891).
- NCEER-88-0018 "An Experimental Study of Seismic Structural Response With Added Viscoelastic Dampers," by R.C. Lin, Z. Liang, T.T. Soong and R.H. Zhang, 6/30/88, (PB89-122212). This report is available only through NTIS (see address given above).
- NCEER-88-0019 "Experimental Investigation of Primary - Secondary System Interaction," by G.D. Manolis, G. Juhn and A.M. Reinhorn, 5/27/88, (PB89-122204).
- NCEER-88-0020 "A Response Spectrum Approach For Analysis of Nonclassically Damped Structures," by J.N. Yang, S. Sarkani and F.X. Long, 4/22/88, (PB89-102909).
- NCEER-88-0021 "Seismic Interaction of Structures and Soils: Stochastic Approach," by A.S. Veletsos and A.M. Prasad, 7/21/88, (PB89-122196).
- NCEER-88-0022 "Identification of the Serviceability Limit State and Detection of Seismic Structural Damage," by E. DiPasquale and A.S. Cakmak, 6/15/88, (PB89-122188). This report is available only through NTIS (see address given above).
- NCEER-88-0023 "Multi-Hazard Risk Analysis: Case of a Simple Offshore Structure," by B.K. Bhartia and E.H. Vanmarcke, 7/21/88, (PB89-145213).

- NCEER-88-0024 "Automated Seismic Design of Reinforced Concrete Buildings," by Y.S. Chung, C. Meyer and M. Shinozuka. 7/5/88. (PB89-122170). This report is available only through NTIS (see address given above).
- NCEER-88-0025 "Experimental Study of Active Control of MDOF Structures Under Seismic Excitations," by L.L. Chung, R.C. Lin, T.T. Soong and A.M. Reinhorn. 7/10/88, (PB89-122600).
- NCEER-88-0026 "Earthquake Simulation Tests of a Low-Rise Metal Structure," by J.S. Hwang, K.C. Chang, G.C. Lee and R.L. Ketter, 8/1/88, (PB89-102917).
- NCEER-88-0027 "Systems Study of Urban Response and Reconstruction Due to Catastrophic Earthquakes," by F. Kozin and H.K. Zhou, 9/22/88, (PB90-162348).
- NCEER-88-0028 "Seismic Fragility Analysis of Plane Frame Structures." by H.H-M. Hwang and Y.K. Low, 7/31/88, (PB89-131445).
- NCEER-88-0029 "Response Analysis of Stochastic Structures," by A. Kardara, C. Bucher and M. Shinozuka. 9/22/88, (PB89-174429).
- NCEER-88-0030 "Nonnormal Accelerations Due to Yielding in a Primary Structure," by D.C.K. Chen and L.D. Lutes, 9/19/88. (PB89-131437).
- NCEER-88-0031 "Design Approaches for Soil-Structure Interaction," by A.S. Veletsos, A.M. Prasad and Y. Tang, 12/30/88, (PB89-174437). This report is available only through NTIS (see address given above).
- NCEER-88-0032 "A Re-evaluation of Design Spectra for Seismic Damage Control." by C.J. Turkstra and A.G. Tallin, 11/7/88, (PB89-145221).
- NCEER-88-0033 "The Behavior and Design of Noncontact Lap Splices Subjected to Repeated Inelastic Tensile Loading," by V.E. Sagan, P. Gergely and R.N. White, 12/8/88, (PB89-163737).
- NCEER-88-0034 "Seismic Response of Pile Foundations," by S.M. Mamoon, P.K. Banerjee and S. Ahmad, 11/1/88, (PB89-145239).
- NCEER-88-0035 "Modeling of R/C Building Structures With Flexible Floor Diaphragms (IDARC2)," by A.M. Reinhorn, S.K. Kunnath and N. Panahshahi, 9/7/88, (PB89-207153).
- NCEER-88-0036 "Solution of the Dam-Reservoir Interaction Problem Using a Combination of FEM, BEM with Particular Integrals, Modal Analysis, and Substructuring," by C-S. Tsai, G.C. Lee and R.L. Ketter, 12/31/88, (PB89-207146).
- NCEER-88-0037 "Optimal Placement of Actuators for Structural Control," by F.Y. Cheng and C.P. Pantelides. 8/15/88, (PB89-162846).
- NCEER-88-0038 "Teflon Bearings in Aseismic Base Isolation: Experimental Studies and Mathematical Modeling," by A. Mokha, M.C. Constantinou and A.M. Reinhorn, 12/5/88. (PB89-218457). This report is available only through NTIS (see address given above).
- NCEER-88-0039 "Seismic Behavior of Flat Slab High-Rise Buildings in the New York City Area," by P. Weidlinger and M. Ettouney, 10/15/88, (PB90-145681).
- NCEER-88-0040 "Evaluation of the Earthquake Resistance of Existing Buildings in New York City," by P. Weidlinger and M. Ettouney, 10/15/88. to be published.
- NCEER-88-0041 "Small-Scale Modeling Techniques for Reinforced Concrete Structures Subjected to Seismic Loads," by W. Kim, A. El-Attar and R.N. White, 11/22/88, (PB89-189625).

- NCEER-88-0042 "Modeling Strong Ground Motion from Multiple Event Earthquakes," by G.W. Ellis and A.S. Cakmak, 10/15/88, (PB89-174445).
- NCEER-88-0043 "Nonstationary Models of Seismic Ground Acceleration," by M. Grigoriu, S.E. Ruiz and E. Rosenblueth, 7/15/88. (PB89-189617).
- NCEER-88-0044 "SARCF User's Guide: Seismic Analysis of Reinforced Concrete Frames," by Y.S. Chung, C. Meyer and M. Shinozuka, 11/9/88, (PB89-174452).
- NCEER-88-0045 "First Expert Panel Meeting on Disaster Research and Planning," edited by J. Pantelic and J. Stoyke, 9/15/88, (PB89-174460).
- NCEER-88-0046 "Preliminary Studies of the Effect of Degrading Infill Walls on the Nonlinear Seismic Response of Steel Frames," by C.Z. Chrysostomou, P. Gergely and J.F. Abel, 12/19/88, (PB89-208383).
- NCEER-88-0047 "Reinforced Concrete Frame Component Testing Facility - Design, Construction, Instrumentation and Operation," by S.P. Pessiki, C. Conley, T. Bond, P. Gergely and R.N. White, 12/16/88, (PB89-174478).
- NCEER-89-0001 "Effects of Protective Cushion and Soil Compliancy on the Response of Equipment Within a Seismically Excited Building," by J.A. HoLung, 2/16/89, (PB89-207179).
- NCEER-89-0002 "Statistical Evaluation of Response Modification Factors for Reinforced Concrete Structures," by H.H-M. Hwang and J-W. Jaw, 2/17/89, (PB89-207187).
- NCEER-89-0003 "Hysteretic Columns Under Random Excitation," by G-Q. Cai and Y.K. Lin, 1/9/89, (PB89-196513).
- NCEER-89-0004 "Experimental Study of 'Elephant Foot Bulge' Instability of Thin-Walled Metal Tanks," by Z-H. Jia and R.L. Ketter, 2/22/89, (PB89-207195).
- NCEER-89-0005 "Experiment on Performance of Buried Pipelines Across San Andrcas Fault," by J. Isenberg, E. Richardson and T.D. O'Rourke, 3/10/89, (PB89-218440). This report is available only through NTIS (see address given above).
- NCEER-89-0006 "A Knowledge-Based Approach to Structural Design of Earthquake-Resistant Buildings," by M. Subramani, P. Gergely, C.H. Conley, J.F. Abel and A.H. Zaghw, 1/15/89, (PB89-218465).
- NCEER-89-0007 "Liquefaction Hazards and Their Effects on Buried Pipelines," by T.D. O'Rourke and P.A. Lane, 2/1/89, (PB89-218481).
- NCEER-89-0008 "Fundamentals of System Identification in Structural Dynamics," by H. Imai, C-B. Yun, O. Maruyama and M. Shinozuka, 1/26/89, (PB89-207211).
- NCEER-89-0009 "Effects of the 1985 Michoacan Earthquake on Water Systems and Other Buried Lifelines in Mexico," by A.G. Ayala and M.J. O'Rourke, 3/8/89, (PB89-207229).
- NCEER-89-R010 "NCEER Bibliography of Earthquake Education Materials," by K.E.K. Ross, Second Revision, 9/1/89, (PB90-125352).
- NCEER-89-0011 "Inelastic Three-Dimensional Response Analysis of Reinforced Concrete Building Structures (IDARC-3D), Part I - Modeling," by S.K. Kunnath and A.M. Reinhorn, 4/17/89, (PB90-114612).
- NCEER-89-0012 "Recommended Modifications to ATC-14," by C.D. Poland and J.O. Malley, 4/12/89, (PB90-108648).

- NCEER-89-0013 "Repair and Strengthening of Beam-to-Column Connections Subjected to Earthquake Loading," by M. Corazao and A.J. Durrani, 2/28/89, (PB90-109885).
- NCEER-89-0014 "Program EXKAL2 for Identification of Structural Dynamic Systems," by O. Maruyama, C-B. Yun, M. Hoshiya and M. Shinozuka, 5/19/89, (PB90-109877).
- NCEER-89-0015 "Response of Frames With Bolted Semi-Rigid Connections, Part I - Experimental Study and Analytical Predictions," by P.J. DiCorso, A.M. Reinhorn, J.R. Dickerson, J.B. Radzinski and W.L. Harper, 6/1/89, to be published.
- NCEER-89-0016 "ARMA Monte Carlo Simulation in Probabilistic Structural Analysis," by P.D. Spanos and M.P. Mignolet, 7/10/89, (PB90-109893).
- NCEER-89-P017 "Preliminary Proceedings from the Conference on Disaster Preparedness - The Place of Earthquake Education in Our Schools," Edited by K.E.K. Ross, 6/23/89, (PB90-108606).
- NCEER-89-0017 "Proceedings from the Conference on Disaster Preparedness - The Place of Earthquake Education in Our Schools," Edited by K.E.K. Ross, 12/31/89, (PB90-207895). This report is available only through NTIS (see address given above).
- NCEER-89-0018 "Multidimensional Models of Hysteretic Material Behavior for Vibration Analysis of Shape Memory Energy Absorbing Devices, by E.J. Graesser and F.A. Cozzarelli, 6/7/89, (PB90-164146).
- NCEER-89-0019 "Nonlinear Dynamic Analysis of Three-Dimensional Base Isolated Structures (3D-BASIS)," by S. Nagarajaiah, A.M. Reinhorn and M.C. Constantinou, 8/3/89, (PB90-161936). This report is available only through NTIS (see address given above).
- NCEER-89-0020 "Structural Control Considering Time-Rate of Control Forces and Control Rate Constraints," by F.Y. Cheng and C.P. Pantelides, 8/3/89, (PB90-120445).
- NCEER-89-0021 "Subsurface Conditions of Memphis and Shelby County," by K.W. Ng, T-S. Chang and H-H.M. Hwang, 7/26/89, (PB90-120437).
- NCEER-89-0022 "Seismic Wave Propagation Effects on Straight Jointed Buried Pipelines," by K. Elhadi and M.J. O'Rourke, 8/24/89, (PB90-162322).
- NCEER-89-0023 "Workshop on Serviceability Analysis of Water Delivery Systems," edited by M. Grigoriu, 3/6/89, (PB90-127424).
- NCEER-89-0024 "Shaking Table Study of a 1/5 Scale Steel Frame Composed of Tapered Members," by K.C. Chang, J.S. Hwang and G.C. Lee, 9/18/89, (PB90-160169).
- NCEER-89-0025 "DYNA1D: A Computer Program for Nonlinear Seismic Site Response Analysis - Technical Documentation," by Jean H. Prevost, 9/14/89, (PB90-161944). This report is available only through NTIS (see address given above).
- NCEER-89-0026 "1:4 Scale Model Studies of Active Tendon Systems and Active Mass Dampers for Aseismic Protection," by A.M. Reinhorn, T.T. Soong, R.C. Lin, Y.P. Yang, Y. Fukao, H. Abe and M. Nakai, 9/15/89, (PB90-173246).
- NCEER-89-0027 "Scattering of Waves by Inclusions in a Nonhomogeneous Elastic Half Space Solved by Boundary Element Methods," by P.K. Hadley, A. Askar and A.S. Cakmak, 6/15/89, (PB90-145699).
- NCEER-89-0028 "Statistical Evaluation of Deflection Amplification Factors for Reinforced Concrete Structures," by H.H.M. Hwang, J-W. Jaw and A.L. Ch'ng, 8/31/89, (PB90-164633).

- NCEER-89-0029 "Bedrock Accelerations in Memphis Area Due to Large New Madrid Earthquakes," by H.H.M. Hwang, C.H.S. Chen and G. Yu, 11/7/89, (PB90-162330).
- NCEER-89-0030 "Seismic Behavior and Response Sensitivity of Secondary Structural Systems," by Y.Q. Chen and T.T. Soong, 10/23/89, (PB90-164658).
- NCEER-89-0031 "Random Vibration and Reliability Analysis of Primary-Secondary Structural Systems," by Y. Ibrahim, M. Grigoriu and T.T. Soong, 11/10/89, (PB90-161951).
- NCEER-89-0032 "Proceedings from the Second U.S. - Japan Workshop on Liquefaction, Large Ground Deformation and Their Effects on Lifelines, September 26-29, 1989," Edited by T.D. O'Rourke and M. Hamada, 12/1/89, (PB90-209388).
- NCEER-89-0033 "Deterministic Model for Seismic Damage Evaluation of Reinforced Concrete Structures," by J.M. Bracci, A.M. Reinhorn, J.B. Mander and S.K. Kunnath, 9/27/89.
- NCEER-89-0034 "On the Relation Between Local and Global Damage Indices," by E. DiPasquale and A.S. Cakmak, 8/15/89, (PB90-173865).
- NCEER-89-0035 "Cyclic Undrained Behavior of Nonplastic and Low Plasticity Silts," by A.J. Walker and H.E. Stewart, 7/26/89, (PB90-183518).
- NCEER-89-0036 "Liquefaction Potential of Surficial Deposits in the City of Buffalo, New York," by M. Budhu, R. Giese and L. Baumgrass, 1/17/89, (PB90-208455).
- NCEER-89-0037 "A Deterministic Assessment of Effects of Ground Motion Incoherence," by A.S. Veletsos and Y. Tang, 7/15/89, (PB90-164294).
- NCEER-89-0038 "Workshop on Ground Motion Parameters for Seismic Hazard Mapping," July 17-18, 1989, edited by R.V. Whitman, 12/1/89, (PB90-173923).
- NCEER-89-0039 "Seismic Effects on Elevated Transit Lines of the New York City Transit Authority," by C.J. Costantino, C.A. Miller and E. Heymsfield, 12/26/89, (PB90-207887).
- NCEER-89-0040 "Centrifugal Modeling of Dynamic Soil-Structure Interaction," by K. Weissman, Supervised by J.H. Prevost, 5/10/89, (PB90-207879).
- NCEER-89-0041 "Linearized Identification of Buildings With Cores for Seismic Vulnerability Assessment," by I-K. Ho and A.E. Aktan, 11/1/89, (PB90-251943).
- NCEER-90-0001 "Geotechnical and Lifeline Aspects of the October 17, 1989 Loma Prieta Earthquake in San Francisco," by T.D. O'Rourke, H.E. Stewart, F.T. Blackburn and T.S. Dickerman, 1/90, (PB90-208596).
- NCEER-90-0002 "Nonnormal Secondary Response Due to Yielding in a Primary Structure," by D.C.K. Chen and L.D. Lutes, 2/28/90, (PB90-251976).
- NCEER-90-0003 "Earthquake Education Materials for Grades K-12," by K.E.K. Ross, 4/16/90, (PB91-251984).
- NCEER-90-0004 "Catalog of Strong Motion Stations in Eastern North America," by R.W. Busby, 4/3/90, (PB90-251984).
- NCEER-90-0005 "NCEER Strong-Motion Data Base: A User Manual for the GeoBase Release (Version 1.0 for the Sun3)," by P. Friberg and K. Jacob, 3/31/90 (PB90-258062).
- NCEER-90-0006 "Seismic Hazard Along a Crude Oil Pipeline in the Event of an 1811-1812 Type New Madrid Earthquake," by H.H.M. Hwang and C.H.S. Chen, 4/16/90(PB90-258054).

- NCEER-90-0007 "Site-Specific Response Spectra for Memphis Sheahan Pumping Station," by H.H.M. Hwang and C.S. Lee, 5/15/90, (PB91-108811).
- NCEER-90-0008 "Pilot Study on Seismic Vulnerability of Crude Oil Transmission Systems," by T. Ariman, R. Dobry, M. Grigoriu, F. Kozin, M. O'Rourke, T. O'Rourke and M. Shinozuka, 5/25/90, (PB91-108837).
- NCEER-90-0009 "A Program to Generate Site Dependent Time Histories: EQGEN," by G.W. Ellis, M. Srinivasan and A.S. Cakmak, 1/30/90, (PB91-108829).
- NCEER-90-0010 "Active Isolation for Seismic Protection of Operating Rooms," by M.E. Talbott, Supervised by M. Shinozuka, 6/8/9, (PB91-110205).
- NCEER-90-0011 "Program LINEARID for Identification of Linear Structural Dynamic Systems," by C-B. Yun and M. Shinozuka, 6/25/90, (PB91-110312).
- NCEER-90-0012 "Two-Dimensional Two-Phase Elasto-Plastic Seismic Response of Earth Dams," by A.N. Yiagos, Supervised by J.H. Prevost, 6/20/90, (PB91-110197).
- NCEER-90-0013 "Secondary Systems in Base-Isolated Structures: Experimental Investigation, Stochastic Response and Stochastic Sensitivity," by G.D. Manolis, G. Juhn, M.C. Constantinou and A.M. Reinhorn, 7/1/90, (PB91-110320).
- NCEER-90-0014 "Seismic Behavior of Lightly-Reinforced Concrete Column and Beam-Column Joint Details," by S.P. Pessiki, C.H. Conley, P. Gergely and R.N. White, 8/22/90, (PB91-108795).
- NCEER-90-0015 "Two Hybrid Control Systems for Building Structures Under Strong Earthquakes," by J.N. Yang and A. Danielians, 6/29/90, (PB91-125393).
- NCEER-90-0016 "Instantaneous Optimal Control with Acceleration and Velocity Feedback," by J.N. Yang and Z. Li, 6/29/90, (PB91-125401).
- NCEER-90-0017 "Reconnaissance Report on the Northern Iran Earthquake of June 21, 1990," by M. Mehraein, 10/4/90, (PB91-125377).
- NCEER-90-0018 "Evaluation of Liquefaction Potential in Memphis and Shelby County," by T.S. Chang, P.S. Tang, C.S. Lee and H. Hwang, 8/10/90. (PB91-125427).
- NCEER-90-0019 "Experimental and Analytical Study of a Combined Sliding Disc Bearing and Helical Steel Spring Isolation System," by M.C. Constantinou, A.S. Mokha and A.M. Reinhorn, 10/4/90, (PB91-125385).
- NCEER-90-0020 "Experimental Study and Analytical Prediction of Earthquake Response of a Sliding Isolation System with a Spherical Surface," by A.S. Mokha, M.C. Constantinou and A.M. Reinhorn, 10/11/90, (PB91-125419).
- NCEER-90-0021 "Dynamic Interaction Factors for Floating Pile Groups," by G. Gazetas, K. Fan, A. Kaynia and E. Kausel, 9/10/90, (PB91-170381).
- NCEER-90-0022 "Evaluation of Seismic Damage Indices for Reinforced Concrete Structures," by S. Rodriguez-Gomez and A.S. Cakmak, 9/30/90, PB91-171322).
- NCEER-90-0023 "Study of Site Response at a Selected Memphis Site," by H. Desai, S. Ahmad, E.S. Gazetas and M.R. Oh, 10/11/90. (PB91-196857).
- NCEER-90-0024 "A User's Guide to Strongmo: Version 1.0 of NCEER's Strong-Motion Data Access Tool for PCs and Terminals," by P.A. Friberg and C.A.T. Susch, 11/15/90, (PB91-171272).

- NCEER-90-0025 "A Three-Dimensional Analytical Study of Spatial Variability of Seismic Ground Motions," by L-L. Hong and A.H.-S. Ang, 10/30/90, (PB91-170399).
- NCEER-90-0026 "MLMROID User's Guide - A Program for the Identification of Modal Parameters," by S. Rodriguez-Gomez and E. DiPasquale, 9/30/90, (PB91-171298).
- NCEER-90-0027 "SARCF-II User's Guide - Seismic Analysis of Reinforced Concrete Frames," by S. Rodriguez-Gomez, Y.S. Chung and C. Meyer, 9/30/90, (PB91-171280).
- NCEER-90-0028 "Viscous Dampers: Testing, Modeling and Application in Vibration and Seismic Isolation," by N. Makris and M.C. Constantinou, 12/20/90 (PB91-190561).
- NCEER-90-0029 "Soil Effects on Earthquake Ground Motions in the Memphis Area." by H. Hwang, C.S. Lee, K.W. Ng and T.S. Chang, 8/2/90. (PB91-190751).
- NCEER-91-0001 "Proceedings from the Third Japan-U.S. Workshop on Earthquake Resistant Design of Lifeline Facilities and Countermeasures for Soil Liquefaction, December 17-19, 1990," edited by T.D. O'Rourke and M. Hamada, 2/1/91, (PB91-179259).
- NCEER-91-0002 "Physical Space Solutions of Non-Proportionally Damped Systems," by M. Tong, Z. Liang and G.C. Lee, 1/15/91, (PB91-179242).
- NCEER-91-0003 "Seismic Response of Single Piles and Pile Groups," by K. Fan and G. Gazetas, 1/10/91, (PB92-174994).
- NCEER-91-0004 "Damping of Structures: Part I - Theory of Complex Damping," by Z. Liang and G. Lee, 10/10/91, (PB92-197235).
- NCEER-91-0005 "3D-BASIS - Nonlinear Dynamic Analysis of Three Dimensional Base Isolated Structures: Part II," by S. Nagarajaiah, A.M. Reinhorn and M.C. Constantinou, 2/28/91, (PB91-190553).
- NCEER-91-0006 "A Multidimensional Hysteretic Model for Plasticity Deforming Metals in Energy Absorbing Devices." by E.J. Graesser and F.A. Cozzarelli, 4/9/91, (PB92-108364).
- NCEER-91-0007 "A Framework for Customizable Knowledge-Based Expert Systems with an Application to a KBES for Evaluating the Seismic Resistance of Existing Buildings," by E.G. Ibarra-Anaya and S.J. Fenves, 4/9/91, (PB91-210930).
- NCEER-91-0008 "Nonlinear Analysis of Steel Frames with Semi-Rigid Connections Using the Capacity Spectrum Method," by G.G. Deierlein, S-H. Hsieh, Y-J. Shen and J.F. Abel, 7/2/91, (PB92-113828).
- NCEER-91-0009 "Earthquake Education Materials for Grades K-12," by K.E.K. Ross, 4/30/91, (PB91-212142).
- NCEER-91-0010 "Phase Wave Velocities and Displacement Phase Differences in a Harmonically Oscillating Pile," by N. Makris and G. Gazetas, 7/8/91, (PB92-108356).
- NCEER-91-0011 "Dynamic Characteristics of a Full-Size Five-Story Steel Structure and a 2/5 Scale Model," by K.C. Chang, G.C. Yao, G.C. Lee, D.S. Hao and Y.C. Yeh," 7/2/91, (PB93-116648).
- NCEER-91-0012 "Seismic Response of a 2/5 Scale Steel Structure with Added Viscoelastic Dampers," by K.C. Chang, T.T. Soong, S-T. Oh and M.L. Lai, 5/17/91, (PB92-110816).
- NCEER-91-0013 "Earthquake Response of Retaining Walls; Full-Scale Testing and Computational Modeling." by S. Alampalli and A-W.M. Elgamal, 6/20/91. to be published.

- NCEER-91-0014 "3D-BASIS-M: Nonlinear Dynamic Analysis of Multiple Building Base Isolated Structures," by P.C. Tsopelas, S. Nagarajaiah, M.C. Constantinou and A.M. Reinhorn, 5/28/91, (PB92-113885).
- NCEER-91-0015 "Evaluation of SEAOC Design Requirements for Sliding Isolated Structures," by D. Theodossiou and M.C. Constantinou, 6/10/91, (PB92-114602).
- NCEER-91-0016 "Closed-Loop Modal Testing of a 27-Story Reinforced Concrete Flat Plate-Core Building," by H.R. Somaprasad, T. Toksoy, H. Yoshiyuki and A.E. Aktan, 7/15/91, (PB92-129980).
- NCEER-91-0017 "Shake Table Test of a 1/6 Scale Two-Story Lightly Reinforced Concrete Building," by A.G. El-Attar, R.N. White and P. Gergely, 2/28/91, (PB92-222447).
- NCEER-91-0018 "Shake Table Test of a 1/8 Scale Three-Story Lightly Reinforced Concrete Building," by A.G. El-Attar, R.N. White and P. Gergely, 2/28/91, (PB93-116630).
- NCEER-91-0019 "Transfer Functions for Rigid Rectangular Foundations," by A.S. Veletsos, A.M. Prasad and W.H. Wu, 7/31/91.
- NCEER-91-0020 "Hybrid Control of Seismic-Excited Nonlinear and Inelastic Structural Systems," by J.N. Yang, Z. Li and A. Danielians, 8/1/91, (PB92-143171).
- NCEER-91-0021 "The NCEER-91 Earthquake Catalog: Improved Intensity-Based Magnitudes and Recurrence Relations for U.S. Earthquakes East of New Madrid," by L. Seeber and J.G. Armbruster, 8/28/91, (PB92-176742).
- NCEER-91-0022 "Proceedings from the Implementation of Earthquake Planning and Education in Schools: The Need for Change - The Roles of the Changemakers," by K.E.K. Ross and F. Winslow, 7/23/91, (PB92-129998).
- NCEER-91-0023 "A Study of Reliability-Based Criteria for Seismic Design of Reinforced Concrete Frame Buildings," by H.H.M. Hwang and H-M. Hsu, 8/10/91, (PB92-140235).
- NCEER-91-0024 "Experimental Verification of a Number of Structural System Identification Algorithms," by R.G. Ghanem, H. Gavin and M. Shinozuka, 9/18/91, (PB92-176577).
- NCEER-91-0025 "Probabilistic Evaluation of Liquefaction Potential," by H.H.M. Hwang and C.S. Lee," 11/25/91, (PB92-143429).
- NCEER-91-0026 "Instantaneous Optimal Control for Linear, Nonlinear and Hysteretic Structures - Stable Controllers," by J.N. Yang and Z. Li, 11/15/91, (PB92-163807).
- NCEER-91-0027 "Experimental and Theoretical Study of a Sliding Isolation System for Bridges," by M.C. Constantinou, A. Kartoum, A.M. Reinhorn and P. Bradford, 11/15/91, (PB92-176973).
- NCEER-92-0001 "Case Studies of Liquefaction and Lifeline Performance During Past Earthquakes, Volume 1: Japanese Case Studies," Edited by M. Hamada and T. O'Rourke, 2/17/92, (PB92-197243).
- NCEER-92-0002 "Case Studies of Liquefaction and Lifeline Performance During Past Earthquakes, Volume 2: United States Case Studies," Edited by T. O'Rourke and M. Hamada, 2/17/92, (PB92-197250).
- NCEER-92-0003 "Issues in Earthquake Education," Edited by K. Ross, 2/3/92, (PB92-222389).
- NCEER-92-0004 "Proceedings from the First U.S. - Japan Workshop on Earthquake Protective Systems for Bridges," Edited by I.G. Buckle, 2/4/92.
- NCEER-92-0005 "Seismic Ground Motion from a Haskell-Type Source in a Multiple-Layered Half-Space," A.P. Theoharis, G. Deodatis and M. Shinozuka, 1/2/92, to be published.

- NCEER-92-0006 "Proceedings from the Site Effects Workshop," Edited by R. Whitman, 2/29/92, (PB92-197201).
- NCEER-92-0007 "Engineering Evaluation of Permanent Ground Deformations Due to Seismically-Induced Liquefaction," by M.H. Baziar, R. Dobry and A-W.M. Elgamal, 3/24/92, (PB92-222421).
- NCEER-92-0008 "A Procedure for the Seismic Evaluation of Buildings in the Central and Eastern United States," by C.D. Poland and J.O. Malley, 4/2/92, (PB92-222439).
- NCEER-92-0009 "Experimental and Analytical Study of a Hybrid Isolation System Using Friction Controllable Sliding Bearings," by M.Q. Feng, S. Fujii and M. Shinozuka, 5/15/92, (PB93-150282).
- NCEER-92-0010 "Seismic Resistance of Slab-Column Connections in Existing Non-Ductile Flat-Plate Buildings," by A.J. Durrani and Y. Du, 5/18/92.
- NCEER-92-0011 "The Hysteretic and Dynamic Behavior of Brick Masonry Walls Upgraded by Ferrocement Coatings Under Cyclic Loading and Strong Simulated Ground Motion," by H. Lee and S.P. Prawl. 5/11/92, to be published.
- NCEER-92-0012 "Study of Wire Rope Systems for Seismic Protection of Equipment in Buildings." by G.F. Demetriades, M.C. Constantinou and A.M. Reinhorn, 5/20/92.
- NCEER-92-0013 "Shape Memory Structural Dampers: Material Properties. Design and Seismic Testing." by P.R. Witting and F.A. Cozzarelli, 5/26/92.
- NCEER-92-0014 "Longitudinal Permanent Ground Deformation Effects on Buried Continuous Pipelines," by M.J. O'Rourke, and C. Nordberg, 6/15/92.
- NCEER-92-0015 "A Simulation Method for Stationary Gaussian Random Functions Based on the Sampling Theorem," by M. Grigoriu and S. Balopoulou, 6/11/92, (PB93-127496).
- NCEER-92-0016 "Gravity-Load-Designed Reinforced Concrete Buildings: Seismic Evaluation of Existing Construction and Detailing Strategies for Improved Seismic Resistance," by G.W. Hoffmann, S.K. Kunnath, A.M. Reinhorn and J.B. Mander, 7/15/92.
- NCEER-92-0017 "Observations on Water System and Pipeline Performance in the Limón Area of Costa Rica Due to the April 22, 1991 Earthquake," by M. O'Rourke and D. Ballantyne, 6/30/92. (PB93-126811).
- NCEER-92-0018 "Fourth Edition of Earthquake Education Materials for Grades K-12," Edited by K.E.K. Ross, 8/10/92.
- NCEER-92-0019 "Proceedings from the Fourth Japan-U.S. Workshop on Earthquake Resistant Design of Lifeline Facilities and Countermeasures for Soil Liquefaction," Edited by M. Hamada and T.D. O'Rourke, 8/12/92. (PB93-163939).
- NCEER-92-0020 "Active Bracing System: A Full Scale Implementation of Active Control," by A.M. Reinhorn, T.T. Soong, R.C. Lin, M.A. Riley, Y.P. Wang, S. Aizawa and M. Higashino, 8/14/92, (PB93-127512).
- NCEER-92-0021 "Empirical Analysis of Horizontal Ground Displacement Generated by Liquefaction-Induced Lateral Spreads," by S.F. Bartlett and T.L. Youd, 8/17/92. (PB93-188241).
- NCEER-92-0022 "IDARC Version 3.0: Inelastic Damage Analysis of Reinforced Concrete Structures," by S.K. Kunnath, A.M. Reinhorn and R.F. Lobo, 8/31/92, (PB93-227502, A07, MF-A02).
- NCEER-92-0023 "A Semi-Empirical Analysis of Strong-Motion Peaks in Terms of Seismic Source, Propagation Path and Local Site Conditions, by M. Kamiyama, M.J. O'Rourke and R. Flores-Berrones, 9/9/92, (PB93-150266).
- NCEER-92-0024 "Seismic Behavior of Reinforced Concrete Frame Structures with Nonductile Details, Part I: Summary of Experimental Findings of Full Scale Beam-Column Joint Tests," by A. Beres, R.N. White and P. Gergely, 9/30/92, (PB93-227783, A05, MF-A01).

- NCEER-92-0025 "Experimental Results of Repaired and Retrofitted Beam-Column Joint Tests in Lightly Reinforced Concrete Frame Buildings." by A. Beres, S. El-Borgi, R.N. White and P. Gergely, 10/29/92, (PB93-227791, A05, MF-A01).
- NCEER-92-0026 "A Generalization of Optimal Control Theory: Linear and Nonlinear Structures," by J.N. Yang, Z. Li and S. Vongchavalitkul, 11/2/92. (PB93-188621).
- NCEER-92-0027 "Seismic Resistance of Reinforced Concrete Frame Structures Designed Only for Gravity Loads: Part I - Design and Properties of a One-Third Scale Model Structure," by J.M. Bracci, A.M. Reinhorn and J.B. Mander, 12/1/92, (PB94-104502, A08, MF-A02).
- NCEER-92-0028 "Seismic Resistance of Reinforced Concrete Frame Structures Designed Only for Gravity Loads: Part II - Experimental Performance of Subassemblages." by L.E. Aycardi, J.B. Mander and A.M. Reinhorn, 12/1/92, (PB94-104510, A08, MF-A02).
- NCEER-92-0029 "Seismic Resistance of Reinforced Concrete Frame Structures Designed Only for Gravity Loads: Part III - Experimental Performance and Analytical Study of a Structural Model," by J.M. Bracci, A.M. Reinhorn and J.B. Mander, 12/1/92, (PB93-227528, A09, MF-A01).
- NCEER-92-0030 "Evaluation of Seismic Retrofit of Reinforced Concrete Frame Structures: Part I - Experimental Performance of Retrofitted Subassemblages," by D. Choudhuri, J.B. Mander and A.M. Reinhorn, 12/8/92, (PB93-198307, A07, MF-A02).
- NCEER-92-0031 "Evaluation of Seismic Retrofit of Reinforced Concrete Frame Structures: Part II - Experimental Performance and Analytical Study of a Retrofitted Structural Model." by J.M. Bracci, A.M. Reinhorn and J.B. Mander, 12/8/92, (PB93-198315, A09, MF-A03).
- NCEER-92-0032 "Experimental and Analytical Investigation of Seismic Response of Structures with Supplemental Fluid Viscous Dampers," by M.C. Constantinou and M.D. Symans. 12/21/92, (PB93-191435).
- NCEER-92-0033 "Reconnaissance Report on the Cairo, Egypt Earthquake of October 12, 1992." by M. Khater, 12/23/92, (PB93-188621).
- NCEER-92-0034 "Low-Level Dynamic Characteristics of Four Tall Flat-Plate Buildings in New York City," by H. Gavin, S. Yuan, J. Grossman, E. Pekelis and K. Jacob, 12/28/92, (PB93-188217).
- NCEER-93-0001 "An Experimental Study on the Seismic Performance of Brick-Infilled Steel Frames With and Without Retrofit," by J.B. Mander, B. Nair, K. Wojtkowski and J. Ma, 1/29/93, (PB93-227510, A07, MF-A02).
- NCEER-93-0002 "Social Accounting for Disaster Preparedness and Recovery Planning." by S. Cole, E. Pantoja and V. Razak. 2/22/93, to be published.
- NCEER-93-0003 "Assessment of 1991 NEHRP Provisions for Nonstructural Components and Recommended Revisions," by T.T. Soong, G. Chen, Z. Wu, R-H. Zhang and M. Grigoriu, 3/1/93, (PB93-188639).
- NCEER-93-0004 "Evaluation of Static and Response Spectrum Analysis Procedures of SEAOC/UBC for Seismic Isolated Structures," by C.W. Winters and M.C. Constantinou, 3/23/93, (PB93-198299).
- NCEER-93-0005 "Earthquakes in the Northeast - Are We Ignoring the Hazard? A Workshop on Earthquake Science and Safety for Educators," edited by K.E.K. Ross, 4/2/93, (PB94-103066, A09, MF-A02).
- NCEER-93-0006 "Inelastic Response of Reinforced Concrete Structures with Viscoelastic Braces," by R.F. Lobo, J.M. Bracci, K.L. Shen, A.M. Reinhorn and T.T. Soong, 4/5/93, (PB93-227486, A05, MF-A02).

- NCEER-93-0007 "Seismic Testing of Installation Methods for Computers and Data Processing Equipment," by K. Kosar, T.T. Soong, K.L. Shen, J.A. HoLung and Y.K. Lin, 4/12/93, (PB93-198299).
- NCEER-93-0008 "Retrofit of Reinforced Concrete Frames Using Added Dampers," by A. Reinhorn, M. Constantinou and C. Li, to be published.
- NCEER-93-0009 "Seismic Behavior and Design Guidelines for Steel Frame Structures with Added Viscoelastic Dampers," by K.C. Chang, M.L. Lai, T.T. Soong, D.S. Hao and Y.C. Yeh, 5/1/93.
- NCEER-93-0010 "Seismic Performance of Shear-Critical Reinforced Concrete Bridge Piers," by J.B. Mander, S.M. Waheed, M.T.A. Chaudhary and S.S. Chen, 5/12/93, (PB93-227494, A08, MF-A02).
- NCEER-93-0011 "3D-BASIS-TABS: Computer Program for Nonlinear Dynamic Analysis of Three Dimensional Base Isolated Structures," by S. Nagarajaiah, C. Li, A.M. Reinhorn and M.C. Constantinou, 8/2/93.
- NCEER-93-0012 "Effects of Hydrocarbon Spills from an Oil Pipeline Break on Ground Water," by O.J. Helweg and H.H.M. Hwang, 8/3/93.
- NCEER-93-0013 "Simplified Procedures for Seismic Design of Nonstructural Components and Assessment of Current Code Provisions," by M.P. Singh, L.E. Suarez, E.E. Matheu and G.O. Maldonado, 8/4/93.
- NCEER-93-0014 "An Energy Approach to Seismic Analysis and Design of Secondary Systems," by G. Chen and T.T. Soong, 8/6/93.
- NCEER-93-0015 "Proceedings from School Sites: Becoming Prepared for Earthquakes - Commemorating the Third Anniversary of the Loma Prieta Earthquake," Edited by F.E. Winslow and K.E.K. Ross, 8/16/93.
- NCEER-93-0016 "Reconnaissance Report of Damage to Historic Monuments in Cairo, Egypt Following the October 12, 1992 Dahshur Earthquake," by D. Sykora, D. Look, G. Croci, E. Karaesmen and E. Karaesmen, 8/19/93.
- NCEER-93-0017 "The Island of Guam Earthquake of August 8, 1993," by S.W. Swan and S.K. Harris, 9/30/93.
- NCEER-93-0018 "Engineering Aspects of the October 12, 1992 Egyptian Earthquake," by A.W. Elgamal, M. Amer, K. Adalier and A. Abul-Fadl, 10/7/93.
- NCEER-93-0019 "Development of an Earthquake Motion Simulator and its Application in Dynamic Centrifuge Testing," by I. Krstelj, Supervised by J.H. Prevost, 10/23/93.
- NCEER-93-0020 "NCEER-Taisei Corporation Research Program on Sliding Seismic Isolation Systems for Bridges: Experimental and Analytical Study of a Friction Pendulum System (FPS)," by M.C. Constantinou, P. Tsopelas, Y-S. Kim and S. Okamoto, 11/1/93.
- NCEER-93-0021 "Finite Element Modeling of Elastomeric Seismic Isolation Bearings," by L.J. Billings, Supervised by R. Shepherd, 11/8/93.
- NCEER-93-0022 "Seismic Vulnerability of Equipment in Critical Facilities: Life-Safety and Operational Consequences," by K. Porter, G.S. Johnson, M.M. Zadeh, C. Scawthorn and S. Eder, 11/24/93.

