

NOARK

Essential Components Catalog

Circuit Protection, Motor Controls and Pilot Devices



Branch, Motor Circuit and Supplementary Protection

[Molded Case Circuit Breakers](#) [A](#)

[Molded Case Switches](#) [B](#)

[Motor Circuit Protectors](#) [C](#)

[Miniature Circuit Breakers](#) [D](#)

Motor Controllers and Overload Protection

[Manual Motor Starters](#) [E](#)

[Contactors](#) [F](#)

[Overloads](#) [G](#)

[Safety Contactors](#) [H](#)

[Safety Control Relays](#) [I](#)

Pilot Devices

[Indicator Lights](#) [J](#)

[Push Buttons](#) [K](#)

[Selector Switches](#) [L](#)

[Appendix A: Short Circuit Current Ratings](#)

Excellent Products. Exceptional Value.

na.noark-electric.com

Company Overview

About us

NOARK Electric is a global manufacturer of low-voltage electrical components for industrial applications. We specialize in motor controls and circuit protection for original equipment manufacturers. Our mission is to provide customers with the highest quality products at an exceptional value and back them with world-class service and support. Every NOARK product is tested and certified to the highest industry standards.

Research and Development

The entire portfolio of high-quality NOARK products is designed for manufacturing and assembly. Each component is developed in-house by our engineering team to meet the strictest standards and performance requirements. This dedication to excellence has led to the development of patented technology found in many of our products.

World-class Manufacturing

After being thoroughly tested, approved and certified – each NOARK product is sent into production at our state-of-the-art manufacturing facilities. This allows us to maintain strict quality control standards throughout the manufacturing process. In addition, NOARK Electric adheres to a policy of environmental protection and sustainability.

North American Distribution

NOARK's primary distribution center is located in Pomona, CA, with the aim of ensuring prompt and reliable deliveries of the entire product range to our customers all over North America. Our supply chain team works closely with our factories and logistics partners to ensure the availability of our products on the North American market and provide logistics services on the level which our customers expect.

NOARK Electric is a wholly subsidiary of the largest electrical manufacturing group in Asia with over 30 thousand employees and sales revenue of \$10 billion USD. We have corporate facilities in Los Angeles, Shanghai and Prague to service the requirements of individual markets and countries.

140+ Countries
300+ Overseas Distributors
20 Overseas Subsidiaries
22 Logistics Centers
3 R & D Centers
10,000,000+ Sq.Ft. Manufacturing Space
30,000+ Employees Worldwide



Table of Contents

Branch and Motor Circuit Protection

Molded Case Circuit Breakers (MCCB) - UL 489 Branch Circuits, UL 60947-4-1.....	1
Technical Data.....	8
Molded Case Switches (MCS) - UL 489 Disconnect	10
Technical Data.....	12
Motor Circuit Protectors (MCP) - UL 60947-4-1.....	13
Technical Data.....	15
Accessories.....	17
Miniature Circuit Breakers (MCB) - UL 489 Branch Circuits	26
Technical Data.....	35
Accessories	36
Miniature Circuit Breakers (MCB) - UL 1077 Supplementary Protectors	38
Technical Data.....	41
Accessories	42

Motor Controllers and Overload Protection

Manual Motor Starters - UL 60947-4-1 (formerly UL 508) Type E and F.....	44
Technical Data.....	48
Accessories	49
Contactors - Standard / Heavy-duty.....	50
Technical Data.....	58
Accessories	65
Contactors - General Purpose	68
Technical Data.....	70
Accessories	71
Overloads.....	72
Technical Data.....	74
Safety Contactors - UL 60947-5-1 Safety function applications	78
Technical Data.....	80
Safety Control Relays - UL 60947-5-1 Safety function applications.....	82
Technical Data.....	84

Pilot Devices

Pilot Devices - UL recognized components, IEC/EN 60947	85
Indicator Lights.....	86
Pushbuttons.....	88
Selector Switches	91
Illuminated Pushbuttons.....	92

Appendix A

Short Circuit Current Rating Tables	94
---	----

Terms and Conditions of Sale.....	100
-----------------------------------	-----

Molded Case Circuit Breakers



UL 489 and UL 60947-4-1 (formerly UL 508) Applications

A molded case circuit breaker can be used to provide overload and short circuit protection for cables, control panels, motors and branch circuits. In addition, the National Electrical Code (NEC) requires the following when controlling a motor:



- A means of disconnecting power from the circuit
- Short circuit protection for the cables
- A way to start and stop the motor (typically a contactor)
- Overload protection for the motor (typically an overload relay)

The molded case circuit breaker can provide the means of disconnecting power and provides short circuit protection under UL 60947-4-1 type C protection. The magnetic only Motor Circuit Protector (MCP) can provide the same function under UL 60947-4-1 type D protection.

TYPE C

Components	Catalog Number	Product
Molded Case Circuit Breaker (MCCB)	M1S	
Contactor	EX9C	
Overload Relay	Ex9R	

TYPE D

Components	Catalog Number	Product
Motor Circuit Protector (MCP)	M1M	
Contactor	EX9C	
Overload Relay	Ex9R	

Disclaimer: Proper Sizing of an overcurrent protection device is the responsibility of the customer and should be determined using the application standards of the NEC*, CEC**, or other applicable standards.

*NEC-National Electrical Code

** CEC-Canadian Electrical Code

Molded Case Circuit Breakers

Product Overview

Features

Molded Case Circuit Breakers, 15-1200 Amperes

NOARK Electric offers a complete range of Molded Case Circuit Breakers in six frame sizes: M1 - 150A, M2 - 250A, M3 - 400A, M4 - 600A, M5 - 800A, and M6 - 1200A. Each frame size offers a range of interrupting ratings up to 100kA at 480Vac and voltage ratings up to 600Vac and 600Vdc..

- High-breaking capacity and a patented arc extinguishing design
- Bearing-type spindle reduces the operating force required to open and close the operating mechanism
- High quality compact modular design
- Fixed and adjustable trip unit settings
- Line and load lugs installed standard
- 5-Year limited warranty

Wide range of accessories:

- Alarm switch and auxiliary contact
- Shunt and under-voltage trip
- Rotary type handle
- Flange type handle



Certifications

- UL 489 Listed, File Number E355392
- Certified to CSA C22.2 No. 5
- IEC/EN 60947-2
- CE Compliant



Molded Case Circuit Breakers

M1-M6 Product Selection

Ratings Summary		M1						M2						M3			M4			M5			M6			
Rating	Amps @ 40° C	15-150						100-250						225-400			400-600			600-800			800-1200			
	Poles	1	2		3			1	2		3			2*,3			3			3			3			
	Frame Type	N	S	N	H	S	N	H	N	S	N	H	S	N	H	S	N	H	S	N	H	S	N	H	S	N
	Maximum Vac	480	600		600			480	600		600			600			600			600			600			
	Maximum Vdc	250	500		600			250	500		600			500			600			600			-			
Interrupting Capacity (kA rms)	240 Vac	50	50	100	150	50	100	150	50	50	100	150	50	100	150	65	100	150	65	100	150	65	100	150	65	100
	480 Vac	10	35	65	100	35	65	100	10	35	65	100	35	65	100	42	65	100	42	65	100	42	65	100	42	65
	600 Vac	-	14	20	25	14	20	25	-	14	20	25	14	20	25	18	25	30	22	30	50	22	30	50	22	42
	250 Vdc (1P)	25	-						25	-						-			-			-			-	
	500 Vdc (2P**)	-	20	35	50	-	-	-	-	20	35	50	-	-	-	35	50	65	-			-			-	
	600 Vdc (3P**)	-			20	35	50	-			20	35	50	35	50	65	35	50	65	35	50	65	35	50	65	-

*3 Pole Case **Poles Connected in Series



M1H150T3L

Amps	2-Pole 80% Rated		3-Pole 80% Rated		
	Catalog Number	Trip Unit	Catalog Number	Trip Unit	
15	M1S15T22L	FT/FM	M1S15T3L	FT/FM	
20	M1S20T22L		M1S20T3L		
25	M1S25T22L		M1S25T3L		
30	M1S30T22L		M1S30T3L		
35	M1S35T22L		M1S35T3L		
40	M1S40T22L	AT/FM	M1S40T3L	AT/FM	
45	M1S45T22L		M1S45T3L		
50	M1S50T22L		M1S50T3L		
60	M1S60T22L		M1S60T3L		
70	M1S70T22L		M1S70T3L		
80	M1S80T22L		M1S80T3L		
90	M1S90T22L		M1S90T3L		
100	M1S100T22L		M1S100T3L		
125	M1S125T22L		M1S125T3L		AT/AM
150	M1S150T22L		M1S150T3L		AT/AM

M1S
2 Pole & 3 Pole
(35 kA @ 480 Vac)
(50 kA @ 240 Vac)
(14 kA @ 600 Vac)

A = Adjustable
T = Thermal
F = Fixed
M = Magnetic

Series M1 Line & Load Lugs: 1 Conductor #14 to #3/0 (CU) OR #12 to 3/0 (AL)

Molded Case Circuit Breakers

M1-M6 Product Selection



M1H150T3L

Amps	1-Pole 80% Rated		2-Pole 80% Rated		3-Pole 80% Rated	
	Catalog Number	Trip Unit	Catalog Number	Trip Unit	Catalog Number	Trip Unit
	15	M1N15T1L	FT/FM	M1N15T22L	FT/FM	M1N15T3L
20	M1N20T1L	M1N20T22L		M1N20T3L		
25	M1N25T1L	M1N25T22L				
30	M1N30T1L	M1N30T22L				
35	M1N35T1L	M1N35T22L				
40	M1N40T1L	M1N40T22L				
45	M1N45T1L	M1N45T22L		M1N45T3L		
50	M1N50T1L	M1N50T22L			M1N50T3L	
60	M1N60T1L	M1N60T22L				
70	M1N70T1L	M1N70T22L				
80	M1N80T1L	M1N80T22L		AT/FM	M1N80T3L	
90	M1N90T1L	M1N90T22L			M1N90T3L	
100	M1N100T1L	M1N100T22L		M1N100T3L		
125	M1N125T1L	M1N125T22L			AT/AM	M1N125T3L
150	M1N150T1L	M1N150T22L		M1N150T3L		

M1N
1 Pole
(10 kA @ 480 Vac)
(50 kA @ 240 Vac)
2 Pole & 3 Pole
(65 kA @ 480 Vac)
(100 kA @ 240 Vac)
(20 kA @ 600 Vac)

A

Amps	2-Pole 80% Rated		3-Pole 80% Rated	
	Catalog Number	Trip Unit	Catalog Number	Trip Unit
15	M1H15T22L	FT/FM	M1H15T3L	FT/FM
20	M1H20T22L		M1H20T3L	
25	M1H25T22L		M1H25T3L	
30	M1H30T22L		M1H30T3L	
35	M1H35T22L		M1H35T3L	
40	M1H40T22L		M1H40T3L	
45	M1H45T22L	M1H45T3L	AT/FM	
50	M1H50T22L	M1H50T3L		
60	M1H60T22L	M1H60T3L		
70	M1H70T22L	M1H70T3L	AT/AM	
80	M1H80T22L	M1H80T3L		
90	M1H90T22L	M1H90T3L		
100	M1H100T22L	M1H100T3L		
125	M1H125T22L	M1H125T3L		
150	M1H150T22L	M1H150T3L		

M1H
2 Pole & 3 Pole
(100 kA @ 480 Vac)
(150 kA @ 240 Vac)
(25 kA @ 600 Vac)

A = Adjustable
T = Thermal
F = Fixed
M = Magnetic

Series M1 Line & Load Lugs: 1 Conductor #14 to #3/0 (CU) OR #12 to 3/0 (AL)

Molded Case Circuit Breakers

M1-M6 Product Selection



M2N250T3L

Amps	2-Pole		3-Pole	
	Catalog Number	Trip Unit	Catalog Number	Trip Unit
100	M2S100T22L	AT/AM	M2S100T3L	AT/AM
125	M2S125T22L		M2S125T3L	
150	M2S150T22L		M2S150T3L	
175	M2S175T22L		M2S175T3L	
200	M2S200T22L		M2S200T3L	
225	M2S225T22L		M2S225T3L	
250	M2S250T22L		M2S250T3L	

Amps	1-Pole		2-Pole		3-Pole	
	Catalog Number	Trip Unit	Catalog Number	Trip Unit	Catalog Number	Trip Unit
100	M2N100T1L	AT/AM	M2N100T2L	AT/AM	M2N100T3L	AT/AM
125	M2N125T1L		M2N125T2L		M2N125T3L	
150	M2N150T1L		M2N150T2L		M2N150T3L	
175	M2N175T1L		M2N175T2L		M2N175T3L	
200	M2N200T1L		M2N200T2L		M2N200T3L	
225	M2N225T1L		M2N225T2L		M2N225T3L	
250	M2N250T1L		M2N250T2L		M2N250T3L	

Amps	2-Pole*		3-Pole	
	Catalog Number	Trip Unit	Catalog Number	Trip Unit
100	M2H100T2L	AT/AM	M2H100T3L	AT/AM
125	M2H125T2L		M2H125T3L	
150	M2H150T2L		M2H150T3L	
175	M2H175T2L		M2H175T3L	
200	M2H200T2L		M2H200T3L	
225	M2H225T2L		M2H225T3L	
250	M2H250T2L		M2H250T3L	

A = Adjustable
 T = Thermal
 F = Fixed
 M = Magnetic
 *3 Pole Case

Line & Load Lugs: 1 Conductor #3 AWG to 300kcmil (CU or AL)

Molded Case Circuit Breakers

M1-M6 Product Selection

	Amps	2-Pole*		3-Pole		Amps	3-Pole 80% Rated	
		Catalog Number	Trip Unit	Catalog Number	Trip Unit		Catalog Number	Trip Unit
M3S 2 Pole & 3 Pole (42 kA @ 480 Vac) (65 kA @ 240 Vac) (18 kA @ 600 Vac)	225	M3S225T2L	AT/AM	M3S225T3L	AT/AM	400	M4S400T3L	AT/AM
	250	M3S250T2L		M3S250T3L				
	300	M3S300T2L		M3S300T3L				
	350	M3S350T2L		M3S350T3L				
	400	M3S400T2L		M3S400T3L				
M4S 3 Pole (42 kA @ 480 Vac) (65 kA @ 240 Vac) (22 kA @ 600 Vac)	400	M4S400T3L	AT/AM	M4S400T3L	AT/AM	400	M4S400T3L	AT/AM
	500	M4S500T3L		M4S500T3L				
	600	M4S600T3L		M4S600T3L				

A

	Amps	2-Pole*		3-Pole		Amps	3-Pole 80% Rated	
		Catalog Number	Trip Unit	Catalog Number	Trip Unit		Catalog Number	Trip Unit
M3N 2 Pole & 3 Pole (65 kA @ 480 Vac) (100 kA @ 240 Vac) (25 kA @ 600 Vac)	225	M3N225T2L	AT/AM	M3N225T3L	AT/AM	400	M4N400T3L	AT/AM
	250	M3N250T2L		M3N250T3L				
	300	M3N300T2L		M3N300T3L				
	350	M3N350T2L		M3N350T3L				
	400	M3N400T2L		M3N400T3L				
M4N 3 Pole (65 kA @ 480 Vac) (100 kA @ 240 Vac) (30 kA @ 600 Vac)	400	M4N400T3L	AT/AM	M4N400T3L	AT/AM	400	M4N400T3L	AT/AM
	500	M4N500T3L		M4N500T3L				
	600	M4N600T3L		M4N600T3L				

	Amps	2-Pole*		3-Pole		Amps	3-Pole 80% Rated	
		Catalog Number	Trip Unit	Catalog Number	Trip Unit		Catalog Number	Trip Unit
M3H 2 Pole & 3 Pole (100 kA @ 480 Vac) (150 kA @ 240 Vac) (30 kA @ 600 Vac)	225	M3H225T2L	AT/AM	M3H225T3L	AT/AM	400	M4H400T3L	AT/AM
	250	M3H250T2L		M3H250T3L				
	300	M3H300T2L		M3H300T3L				
	350	M3H350T2L		M3H350T3L				
	400	M3H400T2L		M3H400T3L				
M4H 3 Pole (100 kA @ 480 Vac) (150 kA @ 240 Vac) (50 kA @ 600 Vac)	400	M4H400T3L	AT/AM	M4H400T3L	AT/AM	400	M4H400T3L	AT/AM
	500	M4H500T3L		M4H500T3L				
	600	M4H600T3L		M4H600T3L				

Line & Load Lugs: 2 Conductor #2/0 AWG to 500 kcmil (CU or AL) Line & Load Lugs: 1 Conductor #4/0 AWG to 750kcmil (CU or AL)

A = Adjustable
 T = Thermal
 F = Fixed
 M = Magnetic
 *3 Pole Case

Molded Case Circuit Breakers

M1-M6 Product Selection

M5S 3 Pole (42 kA @ 480 Vac) (65 kA @ 240 Vac) (22 kA @ 600 Vac)	Amps	3-Pole 80% Rated	
		Catalog Number	Trip Unit
		600	M5S600T3L
700	M5S700T3L		
800	M5S800T3L		

M6S 3 Pole (42 kA @ 480 Vac) (65 kA @ 240 Vac) (22 kA @ 600 Vac)	Amps	3-Pole		
		80% Rated		100% Rated
		Catalog Number	Catalog Number	Trip Unit
800	M6S800E3L	M6S800E3LF	ET	
1000	M6S1000E3L	M6S1000E3LF		
1200	M6S1200E3L	M6S1200E3LF		

M5N 3 Pole (65 kA @ 480 Vac) (100 kA @ 240 Vac) (30 kA @ 600 Vac)	Amps	3-Pole 80% Rated	
		Catalog Number	Trip Unit
		600	M5N600T3L
700	M5N700T3L		
800	M5N800T3L		

M6N 3 Pole (65 kA @ 480 Vac) (100 kA @ 240 Vac) (42 kA @ 600 Vac)	Amps	3-Pole		
		80% Rated		100% Rated
		Catalog Number	Catalog Number	Trip Unit
800	M6N800E3L	M6N800E3LF	ET	
1000	M6N1000E3L	M6N1000E3LF		
1200	M6N1200E3L	M6N1200E3LF		

M5H 3 Pole (100 kA @ 480 Vac) (150 kA @ 240 Vac) (50 kA @ 600 Vac)	Amps	3-Pole 80% Rated	
		Catalog Number	Trip Unit
		600	M5H600T3L
700	M5H700T3L		
800	M5H800T3L		

Series M6 Line & Load Lugs:

- 1000A Max - 3 Conductor 3/0-750 kcmil CU or AL
- 1200^A - 4 Conductor 3/0-500 kcmil CU or AL

A = Adjustable
 T = Thermal
 F = Fixed
 M = Magnetic
 ET = Electronic

Series M5 Line & Load Lugs:

- 700A Max - 2 Conductor 250-600kcmil CU or AL
- 800 - 3 Conductor 250-600kcmil CU or AL

Molded Case Circuit Breakers

M1-M6 Technical Data

Ratings & Specifications	M1							M2						
Amps @ 40° C	15-150							100-250						
Poles	1	2		3			1	2		3				
Frame Type	N	S	N	H	S	N	H	N	S	N	H*	S	N	H
Maximum Vac	480	600		600			480	600		600				
Maximum Vdc	250	500		500			250	500		500				
Interrupting Capacity (kA rms)														
240 Vac	50	50	100	150	50	100	150	50	50	100	150	50	100	150
480 Vac	10	35	65	100	35	65	100	10	35	65	100	35	65	100
600 Vac	-	14	20	25	14	20	25	-	14	20	25	14	20	25
250 Vdc 1 Pole	25	-					25	-						
500 Vdc 2 Poles**	-	20	35	50	20	35	50	-	20	35	50	20	35	50
600 Vdc 3 Poles**	-			20	35	50	-			20	35	50		
*3 Pole Case														
**Poles Connected in Series														
General Specifications														
Insulation Voltage (V)	800 Vac							800 Vac						
Impulse Withstand Voltage (Vimp)	8k Vac							8k Vac						
Operational Voltage (Ve)(IEC)	690 Vac							690 Vac						
Operational Voltage (Ve)(UL)	600 Vac							600 Vac						
Utilization Category	A							A						
Mechanical Operating Cycles	10,000							10,000						
Electrical Operating Cycles	6,000							6,000						
Trip Unit Type	FT/FM	15~45 FT/FM 50~150A AT/FM			15~45A FT/FM 50~100A AT/FM 125~150A AT/AM			FT/ FM	AT/AM					
	A=Adjustable T=Thermal F=Fixed M=Magnetic													
Dimensions LxWxD in (mm)	1 Pole	6.46x1.4x3.33 (164x35x84.5)					7.17x1.57x3.47 (182x40x88)							
	2 Pole	6.46x2.44x3.33 (164x62x84.5)					7.17x4.13x3.47 (182x75x88)							
	2 Pole*	6.46x3.54x3.33 (164x90x84.5)					7.17x4.13x3.47 (182x105x88)							
	3 Pole													
	4 Pole	-					-							
Wieght lb (kg)	1 Pole	1.47 (0.67)					1.76 (0.8)							
	2 Pole	2.53 (1.15)					3.3 (1.5)							
	2 Pole*	3.17 (1.67)					3.75 (1.70)							
	3 Pole	3.68 (1.67)					4.41 (2.00)							
	4 Pole	-					-							
Cable Lug Size 75°C CU or AL Wire Only AWG (mm²)	1-Hole, #14-3/0 (2.5-95) CU OR 1-Hole, #12-3/0 (2.5-95) AL							1-Hole #3-300 cmil (35-150)						
Lug Torque in-lb (Nm)	89 (10)							230 (23)						

A

Molded Case Circuit Breakers

M1-M6 Technical Data

Ratings & Specifications	M3			M4			M5			M6	
Amps @40° C	225-400			400-600			600-800			800-1200	
Poles	2*,3			2*,3			2*,3,4			3,4	
Frame Type	S	N	H	S	N	H	S	N	H	S	N
Maximum Vac	600			600**			600**			600	
Maximum Vdc										-	
Interrupting Capacity (kA rms)											
240 Vac	65	100	150	65	100	150	65	100	150	65	100
480 Vac	42	65	100	42	65	100	42	65	100	42	65
600 Vac	18	25	30	22	30	50	22	30	50	22	42
250 Vdc 1 Pole	-			-			-			-	
500 Vdc 2 Poles **	35	50	65	35	50	65	35	50	65	-	
600 Vdc 3 Poles**	35	50	65	35	50	65	35	50	65	-	
*3 Pole Case											
**Poles Connected in Series											
General Specifications											
Insulation Voltage (Vi)	800 Vac			800 Vac			800 Vac			800 Vac	
Impulse Withstand Voltage (Vimp)	8k Vac			8k Vac			8k Vac			8k Vac	
Operational Voltage (Ve) (IEC)	690 Vac			690 Vac			690 Vac			690 Vac	
Operational Voltage (Ve) (UL)	600 Vac			600 Vac			600 Vac			600 Vac	
Utilization Category	A			A			A			A	
Mechanical Operating Cycles	8,000						3,000				
Electrical Operating Cycles	5,000						500				
Trip Unit Type	AT/AM			AT/AM			AT/AM			Electronic	
Dimensions LxWxD in (mm)	11.22x5.51x4.59 (285x140x116.5)			12.32x7.68x7.58 (411x195x192.5)			16.18x7.68x7.58 (411x195x192.5)			-	
	-			-			16.18x10.2x7.58 (411x260x192.5)			22.64x9.84x15.16 (575x320x385)	
	-			-			-			22.64x12.6x15.16 (575x320x385)	
Weight lb (kg)	-			-			-			-	
	8.97 (4.07)			20.94 (9.5)			27.8 (12.5)			-	
	13.45 (6.1)			25.35 (11.5)			33.18 (15.05)			55.56 (25.2)	
	-			-			43.43 (19.7)			69.67 (31.6)	
Cable Lug Size 75°C CU or AL Wire Only AWG (mm ²)	1-Hole 3/0-500 kcmil (95-240)			2-Holes 3/0-400 kcmil (2x 95-185)			2-Holes 250-600 kcmil (120-300)			3-Holes 3/0-500 kcmil (95-300)	
Lug Torque in-lb (Nm)	2-Holes #3-250 kcmil (35-120)			310 (35)			3-Holes 250-600 kcmil (100-250)			398 (45)	
										310 (35)	

Molded Case Switches

Product Overview

Features

Molded Case Switches, 100-1200 Amperes

NOARK Electric offers a complete range of Molded Case Switches in six frame sizes: M1 - 150A, M2 - 250A, M3 - 400A, M4 - 600A, M5 - 800A, and M6 - 1200A. Each frame size offers a range of interrupting ratings at 240-690 Vac and 250-600 Vdc. Molded Case Switches are only used as disconnect switches.

Features:

- Instantaneous trip ability and a patented arc extinguishing design
- Bearing-type spindle reduces the operating force required to open and close the operating mechanism
- High-quality compact modular design
- 5-Year limited warranty

Wide range of accessories:

- Alarm switch and auxiliary contact
- Shunt and under-voltage trip
- Rotary type handle
- Flange type handle



B



Certifications

- UL 489 Listed, File Number E355396
- Certified to CSA C22.2 No. 5
- IEC/EN 60947-2
- CE Compliant



Molded Case Switches

Line/Load Lug Connection

- Terminal lugs are provided standard on all NOARK MCCBs.
- Additional terminal lug configurations available. See pages 19-20.



Withstand Rating* (kA rms)	Rated Amperes (A)	Line/Load Lug Connection		Lug Configuration
		2-Pole	3-Pole	
		Catalog Number		
M1D (100 kA @ 240 Vac) (65 kA @ 480 Vac) (20 kA @ 600 Vac)	100	M1D1002L	M1D1003L	1 Conductor
	150	M1D1502L	M1D1503L	#14 to #3/0 AWG CU OR #12 to 3/0 AWG AL
M2D (100 kA @ 240 Vac) (65 kA @ 480 Vac) (20 kA @ 600 Vac)	225	M2D2252L	M2D2253L	1 Conductor
	250	M2D2502L	M2D2503L	#3 AWG to 300kcmil CU or A
M3D (100 kA @ 240 Vac) (65 kA @ 480 Vac) (25 kA @ 600 Vac)	400	-	M3D4003L	1 Conductor #4/0 AWG to 750 kcmil CU or AL
M4D (100 kA @ 240 Vac) (65 kA @ 480 Vac) (30 kA @ 600 Vac)	600	-	M4D6003L	2 Conductor #2/0 AWG to 500 kcmil CU or AL
M5D (100 kA @ 240 Vac) (65 kA @ 480 Vac) (30 kA @ 600 Vac)	800	-	M5D8003L	3 Conductor 250kcmil to 500kcmil CU or AL
M6D (100 kA @ 240 Vac) (65 kA @ 480 Vac) (42 kA @ 600 Vac)	1000	-	M6D10003LF	3 Conductor #3/0 AWG to 750kcmil CU or AL
	1200	-	M6D12003LF	4 Conductor #3/0 AWG to 500kcmil CU or AL

Molded Case Switches

M1D - M6D Technical Data

		M1D	M2D	M3D	M4D	M5D	M6D
Rated Current (A)		100 - 150	225 - 250	400	600	800	1000 -1200
Number of Poles		2, 3		3			
Switch Type		M1D	M2D	M3D	M4D	M5D	M6D
Rated Voltage 50/60 Hz	Vac	600					
	Vdc	600					-
Withstand Rating* (kA rms)							
Circuit Breaker Ratings UL 489- -C-SA C22.2 (kA rms) Vac 50/60 Hz	240 Vac	100	100	100	100	100	100
	480 Vac	65	65	65	65	65	65
	600 Vac	20	20	25	30	30	42
	500 Vdc 2-Pole	35	35	50	50	50	-
	600 Vdc 3-Pole	35	35	50	50	50	-
Circuit Breaker Ratings IEC 60947-2	220 / 240 Vac	100	100	100	100	100	85 (60) Icu/Ics
	380 / 415 Vac						
Ultimate Breaking Capacity (Icu = 100% Ics) (kA rms)	660 / 690 Vac	8	10	15	15	15	30
	500 Vdc 3-Pole	35	35	50	50	-	-
	500 Vdc 2-Pole	35	35	50	50	50	-
Trip Current (A)		15xIn	12xIn	12xIn	10xIn	10xIn	15xIn
Connection							
Line/Load Lug Connection		■					
Insulation Voltage (Vi)		800 Vac					
Impulse Withstand Voltage (Vimp)		8 kVac					
Operational Voltage (Ve)	UL	600 Vac					
Mechanical Operating Cycles		10,000		8,000		3,000	
Electrical Operating Cycles		6,000		5,000		500	
Dimensions LxWxD in		6.46 x 3.54 x 3.33	7.17 x 4.13 x 3.47	11.22 x 5.51 x 4.59	12.32 x 7.68 x 5.43	16.18 x 7.68 x 7.58	22.64 x 9.84 x 15.16
Weight of Unit lb	2-Pole	3.17	3.75	-	-	-	-
	3-Pole	3.68	4.41	13.45	25.35	33.18	55.56
Lugs lb-in (N.m)		89 (10)	230 (23)	310 (35)		398 (45)	310 (35)

*NOTE: Molded Case Switches do not provide branch circuit protection and must be protected by an upstream OCPD (fuse or circuit breaker). The withstand rating is provided for coordination purposes.

B

Molded Case Motor Circuit Protectors

Product Overview

Features

Molded Case Motor Circuit Protectors, 3-1200 Amperes

NOARK Electric offers a complete range of 3 pole Molded Case Motor Circuit Protectors (MCPs, magnetic or short circuit protection only) which are used to protect the cables feeding three phase motors in six frame sizes: M1M - 150A, M2M - 250A, M3M - 400A, M4M - 600A, M5M - 800A, and M6M - 1200A. Each frame size offers a range of interrupting ratings at 240-690 Vac and 250-600 Vdc.

The National Electrical Code (NEC) requires the following when controlling a motor:

- A means of disconnecting power from the circuit
- Short circuit protection for the cables
- A way to start and stop the motor (typically a contactor)
- Overload protection for the motor (typically an overload relay)

A motor circuit protector serves as means of disconnecting power and short circuit protection for the cables.



Certifications

- UL 489 Recognized, File Number E355392
- Approved to CSA C22.2 No. 5
- IEC/EN 60947-2
- CE Compliant



Molded Case Motor Circuit Protectors

Line/Load Lug Connection

- Additional terminal lug configurations available. See pages 19-20.
- Terminal lugs are provided standard on all NOARK MCCBs.



Rated Amperage (A)	Magnetic Trip Setting Range	Line/Load Lug Connection		Lug Configuration
		S Interrupting	N Interrupting	
		Catalog Number		
3	7x-11x	50kA @ 240 Vac 35kA @ 480 Vac 14kA @ 600 Vac	100kA @ 240 Vac 65kA @ 480 Vac 20kA @ 600 Vac	1 Conductor #14 to #3/0 AWG CU OR #12 to 3/0 AWG AL
7	5x-10x	M1MS07T3L	M1MN07T3L	
15	5x-10x	M1MS15T3L	M1MN15T3L	
30	5x-11x	M1MS30T3L	M1MN30T3L	
50	5x-11x	M1MS50T3L	M1MN50T3L	
70	5x-11x	M1MS70T3L	M1MN70T3L	
100	5x-11x	M1MS100T3L	M1MN100T3L	
150	5x-11x	M1MS150T3L	M1MN150T3L	
250	5x-11x	M2MS250T3L	M2MN250T3L	

Rated Amperage (A)	Magnetic Trip Setting Range	Line/Load Lug Connection		Lug Configuration
		S Interrupting	N Interrupting	
		Catalog Number		
400	5x-11x	65kA @ 240 Vac 42kA @ 480 Vac 18kA @ 600 Vac	100kA @ 240 Vac 65kA @ 480 Vac 25kA @ 600 Vac	1 Conductor #4/0 AWG to 750kcmil CU or AL
		M3MS400T3L	M3MN400T3L	

Rated Amperage (A)	Magnetic Trip Setting Range	Line/Load Lug Connection			Lug Configuration
		S Interrupting	N Interrupting	N Interrupting	
		Catalog Number			
600	5x-11x	65kA @ 240 Vac 42kA @ 480 Vac 22kA @ 600 Vac	100kA @ 240 Vac 65kA @ 480 Vac 30kA @ 600 Vac	100kA @ 240 Vac 65kA @ 480 Vac 42kA @ 600 Vac	2 Conductor #2/0 AWG to 500kcmil CU or AL
		M4MS600T3L	M4MN600T3L	-	
800	5x-11x	M5MS800T3L	M5MN800T3L	-	3 Conductor 250kcmil to 500kcmil CU or AL
1200	2x-12x	M6MS1200E3LF	-	M6MN1200E3LF	4 Conductor #3/0 AWG to 500kcmil CU or AL

Molded Case Motor Circuit Protectors

M1M - M6M Technical Data

		M1M		M2M		M3M		M4M		M5M		M6M	
Current Range (A)		3-150		250		400		600		800		1200	
Number of Poles		3											
Breaker Type		S	N	S	N	S	N	S	N	S	N	S	N
Rated Voltage 50/60 Hz Vac		600											
Interrupting Capacity (kA rms)													
Circuit Breaker Ratings	240 Vac	50	100	50	100	65	100	65	100	65	100	65	100
	480 Vac	35	65	35	65	42	65	42	65	42	65	42	65
	600 Vac	14	20	14	20	18	25	22	30	22	30	22	42
Accessories													
Alarm Switch													
Auxiliary Contact													
Shunt Trip													
Under-Voltage Trip		■						■					
Handle Lock													
Flange Type Handle													
Rotary Type Handle													
Connection													
Line/Load Lug Connection		■											

Molded Case Circuit Breakers

Temperature & Altitude Compensation

Rated Current	Temperature	+40°C	+50°C	+60°C	+70°C
M1	15A	15	14.3	12.9	12
	20A	20	19	17.2	16
	25A	25	24	21.5	20
	30A	30	28.1	25.8	24
	35A	35	32.8	30.1	28
	40A	40	38	34.4	32
	45A	45	42.5	48.7	36
	50A	50	47.5	43	40
	60A	60	57	51.6	48
	70A	70	66.5	60.2	56
	80A	80	76	68.8	64
	90A	90	85.5	77.4	72
	100A	100	95	86	80
	125A	125	112.5	107.5	100
150A	150	135	129	120	
M2	125A	125	112.5	100	87.5
	150A	150	135	120	105
	175A	175	166.2	157.5	148.7
	200A	200	190	180	170
	225A	225	202.5	184.5	168
	250A	250	237.5	225	195
M3	250A	250	237.5	212.5	187.5
	300A	300	285	255	225
	350A	350	332.5	297.5	262.5
	400A	400	380	340	300
M4	400A	400	380	360	340
	500A	500	465	430	400
	600A	600	558	516	480
M5	600A	600	558	516	480
	700A	700	644	595	546
	800A	800	736	680	624
M6	800A	800	800	800	800
	1000A	1000	1000	1000	900
	1200A	1200	1080	1080	960

C

Altitude m		2000m	3000m	4000m	5000m
I _n		1×I _n	0.96×I _n	0.93×I _n	0.9×I _n
U _e (V)	AC/DC	600	480	420	360
Dielectric properties (V)	AC/DC	2400	2000	1680	1440
Rated insulation impulse voltage U _{imp} (kV)		8	8	8	8

Accessories For MCCB/MCP/MCS

Internal Accessories

Alarm Switch (AL)

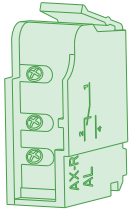

Function:

- Sends a signal when the circuit breaker trips
- UL File Number E355392

1

Accessory Description	Rated Operational Voltage	Rated Operational Current	Catalog Number
Alarm Switch 1NO / 1NC	240/480 Vac, 110/220 Vdc	.25A @ 110V .25A @ 220V 5A @ 240V 2A @ 480V	AL21N

Auxiliary Contact (AX)

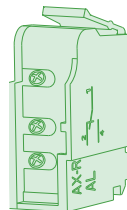

Function:

- Indicates the state of a circuit breaker (on/off)
- UL File Number E355392

2

Accessory Description	Rated Operational Voltage	Rated Operational Current	Catalog Number
Auxiliary Contact 1NO / 1NC	240/480 Vac, 110/220 Vdc	.25A @ 110V .25A @ 220V 5A @ 240V 2A @ 480V	AX21P

Shunt Release (SHT)

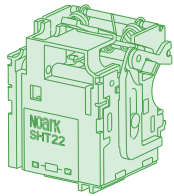

Function:

- Allows circuit breaker to be remotely operated
- Response Voltage, Pick-Up: U_s 70-110%
- Opening Time: Interrupts Automatically ≥ 10 ms, ≤ 60 ms
- UL File Number E355392

3

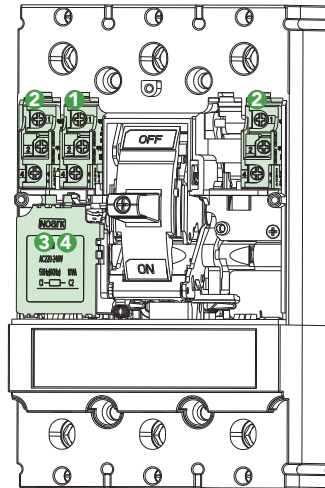

Under-Voltage Trip (UVT)

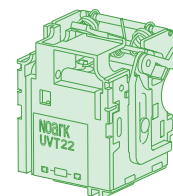

Function:

- Prevents circuit breaker from closing during an under-voltage situation
- Response Voltage, Drop: U_e 35-70%
- Response Voltage, Pick-Up: U_e 85-110%
- Opening Time: Interrupts Automatically ≥ 10 ms, ≤ 60 ms
- UL File Number E355392

4

Accessory Description	Frame Size	Voltage	Catalog Number
Shunt Trip	M1	100-130 Vac	SHT21NA
		220-240 Vac	SHT21NB
		480-500 Vac	SHT21ND
		24 Vdc	SHT21NE
	M2-M3	100-130 Vac	SHT22NA
		220-240 Vac	SHT22NB
		480-500 Vac	SHT22ND
		24 Vdc	SHT22NE
	M4-M5	100-130 Vac	SHT24NA
		220-240 Vac	SHT24NB
		480-500 Vac	SHT24ND
		24 Vdc	SHT24NE
M6	220-240Vac	SHT26NB	
	480-500Vac	SHT26ND	
	24-30Vdc	SHT26NE	

Accessory Description	Frame Size	Voltage	Catalog Number
Under-Voltage Trip	M1	110-127 Vac	UVT21NA
		220-240 Vac	UVT21NB
		24-30 Vdc	UVT21ND
	M2-M3	110-127 Vac	UVT22NA
		220-240 Vac	UVT22NB
		24-30 Vdc	UVT22ND
	M4-M5	110-127 Vac	UVT24NA
		220-240 Vac	UVT24NB
		24-30 Vdc	UVT24ND
	M6	110-127 Vac	UVT26NA
220-240 Vac		UVT26NB	
480-500 Vac		UVT26NC1	

Additional products, accessories and higher ratings available. Contact your NOARK representative or visit na.noark-electric.com for additional information.

Accessories For MCCB/MCP/MCS

Internal Accessories: Shunt Trip



SHT	21	N	A
Description	Type	Device Category	Control Voltage
Shunt Trip	21: for M1 22: for M2-M3 24: for M4-M5 26: for M6	N: UL 489	A: 100~130 Vac B: 220~240 Vac C: 380~440 Vac D: 480~500 Vac E: 24 Vdc H: 220~250 Vdc

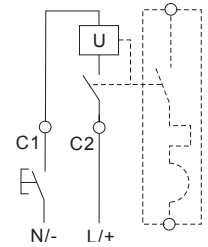

- Response Voltage, Pick-Up: Us 70-110%
- Opening Time: Interrupts Automatically ≥ 10 ms, ≤ 60 ms

Accessory Description	Type	Voltage	Product	Part Number
Shunt Trip	M1	100-130 Vac	SHT21NA	1100505
		220-240 Vac	SHT21NB	1100506
		380-440 Vac	SHT21NC	1100507
		480-500 Vac	SHT21ND	1100508
		24 Vdc	SHT21NE	1100509
		M2-M3	100-130 Vac	SHT22NA
	220-240 Vac		SHT22NB	1100514
	380-440 Vac		SHT22NC	1100515
	480-500 Vac		SHT22ND	1100516
	24 Vdc		SHT22NE	1100517
	M4-M5		100-130 Vac	SHT24NA
		220-240 Vac	SHT24NB	1100522
		380-440 Vac	SHT24NC	1100523
		480-500 Vac	SHT24ND	1100524
		24 Vdc	SHT24NE	1100525
		M6	100-130Vac	SHT26NA
	220-240Vac		SHT26NB	1101169
	380-440Vac		SHT26NC	1101170
480-500Vac	SHT26ND		1101171	
24-30Vdc	SHT26NE		1101172	
110-125Vdc	SHT26NG		1101173	
220-250Vdc	SHT26NH	1101174		

C

Accessories For MCCB/MCP/MCS

External Accessories: Extended Rotary Handle

Shown: NEH2R2 handle with ES32A extended handle shaft and HM1A operating mechanism.

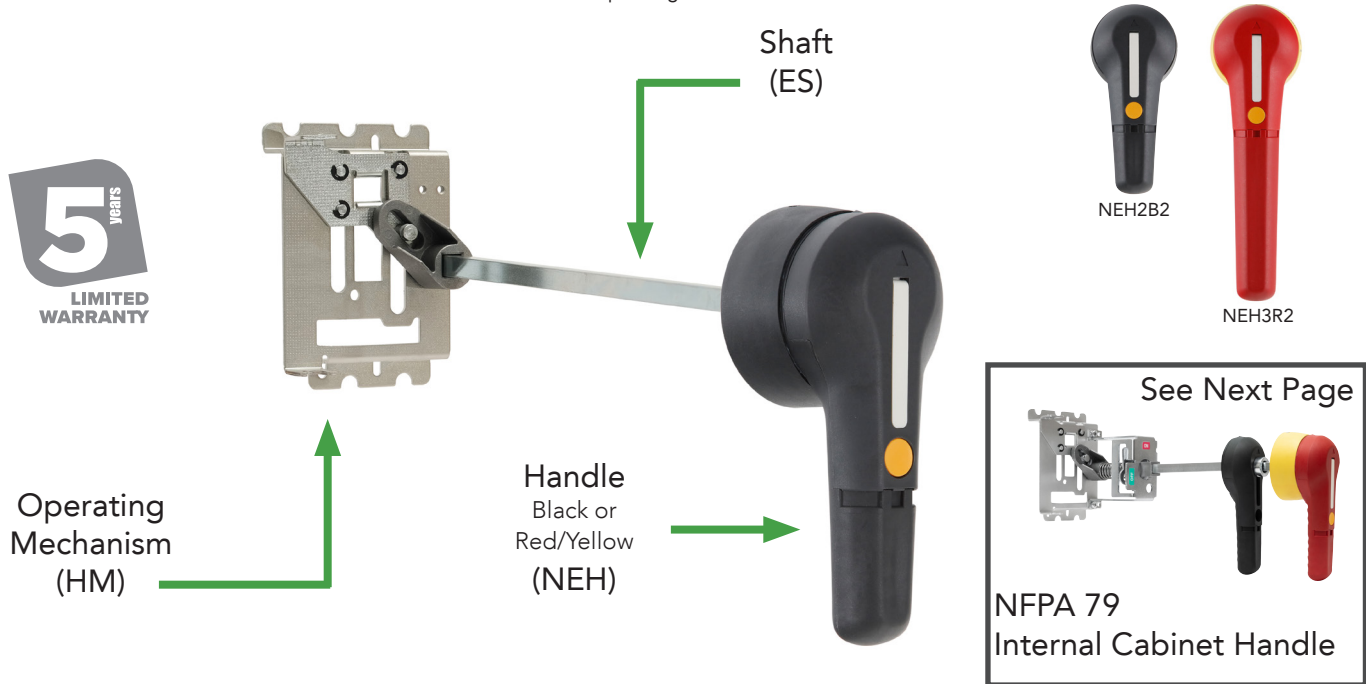

NEMA extended rotary handle mechanism selection consists of 3 components (sold separately): operating mechanism (HM), shaft (ES), and rotary handle (NEH).

- UL File Numbers E484125 and E355392

Selection Process

- Step 1.** Identify breaker frame size to select corresponding operating mechanism (HM).
- Step 2.** Select shaft (ES) based on the length needed and diameter required.
- Step 3.** Select handle (NEH) with the matching shaft diameter based on desired color combination and UL rating.

Step 1

Operating Mechanism		
Select One		
Frame Size	Use Shaft Diameter	Catalog Number
M1	10mm ²	HM1A
M1-2 Pole	10mm ²	HMD1A
M2	10mm ²	HM2A
M2-2 Pole	10mm ²	HMD2A
M3	12mm ²	HM3B
M4 / M5	12mm ²	HM4B
M6	12mm ²	HOM6B

+

Step 2

Shaft		
Select One		
Shaft Diameter	Length	Catalog Number
10mm ² M1 or M2	7.9 inch (200mm)	ES20A
	12.6 inch (320mm)	ES32A
	19.7 inch (500mm)	ES50A
12mm ² M3, M4, M5 or M6	7.9 inch (200mm)	ES20B
	12.6 inch (320mm)	ES32B
	19.7 inch (500mm)	ES50B

+

Step 3

4/4X Handle			
Select One			
Frame Size	Use Shaft Diameter	Color	Catalog Number
M1 or M2	10mm ²	Black	NEH2B2
		Red / Yellow	NEH2R2
M3, M4, M5 or M6	12mm ²	Black	NEH3B2
		Red / Yellow	NEH3R2

Accessories For MCCB/MCP/MCS

External Accessories: NFPA 79 Internal Cabinet Handle

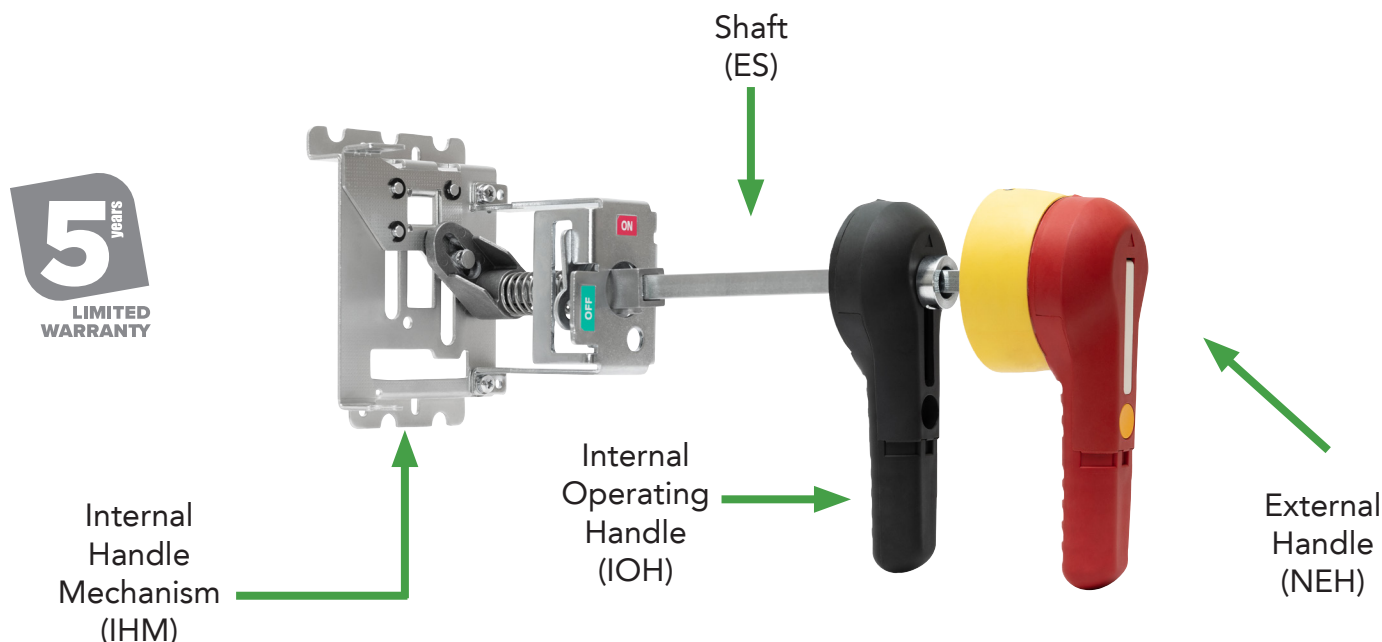

• UL File Numbers E484125 and E355392

Selection Process

- Step 1.** Identify breaker frame size to select corresponding internal handle mechanism (IHM).
- Step 2.** Select shaft (ES) based on the length needed and diameter required.
- Step 3.** Select the internal operating handle (IOH) based on the breaker frame size.
- Step 4.** Select handle (NEH) with the matching shaft diameter based on desired color combination and UL rating.

Step 1

Step 2

Step 3

Step 4

Internal Handle Mechanism			Shaft			Internal Operating Handle			4/4X Handle			
Select One			Select One			Select One			Select One			
Frame Size	Use Shaft Diameter	Catalog Number	Shaft Diameter	Length	Catalog Number	Frame Size	Use Shaft Diameter	Catalog Number	Frame Size	Use Shaft Diameter	Color	Catalog Number
M1	10mm ²	IHM1	10mm ² M1 or M2	7.9 inch (200mm)	ES20A	M1 or M2	10mm ²	IOH2	M1 or M2	10mm ²	Black	NEH2B2
M2	10mm ²	IHM2		12.6 inch (320mm)	ES32A						Red / Yellow	NEH2R2
				19.7 inch (500mm)	ES50A							
M3	12mm ²	IHM3	12mm ² M3, M4 or M5	7.9 inch (200mm)	ES20B	M3, M4 or M5	12mm ²	IOH3	M3, M4 or M5	12mm ²	Black	NEH3B2
M4 or M5	12mm ²	IHM4		12.6 inch (320mm)	ES32B						Red / Yellow	NEH3R2
				19.7 inch (500mm)	ES50B							

Accessories For MCCB/MCP/MCS

External Accessories: M1-M5 Flange Handle Mechanism

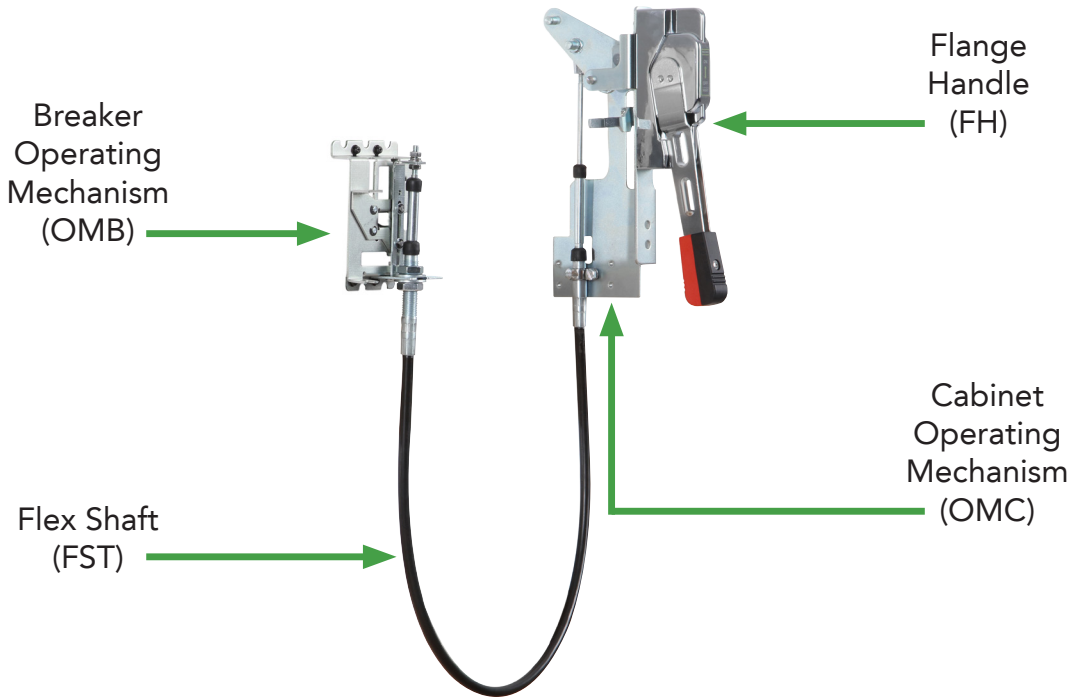

M1-M5 Flange handle mechanism selection is separated into 4 components (sold separately): flange handle (FH), flex shaft (FST), cabinet operating mechanism (OMC) and breaker operating mechanism (OMB). NOARK UL MCCB frame size: M1 (15-150A), M2 (175-250A), M3 (300-400A), M4 (500-600A), M5 (700-800A).

Selection Process

• UL File Numbers E355392, E484125

- Step 1.** Select desired flange handle.
- Step 2.** Select cabinet operating mechanism.
- Step 3.** Select breaker operating mechanism based on frame size.
- Step 4.** Select flex shaft* based on enclosure requirements.

Step 1

Flange Handle		
Select One		
Frame Size	Handle Type / Length	Catalog Number
M1 / M2 / M3 / M4 / M5	Compact fixed length (9.57 in) UL 4, 4X Rated	FH4XC
	Adjustable length (11.81 - 13.62 in) UL 4, 4X Rated	FH4XD

Step 2

Cabinet Operating Mechanism	
Select One	
Frame Size	Catalog Number
M1 / M2 / M3 / M4 / M5	OMC

Step 3

Breaker Operating Mechanism	
Select One	
Frame Size	Catalog Number
M1	OMB21
M2	OMB22
M3	OMB23
M4 / M5	OMB24

Step 4

Flex Shaft*	
Select One	
Length	Catalog Number
3 feet	FST3
4 feet	FST4
5 feet	FST5
6 feet	FST6

Note: Flange handle mechanism available for M6 frame size on next page.

* When selecting the length of shaft, ensure minimum bending radius of 6 inches is maintained to operate properly. Contact NOARK if additional lengths are needed.

Accessories For MCCB/MCP/MCS

External Accessories: M6 Flange Handle Mechanism

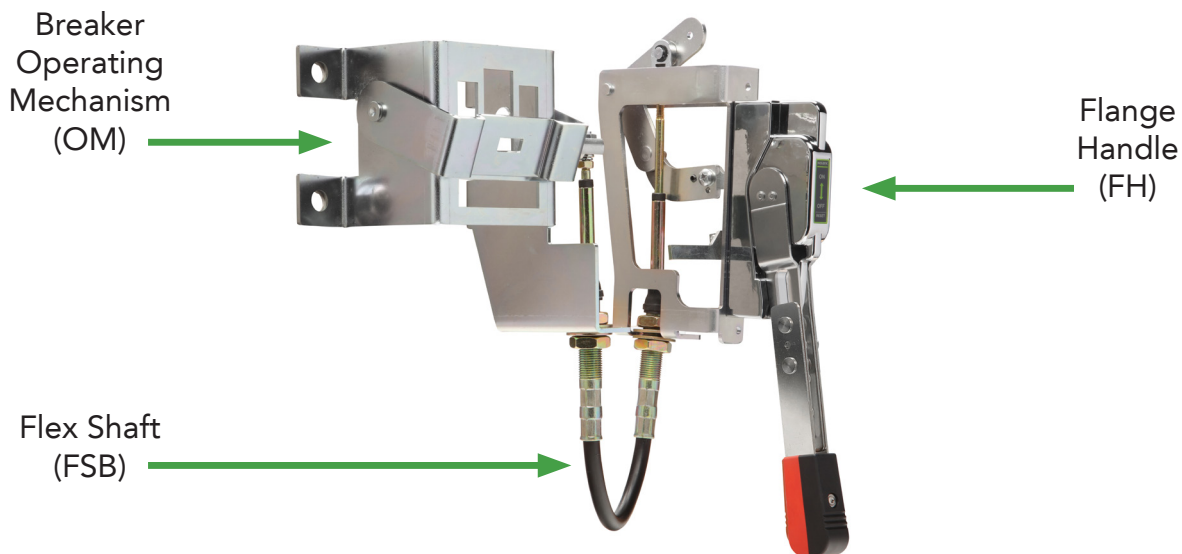

Flange handle mechanism selection is separated into three components (sold separately): flange handle (FH), flex shaft (FSB), and breaker operating mechanism (OM). NOARK UL MCCB frame size: M6 (800-1200A).

Selection Process

• UL File Numbers E355392, E484125

- Step 1.** Select desired flange handle.
- Step 2.** Select breaker operating mechanism based on frame size.
- Step 3.** Select flex shaft* based on enclosure requirements.

Step 1			Step 2		Step 3	
Flange Handle			Breaker Operating Mechanism		Flex Shaft*	
Frame Size	Handle Type / Length	Catalog Number	Frame Size	Catalog Number	Select One	
M6	Adjustable length (11.81 - 13.62 in) UL 4, 4X Rated Single	FH4XA	M6	OM26	Length	Catalog Number
					3 feet	FSB3
					4 feet	FSB4
					5 feet	FSB5
					6 feet	FSB6

*When selecting the length of shaft, ensure minimum bending radius of 6 inches is maintained to operate properly. Contact NOARK if additional lengths are needed.

Accessories For MCCB/MCP/MCS

Connection Hardware: Terminal Lugs



1-Hole

- Terminal lugs included with molded case circuit breakers standard. Listed individually for replacement purposes only.
- Sold Individually Example: Line / Load Terminal Lugs for 3-pole breaker requires six
- UL File Number E349009

Accessory Description	Frame Size	Configuration	Specifications	Catalog Number
Terminal Lugs	M1 (150A)	1-Hole Standard	#14 AWG~3/0 AWG 1 CU wire #12 AWG~3/0 AWG 1 AL wire	LTC21NAA
	M2 (250A)	1-Hole Standard	#3 AWG~300kcmil 1 CU/AL wire	LTC22NAA
	M3 (400A)	1-Hole Standard	#4/0 AWG~750 kcmil 1 CU/AL wire	LTC23NAA
		2-Hole** Optional	#3 AWG~250 kcmil 2 CU/AL wire	LTC23NBA
	M4 (600A)	2-Hole Standard	#2/0 AWG~500 kcmil 2 CU/AL wire	LTC24NBA
	M5 (800A)	2-Hole (700A) Standard	75°C Al/Cu Wire (2) 250kcmil-600kcmil	LTC25NBA
		3-Hole (800A) Standard	75°C Al/Cu Wire (3) 250kcmil-500kcmil	LTC25NCA
	M6 (1200A)	3-Hole (800-1000A) Standard	75°C Al/Cu Wire (3) 3/0 AWG*-750kcmil	LTC26NCA
		4-Hole (1200A) Standard	75°C Al/Cu Wire (4) 3/0 AWG*-500kcmil	LTC26NDA

NOTE: Terminals are rated 90° when a 100% breaker is used.

** Requires external terminal cover part no. TC23NB ordered separately

* AWG = American Wire Gauge



Accessory Description	Type	Configuration	Catalog Number
Terminal Cover	M3	2-Holes	TC23NB

- Required for installation of M3 2-Hole terminal LTC23NB or LTC23NBA

Additional products, accessories and higher ratings available. Contact your NOARK representative or visit na.noark-electric.com for additional information.

Accessories For MCCB/MCP/MCS

Connection Hardware: Multi-wire Terminal Lug Kits



- Multi-wire terminal lug kits include: three terminal lugs and one terminal shield.
- Al/Cu rated
- UL File Number E355392

Accessory Description	Frame Size	Configuration	Specifications	Catalog Number
Multi-wire Terminal Lug Kits	M1 (150A)	3-Hole	167 °F (75 °C) #12 AWG*~#3 AWG* Al wire or #14 AWG*~#3 AWG* Cu wire	LK21NCA
		6-Hole	167 °F (75 °C) #12 AWG*~#6 AWG* Al wire or #14 AWG*~#6 AWG* Cu	LK21NFA
	M2 (250A)	3-Hole	167 °F (75 °C) #8 AWG*~#2/0 AWG* Al/Cu wire	LK22NCA
		3-Hole (one large, two small)	167 °F (75 °C) #3 AWG*~#2/0 AWG*, (1) Al/Cu wire and # 12 AWG*~#1 AWG*, (2) Al/Cu wire	LK22NGA
		6-Hole	167 °F (75 °C) #12 AWG*~#6 AWG Al/Cu wire	LK22NFA
	M3 (400A)	2-Hole	167 °F (75 °C) #3AWG*~250 kcmil Al/Cu wire	LK23NBA
		3-Hole	167 °F (75 °C) #3AWG*~250 kcmil Al/Cu wire	LK23NCA
		5-Hole (two large, three small)	167 °F (75 °C) #12 AWG*~#1 AWG*, (3) Al/Cu wire and #3 AWG*~#3/0 AWG*, (2) Al/Cu wire	LK23NEA
		6-Hole	167 °F (75 °C) 12 AWG*~#3 AWG* Al/Cu wire	LK23NFA
	M4 (600A)	3- Hole	167 °F (75 °C) #2/0 AWG*~250 kcmil Al/Cu wire	LK24NCA
5-Hole		167 °F (75 °C) #12 AWG*~#1 AWG*, (3) Al/Cu wire and #3 AWG*~#3/0 AWG*, (2) Al/Cu wire	LK24NEA	

* AWG = American Wire Gauge

Additional products, accessories and higher ratings available. Contact your NOARK representative or visit na.noark-electric.com for additional information.

Accessories For MCCB/MCP/MCS

Lugs to Bus Bar Conversion Kits

Frame Size	Bus Pad Dimensions (mm)										Bolt Size	Bolt Torque	Conversion Kit Catalog Number
	Line Side (Top)					Load Side (Bottom)							
	W	D	D1	C	H	W	D	D1	C	H			
M1	14.2	14.8	7.3	-	18.5	14.2	16.8	7.3	-	17.5	M6 x 16	10Nm/89 lb in	CKLB21
M2	25	18.5	8.5	-	23	25	18.1	8.5	-	21	M8 x 20	11Nm/97.4 lb in	CKLB22
M3	30	30	13.5	-	27.8	26	27	13.5	-	25.9	M10 x 30	25Nm/222lb-in	Not Required
M4	50	33.3	16.5	-	33.5	50	33	17	-	33.5	M12 x 30	30Nm/265lb-in	Not Required
M5	50	33.4	16.5	-	33.5	50	33	17	-	33.5	M12 x 30	30Nm/265lb-in	Not Required
M6	50	30	12	25	32.6	50	27.5	11.7	25	32.6	M10 x 40(2)	25Nm/222lb-in	Not Required

M1-M5 Breaker Bus Pad Dimensions

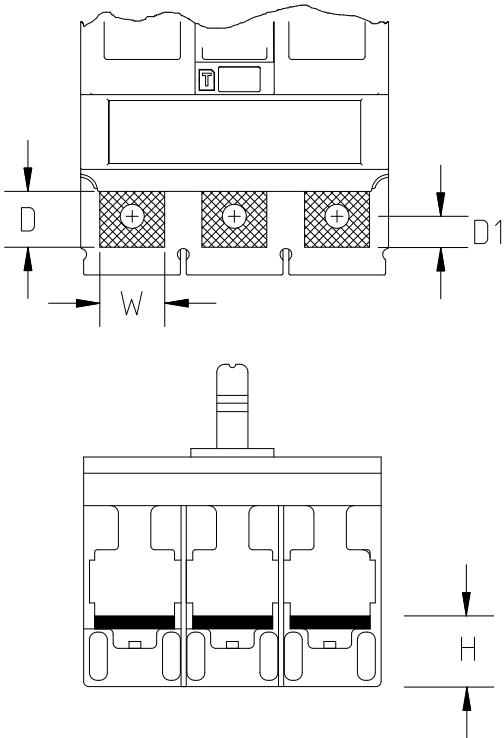

M6 Breaker Bus Pad Dimensions

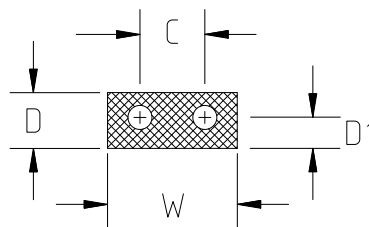

CKLB Conversion Kit



Miniature Circuit Breakers

Understanding UL 489 & UL 1077 Devices

The key to understanding UL 1077 supplementary protection and UL 489 branch protection requirements is to first understand how to identify the products, the applications they can be used for and importance of selecting the correct device in compliance with UL standards and NEC Codes.

- A UL 489 device can be used as branch circuit protection or supplementary protection.
- UL 1077 devices are only acceptable for providing supplementary protection where there is branch circuit protection ahead of it.

UL 489 Circuit Breakers and Branch Circuit Overcurrent Devices

National Electrical Code (NEC) defines a branch circuit as the circuit conductors between the final overcurrent device protecting the circuit and the outlets. UL 489 opens automatically on overload and short circuit. It also protects wire and cable against overload and short circuit. UL 489 circuit breaker used for branch circuit protection.

UL 489 Applications:

- Receptacles and branch lighting
- Control Panels
- Load circuits leaving the equipment (external)
- Uninterruptible power supply (UPS)
- Relays
- Heating, ventilation, air conditioning and refrigeration equipment (HVAC/R)
- Variable frequency drives (VFD)

Features:

- DIN rail mountable
- Stand alone Branch Circuit Protection
- External handle mechanisms available
- Field mounted accessories
- Various levels of protection (curves)



UL 489 products have larger dimensions to provide the necessary phase to phase voltage air gap.

UL 1077 Supplementary Protectors & Overcurrent Devices

UL 1077 Supplementary Protector is a manually re-settable device designed to open the circuit automatically on a predetermined value of time versus current or voltage within an appliance or other electrical equipment. A supplementary protective device is intended to provide limited overcurrent protection for specific applications and utilization equipment such as cabinet lighting and appliances.

Example: only use UL 1077 to protect circuits inside the equipment that do not feed circuits that exit the equipment.

UL 1077 Applications:

- Cabinet Lighting
- Appliances
- Control Power Transformers
- Relays
- Control Circuits

Features:

- DIN rail mountable
- Field mounted accessories
- Various levels of protection (curves)



Disclaimer: Proper Sizing of an overcurrent protection device is the responsibility of the customer and should be determined using the application standards of the NEC*, CEC**, or other applicable standards.

*NEC-National Electrical Code

** CEC-Canadian Electrical Code

Miniature Circuit Breakers

Applying UL 489 Breakers Based on Common System Voltages

Voltage 120/240V 1 Phase

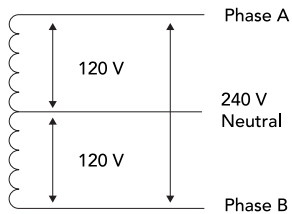

Connection		Style	Rating
Poles	Voltage		
One	120V	B1N or B1NQ	120/240V
Two	240V	B1N or B1NQ	120/240V

Voltage 208/120 3 Phase

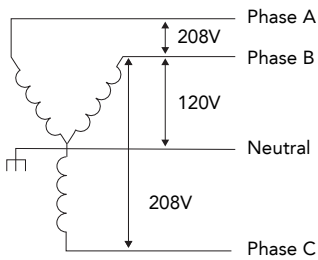

Connection		Style	Rating
Poles	Voltage		
One	120V	B1N or B1NQ	120/240V
Two	208V	B1N or B1NQ	120/240V
Three	208V	B1N	240V

Voltage 240V Delta Ungrounded

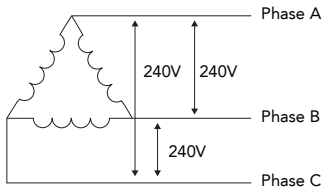

Connection		Style	Rating
Poles	Voltage		
Two	240V	B1N	240V
Three	240V	B1N	240V

Note: For high-leg delta or 480V delta systems, please call your NOARK representative.

Voltage 3 Phase 480/277V

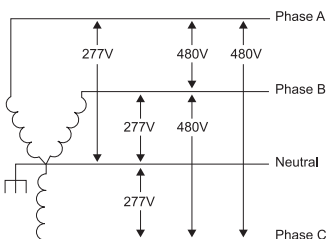

Connection		Style	Rating
Poles	Voltage		
One	277V	B1H	480/277V
Two	480V	B1H	480/277V
Three	480/277V	B1H	480/277V

Note: One can always use a higher rated breaker. (ie. B1NQ<B1N<B1H)

Disclaimer: Proper Sizing of an overcurrent protection device is the responsibility of the customer and should be determined using the application standards of the NEC*, CEC**, or other applicable standards.

Miniature Circuit Breakers

Curves

Miniature circuit breakers have different protection curves to accommodate different applications.

C Curve

In Type C curve applications, the magnetic trip is set between 5-10 times the full load current. This is the most common protection used for cables, lighting, resistive loads, general purpose applications and when properly sized, for motors.



C Curve
(5-10 In)

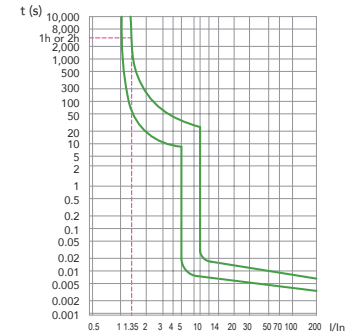

D Curve

Type D curve applications have a higher setting of 7-15 times the full load current due to the inrush current of motor loads and the magnetizing current on the primary of a transformer or solenoid. Application for this curve include motor loads, transformer primary and solenoids due to the inrush or magnetizing currents.



D Curve
(10-20 In)

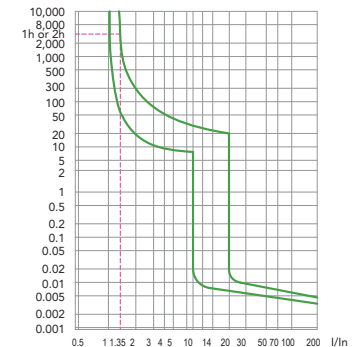

B Curve

Type B curves provide a magnetic trip setting of 3-5 times the full load current. Applications: electronic circuits.

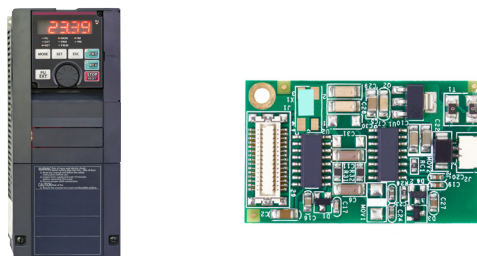

B Curve
(3-5 In)

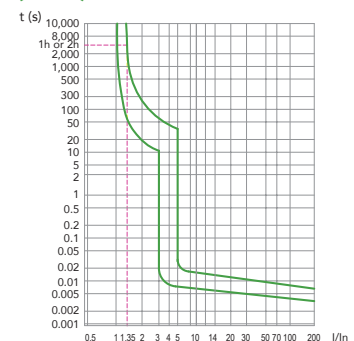

Disclaimer: Proper Sizing of an overcurrent protection device is the responsibility of the customer and should be determined using the application standards of the NEC*, CEC**, or other applicable standards.

*NEC-National Electrical Code
** CEC-Canadian Electrical Code

Miniature Circuit Breakers

UL 489 Product Overview

Features

The B1 UL 489 miniature circuit breakers are available in a complete range of amperages from 0.5A to 63A. Standard ratings of 10 kA at 480Y/277 Vac and 10 kA at 125 Vdc. These are suitable for branch circuit protection.

- Breakers mount on standard 35 mm DIN rail
- Can be used in UL 1077 or CSA C22.2 No.235 applications
- Field installable shunt trip and auxiliary switch
- Available with provisions for ring tongue terminals
- Module width of only 0.71 in (18 mm) per pole
- Contact position indicator (red/green)
- Provision for pad locking the toggle in ON or OFF position



LIMITED WARRANTY

Typical Applications

- Branch Circuit Protection
- Receptacle and lighting circuits
- Motor control circuits
- Load circuits leaving the equipment (external)
- Heating, ventilation, air conditioning, refrigeration equipment
- Power supplies
- Control instrumentation
- Relays
- Uninterruptible power supply (UPS)
- Power conditioners

Certifications

UL 489 File Number E355392 / CSA C22.2 No. 5-16 / IEC 60947-2

- Certified for Canada CSA standards 22.2 No. 5 for branch circuit protection.
- UL 489 file number E355392 standard for connection terminals which allows the user to apply field wiring directly to the breaker.
- UL 486 standard for connection terminals which allows the user to apply field wiring directly to the breaker.
- IEC 60947-2 standard for industrial applications of circuit protection.
- CCC China Compulsory Certification



Miniature Circuit Breakers

B1N UL 489 240 Vac; 60/125 Vdc 10 kA - Box Lugs

Certifications
IEC/EN 60947-2



Rated Amperage (A)	C Curve (5-10 In) Standard		D Curve (10-20 In) Inductive		B Curve (3-5 In) Electronic	
	1-Pole - 240 Vac / 60 Vdc	2-Pole - 240 Vac / 125 Vdc	1-Pole - 240 Vac / 60 Vdc	2-Pole - 240 Vac / 125 Vdc	1-Pole - 240 Vac / 60 Vdc	2-Pole - 240 Vac / 125 Vdc
	Catalog Number	Catalog Number	Catalog Number	Catalog Number	Catalog Number	Catalog Number
0.5	B1N1C0.5	B1N2C0.5	B1N1D0.5	B1N2D0.5	B1N1B0.5	B1N2B0.5
1	B1N1C1	B1N2C1	B1N1D1	B1N2D1	B1N1B1	B1N2B1
1.6	B1N1C1.6	B1N2C1.6	B1N1D1.6	B1N2D1.6	B1N1B1.6	B1N2B1.6
2	B1N1C2	B1N2C2	B1N1D2	B1N2D2	B1N1B2	B1N2B2
3	B1N1C3	B1N2C3	B1N1D3	B1N2D3	B1N1B3	B1N2B3
4	B1N1C4	B1N2C4	B1N1D4	B1N2D4	B1N1B4	B1N2B4
5	B1N1C5	B1N2C5	B1N1D5	B1N2D5	B1N1B5	B1N2B5
6	B1N1C6	B1N2C6	B1N1D6	B1N2D6	B1N1B6	B1N2B6
7	B1N1C7	B1N2C7	B1N1D7	B1N2D7	B1N1B7	B1N2B7
8	B1N1C8	B1N2C8	B1N1D8	B1N2D8	B1N1B8	B1N2B8
10	B1N1C10	B1N2C10	B1N1D10	B1N2D10	B1N1B10	B1N2B10
13	B1N1C13	B1N2C13	B1N1D13	B1N2D13	B1N1B13	B1N2B13
15	B1N1C15	B1N2C15	B1N1D15	B1N2D15	B1N1B15	B1N2B15
16	B1N1C16	B1N2C16	B1N1D16	B1N2D16	B1N1B16	B1N2B16
20	B1N1C20	B1N2C20	B1N1D20	B1N2D20	B1N1B20	B1N2B20
25	B1N1C25	B1N2C25	B1N1D25	B1N2D25	B1N1B25	B1N2B25
30	B1N1C30	B1N2C30	B1N1D30	B1N2D30	B1N1B30	B1N2B30
32	B1N1C32	B1N2C32	B1N1D32	B1N2D32	B1N1B32	B1N2B32
35	B1N1C35	B1N2C35	B1N1D35	B1N2D35	B1N1B35	B1N2B35
40	B1N1C40	B1N2C40	B1N1D40	B1N2D40	B1N1B40	B1N2B40
50	B1N1C50	B1N2C50	B1N1D50	B1N2D50	B1N1B50	B1N2B50
60	B1N1C60	B1N2C60	B1N1D60	B1N2D60	B1N1B60	B1N2B60
63	B1N1C63	B1N2C63	B1N1D63	B1N2D63	B1N1B63	B1N2B63

D

Additional products, accessories and higher ratings available. Contact your NOARK representative or visit na.noark-electric.com for additional information.

Miniature Circuit Breakers

B1N UL 489 240 Vac; 10 kA - Box Lugs



Rated Amperage (A)	C Curve (5-10 In) Standard	D Curve (10-20 In) Inductive	B Curve (3-5 In) Electronic
	3-Pole - 240 Vac	3-Pole - 240 Vac	3-Pole - 240 Vac
	Catalog Number	Catalog Number	Catalog Number
0.5	B1N3C0.5	B1N3D0.5	B1N3B0.5
1	B1N3C1	B1N3D1	B1N3B1
1.6	B1N3C1.6	B1N3D1.6	B1N3B1.6
2	B1N3C2	B1N3D2	B1N3B2
3	B1N3C3	B1N3D3	B1N3B3
4	B1N3C4	B1N3D4	B1N3B4
5	B1N3C5	B1N3D5	B1N3B5
6	B1N3C6	B1N3D6	B1N3B6
7	B1N3C7	B1N3D7	B1N3B7
8	B1N3C8	B1N3D8	B1N3B8
10	B1N3C10	B1N3D10	B1N3B10
13	B1N3C13	B1N3D13	B1N3B13
15	B1N3C15	B1N3D15	B1N3B15
16	B1N3C16	B1N3D16	B1N3B16
20	B1N3C20	B1N3D20	B1N3B20
25	B1N3C25	B1N3D25	B1N3B25
30	B1N3C30	B1N3D30	B1N3B30
32	B1N3C32	B1N3D32	B1N3B32
35	B1N3C35	B1N3D35	B1N3B35
40	B1N3C40	B1N3D40	B1N3B40
50	B1N3C50	B1N3D50	B1N3B50
60	B1N3C60	B1N3D60	B1N3B60
63	B1N3C63	B1N3D63	B1N3B63

Additional products, accessories and higher ratings available. Contact your NOARK representative or visit na.noark-electric.com for additional information.

Miniature Circuit Breakers

B1H UL 489 480Y/277 Vac 10 kA - Box Lugs

Certifications
IEC/EN 60947-2



Rated Amperage (A)	C Curve (5-10 In) Standard		D Curve (10-20 In) Inductive		B Curve (3-5 In) Electronic	
	1-Pole 277 Vac	2-Pole 480Y/277 Vac	1-Pole 277 Vac	2-Pole 480Y/277 Vac	1-Pole 277 Vac	2-Pole 480Y/277 Vac
	Catalog Number	Catalog Number	Catalog Number	Catalog Number	Catalog Number	Catalog Number
0.5	B1H1C0.5	B1H2C0.5	B1H1D0.5	B1H2D0.5	B1H1B0.5	B1H2B0.5
1	B1H1C1	B1H2C1	B1H1D1	B1H2D1	B1H1B1	B1H2B1
1.6	B1H1C1.6	B1H2C1.6	B1H1D1.6	B1H2D1.6	B1H1B1.6	B1H2B1.6
2	B1H1C2	B1H2C2	B1H1D2	B1H2D2	B1H1B2	B1H2B2
3	B1H1C3	B1H2C3	B1H1D3	B1H2D3	B1H1B3	B1H2B3
4	B1H1C4	B1H2C4	B1H1D4	B1H2D4	B1H1B4	B1H2B4
5	B1H1C5	B1H2C5	B1H1D5	B1H2D5	B1H1B5	B1H2B5
6	B1H1C6	B1H2C6	B1H1D6	B1H2D6	B1H1B6	B1H2B6
7	B1H1C7	B1H2C7	B1H1D7	B1H2D7	B1H1B7	B1H2B7
8	B1H1C8	B1H2C8	B1H1D8	B1H2D8	B1H1B8	B1H2B8
10	B1H1C10	B1H2C10	B1H1D10	B1H2D10	B1H1B10	B1H2B10
13	B1H1C13	B1H2C13	B1H1D13	B1H2D13	B1H1B13	B1H2B13
15	B1H1C15	B1H2C15	B1H1D15	B1H2D15	B1H1B15	B1H2B15
16	B1H1C16	B1H2C16	B1H1D16	B1H2D16	B1H1B16	B1H2B16
20	B1H1C20	B1H2C20	B1H1D20	B1H2D20	B1H1B20	B1H2B20
25	B1H1C25	B1H2C25	B1H1D25	B1H2D25	B1H1B25	B1H2B25
30	B1H1C30	B1H2C30	B1H1D30	B1H2D30	B1H1B30	B1H2B30
32	B1H1C32	B1H2C32	B1H1D32	B1H2D32	B1H1B32	B1H2B32

D

Additional products, accessories and higher ratings available. Contact your NOARK representative or visit na.noark-electric.com for additional information.

Miniature Circuit Breakers

B1H UL 489 480Y/277 Vac 10 kA - Box Lugs

Certifications
IEC/EN 60947-2



Rated Amperage (A)	C Curve (5-10 In) Standard	D Curve (10-20 In) Inductive	B Curve (3-5 In) Electronic
	3-Pole 480Y/277 Vac	3-Pole 480Y/277 Vac	3-Pole 480Y/277 Vac
	Catalog Number	Catalog Number	Catalog Number
0.5	B1H3C0.5	B1H3D0.5	B1H3B0.5
1	B1H3C1	B1H3D1	B1H3B1
1.6	B1H3C1.6	B1H3D1.6	B1H3B1.6
2	B1H3C2	B1H3D2	B1H3B2
3	B1H3C3	B1H3D3	B1H3B3
4	B1H3C4	B1H3D4	B1H3B4
5	B1H3C5	B1H3D5	B1H3B5
6	B1H3C6	B1H3D6	B1H3B6
7	B1H3C7	B1H3D7	B1H3B7
8	B1H3C8	B1H3D8	B1H3B8
10	B1H3C10	B1H3D10	B1H3B10
13	B1H3C13	B1H3D13	B1H3B13
15	B1H3C15	B1H3D15	B1H3B15
16	B1H3C16	B1H3D16	B1H3B16
20	B1H3C20	B1H3D20	B1H3B20
25	B1H3C25	B1H3D25	B1H3B25
30	B1H3C30	B1H3D30	B1H3B30
32	B1H3C32	B1H3D32	B1H3B32

Additional products, accessories and higher ratings available. Contact your NOARK representative or visit na.noark-electric.com for additional information.

Miniature Circuit Breakers

B1NQ UL 489 120/240 Vac 10 kA - Box Lugs

Certifications
IEC/EN 60947-2



Rated Amperage (A)	C Curve (5-10 In) Standard		D Curve (10-20 In) Inductive	
	1-Pole - 120 / 240 Vac	2 Pole - 120 / 240 Vac	1-Pole - 120 / 240 Vac	2 Pole - 120 / 240 Vac
	Catalog Number	Catalog Number	Catalog Number	Catalog Number
1	B1NQ1C1	B1NQ2C1	B1NQ1D1	B1NQ2D1
1.6	B1NQ1C1.6	B1NQ2C1.6	B1NQ1D1.6	B1NQ2D1.6
2	B1NQ1C2	B1NQ2C2	B1NQ1D2	B1NQ2D2
3	B1NQ1C3	B1NQ2C3	B1NQ1D3	B1NQ2D3
4	B1NQ1C4	B1NQ2C4	B1NQ1D4	B1NQ2D4
5	B1NQ1C5	B1NQ2C5	B1NQ1D5	B1NQ2D5
6	B1NQ1C6	B1NQ2C6	B1NQ1D6	B1NQ2D6
8	B1NQ1C8	B1NQ2C8	B1NQ1D8	B1NQ2D8
10	B1NQ1C10	B1NQ2C10	B1NQ1D10	B1NQ2D10
13	B1NQ1C13	B1NQ2C13	B1NQ1D13	B1NQ2D13
15	B1NQ1C15	B1NQ2C15	B1NQ1D15	B1NQ2D15
16	B1NQ1C16	B1NQ2C16	B1NQ1D16	B1NQ2D16
20	B1NQ1C20	B1NQ2C20	B1NQ1D20	B1NQ2D20
25	B1NQ1C25	B1NQ2C25	B1NQ1D25	B1NQ2D25
30	B1NQ1C30	B1NQ2C30	B1NQ1D30	B1NQ2D30
32	B1NQ1C32	B1NQ2C32	B1NQ1D32	B1NQ2D32
35	B1NQ1C35	B1NQ2C35	B1NQ1D35	B1NQ2D35
40	B1NQ1C40	B1NQ2C40	B1NQ1D40	B1NQ2D40
45	B1NQ1C45	B1NQ2C45	B1NQ1D45	B1NQ2D45
50	B1NQ1C50	B1NQ2C50	B1NQ1D50	B1NQ2D50
60	B1NQ1C60	B1NQ2C60	B1NQ1D60	B1NQ2D60
63	B1NQ1C63	B1NQ2C63	B1NQ1D63	B1NQ2D63

D



Accessory Description	Catalog Number
Flush Mount Clip (B1NQ only) - 1-Pole*	FMC31N

* Note: This accessory is not compatible with comb bus bar applications. They cannot be used on miniature circuit breakers when utilizing a comb bus bar.

Additional products, accessories and higher ratings available. Contact your NOARK representative or visit na.noark-electric.com for additional information.

Miniature Circuit Breakers

UL 489 Technical Data

		B1N			B1H			B1NQ		
Conformed Standard		UL 489								
Number of Poles		1	2	3	1	2	3	1	2	
Rated Operational Voltage (V)		240 Vac 60 Vdc	240 Vac 125 Vdc	240 Vac	480Y/277 Vac			120/240 Vac		
Rated Frequency (Hz)		50/60								
Rated Current (A)		0.5-63			0.5-32			1-63		
Instantaneous Tripping Type		B (3-5 In), C (5-10 In), D (10-20 In)						C (5-10 In), D (10-20 In)		
Interrupting (kA)	120 Vac	10	-	-	10	-	-	10	-	
	240 Vac	10			10	10			-	
	277 Vac	-			-	-			-	
	480Y/277 Vac	-			-	-			-	
	60 Vdc	10	10	-	-			-	-	
	125 Vdc	-	-	-	-			-	-	
Inverse Time-Delay Over-Current Release Type		Thermal-Magnetic								
Service Life	Electrical	10,000						6,000		
	Mechanical	20,000						10,000		
Protection Degree		IP 20								
Wire AWG	Single Wire	18-4								
	Two Wires	#18-6 / #14-10								
Operating Temperature Range		-22 °F to 167 °F (-30 °C to +75 °C)								
Insulation Coordination	Rated Insulation Voltage (Vac)	500								
	Rated Impulse Withstand Voltage (kV)	6								
Pollution Degree		Class III								
Over Voltage Category		Class III								
Mounting		35 mm DIN rail / Flush and surface mount available on B1NQ with the use of additional mounting clips								
Altitude ft (m)		<6,561 (2,000)								
Atmospheric Conditions		At 68 °F (+20), the relative humidity does not exceed 90% At 104 °F (+40), the relative humidity does not exceed 50%								

* AWG = American Wire Gauge

Miniature Circuit Breakers

UL 489 Accessories



Accessory Description	Auxiliary Contact	Catalog Number
Alarm Switch*	1NO+1NC	AL3111N
Auxiliary Contact*	1NO+1NC	AX3111N

		Alarm Switch	Auxiliary Contact
		AL	AX
Ratings (50/60 Hz)	Vac	480/277V (3A) 240V (6A)	
	Vdc	250V (0.5A) 125V (1A) 24V (6A)	



Accessory Description	Voltage Ratings	Auxiliary Contact	Catalog Number
Shunt Trip*	12-24 Vac/dc	-	SHT31NC
	48-60 Vac/dc	-	SHT31NB
	110-415 Vac/110-130 Vdc	-	SHT31NA
	12-24 Vac/dc	1NO+1NC	SHT3111NC
	48-60 Vac/dc	1NO+1NC	SHT3111NB
Under-Voltage Trip*	110-415 Vac/110-130 Vdc	1NO+1NC	SHT3111NA
	240 Vac	1NC	UVT3101NA
	48 Vac/dc	1NC	UVT3101NB
	120 Vac	1NC	UVT3101NC
	240 Vac	1NO	UVT3110NA
	48 Vac/dc	1NO	UVT3110NB
	120 Vac	1NO	UVT3110NC
	240 Vac	-	UVT31NA
	48 Vac/dc	-	UVT31NB
120 Vac	-	UVT31NC	



Accessory Description	Catalog Number
Padlock* (Lock Off)	LK31N



Accessory Description	Catalog Number
Surface Mount Clip - 1-Pole*	SMC311N
Surface Mount Clip - 2 Pole*	SMC312N



Accessory Description	Catalog Number
35 mm DIN rail	TH35A75

* Note: These accessories are not compatible with comb bus bar.

Additional products, accessories and higher ratings available. Contact your NOARK representative or visit na.noark-electric.com for additional information.

D

Miniature Circuit Breakers

UL 489 Accessories: Comb Bus Bar Specifications

Description	Catalog Number
Top Feed Terminal (35mm) *	FD35UL
Bottom Feed Terminal (50mm) *	FD50UL
End Cap 1-3p *	EC489
Protective Cap *	PC489

* Sold in multiples of 10.
Example: FD35UL order quantities of 10, 20, 30, 40 etc.

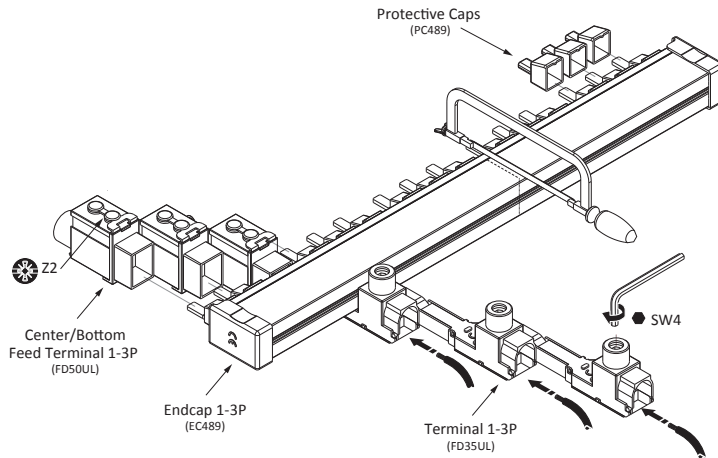

	Phase	No. of Pins	No. of Circuit Breakers	Poles	Cross Section	Rating	Catalog Number
UL 489	1	6	6x	1	25mm	100A (End Feed) 200A (Center Feed)	CBA1P06P25UL
	1	12	12x	1			CBA1P12P25UL
	1	18	18x	1			CBA1P18P25UL
	1	57	57x	1			CBA1P57P25UL
	2	6	3x	2			CBA2P06P25UL
	2	12	6x	2			CBA2P12P25UL
	2	18	9x	2			CBA2P18P25UL
	2	56	28x	2			CBA2P56P25UL
	3	6	2x	3			CBA3P06P25UL
	3	12	4x	3			CBA3P12P25UL
	3	18	6x	3			CBA3P18P25UL
	3	57	19x	3			CBA3P57P25UL

Note: J Fuse Rating 14 kA

Additional products, accessories and higher ratings available. Contact your NOARK representative or visit na.noark-electric.com for additional information.

Supplementary Protectors

UL 1077 Product Overview

Features

The B1E UL 1077 miniature circuit breaker has a complete range of amperages from 1A to 125A. Standard ratings of 5 kA at 480Y/277 Vac and 10 kA at 240 Vac. These are suitable for supplementary protection.

- Breakers mount on standard 35 mm DIN rail
- Thermal-magnetic over current protection – three levels of protection, categorized by B, C and D curves
- Fulfills UL 1077, IEC 60947-2 standard
- Field-installable shunt trip and auxiliary switch up to 63A
- Module width of only 0.71 in (18 mm) per pole
- Contact position indicator (red/green)
- 5-Year limited warranty



D

Typical Application

- Supplementary protection control circuits
- Cabinet lighting
- Business equipment
- Appliances

Certifications

UL 1077 No. E355391 / CSA C22.2 No.235 / IEC 60947-2

- Supplementary Protectors are UL Recognized for use in the United States in accordance with NFPA® 70 (NEC).
- These devices comply with UL 1077 No. E355391 and Certified for Canada CSA standards 22.2 No. 5 meeting the requirements for supplementary protectors.
- These devices are for international and domestic use, and also comply with IEC 60947-2 and are CE marked.



Supplementary Protectors

B1E 1-63 Amperes UL 1077 480Y/277 Vac



Rated Amperage (A)	Curve (5-10 In) (General)		
	1-Pole - 277 Vac	2-Pole - 480 Vac	3-Pole - 480 Vac
	Catalog Number	Catalog Number	Catalog Number
1	B1E1C1	B1E2C1	B1E3C1
1.6	B1E1C1.6	B1E2C1.6	B1E3C1.6
2	B1E1C2	B1E2C2	B1E3C2
3	B1E1C3	B1E2C3	B1E3C3
4	B1E1C4	B1E2C4	B1E3C4
5	B1E1C5	B1E2C5	B1E3C5
6	B1E1C6	B1E2C6	B1E3C6
8	B1E1C8	B1E2C8	B1E3C8
10	B1E1C10	B1E2C10	B1E3C10
13	B1E1C13	B1E2C13	B1E3C13
15	B1E1C15	B1E2C15	B1E3C15
16	B1E1C16	B1E2C16	B1E3C16
20	B1E1C20	B1E2C20	B1E3C20
25	B1E1C25	B1E2C25	B1E3C25
30	B1E1C30	B1E2C30	B1E3C30
32	B1E1C32	B1E2C32	B1E3C32
35	B1E1C35	B1E2C35	B1E3C35
40	B1E1C40	B1E2C40	B1E3C40
50	B1E1C50	B1E2C50	B1E3C50
60	B1E1C60	B1E2C60	B1E3C60
63	B1E1C63	B1E2C63	B1E3C63

Rated Amperage (A)	D Curve (10-20In) (Inductive)		
	1-Pole - 277 Vac	2-Pole - 480 Vac	3-Pole - 480 Vac
	Catalog Number	Catalog Number	Catalog Number
1	B1E1D1	B1E2D1	B1E3D1
1.6	B1E1D1.6	B1E2D1.6	B1E3D1.6
2	B1E1D2	B1E2D2	B1E3D2
3	B1E1D3	B1E2D3	B1E3D3
4	B1E1D4	B1E2D4	B1E3D4
5	B1E1D5	B1E2D5	B1E3D5
6	B1E1D6	B1E2D6	B1E3D6
8	B1E1D8	B1E2D8	B1E3D8
10	B1E1D10	B1E2D10	B1E3D10
13	B1E1D13	B1E2D13	B1E3D13
15	B1E1D15	B1E2D15	B1E3D15
16	B1E1D16	B1E2D16	B1E3D16
20	B1E1D20	B1E2D20	B1E3D20
25	B1E1D25	B1E2D25	B1E3D25
30	B1E1D30	B1E2D30	B1E3D30
32	B1E1D32	B1E2D32	B1E3D32
35	B1E1D35	B1E2D35	B1E3D35
40	B1E1D40	B1E2D40	B1E3D40
50	B1E1D50	B1E2D50	B1E3D50
60	B1E1D60	B1E2D60	B1E3D60
63	B1E1D63	B1E2D63	B1E3D63



Rated Amperage (A)	1-Pole	2-Pole	3-Pole
	Catalog Number	Catalog Number	Catalog Number
80*	B1E1P80	B1E2P80	B1E3P80
100*	B1E1P100	B1E2P100	B1E3P100
125*	B1E1P125	B1E2P125	B1E3P125

*Note: No accessories available for B1E 80-125 A

Additional products, accessories and higher ratings available. Contact your NOARK representative or visit na.noark-electric.com for additional information.

Supplementary Protectors

B1E 1-63 Amperes UL 1077 480Y/277 Vac



Rated Amperage (A)	B Curve (3-5 In) (Electronic)		
	1-Pole - 277 Vac	2-Pole - 480 Vac	3-Pole - 480 Vac
	Catalog Number	Catalog Number	Catalog Number
1	B1E1B1	B1E2B1	B1E3B1
1.6	B1E1B1.6	B1E2B1.6	B1E3B1.6
2	B1E1B2	B1E2B2	B1E3B2
3	B1E1B3	B1E2B3	B1E3B3
4	B1E1B4	B1E2B4	B1E3B4
5	B1E1B5	B1E2B5	B1E3B5
6	B1E1B6	B1E2B6	B1E3B6
8	B1E1B8	B1E2B8	B1E3B8
10	B1E1B10	B1E2B10	B1E3B10
13	B1E1B13	B1E2B13	B1E3B13
15	B1E1B15	B1E2B15	B1E3B15
16	B1E1B16	B1E2B16	B1E3B16
20	B1E1B20	B1E2B20	B1E3B20
25	B1E1B25	B1E2B25	B1E3B25
30	B1E1B30	B1E2B30	B1E3B30
32	B1E1B32	B1E2B32	B1E3B32
35	B1E1B35	B1E2B35	B1E3B35
40	B1E1B40	B1E2B40	B1E3B40
50	B1E1B50	B1E2B50	B1E3B50
60	B1E1B60	B1E2B60	B1E3B60
63	B1E1B63	B1E2B63	B1E3B63

D

Additional products, accessories and higher ratings available. Contact your NOARK representative or visit na.noark-electric.com for additional information.

Supplementary Protectors

UL 1077 B1E 1-63 Amperes Technical Data

		B1E 1-63A			B1E 80-125A		
Conformed Standard		UL 1077					
Rated Operational Voltage (V)		480Y/277 Vac; 60/125 Vdc			480Y/277 Vac, 110/220 Vdc		
Rated Frequency (Hz)		50/60					
Rated Current (A)		1-63			80-125		
Number of Poles		1	2	3	1	2	3
Instantaneous Tripping Type		B (3-5 In), C (5-10 In), D (10-20 In)			(8-12 In)		
Interrupting (kA)	120 Vac	10	-		5	-	
	120/240 Vac	-					
	208 Vac	-					
	240 Vac	10					
	277 Vac	5	-		-	5	
	480/277 Vac	-	5				
	60 Vdc	10	-		10	-	
	110 Vdc				10	10	
	125 Vdc	-	10	-		-	
220 Vdc	-				10	-	
Inverse Time-Delay Over-Current Release Type		Thermal-Magnetic					
Service Life	Electrical	6,000			1,500 (80-100A) 1,000 (125 A)		
	Mechanical	20,000			8,000 (80-100A) 7,000 (125A)		
Protection Degree		IP 20					
Wire AWG*		#18-4			#4-1/0		
Operating Temperature Range		-22 °F to 167 °F (-30 °C to +75 °C)					
Insulation Coordination	Rated Insulation Voltage (Vac)	500					
	Rated Impulse Withstand Voltage (kV)	6			8		
Pollution Degree		Class III					
Over Voltage Category / Mounting		Class III / 35 mm DIN rail					
Altitude ft (m)		<6,561 (2,000)					
Atmospheric Conditions		At 68 °F (+20), the relative humidity does not exceed 90% At 104 °F (+40), the relative humidity does not exceed 50%					

* AWG = American Wire Gauge

Supplementary Protectors

UL 1077 Accessories: Alarm Switch, Auxiliary Contact



Accessory Description	Catalog Number
Alarm Switch*	AL3111U
Auxiliary Contact*	AX3111U

- Not for use with 80-125 A

		Alarm Contact	Auxiliary Contact
		AL	AX
Ratings (50/60 Hz)	Vac	480 (3A) 277 (3A) 240 (6A)	
	Vdc	250 (0.5A) 125 (1A) 48 (2A) 24 (6A)	

D

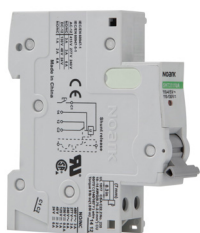

Accessory Description	Rated Voltage	Auxiliary Contact	Catalog Number
Shunt Trip*	12-24 Vac/dc	-	SHT31UC
	48-60 Vac/dc	-	SHT31UB
	110-415 Vac/110-130 Vdc	-	SHT31UA
	12-24 Vac/dc	1NO+1NC	SHT3111UC
	48-60 Vac/dc	1NO+1NC	SHT3111UB
	110-415 Vac/110-130 Vdc	1NO+1NC	SHT3111UA
Under-Voltage Trip*	240 Vac	1NC	UVT3101UA
	48 Vac/dc	1NC	UVT3101UB
	120 Vac	1NC	UVT3101UC
	240 Vac	1NO	UVT3110UA
	48 Vac/dc	1NO	UVT3110UB
	120 Vac	1NO	UVT3110UC
	240 Vac	-	UVT31UA
	48 Vac/dc	-	UVT31UB
	120 Vac	-	UVT31UC

* Note: These accessories are not compatible with comb bus bar.

Additional products, accessories and higher ratings available. Contact your NOARK representative or visit na.noark-electric.com for additional information.

Supplementary Protectors

UL 1077 Accessories: Comb Bus Bar

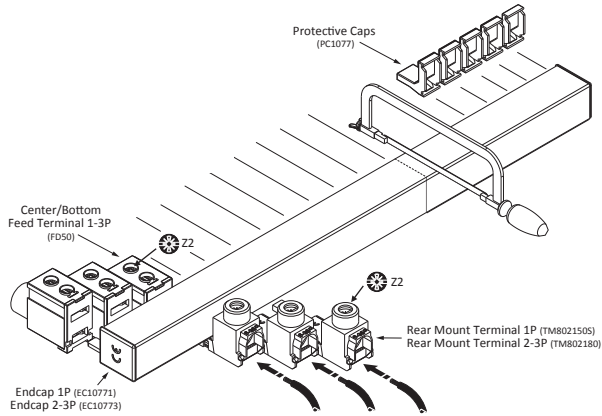

Description	Poles	Cross Section	Catalog Number
Top Feed Terminal*	1	35 mm	TM802150S
	2/3	35 mm	TM802180
Bottom Feed Terminal*	-	50 mm	FD50
End Cap*	1	-	EC10771
	2/3	-	EC10773
Protective Cap*	-	-	PC1077

* Sold in multiples of 10.
Example: PC1077 order quantities of 10, 20, 30, 40 etc.

UL 1077	Phase	No. of Pins	No. of Circuit Breakers	Poles	Cross Section	Rating	Catalog Number
	1	6	6	1	25 mm	100 amp (End Feed) 200 amp (Center Feed)	CBB1P06P25
	1	12	12	1			CBB1P12P25
	1	18	18	1			CBB1P18P25
	1	57	57	1			CBB1P57P25
	2	6	3	2			CBB2P06P25
	2	12	6	2			CBB2P12P25
	2	18	9	2			CBB2P18P25
	2	56	28	2			CBB2P56P25
	3	6	2	3			CBB3P06P25
	3	12	4	3			CBB3P12P25
	3	18	6	3			CBB3P18P25
	3	57	19	3			CBB3P57P25

Comb Bus Bar Specifications			UL 1077	
			1-Pole	2 & 3-Pole
Voltage Ratings	Maximum AC Voltage (Vac)		600	
	Maximum DC Voltage (Vdc)		1,000	600
Current Ratings	Maximum Current 25 mm ² Cross Sections (A)	End Feed	100	
		Center Feed	200	
Protection Class			IP 20	
J Fuse Rating (kA)			10	

Additional products, accessories and higher ratings available. Contact your NOARK representative or visit na.noark-electric.com for additional information.

Manual Motor Starters

Ex9S32 Product Overview

Features

Ex9S32 Manual Motor Starter provide manual isolation, manual motor control, and overcurrent protection. Ex9S32 Manual Motor Starters are electro-mechanical devices combining the functions below in one unit.

- Disconnect for Motor Branch Circuit
- Manual Motor Control (Automatic when used with contactor)
- Branch-Circuit Short Circuit Protection (Magnetic Protection)
- Overload Protection (Thermal Protection) - Trip Class 10
- 5-Year limited warranty



The National Electrical Code (NEC) requires an individual motor branch circuit be protected by a UL/CSA listed fuse, circuit breaker or self-protected combination motor controller.

Available as:

- Up to 32A @ 600 Vac
- Full range of accessories
- UL 60941-4-1 (formerly UL 508) Type E Self Protection or UL 60947-4-1 Type F Group Motor Protection
- Lockable handle

Certifications

- UL 60947-1/UL 60947-4-1 listed, file No. E467185
- UL 508 listed, file No. E476273
- IEC/EN 60947-2/-4-1
- CCC Certified



Standards Compliance

- IEC/EN 60947-1, -2, -4-1, -5-1
- UL 508
- UL 60947-1; -4-1
- UL 489

Manual Motor Starters

Ex9S32



Certifications

IEC/EN 60947-4-1



32A	
Rated Amperage (Min - Max)	Rotary Handle Catalog Number
0.10-0.16	Ex9S32A0.16A
0.16-0.25	Ex9S32A0.25A
0.25-0.40	Ex9S32A0.4A
0.40-0.63	Ex9S32A0.63A
0.63-1	Ex9S32A1A
1-1.6	Ex9S32A1.6A
1.6-2.5	Ex9S32A2.5A
2.5-4	Ex9S32A4A

32A	
Rated Amperage (Min - Max)	Rotary Handle Catalog Number
4-6.3	Ex9S32A6.3A
6-10	Ex9S32A10A
9-14	Ex9S32A14A
13-18	Ex9S32A18A
17-23	Ex9S32A23A
20-25	Ex9S32A25A
24-32	Ex9S32A32A

Technical Data

Description	Ex9S32	
Rated operational current I_e (A)	32A	
Conventional rated thermal current I_{th} (A)	0.16-32A	
Tripping Class	10	
Rated insulation voltage U_i (Vac)	690/IEC; 600/UL, 600/CSA	
Rated operational voltage U_e (AC)	230/240, 400/415, 460/480, 575/600	
Rated impulse withstand voltage U_{imp} (AC)	6000V	
Rated Operational Frequency (Hz)	50/60Hz	
Resistance to shock	30 gn -11 ms	
Resistance to vibrations	5 gn (5 -150Hz)	
Environmental Temperature	Transportation or Storage	-76 to 176°F (-60 to 80°C) ¹
	Working at	-4 to 158°F (-20 to 70°C) ²
	Testing at	23 to 104°F (-5 to 40°C)
Altitude ft (m)	<6,562 (2,000)	
Ambient Conditions	At mounting site, relative humidity not exceed 90% at the max testing temperature 104°F (40°C), higher relative humidity is allowable under lower temperature	
Pollution Grade	III	
Mounting Conditions	The inclination between the mounting plane and the vertical plane shall not exceed 30°; The product shall be installed and operated at a place without obvious shake, impact and vibration.	
Interrupting Rating I_{cu}	See Technical Data on page 44	
Service life (cycles)	Electrical	100,000
	Mechanical	100,000
Duty Class (cycles/hr)	30, max. operating rate	
Degree of Protection	IP 20	

Additional products, accessories and higher ratings available. Contact your NOARK representative or visit na.noark-electric.com for additional information.

Manual Motor Starters

UL 60947-4-1 (formerly UL 508) Type E Application

The National Electrical Code (NEC) requires the following when controlling a motor:

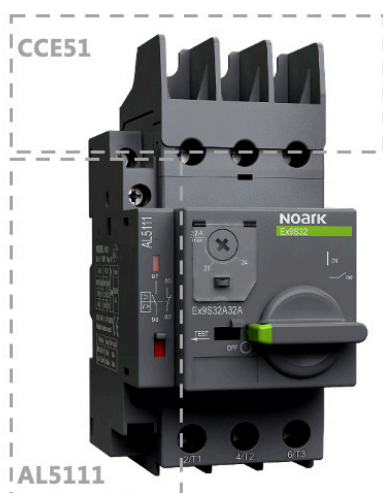

- A means of disconnecting power from the circuit
- Short circuit protection for the cables
- A way to start and stop the motor (typically a contactor)
- Overload protection for the motor (typically an overload relay)

The EX9S32 can provide (self protected) UL 60947-4-1 (formerly UL 508) Type E protection when used in conjunction with a terminal extension, and an alarm contact.



Type E :

9S+CCE51+AL5111

TYPE E		
Components	Catalog Number	Product
Manual Motor Starter 0.10-32 Amps	EX9S32	
Terminal cover/extension for Ex9S32 for use in type E application	CCE51	
Fault Signaling/Alarm Contact	AL5111	

E

Disclaimer: Proper Sizing of an overcurrent protection device is the responsibility of the customer and should be determined using the application standards of the NEC*, CEC**, or other applicable standards.

*NEC-National Electrical Code

** CEC-Canadian Electrical Code

Manual Motor Starters

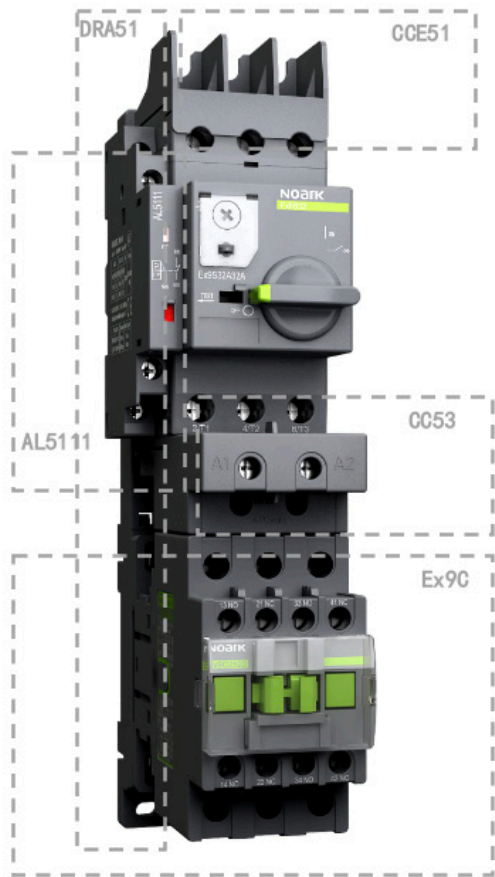

UL 60947-4-1 (formerly UL 508) Type F Application

The EX9S32 can provide (group motor) UL 60947-4-1 (formerly UL 508) Type F protection when used in conjunction with a contactor, terminal extension and an alarm contact.



Type F:

9S+CCE51+AL5111+9C +CC53+DRA51

TYPE F		
Components	Catalog Number	Product
Manual Motor Starter 0.10-32 Amps	EX9S32	
Terminal cover/extension for Ex9S32 for use in type E application	CCE51	
Contactor	EX9C or EX9CS	
Fault Signaling/Alarm Contact	AL5111	
Mounting Bracket for mounting a Ex9S32 to a Ex9C Standard Type Contactor, 9-38A	DRA51	
Connection Block between Ex9S32 and Ex9CS Mini Type Contactor 9-12A	CC51	
	or	
Connection Block between Ex9S32 and Ex9C Standard Type Contactor 9-18A	CC52	
	or	
Connection Block between Ex9S32 and Ex9C Standard Type Contactor 25-38A	CC53	

Disclaimer: Proper Sizing of an overcurrent protection device is the responsibility of the customer and should be determined using the application standards of the NEC*, CEC**, or other applicable standards.

Manual Motor Starters

Ex9S32 and Accessories: Technical Data

Manual Self-Protected Starter	Overload Trip Range (A)	Standard Motor Ratings @50/60 Hertz						Short Circuit Rating (SCCR)						UL 60947-4-1 Type F Components			
		1 Phase		3 Phase				Stand Alone		UL 508 Type E		UL 508 Type F		UL 60947 4-1 Type E Components	Contactor	DIN rail Base Plate	Manual Motor Starter Connector
		110/120V	230/240V	200/208V	230/240V	460/480V	575/600V	240V or 480/277V	600/347V	240V or 480/277V	600/347V	240V or 480/277V	600/347V				
Ex9S32A0.16A	0.1-0.16	-	-	-	-	-	-	65,000	5,000	65,000	10,000	65,000	10,000	CCE51 and AL5111	Ex9CS09 or Ex9C12	DRA51	CC51 (Mini Contactor) or CC52 (Standard Contactor)
Ex9S32A0.25A	0.16-0.25	-	-	-	-	-	-										
Ex9S32A0.4A	0.25-0.4	-	-	-	-	-	-										
Ex9S32A0.63A	0.4-0.63	-	-	-	-	-	-										
Ex9S32A1A	0.63-1	-	-	-	-	-	1/2										
Ex9S32A1.6A	1-1.6	-	-	-	-	3/4	3/4										
Ex9S32A2.5A	1.6-2.5	-	1/6	1/2	1/2	1	1.5										
Ex9S32A4A	2.5-4	1/8	1/3	3/4	3/4	2	3										
Ex9S32A6.3A	4-6.3	1/4	1/2	1	1.5	3	5										
Ex9S32A10A	6-10	1/2	1.5	2	3	5	7.5										
Ex9S32A14A	9-14	3/4	2	3	3	10	10	42,000	42,000	-	42,000	-	CCE51 and AL5111	Ex9C18	DRA51	CC52	
Ex9S32A18A	13-18	1	3	5	5	10	-										
Ex9S32A23A	17-23	1.5	3	5	7.5	15	-										
Ex9S32A25A	20-25	2	-	-	7.5	15	-										
Ex9S32A32A	24-32	2	5	7.5	10	20	-	42,000	42,000	-	42,000	-	CCE51 and AL5111	Ex9C25	DRA51	CC53	
Ex9S32A32A	24-32	2	5	7.5	10	20	-										

Ex9S32 Accessories: Technical Data

Auxiliary contacts	AX51	AX52	AL51
Rated operational voltage Ue	300V	600V	600V
Rated frequency	50/60Hz	50/60Hz	50/60Hz
Rated impulse withstand voltage Uimp	2500V	6000V	6000V
Conventional rated thermal current (Ith)	2.5A	5A	5A
Mechanical life (C-O operations)	100,000	100,000	100,000
Electrical life (C-O operations)	AC-15 : 10,000	AC-15 : 10,000	AC-14 : 1,000

Terminal Wiring

Model	Wire Ranges (AWG*)	Torque in-lb (N.m)	Screw Type
Ex9S32	(1) x #14 - (2) x #8	1.85 (2.5)	M4
AX51	(1) x #18 - (2) x #12	0.59 (0.8)	M3
AX52	(1) x #18 - (2) x #12	0.59 (0.8)	M3
AL51	(1) x #18 - (2) x #12	0.59 (0.8)	M3
UVT51	(1) x #18 - (2) x #12	1.254 (1.7)	M3.5
SHT51	(1) x #18 - (2) x #12	1.254 (1.7)	M3.5

* AWG = American Wire Gauge

Manual Motor Starters Ex9S32 Accessories

Auxiliary Contact Blocks

Description	Mounting Location	Max. No. of Blocks	Contact Type	Catalog Number
Instantaneous auxiliary contacts	Front	1	NO+NC	AX5111
	Left Side	2	NO+NC	AX5211
Fault Signaling Contact		1	NO+NC	AL5111

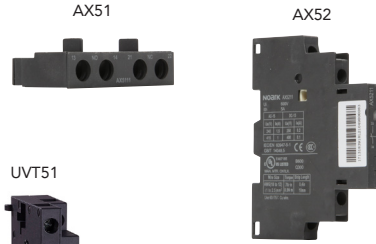

Electrical Trip Unit

Description	Mounting Location	Voltage	Hz	Catalog Number
Undervoltage Release	Right Side	110-120V	60	UVT51A
		208V	60	UVT51C
		480V	60	UVT51E
		600V	60	UVT51F
Shunt Release	Right Side	100-130V	50/60	SHT51A

UVT51



Ex9S32 + CC53 + Ex9C32 + DRA51



Terminal Cover

Description	Application	Catalog Number
Terminal Cover	Terminal cover for Ex9S32 for use in type E application	CCE51

CCE51



Busbars

Description	No. of Ex9S32 Starter	No. of Side-Mounted Aux Contact on each Ex9S32 starter	Busbar Pitch (mm)	SKU
Sets of 3-pole, 63A Busbar	2	None	45	BBUM 245
		1 of AX52, AL51	54	BBUM 254
		2 of AX52 or 1 UVT51, SHT51	63	BBUM 263
	3	None	45	BBUM 345
		1 of AX52, AL51	54	BBUM 354
		2 of AX52 or 1 UVT51, SHT51	63	BBUM 363
	4	None	45	BBUM 445
		1 of AX52, AL51	54	BBUM 454
		2 of AX52 or 1 UVT51, SHT51	63	BBUM 463
	5	None	45	BBUM 545
		1 of AX52, AL51	54	BBUM 554
		2 of AX52 or 1 UVT51, SHT51	63	BBUM 563



BBUM 4

Bus Bar Wiring Accessories

Description	Application	Catalog Number
Input Terminal for BBUM Busbar	Terminal block for power supply to one or more BBUM busbar	FD51*
Protective End Cover	For unused busbar outlets	PC51*

PC51



FD51



CC51



CC52



CC53



Mounting Accessories

Description	Application	Catalog Number
Connection Block	Between Ex9S32 and Ex9C Mini Type Contactor, 09-12A	CC51
	Between Ex9S32 and Ex9C Standard Type Contactor, 09-18A	CC52
	Between Ex9S32 and Ex9C Standard Type Contactor, 25-38A	CC53
Mounting Bracket	For mounting a Ex9S32 to a Ex9C Standard Type Contactor, 9-38A	DRA51

DRA51



Enclosures

Description	Type	Color	Rating	Catalog Number
Waterproof Enclosure; Ex9S32 Protectors	Operation by rotary handle	Black/ Gray	NEMA 4/4X, IP 65	WPB51B
		Yellow/ Red		WPB51Y

WPB51B



WPB51Y



Operation Handle

- Typically used with enclosures 6" to 12" depth.

Description	Type	Color	Rating	Catalog Number
Extended Rotary Handle	9 inch (230mm) shaft, with bracket	Black/ Gray	NEMA 4/4X, IP 65	ERH51B
		Yellow/ Red		ERH51Y

ERH51B



Additional products, accessories and higher ratings available. Contact your NOARK representative or visit na.noark-electric.com for additional information.

IEC Contactors

Ex9C Product Overview

Features

Ex9C series contactors are suitable for a broad range of motor control applications. With many available accessories and options, these contactors have ampacity ratings from 6A to 1000A at 600Vac and can be applied in systems up to 600Vac. A range of overload relays are available in a variety of frame sizes to fit respective contactors of given rated current.

- Nine frame sizes with rated current up to 1000A at 690V AC-3
- Coil control voltage from 24-600Vac and 24-500Vdc
- Wide range electronic coil available for 9-500A contactors features built-in surge suppression
- DIN rail 35 mm and panel mountable



Certifications

- UL 508 Listed, File Number E353866, UL 60947-1 and 60947-4-1
- Certified to CSA C22.2 No. 14
- IEC/EN 60947-4-1
- CE Approved
- CCC Certified



IEC Contactors Ex9CS/CSR 6 -12 Amperes Miniature

- Built-in auxiliary contacts on 3-pole; additional auxiliary contacts are front mounted
- Non-Reversing



Certifications
IEC/EN 60947-1, 60947-4-1
UL 60947-1, 60947-4-1

CE cUL US LISTED

CCC

Rated Amperage (A)	120 Vac Coil		24 Vdc Coil	
	Catalog Number	Catalog Number	Catalog Number	Catalog Number
	Power Poles - 3NO Auxiliary Contact - 1NO	Power Poles - 3NO Auxiliary Contact - 1NC	Power Poles - 3NO Auxiliary Contact - 1NO	Power Poles - 3NO Auxiliary Contact - 1NC
3-Pole	6	Ex9CS0610G7	Ex9CS0601G7	Ex9CS06D10B
	9	Ex9CS0910G7	Ex9CS0901G7	Ex9CS09D10B
	12	Ex9CS1210G7	Ex9CS1201G7	Ex9CS12D10B
	Power Poles - 4NO	Power Poles - 2NO+2NC	Power Poles - 4NO	Power Poles - 2NO+2NC
4-Pole	6	Ex9CS06G7C	Ex9CS06G7B	Ex9CS06DBC
	9	Ex9CS09G7C	Ex9CS09G7B	Ex9CS09DBC
	12	Ex9CS12G7C	Ex9CS12G7B	Ex9CS12DBC

- Built-in auxiliary contacts on 3-pole; additional auxiliary contacts are front mounted
- Reversing





Rated Amperage (A)	120 Vac Coil		24 Vdc Coil	
	Catalog Number	Catalog Number	Catalog Number	Catalog Number
	Power Poles - 3NO Auxiliary Contact - 1NO	Power Poles - 3NO Auxiliary Contact - 1NC	Power Poles - 3NO Auxiliary Contact - 1NO	Power Poles - 3NO Auxiliary Contact - 1NC
3-Pole	6	Ex9CSR0610G7	Ex9CSR0601G7	Ex9CSR06D10B
	9	Ex9CSR0910G7	Ex9CSR0901G7	Ex9CSR09D10B
	12	Ex9CSR1210G7	Ex9CSR1201G7	Ex9CSR12D10B
	Power Poles - 4NO	Power Poles - 2NO+2NC	Power Poles - 4NO	Power Poles - 2NO+2NC
4-Pole	6	Ex9CSR06G7C	-	Ex9CSR06DBC
	9	Ex9CSR09G7C	-	Ex9CSR09DBC
	12	Ex9CSR12G7C	-	Ex9CSR12DBC

Additional products, accessories and higher ratings available. Contact your NOARK representative or visit na.noark-electric.com for additional information.

IEC Contactors

Ex9CS/CSR Technical Data

		Ex9CS/CSR		
		6	9	12
General Information				
Pole		3, 4		
Production Standard		IEC 60947-1, IEC 60947-4-1, UL 60947-1, UL 60947-4-1		
Environmental Testing According to		IEC 60068-2-1, IEC 60068-2-2, IEC 60068-2-11, IEC 60068-2-30		
Rated Frequency (Hz)		50/60		
Conventional Free Air Thermal	0≤104 °F (0≤40 °C)	20		
	0≤140 °F (0≤60 °C)			
Current Ith (A)		16		
Rated Insulating Voltage Ui (V)		690		
Rated Impulse Withstand Voltage Uimp (kV)		6		
Electrical Life	AC-3	1,200,000		
	AC-4	50,000	40,000	
Mechanical Life		10,000,000		
Operating Cycles Per Hour (cycles/h)	AC-3	1,200		
	AC-4	300		
Environmental Temperature	Transportation or Storage	-76 to 176 °F (-60 to +80 °C)		
	Working At	-4 to 140 °F (-20 to +60 °C)		
	Maximum	-40 to 158 °F (-40 to +70 °C)		
Altitude ft (m)		<6,562 (2,000)		
Pollution Degree		Class III		
Rated Operational Current Ie (A)				
At -82 to 131 °F (-25 to 40 °C)	AC-1	690V		
	AC-3	380/400V		
	AC-3	6	9	12
	AC-4	3.8	4.9	
	AC-4	6	9	12
Rated Power of 3-Phase Motor				
For IEC (kW)	AC-3	230 Vac		
	AC-4	-		
	AC-3	380/400 Vac		
	AC-4	2.2	4	5.5
	AC-3	660/690 Vac		
	AC-4	3	4	
	AC-3	1,000 Vac		
AC-4	-			
UL Rating				
Ith (A)		20		
Single-Phase (HP)	110-120 Vac	0.5		0.75
	220-240 Vac	1	1.5	2
Three-Phase (HP)	200-208 Vac	1.5	3	
	220-240 Vac	2		
	440-480 Vac	3	5	7.5
	550-600 Vac	5	7.5	10
Coil Voltage (V)		24-500 Vac, 12-250 Vdc		

			Ex9CS/CSR		
			6	9	12
Coil Electrical Parameters					
Tolerance of Control Voltage 50/60 Hz	Operation (Uc)	Standard	85% -,110%		
	Drop-Off (Uc)	Standard	20% - 75% (AC) 10% - 75% (DC)		
Coil Power Consumption					
In Rush (VA)		AC	70		
Sealed (VA)		AC	9		
Pick-Up (W)		DC	4		
Hold (W)		DC	4		
Operating Time (ms)	Operation	Standard	10-20		
	Drop-Off	Standard	4-16		
IEC AC Contactor Working at DC Power Data					
	Rated Working Voltage (V)	Poles connected in Series	Rated Working Current (A)		
Working Type: DC-1, Resistive Load	24	1	15		
		2			
		3			
Time Data: L/R≤1ms	48/75	1	4		
		2			
		3			
Environmental Temperature: ≤140 °F (≤60 °C)	125	1	15		
		2			
		3			
	225	1	1		
		2			
		3			
IEC AC Contactor Working at DC Power Data					
	Rated Working Voltage (V)	Poles connected in Series	Rated Working Current (A)		
Working Type: DC-2 to DC-5, Inductive Load	24	1	15		
		2			
		3			
Time Data: L/R≤15ms	48/75	1	5		
		2			
		3			
Environmental Temperature: ≤140 °F (≤60 °C)	125	1	1.5		
		2			
		3			
	225	1	11		
		2			
		3			
	225	1	0.5		
		2			
		3			
	225	1	1.5		
		2			
		3			

F

IEC Contactors

Ex9CS/CSR Technical Data

		Ex9CS/CSR		
		6	9	12
Built-In Auxiliary Contacts				
Auxiliary Contacts		1NO or 1NC (3P), None (4P)		
Rated Operation Voltage Ue (V)		690		
Rated Insulating Voltage Ui (V)		690		
Rated Impulse Withstand Voltage Uimp (kV)		6		
Rated Frequency (Hz)		50/60		
Conventional Free Air Thermal Current Ith (A)		10		
Rated Operational Current Ie (A)				
AC-15	120 V	6		
	240 V	3		
	380 V	1.9		
	600 V	1.2		
DC-13	125 V	0.55		
	220 V	0.31		
Mounting	Screw (mm)	ø4		
	DIN rail (mm)	35/7.5		
Dimension LxWxH in		1.93 x 2.32 x 2.28		
Weight lb (kg)		0.40 (0.18)		
Degree of Protection		IP 20		
Main Power Terminal Connection				
Flexible Cable Without Cold-Press Terminal AWG*	Single Cable	#18-12		
	Dual Cable			
Stiff Cable Without Cold-Press Terminal AWG*	Single Cable			
	Dual Cable			
Screw Size ø (mm)		M3		
Torque of Terminals in-lb (N.m)		7 (0.80)		
Auxiliary Contact Terminal Connection				
Flexible Cable Without Cold-Press Terminal AWG*	Single Cable	#18-12		
	Dual Cable			
Stiff Cable With Cold-Press Terminal AWG*	Single Cable			
	Dual Cable			
Stiff Cable Without Cold-Press Terminal AWG*	Single Cable			
	Dual Cable			
Screw Size ø (mm)		M3		
Torque of Terminals in-lb (N.m)		7 (0.80)		

* AWG = American Wire Gauge

IEC Contactors

Ex9CS/R Accessories

The Ex9CS/C line shares accessories and every contactor can be equipped with one front-mounted unit, two units of side-mounted contact (one from the left, the other from the right) and surge suppressor block.



- For contactors Ex9CS and Ex9CSR
- Field installable
- One unit used with a contactor

Accessory Description	Matched Contactor	Catalog Number
Auxiliary Contact Front Mount Mechanically Linked Contacts (in accordance with IEC 60947-5-1 Annex L) and Mirror Contacts (in accordance with IEC 60947-4-1 Annex F)	Ex9CS06-12 Ex9CSR06-12 (Front Mount)	AX4122UL

Auxiliary Contact Specifications		
UL Standard File Number	E353866	
IEC Standard File Number	IEC/EN 60947-5-1	
Certifications	UL Listed, CSA, CCC	
Electrical Parameters		
Rated Frequency (Hz)	50/60	
Rated Working Voltage Ue	AC-15 (V)	380/400/415
	DC-13 (V)	220/250
Rated Working Current Ie	AC-15 (A)	1.9A
	DC-13 (A)	0.31
Rated Capacity	AC-15 (VA)	720
	DC-13 (W)	69
Rated Thermal Current Ith (A)	10	
Rated Impulse Withstand Voltage Uimp (kV)	6 (1.2/50 ms)	
Rated Insulation Voltage Ui (V)	690	
Mechanical Parameters		
Dimensions (L x W x H) in	1.46 x 1.30 x 1.54	
Degree of Protection	IP 20	
Terminals	Lift	
Terminal Capacity AWG*	#18-12	
Torque of Terminals in-lb (N.m)	7 (0.80)	



- Reduces voltage peaks in control circuit
- Versions with varistor and RC circuit technology
- Includes cable lugs for connecting to contactor terminals

Accessory Description	Matched Contactor	Catalog Number
Surge Suppressor Block	Ex9CS06-12	CCU41BUL

Note: external surge protection accessory, CCU42BUL / CCU43BUL is not needed on the F-type contactor with a wide range coil since it is already integral to the coil.

Surge Suppressor Block Specifications	
Electrical Parameters	
Internal Technology	Varistor
Control Coil Voltage Uc (Protection Range)	24-48 Vac/dc
	110-240 Vac/dc
	380-415 Vac/dc
Maximum Peak Voltage Up (Uc)	2 kV
Mechanical Parameters	
Matched Contactor Type	Ex9CS06-12
Mounting	Mounts to Contactor Control Coil Terminals
Weight lb (kg)	0.04 (0.02)

Accessory Description	Suitable For	Catalog Number
Star Delta Wiring Kit (SDWK)	Ex9CS or Ex9CSR	SDWK41

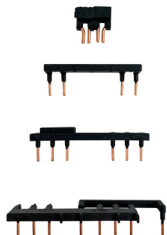

* AWG = American Wire Gauge

IEC Contactors

Ex9C 9-1000 Amperes Standard

- Built-in auxiliary contacts; 1NO/1NC additional auxiliary contacts are front or side mounted
- Non-Reversing

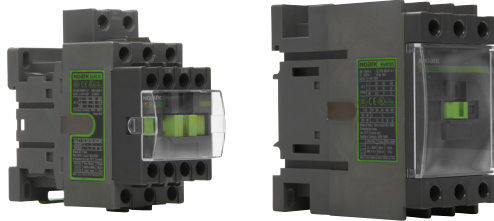

Certifications
 IEC/EN 60947-1, 60947-4-1
 UL 60947-1, 60947-4-1

Rated Amperage (A)	Wide Range Electronic Coil (with built-in surge suppression)					
	120 Vac Coil Catalog Number	24-60 Vac/dc Coil Catalog Number	48-130 Vac/dc Coil Catalog Number	100-250 Vac/dc Coil Catalog Number	250-500 Vac/dc Coil	
Power Poles - 3NO Auxiliary Contact - 1NO+1NC						
3-Pole	9	Ex9C0911G7	Ex9C09F11J	Ex9C09F11H	Ex9C09F11K	-
	12	Ex9C1211G7	Ex9C12F11J	Ex9C12F11H	Ex9C12F11K	-
	18	Ex9C1811G7	Ex9C18F11J	Ex9C18F11H	Ex9C18F11K	-
	25	Ex9C2511G7	Ex9C25F11J	Ex9C25F11H	Ex9C25F11K	-
	32	Ex9C3211G7	Ex9C32F11J	Ex9C32F11H	Ex9C32F11K	-
	38	Ex9C3811G7	Ex9C38F11J	Ex9C38F11H	Ex9C38F11K	-
	40	Ex9C4011G7	Ex9C40F11J	Ex9C40F11H	Ex9C40F11K	-
	50	Ex9C5011G7	Ex9C50F11J	Ex9C50F11H	Ex9C50F11K	-
	65	Ex9C6511G7	Ex9C65F11J	Ex9C65F11H	Ex9C65F11K	-
	80	Ex9C8011G7	Ex9C80F11J	Ex9C80F11H	Ex9C80F11K	-
	100	Ex9C10011G7	Ex9C100F11J	Ex9C100F11H	Ex9C100F11K	-
Power Poles - 3NO Auxiliary Contact - 2NO+2NC						
115	Ex9C115E22G	-	Ex9C115F22H	Ex9C115F22K	Ex9C115F22L	
150	Ex9C150E22G	-	Ex9C150F22H	Ex9C150F22K	Ex9C150F22L	
185	Ex9C185E22G	-	Ex9C185F22H	Ex9C185F22K	Ex9C185F22L	
225	Ex9C225E22G	-	Ex9C225F22H	Ex9C225F22K	Ex9C225F22L	
265	Ex9C265E22G	-	Ex9C265F22H	Ex9C265F22K	Ex9C265F22L	
300	Ex9C300E22G	-	Ex9C300F22H	Ex9C300F22K	Ex9C300F22L	
400	Ex9C400E22G	-	Ex9C400F22H	Ex9C400F22K	Ex9C400F22L	
500	Ex9C500E22G	-	Ex9C500F22H	Ex9C500F22K	Ex9C500F22L	
630	Ex9C630E22GG	-	-	-	-	
800	Ex9C800E22GG	-	-	-	-	
1,000	Ex9C1000E22GG	-	-	-	-	

Additional products, accessories and higher ratings available. Contact your NOARK representative or visit na.noark-electric.com for additional information.

IEC Reversing Contactors

Ex9CR 9-500 Amperes Standard Reversing

- Built-in auxiliary contacts; additional auxiliary contacts are front or side mounted
- Reversing
- Reversing contactor is comprised of 2 contactor joined by a mechanical interlock and power connection on 115A and above.



Certifications
 IEC/EN 60947-1, 60947-4-1
 UL 60947-1, 60947-4-1

CE cULus LISTED

CCC

Rated Amperage (A)	120 Vac Coil		Components to build Reversing Contactor*			
	Catalog Number		Quantity	Contactor	Quantity	Mechanical Interlock
	Power Poles - 3NO Auxiliary Contact - 1NO+1NC					
3-Pole	9	Ex9CR0911G7	2	Ex9C0911G7	1	MIT42UL
	12	Ex9CR1211G7	2	EX9C1211G7	1	MIT42UL
	18	Ex9CR1811G7	2	EX9C1811G7	1	MIT42UL
	25	Ex9CR2511G7	2	EX9C2511G7	1	MIT42UL
	32	Ex9CR3211G7	2	EX9C3211G7	1	MIT42UL
	38	Ex9CR3811G7	2	EX9C3811G7	1	MIT42UL
	40	Ex9CR4011G7	2	EX9C4011G7	1	MIT43UL
	50	Ex9CR5011G7	2	EX9C5011G7	1	MIT43UL
	65	Ex9CR6511G7	2	EX9C6511G7	1	MIT43UL
	80	Ex9CR8011G7	2	EX9C8011G7	1	MIT43UL
	100	Ex9CR10011G7	2	EX9C10011G7	1	MIT43UL

*Power connection not included for 09-100A

- Built-in auxiliary contacts; additional auxiliary contacts are front or side mounted
- Reversing
- Reversing contactor is comprised of 2 contactor joined by a mechanical interlock and power connection



F

Rated Amperage (A)	120 Vac Coil		Components to build Reversing Contactor					
	Catalog Number		Quantity	Contactor	Quantity	Mechanical Interlock	Quantity	Power Connection
	Power Poles - 3NO Auxiliary Contact - 2NO+2NC							
3-Pole	115	Ex9CR115E22G	2	Ex9C115E22G	1	MIT44UL	1	PCL185UL
	150	Ex9CR150E22G	2	Ex9C150E22G	1	MIT44UL	1	PCL185UL
	185	Ex9CR185E22G	2	Ex9C185E22G	1	MIT44UL	1	PCL185UL
	225	Ex9CR225E22G	2	Ex9C225E22G	1	MIT45UL	1	PCL300UL
	265	Ex9CR265E22G	2	Ex9C265E22G	1	MIT45UL	1	PCL300UL
	300	Ex9CR300E22G	2	Ex9C300E22G	1	MIT45UL	1	PCL300UL
	400	Ex9CR400E22G	2	Ex9C400E22G	1	MIT46UL	1	PCL500UL
	500	Ex9CR500E22G	2	Ex9C500E22G	1	MIT46UL	1	PCL500UL

Additional products, accessories and higher ratings available. Contact your NOARK representative or visit na.noark-electric.com for additional information.

IEC Reversing Contactors

Ex9CR 115-500 Amperes Standard Reversing

- Built-in auxiliary contacts; additional auxiliary contacts are front or side mounted
- Reversing
- Reversing contactor is comprised of 2 contactor joined by a mechanical interlock and power connection



Green Highlight = Most Popular

Certifications

IEC/EN 60947-1, 60947-4-1
UL 60947-1, 60947-4-1

Rated Amperage (A)	Wide Range Electronic Coil (built-in surge suppression)			
	48-130Vac/dc Coil	100-250 Vac/dc Coil	250-500 Vac/dc Coil	
	Catalog Number	Catalog Number	Catalog Number	
Power Poles - 3NO Auxiliary Contact - 2NO+2NC				
3-Pole	115	Ex9CR115F22H	Ex9CR115F22K	Ex9CR115F22L
	150	Ex9CR150F22H	Ex9CR150F22K	Ex9CR150F22L
	185	Ex9CR185F22H	Ex9CR185F22K	Ex9CR185F22L
	225	Ex9CR225F22H	Ex9CR225F22K	Ex9CR225F22L
	265	Ex9CR265F22H	Ex9CR265F22K	Ex9CR265F22L
	300	Ex9CR300F22H	Ex9CR300F22K	Ex9CR300F22L
	400	Ex9CR400F22H	Ex9CR400F22K	Ex9CR400F22L
	500	Ex9CR500F22H	Ex9CR500F22K	Ex9CR500F22L

Additional products, accessories and higher ratings available. Contact your NOARK representative or visit na.noark-electric.com for additional information.

IEC Contactors

Ex9C/CR Technical Data

			Ex9C/CR								
			9	12	18	25	32	38	40	50	
General Information											
Pole			3								
Production Standard			IEC 60947-1, IEC 60947-4-1, UL 60947-1, UL 60947-4-1								
Environmental Testing According to			IEC 60068-2-1, IEC 60068-2-2, IEC 60068-2-11, IEC 60068-2-30								
Rated Frequency (Hz)			50/60								
Conventional Free Air Thermal Current Ith (A)	0≤104 °F (0≤40 °C)		25	32	40	50	60	80			
	0≤140 °F (0≤60 °C)										
	0≤158 °F (0≤70 °C)		17	22	28	35	42	56			
Rated Insulating Voltage Ui (V)			690					1,000			
Rated Impulse Withstand Voltage Uimp (kV)			6					8			
Electrical Life	AC-3	380/400V	1,200,000								
	AC-4		50,000	40,000	50,000	40,000	35,000	30,000			
Mechanical Life			10,000,000								
Operating Cycles Per Hour (cycles/h)	AC-3		1200			1000					
	AC-4		300			150		120			
Environmental Temperature	Transportation or Storage		-76 to 176 °F (-60 to +80 °C)								
	Working At		-4 to 140 °F (-20 to +60 °C)								
	Maximum		-40 to 158 °F (-40 to +70 °C)								
Altitude ft (m)			<6,562 (2,000)								
Pollution Degree			Class III								
Rated Operational Current Ie (A)											
At -82 to 131 °F (-25 to 40 °C)	AC-1	690V	25	32	40	50	60	80			
	AC-3	380/400V	9	12	18	25	32	38	40	50	
	AC-3	660/690V	6.7	9	10.6	17.3	21.9	34	39		
	AC-4	380/400V	9	12	18	25	32	40	50		
	AC-4	660/690V	6.7	8.9	14	17.3	34	39			
Rated Power of 3-Phase Motor											
For IEC (kW)	AC-3	380/400 Vac	4	5.5	7.5	11	15	18.5	22		
	AC-4										
	AC-3	660/690 Vac	5.5	7.5	9	15	18.5	30	33		
	AC-4		5.5	7.5	11	15					
UL Rating											
Ith (A)			25	32	40	50	60	80			
Single-Phase (HP)	110-120 Vac		0.5	1	1.5	2	3	5			
	220-240 Vac		1.5	2	3	5	7.5	10			
Three-Phase (HP)	200-208 Vac		3		5	7.5	10	15	20		
	220-240 Vac		3		5	7.5	10	15	20		
	440-480 Vac		5	7.5	10	15	20	30	40		
	550-600 Vac		7.5	10	15	20	25				
Coil Voltage (V)			24-600 Vac, 24-250 Vac/dc								

F



IEC Contactors

Ex9C/CR Technical Data

		Ex9C/CR														
		65	80	100	115	150	185	225	265	300	400	500	630	800	1000	
General Information																
Pole		3														
Production Standard		IEC 60947-1, IEC 60947-4-1, UL 60947-1, UL 60947-4-1														
Environmental Testing According to		IEC 60068-2-1, IEC 60068-2, IEC 60068-2-11, IEC 60068-2-30														
Rated Frequency (Hz)		50/60														
Conventional Free Air Thermal Current I _{th} (A)	0≤104 °F (0≤40 °C)	80	125	160	185	215	275	330	400	500	610	800	1000	1000		
	0≤140 °F (0≤60 °C)				170	200	260	300	360	430	550	720	850	850		
	0≤158 °F (0≤70 °C)	56	80	140	160	180	200	260	290	400	480	630	750	750		
Rated Insulating Voltage U _i (V)		1,000										1,000				
Rated Impulse Withstand Voltage U _{imp} (kV)		8										8				
Electrical Life	AC-3	1,200,000				1,000,000						800,000	500,000			
	AC-4	30,000	25,000		200,000						200,000					
Mechanical Life		10,000,000				8,000,000						5,000,000		3,000,000		
Operating Cycles Per Hour (cycles/h)	AC-3	1,000	900		750		500			420		300	120			
	AC-4	120			130						100					
Environmental Temperature	Transportation or Storage	-76 to 176 °F (-60 to +80 °C)														
	Working At	-4 to 140 °F (-20 to +60 °C)														
	Maximum	-40 to 158 °F (-40 to +70 °C)														
Altitude ft (m)		<6,562 (2,000)														
Pollution Degree		Class III														
Rated Operational Current I_e (A)																
At -82 to 131 °F (-25 to 40 °C)	AC-1	690V	80	125	160	185	215	275	330	400	500	650	800	1000	1260	
	AC-3	380/400V	65	80	100	115	150	185	225	265	300	400	500	630	800	1000
	AC-3	660/690V	42	49				170		280		450	560	650	700	
	AC-4	380/400V	65	80	100	54	68	81	96	117	125	150	175	225	242	260
	AC-4	660/690V	42	49		48	57	65	85	105	115	135	150	200	215	230
Rated Power of 3-Phase Motor																
For IEC (kW)	AC-3	230 Vac	-			37	45	55		75	90	132	160	200	250	315
						18.5	22	30		37	40	45	55	75		80
	AC-3	380/400 Vac	30	37	45	55	75	90	110	132	160	220	250	335	450	560
						30	37	45	55	63	75	90	100	110	132	150
	AC-3	660/690 Vac	37	45		110	132	160	200	250		355	400	560	630	710
						50	55	63	80	100	110	132	150	185	200	220
	AC-3	1,000 Vac	-			75	90	90		132	250	315	400	450	500	
						50	55	63		80	110		150	200		
UL Rating																
I _{th} (A)		80	125	160	185	215	275	330	400	500	610	800	900	1000		
Single-Phase (HP)	110-120 Vac	5	7.5	10	15	-			-				-			
	220-240 Vac	15	20		25	30	40	-							-	
Three-Phase (HP)	200-208 Vac	20	30	30	40	50	60		75	100	125	150	-			
	220-240 Vac	25		40	50	60	75		100	125	150	200	250	300	350	
	440-480 Vac	50	60		100	125	150		200	250	300	400	500	600	750	
	550-600 Vac				125	150	200		250	300	400	500	600	700	800	
Coil Voltage (V)		24-600 Vac			24-600 Vac/dc						36-600 Vac/dc		48 - 480 Vac/dc			

IEC Contactors



Ex9C/CR Technical Data

			Ex9C/CR											
			9	12	18	25	32	38	40	50				
Coil Electrical Parameters														
Tolerance of Control Voltage 50/60 Hz	Operation (Uc)	Standard	85% - 110%											
		AC/DC Widerange	85% - 110%											
	Drop-Off (Uc)	Standard	20% - 75% (AC) 10 - 75% (DC)											
		AC/DC Widerange	20% - 75% (AC), 10 - 75% (DC)											
Coil Power Consumption														
AC Only Coil	In Rush (VA)		90		100		240							
	Sealed (VA)		9.5		11.4		36.6							
DC Only Coil	Pick-Up (W)		7		17		36.6							
	Hold (W)		7		17		6							
AC/DC (Widerange)	In Rush (VA)				55		200							
	Sealed (VA)				5.1		6							
	Pick-Up (W)				30		150							
	Hold (W)				2		4.5							
Operating Time (ms)	AC Only and DC Only Coil	Operation	12-24		14-27		20-30							
		Drop-Off	6-20		7-22		8-20							
	AC/DC (Widerange)	Operation			45-65		50-100							
		Drop-Off			20-90		20-120							
IEC AC Contactor Working at DC Power Data														
	Rated Working Voltage (V)	Poles of Series Connection	Rated Working Current (A)											
Working Type: DC-1, Resistive Load	24	1												
		2												
		3												
Time Data: L/R _s 1ms	48/75	1	20		25		32		40		50		65	
		2												
		3												
Environmental Temperature: ≤140 °F (≤60 °C)	125	1	4				7							
		2	20		25		32		40		50		65	
		3												
	225	1	1						1.5					
		2	4		7									
		3	20		25		32		40		50		65	
IEC AC Contactor Working at DC Power Data														
	Rated Working Voltage (V)	Poles of Series Connection	Rated Working Current (A)											
Working Type: DC-2 to DC-5, Inductive Load	24	1	20		25		32		40		50		65	
		2												
		3												
Time Data: L/R _s 15ms	48/75	1	8				32		40		50		65	
		2	20		25									
		3												
Environmental Temperature: ≤140 °F (≤60 °C)	125	1	2		3		4							
		2	15		32		40		50		65			
		3	20		25									
	225	1	0.5				1		1.5					
		2	2		3		4							
		3	8		32		40		50		65			

F

IEC Contactors

Ex9C/CR Technical Data

			Ex9C/CR										Ex9C			
			65	80	100	115	150	185	225	265	300	400	500	630	800	1000
Coil Electrical Parameters																
Tolerance of Control Voltage 50/60 Hz	Operation (Uc)		85% - 110%													
	Drop-Off (Uc)		20% - 70%					20% - 60%								
Coil Power Consumption																
AC Only Coil	In Rush (VA)		240	280		400		590		600		850				
	Sealed (VA)		36			10										
DC Only Coil	Pick-Up (W)		17			400		590		600		850				
	Hold (W)		10													
AC/DC (Wide-range)	In Rush (VA)		200		400		590		600		-					
	Sealed (VA)		6			10										
	Pick-Up (W)		150			400		590		600		-				
	Hold (W)		4.5			10										
Operating Time (ms)	AC Only and DC Only Coil	Operation	20-30	20-35		31-64		45-100		58-95		100-180				
		Drop-Off	8-20	6-20		44-68		47-67		85-120		100-120				
	AC/DC Wide- range	Operation	50-100			31-64		45-100		58-95		-				
		Drop-Off	20-120			44-68		47-67		85-120		-				
IEC AC Contactor Working at DC Power Data																
	Rated Working Voltage (V)	Poles of Series Connection	Rated Working Current (A)													
Working Type: DC-1, Resistive Load	24	1														
		2														
		3														
	48/75	1	65	100	160	200	300	400								
		2														
		3														
Time Data: L/R ≤ 1ms	125	1	7	12	18	33										
		2														
		3														
	225	1		1.5	3.4	3.8										
		2	65	100	160	200	300	400								
		3														
Environmental Temperature: ≤ 140 °F (≤ 60 °C)	24	1														
		2														
		3														
	48/75	1	7	12	20	30			40							
		2														
		3	65	100	160	200	300	400								
IEC AC Contactor Working at DC Power Data																
	Rated Working Voltage (V)	Poles of Series Connection	Rated Working Current (A)													
Working Type: DC-2 to DC-5, Inductive Load	24	1														
		2														
		3														
	48/75	1	65	100	160	200	300	400								
		2														
		3														
Time Data: L/R ≤ 15ms	125	1	4	5	7.5	11										
		2														
		3	65	100	160	200	300	400								
	225	1	1.5	2	2.5											
		2	4	5	7.5	11										
		3	65	100	160	200	300	400								

IEC Contactors

Ex9C/CR Technical Data

		Ex9C/CR							
		9	12	18	25	32	38	40	50
Built-In Auxiliary Contacts									
Auxiliary Contacts		1NO+1NC, 2NO+2NC					1NO+1NC		
Rated Operation Voltage Ue (V)		690							
Rated Insulating Voltage Ui (V)		6							
Rated Impulse Withstand Voltage Uimp (kV)		50/60							
Rated Frequency (Hz)		10							
Conventional Free Air Thermal Current Ith (A)									
Rated Operational Current Ie (A)									
AC-15	120V	6							
	240V	3							
	380V	1.9							
	600V	1.2							
	125V	0.55							
	220V	0.31							
	250V	0.27							
Mounting	Screw (mm)	ø4					ø5		
	DIN rail (mm)	35					35 or 75		
Dimension LxWxH in		3.50 x 1.77 x 3.70			3.94 x 1.77 x 4.25		4.80 x 2.99 x 4.84		
Weight lb (kg)		0.77 (0.35)			0.88 (0.40)		2.71 (1.23)		
Degree of Protection		IP 20 (Control Circuit Terminal), IP 00 (Main Circuit Terminal)							
Main Power Terminal Connection									
Flexible Cable Without Cold-Press Terminal AWG*	Single Cable	#18-10			#14-8		#14-4		
	Dual Cable								
Stiff Cable Without Cold-Press Terminal AWG*	Single Cable	#18-10			#14-8		#14-4		
	Dual Cable								
Screw Size ø (mm)		M3.5			M4		M8		
Torque of Terminals in-lb (N.m)		15 (1.70)			22 (2.50)		53 (6)		
Auxiliary Contact Terminal Connection									
Flexible Cable Without Cold-Press Terminal AWG*	Single Cable	#18-12							
	Dual Cable								
Stiff Cable With Cold-Press Terminal AWG*	Single Cable	#18-12							
	Dual Cable								
Stiff Cable Without Cold-Press Terminal AWG*	Single Cable	#18-12							
	Dual Cable								
Screw Size ø (mm)		M3.5							
Torque of Terminals in-lb (N.m)		15 (1.70)							

* AWG = American Wire Gauge

F

IEC Contactors

Ex9C/CR Technical Data

		Ex9C/CR											
		65	80	100	115	150	185	225	265	300	400	500	
Built-In Auxiliary Contacts													
Auxiliary Contacts		1NO+1NC					2NO+2NC						
Rated Operation Voltage U _e (V)		690											
Rated Insulating Voltage U _i (V)		690											
Rated Impulse Withstand Voltage U _{imp} (kV)		6											
Rated Frequency (Hz)		50/60											
Conventional Free Air Thermal Current I _{th} (A)		10											
Rated Operational Current I_e (A)													
AC-15	24V	-					6						
	120V	6					-						
	230V	-					3.13						
	240V	-					3						
	380V	1.9					-						
	400V	-					1.8						
	600V	1.2					-						
DC-13	24V	-					0.55						
	125V	-					0.55						
	220V	-					0.31						
	250V	-					0.27						
Mounting	Screw (mm)	ø5			ø8			ø9					
	DIN rail (mm)	35 or 75			-			-					
Dimension LxWxH in		4.80 x 2.99 x 4.84	5.12 x 3.43 x 5.12		6.81 x 4.72 x 6.85			8.39 x 5.71 x 8.19			8.50 x 6.30 x 9.02		
Weight lb (kg)		2.71 (1.23)	3.31 (1.50)		6.61 (3)			13.23 (6)			20.94 (9.5)		
Degree of Protection		IP 20											
Main Power Terminal Connection													
Flexible Cable Without Cold-Press Terminal AWG*	Single Cable	#14-4	#12 - 1/0		(1x) #4 - (2x) 250 MCM			(1x) 1/0 - (2x) 500 MCM					
	Dual Cable		#12 - 1										
Stiff Cable Without Cold-Press Terminal AWG*	Single Cable		#12 - 1/0										
	Dual Cable		#12 - 1										
Screw Size ø (mm)		M8					M10						
Torque of Terminals in-lb (N.m)		53 (6)	79 (9)		159 (18)			310 (35)					
Bus Bar Terminal Connection													
Bus Bar Size		-			2x0.75x0.25 (2x20x5)			2x1x0.25 (2x30x5)			2x1.25x0.25 (2x40x5)		
Screw Size ø (mm)		-			M8			M10					
Torque of Terminals in-lb (N.m)		-			159 (18)			310 (35)					
Auxiliary Contact Terminal Connection													
Flexible Cable Without Cold-Press Terminal AWG*	Single Cable	#18-12											
	Dual Cable												
Stiff Cable With Cold-Press Terminal AWG*	Single Cable												
	Dual Cable												
Stiff Cable Without Cold-Press Terminal AWG*	Single Cable												
	Dual Cable												
Screw Size ø (mm)		M3.5											
Torque of Terminals in-lb (N.m)		15 (1.70)											

* AWG = American Wire Gauge

IEC Contactors

Ex9C Technical Data

		Ex9C		
		630	800	1000
Built-In Auxiliary Contacts				
Auxiliary Contacts		2NO+2NC		
Rated Operation Voltage Ue (V)		690		
Rated Insulating Voltage Ui (V)		690		
Rated Impulse Withstand Voltage Uimp (kV)		6		
Rated Frequency (Hz)		50/60		
Conventional Free Air Thermal Current Ith (A)		10		
Rated Operational Current Ie (A)				
AC-15	24V	6		
	230V	3.13		
	240V	3		
	400V	1.8		
	690V	1.04		
DC-13	24V	0.55		
	125V	0.55		
	220V	0.31		
	250V	0.27		
Mounting	Screw (mm)	11.5		
	DIN rail (mm)	-		
Dimension LxWxH in		11.73 x 9.06 x 10.47	12.68 x 9.06 x 10.47	
Weight lb		44.53	48.5	49.16
Degree of Protection		IP 20 (Control Circuit Terminal) IP 00 (Main Circuit Terminal)		
Main Power Terminal Connection				
Flexible Cable Without Cold-Press Terminal AWG*	Single Cable	LTC25NB 250-600 LTC25NC 4/0-500	LTC26NC 3/0-750 LTC26ND 3/0-500	
	Dual Cable			
Stiff Cable Without Cold-Press Terminal AWG*	Single Cable			
	Dual Cable			
Screw Size ϕ (mm)		M12	4*M10	
Torque of Terminals in-lb (N.m)		310(45)	310(35)	
Auxiliary Contact Terminal Connection				
Flexible Cable Without Cold-Press Terminal AWG*	Single Cable	#18-12		
	Dual Cable			
Stiff Cable With Cold-Press Terminal AWG*	Single Cable			
	Dual Cable			
Stiff Cable Without Cold-Press Terminal AWG*	Single Cable			
	Dual Cable			
Screw Size ϕ (mm)		M3.5		
Torque of Terminals in-lb (N.m)		15 (1.70)		

* AWG = American Wire Gauge

F

IEC Contactors

Ex9C Accessories

The Ex9CS/C line shares accessories and every contactor can be equipped with one front-mounted unit, two side-mounted contacts (one left, one right) and surge suppressor block.

Front Mount Auxiliary Contact



- Field installable
- One unit used with a contactor

Side Mount Auxiliary Contact



- Field installable
- One unit used with a contactor on the left side, another unit on the right side

Accessory Description	Matched Contactor	Auxiliary Contact	Catalog Number
Auxiliary Contact	Ex9C09-500 Ex9CR09-500 (Front Mount)	1NO+1NC	AX4211UL
		2NO+2NC	AX4222UL
		3NO+1NC	AX4231UL
Mechanically Linked Contacts (in accordance with IEC 60947-5-1 Annex L) and Mirror Contacts (in accordance with IEC 60947-4-1 Annex F)	Ex9C09-100 Ex9CR09-100 (Side Mount)	1NO+1NC	AX4311UL

Auxiliary Contact	Front Mount AX42		Side Mount AX43
UL Standard File Number	E353866		
IEC Standard File Number	IEC/EN 60947-5-1		
Certifications	UL Listed, CSA, CCC		
Electrical Parameters			
Rated Frequency (Hz)	50/60		
Rated Working Voltage Ue	AC-15 (V)	380/400/415	
	DC-13 (V)	220/250	
Rated Working Current Ie	AC-15 (A)	1.9A	
	DC-13 (A)	0.31	
Rated Capacity	AC-15 (VA)	720	
	DC-13 (W)	69	
Rated Thermal Current Ith (A)	10		
Rated Impulse Withstand Voltage Uimp (kV)	6 (1.2/50 ms)		
Rated Insulation Voltage Ui (V)	690		
Mechanical Parameters			
Device Width in	1.89		0.43
Device Height in	1.46		2.72
Device Depth in	1.02 (1NO+1NC)	1.77 (2NO+2NC, 3NO+1NC)	2.76 (1NO+1NC)
Degree of Protection	IP 20		
Terminals	Lift		
Terminal Capacity AWG*	#18-12		
Torque of Terminals in-lb (N.m)	15 (1.70)		

* AWG = American Wire Gauge

Additional products, accessories and higher ratings available. Contact your NOARK representative or visit na.noark-electric.com for additional information.

IEC Contactors

Ex9C Accessories

Mechanical Interlock



Power Connection

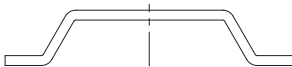

Surge Suppressor Block

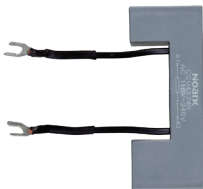

- Reduces voltage peaks in control circuit
- Versions with varistor and RC circuit technology
- Includes cable lugs for connecting to contactor terminals

Accessory Description	Matched Contactor	Catalog Number
Mechanical Interlock (for Ex9C)	Ex9C09-38	MIT42UL
	Ex9C40-100	MIT43UL
	Ex9C115-185	MIT44UL
	Ex9C225-300	MIT45UL
	Ex9C400-500	MIT46UL
Power Connection (for Ex9C)	Ex9C115-185	PCL185UL
	Ex9C225-300	PCL300UL
	Ex9C400-500	PCL500UL
Surge Suppressor Block	Ex9C09-38	CCU42BUL
	Ex9C40-100	CCU43BUL

Note: external surge protection accessory, CCU42BUL / CCU43BUL is not needed with wide range coil since it is already integral to the coil.

Specifications	CCU42	CCU43
Electrical Parameters		
Internal Technology	Resistance	
Control Coil Voltage U_c (Protection Range)	110-240 Vac/dc	
Maximum Peak Voltage U_p (U_c)	3 kV	
Mechanical Parameters		
Matched Contactor Type	Ex9C09-38	Ex9C40-100
Mounting	Mounts to Contactor Control Coil Terminals	
Weight lb (kg)	0.04 (0.02)	

F

Additional products, accessories and higher ratings available. Contact your NOARK representative or visit na.noark-electric.com for additional information.

IEC Contactors

Ex9C Accessory Specifications



Accessory Description	Matched Contactor	Relay Type	Timing Range	Catalog Number
Time Delay Relay (Pneumatic Timer)	Ex9C09-500	Off Delay	0.1 - 3 s	AXCD0UL
			0.1 - 30 s	AXCD2UL
			10 - 180 s	AXCD4UL
		On Delay	0.1 - 3 s	AXCT0UL
			0.1 - 30 s	AXCT2UL
			10 - 180 s	AXCT4UL



Accessory Description	Type	Catalog Number
Terminal Cover	Ex9C115~185	TCV46
	Ex9C225~500	TCV47

** = See page 19 for terminal specifications.

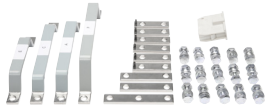

Accessory Description	Suitable For	Catalog Number
Star Delta Wiring Kit	Ex9C 115-185	SDWK45

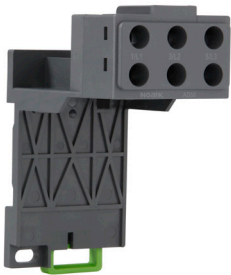

Accessory Description	Use with Relay	Catalog Number
Surface mount	Ex9R38	AD56UL
	Ex9R100	AD53UL
	Ex9R185	AD54UL
	Ex9R500	AD55UL

AD56UL

Green Highlight = Most Popular

Mounting Base	AD56UL	AD53UL	AD54UL	AD55UL
Current Rating (A)	38	104	185	500
Voltage (Vac)	600			
Terminal Wire Range AWG*	#18 - #8	#12 - #1	-	
Terminal Torque in-lb (N.m)	22 (2.50)	80 (9)		
Wire Strip Length in	0.51	0.71		
Matched Contactor Type	Ex9C09-38	Ex9C40-100	Ex9C115-185	Ex9C225-500

* AWG = American Wire Gauge

Additional products, accessories and higher ratings available. Contact your NOARK representative or visit na.noark-electric.com for additional information.

IEC Contactors

Ex9CDS Product Overview

Features

Ex9CDS are general purpose contactors used mainly for controlling 3-phase motors and power circuits up to 600 Vac. This entry level line includes magnetic coils and basic accessories for front and side mounting.

- 5 kA @ 600 Vac
- Built-in NO or NC auxiliary contacts on 9-32A frames
- 3 and 4-pole versions including 2NO+2NC and 4NO configurations
- 95 A mounts on standard 35mm DIN rail (40-95A can also mount on 75 mm DIN rail)
- 12 month warranty



F

Certifications

- UL Listed, File Number E353866
- Certified for Canada CSA standards 22.2 No. 14 under cUL testing
- IEC/EN 60947
- CE Compliant



IEC Contactors

Ex9CDS 9-95 A General Purpose

- Auxiliary contacts are side mounted; front mounted also available



Certifications
IEC/EN 60947-4-1



Rated Amperage (A)		120 Vac Coil	
		Catalog Number	Catalog Number
		Power Poles - 3NO Auxiliary Contact - 1NO	Power Poles - 3NO Auxiliary Contact - 1NC
3-Pole	9	Ex9CDS09A30G7A	Ex9CDS09A30G7B
	12	Ex9CDS12A30G7A	Ex9CDS12A30G7B
	18	Ex9CDS18A30G7A	Ex9CDS18A30G7B
	25	Ex9CDS25A30G7A	Ex9CDS25A30G7B
	32	Ex9CDS32A30G7A	Ex9CDS32A30G7B
Rated Amperage (A)		120 Vac Coil	
		Catalog Number	
		Power Poles - 3NO Auxiliary Contact - 1NO/1NC	
3-Pole	40	Ex9CDS40A30G7C	
	50	Ex9CDS50A30G7C	
	65	Ex9CDS65A30G7C	
	80	Ex9CDS80A30G7C	
	95	Ex9CDS95A30G7C	

Rated Amperage (A)		120 Vac Coil	
		Catalog Number	Catalog Number
		Power Poles - 4NO	Power Poles - 2NO Auxiliary Contact - 2NC
4-Pole	9	Ex9CDS09A40G7	Ex9CDS09A22G7
	12	Ex9CDS12A40G7	Ex9CDS12A22G7
	25	Ex9CDS25A40G7	Ex9CDS25A22G7
	40	Ex9CDS40A40G7	Ex9CDS40A22G7
	50	Ex9CDS50A40G7	Ex9CDS50A22G7
	65	Ex9CDS65A40G7	Ex9CDS65A22G7
	80	Ex9CDS80A40G7	Ex9CDS80A22G7
	95	Ex9CDS95A40G7	Ex9CDS95A22G7

Additional products, accessories and higher ratings available. Contact your NOARK representative or visit na.noark-electric.com for additional information.

IEC Contactors

Ex9CDS Technical Data

Ex9CDS/CDR			09	12	18	25	32	40	50	65	80	95		
Frame			Frame 1			Frame 2		Frame 3			Frame 4			
Poles			3 & 4		3	3 & 4	3	3 & 4						
Rated Insulation Voltage (Vac)			690											
Operating Frequency (Operations/h)	Electrical	AC-3	1,200				600							
		AC-4	300											
	Mechanical	3,600												
Electrical Life Operations	AC-3	1,000,000				800,000		600,000						
	AC-4	200,000				150,000			100,000					
Ambient Temperature			23 to 104°F (-5 to 40°C)											
Mechanical Life Operations			10,000,000				8,000,000				6,000,000			
Matched Overload Relay Type			Ex9RD25				Ex9RD36		Ex9RD93					
Rated Conventional Heating Current (A) AC-1			20		32	40	50	60	80		95			
AC-3	Ie (A)	220/230V	9	12	18	25	32	40	50	65	80	95		
		380/400V	6.6	8.9	12	18	21	34	39	42	49			
		660/690V	2.2	3	4	5.5	7.5	11	15	18.5	22	25		
	Pe (kW)	220/230V	4	5.5	7.5	11	15	18.5	22	30	37	45		
		380/400V	5.5	7.5	10	15	18.5	30	37		45			
		660/690V	3	5	7.5	7.5	10	15	20	25	30	30		
Power of Controlled Three-Phase Cage Motor AC-3 (hp)	200V	5	7.5	10	15	20	25	30	40		50			
	240V													
	460V													
	600V													
Terminal Connection		Number of Pieces												
Flexible Cable with Cold-Pressed Socket AWG*	1	#16-14		#16-12		#14-10		#10-4			#8-2			
	2							#12-8			#10-6			
Flexible Cable without Cold-Pressed Socket AWG*	1	#16-12		#16-10	#1.5-10	#14-8		#10-4			#8-2			
	2	#1-2.5		#16-12	#1.5-6	#14-10		#4-10			#10-6			
Inflexible Cable AWG*	1	#16-12		#16-10		#14-8		#6-25			#8-2			
	2							#12-8			#10-6			
Screw Size			M3.5			M4		M8			M10			
Tightening Torque in-lb (N.m)			7 (0.80)			10 (1.20)		45 (3.50)			89 (10)			
Coil Parameters														
Coil Power	In-Rush (VA)	70				110		200						
	Sealed (VA)	8		8		11		20						
	Power (W)	1.8-2.7		3-4				6-10						
Operation Range	Operation Voltage (Us)	85-110%												
	Drop-Out Voltage (Us)	20-75%												
Coil Voltage (50/60 Hz)			120V											

* AWG = American Wire Gauge

F

IEC Contactors

Ex9CD/CM Accessories: Auxiliary Contact

Green Highlight = Most Popular



Front Mount

- For contactors Ex9CD
- Field installable
- One unit used with a contactor

Accessory Description	Matched Contactor	Contacts	Catalog Number
Auxiliary Contact	Ex9CDS09-630 Ex9CDR09-630	1NO+1NC	AXA11
Mechanically Linked Contacts (in accordance with IEC 60947-5-1 Annex L) and Mirror Contacts (in accordance with IEC 60947-4-1 Annex F)		2NO+2NC	AXA22

Auxiliary Contact CDS Front Mount AXA 11 - 1 NO + 1NC / 22 - 2NO+2NC		
UL Standard File Number	E353866	
IEC Standard File Number	IEC/EN 60947-5-1	
Certifications	UL Listed, CSA, CCC	
Electrical Parameters		
Rated Frequency (Hz)	50/60	
Rated Working Voltage Ue	AC-15 (V)	380/400/415
	DC-13 (V)	220/250
Rated Working Current Ie	AC-15 (A)	0.19
	DC-13 (A)	0.31
Rated Capacity	AC-15 (VA)	720
	DC-13 (W)	69
Rated Thermal Current Ith (A)	10	
Rated Impulse Withstand Voltage Uimp (kV)	6 (1.2/50 μs)	
Rated Insulation Voltage Ui (V)	690	
Mechanical Parameters		
Device Width in	1.89	
Device Height in	1.46	
Device Depth in	1.02 / 1.77	
Degree of Protection	IP 20	
Terminal Capacity AWG*	#17-9	
Torque of Terminals in-lb (N.m)	8.85 (1)	

* AWG = American Wire Gauge

Thermal Overload Relays

Ex9R Product Overview

Features

- For use with Ex9C and Ex9CR*
- Rated current up to 500A @ 600 Vac, 50/60 Hz
- Adjustable current setting for overload protection
- Overload protection trip Class 10 and Class 10A
- Phase loss protection
- Automatic or manual reset selectable
- Status indication
- STOP and TEST function
- Direct mount to contactors or 35 mm DIN rail mounting base option
- 5-Year limited warranty

*see page 49 for overloads for use with miniature contactors.



Certifications

- UL Listed, File Number E353865, UL 60947-1 and 60947-4-1
- Certified for Canada CSA standards under cUL testing
- IEC/EN 60947-4-1
- CE Approved
- CCC Certified



Thermal Overload Relays

Ex9R 38-500 Amperes



Certifications
IEC/EN 60947-4-1

CE cUL LISTED

CCC

Rated Amperage (Min - Max)	38A	
	Use with Contactors: Ex9C9-38	
	Catalog Number	
0.63-1	Ex9R38B1A	
1-1.6	Ex9R38B1.6A	
1.6-2.5	Ex9R38B2.5A	
2.5-4	Ex9R38B4A	
4-6	Ex9R38B6A	
5.5-8	Ex9R38B8A	
7-10	Ex9R38B10A	
9-13	Ex9R38B13A	
12-18	Ex9R38B18A	
16-24	Ex9R38B24A	
23-32	Ex9R38B32A	
30-38	Ex9R38B38A	

Rated Amperage (Min - Max)	100A	
	Use with Contactors: Ex9C40-100	
	Catalog Number	
23-32	Ex9R100B32A	
30-40	Ex9R100B40A	
37-50	Ex9R100B50A	
48-65	Ex9R100B65A	
55-70	Ex9R100B70A	
63-80	Ex9R100B80A	
80-104	Ex9R100B104A	



Rated Amperage (Min - Max)	185A	
	Use with Contactors: Ex9C115-185	
	Catalog Number	
75-115	Ex9R185B115A	
110-150	Ex9R185B150A	
140-210	Ex9R185B210A	

Rated Amperage (Min - Max)	500A	
	Use with Contactors: Ex9C225-500	
	Catalog Number	
160-225	Ex9R500B225A	
210-300	Ex9R500B300A	
280-400	Ex9R500B400A	
380-500	Ex9R500B500A	

Additional products, accessories and higher ratings available. Contact your NOARK representative or visit na.noark-electric.com for additional information.

Thermal Overload Relays

Ex9R Technical Data

		Ex9R	
Tripping Class		Class 10/10A	
Operating Frequency (Hz)		50/60	
Phase Failure Protection Function			
Automatic and Manual Reset			
Temperature Compensation		Yes	
Tripping Indicator			
Test and Stop Pushbutton			
Environmental Conditions	Altitude ft (m)	<6,562 (2,000)	
	Pollution Degree	Class III	
Rated Tripping Current (In)		1.2	
Sensitivity to Phase Failure (In)		30%	
Rated Working Voltage (V)		600	
Rated Impulse Withstand Voltage Uimp		6 kV	
Auxiliary Contacts	Number of Contacts		1NO+1NC
	Rated Operating Voltage Ue (V)	AC-15	220/380
		DC-13	220
	Rated Operating Current Ie (A)	AC-15	1.64 / 0.95
		DC-13	0.13
	Circuit Continuous Current		5 A 600 Vac, 1 A 300 Vdc
	Contact Rating		B600, R300
	Terminal Wire Range AWG*		#18-12
Terminal Torque in-lb (N.m)		15 (1.70)	
Terminal Wire Strip Length in		0.43	

* AWG = American Wire Gauge



Thermal Overload Relays

Ex9R Technical Data

Frame Size	38A											
Current Setting Range (A)	0.63-1	1-1.6	1.6-2.5	2.5-4	4-6	5.5-8	7-10	9-13	12-18	16-24	23-32	30-38
Short Circuit Rating, 3 Phase at 600 Vac (kA)	1			5								
Power Terminal	#18-8 AWG*											
Power Terminal Torque in-lb (N.m)	22 (2.5)											
Matched Contactor Type	Ex9C9-38											
Surface mount adapter for remote mounting	AD56UL											

Frame Size	100A						
Current Setting Range (A)	23-32	30-40	37-50	48-65	55-70	63-80	80-104
Short Circuit Rating, 3 Phase at 600 Vac (kA)	5			10			
Power Terminal	#12-1 AWG*						
Power Terminal Torque in-lb (N.m)	80 (9)						
Matched Contactor Type	Ex9C40-100						
Surface mount adapter for remote mounting	AD53UL						

Frame Size	185A		
Current Setting Range (A)	75-115	110-150	140-210
Short Circuit Rating, 3 Phase at 600 Vac (kA)	10		
Power Terminal	Bus Bar Only		
Power Terminal Torque in-lb (N.m)	159 (18)		
Matched Contactor Type	Ex9C115-185		
Surface mount adapter for remote mounting	AD54UL		

Frame Size	500A			
Current Setting Range (A)	160-225	210-300	280-400	380-500
Short Circuit Rating, 3 Phase at 600 Vac (kA)	30			
Power Terminal	Bus Bar Only			
Power Terminal Torque in-lb (N.m)	310 (35)			
Matched Contactor Type	Ex9C225-500			
Surface mount adapter for remote mounting	AD55UL			

* AWG = American Wire Gauge

Thermal Overload Relay

Ex9R - Thermal Overload Relay (For Ex9CS Miniature Contactors)



12 A	
Rated Amperage (Min - Max)	Use with Contactors: Ex9CS06-12 Catalog Number
0.1-0.16	Ex9R12B0.16A
0.16-0.25	Ex9R12B0.25A
0.25-0.4	Ex9R12B0.4A
0.4-0.63	Ex9R12B0.63A
0.63-1	Ex9R12B1A
1-1.6	Ex9R12B1.6A
1.6-2.5	Ex9R12B2.5A
2.5-4	Ex9R12B4A
4-6	Ex9R12B6A
5.5-8	Ex9R12B8A
7-10	Ex9R12B10A
9-12	Ex9R12B12A

		Ex9R	
Tripping Class		Class 10/10A	
Operating Frequency (Hz)		50/60	
Phase Failure Protection Function			
Automatic and Manual Reset			
Temperature Compensation		Yes	
Tripping Indicator			
Test and Stop Pushbutton			
Environmental Conditions	Altitude ft (m)	<6,562 (2,000)	
	Pollution Degree	Class III	
Rated Tripping Current (In)		1.2	
Sensitivity to Phase Failure (In)		30%	
Rated Working Voltage (V)		600	
Rated Impulse Withstand Voltage Uimp		6 kV	
Auxiliary Contacts	Number of Contacts		1NO+1NC
	Rated Operating Voltage Ue (V)	AC-15	220/380
		DC-13	220
	Rated Operating Current Ie (A)	AC-15	1.64 / 0.95
		DC-13	0.13
	Circuit Continuous Current		(5 A) 600 Vac, (1 A) 300 Vdc
	Contact Rating		B600, R300
Terminal Wire Range AWG*		#18-12	
Terminal Torque in-lb (N.m)		15 (1.70)	
Terminal Wire Strip Length in		0.43	

Ex9R	12 A											
Current Rated (A)	0.16-1.6						2.5-12					
Current Setting Range (A)	0.1-0.16	0.16-0.25	0.25-0.4	0.4-0.63	0.63-1	1-1.6	1.6-2.5	2.5-4	4-6	5.5-8	7-10	9-12
Short Circuit Rating, 3 Phase at 600 Vac (kA)	1						5					
Power Terminal	#18-10 AWG*											
Power Terminal Torque in-lb (N.m)	15 (1.7)											
Matched Contactor Type	Ex9CS06-12											
Matched Adapter	AD51UL											

* AWG = American Wire Gauge



AD51UL

Accessory Description	Catalog Number
Surface mount for Ex9R 0.16-12A only	AD51UL

Mounting Base	AD51UL
Current Rating (A)	12
Voltage (Vac)	600
Terminal Wire Range	#18-12 AWG*
Terminal Torque in-lb (N.m)	7 (0.80)
Matched Contactor Type	Ex9CS06-12

- Allows surface mounting of overload relays listed above (Ex9R 0.16-12A) remotely from miniature contactor (Ex9CS).

Disclaimer: Proper Sizing of an overcurrent protection device is the responsibility of the customer and should be determined using the application standards of the NEC*, CEC**, or other applicable standards.

*NEC-National Electrical Code

** CEC-Canadian Electrical Code

Additional products, accessories and higher ratings available. Contact your NOARK representative or visit na.noark-electric.com for additional information.

Electronic Thermal Overload Relay

Ex9RE - Electronic Thermal Overload Relay



Rated Amperage (min-Max)	Power Supply Voltage	Auxiliary Contacts	Trip Curve Class	Catalog Number
Use with Ex9C 09-38A Contactor				
0.1 - 0.5A	24 Vac/Vdc	1NO+1NC	5/10/20/30	Ex9RE40A0.5
	110/120 Vac			Ex9RE40B0.5
	220/240 Vac			Ex9RE40C0.5
0.4 - 2A	24 Vac/Vdc	1NO+1NC	5/10/20/30	Ex9RE40A02
	110/120 Vac			Ex9RE40A02
	220/240 Vac			Ex9RE40C02
1.8 - 9A	24 Vac/Vdc	1NO+1NC	5/10/20/30	Ex9RE40A09
	110/120 Vac			Ex9RE40B09
	220/240 Vac			Ex9RE40C09
8 - 40A	24 Vac/Vdc	1NO+1NC	5/10/20/30	Ex9RE40A40
	110/120 Vac			Ex9RE40B40
	220/240 Vac			Ex9RE40C40

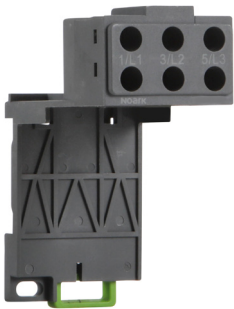

AD57UL

Accessory Description	Catalog Number
DIN Rail Mount for Ex9RE40 only	AD57UL

- Allows DIN rail mounting of electronic overload relays listed above (Ex9RE40) remotely from contactor (Ex9C).

Additional products, accessories and higher ratings available. Contact your NOARK representative or visit na.noark-electric.com for additional information.

Safety Contactors

Ex9CA Product Overview

Features

The NOARK Ex9CA Safety Contactor is designed for use in safety function applications. It offers special features that allow the design of safe control circuits with current ratings up to 38 Amps.

The Normally Closed (NC) Auxiliary contact is a mirror contact to the main contacts and is mechanically linked to the Normally Open (NO) Auxiliary contacts. This allows for optimal design selections in SRP/CS*.

* SRP/CS is the term given by ISO short for safety-related part of a control system, meaning part of a control system that responds to safety-related input signals and generates safety-related output signals.

- Positively guided mirror contacts/mechanically linked contacts according to IEC/UL 60947-4-1 Annex F, IEC/UL 60947-5-1 Annex L
- Mirror contacts/ mechanically linked symbol on the side of auxiliary block
- Fixed transparent anti-dust cover for easy identification of the device action and prevents the manual operation
- AC or DC operating coils
- Integrated body with built in auxiliary contacts up to 2NC and 2NO
- Integrated surge suppression on DC coil models
- 5-Year limited warranty



Certifications

- UL Listed, File Number E353865, UL 60947-1
- Certified for Canada CSA standards under cUL testing
- IEC/EN 60947-4-1
- CE Approved
- CCC Certified



Safety Contactors

Ex9CA 9 - 38 A

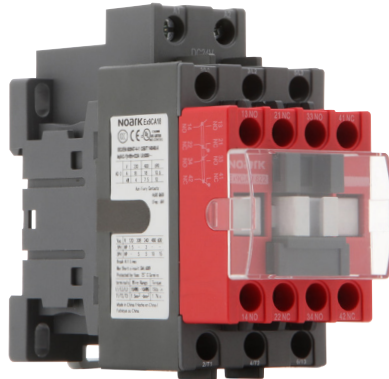

Certifications

IEC/EN 60947-4-1



Rated Amperage (A)		9A		12A	
Coil Voltage		Catalog Number	Catalog Number	Catalog Number	Catalog Number
		Power Poles - 3NO Auxiliary Contact - 1NO+1NC	Power Poles - 3NO Auxiliary Contact - 2NO+2NC	Power Poles - 3NO Auxiliary Contact - 1NO+1NC	Power Poles - 3NO Auxiliary Contact - 2NO+2NC
AC	120	Ex9CA0911G7	Ex9CA0922G7	Ex9CA1211G7	Ex9CA1222G7
DC	24	Ex9CA09D11B	Ex9CA09D22B	Ex9CA12D11B	Ex9CA12D22B

Rated Amperage (A)		18A		25A	
Coil Voltage		Catalog Number	Catalog Number	Catalog Number	Catalog Number
		Power Poles - 3NO Auxiliary Contact - 1NO+1NC	Power Poles - 3NO Auxiliary Contact - 2NO+2NC	Power Poles 3NO Auxiliary Contact - 1NO+1NC	Power Poles 3NO Auxiliary Contact - 2NO+2NC
AC	120	Ex9CA1811G7	Ex9CA1822G7	Ex9CA2511G7	Ex9CA2522G7
DC	24	Ex9CA18D11B	Ex9CA18D22B	Ex9CA25D11B	Ex9CA25D22B

Rated Amperage (A)		32A		38A	
Coil Voltage		Catalog Number	Catalog Number	Catalog Number	Catalog Number
		Power Poles - 3NO Auxiliary Contact - 1NO+1NC	Power Poles - 3NO Auxiliary Contact - 2NO+2NC	Power Poles - 3NO Auxiliary Contact - 1NO+1NC	Power Poles - 3NO Auxiliary Contact - 2NO+2NC
AC	120	Ex9CA3211G7	Ex9CA3222G7	Ex9CA3811G7	Ex9CA3822G7
DC	24	Ex9CA32D11B	Ex9CA32D22B	Ex9CA38D11B	Ex9CA38D22B

Additional products, accessories and higher ratings available. Contact your NOARK representative or visit na.noark-electric.com for additional information.

Safety Contactors

Technical Data

			Ex9CA					
			9	12	18	25	32	38
General Information								
Pole			3					
Production Standard			IEC 60947-1, IEC 60947-4-1, UL 60947-1, UL 60947-4-1, GB/T14048.4					
Environmental Testing According to			IEC 60068-2-1, IEC 60068-2-2, IEC 60068-2-11, IEC 60068-2-30					
Rated Frequency (Hz)			50/60					
Conventional Free Air Thermal Current Ith (A)	0≤104 °F (0≤40 °C)		25	32	40	50		
	0≤140 °F (0≤60 °C)							
	0≤158 °F (0≤70 °C)		17	22	28	35		
Rated Insulating Voltage Ui (V)			690					
Rated Impulse Withstand Voltage Uimp (kV)			6					
Electrical Life	AC-3	380/400 V	1,200,000					
	AC-4		50,000	40,000		50,000	40,000	
Mechanical Life			10,000,000					
Operating Cycles Per Hour (cycles/h)	AC-3		1,200			1,000		
	AC-4		300			150		
Environmental Temperature	Transportation or Storage		-76 to 176 °F (-60 to +80 °C)					
	Working At		-4 to 140 °F (-20 to +60 °C)					
	Maximum		-40 to 158 °F (-40 to +70 °C)					
Altitude ft (m)			<6,562 (2,000)					
Pollution Degree			Class III					
Rated Operating Voltage (U e)	AC 50/60 HZ		24, 48, 120, 240					
	DC							
Rated Operational Current Ie (A)								
At -82 to 131 °F (-25 to 40 °C)	AC-1	690V	25	32	40	50		
	AC-3	380/400V	9	12	18	25	32	38
	AC-3	660/690V	6.7	9	10.6	17.3	21.9	
	AC-4	380/400V	9	12	18	25	32	
	AC-4	660/690V	6.7		8.9	14	17.3	
Rated Power of 3-Phase Motor								
For IEC (kW)	AC-3	230 Vac	-					
	AC-4							
	AC-3	380/400 Vac	4	5.5	7.5	11	15	18.5
	AC-4		15					
	AC-3	660/690 Vac	5.5	7.5	9	15	18.5	
	AC-4		5.5		7.5	11	15	
AC-3	1,000 Vac	-						
AC-4								
UL Rating								
Ith (A)			25		32	40	50	
Single-Phase (HP)	110-120 Vac		0.5	1	1.5	2	3	
	220-240 Vac		1.5	2	3		5	
Three-Phase (HP)	200-208 Vac		3		5	7.5	10	
	220-240 Vac							
	440-480 Vac		5	7.5	10	15	20	
	550-600 Vac		7.5	10	15	20	25	

H

Safety Contactors

Technical Data

			Ex9CA					
			9	12	18	25	32	38
Auxiliary Contact Amperage Ratings								
A600 AC (V)	Make and emergency interrupting capacity (Amp)	120V (A)	60					
		240V (A)	30					
		480V (A)	15					
		600V (A)	12					
	Normal load break (Amp)	120V (A)	6					
		240V (A)	3					
		480V (A)	1.6					
		600V (A)	1.2					
	Thermal current (Amp)		10					
Q600 DC (V)	Make and emergency interrupting capacity (Amp)	125V (A)	0.55					
		250V (A)	0.27					
		440V (A)	0.1					
		600V (A)	0.1					
	Normal load break (Amp)	125V (A)	0.55					
		250V (A)	0.27					
		440V (A)	0.1					
		600V (A)	0.1					
	Thermal current (Amp)		2.5					
Tolerance of Control Voltage								
AC control (50/60 Hz)	pick-up (Operating Voltage)		85...110%					
	dropout (Operating Voltage)		20...75%					
DC control	pick-up (Operating Voltage)		80...110%					
	dropout (Operating Voltage)		10...75%					
Coil Power Consumption								
AC control (50/60 Hz)	pick-up (VA)		120VA (Ex9CA09-18)/140VA (Ex9CA25-38)					
	hold-in (VA)		12VA (Ex9CA09-18)/14VA (Ex9CA25-38)					
DC control	pick-up (W)		≤70					
	hold-in (W)		≤3.5					
Operating Time								
AC	closing delay (ms)		15...30					
	opening delay (ms)		15...25					
DC	closing delay (ms)		100...170					
	opening delay (ms)		30-100					
Typical Lifetime								
B ₁₀₀ Value (Electrical)	DC Coil		1,080,000			1,013,000		
	AC Coil		1,280,000			1,025,000		

Safety Control Relays

Ex9RCA Product Overview

Features

The NOARK Electric Ex9RCA Safety Control Relay is designed to provide fail-safe performance for safety function applications. It features mechanically linked contacts for use on safety feedback circuits with up to 8 contacts. When installed, the normally closed contact is force guided with the normally open contacts, making the Ex9RCA ideal for SRP/CS*.



* SRP/CS is the term given by ISO short for safety-related part of a control system, meaning part of a control system that responds to safety-related input signals and generates safety-related output signals

- Force guided/mechanically linked contacts as per IEC/UL 60947-5-1 Annex L
- Mechanically linked contacts symbol prominently displayed on red front cover
- Fixed transparent anti-dust cover allows easy identification of device action and prevents manual operation
- 4-pole models available with AC or DC operating coils
- 8-pole models available DC only
- Easily mounts on DIN 35mm or panel
- 5 year limited warranty



Certifications

- UL Listed, File Number E353865, UL 60947-1
- Certified for Canada CSA standards under cUL testing
- IEC/EN 60947-5-1
- CE Approved
- CCC Certified



Safety Control Relays

Ex9RCA

Green Highlight = Most Popular



Certifications

IEC/EN 60947-4-1



Coil Voltage		4-Pole		
		Catalog Number	Catalog Number	Catalog Number
		Contact Configuration 1NO+3NC	Contact Configuration 2NO+2NC	Contact Configuration 3NO+1NC
Vac	120	Ex9RCA13G	Ex9RCA22G	Ex9RCA31G
Vdc	24	Ex9RCADBS	Ex9RCA22DBS	Ex9RCA31DBS



Coil Voltage		8-Pole		
		Catalog Number	Catalog Number	Catalog Number
		Contact Configuration 2NO+6NC	Contact Configuration 3NO+5NC	Contact Configuration 4NO+4NC
Vdc	24	Ex9RCA26DBS	Ex9RCA35DBS	Ex9RCA35DBS

Coil Voltage		8-Pole		
		Catalog Number	Catalog Number	Catalog Number
		Contact Configuration 5NO+3NC	Contact Configuration 6NO+2NC	Contact Configuration 7NO+1NC
Vdc	24	Ex9RCA53DBS	Ex9RCA62DBS	Ex9RCA71DBS

Additional products, accessories and higher ratings available. Contact your NOARK representative or visit na.noark-electric.com for additional information.

Safety Control Relay

Technical Data

General Information		Ex9RCA	
Poles		4, 8	
Production Standard		UL 60947-5-1, GB/T 14048.5, IEC/EN 60947-5-1	
Rated Operating Voltage (U _e)	AC 50/60 HZ	24, 120	
	DC	24	
Rated Insulating Voltage U _i (V)	IEC	690	
	UL, CSA	600	
Rated Impulse Withstand Voltage U _{imp} (kV)		6	
Electrical Life AC-15 (240V/2A)		1,000,000	
Mechanical Life		10,000,000	
Protection Class		IP20	
Ambient Temperature	Transportation or Storage (°C)	-60...+80	
	Operation at rated voltage (°C)	-20...+60	
Max. Altitude of Installation Site ft (m)		<6,562 (2,000)	
Contact Ratings		Main and Auxiliary Contacts (A600)	
AC Ratings Maximum Amps (A)	AC Volts (V)	Make	Break
		120	6
		240	3
		480	1.6
	600	1.2	
	Thermal current (Amp)	10	
DC Ratings Maximum Amps (A)	DC Volts (V)	Auxiliary Contacts (Q600)	Power Contacts (P600)
		24	5.0
		48	2.5
		125	1.10
		250	0.55
	301 to 600	0.20	
	Thermal current (Amp)	2.5	5.0
Load Carrying Capacity per UL			
Rated voltage AC (V)		Max. 600	
Continuous rating 40 °C (A)		10	
Switching capacity AC (A)		A600	
Rated voltage DC (V)		Max. 600	
Switching capacity DC (A)		Auxiliary Contacts Q600	Power Contacts P600
Tolerance of Control Voltage			
AC control (50/60 Hz)	pick-up (x Operating Voltage)	85%...110%	
	dropout (x Operating Voltage)	20%...75%	
DC control	pick-up (x Operating Voltage)	80%...110% (4-Pole), 85%...110%	
	dropout (x Operating Voltage)	10%...75%	
Coil Power Consumption			
AC control(50/60 Hz)	pick-up (VA)	40	
	hold-in (VA)	9	
DC control	pick-up (W)	3.2-4.0	
	hold-in (W)	3.2-4.0	
Operating Time			
AC	closing delay (ms)	15...30	
	opening delay (ms)	15...25	
DC	closing delay (ms)	25-40	
	opening delay (ms)	10...15	

22 mm Pilot Devices Product Guide

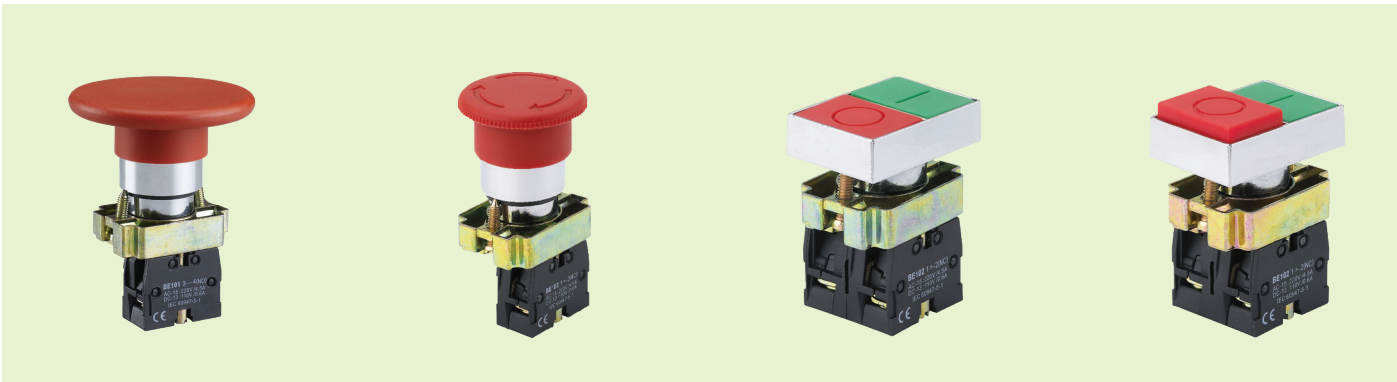

22 mm Indicator Lights

Ex9IL Product Overview

Features

- UL listed and IP65 rated
- Compact profile and depth
- Operators mount in a round 7/8 in (22.5 mm) hole that is interchangeable with other industry products
- Modular construction makes assembly fast and simple



Certifications

- UL Listed, File Number E353866
- Certified for Canada CSA standards under cUL testing
- IEC/EN 60947
- VDE 0660
- CE Approved



22 mm Indicator Lights

Ex9IL2 Compact Pilot Lights



Certifications
IEC/EN 60947-5-1

CE LISTED



Green Highlight = Most Popular



Resistance Type		
Color	LED Lamp Voltage (Vac/dc)	Catalog Number
●	12	Ex9IL2C3
●	12	Ex9IL2C4
○	24	Ex9IL2D1
●	24	Ex9IL2D3
●	24	Ex9IL2D4
●	24	Ex9IL2D5
●	24	Ex9IL2D6

Capacitance Type		
Color	LED Lamp Voltage (Vac)	Catalog Number
○	110/120	Ex9IL2N1
●	110/120	Ex9IL2N3
●	110/120	Ex9IL2N4
●	110/120	Ex9IL2N5
●	110/120	Ex9IL2N6
●	220/240	Ex9IL2H3
●	220/240	Ex9IL2H4

Specifications

		Ex9IL
Rated Operational Voltage Ue (V)	Vac	12-240
	Vdc	12-24
Rated Operational Current (mA)		le≤20
Service Life (h)		≥30,000
Brightness (cd/m ²)		≥60
Standard Colors		(Green) ● (Red) ●
Other Available Colors		(White)○ (Yellow) ● (Blue) ●

Note: For AC power supply, the limit voltage range is 0.85Ue-1.1Ue between terminals.

Additional products, accessories and higher ratings available. Contact your NOARK representative or visit na.noark-electric.com for additional information.

22 mm Pushbuttons

Ex9PB Product Overview

Features

- Metal construction for superior durability and visual appeal
- UL recognized component and labeled IP40 rated (can be customized into IP65)
- LED replaceable lamps are standard
- Low behind the panel depth
- Operators mount in a round 7/8 in (22.5 mm) hole that is interchangeable with competitor's products
- Field convertible from maintained to momentary (available on maintained pushbuttons only)
- More than one million mechanical operations on momentary and half million on maintained pushbuttons



Certifications

- UL Recognized Component, File Number E353865
- Certified for Canada CSA standards under cUL testing
- IEC/EN 60947
- VDE 0660
- CE Approved



Specifications

		Ex9PB
Rated Operational Voltage Ue (V)		125
Rated Operational Current (mA)	DC-13	0.55
Illuminated Button Lamp Parameters		Direct Type LED Lamp
Rated Operational Current Ie (mA)		Ie≤20
Rated Operational Voltage (V)		6-230 Vac/dc

Note: Conventional thermal current Ith: 10A

22 mm Pushbuttons Momentary Non-Illuminated



Momentary Flush*		
Color	Contacts	Catalog Number
○	1NO	Ex9PBA11
●		Ex9PBA21
●		Ex9PBA31
●		Ex9PBA41
●		Ex9PBA51
●		Ex9PBA61
○	1NC	Ex9PBA12
●		Ex9PBA22
●		Ex9PBA32
●		Ex9PBA42
●		Ex9PBA52
●		Ex9PBA62
○	1NO+1NC	Ex9PBA15
●		Ex9PBA25
●		Ex9PBA35
●		Ex9PBA45
●		Ex9PBA55
●		Ex9PBA65

Momentary Flush+Symbol*		
Color	Contacts	Catalog Number
●	1NO	Ex9PBA3311
●	1NC	Ex9PBA4322



Momentary Extended		
Color	Contacts	Catalog Number
●	1NO	Ex9PBL31
●	1NC	Ex9PBL42

* Ex9PBA momentary flush pushbuttons available up to IP 65. Contact a NOARK representative for more information.



Momentary ø40 mm Mushroom Head		
Color	Contacts	Catalog Number
●	1NO+1NC	Ex9PBC35
●		Ex9PBC45

Momentary ø60 mm Mushroom Head		
Color	Contacts	Catalog Number
●	1NO+1NC	Ex9PBR35
●		Ex9PBR45

Additional products, accessories and higher ratings available. Contact your NOARK representative or visit na.noark-electric.com for additional information.

22 mm Pushbuttons

Momentary and Push On/Twist Off Non-Illuminated



Certifications
IEC/EN 60947-5-1

CE cRU8

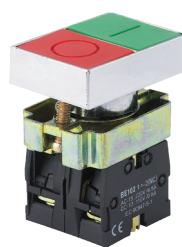

Push On/Twist Off ø30 mm Mushroom Head

Color	Contacts	Catalog Number
●	1NO	Ex9PBS441
	1NC	Ex9PBS442
	2NO	Ex9PBS443
	2NC	Ex9PBS444
	1NO+1NC	Ex9PBS445

Momentary Double Head - Flush

Color	Contacts	Catalog Number
● + ●	1NO+1NC	Ex9PBL8325

Push On/Twist Off ø40 Mushroom Head

Color	Contacts	Catalog Number
●	1NO	Ex9PBS541
	1NC	Ex9PBS542
	2NO	Ex9PBS543
	2NC	Ex9PBS544
	1NO+1NC	Ex9PBS545



Momentary Double Head - Extended

Color	Contacts	Catalog Number
● + ●	1NO+1NC	Ex9PBL8425

Push On/Twist Off ø60 Mushroom Head

Color	Contacts	Catalog Number
●	1NO	Ex9PBS641
	1NC	Ex9PBS642
	2NO	Ex9PBS643
	2NC	Ex9PBS644
	1NO+1NC	Ex9PBS645

Additional products, accessories and higher ratings available. Contact your NOARK representative or visit na.noark-electric.com for additional information.

22 mm Pushbuttons Selector Switch Non-Illuminated



Certifications
IEC/EN 60947-5-1

CE cULus



Selector Switch - Rotary Knob		
Positions	Contacts	Catalog Number
2-Position		
	1NO+1NC	Ex9PBD25
	1NO+1NC	Ex9PBD45
3-Position		
	2NO	Ex9PBD33
	1NO+1NC	Ex9PBD35
	2NO	Ex9PBD53
	1NO+1NC	Ex9PBD55



Selector Switch - Key		
Positions	Contacts	Catalog Number
2-Position		
	1NO+1NC	Ex9PBG25
	1NO+1NC	Ex9PBG45
	1NO+1NC	Ex9PBG25B
3-Position		
	2NO	Ex9PBG33
	1NO+1NC	Ex9PBG35
	2NO	Ex9PBG53
	1NO+1NC	Ex9PBG55
	2NO	Ex9PBG33D
	1NO+1NC	Ex9PBG35D

= Key removed at this position only.

Selector Switch - Rotary Handle		
Positions	Contacts	Catalog Number
2-Position		
	1NO+1NC	Ex9PBJ25
	1NO+1NC	Ex9PBJ45
3-Position		
	2NO	Ex9PBJ33
	1NO+1NC	Ex9PBJ35
	2NO	Ex9PBJ53
	1NO+1NC	Ex9PBJ55

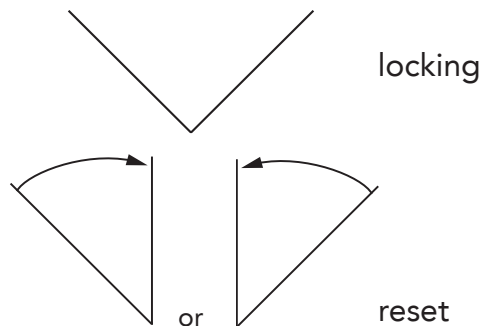

Additional products, accessories and higher ratings available. Contact your NOARK representative or visit na.noark-electric.com for additional information.

22 mm Pushbuttons Illuminated and Contact Blocks



Certifications
IEC/EN 60947-5-1

CE cRU_{us}



Momentary Flush with Guard		
Color	LED Lamp Voltage Vac/dc	Catalog Number
1NO		
●	24	Ex9PBW3561D
●	24	Ex9PBW3661D
2NO		
●	24	Ex9PBW3363D
●	230	Ex9PBW3363H
1NO+1NC		
●	24	Ex9PBW3365D
●		Ex9PBW3465D
●	110	Ex9PBW3365N
●		Ex9PBW3465N

Momentary Double Head - Flush+Projecting		
Color	Contacts	Catalog Number
1NO+1NC		
● + ●	24	Ex9PBW8465D
	110	Ex9PBW8465N



Indicator Light		
Color	LED Lamp Voltage Vac/dc	Catalog Number
1NO+1NC		
●	24	Ex9PBV63D
●		Ex9PBV64D
●	110	Ex9PBV63N
●		Ex9PBV64N



Contact Blocks		
Accessory Description	Poles	Catalog Number
Contact Block	NO	Ex9PBE101
Contact Block	NC	Ex9PBE102

Additional products, accessories and higher ratings available. Contact your NOARK representative or visit na.noark-electric.com for additional information.

22 mm Pushbutton Accessories

Ex9PB Enclosures



Accessory Description	Catalog Number
Enclosure Start (Pushbuttons included)	Ex9PB101H29
Enclosure Stop/Start Rotary Handle (Pushbuttons included)	Ex9PB132H29



Accessory Description	Catalog Number
Enclosure Start/Stop (Pushbuttons included)	Ex9PB211H29
Enclosure Start/Stop (Pushbuttons included)	Ex9PB213
Enclosure Start/Stop (Pushbuttons included)	Ex9PB215



Additional products, accessories and higher ratings available. Contact your NOARK representative or visit na.noark-electric.com for additional information.

Appendix A

Short Circuit Current Rating Tables

UL60947-4-1 and CSA C22.2 No. 60947-4-1 Short Circuit Current Ratings

UL 60947-4-1 and CSA C22.2 No. 60947-4-1 are the safety standards for industrial control equipment in the USA and Canada. They may be used in place of UL508 and CSA C22.2 No. 14, which are superseded by this harmonized standard.

Establishing the Short Circuit Current Rating (SCCR) of an industrial control panel is an important factor in meeting the requirements of UL 60947-4-1 and its CSA equivalent. This rating establishes the maximum short circuit current that the entire control panel can safely withstand. This required rating is based on the magnitude of the fault current that is available at the control panel's incoming terminals.

The standard defines three separate methods to determine the SCCR of the control panel, based on the individual ratings of the current-carrying components:

- Use the SCCR value marked on each component. The control panel must be labeled with the SCCR value of the lowest-rated component.
- Use assumed SCCR values in Table SB4.1 of Supplement SB. The control panel must be labeled with the SCCR value of the lowest rated component.
- Use the tested SCCR from component combinations per UL 508. In this method, individual motor branch circuit components are tested together in specific combinations to achieve a system or "combination" rating. This combination rating is not specifically limited by each individual component rating.

The tables in this Appendix show all the tested combinations of Noark Electric Molded Case Breakers, Motor Contactors and Overload Relays.

UL 60947-4-1 Combination Motor Controllers

UL 60947-4-1 defines the components, product standards, testing and performance requirements for five types of combination motor controller (also called a combination starter) arrangements. Each of these five styles meet the requirements of the NEC and CEC installation codes for motor branch circuit protection. The table below outlines the products and standards used in each combination type.

UL60947-4-1 and CSA C22.2 No. 60947-4-1 Combination Starter Types

Type	Disconnect Device	Short Circuit Protection	Overload Protection	Motor Controller
A	UL 98 Disconnect Switch	UL 248 Fuses	UL 60947-4-1 Overload Relay (Thermal or Electronic)	UL 60947-4-1 Magnetic Contactor
C	UL 489 Molded Case Breaker (Thermal-Magnetic or Electronic)			UL 60947-4-1 Magnetic Contactor
D	UL 489 Motor Circuit Protector (Instantaneous Magnetic Only)		UL 60947-4-1 Overload Relay (Thermal or Electronic)	UL 60947-4-1 Magnetic Contactor
E	UL 60947-4-1 Self-Protected Manual Motor Starter			
F	UL 60947-4-1 Self-Protected Manual Motor Starter			UL 60947-4-1 Magnetic Contactor

Table A1: Type C Short Circuit Current Ratings

200Vac Maximum					
Motor (HP)	FLA (A)	SCCR (kA)	Molded Case Breaker	Contactor	Overload
3	10.6	65	M1N15T3L	Ex9C09...	Ex9R38B... Ex9RE40...
				Ex9C12...	Ex9R38B... Ex9RE40...
		100	M1H15T3L	Ex9C09...	Ex9R38B... Ex9RE40...
				Ex9C12...	Ex9R38B... Ex9RE40...
5	16.7	65	M1N30T3L	Ex9C18...	Ex9R38B... Ex9RE40...
		100	M1H30T3L	Ex9C18...	Ex9R38B... Ex9RE40...
7.5	24.2	65	M1N50T3L	Ex9C25...	Ex9R38B... Ex9RE40...
		100	M1H50T3L	Ex9C25...	Ex9R38B... Ex9RE40...
10	30.8	65	M1N50T3L	Ex9C32...	Ex9R38B... Ex9RE40...
				Ex9C38...	Ex9R38B... Ex9RE40...
		100	M1N70T3L	Ex9C40...	Ex9R100B...
				M1H50T3L	Ex9C32...
Ex9C38...	Ex9R38B... Ex9RE40...				
15	48.3	65	M1N70T3L	Ex9C50...	Ex9R100B...
		100	M1H70T3L		
20	62.1	65	M1N100T3L	Ex9C65...	Ex9R100B...
		100	M1H100T3L		
30	88	65	M1N150T3L	Ex9C100...	Ex9R100B...
		100	M1H150T3L	Ex9C80...	
Ex9C100...					
40	114	65	M2N200T3L	Ex9C115...	Ex9R185B...
		100	M2H200T3L		
50	143	65	M2N200T3L	Ex9C150...	Ex9R185B...
		100	M2H200T3L		
60	169	65	M2N250T3L	Ex9C185...	Ex9R185B...
		100	M2H250T3L	Ex9C225...	Ex9R500B...
Ex9C185...	Ex9R185B...				
75	211	65	M3N400T3L	Ex9C265...	Ex9R500B...
		100	M3H400T3L		
100	273	65	M3N400T3L	Ex9C300...	Ex9R500B...
		100	M3H400T3L		
125	343	65	M4N500T3L	Ex9C400...	Ex9R500B...
		100	M4H500T3L		
150	396	65	M4N600T3L	Ex9C500...	Ex9R500B...
		100	M4H600T3L		

Appendix A

Short Circuit Current Rating Tables

Table A2: Type C Short Circuit Current Ratings					
208Vac Maximum					
Motor (HP)	FLA (A)	SCCR (kA)	Molded Case Breaker	Contactors	Overload Relay
3	11	65	M1N15T3L	Ex9C09...	Ex9R38B... Ex9RE40...
				Ex9C12...	Ex9R38B... Ex9RE40...
		100	M1H15T3L	Ex9C09...	Ex9R38B... Ex9RE40...
				Ex9C12...	Ex9R38B... Ex9RE40...
5	17.5	65	M1N30T3L	Ex9C18...	Ex9R38B... Ex9RE40...
		100	M1H30T3L	Ex9C18...	Ex9R38B... Ex9RE40...
7.5	25.3	65	M1N30T3L	Ex9C25...	Ex9R38B... Ex9RE40...
		100	M1H30T3L	Ex9C25...	Ex9R38B... Ex9RE40...
10	32.2	65	M1N50T3L	Ex9C32...	Ex9R38B... Ex9RE40...
				Ex9C38...	Ex9R38B... Ex9RE40...
		100	M1H50T3L	Ex9C32...	Ex9R38B... Ex9RE40...
				Ex9C38...	Ex9R100B... Ex9R100B...
15	48.3	65	M1N70T3L	Ex9C50...	Ex9R100B...
		100	M1H70T3L	Ex9C50...	Ex9R100B...
20	62.1	65	M1N100T3L	Ex9C65...	Ex9R100B...
		100	M1N100T3L	Ex9C65...	Ex9R100B...
30	92	65	M1N150T3L	Ex9C80...	Ex9R100B...
				Ex9C100...	
40	120	65	M2N200T3L	Ex9C115...	Ex9R185B...
				Ex9C115...	
50	150	65	M2N200T3L	Ex9C150...	Ex9R185B...
				Ex9C150...	
60	177	65	M2N250T3L	Ex9C150...	Ex9R185B... Ex9R500B...
				Ex9C225...	Ex9R185B... Ex9R500B...
75	221	65	M3N400T3L	Ex9C265...	Ex9R500B...
				Ex9C265...	
100	285	65	M3H400T3L	Ex9C300...	Ex9R500B...
				Ex9C300...	
125	359	65	M4N500T3L	Ex9C400...	Ex9R500B...
				Ex9C400...	
150	414	65	M4N600T3L	Ex9C500...	Ex9R500B...
				Ex9C500...	

Table A3: Type C Short Circuit Current Ratings					
240Vac Maximum					
Motor (HP)	FLA (A)	SCCR (kA)	Molded Case Breaker	Contactors	Overload Relay
3	9.6	65	M1N15T3L	Ex9C09...	Ex9R38B... Ex9RE40...
				Ex9C12...	Ex9R38B... Ex9RE40...
		100	M1H15T3L	Ex9C09...	Ex9R38B... Ex9RE40...
				Ex9C12...	Ex9R38B... Ex9RE40...
5	15.2	65	M1N30T3L	Ex9C18...	Ex9R38B... Ex9RE40...
		100	M1H30T3L	Ex9C18...	Ex9R38B... Ex9RE40...
7.5	22	65	M1N30T3L	Ex9C25...	Ex9R38B... Ex9RE40...
		100	M1H30T3L	Ex9C25...	Ex9R38B... Ex9RE40...
10	28	65	M1N50T3L	Ex9C32...	Ex9R38B... Ex9RE40...
				Ex9C38...	Ex9R38B... Ex9RE40...
		100	M1H50T3L	Ex9C32...	Ex9R38B... Ex9RE40...
				Ex9C38...	Ex9R100B... Ex9R100B...
15	42	65	M1N70T3L	Ex9C40...	Ex9R100B...
		100	M1H70T3L	Ex9C40...	Ex9R100B...
20	54	65	M1N100T3L	Ex9C50...	Ex9R100B...
		100	M1H100T3L	Ex9C50...	Ex9R100B...
25	68	65	M1N100T3L	Ex9C65...	Ex9R100B...
				Ex9C65...	
30	80	65	M1N100T3L	Ex9C80...	Ex9R100B...
				Ex9C80...	
40	104	65	M1N150T3L	Ex9C100...	Ex9R100B...
				Ex9C100...	
50	130	65	M2N200T3L	Ex9C115...	Ex9R185B...
				Ex9C115...	
60	154	65	M2N200T3L	Ex9C150...	Ex9R185B...
				Ex9C150...	
75	192	65	M2N250T3L	Ex9C185...	Ex9R185B... Ex9R500B...
				Ex9C225...	Ex9R185B... Ex9R500B...
100	248	65	M3N400T3L	Ex9C265...	Ex9R500B...
				Ex9C265...	
125	312	65	M3H400T3L	Ex9C300...	Ex9R500B...
				Ex9C300...	
150	360	65	M4N500T3L	Ex9C400...	Ex9R500B...
				Ex9C400...	
200	480	65	M4N600T3L	Ex9C500...	Ex9R500B...
				Ex9C500...	

Appendix A

Short Circuit Current Rating Tables

Table A4: Type C Short Circuit Current Ratings						
480Vac Maximum						
Motor (HP)	FLA (A)	SCCR (kA)	Molded Case Breaker	Contactors	Overload Relay	
5	7.6	35	M1S15T3L	Ex9C09...	Ex9R38B...	
		65	M1N15T3L	Ex9C09...	Ex9R38B... Ex9RE40...	
		100	M1H15T3L	Ex9C09...	Ex9R38B... Ex9RE40...	
7.5	11	35	M1S15T3L	Ex9C12...	Ex9R38B...	
		65	M1N15T3L	Ex9C12...	Ex9R38B... Ex9RE40...	
		100	M1H15T3L	Ex9C12...	Ex9R38B... Ex9RE40...	
10	14	35	M1S30T3L	Ex9C18...	Ex9R38B...	
		65	M1N30T3L	Ex9C18...	Ex9R38B... Ex9RE40...	
		100	M1H30T3L	Ex9C18...	Ex9R38B... Ex9RE40...	
15	21	35	M1S30T3L	Ex9C25...	Ex9R38B...	
		65	M1N30T3L	Ex9C25...	Ex9R38B... Ex9RE40...	
		100	M1H30T3L	Ex9C25...	Ex9R38B... Ex9RE40...	
20	27	35	M1S50T3L	Ex9C32... Ex9C38...	Ex9R38B... Ex9RE40...	
			65	M1N50T3L	Ex9C32... Ex9C38...	Ex9R38B... Ex9RE40...
				100	M1H50T3L	Ex9C32... Ex9C38...
		35			M1S70T3L	Ex9C40...
			65		M1N70T3L	Ex9C40...
				100	M1H70T3L	Ex9C40...
40	52	35			M1S70T3L	Ex9C50...
		65	M1N70T3L		Ex9C50...	Ex9R100B...
		100	M1H70T3L	Ex9C50...	Ex9R100B...	
50	65	35	M1S100T3L	Ex9C65...	Ex9R100B...	
		65	M1N100T3L	Ex9C65...	Ex9R100B...	
		100	M1H100T3L	Ex9C65...	Ex9R100B...	
60	77	35	M1S100T3L	Ex9C100... Ex9C80...	Ex9R100B...	
			65	M1N100T3L	Ex9C100... Ex9C80...	Ex9R100B...
				100	M1H100T3L	Ex9C100... Ex9C80...
100	124	35			M2S200T3L	Ex9C115...
		65	M2N200T3L		Ex9C115...	Ex9R185B...
		100	M2H200T3L	Ex9C115...	Ex9R185B...	
125	156	35	M2S200T3L	Ex9C150...	Ex9R185B...	
		65	M2N200T3L	Ex9C150...	Ex9R185B...	
		100	M2H200T3L	Ex9C150...	Ex9R185B...	
150	180	35	M2S250T3L	Ex9C185... Ex9C225...	Ex9R185B...	
			65	M2N250T3L	Ex9C185... Ex9C225...	Ex9R185B...
				100	M2H250T3L	Ex9C185... Ex9C225...
200	240	35			M3S400T3L	Ex9C265...
		65	M3N400T3L		Ex9C265...	Ex9R500B...
		100	M3H400T3L	Ex9C265...	Ex9R500B...	
250	302	35	M3S400T3L	Ex9C300...	Ex9R500B...	
		65	M3N400T3L	Ex9C300...	Ex9R500B...	
		100	M3H400T3L	Ex9C300...	Ex9R500B...	
300	361	35	M4S500T3L	Ex9C400...	Ex9R500B...	
		65	M4N500T3L	Ex9C400...	Ex9R500B...	
		100	M4H500T3L	Ex9C400...	Ex9R500B...	
400	477	35	M4S600T3L	Ex9C500...	Ex9R500B...	
		65	M4N600T3L	Ex9C500...	Ex9R500B...	
		100	M4H600T3L	Ex9C500...	Ex9R500B...	

Table A5: Type C Short Circuit Current Ratings					
600Vac Maximum					
Motor (HP)	FLA (A)	SCCR (kA)	Molded Case Breaker	Contactors	Overload Relay
7.5	9	20	M1N15T3L	Ex9C09...	Ex9RE40...
		25	M1H15T3L	Ex9C09...	Ex9RE40...
10	11	20	M1N15T3L	Ex9C12...	Ex9RE40...
		25	M1H15T3L	Ex9C12...	Ex9RE40...
15	17	20	M1N30T3L	Ex9C18...	Ex9RE40...
		25	M1H30T3L	Ex9C18...	Ex9RE40...
20	22	20	M1N30T3L	Ex9C25...	Ex9RE40...
		25	M1H30T3L	Ex9C25...	Ex9RE40...
25	27	20	M1N50T3L	Ex9C32... Ex9C38...	Ex9RE40...
			M1H50T3L	Ex9C32... Ex9C38...	Ex9RE40...
		25	M1N50T3L	Ex9C32... Ex9C38...	Ex9RE40...
			M1H50T3L	Ex9C32... Ex9C38...	Ex9RE40...
30	32	20	M1N70T3L	Ex9C40...	Ex9R100B...
		25	M1H70T3L	Ex9C40...	Ex9R100B...
40	41	20	M1N70T3L	Ex9C50...	Ex9R100B...
		25	M1H70T3L	Ex9C50...	Ex9R100B...
50	52	20	M1N70T3L	Ex9C65...	Ex9R100B...
		25	M1H70T3L	Ex9C65...	Ex9R100B...
60	62	20	M1N100T3L	Ex9C100... Ex9C80...	Ex9R100B...
			M1H100T3L	Ex9C100... Ex9C80...	Ex9R100B...
		25	M1N100T3L	Ex9C100... Ex9C80...	Ex9R100B...
			M1H100T3L	Ex9C100... Ex9C80...	Ex9R100B...
125	125	20	M2N200T3L	Ex9C115...	Ex9R185B...
		25	M2H200T3L	Ex9C115...	Ex9R185B...
150	144	20	M2N200T3L	Ex9C150...	Ex9R185B...
		25	M2H200T3L	Ex9C150...	Ex9R185B...
200	192	20	M2N250T3L	Ex9C185... Ex9C225...	Ex9R185B...
			M2H250T3L	Ex9C185... Ex9C225...	Ex9R185B...
		25	M2N250T3L	Ex9C185... Ex9C225...	Ex9R185B...
			M2H250T3L	Ex9C185... Ex9C225...	Ex9R185B...
250	242	18	M3S400T3L	Ex9C265...	Ex9R500B...
		25	M3N400T3L	Ex9C265...	Ex9R500B...
		30	M3H400T3L	Ex9C265...	Ex9R500B...
300	289	18	M3S400T3L	Ex9C300...	Ex9R500B...
		25	M3N400T3L	Ex9C300...	Ex9R500B...
		30	M3H400T3L	Ex9C300...	Ex9R500B...
400	382	22	M4S500T3L	Ex9C400...	Ex9R500B...
		30	M4N500T3L	Ex9C400...	Ex9R500B...
		50	M4H500T3L	Ex9C400...	Ex9R500B...
500	472	22	M4S600T3L	Ex9C500...	Ex9R500B...
		30	M4N600T3L	Ex9C500...	Ex9R500B...
		50	M4H600T3L	Ex9C500...	Ex9R500B...

Appendix A

Short Circuit Current Rating Tables

Table A6: Type D Short Circuit Current Ratings

200Vac Maximum						
Motor (HP)	FLA (A)	SCCR (kA)	Molded Case Breaker	Contactors	Overload Relay	
3	2.5	65	M1MN3T3L	Ex9C09...	Ex9R38B... Ex9RE40...	
		100	M1MH3T3L	Ex9C09...	Ex9R38B... Ex9RE40...	
	4.8	65	M1MN7T3L	Ex9C09...	Ex9R38B... Ex9RE40...	
		100	M1MH7T3L	Ex9C09...	Ex9R38B... Ex9RE40...	
	7.8	65	M1MN15T3L	Ex9C09... Ex9C12...	Ex9RE40... Ex9RE40...	
		100	M1MH15T3L	Ex9C09... Ex9C012...	Ex9RE40... Ex9RE40...	
	11	65	M1MN15T3L	Ex9C09... Ex9C12...	Ex9R38B... Ex9R38B...	
		100	M1MH15T3L	Ex9C09... Ex9C12...	Ex9R38B... Ex9R38B...	
	5	17.5	65	M1MN30T3L	Ex9C18...	Ex9R38B... Ex9RE40...
			100	M1MH30T3L	Ex9C18...	Ex9R38B... Ex9RE40...
	7.5	25.3	65	M1MH50T3L	Ex9C25...	Ex9R38B... Ex9RE40...
			100	M1MH50T3L	Ex9C25...	Ex9R38B... Ex9RE40...
10	32.2	65	M1MN50T3L	Ex9C32... Ex9C38...	Ex9R38B... Ex9RE40... Ex9R38B... Ex9RE40...	
			M1MN70T3L	Ex9C40...	Ex9R100B... Ex9R38B... Ex9RE40...	
		100	M1MH50T3L	Ex9C32... Ex9C38...	Ex9R38B... Ex9RE40... Ex9R38B... Ex9RE40...	
			M1MH70T3L	Ex9C40...	Ex9R100B... Ex9R100B...	
15	48.3	65 100	M1MN70T3L M1MH70T3L	Ex9C50... Ex9C50...	Ex9R100B... Ex9R100B...	
20	62.1	65 100	M1MN100T3L M1MH100T3L	Ex9C65... Ex9C65...	Ex9R100B... Ex9R100B...	
30	92	65	M1MN150T3L	Ex9C100... Ex9C80...	Ex9R100B... Ex9R100B...	
		100	M1MH150T3L	Ex9C100... Ex9C80...	Ex9R100B... Ex9R100B...	
40	120	65 100	M2MN250T3L M2MH250T3L	Ex9C115... Ex9C115...	Ex9R185B... Ex9R185B...	
		65 100	M2MN250T3L M2MH250T3L	Ex9C150... Ex9C150...	Ex9R185B... Ex9R185B...	
60	177	65	M2MN250T3L	Ex9C185... Ex9C225...	Ex9R185B... Ex9R500B...	
		100	M2MH250T3L	Ex9C185... Ex9C225...	Ex9R185B... Ex9R500B...	
75	221	65 100	M3MN400T3L M3MH400T3L	Ex9C265... Ex9C265...	Ex9R500B... Ex9R500B...	
		65 100	M3MN400T3L M3MH400T3L	Ex9C300... Ex9C300...	Ex9R500B... Ex9R500B...	
125	359	65 100	M4MN600T3L M4MH600T3L	Ex9C400... Ex9C400...	Ex9R500B... Ex9R500B...	
		65 100	M4MN600T3L M4MH600T3L	Ex9C500... Ex9C500...	Ex9R500B... Ex9R500B...	

Table A7: Type D Short Circuit Current Ratings

208Vac Maximum						
Motor (HP)	FLA (A)	SCCR (kA)	Molded Case Breaker	Contactors	Overload Relay	
3	2.4	65	M1MN3T3L	Ex9C09...	Ex9R38B... Ex9RE40...	
		100	M1MH3T3L	Ex9C09...	Ex9R38B... Ex9RE40...	
	4.6	65	M1MN7T3L	Ex9C09...	Ex9R38B... Ex9RE40...	
		100	M1MH7T3L	Ex9C09...	Ex9R38B... Ex9RE40...	
	10.6	65	M1MN15T3L	Ex9C09... Ex9C12...	Ex9RE40... Ex9RE40...	
		65	M1MN15T3L	Ex9C12... Ex9C09...	Ex9RE40... Ex9RE40...	
	10.6	100	M1MH15T3L	Ex9C09... Ex9C12...	Ex9R38B... Ex9R38B...	
		100	M1MH15T3L	Ex9C12... Ex9C09...	Ex9R38B... Ex9R38B...	
	5	16.7	65	M1MN30T3L	Ex9C18...	Ex9R38B... Ex9RE40...
			100	M1MH30T3L	Ex9C18...	Ex9R38B... Ex9RE40...
	7.5	24.2	65	M1MN50T3L	Ex9C25... Ex9C32...	Ex9R38B... Ex9RE40... Ex9R38B... Ex9RE40...
			100	M1MH50T3L	Ex9C25... Ex9C32...	Ex9R38B... Ex9RE40... Ex9R38B... Ex9RE40...
10	30.8	65	M1MN50T3L	Ex9C32... Ex9C38...	Ex9R38B... Ex9RE40... Ex9R38B... Ex9RE40...	
			M1MN70T3L	Ex9C40... Ex9C32...	Ex9R100B... Ex9R38B... Ex9RE40...	
		100	M1MH50T3L	Ex9C32... Ex9C38...	Ex9R38B... Ex9RE40... Ex9R38B... Ex9RE40...	
			M1MH70T3L	Ex9C40...	Ex9R100B... Ex9R100B...	
15	46.2	65 100	M1MN70T3L M1MH70T3L	Ex9C50... Ex9C50...	Ex9R100B... Ex9R100B...	
20	59.4	65 100	M1MN100T3L M1MH100T3L	Ex9C65... Ex9C65...	Ex9R100B... Ex9R100B...	
30	88	65	M1MN150T3L	Ex9C100... Ex9C80...	Ex9R100B... Ex9R100B...	
		100	M1MH150T3L	Ex9C100... Ex9C80...	Ex9R100B... Ex9R100B...	
40	114	65 100	M2MN250T3L M2MH250T3L	Ex9C115... Ex9C115...	Ex9R185B... Ex9R185B...	
		65 100	M2MN250T3L M2MH250T3L	Ex9C150... Ex9C150...	Ex9R185B... Ex9R185B...	
60	169	65	M2MN250T3L	Ex9C185... Ex9C225...	Ex9R185B... Ex9R500B...	
		100	M2MH250T3L	Ex9C185... Ex9C225...	Ex9R185B... Ex9R500B...	
75	211	65 100	M3MN400T3L M3MH400T3L	Ex9C265... Ex9C265...	Ex9R500B... Ex9R500B...	
		65 100	M3MN400T3L M3MH400T3L	Ex9C300... Ex9C300...	Ex9R500B... Ex9R500B...	
125	343	65 100	M4MN600T3L M4MH600T3L	Ex9C400... Ex9C400...	Ex9R500B... Ex9R500B...	
		65 100	M4MN600T3L M4MH600T3L	Ex9C500... Ex9C500...	Ex9R500B... Ex9R500B...	

Appendix A

Short Circuit Current Rating Tables

Table A8: Type D Short Circuit Current Ratings					
240Vac Maximum					
Motor (HP)	FLA (A)	SCCR (kA)	Molded Case Breaker	Contactors	Overload Relay
3	2.2	65	M1MN3T3L	Ex9C09...	Ex9R38B...
		100	M1MH3T3L		
	6	65	M1MN7T3L	Ex9C09...	
		100	M1MH7T3L		
	9.6	65	M1MN15T3L	Ex9C09...	
		100	M1MH15T3L	Ex9C12... Ex9C09... Ex9C12...	
5	15.2	65	M1MN30T3L	Ex9C18...	Ex9R38B...
7.5	22	65	M1MN30T3L	Ex9C25...	Ex9R38B...
		100	M1MH30T3L		
10	28	65	M1MN50T3L	Ex9C32...	Ex9R38B...
			M1MH50T3L	Ex9C38...	
		100	M1MH50T3L	Ex9C32... Ex9C38...	
15	42	65	M1MN70T3L	Ex9C40...	Ex9R100B...
		100	M1MH70T3L		
20	54	65	M1MN70T3L	Ex9C50...	Ex9R100B...
		100	M1MH70T3L		
25	68	65	M1MN100T3L	Ex9C65...	Ex9R100B...
		100	M1MH100T3L		
30	80	65	M1MN100T3L	Ex9C80...	Ex9R100B...
		100	M1MH100T3L		
40	104	65	M1MN150T3L	Ex9C100...	Ex9R100B...
		100	M1MH150T3L		
50	130	65	M2MN250T3L	Ex9C115...	Ex9R185B...
		100	M2MH250T3L		
60	154	65	M2MN250T3L	Ex9C150...	Ex9R185B...
		100	M2MH250T3L		
75	192	65	M2MN250T3L	Ex9C185...	Ex9R185B...
			M2MH250T3L	Ex9C225...	Ex9R500B...
		100	M2MH250T3L	Ex9C225... Ex9C225...	Ex9R185B... Ex9R500B...
100	248	65	M3MN400T3L	Ex9C265...	Ex9R500B...
		100	M3MH400T3L		
125	312	65	M3MN400T3L	Ex9C300...	Ex9R500B...
		100	M3MH400T3L		
150	360	65	M4MN600T3L	Ex9C400...	Ex9R500B...
		100	M4MH600T3L		
200	480	65	M4MN600T3L	Ex9C500...	Ex9R500B...
		100	M4MH600T3L		

Table A9: Type D Short Circuit Current Ratings					
480Vac Maximum					
Motor (HP)	FLA (A)	SCCR (kA)	Molded Case Breaker	Contactors	Overload Relay
5	2.1	35	M1MS3T3L	Ex9C09...	Ex9R38B...
		65	M1MN3T3L	Ex9C09...	Ex9R38B... Ex9RE40...
		100	M1MH3T3L	Ex9C09...	Ex9R38B... Ex9RE40...
	4.8	35	M1MS7T3L	Ex9C09...	Ex9R38B...
		65	M1MN7T3L	Ex9C09...	Ex9R38B... Ex9RE40...
		100	M1MH7T3L	Ex9C09...	Ex9R38B... Ex9RE40...
7.5	7.6	35	M1MS15T3L	Ex9C09...	Ex9R38B...
		65	M1MN15T3L	Ex9C09...	Ex9R38B... Ex9RE40...
		100	M1MH15T3L	Ex9C09...	Ex9R38B... Ex9RE40...
10	11	35	M1MS15T3L	Ex9C12...	Ex9R38B...
		65	M1MN15T3L	Ex9C12...	Ex9R38B... Ex9RE40...
		100	M1MH15T3L	Ex9C12...	Ex9R38B... Ex9RE40...
15	14	35	M1MS30T3L	Ex9C18...	Ex9R38B...
		65	M1MN30T3L	Ex9C18...	Ex9R38B... Ex9RE40...
20	21	35	M1MS30T3L	Ex9C25...	Ex9R38B...
		65	M1MN30T3L	Ex9C25...	Ex9R38B... Ex9RE40...
30	27	35	M1MS50T3L	Ex9C32... Ex9C38...	Ex9R38B... Ex9RE40...
		65	M1MN50T3L	Ex9C32... Ex9C38...	Ex9R38B... Ex9RE40... Ex9R38B... Ex9RE40...
40	40	35	M1MS70T3L	Ex9C40...	Ex9R100B...
		65	M1MN70T3L		
50	52	35	M1MS70T3L	Ex9C50...	Ex9R100B...
		65	M1MN70T3L		
60	65	35	M1MS100T3L	Ex9C65...	Ex9R100B...
		65	M1MN100T3L		
75	77	35	M1MS100T3L	Ex9C100... Ex9C80...	Ex9R100B...
		65	M1MN100T3L	Ex9C100... Ex9C80...	
100	124	35	M2MS250T3L	Ex9C115...	Ex9R185B...
		65	M2MN250T3L		
125	156	35	M2MS250T3L	Ex9C150...	Ex9R185B...
		65	M2MN250T3L		
150	180	35	M2MS250T3L	Ex9C185...	Ex9R185B...
			M2MN250T3L	Ex9C225... Ex9C225...	Ex9R500B... Ex9R500B...
200	240	35	M3MS400T3L	Ex9C265...	Ex9R500B...
		65	M3MN400T3L		
250	302	35	M3MS400T3L	Ex9C300...	Ex9R500B...
		65	M3MN400T3L		
300	361	35	M4MS600T3L	Ex9C400...	Ex9R500B...
		65	M4MN600T3L		
400	477	35	M4MS600T3L	Ex9C500...	Ex9R500B...
		65	M4MN600T3L		
		100	M4MH600T3L		

Appendix A

Short Circuit Current Rating Tables

Table A10: Type D Short Circuit Current Ratings

600Vac Maximum					
Motor (HP)	FLA (A)	SCCR (kA)	Molded Case Breaker	Contactors	Overload Relay
7.5	2.4	20	M1MN3T3L	Ex9C09...	Ex9RE40...
		25	M1MH3T3L		
	3.9	20	M1MN7T3L		
		25	M1MH7T3L		
	9	20	M1MN15T3L		
25	M1MH15T3L				
10	11	20	M1MN15T3L	Ex9C12...	Ex9RE40...
		25	M1MH15T3L		
15	17	20	M1MN30T3L	Ex9C18...	Ex9RE40...
		25	M1MH30T3L		
20	22	20	M1MN30T3L	Ex9C25...	Ex9RE40...
		25	M1MH30T3L		
25	27	20	M1MN50T3L	Ex9C32...	Ex9RE40...
		20	M1MN50T3L	Ex9C38...	
		25	M1MH50T3L	Ex9C32...	
		25	M1MH50T3L	Ex9C38...	
30	32	20	M1MN70T3L	Ex9C40...	Ex9R100B...
		25	M1MH70T3L		
40	41	20	M1MN70T3L	Ex9C50...	Ex9R100B...
		25	M1MH70T3L		
50	52	20	M1MN70T3L	Ex9C65...	Ex9R100B...
		25	M1MH70T3L		
60	62	20	M1MN100T3L	Ex9C100...	Ex9R100B...
			M1MH100T3L	Ex9C80...	
		25	M1MH100T3L	Ex9C100...	
125	125	20	M2MN250T3L	Ex9C115...	Ex9R185B...
		25	M2MH250T3L		
150	144	20	M2MN250T3L	Ex9C150...	Ex9R185B...
		25	M2MH250T3L		
200	192	20	M2MN250T3L	Ex9C185...	Ex9R185B...
			M2MH250T3L	Ex9C225...	Ex9R500B...
		25	M2MH250T3L	Ex9C185...	Ex9R185B...
250	242	18	M3MS400T3L	Ex9C265...	Ex9R500B...
			M3MN400T3L		
			M3MH400T3L		
300	289	25	M3MS400T3L	Ex9C300...	Ex9R500B...
			M3MN400T3L		
		30	M3MH400T3L		
400	382	22	M4MS600T3L	Ex9C400...	Ex9R500B...
			M4MN600T3L		
		50	M4MH600T3L		
500	472	30	M4MN600T3L	Ex9C500...	Ex9R500B...
			50		

Terms and Conditions of Sale

These general terms and conditions of sale (along with any associated written specification, quotation and/or supplemental terms and conditions provided by Seller) exclusively will govern the sale of all goods furnished to Buyer hereunder and represents the entire agreement between Buyer and Seller with respect thereto. Buyer's receipt or acceptance of delivery of any of the Products ordered or purchased hereunder will constitute its acceptance of these terms and conditions. No addition or modification to these terms and conditions will be binding on Seller unless agreed to in writing signed by an authorized representative at Seller's headquarters. Seller objects to and rejects other terms and conditions that may be proposed by Buyer or that appear on or are referenced in Buyer's purchase order or requisition that are in addition to or otherwise not consistent with the terms and conditions set forth or referenced herein.

PAYMENT TERMS

Payment terms are Net 30 days (Net thirty days) from date of invoice with ongoing approved credit as determined by Seller. No payment by offset is permitted. Interest charges will be added to overdue invoices at the rate of 1.5% per month (subject to any limit imposed by applicable law).

DELIVERY TERMS

Standard delivery terms are FOB Pomona, CA, freight prepaid and billed or as otherwise agreed to as evidenced by Seller's order acknowledgment. Acknowledged shipping dates are approximate only and based on prompt receipt of all necessary information from Buyer. International orders shall be Ex Works Shanghai. Seller disclaims all liability for late delivery.

RISK OF LOSS

Risk of loss or damage will pass to the buyer at the point of shipment

LIMITED WARRANTY

Seller warrants that new Products (excluding Ex9CDS series) furnished hereunder will be free from defects in material, workmanship and design for a period of five (5) years from the date of invoice from Seller or its appointed distributor, as the case may be. Ex9CDS series product are warranted to be free of defects in material, workmanship and design for a period of (1) year from the date of invoice from Seller or its appointed distributor as the case may be.

Remedies under the above warranties will be limited, at Seller's option, to the replacement, repair, or issuance of a credit for the purchase price, of the Products involved, and only after the return of such Products pursuant to Seller's instructions. The foregoing will be the exclusive remedies for any breach of warranty or breach of contract arising therefrom.

Warranty satisfaction is available only if (a) Seller is provided prompt written notice of the warranty claim and (b) Seller's examination discloses that any alleged defect has not been caused by misuse; neglect; improper installation, operation, maintenance, repair, alteration or modification by other than Seller; accident; or unusual deterioration or degradation of the Products or parts thereof due to physical environment or electrical or electromagnetic noise environment.

The above warranties are in lieu of all other warranties and conditions, whether expressed, implied or statutory, including implied warranties of merchantability or fitness for a particular use, or performance or application warranties, to the fullest extent permitted by applicable law.

DISCLAIMER AND LIMITATION OF LIABILITY

To the fullest extent permitted by applicable law, seller will not be liable for any business interruption or loss of profit, revenue, materials, anticipated savings, data, contract, goodwill or the like (whether direct or indirect in nature) or for any other form of incidental, indirect or consequential damages of any kind. Seller's maximum cumulative liability relative to all other claims and liabilities, including obligations under any indemnity, whether or not insured, will not exceed the cost of the product(s) giving rise to the claim or liability. Seller disclaims all liability relative to gratuitous information or assistance provided by, but not required of seller hereunder. Any action against seller must be brought within eighteen (18) months after the cause of action accrues. These disclaimers and limitations of liability will apply regardless of any other contrary provision hereof and regardless of the form of action, whether in contract, tort (including negligence and strict liability) or otherwise, and further will extend to the benefit of seller's vendors, appointed distributors and other authorized resellers as third-party beneficiaries. Each provision hereof which provides for a limitation of liability, disclaimer of warranty or condition or exclusion of damages is severable and independent of any other provision and is to be enforced as such.

FORCE MAJEURE

Seller shall not be liable for delay in performance due to fire, flood, strike or other labor difficulty, act of god, act of government authority or of the acts of the Buyer, acts of terrorism, riot, embargo, epidemic, fuel or energy storage, car shortage, wrecks or delays in transportation, or due to any other cause beyond Seller's reasonable control.

LIQUIDATED DAMAGES

Any orders that include liquidated damages are not acceptable or binding on the seller.

PRICES

Prices and other information shown in any Seller publication (including product catalogs and brochures) are subject to change without notice and to confirmation by specific quotation. Such publications are not offers to sell and are maintained only as a source of general information. Unless otherwise noted in writing, all price quotations are conditioned upon acceptance by Buyer within thirty (30) days from quotation date.

TAXES

Taxes are not included in the price of the goods. Buyer is responsible for all applicable taxes:

TARIFF

A tariff surcharge may be added to the order and will amount will be determined by the present tariff condition during the sale

MINIMUM ORDERS

\$250 minimum order. \$25 minimum order fee will be added to any orders less than \$250. Minimum order quantities also apply.

CHANGES AND SUBSTITUTIONS

Buyer-requested order changes, including those affecting the identity, scope and delivery of the Products, must be documented in writing and are subject to Seller's prior approval and adjustments in price, scheduling and other affected terms and conditions.

Any exceptions to the policy must be approved by the Director of Marketing and Sales and/or the General Manager

NOARK

NOARK Electric North America

(626) 330-7007

na.noark-electric.com • nasales@noark-electric.com

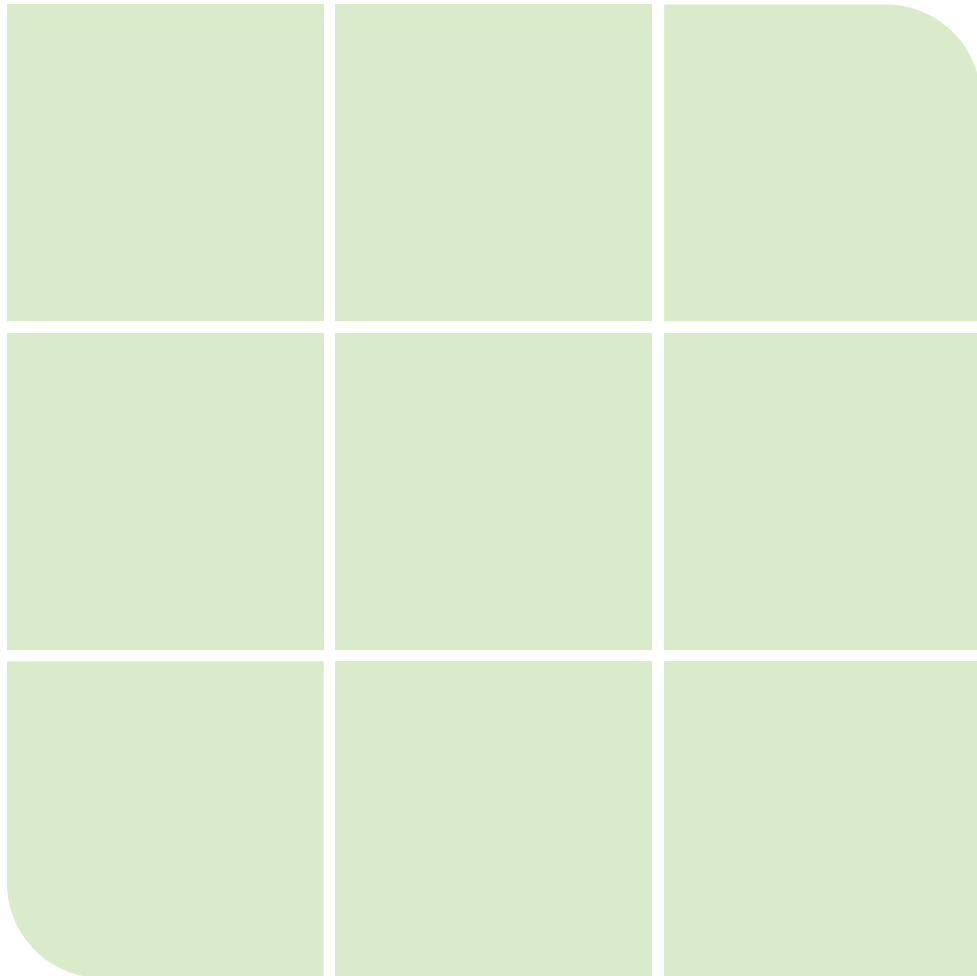

Note: NOARK Electric reserves the right to make technical changes or modify the contents of this document without prior notice. With regard to purchase orders, the agreed particulars shall prevail. NOARK Electric does not accept any responsibility whatsoever for potential errors or possible lack of information in this document. NOARK Electric reserves all rights in this document and in the subject matter and illustrations contained therein. Any reproduction, disclosure to third parties or utilization of its contents – in whole or in parts – is forbidden without prior written consent of NOARK Electric.