

# NOARK®

Data Sheet  
**Manual Motor Starter**  
Ex9S32 Series

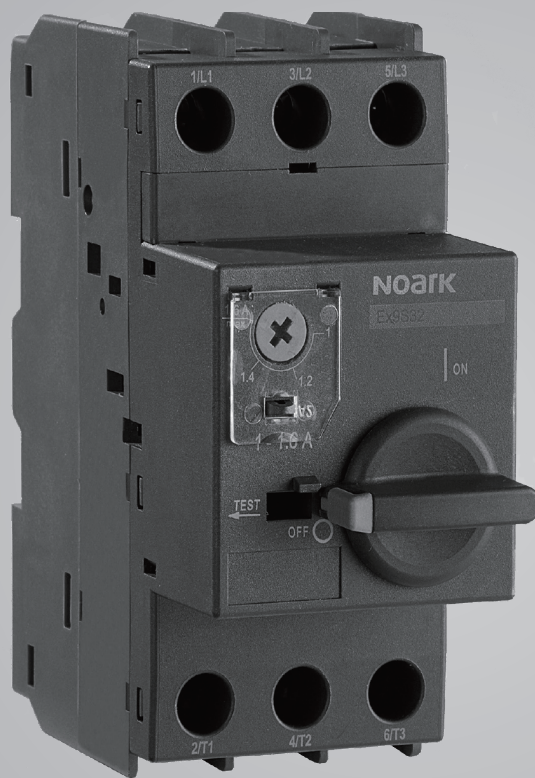

## Manual Motor Starter

### NOARK Ex9S32 Series

### Features

Ex9S32 Manual Motor Starter provides manual isolation, manual motor control, and overcurrent protection in one unit. Ex9S32 Manual Motor Starters are electro-mechanical devices combining functions below in one unit.

- Disconnect for Motor Branch Circuit
- Manual Motor Control
- Branch-Circuit Short Circuit Protection (Magnetic Protection)
- Overload Protection (Thermal Protection) - Trip Class 10
- Switching (Manual)

In North American Electrical Codes require an individual Motor Branch Circuit be protected by a UL/CSA Listed Fuse, Circuit breaker or Self-Protected Combination Motor Controller.

#### Available with:

- Up to 32A @600Vac
- Type E and F combination
- Built-in fault indication
- Full range of accessories
- Lockable handle

### Certifications



- UL60947-1/UL60947-4-1A listed, file No. E467185
- UL508 listed, file No. E476273
- IEC/EN 60947-2/-4-1
- CCC Approved



### Standards Compliance

- IEC/EN 60947-1, -2, -4-1, -5-1
- UL 508
- UL 60947-1; -4-1A
- UL 489
- GB 14048.2
- GB 14048.4

## Manual Motor Starter Ex9S32 Product Selection and Packaging

### Product Selection Guide

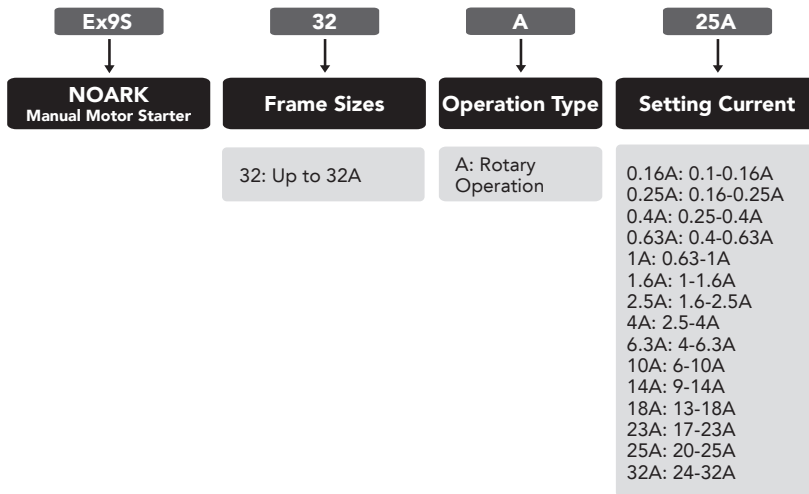

### Packaging

	Weight/Pcs lb(g)	Pieces/Box	Box Dimension in(mm)	Full Box Weight lbs(kgs)	Pieces/Carton	Carton Dimension in(mm)	Full Carton Weight lbs(kgs)
0.16 - 1A	0.58 (257.5)	1	4.25x4.33x1.97 (108x110x50)	68.01(30.85)	30	14.73x9.45x11.22 (365x240x285)	22.05 (10)
1.6 - 32A	0.72 (325)	1	4.25x4.33x1.97 (108x110x50)	82.89 (37.60)	30	14.73x9.45x11.22 (365x240x285)	26.46 (12)

## Manual Motor Starter Ex9S32 Specifications

### Technical Data

(Table 1)

Description		Ex9S32
Rated operational current $I_e$ (A)		32A
Conventional rated thermal current $I_{th}$ (A)		0.16~32A
Tripping Class		10
Rated insulation voltage $U_i$ (Vac)		690/IEC; 600/UL, CSA
Rated operational voltage $U_e$ (AC)		230/240, 400/415, 460/480, 575/600
Rated impulse withstand voltage $U_{imp}$ (AC)		6000V
Rated Operational Frequency (Hz)		50/60Hz
Resistance to shock		30 gn -11 ms
Resistance to vibrations		5gn (5 -150Hz)
Environmental Temperature	Transportation or Storage	-76 to 176°F (-60 to 80°C) <sup>1</sup>
	Working at	-4 to 158°F (-20 to 70°C) <sup>2</sup>
	Testing at	23 to 104°F (-5 to 40°C)
Altitude ft (m)		Not to exceed 6,562 (2,000)
Environment		At mounting site, relative humidity not exceed 90% at the max testing temperature 104°F (40°C), higher relative humidity is allowable under lower temperature
Pollution Grade		III
Mounting Conditions		The inclination between the mounting plane and the vertical plane shall not exceed 5°; The product shall be installed and operated at a place without obvious shake, impact and vibration.
Interrupting Rating $I_{cu}$		Check Table 3 & 4
Service life* (cycles)	Electrical	100,000*
	Mechanical	200,000*
Duty Class (cycles/hr)		30, max. operating rate
Degree of Protection		IP 20

1: 24 hours max. at the ultimated temperature

2: with temperature reduction factor, table 8

\*: close/open operation, and 30 cycles/hr for AC-3 Duty@400/415 Vac

# Manual Motor Starter Ex9S32 Specifications

**(Table 2)**

Overload Protection Properties						
Series Number	Multiple of Setting Current	Initial Status	Time	Expected Results	Ambient Temperature	
1	1.05	Cold Status	$t \geq 2h$	Non-Tripping	68°F to ±35.6°F (+20°C to ±2°C)	
2	1.20	Heat Status (right after test 1)	$t < 2h$	Tripping		
3	1.50		$10 t < 4 \text{ min}$			
4	7.20	Cold Status	$10 4s < t \leq 10s$			
Phase Failure Protection Properties						
Series Number	Multiple of Setting Current Any 2 Phase	The Other Phase	Initial Status	Time	Expected Results	Ambient Temperature
1	1.0	0.9	Cold Status	$t \geq 2h$	Non-Tripping	68°F to ±35.6°F (+20°C to ±2°C)
2	1.15	0	Heat Status (right after test 1)	$t < 2h$	Tripping	
Temperature Compensation Properties						
Series Number	Multiple of Setting Current	Initial Status	Time	Expected Results	Ambient Temperature	
1	1.0	Cold Status	$t \geq 2h$	Non-Tripping	104°F to ±35.6°F (+40°C to ±2°C)	
2	1.2	Heat Status (right after test 1)	$t < 2h$	Tripping		
3	1.05	Cold Status	$t \geq 2h$	Non-Tripping	-23°F to ±35.6°F (-5°C to ±2°C)	
4	1.3	Heat Status (right after test 1)	$t < 2h$	Tripping		

## Interrupting Capacity

**For IEC (Table 3)**

Type	400Vac		690Vac	
	Icu kA	Ics kA	Icu kA	Ics kA
0.16A	100	100	100	100
0.25A	100	100	100	100
0.4A	100	100	100	100
0.63A	100	100	100	100
1A	100	100	100	100
1.6A	100	100	100	100
2.5A	100	100	6	4
4A	100	100	6	4
6.3A	100	100	6	4
10A	100	100	6	4
14A	50	30	6	4
18A	50	30	6	4
23A	50	30	6	4
25A	50	30	6	4
32A	50	30	6	4

## Manual Motor Starter Ex9S32 Specifications

### Interrupting Capacity continued

For UL (Table 4)

Type	Short-Circuit Rating		Manual motor controllers for motor disconnect <sup>1</sup>	Max. Horsepower Rating					
	240/ 480Vac	600Vac		1PH		3PH			
	kA	kA		600 Vac	110/120Vac	230/240Vac	200/208Vac	230/240Vac	460/480Vac
0.16A	65	30	5	-	-	-	-	-	-
0.25A	65	30	5	-	-	-	-	-	-
0.4A	65	30	5	-	-	-	-	-	-
0.63A	65	30	5	-	-	-	-	-	-
1A	65	30	5	-	-	-	-	-	1/2
1.6A	65	30	5	-	1/10	-	-	3/4	3/4
2.5A	65	30	5	-	1/6	1/2	1/2	1	1.5
4A	65	30	5	1/8	1/3	3/4	3/4	2	3
6.3A	65	30	5	1/4	1/2	1	1.5	3	5
10A	65	30	5	1/2	1.5	2	3	5	7.5
14A	65	30	5	3/4	2	3	3	10	10
18A	50	30	5	1	3	5	5	10	15
23A	50	30	5	1.5	3	5	7.5	15	20
25A	50	30	5	2	3	5	7.5	15	20
32A	50	30	5	2	5	7.5	10	20	25

### Short-Circuit Current Rating

Type E: Self-Protected Combination Motor Controller (with CCT51) (Table 5)

Type	Overload Trip Range	Max. HP Rating						SCCR (kA)	
		1PH		3PH				240/480V	600V
		110/120Vac	230/240Vac	200/208Vac	230/240Vac	460/480Vac	575/600Vac		
Ex9S32A 0.16A	0.1 - 0.16A	—	—	—	—	—	—	65	10
Ex9S32A 0.25A	0.16 - 0.25A	—	—	—	—	—	—	65	10
Ex9S32A 0.4A	0.25 - 4A	—	—	—	—	—	—	65	10
Ex9S32A 0.63A	0.4 - 0.63A	—	—	—	—	—	—	65	10
Ex9S32A 1A	0.63 - 1A	—	—	—	—	—	1/2	65	10
Ex9S32A 1.6A	1 - 1.6A	—	1/10	—	—	3/4	3/4	65	10
Ex9S32A 2.5A	1.6 - 2.5A	—	1/6	1/2	1/2	1	1.5	65	10
Ex9S32A 4A	2.5 - 4A	1/8	1/3	3/4	3/4	2	3	65	10
Ex9S32A 6.3A	4 - 6.3A	1/4	1/2	1	1.5	3	5	65	10
Ex9S32A 10A	6 - 10A	1/2	1.5	2	3	5	7.5	65	10
Ex9S32A14A	9 - 14A	3/4	2	3	3	10	10	65	10
Ex9S32A18A	13 - 18A	1	3	5	5	10	15	42	—
Ex9S32A23A	17 - 23A	1.5	3	5	7.5	15	20	42	—
Ex9S32A25A	20 - 25A	2	3	5	7.5	15	20	42	—
Ex9S32A32A	24 - 32A	2	5	7.5	10	20	25	42	—

# Manual Motor Starter Ex9S32 Specifications

## Short-Circuit Current Rating Continued

**Type F: Manual Self-Protected Combination Motor Controller (Table 6)**

Manual Self-Protected Starter	Associated Cable, AWG 75°C, Cu	Type of Contactor Required	Overload Trip Range(A)	Standard Motor Ratings@50/60						SCCR (kA)			Combination Block	Mounting Bracket
				1 PH		3 PH				240V	480Y/ 277V	600Y/ 347V		
				110/120V	230/240V	200/208V	230/240V	460/480V	575/600V					
Ex9S32A0.16A	14	Ex9CS12/ Ex9C12	0.1-0.16	—	—	—	—	—	—	65	10	wCC51/CC52	-/DRA51	
Ex9S32A0.25A			0.16-0.25	—	—	—	—	—	—					
Ex9S32A0.4A			0.25-0.4	—	—	—	—	—	—					
Ex9S32A0.63A			0.4-.63	—	—	—	—	—	—					
Ex9S32A1A			0.63-1	—	—	—	—	—	1/2					
Ex9S32A1.6A			1-1.6	—	1/10	—	—	3/4	3/4					
Ex9S32A2.5A			1.6-2.5	—	1/6	1/2	1/2	1	1.5					
Ex9S32A4A			2.5-4	1/8	1/3	3/4	3/4	2	3					
Ex9S32A6.3A			4-6.3	1/4	1/2	1	1.5	3	5					
Ex9S32A10A			6-10	1/2	1.5	2	3	5	7.5					
Ex9S32A14A	12	Ex9C18	9-14	3/4	2	3	3	10	10	42	—	CC52	DRA51	
Ex9S32A18A			13-18	1	3	5	5	10	15					
Ex9S32A23A	10	Ex9C25	17-23	1.5	3	5	7.5	15	20	42	—	CC53	DRA51	
Ex9S32A25A			20-25	2	5	5	7.5	15	20					
Ex9S32A32A	8	Ex9C38	24-32	2	5	7.5	10	20	25					

## Thermal Settings And Magnetic Trip Current\*

\*Rated supply current Ambient Temperature at 40°C (Table 7)

Ex9S Heater Designation	Thermal Setting (A)		Magnetic Trip Rating (A)	Ex9S Heater Designation	Thermal Setting (A)		Magnetic Trip Rating (A)
	Minimum	Maximum			Minimum	Maximum	
0.16A	0.1	0.16	2.1	6.3A	4	6.3	72.5
0.25	.16	0.25	3.2	10A	6	10	130
0.4A	0.25	4	4.8	14A	9	14	175
0.63A	0.4	0.63	7.2	18A	13	18	230
1A	0.63	1	11	23A	17	23	280
1.6A	1	1.6	20	25A	20	25	280
2.5A	1.6	2.5	30	32A	24	32	416
4A	2.5	4	50				

Rated supply current (Ith) at Ambient Temperature: Check Ex9S32 Temperature Reduction Factor table

## Temperature Reduction Factor

**For Ex9S32 (Table 8)**

Device	-20°C (-4°F)		-5°C (23°F) 1PH		0°C (-32°F)		20°C (68°F)		40°C (104°F)		60°C (140°F)		70°C (158°F)	
	single	group	single	group	single	group	single	group	single	group	single	group	single	group
Ex9S32 0.16A														
Ex9S32 0.25A														
Ex9S32 0.4A														
Ex9S32 0.63A														
Ex9S32 1A														
Ex9S32 1.6A														
Ex9S32 2.5A														
Ex9S32 4A	1.00	1.00	1.00	1.00		1.00		1.00					0.95	0.91
Ex9S32 6.3A														
Ex9S32 10A														
Ex9S32 14A														
Ex9S32 18A														
Ex9S32 23A										0.95	0.92	0.90		
Ex9S32 25A													0.87	0.83
Ex9S32 32A	0.95	0.95		0.95										

## Manual Motor Starter Ex9S32 Dimensions

### Ex9S32

Unit: in. [mm]

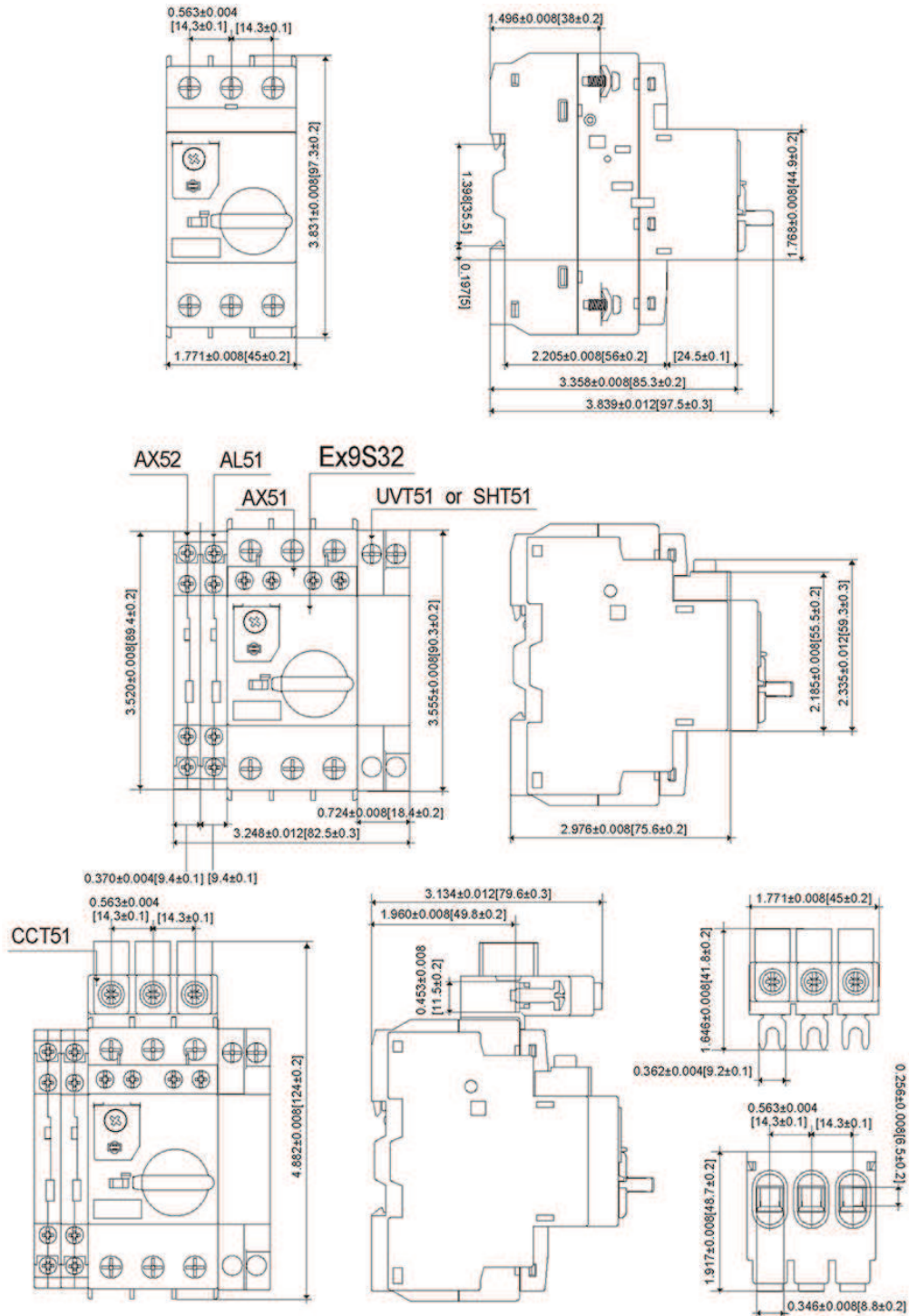



## Manual Motor Starter Ex9S32 Accessories: Selection Guide

### Selection

Ex9S	AX51	A	G
<b>NOARK Ex9S32 Series</b>	<b>Description</b>	<b>Auxiliary Contact</b>	<b>Rated Voltage</b>
	AX51: Auxiliary contact (front mount only) AX52: Auxiliary contact (left side only) AL51: Fault Signaling Contact (left side only) UVT51: Undervoltage release (right side only) SHT51: Shunt release (right side only) CCT51: Terminal Block	11: 1NO+1NC (AX51,AX52,AL51) 20: 2NO (AX51,AX52) 02: 2NC (AX52)	A: 100~130V 50/60Hz(SHT51) 110~120V 60Hz(UVT51) B: 190~330V 50/60Hz(SHT51) 110~120V 50Hz & 127V 60Hz(UVT51) C:330~440V 50/60Hz(SHT51) 208V 60Hz(UVT51) D: 480~500V 50/60Hz(SHT51) 240V 60Hz(UVT51) E: 575~600V 50/60Hz(SHT51) 480V 60Hz(UVT51) F: 600V 60Hz(UVT51) G: 220~240V 50Hz(UVT51) H: 380~415V 50Hz(UVT51)

CC	51
Description	Type
Combination Block	51:Ex9CS 12A
	52: Ex9C 9-18A
	53: Ex9C 25-38A

DRA	51
Description	Type
Mounting Bracket	51: for mounting Ex9S32 with Ex9C 9-38A

ERH	51	B
Description	Type	Color of Handle
Extended Rotary Handle	51: for Ex9S32	B: Black/Gray
		Y: Yellow/Red

WPB	51	B
Description	Type	Color of Handle
Waterproof Enclosure	51: with rotary handle	B: Black/Gray
		Y: Yellow/Red

## Manual Motor Starter Ex9S32 Accessories: Specifications

### Auxiliary Contact Blocks

Description	Mounting Location	Max. No. of Blocks	Contact Type	SKU
Instantaneous auxiliary contacts	Front	1	NO+NC	AX5111
			NO+NO	AX5120
	Left Side	2	NO+NC	AX5211
			NO+NO	AX5220
Fault Signaling Contact		1	NC+NC	AX5202
			NO+NC	AL5111

### Electrical Trip Unit

Description	Mounting Location	Voltage	Hz	SKU
Undervoltage Release	Right Side	110-120V	60	UVT51A
		127V	60	UVT51B
		110-120V	50	UVT51B
		208V	60	UVT51C
		240V	60	UVT51D
		480V	60	UVT51E
		600V	60	UVT51F
		220-240V	50	UVT51G
Shunt Release	Right Side	380-415V	50	UVT51H
		100-130V	50/60	SHT51A
		190-330V	50/60	SHT51B
		330-440V	50/60	SHT51C
		480-500V	50/60	SHT51D
		575-600V	50/60	SHT51E

### Terminal Block

Description	Mounting Location	Pole	SKU
Large spacing, UL 508 Type E	Line-in Side	3	CCT51

### Busbars

Description	No. of Ex9S32 Starter	No. of Side-Mounted Aux Contact on each Ex9S32 starter	Busbar Pitch (mm)	SKU
Sets of 3-pole, 63A Busbar	2	None	45	BBUM 245
		1 of AX52, AL51	54	BBUM 254
	3	2 of AX52, AL51 or 1 UVT51, SHT51	63	BBUM 263
		None	45	BBUM 345
	4	1 of AX52, AL51	54	BBUM 354
		2 of AX52, AL51 or 1 UVT51, SHT51	63	BBUM 363
	5	None	45	BBUM 445
		1 of AX52, AL51	54	BBUM 454
	5	2 of AX52, AL51 or 1 UVT51, SHT51	63	BBUM 463
		None	45	BBUM 545
	5	1 of AX52, AL51	54	BBUM 554
		2 of AX52, AL51 or 1 UVT51, SHT51	63	BBUM 563

### Wiring Accessories

Description	Application	SKU
Input Terminal for CBB51 Busbar	Terminal block for power supply to one or more CBB51 bus bar	FD51
Protective end cover	For unused busbar outlets	PC51
Terminal Cover	Terminal cover for Ex9S32 for use in type E application	CCE51

### Mounting Accessories

Description	Application	SKU
Combination Block	Between Ex9S32 and Ex9C Mini Type Contactor, 09-12A	CC51
	Between Ex9S32 and Ex9C Standard Type Contactor, 09-18A	CC52
	Between Ex9S32 and Ex9C Standard Type Contactor, 25-38A	CC53
Mounting Bracket	For mounting a Ex9S32 to a Ex9C Standard Type Contactor, 09-38A	DRA51

### Enclosures

Description	Type	Color	Rating	SKU
Waterproof Enclosure; Ex9S32 Protectors	Operation by rotary handle	Black/ Gray	NEMA 4X/4, IP 65	WPB51B
		Yellow/ Red		WPB51Y

### Operation Handle

The extended rotary handle makes it possible for a door-mounted rotary handle to operate starter installed on the inside back panel of an enclosure. The extended rotary handle consists of the following:

- a set of screws onto the handle of the starter
- an assembly (handle and front plate) that fits on the enclosure door
- an extension shaft which must be adjusted according to the distance between the mounting surface and the door: 9 inch (230 mm)
- a bracket that install with starter and the shaft through

Description	Type	Color	Rating	SKU
Extended Rotary Handle	9 inch (230mm) shaft, with bracket	Black/ Gray	NEMA 4X/4, IP65	ERH51B
		Yellow/ Red		ERH51Y

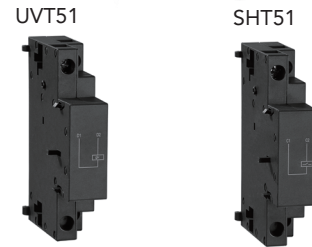
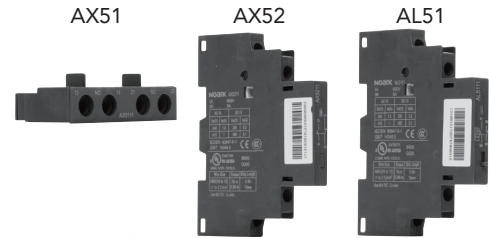

CCT51



BBUM 4



DRA51



Ex9S32 + CC53 + Ex9C32 + DRA51

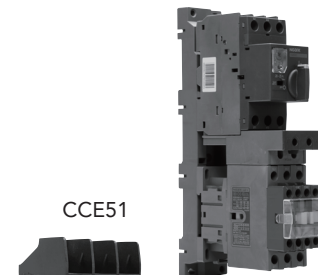

CCE51



CC51



CC52



CC53



WPB51B



WPB51Y



ERH51B



## Manual Motor Starter Ex9S32 Accessories: Packaging and Specifications

Part Number	Product's N.W. (g)	Inner Box			Carton		
		Qty/box (pcs)	Dimensions (mm)	G.W. (g)	Full Carton Qty (pcs)	Dimensions (mm)	G.W. (kgs)
AX51	16	10	81x63x58	189	720/72	405x265x265	14.2
AX52	42	2	98x82x27	106	192/96	415x240x285	10.8
AL51	43	1	98x82x27	65	96/96	415x240x285	6.9
UVT51	125	1	98x82x27	147	96/96	415x240x285	14.8
SHT51	102	1	98x82x27	124	96/96	415x240x285	12.6
CCT51	54	6	144x112x65	396	144/24	353x292x314	10.3

## Technical Data

	Auxiliary contacts - AX51	Auxiliary contacts - AX52	Auxiliary contacts - AL51	Shunt Release - SHT51	Undervoltage Release - UVT51	Adapter - CCT51
Rated operational voltage Ue	300V	600V	600V			
Rated frequency	50/60Hz	50/60Hz	50/60Hz	50/60Hz	50/60Hz	50/60Hz
Rated impulse withstand voltage Uimp	6000V	6000V	6000V			
Conventional rated thermal current (Ith)"	2.5A	5A	5A			
Mechanical life (C-O operations)	100000	100000	100000			
Electrical life (C-O operations) (for AC-3 duty) (for AC-3 duty)	AC-15 : 10,000	AC-15 : 10,000	AC-14 : 1000			

## Terminal Wiring

Ex9S32 Main Terminal	Screw Type	M4, Phil-Slot head
	Pull wire length inch (mm)	
Wire range AWG		(1)x14-(2)x8
Torques in-lb (N.m)		1.85 (2.5)

Model	Wire Ranges(AWG)	Torques in-lb (N.m)	Screw Type	Phil-Slot Head
AX51	(1)x18-(2)x12	0.59 (0.8)	M3	
AX52	(1)x18-(2)x12	0.59 (0.8)	M3	
AL51	(1)x18-(2)x12	0.59 (0.8)	M3	
UVT51	(1)x18-(2)x12	1.254 (1.7)	M3.5	
SHT51	(1)x18-(2)x12	1.254 (1.7)	M3.5	
CCT51	(1)x14-(2)x8	1.844 (2.5)	M4	

## Manual Motor Starter Ex9S32 Accessories: Dimensions

### Ex9S32 + CC51 + Ex9CS06, 09, 12

Unit: in [mm]

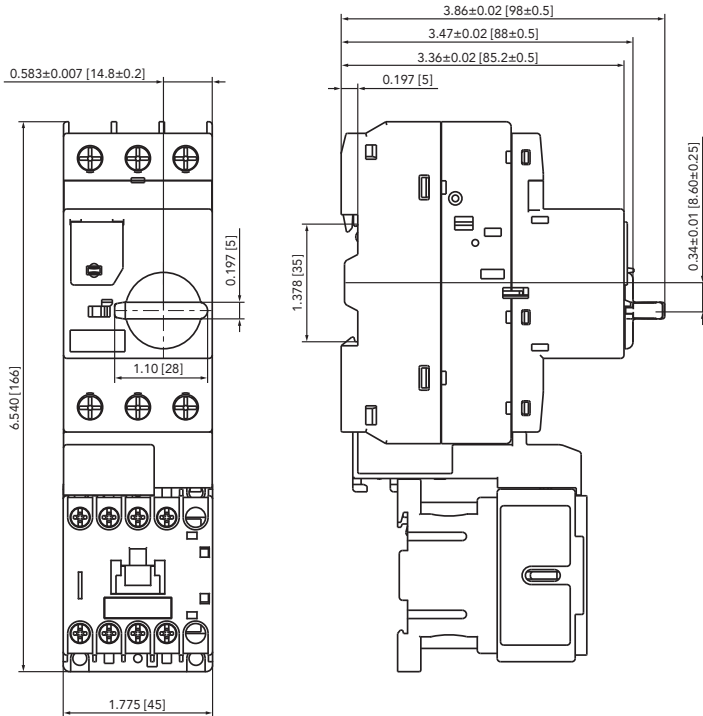

### CC51

Unit: in [mm]

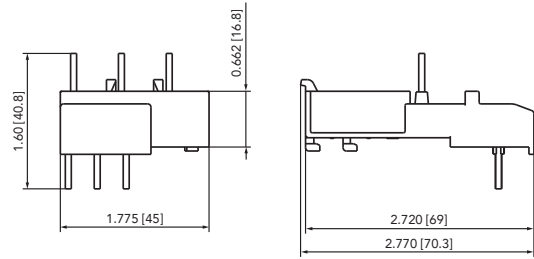

### Ex9S32 + CC52 + Ex9C09, 12 18

Unit: in [mm]

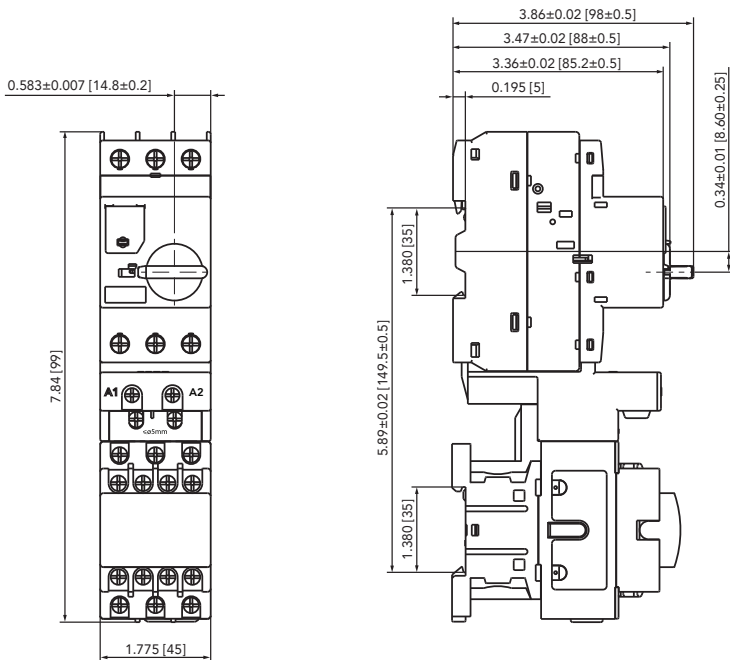

### CC52

Unit: in [mm]

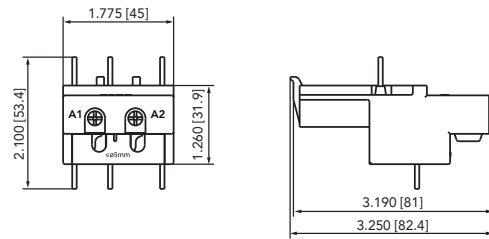

## Manual Motor Starter Ex9S32 Accessories: Dimensions

### Ex9S32 + CC52 + Ex9C09, 12, 18 + DRA51

Unit: in [mm]

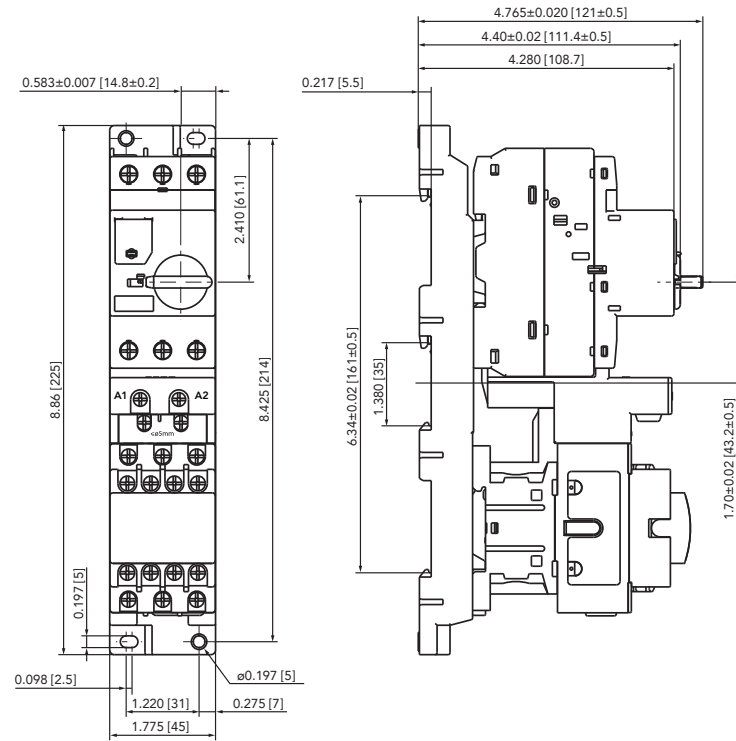

### CC52

Unit: in [mm]

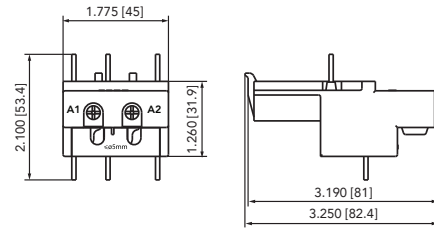

### DRA51

Unit: in [mm]

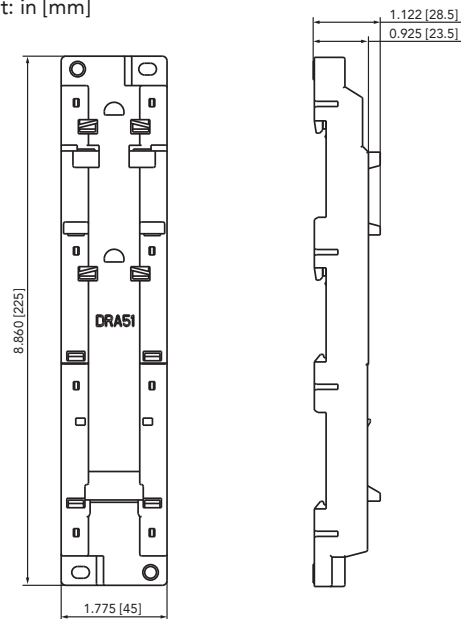

### Ex9S32 + CC53 + Ex9C25, 32, 38

Unit: in [mm]

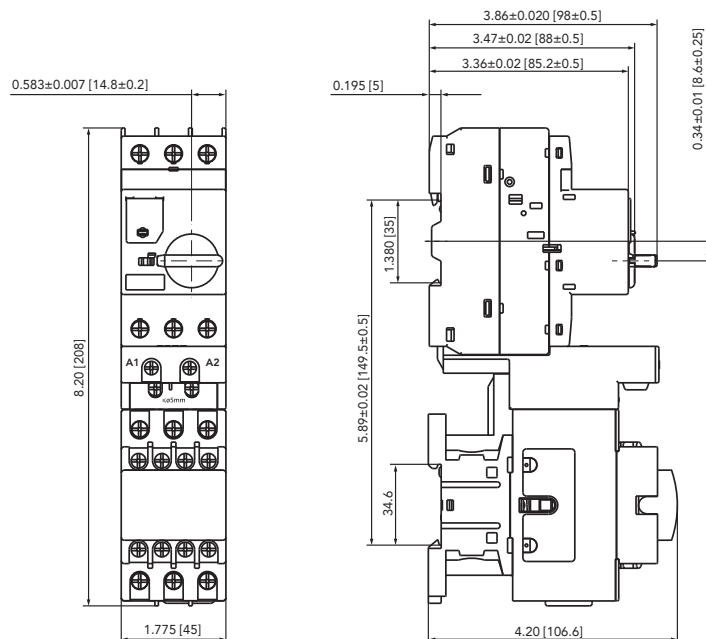

### CC53

Unit: in [mm]

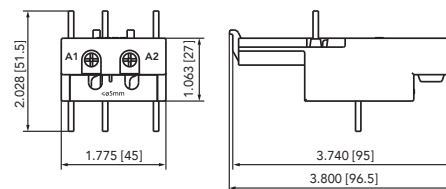

## Manual Motor Starter Ex9S32 Accessories: Dimensions

### Ex9S32 + CC53 + Ex9C25, 32, 38 + DRA51

Unit: in [mm]

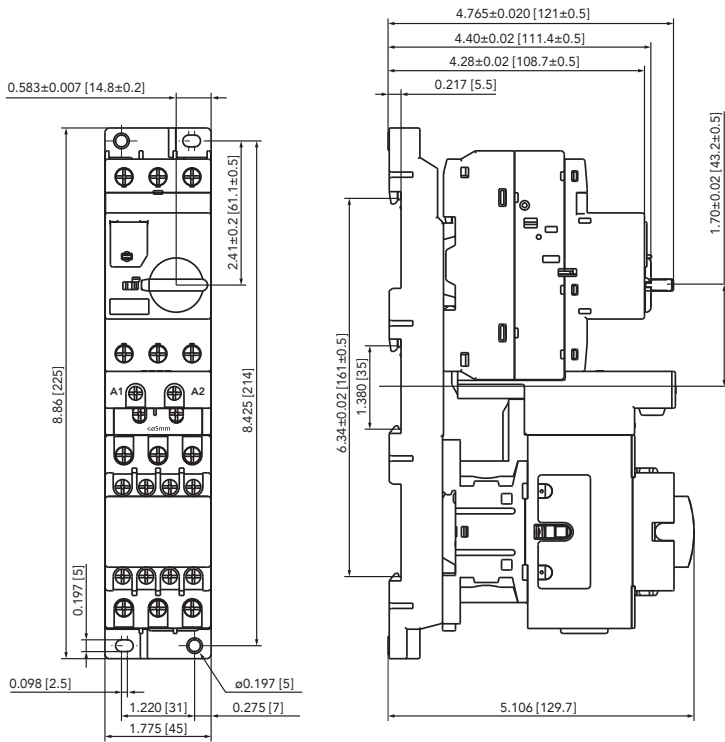

### CC53

Unit: in [mm]

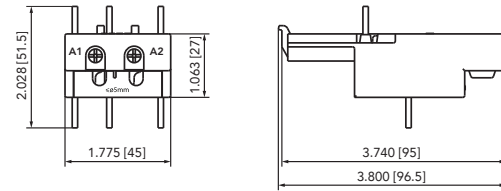

### DRA51

Unit: in [mm]

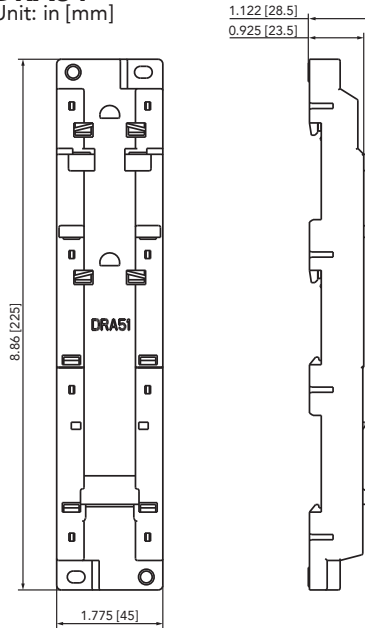

### ERH51

Unit: in [mm]

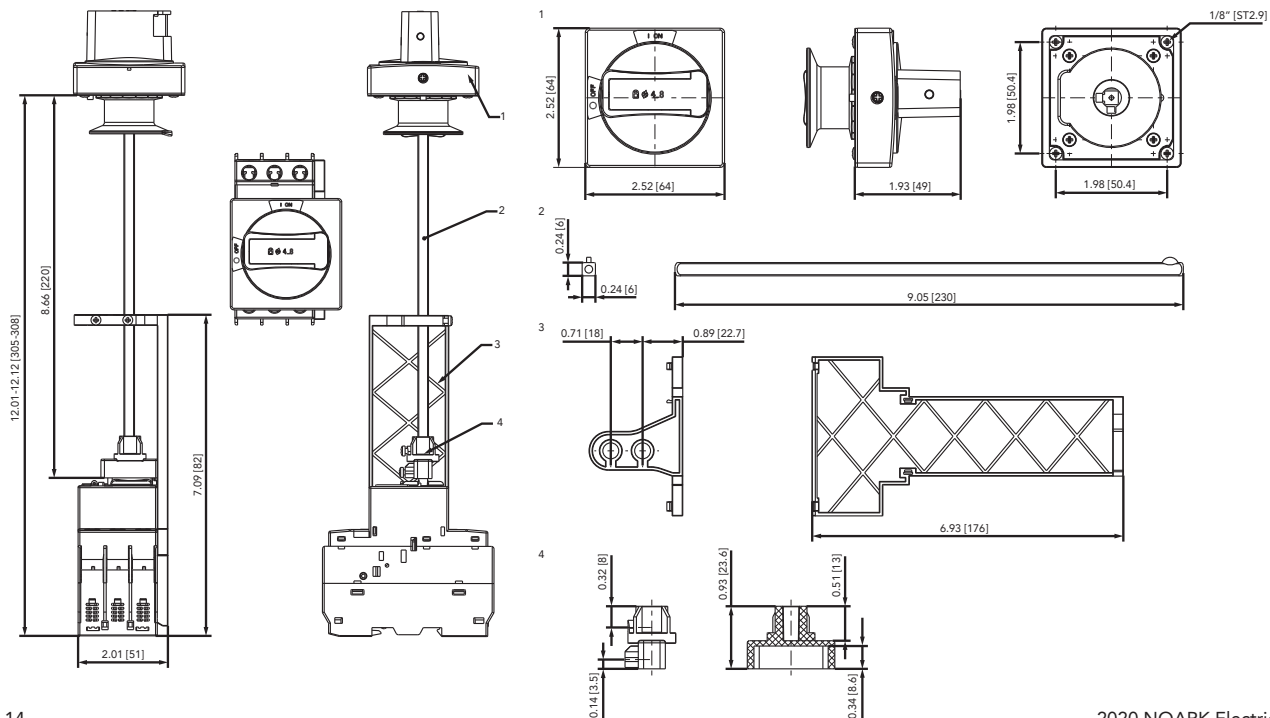

## Manual Motor Starter Ex9S32 Accessories: Dimensions

**WPB51**  
Unit: in [mm]

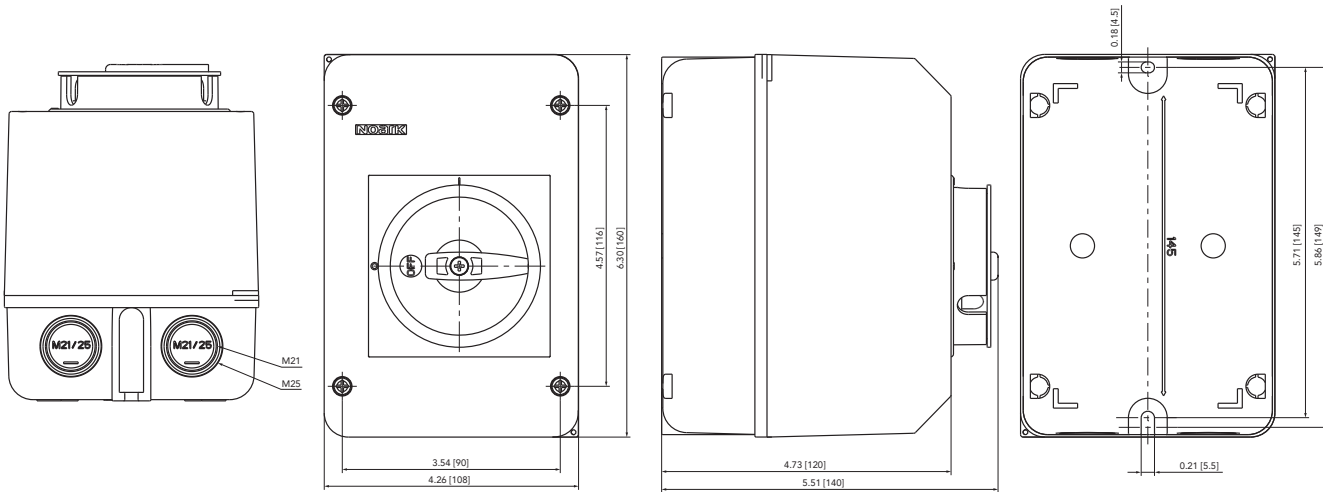

# NOARK®

---

**NOARK Electric North America**

2188 Pomona Blvd, Pomona Ca 91768

(626) 330-7007

na.noark-electric.com • nasales@noark-electric.com



**Note:** NOARK Electric reserves the right to make technical changes or modify the contents of this document without prior notice. With regard to purchase orders, the agreed particulars shall prevail. NOARK Electric nor any of its affiliates or subsidiaries shall be responsible or liable for potential errors or possible lack of information in this document. NOARK Electric reserves all rights in this document and in the subject matter and illustrations contained therein. Any reproduction, disclosure to third parties or utilization of its contents – in whole or in parts – is forbidden without prior written consent of NOARK Electric.