



**2010 Volume One**  
Railking and Premier O Gauge Trains

# 30 Years

In 2010, M.T.H. will celebrate its 30th anniversary. Thirty years ago, the three-rail O gauge hobby consisted mainly of restoring and running postwar Lionel® trains. Thirty years ago, the most elaborate way to run three-rail trains was a rebuilt ZW transformer. Thirty years ago, a twenty-year-old named Mike Wolf opened a toy train mail order business in a bedroom of his parents' home. At train shows, customers approaching his table didn't realize he was the business owner, and often asked to speak with his father.



Fast forward three decades and we all look a little older. We are arguably in the golden age of O scale, with more product choices, both scale and semi-scale, than we ever dreamed possible back in 1980. Our trains have amazing detail, CD-quality sound, and run smoothly at scale speeds. We can model almost any railroad in almost any era. Three-railers can choose among two command control systems — both of which are easier to use and have more features than the DCC system used in other scales — and run both systems together on the same layout.

How did this happen? Two things came together: A generation of children raised on Lionel and American Flyer trains reached a point in their lives when they had the time, money, and desire to have a hobby. And folks with vision created products to fill that desire, at M.T.H., Lionel, Atlas, Williams, Weaver, QSI, Third Rail, and others, along with pioneers who are no longer in the hobby, like Jerry Williams, Bill Benson of Right of Way, and Maury Klein of K-Line.

Many of you have been with us since the beginning, and others have joined our journey along

the way. We believe that M.T.H. continues to be a leader in this hobby, for several reasons. First and most important, we try to be a leader in communicating with you. We're the only model railroad company that publishes a weekly e-newsletter, and we try to make our catalogs and other literature as inviting, informative, and fun to read as possible. During our anniversary year, we'll be expanding our efforts to communicate with you, through online and social media. And in early November, we'll re-launch [www.mthtrains.com](http://www.mthtrains.com) with faster, easier-to-use navigation; additional features will be introduced over the following months.

Second, we have the broadest product range of any model train company in the world. M.T.H. offers full product lines in HO scale, two-rail and three-rail O Gauge, One Gauge, and Lionel Corporation Tinplate. The benefit for you is that research and development in one scale often leads to new products in other scales; in addition, our broad reach across many segments of the hobby increases our financial stability, an important factor in tough economic times.

Technology, service, and management are other factors that have made us a leader. We have a separate research and development facility in Michigan, with its own dedicated staff. We were the first model railroad company to establish ongoing seminars to train and update technicians at more than 150 M.T.H. Authorized Service Centers.



Finally, we believe that one of our greatest resources is a management team distinguished for its unique blend of talent, continuity, and cohesiveness. As his company grew, Mike hired the most talented people he could find to head each department. Many of them are folks he grew up with, who proved their



# Table of Contents



## What's new in this catalog

As always, this catalog announces new models we've never offered before, upgrades of previous models, and paint schemes appearing for the first time in O scale. The first second-generation American diesel, GE's U-25B "U-Boat," joins the Premier line along with Amtrak's TurboTrain and a Swiss mountain goat, the Crocodile electric. Our nineteenth-century 4-6-0 returns to the RailKing line, along with diesels for lesser-known railroads like the Providence & Worcester and the New York, Ontario & Western; there are also new paint schemes for our SW1, which offers Premier-level details at a RailKing price.

If you haven't already done so, we invite you now to turn the page and see for yourself what we have to offer. As always, we hope you'll find items in this catalog that will surprise and delight you, and help you continue to enjoy this most wonderful of hobbies.

talents in other careers and then joined Mike in his adventure. A large number of us have known each other since high school. As a result, the management team at MTH has a shared philosophy, a unity of purpose, and a history together that we think are unmatched in this hobby. We think that bodes well for the future of this company and for your investment in MTH products — because you can rest assured that the direction of this company and its commitment to the hobby will never be in question.



M.T.H. History	2
Proto-Sound® 2.0	4
DCS™	6
M.T.H. HO Steam	9
RailKing®	11
Steam	12
Diesel	18
Electric	30
Transit Sets	32
Freight Cars	33
Passenger Cars	58
Premier	60
Steam	62
Diesel & Electric	76
Transit	96
Specialty Sets	100
Freight Cars	102
Passenger Cars	126
Transformers	130
ScaleTrax™	132
Accessories	136
M.T.H. RailRoaders Club	142
Mega Stations	144
MTH Online	145

For exciting announcements throughout our anniversary year, as well as the latest updates on catalog items, sign up for our weekly e-newsletter. Go to the News link at the top of our home page,

[www.mthtrains.com](http://www.mthtrains.com)

# 30 Years of Innovation and Fun



**1980**

**Mike's Train House:**

Armed with a separate phone line and a fancy new device called a FAX machine, 20-year-old Mike Wolf opens Mike's Train House, a toy train mail order

and retail business run out of a spare bedroom in his parents' home. Along with high school classmates Andy Edleman, Jeff Strank, Mark Hipp, and Ryan Iseman — all of whom will later become M.T.H. vice-presidents — Mike continues to work for Jerry Williams of Williams Reproductions, a pioneer in the revival of tinplate production and 3-rail O Gauge model railroading.

**1982**

**Replacement Parts:** Mike graduates from college and gets his start in manufacturing by purchasing Jerry Williams' replacement parts business, which sells parts for prewar and postwar Lionel trains.

**1983**

**Tinplate Manufacturer:** Jerry sells Mike the tooling for his Standard Gauge tinplate reproductions line, and Mike becomes a full-fledged manufacturer. Paul Wolf withdraws his entire retirement savings account to loan his son the money to buy the business.

The first M.T.H. catalog, printed in black and white, offers No. 9, No. 381, and No. 408 locomotives. Sheet metal parts are stamped in Minnesota, painted by Mark Hipp in his parents' garage, and assembled in the Wolf family's basement.

**1985**

**Korea:** Mike meets Mr. Se Yong Lee of Samhongs Co. and contracts to have Standard Gauge tinplate reproductions made in Korea. With Jerry Williams' blessing, Mike leaves his job at Williams Reproductions to concentrate on his own



business full time. Working as many as 30 train shows annually and driving a beat-up van purchased for \$100, he becomes one of the largest sellers of Williams O Gauge brass locomotives, in addition to his own Standard Gauge items.

**1986**

**Columbia:** Mike moves the business out of his parents' home to his first of three addresses in Columbia, Maryland, just a few doors away from Williams. Mike begins traveling to Korea to work with Samhongs Co. The M.T.H. "Blue Comet" corporate logo is introduced.

**1987**

**Lionel Classics:** Mike stops producing his own tinplate and becomes a subcontractor for Lionel®, manufacturing Lionel Classics tinplate reproductions in Korea — an arrangement that begins with the Hiawatha passenger set and foretells the formation of Lionel Corporation Tinplate two decades later. Mike's Train House becomes a full-service Lionel distributor.

**1989**

**Lionel Collector Line:** The Reading T-1, modeling a real locomotive owned by Lionel Chairman Richard Kuhn, becomes the first scale-detailed Lionel product produced by Mike and Samhongs Co. The following year, Andy Edleman joins M.T.H. as Project Manager for Lionel items. In the space of a few years, M.T.H. will produce models for Lionel that set new standards for full-scale, three-rail O Gauge trains, including the die-cast Pennsylvania S2 Turbine, ALCo PA diesel, the first three-rail Shay, and an operating lift bridge.

**1990**

**Weaver Gold Edition Line:** Mike contracts with Quality Craft Models/Weaver Trains to build scale O Gauge brass locomotives for Weaver under the Gold Edition label. The relationship continues through 1996, also producing scale plastic diesels including the EMD E8 and Baldwin Sharknose. The diesels later become part of the M.T.H. Premier lineup. At its ten-year anniversary, Mike's Train House has nearly a dozen employees.

**1993**

**Dash-8:** The company name is officially changed to M.T.H. Electric Trains, and the initial M.T.H. catalog announces a Dash-8 diesel — the first scale O gauge locomotive produced under the M.T.H.

banner. Lionel ends Mike's subcontracting and dealership relationships. Mike's Train House closes its retail store to concentrate on manufacturing.

**1994**

**Challenger and Proto-Sound®:** M.T.H. delivers the Union Pacific Challenger, the first die-cast O gauge articulated steam engine and the first M.T.H. product with factory-installed Proto-Sound, licensed from QSI, Inc.



**1995**

**RailKing®, Smoke, and Dave Krebiehl:**

A 4-8-2 Mohawk with synchronized, puffing smoke and the Pennsylvania GG1 inaugurate the RailKing line, intended for hobbyists who want traditional-sized O Gauge trains that operate on tighter O-31 and O-27 curves. RailKing sales will eventually dwarf the scale-sized Premier line. Dave Krebiehl is hired to initiate manufacturing contacts in China and eventually becomes VP of Research and Development, leading the Michigan-based R&D team. Fan-driven smoke debuts on the Premier Empire State Express Hudson.

**1996**

**RailTown™ and Tinplate Traditions™:** Fully painted and assembled RailTown buildings enter the RailKing lineup, along with the first ready-to-run RailKing sets. Passenger station and freight yard sounds are added to Proto-Sounds. M.T.H. returns to its tinplate roots with the first Tinplate



Traditions products, the No. 408E electric and No. 613 passenger set; the following year, tinplate engines are offered for the first time with Proto-Sounds and puffing smoke.

## 1997

**Gateway Drive, RealTrax™, and Accessories:** M.T.H. moves into its own 125,000 sq. ft. building at 7020 Columbia Gateway Drive, Columbia, MD. Mike's favorite memento of the occasion is a photo with his wife Rasamee and his parents, Doris and Paul Wolf. RealTrax is introduced, the first O Gauge track system with roadbed. An operating gas station, the first M.T.H. accessory to combine action and sound effects, joins the RailTown line; a firehouse, car wash, and Mel's Diner soon follow.



## 1998



**Z-4000®, Subways, and MTHRC:** The Z-4000 transformer is introduced — the first truly viable replacement for the venerable Lionel ZW, and still the most powerful UL-approved transformer in O Gauge (and the best-selling product in

M.T.H. history). The RailKing Metropolitan Transit Authority R-42 becomes the first ready-to-run 3-rail O gauge subway, complete with station announcements. The M.T.H. Railroaders Club™ is introduced, offering unique cars, the CrossingGate newsletter, and discounts on special items.

## 1999



**It Flies!:** The RailKing operating helicopter car becomes the first toy train accessory to really fly.

## 2000

**Proto-Sound 2.0:** Pennsylvania E6 Atlantic, the first Proto-Sound 2.0 steamer, introduces hobbyists to synchronized puffing smoke combined with digital sounds and smooth, steady performance down to 3 scale miles per hour. Later this year, the RailKing Metropolitan Transit Authority R-21,

the first PS 2.0 subway, introduces Transit Stop Proto-Effects. Operators can program the R-21 to run automatically on a loop or out-and-back route, calling out nine different New York City station stops.

## 2001

**RailKing One-Gauge:** The first M.T.H. One-Gauge locomotives, a Dash-8, Hudson, and Challenger, bring sound, smoke, and command control to 1:32 scale garden rail-roading. The first operating reefer with frost (smoke) joins the O Gauge lineup.



## 2002



**DCS and York:** The arrival of DCS, the M.T.H. Digital Command System, brings out the full potential of Proto-Sound 2.0 engines introduced two years earlier — and offers the hobby's first (and, so far, only) command control software that can be upgraded for free over the Internet. Within six months, the first upgrade adds new features to the DCS system. M.T.H. adjusts its catalog schedule to coincide with the Spring and Fall York TCA shows and begins a tradition of offering limited-run York Cars to show attendees.

## 2004

**Proto-Scale 3-2™, Period Engines, and DCS Upgrade Kits:** Proto-Scale 3-2 allows select Premier locomotives to change quickly between 3-rail and 2-rail operation, using AC or DC power. The Premier Pennsylvania H-3 2-8-0 is the first ready-to-run 19th Century scale-detailed O gauge locomotive. DCS upgrade kits arrive, allowing modelers to upgrade non-Proto-Sound 2.0 engines to command control, digital sound, and speed control.



## 2005

**HO Engines and Automatic Operating Pantographs:** DCS arrives in HO scale with the Pennsylvania K4s Pacific;

locomotive features Proto-Sound 3.0, which includes both DCS and NMRA-standard DCC receivers. Premier Pennsylvania GG1s are the first O Gauge models to feature pantographs that raise and lower automatically, according to the direction of travel.

## 2007

**Silver Bullet and Chapelon Pacific:** The Coors Silver Bullet set introduces a new Proto-Sound feature: the ability of a locomotive to send operating commands to its trailing cars or trackside accessories. The Chapelon Pacific, with passenger station announcements and crew conversations in French, is announced as the first European-prototype M.T.H. model.



## 2008

**DCS 4.0 and Quillable Whistle:** DCS 4.0, a free downloadable software upgrade, allows operators to access all Lionel TMCC® features from the DCS handheld. The "quillable" whistle, a DCS feature that simulates the varying sounds of a prototype steam whistle, debuts on the Premier 2-8-8-2 Triplex and 4-8-4 Norfolk & Western Class J.

## 2009

**Smoking Whistle and Lionel Corp. Tinplate:** The



RailKing One-Gauge Triplex is the first North American model in any scale with a quillable, smoking whistle. Lionel and M.T.H. announce their first cooperative venture since the Kuhn era, Lionel Corporation Tinplate. One of the new firm's first products is the legendary Brute, a huge 1920s Lionel prototype that was never produced. Including the 2010 Volume One catalog, M.T.H. has cataloged nearly 17,000 model train items in its 30-year history.

# Proto-Sound® 2.0

## The Richest Set of Features in Model Railroading

Whether you operate with a conventional transformer or in command mode with DCS™ (M.T.H.'s Digital Command System), the Proto-Sound® 2.0 system found in every O gauge locomotive in this catalog offers more realism, more fun, and more variety than any other locomotive control system in any scale.

### VIVID ENGINE SOUNDS

Proto-Sound features digital recordings with CD-quality playback. We strive to make our sounds as authentic as possible, using the characteristic whistle for a particular steam engine, for example, and the correct prime mover sound for each manufacturer's diesels. With the optional DCS system, you can tune each engine to your preference by individually adjusting bell, horn or whistle, and chuff or diesel motor volume.

### STATION SOUNDS

Proto-Sound passenger engines offer Passenger Station Proto-Effects™, a complete arrival and departure sequence that you can activate from your transformer or DCS handheld. In most cases, the station sequence features an actual name train pulled by that particular engine. Freight engines include Freight Yard Proto-Effects, a symphony of freight terminal sounds.

### ATMOSPHERIC SOUNDS

Crew conversations, the whoosh of a steam engine opening its cylinder cocks, and a host of other atmospheric sounds play automatically at random when using a conventional transformer — or can be activated manually from the DCS handheld.

### EXTRAORDINARY SLOW SPEED CAPABILITY

Proto-Sound engines can throttle down as slow as three scale miles per hour, highball down the main line, and maintain any speed in between. In DCS mode you can set engine speed in one-scale-mile-per-hour increments up to 120 smph. Go ahead, get out your stop watch and ruler and see how accurate our scale speeds are.

### SPEED CONTROL

The Proto-Speed Control™ built into Proto-Sound 2.0 acts like the cruise control on a car, keeping your train moving at the speed you select, regardless of hills and curves. You can even switch off the speed control if you prefer.

### MULTIPLE UNIT CAPABILITY

In DCS command mode, all locomotives set to the same speed — 37 scale miles per hour, for example — will move at virtually the same speed. This makes it easy to double or even triple-head nearly any combination of Proto-Sound 2.0 locomotives.

### LIGHTING EFFECTS

Proto-Sound locomotives feature a variety of prototypical lighting effects. Depending on the locomotive, these may include constant-brightness headlights, illuminated number boards, marker lamps, firebox glow in many steam locomotives, and operating Mars lights or oscillating ditch lights (where appropriate) on diesels. In DCS operation, many of these lighting effects can be individually controlled.

### GREAT SMOKE

Proto-Sound steam engines and diesels feature fan-driven ProtoSmoke™, the most powerful smoke system in the hobby. You can vary the intensity with the smoke "volume" control on the locomotive or remotely with a DCS handheld.



## SYNCHRONIZED CHUFF AND PUFF

Like a real steam engine, M.T.H. steamers feature puffs of smoke and steam chuff sounds synchronized with the drive wheels. Better than any other model train, an M.T.H. locomotive portrays the drama of a steam engine slowly chuffing and puffing as it pulls out of a station and gets up to speed. And many M.T.H. diesels feature exhaust smoke output based on speed, just like the real thing!

## BRAKE SOUNDS

Engine brakes squeal whenever you throttle back sharply or pull into a station. In DCS mode, you can trigger the brake sound with the Brake button on the DCS handheld.

every Proto-Sound 2.0 locomotive. Operate up to 99 engines on the same track at the same time with individual control over each engine. For more information on command control and DCS, see the next page or go to [www.protosound2.com](http://www.protosound2.com).

## UPDATED ENGINE FEATURES

Using a DCS system, any Proto-Sound 2.0 engine can be updated with new sounds or features without ever taking the engine apart or even off the track. Simple downloads of new Proto-Sound sound sets from the M.T.H. Web site mean your engine will never be obsolete. It can change from a passenger loco to a freight loco or get a new whistle or horn in just minutes.

## BI-DIRECTIONAL COMMUNICATION

Proto-Sound 2.0 engines not only receive commands from the DCS system, they can report back vital information, trigger other devices to operate, and diagnose your layout's wiring and signal quality.

Imagine querying a Proto-Sound 2.0 locomotive to find out how many scale miles it's run or how many hours it's been powered up. How about checking out the strength of



## REMOTE UNCOUPLING

Proto-Sound steam and diesel engines offer remote uncoupling anywhere on your layout, controlled from your transformer or DCS remote. The opening of the coupler is accompanied by the hiss of air hoses parting and the clank of the coupler knuckle opening.

## COMMAND CONTROL

Add the M.T.H. Digital Command System (DCS) to your railroad and enjoy the command control capability built into

the DCS signal on the track or measuring the track voltage at a trouble spot? What about learning how long your track is in scale miles? All of this is possible today, but only in a Proto-Sound 2.0 equipped locomotive when operated using the DCS Digital Command System.

## About Our Product Lines

In this catalog you'll find two of the five M.T.H. product lines, our O Gauge Premier and RailKing lines. While they differ in detail level and price, under the shell they're very much the same. Every engine in this catalog shares the same Proto-Sound 2.0 or later electronics and the same quality M.T.H. construction. Premier and RailKing O Gauge engines can be run together on your railroad in conventional or DCS command mode.

**Premier** engines are full O scale models, 1/48 the size of their prototypes. Because of this, they often require larger radius curves than comparable RailKing models. Premier engines are as detailed as we can reasonably make them, and feature a large number of added-on parts. On Premier steamers, for example, most piping is separately applied, whereas piping on RailKing steam engines is cast onto the boiler. While smoke is standard on virtually all M.T.H. steamers, only Premier and RailKing Scale and Imperial diesels feature smoke. Premier engines also have more elaborate lighting effects.

**RailKing** models have less detail and are lower priced than their Premier counterparts. Unless otherwise noted, all RailKing engines will negotiate O-31 curves. While RailKing Scale engines are full O scale size, other RailKing engines may have smaller proportions than their prototypes, to make them appropriate for smaller traditional layouts with O-31 curves. RailKing Imperial models are our top-of-the-line RailKing engines, with features such as real coal loads and separately illuminated marker lamps.

**RailKing One Gauge** equipment offers long-lasting, impact-resistant polycarbonate bodies, powerful flywheel-equipped DC can motors, and precise 1:32 scale proportions and detail. Features include metal handrails, spinning fans, constant voltage lighting, puffing smoke timed to the engine's chuffing, firebox glow, cab figures, sliding cab windows, and much, much more. In addition to the eye-popping detail, the line is built tough for years of outdoor operation.

**Lionel Corporation Tinplate** models are made of stamped tinplate or die-cast metal, generally boasting bright, colorful enamel paint and M.T.H.'s state-of-the-art digital electronics. Unlike Premier and RailKing models, these are not meant to be accurate reproductions of real trains. They provide collectors who cannot afford a pre-World War II original access to faithful, high quality, and highly detailed reproductions of model railroading's most nostalgic era.

The **M.T.H. HO** product line is our newest venture, with locomotives sporting the absolute latest in cutting-edge digital electronics for the HO market.



# SIMPLY TO RUN

THIS REMOTE IS **SIMPLE**.

IT SPEAKS **ENGLISH,  
NOT ICONS**.

IT CAN BE **OPERATED  
EASILY WITH ONE HAND**.

IT CAN BE  
**UPGRADED FOR FREE**  
OVER THE INTERNET.

It can run over 1100\* Proto-Sound® 2.0 engines and every Lionel®, Atlas, Weaver, and Third Rail TMCC®, EOB, or Legacy™ engine ever made — and run 99 of them at the same time, on the same track, independently, in command mode.

It can also **RUN ALL CONVENTIONAL AC LOCOMOTIVES** without the purchase of any additional hardware.

With the addition of an Accessory Interface Unit (AIU), it can **OPERATE ANY O SCALE ACCESSORY OR SWITCH**. It can create scenes and routes that are triggered with one push of a button.

## WHAT CAN YOUR REMOTE DO?

Remote Shown Actual Size

\* Number of different Proto-Sound® 2.0 engines cataloged through the 2010 Volume 1 Catalog.



# THE BEST WAY A RAILROAD™

## Command Control Explained

In conventional operation, an AC or DC transformer varies track voltage to adjust engine speed and direction. Command systems such as DCS, however, put a constant voltage on the track (around 18 volts for DCS) and vary speed by telling each engine how much of that voltage to use. Command control allows different engines to do different things — like run at different speeds, go in different directions, or make different sounds — even when they are on the same track.

In the DCS system, commands such as speed, direction, and sound control are sent as radio signals from the handheld throttle to a TIU (track interface unit). The TIU translates those radio signals into digital information that is sent through the rails and picked up by a receiver in the appropriate engine — telling it to go, for example, 37 miles per

hour, blow the whistle, smoke more heavily, or any other command. DCS locomotives can also send information back to the handheld to let the operator know what they're doing.

### LEARN MORE ABOUT IT



Try It at your local DCS Demo Center

Request a Complimentary DVD on DCS and M.T.H.

technology. Log On to the DCS Web site, [www.protosound2.com](http://www.protosound2.com)

Take your favorite Proto-Sound 2.0 or 3.0 engine to any DCS Demo Center and experience the additional features your engine has with DCS control. To find your nearest demo center or request your complimentary DVD, visit [www.mthtrains.com](http://www.mthtrains.com).

### DCS COMMANDER: Get into DCS on a budget

Ideal for small layouts running two or three Proto-Sound 2.0 locomotives\*\*. Learn more about it in the 2009 RailKing Train Set catalog — or use our online Product Search feature to see more information and read the instruction manual.



**DCS Commander System**  
w/100-Watt Power Supply  
50-1029 \$229.95

\*\*Requires Proto-Sound 2.0 locomotives with onboard 3-volt system, which can be identified by their square battery-charging jack; see the operator's manual for exact jack location.

Also available:  
**DCS Commander Controller** (w/o power supply)  
50-1028 \$149.95

**INTUITIVE MENUS** ALLOW YOU TO  
**PROGRAM, SELECT, AND**  
**CONTROL ENGINES, SWITCHES,**  
AND **ACCESSORIES.**

**1** Go to the engine setup menu

► ADD ENGINE  
EDIT ENGINE  
DELETE ENGINE  
MENU:ENGINE SETUP

**2** Choose your engine type

► ADD MTH ENGINE  
ADD TMCC ENGINE  
MENU:ADD ENGINE

**3** DCS will "look" for Proto-Sound® or TMCC command-equipped engines on your layout. When it finds one, it adds it onto your remote and tells you when it's done.

CONGRATULATIONS  
YOU SUCCESSFULLY  
ADDED AN MTH ENGINE

SMPH: 10  
1: FRR S1  
MTC SCS S81 LIN →



**DCS Remote Control System**  
(Contains Handheld and TIU)  
50-1001 \$299.95



**DCS Remote Control Handheld Unit**  
50-1002 \$149.95



**DCS Track Interface Unit (TIU)**  
50-1003 \$179.95



**DCS Accessory Interface Unit (AIU)**  
50-1004 \$99.95



**Proto-Sound 2.0 Battery Charger**  
50-1019 \$14.95



**6' Mini-to-Mini Cable**  
50-1009 \$9.95

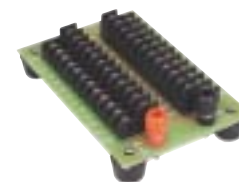

**24-Port Terminal Block**  
50-1020 \$29.95



**TIU/Barrel Jack Adapter Cable**  
50-1017 \$9.95

**12-Port Terminal Block**  
50-1014 \$19.95

**Proto-Sound Battery**  
50-1008 \$9.95



**AA NiCad Proto-Sound® Battery**  
50-1024 \$9.95



**DCS Companion** \$12.95  
168-page illustrated guide  
available as PDF download



**Video Guide To DCS - DVD**  
60-1191 \$19.95

# Benefits

## From Other M.T.H. Product Lines



Even if you're not interested in Tinplate, One Gauge, or HO scale, our products in these other areas have benefits for you — because new features developed for other scales or gauges may eventually appear in Premier and RailKing O gauge trains.

Our One Gauge Triplex, for example, is North America's first production model with a smoking whistle — a feature we're currently developing for O gauge steamers.

Our Proto-Sound 3.0 HO engines have smaller electronics compatible with both our DCS system and the DCC command control system popular with 2-rail modelers around the globe. Our HO diesels have operating, scale proportioned Proto-Couplers that — like their O Gauge brethren — can be triggered anywhere on the layout.

Unlike most other model train companies, we have a Research & Development team — located in its own facility in Michigan — that benefits hobbyists across a wide range of interests and scales.



2010 ONE-GAUGE TRAINS & ACCESSORIES CATALOG

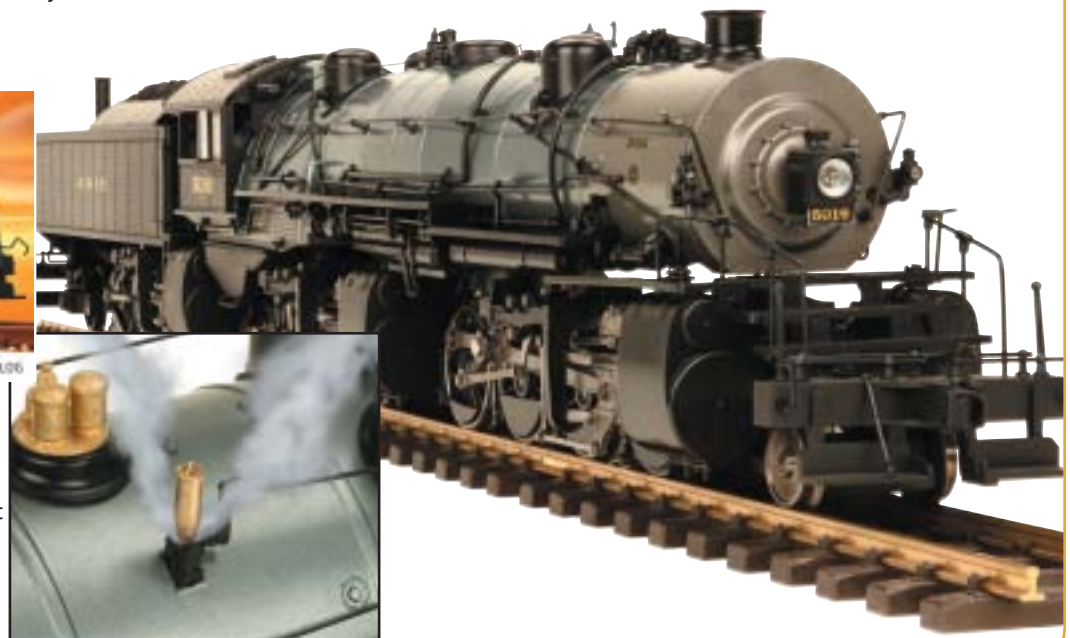

## Celebrate Lionel Corporation Tinplate!

Modelers in other scales can celebrate Lionel Corporation Tinplate, the newest M.T.H. product line, with these HO and One Gauge freight cars. The new HO Operating Action Car was inspired by Lionel's 1950s aquarium car and features moving, backlit images of classic tinplate trains.



# M.T.H. HO Steam



HO TRAINS THAT DO MORE

Because many of you model in multiple scales or have friends who model in HO, we've included the following sample of HO engines currently in stock — to give you an idea of the exciting things we're doing in other scales too.

## FULL COMPATIBILITY WITH ALL HO OPERATING SYSTEMS

Right out of the box, every M.T.H. engine is compatible with all HO operating systems: conventional DC, DCC, and our own Digital Command System (DCS). No switches to flip or adjustments to make. Your Proto-Sound engine senses what kind of power is on the rails; just set it on the track and run it!



### Pennsylvania - 2-8-2 USRA Light Mikado

80-3140-1	Cab Number 9630	\$449.95
80-3141-1	Cab Number 9627	\$449.95
80-3142-1	Cab Number 9631	\$449.95

Footboard pilot, high-mounted headlight, boiler-top bell

### New York Central - 2-8-2 USRA Light Mikado

80-3137-1	Cab Number 6104	\$449.95
80-3138-1	Cab Number 6109	\$449.95
80-3139-1	Cab Number 6106	\$449.95

Footboard pilot, centered headlight, bell mounted on smokebox

### Union Pacific - 2-8-2 USRA Light Mikado

80-3134-1	Cab Number 2498	\$449.95
80-3135-1	Cab Number 2495	\$449.95
80-3136-1	Cab Number 2486	\$449.95

Boiler-tube pilot, centered headlight, bell mounted on smokebox

### Baltimore & Ohio - 2-8-2 USRA Light Mikado

80-3131-1	Cab Number 4500	\$449.95
80-3132-1	Cab Number 4519	\$449.95
80-3133-1	Cab Number 4515	\$449.95

Boiler-tube pilot, centered headlight, bell mounted on smokebox

### New York Central - 4-6-4 Empire State Express Steam Engine

80-3169-1	Cab Number 5426	\$449.95
80-3170-1	Cab Number 5429	\$449.95



## Features

- Die-Cast Boiler and Tender Body
- Die-Cast Metal Chassis
- Authentic Paint Scheme & Cab Numbers
- RP-25 Metal Wheels Mounted On Metal Axles
- Operating Lighted Marker Lights
- Constant Voltage Headlight
- Prototypical Rule 17 Lighting

- Detailed Truck Sides
- Detailed Cab Interior
- Powerful Balanced 12-Volt 5-Pole Precision Skew-Wound, Flywheel-Equipped Motor
- (2) Kadee Compatible Scale Couplers
- Metal Handrails and Bell
- Metal Whistle
- Sprung Drive Wheels

- Synchronized Puffing ProtoSmoke System
- Locomotive Speed Control
- Locomotive Cab-To-Tender Deck Plate
- Detailed Tender Undercarriage
- Real Coal Load
- Operating Tender Back-up Light
- Interchangeable Traction Tire-Equipped Drive Wheels

- On-Board DCC Receiver
- Operates On Code 70, 83, & 100 Track
- Proto-Sound 3.0 With The Digital Command System Featuring Quillable Whistle

# M.T.H. HO Steam



**Union Pacific**  
**4-6-6-4 Challenger Steam Engine**  
**Two-Tone Gray w/Yellow Stripes**  
 80-3160-1 Cab Number 3977 \$599.95  
**Two-Tone Gray w/Silver Stripes**  
 80-3159-1 Cab Number 3983 \$599.95



**Union Pacific**  
**4-12-2 9000 Steam Engine**  
 80-3152-1 Cab Number 9000 \$549.95  
 80-3154-1 Cab Number 9503 \$549.95\*  
 80-3155-1 Cab Number 9512 \$549.95\*  
 \* Oregon Short Line Markings (UP subsidiary in Idaho and Oregon)



**Norfolk & Western**  
**4-8-4 J Steam Locomotive**  
 80-3148-1 Cab Number 600 \$449.95  
 80-3149-1 Cab Number 603 \$449.95  
 80-3150-1 Cab Number 604 \$449.95  
 80-3145-1 Cab Number 613 \$449.95  
 80-3146-1 Cab Number 611 \$449.95  
 80-3147-1 Cab Number 612 \$449.95



**New York Central - 4-8-2 L-3c Mohawk Steam Engine**  
 80-3125-1 Cab Number 3064 \$449.95  
**New York Central - 4-8-2 L-4b Mohawk Steam Engine**  
 80-3127-1 Cab Number 3125 \$449.95



**New York Central - 4-8-2 L-3a Mohawk Steam Engine**  
 80-3123-1 Cab Number 3006 \$449.95  
**New York Central - 4-8-2 L-3b Mohawk Steam Engine**  
 80-3124-1 Cab Number 3037 \$449.95  
**New York Central - 4-8-2 L-4a Mohawk Steam Engine**  
 80-3126-1 Cab Number 3117 \$449.95



**New York Central - 4-6-4 Dreyfuss Steam Engine**  
 80-3165-1 Cab Number 5449 (1938 paint scheme with Blue Stripes) \$449.95  
 80-3166-1 Cab Number 5448 (1938 paint scheme with Blue Stripes) \$449.95  
 80-3167-1 Cab Number 5445 (1940 paint scheme) \$449.95  
 80-3168-1 Cab Number 5446 (1940 paint scheme) \$449.95



**New York Central - 4-6-4 Dreyfuss Steam Engine**  
 80-3163-1 Cab Number 5452 (1940 paint scheme) \$449.95  
 80-3164-1 Cab Number 5453 (1940 paint scheme) \$449.95

# RailKing®

## The Best Value in O Gauge

First appearing in 1995 and now encompassing more than 5,000 items, RailKing is M.T.H.'s best-selling and most attractively priced product line. Cars and locomotives featured in the M.T.H. RailKing line are equipped with moderate detail and run on the same O gauge track as the intricately detailed O scale models found in our Premier Line. But, because RailKing models are shorter in length, they can negotiate tighter curves. In fact, most RailKing models can negotiate a circle as small as 31 inches in diameter, and some can operate on curves even smaller than that. This is a real advantage for model train enthusiasts with modestly sized layouts.

Over the years, the RailKing line has evolved into three subcategories: RailKing, RailKing Scale, and RailKing Imperial.



**IMPERIAL**  
SERIES

**RailKing Imperial locomotives** retain traditional proportions and O-31 minimum curve operation like regular RailKing locomotives, but are equipped with a level of detail usually found only on more expensive, full-scale engines that require much larger curves.

### Features typically found on Imperial models include all of our RailKing features, plus:

- Separate marker light housings with individual LED illumination
- Additional grab iron detail
- Authentic, legible builder's plates
- Cab interior lights
- Painted steam locomotive backhead gauges
- Safety chains for tender trucks
- Real tender coal loads



**RAILKING**  
scale

### Features typically found on RailKing Scale models include all of our RailKing features, plus:

- Full 1/48 O scale proportions
- Additional grab iron detail
- Authentic, legible builder's plates
- Cab interior lighting
- Locomotive engineer figures
- Diesel cab interior detail
- Operating diesel smoke on larger models

**RailKing Scale diesels** are full scale-proportioned models featuring a higher level of detail than that found on regular RailKing models. Because of their scale proportions, RailKing Scale models require a minimum of O-31 curves in order to operate.

While RailKing Scale models are not as intricately detailed as their Premier counterparts, they mix well with any O scale 3-rail models, regardless of manufacturer. RailKing Scale diesels are an attractively priced alternative for modelers who want to operate full 1/48 O scale trains.

**RAILKING**  
By M.T.H. Electric Trains

### Features typically found on RailKing models include:

- Durably constructed ABS diesel locomotive and car bodies
- Die-Cast metal steam locomotive boilers
- All-metal diesel and steam locomotive chassis
- All-metal wheels, gears and axles
- All-metal couplers
- All-metal freight and passenger car trucks w/operating couplers
- Precision flywheel-equipped motors
- Synchronized Puffing Proto-Smoke™-equipped steam locomotives



**New to Model Railroading? Check out the RailKing Ready-To-Run Train Set Catalog**



# 4-6-4 Hudson Steam Engine



## Features

- Die-Cast Metal Chassis
- Metal Wheels and Axles
- Precision Flywheel-Equipped Motor
- Metal Handrails and Bell
- Metal Whistle
- Die-Cast Boiler and Tender Body
- Constant Voltage Headlight
- Die-Cast Truck Sides
- Colorful Paint Scheme
- Remote Controlled Proto-Coupler™
- Synchronized Puffing ProtoSmoke™ System
- Locomotive Speed Control in Scale MPH Increments
- Engineer Cab Figure
- Operating Tender Back-up Light
- Proto-Sound 2.0 With The Digital Command System Featuring Passenger Station Proto-Effects
- Measures: 20 3/4" x 2 1/2" x 3 5/8"
- Operates On O-31 Curves



## Did You Know?

Although NYC gets the credit for the first Hudsons, it was actually the Milwaukee Road's designer C.H. Bilty that designed the first 4-6-4, which he called a "Baltic," in 1925. However, they delayed building the locomotive, and NYC got to claim the success.



**Santa Fe - 4-6-4 Hudson Steam Engine**  
30-1533-1 w/Proto-Sound 2.0 \$399.95



**New York Central - 4-6-4 Hudson Steam Engine**  
30-1534-1 w/Proto-Sound 2.0 \$399.95

**Add a Matching Passenger Set!**  
See Page 59



**Chicago & North Western - 4-6-4 Hudson Steam Engine**  
30-1536-1 w/Proto-Sound 2.0 \$399.95



**Southern - 4-6-4 Hudson Steam Engine**  
30-1535-1 w/Proto-Sound 2.0 \$399.95

In *Thoroughbreds*, Alvin Stauffer and Edward May's definitive book on the New York Central Hudsons, Al summarizes the attraction of this engine in a few perhaps-biased but nonetheless eloquent words: "The Hudsons had it all: looks, performance, and timing. ... The forte of all Hudsons was power at speed.... That the NYC Hudson was the first of her wheel arrangement in the United States matters not nearly as much as what she hauled and how she hauled it. The Hudsons were designed to haul the Great Steel Fleet on the Water Level Route [the NYC's raceway from New York to Chicago, home of the *20th Century Limited* and the *Empire State Express*, and the bane of rival Pennsylvania Railroad, whose route lay over the Allegheny Mountains]. The Hudsons were a New York Central phenomenon. They were a special machine for that special road. They were synonymous with the best. They were the best."

Built mainly in Alco's Schenectady shops in the late 1920s and 1930s, the NYC Hudsons were part of the "super-power" era of steam technology that began with Lima's A1 Berkshire in 1924. Super power engines were the external combustion engine refined to its finest form, with technological advances such as bigger fireboxes supported by 4-wheel trailing trucks; higher pressure, more efficient boilers; superheaters to increase the heat of the steam so it could do more work; and larger drivers for speed *and* power (79" on the Hudsons).

Our model of this famous engine exemplifies the best in today's O gauge locomotives. Relive the drama of the Hudsons as they performed on the New York Central and many other American railroads, with synchronized puffing smoke, a full range of authentic steam sounds, and realistic passenger station announcements. A powerful flywheel-equipped motor and twin traction tires ensure the RailKing Hudson duplicates the magnificent performance of the originals.

# 4-6-6-4 Imperial Challenger Steam Engine



## Features

- Die-Cast Boiler and Tender Body
- Die-Cast Metal Chassis
- Authentic Paint Scheme
- Metal Wheels and Axles
- Constant Voltage Headlight
- Die-Cast Truck Sides
- (2) Precision Flywheel-Equipped Motors
- Locomotive Speed Control in Scale MPH Increments
- Remote Controlled Proto-Coupler™
- Engineer and Fireman Figures
- Operating Firebox Glow
- Metal Handrails and Bell
- Metal Whistle
- Operating Classification and Tender Marker lights
- Real Coal Load
- Synchronized Puffing ProtoSmoke™ System
- Proto-Sound 2.0 With The Digital Command System Featuring Passenger Station or Freight Yard Proto-Effects
- Measures: 25 1/2" x 2 5/8" x 3 7/8"
- Operates On O-31 Curves

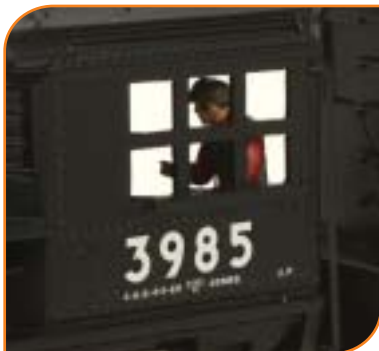

## Did You Know?

The UP apparently expected to get the remaining six Challengers they had ordered after the war — but the U.S. government, who owned them, stored them in Salt Lake City until striking the deal that sent them to the Clinchfield.





**Union Pacific - 4-6-6-4 Imperial Challenger Steam Engine**  
30-1541-1 w/Proto-Sound 2.0 \$699.95



**Union Pacific (Two-Tone Gray with Yellow Stripes)- 4-6-6-4 Imperial Challenger Steam Engine**

30-1542-1 w/Proto-Sound 2.0 \$699.95

**Add a Matching Passenger Set!**

*See Page 59*



**Clinchfield - 4-6-6-4 Imperial Challenger Steam Engine**

30-1543-1 w/Proto-Sound 2.0 \$699.95



**Rio Grande - 4-6-6-4 Imperial Challenger Steam Engine**

30-1544-1 w/Proto-Sound 2.0 \$699.95



**Western Maryland - 4-6-6-4 Imperial Challenger Steam Engine**

30-1545-1 w/Proto-Sound 2.0 \$699.95

The first Challengers were conceived in 1936 as fast freight engines to replace the Union Pacific's fleet of three-cylinder 4-12-2 locomotives. With an extra center cylinder for added power and a top speed of 45 mph, the 4-12-2s had been successful freight engines when built in 1926. But a decade later they were considered slow and difficult to maintain. So American Locomotive Works (Alco) was commissioned to build what became one of the most successful fleets of articulated engines on any railroad. Forty Challengers were built in the 1930s. The pressure of wartime traffic brought an order for 65 more with bigger tenders and many minor improvements.

The Challengers were steam power at its zenith. They incorporated all the technology that represented super-power steam, including roller bearings on all axles and drive rods — but none of the foolishness that characterized some of the desperate efforts to save steam in the post-war years. Most Challengers were assigned to freight duty, but a number were designated for passenger service, hustling 20-car trains across mountains and deserts to California and Oregon at speeds up to 70mph.

It was in a roundabout way that six Challengers ordered by the UP ended up hauling coal through the Appalachians for the Clinchfield Railroad. In the midst of World War II, the War Production Board refused the Rio Grande's request to order new articulateds of its own design from Baldwin Locomotive Works. Instead, the Board diverted the last six Challengers in UP's order to the Rio Grande — which turned up its nose at the locos and decided to lease them for the duration rather than buying them. After war's end, the Rio Grande returned the unwanted engines to the government. In 1947, the War Assets Administration sold the orphan locos to the Atlantic Coast Line and Louisville & Nashville Railroads, which put the Challengers to work on their jointly-owned subsidiary, the Clinchfield, Carolina & Ohio. Thus a group of engines intended to speed over western deserts and mountains ended up thundering through Appalachia.

M.T.H. is proud to return the Challenger to the RailKing lineup in the classic markings of four different railroads. Enhanced with the awesome sound and performance of Proto-Sound® 2.0, these smooth-running 4-6-6-4s are equipped with RailKing Imperial features that include classification light housings with individual LED illumination; authentic, legible builder's plates; operating firebox glow; cab interior lighting; painted backhead gauges; real coal load; and operating tender marker light.

# 4-6-0 Ten Wheeler Steam Engine



## Features

- Die-Cast Boiler and Chassis
- Metal Wheels and Axles
- Precision Flywheel-Equipped Motor
- Metal Handrails and Bell
- Metal Whistle
- Constant Voltage Headlight
- Die-Cast Truck Sides
- Remote Controlled Proto-Coupler™
- Synchronized Puffing ProtoSmoke™ System
- Colorful Paint Scheme
- Locomotive Speed Control in Scale MPH Increments
- Die-Cast Tender Body
- Proto-Sound 2.0 With The Digital Command System Featuring Passenger Station Proto-Effects
- Unit Measures:  
17 1/2" x 2 7/8" x 3 1/2"
- Operates On O-31 Curves



The 4-6-0 steam locomotive appeared on the railroad scene in the mid- to late-19th Century. It largely replaced the 4-4-0 American type popularized in Currier & Ives prints, as heavier trains and mountainous terrain demanded more power.

The 4-4-0 design was first modified by locomotive builder Richard Norris & Son of Philadelphia, who added an extra driving axle at the rear of the locomotive to create the 4-6-0, or "Ten Wheeler" as it became known. The extra pair of drivers permitted the construction of a bigger boiler and firebox. Combined with the traction of the extra wheels, these changes produced a 50% increase in tractive effort over a 4-4-0. It would still be some time before designers thought to add a trailing truck to support an even larger firebox.

After the transcontinental railroad was completed in 1869, fleets of Ten Wheelers were among the engines that conquered the American West and built the young nation's first truly national transportation network. In a time when railroads were still new technology and black had not yet become the standard color of steam locomotives, many 4-6-0's were flamboyantly decorated in the colors of their individual railroads.

Relive the pioneering spirit of 19th-century railroading with the RailKing Ten Wheeler and RailKing period rolling stock. Featuring the incredible speed control, variable smoke output, and digital sound quality of ProtoSound® 2.0, this locomotive is sure to become a favorite on your layout.

**Add a Matching Passenger Set!**  
See Page 59



**Virginia & Truckee - 4-6-0 Ten Wheeler Steam Engine**

30-1537-1 w/Proto-Sound 2.0 \$399.95



**Norfolk & Western - 4-6-0 Ten Wheeler Steam Engine**

30-1540-1 w/Proto-Sound 2.0 \$399.95



**Chesapeake & Ohio - 4-6-0 Ten Wheeler Steam Engine**

30-1538-1 w/Proto-Sound 2.0 \$399.95



**Philadelphia & Reading - 4-6-0 Ten Wheeler Steam Engine**

30-1539-1 w/Proto-Sound 2.0 \$399.95

# EMD GP20 Diesel Engine



## Features

- Metal Wheels, Axles and Gears
- Die-Cast Truck Sides, Pilots and Fuel Tank
- Colorful Paint Scheme
- Metal Chassis
- Metal Handrails and Horn
- Intricately Detailed ABS Body
- Locomotive Speed Control in Scale MPH Increments
- (2) Precision Flywheel-Equipped Motors
- (2) Remotely Controlled Proto-Couplers™
- (2) Engineer Cab Figures
- Operating Smoke Unit
- Directionally Controlled Headlights
- Proto-Sound 2.0 With The Digital Command System Featuring Freight Yard Proto-Effects™
- Measures: 14 7/8" x 2 3/4" x 4"
- Operates On O-31 Curves

## Non-Powered Features

- Die-Cast Truck Sides, Pilots and Fuel Tank
- Colorful Paint Scheme
- Metal Chassis
- Metal Handrails and Horn
- Intricately Detailed ABS Body
- (2) Operating Metal Couplers
- (2) Engineer Cab Figures
- Metal Wheels and Axles
- Measures: 14 7/8" x 2 3/4" x 4"
- Operates On O-31 Curves



In the late '50s, railroads were looking for units with high-horsepower output. General Electric and Alco obliged by releasing units with 2,400 and 2,500-h.p. capability. General Motor's Electro-Motive Division, at first, was reluctant to chime in. They figured that turbocharging their 567 engine would drive up maintenance costs, and that was to be avoided. Yet, in 1959, EMD outshopped the GP20, a 16-cylinder, 2,000-h.p. road switcher, with its turbocharged 567D2 engine.

Union Pacific fostered EMD's change of heart. For it was only after the road experimented with and found success with turbocharging EMD's 567 engine in the GP9s on their roster, that EMD rec-

ognized the engine's potential. GP20s, closely resembled earlier Geeps, such as the GP7, GP9 and GP18. The increased power made the difference. As a result of that power, one distinguishing feature of the GP20 from prior Geeps, was its short exhaust stack, located just aft of the first fan behind the cab. These units were produced until 1962.

These popular units come alive once again in the exciting RailKing Scale division in five exciting roadnames. Each locomotive is built to scale proportions and includes more detail than engines in the regular RailKing product line.



**Wisconsin & Southern - GP20 Diesel Engine**

30-2975-1 w/Proto-Sound 2.0 \$299.95  
 30-2975-3 Non-Powered \$149.95



**Norfolk Southern - GP20 Diesel Engine**

30-2976-1 w/Proto-Sound 2.0 \$299.95  
 30-2976-3 Non-Powered \$149.95



**Maryland Midland - GP20 Diesel Engine**

30-2973-1 w/Proto-Sound 2.0 \$299.95  
 30-2973-3 Non-Powered \$149.95



**Central New England - GP20 Diesel Engine**

30-2974-1 w/Proto-Sound 2.0 \$299.95  
 30-2974-3 Non-Powered \$149.95



**Alaska - GP20 Diesel Engine**

30-2977-1 w/Proto-Sound 2.0 \$299.95  
 30-2977-3 Non-Powered \$149.95

# EMD E3 A-A Diesel Engine

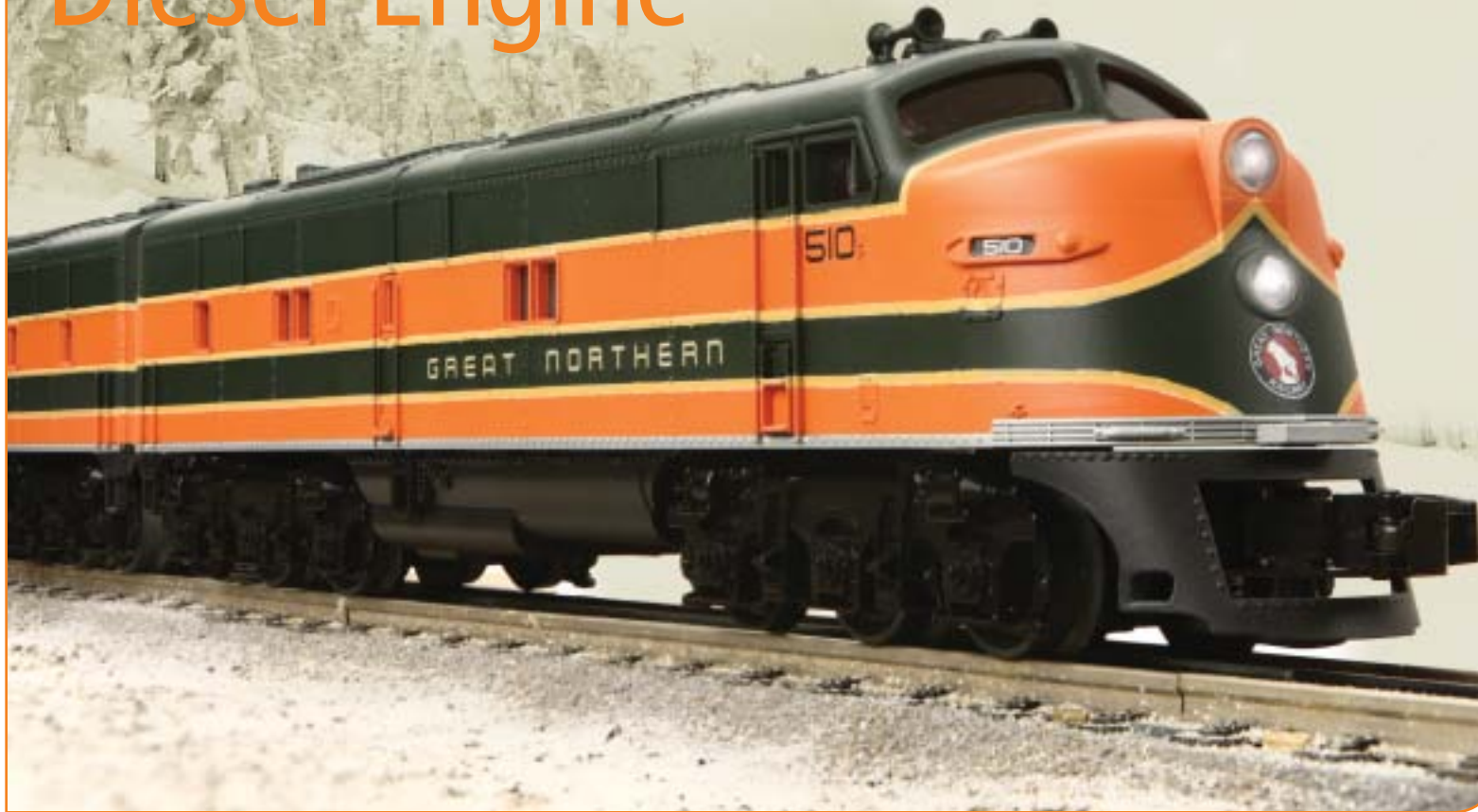

## Features

- Intricately Detailed ABS Bodies
- Directionally Controlled Headlights
- Metal Wheels, Axles and Gears
- Die-Cast Truck Sides, Pilots and Fuel Tank
- (2) Remotely Controlled Proto-Couplers™
- Colorful Paint Scheme
- Metal Chassis
- (2) Precision Flywheel-Equipped Motors
- Locomotive Speed Control In Scale MPH Increments
- Proto-Sound 2.0 With The Digital Command System Featuring Passenger Station Proto-Effects
- Unit Measures:  
29 1/4" x 2 1/2" x 3 5/8"
- Operates On O-31 Curves

## B-Unit Features

- Intricately Detailed ABS Body
- Metal Wheels and Axles
- Colorful Paint Scheme
- Die-Cast Truck Sides
- Metal Chassis
- Unit Measures:  
14 3/4" x 2 1/2" x 3 3/8"
- Operates On O-31 Curves



## Did You Know?

EMD's hugely successful and long-lived 567 engine was first used in the E3. The 567 raised the engine's rating to 2000 horsepower instead of the 1800 horses that gave the original E-units their name, but the series kept the "E" designation as long as they were in production.



**Pennsylvania - E3 A-A Diesel Engine**

30-2967-1 w/Proto-Sound 2.0 \$349.95

30-2967-3 Non-Powered B-Unit \$119.95

**Add a Matching Passenger Set!**

*See Page 58*



**Santa Fe - E3 A-A Diesel Engine**

30-2968-1 w/Proto-Sound 2.0 \$349.95

30-2968-3 Non-Powered B-Unit \$119.95

**Add a Matching Passenger Set!**

*See Page 58*



**Great Northern - E3 A-A Diesel Engine**

30-2969-1 w/Proto-Sound 2.0 \$349.95

30-2969-3 Non-Powered B-Unit \$119.95

**Add a Matching Passenger Set!**

*See Page 58*



**Richmond Fredericksburg & Potomac - E3 A-A Diesel Engine**

30-2970-1 w/Proto-Sound 2.0 \$349.95

30-2970-3 Non-Powered B-Unit \$119.95

**Add a Matching Passenger Set!**

*See Page 59*



For many railfans, EMD's E-Series symbolizes all that was right about the golden age of passenger service. In the middle of the Great Depression, General Motors asked its Detroit stylists to design a sleek streamlined engine to head up consists of the lightweight passenger cars that had become fashionable. And because diesels did not have the pulling power of steam engines, these new units needed to be equipped to run in multi-unit lash-ups when more horsepower was needed to pull a long train. In addition to their modern appearance and multiple-unit capabilities, the E-series engines were also safer for the cab crew than the earlier box cabs, which put too little protection between the enginemen and any foreign object that might appear on the track.

Fully outfitted with the power and performance of Proto-Sound 2.0, these streamlined workhorses may just be the pride of your passenger fleet. Marvel at sound and sights as these landmark engines streak by at the head of a glamorous passenger train in four colorful liveries.

# EMD SW1 Diesel Switcher



## Features

- Intricately Detailed ABS Body
- Colorful Paint Scheme
- Die-Cast Metal Chassis
- Directionally Controlled Headlight
- Metal Wheels, Axles and Gears
- Die-Cast Truck Sides, Pilots and Fuel Tank
- (2) Remotely Controlled Proto-Couplers™
- Metal Handrails and Horn
- (2) Precision Flywheel-Equipped Motors
- Locomotive Speed Control In Scale MPH Increments
- Proto-Sound 2.0 With The Digital Command System Featuring Freight Yard Proto-Effects
- Unit Measures: 12" x 2 3/4" x 4"
- Operates On O-27 Curves







**Norfolk Southern - SW1 Diesel Switcher**  
30-2963-1 w/Proto-Sound 2.0 \$299.95



**Amtrak - SW1 Diesel Switcher**  
30-2964-1 w/Proto-Sound 2.0 \$299.95



**Burlington - SW1 Diesel Switcher**  
30-2965-1 w/Proto-Sound 2.0 \$299.95



**Chessie - SW1 Diesel Switcher**  
30-2966-1 w/Proto-Sound 2.0 \$299.95

The birth of the SW1 in January 1939 was a historic moment for the Electro-Motive Corporation. The tiny switcher ("S" for six hundred horsepower, "W" for welded frame) was EMC's first truly mass-produced loco, the first with Electro-Motive's own electrical gear, and the first mass-produced engine powered by the 567 diesel motor — which would become the backbone of first-generation American diesel power. Popular with railroads large and small, the SW1 stayed in production for 15 years, and many remained in service for three or more decades.

Our RailKing Scale SW1 offers Premier level details at a RailKing price. Separately added metal detail parts include front, side, and rear handrails; bell and horn; grab irons to allow access to the top of the hood; and handles for the sandbox lid on the front pilot (which doubled as a convenient seat for yard brakemen). Built to full 1/48 scale proportions, this model also offers authentic, legible EMD builder's plates and directionally operating front and rear headlights. Single or dual exhaust stacks, per individual prototypes, are also featured.

Our SW1 includes dual pickup rollers on each truck, making this model nearly stall-proof on any three-rail O gauge switches, despite its short wheelbase. Throttle down as low as three scale miles per hour to muscle a heavy cut of freight or passenger cars around your terminal — and maintain that speed as long as you wish, thanks to Proto-Speed Control and twin flywheel-equipped motors. Listen to the authentic chant of a first-generation EMD 567 motor. Pick up and drop off cars wherever you like, with remotely activated front and rear Proto-Couplers. Our full-scale, fully featured model of this tiny EMD workhorse offers everything you could want in a hard-working yard switcher.

# Alco RS-3 Diesel Engine



## Features

- Die-Cast Truck Sides, Pilots and Fuel Tank
- Colorful Paint Scheme
- Metal Chassis
- Metal Handrails and Horn
- Intricately Detailed ABS Body
- Locomotive Speed Control in Scale MPH Increments
- (2) Precision Flywheel-Equipped Motors
- (2) Remotely Controlled Proto-Couplers™
- Metal Wheels, Axles and Gears
- Directionally Controlled Headlights
- Proto-Sound 2.0 With The Digital Command System Featuring Freight Yard Proto-Effects
- Unit Measures:  
14 1/2" x 2 1/2" x 3 3/4"
- Operates On O-27 Curves

## Non-Powered Features

- Die-Cast Truck Sides, Pilots and Fuel Tank
- Colorful Paint Scheme
- Metal Chassis
- Metal Handrails and Horn
- Intricately Detailed ABS Body
- Metal Wheels and Axles
- (2) Operating Metal Couplers
- Unit Measures:  
14 1/2" x 2 1/2" x 3 3/4"
- Operates On O-27 Curves





**Gulf, Mobile & Ohio - RS-3 Diesel Engine**

30-2955-1 w/Proto-Sound 2.0 \$299.95  
 30-2955-3 Non-Powered \$149.95

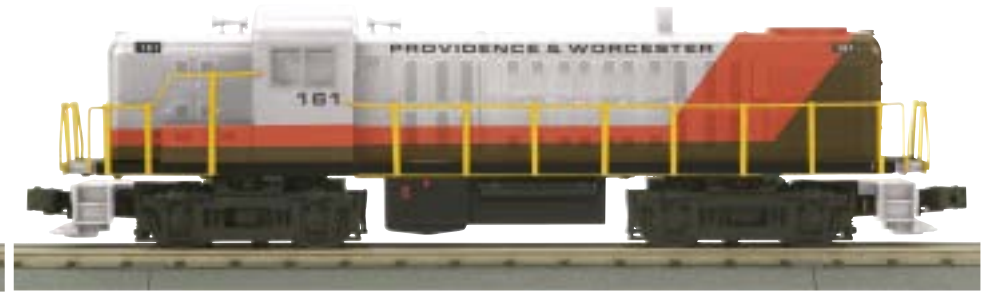

**Providence & Worcester - RS-3 Diesel Engine**

30-2956-1 w/Proto-Sound 2.0 \$299.95  
 30-2956-3 Non-Powered \$149.95



**Canadian National - RS-3 Diesel Engine**

30-2957-1 w/Proto-Sound 2.0 \$299.95  
 30-2957-3 Non-Powered \$149.95



**Burlington Northern - RS-3 Diesel Engine**

30-2958-1 w/Proto-Sound 2.0 \$299.95  
 30-2958-3 Non-Powered \$149.95

By the time the first RS-3's rolled off the assembly line in 1950, Alco had refined its road switcher concept to create "a truly universal locomotive which could do anything and go almost anywhere," in the words of author J.W. Swanson in *New Haven Power*. In contrast with its predecessor, the 1000 hp RS-1, the 1600 hp RS-3 had all the power of a road diesel of its time and could boil along at up to 80 mph.

For awhile in the early 1950's, ALCO looked like a true contender in the burgeoning road switcher market. RS-3's could be found on a majority of class one railroads doing everything from switching and transfer duties to mainline freight and even passenger and commuter service.

Ultimately, however, the RS-3 took a distant second place to Electro-Motive's GP7 and GP9 in sales volume. Perhaps what doomed Alco was EMD's already-commanding lead in the road diesel market — in part

because EMD's FT was the only road diesel allowed to be produced during World War II, when diesels began their takeover of American railroads. Other builders were relegated to producing diesel switchers until the conflict ended.

There was also talk that Alcos were less dependable. In hindsight, however, that seems to have been a result of EMD's sales lead. Perhaps shop crews were simply less familiar with Alco's model 244 prime mover and how to service it. In fact, roads with primarily Alco fleets, such as the New Haven, found Alco products to be very reliable when maintained properly. With their power and flexibility, RS-3's proved their worth so successfully that many railroads kept them on active duty after other first-generation diesels had been retired. They survived on class 1 railroads until the Delaware & Hudson retired its last RS-3 in 1986 and remained active in shortline and industrial service for years afterward.

Bring the versatility of this do-anything/go-anywhere engine to your railroad with the RailKing Scale RS-3. Thanks to ProtoSound 2.0, our model features authentic Alco prime mover sounds, pulling power to match its hardy prototype, and a speed range from a slow crawl to full throttle.

**Did You Know?**

The first RS-3's were delivered with an air-cooled turbocharger that soon proved troublesome. Most engines were later refitted with a more dependable water-cooled unit. The crosswise exhaust stack on our model indicates it has the later water-cooled version. (A turbocharger is a blower, driven by exhaust gases, that pressurizes air coming into the engine and thereby increases horsepower.)

# EMD NW2 Diesel Switcher



## Features

- Directionally Controlled Headlight
- Intricately Detailed ABS Body
- Colorful Paint Scheme
- (2) Precision Flywheel-Equipped Motors
- Die-Cast Truck Sides, Pilots and Fuel Tank
- Metal Wheels, Axles and Gears
- (2) Remotely Controlled Proto-Couplers
- Metal Handrails and Horn
- Locomotive Speed Control In Scale MPH Increments
- Metal Chassis
- Proto-Sound 2.0 With The Digital Command System Featuring Freight Yard Proto-Effects
- Unit Measures:  
12 3/8" x 2 1/2" x 3 7/8"
- Operates On O-27 Curves



## Did You Know?

An interesting NW2 variation was the "calf." This cabless version was designed to be run in tandem with a normal NW2 for heavy-duty switching and transfer service between railroad yards. A number of railroads rostered TR2 cow-and-calf combinations, and the Chesapeake & Ohio owned two TR3 "herds" — a cow and two calves.

The NW2 was the big brother of the SW1 switcher shown elsewhere in this catalog. The longer hood of the NW2 housed a 12-cylinder diesel, twice as large as the prime mover in the SW1. The "N" in NW2 stood for nine hundred horsepower, the power output of the first Electro-Motive Corporation N-series switchers with Winton motors. Power increased to 1000 hp with the 1939 debut of the NW2, the first N-series locomotive with EMC's new 567 diesel motor — the prime mover that would power nearly all of the most successful first-generation diesels. Within a few years, EMC and Winton Engine, which had been owned by GM since 1930, would become the Electro-Motive Division of General Motors.

EMD cataloged the NW2 for a decade, except for a hiatus in production from 1942-1945, ordered by the War Production Board. While rival manufacturers were asked to produce switchers, EMD was the only firm allowed to produce road diesels — a situation that, in retrospect, gave GM a commanding lead in the diesel revolution after the war.

By the end of NW2 production in 1949, over 1100 engines had been sold in the United States and Canada, and the hardy N-series switchers were ubiquitous from coast to coast. A popular, near-scale Lionel model ensured the engine was familiar to almost any boy who grew up in the 1950s.

The NW2 returns to the RailKing lineup in 2010 with everything you need in a hard-working switcher: twin-motored pulling power down to 3 scale miles per hour, dual Proto-Couplers to drop off cars anywhere, and authentic EMD 567 engine sounds.



**Northern Pacific - NW2 Diesel Switcher**  
30-2961-1 w/Proto-Sound 2.0 \$299.95



**CSX - NW2 Diesel Switcher**  
30-2962-1 w/Proto-Sound 2.0 \$299.95



**Clinchfield - NW2 Diesel Switcher**  
30-2959-1 w/Proto-Sound 2.0 \$299.95



**New York Ontario & Western - NW2 Diesel Switcher**  
30-2960-1 w/Proto-Sound 2.0 \$299.95

# RailKing Diesel Locomotives

The locomotives below were announced in previous catalogs and are currently in stock and available for delivery.

**LEARN MORE ABOUT THEM:** For more information on any M.T.H. locomotive, search its item number on our homepage, [www.mthtrains.com](http://www.mthtrains.com).



**Denver & Rio Grande - SD70ACe Imperial Diesel Engine**  
30-2877-1 w/Proto-Sound 2.0 \$299.95



**Chicago & Northwestern - SD70ACe Imperial Diesel Engine**  
30-2876-1 w/Proto-Sound 2.0 \$299.95



**Canadian Pacific  
MP15AC Diesel Engine**  
30-2812-1 w/Proto-Sound 2.0 \$299.95



**Western Pacific - SD70ACe Imperial Diesel Engine**  
30-2881-1 w/Proto-Sound 2.0 \$299.95



**MKT - SD70ACe Imperial Diesel Engine**  
30-2879-1 w/Proto-Sound 2.0 \$299.95



**CSX - MP15AC Diesel Engine**  
30-2813-1 w/Proto-Sound 2.0 \$299.95



**Union Pacific - E-8 A-A Diesel Engine Set**

30-2912-1 w/Proto-Sound 2.0 \$349.95

30-2912-3 Non-Powered B-Unit \$119.95



**Ontario Northland - E-8 A-A Diesel Engine Set**

30-2836-1 w/Proto-Sound 2.0 \$349.95



**Rio Grande Southern - Galloping Goose**

30-2890-1 w/Proto-Sound 2.0 \$249.95



**Long Island - RDC Budd Car Set**

30-2843-1 w/Proto-Sound 2.0 \$399.95



**Caterpillar® - F-3 A-B-A Diesel Engine Set**

30-2849-1 w/Proto-Sound 2.0 \$499.95



**Santa Fe - Alco PA A-A Diesel Set**

30-2857-1 w/Proto-Sound 2.0 \$349.95

30-2857-3 Non-Powered B-Unit \$119.95



© 2009 Caterpillar  
 CAT, CATERPILLAR, their respective logos, "Caterpillar Yellow" and the "Power Edge" trade dress, as well as corporate and product identity used herein, are trademarks of Caterpillar and may not be used without permission.

# EP-5 Electric Engine



## Features

- Directionally Controlled Headlights
- Intricately Detailed ABS Body
- Metal Wheels, Axles and Gears
- Die-Cast Truck Sides & Pilots
- (2) Remotely Controlled Proto-Couplers™
- Colorful Paint Scheme
- Metal Chassis
- (2) Precision Flywheel-Equipped Motors
- Locomotive Speed Control In Scale MPH Increments
- Proto-Sound 2.0 With The Digital Command System Featuring Passenger Station or Freight Yard Proto-Effects
- Unit Measures: 14" x 2 1/2" x 4"
- Operates On O-27 Curves





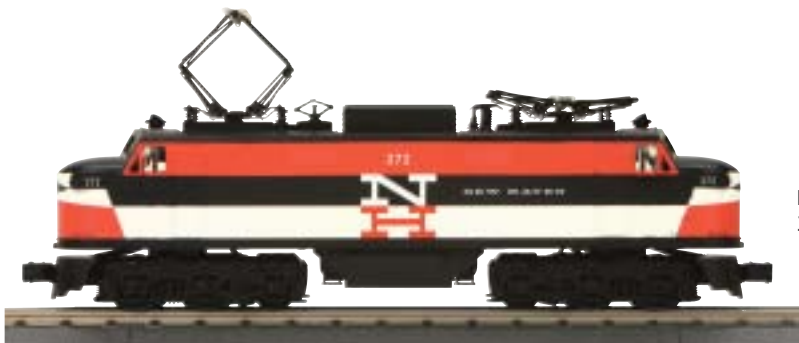

**New Haven - EP-5 Electric**  
30-5113-1 w/Proto-Sound 2.0 \$299.95



**Milwaukee Road - EP-5 Electric**  
30-5114-1 w/Proto-Sound 2.0 \$299.95



**Great Northern - EP-5 Electric**  
30-5111-1 w/Proto-Sound 2.0 \$299.95

**Add a Matching  
Caboose and  
Freight Cars!**  
See Pages 42, 46,  
and 56



By the early 1950s, the New Haven Railroad's electric passenger engines were getting a bit long in the tooth, with the newest engines dating from 1938. President F.C. Dumaine, Jr. ordered ten engines from General Electric incorporating a new technology: ignitron rectifier tubes that changed AC power from the overhead catenary into DC, enabling the new engines to use standard DC diesel traction motors.

Before the engines could be delivered, Dumaine was ousted in a shareholder proxy fight led by Patrick McGinnis. While the subsequent McGinnis administration was a disaster in almost every other way, it did leave the New Haven with a memorable paint scheme that originated with the EP-5. Mrs. McGinnis hired famed graphic designer Herbert Matter to create a new look for the railroad. Prior to delivery in 1955, two EP-5s were painted in Matter's "block NH" scheme, one in yellow, white, and black, and the other in red, white, and black. Mrs. McGinnis chose the red version, and the result was a corporate identity that still looks modern more than a half-century later.

Beyond the paint scheme, the EP-5s were famous for their sound. The combination of whining cooling blowers in the rooftop resistor box and high-speed cooling blowers in the body compartment led crews to call them "screaming Marys" or "Jets," and the latter name stuck. After some initial teething problems, the 4000 hp Jets proved dependable and powerful in passenger, mail/express, and nighttime piggyback service between New Haven and Grand Central Station. The EP-5 returns to the RailKing lineup for 2010 in the original McGinnis scheme, a fanciful new M&M'S® scheme, and decorated for the Great Northern and Milwaukee, which rostered similar-looking electrics.

**M&M'S® - EP-5 Electric**  
30-5112-1 w/Proto-Sound 2.0 \$329.95



®/™ M&M'S, the letter M and the M&M'S Characters are registered trademarks of Mars, Incorporated and its affiliates.  
©MARS, Incorporated 2009

# RailKing Transit Sets

The transit sets below were announced in previous catalogs and are currently in stock and available for delivery. Each set features Transit Stop Proto-Effects, which allows operators to program the train to run automatically on a loop or out-and-back route, stopping at pre-set locations and announcing appropriate commuter station stops.

**LEARN MORE ABOUT THEM:** For more information on any M.T.H. transit set, search its item number on our homepage, [www.mthtrains.com](http://www.mthtrains.com).



**New York Transit (Blue) - Q Type 3-Car Subway Set**

30-2760-1 w/Proto-Sound 2.0 \$349.95  
30-2760-3 Non Powered \$199.95



**Metropolitan Work Train - LO-V 4-Car Subway Set**

30-2758-1 w/Proto-Sound 2.0 \$399.95  
30-2758-3 2-Car Non Powered Add-On \$149.95



**New York Transit (Green) - Q Type 3-Car Subway Set**

30-2759-1 w/Proto-Sound 2.0 \$349.95  
30-2759-3 Non Powered \$199.95



**Reading - 4-Car MU Passenger Set**

30-2844-1 w/Proto-Sound 2.0 \$499.95



**New York Central - 4-Car MU Passenger Set**

30-2846-1 w/Proto-Sound 2.0 \$499.95

# Operating Freight



**Blue Marlin - Operating Aquarium**  
30-79280 \$69.95

## Aquarium Car Features

- Backlit, Moving Fish Swim Past Aquarium Windows
- Unit Measures: 11 1/2" x 2 3/8" x 2 5/16"
- Operates On O-27 Curves



**Flesh Eating Piranha - Operating Aquarium**  
30-79279 \$69.95



SEE IT IN  
**ACTION**  
ON THE WEB

By searching on each  
car's item number on  
[www.mthtrains.com](http://www.mthtrains.com)



**Nasa LN2 - Smoking Tank Car**  
30-73320 \$59.95



**Hawaiian Kona Coffee - Smoking Tank Car**  
30-73302 \$59.95

## Smoking Tank Features

- Car Smokes to Simulate Steaming Coffee or Supercooled NASA Fuel
- Unit Measures: 10 3/8" x 2 3/8" x 3 13/16"
- Operates On O-27 Curves

# 19th Century 34' Box Car



**Virginia & Truckee - 19th Century 34' Box Car**  
30-74581 \$42.95



**Klausmann Brewing - 19th Century 34' Box Car**  
30-74580 \$42.95



**Harley-Davidson® - 19th Century 34' Box Car**  
30-74579 \$44.95



© 2009 H-D, All Rights Reserved.



**Colorado Midland - 19th Century 34' Box Car**  
30-74578 \$42.95



## Features

- Unit Measures: 9 11/16" x 2 7/16" x 3 7/16"
- Operates On O-27 Curves

# 19th Century Stock Car



**Fort Worth & Denver - 19th Century Stock Car**  
30-7183 \$42.95



**Missouri Pacific - 19th Century Stock Car**  
30-7182 \$42.95

## Features

- Unit Measures: 9 3/4" x 2 1/2" x 3 1/2"
- Operates On O-27 Curves



**International & Great Northern Ry  
19th Century Stock Car**  
30-7181 \$42.95



**Wheeling & Lake Erie - 19th Century Stock Car**  
30-7180 \$42.95

# 19th Century Wooden Tank Car



**Union Pacific - 19th Century Wooden Tank Car**  
30-73319 \$42.95



**Imperial Extract Co.  
19th Century Wooden Tank Car**  
30-73316 \$42.95



**New York Central - 19th Century Wooden Tank Car**  
30-73317 \$42.95



**Santa Fe - 19th Century Wooden Tank Car**  
30-73318 \$42.95



## Features

- Unit Measures: 9 11/16" x 2 1/4" x 3 1/4"
- Operates On O-27 Curves

# 19th Century Reefer

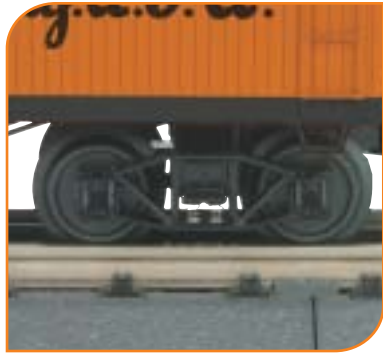

**Ruddy Refrigerator Line - 19th Century Reefer**  
30-78114 \$42.95

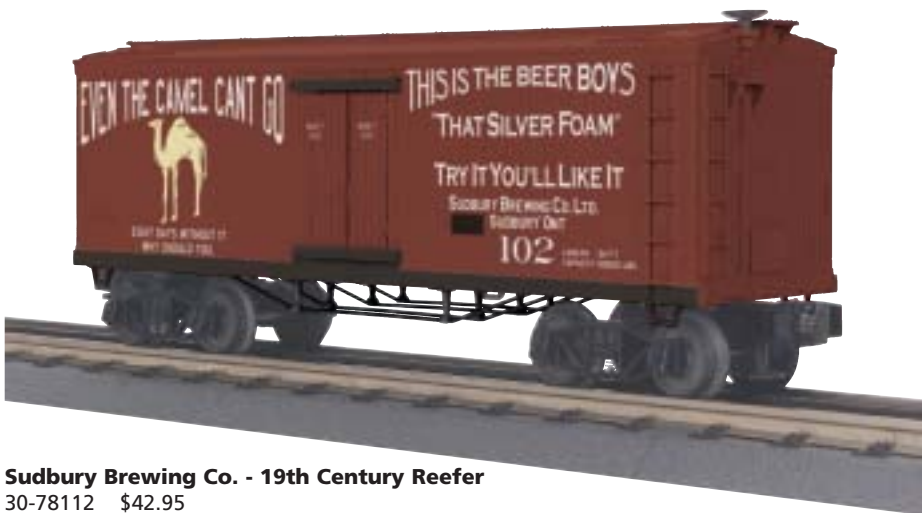

**Sudbury Brewing Co. - 19th Century Reefer**  
30-78112 \$42.95

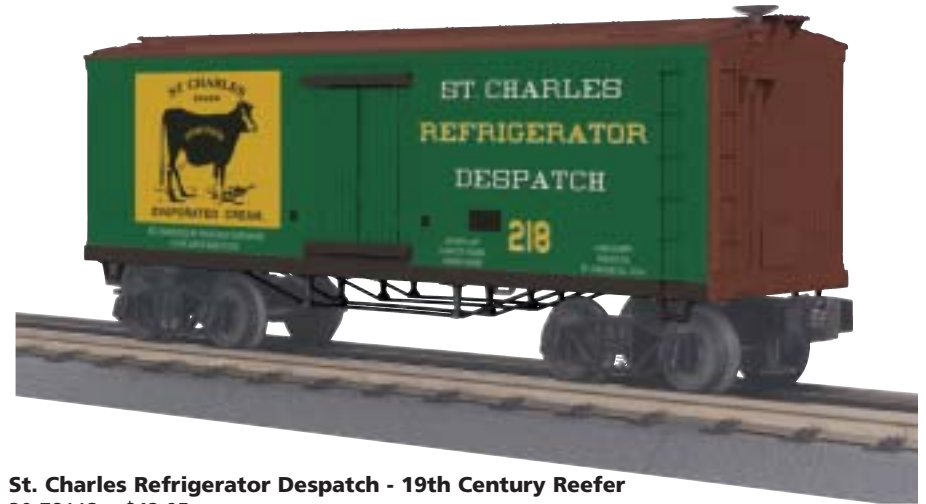

**St. Charles Refrigerator Despatch - 19th Century Reefer**  
30-78113 \$42.95



**Morrell Refrigerator Line - 19th Century Reefer**  
30-78115 \$42.95

## Features

- Unit Measures: 9 11/16" x 2 7/16" x 3 7/16"
- Operates On O-27 Curves

# 19th Century Gondola Car



**Philadelphia & Reading - 19th Century Gondola Car**  
30-72054 \$39.95



**Virginia & Truckee - 19th Century Gondola Car**  
30-72053 \$39.95



**Chesapeake & Ohio - 19th Century Gondola Car**  
30-72056 \$39.95



**New York Ontario & Western - 19th Century Gondola Car**  
30-72055 \$39.95



## Features

- Gondola Measures: 9 5/8" x 2 7/16" x 2 1/16"
- Flat Car Measures: 6 3/4" x 2 5/16" x 3 9/16"
- Operates On O-27 Curves

# 19th Century Flat Car



**Virginia & Truckee - 19th Century Flat Car with Cannon**  
30-76385 \$39.95



**New York & Hudson River  
19th Century Flat Car with Cannon**  
30-76388 \$39.95



# 19th Century Woodsided Caboose



**Chesapeake & Ohio - 19th Century Woodsided Caboose**  
30-77180 \$49.95



**Virginia & Truckee - 19th Century Woodsided Caboose**  
30-77179 \$49.95



**Norfolk & Western - 19th Century Woodsided Caboose**  
30-77182 \$49.95



**Philadelphia & Reading - 19th Century Woodsided Caboose**  
30-77181 \$49.95

## Features

- Interior Illumination
- Unit Measures: 9 3/4" x 2 1/2" x 3 11/16"
- Operates On O-27 Curves

## with Cannon



**Union Pacific - 19th Century Flat Car with Cannon**  
30-76387 \$39.95



**Pennsylvania - 19th Century Flat Car with Cannon**  
30-76386 \$39.95



# Box Car



**Budweiser - Box Car**

30-74583 \$44.95

"© 2009 Anheuser-Busch, Inc. All Rights Reserved."



**3 Musketeers (Raspberry) - Box Car**

30-74582 \$44.95

©/TM THREE MUSKETEERS and the THREE MUSKETEERS logo are registered trademarks of Mars, Inc. and its affiliates. Used under license by M.T.H. Electric Trains® © Mars, Incorporated 2009

## Features

- Unit Measures: 11 1/2" x 2 3/8" x 2 5/16"
- Operates On O-27 Curves



**Southern Pacific- Box Car**

30-74585 \$42.95



**Southern - Box Car**

30-74584 \$42.95



# 40' Double Door Box Car



**Jersey Central - 40' Double Door Box Car**  
30-74591 \$44.95



**Milwaukee Road - 40' Double Door Box Car**  
30-74593 \$44.95

## Features

- Unit Measures: 11 1/2" x 2 1/2" x 3 7/16"
- Operates On O-31 Curves



**Illinois Central - 40' Double Door Box Car**  
30-74592 \$44.95



**Pennsylvania - 40' Double Door Box Car**  
30-74590 \$44.95

# 40' High Cube Box Car



**M&M'S® - 40' High Cube Box Car**  
30-74575 \$54.95



©/™ M&M'S, the letter M and the M&M'S Characters are registered trademarks of Mars, Incorporated and its affiliates.  
©MARS, Incorporated 2009



**Union Pacific**  
**40' High Cube Box Car**  
30-74577 \$49.95



**Norfolk Southern**  
**40' High Cube Box Car**  
30-74576 \$49.95



**Caterpillar® - 40' High Cube Box Car**  
30-74574 \$54.95



© 2009 Caterpillar  
CAT, CATERPILLAR, their respective logos, "Caterpillar Yellow" and the "Power Edge" trade dress, as well as corporate and product identity used herein, are trademarks of Caterpillar and may not be used without permission.

## Features

- Unit Measures: 11 1/4" x 2 9/16" x 3 17/16"
- Operates On O-27 Curves

# 40' Window Box Car



**It's A Girl - 40' Window Box Car**  
30-74589 \$59.95



**It's A Boy - 40' Window Box Car**  
30-74588 \$59.95



## Features

- Unit Measures: 11 3/4" x 2 1/2" x 2 3/8"
- Operates On O-27 Curves



**It's Your Birthday - 40' Window Box Car**  
30-74587 \$59.95

# Modern Reefer



**Pacific Fruit Express - Modern Reefer**  
30-78106 \$44.95



**7UP - Modern Reefer**  
30-78104 \$49.95

7UP is a trademark of Dr Pepper/Seven Up, Inc., used by M.T.H. Electric Trains under license. ©2009 Dr Pepper/Seven up, Inc.



**Dr Pepper - Modern Reefer**  
30-78105 \$49.95

DR PEPPER is a trademark of Dr Pepper/Seven Up, Inc., used by M.T.H. Electric Trains under license. ©2009 Dr Pepper/Seven up, Inc.



**Iowa Beef Packers - Modern Reefer**  
30-78107 \$44.95

## Features

- Unit Measures: 11 1/2" x 2 3/8" x 2 5/16"
- Operates On O-27 Curves



# Woodsided Reefer



**Miller High Life - Reefer**  
30-78109 \$44.95

© 2009 MillerCoors, LLC. All rights reserved.  
Produced under license by M.T.H. Electric Trains. This licensed product is intended for adults of legal drinking age.



**Schott Brewing Co. - Reefer**  
30-78111 \$42.95



**Muessel Brewing Co. - Reefer**  
30-78110 \$42.95



**Cook's Goldblume - Reefer**  
30-78108 \$42.95

## Features

- Unit Measures: 11 5/8" x 2 1/2" x 3 3/16"
- Operates On O-27 Curves

# Gondola Car with Crates



**M&M'S® - Gondola Car with Crates**  
30-72050 \$49.95



©/™ M&M'S, the letter M and the M&M'S Characters are registered trademarks of Mars, Incorporated and its affiliates.  
©MARS, Incorporated 2009



**Rolling Rock - Gondola Car with Crates**  
30-72051 \$49.95



**Budweiser - Gondola Car with Crates**  
30-72049 \$49.95

"© 2009 Anheuser-Busch, Inc. All Rights Reserved."



**Boston & Maine - Gondola Car with Crates**  
30-72052 \$44.95

## Features

- Unit Measures: 11 15/16" x 2 3/16" x 1 11/16"
- Operates On O-27 Curves





# Gondola Car with LCL Containers



**Ann Arbor - Gondola Car with LCL Containers**  
30-72060 \$49.95



**Railway Express Agency - Gondola Car with LCL Containers**  
30-72059 \$49.95



**Milwaukee Road - Gondola Car with LCL Containers**  
30-72057 \$49.95

## Features

- Unit Measures: 11 7/8" x 2 3/16" x 1 11/16"
- Operates On O-27 Curves



**Chesapeake & Ohio  
Gondola Car with LCL Containers**  
30-72058 \$49.95

# 4-Bay Hopper

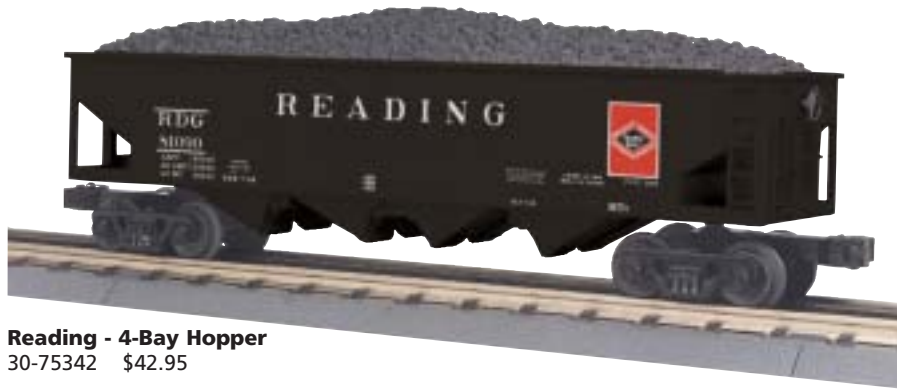

**Reading - 4-Bay Hopper**  
30-75342 \$42.95



**Miller - 4-Bay Hopper**  
30-75339 \$44.95

© 2009 MillerCoors, LLC. All rights reserved.  
Produced under license by M.T.H. Electric Trains. This licensed product is intended for adults of legal drinking age.

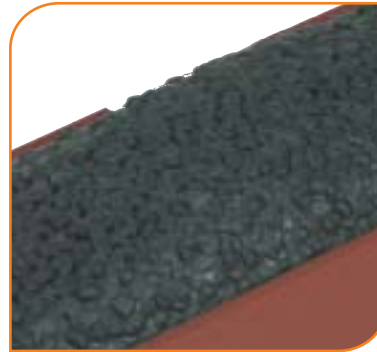

**Maryland Midland - 4-Bay Hopper**  
30-75340 \$42.95



**Bessemer & Lake Erie - 4-Bay Hopper**  
30-75341 \$42.95

## Features

- Unit Measures: 11 3/4 x 2 1/2 x 2 3/4
- Operates On O-27 Curves

# Husky Stack Car

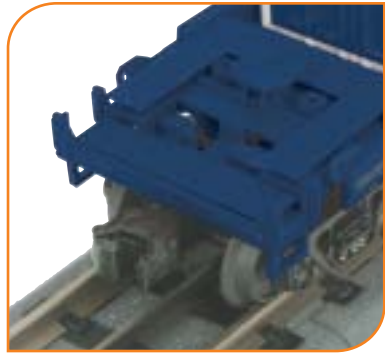

**Pittsburgh & Lake Erie - Husky Stack Car**  
30-76376 \$54.95



**Pennsylvania - Husky Stack Car**  
30-76378 \$54.95



**Great Northern - Husky Stack Car**  
30-76379 \$54.95



**Alaska - Husky Stack Car**  
30-76377 \$54.95

## Features

- Unit Measures: 14 3/4" x 2 5/16" x 5"
- Operates On O-31 Curves

# 3-Dome Tank Car



**Richmond Fredericksburg & Potomac - 3-Dome Tank Car**  
30-73311 \$49.95



**Union Pacific - 3-Dome Tank Car**  
30-73310 \$49.95



**Coors Light - 3-Dome Tank Car**  
30-73308 \$54.95

© 2009 MillerCoors, LLC. All rights reserved.  
Produced under license by M.T.H. Electric Trains. This licensed product is intended for adults of legal drinking age.

## Features

- Unit Measures: 10 1/4" x 2 3/8" x 3 9/16"
- Operates On O-27 Curves

**Chrome  
Plated  
Finish!**



**Alaska - 3-Dome Tank Car**  
30-73309 \$49.95



# Modern Tank Car



**Snickers - Modern Tank Car**  
30-73314 \$54.95

©/TM SNICKERS and the SNICKERS logo are registered trademarks of Mars, Inc. and its affiliates. Used under license by M.T.H. Electric Trains® © Mars, Incorporated 2009



**CSX - Modern Tank Car**  
30-73315 \$49.95



**Northern Pacific - Modern Tank Car**  
30-73312 \$49.95



**Miller High Life - Modern Tank Car**  
30-73313 \$54.95

© 2009 MillerCoors, LLC. All right reserved.  
Produced under license by M.T.H. Electric Trains. This licensed product is intended for adults of legal drinking age.

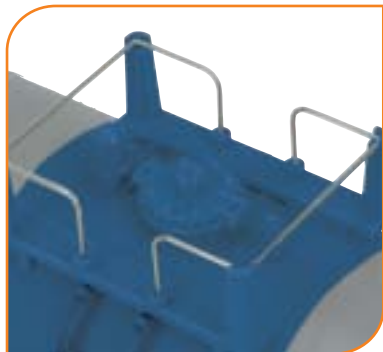

## Features

- Unit Measures: 10 7/8" x 2 3/8" x 3 7/8"
- Operates On O-27 Curves

# Fire Car



**Harley-Davidson® - Fire Car**  
30-79271 \$49.95



© 2009 H-D, All Rights Reserved.



**Canadian National - Fire Car**  
30-79274 \$49.95



**Baltimore & Ohio - Fire Car**  
30-79273 \$49.95



**Amtrak - Fire Car**  
30-79272 \$49.95

## Features

- Unit Measures: 11 11/16" x 2 5/16" 4 3/4"
- Operates On O-27 Curves



# Slag Car



**Western Maryland - Slag Car**  
30-79275 \$47.95

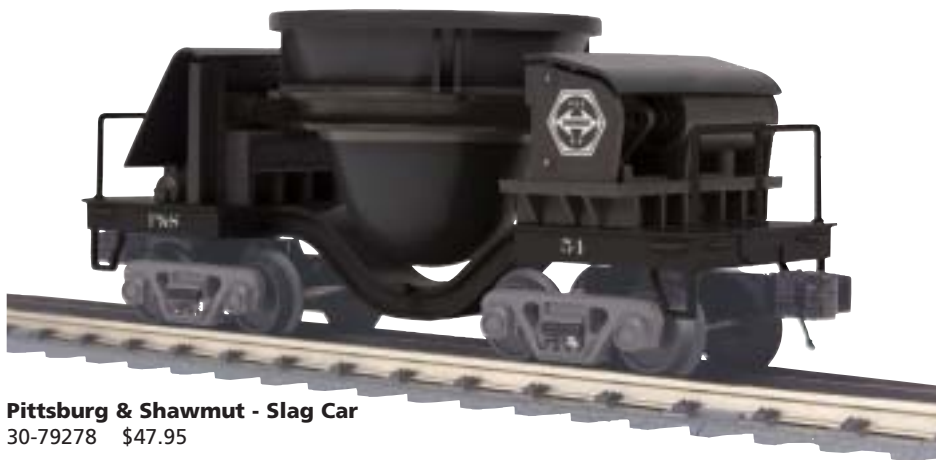

**Pittsburg & Shawmut - Slag Car**  
30-79278 \$47.95



**Buffalo & Pittsburgh - Slag Car**  
30-79277 \$47.95



**Wheeling & Lake Erie - Slag Car**  
30-79276 \$47.95

## Features

- Unit Measures: 8 1/4" x 2 1/8" x 3 3/8"
- Operates On O-31 Curves

# Flat Car with Load



**Rolling Rock - Flat Car with Trailer**  
30-76375 \$54.95

"© 2009 Anheuser-Busch, Inc. All Rights Reserved."



**Coors - Flat Car with Trailer**  
30-76372 \$54.95

© 2009 MillerCoors, LLC. All rights reserved.  
Produced under license by M.T.H. Electric Trains. This licensed product is intended for adults of legal drinking age.



**New York Central - Flat Car with Trailer**  
30-76374 \$49.95



**A&W Rootbeer - Flat Car with Trailer**  
30-76373 \$54.95

A&W is a trademark of A&W Concentrate Company, used under license by M.T.H. Electric Trains. ©2009 A&W Concentrate Company



**Pennsylvania Flat Car w/(2) Car Trailers**  
30-76389 \$49.95



**Milwaukee Road Flat Car w/(2) Car Trailers**  
30-76390 \$49.95

## Features

- Unit Measures: 11 5/8" x 2 1/4" x 3 3/4"
- Operates On O-27 Curves



# Flat Car with Auto Load and Auto-Carriers



**Santa Fe - Flat Car w/(2) '57 Chevys**  
30-76381 \$49.95



**Pennsylvania  
Flat Car w/(2) '37 Ford V8 Convertibles**  
30-76380 \$49.95



**New York Central  
Auto Carrier Flat Car w/(4) '67 Mustangs**  
30-76383 \$59.95



**Great Northern - Flat Car w/(2) '57 Chevys**  
30-76382 \$49.95



**Chesapeake & Ohio  
Auto Carrier Flat Car w/(4) '58 Studebakers**  
30-76384 \$59.95

## Features

- Flat Car Measures: 11 3/4" x 2 5/16" x 1 15/16"
- Auto-Carrier Measures: 11 11/16" x 2 5/16" x 3 1/2"
- Operates On O-27 Curves

# Bay Window Caboose



**Budweiser - Bay Window Caboose**  
30-77171 \$59.95



**Harley-Davidson® - Bay Window Caboose**  
30-77172 \$59.95

HARLEY-DAVIDSON © 2009 H-D, All Rights Reserved.



**Rolling Rock - Bay Window Caboose**  
30-77174 \$59.95

"© 2009 Anheuser-Busch, Inc. All Rights Reserved."



**M&M's® - Bay Window Caboose**  
30-77173 \$59.95



®/™ M&M'S, the letter M and the M&M'S Characters are registered trademarks of Mars, Incorporated and its affiliates. ©MARS, Incorporated 2009

## Features

- Unit Measures: 14 1/2" x 2 1/2" x 3 1/2"
- Operates On O-31 Curves

# Steel Caboose



**Alaska - Steel Caboose**  
30-77175 \$52.95

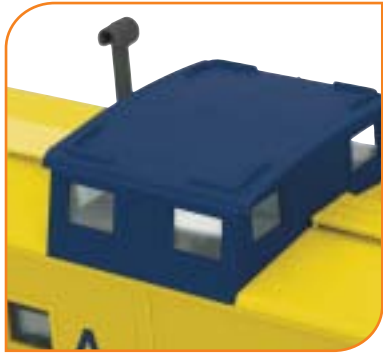

**Norfolk Southern - Steel Caboose**  
30-77178 \$52.95



**Maryland Midland - Steel Caboose**  
30-77176 \$52.95



**New York Central - Steel Caboose**  
30-77177 \$52.95

## Features

- Unit Measures: 10 1/4" x 2 1/2" x 4 1/4"
- Operates On O-27 Curves

# RailKing Passenger Cars



**Pennsylvania - 4-Car 60' Streamlined ABS Passenger Set**  
30-67522 \$219.95



**Pennsylvania - 60' Streamlined ABS Coach**  
30-67524 \$54.95



**Pennsylvania - 60' Streamlined ABS Full-Length Vista Dome Car**  
30-67525 \$59.95



**Pennsylvania - 2-Car 60' Streamlined ABS Sleeper/Diner**  
30-67523 \$109.95



**Great Northern - 4-Car 60' Streamlined ABS Passenger Set**  
30-67530 \$219.95



**Great Northern - 2-Car 60' Streamlined ABS Sleeper/Diner**  
30-67531 \$109.95



**Great Northern - 60' Streamlined ABS Coach**  
30-67532 \$54.95



**Great Northern - 60' Streamlined ABS Full-Length Vista Dome Car**  
30-67533 \$59.95



**Santa Fe - 2-Car 60' Streamlined ABS Sleeper/Diner**  
30-67527 \$109.95



**Santa Fe - 60' Streamlined ABS Full-Length Vista Dome Car**  
30-67529 \$59.95

## Streamlined Features

- Illuminated Interior
- 4-Car Sets Feature: (1) Baggage, (1) Coach, (1) Vista Dome, (1) Observation
- 4-Car Set Measures: 68 3/4" x 2 5/8" x 3 5/16"
- 2-Car Set Features (1) Sleeper, (1) Diner
- 2-Car Set Measures: 34 6/16" x 2 5/8" x 3 5/16"
- Coach Measures: 16 11/16" x 2 1/2" x 3 5/16"
- FLVD Measures: 16 11/16" x 2 1/2" x 3 13/16"
- Operates On O-31 Curves



**Santa Fe - 4-Car 60' Streamlined ABS Passenger Set**  
30-67526 \$219.95

**Santa Fe - 60' Streamlined ABS Coach**  
30-67528 \$54.95

RailKing Overton Passenger Cars are the perfect complement for any 19th century steam locomotive. Configured in 3-coach sets, Overton cars feature interior detail, overhead interior lighting, intricate under-car detail, and die-cast metal 4-wheel trucks with operating metal couplers, metal wheels, and metal axles.

Designed to bring authenticity and smooth performing operation to any O Gauge layout, modelers will find no finer O Gauge value than RailKing Passenger Cars.

## Overton Features

- Each Car Measures: 10 3/4" x 2 3/8" x 3 1/8"
- Operates On O-27 Curves



**Chesapeake & Ohio - 3-Car Overton Passenger Coach Set**

30-6425 \$149.95



**Virginia & Truckee - 3-Car Overton Passenger Coach Set**

30-6424 \$149.95



**Norfolk & Western - 3-Car Overton Passenger Coach Set**

30-6427 \$149.95



**Philadelphia & Reading - 3-Car Overton Passenger Coach Set**

30-6426 \$149.95



**Union Pacific - 4-Car 60' Madison Passenger Set**

30-69091 \$219.95



**Union Pacific - 2-Car 60' Madison Combine/Diner Set**

30-69092 \$109.95



**Union Pacific - 60' Madison Coach**

30-69093 \$54.95



**New York Central - 2-Car 60' Madison Combine/Diner Set**

30-69089 \$109.95



**New York Central - 60' Madison Coach**

30-69090 \$54.95



**New York Central - 4-Car 60' Madison Passenger Set**

30-69088 \$219.95

## Madison Features

- Illuminated Interiors
- 4-Car Set Features: (1) Baggage, (2) Coaches, (1) Observation
- 2-Car Sets Feature (1) Combine, (1) Diner
- 4-Car Set Measures: 68 3/4" x 2 5/8" x 3 5/16"
- 2-Car Set Measures: 34 6/16" x 2 5/8" x 3 5/16"
- Coach Measures: 16 11/16" x 2 5/8" x 4 5/16"
- Operates On O-31 Curves



**Richmond Fredericksburg & Potomac - 2-Car 60' Madison Combine/Diner Set**

30-69098 \$109.95

**Richmond Fredericksburg & Potomac 60' Madison Coach**

30-69099 \$54.95



**Richmond Fredericksburg & Potomac - 4-Car 60' Madison Passenger Set**

30-69097 \$219.95

# Anatomy of a Premier Diesel

Premier Line engines are full O scale models, 1/48 the size of their prototypes\*. Because of this, they often require larger radius curves than comparable RailKing models. Premier engines, like the Electro-Motive Division SD35 shown here, are as detailed as we can reasonably make them, and feature a large number of added-on details. Premier engines also offer more elaborate lighting effects than RailKing models.

Look closely at any Premier Line model and you'll find a combination of superb detailing, prototype accuracy, rugged construction, and smooth, dependable operation that is unmatched by any other manufacturer.

\*European models are scaled 1:43 or 1:45 depending on prototype

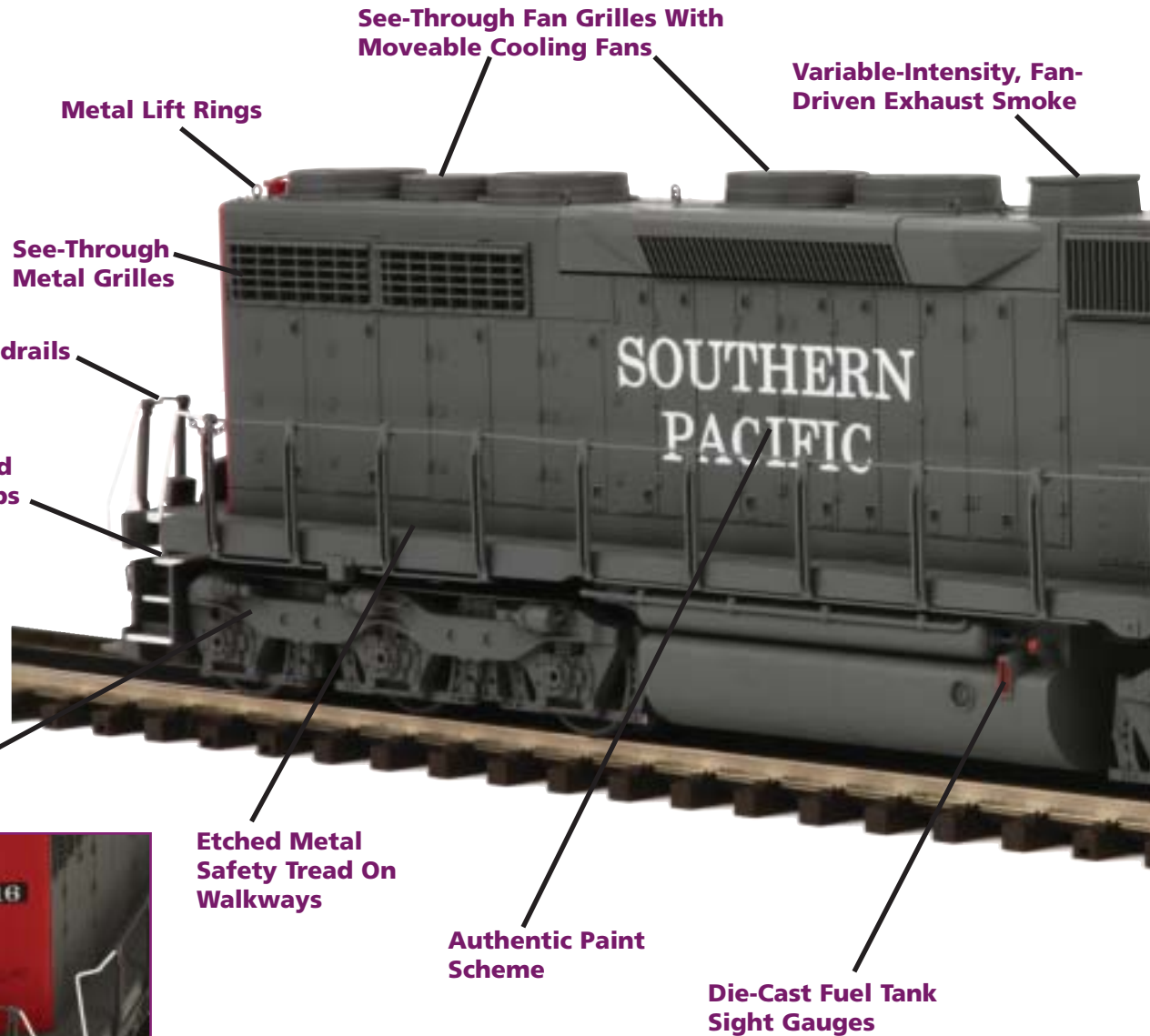

Single-unit powered Premier diesels offered in three road numbers\*

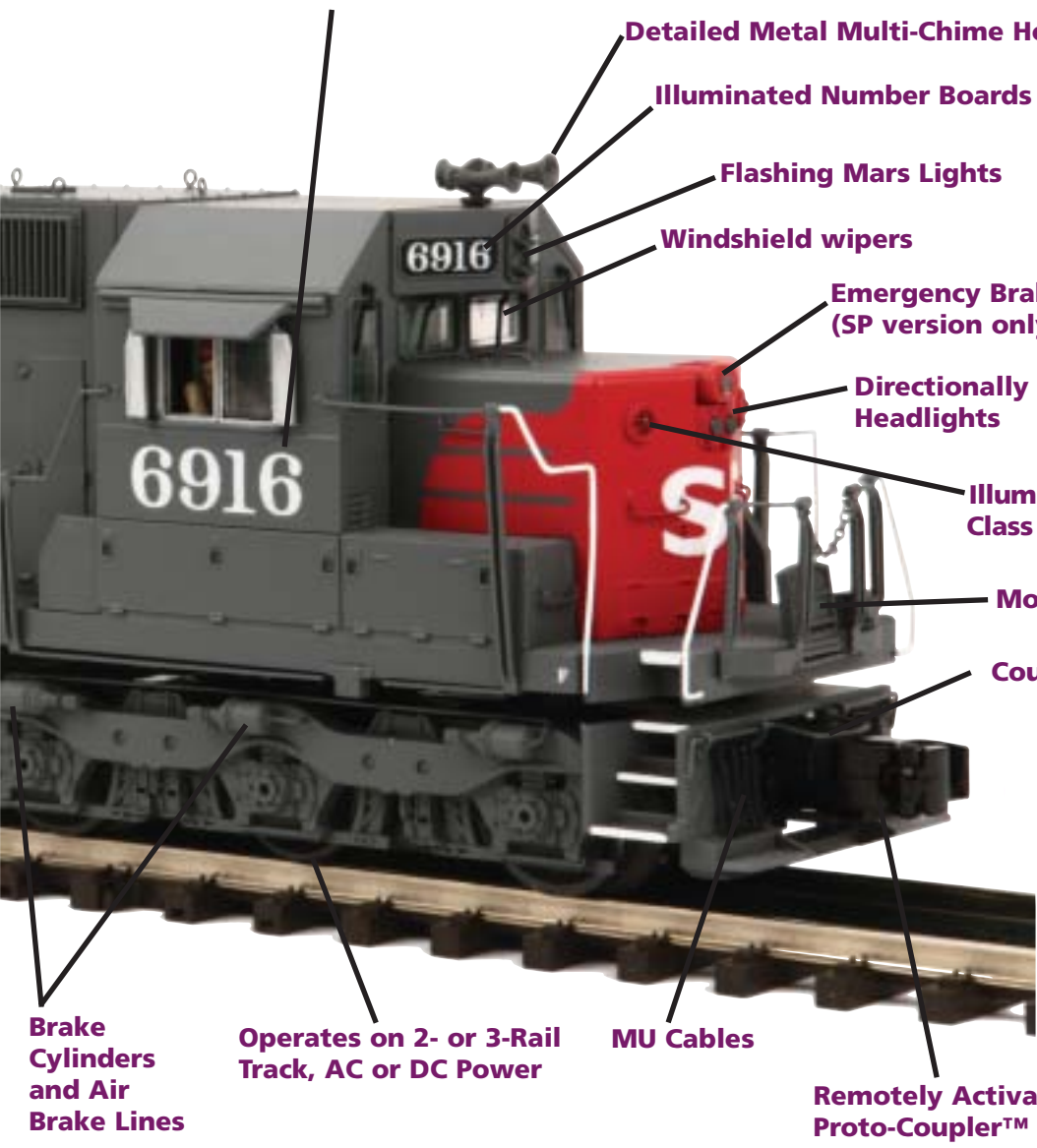

Detailed Metal Multi-Chime Horn

Illuminated Number Boards

Flashing Mars Lights

Windshield wipers

Emergency Brake Light (SP version only)

Directionally Controlled Headlights

Illuminated Class Lights

Moveable Drop Step

Coupler Lift Bar

Brake Cylinders and Air Brake Lines

Operates on 2- or 3-Rail Track, AC or DC Power

MU Cables

Remotely Activated Proto-Coupler™

# 32 PROTO-SCALE™ Proto-Scale 3-2™

Operate on 3-Rail or 2-Rail Track with AC or DC Power!

Many Premier steam and diesel engines in this catalog are equipped with Proto-Scale 3-2, a unique M.T.H. feature that allows you to run the same engine on 2-rail or 3-rail track, under AC or DC power. Engines cataloged with hi-rail wheels are intended primarily for 3-rail operators, while engines with scale wheels are aimed at 2-rail DC operators as well as 3-rail AC operators looking for more scale realism. Scale-Wheeled versions of diesels have more-realistic fixed pilots, while Hi-Rail versions have swinging pilots to negotiate smaller-radius curves.

The conversion kits listed on page 139 offer additional versatility. Each kit contains enough wheel sets for (2) power trucks. Scale wheels are polished, turned metal with scale treads and flange height, and are mounted on metal axles with one insulated side for use on 2-rail O Scale track systems. Two wheel sets in each kit contain a pre-mounted drive gear.

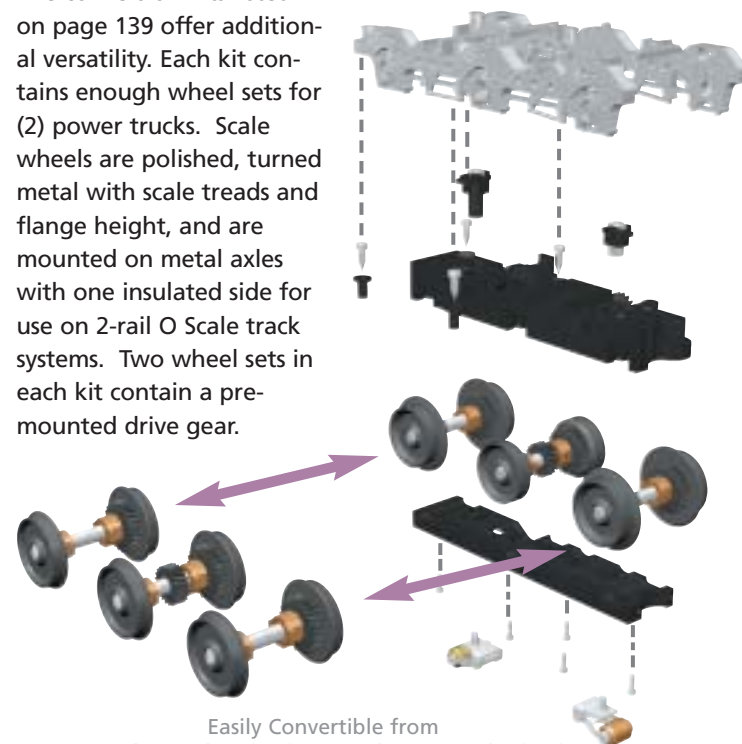

Easily Convertible from Hi-Rail to Scale Wheels OR Scale to Hi-Rail Wheels

\*Where Prototypical

# Premier Steam Engines

The locomotives pictured below were announced in previous catalogs and are currently in stock and available for delivery.

**LEARN MORE ABOUT THEM:** For more information on any M.T.H. Locomotive, search its item number on our homepage, [www.mthtrains.com](http://www.mthtrains.com).



**Canadian Pacific** - 4-6-4 Royal Hudson Steam Engine  
20-3315-1 w/Proto-Sound 2.0 \$999.95



**Norfolk & Western** - 4-8-4 J Steam Engine  
20-3363-1 w/Proto-Sound 2.0 \$1099.95



**Jersey Central** - 4-6-0 Camelback Steam Engine  
20-3356-1 w/Proto-Sound 2.0 \$899.95



**Reading** - 4-6-0 Camelback Steam Engine  
20-3359-1 w/Proto-Sound 2.0 \$899.95



**Pittsburgh Shawmut & Northern** - 2-10-0 Russian Decapod Steam Engine  
20-3310-1 w/Proto-Sound 2.0 \$999.95





**Pittsburgh & West Virginia** - 0-6-0 USRA Steam Engine  
20-3269-1 w/Proto-Sound 2.0 \$599.95



**Seaboard Air Line** - 0-6-0 USRA Steam Engine  
20-3268-1 w/Proto-Sound 2.0 \$599.95



**Western Maryland** - 2-10-0 Russian Decapod Steam Engine  
20-3311-1 w/Proto-Sound 2.0 \$999.95



**Atlantic Coast Line** - 0-6-0 USRA Steam Engine  
20-3304-1 w/Proto-Sound 2.0 \$599.95



**New York Central** - 0-6-0 USRA Steam Engine  
20-3281-1 w/Proto-Sound 2.0 \$599.95

# 4-6-2 USRA Heavy Pacific Steam Engine



## Features

- Die-Cast Metal Chassis
- Authentic Paint Scheme
- Metal Wheels and Axles
- Constant Voltage Headlight
- Die-Cast Truck Sides
- Remote Controlled Proto-Coupler™
- Engineer and Fireman Figures
- Operating Firebox Glow
- Metal Handrails and Bell
- Metal Whistle
- Operating Class Lights
- Lighted Cab Interior
- Synchronized Puffing ProtoSmoke™ System
- Operating Tender Back-up Light
- Locomotive Speed Control in Scale MPH Increments
- Die-Cast Boiler and Chassis
- Die-Cast Tender Body
- Real Coal Load
- 1:48 Scale Proportions
- Precision Flywheel-Equipped Motor
- Wireless Drawbar
- Proto-Sound 2.0 With The Digital Command System Featuring Quillable Whistle With Passenger Station Proto-Effects™
- Unit Measures:
  - 24 5/16" x 2 9/16" x 3 15/16"
- Operates On O-42 Curves



## Did You Know?

William E. Woodard, V.P. of Engineering at Lima Locomotive Works and one of the designers on the USRA Locomotive Committee, went on to inaugurate the "Super Power" concept that guided steam locomotive design from the mid-1920s to the end of the steam era.



**Santa Fe - 4-6-2 USRA Heavy Pacific Steam**  
20-3395-1 w/Proto-Sound 2.0 \$899.95

*Add a Matching Passenger Set!*  
*See Page 126*



**New York Central - 4-6-2 USRA Heavy Pacific Steam**  
20-3394-1 w/Proto-Sound 2.0 \$899.95

*Add a Matching Passenger Set!*  
*See Page 126*



**Baltimore and Ohio - 4-6-2 USRA Heavy Pacific Steam**  
20-3396-1 w/Proto-Sound 2.0 \$899.95



**Erie - 4-6-2 USRA Heavy Pacific Steam**  
20-3397-1 w/Proto-Sound 2.0 \$899.95

During World War I, Uncle Sam nationalized the railroads when they proved unequal to the task of moving massive amounts of men and materiel for the war effort. The agency that ran the trains was the United States Railroad Administration, or USRA, and one of its chief accomplishments was the creation of 12 steam engine designs that lasted for decades. According to the American Society of Mechanical Engineers, USRA locomotives were "the first successful standardization of American motive power" — and the only standard designs until the diesel era.

In the World War I period, the 4-6-2 Pacific was the favored mainline passenger engine in relatively level territory, so the USRA designs included light and heavy 4-6-2s. The heavy version, designed for trackage that allowed a heavier axle load, was similar in most major dimensions to the existing Pennsylvania K4s and Chesapeake & Ohio F-17 Pacifics. Both had been designed around 1913 and were considered powerful and fast locomotives for their time.

Only 20 government-issue heavy Pacifics were actually built, all of them going to the Erie Railroad. But like most USRA designs, the heavy Pacific was so good that a number of railroads ordered copies after government control ended. The Erie bought 11 more, and at least three of the most successful heavy Pacifics built in the 1920s were based on the USRA design: the Baltimore & Ohio P-7d "President" class, the C&O F-19, and the Southern Railway Ps-4. A survivor of the latter class resides today in the Smithsonian Institution's National Museum of American History in Washington, D.C., resplendent in the Southern's famous green livery with gold striping.

The USRA heavy Pacific returns to the Premier line for 2010, upgraded with wireless drawbar, quillable whistle, cab-to-tender deck plate, and additional details (not all details are shown in photos). Relive the days when these high-stepping Pacifics led mainline passenger runs, or their later years when they were relegated to local passenger trains and even freight service.

# 4-4-0 American Steam Engine



## Features

- Die-Cast Boiler and Tender Body
- 1:48 Scale Proportions
- Die-Cast Metal Chassis
- Authentic Paint Scheme
- Metal Wheels and Axles
- Constant Voltage Headlight
- Die-Cast Truck Sides
- Engineer and Fireman Figures
- Metal Handrails and Bell
- Metal Whistle
- Locomotive Speed Control in Scale MPH Increments
- Synchronized Puffing ProtoSmoke™ System
- Lighted Cab Interior
- Precision Flywheel-Equipped Motor
- Proto-Scale 3-2 3-Rail/2-Rail Conversion Capable
- Remote Controlled Proto-Coupler™
- Proto-Sound 2.0 With The Digital Command System Featuring Quillable Whistle With Passenger Station Proto-Effects™
- Measures: 16 ¾" x 3 ¾" x 2 ½"
- Hi-Rail Wheels Operate On O-42 Curves
- Scale Wheels Operate On 31" Radius Curves

## Did You Know?

At the Golden Spike National Historic Site, in the desert of northeastern Utah, you can see where the Golden Spike was driven and enjoy a reenactment of the ceremony, performed by accurate replicas of the Jupiter and the No. 119. And a full-sized reproduction of Leviathan completed in 2009 is currently hailed as "America's Newest Operating Steam Locomotive."

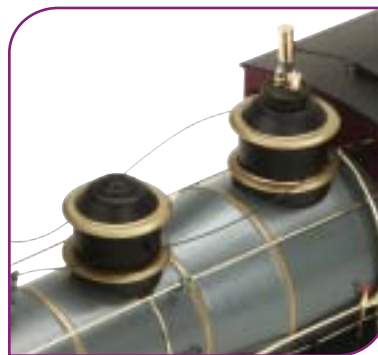



**Central Pacific Jupiter - 4-4-0 American Steam Engine**

- 20-3389-1 Hi-Rail Wheels \$699.95
- 20-3389-2 Scale Wheels \$699.95

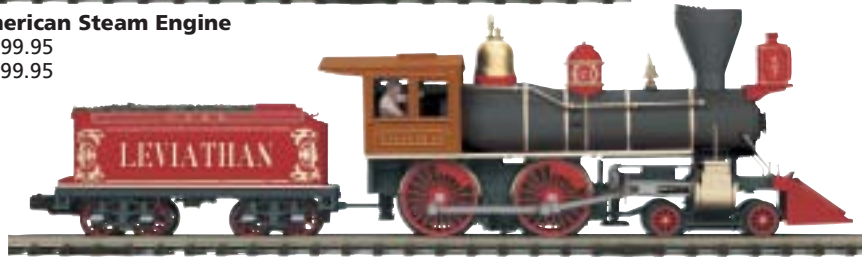

**Central Pacific Leviathan - 4-4-0 American Steam Engine**

- 20-3391-1 Hi-Rail Wheels \$699.95
- 20-3391-2 Scale Wheels \$699.95



**New York & New England - 4-4-0 American Steam Engine**

- 20-3392-1 Hi-Rail Wheels \$699.95
- 20-3392-2 Scale Wheels \$699.95



**Boston & Maine - 4-4-0 American Steam Engine**

- 20-3393-1 Hi-Rail Wheels \$699.95
- 20-3393-2 Scale Wheels \$699.95

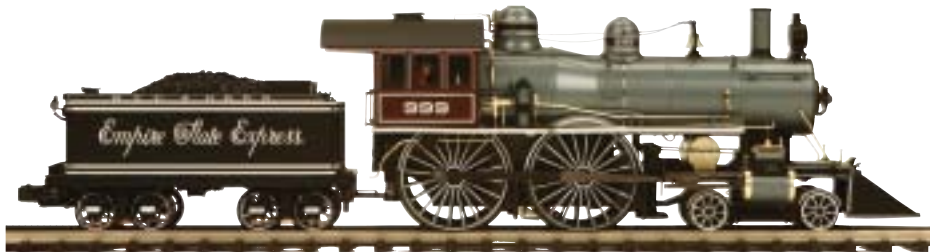

**New York Central - 4-4-0 Empire State Express Steam Engine**

- 20-3385-1 86" Hi-Rail Wheels \$699.95
- 20-3385-2 86" Scale Wheels \$699.95



**New York Central - 4-4-0 Empire State Express Steam Engine**

- 20-3386-1 70" Hi-Rail Wheels \$699.95
- 20-3386-2 70" Scale Wheels \$699.95

*Add a Matching Passenger Set!  
See Page 128 & 129*

Just a few years after the Civil War divided the country, the transcontinental railroad united it. At Promontory Summit, Utah Territory, the Golden Spike was driven and two brightly painted locomotives touched cowcatchers: the Central Pacific's Jupiter and the Union Pacific's No. 119. At 12:47 p.m. on May 10, 1869, the telegraphed message "DONE!" signaled an entire nation that the Pacific Railroad had joined the east and west coasts. As the former Union and Confederacy united in celebration, cannons boomed, firecrackers exploded, and the Liberty Bell and countless other bells pealed across the country. Chicago hosted a seven-mile-long parade. A coast-to-coast trip that had formerly taken months and cost over \$1000 was suddenly reduced to a week, including stops, at a cost of \$150 first class. The trip was said to be so fast "that you don't even have time to take a bath."

The locomotives that united the nation at Promontory Summit were, naturally, 4-4-0 Americans. The 4-4-0 was the passenger engine of the last half of the nineteenth century. Subject of dozens of Currier & Ives lithographs, the 4-4-0 carried the nation westward, transported millions of Americans out of their home towns for the first time, and hauled a good deal of freight as well. Beautifully colored and pinstriped in mid-century, and somewhat less colorfully decorated toward the end of the 1800s, the 4-4-0 steam engine became a symbol of U.S. railroading — which is why this wheel arrangement was named the "American."

Continuing with our line of Premier nineteenth-century locomotives, M.T.H. announces replicas of Golden Spike engine Jupiter and Central Pacific sister engine Leviathan, in the glorious decoration they wore in the 1860s, as well as versions of our 4-4-0 in less flashy 1890s-era paint schemes. Also offered is the hot-rod 4-4-0 "999," the first locomotive to break 100 mph (at least according to observers in 1893). These Americans are fully outfitted with the industry-leading smoke, slow-speed capability, and CD-quality sound of Proto-Sound 2.0, and are available in both scale-wheeled and hi-rail versions. Each is equipped with Proto-Scale 3-2™, which allows the user to quickly convert either version for operation on 2- or 3-rail track.

# LMS Duchess Class Steam Engine

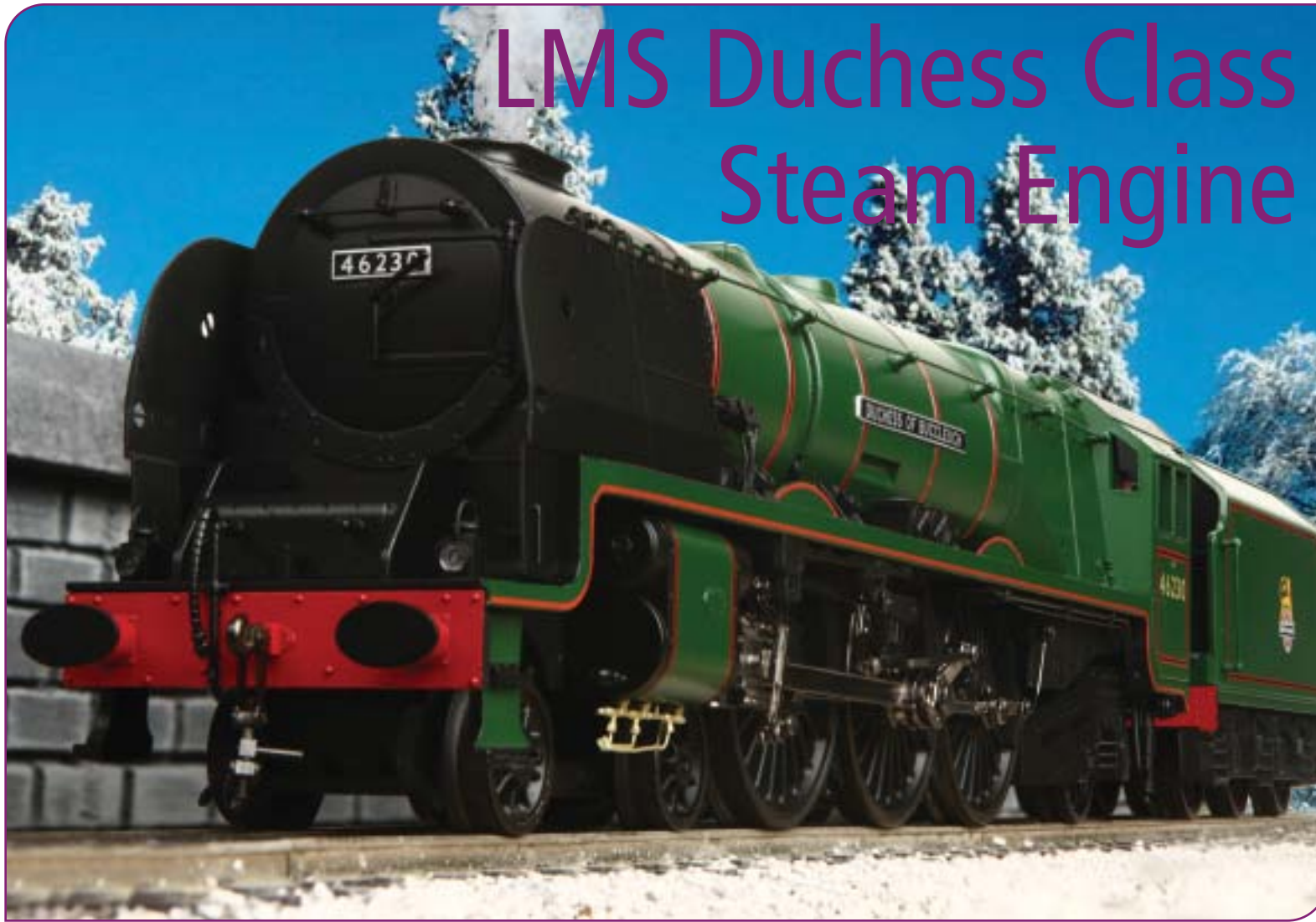

## Features

- Die-Cast Boiler and Tender Body
- 1:43.5 Scale Proportions
- Die-Cast Metal Chassis
- Authentic Paint Scheme
- Metal Wheels and Axles
- Constant Voltage Headlight
- Die-Cast Truck Sides
- Precision Flywheel-Equipped Motor
- Remote Controlled Proto-Coupler™ ; A Scale European-Style Coupler and Ace Trains-Compatible Coupler Are Also Supplied
- Engineer and Fireman Figures
- Operating Firebox Glow
- Metal Handrails
- Metal Whistle
- Lighted Cab Interior
- Locomotive Speed Control in Scale MPH Increments
- Proto-Scale 3-2™ 3-Rail/2-Rail Conversion Capable
- Synchronized Puffing ProtoSmoke™ System
- Wireless Drawbar
- Proto-Sound 2.0 With The Digital Command System Featuring Passenger Station Proto-Effects™
- Unit Measures: 23 7/16" x 2 11/16" x 4 5/16"
- Hi-Rail Wheels Operate On O-54 Curves
- Scale Wheels Operate On 42" Radius Curves



## Did You Know?

The Railways Act of 1921 mandated the merger of Britain's myriad railways into four companies in 1923: the London, Midland & Scottish Railway (LMS), the London & North Eastern Railway (LNER), the Great Western Railway (GWR), and the Southern Railway (SR). In 1948, these four companies were nationalized to form British Railways.



**British Railways - Duchess Class Duchess of Abercorn Steam Engine**

- 20-3369-1 Hi-Rail Wheels \$1199.95
- 20-3369-2 Scale Wheels \$1199.95



**London, Midland and Scottish Railway - Duchess Class Duchess of Sutherland Steam Engine**

- 20-3368-1 Hi-Rail Wheels \$1199.95
- 20-3368-2 Scale Wheels \$1199.95



**British Railways - Duchess Class Duchess of Buccleuch Steam Engine**

- 20-3367-1 Hi-Rail Wheels \$1199.95
- 20-3367-2 Scale Wheels \$1199.95



**British Railways - Duchess Class Duchess of Atholl Steam Engine**

- 20-3371-1 Hi-Rail Wheels \$1199.95
- 20-3371-2 Scale Wheels \$1199.95



**London, Midland and Scottish Railway - Duchess Class Duchess of Montrose Steam Engine**

- 20-3370-1 Hi-Rail Wheels \$1199.95
- 20-3370-2 Scale Wheels \$1199.95

**Add a Set of  
British  
Passenger Cars!**  
See Page 127

In the years before World War II, Londoners had at least two ways to get to Scotland in style. From Kings Cross, one could speed up the East Coast main to Edinburgh on the LNER's *Flying Scotsman*, behind one of Nigel Gresley's handsome Pacifics — perhaps a streamlined A4 or maybe an older, apple-green A3. Or one could depart instead from Euston station on the LMS and fly northward to Glasgow on the *Coronation Scot* or the *Royal Scot* behind the most powerful steam locomotives in the land, William Stanier's Duchess Class (also known as Princess Coronation Class) 4-6-2's.

While the London, Midland & Scottish was the largest of England's four major railways, its motive power department had been hobbled by internal rivalries, a legacy from the several railways that combined in 1923 to form the LMS. Locomotive designer William Stanier, with a direct line to the president of the railroad, was hired in 1932 to resolve those problems. He brought the LMS from an also-ran to a leader in British engine design. Stanier's crowning achievement was the four-cylinder Duchess Class Pacifics, built from 1937-1948. In contrast with American designers, who generally shunned engines with more than two cylinders as being too hard to maintain, Europeans often used three or four cylinders to produce a more balanced engine that was easier on the track. In Stanier's design, the Walschaert's valve gear on the outside cylinders also drove the valves on the inside cylinders, located within the frame, through a set of rocker arms.

To Stanier's chagrin, the first examples of the class wore a streamlined shroud to match the *Coronation Scot* train they were designed to haul. Various described as an upside-down bathtub or a sausage, the streamlining was omitted on later engines in the class, revealing muscular lines that looked particularly handsome in LMS crimson lake livery with gilt lining. In the British tradition, all of these passenger engines were named. No. 6234, *Duchess of Abercorn*, set an all-time record for British steam when she recorded 3,300 horsepower in February 1939.

Relive the glory days of LMS express passenger service with our superbly detailed Duchess Class Pacific, complete with synchronized puffing smoke with a correct eight chuffs per driver revolution, and station sounds for the appropriate British name trains..

**Learn more about it:** Search on the item number for this model on the M.T.H. Web site for links to additional information on this locomotive and prototype British railroading.

# 2-8-8-2 Great Northern R-2 Steam Engine



## Engine Features

- Die-Cast Boiler and Tender Body
- 1:48 Scale Proportions
- Die-Cast Metal Chassis
- Authentic Paint Scheme
- Metal Wheels and Axles
- Constant Voltage Headlight
- Die-Cast Truck Sides
- Precision Flywheel-Equipped Motor
- Remote Controlled Proto-Coupler
- Engineer and Fireman Figures
- Operating Firebox Glow
- Metal Handrails and Bell
- Metal Whistle
- Lighted Cab Interior
- Locomotive Speed Control In Scale MPH Increments
- Synchronized Puffing ProtoSmoke System
- Wireless Drawbar
- Proto-Sound 2.0 With The Digital Command System Featuring Quillable Whistle With Freight Yard Proto-Effects
- Unit Measures:  
30" x 2 3/4" x 4 1/4"
- Operates On O-72 Curves

## Set Contents

- R-2 Steam Locomotive
- 5-Car Ore Set
- CA-1 Caboose

## Car Features

- Intricately Detailed Durable ABS Body
- Metal Wheels and Axles
- Die-Cast 4-Wheel Trucks
- Operating Die-Cast Metal Couplers
- Colorful, Attractive Paint Schemes
- Brake Wheels
- 1:48 Scale Dimensions







**Great Northern - 2-8-8-2 R-2 Steam Engine**  
20-3384-1 w/Proto-Sound 2.0 \$1399.95

On James J. Hill's transcontinental railroad, the massive R-2 was king of the road. Although often lumped with the "robber barons" of the late nineteenth century, Hill built the Great Northern Railway without the government land grants and political shenanigans used by many of his contemporaries. One of his crowning achievements, according to author Burton Folsom, was his conquest of the Rocky Mountains "by finding the legendary Marias Pass. Lewis and Clark had described a low pass through the Rockies back in 1805; but later no one seemed to know whether it really existed or, if it did, where it was. Hill wanted the best gradient so much that he hired a man to spend months searching western Montana for this legendary pass. He did in fact find it, and the ecstatic Hill shortened his route by almost 100 miles."

Decades later, it was the Marias Pass that the R-2 was designed to roam, hustling freight over the easiest traverse of the Rockies enjoyed by any of the northern transcontinental railroads. Assembled in the Great Northern's own shops in 1929 and 1930, the R-2s benefited from the "superpower" steam technology developed in the late 1920s; they were the largest 2-8-8-2s ever built and exerted more tractive effort (pulling force) than a Union Pacific Big Boy or a DM&IR Yellowstone. In fast freight service between Whitefish and Havre, Montana, the R-2s could handle trains of almost any length, limited only by the strength of couplers and draft gear and the response time of the air brake system. (As train length increases, it takes longer for a brake application by the engineer to reach the final car on the train.)

Hard use during World War II led to cracks in many R-2 boilers, and all 16 engines in the class received new ALCo boilers in 1947-48. Soon after, F-unit diesels replaced the articulateds on the Marias Pass route, and the R-2s moved east to haul iron ore from Minnesota's mines. By 1958, when the final R-2s were retired, the Great Northern and the Norfolk & Western were the last American railroads to roster articulated power.

The R-2 returns to the Premier lineup, upgraded with additional details, wireless drawbar, quillable whistle, and cab-to-tender deck plate. Featuring authentic articulated engine sounds and pulling power to rival the prototype, our model captures all the signature Great Northern details — including pilot-mounted headlight, massive smokebox-mounted air pumps, all-weather cab, Vanderbilt-style oil tender, and Belpaire firebox.



**Great Northern - 2-8-8-2 R-2 Steam Engine Freight Set**  
20-3387-1 w/Proto-Sound 2.0 \$1499.95

# Bavarian Class S 3/6 Express Locomotive



## Features

- Authentic Paint Scheme
- Metal Wheels and Axles
- Constant Voltage Headlights
- Die-Cast Truck Sides
- Remote Controlled Proto-Coupler™; A Scale European-Style Coupler and Ace Trains-Compatible Coupler Are Also Supplied
- Sprung Buffers
- Engineer and Fireman Figures
- Operating Firebox Glow
- Metal Handrails
- Metal Whistle
- Lighted Cab Interior
- Synchronized Puffing ProtoSmoke™ System
- Operating Tender Back-up Lights
- Locomotive Speed Control In Scale MPH Increments
- Die-Cast Boiler and Chassis
- Die-Cast Tender Body
- Precision Flywheel-Equipped Motor
- Proto-Scale 3-2™ 3-Rail/2-Rail Conversion Capable
- Wireless Drawbar
- 1:43.5 Scale Proportions
- Proto-Sound 2.0 With The Digital Command System Featuring Quillable Whistle With Passenger Station Proto-Effects™
- Hi-Rail Wheels Operate On O-54 Curves
- Scale Wheels Operate On 42" Radius Curves



## Did You Know?

As reparations after World War I, three S 3/6 steamers went to Belgium and 16 were given to France.



**NEW TOOLING!** **KBayStsB** - Bavarian S 3/6 Express Steam Locomotive (Blue with Black Wheels)  
 20-3398-1 Hi-Rail Wheels \$1195.95  
 20-3398-2 Scale Wheels \$1195.95



**NEW TOOLING!** **KBayStsB** - Bavarian S 3/6 Express Steam Locomotive (Green with Red Wheels)  
 20-3399-1 Hi-Rail Wheels \$1195.95  
 20-3399-2 Scale Wheels \$1195.95



**NEW TOOLING!** **KBayStsB** - Bavarian S 3/6 Express Steam Locomotive (Green with Black Wheels)  
 20-3400-1 Hi-Rail Wheels \$1195.95  
 20-3400-2 Scale Wheels \$1195.95



**NEW TOOLING!** **KBayStsB** - German BR18 Steam Locomotive (Black with Red Wheels)  
 20-3401-1 Hi-Rail Wheels \$1195.95  
 20-3401-2 Scale Wheels \$1195.95

In 1871, Germany became the last major European country to unify, combining a hodgepodge of kingdoms and duchies. But it would be another 50 years before the 11 provincial railroads were nationalized into the German Imperial Railway Company (DRG, with the logo DR). In the meantime, each road continued to develop its own locomotive designs. One of the best was the Class S 3/6 of the Royal Bavarian State Railways (abbreviated *K. Bay. Sts. B.* in German)

Regarded by European enthusiasts as one of the most beautiful and successful of all steam locomotives, the Class S 3/6 ("S" for *schnellzuglok*, indicating an express passenger engine, and 3/6 to indicate 3 powered axles, 6 axles total) was built by A G Maffei beginning in 1908 and showcased the talent of that firm's chief designer, Heinrich Leppla. The stylish conical smokebox front of the S 3/6 was complemented by a handsome holly green paint scheme. Two inboard high pressure cylinders and two outboard low pressure cylinders drove the center axle. The S 3/6 was one of the first European engines to follow the American practice of casting the cylinders and smoke box saddle as one huge casting, which gave the engine a very distinctive look. The majority of the class were fitted with 74" drivers to conquer Bavaria's mountainous terrain. A smaller group of S 3/6 engines, however, was built with 79" drivers for high-speed service on flatter routes and acquired the nickname "High Steppers."

After nationalization in 1920, the engines were painted in the black and red Deutsche Reichsbahn (DR) scheme and became classes 18.3 through 18.5. While the DR intended to develop new standard engines of its own, the S 3/6 was deemed so good that the DR continued to order new engines of this 1908 design through 1931. The relatively light axle loading of the S 3/6, 18 tons, was also a plus, as the DR was behind schedule in upgrading main lines to its new 20-ton standard. So successful were the Bavarian Pacifics that they were chosen over more modern power to lead the glorious cream and blue *Rheingold Express* on part of its scenic route down the Rhine Valley, both before and after WWII. An S 3/6 could also be seen often on the point of the *Orient Express*.

Even after World War II, the aging engines continued to be great performers. A large number were modernized with new boilers and became the most economical steamers on the Deutsche Bundesbahn (DB), the new name for West Germany's railroad system. By the 1960s however, the S 3/6 class, which originally numbered 159 locomotives, had been retired, with a number of engines preserved in museums or in operating condition. New for 2010, M.T.H. introduces this superbly detailed, smooth running model of one of Europe's favorite steam engines, offered in original Royal Bavarian paint schemes as well as post-nationalization black and red.

# EST Era II Class 241A Steam Engine



## Features

- Authentic Paint Scheme
- Metal Wheels and Axles
- Constant Voltage Headlights
- Die-Cast Truck Sides
- Remote Controlled Proto-Coupler™; A Scale European-Style Coupler and Ace Trains-Compatible Coupler Are Also Supplied
- Sprung Buffers
- Engineer and Fireman Figures
- Operating Firebox Glow
- Metal Handrails
- Metal Whistle
- Lighted Cab Interior
- Synchronized Puffing ProtoSmoke™ System
- Operating Tender Back-up Light
- Locomotive Speed Control In Scale MPH Increments
- Die-Cast Boiler and Chassis
- Die-Cast Tender Body
- Precision Flywheel-Equipped Motor
- Proto-Scale 3-2™ 3-Rail/2-Rail Conversion Capable
- Wireless Drawbar
- Proto-Sound 2.0 With The Digital Command System Featuring Quillable Whistle With Passenger Station Proto-Effects™
- Hi-Rail Wheels Operate On O-54 Curves
- Scale Wheels Operate On 54" Radius Curves





**NEW TOOLING!** EST - EST Era II Class 241A Steam Engine (Gray)

20-3402-1	Hi-Rail Wheels	\$1195.95
20-3402-2	Scale Wheels	\$1195.95



**NEW TOOLING!** SCNF - EST Era II Class 241A Steam Engine (1931 Black)

20-3406-1	Hi-Rail Wheels	\$1195.95
20-3406-2	Scale Wheels	\$1195.95



**NEW TOOLING!** SCNF - EST Era II Class 241A Steam Engine (1945 Green/Black)

20-3404-1	Hi-Rail Wheels	\$1195.95
20-3404-2	Scale Wheels	\$1195.95



**NEW TOOLING!** EST - EST Era II Class 241A Steam Engine (1932 Green/Black)

20-3405-1	Hi-Rail Wheels	\$1195.95
20-3405-2	Scale Wheels	\$1195.95



**NEW TOOLING!** SCNF - EST Era II Class 241A Steam Engine (1936 Black)

20-3403-1	Hi-Rail Wheels	\$1195.95
20-3403-2	Scale Wheels	\$1195.95

The 4-8-2 wheel arrangement — 241 in French parlance, which counts axles rather than wheels — represented the largest regular-production passenger locomotives ever to serve in France. The first of the type were 41 engines of class 241A, built starting in 1925 for the Chemins de Fer de l'Est (Eastern Railway), which ran due east from Paris to cities such as Nancy and Strasbourg.

Like most French express engines, the 241A was a de Glehn compound, a design that would seem frighteningly complex to engineers or shop crews anywhere outside of France. To make more efficient use of steam, a compound engine uses steam twice. Boiler steam is fed to high-pressure cylinders and then exhausted into one or two larger, low-pressure cylinders to work again before going up the stack. Following in the footsteps of their countryman Anatole Mallet, one of the earliest advocates of compounding, Alfred de Glehn and Gaston du Bousquet at the end of the nineteenth century designed a four-cylinder compound system, with high-pressure cylinders outside the frames and low-pressure cylinders inside the frames.

The *chauffeur* of a de Glehn compound had five working possibilities: normal compounding; four-cylinder simple operation for starting (high-pressure boiler steam to all cylinders); compounding with some additional high-pressure steam to the low-pressure cylinders, for extra power on hills; and high-pressure steam to only the low-pressure or only the high-pressure cylinders, to limp home in case of mechanical failure. All of this was controlled by two throttles (one for each pair of cylinders), two reverse levers, and an intercepting valve to manage the flow of steam from high-pressure to low-pressure cylinders. In the 241A, an additional task was controlling the six-jet blast-pipe in the smokebox, which varied the firebox draft. In most countries, shop crews would have declared the de Glehn system a maintenance nightmare and engineers would have found it horribly complicated. But French shop crews appeared to thrive on its complexity. And French *chauffeurs*, trained as *mécaniciens* (engine mechanics) rather than firemen as in other countries, prided themselves on the throttle artistry needed to achieve the wonderful performance that a de Glehn compound could deliver.

The original 241As worked well enough that 49 more were ordered for the Chemins de Fer de l'État (State Railways). A series of trials in 1933, however, showed the 241A was inferior to the smaller, famous Pacifics of the Paris-Orleans Railway, as rebuilt by André Chapelon, "the genius of French steam." As a result, the 241As — like several other classes of French steamers — were rebuilt along Chapelon lines, resulting in a 40% increase in horsepower with a 15% decrease in coal consumption. The rebuilt engines served the Est, Etat, and later the nationalized French railways (SNCF) into the 1960s. At least two are preserved: the prototype, No. 241A1, in the Cité du Train in Mulhouse, France, and 241A65, the largest hand-fired, operating steam engine in Europe (which barnstormed across Switzerland this past summer, doubleheading with postwar French steamer 241P17). New for 2010, M.T.H. introduces our superdetailed model of this premier French steamer — complete with French passenger station announcements and crew talk, and authentic French whistle — as it appeared in Era II after Chapelon had worked his magic.



## Features

- Intricately Detailed Die-Cast Body
- Directionally Controlled Headlights
- Metal Wheels, Axles and Gears
- (2) Remotely Controlled Proto-Couplers™ ; Scale European-Style Couplers and Ace Trains-Compatible Couplers Are Also Supplied
- Colorful Paint Scheme
- Metal Chassis
- Metal Handrails and Horn
- Locomotive Speed Control In Scale MPH Increments
- Lighted Cab Interiors
- Metal Body Side Grilles
- Proto-Scale 3-2 3-Rail/2-Rail Conversion Capable
- (2) Precision Flywheel-Equipped Motors
- (2) Engineer Cab Figures
- Proto-Sound 2.0 With The Digital Command System Featuring Passenger Station Proto-Effects™
- Unit Measures:  
16 1/2" x 2 1/2" x 3 3/4"
- Hi-Rail Wheels Operate on O-72 Curves
- Scale Wheels Operate on 54" Radius Curves

### Did You Know?

The Gotthard Base Tunnel, currently under construction, will bore through the Alps at nearly ground level, almost 2000 feet below the existing Gotthard Tunnel. The new high-speed route will feature the world's longest tunnel (35.4 miles) when it opens around 2018.

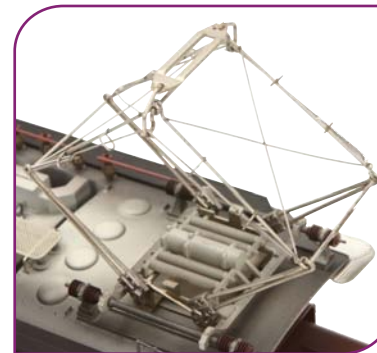

In a country famous for mountain railroading, the Gotthard route is the greatest challenge, the one by which the Swiss Federal Railways measures its locomotives. Constructed at a cost of more than 200 lives, the Gotthard line snakes its way around spiral tunnels, across more than a thousand bridges and open passages, and through narrow mountain valleys, culminating in a 2.6% climb to the 9-mile-long Goddard Tunnel — the longest in the world when it was opened in 1882. The Gotthard was the stomping ground for the 2-10-0 "Elephants," the largest steam engines ever used in Switzerland. But when the decision was made to electrify the route, the Elephants were replaced by Crocodiles.

To conquer the Gotthard's tight turns and steep grades, Swiss Locomotive and Machine Works (SLM) designed a freight locomotive in three articulated sections: a double-ended center section housing two engineer's stations, twin pantographs, and the huge high voltage transformer; and two end sections, each with two electric

motors powering a single jackshaft that transmitted power to the 53" drivers, using steam-locomotive-type drive rods. The jackshaft drive was dictated by the motors available at the time, which were too large to be truck-mounted as in later designs. The nickname "crocodile" (krokodil in German) arose from the engine's long articulated "snouts."

In the 33 first-generation engines built in 1919-21, the powered jackshaft drove a main rod that was connected to both the first set of drivers and a second idler jackshaft. The 18 second-generation crocodiles, built in 1925-26, used a simpler arrangement with the powered jackshaft driving a main rod connected to the third set of drivers. In Swiss parlance, the two generations of engines were designated Ce 6/8" and Ce 6/8'" (C for their speed range, maximum 40 mph ("A" being the fastest); e for electric; 6 indicating 6 driven axles; 8 signifying 8 axles total). Many were upgraded in the 1940s and '50s, raising their top speed to 47 mph and changing their class

designation to Be 6/8. All crocodiles were delivered in brown paint, but many were later repainted green. Initial practice was to run with both pantographs raised, but some engines were later refitted with improved pans that allowed single-pantograph operation. The hugely successful Crocodiles ruled the Gotthard route into the 1950s, when they were displaced by newer power. Many worked into the 1970s on less strenuous routes and switching, and several have been preserved.

For American modelers, the Crocodile is perhaps the single most recognizable European locomotive, having been imported as a Märklin model in several scales since the 1930s. Like the Lionel Santa Fe F3, the Märklin HO Crocodile was a top of the line model that many boys of the 1950s and '60s dreamed of, but few actually owned. If you were one of those boys (or even if you weren't), this new Premier model offers the chance to own the most detailed, smoothest running O gauge model of this iconic mountain goat ever made, available in the original, as-built dual jackshaft version.



**Tuscan** - Swiss Crocodile Electric w/Proto Sound 2.0

20-5637-1	Hi-Rail Wheels	\$899.95
20-5637-2	Scale Wheels	\$899.95

**Dark Green** - Swiss Crocodile Electric w/Proto Sound 2.0

20-5638-1	Hi-Rail Wheels	\$899.95
20-5638-2	Scale Wheels	\$899.95



# EMD F3 A-B-A



## Features

- Directionally Controlled Headlights
- Intricately Detailed ABS Bodies
- Metal Wheels, Axles and Gears
- Die-Cast Truck Sides, Pilots and Fuel Tank
- (2) Remotely Controlled Proto-Couplers™
- Colorful Paint Scheme
- Metal Chassis
- Metal Handrails and Horn
- (2) Precision Flywheel-Equipped Motors In Each A Unit
- Locomotive Speed Control In Scale MPH Increments
- Lighted Cab Interiors
- Illuminated Number Boards
- Lighted Front Marker Lights
- Lighted Rear Marker Lights
- (2) Engineer Cab Figures In Each A Unit
- Spinning Roof Fans
- Metal Body Side Grilles
- (2) Operating Smoke Units
- Proto-Sound 2.0 With The Digital Command System Featuring Passenger Station or Freight Yard Proto-Effects™
- Unit Measures:
  - 40 1/4" x 2 5/8" x 3 3/4"
- Operates On O-31 Curves

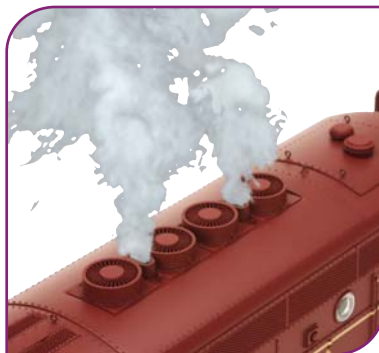





**Northern Pacific - F3 A-B-A Diesel Set**  
 20-20045-1 w/Proto-Sound 2.0 \$699.95  
 20-20045-3 Non-Powered B-Unit \$159.95



**Pennsylvania - F3 A-B-A Diesel Set**  
 20-20042-1 w/Proto-Sound 2.0 \$699.95  
 20-20042-3 Non-Powered B-Unit \$159.95



**Jersey Central - F3 A-B-A Diesel Set**  
 20-20043-1 w/Proto-Sound 2.0 \$699.95  
 20-20043-3 Non-Powered B-Unit \$159.95



**Southern - F3 A-B-A Diesel Set**  
 20-20044-1 w/Proto-Sound 2.0 \$699.95  
 20-20044-3 Non-Powered B-Unit \$159.95



**Santa Fe (Warbonnet) - F3 A-B-A Diesel Set**  
 20-20046-1 w/Proto-Sound 2.0 \$699.95  
 20-20046-3 Non-Powered B-Unit \$159.95

**PLATED STAINLESS  
 SIDE PANELS,  
 PER PROTOTYPE**      **ADD A MATCHING PASSENGER SET  
 SEE PAGE 127**

From 1942-1945, Electro Motive Division's F-unit was the only road freight diesel built in America. While the War Production Board limited competitors Alco and Baldwin to diesel switcher and steam locomotive production during World War II, EMD's 1,350 hp FT became a runaway best-seller. By war's end, Electro Motive had a lead over its competitors that would last until they closed their doors. With production restrictions lifted and the U.S. economy humming with pent-up demand, railroads clamored for new diesels to replace a steam fleet exhausted by wartime traffic. In July 1946, EMD introduced a new model F-unit, the F3. Horsepower was upgraded to 1,500 and lessons learned on the FT gave the F3 better reliability and lower maintenance. Under the hood throbbed an improved 567-series V-12 engine. With 567 cubic inches of displacement per cylinder, this same engine would power virtually the entire first generation of EMD diesel locomotives.

The F3 hit the market in an era when almost every boy in America wanted toy trains for Christmas, and F3 models quickly became a hot topic in letters to Santa. Such was the desire of railroads for publicity that Lionel® convinced the Santa Fe, the New York Central, and EMD to share the tooling costs for its top-of-the line F3. Even today, half a century later, the Santa Fe F-unit remains an icon of railroading to the American public.

Capture the excitement of the first-generation diesel era with this full-scale Premier model. With four flywheel-equipped motors, the M.T.H. F3 duplicates the bulldog tenacity of its prototype. Proto-Sound 2.0 offers authentic EMD 567 prime mover sounds, a first-generation diesel horn and bell, crew sounds, passenger station or freight yard sounds, adjustable smoke volume, and the ability to maintain any speed down to 3 scale miles per hour. Our model features the see-through "chicken wire" screens and rectangular rooftop dynamic brake grilles that characterize most F3s, as well as a host of added-on details — including legible builder's plates, grab irons, multiple-unit hoses, rooftop lift rings, see-through rooftop fans, steam generator exhaust stack (for passenger car heating), windshield wipers, and trucks with separately-applied spring hangers, brake cylinders, and air pipes.



# GE Genesis Diesel Engine

## Features

- Directionally Controlled Headlights
- Intricately Detailed ABS Body
- Metal Wheels, Axles and Gears
- Die-Cast Truck Sides, Pilots and Fuel Tank
- (2) Remotely Controlled Proto-Couplers™
- (2) Precision Flywheel-Equipped Motors
- Lighted Cab Interior
- Illuminated Number Board
- Lighted Marker Lights
- (2) Engineer Cab Figures
- Spinning Roof Fans
- Metal Body Side Grilles
- Proto-Scale 3-2™ 3-Rail/2-Rail Conversion Capable
- Operating Ditch Lights
- Operating Smoke Unit
- Locomotive Speed Control In Scale MPH Increments
- Proto-Sound 2.0 With The Digital Command System Featuring Passenger Station Proto-Effects™
- Unit Measures:  
18 1/2" x 2 1/2" x 3 3/4"
- Operates On O-31 Curves



**POWERED UNITS  
AVAILABLE IN THREE  
ROAD NUMBERS\***

\*Where Prototypical



**Amtrak Phase III - Genesis Diesel Engine**  
 20-2722-1 w/Proto-Sound 2.0 \$429.95  
 20-2722-3 Non-Powered \$199.95

**ADD A MATCHING PASSENGER SET  
 SEE PAGE 126**



**Amtrak Phase IV - Genesis Diesel Engine**  
 20-2723-1 w/Proto-Sound 2.0 \$429.95  
 20-2723-3 Non-Powered \$199.95

**ADD A MATCHING PASSENGER SET  
 SEE PAGE 126**



**VIA Canada - Genesis Diesel Engine**  
 20-2725-1 w/Proto-Sound 2.0 \$429.95  
 20-2725-3 Non-Powered \$199.95



**New Haven - Genesis Diesel Engine**  
 20-2800-1 w/Proto-Sound 2.0 \$429.95  
 20-2800-3 Non-Powered \$199.95

By the late 1980's, Amtrak was searching for a replacement for its outdated and aging fleet of F40PH and GP40 diesels. Wary of getting more locomotives that were really designed for freight operation, Amtrak searched for a new, lightweight, high-tech alternative. General Electric provided Amtrak with an answer with its unveiling of the "Genesis." Featuring a monocoque frame, advanced electronics, and special environmental and safety features, the Genesis represents the state-of-the-art in U.S. passenger diesels.

While GE officially designated these engines as model AMD-103 (for Amtrak Diesel-103 mph), they are popularly called the Genesis engines because they represent an entirely new stage in passenger locomotive technology. Forty-four of these 4,000 hp engines, numbered 800-843, were delivered between April and December 1993.

The M.T.H. Premier Line Genesis is as state-of-the-art as the original. Our scale reproduction of the Genesis prototype brings you everything you have come to expect from M.T.H. diesels, including the standard features listed.

# EMD GP35 Diesel



## Features

- Directionally Controlled Headlights
- Intricately Detailed ABS Body
- Metal Wheels, Axles and Gears
- Die-Cast Truck Sides, Pilots and Fuel Tank
- Colorful Paint Scheme
- Metal Chassis
- Metal Handrails and Horn
- (2) Precision Flywheel-Equipped Motors
- Locomotive Speed Control In Scale MPH Increments
- Proto-Scale 3-2™ 3-Rail/2-Rail Conversion Capable
- Lighted Cab Interior
- Illuminated Number Boards
- Lighted Marker Lights
- (2) Engineer Cab Figures
- Moveable Roof Fan Blades
- Metal Body Side Grilles
- Operating Smoke Unit
- Proto-Sound 2.0 With The Digital Command System Featuring Freight Yard Proto-Effects™
- Unit Measures:  
14 3/4" x 2 1/2" x 4 5/16"
- Hi-Rail Wheels Operate on O-42 Curves
- Scale Wheels Operate On 31" Radius Curves and Have Fixed Pilots



**POWERED UNITS  
AVAILABLE IN THREE  
ROAD NUMBERS\***

\*Where Prototypical



<b>CP Rail - GP35 Diesel Engine</b>		
20-20014-1	Hi-Rail Wheels	\$429.95
20-20014-2	Scale Wheels	\$449.95
20-20014-3	Non-Powered	\$199.95



<b>Santa Fe - GP35 Diesel Engine</b>		
20-20015-1	Hi-Rail Wheels	\$429.95
20-20015-2	Scale Wheels	\$449.95
20-20015-3	Non-Powered	\$199.95



<b>Western Maryland - GP35 Diesel Engine</b>		
20-20016-1	Hi-Rail Wheels	\$429.95
20-20016-2	Scale Wheels	\$449.95
20-20016-3	Non-Powered	\$199.95



<b>Southern - GP35 High Hood Diesel Engine</b>		
20-20017-1	Hi-Rail Wheels	\$429.95
20-20017-2	Scale Wheels	\$449.95
20-20017-3	Non-Powered	\$199.95



<b>Wheeling &amp; Lake Erie - GP35 High Hood Diesel Engine</b>		
20-20018-1	Hi-Rail Wheels	\$429.95
20-20018-2	Scale Wheels	\$449.95
20-20018-3	Non-Powered	\$199.95

Produced from 1963 to 1966, the GP35, along with its six-axle SD35 sibling, marked both an end and a beginning. They were the last road diesels to use the EMD 567 motor that had powered switchers, F-units, and Geeps since 1939 (so named because each cylinder displaced 567 cubic inches). For the horsepower race of the 1960s, EMD tweaked the 567 to a turbocharged V-16 delivering 2500 hp. That was it for the 567, however, and in 1966 the baton was passed to the more powerful model 645. But while the "35 line" diesels ushered out an old motor, they inaugurated a new look. Their angled cab roofs and the clean, squared-off lines of their car bodies established the look of EMD power for the next three decades.

Introduced to compete with General Electric's landmark U25B, which had ushered in the second generation of diesel power, the GP35 outsold the "U-Boat" nearly three to one. There was a strong market for new power in the mid-1960s because the first-generation diesels that had vanquished steam were wearing out. While first-generation rosters had often been a hodgepodge of manufacturers and models as railroads experimented with the new technology, by 1960 Alco, EMD, and GE were the only manufacturers left standing — and Alco would soon throw in the towel. As a result, virtually every major U.S. railroad became a GP35 customer and over 1300 engines were sold in the United States, Canada, and Mexico.

While our Premier model is not the first O gauge version of this second-generation pioneer, it offers the best combination of detail, realism, and performance of any 1/48 scale GP35. Added-on detail parts include windshield wipers, metal see-thru body grilles, lift rings, metal grab irons and handrails, see-thru rooftop fan housings, and brake cylinders, air pipes, and swing hangers on our super-detailed trucks. And in command mode with the DCS system, you can create a lashup combining one or more GP35s with other Proto-Sound 2.0 first- or second-generation power, and run them from a single throttle just like the prototype.

# GE U25B Diesel Engine



Photos depict HO model, not Premier tooling.

## Features

- Die-Cast Truck Sides, Pilots and Fuel Tank
- Intricately Detailed ABS Body
- Authentic Paint Scheme
- Metal Body Side Grilles
- Moveable Roof Fan Blades
- Metal Chassis
- Metal Handrails and Horn
- Directionally Controlled Headlights
- Metal Wheels, Axles and Gears
- (2) Remotely Controlled Proto-Couplers™
- (2) Precision Flywheel-Equipped Motors
- Lighted Cab Interior
- Illuminated Number Boards
- Operating Smoke Unit
- (2) Engineer Cab Figures
- Locomotive Speed Control In Scale MPH Increments
- Proto-Scale 3-2™ 3-Rail/2-Rail Conversion Capable
- Proto-Sound 2.0 With The Digital Command System Featuring Freight Yard Proto-Effects™
- Unit Measures:
  - 16" x 3 1/8" x 4"
- Hi-Rail Wheels Operate on O-42 Curves
- Scale Wheels Operate On 31" Radius Curves and Have Fixed Pilots



**POWERED UNITS  
AVAILABLE IN THREE  
ROAD NUMBERS\***

\*Where Prototypical



**Erie Lackawanna** - U25B Diesel Engine  
 20-2963-1 Hi-Rail Wheels \$429.95  
 20-2963-2 Scale Wheels \$449.95  
 20-2963-3 Non-Powered \$199.95

**NEW TOOLING!**



**New York Central** - U25B Diesel Engine  
 20-2964-1 Hi-Rail Wheels \$429.95  
 20-2964-2 Scale Wheels \$449.95  
 20-2964-3 Non-Powered \$199.95

**NEW TOOLING!**



**Great Northern** - U25B Diesel Engine  
 20-2965-1 Hi-Rail Wheels \$429.95  
 20-2965-2 Scale Wheels \$449.95  
 20-2965-3 Non-Powered \$199.95

**NEW TOOLING!**



**Santa Fe** - U25B Diesel Engine  
 20-2966-1 Hi-Rail Wheels \$429.95  
 20-2966-2 Scale Wheels \$449.95  
 20-2966-3 Non-Powered \$199.95

**NEW TOOLING!**

By 1960, EMD – the Electro-Motive Division of General Motors – looked like the clear winner in the race to dieselize America. ALCo was running a distant second, Baldwin was gone, and Fairbanks-Morse was on life support. General Electric, having dissolved its partnership with ALCo in 1953, had seemingly settled into a secondary role as supplier of electrical gear to other manufacturers and builder of small export locomotives. What nobody realized was that GE had quietly been preparing a comeback of such epic proportions that in little more than two decades it would overtake EMD as America's number one locomotive builder – a lead that continues to this day. GE's comeback engine was the U25B.

The year after its breakup with ALCo, GE had begun testing an A-B-B-A diesel set on the Erie Railroad, powered by Cooper Bessemer prime movers; GE had purchased the rights to refine and develop the motors on its own. What the world assumed was an experimental export engine was in fact a rolling laboratory aimed at developing a heavy freight locomotive that would be more powerful, more reliable, and require less maintenance than the competition. When the U25B (Universal Series, 2500 horsepower, 4-wheel trucks) debuted in 1960, its turbocharged 4-cycle, 16-cylinder diesel outperformed its rivals by 100hp. More important, its modular electronics were more reliable than those of contemporary engines and, according to GE, used up to 60% fewer components. And while the louvered flanks of competitive diesels concealed numerous air filters that required frequent cleaning, the "U-Boat," as it came to be called, featured a central cooling air system with a self-cleaning filter. The carbody was pressurized to keep dirt out of the machinery, and the locomotive featured an advanced wheel-slip system. Together, these features helped define the second generation of diesel power, which would replace the F-units, Geeps, and other pioneering engines that were wearing out.

Because the railroad industry was in a slump, not a single U-boat was sold the first year. In 1961, four demonstrators barnstormed across the West, and the Union Pacific placed the first order. At the request of Southern Pacific, the original high short hood design was replaced by a low short hood for better visibility, and in 1962 sales began to take off. By the end of production in 1966, 17 Class 1 railroads would purchase U-boats and GE would be solidly in the locomotive business.

New for 2010, M.T.H. introduces our superbly detailed model of America's first second-generation diesel. Per prototypes, our models will replicate both the "classic" U25B with its wide windshield and flat-top nose, and the later-production version with split windshield and sloping nose.

# EMD SD35 Diesel Engine



## Features

- Directionally Controlled Headlights
- Intricately Detailed ABS Body
- Metal Wheels, Axles and Gears
- Die-Cast Truck Sides, Pilots and Fuel Tank
- (2) Remotely Controlled Proto-Couplers™
- Colorful Paint Scheme
- Metal Chassis
- Metal Handrails and Decorative Horn
- (2) Precision Flywheel-Equipped Motors
- Locomotive Speed Control In Scale MPH Increments
- Proto-Scale 3-2™ 3-Rail/2-Rail Conversion Capable
- Lighted Cab Interior
- Illuminated Number Boards
- Lighted Class Lights
- (2) Engineer Cab Figures
- Moveable Roof Fan Blades
- Metal Body Side Grilles
- Operating Smoke Unit
- Proto-Sound 2.0 With The Digital Command System Featuring Freight Yard Proto-Effects™
- Unit Measures:  
17 1/2" x 2 1/2" x 4 5/16"
- Hi-Rail Wheels Operate on O-42 Curves
- Scale Wheels Operate On 31" Radius Curves and Have Fixed Pilots



**POWERED UNITS  
AVAILABLE IN THREE  
ROAD NUMBERS\***

\*Where Prototypical





<b>CSX - SD35 Diesel Engine</b>		
20-20019-1	Hi-Rail Wheels	\$429.95
20-20019-2	Scale Wheels	\$449.95
20-20019-3	Non-Powered	\$199.95

**Jersey Central - SD35 Diesel Engine**

20-20020-1	Hi-Rail Wheels	\$429.95
20-20020-2	Scale Wheels	\$449.95
20-20020-3	Non-Powered	\$199.95



**Southern Pacific - SD35 Diesel Engine**

20-20021-1	Hi-Rail Wheels	\$429.95
20-20021-2	Scale Wheels	\$449.95
20-20021-3	Non-Powered	\$199.95



**Norfolk & Western - SD35 High Hood Diesel Engine**

20-20022-1	Hi-Rail Wheels	\$429.95
20-20022-2	Scale Wheels	\$449.95
20-20022-3	Non-Powered	\$199.95

Produced from 1964 to 1966, the SD35, along with its four-axle GP35 sibling, marked both an end and a beginning. They were the last road diesels to use the EMD 567 motor that had powered switchers, F-units, and Geeps since 1939 (so named because each cylinder displaced 567 cubic inches). For the horsepower race of the 1960s, EMD tweaked the 567 to a turbocharged V-16 delivering 2500 hp. That was it for the 567, however, and in 1966 the baton was passed to the more powerful model 645. But while the "35 line" diesels ushered out an old motor, they ushered in a new look. Their angled cab roofs and the clean, squared-off lines of their car bodies established the look of EMD road power for the next three decades.

In an era when 4-axle diesels were the norm, the six-axle SD version was intended for lighter track, because its weight was spread out over more wheels. Those extra wheels were also an advantage in lower-speed service with heavier loads. While a majority of railroads ordered the low-nose version, the Southern and Norfolk & Western ordered SD35s with the high short nose and often ran them long-hood forward for better crew protection.

While our Premier model is not the first O gauge version of this heavy hauler, it offers the best combination of detail, realism, and performance of any 1/48 scale SD35. Added-on detail parts include windshield wipers, metal see-thru body grilles, lift rings, metal grab irons and handrails, see-thru rooftop fan housings, and truck-mounted brake cylinders and air pipes. Thanks to Proto-Speed Control, this model can dig in and haul heavy loads at low speeds just like the prototype, or highball down the main line with a fast freight. And in command mode with the DCS system, you can create a lashup combining one or more SD35s with any other Proto-Sound 2.0 locomotives, and run them from a single throttle just like the prototype.

# GE AC4400CW Diesel Engine



## Features

- (2) Remotely Controlled Proto-Couplers™
- Metal Chassis
- (2) Precision Flywheel-Equipped Motors
- Illuminated Number Boards
- Intricately Detailed ABS Body
- Directionally Controlled Headlights
- Die-Cast Truck Sides, Pilots and Fuel Tank
- Authentic Paint Scheme
- Metal Handrails and Horn
- Lighted Cab Interior
- (2) Engineer Cab Figures
- Moveable Roof Fan Blades
- Metal Body Side Grilles
- Operating Ditch Lights
- Operating Smoke Unit
- Metal Wheels, Axles and Gears
- Locomotive Speed Control In Scale MPH Increments
- Proto-Scale 3-2™ 3-Rail/2-Rail Conversion Capable
- Proto-Sound 2.0 With The Digital Command System Featuring Freight Yard Proto-Effects™
- Unit Measures:
  - 19 1/2" x 2 1/2" x 4"
- Hi-Rail Wheels Operate on O-42 Curves
- Scale Wheels Operate On 42" Radius Curves Curves and Have Fixed Pilots



**POWERED UNITS  
AVAILABLE IN THREE  
ROAD NUMBERS\***

\*Where Prototypical



**BNSF - AC4400CW Diesel Engine**

20-20009-1	Hi-Rail Wheels	\$429.95
20-20009-2	Scale Wheels	\$449.95
20-20009-3	Non-Powered	\$199.95



**Canadian Pacific - AC4400CW Diesel Engine**

20-20010-1	Hi-Rail Wheels	\$429.95
20-20010-2	Scale Wheels	\$449.95
20-20010-3	Non-Powered	\$199.95



**CSX - AC4400CW Diesel Engine**

20-20011-1	Hi-Rail Wheels	\$429.95
20-20011-2	Scale Wheels	\$449.95
20-20011-3	Non-Powered	\$199.95



**Union Pacific - AC4400CW Diesel Engine**

20-20012-1	Hi-Rail Wheels	\$429.95
20-20012-2	Scale Wheels	\$449.95
20-20012-3	Non-Powered	\$199.95

From the dawn of dieselization through its first six decades, virtually every American diesel locomotive used DC traction motors. By the early 1990s, however, a series of technological advances allowed designers to tap the inherent superiority of AC traction — namely, the ability of an AC motor to start a heavier load than a DC motor, with the same prime mover. The superior adhesion of AC power touched off a new horsepower race because, with the same number of wheels, AC traction could put more horsepower on the rails.

Two years behind rival EMD, General Electric entered the AC traction business in June 1993 with the AC4400CW — 4400 horsepower, “C” for 3-axle trucks, and “W” for wide North American cab. The new engine was basically an AC version of the Dash 9-44CW introduced the same year. The key external difference between the two engines is the large box behind the cab on the left side of the AC 4400CW, which houses much of the AC traction electronics.

Although General Electric’s AC power arrived on the scene later, its AC engines have outsold those made by EMD. One reason may be GE’s use of one inverter bank per traction motor, a design that allows the crew to cut out a single malfunctioning motor and still retain more than 80% of a locomotive’s function. On a comparable EMD AC-powered engine, an entire truck has to be taken offline if one of its three motors fails.

One area of weakness for GE was its high adhesion trucks, which were generally acknowledged to be inferior to EMD’s steerable radial truck. Later model AC4400CWs feature GE’s own version of a steerable truck, which improves adhesion on curves.

Now you can bring the brute strength of the AC4400CW to your own freight operations. This model offers the industry-leading features you expect in a Premier diesel: awe-some sounds, superb detailing, see-through body grilles, a wealth of added-on details, and smooth operation at any throttle setting from a crawl to high-speed mainline service.

# EMD GP7 & GP9 Diesels



## Features

- Intricately Detailed ABS Body
- Die-Cast Truck Sides, Pilots and Fuel Tank
- (2) Precision Flywheel-Equipped Motors
- Illuminated Number Boards
- Directionally Controlled Headlights
- Operating Smoke Unit
- Colorful Paint Scheme
- Metal Chassis
- Metal Handrails and Horn
- (2) Engineer Cab Figures
- Spinning Roof Fans
- Metal Body Side Grilles
- Operating Smoke
- Metal Wheels, Axles, and Gears
- (2) Remotely Controlled Proto-Couplers™
- Proto-Sound 2.0 With The Digital Command System Featuring Freight Yard Proto-Effects™
- Unit Measures:  
14 3/4" x 2 1/2" x 3 3/4"
- Operates On O-31 Curves



**POWERED UNITS  
AVAILABLE IN THREE  
ROAD NUMBERS\***

\*Where Prototypical



**Pittsburgh & Lake Erie** - GP7 Diesel Engine  
 20-20031-1 w/Proto-Sound 2.0 \$429.95  
 20-20031-3 Non-Powered \$199.95



**Great Northern** - GP9 Diesel Engine  
 20-20032-1 w/Proto-Sound 2.0 \$429.95  
 20-20032-3 Non-Powered \$199.95



**New Haven** - GP9 Diesel Engine  
 20-20033-1 w/Proto-Sound 2.0 \$429.95  
 20-20033-3 Non-Powered \$199.95



**Northern Pacific** - GP9 Diesel Engine  
 20-20034-1 w/Proto-Sound 2.0 \$429.95  
 20-20034-3 Non-Powered \$199.95

Electro-Motive Division's GP (for "General Purpose") engines were the brainchild of project engineer Dick Dilworth. In the late 1940s, Dilworth saw that America's 30,000 miles of main line rail had been virtually dieselized, but the 130,000 miles of secondary lines that carried half of the nation's freight traffic were still largely steam powered. He viewed that as a huge marketing opportunity.

In *The Dilworth Story*, a book published by Electro-Motive Division in 1954, Dilworth explained how he tried to meet that opportunity: "In planning the GP, I had two dreams. The first was to make a locomotive so ugly in appearance that no railroad would want it on the main line or anywhere near headquarters, but would keep it out as far as possible in the back country, where it could do really useful work. My second dream was to make it so simple in construction and so devoid of Christmas-tree ornaments and other whimsy that the price would be materially below our standard main-line freight locomotives."

Of course, Dilworth's explanation conveniently ignored the fact that Alco's arguably uglier RS-1 had introduced the road switcher concept eight years before EMD. And in one sense, Dilworth's project was a failure. Railroads bought Geeps for mainline service and relegated older power to secondary lines as they had always done. But his brainchild became the runaway best-seller among first-generation diesel power. U.S. and Canadian railroads bought nearly 7,000 copies of the 1500 horsepower GP7, introduced in 1949, and the 1750 horsepower GP9, produced from 1954 through 1963.

In those early days of diesel power, experienced engineers loved the Geep cab because, unlike the new streamliners, it felt like home to them. An engineer in a Geep running long hood forward sat near the back of the engine, looking out over the power plant — just as he had in a steam engine. Even running short hood forward, the engineer's view was out past the engine's nose, similar to a steamer.

The GP7 and GP9 return to the Premier line with the full range of superb detailing you expect in a Premier locomotive: see-through end steps, body side grilles, and roof fan housings; metal side and end handrails; separate metal grab irons; and super-detailed Blomberg trucks with separately applied swing hangers, brake cylinders, and air lines. Our Geeps also feature authentic first-generation diesel sounds including a single-chime air horn and the throb of an EMD 16-cylinder model 567 prime mover — so named because each of its cylinders displaced 567 cubic inches.

# EMD SD40-2 Diesel Engine



## Features

- Intricately Detailed ABS Body
- Colorful Paint Scheme
- Metal Chassis
- Die-Cast Truck Sides, Pilots and Fuel Tank
- Metal Wheels, Axles and Gears
- (2) Remotely Controlled Proto-Couplers™
- Metal Handrails and Horn
- (2) Precision Flywheel-Equipped Motors
- Locomotive Speed Control In Scale MPH Increments
- Directionally Controlled Headlights
- Lighted Cab Interior
- Illuminated Number Boards
- Lighted Class Lights
- (2) Engineer Cab Figures
- Moveable Roof Fan Blades
- Metal Body Side Grilles
- Operating Smoke Unit
- Proto-Scale 3-2™ 3-Rail/2-Rail Conversion Capable
- Proto-Sound 2.0 With The Digital Command System Featuring Freight Yard Proto-Effects™
- Unit Measures:
  - 17 1/2" x 2 5/8" x 3 7/8"
- Operates On O-42 Curves

## Did You Know?

Introduced on January 1, 1972, the SD40-2 had become the best-selling 6-axle road switcher in history by December 31, 1978.

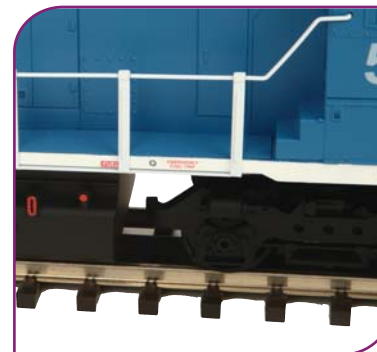
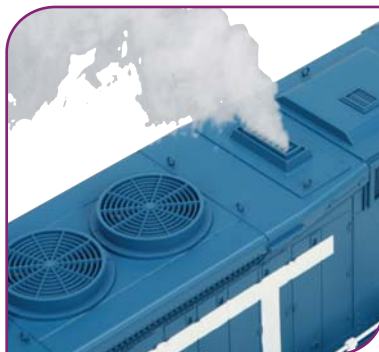

**POWERED UNITS  
AVAILABLE IN THREE  
ROAD NUMBERS\***

\*Where Prototypical



**BNSF - SD40-2 Diesel Engine**  
 20-20023-1 w/Proto-Sound 2.0 \$429.95  
 20-20023-3 Non-Powered \$199.95



**Grand Trunk Western - SD40-2 Diesel Engine**  
 20-20024-1 w/Proto-Sound 2.0 \$429.95  
 20-20024-3 Non-Powered \$199.95

**MKT - SD40-2 Diesel Engine**  
 20-20025-1 w/Proto-Sound 2.0 \$429.95  
 20-20025-3 Non-Powered \$199.95



**Norfolk & Western - SD40-2 Diesel Engine**  
 20-20026-1 w/Proto-Sound 2.0 \$429.95  
 20-20026-3 Non-Powered \$199.95

Offering better reliability and lower maintenance costs than the higher powered SD-45, EMD's SD40-2 enjoyed a long production run of 3,100 units. The 3,000 horsepower diesel was the primary motive power for many railroads throughout the 1970's and 80's.

One of the most striking features of the EMD workhorse was its long "back porch" or decking that extended in front and behind the locomotive's cab. These porches differentiated the SD40-2 from its earlier cousin, the SD35 and were the result of the SD40-2's requirement for a longer frame, which helped increase the locomotive's tractive effort.

As one of the most popular road engines for EMD, the SD40-2 has been well represented in the O Gauge marketplace in the past. M.T.H.'s Premier Line SD40-2 offers the user more features and value than any other model. Fully equipped with Proto-Sound® 2.0, operating smoke, Proto-Speed Control™ and incredible details, this engine operates as well as it looks.



# EMD SD80MAC & SD9043MAC Diesel Engines

## Features

- Directionally Controlled Headlights
- Intricately Detailed ABS Body
- Metal Wheels, Axles and Gears
- Die-Cast Truck Sides, Pilots and Fuel Tank
- (2) Remotely Controlled Proto-Couplers™
- Authentic Paint Scheme
- Metal Handrails and Horn
- (2) Precision Flywheel-Equipped Motors
- Lighted Cab Interior
- Illuminated Number Boards
- Lighted Class Lights
- (2) Cab Figures
- Moveable Roof Fan Blades
- Operating Ditch Lights
- Operating Smoke Unit
- Metal Body Side Grilles
- Metal Chassis
- Locomotive Speed Control in SMPH Increments
- Proto-Scale 3-2™ 3-Rail/2-Rail Conversion Capable
- Proto-Sound 2.0 With The Digital Command System Featuring Freight Yard Proto-Effects™
- Unit Measures:  
20 1/2" x 2 3/4" x 3 7/8"
- Operates On O-42 Curves



**POWERED UNITS  
AVAILABLE IN THREE  
ROAD NUMBERS\***

\*Where Prototypical





**Conrail** - SD80MAC Diesel Engine  
 20-20027-1 w/Proto-Sound 2.0 \$429.95  
 20-20027-3 Non-Powered \$199.95



**Indiana Railway** - SD9043MAC Diesel Engine  
 20-20028-1 w/Proto-Sound 2.0 \$429.95  
 20-20028-3 Non-Powered \$199.95



**Union Pacific** - SD9043MAC Diesel Engine  
 20-20029-1 w/Proto-Sound 2.0 \$429.95  
 20-20029-3 Non-Powered \$199.95



**Electro-Motive Division** - SD9043MAC Diesel Engine  
 20-20030-1 w/Proto-Sound 2.0 \$429.95  
 20-20030-3 Non-Powered \$199.95

In the horsepower race of the 1990s — which turned out to be a passing fad — the Holy Grail became a 6000 hp diesel. But neither EMD nor GE had a prime mover capable of being upgraded to that size. As a stopgap measure, EMD added four cylinders to its proven model 710 engine to create the 5000 hp, 20 cylinder, 80 foot long SD80MAC in 1995. Conrail was the only taker, rostering all 30 units produced.

Other railroads waited for EMD to deliver its all-new power plant, the 6000 hp "H" engine, EMD's first four-stroke diesel. When the H engine was delayed, EMD offered what was intended to be a temporary solution: its new SD90MAC locomotive, designed for the H engine but temporarily powered with a 4300 hp, 16-cylinder model 710 engine. The hybrid "SD9043MAC" was externally the same as the SD80MAC and sold rather well — much better than the 6000 hp version when it finally arrived. As it turned out, American railroads decided a 4300-4400 hp diesel was a more versatile building block for multiple-unit consists, and the craze for 6000 hp engines faded. The SD9043MACs were never upgraded to the H engine. Today most 6000 hp SD90MACs are gradually being withdrawn from service while the "temporary" 710-powered SD9043s soldier on. And while the H engine was not a great success in the United States, it has started to gain a foothold in China and other overseas markets.



# TurboTrain Passenger Set

## Features

### TurboTrain Passenger Set

- (2) Powered Locomotives
- Non-Powered Passenger Car
- Directionally Controlled Headlights
- Intricately Detailed ABS Bodies
- Metal Wheels, Gears and Axles
- Die-Cast Truck Sides
- Authentic Deco Scheme
- Metal Chassis
- Metal Handrails and Horn
- (2) Precision Flywheel-Equipped Motors
- Lighted Marker Lights
- (2) Engineer Cab Figures
- 12 Passenger Figures In Each Car
- Operating Smoke Unit
- Locomotive Speed Control In Scale MPH Increments
- Proto-Sound 2.0 w/Passenger Station Proto-Effects™
- Operates on O-72 Curves

### TurboTrain Passenger Car

- Intricately Detailed ABS Body
- Metal Wheels and Axles
- Overhead Interior Lighting
- Die-Cast 2-Wheel Truck
- Colorful, Attractive Paint Schemes
- End-of-Car Diaphragms
- 12 Passenger Figures In Each Car
- Separate Metal Handrails
- Detailed Car Interior
- Stamped Metal Floor
- 1:48 Scale Dimensions
- Detailed Car Undercarriage



The TurboTrain was largely the brainchild of one man, Alan R. Cripe. Fresh out of college in the 1950s, Cripe joined the Chesapeake & Ohio's Train X project. He eventually led the development of plans for a high-speed, diesel powered train with cars that would tilt outward on curves, much like a pendulum, to allow higher speeds on existing track. The train was never built, however, and Cripe moved on, only to be approached years later by United Aircraft Corp. (UAC) to resuscitate his ideas. Armed with tilting train patents purchased from the C&O, United and Cripe won a government contract to build demonstration trains under the High Speed Ground Transportation Act of 1965.

Introduced in 1967, the TurboTrain was, according to UAC, "a modern, streamlined, high-speed intercity passenger train designed by aerospace engineers and based on the principles of flight." There was little exaggeration in those claims. The tilting cars allowed passengers to comfortably cruise through curves 30% to 40% faster than conventional trains. Power was provided by up to seven (depending on configuration) Pratt &

Whitney aircraft-style gas turbine engines. The engines and many other components were designed to be changed out quickly for ease of maintenance. Seating was comparable to first-class airplane accommodations and, according to famed railroad writer William D. Middleton, "The over-the-engineer's-shoulder, straight-ahead view from the forward dome represents the best railfan seating since the Electroliner."

Owned by the Department of Transportation, the TurboTrains went into U.S. service in 1968 between Boston and New York, operated first by Penn Central and later by Amtrak. Canadian versions, purchased by Canadian National Railways and assembled by Montreal Locomotive Works, served briefly in 1968-1969 and later entered Montreal-Toronto service in 1973.

Why was the TurboTrain ultimately a failure, with no more units built, the U.S. trains retired in 1976, and the Canadian Turbos out of service by 1982? The conventional wisdom is that they were trouble-prone — but in fact the Canadian trains, after some initial teething

problems, boasted a 97% availability record on CN and VIA Rail. Perhaps the greater truth is that the railroads involved could not get comfortable with a jet-powered land vehicle, and that the U.S. government and the railroads were simply not ready to make a commitment to providing competitive passenger service. Today's Acela seems confirmation that Alan Cripe indeed had the right idea. With its low-slung aerodynamic design, tilting cars, and double-ended trainsets, the Acela is in many respects an electric-powered TurboTrain — but without the magnificent view from the domes. Forty years and billions of dollars later, the Acela's best Boston—New-York time is only nine minutes faster than the Turbo's schedule, and the Acela has yet to beat the 170.8 mph speed record set by the TurboTrain in 1967.

New for 2010, M.T.H. introduces the first O scale model of the magnificent experiment that was the TurboTrain. Imagine what might have been, as you run this superbly detailed model in its original U.S. 3-car configuration — or add a car to simulate the trains as they were expanded to meet passenger demand.



**Amtrak - TurboTrain Passenger Set**  
20-20035-1 w/Proto-Sound 2.0 \$799.95

**NEW TOOLING!**



**Amtrak - TurboTrain Passenger Car**  
20-60014 \$99.95



**Canadian National - TurboTrain Passenger Car**  
20-60015 \$99.95



**Canadian National - TurboTrain Passenger Set**  
20-20036-1 w/Proto-Sound 2.0 \$799.95

**NEW TOOLING!**



**Penn Central - TurboTrain Passenger Set**  
20-20037-1 w/Proto-Sound 2.0 \$799.95

**NEW TOOLING!**



**Penn Central - TurboTrain Passenger Car**  
20-60016 \$99.95

# Premier Transit Sets

The transit sets below were announced in previous catalogs and are currently in stock and available for delivery. Each set features Transit Stop Proto-Effects, which allows operators to program the train to run automatically on a loop or out-and-back route, stopping at pre-set locations and announcing appropriate commuter station stops.

**LEARN MORE ABOUT THEM:** For more information on any M.T.H. transit set, search its item number on our homepage, [www.mthtrains.com](http://www.mthtrains.com).

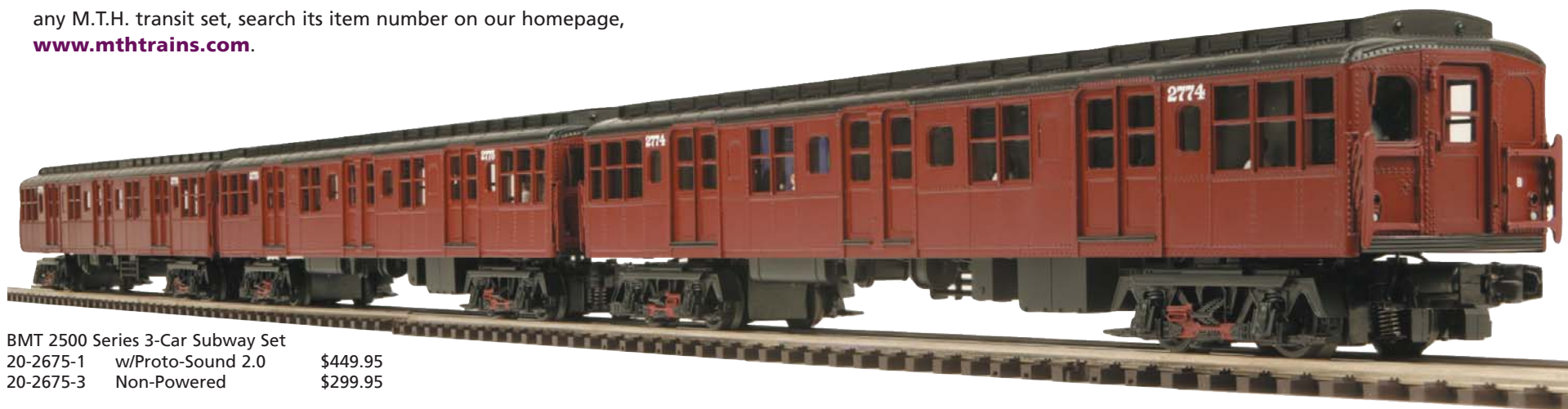

**BMT 2500 Series 3-Car Subway Set**  
20-2675-1 w/Proto-Sound 2.0 \$449.95  
20-2675-3 Non-Powered \$299.95



**Metropolitan Transportation - R-34 4-Car Subway Set**  
20-2934-1 w/Proto-Sound 2.0 \$499.95  
**Metropolitan Transportation - R-34 2-Car Subway Set Add-On**  
20-2934-3 Non-Powered \$199.95



**Metropolitan Transportation** - R-11 4-Car Subway Set  
 20-2933-1 w/Proto-Sound 2.0 \$499.95

**Metropolitan Transportation** - R-11 2-Car Subway Set Add-On  
 20-2933-3 Non-Powered \$199.95



R40 2-Car Subway Set  
 20-2717-3 Non-Powered \$199.95

R40 4-Car Subway Set  
 20-2717-1 w/Proto-Sound 2.0 \$499.95



# AC4400CW Diesel Solid Rocket Motor Transport

If you have ever wondered how NASA moves those solid rockets around prior to launch, then this Solid Rocket Transport train should give you the answer.

Due to the rocket motor's large size, moving it completely assembled from its Utah manufacturing site to Cape Canaveral, Florida is impractical. Consequently, the rocket's sections are loaded atop heavy-duty flat

cars and transported by rail in a unit train to the launch area where the rocket is then assembled. The route traveled takes the train southeast via the Union Pacific, Kansas City Southern, CSX, and Florida East Coast routes. Each rocket section is covered with a removable large steel cover for both protection and secrecy as to the car's load. Often each car in the unit train is separated by a "buffer" car that can absorb any

impact caused by a derailment or other mishap. The buffer cars can take the form of additional flat cars with covers or a boxcar. A trailing passenger car provides crew accommodations.

This set can also be combined with a Union Pacific Dash-9 diesel locomotive and a 6-car Missouri Pacific Hi-Cube Box Car set (found on page 124) for use as buffer cars.



NASA - AC4400CW Diesel Solid Rocket Motor Transport Boxed Set  
20-20013-1 w/Proto-Sound 2.0 \$749.95

# Harley-Davidson ES44AC Diesel Freight Set

Put your railroad to work with this very unique Harley-Davidson® diesel freight collector set. Bearing the markings of the most famous motorcycle manufacturer in the world, this set is a must-have for any motorcycle or model railroading enthusiast.

Headed up by a powerful ES44 diesel engine decorated in stunning black and orange livery, there will be no mistaking the destination of this train as it pulls its four flat cars with trailers and a trailing caboose to the local Harley-Davidson® dealership.

Like all Premier locomotives, the ES44AC offers O scale's finest combination of detail, realism, and performance. Listen to the chant of an authentic GEVO-12 motor, and throttle down as low as three scale miles per hour so you can admire the details as the Evolution Series glides by: see-through fans and grilles, walkways with safety tread, opening doors with working door handles, and a host of other separately applied metal details.

Outfitted with all-metal wheels and gears, the two-motored diesel runs as good as it looks and comes equipped with digital sound and revolutionary speed control features found only in Proto-sound 2.0. We've even included the trademarked sounds of a Harley-Davidson® motorcycle in the sound file for an added touch of realism sure to make this set a favorite of all who hear and see it run.



## Removable Covers & Rocket Sections

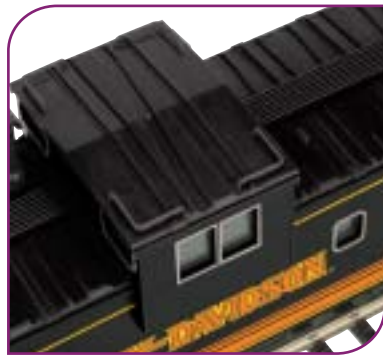
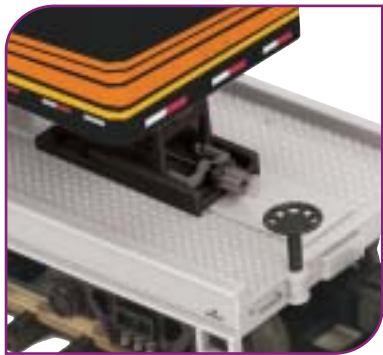
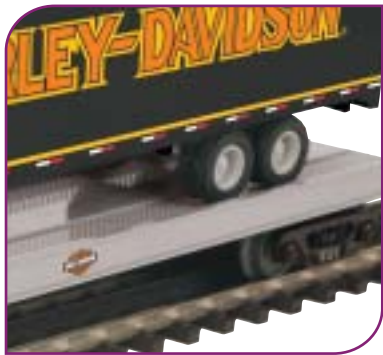
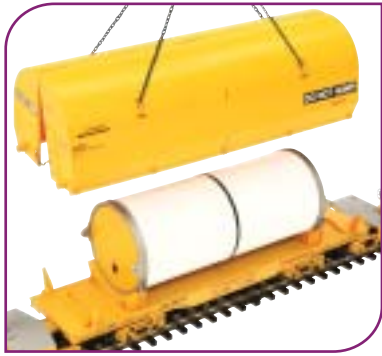

Harley-Davidson® - ES44AC Diesel Engine Freight Set  
20-20007-1 w/Proto-Sound 2.0 \$649.95



© 2009 H-D, All Rights Reserved.

# Operating Freight



**Pennsylvania** - Operating Reefer Car  
20-94230 \$99.95



**Santa Fe** - Operating Reefer Car  
20-94231 \$99.95

## DOOR OPENS, FROST ESCAPES, WORKMAN PUSHES OUT LOADS



SEE IT IN  
**ACTION**  
ON THE WEB

By searching on each car's item number on  
[www.mthtrains.com](http://www.mthtrains.com)



**Chessie** - Operating Dump Car w/Pipe Load  
20-98722 \$59.95



**Southern Pacific** - Operating Dump Car w/Pipe Load  
20-98721 \$59.95



**Southern** - Operating Dump Car w/Pipe Load  
20-98723 \$59.95



**Alaska** - Operating Dump Car w/Pipe Load  
20-98724 \$59.95



# Operating Log Car



**Pennsylvania** - Operating Log Car  
20-98717 \$59.95



**Northern Pacific** - Operating Log Car  
20-98719 \$59.95



**Boston & Maine** - Operating Log Car  
20-98720 \$59.95



**Union Pacific** - Operating Log Car  
20-98718 \$59.95

## Features

- Operating Bay Rises Up On One Side
- Side Wall Drops Down To Release Pipe or Log Load
- Unit Measures:  
12" x 2 5/8" x 2 11/16"
- Operates On O-27 Curves

SEE IT IN  
**ACTION**  
ON THE WEB

By searching on each car's item number on  
[www.mthtrains.com](http://www.mthtrains.com)

# 40' AAR Box Car



**Canadian Pacific - 40' AAR Box Car**  
20-93481 \$49.95



**Baltimore & Ohio - 40' AAR Box Car**  
20-93480 \$49.95



**Denver Rio Grande Western - 40' AAR Box Car**  
20-93483 \$49.95



**Erie Lackawanna - 40' AAR Box Car**  
20-93482 \$49.95



SEE IT  
ON THE WEB

**Check out the details!** For additional detail photos of any Premier freight car, search on its item number on our home page, [www.mthtrains.com](http://www.mthtrains.com).

## Features

- O Scale Kadee® Compatible Mounting Pad
- Opening Doors
- Unit Measures:  
11 1/2" x 2 5/8" x 3 3/4"
- Operates on O-31 Curves



# 50' Box Car w/Graffiti



## Features

- Opening Doors
- Unit Measures:  
14 1/2" x 2 5/8" x 4 3/16"
- Operates on O-31 Curves



**New York Central** - 50' Box Car  
20-93488 \$54.95



**Conrail** - 50' Box Car  
20-93489 \$54.95



**Rail Box** - 50' Box Car  
20-93490 \$54.95



**Santa Fe** - 50' Box Car  
20-93491 \$54.95



SEE IT  
ON THE WEB

**Check out the details!** For additional detail photos of any Premier freight car, search on its item number on our home page, [www.mthtrains.com](http://www.mthtrains.com).

# 50' Dbl. Door Plugged Boxcar



**Tropicanna** - 50' Dbl. Door Plugged Boxcar  
20-93487 \$54.95



**Tropicanna** - 50' Dbl. Door Plugged Boxcar  
20-93486 \$54.95

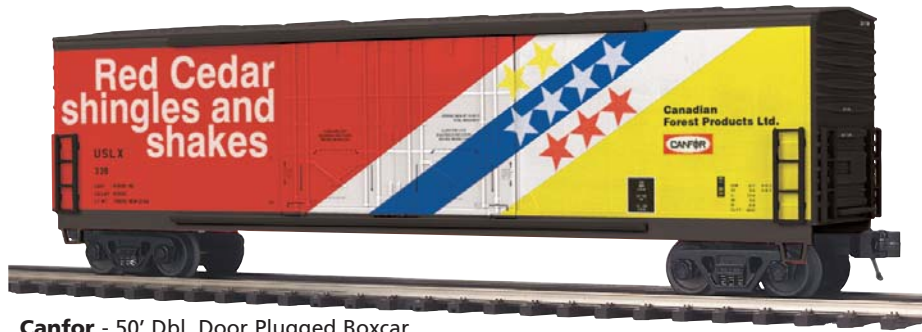

**Canfor** - 50' Dbl. Door Plugged Boxcar  
20-93485 \$54.95



**British Columbia Railway** - 50' Dbl. Door Plugged Boxcar  
20-93484 \$54.95

## Features

- Unit Measures:  
14 1/8" x 2 11/16" x 3 15/16"
- Operates On O-31 Curves



SEE IT  
ON THE WEB

**Check out the details!** For additional detail photos of any Premier freight car, search on its item number on our home page, [www.mthtrains.com](http://www.mthtrains.com).



# Tank Car



**Western Maryland - Tank Car**  
20-96196 \$49.95



**Montana Rail Link - Tank Car**  
20-96197 \$49.95



**Citizens Ethyl - Tank Car**  
20-96195 \$49.95



**Mutual Gasoline - Tank Car**  
20-96194 \$49.95

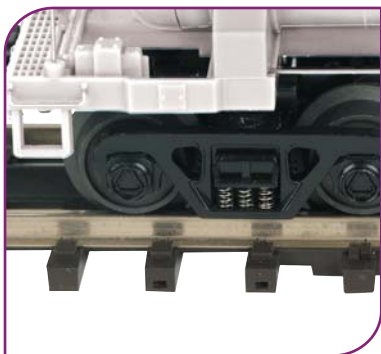

## Features

- O Scale Kadee® Compatible Mounting Pad
- Unit Measures:  
12" x 2 3/4" x 4 3/16"
- Operates on O-31 Curves

# 34' Composite Hopper Car



**Chesapeake & Ohio** - 34' Composite Hopper Car  
20-97251 \$54.95



**Wabash** - 34' Composite Hopper Car  
20-97252 \$54.95



**Virginian** - 34' Composite Hopper Car  
20-97254 \$54.95



**Atlantic Coast Line** - 34' Composite Hopper Car  
20-97253 \$54.95



SEE IT  
ON THE WEB

**Check out the details!** For additional detail photos of any Premier freight car, search on its item number on our home page, [www.mthtrains.com](http://www.mthtrains.com).

## Features

- O Scale Kadee® Compatible Mounting Pad
- Unit Measures:  
9 1/2" x 2 3/4" x 2 3/4"
- Operates On O-31 Curves



# 70-ton 3-Bay Hopper Car



**Union Pacific** - 70-ton 3-Bay Hopper Car  
20-97704 \$54.95



**Burlington Northern** - 70-ton 3-Bay Hopper Car  
20-97703 \$54.95



**Western Maryland** - 70-ton 3-Bay Hopper Car  
20-97702 \$54.95



**Cambria & Indiana** - 70-ton 3-Bay Hopper Car  
20-97701 \$54.95

## Features

- O Scale Kadee® Compatible Mounting Pad
- Unit Measures: 11" x 2 5/8" x 2 3/4"
- Operates On O-31 Curves

# 60' Reefer Car



**Miller - 60' Reefer Car**  
20-94222 \$59.95

© 2009 MillerCoors, LLC. All right reserved.  
Produced under license by M.T.H. Electric Trains. This licensed product is intended for adults of legal drinking age.



**Pittsburgh Brewing Co. - 60' Reefer Car**  
20-94224 \$59.95

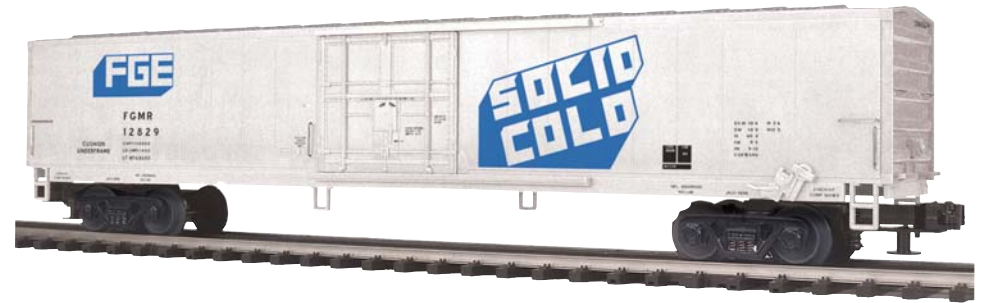

**Fruit Growers Express - 60' Reefer Car**  
20-94223 \$59.95



**Rolling Rock - 60' Reefer Car**  
20-94225 \$59.95

"© 2009 Anheuser-Busch, Inc. All Rights Reserved."



SEE IT  
ON THE WEB

**Check out the details!** For additional detail photos of any Premier freight car, search on its item number on our home page, [www.mthtrains.com](http://www.mthtrains.com).

## Features

- O Scale Kadee® Compatible Mounting Pad
- Unit Measures:  
16 1/2" x 2 1/2" x 3 1/2"
- Operates On O-42 Curves





# R50B Express Reefer Car

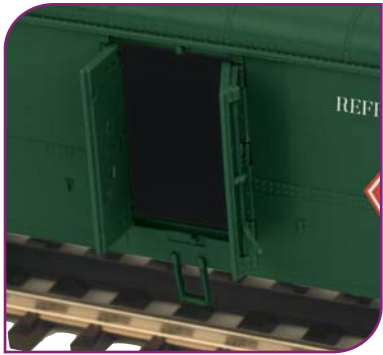

**Pennsylvania** - R50B Express Reefer Car  
20-94167 \$69.95



**Railway Express Agency** - R50B Express Reefer Car  
20-94166 \$69.95



**Hood's Dairy** - R50B Express Reefer Car  
20-94168 \$69.95



**Sheffield Farms** - R50B Express Reefer Car  
20-94169 \$69.95

## Features

- O Scale Kadee® Compatible Mounting Pad
- Unit Measures:  
14 1/2" x 2 1/2" x 3 1/2"
- Operates On O-31 Curves

# 36' Woodsided Reefer Car



**Gluek Brewing Company** - 36' Woodsided Reefer Car  
20-94355 \$54.95



**Pacific Fruit Express** - 36' Woodsided Reefer Car  
20-94357 \$54.95



**Peter Fox Brewing Co.** - 36' Woodsided Reefer Car  
20-94356 \$54.95



**Mandan Creamery & Produce Co.** - 36' Woodsided Reefer Car  
20-94358 \$54.95



SEE IT  
ON THE WEB

**Check out the details!** For additional detail photos of any Premier freight car, search on its item number on our home page, [www.mthtrains.com](http://www.mthtrains.com).

## Features

- O Scale Kadee® Compatible Mounting Pad
- Opening Doors
- Unit Measures: 10 3/4" x 2 1/38" x 3 1/4"
- Operates on O-31 Curves



# 40' Steel Sided Reefer Car



**Rock Island** - 40' Steel Sided Reefer Car  
20-94228 \$54.95



**Santa Fe** - 40' Steel Sided Reefer Car  
20-94226 \$54.95

## Features

- Opening Doors and Roof Hatches
- Unit Measures:  
11 3/4" x 2 9/16" x 3 1/2"
- Operates on O-31 Curves



**Canadian National** - 40' Steel Sided Reefer Car  
20-94229 \$54.95



**Pacific Fruit Express** - 40' Steel Sided Reefer Car  
20-94227 \$54.95

# Coke Hopper Car



**Norfolk Southern** - Coke Hopper Car  
20-97248 \$54.95



**CSX** - Coke Hopper Car  
20-97247 \$54.95



**MKT** - Coke Hopper Car  
20-97250 \$54.95



**Union Pacific** - Coke Hopper Car  
20-97249 \$54.95



SEE IT  
ON THE WEB

**Check out the details!** For additional detail photos of any Premier freight car, search on its item number on our home page, [www.mthtrains.com](http://www.mthtrains.com).

## Features

- O Scale Kadee® Compatible Mounting Pad
- Unit Measures: 13 5/8" x 2 5/8" x 4"
- Operates On O-31 Curves



# 3-Bay Centerflow Hopper w/Graffiti



**Chessie** - 3-Bay Centerflow Hopper  
20-97697 \$54.95



**Pennsylvania** - 3-Bay Centerflow Hopper  
20-97699 \$54.95

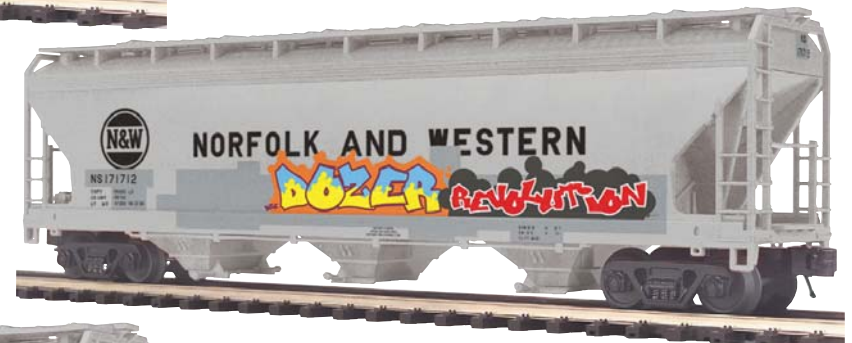

**Norfolk Southern** - 3-Bay Centerflow Hopper  
20-97698 \$54.95



**Western Maryland** - 3-Bay Centerflow Hopper  
20-97700 \$54.95

## Features

- O Scale Kadee® Compatible Mounting Pad
- Unit Measures:  
13 7/8" x 2 11/16" x 3 7/8"
- Operates on O-31 Curves

# Gondola Car w/Load



**Wabash** - Gondola Car w/Wheel Scrap Load  
20-98196 \$49.95



**New Haven** - Gondola Car w/Wheel Scrap Load  
20-98197 \$49.95



**Norfolk & Western** - Gondola Car w/Coiled Wire Load  
20-98199 \$49.95



**Chessie** - Gondola Car w/Coiled Wire Load  
20-98198 \$49.95

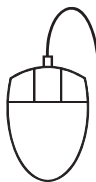

SEE IT  
ON THE WEB

**Check out the details!** For additional detail photos of any Premier freight car, search on its item number on our home page, [www.mthtrains.com](http://www.mthtrains.com).

## Features

- O Scale Kadee® Compatible Mounting Pad
- Unit Measures:  
14 5/8 x 2 5/8 x 3 15/16"
- Operates On O-31 Curves



# Flat Car w/(2) 20' Trailers



**Great Northern** - Flat Car w/(2) 20' Trailers  
20-98732 \$59.95



**CP Rail** - Flat Car w/(2) 20' Trailers  
20-98731 \$59.95



**Santa Fe** - Flat Car w/(2) 20' Trailers  
20-98730 \$59.95



**Southern Pacific** - Flat Car w/(2) 20' Trailers  
20-98729 \$59.95

## Features

- O Scale Kadee® Compatible Mounting Pad
- Unit Measures: 14 1/2" x 2 1/2" x 4 1/2"
- Operates On O-54 Curves

# Flat Car w/Log Load

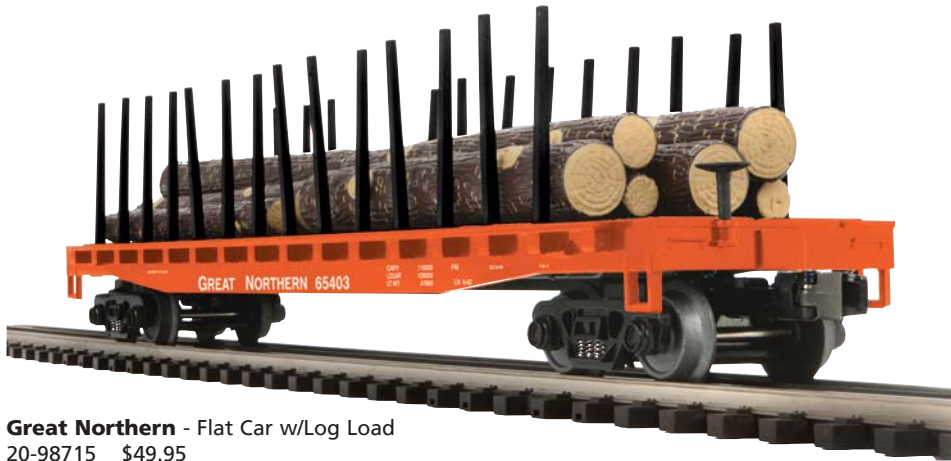

**Great Northern - Flat Car w/Log Load**  
20-98715 \$49.95



**Chicago Northwestern - Flat Car w/Log Load**  
20-98714 \$49.95



**Spokane Portland & Seattle - Flat Car w/Log Load**  
20-98716 \$49.95



**Pennsylvania - Flat Car w/Log Load**  
20-98713 \$49.95



SEE IT  
ON THE WEB

**Check out the details!** For additional detail photos of any Premier freight car, search on its item number on our home page, [www.mthtrains.com](http://www.mthtrains.com).

## Features

- O Scale Kadee® Compatible Mounting Pad
- Removable Log Load
- Unit Measures:  
14 5/8 x 2 3/4 x 1 11/16
- Operates On O-31 Curves

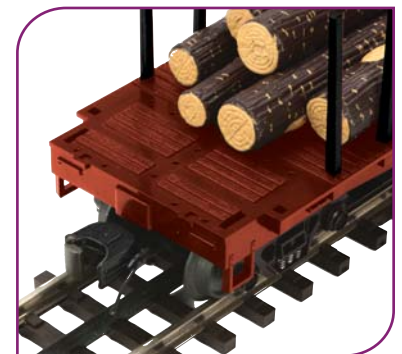



# 47' TTX Heavy Duty Flat Car w/Transformer

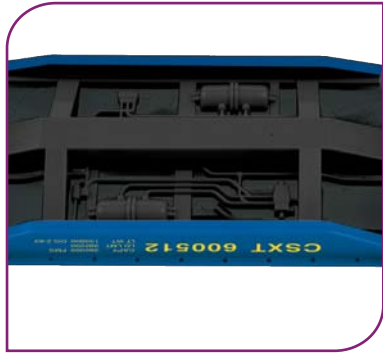
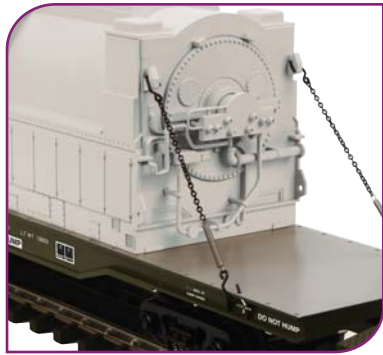

**Union Pacific** -47' TTX Heavy Duty Flat Car w/Transformer  
20-98728 \$69.95



**General Electric** - 47' TTX Heavy Duty Flat Car w/Transformer  
20-98727 \$69.95



**U.S. Army** - 47' TTX Heavy Duty Flat Car w/Transformer  
20-98726 \$69.95



**CSX** - 47' TTX Heavy Duty Flat Car w/Transformer  
20-98725 \$69.95

## Features

- O Scale Kadee® Compatible Mounting Pad
- Removable Transformer Load
- Unit Measures:  
16 1/2" x 2 11/16" x 2 1/8"
- Operates On O-42 Curves

# Corrugated Auto Carrier



**TTX** - Corrugated Auto Carrier  
20-98709 \$59.95



**BNSF** - Corrugated Auto Carrier  
20-98710 \$59.95

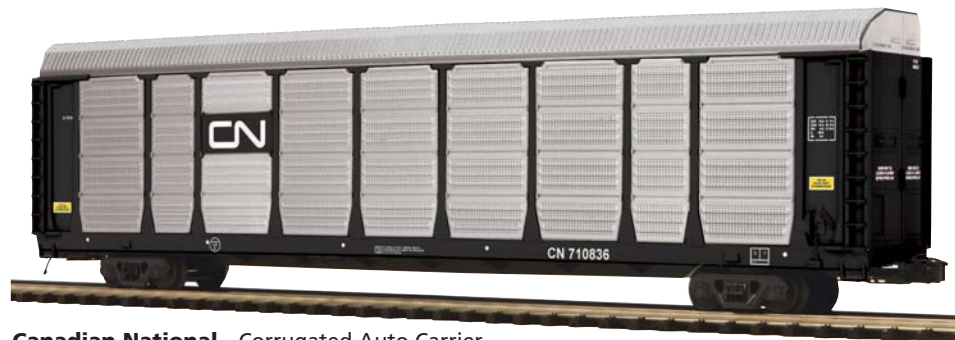

**Canadian National** - Corrugated Auto Carrier  
20-98712 \$59.95



**Norfolk Southern** - Corrugated Auto Carrier  
20-98711 \$59.95



SEE IT  
ON THE WEB

**Check out the details!** For additional detail photos of any Premier freight car, search on its item number on our home page, [www.mthtrains.com](http://www.mthtrains.com).

## Features

- O Scale Kadee® Compatible Mounting Pad
- Unit Measures:  
20 1/8" x 2 5/8" x 5 1/16"
- Operates on O-54 Curves



# 75' AutoTrain Auto Carrier

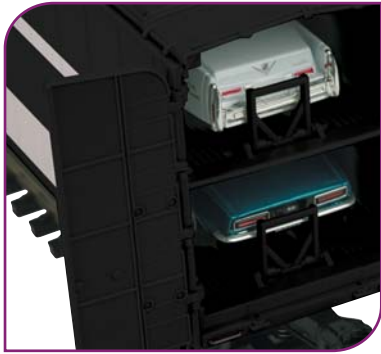

**Amtrak** - 75' AutoTrain Auto Carrier  
20-98706 \$59.95



**Canadian National** - 75' AutoTrain Auto Carrier  
20-98705 \$59.95

## Features

- O Scale Kadee® Compatible Mounting Pad
- Unit Measures:  
19 7/8" x 2 3/4" x 4 3/16"
- Operates On O-54 Curves



**Canadian National** - 75' AutoTrain Auto Carrier  
20-98708 \$59.95



**Amtrak** - 75' AutoTrain Auto Carrier  
20-98707 \$59.95

# Extended Vision Caboose



**Santa Fe** - Extended Vision Caboose  
20-91312 \$59.95



**Chessie** - Extended Vision Caboose  
20-91309 \$59.95



**Pennsylvania** - Extended Vision Caboose  
20-91311 \$59.95



**Union Pacific** - Extended Vision Caboose  
20-91310 \$59.95



SEE IT  
ON THE WEB

**Check out the details!** For additional detail photos of any Premier freight car, search on its item number on our home page, [www.mthtrains.com](http://www.mthtrains.com).

## Features

- O Scale Kadee® Compatible Mounting Pad
- Lighted, Detailed Interior
- Unit Measures: 10 3/4" x 2 3/4" x 4"
- Operates on O-31 Curves

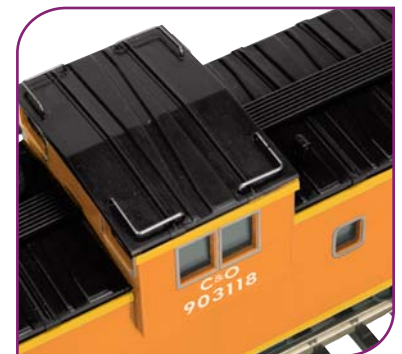

# Bobber Caboose



**Long Island** - Bobber Caboose  
20-91306 \$44.95



**Union Pacific** - Bobber Caboose  
20-91308 \$44.95

## Features

- O Scale Kadee® Compatible Mounting Pad
- Lighted, Detailed Interior
- Unit Measures:  
6 5/8" x 2 5/8" x 3 1/2"
- Operates On O-27 Curves



**Pennsylvania** - Bobber Caboose  
20-91305 \$44.95



**Baltimore & Ohio** - Bobber Caboose  
20-91307 \$44.95

# Freight Sets



## CSX - Coke Hopper Car Set

20-90517 (#205033, 205045, 205010, 206185) \$199.95

20-90518 (#205018, 205033, 205021, 205048) \$199.95



## MKT - Coke Hopper Car Set

20-90521 (#10972, 10966, 10979, 10973)

\$199.95

20-90522 (#10970, 10962, 10964, 10969)

\$199.95



## Caterpillar® - 2-Bay Offset Hopper Car Set

20-90467 (#200958, 200952, 200950, 200951, 200957, 200955) \$269.95

20-90467 (#200964, 200960, 200948, 200966, 200963, 200956) \$269.95



## TTX - Corrugated Auto Carrier Set

20-90526 (#ETTX 702754, ETTX 702755, ETTX 702756, ETTX 702757, ETTX 702758, ETTX 702760) \$279.95

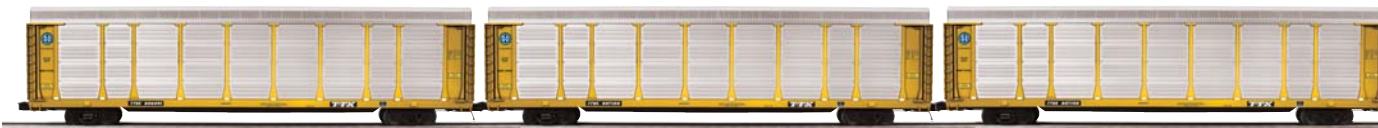

## BNSF - Corrugated Auto Carrier Set

20-90525 (#TTGX 987108 BNSF 24040, TTGX 987198 BNSF 24166, TTGX 989097 BNSF 24801, TTGX 986736 BNSF 23712, TTGX 986762 BNSF 23737, TTGX 986891 BNSF 23765) \$279.95



## Missouri Pacific - 50' High Cube Box Car Set

20-90528 (#357102, 357507, 357200, 357315, 357283, 357324) \$269.95



**Union Pacific - Coke Hopper Car Set**

20-90519 (#38798, 38795, 38784, 38780) \$199.95  
 20-90520 (#38790, 38792, 38786, 38783) \$199.95



**Norfolk Southern - Coke Hopper Car Set**

20-90523 (#802735, 802624, 802679, 802589) \$199.95  
 20-90524 (#802738, 802620, 802672, 802581) \$199.95



© 2009 Caterpillar  
 CAT, CATERPILLAR, their respective logos, "Caterpillar Yellow" and the "Power Edge" trade dress, as well as corporate and product identity used herein, are trademarks of Caterpillar and may not be used without permission.



# Premier Passenger Cars



**Amtrak** - 2-Car 70' ABS Baggage/Coach Passenger Set (Ribbed)  
20-69151 \$159.95



**Amtrak** - 70' ABS RPO Passenger Car (Ribbed)  
20-68151 \$89.95



**Amtrak** - 2-Car 70' ABS Slpr/Diner Passenger Set (Ribbed)  
20-66151 \$159.95



**Amtrak** - 5-Car 70' ABS Passenger Set (Ribbed)  
20-65151 \$399.95



**Santa Fe** - 5-Car 70' Madison Passenger Set  
20-40006 \$399.95



**Santa Fe** - 2-Car 70' Madison  
Comb/Din Passenger Set  
20-41006 \$159.95



**Santa Fe** - 2-Car 70' Madison Baggage/Coach Passenger Set  
20-44006 \$159.95



**Santa Fe** - 70' Madison RPO Passenger Car  
20-42006 \$89.95



**New York Central** - 5-Car 70' Madison Passenger Set  
20-40005 \$399.95

## Features

- 5 Car Sets Feature (1) Baggage, (3) Coaches, (1) Observation
- Each Car Measures: 19' x 2 7/16" x 3 1/2"
- Operates on O-42 Curves



**New York Central** - 2-Car 70' Madison Comb/Din Passenger Set  
20-41005 \$159.95





**London, Midland & Scottish Railway** - LMS Standard Passenger Car  
20-60007 \$109.95  
**British Railways** - LMS Standard Passenger Car  
(Crimson & Cream; Not Illustrated)  
20-60010 \$109.95  
**British Railways** - LMS Standard Passenger Car  
(Maroon; Not Illustrated)  
20-60013 \$109.95



**London, Midland & Scottish Railway** - LMS Standard Baggage Car  
20-60006 \$109.95  
**British Railways** - LMS Standard Baggage Car  
(Crimson & Cream; Not Illustrated)  
20-60009 \$109.95  
**British Railways** - LMS Standard Baggage Car  
(Maroon; Not Illustrated)  
20-60012 \$109.95



**London, Midland & Scottish Railway** - 4-Car LMS Standard Passenger Set  
20-60005 \$429.95  
**British Railways** - 4-Car LMS Standard Passenger Set  
(Crimson & Cream; Not Illustrated)  
20-60008 \$429.95  
**British Railways** - 4-Car LMS Standard Passenger Set  
(Maroon; Not Illustrated)  
20-60011 \$429.95



**Santa Fe** - 5-Car 70' ABS Passenger Set (Smooth)  
20-65152 \$449.95



**Santa Fe** - 2-Car 70' ABS Slpr/Diner  
Passenger Set (Smooth)  
20-66152 \$179.95



**Santa Fe** - 70' ABS RPO Passenger Car (Smooth)  
20-68152 \$99.95



**Santa Fe** - 70' ABS Full Length Vista Dome Passenger Car  
20-67152 \$99.95



**Santa Fe** - 2-Car 70' ABS Baggage/Sleeper Passenger Set  
20-69152 \$179.95

**PLATED  
STAINLESS  
FINISH**



**New York Central** - 2-Car 70' Madison Baggage/Coach Passenger Set  
20-44005 \$159.95



**New York Central** - 70' Madison RPO Passenger Car  
20-42005 \$89.95

# Woodsided Passenger Cars



**New York Central** - 64'  
Woodsided Coach  
20-62032 \$89.95



**New York Central** - 3-Car 64' Woodsided Passenger Set  
20-62031 \$259.95



**New York Central** - 3-Car 64' Woodsided Passenger Add-On Set  
20-62030 \$259.95



**New York & New England** - 3-Car 64' Woodsided Passenger Set  
20-62033 \$259.95

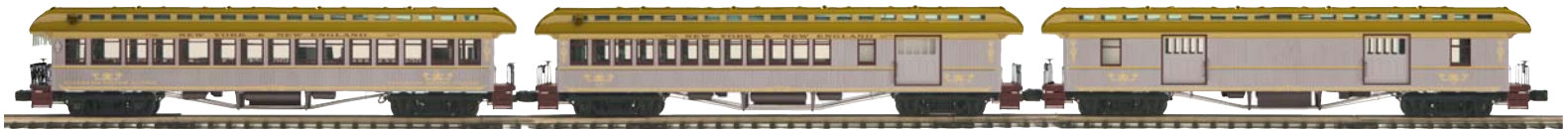

**New York & New England** - 3-Car 64' Woodsided Passenger Add-On Set  
20-62035 \$259.95



**New York & New England**  
64' Woodsided Coach  
20-62034 \$89.95





**Central Pacific - 3-Car 64' Woodsided Passenger Set**  
20-62039 \$259.95



**Central Pacific - 3-Car 64' Woodsided Passenger Add-On Set**  
20-62028 \$259.95

**Central Pacific - 64' Woodsided Coach**  
20-62040 \$89.95



## Features

- 3-Car Sets Include 3 Coaches or Baggage Car, Combine, and Observation
- Kadee® Compatible Coupler Mounting Pad
- Illuminated Interior With Passengers
- Each Car Measures: 17 1/4" x 2 1/2" x 3 5/8"
- Operates on O-42 Curves



**Boston & Maine - 64' Woodsided Coach**  
20-62037 \$89.95



**Boston & Maine - 3-Car 64' Woodsided Passenger Set**  
20-62036 \$259.95



**Boston & Maine - 3-Car 64' Woodsided Passenger Add-On Set**  
20-62038 \$259.95

# POWER UP with the best transformers in O Gauge!



**100 Watts**

## Z-1000™ Transformer

40-1000 \$99.95

With 14 Volt Accessory Port  
Also supplied with most RailKing Ready-to-Run sets, the Z-1000 is the smoothest-operating, most powerful train set transformer in O gauge.

Whether you operate with conventional AC power or the M.T.H. Digital Command System (DCS), our UL-approved transformers offer the best way to power your layout. Choose the 100-watt Z-1000™ for a small- to medium-sized layout, or step up to the 400-watt, feature-laden Z-4000®, the most powerful UL-approved transformer in the hobby. All M.T.H. transformers offer

- Incredibly smooth, wide range throttle for precise speed control
- Bell and whistle/horn buttons that work with all makes of locomotives
- Fast-acting circuit breakers to protect your equipment
- Continuous useable wave power output compatible with all AC-powered engines

## WHY THE LISTING?

To protect our customers and their trains, M.T.H. Electric Trains is committed to manufacturing safe, UL-approved transformers and power supplies. By subjecting our transformers to the strenuous tests and requirements of Underwriters Laboratories, M.T.H. helps ensure that our products meet the same requirements as other consumer electronics sold today. When choosing a new transformer, model railroaders should only look for those that have received a UL listing.

## Z-DC350 Transformer

40-350 \$99.95

Featuring 35 watts of power and a 16 volt AC accessory port, the UL approved DC-350 will comfortably run up to five HO locomotives.

- Controller LED On Light
- Overload Light
- Power On Switch
- Momentum Control
- Brake Control
- Direction Control
- Built-In Circuit Breaker Protection
- 35 Watt DC Power Supply w/16v AC Accessory Output Jacks

**35 Watts**



## Z-DC1 Transformer

40-200 \$19.95

A perfect small power supply to power up accessory lights, the ZDC1 includes a smooth feeling power knob atop its UL approved enclosure.

- U.L. Approved
- 20 Watts DC Max Power Output
- Smooth Operating Throttle Knob
- Built-In Circuit Breaker Protection



## 100-Watt Accessory Power Supply

40-1000A \$79.95

- Ideal for powering accessories, or for DCS users who don't need a conventional transformer
- TIU/Barrel Jack adapter available separately for easy connection to DCS Track Interface Unit
- 18-volt track power output
- 14-volt accessory output



**50 Watts**

## Z-500™ Transformer

40-500 \$59.95

Designed for smaller layouts, the Z-500 offers the same control features as the Z-1000 but with less power.

# 400 Watts! The Most Powerful Listed Transformer!

## Learn More About It

The instruction manual for every M.T.H. transformer is available at [www.mthtrains.com](http://www.mthtrains.com). Just look up the transformer in our Product Search feature.



Overload indicator

Smooth-operating, wide-range **dual throttles**

**Dual ammeters** show how much current each throttle is using and warn of potential overloads

**Bell and whistle-horn buttons** compatible with all AC engines

**Programming button** for original Proto-Sound and QSI® AC sound systems

Internal cooling fan

**Direction button** for each channel

**On-off switch with Accidental Startup Protection:** If throttles are not in Off position when Z-4000 is turned on, no power will be applied to the track.

Smooth-operating, wide-range **dual throttles**

**Power-on indicator**

**Dual voltmeters** show how much power you're putting on the track

## Rear Panel Outputs

0~22 Volts Track Power (10 AMP)    10-Volt Accessory Power (5 AMP)    14-Volt Accessory Power (5 AMP)    0~22 Volts Track Power (10 AMP)

**Accepts bare wires, spade lugs, or banana plugs** (recommended) for easy connections

## Z-4000® Transformer

40-4000    \$429.95

Two throttles, each with its own complete set of controls, plus 10-volt and 14-volt accessory outputs

# Three-Rail Trains Look—and Run—Better on ScaleTrax™



**It's not about the track.** Railroading is about huge machinery that makes the ground shake when it goes by. In model railroading, the track is just a stage setting that should make your trains look more real and more massive -- and no three-rail track does that better than ScaleTrax, the lowest-profile, best-running 3-rail O gauge track system.

**Compare** our track with 3-rail track systems from Atlas O and Ross Custom Switches, and check out the advantages of ScaleTrax:

## Track Features

- Solid, rust-proof nickel silver rails
- Durable ABS ties for years of use
- Easy, snap-together assembly
- Built-in electrical connections eliminate need for rail joiners or track pins
- Built-in Lockon receptacle in every track section
- Non-derailing switches
- Snap-in, reversible switch motors work on either side of track
- Compatible with virtually all three-rail locomotives and cars

## Lower Cost

ScaleTrax track and switches are more affordable than comparable Atlas and Ross products.

## More Realism

Prototypically scaled, lower profile rail and ties make your locomotives and rolling stock look more massive on ScaleTrax.

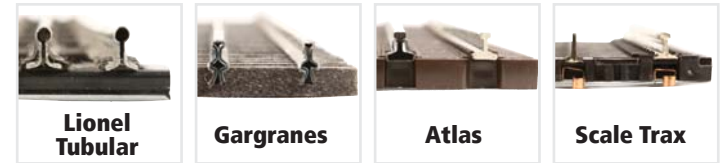

*Lowest Profile 3-Rail O Gauge Track*

## Smaller Third Rail

The thinnest, lowest-profile center rail of any major track brand gives ScaleTrax a more realistic look.

## Better Electrical Contact

Concealed, large, spring-loaded contacts deliver more secure electrical connections between track sections.

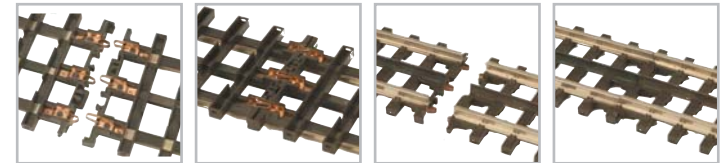

## Smoother Switches

Thanks to our ramped and beveled frog and lower profile rail, ScaleTrax offers the smoothest-rolling switches in O gauge.

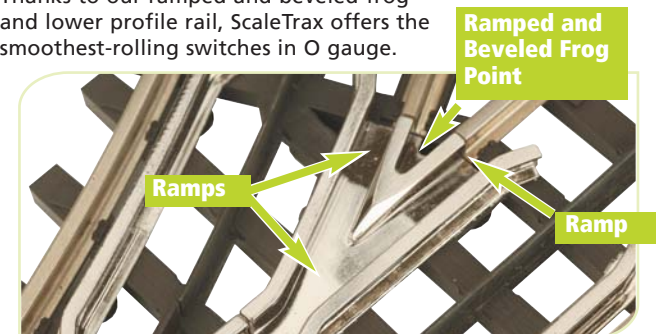

## Easier-To-Use Flex Track

Low-profile rail and ties make ScaleTrax flex easier to bend than other brands.



# Dave Hikel ScaleTrax™ Layout Packages



12x24 Tall Timber Mountain

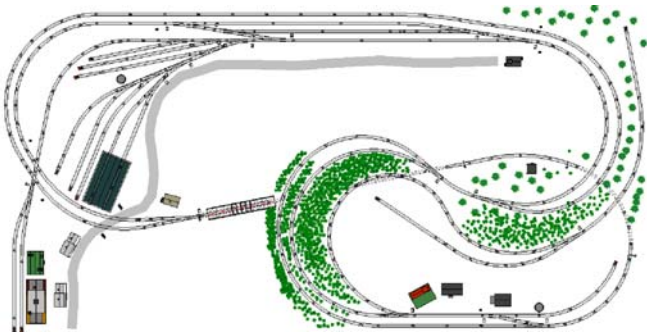

**NEW!**

## Dave Hikel Layout Packages

Don't have the time or inclination to design your own layout? Check out ScaleTrax layout packages, featuring track plans designed by Dave Hikel, renowned West Coast custom layout builder. Each package includes all the track and switches needed to build a complete layout. For details and track plans, click the ScaleTrax logo at the bottom of the M.T.H. home page, [www.mthtrains.com](http://www.mthtrains.com). Order the Scaletrax components from any M.T.H. Authorized Retailer and M.T.H. will drop ship your order directly from Maryland. If you prefer to design your own plan use RR Track layout design software and take your design to any M.T.H. Authorized Retailer and we will drop ship the order for them.



RR Track Layout Design Software \$49.95

6x10 Main Street

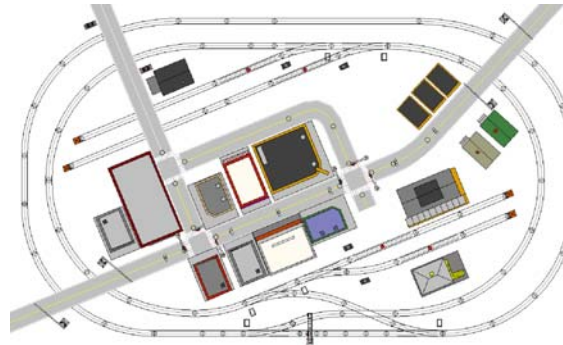

8x9 Spare Room and Pacific RR

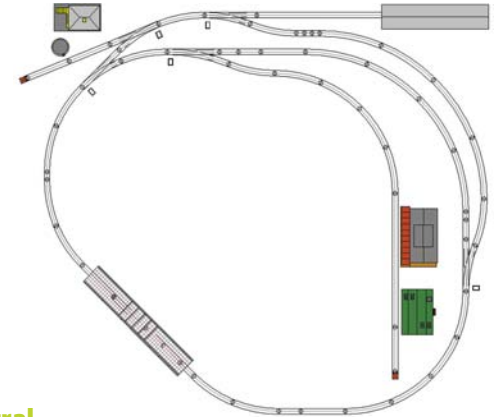

Item #	Description	MSRP	QTY	Extension
45-1001	10 inch straight	\$3.99	14	\$55.86
45-1002	O-31 curve	\$3.99	0	\$0.00
45-1003	O-31 LH switch	\$49.95	0	\$0.00
45-1004	O-31 RH switch	\$49.95	0	\$0.00
45-1005	90 deg crossing	\$19.95	0	\$0.00
45-1006	45 deg crossing	\$19.95	2	\$39.90
45-1007	O-54 curve	\$3.99	10	\$39.90
45-1008	O-54 LH switch	\$49.95	0	\$0.00
45-1009	O-54 RH switch	\$49.95	0	\$0.00
45-1010	O-72 curve	\$4.99	41	\$204.59
45-1011	1.75 inch straight	\$2.49	4	\$9.96
45-1012	4.25 inch straight	\$3.50	5	\$17.50
45-1013	5 inch straight	\$3.50	1	\$3.50
45-1014	5.5 inch straight	\$3.50	2	\$7.00
45-1015	22.5 deg crossing	\$19.95	0	\$0.00
45-1019	30 inch straight	\$10.99	30	\$329.70
45-1020	O-72 RH switch	\$49.95	1	\$49.95
45-1021	O-72 LH switch	\$49.95	5	\$249.75
45-1025	bumper	\$15.95	11	\$175.45
45-1033	lock-on	\$3.99	30	\$119.70
45-1034	O-80 curve	\$5.99	22	\$131.78
45-1035	15 inch uncoupling section	\$19.95	0	\$0.00
45-1049	30 inch flex	\$9.95	23	\$228.85
45-1050	#4 LH switch	\$59.95	3	\$179.85
45-1051	#4 RH switch	\$59.95	5	\$299.75
45-1052	#6 LH switch	\$69.95	4	\$279.80
45-1053	#6 RH switch	\$69.95	3	\$209.85

**Total \$2,632.64**

4x8 Freight Central

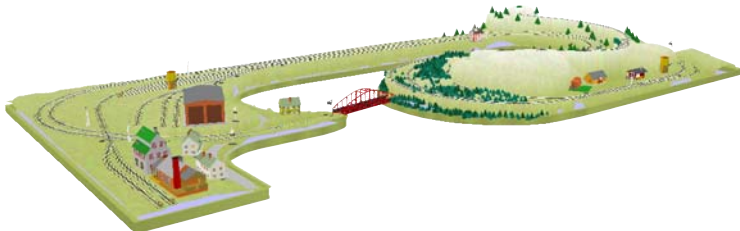
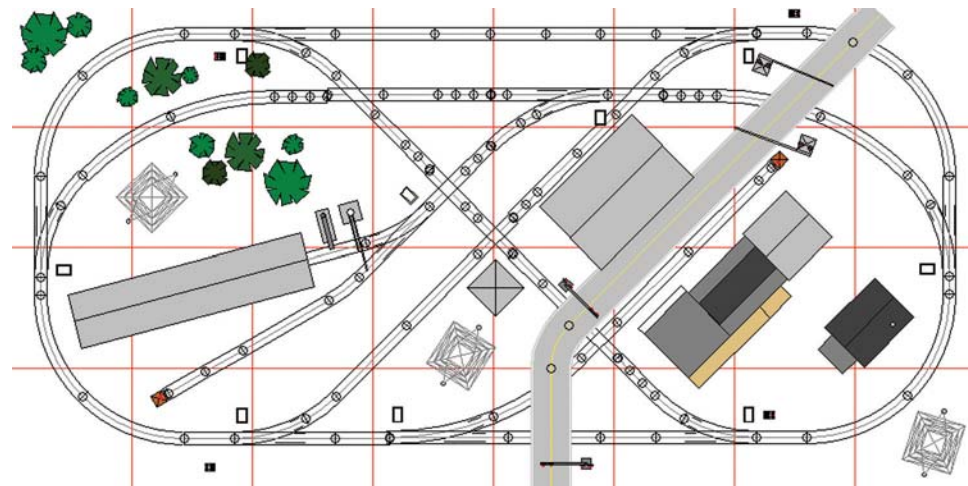



# Scale Trax



## STRAIGHT, FLEX & OPERATING TRACK SECTIONS

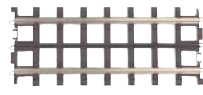

It takes EIGHT O-31 CURVES to make a circle.  
 It takes TWELVE O-54 CURVES to make a circle.  
 It takes SIXTEEN O-72 CURVES to make a circle.  
 It takes SIXTEEN O-80 CURVES to make a circle.

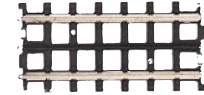

 ScaleTrax™ - 1.75" Track Section  
 45-1011 \$2.49  
 ScaleTrax™ - 1.75" Track Section 4-Pack  
 45-1011-4 \$9.99

 ScaleTrax™ - 5.0" Track Section  
 45-1013 \$3.50  
 ScaleTrax™ - 5.0" Track Section 2-Pack  
 45-1013-2 \$7.99

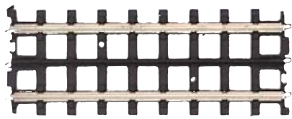
 ScaleTrax™ - 4.25" Track Section  
 45-1012 \$3.50  
 ScaleTrax™ - 4.25" Track Section 2-Pack  
 45-1012-2 \$7.99

 ScaleTrax™ - 5.5" Track Section  
 45-1014 \$3.50  
 ScaleTrax™ - 5.5" Track Section 2-Pack  
 45-1014-2 \$7.99

 ScaleTrax™ - 10" Straight Track Section  
 45-1001 \$3.99

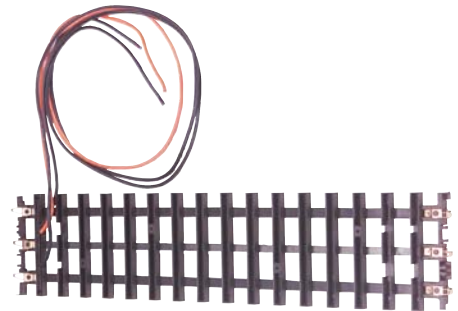

ScaleTrax™ - Lockon (Track Not Included)  
 45-1033 \$3.99  
 Each FlexTrack Section Requires 1 Lockon

 ScaleTrax™ - 30" Track Section  
 45-1019 \$10.99

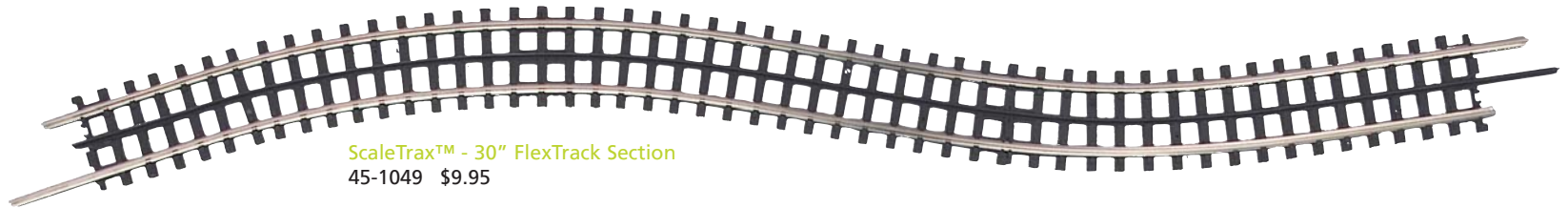
 ScaleTrax™ - 30" FlexTrack Section  
 45-1049 \$9.95

**Lowest Profile, Most Realistic 3-Rail Track in O Gauge!**

 ScaleTrax™ - 15" Operating Track Section  
 45-1035 \$19.95

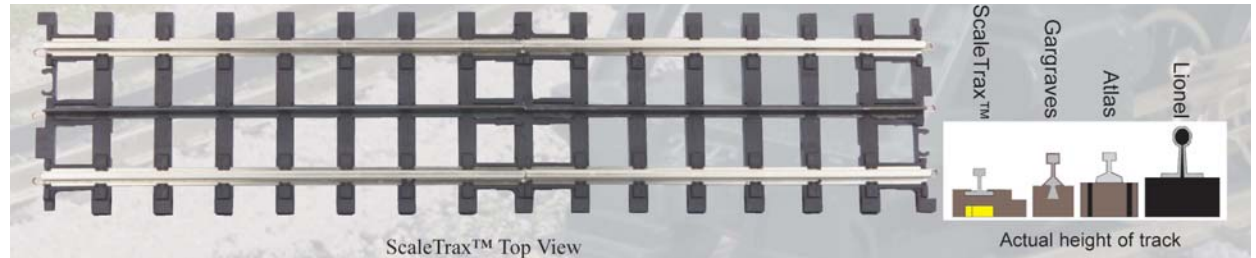



## CURVED TRACK SECTIONS



ScaleTrax™ - O-31 Curved Track Section  
45-1002 \$3.99

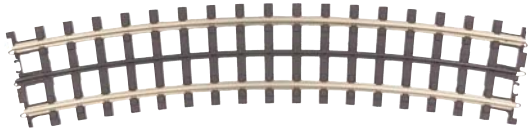

ScaleTrax™ - O-54 Curved Track Section  
45-1007 \$3.99

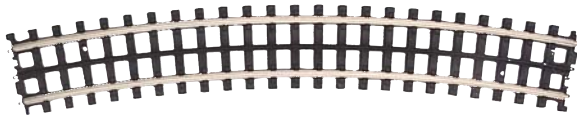

ScaleTrax™ - O-72 Curved Track Section  
45-1010 \$4.99

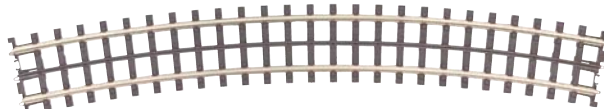

ScaleTrax™ - O-80 Curved Track Section  
45-1034 \$5.99

## CROSSOVERS



ScaleTrax™ - 22.5 Degree Crossing  
45-1015 \$19.95



ScaleTrax™ - 45 Degree Crossing  
45-1006 \$19.95

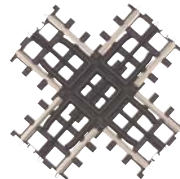

ScaleTrax™ - 90 Degree Crossing  
45-1005 \$19.95

## SWITCHES

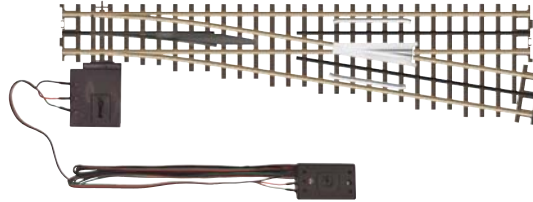

ScaleTrax™ - No. 6 Right Hand Switch  
45-1053 \$69.95  
ScaleTrax™ - No. 6 Left Hand Switch  
45-1052 \$69.95

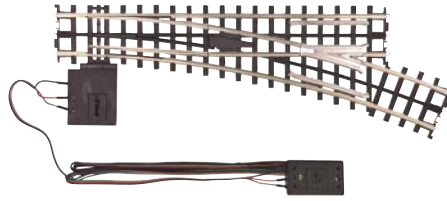

ScaleTrax™ - O-72 Right Hand Switch  
45-1020 \$49.95  
ScaleTrax™ - O-72 Left Hand Switch  
45-1021 \$49.95

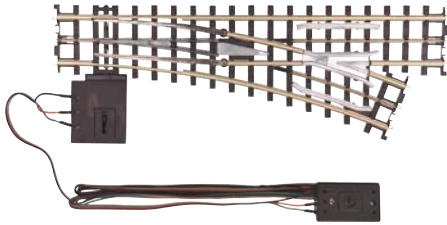

ScaleTrax™ - O-54 Right Hand Switch  
45-1009 \$49.95  
ScaleTrax™ - O-54 Left Hand Switch  
45-1008 \$49.95

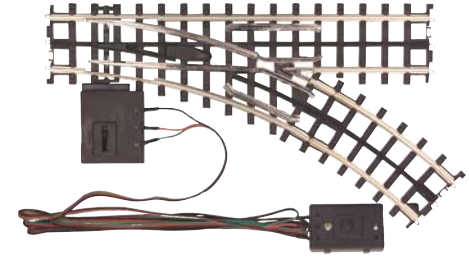

ScaleTrax™ - O-31 Right Hand Switch  
45-1004 \$49.95  
ScaleTrax™ - O-31 Left Hand Switch  
45-1003 \$49.95

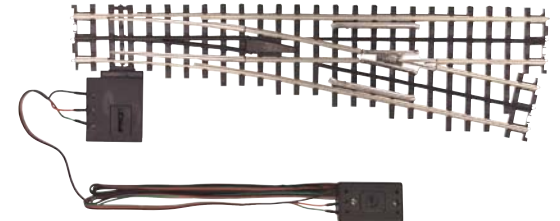

ScaleTrax™ - No. 4 Right Hand Switch  
45-1051 \$59.95  
ScaleTrax™ - No. 4 Left Hand Switch  
45-1050 \$59.95

## ACCESSORIES



ScaleTrax™ - Bumper  
45-1025 \$15.95

ScaleTrax™ - ITAD  
45-1028 \$29.95  
(used to activate signals  
and trackside accessories)



# Accessories



**Over & Under Tunnel**  
40-1070 \$59.95  
Measures: 21" x 17" x 8 1/4"



**90 Degree 031 Curved Tunnel**  
40-1072 \$59.95  
Measures: 21 1/2" x 21" x 11 1/2"

**DURABLE, RESIN-MOLDED  
SCENIC MOUNTAINS**

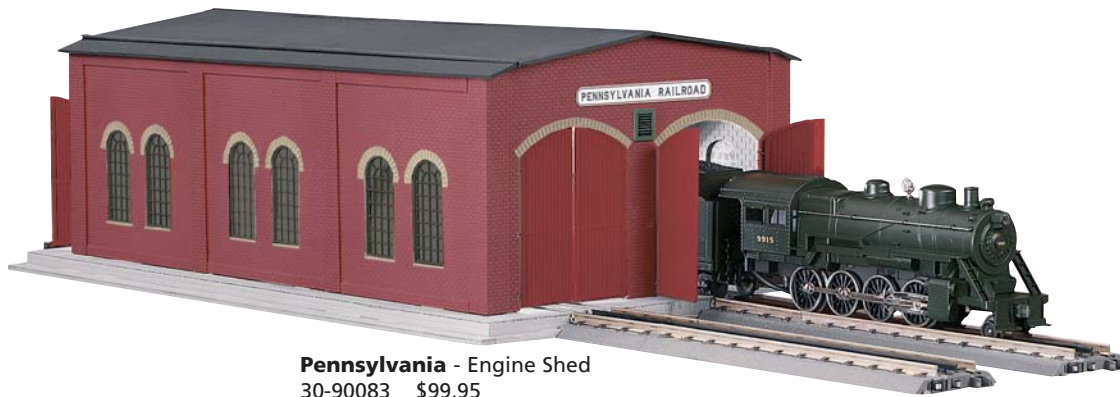

**Pennsylvania - Engine Shed**  
30-90083 \$99.95  
Measures: 24" x 8 1/2" x 13 1/2"

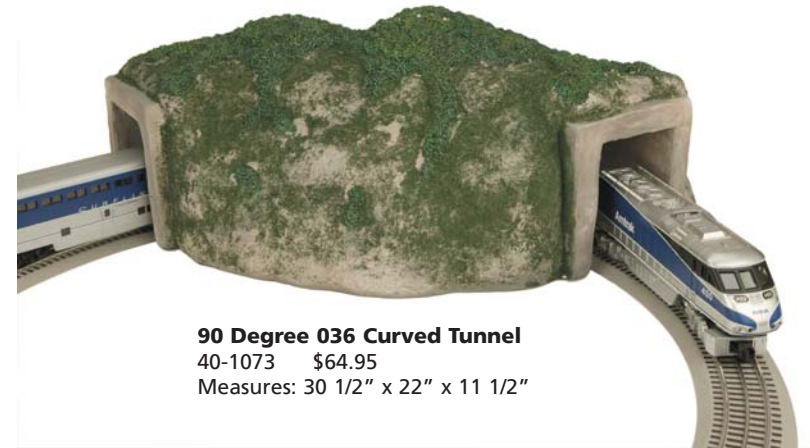

**90 Degree 036 Curved Tunnel**  
40-1073 \$64.95  
Measures: 30 1/2" x 22" x 11 1/2"



**Western Maryland - 314 Die-Cast Girder Bridge**  
30-12010 \$29.95  
Measures: 10" x 4 1/2" x 1 3/4"



**Santa Fe - 314 Die-Cast Girder Bridge**  
30-12009 \$29.95  
Measures: 10" x 4 1/2" x 1 3/4"



**Pennsylvania - 314 Die-Cast Girder Bridge**  
30-12001 \$29.95  
Measures: 10" x 4 1/2" x 1 3/4"



**Track Cleaning Block**  
40-1099 \$17.99



**Pennsy** - Single Stall Engine Shed  
30-90267 \$79.95  
Measures: 24" x 5 1/2" x 13 1/2"



**Gray & White** - Public Works Building  
30-90007 \$69.95  
Measures: 14 1/8" x 9 7/8" x 8 1/8"



**White & Red** - #5 Country Church  
30-9057 \$29.95  
Measures: 7 7/8" x 4 5/8" x 10 9/16"



**Brown** - Work Office w/Flickering Fire  
30-90012 \$39.95  
Measures: 11 1/2" x 3" x 4"



**Orange** - Yard Office w/Flickering Fire  
30-90013 \$39.95  
Measures: 11 1/2" x 6 11/16" x 3 3/8"



**Santa's Workshop**  
30-90256 \$34.95  
Measures: 9 1/4" x 6 1/8" x 5"



**Harley-Davidson®** - 4-Pack Motorcycle Set  
30-90126 \$19.95



© 2009 H-D, All Rights Reserved.



**Assortment 1** - 6-Piece Figure Set  
30-11071 \$19.95



**Assortment 2** - 6-Piece Figure Set  
30-11072 \$19.95



**Assortment 1** - 6-Piece Figure Set #12  
30-11074 \$19.95



**Undecorated** - 120-Piece Passenger Figure Set  
30-11043 \$29.95

# Accessories

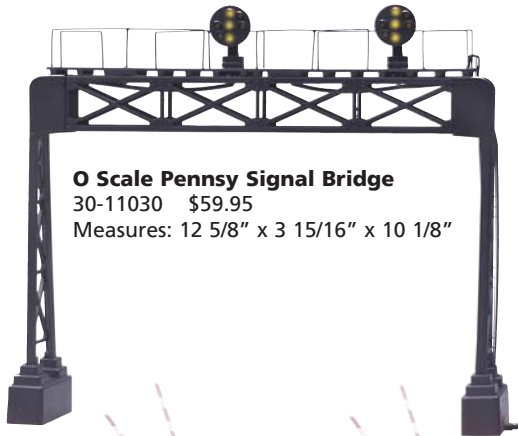

**O Scale Pennsy Signal Bridge**  
30-11030 \$59.95  
Measures: 12 5/8" x 3 15/16" x 10 1/8"



**O-Scale Operating Crossing Gate Signal Set**  
30-11012 \$59.95  
Measures: 8 1/2" x 2"



**O Scale Vertical Signal**  
30-11036 \$49.95  
Measures: 1 3/16" x 2 5/8" x 7 1/8"



**O Operating Crossing Flasher Set w/Sound**  
30-11014 \$59.95  
Measures: 5 1/2" x 2 1/2" x 1"

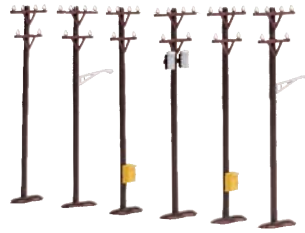

**Telephone Pole Set**  
30-1088 \$19.95  
Measures: 5 3/4" Tall



**Road Sign Set (2 Each)**  
30-1087 \$14.95  
Measures: 2" Tall



**Green Base - #151 Operating Semaphore**  
30-1075 \$29.95  
Measures: 9 5/8" Tall



**O-Scale 7 Light Block Signal**  
30-11013 \$49.95  
Measures: 7" x 1 1/2" x 2"



**O-Scale Dwarf Signal Set**  
30-11011 \$24.95  
Measures: 1" x 7/8" x 1 3/4"



**Operating Traffic Light Set Double Lamp**  
30-1089-2 \$34.95  
Measures: 5" Tall



**Operating Traffic Light Set - Single Lamp**  
30-1089-1 \$29.95  
Measures: 5" Tall

**O Scale Flashing Barricades (4)**  
30-11021 \$29.95  
Measures: 1" x 1" x 2"



**O Scale Position Light Signal lamps**  
30-11030-A \$15.95  
Measures: 1 1/4" Tall



**O Scale Modern Operating Crossing Signal**  
30-11006 \$49.95  
Measures: 7" Tall



**O Lamp Set Triple Park Light**  
30-11034 \$29.95  
Measures: 3/4" x 4 7/16"



**O Lamp Set - Street Gas Light**  
30-11033 \$24.95  
Measures: 3/4" x 4 3/8"



**Black - O Lamp Set - Hexagonal**  
30-1062 \$24.95  
Measures: 4" Tall



**Black - O Lamp Set Round**  
30-1078 \$24.95  
Measures: 4" Tall



**Black - O Lamp Set Square**  
30-1079 \$24.95  
Measures: 4" Tall

# 0-Gauge or 2-Rail 0 Scale Couplers and Trucks

## 3-RAIL

### RailKing 3-Rail Roller Bearing Freight Car Two Truck Pack

30-89002 \$14.99

### RailKing 3-Rail Bettendorf Freight Car Two Truck Pack

30-89001 \$14.99



### Premier 3-Rail Roller Bearing Die-Cast Freight Car Two Truck Pack

20-89004 \$14.99

### Premier 3-Rail Bettendorf Die-Cast Freight Car Two Truck Pack

20-89003 \$14.99



## PREMIER 2-RAIL

### 2-Rail Lightweight Die-Cast Passenger Car Two-Truck Pack\*

20-89007 \$24.95

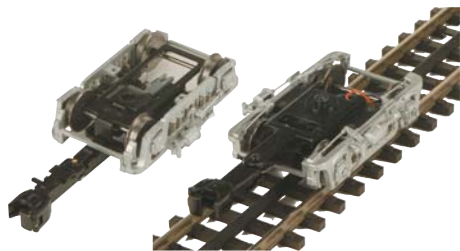

### 2-Rail Heavyweight Passenger Car Two-Truck Pack\*

20-89014 \$24.95



### 2-Rail 64' Woodsided Passenger Car Two-Truck\*

20-89012 \$24.95



### 2-Rail Bettendorf Caboose Two-Truck Pack\*

20-89015 \$14.99

### 2-Rail Roller Bearing Caboose Two-Truck Pack\*

20-89016 \$14.99



### 2-Rail Bettendorf Die-Cast Freight Car Two-Truck Pack

20-89001 \$14.99

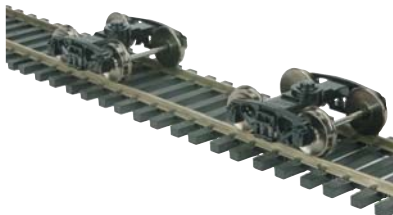

### 2-Rail Roller Bearing Die-Cast Freight Car Two-Truck Pack

20-89002 \$14.99

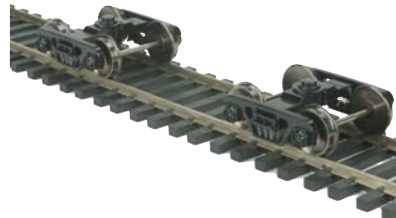

\*Includes Removable 3-Rail Couplers

## End-of-Train-Device Roller Bearing Freight Truck

This long requested accessory can convert any M.T.H. Premier Line freight car to an end-of-train car in just minutes.

The all die-cast sprung roller bearing truck includes a center-rail pickup roller that powers a bright flashing LED, reproducing the end-of-train effect found on modern freight drags.

The ETD truck easily mounts to your existing freight cars in just a few minutes.

### Features:

- Die-Cast Construction
- Fully Assembled
- Self-Powered Strobe Light
- Mounts To Any M.T.H. Freight Car
- Unit Measures: 1" High



### White End-of-Train-Device Roller Bearing Freight Truck

20-89013 \$19.95

### Yellow End-of-Train-Device Roller Bearing Freight Truck

20-89010 \$19.95



### Wireless Drawbar Set

20-89011 \$29.95

## CONVERSION WHEEL KITS

### Proto-Scale 3-2™ 4-Wheel Truck Scale Wheel Set

20-89005 \$39.95

### Proto-Scale 3-2™ 6-Wheel Truck Scale Wheel Set

20-89006 \$59.95

### Proto-Scale 3-2™ 4-Wheel Truck Hi-Rail Wheel Set

20-89008 \$39.95

### Proto-Scale 3-2™ 6-Wheel Truck Hi-Rail Wheel Set

20-89009 \$59.95

# Accessories



**Coney Island Hot Dogs - Fast Food Restaurant Stand**  
 30-90309 \$59.95  
 Measures: 14 1/2" x 12" x 7 1/2"



**Engine Company 49 - Operating Firehouse**  
 30-9157 \$149.95  
 Measures: 16 5/8" x 15 3/8" x 12 3/8"

**Miller - Vendor Trailer**  
 30-50048 \$34.95

© 2009 MillerCoors, LLC. All right reserved.  
 Produced under license by M.T.H. Electric  
 Trains. This licensed product is intended for  
 adults of legal drinking age.



**Opening Side Doors**

**Pittsburgh Brewing Co - Vendor Trailer**  
 30-50050 \$34.95

**Interior Illumination**



**Rolling Rock - Vendor Trailer**  
 30-50047 \$34.95

"© 2009 Anheuser-Busch, Inc. All Rights Reserved."



**M&M'S® - Vendor Trailer**  
 30-50049 \$34.95



©/™ M&M'S, the letter M and the M&M'S Characters are  
 registered trademarks of Mars, Incorporated and its affiliates.  
 ©MARS, Incorporated 2009



**Harley Davidson® - Country Gas Station**  
 30-90327 \$54.95  
 Measures: 11" x 10 1/16" x 5 3/16"

 © 2009 H-D, All Rights Reserved.



**Coors Brewing Company - Brewery w/Operating Smoke**  
 30-90220 \$99.95  
 Measures: 19 3/8" x 8 5/16" x 6 5/8"

© 2009 MillerCoors, LLC. All right reserved.  
 Produced under license by M.T.H. Electric Trains. This licensed product is intended for adults of legal drinking age.



**Operating Transfer Dock**  
 30-9110 \$149.95  
 Measures: 18 7/8" x 10 3/16" x 9 3/4"



**Esso - Country Gas Station**  
 30-90301 \$49.95  
 Measures: 11" x 10 1/16" x 5 3/16"

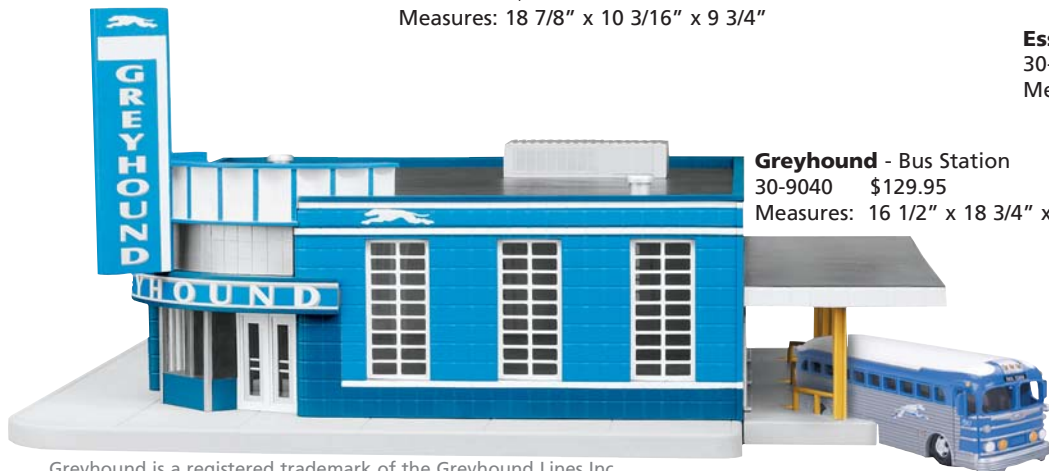

**Greyhound - Bus Station**  
 30-9040 \$129.95  
 Measures: 16 1/2" x 18 3/4" x 9 1/2"

Greyhound is a registered trademark of the Greyhound Lines Inc.



**See More  
 Accessories in the  
 2009 Ready-To-Run  
 Catalog!**

# M.T.H. RailRoders Club

## Join The Club

There are EIGHT different types of memberships, based on the style of model railroading that most interests you.

### RAILKING MEMBERSHIP



30-72048 MTHRRRC Gondola Car with Crates  
**RailKing Membership is \$50.00**

### PREMIER MEMBERSHIP



20-98093 Gondola Car  
**Premier Membership is \$50.00**

### LIONEL CORP. STD. GAUGE MEMBERSHIP



11-30054 Lionel Corp. No. 516 Std. Gauge Coal Car  
**Lionel Corp. 500 Series Membership is \$120.00**

### TINPLATE O GAUGE MEMBERSHIP



10-8081 MTHRRRC 2800 Series O Gauge Hopper  
**Tinplate 2800 Series Membership is \$80.00**

### TINPLATE STD. GAUGE MEMBERSHIP



10-2240 MTHRRRC 500 Series Std. Gauge Hopper  
**Tinplate 500 Series Membership is \$120.00**

### LIONEL CORP. O GAUGE MEMBERSHIP

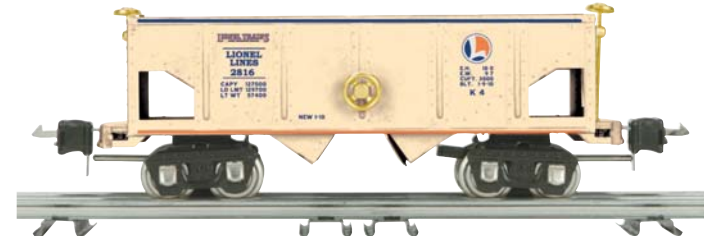

11-70023 Lionel Corp. No. 2816 O Gauge Coal Car  
**Lionel Corp. 2800 Series Membership is \$80.00**

### ONE-GAUGE MEMBERSHIP



70-74071 Chesapeake & Ohio 40' Box Car  
**One-Gauge Membership is \$100.00**

### BASIC MEMBERSHIP

60-1000 - The Basic Club Membership does not include a club car  
**Basic Membership is \$25.00**



**GET THE MOST FROM MODEL RAILROADING**  
JOIN ONLINE! IT'S EASY — JUST GO TO [WWW.MTHTRAINS.COM](http://WWW.MTHTRAINS.COM)



## AS A MEMBER OF THE M.T.H. RAILROADERS CLUB YOU'LL RECEIVE:

### Limited-Edition Club Car



Each year we produce beautifully decorated cars exclusively for our Club members. Members automatically receive the car that matches their Club membership (RailKing, Premier, Tinplate Traditions or One Gauge) & have the option to collect the other Club cars as well.

### The CrossingGate™ Club Magazine

You will receive our full color Club magazines, jam-packed with product news, ideas from other members, rail history, & step-by-step articles explaining how M.T.H. technology can bring your railroad to life.



### 1<sup>st</sup> Class Mailing of M.T.H. Catalogs

Club Members get all of our catalogs earlier than all our other mailing list members via First-Class mailings, so they can order from their local train store before the best items are sold out.



### RailWare™ Software

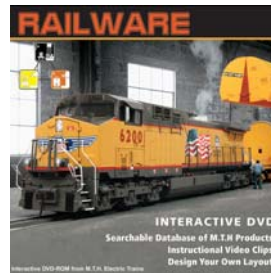

Use your computer to design track layouts, search the database of all M.T.H. products, look at our past catalogs, listen to Proto-Sound 2.0 train effects, & much more. This CD retails for \$79.95, but is yours FREE as a Club member.

### Club Card & Lapel Pin



Show the world your membership in this elite group of model railroaders with your high-quality embossed membership card & beautiful enamel lapel pin.

### Proto-Sound® 2.0 Upgrade Kits

Club members can save an additional 15% on these kits by visiting the MTHRC web page.

### Club Web Site

Visit [www.MTHtrains.com](http://www.MTHtrains.com) & type in your member number to gain access to the Club web site. Here you can exchange messages with other Club members, keep up with the latest news, & even build your own homepage.

## CARRY ON THE M.T.H. TRADITION WITH MEMORABILIA AND COLLECTIBLES

### MTH Promotional DVD

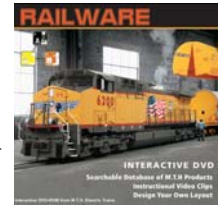

This interactive DVD is packed full of sights & sounds guaranteed to make you rethink how far the hobby of model railroading has come. You'll learn about some of the most innovative products ever produced & marvel at the sophistication of a product line unmatched by other model train manufacturers.



### Previous Year Club Cars

MTHRC members can still obtain earlier produced MTHRC cars by visiting the MTHRC pages on the website. Only MTHRC members can get these cars!

### A Toy Train Story



This comprehensive book is a must for collectors & other lovers of toy trains. 350 pages & 1900 color photos, hard cover. Add this book to your membership for only \$25.00 (50% off the \$49.95 cover price)!

# MegaStations

There are over 1,100 M.T.H. Authorized Retailers in North America ready to serve your model railroading needs. Of these, a select few qualify for inclusion in M.T.H.'s Mega Station program. So just what is a Mega Station?

Simply put, M.T.H. Authorized Mega Stations are your best bet for finding the widest selection of M.T.H. products in stock, when you want them. Mega Station retailers also meet our DCS Demo Center qualifications so you'll find expert assistance in seeing M.T.H. products in action whenever you visit a Mega Station retailer.

Each of our Mega Station dealers has the option of qualifying for one or more categories covering our RailKing O Gauge, Premier Line O Scale, Lionel Corporation Tinplate and RailKing One Gauge product lines.

The list to the right includes our current RailKing and Premier O Gauge Mega Station accounts. Of course, if your favorite M.T.H. Authorized Retailer isn't listed, they can still order any of our current offerings. To find a local M.T.H. Authorized Retailer, visit our Web site and click on the Dealer Locator link.

## ARIZONA

ARIZONA TRAIN DEPOT  
Mesa  
Phone: (480) 833-9486  
www.arizonatraindepot.com  
O GAUGE

## CALIFORNIA

WESTERN DEPOT  
Yuba City  
Phone: (530) 673-6776  
www.westerndepot.com  
O GAUGE,

## DELAWARE

JUST TRAINS  
Newark  
Phone: (888) 453-9742  
www.justrains.com  
O GAUGE

## FLORIDA

READY TO ROLL  
Miami  
Phone: (305) 688-8868  
www.readytorolltrains.com  
O GAUGE

## ROUNDHOUSE SOUTH

Port Orange  
Phone: (386) 304-7002  
www.roundhousesouth.com  
O GAUGE

## ILLINOIS

BERWYN'S TOY TRAINS  
Berwyn  
Phone: (708) 484-4384  
www.berwynstoytrains.com  
O GAUGE

## MARYLAND

CATOCTIN MTN. TRAINS & HOBBIES  
Thurmont  
Phone: (301) 271-6914  
www.cmtrains.com  
O GAUGE

## SIDETRACK HOBBIES

Leonardtown  
Phone: (301) 475-5381  
www.sidetrackhobbies.com  
O GAUGE

## MICHIGAN

WILD BILL'S TRAINS & TOYS  
Clinton Township  
Phone: (586)-792-0530  
www.wildbillstrains.com

## NEW JERSEY

THE HOBBY SHOP  
Aberdeen  
Phone: (732) 583-0505  
www.hobbyshopnj.com  
O GAUGE

## NEW YORK

NASSAU HOBBY CENTER, INC  
Freeport  
Phone: (516) 378-9594  
www.nassauhobby.com  
O GAUGE

## TRAIN WORLD

Brooklyn  
Phone: (718) 436-7072  
www.trainworld.com  
O GAUGE

## TRAIN LAND

Lynbrook  
Phone: (516) 599-7080  
www.trainworld.com

## O GAUGE

E-Z CATCH TRAINS SHOP  
Staten Island  
Phone: (718) 727-7373  
www.e-zcatch.com  
O GAUGE

## NORTH CAROLINA

TRAIN LOFT  
Winston-Salem  
Phone: (877) 550-6019  
www.trainloft.com  
O GAUGE

## OHIO

DIXIE UNION STATION  
Mason  
Phone: (513) 459-0460  
www.dixieunionstation.com  
O GAUGE

## PENNSYLVANIA

BRADY'S TRAIN OUTLET  
Greensburg  
Phone: (724) 838-8448  
www.bradystrainoutlet.com  
O GAUGE

IMPERIAL TRAIN COMPANY  
Imperial  
Phone: (724) 695-7552  
www.imperialtrainco.com  
O GAUGE

JIM'S TRAIN SHOP  
Homer City  
Phone: (724) 479-2026  
www.jimstrainshop.com  
O GAUGE

VALLEY FARM MARKET  
Weedville  
Phone: (814) 787-8911  
O GAUGE

## RHODE ISLAND

B & F HOBBIES  
Wakefield  
Phone: (401) 782-6400  
O GAUGE, TINPLATE

Not all products depicted in this catalog are production models. In some cases, the items pictured may be models in HO scale, O scale, or another scale that have been altered digitally. Each item's graphic features and content are subject to change after publication. All product features may be verified on their retail packages.

M.T.H. Electric Trains is in no way affiliated with any of the railroads featured in this catalog.

©2009, M.T.H. Electric Trains, 7020 Columbia Gateway Drive, Columbia Maryland 21046-1532 • www.mthtrains.com • 410-381-2580

MTH Trademarks: M.T.H. Electric Trains®, M.T.H.®, MTH Railroaders Club™, CrossingGate™, Ives®, Loco-Sound™, Proto-Sound® 2.0, Proto-Speed Control™, Proto-Doppler™, Proto-Dispatch™, Proto-Cast™, ProtoSmoke™, Proto-Coupler™, Proto-Effects™, RailKing®, Rugged Rails®, RailKing One-Gauge™, RailTown™, Tinplate Traditions™, ScaleTrax™, RealTrax®, Z-750™, Z-4000®, Z-1000™, DCS™ and the MTH Numbering System and all others indicated throughout this catalog. DCS™ Simply The Best Way To Run A Railroad™

M.T.H.'s DCS Digital Command System has received U.S. Patent No. 6,457,681. M.T.H.'s Proto-Sound® 2.0 system has received U.S. Patent No's 6,457,681 B1 (sound system), 6,457,681 B1 (Proto-Speed Control™), 6,604,641 (Proto-Coupler™), 7,210,656 (Sound), 6,662,917 (Z/3Rail), 7,210,656 (Internet Downloads, Music & Doppler). 6,655,640 (Smoke Synchronization)

M.T.H.'s RealTrax® has received U.S. Patent No. 6,019,289.

M.T.H.'s Z-4000® Transformer has received U.S. Patent No's. 6,281,606 & 6,624,537.

Some images used in this publication © 2009 www.clipart.com

Lionel®, TMCC, and TMCC-2 Legacy are registered trademarks of Lionel® Trains LLC.

Lionel Corporation Tinplate is licensed by Lionel® LLC

RealTrax® layouts created with RR-Track™ which is a registered trademark of R&S Enterprises.

© 2009 MillerCoors, LLC. All rights reserved. Produced under license by M.T.H. Electric Trains. This licensed product is intended for adults of legal drinking age.

© 2009 H-D, All Rights Reserved. Manufactured by M.T.H. Electric Trains under license from Harley-Davidson Motor Company.  
© 2009 M.T.H. Electric Trains, 7020 Columbia Gateway Drive, Columbia, Maryland 21046

7UP is a trademark of Dr Pepper/Seven Up, Inc., used by M.T.H. Electric Trains under license. ©2009 Dr Pepper/Seven up, Inc.

A&W is a trademark of A&W Concentrate Company, used under license by M.T.H. Electric Trains. ©2009 A&W Concentrate Company

DR PEPPER is a trademark of Dr Pepper/Seven Up, Inc., used by M.T.H. Electric Trains under license. ©2009 Dr Pepper/Seven up, Inc.

"© 2009 Anheuser-Busch, Inc. All Rights Reserved."

®/™ M&M'S, the letter M and the M&M'S Characters are registered trademarks of Mars, Incorporated and its affiliates. ©MARS, Incorporated 2009

®/TM SNICKERS and the SNICKERS logo are registered trademarks of Mars, Inc. and its affiliates. Used under license by M.T.H. Electric Trains® © Mars, Incorporated 2009

®/TM THREE MUSKETEERS and the THREE MUSKETEERS logo are registered trademarks of Mars, Inc. and its affiliates. Used under license by M.T.H. Electric Trains® © Mars, Incorporated 2009

© 2009 Caterpillar  
CAT, CATERPILLAR, their respective logos, "Caterpillar Yellow" and the "Power Edge" trade dress, as well as corporate and product identity used herein, are trademarks of Caterpillar and may not be used without permission.

Greyhound is a registered trademark of the Greyhound Lines Inc.

Products bearing Chicago and North Western, Denver & Rio Grande, Denver & Rio Grande Western, MKT/Katy, Missouri Pacific, Southern Pacific, Union Pacific, Western Pacific are made under trademark license from Union Pacific Railroad Company.

# M.T.H. Online

We don't think we're exaggerating when we say M.T.H. has the most useful train manufacturer's site on the Internet. Here's just a sample of the answers you can find online.

## ① WHAT'S THE LATEST INFO ON ...?

Use Product Search to find the latest info on new products before they're delivered — sound sets, cab numbers, feature and paint scheme updates, and other information that arrived after the catalog was published.

## DID YOU EVER MAKE .....?

Use Product Search to search through nearly all of the 14,000 items we've made in the past 29 years, for your favorite road name, engine, or type of rolling stock.

## ② DOES ANY DEALER STILL HAVE ...?

Locate hard-to-find items with our Product Locator, which searches the inventories of M.T.H. dealers across the country.

## ③ WHEN IS IT COMING?

Our online Shipping schedule is updated frequently to let you know what's coming soon to your hobby shop.

## ④ ARE YOU GOING TO MAKE .....?

View the last several M.T.H. Catalogs online. Or click on Video to see M.T.H. products in action.

## ⑤ HOW CAN I FIX...?

The Service area of our site allows you to email a question to our factory technicians or find which of our 150+ local service centers is closest to you.

## WHAT REPAIR PART DO I NEED?

Use Product Search to find exploded diagrams and parts lists for M.T.H. locomotives and accessories, and then order the parts online or by phone.

## ⑥ WHAT'S NEW?

New arrivals and other news are posted frequently on our home page. To get the news as it happens, sign up for our free weekly electronic newsletter, with information on new M.T.H. products, industry news, and sneak peeks at upcoming specials!

## ⑦ HOW CAN I LEARN MORE ABOUT DCS?

Follow the link to the protosound2.com Web site for DCS and Proto-Sound 2.0 information — and a list of Authorized DCS Demo Centers where you can try DCS hands-on.

## HOW CAN I UPDATE MY DCS SYSTEM OR CHANGE A SOUND SET?

Only M.T.H. allows you to update your control system or change an engine's sound set right over the Internet. Follow the link to the protosound2.com Web site for DCS and Proto-Sound 2.0 downloads.

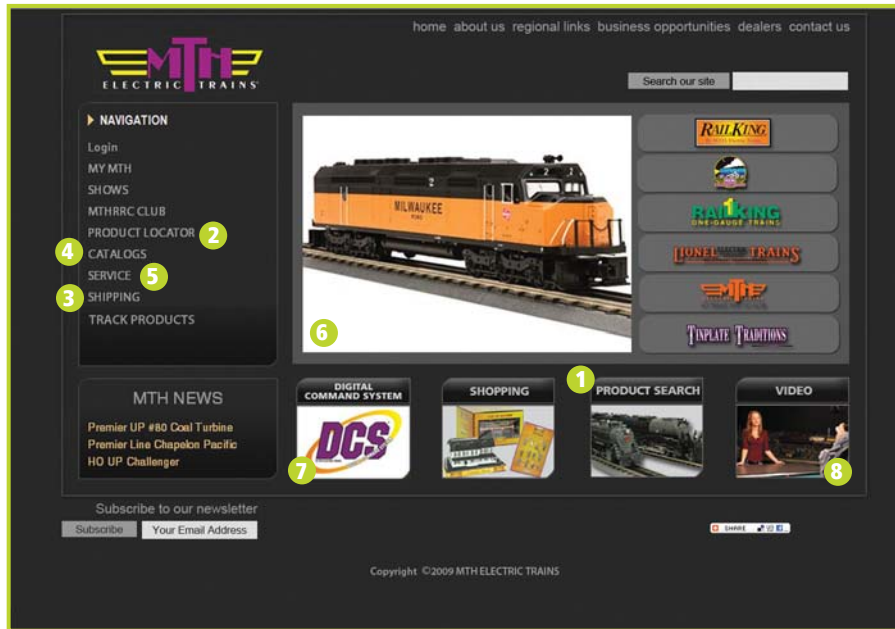

## HOW DOES IT WORK?

Misplaced an instruction manual or just want to know how a product works? Use Product Search to look up the item and view its instruction manual.

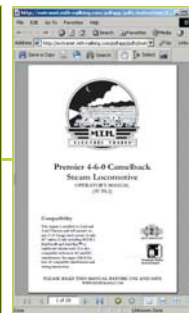



# ...SIMPLY THE BEST WAY TO RUN A RAILROAD™

**TRY IT** at your local DCS Demo Center or learn more with a **Complimentary DVD** on DCS & M.T.H. technology.

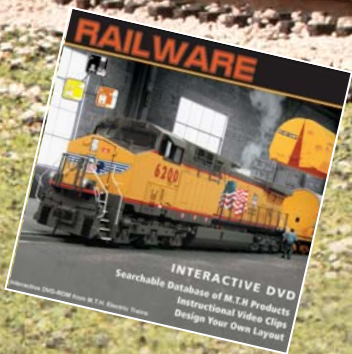

Take your favorite Proto-Sound® 2.0 Locomotive to any demo center and experience the additional features your engine has with DCS Control.

To Find Your Nearest DCS Demo Center or Request Your Complimentary DVD Visit

## WWW.MTHTRAINS.COM

