



Abrasão - Lixas



Lixadora de parede a bateria muito confortável e manobrável

DSL800

LXT



**BL
MOTOR**



AWS

>> Auto-start Wireless System <<

*Comprimento ajustável da barra
para facilitar todas as tarefas.*

Lixadoras orbitais

Lixas para BO4556/BO4553



- Lixamento de alto desempenho para aplicações profissionais.
- Aplicações: Lixamento de madeira, ferro e madeira pintada. Óxido de alumínio.
- Com grão semiabierto e revestimento de resina sobre cola.

Medida (mm)	Grão	Unidades	Código	EAN	P.V.P. (€)
114 x 140	40	10	P-36398	0088381972109	3,75
	60		P-32904	0088381961066	3,25
	80		P-36407	0088381972116	3,25
	100		P-32910	0088381961073	3,00
	120		P-32926	0088381961080	3,00
	150		P-32932	0088381961097	2,75
	180		P-36413	0088381972123	3,00
	240		P-36429	0088381972130	3,00

Lixas para BO4566/BO4563

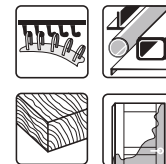
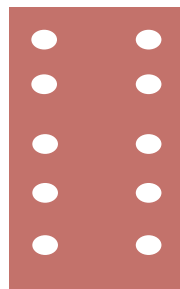

- Lixa de grão aberto de corindo com duplo revestimento em resina.
- Aplicações: Lixamento de madeiras secas, pintadas ou envernizadas
- Também para metal. Ideal para marcenaria e carroçarias. Orifícios de aspiração 5+5.

Medida (mm)	Grão	Unidades	Código	EAN	P.V.P. (€)
100 x 240	40	10	P-42868	0088381970730	6,00
	60		P-42874	0088381970747	6,00
	80		P-42880	0088381970754	5,75
	100		P-42896	0088381970761	5,75
	120		P-42905	0088381970778	5,75
	150		P-42911	0088381970785	5,50
	180		P-42927	0088381970792	5,50
	240		P-42933	0088381970808	5,50

- Especial pintura.
- Excelente desempenho em aplicações profissionais.
- Aplicações: Lixamento de tinta, verniz, madeira pintada...



Medida (mm)	Grão	Unidades	Código	EAN	P.V.P. (€)
114 x 140	40	10	P-36516	0088381972222	4,50
	60		P-36522	0088381972239	4,00
	80		P-36538	0088381972246	4,00
	100		P-36544	0088381972253	4,00
	120		P-36550	0088381972260	4,00
	150		P-36566	0088381972277	4,00
	180		P-36572	0088381972284	4,00
	240		P-36588	0088381972291	4,00



Lixadoras orbitais

Lixas para BO4565/BO4561

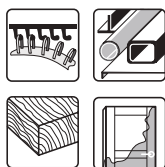

- Lixamento de alto desempenho para aplicações profissionais.
- Aplicações: Lixamento de madeira, ferro e madeira pintada.
- Óxido de alumínio extra-resistente e aderência por velcro. Orifícios de aspiração 3+3.

Medida (mm)	Grão	Unidades	Código	EAN	P.V.P. (€)
114 x 102	40	10	P-33087	0088381961240	4,50
	60		P-33093	0088381961257	4,50
	80		P-33102	0088381961264	4,50
	100		P-33118	0088381961271	4,50
	120		P-33124	0088381961288	4,00
	150		P-33130	0088381961295	4,00
	180		P-33146	0088381961301	4,00
	240		P-33152	0088381961318	4,00
	320		P-33168	0088381961325	4,00

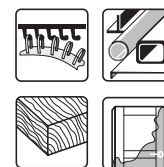

- Para utilizar com a maioria das lixadoras tipo delta com base triangular.
- Aplicações: Lixamento de madeira, metal. Ideal para esquinas e lixamento de acabamento.
- Lixa triangular com aderência por velcro e 6 orifícios de aspiração.

Medida (mm)	Grão	Unidades	Código	EAN	P.V.P. (€)
93 x 93 x 93	40	10	P-33255	0088381961417	3,75
	60		P-33261	0088381961424	3,75
	80		P-33277	0088381961431	3,75
	100		P-33283	0088381961448	3,50
	120		P-33299	0088381961455	3,50
	150		P-33308	0088381961462	3,50
	180		P-33314	0088381961479	3,50
	240		P-33320	0088381961486	3,50
	320		P-33336	0088381961493	3,50



- Especial pintura. Excelente desempenho em aplicações profissionais. 6 orifícios de aspiração.
- Aplicações: Lixamento de tinta, verniz, madeira pintada.

Medida (mm)	Grão	Unidades	Código	EAN	P.V.P. (€)
114 x 102	40	10	P-35807	0088381964968	5,25
	60		P-35813	0088381964975	5,00
	80		P-35829	0088381964982	4,75
	100		P-35835	0088381964999	4,75
	120		P-35841	0088381965002	4,75
	150		P-35857	0088381966016	4,75
	180		P-35863	0088381966023	4,75
	240		P-35879	0088381966030	4,75
	320		P-35885	0088381966047	4,75



- Especial pintura. Para utilizar com a maioria das lixadoras tipo delta com base triangular. 6 orifícios de aspiração.
- Excelente desempenho em aplicações profissionais.
- Aplicações: Lixamento de tinta, verniz, madeira pintada.

Medida (mm)	Grão	Unidades	Código	EAN	P.V.P. (€)
93 x 93 x 93	40	10	P-42684	0088381970556	4,00
	60		P-42690	0088381970563	3,75
	80		P-42709	0088381970570	3,75
	100		P-42715	0088381970587	3,75
	120		P-42721	0088381970594	3,75
	150		P-42737	0088381970600	3,75
	180		P-42743	0088381970617	3,75
	240		P-42759	0088381970624	3,75
	320		P-42765	0088381970631	3,75

Lixadoras orbitais

Lixas para BO3700/9036/BO3711

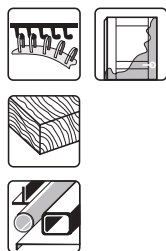

- Lixamento de alto desempenho para aplicações profissionais.
- Aplicações: Lixamento de madeira, ferro e madeira pintada.
- 4+4 orifícios.

Medida (mm)	Grão	Unidades	Código	EAN	P.V.P. (€)
93 x 185	40	10	P-31871	0088381960038	5,00
	60		P-31887	0088381960045	4,50
	80		P-31893	0088381960052	4,50
	100		P-31902	0088381960069	4,50
	120		P-35891	0088381966054	4,50
	150		P-35900	0088381966061	4,50
	180		P-35916	0088381966078	4,50
	240		P-35922	0088381966085	4,50



- Lixamento de alto desempenho para aplicações profissionais.
- Lixa de grão aberto de corindo com duplo revestimento em resina.
- Ideal para lixar madeiras secas, pintadas ou envernizadas.
- Também é adequada para metal. Ideal para marcenaria e carroçarias.

Medida (mm)	Grão	Unidades	Código	EAN	P.V.P. (€)
93 x 228	40	10	P-36136	0088381966290	3,00
	60		P-32948	0088381961103	2,75
	80		P-36142	0088381966306	2,75
	100		P-32954	0088381961110	2,75
	120		P-36158	0088381966313	2,75
	150		P-32960	0088381961127	2,25



- Lixamento de alto desempenho para aplicações profissionais.
- Lixa de grão aberto de corindo com duplo revestimento em resina.
- Ideal para lixar madeiras secas, pintadas ou envernizadas. Também é adequada para metal.
- Ideal para marcenaria e carroçarias.
- 4+4 orifícios.

Medida (mm)	Grão	Unidades	Código	EAN	P.V.P. (€)
93 x 228	40	10	P-31837	0088381959995	3,50
	60		P-31843	0088381960007	3,25
	80		P-31859	0088381960014	3,25
	100		P-31865	0088381960021	3,25
	120		P-36011	0088381966177	3,25
	150		P-36027	0088381966184	3,25
	180		P-36033	0088381966191	3,25
	240		P-36049	0088381966207	3,25



Lixadoras orbitais

Lixas para BO4900V/9046/BO4901

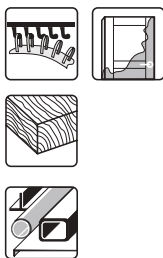

- Lixamento de alto desempenho para aplicações profissionais.
- Lixa de grão aberto de corindo com duplo revestimento em resina.
- Ideal para lixar madeiras secas, pintadas ou envernizadas.
- Também é adequada para metal.
- Ideal para marcenaria e carroçarias.
- 5+5 orifícios.

Medida (mm)	Grão	Unidades	Código	EAN	P.V.P. (€)
115 x 229	40	10	P-33174	0088381961332	6,25
	60		P-33180	0088381961349	6,00
	80		P-33196	0088381961356	6,00
	100		P-33205	0088381961363	6,00
	120		P-33211	0088381961370	6,00
	180		P-33233	0088381961394	5,75
	240		P-33249	0088381961400	5,75



- Lixamento de alto desempenho para aplicações profissionais.
- Lixa de grão aberto de corindo com duplo revestimento em resina.
- Ideal para lixar madeiras secas, pintadas ou envernizadas.
- Também é adequada para metal.
- Ideal para marcenaria e carroçarias.
- 5+5+2+2 orifícios.

Medida (mm)	Grão	Unidades	Código	EAN	P.V.P. (€)
115 x 280	40	10	P-33009	0088381961165	4,25
	60		P-33015	0088381961172	4,00
	80		P-33021	0088381961189	4,00
	100		P-33037	0088381961196	4,00
	120		P-33043	0088381961202	4,00
	150		P-33059	0088381961219	4,00
	180		P-33065	0088381961226	4,00
	240		P-33071	0088381961233	3,75

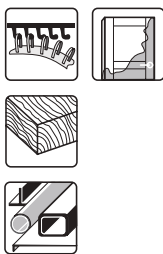

- Lixa de elevada resistência. Lixamento de alto desempenho para aplicações profissionais.
- Lixa de grão aberto de corindo com duplo revestimento em resina.
- Ideal para lixar madeiras secas, pintadas ou envernizadas. Também é adequada para metal.
- Ideal para marcenaria e carroçarias.
- 5+5+2+2 orifícios.

Medida (mm)	Grão	Unidades	Código	EAN	P.V.P. (€)
115 x 229	40	10	P-43022	0088381970891	7,00
	60		P-43038	0088381970907	6,50
	80		P-43044	0088381970914	6,25
	100		P-43050	0088381970921	6,00
	120		P-43066	0088381970938	6,00
	150		P-43072	0088381970945	5,50
	180		P-43088	0088381970952	6,00
240	P-43094	0088381970969	6,00		



- Lixamento de alto desempenho para aplicações profissionais.
- Lixa de grão aberto de corindo com duplo revestimento em resina.
- Ideal para lixar madeiras secas, pintadas ou envernizadas.
- Também é adequada para metal.
- Ideal para marcenaria e carroçarias.

Medida (mm)	Grão	Unidades	Código	EAN	P.V.P. (€)
115 x 280	40	10	P-36267	0088381966429	4,00
	60		P-32976	0088381961134	3,75
	80		P-36273	0088381966436	3,75
	100		P-32982	0088381961141	3,75
	120		P-36289	0088381966443	3,75
	150		P-32998	0088381961158	3,00

Lixadoras orbitais

Rolos de lixa



- Para utilização geral. Adequado para madeira, metal, tinta e verniz.
- Rolo de 5 m.
- Ideal para lixadoras orbitais.
- Adequado para utilização manual.

Largura (mm)	Grão	Comprimento (m)	Unidades	Código	EAN	P.V.P. (€)
120	40	5	1	P-38102	0088381973816	7,75
	60			P-38118	0088381973823	6,00
	80			P-38124	0088381973830	5,25
	100			P-38130	0088381973847	5,00
	120			P-38146	0088381973854	5,00
	180			P-38152	0088381973861	5,00
	240			P-38168	0088381973878	5,00
	320			P-38174	0088381973885	5,00
	400			P-38180	0088381973892	4,00



- Para utilização geral. Adequado para madeira, metal, tinta e verniz.
- Rolo de 50 m.
- Ideal para lixadoras orbitais.
- Adequado para utilização manual.

Largura (mm)	Grão	Comprimento (m)	Unidades	Código	EAN	P.V.P. (€)
120	40	50	1	P-38196	0088381973908	53,00
	60			P-38205	0088381973915	44,00
	80			P-38211	0088381973922	38,00
	100			P-38227	0088381973939	35,00
	120			P-38233	0088381973946	35,00
	180			P-38249	0088381973953	35,00
	240			P-38255	0088381973960	35,00
	320			P-38261	0088381973977	35,00
	400			P-38277	0088381973984	35,00

Bases para lixadoras orbitais



158324-9



158326-5



158325-7



Base de borracha do modelo BO3711

Modelo	Tipo	Medida	Unidades	Código	EAN	P.V.P. (€)
BO4556 BO4565 BO4566	Quadrada de borracha *	112 x 102	1	158324-9	-	3,00
	Triangular de velcro	112 x 190	1	158325-7	3240890999597	8,00
	Retangular de velcro	100 x 164	1	158326-5	3240890999580	7,00
BO3700 BO3711	Borracha	93 x 185	1	140441-9	-	4,20
	Velcro	93 x 185	1	194930-6	0088381355759	14,00
BO4900V BO4901	Borracha	115 x 229	1	193523-6	-	15,00
	Velcro	115 x 229	1	193521-0	-	28,00
9046	Velcro	115 x 229	1	162172-0	3240890063304	37,00

* Para substituir a base de borracha do modelo BO4556 pela base de velcro triangular ou retangular é necessário utilizar a base 450068-0.

Lixadoras rotorbitais

Lixas para BO5030/31 - BO5040/41



- Lixa de grão semiaberto de óxido de alumínio com revestimento de resinas fenólicas.
- Ideal para trabalhos em madeira, plástico, chapa metálica, madeiras envernizadas e metais pintados.
- 8 orifícios.

Ø (mm)	Grão	Unidades	Código	EAN	P.V.P. (€)
125	40	10	P-43533	0088381971409	5,00
	60		P-43549	0088381971416	4,75
	80		P-43555	0088381971423	4,50
	100		P-43561	0088381971430	4,50
	120		P-43577	0088381971447	4,50
	180		P-43583	0088381971454	4,50
	240		P-43599	0088381971461	4,50
	320		P-43608	0088381971478	4,25
	400		P-43614	0088381971485	4,25

Lixas para BO6030/BO6040/BO6050

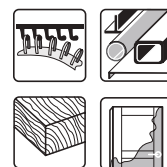

- Lixa de grão semiaberto de óxido de alumínio com revestimento de resinas fenólicas.
- Ideal para trabalhos em madeira, plástico, chapa metálica, madeiras envernizadas e metais pintados.
- 8 orifícios.

Ø (mm)	Grão	Unidades	Código	EAN	P.V.P. (€)
150	40	10	P-31918	0088381960076	7,00
	60		P-31924	0088381960083	6,75
	80		P-31930	0088381960090	6,50
	100		P-31946	0088381960106	6,25
	120		P-31952	0088381960113	6,25
	150		P-31968	0088381960120	6,25
	180		P-31974	0088381960137	6,25
	220		P-31980	0088381960144	6,25
	240		P-31996	0088381960151	6,25
	320		P-32007	0088381960168	6,25
	400		P-32013	0088381960175	6,25

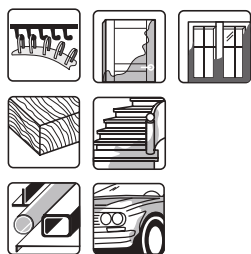

- Especial pintura.
- Excelente desempenho em trabalhos do setor automóvel.
- Revestimento antiestático que evita o encravamento da lixa para um acabamento mais fino.
- 8 orifícios.

Ø (mm)	Grão	Unidades	Código	EAN	P.V.P. (€)
125	40	10	P-33342	0088381961509	4,50
	60		P-33358	0088381961516	4,25
	80		P-33364	0088381961523	4,00
	100		P-33370	0088381961530	4,00
	120		P-33386	0088381961547	4,00
	180		P-33392	0088381961554	4,00
	240		P-33401	0088381961561	4,00
	320		P-33417	0088381961578	4,00
	400		P-33423	0088381961585	4,00

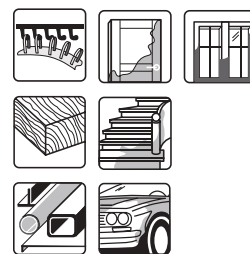
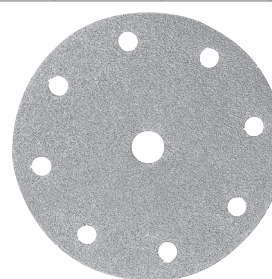

- Especial pintura.
- Excelente desempenho em trabalhos do setor automóvel.
- Revestimento antiestático que evita o encravamento da lixa para um acabamento mais fino.
- 8 orifícios.

Ø (mm)	Grão	Unidades	Código	EAN	P.V.P. (€)
150	40	10	P-37839	0088381973540	6,75
	60		P-37845	0088381973557	6,25
	80		P-37851	0088381973564	6,00
	100		P-37867	0088381973571	5,75
	120		P-37873	0088381973588	5,75
	150		P-37889	0088381973595	5,75
	180		P-37895	0088381973601	5,75
	220		P-37904	0088381973618	5,75
	240		P-37910	0088381973625	5,75
	320		P-37926	0088381973632	5,75
	400		P-37932	0088381973649	5,75

Lixadoras rotorbitais e de disco

Caixas de discos de velcro perfurados de 150 mm

- Gama de lixas de óxido de alumínio para lixadoras rotorbitais de 150 mm.
- Pacotes de 50 e 100 unidades.
- Ideais para utilizadores que gastem muita lixa.
- Ideais para acabamento em fibra de vidro, madeira, metal e chapa de veículos.
- 6+8 orifícios.

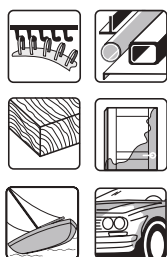

Ø (mm)	Grão	Unidades	Código	EAN	P.V.P. (€)
150	40	50	B-39300	0088381434041	28,50
			B-39316	0088381434058	26,00
	80	100	B-39322	0088381434065	47,00
			B-39338	0088381434072	44,00
			B-39344	0088381434089	42,00
			B-39350	0088381434096	41,00
			B-39366	0088381434102	41,00
			B-39372	0088381434119	41,00
			B-39388	0088381434126	41,00
			B-39394	0088381434133	41,00
	600	100	B-39403	0088381434140	41,00
			B-39419	0088381434157	41,00
	1000	100	B-39425	0088381434164	41,00

Lixas para lixadora girafa DSL800 de 225 mm

- Discos indicados para trabalhos em gesso cartonado.
- Grão cerâmico com resina.
- O revestimento especial evita que embote e, assim, o desgaste.
- Mais durabilidade do que um disco abrasivo.



Ø (mm)	Grão	Unidades	Código	EAN	P.V.P. (€)
225	40	25	B-68389	-	31,00
	80		B-68395	-	30,00
	120		B-68404	-	26,00
	180		B-68410	-	26,00
	320		B-68426	-	26,00

Lixas para lixadoras de disco de 115 mm/125 mm/180 mm

- Discos de fibra ideais para remover verniz e tinta em madeira e metal, bem como correção de soldaduras.



Ø (mm)	Grão	Unidades	Código	EAN	P.V.P. (€)
115	24	5	P-00860	0088381918787	4,00
	40		P-00882	0088381918800	5,25
	60		P-00907	0088381918824	5,25
	80		P-00913	0088381918831	5,25
	120		P-00935	0088381918848	5,50
125	24	5	P-00957	0088381922203	4,75
	40		P-00979	0088381922227	6,00
	60		P-00985	0088381922234	6,00
	80		P-00991	0088381922241	6,25
	100		P-01002	0088381922258	6,50
180	120	5	P-01018	0088381922265	6,50
	24		P-01030	0088381918879	7,50
	40		P-01052	0088381918893	7,75
	60		P-01074	0088381918916	7,75
	80		P-01080	0088381918923	7,75
	100		P-01096	0088381918930	7,25
	120		P-01105	0088381918947	7,25

Lixas para lixadoras de disco de 180 mm

- Lixa de grão aberto de óxido de alumínio com revestimento de resina e cola à base de látex.
- Excelente desempenho em trabalhos do setor automóvel.
- Ideal para trabalhos em madeiras por tratar, madeiras envernizadas e carroçarias.
- Ideal para lixar tinta.



Ø (mm)	Grão	Unidades	Código	EAN	P.V.P. (€)
180	40	10	P-33439	0088381961592	10,00
	60		P-38037	0088381973748	8,25
	80		P-33445	0088381961608	7,75
	100		P-38043	0088381973755	7,50
	120		P-33451	0088381961615	7,50
	240		P-38059	0088381973762	7,50
	320		P-38065	0088381973779	7,50

Pratos de velcro para lixadoras/polidoras de disco

PO6000C



197925-8



M14

743060-6



DSL800

199939-3



Descrição	Ø (mm)	Unidades	Código	EAN	P.V.P. (€)
PO6000C	100	1	197925-8	008838114683 67	56,00
	125		197922-4	00883811468343	55,00
	150		197928-2	00883811468381	52,00
M14	115	1	743060-6	0088381156967	14,00
	117		P-21777	0088381948876	12,00
	165		743053-3	0088381146104	19,00
DSL800	Macio	210	199939-3	-	52,00
	Médio		199940-8	-	59,00
	Duro		199938-5	-	57,00

Pratos de borracha para lixadoras/polidoras de disco



Descrição	Ø (mm)	Unidades	Código	EAN	P.V.P. (€)
Requer porca	115	1	743015-1	0088381102094	7,50
	120		743025-8	0088381101295	4,50
	125		743016-9	0088381109017	8,25
	170		743008-8	0088381109055	20,50
5/8"	170		743012-7	0088381101233	15,00

Porca para pratos de borracha



Descrição	Unidades	Código	EAN	P.V.P. (€)
M14	1	224515-5	0088381116190	4,75



Lixas para lixadoras de banda

- Lixa de óxido de alumínio com grão fechado e revestimento duplo de resina sobre base de tela.
- Produto de elevada resistência especialmente concebido para lixadoras de banda.
- Adequadas para todos os tipos de madeiras e metais.



Modelos	Medida (mm)	Grão	Unidades	Código	EAN	P.V.P. (€)
9910 9911	76 x 457	40	5	P-37091	0088381972802	9,00
		60		P-37100	0088381972819	8,75
		80		P-37116	0088381972826	8,75
		100		P-37122	0088381972833	8,75
		120		P-37138	0088381972840	8,75
		150		P-37144	0088381972857	8,75
		240		P-37150	0088381972864	8,75



Modelo	Medida (mm)	Grão	Unidades	Código	EAN	P.V.P. (€)
9903	76 x 533	40	5	P-37172	0088381972888	9,50
		60		P-37188	0088381972895	9,00
		80		P-37194	0088381972901	8,50
		100		P-37203	0088381972918	8,25
		120		P-37219	0088381972925	8,25
		150		P-37225	0088381972932	8,25
		240		P-37231	0088381972949	8,25



Modelos	Medida (mm)	Grão	Unidades	Código	EAN	P.V.P. (€)
9920 9924DB	76 x 610	40	5	P-37312	0088381973021	10,50
		60		P-37328	0088381973038	10,00
		80		P-37334	0088381973045	9,50
		100		P-37340	0088381973052	8,75
		120		P-37356	0088381973069	8,75
		150		P-37362	0088381973076	8,75
		240		P-37378	0088381973083	8,75



Modelos	Medida (mm)	Grão	Unidades	Código	EAN	P.V.P. (€)
9402 9403 9404	100 x 610	40	5	P-36887	0088381972598	12,50
		60		P-36893	0088381972604	11,50
		80		P-36902	0088381972611	11,50
		100		P-36918	0088381972628	11,50
		120		P-36924	0088381972635	11,50
		150		P-36930	0088381972642	11,50
		240		P-36946	0088381972659	11,50

Placas grafitadas



Modelo	Unidades	Código	EAN	P.V.P. (€)
9924DB	1	423036-6	0088381116398	2,00
9402		423029-3	0088381116367	2,50
9403		421648-9	0088381148191	3,25
9404		193201-8	0088381157056	6,75
9903		423315-2	0088381157018	2,00
9920		423316-0	0088381157025	2,50

Placas de cortiça



Modelo	Unidades	Código	EAN	P.V.P. (€)
9404	1	193202-6	0088381157063	4,50
9903		423312-8	0088381157032	2,00
9402		421093-8	0088381123839	4,00
9924DB		423035-8	0088381152532	3,75
9403		421646-3	0088381148177	2,50
9901		423149-3	0088381126397	2,50
9920		423313-6	0088381157049	2,50

Placas de metal



Modelo	Unidades	Código	EAN	P.V.P. (€)
9402	1	342328-3	0088381116244	2,75
9924DB		341705-6	0088381116268	3,25
9404		151751-9	0088381154284	7,75
9902 9903		151749-6	0088381154246	5,00
9920		151750-1	0088381154277	5,00
9403 (metal + cortiça)		150980-1	0088381148153	5,00
9903		344620-3	0088381148160	2,00
9910 9911	344586-7	0088381146791	2,50	

Lixas de banda de alta qualidade para 9032

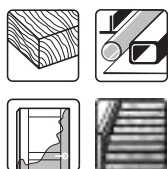
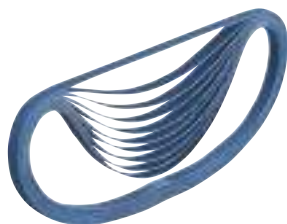

10 unidades

Modelo	Medida (mm)	Grão	Unidades	Código	EAN	P.V.P. (€)
9032	6x533	40	10	A-34512	0088381164436	20,50
		60		A-34528	0088381164443	19,50
		80		A-34534	0088381164450	19,50
		100		A-34540	0088381164467	18,50
		120		A-34556	0088381164474	17,50
	9x533	40		A-34447	0088381164382	20,00
		60		A-34453	0088381164399	20,00
		80		A-34469	0088381164405	18,50
	13x533	100		A-34475	0088381164412	16,00
		120		A-34481	0088381164429	16,00
		40		A-34562	0088381164481	22,50
		60		A-34578	0088381164498	22,50
		80		A-34584	0088381164504	21,50
		100		A-34590	0088381164511	21,50
	120	A-34609		0088381164528	18,50	

Lixas de banda standard para 9032

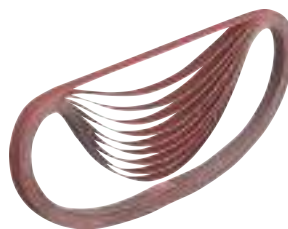

5 unidades

Modelo	Medida (mm)	Grão	Unidades	Código	EAN	P.V.P. (€)
9032	6x533	40	5	P-43181	0088381971058	5,25
		60		P-43197	0088381971065	5,25
		80		P-43206	0088381971072	5,00
		100		P-43212	0088381971089	5,00
		120		P-43228	0088381971096	5,00
		150		P-43234	0088381971102	5,00
	9x533	240		P-43240	0088381971119	5,00
		40		P-43256	0088381971126	6,00
		60		P-43262	0088381971133	6,00
		80		P-43278	0088381971140	5,75
		100		P-43284	0088381971157	5,75
		120		P-43290	0088381971164	5,75
	13x533	150		P-43309	0088381971171	5,75
		240		P-43315	0088381971188	5,75
		40		P-43321	0088381971195	7,75
		60		P-43337	0088381971201	7,50
		80		P-43343	0088381971218	7,25
		100		P-43359	0088381971225	7,00
		120		P-43365	0088381971232	7,00
		150		P-43371	0088381971249	7,25
		240		P-43387	0088381971256	7,25

25 unidades

Modelo	Medida (mm)	Grão	Unidades	Código	EAN	P.V.P. (€)
9032	6x533	60	25	P-39394	0088381967266	29,00
	6x533	100		P-39419	0088381967280	29,00
	6x533	120		P-39425	0088381967297	29,00

Lixas de banda de alta qualidade para 9031

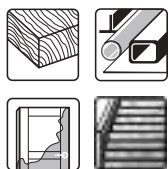

Modelo	Medida (mm)	Grão	Unidades	Código	EAN	P.V.P. (€)
9031	30 x 533	40	5	P-36675	0088381972383	4,75
	30 x 533	60	5	P-36681	0088381972390	4,25
	30 x 533	80	5	P-36697	0088381972406	4,25
	30 x 533	100	5	P-36706	0088381972413	4,25
	30 x 533	120	5	P-36712	0088381972420	4,25
	30 x 533	150	5	P-36728	0088381972437	4,25
	30 x 533	240	5	P-36734	0088381972444	4,25

Lixas de banda especiais vidro para 9031



Modelo	Medida (mm)	Grão	Unidades	Código	EAN	P.V.P. (€)
9031	30 x 533	40	5	P-01395	0088381922302	11,00
	30 x 533	60	5	P-01404	0088381922319	11,00
	30 x 533	80	5	P-01199	0088381913928	10,00
	30 x 533	100	5	P-01208	0088381913935	10,00
	30 x 533	120	5	P-01214	0088381913942	10,00
	30 x 533	150	5	P-01220	0088381913959	10,00
	30 x 533	180	5	P-01236	0088381913966	10,00

Lixas de banda para LB1200F



Grão	Dimensões (mm)	Unidades	Código	EAN	P.V.P. (€)
G80	20 x 2240	1	B-42581	0088381440738	13,00
G120	20 x 2240	1	B-42597	0088381440745	13,00

Prato de velcro



Modelo	Descrição	Ø (mm)	Unidades	Código	EAN	P.V.P. (€)
BO5030 BO5031 BO5040 BO5041	Macio (lixamento em geral)	123	1	743081-8	0088381350044	27,50
BO6040 BO6030	Duro (lixamento grosso)	150	1	196685-9	0088381438957	23,50
	Macio (lixamento em geral)	150	1	196684-1	0088381438940	27,00
	Supermacio (lixamento fino)	150	1	196686-7	0088381438964	25,50
BO6050J	Duro (lixamento grosso)	150	1	197315-5	0088381461955	48,00
	Macio (lixamento em geral)	150	1	197314-7	0088381461948	44,00
	Supermacio (lixamento fino)	150	1	197316-3	0088381461962	48,00
	Polimento	130	1	197317-1	0088381461979	44,00

Adaptador de boina dupla



Descrição	Unidades	Código	EAN	P.V.P. (€)
Adaptador de boina dupla	1	D-56960	0088381457620	2,00

Boinas de lã dupla



Ø (mm)	Modelos	Unidades	Código	EAN	P.V.P. (€)
230	9237CB	1	D-56954	0088381457613	26,00

Espojas



Ø (mm)	Tipo	Unidades	Código	EAN	P.V.P. (€)
100	Velcro	1	197893-5	-	17,00
125	Velcro	1	794558-6	0088381149358	23,00
150	Velcro	1	197894-3	-	20,00
150	Velcro	1	P-21727	0088381948821	14,00
150	Velcro	1	P-21733	0088381948838	9,75

Boinas de lã com velcro. Polimentos de alto brilho



Ø (mm)	Unidades	Código	EAN	P.V.P. (€)
100	1	197896-9	0088381468305	16,50
125	1	197897-7	0088381468329	14,50
150	1	199424-6	0088381534567	25,00
150	1	794560-9	0088381149365	21,50
100	1	192629-7	0088381140690	19,00

Feltro (com velcro)



Ø (mm)	Tipo	Unidades	Código	EAN	P.V.P. (€)
100	Velcro	1	197895-1	0088381468282	26,00
125	Velcro	1	196152-4	0088381413572	23,00
150	Velcro	1	794618-4	0088381157841	15,00

Boinas de lã



794176-0

Ø (mm)	Tipo	Unidades	Código	EAN	P.V.P. (€)
100	Lã	1	794173-6	0088381103848	12,00
180	Cordeiro	1	794176-0	0088381117159	21,00

Placas perfuradoras



Modelo	Tipo	Unidades	Código	EAN	P.V.P. (€)
BO4553	Metálica	1	413094-0	0088381201025	1,25
BO4556	Plástico	1	450066-4	0088381346085	0,75
BO3711	Metálica	1	192989-7	0088381151160	7,00
9046 BO4900V BO4901	Metálica	1	192523-3	0088381132282	19,00



Suporte + Saco de papel



Modelo	Modelo	Unidades	Código	EAN	P.V.P. (€)
Suporte + Saco	BO4900V BO5020 BO5021 BO6030 BO9046	1	193294-5	0088381160247	12,00

Sacos de tela



Modelo	Modelo	Unidades	Código	EAN	P.V.P. (€)
Pano vermelho (com adaptador)	9046	1	152456-4	0088381133548	15,50
Pano vermelho (com adaptador)	BO3700 BO3711	1	151780-2	0088381156929	2,25
Pano vermelho (sem adaptador) para 151518-5	BO4901 BO4900V BO6030	1	151517-7*	0088381150859	8,00
Tela (com adaptador)	BO4556 BO4565 BO4566	1	135222-4	3240890282941	4,25

Sacos de papel y nylon



Modelo	Modelo	Unidades	Código	EAN	P.V.P. (€)
Papel (11 cm)	BO3711 BO4556 BO4565 BO4566 BO5030 BO5031 BO5040 BO5041	5	194746-9*	3240890284426	4,75
Papel (15 cm)	BO4553	5	193712-3	0088381181730	6,00
Papel (grande)	BO4900V BO6030 9046	5	193293-7	0088381160254	7,25
Nylon (11 cm)	BO4556 BO4565 BO4566	1	168557-8*	3240890313324	2,25

* Adequadas para depósito de recolha de pó.

Depósito de recolha de pó



Modelo	Modelo	Unidades	Código	EAN	P.V.P. (€)
Com adaptador e saco de papel pequeno	BO5030 BO5031 BO5040 BO5041 BO3711 DBO180	1	135246-0	3240890284365	4,50
Com adaptador e saco de nylon		1	135327-0	0088381365611	6,00
Sem adaptador e sem saco		1	450770-5	-	2,40

Extensão para DSL800



Descrição	Unidades	Código	EAN	P.V.P. (€)
Conjunto para punho extensível	1	199937-7	-	170,00

Punhos

1



2



Modelo	Tipo	Descrição	Unidades	Código	EAN	P.V.P. (€)
GV7000C PV7000C	1	Punho	1	152491-2	0088381131605	1,75
9227CB	2	Pega	1	416348-4	0088381201193	10,00
PO6000C	1	Punho	1	198043-5	0088381473033	8,50

Suporte de lixa para 9032



Descrição	Modelo	Unidades	Código	EAN	P.V.P. (€)
Suporte de lixa de 6 mm	9032	1	125157-7	0088381164009	57,00
Suporte de lixa de 9 mm		1	125158-5	0088381164016	32,00
Suporte de lixa de 13 mm		1	125159-3	0088381164023	67,00

Adaptador de aspiração



Modelos	Unidades	Código	EAN	P.V.P. (€)
BO4553 BO4561 BO4565	1	192504-7	0088381131872	4,00

Protetores de plástico



Modelo	Descrição	Unidades	Código	EAN	P.V.P. (€)
9565CLR	Protetor de plástico	1	417322-5	0088381156981	7,00
9227CB		1	417671-0	0088381169424	15,00
SA5040C		1	453378-4	-	9,00
SA7000C		1	418529-6	0088381191975	2,25

Acessórios para polidoras



Modelo	Tipo	Descrição	Unidades	Código	EAN	P.V.P. (€)
9227CB PV7000C SA7000C	A	Centrador para acessórios de velcro	1	262542-4	0088381142915	2,00

Suporte vertical



Modelos	Unidades	Código	EAN	P.V.P. (€)
9032	1	193618-5	0088381173988	32,00

Grampo de aperto



Modelos	Unidades	Código	EAN	P.V.P. (€)
9910 9911	2	192694-6	0088381145626	37,00

Nivelador

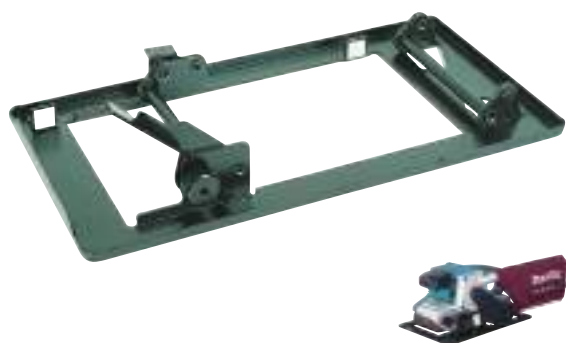

Modelos	Unidades	Código	EAN	P.V.P. (€)
9902 9903	1	193070-7	0088381154369	91,00
9404	1	193072-3	0088381154383	92,00

Suporte



Modelos	Unidades	Código	EAN	P.V.P. (€)
9402 9401	1	342332-2	0088381116350	3,50

Bolsa de recolha de pó para lixadoras de banda



Modelos	Unidades	Código	EAN	P.V.P. (€)
9402	1	122297-2	0088381116299	10,00
9403	1	122562-9	0088381148184	12,00
9404 9920	1	122591-2	0088381154239	11,00
9911	1	122548-3	0088381146784	5,00
9924DB	1	122296-4	0088381116282	12,00

Suporte com guia lateral



Modelos	Unidades	Código	EAN	P.V.P. (€)
9903 - 9920 - 9404	1	193055-3	0088381151955	75,00
9924DB	1	STEX122299	0088381116336	85,00

Desviador de ar para 9402



Modelos	Unidades	Código	EAN	P.V.P. (€)
9402	1	503174	-	13,50



ACE. **MULTIFUNÇÕES**



Multifunções



Resumo



Nome	Descrição	Ø (mm)	Material/Indicado para	Unidades	Código	EAN	P.V.P (€)
TMA064	Lâmina de corte segmentada 85	85	BiM-TiN, multimaterial	1	B-64973	0088381536479	22,00
TMA046	Lâmina de corte segmentada 100	100	BiM, madeira e metal	1	B-64808	0088381536301	23,00
TMA049	Lâmina de corte segmentada 100	85	HCS/madeira	1	B-64836	0088381536332	14,00
TMA045	Lâmina de corte segmentada 85	85	BiM, madeira e metal	1	B-64799	0088381536295	16,50



Nome	Descrição	Tamanho (mm)	Material/Indicado para	Unidades	Código	EAN	P.V.P (€)
TMA048	Lâmina de imersão 65	65 x 40	BiM, madeira e metal	1	B-64820	0088381536325	17,50
TMA052	Lâmina de imersão 65	65 x 40	HCS, madeira	1	B-64864	0088381536363	13,00
TMA047	Lâmina de imersão 28	32 x 50	BiM, madeira e metal	1	B-64814	0088381536318	12,50
				20	B-64814-20	0088381541213	195,00
TMA051	Lâmina de imersão 32	32 x 50	HCS, madeira	1	B-64858	0088381536356	11,00
				20	B-64858-20	0088381541220	120,00
TMA055	Lâmina de imersão 65	65 x 40	BiM, madeira	1	B-64892	0088381536394	17,00
TMA056	Lâmina de imersão 65	65 x 40	HCS, madeira	1	B-64901	0088381536400	14,00
TMA053	Lâmina de imersão 32	32 x 50	BiM, madeira	1	B-64870	0088381536370	11,00
				20	B-64870-20	0088381541237	195,00
TMA050	Lâmina de imersão 24	24 x 50	HCS, madeira	1	B-64842	0088381536349	7,50
TMA058	Lâmina de imersão 20	20 x 30	BiM, metal	1	B-64923	0088381536424	8,50
TMA061	Lâmina de imersão 32	32 x 40	TC/HM, Metal	1	B-64951	0088381536455	22,00
TMA059	Lâmina de imersão 32	32 x 50	BiM, metal	1	B-64939	0088381536431	11,00
TMA057	Lâmina de imersão 10	65 x 40	HCS, madeira	1	B-64917	0088381536417	7,50
TMA060	Lâmina de imersão 32	20 x 40	TC/HM, Metal	1	B-64945	0088381536448	19,00
TMA054	Lâmina de imersão 32	32 x 50	HCS, madeira	1	B-64886	0088381536387	11,00



Nome	Descrição	Tamanho (mm)	Material/Indicado para	Unidades	Código	EAN	P.V.P (€)
TMA065	Raspador rígido 52	52 x 26	HCS	1	B-64989	0088381536486	8,75
TMA066	Raspador flexível 52	52 x 40	HCS	1	B-64995	0088381536493	-



Nome	Descrição	Tamanho (mm)	Material/Indicado para	Unidades	Código	EAN	P.V.P (€)
TMA063	Lâmina segmentada de serra 100	100	BiM	1	B-64967	0088381536462	22,00
TMA067	Lâmina de corte	28 x 40	HCS	1	B-65006	0088381536509	15,50
TMA068	Lâmina universal multicorte	11 x 24	HCS	1	B-65012	0088381536516	16,50



Nome	Descrição	Tamanho (mm)	Material/Indicado para	Unidades	Código	EAN	P.V.P (€)
TMA075	Lâmina de limpeza TC HM 32	32 x 30	TC/HM Grão 50	1	B-65084	0088381536585	22,00
TMA076	Lâmina de limpeza TC HM 32	32 x 50	TC/HM Grão 40	1	B-65090	0088381536592	20,00
TMA077	Lâmina de limpeza TC HM 32	32 x 50	TC/HM Grão 100	1	B-65109	0088381536608	20,00
TMA074	Lâmina de limpeza HM	70	TC/HM Grão 40	1	B-65078	0088381536578	35,00
TMA069	Lâmina de limpeza TC HM 85	85	TC/HM Grão 40	1	B-65028	0088381536523	25,00
TMA070	Lâmina de corte e limpeza de diamante segmentada HM 65	85	TC/HM Grão 40	1	B-65034	0088381536530	41,00
TMA071	Lâmina de corte e limpeza segmentada HM 70	70	TC/HM Grão 50	1	B-65040	0088381536547	22,00
TMA072	Lâmina de corte e limpeza segmentada HM 85	85	TC/HM Grão 40	1	B-65056	0088381536554	21,50
TMA073	Lâmina de limpeza TC HM 78	78	TC/HM Grão 20	1	B-65062	0088381536561	21,00



Nome	Descrição	Tamanho (mm)	Material/Indicado para	Unidades	Código	EAN	P.V.P (€)
TMA075	Lixas para madeira	32 x 30	TC/HM Grão 50	1	B-65084	0088381536585	22,00
TMA076	Lixas para tinta e madeira	32 x 50	TC/HM Grão 40	1	B-65090	0088381536592	20,00
TMA077	Abrasivo de lã para eliminar óxido do metal e a sujidade da madeira	32 x 50	TC/HM Grão 100	1	B-65109	0088381536608	20,00
TMA074	Lixas para madeira dura, placas para construção e metal	70	TC/HM Grão 40	1	B-65078	0088381536578	35,00
TMA069	Lixas para materiais duros como pedra, mármore ou vidro	85	TC/HM Grão 40	1	B-65028	0088381536523	25,00
TMA070	Feltro para o pré-polimento de superfícies sujas ou riscadas	85	TC/HM Grão 40	1	B-65034	0088381536530	41,00

Acessórios de corte

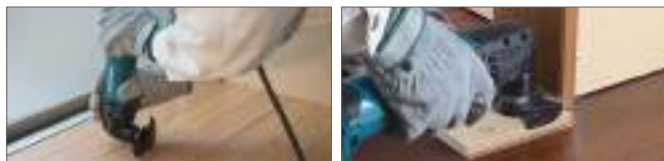

Lâmina de corte segmentada 85

TMA064



- Metais não ferrosos, FRP, PVC.
- Adequado para esquinas.
- Corte por imersão em placas de gesso ou de fibra de cimento.
- Fresagem em fibra de vidro (PRFV)/epóxi



Ø (mm)	Material/Indicado para	Unidades	Código	EAN	P.V.P (€)
85	BiM-TiN, multimaterial	1	B-64973	0088381536479	22,00

Lâmina de corte segmentada 100

TMA046



- Madeira e metal.
- Indicado para cortes profundos nivelados.
- Caixilhos de portas.
- Parquê/piso laminado.



Ø (mm)	Material/Indicado para	Unidades	Código	EAN	P.V.P (€)
100	BiM, madeira e metal	1	B-64808	0088381536301	23,00

Lâmina de corte segmentada 100

TMA049



- Cortes de imersão em madeira sólida.
- Indicado para cortes nivelados.
- Tubo de PVC.



Ø (mm)	Material/Indicado para	Unidades	Código	EAN	P.V.P (€)
85	HCS/madeira	1	B-64836	0088381536332	14,00

Lâmina de corte segmentada 85

TMA045



- Madeira e metal.
- Indicado para corte nivelado
- Caixilhos de portas.
- Parquê/piso laminado.



Ø (mm)	Material/Indicado para	Unidades	Código	EAN	P.V.P (€)
85	BiM, madeira e metal	1	B-64799	0088381536295	16,50

Acessórios de corte de imersão

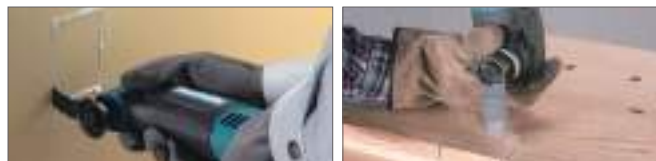

Lâmina de imersão 65



TMA048



- Madeira e pregos.
- Caixilhos de porta.
- Cortes por imersão em painéis laminados.



Tamanho (mm)	Material/Indicado para	Unidades	Código	EAN	P.V.P (€)
65 x 40	BiM, madeira e metal	1	B-64820	0088381536325	17,50

Lâmina de imersão 65



TMA052



- Madeira e metal.
- Indicado para corte nivelado
- Parquê/piso laminado.
- Cortes de imersão em madeira.



Tamanho (mm)	Material/Indicado para	Unidades	Código	EAN	P.V.P (€)
65 x 40	HCS, madeira	1	B-64864	0088381536363	13,00

Lâmina de imersão 28



TMA047



- Madeira e metal.
- Adequado para corte por imersão precisa.
- Corte por imersão em madeira dura.



Tamanho (mm)	Material/Indicado para	Unidades	Código	EAN	P.V.P (€)
32 x 50	BiM, madeira e metal	1	B-64814	0088381536318	12,50
32 x 50	BiM, madeira e metal	20	B-64814-20	0088381541213	195,00

Lâmina de imersão 32



TMA051



- Fresagem em móveis.
- Cortes profundos em madeira macia.
- Cortes de imersão em madeira macia.



Tamanho (mm)	Material/Indicado para	Unidades	Código	EAN	P.V.P (€)
32 x 50	HCS, madeira	1	B-64858	0088381536356	11,00
32 x 50	HCS, madeira	20	B-64858-20	0088381541220	120,00

Acessórios de corte de imersão

Lâmina de imersão 65



TMA055



- Fresagem em móveis.
- Cortes nivelados.
- Corte de imersão em painéis laminados ou madeira dura.

Tamanho (mm)	Material/Indicado para	Unidades	Código	EAN	P.V.P (€)
65 x 40	BiM, madeira	1	B-64892	0088381536394	17,00

Lâmina de imersão 65



TMA056



- Fresagem em móveis.
- Cortes nivelados.
- Corte de imersão em painéis laminados ou madeira.

Tamanho (mm)	Material/Indicado para	Unidades	Código	EAN	P.V.P (€)
65 x 40	HCS, madeira	1	B-64901	0088381536400	14,00

Lâmina de imersão 32



TMA053



- Madeira dura.
- Fresagem em móveis.
- Cortes de imersão em madeira dura e painéis laminados.

Tamanho (mm)	Material/Indicado para	Unidades	Código	EAN	P.V.P (€)
32 x 50	BiM, madeira	1	B-64870	0088381536370	11,00
32 x 50	BiM, madeira	1	B-64870-20	0088381541237	195,00

Lâmina de imersão 24



TMA050



- Fresagem em móveis.
- Cortes nivelados em madeira. Cortes profundos em madeira macia.
- Cortes de imersão em madeira macia.

Tamanho (mm)	Material/Indicado para	Unidades	Código	EAN	P.V.P (€)
24 x 50	HCS, madeira	1	B-64842	0088381536349	7,50



Lâmina de imersão 20



TMA058



- Metal/Adequado para corte nivelado em pregos ou tubo de cobre.
- Cortes em rodapés.

Tamanho (mm)	Material/Indicado para	Unidades	Código	EAN	P.V.P (€)
20 x 30	BiM, metal	1	B-64923	0088381536424	8,50

Lâmina de imersão 32



TMA061



- Corte de aço inoxidável.
- Adequado para o corte nivelado de parafusos e pregos encravados.
- Corte de fibra de vidro.

Tamanho (mm)	Material/Indicado para	Unidades	Código	EAN	P.V.P (€)
32 x 40	TC/HM, Metal	1	B-64951	0088381536455	22,00

Lâmina de imersão 32



TMA059



- Cortes em rodapés.
- Metal/Adequado para corte nivelado em pregos ou tubo de cobre.

Tamanho (mm)	Material/Indicado para	Unidades	Código	EAN	P.V.P (€)
32 x 50	BiM, metal	1	B-64939	0088381536431	11,00

Lâmina de imersão 10



TMA057



- Metal/Adequado para corte nivelado em pregos.
- Corte de imersão em placas de gesso.
- Cortes em rodapés.

Tamanho (mm)	Material/Indicado para	Unidades	Código	EAN	P.V.P (€)
65 x 40	HCS, madeira	1	B-64917	0088381536417	7,50

Lâmina de imersão 32



TMA060



- Corte de aço inoxidável.
- Adequado para o corte nivelado de parafusos e pregos encravados.
- Corte de fibra de vidro.

Tamanho (mm)	Material/Indicado para	Unidades	Código	EAN	P.V.P (€)
20 x 40	TC/HM, Metal	1	B-64945	0088381536448	19,00

Lâmina de imersão 32



TMA054



- Fresagem em móveis.
- Cortes de imersão em madeira.

Tamanho (mm)	Material/Indicado para	Unidades	Código	EAN	P.V.P (€)
32 x 50	HCS, madeira	1	B-64886	0088381536387	11,00

Raspadores



Raspador rígido 52



TMA065



- Retirar restos de alcatifa, argamassa...
- Eliminação de resíduos: cola, argamassa e betão.

Tamanho (mm)	Material/Indicado para	Unidades	Código	EAN	P.V.P (€)
52 x 26	HCS	1	B-64989	0088381536486	8,75

Raspador flexível 52



TMA066



- Eliminação de resíduos de tinta.
- Retirar juntas de silicone.
- Eliminação de resíduos de colas de alcatifa.

Tamanho (mm)	Material/Indicado para	Unidades	Código	EAN	P.V.P (€)
52 x 40	HCS	1	B-64995	0088381536493	9,00

Lâminas de corte



Lâmina segmentada de serra 100

TMA063



- Ideal para materiais de isolamento.
- Corte nivelado de poliestireno.
- Cortar materiais macios (alcatifa, couro...)

Ø (mm)	Material/Indicado para	Unidades	Código	EAN	P.V.P (€)
100	BIM	1	B-64967	0088381536462	22,00

Lâmina de corte



TMA067



- Cortar juntas de expansão macias.
- Remover silicone de janelas.
- Recortar material isolante.

Tamanho (mm)	Material/Indicado para	Unidades	Código	EAN	P.V.P (€)
28 x 40	HCS	1	B-65006	0088381536509	15,50

Lâmina universal multicorte



TMA068



- Cortar juntas de expansão macias.
- Remover silicone de janelas.
- Recortar material isolante.

Tamanho (mm)	Material/Indicado para	Unds.s	Código	EAN	P.V.P (€)
11 x 24	HCS	1	B-65012	0088381536516	16,50



Limpeza e corte



Lâmina de limpeza TC HM 32

TMA075



Corte por imersão e raspagem em fibra de vidro.

- Eliminar argamassas em esquinas estreitas o juntas de cimento.

Tamanho (mm)	Material/Indicado para	Unidades	Código	EAN	P.V.P (€)
32 x 30	TC/HM Grão 50	1	B-65084	0088381536585	22,00

Lâmina de limpeza TC HM 32

TMA076



- Lixamento de verniz ou tinta em zonas de difícil acesso.
- Lixamento de madeira, composto de madeira/plástico e epóxi.

Tamanho (mm)	Material/Indicado para	Unidades	Código	EAN	P.V.P (€)
32 x 50	TC/HM Grão 40	1	B-65090	0088381536592	20,00

Lâmina de limpeza TC HM 32

TMA077



- Lixamento de verniz ou tinta em zonas de difícil acesso.
- Lixamento de madeira, composto de madeira/plástico e epóxi.

Tamanho (mm)	Material/Indicado para	Unidades	Código	EAN	P.V.P (€)
32 x 50	TC/HM Grão 100	1	B-65109	0088381536608	20,00

Lâmina de limpeza HM

TMA074



- Para levantar argamassa.
- Limpar as juntas de azulejos de chão.
- Limpeza de juntas de esquinas com a ponta de carbono de tungstênio.

Tamanho (mm)	Material/Indicado para	Unidades	Código	EAN	P.V.P (€)
70	TC/HM Grão 40	1	B-65078	0088381536578	35,00

Lâmina de limpeza TC HM 85

TMA069



- Limpeza de juntas em paredes e pisos.
- Pequenos cortes em azulejo macio.
- Abrir rasgos em betão poroso para cabos e tubagens.

Ø (mm)	Material/Indicado para	Unidades	Código	EAN	P.V.P (€)
85	TC/HM Grão 40	1	B-65028	0088381536523	25,00

Lâmina de corte e limpeza de diamante segmentada HM 65

TMA070



- Pequenos cortes em azulejo macio.
- Abrir rasgos em epóxi, fibra de vidro, PVC porcelânico.

Ø (mm)	Material/Indicado para	Unidades	Código	EAN	P.V.P (€)
85	TC/HM Grão 40	1	B-65034	0088381536530	41,00

Lâmina de corte e limpeza segmentada HM 70

TMA071



- Limpeza de juntas em paredes e pisos.
- Pequenos cortes em azulejo macio.
- Abrir rasgos em betão poroso para cabos e tubagens.

Ø (mm)	Material/Indicado para	Unidades	Código	EAN	P.V.P (€)
70	TC/HM Grão 50	1	B-65040	0088381536547	22,00

Lâmina de corte e limpeza segmentada HM 85

TMA072



- Limpeza de juntas em paredes e pisos.
- Pequenos cortes em azulejo macio.
- Abrir rasgos em betão poroso.

Ø (mm)	Material/Indicado para	Unidades	Código	EAN	P.V.P (€)
85	TC/HM Grão 40	1	B-65056	0088381536554	21,50

Lâmina de limpeza

Lâmina de limpeza TC HM 78



TMA073



- Retirar argamassa ou cola de azulejo.
- Limpar cola de alcatifas.

Tamanho (mm)	Material/Indicado para	Unidades	Código	EAN	P.V.P (€)
78	TC/HM Grão 20	1	B-65062	0088381536561	21,00

Prato de lixa



TMA078



Tamanho (mm)	Material/Indicado para	Unidades	Código	EAN	P.V.P (€)
93	Velcro	1	B-65115	0088381536615	11,00

Conjunto de lâminas

Conjunto de lâminas de imersão

TMA045 Lâmina de corte segmentada 8

TMA047 Lâmina de imersão 32

TMA053 Lâmina de imersão 32

TMA058 Lâmina de imersão 20



Tamanho (mm)	Material/Indicado para	Unidades	Código	EAN	P.V.P (€)
-	Cortes por imersão	4	B-67480	0088381541145	44,00

Conjunto de lâminas para azulejo

TMA058 Lâmina de imersão 20

TMA065 Raspador rígido 52

TMA069 Lâmina de limpeza HM 85

TMA073 Lâmina de limpeza TC HM 78



Tamanho (mm)	Material/Indicado para	Unidades	Código	EAN	P.V.P (€)
-	Azulejo	4	B-67496	0088381541152	50,00



Tabela de aplicação - Lixas para multifunções

		Grão	Tinta	Verniz	Lacas	Gesso	Madeira	Madeira macia	Madeira dura	Contraplacado de madeira	Aglomerado/MDF	Fibra de vidro/Plásticos	Metal	Aço	Pedra	Mármore	Granito	Vidro	Metacrílico	
																				Madeira/longa duração
Madeira/longa duração	Grosso	60																		
	Médio	80																		
		100					✓	✓	✓	✓	✓	✓	✓							
		120					✓	✓	✓	✓	✓	✓	✓							
		180					✓	✓	✓	✓	✓	✓	✓							
Madeira	Fino	240				✓	✓	✓	✓	✓	✓	✓								
		60																		
		80																		
		100					✓	✓	✓	✓	✓									
		120					✓	✓	✓	✓	✓									
Tinta	Fino	150				✓	✓	✓	✓	✓	✓									
		180	✓	✓	✓	✓														
		240	✓	✓	✓	✓														
		320	✓	✓	✓	✓														
		60																		
Pedra	Muito fino	120																		
		240																		
		400	✓	✓											✓	✓	✓	✓	✓	
		600	✓	✓											✓	✓	✓	✓	✓	
		1200	✓	✓											✓	✓	✓	✓	✓	



Lixas

Lixas para madeira

- Adequado para lixar madeira, madeira dura, aglomerado, placas para construção e metal.



Medida (mm)	Tipo	Grão	Unidades	Código	EAN	P.V.P (€)
93 x 93 x 93	Madeira	60	10	B-21624	0088381401081	3,50
		80	10	B-21630	0088381401098	3,25
		100	10	B-22947	0088381403344	3,25
		120	10	B-21646	0088381401104	3,25
		150	10	B-22953	0088381403351	3,25
		180	10	B-21652	0088381401111	3,25
		240	10	B-21668	0088381401128	3,25
		60, 80, 120, 180, 240	10 (2 de cada)	B-21618	0088381401074	3,80

Lixas para madeira dura, placas para construção e metal

- Adequado para trabalhos em madeira, plástico, metal em placas, madeiras envernizadas e metais pintados.



Medida (mm)	Tipo	Grão	Unidades	Código	EAN	P.V.P (€)
93 x 93 x 93	Madeira dura	40	10	P-33255	0088381961417	3,75
		60	10	P-33261	0088381961424	3,75
		80	10	P-33277	0088381961431	3,75
		100	10	P-33283	0088381961448	3,50
		120	10	P-33299	0088381961455	3,50
		180	10	P-33314	0088381961479	3,50
		240	10	P-33320	0088381961486	3,50
		60, 80, 100, 120, 180	10 (2 de cada)	B-21559	0088381401012	4,00

Lixas para tinta e verniz

- Adequado para lixar tinta e verniz ou desbastar.



Medida (mm)	Tipo	Grão	Unidades	Código	EAN	P.V.P (€)
93 x 93 x 93	Tinta	60	10	B-21680	0088381401142	3,75
		80	10	B-21696	0088381401159	3,75
		100	10	B-21705	0088381401166	3,75
		120	10	B-22969	0088381403368	3,75
		240	10	B-21711	0088381401173	3,75
		320	10	B-21727	0088381401180	3,75
		60, 80, 100, 240, 320	10 (2 de cada)	B-21674	0088381401135	4,00

Lixas para materiais duros como pedra, mármore ou vidro

- Adequado para o lixamento grosso ou brilhante de materiais duros como pedra, mármore ou vidro.



Medida (mm)	Tipo	Grão	Unidades	Código	EAN	P.V.P (€)
93 x 93 x 93	Pedra	120	10	B-21749	0088381401203	3,75
		240	10	B-21755	0088381401210	3,75
		400	10	B-21761	0088381401227	3,75
		600	10	B-21777	0088381401234	3,50
		1200	10	B-21783	0088381401241	3,50
		120, 240, 400, 600, 1200	10 (2 de cada)	B-21733	0088381401197	4,00

Abrasivo de lã para eliminar óxido do metal e a sujidade da madeira

- Adequado para eliminar o óxido do metal e a sujidade da madeira.



Medida (mm)	Tipo	Grão	Unidades	Código	EAN	P.V.P (€)
93 x 93 x 93	Lã	100	1	B-21808	0088381401265	3,00
		280	1	B-21799	0088381401258	3,00
		Sem grão	1	B-21814	0088381401272	3,00

Feltro para o pré-polimento de superfícies sujas ou riscadas

- Feltro para o pré-polimento de superfícies sujas ou riscadas.



Medida (mm)	Tipo	Grão	Unidades	Código	EAN	P.V.P (€)
93 x 93 x 93	Feltro	Duro	1	B-21820	0088381401289	3,00

Kit de aspiração



Modelo	Unidades	Código	EAN	P.V.P (€)
TM3000C	1	196022-7	0088381411493	5,00
TM3010C	1	196550-2	0088381432726	5,00
DTM51	1	196765-1	0088381436533	7,00

Adaptador universal



Unidades	Código	EAN	P.V.P (€)
1	313248-8	-	2,50



Serras

- *Circulares*
- *Serras de esquadria*
- *Incisão*





Tipos de serrilha

ATB

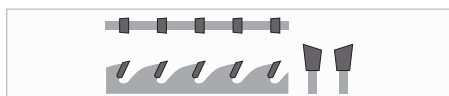

ATAF

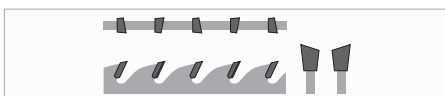

M-FORCE

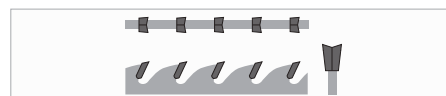

FTG

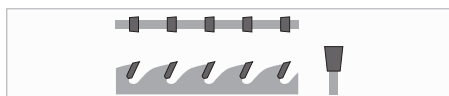

TCG

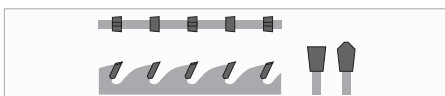

SMTCG

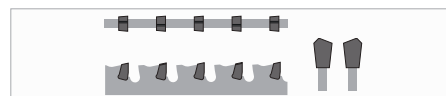

Tecnologia

Ranhurado a laser

Laser slit

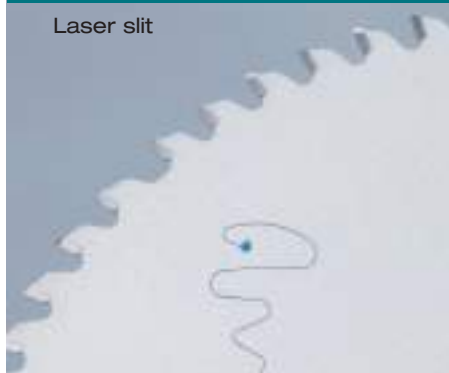

Reduz o ruído e as vibrações.

Revestido



Revestido a PTFE (politetrafluoroetileno), que reduz a acumulação de sujeira e o atrito sobre o material.































Reforçado





















O design de dente embutido aumenta a superfície de aderência para suportar trabalhos mais duros.



Tipos de discos para serras circulares, serras de esquadria e serras de incisão.

			85 mm	136 mm	165 mm	185 mm	190 mm	210 mm	235 mm	270 mm	355 mm
MAKFORCE		 			160 mm	170 mm	180 mm	230 mm	235 mm	✓	✓
SPECIALIZED REFORZADO		 			✓	✓	✓	✓	✓	✓	✓
MFORCE		 			✓	✓	-	-	✓	-	-
SPECIALIZED STANDARD		 			✓	✓	-	✓	✓	-	-
SPECIALIZED STANDARD economy		 			✓	✓	✓	-	✓	-	-
SPECIALIZED ALUMINIO		 			160 mm	-	✓	✓	✓	-	360 mm
SPECIALIZED CONSTRUCCION		 			-	-	✓	✓	✓	-	-
SPECIALIZED PANEL SANDWICH		 			✓	-	-	-	✓	✓	✓
SPECIALIZED MAQUINAS DE BATERIA		 	✓	✓	✓	-	✓	-	-	-	-
SPECIALIZED INCISION		 			160 mm	-	-	-	-	-	-

			136 mm	165 mm	190 mm	216 mm	250 mm	260 mm	300 mm	305 mm	315 mm
MAKBLADE PLUS		 			✓	-	✓	-	-	-	-
MAKBLADE		 			✓	✓	255 mm	✓	-	✓	-
SPECIALIZED ALUMINIO		 			✓	✓	-	✓	-	✓	350 mm
SPECIALIZED S. MESA		 			-	210 mm	-	✓	-	-	✓
SPECIALIZED S. MESA		 			-	-	-	✓	✓	-	350 mm
SPECIALIZED LAMINADOS		 	✓	✓	✓	✓	-	✓	-	✓	-

Discos para serras circulares

Discos Makforce



Uma vasta seleção de discos para todas as marcas e modelos de serras circulares portáteis.

Vasta gama de medidas, de 160 mm a 355 mm, e de número de dentes, de 12 a 60. A gama abrange um vasto leque de aplicações, desde corte grosso e transversal a corte fino e longitudinal.

- A estrutura do disco é de aço temperado de precisão para absorver os impactos sem se deformar.
- Carboneto de tungsténio de alta qualidade e baixo desgaste para uma vida prolongada da serra.
- Afição perfeita para cortes mais precisos.
- Corte fino, com menos limalhas e menor esforço do motor.

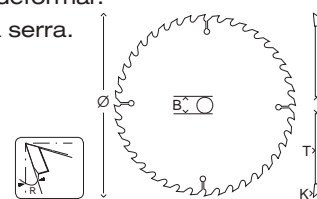

Ø 165 mm DHS660 - DHS661 - DHS680 - DSS610 - HS6100 - HS6601

Ø ext. (mm)	Ø int. (mm)	K (mm)	T (mm)	N.º de dentes	R	Tipo de dente	Redução	Código	EAN	P.V.P (€)
160	20	2,4	1,5	16	20°	ATB	15,88	B-08143	0088381336130	17,00
160	20	2,4	1,5	24	20°	ATB	15,88	B-08296	0088381336284	20,00
160	20	2,4	1,5	40	20°	ATB	15,88	B-08420	0088381336413	25,00
165	20	2,4	1,5	10	20°	FTG	-	B-08159	0088381336147	20,00
170	30	2,4	1,5	16	20°	ATB	15,88	B-08171	0088381336161	20,00
170	30	2,4	1,5	24	20°	ATB	15,88	B-08311	0088381336307	22,00
170	30	2,4	1,5	40	20°	ATB	15,88	B-08442	0088381336437	23,00

Ø 190 mm DHS710 - DHS782 - DHS783 - HS7601 - HS7100 - HS7101

180	20	2,4	1,5	16	20°	ATB	-	B-08187	0088381336178	17,00
180	20	2,4	1,5	24	20°	ATB	-	B-08327	0088381336314	21,00
190	30	2	1,4	12	20°	FTG	20/15,88	B-08224	0088381336215	21,00
190	30	2,2	1,4	24	20°	ATB	20/15,88	B-08355	0088381336345	22,00
190	30	2,2	1,4	40	20°	ATB	20/15,88	B-08486	0088381336475	30,00
190	30	2,2	1,4	60	15°	ATAF	20/15,88	B-08551	0088381336543	32,00

Ø 210 mm 5008MG

210	30	2,4	1,6	16	20°	ATB	-	B-08230	0088381336222	21,00
210	30	2,4	1,6	24	20°	ATB	-	B-08377	0088381336369	27,00
210	30	2,4	1,6	40	20°	ATB	-	B-08501	0088381336499	32,00

Ø 235 mm 5903R - 5903RK

230	30	2,3	1,6	24	20°	ATB	-	B-08383	0088381336376	27,00
230	30	2,6	1,6	40	20°	ATB	-	B-08517	0088381336505	29,00
235	30	2,3	1,6	20	20°	ATB	-	B-08399	0088381336383	22,00
235	30	2,6	1,6	40	20°	ATB	-	B-08523	0088381336512	29,00
235	30	2,8	1,8	60	15°	ATAF	-	B-08589	0088381336574	30,00

Ø 270 mm 5103R - HS0600

270	30	2,6	1,8	24	20°	ATB	-	B-08268	0088381336253	34,00
270	30	2,6	1,6	40	20°	ATB	-	B-08539	0088381336529	40,00
270	30	2,8	1,8	60	15°	ATAF	-	B-08573	0088381336567	43,00

Ø 355 mm 5143R

355	30	3,0	2,2	24	20°	ATB	-	B-08274	0088381336260	48,00
355	30	3,0	2,2	40	20°	ATB	-	B-08414	0088381336406	54,00
355	30	3,0	2,2	60	20°	ATB	-	B-08545	0088381336536	46,00



Discos para serras circulares

Discos Specialized Reforçado



Concebidos para serras circulares da Makita e outras marcas de serras, os dentes reforçados, ou “dentes embutidos”, garantem elevada resistência e desgaste reduzido. Para cortes fáceis em madeiras com nós. Concebido para evitar que saltem dentes ao cortar pregos na madeira acidentalmente. Especialmente adequado para a recuperação de madeira de trabalhos de demolição.

- Corte em madeira com pregos ocasionais e nós.
- Extremamente resistente e com desgaste reduzido.
- Aumentam a vida útil da serra e a produtividade.
- Corte fino, com menos limalhas e menor esforço do motor.

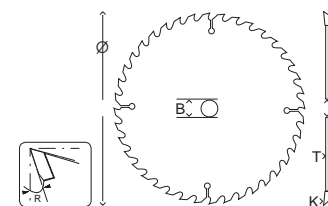

Ø 165 mm DHS660 - DHS661 - DHS680 - DSS610 - HS6100 - HS6601

Ø ext. (mm)	Ø int. (mm)	K (mm)	T (mm)	N.º de dentes	R	Tipo de dente	Redução	Código	EAN	P.V.P (€)
165	20	2,0	1,25	16	23°	ATB reforçado	-	B-09329	0088381337366	24,00
165	20	2,0	1,25	24	23°	ATB reforçado	-	B-09391	0088381337434	23,50
165	20	2,0	1,25	40	18°	ATB reforçado	-	B-09472	0088381337519	25,50

Ø 190 mm DHS782 - DHS783 - HS7601 - HS7100 - HS7101 - DHS710

185	30	2,0	1,25	16	25°	ATB reforçado	-	B-09341	0088381337380	19,00
185	30	2,0	1,25	40	25°	ATB reforçado	-	B-09494	0088381337533	25,00
190	30	2,0	1,25	16	23°	ATB reforçado	-	B-09357	0088381337397	19,00
190	30	2,0	1,25	24	23°	ATB reforçado	-	B-09422	0088381337465	27,00
190	30	2,0	1,25	40	23°	ATB reforçado	-	B-09503	0088381337540	35,00

Ø 210 mm 5008MG

210	30	1,9	1,4	18	23°	ATB reforçado	-	B-09363	0088381337403	23,00
-----	----	-----	-----	----	-----	---------------	---	---------	---------------	-------

Ø 235 mm 5903R - 5903RK

235	30	2,3	1,6	24	23°	ATB reforçado	-	B-09444	0088381337489	29,00
235	30	2,3	1,6	48	18°	ATB reforçado	-	B-09519	0088381337557	45,00

Ø 270 mm 5103R - HS0600

270	30	2,6	1,8	24	23°	ATB reforçado	-	B-09450	0088381337496	58,00
270	30	2,6	1,8	40	18°	ATB reforçado	-	B-09525	0088381337564	65,00
270	30	2,6	1,8	60	18°	ATB reforçado	-	B-09531	0088381337571	73,00

Ø 355 mm 5143R

355	30	3,0	2,2	24	23°	ATB reforçado	-	B-09385	0088381337427	75,00
355	30	3,0	2,2	60	18°	ATB reforçado	-	B-09547	0088381337588	99,00

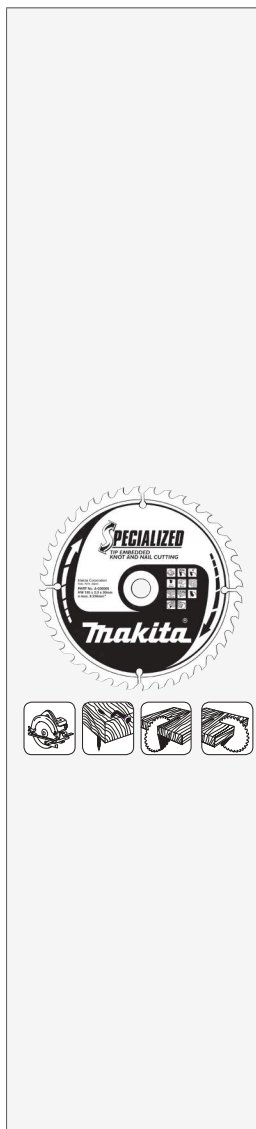

Discos para serras circulares

Discos MForce



Design avançado e revolucionário para serras circulares.

O dente com dupla face biselada proporciona um corte fino e a forma em "M" produz um efeito de dente duplo.

A superfície de corte mais ampla do dente garante maior duração em relação aos discos tradicionais. A fricção é reduzida graças a um corte e dentes estreitos, o que garante um menor aumento da corrente e protege o motor da serra. Corte em madeira com pregos ocasionais e nós.

- Acabamento perfeito, já que o número de dentes em M se multiplica por 2.
- Corte agressivo.
- Área de trabalho mais ampla.
- Mais duradouro.

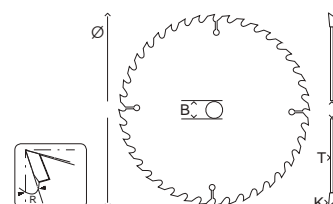

Ø 165 mm DHS660 - DHS661 - DHS680 - DSS610 - HS6100 - HS6601											
Ø ext. (mm)	Ø int. (mm)	K (mm)	T (mm)	N.º de dentes	R	Tipo de dente	Redução	Código	EAN	P.V.P (€)	
165	20	2,0	1,2	16	15°	M-Force	-	B-07901	0088381335898	13,50	
165	20	2,0	1,2	24	15°	M-Force	-	B-08006	0088381337892	16,50	
Ø 190 mm DHS710 - DHS782 - DHS783 - HS7100 - HS7101 - HS7601											
185	30	2,0	1,2	24	15°	M-Force	20/15,88	B-08040	0088381336031	19,00	
Ø 235 mm 5903R - 5903RK											
235	30	2,3	1,6	20	15°	M-Force	25/15,88	B-07995	0088381335980	28,00	
235	30	2,3	1,6	40	15°	M-Force	25/15,88	B-08121	0088381336116	30,00	

Discos Specialized Standard



Concebidos para serras circulares Makita e outras marcas de serras.



Ø 165 mm DHS660 - DHS661 - DHS680 - DSS610 - HS6100 - HS6601											
Ø ext. (mm)	Ø int. (mm)	K (mm)	T (mm)	N.º de dentes	R	Tipo de dente	Redução	Código	EAN	P.V.P (€)	
165	20	2,4	1,5	10	20°	ATB	-	D-03327	0088381173667	10,00	
165	20	2,0	1,5	16	20°	ATB	-	D-09628	0088381184816	11,00	
165	20	2,4	1,5	24	20°	ATB	-	D-03333	0088381173674	12,00	
165	20	2,4	1,5	40	18°	ATB	-	D-03349	0088381173681	14,50	
Ø 190 mm DHS710 - DHS782 - DHS783 - HS7100 - HS7101 - HS7601											
185	30	1,8	1,2	16	20°	ATB	20	D-03903	0088381174336	11,00	
185	30	2,0	1,2	20	20°	ATB	30/20	D-09634	0088381184823	12,00	
185	30	1,8	1,2	40	18°	ATB	20	D-03919	0088381174343	13,50	
Ø 210 mm 5008MG											
210	30	2,0		24	20°	ATB	-	D-29050	0088381343466	20,00	
Ø 235 mm 5903R - 5903RK											
235	30	2,3	1,6	20	20°	ATB	25	D-03925	0088381174350	16,00	
235	30	2,3	1,6	48	18°	ATB	25	D-03931	0088381174367	19,50	
235	30	2,3	1,6	60	15°	ATB	25	D-09640	0088381184830	25,00	

Discos para serras circulares

Discos Specialized Standard Economy



- Concebidos para serras circulares Makita e outras marcas de serras.
- Cortes em madeiras macias.
- Excelente qualidade/preço.

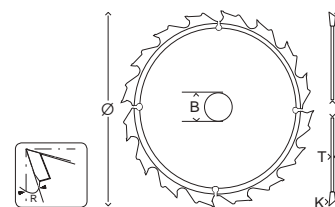

Ø 165 mm DHS660 - DHS661 - DHS680 - DSS610 - HS6100 - HS6601

Ø ext. (mm)	Ø int. (mm)	K (mm)	T (mm)	N.º de dentes	R	Tipo de dente	Redução	Código	EAN	P.V.P (€)
165	20	2,0	1,2	16	12°	ATB	-	D-52554	0088381444422	6,00
165	20	2,0	1,2	24	12°	ATB	-	D-52560	0088381444439	7,00
165	20	2,0	1,2	40	12°	ATB	-	D-52576	0088381444446	8,50

Ø 185 mm DHS710 - DHS782 - DHS783 - HS7601 - HS7100 - HS7101

185	30	2,2	1,4	16	18°	ATB	-	D-52582	0088381444453	7,50
185	30	2,2	1,4	24	15°	ATB	-	D-52598	0088381444460	8,50
185	30	2,2	1,4	40	14°	ATB	-	D-52607	0088381444477	9,50

Ø 190 mm DHS710 - DHS782 - DHS783 - HS7601 - HS7100 - HS7101

190	30	2,2	1,4	24	15°	ATB	-	D-64951	0088381533096	8,75
190	30	2,2	1,4	40	15°	ATB	-	D-64967	0088381533102	10,00
190	30	2,0	1,4	40	18°	ATB	-	D-64973	0088381533119	12,50

Ø 235 mm 5903R - 5903RK

235	30	2,5	1,6	20	14°	ATB	-	D-52613	0088381444484	13,00
235	30	2,5	1,6	40	12°	ATB	-	D-52629	0088381444491	15,00
235	30	2,5	1,6	60	12°	ATB	-	D-52635	0088381444507	17,00



Discos Specialized Alumínio



Vasta gama de discos para serras circulares com um excelente desempenho de corte em alumínio, latão, bronze e outros metais não ferrosos. Os discos também podem ser utilizados em plásticos e madeiras laminadas. Aplicar cera para discos na zona dos dentes com frequência para evitar a acumulação de limalhas nos dentes ao cortar metais não ferrosos.

- A estrutura do disco é de aço temperado de precisão para maior rigidez e cortes mais retos.
- Excelente qualidade de corte em materiais não ferrosos.
- Corte otimizado em pisos laminados.

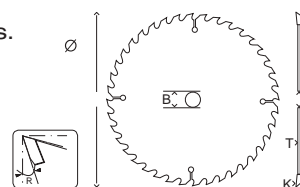

Ø 165 mm DHS680 - DHS660 - DHS661 - DSS610 - HS6601 - HS6100										
Ø ext. (mm)	Ø int. (mm)	K (mm)	T (mm)	N.º de dentes	R	Tipo de dente	Redução	Código	EAN	P.V.P (€)
160	20	2,4	1,8	60	0°	TCG	-	B-09553	0088381337595	38,00
Ø 190 mm DHS782 - DHS783 - HS7601 - HS7100 - HS7101 - DHS710										
190	30	2,4	1,8	60	0°	TCG	20/15,88	B-09597	0088381337632	51,00
Ø 210 mm 5008MG										
210	30	2,8	2,0	54	-5°	TCG	25	B-12435	0088381354752	51,00
Ø 235 mm 5903R - 5903RK										
235	30	2,4	1,8	80	0°	TCG	-	B-09606	0088381337649	58,00
Ø 355 mm 5143R										
350	30	3,2	2,6	100	0°	TCG	-	B-09737	0088381337779	93,00

Discos para serras circulares

Discos Specialized Construção



Estes discos são indicados para madeiras de construção, madeiras de cofragem, madeiras com pregos, madeiras prensadas e madeiras com resíduos de betão.

- O dente está embutido dentro do corpo do disco, garantindo uma elevada resistência.
- Os dentes podem ser novamente afiados para um maior aproveitamento do disco.
- Graças à sua estrutura reforçada, é possível obter cortes retos sem desvios e sem a necessidade de guias.

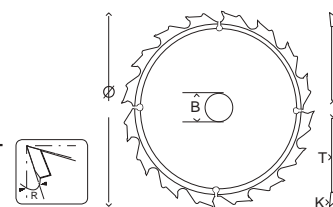

Ø 190 mm DHS782 - DHS783 - HS7601 - HS7100 - HS7101 - DHS710										
Ø ext. (mm)	Ø int. (mm)	K (mm)	T (mm)	N.º de dentes	R	Tipo de dente	Redução	Código	EAN	P.V.P (€)
190	30	2,6	1,6	12	20°	FTG reforçado	-	B-13683	0088381359795	25,00
Ø 210 mm 5008MG										
210	30	2,8	1,8	14	20°	FTG reforçado	-	B-27246	0088381411172	26,00
Ø 235 mm 5903R - 5903RK										
235	30	2,8	1,8	16	20°	FTG reforçado	-	B-13699	0088381359801	31,00

Discos Specialized Painel Sandwich



Discos com dentes HM para o corte específico de painel sandwich.

Dente em forma triangular contraposto:

- Reduz a rebarba na peça.
- Evita a rutura do disco.
- Ranhuras para evitar vibração e ruído.
- O dente está embutido no disco.

- Ideal para utilizar nos nossos modelos 5903R, 5104S, 5103R e 5143R.
- Longa duração.
- Acabamento de alta qualidade graças ao tipo de dente que evita fendas na chapa.

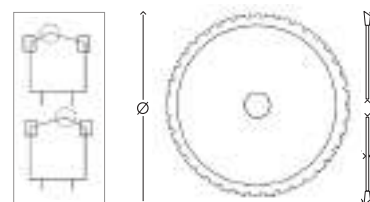

Ø 165 mm DHS660 - DHS661 - DSS610 - DHS680 - HS6601 - HS6100

Ø ext. (mm)	Ø int. (mm)	K (mm)	T (mm)	N.º de dentes	R	Tipo de dente	Redução	Código	EAN	P.V.P (€)
165	20	1,75	1,4	42	0°	SMTCG LaserSilt	-	B-63133	0088381529921	57,00

Ø 235 mm 5903R - 5903RK

235	30	2,2	1,8	50	-	SMTCG LaserSilt	-	B-17675	0088381369343	80,00
-----	----	-----	-----	----	---	-----------------	---	---------	---------------	-------

Ø 270 mm 5103R - HS0600

270	30	2,4	2,0	60	-	SMTCG LaserSilt	-	B-17681	0088381369350	115,00
-----	----	-----	-----	----	---	-----------------	---	---------	---------------	--------

Ø 355 mm 5143R

355	30	2,6	2,2	80	-	SMTCG LaserSilt	-	B-17697	0088381369367	140,00
-----	----	-----	-----	----	---	-----------------	---	---------	---------------	--------

Discos para serras circulares

Discos Specialized Bateria



Os discos de qualidade superior foram especificamente fabricados para serras a bateria.

Discos para cortar madeira, agora disponíveis para as serras circulares a bateria mais populares.

"Todas com a qualidade Makita".

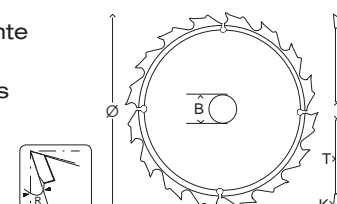

Ø 85 mm HS301D

Ø ext. (mm)	Ø int. (mm)	K (mm)	T (mm)	N.º de dentes	R	Tipo de dente	Redução	Código	EAN	P.V.P (€)
85	15	1,0	0,7	20	10°	ATB	Madeira	B-14607	0088381362689	9,25
85	15	0,5	0,5	50	-	-	Contraplacado	792299-8	0088381101004	13,00
85	15	0,5	0,5	50	-	-	Plástico	792259-0	0088381100816	10,00

Ø 136 mm BSS501

136	20	1,5	1,0	16	20°	ATAF	Madeira	B-10643	0088381347815	22,00
-----	----	-----	-----	----	-----	------	---------	---------	---------------	-------

Ø 165 mm DHS660 - DHS661 - DSS610 - DHS680

165	20	1,6	1,0	40	18°	ATAF	Madeira	B-09232	0088381337274	24,00
165	20	1,5	1,0	24	20°	ATAF	Madeira	B-09173	0088381337212	21,00

Ø 190 mm DHS710 - DHS782 - DHS783

190	30	2,0	1,4	24	20°	ATAF	Madeira	B-09195	0088381337236	19,00
190	30	2,0	1,4	40	10°	ATAF	Madeira	B-09254	0088381337922	22,00

Discos para serras circulares

Discos Specialized Incisão



Estes discos são específicos para serras de incisão. Foram especificamente concebidos para garantir um corte totalmente limpo. Os discos para serras de incisão têm uma tecnologia patenteada contra as vibrações. Os discos de baixa vibração executam o corte com menos vibrações, pelo que o disco penetra mais facilmente o material e com menor esforço.

- A estrutura do disco é de aço temperado de precisão para maior rigidez e cortes mais retos.
- Adequado para cortar madeira.

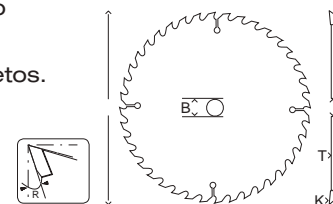

Ø 165 mm DSP600 - DSP601 - SP6000

Ø ext. (mm)	Ø int. (mm)	K (mm)	T (mm)	N.º de dentes	R	Tipo de dente	Redução	Código	EAN	P.V.P (€)
160	20	2,2	1,6	28	23°	ATB cortado a laser	-	B-09260	0088381337304	27,00
165	20	2	1,4	28	15°	ATB cortado a laser	-	B-56699	0088381534765	43,00
160	20	2,2	1,6	48	8°	ATB cortado a laser	-	B-09276	0088381337311	33,00
165	20	2,2	1,6	48	8°	ATB cortado a laser	-	B-09298	0088381337335	49,00

Especial Madeira

165	20	1,85	1,25	48	8°	Corte limpo.	-	B-56708	0088381490375	67,00
165	20	1,45	1	56	23°	Efficut	-	B-57320	0088381518413	46,00

Especial MDF

165	20	2,2	1,6	60	5°	Extralimpo	-	B-45428	0088381448963	61,00
165	20	2,2	1,6	60	5°	Corte limpo	-	B-45434	0088381448970	61,00
165	20	2,0	1,4	60	5°	Extralimpo	-	B-56720	0088381534789	55,00

Especial para Corian

165	20	2,4	1,7	48	5°	TCG	-	B-10344	0088381342100	55,00
165	20	2,4	1,7	48	5°	TCG	-	B-56742	0088381495981	64,00

Especial para Alumínio

165	20	2,4	1,7	56	-3°	TCG LaserSlit	-	B-09307	0088381337342	53,00
165	20	2,4	1,7	56	-3°	TCG LaserSlit	-	B-56714	0088381534802	66,00



Discos para serras de esquadria

Discos MakBlade de corte silencioso



Os discos MAKBLADE PLUS para serras de esquadria possuem tecnologia exclusiva e patenteada. Estes discos foram concebidos para atenuar as vibrações e o ruído. Estes discos característicos melhoram o ambiente de trabalho, a durabilidade da folha e a fiabilidade da máquina como um todo. A duração dos dentes é significativamente prolongada graças ao carboneto de tungsténio superior ao dos discos convencionais.

- Menor vibração e menos ruído.

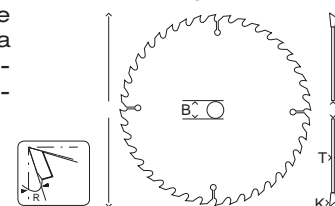

Ø 190 mm DLS714 - DLS600 - LS0714F

Ø ext. (mm)	Ø int. (mm)	K (mm)	T (mm)	N.º de dentes	R	Tipo de dente	Redução	Código	EAN	P.V.P (€)
190	20	2.0	1,4	60	5°	ATAF	-	B-08757	0088381336741	40,00

Ø 250 mm/260 mm DLS111 - LS1040F - LH1040F - LF1000 - LS1018L - LS1019L

250	30	2,6	1,8	80	5°	-	-	B-42640	0088381440882	85,00
250	30	2,6	1,8	80	5°	-	-	B-42662	0088381440905	85,00
250	30	3,2	2,2	80	5°	-	-	B-42830	0088381433969	85,00
250	30	3,2	2,2	80	5°	-	-	B-42852	0088381433983	85,00
260	30	2,3	1,8	70	5°	ATAF	-	B-08707	0088381337915	57,00

Ø 305 mm LS1219L - LH1201FL

300	30	2,6	1,8	96	5°	-	-	B-42656	0088381440899	95,00
300	30	2,6	1,8	96	5°	-	-	B-42678	0088381440912	95,00
300	30	3,2	2,2	96	5°	-	-	B-42846	0088381433976	95,00
300	30	3,2	2,2	96	5°	-	-	B-42868	0088381433990	95,00
305	30	2,5	1,9	70	0°	ATAF	-	B-08735	0088381336727	67,00



Discos MakBlade



Uma vasta seleção de discos para todas as marcas e modelos de serras de esquadria.

Vasta gama de medidas, de 190 mm a 305 mm, e de número de dentes, de 24 a 100. A gama abrange um vasto leque de aplicações, desde corte grosso a corte com um acabamento extrafino.

- As serras de aço temperado absorvem os impactos sem se deformarem.
- Carboneto de tungsténio de alta qualidade e baixo desgaste para uma vida prolongada da serra.
- Corte fino, com menos limalhas e menor esforço do motor.

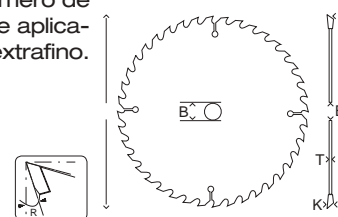

Ø 190 mm DLS600 - LS0714F - DLS714

Ø ext. (mm)	Ø int. (mm)	K (mm)	T (mm)	N.º de dentes	R	Tipo de dente	Redução	Código	EAN	P.V.P (€)
190	20	2,2	1,6	24	5°	ATB	-	B-08894	0088381336932	21,00
190	20	2,2	1,6	48	5°	ATB	-	B-08953	0088381336994	31,00
190	20	2,0	1,4	60	5°	ATB	-	B-09042	0088381337083	31,00

Ø 216 mm LS0815FL

216	30	2,1	1,6	40	10°	ATB	-	A-86169	0088381150026	42,00
216	30	2,4	1,6	48	5°	ATB	-	B-39506	0088381435123	39,00
216	30	2,2	1,6	80	5°	ATB	-	A-86468	0088381150804	64,00

Ø 260 mm DLS111 - LS1040F - LH1040F - LF1000 - LS1018L - LS1019L

250	30	2,4	1,6	32	5°	ATAF	-	B-08919	0088381336956	27,00
250	30	2,4	1,8	72	5°	ATB	-	B-09064	0088381337106	36,00
250	30	2,3	1,8	100	5°	ATB	-	B-09101	0088381337144	40,00
255	30	2,3	1,8	32	5°	ATB	-	B-08925	0088381336963	48,00
255	30	2,3	1,8	60	5°	ATB	-	B-09014	0088381337052	35,00
260	30	2,3	1,8	40	5°	ATB	-	B-08981	0088381337021	34,00
260	30	2,3	1,8	60	5°	ATB	-	B-09020	0088381337069	42,00
260	30	2,3	1,8	80	5°	ATB	-	B-09070	0088381337113	45,00
260	30	2,3	1,8	100	5°	ATB	-	B-09117	0088381337151	46,00
260	30	2,5	1,65	80	10°	Efficut	-	B-67240	0088381541015	63,00

Ø 305 mm - LH1201FL - LS1219L

305	30	2,3	1,8	40	5°	ATB	-	B-08997	0088381337038	45,00
305	30	2,3	1,8	60	5°	ATB	-	B-09036	0088381337076	60,00
305	30	2,3	1,8	80	5°	ATB	-	B-09086	0088381337120	70,00
305	30	2,3	1,8	100	5°	ATB	-	B-09123	0088381337168	80,00
305	30	2,5	1,65	80	10°	Efficut	-	B-67256	0088381541022	-



Discos para serras de esquadria

Discos Specialized Alumínio



- Chapa de precisão em aço temperado para maior rigidez e cortes mais retos.
- Excelente qualidade de corte em materiais não ferrosos.
- Corte otimizado em pisos laminados.

Aplicar cera para discos na zona dos dentes com frequência para evitar a acumulação de limalhas nos dentes ao cortar metais não ferrosos.

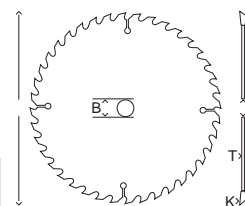

Ø 190 mm DLS600 - DLS714Z - LS0714F

Ø ext. (mm)	Ø int. (mm)	K (mm)	T (mm)	N.º de dentes	R	Tipo de dente	Redução	Código	EAN	P.V.P (€)
190	20	2,0	1,4	60	-5°	TCG	-	B-09612	0088381337656	38,00

Ø 216 mm LS0815FL

216	30	2,2	1,6	64	-5°	TCG	-	B-09628	0088381337663	45,00
-----	----	-----	-----	----	-----	-----	---	---------	---------------	-------

Ø 260 mm DLS111 - LF1000 - LH1040F - LS1018L - LS1019L - LS1040F

250	30	2,4	1,8	100	-5°	TCG	-	B-09640	0088381337687	65,00
260	30	2,4	1,8	80	-5°	TCG	-	B-09656	0088381337694	60,00
260	30	2,4	1,8	100	-5°	TCG	-	B-09662	0088381337700	65,00

Ø 305 mm LS1219L - LH1201FL

305	30	2,4	1,8	80	-5°	TCG	-	B-09678	0088381337717	61,00
305	30	2,4	1,8	100	-5°	TCG	-	B-09684	0088381337724	85,00

Ø 350 mm LS1440

350	30	3,2	2,6	100	0°	TCG	25	B-09737	0088381337779	93,00
-----	----	-----	-----	-----	----	-----	----	---------	---------------	-------



Discos Specialized Serras de mesa - Madeira



Concebidos para serras de mesa Makita e outras marcas de serras.

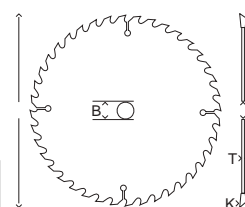

Ø 210 mm

Ø ext. (mm)	Ø int. (mm)	K (mm)	T (mm)	N.º de dentes	R	Tipo de dente	Redução	Código	EAN	P.V.P (€)
210	30	1,9	1,5	48	8°	TCG	25	A-81789	0088381143172	40,00

Ø 260 mm 2704 e MLT100

260	30	2,3	1,5	40	20°	TCG	-	B-05072	0088381200677	42,00
-----	----	-----	-----	----	-----	-----	---	---------	---------------	-------

Ø 315 mm 2712

315	30	2,8	2,0	24	20°	Corte rápido	-	B-46171	0088381451819	59,00
315	30	2,8	2,0	40	16°	Corte rápido	-	JM27170001	0088381531641	29,00
315	30	2,8	2,0	48	10°	Corte limpo	-	B-46187	0088381451826	69,00
315	30	2,8	2,0	60	10°	Corte limpo	-	B-46193	0088381451833	74,00



Discos Specialized Serras de mesa - Alumínio

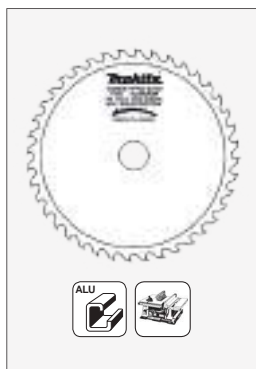

Ø 260 mm 2704 - MLT100											
Ø ext. (mm)	Ø int. (mm)	K (mm)	T (mm)	N.º de dentes	R	Tipo de dente	Redução	Código	EAN	P.V.P (€)	
260	30	2,8	2,2	80	0°	TCG	-	B-09715	0088381337755	65,00	
Ø 300 mm											
300	30	2,8	2,2	80	0°	TCG	-	B-09721	0088381337762	71,00	
Ø 350mm											
350	30	3,2	2,6	100	0°	TCG	25	B-09737	0088381337779	93,00	

Discos para serras de esquadria e serras circulares

Discos Specialized Laminados



- Excelente qualidade de corte em pisos laminados.
- Grande precisão de corte em molduras e rodapés.

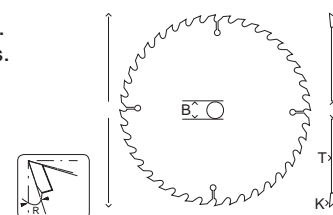

Ø 136 mm BSS501											
Ø ext. (mm)	Ø int. (mm)	K (mm)	T (mm)	N.º de dentes	R	Tipo de dente	Redução	Código	EAN	P.V.P (€)	
136	20	1,4	1	48	10	AMAF	-	B-29446	0088381416597	42,00	
Ø 165 mm DHS680 - DHS660 - DHS661 - DSS610 - HS6601 - HS6100											
165	20	1,45	1	52	5	TCG	-	B-29452	0088381416603	61,00	
Ø 190 mm DHS782 - DHS783 - HS7601 - HS7100 - HS7101 - DHS710											
190	20	2	1,4	60	5	TCG	20	B-29468	0088381416610	75,00	
Ø 216 mm LS0815FL											
216	30	2,5	1,8	72	5	TCG	-	B-29474	0088381416627	100,00	
Ø 260 mm DLS111 - LS1019L - LS1040F - LH1040F - LF1000 - LS1018L											
260	30	2,5	1,8	84	5	TCG	-	B-29496	0088381416641	88,00	
Ø 305 mm LH1201FL - LS1219L											
305	30	2,5	1,8	96	5	TCG	-	B-29505	0088381416658	152,00	



Discos Specialized Fresagem CA5000



Ø 118 mm - CA5000

Ø ext. (mm)	Ø int. (mm)	K (mm)	T (mm)	N.º dentes	R	Tipo de dente	Redução	Código	EAN	P.V.P (€)
118	20	14	6	6	90°	-	-	B-48832	0088381458733	153,00
118	20	18	6	6	135°	-	-	B-48860	0088381458740	169,00

Lâminas de corte DSC102



Tipo	Código	EAN	P.V.P (€)
M6	199087-8	0088381524766	66,00
M8	199085-2	0088381524759	66,00
M10	199083-6	0088381524742	66,00

Disco de corte CP100D



Código	EAN	P.V.P (€)
198603-3	0088381487344	8,25

Disco de corte DSC250



Ø 110 mm - DSC250

Ø ext. (mm)	Ø int. (mm)	K (mm)	T (mm)	N.º dentes	R	Tipo de dente	Redução	Código	EAN	P.V.P (€)
110	15	-	-	24	0°	SMTCG	-	SC09002890	0088381496131	144,00



Makita

Discos de serra para cortadores de metal

Discos Specialized - Corte de metal

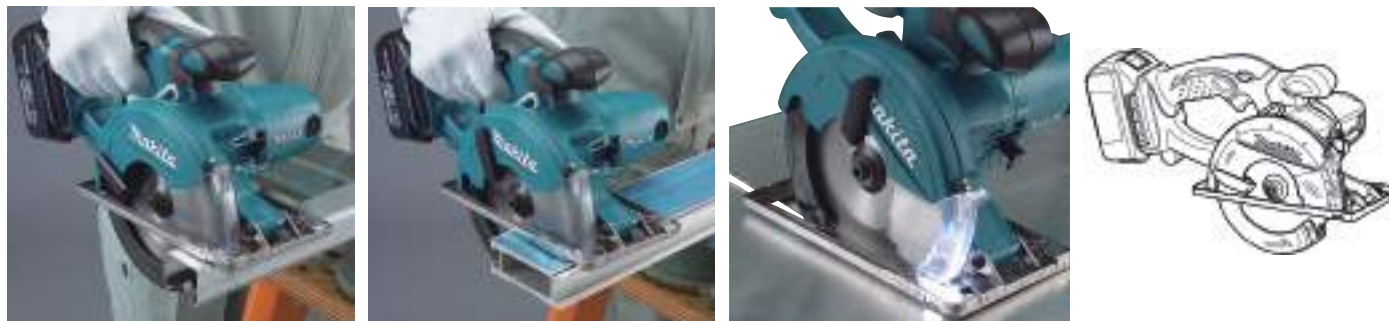

Ø 136 mm DCS550											
Ø ext. (mm)	Ø int. (mm)	K (mm)	T (mm)	N.º de dentes	Tipo	Tipo de dente	Redução	Código	EAN	P.V.P (€)	
136	20	1,5	1,2	30	-	SMTCG	Metal	B-10615	0088381346689	41,00	
136	20	1,4	1,0	50	-	SMTCG	Chapa fina	B-07325	0088381312813	41,00	
136	20	1,1	0,95	56	-	SMTCG	Inox	B-23086	0088381406239	71,00	

Ø 150 mm DCS551 - DCS553											
Ø ext. (mm)	Ø int. (mm)	K (mm)	T (mm)	N.º de dentes	Tipo	Tipo de dente	Redução	Código	EAN	P.V.P (€)	
150	20	1,5	1,2	32	-	SMTCG	Metal	B-47151	0088381454247	40,00	
150	20	1,4	1,1	52	-	SMTCG	Chapa fina	B-47167	0088381454254	55,00	
150	20	1,1	0,95	60	-	SMTCG	Inox	B-47173	0088381454261	60,00	
150	20	1,6	1,0	52	-	SMTCG	Alumínio	B-47189	0088381454278	55,00	



Ø 185 mm 4131											
Ø ext. (mm)	Ø int. (mm)	K (mm)	T (mm)	N.º de dentes	Tipo	Tipo de dente	Redução	Código	EAN	P.V.P (€)	
185	30	1,7	1,3	70	-	HM	Aço	B-09771	0088381337816	49,00	
185	30	2,0	1,6	48	-	HM	Aço	B-09787	0088381337830	48,00	
185	30	2,0	1,6	38	-	HM	Aço	B-09759	0088381337793	44,00	
185	30	1,9	1,5	36	-	Cermet	Aço	B-09743	0088381337786	60,00	













Ø 305 mm LC1230											
Ø ext. (mm)	Ø int. (mm)	K (mm)	T (mm)	N.º de dentes	Tipo	Tipo de dente	Redução	Código	EAN	P.V.P (€)	
305	25,4	2,1	1,7	60	-	HM	Aço	B-09765	0088381337809	107,00	
305	25,4	2,4	2,0	60	Silencioso	HM	Aço	A-86723	0088381151146	188,00	
305	25,4	2,3	2,0	78	-	HM	Aço suave	B-09793	0088381337830	115,00	
305	25,4	1,95	1,95	76	-	HM	Inox	A-87579	0088381160445	217,00	
305	25,4	2,4	1,5	100	Silencioso	HM	Inox	B-23123	0088381406277	319,00	



Discos HM para LC1230

	Ø (mm)	N.º de dentes	Código
	305	HM60	B-09765
		HM60	A-86723*
		HM78	B-09793
		HM76	A-87579
		HM100	B-23123

Código		B-09765	A-86723*	B-09793	A-87579	B-23123*
Ø (mm.)		305 x 25,4				
N.º de dentes		HM60	HM60	HM78	HM76	HM100
Material		Aço	Aço	Aço suave fino	Inox	Inox
	3 mm.	△	△	⊙	○	○
	4 - 6 mm.	⊙	⊙	○	○	○
	7 mm. -	○	○	×	○	○
	1,2 - 3 mm.	△	△	⊙	○	○
	3 - 5 mm.	⊙	⊙	○	○	○
	2 - 4 mm.	△	△	⊙	○	○
	4 mm. -	⊙	⊙	○	○	○
	Inox 1,2 - 3 mm.	×	×	×	⊙	⊙
	Inox 2 - 5 mm.	×	×	×	⊙	⊙
	Inox 3 - 4 mm.	×	×	×	⊙	⊙

* Silencioso



Discos HM para 4131

	Ø (mm)	N.º de dentes	Código
	185	HM70	B-09771
		HM48	B-09787
		HM38	B-09759
		Cermet 36	B-09743

Código		B-09771	B-09787	B-09759	B-09743
Ø (mm.)		185x30x2	185x30x2	185x30x2	185x30x1,9
N.º de dentes		HM70 (-10°)	HM48 (0°)	HM38 (0°)	*Cermet36 (0°)
Quadrado de ferro	50 x 50 x 4 mm.	×	△	○	⊙
	50 x 50 x 4 mm.	×	○	△	⊙
	50 x 50 x 6 mm.	×	○	⊙	⊙
	50 x 100 x 3,2 mm.	×	○	○	⊙
Aço em placas	0,9 x 500 mm.	⊙	○	△	×
	3,0 x 500 mm.	△	○	○	⊙
Perfis em U	50 x 100 x 1,6 mm.	×	○	△	×
	45 x 90 x 3,2 mm.	×	○	○	⊙
Ângulo	50 x 50 x 4 mm.	×	△	○	⊙
	50 x 50 x 6 mm.	×	○	⊙	⊙
Tubos de aço temperado	Ø 25 x 1,2 mm.	×	⊙	⊙	×
Tubos metálicos	Ø 60 x 4 mm.	×	△	○	⊙
Varão	Ø 20 mm.	×	△	○	⊙
Perfis de gesso cartonado	1 mm.	⊙	×	×	×
	1 - 2 mm.	×	⊙	△	×
Chapa ondulada (Pégaso)	0,9 mm.	⊙	×	×	×
	1 - 2 mm.	△	△	×	×

- ⊙ Disco ideal.
 - Disco adequado.
 - △ Disco não recomendado.
 - ×
- Disco muito desaconselhado.

Guias de carril e acessórios



Peça para unir dois carris



Estojo para guia de carril de guiamento



Guia de carril

Descrição	Comprimento (m)	Unidades	Código	EAN	P.V.P (€)
Peça para unir dois carris		1	P-45777	0088381976213	23,00
Guia de carril	1	1	199140-0	0088381528672	40,00
	1,4	1	194368-5	0088381313353	69,00
	1,9	1	194925-9	0088381354790	106,00
	3	1	194367-7	0088381335201	180,00
Estojo para guia de carril de guiamento	-	1	B-57613	0088381519854	41,00

Guia de ângulos



Unidades	Código	EAN	P.V.P (€)
1	196664-7	0088381438414	34,00

Peças sobresselentes para guia de carril

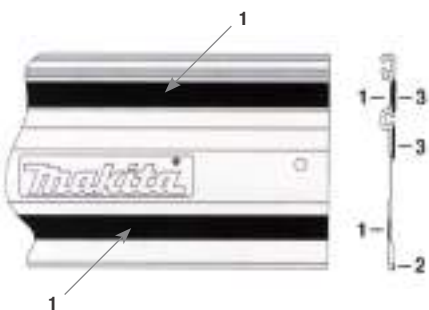

Descrição	Comprimento	Número	Unidades	Código	EAN	P.V.P (€)
Borracha deslizante	1,4	1	1	413101-9	3240890284549	4,00
	1,9		1	451330-6	-	6,00
	3,0		1	413102-7	3240890284488	15,00
Borracha anti-lascas	1,4	2	1	423359-2	3240890283870	5,50
	1,9		1	423386-9	-	8,00
	3,0		1	423360-7	3240890284136	11,00
Borracha antideslizante	1,4	3	1	423361-5	3240890282088	6,50
	1,9		1	423390-8	-	9,00
	3,0		1	423362-3	3240890281838	15,00

Suporte de guia de carril

A



B

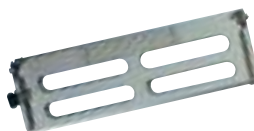

C



Modelos	Imagem	Unidades	Código	EAN	P.V.P (€)
5603R 5705R	A	1	192505-5	0088381131919	28,00
5903R	B	1	192506-3	0088381132190	105,00
5103R	B	1	192507-1	0088381132206	79,00
HS6100 HS7100 HS7101 DHS710	C	1	197252-3	0088381453790	61,00
HS0600	C	1	198570-2	0088381495912	195,00
HS6601	C	1	197462-2	0088381523837	25,00
HS7601	C	1	197005-0	0088381484602	60,00
DHS680	C	1	196953-0	0088381463751	48,00



Grampo para guia de carril de guiamento



Modelos	Unidades	Código	EAN	P.V.P (€)
Guias de carril	2	194385-5	0088381314084	22,50

Guia paralela



Tipo 1

Tipo 2

Modelos	Tipo	Unidades	Código	EAN	P.V.P (€)
5604R 5704R HS6100 HS7100 HS7101 HS7601	1	1	164095-8	0088381101080	1,75
5017RKB 5603R 5703R 5705R		1	165108-8	0088381141376	6,25
5903R 5103R		1	165084-6	0088381152464	3,25
5143R		1	152498-8	0088381156295	46,00
DSP600 DSP601 SP6000	2	1	165447-6	0088381347587	14,50

Placa-guia para CA5000

- Marca a linha de fresagem.



Modelos	Unidades	Código	EAN	P.V.P (€)
CA5000	1	143396-7	-	4,00

Ganchos



199386-8

199231-7



Modelos	Unidades	Código	EAN	P.V.P (€)
HS780	1	199386-8	0088381534963	14,50
DHS660	1	199231-7	0088381532839	8,25

Mesa para serras de esquadria



194043-3



DEAWST05



DEAWST06

Comprimento (mm)	Elevado (mm)	Largura (mm)	Modelos	Unidades	Código	EAN	P.V.P (€)
762	841	743	LS0714F LH1040F LS1019L LS1018L LS1040F LS1219L LH1201FL	1	194043-3	0088381194778	72,00
2.700	500	800	Todos os modelos	1	DEAWST05	0088381424318	253,00
2.550	750	850		1	DEAWST06	0088381442091	236,00

Mesas para serras de mesa



194093-8

JM27000300

Modelos	Unidades	Código	EAN	P.V.P (€)
2704	1	194093-8	0088381205702	240,00
MLT100	1	JM27000300	0088381351003	180,00



Extensão de suporte



Modelos	Tipo	Unidades	Código	EAN	P.V.P (€)
LH1040 LS1040 LS0714F MLS100	Escova	1	122446-1	0088381156158	25,00
-	Barras	1	256812-1	0088381146517	23,00

Batentes para cortes de molduras



Modelos	Unidades	Código	EAN	P.V.P (€)
LS1019L LS1219L	2	192628-9	0088381141710	37,00
LS1016/L	2	192669-5	0088381146470	63,00
LS1216FL/L	2	195253-5	0088381366267	67,00

Rolo auxiliar



Comprimento (mm)	Altura regulável (mm)	Unidades	Código	EAN	P.V.P (€)
250	47 - 140	1	A-47450	0088381289535	94,00

Suportes laterais



Batente de apoio



Modelos	Unidades	Código	EAN	P.V.P (€)
LS1013F/FLB LS1214F/L	1	194002-7	0088381193795	54,00

Modelos	Unidades	Código	EAN	P.V.P (€)
LS0810	1	164806-1	0088381162517	7,50
LS1013F/FLB LS1214F/L	1	322932-4	0088381141673	6,00
LH1040F LS1040F	1	123101-8	0088381538244	14,50
LS1440	2 + batente ajustável	191239-7	0088381112093	27,00
MLS100	1	JM23000127	0088381347907	9,00
LS1016/L LS1216/FLB	2	195240-4	0088381366250	7,75
LH1200FL	1	JM23100500	3240890343321	10,00
LS1019L LS1219L	1	327095-1	-	5,00

Grampos para serras de esquadria

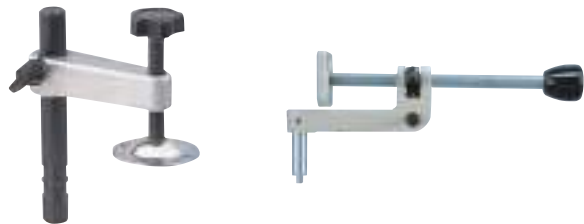

Vertical

Horizontal

Modelos	Tipo	Unidades	Código	EAN	P.V.P (€)
LS0714F BLS713RFE	Vertical	1	122571-8	0088381151863	19,50
LS1013 LS1214		1	122538-6	0088381141697	18,00
LH1040F LS1040F		1	192625-5	0088381150729	18,00
LS1016/L LS1216/FL		1	122854-6	0088381356619	22,50
LF1000		1	122728-1	0088381288484	16,00
LS1018 LH1200FL		1	JM23100502	3240890343369	5,75
LS1219L		1	126617-2	-	25,00
MLS100		1	JM23000131	0088381347938	7,00
LS0714F LS1040 LH1040		Horizontal	1	122567-9	0088381151573
LS1013 LS1214 LS1016/L LS1019L LS1219L	1		122470-4	0088381142625	67,00
LS1216/FLB LH1200FL LS1018L	1		122930-6	0088381366274	68,00

Guias paralelas



Modelos	Unidades	Código	EAN	P.V.P (€)
2704	1	122739-6	0088381277020	87,00
LH1040F	1	122707-9	0088381195386	14,00
LF1000	1	122729-9	0088381288460	26,00
LH1201FL	1	JM23300008	3240890401823	50,00
2712	1	JM27110005	-	36,00

Botão de segurança



Modelos	Unidades	Código	EAN	P.V.P (€)
Todos os modelos	1	417113-4	-	0,60

Arnês para DLS600



Modelos	Unidades	Código	EAN	P.V.P (€)
DLS600	1	166058-0	0088381494953	10,50

Guias de ângulo



Modelos	Unidades	Código	EAN	P.V.P (€)
2704	1	122734-6	0088381277006	35,00
LF1000	1	122730-4	0088381288477	15,00

Extensões para 2704

Extensão traseira

Extensão esquerda



Descrição	Unidades	Código	EAN	P.V.P (€)
Extensão traseira	1	194087-3	0088381200301	26,50
Extensão esquerda	1	194086-5	0088381200295	28,00

Batentes ajustáveis



Modelos	Unidades	Código	EAN	P.V.P (€)
LH1040 LS0714 LS1040	1	122472-0	0088381155892	5,00
MLS100	1	JM23000128	0088381347914	0,75

Lâmpada



Modelos	Unidades	Código	EAN	P.V.P (€)
LS0714F LS1013F LS1214F LS1040F	1	193730-1	0088381160353	3,50

Anilha de redução

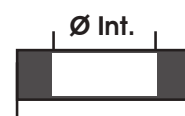

Ø Interior (mm)	Ø Exterior (mm)	Unidades	Código	EAN	P.V.P (€)
88	25	1	257022-3	0088381189293	0,75
15,88	25,4	1	257060-5	0088381189309	1,25
88	30	1	257262-3	-	0,75

Saco e depósito de recolha de pó



122852-0



194175-6



Descrição	Tipo	Unidades	Código	EAN	P.V.P (€)
Saco	LS1018 LH1200FL	1	JM23100501	0088381373654	3,25
Saco	LS0810	1	122351-2	0088381115537	7,25
Saco	LS1440	1	122330-0	0088381115544	14,00
Saco	LS1013 LH1040 LS1214 LS1040 MLS100 LS1016/L LS1216/FLB	1	122852-0	0088381356602	3,25
Depósito	Modelos FLB	1	194175-6	0088381349994	34,00

Trave de impulso



Unidades	Código	EAN	P.V.P (€)
1	416772-1	0088381149426	3,50





Serras de sabre





***Gama de serras de sabre Makita
com motor BL sem escovas
e tecnologia XPT.***



Símbolos



Tipo de serra

Tipo A	Tipo B	Tipo C	Tipo C
<ul style="list-style-type: none"> Serrilha: afiação alternada, cortes rápidos em madeiras duras e macias, alumínio, plásticos e metais não ferrosos. 	<ul style="list-style-type: none"> Serrilha: afiação ondulada, corte fino e limpo em madeira, aço macio, alumínio e metais não ferrosos. 	<ul style="list-style-type: none"> Serrilha: afiação trapezoidal, cortes finos e limpos em madeira e plásticos. 	<ul style="list-style-type: none"> Serrilha: afiação alternada trapezoidal, cortes espessos e rápidos em madeira.

Serras de serra

Metal

Características	Tipo	Tipo de dentes	Dentes/polegada	Comprimento (mm)	Largura (mm)	Unidades	Código	EAN	P.V.P (€)
Para corte de aço, aço inoxidável e metais não ferrosos entre 3,5 mm e 5 mm. (A cor da folha pode variar — azul ou branca).	BIM	B	10	305	0,9	5	B-16857	0088381367554	19,50
				225			P-47008	0088381977432	18,00
				152			P-46997	0088381977425	14,00
Para corte de metal de 4 mm a 12 mm. Corte rápido.	BIM	B	8/10	305	0,9	5	B-43212	0088381443081	23,50
				225			B-43181	0088381443050	20,00
				152			B-43147	0088381443012	16,00
Dente em M para o corte rápido de aço, inoxidável e metais não ferrosos. Corta nas duas direções para aumentar a velocidade de corte.	BIM	-	M	260	0,9	5	P-45727	0088381976169	23,00
				200			P-45711	0088381977456	19,50
				150			P-45705	0088381976145	16,00
Chapa grossa. 4-12 mm, tubo <100 mm.	TC/HM	-	8	152	25	1	B-55572	0088381483575	17,00

Metal



Características	Tipo	Tipo de dentes	Dentes/polegada	Comprimento (mm)	Largura (mm)	Unidades	Código	EAN	P.V.P (€)
Para corte de chapa com menos de 1,2 mm	BIM	B	32	150	0,9	5	P-04955	0088381914109	14,50

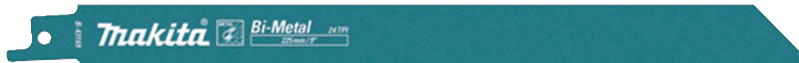

Características	Tipo	Tipo de dentes	Dentes/polegada	Comprimento (mm)	Largura (mm)	Unidades	Código	EAN	P.V.P (€)
Para corte de chapa com mais de 1,2 mm (A cor da folha pode variar — azul ou branca).	BIM	B	24	225	0,9	5	B-43169	0088381443036	17,00
				152			B-16835	0088381367530	11,50
				100			P-04896	0088381914048	13,00



Características	Tipo	Tipo de dentes	Dentes/polegada	Comprimento (mm)	Largura (mm)	Unidades	Código	EAN	P.V.P (€)
Para corte de aço e aço inoxidável entre 1,5 mm e 2,5 mm (A cor da folha pode variar — azul ou branca).	BIM	B	12	225	0,9	5	B-16776	0088381367479	16,00
				152			B-05169	0088381204224	12,50
				100			P-04874	0088381914024	13,00



Características	Tipo	Tipo de dentes	Dentes/polegada	Comprimento (mm)	Largura (mm)	Unidades	Código	EAN	P.V.P (€)
Para cortes curvos em todos os tipos de metais.	BIM	B	18	100	0,9	5	P-04977	0088381914123	14,50



Características	Tipo	Tipo de dentes	Dentes/polegada	Comprimento (mm)	Largura (mm)	Unidades	Código	EAN	P.V.P (€)
Para corte de metal de 3 mm a 8 mm	BIM	B	14/18	305	1,1	5	B-43206	0088381443074	23,50
				225			B-43175	0088381443043	20,00
				152			B-43131	0088381443005	16,00



















Características	Tipo	Tipo de dentes	Dentes/polegada	Comprimento (mm)	Largura (mm)	Unidades	Código	EAN	P.V.P (€)
Para corte de aço e aço inoxidável entre 1,5 mm e 2,5 mm	BIM	B	18	225	0,9	5	B-16782	0088381367486	16,00
				152			B-16841	0088381367547	11,50





Características	Tipo	Tipo de dentes	Dentes/polegada	Comprimento (mm)	Largura (mm)	Unidades	Código	EAN	P.V.P (€)
Para corte de metal de 2 mm a 10 mm Corte fino.	BIM	B	10/14	305	1,25	5	B-43228	0088381443098	23,50
				225			B-43197	0088381443067	20,00
				152			B-43153	0088381443029	16,00

Madeira

									
Características	Tipo	Tipo de dentes	Dentes/polegada	Comprimento (mm)	Largura (mm)	Unidades	Código	EAN	P.V.P (€)
Para todo o tipo de madeiras com um acabamento fino.	HCS/CV	A	10	152	1,05	5	B-16807	0088381367509	8,75
									
Características	Tipo	Tipo de dentes	Dentes/polegada	Comprimento (mm)	Largura (mm)	Unidades	Código	EAN	P.V.P (€)
Folha grossa para cortes rápidos em madeira, plásticos e placas de gesso.	HCS/CV	A	6	305	1,25	5	B-16829	0088381367523	14,50
									
Características	Tipo	Tipo de dentes	Dentes/polegada	Comprimento (mm)	Largura (mm)	Unidades	Código	EAN	P.V.P (€)
Folha grossa para cortes rápidos em madeira, plásticos e placas de gesso.	HCS/CV	A	6	225	1,27	5	P-47092	0088381977524	13,00
									
Características	Tipo	Tipo de dentes	Dentes/polegada	Comprimento (mm)	Largura (mm)	Unidades	Código	EAN	P.V.P (€)
Folha grossa para cortes rápidos em madeira, plásticos e placas de gesso.	HCS/CV	C	6	150	1,27	5	P-47086	0088381977517	12,00
									
Características	Tipo	Tipo de dentes	Dentes/polegada	Comprimento (mm)	Largura (mm)	Unidades	Código	EAN	P.V.P (€)
Folha grossa para cortes rápidos em madeira, plásticos e placas de gesso.	BIM	A	6	150	1,27	5	P-05088	0088381914314	19,00
									
Características	Tipo	Tipo de dentes	Dentes/polegada	Comprimento (mm)	Largura (mm)	Unidades	Código	EAN	P.V.P (€)
Folha especial para madeira verde	HCS/CV	C	5	305	1,5	5	B-16863	0088381367561	18,50
									
Características	Tipo	Tipo de dentes	Dentes/polegada	Comprimento (mm)	Largura (mm)	Unidades	Código	EAN	P.V.P (€)
Folha especial para madeira verde	HCS/CV	C	4 - 5	240	1,27	5	P-47117	0088381977548	14,50
									
Características	Tipo	Tipo de dentes	Dentes/polegada	Comprimento (mm)	Largura (mm)	Unidades	Código	EAN	P.V.P (€)
Para corte curvo em madeira e plástico.	HCS/CV	C	6	152	1,27	5	B-16798	0088381367493	8,75

Madeira

Características	Tipo	Tipo de dentes	Dentes/polegada	Comprimento (mm)	Largura (mm)	Unidades	Código	EAN	P.V.P (€)
Para corte curvo e limpo em madeira, plástico e plexiglas.	HCS/CV	D	6	150	1,8	5	P-47101	0088381977531	18,00



Características	Tipo	Tipo de dentes	Dentes/polegada	Comprimento (mm)	Largura (mm)	Unidades	Código	EAN	P.V.P (€)
Folha grossa para cortes rápidos em madeira, plásticos e placas de gesso.	HCS/CV	A	3	152	1,25	5	B-16813	0088381367516	8,75



Características	Tipo	Tipo de dentes	Dentes/polegada	Comprimento (mm)	Largura (mm)	Unidades	Código	EAN	P.V.P (€)
Serrilha muito espessa para cortes rápidos e contundentes em madeiras húmidas.	HCS/CV	C	3	240	1,27	5	P-47123	0088381977555	15,50



Características	Tipo	Tipo de dentes	Dentes/polegada	Comprimento (mm)	Largura (mm)	Unidades	Código	EAN	P.V.P (€)
Serrilha muito espessa para cortes rápidos e contundentes em madeiras húmidas.	HCS	D	8,5	250	1,0	5	B-62016	0088381528719	15,00

S-EXPRESS



Características	Tipo	Tipo de dentes	Dentes/polegada	Comprimento (mm)	Largura (mm)	Unidades	Código	EAN	P.V.P (€)
Folha superexpress de elevado desempenho para serras de sabre a bateria. Metal.	BIM	-	7 - 18	152	-	5	B-05038	0088381200592	16,00



Características	Tipo	Tipo de dentes	Dentes/polegada	Comprimento (mm)	Largura (mm)	Unidades	Código	EAN	P.V.P (€)
Folha superexpress de elevado desempenho para serras de sabre a bateria. Universal.	BIM	-	6 - 11	152	-	5	B-05044	0088381200608	14,00



Características	Tipo	Tipo de dentes	Dentes/polegada	Comprimento (mm)	Largura (mm)	Unidades	Código	EAN	P.V.P (€)
Folha superexpress de elevado desempenho para serras de sabre a bateria. Madeira.	BIM	-	6 - 10	203	-	5	B-05153	0088381200943	14,50

Madeira + Metal



LONG LIFE   

Características	Tipo	Tipo de dentes	Dentes/polegada	Comprimento (mm)	Largura (mm)	Unidades	Código	EAN	P.V.P (€)
Especial Palete	BIM	B	10	180	0,9	200	B-54265		355,00





LONG LIFE   

Características	Tipo	Tipo de dentes	Dentes/polegada	Comprimento (mm)	Largura (mm)	Unidades	Código	EAN	P.V.P (€)
Indicada para a reparação de paletes. Para corte de madeira com resíduos metálicos. Folha grossa.	BIM	A	8/10	150	1,27	5	P-47064	0088381977494	18,00



5-8 TPI   

Características	Tipo	Tipo de dentes	Dentes/polegada	Comprimento (mm)	Largura (mm)	Unidades	Código	EAN	P.V.P (€)
Madeira com pregos, PVC, demolição.	BIM	-	5/8	305	1,6	5	B-43278	0088381443142	29,00
	BIM	-	5/8	225	1,6	5	B-43256	0088381443128	25,00
	BIM	-	5/8	152	1,6	5	B-43234	0088381443104	20,50



6 TPI   

Características	Tipo	Tipo de dentes	Dentes/polegada	Comprimento (mm)	Largura (mm)	Unidades	Código	EAN	P.V.P (€)
Dente em M para corte rápido de madeira e madeira com pregos. Corta nas duas direções para aumentar a velocidade de corte.	BIM	A	6	152	1,25	5	B-05175	0088381204231	14,50



M-Zen 808 mm   **LONG LIFE** 

Características	Tipo	Tipo de dentes	Dentes/polegada	Comprimento (mm)	Largura (mm)	Unidades	Código	EAN	P.V.P (€)
Dente em M para corte rápido de madeira e madeira com pregos. Corta nas duas direções para aumentar a velocidade de corte.	BIM	M	-	200	0,9	5	P-45696	0088381976138	19,50
	BIM	M	-	150	0,9	5	P-45680	0088381976121	16,00



Madeira + Metal



Características	Tipo	Tipo de dentes	Dentes/polegada	Comprimento (mm)	Largura (mm)	Unidades	Código	EAN	P.V.P (€)
Indicada para a reparação de paletes. Para corte de madeira com resíduos metálicos. Folha grossa.	BIM	A	10/14	225	1,27	5	P-47195	0088381977623	18,50
	BIM	A	10/14	150	1,27	5	P-47189	0088381977616	14,00



Características	Tipo	Tipo de dentes	Dentes/polegada	Comprimento (mm)	Largura (mm)	Unidades	Código	EAN	P.V.P (€)
Indicada para a reparação de paletes. Para corte de madeira com resíduos metálicos. Folha fina.	BIM	A	10/14	280	0,9	5	P-67767	0088381998291	22,50
	BIM	A	10/14	152	0,9	5	P-47014	0088381977449	14,00



Características	Tipo	Tipo de dentes	Dentes/polegada	Comprimento (mm)	Largura (mm)	Unidades	Código	EAN	P.V.P (€)
Especial palete. Madeira com pregos, PVC e alumínio.	BIM	B	10/14	225	0,9	5	B-43262	0088381443135	17,00
	BIM	B	10/14	152	0,9	5	B-43240	0088381443111	12,50

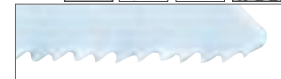

Características	Tipo	Tipo de dentes	Dentes/polegada	Comprimento (mm)	Largura (mm)	Unidades	Código	EAN	P.V.P (€)
Especial palete, madeira com pregos, alumínio.	BIM	B	10	225	0,9	5	B-31859	0088381420129	17,00
	BIM	B	10	152	0,9	5	B-31843	0088381420112	12,50



Makita

ESPECIAIS



Características	Tipo	Tipo de dentes	Dentes/polegada	Comprimento (mm)	Largura (mm)	Unidades	Código	EAN	P.V.P (€)
Ideal para madeiras duras, betão esponjoso, Eternit e plásticos reforçados com fibra de vidro e epóxi. Dentes de carboneto de tungsténio	CV-HM	A	3	400	1,3	1	P-05066	0088381914215	43,00
	CV-HM	A	6	300	1,3	-	P-05050	0088381914208	46,00
				150			P-05044	0088381914192	22,50
				100			P-05038	0088381914185	19,50



Características	Tipo	Tipo de dentes	Dentes/polegada	Comprimento (mm)	Largura (mm)	Unidades	Código	EAN	P.V.P (€)
Especial para tijolo.	HM	-	2	400	-	1	B-10403	0088381342667	45,00
				265			B-10394	0088381342650	33,00



Características	Tipo	Tipo de dentes	Dentes/polegada	Comprimento (mm)	Largura (mm)	Unidades	Código	EAN	P.V.P (€)
Especial para tijolo oco.	HM/TC	-	2	240	-	1	B-12809	0088381355544	25,50



Características	Tipo	Tipo de dentes	Dentes/polegada	Comprimento (mm)	Largura (mm)	Unidades	Código	EAN	P.V.P (€)
Para cortes em cerâmica, ferro fundido, tijolo muito duro e plásticos reforçados com fibra de vidro e epóxi.	CV-HM	-	-	180	1,05	2	P-47173	0088381977609	15,00



Características	Tipo	Tipo de dentes	Dentes/polegada	Comprimento (mm)	Largura (mm)	Unidades	Código	EAN	P.V.P (€)
Especial para produtos congelados. Folha de aço inoxidável sem tinta.	-	A	6	152	-	1	B-52043	-	-
				250			B-10609	0088381346641	9,25
				228			B-30564	0088381418607	20,50



Características	Tipo	Tipo de dentes	Dentes/polegada	Comprimento (mm)	Largura (mm)	Unidades	Código	EAN	P.V.P (€)
Especial para corte em aço inoxidável.	HN	-	18	152	-	2	B-07250	0088381310734	29,50



Características	Tipo	Tipo de dentes	Dentes/polegada	Comprimento (mm)	Largura (mm)	Unidades	Código	EAN	P.V.P (€)
Fibrocimento/tijolo de 10 a 250 mm epóxi 6-150 mm	TC/HM	-	3	305	1,5	2	B-63585	0088381532846	39,00



Características	Tipo	Tipo de dentes	Dentes/polegada	Comprimento (mm)	Largura (mm)	Unidades	Código	EAN	P.V.P (€)
Fibrocimento/tijolo de 20 a 350 mm epóxi 6-150 mm	TC/HM	-	2	400	1,5	2	B-63591	0088381532853	47,00

Para serra de sabre JR100D - DJR183



Características	Tipo	Tipo de dentes	Dentes/polegada	Comprimento (mm)	Largura (mm)	Unidades	Código	EAN	P.V.P (€)
Metal	BIM	-	24	100	0,7 - 3,0	5	B-20395	0088381375986	11,00



Características	Tipo	Tipo de dentes	Dentes/polegada	Comprimento (mm)	Largura (mm)	Unidades	Código	EAN	P.V.P (€)
Metal	BIM	-	18	100	1,5 - 4,0	5	B-20404	0088381375993	11,00



Características	Tipo	Tipo de dentes	Dentes/polegada	Comprimento (mm)	Largura (mm)	Unidades	Código	EAN	P.V.P (€)
Metal	BIM	-	14	100	3,0 - 8,0	5	B-20410	0088381376006	11,00



Características	Tipo	Tipo de dentes	Dentes por polegada	Largura total (mm)	Largura (mm)	Unidades	Código	EAN	P.V.P (€)
Madeira - metal	BIM	-	10	100	Metal 3,0 - 12 / Madeira 10 - 50	5	B-20426	0088381376013	11,00



Características	Tipo	Tipo de dentes	Dentes/polegada	Comprimento (mm)	Largura (mm)	Unidades	Código	EAN	P.V.P (€)
Madeira com pregos	BIM	-	6	100	10 - 50	5	B-20432	0088381376020	11,00



Características	Tipo	Tipo de dentes	Dentes/polegada	Comprimento (mm)	Largura (mm)	Unidades	Código	EAN	P.V.P (€)
Placas de fibra	BIM	-	6	100	5,0 - 50	5	B-20448	0088381376037	11,00



Características	Tipo	Tipo de dentes	Dentes/polegada	Comprimento (mm)	Largura (mm)	Unidades	Código	EAN	P.V.P (€)
Madeira - metal	BIM	-	14/18	100	Metal 3,0 - 8,0 / Madeira 10 - 50	5	B-20454	0088381376044	11,00



Folhas para 2107FK / 2107FXK (13 mm x 0,5 mm x 1140 mm)

Corte METAL



P. não f./ Metal	A. m./Gusa	Velocidade		Espessura (mm)	Material	Dentes por polegada	Unidades	Código	EAN	P.V.P (€)
		Alta	Baixa							
1	2	1	2	0,5	Aço - carbono	14	3	792560-3	0088381117517	36,00
1	2	1	2	0,5		18	3	792559-8	0088381117524	36,00
1	2	1	2	0,5		24	3	792558-0	0088381117531	36,00
1	2	1	2	0,5	Bimetal	14HSS	1	194691-8	0088381350808	20,50
1	2	1	2	0,5		18HSS	1	792556-4	0088381117555	22,00
1	2	1	2	0,5		24HSS	1	194692-6	0088381350815	20,50

Corte MADEIRA



Madeira		Velocidade		Espessura (mm)	Material	Dentes por polegada	Unidades	Código	EAN	P.V.P (€)
Com pregos	Sem pregos	Alta	Baixa							
1	1	1	-	0,5	Aço-carbono	6	3	792567-9	0088381117579	36,00

Serras de fita para LB1200F (2240 mm)

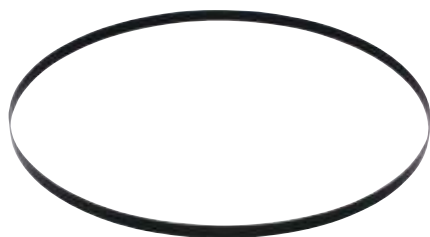

Aplicação	Material	Espessura (mm)	Dentes por polegada	Largura da folha (mm)	Unidades	Código	EAN	P.V.P (€)
Madeira corte transversal	Aço-carbono	0,5	4	16	3	B-16667	0088381366731	52,00
Madeira corte universal		0,5	4	13	3	B-16673	0088381366748	44,00
Madeira corte curvo		0,5	6	6	3	B-16689	0088381366755	45,00
Metais não ferrosos		0,5	14	16	3	B-16695	0088381366762	58,00

Serras de fita para DPB181 - DPB182 (835 mm)



Aplicação	Material	Espessura	Dentes por polegada	Largura da folha (mm)	Unidades	Código	EAN	P.V.P (€)
Plásticos, metais não ferrosos, ferro, aço inoxidável	Bimetal	0,5	14	13	5	B-40543	0088381438377	47,00
		0,5	18	13	5	B-40559	0088381438384	47,00
		0,5	24	13	5	B-40565	0088381438391	46,00

Serras para DSD180



Aplicação	Unidades	Código	EAN	P.V.P (€)
Tabique seco*	2	B-49703	0088381460934	20,50
Madeira	2	B-49719	0088381460941	26,00

* Ideal para fresagem em gesso cartonado.



Makita



Suporte de lixas LB1200F



Unidades	Código	EAN	P.V.P (€)
1	JM21000330	0088381374170	14,50

Conjunto de corte circular para LB1200F



Unidades	Código	EAN	P.V.P (€)
1	JM21080230	3240890352613	19,00

Guia angular



Unidades	Código	EAN	P.V.P (€)
1	JM21080260	3240890352620	10,50

Extensão de mesa para LB1200F



Unidades	Código	EAN	P.V.P (€)
1	JM21000300	0088381374156	81,00

Conjunto de corte circular para LB1200F



Unidades	Código	EAN	P.V.P (€)
1	JM21000320	0088381374163	22,50

Entrada de aspiração



Unidades	Código	EAN	P.V.P (€)
1	JM27000090	3240890357519	0,75



ACESSÓRIOS. SERRAS DE SABRE

Suporte e protetor para 2107FK



Protetor



Suporte



Descrição	Unidades	Código	EAN	P.V.P (€)
Protetor	1	196325-9	0088381431576	100,00
Suporte	1	194026-3	0088381194662	318,00



Batente de profundidade



Fixo

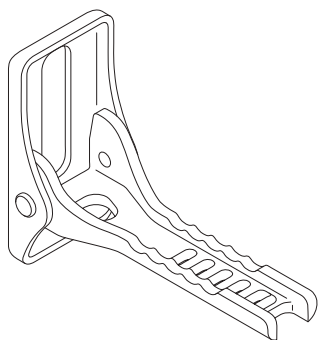

Móvel

Modelo	Tipo	Unidades	Código	EAN	P.V.P (€)
R JR3050T JR3060T	Fixo (equipamento básico)	1	165396-7	-	5,50
R JR3070CT	Fixo (equipamento básico)	1	165406-0	-	4,80
JR3070CT	Móvel (opcional)	1	163453-5	-	6,25

Massa lubrificante



Unidades	Código	EAN	P.V.P (€)
1	191897-9	0088381117319	10,50





Serras tico-tico





Nova serra tico-tico de 12 V. Motor BL sem escovas.

JV103



CXT

**BL
MOTOR**

**Velocidade variável.
Coletor de pó aplicável à
nossa gama de aspiradores.**

















Sistema pendular de 4 posições para cortes rápidos.

**12V^{max}
LITHIUM-ION**















Explicação de símbolos e materiais

Materiais

 Madeira	 Corte imperfeito
 Madeira com pregos	 Corte perfeito
 Aglomerado	 Alumínio
 Parquê laminado	 Aço inoxidável
 Plástico reforçado com fibra de vidro	 Placas Sandwich
 PVC (plástico)	 Vidro, cerâmica
 Metal	 Borracha, couro, material isolante

Tipo de folha

 HSS	 HCS	Qualidade do material da serra	 LONG LIFE	Longa duração
 BIM	 CV		 SHARP	Lâmina extremamente afiada
 ↑	Corte reto		 FAST	Corte rápido
 ↗	Corte curvo		 DBL	Lâmina dupla
 !	Serrilha com os dentes inclinados		 COMBO	Combinado



Corte Super Express

Tipo	Descrição	Dentes por polegada	Comprimento comprimento útil (mm)	Qualidades material	Madeira	Plástico	Alumínio	Metal inox	Metais não ferrosos	Metal	Tipo Classe B	Unidades pacote	Código	EAN	P.V.P (€)
B-50	Folha superexpress de elevado desempenho para serras tico-tico a bateria. Madeira	8,5 - 10,6	77	HCS	5,5	5,5	-	-	-	-	T234X	5	B-06460	0088381276702	7,75
B-51	Folha superexpress de elevado desempenho para serras tico-tico a bateria. Metal	9,8 - 18,1	77	HHS	-	-	-	1,3	-	1,8	T123X	5	B-06476	0088381276719	7,75
B-52	Folha superexpress de elevado desempenho para serras tico-tico a bateria. Universal	5,5 - 9,8	77	HHS	5,5	5,5	-	-	-	-	T345XF	5	B-06482	0088381276726	9,25
-	Conjunto Super Express	-	77	HHS	-	-	-	-	-	-	-	3	B-06292	0088381249713	6,00

Corte básico - Madeira

Tipo	Descrição	Dentes por polegada	Comprimento comprimento útil (mm)	Qualidades material	Madeira	Plástico	Alumínio	Metal inox	Metais não ferrosos	Metal	Tipo Classe B	Unidades pacote	Código	EAN	P.V.P (€)
B13	Para cortes em madeira e plásticos	8	80	HCS	4-65	4-65	-	-	-	-	T111C	5	A-85656	0088381149653	4,00
B15	Para madeira prensada e placas de fibra de até 3 mm, plásticos até 35 mm.	12	50	HCS	3-35	3-35	-	-	-	-	T119B	5	A-85678	0088381149655	3,75
B14	Para madeira prensada e placas de fibra de até 8 mm, plásticos até 35 mm (corte rápido).	18	50	HCS	2-35	2-35	-	-	-	-	-	5	A-85662	0088381149648	3,75
B18	Ideal para cortes curvos em madeira e plástico	14	45	HCS	2-35	2-35	-	-	-	-	T119BO	5	A-85709	0088381149662	4,25

Corte rápido - Madeira

Tipo	Descrição	Dentes por polegada	Comprimento comprimento útil (mm)	Qualidade material	Madeira	Plástico	Alumínio	Metal inox	Metais não ferrosos	Metal	Tipo Classe B	Unidades pacote	Código	EAN	P.V.P (€)
B16	Para corte rápido em madeira e plástico. Corte rápido e grosseiro.	6	75	HCS	5-65	5-65	-	-	-	-	T144D	5	A-85684	0088381149686	5,25
L02	Ideal para cortes rápidos em materiais espessos	6	100	HCS	5-90	5-90	-	-	-	-	-	5	A-86309	0088381150279	7,75
L10	Para todos os tipos de cortes em madeira. Corte rápido e grosseiro.	6	151	HCS	5-135	5-135	-	-	-	-	T344D	5	A-86315	0088381150286	10,50
B17	Ideal para cortes curvos em madeira e plásticos (corte rápido).	6	70	HCS	5-60	-	-	-	-	-	T244D	5	A-85690	0088381149693	5,50
-	Corte curvo e rápido em todos os tipos de madeiras.	6	75	HCS/CV	8-65	-	-	-	-	-	-	5	P-31572	0088381959735	7,25
-	Corte rápido em todos os tipos de madeiras com uma vida útil prolongada.	6	75	BIM	8-65	-	-	-	-	-	T144DF	5	P-31588	0088381959742	9,50

Corte de madeiras laminadas

Tipo	Descrição	Dentes por polegada	Comprimento comprimento útil (mm)	Qualidade material	Madeira	Plástico	Alumínio	Metal inox	Metais não ferrosos	Metal	Tipo Classe B	Unidades pacote	Código	EAN	P.V.P (€)
B19	Para madeira laminada e chapa decorativa de acabamento. Dentes invertidos.	12	63	HCS	3-50	3-50	-	-	-	-	T101BR	5	A-85715	0088381149709	5,25
B28	Para madeira laminada e chapa decorativa de acabamento.	16	63	HSS	2-50	2-50	-	-	-	-	T101BIF	5	A-80391	0088381136938	10,00
B-53	Para corte reto em laminados, pisos de madeira e madeiras decorativas. Sem lascas.	15	82	-	-	-	-	-	-	-	T101BIF	5	B-10970	0088381351461	12,00
B-54	Para corte curvo em laminados, pisos de madeira e madeiras decorativas. Sem lascas.	15	82	-	-	-	-	-	-	-	T101AOF	5	B-10986	0088381351478	14,00
B16	Folha especial para cortes em superfície sem lascas, em laminado e parqué	12	60	BIM	5-20	-	-	-	-	-	T101AIF	5	P-31566	0088381959728	9,75

Corte limpo em madeira

Tipo	Descrição	Dentes por polegada	Comprimento comprimento útil (mm)	Qualidade material	Madeira	Plástico	Alumínio	Metal inox	Metais não ferrosos	Metal	Tipo Classe B	Unidades pacote	Código	EAN	P.V.P (€)
N59	Corte rápido e limpo em todos os tipos de madeiras e plásticos.	8	75	HCS	4-65	4-65	-	-	-	-	T101B	5	A-86583	0088381150934	7,00
B10	Corte rápido e limpo e madeira e plásticos, especialmente indicado para contraplacado de madeira.	9	75	HCS	3-65	3-65	-	-	-	-	-	5	A-85628	0088381149716	5,75
B11	Para acabar trabalhos rápidos. Corte limpo.	9	75	HCS	3-60	3-60	-	-	-	-	T101B	5	A-85634	0088381149549	6,25
B12	Para acabar trabalhos rápidos. Corte limpo.	6	75	HCS	5-65	5-65	-	-	-	-	T101D	5	A-85640	0088381149556	5,00
L01	Folha grossa e ampla para cortes limpos e retos.	6	100	HCS	5-90	5-90	-	-	-	-	T301CD	5	A-86290	0088381150262	11,00
B29	Ideal para corte curvo em madeira e plásticos (acabamento).	16	42	HCS	2-35	2-35	-	-	-	-	T101AO	5	A-80400	0088381136945	9,50
BR13	Corte sem lascas em madeira, não requerem lixamento. A folha corta para cima e para baixo para um bom acabamento da superfície.	9	64	HCS	5-65	-	-	-	-	-	-	5	A-85793	0088381149679	4,25
-	Corte limpo em todos os tipos de madeiras e plásticos com uma vida útil prolongada.	10	75	BIM	5-65	5-65	-	-	-	-	T101BF	5	P-31594	0088381959759	10,00

Corte - Madeiras duras

Tipo	Descrição	Dentes por polegada	Comprimento comprimento útil (mm)	Qualidade material	Madeira	Plástico	Alumínio	Metal inox	Metais não ferrosos	Metal	Tipo Classe B	Unidades pacote	Código	EAN	P.V.P (€)
B25	Para madeira dura, para chapa.	9	75	HSS	3-60	3-60	3-6	-	-	3-6	T127D	5	A-85765	0088381149600	4,75
B26	Para cortes curvos em madeira dura, metal, metal não ferroso e plásticos duros.	9	70	HSS	3-60	3-60	3-10	-	3-10	3-10	T227D	5	A-85771	0088381149617	5,25

Corte - Madeira com pregos

Tipo	Descrição	Dentes por polegada	Comprimento comprimento útil (mm)	Qualidades material	Madeira	Plástico	Alumínio	Metal inox	Metais não ferrosos	Metal	Tipo Classe B	Unidades pacote	Código	EAN	P.V.P (€)
M-Force	Dente em M para o corte rápido de madeira, metais e madeira com pregos. Corta nas duas direções para aumentar a velocidade de corte.	5	130	BIM	105	-	-	-	-	-	-	2	P-45749	0088381976183	7,50
-	Ideal para madeira com pregos.	9-10	105	BIM	5-95	-	-	-	-	2,5-10	-	5	P-49638	0088381980081	11,00
-	Ideal para madeira com pregos.	9-10	75	BIM	5-65	-	-	-	-	2,5-10	T111HF	5	P-49622	0088381980074	9,75



Corte básico - Metal

Tipo	Descrição	Dentes por polegada	Comprimento comprimento útil (mm)	Qualidades material	Madeira	Plástico	Alumínio	Metal inox	Metais não ferrosos	Metal	Tipo Classe B	Unidades pacote	Código	EAN	P.V.P (€)
N51	Para chapa fina de aço e aço inoxidável.	24	75	HSS	-	1,5-6	1,5-6	1-3	-	1-3	-	5	A-86561	0088381150910	6,50
B22	Para aço médio, aço inoxidável e plásticos duros, especialmente indicado para chapa fina.	24	50	HSS	-	1-6	1-3	1-3	-	1-3	T118A	5	A-85737	0088381149570	5,00
B24	Para aço médio fino, aço inoxidável e chapas de aço muito finas.	32	50	HSS	-	1-3	1-2	0,5-2	-	0,5-2	T118G	5	A-85759	0088381149594	4,75
B23	Aço médio, chapa de espessura média, madeira, painel de madeira decorativa e aço não ferrosos.	14	50	HSS	3-35	3-35	2-6	-	2-6	2-6	T118B	5	A-85743	0088381149587	4,75
B27	Para cortes curvos em aço médio e metal não ferrosos.	24	50	HSS	-	1-6	1-3	1-3	1-3	1-3	T218A	5	A-85787	0088381149631	6,00

Corte em metal

Tipo	Descrição	Dentes por polegada	Comprimento comprimento útil (mm)	Qualidades material	Madeira	Plástico	Alumínio	Metal inox	Metais não ferrosos	Metal	Tipo Classe B	Unidades pacote	Código	EAN	P.V.P (€)
-	Para revestimento de 80 mm e materiais sandwich (folha flexível).	25	105	BIM	-	-	-	-	-	1-3	T318AF	5	P-47204	0088381977630	9,25
-	Para tubos finos de materiais não ferrosos e revestimentos.	13	105	BIM	-	-	-	-	2,5-6	2,5-6	T318BF	5	P-47210	0088381977647	8,75
-	Folha flexível para chapa fina de aço médio e aço inoxidável com uma vida útil prolongada.	21	55	BIM	-	-	-	1,2-2	-	1,2-2	T118AF	5	P-47226	0088381977654	7,25

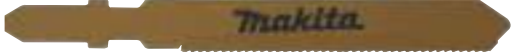
Corte - Especial inox

Tipo	Descrição	Dentes por polegada	Comprimento comprimento útil (mm)	Qualidades material	Madeira	Plástico	Alumínio	Metal inox	Metais não ferrosos	Metal	Tipo Classe B	Unidades pacote	Código	EAN	P.V.P (€)
-	Para aço médio e aço inoxidável	24	50	CV-HM	-	-	1,5-3	1,5-3	-	1,5-3	T118AHM	1	P-05929	0088381944441	12,50
-	Folha flexível para aços médio e aço inoxidável, metal não ferroso com uma vida útil prolongada.	14	55	BIM	-	-	2-3	2-3	-	2-3	T118BF	5	P-47232	0088381977661	7,25

Corte - Especial plásticos







Tipo	Descrição	Dentes por polegada	Comprimento comprimento útil (mm)	Qualidades material	Madeira	Plástico	Alumínio	Metal inox	Metais não ferrosos	Metal	Tipo Classe B	Unidades pacote	Código	EAN	P.V.P (€)
B21	Para trabalhos de acabamento em plásticos e alumínio.	12	75	HSS	-	3-60	1-10	-	-	-	T101A	5	A-85721	0088381149624	8,00

Corte - Especial materiais macios



Tipo	Descrição	Dentes por polegada	Comprimento comprimento útil (mm)	Qualidades material	Madeira	Plástico	Alumínio	Metal inox	Metais não ferrosos	Metal	Tipo Classe B	Unidades pacote	Código	EAN	P.V.P (€)
-	Ideal para cortar papel, cortiça, borracha e couro.	-	75	HCS	-	-	-	-	-	-	T113A	5	A-80416	0088381136952	15,00

Corte - Especial cerâmica e fibra de vidro

Tipo	Descrição	Dentes por polegada	Comprimento comprimento útil (mm)	Qualidades material	Madeira	Plástico	Alumínio	Metal inox	Metais não ferrosos	Metal	Tipo Classe B	Unidades pacote	Código	EAN	P.V.P (€)
-	Para cerâmica de 5 - 15 mm corte espesso.	-	54	CV-HM	-	-	-	-	-	-	T130RI-FF	3	P-38788	0088381966696	13,50
-	Para cerâmica com espessura entre 5 e 20 mm e corte fino.	-	54	CV-HM	-	-	-	-	-	-	T150RI-FF	3	P-38794	0088381966702	13,50
-	Para fibra de vidro e plásticos reforçados. Dentes de carboneto de tungstênio.	6	75	CV-HM	10-60	-	-	-	-	-	T141HM	3	B-06890	0088381289177	23,00
-	Para fibra de vidro e plásticos reforçados. Dentes de carboneto de tungstênio.	6	105	CV-HM	10-95	-	-	-	-	-	T341HM	3	B-06909	0088381289184	31,00

Corte - Especial painel sandwich



Tipo	Descrição	Dentes por polegada	Comprimento comprimento útil (mm)	Qualidades material	Madeira	Plástico	Alumínio	Metal inox	Metais não ferrosos	Metal	Tipo Classe B	Unidades pacote	Código	EAN	P.V.P (€)
-	Ideal para cortar papel, cortiça, borracha e couro.	24	155	BIM	5-145	5-145	-	-	-	-	T718BF	5	P-49644	0088381980098	12,50

Conjuntos de folhas a granel

Para corte rápido e limpo em madeira e plásticos. Especial contraplacado de madeira



Tipo	Descrição	Dentes por polegada	Comprimento comprimento útil (mm)	Qualidades material	Madeira	Plástico	Alumínio	Metal inox	Metais não ferrosos	Metal	Tipo Classe B	Unidades pacote	Código	EAN	P.V.P (€)
B10	Conjunto de folhas a granel	9	75	HCS	3-65	3-65	-	-	-	-	T301CD	100	B-07674	0088381335294	95,00

Para acabar trabalhos rápidos. Corte limpo.



Tipo	Descrição	Dentes por polegada	Comprimento comprimento útil (mm)	Qualidades material	Madeira	Plástico	Alumínio	Metal inox	Metais não ferrosos	Metal	Tipo Classe B	Unidades pacote	Código	EAN	P.V.P (€)
B11	Conjunto de folhas a granel	9	75	HCS	3-60	3-60	-	-	-	-	T101B	100	B-07680	0088381335300	100,00

Para cortes em madeira e plásticos



Tipo	Descrição	Dentes por polegada	Comprimento comprimento útil (mm)	Qualidades material	Madeira	Plástico	Alumínio	Metal inox	Metais não ferrosos	Metal	Tipo Classe B	Unidades pacote	Código	EAN	P.V.P (€)
B13	Conjunto de folhas a granel	8	80	HCS	4-65	4-65	-	-	-	-	T111C	100	B-07705	0088381335324	65,00

Para corte rápido em madeira e plásticos. Corte rápido e grosseiro.



Tipo	Descrição	Dentes por polegada	Comprimento comprimento útil (mm)	Qualidades material	Madeira	Plástico	Alumínio	Metal inox	Metais não ferrosos	Metal	Tipo Classe B	Unidades pacote	Código	EAN	P.V.P (€)
B16	Conjunto de folhas a granel	6	75	HCS	5-65	5-65	-	-	-	-	T144D	100	B-07711	0088381335331	85,00

Para aço médio, aço inoxidável e plásticos duros. Indicado para chapa fina

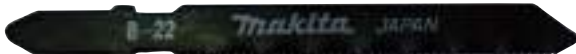

Tipo	Descrição	Dentes por polegada	Comprimento comprimento útil (mm)	Qualidades material	Madeira	Plástico	Alumínio	Metal inox	Metais não ferrosos	Metal	Tipo Classe B	Unidades pacote	Código	EAN	P.V.P (€)
B22	Conjunto de folhas a granel	24	50	HSS	-	1-6	1-3	1-3	-	1-3	T118A	100	B-07733	0088381335355	80,00



Tipos de folhas - Inserção Makita

Corte - Madeira



Tipo	Descrição	Dentes por polegada	Comprimento comprimento útil (mm)	Qualidades material	Madeira	Plástico	Alumínio	Metal inox	Metais não ferrosos	Metal	Tipo Classe B	Unidades pacote	Código	EAN	P.V.P (€)
3	Para todos os tipos de madeiras e plásticos.	9	60	HCS	3-50	3-50	-	-	-	-	-	5	A-85868	0088381149457	4,25



16	Corte curvo em madeiras macias e material isolante.	9	60	HCS	3-50	3-50	-	-	-	-	-	5	792207-9	0088381100342	4,75
----	---	---	----	-----	------	------	---	---	---	---	---	---	----------	---------------	------

Corte rápido - Madeira



Tipo	Descrição	Dentes por polegada	Comprimento comprimento útil (mm)	Qualidades material	Madeira	Plástico	Alumínio	Metal inox	Metais não ferrosos	Metal	Tipo Classe B	Unidades pacote	Código	EAN	P.V.P (€)
8	Corte rápido em todos os tipos de madeiras e plásticos.	8	60	HCS	4-50	4-50	-	-	-	-	-	5	A-85911	0088381149723	5,25

Corte de acabamento - Madeira



Tipo	Descrição	Dentes por polegada	Comprimento comprimento útil (mm)	Qualidades material	Madeira	Plástico	Alumínio	Metal inox	Metais não ferrosos	Metal	Tipo Classe B	Unidades pacote	Código	EAN	P.V.P (€)
9	Corte limpo e rápido em todos os tipos de madeiras e plásticos.	8	60	HCS	4-50	4-50	-	-	-	-	-	5	A-85927	0088381149730	6,75



10	Corte limpo e rápido em todos os tipos de madeiras e plásticos. Especial para contraplacado.	9	60	HCS	4-50	4-50	-	-	-	-	-	5	A-85818	0088381149488	7,00
----	--	---	----	-----	------	------	---	---	---	---	---	---	---------	---------------	------



BR3	Folha especial para cortes de superfície sem lascas.	9	60	HCS	4-50	-	-	-	-	-	-	5	A-85933	0088381149747	4,25
-----	--	---	----	-----	------	---	---	---	---	---	---	---	---------	---------------	------

Corte - Madeiras duras e contraplacados decorativos



Tipo	Descrição	Dentes por polegada	Comprimento comprimento útil (mm)	Qualidades material	Madeira	Plástico	Alumínio	Metal inox	Metais não ferrosos	Metal	Tipo Classe B	Unidades pacote	Código	EAN	P.V.P (€)
2	Para chapas finas de aço e aço inoxidável.	14	60	HSS	3-50	3-50	2-6	-	2-6	-	-	5	A-85852	0088381149440	5,25



4	Para madeira dura, metal não ferroso e plásticos duros.	9	60	HSS	3-50	3-50	3-6	-	3-6	-	-	5	A-85874	0088381149464	5,25
---	---	---	----	-----	------	------	-----	---	-----	---	---	---	---------	---------------	------

Corte - Madeira



Tipo	Descrição	Dentes por polegada	Comprimento comprimento útil (mm)	Qualidades material	Madeira	Plástico	Alumínio	Metal inox	Metais não ferrosos	Metal	Tipo Classe B	Unidades pacote	Código	EAN	P.V.P (€)
41	Para corte de madeira e plástico sem lascas. Dentes invertidos.	12	60	HSS	3-50	3-50	-	-	-	-	-	5	A-85880	0088381149525	5,50



42	Folha especial sem inclinação para um bom acabamento de ambos os lados, laminados e placas variadas.	16	60	HSS	2-50	-	-	-	-	-	-	5	A-85896	0088381149532	8,50
----	--	----	----	-----	------	---	---	---	---	---	---	---	---------	---------------	------

Corte - Metal



Tipo	Descrição	Dentes por polegada	Comprimento comprimento útil (mm)	Qualidades material	Madeira	Plástico	Alumínio	Metal inox	Metais não ferrosos	Metal	Tipo Classe B	Unidades pacote	Código	EAN	P.V.P (€)
1	Para chapas finas de aço e aço inoxidável.	24	60	HSS	-	-	1-3	0,5-3	1-3	-	-	5	A-85802	0088381149433	5,25



5	Para chapas finas de aço e aço inoxidável.	24	42	HSS	-	-	1-3	1-3	1-3	-	-	5	A-85905	0088381149471	5,75
---	--	----	----	-----	---	---	-----	-----	-----	---	---	---	---------	---------------	------

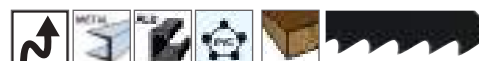

17	Corte curvo em madeira dura, metal não ferroso e plásticos duros.	14	63	HSS	2-50	2-50	2-6	-	2-6	-	-	5	792216-8	0088381100359	8,00
----	---	----	----	-----	------	------	-----	---	-----	---	---	---	----------	---------------	------



Guias de carril e acessórios



Peça para unir dois carris



Estojo para guia de carril de guiamento



Guia de carril

Descrição	Comprimento (m)	Unidades	Código	EAN	P.V.P (€)
Peça para unir dois carris	-	1	P-45777	0088381976213	23,00
Guia de carril	1,0	1	199140-0	0088381528672	40,00
	1,4	1	194368-5	0088381313353	69,00
	1,9	1	194925-9	0088381354790	106,00
	3	1	194367-7	0088381335201	180,00
Estojo para guia de carril de guiamento	1,4	1	B-57613	0088381519854	41,00

Grampo para guia de carril de guiamento



Modelos	Unidades	Código	EAN	P.V.P (€)
Guias de carril	2	194385-5	0088381314084	22,50

Chaves Allen



Modelos	Unidades	Código	EAN	P.V.P (€)
4326 4327 4328 4329	1	783201-2	0088381101288	1,00
4350T/CT/FCT 4351T/CT/FCT	1	783202-0	0088381102667	1,00

Adaptador para guia de carril



Modelos	Unidades	Código	EAN	P.V.P (€)
4350T/CT/FCT 4351CT/FCT 4329 JV0600	1	193517-1	0088381170659	29,00

Guia lateral + circular (A + B)



Tipo	Modelo	Unidades	Código	EAN	P.V.P (€)
A + B	DJV180 DJV182	1	193516-3	0088381170666	8,75
A + B	4326 4327 4328 4329 JV0600 JV100D JV103	1	192732-4	0088381148054	7,50

Acessórios

Placa antilascas



415524-7

Protetor de base



417852-6

Adaptador de aspiração



417853-4

Adaptador de aspiração



192349-3

Tipo	Modelo	Unidades	Código	EAN	P.V.P (€)
Placa antilascas	DJV182 4350T/CT/ FCT 4351CT/ FCT	1	415524-7	0088381131681	0,75
	4322 4323 4324	1	416477-3	0088381148207	0,50
Protetor de base	4329 4350T/CT/ FCT 4351T/ CT/FCT, JV0600		417852-6	0088381177498	2,50
Adaptador de aspiração	4326 4327 4328 4329 JV0600	1	192349-3	0088381126229	7,50
	4350T/CT/ FCT 4351CT/ FCT DJV180	1	417853-4	0088381170833	1,00



Fresagem



Fresas - Índice

Fresas retas *pág. 205 - 206*

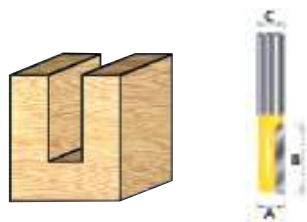

Fresas em V *pág. 208*

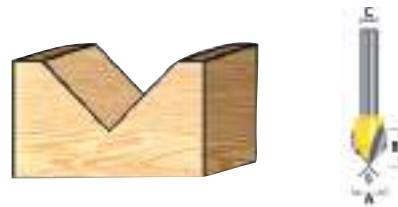

Fresas para painéis *pág. 206*



Fresas de meia cana *pág. 208*



Fresas em U *pág. 207*

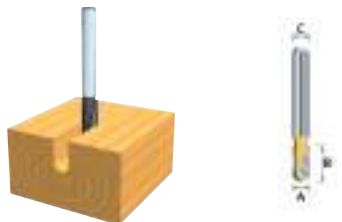

Fresas macho/fêmea *pág. 208*

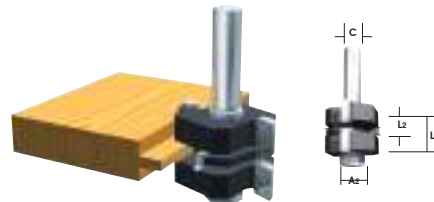

Fresas de recorte *pág. 207*



Fresas para alumínio *pág. 209*

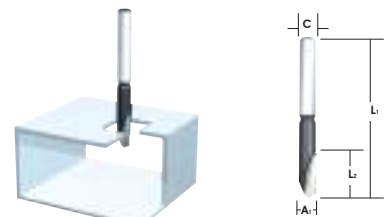

Fresas para molduras *pág. 207*



Fresas para 3706 *pág. 209*



Fresas para arredondar *pág. 207*



Discos e lamelas para PJ7000 *pág. 210*



Fresas biseladoras

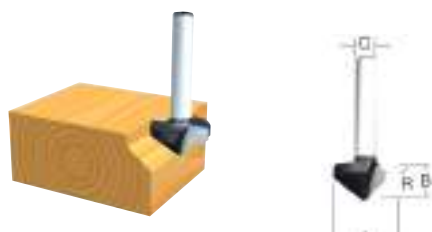

Acessórios para 7104L *pág. 210*



Fresas para madeira

Estojos de fresas

- Estojos com vários tipos de fresas para diversas aplicações.

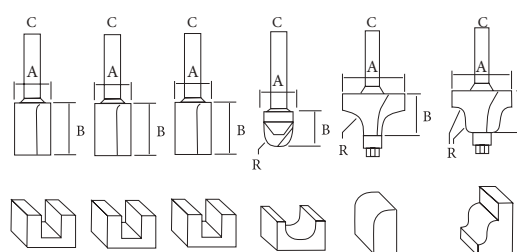
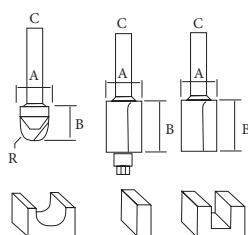

A (mm)	B (mm)	C (mm)	Tipo	Unidades	Código	EAN	P.V.P (€)
-	-	6	HM	3	D-30209	0088381352772	18,00
-	-	6	HM				
-	-	6	HM				

A (mm)	B (mm)	C (mm)	R (mm)	Unidades	Código	EAN	P.V.P (€)
6	16	8	-	6	D-53540	0088381449915	60,00
10	19	8	-				
12	19	8	-				
12,7	10	8	6,35				
31,8	16,7	8	9,5				
28,6	13	8	4				

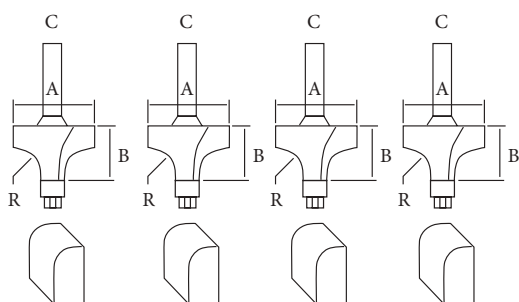

A (mm)	B (mm)	C (mm)	R (mm)	Unidades	Código	EAN	P.V.P (€)
19	9,5	8	3,2	4	D-53534	0088381449908	58,00
25,4	13,5	8	6,35				
31,8	16,7	8	9,5				
38,1	19	8	38,1				

Fresas retas de um fio

- Fresas indicadas para pequenas ranhuras.
- Ferramenta de corte HM.
- Ideal para madeira e contraplacado.



A (mm)	B (mm)	C (mm)	Tipo	Unidades	Código	EAN	P.V.P (€)
6	18	6	HM	1	D-09167	0088381181990	9,25
3	8	8	HM	1	D-10001	0088381165044	7,50
4	10	8	HM	1	D-10017	0088381165051	8,25
5	12,7	8	HM	1	D-10023	0088381165068	8,25
6	8	8	HM	1	D-10039	0088381165075	8,25

Fresas para madeira

Fresas retas de dois fios

- Ferramenta de corte HM.
- Máxima precisão de corte.
- Ideal para madeira, contraplacados, plásticos e materiais abrasivos.

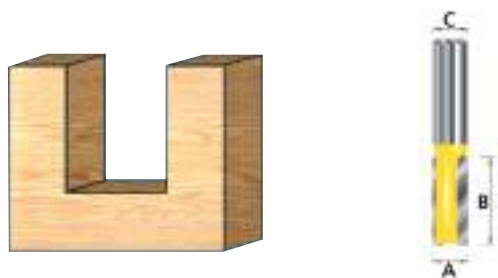

A (mm)	B (mm)	C (mm)	Tipo	Unidades	Código	EAN	P.V.P (€)
3	95	6	HM	1	D-09210	0088381181969	16,00
4	10	6	HM	1	D-09226	0088381181976	17,00
5	12	6	HM	1	D-09232	0088381181983	8,50
6	16	6	HM	1	D-09248	0088381182003	8,50
7	25	6	HM	1	D-09254	0088381182010	8,25
8	20	6	HM	1	D-09260	0088381182027	8,25
9	25	6	HM	1	D-09276	0088381182034	8,75
10	25	6	HM	1	D-09282	0088381182041	8,75
12	32	6	HM	1	D-09298	0088381182058	9,25
15	20	6	HM	1	D-09307	0088381182065	10,50
20	20	6	HM	1	D-09313	0088381182072	12,00
6	19	8	HM	1	D-10051	0088381165099	10,00
8	20	8	HM	1	D-10067	0088381165105	11,00
10	20	8	HM	1	D-10285	0088381165327	16,00
12	20	8	HM	1	D-10291	0088381165334	18,00
14	20	8	HM	1	D-10300	0088381165341	20,00
15	20	8	HM	1	D-10316	0088381165358	20,00
16	20	8	HM	1	D-10322	0088381165365	21,50
18	20	8	HM	1	D-10338	0088381165372	23,00
20	20	8	HM	1	D-10344	0088381165389	22,00
22	20	8	HM	1	D-10350	0088381165396	24,00
24	20	8	HM	1	D-10366	0088381165402	25,50
25	20	8	HM	1	D-10372	0088381165419	25,50
8	30	12	HM	1	D-10176	0088381165211	11,50
10	30	12	HM	1	D-10182	0088381165228	12,50
10	35	12	HM	1	D-10388	0088381165426	19,50
12	32	12	HM	1	D-10198	0088381165235	12,50
14	35	12	HM	1	D-10403	0088381165440	23,00
15	35	12	HM	1	D-10419	0088381165457	24,50
16	35	12	HM	1	D-10425	0088381165464	27,50
18	35	12	HM	1	D-10431	0088381165471	27,50
20	35	12	HM	1	D-10447	0088381165488	29,50
22	35	12	HM	1	D-10453	0088381165495	31,00
24	35	12	HM	1	D-10469	0088381165501	31,00
25	35	12	HM	1	D-10475	0088381165518	31,00

Fresas para painéis

- Ferramenta de corte HM.
- Para a fresagem de painéis. Com ponta de broca para penetrar rapidamente o material.



A (mm)	B (mm)	C (mm)	Tipo	Unidades	Código	EAN	P.V.P (€)
6	19	6	HM	1	D-09335	0088381182096	12,50
8	19	8	HM	1	D-10578	0088381165617	12,50
12	25,4	12	HM	1	D-10584	0088381165624	14,50

Fresas duplas para painéis

- Ferramenta de corte HM.
- Para a fresagem simultânea dos painéis superior e inferior de contraplacado.
- Ponta de broca para penetrar rapidamente.

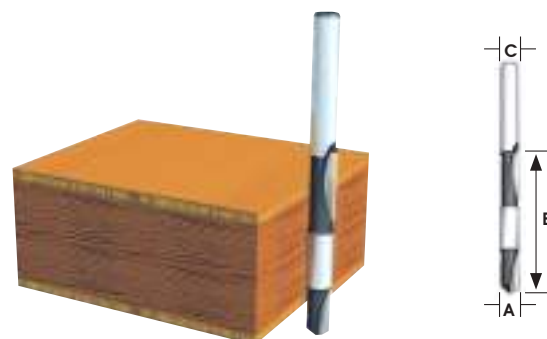

A (mm)	B (mm)	C (mm)	Tipo	Unidades	Código	EAN	P.V.P (€)
6	40	6	HM	1	D-09341	0088381182102	23,00
8	55	8	HM	1	793061-4	0088381108225	31,00

Fresas para madeira

Fresas em "U"

- Ferramenta de corte HM.
- Para realizar trabalhos decorativos.
- Para utilizar em madeira maciça e materiais abrasivos.

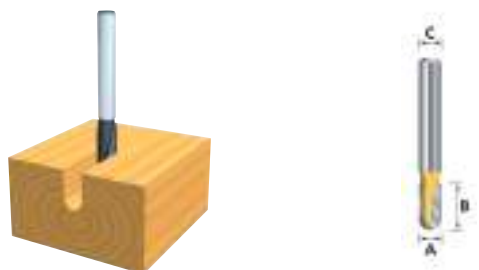

A (mm)	B (mm)	C (mm)	Tipo	Unidades	Código	EAN	P.V.P (€)
6	13	6	HM	1	D-09329	0088381182089	12,50

Fresa para molduras sem rolamento

- Ferramenta de corte HM.
- Fresas para cantos e ranhuras.
- Ideal para madeiras maciças e materiais abrasivos.



A (mm)	B (mm)	R (mm)	C (mm)	Tipo	Unidades	Código	EAN	P.V.P (€)
16	9	4	6	HM	1	D-09357	0088381182119	19,00
25	13	8	6	HM	1	D-09363	0088381182126	23,50

Fresas de recorte com rolamento

- Ferramenta de corte HM.
- Com rolamento que serve como guia.
- Perfeita para copiar peças com muito desbaste.
- Para madeira maciça e materiais abrasivos.



A (mm)	B (mm)	C (mm)	Tipo	Unidades	Código	EAN	P.V.P (€)
9,5	25,4	6	HM	1	D-09472	0088381182232	14,00
12,7	25,4	8	HM	1	D-10481	0088381165525	15,50
12,7	38,1	12	HM	1	D-10497	0088381165532	20,50

Fresa para molduras

- Ferramenta de corte HM.
- Fresas para criar perfis e molduras com ângulo convexo.
- Para madeira maciça.



A (mm)	B (mm)	R (mm)	C (mm)	Tipo	Unidades	Código	EAN	P.V.P (€)
20	10	2,5	6	HM	1	D-09575	0088381182331	24,00
22	10	3	6	HM	1	D-09553	0088381182317	25,00
26	12	5	6	HM	1	D-09569	0088381182324	27,00
26	12	3	6	HM	1	D-09581	0088381182348	22,00

Fresa para arredondar com rolamento

- Ferramenta de corte HM.
- Fresa com rolamento inferior, ideal para cantos.
- Para madeira maciça e materiais abrasivos.



A (mm)	B (mm)	R (mm)	C (mm)	Tipo	Unidades	Código	EAN	P.V.P (€)
15	7	3	6	HM	1	D-09422	0088381182188	16,00
21	10	6	6	HM	1	D-09444	0088381182201	20,00

Fresa para molduras com rolamento

- Ferramenta de corte HM.
- Semelhante à fresas para arredondar, mas com um rolamento mais pequeno, proporcionando uma forma mais decorativa.
- Para madeira maciça e materiais abrasivos.

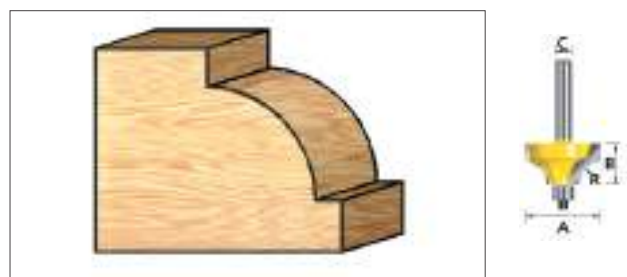

A (mm)	B (mm)	R (mm)	C (mm)	Tipo	Unidades	Código	EAN	P.V.P (€)
20	10	4	6	HM	1	D-09525	0088381182287	17,50
26	12	7	6	HM	1	D-09547	0088381182300	20,50

Fresas para madeira

Biseladora com rolamento

- Ferramenta de corte HM.
- Fresas ideais para biselar de forma fácil e rápida graças ao rolamento.
- Para madeira maciça.

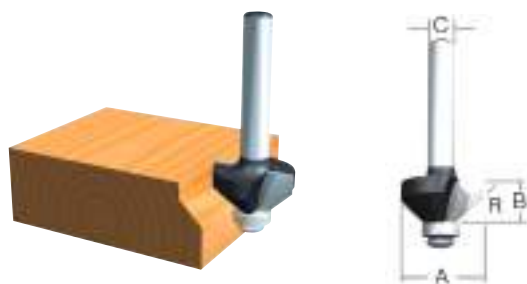

A (mm)	B (mm)	C (mm)	Tipo	Unidades	Código	EAN	P.V.P (€)
20	11	6	HM	1	D-09494	0088381182256	19,00
26	12	6	HM	1	D-09488	0088381182249	19,50

Meia cana

- Ferramenta de corte HM.
- Para a fresagem de cantos em móveis, gavetas, etc. com perfil convexo.
- Para madeira maciça.

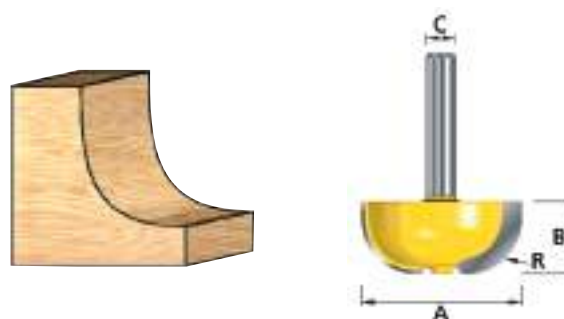

A (mm)	B (mm)	R (mm)	C (mm)	Tipo	Unidades	Código	EAN	P.V.P (€)
20	8	4	6	HM	1	D-09400	-	24,00
25	13	8	6	HM	1	D-09416	0088381182171	22,50

Macho/fêmea (macho)

- Ferramenta de corte HM.
- Para ensamblar molduras (macho).
- Para madeira maciça.

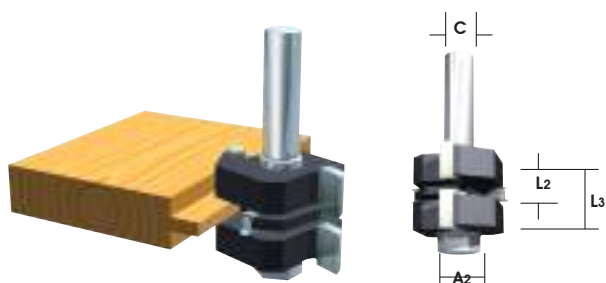

A (mm)	A1 (mm)	L2/L3 (mm)	C (mm)	Tipo	Unidades	Código	EAN	P.V.P (€)
38	27	4/20	12	HM	1	D-12027	0088381167062	38,00

Fresas em "V"

- Ferramenta de corte HM.
- Perfeita para ranhuras, biselados ou fresagem de precisão.
- Adequada para madeira maciça, Alucobond e materiais abrasivos.

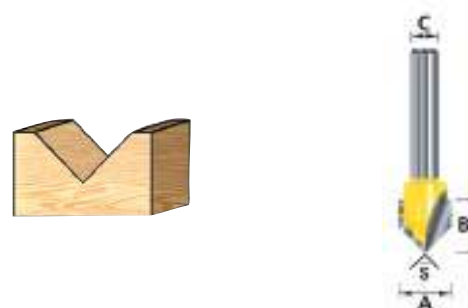

A (mm)	B (mm)	R (°)	C (mm)	Tipo	Unidades	Código	EAN	P.V.P (€)
19	20	60°	6	HM	1	D-09391	0088381182157	21,50
20	15	30°	6	HM	1	D-09379	0088381182133	21,00
20	15	45°	6	HM	1	D-09385	0088381182140	21,00
12,7	12,7	90°	8	HM	1	D-10687	0088381165723	15,50
15,9	12,7	90°	8	HM	1	D-10693	0088381165730	18,00
12,7	12,7	90°	12	HM	1	D-10702	0088381165747	15,50
15,9	12,7	90°	12	HM	1	D-10718	0088381165754	18,50
32	22	90°	12	HM	1	D-10746	0088381165785	28,50



Fresas para perfurar alumínio

- Ferramenta de corte HM.
- Para perfurar alumínio.
- Também adequada para fresar alumínio.

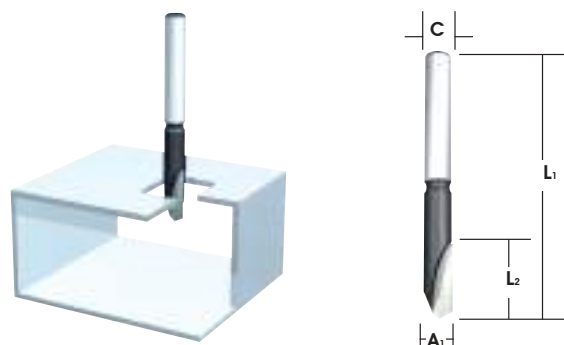

A1/ A2 (mm)	L1 (mm)	L2 (mm)	C (mm)	Tipo	Unidades	Código	EAN	P.V.P (€)
6	65	30	6	HM	1	D-16988	0088381194761	10,00



Fresas para 3706

Fresas para gesso cartonado



Inserção (mm)	Modelo	Unidades	Código	EAN	P.V.P (€)
3,18 (1/8")	3706	1	733229-0	0088381160537	3,00
6,35 (1/4")		1	733232-1	0088381160544	10,00
3,18 (1/8") (multiuso)		1	193483-2	0088381163927	5,00

Fresa de diamante



Inserção (mm)	Modelo	Unidades	Código	EAN	P.V.P (€)
6,35 (1/4")	3706	1	A-87915	0088381163644	48,00



Acessórios para PJ7000 e 3901

Discos HM



Ø (mm)	Modelo	Unidades	Código	EAN	P.V.P (€)
100	PJ7000 3901	1	B-20644	0088381377133	23,00
110		1	P-13605	0088381947275	39,00

Lamelas

- União de placas mais fácil e simples, mais fáceis de usar, permitem uma folga (tolerância) entre as placas a unir, mais seguras e resistentes graças às lamelas de elevada resistência.

Pacotes de 1000 peças. Alta qualidade. Elevada dureza.



Modelo	Medida (mm)	Grão	Unidades	Código	EAN	P.V.P (€)
50x20x4	3901 n.º 10	1000 peças	1	P-08844	0088381921206	45,00
55x25x4	3901 n.º 20	1000 peças	1	P-08850	0088381921213	45,00

Acessórios para 7104

Correntes



Tipo	Medida (mm)	Modelo	Unidades	Código	EAN	P.V.P (€)
-	15	7104L	1	A-16564	0088381131612	337,00
-	16,5		1	A-16570	0088381131629	335,00
-	18,0		1	A-16586	0088381131636	354,00
-	21		1	A-16592	0088381131643	393,00
-	24,0		1	A-16601	0088381131650	455,00
Utilizar com o pinhão cód. 221502-5 e barra cód. 122235-4.	30		1	A-16617	0088381131667	698,00

Óleo de corrente



Unidades	Código	EAN	P.V.P (€)
1	181434-7	0088381194747	1,00

Barra guia



Corrente	Descrição Tipo/uso	Unidades	Código	EAN	P.V.P (€)
30 mm	Utilizar juntamente com corrente de 30 mm.	1	122235-4	0088381122764	295,00

Pinhão



Corrente	Descrição Tipo/uso	Unidades	Código	EAN	P.V.P (€)
30 mm	Utilizar juntamente com corrente de 30 mm.	1	221502-5	-	17,00



Guia de ângulo



Modelo	Unidades	Código	EAN	P.V.P (€)
3901	1	122473-8	0088381127530	35,00
PJ7000 DPJ180	1	123149-0	0088381443173	17,50

Placa de ajuste



Modelos	Unidades	Código	EAN	P.V.P (€)
3901 PJ7000 DPJ180	1	415579-2	0088381155038	5,50

Chave de pivotes 20



Modelos	Unidades	Código	EAN	P.V.P (€)
3901 PJ7000 DPJ180	1	782401-1	0088381101240	0,75

Bolsa de recolha de pó



Modelos	Unidades	Código	EAN	P.V.P (€)
3901	1	122474-6	0088381127547	6,50
PJ7000 DPJ180	1	123150-5	0088381403092	6,00

Casquilhos cónicos



Modelo	Ø (mm)	Descrição	Unidades	Código	EAN	P.V.P (€)
3707FC	6		1	763607-0	0088381114806	2,50
	6,35 (1/4")		1	763608-8	0088381102292	3,00
3709 3710 4403	6		1	763662-2	0088381431606	3,60
	6,35 (1/4")		1	763663-0	-	4,00
RP1800 RP2300FC	1/2"		1	763622-4	0088381102315	15,00
	12		1	763628-2	0088381114813	15,00
	13		1	763632-1	0088381118538	23,00
3601B	12		1	763601-2	0088381123945	37,00
RP0900 RT0700C	6		1	763636-3	0088381142830	10,50
	6,35 (1/4")		1	763637-1	0088381102353	8,75
	8		1	763618-5	0088381114820	2,50
RP0910 RP1110C	6	Com porca	1	193180-0	0088381156714	23,00
	8	Com porca	1	193178-7	0088381156721	19,00

Chaves



Redução (mm)	Modelo	Unidades	Código	EAN	P.V.P (€)
8	RP0910 RP1110C RP0900	1	781213-9	0088381102520	2,00
10	3707FC 3709 3710 4403	1	781003-0	0088381102391	2,00
13	RT0700C RP0900	1	781006-4	0088381102407	1,75
17	3709 3710 3706 3707FC RP0910 RP1110C 4403	1	781008-0	0088381102414	1,75
22	RP0900 RT0700C	1	781011-1	0088381102438	2,00
23	3601B	1	781012-9	0088381102445	2,00
24	RP1800 RP2300FC	1	781030-7	0088381151559	2,50

Casquilho redutor



Redução (mm)	Modelo	Unidades	Código	EAN	P.V.P (€)
12 - 6	3601B RP1800 RP2300FC	1	763801-4	0088381114646	3,00
12 - 8		1	763804-8	0088381114653	3,00
12 - 10		1	763807-2	0088381124003	3,50
12 - 1/4"		1	763803-0	0088381102360	3,00

Porca



Modelos	Unidades	Código	EAN	P.V.P (€)
3707FC 3709 3710 4403	1	763606-2	0088381123952	3,75
RP0900 RT0700C	1	763615-1	0088381123969	3,00
RP0910 RP110C	1	763652-5	0088381170352	4,00
RP1800 RP2300FC	1	763629-0	0088381123983	6,00

Acessórios para 3706 e DCO180



Guia circular



Modelos	Unidades	Código	EAN	P.V.P (€)
3706 DCO180	1	193448-4	0088381160483	22,00

Coletor de pó



Modelos	Unidades	Código	EAN	P.V.P (€)
3706 DCO180	1	193449-2	0088381160490	6,50

Casquilhos cónicos



Medida (mm)	Modelo	Unidades	Código	EAN	P.V.P (€)
3,18	3706 DCO180	1	324149-5	0088381161060	9,25
6,35 (1/4")		1	763608-8	0088381102292	3,00
3,18	DCO180	1	763677-9	0088381468824	11,50
6,35 (1/4")		1	763676-1	0088381469012	14,50

Porca



Modelos	Unidades	Código	EAN	P.V.P (€)
3706 DCO180	1	763606-2	0088381123952	3,75

Guias de molde

1



1. Para os modelos 3709, 3710, 3707FC, RT0700C

A (mm)	B (mm)	C (mm)	Modelos	Unidades	Código	EAN	P.V.P (€)
8,0	10,0	9,5	3709 3710 3707FC RT0700C	1	343577-5	0088381115681	0,75

2



2. Para os modelos RP0900, RP1800X, RP2300FCX e RT0700*.

A (mm)	B (mm)	C (mm)	Modelos	Unidades	Código	EAN	P.V.P (€)
7,7	9,5	11,5	RP0900 RP1800X RP2300FCX RT0700*	1	164379-4	0088381111676	13,50
9,0	11,0	13,0		1	164775-6	0088381111720	12,50
10,0	12,0	9,0		1	164388-3	0088381156356	11,50
11,0	12,7	13,0		1	164776-4	0088381112062	13,00
14,5	16,0	13,0		1	344364-5	0088381141222	2,00
18,0	20,0	13,0		1	164393-0	008838111683	13,50
24,0	27,0	13,0		1	164470-8	008838111690	10,00
25,0	29,0	150,0		1	163080-8	008838111645	10,50
27,0	30,0	13,0		1	164471-6	008838111706	10,50
37,0	40,0	11,5		1	165046-4	0088381161237	11,50

* Com base de superfície

3



3. Para os modelos RP0910, RP1110C

A (mm)	B (mm)	C (mm)	Modelos	Unidades	Código	EAN	P.V.P (€)
9,0	11,0	11,5	RP0910 RP1110C	1	193331-5	0088381159906	12,50
10,5	12,0	14,0		1	193332-3	0088381156615	9,25
14,5	16,0	11,5		1	193334-9	0088381159920	10,00
18,0	20,0	13,0		1	193335-7	0088381159937	15,00
22,0	14,0	13,0		1	193340-4	0088381159982	12,50
24,0	27,0	13,0		1	193336-5	0088381159944	11,50
27,0	30,0	13,0		1	193338-1	0088381159968	12,00
37,0	40,0	13,0		1	193339-9	0088381159975	14,00

Guia de molde completa

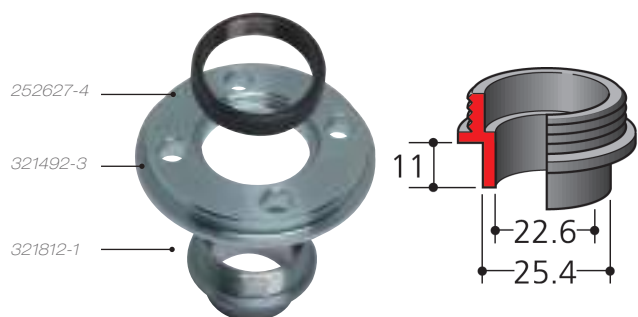

Modelo	Ø (mm)	Modelos	Unidades	Código	EAN	P.V.P (€)
Porca	M30	RP0900 RP1800X RP2300FCX RT0700*	1	252627-4	0088381111782	10,00
Adaptador	-		1	321492-3	008838111799	15,00
Casquilho	25,4 mm		1	321812-1	008838111805	9,75





ACESSÓRIOS. FRESAGEM

Guias de carril e acessórios

A



Peça para unir dois carris

B



Guia de carril

C



Estojo para guia de carril de guiamento

Tipo	Descrição	Comprimento (m)	Unidades	Código	EAN	P.V.P (€)
A	Peça para unir dois carris	-	1	P-45777	0088381976213	23,00
B	Guia de carril	1,0	1	199140-0	0088381528672	40,00
		1,4	1	194368-5	0088381313353	69,00
		1,9	1	194925-9	0088381354790	106,00
		3	1	194367-7	0088381335201	180,00
C	Estojo para guia de carril de guiamento	1,4	1	B-57613	0088381519854	41,00

Grampos para guia de carril de guiamento



Descrição	Unidades	Código	EAN	P.V.P (€)
Conjunto de suporte para guia de carril de guiamento.	2	194385-5	0088381314084	22,50

Adaptador para guia de carril



Modelos	Unidades	Código	EAN	P.V.P (€)
RP0910 RP110C RP1800 RP2300FC RP0900 RT0700*	1	194579-2	0088381352611	33,00

* Com base de superfície



Acessórios para fresadora RT0700C multifunções

Base reta

Placa para base



*Placa base incluída

Descrição	Modelo	Unidades	Código	EAN	P.V.P (€)
Base	RT0700C	1	196612-6	3240890408365	22,50
Placa para base		1	454842-8	-	2,40



Base para superfície

Placa para base



*Placa base incluída

Descrição	Modelo	Unidades	Código	EAN	P.V.P (€)
Base	RT0700C	1	195563-0	0088381376099	62,00
Placa para base		1	450819-1	-	3,00



Base inclinável 30° a 45°

Placa para base



*Placa base incluída

Descrição	Modelo	Unidades	Código	EAN	P.V.P (€)
Base	RT0700C	1	198987-9	0088381525848	28,00
Placa para base		1	413150-6	-	2,50



Base de eixo excêntrico

Placa para base



*Placa base incluída

Descrição	Modelo	Unidades	Código	EAN	P.V.P (€)
Base	RT0700C	1	195562-2	0088381376082	75,00
Placa para base		1	413148-3	-	4,50



Guias de recorte

1



2



3



Tipo	Modelo	Unidades	Código	EAN	P.V.P (€)
1	3707FC 3709 3710 RT0700C	1	122703-7	3240890257048	3,25
2	RP1800X RP2300FCX	1	123022-4*	0088381115643	5,00
3	RP0900 RT0700C**	1	STEX122385	008838111164	29,00
	3601B	1	122343-1	0088381111621	14,00

* É necessário utilizar batente ajustável

** Com base de superfície

Batente ajustável



* Para colocar guia de recorte.

Modelos	Unidades	Código	EAN	P.V.P (€)
RP1800 RP2300FC	1	122700-3	-	16,00

Adaptadores de aspiração



Modelos	Unidades	Código	EAN	P.V.P (€)
3612 3612C	1	415412-8	0088381155014	4,75
RP1800X RP2300FCX	1	194934-8	3240890298089	10,50
RP0900 RT0700C*	1	194733-8	0088381358972	2,00
RT0700C	1	195559-1	0088381411295	3,00

* Com base de superfície

Parafuso de fixação



Descrição	Unidades	Código	EAN	P.V.P (€)
Fixa a profundidade quando utilizamos a fresa invertida numa mesa.	1	266491-7	-	2,00

Bases



Base reta



Base inclinada

Tipo	Modelo	Unidades	Código	EAN	P.V.P (€)
Base reta	3707/F/FC	1	123544-4	-	27,00
Base inclinada		1	193904-4	0088381164726	45,00
Base reta	3709 3710	1	194268-9	0088381248846	12,00
Base inclinada		1	194270-2	0088381248860	39,00

Guias paralelas



Guia paralela com regulação milimétrica

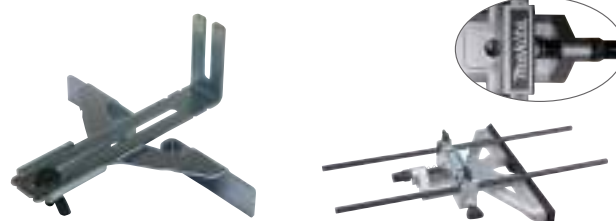

195136-9

Modelos	Unidades	Código	EAN	P.V.P (€)
3707FC 3709 3710 RT0700C	1	122391-0	0088381115674	5,50
RP0900 RP0910 RP110C	1	164834-6	0088381111737	3,25
3612C 3612	1	342428-9	0088381115667	6,25
RP0900 RT0700* RP110C RP1800 RP2300FCX	1	195136-9	0088381360623	45,00

* Com base de superfície



Decapar





Nova gama de decapadores de ar quente.



• **HG5030K**



• **HG6031VK**



• **HG6531CK**



Acessórios para decapadores HG5030K, HG6031VK e HG6531VK

Descrição		HG5030K	HG6031VK	HG6531VK	unida- des	Código	EAN	P.V.P (€)
		✓	✓	✓	1	PR00000029	0088381527934	7,00
		✓	✓	✓	1	PR00000028	0088381527927	7,00
		✓	✓	✓	1	PR00000030	0088381527941	9,00
		-	✓	✓	1	PR00000031	0088381527958	7,50
		-	-	✓	1	PR00000039	0088381528030	8,25
		-	-	✓	1	PR00000034	0088381527965	15,00
		-	-	✓	1	PR00000032	0088381527972	16,50
		-	-	✓	1	PR00000033	0088381527989	7,00
		✓	✓	✓	1	PR00000035	0088381527996	10,75
		✓	✓	✓	1	PR00000041	0088381528054	-





ACESSÓRIOS. **DECAPAR**

Acessórios para decapadores HG5012, HG551V e HG651CK

Descrição	HG5012K	HG551VK	HG651CK	unidades	Código	EAN	P.V.P (€)
 Bocal protetor de vidro	✓	✓	✓	1	P-71417	0088381702003	8,50
 Bocal de ranhura ampla	✓	✓	✓	1	P-71423	0088381702010	8,00
 Bocal de redução de ø 20 mm	-	✓	✓	1	P-71439	0088381702027	7,25
 Bocal defletor	✓	✓	✓	1	P-71445	0088381702034	7,25
 Bocal para soldar	-	-	✓	1	P-71451	0088381702041	11,00
 Bocal para soldadura por sobreposição	-	-	✓	1	P-71489	0088381702072	11,00
 Soldadura	-	-	✓	1	P-71473	0088381702065	17,50
 Rolo de pressão	✓	✓	✓	1	P-71504	0088381702096	9,50
 Conjunto de raspadores	✓	✓	✓	1	P-71554	0088381702140	19,00
 Defletor para soldadura	-	-	✓	1	P-71495	0088381702089	13,50

Plástico de soldadura



Características	Comprimento (mm)	unidades	Código	EAN	P.V.P (€)
Polipropileno	230	20	P-71510	0088381702102	23,00
Poliétileno			P-71526	0088381702119	23,00
Acronitrilo			P-71532	0088381702126	22,50





Parafusos e pregos





ACESSÓRIOS. **PARAFUSOS E PREGOS**

Vasta gama de aparafusadores autoalimentados, pregadoras e agrafadoras Makita.



Réstia de parafusos para máquinas autoalimentadas



Parafuso para gesso cartonado sobre guia metálica

Ø (mm)	Comprimento (mm)	Tipo de rosca	Tratamento	BFR440	BFR550	6842	6844	Unidades	Código	EAN	P.V.P. (€)
				✓	✓	X	X				
3,5	25	Fina	Fosfatado	✓	✓	X	X	1000	F-31227	0088381291781	14,00
3,5	35			✓	✓	X	X		F-31230	-	15,50
3,9	25			✓	✓	✓	X		F-30913	0088381291477	14,50
3,9	35			✓	✓	✓	X		P-04123	0088381921695	23,00
3,9	41			✓	✓	✓	X		F-31166	0088381291729	18,50
3,9	55			✓	✓	✓	X		F-30942	0088381291507	20,00

Parafuso para gesso cartonado sobre guia de madeira

Ø (mm)	Comprimento (mm)	Tipo de rosca	Tratamento	BFR440	BFR550	6842	6844	Unidades	Código	EAN	P.V.P. (€)
				✓	✓	✓	✓				
3,9	35	Grossa	Fosfatado	✓	✓	✓	✓	1000	F-31179	0088381291736	17,00
3,9	41			✓	✓	✓	X		F-31182	0088381291743	25,00
3,9	55			X	X	✓	✓		F-31140	0088381291705	19,50

Parafuso especial para gesso cartonado e gesso reforçado por fibra

Ø (mm)	Comprimento (mm)	Tipo de rosca	Tratamento	BFR440	BFR550	6842	6844	Unidades	Código	EAN	P.V.P. (€)
3,9	30	fio	Fosfatado	✓	✓	✓	X	1000	P-04145	0088381921954	33,00

Parafuso para madeiras duras, aglomerados laminados, etc.

- Cabeça escareada para introduzir a cabeça do parafuso sem danificar o laminado.

Ø (mm)	Comprimento (mm)	Tipo de rosca	Tratamento	BFR440	BFR550	6842	6844	Unidades	Código	EAN	P.V.P. (€)
4,2	40	Fendida	Zincado	✓	✓	✓	✓	1000	F-31201	0088381291767	30,00

Parafuso anticorrosão

Ø (mm)	Comprimento (mm)	Tipo de rosca	Tratamento	BFR440	BFR550	6842	6844	Unidades	Código	EAN	P.V.P. (€)
3,9	32	D/G	Anticorrosão	✓	✓	X	X	1000	P-38283	0088381963879	28,00



Parafusos para aparafusador autoalimentado - AR410HR

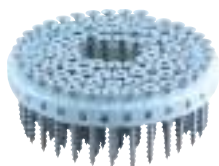

Ø cana (mm)	Ø cabeça (mm)	Comprimento (mm)	Tipo	Rosca	Modelo	Unidades/ caixa	Código	EAN	P.V.P. (€)
3,5	8,2	25	PH2	Fina	AR410HR	2.000	F-32830	0088381293396	32,00
3,5		28		Fina			F-32843	0088381293402	34,00
3,5		41		Fina			F-32856	0088381293419	36,00
3,8		25		Grosso			F-32869	0088381293426	31,00
3,8		28		Grosso			F-32872	0088381293433	32,00
3,8		32		Grosso			F-32885	0088381293440	34,00
3,8		41		Grosso			F-32898	0088381293457	40,00

Pregos de 0,6 mm (23Ga) Inox - DPT351 e DPT353



Ø (mm)	Comprimento (mm)	Tipo	Apalpa-folgas	Material	Modelos	Unidades/ caixa	Código	EAN	P.V.P. (€)
0,6	18	Pin	23Ga	Inox	DPT351 DPT353	10.000	F-32142	0088381292702	23,00
	25						F-32155	0088381292719	27,50
	30						F-32168	0088381292726	31,00
	35						F-32171	0088381292733	34,00

Pregos de 0,6 mm (23Ga) Aço - DPT351 e DPT353



Ø (mm)	Comprimento (mm)	Tipo	Apalpa-folgas	Material	Modelos	Unidades/ caixa	Código	EAN	P.V.P. (€)
0,6	18	Pin	23Ga	Aço	DPT351 DPT353	10.000	F-31825	0088381292382	13,00
	25						F-31838	0088381292399	14,00
	30						F-31841	0088381292405	15,50
	35						F-31854	0088381292412	17,50

Pregos de 1,2 mm (18Ga) - AF505N, DBN500 e DFN350



Ø (mm)	Comprimento (mm)	Tipo	Apalpa-folgas	Modelos	Unidades/ caixa	Código	EAN	P.V.P. (€)
1,2	20	Brad	18Ga	AF505N DBN500 DFN350*	5.000	P-45923	0088381976367	10,50
	25					P-45939	0088381976374	12,00
	30					P-45945	0088381976381	14,00
	40					P-45951	0088381976398	15,00
	50					P-45967	0088381976404	17,50

* Apenas até prego de 30 mm

Pregos de 1,4 mm (16Ga) Galvanizados. Cada caixa contém duas botijas de gás - GF600 e DBN600



Ø (mm)	Comprimento (mm)	Tipo	Apalpa-folgas	Unidades GÁS	Modelos	Unidades/ caixa	Código	EAN	P.V.P. (€)
1,4	15 mm	Brad	16Ga	2	GF600	2.000	195667-8	0088381399555	33,00
	19 mm						195668-6	0088381399562	34,00
	22 mm						195669-4	0088381399579	34,00
	25 mm						195670-9	0088381399586	35,00
	30 mm						195671-7	0088381399593	36,00
	32 mm						195672-5	0088381399609	36,00
	35 mm						195673-3	0088381399616	37,00
	38 mm						195674-1	0088381399623	38,00
	40 mm						195675-9	0088381399630	39,00
	45 mm						195676-7	0088381399647	41,00
	50 mm						195677-5	0088381399654	42,00
	57 mm						195678-3	0088381399661	45,00
	60 mm						195679-1	0088381399678	46,00
	64 mm						F-34027	0088381543897	20,00

Pregos multimaterial. Cada caixa contém uma botija de gás. - GN420C



Ø (mm)	Comprimento (mm)	Qualidade	Tipo	Unidades GÁS	Modelos	Unidades/caixa	Código	EAN	P.V.P. (€)
3,1	15	Premium	Para todos os tipos de materiais	1	GN420C	1000	196285-5	0088381422932	78,00
	17						196286-3	0088381422949	78,00
	22						196287-1	0088381422956	78,00
	27						196288-9	0088381422963	78,00
	32						196289-7	0088381422970	78,00



2,6	20	Standard	Para todos os tipos de materiais exceto betão	1	GN420C	1000	196290-2	0088381422987	72,00
	25						196291-0	0088381422994	72,00
	30						196292-8	0088381423007	72,00
	35						196293-6	0088381423014	72,00
	40						196294-4	0088381423021	72,00

Carregador de pregos - GN420C



Modelos	Unidades/caixa	unidades por carregamento	Código	EAN	P.V.P. (€)
GN420C	1	20	196246-5	0088381417891	195,00



Makita

Pregos multimaterial - AN250HC

- O prego de betão possui uma guia (casquilho de plástico) que impede que o prego se incline e permite um disparo reto, pregos de 19 a 25 mm e sem inclinação.
- Recomendações: Não pregar diretamente no betão, colocar o prego a 10 cm da extremidade do betão, colocar os pregos a 10 cm de distância mínima.



Ø cana (mm)	Ø cabeça (mm)	Comprimento (mm)	Tipo	Modelos	Unidades/caixa	Código	EAN	P.V.P. (€)
2,5	6,3	19	Liso	AN250HC	1000	F-33562	0088381294126	41,00
2,5		22				F-33575	0088381294133	50,00
2,5		25				F-33588	0088381294140	52,00
3		19				F-33591	0088381294157	78,00

Pregos cintados com papel com cabeça tipo "D" - GN900

- Aço brilhante: Utiliza-se em interiores.



Comprimento (mm)	Ø cabeça (mm)	Ø cana (mm)	Tipo	Pregos/réstia	Réstias por caixa	Modelos	Unidades/caixa	Código	EAN	P.V.P. (€)
51	7,2	2,9	Anelado	40	84	GN900	3.300	194764-7	0088381351508	80,00
63		2,9	Anelado				3.300	194767-1	0088381351539	86,00
90		3,1	Liso				2.200	194776-0	0088381351621	71,00
75		3,1	Anelado				2.200	194772-8	0088381351584	65,00
51		2,9	Anelado				1.100	194780-9	0088381351669	31,00
63		2,9	Anelado				1.100	194784-1	0088381351706	32,00

- Aço galvanizado: o mais popular, está protegido contra a corrosão, costuma utilizar-se no exterior.



Comprimento (mm)	Ø cabeça (mm)	Ø cana (mm)	Tipo	Pregos/réstia	Réstias por caixa	Modelos	Unidades/caixa	Código	EAN	P.V.P. (€)
63	7,2	2,9	Anelado	40	84	GN900	4.000	P-77067	0088381707817	81,00
51		2,9	Anelado				3.300	194765-5	0088381351515	88,00
57		2,9	Anelado				3.300	194766-3	0088381351522	91,00
63		3,1	Anelado				2.200	194770-2	0088381351560	69,00
75		3,1	Anelado				2.200	194773-6	0088381351591	77,00
90		3,1	Liso				2.200	194777-8	0088381351638	84,00
51		2,9	Anelado galvanizado				1.100	194782-5	0088381351683	33,00
63		2,9	Anelado galvanizado				1.100	194785-9	0088381351713	36,00
63		3,1	Anelado galvanizado				1.100	194788-3	0088381351744	38,00
75		2,9	Anelado galvanizado				1.100	194792-2	0088381351782	38,00

- Aço galvanizado por fundição: alta resistência à corrosão para uso externo.



Comprimento (mm)	Ø cabeça (mm)	Ø cana (mm)	Tipo	Pregos/réstia	Réstias por caixa	Modelos	Unidades/caixa	Código	EAN	P.V.P. (€)
63	7,2	2,9	Anelado	40	84	GN900	3.300	194769-7	0088381351553	134,00
63		3,1	Anelado				2.200	194771-0	0088381351577	97,00
75		3,1	Anelado				2.200	194774-4	0088381351607	108,00
75		3,1	Roscado				2.200	194775-2	0088381351614	108,00
90		3,1	Liso				2.200	194778-6	0088381351645	123,00
90		3,1	Roscado				2.200	194779-4	0088381351652	127,00
57		2,9	Anelado				1.100	194783-3	0088381351690	44,00
63		2,9	Anelado				1.100	194786-7	0088381351720	46,00
63		3,1	Anelado				1.100	194790-6	0088381351768	49,00
75		3,1	Anelado				1.100	194793-0	0088381351799	55,00
83		3,1	Anelado				1.100	194794-8	0088381351805	59,00
90		3,1	Liso				1.100	194797-2	0088381351836	62,00

* Todas as caixas são fornecidas sem gás.

Pregos em bobina para pregadoras de madeira



Comprimento (mm)	Ø cabeça (mm)	Ø cana (mm)	Tipo	AN610H 32-65 mm	AN711H 45-75 mm	AN930H 45-90 mm	AN902 45-90 mm	Unidades	Código	EAN	P.V.P. (€)
45	5,8	2,5	Liso	✓	✓	✓	✓	10.800	F-30810	0088381291378	69,00
50	6,0	2,5	Anelado	✓	✓	✓	✓	10.800	F-30865	0088381291422	85,00
50	6,0	2,5	Liso	✓	✓	✓	✓	10.800	F-31243	0088381291804	70,00
57	6,0	2,5	Anelado	✓	✓	✓	✓	8.100	F-30878	0088381291439	67,00
57	6,0	2,5	Liso	✓	✓	✓	✓	8.100	F-31256	0088381291811	60,00
65	6,0	2,5	Liso	✓	✓	✓	✓	8.100	F-30900	0088381291460	72,00
65	6,0	2,5	Anelado	✓	✓	✓	✓	8.100	F-31269	0088381291828	77,00
50	6,8	2,9	Liso		✓	✓	✓	9.000	F-30849	0088381291408	78,00
50	7,0	2,9	Anelado		✓	✓	✓	9.000	F-30971	0088381291538	96,00
57	7,0	2,9	Anelado		✓	✓	✓	6.750	F-31272	0088381291835	68,00
65	7,0	2,9	Anelado		✓	✓	✓	6.750	F-30881	0088381291446	79,00
65	7,3	3,1	Liso		✓	✓	✓	6.075	F-30836	0088381291392	68,00
75	7,2	3,1	Liso		✓	✓	✓	4.050	F-31298	0088381291859	56,00
75	7,0	3,2	Anelado		✓	✓	✓	4.050	F-31320	0088381291880	69,00
85	7,2	3,1	Liso			✓	✓	4.050	F-31304	0088381291866	69,00
85	7,0	3,1	Anelado			✓	✓	4.050	F-31333	0088381291897	74,00
90	7,5	3,1	Liso			✓	✓	4.050	F-31317	0088381291873	75,00
65	7,1	3,3	Liso		✓	✓	✓	4.050	F-30852	0088381291415	45,00
75	7,5	3,4	Liso		✓	✓	✓	3.600	F-31359	0088381291910	67,00
32	5,0	2,1	Liso	✓	✓	✓		21.600	F-32766	0088381293327	59,00
38	5,0	2,1	Liso	✓	✓	✓		18.000	F-32779	0088381293334	71,00
45	5,0	2,1	Liso	✓	✓	✓		18.000	F-32782	0088381293341	90,00
50	5,0	2,1	Liso	✓	✓	✓		14.400	F-32795	0088381293358	64,00

Agrafos

Agrafos de 90 - AT638



Largura do agrafó (mm)	Comprimento (mm)	Tipo	Modelos	Unidades/caixa	Código	EAN	P.V.P. (€)
1/4"	15	18Ga	AT638	5.000	P-45864	0088381976305	13,50
	18				P-45870	0088381976312	14,50
	25				P-45886	0088381976329	18,00
	30				P-45892	0088381976336	20,50
	35				P-45901	0088381976343	22,50
	38				P-45917	0088381976350	25,50

Agrafos para máquinas a bateria

Boião de óleo



Largura do agrafó (mm)	Comprimento (mm)	Modelos	Unidades caixa	Código	EAN	P.V.P. (€)
------------------------	------------------	---------	----------------	--------	-----	------------

DST221

10	10	DST221 T221D	5.000	F-32647	0088381293204	13,50
	13			F-32650	0088381293211	12,00
	16			F-32663	0088381293228	16,00
	19			F-32676	0088381293235	18,00
	22			F-32689	0088381293242	19,00

ST113D e DST112

10	7	ST113D DST112	2.500	F-81518	0088381342308	7,50
	10			F-81521	0088381342322	7,50



Conteúdo	Modelos	Unidades	Código	EAN	P.V.P. (€)
30 ml	Todos	1	181434-7	0088381194747	1,00

DIVERSOS

Botija de gás



Modelos	Unidades	Código	EAN	P.V.P. (€)
GN900 GN420C	1	242094-1	0088381415712	16,00

Óleo lubrificante



Modelos	Unidades	Código	EAN	P.V.P. (€)
GN900 GN420C	1	242077-1	0088381351973	10,50

Botija de gás



Modelo	Unidades	Código	EAN	P.V.P. (€)
GF600	1	242088-6	3240890377913	14,00

Spray de limpeza



Modelos	Unidades	Código	EAN	P.V.P. (€)
GN900 GN420C	1	242075-5	0088381351966	19,00

Óculos de segurança



Modelos	Unidades	Código	EAN	P.V.P. (€)
Todos	1	195246-2	0088381365413	4,00

Kit de limpeza



Modelos	Unidades	Código	EAN	P.V.P. (€)
GN900 GN420C GF600	1	194852-0	0088381351959	44,00

Acessórios para alta pressão

Mangueiras - AC310H



B-80008



B-80014

Conteúdo	Modelo	Unidades	Código	EAN	P.V.P. (€)
Mangueira 30 m com enrolador	AC310H	1	B-80008	0088381350747	503,00
Mangueira 30 m		1	B-80020	0088381350761	286,00
Mangueira de 15 m		1	B-80014	0088381350754	195,00
Mangueira de 7,5 m		1	B-80036	0088381350778	159,00

Carrinho de transporte - AC310H



Conteúdo	Modelo	Unidades	Código	EAN	P.V.P. (€)
Carrinho de transporte	AC310H	1	HY00000212	0088381351188	139,00



Aspiração



**Vasta gama de aspiradores a bateria.
Potentes - Leves - Manobráveis.**

**18V
LITIO-ION**



Para mais informações, consulte o catálogo de ferramentas.

Acessórios para aspiradores



Modelo + acessório

Aspirador + acessório

Modelo + acessório

Aspirador + acessório

1100



KP312S



1806B

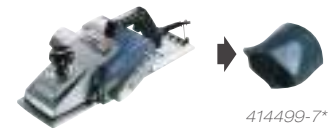

KP0810
KP0810C



KP0800



RP1800X
RP2300FC



RP0900



LS0714F
LS1018L
LS1016F
MLS100
LS1040F
LH1040F
LS1016FLB
LS1216F
LF1000
LS1440
LS1216FLB



VC3012L
VC4210LX



+



+



N9741



SG1251
SG1250
SG150



PC5001C

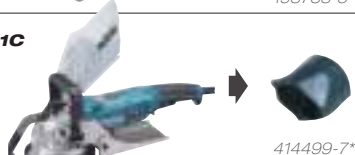

* Incluído no equipamento básico da máquina.

VC3012L
VC4210LX



+



+



4112HS
4114S



N4105KB



GA9030



** Inclui bocal 192613-2 no equipamento básico do acessório.

VC3012L
VC4210LX



+



+



* Incluído no equipamento básico da máquina.

Tabela esquemática



Modelo + acessório

Aspirador + acessório

Modelo + acessório

Aspirador + acessório

- 9032
- 9910
- 9911
- BO4556K
- BO4565K
- BO4566
- BO3711
- 9046
- BO4900V
- BO4901
- BO5030
- BO5031
- BO5040
- BO5041
- BO6030
- BO6040



3706



193449-2*

- HR1830
- HR2230
- HR2460
- HR2470
- HR2470FT
- HR2800
- HR2810
- HR2810T
- HR2811FT



193472-7

- HR2300
- HR2610
- HR2600

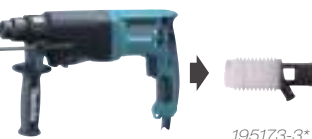

195173-3*

- HR2611FT
- HR2610T



195180-6*

- 3901
- PJ7000



415252-4*

- 9031
- 9903
- 9920
- 9404
- 9402
- 9403



VC3012L
VC4210LX



+



+



VC3012L
VC4210LX



+



+



- 5903R
- 5903RK
- 5103R



192419-8*

- 5604R
- 5017RKB



- SP6000



- 5008MG



450079-5*

- 5603RK
- 5704R
- 5705RK



192420-3*

- 5143R



415816-4*

VC3012L
VC4210LX



+



+



* Incluído no equipamento básico da máquina.

Tabela esquemática



Modelo + acessório

Aspirador + acessório

Modelo + acessório

Aspirador + acessório

4326
4327
4328
4329K



4350T
4350CT
4350FCT
4351CT
4351FCT



RP0910
RP1110C



417853-4*

122609-9*

122615-4*

VC3012L
VC4210LX



+



+



Rebarbadoras
125 mm



196845-3

VC3012L
VC4210LX



+



+



* Incluído no equipamento básico da máquina.



VC2012L



VC3011L



VC2512L



P-72942

417408-5



P-70421



192613-2



P-81745



W14295



W29541



P-70465

Modelo + acessório

Aspirador + acessório

Modelo + acessório

Aspirador + acessório

Rebarbadoras
125 mm



196845-3

SG1251
SG1250
SG150



VC2012L
VC3011L
VC2512L



+



+



Amoladoras
230 mm



198440-5**

** Inclui bocal 192613-2 no equipamento básico do acessório.

VC2012L
VC3011L
VC2512L



+



+



+

Acessórios para aspiradores



Modelo + acessório

Aspirador + acessório

Modelo + acessório

Aspirador + acessório

9031



9903

9920

9404

9402

9403



3901

PJ7000



415252-4*

4326

4327

4328

4329K



4350T

4350CT

4350FCT

4351CT

4351FCT



417853-4*

HR1830

HR2230

HR2460

HR2470

HR2470FT

HR2800

HR2810

HR2810T

HR2811FT



193472-7

VC2012L

VC3011L

VC2512L



+



+



+



B04556

B04565

B04566



B03711

B04900I

B04901

9046



B05030

B05031

B05040

B05041

B06030

B06040



415252-4*

9910

9911



3706



193449-2*

9032



122652-8

VC2012L

VC3011L

VC2512L



+



+



+



* Incluído no equipamento básico da ferramenta.

Bolsas

Para modelos elétricos



P-72899



P-70194



P-70203



W107418353



W107418355

Descrição	Unidades	VC2012L	VC2512L	VC3011L	VC3012L	VC4210LX	Código	EAN	P.V.P. (€)
Saco de feltro	5	✓	✓	✓	-	-	P-72899	0088381703550	25,00
Saco de papel	5	-	-	-	✓	-	P-70194	0088381700757	30,00
Saco de papel	5	-	-	-	-	✓	P-70203	0088381700764	56,00
Saco de feltro	5	-	-	-	-	✓	W107418353	0088381490153	35,00

Sacos de plástico



P-70297



P-70306



W107418353

Descrição	Unidades	VC2012L	VC2512L	VC3011L	VC3012L	VC4210LX	Código	EAN	P.V.P. (€)
Saco de plástico com papel	5	✓	✓	✓	-	-	P-70297	0088381700856	23,00
Saco de plástico	5	-	-	-	✓	-	P-70306	0088381700863	61,00
Bolsa de plástico	5	-	-	-	-	✓	W107418355	0088381490177	32,00

Para modelos a bateria



197903-8



197899-3



194566-1



166043-3



195557-5

Descrição	Unidades	DCL180	DCL281	DVC260	DVC261	DVC265	DVC150LZ	DVC154LZ	DVC860L	DVC862L	DVC864L	Código	EAN	P.V.P. (€)
Saco de papel	10	-	-	✓	✓	✓	-	-	-	-	-	197903-8	0088381468107	27,00
Saco de nylon	1	-	-	✓	✓	✓	-	-	-	-	-	197899-3	0088381468060	24,00
Saco de papel	5	✓	✓	-	-	-	-	-	-	-	-	194566-1	0088381351270	3,50
Saco de nylon	1	✓	✓	-	-	-	-	-	-	-	-	166043-3	0088381140720	2,00
Saco de nylon	5	-	-	-	-	-	-	-	✓	✓	✓	195557-5	0088381370479	23,00

Tubos flexíveis para aspiradores

Para modelos elétricos



P-81739



P-70487



W25537



P-84084

Descrição	Unidades	Adaptador no tubo	VC2012L	VC2512L	VC3011L	VC3012L	VC4210LX	Código	EAN	P.V.P. (€)
Tubo de ø 32 mm x 3,5 m	1	-	✓	✓	✓	-	-	P-81739	0088381457552	35,00
Tubo de ø 27 mm x 3,5 m Antiestático	1	P-70415	-	-	-	✓	✓	P-70487	0088381701044	40,00
Tubo de ø 36 mm x 4,0 m Recomendado para a limpeza de pisos.	1	-	-	-	-	✓	✓	W25537	-	36,00
Tubo de ø 36 mm x 4 m Antiestático.	1	P-70415	-	-	-	✓	✓	P-84084	0088381483896	63,00

Para modelos a bateria



143787-2



A-34235*

* Inclui bocal de 22 mm



195434-1



195433-3*

* Inclui bocal de 22 e 24 mm



198544-3

Dimensões	Unidades	DCL180	DCL281	DVC260	DVC261	DVC265	DVC150LZ	DVC154LZ	DVC860L	DVC862L	DVC864L	Código	EAN	P.V.P. (€)
28 mm x 1 m	1	-	-	✓	✓	✓	-	-	-	-	-	143787-2	0088381485838	28,50
28 mm x 1,5 m	1	-	-	✓	✓	✓	-	-	-	-	-	A-34235	0088381163293	34,00
38 mm x 2,5 m	1	-	-	-	-	-	✓	✓	✓	✓	✓	195434-1	0088381370271	57,00
28 mm x 3,5 m	1	-	-	-	-	-	✓	✓	✓	✓	✓	195433-3	0088381370264	54,00
28 mm x 430 mm	1	✓	✓	-	-	-	-	-	-	-	-	198544-3	0088381484442	7,75



Tubos

Tubos curvos para modelos elétricos



Anel regulador de ar

P-72908



P-70346



W302000447

Descrição	Unidades	VC2012L	VC2512L	VC3011L	VC3012L	VC4210LX	Código	EAN	P.V.P. (€)
Para tubo de 32 mm	1	✓	✓	✓	-	-	P-72908	0088381703567	22,50
Para tubo de 36 mm INOX. Curvo. Sem adaptador.	1	-	-	-	✓	✓	P-70346	0088381700900	28,00
Para tubo de 36 mm INOX. Curvo. Com adaptador.	1	-	-	-	✓	✓	W302000447	3240890251589	43,00

Tubos retos para modelos elétricos



P-72908



P-70437



W107418350

Descrição	Unidades	VC2012L	VC2512L	VC3011L	VC3012L	VC4210LX	Código	EAN	P.V.P. (€)
Alumínio ø 36 x 520 mm	1	✓	✓	✓	-	-	P-72942	0088381703604	26,00
Inox ø 36 x 505 mm	1	-	-	-	✓	-	P-70437	0088381700993	32,00
Conjunto de tubos retos VC4210	1	-	-	-	-	✓	W107418350	0088381490122	32,00

Tubos para modelos a bateria



192562-3



126756-8



198560-5



451244-9



192563-1

Descrição	Unidades	DCL180	DVC260	DVC261	DVC265	DVC150LZ	DVC154LZ	DVC860L	DVC862L	DVC864L	Código	EAN	P.V.P. (€)
Tubo curvo de alumínio 38 mm	1	-	-	-	-	✓	✓	✓	✓	✓	192562-3	0088381141116	8,25
Tubo curvo de 28 mm	1	-	✓	✓	✓	-	-	-	-	-	126756-8	0088381548403	7,75
Tubo extensível 28 mm	1	-	✓	✓	✓	-	-	-	-	-	198560-5	0088381484589	22,00
Tubo reto 28 mm	1	✓	-	-	-	-	-	-	-	-	451244-9	-	3,75
Tubo extensível alumínio 38 mm	1	-	-	-	-	✓	✓	✓	✓	✓	192563-1	0088381141123	8,00

Escovas de aspiração

Para modelos elétricos (tubo Ø 36 mm)



P-70465

W107402706

W8046

P-72958

P-72964

Descrição	Unidades	VC2012L	VC2512L	VC3011L	VC3012L	VC4210LX	Código	EAN	P.V.P. (€)
Escova para carpetes 275 mm (seco/molhado) Base de plástico	1	✓	✓	✓	-	-	P-70465	0088381701020	29,00
Escova para carpetes 275 mm (seco/molhado) Base de chapa	1	✓	✓	✓	-	-	W107402706	-	14,00
Escova para carpetes 275 mm (seco/molhado) Base de chapa	1	-	-	-	✓	✓	W8046	3240890251503	31,00
Escova de 350 mm (seco/molhado) Ideal para construção civil	1	-	-	-	✓	✓	P-72958	0088381703611	45,00
Escova extragrande de 405 mm (seco/molhado) Ideal para construção civil	1	-	-	-	✓	✓	P-72964	0088381703628	55,00

Para modelos a bateria (tubo Ø 28 mm)



198149-9

198533-8

122520-5

198532-0

Descrição	Unidades	DCL180	DCL281	DVC260	DVC261	DVC265	DVC150LZ	DVC154LZ	DVC860L	DVC862L	DVC864L	Código	EAN	P.V.P. (€)
Para seco 220 mm	1	-	-	-	-	-	✓	✓	✓	✓	✓	198149-9	0088381475020	14,00
Para molhado 320 mm	1	-	-	-	-	-	✓	✓	✓	✓	✓	198533-8	0088381484336	23,50
Para piso 230 mm	1	✓	✓	-	-	-	-	-	-	-	-	122520-5	0088381141260	7,75
Para piso/carpete 220 mm	1	-	-	✓	✓	✓	-	-	-	-	-	198532-0	0088381484329	22,50



Bocais de aspiração

Para modelos elétricos

• Modelos de aspiradores: VC2012L, VC2512L, VC3011L, VC3012L y VC4210LX.



Descrição	Código	EAN	P.V.P. (€)
Escova para tapete 230 PP/PA (tubo Ø 36 mm)	P-70471	0088381701037	9,25



Bocal para ranhuras (tubo Ø 36 mm)	W6084	0088381431095	5,00
------------------------------------	-------	---------------	------



Bocal para ranhuras (tubo Ø 36 mm)	W29541	-	4,25
------------------------------------	--------	---	------



Bocal flexível (tubo Ø 36 mm)	W5067	3240890251527	12,00
-------------------------------	-------	---------------	-------

Para modelos a bateria

Escova redonda



Ø mm	Unidades	Código	EAN	P.V.P. (€)
28	1	198552-4	0088381484527	5,25

Bocal de esquina

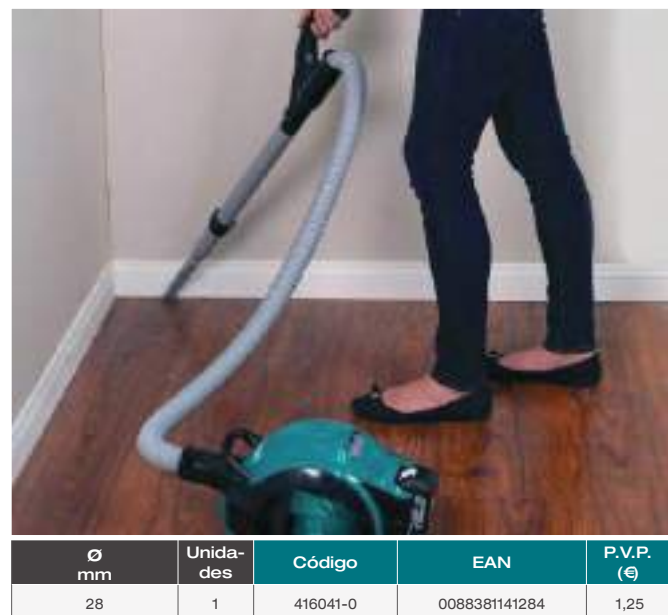

Ø mm	Unidades	Código	EAN	P.V.P. (€)
28	1	416041-0	0088381141284	1,25

Escova



Ø mm	Unidades	Código	EAN	P.V.P. (€)
28	1	198537-0	0088381484374	7,00

Bocal flexível



Bocal cónico grande



Ø mm	Modelos	Unidades	Código	EAN	P.V.P. (€)
28	DCL180 DVC260	1	192236-6	0088381117746	5,50

Conjunto de aspiração

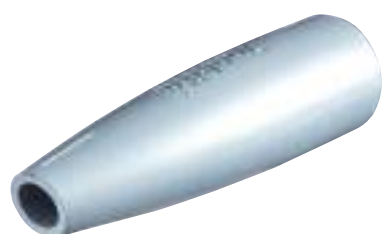

Ø mm	Modelos	Unidades	Código	EAN	P.V.P. (€)
28	DCL180 DVC260	1	197901-2	0088381468084	6,00

Modelo	Unidades	Código	EAN	P.V.P. (€)
4014N	1	191750-9	0088381125130	13,00

Vários



Descrição	Código	EAN	P.V.P. (€)
Makita SET - Tubo ø 36 x 4000 mm. - Tubo curvo de crómio. - 2 x tubo reto de 500 mm de crómio. - Escova de 350 mm para a limpeza de pisos	P-70328	0088381700887	100,00
Ligação dupla	W15331	-	15,50
Bocal rotativo para tubo de 36 mm	P-70390	0088381700955	14,50
Bocal rotativo para tubo de 27 mm	P-70409	0088381700962	14,00

Adaptadores de ligação para tubos de aspirador

Para modelos elétricos



Descrição	Código	EAN	P.V.P. (€)
Adaptador para tubo de 27 mm Int. 25 mm. Ext. 38 mm.	P-70415	0088381700979	9,50
Adaptador para tubo de 36 mm Int. 38 mm. Ext. 46 mm.	P-70421	0088381700986	17,50
Adaptador para tubo de 32 mm. Int. 25 mm. Ext. 38 mm. (*Para os modelos VC2010L, VC2511 e VC3511L)	*P-72936	0088381703598	11,50
Adaptador para tubo de 32 mm. Int. 25 mm. Ext. 38 mm. (*Para modelos VC2012L, VC2512L e VC3011L)	*P-81745	0088381457569	20,50
Adaptador ext. 25 mm Int. 20 mm. Ext. 25 mm. Int. 23 mm.	192349-3	0088381126229	7,50
Adaptador para tubo ø 27 mm Int. 22 mm. Ext. 29 mm.	417408-5	0088381700955	1,90
Adaptador curvo com fecho int. de 32 mm. Ext. 37 mm.	192613-2	0088381700955	14,00
Bocal para o modelo 9032.	122652-8	0088381700931	2,50
Adaptador de mangueira VC4210LX	P-70378	0088381700931	21,00

Para modelos a bateria



Ø mm	Ø saída	Modelos	Unidades	Código	EAN	P.V.P. (€)
28	22	DVC860L DVC862L	1	195547-8	0088381370349	2,75
28	24	DVC260 DVC261	1	195546-0	0088381370332	3,75
28	38	DVC265	1	195545-2	0088381370325	6,50

Filtros

Para modelos elétricos



P-70219



P-70225



Descrição	Unidades	VC2010L	VC2012L	VC2511L	VC2512L	VC3011L	VC3012L	VC3511L	VC4210LX	446LX	447LX	Código	EAN	P.V.P. (€)
PET	1	✓	✓	✓	✓	✓	✓	✓	-	✓	-	P-70219		36,00
PET	1	-	-	-	-	-	-	-	-	-	✓	P-70225		61,00
PET	1	-	-	-	-	-	-	-	✓	-	-	W107413540		60,00

Para modelos a bateria



123636-9



197166-6



443060-3



451208-3

Descrição	Unidades	DCL180	DCL281	DVC260	DVC261	DVC265	DVC150LZ	DVC154LZ	DVC860L	DVC862L	DVC864L	Código	EAN	P.V.P. (€)
HEPA	1	-	-	✓	-	-	-	-	-	-	-	123636-9	-	9,00
HEPA	1	-	-	-	-	-	-	-	✓	✓	✓	197166-6	-	59,00
Filtro de tela	1	✓	-	-	-	-	-	-	-	-	-	443060-3	0088381123853	1,00
Pré-filtro	1	✓	-	-	-	-	-	-	-	-	-	451208-3	0088381359993	1,75



Acessórios para DRC200



Descrição	Unidades	Código	EAN	P.V.P. (€)
Cobertura de escova	1	SH00000064	-	39,00



Descrição	Unidades	Código	EAN	P.V.P. (€)
Escova de recolha	1	SH00000063	-	80,00



Descrição	Unidades	Código	EAN	P.V.P. (€)
Fita de delimitação 15 m	1	SH00000231	-	58,00



Descrição	Unidades	Código	EAN	P.V.P. (€)
Escova lateral	2	SH00000065	-	45,00



Descrição	Unidades	Código	EAN	P.V.P. (€)
Filtro de pó	1	SH00000213	-	80,00





ACESSÓRIOS. ASPIRAÇÃO

Acessórios para UB1103

Conjunto flexível



Modelo	Unidades	Código	EAN	P.V.P. (€)
UB1103	1	196643-5	0088381437325	13,00

Lanças



123245-4

123246-2



196729-5

Descrição	Unidades	Código	EAN	P.V.P. (€)
220 mm	1	123245-4	0088381451215	5,00
430 mm	1	123246-2	0088381437332	11,00
Curva	1	196729-5	0088381434973	20,00

Conjunto flexível



Modelo	Unidades	Código	EAN	P.V.P. (€)
UB1103	1	123241-2	0088381437103	7,50





Níveis laser





Novos níveis laser em cruz de alta visibilidade.

Muito **compactos** e **precisos** graças à tecnologia **CXT**.



Níveis laser em cruz. Raio **vermelho**:

Linha em cruz + Ponto
SK106D

Linha em cruz
SK105D



Níveis laser em cruz. Raio **verde**:

Linha em cruz + Ponto
SK106GD

Linha em cruz
SK106D



Tripés



Tipo	Descrição	Rosca	Unidades	Código	EAN	P.V.P. (€)
1	Tripé alumínio 1,65 m máx.	5/8"	1	P-81088	0088381449564	78,00
2	Tripé alumínio 2,70 m máx.	5/8"	1	P-81315	0088381451291	232,00
3	Tripé 1,58 m máx.	1/4"	1	B-8539	3240890901187	46,00
4	Tripé 1800 para SK09	1/4"	1	TK0LM4001F	0088381442374	137,00
5	Tripé 2900 para SK09	1/4"	1	TK0LM5030F	0088381442381	198,00



Acessórios para SK209



Tipo	Descrição	Unidades	Código	EAN	P.V.P. (€)
1	Cabo USB	1	199010-3	0088381519663	12,50
2	Suporte de recetor laser	1	TK0LDG301G	0088381488853	312



Comando remoto SKR200



Descrição	Rosca	Unidades	Código	EAN	P.V.P. (€)
Comando remoto	SKR200Z	1	LE00796588	3240890394163	56,00

Recetor LR150 e suporte de recetor



Tipo	Descrição	Modelo	Unidades	Código	EAN	P.V.P. (€)
1	Recetor LR150	SKR200Z	1	LE00796587	3240890394156	303,00
2	Suporte do recetor	SKR200Z	1	LE00784968	3240890394200	62,00

Régua graduada de alumínio



Comprimento	Unidades	Código	EAN	P.V.P. (€)
1,2 - 4,0 m	1	P-81309	0088381451178	66,00

Suportes



Descri.	Descrição	Modelo	Unidades	Código	EAN	P.V.P. (€)
1	Suporte parede	SKR200Z	1	LE00791661	3240890394170	90,00
2	Suporte parede	SK104Z SK103PZ	1	LE00785637	3240890328847	112,00
3	Suporte magnetizado	SK104Z SK103PZ	1	LE00785633	3240890347763	14,00
4	Suporte parede	SK105 SK106	1	LE00789389	0088381488860	41,00



Comando remoto para SK104 e SK103



Descrição	Modelo	Unidades	Código	EAN	P.V.P. (€)
Comando detetor	SK104Z SK103PZ	1	LE00837085	0088381488877	154,00

Cartão magnético



Descrição	Unidades	Código	EAN	P.V.P. (€)
Cartão magnético	1	LE00785638	3240890328830	15,50

Bolsa



Descrição	Modelo	Unidades	Código	EAN	P.V.P. (€)
Bolsa	SK104Z SK103PZ	1	LE00822220	-	28,50

Óculos para medidor laser



Descrição	Unidades	Código	EAN	P.V.P. (€)
Óculos para medidor laser	1	LE00834534	-	18,00



Roedoras e tesouras



Capacidade de corte circular JN1601 e JN3201

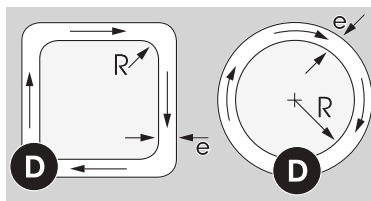

D	21 mm.	JN1601
e	5 mm.	
R	50 mm.	
D	42 mm.	JN3201
e	8 mm.	
R	128 mm.	

JS8000



Descrição	Unidades	Código	EAN	P.V.P (€)
Cabeça completa	1	125354-5	3240890285218	116,00
Lâmina central	1	725129-8	0088381341455	63,00
Lâmina lateral	1	725130-3	0088381341448	54,00

Punções



Modelo	Unidades	Código	EAN	P.V.P (€)
JN1601 DJN161	1	A-83951	0088381146630	24,00
JN3200 JN3201	1	792728-1	0088381130882	25,00

Lâmina central



Modelo	Unidades	Código	EAN	P.V.P (€)
JS1601	1	792534-4	0088381105477	55,00
JS1000	1	792537-8	0088381105484	71,00

Jogo de lâminas



Modelo	Unidades	Código	EAN	P.V.P (€)
JS1602	1	191383-0	0088381111874	28,00
JS1601	1	792533-6	0088381105453	42,00
JS1000	1	792536-0	0088381105460	42,00
JS3200 JS3201	1	792287-5	0088381103589	31,00

Matrizes



Modelo	Unidades	Código	EAN	P.V.P (€)
JN1601 DJN161	1	A-15051	0088381130219	21,00
JN3200 JN3201	1	792292-2	0088381103619	25,00

Jogo calibrador de folgas



Modelo	Unidades	Código	EAN	P.V.P (€)
JS1601	1	762013-6	0088381102162	3,50
JS3200 JS3201	1	762007-1	0088381102155	4,20

Chaves Allen

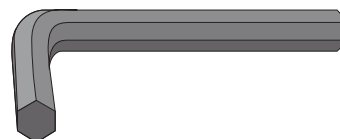

Modelo	Unidades	Código	EAN	P.V.P (€)
JS1601 JS1602 JS1000 JN3201	1	783201-2	0088381101288	1,00
JN1601	1	783208-8	0088381152624	1,00
JS3200 JS3201	1	783202-0	0088381102667	1,00

Chaves para roedoras



Modelo	Unidades	Código	EAN	P.V.P (€)
JN1601	1	781028-4	0088381152600	2,70
JN3200 JN3201	1	781019-5	0088381102452	3,00

Anilha complementar

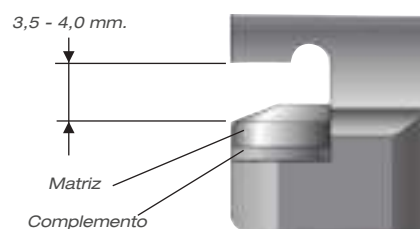

Modelo	Unidades	Código	EAN	P.V.P (€)
JN3200 JN3201	1	341796-7	0088381152298	1,00



Jardim



Barras e correntes para motosserras e eletrosserras

DUC122



DUC254



DUC254C



DUC252



DUC353
DUC355



UC4041A



UC3550A



UC4050A
ES2141KX



EA3110T25B
PS311TH/25



EA3200S35B
PS32C/35



EA3201S35A
PS32CTL/35



EA3500F35B
PS35C/35



EA4300F38C
PS420SC/38



DCS460/38
PS460/38



DCS500/45
PS500/45



DCS5030/45
PS5105C/45



DCS7301/50
PS7310/50



BARRAS				
Características	Unidades	Código	EAN	P.V.P. (€)
11,5 cm 1/4"	1	158476-6	0088381354660	14,50
25 cm 3/8" b.p.	1	161846-0	0088381540216	14,00
25 cm 1/4"	1	168407-7	0088381197786	45,00
25 cm (10") 3/8" - b.p.	1	168408-5	0088381197571	11,00
35 cm (14") 3/8" - b.p.	1	412035661	4002829361450	13,00
40 cm (16") 3/8" - b.p.	1	165247-4	0088381358569	21,00
35 cm (14") 3/8" - b.p.	1	412035661	4002829361450	13,00
40 cm (16") 3/8" - b.p.	1	165247-4	0088381358569	21,00
25 cm (10") 3/8" - b.p.	1	168408-5	0088381197571	11,00
35 cm (14") 3/8" - b.p.	1	412035661	4002829361450	13,00
35 cm (14") 3/8" - b.p.	1	412035661	4002829361450	13,00
35 cm (14") 3/8" - b.p.	1	412035661	4002829361450	13,00
38 cm (15") 0,325"	1	414038141	4002829428078	19,00
38 cm (15") 0,325"	1	415038631	4002829428221	24,00
45 cm (18") 0,325"	1	415045631	4002829428238	26,00
45 cm (18") 3/8"	1	958500044	4002829000847	26,00
50 cm (20") 3/8"	1	415050655	4002829476642	28,00

CORRENTES				
Características	Unidades	Código	EAN	P.V.P. (€)
1/4" 25AP 42 elos	1	791284-8	0088381141741	13,50
3/8" b.p. 0,50	1	199075-5	0088381527767	12,50
1/4" 25AP 60 elos	1	194098-8	0088381197656	22,00
3/8" b.p. - 0,50 91VG 40 elos	1	511492740	4002829806609	13,00
3/8" b.p. - 0,50 91VG 52 elos	1	511492752	4002829806883	12,50
3/8" b.p. - 0,50 90SG 56 elos	1	511291756	4002829845172	12,50
3/8" b.p. - 0,50 91VG 52 elos	1	511492752	4002829806883	12,50
3/8" b.p. - 0,50 91VG 56 elos	1	511492756	4002829807125	13,00
3/8" b.p. - 0,50 91VG 40 elos	1	511492740	4002829806609	13,00
3/8" b.p. - 0,50 91VG 52 elos	1	511492752	4002829806883	12,50
3/8" b.p. - 0,50 91VG 52 elos	1	511492752	4002829806883	12,50
0,325" - 0,50 95VP 64 elos	1	512484764	4002829782620	14,00
0,325" - 0,58 21BP 72 elos	1	528086764	4002829783092	15,00
0,325" - 0,58 21BP 72 elos	1	528086772	4002829783375	16,50
3/8" - 0,58 73DP 64 elos	1	523093764	4002829783030	15,00
3/8" - 0,58 73LP 72 elos	1	528099772	4002829783313	18,50

Resguardos de lâmina para motosserras e eletrosserras

Resguardos de lâmina					
Modelo	Características	Unidades	Código	EAN	P.V.P. (€)
DUC122RFE		1	416311-7	0088381144209	4,00
DUC254		1	199067-4	-	3,00
PS220TH		1	199067-4	-	3,00
DUC252		1	452093-7 R	-	1,90
DUC353		1	952010640	4002829615454	4,20
UC4041A		1	419242-9	-	2,50
UC3550A		1	952010640	4002829615454	4,20
UC4050A		1	952010640	4002829615454	4,20
EA3110T25B	Resguardos de lâmina	1	452093-7 R	-	1,90
EA3200S35B		1	952010640	4002829615454	4,20
EA3201S35A		1	952010640	4002829615454	4,20
EA3500F35B		1	952010640	4002829615454	4,20
EA4300F38C		1	952010640	4002829615454	4,20
DCS460/38		1	952010640	4002829615454	4,20
DCS500/45		1	952010640	4002829615454	4,20
DCS5030/45		1	952010640	4002829615454	4,20
DCS7301/50		1	952020660	4002829615515	6,50



Nova serra de poda a bateria de 18 V com uma eficiência equivalente a uma motosserra de 25 cc.



DUC254
Ideal para podar



- Acesso fácil ao depósito de óleo da corrente. Depósito de óleo de corrente.
- Gatilho com velocidade variável.
- Interruptor principal. Com função de corte automático.
- Interruptor principal. Com função de corte automático.
- Bomba de lubrificação de corrente regulável.

Tração direta.

250 mm
22,5m/seg
3,3 kg

LXT
Li-Ion EXTREMA TECNOLOGIA

XPT
EXTREME PROTECTION TECHNOLOGY

BL
MOTOR



Alta velocidade de corte.



Pala para ramagem

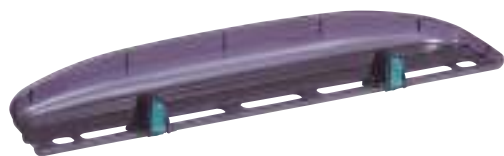

Modelo	Unidades	Código	EAN	P.V.P. (€)
UH201	1	198401-5	-	8,00
UH5570 UH5580 UH6570 UH6580	1	194681-1	0088381354349	22,00
EH7500S	1	195321-4	0088381403375	19,00



Sistema de desconexão automática elétrica



• Para todos os modelos elétricos.

Características	Unidades	Código	EAN	P.V.P. (€)
Fecho de prolongador	1	158024-1	0088381122955	1,50

Lima redonda



Ø de lima	Tipo de corrente	Unidades	Código	EAN	P.V.P. (€)
Punho de lima		1	953004010	4002829111727	1,00
4,0 mm - 5/32"	91VG, 90SG	1	953003090	4002829111703	1,50
4,8 mm - 3/16"	95VP, 21BP	1	953003070	4002829111666	1,50
5,2 mm - 3/64"	73LP, 73DP0	1	953003110	4002829477212	1,50
5,5 mm - 7/32"	73LP, 73DP	1	953003040	4002829111628	1,50

Lima plana e punho de lima



Punho



Lima plana

Descrição	Unidades	Código	EAN	P.V.P. (€)
Punho de lima	1	953004010	4002829111727	1,00
Lima plana	1	953003060	4002829111659	4,00

Conjunto porta-limas



Ø de lima	Tipo de corrente	Unidades	Código	EAN	P.V.P. (€)
4,0 mm - 5/32"	91VG, 90SG	1	953030010	4002829111871	10,00
4,8 mm - 3/16"	95VP, 21BP	1	953030030	4002829175873	8,00
5,5 mm - 7/32"	73LP, 73DP	1	953009000	4002829111857	10,00

Calibrador de corrente



Descrição	Unidades	Código	EAN	P.V.P. (€)
Calibrador	1	953100090	4002829111956	3,75

Chaves de velas



941713001

Modelo	Ø (mm)	Unidades	Código	EAN	P.V.P. (€)
DCS232T DCS232TC DCS3410TH	13/16 mm.	1	941716132	4002829824498	2,75
Restantes modelos	13/19 mm	1	941719133	4002829824511	2,75
ELETROSSERRAS	13 mm.	1	941713001	4002829172780	2,25

Sopradores

Bocais de saída



Extensão



Bocal plano

Modelo	Descrição	Unidades	Código	EAN	P.V.P. (€)
BHX2501	Bocal plano	1	451753-8	3240890355935	2,75
EB7660TH	Bocal plano	1	455634-8	-	12,00
DUB362	Bocal plano	1	456958-5	0088381497169	10,50
	Extensão de bocal	1	456957-7	0088381497152	9,75
	Bocal de saída grande	1	455915-0	-	10,00

Kit de aspiração



Modelo	Descrição	Unidades	Código	EAN	P.V.P. (€)
BHX2501	kit de aspiração	1	197235-3	0088381474924	62,00

Kit de aspiração UB0800 e UB0801



Modelo	Descrição	Unidades	Código	EAN	P.V.P. (€)
UB0800	kit de aspiração	1	B-35128	0088381425520	26,50
UB0801	kit de aspiração	1	GT00000002	0088381488426	26,50

Roçadoras







Discos para roçadoras

Tipo	Modelo	Características	Unidades	Código	EAN	P.V.P. (€)
	EBH341U EM2600U EM2651UH EM4350UH EM4351UH	255 x 25,4	1	195299-1	0088381364935	18,00
		300 x 25,4	1	385224150	4002829752159	23,00
		230 x 25,4	1	B-14118	0088381361064	10,50
		255 x 25,4	1	B-14124	0088381361071	11,00
		230 x 25,4	1	B-14130	0088381361088	11,00
		255 x 25,4	1	B-14146	0088381361095	12,50
		230 x 25,4	1	B-14152	0088381361101	12,50
		255 x 25,4	1	B-14168	0088381361118	14,00

Cabeças de nylon

- As cabeças Tap&Go são fáceis de colocar. Não é necessário desmontar a cabeça para carregar o fio.
- Cinco novas cabeças de nylon que se adaptam a todos os nossos modelos de roçadoras.
- Gama simplificada para facilitar a escolha dos nossos clientes.



Tipo cabeça	Rosca	Capacidade	Recomendado	Descrição	Unidades	Código	EAN	P.V.P. (€)
 Cabeça de nylon	-	-	ET40	-	1	DA00000002	0088381374033	7,25
 Cabeça de nylon	Rosca M8 x 125LH	-	DUR182 DUR187 DUR189	Fio silencioso de 2,0 mm	1	123235-7	0088381498098	10,00
 Cabeça fixa	Universal	20 cm	-	Fio silencioso de 2,7 mm	1	384224270	4002829757741	21,00
 Cabeça manual	M10 x 1,25 LH (esq.)	5 m	Todos os modelos	Fio silencioso de 2,4 mm	1	385224240	4002829757734	16,00
 T&G small	Rosca M8 x 1,25RH (dir.)	3,5 m	DUR365 DUX60 (com adaptador UA-1048)	Fio silencioso de 2,0 mm	1	680224200	4002829757703	13,00
 T&G medium	M10 x 1,25 LH (esq.)	4,5 m	EM2600U EM2651UH EM3400U EBH341U DUR365 DUX60	Fio silencioso de 2,4 mm	1	381224240	4002829757710	16,00
 T&G large	M10 x 1,25 LH (esq.)	4,5 m	EM4350UH EM4351UH BBC4500* BBC5700*	Fio silencioso de 2,7 mm	1	382224300	4002829757727	18,00



Adaptadores de cabeça

Tipo de cabeça	Descrição/medida	Unidades	Código	EAN	P.V.P. (€)
 Cabeça manual	Casquilho LH 8 x 1,25 Casquilho LH 10 x 1,00 Pino LM8x1,25/0x1,25"	1	385224250	4002829760161	8,50
Cabeça T&G Medium	Casquilho LH 8 x 1,25 Casquilho LH 10 x 1,00 Pino LM 8x1,25/10x1,25"	1	381224230	4002829760147	5,00
Cabeça T&G Large	Casquilho LH 8 x 1,25 Casquilho LH 10 x 1,00 Casquilho LH12x1,50 Casquilho LH 12x1,75 Pino LM 8x1,25/10x1,25"	1	382224310	4002829760154	7,00
Cabeça T&G Small	Casquilho LH 10x1,25	1	UA-1048	-	3,75

* É necessário utilizar adaptador.





Tabela de compatibilidade de modelos

		Fixo 	Manual 	T&G small 	T&G medium 	T&G large 
EM2600U	M10x1,25 LM	✓	✓	◇	✓	✓
EM2651UH	M10x1,25 LM	✓	✓	◇	✓	✓
EM3400U	M10x1,25 LM	✓	✓	◇	✓	✓
EM4350UH	M10x1,25 LM	✓	✓	◇	✓	✓
EM4351UH	M10x1,25 LM	✓	✓	◇	✓	✓
EBH341U	M10x1,25 LM	✓	✓	◇	✓	✓
BBC4500	M10x1,00 LM	✓	*	-	*	*
BBC5700	M10x1,00 LM	✓	*	-	*	*
DUR365	M10x1,25 LM	✓	✓	◇	✓	✓
DUX60	M10x1,25 LM	✓	✓	◇	✓	✓

- : Não compatível. ✓✓ Compatível. * É necessário utilizar adaptador. ◇ Adequado com adaptador UA-1048.

Cabeça Policut



Tipo cabeça	Rosca	Modelo	Descrição	Unidades	Código	EAN	P.V.P. (€)
	Universal	"Recomendado para modelos a bateria"	Cabeça de lâminas flutuantes substituíveis	1	197188-6	0088381458214	27,00
	Universal	-	12 lâminas	1	197189-4	-	21,00
	Universal	"Recomendado para modelos a bateria"	Cabeça de lâminas flutuantes substituíveis	1	198383-1	0088381488129	24,00
	Universal	"Para policut curvo"	3 lâminas	1	198426-9	0088381488143	12,00

Fios de nylon

Tipo	Descrição	Ø (mm)	Comprimento (m)	Unidades	Código	EAN	P.V.P. (€)
Redondo	<ul style="list-style-type: none"> Destinado ao utilizador mais exigente para utilização privada. Indicado para roçadoras de baixa cilindrada. 	2,4	5	1	B-01971	0088381120494	2,25
		3,0	4	1	B-07375	0088381349291	3,00
Round Trim	<ul style="list-style-type: none"> Destinado ao utilizador mais exigente para utilização privada. Duas cores. Indicado para roçadoras de baixa cilindrada. O fio redondo oferece maior resistência ao ar e ao impacto. 	1,3	15	1	369224807	-	2,00
		1,6	15	1	369224808	-	2,25
		2,0	15	1	369224790	4002829756614	2,50
		2,0	126	1	369224791	4002829756621	10,00
Round Trim PLUS	<ul style="list-style-type: none"> Concebido para utilização privada e semiprofissional. Aumentamos a resistência ao desgaste e o ponto de fusão. Indicado para máquinas de média cilindrada. 	2,4	15	1	369224792	4002829756638	3,25
			87	1	369224793	4002829756645	10,00
			262	1	369224794	4002829756652	27,00
		3,0	15	1	369224809	-	3,75
			56	1	369224811	-	10,00
			168	1	369224815	-	26,50
		3,3	15	1	369224810	-	4,25
			46	1	369224812	-	10,00
			139	1	369224816	-	26,50
Square Trim PLUS	<ul style="list-style-type: none"> Concebido para uma utilização semiprofissional. Aumentamos a resistência ao desgaste e o ponto de fusão. Reduz a perda de rotação por roçamento graças às suas arestas. Indicado para máquinas de média cilindrada. 	2,4	15	1	369224795	-	3,75
			69	1	369224796	-	10,00
			206	1	369224797	-	27,00
		3,0	15	1	369224819	-	4,75
			44	1	369224821	-	10,00
			132	1	369224825	-	26,50
		3,3	15	1	369224820	-	4,50
			36	1	369224822	-	10,00
			109	1	369224826	-	26,50
		3,5	32	1	369224823	-	10,00
			96	1	369224827	-	26,50
		4,0	25	1	369224824	-	10,00
75	1		369224828	-	26,50		
Round Trim PRO	<ul style="list-style-type: none"> Desenvolvido para utilização profissional. Elevada resistência ao calor. Para os trabalhos mais exigentes. Indicado para roçadoras de alta cilindrada. Combina duas camadas de material de diferentes durezas. 	3,0	15	1	369224798	4002829756669	4,75
			56	1	369224799	4002829756676	12,00
			168	1	369224800	-	30,50
			279	1	369224801	4002829756690	48,00
Square Trim PRO	<ul style="list-style-type: none"> Desenvolvido para utilização profissional. Elevada resistência ao calor. Para os trabalhos mais exigentes. Indicado para roçadoras de alta cilindrada. Reduz a perda de rotação por roçamento graças às suas arestas. Combina duas camadas de material de diferentes durezas. 	3,0	15	1	369224802	-	5,25
			44	1	369224803	4002829756799	12,00
			132	1	369224804	-	31,00
			219	1	369224805	-	48,00
Silencioso	<ul style="list-style-type: none"> A sua secção trançada oferece um desempenho de corte superior. Menos ruído. Menos desgaste graças à sua forma trançada. Maior qualidade de corte. 	2,0	15	1	369224060	4002829434314	2,75
			15	1	369224070	4002829432969	3,75
		2,4	120	1	369224072	4002829446096	14,50
			15	1	369224673	4002829552827	4,25
		3,0	90	1	369224063	4002829454350	16,50
3,0	70	1	369224073	4002829454343	17,00		

Acessórios para multifunções UX360/DUX60



Descrição	Unidades	Código	EAN	P.V.P. (€)
Corta-sebes	1	196345-3	0088381424905	265,00



Descrição	Unidades	Código	EAN	P.V.P. (€)
Roçadora	1	195566-4	0088381397650	95,00



Descrição	Unidades	Código	EAN	P.V.P. (€)
Motosserra	1	199930-1	0088381544511	240,00



Descrição	Unidades	Código	EAN	P.V.P. (€)
Cultivador	1	195717-9	0088381398060	260,00



Descrição	Unidades	Código	EAN	P.V.P. (€)
Roçadora	1	195663-6	0088381376853	95,00



Descrição	Unidades	Código	EAN	P.V.P. (€)
Prolongador	1	196035-8	0088381413121	115,00

Brocas para piso de 3/4"



Broca Adaptador

Modelo	Descrição	Unidades	Código	EAN	P.V.P. (€)
DTW1001	Ø 20 mm/600 mm	1	B-54346	0088381477468	180,00
	Ø 25 mm/600 mm	1	B-54352	0088381477475	184,00
	Ø 30 mm/600 mm	1	B-54368	0088381477482	208,00
	Ø 35 mm/600 mm	1	B-54374	0088381477499	246,00
	Adaptador de 3/4"	1	B-54380	0088381477505	46,00

Chave de fendas com regulação



Descrição	Unidades	Código	EAN	P.V.P. (€)
Aparafusador Philips n.º 2	1	783002-8	0088381102650	1,75
Regulação do carburador	1	783012-5	0088381417839	0,50

Acessórios para DUC122 e UC120D



Modelo	Descrição	Unidades	Código	EAN	P.V.P. (€)
DUC122	Extensão	1	195595-7	-	149,00
UC120D	Extensão 1,3 - 2,2 m.	1	192755-2	0088381146142	148,00



Modelo	Descrição	Unidades	Código	EAN	P.V.P. (€)
DUC122	Lima	1	953003090	4002829111703	1,50



Modelo	Descrição	Unidades	Código	EAN	P.V.P. (€)
DUC122	Óleo	1	182229-1	0088381152853	1,25

Óleos

Óleo de 2T mineral



Quantidade	Unidades	Código	EAN	P.V.P. (€)
100 ml	1	980008106	4002829239551	1,75
1 litro	1	980008107	4002829000274	6,00
1 litro com doseador	1	980008112	4002829414477	10,00
5 litros	1	980008118	4002829486030	28,50

Óleo de 4T HD30 monograu



Quantidade	Unidades	Código	EAN	P.V.P. (€)
600 ml	1	980008120	4002829441336	3,50

Óleo de 4T SJ10W30 multigrau



Quantidade	Unidades	Código	EAN	P.V.P. (€)
80 ml	1	196122-3	-	2,00
100 ml	1	197010-7	0088381452731	4,50

Óleo de 4T 5W30 multigrau



Quantidade	Unidades	Código	EAN	P.V.P. (€)
1 litro	1	980008121	4002829760475	7,00

Óleo de 2T sintético



Quantidade	Unidades	Código	EAN	P.V.P. (€)
1 litro	1	980008103	4002829760314	10,50

Óleo de corrente Biotop (Biodegradável)



Quantidade	Unidades	Código	EAN	P.V.P. (€)
1 litro	1	980008210	4002829155028	5,50
5 litros	1	980008211	4002829155035	21,50

Óleo de corrente



Quantidade	Unidades	Código	EAN	P.V.P. (€)
1 litro	1	988002256	4002829137390	4,00
5 litros	1	988002258	4002829137406	14,50

Arneses para roçadoras



Modelos	Unidades	Código	EAN	P.V.P. (€)
Todos os modelos	1	122907-1	0088381426909	23,00



Modelos	Unidades	Código	EAN	P.V.P. (€)
Todos os modelos	1	196129-9	0088381442459	45,00

Acessórios para BUM168, DUM168, UH200D, UH201D, UM164D e UM600D

Lâmina corta-ervas



Descrição	Unidades	Código	EAN	P.V.P. (€)
Lâmina corta-ervas	1	195267-4	0088381362375	45,00

Lâmina corta-sebes



Descrição	Unidades	Código	EAN	P.V.P. (€)
Lâmina corta-sebes	1	195272-1	0088381362399	19,50

Protetor para lâmina corta-ervas



Descrição	Unidades	Código	EAN	P.V.P. (€)
Protetor para lâmina corta-ervas	1	452055-5	-	2,40

Protetor de lâmina corta-sebes



Descrição	Unidades	Código	EAN	P.V.P. (€)
Protetor de lâmina corta-sebes	1	451816-0	-	1,90



DUM604

UH200D

Punho extensível



Descrição	Unidades	Código	EAN	P.V.P. (€)
Punho extensível	1	195187-2	0088381362412	50,00

Lâminas e acessórios para tesouras de poda



197367-6

197366-8

Modelo	Descrição	Unidades	Código	EAN	P.V.P. (€)
DUP361	Lâmina fixa	1	197367-6	0088381465373	40,00
	Lâmina móvel	1	197366-8	0088381463720	46,00



A-86664

B-05016

Modelo	Descrição	Unidades	Código	EAN	P.V.P. (€)
4604D	Lâmina fixa	1	A-86664	0088381150965	42,00
	Lâmina móvel	1	B-05016	-	30,00

Arnês para tesoura de poda DUP361



Descrição	Unidades	Código	EAN	P.V.P. (€)
Arnês para DUP361	1	161377-9	0088381473750	32,00

Lima de diamante e óleo



Modelo	Descrição	Unidades	Código	EAN	P.V.P. (€)
4604D DUP361	Lima de diamante	1	794530-8	0088381116893	11,00
	Óleo	1	182470-6	0088381498135	1,35

Proteção

Viseiras de proteção

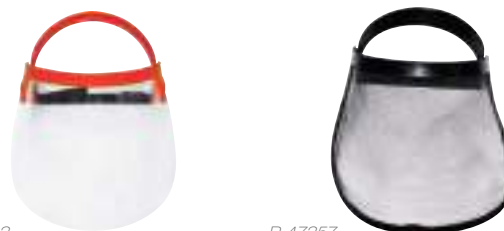

P-47363

P-47357

Descrição	Unidades	Código	EAN	P.V.P. (€)
Viseira de proteção transparente com borracha	1	P-47363	0088381977791	10,00
Viseira de proteção metálica com borracha	1	P-47357	0088381977784	7,75

Protetor de ouvidos



Descrição	Unidades	Código	EAN	P.V.P. (€)
Protetor de ouvidos	1	988000040	4002829215838	23,00



Conjunto de hastas para HL360D

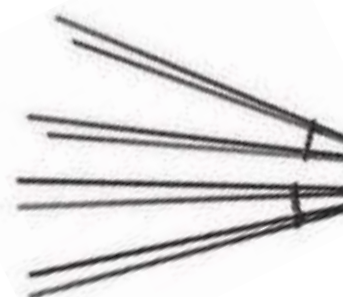

Descrição	Unidades	Código	EAN	P.V.P. (€)
Conjunto de hastas	8	UL23-08/C	-	44,00

Hidrolimpadoras



Pistolas



Modelo	Material	Unidades	Código	EAN	P.V.P. (€)
HW102 HW111	Plástico	1	HW3320152	-	8,00
HW120	Metálica	1	HW41847	-	47,00
HW131RLV	Metálica	1	HW40925	8016287409254	47,00
HW132	Plástico	1	HW3640920	-	24,00
HW151	Metálica	1	HW41154	8016287411547	22,00
HW1200 HW1300	Plástico	1	197842-2	-	20,50

Lança com bocal



P-64917



197876-5



197824-4

Modelo	Tipo	Unidades	Código	EAN	P.V.P. (€)
HW102	Plana	1	HW3640640	-	3,25
HW102 HW111	Turbo	1	HW3320120	-	4,00
HW120	Plana	1	HW3718	-	23,00
HW131RLV	Plana	1	P-64901	0088381995429	37,00
HW131RLV	Turbo	1	P-64917	0088381995436	81,00
HW132	Plana	1	HW3641150	-	9,50
HW132	Turbo	1	HW3640940	-	9,50
HW151	Plana	1	HW40551	8016287405515	25,00
HW151	Turbo	1	HW40167	8016287401678	49,00
HW1200	Plana	1	197822-8	0088381484626	12,50
HW1200	Spray	1	197876-5	0088381496032	23,00
HW1200	Turbo	1	197824-4	0088381518383	13,00

Mangueira de alta pressão



Modelo	Comprimento	Unidades	Código	EAN	P.V.P. (€)
HW102	5 m	1	HW3640630	-	9,50
HW111	5,5 m/12 mm	1	HW3640660	-	39,00
HW120	10 m	1	HW3163270	-	139,00
HW131	15 m	1	HW2500390	-	165,00
HW132	8 m	1	HW3641570	-	51,00
HW151	10 m	1	HW3083550	-	67,00
HW1200 HW1300	5 m	1	197845-6	0088381484688	27,00
HW1200 HW1300	8 m	1	197847-2	0088381484695	37,00
HW1200 HW1300	10 m	1	197850-3	0088381484701	44,00

Extensão



Modelo	Material	Unidades	Código	EAN	P.V.P. (€)
HW102 HW111	Plástico	1	HW3320130	-	4,00
HW1200 HW1300	Plástico	1	197870-7	0088381484671	45,00
HW1200 HW1300	Plástico	1	198909-9	0088381497367	30,00

Bocais



HW3086

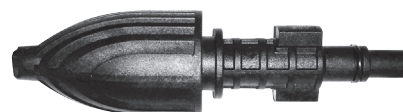

HW3640670

Modelo	Descrição	Unidades	Código	EAN	P.V.P. (€)
HW120	Bocal	1	HW3086	-	15,00
HW111 HW132	Bocal	1	HW3640670	-	2,25

Mangueira de desentupimento



Para a limpeza de tubagens.

Modelo	Comprimento	Unidades	Código	EAN	P.V.P. (€)
HW102 HW111 HW132	8 m	1	P-64892	0088381995412	40,00
HW131 HW151	8 m	1	P-66503	0088381997034	44,00
HW102 HW111 HW132 HW151	10 m	1	HW41165	8016287411653	53,00
HW102 HW111 HW132 HW151	16 m	1	HW41167	8016287411677	84,00
HW1200	10 m	1	197837-5	0088381484657	24,50
HW1200 HW1300	15 m	1	197840-6	0088381484664	30,00

Extensão de mangueira de alta pressão



Modelo	Comprimento	Unidades	Código	EAN	P.V.P. (€)
HW102	5 m	1	HW41179	8016287411790	22,50
HW111 HW132	8 m	1	HW41181	8016287411813	61,00

Kit de sucção de água



Modelo	Descrição	Unidades	Código	EAN	P.V.P. (€)
HW102 HW111 HW132 HW151	Kit de sucção de água	1	HW41163	8016287411639	48,00
HW1200 HW1300	Kit de mangueira de aspiração	1	197873-1	0088381484633	32,00

Plainas



* Requer adaptador HW3082750.

Modelo	Descrição	Unidades	Código	EAN	P.V.P. (€)
HW111 HW132 HW151* HW131RLW*	Triangular	1	HW3640950	-	5,50



* Requer adaptador HW3082750.

Modelo	Descrição	Unidades	Código	EAN	P.V.P. (€)
HW111 HW132 HW151* HW131RLW*	Rotativo	1	P-64858	0088381995375	18,50



* Requer adaptador HW3082750.

Modelo	Descrição	Unidades	Código	EAN	P.V.P. (€)
HW131RLW HW111 HW132 HW151	Para pisos sem depósito. Adaptador HW40542 incluído	1	HW41849	-	70,00



Modelo	Descrição	Unidades	Código	EAN	P.V.P. (€)
HW131RLW HW151	Rotativo	1	HW41187	8016287411875	26,50



Modelo	Descrição	Unidades	Código	EAN	P.V.P. (€)
HW1200 HW1300	Rotativo	1	197831-7	0088381484640	15,50



Plainas



Modelo	Descrição	Unidades	Código	EAN	P.V.P. (€)
HW1200 HW1300	Escova triangular	1	197828-6	0088381489010	9,50



Modelo	Descrição	Unidades	Código	EAN	P.V.P. (€)
HW1200 HW1300	Escova antissalpicos	1	197864-2	0088381496001	20,50

Adaptadores para hidrolimpadoras



HW3082750



P-64870



197883-8



197867-6



197883-8

Depósitos para detergente e detergente neutro



HW3640090



P-64864



197886-2

Modelo	Descri.	Unidades	Código	EAN	P.V.P. (€)
HW102	Depósito para detergente	1	HW3640090	-	3,00
Todos os modelos	Detergente neutro 1 l	1	P-64864	0088381995382	14,50
HW1200	Reservatório de detergente	1	197886-2	0088381489003	19,00

Cuba e plataforma de transporte para DCU180



199008-0



199009-8

Modelo	Descri.	Unidades	Código	EAN	P.V.P. (€)
DCU180	Plataforma transporte	1	199009-8	0088381519632	145,00
	Conjunto de balde	1	199008-0	0088381519625	115,00



Baterias, carregadores e compatibilidade de carregamento



Litio-ion **EXTREMA TECNOLOGIA**

36V
Carregador rápido

BL3626 194873-2 DC36RA 194863-5

P.V.P. 245,00 € Tempo de carregamento **22** min P.V.P. 170,00 €

36V
Carregador normal

BL3622A 195410-5 DC36WA 195471-5

P.V.P. 175,00 € Tempo de carregamento **60** min P.V.P. 89,00 €

NI-MH

24V
Ni-MH

DC24SC 194164-1 **162€**

3,1 Ah BH2433 193739-3 **260€**

60 min.

MAKSTAR

12V
Ni-MH

DC24SC 194164-1 **162€**

3,1 Ah BH1233C 193930-3 **150€**

30 min.

DC18RC 195584-2 **109€**

22 min.

DC18SD 195533-6 **74€** DC18SE Automóvel 194622-7 **105€**

70 min.

9,6V
Ni-MH

DC24SC 194164-1 **140€**

3,1 Ah BH9033C 193636-3 **140€**

30 min.

DC18RC 195584-2 **109€**

30 min.

DC18SD 195533-6 **74€** DC18SE Automóvel 194622-7 **109€**

70 min.

1,8 Ah BH9020 193631-3 **130€**

20 min.

15 min.

40 min.

NI-MH

18V

DC1804 193827-6 **74€** DC1822 Automóvel 193439-5 **103€**

2,8 Ah 1835 193061-8 **146€**

70 min.

DC1414 193864-0 **60€**

70 min.

14,4V

2,8 Ah 1435 193060-0 **112€**

70 min.

70 min.

70 min.

18V

2,8 Ah 1235 193059-5 **96€**

70 min.

70 min.

70 min.



PORTA-FERRAMENTAS



Bolsa com cartucheira

- Porta-ferramentas universal para berbequim.
- Cartucheira dividida em compartimentos e bolsa de grande profundidade.



Medidas (C x L x A)	Peso (kg)	Capacidade (C)	Unidades	Código	EAN	P.V.P (€)
255 x 160 x 280 mm	0,58	1,50	1	P-71722	0088381702317	46,00

Bolsa para electricista

- Preparada para transportar vários acessórios elétricos.
- Especialmente concebida para chaves de fendas e alicates.



Medidas (C x L x A)	Peso (kg)	Capacidade (C)	Unidades	Código	EAN	P.V.P (€)
250 x 140 x 315 mm	0,5	1,65	1	P-71738	0088381702324	32,00

Bolsa de carpinteiro

- Especialmente concebida para manter a verticalidade a qualquer momento e evitar que os acessórios possam cair.



Medidas (C x L x A)	Peso (kg)	Capacidade (C)	Unidades	Código	EAN	P.V.P (€)
265 x 155 x 270 mm	0,65	2,90	1	P-71788	0088381702379	51,00

Cartucheira grande

- Concebida para berbequins com fios e sem fios.
- Com compartimentos para brocas e acessórios.
- Pode colocar-se à direita e à esquerda.



Medidas (C x L x A)	Peso (kg)	Capacidade (C)	Unidades	Código	EAN	P.V.P (€)
170 x 85x 290 mm	0,26	-	1	P-71794	0088381702386	25,00

Organizador com 3 bolsas

- Forradas em pele resistente para garantir uma boa organização de acessórios e ferramentas.



Medidas (C x L x A)	Peso (kg)	Capacidade (C)	Unidades	Código	EAN	P.V.P (€)
315 x 175 x 325 mm	0,76	3,90	1	P-71766	0088381702355	46,00

Bomba para cofragem

- Bolsa de utilização geral com dois compartimentos.
- Pode prender-se ao cinto ou levar-se na mão.



Medidas (C x L x A)	Peso (kg)	Capacidade (C)	Unidades	Código	EAN	P.V.P (€)
350 x 170 x 320 mm	0,72	3,15	1	P-71744	0088381702331	45,00

Bolsa multiusos dupla

- Dois bolsos de grande capacidade ideais para um rápido reconhecimento das ferramenta.
- Pode prender-se ao cinto ou levar-se na mão.



Medidas (C x L x A)	Peso (kg)	Capacidade (C)	Unidades	Código	EAN	P.V.P (€)
260 x 135 x 265 mm	0,53	2,60	1	P-71750	0088381702348	34,00

Porta-ferramentas para electricista

- Guarda tudo o que é necessário num espaço reduzido.
- Pode prender-se ao cinto ou colocar-se no bolso.



Medidas (C x L x A)	Peso (kg)	Capacidade (C)	Unidades	Código	EAN	P.V.P (€)
155 x 50 x 160 mm	0,26	-	1	P-71881	0088381702478	22,00

Porta-bolsas com correia

- Com vários compartimentos e ganchos para manter tudo perfeitamente organizado.



Medidas (C x L x A)	Peso (kg)	Capacidade (C)	Unidades	Código	EAN	P.V.P (€)
640 x 170 x 290 mm	1,4	6	1	P-71772	0088381702362	97,00

Cinto completo

- O mais completo. Conta com fixações para berbequim, martelo, telemóvel, várias bolsas para guardar parafusos, pregos...



Medidas (C x L x A)	Peso (kg)	Capacidade (C)	Unidades	Código	EAN	P.V.P (€)
865 x - x 340 mm	1,58	2,70	1	P-71897	0088381702485	111,00

Cinto de couro

- Em couro de alta qualidade.
- Personalize o seu porta-ferramentas adicionando complementos ao cinto.



Medidas (C x L x A)	Peso (kg)	Capacidade (C)	Unidades	Código	EAN	P.V.P (€)
1,380 x - x 48 mm	0,29	-	1	P-71803	0088381702393	22,50

Cinto de nylon

- Adapta-se perfeitamente ao corpo do utilizador.
- Compatível com todos os porta-ferramentas Makita.



Medidas (C x L x A)	Peso (kg)	Capacidade (C)	Unidades	Código	EAN	P.V.P (€)
1340 x - x 50 mm	0,23	-	1	P-71825	0088381702416	15,50

Cinto porta-bolsas.

- Cinto acolchoado com ilhós para fixar qualquer tipo de bolsa ou cartucheira.



Medidas (C x L x A)	Peso (kg)	Capacidade (C)	Unidades	Código	EAN	P.V.P (€)
865 x - x 140 mm	0,62	-	1	P-71819	0088381702409	41,00

Porta-flexómetro

- Com capacidade para fitas métricas de 3 a 10 metros.



Medidas (C x L x A)	Peso (kg)	Capacidade (C)	Unidades	Código	EAN	P.V.P (€)
120 x 75 x 165 mm	0,1	-	1	P-71831	0088381702423	11,00

Porta-martelo

- Transporta comodamente o martelo.
- Adapta-se a qualquer cinto.



Medidas (C x L x A)	Peso (kg)	Capacidade (C)	Unidades	Código	EAN	P.V.P (€)
105 x 70 x 160 mm	0,12	-	1	P-71869	0088381702454	14,50

Porta-ferramentas aberto

- Com vários compartimentos para organizar as ferramentas.
- Tiras elásticas nos bolsos para evitar a perda de acessórios.



Medidas (C x L x A)	Peso (kg)	Capacidade (C)	Unidades	Código	EAN	P.V.P (€)
450 x 285 x 335 mm	2,3	26,20	1	P-72001	0088381702591	58,00

Bolsa para telemóvel

- Protetor acolchoado para o telemóvel com um clipe para as chaves ou outros acessórios.



Medidas (C x L x A)	Peso (kg)	Capacidade (C)	Unidades	Código	EAN	P.V.P (€)
70 x 40 x 115 mm	0,06	0,09	1	P-71847	0088381702430	13,50

Cartucheira pequena

- A correia de segurança mantém o berbequim perfeitamente fixo em todos os momentos. Inclui a subir escadas ou andaimes.



Medidas (C x L x A)	Peso (kg)	Capacidade (C)	Unidades	Código	EAN	P.V.P (€)
155 x 75 x 235 mm	0,13	-	1	P-71940	0088381702539	19,00

Porta-martelo com fecho

- Graças ao seu fecho, é possível transportar o martelo comodamente e guardá-lo sem olhar.



Medidas (C x L x A)	Peso (kg)	Capacidade (C)	Unidades	Código	EAN	P.V.P (€)
105 x 75 x 160 mm	0,14	-	1	P-71875	0088381702461	15,00

Porta-objetos

- Bolsa com fecho de correr.
- Ideal para manter os objetos pessoais seguros.



Medidas (C x L x A)	Peso (kg)	Capacidade (C)	Unidades	Código	EAN	P.V.P (€)
180 x 115 x 185 mm	0,23	1,30	1	P-71962	0088381702553	23,00

Porta-pregos para cofragem

- A sua forma foi especialmente concebida para manter a verticalidade a qualquer momento e evitar que os pregos possam cair.



Medidas (C x L x A)	Peso (kg)	Capacidade (C)	Unidades	Código	EAN	P.V.P (€)
180 x 110 x 210 mm	0,25	1,10	1	P-71906	0088381702492	22,50

Porta-ferramentas leve

- Com fecho de correr e correias de alta qualidade para garantir maior robustez.



Medidas (C x L x A)	Peso (kg)	Capacidade (C)	Unidades	Código	EAN	P.V.P (€)
520 x 250 x 290 mm	1,82	25,00	1	P-71990	0088381702584	52,00

Mala porta-ferramentas

- Graças à sua grande capacidade de armazenamento, poderá transportar todos os seus acessórios e ferramentas.



Medidas (C x L x A)	Peso (kg)	Capacidade (C)	Unidades	Código	EAN	P.V.P (€)
505 x 295 x 265 mm	3,9	32,9	1	P-72073	0088381702676	80,00



Colete porta-ferramentas

- Vários bolsos para transportar tudo o que é necessário.
- Conta com faixas refletoras e correias ajustáveis.



Medidas (C x L x A)	Peso (kg)	Capacidade (C)	Unidades	Código	EAN	P.V.P (€)
500 x - x 640 mm	0,74	-	1	P-72089	0088381702676	55,00

Mala térmica

- Interior em alumínio para manter sempre os alimentos frescos.



Medidas (C x L x A)	Peso (kg)	Capacidade (C)	Unidades	Código	EAN	P.V.P (€)
280 x 170 x 230 mm	0,36	7,50	1	P-72023	0088381702614	25,00

Joelheiras de alta proteção

- Joelheiras rígidas com forro em gel para garantir a segurança e o conforto do utilizador.



Medidas (C x L x A)	Peso (kg)	Capacidade (C)	Unidades	Código	EAN	P.V.P (€)
165 x 90 x 210 mm	0,49	-	1	P-71978	0088381702560	34,00

Joelheiras

- Flexíveis e leves, fabricadas em couro artificial de alta qualidade.
- Joelheiras flexíveis, ideais para trabalhos no solo em espaços interiores.



Medidas (C x L x A)	Peso (kg)	Capacidade (C)	Unidades	Código	EAN	P.V.P (€)
175 x 50 x 210 mm	0,18	-	1	P-71984	0088381702577	24,50





Bolsa para tesoura de poda

- Fabricada em polietileno de alta resistência com reforços de couro nas zonas de maior fricção.
- Adapta-se a qualquer tipo de cinto e é muito fácil de limpar.



Medidas (C x L x A)	Peso (kg)	Capacidade (C)	Unidades	Código	EAN	P.V.P (€)
130 x 55 x 270 mm	0,1	0,20	1	P-72104	0088381702690	12,00

Bolsa para tesoura de poda grande

- Bolsa de grande capacidade com esticadores ajustáveis.
- Conta com um bolso adicional na parte frontal, ideal para guardar a pedra de afiar.



Medidas (C x L x A)	Peso (kg)	Capacidade (C)	Unidades	Código	EAN	P.V.P (€)
160 x 95 x 370 mm	0,37	0,60	1	P-72182	0088381702775	34,00

Porta-ferramentas de jardim

- Bolsa ampla forrada em couro para guardar tudo o que é necessário.
- Dispõe de um gancho metálico giratório para manter a ferramenta no ângulo certo.



Medidas (C x L x A)	Peso (kg)	Capacidade (C)	Unidades	Código	EAN	P.V.P (€)
225 x 105 x 275 mm	0,49	1,30	1	P-72154	0088381702744	41,00

Porta-ferramentas de 4 compartimentos

- Compartimentos de 2 tamanhos diferentes.
- Muito resistente, ideal para ferramentas de jardim.



Medidas (C x L x A)	Peso (kg)	Capacidade (C)	Unidades	Código	EAN	P.V.P (€)
190 x 80 x 245 mm	0,2	0,60	1	P-72110	0088381702706	19,50

Porta-ferramentas fino

- O seu formato aberto facilita o acesso às ferramentas.
- Conta com tiras elásticas nos bolsos e um gancho metálico giratório. Adapta-se a qualquer cinto.



Medidas (C x L x A)	Peso (kg)	Capacidade (C)	Unidades	Código	EAN	P.V.P (€)
115 x 70 x 280 mm	0,25	0,25	1	P-72132	0088381702720	21,50

Esticadores

- Os esticadores resistentes e ergonómicos reduzem o peso na zona lombar e transferem-no para os ombros.
- Tamanho único ajustável.



Medidas (C x L x A)	Peso (kg)	Capacidade (C)	Unidades	Código	EAN	P.V.P (€)
-	0,23	-	1	P-72176	0088381702768	20,00





MALAS

Malas



275

275

Malas Makpac empilháveis.

- **Dispomos de um vasto catálogo para transportar os seus equipamentos de trabalho nas melhores condições. Além disso, pode expandir os seus equipamentos de trabalho de forma sistemática.**



- Com o sistema de armazenamento Makpac, é possível modificar a qualquer momento as várias modalidades de armazenamento, combiná-las separadamente e transportar os seus dispositivos adicionais.
- No seu armazém, as possibilidades são infinitas.
- De facto, o número de malas que é possível empilhar é ilimitado.



- **Puxadores fortes e retráteis garantem um transporte e um armazenamento corretos.**

Quatro tamanhos diferentes.

- Existem quatro tamanhos de malas disponíveis.
- Também pode optar por um plástico específico para armazenar corretamente as suas ferramentas.
- As malas MAKPAC são empilháveis e podem ser unidas ou separadas mediante as quatro patilhas de bloqueio manual.
- Uma vez unidas, podem ser transportadas em conjunto com apenas uma mão.
- Puxadores fortes e retráteis garantem um transporte e um armazenamento corretos.



Tipo 1



Tipo 2



Tipo 3



Tipo 4

Mala térmica Makpac

A melhor forma de manter as bebidas frescas no local de trabalho!

- Em poliestireno de 20 mm de espessura e com faixa vedante na união entre a tampa e a caixa.

18 l



500mL x 20 2L x 4

Dimensões	Mala	Unidades	Código	EAN	P.V.P. (€)
295 x 395 x 315mm	Tipo 4	1	198253-4	0088381476607	91,00

Carrinho de transporte



Descrição	Unidades	Código	EAN	P.V.P. (€)
Carrinho de transporte Admite até 100 kg de carga	1	P-83886	0088381468411	111,00

Carrinho de transporte



Mala Makpac não incluída

Descrição	Unidades	Código	EAN	P.V.P. (€)
Trólei com rodas Admite até 25 kg de carga.	1	TR00000001	0088381468190	154,00

Plástico separador interior

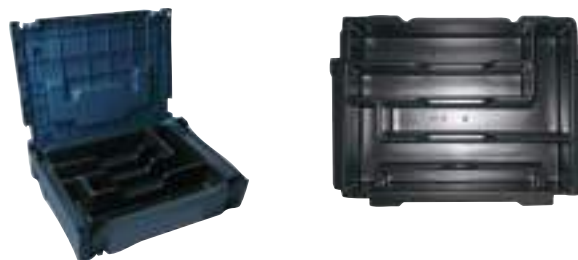

Mala Makpac não incluída

Descrição	Unidades	Código	EAN	P.V.P. (€)
Classificador com vários compartimentos	1	P-83668	0088381463805	10,50

Plástico separador interior colorido

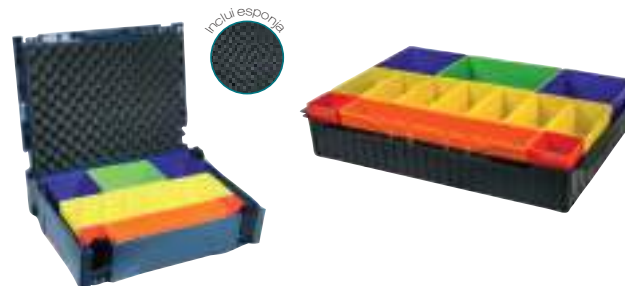

Mala Makpac não incluída

Descrição	Unidades	Código	EAN	P.V.P. (€)
Classificador com vários compartimentos	1	P-83652	0088381463799	31,00

Separador de esponja

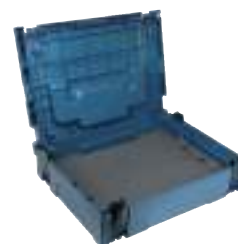

Descrição	Unidades	Código	EAN	P.V.P. (€)
Separador de esponja adequado para todas as malas Makpac	1	P-83705	0088381463843	21,00

Separador de esponja



Descrição	Unidades	Código	EAN	P.V.P. (€)
Caixa de ferramentas prática com vários compartimentos.	1	P-84137	0088381524865	85,00

Plásticos interiores e malas MAKPAC

Tipo 1



Descrição	Unidades	Código	EAN	P.V.P. (€)
39,5 x 29,5 x 10,5 cm	1	821549-5	0088381432986	26,50

PLÁSTICOS INTERIORES

Makpac	Modelo (Ferramenta)	Unidades	Código	EAN	P.V.P. (€)
821549-5	4326 4328 4326 4329 4350CT 4350FCT 4351FCT JV0600	1	837803-7	0088381436090	7,50
	DA330D	1	837695-4	0088381436083	8,75
	DF030D DF330D HP330D TD090D TW100D	1	837866-3	0088381525954	7,50
	DF031D DF032D DF033D DF331D DF332D DF333D HP331D HP332D HP333D TD110D TD111D	1	838312-9	0088381526166	6,00
	DP3002 DP3003 DP4001 DP4002 DP4003 DP4011 HP2051 HP2071	1	838039-1	0088381441452	7,50
	JR100D	1	837664-5	0088381436052	7,50
	6904V 6952 TW0200	1	837869-7	0088381525978	7,25

Tipo 2



Descrição	Unidades	Código	EAN	P.V.P. (€)
39,5 x 29,5 x 15,5 cm	1	821550-0	0088381430128	28,00

PLÁSTICOS INTERIORES

Makpac	Modelo (Ferramenta)	Unidades	Código	EAN	P.V.P. (€)
821550-0	DBO180	1	837809-5	0088381436090	7,50
	DDA350	1	838040-6	0088381436083	6,75
	DDF343 DDF441 DDF446 DDF448 DDF451 DDF453 DDF456 DDF459 DDF480 DDF482 DDF484 DHP343 DHP441 DHP446 DHP448 DHP451 DHP453 DHP456 DHP459 DHP480 DHP481 DHP482 DHP484	1	837916-4	0088381525954	7,50
	DFS250 DFS251 DFS451 DFS452 FS2300 FS2500 FS2700 FS4200 FS6300	1	837805-3	0088381526166	7,50
	DGD800		837806-1		7,50
	DJV180 DJV182	1	837639-4	0088381441452	11,00
	BO4900V BO4901	1	837675-0	0088381436052	7,75
	BST221 DPT351		837640-9		8,50
	DDF083 DDF483 DHP483 DTD129 DTD134 DTD146 DTD147 DTD148 DTD152 DTD153 DTD154 DTD155 DTD170 DTD171 DTP140 DTP141 DTW250 DTW251 DTW281 DTW285		837670-0		10,00
	DTL061		837644-1		7,75
	GA4540 GA4540C GA5040 GA5040C SA5040C		837672-6		4,00
	HR2300 HR2600 HR2610 HR2610T HR2611FT		837651-4		7,50
	HS300D		837662-9		14,00
	JN3201 JS3201		837630-2		8,25
	RP0900		837646-7		7,50
	RP0910 RP1110C		837660-3		7,75
	TM3000C TM3010C		837673-4		7,50
	TW0350		837870-2		7,00
	BO5030 BO5031 BO5040 BO5041		837874-4		9,75
	6906		838024-4		9,75
	9046		838025-2		9,75
	3709 3710		837674-2		8,00
	HR166D		838683-4		6,00
	DJR183		837897-2		5,00
	HR140		839245-1		4,50

Plásticos interiores e malas MAKPAC

Tipo 3



Descrição	Unidades	Código	EAN	P.V.P. (€)
39,5 x 29,5 x 21,5 cm	1	821551-8	0088381432993	35,00

Tipo 4



Descrição	Unidades	Código	EAN	P.V.P. (€)
39,5 x 29,5 x 31,5 cm	1	821552-6	0088381433006	39,00

PLÁSTICOS INTERIORES

Makpac	Modelo (Ferramenta)	Unidades	Código	EAN	P.V.P. (€)
821551-8	9403	1	837652-2	0088381436359	8,00
	9404	1	837653-0	0088381436366	7,50
	9911 9910	1	837658-0	0088381436397	7,50
	BO6030	1	837654-8	0088381436373	8,00
	BO6040		837655-6	0088381436380	7,75
	DBN500	1	838023-6	0088381453967	6,75
	DSS501 DCS550	1	837628-9	0088381436274	7,75
	DFR550Z		837631-0	0088381447201	7,00
	DGA504 DGA508 DGA454 DGA458 DGA461 DGA467 DGA511 DGA517 DTD171 DTD171		838175-3	0088381453981	9,25
	DGA452		837632-8	0088381436281	7,50
	DHR165		838109-6	0088381453998	7,750
	DHR202		837634-4	0088381436304	7,50
	DHS680		838182-6	0088381454018	9,25
	DKP180		837808-7	0088381436434	7,50
	DPJ180		837648-3	0088381436342	7,50
	DSS610		837642-5	0088381436328	8,25
	DTM50 DTM51		837671-8	0088381436427	7,50
	DTW450 DTW1001 DTW1002		837645-9	0088381436335	8,00
	KP0800 KP0810 KP0810C		837659-8	0088381436403	7,50
	N9741		838026-0	-	8,00
	PJ7000		837661-1	0088381436410	10,50
	DHR171		839387-1	0088381535588	4,75
	DPT353		839128-5	0088381535601	7,75
	DLX2221		837864-7	0088381441216	5,00
	DJN161		837678-4	0088381436229	11,00
	DJR188		839458-4	0088381526319	6,75
	BO6050J		838246-6	0088381526142	5,00
DHS661Z		839752-4	-	4,75	

PLÁSTICOS INTERIORES

Makpac	Modelo (Ferramenta)	Unidades	Código	EAN	P.V.P. (€)
821552-6	5008MG 5604R 5704R	1	837657-2	0088381436489	8,75
	CA5000	1	838390-9	0088381526197	9,00
	DHR242 DHR243	1	837649-1	0088381535595	7,50
	DHR262 DHR262T	1	837650-6	0088381436472	7,75
	DHR263 DHR264		837988-9	0088381454001	8,50
	DHS710	1	837861-3	0088381441445	16,00
	HS6101 HS7101	1	837807-9	0088381436502	7,75
	RP1800 RP2300FC		837647-5	0088381436465	7,50
	RT0700C		837247-1	0088381436441	7,50
	SP6000		837945-7	0088381437356	7,50
	SG1251		838111-9	0088381526135	7,50
	BO5030 BO5031 BO5040 BO5041		837247-1	0088381436441	-
	DHR280 DHR281 DHR282 DHR283		839559-8	0088381526333	4,00
	CC301		838315-3		6,25
	KITS DE BATERIAS 4,0 Ah 5,0 Ah 6,0 Ah		839205-3	0088381436342	4,75

Modelo	Descrição	Unidades	Código	EAN	P.V.P. (€)
1100	Metálico	1	181790-5	008838118705	60,00
4326	Plástico	1	824572-9	0088381151627	11,00
4327	Plástico	1	824572-9	0088381151627	11,00
4328	Plástico	1	824572-9	0088381151627	11,00
4329	Plástico	1	824572-9	0088381151627	11,00
6807	Plástico	1	824890-5	3240890391902	15,00
6842	Plástico	1	824808-6	0088381347204	30,00
6844	Plástico	1	824808-6	0088381347204	30,00
2107F	Plástico	1	824728-4	0088381197700	37,00
2107FX	Plástico	1	824728-4	0088381197700	37,00
4350CT	Plástico	1	824809-4	0088381345729	22,00
4350T	Plástico	1	824809-4	0088381345729	22,00
4351CT	Plástico	1	824809-4	0088381345729	22,00
5603R	Plástico	1	824555-9	0088381189422	45,00
5604R	Plástico	1	824555-9	0088381189422	45,00
5704R	Plástico	1	824554-1	0088381189415	42,00
5705R	Plástico	1	824554-1	0088381189415	42,00
5903R	Plástico	1	193196-5	0088381189385	56,00
6019D	Plástico	1	824723-4	0088381200455	16,50
6096D	Plástico	1	824723-4	0088381200455	16,50
6207DW	Plástico	1	183763-4	0088381139595	21,00
6260D (3 baterias)	Plástico	1	824652-1	0088381196949	9,00
6260D (lanterna)	Plástico	1	824581-8	0088381156790	12,00
6261D (3 baterias)	Plástico	1	824852-3	0088381350631	13,00
6270D (3 baterias)	Plástico	1	824652-1	0088381196949	9,00
6270D (lanterna)	Plástico	1	824581-8	0088381156790	12,00
6271D (3 baterias)	Plástico	1	824852-3	0088381350631	13,00
6280D (3 baterias)	Plástico	1	824652-1	0088381196949	9,00
6280D (lanterna)	Plástico	1	824581-8	0088381156790	12,00
6281D (3 baterias)	Plástico	1	824852-3	0088381350631	13,00
6317D	Plástico	1	183763-4	0088381139595	21,00
6337D	Plástico	1	183763-4	0088381139595	21,00
6347D	Plástico	1	183763-4	0088381139595	21,00
6391D (3 baterias)	Plástico	1	824852-3	0088381350631	13,00
6904V	Plástico	1	824698-7	0088381183789	27,50
6905B	Plástico	1	824698-7	0088381183789	27,50
6905H	Plástico	1	824698-7	0088381183789	27,50
6918FD	Plástico	1	824635-1	0088381161145	10,00
6934FD	Plástico	1	824635-1	0088381161145	10,00
6935FD	Plástico	1	824635-1	0088381161145	10,00
6936FD	Plástico	1	824635-1	0088381161145	10,00
6980FD	Plástico	1	824635-1	0088381161145	10,00
8270D	Plástico	1	824635-1	0088381161145	10,00
8280D	Plástico	1	824635-1	0088381161145	10,00
8390D	Plástico	1	824744-6	0088381202039	11,50
9554NB	Metálico	1	188627-7	3240890271303	23,00
9555NB	Metálico	1	188627-7	3240890271303	23,00
9557NB	Metálico	1	188627-7	3240890271303	23,00
9558NB	Metálico	1	188627-7	3240890271303	23,00
AF505	Plástico	1	HY00000090	0088381335218	18,00
AN250CH	Plástico	1	824490-1	3240890326829	20,50
AN610H	Plástico	1	824490-1	3240890326829	20,50

Modelo	Descrição	Unidades	Código	EAN	P.V.P. (€)
AN711H	Plástico	1	824490-1	3240890326829	20,50
AN911H	Plástico	1	824490-1	3240890326829	20,50
AR410HR	Plástico	1	824864-6	0088381376501	46,00
BDF440	Plástico	1	141205-4	0088381538329	60,00
BDF450	Plástico	1	141205-4	0088381538329	60,00
BFR440	Plástico	1	824756-9	0088381341981	21,50
BGA452	Plástico	1	824767-4	0088381289702	18,00
BHP440	Plástico	1	141205-4	0088381538329	60,00
BHP450	Plástico	1	141205-4	0088381538329	60,00
BHR162	Plástico	1	824863-8	0088381351010	51,00
BHR200SJEP	Plástico	1	824690-3	-	33,00
BHR202	Plástico	1	141642-2	-	23,00
BJR181	Plástico	1	824760-8	0088381341998	19,50
BO4556	Plástico	1	824806-0	0088381346092	12,00
BO4565	Plástico	1	824806-0	0088381346092	12,00
BO5020	Plástico	1	183782-0	0088381189262	22,00
BO5021	Plástico	1	183782-0	0088381189262	22,00
BO5030	Plástico	1	183782-0	0088381189262	22,00
BO5031	Plástico	1	183782-0	0088381189262	22,00
BSS610	Plástico	1	824757-7	0088381252898	29,00
BTW200	Plástico	1	824593-1	0088381158084	34,00
BTW250	Plástico	1	141205-4	-	60,00
BTW251	Plástico	1	141205-4	-	60,00
BUC122	Plástico	1	824820-6	3240890258571	41,00
DA400LR	Plástico	1	824646-6	0088381171052	42,00
DBM080	Metálico	1	P-45135	0088381975247	46,00
DBM130	Metálico	1	P-45141	0088381975254	47,00
DBM131	Metálico	1	P-45141	0088381975254	47,00
DBN500	Metálico	1	821604-3	-	54,00
DF010D	Plástico	1	158775-6	3240890276278	10,50
DF030D	Plástico	1	824842-6	3240890276261	11,00
DF330D	Plástico	1	824842-6	3240890276261	11,00
DF347D	Plástico	1	824981-2	0088381401517	18,00
DF457D	Plástico	1	824981-2	0088381401517	18,00
DP4011	Plástico	1	824695-3	3240890275165	14,00
DFS452	Plástico	1	821645-9	-	21,00
FS2300	Plástico	1	824890-5	3240890391902	15,00
FS2500	Plástico	1	824890-5	3240890391902	15,00
FS2700	Plástico	1	824890-5	3240890391902	15,00
FS4200	Plástico	1	824890-5	3240890391902	15,00
FS6300R	Plástico	1	824890-5	3240890391902	15,00
GA7020R	Plástico	1	824958-7	0088381371438	27,00
GA7030R	Plástico	1	824958-7	0088381371438	27,00
GA7040R	Plástico	1	824958-7	0088381371438	27,00
GA9020R	Plástico	1	824958-7	0088381371438	27,00
GA9030R	Plástico	1	824958-7	0088381371438	27,00
GA9040R	Plástico	1	824958-7	0088381371438	27,00
GN900SE	Plástico	1	824875-1	3240890414328	45,00
HG5002	Plástico	1	HG130442	3240890345578	21,00
HG5012	Plástico	1	HG130442	3240890345578	21,00
HG550V	Plástico	1	HG130442	3240890345578	21,00
HG551V	Plástico	1	HG130442	3240890345578	21,00

MALAS

Modelo	Descrição	Unidades	Código	EAN	P.V.P. (€)
HG650C	Plástico	1	HG118897	3240890287465	21,00
HG651C	Plástico	1	HG130442	3240890345578	21,00
HK0500	Plástico	1	824523-2	0088381151849	37,00
HK1810	Metálico	1	150640-5	0088381152426	33,00
HK1820	Plástico	1	824789-4	0088381346108	17,00
HM0830T	Plástico	1	154828-9	0088381349970	37,00
HM0860C	Plástico	1	824708-0	0088381187725	36,00
HM0870C	Plástico	1	824905-8	-	61,00
HM0871C	Plástico	1	824904-0	0088381361743	63,00
HM1101C	Plástico	1	140561-9	0088381367639	128,00
HM1111C	Plástico	1	140561-9	0088381367639	128,00
HM1200K	Plástico	1	150583-1	0088381152402	45,00
HM1202C	Plástico	1	824564-8	0088381154536	61,00
HM1203C	Plástico	1	824908-2	0088381359504	94,00
HM1213C	Plástico	1	824908-2	0088381359504	94,00
HM1214C	Plástico	1	824882-4	0088381359788	135,00
HM1303	Metálico	1	182851-4	0088381155618	144,00
HM1304B	Metálico	1	183598-3	0088381183796	54,00
HM1307C	Plástico	1	824898-9	-	131,00
HM1317C	Plástico	1	824898-9	-	131,00
HM1317CB	Plástico	1	824898-9	-	131,00
HP1620	Plástico	1	824724-2	0088381193887	17,50
HP1621	Plástico	1	824724-2	0088381193887	17,50
HP1631	Plástico	1	824811-7	0088381351140	16,00
HP1640	Plástico	1	824811-7	0088381351140	16,00
HP1641	Plástico	1	824811-7	0088381351140	16,00
HP2033	Plástico	1	824890-5	3240890391902	15,00
HP2050	Plástico	1	824695-3	3240890275165	14,00
HP2051	Plástico	1	824695-3	3240890275165	14,00
HP2070	Plástico	1	824695-3	3240890275165	14,00
HP2071	Plástico	1	824695-3	3240890275165	14,00
HP330D	Plástico	1	824842-6	3240890276261	11,00
HP347D	Plástico	1	824981-2	0088381401517	18,00
HP457D	Plástico	1	824981-2	0088381401517	18,00
HR160D	Plástico	1	824550-9	0088381157612	19,50
HR1830	Plástico	1	824695-3	3240890275165	14,00
HR2020	Plástico	1	824695-3	3240890275165	14,00
HR2230	Plástico	1	824799-1	0088381346849	15,00
HR2440	Plástico	1	824695-3	3240890275165	14,00
HR2450	Plástico	1	824695-3	3240890275165	14,00
HR2460	Plástico	1	824799-1	0088381346849	15,00
HR2470	Plástico	1	824799-1	0088381346849	15,00
HR2610T	Plástico	1	140404-5	-	31,00
HR2800	Plástico	1	824789-4	0088381346108	17,00
HR2810	Plástico	1	824789-4	0088381346108	17,00
HR2811	Plástico	1	824789-4	0088381346108	17,00
HR3200C	Plástico	1	824819-1	3240890266422	49,00
HR3210C	Plástico	1	824825-6	0088381349727	50,00
HR3540C	Plástico	1	824819-1	3240890266422	49,00
HR3541FC	Plástico	1	824825-6	0088381349727	50,00
HR4000C	Plástico	1	824479-9	0088381152778	46,00
HR4500C	Plástico	1	824607-6	0088381160070	50,00

Modelo	Descrição	Unidades	Código	EAN	P.V.P. (€)
HR4501C	Plástico	1	158274-8	3240890306630	67,00
HR4511C	Plástico	1	158273-0	0088381346429	68,00
HR5000	Plástico	1	150589-9	0088381146661	55,00
HR5001C	Plástico	1	824519-3	0088381152952	60,00
HR5201C	Plástico	1	158274-8	3240890306630	67,00
HR5211C	Plástico	1	158273-0	0088381346429	68,00
JN3201	Plástico	1	821550-0	0088381430128	23,00
JR3060T	Plástico	1	821621-3	-	22,00
JR3070CT	Plástico	1	821621-3	-	22,00
JS3200	Metálico	1	181797-1	0088381116060	36,00
JS3201	Plástico	1	821550-0	0088381430128	23,00
JS8000	Plástico	1	824780-2	0088381341004	23,00
JV0600K	Plástico	1	824998-5	0088381401487	20,50
KP0800	Plástico	1	824892-1	0088381361408	14,50
PC1100	Metálico	1	181789-0	0088381116213	51,00
PC5001C	Metálico	1	140073-2	3240890271624	66,00
SG150	Metálico	1	B50856	3240890267061	38,00
SP6000	Plástico	1	821552-6	0088381433006	35,00
TD090D	Plástico	1	824842-6	3240890276261	11,00
TM3000C	Plástico	1	821596-6	-	20,00
TM3010C	Plástico	1	821596-6	-	20,00
TW0200	Plástico	1	824703-0	0088381185424	14,00
TW0350	Plástico	1	824702-2	0088381185837	18,50
TW1000	Plástico	1	824737-3	0088381200042	40,00
TW100D	Plástico	1	141104-0	3240890414243	15,00
UC120DWAE	Plástico	1	824491-9	0088381152747	36,00
JV101	Plástico	1	821691-2	-	20,00
HR4001	Plástico	1	196183-3	-	90,00
HR4011C	Plástico	1	196185-9	-	96,00
DFS451RFE	Plástico	1	824978-1	0088381401531	34,00
DTM51	Plástico	1	821608-5	-	22,50
BHP458	Plástico	1	143603-8	-	34,00
HS7101	Plástico	1	141736-3	-	55,00
TD110D	Plástico	1	821661-1	-	16,00
DJR187	Plástico	1	821620-5	-	27,00
DJR181	Plástico	1	141354-7	-	26,50
HS301D	Plástico	1	821663-7	-	20,00
DCG180	Plástico	1	821568-1	0088381437516	60,00
DGA900	Plástico	1	821717-0	0088381536172	55,00
DGA511	Plástico	1	821734-0	-	35,00
CG100	Plástico	1	821710-4	-	31,00
DJR360	Plástico	1	821670-0	0088381524209	47,00
9069K1	Plástico	1	824707-2	-	15,00
BHP440SFE	Plástico	1	824753-5	0088381207287	46,00
SP6000	Plástico	1	824783-6	0088381345651	77,00
BHR242	Plástico	1	141401-4	0088381432764	28,50

Escovas (por modelo de máquina)

1		6319D		BPJ180	430	DTW450	441	HP1631K	419	LF1016F	
1100	100	6337D		BSS501		F		HP2010N	106	LH1040F	153
1902	51	6339D	430	BSS610	441	FS2300		HP2033		LH1200FL	
1806B	153	6347D		BTD130F	440	FS2500		HP2050		LS0714F	303
1902K		6349D		BTD140		FS2700	419	HP2071	419	LS0815FL	JM23500117
1923B	51	6501X	70	BTD200	441	FS4200		HR1830		LS1013F	
1923H	132	6797F	424	BTP130	440	FS6300R		HR2020		LS1013FL	
2		6805BV	64	BTP140		G		HR2230		LS1013L	
2012NB	153	6824N		BTS130	440	GA4530		HR2240		LS1016FL	
2107FK		6825R	419	BTW200	441	GA5030		HR2300	325	LS1018L	
2107FXK	303	6826N		BTW250	440	GA4534	459	HR2400		LS1040F	153
2414B		6904V	415	BTW251		GA5034		HR2432		LS1214F	
2414EN	203	6905B	65	BUC122	430	GA4540C	318*	HR2440	419	LS1214L	
2414NB		6905H	415	D		GA4540Z	325	HR2450		LS1216F	
2704	153	6918FD		DA3000R	65	GA5021C	253	HR2450T		LS1216FL	
3		6932FD		DA3010F	419	GA5040C	318*	HR2460		M	
3612	203	6934FD		DA3011F		GA5040Z	325	HR2460F		MLS100	JM23000123
3620	106	6935FD	434	DA4000LR	303	GA6021C	253	HR2470	325	MLT100	
3706	64	6936FD		DA4031		GA6040C	318*	HR2470F		N	
3709		6980FD		DA6301	100	GA7010C		HR2470FT		N4105KB	
3710	411	7		DBM130		GA7012C	204*	HR2510	105*	N9741	100
3901		7104L	153	DBM131	EE80700019	GA7020S		HR2600		NPC1100	
3601B	153	8		DBM230		GA7020R		HR2610		P	
3612C	203	8414D		DCS550	430	GA7030S		HR2610T	325	PC5001C	253
3707FC	411	8434D	430	DDA340		GA7030R		HR2611FT		PJ7000C	459
4		8444D		DDF440		GA7040S		HR262D	442	PV7000C	303
440	80051B5X	9		DDF441		GA7040R		HR262TD		PW5000CH	318*
443	W26774	906	64	DDF442		GA7050R		HR2800		R	
445X	80051B5X	9031	411	DDF445		GA9010C		HR2810		RP0900	106
446L		9032		DDF451		GA9012C	204*	HR2810T	325	RP0910	303
447L	W49625	9046	419	DDF452	440	GA9020S		HR2811FT		RP1100C	
4131	303	9402	153	DDF458		GA9020R		HR3000C	327*	RP1800	203
4326		9403		DFR440		GA9030S		HR3200C		RP2300FC	411
4327	64	9404	303	DFR550		GA9030R		HR3210C		RT0700C	
4328		9903		DFR750		GA9040S		HR3210FCT	350*	S	
4329		9910	411	DFS440		GA9040R		HR3540C		SA5040C	318*
4402		9911		DFS450		GA9050R		HR3541FC		SA7000C	204*
4403	411	9920		DFS451		GD0600		HR4000C	327*	SC161D	430
4101RH	303	9015B	303	DGA452	430	GD0601	325	HR4001C		SG1250	318*
4112HS		9016B		DGD800		GD0602		HR4003C		SG1251J	
4114S	204*	9049S		DHP440		GD0800C		HR4011C	350*	SG150	B45872
4157KB	153	9059S	204*	DHP441		GD0801C		HR4013C		SL7000	MO1401045
4329K	64	9077S		DHP442		GD0801C	318*	HR4500C	155*	SP6000	303
4331D		9079S		DHP450	440	GD0810C		HR4501C	171	SR2300	155*
4333D	430	9218SB	100	DHP451		GS5000	204*	HR5000	155*	T	
4334D	441	9227CB	303	DHP452		GS6000		HR5001C		TD0101F	411
4340CT		9554NB		DHR160	430	GV5010	64	HR5201C	171	TM3000C	459
4350CT		9555NB		DHR220		GV7000C	303	HR5202C	175	TM3010C	
4350FCT		9557NB	325	DHR262	442	H		HR5211C	171	TW0200	411
4350T	419	9558NB		DHR261		HB500	EIB106C	HR5212C	175	TW0350	
4351CT		9558PBY		DJR181		HK0500	113	HS6100		TW1000	153
4351FCT		9561CH		DJR182	441	HK1810	105*	HS7100	174	U	
5		9562C	318*	DJR240		HK1820	350*	JN1601	411	UB1101	303
5008MG	153	9562CH		DJR242	441	HM0810B	105*	JN3200	100	UC3530A	957805410
5017RKB	303	9562CVH		DJV140	430	HM0880T	327*	JN3201	303	UC4020A	132
5103R		9564C		DJV180		HM0880C		JR1000FT	419	UC4030A	957805410
5104S	203	9564H	325	DDF446		HM0870C	350*	JR140D	441	UH5540	223804410
5143R		9565CV		DDF458	440	HM0871C		JR180D		UT120	EE80700013
5603R		9565CVL	318*	DFS451		HM1101C	171	JR3050T	303	SG150	B45872
5604R	303	9565H	325	DGA452	430	HM1200B		JR3060T		SP6000	303
5704R		9566PCV		DHP456	440	HM1200K	155*	JR3070CT		SR2300	155*
5705R		9566C	318*	DHP458		HM1202C		J		T	
5903R	203	9566CV		DHR202	441	HM1203C		JS1000	459	TM3000C	459
6		9566PCV		DHR262		HM1213C	171	JS1600	65	TM3010C	
6305	303	9924DB	100	DJR181	441	HM1214C		JS1602	459	TW0200	411
6310	419	B		DJR182		HM1304	204*	JS1670	65	TW0350	
6408	64	BLS820	441	DJV180	430	HM1307C		JS1670		TW1000	153
6413	70	BO3700	64	DP2010		HM1307C		JS3201	303	U	
6501		BO4556		DP2011		HM1317CB	171	JS8000	419	UB1101	303
6807		BO4557		DP3002		HM1400	155*	JV0600	64	UC3530A	957805410
6821		BO4558	419	DP3003		HM1801	204*	K		UC4020A	132
6823		BO4566		DP4000	419	HM1810		KP0800	411	UC4030A	
6824	419	BO4900V		DP4001		HP1620	419	KP0810	132	UH5540	957805410
6826		BO4901		DP4002		HP1621		KP312S	203	UT120	EE80700013
6827		BO5010		DP4003		HP1631	85	L		UT1200	
6842		BO5020	64	DS4012	411	HP1641	419	LC1230	203		
6844	411	BO5021		DP4700	64	HP1641K		LF1000	153		
6906	100	BO5030	419	DS4010	411						
6952	411	BO5031		DTD146	440						
6013B	51	BO5040	64	DTW251							
6300-4		BO5041									
6305W	303	BO6030	419								
6317D	430	BO6040	318*								

Escovas (por modelo de escova)

51	1902 1902K 1923B 6013B 6300-4 3706 4326 4327 4328 4329 4329K 6413 6805BV 906 BO3700 BO5010 BO5020 BO5021 BO5040 BO5041 DP4700 GV5010 JV0600	155*	HM1200B HM1200K HM1202C HM1400 HR4500C HR5000 HR5001C SR2300 HM1101C HM1111C HM1203C HM1213C HM1214C HM1307C HM1317C HM1317CB HR4501C HR4511C HR5201C HR5211C	303	4101RH 5017RKB 5603R 5604R 5704R 5705R 6305 6305W 9403 9404 9903 9920 9015B 9016B 9227CB DA4000LR DA4031 GV7000C JN3201 JR3050T JR3060T JR3070CT JS3201 LS0714F PV7000C RP0910 RP110C SP6000 UB1101 9561CH 9562C 9562CH 9562CVH 9564C 9565CV 9565CVL 9565PCV 9566C 9566CV 9566PCV B06040 GA4540C GA5040C GA6040C GD0800C GD0801C GD0810C GD0811C PW5000CH SA5040C SG1250 SG1251J 9554NB 9555NB 9557NB 9558NB 9558PHY 9564H 9565H GA4540Z GA5040Z GD0600 GD0601 GD0602 HR2230 HR2300 HR2460 HR2460F HR2470 HR2470F HR2470FT HR2600 HR2610 HR2610T HR2611FT HR2800 HR2810	325	HR2810T HR2811FT HM0830T HM0860C HR3000C HR4000C HK1820 HM0870C HM0871C HR3200C HR3210C HR3210FCT HR3540C HR3541FC HR4001C HR4003C HR4011C HR4013C	419	DP4003 DP4011 FS2300 FS2500 FS2700 FS4200 FS6300R HP1620 HP1621 HP1640 HP1641 HP1641K HP1631K HP2033 HP2050 HP2051 HP2070 HP2071 HR1830 HR2020 HR2410 HR2432 HR2440 HR2450 HR2450T JRI000FT JS8000	440	DFR750 DFS440 DFS450 DFS451 DHP440 DHP441 DHP442 DHP450 DHP451 DHP452 DHP458 DDF446 DDF458 DFS451 DHP456 DHP458 DTD146 DTW251 4334D BLS820 BSS610 BTD200 BTW200 BTW450 DHR202 DJR181 DJR182 DJR240 DHR202 DJR181 DTW450 JRI140D JRI80D DHR261 DHR262 HR262D HR262TD 8414D 8434D 8444D BPJ180 BSS501 BUC122 DCS550 DGA452 DGD800 DHP460 DHR162 DHR200 DUN161 DJV140 DJV180 DGA452 DJV180 SCI61D 6918FD 6932FD 6934FD 6935FD 6936FD 6980FD BTD130F BTD140 BTP130 BTP140 BTP140 BTS130 BTW250 BTW251 DDA340 DDF440 DDF441 DDF442 DDF451 DDF452 DDF458 DFR440 DFR550	441	DJR181 DJR182 DJR240 DHR202 DJR181 DTW450 JRI140D JRI80D DHR261 DHR262 HR262D HR262TD 8414D 8434D 8444D BPJ180 BSS501 BUC122 DCS550 DGA452 DGD800 DHP460 DHR162 DHR200 DUN161 DJV140 DJV180 DGA452 DJV180 SCI61D 6918FD 6932FD 6934FD 6935FD 6936FD 6980FD BTD130F BTD140 BTP130 BTP140 BTP140 BTS130 BTW250 BTW251 DDA340 DDF440 DDF441 DDF442 DDF451 DDF452 DDF458 DFR440 DFR550	442	DHR202 DJR181 DTW450 JRI140D JRI80D DHR261 DHR262 HR262D HR262TD 8414D 8434D 8444D BPJ180 BSS501 BUC122 DCS550 DGA452 DGD800 DHP460 DHR162 DHR200 DUN161 DJV140 DJV180 DGA452 DJV180 SCI61D 6918FD 6932FD 6934FD 6935FD 6936FD 6980FD BTD130F BTD140 BTP130 BTP140 BTP140 BTS130 BTW250 BTW251 DDA340 DDF440 DDF441 DDF442 DDF451 DDF452 DDF458 DFR440 DFR550	449	GA4530 GA5030 GA4534 GA5034 JS1000 JS1601 JS1602 PJ7000C TM3000C TM3010C UH5540 UH6540 UC3530A UC4030A 440 445X SG150 UT120 DBM130 DBM131 DBM230 UT121 UT1200 EIB106C HB500 MLS100 MLT100 LS0815FL SL7000 443 446L 447L
----	---	------	--	-----	---	-----	---	-----	--	-----	---	-----	--	-----	--	-----	--

Código	Tipo	P.V.P. (€)	Código	Tipo	P.V.P. (€)	Código	Tipo	P.V.P. (€)	Código	Tipo	P.V.P. (€)	Código	Tipo	P.V.P. (€)
CB-51	181021-2	1,50	CB-113	191904-8	5,50	CB-303	191963-2	3,00	CB-424	191966-6	1,90	80051B5X	80051B5X	12,00
CB-64	191627-8	1,50	CB-132	191972-1	3,60	CB-318*	191978-9	8,00	CB-432	191976-3	3,60	957800410	957800410	6,75
CB-65	191628-6	3,00	CB-153	181044-0	3,00	CB-325	194074-2	1,40	CB-430	191971-3	2,40	957802410	957802410	6,50
CB-70	191914-5	2,40	CB-155*	181048-2	7,00	CB-327*	194285-9	4,25	CB-434	193466-2	2,25	B45872	B45872	8,00
CB-85	191998-3	1,50	CB-171	195844-2	3,60	CB-350*	194160-9	3,60	CB-440	194427-5	3,00	EE80700013	EE80700013	6,20
CB-100	181030-1	2,40	CB-203	191953-5	3,00	CB-411	191940-4	2,00	CB-441	194435-6	3,60	EE80700019	EE80700019	6,20
CB-105*	181038-5	5,50	CB-204*	191957-7	3,00	CB-415	191950-1	4,80	CB-459	194722-3	1,90	JM23000123	JM23000123	3,00
CB-106	181410-1	2,75	CB-253	194547-5	4,20	CB-419	191962-4	1,75	223804410	223804410	4,20	W49625	W49625	25,00

* Com desconnexão automática.

KITS DE MANUTENÇÃO

Kits de manutenção para martelos



Modelos	Unidades	Código	EAN	P.V.P. (€)
DHR162	1	188580-7	0088381350662	8,00
DHR200	1	195258-5	-	13,00
DHR202	1	195193-7	-	7,00
DHR242 DHR281 DHR282	1	195833-7	-	8,50
DHR243	1	195834-5	-	9,00
DHR261 DHR262 DHR263 DHR264	1	195189-8	-	12,00
HK0500	1	193397-5	-	17,00
HK1810	1	193394-1	-	13,00
HK1820	1	195194-5	-	17,00
HM0810 HM0810T	1	193242-4	-	28,00
HM0830T	1	188048-3	-	19,00
HM0860C	1	195204-8	-	31,00
HM0870C HM0871C	1	195113-1	-	28,00
HM1100 HM1100C	1	193243-2	-	21,00
HM1101C HM1111C	1	195260-8	-	32,00
HM1200 HM1200B	1	193244-0	-	37,00
HM1200K	1	193279-1	-	34,00
HM1202C	1	193391-7	0088381162326	28,00
HM1203C HM1213C HM1214C	1	195114-9	-	34,00
HM1303 HM1303B	1	193393-3	0088381162166	25,00
HM1304 HM1304B	1	195201-4	-	28,00
HM1307C HM1307CB HM1317C	1	195103-4	-	17,00
HM1400	1	193399-1	0088381162210	48,00
HM1801 HM1810	1	195205-6	-	34,00
HM1812	1	197127-6	-	31,00
HR1830	1	188389-7	-	10,00
HR2010	1	193395-9	-	13,00

Modelos	Unidades	Código	EAN	P.V.P. (€)
HR2020 HR2432 HR2440 HR2450 HR2450T HR2450FT	1	193606-2	-	17,00
HR2300 HR2600 HR2610	1	195105-0	-	15,00
HR2400	1	193386-0	-	14,00
HR2410 HR2430 HR2431	1	193388-6	-	12,00
HR2230 HR2460 HR2470/T HR2800 HR2810/T HR2811FT	1	195206-4	-	11,00
HR2510	1	193404-4	-	13,00
HR2630	1	196968-7	-	11,00
HR3000C	1	193390-9	0088381162159	21,00
HR3200C HR3210C HR3210FCT	1	195199-5	-	17,00
HR3520 HR3520T	1	193280-6	-	28,00
HR3540C	1	188646-3	-	11,00
HR3850 HR3850B	1	193281-4	-	31,00
HR3850K	1	193282-2	-	37,00
HR4000C	1	193283-0	-	23,00
HR4001C HR4011C	1	195195-3	-	23,00
HR4003C HR4013C	1	196532-4	-	24,00
HR4500C	1	193407-8	0088381162289	23,00
HR4501C HR4511C	1	195210-3	-	25,00
HR5000	1	193284-8	-	21,00
HR5000K	1	193285-6	-	28,00
HR5001C	1	193392-5	0088381163323	28,00
HR5201C HR5211C	1	195191-1	-	25,00
HR5202C HR5212C	1	196865-7	-	34,00



NORTE

ASSEADA

R. Presa Rei, 209, Carregosa
3720 OLIVEIRA AZEMÉIS
Tel.: 256 412 357

BRICOFEL

Z. Ind. Cantarias, Lt. 167
5300 BRAGANÇA
Tel.: 273 312 371

J.M.M.

R. da Boavista, 40, Lordelo
4816 GUIMARÃES
Tel.: 252 840 510

MACHADO & CARDOSO

R. Prof. Dr. José Azevedo Ferreira, 38, Maximinos
4701 BRAGA
Tel.: 253 617 883

OXIBEIRAS

R. Estádio Municipal, 6 R/C
6300 GUARDA
Tel.: 271 222 788

VHS

R. da Gandarra, 1223, Touginho
4480 VILA DO CONDE
Tel.: 252 684 560

CENTRO

ABR

R. Casal Frazão, S/N
2025 AMIAIS BAIXO
Tel.: 249 870 716

AGROSPORT

Est. Várzeas Casal 3, Pinheiros
2070 CARTAXO
Tel.: 243 770 514

BENEMÁQUINA

R. Monges de Cister, 10 A
2475 BENEDITA
Tel.: 262 921 359

BOBINADORA POMBALENSE

Estrada Nacional, 1, Moncalva
3100 POMBAL
Tel.: 236 209 970

MAQUIVEDRAS

Av. 10 de Junho, 73-75
2565 TORRES VEDRAS
Tel.: 261 950 060

PARAMÁQUINAS

Lugar do Brejo, Est. Ponte, Fração C, Antanhol
3040 COIMBRA
Tel.: 239 442 059

SUL

FEREXCEL

Av. 1º Maio, 47, Lj. Esq
2845 AMORA
Tel.: 212 258 734

FIEL TÉCNICA

Pçt. São João Bosco, 8
2735 CACÉM
Tel.: 219 134 725

JAIME MACHADO SANTOS

Zona Ind. Lt. 2,
Casais da Serra, Milharado
2665 MALVEIRA
Tel.: 212 258 734

PROVEDA

Av. de Angola, 60
2530 LOURINHÃ
Tel.: 261 413 044





AÇORES

ELETROXI

Rua da Juventude, & 17R/C Esq.
9500 - 211 Ponta Delgada
Tel.: 296 205 580

LOS LIVE OUR STYLE

R. Serpa Pinto, 41, Horta
9990 FAIAL
Tel.: 292 391 990

TERCEIRA FARMA

Pico Redondo, 145,
Praia Vitória
9700 TERCEIRA
Tel.: 295 512 509

MADEIRA

SOMATERIAL

Caminho da Igreja, 36, Caniço
9125 FUNCHAL
Tel.: 291 930 380

