

# PROFILE RAIL LINEAR GUIDES

July 2006

[www.DanaherMotion.com](http://www.DanaherMotion.com)

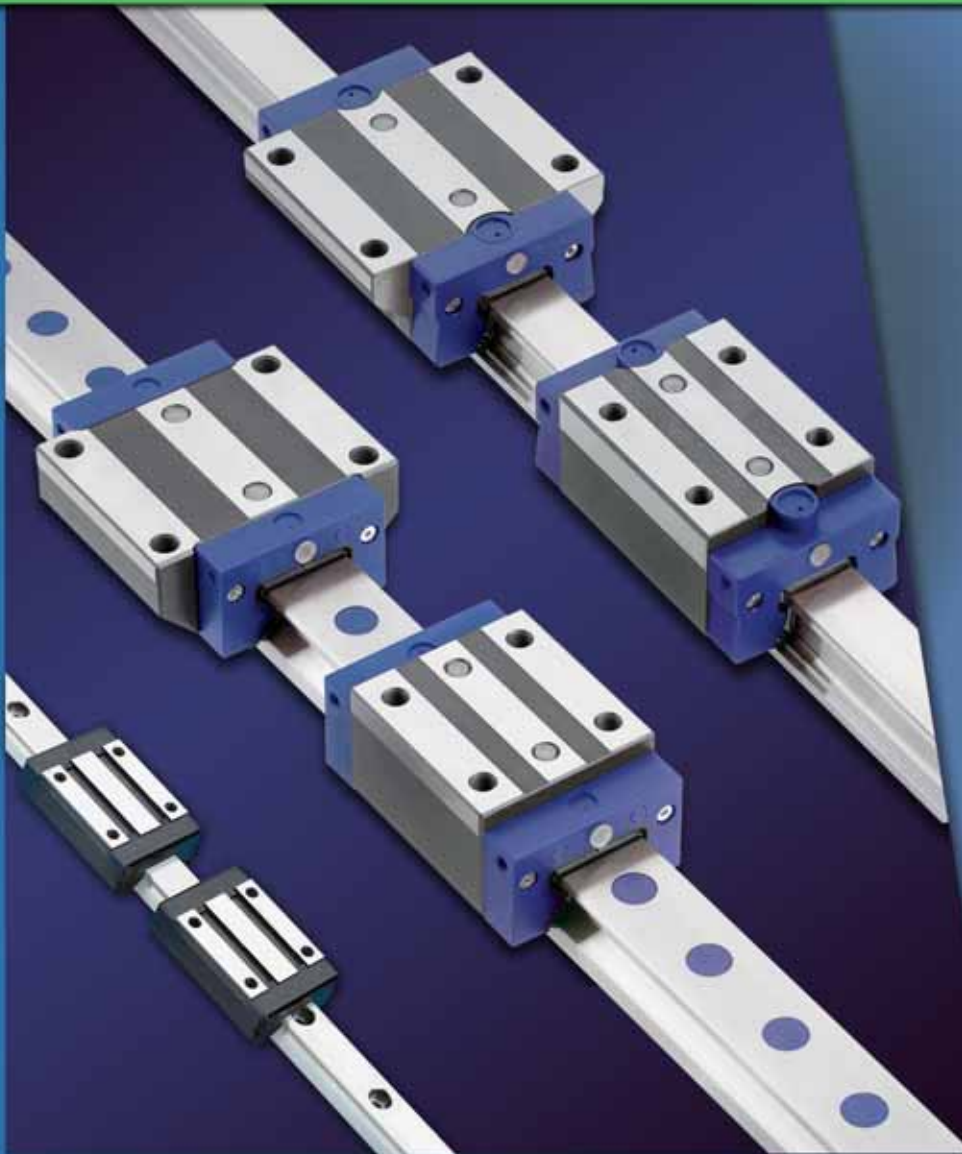

**THOMSON™**

- 500 Series Ball Profile Rail
- 500 Series Roller Profile Rail
- AccuMini

 **DANAHER**  
MOTION

Solutions by

# Mechanical and Electro-Mechanical Product Solutions by Danaher Motion

## New Name, Established Brands

Danaher Motion's wide range of motion control systems and components offer customers an unprecedented choice in selecting the right solution for their particular application requirements. Our product innovations have been improving the efficiency and productivity of complex manufacturing operations for over 60 years through trusted brand names such as Dover, Kollmorgen, Pacific Scientific, Portescap and Thomson in industries as diverse as semiconductor, aerospace and defense, mobile-off-highway, packaging, medical and robotics.

Danaher Motion's growing family of leading motion control products tells only half the story. With a worldwide service and support infrastructure, our field service engineers and support teams are available when you need them. It is part of the Danaher Corporation's unrelenting focus on you, our customer. That's why more and more design engineers are turning to Danaher Motion to meet their motion control requirements.

### Danaher Motion Values

- Application Expertise
- Broad & Innovative Motion Control Products and Systems
- Customer Focus
- Customizable Products and Services
- Motion Control Pioneers with Global Staying Power
- Operational Excellence



**KOLLMORGEN**



**Portescap**<sup>TM</sup>

## An Overview of Danaher Motion — Thomson Profile Rail

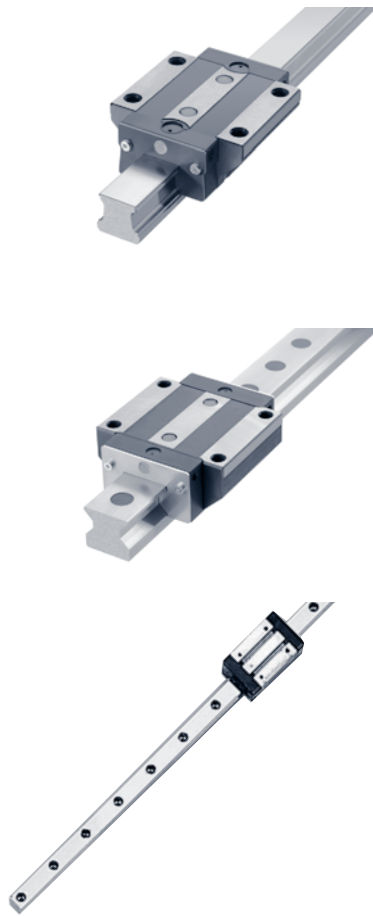

<b>Overview</b> .....	4
<b>500 Series Ball Profile Rail Linear Guide</b> .....	7
<b>Thomson Next Generation Profile Rail. Superior Design. Superior Quality.</b>	
Product overview .....	8
Part numbering .....	16
Datasheets .....	18
Options and accessories .....	26
Accuracy information .....	39
Preload information .....	39
<b>500 Series Roller Profile Rail Linear Guide</b> .....	41
<b>Thomson Next Generation Profile Rail. Superior Design. Superior Quality.</b>	
Product overview .....	41
Part numbering .....	50
Datasheets .....	52
Options and accessories .....	56
Accuracy information .....	67
Preload information .....	67
<b>AccuMini</b> .....	69
<b>Ultra Compact, High Roll &amp; Superior, Patented Ball Control Design.</b>	
Product overview .....	69
Part numbering .....	69
Datasheets .....	70
Accuracy information .....	72
Preload information .....	72
<b>Lubrication Fittings</b> .....	73
<b>Installation Guide</b> .....	75
<b>Engineering Guide</b> .....	79
Sizing, selection and life load calculations .....	81
Deflection .....	86
Lubrication .....	109
Bellow cover calculations .....	111
Butt joint specification sheets .....	112
Conversion factors .....	115
<b>Interchange Guide</b> .....	117

For more information, or to place an order, please contact your local authorized Thomson distributor or Danaher Motion at 1-540-633-3400, Fax: 1-540-633-4162, or E-mail at [profilerrail@danahermotion.com](mailto:profilerrail@danahermotion.com).

DANAHER MOTION is a registered trademark of Danaher Corporation. Danaher Motion makes every attempt to ensure accuracy and reliability of the specifications in this publication. Specifications are subject to change without notice. Danaher Motion provides this information "AS IS" and disclaims all warranties, express or implied, including, but not limited to, implied warranties of merchantability and fitness for a particular purpose. It is the responsibility of the product user to determine the suitability of this product for a specific application. ©2004 Danaher Motion.

## Overview of Danaher Motion – Thomson Profile Rail Linear Guides

Since the invention of the linear anti-friction Ball Bushing bearing by Thomson over 50 years ago, the Thomson precision linear products have meant high quality, innovative products. Today, Danaher Motion continues producing and developing these high quality, innovative products. The Danaher Motion Thomson Profile Rail assortment consists of the Next Generation Profile Rail "500 Series" Ball and Roller Linear Guides, compact miniature "MicroGuide,™" lightweight "T-Series," and AccuMini.

The Danaher Motion Profile Rail – Linear Guide Assortment is a complete assortment of rails and carriages in a broad range of styles, sizes and unique features produced to industry standard dimensions for easy retrofitting into existing applications or designing into new applications.

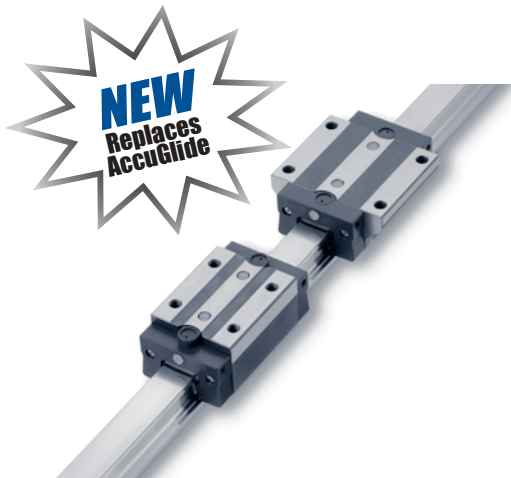

### 500 Series Ball Profile Rail Linear Guide

#### Features & Benefits

Superior Design. Superior Quality.

- Straight rails through advanced grinding technologies
- Simple installation and greater accuracy with joint-free rails up to 6 meters
- Smooth, quiet movement through patented insert molded recirculation paths and optimized geometries
- Extended lubrication life as a result of grease pockets built into the recirculation path
- Multiple carriage styles and sizes available
- On site field modifiable modular seals
- Rail and carriage options from stock or short delivery
- Customization with expanded accessory offering

#### Typical Applications

- Industrial Automation
- Machine Tool Equipment
- Material Handling
- Precision Measuring Equipment
- Industrial Robots
- Food Processing Equipment

For more information, or to place an order, please contact your local authorized Thomson distributor or Danaher Motion at 1-540-633-3400, Fax: 1-540-633-4162, or E-mail at [profilerail@danahermotion.com](mailto:profilerail@danahermotion.com).

DANAHER MOTION is a registered trademark of Danaher Corporation. Danaher Motion makes every attempt to ensure accuracy and reliability of the specifications in this publication. Specifications are subject to change without notice. Danaher Motion provides this information "AS IS" and disclaims all warranties, express or implied, including, but not limited to, implied warranties of merchantability and fitness for a particular purpose. It is the responsibility of the product user to determine the suitability of this product for a specific application. ©2004 Danaher Motion.

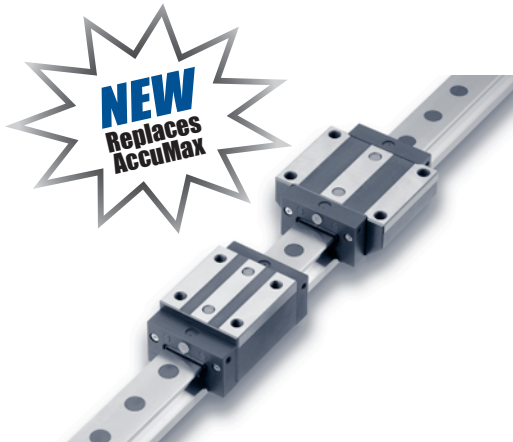

## 500 Series Roller Profile Rail Linear Guide

### Features & Benefits

Superior Design. Superior Quality.

- Industry leading load capacities
- High rigidity from back to back four roller track arrangement
- Straight rails through advanced grinding technologies
- Simple installation and greater accuracy with joint-free rails up to 6 meters
- Smooth, quiet movement through patented insert molded recirculation paths and optimized geometries
- Multiple carriage styles and sizes available
- On site field modifiable modular seals
- Rail and carriage options from stock or short delivery
- Customization with expanded accessory offering

### Typical Applications

- Industrial Automation
- Machine Tool Equipment
- Material Handling
- Precision Measuring Equipment
- Industrial Robots
- Food Processing Equipment

## AccuMini

### Features & Benefits

- Ball control design for smooth, quiet, low friction at high speeds
- Full length integral wiper which protects important bearing from contaminants... effective system life is maximized
- Gothic design, which provides high roll moment capacity...a requirement for stand-alone applications
- Wear-resistant, engineered polymer retainer which reduces system inertia and noise

### Typical Applications

- Wafer Handling Equipment
- Assembly Equipment
- Inspection and Measurement Equipment



*For more information, or to place an order, please contact your local authorized Thomson distributor or Danaher Motion at 1-540-633-3400, Fax: 1-540-633-4162, or E-mail at [profilerrail@danahermotion.com](mailto:profilerrail@danahermotion.com).*

DANAHER MOTION is a registered trademark of Danaher Corporation. Danaher Motion makes every attempt to ensure accuracy and reliability of the specifications in this publication. Specifications are subject to change without notice. Danaher Motion provides this information "AS IS" and disclaims all warranties, express or implied, including, but not limited to, implied warranties of merchantability and fitness for a particular purpose. It is the responsibility of the product user to determine the suitability of this product for a specific application. ©2004 Danaher Motion.

## Assortment

SIZE MM	500 Series Ball							500 Series Roller				AccuMini	
	Standard		Narrow					Standard		Narrow		Standard	
	—	Long	—	Long	High	High	Short	—	Long	—	Long	—	
5	—	—	—	—	—	—	—	—	—	—	—	—	—
7													
9													
10													•
12													
15	•		•		•		•						•
20	•	•	•	•			•						•
25	•	•	•	•	•	•		•	•	•	•		
30	•	•	•	•	•	•							
35	•	•	•	•	•	•		•	•	•	•		
45	•	•	•			•		•	•	•	•		
55								•	•	•	•		
65								•	•	•	•		
Style	A	B	C	D	E	F	G	A	B	C	D	A	
Page	12	26	18	18	20	20	24	52	52	54	54	69	

## Application Criteria

Feature	500 Series Ball	500 Series Roller	AccuMini
Load Capacity	••••	•••••	••
Equivalent Loads all directions	••••	•••••	••
Ultra Compactness	•	•	••••
High Travel Accuracy	•••••	•••••	•••••
Rigidity	••••	•••••	••
Smoothness	••••	••	•••••
Friction Characteristic	•••••	••	•••••
Admissable Speed	•••••	••••	•••••
Ease of Installation	••••	••	••
Lightweight	•	•	••
Industry Standard Dimensions	•••••	•••••	
Page	7	41	69

• = satisfactory    •••• = excellent

For more information, or to place an order, please contact your local authorized Thomson distributor or Danaher Motion at 1-540-633-3400, Fax: 1-540-633-4162, or E-mail at [profilerrail@danahermotion.com](mailto:profilerrail@danahermotion.com).

DANAHER MOTION is a registered trademark of Danaher Corporation. Danaher Motion makes every attempt to ensure accuracy and reliability of the specifications in this publication. Specifications are subject to change without notice. Danaher Motion provides this information "AS IS" and disclaims all warranties, express or implied, including, but not limited to, implied warranties of merchantability and fitness for a particular purpose. It is the responsibility of the product user to determine the suitability of this product for a specific application. ©2004 Danaher Motion.



# 500 Series Ball Profile Rail Linear Guide

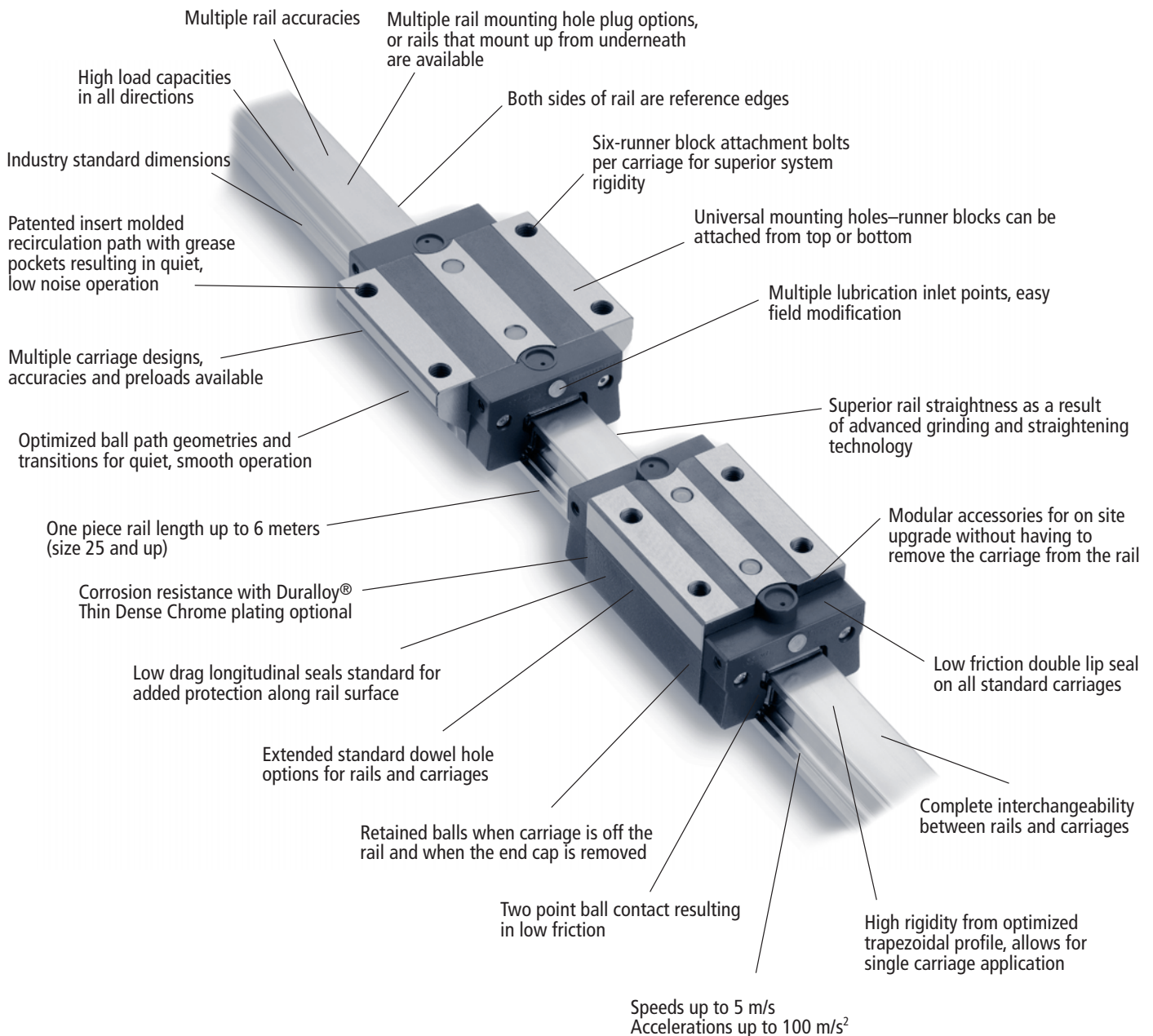

For more information, or to place an order, please contact your local authorized Thomson™ distributor or Danaher Motion at 1-540-633-3400, Fax: 1-540-633-4162, or E-mail at [profilerail@DanaherMotion.com](mailto:profilerail@DanaherMotion.com).

DANAHER MOTION is a registered trademark of Danaher Corporation. Danaher Motion makes every attempt to ensure accuracy and reliability of the specifications in this publication. Specifications are subject to change without notice. Danaher Motion provides this information "AS IS" and disclaims all warranties, express or implied, including, but not limited to, implied warranties of merchantability and fitness for a particular purpose. It is the responsibility of the product user to determine the suitability of this product for a specific application. ©2004 Danaher Motion.

## 500 Series Ball Profile Rail Linear Guide

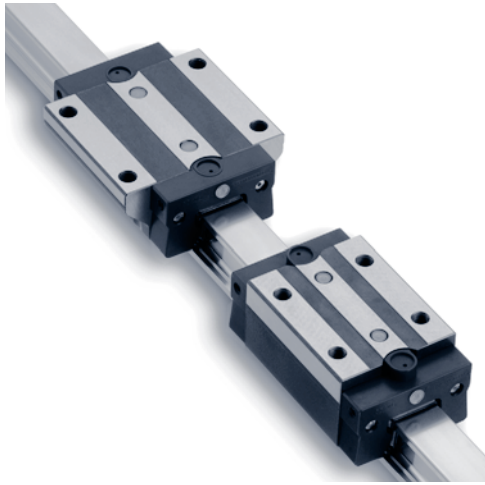

### Features

The Thomson 500 Series Ball Linear Guide provides long life, exceptional rigidity, high dynamic and static load capacities, accommodation for high moment loads, high running accuracy, multiple sealing options and multiple lubrication inlet options. This allows for on-site field modifications, and interchangeability with competitor offering.

These properties result in improved machine accuracies and rigidity resulting in reduced vibration extending machine and tool life. This has a direct effect on operational efficiency resulting in cost savings for the user.

Available in 7 carriage designs, and sizes 15 to 45mm.

### Materials Linear Guides

The 500 Series Ball Linear Guides are produced from high quality bearing steel. All carriages and rolling elements are through hardened and all rails are case hardened (except size 15 rail which is through hardened). The end cap is constructed of a high strength, glass filled nylon with nitrile rubber seal. Stringent quality controls are in place to ensure consistency of materials from the source, allowing us to ensure that we deliver the highest quality product.

### Interchangeability

The 500 Series Ball Linear Guides are completely interchangeable. Any carriage can be run on any rail of the same accuracy without compromising system accuracy. This is the result of our stringent manufacturing process controls.

### Accuracy and Preload

The 500 Series Ball Linear Guides are available in three different accuracy classes, three different preload ranges and with clearance to allow for customization to your application needs.

### Straightness

The 500 Series Ball rail is subjected to multiple straightening processes during and after grinding of the roller paths.

These added processes and inspections result in some of the straightest rails in the market today, improving machine accuracies wherever the 500 Series Ball is used.

### Rigidity

The 500 Series Ball Linear Guide rail utilizes a special trapezoidal profile that maximizes the carriage cross section, resulting in the highest possible rigidity.

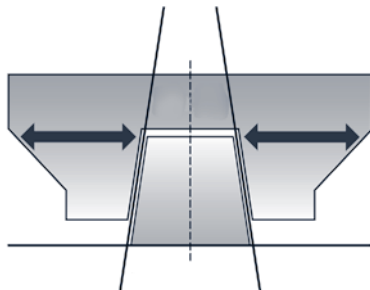

For more information, or to place an order, please contact your local authorized Thomson™ distributor or Danaher Motion at 1-540-633-3400, Fax: 1-540-633-4162, or E-mail at [profilerrail@DanaherMotion.com](mailto:profilerrail@DanaherMotion.com).

DANAHER MOTION is a registered trademark of Danaher Corporation. Danaher Motion makes every attempt to ensure accuracy and reliability of the specifications in this publication. Specifications are subject to change without notice. Danaher Motion provides this information "AS IS" and disclaims all warranties, express or implied, including, but not limited to, implied warranties of merchantability and fitness for a particular purpose. It is the responsibility of the product user to determine the suitability of this product for a specific application. ©2004 Danaher Motion.



## 500 Series Ball Profile Rail Linear Guide

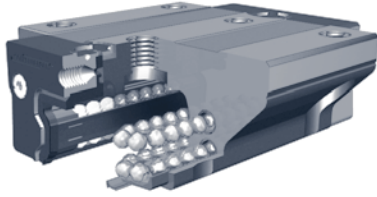

### Running Smoothness/Low Noise

The running smoothness and low noise are the result of a patented, custom insert molded recirculation path that has an optimized geometric shape and minimal transitions, to ensure smooth and quiet operation in both low and high-speed operation.

In addition, the balls make contact at only two points between rail and carriage. As a result, friction is reduced to a minimum, resulting in quiet, smooth operation.

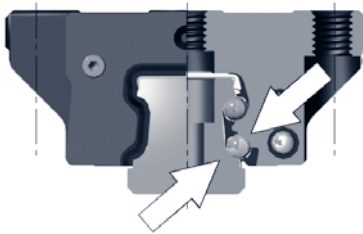

### Back-to-Back

The 500 Series Linear Guide utilizes a back-to-back bearing arrangement, resulting in added rigidity. As a result, the 500 Series Ball can be used in single rail applications.

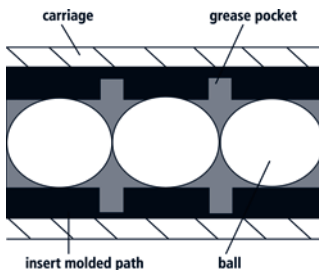

### Internal Grease Pockets

The patented insert molded recirculation path has built in grease pockets. These provide an extra level of security by ensuring adequate lubrication is available to the ball bearings to help extend life.

The pocket and area between the balls provide greater grease quantities in the ball path than a conventional designed linear guide bearing.

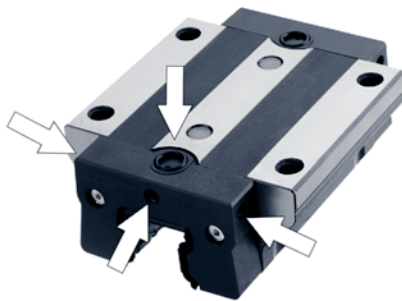

### Multiple Lubrication Options

The standard end cap is designed for flexibility. The end cap comes standard with four lubrication inlet options. These inlet options are easily changed on-site in the field or can be supplied from the factory.

Unsure of the best lubrication inlet location? These carriages allow the user to make these changes easily in the field to optimize the system performance. In addition, they allow for ease in maintenance—all without removing the carriage from the rail.

For more information, or to place an order, please contact your local authorized Thomson™ distributor or Danaher Motion at 1-540-633-3400, Fax: 1-540-633-4162, or E-mail at [profilerail@DanaherMotion.com](mailto:profilerail@DanaherMotion.com).

DANAHER MOTION is a registered trademark of Danaher Corporation. Danaher Motion makes every attempt to ensure accuracy and reliability of the specifications in this publication. Specifications are subject to change without notice. Danaher Motion provides this information "AS IS" and disclaims all warranties, express or implied, including, but not limited to, implied warranties of merchantability and fitness for a particular purpose. It is the responsibility of the product user to determine the suitability of this product for a specific application. ©2004 Danaher Motion.

## 500 Series Ball Profile Rail Linear Guide

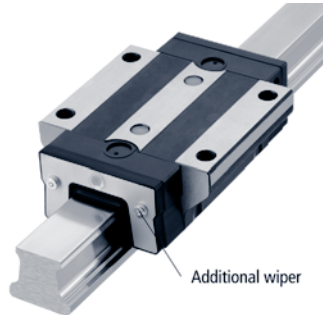

### Modular Accessory Options

The standard carriage is supplied with low friction double lip seals and longitudinal seals that completely encase the bearing carriage to protect the balls and track surfaces and minimize lubrication loss.

Optional metal scrapers or wipers, lube blocks and oil reservoir components can be easily added on-site in the field or can be supplied assembled from the factory.

The trapezoidal rail profile allows for easy servicing and replacing or adding of the end cap, additional wiper and oil reservoir without removing the carriage from the rail.

These innovative design features allow users to easily, efficiently, and economically upgrade carriage sealing.

### Longitudinal Seals

The carriage has built-in under carriage low drag longitudinal seals that protect the balls and ball path from contamination. These longitudinal seals are an added protection to increase the life and overall performance

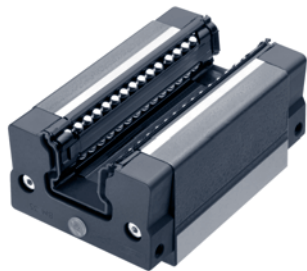

### Extended Standards

Extended Standards are an assortment of Danaher Motion dowel hole options for both carriage and rail products. Take the guesswork out of design by using our standard assortment of dowel hole options for ease of design and availability, another solution from Danaher Motion. Refer to page 26, 27 and 30 for more information and detailed datasheets.

### Rail Accessories

The rails have multiple options to protect the mounting holes to eliminate possible contamination entry into the bearing. Custom designed plastic plugs, mylar tape and stainless steel rail cover strip are available.

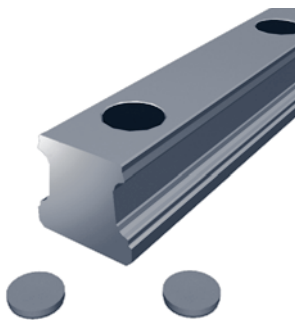

### Retained Balls

The rolling elements of the carriages are retained within the bearing so the carriage can be removed from the rail, or the end cap from the carriage, without worrying about the balls falling out. It is recommended to place any removed carriage onto an assembly rail or shipping arbor to provide added protection to the rolling elements.

For more information, or to place an order, please contact your local authorized Thomson™ distributor or Danaher Motion at 1-540-633-3400, Fax: 1-540-633-4162, or E-mail at [profilerail@DanaherMotion.com](mailto:profilerail@DanaherMotion.com).

DANAHER MOTION is a registered trademark of Danaher Corporation. Danaher Motion makes every attempt to ensure accuracy and reliability of the specifications in this publication. Specifications are subject to change without notice. Danaher Motion provides this information "AS IS" and disclaims all warranties, express or implied, including, but not limited to, implied warranties of merchantability and fitness for a particular purpose. It is the responsibility of the product user to determine the suitability of this product for a specific application. ©2004 Danaher Motion.

## 500 Series Ball Profile Rail Linear Guide

### Modular Accessory Exploded View

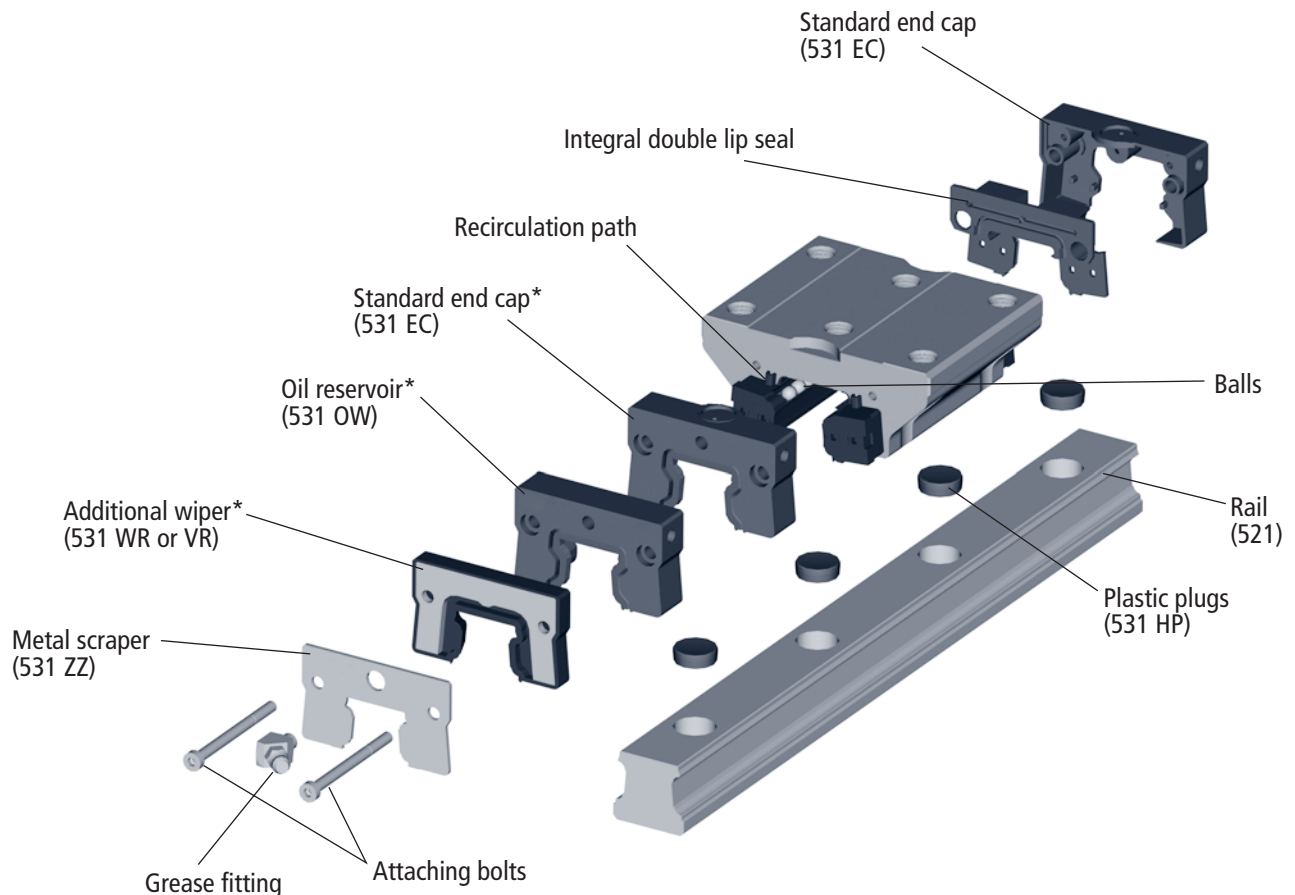

Also available (not shown):

- Lube Block (531 LL)
- Mylar Rail Tape (531 RT)
- Bolt up from bottom rail (521 Type U)
- Stainless Steel Rail, Cover Strip and Rail (521 Type C and 531RCS)

\* Can be installed without removing carriage from the rail

The modular building block design of the 500 Series Ball Profile Rail Linear Guide assembly allows for easy on-site field upgrades for quick seal or lubrication changes, all without the need to remove the carriage from the rail

For more information, or to place an order, please contact your local authorized Thomson™ distributor or Danaher Motion at 1-540-633-3400, Fax: 1-540-633-4162, or E-mail at [profilerail@DanaherMotion.com](mailto:profilerail@DanaherMotion.com).

DANAHER MOTION is a registered trademark of Danaher Corporation. Danaher Motion makes every attempt to ensure accuracy and reliability of the specifications in this publication. Specifications are subject to change without notice. Danaher Motion provides this information "AS IS" and disclaims all warranties, express or implied, including, but not limited to, implied warranties of merchantability and fitness for a particular purpose. It is the responsibility of the product user to determine the suitability of this product for a specific application. ©2004 Danaher Motion.

# 500 Series Ball Standard Carriages

Danaher Motion offers six carriage styles with six mounting holes allowing for additional mounting configurations in the field or for retrofitting. All provide superior rigidity and design flexibility.

Style	Size	Accuracy	Basic Part Number			Appropriate Rail Standard Style	Max. Single Piece Rail Length (mm)		
			Clearance	Preload					
				0.03C	0.08C			0.13C	
Standard Carriage A	15	H	511H15A0	511H15A1	511H15A2	—	521H15A	1500	
		P	—	511P15A1	511P15A2	511P15A3	521P15A		
		U	—	511U15A1	511U15A2	511U15A3	521U15A		
	20	H	511H20A0	511H20A1	511H20A2	—	521H20A	3000	
		P	—	511P20A1	511P20A2	511P20A3	521P20A		
		U	—	511U20A1	511U20A2	511U20A3	521U20A		
	25	H	511H25A0	511H25A1	511H25A2	—	521H25A	6000	
		P	—	511P25A1	511P25A2	511P25A3	521P25A		
		U	—	511U25A1	511U25A2	511U25A3	521U25A		
	30	H	511H30A0	511H30A1	511H30A2	—	521H30A	6000	
		P	—	511P30A1	511P30A2	511P30A3	521P30A		
		U	—	511U30A1	511U30A2	511U30A3	521U30A		
	35	H	511H35A0	511H35A1	511H35A2	—	521H35A	6000	
		P	—	511P35A1	511P35A2	511P35A3	521P35A		
		U	—	511U35A1	511U35A2	511U35A3	521U35A		
	45	H	511H45A0	511H45A1	511H45A2	—	521H45A	6000	
		P	—	511P45A1	511P45A2	511P45A3	521P45A		
		U	—	511U45A1	511U45A2	511U45A3	521U45A		
Standard Long Carriage B	20	H	511H20B0	511H20B1	511H20B2	—	521H20A	3000	
		P	—	511P20B1	511P20B2	511P20B3	521P20A		
		U	—	511U20B1	511U20B2	511U20B3	521U20A		
	25	H	511H25B0	511H25B1	511H25B2	—	521H25A	6000	
		P	—	511P25B1	511P25B2	511P25B3	521P25A		
		U	—	511U25B1	511U25B2	511U25B3	521U25A		
	30	H	511H30B0	511H30B1	511H30B2	—	521H30A	6000	
		P	—	511P30B1	511P30B2	511P30B3	521P30A		
		U	—	511U30B1	511U30B2	511U30B3	521U30A		
	35	H	511H35B0	511H35B1	511H35B2	—	521H35A	6000	
		P	—	511P35B1	511P35B2	511P35B3	521P35A		
		U	—	511U35B1	511U35B2	511U35B3	521U35A		
	45	H	511H45B0	511H45B1	511H45B2	—	521H45A	6000	
		P	—	511P45B1	511P45B2	511P45B3	521P45A		
		U	—	511U45B1	511U45B2	511U45B3	521U45A		
	Narrow Carriage C	15	H	511H15C0	511H15C1	511H15C2	—	521H15A	1500
			P	—	511P15C1	511P15C2	511P15C3	521P15A	
			U	—	511U15C1	511U15C2	511U15C3	521U15A	
20		H	511H20C0	511H20C1	511H20C2	—	521H20A	3000	
		P	—	511P20C1	511P20C2	511P20C3	521P20A		
		U	—	511U20C1	511U20C2	511U20C3	521U20A		
25		H	511H25C0	511H25C1	511H25C2	—	521H25A	6000	
		P	—	511P25C1	511P25C2	511P25C3	521P25A		
		U	—	511U25C1	511U25C2	511U25C3	521U25A		
30		H	511H30C0	511H30C1	511H30C2	—	521H30A	6000	
		P	—	511P30C1	511P30C2	511P30C3	521P30A		
		U	—	511U30C1	511U30C2	511U30C3	521U30A		
35		H	511H35C0	511H35C1	511H35C2	—	521H35A	6000	
		P	—	511P35C1	511P35C2	511P35C3	521P35A		
		U	—	511U35C1	511U35C2	511U35C3	521U35A		
Narrow Long Carriage D		20	H	511H20D0	511H20D1	511H20D2	—	521H20A	3000
			P	—	511P20D1	511P20D2	511P20D3	521P20A	
			U	—	511U20D1	511U20D2	511U20D3	521U20A	
	25	H	511H25D0	511H25D1	511H25D2	—	521H25A	6000	
		P	—	511P25D1	511P25D2	511P25D3	521P25A		
		U	—	511U25D1	511U25D2	511U25D3	521U25A		
	30	H	511H30D0	511H30D1	511H30D2	—	521H30A	6000	
		P	—	511P30D1	511P30D2	511P30D3	521P30A		
		U	—	511U30D1	511U30D2	511U30D3	521U30A		
	35	H	511H35D0	511H35D1	511H35D2	—	521H35A	6000	
		P	—	511P35D1	511P35D2	511P35D3	521P35A		
		U	—	511U35D1	511U35D2	511U35D3	521U35A		

DANAHER MOTION is a registered trademark of Danaher Corporation. Danaher Motion makes every attempt to ensure accuracy and reliability of the specifications in this publication. Specifications are subject to change without notice. Danaher Motion provides this information "AS IS" and disclaims all warranties, express or implied, including, but not limited to, implied warranties of merchantability and fitness for a particular purpose. It is the responsibility of the product user to determine the suitability of this product for a specific application. ©2004 Danaher Motion.

Style	Size	Accuracy	Basic Part Number				Appropriate Rail Standard Style	Max. Single Piece Rail Length (mm)	
			Clearance	Preload					
				0.03C	0.08C	0.13C			
Narrow High Carriage	E	15	H	511H15E0	511H15E1	511H15E2	—	521H15A	1500
			P	—	511P15E1	511P15E2	511P15E3	521P15A	
			U	—	511U15E1	511U15E2	511U15E3	521U15A	
	25	H	511H25E0	511H25E1	511H25E2	—	521H25A	6000	
		P	—	511P25E1	511P25E2	511P25E3	521P25A		
		U	—	511U25E1	511U25E2	511U25E3	521U25A		
	30	H	511H30E0	511H30E1	511H30E2	—	521H30A	6000	
		P	—	511P30E1	511P30E2	511P30E3	521P30A		
		U	—	511U30E1	511U30E2	511U30E3	521U30A		
	35	H	511H35E0	511H35E1	511H35E2	—	521H35A	6000	
		P	—	511P35E1	511P35E2	511P35E3	521P35A		
		U	—	511U35E1	511U35E2	511U35E3	521U35A		
45	H	511H45E0	511H45E1	511H45E2	—	521H45A	6000		
	P	—	511P45E1	511P45E2	511P45E3	521P45A			
	U	—	511U45E1	511U45E2	511U45E3	521U45A			
Narrow High Long Carriage	F	25	H	511H25F0	511H20F1	511H20F2	—	521H25A	6000
			P	—	511P20F1	511P20F2	511P20F3	521P25A	
			U	—	511U20F1	511U20F2	511U20F3	521U25A	
	30	H	511H30F0	511H25F1	511H25F2	—	521H30A	6000	
		P	—	511P30F1	511P30F2	511P30F3	521P30A		
		U	—	511U30F1	511U30F2	511U30F3	521U30A		
	35	H	511H35F0	511H35F1	511H35F2	—	521H35A	6000	
		P	—	511P35F1	511P35F2	511P35F3	521P35A		
		U	—	511U35F1	511U35F2	511U35F3	521U35A		
	45	H	511H45F0	511H45F1	511H45F2	—	521H45A	6000	
		P	—	511P45F1	511P45F2	511P45F3	521P45A		
		U	—	511U45F1	511U45F2	511U45F3	521U45A		
Narrow Short Carriage	G	15	H	511H15G0	511H15G1	511H15G2	—	521H15A	1500
			P	—	511P15G1	511P15G2	511P15G3	521P15A	
			U	—	511U15G1	511U15G2	511U15G3	521U15A	
	20	H	511H20G0	511H20G1	511H20G2	—	521H20A	3000	
		P	—	511P20G1	511P20G2	511P20G3	521P20A		
		U	—	511U20G1	511U20G2	511U20G3	521U20A		

### Extended Standard Carriage Options

The carriages are also available with the Thomson standard dowel holes or lubrication inlets as shown on page 26 to 30 or special lubricants either from stock or with a short lead-time.

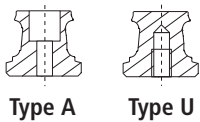

### Rail Types and Accessories

The rails are available in two configurations:

- Bolt down from the top – 521 Type A
- Bolt up from the bottom – 521 Type U

The standard 521 rail mounting holes can be plugged or sealed after installation with the options below.

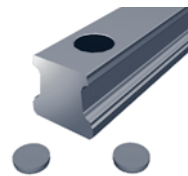

### Plastic Plugs

531HP plastic plugs are an inexpensive and simple method to seal the rail attachment bolt area. The plastic plugs are easily driven in place to any rail with a soft non-metallic drift. They can easily be removed.

### Mylar Tape

A simple and low cost alternative is specialty Mylar tape that can be placed quickly on the top surface of the rail. Part number 531RT is available in 3 meter lengths.

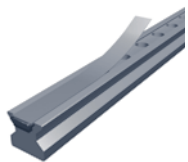

### Stainless Steel Cover Strip

Option 531RCS utilizes a special rail (521 Type C) and stainless steel cover strip that is easily installed with the proper mounting tool.

DANAHER MOTION is a registered trademark of Danaher Corporation. Danaher Motion makes every attempt to ensure accuracy and reliability of the specifications in this publication. Specifications are subject to change without notice. Danaher Motion provides this information "AS IS" and disclaims all warranties, express or implied, including, but not limited to, implied warranties of merchantability and fitness for a particular purpose. It is the responsibility of the product user to determine the suitability of this product for a specific application. ©2004 Danaher Motion.

## Additional Seal Types and Lubrication Accessories

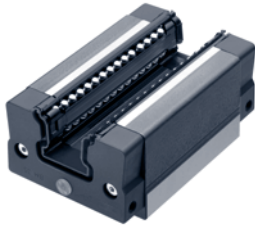

The carriage is designed with modular sealing and lubrication options for simple on-site field modification or can be supplied factory direct.

The standard carriage end cap has an integral low friction double lip seal and longitudinal seal that completely encase the bearing carriage. The double lip design keeps contaminants out and lubrication in. It also allows for grease to purge out of the carriage to prevent excessive lubrication, which can result in higher operating temperatures. This double lip design can be used with oil lubrication.

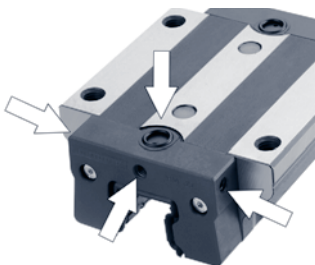

The standard carriage end cap is equipped with a lubrication inlet centered with a specially designed lubricant channel to direct the lubrication to individual ball tracks. The lubrication inlet can be easily changed in the field or supplied from the factory with a side inlet or top inlet.

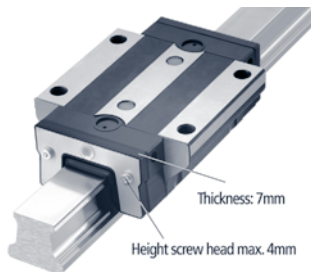

### Additional Seal

The **531 WR** and **531 VR** seals provide an additional level of protection from contaminants to the assembly. These additional components can easily be added on-site without removing the carriage from the rail. They are supplied with the required screws to make the installation simple.

531 WR is constructed from durable nitrile rubber (Buna N)

531 VR is constructed from durable Viton®

These seals can be used in conjunction with other optional modular accessories providing an easy upgrade to the standard seal. These can be easily installed on-site in the field or can be supplied from the factory.

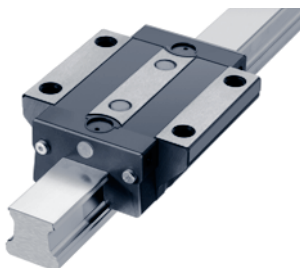

### Metal Scraper

The Type **531 ZZ Metal Scraper** made of stainless steel, serves as an added protection to the seal lips against large dirt particles, metal shavings or chips. Large contaminants are easily pushed away providing an extra level of protection to the seal lips. The Metal Scraper is easily installed in conjunction with the other optional modular accessories providing you with an easy upgrade to the standard seal. These can be easily installed on-site in the field or can be supplied from the factory.

For more information, or to place an order, please contact your local authorized Thomson™ distributor or Danaher Motion at 1-540-633-3400, Fax: 1-540-633-4162, or E-mail at [profilerail@DanaherMotion.com](mailto:profilerail@DanaherMotion.com).

DANAHER MOTION is a registered trademark of Danaher Corporation. Danaher Motion makes every attempt to ensure accuracy and reliability of the specifications in this publication. Specifications are subject to change without notice. Danaher Motion provides this information "AS IS" and disclaims all warranties, express or implied, including, but not limited to, implied warranties of merchantability and fitness for a particular purpose. It is the responsibility of the product user to determine the suitability of this product for a specific application. ©2004 Danaher Motion.



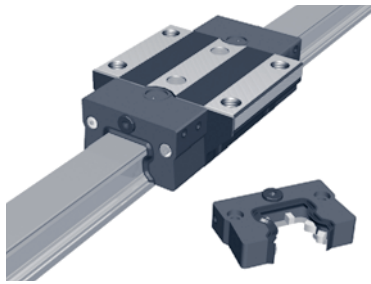

### Oil Reservoir

The Type **531 OW oil reservoir** is a cost effective, automatic lubrication system. It is constructed with an integrated oil reservoir that provides a uniform, consistent lubricating oil to the ball paths for extended periods of time. The Type 531 OW oil reservoir lubrication plate eliminates the need for a routine maintenance schedule, assures lubrication gets to the required points, can be refilled if required, and can operate up to 5000 km of travel. The Type 531 OW oil reservoir can be easily installed in conjunction with other optional modular accessories providing an easy upgrade to the standard seals. These can be easily installed on-site in the field or can be supplied from the factory.

### Lube Block

The **531 LL Lube Block** is a solid lubricant that is a mixture of polymers, oils and selected additives that reduce the penetration of dirt, grit, and liquids into the ball path, preventing premature failures. The oil diffuses, lubricating the ball path surfaces by capillary action. Additional oil is supplied to the ball path surfaces from the polymer. For additional protection the assembly is packed with EP2 grease. There is no need for maintenance or additional lubrication during the life of the Lube Block filled bearing. The 531 LL Lube Block can be easily installed in conjunction with the other optional modular accessories providing an easy upgrade to the standard seal. These can be easily installed on-site in the field or can be supplied from the factory.

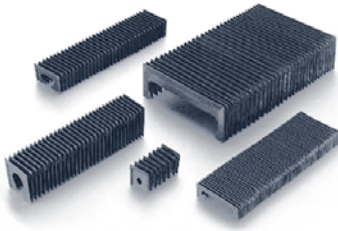

### Bellows

**Standard bellows** are available for all assemblies. The bellows cover the entire length of the rail. The bellows are used to provide additional protection against dirt, dust and splashed liquids. Installation is simple and requires little time. Retrofitting is possible when the rail ends are drilled for the attachment of the end plate 531. Bellows are available in three styles:

- Type B "Low Profile" with outside dimensions that do not exceed the carriage
- Type C "High Compression"
- Type W "Walk On" capable of handling the harshest environments with a 90kg load bearing capacity

The bellow can be easily installed in conjunction with other optional modular seals providing you with a simple upgrade to the standard seal. These can be installed on-site in the field or can be supplied from the factory.

Note: Additional modular accessories add additional drag to the carriage assembly resulting in increased start up friction and power consumption.

### Relative Drag Comparison for Design Consideration

Type	Relative Drag
Standard carriage	•
Rubber Wiper (531 WR)	• • •
Viton® Wiper (531 VR)	• • •
Metal Scraper (531 ZZ)	•
Oil Reservoir (531 OW)	• •
Lube Block (531 LL)	• • • •

• Low

**For ordering information  
or for additional  
Seal Types and  
Lubrication Accessories,  
see pages 32 to 33.**

# 500 Series Ball

## Part Numbering Description

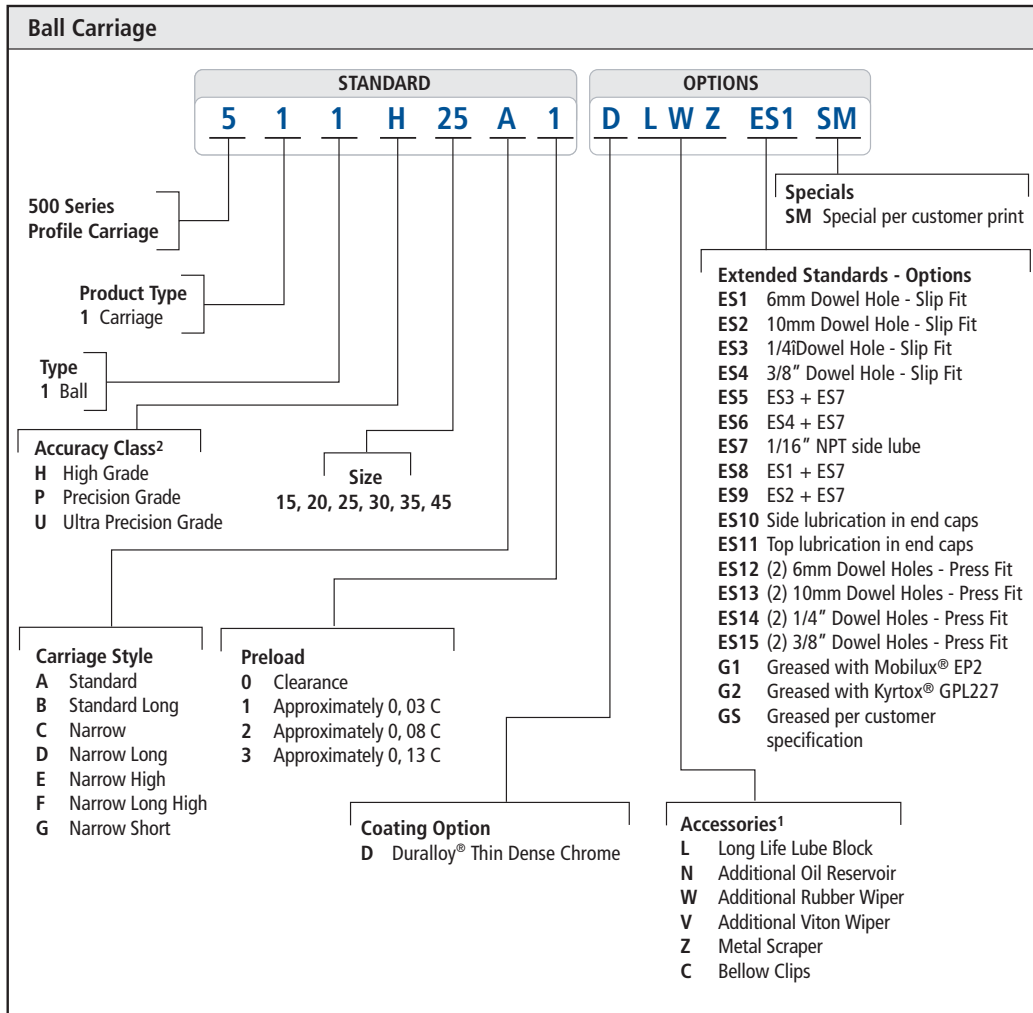

1. Accessory combination part numbers are listed from carriage end cap outward. Not all combinations are available. For specific combination availability see pages 32-33 or consult Danaher Motion.

2. The 500 Series Ball lowest accuracy grade is High as a result of tight manufacturing controls and grinding capabilities. We do not offer Normal grade accuracy, our High grade is our Normal grade.

For more information, or to place an order, please contact your local authorized Thomson™ distributor or Danaher Motion at 1-540-633-3400, Fax: 1-540-633-4162, or E-mail at [profilerrail@DanaherMotion.com](mailto:profilerrail@DanaherMotion.com).

DANAHER MOTION is a registered trademark of Danaher Corporation. Danaher Motion makes every attempt to ensure accuracy and reliability of the specifications in this publication. Specifications are subject to change without notice. Danaher Motion provides this information "AS IS" and disclaims all warranties, express or implied, including, but not limited to, implied warranties of merchantability and fitness for a particular purpose. It is the responsibility of the product user to determine the suitability of this product for a specific application. ©2004 Danaher Motion.

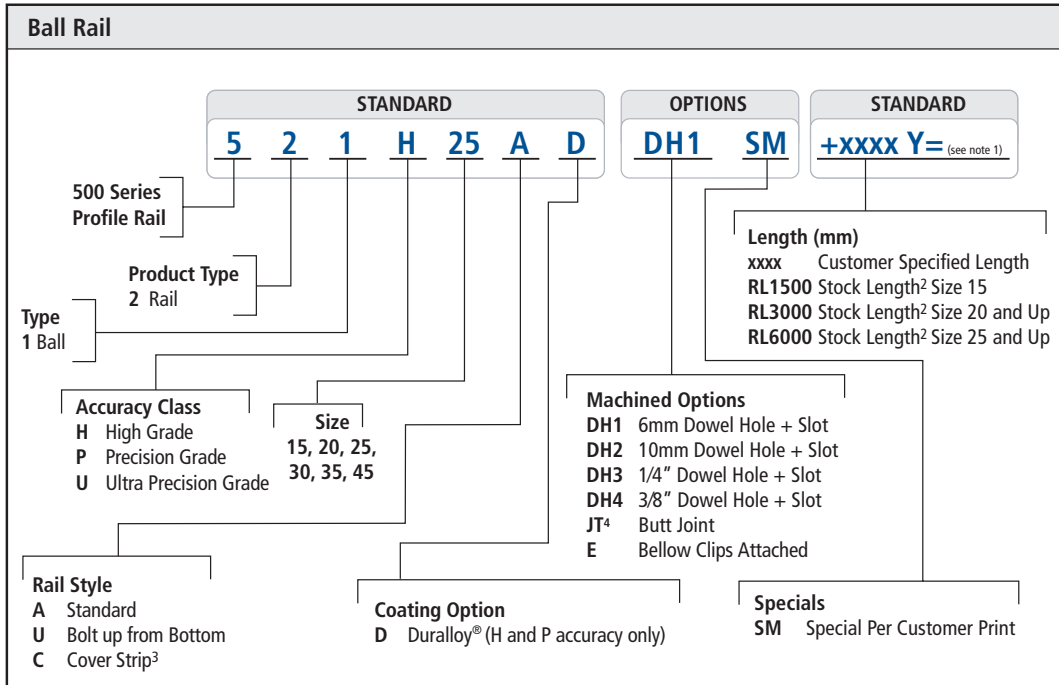

1. Y = Distance from end of rail to center of first mounting hole, Y1 = Y2 unless specified
2. Stock length rails are considered random length, total length may exceed specified length, and Y1/Y2 are not equal. To be used by customer who will cut to length.
3. Cover strip available size 25 and up only.
4. Customer drawing required at time of quote and order. See page 112 for more information and templates.

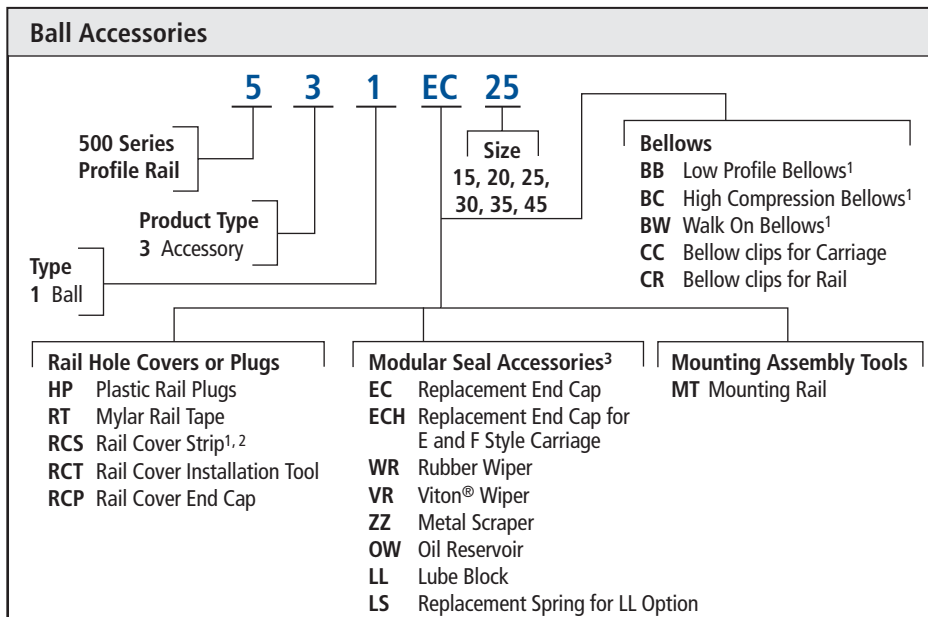

1. Bellows and rail cover strip must include length at time of order. Example: 531BB25 + 1000mm. See page 111 on how to calculate bellows length.
2. Cover strip available size 25 and up only.
3. Two standard screws included with each item. Screws for attaching this accessory to carriage and not combinations of accessories.

DANAHER MOTION is a registered trademark of Danaher Corporation. Danaher Motion makes every attempt to ensure accuracy and reliability of the specifications in this publication. Specifications are subject to change without notice. Danaher Motion provides this information "AS IS" and disclaims all warranties, express or implied, including, but not limited to, implied warranties of merchantability and fitness for a particular purpose. It is the responsibility of the product user to determine the suitability of this product for a specific application. ©2004 Danaher Motion.

# 500 Series Ball

## 511 Style A and B

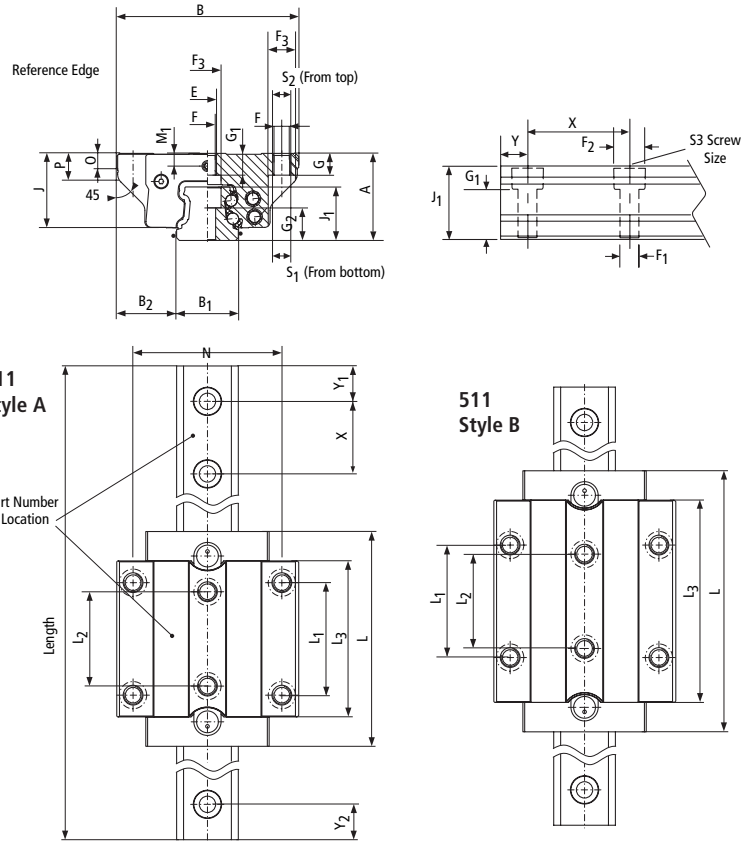
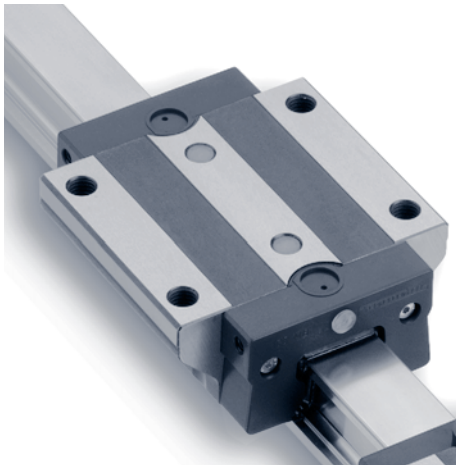

### 511 Style A – Standard Ball

Size	Dimensions (mm)				J	J <sub>1</sub>	L	L <sub>1</sub>	L <sub>2</sub>	L <sub>3</sub>	X	N	S <sub>1</sub>	S <sub>2</sub>	S <sub>3</sub>	F	F <sub>1</sub>	F <sub>2</sub>	F <sub>3</sub>	Ball						
	A	B	B <sub>1</sub> *	B <sub>2</sub>																Ø	G	G <sub>1</sub>	G <sub>2</sub>	M <sub>1</sub>	O	P
15	24	47	15	16	20.2	15.7	59.8	30	26	42.8	60	38	M 5	M 5	M 4	4.4	4.5	8	7.5	3.2	7	4.5	9.5	4	7	7
20	30	63	20	21.5	25.5	19	75.5	40	35	53.5	60	53	M 6	M 6	M 5	5.4	5.8	10	9.5	4.0	8	6.5	11.5	5.2	8	8
25	36	70	23	23.5	30.5	22.7	89.3	45	40	64.3	60	57	M 8	M 8	M 6	6.8	7	11	11	4.8	9	8	14	5.5	7	11
30	42	90	28	31	35.9	26	103	52	44	75	80	72	M 8	M 10	M 8	8.5	9	15	15	5.6	12	10	14.5	7	8	12
35	48	100	34	33	41	29.5	118	62	52	86	80	82	M 10	M 10	M 8	8.5	9	15	15	6.4	12	12	18	7	8	14
45	60	120	45	37.5	50.8	37	145	80	60	107	105	100	M 12	M 12	M 12	10.5	14	20	18	7.9	15	15	22	8	10	17.5

### 511 Style B – Standard Long Ball

Size	Dimensions (mm)				J	J <sub>1</sub>	L	L <sub>1</sub>	L <sub>2</sub>	L <sub>3</sub>	X	N	S <sub>1</sub>	S <sub>2</sub>	S <sub>3</sub>	F	F <sub>1</sub>	F <sub>2</sub>	F <sub>3</sub>	Ball						
	A	B	B <sub>1</sub> *	B <sub>2</sub>																Ø	G	G <sub>1</sub>	G <sub>2</sub>	M <sub>1</sub>	O	P
20	30	63	20	21.5	25.5	19	91.5	40	35	69.5	60	53	M 6	M 6	M 5	5.4	5.8	10	9.5	4.0	8	6.5	11.5	5.2	8	8
25	36	70	23	23.5	30.5	22.7	108.3	45	40	83.3	60	57	M 8	M 8	M 6	6.8	7	11	11	4.8	9	8	14	5.5	7	11
30	42	90	28	31	35.9	26	125	52	44	97	80	72	M 10	M 10	M 8	8.5	9	15	15	5.6	12	10	14.5	7	8	12
35	48	100	34	33	41	29.5	143.5	62	52	111.5	80	82	M 10	M 10	M 8	8.5	9	15	15	6.4	12	12	18	7	8	14
45	60	120	45	37.5	50.8	37	176.5	80	60	138.5	105	100	M 12	M 12	M 12	10.5	14	20	18	7.9	15	15	22	8	10	17.5

\*Standard tolerance shown, special lower tolerances are available upon request. Please consult application engineering for additional information.

\*\*When using additional modular seals or lubrication plates, the total length L will increase. Consult pages 34-35 for additional information.

Length of rail to be specified at time of order, Y1 will equal Y2 unless specified otherwise at time of order.

DANAHER MOTION is a registered trademark of Danaher Corporation. Danaher Motion makes every attempt to ensure accuracy and reliability of the specifications in this publication. Specifications are subject to change without notice. Danaher Motion provides this information "AS IS" and disclaims all warranties, express or implied, including, but not limited to, implied warranties of merchantability and fitness for a particular purpose. It is the responsibility of the product user to determine the suitability of this product for a specific application. ©2004 Danaher Motion.

## 500 Series Ball

### 511 Style A and B

#### Dynamic Load and Moment Ratings

C = Dynamic load rating  
 $M_P$  = Dynamic pitch and yaw moment rating  
 $M_R$  = Dynamic roll moment rating

#### Static Load and Moment Ratings

$C_0$  = Static load rating  
 $M_{OP}$  = Static pitch and yaw moment rating  
 $M_{OR}$  = Static roll moment rating

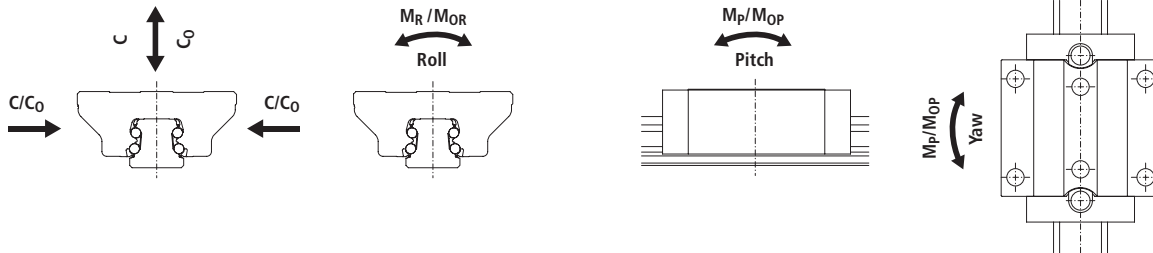

Style	Size	Load Rating									Weights	
		Static			Dynamic						Carriage (kg)	Rail (kg/m)
		$C_0$ (N)	$M_{OR}$ (Nm)	$M_{OP, OY}$ (Nm)	100 Km			50 Km				
C	$M_R$	$M_{P, Y}$	C	$M_R$	$M_{P, Y}$	C	$M_R$	$M_{P, Y}$	(kg)	(kg/m)		
A	15	19 600	181	146	9 000	83	67	11 339	105	84	0.2	1.4
	20	31 400	373	292	14 400	171	134	18 143	215	169	0.5	2.2
	25	46 100	631	513	21 100	289	235	26 584	364	296	0.7	3.0
	30	63 700	1 084	829	29 200	497	380	36 790	626	479	1.2	4.3
	35	84 400	1 566	1 252	38 700	718	574	48 759	905	723	1.8	5.4
	45	134 800	3 193	2 498	61 900	1 466	1 147	77 989	1 847	1 445	3.3	8.8
B	20	41 100	490	495	17 400	206	208	21 923	260	262	0.6	2.2
	25	60 300	825	863	25 500	349	365	32 128	440	460	0.9	3.0
	30	83 300	1 414	1 390	35 300	599	589	44 475	755	742	1.5	4.3
	35	110 300	2 048	2 104	46 700	867	891	58 838	1 092	1 123	2.3	5.4
	45	176 300	4 175	4 199	74 700	1 769	1 779	94 116	2 229	2 241	4.2	8.8

- The dynamic load and moment ratings are based on the travel life specified on the table (100 Km or 50 Km). When comparing these load ratings with other bearings you must take into consideration the proper travel life basis.
- The static load and moment ratings are the maximum radial load and moment load that should be applied to the bearing when there is no relative motion between the carriage and the rail.

### Bearing Travel Life Comparison

$$L = (C/F)^3 \times 100\text{km}$$

where:

L = travel life, km

C = dynamic load rating, N

F = applied dynamic load, N

$$C_{\min} = F \left( \frac{L}{100} \right)^{1/3}$$

where:

$C_{\min}$  = minimum required dynamic load rating, N

F = applied dynamic load, N

L = required travel life, km

#### Operating Parameters:

Maximum Velocity:

5 m/s

Maximum Acceleration:

100 m/s<sup>2</sup>

Temperature:

Min: -40° C

Max: 80° C

Max peak: 120° C short time\*

\*without bellows

Conversion Factors: See Page 121

For more information, or to place an order, please contact your local authorized Thomson™ distributor or Danaher Motion at 1-540-633-3400, Fax: 1-540-633-4162, or E-mail at [profilerail@DanaherMotion.com](mailto:profilerail@DanaherMotion.com).

DANAHER MOTION is a registered trademark of Danaher Corporation. Danaher Motion makes every attempt to ensure accuracy and reliability of the specifications in this publication. Specifications are subject to change without notice. Danaher Motion provides this information "AS IS" and disclaims all warranties, express or implied, including, but not limited to, implied warranties of merchantability and fitness for a particular purpose. It is the responsibility of the product user to determine the suitability of this product for a specific application. ©2004 Danaher Motion.

# 500 Series Ball

## 511 Style C and D

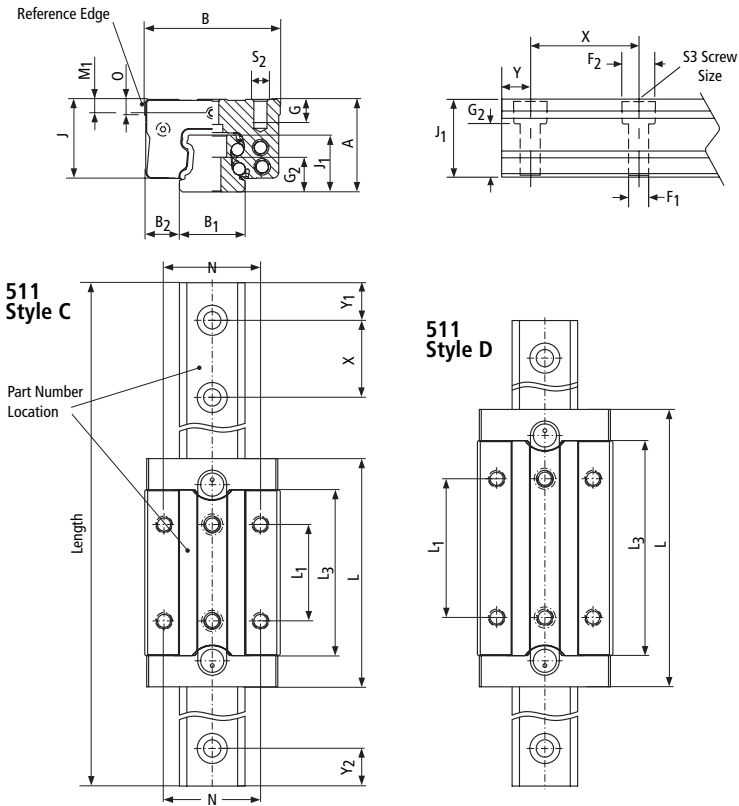
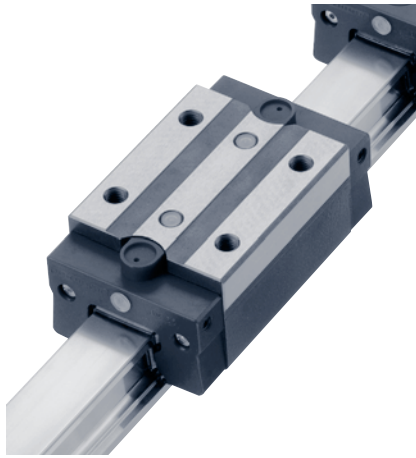

### 511 Style C Narrow

Size	Dimensions (mm)			B <sub>2</sub>	J	J <sub>1</sub>	L	L <sub>1</sub>	L <sub>3</sub>	X	N	S <sub>2</sub> /S <sub>3</sub>	F <sub>1</sub>	F <sub>2</sub>	Ball Ø	G	G <sub>2</sub>	M <sub>1</sub>	O
	A	B +0.4 -0.0	B <sub>1</sub> * +0.05																
15	24	34	15	9.5	20.2	15.7	59.8	26	42.8	60	26	M 4	4.5	8	3.2	5	9.5	4	5.5
20	30	44	20	12	25.5	19	75.5	36	53.5	60	32	M 5	5.8	10	4.0	7	11.5	5.2	6
25	36	48	23	12.5	30.5	22.7	89.3	35	64.3	60	35	M 6	7	11	4.8	9	14	5.5	7.5
30	42	60	28	16	35.9	26	103	40	75	80	40	M 8	9	15	5.6	11	14.5	7	8
35	48	70	34	18	41	29.5	118	50	86	80	50	M 8	9	15	6.4	12	18	7	8

### 511 Style D Narrow Long

Size	Dimensions (mm)			B <sub>2</sub>	J	J <sub>1</sub>	L	L <sub>1</sub>	L <sub>3</sub>	X	N	S <sub>2</sub> /S <sub>3</sub>	F <sub>1</sub>	F <sub>2</sub>	Ball Ø	G	G <sub>2</sub>	M <sub>1</sub>	O
	A	B +0.4 -0.0	B <sub>1</sub> * +0.05																
20	30	44	20	12	25.5	19	91.5	50	60	69.5	32	M 5	5.8	10	4.0	7	11.5	5.2	6
25	36	48	23	12.5	30.5	22.7	108.3	50	83.3	60	35	M 6	7	11	4.8	9	14	5.5	7.5
30	42	60	28	16	35.9	26	125	60	97	80	40	M 8	9	15	5.6	11	14.5	7	8
35	48	70	34	18	41	29.5	143.5	72	111.5	80	50	M 8	9	15	6.4	12	18	7	8

\*Standard tolerance shown, special lower tolerances are available upon request. Please consult application engineering for additional information.

\*\*When using additional modular seals or lubrication plates, the total length L will increase. Consult page 34-35 for additional information.

Length of rail to be specified at time of order, Y1 will equal Y2 unless specified otherwise at time of order.



## 500 Series Ball

### 511 Style C and D

#### Dynamic Load and Moment Ratings

C = Dynamic load rating  
 $M_P$  = Dynamic pitch and yaw moment rating  
 $M_R$  = Dynamic roll moment rating

#### Static Load and Moment Ratings

$C_0$  = Static load rating  
 $M_{OP}$  = Static pitch and yaw moment rating  
 $M_{OR}$  = Static roll moment rating



Style	Size	Load Rating									Weights	
		Static			Dynamic						Carriage (kg)	Rail (kg/m)
		$C_0$ (N)	$M_{OR}$ (Nm)	$M_{OP, OY}$ (Nm)	100 Km			50 Km				
C (N)	$M_R$ (Nm)	$M_{P, Y}$ (Nm)	C (N)	$M_R$ (Nm)	$M_{P, Y}$ (Nm)	C (N)	$M_R$ (Nm)	$M_{P, Y}$ (Nm)				
C	15	19 600	181	146	9 000	83	67	11 339	105	84	0.2	1.4
	20	31 400	373	292	14 400	171	134	18 143	215	169	0.5	2.2
	25	46 100	631	513	21 100	289	235	26 584	364	296	0.7	3.0
	30	63 700	1 084	829	29 200	497	380	36 790	626	479	1.2	4.3
	35	84 400	1 566	1 252	38 700	718	574	48 759	905	723	1.8	5.4
D	20	41 100	490	495	17 400	206	208	21 923	260	262	0.6	2.2
	25	60 300	825	863	25 500	349	365	32 128	440	460	0.9	3.0
	30	83 300	1 414	1 390	35 300	599	589	44 475	755	742	1.5	4.3
	35	110 300	2 048	2 104	46 700	867	891	58 838	1 092	1 123	2.3	5.4

- The dynamic load and moment ratings are based on the travel life specified on the table (100 Km or 50 Km). When comparing these load ratings with other bearings you must take into consideration the proper travel life basis.
- The static load and moment ratings are the maximum radial load and moment load that should be applied to the bearing when there is no relative motion between the carriage and the rail.

### Bearing Travel Life Comparison

$$L = (C/F)^3 \times 100 \text{ km}$$

where:

L = travel life, km

C = dynamic load rating, N

F = applied dynamic load, N

$$C_{\min} = F \left( \frac{L}{100} \right)^{1/3}$$

where:

$C_{\min}$  = minimum required dynamic load rating, N

F = applied dynamic load, N

L = required travel life, km

#### Operating Parameters:

Maximum Velocity:

5 m/s

Maximum Acceleration:

100 m/s<sup>2</sup>

Temperature:

Min: -40°C

Max: 80°C

Max peak: 120°C short time\*

\*without bellows

Conversion Factors: See page 121

For more information, or to place an order, please contact your local authorized Thomson™ distributor or Danaher Motion at 1-540-633-3400, Fax: 1-540-633-4162, or E-mail at [profilerail@DanaherMotion.com](mailto:profilerail@DanaherMotion.com).

DANAHER MOTION is a registered trademark of Danaher Corporation. Danaher Motion makes every attempt to ensure accuracy and reliability of the specifications in this publication. Specifications are subject to change without notice. Danaher Motion provides this information "AS IS" and disclaims all warranties, express or implied, including, but not limited to, implied warranties of merchantability and fitness for a particular purpose. It is the responsibility of the product user to determine the suitability of this product for a specific application. ©2004 Danaher Motion.

# 500 Series Ball 511 Style E and F

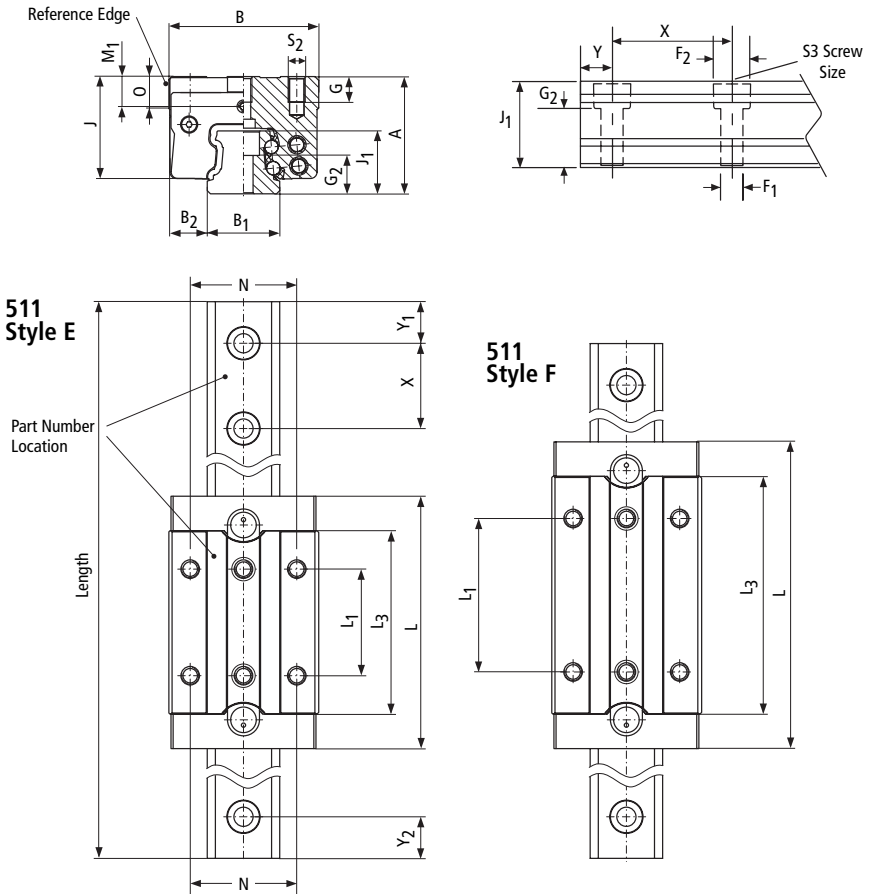
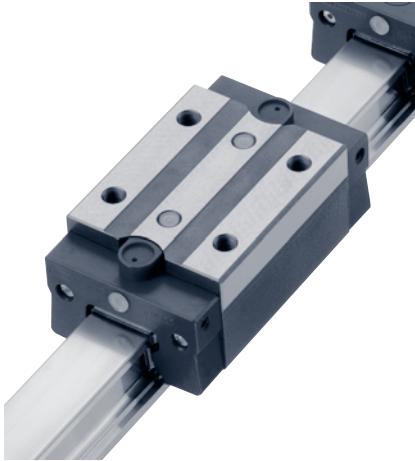

### 511 Style E Narrow High

Size	Dimensions (mm)				B <sub>2</sub>	J	J <sub>1</sub>	L	L <sub>1</sub>	L <sub>3</sub>	X	N	s <sub>2</sub> /s <sub>3</sub>	F <sub>1</sub>	F <sub>2</sub>	Ball Ø	G	G <sub>2</sub>	M <sub>1</sub>	O
	A	B +0.4 -0.0	B <sub>1</sub> *	+0.05																
15	28	34	15	9.5	24.2	15.7	59.8	26	42.8	60	26	M 4	4.5	8	3.2	6	9.5	8	6	
25	40	48	23	12.5	34.5	22.7	89.3	35	64.3	60	35	M 6	7	11	4.8	9	14	9.5	11	
30	45	60	28	16	38.9	26	103	40	75	80	40	M 8	9	15	5.6	11	14.5	10	11	
35	55	70	34	18	48	29.5	118	50	86	80	50	M 8	9	15	6.4	12	18	14	15	
45	70	86	45	20.5	60.8	37	145	60	107	105	60	M 10	14	20	7.9	18	22	18	19	

### 511 Style F Narrow Long High

Size	Dimensions (mm)				B <sub>2</sub>	J	J <sub>1</sub>	L	L <sub>1</sub>	L <sub>3</sub>	X	N	s <sub>2</sub> /s <sub>3</sub>	F <sub>1</sub>	F <sub>2</sub>	Ball Ø	G	G <sub>2</sub>	M <sub>1</sub>	O
	A	B +0.4 -0.0	B <sub>1</sub> *	+0.05																
25	40	48	23	12.5	34.5	22.7	108.3	50	83.3	60	35	M 6	7	11	4.8	9	14	9.5	11	
30	45	60	28	16	38.9	26	125	60	97	80	40	M 8	9	15	5.6	11	14.5	10	11	
35	55	70	34	18	48	29.5	143.5	72	111.5	80	50	M 8	9	15	6.4	12	18	14	15	
45	70	86	45	20.5	60.8	37	176.5	80	138.5	105	60	M 10	14	20	7.9	18	22	18	19	

\*Standard tolerance shown, special lower tolerances are available upon request. Please consult application engineering for additional information.

\*\*When using additional modular seals or lubrication plates, the total length L will increase. Consult page 34-35 for additional information.

Length of rail to be specified at time of order, Y1 will equal Y2 unless specified otherwise at time of order.

DANAHER MOTION is a registered trademark of Danaher Corporation. Danaher Motion makes every attempt to ensure accuracy and reliability of the specifications in this publication. Specifications are subject to change without notice. Danaher Motion provides this information "AS IS" and disclaims all warranties, express or implied, including, but not limited to, implied warranties of merchantability and fitness for a particular purpose. It is the responsibility of the product user to determine the suitability of this product for a specific application. ©2004 Danaher Motion.

# 500 Series Ball

## 511 Style E and F

### Dynamic Load and Moment Ratings

C = Dynamic load rating  
 M<sub>P</sub> = Dynamic pitch and yaw moment rating  
 M<sub>R</sub> = Dynamic roll moment rating

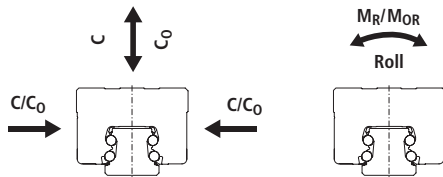

### Static Load and Moment Ratings

C<sub>0</sub> = Static load rating  
 M<sub>OP</sub> = Static pitch and yaw moment rating  
 M<sub>OR</sub> = Static roll moment rating

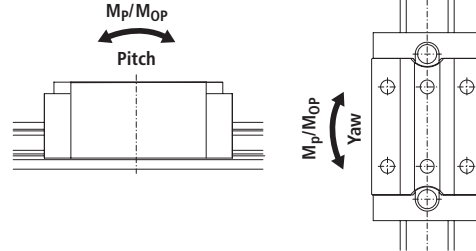

Style	Size	Load Rating									Weights	
		Static			Dynamic						Carriage (kg)	Rail (kg/m)
		C <sub>0</sub> (N)	M <sub>OR</sub> (Nm)	M <sub>OP, OY</sub> (Nm)	100 Km			50 Km				
C (N)	M <sub>R</sub> (Nm)	M <sub>P, Y</sub> (Nm)	C (N)	M <sub>R</sub> (Nm)	M <sub>P, Y</sub> (Nm)	C (N)	M <sub>R</sub> (Nm)	M <sub>P, Y</sub> (Nm)				
E	15	19 600	181	146	9 000	83	67	11 339	105	84	0.2	1.4
	25	46 100	631	513	21 100	289	235	26 584	364	296	0.5	2.2
	30	63 700	1 084	829	29 200	497	380	36 790	626	479	0.7	3.0
	35	84 400	1 566	1 252	38 700	718	574	48 759	905	723	1.2	4.3
	45	134 800	3 193	2 498	61 900	1 466	1 147	77 989	1 847	1 445	1.8	5.4
F	25	60 300	825	863	25 500	349	365	32 128	440	460	0.6	2.2
	30	83 300	1 414	1 390	35 300	599	589	44 475	755	742	0.9	3.0
	35	110 300	2 048	2 104	46 700	867	891	58 838	1 092	1 123	1.5	4.3
	45	176 300	4 175	4 199	74 700	1 769	1 779	94 116	2 229	2 241	2.3	5.4

- The dynamic load and moment ratings are based on the travel life specified on the table (100 Km or 50 Km). When comparing these load ratings with other bearings you must take into consideration the proper travel life basis.
- The static load and moment ratings are the maximum radial load and moment load that should be applied to the bearing when there is no relative motion between the carriage and the rail.

## Bearing Travel Life Calculation

$$L = (C/F)^3 \times 100 \text{ km}$$

where:

L = travel life, km

C = dynamic load rating, N

F = applied dynamic load, N

$$C_{\min} = F \left( \frac{L}{100} \right)^{1/3}$$

where:

C<sub>min</sub> = minimum required dynamic load rating, N

F = applied dynamic load, N

L = required travel life, km

### Operating Parameters:

Maximum Velocity: 5 m/s

Maximum Acceleration: 100 m/s<sup>2</sup>

Temperature:

Min: -40°C

Max: 80°C

Max peak: 120°C short time\*

\*without bellows

Conversion Factors: See page 121

For more information, or to place an order, please contact your local authorized Thomson™ distributor or Danaher Motion at 1-540-633-3400, Fax: 1-540-633-4162, or E-mail at [profilerail@DanaherMotion.com](mailto:profilerail@DanaherMotion.com).

DANAHER MOTION is a registered trademark of Danaher Corporation. Danaher Motion makes every attempt to ensure accuracy and reliability of the specifications in this publication. Specifications are subject to change without notice. Danaher Motion provides this information "AS IS" and disclaims all warranties, express or implied, including, but not limited to, implied warranties of merchantability and fitness for a particular purpose. It is the responsibility of the product user to determine the suitability of this product for a specific application. ©2004 Danaher Motion.

# 500 Series Ball 511 Style G

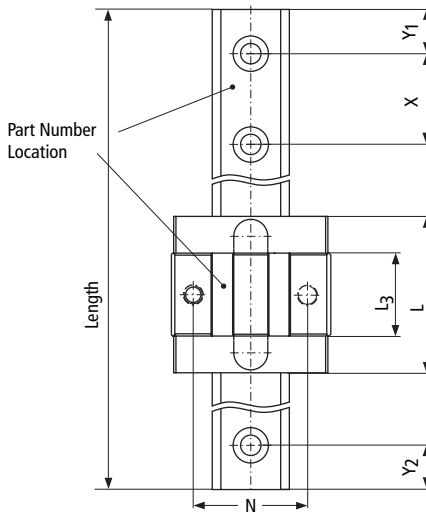
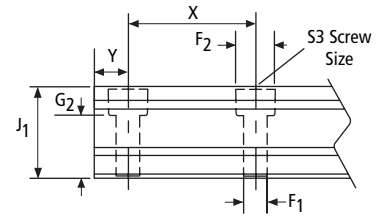
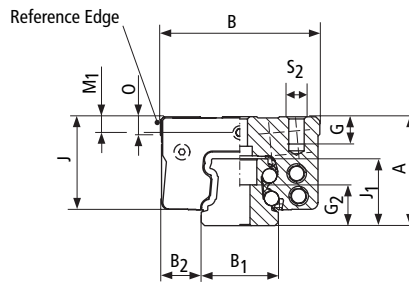
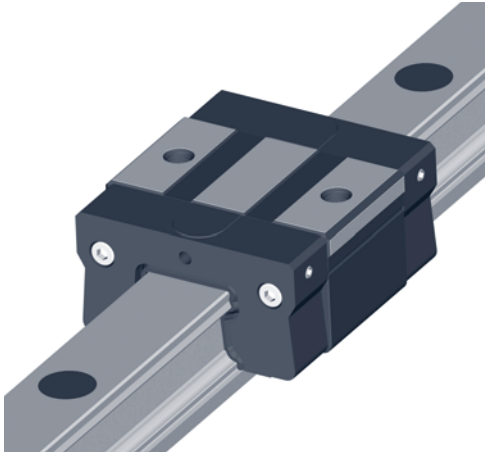

## 511 Style G Narrow High

Size	Dimensions (mm)																	
	A	B +0.4 -0.0	B <sub>1</sub> * +0.05	B <sub>2</sub>	J	J <sub>1</sub>	L	L <sub>3</sub>	X	N	s <sub>2</sub> /s <sub>3</sub>	F <sub>1</sub>	F <sub>2</sub>	Ball Ø	G	G <sub>2</sub>	M <sub>1</sub>	O
15	24	34	15	9.5	20.2	15.7	37.6	20.6	60	26	M4	4.5	8	3.2	6	9.5	4	6
20	28	44	20	12	23.5	19	47.7	25.7	60	32	M5	5.8	10	4.0	6	11.5	4.2	4

\*Standard tolerance shown, special lower tolerances are available upon request. Please consult application engineering for additional information.

\*\*When using additional modular seals or lubrication plates, the total length L will increase. Consult page 34-35 for additional information.

Length of rail to be specified at time of order, Y1 will equal Y2 unless specified otherwise at time of order.

For more information, or to place an order, please contact your local authorized Thomson™ distributor or Danaher Motion at 1-540-633-3400, Fax: 1-540-633-4162, or E-mail at [profilerrail@DanaherMotion.com](mailto:profilerrail@DanaherMotion.com).

DANAHER MOTION is a registered trademark of Danaher Corporation. Danaher Motion makes every attempt to ensure accuracy and reliability of the specifications in this publication. Specifications are subject to change without notice. Danaher Motion provides this information "AS IS" and disclaims all warranties, express or implied, including, but not limited to, implied warranties of merchantability and fitness for a particular purpose. It is the responsibility of the product user to determine the suitability of this product for a specific application. ©2004 Danaher Motion.

## 500 Series Ball 511 Style G

### Dynamic Load and Moment Ratings

C = Dynamic load rating  
 $M_P$  = Dynamic pitch and yaw moment rating  
 $M_R$  = Dynamic roll moment rating

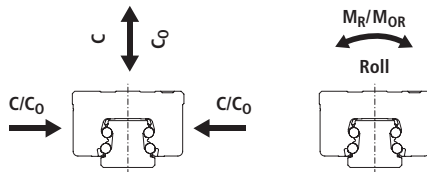

### Static Load and Moment Ratings

$C_0$  = Static load rating  
 $M_{OP}$  = Static pitch and yaw moment rating  
 $M_{OR}$  = Static roll moment rating

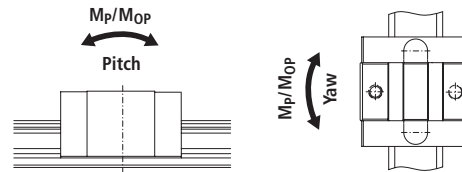

Style	Size	Load Rating									Weights	
		Static			Dynamic						Carriage (kg)	Rail (kg/m)
		$C_0$ (N)	$M_{OR}$ (Nm)	$M_{OP, OY}$ (Nm)	100 Km			50 Km				
C (N)	$M_R$ (Nm)	$M_{P, Y}$ (Nm)	C (N)	$M_R$ (Nm)	$M_{P, Y}$ (Nm)	C (N)	$M_R$ (Nm)	$M_{P, Y}$ (Nm)				
G	15	8 500	78	30	5 200	48	18	6 552	60	23	0.2	1.4
	20	13 100	150	58	8 400	99	37	10 583	125	47	0.5	2.2

- The dynamic load and moment ratings are based on the travel life specified on the table (100 Km or 50 Km). When comparing these load ratings with other bearings you must take into consideration the proper travel life basis.
- The static load and moment ratings are the maximum radial load and moment load that should be applied to the bearing when there is no relative motion between the carriage and the rail.

## Bearing Travel Life Calculation

$$L = (C/F)^3 \times 100 \text{ km}$$

where:

L = travel life, km

C = dynamic load rating, N

F = applied dynamic load, N

$$C_{\min} = F \left( \frac{L}{100} \right)^{1/3}$$

where:

$C_{\min}$  = minimum required dynamic load rating, N

F = applied dynamic load, N

L = required travel life, km

### Operating Parameters:

Maximum Velocity: 5 m/s

Maximum Acceleration: 100 m/s<sup>2</sup>

Temperature:

Min: -40°C

Max: 80°C

Max peak: 120°C short time\*

\*without bellows

Conversion Factors: See page 121

For more information, or to place an order, please contact your local authorized Thomson™ distributor or Danaher Motion at 1-540-633-3400, Fax: 1-540-633-4162, or E-mail at [profilerail@DanaherMotion.com](mailto:profilerail@DanaherMotion.com).

DANAHER MOTION is a registered trademark of Danaher Corporation. Danaher Motion makes every attempt to ensure accuracy and reliability of the specifications in this publication. Specifications are subject to change without notice. Danaher Motion provides this information "AS IS" and disclaims all warranties, express or implied, including, but not limited to, implied warranties of merchantability and fitness for a particular purpose. It is the responsibility of the product user to determine the suitability of this product for a specific application. ©2004 Danaher Motion.

## Extended Standard Carriage Options

### Carriage Dowel Holes

Dowel holes are commonly used to ensure proper alignment during installation and replacement of carriages and rails. The standard slip fit dowel hole options for the 500 series Standard Ball Carriages are:

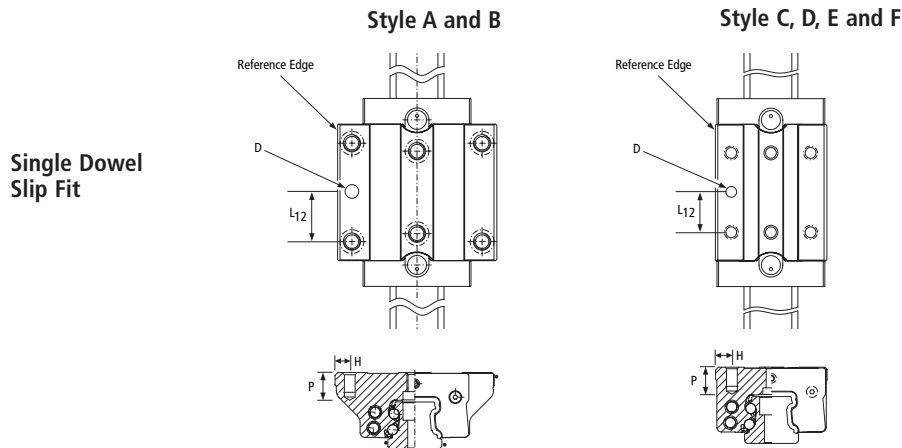

511		L <sub>12</sub>	ES1			ES2			ES3			ES4		
Style	Size		ØD	H	P	ØD	H	P	ØD	H	P	ØD	H	P
Type A	15	15	6	4.5	7	—	—	—	1/4"	4.5	7	—	—	—
	20	20	6	5	9	—	—	—	1/4"	5	9	—	—	—
	25	22.5	6	6.5	9	—	—	—	1/4"	6.5	9	—	—	—
	30	26	6	9	12	10	9	12	1/4"	9	12	3/8"	9	12
	35	31	—	—	—	10	9	14	—	—	—	3/8"	9	14
	45	40	—	—	—	10	10	18	—	—	—	3/8"	10	18
Type B	20	20	6	5	9	—	—	—	1/4"	5	9	—	—	—
	25	22.5	6	6.5	9	—	—	—	1/4"	6.5	9	—	—	—
	30	26	6	9	12	10	9	12	1/4"	9	12	3/8"	9	12
	35	31	—	—	—	10	9	14	—	—	—	3/8"	9	14
	45	40	—	—	—	10	10	18	—	—	—	3/8"	10	18
Type C	15	13	6	4	6	—	—	—	1/4"	4	6	—	—	—
	20	18	6	6	9	—	—	—	1/4"	6	9	—	—	—
	25	17.5	6	6.5	9	—	—	—	1/4"	6.5	9	—	—	—
	30	20	6	10	12	10	10	12	1/4"	10	12	3/8"	10	12
	35	25	—	—	—	10	10	12	—	—	—	3/8"	10	12
Type D	20	25	6	6	9	—	—	—	1/4"	6	9	—	—	—
	25	25	6	6.5	9	—	—	—	1/4"	6.5	9	—	—	—
	30	30	6	10	12	10	10	12	1/4"	10	12	3/8"	10	12
	35	36	—	—	—	10	10	12	—	—	—	3/8"	10	12
Type E	15	13	6	4	6	—	—	—	1/4"	4	6	—	—	—
	25	17.5	6	6.5	9	—	—	—	1/4"	6.5	9	—	—	—
	30	20	6	10	12	10	10	12	1/4"	10	12	3/8"	10	12
	35	25	—	—	—	10	10	12	—	—	—	3/8"	10	12
	45	30	—	—	—	10	13	12	—	—	—	3/8"	13	12
Type F	25	25	6	6.5	9	—	—	—	1/4"	6.5	9	—	—	—
	30	30	6	10	12	10	10	12	1/4"	10	12	3/8"	10	12
	35	36	—	—	—	10	10	12	—	—	—	3/8"	10	12
	45	40	—	—	—	10	13	12	—	—	—	3/8"	13	12

All dimensions in mm, unless otherwise specified.  
Hole Tolerance  $\phi D +0/-0.013$

DANAHER MOTION is a registered trademark of Danaher Corporation. Danaher Motion makes every attempt to ensure accuracy and reliability of the specifications in this publication. Specifications are subject to change without notice. Danaher Motion provides this information "AS IS" and disclaims all warranties, express or implied, including, but not limited to, implied warranties of merchantability and fitness for a particular purpose. It is the responsibility of the product user to determine the suitability of this product for a specific application. ©2004 Danaher Motion.



### Carriage Dowel Holes (continued)

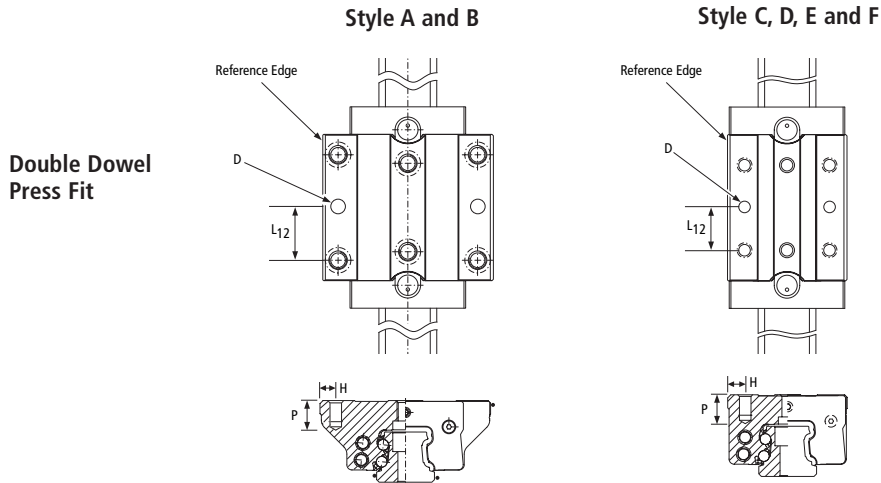

511		L <sub>12</sub>	ES12			ES13			ES14			ES15		
Style	Size		ØD	H	P	ØD	H	P	ØD	H	P	ØD	H	P
Type A	15	15	6	4.5	7	—	—	—	1/4"	4.5	7	—	—	—
	20	20	6	5	9	—	—	—	1/4"	5	9	—	—	—
	25	22.5	6	6.5	9	—	—	—	1/4"	6.5	9	—	—	—
	30	26	6	9	12	10	9	12	1/4"	9	12	3/8"	9	12
	35	31	—	—	—	10	9	14	—	—	—	3/8"	9	14
	45	40	—	—	—	10	10	18	—	—	—	3/8"	10	18
Type B	20	20	6	5	9	—	—	—	1/4"	5	9	—	—	—
	25	22.5	6	6.5	9	—	—	—	1/4"	6.5	9	—	—	—
	30	26	6	9	12	10	9	12	1/4"	9	12	3/8"	9	12
	35	31	—	—	—	10	9	14	—	—	—	3/8"	9	14
	45	40	—	—	—	10	10	18	—	—	—	3/8"	10	18
Type C	15	13	6	4	6	—	—	—	1/4"	4	6	—	—	—
	20	18	6	6	9	—	—	—	1/4"	6	9	—	—	—
	25	17.5	6	6.5	9	—	—	—	1/4"	6.5	9	—	—	—
	30	20	6	10	12	10	10	12	1/4"	10	12	3/8"	10	12
	35	25	—	—	—	10	10	12	—	—	—	3/8"	10	12
Type D	20	25	6	6	9	—	—	—	1/4"	6	9	—	—	—
	25	25	6	6.5	9	—	—	—	1/4"	6.5	9	—	—	—
	30	30	6	10	12	10	10	12	1/4"	10	12	3/8"	10	12
	35	36	—	—	—	10	10	12	—	—	—	3/8"	10	12
Type E	15	13	6	4	6	—	—	—	1/4"	4	6	—	—	—
	25	17.5	6	6.5	9	—	—	—	1/4"	6.5	9	—	—	—
	30	20	6	10	12	10	10	12	1/4"	10	12	3/8"	10	12
	35	25	6	10	12	10	10	12	1/4"	10	12	3/8"	10	12
	45	30	6	13	12	10	13	12	1/4"	13	12	3/8"	13	12
Type F	25	25	6	6.5	9	—	—	—	1/4"	6.5	9	—	—	—
	30	30	6	10	12	10	10	12	1/4"	10	12	3/8"	10	12
	35	36	—	—	—	10	10	12	—	—	—	3/8"	10	12
	45	40	—	—	—	10	13	12	—	—	—	3/8"	13	12

All dimensions in mm, unless otherwise specified.  
Hole Tolerance  $\phi D +0/-0.013$

DANAHER MOTION is a registered trademark of Danaher Corporation. Danaher Motion makes every attempt to ensure accuracy and reliability of the specifications in this publication. Specifications are subject to change without notice. Danaher Motion provides this information "AS IS" and disclaims all warranties, express or implied, including, but not limited to, implied warranties of merchantability and fitness for a particular purpose. It is the responsibility of the product user to determine the suitability of this product for a specific application. ©2004 Danaher Motion.

## Lubrication Inlet Options

The standard carriage is supplied with a lubrication inlet centered over the rail. The carriage has multiple lubrication inlet point options. The options can be easily modified on-site in the field or can be supplied factory direct (Standard inlet hole is M3 for 15mm, M6 for 20mm, 25mm, 30mm, 35mm, 45mm). See page 73 for available lubrication fittings.

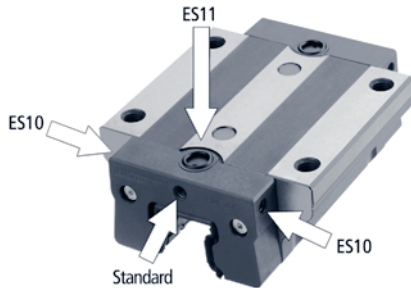

### Option

- ES10 Inlets on side—both ends—all sides
- ES11 Inlet on top\*—both ends

### Notes:

1. \*An O-Ring is required to properly seat the mating surfaces to prevent grease or oil from escaping. One is supplied with this option. Size 15 O-ring ID M3x1.78mm thick, sizes 20–45 O-ring ID M6x1.78mm thick.
2. Set screws are installed to plug all holes.

Lubrication inlet locates standard and ES10 option.

Size	Style	M1	M3	M4	D1	D2
15	A	4	4	4	M3	M3
	C					
	E	8	8			
	G	4	4			
20	A	5.2	5.2	5.2	M6	M3
	B					
	C					
	D					
	G	4.2	4.2	5	M3	M3
25	A	5.5	5.5	6	M6	M6
	B					
	C					
	D					
	E	9.5	9.5			
	F					
30	A	7	7	6	M6	M6
	B					
	C					
	D					
	E	10	10			
	F					
35	A	7	7	6	M6	M6
	B					
	C					
	D					
	E	14	14			
	F					
45	A	8	8	7.5	M6	M6
	B					
	E	18	18			
	F					

All dimensions in mm unless specified.

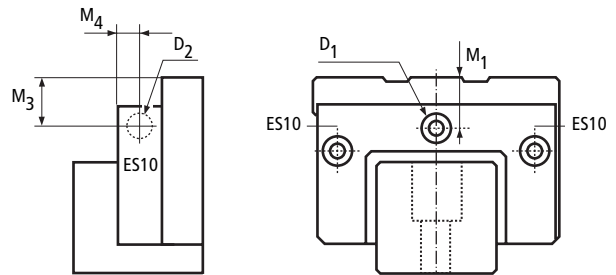

1. D1 and D2 are threaded holes in the end cap to ensure proper integrity and durability of connection.
2. Carriages are shipped with a grease fitting in the box. Size 15 include fitting 530LF3, Size 20 and up include fitting 530LN. See page 73 for more information.

For more information, or to place an order, please contact your local authorized Thomson™ distributor or Danaher Motion at 1-540-633-3400, Fax: 1-540-633-4162, or E-mail at [profilerail@DanaherMotion.com](mailto:profilerail@DanaherMotion.com).

DANAHER MOTION is a registered trademark of Danaher Corporation. Danaher Motion makes every attempt to ensure accuracy and reliability of the specifications in this publication. Specifications are subject to change without notice. Danaher Motion provides this information "AS IS" and disclaims all warranties, express or implied, including, but not limited to, implied warranties of merchantability and fitness for a particular purpose. It is the responsibility of the product user to determine the suitability of this product for a specific application. ©2004 Danaher Motion.

Lubrication inlet location ES11 option.

Size	Style	C7	D1	D2	D3	D4
15	A	8.000	4.47	8	1.78	4
	C	10.000				
	E	10.000				
20	A	10.500	6.75	10	1.78	6
	B	18.500				
	C	12.500				
	D	13.500				
		13.500				
25	A	13.200	8.75	12	1.78	8
	B	22.700				
	C	18.200				
	D	20.200				
	E	18.200				
	F	20.200				
30	A	13.200	8.75	12	1.78	8
	B	22.700				
	C	18.200				
	D	20.200				
	E	18.200				
	F	20.200				
35	A	14.500	8.75	12	1.78	8
	B	27.250				
	C	20.500				
	D	22.250				
	E	20.500				
	F	22.250				
45	A	17.000	8.75	12	1.78	8
	B	32.750				
	E	27.000				
	F	32.750				

All dimensions in mm.

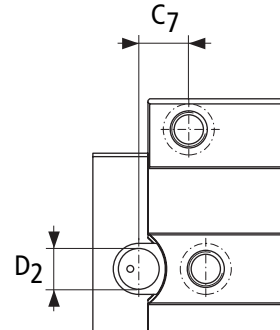

- D1 = O-Ring internal diameter
- D2 = Counterbore diameter
- D3 = O-Ring thickness
- D4 = Max. recommended diameter of lubrication inlet from above plate

1/16" NPT hole drilled in carriage ES7 option.

Style	511		D	ES7 L <sub>14</sub>	J <sub>2</sub>
	Size				
A	20	1/16"-27 NPT	12.0	5.2	
	25	1/16"-27 NPT	12.0	5.5	
	30	1/16"-27 NPT	13.0	7	
	35	1/16"-27 NPT	12.5	7	
	45	1/16"-27 NPT	15.0	8	
B	20	1/16"-27 NPT	12.0	5.2	
	25	1/16"-27 NPT	12.0	5.5	
	30	1/16"-27 NPT	13.0	7	
	35	1/16"-27 NPT	12.5	7	
	45	1/16"-27 NPT	15.0	8	
C	25	1/16"-27 NPT	9.2	5.5	
	30	1/16"-27 NPT	15.4	6	
	35	1/16"-27 NPT	14.3	7	
D	25	1/16"-27 NPT	9.2	5.5	
	30	1/16"-27 NPT	15.4	6	
	35	1/16"-27 NPT	14.3	7	
E	20	1/16"-27 NPT	10.0	5.2	
	25	1/16"-27 NPT	9.2	8.5	
	30	1/16"-27 NPT	15.4	9	
	35	1/16"-27 NPT	14.3	13	
	45	1/16"-27 NPT	13.9	18	
F	20	1/16"-27 NPT	10.0	5.2	
	25	1/16"-27 NPT	9.2	8.5	
	30	1/16"-27 NPT	15.4	9	
	35	1/16"-27 NPT	14.3	13	
	45	1/16"-27 NPT	13.9	18	

All dimensions in mm unless specified.

Style A and B

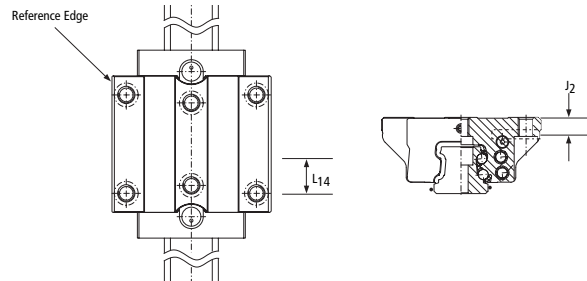

Style C, D, E and F

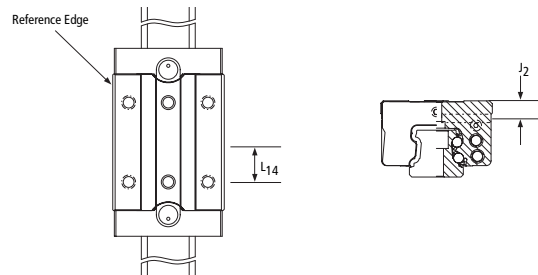

This is typically not a stocked item, please consult Danaher Motion for availability. For short lead time we recommend ES10 option.

DANAHER MOTION is a registered trademark of Danaher Corporation. Danaher Motion makes every attempt to ensure accuracy and reliability of the specifications in this publication. Specifications are subject to change without notice. Danaher Motion provides this information "AS IS" and disclaims all warranties, express or implied, including, but not limited to, implied warranties of merchantability and fitness for a particular purpose. It is the responsibility of the product user to determine the suitability of this product for a specific application. ©2004 Danaher Motion.

## Grease Lubricants

Standard carriages are sold with oil preservative to protect the balls from corrosion during storage and transit. The carriages are available with the following assortment of lubricants. Additional greases are available upon request, please consult Danaher Motion Application Engineering.

Option	Type	Notes	Viscosity	Temperature Range
G1	Mobilux® EP2	All purpose NLGI2 grease	160cSt @40°C	-20°C to 130°C
G2	Kyrtox® GPL227	High Temperature NLGI2	440cSt @40°C	-30°C to 288°C
GS	Customer specified at time of order			

## Rail Length

### Maximum Length of One Piece Rail

Size (mm)	15	20	25	30	35	45
One Piece Rail Length	1500mm	3000mm	6000mm			

## Extended Standard Rail Options

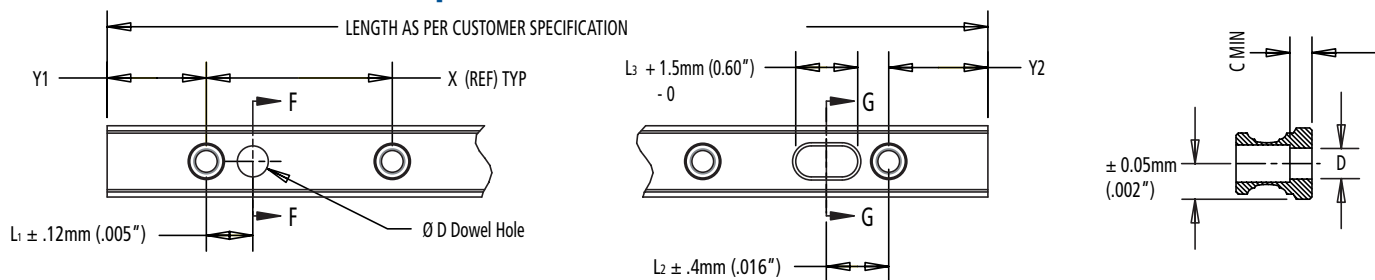

Option	D	L1	L2	L3	C
DH1	6mm	30mm	30mm	10.2 mm	9.5 mm
DH2	10mm	30mm	30mm	13.8 mm	9.5 mm
DH3	1/4"	1.181"	1.181"	.542"	3/8"
DH4	3/8"	1.181"	1.181"	.542"	3/8"

Y1 = Y2 unless specified at time of ordering

\*Size 25 and up step will be present around bottom of slot to control width tolerance during milling of slot.

The rail can be supplied with dowel holes, radial holes and coaxial holes to meet your application needs. Please provide a drawing of your requirement and our Application Engineering Team can provide a quote or select one of our extended standard options.

For more information, or to place an order, please contact your local authorized Thomson™ distributor or Danaher Motion at 1-540-633-3400, Fax: 1-540-633-4162, or E-mail at [profilerail@DanaherMotion.com](mailto:profilerail@DanaherMotion.com).

DANAHER MOTION is a registered trademark of Danaher Corporation. Danaher Motion makes every attempt to ensure accuracy and reliability of the specifications in this publication. Specifications are subject to change without notice. Danaher Motion provides this information "AS IS" and disclaims all warranties, express or implied, including, but not limited to, implied warranties of merchantability and fitness for a particular purpose. It is the responsibility of the product user to determine the suitability of this product for a specific application. ©2004 Danaher Motion.

## 521 Type U Rail – Bolt Up From Bottom

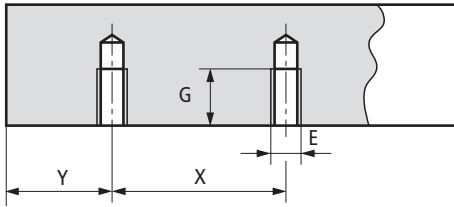

Size	X	E	G (mm)	Weight (kg/m)
15	60	M5	8	1.4
20	60	M6	10	2.2
25	60	M6	12	3
30	80	M8	15	4.3
35	80	M8	15	5.4
45	105	M12	19	8.8

Customer to specify Y dimensions upon ordering  $Y_1 = Y_2$  if not specified

## Thin Dense Chrome Plating

Rails and carriages are available with Duralloy® DSV Thin Dense Chrome Plating with a thickness of 2–4 μm. As a result of the plating thickness range compared to the tolerance ranges in the different accuracy classes, it is only available in the High and Precision accuracy classes up to 3 meters long as a single rail; longer lengths require butt joints.

### Carriage assortment with Thin Dense Chrome

Type	Style	Size	Accuracy	Clearance	Preload			
					0.03C	0.08C	0.13C	
511	A	15	H	511H15A0D	511H15A1D	511H15A2D	-	
			P	-	511P15A1D	511P15A2D	511P15A3D	
		20	H	511H20A0D	511H20A1D	511H20A2D	-	
			P	-	511P20A1D	511P20A2D	511P20A3D	
		25	H	511H25A0D	511H25A1D	511H25A2D	-	
			P	-	511P25A1D	511P25A2D	511P25A3D	
		30	H	511H30A0D	511H30A1D	511H30A2D	-	
			P	-	511P30A1D	511P30A2D	511P30A3D	
		35	H	511H35A0D	511H35A1D	511H35A2D	-	
			P	-	511P35A1D	511P35A2D	511P35A3D	
		45	H	511H45A0D	511H45A1D	511H45A2D	-	
			P	-	511P45A1D	511P45A2D	511P45A3D	
	B	20	H	511H20B0D	511H20B1D	511H20B2D	-	
			P	-	511P20B1D	511P20B2D	511P20B3D	
		25	H	511H25B0D	511H25B1D	511H25B2D	-	
			P	-	511P25B1D	511P25B2D	511P25B3D	
		30	H	511H30B0D	511H30B1D	511H30B2D	-	
			P	-	511P30B1D	511P30B2D	511P30B3D	
		35	H	511H35B0D	511H35B1D	511H35B2D	-	
			P	-	511P35B1D	511P35B2D	511P35B3D	
		45	H	511H45B0D	511H45B1D	511H45B2D	-	
			P	-	511P45B1D	511P45B2D	511P45A3D	
		C	15	H	511H15C0D	511H15C1D	511H15C2D	-
				P	-	511P15C1D	511P15C2D	511P15C3D
	20		H	511H20C0D	511H20C1D	511H20C2D	-	
			P	-	511P20C1D	511P20C2D	511P20C3D	
	25		H	511H25C0D	511H25C1D	511H25C2D	-	
			P	-	511P25C1D	511P25C2D	511P25C3D	
	30	H	511H30C0D	511H30C1D	511H30C2D	-		
		P	-	511P30C1D	511P30C2D	511P30C3D		
35	H	511H35C0D	511H35C1D	511H35C2D	-			
	P	-	511P35C1D	511P35C2D	511P35C3D			

Type	Style	Size	Accuracy	Clearance	Preload			
					0.03C	0.08C	0.13C	
511	D	20	H	511H20D0D	511H20D1D	511H20D2D	-	
			P	-	511P20D1D	511P20D2D	511P20D3D	
		25	H	511H25D0D	511H25D1D	511H25D2D	-	
			P	-	511P25D1D	511P25D2D	511P25D3D	
		30	H	511H30D0D	511H30D1D	511H30D2D	-	
			P	-	511P30D1D	511P30D2D	511P30D3D	
		35	H	511H35D0D	511H35D1D	511H35D2D	-	
			P	-	511P35D1D	511P35D2D	511P35D3D	
		E	15	H	511H15E0D	511H15E1D	511H15E2D	-
				P	-	511P15E1D	511P15E2D	511P15E3D
			25	H	511H25E0D	511H25E1D	511H25E2D	-
				P	-	511P25E1D	511P25E2D	511P25E3D
	30		H	511H30E0D	511H30E1D	511H30E2D	-	
			P	-	511P30E1D	511P30E2D	511P30E3D	
	35		H	511H35E0D	511H35E1D	511H35E2D	-	
			P	-	511P35E1D	511P35E2D	511P35E3D	
	45		H	511H45E0D	511H45E1D	511H45E2D	-	
			P	-	511P45E1D	511P45E2D	511P45E3D	
	F		25	H	511H25F0D	511H25F1D	511H25F2D	-
				P	-	511P25F1D	511P25F2D	511P25F3D
		30	H	511H30F0D	511H30F1D	511H30F2D	-	
			P	-	511P30F1D	511P30F2D	511P30F3D	
		35	H	511H35F0D	511H35F1D	511H35F2D	-	
			P	-	511P35F1D	511P35F2D	511P35F3D	
	45	H	511H45F0D	511H45F1D	511H45F2D	-		
		P	-	511P45F1D	511P45F2D	511P45F3D		
	G	15	H	511H15G0D	511H15G1D	511H15G2D	-	
			P	-	511P15G1D	511P15G2D	511P15G3D	
		20	H	511H20G0D	511H20G1D	511H20G2D	-	
			P	-	511P20G1D	511P20G2D	511P20G3D	

Duralloy carriages and rails are designed and manufactured to be used together. If a non-Duralloy carriage is used on a Duralloy rail the clearance or preload of the carriage will be increased approximately one class. If a Duralloy carriage is used on a non-Duralloy rail the clearance or preload will be decreased approximately one class. This is the result of the coating thickness.

For more information, or to place an order, please contact your local authorized Thomson™ distributor or Danaher Motion at 1-540-633-3400, Fax: 1-540-633-4162, or E-mail at [profilerrail@DanaherMotion.com](mailto:profilerrail@DanaherMotion.com).

DANAHER MOTION is a registered trademark of Danaher Corporation. Danaher Motion makes every attempt to ensure accuracy and reliability of the specifications in this publication. Specifications are subject to change without notice. Danaher Motion provides this information "AS IS" and disclaims all warranties, express or implied, including, but not limited to, implied warranties of merchantability and fitness for a particular purpose. It is the responsibility of the product user to determine the suitability of this product for a specific application. ©2004 Danaher Motion.

## Modular Accessory Combination Options and Screw Size

Option	Description	Size					
		15		20		25	
L <sup>3</sup>	"Lube for Life" Lube Block	Low/socket head screw	M2.5-0.45x20	Low/socket head screw	M2.5-0.45x25	Low/socket head screw	M4-0.7x35
N <sup>3</sup>	Oil Reservoir	Low/socket head screw	M2.5-0.45x20	Low/socket head screw	M2.5-0.45x25	Low/socket head screw	M4-0.7x30
W <sup>3</sup>	Rubber Wiper	Low/socket head screw	M2.5-0.45x20	Low/socket head screw	M2.5-0.45x20	Low/socket head screw	M4-0.7x25
V <sup>3</sup>	Viton Wiper	Low/socket head screw	M2.5-0.45x20	Low/socket head screw	M2.5-0.45x20	Low/socket head screw	M4-0.7x25
Z <sup>3</sup>	Metal Scraper	Low/socket head screw	M2.5-0.45x15	Low/socket head screw	M2.5-0.45x15	Low/socket head screw	M4-0.7x20
C <sup>3</sup>	Bellows Clips	Flat/socket head screw	M2.5-0.45x15	Flat/socket head screw	M2.5-0.45x15	Flat/socket head screw	M4-0.7x20
LW	Lube Block + Wiper	Low/socket head screw	M2.5-0.45x25	Low/socket head screw	M2.5-0.45x30	Low/socket head screw	M4-0.7x35
LWC	Lube Block, Wiper + Bellows Clip	Flat/socket head screw	M2.5-0.45x25	Flat/socket head screw	M2.5-0.45x30	Flat/socket head screw	M4-0.7x35
LWZ	Lube Block, Wiper + Scraper	Low/socket head screw	M2.5-0.45x25	Low/socket head screw	M2.5-0.45x30	Low/socket head screw	M4-0.7x35
LWZC	Lube Block, Wiper, Scraper + Bellows Clip	Flat/socket head screw	M2.5-0.45x25	Flat/socket head screw	M2.5-0.45x30	Flat/socket head screw	M4-0.7x35
LZ	Lube Block + Scraper	Low/socket head screw	M2.5-0.45x20	Low/socket head screw	M2.5-0.45x25	Low/socket head screw	M4-0.7x35
LZC	Lube Block, Scraper + Bellows Clip	Flat/socket head screw	M2.5-0.45x20	Flat/socket head screw	M2.5-0.45x25	Flat/socket head screw	M4-0.7x35
LC	Lube Block + Bellows Clip	Flat/socket head screw	M2.5-0.45x20	Flat/socket head screw	M2.5-0.45x25	Flat/socket head screw	M4-0.7x35
NW	Oil Reservoir + Wiper	Low/socket head screw	M2.5-0.45x30	Low/socket head screw	M2.5-0.45x30	Low/socket head screw	M4-0.7x40
NWZ	Oil Reservoir, Wiper + Scraper	Low/socket head screw	M2.5-0.45x30	Low/socket head screw	M2.5-0.45x35	Low/socket head screw	M4-0.7x40
NWC	Oil Reservoir, Wiper + Bellows Clip	Flat/socket head screw	M2.5-0.45x30	Flat/socket head screw	M2.5-0.45x30	Flat/socket head screw	M4-0.7x40
NWZC	Oil Reservoir, Wiper, Scraper + Bellows Clip	Flat/socket head screw	M2.5-0.45x30	Flat/socket head screw	M2.5-0.45x35	Flat/socket head screw	M4-0.7x40
NZ	Oil Reservoir + Scraper	Low/socket head screw	M2.5-0.45x25	Low/socket head screw	M2.5-0.45x30	Low/socket head screw	M4-0.7x35
NZC	Oil Reservoir, Scraper + Bellows Clips	Flat/socket head screw	M2.5-0.45x25	Flat/socket head screw	M2.5-0.45x30	Flat/socket head screw	M4-0.7x35
NC	Oil Reservoir + Bellows Clips	Flat/socket head screw	M2.5-0.45x20	Flat/socket head screw	M2.5-0.45x25	Flat/socket head screw	M4-0.7x35
WC	Wiper + Bellows Clip	Flat/socket head screw	M2.5-0.45x20	Flat/socket head screw	M2.5-0.45x20	Flat/socket head screw	M4-0.7x25
WZ	Wiper + Scraper	Low/socket head screw	M2.5-0.45x20	Low/socket head screw	M2.5-0.45x25	Low/socket head screw	M4-0.7x25
WZC	Wiper, Scraper + Bellows Clip	Flat/socket head screw	M2.5-0.45x20	Flat/socket head screw	M2.5-0.45x25	Flat/socket head screw	M4-0.7x30
VZ	Viton Wiper + Scraper	Low/socket head screw	M2.5-0.45x20	Low/socket head screw	M2.5-0.45x25	Low/socket head screw	M4-0.7x25
ZC	Scraper + Bellows Clip	Flat/socket head screw	M2.5-0.45x15	Flat/socket head screw	M2.5-0.45x15	Flat/socket head screw	M4-0.7x20

1. All fasteners are standard threads.
2. Consult Danaher Motion for options not listed, engineering review is required.
3. When ordering component only, two screws include.

For more information, or to place an order, please contact your local authorized Thomson™ distributor or Danaher Motion at 1-540-633-3400, Fax: 1-540-633-4162, or E-mail at [profilerrail@DanaherMotion.com](mailto:profilerrail@DanaherMotion.com).

DANAHER MOTION is a registered trademark of Danaher Corporation. Danaher Motion makes every attempt to ensure accuracy and reliability of the specifications in this publication. Specifications are subject to change without notice. Danaher Motion provides this information "AS IS" and disclaims all warranties, express or implied, including, but not limited to, implied warranties of merchantability and fitness for a particular purpose. It is the responsibility of the product user to determine the suitability of this product for a specific application. ©2004 Danaher Motion.



Option	Description	Size					
		30		35		45	
L	"Lube for Life" Lube Block	Low/socket head screw	M4-0.7x40	Low/socket head screw	M4-0.7x45	Low/socket head screw	M5-0.8x50
N	Oil Reservoir	Low/socket head screw	M4-0.7x30	Low/socket head screw	M4-0.7x35	Low/socket head screw	M5-0.8x45
W	Rubber Wiper	Low/socket head screw	M4-0.7x25	Low/socket head screw	M4-0.7x30	Low/socket head screw	M5-0.8x35
V	Viton Wiper	Low/socket head screw	M4-0.7x25	Low/socket head screw	M4-0.7x30	Low/socket head screw	M5-0.8x35
Z	Metal Scraper	Low/socket head screw	M4-0.7x20	Low/socket head screw	M4-0.7x25	Low/socket head screw	M5-0.8x30
C	Bellows Clips	Flat/socket head screw	M4-0.7x20	Flat/socket head screw	M4-0.7x25	Flat/socket head screw	M5-0.8x30
LW	Lube Block + Wiper	Low/socket head screw	M4-0.7x40	Low/socket head screw	M4-0.7x45	Low/socket head screw	M5-0.8x50
LWC	Lube Block, Wiper + Bellows Clip	Flat/socket head screw	M4-0.7x40	Flat/socket head screw	M4-0.7x45	Flat/socket head screw	M5-0.8x50
LWZ	Lube Block, Wiper + Scraper	Low/socket head screw	M4-0.7x40	Low/socket head screw	M4-0.7x45	Low/socket head screw	M5-0.8x50
LWZC	Lube Block, Wiper, Scraper + Bellows Clip	Flat/socket head screw	M4-0.7x40	Flat/socket head screw	M4-0.7x45	Flat/socket head screw	M5-0.8x50
LZ	Lube Block + Scraper	Low/socket head screw	M4-0.7x40	Low/socket head screw	M4-0.7x45	Low/socket head screw	M5-0.8x50
LZC	Lube Block, Scraper + Bellows Clip	Flat/socket head screw	M4-0.7x40	Flat/socket head screw	M4-0.7x45	Flat/socket head screw	M5-0.8x50
LC	Lube Block + Bellows Clip	Flat/socket head screw	M4-0.7x40	Flat/socket head screw	M4-0.7x45	Flat/socket head screw	M5-0.8x50
NW	Oil Reservoir + Wiper	Low/socket head screw	M4-0.7x40	Low/socket head screw	M4-0.7x45	Low/socket head screw	M5-0.8x50
NWZ	Oil Reservoir, Wiper + Scraper	Low/socket head screw	M4-0.7x40	Low/socket head screw	M4-0.7x45	Low/socket head screw	M5-0.8x55
NWC	Oil Reservoir, Wiper + Bellows Clip	Flat/socket head screw	M4-0.7x40	Flat/socket head screw	M4-0.7x45	Flat/socket head screw	M5-0.8x55
NWZC	Oil Reservoir, Wiper, Scraper + Bellows Clip	Flat/socket head screw	M4-0.7x45	Flat/socket head screw	M4-0.7x50	Flat/socket head screw	M5-0.8x55
NZ	Oil Reservoir + Scraper	Low/socket head screw	M4-0.7x35	Low/socket head screw	M4-0.7x40	Low/socket head screw	M5-0.8x45
NZC	Oil Reservoir, Scraper + Bellows Clips	Flat/socket head screw	M4-0.7x35	Flat/socket head screw	M4-0.7x40	Flat/socket head screw	M5-0.8x50
NC	Oil Reservoir + Bellows Clips	Flat/socket head screw	M4-0.7x35	Flat/socket head screw	M4-0.7x40	Flat/socket head screw	M5-0.8x50
WC	Wiper + Bellows Clip	Flat/socket head screw	M4-0.7x25	Flat/socket head screw	M4-0.7x30	Flat/socket head screw	M5-0.8x35
WZ	Wiper + Scraper	Low/socket head screw	M4-0.7x25	Low/socket head screw	M4-0.7x30	Low/socket head screw	M5-0.8x35
WZC	Wiper, Scraper + Bellows Clip	Flat/socket head screw	M4-0.7x30	Flat/socket head screw	M4-0.7x30	Flat/socket head screw	M5-0.8x35
VZ	Viton Wiper + Scraper	Low/socket head screw	M4-0.7x25	Low/socket head screw	M4-0.7x30	Low/socket head screw	M5-0.8x35
ZC	Scraper + Bellows Clip	Flat/socket head screw	M4-0.7x20	Flat/socket head screw	M4-0.7x25	Flat/socket head screw	M5-0.8x30

Consult Danaher Motion for options not listed, engineering review required.

For more information, or to place an order, please contact your local authorized Thomson™ distributor or Danaher Motion at 1-540-633-3400, Fax: 1-540-633-4162, or E-mail at [profilerail@DanaherMotion.com](mailto:profilerail@DanaherMotion.com).

DANAHER MOTION is a registered trademark of Danaher Corporation. Danaher Motion makes every attempt to ensure accuracy and reliability of the specifications in this publication. Specifications are subject to change without notice. Danaher Motion provides this information "AS IS" and disclaims all warranties, express or implied, including, but not limited to, implied warranties of merchantability and fitness for a particular purpose. It is the responsibility of the product user to determine the suitability of this product for a specific application. ©2004 Danaher Motion.

## Modular Accessories

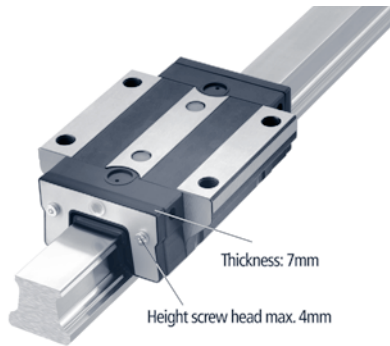

### Additional Wiper

Size	Rubber Part No.	Viton® Part No.	L1 (mm)	L2 (mm)	Weight (kg)
15	531WR15	531VR15	7	4	0.005
20	531WR20	531VR20	7	4	0.008
25	531WR25	531VR25	7	4	0.010
30	531WR30	531VR30	7	4	0.016
35	531WR35	531VR35	7	4	0.022
45	531WR45	531VR45	7	4	0.036

L1 – wiper thickness, L2 – max. screw head stickout

Can be installed without removing carriage from rail

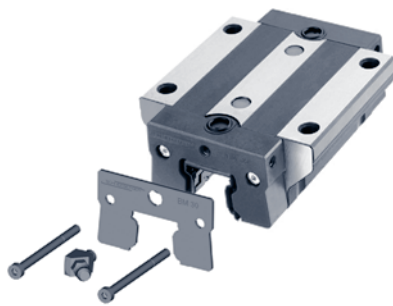
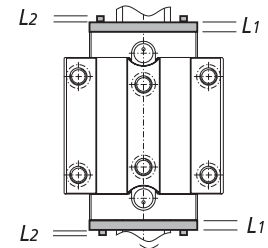

### Metal Scraper

Size	Scraper Part No.	L1 (mm)	L2 (mm)	Weight (kg)
15	531ZZ15	1.5	4	0.005
20	531ZZ20	1.5	4	0.009
25	531ZZ25	1.5	4	0.011
30	531ZZ30	1.5	4	0.018
35	531ZZ35	1.5	4	0.024
45	531ZZ45	1.5	4	0.057

L1 – scraper thickness, L2 – max. screw head stickout

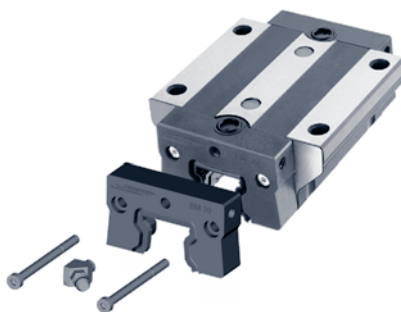
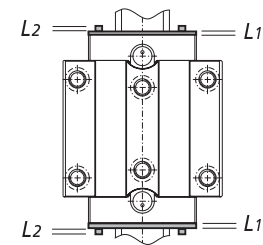

### Oil Reservoir

Size	Lubrication Plate	L1 (mm)	Weight (kg)
15	531OW15	8.5	0.004
20	531OW20	11	0.010
25	531OW25	12.7	0.017
30	531OW30	14	0.023
35	531OW35	16.2	0.039
45	531OW45	19.2	0.065

L1 = Oil reservoir thickness, screw heads are recessed in plate

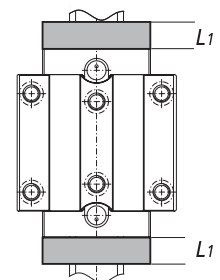

For more information, or to place an order, please contact your local authorized Thomson™ distributor or Danaher Motion at 1-800-554-8466, Fax: 1-800-445-0329, or E-mail at [profilerail@DanaherMotion.com](mailto:profilerail@DanaherMotion.com).

DANAHER MOTION is a registered trademark of Danaher Corporation. Danaher Motion makes every attempt to ensure accuracy and reliability of the specifications in this publication. Specifications are subject to change without notice. Danaher Motion provides this information "AS IS" and disclaims all warranties, express or implied, including, but not limited to, implied warranties of merchantability and fitness for a particular purpose. It is the responsibility of the product user to determine the suitability of this product for a specific application. ©2004 Danaher Motion.

**Lube Block**

Size	Lubrication Plate	L1 (mm)	L2 (mm)	Weight (kg)
15	531 LL15	9.9	4	0.009
20	531 LL20	11.9	4	0.024
25	531 LL25	19.5	4	0.083
30	531 LL30	21.2	4	0.213
35	531 LL35	24.7	4	0.069
45	531 LL45	26.9	4	0.123

L1 = Lube Block thickness, L2 = max. screw head stickout

When supplied from the factory as a complete unit the carriage is packed with EP2 grease and spring is loose for customer to install after assembling carriage on the rail.

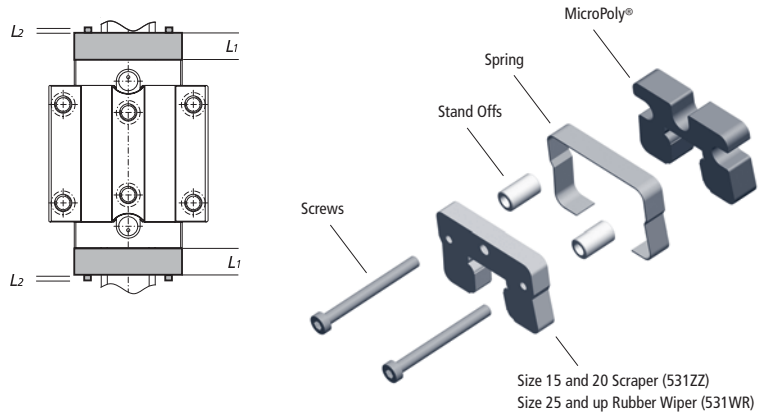

**Example:**

511 Size 45 carriage with 531OW and 531WR modular seals on both sides:	
Carriage Length (L)	= 89.3
531 OW45 L <sub>1</sub> x 2	= 12.7 x 2
531 WR45 L <sub>1</sub> x 2	= 7 x 2
531 WR45 L <sub>2</sub> x 2	= 4 x 2
Total Length	= 136.7 mm

Each modular seal is supplied with the proper screws to install the seal over the standard end cap. When combinations of modular seals are used longer screws may be required, consult table on page 32 & 33 for proper screw size.

**Replacement End Cap**

Size	Style	Part No.	Style	Part No. <sup>1</sup>	L1(mm)	Weight(kg)
15	A, C & G	531EC15	E	531ECH15	8.5	0.004
20	A, B, C, D	531EC20	G	531ECG20	11	0.01
25	A, B, C & D	531EC25	E & F	531ECH25	12.5	0.017
30	A, B, C & D	531EC30	E & F	531ECH30	14	0.023
35	A, B, C & D	531EC35	E & F	531ECH35	16	0.039
45	A & B	531EC45	E & F	531ECH45	19	0.065

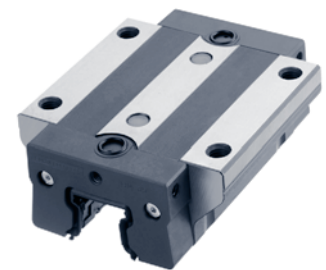

1. 531ECH is required when you want to use top lube inlet, otherwise standard 531EC will fit.
2. End cap can be installed without removing carriage from the rail.

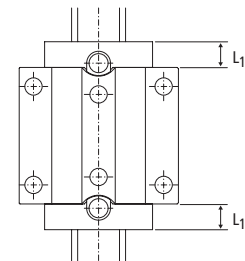

DANAHER MOTION is a registered trademark of Danaher Corporation. Danaher Motion makes every attempt to ensure accuracy and reliability of the specifications in this publication. Specifications are subject to change without notice. Danaher Motion provides this information "AS IS" and disclaims all warranties, express or implied, including, but not limited to, implied warranties of merchantability and fitness for a particular purpose. It is the responsibility of the product user to determine the suitability of this product for a specific application. ©2004 Danaher Motion.

## Bellows Dimensional Information

Bellows are available in three styles:

- 531 BB "Low Profile" with outside dimensions that do not exceed the carriage, constructed of polyurethane coated polyester, maximum ambient temperature of 80°C (175°F)
- 531 BC "High Compression" constructed of a spark resistant Teflon® coated fiberglass and designed to allow for higher compression, maximum ambient temperature exceeds maximum bearing peak temperatures.
- 531 WC "Walk On" capable of handling the harshest environments with a 90kg load bearing capacity.

The bellows can be easily installed in conjunction with the other optional modular seals providing you with an easy upgrade to the standard seal. Installation is simple and requires little time. Retrofitting is possible. The rail ends have to be drilled for the attachment of the bellow clip adapter plate, 531 CR. These can be easily installed on-site in the field or can be supplied from the factory.

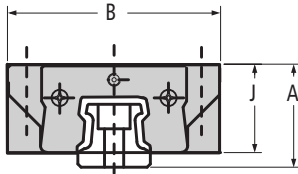

### 531 BB "Low Profile" Bellows

Size	Part No.	B	J	A	CR
15	531BB15	45	23	26	0.17
20	531BB20	41.6	24	29	0.17
25	531BB25	43.7	29	35.5	0.17
30	531BB30	51.2	33.3	40.3	0.17
35	531BB35	64	39.5	47.5	0.15
45	531BB45	76	48	58	0.15

Customer to specify extended length at time of order, see page 111 for how to calculate.

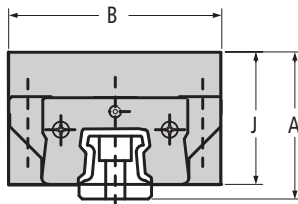

### 531 BC "High Compression" Bellows

Size	Part No.	B	J	A	CR
15	531BC15	59	33	36	0.10
20	531BC20	61.6	34	39	0.10
25	531BC25	63.7	39	45.5	0.10
30	531BC30	71.5	43.3	50.3	0.10
35	531BC35	84	49.5	57.5	0.07
45	531BC45	76	58	68	0.07

Customer to specify extended length at time of order, see page 111 for how to calculate.

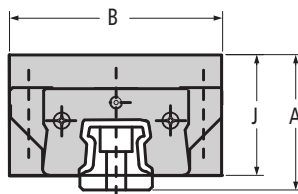

### 531 BW "Walk On" Bellows

Size	Part No.	B	J	A	CR
15	531BW15	55	30	31	0.19
20	531BW20	61	33	34	0.19
25	531BW25	65	36	40.5	0.19
30	531BW30	70	39	44.2	0.19
35	531BW35	77	42	48	0.19
45	531BW45	101	53	61	0.015

Customer to specify extended length at time of order, see page 111 for how to calculate.

## Bellow Clip Adapter Plates

### 531 CC Carriage Bellows Clips– Attachment Plate

Size	Part No.
15	531 CC15
20	531 CC20
25	531 CC25
30	531 CC30
35	531 CC35
45	531 CC45

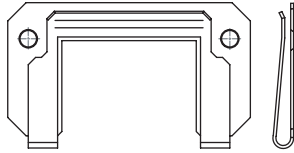

The 531 CC Carriage Bellows Clip–Attachment Plate is used to attach the bellows to the carriage. The bellows clip–adapter plate is made of steel.

### 531 CR Rail Bellows Clips– Attachment Plate

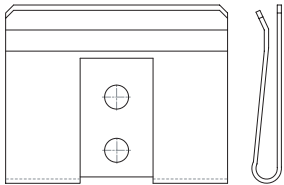

The 531 CR Rail Bellow Clip–Attachment Plate is used to attach the bellows to the rail. The attaching holes can be drilled in the end of the rail if retrofitting or can be supplied from the factory. (Note: Size 15 rail is through hardened, annealing the end of the rail is required to properly drill end plate clip this results in an area on the end of the rail that will be soft and possibly out of tolerance). The bellows clip–adapter plate is made of steel.

Size	Part No.	Rail Machining Detail					Screw <sup>1</sup>				MinY <sup>2</sup>
		A	B	C	Depth Min	Depth Max	Size	Pitch	Length	Type	
15 <sup>3</sup>	531 CR15	3.50	8.00	7.50	5.70	7.70	M3	0.5	8	Button Head Cap Screw	14
20	531 CR20	5.00	8.00	10.00							15
25	531 CR25	7.24	10.00	11.50	7.70	9.70	M4	0.7	10	Button Head Cap Screw	17
30	531 CR30	9.12	10.00	14.00							20
35	531 CR35	11.00	10.00	17.00							20
45	531 CR45	15.01	10.00	22.50							22

#### Rail End Machine Detail

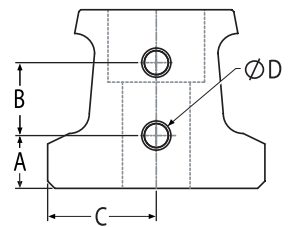

All dimensions in mm, unless otherwise specified.

- Two screws are supplied with each Rail Bellow Clip.
- Min Y dimension to ensure drill depth does not break through rail mounting hole.
- Rail end may require annealing, see note above.

## Maintenance and Installation Tools and Accessories

### Assembly Rail—531 MT

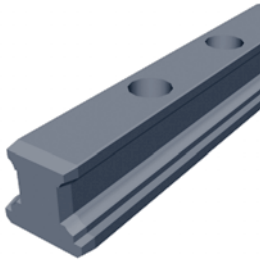

The assembly rail is required when the carriage must be removed from the rail and then reinstalled to ensure proper installation. It is recommended to leave the carriage on the assembly rail when it is removed to protect the balls against contamination. If necessary, the two internal mounting screws for fastening runner blocks to the carriage can be tightened to ensure the carriage remains on the assembly rail. The assembly rail is made of plastic.

Part Number	Size	Length (mm)	Weight (kg)
531 MT15	15	80	0.010
531 MT20	20	115	0.021
531 MT25	25	130	0.031
531 MT30	30	160	0.061
531 MT35	35	165	0.076
531 MT45	45	200	0.135

### Standard Rail Plugs and Tape for use with to 500 Series Ball Carriage Type A

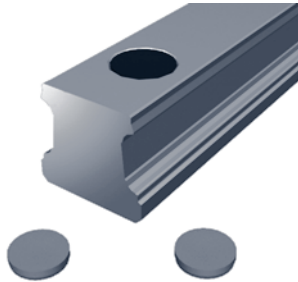

Type HP plastic plugs	Size
531 HP15	15
531 HP20	20
531 HP25	25
531 HP30	30
531 HP35	35
531 HP45	45

Mylar Tape	Size	Length
531 RT15	15	3m
531 RT20	20	3m
531 RT25	25	3m
531 RT30	30	3m
531 RT35	35	3m
531 RT45	45	3m

Material: Nylon

### 500 Series Rail with Stainless Steel Cover Strip

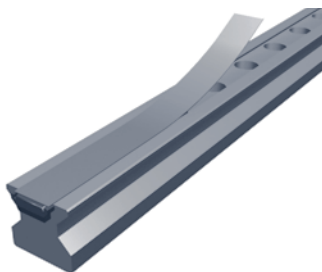

Size	Rail Coverstrip End Caps	Mounting Tool	Replacement End Caps	Standard Coverstrip Rail	Coverstrip Width (mm)	Max Single PC Length (mm)
	Part Number <sup>1</sup>	Part Number	Part Number <sup>2</sup>	Part Number <sup>3</sup>		
25	531RCS25	531RCT25	531RCP25	521H25C	15	6000
30	531RCS30	531RCT30	531RCP30	521H30C	19	6000
35	531RCS35	531RCT35	531RCP35	521H35C	25	6000
45	531RCS45	531RCT45	531RCP45	521H45C	25	6000

- Customer to specify length of rail to be used on at time of order. Delivered piece will be 2 to 3.5 mm longer in order to properly install and fit end caps.
- Two end caps are supplied with each piece of 531RCS ordered.
- H grade accuracy shown for example purposes, P and U grade accuracy are available.

For more information, or to place an order, please contact your local authorized Thomson™ distributor or Danaher Motion at 1-540-633-3400, Fax: 1-540-633-4162, or E-mail at [profilerail@DanaherMotion.com](mailto:profilerail@DanaherMotion.com).

DANAHER MOTION is a registered trademark of Danaher Corporation. Danaher Motion makes every attempt to ensure accuracy and reliability of the specifications in this publication. Specifications are subject to change without notice. Danaher Motion provides this information "AS IS" and disclaims all warranties, express or implied, including, but not limited to, implied warranties of merchantability and fitness for a particular purpose. It is the responsibility of the product user to determine the suitability of this product for a specific application. ©2004 Danaher Motion.

## Accuracy Class

Three tolerances describe the accuracy of a Profile Rail bearing: Running Parallelism, Pair Variation, and Assembly Accuracy. These are measured from the rail base to the center of the carriage top (H), and from the rail reference edge to the center of the carriage reference edge (A3).

Running Parallelism describes the tolerance on H and A3 as a function of axial travel, measured from one carriage down the length of the rail. This is analogous to straightness of travel. As such, parallelism describes attributes of the rail only.

Assembly Accuracy describes the tolerance on H and A3 as a function of a carriage–rail assembly, measured from the nominal dimensions.

Pair Variation describes tolerance on H and A3 as a function of carriages at the same position on a common rail. Pair variation describes carriage precision only.

The accuracy class selected will partially determine the accuracy of the system. Other factors such as mounting surface flatness and straightness also significantly affect system accuracy.

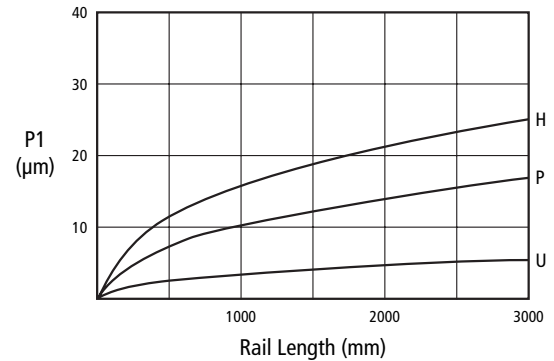
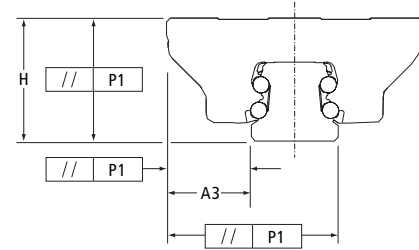

### Tolerances

	Accuracy Class		
	H - High	P - Precision	U - Ultra Precision
Assembly Accuracy Tolerance on dimension H and A3 (measured at middle of carriage at any point along rail)	±50	±20	±5
Pair Variation Max variation in dimensions H and A3 measured on multiple carriages mounted on the same rail (measured at the middle of carriage at same position on rail)	15	7	3
Running Parallelism	100	40	10

All values in µm

## Preload

Three Preload classes and one clearance class are available with the 500 Series Ball Profile Rail carriages. Preload will minimize elastic deformation caused by external forces resulting in increased rigidity. Preload will eliminate internal clearances between the rail and carriage resulting in zero backlash.

### Preload Accuracy Combinations

Accuracy Class	Clearance	Preload		
		0.03C <sup>1</sup>	0.08C <sup>1</sup>	0.13C <sup>1</sup>
H	0	1	2	
P, U		1	2	3

- C=Dynamic load capacity of the bearing
- A preloaded bearing loaded beyond the preload value has the same characteristics as a clearance bearing.  
Example: Size 25 A style carriage has dynamic load capacity of 21.1kN, Medium Preload = 0.08C = 0.08 x 21.1kN = 1.7kN; if applied load is greater than 1.7kN preload has no benefit.

DANAHER MOTION is a registered trademark of Danaher Corporation. Danaher Motion makes every attempt to ensure accuracy and reliability of the specifications in this publication. Specifications are subject to change without notice. Danaher Motion provides this information "AS IS" and disclaims all warranties, express or implied, including, but not limited to, implied warranties of merchantability and fitness for a particular purpose. It is the responsibility of the product user to determine the suitability of this product for a specific application. ©2004 Danaher Motion.



NOTES:

A large grid area for taking notes, consisting of a 30x30 grid of small squares. The grid is empty and occupies the central portion of the page.

DANAHER MOTION is a registered trademark of Danaher Corporation. Danaher Motion makes every attempt to ensure accuracy and reliability of the specifications in this publication. Specifications are subject to change without notice. Danaher Motion provides this information "AS IS" and disclaims all warranties, express or implied, including, but not limited to, implied warranties of merchantability and fitness for a particular purpose. It is the responsibility of the product user to determine the suitability of this product for a specific application. ©2004 Danaher Motion.

# 500 Series Roller Profile Rail Linear Guide

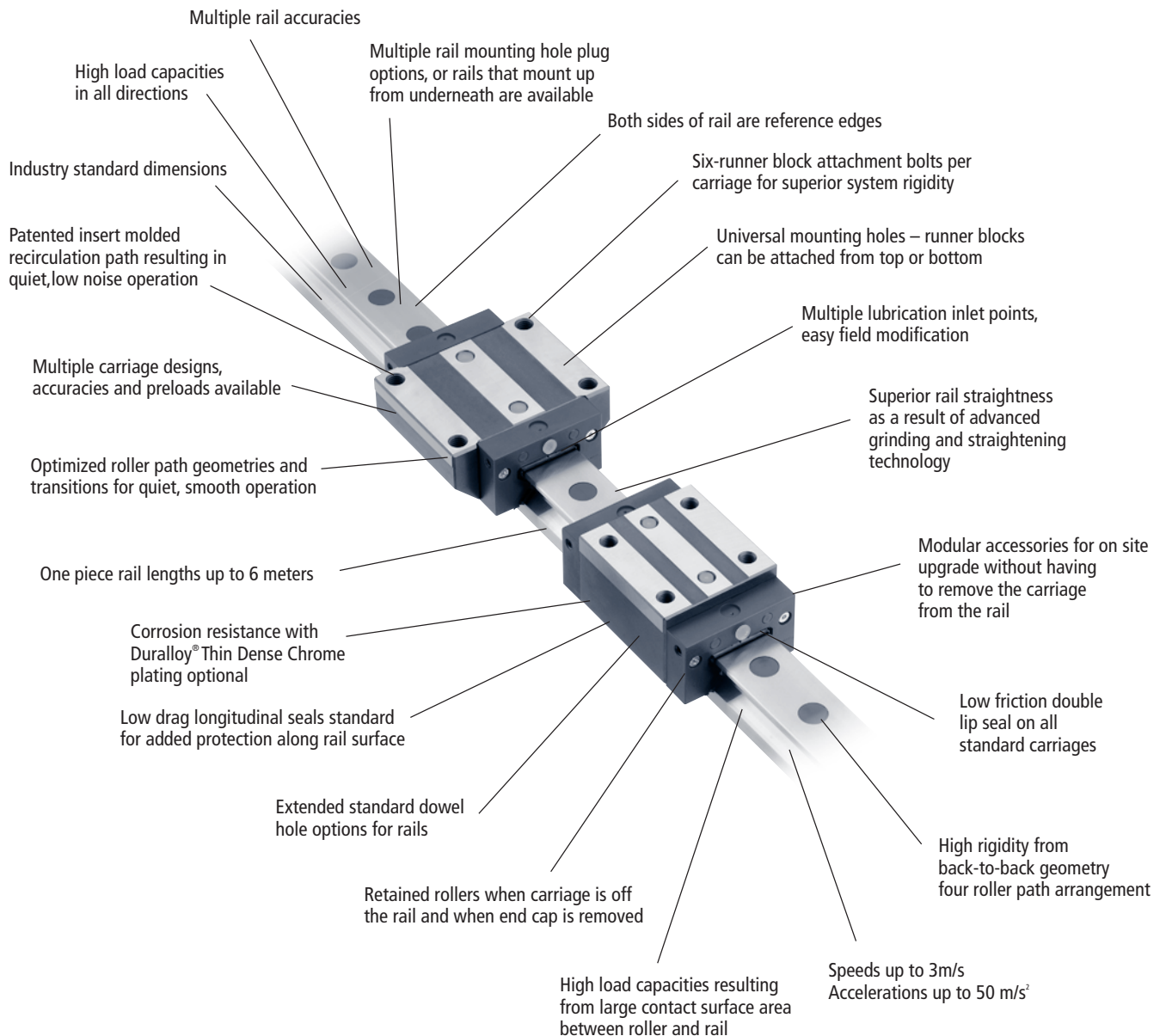

For more information, or to place an order, please contact your local authorized Thomson™ distributor or Danaher Motion at 1-540-633-3400, Fax: 1-540-633-4162, or E-mail at [profilerail@DanaherMotion.com](mailto:profilerail@DanaherMotion.com).

DANAHER MOTION is a registered trademark of Danaher Corporation. Danaher Motion makes every attempt to ensure accuracy and reliability of the specifications in this publication. Specifications are subject to change without notice. Danaher Motion provides this information "AS IS" and disclaims all warranties, express or implied, including, but not limited to, implied warranties of merchantability and fitness for a particular purpose. It is the responsibility of the product user to determine the suitability of this product for a specific application. ©2004 Danaher Motion.

## 500 Series Roller Profile Rail Linear Guide

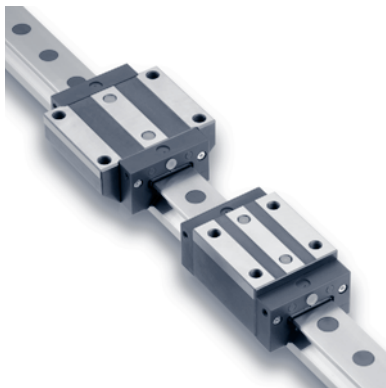

### Features

The Thomson 500 Series Linear Guide provides long life, exceptional rigidity, high dynamic and static load capacities, accommodation for high moment loads, high running accuracy, multiple sealing options and multiple lubrication inlet options. This allows for on-site field modification, and interchangeability with competitor offering.

These properties result in improved machine accuracies and rigidity resulting in reduced vibration extending machine and tool life. This has a direct effect on your operational efficiency resulting in cost savings for the user.

Available in 4 carriage designs.

### Materials

The 500 Series Roller Linear Guide is produced from high quality bearing steel. The end cap is made of a high strength, glass-filled nylon with a nitrile rubber seal. All carriages and rolling elements are through hardened and all rails are case hardened. Stringent quality controls are in place to ensure consistency of materials from the source, allowing us to ensure that we deliver the highest quality product.

### Interchangeability

The 500 Series Roller Linear Guide is completely interchangeable. Any carriage can be run on any rail of the same accuracy without compromising system accuracy. This is the result of our stringent manufacturing process controls.

### Accuracy and Preload

The 500 Series Roller Linear Guide is available in three different accuracy classes, and three different preload ranges to allow for customization to your application needs.

### Straightness

The 500 Series Roller rail is subjected to multiple straightening processes during and after grinding of the roller paths, on one piece rails up to 6 meters long.

These added processes and inspections result in some of the straightest rails in the market today, improving machine accuracies wherever the 500 Series Roller is used.

*For more information, or to place an order, please contact your local authorized Thomson™ distributor or Danaher Motion at 1-540-633-3400, Fax: 1-540-633-4162, or E-mail at [profilerrail@DanaherMotion.com](mailto:profilerrail@DanaherMotion.com).*

DANAHER MOTION is a registered trademark of Danaher Corporation. Danaher Motion makes every attempt to ensure accuracy and reliability of the specifications in this publication. Specifications are subject to change without notice. Danaher Motion provides this information "AS IS" and disclaims all warranties, express or implied, including, but not limited to, implied warranties of merchantability and fitness for a particular purpose. It is the responsibility of the product user to determine the suitability of this product for a specific application. ©2004 Danaher Motion.

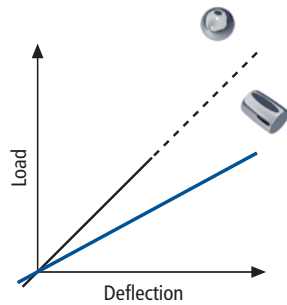

## Rigidity

Profile Rail Linear Guide bearings have a significant effect on the overall system rigidity. The 500 Series Roller rigidity is achieved by using the equivalent of a back-to-back bearing arrangement, complemented by special rollers that are crowned to prevent roller edge loading when misalignment is present. This results in lower elastic deformation as the load increases compared to a ball carriage or face-to-face bearing arrangement.

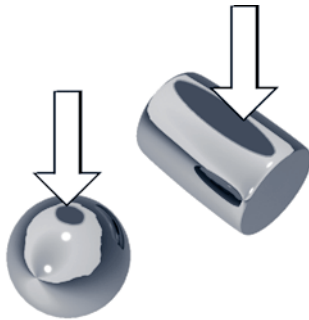

## Load Capacity

The roller has an increased load capacity over the ball as a result of the increased contacting surface across the length of the roller. A ball provides a single point contact area, while a roller provides a much greater line contact area. This results in a substantially higher load carrying capacity and lower wear with minimum rolling friction.

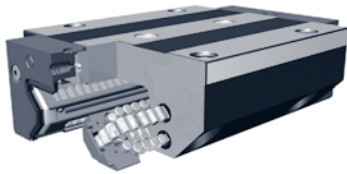

## Running Smoothness/Low Noise

The running smoothness and low noise are the result of a propriety insert molded recirculation path that has an optimized geometric shape and minimal transitions. This ensures smooth, quiet operation.

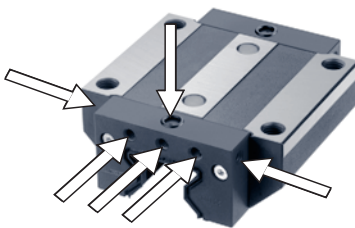

## Multiple Lubrication Options

The carriage standard end cap is designed for flexibility. The end cap is equipped with six lubrication inlet points and additional internal options for directing grease or oil to the proper location. These options are easily changed on-site in the field or can be supplied from the factory. Not all options available on size 25.

Unsure of the best lubrication inlet location? These carriages will allow the user to make these changes easily in the field to optimize the system performance. In addition, they allow for ease in maintenance.

For more information, or to place an order, please contact your local authorized Thomson™ distributor or Danaher Motion at 1-540-633-3400, Fax: 1-540-633-4162, or E-mail at [profilerail@DanaherMotion.com](mailto:profilerail@DanaherMotion.com).

DANAHER MOTION is a registered trademark of Danaher Corporation. Danaher Motion makes every attempt to ensure accuracy and reliability of the specifications in this publication. Specifications are subject to change without notice. Danaher Motion provides this information "AS IS" and disclaims all warranties, express or implied, including, but not limited to, implied warranties of merchantability and fitness for a particular purpose. It is the responsibility of the product user to determine the suitability of this product for a specific application. ©2004 Danaher Motion.

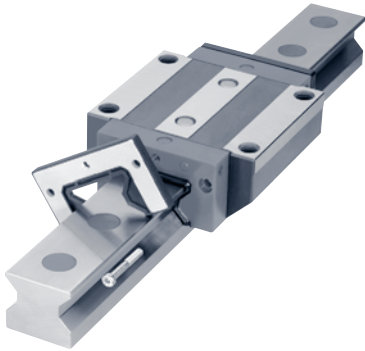

## Modular Accessory Options

The carriage is supplied standard with low friction double lip seals and longitudinal seals that completely enclose the bearing carriage to protect the rollers and track surfaces and minimize lubrication loss.

Optional metal scrapers or wiper and oil reservoir components can be easily added on-site in the field or can be supplied assembled from the factory.

These innovative design features allow users to easily, efficiently, and economically upgrade carriage sealing and lubrication without needing to replace the entire carriage assembly.

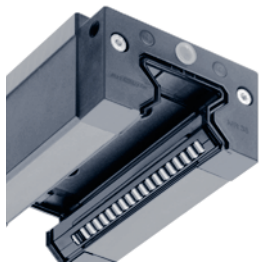

## Longitudinal Seals

The carriage has built-in under carriage low drag longitudinal seals that protect the rollers and roller track surfaces from contamination. These longitudinal seals are an added protection to increase the life and overall performance.

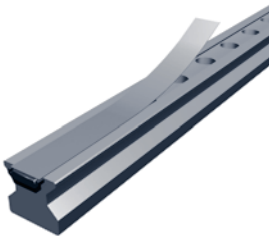

## Rail Accessories

The rails have multiple options to fill the mounting holes to eliminate possible contamination entry into the bearing. Custom designed plugs are available in plastic, brass, or stainless steel. A special rail is available that utilizes a custom cover strip. In addition, Danaher Motion stocks an assortment of bellows to protect the entire assembly. All options are available from stock and represent another innovative design feature of the 500 Series. Mounting tools for easy and correct installation are available as well.

## Retained Rollers

The rolling elements of the carriages are retained within the bearing so the carriage can be removed from the rail, or the end cap from the carriage, without worrying about the rollers falling out. It is recommended to place any removed carriage onto a mounting rail or shipping arbor to provide added protection to the rolling elements.

For more information, or to place an order, please contact your local authorized Thomson™ distributor or Danaher Motion at 1-540-633-3400, Fax: 1-540-633-4162, or E-mail at [profilerrail@DanaherMotion.com](mailto:profilerrail@DanaherMotion.com).

DANAHER MOTION is a registered trademark of Danaher Corporation. Danaher Motion makes every attempt to ensure accuracy and reliability of the specifications in this publication. Specifications are subject to change without notice. Danaher Motion provides this information "AS IS" and disclaims all warranties, express or implied, including, but not limited to, implied warranties of merchantability and fitness for a particular purpose. It is the responsibility of the product user to determine the suitability of this product for a specific application. ©2004 Danaher Motion.

## 500 Series Roller Profile Rail Linear Guide

### Modular Design Exploded View

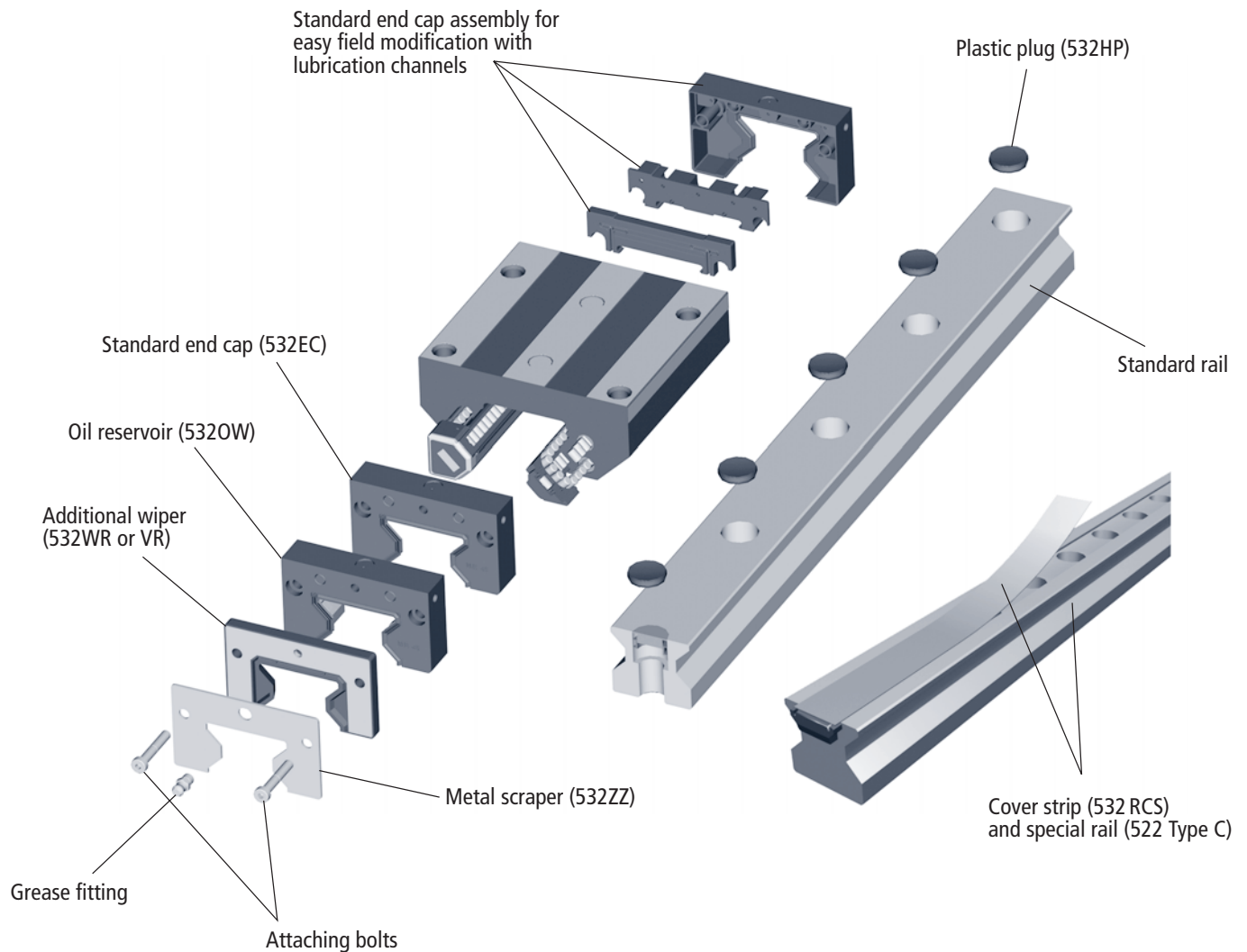

Also available (not shown):

- Stainless Steel Rail Plugs (532 HS)
- Mylar Tape (532 RT)
- Brass Rail Plugs (532 HB)
- Bolt up from bottom rail (522 Type U)

The modular, building block design of the 500 Series Roller Profile Rail Linear Guide assembly for easy on-site field upgrades, for quick seal or lubrication upgrades all without the need for new carriage or rails.

For more information, or to place an order, please contact your local authorized Thomson™ distributor or Danaher Motion at 1-540-633-3400, Fax: 1-540-633-4162, or E-mail at [profilerail@DanaherMotion.com](mailto:profilerail@DanaherMotion.com).

DANAHER MOTION is a registered trademark of Danaher Corporation. Danaher Motion makes every attempt to ensure accuracy and reliability of the specifications in this publication. Specifications are subject to change without notice. Danaher Motion provides this information "AS IS" and disclaims all warranties, express or implied, including, but not limited to, implied warranties of merchantability and fitness for a particular purpose. It is the responsibility of the product user to determine the suitability of this product for a specific application. ©2004 Danaher Motion.

## 500 Series Roller Standard Carriages

Danaher Motion offers four carriage styles with six mounting holes allowing for additional mounting configurations in the field or retrofiting. All provide superior rigidity and design flexibility.

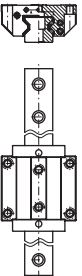
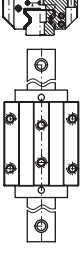
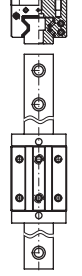
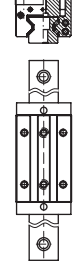
Style			Size	Accuracy	Basic Part Number			Standard Rail Part Number	Max. Single Piece Rail Length (mm)			
					Preload							
					0.03C	0.08C	0.13C					
Narrow High Carriage	A		25	P	512P25A1	512P25A2	512P25A3	522P25A	6000			
				S	512S25A1	512S25A2	512S25A3	522S25A				
				U	512U25A1	512U25A2	512U25A3	522U25A				
			35	P	512P35A1	512P35A2	512P35A3	522P35A	6000			
				S	512S35A1	512S35A2	512S35A3	522S35A				
				U	512U35A1	512U35A2	512U35A3	522U35A				
			45	P	512P45A1	512P45A2	512P45A3	522P45A	6000			
				S	512S45A1	512S45A2	512S45A3	522S45A				
				U	512U45A1	512U45A2	512U45A3	522U45A				
			55	P	512P55A1	512P55A2	512P55A3	522P55A	6000			
				S	512S55A1	512S55A2	512S55A3	522S55A				
				U	512U55A1	512U55A2	512U55A3	522U55A				
Narrow High Long Carriage	B		25	P	512P25B1	512P25B2	512P25B3	522P25A	6000			
				S	512S25B1	512S25B2	512S25B3	522S25A				
				U	512U25B1	512U25B2	512U25B3	522U25A				
			35	P	512P35B1	512P35B2	512P35B3	522P35A	6000			
				S	512S35B1	512S35B2	512S35B3	522S35A				
				U	512U35B1	512U35B2	512U35B3	522U35A				
			45	P	512P45B1	512P45B2	512P45B3	522P45A	6000			
				S	512S45B1	512S45B2	512S45B3	522S45A				
				U	512U45B1	512U45B2	512U45B3	522U45A				
			55	P	512P55B1	512P55B2	512P55B3	522P55A	6000			
				S	512S55B1	512S55B2	512S55B3	522S55A				
				U	512U55B1	512U55B2	512U55B3	522U55A				
			65	P	512P65B1	512P65B2	512P65B3	522P65A	6000			
				S	512S65B1	512S65B2	512S65B3	522S65A				
				U	512U65B1	512U65B2	512U65B3	522U65A				
			Narrow Short Carriage	C		25	P	512P25C1	512P25C2	512P25C3	522P25A	6000
							S	512S25C1	512S25C2	512S25C3	522S25A	
							U	512U25C1	512U25C2	512U25C3	522U25A	
35	P	512P35C1				512P35C2	512P35C3	522P35A	6000			
	S	512S35C1				512S35C2	512S35C3	522S35A				
	U	512U35C1				512U35C2	512U35C3	522U35A				
45	P	512P45C1				512P45C2	512P45C3	522P45A	6000			
	S	512S45C1				512S45C2	512S45C3	522S45A				
	U	512U45C1				512U45C2	512U45C3	522U45A				
55	P	512P55C1				512P55C2	512P55C3	522P550A	6000			
	S	512S55C1				512S55C2	512S55C3	522S55A				
	U	512U55C1				512U55C2	512U55C3	522U55A				
Narrow Long Carriage	D		25	P	512P25D1	512P25D2	512P25D3	522P25A	6000			
				S	512S25D1	512S25D2	512S25D3	522S25A				
				U	512U25D1	512U25D2	512U25D3	522U25A				
			35	P	512P35D1	512P35D2	512P35D3	522P35A	6000			
				S	512S35D1	512S35D2	512S35D3	522S35A				
				U	512U35D1	512U35D2	512U35D3	522U35A				
			45	P	512P45D1	512P45D2	512P45D3	522P45A	6000			
				S	512S45D1	512S45D2	512S45D3	522S45A				
				U	512U45D1	512U45D2	512U45D3	522U45A				
			55	P	512P55D1	512P55D2	512P55D3	522P55A	6000			
				S	512S55D1	512S55D2	512S55D3	522S55A				
				U	512U55D1	512U55D2	512U55D3	522U55A				
			65	P	512P65D1	512P65D2	512P65D3	522P65A	6000			
				S	512S65D1	512S65D2	512S65D3	522S65A				
				U	512U65D1	512U65D2	512U65D3	522U65A				

DANAHER MOTION is a registered trademark of Danaher Corporation. Danaher Motion makes every attempt to ensure accuracy and reliability of the specifications in this publication. Specifications are subject to change without notice. Danaher Motion provides this information "AS IS" and disclaims all warranties, express or implied, including, but not limited to, implied warranties of merchantability and fitness for a particular purpose. It is the responsibility of the product user to determine the suitability of this product for a specific application. ©2004 Danaher Motion.



## 500 Series Roller Rail Options

Bolt down from the top – 522 Type A

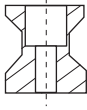

Bolt down from the bottom – 522 Type U

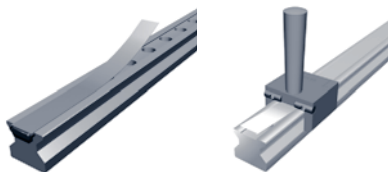
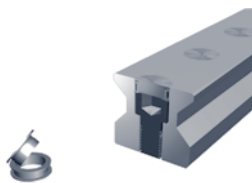
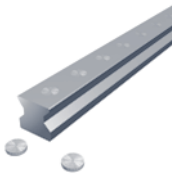

### Rail Types and Accessories

The 500 Series Roller Profile Rail is available in two configurations:

- Bolt Down from the top – 522 Type A
- Bolt Up from the bottom – 522 Type U

The bolt down from the top design has various types of options to plug the holes.

The standard 522 Type A rail mounting holes can be plugged or sealed after installation using the options below.

### Plastic Plugs

532 HP plastic plugs are an inexpensive and simple method to seal the rail attachment bolt area. The plastic plugs are easy driven in place to any rails with a soft non-metallic drift. They can easily be removed.

### Brass Plugs

532 HB brass plugs are more rugged than the plastic plug, slightly more expensive, and require more precision during installation. They fit in all stand 500 Series Roller Rails and require some hand buffing or polishing of the rail surface after installation.

### Two-piece Stainless Steel Plugs

532 HS two-piece stainless plugs are the most rugged plugs available for the roller rails. The two piece construction and design allows the plugs to lock into place and rest on the top of the socket head bolt. They require no post installation polishing. The recommended hex head socket must be used to properly install the 532 HS plugs. For correct installation we recommend use of the 532 HST mounting tools found on page 66.

### Mylar Tape

A simple and low cost alternative is specialty Mylar tape that can be placed quickly on the top surface of the rail. Part number 532 RT is available in 3 meter lengths.

### Optional 500 Series Rail

Option 532 RC utilizes a special rail 522 Type C that is easily installed with the 532 RCT mounting tool found on page 66.

### Carriage Option

The 500 Series Roller Profile carriages are also available with special lubrications. They can be ordered directly from stock or with a short lead-time.

## 500 Series Roller Profile Rail

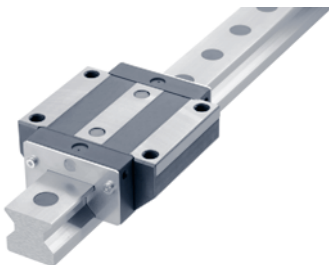
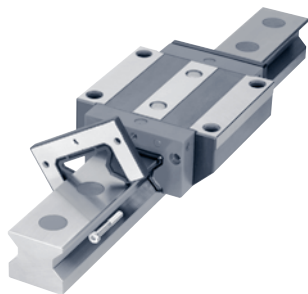
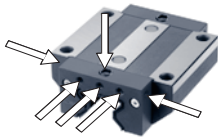
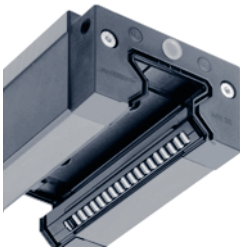

### Additional Seal Types and Lubrication Accessories

The carriages are designed with modular sealing and lubrication options for simple on-site field modification or factory direct.

The standard carriage end cap has an integral low friction double lip seal and longitudinal seals that completely enclose the bearing carriage. The double lip design keeps contaminants out and lubrication in. It also allows for grease to purge out of the carriage to prevent excessive lubrication, which can result in higher operating temperatures. This double lip design allows for use with oil lubrication.

This standard carriage end cap comes standard with a lubrication inlet centered in the end cap with specially designed and modified lubrication channels to direct the lubrication to the different roller tracks. The lubrication inlet can be easily changed in the field or supplied from the factory for side inlet, offset inlet or top inlet. Additionally, the internal configuration can be modified to allow for separating the lubrication paths for vertical mounting or oil lubrication.

The standard carriage end cap is equipped with lubrication channels directing lubrication to proper roller paths. The standard carriage end plate can be easily modified on-site in the field to channel lubrication separately or can be factory ordered.

### Optional—on site field installable modular seals and accessories

#### Additional Seal

The **532 WR** and **532 VR** seals provide an additional level of protection from contaminants to the assembly. These additional components can be easily added on-site. They are supplied with the required screws to make installation simple.

532 WR is made of durable nitrile rubber (Buna N)

532 VR is made of durable Viton®

These seals can be used in conjunction with other optional modular accessories providing an easy upgrade to the standard seal. These can be easily installed on-site in the field or can be supplied from the factory.

#### Metal Scraper

The **532 ZZ Metal Scraper** made of stainless steel, serves as an added protection to the seal lips against large dirt particles, metal shavings or chips. Large contaminants are easily pushed away for an extra level of protection to the seal lips. The Metal Scraper is easily installed in conjunction with other optional modular accessories providing you with an easy upgrade to the standard seal. These are easily installed on-site in the field or can be supplied from the factory.

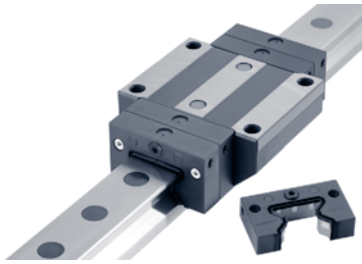

### Oil Reservoir

The **532 OW Oil Reservoir** is a cost effective, automatic lubrication system. It is constructed with an integrated oil reservoir that provides a uniform, consistent lubricating oil to the roller paths for extended periods of time. The Type 532 OW oil reservoir eliminates the need for a routine maintenance schedule, assures lubrication gets to the required points, can be refilled if required, and can operate up to 5000 km of travel. The Type 532 OW oil reservoir can be easily installed in conjunction with other optional modular seals for an easy upgrade to the standard seal. These can be easily installed on-site in the field or can be supplied from the factory.

### Bellows

**Standard bellows** are available for all assemblies. The bellows cover the entire length of the rail. The bellows are used to provide additional protection against dirt, dust and splashed liquid. Installation is simple and requires little time. Retrofitting is possible when the rail ends are drilled for the attachment of the rail clip 532 CR.

Bellows are available in three styles:

- Type B "Low Profile" with outside dimensions that do not exceed the carriage
- Type C "High Compression"
- Type W "Walk-On" capable of handling the harshest environments with a 90 kg load bearing capacity

The bellow can be easily installed in conjunction with the other optional modular accessories and are an easy upgrade to the standard seal. These can be easily installed on-site in the field.

Note: Additional Modular accessories add additional drag to the carriage assembly resulting in increased start-up friction and power consumption.

### Relative Drag Comparison for Design Consideration

Type	Relative Drag
Standard carriage	●
Rubber Wiper (531 WR)	● ● ●
Viton® Wiper (531 VR)	● ● ●
Metal Scraper (531 22)	●
Oil Reservoir (531 OW)	● ●

• Low

**For ordering information  
or for additional  
Seal Types and  
Lubrication Accessories,  
see page 60.**

For more information, or to place an order, please contact your local authorized Thomson™ distributor or Danaher Motion at 1-540-633-3400, Fax: 1-540-633-4162, or E-mail at [profilerail@DanaherMotion.com](mailto:profilerail@DanaherMotion.com).

DANAHER MOTION is a registered trademark of Danaher Corporation. Danaher Motion makes every attempt to ensure accuracy and reliability of the specifications in this publication. Specifications are subject to change without notice. Danaher Motion provides this information "AS IS" and disclaims all warranties, express or implied, including, but not limited to, implied warranties of merchantability and fitness for a particular purpose. It is the responsibility of the product user to determine the suitability of this product for a specific application. ©2004 Danaher Motion.

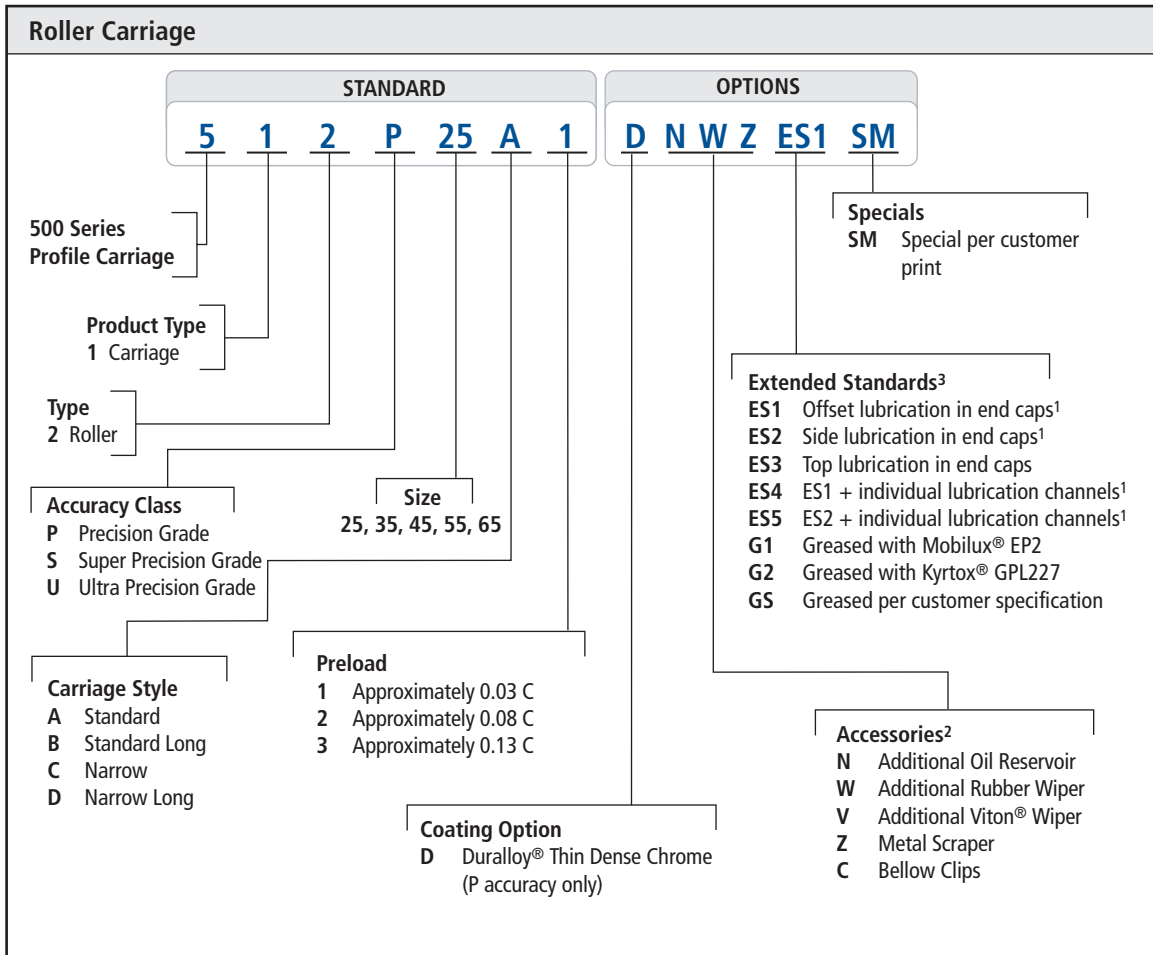

- ES1, ES2, ES4 and ES5 options are available size 35, 45, 55 and 65 only.
- Accessory combination part numbers are listed from carriage end cap outward. Not all combinations are available. For specific combination availability see page 60 or consult Danaher Motion.
- Optional inlet and grease options may not be functional with all accessory combinations. (Example: G1 and Oil Reservoir "N"). Prior to selecting an inlet option review any interference or conflicts with the accessories selected.

DANAHER MOTION is a registered trademark of Danaher Corporation. Danaher Motion makes every attempt to ensure accuracy and reliability of the specifications in this publication. Specifications are subject to change without notice. Danaher Motion provides this information "AS IS" and disclaims all warranties, express or implied, including, but not limited to, implied warranties of merchantability and fitness for a particular purpose. It is the responsibility of the product user to determine the suitability of this product for a specific application. ©2004 Danaher Motion.

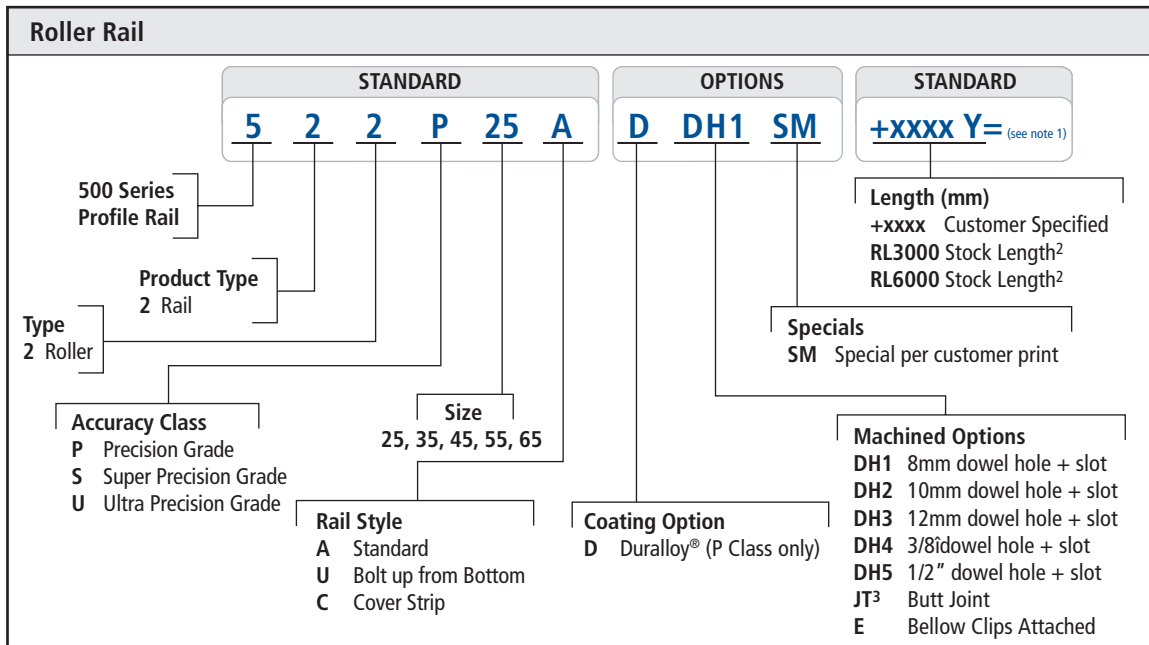

1. Y = Distance from end of rail to center of first mounting hole, Y1 = Y2 unless specified.
2. Stock length rails are considered random length, total length may exceed specified length, and Y1/Y2 are not equal. To be used by customer who will cut to length.
3. Customer drawing required at time of quote and order. See page 112 for more information and templates.

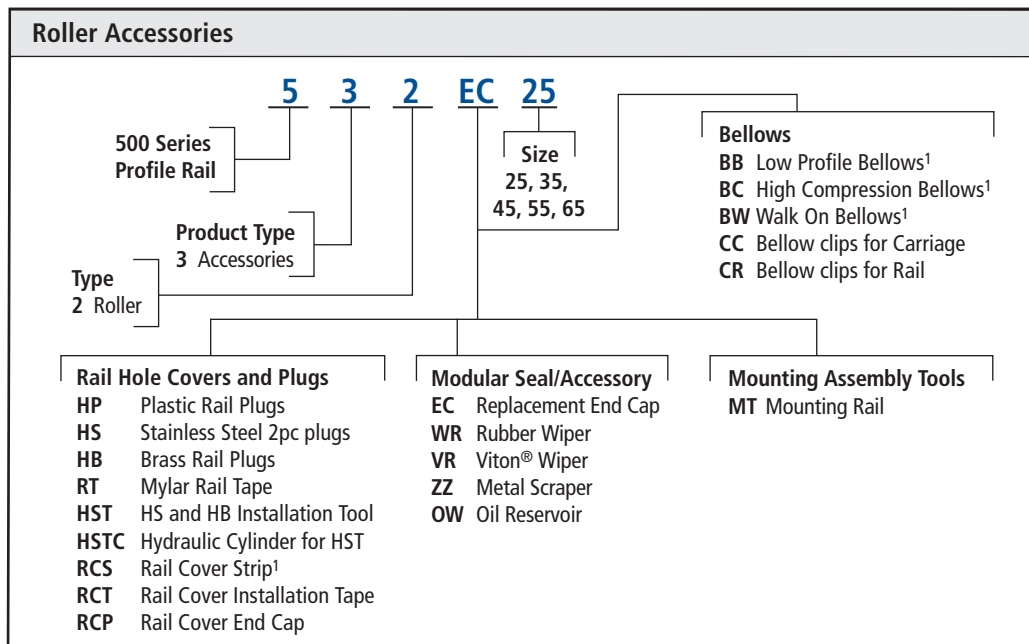

1. Bellows and rail cover strip must include length at time of order. (Example: 532BB35 + 1000 mm). See page 111 for how to calculate bellows length.

For more information, or to place an order, please contact your local authorized Thomson™ distributor or Danaher Motion at 1-540-633-3400, Fax: 1-540-633-4162, or E-mail at [profilerail@DanaherMotion.com](mailto:profilerail@DanaherMotion.com).

DANAHER MOTION is a registered trademark of Danaher Corporation. Danaher Motion makes every attempt to ensure accuracy and reliability of the specifications in this publication. Specifications are subject to change without notice. Danaher Motion provides this information "AS IS" and disclaims all warranties, express or implied, including, but not limited to, implied warranties of merchantability and fitness for a particular purpose. It is the responsibility of the product user to determine the suitability of this product for a specific application. ©2004 Danaher Motion.

# 500 Series Roller

## 512 Style A and B

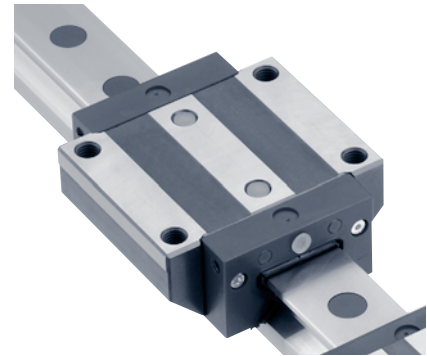
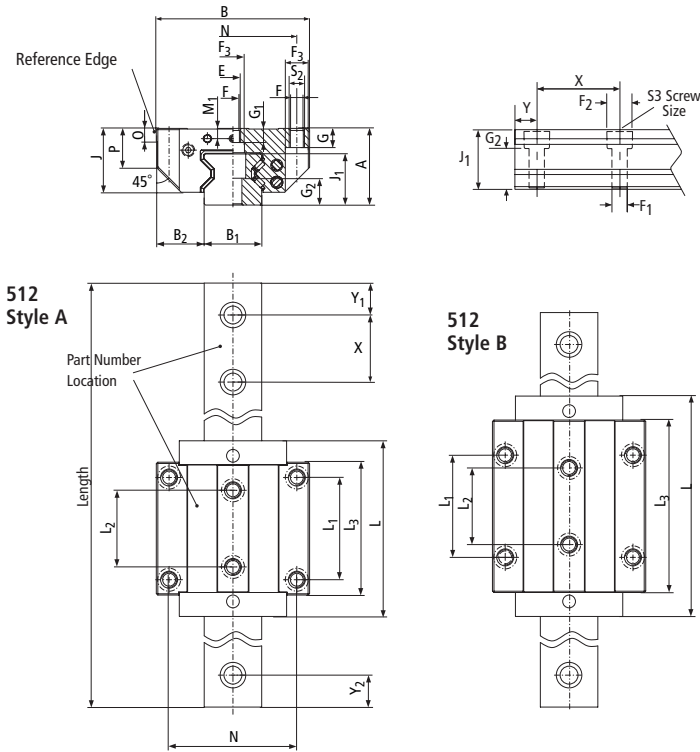

### 512 Style A – Standard Roller

Size	Dimensions (mm)																	Roller							
	A	B	B <sub>1</sub> * ±0.05	B <sub>2</sub>	J	J <sub>1</sub>	L	L <sub>1</sub>	L <sub>2</sub>	L <sub>3</sub>	X	N	S <sub>2</sub>	S <sub>3</sub>	F	F <sub>1</sub>	F <sub>2</sub>	F <sub>3</sub>	Ø	G	G <sub>1</sub>	G <sub>2</sub>	M <sub>1</sub>	O	P
25	36	70	23	23.5	29.5	24.5	81	45	40	60	30	57	M6	M6	6.8	7	11	11	3.2	9	6.5	13	5.5	7.5	17.5
35	48	100	34	33	40	32	109	62	52	80	40	82	M8	M8	8.5	9	15	15	4.5	12	10	15	7	8	23
45	60	120	45	37.5	50	40	137.5	80	60	104	52.5	100	M12	M12	10.5	14	20	18	5	15	11	21	8	10	30.5
55	70	140	53	43.5	57	48	163.5	95	70	120	60	116	M14	M14	12.5	16	24	20	6	18	13.5	26	9	12	34.5

### 512 Style B – Standard Long Roller

Size	Dimensions (mm)																	Roller							
	A	B	B <sub>1</sub> * ±0.05	B <sub>2</sub>	J	J <sub>1</sub>	L	L <sub>1</sub>	L <sub>2</sub>	L <sub>3</sub>	X	N	S <sub>2</sub>	S <sub>3</sub>	F	F <sub>1</sub>	F <sub>2</sub>	F <sub>3</sub>	Ø	G	G <sub>1</sub>	G <sub>2</sub>	M <sub>1</sub>	O	P
25	36	70	23	23.5	29.5	24.5	103.4	45	40	79.4	30	57	M8	M6	6.8	7	11	11	3.2	9	6.5	13	5.5	7.5	17.5
35	48	100	34	33	40	32	136	62	52	103	40	82	M10	M8	8.5	9	15	15	4.5	12	10	15	7	8	23
45	60	120	45	37.5	50	40	172.5	80	60	135	52.5	100	M12	M12	10.5	14	20	18	5	15	11	21	8	10	30.5
55	70	140	53	43.5	57	48	205.5	95	70	162	60	116	M14	M14	12.5	16	24	20	6	18	13.5	26	9	12	34.5
65	90	170	63	53.5	76	58	251	110	82	201	75	142	M16	M16	14.5	18	26	23	7	23	19	32	13	15	51

\*Standard tolerance shown, special lower tolerances are available upon request. Please consult application engineering for additional information.  
 \*\*When using additional modular seals or lubrication plates, the total length L will increase. Consult page 61-62 for additional information.  
 Length of rail to be specified at time of order, Y<sub>1</sub>=Y<sub>2</sub> unless specified otherwise at time of order.

DANAHER MOTION is a registered trademark of Danaher Corporation. Danaher Motion makes every attempt to ensure accuracy and reliability of the specifications in this publication. Specifications are subject to change without notice. Danaher Motion provides this information "AS IS" and disclaims all warranties, express or implied, including, but not limited to, implied warranties of merchantability and fitness for a particular purpose. It is the responsibility of the product user to determine the suitability of this product for a specific application. ©2004 Danaher Motion.

## 500 Series Roller 512 Style A and B

### Dynamic Load and Moment Ratings

C = Dynamic load rating  
 $M_L$  = Dynamic pitch and yaw moment rating  
 $M_Q$  = Dynamic roll moment rating

### Static Load and Moment Capacities

$C_0$  = Static load capacity  
 $M_{OL}$  = Static pitch and yaw moment capacity  
 $M_{OQ}$  = Static roll moment capacity

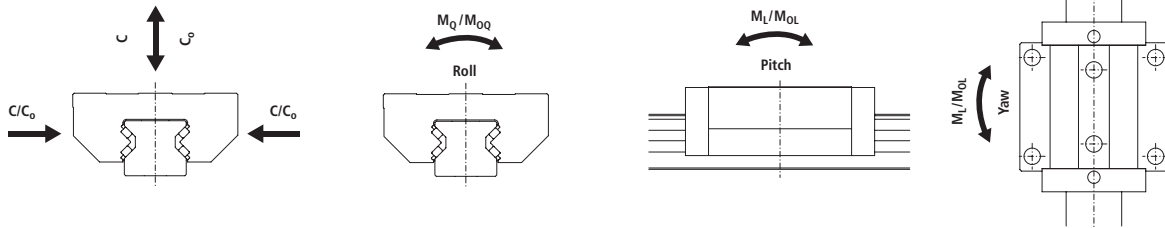

Size & Style	Loading Capabilities		Moments				Weights	
	$C_0$ (N)	C (N)	$M_{OQ}$ (Nm)	$M_Q$ (Nm)	$M_{OL}$ (Nm)	$M_L$ (Nm)	Carriage (kg)	Rail (kg/m)
25A	49800	27700	733	408	476	265	0.7	3.4
25B	70300	39100	1035	576	936	521	0.9	
35A	93400	52000	2008	1118	1189	662	1.6	6.5
35B	128500	71500	2762	1537	2214	1232	2.2	
45A	167500	93400	4621	2577	2790	1556	3.2	10.7
45B	229500	127800	6333	3527	5161	2874	4.3	
55A	237000	131900	7771	4325	4738	2637	5.0	15.2
55B	324000	180500	10624	5919	8745	4872	6.8	
65B	530000	295000	20912	11640	17930	9980	13.5	22.5

### Notes:

- The dynamic load and moment ratings are based upon 100 km travel life. When comparing these load ratings with other bearings take into consideration that some manufacturers dynamic and moment ratings are based on 50 km travel life. In order to compare with bearing dynamic and moment ratings based on 50 km travel life, divide the dynamic capacity of the bearing rated for 50 km by 1.26 to get an accurate comparison.
- The static load and moment rating are the maximum radial load and moment load that should be applied to the bearing while there is no relative motion between the carriage and rail.

### Bearing Travel Life Comparison

$$L = (C/F)^3 \times 100\text{km}$$

where:

L = travel life, km

C = dynamic load rating, N

F = applied dynamic load, N

$$C_{\min} = F \left( \frac{L}{100} \right)^{1/3}$$

where:

$C_{\min}$  = minimum required  
dynamic load rating, N

F = applied dynamic load, N

L = required travel life, km

### Operating Parameters:

Maximum Velocity: 3 m/s

Maximum Acceleration: 50 m/s<sup>2</sup>

Temperature: Min: -40° C

Max: 80° C

Max peak: 120° C short time\*

\*without bellows

For more information, or to place an order, please contact your local authorized Thomson™ distributor or Danaher Motion at 1-540-633-3400, Fax: 1-540-633-4162, or E-mail at [profilerail@DanaherMotion.com](mailto:profilerail@DanaherMotion.com).

DANAHER MOTION is a registered trademark of Danaher Corporation. Danaher Motion makes every attempt to ensure accuracy and reliability of the specifications in this publication. Specifications are subject to change without notice. Danaher Motion provides this information "AS IS" and disclaims all warranties, express or implied, including, but not limited to, implied warranties of merchantability and fitness for a particular purpose. It is the responsibility of the product user to determine the suitability of this product for a specific application. ©2004 Danaher Motion.



# 500 Series Roller

## 512 Style C and D

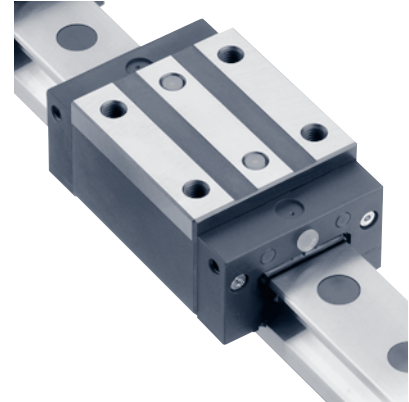
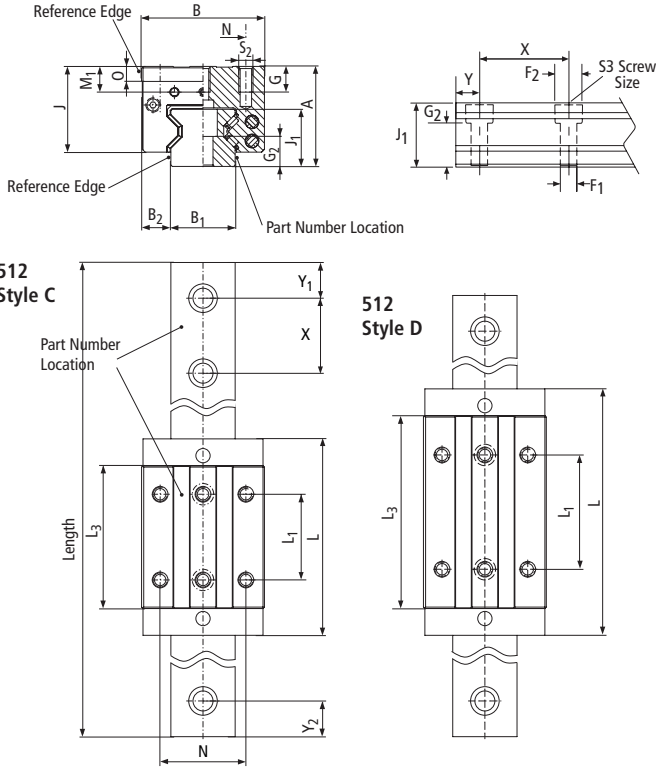

### 512 Style C Narrow Roller

Size	Dimensions (mm)					J <sub>1</sub>	L	L <sub>1</sub>	L <sub>3</sub>	X	N	S <sub>2</sub>	S <sub>3</sub>	F <sub>1</sub>	F <sub>2</sub>	Roller				
	A	B	B <sub>1</sub> * +0.05	B <sub>2</sub>	J											Ø	G	G <sub>2</sub>	M <sub>1</sub>	O
25	40	48	23	12.5	33.5	24.5	81	35	57	30	35	M6	M6	7	11	3.2	9	13	9.5	7.5
35	55	70	34	18	47	32	109	50	76	40	50	M8	M8	9	15	4.5	12	15	14	8
45	70	86	45	20.5	60	40	137.5	60	100	52.5	60	M10	M12	14	20	5	18	21	18	10
55	80	100	53	23.5	67	48	163.5	75	120	60	75	M12	M14	16	24	6	19	26	19	12

### 512 Style D Narrow Long Roller

Size	Dimensions (mm)					J <sub>1</sub>	L	L <sub>1</sub>	L <sub>3</sub>	X	N	S <sub>2</sub>	S <sub>3</sub>	F <sub>1</sub>	F <sub>2</sub>	Roller				
	A	B	B <sub>1</sub> * +0.05	B <sub>2</sub>	J											Ø	G	G <sub>2</sub>	M <sub>1</sub>	O
25	40	48	23	12.5	33.5	24.5	103.4	50	79.4	30	35	M6	M6	7	11	3.2	9	13	9.5	7.5
35	55	70	34	18	47	32	136	72	103	40	50	M8	M8	9	15	4.5	12	15	14	8
45	70	86	45	20.5	60	40	172.5	80	135	52.5	60	M10	M12	14	20	5	18	21	18	10
55	80	100	53	23.5	67	48	205.5	95	162	60	75	M12	M14	16	24	6	19	26	19	12
65	90	126	63	31.5	76	58	251	120	201	75	76	M16	M16	18	26	7	20	32	13	15

\*Standard tolerance shown, special lower tolerances are available upon request. Please consult application engineering for additional information.

\*\*When using additional modular seals or lubrication plates, the total length L will increase. Consult page 61-62 for additional information.

Length of rail to be specified at time of order, Y1 = Y2 unless specified otherwise at time of order

## 500 Series Roller 512 Style C and D

### Dynamic Load and Moment Ratings

C = Dynamic load rating  
M<sub>L</sub> = Dynamic pitch and yaw moment rating  
M<sub>Q</sub> = Dynamic roll moment rating

### Static Load and Moment Capacities

C<sub>0</sub> = Static load capacity  
M<sub>OL</sub> = Static pitch and yaw moment capacity  
M<sub>OQ</sub> = Static roll moment capacity

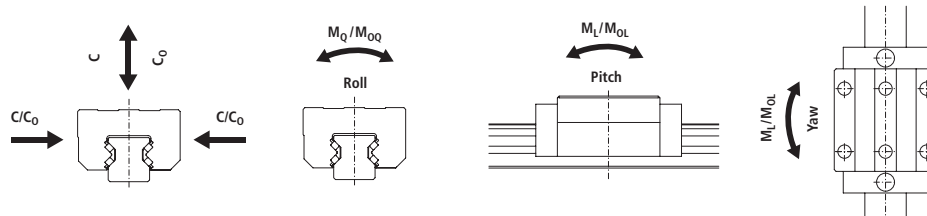

Size & Style	Loading Capabilities		Moments				Weights	
	C <sub>0</sub> (N)	C (N)	M <sub>OQ</sub> (Nm)	M <sub>Q</sub> (Nm)	M <sub>OL</sub> (Nm)	M <sub>L</sub> (Nm)	Carriage (kg)	Rail (kg/m)
25C	49800	27700	733	408	476	265	0.6	
25D	70300	39100	1035	576	936	521	0.7	3.4
35C	93400	52000	2008	1118	1189	662	1.5	
35D	128500	71500	2762	1537	2214	1232	2.0	6.5
45C	167500	93400	4621	2577	2790	1556	3.0	
45D	229500	127800	6333	3527	5161	2874	4.0	10.7
55C	237000	131900	7771	4325	4738	2637	4.5	
55D	324000	180500	10624	5919	8745	4872	6.1	15.2
65D	530000	295000	20912	11640	17930	9980	10.4	22.5

### Notes:

- The dynamic load and moment ratings are based upon 100 km travel life. When comparing these load ratings with other bearings take into consideration some manufacturers dynamic and moment ratings are based on 50 km travel life. In order to compare with bearing dynamic and moment ratings based on 50 km travel life, divide the dynamic capacity of the bearing rated for 50 km by 1.26 to get an accurate comparison.
- The static load and moment rating are the maximum radial load and moment load that should be applied to the bearing while there is no relative motion between the carriage and rail.

### Bearing Travel Life Calculation

$$L = (C/F)^3 \times 100\text{km}$$

where:

L = travel life, km

C = dynamic load rating, N

F = applied dynamic load, N

$$C_{\min} = F \left( \frac{L}{100} \right)^{1/3}$$

where:

C<sub>min</sub> = minimum required dynamic load rating, N

F = applied dynamic load, N

L = required travel life, km

### Operating Parameters:

Maximum Velocity:

3 m/s

Maximum Acceleration:

50 m/s<sup>2</sup>

Temperature:

Min: -40° C

Max: 80° C

Max peak: 120° C short time\*

\*without bellows

## Rail Modifications

The rails can be supplied with dowel holes, radial holes and coaxial holes. Please provide a drawing of your requirement and our Application Engineering Team can provide a quote.

### Maximum Length of Single Piece Rail

Size (mm)	25	35	45	55	65
Maximum Length	6000mm				

## Extended Standard Rail Options

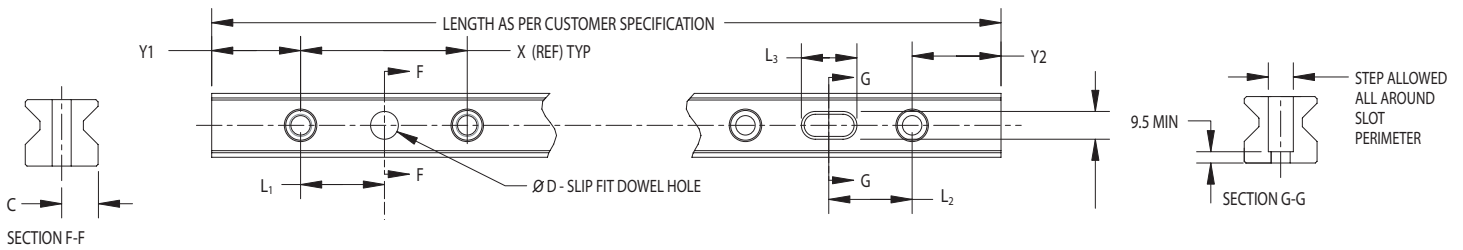

Option	Size	D +.013 -0	L <sub>1</sub> ±0.12	L <sub>2</sub> ±0.40	L <sub>3</sub> +1.5 -0	C ±0.05
DH1	25	8	15	15	12	11.5
	35		20	20		17
	45		30	30		22.5
	55					26.5
	65					31.5
DH2	25	N/A	N/A	N/A	N/A	N/A
	35	10	20	20	15	17
	45		30	30		22.5
	55					26.5
	65					31.5
DH3	25		N/A	N/A		N/A
	35	12	30	30	18	22.5
	45					26.5
	55					31.5
	65					
DH4	25	N/A	N/A	N/A	N/A	N/A
	35	3/8"	.787"	.787"	.550"	.669"
	45		1.181"	1.181"		.886"
	55					1.043"
	65					1.240"
DH5	25		N/A	N/A		N/A
	35	1/2"	1.181"	1.181"	.750"	.886"
	45					1.043"
	55					1.240"
	65					

All dimensions in mm unless otherwise specified.

Y1 = Y2 unless otherwise specified.

For more information, or to place an order, please contact your local authorized Thomson™ distributor or Danaher Motion at 1-540-633-3400, Fax: 1-540-633-4162, or E-mail at [profilerail@DanaherMotion.com](mailto:profilerail@DanaherMotion.com).

## 522 Type U Rail Bolt Up From Bottom

Size	X	E	G (mm)	Weight (kg/in)
25	30	M6	12	3.4
35	40	M8	15	6.5
45	52.5	M12	19	10.7
55	60	M14	22	15.2
65	75	M16	25	22.5

Y1 = Y2 unless specified at time of ordering.

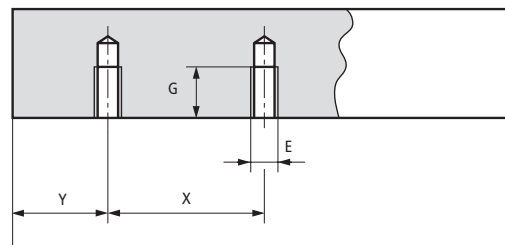

## Lubrication Inlet Options

The standard carriage is supplied with a straight lubrication fitting centered. The carriage end cap has multiple lubrication inlet points and lubrication channels options and is supplied standard with the end cap center inlet plugged. These options can be easily modified on-site in the field or can be supplied factory direct. (Not available for size 25.)

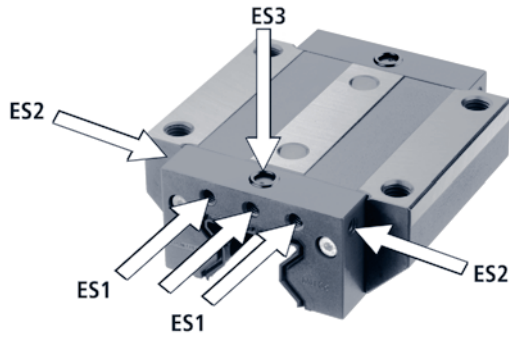

Option	Inlet	Lubrication Channel
ES1 <sup>2</sup>	Inlets offset - both sides - all four	Standard channel
ES2	Inlets on side - both sides - all four	Standard channel
ES3 <sup>1</sup>	Inlet on top	Standard channel
ES4 <sup>2</sup>	Inlets offset - both sides - all four	Individually channeled path
ES5	Inlets offset - both sides - all four	Individually channeled path

1. An O-Ring or adapter is required to properly seal the mating surfaces to prevent grease or oil from escaping. One is supplied with this option. The adapter is for C and D style carriages. Lubrication options available in size 35, 45, 55 and 65 only.
2. Option can not be used in combination with additional modular accessories.
3. Set screws are installed to plug all holes.

### Lubrication inlet locations. Front of end cap above rail and slide.

Size	Style	M <sub>1</sub>	M <sub>2</sub>	M <sub>4</sub>	M <sub>3</sub>	D <sub>1</sub>	D <sub>2</sub>
25	A	5.5	N/A	N/A	N/A	M6	N/A
	B						
	C						
	D						
35	A	7	32	6.5	7	M6	M6
	B						
	C						
	D						
45	A	8	40	7.5	8	M6	M6
	B						
	C						
	D						
55	A	9	50	8.5	9	M6	M6
	B						
	C						
	D						
65	B	13	64	12.5	13	M6	M6
	D						

All dimensions in mm.

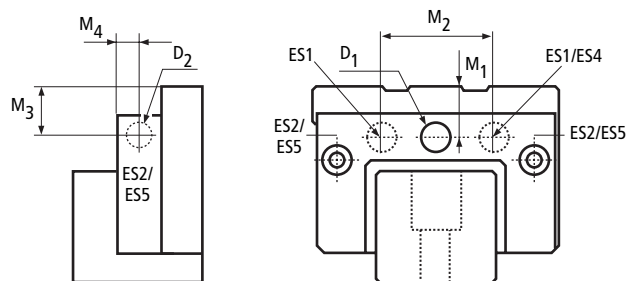

#### Notes:

1. D1 and D2 are threaded holes in the end cap to ensure proper integrity and durability of connection.
2. Carriages are shipped with a grease fitting in the box (fitting 530LN). See page 73 for more information.

## Lubricant Inlet Options, cont'd

Lubrication inlet locations. Inlet on top. "ES3"

Size	Style	C7	D1	D2	D3	D4	Adapter <sup>1</sup>
25	A	12.0	6.75	10	1.78	6	N/A
	B	23.2					N/A
	C	17.0					532ES3ADP25
	D	20.7					532ES3ADP25
35	A	14.0	6.75	10	1.78	6	N/A
	B	27.5					N/A
	C	20.0					532ES3ADP35
	D	22.5					532ES3ADP35
45	A	17.0	6.75	10	1.78	6	N/A
	B	34.5					N/A
	C	27.0					532ES3ADP45/55
	D	34.5					532ES3ADP45/55
55	A	21.5	6.75	10	1.78	6	N/A
	B	42.5					N/A
	C	31.5					532ES3ADP45/55
	D	42.5					532ES3ADP45/55
65	B	54.0	6.5	10	2	6	N/A
	D	49.0					N/A

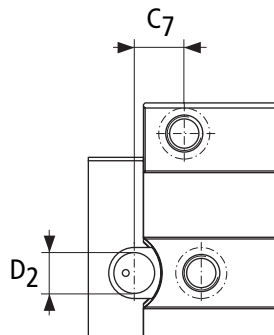

- D1 = O-Ring internal diameter
- D2 = Counterbore diameter
- D3 = O-Ring thickness
- D4 = Max. diameter of lubrication inlet diameter from above

All dimensions in mm.

1. Adapter supplied when ordering ES3 option.

## Grease Lubricants

Standard carriages are sold with oil preservative to protect the rollers from corrosion during storage and transit. The carriages are available with the following assortment of lubricants as standard.

Option	Type	Notes	Viscosity	Temperature Range
G1	Mobilux <sup>®</sup> EP2	All purpose NLG I2 grease	160cSt @40°C	-20°C to 130°C
G2	Kyrtox <sup>®</sup> GPL227	High Temperature NLG I2	440cSt @40°C	-30°C to 288°C
GS	Customer specified grease			

Additional greases may be available upon request. Please consult Danaher Motion Application Engineering.

For more information, or to place an order, please contact your local authorized Thomson™ distributor or Danaher Motion at 1-540-633-3400, Fax: 1-540-633-4162, or E-mail at [profilerrail@DanaherMotion.com](mailto:profilerrail@DanaherMotion.com).

DANAHER MOTION is a registered trademark of Danaher Corporation. Danaher Motion makes every attempt to ensure accuracy and reliability of the specifications in this publication. Specifications are subject to change without notice. Danaher Motion provides this information "AS IS" and disclaims all warranties, express or implied, including, but not limited to, implied warranties of merchantability and fitness for a particular purpose. It is the responsibility of the product user to determine the suitability of this product for a specific application. ©2004 Danaher Motion.

## Thin Dense Chrome Plating

Rails and carriages are available with Duralloy® DSV Thin Dense Chrome Plating with a thickness of 2–4 µm. As a result of the plating thickness range compared to the tolerance ranges in the different accuracy classes, it is only available with Precision accuracy classes up to 3 meters long as a single rail; long lengths can be butt jointed.

### Carriage Assortment with Thin Dense Chrome

Type	Style	Size	Accuracy	Preload			Appropriate Standard Rail	Max One Piece Rail Length (mm)
				0.03C	0.08C	0.13C		
512	A	25	P	512P25A1D	512P25A2D	512P25A3D	522P25AD	3000
		35	P	512P35A1D	512P35A2D	512P35A3D	522P35AD	3000
		45	P	512P45A1D	512P45A2D	512P45A3D	522P45AD	3000
		55	P	512P55A1D	512P55A2D	512P55A3D	522P55AD	3000
	B	25	P	512P25B1D	512P25B2D	512P25B3D	522P25AD	3000
		35	P	512P35B1D	512P35B2D	512P35B3D	522P35AD	3000
		45	P	512P45B1D	512P45B2D	512P45B3D	522P45AD	3000
		55	P	512P55B1D	512P55B2D	512P55B3D	522P55AD	3000
		65	P	512P65B1D	512P65B2D	512P65B3D	522P65AD	3000
	C	25	P	512P25C1D	512P25C2D	512P25C3D	522P25AD	3000
		35	P	512P35C1D	512P35C2D	512P35C3D	522P35AD	3000
		45	P	512P45C1D	512P45C2D	512P45C3D	522P45AD	3000
		55	P	512P55C1D	512P55C2D	512P55C3D	522P55AD	3000
	D	25	P	512P25D1D	512P25D2D	512P25D3D	522P25AD	3000
		35	P	512P35D1D	512P35D2D	512P35D3D	522P35AD	3000
		45	P	512P45D1D	512P45D2D	512P45D3D	522P45AD	3000
		55	P	512P55D1D	512P55D2D	512P55D3D	522P55AD	3000
		65	P	512P65D1D	512P65D2D	512P65D3D	522P65AD	3000

Note: Duralloy carriages and rails are designed and manufactured to be used together. If a non-Duralloy carriage is used on a Duralloy rail the preload of the carriage will be increased approximately one class. If a Duralloy carriage is used on a non-Duralloy rail the preload will be decreased approximately one class. This is the result of the coating thickness.

For more information, or to place an order, please contact your local authorized Thomson™ distributor or Danaher Motion at 1-540-633-3400, Fax: 1-540-633-4162, or E-mail at [profilerail@DanaherMotion.com](mailto:profilerail@DanaherMotion.com).

DANAHER MOTION is a registered trademark of Danaher Corporation. Danaher Motion makes every attempt to ensure accuracy and reliability of the specifications in this publication. Specifications are subject to change without notice. Danaher Motion provides this information "AS IS" and disclaims all warranties, express or implied, including, but not limited to, implied warranties of merchantability and fitness for a particular purpose. It is the responsibility of the product user to determine the suitability of this product for a specific application. ©2004 Danaher Motion.

## Modular Accessory Combination Options and Screw Size

Option	Description	Size									
		25		35		45		55		65	
N <sup>3</sup>	Oil Reservoir	Low/socket head screw	M4x30	Low/socket head screw	M4x35	Low/socket head screw	M5x45	Low/socket head screw	M6x45	Low/socket head screw	M6x55
W <sup>3</sup>	Rubber Wiper	Low/socket head screw	M4x25	Low/socket head screw	M4x30	Low/socket head screw	M5x35	Low/socket head screw	M6x35	Low/socket head screw	M6x40
V <sup>3</sup>	Viton Wiper	Low/socket head screw	M4x25	Low/socket head screw	M4x30	Low/socket head screw	M5x35	Low/socket head screw	M6x35	Low/socket head screw	M6x40
Z <sup>3</sup>	Metal Scraper	Low/socket head screw	M4x20	Low/socket head screw	M4x25	Low/socket head screw	M5x30	Low/socket head screw	M6x35	Low/socket head screw	M6x35
C <sup>3</sup>	Bellows Clips	Flat/socket head screw	M4x20	Flat/socket head screw	M4x25	Flat/socket head screw	M5x25	Flat/socket head screw	M6x30	Flat/socket head screw	M6x35
NW	Oil Reservoir + Wiper	Low/socket head screw	M4x40	Low/socket head screw	M4x45	Low/socket head screw	M5x50	Low/socket head screw	M6x55	Low/socket head screw	M6x65
NWZ	Oil Reservoir, Wiper + Scraper	Low/socket head screw	M4x40	Low/socket head screw	M4x45	Low/socket head screw	M5x55	Low/socket head screw	M6x60	Low/socket head screw	M6x65
NWC	Oil Reservoir, Wiper + Bellows Clip	Flat/socket head screw	M4x40	Flat/socket head screw	M4x45	Flat/socket head screw	M5x50	Flat/socket head screw	M6x55	Flat/socket head screw	M6x65
NWZC	Oil Reservoir, Wiper, Scraper + Bellows Clip	Flat/socket head screw	M4x40	Flat/socket head screw	M4x50	Flat/socket head screw	M5x55	Flat/socket head screw	M6x60	Flat/socket head screw	M6x65
NZ	Oil Reservoir + Scraper	Low/socket head screw	M4x35	Low/socket head screw	M4x40	Low/socket head screw	M5x50	Low/socket head screw	M6x55	Low/socket head screw	M6x60
NZC	Oil Reservoir, Scraper + Bellows Clips	Flat/socket head screw	M4x35	Flat/socket head screw	M4x40	Flat/socket head screw	M5x50	Flat/socket head screw	M6x55	Flat/socket head screw	M6x60
NC	Oil Reservoir + Bellows Clips	Flat/socket head screw	M4x35	Flat/socket head screw	M4x40	Flat/socket head screw	M5x50	Flat/socket head screw	M6x55	Flat/socket head screw	M6x60
WC	Wiper + Bellows Clip	Flat/socket head screw	M4x25	Flat/socket head screw	M4x30	Flat/socket head screw	M5x30	Flat/socket head screw	M6x35	Flat/socket head screw	M6x40
WZ	Wiper + Scraper	Low/socket head screw	M4x25	Low/socket head screw	M4x30	Low/socket head screw	M5x35	Low/socket head screw	M6x35	Low/socket head screw	M6x40
WZC	Wiper, Scraper + Bellows Clip	Flat/socket head screw	M4x25	Flat/socket head screw	M4x30	Flat/socket head screw	M5x35	Flat/socket head screw	M6x35	Flat/socket head screw	M6x40
VZ	Viton Wiper + Scraper	Low/socket head screw	M4x25	Low/socket head screw	M4x30	Low/socket head screw	M5x35	Low/socket head screw	M6x35	Low/socket head screw	M6x40
ZC	Scraper + Bellows Clip	Flat/socket head screw	M4x20	Flat/socket head screw	M4x25	Flat/socket head screw	M5x25	Flat/socket head screw	M6x30	Flat/socket head screw	M6x35

1. All fasteners standard thread.
2. Consult Danaher Motion for options not listed, engineering review is required.
3. Each modular accessory is supplied with proper screws to install over end cap only and not combinations of modular accessories.

For more information, or to place an order, please contact your local authorized Thomson™ distributor or Danaher Motion at 1-540-633-3400, Fax: 1-540-633-4162, or E-mail at [profilerrail@DanaherMotion.com](mailto:profilerrail@DanaherMotion.com).

DANAHER MOTION is a registered trademark of Danaher Corporation. Danaher Motion makes every attempt to ensure accuracy and reliability of the specifications in this publication. Specifications are subject to change without notice. Danaher Motion provides this information "AS IS" and disclaims all warranties, express or implied, including, but not limited to, implied warranties of merchantability and fitness for a particular purpose. It is the responsibility of the product user to determine the suitability of this product for a specific application. ©2004 Danaher Motion.



## Modular Seals and Lubrication Accessories

### Additional Wipers

532WR – Rubber Wiper

532VR – Viton® Wiper

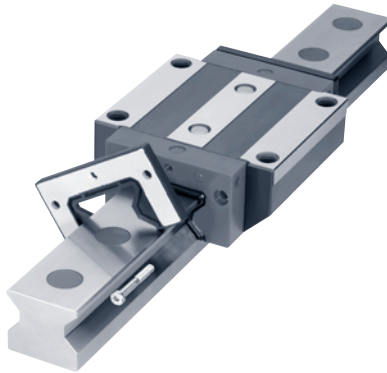

Size	Rubber Part Number	Viton® Part Number	L1 (mm)	L2 (mm)	Weight (kg)
25	532WR25	532VR25	7	4	0.005
35	532WR35	532VR35	7	4	0.012
45	532WR45	532VR45	7	4	0.024
55	532WR55	532VR55	7	4	0.029
65	532WR65	532VR65	7	4	0.040

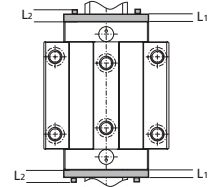

L1 – wiper thickness, L2 – max. screw head stickout

### Metal Scraper

532ZZ

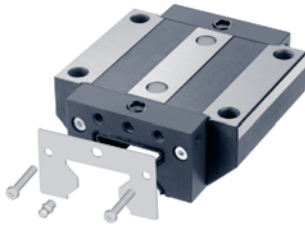

Size	Part Number	L1 (mm)	L2 (mm)	Weight (kg)
25	532ZZ25	1.5	4	0.011
35	532ZZ35	1.5	4	0.022
45	532ZZ45	1.5	4	0.034
55	532ZZ55	1.5	4	0.044
65	532ZZ65	1.5	4	0.078

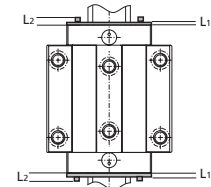

L1 = scraper thickness, L2 = max. screw head stickout

### Oil Reservoir

532OW



Size	Lubrication Plate	L1 (mm)	Weight (kg)
25	532OW25	12.7	0.013
35	532OW35	16.7	0.032
45	532OW45	19	0.056
55	532OW55	22	0.103
65	532OW65	25.2	0.179

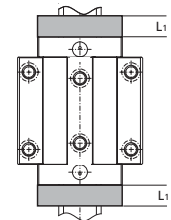

L1 = lubrication plate thickness, screw heads are recessed in plate

For more information, or to place an order, please contact your local authorized Thomson™ distributor or Danaher Motion at 1-540-633-3400, Fax: 1-540-633-4162, or E-mail at [profilerail@DanaherMotion.com](mailto:profilerail@DanaherMotion.com).

DANAHER MOTION is a registered trademark of Danaher Corporation. Danaher Motion makes every attempt to ensure accuracy and reliability of the specifications in this publication. Specifications are subject to change without notice. Danaher Motion provides this information "AS IS" and disclaims all warranties, express or implied, including, but not limited to, implied warranties of merchantability and fitness for a particular purpose. It is the responsibility of the product user to determine the suitability of this product for a specific application. ©2004 Danaher Motion.

When using a combination of different plates, add the cumulative thickness of the plates to get an accurate overall carriage length.

### Example:

512 Size 45 carriage with 532OW and 532WR modular seals on both sides:

Carriage Length (L)	= 137.5
532OW L1 x 2	= 19 x 2
532WR L1 x 2	= 7 x 2
532WR L2 x 2	= 4 x 2
Total Length	= 193.5 mm

511 Size 35 carriage with 531OW modular seal on both sides and 531VR modular seals on one side:

Carriage Length (L)	= 109
532OW L1 x 2	= 16.7 x 2
532VR L1 x 1	= 7 x 1
532VR L2 x 1	= 4 x 1
Total Length	= 153.4 mm

Each modular accessory is supplied with the proper screws to install them over the end cap. When combinations of modular seals are used longer screws may be required. The following sizes are available from our stock.

## Replacement End Cap

### 532EC

Size	Replacement Front Plate	L1 (mm)	Weight (kg)
25	532EC25	10.5	0.006
35	532EC35	14.5	0.022
45	532EC45	16.75	0.038
55	532EC55	21.75	0.057
65	532EC65	25	0.089

L1 = Front Plate thickness, screw heads are recessed in plate

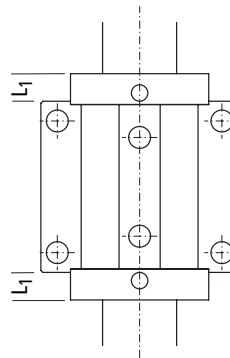

For more information, or to place an order, please contact your local authorized Thomson™ distributor or Danaher Motion at 1-540-633-3400, Fax: 1-540-633-4162, or E-mail at [profilerrail@DanaherMotion.com](mailto:profilerrail@DanaherMotion.com).

DANAHER MOTION is a registered trademark of Danaher Corporation. Danaher Motion makes every attempt to ensure accuracy and reliability of the specifications in this publication. Specifications are subject to change without notice. Danaher Motion provides this information "AS IS" and disclaims all warranties, express or implied, including, but not limited to, implied warranties of merchantability and fitness for a particular purpose. It is the responsibility of the product user to determine the suitability of this product for a specific application. ©2004 Danaher Motion.

## Bellows Dimensional Information

Bellows are available in three styles:

- 532 BB "Low Profile" with outside dimensions that do not exceed the carriage, constructed of polyurethane coated polyester, maximum ambient temperature of 80°C (175°F)
- 532 BC "High Compression" constructed of a spark resistant Teflon® coated fiberglass and designed to allow for higher compression, maximum ambient temperature exceeds maximum bearing peak temperatures.
- 532 BW "Walk On" capable of handling the harshest environments with a 90kg load bearing capacity.

The bellow can be easily installed in conjunction with the other optional modular seals providing you with an easy upgrade to the standard seal. Installation is simple and requires little time. Retrofitting is possible. The rail ends have to be drilled for the attachment of the bellow clip adapter plate, 532 CR. These can be easily installed on-site in the field or can be supplied from the factory.

### 532 BB "Low Profile" Bellows

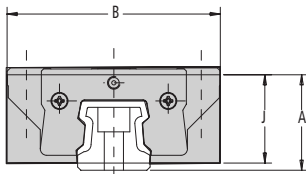

Size	Part No.	B	J	A	CR
25	532 BB25	47	30.5	36	0.17
35	532 BB35	70	41.3	47.5	0.15
45	532 BB45	81	51	59	0.15
55	532 BB55	99	58	69	0.10
65	532 BB65	109	65	79	0.10

Customer to specify extended length at time of order, see page 111 for how to calculate.

### 532 BC "High Compression" Bellows

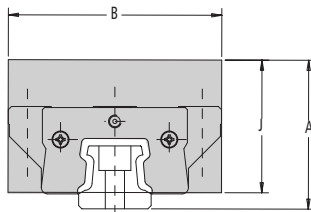

Size	Part No.	B	J	A	CR
25	532 BC25	67	40.5	46	0.10
35	532 BC35	90	51.3	57.5	0.07
45	532 BC45	101	61	69	0.07
55	532 BC55	119	68	79	0.06
65	532 BC65	129	75	89	0.06

Customer to specify extended length at time of order, see page 111 for how to calculate.

### 532 BW "Walk On" Bellows

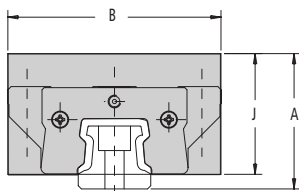

Size	Part No.	B	J	A	CR
25	532 BW25	57	35.5	41	0.19
35	532 BW35	77	42	48.2	0.19
45	532 BW45	101	53	61	0.15
55	532 BW55	111	58	69	0.15
65	532 BW65	119	70	84	0.15

Customer to specify extended length at time of order, see page 111 for how to calculate.

For more information, or to place an order, please contact your local authorized Thomson™ distributor or Danaher Motion at 1-540-633-3400, Fax: 1-540-633-4162, or E-mail at [profilerrail@DanaherMotion.com](mailto:profilerrail@DanaherMotion.com).

## Bellow Clip Adapter Plates

### 532CC Carriage Bellow Clips– Attachment Plate

Size	Part No.
25	532CC25
35	532CC35
45	532CC45
55	532CC55
65	532CC65

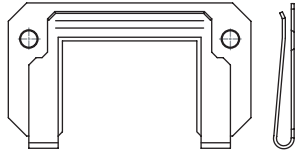

The 532CC Carriage Bellow Clip–Adapter Plate is used to attach the bellows to the carriage. The bellows clip–adapter plate is made of steel.

### 532CR Rail Bellow Clips– Attachment Plate

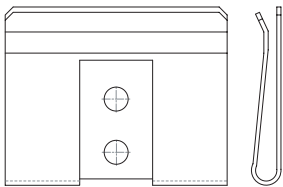

The 532CR Rail Bellow Clip–Adapter Plate is used to attach the bellows to the rail. The attaching holes can be drilled in the end of the rail if retrofitting or can be supplied from the factory. The bellows clip–adapter plate is made of steel.

Size	Part No.	Rail Machining Detail					Screw <sup>1</sup>				MinY <sup>2</sup>
		A	B	C	Depth Min	Depth Max	Size	Pitch	Length	Type	
25	532CR25	7.24	10	11.50	7.7	9.70	M4	0.70	10.00	Button Head Cap Screw	12
35	532CR35	11.00		17.00							20
45	532CR45	15.01		22.50							22
55	532CR55	18.01		26.50							24
65	532CR65	24.00		31.50							28

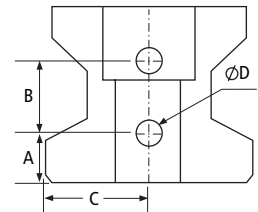

All dimensions in mm.

- Two screws are supplied with each Rail Bellow Clip.
- Min Y dimension to ensure drill depth does not break through rail mounting hole.

For more information, or to place an order, please contact your local authorized Thomson™ distributor or Danaher Motion at 1-540-633-3400, Fax: 1-540-633-4162, or E-mail at [profilerail@DanaherMotion.com](mailto:profilerail@DanaherMotion.com).

DANAHER MOTION is a registered trademark of Danaher Corporation. Danaher Motion makes every attempt to ensure accuracy and reliability of the specifications in this publication. Specifications are subject to change without notice. Danaher Motion provides this information "AS IS" and disclaims all warranties, express or implied, including, but not limited to, implied warranties of merchantability and fitness for a particular purpose. It is the responsibility of the product user to determine the suitability of this product for a specific application. ©2004 Danaher Motion.

## 500 Series Roller Rail Information

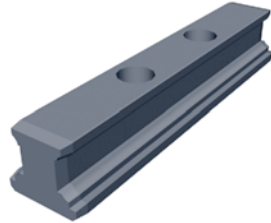

### Maintenance and Installation Tools & Accessories: Assembly Rail – 532 MT

An assembly rail is required when the carriage must be removed from the rail and then reinstalled during the installation. It is recommended to leave the carriage on the assembly rail to protect the rollers against contamination. If necessary, the two internal mounting screws for fastening runner blocks to the carriage can be tightened. The assembly rail is made of plastic.

Size	Standard Rail Part Number	Length (mm)	Weight (kg)
25	532 MT25	145	0.062
35	532 MT35	185	0.152
45	532 MT45	230	0.317
55	532 MT55	265	0.525
65	532 MT65	320	0.914

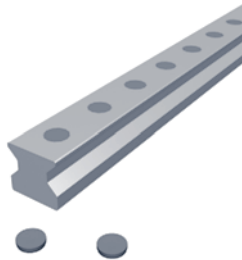

### Standard Rail Plugs and Tape

#### HP plastic plugs

Size	Part Number	Qty per pack	Weight (kg)
25	532 HP25	25	.007
35	532 HP35	25	.014
45	532 HP45	25	.025
55	532 HP55	25	.047
65	532 HP65	25	.053



#### HB brass plugs

Size	Part Number	Qty per pack	Weight (kg)
25	532 HB25	1	.002
35	532 HB35	1	.005
45	532 HB45	1	.008
55	532 HB55	1	.011
65	532 HB65	1	.013



#### HS two-piece stainless steel plugs

Size	Part Number	Qty per pack	Weight (kg)
25	532 HS25	1 set	.003
35	532 HS35	1 set	.008
45	532 HS45	1 set	.012
55	532 HS55	1 set	.019
65	532 HS65	1 set	.026

For more information, or to place an order, please contact your local authorized Thomson™ distributor or Danaher Motion at 1-540-633-3400, Fax: 1-540-633-4162, or E-mail at [profilerail@DanaherMotion.com](mailto:profilerail@DanaherMotion.com).

DANAHER MOTION is a registered trademark of Danaher Corporation. Danaher Motion makes every attempt to ensure accuracy and reliability of the specifications in this publication. Specifications are subject to change without notice. Danaher Motion provides this information "AS IS" and disclaims all warranties, express or implied, including, but not limited to, implied warranties of merchantability and fitness for a particular purpose. It is the responsibility of the product user to determine the suitability of this product for a specific application. ©2004 Danaher Motion.

## Mylar tape

Size	Part Number	Length
25	532RT25	3m
35	532RT35	3m
45	532RT45	3m
55	532RT55	3m
65	532RT65	3m

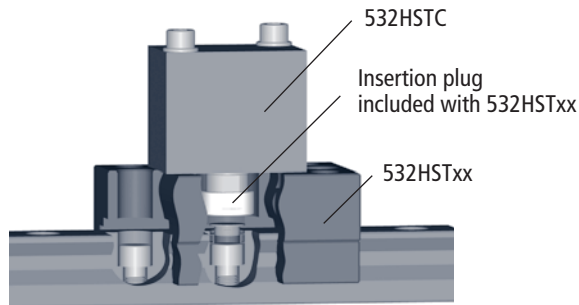

## HST Stainless Steel and Brass installation tool

Sliding Block with insertion plug	Weight (kg)
532HST25 For size 25 rail	2.0
532HST35 For size 35 rail	3.5
532HST45 For size 45 rail	3.9
532HST55 For size 55 rail	5.4
532HST65 For size 65 rail	6.5
Hydraulic cylinder (for all sizes)	Weight (kg)
532HSTC <sup>1</sup>	0.53

1. Hydraulic fitting size 1/4"-18 NPT, max pressure 120 x 103 hPa (120 bar).

## Optional 500 Series Rail with Stainless Steel Cover Strip

Size	Rail Coverstrip End Caps	Mounting Tool	Replacement End Caps	Standard Coverstrip Rail	Coverstrip Width (mm)	Max Single PC Length (mm)
	Part Number <sup>1</sup>	Part Number	Part Number <sup>2</sup>	Part Number <sup>3</sup>		
25	532RCS25	532RCT25	532RCP25	522P25C	15	6000
35	532RCS35	532RCT35	532RCP35	522P35C	19	6000
45	532RCS45	532RCT45	532RCP45	522P45C	25	6000
55	532RCS55	532RCT55	532RCP55	522P55C	28.5	6000
65	532RCS65	532RCT65	532RCP65	522P65C	32	6000

- Customer to specify length of rail to be used on at time of order. Delivered piece will be 2 to 3.5 mm longer in order to properly install and fit end caps.
- Two end caps are supplied with each piece of 532RCS ordered.
- P grade accuracy shown for example purposes, S and U grade accuracy are available.

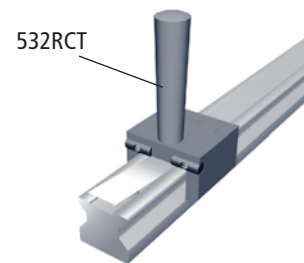
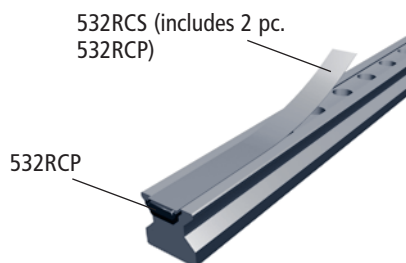

## Accuracy Class

Three tolerances describe the accuracy of a Profile Rail bearing: Running Parallelism, Pair Variation, and Assembly accuracy. These are measured from the rail base to the center of the carriage top (H), and from the rail reference edge to the center of the carriage reference edge (A3) (Figure 1).

Running Parallelism describes the tolerance on H and A3 as a function of axial travel, measured from one carriage down the length of the rail (Figure 2). This is analogous to straightness of travel. As such, parallelism describes attributes of the rail only.

Assembly Accuracy [Table 1] describes the tolerance on H and A3 as a function of a carriage–rail assembly, measured from the nominal dimensions.

Pair Variation [Table 1] describes tolerance on H and A3 as a function of carriages at the same position on a common rail. Pair variation describes carriage precision only.

The accuracy class selected will partially determine the accuracy of the system. Other factors such as mounting surface flatness and straightness also significantly affect system accuracy.

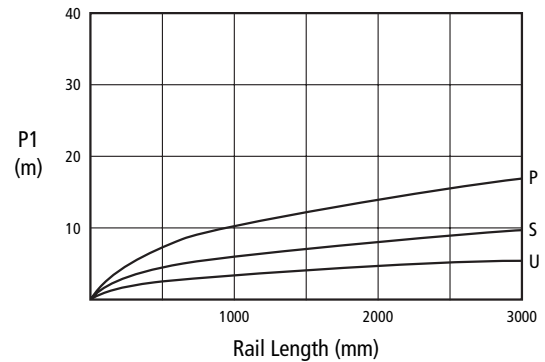
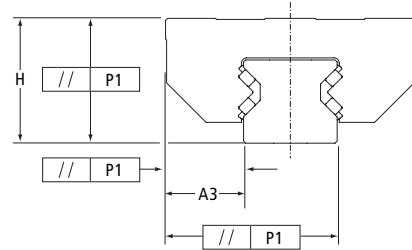

### Tolerances

	Accuracy Class		
	P - Precision	S - Super Precision	U - Ultra Precision
Assembly Accuracy Tolerance on dimension H and A3 (measured at middle of carriage at any point along rail)	±20	±10	±5
Pair Variation Max variation in dimensions H and A3 measured on multiple carriages mounted on the same rail (measured at the middle of carriage at same position on rail)	10	5	3
Running Parallelism	40	20	10

All values in  $\mu\text{m}$

## Preload

Three Preload classes are available with the 500 Series Roller Profile rail carriages. Preload will minimize elastic deformation caused by external forces resulting in increased rigidity.

### Preload Accuracy Combinations

Accuracy Class	Preload		
	0.03C <sup>1</sup>	0.08C <sup>1</sup>	0.13C <sup>1</sup>
P, S, U	1	2	3

1. C = Dynamic load capacity of the bearing

DANAHER MOTION is a registered trademark of Danaher Corporation. Danaher Motion makes every attempt to ensure accuracy and reliability of the specifications in this publication. Specifications are subject to change without notice. Danaher Motion provides this information "AS IS" and disclaims all warranties, express or implied, including, but not limited to, implied warranties of merchantability and fitness for a particular purpose. It is the responsibility of the product user to determine the suitability of this product for a specific application. ©2004 Danaher Motion.

NOTES:

A large grid area for taking notes, consisting of a 30x30 grid of small squares.

DANAHER MOTION is a registered trademark of Danaher Corporation. Danaher Motion makes every attempt to ensure accuracy and reliability of the specifications in this publication. Specifications are subject to change without notice. Danaher Motion provides this information "AS IS" and disclaims all warranties, express or implied, including, but not limited to, implied warranties of merchantability and fitness for a particular purpose. It is the responsibility of the product user to determine the suitability of this product for a specific application. ©2004 Danaher Motion.



# AccuMini Linear Ball Guides

Ultra compact, high roll moment capacity

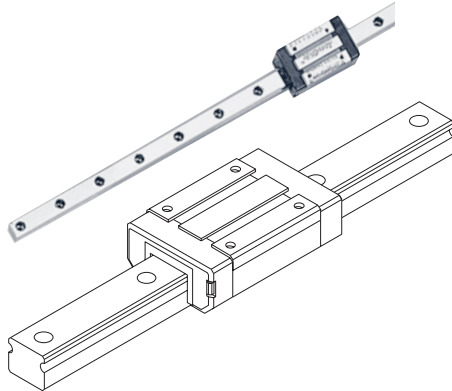

Thomson AccuMini Linear Ball Guides offer:

- A ball control design for smooth, quiet, low friction at high speeds
- A full length integral wiper which protects important bearing from contaminants...effective system life is maximized
- A Gothic design, which provides high roll moment capacity... a requirement for stand-alone applications
- A resistant, engineered polymer retainer which reduces system inertia noise

## Part Number Description and Specification

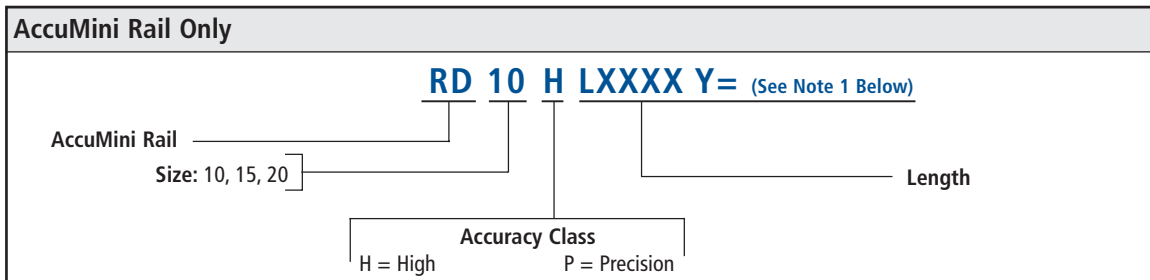
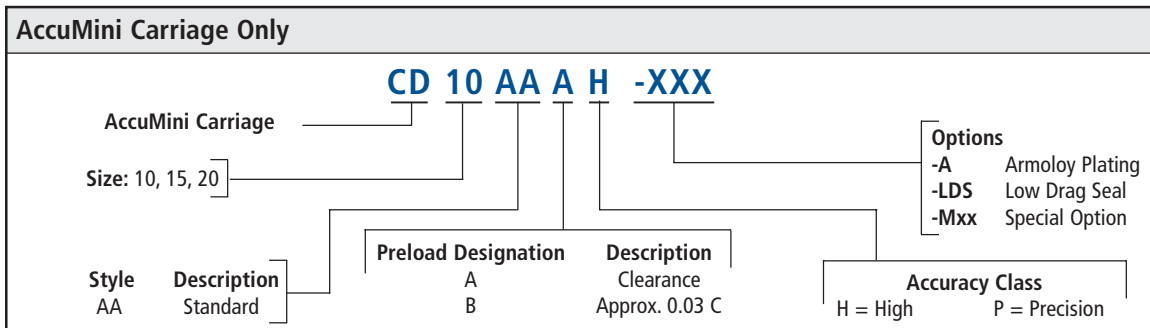
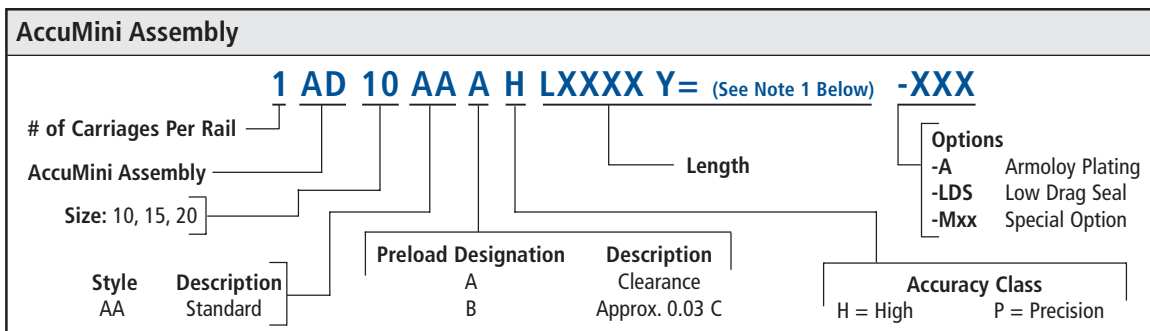

1. Y= Distance from end of rail to center of 1st mounting hole

DANAHER MOTION is a registered trademark of Danaher Corporation. Danaher Motion makes every attempt to ensure accuracy and reliability of the specifications in this publication. Specifications are subject to change without notice. Danaher Motion provides this information "AS IS" and disclaims all warranties, express or implied, including, but not limited to, implied warranties of merchantability and fitness for a particular purpose. It is the responsibility of the product user to determine the suitability of this product for a specific application. ©2004 Danaher Motion.

# AccuMini

(Miniature Series)

*Low Profile, Compact Design*

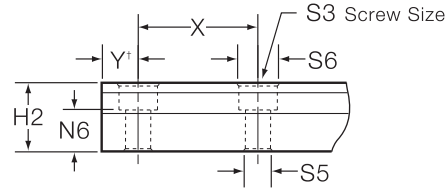
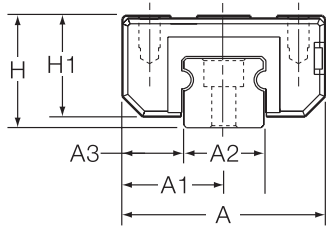

† "Y" dimension will be equal on both ends unless specified by customer.

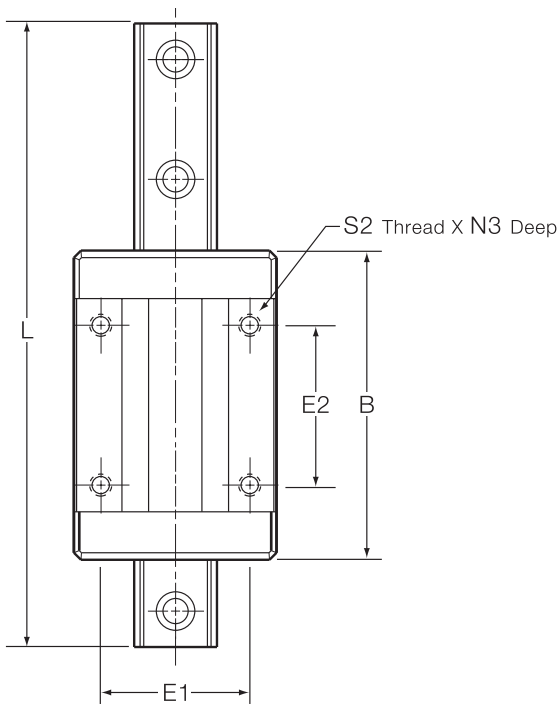

**NOTE:**

The AccuMini linear guide series carriages do not have retained balls. Removing the carriage from the rail without an arbor will result in the balls falling out.

## AccuMini Linear Guide Series

	(mm)													
Size	A	A1	A2	A3	H	H1	H2	B	E1	E2	S2	S3	S5	S6
10	26	13	10	8	15	13	9	40	17	20	M2,5	M2,5	3	5,5
15	38	19	15	11,5	21	19	13	58	28	30	M4	M4	4,5	8
20	50	25	20	15	28	25,6	18	76	37	40	M5	M5	5,5	9,5

For more information, or to place an order, please contact your local authorized Thomson™ distributor or Danaher Motion at 1-540-633-3400, Fax: 1-540-633-4162, or E-mail at [profilerrail@DanaherMotion.com](mailto:profilerrail@DanaherMotion.com).

DANAHER MOTION is a registered trademark of Danaher Corporation. Danaher Motion makes every attempt to ensure accuracy and reliability of the specifications in this publication. Specifications are subject to change without notice. Danaher Motion provides this information "AS IS" and disclaims all warranties, express or implied, including, but not limited to, implied warranties of merchantability and fitness for a particular purpose. It is the responsibility of the product user to determine the suitability of this product for a specific application. ©2004 Danaher Motion.

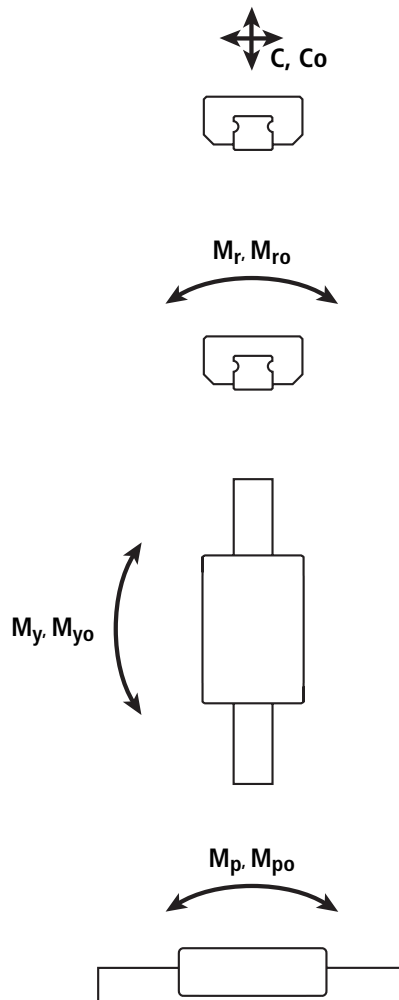

## Dynamic Load and Moment Ratings

$C$  = Dynamic load rating

$M_p$  = Dynamic pitch moment rating

$M_r$  = Dynamic roll moment rating

$M_y$  = Dynamic yaw moment rating

The dynamic load and moment ratings are based upon a 100 km travel life. In order to compare with bearings rated for 50 km, divide the dynamic capacity of the bearing rated for 50 km by 1.26.

## Static Load and Moment Capacities

$C_o$  = Static load capacity

$M_{po}$  = Static pitch moment capacity

$M_{ro}$  = Static roll moment capacity

$M_{yo}$  = Static yaw moment capacity

The static load and moment capacities are the maximum radial load and moment load that should be applied to the bearing while there is no relative motion between the carriage and rail.

## Bearing Travel Life Calculation

$$L = (C/F)^3 \times 100 \text{ km}$$

where:

$L$  = travel life, km

$C$  = dynamic load rating, N

$F$  = applied dynamic load, N

$$C_{\min} = F \left( \frac{L}{100} \right)^{1/3}$$

where:

$C_{\min}$  = minimum required dynamic load rating, N

$F$  = applied dynamic load, N

$L$  = required travel life, km

## Operating Parameters

Maximum Velocity = 3 m/s

Maximum Acceleration = 50 m/s<sup>2</sup>

Maximum Temperature = 80 °C

## AccuMini Series

Size	(mm)				Load Rating C (@100km)	N (lbf) C <sub>o</sub>	Moment Rating				MASS	
	N3	N6	X	L <sub>max</sub> †			M <sub>p</sub> , M <sub>y</sub>	M <sub>po</sub> , M <sub>yo</sub>	M <sub>r</sub>	M <sub>ro</sub>	Carriage kg	Rail kg/m
10	4,5	5,5	25	1 500	2 820 (635)	5 300 1,190	10 (7)	20 (15)	15 (11)	28 (21)	0,045	0,65
15	6	7,5	40	1 500	6 375 (1,430)	15 200 (3,420)	35 (26)	66 (49)	51 (38)	96 (71)	0,141	1,42
20	8	9,5	60	3 000	11 870 (2,670)	23 000 (5,170)	75 (55)	140 (105)	125 (92)	235 (175)z	0,345	2,55

† Maximum rail length in one section. Multiple sections can be butt jointed together for longer lengths.

For more information, or to place an order, please contact your local authorized Thomson™ distributor or Danaher Motion at 1-540-633-3400, Fax: 1-540-633-4162, or E-mail at [profilerrail@DanaherMotion.com](mailto:profilerrail@DanaherMotion.com).

DANAHER MOTION is a registered trademark of Danaher Corporation. Danaher Motion makes every attempt to ensure accuracy and reliability of the specifications in this publication. Specifications are subject to change without notice. Danaher Motion provides this information "AS IS" and disclaims all warranties, express or implied, including, but not limited to, implied warranties of merchantability and fitness for a particular purpose. It is the responsibility of the product user to determine the suitability of this product for a specific application. ©2004 Danaher Motion.

Figure 1 - Dimensions H and A3

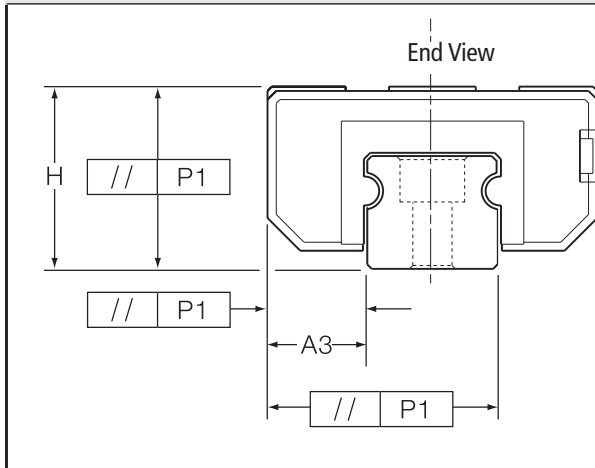

Figure 2 - Running Parallelism

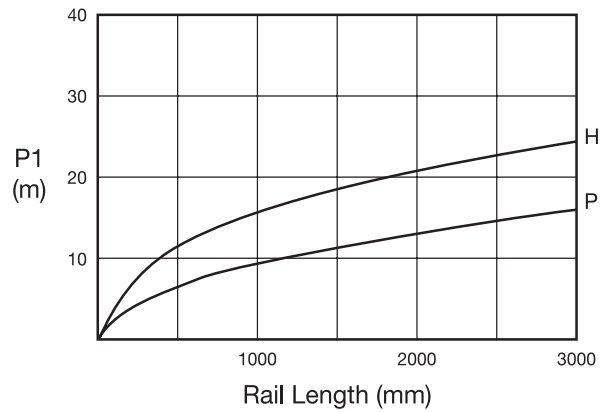

Table 1 - Tolerances (µm)

	Accuracy Classes	
	H High	P Precision
1. Dim. H and A3 (measured at middle of carriage at any point along rail)	±40	±20
2. Max variation in dimensions H and A3 measured on multiple carriages mounted on the same rail (measured at middle of carriage at same position on rail)	15	7
3. Parallelism (applies to the system)	See Figures 1 and 2	

Table 3 - Calculations

To determine proper carriage size:	To determine travel life:
$C_{min} = F \cdot \left(\frac{L}{100}\right)^{1/3}$	$L = \left(\frac{C}{F}\right)^3 \cdot 100$
$C_{min}$ = minimum required dynamic load capacity of carriage (N)	L = normal travel life (km)
F = equivalent load on carriage (N)	C = rated dynamic load capacity of carriage (N)
L = required travel life (km)	F = equivalent load on carriage (N)

Table 4 - Conversions

1 lb <sub>f</sub>	=	4,448 N
1 kg <sub>f</sub>	=	9,8 N
1 km	=	39,370 inches
1 Nm	=	0.7376 lb <sub>f</sub> - ft

Table 2 - Preload/Accuracy Combinations

Accuracy Class	Preload	
	Clearance up to 10 µm	Light approximately 0,03 C <sup>1</sup>
P	—	B
H	A	B

<sup>1</sup>Where C=Dynamic Load Rating

### Operating Parameters

Maximum Velocity = 3 m/s

Maximum Acceleration = 50 m/s<sup>2</sup>

Maximum Temperature = 80 °C

For more information, or to place an order, please contact your local authorized Thomson™ distributor or Danaher Motion at 1-540-633-3400, Fax: 1-540-633-4162, or E-mail at [profilerail@DanaherMotion.com](mailto:profilerail@DanaherMotion.com).

DANAHER MOTION is a registered trademark of Danaher Corporation. Danaher Motion makes every attempt to ensure accuracy and reliability of the specifications in this publication. Specifications are subject to change without notice. Danaher Motion provides this information "AS IS" and disclaims all warranties, express or implied, including, but not limited to, implied warranties of merchantability and fitness for a particular purpose. It is the responsibility of the product user to determine the suitability of this product for a specific application. ©2004 Danaher Motion.

# Lubrication Fittings

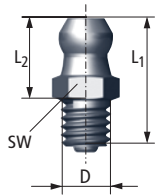

**530LN**  
Hydraulic-type lubricating nipple, straight.  
530BF6=2.5 mm/530BF8 =4mm

D	L <sub>1</sub>	L <sub>2</sub>	SW
M6	16	10.5	7

\*Note: 1 pc included with each carriage

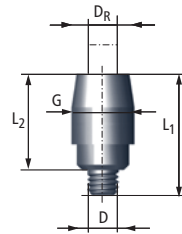

**530LA3**  
Straight screw-in connection M3  
For tubing with ext. diameter DR = 3 mm

D	ØG	L <sub>1</sub>	L <sub>2</sub>
M3	6	12	9.5

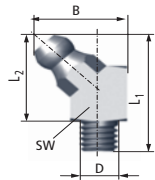

**530LN45**  
Hydraulic-type lubricating nipple, 45° angle

D	L <sub>1</sub>	L <sub>2</sub>	B	SW
M6	21	15.5	15	9

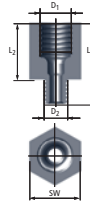

**530LA... Adapter**  
Adapter with hexagon insert bit  
For tubing with ext. diameter = 4 mm

PIN	D <sub>1</sub>	D <sub>2</sub>	L <sub>1</sub>	L <sub>2</sub>
530LA4	G1/8	M6	20	14
530LA5	M8x1"	M6	20	14

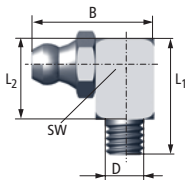

**530LN90**  
Hydraulic-type lubricating nipple, 90° angle

D	L <sub>1</sub>	L <sub>2</sub>	B	SW
M6	18	12.5	19	9

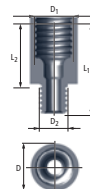

**530LA6**  
Adapter, external round  
For tubing with ext. diameter = 4 mm

D <sub>1</sub>	D <sub>2</sub>	L <sub>1</sub>	L <sub>2</sub>	Ø
M8x1"	M6	20	14	10

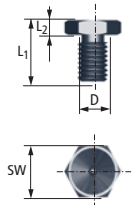

**530LF3**  
Funnel type lubricating nipple M3

D	L <sub>1</sub>	L <sub>2</sub>	SW
M3	6.6	1.6	5

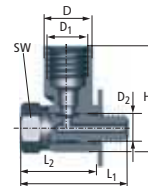

**530BF... Banjo Fittings**  
For tubing with ext. diameter  
530BF6=2.5 mm/530BF8 =4mm

P/N	D <sub>1</sub>	D <sub>2</sub>	L <sub>1</sub>	L <sub>2</sub>	H
530BF6	M6x0.75	M6	22	16	18
530BF8	M8x1"	M6	22	15.5	22

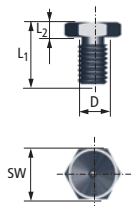

**530LF6**  
Funnel type lubricating nipple M6

D	L <sub>1</sub>	L <sub>2</sub>	SW
M6	9.5	3	7



**530LGA... Grease Gun Extension**  
Grease gun extension, for lubricating 530LF3 and 530LF6 funnel type lubricating nipples

P/N	L	D	Manu	Manu P/N
530GLA1	3"		Lincoln Industrial	5803
539GLA2	6"		Lincoln Industrial	5806

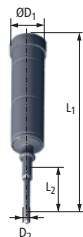

**530LG**  
Grease gun for funnel type lubricating nipple M3

L <sub>1</sub>	L <sub>2</sub>	ØD <sub>1</sub>	ØD <sub>2</sub>
210	55	34	5.5

DANAHER MOTION is a registered trademark of Danaher Corporation. Danaher Motion makes every attempt to ensure accuracy and reliability of the specifications in this publication. Specifications are subject to change without notice. Danaher Motion provides this information "AS IS" and disclaims all warranties, express or implied, including, but not limited to, implied warranties of merchantability and fitness for a particular purpose. It is the responsibility of the product user to determine the suitability of this product for a specific application. ©2004 Danaher Motion.

**NOTES:**

A large grid area for taking notes, consisting of a 30x30 grid of small squares.

DANAHER MOTION is a registered trademark of Danaher Corporation. Danaher Motion makes every attempt to ensure accuracy and reliability of the specifications in this publication. Specifications are subject to change without notice. Danaher Motion provides this information "AS IS" and disclaims all warranties, express or implied, including, but not limited to, implied warranties of merchantability and fitness for a particular purpose. It is the responsibility of the product user to determine the suitability of this product for a specific application. ©2004 Danaher Motion.

## Installation Guidelines for 500 Series Ball, Roller, and AccuMini

### Surface Preparation

ProfileRail\* bearings are generally mounted to structures that are inherently stiffer than the rail. For this reason, the bearings tend to assume the orientation of the surfaces to which they are fastened, through bearing deflection. When a deflection is imposed upon a bearing, especially a preloaded one, resultant forces occur. These forces are transferred to the rolling elements and races, potentially resulting in an increase in system friction and a decrease in system resolution, precision and life.

Figure 1

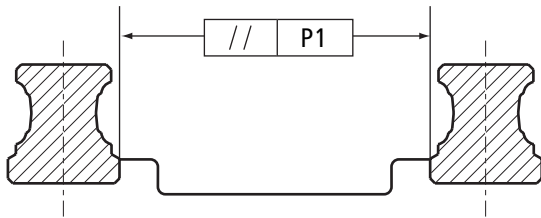

Table 1. Parallelism Between Multiple Rails, mm

Bearing Type	Clearance	Preload		
		0,03 C <sup>†</sup>	0,08 C <sup>†</sup>	0,13 C <sup>†</sup>
500 Series Ball Linear Guide				
15	.015	.010	.007	.003
20	.017	.012	.008	.004
25	.024	.016	.010	.005
30	.024	.016	.010	.005
35	.032	.021	.014	.008
45	.036	.024	.016	.009
500 Series Roller Linear Guide				
25	–	.016	.010	.005
35	–	.021	.014	.008
45	–	.024	.016	.009
55	–	.026	.017	.01
65	–	.028	.018	.011
AccuMini Linear Guide				
10	.009	.004	–	–
15	.011	.006	–	–
20	.013	.008	–	–

<sup>†</sup>Where C = Dynamic Load Capacity

Various sources can contribute to the overall error of the mounting surfaces. These include the surface flatness of the base surfaces, the location and parallelism of the reference surfaces, and the attendant errors of the bearing as described within the accuracy classes.

The surfaces that contact the base and reference edges may be milled, scraped, ground, or prepared by any other method that will produce a flat mounting surface free of inconsistencies, which would tend to distort or skew the bearing. A simple stone may be used to remove high spots. Dirt and debris should be cleaned off, as they could contribute to the inaccuracies.

Associated with preload is a slight potential concavity of the carriage top surface. The preload is established when all the carriage screws are affixed to a planar surface, flattening the carriage base. Deviations affecting the planarity of the carriage mounting surface could result in a preload change.

### Mounting Tolerances

The tolerances found in Tables 1-3 are intended to provide an installation for which the associated derating is negligible. These specifications are based upon the assumption that the structures of the application are infinitely rigid and are of consideration for the bearing reactions only.

### Rail Parallelism (See Figure 1)

A variation in the distance between the rails will induce a shear or side load on the bearings.

In order to minimize the effect of this shear load, tolerances for rail reference edge parallelism may be found in Table 1.

For more information, or to place an order, please contact your local authorized Thomson™ distributor or Danaher Motion at 1-540-633-3400, Fax: 1-540-633-4162, or E-mail at [profilerail@DanaherMotion.com](mailto:profilerail@DanaherMotion.com).

DANAHER MOTION is a registered trademark of Danaher Corporation. Danaher Motion makes every attempt to ensure accuracy and reliability of the specifications in this publication. Specifications are subject to change without notice. Danaher Motion provides this information "AS IS" and disclaims all warranties, express or implied, including, but not limited to, implied warranties of merchantability and fitness for a particular purpose. It is the responsibility of the product user to determine the suitability of this product for a specific application. ©2004 Danaher Motion.

Figure 2

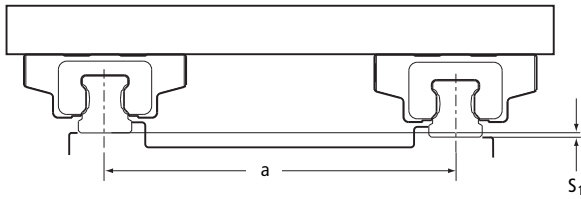

Table 2. Allowable Vertical Offsets Between Rails (S1/a)

Bearing Type	Preload			
	Clearance	0,03 C <sup>†</sup>	0,08 C <sup>†</sup>	0,13 C <sup>†</sup>
500 Series Ball	0,0006	0,0004	0,0003	0,0002
500 Series Roller	–	0,0007	0,0005	0,0004
AccuMini Linear Guide	0,0006	0,0004	–	–

<sup>†</sup>Where C=Dynamic Load Capacity

Figure 3

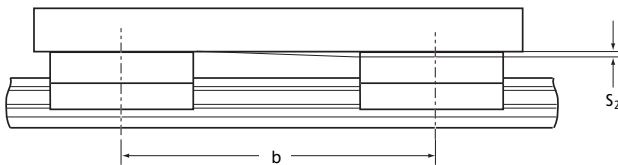

Figure 4

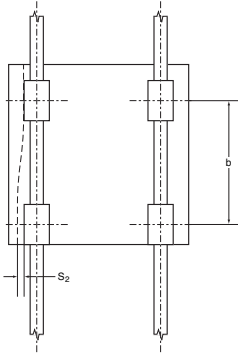

Figure 5. Shoulder Heights and Corner Radii

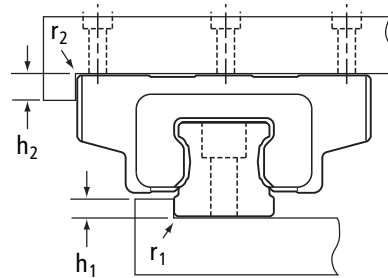

Table 3. Allowable Carriage Offsets (S2/b)

Clearance	Preload		
	0,03 C <sup>†</sup>	0,08 C <sup>†</sup>	0,13 C <sup>†</sup>
0,00006	0,00005	0,00004	0,00003

<sup>†</sup>Where C=Dynamic Load Capacity

### Rail Vertical Offset (See Figure 2)

A vertical offset of the rails across the axis will induce a roll moment onto the carriages.

To minimize the effect of this roll moment, tolerances for the vertical offset may be found in Table 2. This tolerance describes the attributes of the mounting surface, perpendicular to the rail axis.

### Vertical Carriage Offset (See Figure 3)

A vertical offset between fore and aft carriages will induce a pitch moment on the bearings.

### Lateral Carriage Offset (See Figure 4)

A lateral offset of the carriage reference edges will induce a yaw moment.

In order to minimize the effects of these pitch and yaw moments, tolerances may be found in Table 3. This tolerance describes the attributes of the mounting surface parallel to the rail axis, and the reference edge straightness.

NOTE: All mounting tolerances should be inclusive of the H and A3 tolerances. Thus, a lower accuracy class bearing may require a more accurate installation.

### Mounting Hole Tolerances

The positional tolerance between the through holes in the rails is 0.5 mm.

The positional tolerance of the first rail mounting hole dimensioned from the datum end (called the "Y-dimension") is  $\pm 1.0$  mm.

The overall rail length tolerance is  $\pm 2.0$  mm.

The positional tolerance between the mounting holes in the carriages is 0.2 mm.

### Reference Edge Specifications

The maximum shoulder heights and corner radii are listed in Table 4.

For more information, or to place an order, please contact your local authorized Thomson™ distributor or Danaher Motion at 1-540-633-3400, Fax: 1-540-633-4162, or E-mail at [profilerail@DanaherMotion.com](mailto:profilerail@DanaherMotion.com).

DANAHER MOTION is a registered trademark of Danaher Corporation. Danaher Motion makes every attempt to ensure accuracy and reliability of the specifications in this publication. Specifications are subject to change without notice. Danaher Motion provides this information "AS IS" and disclaims all warranties, express or implied, including, but not limited to, implied warranties of merchantability and fitness for a particular purpose. It is the responsibility of the product user to determine the suitability of this product for a specific application. ©2004 Danaher Motion.



Table 4. Shoulder heights and corner radii, mm

Guide Type	Rail		Carriage	
	h1 max	r1 max	h2	r2 max
500 Series Ball Linear Guide				
15	3.5	.8	3.5	.6
20	4	.9	4	.9
25	5	1.1	5	1.1
30	5.5	1.3	5.5	1.3
35	6	1.3	6	1.3
45	8	1.3	8	1.3
500 Series Roller Linear Guide				
25	5	.8	5	.8
35	6	.8	6	.8
45	8	.8	8	.8
55	10	1.2	10	1.2
65	10	1.5	10	1.5
AccuMini Linear Guide				
10	1.75	0.4	3.5	0.4
15	1.75	0.4	5	0.4
20	2	0.5	7	0.5

## Recommended Bolt Tightening Torque, Nm

Table 5

Bolt Size	Class 8.8	Class 12.9
M2.5	0,7	1,2
M4	2,8	4,6
M5	5,7	9,5
M6	9,5	16
M8	23	39
M10	46	77
M12	80	135
M14	129	215
M16	198	330

For more information, or to place an order, please contact your local authorized Thomson™ distributor or Danaher Motion at 1-540-633-3400, Fax: 1-540-633-4162, or E-mail at [profilerrail@DanaherMotion.com](mailto:profilerrail@DanaherMotion.com).

## Installation Procedure

Clean and inspect all mating surfaces for burrs, nicks, dirt, etc. A simple stone can be used to remove minor imperfections in the mounting surfaces.

**Note:** T-Series is not as sensitive to imperfections of the mounting surface.

## Rail Mounting

- Carefully place the rail on the mounting surface.
- Insert screws into the mounting holes and tighten lightly.
- Clamp the reference edge of the rail against a locating edge on the mounting surface.

The locating edge can be a machined reference edge, a straight edge, a row of dowels or keys, or some other edge which the rail can be clamped against. It should be straight, either within the mounting tolerances shown in Table 3 or according to the application requirements, whichever is tighter.

- Starting from the center of the rail moving outwards, tighten each screw to the recommended tightening torque in Table 5.
- If parallel rails are to be used, one of the following methods may be employed to obtain the parallelism recommended in Table 1.
  - two parallel locating edges
  - a gage block or parallel between the rails
  - the use of the top plate with the carriages mounted, to locate or "float" the second rail into place.
- Repeat steps 1– 4 to install the second rail.
- Insert a rail plug into each counterbore in the rail. Carefully tap rail plugs into place using a soft material such as brass or wood. When properly installed, the rail plugs should be flush with the top surface of the rail. Do not countersink the rail plugs.
 

**Note:** Rail plugs are available and are shipped with all rails except for the AccuGlide\* Miniature Linear Guide size 10.
- If desired, rail tape can then be applied to the top of the rail. For sizes 35 and below, the rail tape may be used without the rail plugs.

Figure 6. Butt jointed rails

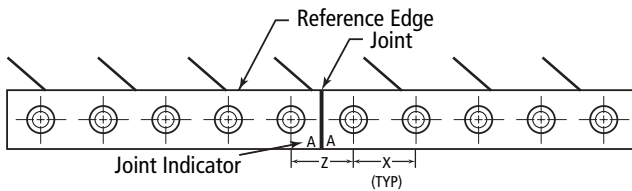
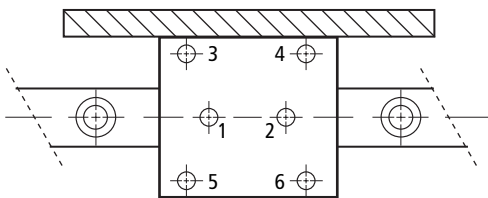

Figure 7. Recommended Tightening Sequence



## Butt Joints

For rails longer than the longest length available in one piece, a butt joint is required. A butt joint is formed by butting the end of two matched rails together. The ends of rails to be butt jointed are specially machined and marked with same letter (A, B, C, etc.).

We strongly recommend the use of a locating edge when using butt jointed rails. This will ensure proper alignment of the raceways across the joint.

500 Series Ball and Roller linear guide rails, the mounting hole spacing across the joint, Z, will be equal to the standard mounting hole spacing, X.

Once mounted, a gap between the ends of the butt jointed rails of 0.5 mm or less is acceptable.

## Carriage Mounting

1. Carefully place the table top on the carriages.
2. Insert the screws into the mounting holes and tighten lightly.
3. Clamp the reference edge of the carriages to locating edges under the top plate.

**Note:** This is only required if the location of the center of the top plate is critical to the application, or if the top plate is being used to position a second rail parallel.

4. Tighten each screw to the recommended tightening torque in Table 5. For carriages with six mounting screws, the tightening sequence shown in Figure 7 is recommended.

5. Lubricate bearings.

**Note:** Extreme care should be taken when mounting the carriages to the rails. Forcing a carriage onto a rail can knock out rolling elements and/or damage the carriage and rail.

For large side forces, hard mounting is recommended to resist any translation. Some methods for hard mounting are the use of tapered gibs, retaining plates, or set screws in combination with machined reference edges. Other methods include the use of an epoxy/replicating material, dowels, and keys. Upon request, carriages and rails can be special machined to accommodate dowels or keys. Consult the factory for details.

For more information, or to place an order, please contact your local authorized Thomson™ distributor or Danaher Motion at 1-540-633-3400, Fax: 1-540-633-4162, or E-mail at [profilerrail@DanaherMotion.com](mailto:profilerrail@DanaherMotion.com).

DANAHER MOTION is a registered trademark of Danaher Corporation. Danaher Motion makes every attempt to ensure accuracy and reliability of the specifications in this publication. Specifications are subject to change without notice. Danaher Motion provides this information "AS IS" and disclaims all warranties, express or implied, including, but not limited to, implied warranties of merchantability and fitness for a particular purpose. It is the responsibility of the product user to determine the suitability of this product for a specific application. ©2004 Danaher Motion.

## Profile Rail Engineering Guide

- Profile Rail Selection
- Technology Overview
- Sizing & Defining Guide Characteristics
- Applied Loading Calculations
- Load Ratings: Rolling Element Guides  
Sliding Contact Guides
- Preloading & Linear Guide Deflection
- Actuation Force
- Lubrication
- Bellow Cover Length Calculations
- Butt Joint Fax-back Worksheet
- Conversion Table



DANAHER MOTION is a registered trademark of Danaher Corporation. Danaher Motion makes every attempt to ensure accuracy and reliability of the specifications in this publication. Specifications are subject to change without notice. Danaher Motion provides this information "AS IS" and disclaims all warranties, express or implied, including, but not limited to, implied warranties of merchantability and fitness for a particular purpose. It is the responsibility of the product user to determine the suitability of this product for a specific application. ©2004 Danaher Motion.

## Profile Rail Selection

The selection of a linear guide can greatly affect machine performance and overall cost. In order to meet the wide variety of demands created by today's applications, proper selection from a broad range of linear guides is required.

For example, selecting a guide with too much rigidity will decrease the allowable installation tolerances, therefore, greatly increasing surface preparation costs. If the mounting surface is not prepared properly, the guide will run rough, and need to be replaced more frequently due to an unexpected reduction in travel life.

Consider all criteria appropriate for the application. Selection criteria include:

- Rigidity
- Travel accuracy
- Travel life
- Smoothness of travel
- Speed & Acceleration
- Envelope
- Environment
- Cost of Product
- Cost of Installation
- Cost of Replacement

Selection of the most appropriate type of guide, should be based on quantitative/ qualitative requirements and ranking by importance of the above selection criteria, as well as the following guidelines for the technology available.

### Technology Overview

The performance of a linear guide is based upon contact type, rolling element type, inner race geometry (Round Rail and Profile Rail), and other characteristics such as self-aligning capabilities. It is important to recognize that the options available for each characteristic have performance attributes. The selection process should be focused on matching these attributes with the most critical requirements of the application. The following technology guidelines can be used to assist in selecting the most appropriate type of profile rail. For a detailed application analysis, contact the **Danaher Motion Assistance Center at (540) 633-3400** or your local Danaher Motion distributor.

*For more information, or to place an order, please contact your local authorized Thomson™ distributor or Danaher Motion at 1-540-633-3400, Fax: 1-540-633-4162, or E-mail at [profilerail@DanaherMotion.com](mailto:profilerail@DanaherMotion.com).*

DANAHER MOTION is a registered trademark of Danaher Corporation. Danaher Motion makes every attempt to ensure accuracy and reliability of the specifications in this publication. Specifications are subject to change without notice. Danaher Motion provides this information "AS IS" and disclaims all warranties, express or implied, including, but not limited to, implied warranties of merchantability and fitness for a particular purpose. It is the responsibility of the product user to determine the suitability of this product for a specific application. ©2004 Danaher Motion.

## Sizing & Defining Guide Characteristics

The following 9 step procedure can be used to select the characteristics necessary to generate the appropriate part number:

1. Determine the load on the most heavily loaded carriage or bearing (see Applied Loading Calculations). Multiply by a safety factor if desired in your application.
2. Determine the minimum required travel life for the application based on the intended duty cycle.
3. Calculate the **Minimum Required Dynamic Load Rating**,  $C_{min}$  (see Page 85).
4. Select the size which offers the load rating,  $C$ , equal to or greater than the minimum required dynamic load rating,  $C_{min}$ . Also, consider **Dynamic Load Limit** and **Static Capacities**.
5. If the guide selected offers various preload<sup>†</sup> levels, select a preload based upon the allowable bearing deflection. Contact the factory for detailed deflection information. Some carriage or bearing **Deflection Charts** are provided in this catalog.
6. If the guide selected offers various accuracy classes, select an accuracy class based upon the required travel accuracy.
7. Determine the need for accessories or options.
8. Calculate the guide length based upon the stroke and platten length. Remember to include additional length of accessories (i.e. self-lubricating option) and the stroke reduction caused by the use of bellows, if applicable.
9. Once the above characteristics have been determined, assign the appropriate part number based on the part numbering instructions located in the catalog section corresponding to the linear guide selected.

<sup>†</sup> Choosing a higher preload level will reduce the allowable installation tolerances. For this reason, the minimum preload which meets the applications requirements should be selected. If the highest preload level does not meet the deflection requirements, a larger size may be required.

*For more information, or to place an order, please contact your local authorized Thomson™ distributor or Danaher Motion at 1-540-633-3400, Fax: 1-540-633-4162, or E-mail at [profilerrail@DanaherMotion.com](mailto:profilerrail@DanaherMotion.com).*

DANAHER MOTION is a registered trademark of Danaher Corporation. Danaher Motion makes every attempt to ensure accuracy and reliability of the specifications in this publication. Specifications are subject to change without notice. Danaher Motion provides this information "AS IS" and disclaims all warranties, express or implied, including, but not limited to, implied warranties of merchantability and fitness for a particular purpose. It is the responsibility of the product user to determine the suitability of this product for a specific application. ©2004 Danaher Motion.

## Applied Loading Calculations

The majority of applications utilize a four carriage or bearing and two rail design for stability. Shown are four typical configurations and calculations for the resultant loads applied to each bearing. Resultant loads are divided into a horizontal and a vertical components, which represent the static or constant velocity condition and account for gravity but not acceleration.

Use the appropriate configuration to determine the horizontal and vertical components of the resultant applied load on the most heavily loaded carriage or bearing. These values will be referred to henceforth as FH & FV, respectively.

### Terms:

$d_0$  = distance between centerlines of carriages or bearings (in) or (mm)

$d_1$  = distance between centerlines of rails (in) or (mm)

$d_2$  = distance from centerline of carriage or bearing to load action point (in) or (mm)

$d_3$  = distance from centerline of carriage or bearing to load action point (in) or (mm)

$W$  = Applied Load (lbf) or (N)

$F_{NH}$  = Horizontal component of resultant applied load with respect to each carriage or bearing (lbf) or (N)

$F_{NV}$  = Vertical component of resultant applied load with respect to each carriage or bearing (lbf) or (N)

### Reminder:

- Be sure to use consistent units (English or metric).
- Be sure to use the appropriate sign (positive or negative).
- A negative number is used when the actual force is in the opposite direction represented by the arrow.

For more information, or to place an order, please contact your local authorized Thomson™ distributor or Danaher Motion at 1-540-633-3400, Fax: 1-540-633-4162, or E-mail at [profilerrail@DanaherMotion.com](mailto:profilerrail@DanaherMotion.com).

$$F_{1v} = \frac{W}{4} + \left( \frac{W}{2} \cdot \frac{d_2}{d_0} \right) - \left( \frac{W}{2} \cdot \frac{d_3}{d_1} \right)$$

$$F_{2v} = \frac{W}{4} - \left( \frac{W}{2} \cdot \frac{d_2}{d_0} \right) - \left( \frac{W}{2} \cdot \frac{d_3}{d_1} \right)$$

$$F_{3v} = \frac{W}{4} - \left( \frac{W}{2} \cdot \frac{d_2}{d_0} \right) + \left( \frac{W}{2} \cdot \frac{d_3}{d_1} \right)$$

$$F_{4v} = \frac{W}{4} + \left( \frac{W}{2} \cdot \frac{d_2}{d_0} \right) + \left( \frac{W}{2} \cdot \frac{d_3}{d_1} \right)$$

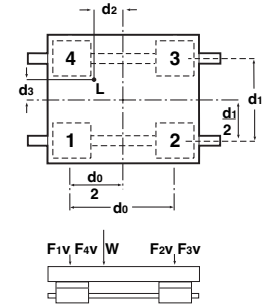

### Horizontal Application I

At the time of movement with uniform velocity or at the time of stop.

$$F_{1v} = \frac{W}{4} + \left( \frac{W}{2} \cdot \frac{d_2}{d_0} \right) - \left( \frac{W}{2} \cdot \frac{d_3}{d_1} \right)$$

$$F_{2v} = \frac{W}{4} - \left( \frac{W}{2} \cdot \frac{d_2}{d_0} \right) - \left( \frac{W}{2} \cdot \frac{d_3}{d_1} \right)$$

$$F_{3v} = \frac{W}{4} - \left( \frac{W}{2} \cdot \frac{d_2}{d_0} \right) + \left( \frac{W}{2} \cdot \frac{d_3}{d_1} \right)$$

$$F_{4v} = \frac{W}{4} + \left( \frac{W}{2} \cdot \frac{d_2}{d_0} \right) + \left( \frac{W}{2} \cdot \frac{d_3}{d_1} \right)$$

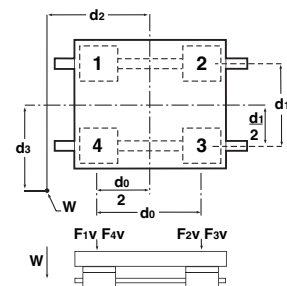

### Horizontal Application II

At the time of movement with uniform velocity or at the time of stop.

$$F_{1v} = F_{2v} = - \left( \frac{W}{2} \cdot \frac{d_3}{d_1} \right)$$

$$F_{3v} = F_{4v} = + \left( \frac{W}{2} \cdot \frac{d_3}{d_1} \right)$$

$$F_{1H} = F_{4H} = \frac{W}{4} + \left( \frac{W}{2} \cdot \frac{d_2}{d_0} \right)$$

$$F_{2H} = F_{3H} = \frac{W}{4} - \left( \frac{W}{2} \cdot \frac{d_2}{d_0} \right)$$

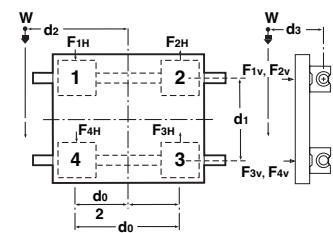

### Side Mounted Application

At the time of movement with uniform velocity or at the time of stop.

$$F_{1v} = F_{4v} = - \left( \frac{W}{2} \cdot \frac{d_2}{d_0} \right)$$

$$F_{2v} = F_{3v} = + \left( \frac{W}{2} \cdot \frac{d_2}{d_0} \right)$$

$$F_{1H} = - F_{2H} = - F_{3H} = F_{4H} = \frac{W}{2} \cdot \frac{d_3}{d_0}$$

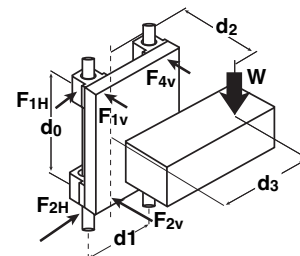

### Vertical Application

At the time of movement with uniform velocity or at the time of stop. At the time of start & stop, the load varies because of inertia.

DANAHER MOTION is a registered trademark of Danaher Corporation. Danaher Motion makes every attempt to ensure accuracy and reliability of the specifications in this publication. Specifications are subject to change without notice. Danaher Motion provides this information "AS IS" and disclaims all warranties, express or implied, including, but not limited to, implied warranties of merchantability and fitness for a particular purpose. It is the responsibility of the product user to determine the suitability of this product for a specific application. ©2004 Danaher Motion.

## Equivalent Applied Load†

An equivalent load is used to consolidate applied load components into one value which can later be used to calculate the minimum required load rating and the expected life of the carriage/bearing selected.

### For ProfileRail\* Carriages & Closed RoundRail\* Bearings:

$$F_{EQ} = F_H + F_V$$

$F_{EQ}$  = Equivalent Load

$F_H$  = Horizontal Component of Resultant Applied Load

$F_V$  = Vertical Component of Resultant Applied Load

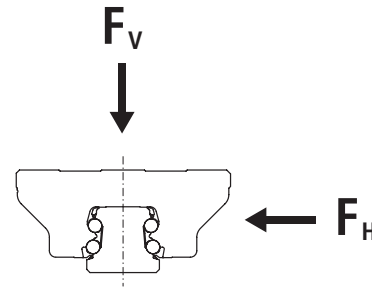

### For Single Carriage or Single Rail Configurations:

$$F_{EQ} = F_H + F_V + (M/M_c) \times C$$

$M$  = Applied Moment Load

$M_c$  = Dynamic Moment Capacity of Bearing

$C$  = Dynamic Load Capacity of Bearing

### For Preloaded Carriages [ Only when $F_{EQ} < (3 \times F_p)$ ] :

Even with no external load applied, a preloaded bearing has a load on the races. A load greater than the externally applied load is present within a bearing with an externally applied load less than the preload end point. In order to calculate the loads on the load sets, the following formulae may be employed:

$$F_{EQ} = F_p + \frac{2}{3} (F_H + F_V)$$

$F_p$  = Initial Preload Force

(i.e., for 'B' Preload Designation  $F_p = .03 \times C$ )

† Before calculating  $F_{EQ}$ , make sure that neither  $F_H$  or  $F_V$  exceeds the Dynamic Load Limit of the guide intended for use. (See **Dynamic Load Limit** on Page E7).

‡ The 0.6 value used accounts for a derating factor of the capacity during tensile loading. Therefore, when calculating expected life based on  $F_{EQ}$ , the Full Dynamic Load Rating (C) may be used.

For more information, or to place an order, please contact your local authorized Thomson™ distributor or Danaher Motion at 1-540-633-3400, Fax: 1-540-633-4162, or E-mail at [profilerail@DanaherMotion.com](mailto:profilerail@DanaherMotion.com).



## Mean Dynamic Load

In applications with loads of varying magnitude, a mean dynamic load should be calculated.

$$F_{EQ} = \sqrt[P]{F_{EQ1}^P \left(\frac{d1}{D}\right) + F_{EQ2}^P \left(\frac{d2}{D}\right) + \dots + F_{EQn}^P \left(\frac{dn}{D}\right)}$$

Where:  $F_{EQ1} \dots F_{EQn}$  = equivalent dynamic load for distances d1 through dn  
 D = total distance of stroke = d1+d2...+dm  
 P = 3 (linear guides w/Ball Type Rolling Elements)  
 10/3 (linear guides w/Roller Type Rolling Elements)

## Load Ratings for Rolling Element Guides

### Dynamic Load Rating, C, and Travel Life

The dynamic load rating, C, is the load at which when applied will yield the rated travel life. The rated travel life, L<sub>r</sub>, for most linear guides is 100km for metric products and 4 million inches for inch products (the rated travel life is listed on the page with the dynamic load rating). For a given applied load, P, the dynamic load rating and rated travel life are used to calculate the travel life using the following load/life equation:

$$L = (C/F_{EQ})^n \times L_r$$

Where:

L = calculated travel life  
 C = dynamic load rating  
 F<sub>EQ</sub> = equivalent applied load  
 n = 3 for ball guides, 10/3 for roller guides  
 L<sub>r</sub> = rated travel life

Some manufacturers dynamic load ratings are based upon a 50km life.

To compare dynamic load ratings for guides with a 50km rated life with a 100km life, divide the 50km dynamic load rating by 1.26.

$$C_{100km} = C_{50km}/1.26$$

Some types of linear guides do not have the same dynamic load rating in all directions. The dynamic load rating for orthogonal load directions is shown as a percentage of C. It is not necessary to use this percentage of C in the load/life equation provided that the **Equivalent Applied Load Section** has been adhered to, because the calculations for equivalent applied load already account for it.

*For more information, or to place an order, please contact your local authorized Thomson™ distributor or Danaher Motion at 1-540-633-3400, Fax: 1-540-633-4162, or E-mail at [profilerrail@DanaherMotion.com](mailto:profilerrail@DanaherMotion.com).*

DANAHER MOTION is a registered trademark of Danaher Corporation. Danaher Motion makes every attempt to ensure accuracy and reliability of the specifications in this publication. Specifications are subject to change without notice. Danaher Motion provides this information "AS IS" and disclaims all warranties, express or implied, including, but not limited to, implied warranties of merchantability and fitness for a particular purpose. It is the responsibility of the product user to determine the suitability of this product for a specific application. ©2004 Danaher Motion.



## Calculating the Minimum Required Dynamic Load Rating, $C_{min}$

The load/life equation above can be rewritten to calculate the minimum required dynamic load rating which should be selected for a given applied load and minimum required travel life:

$$C_{min} = P(L_m/L_r)^{1/n}$$

Where:

- $C_{min}$  = minimum required dynamic load rating
- $P$  = applied load
- $L_m$  = minimum required travel life
- $L_r$  = rated travel life
- $n$  = 3 for ball guides, 10/3 for roller guides

Note: Check that the applied load,  $P$  does not exceed the dynamic load limit.

### Dynamic Load Limit

The dynamic load limit, is the maximum load which should be applied to the carriage/pillowblock. In some cases, the dynamic load capacity equals the dynamic load rating. In others, a limit shown as a percentage of the dynamic load rating is the maximum load which should be applied. A dynamic load limit less than the dynamic load rating does not derate the life of the guide.

### Static Capacities

The static capacities are the maximum loads that should be applied to the bearing while there is no relative motion between the rolling elements and the raceways. The value  $C_0$  is the static load capacity for a radial load acting orthogonal to the axis of travel. The values  $M_{OL}$  and  $M_{OQ}$  are the static roll, pitch, and yaw moment capacities.

It is important to analyze the application so that shock loads do not exceed these capacities. Exceeding these capacities may permanently deform the rolling elements and raceways. This type of damage will be realized by an increase in friction, noise, and vibration, as well as by an increase in clearance between the carriage and the rail.

For systems experiencing repetitive shock loading less than the static load capacities, the bearing life should be determined by means of fatigue calculations.

*For more information, or to place an order, please contact your local authorized Thomson™ distributor or Danaher Motion at 1-540-633-3400, Fax: 1-540-633-4162, or E-mail at [profilerail@DanaherMotion.com](mailto:profilerail@DanaherMotion.com).*

DANAHER MOTION is a registered trademark of Danaher Corporation. Danaher Motion makes every attempt to ensure accuracy and reliability of the specifications in this publication. Specifications are subject to change without notice. Danaher Motion provides this information "AS IS" and disclaims all warranties, express or implied, including, but not limited to, implied warranties of merchantability and fitness for a particular purpose. It is the responsibility of the product user to determine the suitability of this product for a specific application. ©2004 Danaher Motion.

## Preloading & Linear Guide Deflection

### Preload

A preloaded bearing has a condition of interference between the races of the rails, the rolling elements, and the races of the carriage.

Preloading decreases the deflection due to external loads. This occurs because the contact reaction has already developed, eliminating much of the initial non-linear deflection associated with rolling elements.

The rolling element reactions within a preloaded bearing may be considered as having two components. One component acts in the direction of external load, and one component acts in the opposing direction in order to maintain static equilibrium. These components are referred to as load sets. As external load is applied, one load set increases in load, as the opposite load set decreases in load. At some point, the load on the decreasing load set becomes zero. This point, at which the preload is relieved, is called the preload end point. Preload end typically occurs when the external load is approximately three times the preload.

Preload end point :  $F_{ext} = 3F_p$

where:

$F_{ext}$  = externally applied load

$F_p$  = preload

By definition, a preloaded bearing, loaded beyond the preload endpoint, has the same deflection characteristics of an unloaded bearing externally loaded to that percentage of its dynamic load capacity. A preload level is assigned as a percentage of the dynamic load capacity of the bearing.

## Deflection Curves

The following pages contain deflection charts for the 500 Series Profile Rail Linear Guides. The charts shown are calculated. The calculation is based on theoretical conditions regarding shape, position and dimension of the balls and raceways of the carriage and rails under the specified loading. The real behavior of the carriage can vary slightly in the application as a result of base flatness, angle of loading, temperature, etc.

Note that the deflection decreases as the preload or the bearing size increases.

For deflection characteristics of linear guide types not shown, contact Danaher Motion Application Engineering at (540) 633-3490.

*For more information, or to place an order, please contact your local authorized Thomson™ distributor or Danaher Motion at 1-540-633-3400, Fax: 1-540-633-4162, or E-mail at [profilerail@DanaherMotion.com](mailto:profilerail@DanaherMotion.com).*

DANAHER MOTION is a registered trademark of Danaher Corporation. Danaher Motion makes every attempt to ensure accuracy and reliability of the specifications in this publication. Specifications are subject to change without notice. Danaher Motion provides this information "AS IS" and disclaims all warranties, express or implied, including, but not limited to, implied warranties of merchantability and fitness for a particular purpose. It is the responsibility of the product user to determine the suitability of this product for a specific application. ©2004 Danaher Motion.

# Deflection vs. Applied Load

511 Style A, C, E  
Size 15

- 1. Preload 3% of C
  - 2. Preload 8% of C
  - 3. Preload 13% of C
- C = Dynamic load carrying capacity

Compressive Load

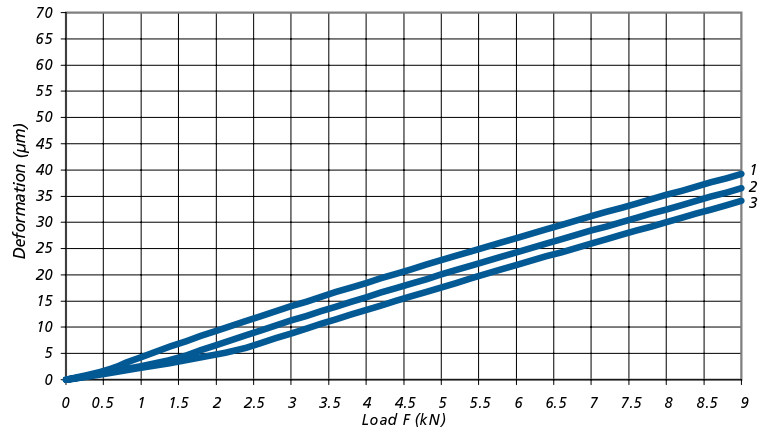
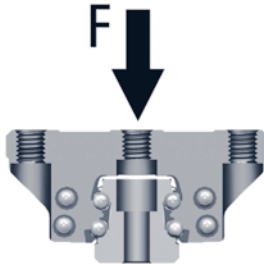

Tensile Load

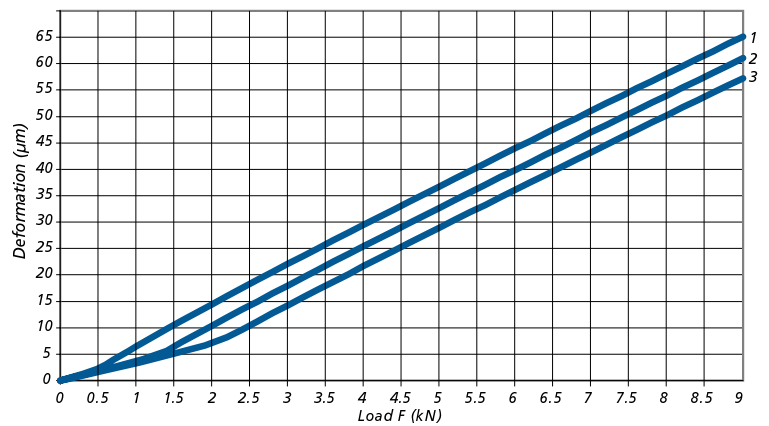
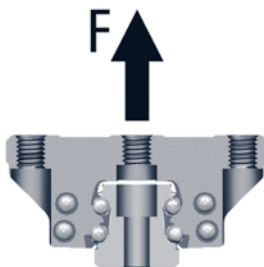

Lateral Load

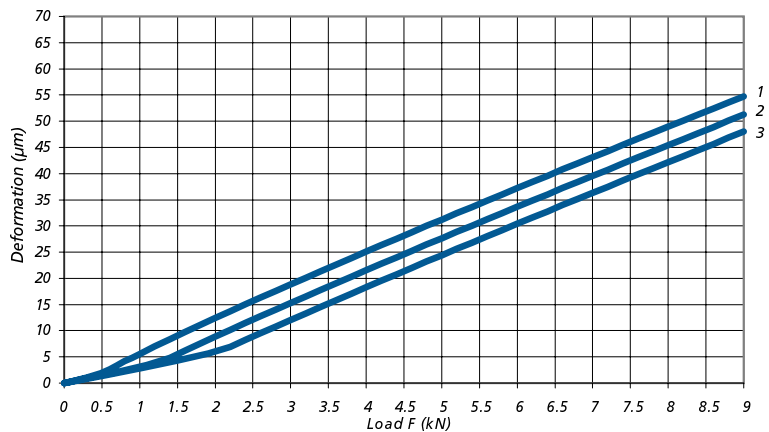
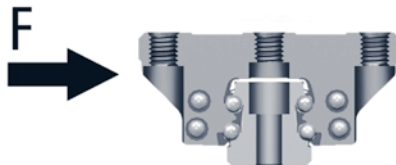

For more information, or to place an order, please contact your local authorized Thomson™ distributor or Danaher Motion at 1-540-633-3400, Fax: 1-540-633-4162, or E-mail at [profilerail@DanaherMotion.com](mailto:profilerail@DanaherMotion.com).

DANAHER MOTION is a registered trademark of Danaher Corporation. Danaher Motion makes every attempt to ensure accuracy and reliability of the specifications in this publication. Specifications are subject to change without notice. Danaher Motion provides this information "AS IS" and disclaims all warranties, express or implied, including, but not limited to, implied warranties of merchantability and fitness for a particular purpose. It is the responsibility of the product user to determine the suitability of this product for a specific application. ©2004 Danaher Motion.

# Deflection vs. Applied Load

511 Style A, C, E  
Size 20

- 1. Preload 3% of C
  - 2. Preload 8% of C
  - 3. Preload 13% of C
- C = Dynamic load carrying capacity

Compressive Load

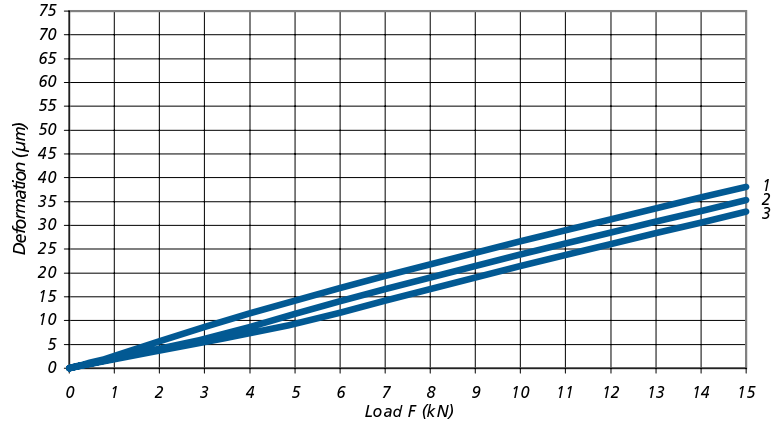
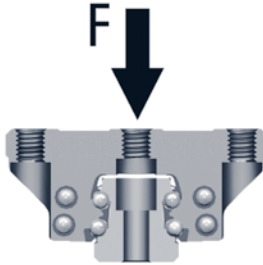

Tensile Load

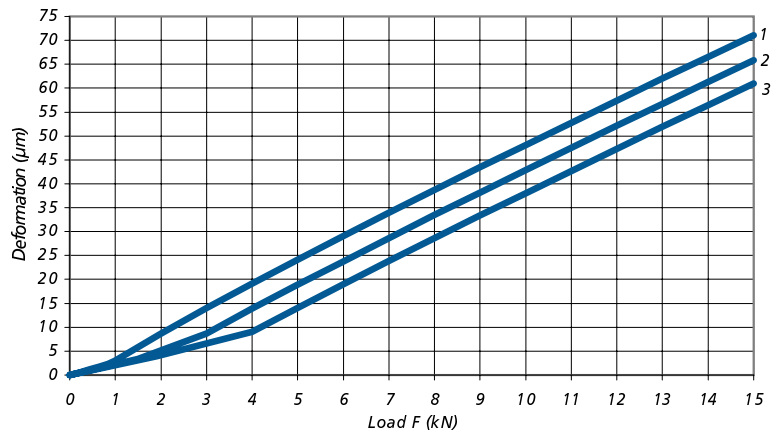
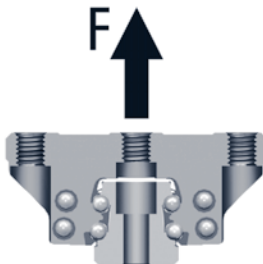

Lateral Load

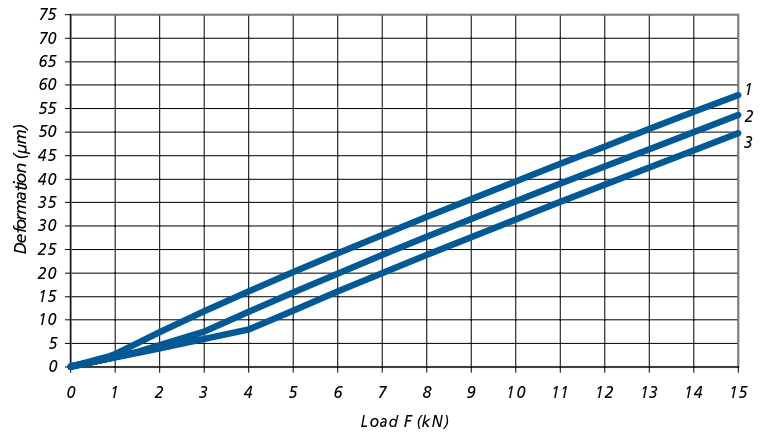
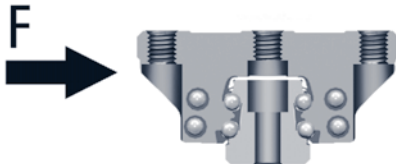

For more information, or to place an order, please contact your local authorized Thomson™ distributor or Danaher Motion at 1-540-633-3400, Fax: 1-540-633-4162, or E-mail at [profilerail@DanaherMotion.com](mailto:profilerail@DanaherMotion.com).

DANAHER MOTION is a registered trademark of Danaher Corporation. Danaher Motion makes every attempt to ensure accuracy and reliability of the specifications in this publication. Specifications are subject to change without notice. Danaher Motion provides this information "AS IS" and disclaims all warranties, express or implied, including, but not limited to, implied warranties of merchantability and fitness for a particular purpose. It is the responsibility of the product user to determine the suitability of this product for a specific application. ©2004 Danaher Motion.

# Deflection vs. Applied Load

511 Style B, D, F  
Size 20

- 1. Preload 3% of C
  - 2. Preload 8% of C
  - 3. Preload 13% of C
- C = Dynamic load carrying capacity

Compressive Load

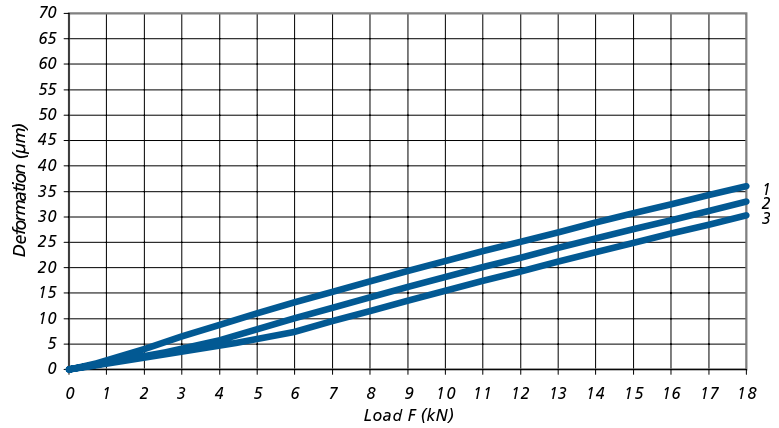
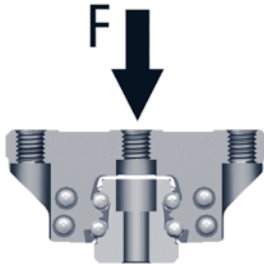

Tensile Load

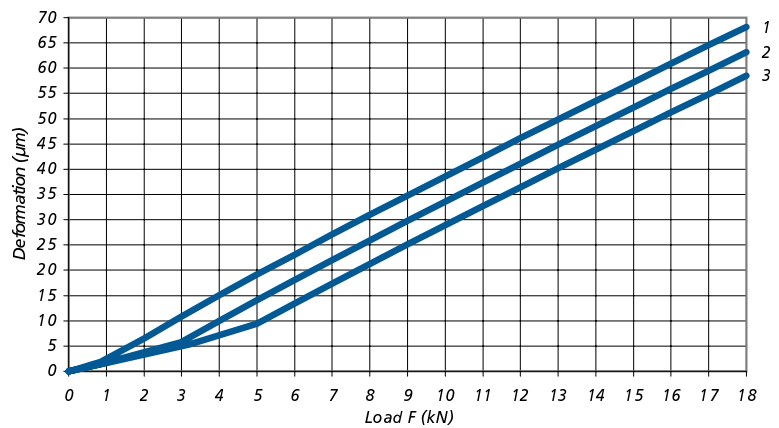
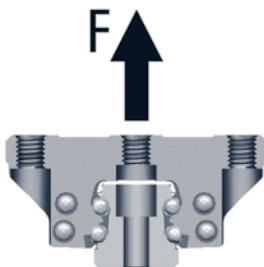

Lateral Load

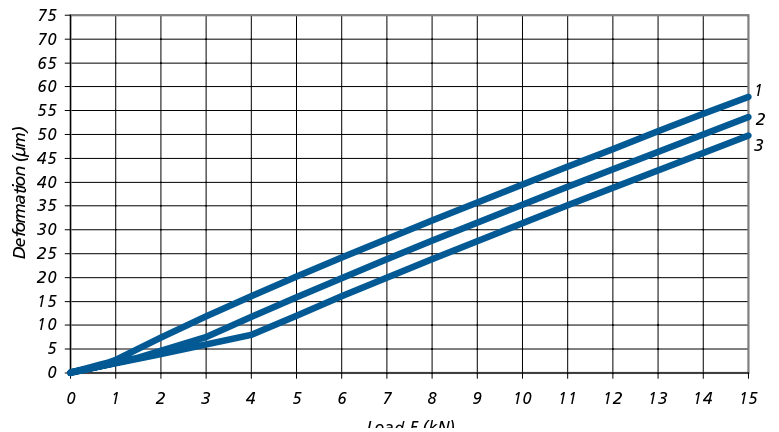
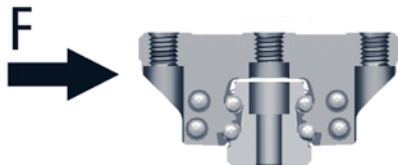

For more information, or to place an order, please contact your local authorized Thomson™ distributor or Danaher Motion at 1-540-633-3400, Fax: 1-540-633-4162, or E-mail at [profilerail@DanaherMotion.com](mailto:profilerail@DanaherMotion.com).

DANAHER MOTION is a registered trademark of Danaher Corporation. Danaher Motion makes every attempt to ensure accuracy and reliability of the specifications in this publication. Specifications are subject to change without notice. Danaher Motion provides this information "AS IS" and disclaims all warranties, express or implied, including, but not limited to, implied warranties of merchantability and fitness for a particular purpose. It is the responsibility of the product user to determine the suitability of this product for a specific application. ©2004 Danaher Motion.

# Deflection vs. Applied Load

511 Style A, C, E  
Size 25

- 1. Preload 3% of C
  - 2. Preload 8% of C
  - 3. Preload 13% of C
- C = Dynamic load carrying capacity

Compressive Load

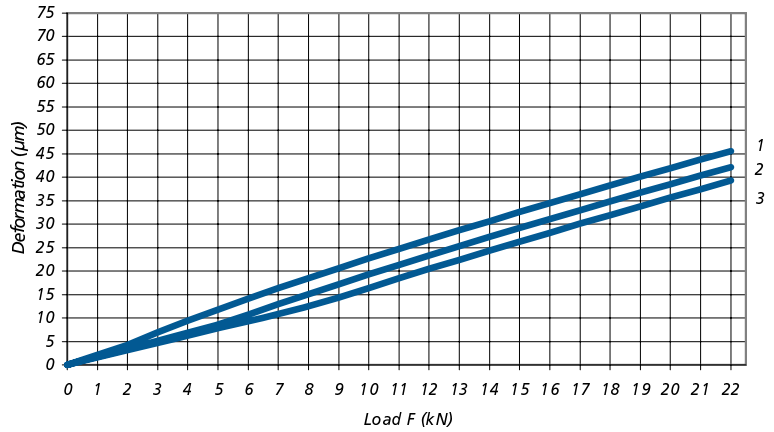
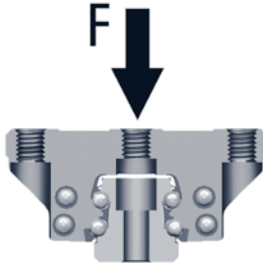

Tensile Load

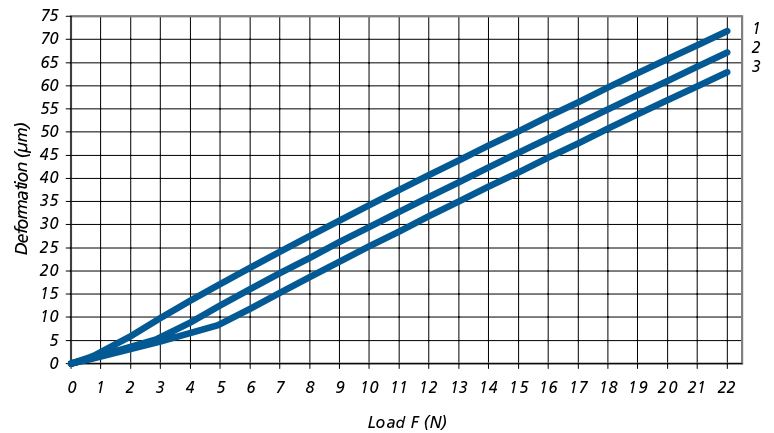
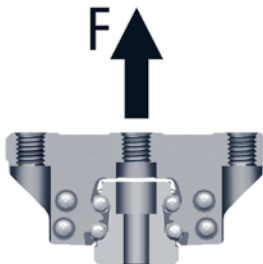

Lateral Load

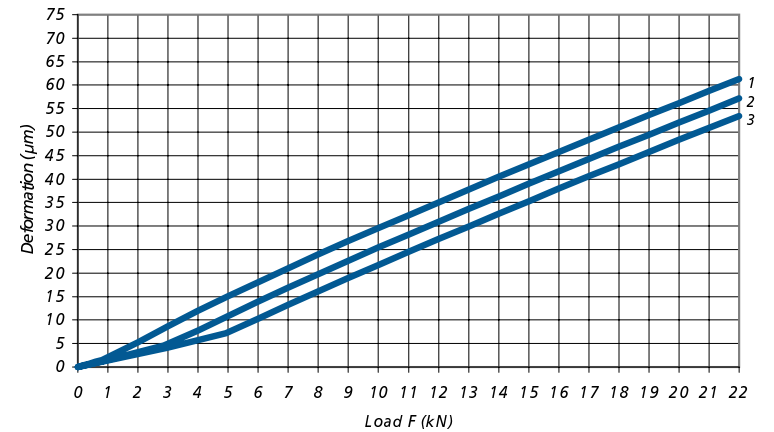
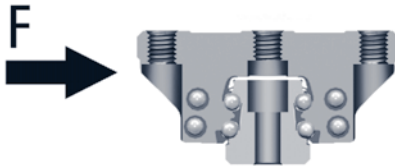

For more information, or to place an order, please contact your local authorized Thomson™ distributor or Danaher Motion at 1-540-633-3400, Fax: 1-540-633-4162, or E-mail at [profilerail@DanaherMotion.com](mailto:profilerail@DanaherMotion.com).

DANAHER MOTION is a registered trademark of Danaher Corporation. Danaher Motion makes every attempt to ensure accuracy and reliability of the specifications in this publication. Specifications are subject to change without notice. Danaher Motion provides this information "AS IS" and disclaims all warranties, express or implied, including, but not limited to, implied warranties of merchantability and fitness for a particular purpose. It is the responsibility of the product user to determine the suitability of this product for a specific application. ©2004 Danaher Motion.

# Deflection vs. Applied Load

511 Style B, D, F  
Size 25

- 1. Preload 3% of C
  - 2. Preload 8% of C
  - 3. Preload 13% of C
- C = Dynamic load carrying capacity

Compressive Load

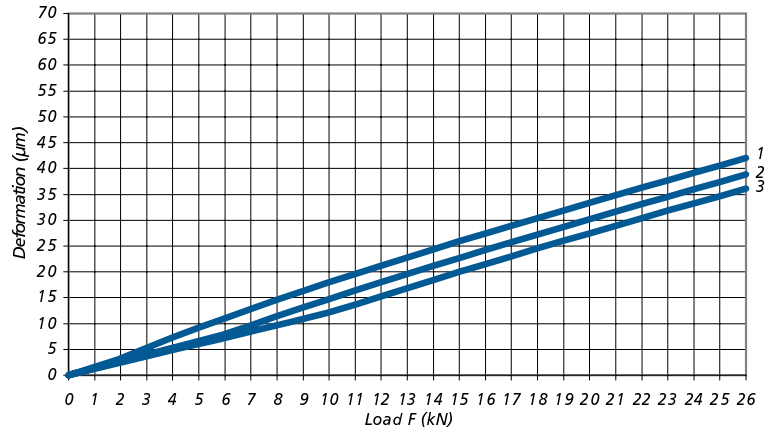
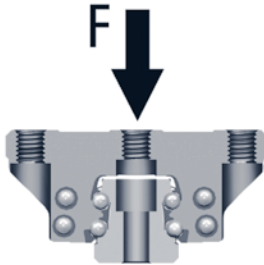

Tensile Load

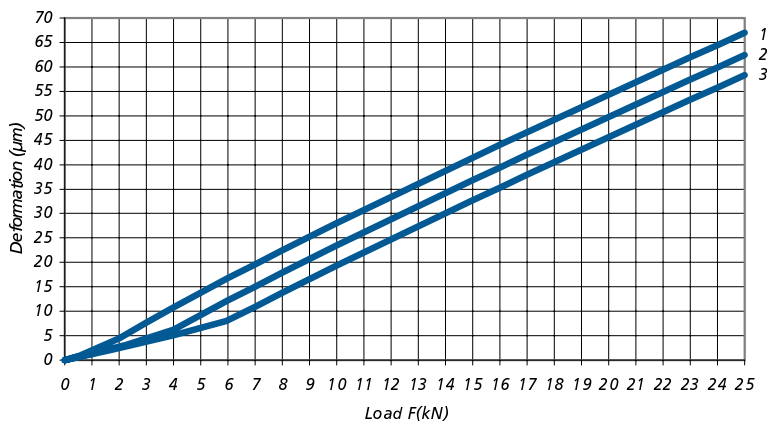
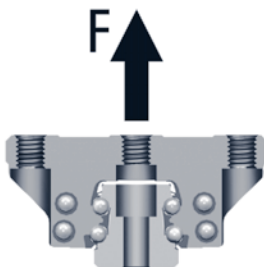

Lateral Load

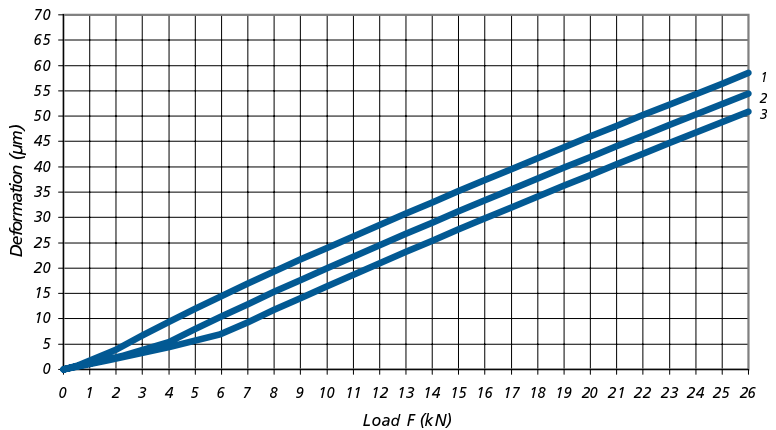
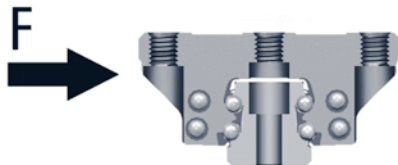

For more information, or to place an order, please contact your local authorized Thomson™ distributor or Danaher Motion at 1-540-633-3400, Fax: 1-540-633-4162, or E-mail at [profilerail@DanaherMotion.com](mailto:profilerail@DanaherMotion.com).

DANAHER MOTION is a registered trademark of Danaher Corporation. Danaher Motion makes every attempt to ensure accuracy and reliability of the specifications in this publication. Specifications are subject to change without notice. Danaher Motion provides this information "AS IS" and disclaims all warranties, express or implied, including, but not limited to, implied warranties of merchantability and fitness for a particular purpose. It is the responsibility of the product user to determine the suitability of this product for a specific application. ©2004 Danaher Motion.

## Deflection vs. Applied Load

511 Style A. C. E  
Size 30

- 1. Preload 3% of C
  - 2. Preload 8% of C
  - 3. Preload 13% of C
- C = Dynamic load carrying capacity

Compressive Load

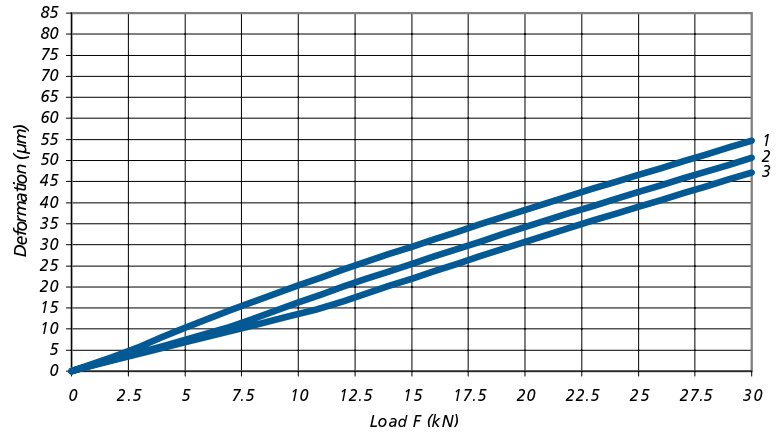
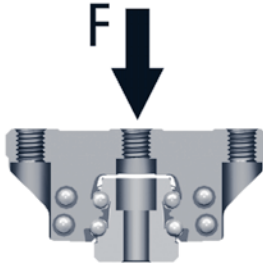

Tensile Load

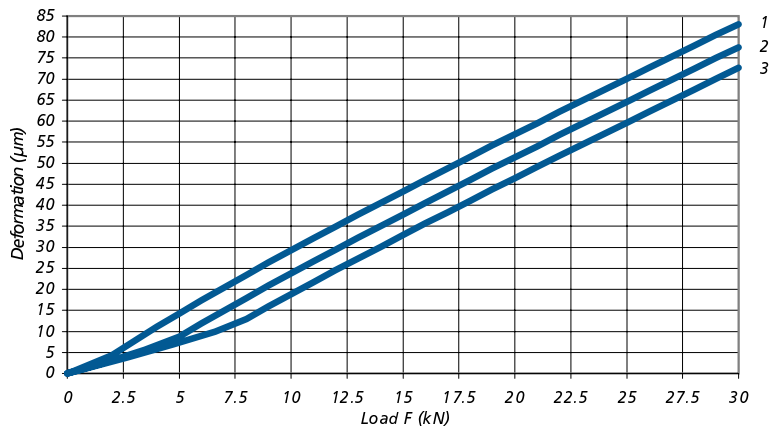
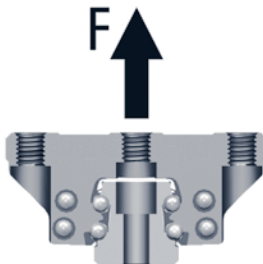

Lateral Load

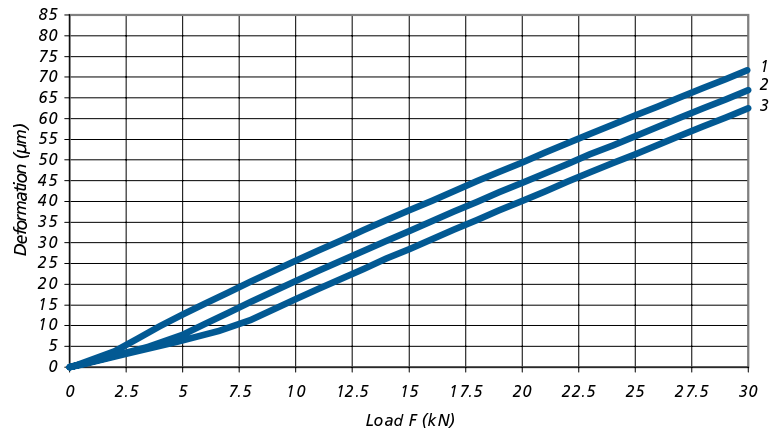
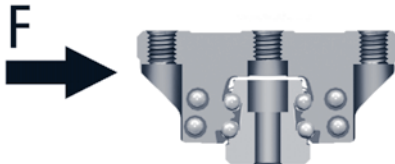

For more information, or to place an order, please contact your local authorized Thomson™ distributor or Danaher Motion at 1-540-633-3400, Fax: 1-540-633-4162, or E-mail at [profilerail@DanaherMotion.com](mailto:profilerail@DanaherMotion.com).

DANAHER MOTION is a registered trademark of Danaher Corporation. Danaher Motion makes every attempt to ensure accuracy and reliability of the specifications in this publication. Specifications are subject to change without notice. Danaher Motion provides this information "AS IS" and disclaims all warranties, express or implied, including, but not limited to, implied warranties of merchantability and fitness for a particular purpose. It is the responsibility of the product user to determine the suitability of this product for a specific application. ©2004 Danaher Motion.



# Deflection vs. Applied Load

511 Style B, D, F  
Size 30

- 1. Preload 3% of C
  - 2. Preload 8% of C
  - 3. Preload 13% of C
- C = Dynamic load carrying capacity

Compressive Load

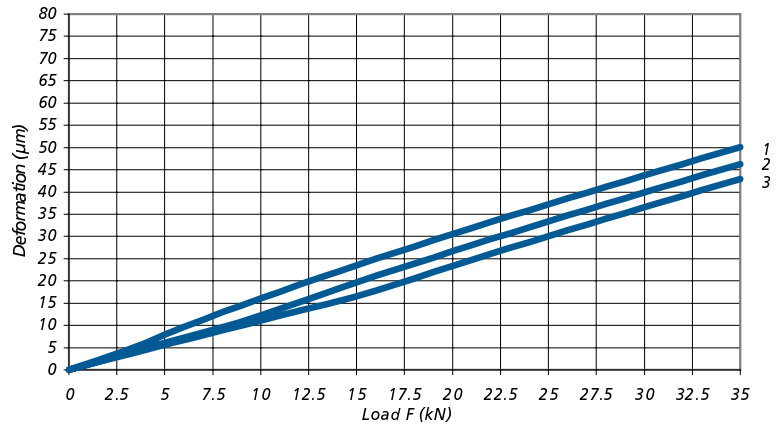
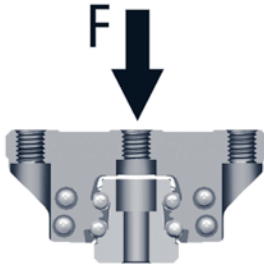

Tensile Load

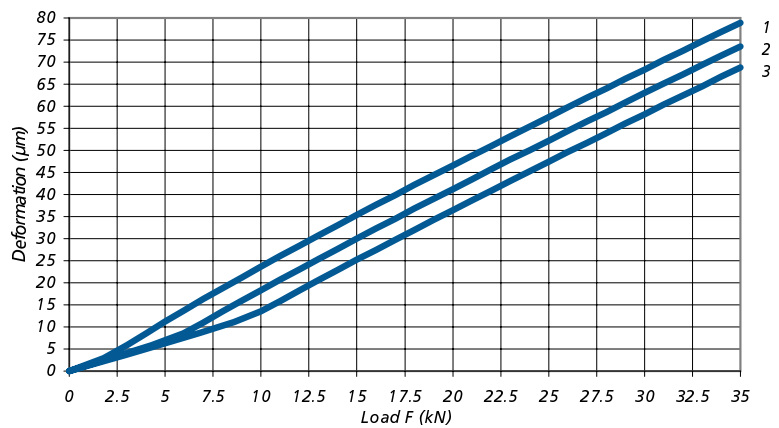
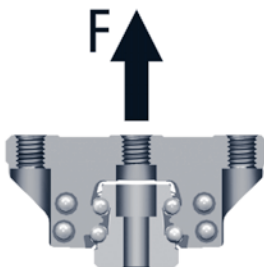

Lateral Load

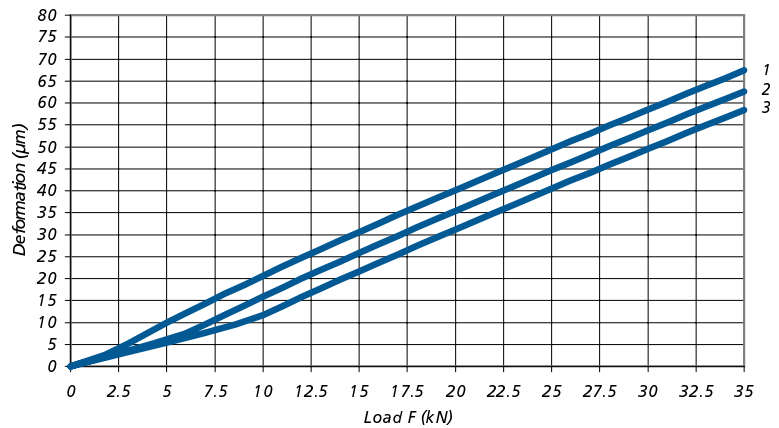
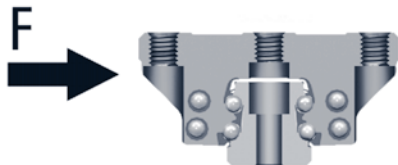

For more information, or to place an order, please contact your local authorized Thomson™ distributor or Danaher Motion at 1-540-633-3400, Fax: 1-540-633-4162, or E-mail at [profilerail@DanaherMotion.com](mailto:profilerail@DanaherMotion.com).

DANAHER MOTION is a registered trademark of Danaher Corporation. Danaher Motion makes every attempt to ensure accuracy and reliability of the specifications in this publication. Specifications are subject to change without notice. Danaher Motion provides this information "AS IS" and disclaims all warranties, express or implied, including, but not limited to, implied warranties of merchantability and fitness for a particular purpose. It is the responsibility of the product user to determine the suitability of this product for a specific application. ©2004 Danaher Motion.

# Deflection vs. Applied Load

511 Style A, C, E  
Size 35

- 1. Preload 3% of C
  - 2. Preload 8% of C
  - 3. Preload 13% of C
- C = Dynamic load carrying capacity

Compressive Load

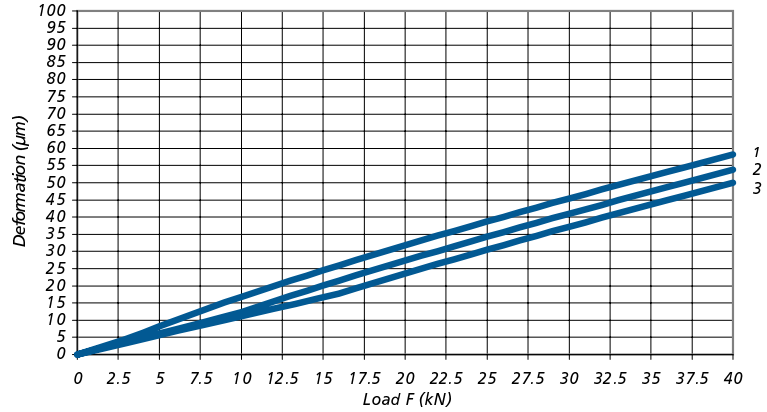
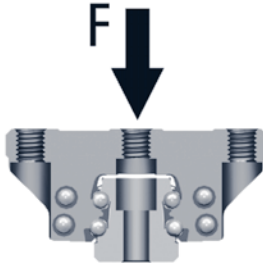

Tensile Load

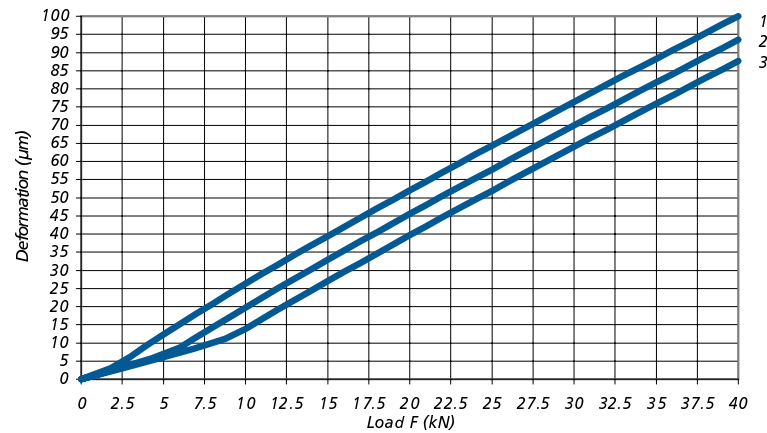
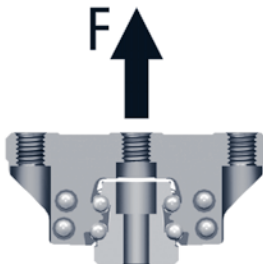

Lateral Load

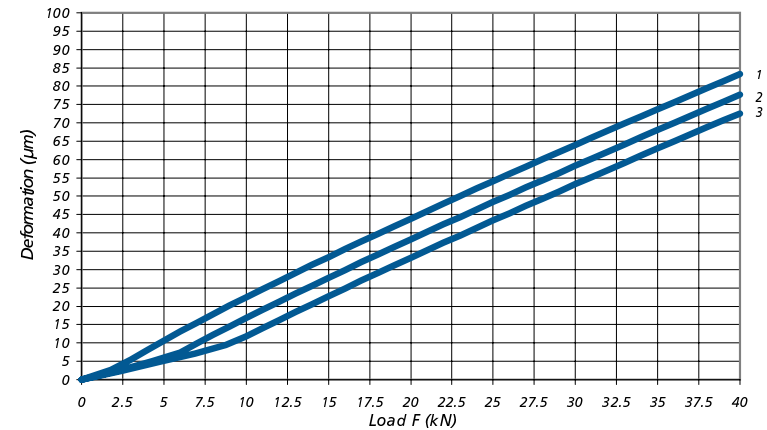
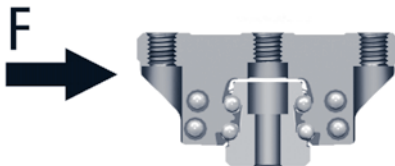

For more information, or to place an order, please contact your local authorized Thomson™ distributor or Danaher Motion at 1-540-633-3400, Fax: 1-540-633-4162, or E-mail at [profilerail@DanaherMotion.com](mailto:profilerail@DanaherMotion.com).

DANAHER MOTION is a registered trademark of Danaher Corporation. Danaher Motion makes every attempt to ensure accuracy and reliability of the specifications in this publication. Specifications are subject to change without notice. Danaher Motion provides this information "AS IS" and disclaims all warranties, express or implied, including, but not limited to, implied warranties of merchantability and fitness for a particular purpose. It is the responsibility of the product user to determine the suitability of this product for a specific application. ©2004 Danaher Motion.

# Deflection vs. Applied Load

511 Style B, D, F  
Size 35

- 1. Preload 3% of C
  - 2. Preload 8% of C
  - 3. Preload 13% of C
- C = Dynamic load carrying capacity

## Compressive Load

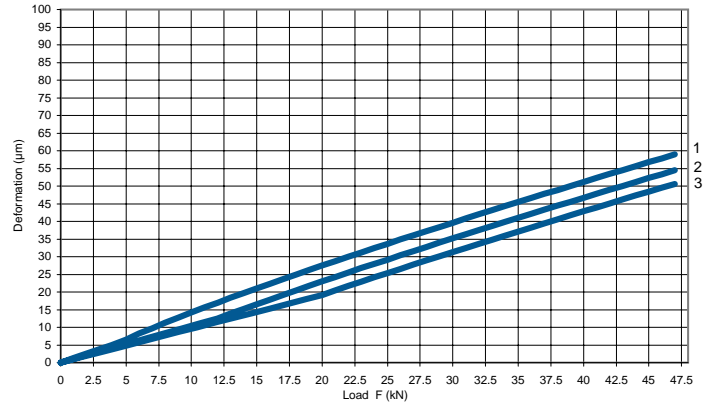
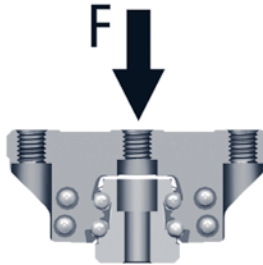

## Tensile Load

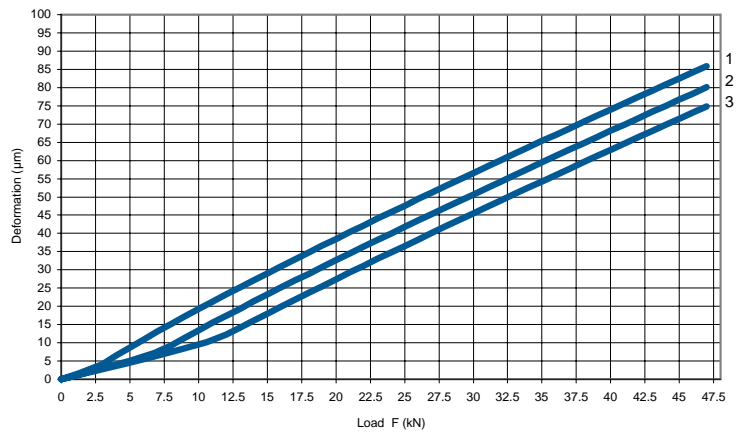
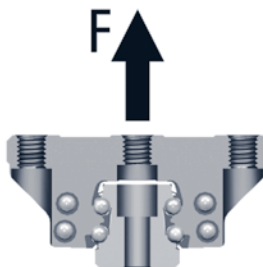

## Lateral Load

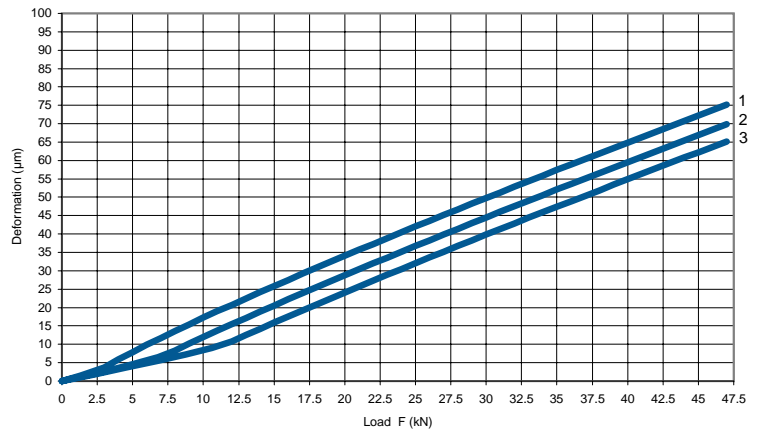
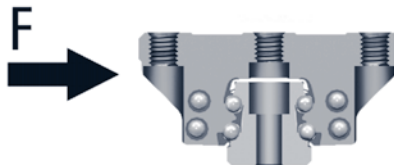

For more information, or to place an order, please contact your local authorized Thomson™ distributor or Danaher Motion at 1-540-633-3400, Fax: 1-540-633-4162, or E-mail at [profilerail@DanaherMotion.com](mailto:profilerail@DanaherMotion.com).

DANAHER MOTION is a registered trademark of Danaher Corporation. Danaher Motion makes every attempt to ensure accuracy and reliability of the specifications in this publication. Specifications are subject to change without notice. Danaher Motion provides this information "AS IS" and disclaims all warranties, express or implied, including, but not limited to, implied warranties of merchantability and fitness for a particular purpose. It is the responsibility of the product user to determine the suitability of this product for a specific application. ©2004 Danaher Motion.

# Deflection vs. Applied Load

511 Style A, C, E  
Size 45

- 1. Preload 3% of C
  - 2. Preload 8% of C
  - 3. Preload 13% of C
- C = Dynamic load carrying capacity

Compressive Load

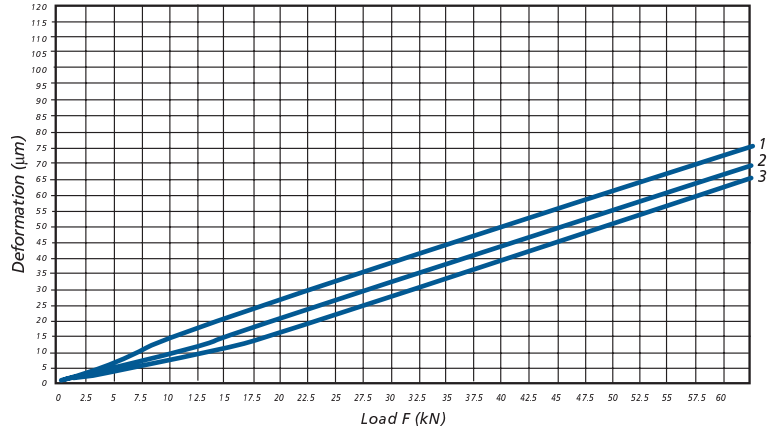
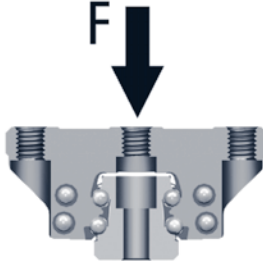

Tensile Load

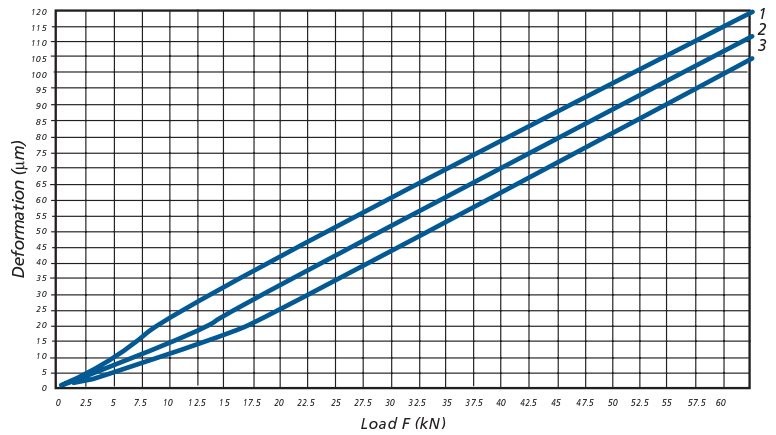
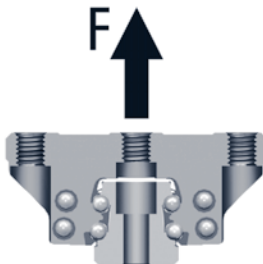

Lateral Load

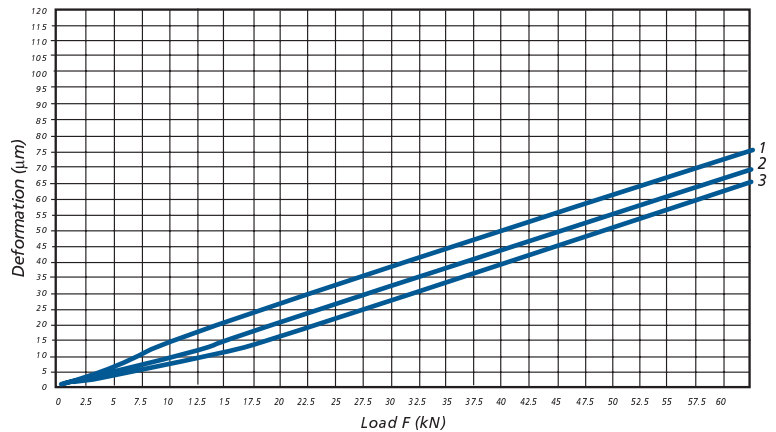
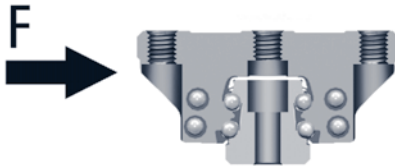

For more information, or to place an order, please contact your local authorized Thomson™ distributor or Danaher Motion at 1-540-633-3400, Fax: 1-540-633-4162, or E-mail at [profilerail@DanaherMotion.com](mailto:profilerail@DanaherMotion.com).

DANAHER MOTION is a registered trademark of Danaher Corporation. Danaher Motion makes every attempt to ensure accuracy and reliability of the specifications in this publication. Specifications are subject to change without notice. Danaher Motion provides this information "AS IS" and disclaims all warranties, express or implied, including, but not limited to, implied warranties of merchantability and fitness for a particular purpose. It is the responsibility of the product user to determine the suitability of this product for a specific application. ©2004 Danaher Motion.

# Deflection vs. Applied Load

511 Style B, D, F  
Size 45

- 1. Preload 3% of C
  - 2. Preload 8% of C
  - 3. Preload 13% of C
- C = Dynamic load carrying capacity

## Compressive Load

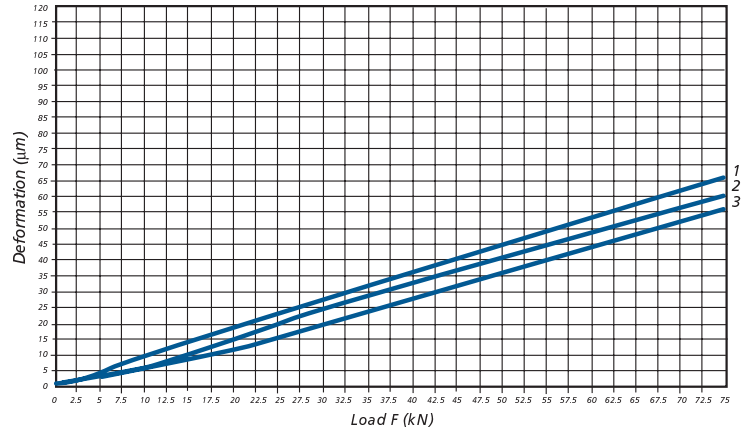
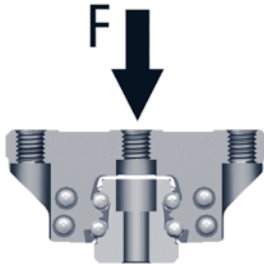

## Tensile Load

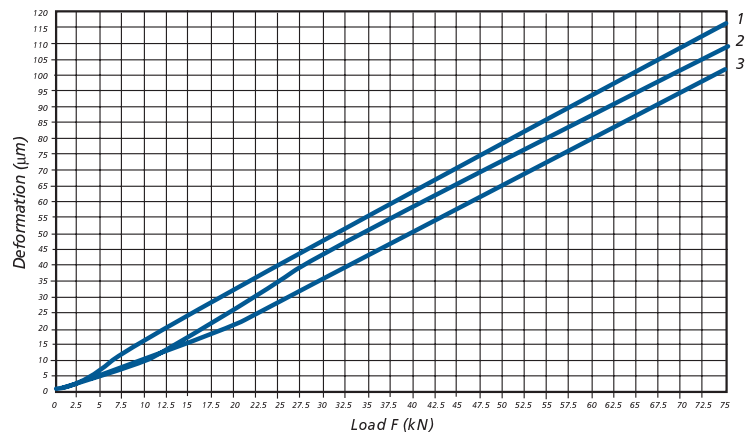
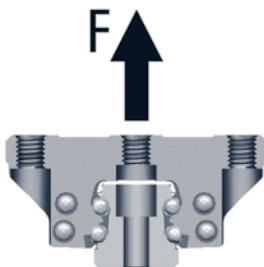

## Lateral Load

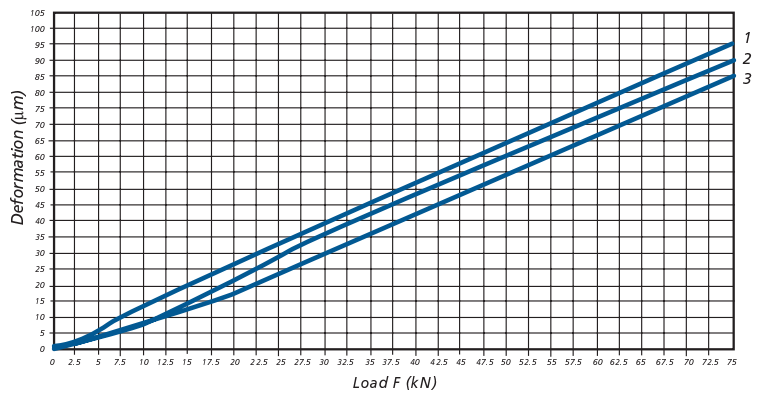
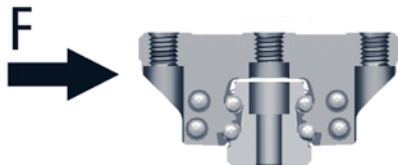

For more information, or to place an order, please contact your local authorized Thomson™ distributor or Danaher Motion at 1-540-633-3400, Fax: 1-540-633-4162, or E-mail at [profilerail@DanaherMotion.com](mailto:profilerail@DanaherMotion.com).

DANAHER MOTION is a registered trademark of Danaher Corporation. Danaher Motion makes every attempt to ensure accuracy and reliability of the specifications in this publication. Specifications are subject to change without notice. Danaher Motion provides this information "AS IS" and disclaims all warranties, express or implied, including, but not limited to, implied warranties of merchantability and fitness for a particular purpose. It is the responsibility of the product user to determine the suitability of this product for a specific application. ©2004 Danaher Motion.

# Deflection vs. Applied Load

- 1. Preload 3% of C
  - 2. Preload 8% of C
  - 3. Preload 13% of C
- C = Dynamic load carrying capacity

512 Style A and C  
Size 25

## Compressive Load

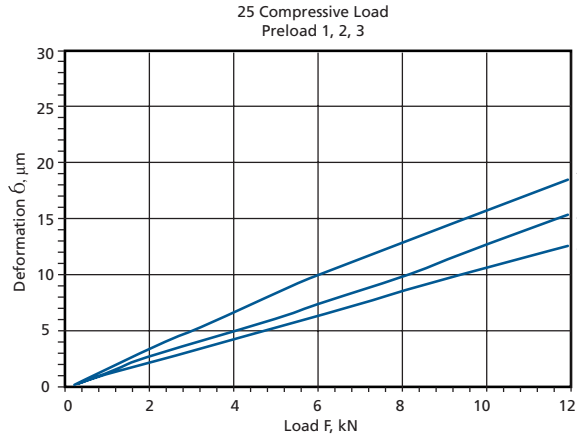
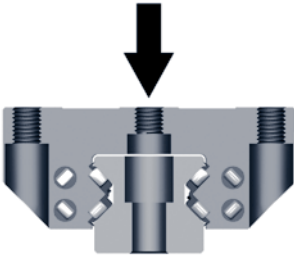

## Tensile Load

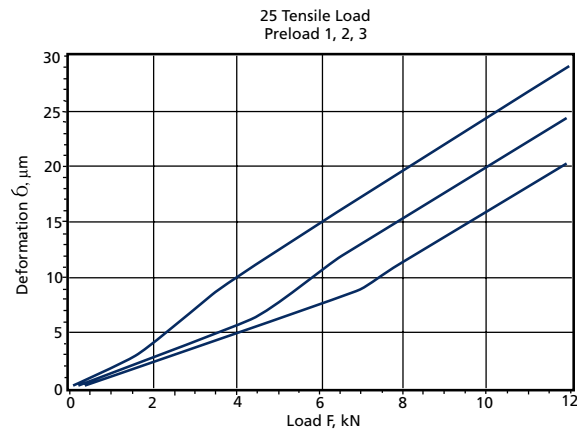
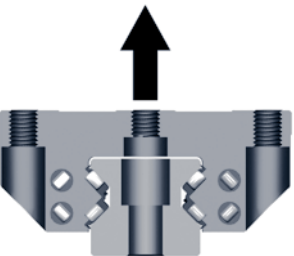

## Lateral Load

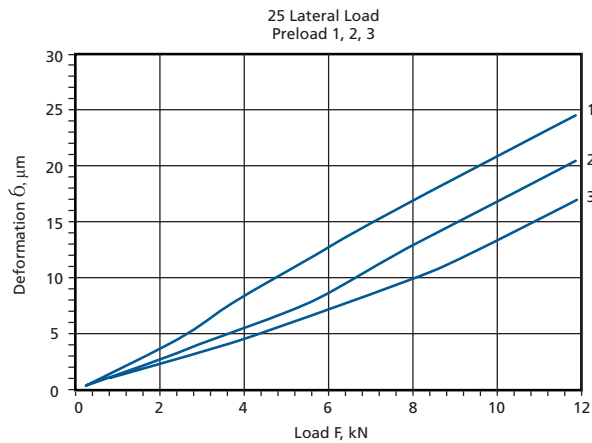
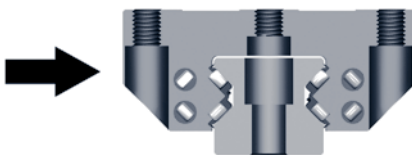

For more information, or to place an order, please contact your local authorized Thomson™ distributor or Danaher Motion at 1-540-633-3400, Fax: 1-540-633-4162, or E-mail at [profilerrail@DanaherMotion.com](mailto:profilerrail@DanaherMotion.com).

DANAHER MOTION is a registered trademark of Danaher Corporation. Danaher Motion makes every attempt to ensure accuracy and reliability of the specifications in this publication. Specifications are subject to change without notice. Danaher Motion provides this information "AS IS" and disclaims all warranties, express or implied, including, but not limited to, implied warranties of merchantability and fitness for a particular purpose. It is the responsibility of the product user to determine the suitability of this product for a specific application. ©2004 Danaher Motion.

# Deflection vs. Applied Load

512 Style B and D  
Size 25

- 1. Preload 3% of C
  - 2. Preload 8% of C
  - 3. Preload 13% of C
- C = Dynamic load carrying capacity

## Compressive Load

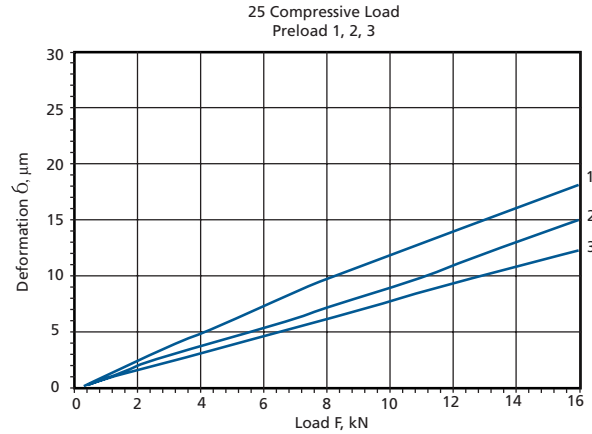
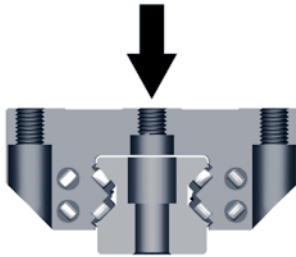

## Tensile Load

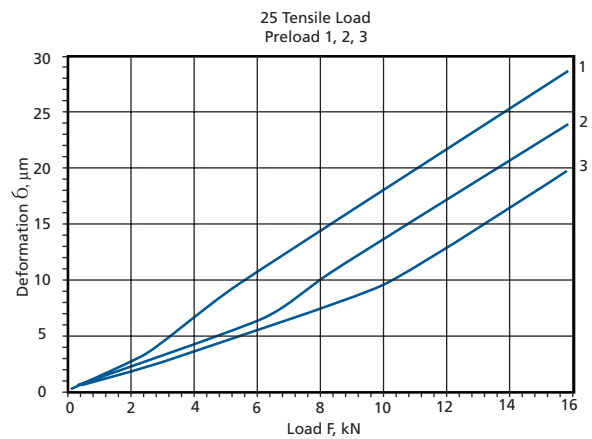
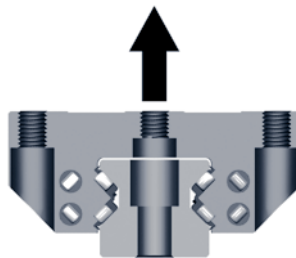

## Lateral Load

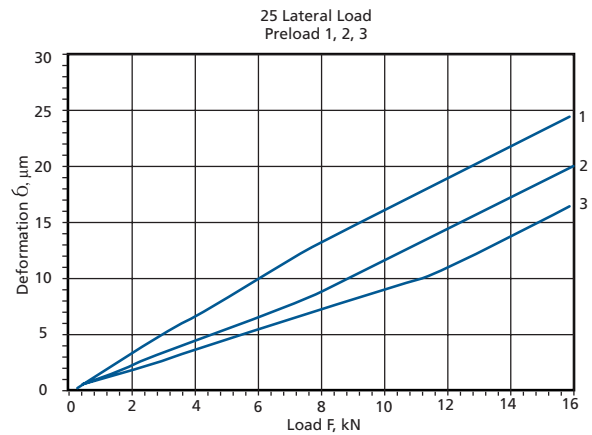
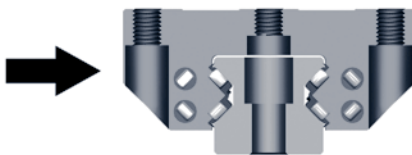

For more information, or to place an order, please contact your local authorized Thomson™ distributor or Danaher Motion at 1-540-633-3400, Fax: 1-540-633-4162, or E-mail at [profilerail@DanaherMotion.com](mailto:profilerail@DanaherMotion.com).

DANAHER MOTION is a registered trademark of Danaher Corporation. Danaher Motion makes every attempt to ensure accuracy and reliability of the specifications in this publication. Specifications are subject to change without notice. Danaher Motion provides this information "AS IS" and disclaims all warranties, express or implied, including, but not limited to, implied warranties of merchantability and fitness for a particular purpose. It is the responsibility of the product user to determine the suitability of this product for a specific application. ©2004 Danaher Motion.

# Deflection vs. Applied Load

512 Style A and C  
Size 35

- 1. Preload 3% of C
  - 2. Preload 8% of C
  - 3. Preload 13% of C
- C = Dynamic load carrying capacity

## Compressive Load

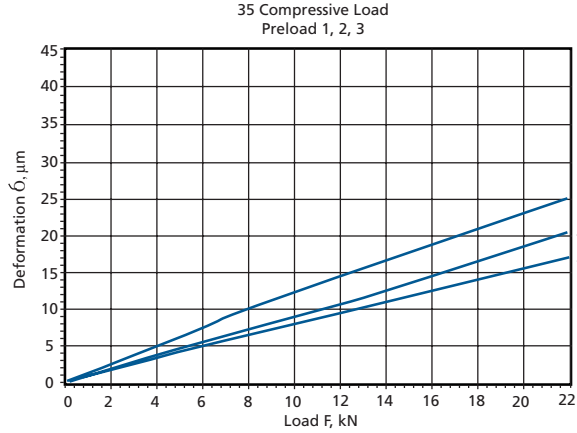
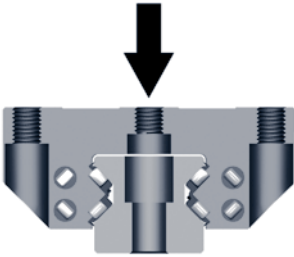

## Tensile Load

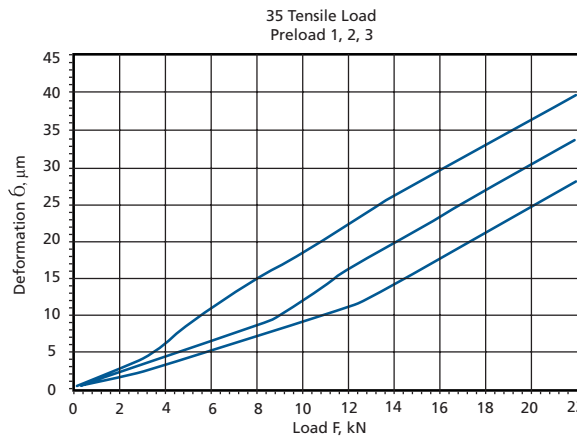
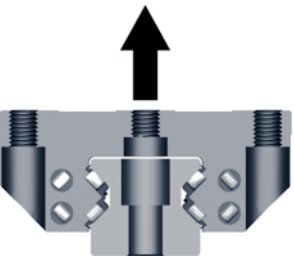

## Lateral Load

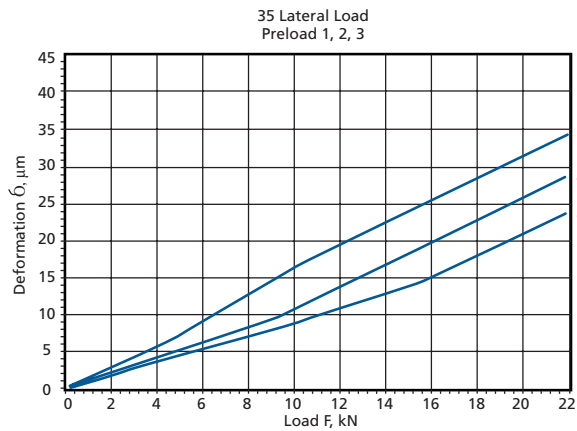
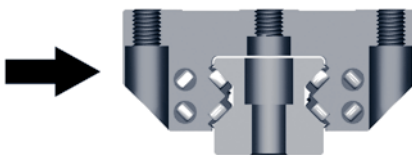

For more information, or to place an order, please contact your local authorized Thomson™ distributor or Danaher Motion at 1-540-633-3400, Fax: 1-540-633-4162, or E-mail at [profilerrail@DanaherMotion.com](mailto:profilerrail@DanaherMotion.com).

DANAHER MOTION is a registered trademark of Danaher Corporation. Danaher Motion makes every attempt to ensure accuracy and reliability of the specifications in this publication. Specifications are subject to change without notice. Danaher Motion provides this information "AS IS" and disclaims all warranties, express or implied, including, but not limited to, implied warranties of merchantability and fitness for a particular purpose. It is the responsibility of the product user to determine the suitability of this product for a specific application. ©2004 Danaher Motion.



# Deflection vs. Applied Load

512 Style B and D  
Size 35

- 1. Preload 3% of C
  - 2. Preload 8% of C
  - 3. Preload 13% of C
- C = Dynamic load carrying capacity

## Compressive Load

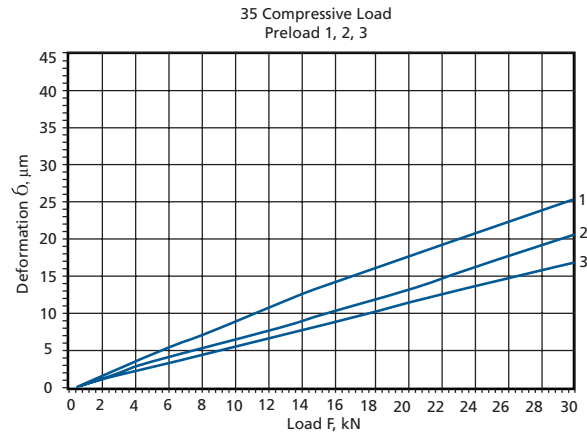
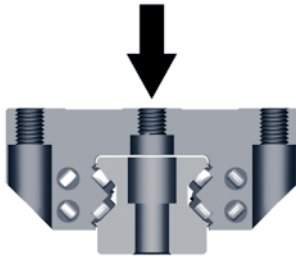

## Tensile Load

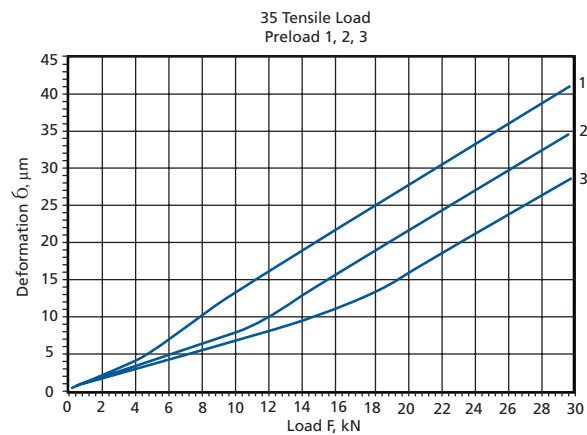
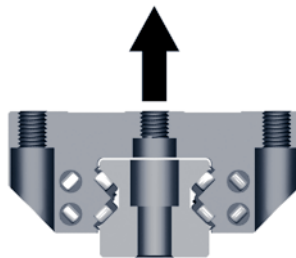

## Lateral Load

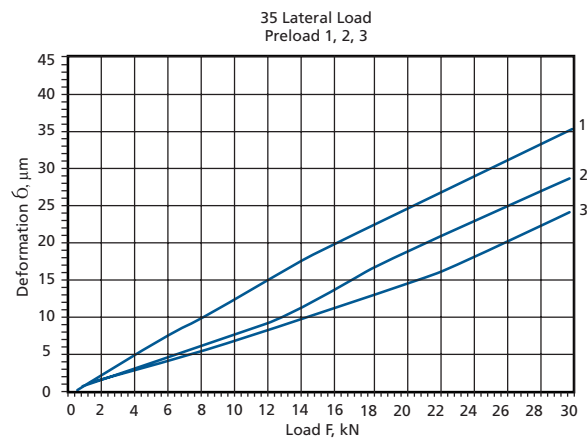
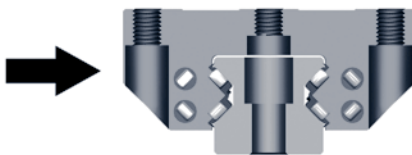

For more information, or to place an order, please contact your local authorized Thomson™ distributor or Danaher Motion at 1-540-633-3400, Fax: 1-540-633-4162, or E-mail at [profilerail@DanaherMotion.com](mailto:profilerail@DanaherMotion.com).

DANAHER MOTION is a registered trademark of Danaher Corporation. Danaher Motion makes every attempt to ensure accuracy and reliability of the specifications in this publication. Specifications are subject to change without notice. Danaher Motion provides this information "AS IS" and disclaims all warranties, express or implied, including, but not limited to, implied warranties of merchantability and fitness for a particular purpose. It is the responsibility of the product user to determine the suitability of this product for a specific application. ©2004 Danaher Motion.

# Deflection vs. Applied Load

512 Style A and C  
Size 45

- 1. Preload 3% of C
  - 2. Preload 8% of C
  - 3. Preload 13% of C
- C = Dynamic load carrying capacity

## Compressive Load

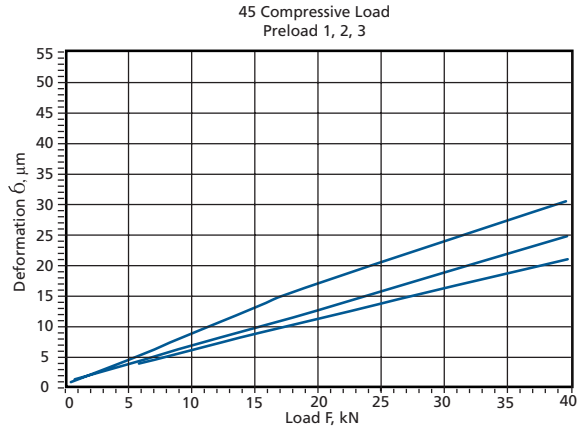
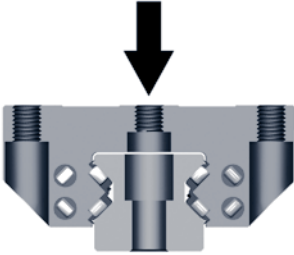

## Tensile Load

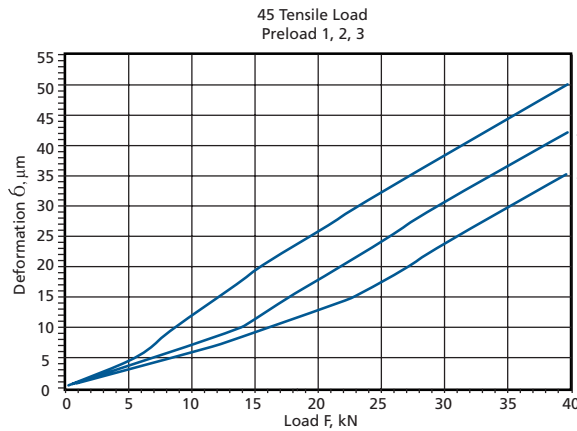
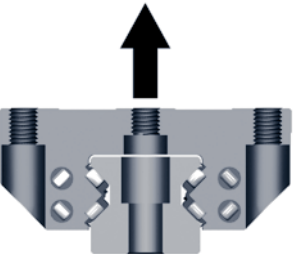

## Lateral Load

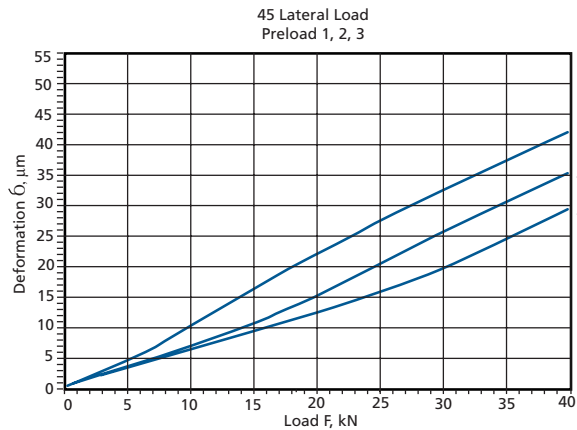
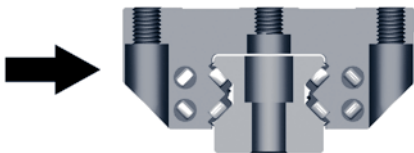

For more information, or to place an order, please contact your local authorized Thomson™ distributor or Danaher Motion at 1-540-633-3400, Fax: 1-540-633-4162, or E-mail at [profilerail@DanaherMotion.com](mailto:profilerail@DanaherMotion.com).

DANAHER MOTION is a registered trademark of Danaher Corporation. Danaher Motion makes every attempt to ensure accuracy and reliability of the specifications in this publication. Specifications are subject to change without notice. Danaher Motion provides this information "AS IS" and disclaims all warranties, express or implied, including, but not limited to, implied warranties of merchantability and fitness for a particular purpose. It is the responsibility of the product user to determine the suitability of this product for a specific application. ©2004 Danaher Motion.

# Deflection vs. Applied Load

512 Style B and D  
Size 45

- 1. Preload 3% of C
  - 2. Preload 8% of C
  - 3. Preload 13% of C
- C = Dynamic load carrying capacity

## Compressive Load

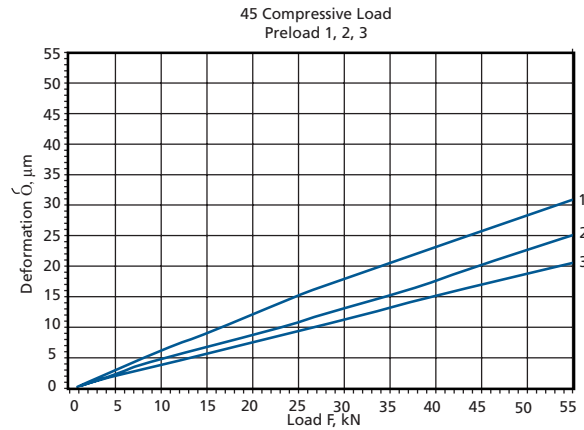
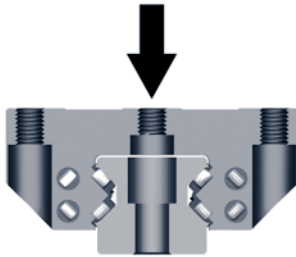

## Tensile Load

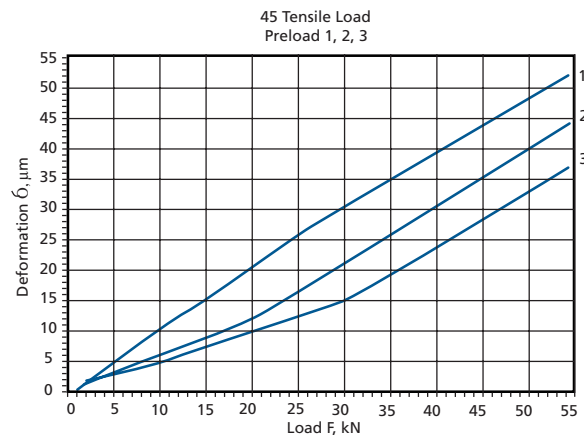
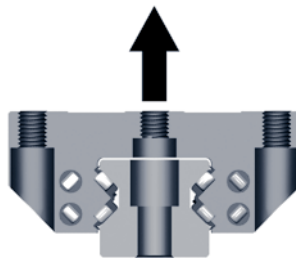

## Lateral Load

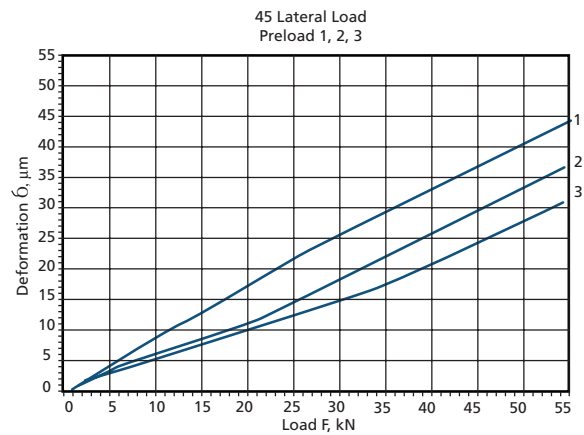
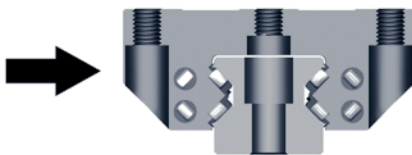

For more information, or to place an order, please contact your local authorized Thomson™ distributor or Danaher Motion at 1-540-633-3400, Fax: 1-540-633-4162, or E-mail at [profilerail@DanaherMotion.com](mailto:profilerail@DanaherMotion.com).

DANAHER MOTION is a registered trademark of Danaher Corporation. Danaher Motion makes every attempt to ensure accuracy and reliability of the specifications in this publication. Specifications are subject to change without notice. Danaher Motion provides this information "AS IS" and disclaims all warranties, express or implied, including, but not limited to, implied warranties of merchantability and fitness for a particular purpose. It is the responsibility of the product user to determine the suitability of this product for a specific application. ©2004 Danaher Motion.

## Deflection vs. Applied Load

512 Style A and C  
Size 55

1. Preload 3% of C
  2. Preload 8% of C
  3. Preload 13% of C
- C = Dynamic load carrying capacity

### Compressive Load

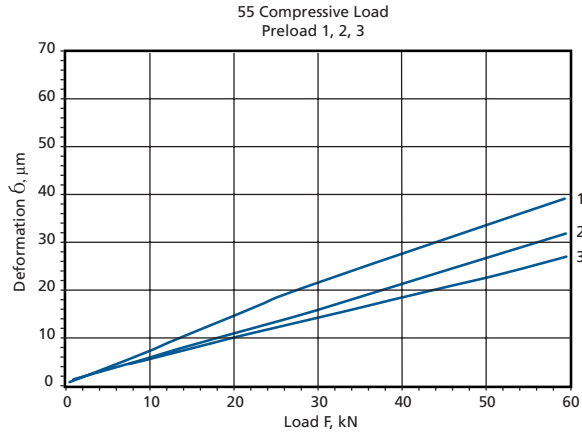
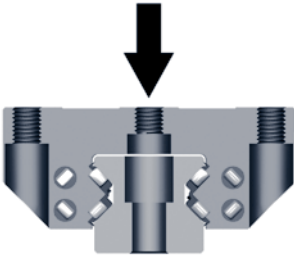

### Tensile Load

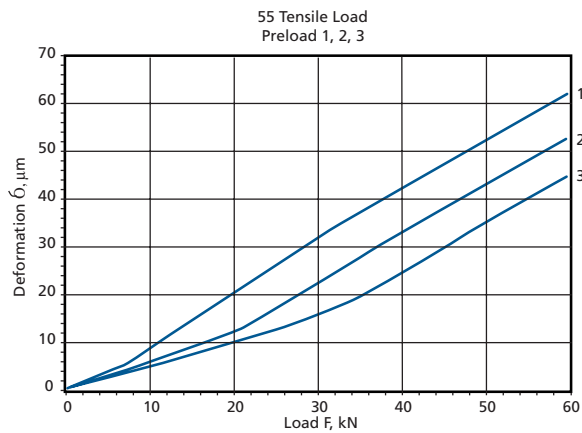
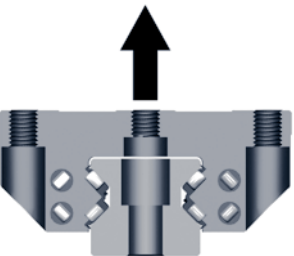

### Lateral Load

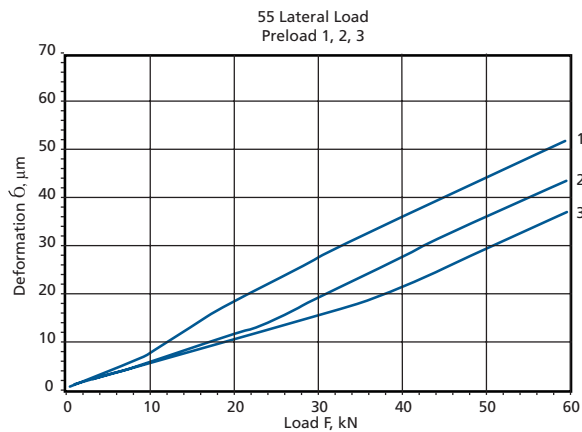
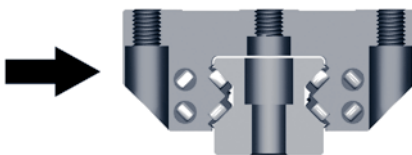

For more information, or to place an order, please contact your local authorized Thomson™ distributor or Danaher Motion at 1-540-633-3400, Fax: 1-540-633-4162, or E-mail at [profilerail@DanaherMotion.com](mailto:profilerail@DanaherMotion.com).

DANAHER MOTION is a registered trademark of Danaher Corporation. Danaher Motion makes every attempt to ensure accuracy and reliability of the specifications in this publication. Specifications are subject to change without notice. Danaher Motion provides this information "AS IS" and disclaims all warranties, express or implied, including, but not limited to, implied warranties of merchantability and fitness for a particular purpose. It is the responsibility of the product user to determine the suitability of this product for a specific application. ©2004 Danaher Motion.

## Deflection vs. Applied Load

512 Style B and D  
Size 55

- 1. Preload 3% of C
  - 2. Preload 8% of C
  - 3. Preload 13% of C
- C = Dynamic load carrying capacity

### Compressive Load

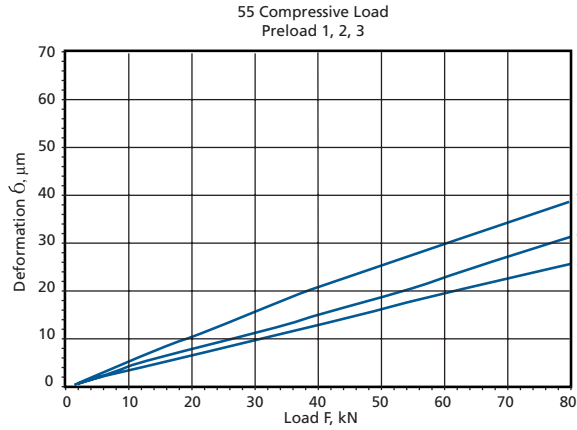
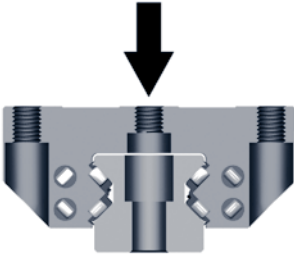

### Tensile Load

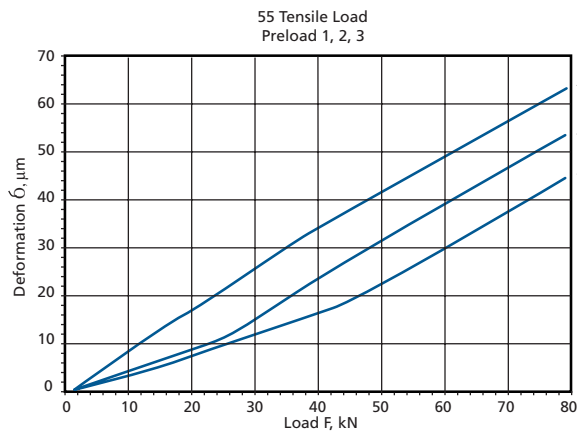
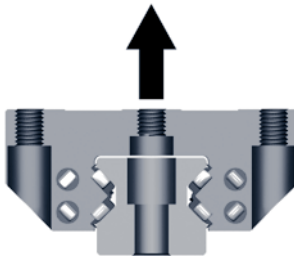

### Lateral Load

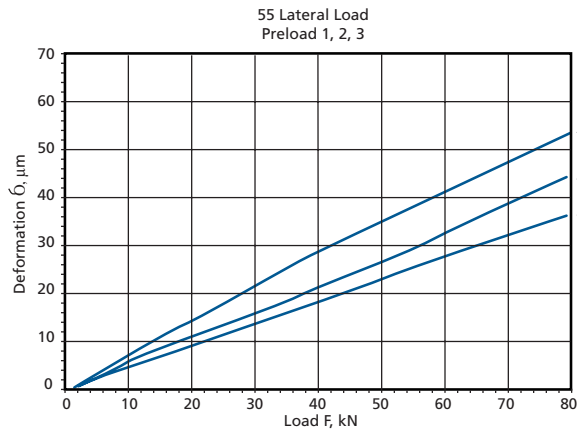
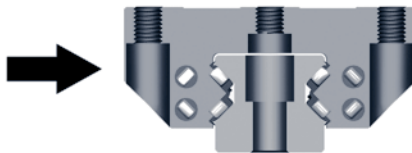

For more information, or to place an order, please contact your local authorized Thomson™ distributor or Danaher Motion at 1-540-633-3400, Fax: 1-540-633-4162, or E-mail at [profilerail@DanaherMotion.com](mailto:profilerail@DanaherMotion.com).

DANAHER MOTION is a registered trademark of Danaher Corporation. Danaher Motion makes every attempt to ensure accuracy and reliability of the specifications in this publication. Specifications are subject to change without notice. Danaher Motion provides this information "AS IS" and disclaims all warranties, express or implied, including, but not limited to, implied warranties of merchantability and fitness for a particular purpose. It is the responsibility of the product user to determine the suitability of this product for a specific application. ©2004 Danaher Motion.

# Deflection vs. Applied Load

512 Style B and D  
Size 65

- 1. Preload 3% of C
  - 2. Preload 8% of C
  - 3. Preload 13% of C
- C = Dynamic load carrying capacity

## Compressive Load

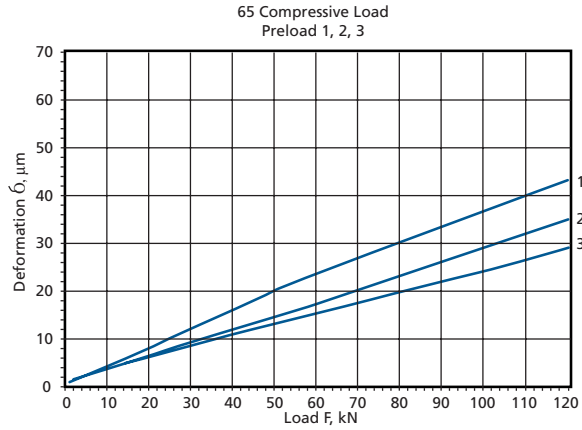
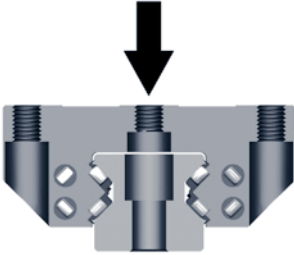

## Tensile Load

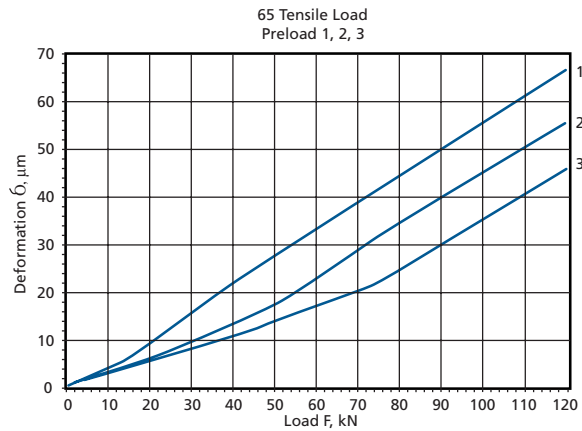
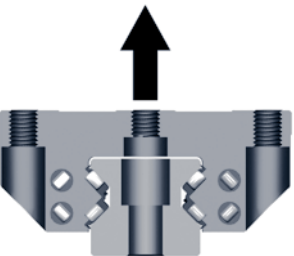

## Lateral Load

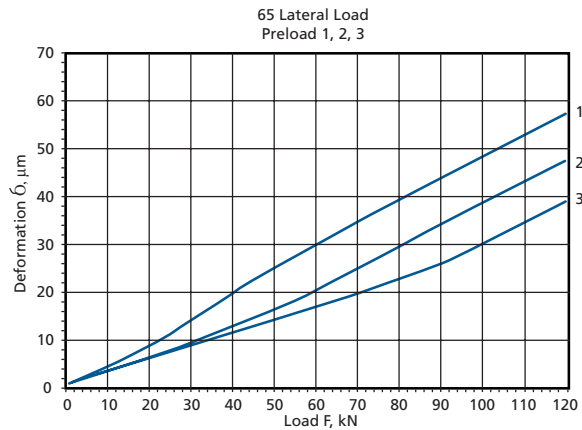
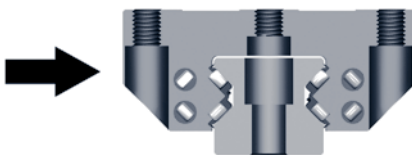

For more information, or to place an order, please contact your local authorized Thomson™ distributor or Danaher Motion at 1-540-633-3400, Fax: 1-540-633-4162, or E-mail at [profilerrail@DanaherMotion.com](mailto:profilerrail@DanaherMotion.com).

DANAHER MOTION is a registered trademark of Danaher Corporation. Danaher Motion makes every attempt to ensure accuracy and reliability of the specifications in this publication. Specifications are subject to change without notice. Danaher Motion provides this information "AS IS" and disclaims all warranties, express or implied, including, but not limited to, implied warranties of merchantability and fitness for a particular purpose. It is the responsibility of the product user to determine the suitability of this product for a specific application. ©2004 Danaher Motion.

## Actuation Force

The force required to actuate a linear guide ( $F_A$ ) has four basic components:

1. Frictional resistance ( $F_f$ )
2. Intrinsic resistance ( $D_{int}$ )

$$F_A = F_f + D_{int} + F_{inertia} + D_l$$

3. Inertia of the moving components ( $F_{inertia}$ )
4. Viscose drag of the lubrication ( $D_l$ )

## Frictional Resistance

### Rolling Element Guides

Friction occurs in rolling element guides as a result of slipping of the rolling elements on the raceways. The frictional resistance can be calculated by means of the following equation:

$$F_f = \mu \times F_i$$

Where:

$\mu$  = coefficient of friction (dependent upon type of guide type, rolling element type and load)

$F_i$  = force internal to the linear guide

The following table lists the coefficient of friction for different types of guides:

Profile Rail	
Ball Type	Roller Type
0.002 - 0.003	0.001 - 0.002

The value for the coefficient of friction is a function of the applied load. The coefficient of friction increases as load is applied. This is due to the increased contact area between the rolling elements and races.

The force internal to the linear guide is equal to the external force ( $F_{ext}$ ) applied to the linear guide in non-preloaded guides, and preloaded guides loaded beyond 3 times the preload value ( $F_p$ ).

$$F_i = F_{ext}$$

For preloaded guides loaded below a level of 3 times the preload value ( $F_p$ ), the internal force can be approximated with the following equation:

$$F_i = 2F_p + 1/3 F_{ext}$$

*For more information, or to place an order, please contact your local authorized Thomson™ distributor or Danaher Motion at 1-540-633-3400, Fax: 1-540-633-4162, or E-mail at [profilerail@DanaherMotion.com](mailto:profilerail@DanaherMotion.com).*

## Intrinsic Resistance

The intrinsic resistance is the measured actuation force required to move the guide at a constant velocity, without lubrication, regardless of load. It consists of the seal drag (larger component) and force required to circulate the rolling elements (smaller component). The intrinsic resistance can be assumed to be a constant for linear guides carrying more than 5% of their dynamic load rating (C). For guides loaded below that value, the force required to circulate the rolling elements will increase.

The following chart shows the intrinsic resistance,  $D_{intr}$ , for different types and sizes of linear guides.

### Inertia of Moving Components

Inertia is directly related to the mass and acceleration by the following equation:  $F_{inertia} = Ma$

### Viscose Drag of the Lubrication

The viscose drag of the lubricant is dependent upon the viscosity of the lubricant selected.

### Preload

Preload of the assembly has an effect on intrinsic resistance, the greater the preload the greater the intrinsic resistance to move the guide.

### 500 Series Ball Profile Rail

Size Dint (N)	Carriage Style A, C Dint (N)		Carriage Style B, D Dint (N)	
	0.03C	0.13C	0.03C	0.13C
Preload				
15	7	15	8	14
20	10	16	11	18
25	13	22	14	22
30	16	26	19	30
35	23	37	25	41
45	27	44	30	49

Values for lubricant oil VG68, speed 0.1 m/s

### 500 Series Roller Profile Rail

Size	Carriage Style A,C $D_{int}$ (N)	Carriage Style B,D $D_{int}$ (N)
25	17	18
35	35	51
45	53	60
55	98	124
65	—	170

Value for 0.13 C Preload, lubricant oil VG68, speed 0.1 m/s

### AccuMini Linear Guide

Size	Carriage Style AA $D_{int}$ (N)
10	0.9
15	2.8
20	7.0

Values for clearance preload, no lubricant

For more information, or to place an order, please contact your local authorized Thomson™ distributor or Danaher Motion at 1-540-633-3400, Fax: 1-540-633-4162, or E-mail at [profilerrail@DanaherMotion.com](mailto:profilerrail@DanaherMotion.com).

DANAHER MOTION is a registered trademark of Danaher Corporation. Danaher Motion makes every attempt to ensure accuracy and reliability of the specifications in this publication. Specifications are subject to change without notice. Danaher Motion provides this information "AS IS" and disclaims all warranties, express or implied, including, but not limited to, implied warranties of merchantability and fitness for a particular purpose. It is the responsibility of the product user to determine the suitability of this product for a specific application. ©2004 Danaher Motion.



## Lubrication

Lubrication provides protection against wear, corrosion, heat, and friction. Application-specific variables, such as load, speed, and environmental conditions, determine the most suitable lubricant and lubrication schedule for that specific application.

Danaher Motion's general lubricant recommendation for linear guides is a grade 2 grease. A maximum of one year or 100km, whichever comes first, between applications of lubricant is recommended. A grease with an extreme pressure additive should be used for guides loaded beyond 50 of their dynamic load rating (C). Oil can also be used and is recommended in applications where the bearings experience high speeds. Use the uppermost lubrication port on oil-lubricated bearings that are vertically oriented to ensure gravity-assisted lubricant dispersal.

Linear guide products are supplied with a light coating of preservative oil. This preservative oil is for storage purposes only and is not recommended as lubrication for the bearing.

### Lubrication Procedure

For best lubrication dispersal, the carriage should be moved on the rail while applying lubricant to ensure circulation to all internal bearing surfaces. It is not possible to over lubricate the bearings, as excess lubricant will merely exit the carriage under the seals.

Recommended initial volumes of lubricant for 500 Series bearings are shown in the tables. The recommended volume for relubrication is 1/2 the initial volume.

### Short Stroke

In the case of a stroke less than 2X's the carriage length, two lubrication connections are recommended, one at each end to ensure adequate lubrication to the entire ball or roller track.

### Oil Reservoir

The oil reservoir is supplied from the factory ready for installation (filled with oil). Relubrication is dependent upon many factors such as speeds, temperature, cleanliness, etc. The following is a guideline for relubrication. (It is recommended to relubricate every 12 months.)

Relubrication Interval								
Size	15	20	25	30	35	45	55	65
Travel Distance	2500km					5000km		

The oil reservoir is filled in the factory with Kluber Lamora D220 oil. If relubricating with different oil it is the responsibility of the user to determine oil compatibility. The recommended refill quantity is shown in the table.

### Initial Grease Volume for 500 Series Ball Bearings

Size	Carriage Style A, C, E (cm <sup>3</sup> )	Carriage Style B, D, F (cm <sup>3</sup> )
15	0.9	--
20	1.7	2.1
25	2.8	3.5
30	4.7	5.8
35	6.6	8.1
45	12.6	15.6

### Initial Grease Volume for 500 Series Roller Bearings

Size	Carriage Style A, C (cm <sup>3</sup> )	Carriage Style B, D (cm <sup>3</sup> )
25	1.9	2.2
35	2.9	3.7
45	5.3	6.6
55	10.6	10.6
65	--	18.9

### Oil Reservoir Refill Quantity

Size	500 Series Ball 5310W Oil (cm <sup>3</sup> )	500 Series Roller 5320W Oil Qty (cm <sup>3</sup> )
15	0.5	—
20	1.4	—
25	2.4	2.2
30	2.9	—
35	5.	6
45	10.9	11
55	—	19
65	—	43

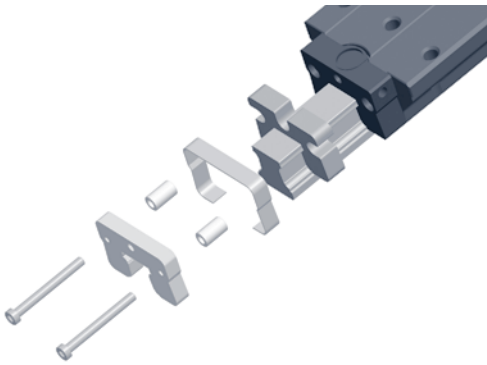

## Self-Lubricating Profile Rail Lube Block

The self-lubricating Lube Block option offers maintenance free operation and enhanced protection for a broad range of applications. It offers:

- Reduced system cost by eliminating the need for designing, purchasing, and installing expensive lubrication systems.
- Environmentally friendly operation
- Increased bearing life by offering enhanced protection

### Design

The self-lubricating option utilizes self-lubricating attachments at both ends of the carriage and includes an initial EP2 grease pack of the carriage. The self-lubricating attachments consist of a section of oil saturated polymer actively compressed by a contact spring, inside a double lip seal.

A contact spring assures continuous contact with the rail, releasing oil as the carriage moves. This ensures a film of lubricant between the rolling elements and races. When the carriage is at rest, oil is re-absorbed by the polymer.

### Performance

The design has incorporated a proven oil-saturated polymer used for over 10 years to lubricate radial bearings. This method of lubrication has a successful track record in applications ranging from food processing to automotive assembly.

The graph below shows the theoretical L10 life expectancy and actual test results for the following two methods of lubrication:

1. Bearing with self-lubricating attachments only.
2. Bearing initially packed with EP2 grease only.

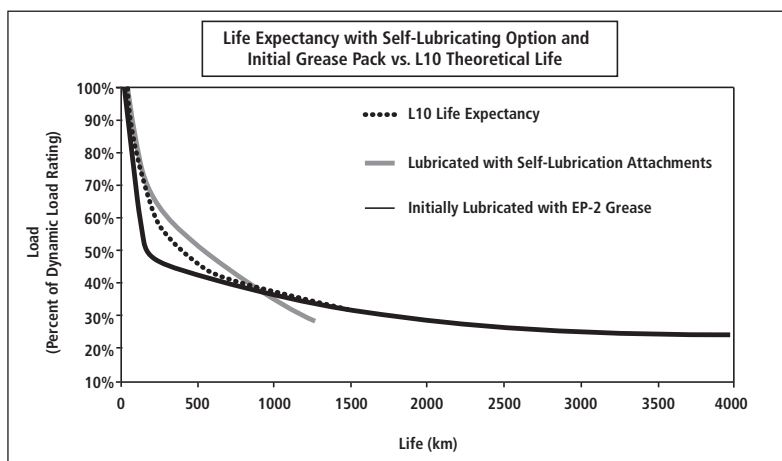

#### Testing Parameters

Stroke: 500 mm  
Speed: 0,6 m/s

This chart illustrates how using the self-lubricating option, which combines the self-lubricating attachments and initial grease pack, will enable the bearing to achieve the L10 life expectancy under all loading condition. Note that for travel lives exceeding 30,000 km, recharging or replacing of the self-lubricating polymer is recommended.

For more information, or to place an order, please contact your local authorized Thomson™ distributor or Danaher Motion at 1-540-633-3400, Fax: 1-540-633-4162, or E-mail at [profilerrail@DanaherMotion.com](mailto:profilerrail@DanaherMotion.com).

DANAHER MOTION is a registered trademark of Danaher Corporation. Danaher Motion makes every attempt to ensure accuracy and reliability of the specifications in this publication. Specifications are subject to change without notice. Danaher Motion provides this information "AS IS" and disclaims all warranties, express or implied, including, but not limited to, implied warranties of merchantability and fitness for a particular purpose. It is the responsibility of the product user to determine the suitability of this product for a specific application. ©2004 Danaher Motion.

## Calculations for Bellows Cover Extended Length & Rail Length

### Given the Stroke and Distance Between Carriage Extremes:

Way Cover Extended Length (mm) = Stroke (mm) / (1-CR). After dividing, round number up to the next increment of 5mm. This value is used as the length in the way cover part number when ordering.

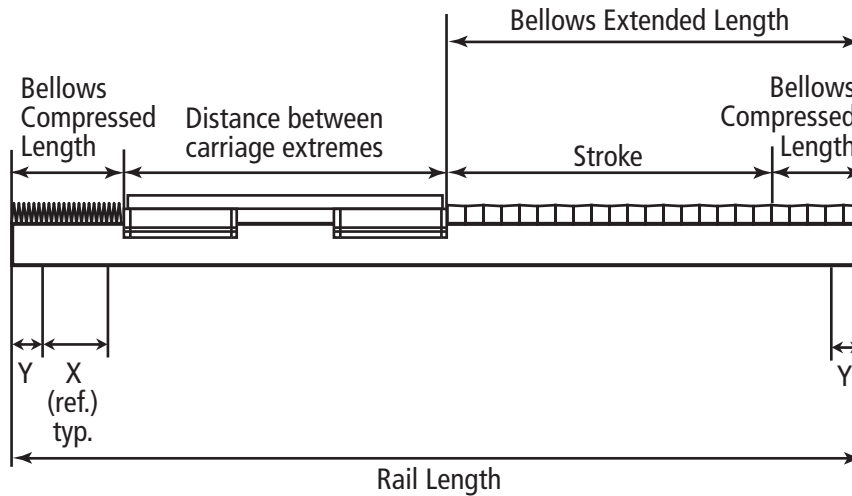

The Way Cover Extended Length will be cut to next vee at the factory.

Way Cover Compressed Length (mm) = Way Cover Extended Length (mm) - Stroke (mm)

Rail Length = Compressed Length + Extended Length + Distance Between Carriage Extremes.

### Example:

Product: 500 Series Ball Linear Guide Size 35

Stroke Length = 200mm

Distance Between Carriage Extremes = 520mm

Bellows Type = Walk-On

CR = 0.19 for size 35 500 Series Ball Walk-on type bellows

Way Cover Extended Length = Stroke / (1-CR) = 200mm / (1-0.19) = 200mm / .81 = 246.91mm

Round up to next increment of 5mm, therefore, Way Cover Extended Length = 250 mm

Way Cover Compressed Length = Way Cover Extended Length - Stroke = 250mm - 200mm = 50mm

Rail Length = Compressed Length + Extended Length + Distance Between Carriage Extremes = 50mm + 250mm + 520mm = 820mm

For more information, or to place an order, please contact your local authorized Thomson™ distributor or Danaher Motion at 1-540-633-3400, Fax: 1-540-633-4162, or E-mail at [profilerail@DanaherMotion.com](mailto:profilerail@DanaherMotion.com).

DANAHER MOTION is a registered trademark of Danaher Corporation. Danaher Motion makes every attempt to ensure accuracy and reliability of the specifications in this publication. Specifications are subject to change without notice. Danaher Motion provides this information "AS IS" and disclaims all warranties, express or implied, including, but not limited to, implied warranties of merchantability and fitness for a particular purpose. It is the responsibility of the product user to determine the suitability of this product for a specific application. ©2004 Danaher Motion.

## Specification Sheet for the Butting of Rails

A butt joint will be required for rail lengths longer than the maximum shown in the chart below. If a butt joint is required, the 1st and 2nd rail lengths must each be less than the maximum shown. The "Y1" and "Y2" dimensions must be between the minimum and maximum shown below to avoid cutting into a mounting hole. The standard "Z" dimension should be used for best performance.

Linear Guide Product	Size	"X" dim	Standard "Z" dim	Minimum "Y" dim	Maximum "Y" dim	Fastener size	Maximum length without a joint
500 Series Ball	15	60	30	8	52	M4	1 500
500 Series Ball	20	60	30	8	52	M5	3 000
500 Series Ball	25	60	30	8	52	M5	6 000
500 Series Ball	30	80	40	10	70	M8	6 000
500 Series Ball	35	80	40	10	70	M8	6 000
500 Series Ball	45	105	52.5	13	92	M12	6 000
500 Series Roller	25	30	30	8	52	M6	6 000
500 Series Roller	35	40	40	10	30	M8	6 000
500 Series Roller	45	52.5	52.5	13	39.5	M12	6 000
500 Series Roller	55	60	60	15	45	M14	6 000
500 Series Roller	65	75	75	17	58	M16	6 000

All dimensions in mm.

For more information, or to place an order, please contact your local authorized Thomson™ distributor or Danaher Motion at 1-540-633-3400, Fax: 1-540-633-4162, or E-mail at [profilerail@DanaherMotion.com](mailto:profilerail@DanaherMotion.com).

DANAHER MOTION is a registered trademark of Danaher Corporation. Danaher Motion makes every attempt to ensure accuracy and reliability of the specifications in this publication. Specifications are subject to change without notice. Danaher Motion provides this information "AS IS" and disclaims all warranties, express or implied, including, but not limited to, implied warranties of merchantability and fitness for a particular purpose. It is the responsibility of the product user to determine the suitability of this product for a specific application. ©2004 Danaher Motion.

### Request for Quotation Form

ABCDEF

## Specification sheet for the butting of 2 rails

1234

1. "Z" composed of the two rail ends that form joint, which must be of equal value from center of closest hole to end of rails.

ABCDEF

4321

Customer: \_\_\_\_\_

Quotation Number: \_\_\_\_\_

DO NOT SCALE DRAWING

APPROVAL	DATE
DRAWN BY	DATE

Drwg Number: \_\_\_\_\_

DANAHER  
MOTION  
Radford, VA

TITLE

ABCDEF

4321

FAX A COPY OF THIS FORM TO SALES ENGINEERING DEPARTMENT, FAX# 1-540-633-3490

DANAHER MOTION is a registered trademark of Danaher Corporation. Danaher Motion makes every attempt to ensure accuracy and reliability of the specifications in this publication. Specifications are subject to change without notice. Danaher Motion provides this information "AS IS" and disclaims all warranties, express or implied, including, but not limited to, implied warranties of merchantability and fitness for a particular purpose. It is the responsibility of the product user to determine the suitability of this product for a specific application. ©2004 Danaher Motion.

## Request for Quotation Form

### Specification sheet for the butting of 3 or more rails

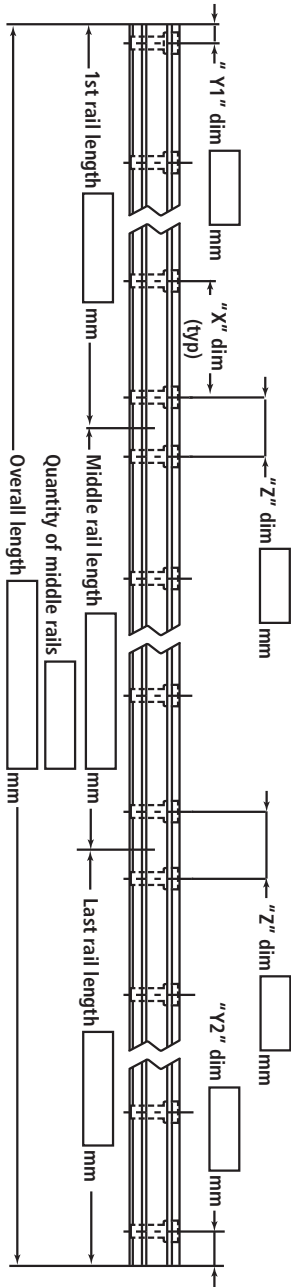

Customer: \_\_\_\_\_

Quotation Number: \_\_\_\_\_

DO NOT SCALE DRAWING

APPROVAL DATE

DRAWN BY DATE

Dwg Number: \_\_\_\_\_



TITLE

FAX A COPY OF THIS FORM TO SALES ENGINEERING DEPARTMENT, FAX# 1-540-633-3490

Quantity	Conventional		SI Unit	Conversion Factors
	Inch Unit	Metric Unit (MKS)		
<b>Length</b>	Inch <b>in</b>	Meter <b>m</b>	Metre <b>m</b>	1 in = 25.4 mm 1 mm = 0.03937 in 1 m = 3.2808 ft 1 ft = 0.3048 m
<b>Area</b>	Square Inch <b>in<sup>2</sup></b>	Square Meter <b>m<sup>2</sup></b>	Square Metre <b>m<sup>2</sup></b>	1 in <sup>2</sup> = 6.4516 cm <sup>2</sup> 1 cm <sup>2</sup> = 0.155 in <sup>2</sup> 1 m <sup>2</sup> = 10.764 ft <sup>2</sup> 1 ft <sup>2</sup> = 0.092903 m <sup>2</sup>
<b>Mass</b>	Pound <b>lb<sub>m</sub></b>	Kilogram <b>kg</b>	Kilogram <b>kg</b>	1 lb <sub>m</sub> = 0.45359237 kg 1 kg = 2.2046 lb
<b>Force</b>	Pound Force <b>lb<sub>f</sub></b>	Kilogram Force <b>kg<sub>f</sub></b>	Newton <b>N</b>	1 lb <sub>f</sub> = 0.45359237 kg <sub>f</sub> 1 lb <sub>f</sub> = 4.44822 N 1 kg <sub>f</sub> = 2.2046 lb <sub>f</sub> 1 kg <sub>f</sub> = 9.80665 N 1 N = 0.1019716 kg <sub>f</sub> 1 N = 0.224809 lb <sub>f</sub>
<b>Stress or Pressure</b>	Pounds per Square Inch <b>lb<sub>f</sub>/in<sup>2</sup></b>	Kilograms per Square Meter <b>kg<sub>f</sub>/m<sup>2</sup></b>	Pascal <b>Pa</b>	1 MPa = 10 <sup>6</sup> N/m <sup>2</sup> = N/mm <sup>2</sup> 1 kPa = 10 <sup>3</sup> N/m <sup>2</sup> 1 lb <sub>f</sub> /in <sup>2</sup> = 0.070307 kg <sub>f</sub> /cm <sup>2</sup> 1 lb <sub>f</sub> /in <sup>2</sup> = 7.0307 x 10 <sup>-4</sup> kg <sub>f</sub> /mm <sup>2</sup> 1 lb <sub>f</sub> /in <sup>2</sup> = 6.8947 x 10 <sup>-3</sup> N/mm <sup>2</sup> (MPa) 1 kg <sub>f</sub> /cm <sup>2</sup> = 14.2233 lb <sub>f</sub> /in <sup>2</sup> 1 kg <sub>f</sub> /cm <sup>2</sup> = 9.80665 x 10 <sup>-2</sup> N/mm <sup>2</sup> (MPa)
<b>Torque or Work</b>	Inch Pounds <b>lbf-in</b>	Kilogram Meters <b>kg<sub>f</sub>-m</b>	Newton-Metres <b>Nm</b>	1 lbf-in = 1.1521 kg <sub>f</sub> -cm 1 kg <sub>f</sub> -cm = 0.8679 lbf-in 1 lbf-in = 0.1129848 Nm 1 kg <sub>f</sub> -m = 9.80665 Nm 1 kg <sub>f</sub> -cm = 9.80665 x 10 <sup>-2</sup> Nm 1 Nm = 8.85 lbf-in 1 Nm = 10.19716 kg <sub>f</sub> -cm
<b>Power</b>	Foot Pound per Minute <b>lb<sub>f</sub>-ft/min</b>	Force per Second <b>kg<sub>f</sub>-m/s</b>	Newton Metre per Second <b>Nm/s</b>	1 kW = 1000 Nm/s 1 kW = 60,000 Nm/s 1 kW = 44,220 lb <sub>f</sub> -ft/min 1 kW = 1.341 hp 1 hp = 75 kg <sub>f</sub> -m/s 1 hp = 44,741 Nm/min 1 hp = 33,000 lb <sub>f</sub> -ft/min 1 hp = 0.7457 kW
<b>Velocity</b>	Feet per Second <b>ft/s</b>	Meters per Second <b>m/s</b>	Metres per Second <b>m/s</b>	1 ft/sec = 0.3048 m/s 1 in/sec = 2.54 cm/s 1 ft/sec = 0.00508 m/s 1 mile/hr = 0.44704 m/s 1 km/hr = 0.27777 m/s 1 mile/hr = 1.609344 km/hr
<b>Acceleration</b>	Feet per Second Squared <b>ft/s<sup>2</sup></b>	Meters per Second Squared <b>m/s<sup>2</sup></b>	Metres per Second Squared <b>m/s<sup>2</sup></b>	1 ft/s <sup>2</sup> = 0.3048 m/s <sup>2</sup>

**NOTES:**

A large grid area for taking notes, consisting of a 30x30 grid of small squares. The grid is empty and occupies the central portion of the page.

DANAHER MOTION is a registered trademark of Danaher Corporation. Danaher Motion makes every attempt to ensure accuracy and reliability of the specifications in this publication. Specifications are subject to change without notice. Danaher Motion provides this information "AS IS" and disclaims all warranties, express or implied, including, but not limited to, implied warranties of merchantability and fitness for a particular purpose. It is the responsibility of the product user to determine the suitability of this product for a specific application. ©2004 Danaher Motion.



## Interchange Guide

THK HSR		Thomson 500 Series Ball	
<b>Assembly Part Number</b> HSR 20 A 2 SS C1 + 1000 P 1 2 3 4 9 5 7 6		<b>Carriage Part Number</b> (2) pcs 511 P 20 A 1 Z 4 1 6 2 3 5 9 and <b>Rail Part Number</b> (2) pcs 521 P 20 A 1000 4 1 6 2 8 7	
<b>Carriage Part Number</b> HSR 20 A UU 1 2 3 9		<b>Carriage Part Number</b> 511 P 20 A 1 1 6 2 3 4	
<b>Rail Part Number</b> HSR 20 + 1000L 1 2 7		<b>Rail Part Number</b> 521 P 20 A 1000 1 6 2 8 7	

1 - TYPE	
THK Carriage - HSR Rail - HSR	THOMSON 500 SERIES BALL Carriage - 511 Rail - 521
2 - SIZE	
THK 15 20 25 30 35 45 55	THOMSON 500 SERIES BALL 15 20 25 30 35 45 N/A
3 - CARRIAGE STYLE	
THK A B CA CB LA LB HA HB R TR LR HTR	THOMSON 500 SERIES BALL A A A A B B B E E F F
4 - CARRIAGES PER RAIL	

5 - PRELOAD	
THK <i>blank</i> C1 C2 N/A	THOMSON 500 SERIES BALL 0 1 2 3
6 - ACCURACY	
THK <i>blank</i> H P SP UP	THOMSON 500 SERIES BALL H H P U U
7 - LENGTH	
THK xxxxL	THOMSON 500 SERIES BALL xxxx
8 - RAIL STYLE	
THK <i>blank</i> K N/A	THOMSON 500 SERIES BALL A U C
9 - SEALS	
THK SS UU ZZ DD KK QZ N/A	THOMSON 500 SERIES BALL <i>blank</i> <i>blank</i> Z W WZ N L

DANAHER MOTION is a registered trademark of Danaher Corporation. Danaher Motion makes every attempt to ensure accuracy and reliability of the specifications in this publication. Specifications are subject to change without notice. Danaher Motion provides this information "AS IS" and disclaims all warranties, express or implied, including, but not limited to, implied warranties of merchantability and fitness for a particular purpose. It is the responsibility of the product user to determine the suitability of this product for a specific application. ©2004 Danaher Motion.

## STAR BALL RAIL SYSTEMS TO THOMSON 500 SERIES BALL INTERCHANGE SHEET

STAR	THOMSON
<p>Carriage Part Number</p> <p><math>\frac{1}{1} \frac{6}{2} \frac{5}{3} \frac{1}{4} - \frac{8}{5} \frac{1}{6} \frac{2}{7} - \frac{10}{7}</math></p> <p>Rail Part Number Rail Part Number</p> <p><math>\frac{1}{1} \frac{6}{2} \frac{0}{3} \frac{5}{4} - \frac{8}{5} \frac{0}{6} \frac{2}{7} - 31, \frac{1000}{6}</math></p>	<p>Carriage Part Number</p> <p><math>\frac{511}{1} \frac{P}{5} \frac{20}{3} \frac{A}{2} \frac{1}{4}</math></p> <p><math>\frac{521}{1} \frac{P}{5} \frac{20}{3} \frac{A}{2} + \frac{1000}{6}</math></p>

1. TYPE		
STAR	THOMSON	
16	Carriage - 511 Rail - 521	
2. TYPE		
STAR	THOMSON	
CARRIAGE	03	B
	04	A
	21	E
	22	C
	23	D
	24	F
	51	A
	53	B
66	G	
RAIL	1605-X0X-XX	A+531HP
	1605-X3X-XX	C+531RCS (size 25 & up)
	1605-X6X-XX	C+531RCS (size 25 & up)
	1607-XXX-XX	U
	1645-X03-XX	AD+531HP
	1645-X33-XX	CD+531RCS (size 25 & up)
	1647-X03-XX	UD

3. SIZE	
STAR	THOMSON
1	15
2	25
3	35
4	45
5	N/A
6	N/A
7	30
8	20
4. PRELOAD	
STAR	THOMSON
1	1
2	2
3	3
9	0
5. ACCURACY	
STAR	THOMSON
1	U
2	P
3	H
4	H
9	U
6. RAIL LENGTH	
STAR	THOMSON
XXXX	+XXXXX
7. REVISION	
10	Blank
20	Blank

For more information, or to place an order, please contact your local authorized Thomson™ distributor or Danaher Motion at 1-540-633-3400, Fax: 1-540-633-4162, or E-mail at [profilerail@DanaherMotion.com](mailto:profilerail@DanaherMotion.com).

DANAHER MOTION is a registered trademark of Danaher Corporation. Danaher Motion makes every attempt to ensure accuracy and reliability of the specifications in this publication. Specifications are subject to change without notice. Danaher Motion provides this information "AS IS" and disclaims all warranties, express or implied, including, but not limited to, implied warranties of merchantability and fitness for a particular purpose. It is the responsibility of the product user to determine the suitability of this product for a specific application. ©2004 Danaher Motion.

### STAR Roller Rail System to Thomson 500 Series Roller Profile Rail Interchange Sheet

STAR	THOMSON 500 Series Roller
<p><b>Carriage Part Number</b></p> <p><u>18</u> <u>5</u> <u>1</u> - <u>2</u> <u>1</u> <u>2</u> - <u>10</u> 1 2 3 4 5 7</p> <p><b>Rail Part Number</b></p> <p><u>18</u> <u>05</u> - <u>2</u> <u>0</u> <u>2</u> - <u>31</u> <u>1000</u> 1 2 3 8 5 9 6</p>	<p><b>Carriage Part Number</b></p> <p><u>512</u> <u>P</u> <u>20</u> <u>A</u> <u>1</u> <u>ES4</u> 1 5 3 2 4 7</p> <p><b>Rail Part Number</b></p> <p><u>521</u> <u>P</u> <u>25</u> <u>A</u> + <u>1000</u> 1 5 3 2 6</p>

1. TYPE		
STAR	THOMSON	
18	Carriage - 512 Rail - 522	
2. STYLE		
STAR	THOMSON	
CARRIAGE	51	A
	53	B
	21	C
	24	D
Rail - see RAIL STYLE - 1, 2, 8, and 9 Section		
3. SIZE		
STAR	THOMSON	
2	25	
3	35	
4	45	
5	55	
6	65	
4. PRELOAD		
STAR	THOMSON	
1*	1	
2	2	
3	3	
5. ACCURACY		
STAR	THOMSON	
3	N/A	
2	P	
1	S	
9	U	

6. LENGTH	
STAR	THOMSON
XXXX	+XXXX
7. VERSION	
STAR	THOMSON
10	Blank
13 (ALUMINUM END CAP)	N/A
18	ES4
60	D-Thine Dense Chrome
RAIL STYLE 1, 2, 8 AND 9	
STAR	THOMSON
1805-x2x-31	C
1805-x3x-31	C + 532RCS (size 25)
1805-x3x-61	C + 532RCS (size 35 & up)
1805-x5x-31	A
1805-x6x-31	C + 532RCS (size 25)
1805-x6x-61	C + 532RCS (size 35 & up)
1806-x5x-31	A
1807-x0x-31	U
1845-x1x-31	A + Thin Dense Chrome
1845-x5x-31	C + Thin Dense Chrome + 532RCS (size 25)
1845-x5x-61	C + Thin Dense Chrome + 532RCS (size 35 & up)
1845-x8x-31	C + Thin Dense Chrome + 532RCS
1847-x1x-31	U + Thin Dense Chrome
18xx-xxx-41	Coated end for Thin Dense Chrome options in place of -31
18xx-xxx-71	Coated end for Thin Dense Chrome options in place of -61

For more information, or to place an order, please contact your local authorized Thomson™ distributor or Danaher Motion at 1-540-633-3400, Fax: 1-540-633-4162, or E-mail at [profilerail@DanaherMotion.com](mailto:profilerail@DanaherMotion.com).

DANAHER MOTION is a registered trademark of Danaher Corporation. Danaher Motion makes every attempt to ensure accuracy and reliability of the specifications in this publication. Specifications are subject to change without notice. Danaher Motion provides this information "AS IS" and disclaims all warranties, express or implied, including, but not limited to, implied warranties of merchantability and fitness for a particular purpose. It is the responsibility of the product user to determine the suitability of this product for a specific application. ©2004 Danaher Motion.

## The Thomson 500 Series Ball Profile Rail replaces the Thomson AccuGlide Profile Rail.

The 500 Series Ball Profile Rail provides the following advantages when compared to AccuGlide:

- Increased rail straightness through advanced grinding technologies
- Simpler installation and greater accuracy on joint-free rails up to 6 meters long
- Smoother, quieter movement through insert molded recirculation paths, minimized transitions and optimized geometries
- Increased load capacity from longer ball paths and total number of rolling elements
- On-site field modifiable and upgradeable easy-to-use modular carriage and seal designs
- Customization with expanded accessories offering

### Thomson AccuGlide\* to Thomson 500 Series Ball Profile Rail Interchange Sheet

Thomson AccuGlide*	Thomson 500 Series Ball																								
<p><b>Assembly Part Number</b></p> <table border="0"> <tr> <td>CG</td><td>20</td><td>AA</td><td>B</td><td>P</td><td>—</td> </tr> <tr> <td>1</td><td>2</td><td>3</td><td>4</td><td>5</td><td>8</td> </tr> </table>	CG	20	AA	B	P	—	1	2	3	4	5	8	<p><b>Carriage Part Number</b></p> <table border="0"> <tr> <td>511</td><td>P</td><td>20</td><td>A</td><td>1</td><td>—</td> </tr> <tr> <td>1</td><td>5</td><td>2</td><td>3</td><td>4</td><td>8</td> </tr> </table>	511	P	20	A	1	—	1	5	2	3	4	8
CG	20	AA	B	P	—																				
1	2	3	4	5	8																				
511	P	20	A	1	—																				
1	5	2	3	4	8																				
<p><b>Rail Part Number</b></p> <table border="0"> <tr> <td>RG</td><td>20</td><td>P</td><td>L1000</td><td>—</td> </tr> <tr> <td>1</td><td>2</td><td>5</td><td>6</td><td>8</td> </tr> </table>	RG	20	P	L1000	—	1	2	5	6	8	<p><b>Rail Part Number</b></p> <table border="0"> <tr> <td>521</td><td>P</td><td>20</td><td>A</td><td>—</td><td>1000</td> </tr> <tr> <td>1</td><td>5</td><td>2</td><td>7</td><td>8</td><td>6</td> </tr> </table>	521	P	20	A	—	1000	1	5	2	7	8	6		
RG	20	P	L1000	—																					
1	2	5	6	8																					
521	P	20	A	—	1000																				
1	5	2	7	8	6																				

1. TYPE	
AccuGlide	THOMSON 500 SERIES BALL
Carriage - CG Rail - RG	Carriage - 511 Rail - 521
2. SIZE	
AccuGlide	THOMSON 500 SERIES BALL
15 20 25 30 35 45 55	15 20 25 30 35 45 N/A
3. CARRIAGE STYLE	
AccuGlide	THOMSON 500 SERIES BALL
AA BA CE DE EE HE	A B C D E F
4. PRELOAD	
AccuGlide	THOMSON 500 SERIES BALL
A B C D	0 1 2 3

5. ACCURACY	
AccuGlide	THOMSON 500 SERIES BALL
N H P S U	H H P U U
6. LENGTH	
AccuGlide	THOMSON 500 SERIES BALL
Lxxxx	xxxx
7. RAIL STYLE	
AccuGlide	THOMSON 500 SERIES BALL
— N/A N/A	A U C
8. OPTIONS <sup>1</sup>	
AccuGlide	THOMSON 500 SERIES BALL
A C2C2 (plastic) C3C3 D#### KK LDS LL M### R2R2 ZZ N/A N/A	D C (steel) C See pg. 122 or Consult Danaher Motion W Standard Longitudinal Seal is low drag L See pg. 122 or Consult Danaher Motion E Z Z V (Viton Wiper) N (Oil Reservoir)

For more information, or to place an order, please contact your local authorized Thomson™ distributor or Danaher Motion at 1-540-633-3400, Fax: 1-540-633-4162, or E-mail at [profilerrail@DanaherMotion.com](mailto:profilerrail@DanaherMotion.com).

DANAHER MOTION is a registered trademark of Danaher Corporation. Danaher Motion makes every attempt to ensure accuracy and reliability of the specifications in this publication. Specifications are subject to change without notice. Danaher Motion provides this information "AS IS" and disclaims all warranties, express or implied, including, but not limited to, implied warranties of merchantability and fitness for a particular purpose. It is the responsibility of the product user to determine the suitability of this product for a specific application. ©2004 Danaher Motion.

## The Thomson 500 Series Roller Profile Rail replaces the Thomson AccuMax Profile Rail.

The 500 Series Roller Profile Rail provides the following advantages when compared to AccuMax:

- Increased rail straightness through advanced grinding technologies
- Simpler installation and greater accuracy on joint-free rails up to 6 meters long
- Smoother, quieter movement through insert molded recirculation paths, minimized transitions and optimized geometries
- Increased load capacity from longer roller paths and total number of rolling elements
- Expanded offering of ultra-rigid roller carriage sizes and styles for all applications
- On-site field modifiable and upgradeable easy-to-use modular carriage and seal designs
- Customization with expanded accessories offering

Thomson AccuMax* to Thomson 500 Series Roller Interchange Sheet																																															
Thomson AccuMax*	Thomson 500 Series Roller																																														
<p><b>Assembly Part Number</b></p> <table border="0"> <tr> <td>CM</td><td>35</td><td>AA</td><td>B</td><td>S</td><td>—</td> </tr> <tr> <td>1</td><td>2</td><td>3</td><td>4</td><td>5</td><td>8</td> </tr> </table> <p><b>Rail Part Number</b></p> <table border="0"> <tr> <td>RM</td><td>35</td><td>S</td><td>L1000</td><td>—</td> </tr> <tr> <td>1</td><td>2</td><td>5</td><td>6</td><td>8</td> </tr> </table>	CM	35	AA	B	S	—	1	2	3	4	5	8	RM	35	S	L1000	—	1	2	5	6	8	<p><b>Carriage Part Number</b></p> <table border="0"> <tr> <td>512</td><td>S</td><td>35</td><td>A</td><td>1</td><td>—</td> </tr> <tr> <td>1</td><td>5</td><td>2</td><td>3</td><td>4</td><td>8</td> </tr> </table> <p><b>Rail Part Number</b></p> <table border="0"> <tr> <td>522</td><td>S</td><td>35</td><td>A</td><td>—</td><td>1000</td> </tr> <tr> <td>1</td><td>5</td><td>2</td><td>7</td><td>8</td><td>6</td> </tr> </table>	512	S	35	A	1	—	1	5	2	3	4	8	522	S	35	A	—	1000	1	5	2	7	8	6
CM	35	AA	B	S	—																																										
1	2	3	4	5	8																																										
RM	35	S	L1000	—																																											
1	2	5	6	8																																											
512	S	35	A	1	—																																										
1	5	2	3	4	8																																										
522	S	35	A	—	1000																																										
1	5	2	7	8	6																																										

1. TYPE	
AccuMax	THOMSON 500 SERIES ROLLER
Carriage - CM Rail - RM	Carriage - 512 Rail - 522
2. SIZE	
AccuMax	THOMSON 500 SERIES ROLLER
N/A 35 45 55 N/A	25 35 45 55 65
3. CARRIAGE STYLE	
AccuMax	THOMSON 500 SERIES ROLLER
AA N/A N/A N/A	A B C D
4. PRELOAD	
AccuMax	THOMSON 500 SERIES ROLLER
B C D	1 2 3

5. ACCURACY	
AccuMax	THOMSON 500 SERIES ROLLER
P S U	P S U
6. LENGTH	
AccuMax	THOMSON 500 SERIES ROLLER
Lxxxx	xxxx
7. RAIL STYLE	
AccuMax	THOMSON 500 SERIES ROLLER
— N/A N/A	A U C
8. OPTIONS <sup>1</sup>	
AccuGlide	THOMSON 500 SERIES BALL
A C2C2 (plastic) C3C3 D####  KK LDS LL M### R2R2 ZZ N/A	D C (steel) C See pg. 122 or Consult Danaher Motion  W Standard Longitudinal Seal is low drag L See pg. 122 or Consult Danaher Motion E Z V (Viton Wiper)

For more information, or to place an order, please contact your local authorized Thomson™ distributor or Danaher Motion at 1-540-633-3400, Fax: 1-540-633-4162, or E-mail at [profilerail@DanaherMotion.com](mailto:profilerail@DanaherMotion.com).

DANAHER MOTION is a registered trademark of Danaher Corporation. Danaher Motion makes every attempt to ensure accuracy and reliability of the specifications in this publication. Specifications are subject to change without notice. Danaher Motion provides this information "AS IS" and disclaims all warranties, express or implied, including, but not limited to, implied warranties of merchantability and fitness for a particular purpose. It is the responsibility of the product user to determine the suitability of this product for a specific application. ©2004 Danaher Motion.

## Common AccuGlide Options

Carriage Options	500 Series Option
C2C2	C
C3C3	C
D035	ES1
D047	ES10*
D065	ES2
D086	ES1ES10*
D087	ES8 or ES1ES10*
D088	ES2ES10*
D089	ES9 or ES2ES10*
D134	ZCES1
D135	CES1
D147	CES10*
D150	ZC
D164	ZCES2
D165	CES2
D186	CES1ES10*
D187	CES7 or CES10*
D188	CES10*
D189	CES9 or CES2ES10*
D192	LCES9 or LCES2ES10*
D234	LES1
D235	LZES1
D236	LZCES1
D237	LCES1
D241	LC
D251	LZC
D262	LES2
D263	LCES2
D264	ZES2
D265	LZES2
D266	LZCES2
D267	LCES2
D274	LES12
D275	LZES12
D289	LES9 or LES2ES10*
D292	LZES9 or LZES2ES10*
LDS	now standard
LL	L
LLZZ	LZ
M035	ES3
M038	CES3
M041	1/4-28 in side options: ES7 or ES10 option*
M043	C + 1/4-28 in side options: CES7 or CES10 option*
M047	ES7 or ES10*
M049	CES7 or CES10*
M063	CES4
M065	ES4
M075	ES14
M077	ES14 + ES7
M087	ES5
M088	ES4ES10
M089	ES6
M094	ES7 + ES15
M095	ES15

Carriage Options	500 Series Option
M097	ZES15
M099	CES15
M125	ES11
M134	ES6
M147	CES7
M153	W
M157	WZ
M168	Duralloy
M171	Z
M183	ZES5
M186	ES5
M187	CES5
M188	CES10*
M189	CES6
M192	ZES6
M209	LES6
M210	WES7
M234	LES3
M235	LZES3
M236	LZCES3
M241	LC
M242	Duralloy + L
M249	LCES7 or LCES10*
M251	LZC
M263	LES4
M264	ZES4
M265	LZES4
M266	LZCES4
M267	LCES4
M275	LZES14G1
M287	LES5
M289	LES6
M290	LCES6
M292	LZES6
M293	WES5
M294	GS
ZZ	Z

\*ES10 option is side lube in end cap, size 15=M3, size 20 and up=M6.

Rail Options	500 Series Designation
D080	DH1
D085	DH2
D181	EDH1
D185	EDH2
D187	EDH2
M080	DH3
M082	EDH3
M083	EDH3
M085	DH4
M088	EDH4
M091	EDH4
R2R2	E
R3R3	E

**NOTES:**

A large grid area for taking notes, consisting of a 30x40 grid of small squares. The grid is empty and occupies the central portion of the page.

DANAHER MOTION is a registered trademark of Danaher Corporation. Danaher Motion makes every attempt to ensure accuracy and reliability of the specifications in this publication. Specifications are subject to change without notice. Danaher Motion provides this information "AS IS" and disclaims all warranties, express or implied, including, but not limited to, implied warranties of merchantability and fitness for a particular purpose. It is the responsibility of the product user to determine the suitability of this product for a specific application. ©2004 Danaher Motion.

**NOTES:**

A large grid area for taking notes, consisting of a 30x30 grid of small squares. The grid is empty and occupies the central portion of the page.

DANAHER MOTION is a registered trademark of Danaher Corporation. Danaher Motion makes every attempt to ensure accuracy and reliability of the specifications in this publication. Specifications are subject to change without notice. Danaher Motion provides this information "AS IS" and disclaims all warranties, express or implied, including, but not limited to, implied warranties of merchantability and fitness for a particular purpose. It is the responsibility of the product user to determine the suitability of this product for a specific application. ©2004 Danaher Motion.



**NOTES:**

A large grid area for taking notes, consisting of a 30x30 grid of small squares. The grid is empty and occupies the central portion of the page.

DANAHER MOTION is a registered trademark of Danaher Corporation. Danaher Motion makes every attempt to ensure accuracy and reliability of the specifications in this publication. Specifications are subject to change without notice. Danaher Motion provides this information "AS IS" and disclaims all warranties, express or implied, including, but not limited to, implied warranties of merchantability and fitness for a particular purpose. It is the responsibility of the product user to determine the suitability of this product for a specific application. ©2004 Danaher Motion.

**NOTES:**

A large grid area for taking notes, consisting of a 30x30 grid of small squares. The grid is empty and occupies the central portion of the page.

DANAHER MOTION is a registered trademark of Danaher Corporation. Danaher Motion makes every attempt to ensure accuracy and reliability of the specifications in this publication. Specifications are subject to change without notice. Danaher Motion provides this information "AS IS" and disclaims all warranties, express or implied, including, but not limited to, implied warranties of merchantability and fitness for a particular purpose. It is the responsibility of the product user to determine the suitability of this product for a specific application. ©2004 Danaher Motion.

**NOTES:**

A large grid area for taking notes, consisting of a 30x30 grid of small squares. The grid is empty and occupies most of the page below the 'NOTES:' header.

DANAHER MOTION is a registered trademark of Danaher Corporation. Danaher Motion makes every attempt to ensure accuracy and reliability of the specifications in this publication. Specifications are subject to change without notice. Danaher Motion provides this information "AS IS" and disclaims all warranties, express or implied, including, but not limited to, implied warranties of merchantability and fitness for a particular purpose. It is the responsibility of the product user to determine the suitability of this product for a specific application. ©2004 Danaher Motion.

**NOTES:**

A large grid area for taking notes, consisting of a 30x40 grid of small squares. The grid is empty and occupies the central portion of the page.

DANAHER MOTION is a registered trademark of Danaher Corporation. Danaher Motion makes every attempt to ensure accuracy and reliability of the specifications in this publication. Specifications are subject to change without notice. Danaher Motion provides this information "AS IS" and disclaims all warranties, express or implied, including, but not limited to, implied warranties of merchantability and fitness for a particular purpose. It is the responsibility of the product user to determine the suitability of this product for a specific application. ©2004 Danaher Motion.

# New Thomson 500 Series Profile Rails

[www.LinearGuides.com](http://www.LinearGuides.com)



**NEW**

## **Next Generation Profile Rails. Superior Design. Superior Quality.**

Danaher Motion introduces a new line of profile rails that can be easily integrated into your new or existing application. The 500 Series of profile rails feature:

- **Increased rail straightness** through advanced grinding technologies
- **Simpler installation and greater accuracy** on joint-free rails up to 6 meters long
- **Smoother, quieter movement** through insert molded recirculation paths
- **On site field modifications** with easy-to-use modular carriage (accessories) design
- **Expanded offering** of ultra-rigid roller carriage sizes and styles for all applications
- **Customization** with expanded accessories offering

**THOMSON™**



500 Series Roller  
Profile Rail



500 Series Ball  
Profile Rail



Also Available:  
AccuMini

Visit:  
[www.DanaherMotion.com](http://www.DanaherMotion.com)  
or call 1-540-633-3400

 **DANAHER**  
MOTION

Solutions by



**THOMSON™**

DANAHER MOTION is a trademark.

Danaher Motion makes every attempt to ensure accuracy and reliability of the specifications in this publication. Specifications are subject to change without notice. Danaher Motion provides this information "AS IS" and disclaims all warranties, express or implied, including, but not limited to, implied warranties of merchantability and fitness for a particular purpose. It is the responsibility of the product user to determine the suitability of this product for a specific application.

©2006 Danaher Motion. TPS 12M RG 7-1-06 200506-03 v4 F102

*Solutions by*  
**DANAHER**  
**MOTION**

203A West Rock Road  
 Radford, VA 24141 USA

**FOR IMMEDIATE ASSISTANCE:**

Internet:	<a href="http://www.DanaherMotion.com">www.DanaherMotion.com</a>	In Europe:	Phone:	++46 (0) 44 24 67 00
In USA, Canada or Mexico:	Phone: 1-540-633-3400 Fax: 1-540-639-4162 E-mail: <a href="mailto:profilerail@danahermotion.com">profilerail@danahermotion.com</a> Literature: <a href="mailto:litrequest@danahermotion.com">litrequest@danahermotion.com</a>	or write:	Fax:	+46 (0) 44 24 40 85
or write:	Danaher Motion 203A West Rock Road Radford, VA 24141 USA		E-mail:	<a href="mailto:helpdesk@tollo.com">helpdesk@tollo.com</a>
In UK:	Phone: 0800 975 1000 Sales Fax: 0800 975 1001 E-mail: <a href="mailto:LMSEurope@danahermotion.com">LMSEurope@danahermotion.com</a>	or	Danaher Motion Tollo Linear AB Box 9053 SE-291 09 Kristianstad Sweden	
or write:	Danaher Linear Motion Systems Fishleigh Road, Roundswell Business Park Barnstaple EX31 3UD UK	or	Phone:	+49 (0) 70 22 504-0
Catalogue request:	<a href="mailto:catalogues@danahermotion.com">catalogues@danahermotion.com</a>	or write:	Fax:	+49 (0) 70 22 541-68
		Elsewhere:	Phone:	1-540-633-3400
			Fax:	1-540-639-4162