

EN

ES

FR



ezviz™

# Vault Plus

## Quick Start Guide



## About the Documents

The documents include instructions for using and managing the product. Pictures, charts, images and all other information hereinafter are for description and explanation only. The information contained in the documents is subject to change, without notice, due to firmware updates or other reasons. Please find the latest version in the website (<http://www.ezvizlife.com>).

Any and all information, including, among others, wordings, pictures, graphs are the properties of EZVIZ Inc. or its subsidiaries (hereinafter referred to be "EZVIZ"). The documents cannot be reproduced, changed, translated, or distributed, partially or wholly, by any means, without the prior written permission of EZVIZ. Unless otherwise stipulated, EZVIZ does not make any warranties, guarantees or representations, express or implied, regarding to the documents.

### Trademarks Acknowledgement

**ezviz**™, ™, and other EZVIZ's trademarks and logos are the properties of EZVIZ in various jurisdictions. Other trademarks and logos mentioned in the documents are the properties of their respective owners.

### Legal Disclaimer

TO THE MAXIMUM EXTENT PERMITTED BY APPLICABLE LAW, THE PRODUCT DESCRIBED, WITH ITS HARDWARE, SOFTWARE AND FIRMWARE, IS PROVIDED "AS IS", WITH ALL FAULTS AND ERRORS, AND EZVIZ MAKES NO WARRANTIES, EXPRESS OR IMPLIED, INCLUDING WITHOUT LIMITATION, MERCHANTABILITY, SATISFACTORY QUALITY, FITNESS FOR A PARTICULAR PURPOSE, AND NON-INFRINGEMENT OF THIRD PARTY. IN NO EVENT WILL EZVIZ, ITS DIRECTORS, OFFICERS, EMPLOYEES, OR AGENTS BE LIABLE TO YOU FOR ANY SPECIAL, CONSEQUENTIAL, INCIDENTAL, OR INDIRECT DAMAGES, INCLUDING, AMONG OTHERS, DAMAGES FOR LOSS OF BUSINESS PROFITS, BUSINESS INTERRUPTION, OR LOSS OF DATA OR DOCUMENTATION, IN CONNECTION WITH THE USE OF THIS PRODUCT, EVEN IF EZVIZ HAS BEEN ADVISED OF THE POSSIBILITY OF SUCH DAMAGES. TO THE MAXIMUM EXTENT PERMITTED BY APPLICABLE LAW, IN NO EVENT SHALL EZVIZ'S TOTAL LIABILITY FOR ALL DAMAGES EXCEED THE PURCHASE PRICE THE PRODUCT.

EZVIZ does not undertake any liability for personal injury or property damage, as the result of product interruption or service termination cause by: a) improper installation or usage other than as requested; b) the protection of national or public interests; c) Force Majeure; d) yourself or the third party, including not limitation, using any third party's products, software, applications, and among others.

REGARDING TO THE PRODUCT WITH INTERNET ACCESS, THE USE OF PRODUCT SHALL BE WHOLLY AT YOUR OWN RISKS. EZVIZ SHALL NOT TAKE ANY RESPONSIBILITIES FOR ABNORMAL OPERATION, PRIVACY LEAKAGE OR OTHER DAMAGES RESULTING FROM CYBER ATTACK, HACKER ATTACK, VIRUS INSPECTION, OR OTHER INTERNET SECURITY RISKS; HOWEVER, EZVIZ WILL PROVIDE TIMELY TECHNICAL SUPPORT IF REQUIRED.

### Regulatory Information

## FCC Information

FCC compliance: This device complies with Part 15 of the FCC Rules. Operation is subject to the following two conditions:

- (1) This device may not cause harmful interference, and
- (2) This device must accept any interference received, including interference that may cause undesired operation.

Note: This product has been tested and found to comply with the limits for a Class B digital device, pursuant to Part 15 of the FCC Rules. These limits are designed to provide reasonable protection against harmful interference in a residential installation. This product generates, uses, and can radiate radio frequency energy and, if not installed and used in accordance with the instructions, may cause harmful interference to radio communications. However, there is no guarantee that interference will not occur in a particular installation. If this product does cause harmful interference to radio or television reception, which can be determined by turning the equipment off and on, the user is encouraged to try to correct the interference by one or more of the following measures:

- Reorient or relocate the receiving antenna.
- Increase the separation between the equipment and receiver.
- Connect the equipment into an outlet on a circuit different from that to which the receiver is connected.
- Consult the dealer or an experienced radio/TV technician for help.

Please take attention that changes or modification not expressly approved by the party responsible for compliance could void the user's authority to operate the equipment.

This equipment should be installed and operated with a minimum distance 20cm between the radiator and your body

This device complies with Industry Canada licence-exempt RSS standard(s). Operation is subject to the following two conditions:

- (1) this device may not cause interference, and
- (2) this device must accept any interference, including interference that may cause undesired operation of the device.

Under Industry Canada regulations, this radio transmitter may only operate using an antenna of a type and maximum (or lesser) gain approved for the transmitter by Industry Canada. To reduce potential radio interference to other users, the antenna type and its gain should be so chosen that the equivalent isotropically radiated power (e.i.r.p.) is not more than that necessary for successful communication.

## EU Conformity Statement



This product and - if applicable - the supplied accessories too are marked with "CE" and comply therefore with the applicable harmonized European standards listed under the Radio Equipment Directive 2014/53/EU, the EMC Directive 2014/30/EU, the RoHS Directive 2011/65/EU.



2012/19/EU (WEEE directive): Products marked with this symbol cannot be disposed of as unsorted municipal waste in the European Union. For proper recycling, return this product to your local supplier upon the purchase of equivalent new equipment, or dispose of it at designated collection points. For more information see: [www.recyclethis.info](http://www.recyclethis.info).



2006/66/EC and its amendment 2013/56/EU (battery directive): This product contains a battery that cannot be disposed of as unsorted municipal waste in the European Union. See the product documentation for specific battery information. The battery is marked with this symbol, which may include lettering to indicate cadmium (Cd), lead (Pb), or mercury (Hg). For proper recycling, return the battery to your supplier or to a designated collection point. For more information see: [www.recyclethis.info](http://www.recyclethis.info).

### Industry Canada ICES-003 Compliance

This device meets the CAN ICES-3 (B)/NMB-3(B) standards requirements.

This device complies with Industry Canada licence-exempt RSS standard(s). Operation is subject to the following two conditions:

(1) this device may not cause interference, and

(2) this device must accept any interference, including interference that may cause undesired operation of the device.

Le présent appareil est conforme aux CNR d'Industrie Canada applicables aux appareils radioexempts de licence. L'exploitation est autorisée aux deux conditions suivantes :

(1) l'appareil ne doit pas produire de brouillage, et

(2) l'utilisateur de l'appareil doit accepter tout brouillage radioélectrique subi, même si le brouillage est susceptible d'en compromettre le fonctionnement.

This equipment should be installed and operated with a minimum distance 20cm between the radiator and your body

Cet équipement doit être installé et utilisé à une distance minimale de 20 cm entre le radiateur et votre corps

Under Industry Canada regulations, this radio transmitter may only operate using an antenna of a type and maximum (or lesser) gain approved for the transmitter by Industry Canada. To reduce potential radio interference to other users, the antenna type and its gain should be so chosen that the equivalent isotropically radiated power (e.i.r.p.) is not more than that necessary for successful communication.

Conformément à la réglementation d'Industrie Canada, le présent émetteur radio peut

fonctionner avec une antenne d'un type et d'un gain maximal (ou inférieur) approuvé pour l'émetteur par Industrie Canada. Dans le but de réduire les risques de brouillage radioélectrique à l'intention des autres utilisateurs, il faut choisir le type d'antenne et son gain de sorte que la puissance isotrope rayonnée équivalente (p.i.r.e.) ne dépasse pas l'intensité nécessaire à l'établissement d'une communication satisfaisante.

La operación de este equipo está sujeta a las siguientes dos condiciones: (1) es posible que este equipo o dispositivo no cause interferencia perjudicial y (2) este equipo o dispositivo debe aceptar cualquier interferencia, incluyendo la que pueda causar su operación no deseada.

## Safety Instruction

CAUTION: THE PRODUCT IS BUILT IN A REPLACEABLE BATTERY. RISK OF EXPLOSION IF BATTERY IS REPLACED BY AN INCORRECT TYPE. DISPOSE OF USED BATTERIES ACCORDING TO THE INSTRUCTIONS.

Due to the product shape and dimension, the name and address of the importer/manufacture are printed on the package.

## EC DECLARATION OF CONFORMITY

Hereby, Hangzhou Hikvision Digital Technology Co., Ltd. declares that the radio equipment type [CS-X3C-8E] is in compliance with Directive 2014/53/EU.

The full text of the EC DECLARATION OF CONFORMITY is available at the following web link:  
<http://www.evizlife.com/declaration-of-conformity>.

For more information, please visit [www.evizlife.com](http://www.evizlife.com)

Need help? Contact us:

Phone:

USA/CAN: +1-855-693-9849

MX: +52-55-8526-1060

Email:

USA/CAN/MX: [service@evizlife.com](mailto:service@evizlife.com)

Other countries: [support@evizlife.com](mailto:support@evizlife.com)

# SAVE THIS MANUAL FOR FUTURE REFERENCE

## Box Contents

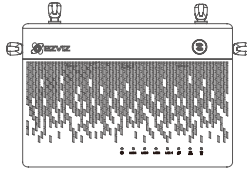

Vault Plus (x1)

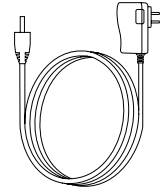

Power Adapter (x1)

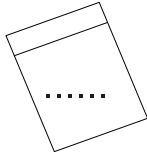

Accessories (x1)



Quick Start Guide (x1)

**i** For models equipped with HDDs, the accessories are not included in the box contents. For models not equipped with HDDs, the accessories include screw kits, and HDD radiator.

## Rear Panel Overview

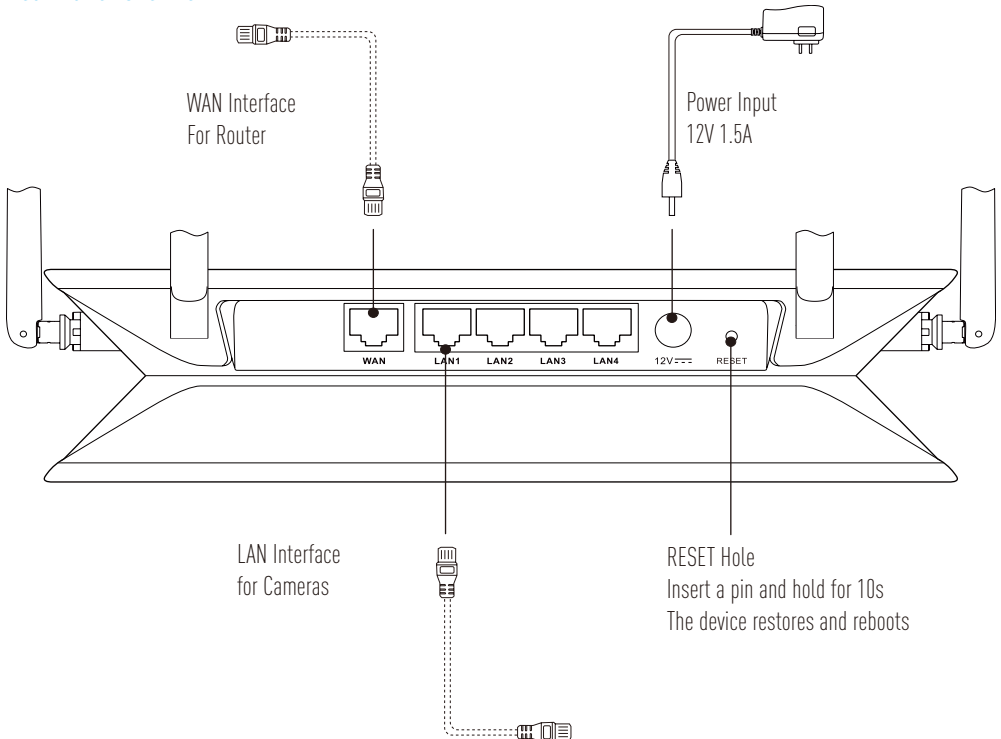

**i** The cables with dotted lines above are not included.

# Product View

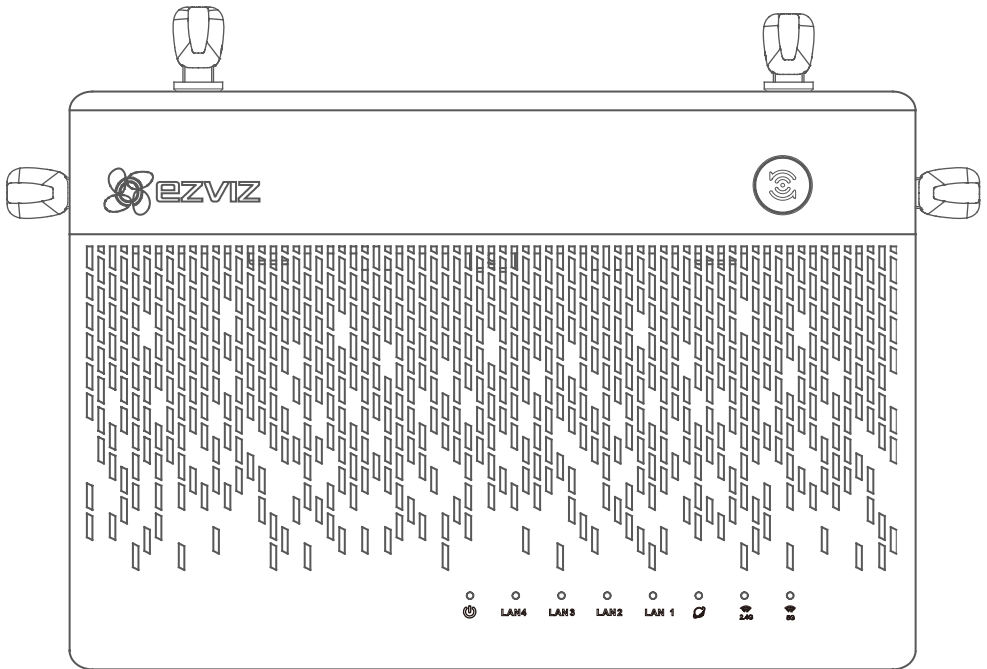

## LED Indicator Status



One-Touch Access



System Status Indicator

**LAN**

LAN Network Indicator



WAN Network Indicator



2.4G Wi-Fi Indicator



5G Wi-Fi Indicator

Once the Vault Plus Internet connection is completely setup, you can use the “One-Touch Access” button to automatically connect EZVIZ camera(s) to the Vault Plus Wi-Fi network. The Vault Plus system status indicator flashes blue during the process. Note: Camera status light will start flashing blue once successfully connected to the Vault Plus Wi-Fi or wait for about 2 mins.

Green: Device is starting up or working properly.

Blue: Network unconnected, upgrading or HDD formatting.

Red: HDD is not formatted, unidentified, or running error.

Steady: Device is connected to the LAN interface.

Flashing: Data is transmitting.

Green: Network is connected.

No Light: Network is not connected.

Green: 2.4G Wi-Fi is enabled.

No Light: 2.4G Wi-Fi is disabled.

Green: 5G Wi-Fi is enabled.

No Light: 5G Wi-Fi is disabled.

# Setup Vault Plus Internet Connection

## A. Wired Network Configuration (Recommended)

1. Connect the WAN interface of the Vault Plus to the LAN interface of your Internet router using the Ethernet cable.

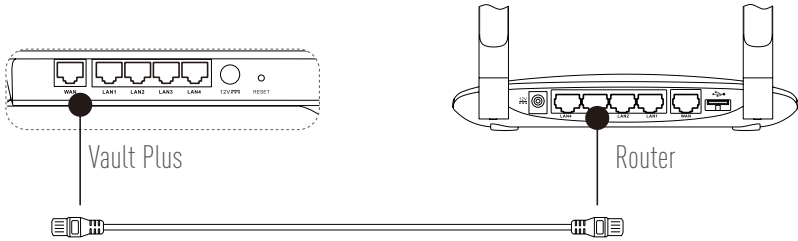

2. Power up the Vault Plus. Connect the power cord to the Vault Plus and plugin the power supply to a power outlet. Start-up time will take 2 minutes to complete. Both the WAN and system status indicators will display green light.
3. Connect your PC to the Vault Plus Wi-Fi network (named as 'ezviz\_XXXXXX', where XXXXXX is a combination of letters and numbers) to access the Vault Plus user interface. You also can find Vault Plus Wi-Fi network name (SSID) on device bottom label.
4. If the Vault Plus user interface did not automatically pop-up, open an Internet browser (IE8/higher or Chrome) and enter 192.168.7.1 to access the Vault Plus user interface.
5. Click "Start" button then follow the steps to setup the Vault Plus Internet settings. Choose "Wired Network Internet Access" as the internet connection mode.

## B. Wi-Fi Relay\* Network Configuration (Optional)

1. Power up the Vault Plus. Connect the power cord to the Vault Plus and plugin the power supply to a power outlet. Wait for 2 minutes to complete the system start-up.
2. Connect your PC to the Vault Plus Wi-Fi network (named as 'ezviz\_XXXXXX', where XXXXXX is a combination of letters and numbers) to access the Vault Plus user interface. You also can find Vault Plus Wi-Fi network name (SSID) on device bottom label.
3. If the Vault Plus user interface did not automatically pop-up, open an internet browser (IE8/higher or Chrome) and enter 192.168.7.1 to access the Vault Plus user interface.
4. Click "Start" button then follow the steps to setup the Vault Plus Internet settings. Choose "Wi-Fi Relay Internet Access" as the Internet connection mode.
5. Search for and connect your Vault Plus to the uplink router (5GHz Wi-Fi only) Wi-Fi network.

\*Actual data throughput and wireless coverage will vary and may be lowered by network and environmental conditions, including network traffic volume and building construction.

## Linking EZVIZ Wi-Fi Camera(s)

6. Power on the camera. Wait until camera status light blinks alternating Blue and Red or wait for 2 mins.
7. Click the “**Ready**” button to start detecting your camera(s). Once detected, camera status light will start flashing blue.
8. Link the camera(s) to the Vault Plus by clicking the “**Link Camera(s)**” button then “**Next**” then “**Enter the Homepage**”. Logout.

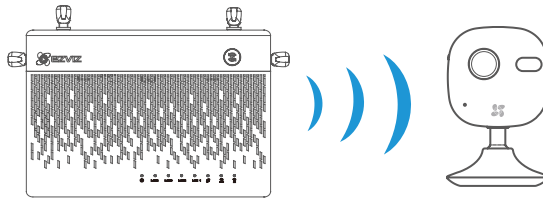

## Adding to EZVIZ Account

9. For first time users, download the EZVIZ App in your Android phone or iPhone. Register an EZVIZ account. For existing users, open the EZVIZ App and login.
10. Add the camera by tapping the (+) sign in the HOME screen then scan the QRcode on the camera or type in its serial number.

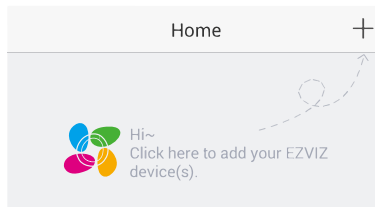

11. Add the Vault Plus by tapping the (+) sign in the HOME screen then scan the QRcode on the Vault Plus or type in its serial number.
12. Once added to the EZVIZ account, tap the Vault Plus in the EZVIZ App Home screen to verify the camera(s) linked to it.

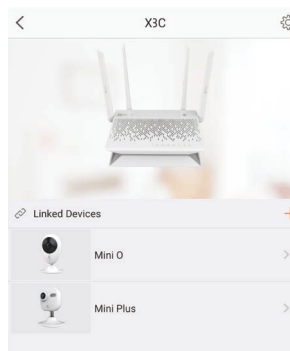



# HDD Installation

1. (Optional) Remove the rubber mats.
2. Loosen four screws on the bottom of the device to take apart the base, see figure below.

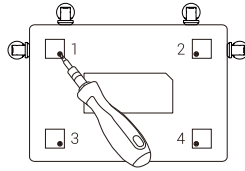

3. Stick the thermal conductive silicone pads to both sides of the HDD, and attach the HDD radiator to the silicone pads.
4. Use the four screws to secure the radiator to the HDD, see figure below.

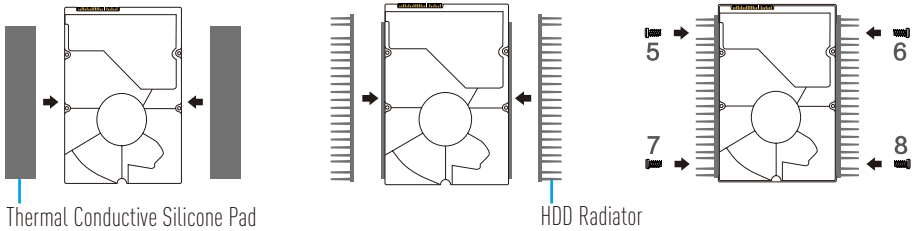

5. Connect the data cable. Make sure the limit line (white) aligns with the connector edge.

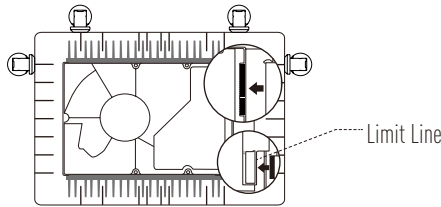

6. Install the HDD shield. See figure below.

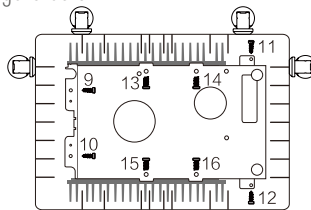

7. Re-assemble the base of the VAULT Plus. Replace the screws and rubber mats to complete the HDD installation.

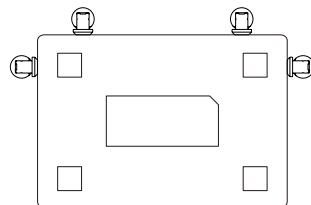

# Información básica

## Contenido de la caja

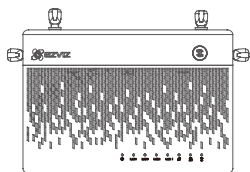

Vault Plus (x1)

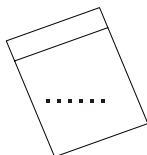

Accesorio (x1)

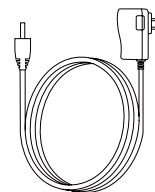

Adaptador de corriente (x1)



Guía de inicio rápido (x1)



En los modelos equipados con una unidad de disco duro, los accesorios no se incluyen en el contenido de la caja. Los modelos sin unidad de disco duro incluyen un juego de tornillos y un radiador de disco duro en los accesorios.

## Vista general del panel trasero

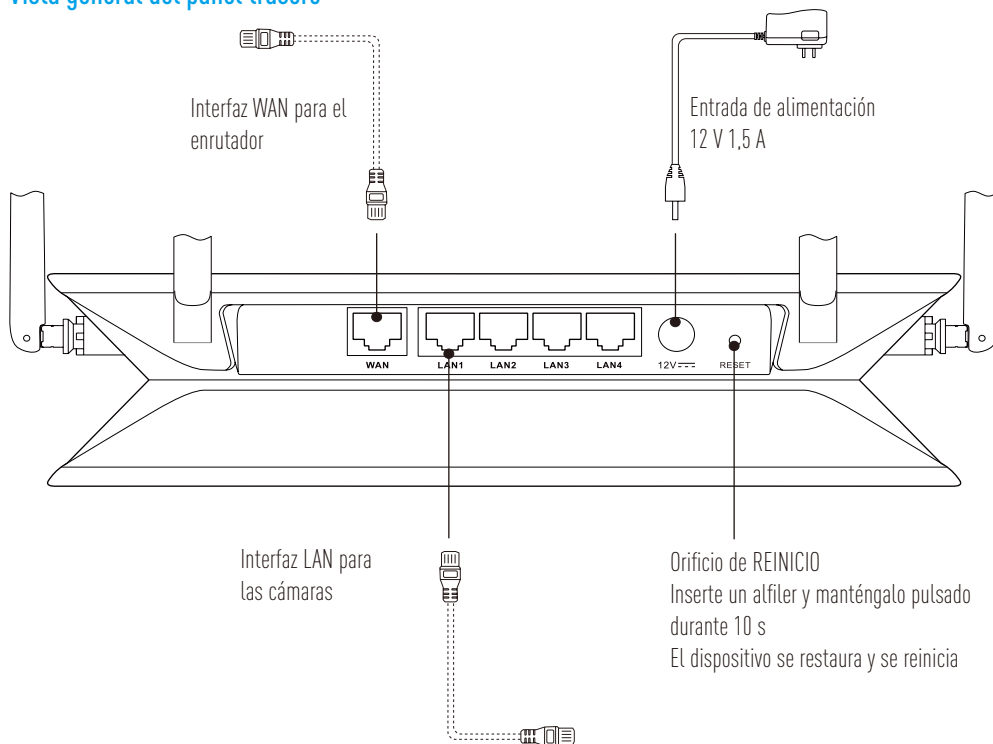

Los cables representados por las líneas de puntos en la figura precedente no están incluidos.

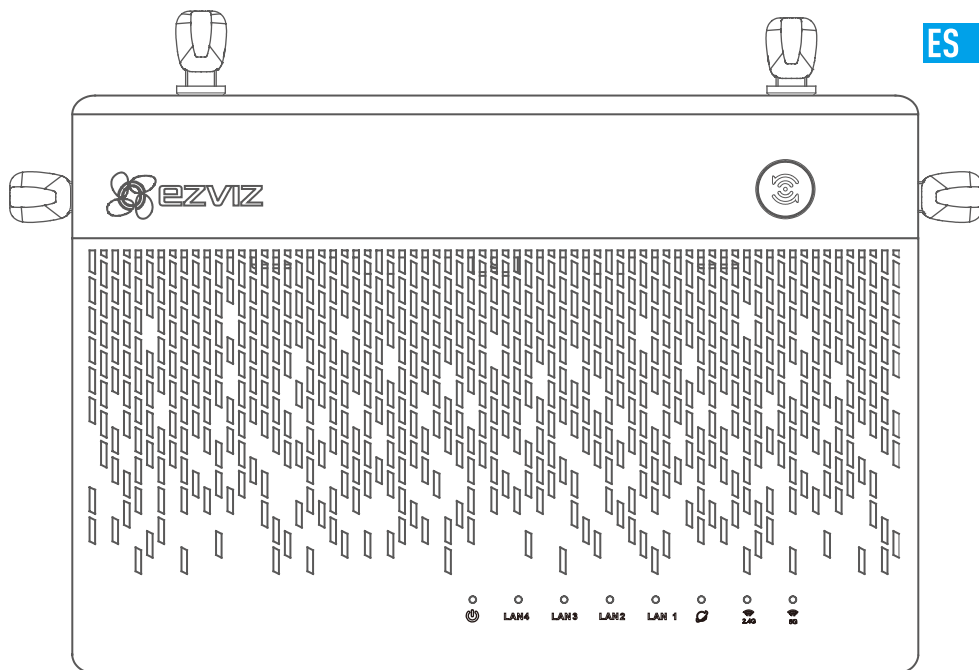

## Indicador de estado LED



Acceso con tan solo un toque



Indicador de estado del sistema

**LAN**

Indicador de la red LAN



Indicador de la red WAN



2.4G

Indicador wifi 2,4 GHz



5G

Indicador wifi 5 GHz

Una vez configurada completamente la conexión a Internet del Vault Plus, podrá utilizar el botón de "acceso con tan solo un toque" para conectar automáticamente las cámaras EZVIZ a la red wifi del Vault Plus. El indicador del estado del sistema del Vault Plus parpadeará en azul durante el proceso. Nota: La luz de estado de la cámara empezará a parpadear en azul una vez conectada correctamente al wifi del Vault Plus.

Verde: el dispositivo está iniciándose o funcionando correctamente.

Azul: red sin conexión, actualizando o formateando la unidad de disco duro.

Rojo: unidad de disco duro sin formato, no identificada o con un error de funcionamiento.

Estable: el dispositivo está conectado a la interfaz LAN.

Parpadeando: transmitiendo datos.

Verde: red conectada.

Sin luz: red sin conectar.

Verde: wifi 2,4 GHz habilitado.

Sin luz: wifi 2,4 GHz desactivado.

Verde: wifi 5 GHz habilitado.

Sin luz: wifi 5 GHz desactivado.

# Configurar la conexión de Internet del Vault Plus

## A. Configuración de red por cable (recomendada)

1. Conecte el conector WAN del Vault Plus al conector LAN de su enrutador de Internet utilizando el cable de Ethernet.

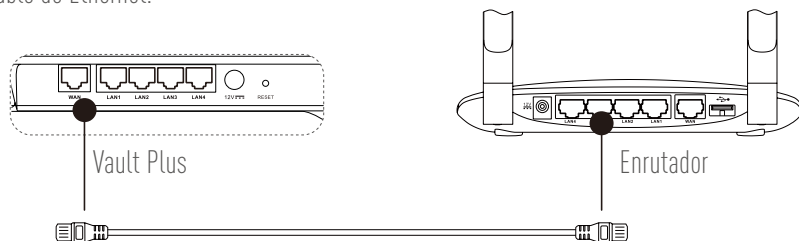

2. Encienda el Vault Plus. Conecte el cable de alimentación al Vault Plus y, a continuación, enchufe la fuente de alimentación a una toma de corriente. La unidad tardará 2 minutos en iniciarse. Ambos indicadores, estado del sistema y WAN, se iluminarán en verde.
3. Conecte su PC a la red wifi del Vault Plus (denominada 'ezviz\_XXXXXX', donde XXXXXX es una combinación de letras y números) para acceder a la interfaz de usuario del Vault Plus. También podrá encontrar el nombre de la red wifi del Vault Plus (SSID) en la etiqueta situada en la parte de abajo del dispositivo.
4. Si no aparece automáticamente la interfaz de usuario del Vault Plus, abra el navegador de Internet (Internet Explorer 8 o superior o Chrome) e introduzca la dirección 192.168.7.1 para acceder a la interfaz de usuario del Vault Plus.
5. Haga clic sobre el botón **"Start (Iniciar)"** y, a continuación, siga los pasos para ajustar los parámetros de Internet del Vault Plus. Seleccione **"Wired Network Internet Access (Acceso a Internet por cable)"** como el modo de conexión a Internet.

## B. Configuración de la red por relé\* wifi (opcional)

1. Encienda el Vault Plus. Conecte el cable de alimentación al Vault Plus y, a continuación, enchufe la fuente de alimentación a una toma de corriente. Espere dos minutos a que se complete el arranque del sistema.
2. Conecte su PC a la red wifi del Vault Plus (denominada 'ezviz\_XXXXXX', donde XXXXXX es una combinación de letras y números) para acceder a la interfaz de usuario del Vault Plus. También podrá encontrar el nombre de la red wifi del Vault Plus (SSID) en la etiqueta situada en la parte de abajo del dispositivo.
3. Si no aparece automáticamente la interfaz de usuario del Vault Plus, abra el navegador de Internet (Internet Explorer 8 o superior o Chrome) e introduzca la dirección 192.168.7.1 para acceder a la interfaz de usuario del Vault Plus.
4. Haga clic sobre el botón **"Start (Iniciar)"** y, a continuación, siga los pasos para ajustar los parámetros de Internet del Vault Plus. Seleccione **"Wi-Fi Relay Internet Access (Acceso a Internet por relé wifi)"** como el modo de conexión a Internet.
5. Busque y conecte su Vault Plus a la red wifi del enrutador de enlace ascendente (wifi de 5 GHz).

\*La capacidad de datos y la cobertura inalámbrica reales variarán y pueden disminuir dependiendo de las condiciones del entorno y de la red, como el volumen de datos en la red y la construcción del edificio.

## Vinculando cámaras wifi EZVIZ

ES

6. Encienda la cámara. Espere hasta que la luz de estado de la cámara parpadee, alternando entre azul y rojo.
7. Haga clic sobre el botón **“Ready (Listo)”** para empezar a detectar sus cámaras.  
Una vez detectada, la luz de estado de la cámara empezará a parpadear en azul.
8. Vincule las cámaras al Vault Plus haciendo clic sobre el botón **“Link Camera(s) (Vincular cámaras)”**, después sobre **“Next (Siguiente)”** y finalmente sobre **“Enter the Homepage (Entrar en la página de inicio)”**. Cierre sesión.

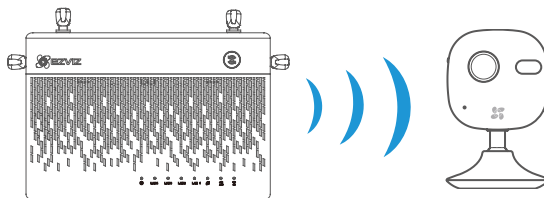

## Agregar una cuenta EZVIZ

9. Si es un usuario nuevo, descargue la aplicación EZVIZ en su teléfono Android o iPhone. Registre una cuenta de usuario EZVIZ. Para usuarios existentes, abra la aplicación EZVIZ e inicie sesión.
10. Agregue la cámara tocando sobre el signo (+) en la pantalla de INICIO y, a continuación, escanee el código QR de la cámara o escriba su número de serie.

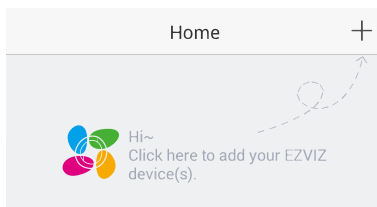

11. Agregue el Vault Plus tocando sobre el signo (+) en la pantalla de INICIO y, a continuación, escanee el código QR del Vault Plus o escriba su número de serie.
12. Una vez agregado a la cuenta EZVIZ, toque sobre el Vault Plus en la pantalla de inicio de la aplicación EZVIZ para verificar las cámaras vinculadas.

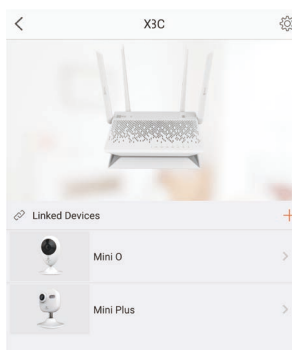

## Instalación de una unidad de disco duro (opcional)

1. (Opcional) Retire las almohadillas de goma.
2. Afloje los cuatro tornillos en la parte inferior del dispositivo y extraiga la base. Consulte la figura siguiente.

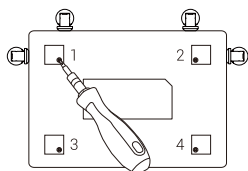

3. Pegue las almohadillas térmicas de silicona conductora a ambos lados de la unidad de disco duro y fije el radiador de la unidad de disco duro a las almohadillas de silicona.
4. Use los cuatro tornillos para fijar el radiador a la unidad de disco duro. Consulte la figura siguiente.

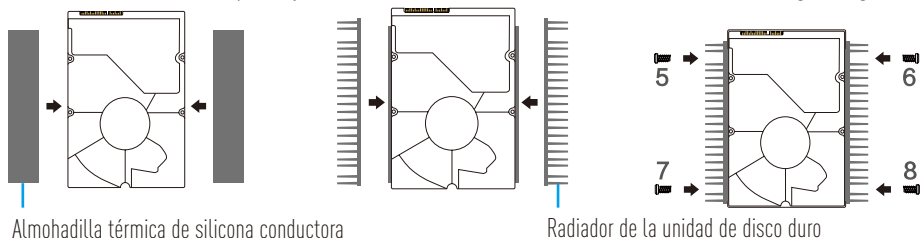

Almohadilla térmica de silicona conductora

Radiador de la unidad de disco duro

5. Conecte el cable de datos. Asegúrese de alinear la línea límite (blanca) con el borde del conector.

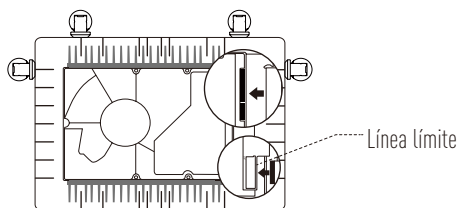

6. Instale el protector de la unidad de disco duro. Consulte la figura siguiente.

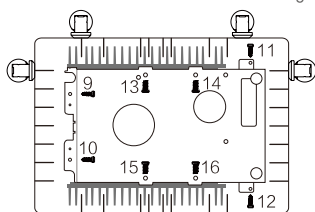

7. Vuelva a montar la base del Vault Plus. Vuelva a colocar los tornillos y las almohadillas de goma para completar la instalación de la unidad de disco duro.

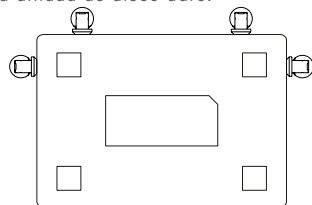

# Informations de base

## Contenu du carton

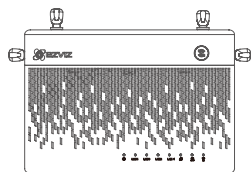

1 Vault Plus

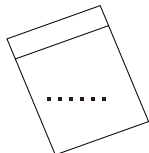

1 kit d'accessoires

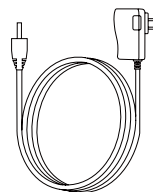

1 adaptateur d'alimentation



1 guide de démarrage rapide



Pour les modèles équipés de disque dur, les accessoires ne sont pas fournis. Pour les modèles sans disque dur, les accessoires (vis et radiateur de disque dur) sont fournis.

## Présentation du panneau arrière

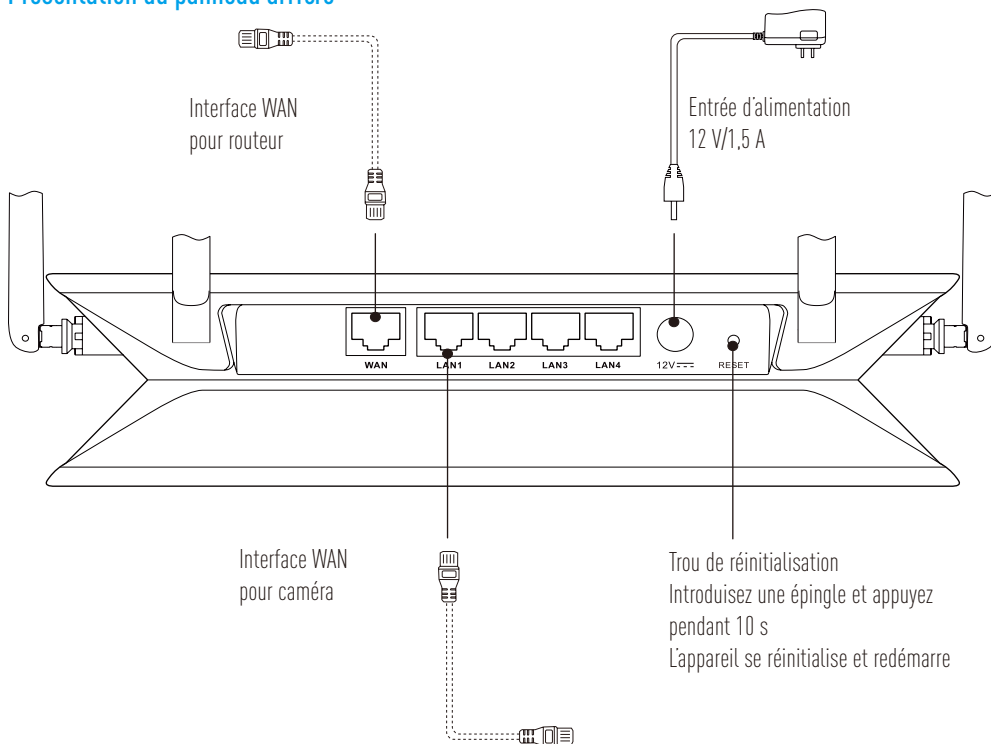

Les câbles représentés en pointillés ne sont pas fournis.

# Présentation du produit

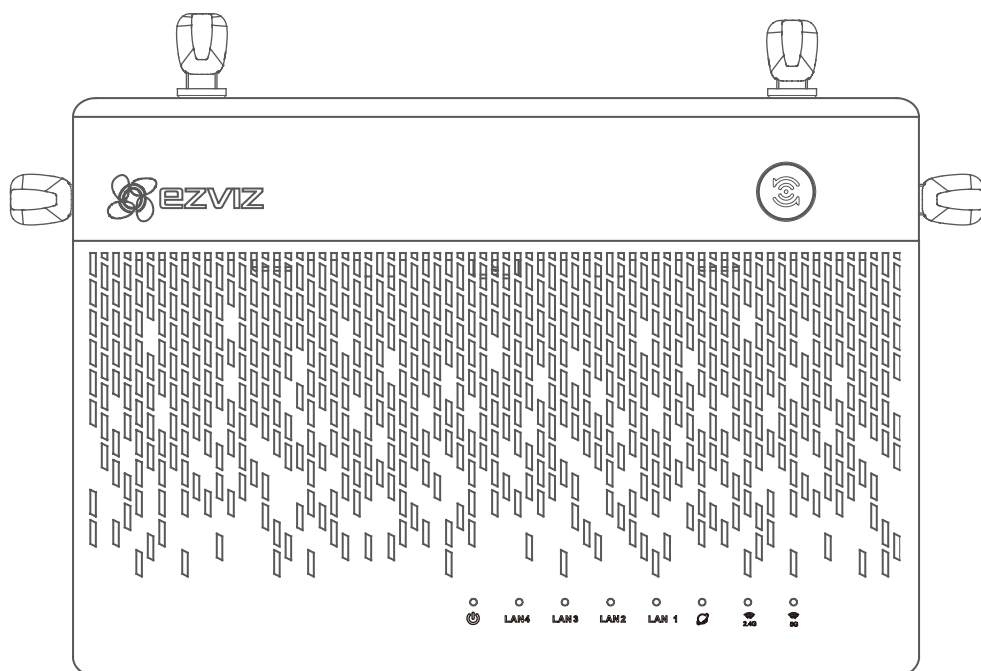

## État de l'indicateur LED



Bouton d'accès rapide



Voyant d'état du système

**LAN**

Voyant du réseau LAN



Voyant du réseau WAN



Voyant de réseau  
Wi-Fi 2.4G



Voyant de réseau Wi-Fi 5G

Une fois la connexion Internet Vault Plus entièrement configurée, connectez automatiquement les caméras EZVIZ au réseau Wi-Fi du Vault Plus à l'aide du bouton d'accès rapide. L'indicateur d'état du système Vault Plus clignote en bleu pendant l'opération. Remarque : le voyant d'état de la caméra se mettra à clignoter en bleu une fois la connexion établie correctement au réseau Wi-Fi du Vault Plus.

Vert : l'appareil est sous tension ou fonctionne normalement.

Bleu : l'appareil est déconnecté au réseau, effectue sa mise à jour ou le disque dur est en cours de formatage.

Rouge : échec formatage du disque dur, disque dur non identifié ou erreur.

Fixe : l'appareil est connecté à l'interface LAN.

Clignotement : transmission de données en cours.

Vert : le réseau est connecté.

Aucun voyant allumé : le réseau est déconnecté.

Vert : le réseau Wi-Fi 2.4G est activé.

Aucun voyant allumé : le réseau Wi-Fi 2.4G est désactivé.

Vert : le réseau Wi-Fi 5G est activé.

Aucun voyant allumé : le réseau Wi-Fi 5G est désactivé.



# Configurer la connexion Internet du Vault Plus

## A. Configuration via un réseau filaire (recommandé)

1. Connectez l'interface WAN du Vault Plus à l'interface du réseau local de votre routeur Internet à l'aide d'un câble Ethernet.

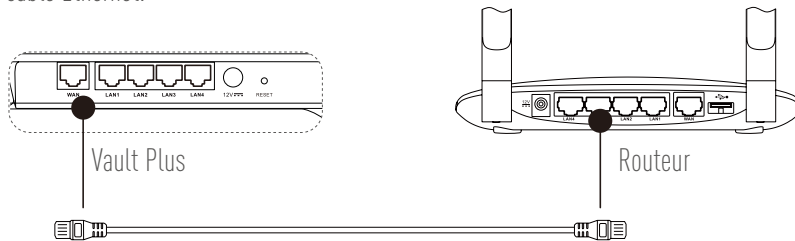

2. Allumez le Vault Plus. Connectez le cordon d'alimentation au Vault Plus et insérez le bloc d'alimentation dans une prise électrique. Le démarrage peut durer 2 minutes. Les indicateurs d'état du système et WAN deviendront verts.
3. Connectez votre ordinateur au réseau Wi-Fi du Vault Plus (dont le nom est « **ezviz\_XXXXXX** », où XXXXXX est une combinaison de lettres et de chiffres) pour accéder à l'interface utilisateur du Vault Plus. Vous trouverez aussi le nom du réseau Wi-Fi du Vault Plus (SSID) sur l'étiquette au bas de l'appareil.
4. Si l'interface utilisateur du Vault Plus ne s'affiche pas automatiquement, ouvrez un navigateur Internet (IE8/version supérieure ou Chrome), puis saisissez 192.168.7.1 pour accéder à l'interface utilisateur du Vault Plus.
5. Cliquez sur le bouton « **Start (Démarrer)** », puis réalisez les étapes suivantes pour configurer les paramètres Internet du Vault Plus. Choisissez « **Wired Network Internet Access (Accès Internet via réseau filaire)** » comme mode de connexion à Internet.

## B. Configuration du réseau via un relais\* Wi-Fi (en option)

1. Allumez le Vault Plus. Connectez le cordon d'alimentation au Vault Plus et insérez le bloc d'alimentation dans une prise électrique. Attendez 2 minutes la fin du démarrage du système.
2. Connectez votre ordinateur au réseau Wi-Fi du Vault Plus (dont le nom est « **ezviz\_XXXXXX** », où XXXXXX est une combinaison de lettres et de chiffres) pour accéder à l'interface utilisateur du Vault Plus. Vous trouverez aussi le nom du réseau Wi-Fi du Vault Plus (SSID) sur l'étiquette au bas de l'appareil.
3. Si l'interface utilisateur du Vault Plus ne s'affiche pas automatiquement, ouvrez un navigateur Internet (IE8/version supérieure ou Chrome), puis saisissez 192.168.7.1 pour accéder à l'interface utilisateur du Vault Plus.
4. Cliquez sur le bouton « **Start (Démarrer)** », puis réalisez les étapes suivantes pour configurer les paramètres Internet du Vault Plus. Choisissez « **Wi-Fi Relay Internet Access (Accès Internet via un relais Wi-Fi)** » comme mode de connexion à Internet.
5. Recherchez et connectez votre Vault Plus au réseau Wi-Fi du routeur de liaison montante (Wi-Fi 5 GHz).

\*Le débit de données réel et la couverture sans fil peuvent varier et être limités par les conditions du réseau et les conditions environnementales, y compris le volume du trafic réseau et la construction du bâtiment.

## Connexion aux caméras Wi-Fi EZVIZ

6. Allumez la caméra. Patientez jusqu'à ce que le voyant d'état de la caméra clignote en bleu et rouge.
7. Cliquez sur le bouton « **Ready (Prêt)** » pour lancer la détection de vos caméras. Dès qu'une caméra est détectée, son voyant d'état se mettra à clignoter en bleu.
8. Connectez les caméras au Vault Plus en cliquant sur le bouton « **Link Camera(s) (Connecter les caméras)** », puis sur « **Next (Suivant)** » et enfin sur « **Enter the Homepage (Accéder à la page d'accueil)** ». Déconnectez-vous.

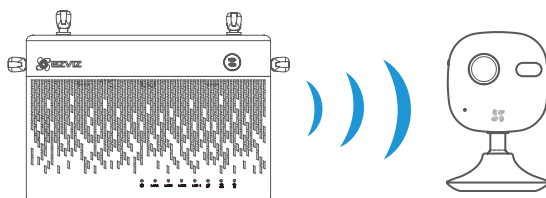

## Ajout à un compte EZVIZ

9. Les nouveaux utilisateurs doivent télécharger l'application EZVIZ sur leur téléphone Android ou iPhone. Créez un compte EZVIZ. Les utilisateurs existants doivent ouvrir l'application EZVIZ et se connecter.
10. Ajoutez la caméra en appuyant sur le signe (+) de l'écran d'accueil, puis scannez le code QR de la caméra ou saisissez son numéro de série.

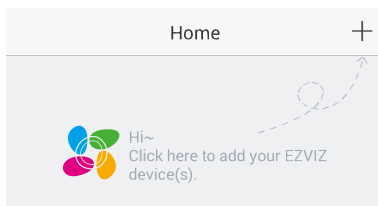

11. Ajoutez le Vault Plus en appuyant sur le signe (+) de l'écran d'accueil, puis scannez le code QR du Vault Plus ou saisissez son numéro de série.
12. Une fois l'appareil ajouté au compte EZVIZ, appuyez sur la représentation du Vault Plus dans l'écran d'accueil de l'application EZVIZ pour vérifier la connexion aux caméras.

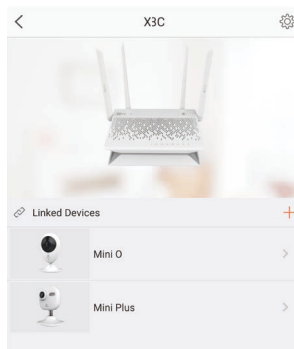

# Installation du disque dur

1. Retirez les pieds en caoutchouc (facultatif).
2. Dévissez les quatre vis situées sur la partie inférieure de l'appareil pour retirer la base (comme illustré ci-dessous).

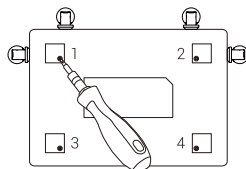

FR

3. Sur les deux longueurs du disque dur, collez les tampons thermoconducteurs en silicone, puis fixez le radiateur du disque dur sur ces tampons.
4. Utilisez les quatre vis pour fixer le radiateur sur le disque dur (comme illustré ci-dessous).

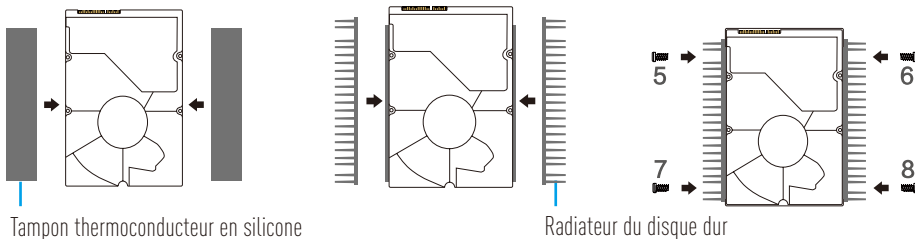

Tampon thermoconducteur en silicone

Radiateur du disque dur

5. Branchez le câble de transmission des données. Assurez-vous que le trait limite blanc s'aligne sur le bord du connecteur.

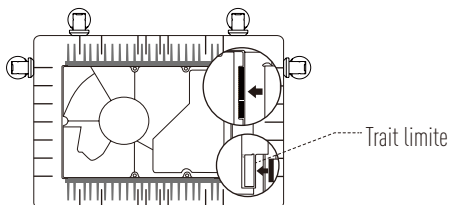

6. Remettez le couvercle du disque dur en place. (comme illustré).

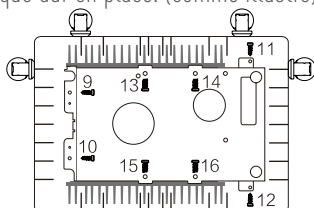

7. Remontez la base de Vault Plus. Remplacez les vis et les pieds en caoutchouc pour terminer l'installation du disque dur.

