

avocorTM

AVW-6555

Windows Collaboration Display



Model AVW-6555 Installation and Operation Manual

COPYRIGHT AND TRADEMARKS:

©Copyright 2019. This document contains proprietary information protected by copyright, trademark and other intellectual property laws. All rights are reserved. No part of this manual may be reproduced by any mechanical, electronic or other means, in any form, without our prior written permission.

The trademarks reproduced in this document and used on the products are either owned or licensed by us, or by their respective holders. You may not reproduce or use the trademarks without our prior written consent.

Important Safety Instructions

- Before using this display, please read this user manual thoroughly to help protect against property damage and to ensure your personal safety and the safety of others.
- Be sure to observe the following instructions.
- For your safety, be sure to observe the warnings located in this manual.
- For installation or adjustment, please follow the instructions in this manual and refer all servicing to qualified service personnel.

Safety Precautions

- If smoke or a peculiar smell comes from the display, remove the power plug from the outlet immediately.
- Failure to do so may result in fire or electrical shock. Contact your dealer for inspection.
- If the display has been turned on but there isn't a picture, remove the power plug from the outlet immediately.
- Failure to do so may result in fire or electrical shock. Contact your dealer for inspection.
- If water is spilled or objects are dropped inside the display, remove the power plug from the outlet immediately.
- Failure to do so may result in fire or electrical shock. Contact your dealer for inspection.
- If the display is dropped or the cabinet is damaged, remove the power plug from the outlet immediately.
- Failure to do so may result in fire or electrical shock. Contact your dealer for inspection.
- To turn off the power of the display, press "O" on the main power switch at side of display.
- The power standby/on indicator will go off and the display cannot to be turned on/off by using the POWER button on the remote control. (To turn on/off the display by the remote control, press the main power switch again and light the power standby/on indicator.)
 - ◆ When turning off the display by pressing the POWER button on the remote control, the main power of the display is not turned off completely.
 - ◆ To disconnect power completely, remove the power plug from the outlet.
- If the power cord or plug is damaged or becomes hot, turn off the main power switch of the display, make sure the power plug has cooled down and remove the power plug from the outlet.
- If the display is still used in this condition, it may cause fire or electrical shock. Contact your dealer for replacement.

Installation

- Don't install in a high-temperature environment.
 - ◆ If the display is used in high-temperature or in direct sunlight, it may cause the case or other parts to become distorted or damaged, resulting in overheating or electrical shock.
- Don't install in a high-humidity environment.
 - ◆ This may cause overheating or electrical shock.
- Don't install near any heat sources such as radiators, heat registers, stoves, or other apparatus that produce heat.
 - ◆ This may cause fire or electrical shock.
- Don't overload outlets or cables beyond electrical capacity.
- Don't use extension cords as it may cause fire or electrical shock.
- Don't insert the power plug into an outlet other than 100~240V AC.
 - ◆ This may cause fire or electrical shock.
- Don't use a damaged power plug or worn outlet.
- Don't insert an improper power plug it may cause fire or electric shock.
- Don't place the display on an unstable shelf or surface.
 - ◆ The display may fall, causing injury. Please install on a horizontal, stable, level surface.
- Don't place objects on the display.
 - ◆ If the display is covered or the vents are blocked, the display could overheat and cause a fire.
 - ◆ If metal or liquid gets into the display, it may cause fire or electrical shock.
 - ◆ Do not put heavy objects on the display as they may fall, causing injury.
 - ◆ Please keep a 10 cm minimum distance between the display and the wall for sufficient ventilation.
- Don't move the display when it is connected to the power cord and AV cables.
 - ◆ When moving the display, make sure to remove the power plug and cables from the outlet or source.
 - ◆ When unpacking or carrying the display, at least 2 people are needed. Make sure the display is carried upright.
 - ◆ Transport the display upright. Avoid placing the display face up or down.
 - ◆ Handle the display gently. Do not drop.

Use

- If you encounter a problem during installation, please contact your dealer for assistance. Don't repair or open the display by yourself.
- Failure to do so may result in fire or electrical shock. Contact your dealer for inspection.
- Protect and correctly use the power cord/plug.
 - ◆ Don't pinch the power cord/plug between hard surfaces.
 - ◆ Don't step on the power cord/plug.
 - ◆ Before inserting the power plug into the wall outlet, connect the power cord to the display.
 - ◆ Don't operate the display with a damaged power cord or it may damage the display.
- Using extension cords (not recommended)
 - ◆ If an extension cord must be used, ensure the voltage rating exceeds the max power consumption of the display. If the voltage rating is less than the display, it will cause the extension cord to overheat.
- If there is thunder or lightning, don't touch the display or the power plug.

This may cause an electric shock.

- Don't use any kind of liquid on the display.
- If liquid is spilled on the display, remove the power and ask qualified service personnel to check the display.
- If the liquid gets on the display's screen, please clean it with a dry and soft cloth immediately.
- Don't use any harsh chemical on the display.
- If metal or liquid gets into the display, it may cause a fire or an electrical shock.
- Don't install or remove the power plug with wet hands.
- If the display will not be used for a long period of time, unplug the display.

This may cause premature wear of electrical components or fire.

- Don't apply excessive pressure on the LCD panel. This may cause personal injury or panel damage.
- Don't push or shake the display.
 - ◆ This may cause damage or injury.
- If the glass of the display panel is broken, liquid may escape. Please don't touch the liquid.
 - ◆ If liquid get into your eyes or touches your skin, wash with the clean water and seek medical attention immediately.
- Precautions with the remote control batteries
 - ◆ Please only use approved AAA type batteries.
 - ◆ Please be sure to insert batteries by matching the + and -.
 - ◆ Don't recharge, heat, disassemble, short or throw batteries into a fire.
 - ◆ Don't mix a new battery with a used one.

- ◆ Don't mix different types of batteries together (only use the specified type). it may cause burn and injury.

Cleaning

- If dust has collected on the power plug, remove the plug from the outlet and clean off the dust.
 - ◆ Dust build-up may cause a fire.
- Take off the power plug before cleaning.
 - ◆ Failure to do so may result in electrical shock or damage.
- Cleaning the surface of the display
 - ◆ When the surface of the display becomes dirty, please wipe the surface lightly with a soft clean cloth.
 - ◆ If the surface requires additional cleaning, lightly moisten the cloth.
 - ◆ Do not to let any kind of liquid enter the display as it may cause electrical shock or damage.
 - ◆ Do not clean the display with alcohol, solvents or ammonia, as this could damage the display.

Warnings

Use

- Do not use the display lying flat on its back.
- Transport the display upright with proper packaging. Avoid placing the display face up or down. Be careful not to bump into the display.
- Do not send a static (non-moving) image to the display, or it may cause image 'burn-in' or image retention.
- "Burn in" and/or image retention is not covered under warranty.
- Make sure to change the image on the display periodically. It is recommended to turn off the display for at least 6 hours after 18 hours of usage in a 24 hour period to help avoid image retention

Exemptions

- This product isn't warranted for any damage caused by natural disaster (such as earthquake, thunder, etc.), fire, acts by third parties, accidents, owner's intentional misuse and fault, or use in other improper conditions.
- This product isn't warranted for incidental damages (such as profit loss or interruption in business, modification or erasure of record data, etc.) caused by use or inability to use of this product.
- This product isn't warranted for any damage caused by inappropriate operation, or from not following the user manual.
- This product isn't warranted for any damage caused by misuse or malfunction through simultaneous use of this product and the connected equipment or software.
- This product isn't warranted for any damage caused by neglect of the instructions described about installation.
- This product isn't warranted for any damage caused by improper installation.
- This product isn't warranted for any damage caused by disassembly, modification or repair by non-authorised service center or people.

Compliance Information

DECLARATION OF CONFORMITY:

AVOCOR hereby declares that the Product's Model Numbers:

AVW-6555

Conform with the provisions of:

- FCC:

FCC CFR Title 47 Part 15 Subpart B Class A, CISPR 22

ANSI C63.4

ICES-003

- CE:

EN 55032

EN 55024

EN 61000-3-2

EN 61000-3-3

- cTUVus:

UL 60950-1

CAN/CSA-C22.2 No. 60950-1

- CB:

IEC 60950-1

- CEC:

California Code of Regulations, Title 20:Division 2, Chapter 4, Article 4, Sections 1601-1609

- PSB:

IEC60950-1

FCC PART 15:

This equipment has been tested and found to comply with the limits for a Class A digital device, pursuant to part 15 of the FCC Rules. These limits are designed to provide reasonable protection against harmful interference when the equipment is operated in a commercial environment. This equipment generates, uses, and can radiate radio frequency energy and, if not installed and used in accordance with the instruction manual, may cause harmful interference to radio communications. Operation of this equipment in a residential area is likely to cause harmful interference in which case the user will be required to correct the interference at his own expense.

CAUTION

Any changes or modifications not expressly approved by the grantee of this device could void the user's authority to operate the equipment.

INDUSTRY CANADA (ICES-003):

CAN ICES-3 (A)/NMB-3(A)

PRODUCT DISPOSAL:

The Product contains small amounts of tin, lead and/or mercury. Disposal of these materials may be regulated due to environmental considerations.

DISPOSAL OF OLD ELECTRICAL AND ELECTRONIC EQUIPMENT (Applicable throughout the European Union and other European countries with separate collection programs)



This symbol found on your product or on its packaging, indicates that this product should not be treated as household waste when you wish to dispose of it. Instead, it should be handed over to an applicable collection point for the recycling of electrical and electronic equipment. By ensuring this product is disposed of correctly, you will help prevent potential negative consequences to the environment and human health, which could otherwise be caused by inappropriate disposal of this product.

The recycling of materials will help to conserve natural resources. This symbol is only valid in the European Union. If you wish to discard this product, please contact your local authorities or dealer and ask for the correct method of disposal.

Notes

Table of Contents

Important Safety Instructions	3
Safety Precautions	3
Installation	4
Use	5
Cleaning	6
Warnings	7
Use	7
Exemptions	7
Compliance Information	8
Table of Contents	11
List of Figures	13
1. Introduction	15
About This Manual	15
Target Audience.....	15
Textual and Graphic Conventions.....	15
Using This Manual	16
Description, Features and Benefits	17
Key Features and Benefits.....	17
Touch Capability.....	17
Parts List.....	17
2. Controls and Functions	18
Display at a Glance	18
Input Panel	22
Remote Control Unit	24
3. Installation	26
Remote Control	26
Notes on Batteries.....	26
Notes on Remote Control Operation.....	26
Quick Setup	27
Installation Considerations	27
Ambient Light.....	27
Ambient Temperature.....	27
Ventilation.....	28
Mounting the Display	28
Connections to the Display	29
Connecting a Control System or PC.....	29
Connecting Source Components to the Display.....	31
Turning on the Power	33
Changing the OSD Language	34
Enabling the Touch Screen	34
Software Installation.....	35
4. Operation	39
Using the On-Screen Menus	39
Input Menu.....	41
Display Settings.....	43
Audio Menu.....	44
Basic Settings.....	45

Advanced Settings	46
Information	49
5. Maintenance and Troubleshooting.....	50
Maintenance.....	50
Troubleshooting.....	50
6. External Control.....	53
Serial Communications	53
RS232 Connection and Port Configuration	53
Command and Response Format.....	53
Command and Response Examples	54
Serial Command List.....	54
Using Discrete IR Codes	59
IR Command Protocol.....	59
IR Control Code List.....	59
7. Specifications	60
Supported Timings	61
Overall Dimensions.....	63
Appendix I: Moving and Carrying Notice	66
Moving the Display.....	66
Carrying the Display.....	66
Appendix II: Installing a Wall Mount.....	67
Appendix III: Installing a NUC VESA Adapter.....	68
Appendix IV: Wall Mount Safety Notes	69
Appendix V: Azure IoT Settings.....	71
Check the IP Address of IoT device	71
Log in to IoT Module.....	72
Configure Network Settings	72
Modify Admin Setup.....	73
Update IoT Module Firmware	74
Setup Azure IoT Service	75
View the Sensor Status.....	76
Configures Sensor Timer Setup	76

List of Figures

FIGURE 2-1. DISPLAY FRONT/ SIDE /REAR VIEW	18
FIGURE 2-2. DISPLAY INPUT PANEL VIEW	22
FIGURE 2-3. DISPLAY REMOTE CONTROL UNIT	24
FIGURE 3-1. VENTILATION REQUIREMENTS FOR ENCLOSURE MOUNTING.....	28
FIGURE 3-2. RS-232 CONTROL SYSTEM CONNECTION.....	29
FIGURE 3-3. ETHERNET CONNECTION.....	30
FIGURE 3-4. DISPLAYPORT SOURCE CONNECTION	31
FIGURE 3-5. HDMI SOURCE CONNECTIONS	32
FIGURE 3-6. TYPE C SOURCE CONNECTIONS	33
FIGURE 3-7. TOUCH SCREEN CONTROLLER (USB) CONNECTION.....	34
FIGURE 4-1. OSD MENU STRUCTURE.....	40
FIGURE 7-1. AVW-6555 DISPLAY DIMENSIONS (INCH)	63
FIGURE 7-2. AVW-6555 DISPLAY DIMENSIONS (MM)	64

Notes

1. Introduction

About This Manual

This Owner's Manual describes how to install, set up and operate the AVOCOR Series LED Display.

Throughout this manual, the AVOCOR Series LED Display is referred to as the "display".

Target Audience

The manufacturer has prepared this manual to help installers and end users get the most out of the display.

The manufacturer has made every effort to ensure that this manual is accurate as of the date it was printed. However, because of ongoing product improvements and customer feedback, it may require updating from time to time.

Textual and Graphic Conventions

Text Conventions: The following conventions are used in this manual, in order to clarify the information and instructions provided:

- Remote and built-in keypad button identifiers are set in upper-case bold type; for example, "Press **EXIT** to return to the previous menu."
- Computer input (commands you type) and output (responses that appear on-screen) is shown in monospace (fixed-width) type; for example: "To change the aspect ratio to Letterbox, type 07 00 02 41 53 50 03 08 <OK>."
- All keys with functional names are initial-capped, set in bold type and enclosed in angle brackets. These keys are the following: <OK>, <Spacebar>, <Control>, <Esc> and <Tab>. <OK> indicates that you may press either the EXIT or OK key on your keyboard if it has both keys.
- In addition to these conventions, underlining, bold face and / or italics are occasionally used to highlight important information, as in this example:



NOTE A carriage return must be used after each command or string.

Graphic Conventions: These symbols appear in numerous places throughout the manual, to emphasise points that you must keep in mind to avoid problems with your equipment or injury:



TIP

TIPS highlight time saving short cuts and helpful guidelines for using certain features.



NOTE

NOTES emphasize text with unusual importance or special significance. They also provide supplemental information.



CAUTION

CAUTIONS alert users that a given action or omitted action can degrade performance or cause a malfunction.



WARNING

WARNINGS appear when a given action or omitted action can result in damage to the equipment, or possible non-fatal injury to the user.



DANGER!

DANGER appears when a given action can cause severe injury or death.

Using This Manual

Use the following table to locate the specific information you need in this manual.

If you need...	... Turn to page:
General information about the AVOCOR Series LED Display	17
Installation instructions	26
First-time configuration instructions	33
Advanced configuration instructions	46
Troubleshooting tips	50
Product specifications	60

Description, Features and Benefits

The AVOCOR AVW-6555 Display is an ultra-high definition touch display that supports a full 3840x2160 @60Hz(4K) resolution and can display 8 bits, 1.07 billion colors.

It combines ultra-high resolution and unparalleled image quality with configurable I/O in a large-format display for room-scale collaboration.

Key Features and Benefits

The display offers these key features and benefits:

- Up to 3840x2160 @60 Hz(4K) resolution
- High-speed InGlass™ touch sensing for up to 20 points and 4 passive pens (for Windows system)
- Single cable connectivity with Type C
- Diverse video connectivity including (2) HDMI 2.0 inputs, DisplayPort 1.2 input with HDCP
- Multiple control connectors including RS-232, USB 2.0/3.0, Touch USB and LAN connections
- MIC array
- Full-range stereo speaker module integrated with premium conference camera
- Compliance with windows 7/8/10, and Mac OS
- Azure IoT services support
- Long lifetime with high reliability

Touch Capability

- Precise, highly responsive touch technology optimized for Windows inking
- High touch sensitivity – no pressure required
- Any touch: finger, gloved hand or pointer
- Calibrated easily by provided software tools
- Compliant with Windows 7 Pro & Ultimate/8/10 and Mac OS 10.10, 10.11, 10.12.1
- Supports 4 passive pens and 2 erasers in Windows system
- One USB cable for easy Plug-and-Play operation

Parts List

Your display is shipped with the following items. If any items are missing or damaged, please contact your dealer or Customer Service.

- AVOCOR UHD LED Display
- Remote Control Unit and Batteries
- AC Power Cord (US, UK, Europe, AU&NZ)
- 2 Touch Stylus
- 5 Cable Clips
- USB Cable - 3 Metres
- HDMI Cable - 3 Metres
- Type C Cable - 1.8 Metres
- VESA Adapter Plate and screws - 75x75mm; 100x100mm
- Quick User Guide (QSG)

2. Controls and Functions

Display at a Glance

Figure 2-1 shows the key display components, and the paragraphs that follow describe them.

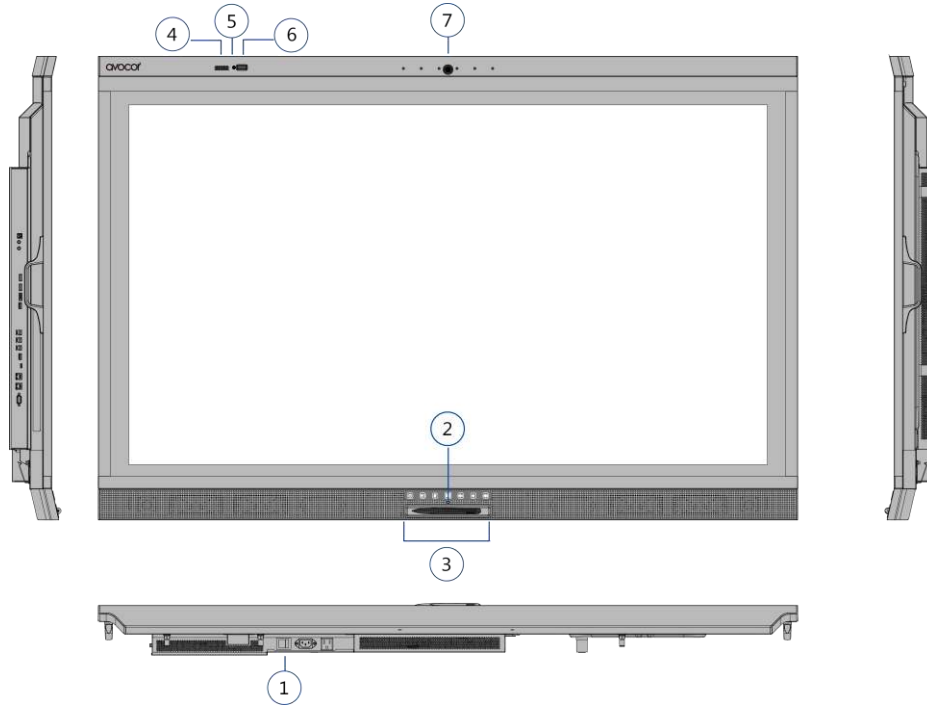

Figure 2-1. Display Front/ Side /Rear View

1. MAIN POWER SWITCH

Connects or disconnects the display panel from the AC power source.

2. Status LED

Solid green: display on, input detected

Blinking orange: display on, no input detected

Solid orange: display in power saving mode

Off: main power switched off

3. KEYPAD



The keyboard allows the user to turn on the display, change sources, access the Windows start menu and adjust the audio settings. The keypad operates as follows:

POWER 

Press the button to turn on/off the monitor screen.

SOURCE 

Press the button to select a media source.

Press and hold the button to go through the input sources.

Release button when desired source is selected.

MICROPHONE MUTE 

Press the button to mute/unmute the microphone.
(PC must be able to support this function)

WINDOWS 

Press the button to activate Windows start menu

VOLUME MUTE 

Press the button to mute/unmute the volume.

VOLUME DOWN  / UP 

Press these two buttons to lower or increase the volume.

Press and hold the button to continuously lower or increase the volume.

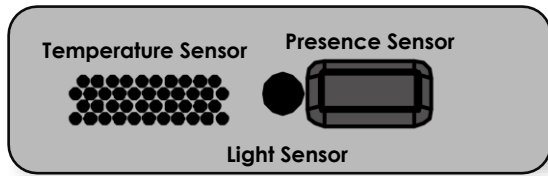

4. Temperature Sensor

Measures the room temperature and displays the data both in °C & °F on the OSD - information menu. Temperature data is also reported to the Azure IoT service.

5. Light Sensor

Senses the ambient lighting condition and shows the illumination data on the OSD - information menu. Light sensor data is also reported to the Azure IoT service.

6. Presence Sensor

Detects movement in a scanned area, for angle coverage and detection range, see the following figures:

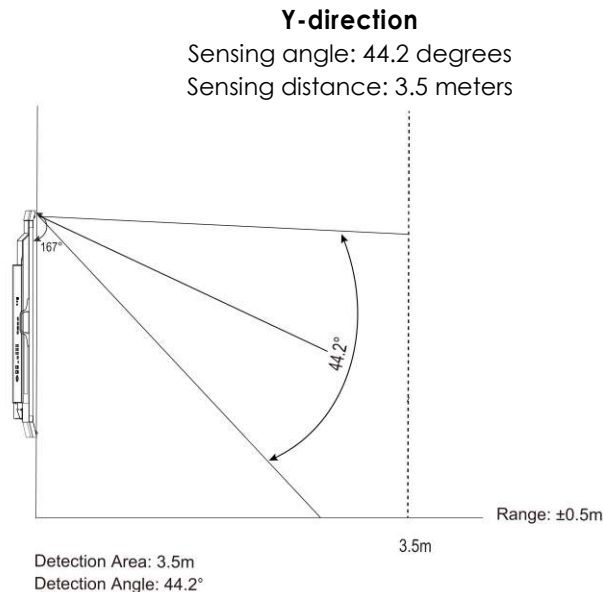
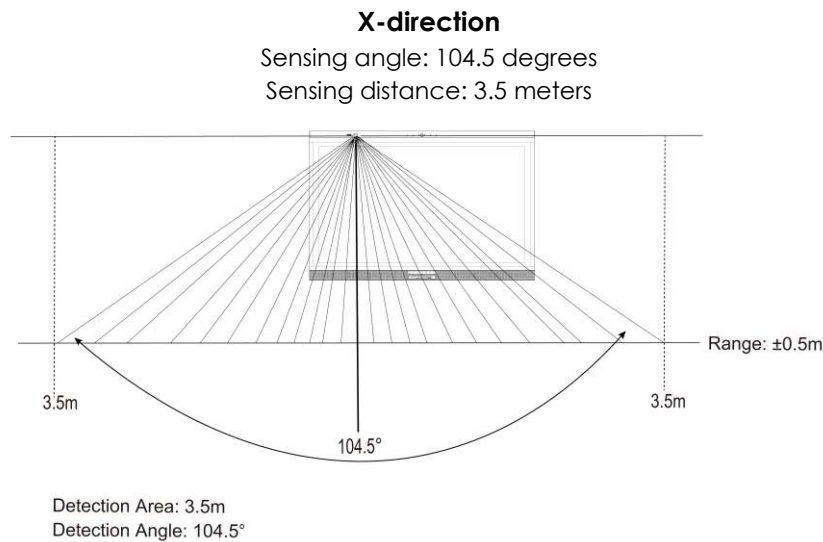

The light gray areas indicate where PIR sensor will not be able to detect motions.

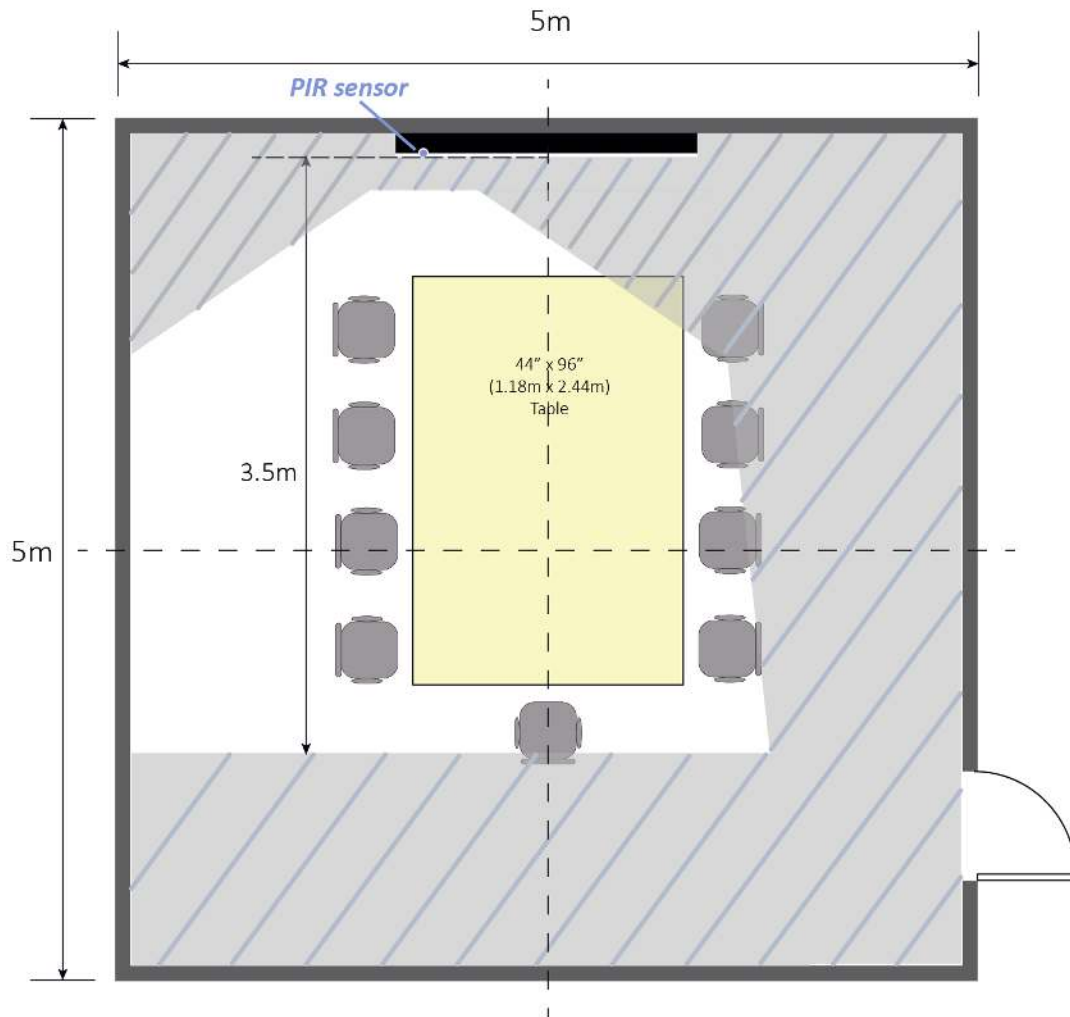

The display will wake up or go into power saving (sleep) mode automatically. The presence data shows on the OSD - information menu.

If no movement is detected, the sensor starts timing and go into power saving (sleep) mode after 5 minutes (minimum) and which is adjustable from 5, 10, 15, 30, 60 & 120 minutes.

The presence sensor data is also reported to the Azure IoT service.

7. Camera Status LED

White: camera power on

Off: camera power off

Input Panel

Figure 2-2 shows the display input panel.

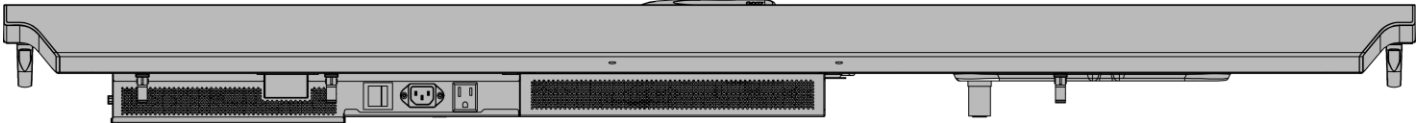
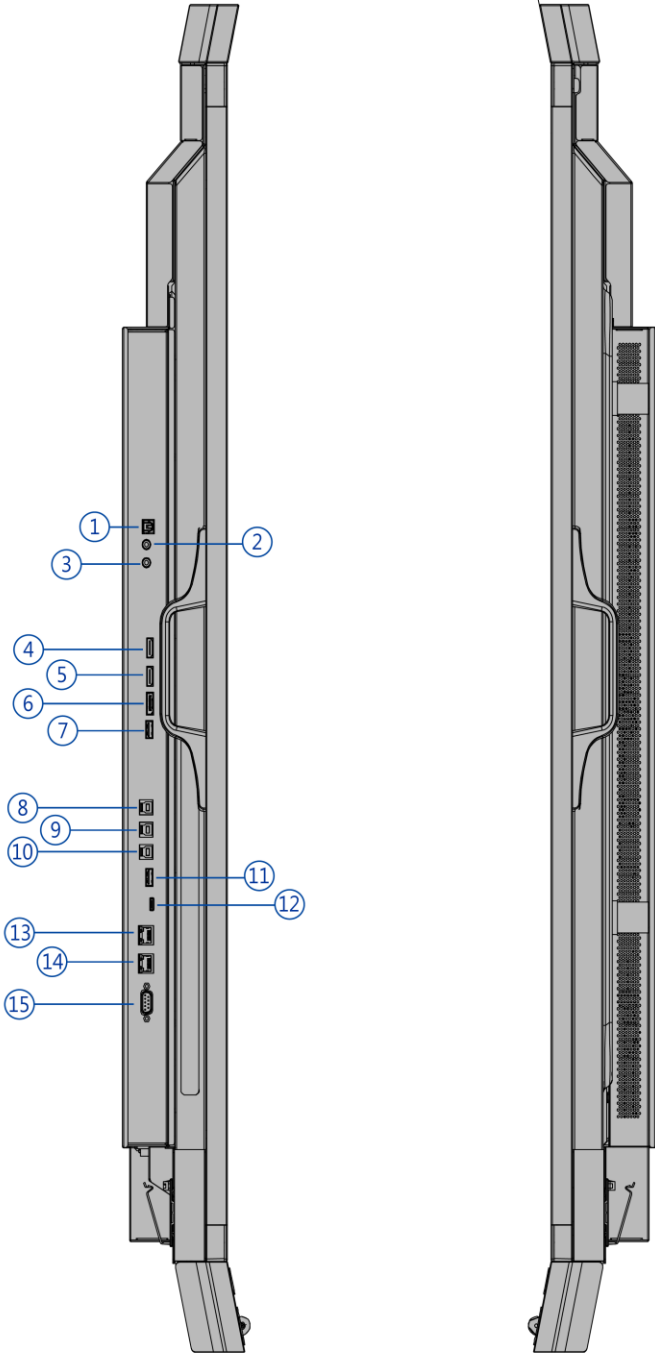

Figure 2-2. Display Input Panel View

No.	Connector
1	SPDIF Connects external and powered digital speakers or audio receiver/amplifier.
2	Audio Out Connects external, powered speakers or an external audio receiver/amplifier.
3	IR Connects an IR Extender cable from this input.
4	HDMI 3 HDCP-compliant HDMI 2.0 digital video input for connecting HDMI sources.
5	HDMI 2 HDCP-compliant HDMI 2.0 digital video input for connecting HDMI sources.
6	DisplayPort DisplayPort 1.2 and DisplayPort-HDCP 1.1 compliant, SD/HD input for connecting SDTV, EDTV or HDTV component video sources.
7	Service Port A standard USB Type A connector for connecting a USB stick for firmware upgrade. Can also be used to power low voltage devices like a Miracast dongle.
8,9,10	Touch USB HUB 3.0 in Type-B USB 3.0 port for connecting touch and media sources to the display for ports 4,5 & 6.
11	HUB USB 3.0 Standard USB 3.0 type A connectors for connecting external media, keyboard, keyboard or mouse.
12	Type C Type C USB port for connecting DisplayPort, USB, Power Delivery and Ethernet.
13	Ethernet In An RJ-45 connector for interfacing with a PC or home theater automation/control system via a Cat 5 cable.
14	Ethernet Out An RJ-45 connector for interfacing with a PC or home theater automation/control system via a Cat 5 cable.
15	RS232C A female, 9-pin D-sub connector for interfacing with a PC or home theatre automation/control system.









Remote Control Unit

Figure 2-3 shows the display remote control, and Table 2-1 describes its functionality.



Figure 2-3. Display Remote Control Unit

Table 2-1. Remote Control Button Descriptions

Button	Description
	Power Turns the display screen on and off
	Home (default setting: DisplayPort1) Home source can be selected in OSD menu – Display Settings on page 43.
	Source Selects a media source
	Navigation arrows Navigates through submenus and settings
	OK Confirms the selection
	Exit Exits the OSD menu
	Volume down Turns down the volume – when AVW-6555 HDMI audio source is selected in your pc, laptop or personal devices (under Sound settings)
	Volume up Turns up the volume – when AVW-6555 HDMI audio source is selected in your pc, laptop or personal devices (under Sound settings)
	Menu Opens the OSD menu

Hot keys for lock and unlock the remote control and built-in keypad

(power and source switch buttons only)

- **Lock:** To lock the remote control and built-in keypad, press **OK, OK, ↩, ↩, OK** and **↩** on the remote control. (This will not lock RS232 and Power On control.)
- **Unlock:** To unlock the remote control and built-in keypad, press **OK, OK, ↩, ↩, OK** and **↩** on the remote control.



NOTE Volume buttons setting on the remote control is only available when “**AVW-6555 HDMI**” audio source selected in your pc, laptop or personal devices, not available for other USB audio sources.

3. Installation



NOTE Installation must be performed by a qualified custom video installation specialist.

Remote Control

To install batteries in the remote control:

1. Press down the tab on the cover and pull the cover up.
2. Insert the included batteries. Ensure that the polarities correctly match the \oplus and \ominus markings inside the battery component.
3. Insert the lower tab of the cover into the opening, and press down the cover until it clicks in place.

Notes on Batteries

Make sure that the battery polarities are correct when installing the batteries.

- Do not mix an old battery with a new one or different types of batteries.
- If you will not use the remote control for a long time, remove the batteries to avoid damage from battery leakage.
- Do not expose batteries to excessive heat such as from sunshine, fire or the like.

Notes on Remote Control Operation

- Make sure that there is nothing obstructing the infrared beam between the remote control and the IR receiver on the display.
- If the effective range of the remote control decreases, or it stops working, replace the batteries with new ones.
- The remote control may fail to operate if the infrared remote sensor is exposed to bright sunlight or fluorescent lighting.
- Ambient conditions may possibly impede the operation of the remote control. If this happens, point the remote control at the display, and repeat the operation.

Quick Setup

Table 3-1 gives a quick overview of the display installation process. The sections following this one provide detailed instructions.

Table 3-1. Installation Overview

Step	Procedure	For Details Refer to page...
1	Mount the display(s) on a wall (optional)	28
2	Connect other external equipment to the display (optional): Automation/control system (RS232, Ethernet)	29
3	Connect signal sources to the display	31
4	Apply power to the display	33
5	Change the OSD language (optional)	34
6	Perform touch screen-specific installation and configuration tasks (AVOCOR): Connect touch screen controller host computer to the display	35
7	Display calibration - adjust the following <i>for each input</i> : <ul style="list-style-type: none">• Aspect ratio• Brightness• Contrast• Color temperature and white balance• Color level• Tint• Input position	41

Installation Considerations

Proper installation of your display will ensure a satisfying viewing experience. Whether a display is installed temporarily or permanently, the following should be taken into account to ensure the best performance of the display.

Ambient Light

In general, minimise or eliminate light sources directed at the screen. Contrast ratio in your images will be noticeably reduced if light directly strikes the screen, such as when a shaft of light from a window or floodlight falls on the image. Images may then appear washed out and less vibrant. Direct sunlight may affect touch operation.

Ambient Temperature

Keep the ambient temperature constant and below 40°C (104°F). Keep the display away from heating and/or air conditioning vents.

Ventilation

If you are mounting the display in an enclosure, leave sufficient space on all sides between it and surrounding objects, as shown in Figure 3-1. This allows heat to disperse, maintaining the proper operating temperature.

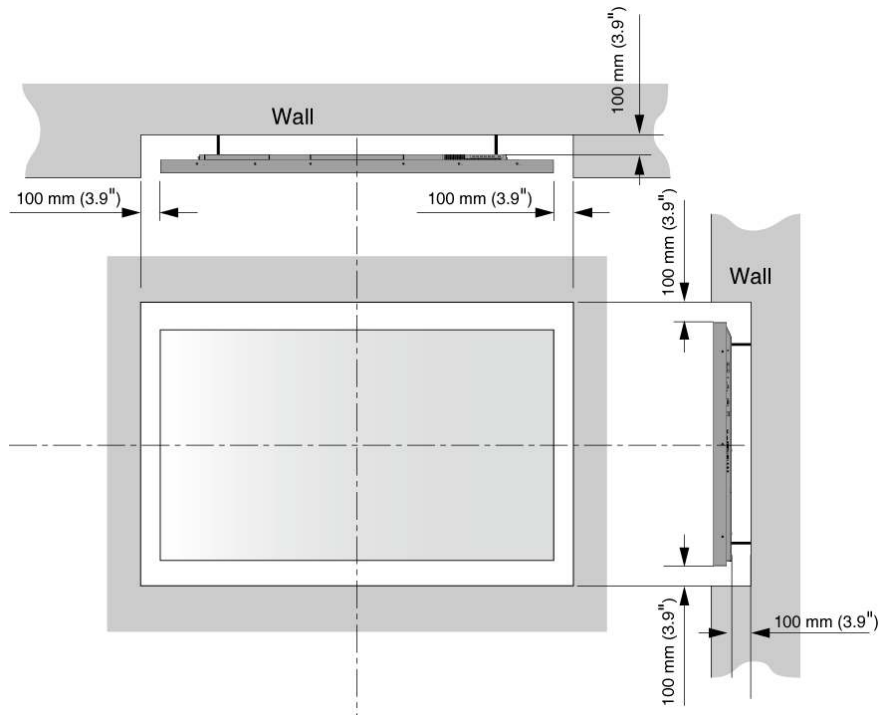

Figure 3-1. Ventilation Requirements for Enclosure Mounting

Mounting the Display

You can mount the display on a wall.

If you do decide to wall-mount the display, ensure that the wall-mount bracket is installed according to the instructions included with it. The wall must be capable of supporting a redundant weight factor three (3) times the weight of the display, or be reinforced.

We recommend that this be done by a custom installation specialist.



NOTE

To safely mount the display on a wall:

- Use only the approved wall-mount kit designed for the display.
- Make sure the tilt degree of the wall **does not exceed 2 degrees**.

For more information of wall mount installation, refer to Appendix II: Installing a Wall Mount on page 67.

Connections to the Display

Proceed as follows to connect the display to your video sources, external controller(s) – if present – and AC power.

When connecting your equipment:

- Turn off all equipment before making any connections.
- Use the correct signal cables for each source.
- For best performance and to minimise cable clutter, use high-quality cables that are only as long as necessary to connect two devices. (Please use the cables that are provided in the packaging box.)
- Ensure that the cables are securely connected. Tighten the thumbscrews on connectors that have them.

Connecting a Control System or PC

RS-232 Connection

Use a straight-through RS-232 cable with a 9-pin male connector to connect a PC or control/ automation system (if present) to the RS-232 port on the display; see **Figure 3-2**.

For more information about using this connection, refer to External Control on page 53.

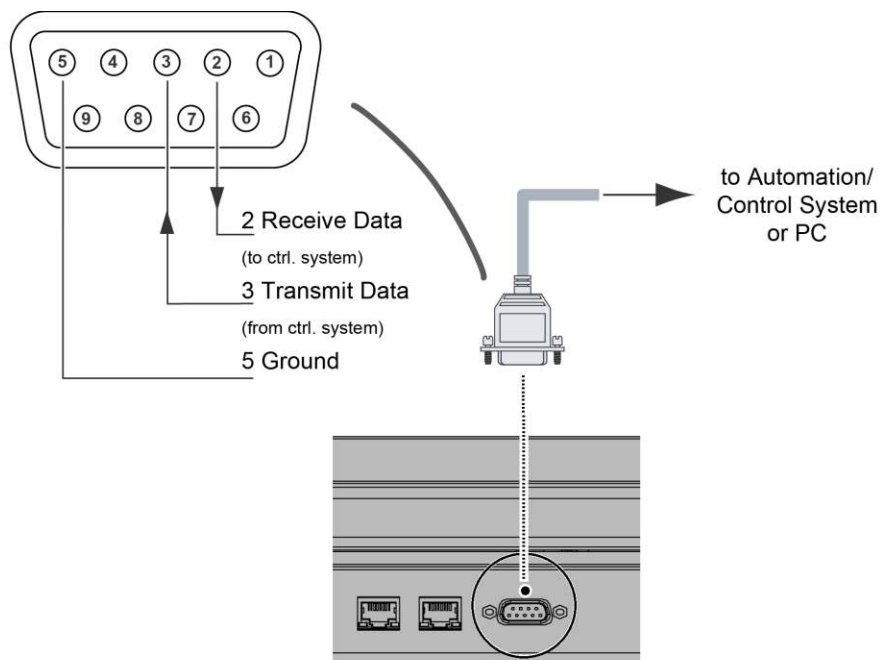

Figure 3-2. RS-232 Control System Connection



NOTE

The RS-232 connection may vary with different control system. If there is any problem regarding the connection, please contact our customer service for further assistance.

Ethernet Connection

Use a standard Ethernet cable with an RJ-45 male connector to connect a PC or control/automation system (if present) to the Ethernet port on the display.

For more information about using this connection, refer to External Control on page 53.

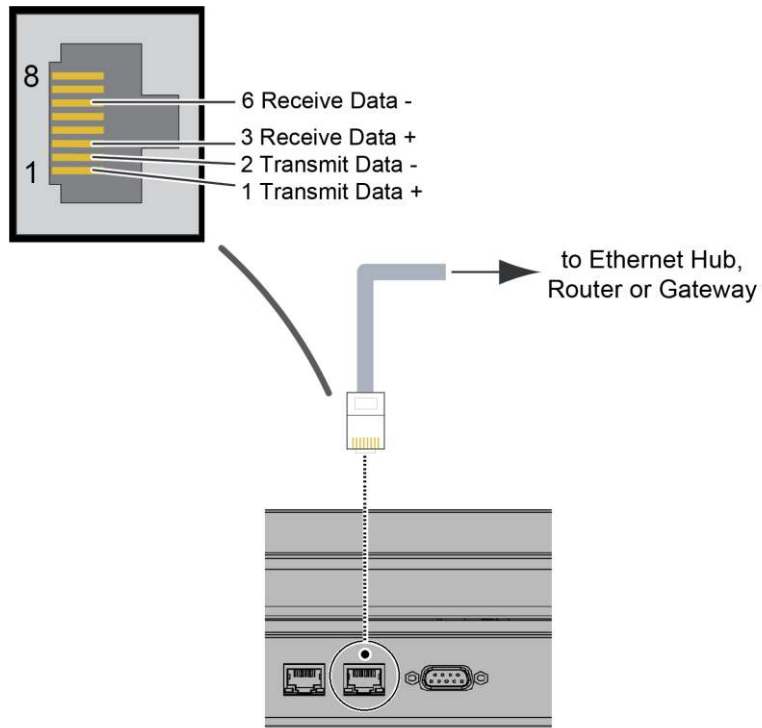

Figure 3-3. Ethernet Connection

Connecting Source Components to the Display

Connect your video sources to the display as shown and described in the sections that follow.

DisplayPort Source Connection: See Figure 3-4.

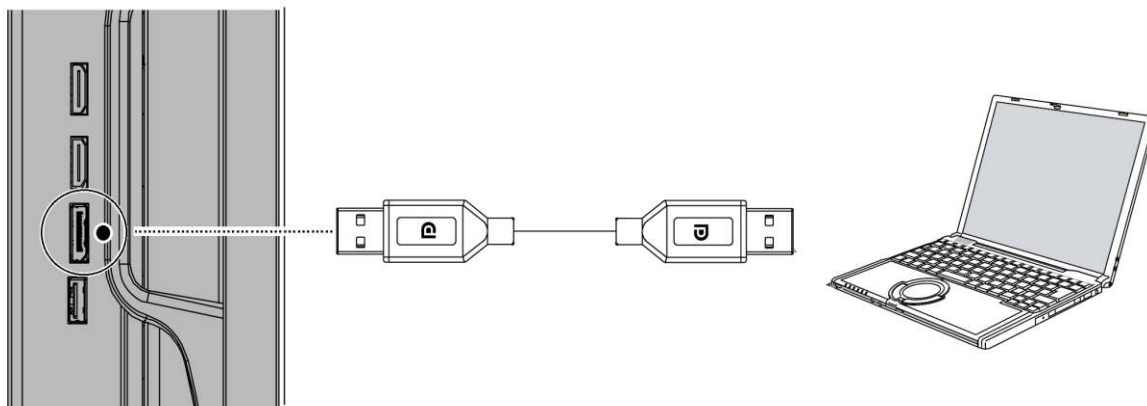

Figure 3-4. DisplayPort Source Connection

HDMI Source Connections: See Figure 3-5.



NOTE This display supports the VESA Display Data Channel (DDC) standard. This standard provides "Plug and Play" capability; the display and a VESA DDC-compatible computer communicate their setting requirements, allowing for quick and easy setup.
For Plug and Play to work correctly, you must turn on the display before you turn on the connected computer.

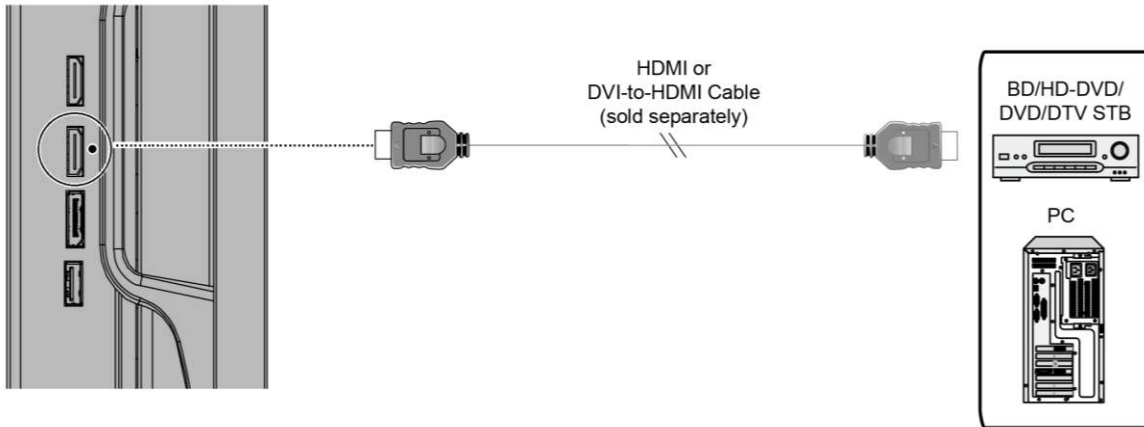

Figure 3-5. HDMI Source Connections

Type C Source Connection:

Connect a personal laptop to the Type C input as shown in Figure 3-6.



NOTE Refer to Supported Timings on page 61 for a list of compatible input signals.

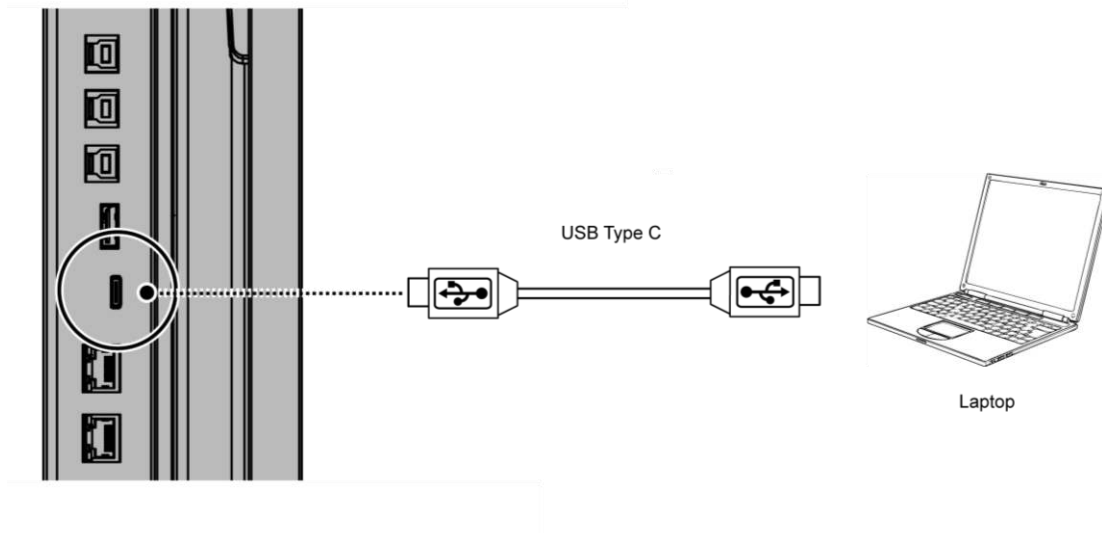



Figure 3-6. Type C Source Connections

Turning on the Power

1. Turn on your source components.
2. Plug the female end of the supplied power cord into the AC receptacle on the side of the display (AC 100V ~ 240V). See Figure 2-2.
3. Connect the other end to your AC power source.
4. Turn on the main power switch at the side of the display (see Figure 2-1). The power indicator lights orange to indicate that the display is in "standby" mode.
5. Press the power button () on the remote control to turn on the display or press the power button () on the keypad.
6. After a brief warm-up period, the display will display an image.



NOTE If there's no input signal for a period, the display will automatically go into power saving (sleep) mode.



Changing the OSD Language

The display OSD language is initially set to English, but can also display the menus in different languages.

To change the OSD language:

1. Press MENU.
2. Select Basic Settings from the Main Menu.
3. Select OSD Language from the Basic Settings Menu.
4. Press ◀ or ▶ to select the desired language and press OK. The change takes effect immediately.

Enabling the Touch Screen

Before setting up your display to support touch screen capability, ensure that:

- Your computer is turned on and connected to the display using Type C or the provided USB cable (for DisplayPort and HDMI source connections). Make sure connect the cable to the display by following the corresponding indicating dots on I/O ports. See Figure 3-7.
- The video output from the computer is connected to a video input on the display. See Figure 3-4, Figure 3-5 or Figure 3-6.
- The display is turned on.
- Using the Remote Control push the source button and select the source you connected or press the Source Button on the KEYPAD to select the source.

Type C connection



DisplayPort connection

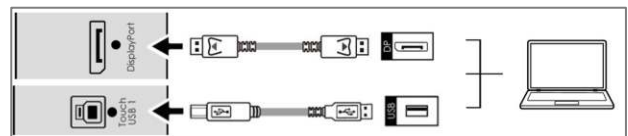

HDMI2 connection

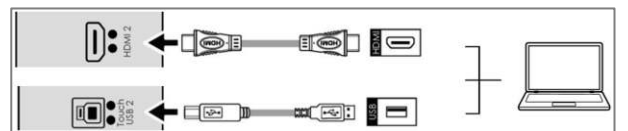

HDMI3 connection

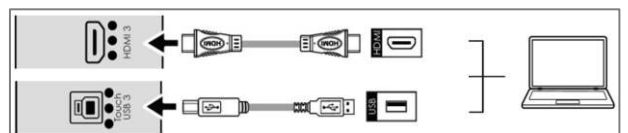

Figure 3-7. Touch Screen Controller (Type C, USB) Connection



NOTE

If the touch screen is not working, please turn off your computer or the display and enabling the touch screen again following the steps above.

Software Installation

This driver is not needed for any touch functionality, but is needed in order to perform firmware upgrade.

Automatic Driver Installation

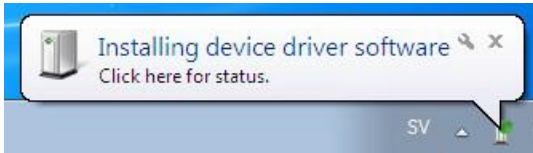

If the automatic driver installation starts, please allow it to run until completion in order to not disrupt the automatic process. Note that the icon may be hidden in the notification area, and that the procedure may take several minutes.

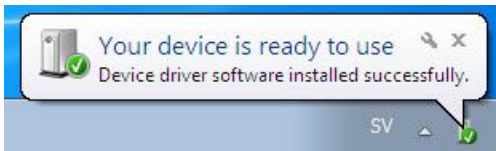

Clicking on the pop-up balloon at this point would show

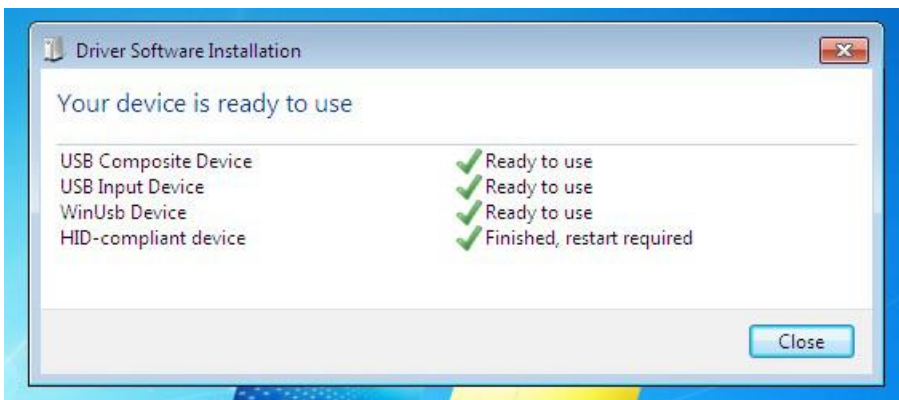

Fully expanded, the view in the Device Manager should look like this (View --> Devices by connection):

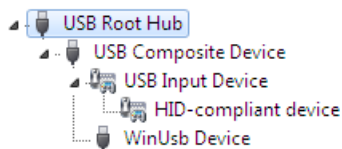

If the automatic installation fails to find the driver, or if automatic driver installation is disabled, or if there is no Internet connection, this is what you will typically see when connecting a FlagFrog touch device.

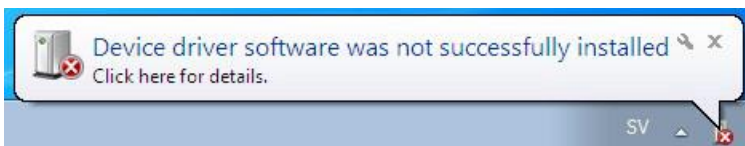

Clicking on the pop-up balloon would show

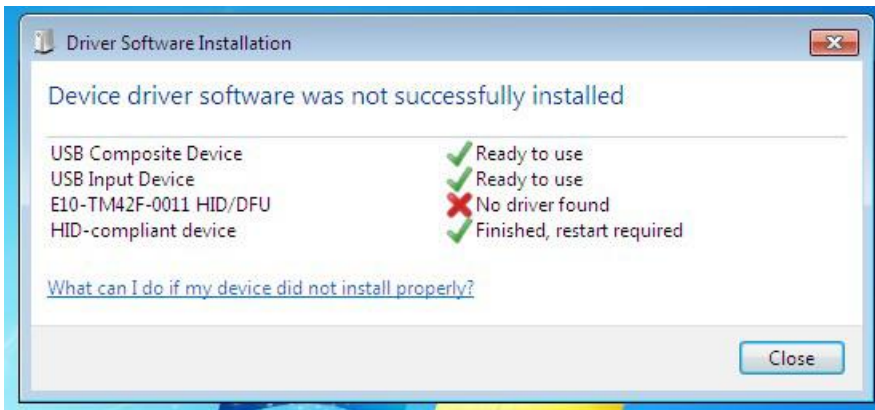

In the Device Manager, the view would be (again, use View --> Devices by connection):

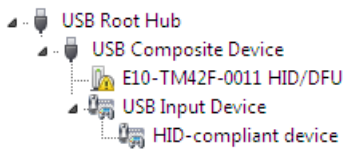

In this case, please proceed with Manual Driver Installation.

Manual Driver Installation

If the automatic driver installation failed for any of the reasons listed above, or if you would like to install the driver without having a FlatFrog touch device connected to the computer, the driver can be installed manually.

The driver provided with this upgrade package was downloaded from <http://catalog.update.microsoft.com> (requires Internet Explorer) and is called "Microsoft – Other hardware – WinUsb Device" (version 1.1.0.0 from 2012-08-30).

Manual Driver Installation - Device Connected

1. Extract the firmware upgrade .zip file (right-click --> Extract all...) to the Desktop.
2. Open the Device Manager and locate the "HID/DFU" device with the yellow exclamation mark.
3. Right-click and select "Update Driver Software..."

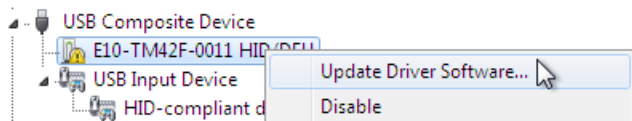

4. Select "Browse my computer for driver software" and select the extracted folder from step 1 and follow the instructions.

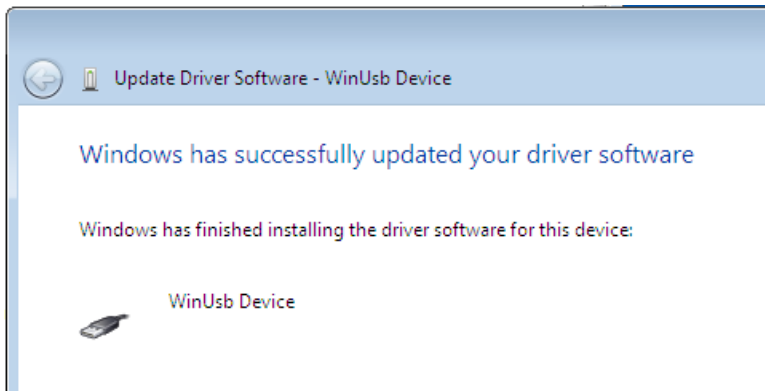

5. If step 4 was unsuccessful, then Windows failed to automatically associate the driver with the device.



6. Choose "Let me pick from a list if device drivers on my computer" in step 4, scroll all the way down to "Universal Serial Bus devices" and click Next.

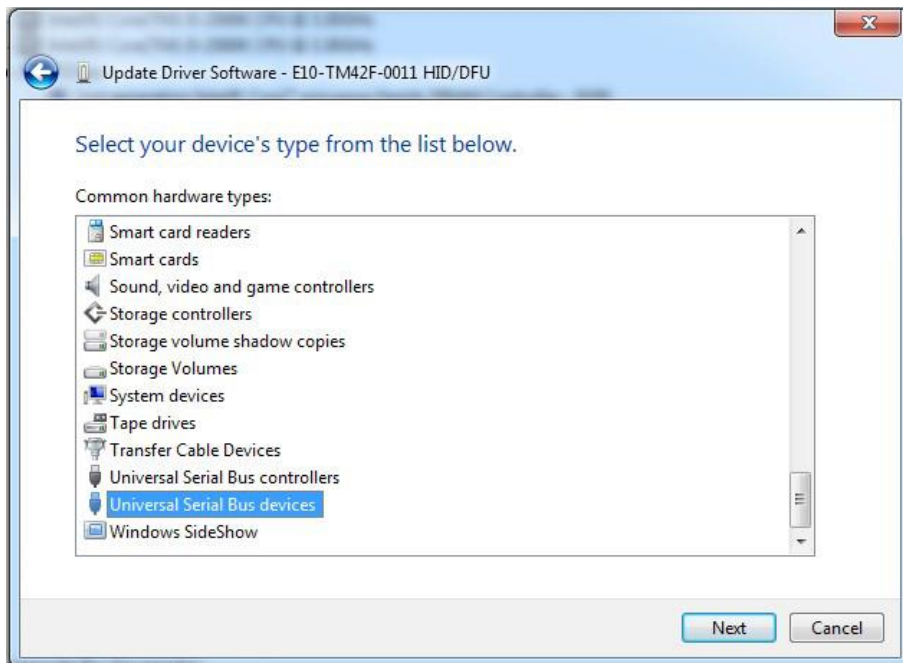

7. Select the WinUsb device driver, and click Next. (If the WinUsb device driver is not in the list, please follow the steps under "Manual Driver Installation - Device Not Connected" first).

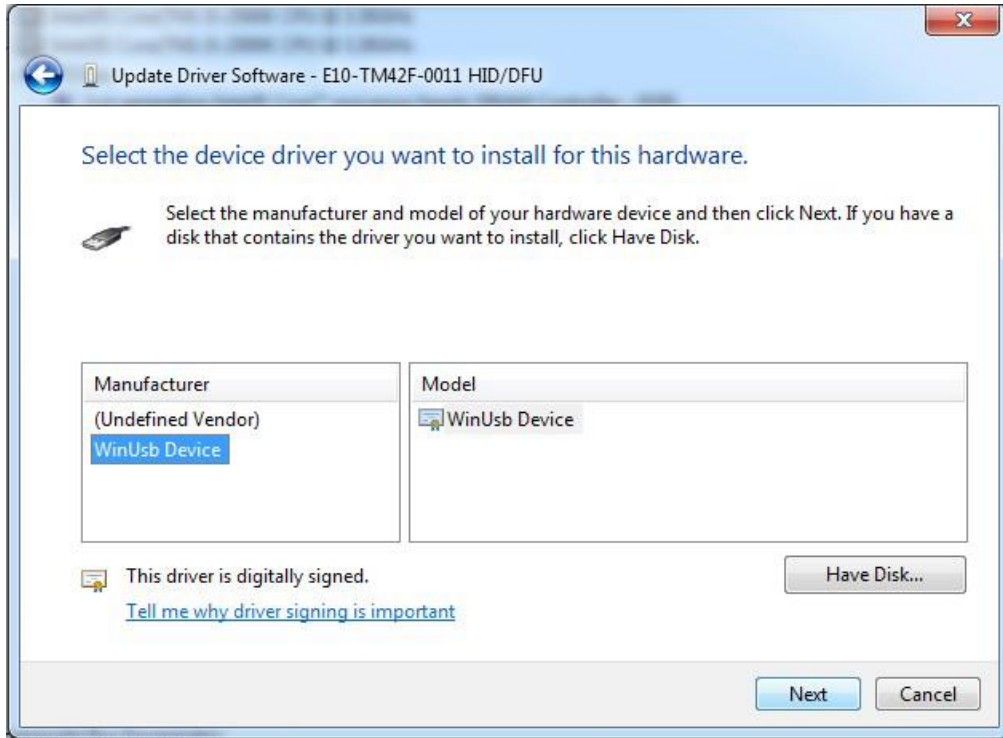

Manual Driver Installation - Device Not Connected

1. Extract the firmware upgrade .zip file (right-click --> Extract all...) to the Desktop.
2. Navigate to the "support" folder.
3. Right-click on the **install_driver.bat** file and select "Run as administrator" and follow the instructions.

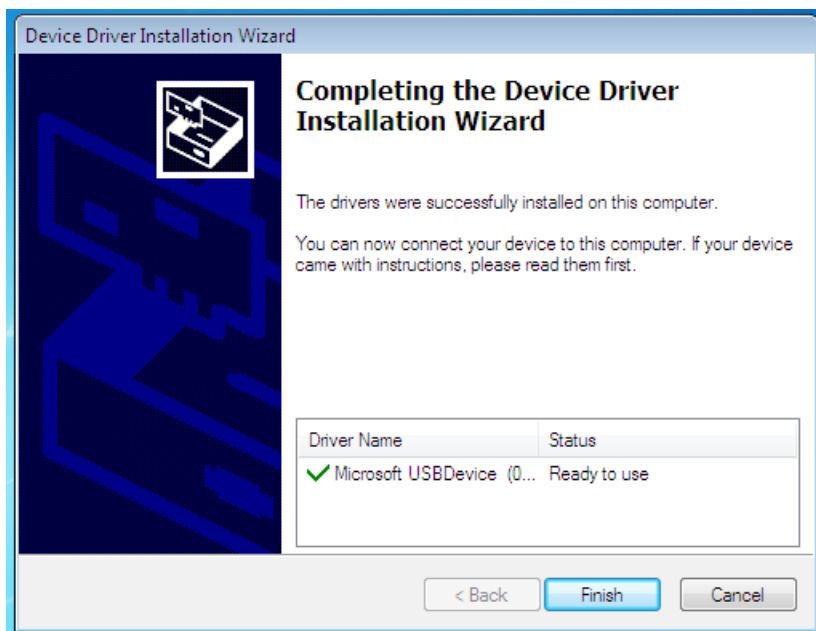

4. Operation

Using the On-Screen Menus

To display the on-screen menus, press MENU on the remote control (Figure 2-3) or built-in keypad (Figure 2-1).

To select a sub-menu, use the ▲ and ▼ buttons to highlight it. Then, press ► to enter that sub-menu.

To select a menu item, use the ▲ and ▼ buttons to highlight it. Then, press ◀ or ▶ to adjust that setting and press OK.

The OSD menus are arranged hierarchically, as shown in Figure 4-1. The default values appear in bold type. Depending on the selected input source and signal characteristics, some menu options may not be available.

Main Menu	SubMenu	Value
Image Settings	Scheme	User , Vivid, Cinema, Game, Sport
	Brightness	0, 1, 2, ..., 50 , ...,100
	Contrast	0, 1, 2, ..., 50 , ...,100
	Sharpness	0, 1, 2, ..., 50 , ...,100
	Saturation	0, 1, 2, ..., 50 , ...,100
	Hue	0, 1, 2, ..., 50 , ...,100
	Backlight	0, 1, 2, ..., 50, ..., 80 , ...,100
	Color Temp & Gamma	Color Temp: 5000K; 6500K; 7500K; 9300K ; User
		Gamma: 2.2 ; off
HDMI RGB Range	Auto; 0-255 ; 16-235	
Display Settings	Input Source	DisplayPort1; HDMI2; HDMI3; Type C
	Aspect Ratio	16:9; 4:3; Auto ; Point To Point; Letterbox
	OverScan	0% ~ 10%
	Source Renaming	Rename the input source.
	No Source Default	DisplayPort1 ; HDMI2; HDMI3; Type C
	Home Source	DisplayPort1 ; HDMI2; HDMI3; Type C
Audio	Volume	0 ~ 100 (70)
	Treble	-10 ~ 10 (0)
	Bass	-10 ~ 10 (0)
	Balance	-10 ~ 10 (0)
	Internal Speaker	On ; Off

Main Menu	SubMenu	Value
Basic Settings	Horizontal Pos.	0 ~ 100 (50)
	Vertical Pos.	0 ~ 100 (50)
	OSD Transparency	0 ~ 4 (0)
	OSD Timeout	5 ~ 60 seconds (30)
	OSD Language	English ; French; Spanish; German; Dutch; Swedish; Portuguese; Danish; Italian
	Splash Screen	Off; Default ; User
	Splash Screen Download	Yes; No
	Power LED	On ; Off
	RTC & Schedule	User Mode ; Workday Mode; Everyday Mode
Adv. Settings	Smart Switch	On ; Off
	Presence Detection	Off; 5 mins; 10 mins; 15 mins; 30 mins; 60 mins; 120 mins
	Wake Up from Sleep	No; Yes ; Never Sleep
	EDID Switch	1080p; 4K2K@30; 4K2K@60
	Touch Input Mapping	Auto ; USB Touch 1; USB Touch 2; USB Touch 3
	Game Mode	On ; Off
	USB Settings	On ; Off (Touch USB, HID USB, Audio USB, External USB, LAN USB)
	Network Configuration	-
	Telemetry Interval	1 ~ 60 seconds (5)
	Firmware Update (USB)	Yes; No
	IoT Firmware Update	Yes; No
	Restore Factory Default	Yes; No
Information	Source	Shows the Name of Input Source
	Resolution	Shows the Current Resolution
	Temperature	Show the Temperature in °C and °F
	Ambient Light	Show the Ambient Light in Lux
	Presence	Show the Presence Detection status (Yes / No)
	IoT Status	Show the IoT connection status
	Model Name	AVW-6555
	Serial Number	Shows the Serial Number of the Monitor



NOTE Default settings appear in bold type.

Figure 4-1. OSD Menu Structure

Input Menu

This menu is used for making common image adjustments.

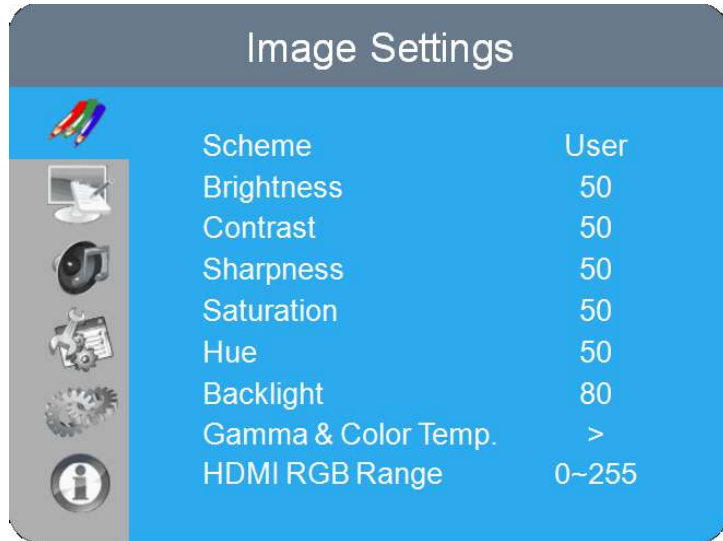

Scheme

Press ◀ or ▶ to select one of the follows:

Options: User, Vivid, Cinema, Game, Sport; **Default:** User

Brightness

Increase or decrease the brightness of picture.

Press ◀ or ▶ to select the desired level, and then press OK.

Range: 0~100; **Default:** 50

Contrast

Increase or decrease the contrast of picture.

Press ◀ or ▶ to select the desired level, and then press OK.

Range: 0~100; **Default:** 50

Saturation

Adjust the brilliance and brightness.

Press ◀ or ▶ to select the desired level, and then press OK.

Range: 0~100; **Default:** 50

Note: This function is not available when displaying PC or graphics sources

Hue

Increase or decrease the green hue.

Press ◀ or ▶ to select the desired level, and then press OK.

Range: 0~100; **Default:** 50

Note: This function is not available when displaying PC or graphics sources

Backlight

Increase or decrease the intensity of the LCD backlight.

Press ◀ or ▶ to select the desired level, and then press OK.

Range: 0~100; **Default:** 80

Color Temp & Gamma

Set Color Temperature and Gamma. See next page.

HDMI RGB Range

Select an RGB range for the HDMI input.

Options: Auto, 0-255, 16-235; **Default:** 0~255

Note: This function is only available when connect HDMI or Type C source.

Color Temperature Settings

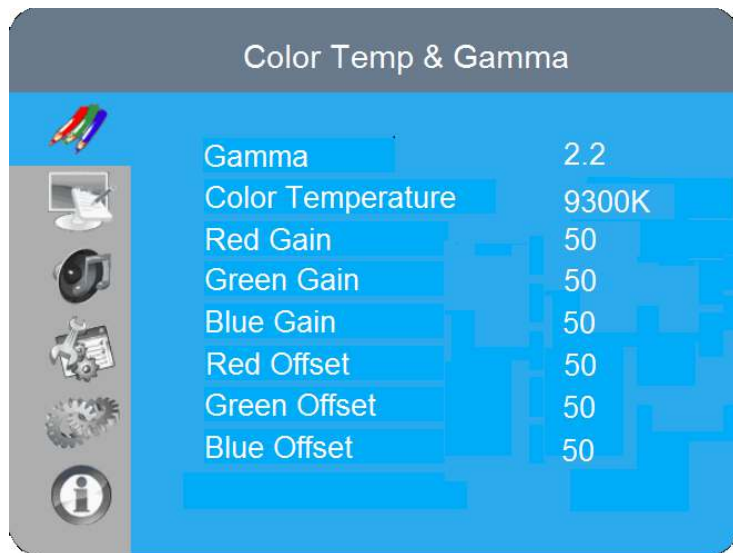

Gamma

Select gamma curve

Options: Off, 2.2; **Default:** 2.2

Color Temperature

Select a color temperature or select User to make RGB adjustments.

Options: User, 5000K, 6500K, 7500K and 9300K; **Default:** 9300K

Red Gain

Set Color Temperature to "User Mode" to adjust this setting.

Range: 0~100; **Default:** 50

Green Gain

Set Color Temperature to "User Mode" to adjust this setting.

Range: 0~100; **Default:** 50

Blue Gain

Set Color Temperature to "User Mode" to adjust this setting.

Range: 0~100; **Default:** 50

Red Offset

Set Color Temperature to "User Mode" to adjust this setting.

Range: 0~100; **Default:** 50

Green Offset

Set Color Temperature to "User Mode" to adjust this setting.

Range: 0~100; **Default:** 50

Blue Offset

Set Color Temperature to "User Mode" to adjust this setting.

Range: 0~100; **Default:** 50

Display Settings

This menu is used for making general display settings.

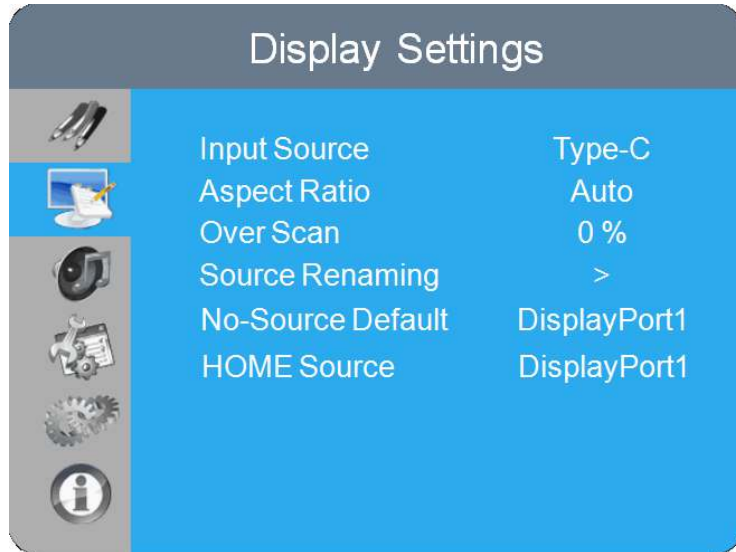

Input Source

Select the main input source

Options: HDMI 2; HDMI 3; DisplayPort; Type C

Default: Type C

Aspect Ratio

Select aspect ratio

Press ◀ or ▶ to select the aspect ratio, and then press OK.

Range: 16:9; 4:3; Auto; Point To Point; Letterbox

Default: Auto

OverScan

Adjust the overscan of the image.

Press ◀ or ▶ to select the desired level, and then press OK.

Range: 0% ~ 10%; **Default:** 0%

Source Renaming

Rename the input source.

Press OK to select the input source you want to rename. Using ▲ or ▼ to change the character and ◀ or ▶ to move forward/back a position. Then press OK button to save the name.

No-Source Default

Select the Input Source when all input source is no signal

Options: HDMI 2; HDMI 3; DisplayPort1; Type C

Default: DisplayPort1

HOME Source

Select the Input Source for HOME key

Options: HDMI 2; HDMI 3; DisplayPort1; Type C

Default: DisplayPort1

Audio Menu

This menu is used for adjusting volume settings.

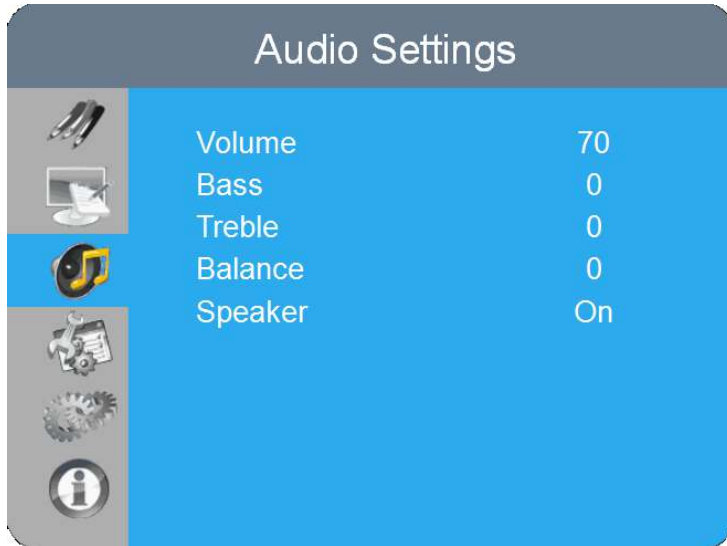

Volume

Adjust the sound. Press ◀ or ▶ to select the desired level, and then press OK.

Range: 0~100; **Default:** 70

Bass

Adjust the sound in low tones (bass). Press ◀ or ▶ to select the desired level, and then press OK.

Range: -10~10; **Default:** 0

Treble

Adjust the sound in high tones (treble). Press ◀ or ▶ to select the desired level, and then press OK.

Range: -10~10; **Default:** 0

Balance

Adjust the balance of the left and right speakers. Press ◀ or ▶ to select the desired level, and then press OK.

Range: -10~10; **Default:** 0

Speaker

Turn the internal speaker on or off

Default: On



NOTE This menu option is only available when " AVW-6555 HDMI " audio source selected in your pc, laptop or personal devices, not available for other USB audio sources.

Basic Settings

This menu is used to make basic settings.

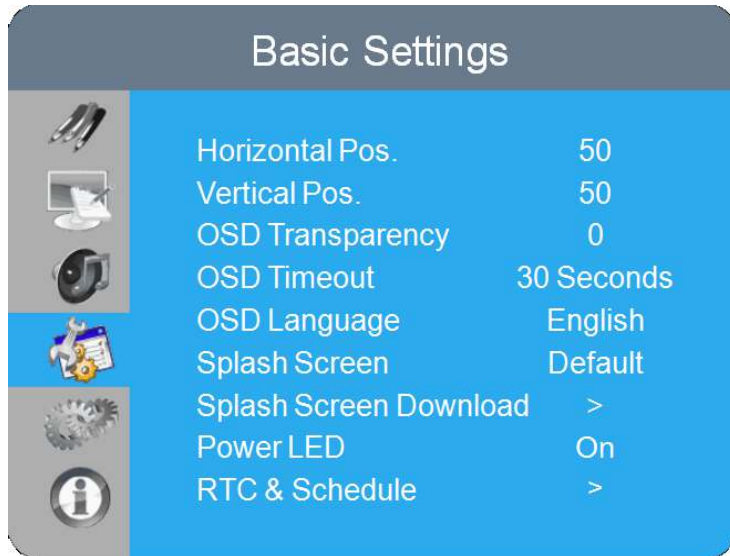

Horizontal Pos.

Adjust the horizontal position of the OSD menu. Press ◀ or ▶ to select the desired level, and then press OK.

Range: 0~100; **Default:** 50

Vertical Pos.

Adjust the vertical position of the OSD menu. Press ◀ or ▶ to select the desired level, and then press OK.

Range: 0~100; **Default:** 50

OSD Transparency

Adjust the transparency of the OSD menu. Press ◀ or ▶ to select the desired level, and then press OK.

Range: 0~4; **Default:** 0

OSD Timeout

Adjust the time in seconds before the OSD menu disappears. Press ◀ or ▶ to select the desired level, and then press OK.

Options: 5s~60s; **Default:** 30s

OSD Language

Select the OSD language:

Options: English; French; Spanish; German; Dutch; Swedish; Portuguese; Danish; Italian; **Default:** English

Splash Screen

Select whether a splash screen appears when the monitor is powered up

Options: Off; Default; User; **Default:** Default

Splash Screen Download

Change the user splash screen image by plugging a thumb drive into Service port

Options: Yes, No

Note: The file name must be named as "userlogo.jpg", in 3840x2160 or 1920x1080 pixels and less than 1MB.

Press Yes to load the splash screen image you want to use. After loaded the image, go to **Splash Screen** setting and change to "User" then press OK

Power LED

Enable or disable the status LED

Options: On, Off; **Default:** On

RTC & Schedule

Set the internal clock of the display, and to power on and off the display at preset times if desired.

Options: User, Workday, Everyday; **Default:** User

Advanced Settings

This menu is used to make advanced settings.

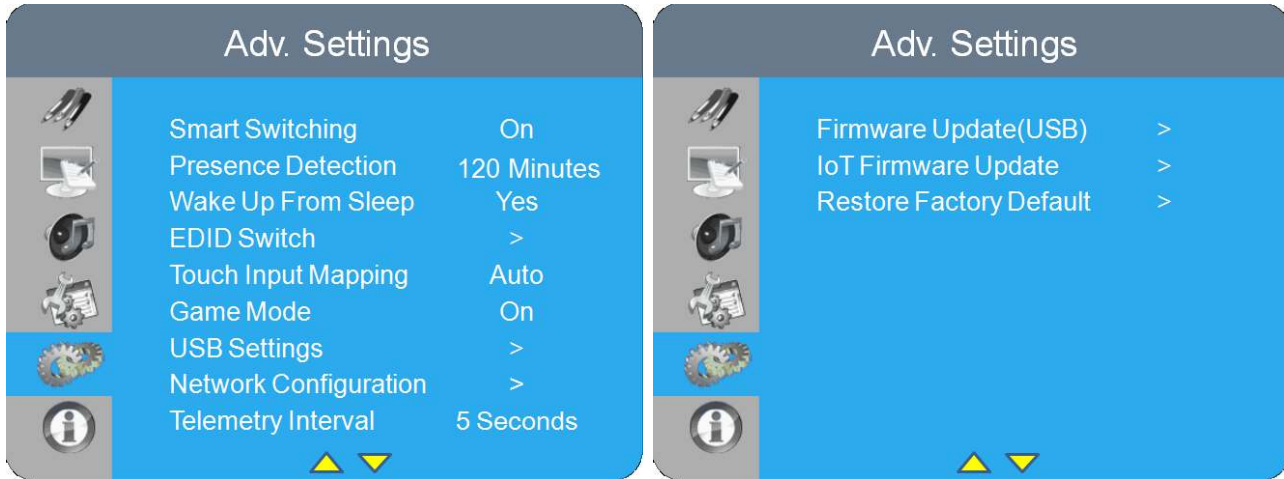

Smart Switch

Detect input and switch source automatically

Options: Off, On; **Default:** On

Presence Detection

Enable presence detection function

Options: Off, 5 mins, 10 mins, 15 mins, 30 mins, 60 mins & 120 mins

Default: 120 mins

Wake Up From Sleep

Options: No, Yes; Never Sleep

Default: Yes

Note: The display wakes up when input HDMI, DisplayPort & Type C & RS232 command.

EDID Switch

Select EDID (Extended Display Identification Data) of the DisplayPort, HDMI 2~3, Type C inputs. **Options:** 1080p, 4K2K@30, 4K2K@60; **Default:** 4K2K@60

Note: Use the 1080p setting for the broadest support of lower resolution sources. Use 4K2K setting to support high resolution sources such as 3840x2160.

Touch Input Mapping

Select one of the touch connections or choose auto detection.

Options: Auto, USB Touch 1, USB Touch 2, USB Touch 3; **Default:** Auto

Game Mode

Select Game mode

Options: On, Off; **Default:** On

USB Settings

Configures USB settings, including Touch USB, HID USB, Audio USB, External USB, LAN USB

Options: On, Off; **Default:** On

Network Configuration

Configures the display's RS232 and Ethernet communication ports.

For more settings, see Network Configuration on page 48

Telemetry Interval

Configures the frequency of sending out sensors data to IoT I web server.

Options: 1s~60s; **Default:** 5s

Firmware Update (USB)

Plug in the USB flash drive and select Yes to proceed with firmware update.

To start updating firmware, select Yes to continue.

Options: No, Yes; **Default:** Yes

IoT Firmware Update

Plug in the USB flash drive and select Yes to process with IoT firmware update.

To start updating IoT firmware, select Yes to continue

Options: No, Yes

Restore Factory Default

Restore all settings to their default value.

Options: No, Yes

Note: To reset network connection to default must go to **Network Configuration - Load Default** and select Yes to restore.

Wake Up from Sleep

By default, the display will enter power saving (Sleep Mode) if no signal is received for 5 minutes. Normally, the Type C, RS-232, DisplayPort, and HDMI inputs are inactive in Sleep Mode, to save power.

To change the behavior of Sleep Mode, change the "**Wake up from Sleep**" setting in the "**Adv. Setup**" menu.

- **Digital, RS232, Ethernet** – The RS-232, DisplayPort, HDMI and Type C inputs stay active when the display is in sleep mode. The display will wake up when it receives a signal at either of the DisplayPort, HDMI, Type C or RS-232 inputs, or via LAN connection.

Network Configuration

This menu configures the display's RS232 and Ethernet communication ports.

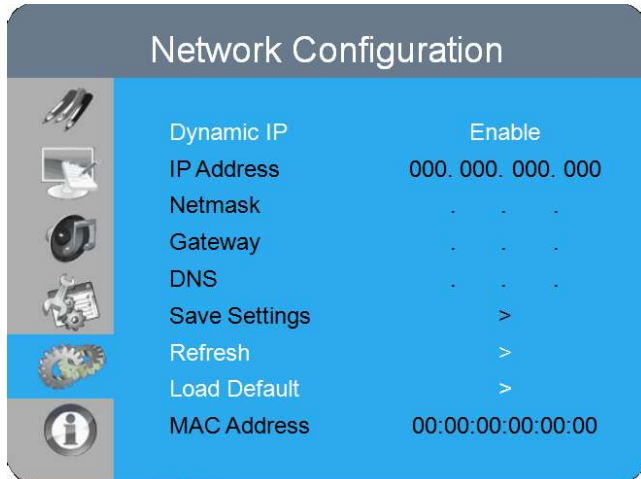

Dynamic IP

Enable or disable Dynamic IP mode

Options: Enable; Disable; **Default:** Enable

IP Address

Display dynamic IP or the static IP address of the display's Ethernet port

Default: 0.0.0.0

Netmask

Set the subnet mask address.

Default: 0.0.0.0

Gateway

Set the Gateway mask address.

Default: 0.0.0.0

DNS

Set the DNS mask address.

Default: 0.0.0.0

Save Settings

Save the network settings and apply to device.

Refresh

Refresh dynamic IP information.

Load Default

Load default communication settings

Options: No, Yes

MAC Address

Display the MAC address of the device.

Information

This read-only menu provides information on the active source, sensor data, IoT connection status the latest firmware version, and the serial number.

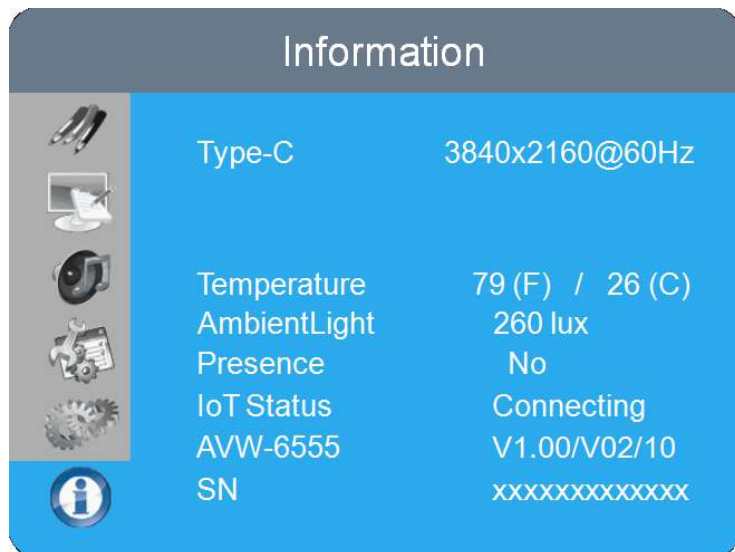

Source	Show the Name of Input Source
Resolution	Show the Current Resolution
Temperature	Display room temperature data both in °C and °F
Ambient Light	Display room brightness data in lux
Presence	Display proximity status Detected: Yes; undetected: No
IoT Status	Display IoT connection status Status: connecting; connected
Model Name	AVW-6555
Firmware Version	Show the Firmware Version of the Monitor
Serial Number	Show the Serial Number of the Monitor

5. Maintenance and Troubleshooting

Maintenance

The AVOCOR Series LED Displays does not require any routine maintenance other than occasional cleaning with a non-abrasive cloth. There are no user-serviceable or replaceable parts. Unless you are a qualified, factory-trained technician, do not attempt to repair or replace any system component yourself. You will void the product warranty if you do so.

Troubleshooting

Table 5-1 provides some general guidelines for troubleshooting problems you may encounter with the AVOCOR Series LED Display. If the suggested solutions fail to resolve the problem or if you encounter an issue not described here, please contact your dealer.

Table 5-1. Troubleshooting Chart







Symptom	Possible Cause(s)	Solution
The display does not turn on.	<p>The display is not plugged in or the AC outlet is not active.</p> <p>The main power switch is off.</p> <p>The remote control batteries have run out.</p>	<p>Ensure that the display is plugged in and that the AC outlet is active.</p> <p>Set the main power switch (see Figure 2-1) to the on position.</p> <p>Replace the batteries.</p>
The display is on and menus appear, but there is no picture.	<p>Incorrect source selection.</p> <p>Source component is not turned on.</p> <p>Source component is connected incorrectly or not at all.</p>	<p>Select the correct source.</p> <p>Turn on the source component.</p> <p>Check connections from the source component to the display.</p>
The remote control does not work.	<p>The remote control batteries have run out.</p> <p>The buttons are locked.</p>	<p>Replace the batteries.</p> <p>Unlock the buttons by pressing      and  in sequence.</p>
Image geometry is incorrect.	<p>Incorrect aspect ratio selection.</p>	<p>Select a different aspect ratio.</p>
The display is jittery or unstable.	<p>Poor-quality or improperly connected source.</p> <p>The horizontal or vertical scan frequency of the input signal may be out of range for the display.</p>	<p>Ensure that the source is properly connected and of adequate quality for detection.</p> <p>Correct at the source.</p>

Table 5-1. Troubleshooting Chart (continued)

Symptom	Possible Cause(s)	Solution
Image is too bright and / or lacks definition in the bright areas of the image.	Contrast is set too high.	Decrease the contrast setting.
Image appears “washed out” and / or dark areas appear too bright.	Brightness is set too high.	Decrease the brightness setting.
Image is too dark.	Brightness and / or Backlight are set too low.	Increase the brightness and / or backlight settings.
Images from an HDMI source do not display.	The resolution and frequency of the video card in the computer are not compatible with the display. HDMI cable from source to display is either defective or too long.	Select a compatible resolution and vertical frequency (refer to Supported Timings on page 61). Try a known-good and / or shorter HDMI cable.
Computer images do not display correctly.	The resolution and frequency of the video card in the computer are not compatible with the display	Select a compatible resolution and vertical frequency (refer to Supported Timings on page 61).
Touch screen doesn't work.	Multi-touch controller host computer is not connected correctly. Host computer hardware or OS incompatibility.	See Figure 3-7. Refer to Enabling the Touch Screen on page 34.

Should you require assistance with a suspected hardware fault, please contact the support line below. You will require your unit serial number. The operator will attempt to diagnose any fault and will take action as appropriate.

The Avocor logo is displayed in a large, bold, black sans-serif font. The letters are lowercase, and a small trademark symbol (TM) is positioned at the top right of the letter 'r'. The logo is centered within a white rectangular box that has a thin black border.

Warranty Support

UK & EMEA. Tel +44 (0) 1276 804 654 - service@avocor.co.uk

US & ROW. Tel. 858-268-7999 - service@avocor.com

6. External Control

In addition to using the display keypad or remote control unit, you can control the display using a serial (RS232) link to send Hexadecimal commands and receive responses to those commands. **(ASCII is not accepted/used)**

You also use discrete infrared (IR) control codes to program a third-party remote control unit. For more information, refer to Using Discrete IR Codes on page 59.

Serial Communications

The display uses a simple text-based control protocol to take requests from control devices and to provide responses to such devices. This section describes how to send control messages over a serial link between the display and an automation/control system or a PC running a terminal emulation program such as Windows® HyperTerminal or Tera Term.

RS232 Connection and Port Configuration

Connect your control system or PC to the RS232 input of the display as shown in Figure 3-2.

Configure the RS232 controller or PC serial port as follows: no parity, 8 data bits, 1 stop bit and no flow control. Set the baud rate to 115200, to match that of the display RS232 port.

Command and Response Format

Commands sent from an automation/control system or PC to the display must have the following format:

[STX] [IDT] [TYPE] [CMD] ([VALUE] or [REPLY]) [ETX]

Where:

- [STX] indicates the start of the command data (07).
- [IDT] is the display ID.
- [TYPE] is the command type:
 - 00 = return to host (response from the LCD panel)
 - 01 = read / action
 - 02 = write
- [VALUE] is the parameter setting for the command.
- [REPLY] is the parameter setting for the command, acknowledged by the display in its response to a command.
- [ETX] indicates the end of the command data (always 08).

Command and Response Examples

Here are some examples of Hexadecimal serial commands and their responses:

Table 6-1. Serial Command/ Response Examples

Description	Command sent to LCD Panel	Response Received from LCD Panel
Turn LCD panel power off.	07 01 02 50 4F 57 00 08	07 01 00 50 4F 57 00 08
Turn LCD panel power on.	07 01 02 50 4F 57 01 08	07 01 00 50 4F 57 01 08
Request LCD panel power status.	07 01 01 50 4F 57 08	07 01 00 50 4F 57 XX 08 (XX = 0 when off or 1 when on)
Set the LCD panel contrast to 30 (1E hex).	07 01 02 43 4F 4E 1E 08	07 01 00 43 4F 4E 1E 08
Reset the LCD panel display settings.	07 01 02 41 4C 4C 00 08	07 01 00 41 4C 4C 00 08
Request LCD panel serial number.	07 01 01 53 45 52 08	07 01 00 53 45 52 S(0)...S(12) 08 S(0) ...S(12) = the serial number in ASCII
Request LCD panel firmware version.	07 01 01 47 56 45 08	07 01 00 47 56 45 S(0)...S(5) 08 S(0)...S(5) = the firmware version in ASCII

Serial Command List

Table 6-2 lists all supported commands.

Table 6-2. Serial Commands

Main Item	Control Item	Type	CMD (HEX)	Value (HEX)	Reply (HEX)	Content	CMD (ASCII)
Power Control and Input Source	Power Control	W/R	50 4F 57 (Note)	0	0	Off (soft power)	POW
				1	1	On (soft power)	
	Input Source	W/R	4D 49 4E	9	9	HDMI 2	MIN
				0A	0A	HDMI 3	
				0D	0D	DisplayPort1	
Display Adjustment	Display Adjustment	W/R	42 52 49	00~64	00~64	Back Light Brightness	BRI
		W/R	42 52 4C	00~64	00~64	Digital Brightness Level	BRL
		W/R	42 4C 43	0	0	Off (Back Light)	BLC
				1	1	On (Back Light)	
		W/R	43 4F 4E	00~64	00~64	Contrast	CON
		W/R	48 55 45	00~64	00~64	Hue	HUE
		W/R	53 41 54	00~64	00~64	Saturation	SAT
		W/R	55 53 52	00~64	00~64	Red Gain (mapping 0~100)	USR
		W/R	55 53 47	00~64	00~64	Green Gain (mapping 0~100)	USG
		W/R	55 53 42	00~64	00~64	Blue Gain (mapping 0~100)	USB
		W/R	55 4F 52	00~64	00~64	Red Offset (mapping 0~100)	UOR
		W/R	55 4F 47	00~64	00~64	Green Offset (mapping 0~100)	UOG
		W/R	55 4F 42	00~64	00~64	Blue Offset (mapping 0~100)	UOB

Main Item	Control Item	Type	CMD (HEX)	Value (HEX)	Reply (HEX)	Content	CMD (ASCII)	
Display Adjustment	Display Adjustment	W/R	43 4F 54	0	0	User	COT	
				1	1	6500K		
				2	2	9300K		
				6	6	5000K		
				7	7	7500K		
	W/R	47 41 43	0	0	Gamma Off	GAC		
1			1	Gamma 2.2				
	Sharpness	W/R	53 48 41	00~64	00~64	Sharpness	SHA	
Other Control	Scaling	W/R	41 53 50	0	0	Main Window Aspect Ratio Native(PointToPoint)	ASP	
				1	1	Full Screen (16:9)		
				2	2	Pillarbox (4:3)		
				3	3	Letterbox		
				4	4	Auto		
			W/R	5A 4F 4D	00~0A	00~0A	Adjust overscan ratio	ZOM
	Other Control	Other Control	W	52 43 55	0	0	MENU Key	RCU
					1	1	INFO Key	
					2	2	UP Key	
					3	3	DOWN Key	
					4	4	LEFT Key	
					5	5	RIGHT Key	
					6	6	OK Key	
					7	7	EXIT Key	
					0A	0A	HDMI2 Key	
					0B	0B	HDMI3 Key	
					17	17	SCALING Key	
					18	18	FREEZE Key	
					19	19	MUTE Key	
1A					1A	BRIGHT Key		
1B	1B	CONTRAST Key						
1D	1D	VOLUME+ Key						
1E	1E	VOLUME- Key						
21	21	Type C Key						

Main Item	Control Item	Type	CMD (HEX)	Value (HEX)	Reply (HEX)	Content	CMD (ASCII)
Other Control	Other Control	W	41 4C 4C	0	0	Reset all	ALL
		W/R	4B 4C 43	0	0	Un-lock keys	KLC
				1	1	Lock keys	
		R	53 45 52		13 bytes	Read Serial Number	SER
		R	4D 4E 41		13 bytes	Read Model Name	MNA
		R	47 56 45		6 bytes	Read Firmware Version	GVE
		R	52 54 56		Current value	Read RS232 table Version	RTV
	W	47 56 53	0	[00]+5 byte	Querying main scaler version	GVS	
	Audio	W/R	56 4F 4C	00~64	00~64	volume	VOL
		W/R	42 41 53	00~14	00~14	Bass (-10~10)	BAS
		W/R	54 52 45	00~14	00~14	Treble (-10~10)	TRE
		W/R	42 41 4C	00~14	00~14	Bass (-10~10)	BAL
		W/R	49 4E 53	0	0	Internal Speaker Off	INS
				1	1	Internal Speaker On	
		W/R	4D 55 54	0	0	Mute Off	MUT
	1			1	Mute On		
	Scheme selection	W/R	53 43 4D	0	0	User	SCM
				1	1	Sport	
				2	2	Game	
3				3	Cinema		
4				4	Vivid		
Other Control	EcoMode WakeUpFromSleep	W/R	57 46 53	0	0	No	WFS
				1	1	Yes	
				2	2	Never Sleep	
	RTC	W/R	52 54 59	00~63	00~63	Set Real time Year	RTY
						Set Real time Month	RTM
						Set Real time Day	RTD
						Set Real time Hour	RTH
						Set Real time Minute	RTN
		W/R	54 4D 53	0	0	Same Settings On All (Everyday)	TMS
				1	1	Same Settings On Work Days (Workday)	
				2	2	User	
		W/R	41 45 4E	1	1	Sunday Alarm Enable	AEN
				2	2	Monday Alarm Enable	
4	4			Tuesday Alarm Enable			

Main Item	Control Item	Type	CMD (HEX)	Value (HEX)	Reply (HEX)	Content	CMD (ASCII)
Other Control	RTC	W/R	41 45 4E	8	8	Wednesday Alarm Enable	AEN
				10	10	Thursday Alarm Enable	
				20	20	Friday Alarm Enable	
				40	40	Saturday Alarm Enable	
		W/R	41 45 46	1	1	Sunday Alarm Disable	AEF
				2	2	Monday Alarm Disable	
				4	4	Tuesday Alarm Disable	
				8	8	Wednesday Alarm Disable	
				10	10	Thursday Alarm Disable	
				20	20	Friday Alarm Disable	
		40	40	Saturday Alarm Disable			
		W/R	4E 4E 48	00~17	00~17	Monday On Hour	NNH
		W/R	4E 4E 4D	00~3B	00~3B	Monday On Minute	NNM
		W/R	4E 46 48	00~17	00~17	Monday Off Hour	NFH
		W/R	4E 46 4D	00~3B	00~3B	Monday Off Minute	NFM
		W/R	45 4E 48	00~17	00~17	Tuesday On Hour	ENH
		W/R	45 4E 4D	00~3B	00~3B	Tuesday On Minute	ENM
		W/R	45 46 48	00~17	00~17	Tuesday Off Hour	EFH
		W/R	45 46 4D	00~3B	00~3B	Tuesday Off Minute	EFM
		W/R	44 4E 48	00~17	00~17	Wednesday On Hour	DNH
		W/R	44 4E 4D	00~3B	00~3B	Wednesday On Minute	DNM
		W/R	44 46 48	00~17	00~17	Wednesday Off Hour	DFH
		W/R	44 46 4D	00~3B	00~3B	Wednesday Off Minute	DFM
		W/R	55 4E 48	00~17	00~17	Thursday On Hour	UNH
		W/R	55 4E 4D	00~3B	00~3B	Thursday On Minute	UNM
		W/R	55 46 48	00~17	00~17	Thursday Off Hour	UFH
		W/R	55 46 4D	00~3B	00~3B	Thursday Off Minute	UFM
		W/R	49 4E 48	00~17	00~17	Friday On Hour	INH
		W/R	49 4E 4D	00~3B	00~3B	Friday On Minute	INM
		W/R	49 46 48	00~17	00~17	Friday Off Hour	IFH
		W/R	49 46 4D	00~3B	00~3B	Friday Off Minute	IFM
		W/R	54 4E 48	00~17	00~17	Saturday On Hour	TNH
		W/R	54 4E 4D	00~3B	00~3B	Saturday On Minute	TNM
		W/R	54 46 48	00~17	00~17	Saturday Off Hour	TFH
W/R	54 46 4D	00~3B	00~3B	Saturday Off Minute	TFM		
W/R	53 4E 48	00~17	00~17	Sunday On Hour	SNH		
W/R	53 4E 4D	00~3B	00~3B	Sunday On Minute	SNM		
W/R	53 46 48	00~17	00~17	Sunday Off Hour	SFH		
W/R	53 46 4D	00~3B	00~3B	Sunday Off Minute	SFM		

Main Item	Control Item	Type	CMD (HEX)	Value (HEX)	Reply (HEX)	Content	CMD (ASCII)
Other Control	Power LED	W/R	4C 45 44	0	0	Off	LED
				1	1	On	
	HDMI RGB Color Range	W/R	48 43 52	0	0	Auto Detect	HCR
				1	1	Full Range	
				2	2	Limited Range	
	Touch Control	W/R	54 4F 43	0	0	Auto	TOC
				2	2	USB Touch 1	
				3	3	USB Touch 2	
				4	4	USB Touch 3	
OSD Control	Transparency	W/R	4F 53 54	00~04	00~04	OSD Transparency	OST
	H Position	W/R	4F 53 48	00~64	00~64	OSD H Position	OSH
	V Position	W/R	4F 53 56	00~64	00~64	OSD V Position	OSV
	OSD Language	W/R	4F 53 4C	0	0	English	OSL
				1	1	French	
				2	2	German	
				3	3	Dutch	
				08	08	Danish	
				0D	0D	Italian	
				0E	0E	Swedish	
				0F	0F	Portuguese	
10	10	Spanish					
OSD Timeout	W/R	4F 53 4F	05~3C	05~3C	OSD Timeout (5, 10, 20, 30, 60 sec)	OSO	



NOTE The command is valid on Power saving/ off mode (The setting of "Wake Up from Sleep" must be "Yes").

Using Discrete IR Codes

The display accepts commands in the form of infrared (IR) signals that conform to the NEC protocol. Each display remote control button has an IR control code associated with it.

You can use these codes to program a third-party, "universal" remote control unit to work with the display. These third-party products usually come with a computer software application for this purpose. For more information, consult the documentation provided with the remote control unit.

IR Command Protocol

The IR control codes have the following characteristics:

Each code consists of the following:

- A leader pulse (a modulated pulse of 9 ms followed by a non-modulated pulse of 4.5 ms);
- 16 address bits (also called a "custom code"): eight (8) bits for the address followed by the logical inverse of the address. The custom code for the display is 16559 decimal (0x40AF, binary 01000000 10101111).
- 16 data bits: eight (8) bits for the command followed by the logical inverse of the command
- An end pulse (a modulated pulse of 0.56 ms, similar to the modulated pulse in the '0' and '1' bits). The end of the modulated pulse constitutes the end of the data transmission.

The carrier frequency is 38 kHz, with the modulated pulses having a 33% duty cycle.

Commands are sent at a maximum rate of 9 Hz.

For example, here is the NEC control code for the POWER button on the display remote control unit:

Hex	40	AF	1C	E3
Binary	01000000	10101111	00011100	11100011
Function	Cust. Code Byte 1	Cust. Code Byte 2	Command	Command (Logical Inverse)

IR Control Code List

Table 6-3 lists the IR control codes for the display.

Table 6-3. Infrared (IR) Control Codes

No.	Customer Code	Data Code	Function
1	40AF	1CE3	POWER
2	40AF	15EA	TYPE C
3	40AF	0FF0	SOURCE
4	40AF	02FD	UP
5	40AF	01FE	LEFT
6	40AF	03FC	RIGHT
7	40AF	19E6	DOWN
8	40AF	12ED	OK
9	40AF	05FA	EXIT
10	40AF	1BF4	Volume -
11	40AF	1DE2	Volume +
12	40AF	0EF1	MENU

7. Specifications

Table 7-1 lists the signal types supported by each input on the **AVW-6555** display.

PANEL	
Diagonal Size (Inch)	65"
Backlight	Direct LED
Aspect Ratio	16:9
Input Resolution	3840 x 2160 @ 60 Hz
Response Time	8 (ms)
Brightness	350 (cd/m ²)
Contrast Ratio	4000:1
Viewing Angle	178° (H) / 178° (V)
Supported Colors	1.07 billion colors
Display Orientation	Landscape compatible
TOUCH SYSTEM	
Interface	Touch USB
Touch	High-resolution inGlass™ touch; Up to 20 points
Glass	Chemically strengthened glass with G2&AF finish;
Supported Operating System	Windows 7 Pro, Ultimate/ 8, 8.1 / 10; Mac OS 10.10, 10.11, 10.12.1
AUDIO	
Built-in Speakers	4Ω / 2 x 30W
Microphone	4 beam-forming, linear array, Far field, SSP, AEC, ANS, DRC, EQ
Camera	
Resolution	6 element aspherical glass lens, HD 1080P 30fps CMOS, AE/AWB, AF, AGC,
AZURE SMART SPACES DATA	
Sensors	Temperature (-5~45 °C, ±3 °C), Brightness (0~3000 lux), Presence(3.5±0.5M)
CONNECTIVITY	
Connections	2 x HDMI 2.0 / 1 x DisplayPort 1.2 / 1 x Type C
Audio	Audio In / Audio Out / SPDIF Out
Control	1 x USB 3.0 HUB / 3 x Touch USB 3.0 / RS232 / Ethernet/ IR
PHYSICAL SPECIFICATIONS	
Dimensions	61.7 x 40.9 x 4.4 (in) / 1,568 x 1039 x 111.5(mm)
Weight	Net: 49 kg / Gross: 69.5 kg
Wall Mount	23.6 x 15.7 (in) / 600 x 400(mm)
MiniPC Mount	75 x 75, 100 x 100 (mm) / 2.9 x 2.9, 3.9 x 3.9 (in)
Fanless Design	Yes
OSD FUNCTIONS	
OSD Languages	English, French, Spanish, German, Dutch, Swedish, Portuguese, Danish, Italian
Source Auto Detect Function	Yes
POWER	
Power Supply	AC100-240V (Worldwide), Max 3.0A, 50/60Hz / Type C Max 60W
Maximum Power Consumption	220 W
AC off	<0.5 W
ENVIRONMENTAL	
Operating Temperature	0 °C ~ 40 °C
Storage Temperature	-20 °C ~ 60 °C
Humidity	35% ~ 85%

Supported Timings

Table 7-2 lists the signal types supported by each input on the display.

Table 7-2. Supported Timings By Input

Timing		fH (kHz)	fV (Hz)	Dot clock (MHz)	HDMI	Type C	DisplayPort	
VESA	VGA 640x480	31.469	59.94	25.175	○	○	○	
		37.861	72.809	31.5	○	○	○	
		37.5	75	31.5	○	○	○	
	SVGA 800x600	35.156	56.25	36	○	○	○	
		37.879	60.317	40	○	○	○	
		48.077	72.188	50	○	○	○	
		46.875	75	49.5	○	○	○	
	XGA 1024x768	48.363	60.004	65	○	○	○	
		56.476	70.069	75	○	○	○	
		60.023	75.029	78.75	○	○	○	
	WXGA1366x768	47.712	59.79	85.5	○	○	○	
	1280 x 720	44.444	59.98	64	-	-	○	
		44.772	59.86	74.5	-	-	○	
		56.456	74.78	95.75	-	-	○	
	1280 x 768	47.776	59.87	79.5	-	-	○	
		47.396	59.995	68.25	-	-	○	
	1280 x 800	49.306	59.91	71	○	○	○	
		49.702	59.81	83	○	○	○	
	SXGA	1152x864	67.5	75	108	○	○	○
		1280x1024	63.981	60.02	108	○	○	○
	79.976		75.025	135	○	○	○	
1440 x 900	55.469	59.901	88.75	-	-	○		
	55.935	59.88	106.5	○	○	○		
WSXGA+ 1680 x1050	64.674	59.883	119	○	○	○		
	65.29	59.954	146.25	○	○	○		
UXGA 1600 x 1200	75	60	162	○	○	○		
1920 x 1080	66.587	59.93	138.5	-	-	○		
WUXA 1920 x 1200	74.038	59.95	154	-	-	○		
QHD 2560x1440	88.787	59.951	241.5	○	○	○		
QSXGA 2560x1600	98.713	59.972	268.5	○	○	○		
EDTV	480p	31.5	60	27.03	○	○	○	
	576p	31.25	50	27	○	○	○	
HDTV	720p	37.5	50	74.25	○	○	○	
	1280x720	44.995	59.94	74.176	○	○	○	
		45	60	74.25	○	○	○	
	1080i	28.13	50	74.25	○	○	○	
	1920x1080	33.716	59.94	74.176	○	○	○	
		33.75	60	74.25	○	○	○	
	1080p 1920x1080	27	24	74.25	○	○	○	
		28.125	25	74.25	○	○	○	
		33.75	30	74.25	○	○	○	
		56.25	50	148.5	○	○	○	
67.433		59.94	148.352	○	○	○		
	67.5	60	148.5	○	○	○		

Timing		fH (kHz)	fV (Hz)	Dot clock (MHz)	HDMI	Type C	DisplayPort
4K2K	3840x2160	54	24	297	○	○	○
		56.25	25	297	○	○	○
		67.5	30	297	○	○	○
		112.5	50	594	○	○	○
		133.313	59.997	533.25	○	○	○
		135	60	594	○	○	○

Overall Dimensions

Figure 7-1 shows the display dimensions of **AVW-6555** (all dimensions are in inches).

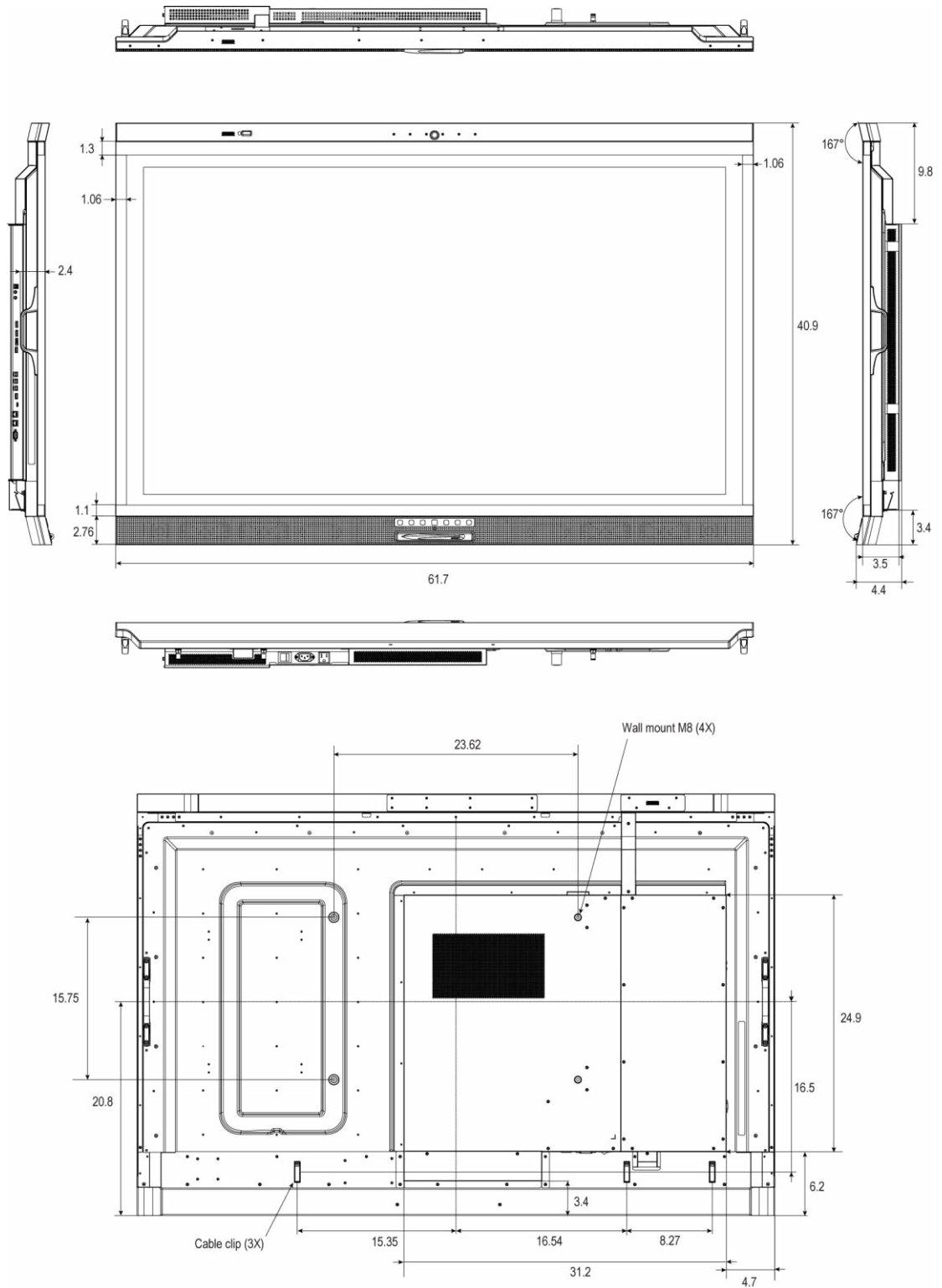

Figure 7-1. AVW-6555 Display Dimensions (inch)

Figure 7-2 shows the display dimensions of **AVW-6555** (all dimensions are in millimeters).

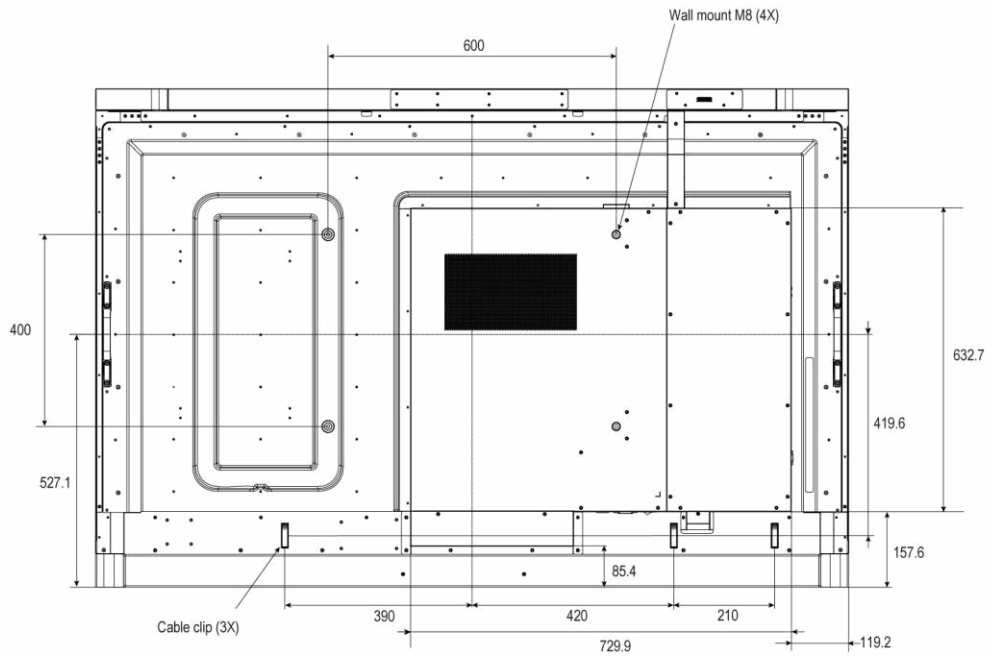
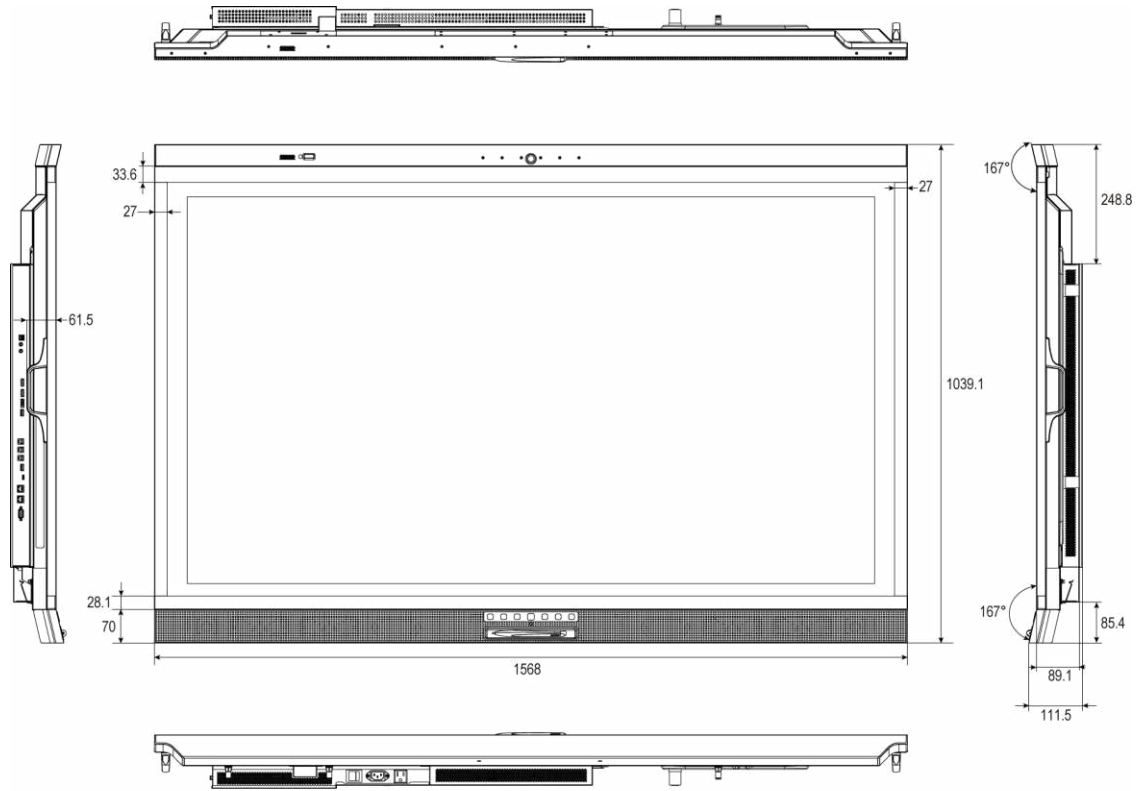

Figure 7-2. AVW-6555 Display Dimensions (mm)

Notes

Appendix I: Moving and Carrying Notice

Moving the Display

Moving the display requires at least two people. Attempting to move the display with one person may result in dropping the display and/or serious injury. When moving a display in its shipping carton, lift the carton using the white handles.

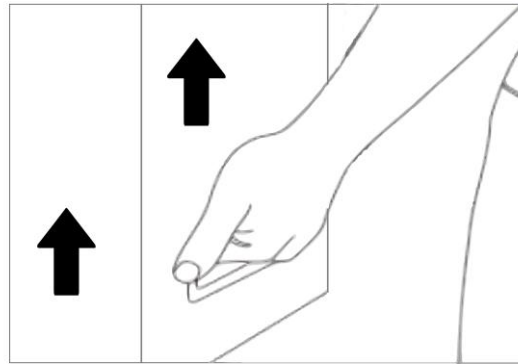
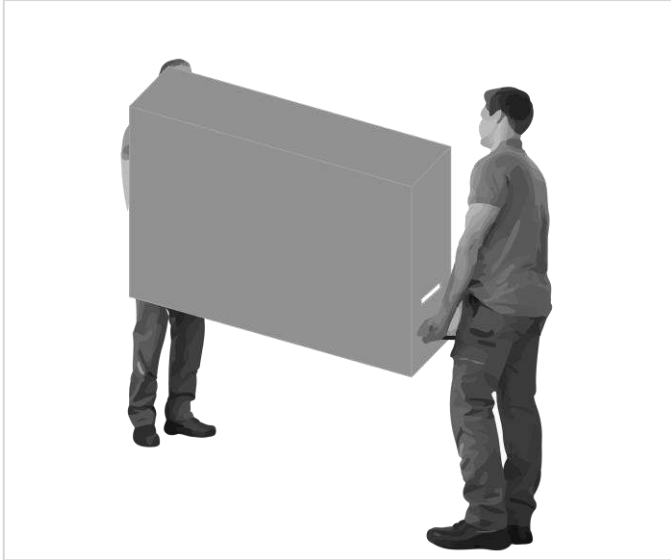

Carrying the Display

This display is heavy; please follow proper lifting technique, as pictured below. Failure to do so may cause injury.



Appendix II: Installing a Wall Mount

Follow the manual instructions for the type of mount you have selected. Refer all servicing to qualified service personnel.

Moving the display requires at least two people. Make sure you use the handles in the back of the display while lifting or moving the display, to avoid touching the front panel during the move.

Before installing, please make sure the wall is strong enough to hold the necessary weight of the display and the mount.

Step1. Keep the display facing the ground and place it on a flat object.

Step2. Remove the screws (M8*15) from the back of the display.

Step3. Align the wall brackets with the mounting holes and attach the brackets to the display using the screws removed in Step 2.

Caution: Longer screws will damage the display.

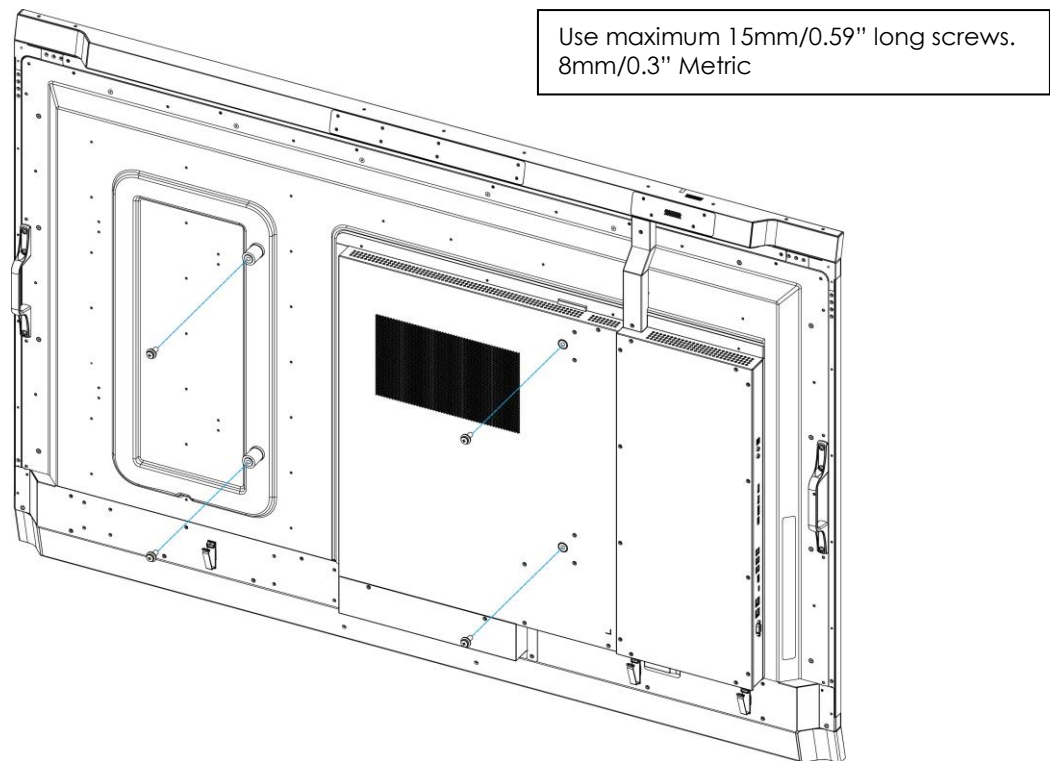

NOTE

To safely mount the display on a wall:

- Use only the approved wall-mount kit designed for the display.
- Make sure the tilt degree of the wall **does not exceed 2 degrees**.

Rear Tilt



Forward Tilt



Appendix III: Installing a NUC VESA Adapter

Follow the steps below to install a NUC or Backpack modules using the VESA Adapter.

Step 1 To install the VESA Adapter. Attach the supplied VESA adapter plate to the back of the display, making sure the plate and the mounting holes align.

Step 2 Secure the plate in position with the four provided screws (size M4*6).

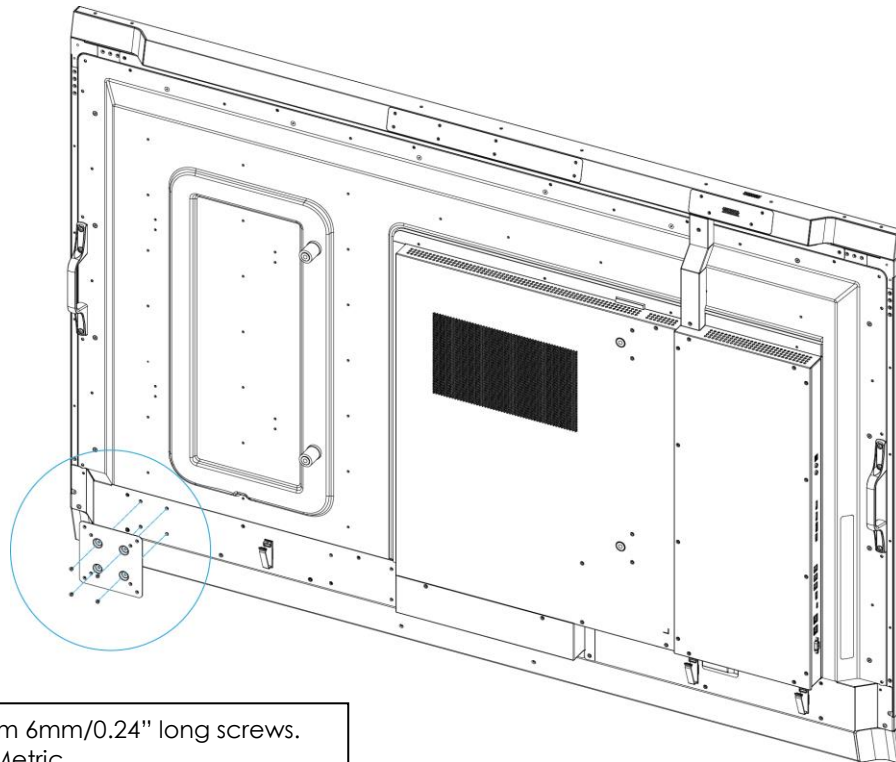

Use maximum 6mm/0.24" long screws.
4mm/0.16" Metric



NOTE

- The VESA adapter plate is compatible for NUC's or Backpacks that have VESA mounting patterns of 75 x 75 and 100 x 100.

Appendix IV: Wall Mount Safety Notes

1. Please make sure if the bracket is fixed to the solid wall / solid pillar for fear of falling due to heavy weight.

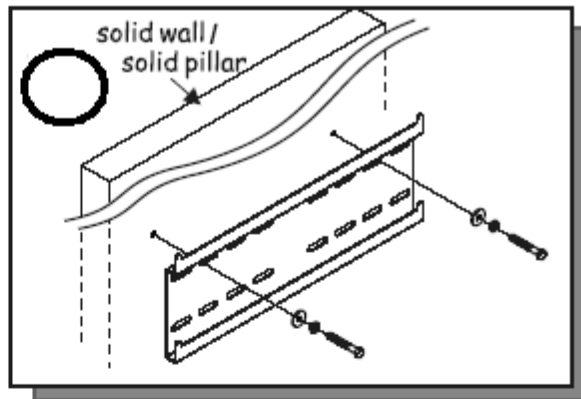
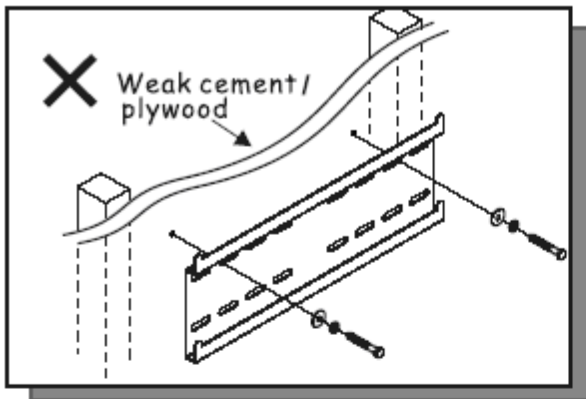

2. After assembling, please don't pull or shake violently.

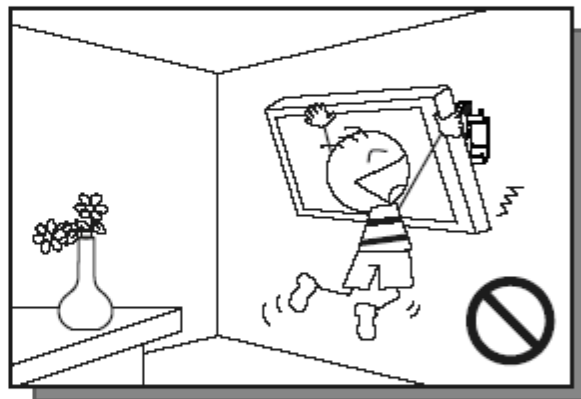
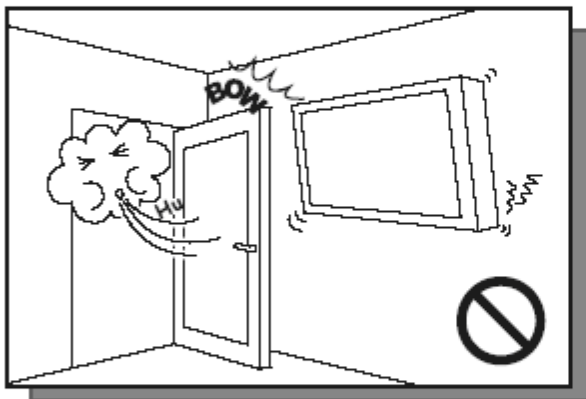

3. Please don't install the bracket directly under the sunshine or humidity / high temperature places for fear that the quality is effected.

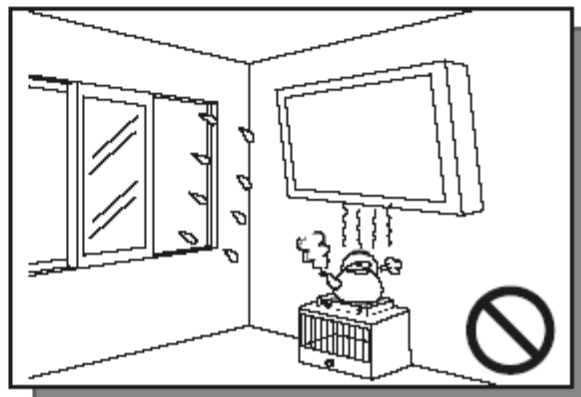
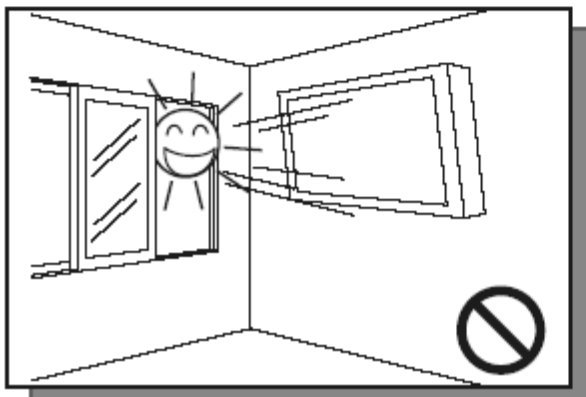

4.

Installing the bracket over 10 cm from each wall side and being vertical to the ground is the suggested installing position.

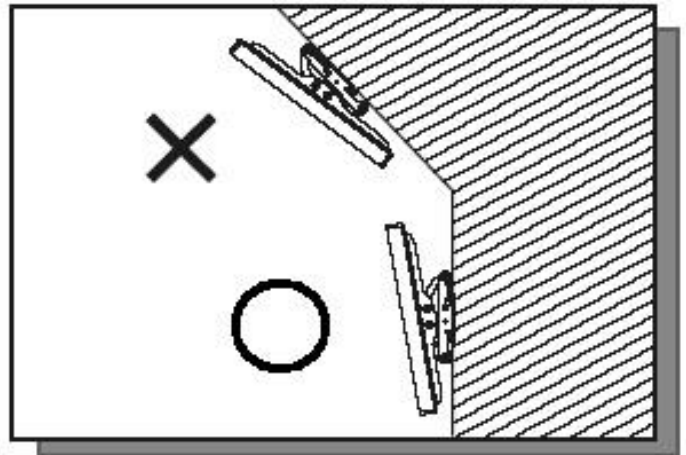
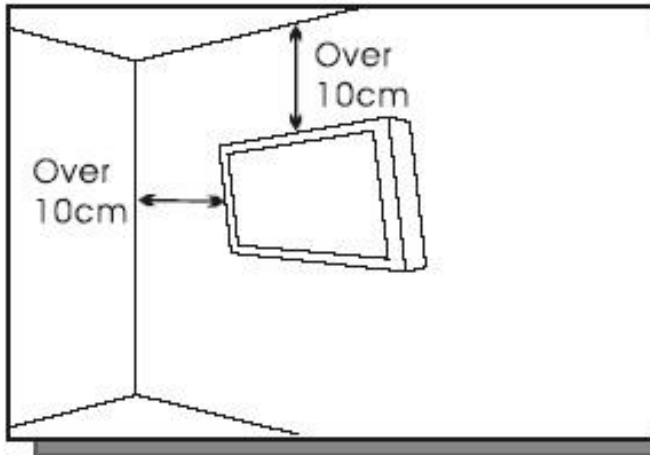

5.

Please make sure to hang on the mounting hooks firmly.

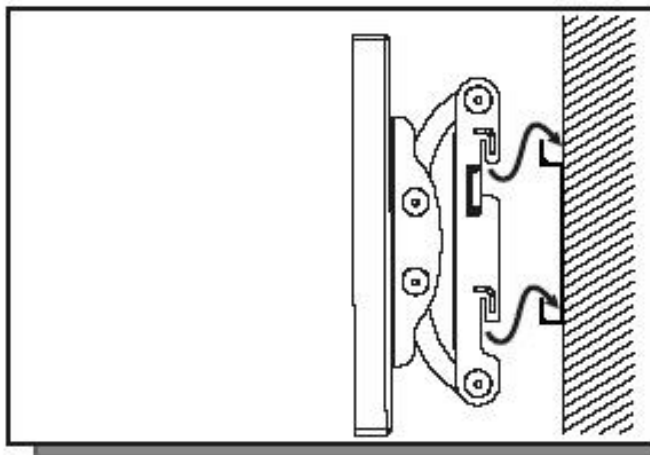

6.

The flat screen must be put in the mid of the bracket for fear of slope.

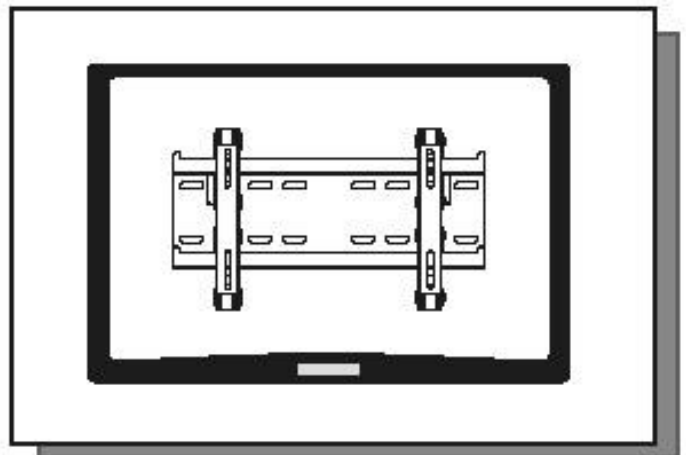

Appendix V: Azure IoT Settings

Check the IP Address of IoT device

1. Enter OSD menu then go to Adv. Settings and select Network Configuration.

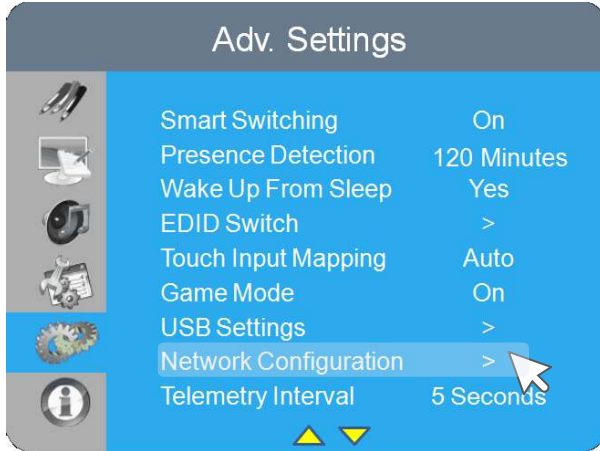

2. Configure network settings, you can select Dynamic IP to Disable or Enable, the default setting is **Enable**

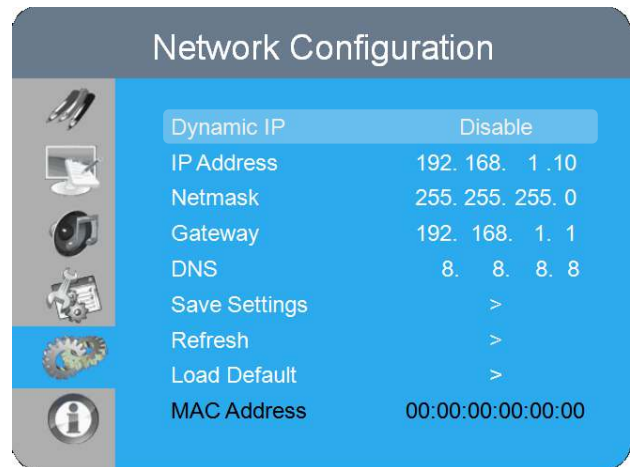
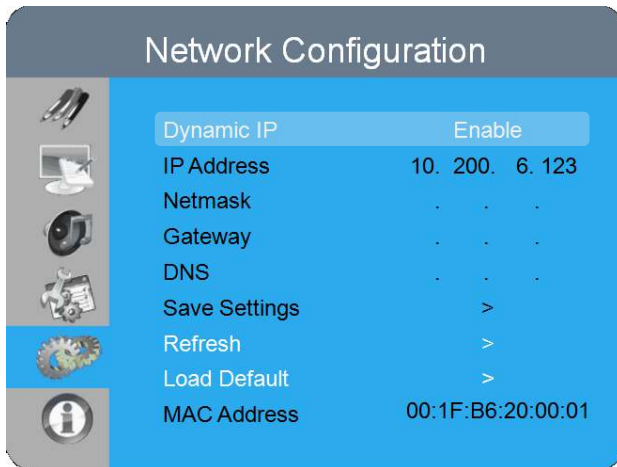

3. Once the network setup is done, the IP and MAC address will be shown on Network Configuration menu.

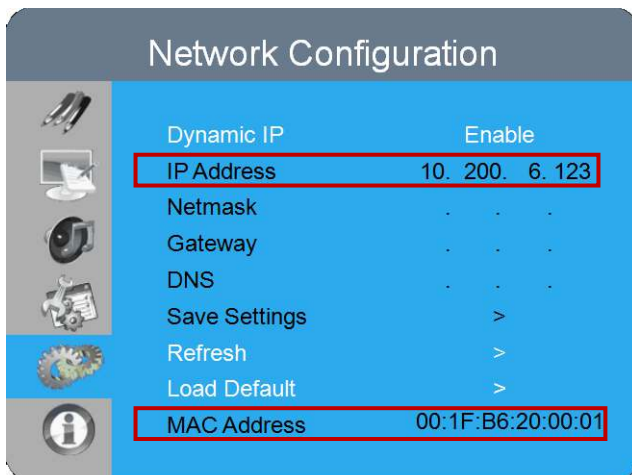

Log in to IoT Module

1. Open a browser, insert the IP address and press Enter, the Login window will pop up.
2. Enter the username and password then click the LOGIN button.
 - **Default Username: admin**
 - **Default Password: system**

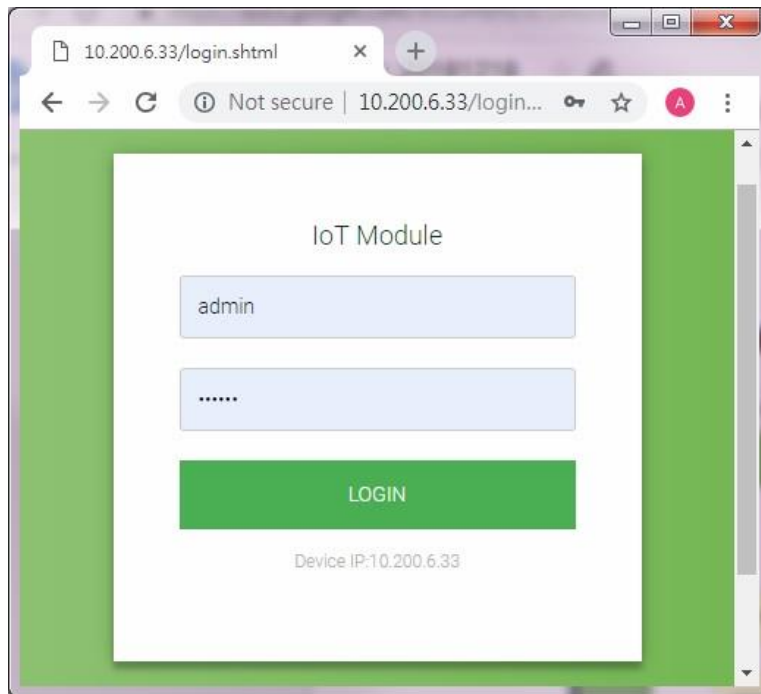

Configure Network Settings

- When Enable DHCP is "On": all the columns of Network Setup are unable to edit.

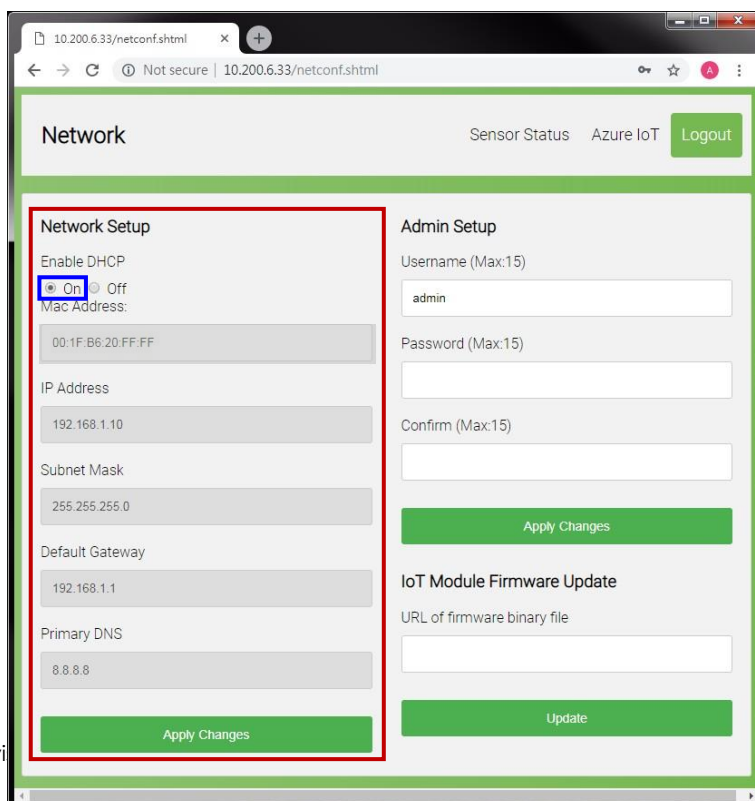

- When Enable DHCP is "Off": You can change the IP Address, Subnet Mask, Default Gateway and Primary DNS in Network Setup; Any changes that you make are automatically synchronized to OSD – Network Configurations.

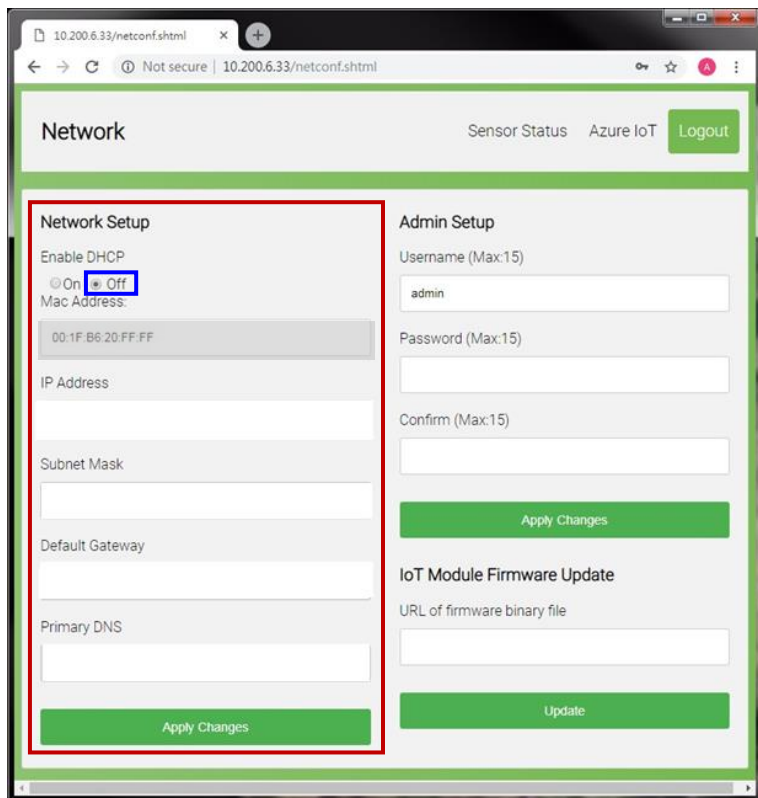

Modify Admin Setup

To change the default username and password and click Apply Changes to save.

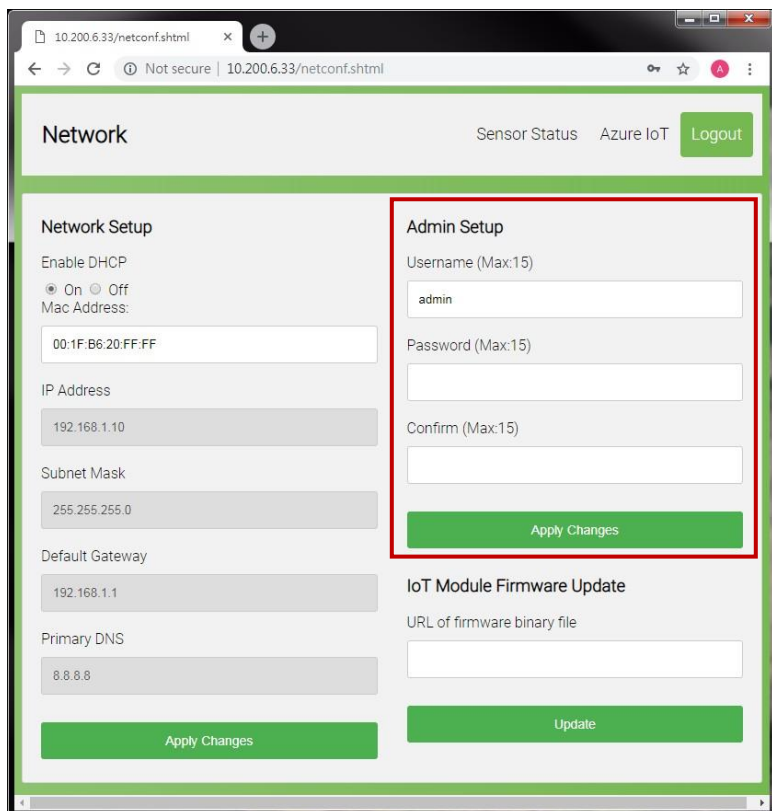

Update IoT Module Firmware

You can update the IoT Module Firmware by inserting the firmware file URL here.

The screenshot shows a web browser window displaying a configuration page for an IoT module. The page has a header with 'Network', 'Sensor Status', 'Azure IoT', and a 'Logout' button. The main content is split into two columns: 'Network Setup' and 'Admin Setup'. The 'Network Setup' column includes options for 'Enable DHCP' (On/Off), 'Mac Address' (00:1F:B6:20:FF:FF), 'IP Address' (192.168.1.10), 'Subnet Mask' (255.255.255.0), 'Default Gateway' (192.168.1.1), and 'Primary DNS' (8.8.8.8). The 'Admin Setup' column includes 'Username (Max:15)' (admin), 'Password (Max:15)', and 'Confirm (Max:15)'. A red box highlights the 'IoT Module Firmware Update' section, which contains a text input field for the 'URL of firmware binary file' and an 'Update' button. There are also 'Apply Changes' buttons at the bottom of both the Network and Admin sections.

Setup Azure IoT Service

To connect the IoT device to Azure Service, user **MUST**:

1. Go to Microsoft Azure website to create an Azure account.
For more details, see [Microsoft Azure New Account Setup](#)
2. Create an IoT hub and register a new device identity in the IoT hub.
Copy the **device's Connection string**-primary key to use it on IoT Module later.
For more information, see [Microsoft Azure IoT Hub Setup and Device Registration](#)
3. Go back to IoT Module then paste the **Device Connection String** and click Apply Changes to enable secure access to the IoT hub.
4. After completing all the above setups, you can check the sensor data in any device if you log in to Azure IoT service.

10.200.6.33/login.cgi

Not secure | 10.200.6.33/login.cgi

Azure IoT Sensor Status Network Logout

Azure Setup

Enable Auto Registration
 On Off

IoT Connection String (Max 256 chars)

IoT Device Id (Max 12 chars)

Auto Registration Agent (Max 128 chars)

Device Connection String

Apply Changes

Sensor Timer Setup

Telemetry Interval (in Second, 1~60 seconds)

5

View the Sensor Status

In this page you can check the sensor status and the general information of the display.

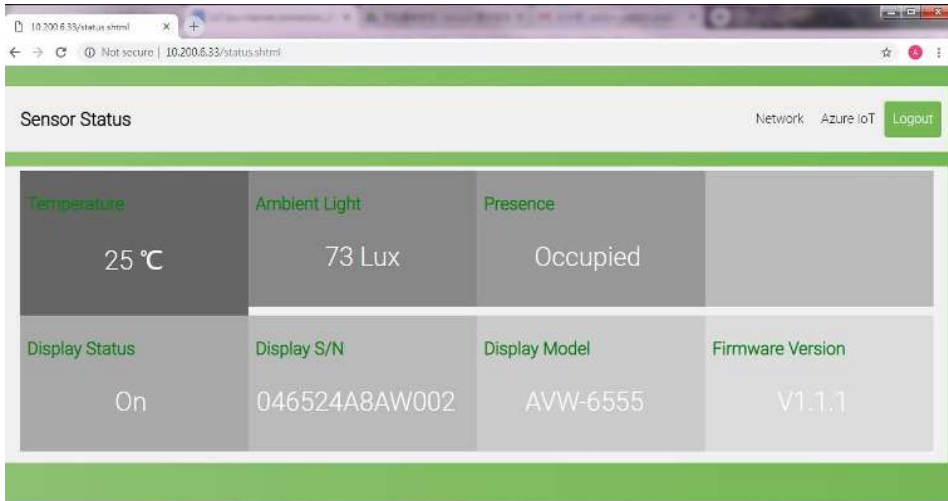

Configures Sensor Timer Setup

To change Sensor Telemetry Interval (range from 1~60 seconds).

Any changes that you save are automatically synchronized to OSD – Adv. Settings

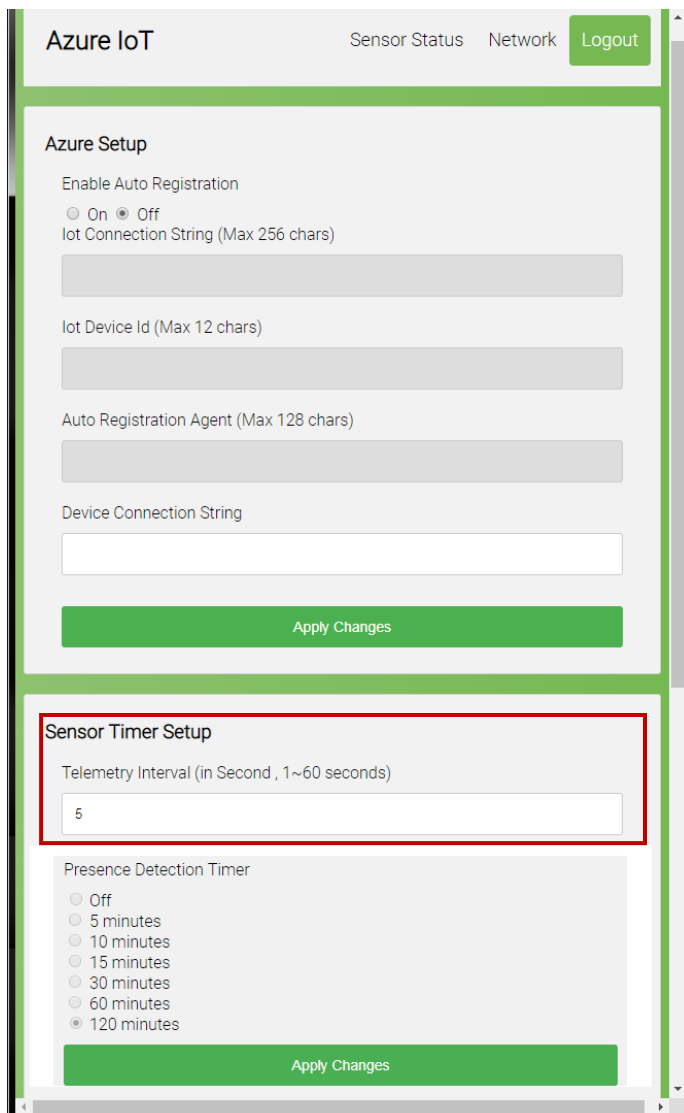

Note: Presence Detection Timer is for display only, you can edit on OSD menu – [Adv. Settings](#)