

FS710 Series

Fast Ethernet Unmanaged Switch

AT-FS710/5

AT-FS710/5E

AT-FS710/8

AT-FS710/8E

AT-FS710/16

AT-FS710/16E

AT-FS710/24

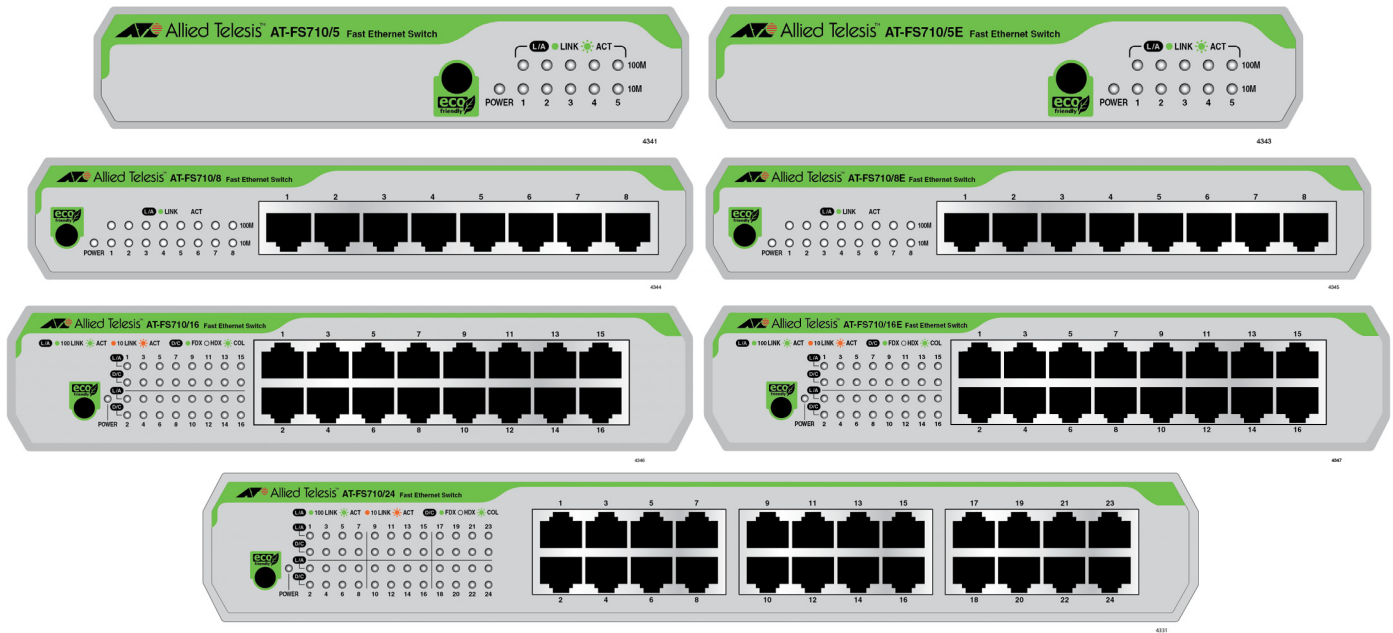

Installation Guide

Copyright © 2017 Allied Telesis, Inc.

All rights reserved. No part of this publication may be reproduced without prior written permission from Allied Telesis, Inc. Microsoft and Internet Explorer are registered trademarks of Microsoft Corporation. Netscape Navigator is a registered trademark of Netscape Communications Corporation. All other product names, company names, logos or other designations mentioned herein are trademarks or registered trademarks of their respective owners.

Allied Telesis, Inc. reserves the right to make changes in specifications and other information contained in this document without prior written notice. The information provided herein is subject to change without notice. In no event shall Allied Telesis, Inc. be liable for any incidental, special, indirect, or consequential damages whatsoever, including but not limited to lost profits, arising out of or related to this manual or the information contained herein, even if Allied Telesis, Inc. has been advised of, known, or should have known, the possibility of such damages.

Electrical Safety and Emissions Standards

This product meets the following standards:

Federal Communications Commission Interference Statement

Declaration of Conformity (Class A)

Manufacturer Name: **Allied Telesis, Inc.**

Declares that the product: **Fast Ethernet Unmanaged Switch**

Model Numbers: AT-FS710/16, AT-FS710/16E and AT-FS710/24

U.S. Federal Communications Commission

Radiated Energy

Note: This equipment has been tested and found to comply with the limits for a Class A digital device pursuant to Part 15 of FCC Rules. These limits are designed to provide reasonable protection against harmful interference when the equipment is operated in a commercial environment. This equipment generates, uses, and can radiate radio frequency energy and, if not installed and used in accordance with this instruction manual, may cause harmful interference to radio communications. Operation of this equipment in a residential area is likely to cause harmful interference in which case the user will be required to correct the interference at his own expense.

Note: Modifications or changes not expressly approved of by the manufacturer or the FCC, can void your right to operate this equipment.

Industry Canada

This Class A digital apparatus complies with Canadian ICES-003.

Cet appareil numérique de la classe A est conforme à la norme NMB-003 du Canada.

European Union Restriction of the Use of Certain Hazardous Substances (RoHS) in Electrical and Electronic Equipment

This Allied Telesis RoHS-compliant product conforms to the European Union Restriction of the Use of Certain Hazardous Substances (RoHS) in Electrical and Electronic Equipment. Allied Telesis ensures RoHS conformance by requiring supplier Declarations of Conformity, monitoring incoming materials, and maintaining manufacturing process controls.

Warning: In a domestic environment this product may cause radio interference in which case the user may be required to take adequate measures.

Declaration of Conformity (Class B)

Manufacturer Name: **Allied Telesis, Inc.**

Declares that the product: **Fast Ethernet Unmanaged Switch**

Model Number: AT-FS710/5, AT-FS710/5E, AT-FS710/8, and AT-FS710/8E

This device complies with Part 15 of the FCC Rules. Operation is subject to the following two conditions: (1) This device may not cause harmful interference, and (2) this device must accept any interference received, including interference that may cause undesired operation.

This equipment has been tested and found to comply with the limits for a Class B digital device, pursuant to Part 15 of the FCC Rules. These limits are designed to provide reasonable protection against harmful interference in a residential installation. This equipment generates, uses and can radiate radio frequency energy and, if not installed and used in accordance with the instructions, may cause harmful interference to radio communications. However, there is no guarantee that interference will not occur in a particular installation. If this equipment does cause harmful interference to radio or television reception, which can be determined by turning the equipment off and on, the user is encouraged to try to correct the interference by one of the following measures:

- Reorient or relocate the receiving antenna.
- Increase the separation between the equipment and receiver.
- Connect the equipment into an outlet on a circuit different from that to which the receiver is connected.
- Consult the dealer or an experienced radio/TV technician for help.



Caution

Any changes or modifications not expressly approved by the party responsible for compliance could void the user's authority to operate this equipment. ⚡ E80



Avertissement

Les changements ou modifications non expressément approuvés par la partie responsable de la conformité pourraient annuler l'autorité de l'utilisateur à utiliser cet équipement. ⚡ E80

Radiation Exposure Statement:

This equipment complies with FCC radiation exposure limits set forth for an uncontrolled environment. This equipment should be installed and operated with minimum distance 20cm between the radiator & your body.

European Union Restriction of the Use of Certain Hazardous Substances (RoHS) in Electrical and Electronic Equipment

- RoHs compliant
- European Union RoHS (Directive 2011/65/EU of the European Parliament and of the Council

of 8 June 2011 on the restriction of the use of certain hazardous substances in electrical and electronic equipment.)

This Allied Telesis RoHS-compliant product conforms to the European Union Restriction of the Use of Certain Hazardous Substances (RoHS) in Electrical and Electronic Equipment. Allied Telesis ensures RoHS conformance by requiring supplier Declarations of Conformity, monitoring incoming materials, and maintaining manufacturing process controls.

Safety and Electromagnetic Emissions Certificates

EMI Certifications

- FCC Part 15 Class A for the AT-FS710/16, AT-FS710/16E and AT-FS710/24
- FCC Part 15 Class B for the AT-FS710/5, AT-FS710/5E, AT-FS710/8, and AT-FS710/8E
- VCCI Class A for the AT-FS710/16, AT-FS710/16E and AT-FS710/24
- VCCI Class B for the AT-FS710/5, AT-FS710/5E, AT-FS710/8, and AT-FS710/8E
- EN 55032 Class A for all models
- EN 55024

Safety Certificates

- UL 60950-1: 2014 2nd Edition
- CSA c22.2 No 60950-1 2nd Edition, Oct. 2014
- EN60950-1: 2006+A11+A1+A12+A2

Translated Safety Statements

Important: The  indicates that a translation of the safety statement is available in a PDF document titled “Translated Safety Statements” on the Allied Telesis website at www.alliedtelesis.com/support.

Contents

Preface	12
Safety Symbols Used in this Document	13
Contacting Allied Telesis	14
Chapter 1: Product Description	15
Overview	16
Front and Rear Panels	16
Key Features	23
10/100Base-TX Twisted Pair Ports	23
External Power Supply DC Power Connector	24
System and Port LEDs	24
Wall and Rack Mount Bracket Summary	26
Ethernet Cable Specifications	26
Ethernet Switching Basics	27
Duplex Mode	27
Store and Forward	27
Back Pressure and Flow Control	27
Chapter 2: Installation	29
Reviewing Safety Precautions	30
Selecting a Site for the Switch	32
Unpacking the Switch	33
Installing the Switch on a Table or Desktop	34
Wall-Mounting the Switch	35
Guidelines for Installing the Switch on a Wall	35
AT-FS710/5 & 5E Wall Installation	35
AT-FS710/8 & 8E Wall Installation	40
AT-FS710/16, /16E & /24 Wall Installation	44
Rack Mounting the Switch	49
Guidelines for Installing the Switch in a Rack	49
Items Need for Rack Installation	49
AT-FS710/8 & 8E Rack Mounting Installation	50
AT-FS710/16, /16E & /24 Rack Mounting Installation	54
Powering On the Switch	56
Energizing Internal Power Supply Models	56
Energizing External AC/DC Power Supply Models	58
Cabling the Switch	60
Chapter 3: Troubleshooting	61
Appendix A: Technical Specifications	62
Physical Specifications	62
Environmental Specifications	63
Chassis Power Specifications	63
External Power Adapter Specifications	63
RJ-45 Twisted Pair Port Connectors	64

List of Figures

Figure 1: AT-FS710/5 Front Panel.....	16
Figure 2: AT-FS710/5 Rear Panel.....	16
Figure 3: AT-FS710/5E Front Panel.....	17
Figure 4: AT-FS710/5E Rear Panel.....	17
Figure 5: AT-FS710/8 Front Panel.....	18
Figure 6: AT-FS710/8 Rear Panel.....	18
Figure 7: AT-FS710/8E Front Panel.....	19
Figure 8: AT-FS710/8E Rear Panel.....	19
Figure 9: AT-FS710/16 Front Panel.....	20
Figure 10: AT-FS710/16 Rear Panel.....	20
Figure 11: AT-FS710/16E Front Panel.....	21
Figure 12: AT-FS710/16E Rear Panel.....	21
Figure 13: AT-FS710/24 Front Panel.....	22
Figure 14: AT-FS710/24 Rear Panel.....	22
Figure 15: Wall Mounting Hole Locations for Left Facing Ports.....	36
Figure 16: Wall Mounting Hole Locations for Up or Down Facing Ports.....	37
Figure 17: Aligning and Securing an AT-FS710/5 or 5E Switch onto Wall Screws.....	38
Figure 18: Removing the Rubber Feet.....	41
Figure 19: Marking the Screw Hole Locations.....	42
Figure 20: Driving the Screws through the Holes.....	43
Figure 21: Placing the Switch into the Brackets.....	43
Figure 22: Removing FS710 Series Rubber Feet.....	45
Figure 23: Marking the Screw Hole Locations.....	46
Figure 24: Attaching Brackets with Screws.....	47
Figure 25: Placing the Switch into the Brackets.....	47
Figure 26: Marking the Screw Hole Locations for the Top Brackets.....	48
Figure 27: Attaching Handles to Brackets.....	52
Figure 28: Attaching Brackets to Plates.....	52
Figure 29: Attaching Cable Tray to Plates.....	52
Figure 30: Attaching the Plates to the Switch.....	53
Figure 31: Attaching the Switch to Equipment Rack.....	53
Figure 32: Removing FS710 Series Switch Rubber Feet.....	54
Figure 33: Attaching Rack Mount Brackets to the Switch.....	54
Figure 34: Attaching the Switch to Equipment Rack.....	55
Figure 35: Plug Power Cord into Rear Panel AC Connector.....	56
Figure 36: Plug AC Power Cord in to AC Outlet.....	57
Figure 37: Package Contents.....	58
Figure 38: Slide AC Plug Into AC/DC Power Adapter.....	58
Figure 39: Plug Power Cord into Rear Panel DC Connector.....	59
Figure 40: RJ-45 Connector and Port Pin Layout.....	64

List of Tables

Table 1: AT-FS710/5, AT-FS710/5E, AT-FS710/8 and AT-FS710/8E System and Port LEDs	24
Table 2: AT-FS710/16, AT-FS710/16E and AT-FS710/24 System and Port LEDs	25
Table 3: Wall and Rack Mount Brackets	26
Table 4: Twisted Pair Cabling and Distances	26
Table 5: Model vs Wall Mount Kit	35
Table 6: List of Components in the AT-BRKT-J23 Wall Mount Kit	40
Table 7: List of Components in the AT-BRKT-J22 Wall Mount Kit	44
Table 8: Model vs Rack Mount Kit	49
Table 9: List of Components in the AT-RKMT-J08 Rack Mount Kit	50
Table 10: Physical Dimensions (W x D x H)	62
Table 11: Product Weight	62
Table 12: Environmental Specifications	63
Table 13: Chassis Input Power Specifications	63
Table 14: AC/DC Power Adapter Specifications	63
Table 15: MDI Pin Signals (10Base-T or 100Base-TX)	64
Table 16: MDI-X Pin Signals (10Base-T or 100Base-TX)	64

Preface

This manual is the installation and user's guide for the FS710 Series switches. This Preface contains the following sections:

- "Safety Symbols Used in this Document" on page 13
- "Contacting Allied Telesis" on page 14

Safety Symbols Used in this Document

This document uses the following conventions:

Note

Notes provide additional information.



Caution

Cautions inform you that performing or omitting a specific action may result in equipment damage or loss of data.



Warning

Warnings inform you that performing or omitting a specific action may result in bodily injury.

Contacting Allied Telesis

If you need assistance with this product, you may contact Allied Telesis technical support by going to the Support & Services section of the Allied Telesis web site at alliedtelesis.com/support. You can find links for the following services on this page:

- ❑ 24/7 Online Support - Enter our interactive support center to search for answers to your questions in our knowledge database, check support tickets, learn about Return Merchandise Authorization (RMA), and contact Allied Telesis technical experts.
- ❑ USA and EMEA phone support - Select the phone number that best fits your location and customer type.
- ❑ Hardware warranty information - Learn about Allied Telesis warranties and register your product online.
- ❑ Replacement Services - Submit an RMA request via our interactive support center.
- ❑ Documentation - View the most recent installation guides, user guides, software release notes, white papers and data sheets for your product.
- ❑ Software Updates - Download the latest software releases for your product.

For sales or corporate contact information, go to alliedtelesis.com/purchase and select your region.

Chapter 1

Product Description

This chapter contains the follows sections:

- “Overview” on page 16
- “Key Features” on page 23
- “Ethernet Switching Basics” on page 27

Overview

The FS710 Series switches provides a simple solution for Ethernet switching between devices operating at either 10 Mbps or 100 Mbps and include the following switch models:

- AT-FS710/5
- AT-FS710/5E
- AT-FS710/8
- AT-FS710/8E
- AT-FS710/16
- AT-FS710/16E
- AT-FS710/24

The FS710 Series switches are designed to be used on a desktop or mounted on a wall. The switch does not require software configuration or management.

Front and Rear Panels

The front and rear panels for each switch model are as follows:

Figure 1 illustrates the AT-FS710/5 front panel.

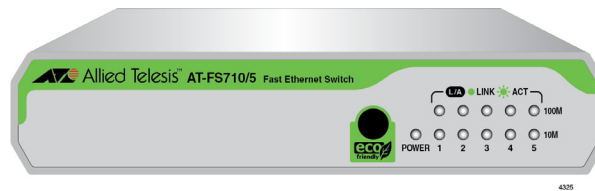

Figure 1. AT-FS710/5 Front Panel

Figure 2 illustrates the AT-FS710/5 rear panel.



Figure 2. AT-FS710/5 Rear Panel

Figure 3 illustrates the AT-FS710/5E front panel.

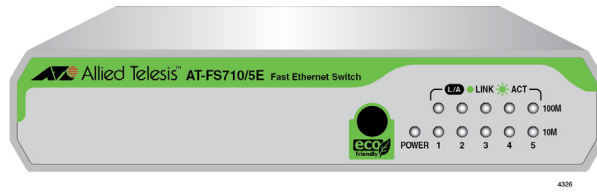

Figure 3. AT-FS710/5E Front Panel

Figure 4 illustrates the AT-FS710/5E rear panel.



Figure 4. AT-FS710/5E Rear Panel

Figure 5 illustrates the AT-FS710/8 front panel.

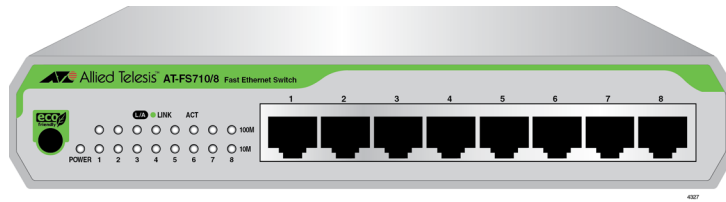

Figure 5. AT-FS710/8 Front Panel

Figure 6 illustrates the AT-FS710/8 rear panel.



Figure 6. AT-FS710/8 Rear Panel

Figure 7 illustrates the AT-FS710/8E front panel.

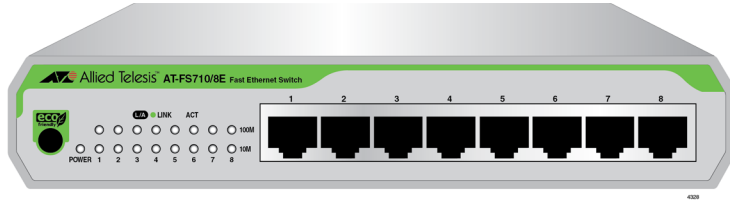

Figure 7. AT-FS710/8E Front Panel

Figure 8 illustrates the AT-FS710/8E rear panel.



Figure 8. AT-FS710/8E Rear Panel

Figure 9 illustrates the AT-FS710/16 front panel.

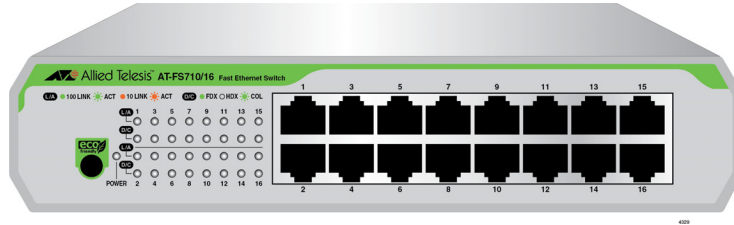

Figure 9. AT-FS710/16 Front Panel

Figure 10 illustrates the AT-FS710/16 rear panel.



Figure 10. AT-FS710/16 Rear Panel

Figure 11 illustrates the AT-FS710/16E front panel.

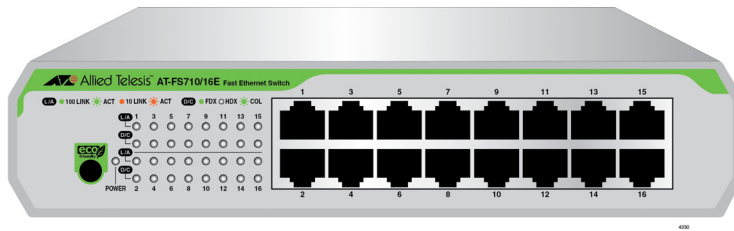

Figure 11. AT-FS710/16E Front Panel

Figure 12 illustrates the AT-FS710/16E rear panel.



Figure 12. AT-FS710/16E Rear Panel

Figure 13 illustrates the AT-FS710/24 front panel.

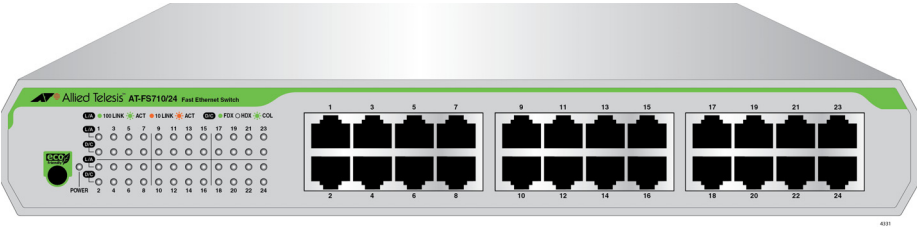

Figure 13. AT-FS710/24 Front Panel

Figure 14 illustrates the AT-FS710/24 rear panel.



Figure 14. AT-FS710/24 Rear Panel

Key Features

The FS710 Series switch has the following key features:

- ❑ 10/100 Mbps (10Base-T/100Base-TX) twisted pair Ethernet ports with RJ-45 connectors
- ❑ Auto-Negotiation (IEEE 802.3u-compliant) on all Ethernet ports
- ❑ Auto MDI/MDI-X on Ethernet pair ports
- ❑ Half- or full-duplex mode on all twisted pair ports
- ❑ Flow control
 - Full duplex: IEEE 802.3x-compliant
 - Half duplex: back pressure
- ❑ Storage of up to 2K MAC addresses for the AT-FS710/5, AT-FS710/5E, AT-FS710/8 and AT-FS710/8E models.
- ❑ Storage of up to 8K MAC addresses for AT-FS710/16, AT-FS710/16E, and AT-FS710/24 models.
- ❑ 200 ~ 300 second MAC address aging time
- ❑ Wire speed reception and transmission
- ❑ Store-and-forward switching method
- ❑ 1536 Byte maximum frame length
- ❑ 2K bytes maximum Jumbo Frame size
- ❑ Tagged VLAN packet pass through
- ❑ BPDU packet pass through
- ❑ Drops PAUSE frame

10/100Base-TX Twisted Pair Ports

The FS710 Series switches feature twisted pair copper ports.

Connector

All twisted pair ports feature 8-pin RJ-45 connectors. For the port pinouts, see “RJ-45 Twisted Pair Port Connectors” on page 64.

Speed

The ports are 10Base-T, and 100Base-T compliant and are capable of 10 Mbps and 100 Mbps speeds. The ports are IEEE 802.3u Auto-Negotiation compliant. With Auto-Negotiation, the switch automatically matches the highest possible common speed between each switch port and each end-node. For example, if an end-node is capable of only 10 Mbps, the switch sets the port connected to the end-node to 10 Mbps.

Duplex Mode

Each twisted pair port on the switch can operate in either half- or full-duplex mode. The twisted pair ports are IEEE 802.3u-compliant and automatically negotiate the duplex mode setting.

Note

In order for the switch to set the duplex mode for each port correctly, the end-nodes that you connect to the switch ports also need to be configured for Auto-Negotiation. Otherwise, a duplex mode mismatch can occur affecting network performance. For further information, refer to “Duplex Mode” on page 27.

Auto MDI/MDI-X

All of the twisted pair ports on the switch feature auto-MDI to automatically configure themselves as MDI or MDI-X when connected to an end-node. Consequently, you can use a straight-through twisted pair cable to connect any network device to a port.

External Power Supply DC Power Connector

The FS710 Series switch (including the AT-FS710/5E, AT-FS710/8E, AT-FS710/16E models) has a single DC power supply socket on the back panel. Use the AC/DC power adapter that is supplied with the switch to supply DC power to the switch.

To power the switch ON or OFF, connect or disconnect the the power adapter to or from an AC wall outlet.

Note

Allied Telesis recommends attaching the DC power cord to the switch before plugging the AC power adapter into an AC wall outlet.

System and Port LEDs

The LEDs on the front panel of the FS710 Series switch display status information. Table 1 describes the LEDs on the AT-FS710/5, AT-FS710/5E, AT-FS710/8 and AT-FS710/8E switches.

Table 1. AT-FS710/5, AT-FS710/5E, AT-FS710/8 and AT-FS710/8E System and Port LEDs

LED	State	Description
POWER	Green	The switch is powered ON.
	Off	The switch is not receiving power.

Table 1. AT-FS710/5, AT-FS710/5E, AT-FS710/8 and AT-FS710/8E System and Port LEDs (Continued)

LED	State	Description
10M L/A (LINK/ACT)	Green	A valid link is established on the port.
	Blinking Green	Frames are being transmitted/received on the port.
	Off	No link is established.
100M L/A (LINK/ACT)	Green	A valid link is established on the port.
	Blinking Green	Frames are being transmitted/received on the port.
	Off	No link is established.

Table 2 describes the LEDs on the AT-FS710/16, AT-FS710/16E and AT-FS710/24 switches.

Table 2. AT-FS710/16, AT-FS710/16E and AT-FS710/24 System and Port LEDs

LED	State	Description
POWER	Green	The switch is powered ON.
	Off	The switch is not receiving power.
L/A (LINK/ACT)	Green	A valid 100M link is established on the port.
	Blinking Green	100M frames are being transmitted/received on the port.
	Amber	A valid 10M link is established on the port.
	Blinking Amber	10M frames are being transmitted/received on the port.
	Off	No link is established.
D/C (DUPLEX /COLLISION)	Green	Link up in Full Duplex Mode
	Off	Link up in Half Duplex Mode or no link is established.
	Blinking Green	Collisions are occurring

Wall and Rack Mount Bracket Summary

The FS710 Series switch can be mounted on a table top, on a wall or in a 19" rack. No additional hardware is required for installing the unit on a table top. If you plan on mounting the unit on a wall or in a rack, Table 3 shows brackets options available.

Table 3. Wall and Rack Mount Brackets

Model	Wall Mount	Rack Mount
AT-FS710/5 and /5E	Use wall mounting holes on bottom of chassis.	These models are not rack mountable.
AT-FS710/8 and /8E	Use AT-BRKT-J23 wall mount kit. NOTE: This kit must be ordered separately.	AT-RKMT-J08 19" rack mount kit. NOTE: This kit must be ordered separately.
AT-FS710/16 and /16E	Use AT-BRKT-J22 wall mount kit. NOTE: This kit must be ordered separately.	Rack *2pcs+screw (to device)*4pcs
AT-FS710/24	Use AT-BRKT-J22 wall mount kit. NOTE: This kit must be ordered separately.	Rack *2pcs+screw (to device)*4pcs

Ethernet Cable Specifications

Table 4 contains the cabling specifications for the twisted pair ports.

Table 4. Twisted Pair Cabling and Distances

Speed	Type of Cable	Maximum Operating Distance
10 Mbps	Category 3 or better unshielded twisted pair cable	100 m (328 ft)
100 Mbps	Category 5 or unshielded twisted pair cable	100 m (328 ft)

Note

The twisted pair ports on the switch feature Auto-MDI. Each port is individually configured as MDI or MDI-X when connected to an end-node. Consequently, you can use a straight-through twisted pair cable when connecting any network device to a twisted pair port on the switch. A port operating at 10 or 100 Mbps uses four of the eight strands in twisted pair wiring. See Table 15 and Table 16 on page 64 for more information.

Ethernet Switching Basics

An Ethernet switch interconnects network devices, such as workstations, printers, routers, and other Ethernet switches, so that they can communicate with each other by sending and receiving Ethernet frames.

Duplex Mode

Duplex mode refers to how an end node receives and transmits data. If an end node can receive or transmit data, but not both simultaneously, it is operating in what is referred to as half-duplex mode. If an end node can both receive and transmit data simultaneously, the end node is operating in full-duplex mode. Naturally, an end node capable of operating in full-duplex can handle data much faster than an end node that can only operate in half-duplex mode.

The twisted pair ports on the FS710 Series switches can operate in half- or full-duplex mode for 10/100 Mbps. They are IEEE 802.3u-compliant and use Auto-Negotiation to set the duplex mode setting for you automatically.

Note

In order for a switch port to successfully Auto-Negotiate its duplex mode with a 10 or 100 Mbps end-node, the end-node should also be configured for Auto-Negotiation. Otherwise, a duplex mode mismatch can occur. A switch port using Auto-Negotiation defaults to half-duplex if it detects that the end-node is not using Auto-Negotiation. This results in a mismatch if the end-node is operating at a fixed duplex mode of full-duplex.

Store and Forward

The FS710 Series switches use store and forward as the method for receiving and transmitting frames. When an Ethernet frame is received on a switch port, the switch does not retransmit the frame out the destination port until it has received the entire frame and stored the frame in a port buffer. It then examines the frame to determine if it is a valid frame. Invalid frames, such as fragments or runts, are discarded by the switch. This insures that only valid frames are transmitted out the switch ports and that damaged frames are not propagated on your network.

Back Pressure and Flow Control

To maintain the orderly movement of data between the end-nodes, an Ethernet switch may periodically need to signal an end-node to stop sending data. This can occur under several circumstances. For example, if two end-nodes are operating at different speeds, the switch, while transferring data between the end-nodes, might need to instruct the faster end-node to stop transmitting data to allow the slower end-node to catch up. An example of this would be when a server operating at 100 Mbps is sending data to a workstation operating at only 10 Mbps.

How a switch signals an end-node to stop transmitting data differs depending on the duplex mode of the end-node and switch port. A twisted pair port operating in half-duplex mode stops an end-node from transmitting data by forcing a collision. A collision on an Ethernet network occurs when two end-nodes attempt to transmit data using the same data link at the same time. A collision causes an end-node to stop sending data, wait for a brief period of time, and then retransmit the same data. Once the switch is ready to receive data again, the switch stops forcing collisions. This is referred to as backpressure.

A port operating in full-duplex mode uses PAUSE frames, as specified in the IEEE 802.3x standard, to stop the transmission of data from an end-node. Whenever the switch wants an end-node to stop transmitting data, it issues this frame. The frame instructs the end-node to cease transmission for a period of time specified within the frame. The switch continues to issue PAUSE frames until it is ready again to receive data from the end-node. This is referred to as flow control.

Chapter 2

Installation

This chapter contains the following sections:

- ❑ “Reviewing Safety Precautions” on page 30
- ❑ “Selecting a Site for the Switch” on page 32
- ❑ “Unpacking the Switch” on page 33
- ❑ “Installing the Switch on a Table or Desktop” on page 34
- ❑ “Wall-Mounting the Switch” on page 35
- ❑ “Rack Mounting the Switch” on page 49
- ❑ “Powering On the Switch” on page 56
- ❑ “Cabling the Switch” on page 60

Reviewing Safety Precautions

Please review the following safety precautions before you begin to install the switch.

Note

Important: The  indicates that translations of the safety statement are available in the PDF document “Translated Safety Statements” posted on the Allied Telesis website at alliedtelesis.com/support.



Warning

To prevent electric shock, do not remove the cover. No user-serviceable parts inside. This unit contains hazardous voltages and should only be opened by a trained and qualified technician. To avoid the possibility of electric shock, disconnect electric power to the product before connecting or disconnecting the cables.  E1



Warning

Do not work on equipment or cables during periods of lightning activity.  E2



Warning

Power cord is used as a disconnection device. To de-energize equipment, disconnect the power cord.  E3



Warning

Class I Equipment. This equipment must be earthed. The power plug must be connected to a properly wired earth ground socket outlet. An improperly wired socket outlet could place hazardous voltages on accessible metal parts.  E4

Note

Pluggable Equipment. The socket outlet shall be installed near the equipment and shall be easily accessible.  E5



Caution

Air vents must not be blocked and must have free access to the room ambient air for cooling.  E6

Note

All Countries: Install product in accordance with local and National Electrical Codes. ⚡ E8



Caution

Power to the hub must be sourced only from the adapter. ⚡ E34



Warning

Operating Temperature. This product is designed for a maximum ambient temperature of 50 degrees C. ⚡ E57



Caution

Only use the AC adapter that is supplied with the unit. ⚡ E85

Selecting a Site for the Switch

Observe the following requirements when choosing a site for your FS710 Series switch:

- ❑ If unit is going to be installed on table top, make sure that the table is level and secure.
- ❑ The site should provide for easy access to the ports on the front of the switch for all other FS710 Series switch models except for the AT-FS710/5 and AT-FS710/5E which have the ports on the back of the switch. Ensure that the switch is positioned so that the LEDs on the front panel are easily viewed.
- ❑ If you plan to install the switch on a wall, make sure that the wall location provides enough space for routing the network and power cables to their respective ports.
- ❑ Ensure that the air flow around the unit and through its side vents are not be restricted to allow proper cooling of the switch.
- ❑ Do not place objects on top of the switch.
- ❑ Do not expose the switch to moisture or water.
- ❑ Ensure that the site is a dust-free environment.
- ❑ Use dedicated power circuits or power conditioners to supply reliable electrical power to the switch.

Unpacking the Switch

To unpack the FS710 Series switch, perform the following procedure:

1. Remove all components from the shipping package.

Note

Store the packaging material in a safe location. Allied Telesis recommends that you use the original shipping material in the event that a problem occurs and you need to return the unit.

2. Place the switch on a level, secure surface.
3. Verify that the following hardware components are included in your switch package:
 - One FS710 Series switch
 - Four rubber feet are provided depending on the model:
 - With adhesive back for desktop installation of the AT-FS710/5 and AT-FS710/5E models only;
 - With four mounting screws for desktop installation of the AT-FS710/8, AT-FS710/8E, AT-FS710/16, AT-FS710/16E and AT-FS710/24 models.
 - Two 10mm x 22mm nylon anchors and two 3.5mm x 16mm pan-head screws (provided only with the AT-FS710/5 and AT-FS710/5E models for wall mounting.)

Note

Wall mounting hardware for all models except for the AT-FS710/5 and AT-FS710/5E must be purchased separately.

- AC Power cord - only for the FS710 Series models with AC power plug.
- Switching AC/DC adapter - only for the FS710/xxE models with external DC power source

If any item is missing or damaged, contact your Allied Telesis sales representative for assistance.

Note

If you plan on mounting the unit on a wall or in a rack, see the information in Table 3, “Wall and Rack Mount Brackets” on page 26. This table shows brackets options available that may need to be ordered separately from the FS710 Series switch.

Installing the Switch on a Table or Desktop

To install the switch on a table or desktop, perform the following procedure:

1. Remove all the items from the packaging as specified in “Unpacking the Switch” on page 33.
2. Place the switch on a flat and secure surface, leaving enough space around the switch for ventilation and the distribution of the Ethernet cables.

Note

You can choose to physically stack up to three switches on top of each other without degradation in performance.

3. Proceed to “Powering On the Switch” on page 56 for the cable installation.

Wall-Mounting the Switch

All of the FS710 Series switches can be mounted on a wall.

Guidelines for Installing the Switch on a Wall

Before planning to install the switch on a wall, review the following guidelines:

- ❑ Refer to Table 5 to select the rack mounting bracket for your switch model.

Table 5. Model vs Wall Mount Kit

Model	Wall Mount
AT-FS710/5 and /5E	Use wall mounting holes on bottom of chassis along with two anchors and screws provided.
AT-FS710/8 and /8E	Use AT-BRKT-J23 wall mount kit. NOTE: This kit must be ordered separately.
AT-FS710/16 and /16E	Use AT-BRKT-J22 wall mount kit. NOTE: This kit must be ordered separately.
AT-FS710/24	Use AT-BRKT-J22 wall mount kit. NOTE: This kit must be ordered separately.

- ❑ All of the FS710 Series switch models can all be mounted on the wall with the front panel facing left, right, up or down, except for the AT-FS710/5 and /5E models. These switches can only be mounted with the front panel facing left, up or down.
- ❑ Before you begin to install the switch, review “Reviewing Safety Precautions” on page 30.
- ❑ See “AT-FS710/5 & 5E Wall Installation” for wall mounting the AT-FS710/5 and AT-FS710/5E models.
- ❑ See “AT-FS710/8 & 8E Wall Installation” on page 40 for wall mounting the AT-FS710/8 and AT-FS710/8E models.
- ❑ See “AT-FS710/16, /16E & /24 Wall Installation” on page 44 for wall mounting the AT-FS710/24, AT-FS710/16 and AT-FS710/16E models.

AT-FS710/5 & 5E Wall Installation

The AT-FS710/5 and /5E switches can be mounted with the ports facing left, up or down by performing the following procedure using the two 10mm x 22mm nylon anchors and two 3.5mm x 16mm pan-head screws provided:

1. Remove all the items from the packaging as specified in “Unpacking the Switch” on page 33.

2. Remove any data cables, and the (AC or DC) power cord from the switch.
3. If the rubber feet are attached, they are fastened with an adhesive. Remove the rubber feet by prying them off the chassis.
4. Select a wall location for the switch and decide which direction you want the ports to be oriented after installation: left, up or down.
5. Mark locations for two holes as follows:
 - a. If the switch ports are to be oriented facing left, then mark the hole locations 48.82 mm (1.92 in) apart and vertically aligned on the wall as shown in Figure 15.

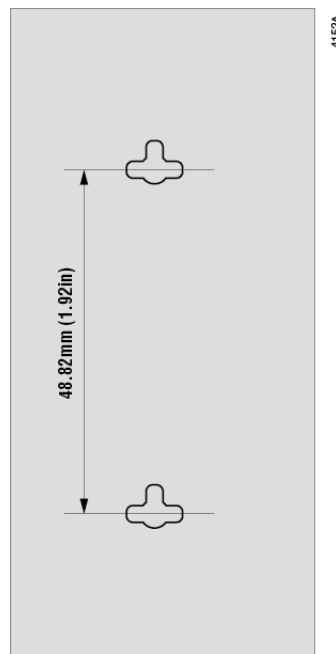
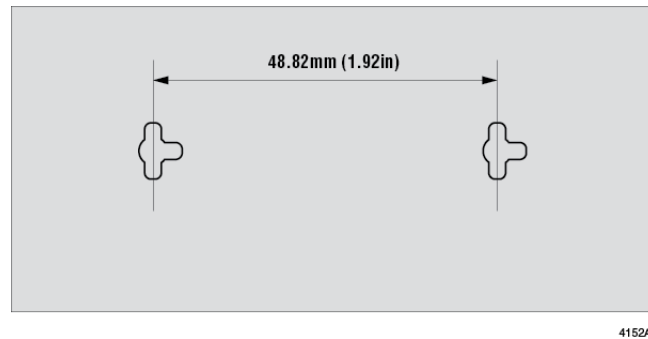

Figure 15. Wall Mounting Hole Locations for Left Facing Ports

- b. If the switch ports are to be oriented facing either up or down, mark the hole locations 48.82 mm (1.92 in) apart and horizontally in-line on the wall as shown in Figure 16.



4152A

Figure 16. Wall Mounting Hole Locations for Up or Down Facing Ports

6. At the marked locations on the wall, drill two 6mm (approximately 1/4in) holes for the anchors.
7. Insert the two 10mm x 22mm nylon anchors until the shoulder of the anchor is flush with the wall.
8. Install the two 3.5mm x 16mm pan-head screws. Turn the screw head until it is 6mm (approximately 1/4in) from the surface of the wall.
9. Position the switch so that the Ethernet ports are physically oriented in the direction (left, up or down) that you have chosen.
10. Align the switch such that the two key-hole slots on the back of the switch chassis line up over the two screw heads.
11. Align the switch chassis over the two screws (towards the wall) as illustrated in Figure 17 and slide it down until it is locked on the two screw heads .

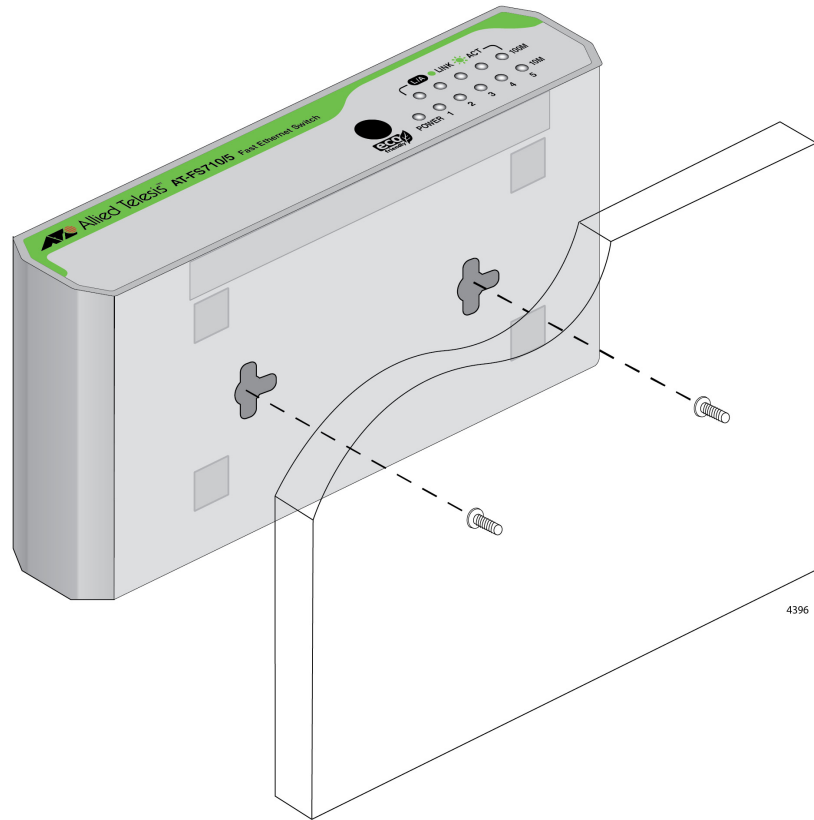

Figure 17. Aligning and Securing an AT-FS710/5 or 5E Switch onto Wall Screws

12. Verify that the switch chassis is securely mounted onto the wall.
 - a. If the switch is loose against the wall, dismount the switch off the wall and tighten the screws 1/4-turn. Repeat steps 7 - 12 until the switch chassis is securely fastened to the wall.
 - b. If the mounting key-holes on the bottom of the switch chassis cannot completely slide over the screw heads on the wall, then loosen the screws 1/4-turn and repeat steps 7 - 12 until the switch chassis is securely fastened to the wall.
13. Proceed to “Cabling the Switch” on page 60 for the cable installation.

AT-FS710/8 & 8E Wall Installation

This section explains the procedure for the installation either a AT-FS710/8 switch or a AT-FS710/8E switch on a wall using the AT-BRKT-J23 wall mount kit which includes metal brackets.

Note

The AT-BRKT-J23 wall mount kit must be ordered separately.

Note

Before you begin to install the switch using the AT-BRKT-J23 wall mount kit, review “Reviewing Safety Precautions” on page 30.

Unpacking the AT-BRKT-J23 Wall Mount Kit

To unpack the AT-BRKT-J23 wall mount kit, perform the following procedure:

1. Remove all components from the shipping package.

Note

Store the packaging material in a safe location. Allied Telesis recommends that you use the original shipping material in the event that a problem occurs and you need to return the unit.

2. Verify that one pair of metal brackets is included in your wall mount package listed in Table 6.

Table 6. List of Components in the AT-BRKT-J23 Wall Mount Kit

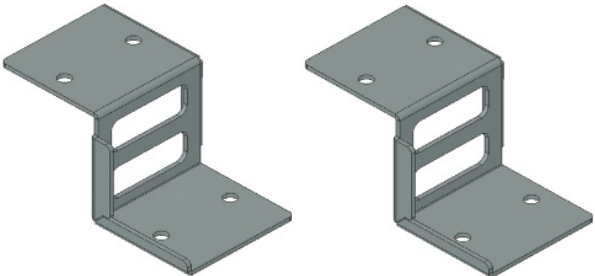
	Components
One pair of metal brackets	

3. If any item is missing or damaged, contact your Allied Telesis sales representative for assistance.

Installing a Switch Using the AT-BRKT-J23 Wall Mount Kit

This section shows you steps to install an AT-FS710/8 switch on a wall using the AT-BRKT-J23 kit. Before installing a switch on a wall, make sure that the following items are ready.

- An AT-BRKT-J23 wall mount kit
- Eight M4 x 32mm round-head wood screws to attach the brackets to a wall
- Eight 6mm x 30mm nylon anchor plug for the screws. These anchors are need only for sheet rock, concrete or cinder block walls.
- Phillips-head screwdriver
- Pencil

Note

The screws, plastic anchors, screwdriver and pencil are not included in the shipping box. You must provide the screws and anchors that hold the switch securely to the wall.

Note

Refer to “Unpacking the Switch” on page 33 to remove the switch and its components from the shipping box.

To install the AT-FS710/8 switch on a wall, perform the following procedure:

1. Review the “Guidelines for Installing the Switch on a Wall” on page 35 before installing the switch.
2. Turn the switch upside down and remove the rubber feet by removing the attaching screws. See Figure 18.

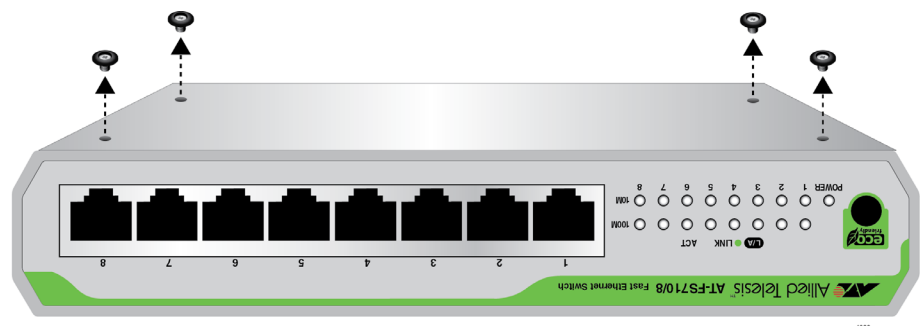

Figure 18. Removing the Rubber Feet

3. Orient the brackets against the sides of the switch.
4. Have another person hold the switch with the brackets at the wall location where the switch is to be installed. Use a pencil to mark the wall for the locations of the four holes in the brackets. See Figure 19.

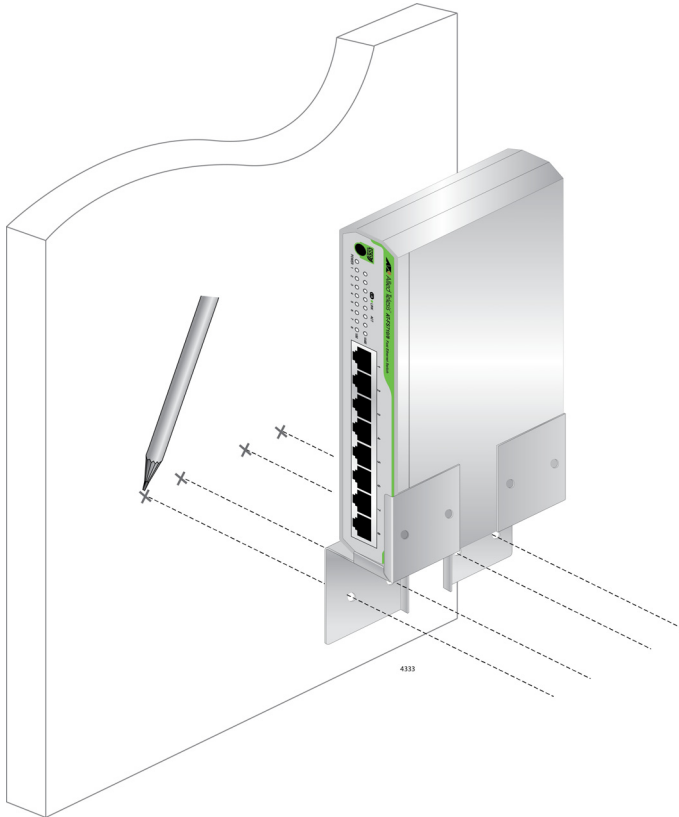

Figure 19. Marking the Screw Hole Locations

Note

Figure 19 shows the front panel oriented toward the left side. However, the switch can be mounted on the wall with the front panel facing left, right, up or down.

5. Pre-drill the marked locations on the wall at the locations marked in Step 4 as follows:
 - a. For a wood wall, drill a 1.5mm (1/16”) pilot hole for screw. (No anchors are required for mounting brackets on a wood wall.)
 - b. For a sheet rock, concrete or cinder block wall, drill a 6mm (1/4”) hole for anchor.
6. If the wall you are mounting the unit on is wood construction, then proceed to Step 8.

7. If the wall you are mounting the unit on is sheet rock, concrete or cinder block construction, install the four plastic anchors into the wall in the holes drilled in Step 5.
8. Position brackets on the wall and drive screws through the holes to attach the brackets on the wall. See Figure 20.

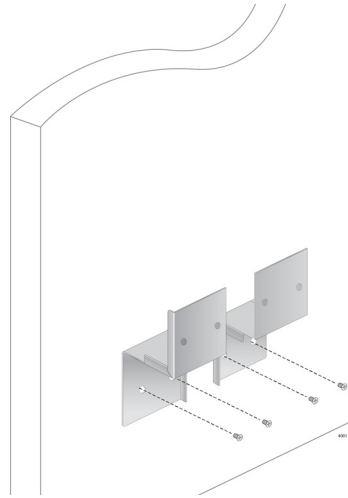

Figure 20. Driving the Screws through the Holes

9. Make sure that the two brackets are installed securely.
10. Slide the switch into the brackets on the wall as shown in Figure 21.

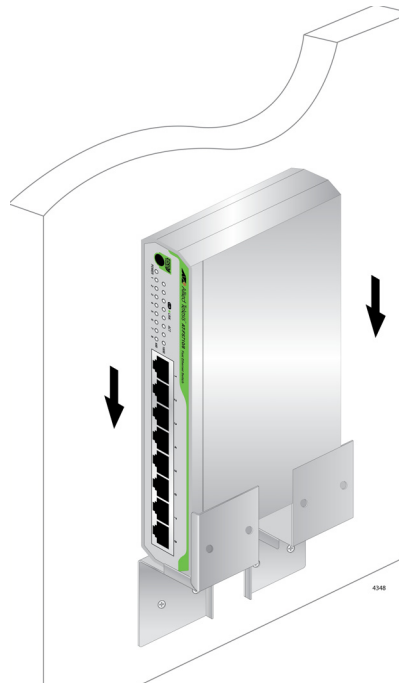

Figure 21. Placing the Switch into the Brackets

11. Proceed to “Cabling the Switch” on page 60.

**AT-FS710/16,
/16E & /24 Wall
Installation**

The AT-FS710/24, AT-FS710/16, and AT-FS710/16E switches use the AT-BRKT-J22 wall mounting kit to be mounted on a wall.

Note

The AT-BRKT-J22 wall mount kit must be purchased separately from the switch.

Note

Before you begin to install the switch using the AT-BRKT-J22 wall mount kit, review “Reviewing Safety Precautions” on page 30.

To unpack the AT-BRKT-J22 wall mount kit, perform the following procedure:

1. Remove all components from the shipping package.

Note

Store the packaging material in a safe location. Allied Telesis recommends that you use the original shipping material in the event that a problem occurs and you need to return the unit.

2. Verify that two pairs of metal brackets are included in your wall mount package listed in Table 9.

Table 7. List of Components in the AT-BRKT-J22 Wall Mount Kit

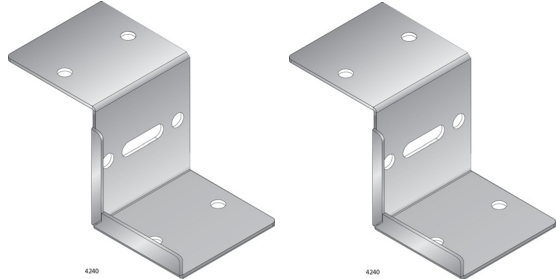
Description	Components
Two pairs of metal brackets	

3. If any item is missing or damaged, contact your Allied Telesis sales representative for assistance.

Installing a Switch Using the AT-BRKT-J22 Wall Mount Kit

This section shows you the steps to install an AT-FS710/24, AT-FS710/16, or /16E switch on a wall using the AT-BRKT-J22 kit. Before beginning the installation, make sure that the following items are ready:

- An AT-BRKT-J22 wall mount kit
- Eight M4 x 32mm round-head wood screws to attach the brackets to a wall
- Eight 6mm x 30mm nylon anchor plug for the screws. These anchors are need only for sheet rock, concrete or cinder block walls.
- Phillips-head screwdriver
- Pencil

Note

The screws, plastic anchors, screwdriver and pencil are not included in the shipping box. You must provide screws and anchors that hold the switch securely to the wall.

Note

Refer to “Unpacking the Switch” on page 33 to remove the switch and its components from the shipping box.

To install the switch on a wall, perform the following procedure:

1. Review the “Guidelines for Installing the Switch on a Wall” on page 35 before installing the switch.
2. Turn the switch upside down and remove the rubber feet by removing the attaching screws. See Figure 22.

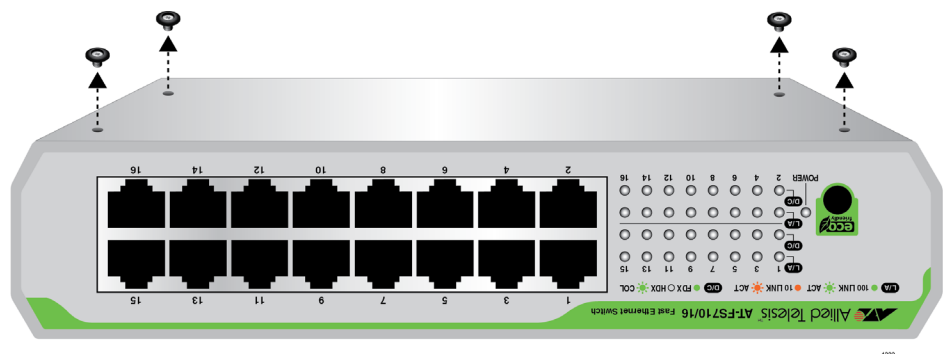

Figure 22. Removing FS710 Series Rubber Feet

3. Orient the brackets against the sides of the switch.

4. Have another person hold the switch with the brackets at the wall location where the switch is to be installed. Use a pencil to mark the wall with the locations of the four holes in the brackets. See Figure 23 as an example.

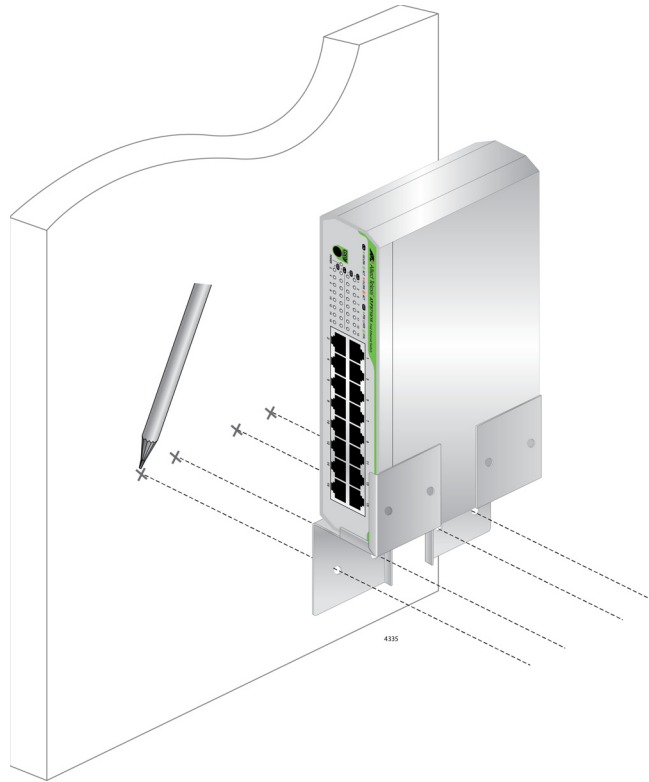

Figure 23. Marking the Screw Hole Locations

5. Pre-drill the marked locations on the wall at the locations marked in Step 4 as follows:
 - a. For a wood wall, drill a 1.5mm (1/16") pilot hole for screw. (No anchors are required for mounting brackets on a wood wall.)
 - b. For a sheet rock, concrete or cinder block wall, drill a 6mm (1/4") hole for anchor.
6. If the wall you are mounting the unit on is wood construction, then proceed to Step 8.
7. If the wall you are mounting the unit on is sheet rock, concrete or cinder block construction, install the four plastic anchors into the wall in the holes drilled in Step 5.

8. Position brackets on the wall and drive screws through the holes to attach the brackets on the wall. See Figure 24.

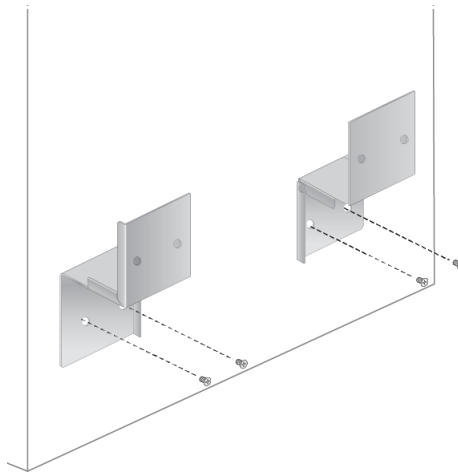

Figure 24. Attaching Brackets with Screws

9. Make sure that the two brackets are installed securely.
10. Slide the switch into the brackets on the wall as shown in Figure 25.

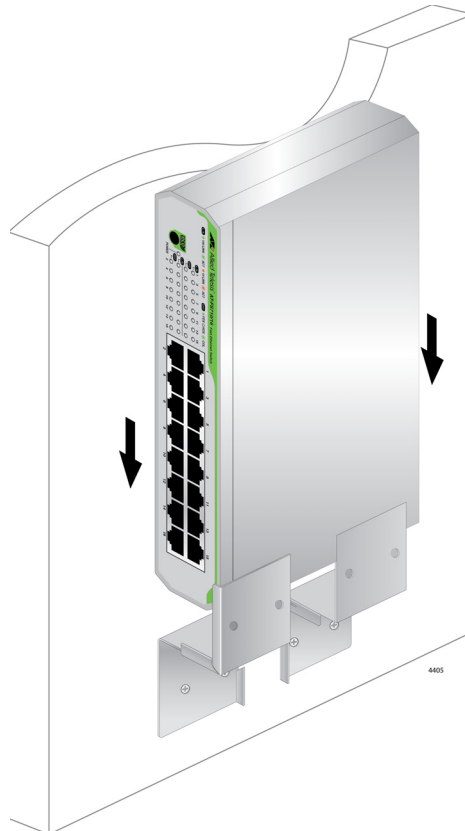

Figure 25. Placing the Switch into the Brackets

11. Place the other two brackets on the top of the switch and mark the screw hole locations with a pencil as shown in Figure 26.

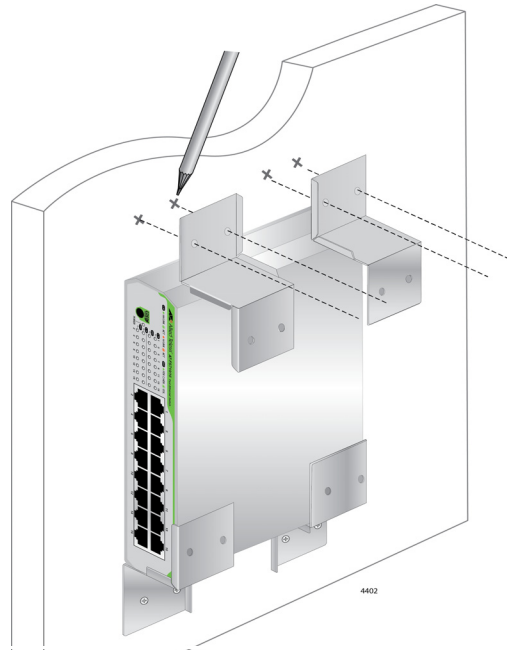

Figure 26. Marking the Screw Hole Locations for the Top Brackets

12. Remove the two brackets and switch and set aside.
13. Pre-drill the marked locations on the wall at the locations marked in Step 11 as follows:
 - a. For a wood wall, drill a 1.5mm (1/16") pilot hole for screw. (No anchors are required for mounting brackets on a wood wall.)
 - b. For a sheet rock, concrete or cinder block wall, drill a 6mm (1/4") hole for anchor.
14. If the wall you are mounting the unit on is wood construction, then proceed to Step 16.
15. If the wall you are mounting the unit on is sheet rock, concrete or cinder block construction, install the four plastic anchors into the wall in the holes drilled in Step 11.
16. Slide the switch into the bottom brackets and place the other two brackets on the top of the switch
17. Install the screws through the bracket holes to attach them to the wall. See Figure 26 on page 48.
18. Proceed to "Powering On the Switch" on page 56.

Rack Mounting the Switch

All of the FS710 Series switches can be mounted in an equipment rack except for the AT-FS710/5 and AT-FS710/5E models.

The preliminary processes and the installation procedures for installing the FS710 Series switches in an equipment rack are as follows:

- "Guidelines for Installing the Switch in a Rack"
- "Items Need for Rack Installation"

Guidelines for Installing the Switch in a Rack

Before planning to install the switch on a rack, review the following guidelines:

- Refer to Table 8 to select the rack mounting bracket for your switch model.

Table 8. Model vs Rack Mount Kit

Model	Rack Mount Kit
AT-FS710/5 AT-FS710/5E	These models are not rack mountable.
AT-FS710/8 AT-FS710/8E	AT-RKMT-J08 Rack Mount Kit
AT-FS710/16 AT-FS710/16E AT-FS710/24	Rack Mount Kit packaged with the switch

- Before you begin to install the switch in the equipment rack, review "Reviewing Safety Precautions" on page 30.

Items Need for Rack Installation

You need the following items to install the switch on a wall:

- A FS710 Series switch
- Rack mount hardware kit
(See Table 8, "Model vs Rack Mount Kit")
- Four equipment rack screws
- Phillips-head screwdriver

Note

You must purchase the rack mount bracket kit separately from your FS710 Series switch.

Note

The screws and Phillip-head screwdriver are not included in the shipping box with the switch or rack mount bracket kit.

AT-FS710/8 & 8E Rack Mounting Installation

This section explains the installation procedure for installing an AT-FS710/8 or AT-FS710/8E switch in a 19-inch equipment rack using the AT-RKMT-J08 rack mount kit.

- “Unpacking the AT-RKMT-J08 Rack Mount Kit” on page 50
- “Installing an AT-FS710/8 or /8E Switch Using the AT-RKMT-J08 Rack Mount Kit” on page 51

Unpacking the AT-RKMT-J08 Rack Mount Kit

To unpack the AT-RKMT-J08 rack mount kit, perform the following procedure:

1. Remove all components from the shipping package.

Note

Store the packaging material in a safe location. Allied Telesis recommends that you use the original shipping material to return the unit to Allied Telesis if required.

2. Verify that all hardware components are included in your rack mount package listed in Table 9.

Table 9. List of Components in the AT-RKMT-J08 Rack Mount Kit





	Components
Two Short Metal Brackets	
Two Metal Handles	
Two Metal Cable Brackets	

Table 9. List of Components in the AT-RKMT-J08 Rack Mount Kit

	Components
Two Long Metal Brackets	
Eight M3x6mm screws	
Eight M4x6mm screws	
Ten Tie-wrap	

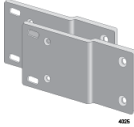
3. If any item is missing or damaged, contact your Allied Telesis sales representative for assistance.

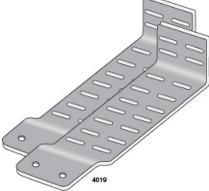
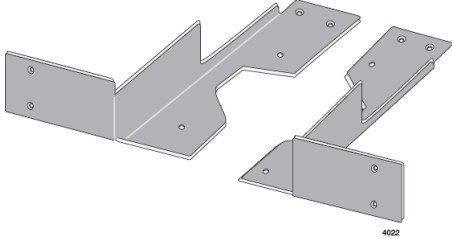
Installing an AT-FS710/8 or /8E Switch Using the AT-RKMT-J08 Rack Mount Kit

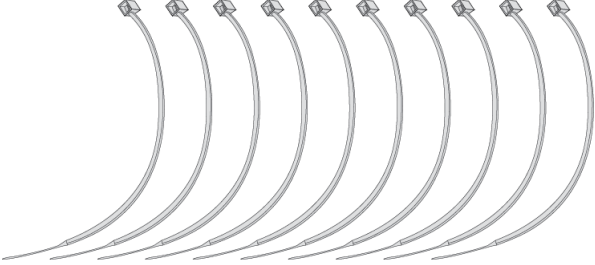
To install an AT-FS710/8 or /8E switch in a rack using the AT-RKMT-J08 rack mount kit, perform the following procedure:

1. Place all the items from the packaging on a work table.
2. Attach the handle to the short bracket with M3x6mm screws using a Phillip-head screw driver as shown in Figure 27.

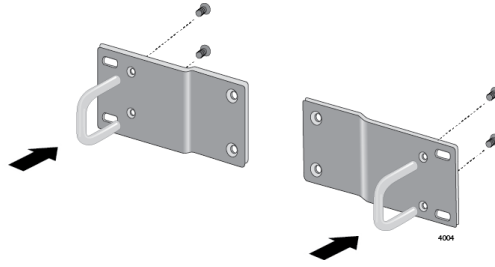

Figure 27. Attaching Handles to Brackets

3. Attach the short bracket and handle to the long bracket with M4x6mm screws using a Phillip-head screw driver as shown in Figure 28.

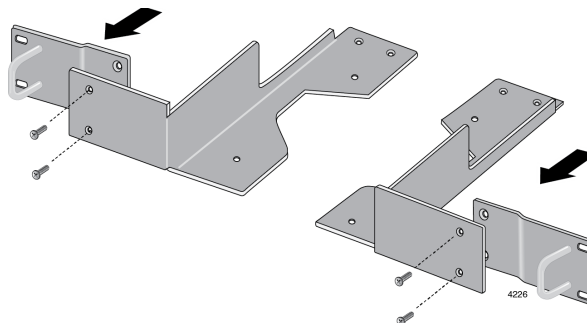

Figure 28. Attaching Brackets to Plates

4. Attach the cable bracket to the unit that you assembled in Step 3 with M4x6mm screws using a Phillip-head screw driver as shown in Figure 29.

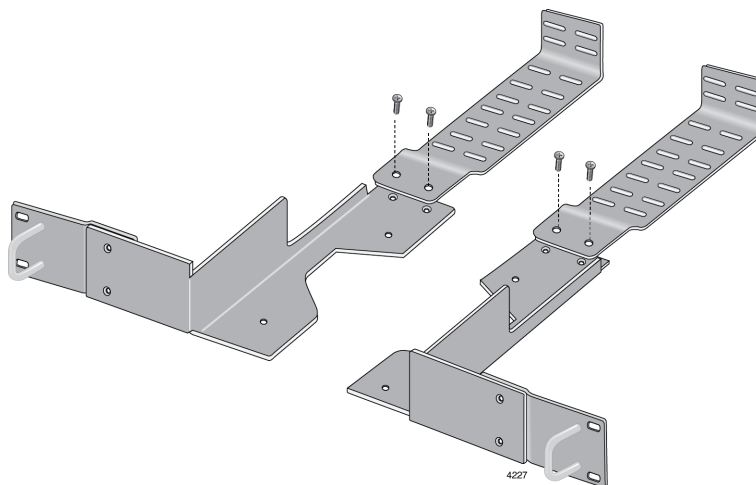

Figure 29. Attaching Cable Tray to Plates

5. Turn the switch upside down and place it on the work table.

6. Attach the mounting plates from Step 4 to the switch with M3x6mm screws using a Phillip-head screw driver as shown in Figure 30.

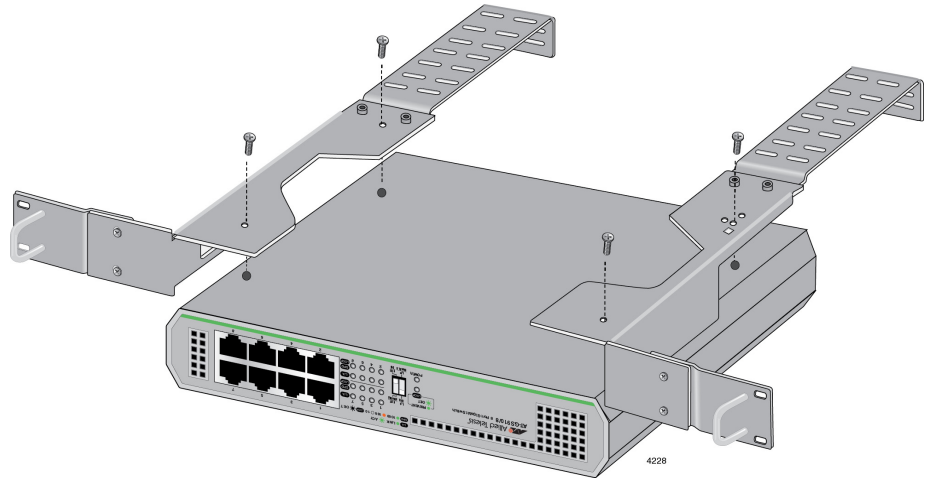

Figure 30. Attaching the Plates to the Switch

7. Mount the switch in a standard 19-inch equipment rack with four equipment rack screws as shown in Figure 31 on page 53.

Note

The screws are not included in the AT-RKMT-J08 rack mount kit.

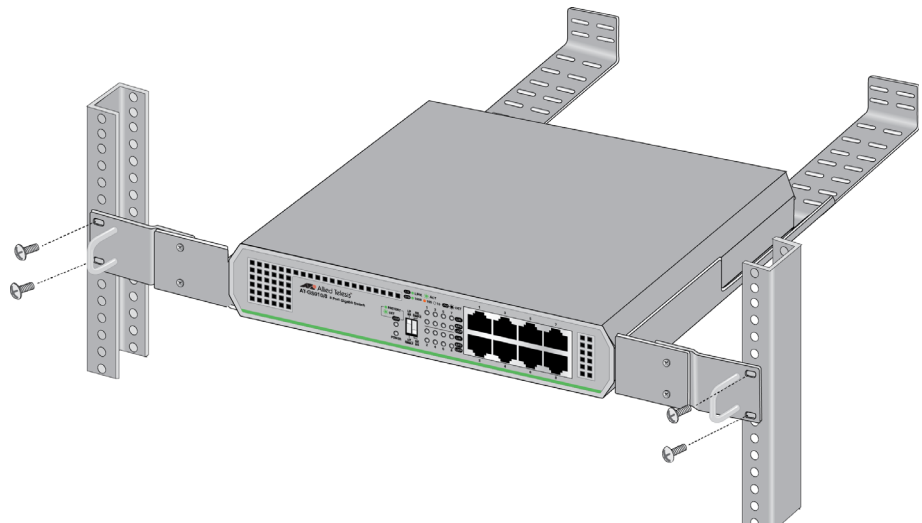

Figure 31. Attaching the Switch to Equipment Rack

8. Attach the power cord to the back panel of the switch.

AT-FS710/16, /16E & /24 Rack Mounting Installation

This section explains the installation procedure for installing an AT-FS710/24, AT-FS710/16, or AT-FS710/16E switch in a 19-inch equipment rack using the rack mount kit provided with the switch.

Note

The following steps apply to the AT-FS710/24, AT-FS710/16 or AT-FS710/16E switches even though the illustrations in this section only show the AT-FS710/24.

1. Place the rack mount brackets and the switch on a work table.
2. Turn the switch upside down and remove the rubber feet by unscrewing the attaching screws. See Figure 32.

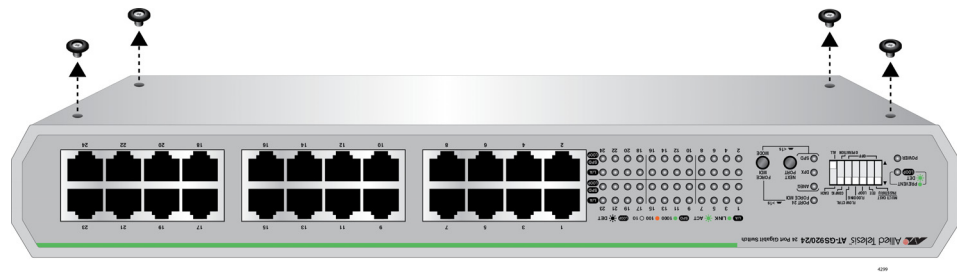

Figure 32. Removing FS710 Series Switch Rubber Feet

3. Attach both rack mount brackets to the side of the switch using the four screws provided as shown in Figure 33..

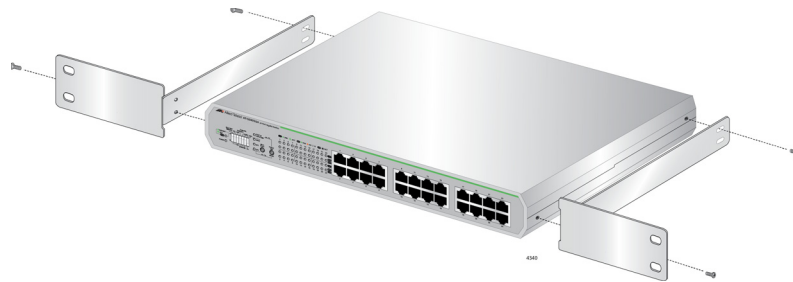

Figure 33. Attaching Rack Mount Brackets to the Switch

4. Mount the switch in a standard 19-inch equipment rack with four equipment rack screws (not provided) as shown in Figure 34.

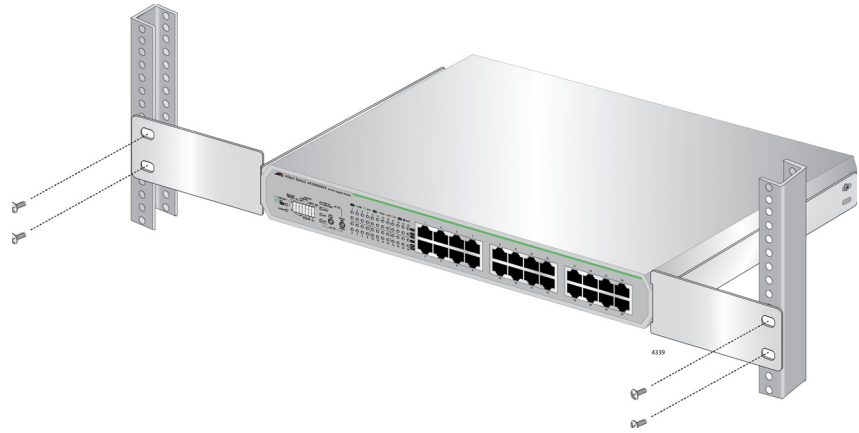

Figure 34. Attaching the Switch to Equipment Rack

5. Proceed to “Powering On the Switch” on page 56.

Powering On the Switch

The FS710 Series provides models that are powered by an internal power supply and other models that are powered by an external AC/DC power supply.

Refer to "Energizing Internal Power Supply Models" to apply power to the FS710 Series models that use the internal AC power supply. These models include:

- ❑ AT-FS710/5
- ❑ AT-FS710/8
- ❑ AT-FS710/16
- ❑ AT-FS710/24

Refer to "Energizing External AC/DC Power Supply Models" on page 58 to apply power to the FS710 Series models that use the external AC/DC power supply. These models include:

- ❑ AT-FS710/5E
- ❑ AT-FS710/8E
- ❑ AT-FS710/16E

Energizing Internal Power Supply Models

Apply power to a switch with an internal AC power supply by performing the following procedure:

Note

See the list of models powered by an internal AC power supply in "Powering On the Switch" above.

1. Insert the AC power cord provided into the rear AC input connector of the switch as shown in Figure 35.

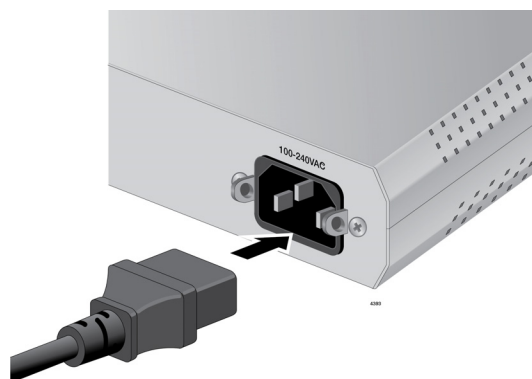

Figure 35. Plug Power Cord into Rear Panel AC Connector

2. Insert the AC power cord in to and external AC wall outlet as shown in Figure 36.

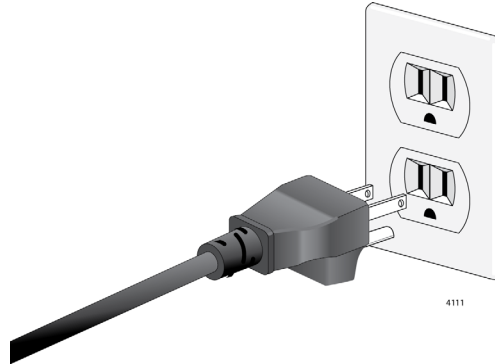

Figure 36. Plug AC Power Cord in to AC Outlet

3. Verify the PWR LED is green. If the LED is off, see Chapter 3, “Troubleshooting” on page 61.

Note

Allied Telesis recommends attaching the power cord to the switch before plugging the power cord into a wall outlet.



Warning

Power cord is used as a disconnection device: To de-energize equipment, disconnect the power cord. ⚡ E3



Caution

Only use the AC adapter that is supplied with the unit. ⚡ E85

4. Go to “Cabling the Switch” on page 60.

Energizing External AC/DC Power Supply Models

Apply power to a switch with an external AC/DC power supply by performing the following procedure:

Note

See the list of models powered by external AC/DC power supply in “Powering On the Switch” on page 56.

1. Ensure that the Multi-region AC/DC Power Adapter package contents include one power adapter and one or more of the plugs shown in Figure 37.

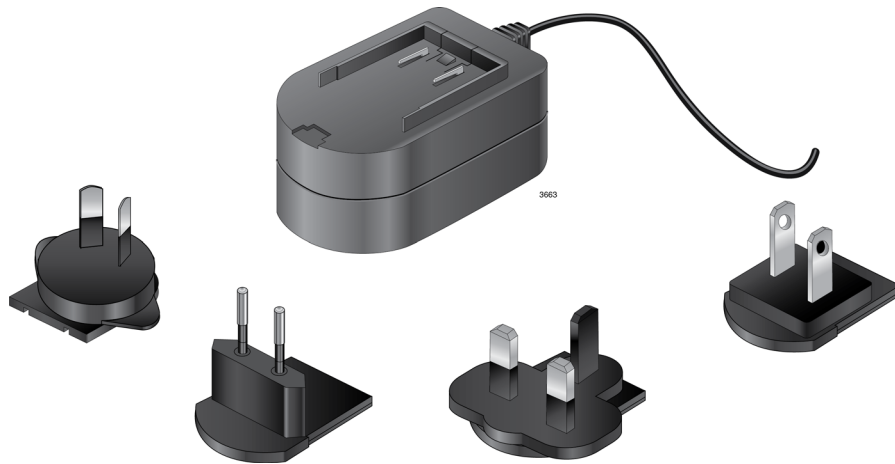

Figure 37. Package Contents

2. Remove the AC power plugs and power adapter from the shipping package.
3. Select the AC power plug that is compatible with your region and slide it into the power adapter as shown in Figure 38.

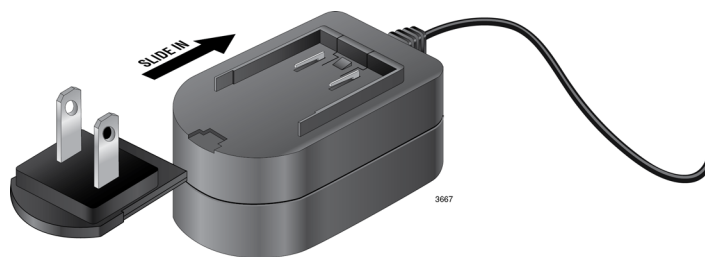

Figure 38. Slide AC Plug Into AC/DC Power Adapter



Warning

To prevent electric shock, slide the AC power plug into the AC/DC power adapter before plugging it into the AC power wall receptacle.

4. Insert the DC power plug into the DC power plug of your FS710 Series switch and the AC power plug into the AC power wall receptacle as shown in Figure 39.

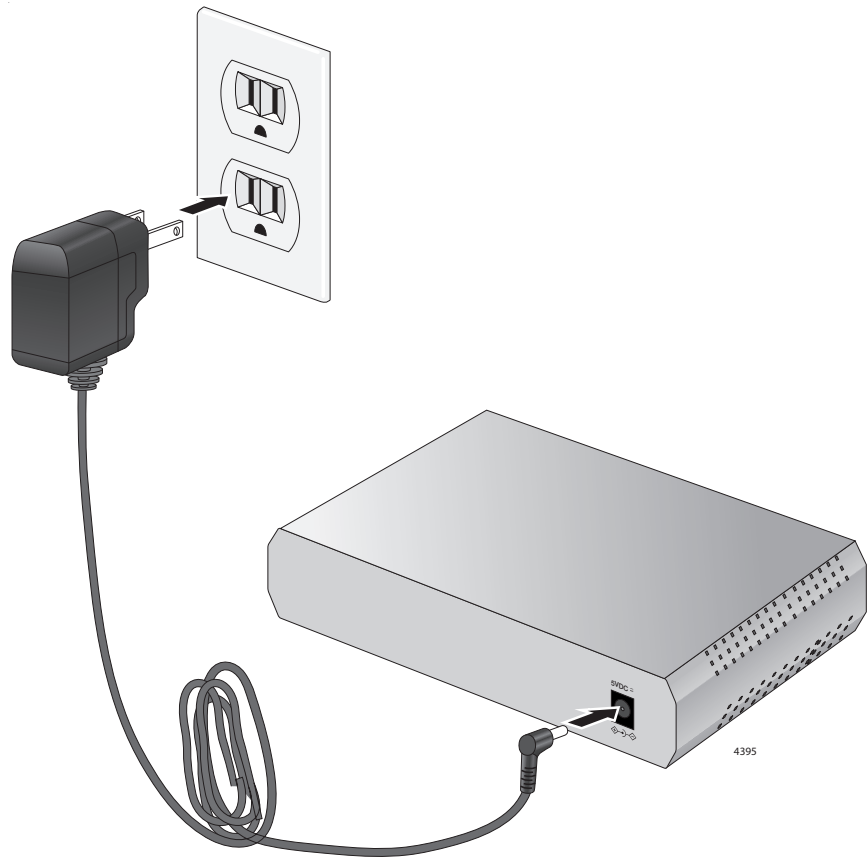

Figure 39. Plug Power Cord into Rear Panel DC Connector

5. Verify the PWR LED is green. If the LED is off, see Chapter 3, “Troubleshooting” on page 61.

Note

Allied Telesis recommends attaching the power cord to the switch before plugging the power cord into a wall outlet.



Warning

Power cord is used as a disconnection device: To de-energize equipment, disconnect the power cord. ⚡ E3



Caution

Only use the AC adapter that is supplied with the unit. ⚡ E85

6. Go to “Cabling the Switch” on page 60.

Cabling the Switch

After installing the switch, connect twisted pair cables to the Ethernet ports. When connecting a twisted pair cable, observe the following guidelines:

- ❑ The RJ-45 connector should fit snugly into the port on the switch. The tab on the connector should lock the connector into place.
- ❑ The ports on the switch are auto-MDI/MDI-X. You can use a straight-through twisted pair cable to connect any type of network device to a port on the switch.
- ❑ The network should not contain data loops, which can adversely affect network performance. A data loop exists when two or more network devices can communicate with each other over more than one data path.

Use cable ties (not provided) to dress and bundle the Ethernet cables as the distance increases away from switch.

The switch is now ready for network operations.

Chapter 3

Troubleshooting

This chapter contains information on how to troubleshoot the switch in the event a problem occurs.

Note

If you are still unable to resolve the problem after following the instructions in this chapter, contact Allied Telesis Technical Support for assistance. Refer to “Contacting Allied Telesis” on page 14.

Check the PWR LED on the front of the switch. If the LED is OFF, indicating that the unit is not receiving power, do the following:

- Verify that the power cord is securely connected to the power source and to the connector on the back panel of the switch.
- Verify that the AC power outlet or power adapter has power by connecting another device to it.
- Try connecting the power adapter to another power source.
- Verify that the voltage from the power source is within the required levels for your region.

Verify that the L/A LED for each port is green. If an L/A LED is OFF, do the following:

- Verify that the end-node connected to the port is powered ON and is operating properly.
- Verify that the twisted pair cable is securely connected to the port on the switch and to the port on the end-node.
- Ensure that the twisted pair cable does not exceed 100 meters (328 feet).
- Verify that you are using the appropriate category of twisted pair cable: Category 3 or better for 10 Mbps operation and Category 5 for 100 Mbps operation.

Appendix A

Technical Specifications

This appendix contains the following sections:

- ❑ "Physical Specifications"
- ❑ "Environmental Specifications" on page 63
- ❑ "Chassis Power Specifications" on page 63
- ❑ "External Power Adapter Specifications" on page 63
- ❑ "RJ-45 Twisted Pair Port Connectors" on page 64

Physical Specifications

Table 10. Physical Dimensions (W x D x H)

Specification	Dimension (W x D x H)
FS710/5 & FS710/5E	130mm x 101mm x 30mm
FS710/8 & FS710/8E	195mm x 124mm x 38mm
FS710/16 & FS710/16E	210mm x 124mm x 44mm
FS710/24	305mm x 180mm x 44mm

Table 11. Product Weight

Model	Weight
AT-FS710/5	0.4 Kg
AT-FS710/8	0.7 Kg
AT-FS710/16	0.9 Kg
AT-FS710/24	1.6 Kg
AT-FS710/5E	0.4 Kg
AT-FS710/8E	0.7 Kg
AT-FS710/16E	0.9 Kg
External AC Adapter	122.3 g

Environmental Specifications

Table 12. Environmental Specifications

Specification	Parameter
Operating Temperature	0° C to 50° C (32° F to 122° F)
Storage Temperature	-25° C to 70° C (-13° F to 158° F)
Operating Humidity	5% to 90% non-condensing
Storage Humidity	5% to 95% non-condensing
Operating Altitude	2000 meters maximum

Chassis Power Specifications

Table 13. Chassis Input Power Specifications

Model	Chassis Input Power Ratings	Frequency
AT-FS710/5	100 - 240 VAC, 0.20 A	50/60 Hz
AT-FS710/8	100 - 240 VAC, 0.20 A	50/60 Hz
AT-FS710/16	100 - 240 VAC, 0.22 A	50/60 Hz
AT-FS710/24	100 - 240 VAC, 0.22 A	50/60 Hz
AT-FS710/5E	5 VDC, 2 A	N/A
AT-FS710/8E	5 VDC, 2 A	N/A
AT-FS710/16E	5 VDC, 2 A	N/A

External Power Adapter Specifications

Table 14. AC/DC Power Adapter Specifications

Specification	Parameter
Rated Input Voltage	100 - 240 VAC
Rated Input Frequency	50/60 Hz
Rated Input Current	0.4 A max
DC Output Voltage	5 V
Output Current	2 A

RJ-45 Twisted Pair Port Connectors

This section lists the connectors and connector pinouts for the AT-FS708 Fast Ethernet switch and its components.

Figure 40 illustrates the pin layout to an RJ-45 connector and port.

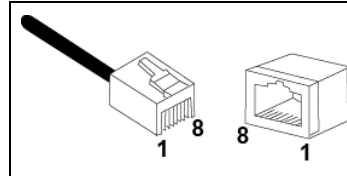

Figure 40. RJ-45 Connector and Port Pin Layout

Table 15 lists the RJ-45 pin signals when a twisted pair port is operating in the MDI configuration.

Table 15. MDI Pin Signals (10Base-T or 100Base-TX)

Pin	Signal
1	TX+
2	TX-
3	RX+
6	RX-

Table 16 lists the RJ-45 port pin signals when a twisted pair port is operating in the MDI-X configuration.

Table 16. MDI-X Pin Signals (10Base-T or 100Base-TX)

Pin	Signal
1	RX+
2	RX-
3	TX+
6	TX-