

HS8PL

8" ARCHITECTURAL CFL HORIZONTAL SHALLOW DOWNLIGHT

NEW

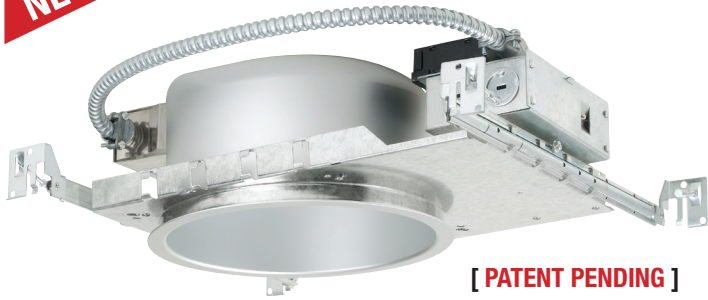

[PATENT PENDING]

TRIM: 8701 REFLECTOR / **SHALLOW 4-3/4" HEIGHT**
TWIN TUBE LAMP ONLY

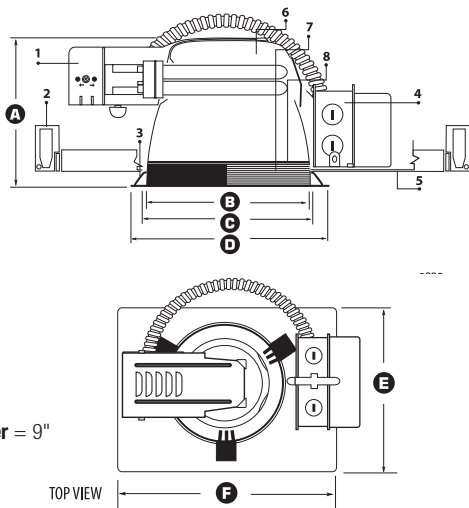

- A. Min. Height = 4-3/4"
- B. Trim Aperture = 7"
- C. Cut-out = 8-3/8"
- D. Trim Outside Diameter = 9"
- E. Width = 9-1/2"
- F. Length = 13"

DESCRIPTION

1. LAMP HOLDER - Aluminum lamp holder effectively provides heat dissipation and ventilation. Unitized optics guarantees proper trim to housing installation. Tool-less installation adjustability from either outside the housing or inside the housing.

2. MOUNTING BRACKET - Preinstalled bar hangers allow housing to be positioned and locked at any point within a 24" joist span and can be shortened for 12" joists. They are designed to be hammered directly without using nails or screws and could be fit onto T-Bar spline for easy installation and quick alignment.

3. RETAINING SPRINGS - Precision tooled springs secure trim to mounting frame, for effortless and tool-less installation.

4. JUNCTION BOX/BALLAST - UL listed for through-branch circuit wiring and has four 1/2" KO's, one 3/4" KO and four Romex knockouts with pry-out slots and strain clamps. Ballast and Junction Box are accessible from below, no tools required. Ballast supplied is manufactured by Phillips Advance, Universal Technologies or Lutron Electronics.

5. MOUNTING FRAME - Die-formed construction for maximum heat dissipation and rust protection.

OPTICS

6. REFLECTOR - Self-flanged .050" aluminum reflector with low iridescent finish. Reflector provides 45-degree lamp-to-reflector image cutoff.

7. GROOVE BAFFLE - Self-flanged one-piece aluminum with concentric rings.

8. LENS - Choice of either tempered clear, tempered prismatic or tempered frosted lens fastened with two torsion springs for easy re-lamping. /UL listed for wet or damp location.

LISTING

UL listed for through-branch circuit wiring and damp locations. Wet location only with lens trims.

Please visit our website for the most updated information on each product.

NEW CONSTRUCTION



LAMP BASE GUIDE (Sockets will accept all designated lamp bases listed.)		
13W	18W	26W
G24q-1 GX24q-1	G24q-2 GX24q-2	G24q-3

HS8PL - ITEM SELECTOR: (Please check the boxes below for the option desired)

WATTAGE	BALLAST	VOLTAGE	EMERGENCY OPTIONS	TRIM TYPE & DESCRIPTION	REFLECTOR	BAFFLE	GLASS																		
1 LAMP <input type="checkbox"/> 1X13 <input type="checkbox"/> 1X18 <input type="checkbox"/> 1X26 <small>*DTT LAMPS ONLY</small>	<input type="checkbox"/> (E) Electronic ¹ <input type="checkbox"/> (S) Energy Star ² DIMMING <input type="checkbox"/> Mark 7 ³ <input type="checkbox"/> Mark 10 ⁴ <input type="checkbox"/> Lut-E (EC3D) ⁵	<input type="checkbox"/> MVOLT (120/277) <input type="checkbox"/> 120 <input type="checkbox"/> 277 <input type="checkbox"/> 347	<input type="checkbox"/> EMG 750 (750 lm) ⁶ <input type="checkbox"/> EMG 1300 (1300 lm) ⁶ <input type="checkbox"/> ICE-1300 (1300 lm) ¹⁰ <input type="checkbox"/> EMG-SD-1300 (1300 lm) ¹⁴ OTHER OPTIONS <input type="checkbox"/> FUSE ¹¹ <input type="checkbox"/> RIF ¹²	<input type="checkbox"/> 8701 Reflector <input type="checkbox"/> 8702 Baffle/Reflector <input type="checkbox"/> 8703 Ref./Fres. Gls. Lns. <input type="checkbox"/> 8704 Ref./Pris. Gls. Lns. <input type="checkbox"/> 8705 Baf./Fres. Gls. Lns. <input type="checkbox"/> 8706 Baf./Pris. Gls. Lns. <input type="checkbox"/> 8707 Wall Wash Ref. <input type="checkbox"/> 8708 Crossblade Ref. <input type="checkbox"/> 8712 Baf./Frost Gls. Lns. <input type="checkbox"/> 8713 Baf./Tem. Clr. Gls. <input type="checkbox"/> 8714 Ref./Frost Gls. Lns. <input type="checkbox"/> 8715 Ref./Tem. Clr. Gls. <input type="checkbox"/> 8716 Ref./Pris. Plas. Lns.	<input type="checkbox"/> 8717 Baf./Pris. Plas. Lns. <input type="checkbox"/> 8718 Ref./Tem. Clr. Plas. <input type="checkbox"/> 8719 Baf./Tem. Clr. Plas. <input type="checkbox"/> 8709 Deco Glass Ring <input type="checkbox"/> 8710 Double Ring <input type="checkbox"/> 8711 Triple Ring <input type="checkbox"/> 8721 Startdust Deco Ring Gls. <input type="checkbox"/> 8722 Euro Deco Ring Gls. <input type="checkbox"/> 8723 Prism Deco Ring Gls. <input type="checkbox"/> 8724 Geo Deco Ring Gls. <input type="checkbox"/> 8725 Central Etched Float Gls. <input type="checkbox"/> 8726 Diff. Screen Wall Wash <input type="checkbox"/> 8727 Geo Deco Ring Gls.	<input type="checkbox"/> CL-WH <input type="checkbox"/> CL-SCH <input type="checkbox"/> SHZ-SHZ <input type="checkbox"/> SHZ-WH <input type="checkbox"/> WT-WH <input type="checkbox"/> W-WH <input type="checkbox"/> MB-WH	<input type="checkbox"/> W-CL-WH <input type="checkbox"/> P-CL-WH <input type="checkbox"/> W-WH <input type="checkbox"/> P-WH	<input type="checkbox"/> Blue <input type="checkbox"/> Green <input type="checkbox"/> Red <input type="checkbox"/> Frost <table border="1"> <tr> <td>REFLECTOR</td> <td>BAFFLE</td> <td>GLASS</td> </tr> <tr> <td>CL Clear</td> <td>WH White</td> <td rowspan="5">Only available on XX09, XX10 and XX11 series.</td> </tr> <tr> <td>SHZ Satin Haze (Low Hidescent)</td> <td>P Black</td> </tr> <tr> <td>WT Wheat</td> <td>RING</td> </tr> <tr> <td>MB Black</td> <td>WH Self-Flange White</td> </tr> <tr> <td>W White</td> <td>SCH Self-Flange Chrome</td> </tr> <tr> <td></td> <td>SHZ Satin Haze</td> <td></td> </tr> </table> <small>*For custom baffle, reflector, trim ring, glass color and lens options, please consult factory.</small>	REFLECTOR	BAFFLE	GLASS	CL Clear	WH White	Only available on XX09, XX10 and XX11 series.	SHZ Satin Haze (Low Hidescent)	P Black	WT Wheat	RING	MB Black	WH Self-Flange White	W White	SCH Self-Flange Chrome		SHZ Satin Haze	
REFLECTOR	BAFFLE	GLASS																							
CL Clear	WH White	Only available on XX09, XX10 and XX11 series.																							
SHZ Satin Haze (Low Hidescent)	P Black																								
WT Wheat	RING																								
MB Black	WH Self-Flange White																								
W White	SCH Self-Flange Chrome																								
	SHZ Satin Haze																								

1 - Electronic = Not available on 9W only • 2 - (S) Energy Star = Available on selected fixtures only, please see list above • 3 - MARK 7 = Must specify voltage, not compatible with Emergency Options • 4 - MARK 10 = Not available on 9W, 13W, 57W, 70W, must specify voltage, not compatible with Emergency Options • 5 - LUT-E (EC3D) = Not available on 9W, 13W, 57W, 70W, must specify voltage • 6 - EMG = Emergency battery pack w/ remote test switch • 7 - INTG = Emergency battery pack w/ integral (reflector) test switch • 8 - EMG-D = Emergency battery pack w/ remote test switch for damp location • 9 - INTG-D = Emergency battery pack w/ integral(reflector) test switch for damp location • 10 - ICE = Emergency battery pack w/ remote test switch operating between -18°C and 55°C • 11 - FUSE = Single slow-blow fuse • 12 - RIF = Radio interference filter • 13 - Magnetic = Available on 9W, 13W, 18W & 26W fixtures only • 14 - SD = Emergency battery pack w/ Self-Diagnostic

Specifications:

HS8PL

WATT BALLAST VOLTAGE EMERGENCY OPTIONS TRIM TYPE REFLECTOR BAFFLE GLASS

Sample of Catalog Number: HS8PL-1X26-E-MVOLT-EMG750-8701-CL-WH

8" ARCHITECTURAL CFL HORIZONTAL SHALLOW DOWNLIGHT

8701 -
Reflector

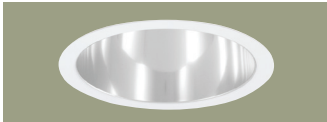

TRIM FINISH:

- CL-WH
- CL-SCH
- SHZ-SHZ
- SHZ-WH
- WT-WH
- W-WH
- MB-WH

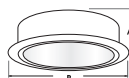

A= 4-3/4"
B= 9"

8702 -
Baffle with Reflector



BAFFLE FINISH:

W, P

REFLECTOR FINISH:

CL

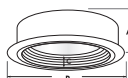

A= 4-3/4"
B= 9"
C= 1-3/4"

8707 -
Wall Wash Reflector



REFLECTOR FINISH:

CL, WT, MB, SHZ, W

RING FINISH:

WH

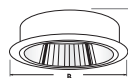

A= 4-3/4"
B= 9"

8708 -
Crossblade Reflector



REFLECTOR FINISH:

CL, WT, MB, SHZ, W

RING FINISH:

WH

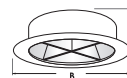

A= 4-3/4"
B= 9"

8703 -
Reflector with Fresnel Glass Lens



REFLECTOR FINISH:

CL, WT, MB, SHZ, W

RING FINISH:

WH

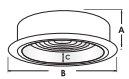

A= 4-3/4"
B= 9"
C= 1-3/4"

8704 -
Reflector with Prismatic Glass Lens



REFLECTOR FINISH:

CL, WT, MB, SHZ, W

RING FINISH:

WH

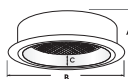

A= 4-3/4"
B= 9"
C= 1-3/4"

*Also available in:
8716 -
Prismatic Plastic Lens

8714 -
Reflector with Frosted Glass Lens



REFLECTOR FINISH:

CL, WT, MB, SHZ, W

RING FINISH:

WH

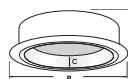

A= 4-3/4"
B= 9"
C= 1-3/4"

8715 -
Reflector with Tempered Clear Glass



REFLECTOR FINISH:

CL, WT, MB, SHZ, W

RING FINISH:

WH

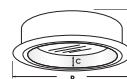

A= 4-3/4"
B= 9"
C= 1-3/4"

*Also available in:
8718 -
Tempered Clear Plastic

8705 -
Baffle with Fresnel Glass Lens

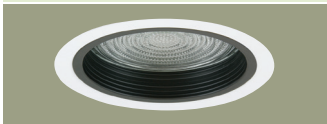

BAFFLE FINISH:

W, P

RING FINISH:

WH

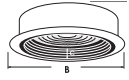

A= 4-3/4"
B= 9"
C= 1-3/4"

8706 -
Baffle with Prismatic Glass Lens



BAFFLE FINISH:

W, P

RING FINISH:

WH

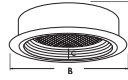

A= 4-3/4"
B= 9"
C= 1-3/4"

*Also available in:
8717 -
Prismatic Plastic Lens

8712 -
Baffle with Frosted Glass Lens



BAFFLE FINISH:

W, P

RING FINISH:

WH

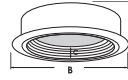

A= 4-3/4"
B= 9"
C= 1-3/4"

8713 -
Baffle with Tempered Clear Glass



BAFFLE FINISH:

W, P

RING FINISH:

WH

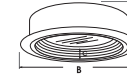

A= 4-3/4"
B= 9"
C= 1-3/4"

*Also available in:
8719 -
Tempered Clear Plastic

8709 -
Deco Glass Reflector

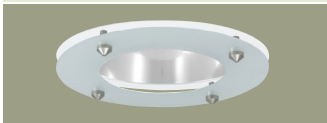

REFLECTOR FINISH:

CL, WT, MB, SHZ, W

RING FINISH:

WH, SCH, SHZ

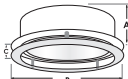

A= 4-3/4"
B= 9"
C= 1-1/4"

GLASS FINISH:
BLUE, RED, GREEN, FROST

8710 -
Double Ring Glass



REFLECTOR FINISH:

CL, WT, MB, SHZ, W

RING FINISH:

WH, SCH, SHZ

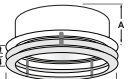

A= 4-3/4"
B= 9"
C= 1-1/2"

GLASS FINISH:
BLUE, RED, GREEN, FROST

8711 -
Triple Ring Glass

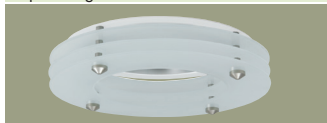

REFLECTOR FINISH:

CL, WT, MB, SHZ, W

RING FINISH:

WH, SCH, SHZ

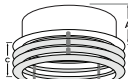

A= 4-3/4"
B= 9"
C= 2-1/4"

GLASS FINISH:
BLUE, RED, GREEN, FROST

8725 -
Center Etched Float Glass



REFLECTOR FINISH:

CL, WT, MB, SHZ, W

RING FINISH:

WH, SCH, SHZ



A= 4-3/4"
B= 9"
C= 1-1/4"

*Also available in:
8726 -
Diffusing Screen Wall Wash

8721 -
Stardust Deco Ring Glass

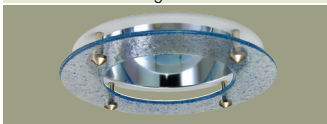

REFLECTOR FINISH:

CL, WT, MB, SHZ, W

RING FINISH:

WH

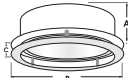

A= 4-3/4"
B= 9"
C= 1-1/4"

8722 -
Euro Deco Ring Glass



REFLECTOR FINISH:

CL, WT, MB, SHZ, W

RING FINISH:

WH

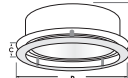

A= 4-3/4"
B= 9"
C= 1-1/4"

8723 -
Prism Deco Ring Glass

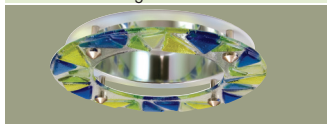

REFLECTOR FINISH:

CL, WT, MB, SHZ, W

RING FINISH:

WH

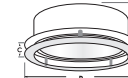

A= 4-3/4"
B= 9"
C= 1-1/4"

8724 -
Geo Deco Ring Glass



REFLECTOR FINISH:

CL, WT, MB, SHZ, W

RING FINISH:

WH

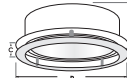

A= 4-3/4"
B= 9"
C= 1-1/4"

*Also available in:
8727 -
Geo Deco Ring Glass

