



HH4-4501
Flanged Downlight



HH4-4507
Flanged Wall Wash



HH4-4577
Flanged Double Wall Wash



HH4-TL-4501
Trimless Downlight



HH4-TL-4507
Trimless Wall Wash



HH4-4535-WH
Polycarbonate

REFLECTOR/
FLANGE COLORS

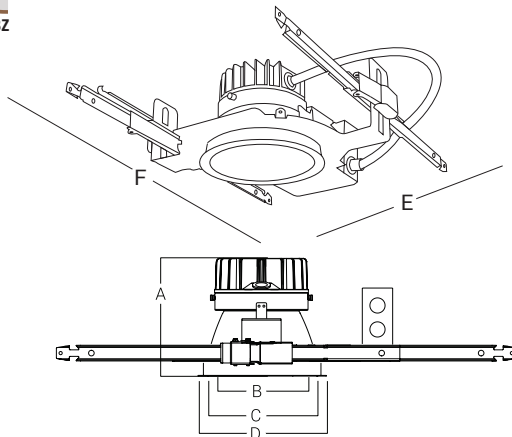
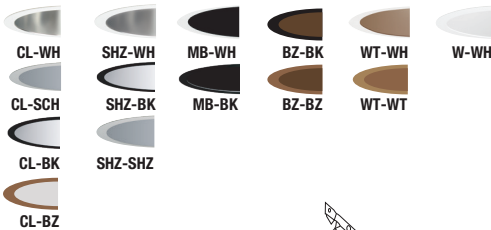

A: Height = 5-3/4"
B: Trim Aperture = 4"
C: Cut-Out = 4-1/2"
D: Trim Outside Dia = 5-3/8"
E: Width = 16"
F: Length = 12-1/2"

NOMINAL LUMENS	DELIVERED LUMENS	WATTAGE
3000	3579	32W
2000	2144	24W
1500	1699	18W
1200	1341	14W
900	995	10W
NOMINAL LUMENS (HP)	DELIVERED LUMENS (HP)	WATTAGE (HP)
1200	1401	12W
2000	2059	18W

Based on 4000K, 90+CRI with semi-specular chrome reflector.
Actual wattage may vary +/-5%

FEATURES

A highly sustainable and ultra-efficient architectural LED downlight that provides even, glare-free illumination. Available in a range of finishes, distributions, and lumen packages, it is ideally suited for use in corporate office space, hospitality, healthcare, commercial, academic, churches and retail.

OPTICS AND REFLECTOR

The reflector has a 45° visual cutoff, and is shipped standard with a Solite lens in a smooth frosted finish. Spun from 0.05" thick aluminum, with a 1-step anodized finish, and available in different colors or custom RAL finishes. Reflector flange options include self-flanged and white painted flange. Various distribution options are available, and all optics are field changeable.

LUMENS	900, 1200, 1500, 2000, 3000* 1 (Custom lumen packages available), HL6-IP-VR, HL6-LED
CCT & DYNAMIC PLATFORMS	22K, 27K, 30K, 35K, 40K, 50K, Tunable White, Dims to Warm, RGB + White
CRI	90+ Standard, 98+ Optional
COLOR QUALITY	2 Step MacAdam Ellipse
DISTRIBUTIONS	VWD, WD, MWD, MD, ND, SPD, NSPD
TRIM OPTIONS	Downlight, Wall Wash, Double Wall Wash, Wet Location
REFLECTOR COLORS	CL (Semi-Specular Chrome), SHZ (Low Iridescent Satin Haze), WT (Wheat), W (White), MB (Black), BZ (Bronze) WAM(White Anti Microbial), Custom RAL
FLANGE COLORS	Self-Flanged WH (White), SCH (Semi-Specular Chrome), SHZ (Low Iridescent Satin Haze), BK (Black), BZ (Bronze)
DIMMING	0-10V Flicker Free 1% Dimming Standard (DIM10), LUTH, LUTFTB, ELDO10.1-LIN, ELDODMX.1, ELDODALJ.1, DIMTR, BLE,POE,ELDO10-LOG, XSR, DIM10-AUX, DIM10-0-Off
EMERGENCY	10W - Up to 1000L Output 20W - Up to 2000L Output EMG-LED-G2-10W-SDT - Self Diagnostic (Consult Factory) GTD-UL924
LIFETIME	L70>60,000-hour reported lifetime L70>200,000-hour calculated lifetime
PHOTOMETRIC TESTS	In Accordance with IES LM79-08, LM80 and TM-30, TM-21

* 3000 Lumens is not ENERGY STAR certified

* Only Available on 85+ CRI

VWD: Very Wide | WD:Wide | MWD:Medium Wide | MD:Medium | ND:Narrow | SPD:Spot | NSPD:Narrow Spot

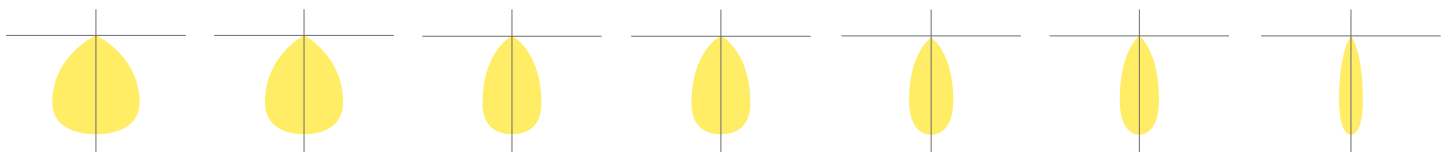

Reference IES files for additional distribution curve information.



THERMAL MANAGEMENT SYSTEM

Passive cooling Diecast Aluminum Heat Sink, LED light engine and driver are replaceable, upgradeable, and can be accessed from below the ceiling. The consistency in the quality of light is delivered with precision performance by the use of a unique locking mechanism that aligns the reflector with the light engine.

MOUNTING FRAME & BRACKETS

The downlight mounting frame is a fabricated assembly constructed of 16-gauge steel, with C-channel mounting brackets, included. The versatility of the mounting brackets allow for an adjustability of up to 28" horizontally, and 2-3/4" vertically, locking into place. With the added die-formed construction of the mounting frame, it provides maximum heat dissipation and rust protection.

DRIVER ELECTRICAL INFORMATION

The LED driver is rated for 50 to 60Hz at 120V/277V, also available in 347V input, produces less than 20%THD, has a power factor between 90% and 100%, and is thermally protected for additional safety. Junction box and Driver can be accessed from below the ceiling and above the ceiling. Junction Box is Listed for through branch circuit wiring.

DIMMING & DRIVER INFORMATION

DIM10 - 0-10V dimming on either MVOLT 120, 277 or 347V. Dimmable down to 1% of initial lumens, standard.

DIMTR - Triac & Electronic low voltage dimming. Available in 120V, and up to 6000 lumens only.

LUTH - Lutron LDE1 Hi-Lume 1% Eco System LED driver with Soft-on, Fade to Black dimming technology.

LUTFB - Lutron PEQ0E Hi-Lume Premier 1% Eco System LED Driver with Soft-on, Fade to Black dimming technology. Available on all luminaires up to 1500 lumens.

ELDO10.1-LIN - EldoLED SoloDrive 0-10V. Dimming down to 0.1%. Linear dimming curve.

DALI - DALI DT6, DT8 dimming down to 1%.

ELDODMX - EldoLED PowerDrive dimming down to 0.1%.

BLE - Luminaires may be controlled, grouped, scheduled or placed in scenes and or zones Via Cassambi Bluetooth 4.0 App.

DIM10-0-OFF - Program DIM10-to OFF with linear dimming curve 0.1%

ELDO10-LOG - ELDO10-LOG with logarithmic dimming curve.

POE - Power-over-Ethernet Depending on the PoE manufacturer selected, The Node will install the node in factory as either integral to the luminaire or as a remote module.

XSR - Xitanium SR Dimming

DIM10-AUX - 0-10V with Auxiliry power

LED DYNAMIC PLATFORM OPTIONS

 Tunable White with Smart White Technology utilizing the Lumenetix Platform allows you to color tune the luminaire via various controls. Create the perfect environment for the desired use of the space, while maintaining a CRI of 90+ across the tunable range of 8000 to 1650K. (Click here for more details)

 Dims to Warm with Smart Dimming Technology. At 100% full brightness the luminaire is at 3000K. When dimmed to 1%, the light transitions to 1800K, creating a warm ambiance within the space. (Click here for more details)

 RGB+White with Smart Hue Technology provides full color mixing of RGB and white colors. Utilizing the Lumenetix Platform allows you to choose from unlimited RGB color options, via various controls. Ideal for Circadian Rhythm applications or to create the perfect human centric environment. (Click here for more details)

OPTICAL

Modular Optics Available with 15°, 24°, 30°, 36°, 52°, 60° and 70° field interchangeable optics design with 45° cutoff to source.

Top-down flash characteristic for superior glare control. The optics attached directly the light engine to the Trim for complete optical alignment and sufficient efficacy.

WARRANTY

Five-year warranty for parts and components. (Labor not included)

LISTINGS

c-UL-us - Listed for Wet Location if used with HH4-4501 Trim.
c-UL-us - Listed for Feed Through Wiring.

U.S Patent No. - D685,118S

CP-City of Chicago environmental air (CCEA) marking for plenum applications.

Energy Star and California Title 24 compliant

Optional Black color trim is not ENERGYSTAR certified and won't meet the requirement.

BAA- Buy American Act Compliant government procurement requirements under FAR, DFARS and DOT regulations.

Example: **HH4-LED-2000L-DIM10-MVOLT-MD-40K-90-HH4-4501-CL-WH**

SERIES	LUMENS	DRIVER	VOLTAGE	CCT	EMERGENCY	TRIM TYPE	REFLECTOR/FLANGE COLORS
HH4-LED	<input type="checkbox"/> 900L	<input type="checkbox"/> DIM10	<input type="checkbox"/> 120	<input type="checkbox"/> 22K	<input type="checkbox"/> EMG-LED-10W	<input type="checkbox"/> HH4-4501 Flanged Downlight	<input type="checkbox"/> CL-WH <input type="checkbox"/> W-WH <input type="checkbox"/> SHZ-SHZ
	<input type="checkbox"/> 1200L	<input type="checkbox"/> DIMTR ^{3 5}	<input type="checkbox"/> 277	<input type="checkbox"/> 27K	<input type="checkbox"/> EMG-LED-20W	<input type="checkbox"/> HH4-4507 Flanged Wall Wash	<input type="checkbox"/> CL-SCH <input type="checkbox"/> MB-WH* <input type="checkbox"/> SHZ-BK
	<input type="checkbox"/> 1500L	<input type="checkbox"/> LUTH ³	<input type="checkbox"/> MVOLT	<input type="checkbox"/> 30K	<input type="checkbox"/> INTG-EMG-LED-10W	<input type="checkbox"/> HH4-4577 Flanged Double Wall Wash	<input type="checkbox"/> CL-BK <input type="checkbox"/> MB-BK* <input type="checkbox"/> WT-WH
	<input type="checkbox"/> 2000L	<input type="checkbox"/> LUTFTB ⁴	<input type="checkbox"/> 347 <small>(DIM10 only)</small>	<input type="checkbox"/> 35K	<input type="checkbox"/> INTG-EMG-LED-20W	<input type="checkbox"/> HH4-4535 Polycarbonate non conductive with "Dead Front" construction	<input type="checkbox"/> CL-BZ <input type="checkbox"/> BZ-BK <input type="checkbox"/> WT-WT
	<input type="checkbox"/> 3000L* ⁴	<input type="checkbox"/> ELDO10-.1-LIN	<input type="checkbox"/> 40K	<input type="checkbox"/> 40K	<input type="checkbox"/> EMG-LED-G2-10W-SDT*	<input type="checkbox"/> HH4-4501 Flanged Downlight	<input type="checkbox"/> SHZ-WH <input type="checkbox"/> BZ-BZ <input type="checkbox"/> WT-WT
	<input type="checkbox"/> 1200L-HP	<input type="checkbox"/> ELDO10-.1	<input type="checkbox"/> 50K ²	<input type="checkbox"/> 50K ²	<input type="checkbox"/> GTD-UL924	<input type="checkbox"/> HH4-4507 Flanged Wall Wash	<input type="checkbox"/> RAL <input type="checkbox"/> WAM <small>White Anti Microbial</small>
	<input type="checkbox"/> 2000L-HP	<input type="checkbox"/> ELDODALI-.1				<small>Typical lumen output of the luminaire is up to 1000L with EMG-LED-10W option & 2000L with EMG-LED-20W option in emergency mode. Contact the factory for details. Remote mounted installation * Consult Factory for Self Diagnostic</small>	<input type="checkbox"/> SHZ-WH <input type="checkbox"/> BZ-BZ <input type="checkbox"/> WT-WT
		<input type="checkbox"/> ELDODMX-.1	OPTICS	CRI	OPTIONS	<input type="checkbox"/> HH4-4501 Flanged Downlight	<input type="checkbox"/> WH <input type="checkbox"/> BZ <input type="checkbox"/> BK
		<input type="checkbox"/> BLE	<input type="checkbox"/> VWD ^{70°}	<input type="checkbox"/> 90+	<input type="checkbox"/> CP (Chicago Plenum)	<input type="checkbox"/> HH4-4507 Flanged Wall Wash	<input type="checkbox"/> SCH <input type="checkbox"/> SHZ
		<input type="checkbox"/> POE	<input type="checkbox"/> WD ^{60°}	<input type="checkbox"/> 98+ ³	<input type="checkbox"/> BAA	<input type="checkbox"/> HH4-4577 Flanged Double Wall Wash	
	<input type="checkbox"/> DIM10-0-OFF	<input type="checkbox"/> MWD ^{52°}	<input type="checkbox"/> Xicato 95 ⁷	<input type="checkbox"/> HP (High Performance) ⁶	<input type="checkbox"/> HH4-4535 Polycarbonate non conductive with "Dead Front" construction		
	<input type="checkbox"/> ELDO10-LOG	<input type="checkbox"/> MD ^{36°}		<input type="checkbox"/> Remote LED Driver Mounting	<input type="checkbox"/> HH4-4501 Trimless Downlight	<input type="checkbox"/> CL	
	<input type="checkbox"/> XSR	<input type="checkbox"/> ND ^{30°}			<input type="checkbox"/> HH4-4507 Trimless Wall Wash	<input type="checkbox"/> MB	
	<input type="checkbox"/> DIM10-AUX	<input type="checkbox"/> SPD ^{24°}				<input type="checkbox"/> SHZ	
		<input type="checkbox"/> NSPD ^{15°}				<input type="checkbox"/> WH	

¹ DIMTR is available in 120V only

² 50K series are available with 85+ CRI only

³ 98+CRI is available in 27K, 30K and 40K only

⁴ 3000 Lumens is not energy Star certified

⁵ LUTFTB Available for luminaires up to 1500L

⁶ 3000K, 3500K and 4000K based on 90 CRI

⁷ Available on 30K, 35K, 40K

-Reference last page for Control Options

* Only Available on 85+ CRI

HH4-LED-3000L-DIM10-MVOLT-MD-40K-90-HH4-4501-CL-WH

TEST NO.: **EL05022201**

INPUT WATTS: **32.1** LUMENS: **3074** EFFICACY: **96** BEAM ANGLE: **37** SPACING CRITERIA: **0.57**

CANDELA DISTRIBUTION

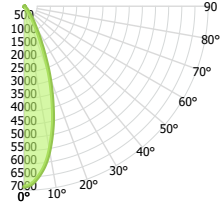

CANDELA TABLE

	0°	90°
0°	6865	6865
10°	5563	5499
20°	2816	2708
30°	777	740
40°	208	220
50°	32	36
60°	3	4
70°	0	0
80°	0	0
90°	0	0

LUMINANCE (cd/sq.m)

	0.00°	90.00°
0.00°	147009	147009
45.00°	2646	2904
55.00°	255	274
65.00°	98	106
75.00°	57	63
85.00°	10	15

LUMENS PER ZONE

ZONE	LUMENS
0° - 10°	604
10° - 20°	1224
20° - 30°	817
30° - 40°	313
40° - 50°	98
50° - 60°	14
60° - 70°	0
70° - 80°	0
80° - 90°	0

ZONAL LUMEN SUMMARY

ZONE	UMENS	% LUMINAIRE
0° - 20°	1828	59%
0° - 30°	2645	86%
0° - 40°	2958	96%
0° - 60°	3069	100%
0° - 80°	3072	100%
0° - 90°	3073	100%

CONE OF LIGHT

MOUNTING HEIGHT	FC AT BEAM CENTER	BEAM DIA. 0°-180°	BEAM DIA. 90°-270°
6.0 ft	190.7 fc	4.0 ft	4.0 ft
8.0 ft	107.3 fc	5.4 ft	5.4 ft
10.0 ft	68.7 fc	6.7 ft	6.7 ft
12.0 ft	47.7 fc	8.1 ft	8.1 ft
14.0 ft	35.0 fc	9.4 ft	9.4 ft
16.0 ft	26.8 fc	10.8 ft	10.8 ft
18.0 ft	21.2 fc	12.1 ft	12.1 ft
20.0 ft	17.2 fc	13.5 ft	13.4 ft

INDOOR COEFFICIENTS OF UTILIZATION

pf	20%												0%						
	80%			70%			50%			30%			10%		0%				
pc	70%	50%	30%	10%	70%	50%	30%	10%	50%	30%	10%	50%	30%	10%	50%	30%	10%	0%	
pw	119	119	119	119	116	116	116	111	111	111	106	106	106	102	102	102	100	0%	
1	114	112	110	108	112	110	108	106	106	104	103	102	101	100	99	98	97	95	0%
2	110	105	102	99	107	104	101	98	100	98	96	98	95	94	95	93	92	90	0%
3	105	100	95	92	103	98	94	91	96	92	90	93	91	88	91	89	87	86	0%
4	101	94	90	86	99	93	89	86	91	88	85	89	86	84	88	85	83	81	0%
5	97	90	85	81	95	89	84	81	87	83	80	86	82	79	84	81	79	77	0%
6	93	85	80	77	92	85	80	77	83	79	76	82	78	76	81	78	75	74	0%
7	89	82	76	73	88	81	76	73	80	75	72	79	75	72	78	74	72	70	0%
8	86	78	73	69	85	77	73	69	76	72	69	76	72	69	75	71	69	67	0%
9	83	75	70	66	82	74	69	66	73	69	66	73	69	66	72	68	66	64	0%
10	80	72	67	63	79	71	67	63	71	66	63	70	66	63	69	66	63	62	0%

HH4-LED-3000L-DIM10-MVOLT-MWD-40K-90-HH4-4501-CL-WH

TEST NO.: **EL05022201**

INPUT WATTS: **32.2** LUMENS: **3579** EFFICACY: **111** BEAM ANGLE: **48** SPACING CRITERIA: **0.74**

CANDELA DISTRIBUTION

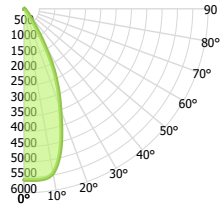

CANDELA TABLE

	0°	90°
0°	5579	5579
10°	5439	5397
20°	3446	3683
30°	1237	1423
40°	215	229
50°	40	48
60°	5	5
70°	0	0
80°	0	0
90°	0	0

LUMINANCE (cd/sq.m)

	0.00°	90.00°
0.00°	477859	477859
45.00°	11776	13161
55.00°	1298	1653
65.00°	608	655
75.00°	374	410
85.00°	69	88

LUMENS PER ZONE

ZONE	LUMENS
0° - 10°	537
10° - 20°	1328
20° - 30°	1180
30° - 40°	410
40° - 50°	100
50° - 60°	17
60° - 70°	0
70° - 80°	0
80° - 90°	0

ZONAL LUMEN SUMMARY

ZONE	UMENS	% LUMINAIRE
0° - 20°	1865	52%
0° - 30°	3045	85%
0° - 40°	3455	97%
0° - 60°	3572	100%
0° - 80°	3577	100%
0° - 90°	3577	100%

CONE OF LIGHT

MOUNTING HEIGHT	FC AT BEAM CENTER	BEAM DIA. 0°-180°	BEAM DIA. 90°-270°
6.0 ft	155.0 fc	5.3 ft	5.3 ft
8.0 ft	87.2 fc	7.1 ft	7.1 ft
10.0 ft	55.8 fc	8.8 ft	8.8 ft
12.0 ft	38.7 fc	10.6 ft	10.6 ft
14.0 ft	28.5 fc	12.4 ft	12.3 ft
16.0 ft	21.8 fc	14.1 ft	14.1 ft
18.0 ft	17.2 fc	15.9 ft	15.9 ft
20.0 ft	13.9 fc	17.7 ft	17.6 ft

INDOOR COEFFICIENTS OF UTILIZATION

pf	20%												0%						
	80%			70%			50%			30%			10%		0%				
pc	70%	50%	30%	10%	70%	50%	30%	10%	50%	30%	10%	50%	30%	10%	50%	30%	10%	0%	
pw	119	119	119	119	116	116	116	111	111	111	106	106	106	102	102	102	100	0%	
1	114	112	109	107	112	109	107	106	105	104	102	100	99	98	97	96	95	95	0%
2	109	105	101	98	107	103	100	97	100	97	95	97	95	93	94	92	91	89	0%
3	104	99	94	91	103	97	93	90	95	91	89	92	90	87	90	88	86	84	0%
4	100	93	88	85	98	92	88	84	90	86	83	88	85	82	86	83	81	80	0%
5	96	88	83	79	94	87	82	79	86	81	78	84	80	77	82	79	77	75	0%
6	92	84	78	75	90	83	78	74	81	77	74	80	76	73	79	75	73	72	0%
7	88	80	74	70	87	79	74	70	78	73	70	77	73	70	75	72	69	68	0%
8	84	76	70	67	83	75	70	67	74	70	66	73	69	66	72	69	66	65	0%
9	81	72	67	63	80	72	67	63	71	66	63	70	66	63	69	65	63	61	0%
10	78	69	64	60	77	68	64	60	68	63	60	67	63	60	66	62	60	59	0%

HH4-LED-3000L-DIM10-MVOLT-SPD-40K-90-HH4-4501-CL-WH

TEST NO.: **EL05022201**

INPUT WATTS: **32.1**

LUMENS: **3026**

EFFICACY: **94**

BEAM ANGLE: **25**

SPACING CRITERIA: **0.44**

CANDELA DISTRIBUTION

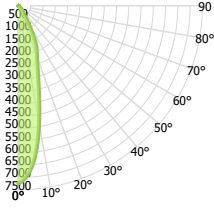

CANDELA TABLE

	0°	90°
0°	7242	7242
10°	4864	5172
20°	2219	2261
30°	778	910
40°	270	295
50°	55	66
60°	7	7
70°	0	0
80°	0	0
90°	0	0

LUMINANCE (cd/sq.m)

	0.00°	90.00°
0.00°	155070	155070
45.00°	4421	4921
55.00°	529	564
65.00°	199	220
75.00°	105	117
85.00°	12	22

LUMENS PER ZONE

ZONE	LUMENS
0° - 10°	617
10° - 20°	1049
20° - 30°	828
30° - 40°	347
40° - 50°	148
50° - 60°	28
60° - 70°	0
70° - 80°	0
80° - 90°	0

ZONAL LUMEN SUMMARY

ZONE	UMENS	% LUMINAIRE
0° - 20°	1667	53%
0° - 30°	2494	86%
0° - 40°	2842	96%
0° - 60°	3018	100%
0° - 80°	3024	100%
0° - 90°	3025	100%

CONE OF LIGHT

MOUNTING HEIGHT	FC AT BEAM CENTER	BEAM DIA. 0°-180°	BEAM DIA. 90°-270°
6.0 ft	201.2 fc	3.3 ft	3.2 ft
8.0 ft	113.1 fc	4.4 ft	4.3 ft
10.0 ft	72.4 fc	5.5 ft	5.4 ft
12.0 ft	50.3 fc	6.5 ft	6.5 ft
14.0 ft	36.9 fc	7.6 ft	7.6 ft
16.0 ft	28.3 fc	8.7 ft	8.6 ft
18.0 ft	22.4 fc	9.8 ft	9.7 ft
20.0 ft	18.1 fc	10.9 ft	10.8 ft

INDOOR COEFFICIENTS OF UTILIZATION

pf	pc	20%																0%				
		80%				70%				50%				30%					10%			
pw	70%	50%	30%	10%	70%	50%	30%	10%	50%	30%	10%	50%	30%	10%	50%	30%	10%	50%	30%	10%	0%	
																						0
1	114	112	109	107	112	109	107	106	105	104	102	102	100	99	98	97	95	93	94	93	91	90
2	109	105	101	98	107	103	100	97	100	97	95	97	95	93	94	93	91	91	91	90	88	85
3	105	99	94	91	103	98	93	90	95	92	89	93	90	87	90	88	86	85	85	84	82	80
4	100	93	89	85	98	92	88	84	90	86	83	88	85	82	87	84	82	80	80	77	76	72
5	96	89	84	80	94	88	83	79	86	82	79	84	81	78	83	80	77	76	74	72	70	69
6	92	84	79	75	91	83	79	75	82	78	75	81	77	74	79	76	74	72	70	67	64	63
7	88	80	75	71	87	80	75	71	78	74	71	77	73	70	76	73	70	67	66	64	61	60
8	85	77	71	68	84	76	71	68	75	71	67	74	70	67	73	70	67	66	64	61	60	60
9	82	73	68	65	81	73	68	65	72	67	64	71	67	64	70	67	64	63	61	60	60	60
10	79	70	65	62	78	70	65	62	69	65	62	68	64	61	68	64	61	60	60	60	60	60

HH4-LED-3000L-DIM10-MVOLT-NSPD-40K-90-HH4-4501-CL-WH

TEST NO.: **EL05022201**

INPUT WATTS: **32.1**

LUMENS: **3153**

EFFICACY: **98**

BEAM ANGLE: **19**

SPACING CRITERIA: **0.42**

CANDELA DISTRIBUTION

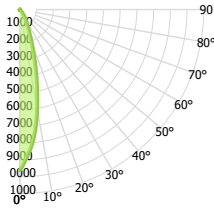

CANDELA TABLE

	0°	90°
0°	9601	9601
10°	5978	6553
20°	2033	2040
30°	737	645
40°	202	223
50°	32	39
60°	3	3
70°	1	1
80°	0	0
90°	0	0

LUMINANCE (cd/sq.m)

	0.00°	90.00°
0.00°	205607	205607
45.00°	2565	2863
55.00°	214	255
65.00°	73	85
75.00°	41	50
85.00°	7	15

LUMENS PER ZONE

ZONE	LUMENS
0° - 10°	798
10° - 20°	1304
20° - 30°	643
30° - 40°	291
40° - 50°	98
50° - 60°	15
60° - 70°	2
70° - 80°	1
80° - 90°	0

ZONAL LUMEN SUMMARY

ZONE	UMENS	% LUMINAIRE
0° - 20°	2102	67%
0° - 30°	2745	87%
0° - 40°	3036	96%
0° - 60°	3149	100%
0° - 80°	3151	100%
0° - 90°	3151	100%

CONE OF LIGHT

MOUNTING HEIGHT	FC AT BEAM CENTER	BEAM DIA. 0°-180°	BEAM DIA. 90°-270°
6.0 ft	266.7 fc	3.1 ft	3.1 ft
8.0 ft	150.0 fc	4.2 ft	4.1 ft
10.0 ft	96.0 fc	5.2 ft	5.1 ft
12.0 ft	66.7 fc	6.3 ft	6.1 ft
14.0 ft	49.0 fc	7.3 ft	7.1 ft
16.0 ft	37.5 fc	8.3 ft	8.2 ft
18.0 ft	29.6 fc	9.4 ft	9.2 ft
20.0 ft	24.0 fc	10.4 ft	10.2 ft

INDOOR COEFFICIENTS OF UTILIZATION

pf	pc	20%																0%				
		80%				70%				50%				30%					10%			
pw	70%	50%	30%	10%	70%	50%	30%	10%	50%	30%	10%	50%	30%	10%	50%	30%	10%	50%	30%	10%	0%	
																						0
1	114	112	110	108	112	110	108	106	106	104	103	102	101	100	99	98	97	96	94	93	91	90
2	110	106	103	100	108	104	101	99	101	99	97	98	96	95	96	94	93	91	91	89	87	85
3	106	101	97	93	104	99	96	93	97	94	91	94	92	90	92	90	88	87	85	84	82	80
4	102	96	91	88	100	95	91	87	93	89	86	91	88	85	89	86	84	83	81	80	77	76
5	98	91	87	83	97	91	86	83	89	85	82	87	84	81	86	83	81	80	77	76	74	73
6	95	87	83	79	93	87	82	79	85	81	78	84	81	78	83	80	77	76	74	73	71	70
7	91	84	79	76	90	83	79	75	82	78	75	81	77	75	80	77	74	73	71	70	68	67
8	88	81	76	73	87	80	76	72	79	75	72	78	74	72	77	74	72	70	68	66	65	65
9	85	78	73	70	84	77	73	70	76	72	69	75	72	69	75	71	69	68	66	65	65	65
10	82	75	70	67	82	74	70	67	74	70	67	73	69	67	72	69	66	65	65	65	65	65

HH4-LED-3000L-DIM10-MVOLT-ND-40K-90-HH4-4501-CL-WH

TEST NO.: **EL05022201**

INPUT WATTS: **32.1** LUMENS: **3181** EFFICACY: **99** BEAM ANGLE: **31** SPACING CRITERIA: **0.48**

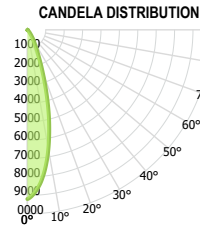

CANDELA TABLE	
0°	90°
0°	9196 9196
10°	6567 6688
20°	2387 2402
30°	702 665
40°	185 201
50°	31 36
60°	3 3
70°	0 0
80°	0 0
90°	0 0

LUMINANCE (cd/sq.m)	
0.00°	90.00°
0.00°	196917 196917
45.00°	2395 2596
55.00°	225 242
65.00°	82 89
75.00°	49 54
85.00°	10 15

LUMENS PER ZONE	
ZONE	LUMENS
0° - 10°	771
10° - 20°	1328
20° - 30°	694
30° - 40°	281
40° - 50°	90
50° - 60°	14
60° - 70°	0
70° - 80°	0
80° - 90°	0

ZONAL LUMEN SUMMARY		
ZONE	UMENS	% LUMINAIRE
0° - 20°	2099	66%
0° - 30°	2792	88%
0° - 40°	3073	97%
0° - 60°	3176	100%
0° - 80°	3179	100%
0° - 90°	3179	100%

CONE OF LIGHT

MOUNTING HEIGHT	FC AT BEAM CENTER	BEAM DIA. 0°-180°	BEAM DIA. 90°-270°
6.0 ft	255.4 fc	3.4 ft	3.4 ft
8.0 ft	143.7 fc	4.5 ft	4.5 ft
10.0 ft	92.0 fc	5.6 ft	5.6 ft
12.0 ft	63.9 fc	6.7 ft	6.7 ft
14.0 ft	46.9 fc	7.9 ft	7.9 ft
16.0 ft	35.9 fc	9.0 ft	9.0 ft
18.0 ft	28.4 fc	10.1 ft	10.1 ft
20.0 ft	23.0 fc	11.2 ft	11.2 ft

INDOOR COEFFICIENTS OF UTILIZATION

pf	20%										0%							
	80%		70%		50%		30%		10%									
pc	70%	50%	30%	10%	70%	50%	30%	10%	50%	30%	10%	50%	30%	10%	0%			
0	119	119	119	119	116	116	116	111	111	111	106	106	106	102	102	100		
1	114	112	110	108	112	110	108	106	106	104	103	102	101	100	99	98	97	95
2	110	106	103	100	108	104	101	99	101	99	97	98	96	95	96	94	93	91
3	106	101	96	93	104	99	95	92	97	94	91	94	92	90	92	90	88	87
4	102	96	91	88	100	95	90	87	93	89	86	91	88	85	89	86	84	83
5	98	91	87	83	97	90	86	83	89	85	82	87	84	81	86	83	81	79
6	94	87	83	79	93	87	82	79	85	81	78	84	80	78	83	80	77	76
7	91	84	79	75	90	83	79	75	82	78	75	81	77	75	80	77	74	73
8	88	80	76	72	87	80	75	72	79	75	72	78	74	72	77	74	71	70
9	85	77	73	69	84	77	72	69	76	72	69	75	72	69	74	71	69	68
10	82	74	70	67	81	74	70	67	73	69	66	73	69	66	72	69	66	65

HH4-LED-3000L-DIM10-MVOLT-VWD-40K-90-HH4-4501-CL-WH

TEST NO.: **EL05022201**

INPUT WATTS: **32.2** LUMENS: **2628** EFFICACY: **82** BEAM ANGLE: **72** SPACING CRITERIA: **1.09 x 1.09**

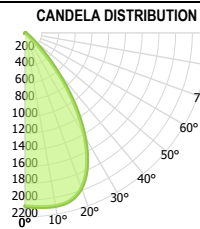

CANDELA TABLE	
0°	90°
0°	2071 2071
10°	2101 2092
20°	1972 1967
30°	1421 1437
40°	590 617
50°	76 85
60°	9 9
70°	0 0
80°	0 0
90°	0 0

LUMINANCE (cd/sq.m)	
0.00°	90.00°
0.00°	44349 44349
45.00°	7851 8507
55.00°	724 750
65.00°	243 258
75.00°	119 130
85.00°	12 22

LUMENS PER ZONE	
ZONE	LUMENS
0° - 10°	199
10° - 20°	584
20° - 30°	825
30° - 40°	697
40° - 50°	278
50° - 60°	35
60° - 70°	0
70° - 80°	0
80° - 90°	0

ZONAL LUMEN SUMMARY		
ZONE	UMENS	% LUMINAIRE
0° - 20°	783	30%
0° - 30°	1609	61%
0° - 40°	2306	90%
0° - 60°	2619	100%
0° - 80°	2626	100%
0° - 90°	2627	100%

CONE OF LIGHT

MOUNTING HEIGHT	FC AT BEAM CENTER	BEAM DIA. 0°-180°	BEAM DIA. 90°-270°
6.0 ft	57.5 fc	8.7 ft	8.7 ft
8.0 ft	32.4 fc	11.6 ft	11.6 ft
10.0 ft	20.7 fc	14.5 ft	14.5 ft
12.0 ft	14.4 fc	17.4 ft	17.5 ft
14.0 ft	10.6 fc	20.3 ft	20.4 ft
16.0 ft	8.1 fc	23.2 ft	23.3 ft
18.0 ft	6.4 fc	26.1 ft	26.2 ft
20.0 ft	5.2 fc	29.0 ft	29.1 ft

INDOOR COEFFICIENTS OF UTILIZATION

pf	20%										0%							
	80%		70%		50%		30%		10%									
pc	70%	50%	30%	10%	70%	50%	30%	10%	50%	30%	10%	50%	30%	10%	0%			
0	119	119	119	119	116	116	116	111	111	111	106	106	106	102	102	100		
1	113	110	108	105	111	108	106	104	104	102	100	100	99	97	96	95	93	
2	107	102	98	94	105	100	96	93	97	94	91	94	91	89	91	89	87	85
3	101	94	89	85	99	93	88	84	90	86	83	88	84	81	85	83	80	78
4	95	87	81	77	94	86	81	76	84	79	76	82	78	75	80	77	74	72
5	90	81	75	70	88	80	74	70	78	73	69	77	72	69	75	71	68	66
6	85	75	69	64	84	75	69	64	73	68	64	72	67	63	70	66	63	61
7	80	70	64	59	79	70	64	59	68	63	59	67	62	59	66	62	58	57
8	76	66	59	55	75	65	59	55	64	59	55	63	58	54	62	57	54	53
9	72	62	55	51	71	61	55	51	60	55	51	59	54	50	58	54	50	49
10	68	58	52	47	67	57	51	47	57	51	47	56	51	47	55	50	47	46

HH4-LED-3000L-DIM10-MVOLT-WD-40K-90-HH4-4501-CL-WH

TEST NO.: EL05022201

INPUT WATTS: 32.2

LUMENS: 2791

EFFICACY: 87

BEAM ANGLE: 58

SPACING CRITERIA: 0.84

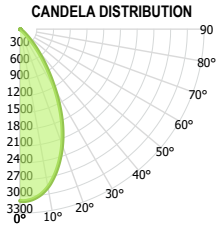

	0°	90°
0°	3079	3079
10°	2876	2898
20°	2205	2247
30°	1260	1315
40°	459	504
50°	65	80
60°	8	0
70°	0	0
80°	0	0
90°	0	0

	0.00°	90.00°
0.00°	65935	65935
45.00°	6347	7185
55.00°	629	682
65.00°	226	247
75.00°	115	125
85.00°	12	12

ZONE	LUMENS
0° - 10°	288
10° - 20°	747
20° - 30°	874
30° - 40°	606
40° - 50°	234
50° - 60°	13
60° - 70°	0
70° - 80°	0
80° - 90°	0

ZONE	UMENS	% LUMINAIRE
0° - 20°	1034	37%
0° - 30°	1908	68%
0° - 40°	2515	90%
0° - 60°	2782	100%
0° - 80°	2790	100%
0° - 90°	2790	100%







CONE OF LIGHT

MOUNTING HEIGHT	FC AT BEAM CENTER	BEAM DIA. 0°-180°	BEAM DIA. 90°-270°
6.0 ft	85.5 fc	6.7 ft	6.6 ft
8.0 ft	48.1 fc	8.9 ft	8.9 ft
10.0 ft	30.8 fc	11.1 ft	11.1 ft
12.0 ft	21.4 fc	13.3 ft	13.3 ft
14.0 ft	15.7 fc	15.5 ft	15.5 ft
16.0 ft	12.0 fc	17.7 ft	17.7 ft
18.0 ft	9.5 fc	20.0 ft	19.9 ft
20.0 ft	7.7 fc	22.2 ft	22.1 ft

INDOOR COEFFICIENTS OF UTILIZATION

pf	20%																0%	
	80%				70%				50%				30%					
pc	70%	50%	30%	10%	70%	50%	30%	10%	50%	30%	10%	50%	30%	10%	50%	30%	10%	0%
0	119	119	119	119	116	116	116	116	111	111	111	106	106	106	102	102	102	100
1	113	111	108	106	111	108	106	104	104	103	101	101	99	98	97	96	95	93
2	108	103	99	95	105	101	97	94	98	95	92	95	92	90	92	90	88	87
3	102	96	91	87	100	94	90	86	92	88	85	89	86	83	87	84	82	80
4	97	89	84	79	95	88	83	79	86	81	78	84	80	77	82	79	76	75
5	92	83	77	73	90	82	77	73	81	76	72	79	75	71	77	74	71	69
6	87	78	72	68	86	77	72	67	76	71	67	74	70	66	73	69	66	65
7	83	73	67	63	81	73	67	63	71	66	62	70	65	62	69	65	62	60
8	79	69	63	59	77	68	63	59	67	62	58	66	61	58	65	61	58	56
9	75	65	59	55	74	64	59	55	63	58	55	63	58	54	62	57	54	53
10	71	61	55	52	70	61	55	51	60	55	51	59	55	51	59	54	51	50

- 1- Luminaire will be shipped with Powerpacks pre-installed, ready to be integrated to designated contol systems
- 2- Luminaire will be shipped with Sensors installed on the luminaire, allowing for individual luminaire control. Luminaires will be ready to be integrated with designated control systems
- 3- Luminaire will be shipped with Sensors to be remotely installed on the ceiling. Luminaires will be ready to be integrated with designated control systems

BRAND							
CONTROL UNIT	<input type="checkbox"/> NXFM-1R2D-0-UNV NX Fixture Module, Offset, 1 Relay, 2 0-10V Dimming Channels, 120-347VAC, Blue	<input type="checkbox"/> FCJS-010 Lutron Vive 0-10V Individual Pow Pak (Luminaire is shipped Vive Enabled) ¹⁴ <input type="checkbox"/> FCJS-ECO Lutron Vive Eco-system Pow Pak (Luminaire is shipped Vive Enabled) <input type="checkbox"/> A-WN-D01-RF-WH Athena wireless node (RF only) (White) <input type="checkbox"/> A-WN-D01-OCC-WH Athena wireless node with sensor (White)	<input type="checkbox"/> CU-4E-FMH Fixture Mount Control Unit ¹⁵	<input type="checkbox"/> ZL027 -NOW Intellect Power Control Module ¹⁶ <input type="checkbox"/> ZL027 -NOW Intellect Power Control Module ¹⁶	<input type="checkbox"/> EN-WCM2-ZB-DR Wireless Control Module ¹⁷ <input type="checkbox"/> EN- ALC-ZB-BK-DR Wireless Area Lighting Control Module ¹⁷ <input type="checkbox"/> ZBHA-CLM-DIM-ENC Connected Lighting Module DIM ¹⁷	<input type="checkbox"/> SBR -BS Xitanium SR Bridge ¹⁸	<input type="checkbox"/> LMFC-011 ON/OFF/0-10V dimming fixture controller ¹⁹
INTEGRAT SENSOR	N/A	N/A	N/A	N/A	N/A	N/A	N/A
*WIRELESS OCCUPANCY SENSOR	<input type="checkbox"/> NXSMPP2-SMI NX Slide Mount Indoor Sensor Module	N/A	N/A	N/A	N/A	N/A	<input type="checkbox"/> LMDC-100 Dual technology PIR Ceiling Mount Occupancy Sensor ³
*WIRELESS DAYLIGHT SENSOR	<input type="checkbox"/> LUXSTATLS Luxstat Light Sensor for Luxstat Control Modules, 3 to 6000 FC	N/A	N/A	N/A	N/A	N/A	<input type="checkbox"/> LMLS-400 Single zone switching and dimming digital photosensor ³
*WIRELESS OCCUPANCY & DAYLIGHT SENSOR	<input type="checkbox"/> NXSMPT Indoor Ceiling Mount Sensor - OMNI	N/A	<input type="checkbox"/> SU-5E-IoT IoT Node Micro Sensor ³ <input type="checkbox"/> SU-5E-CL Connected Lighting Micro Sensor ³ <input type="checkbox"/> SU-5E-IL Independent Lighting / Enlighted One Micro Sensor ³ <input type="checkbox"/> SU-5S-H-(IoT/CL/IL) Surface Mount Sensor ³ (Must be specified with CU-4E-FMH Control Unit)	<input type="checkbox"/> ZL00J -TOW Intellect Intelligent Fixture Control System ³ (Must be specified with ZL027 -NOW Control Unit)	<input type="checkbox"/> EN-CLM-PIR-DD-ZB SensiLUM™ Wireless Integrated Sensor <input type="checkbox"/> EN-SCPPH-1500-ZB Wireless Passive Infrared Occupancy and Photo Sensors ³ (Must be specified with EN-WCM2-ZB-DR or EN-ALC-ZB-BK-DR Control Unit)	<input type="checkbox"/> SNS200-CMP SNS200 for grouping ³	N/A
ACCESORIES	N/A	N/A	<input type="checkbox"/> TMC-SU-5E Tile Mount Carrier <input type="checkbox"/> CBL-5E-CU4-30N 30 inch Sensor Cable for CU-4 and IoT Ready™ drivers <input type="checkbox"/> CBL-5E-CU4-7F 7 foot Sensor Cable for CU-4 and IoT Ready™ drivers	N/A	N/A	N/A	N/A
NOTES	N/A	4- Luminaire will be compatible with Lutron LRF2-OCR2B-P-WH Ceiling mount 360° occupancy/vacancy sensor & LRF2-DCRB-WH Ceiling-mount daylight sensor. Sensors must be ordered through Lutron.	5- Luminaire will be compatible with ENLIGHTED SU-5E-IoT, SU-5E-CL, SU-5E-IL, SU-5S-H, Sensors.	6-Luminaire will be compatible with Leviton Intellect App & Keypad Room Controller	7-Luminaire will be compatible with EN-SCPPH-1500-ZB Wireless Passive Infrared Occupancy and Photo Sensors	8-Luminaire will be compatible with Philips field and wireless switch.	9-Luminaire will be compatible with DLM Room control system LMPB-100. DLM control system must be orderd through Legrand.