



42EA RightSight S18 General Purpose Photoelectric Sensors

Catalog Numbers 42EA-B2MEB1-xx, 42EA-B2MEB2-xx, 42EA-D1MEA1-xx, 42EA-E1EZB1-xx, 42EA-P2MEA1-xx, 42EA-R1MEA1-xx

Topic	Page
Summary of Changes	2
Product Overview	2
Product Selection	2
Specifications	3
Status Indicators and User Interface	3
Wiring	3
Typical Response Curves	4
Approximate Dimensions	5

Summary of Changes

This publication contains the following new or updated information. This list includes substantive updates only and is not intended to reflect all changes.

Topic	Page
Updated Features text	2
Updated Certifications	3

Product Overview

The Allen-Bradley® RightSight™ S18 family of photoelectric sensors offers a wide range of sensing modes, an adjustment knob that simplifies sensitivity adjustment, and push-pull (PNP and NPN) outputs for maximum application flexibility.

The RightSight offers an industry standard 18 mm (0.71 in.) housing and 25.4 mm (1 in.) for fast mounting and replacement.



Features

- Selectable light operate or dark operate based on wiring
- 360° visible light-emitting diode (LED) status indicators
- 4-in-1 PNP and NPN outputs, light, and dark operate
- Input to disable light source on transmitted beam emitter
- IP67 rated enclosure

Available Models

- Diffuse
- Background suppression
- Polarized retroreflective
- Transmitted beam

Product Selection

Sensing Mode	Light Source	Sensing Distance	Sensitivity Adjustment	Output Function	Output Type	Cat. No. (1)
Polarized retroreflective	Visible red (626 nm)	3.5 m (11.5 ft) with 92-125 reflector	Adjustment knob	Light operate and dark operate	PNP and NPN (push-pull)	42EA-P2MEA1-x
Diffuse	Infrared (950 nm)	10...450 mm (0.39...17.72 in.)	Adjustment knob		PNP and NPN (push-pull)	42EA-D1MEA1-x
Background suppression	Visible red (626 nm)	10...50 mm (0.39...1.97 in.)	No adjustment knob		PNP and NPN (push-pull)	42EA-B2MEB1-x
		10...100 mm (0.39...3.94 in.)			42EA-B2MEB2-x	
Transmitted beam	Infrared (950 nm)	10 m (32.81 ft)	No adjustment knob		—	42EA-E1EZB1-x
			Adjustment knob		PNP and NPN (push-pull)	42EA-R1MEA1-x

(1) Replace the x with the following connection option suffixes:

D4: An integral 4-pin DC micro (M12)

P4: An integral 4-pin Pico™ (M8) QD

A2: A 2 m (6.6 ft) PVC cable

RJ11: An RJ11 connector on a 2 m (6.6 ft) length cable (only available for 42EA-P2MEA1-RJ11)

Additional connection options are available. See ProposalWorks™ for available options by sensing mode.

Specifications

Attribute	Value
Certifications	cULus Listed, CE Marked for all applicable directives, and UKCA Marked for all applicable regulations
EMC Directive	EN 60947-5-2
Standards	UL 60947-5-2
Ambient light immunity	EN 60697-5-2:2007+A:2012
Functional Safety Parameters Diffuse	
MTBF	514 years
MTTFd	1028.6 years
Background Suppression	
MTBF	510 years
MTTFd	1021 years
Polarized Retroreflective	
MTBF	540.6 years
MTTFd	1081.2 years
Transmitted Beam Emitter	
MTBF	844.6 years
MTTFd	1689.2 years
Transmitted Beam Receiver	
MTBF	658 years
MTTFd	1316 years
User Interface	
Status indicators	Green and orange
Adjustments	Adjustable knob (specific models)
Optical	
Light-emitting diode (LED)	Red and infrared (specific models)
Electrical	
Operating voltage	10...30V DC
Current consumption	Less than 25 mA
Sensor protection	Reverse polarity and short circuit
Output	
Output types	Two push-pull outputs (PNP and NPN), light operate, and dark operate
Response Time	
Diffuse, background suppression, and polarized retroreflective	1 ms, max
Transmitted beam	3 ms, max
Load current	100 mA, max (resistive load)
Mechanical	
Housing material	ABS
Lens material	Acrylic
Environmental	
Enclosure rating	IP67
Operating temperature	-20...+55 °C (-4...+131 °F)

Status Indicators and User Interface

Figure 1 - Diffuse, Polarized Retroreflective, and Transmitted Beam Receiver Models

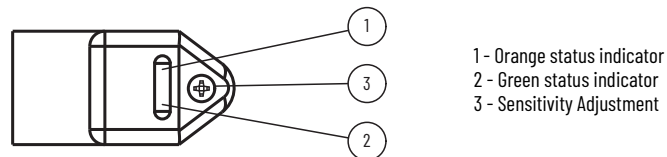

Figure 2 - Background Suppression and Transmitted Beam Emitter Models

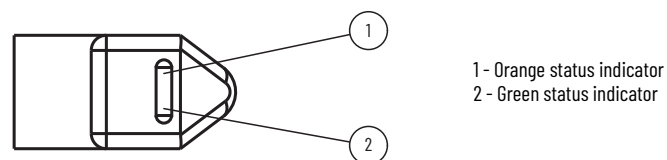

Table 1 provides an indicator status in RUN mode during operation for all sensing models: diffuse, polarized retroreflective, background suppression, background reflection, and transmitted beam.

Table 1 - Operating Mode Indication

Status Indicator Color	Status	Description
Green	OFF	Power is OFF
	ON	Power is ON
Orange	OFF	Output de-energized
	ON	Output energized

Wiring

Figure 3 shows the quick disconnect connector. The pin numbers correspond to the convex connectors on the sensor.

Figure 3 - Pinouts

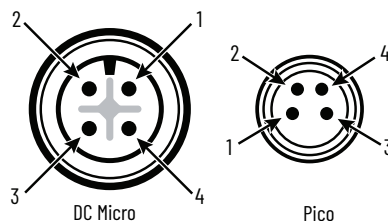

Wiring Diagrams

Figure 4 - NPN and PNP - Pin 4 (Light Operate), Pin 2 (Dark Operate)

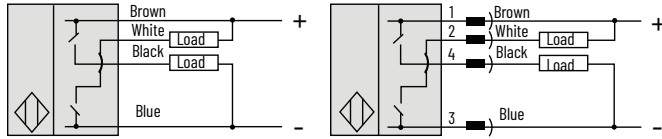

Figure 5 - NPN and PNP - Pin 4 (Dark Operate), Pin 2 (Light Operate)

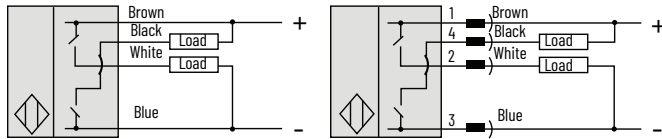
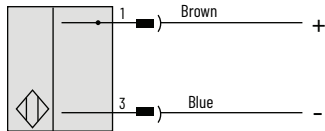

Figure 6 - Transmitted Beam Emitter



Typical Response Curves

Figure 7 - Background Suppression - 50 mm (1.97 in.) Beam Pattern

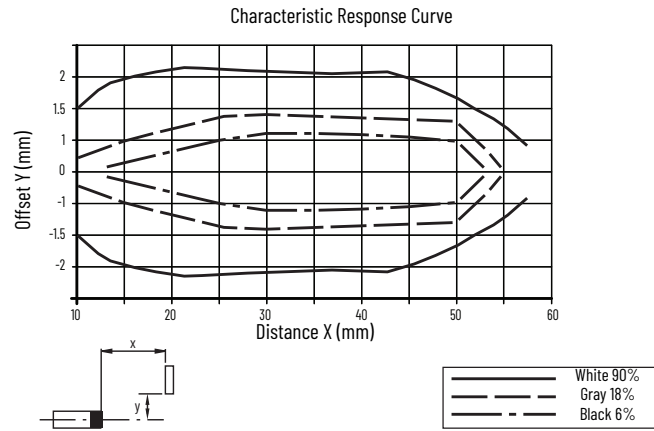

Figure 8 - Background Suppression - 50 mm (1.97 in.) Detection Distance

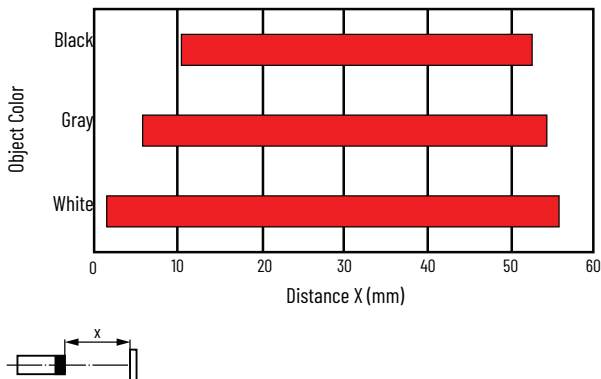

Figure 9 - Background Suppression - 100 mm (3.94 in.) Beam Pattern

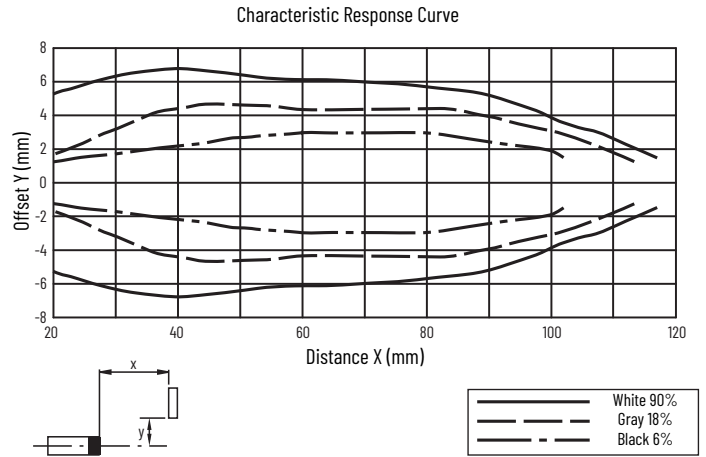

Figure 10 - Background Suppression - 100 mm (3.94 in.) Detection Distance

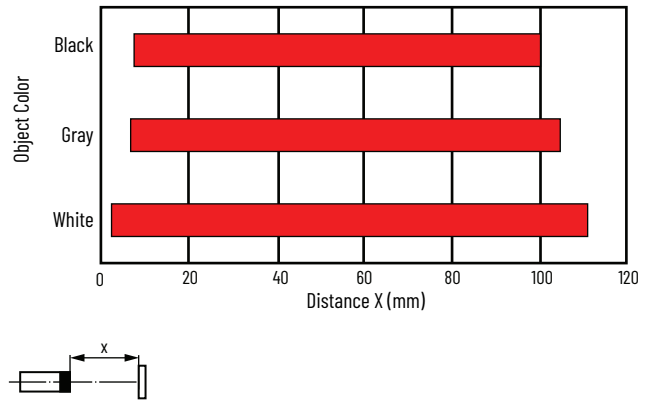

Figure 11 - Diffuse - Beam Pattern

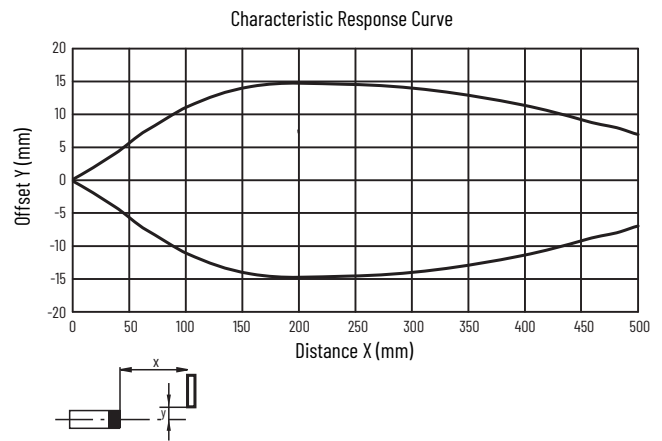

Figure 12 - Diffuse - Margin Curve

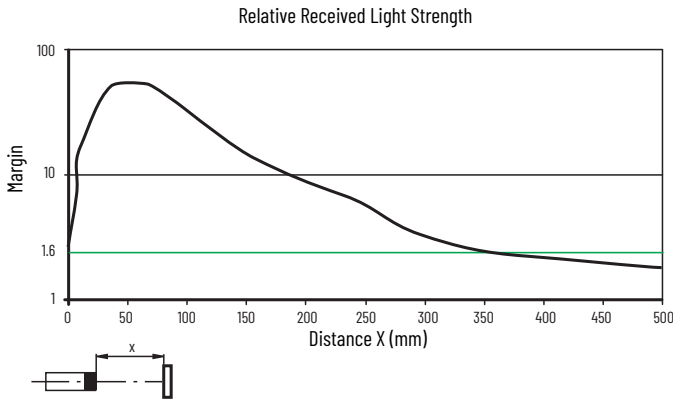

Figure 13 - Polarized Retroreflective - Beam Pattern

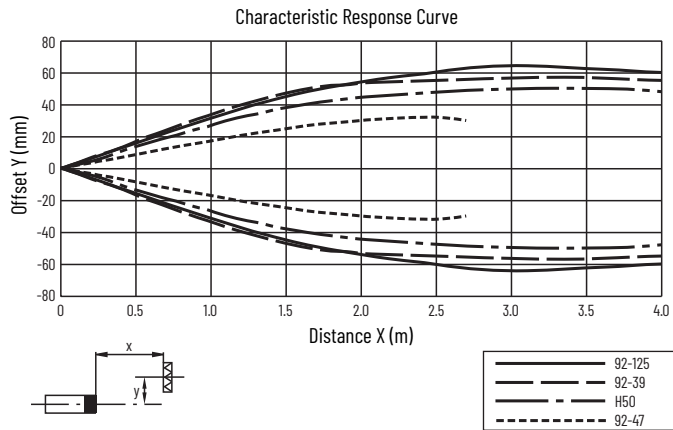

Figure 14 - Transmitted Beam - Beam Pattern

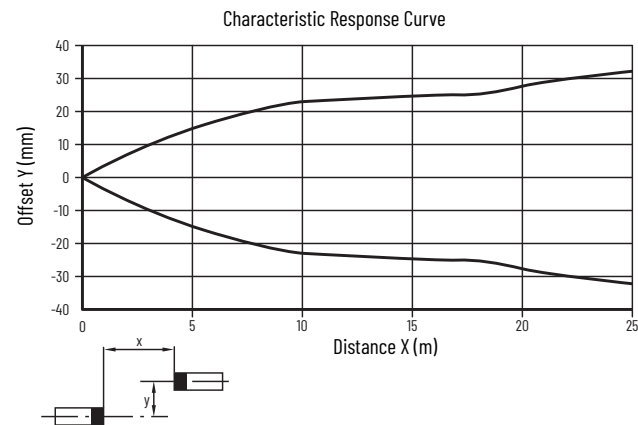
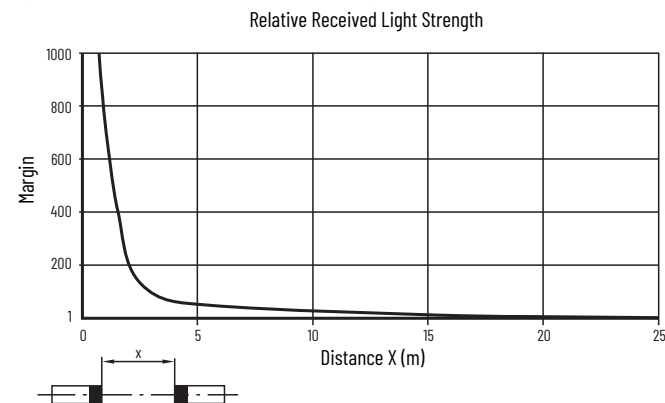

Figure 15 - Transmitted Beam - Margin Curve



Approximate Dimensions

Figure 16 - 2 m (6.6 ft) Cable Models [mm (in.)]

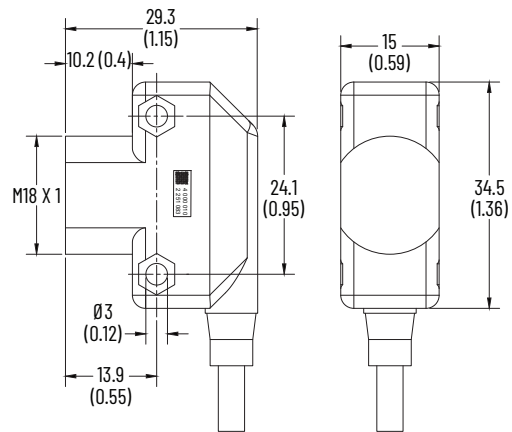

Figure 17 - Integral M8 Pico QD Models [mm (in.)]

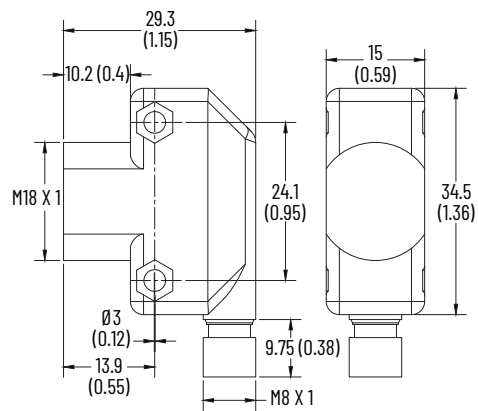
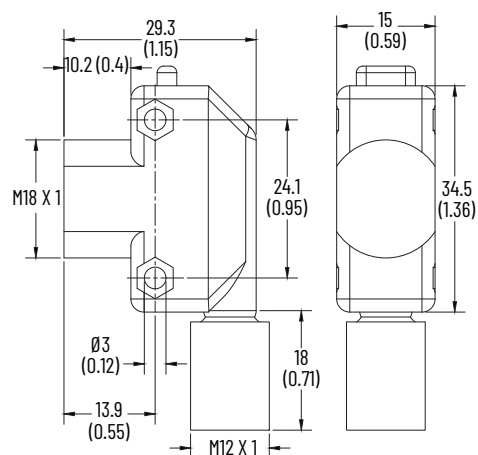

Figure 18 - Integral M12 Micro QD Models [mm (in.)]



Rockwell Automation Support

Use these resources to access support information.

Technical Support Center	Find help with how-to videos, FAQs, chat, user forums, Knowledgebase, and product notification updates.	rok.auto/support
Local Technical Support Phone Numbers	Locate the telephone number for your country.	rok.auto/phonesupport
Technical Documentation Center	Quickly access and download technical specifications, installation instructions, and user manuals.	rok.auto/techdocs
Literature Library	Find installation instructions, manuals, brochures, and technical data publications.	rok.auto/literature
Product Compatibility and Download Center (PCDC)	Download firmware, associated files (such as AOP, EDS, and DTM), and access product release notes.	rok.auto/pcdc





Documentation Feedback

Your comments help us serve your documentation needs better. If you have any suggestions on how to improve our content, complete the form at rok.auto/docfeedback.

Allen-Bradley, expanding human possibility, Pico, ProposalWorks, RightSight, and Rockwell Automation are trademarks of Rockwell Automation, Inc. Trademarks not belonging to Rockwell Automation are property of their respective companies.

Rockwell Automation maintains current product environmental compliance information on its website at rok.auto/pec.

Rockwell Otomasyon Ticaret A.Ş. Kar Plaza İş Merkezi E Blok Kat:6 34752, İçerenköy, İstanbul, Tel: +90 (216) 5698400 EEE Yönetmeliğine Uygundur

Connect with us.    

rockwellautomation.com — expanding **human possibility**[®]

AMERICAS: Rockwell Automation, 1201 South Second Street, Milwaukee, WI 53204-2496 USA, Tel: (1) 414.382.2000, Fax: (1) 414.382.4444

EUROPE/MIDDLE EAST/AFRICA: Rockwell Automation NV, Pegasus Park, De Kleetlaan 12a, 1831 Diegem, Belgium, Tel: (32) 2663 0600, Fax: (32) 2 663 0640

ASIA PACIFIC: Rockwell Automation SEA Pte Ltd, 2 Corporation Road, #04-05, Main Lobby, Corporation Place, Singapore 618494, Tel: (65) 6510 6608, FAX: (65) 6510 6699

UNITED KINGDOM: Rockwell Automation Ltd., Pitfield, Kiln Farm, Milton Keynes, MK11 3DR, United Kingdom, Tel: (44)(1908) 838-800, Fax: (44)(1908) 261-917

Publication 42EA-TD001D-EN-P - December 2023

Supersedes Publication 42EA-TD001C-EN-P - April 2022

Copyright © 2023 Rockwell Automation, Inc. All rights reserved. Printed in the U.S.A.