



Enclosed SMC-3, SMC Flex, and SMC-50 Smart Motor Controllers Specifications

Bulletins 150C, 150F, 150S, 152C, 152F, 152H, 152S, 153C, 153F, 153H, 153S

Topic	Page
Summary of Changes	2
Overview	3
Enclosed SMC-3 Controllers	5
Catalog Number Explanation	5
Product Selection	7
Accessories	10
Wiring Diagrams	13
Specifications	15
Approximate Dimensions	17
Enclosed SMC Flex Controllers	21
Catalog Number Explanation	21
Product Selection	24
Accessories	28
Wiring Diagrams	31
Specifications	34
Approximate Dimensions	36
Enclosed SMC-50 Controllers	43
Catalog Number Explanation	43
Product Selection	45
Accessories	50
Wiring Diagrams	54
Specifications	60
Approximate Dimensions	63
Circuit Breakers and Accessories	70
Disconnect Switches and Accessories	72
Additional Resources	75

Summary of Changes

This publication contains the following new or updated information. This list includes substantive updates only and is not intended to reflect all changes.

Topic	Page
Added accessories and replacement parts for enclosed SMC™-3 controllers	10
Added accessories and replacement parts for enclosed SMC™ Flex controllers	28
Added accessories and replacement parts for enclosed SMC™-50 controllers	50
Added circuit breaker selection and accessory information	70
Added disconnect switch selection and accessory information	72



Rockwell Automation recognizes that some of the terms that are currently used in our industry and in this publication are not in alignment with the movement toward inclusive language in technology.

We are proactively collaborating with industry peers to find alternatives to such terms and making changes to our products and content. Please excuse the use of such terms in our content while we implement these changes.

Overview

Our Enclosed soft starters can be fully customized with a wide variety of factory-installed options and are pre-engineered for quick factory lead times.



This publication supplies the minimum information needed to select an enclosed SMC™ soft starter for applications with low starting torque requirements. For product selection involving loads with high starting torque requirements (such as large fan, rock crusher, chipper), we recommend that you use the free tools available from our website. See [Additional Resources on page 75](#).

You can find full descriptions of features and modes of operation, as well as specifications for open SMC Controllers in the open style SMC controllers technical data, [publication 150-TD009](#).



Enclosed Starter Features	SMC-3	SMC Flex	SMC-50 Solid-state Controller with External Bypass	SMC-50 Controller with Internal Bypass
True 3-phase control	Yes	Yes	Yes	Yes
Bypass	Internal	Internal	External	Internal
Protection and diagnostics	Basic	Advanced	Advanced, with optional expansion modules	Advanced, with optional expansion modules
Start/stop modes	5	9	17	17
Enclosure type	1/12/4 or 3R	1/12/4 or 3R	1/12/4 or 3R	1/12/4 or 3R
Factory-installed communication modules (optional)	None	RS-485, DeviceNet™, Ethernet/IP, ControlNet® ProfiBUS	RS-485, DeviceNet, Ethernet/IP, ControlNet, ProfiBUS	
Rated Current	1...480 A ⁽¹⁾	1...1250 A ⁽¹⁾	90...520 A	108...480 A
Voltage range	200...575V AC	200...575V AC	200...575V AC	200...575V AC
Control voltage	100...240V AC	100...240V AC	100...240V AC	100...240V AC
Option offering and customization	Moderate	Extensive	Extensive	Extensive
Customization via Modified Industrial Controls	Yes	Yes	Yes	Yes

(1) Controllers rated < 85 A use wall-mounted enclosures.

				
Controller Features ⁽¹⁾	SMC-3	SMC Flex	SMC-50 Controller	
			Solid-state	with Internal Bypass
Soft Start	S	S	S	S
Linear Acceleration/Deceleration	—	S	S	S
Torque Control	—	—	S	S
Kickstart	S	S	S	S
Pump Control	—	O	S	S
Current Limit	S	S	S	S
Dual Ramp Start	—	S	S	S
Full Voltage	—	S	S	S
Energy Saver	—	—	S	S
Phase Rebalance	—	—	S	—
Soft Stop	S	S	S	S
Preset Slow Speed	—	S ⁽²⁾	S ⁽³⁾	S ⁽³⁾
Dual Slow Speed Commands	—	—	S	S
SMB™ Smart Motor Braking	—	O	S	S
Accu-Stop™	—	O	S ⁽⁴⁾	S ⁽⁴⁾
Slow Speed with Braking	—	O	S	S
Integrated Bypass Contactor (SMC-50 firmware rev. 5.XXX and higher)	S	S	— ⁽⁵⁾	S
Integrated Motor Overload Protection	S	S	S	S
DPI™ Communication	—	S	S	S
Metering	—	S	S	S
Real Time Clock	—	—	S	S
Energy Saver Mode	—	—	S	—
Motor Winding Heater Function	—	—	S	S
Resistive Load Control (Firmware rev. 5.XXX and higher, solid-state devices only.)	—	—	S	—
Diagnostic Faults and Alarms	—	S	S	S
Parameter Configuration/Programming Tools	—	S	O	O
Human Interface Module (HIM)	—	O	O	O
Parameter Configuration Module	—	—	O	O
DriveExplorer™ and DriveExecutive™	—	O	O	O
Configuration Software: Connected Components Workbench	—	O	O	O
Network Communications	—	O	O	O
Inside-the-Delta Functionality	S	S	S	S
Individual Bit Enable of Faults and Alarms	—	—	S	S
Automatic Tuning of Motor Parameters	—	—	S	S
Digital I/O Expansion Module ⁽⁶⁾	—	—	O	O
Analog I/O Expansion Module ⁽⁶⁾	—	—	O	O
Ground Fault/CT/PTC Module ⁽⁶⁾	—	—	O	O
DeviceLogix™ (Firmware rev. 4.XXX and higher.)	—	—	S	S

(1) S = Standard Feature; O = Optional Feature

(2) Limited slow speed capability

(3) Advanced slow speed capability

(4) Accu-Stop is not included as a parameter/function for the SMC-50 controller. You can accomplish the Accu-Stop function with the Stop Option and Slow Speed with Braking functions.

(5) You can add an external bypass contactor as an option.

(6) With removable terminal block.

Catalog Number Explanation

Examples that are given in this section are not intended to be used for product selection. Not all combinations generate a valid catalog number. Use ProposalWorks™ software to configure the SMC-3 controller. ProposalWorks software is available from rok.auto/systemtools.



Use the SMC Estimation Wizard and SMC Thermal Estimation Wizard to confirm that the SMC controller selection meets the application requirements. See SMC-3, SMC Flex, and SMC-50 Technical Data, publication [150-TD009](#) for more information.

Controllers Rated 5...85 A



Controllers rated 5...85 A do not include snap-together wiring.

150
-
C
30
F
-
B
-
D
-
8L

a
b
c
d
e
f
g

a	
Bulletin Number	
Code	Description
150	Non-combination solid-state controller
152H	Combination solid-state controller with fusible disconnect
153H	Combination solid-state controller with circuit breaker

b	
Controller Type	
Code	Description
C	SMC-3

c	
Controller Rating [A]	
Code	Description
3	3
9	9
16	16
25	25
30	30
37	37
43	43
60	60
85	85

d	
Enclosure Type	
Code	Description
F	NEMA Type 4/12 (IP65)
X	NEMA Type 3R (IP44) (Combination only)

e	
Input Line Voltage, 120V AC Control Voltage	
Code	Description
HD	200...208V AC, 3-Phase, 50 / 60 Hz
AD	230V AC, 3-Phase, 50/60 Hz
BD	400...460V AC, 3-Phase, 50/60 Hz
CD	500...575V AC, 3-Phase, 50/60 Hz

f					
Horsepower (Combination Controllers only)					
Code	Rating	Code	Rating	Code	Rating
33	0.5	44	25	56	250
34	0.75	45	30	57	300
35	1	46	40	58	350
36	1.5	47	50	59	400
37	2	48	60	60	450
38	3	49	75	61	500
39	5	50	100	62	600
40	7.5	51	125	63	700
41	10	52	150	65	800
42	15	54	200	67	1000
43	20				

g	
Options	
Code	Description
1	Start-Stop push button
3	Hand-Off-Auto selector switch
4R	Transformer Pilot Light - Red Run Indicator
6P	Control circuit transformer
8L	Line-mounted protective module ⁽¹⁾
8M	Load-mounted protective module ⁽¹⁾
8B	Line- and load-mounted protective modules
90	1 N.O. auxiliary contact
900	2 N.O. auxiliary contacts
901	1 N.O. and 1 N.C. auxiliary contacts
98	N.O. disconnect auxiliary mounted on the operating mechanism
99	N.C. disconnect auxiliary mounted on the operating mechanism
NB	NEMA Bypass Starter
BP	IEC Bypass Starter

(1) Load-side MOVs are not available with Pump and Braking options, or on delta-connected motors.

Controllers Rated 90...1250 A

152C - D10 J B D - J20 - 3
a b c d e f g

a	
Bulletin Number	
Code	Description
150C	SMC-3 Non-combination
152C	SMC-3 Combination with fusible disconnect switch
153C	SMC-3 Combination with circuit breaker

b	
Controller Rating [A]	
Code	Description
D10	108
D13	135
D20	201
D25	251
D31	317
D36	361
D48	480

c	
Enclosure Type	
Code	Description
J	1/12/3R

d	
Input Line Voltage	
Code	Description
H	200...208V AC, 3-Phase, 50 /60 Hz
A	230V AC, 3-Phase, 50/60 Hz
B	400...460V AC, 3-Phase, 50/60 Hz
C	500...575V AC, 3-Phase, 50/60 Hz

e	
Control Voltage	
Code	Description
D	120V AC
J	24V AC
A	240V AC
EJ	24V DC

f	
Fuse Clip/Circuit Breaker (CB)–Combination Controllers Only	
Code	Description
J20	200 A, Class J
J40	400 A, Class J
J60	600 A, Class J
L80	800 A, Class L
L12	1200 A, Class L
L16	1600 A, Class L
D16	160 A, DIN
D25	250 A, DIN
D40	400 A, DIN
D63	630 A, DIN
D80	800 A, DIN
N12	1250 A, DIN
D12	125 A, CB
D17	175 A, CB
D25	250 A, CB
D40	400 A, CB
D60	600 A, CB
D80	800 A, CB
E12	1200 A, CB

g					
Options					
Code	Description	Code	Description	Code	Description
1	Start-Stop push button	8L	Line-mounted protective module ⁽³⁾	TB10	10 Spare terminal blocks
1E	On-Off push button	8M	Load-mounted protective module ⁽¹⁾	TB20	20 Spare terminal blocks
3	Hand-Off-Auto selector switch	8B	Line- and load-mounted protective modules	P10	100 mm mounting foot, sheet metal
3E	On-Off selector switch	BP	IEC Bypass Starter	P20	200 mm mounting foot, sheet metal
3H	Hand-Auto selector switch	989	1 N.O/1 N.C Auxiliary Contact on circuit breaker or fusible disconnect switch	F10	100 mm mounting foot, high-strength plastic
3B	SMC-Off-Bypass selector switch	20S	RS-485 Communication	F20	200 mm mounting foot, high-strength plastic
13	Start-Stop push button and Hand-Off-Auto selector switch	20D	DeviceNet Communication	416	Plug-in control relay, 2-pole
4_ ⁽¹⁾	Pilot Lights	20E	Ethernet/IP Communication	417	Plug-in control relay, On Delay
5_ ⁽¹⁾	Push-to-test pilot lights	20C	ControlNet® Communication	418	Plug-in control relay, Off Delay
1XA	Soft Stop push button	20P	Profibus Communication	425	Hour Meter
1XB	Pump Stop push button	PC	Pump Control	428	Ammeter
1XC	Slow Speed push button	BC	Braking Control	429	Ground Fault Relay
1XD	Brake push button			430	Undervoltage Relay
6P	Control circuit transformer			22	Control Circuit Fusing
6XP	1-Factor Additional VA ⁽²⁾			OPS	Bul. 509 NEMA Size 1 starter and Bul. 592 solid-state overload relay
6YP	2-Factor Additional VA ⁽²⁾				

(1) Pilot lights require configuration. See [page 7](#).
 (2) VA values depend on the size of the controller.
 (3) Load-side MOVs are not available with Pump and Braking options, or on delta-connected motors.

Pilot Light Configuration

 The final character in the configuration string cannot be "X".

4
a
R
b
G
c
X
d
W
e

a	
Option	
Code	Description
4	Pilot Light
5	Push-to-test Pilot Light

b	
ON Indication	
Code	Description
R	Red
G	Green
X	none

c	
OFF Indication	
Code	Description
R	Red
G	Green
X	none

d	
Fault Indication	
Code	Description
A	Amber
X	none

e	
Power ON Indication	
Code	Description
W	White

Product Selection

 You can configure enclosed soft starters by selecting a power center, snap-together kits, transformers, and/or any applicable controller accessories.

Table 1 - Power Centers

Motor Current [A]	Rated Hp [Hp]				Non-combination Starter Cat. No.	Combination Starter Cat. No.	
	200...208V	230V	400...460V	500...575V		with Fusible Disconnect Switch	with Circuit Breaker
108	30	40	75	100	150C-D10JCD	152C-D10JCD-J20	153C-D10JCD-D17
135	40	50	100	125	150C-D13JCD	152C-D13JCD-J20	153C-D13JCD-D25
201	60	75	150	150	150C-D20JCD	152C-D20JCD-J40	153C-D20JCD-D25
251	75	100	200	200	150C-D25JCD	152C-D25JCD-J40	153C-D25JCD-D40
317	100	125	250	300	150C-D31JCD	152C-D31JCD-J60	153C-D31JCD-D40
361	125	150	300	350	150C-D36JCD	152C-D36JCD-J60	153C-D36JCD-D80
480	150	200	400	500	150C-D48JCD	152C-D48JCD-L80	153C-D48JCD-D80

Table 2 - Transformers⁽¹⁾

	Controller Current [A]	Capacity	VA	208V x 120V Cat. No.	240V x 120V Cat. No.	460V x 120V Cat. No.	575V x 120V Cat. No.
	108, 135, 201, 251, 317, 361, 480	Standard	200	1497-HD200	1497-AD200	1497-BD200	1497-CD200
		Extra Capacity	350	1497-HD350	1497-AD350	1497-BD350	1497-CD350
			500	1497-HD500	1497-AD500	1497-BD500	1497-CD500

(1) All transformers include grounding wires and fuse covers.

Snap-together Pilot Device Wiring

 This option applies only to controllers with current ratings greater than 90 A.

Component wiring is color coded by function. The wiring sleeve color corresponds to a colored label on the terminal block. Keyed connectors snap these components into the terminal block. This greatly reduced assembly time is ideal for the quick installation of pilot devices and control circuit transformers, and significantly reduces wiring errors. [Figure 1](#) shows an example of this feature.

Figure 1 - Snap-together Wiring Example

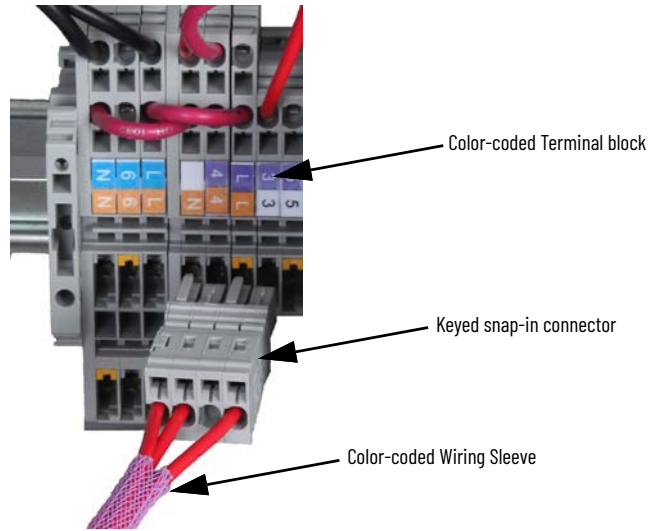

Figure 2 - SMC-3 Controller Snap-together Wiring

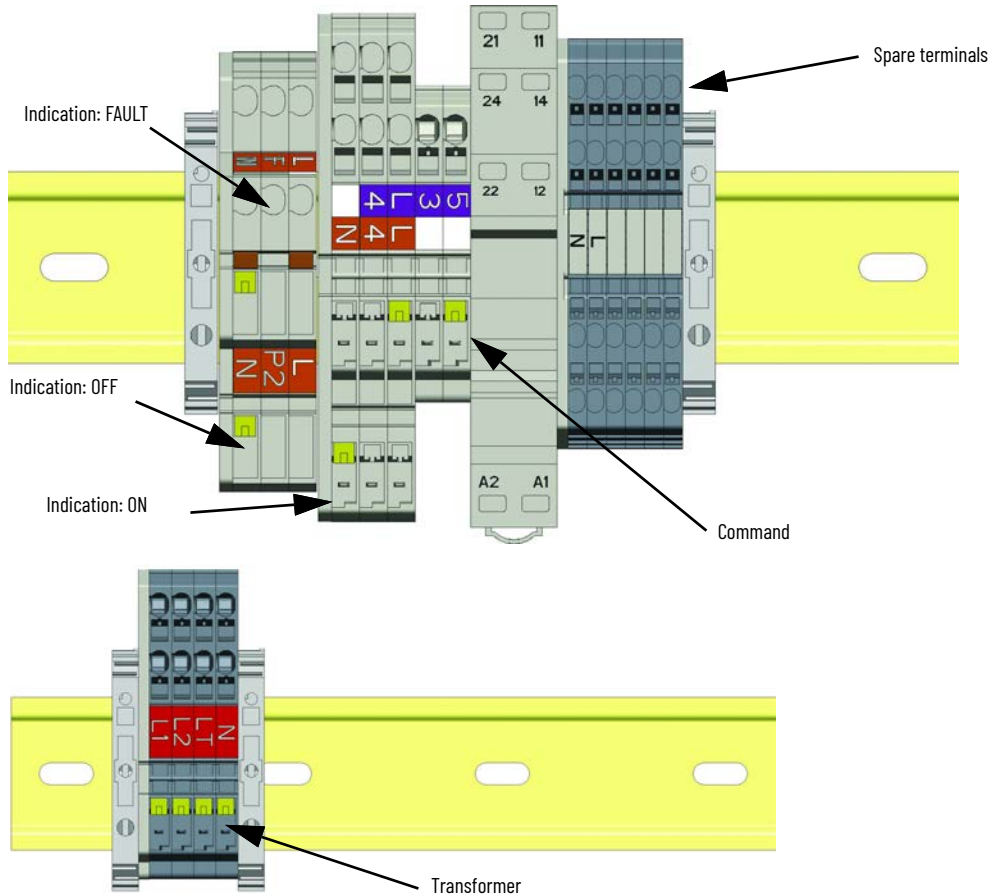
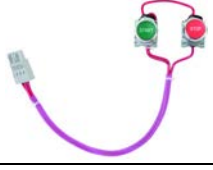

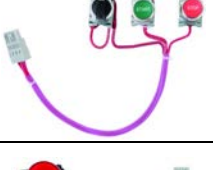







Table 3 - Snap-together Pilot Device Wiring Kits

	Description	Operator Size	Cat. No.	
	Snap-together push button Kit • Metal Bezel	Start-Stop	22.5 mm	198-SSPBM
	Snap-together selector switch Kit • Metal Bezel	3-Position Hand-Off-Auto	22.5 mm	198-3SSM
		2-Position On-Off or Hand-Auto	22.5 mm	198-2SSM
	Selector switch and push button Combination Kits • Metal Bezel	3-Position Hand-Off-Auto and Start-Stop push button	22.5 mm	198-3SSPBM
		2-Position On-Off or Hand-Auto and Start-Stop push button	22.5 mm	198-2SSPBM
	Universal LED Pilot Light Snap-together Kit	Red	22.5 mm	198-RUPL
		Green	22.5 mm	198-GUPL
		White or Amber	22.5 mm	198-WUPL
	Universal LED Push-to-test Pilot Light Snap-together Kit	Red	22.5 mm	198-RUPPLM
		Green	22.5 mm	198-GUPPLM
		White or Amber	22.5 mm	198-WUPPLM

Accessories

Table 4 - Auxiliary Contact Blocks





Description		N.O.	N.C.	Connection Diagram				Cat. No.
 Auxiliary Contact Blocks for side mounting with sequence terminal designations <ul style="list-style-type: none"> • 1- and 2-pole • Quick and easy mounting without tools • One block per device only 	1	0	 23 24 -CA10	 23 33 24 34 -CA20	 11 12 -CA01	 23 11 24 12 -CA11	150-CA10	
	2	0					150-CA20	
	0	1	150-CA01					
	1	1	150-CA11 (Form C)					

Table 5 - Fans



Description		For Use With	Pkg. Qty.	Cat. No.
 Fan <ul style="list-style-type: none"> • Field installed 	Optional	150-C3...37	1	150-CF64
	Replacement	150-C43...85		150-CF147
		150-C108, 150-C135		41391-801-03
		150-C201, 150-C251		41391-801-01
		150-C317...C480		41391-801-02

Table 6 - Protective Modules

Description		For Use With	Pkg. Qty.	Cat. No.
 480V Protective Module	480V Protective Module	150-C3...37NB	1	150-C84
		150-C43...85NB (line and/or load)	1	150-C84P
		150-C108...480NB (line and/or load)	1	150-F84L
	600V Protective Module	150-C3...37NC	1	150-C86
		150-C43...85NC (line and/or load)	1	150-C86P
		150-C108...480NC (line and/or load)	1	150-F86L

IMPORTANT Do not place protective modules on the load side of a device when using an inside-the-delta connection.

Table 7 - IEC Line- or Load-side Terminal Covers

Description ⁽¹⁾		Current Range [A]	Pkg. Quantity	Cat. No.
 <ul style="list-style-type: none"> • Dead front protection • IP2X finger safe when used with 250 MCM cable 		108...135	1	150-TC1
		201...251	1	150-TC2
	<ul style="list-style-type: none"> • Dead front protection • IP2X finger safe when used with 500 MCM cable 	317...480	1	150-TC3

(1) 5...85 A units have terminal guards as standard. No additional terminal guards are required.

Table 8 - Terminal Lug Kits

	Current Range [A] ⁽¹⁾	Wire Size Range	Total No. of Terminal Lugs Possible Each Side		Pkg. Qty.	Cat. No.
			Line Side	Load Side		
	108...135	#6...250 MCM AWG	3	3	3	199-LF1
	201...251	16...120 mm ²	6	6		
	317...480	#4...500 MCM AWG 25...240 mm ²	6	6	3	199-LG1

(1) 5...85 A units have box lugs standard. No additional lugs are required.

Table 9 - Marking Tags and Covers



Description		For Use With	Pkg. Qty.	Cat. No.
 Marking Tag Sheet <ul style="list-style-type: none"> • 160 perforated paper labels each, 6 x 17 mm • To be used with a transparent cover 		150-C, 150-D	10	100-FMP
	Transparent Cover <ul style="list-style-type: none"> • To be used with marking tag sheets 		100	100-FMC

Table 10 - Remote Reset Solenoid

	Description	For Use With	Pkg. Qty.	Cat. No.
	Remote Reset Solenoid • for remote reset of electronic overload	193-T all, 150-C	1	193-ER1⊗

⊗ Voltage Suffix Codes

120V AC coils are standard. All other control voltages are engineered to order. Surcharge for special voltages up to 20 pieces (no surcharge for quantities greater than 20 pieces).

Voltage	24	110	120	220	240
50 Hz, 12...600V	J	D	—	A	—
60 Hz, 12...600V	J	—	D	—	A
DC	EJ	—	—	—	—

Table 11 - System Accessories





	Description			Cat. No.
	Power Monitor Kit • Includes Time Mark Power Monitor, fuse Blocks, and Socket	3-Phase 240V AC	Time Mark Model 258B	599-PM1
		3-Phase 480V AC	Time Mark Model A258B	599-PM2
	Timing Relays • Socket Required	ON Delay	1...10 s	700-HT12AA1
			1.0...180 s	700-HT12BA1
		OFF Delay	1...10 s	700-HT22AA1
			1.0...180 s	700-HT22BA1
	Timing Relay Sockets	ON Delay	1...10 s, 1.0...180 s	700-HN125
		OFF Delay	1...10 s, 1.0...180 s	700-HN126
	Control Relays • Socket Required	120V	2-Pole	700-HK32A1
			4-Pole	700-HC24A1
	Control Relay Socket	120V	2-Pole	700-HN224
			4-Pole	700-HN104
	Terminal blocks	Terminal block	Spring Clamp	1492-L2Q
		End Barrier		1492-EBL2Q
		End Anchor		1492-ERL35

Table 12 - Enclosure Accessories



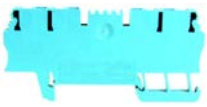

	Description	Construction Material	For Use With Enclosure Width	Cat. No.
	Perforated frame strip • Mounting rail for door or panel installation	Sheet steel	400 mm (15.75 in.)	198-DS400
			600 mm (23.62 in.)	198-DS600
			1000 mm (39.37 in.)	198-DS1000
	Enclosure mounting foot • 100 mm height	High-strength plastic	400 mm (15.75 in.)	198-FB100 A
			600 mm (23.62 in.)	198-FB100B
			1000 mm (39.37 in.)	198-FB100C
	Enclosure mounting foot • 200 mm height	Sheet steel	400 mm (15.75 in.)	198-PL100 A
			600 mm (23.62 in.)	198-PL100B
			1000 mm (39.37 in.)	198-PL100C
		Sheet steel	400 mm (15.75 in.)	198-PL200 A
			600 mm (23.62 in.)	198-PL200B
			1000 mm (39.37 in.)	198-PL200C

Table 13 - Bypass Starter Kits

	Description	Controller Rating [A]	Components	Cat. No.
 <p>100-E116 contactor</p>  <p>Bul. 1411 current transformer</p>  <p>E100 overload relay</p>	Bypass Starter Kit • Consists of: - Bulletin 193 E100™ electronic overload relay - Bulletin 100-E IEC contactor (includes 1 N.O. and 1 N.C. auxiliary contact) - Bulletin 1411 current transformer	3, 5, 9, 16	Contactor	100-C16D10
			Overload relay	193-1EEDB
		25, 37, 43	Contactor	100-C43D10
			Overload relay	193-1EEFD
		60	Contactor	100-C60D10
			Overload relay	193-1EEGE
		90, 108, 110, 135, 140, 180	Contactor	100-E190KD11
			Overload relay	193-1EFJZ
			Current transformer (qty. 3 needed)	1411-2SFT-201
		201, 210, 251, 260	Contactor	100-E370KD11
			Overload relay	193-1EFJZ
			Current transformer (qty. 3 needed)	1411-AL-401
		317, 320, 361	Contactor	100-E370KD11
			Overload relay	193-1EFJZ
			Current transformer (qty. 3 needed)	1411-AL-401
		420, 520	Contactor	100-E580ED11
			Overload relay	193-1EFMZ
			Current transformer (qty. 3 needed)	25645-006-08

Wiring Diagrams

The diagrams in this section illustrate basic SMC controller wiring. For specific wiring diagrams, please consult your local Rockwell Automation sales office or Allen-Bradley distributor.

Notes:

- Use 75 °C (167 °F) Cu wire only
- Line fuses are customer supplied on controllers with factory-supplied disconnect switch. Refer to NEC when selecting short-circuit protection.
- Additional control circuit overcurrent protection is required for non-combination starters. Refer to NEC.

Figure 3 - SMC-3 Controller Basic Wiring Diagram

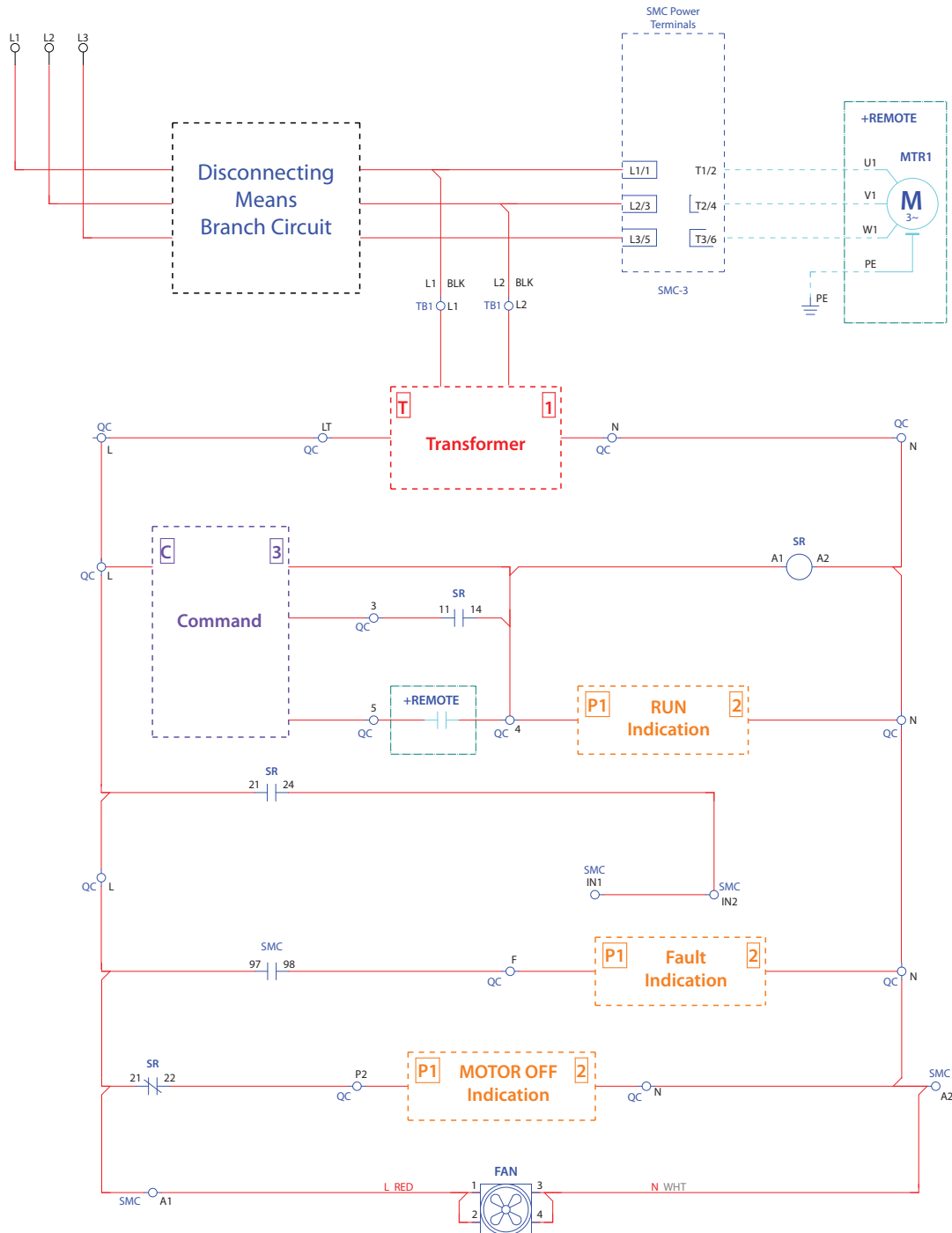

- For wiring diagrams for snap-together kits, please see the following figures:
 - Command kits: [Figure 4](#), [Figure 5](#), and [Figure 6](#)
 - Indication kit: [Figure 7](#)
 - Transformer kit: [Figure 8](#)

Wiring Diagrams for Snap-together Kits

Figure 4 - Start-Stop Command Kit Wiring Diagram

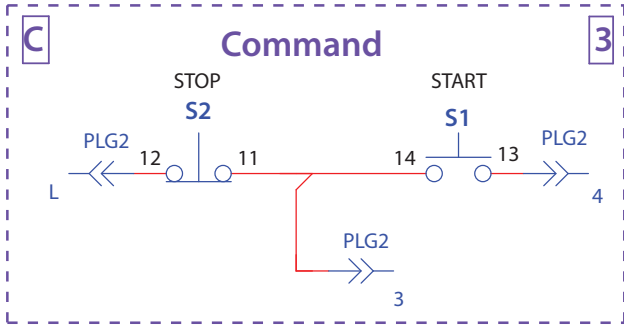

Figure 5 - Hand-Off-Auto Command Kit Wiring Diagram

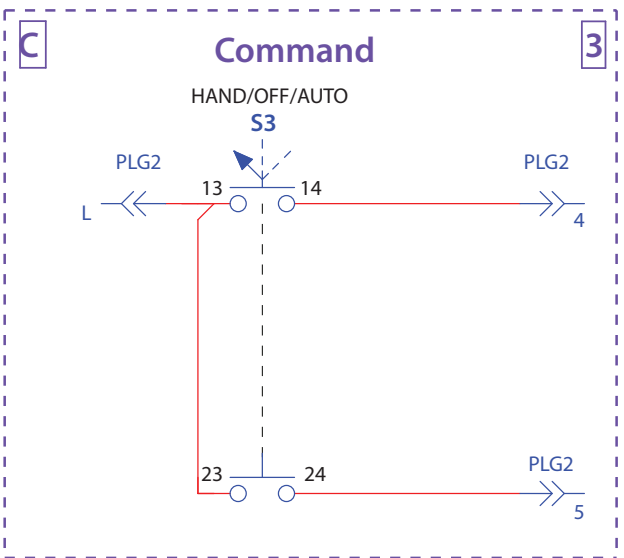

Figure 6 - Hand-Off-Auto and Start-Stop Command Kit Wiring Diagram

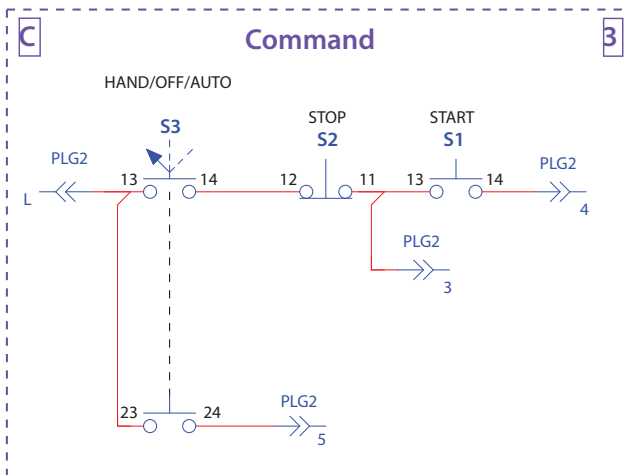

Figure 7 - Indication Kit Wiring Diagram

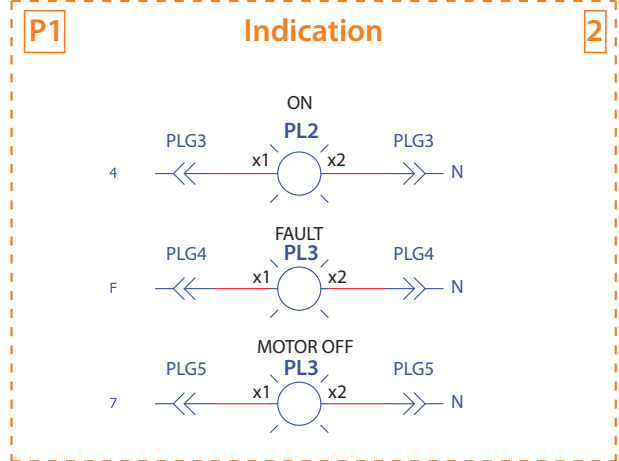
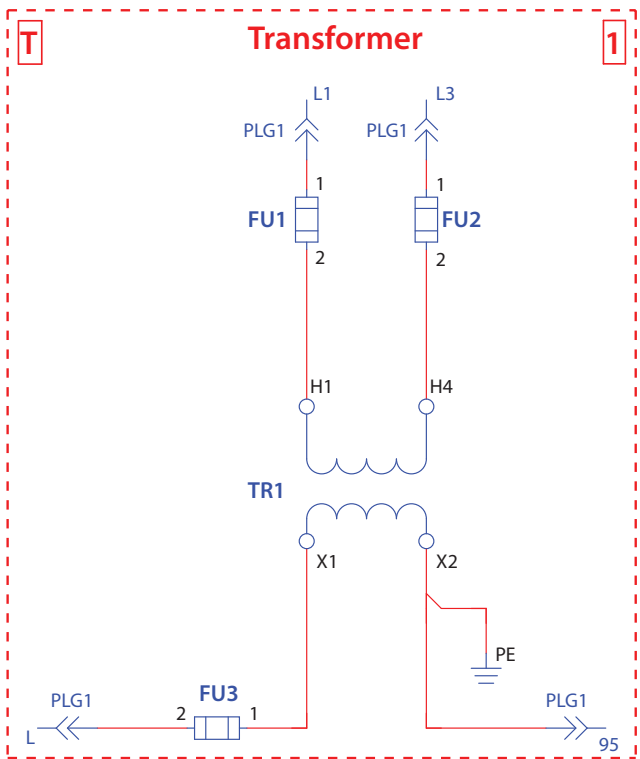

Figure 8 - Transformer Kit Wiring Diagram



Specifications

For complete specifications of your SMC-3 controller, see SMC-3, SMC Flex, and SMC-50 Technical Data, publication [150-TD009](#).

Table 14 - Standards Compliance and Certifications⁽¹⁾

Standards Compliance—Open Controllers	Certifications—Open Controllers	Standards Compliance—Enclosed Controllers	Certifications—Enclosed Controllers
UL 508	cULus Listed (Open Type) (File No. E96956, Guides NMFT, NMFT7)	UL 508A	cULus Listed
CSA C22.2 No.14	CSA Certified (File No. LR 1234)		
EN/IEC 60947-1			
EN/IEC 60947-4-2			

(1) For complete certification information, see our product certifications website: website.rockwellautomation.com/certifications.

Short-circuit Current Ratings

Determining the short circuit current ratings (SCCR) of a complex system can be very challenging, especially if proper considerations are not made during the initial stages of the component selection process.

The SCCR information in this section provides coordinated high-fault branch circuit for enclosed soft starters and is based on compliance to IEC and UL standards. For comprehensive SCCR information, please consult the Rockwell Automation Global SCCR tool, rockwellautomation.com/sccr.



Ratings provided are for standard options only; does not include bypass or isolation contactor configurations.

Table 15 - Short-circuit Current Ratings—Non-combination Enclosed Soft Starters with SMC-3 Controllers

Controller Rating [A]	SCCR		
	Max SCCR [kA rms symmetrical]	Max Voltage [V]	Max Fuse or Circuit Breaker
3	70	600	6 A Class J fuse
	5		12 A fuse
	5		15 A circuit breaker
9	70	600	15 A Class J fuse
	5		30 A fuse or circuit breaker
30	70	600	60 A Class J fuse
	10		110 A fuse or circuit breaker
37	70	600	60 A Class J fuse
	10		125 A fuse or circuit breaker
43	70	600	90 A Class J fuse
	10		150 A fuse or circuit breaker
60	70	600	125 A Class J fuse
	10		225 A fuse or circuit breaker
85	70	600	175 A Class J fuse
	10		300 A fuse or circuit breaker
108	70	600	200 A Class J fuse
	10		400 A fuse
	10		300 A circuit breaker
135	70	600	250 A Class J fuse
	10		500 A fuse
	10		400 A circuit breaker

Table 15 - Short-circuit Current Ratings—Non-combination Enclosed Soft Starters with SMC-3 Controllers

Controller Rating [A]	SCCR		
	Max SCCR [kA rms symmetrical]	Max Voltage [V]	Max Fuse or Circuit Breaker
201	70	600	350 A Class J fuse
	18		600 A fuse or circuit breaker
251	70	600	400 A Class J fuse
	18		700 A fuse or circuit breaker
317	69	600	500 A Class J fuse
	30		800 A fuse or circuit breaker
351	69	600	600 A Class J fuse
	30		1000 A fuse or circuit breaker
480	69	600	800 A Class J fuse
	30		1200 A fuse or circuit breaker

Table 16 - Combination Enclosed Soft Starters with SMC-3 Controllers and Circuit Breakers

Controller Rating [A]	SCCR	
	Max SCCR [kA rms symmetrical]	Max Voltage [V]
3...25	5	600
30...135	10	
201...251	18	
317...361	30	
480	42	

Table 17 - Combination Enclosed Soft Starters with SMC-3 Controllers and Fusible Disconnect Switch

Controller Rating [A]	SCCR		
	Max SCCR [kA rms symmetrical]	Max Voltage [V]	Max Fuse or Circuit Breaker
3	70	600	6 A Class J fuse
9	70		15 A Class J fuse
16	70		30 A Class J fuse
25	70	600	50 A Class J fuse
30...37	70		60 A Class J fuse
43	70	600	90 A Class J fuse
60	70		125 A Class J fuse
85	70	600	125 A Class J fuse
108	10		200 A Class J fuse
135	70	600	250 A Class J fuse
201	70	600	350 A Class J fuse
	18		600 A fuse or circuit breaker
251	70	600	400 A Class J fuse
	18		700 A fuse or circuit breaker
317	69	600	500 A Class J fuse
	30		800 A fuse or circuit breaker
361	69	600	600 A Class J fuse
	30		1000 A fuse or circuit breaker
480	69	600	800 A Class J fuse
	42		1200 A fuse or circuit breaker

Approximate Dimensions

Examples given in this section include standard options. Use ProposalWorks to obtain dimensions for Smart Motor Controllers with all available options. ProposalWorks software is available from rok.auto/systemtools.

Dimensions are in inches (millimeters) unless otherwise noted. Dimensions are not to be used for manufacturing purposes.

Figure 9 - Enclosure for SMC Controllers—1400 mm x 400 mm x 500 mm

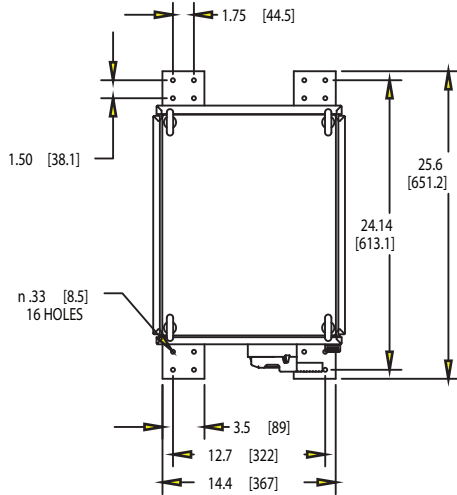

Shipping Bracket dimensions. Can be used for customer mounting or removed. Not included if mounting foot is factory installed. Handle may vary by controller size.

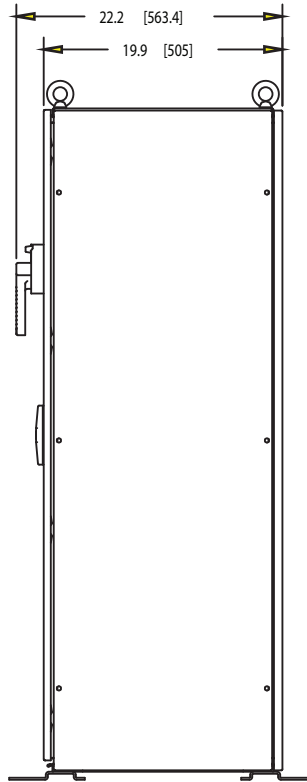
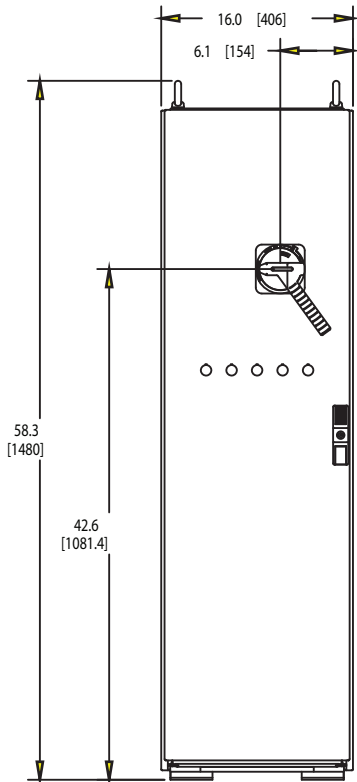

Figure 10 - Enclosure for SMC Controllers—1400 mm x 600 mm x 500 mm

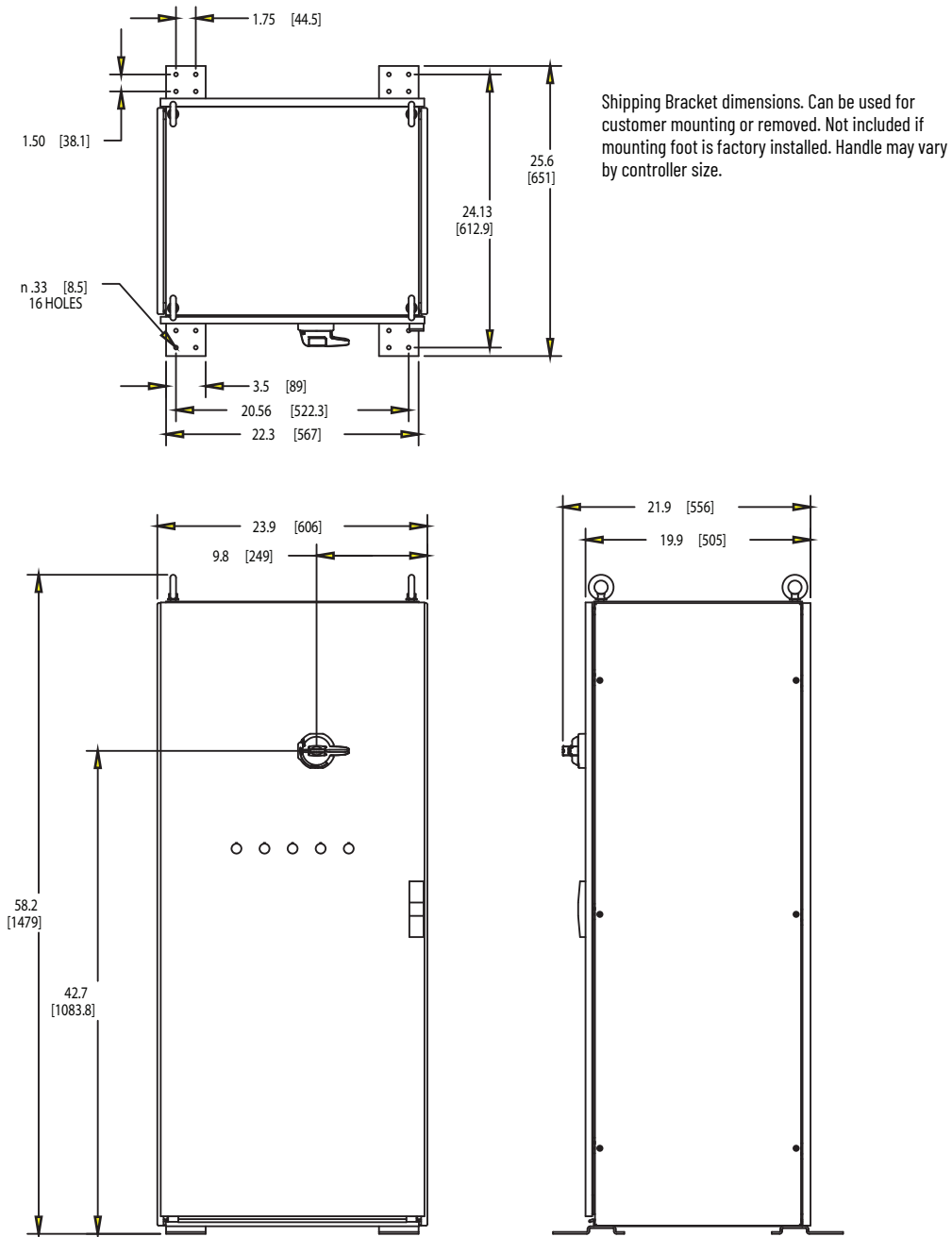
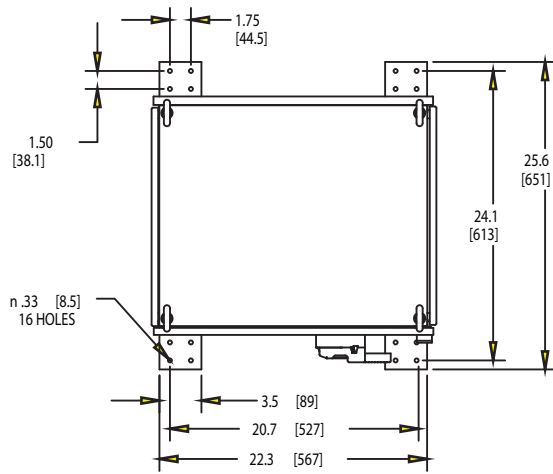

Figure 11 - Enclosure for SMC Controllers—2000 mm x 600 mm x 500 mm



Shipping Bracket dimensions. Can be used for customer mounting or removed. Not included if mounting foot is factory installed. Handle may vary by controller size.

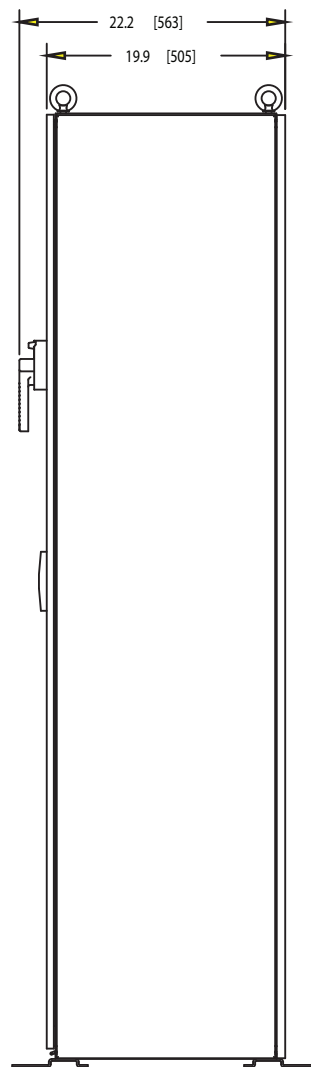
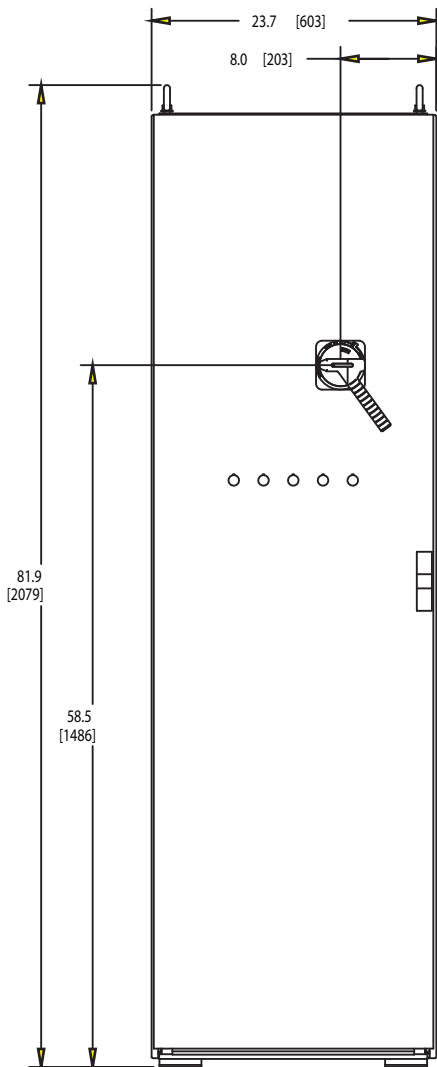

Table 18 - SMC-3 Controller Enclosure Dimensions

Non-combination Controllers		Combination Controllers			
		With Fusible Disconnect Switch		With Circuit Breaker	
Cat. No.	Dimensions (H x W x D)	Cat. No.	Dimensions (H x W x D)	Cat. No.	Dimensions (H x W x D)
150C-D10J...	1400 x 400 x 500 (55.1 x 15.7 x 19.7) see Figure 9	152C-D10J...	1400 x 400 x 500 (55.1 x 15.7 x 19.7) see Figure 9	153C-D10J...	1400 x 400 x 500 (55.1 x 15.7 x 19.7) see Figure 9
150C-D13J...		152C-D13J...		153C-D13J...	
150C-D20J...		152C-D20J...	153C-D20J...		
150C-D25J...			152C-D25J...	153C-D25J...	
150C-D31J...			152C-D31J...	153C-D31J...	2000 x 600 x 500 (78.7 x 23.6 x 19.7) see Figure 11
150C-D36J...			152C-D36J...	153C-D36J...	
150C-D48J...			152C-D48J...	153C-D48J...	

 Wall-mounted controllers do not include Snap-together wiring

Figure 12 - Wall-mounted Enclosure Dimensions

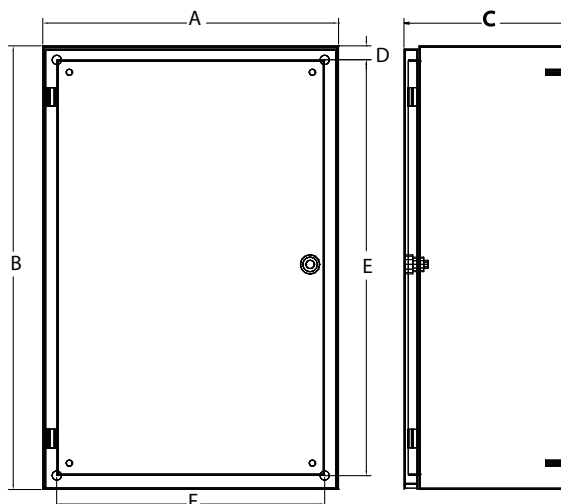

Table 19 - Wall-mounted Enclosed SMC-3 Controllers

Controller Rating [A]	Bulletin	With Option	Dimensions in inches (mm)					
			A (Width)	B (Height)	C (Depth)	D (Mtg. Dim.)	E (Mtg. Dim.)	F (Mtg. Dim.)
Non-Combination Controller								
3...37	150	—	8 (203)	12 (305)	6 (152)	2.44 (62)	10.43 (265)	3.0 (76)
		6P	12 (305)	12 (305)	6 (152)	2.41 (61)	10.43 (265)	7.0 (178)
43...85	150	—	8 (203)	14 (356)	8 (203)	2.44 (62)	12.40 (315)	3.0 (76)
		6P	16 (406)	14 (356)	8 (203)	4.38 (111)	12.40 (315)	7.0 (178)
Combination Controller								
3...37	152H,153H	Any	16 (406)	14 (356)	8 (203)	4.38 (111)	12.40 (315)	7.0 (178)
43	152H	Any	16 (406)	14 (356)	8 (203)	4.38 (111)	12.40 (315)	7.0 (178)
	153H	Any	16 (406)	24 (610)	10 (254)	0.75 (19)	22.5 (572)	14.5 (368)
60	152H, 153H	Any	16 (406)	24 (610)	9 (229)	0.75 (19)	22.5 (572)	14.5 (368)
	152H	Any	24 (610)	30 (762)	12 (305)	0.75 (19)	28.5 (724)	22.5 (572)
85	152H	Any ⁽¹⁾	16 (406)	24 (610)	9 (229)	0.75 (19)	22.5 (572)	14.5 (368)
		Any ⁽²⁾	24 (610)	30 (762)	12 (305)	0.75 (19)	28.5 (724)	22.5 (572)
	153H	Any	16 (406)	24 (610)	9 (229)	0.75 (19)	22.5 (572)	14.5 (368)

(1) Rating 20 Hp @208V, 25 Hp @240V, 50 Hp @ 480V, 60 Hp @ 600V.

(2) Rating 25 Hp @208V, 30 Hp @240V, 60 Hp @ 480V, 75 Hp @ 600V.

Catalog Number Explanation

Examples that are given in this section are not intended to be used for product selection. Not all combinations generate a valid catalog number. Use ProposalWorks™ software to configure the SMC Flex controller. ProposalWorks software is available from rok.auto/systemtools.



Use the SMC Estimation Wizard and SMC Thermal Estimation Wizard to confirm that the SMC controller selection meets the application requirements. See SMC-3, SMC Flex, and SMC-50 Technical Data, publication [150-TD009](#) for more information.

Controllers Rated 5...85 A



Controllers rated 5...85 A do not include snap-together wiring.

152H
-
F85
F
BD
-
D
-
B
-
8L

a
b
c
d
e
f
g

a	
Bulletin Number	
Code	Description
150	Non-combination solid-state controller
150B	Non-combination solid-state controller with isolation contactor
152H	Combination solid-state controller with fusible disconnect
152B	Combination solid-state controller with fusible disconnect and isolation contactor
153H	Combination solid-state controller with circuit breaker
153B	Combination solid-state controller with circuit breaker and isolation contactor

b	
Controller Rating [A]	
Code	Description
F5	5 A
F25	25 A
F43	43 A
F60	60 A
F85	85 A

c	
Enclosure Type	
Code	Description
F	NEMA Type 4/12 (IP65)

d	
Input Line Voltage, 120V AC Control Voltage	
Code	Description
HD	200...208V AC, 3-Phase, 50 /60 Hz
AD	230V AC, 3-Phase, 50/60 Hz
BD	400...460V AC, 3-Phase, 50/60 Hz
CD	500...575V AC, 3-Phase, 50/60 Hz

e	
Control Options	
Code	Description
Blank	Standard
B	Pump Control
D	Braking Control

f									
Horsepower (Combination Controllers only)									
Code	Rating	Code	Rating	Code	Rating	Code	Rating	Code	Rating
33	0.5	39	5	45	30	51	125	59	400
34	0.75	40	7.5	46	40	52	150	60	450
35	1	41	10	47	50	54	200	61	500
36	1.5	42	15	48	60	56	250	62	600
37	2	43	20	49	75	57	300	63	700
38	3	44	25	50	100	58	350	65	800
								67	1000

g
Options
See page 22

g	
Options	
Code	Description
1	Start-Stop push button
1F	Start-Stop push button with Hand-Off-Auto selector switch
1XA ⁽¹⁾	Soft Stop push button
1XB ⁽¹⁾	Pump Stop push button
1XC ⁽¹⁾	Slow Speed push button
1XD ⁽¹⁾	Brake push button
1XE ⁽¹⁾	Accu-Stop/Slow Speed push button
3	Hand-Off-Auto selector switch
3B ⁽²⁾	SMC-Off-Bypass selector switch
4G	Transformer Pilot Light - Green Power On Indicator
4R	Transformer Pilot Light - Red Run Indicator
5R	Push-to-Test Pilot Light - Red Run Indicator
6P	Control circuit transformer (fused primary and secondary)
6PX	Additional 100VA Control circuit transformer (fused primary and secondary)
Code	Description
8L	Line-mounted protective module ⁽³⁾
8M	Load-mounted protective module ⁽³⁾
8B	Line- and load-mounted protective modules
HC3	Human Interface Module; Door-mounted, Full Numeric (Type 4/12)
20S	Communication: RS-485
20D	Communication: DeviceNet
20E	Communication: Ethernet/IP
20C	Communication: Control Net
20P	Communication: ProfiBUS
98	N.O. disconnect auxiliary mounted on operating mechanism
99	N.C. disconnect auxiliary mounted on operating mechanism
98X	Internal N.O. circuit breaker auxiliary
99X	Internal N.C. circuit breaker auxiliary
SEL	Service Entrance Label
OPS	Oil Pump Starter; Bulletin 509 NEMA Size 1 starter and Bulletin 592 solid-state overload relay

- (1) Option push buttons are available only when the corresponding option module is selected.
- (2) Bypass contactor and overload are not included with this option. You must add -NB or -BP to the catalog string to add these devices.
- (3) Load-side MOVs are not available with Pump and Braking options, or on delta-connected motors.

Controllers Rated 90...1250 A

152F
a
-
D10
b
J
c
B
d
-
D
e
-
J20
f
-
3
g

a	
Bulletin Number	
Code	Description
150F	SMC Flex Non-combination
152F	SMC Flex Combination with fusible disconnect switch
153F	SMC Flex Combination with circuit breaker

b	
Controller Rating [A]	
Code	Description
D10	108
D13	135
D20	201
D25	251
D31	317
D36	361
D48	480
D62	625
D78	780
D97	970
E12	1250

c	
Enclosure Type	
Code	Description
J	1/12/3R (3R)

d	
Input Line Voltage	
Code	Description
H	200...208V AC, 3-Phase, 50 /60 Hz
A	230V AC, 3-Phase, 50/60 Hz
B	400...460V AC, 3-Phase, 50/60 Hz
C	500...575V AC, 3-Phase, 50/60 Hz

e	
Control Voltage	
Code	Description
D	120V AC
J	24V AC
A	240V AC
EJ	24V DC

f...g	
Fuse Clip/Circuit Breaker and Options	
See page 22	

f			
Fuse Clip/Circuit Breaker (CB)– Combination Controllers Only			
Code	Description	Code	Description
J20	200 A, Class J	D12	125 A, CB
J40	400 A, Class J	D17	175 A, CB
J60	600 A, Class J	D25	250 A, CB
L80	800 A, Class L	D40	400 A, CB
L12	1200 A, Class L	D60	600 A, CB
L16	1600 A, Class L	D80	800 A, CB
D16	160 A, DIN	E12	1200 A, CB
D25	250 A, DIN		
D40	400 A, DIN		
D63	630 A, DIN		
D80	800 A, DIN		
N12	1250 A, DIN		

g					
Options					
Code	Description	Code	Description	Code	Description
1	Start-Stop push button	6P	Control circuit transformer	20C	Communication: ControlNet
1E	On-Off push button	6XP	1-Factor Additional VA ⁽²⁾	20P	Communication: ProfIBUS
3	Hand-Off-Auto selector switch	6YP	2-Factor Additional VA ⁽²⁾	PC	Pump Control
3E	On-Off selector switch	8L	Line-mounted protective module	BC	Braking Control
3H	Hand-Auto selector switch	8M	Load-mounted protective module	TB10	10 Spare terminal blocks
3B	SMC-Off-Bypass selector switch	8B	Line- and load-mounted protective modules	TB20	20 Spare terminal blocks
13	Start-Stop push button and Hand-Off-Auto selector switch	BP	IEC Bypass starter	P10	100 mm mounting foot, sheet metal
4_ _ _ _ ⁽¹⁾	Pilot Lights	IC	Isolation contactor	P20	200 mm mounting foot, sheet metal
5_ _ _ _ ⁽¹⁾	Push-to-test pilot lights	989	1N.O/1N.C Auxiliary contact on circuit breaker or fusible disconnect switch	F10	100 mm mounting foot, high-strength plastic
1XA	Soft Stop push button	HC3	SMC Flex Human Interface Module; Door mounted type 4/12	F20	200 mm mounting foot, high-strength plastic
1XB	Pump Stop push button	20S	Communication: RS-485	416	Plug-in control relay, 2-pole
1XC	Slow Speed push button	20D	Communication: DeviceNet	417	Plug-in control relay, On Delay
1XD	Brake push button	20E	Communication: Ethernet/IP	418	Plug-in control relay, Off Delay

(1) Pilot Lights require configuration. See [page 23](#)
 (2) VA values depend on the size of the controller.

Pilot Light Configuration



The final character in the configuration string cannot be "X".

4
R
G
X
W
a
b
c
d
e

a	
Option	
Code	Description
4	Pilot light
5	Push-to-test pilot light

b	
ON Indication	
Code	Description
R	Red
G	Green
X	none

c	
OFF Indication	
Code	Description
R	Red
G	Green
X	none

d	
Fault Indication	
Code	Description
A	Amber
X	none

e	
Power ON Indication	
Code	Description
W	White

Product Selection



You can configure enclosed soft starters by selecting a power center, snap-together kits, transformers, and/or any applicable controller accessories.

Table 20 - Power Centers

Motor Current [A]	Rated Hp [Hp]				Non-combination Starters Cat. No.	Combination Starters Cat. No.	
	200...208V	230V	400...460V	500...575V		with Fusible Disconnect Switch	with Circuit Breaker
108	30	40	75	100	150F-D10JCD	152F-D10JCD-J20	153F-D10JCD-D17
135	40	50	100	125	150F-D13JCD	152F-D13JCD-J20	153F-D13JCD-D25
201	60	75	150	150	150F-D20JCD	152F-D20JCD-J40	153F-D20JCD-D25
251	75	100	200	200	150F-D25JCD	152F-D25JCD-J40	153F-D25JCD-D40
317	100	125	250	300	150F-D31JCD	152F-D31JCD-J60	153F-D31JCD-D40
361	125	150	300	350	150F-D36JCD	152F-D36JCD-J60	153F-D36JCD-D80
480	150	200	400	500	150F-D48JCD	152F-D48JCD-L80	153F-D48JCD-D80

Table 21 - Transformers⁽¹⁾

	Controller Current [A]	Capacity	VA	208V x 120V Cat. No.	240V x 120V Cat. No.	460V x 120V Cat. No.	575V x 120V Cat. No.
	108, 135, 201, 251, 317, 361, 480	Standard	200	1497-HD200	1497-AD200	1497-BD200	1497-CD200
		Extra Capacity	350	1497-HD350	1497-AD350	1497-BD350	1497-CD350
			500	1497-HD500	1497-AD500	1497-BD500	1497-CD500

(1) All transformers include grounding wires and fuse covers.

Snap-together Pilot Device Wiring

 This option applies only to controllers with current ratings greater than 90 A.

Component wiring is color coded by function. The wiring sleeve color corresponds to a colored label on the terminal block. Keyed connectors snap these components into the terminal block. This greatly reduced assembly time is ideal for the quick installation of pilot devices and control circuit transformers, and significantly reduces wiring errors. [Figure 13](#) shows an example of this feature.

Figure 13 - Snap-together Wiring Example

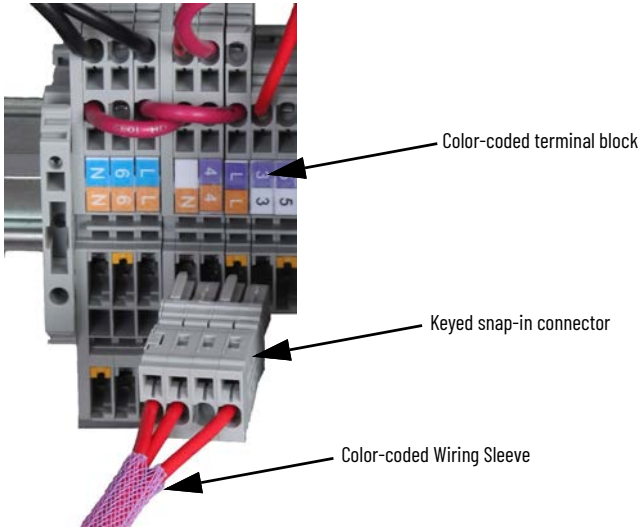

Figure 14 - SMC Flex Controller Snap-together Wiring

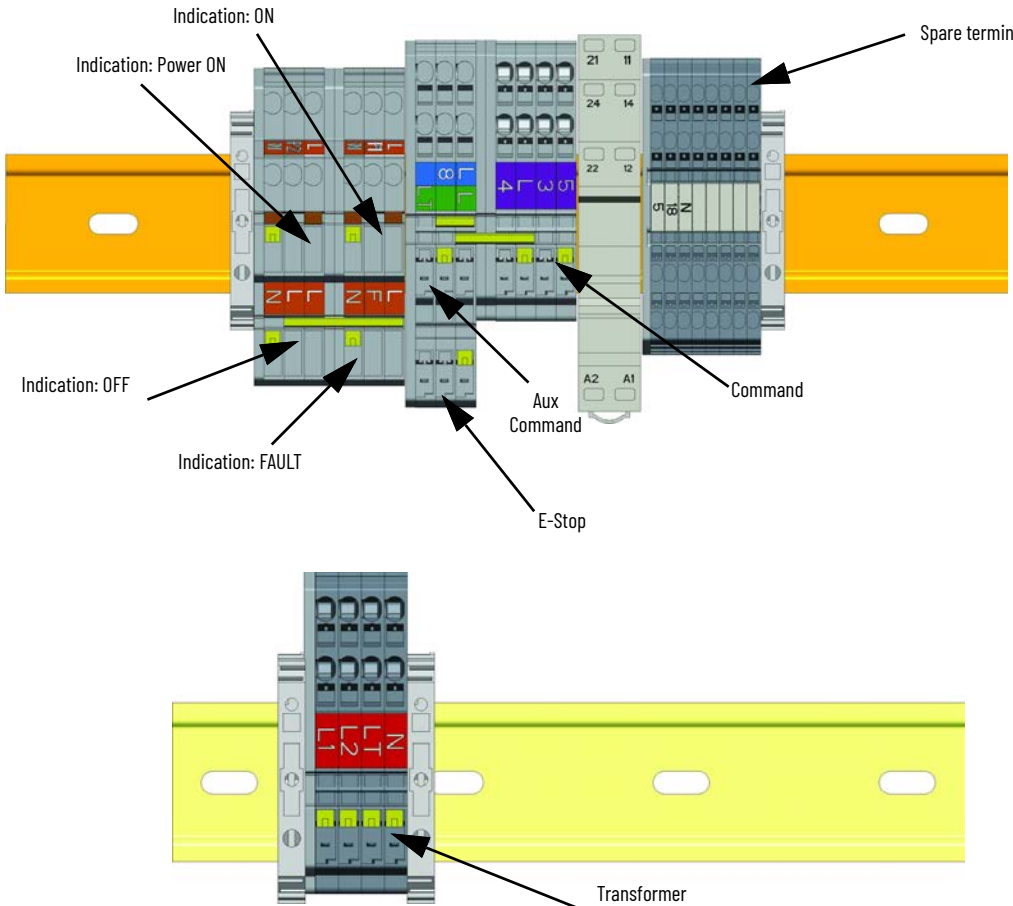

Table 22 - Snap-together Pilot Device Wiring Kits















	Description	Operator Size	Cat. No.
	Snap-together push button Kit • Metal Bezel	Start-Stop	22.5 mm 198-SSPBM
	Snap-together selector switch Kit • Metal Bezel	3-Position Hand-Off-Auto	22.5 mm 198-3SSM
	Selector switch and push button Combination Kits • Metal Bezel	2-Position On-Off or Hand-Auto	22.5 mm 198-2SSM
		3-Position Hand-Off-Auto and Start-Stop push button	22.5 mm 198-3SSPBM
		2-Position On-Off or Hand-Auto and Start-Stop push button	22.5 mm 198-2SSPBM
	Universal LED Pilot Light Snap-together Kit	Red	22.5 mm 198-RUPL
		Green	22.5 mm 198-GUPL
		White or Amber	22.5 mm 198-WUPL

Table 22 - Snap-together Pilot Device Wiring Kits (Continued)

	Description	Operator Size	Cat. No.	
	Universal LED Push-to-test Pilot Light Snap-together Kit	Red	22.5 mm	198-RUPPLM
		Green	22.5 mm	198-GUPPLM
		White or Amber	22.5 mm	198-WUPPLM
	Stop push button Snap-together Kit	N.C., Momentary	22.5 mm	198-PBM
	Emergency Stop Snap-together Kit			198-ESP

Accessories

Table 23 - Protective Modules

Description		Current Rating [A]	Pkg. Qty.	Cat. No.
	480V Protective Module	5...85	1	150-F84
		90...520	1	150-F84L
	600V Protective Module	5...85	1	150-F86
		90...520	1	150-F86L

IMPORTANT Do not place protective modules on the load side of a device when using an inside-the-delta connection.

Table 24 - IEC Line- or Load-side Terminal Covers

Description ⁽¹⁾		Current Range [A]	Pkg. Quantity	Cat. No.
	• Dead front protection	108...135	1	150-TC1
	• IP2X finger safe when used with 250 MCM cable	201...251	1	150-TC2
	• Dead front protection	317...480	1	150-TC3
• IP2X finger safe when used with 500 MCM cable				

(1) 5...85 A units have terminal guards as standard. No additional terminal guards are required.

Table 25 - Terminal Lug Kits

	Current Range [A] ⁽¹⁾	Wire Size Range	Total No. of Terminal Lugs Possible Each Side		Pkg. Qty.	Cat. No.
			Line Side	Load Side		
	108...135	#6...250 MCM AWG	3	3	3	199-LF1
	201...251	16...120 mm ²	6	6		
	317...480	#4...500 MCM AWG	6	6	3	199-LG1
	625...780	2/0...500 MCM	6	6	3	100-DL630
	970	4/0...500 MCM	3	3	3	100-DL860
	1250 ⁽²⁾	2/0...500 MCM	3	3	3	100-DL630
4/0...500 MCM		3	3	3	100-DL860	

(1) 5...85 A units have box lugs standard. No additional lugs are required.

(2) The 1250 A device requires (1)100-DL630 and (1)100-DL860 per connection.

Table 26 - Human Interface Modules (HIMs) and Communication Modules



Description		Cat. No.
	Hand-held HIM	LCD display, Programmer only ⁽¹⁾ 20-HIM-A5
	Door-mounted HIM	Remote (panel mount) LCD display, full numeric keypad (version of Cat. No. 20-HIM-A6) 20-HIM-C6S ⁽²⁾
HIM interface cables	HIM interface cable, 1 m (39 in)	20-HIM-H10 ⁽³⁾
	Cable kit (plug-socket) 0.33 m (1.1 ft)	1202-H03
	Cable kit (plug-socket) 1 m (3.3 ft)	1202-H10
	Cable kit (plug-socket) 3 m (9.8 ft)	1202-H30
	Cable kit (plug-socket) 9 m (29.5 ft)	1202-H90
	DPI/SCANport™ one- to two-port splitter cable	1203-S03

Table 26 - Human Interface Modules (HIMs) and Communication Modules (Continued)

Description		Cat. No.
 <p>Communication modules</p> <ul style="list-style-type: none"> for use with non-combination controllers installed into the physical space assigned to control module expansion port 9 connected to DPI port 4 via cable 	RS-485 DF1 Communication Adapter	20-COMM-S
	PROFIBUS DP Communication Adapter	20-COMM-P
	ControlNet® Communication Adapter (Coax)	20-COMM-C
	Interbus Communication Adapter	20-COMM-I
	Modbus/TCP Communication Adapter	20-COMM-M
	DeviceNet® Communication Adapter	20-COMM-D
	EtherNet/IP™ Communication Adapter	20-COMM-E
	Dual-port EtherNet/IP Communication Adapter	20-COMM-ER
	HVAC Communication Adapter	20-COMM-H
	ControlNet Communication Adapter (Fiber)	20-COMM-Q
<p>Programming Software</p> <ul style="list-style-type: none"> For use with <ul style="list-style-type: none"> Windows 7/2000/XP/Vista Windows 10⁽⁴⁾ 	Connected Components Workbench Software	Available for download at rok.auto/ccw
	DriveTools™ SP ⁽⁵⁾	9303-4DTS01ENE
Personal computer interface	DPI to USB	1203-USB ⁽⁶⁾

- (1) Requires a 20-HIM-H10 cable to connect to the SMC Flex controller.
- (2) A 3 m (9.8 ft.) Cat. No. 1202-C30 cable is provided.
- (3) A cable is required if 20-HIM-A6 is connected to the SMC-50 DPI Port #2 and used as a hand-held device.
- (4) Connected Components Workbench software only.
- (5) Includes DriveExecutive™ and DriveObserver™ software.
- (6) Includes Cat. No. 20-HIM-H10 and 22-HIM-H10 cables.

Table 27 - Bypass Starter Kits



Description	Controller Rating [A]	Components	Cat. No.
 <p>100-E116 contactor</p>  <p>Bul. 1411 current transformer</p>  <p>E100 overload relay</p> <p>Bypass Starter Kit</p> <ul style="list-style-type: none"> Consists of: <ul style="list-style-type: none"> Bulletin 193 E100™ electronic overload relay Bulletin 100-E IEC contactor (includes 1 N.O. and 1 N.C. auxiliary contact) Bulletin 1411 current transformer 	3, 5, 9, 16	Contactor	100-C16D10
	25, 37, 43	Overload relay	193-1EEDB
		Contactor	100-C43D10
	60	Overload relay	193-1EEFD
		Contactor	100-C60D10
	90, 108, 110, 135, 140, 180	Overload relay	193-1EEGE
		Contactor	100-E190KD11
	201, 210, 251, 260	Overload relay	193-1EFJZ
		Current transformer (qty. 3 needed)	1411-2SFT-201
		Contactor	100-E370KD11
	317, 320, 361	Overload relay	193-1EFJZ
		Current transformer (qty. 3 needed)	1411-AL-401
		Contactor	100-E370KD11
	420, 520	Overload relay	193-1EFJZ
		Current transformer (qty. 3 needed)	1411-AL-401
		Contactor	100-E580ED11
420, 520	Overload relay	193-1EFMZ	
	Current transformer (qty. 3 needed)	25645-006-08	

Table 28 - System Accessories







		Description		Cat. No.
	Power Monitor Kit • Includes Time Mark Power Monitor, fuse Blocks, and Socket	3-Phase 240V AC	Time Mark Model 258B	599-PM1
		3-Phase 480V AC	Time Mark Model A258B	599-PM2
	Timing Relays • Socket Required	ON Delay	1...10 s	700-HT12AA1
			1.0...180 s	700-HT12BA1
		OFF Delay	1...10 s	700-HT22AA1
			1.0...180 s	700-HT22BA1
	Timing Relay Sockets	ON Delay	1...10 s, 1.0...180 s	700-HN125
		OFF Delay	1...10 s, 1.0...180 s	700-HN126
	Control Relays • Socket Required	120V	2-Pole	700-HK32A1
			4-Pole	700-HC24A1
	Control Relay Socket	120V	2-Pole	700-HN224
			4-Pole	700-HN104
	Terminal blocks	Terminal block	Spring Clamp	1492-L2Q
		End Barrier		1492-EBL2Q
		End Anchor		1492-ERL35

Table 29 - Enclosure Accessories

	Description	Construction Material	For Use With Enclosure Width	Cat. No.
	Perforated frame strip • Mounting rail for door or panel installation	Sheet steel	400 mm (15.75 in.)	198-DS400
			600 mm (23.62 in.)	198-DS600
			1000 mm (39.37 in.)	198-DS1000
	Enclosure mounting foot • 100 mm height	High-strength plastic	400 mm (15.75 in.)	198-FB100 A
			600 mm (23.62 in.)	198-FB100B
			1000 mm (39.37 in.)	198-FB100C
	Enclosure mounting foot • 200 mm height	Sheet steel	400 mm (15.75 in.)	198-PL100 A
			600 mm (23.62 in.)	198-PL100B
			1000 mm (39.37 in.)	198-PL100C
Enclosure mounting foot • 200 mm height	Sheet steel	400 mm (15.75 in.)	198-PL200 A	
		600 mm (23.62 in.)	198-PL200B	
		1000 mm (39.37 in.)	198-PL200C	

Wiring Diagrams

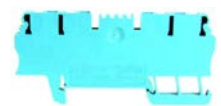
The diagrams in this section illustrate basic SMC controller wiring. For specific wiring diagrams, please consult your local Rockwell Automation sales office or Allen-Bradley distributor.

Notes:

- Use 75 °C (167 °F) Cu wire only
- Line fuses are customer supplied on controllers with factory-supplied disconnect switch. Refer to NEC when selecting short-circuit protection.
- Additional control circuit overcurrent protection is required for non-combination starters. Refer to NEC.

Figure 15 - SMC Flex Controller Basic Wiring Diagram

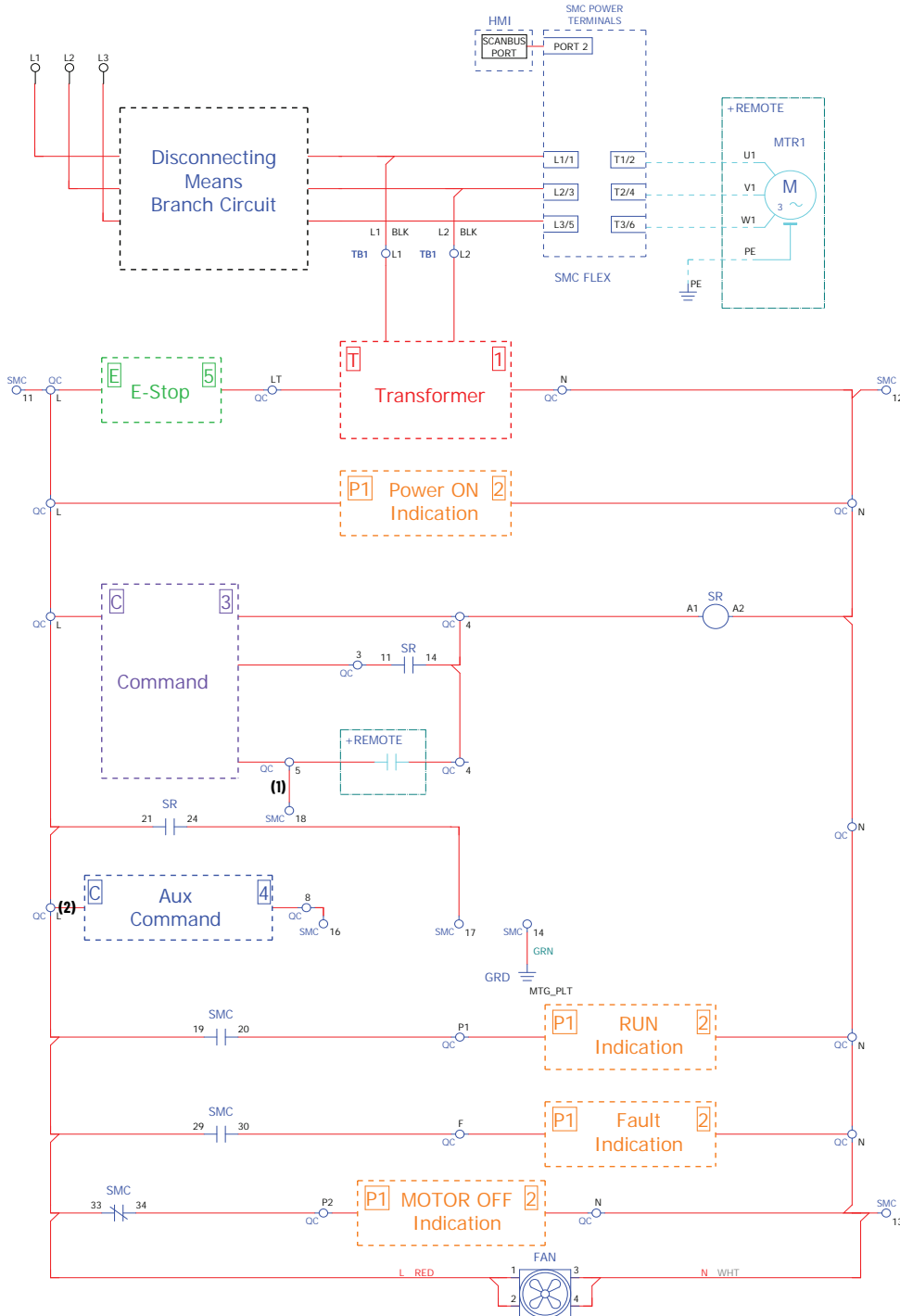

Note No.	Information
1	Add jumper from terminal block 18 to terminal block 5 when using DPI (jumper is included in the rail in terminal block 18).
2	Remove the pre-installed yellow jumper between terminal block L and terminal block 8 when using an auxiliary command device

- SMC Flex controller factory pre-programmed parameters; Parameter 109: AUX4CFG set to NORMAL NC TO NORMAL NC.
- For wiring diagrams for snap-together kits, please see the following figures:
 - Command kits: [Figure 16](#), [Figure 17](#), and [Figure 18](#); Auxiliary Command kits: [Figure 19](#), [Figure 20](#), and [Figure 21](#)
 - Emergency Stop (E-Stop) kit: [Figure 22](#)
- For units with DPI, set Logic Mask (Parameter 87) to 0010 0100.
 - Indication kit: [Figure 23](#)
 - Transformer kit: [Figure 24](#)

Wiring Diagrams for Snap-together Kits

Figure 16 - Start-Stop Command Kit Wiring Diagram

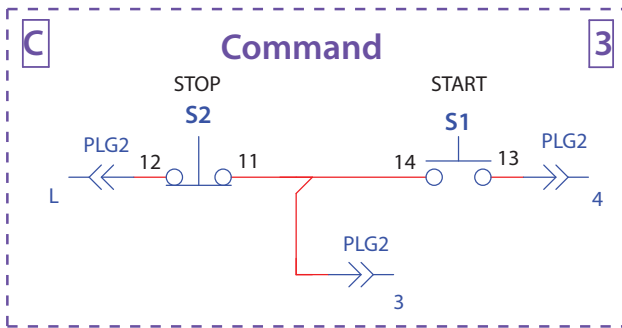

Figure 17 - Hand-OFF-Auto Command Kit Wiring Diagram

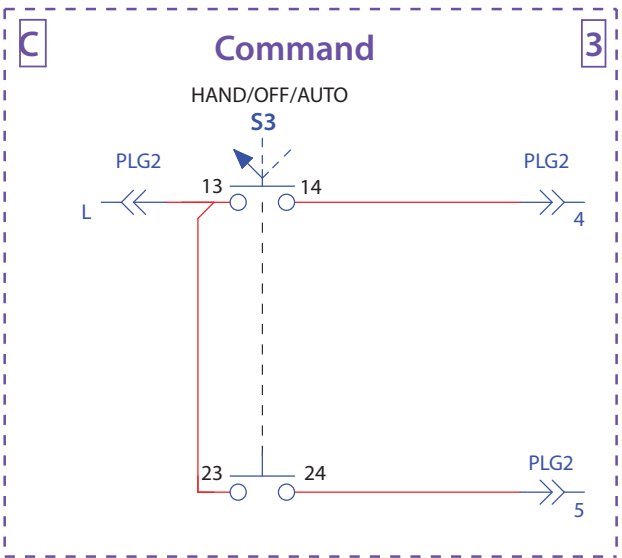

Figure 18 - Hand-OFF-Auto and Start-Stop Command Kit Wiring Diagram

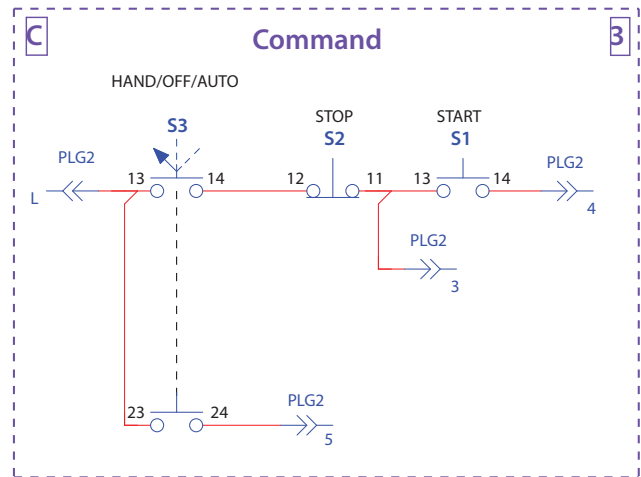

Figure 19 - Soft Stop Auxiliary Command Kit Wiring Diagram

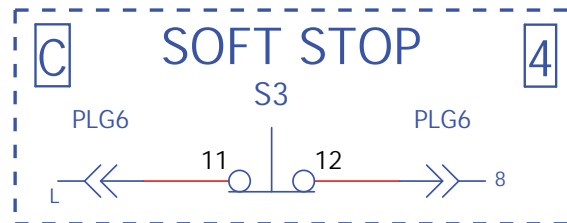

Figure 20 - Pump Stop Auxiliary Command Kit Wiring Diagram

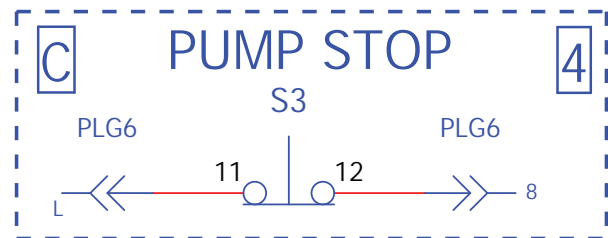

Figure 21 - Brake Auxiliary Command Kit Wiring Diagram

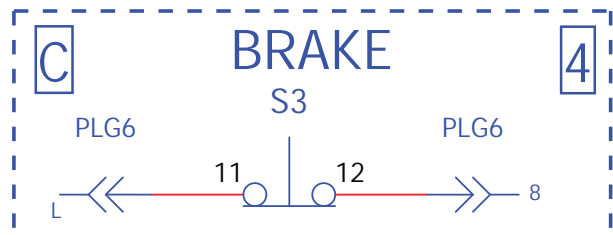

Figure 22 - E-Stop Kit Wiring Diagram

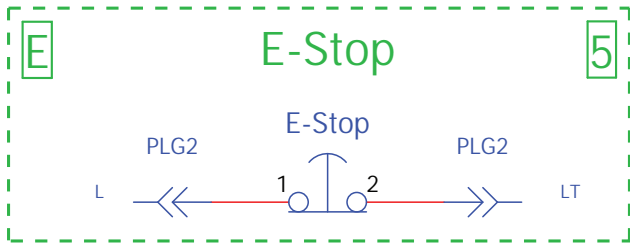

Figure 23 - Indication Kit Wiring Diagram

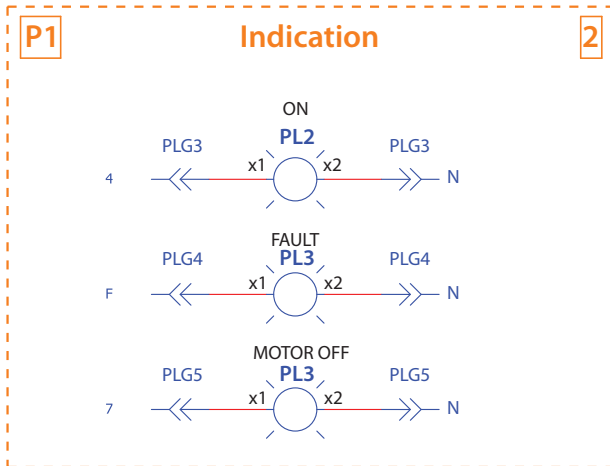
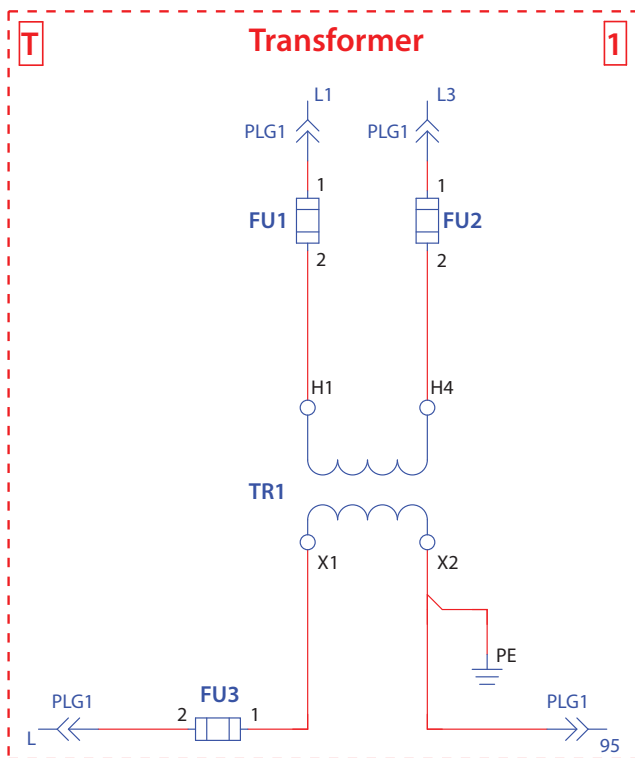

Figure 24 - Transformer Kit Wiring Diagram



Specifications

For complete specifications of your SMC Flex controller, see SMC-3, SMC Flex, and SMC-50 Technical Data, publication [150-TD009](#).

Table 30 - Standards Compliance and Certifications⁽¹⁾

Standards Compliance—Open Controllers	Certifications—Open Controllers	Standards Compliance—Enclosed Controllers	Certifications—Enclosed Controllers
UL 508	cULus Listed (Open Type) (File No. E96956, Guides NMFT, NMFT7)	UL 508A	cULus Listed
CSA C22.2 No.14	CSA Certified (File No. LR 1234)		
EN/IEC 60947-1	CE Marked		
EN/IEC 60947-4-2	CCC Certified		

(1) For complete certification information, see our product certifications website: website.rockwellautomation.com/certifications.

Short-circuit Current Ratings

Determining the short circuit current ratings (SCCR) of a complex system can be very challenging, especially if proper considerations are not made during the initial stages of the component selection process.

The SCCR information in this section provides coordinated high-fault branch circuit for enclosed soft starters and is based on compliance to IEC and UL standards. For comprehensive SCCR information, please consult the Rockwell Automation Global SCCR tool, rockwellautomation.com/sccr.



Ratings provided are for standard options only; does not include bypass or isolation contactor configurations.

Table 31 - Non-combination Enclosed Soft Starters with SMC Flex Controllers

Controller Rating [A]	SCCR		
	Max SCCR [kA rms symmetrical]	Max Voltage [V]	Max Fuse or Circuit Breaker
5	70	600	10 A Class J fuse
	5		20 A fuse or circuit breaker
25	70	600	50 A Class J fuse
	5		100 A fuse or circuit breaker
43	70	600	90 A Class J fuse
	10		150 A fuse or circuit breaker
60	70	600	125 A Class J fuse
	10		225 A fuse or circuit breaker
85	70	600	175 A Class J fuse
	10		300 A fuse or circuit breaker
108	70	600	200 A Class J fuse
	10		400 A fuse
	10		300 A circuit breaker
135	70	600	250 A Class J fuse
	10		500 A fuse
	10		400 A circuit breaker
201	70	600	350 A Class J fuse
	18		600 A fuse or circuit breaker
251	70	600	400 A Class J fuse
	18		700 A fuse or circuit breaker

Table 31 - Non-combination Enclosed Soft Starters with SMC Flex Controllers (Continued)

Controller Rating [A]	SCCR		
	Max SCCR [kA rms symmetrical]	Max Voltage [V]	Max Fuse or Circuit Breaker
317	69	600	500 A Class J fuse
	30		800 A fuse or circuit breaker
351	69	600	600 A Class J fuse
	30		1000 A fuse or circuit breaker
480	69	600	800 A Class L fuse
	30		1200 A fuse or circuit breaker
625	74	600	1600 A Class L fuse
	42		1600 A fuse or circuit breaker
780	74	600	1600 A Class L fuse
	42		1600 A fuse
	42		2000 A circuit breaker

Table 32 - Combination Enclosed Soft Starters with SMC Flex Controllers and Circuit Breakers

Controller Rating [A]	SCCR	
	Max SCCR [kA rms symmetrical]	Max Voltage [V]
5...25	5	600
43...135	10	
201...251	18	
317...361	30	
480	42	
625...780	42	

Table 33 - Combination Enclosed Soft Starters with SMC Flex Controllers and Fusible Disconnect Switch

Controller Rating [A]	SCCR		
	Max SCCR [kA rms symmetrical]	Max Voltage [V]	Max Fuse
5	70	600	10 A Class J fuse
	5		20 A Class J fuse
25	70	600	50 A Class J fuse
	5		100 A Class J fuse
43	70	600	90 A Class J fuse
	10		150 A Class J fuse
60	70	600	125 A Class J fuse
	10		225 A Class J fuse
85	70	600	175 A Class J fuse
	10		300 A Class J fuse
108	70	600	200 A Class J fuse
	10		400 A Class J fuse
135	70	600	225 A Class J fuse
	10		500 A Class J fuse
201	70	600	350 A Class J fuse
	18		600 A Class J fuse
251	70	600	400 A Class J fuse
	18		700 A Class J fuse
317	69	600	500 A Class J fuse
	30		800 A fuse
361	69	600	600 A Class J fuse
	30		1000 A fuse
480	69	600	600 A Class L fuse
	42		1200 A fuse
625	74	600	1600 A Class L fuse
	42		1600 A fuse
780	74	600	1600 A Class L fuse
	42		1600 A fuse

Approximate Dimensions

Examples given in this section include standard options. Use ProposalWorks to obtain dimensions for Smart Motor Controllers with all available options. ProposalWorks software is available from rok.auto/systemtools.

Dimensions are in inches (millimeters) unless otherwise noted. Dimensions are not to be used for manufacturing purposes.

Figure 25 - Enclosure for SMC Controllers—1400 mm x 400 mm x 500 mm

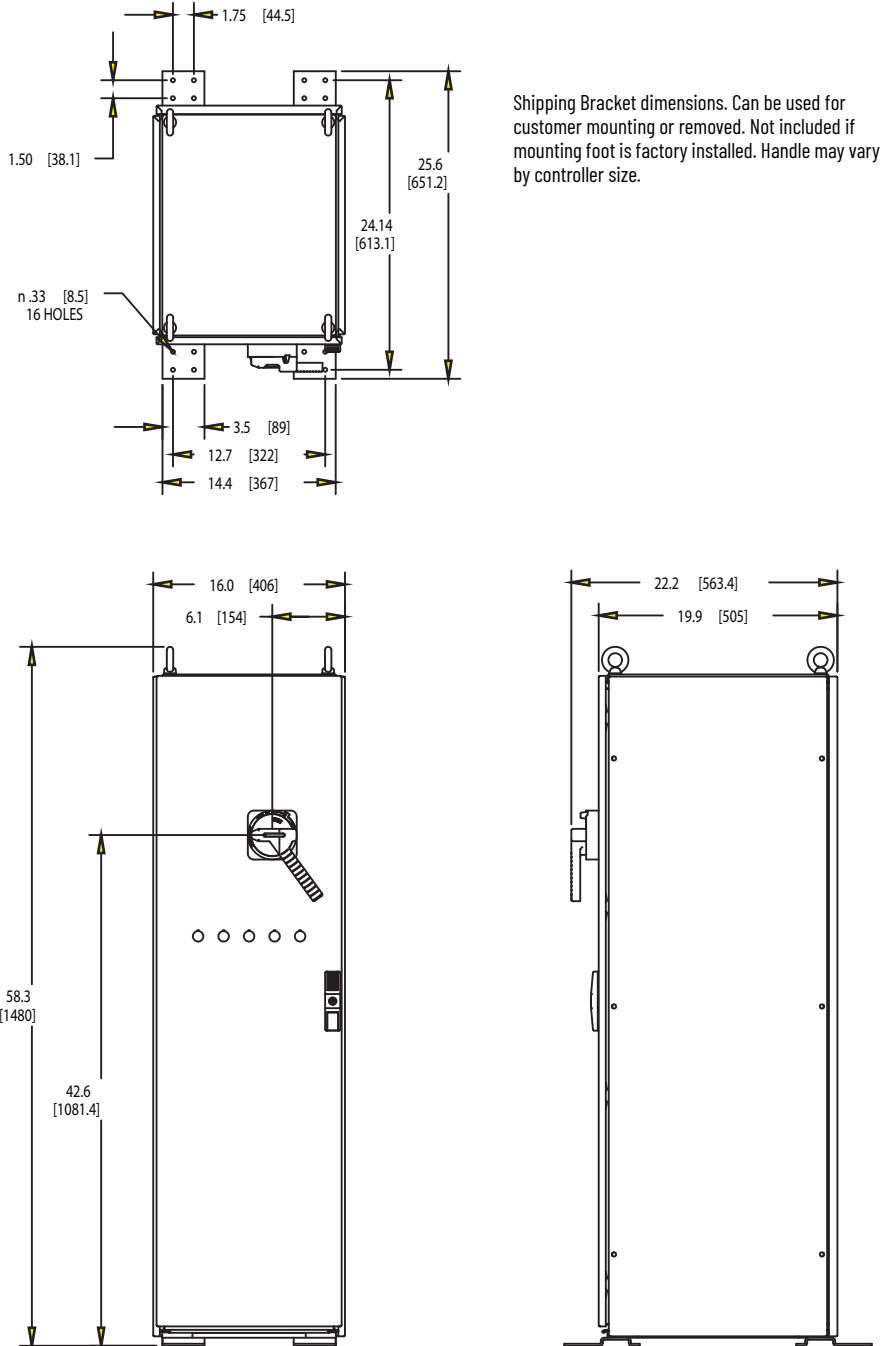

Figure 26 - Enclosure for SMC Controllers—1400 mm x 600 mm x 500 mm

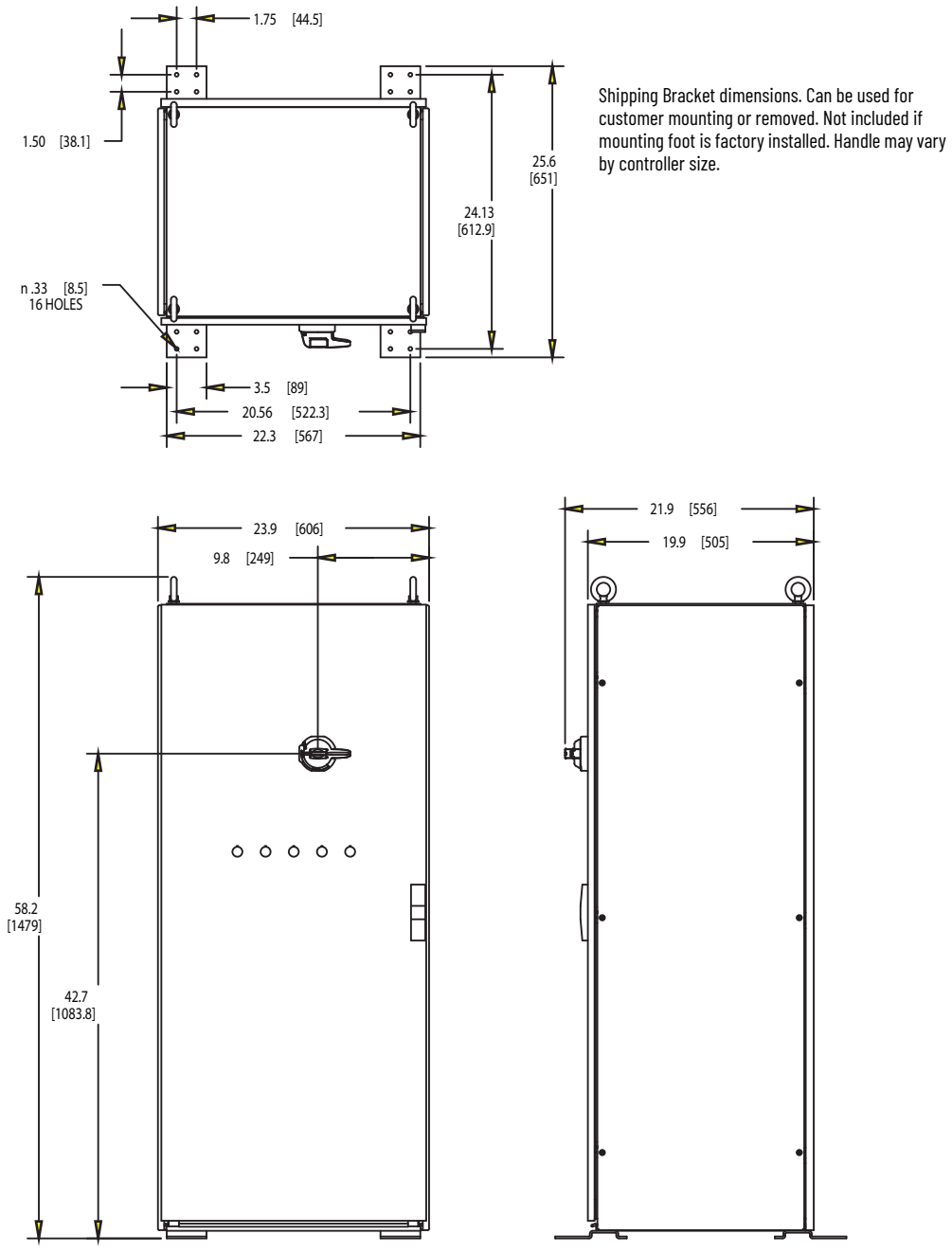
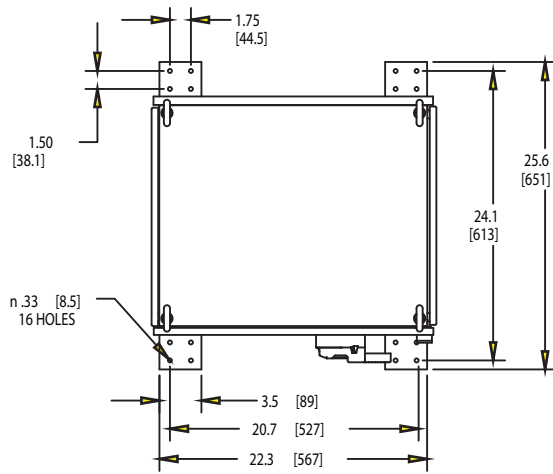

Figure 27 - Enclosure for SMC Controllers—2000 mm x 600 mm x 500 mm



Shipping Bracket dimensions. Can be used for customer mounting or removed. Not included if mounting foot is factory installed. Handle may vary by controller size.

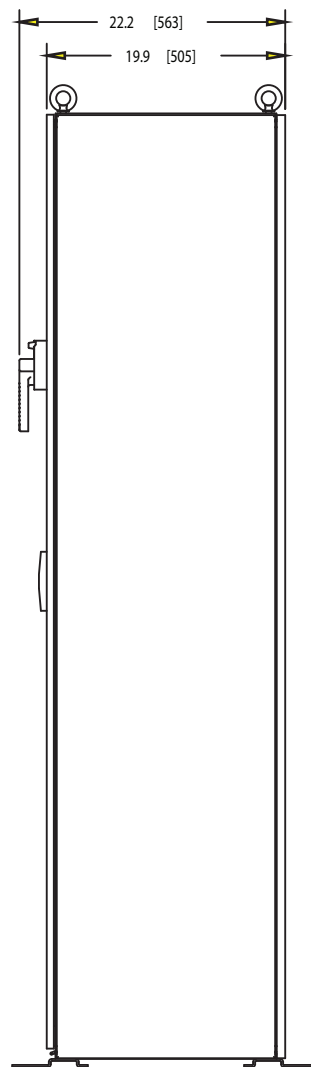
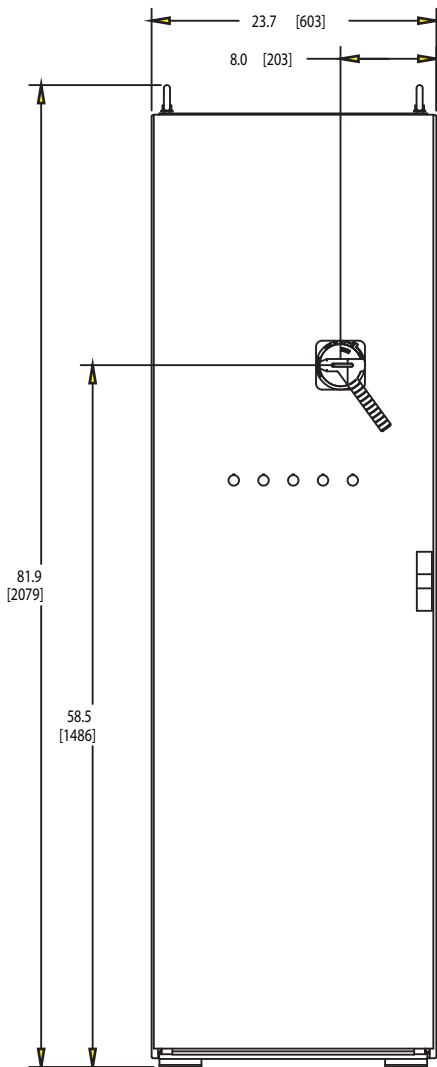
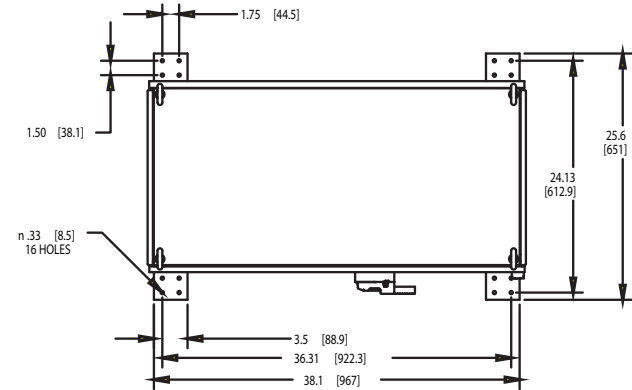

Figure 28 - Enclosure for SMC Controllers—2000 mm x 1000 mm x 500 mm



Shipping Bracket dimensions. Can be used for customer mounting or removed. Not included if mounting foot is factory installed. Handle may vary by controller size.

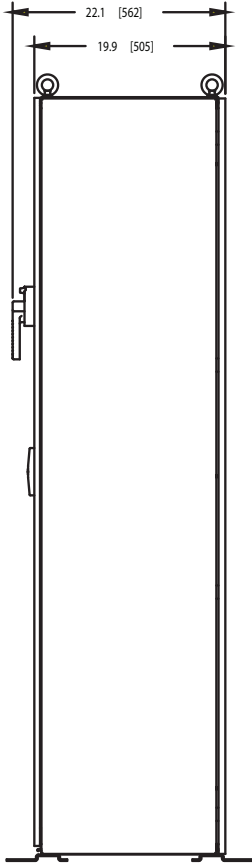
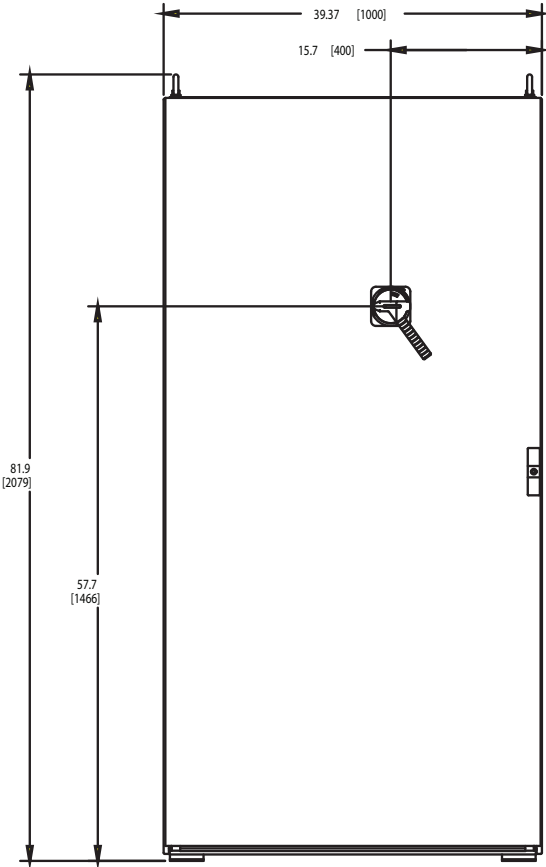
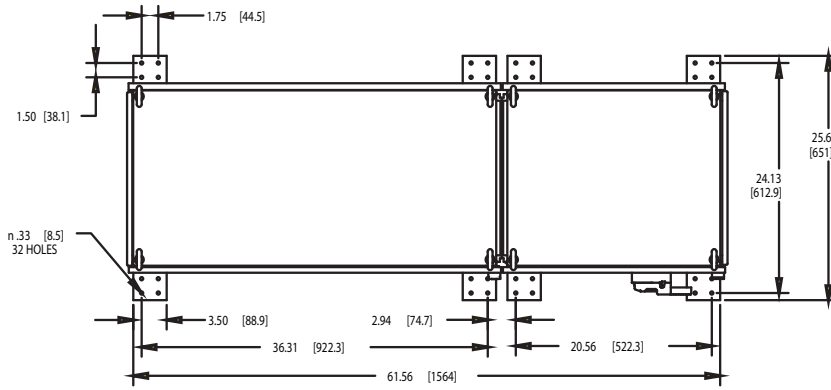

Figure 29 - Enclosure for SMC Controllers—2000 mm x 1600 mm x 500 mm



Shipping Bracket dimensions. Can be used for customer mounting or removed. Not included if mounting foot is factory installed. Handle may vary by controller size.

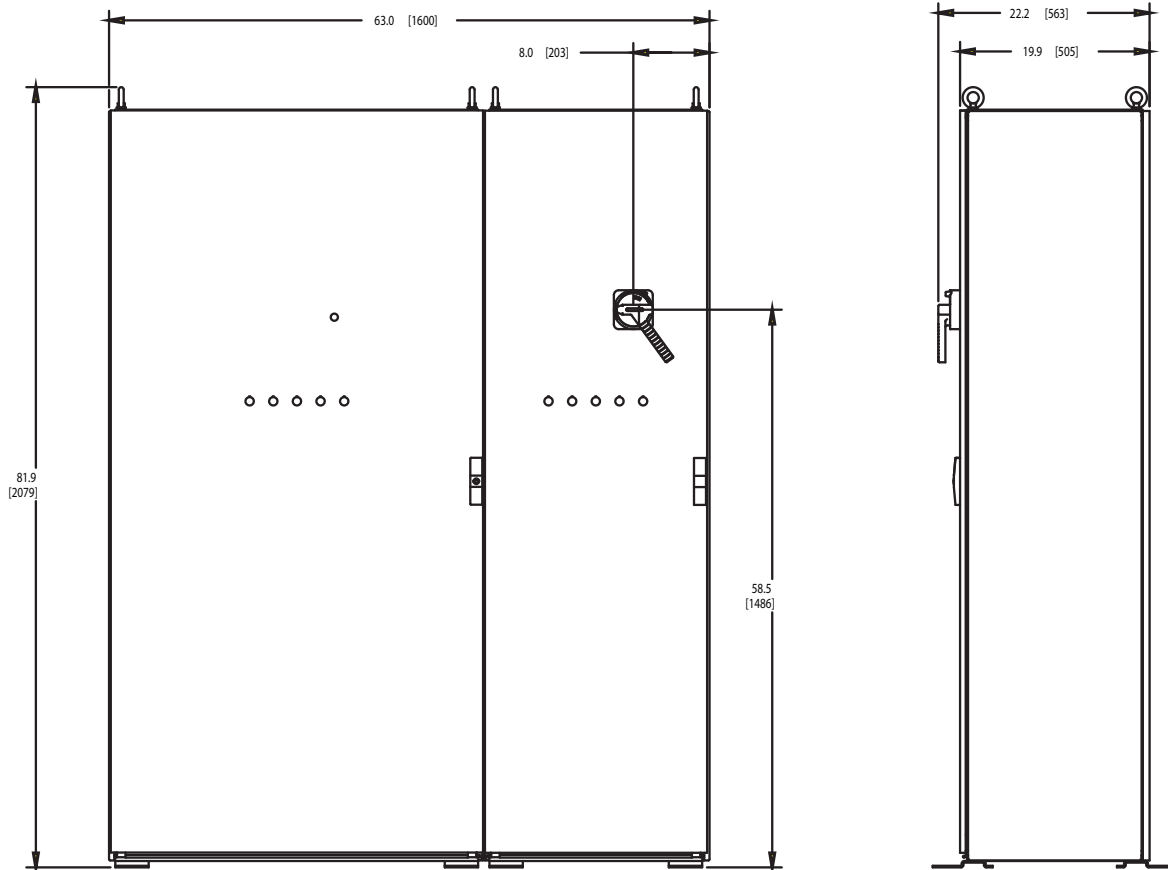

Table 34 - SMC Flex Controller Enclosure Dimensions

Non-combination Controllers		Combination Controllers				
		With Fusible Disconnect Switch		With Circuit Breaker		
Cat. No.	Dimensions (H x W x D)	Cat. No.	Dimensions (H x W x D)	Cat. No.	Dimensions (H x W x D)	
150F-D10J...	1400 x 400 x 500 (55.1 x 15.7 x 19.7) see Figure 25	152F-D10J...	1400 x 400 x 500 (55.1 x 15.7 x 19.7) see Figure 25	153F-D10J...	1400 x 400 x 500 (55.1 x 15.7 x 19.7) see Figure 25	
150F-D13J...		152F-D13J...		153F-D13J...		
150F-D20J...		152F-D20J...	153F-D20J...			
150F-D25J...		152F-D25J...	153F-D25J...			
150F-D31J...		152F-D31J...	2000 x 600 x 500 (78.7 x 23.6 x 19.7) see Figure 27	153F-D31J...		2000 x 600 x 500 (78.7 x 23.6 x 19.7) see Figure 27
150F-D36J...		152F-D36J...	153F-D36J...			
150F-D48J...		152F-D48J...	153F-D48J...			
150F-D62J...	2000 x 1000 x 500 (78.7 x 39.4 x 19.7) see Figure 28	152F-D62J...	2000 x 1600 x 500 (78.7 x 63 x 19.7) see Figure 29	153F-D62J...	2000 x 1600 x 500 (78.7 x 63 x 19.7) see Figure 29	
150F-D78J...		152F-D78J...		153F-D78J...		

 Wall-mounted controllers do not include Snap-together wiring

Figure 30 - Wall-mounted Enclosure Dimensions

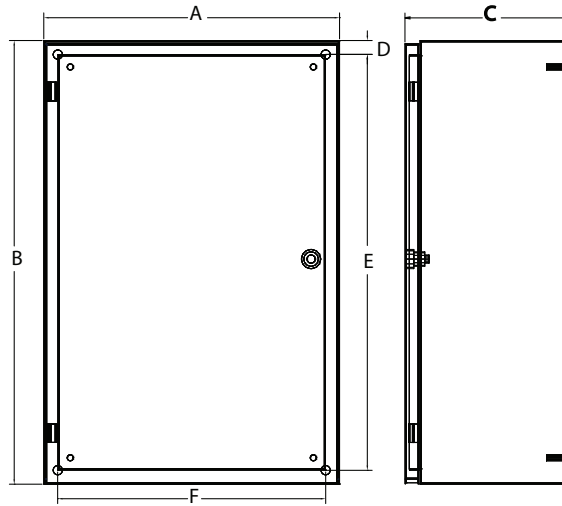

Table 35 - Wall-mounted Enclosed SMC Flex Controllers

Controller Rating [A]	Bulletin	With Option	Dimensions in inches (mm)					
			A (Width)	B (Height)	C (Depth)	D (Mtg. Dim.)	E (Mtg. Dim.)	F (Mtg. Dim.)
Non-combination Controller								
5...43	150	—	16 (406)	24 (610)	10 (254)	0.75 (19)	22.5 (572)	14.5 (368)
		6 ⁽¹⁾	16 (406)	24 (610)	10 (254)		22.5 (572)	14.5 (368)
		BP	24 (610)	30 (762)	12 (305)		28.5 (724)	22.5 (572)
	150, 150B	NB, NI	24 (610)	30 (762)	12 (305)		28.5 (724)	22.5 (572)
	150	NB, 6P ⁽²⁾	30 (762)	38 (965)	14 (356)		36.5 (927)	28.5 (724)
60	150	—	16 (406)	24 (610)	10 (254)	0.75 (19)	22.5 (572)	14.5 (368)
	150B	—	24 (610)	30 (762)	12 (305)		28.5 (724)	22.5 (572)
		BP	24 (610)	30 (762)	12 (305)		28.5 (724)	22.5 (572)
	150	6 ₋	24 (610)	30 (762)	12 (305)		28.5 (724)	22.5 (572)
		NB	24 (610)	30 (762)	12 (305)		28.5 (724)	22.5 (572)
	150, 150B	NI	30 (762)	38 (965)	14 (356)		36.5 (927)	28.5 (724)
85	150	—	16 (406)	24 (610)	10 (254)	0.75 (19)	22.5 (572)	14.5 (368)
	150B	—	24 (610)	30 (762)	12 (305)		28.5 (724)	22.5 (572)
		BP	24 (610)	30 (762)	12 (305)		28.5 (724)	22.5 (572)
	150	NB	24 (610)	30 (762)	12 (305)		28.5 (724)	22.5 (572)
		6 ⁽²⁾	24 (610)	30 (762)	12 (305)		28.5 (724)	22.5 (572)
	150, 150B	NB, NI, 6P ⁽²⁾	30 (762)	38 (965)	14 (356)		36.5 (927)	28.5 (724)
Combination Controller								
5...25	152H, 152B, 153H, 153B	—	16 (406)	24 (610)	10 (254)	0.75 (19)	22.5 (572)	14.5 (368)
		BP, NB, NI, 6 ₋	24 (610)	30 (762)	12 (305)		28.5 (724)	22.5 (572)
43	152H, 152B, 153H, 153B	—	16 (406)	24 (610)	10 (254)	0.75 (19)	22.5 (572)	14.5 (368)
		BP, 6 ₋	24 (610)	30 (762)	12 (305)		28.5 (724)	22.5 (572)
		NI, NB	30 (762)	38 (965)	14 (356)		36.5 (927)	28.5 (724)
60	153H, 153B	—	16 (406)	24 (610)	10 (254)	0.75 (19)	22.5 (572)	14.5 (368)
	152H, 153H, 153B	6 ₋	24 (610)	30 (762)	12 (305)		28.5 (724)	22.5 (572)
	152H, 152B	—	24 (610)	30 (762)	12 (305)		28.5 (724)	22.5 (572)
	152H, 152B, 153H, 153B	NI, NB	30 (762)	38 (965)	14 (356)		36.5 (927)	28.5 (724)
85	153H, 153B	—	16 (406)	24 (610)	10 (254)	0.75 (19)	22.5 (572)	14.5 (368)
	152H, 152B	—	24 (610)	30 (762)	12 (305)		28.5 (724)	22.5 (572)
	152H, 153H, 153B	6 ₋	24 (610)	30 (762)	12 (305)		28.5 (724)	22.5 (572)
	153H	BP	24 (610)	30 (762)	12 (305)		28.5 (724)	22.5 (572)
		BP, 6 ₋	30 (762)	38 (965)	14 (356)		36.5 (927)	28.5 (724)
	152H, 152B, 153B	BP, NB, NI	30 (762)	38 (965)	14 (356)		36.5 (927)	28.5 (724)

(1) Extra capacity transformer may require a larger enclosure; consult your local Rockwell Automation sales office or Allen-Bradley distributor.

(2) 1 kVA control transformers or larger extra capacity transformers may require a larger enclosure; consult your local Rockwell Automation sales office or Allen-Bradley distributor.

Catalog Number Explanation

Examples that are given in this section are not intended to be used for product selection. Not all combinations generate a valid catalog number. Use ProposalWorks™ software to configure the SMC Flex controller. ProposalWorks software is available from rok.auto/systemtools.

Controllers Rated 90...1250 A



Use the SMC Estimation Wizard and SMC Thermal Estimation Wizard to confirm that the SMC controller selection meets the application requirements. See SMC-3, SMC Flex, and SMC-50 Technical Data, publication [150-TD009](#) for more information.

152S - **D10** **J** **B** **D** - **J20** - **3**
 a b c d e f g

a	
Bulletin Number	
Code	Description
150S	SMC-50 Non-combination
152S	SMC-50 Combination with fusible disconnect switch
153S	SMC-50 Combination with circuit breaker

b			
Controller Rating [A]			
Solid-state		External Bypass	
Code	Description	Code	Description
C90	90	D10	108
D11	110	D13	135
D14	140	D20	201
D18	180	D25	251
D21	210	D31	317
D26	260	D36	361
D32	320	D48	480
D36	361		
D42	420		
D52	520		

c	
Enclosure Type	
Code	Description
J	1/12/3R (3R)

d	
Input Line Voltage	
Code	Description
H	200...208V AC, 3-Phase, 50/60 Hz
A	230V AC, 3-Phase, 50/60 Hz
B	400...460V AC, 3-Phase, 50/60 Hz
C	500...575V AC, 3-Phase, 50/60 Hz

e	
Control Voltage	
Code	Description
D	120V AC
J	24V AC
A	240V AC
EJ	24V DC

f			
Fuse Clip/Circuit Breaker (CB)—Combination Controllers Only			
Code	Description	Code	Description
J20	200 A, Class J	D12	125 A, CB
J40	400 A, Class J	D17	175 A, CB
J60	600 A, Class J	D25	250 A, CB
L80	800 A, Class L	D40	400 A, CB
L12	1200 A, Class L	D60	600 A, CB
L16	1600 A, Class L	D80	800 A, CB
D16	160 A, DIN	E12	1200 A, CB
D25	250 A, DIN		
D40	400 A, DIN		
D63	630 A, DIN		
D80	800 A, DIN		
N12	1250 A, DIN		

g
Options
See page 44

g					
Options					
Code	Description	Code	Description	Code	Description
1	Start-Stop push button	8L	Line-mounted protective module ⁽³⁾	TB10	10 Spare terminal blocks
1E	On-Off push button	8M	Load-mounted protective module ⁽³⁾	TB20	20 Spare terminal blocks
3	Hand-Off-Auto selector switch	8B	Line- and load-mounted protective modules	P10	100 mm mounting foot, sheet metal
3E	On-Off selector switch	BP	IEC Bypass starter	P20	200 mm mounting foot, sheet metal
3H	Hand-Auto selector switch	NB	NEMA Bypass starter	F10	100 mm mounting foot, high-strength plastic
3B	SMC-Off-Bypass selector switch	IC	IEC Isolation contactor	F20	200 mm mounting foot, high-strength plastic
13	Start-Stop push button and Hand-Off-Auto selector switch	NI	NEMA Isolation contactor	416	Plug-in control relay, 2-pole
4_ _ _ (1)	Pilot lights	989	1 N.O/1 N.C Auxiliary contact on circuit breaker or fusible disconnect switch	417	Plug-in control relay, On Delay
5_ _ _ (1)	Push-to-test pilot lights	HC6	SMC-50 Human Interface Module- Door mounted type 4/12	418	Plug-in control relay, Off Delay
1XA	Soft Stop push button	20S	Communication: RS-485	425	Hour Meter
1XB	Pump Stop push button	20D	Communication: DeviceNet	428	Ammeter
1XC	Slow Speed push button	20E	Communication: Ethernet/IP	429	Ground fault relay
1XD	Brake push button	20C	Communication: Control Net	430	Undervoltage relay
6P	Control circuit transformer	20P	Communication: ProfiBUS	22	Control circuit fusing
6XP	1-Factor Additional VA ⁽²⁾	PC	Pump Control	OPS	Bul. 509 NEMA Size 1 starter and Bul. 592 solid-state overload
6YP	2-Factor Additional VA ⁽²⁾	BC	Braking Control		

- (1) Pilot Lights require configuration. See [page 44](#)
- (2) VA values depend on the size of the controller.
- (3) Load-side MOVs are not available with Pump and Braking options, or on delta-connected motors.

Pilot Light Configuration



The final character in the configuration string cannot be "X".

4
a
R
b
G
c
X
d
W
e

a	
Option	
Code	Description
4	Pilot Light
5	Push-to-test Pilot Light

b	
ON Indication	
Code	Description
R	Red
G	Green
X	none

c	
OFF Indication	
Code	Description
R	Red
G	Green
X	none

d	
Fault Indication	
Code	Description
A	Amber
X	none

e	
Power ON Indication	
Code	Description
W	White

Product Selection



You can configure enclosed soft starters by selecting a power center, snap-together kits, transformers, and/or any applicable controller accessories.

Table 36 - Power Centers for SMC-50 Controllers with External Bypass

Motor Current [A]	Rated Hp [Hp]				Non-combination Starters Cat. No.	Combination Starters Cat. No.	
	200...208V	230V	400...460V	500...575V		with Fusible Disconnect Switch	with Circuit Breaker
90	25	30	60	75	150S-C90JCD-3B-BP	152S-C90JCD-J20-3B-BP	153S-C90JCD-D12-3B-BP
110	30	40	75	100	150S-D11JCD-3B-BP	152S-D11JCD-J20-3B-BP	153S-D11JCD-D17-3B-BP
140	40	50	100	125	150S-D14JCD-3B-BP	152S-D14JCD-J20-3B-BP	153S-D14JCD-D25-3B-BP
180	60	60	150	150	150S-D18JCD-3B-BP	152S-D18JCD-J40-3B-BP	153S-D18JCD-D25-3B-BP
210	60	75	150	150	150S-D21JCD-3B-BP	152S-D21JCD-J40-3B-BP	153S-D21JCD-D25-3B-BP
260	75	100	200	250	150S-D26JCD-3B-BP	152S-D26JCD-J40-3B-BP	153S-D26JCD-D40-3B-BP
320	100	125	250	300	150S-D32JCD-3B-BP	152S-D32JCD-J60-3B-BP	153S-D32JCD-D40-3B-BP
361	125	150	300	350	150S-D36JCD-3B-BP	152S-D36JCD-J60-3B-BP	153S-D36JCD-D80-3B-BP
420	150	150	350	400	150S-D42JCD-3B-BP	152S-D42JCD-J60-3B-BP	153S-D42JCD-D80-3B-BP
520	150	200	450	500	150S-D52JCD-3B-BP	152S-D52JCD-L80-3B-BP	153S-D52JCD-D80-3B-BP

Table 37 - Power Centers for SMC-50 Controllers with Internal Bypass

Motor Current [A]	Rated Hp [Hp]				Non-combination Starters Cat. No.	Combination Starters Cat. No.	
	200...208V	230V	400...460V	500...575V		with Fusible Disconnect Switch	with Circuit Breaker
108	30	40	75	100	150S-D10JCD	152S-D10JCD-J20	153S-D10JCD-D17
135	40	50	100	125	150S-D13JCD	152S-D13JCD-J20	153S-D13JCD-D25
201	60	75	150	150	150S-D20JCD	152S-D20JCD-J40	153S-D20JCD-D25
251	75	100	200	200	150S-D25JCD	152S-D25JCD-J40	153S-D25JCD-D40
317	100	125	250	300	150S-D31JCD	152S-D31JCD-J60	153S-D31JCD-D40
361	125	150	300	350	150S-D36JCD	152S-D36JCD-J60	153S-D36JCD-D80
480	150	200	400	500	150S-D48JCD	152S-D48JCD-L80	153S-D48JCD-D80

Table 38 - Transformers⁽¹⁾

	Controller Current [A]	Capacity	VA	208V x 120V Cat. No.	240V x 120V Cat. No.	460V x 120V Cat. No.	575V x 120V Cat. No.
	90, 110, 140, 180, 210, 260, 320	Standard	350	1497-HD350	1497-AD350	1497-BD350	1497-CD350
		Extra Capacity	500	1497-HD500	1497-AD500	1497-BD500	1497-CD500
	361, 420, 520	Standard	500	1497-HD500	1497-AD500	1497-BD500	1497-CD500

(1) All transformers include grounding wires and fuse covers.

Snap-together Pilot Device Wiring



This option applies only to controllers with current ratings greater than 90 A.

Component wiring is color coded by function. The wiring sleeve color corresponds to a colored label on the terminal block. Keyed connectors snap these components into the terminal block. This greatly reduced assembly time is ideal for the quick installation of pilot devices and control circuit transformers, and significantly reduces wiring errors. [Figure 31](#) shows an example of this feature.

Figure 31 - Snap-together Wiring Example

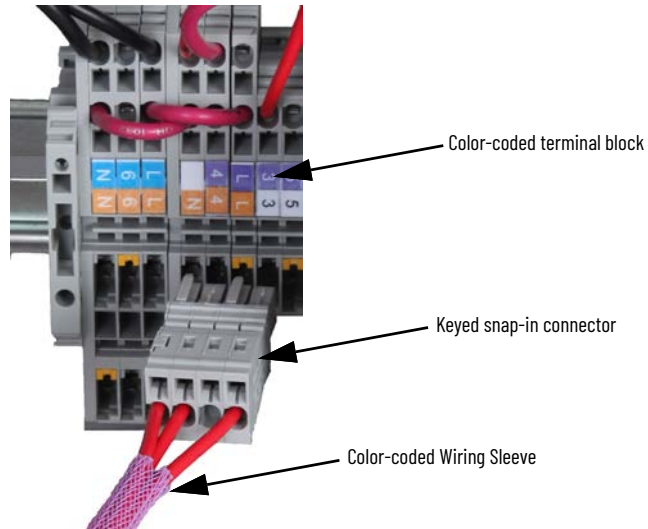

Figure 32 - SMC-50 Controller with External Bypass Snap-together Wiring

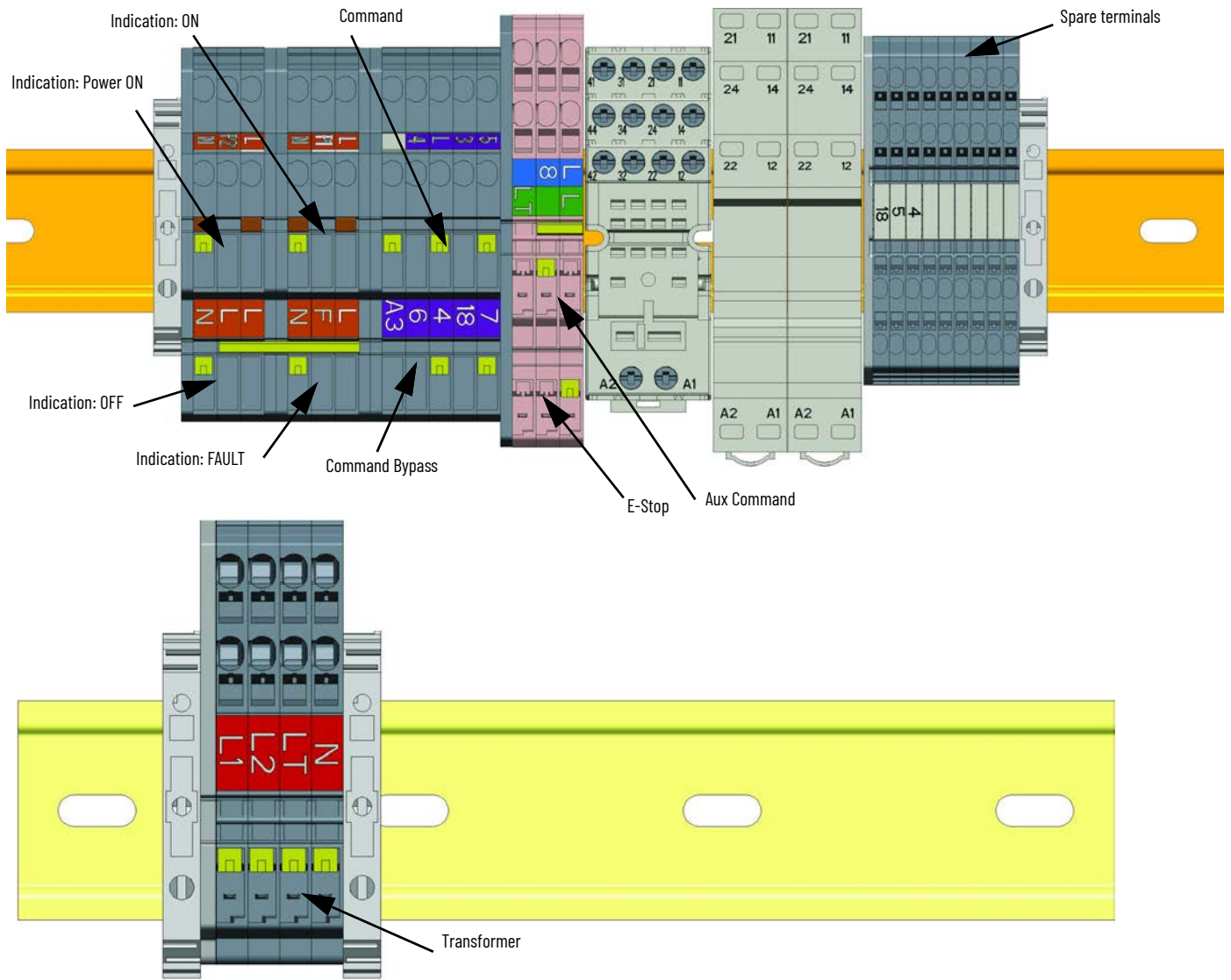

Figure 33 - SMC-50 Controller with Internal Bypass Snap-together Wiring

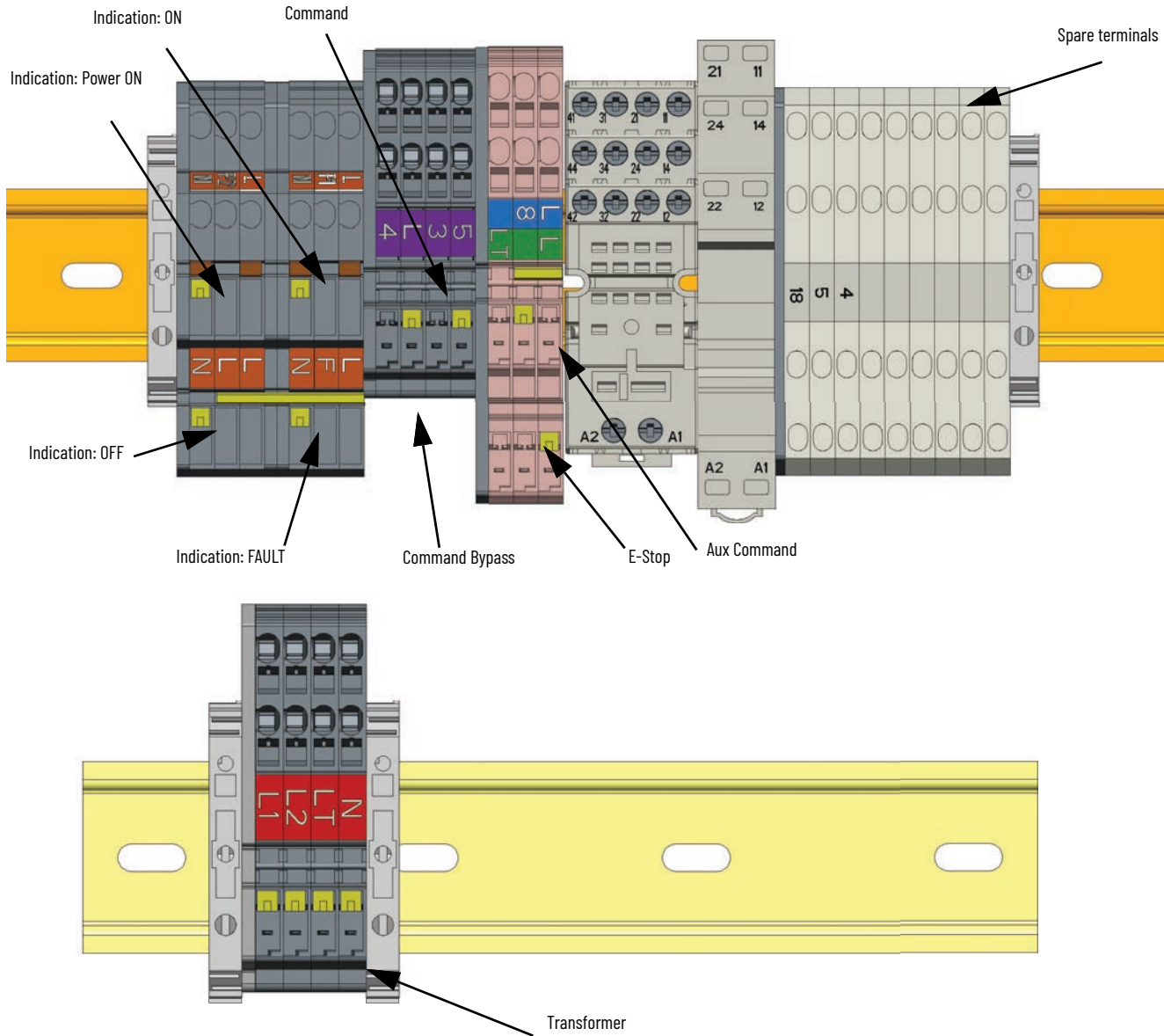

Table 39 - Snap-together Pilot Device Wiring Kits











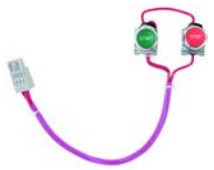

	Description	Operator Size	Cat. No.	
	Snap-together push button Kit • Metal Bezel	Start-Stop	22.5 mm	198-SSPBM
	Snap-together selector switch Kit • Metal Bezel	3-Position Hand-Off-Auto	22.5 mm	198-3SSM
		2-Position On-Off or Hand-Auto	22.5 mm	198-2SSM

Table 39 - Snap-together Pilot Device Wiring Kits (Continued)

	Description	Operator Size	Cat. No.
	Selector switch and push button Combination Kits • Metal Bezel	3-Position Hand-Off-Auto and Start-Stop push button	22.5 mm 198-3SSPBM
		2-Position On-Off or Hand-Auto and Start-Stop push button	22.5 mm 198-2SSPBM
	Universal LED Pilot Light Snap-together Kit	Red	22.5 mm 198-RUPL
		Green	22.5 mm 198-GUPL
		White or Amber	22.5 mm 198-WUPL
	Universal LED Push-to-test Pilot Light Snap-together Kit	Red	22.5 mm 198-RUPPLM
		Green	22.5 mm 198-GUPPLM
		White or Amber	22.5 mm 198-WUPPLM
	Stop push button Snap-together Kit	N.C., Momentary	22.5 mm 198-PBM
	Emergency Stop Snap-together Kit		22.5 mm 198-ESP

Accessories

Table 40 - Protective Modules

Description	Current Rating [A]	Pkg. Qty.	Cat. No.
	480V Protective Module	1	150-F84L
	600V Protective Module	1	150-F86L



Use of protective modules is highly recommended. For applications that require both line and load side protection, you must order two protective modules.

IMPORTANT Do not place protective modules on the load side of a device when using an inside-the-delta connection.

Table 41 - IEC Line- or Load-side Terminal Covers

Description ⁽¹⁾	Current Range [A]	Pkg. Quantity	Cat. No.
 <ul style="list-style-type: none"> • Dead front protection • IP2X finger safe when used with 250 MCM cable 	108...135	1	150-TC1



(1) 5...85 A units have terminal guards as standard. No additional terminal guards are required.

Table 42 - Terminal Lug Kits

	Current Range [A] ⁽¹⁾	Wire Size Range	Total No. of Terminal Lugs Possible Each Side		Pkg. Qty.	Cat. No.
			Line Side	Load Side		
	90...180	(2) 1/0...250 MCM AWG 50 mm ² ...120 mm ²	3	3	3	1494R-N14
	108...135	#6...250 MCM AWG 16...120 mm ²	3	3	3	199-LF1
	201...251		6	6	3	
	317...480	#4...500 MCM AWG 25...240 mm ²	6	6	3	199-LG1

(1) 5...85 A units have box lugs standard. No additional lugs are required.





Table 43 - Converter Modules

Description	For Use With	Rated Current [A]	Cat. No.
	Used with a Cat. No. 150-SM2 to provide current feedback to the SMC-50 controller when in external bypass configuration. ⁽¹⁾	30...180	825-MCM180
		181...520	825-MCM20
Connection Cable (replacement) • Cat. No. 150-SM2 to Bul. 825-MCM connection	All	—	825-MCA
	Used with a Cat. No. 150-SM2 to provide ground current feedback. ⁽²⁾	Turns Ratio: 100:1	825-CBCT

(1) Requires user-supplied current transformers with 5 A secondary.

(2) The ground fault sensing feature of the SMC-50 controller is intended for monitoring purposes only. It is not to be used as a ground fault circuit interrupter for personnel protection as defined by Article 100 of the NEC. The sensing feature has not been evaluated to UL 1053.

Table 44 - Option Modules

Description		Compatible Control Module Ports	Maximum No. of Option Modules of this Type Per Controller	Cat. No.	
	Option Module • Adds or expands the functionality of the SMC-50 control module	PTC, Ground Fault, and Current Feedback Option Module	7 and 8	1	150-SM2
		Analog I/O Option Module • 2 analog inputs (voltage or current) • 2 analog outputs (voltage or current)	7, 8, 9	3	150-SM3
		Digital I/O Option Module • 4 100...240V AC inputs • 3 relay outputs	7, 8, 9	3	150-SM4
		Parameter Configuration Module • DIP and rotary dial	7, 8, 9	1	150-SM6



If the application requires network communication, a Cat. No. 20-COMM-X communication adapter must be inserted in expansion port 9.

Table 45 - Bypass Starter Kits





Description		Controller Rating [A]	Components	Cat. No.
 <p>100-E116 contactor</p>  <p>Bul. 1411 current transformer</p>  <p>E100 overload relay</p>	Bypass Starter Kit • Consists of: - Bulletin 193 E100™ electronic overload relay - Bulletin 100-E IEC contactor (includes 1 N.O. and 1 N.C. auxiliary contact) - Bulletin 1411 current transformer	3, 5, 9, 16	Contactor	100-C16D10
			Overload relay	193-1EEDB
		25, 37, 43	Contactor	100-C43D10
			Overload relay	193-1EEFD
		60	Contactor	100-C60D10
			Overload relay	193-1EEGE
		90, 108, 110, 135, 140, 180	Contactor	100-E190KD11
			Overload relay	193-1EFJZ
			Current transformer (qty. 3 needed)	1411-2SFT-201
		201, 210, 251, 260	Contactor	100-E370KD11
			Overload relay	193-1EFJZ
			Current transformer (qty. 3 needed)	1411-AL-401
317, 320, 361	Contactor	100-E370KD11		
	Overload relay	193-1EFJZ		
	Current transformer (qty. 3 needed)	1411-AL-401		
420, 520	Contactor	100-E580ED11		
	Overload relay	193-1EFMZ		
	Current transformer (qty. 3 needed)	25645-006-08		

Table 46 - Human Interface Modules (HIMs) and Communication Modules

Description			Cat. No.
	SMC-50 Controller – bezel mounted	Enhanced, LCD display, full numeric keypad	20-HIM-A6
	Door-mounted HIM	Remote (panel mount) LCD display, full numeric keypad (version of Cat. No. 20-HIM-A6)	20-HIM-C6S ⁽¹⁾
	HIM interface cables	HIM interface cable, 1 m (39 in)	20-HIM-H10 ⁽²⁾
		Cable kit (plug-socket) 0.33 m (1.1 ft)	1202-H03
		Cable kit (plug-socket) 1 m (3.3 ft)	1202-H10
		Cable kit (plug-socket) 3 m (9.8 ft)	1202-H30
		Cable kit (plug-socket) 9 m (29.5 ft)	1202-H90
		DPI/SCANport™ one- to two-port splitter cable	1203-S03
 <p>Communication modules</p> <ul style="list-style-type: none"> for use with non-combination controllers installed into the physical space assigned to control module expansion port 9 connected to DPI port 4 via cable 	RS-485 DFI Communication Adapter	20-COMM-S	
	PROFIBUS DP Communication Adapter	20-COMM-P	
	ControlNet® Communication Adapter (Coax)	20-COMM-C	
	Interbus Communication Adapter	20-COMM-I	
	Modbus/TCP Communication Adapter	20-COMM-M	
	DeviceNet® Communication Adapter	20-COMM-D	
	EtherNet/IP™ Communication Adapter	20-COMM-E	
	Dual-port EtherNet/IP Communication Adapter	20-COMM-ER	
	HVAC Communication Adapter	20-COMM-H	
	ControlNet Communication Adapter (Fiber)	20-COMM-Q	
<p>Programming Software</p> <ul style="list-style-type: none"> For use with <ul style="list-style-type: none"> Windows 7/2000/XP/Vista Windows 10⁽³⁾ 	Connected Components Workbench Software	Available for download at rok.auto/ccw	
	DriveTools™ SP ⁽⁴⁾	9303-4DTS01ENE	
Personal computer interface	DPI to USB	1203-USB ⁽⁵⁾	

(1) A 3 m (9.8 ft.) Cat. No. 1202-C30 cable is provided.
 (2) A cable is required if 20-HIM-A6 is connected to the SMC-50 DPI Port #2 and used as a hand-held device.
 (3) Connected Components Workbench software only.
 (4) Includes DriveExecutive™ and DriveObserver™ software.
 (5) Includes Cat. No. 20-HIM-H10 and 22-HIM-H10 cables.

Table 47 - Distribution Blocks

	For Use With Controller Type	Current Range [A]	Wire Size Range		Total No. Distribution Blocks Needed		Pkg. Qty.	Cat. No.	
			Line Side	Load Side	Line Side	Load Side			
	Solid-state	150-SB...	155...311	(2) #4 AWG...500 MCM 25...240 mm ²	(2) #4 AWG...500 MCM 25...240 mm ²	3	—	1	1492-BG
		150-SC...	363...554	(2) 1/0 AWG...750 MCM 54...400 mm ²	(6) 6 AWG...250 MCM 16...120 mm ²	1	6	1	Marathon Special Products Cat. No. 1353703
		150-SD...	625...900	(4) 1/0 AWG...750 MCM 54...400 mm ²	(4) 1/0 AWG...750 MCM 54...400 mm ²	3	6	1	Marathon Special Products Cat. No. 1352702

Table 48 - Capacitor Module

Description	For Use With	Cat. No.
 <p>Required for EMC directive compliance (EN60947-4-2)</p>	150-SB... (90...180 A units only)	150-SMCAP

Table 49 - System Accessories







	Description	Description		Cat. No.
	Power Monitor Kit • Includes Time Mark Power Monitor, fuse Blocks, and Socket	3-Phase 240V AC	Time Mark Model 258B	599-PM1
		3-Phase 480V AC	Time Mark Model A258B	599-PM2
	Timing Relays • Socket Required	ON Delay	1...10 s	700-HT12AA1
			1.0...180 s	700-HT12BA1
		OFF Delay	1...10 s	700-HT22AA1
			1.0...180 s	700-HT22BA1
	Timing Relay Sockets	ON Delay	1...10 s, 1.0...180 s	700-HN125
		OFF Delay	1...10 s, 1.0...180 s	700-HN126
	Control Relays • Socket Required	120V	2-Pole	700-HK32A1
			4-Pole	700-HC24A1
	Control Relay Socket	120V	2-Pole	700-HN224
			4-Pole	700-HN104
	Terminal blocks	Terminal block	Spring Clamp	1492-L2Q
		End Barrier		1492-EBL2Q
		End Anchor		1492-ERL35

Table 50 - Enclosure Accessories

	Description	Construction Material	For Use With Enclosure Width	Cat. No.
	Perforated frame strip • Mounting rail for door or panel installation	Sheet steel	400 mm (15.75 in.)	198-DS400
			600 mm (23.62 in.)	198-DS600
			1000 mm (39.37 in.)	198-DS1000
	Enclosure mounting foot • 100 mm height	High-strength plastic	400 mm (15.75 in.)	198-FB100 A
			600 mm (23.62 in.)	198-FB100B
			1000 mm (39.37 in.)	198-FB100C
	Enclosure mounting foot • 200 mm height	Sheet steel	400 mm (15.75 in.)	198-PL100 A
			600 mm (23.62 in.)	198-PL100B
			1000 mm (39.37 in.)	198-PL100C
Enclosure mounting foot • 200 mm height	Sheet steel	400 mm (15.75 in.)	198-PL200 A	
		600 mm (23.62 in.)	198-PL200B	
		1000 mm (39.37 in.)	198-PL200C	

Wiring Diagrams

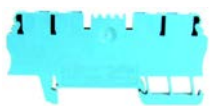
The diagrams in this section illustrate basic SMC controller wiring. For specific wiring diagrams, please consult your local Rockwell Automation sales office or Allen-Bradley distributor.

Notes:

- Use 75 °C (167 °F) Cu wire only
- Line fuses are customer supplied on controllers with factory-supplied disconnect switch. Refer to NEC when selecting short-circuit protection.
- Additional control circuit overcurrent protection is required for non-combination starters. Refer to NEC.

Figure 34 - SMC-50 Controller with External Bypass Basic Wiring Diagram

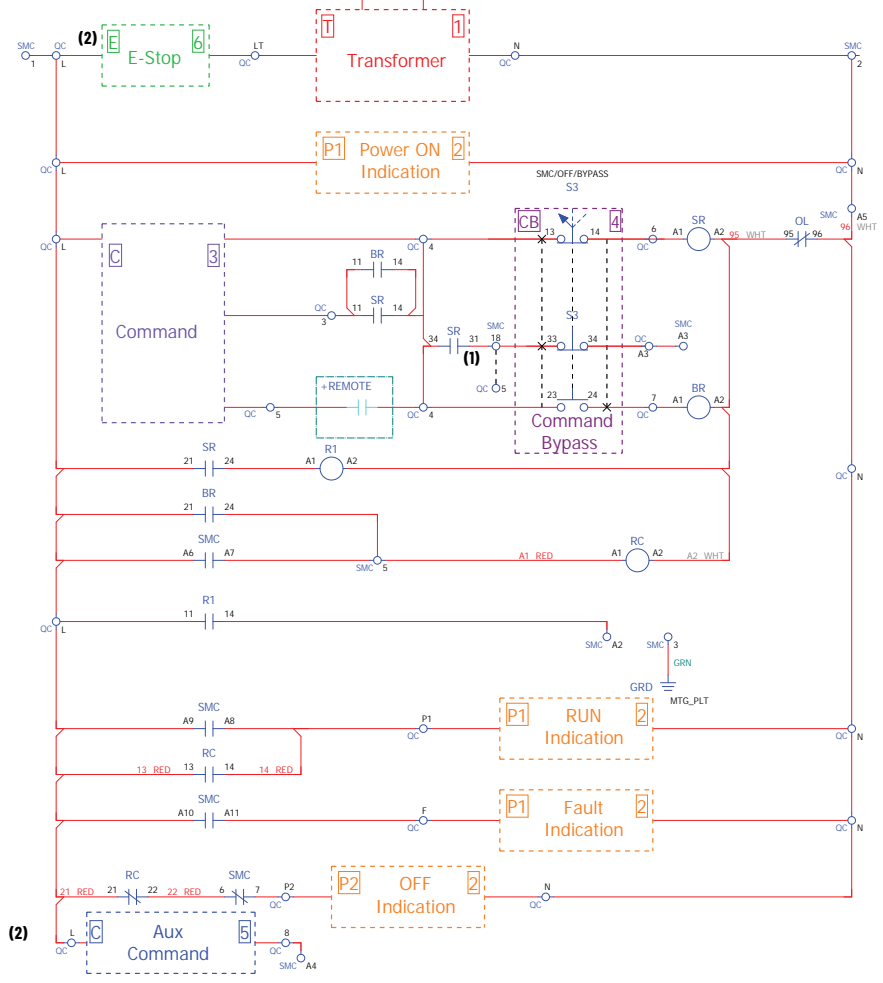
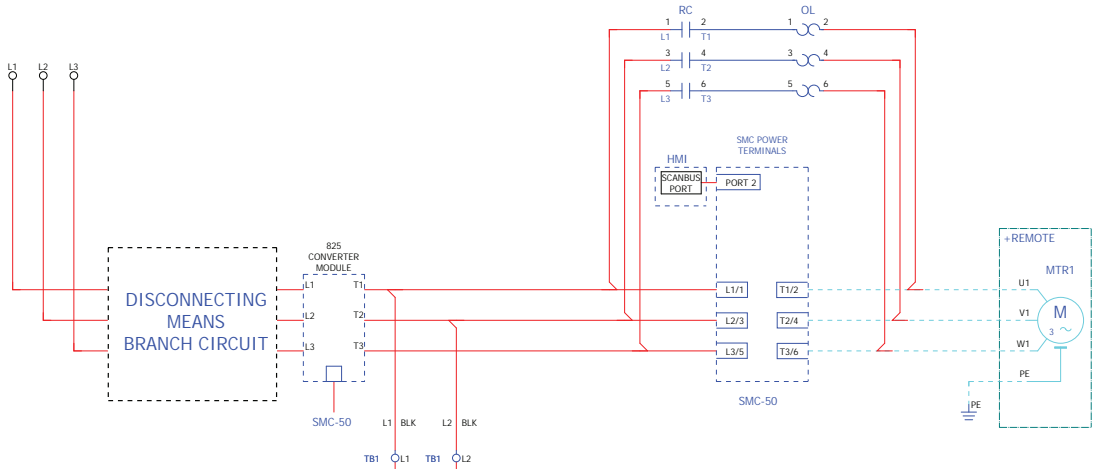

Note No.	Information
1	Add jumper from terminal block 18 to terminal block 5 when using DPI (jumper is included in the rail in terminal block 18).
2	Remove the pre-installed yellow jumper between terminal block L and terminal block 8 when using an auxiliary command device

- For additional wiring diagram notes, please see [Table 51](#), [Table 52](#), and [Table 53](#)
- For wiring diagrams for snap-together kits, please see the following figures:
 - Command kits: [Figure 36](#), [Figure 37](#), and [Figure 38](#); Auxiliary Command kits: [Figure 39](#), [Figure 40](#), and [Figure 41](#)
 - Command bypass kit: [Figure 42](#)
 - Emergency Stop (E-Stop) kit: [Figure 43](#)
 - Indication kit: [Figure 44](#)
 - Transformer kit: [Figure 45](#)

Table 51 - SMC-50 Controller with External Bypass Factory Pre-programmed Parameters

Parameter	Value
A2	Start
A3	Coast
A4	Option Stop
56	Disable 0
57	Disable 0
172	Aux1 Config to Ext Bypass 4
176	Aux2 Config to Fault Normal (0)
177	Enabled (1)
230 (upper)	XXXX XXXX 0000 0010
230 (lower)	0000 0000 0000 0001

Table 52 - SMC-50 Controller with External Bypass I/O (Cat. No. 150-SM4) Device Parameters⁽¹⁾

Parameter	Value
148	X000 0000 0001 0100
3	Input 2 (A2) Start 1
4	Input 3 (A3) Coast 2
5	Input 4 (A4) Stop Option 3
6	Aux1Cfg Ext Bypass 4
10	Aux2Cfg Normal 0
Set 14	Aux3Cfg Fault 2

(1) With HIM and Communication Card installed on Port 00.

Table 53 - SMC-50 Controller with External Bypass Relay Functions

Relay No.	Function
R1	Prevent race condition between A3 and A2
BR 11-14	Hold-in contact with Start-Stop for bypass
SR 11-14	Hold-in contact with Start-Stop for SR Relay (Starts SMC controller)
SR 31-34	Starts SMC controller with pilot device (no DPI present)
R1 11-14	SMC controller start command

Figure 35 - SMC-50 Controller with Internal Bypass Basic Wiring Diagram

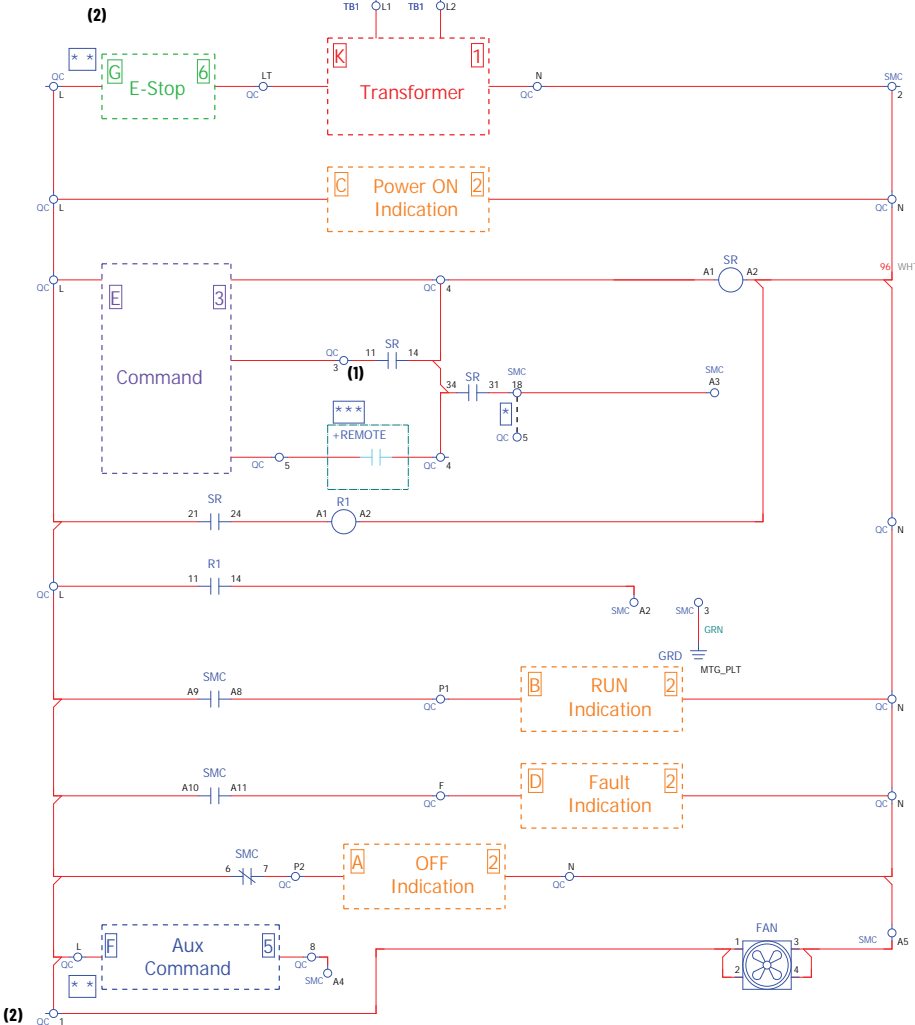
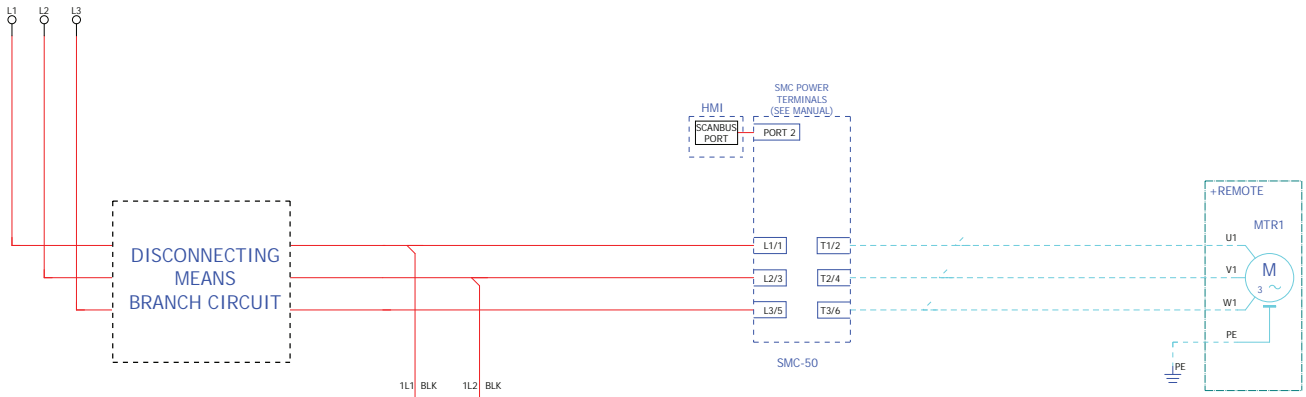

Note No.	Information
1	Add jumper from terminal block 18 to terminal block 5 when using DP1 (jumper is included in the rail in terminal block 18).
2	Remove the pre-installed yellow jumper between terminal block L and terminal block 8 when using an auxiliary command device

- For additional wiring diagram notes, please see [Table 54](#), [Table 55](#), and [Table 56](#)
- For wiring diagrams for snap-together kits, please see the following figures:
 - Command kits: [Figure 36](#), [Figure 37](#), and [Figure 38](#); Auxiliary Command kits: [Figure 39](#), [Figure 40](#), and [Figure 41](#)
 - Command bypass kit: [Figure 42](#)
 - Emergency Stop (E-Stop) kit: [Figure 43](#)
 - Indication kit: [Figure 44](#)
 - Transformer kit: [Figure 45](#)

Table 54 - SMC-50 Controller with Internal Bypass Factory Pre-programmed Parameters

Parameter	Value
A2	Start
A3	Coast
A4	Option Stop
56	Disable 0
57	Disable 0
172	Aux1 Config to Normal
176	Aux2 Config to Fault Normal (0)
177	Enabled (1)
230 (upper)	XXXX XXXX 0000 0010
230 (lower)	0000 0000 0000 0001

Table 55 - SMC-50 Controller with Internal Bypass I/O (Cat. No. 150-SM4) Device Parameters⁽¹⁾

Parameter	Value
148	X000 0000 0001 0100
3	Input 2 (A2) Start 1
4	Input 3 (A3) Coast 2
5	Input 4 (A4) Stop Option 3
6	Aux1Cfg Normal
10	Aux2Cfg Normal 0
Set 14	Aux3Cfg Fault 2

(1) With HIM and Communication Card installed on Port 00.

Table 56 - SMC-50 Controller with Internal Bypass Relay Functions

Relay No.	Function
R1	Prevent race condition between A3 and A2
SR 11-14	Hold-in contact with Start-Stop for SR Relay (Starts SMC controller)
SR 31-34	Starts SMC controller with pilot device (no DPI present)
R1 11-14	SMC controller start command

Wiring Diagrams for Snap-together Kits

Figure 36 - Start-Stop Command Kit Wiring Diagram

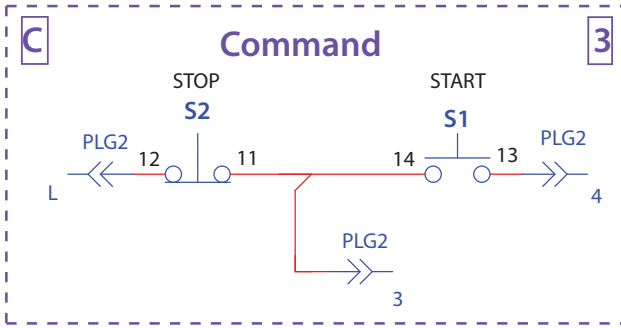

Figure 37 - Hand-OFF-Auto Command Kit Wiring Diagram

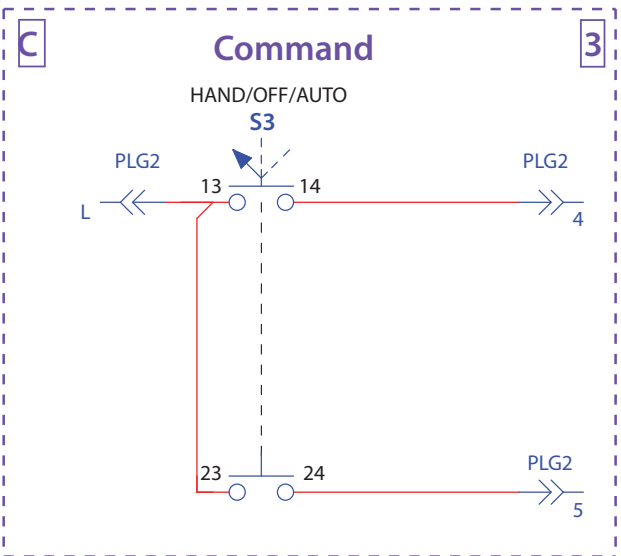

Figure 38 - Hand-OFF-Auto and Start-Stop Command Kit Wiring Diagram

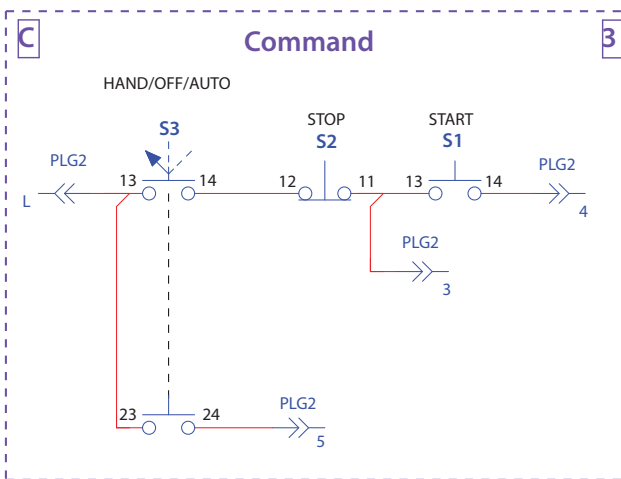

Figure 39 - Soft Stop Auxiliary Command Kit Wiring Diagram

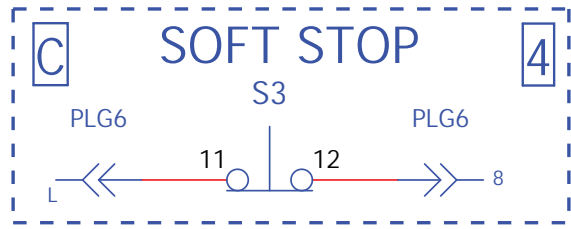

Figure 40 - Pump Stop Auxiliary Command Kit Wiring Diagram

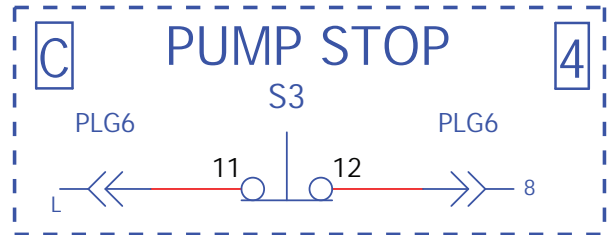

Figure 41 - Brake Auxiliary Command Kit Wiring Diagram

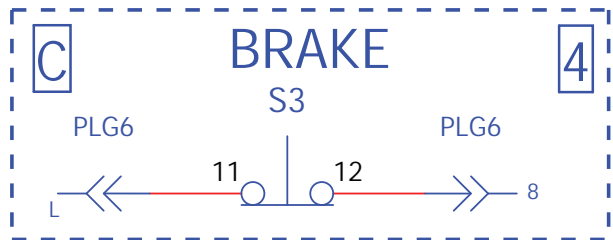

Figure 42 - Command Bypass Kit Wiring Diagram

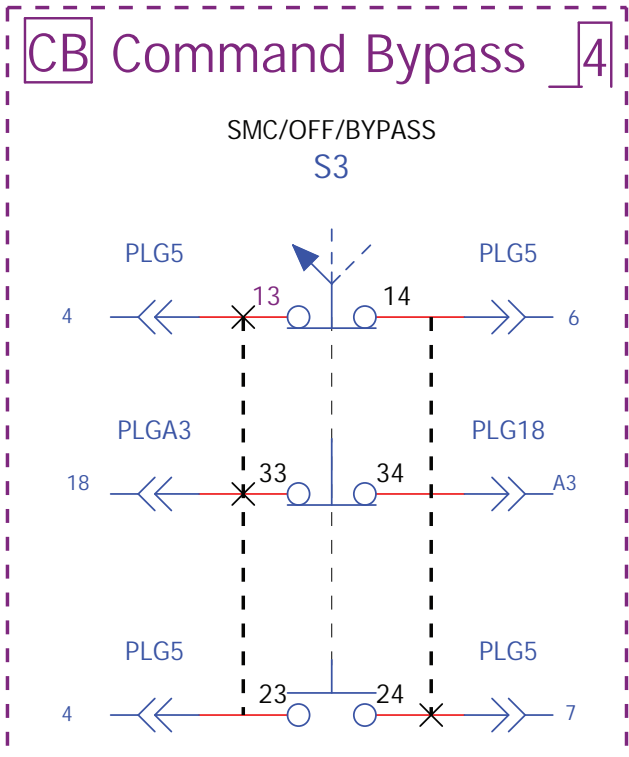

Figure 43 - E-Stop Kit Wiring Diagram

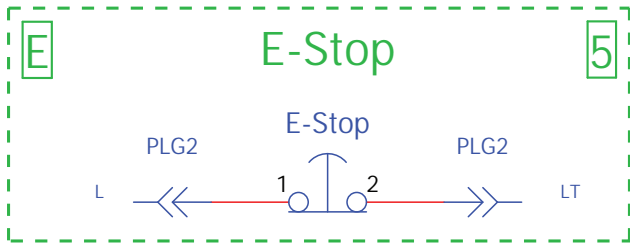

Figure 44 - Indication Kit Wiring Diagram

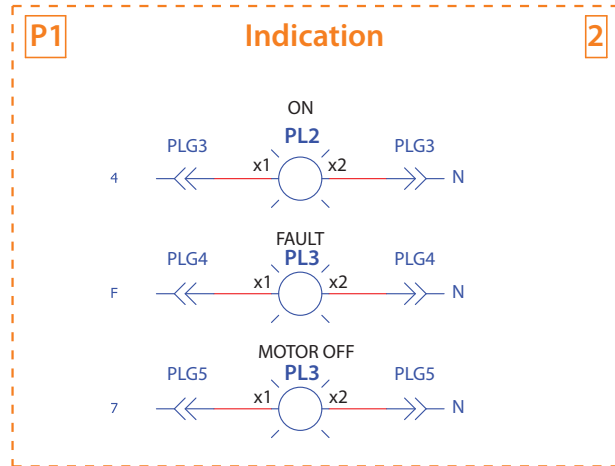
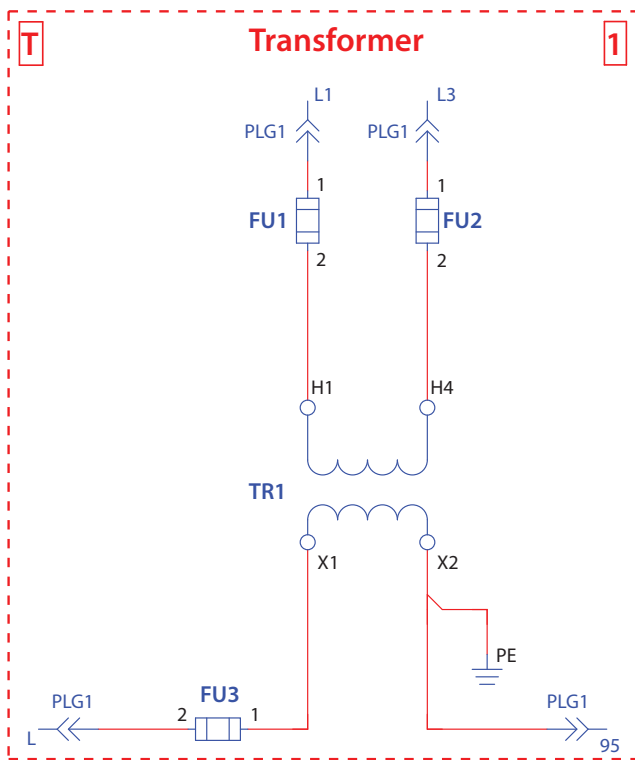

Figure 45 - Transformer Kit Wiring Diagram



Specifications

For complete specifications of your SMC-3 controller, see SMC-3, SMC Flex, and SMC-50 Technical Data, publication [150-TD009](#).

Table 57 - Standards Compliance and Certifications⁽¹⁾

Standards Compliance—Open Controllers	Certifications—Open Controllers	Standards Compliance—Enclosed Controllers	Certifications—Enclosed Controllers
UL 508	cULus Listed (Open Type) (File No. E96956)	UL 508A	cULus Listed
EN 60947-4-2	CE Marked per EMC Directive and Low Voltage Directive		
	CCC ⁽²⁾		
	C-Tick ⁽²⁾		
	EAC ⁽²⁾		
	KCC ⁽²⁾		
	ABS ⁽²⁾		

(1) For complete certification information, see our product certifications website: www.rockwellautomation.com/certifications.
 (2) For updated certification status of controllers with 24V DC control power, consult your local Rockwell Automation sales office or Allen-Bradley distributor.

Short-circuit Current Ratings

Determining the short circuit current ratings (SCCR) of a complex system can be very challenging, especially if proper considerations are not made during the initial stages of the component selection process.

The SCCR information in this section provides coordinated high-fault branch circuit for enclosed soft starters and is based on compliance to IEC and UL standards. For comprehensive SCCR information, please consult the Rockwell Automation Global SCCR tool, www.rockwellautomation.com/global-sccr.



Ratings provided are for standard options only; does not include bypass or isolation contactor configurations.

Table 58 - Non-combination Enclosed Soft Starters with SMC-50 Solid-state Controllers with External Bypass

Controller Rating [A]	SCCR		
	Max SCCR [kA rms]	Max Voltage [V]	Max Fuse or Circuit Breaker
90	100	600	200 A Class J fuse
	65	480	350 A circuit breaker
	10	600	
110	100	600	225 A Class J fuse
	65	480	300 A circuit breaker
	10	600	
140	100	600	300 A Class J fuse
	65	480	400 A circuit breaker
	10	600	
180	100	600	400 A Class J fuse
	65	480	400 A circuit breaker
	10	600	
210	100	600	450 A Class J fuse
	42	480	600 A circuit breaker
	18	600	
260	100	600	500 A Class J fuse
	42	480	700 A circuit breaker
	18	600	
320	100	600	700 A Class L fuse
	42	480	800 A circuit breaker
	18	600	

Table 58 - Non-combination Enclosed Soft Starters with SMC-50 Solid-state Controllers with External Bypass (Continued)

Controller Rating [A]	SCCR		
	Max SCCR [kA rms]	Max Voltage [V]	Max Fuse or Circuit Breaker
361	100	600	800 A Class L fuse
	42	480	1000 A circuit breaker
	25	600	
420	100	600	800 A Class L fuse
	42	480	1200 A circuit breaker
	25	600	
520	42	600	1000 A Class L fuse
	65	480	1200 A circuit breaker
	30	600	

Table 59 - Non-combination Enclosed Soft Starters with SMC-50 Solid-state Controllers with Internal Bypass

Controller Rating [A]	SCCR		
	Max SCCR [kA rms symmetrical]	Max Voltage [V]	Max Fuse or Circuit Breaker
108	70	600	200 A Class J fuse
	65	480	300 A circuit breaker
	10	600	
135	70	600	225 A Class J fuse
	65	480	400 A circuit breaker
	10	600	
201	70	600	350 A Class J fuse
	65	480	600 A circuit breaker
	18	600	
251	70	600	400 A Class J fuse
	65	480	700 A circuit breaker
	18	600	
317	69	600	500 A Class J fuse
	65	480	800 A circuit breaker
	30	600	
361	69	600	600 A Class J fuse
	65	480	1000 A circuit breaker
	30	600	
480	69	600	800 A Class L fuse
	65	480	1200 A circuit breaker
	42	600	

Table 60 - Non-combination Enclosed Soft Starters with SMC-50 Controllers with Internal Bypass and Circuit Breaker

Controller Rating [A]	SCCR	
	Max SCCR [kA rms symmetrical]	Max Voltage [V]
108	25	480
	10	600
135	25	480
	10	600
201	25	480
	14	600
251	35	480
	18	600
317	50	480
	25	600
361	50	480
	25	600
480	50	480
	25	600

Table 61 - Non-combination Enclosed Soft Starters with SMC-50 Controllers with Internal Bypass and Fusible Disconnect Switch

Controller Rating [A]	SCCR		
	Max SCCR [kA rms symmetrical]	Max Voltage [V]	Max Fuse
108	70	600	200 A Class J fuse
135	70		225 A Class J fuse
201	70		350 A Class J fuse
251	70		400 A Class J fuse
317	69		500 A Class J fuse
361	69		600 A Class J fuse
480	69		800 A Class J fuse
			800 A Class J fuse

Table 62 - Combination Enclosed Soft Starters with SMC-50 Controllers with External Bypass and Circuit Breaker

Controller Rating [A]	SCCR	
	Max SCCR [kA rms symmetrical]	Max Voltage [V]
90...180	25	480
	10	600
210	25	480
	14	600
260	35	480
	18	600
320	35	480
	18	600
361...420	42	480
	25	600
520	50	480
	30	600

Table 63 - Combination Enclosed Soft Starters with SMC-50 Controllers with External Bypass and Fusible Disconnect Switch

Controller Rating [A]	SCCR		
	Max SCCR [kA rms symmetrical]	Max Voltage [V]	Max Fuse
90	100	600	200 A Class J fuse
110	100		225 A Class J fuse
140	100		300 A Class J fuse
180	100		400 A Class J fuse
210	100		450 A Class J fuse
260	100		500 A Class J fuse
320	100		700 A Class L fuse
361	100		800 A Class L fuse
420	100		800 A Class L fuse
520	42		1000 A Class L fuse
			1000 A Class L fuse

Table 64 - Combination Enclosed Soft Starters with SMC-50 Controllers with Internal Bypass and Fusible Disconnect Switch

Controller Rating [A]	SCCR		
	Max SCCR [kA rms symmetrical]	Max Voltage [V]	Max Fuse
108	70	600	200 A Class J fuse
135	70		225 A Class J fuse
201	70		350 A Class J fuse
251	70		400 A Class J fuse
317	69		500 A Class J fuse
361	69		600 A Class J fuse
480	69		800 A Class J fuse

Approximate Dimensions

Examples given in this section include standard options. Use ProposalWorks to obtain dimensions for Smart Motor Controllers with all available options. ProposalWorks software is available from rok.auto/systemtools.

Dimensions are in inches (millimeters) unless otherwise noted. Dimensions are not to be used for manufacturing purposes.

Figure 46 - Enclosure for SMC Controllers—1400 mm x 400 mm x 500 mm

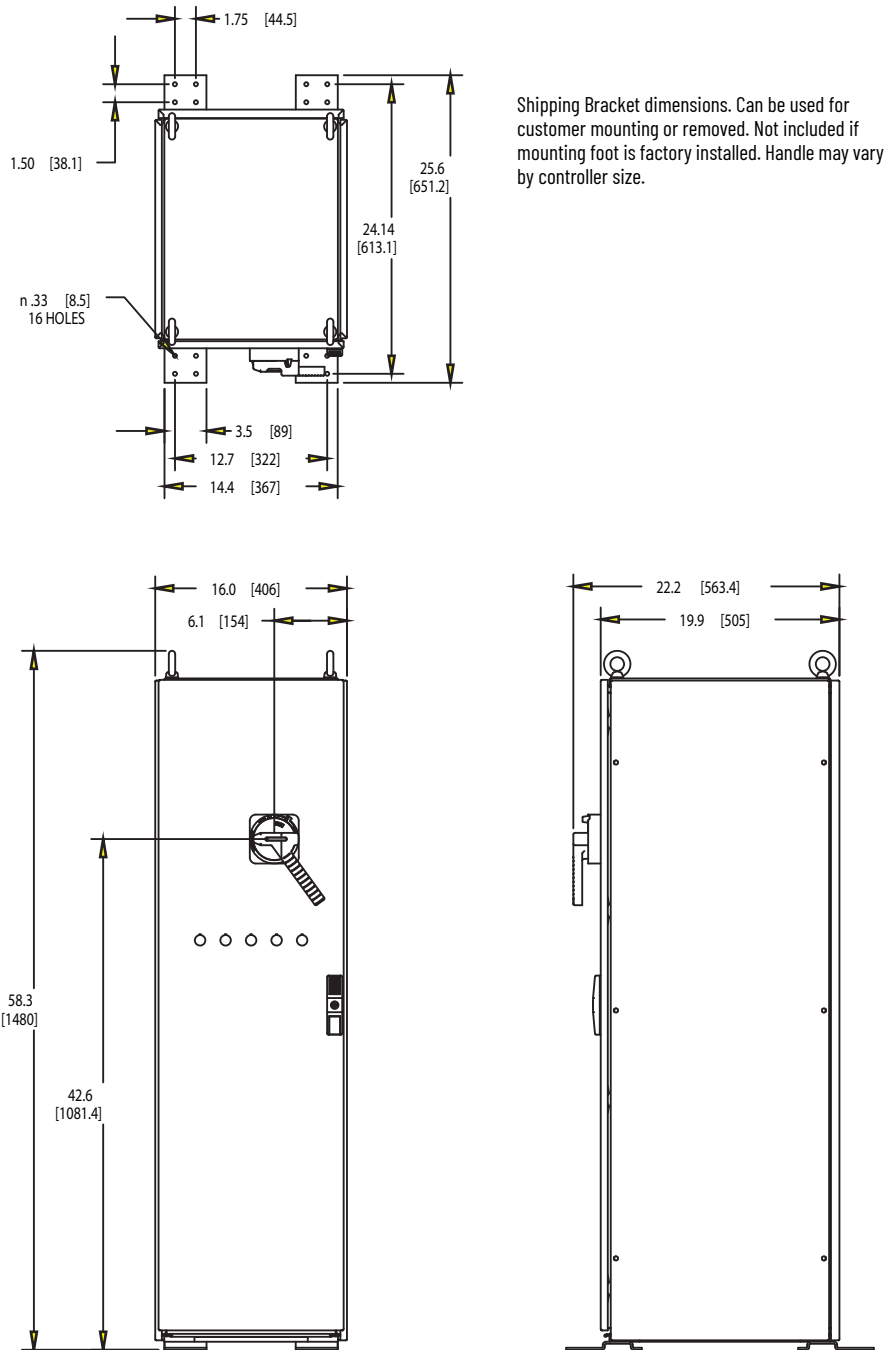

Figure 47 - Enclosure for SMC Controllers—1400 mm x 600 mm x 500 mm

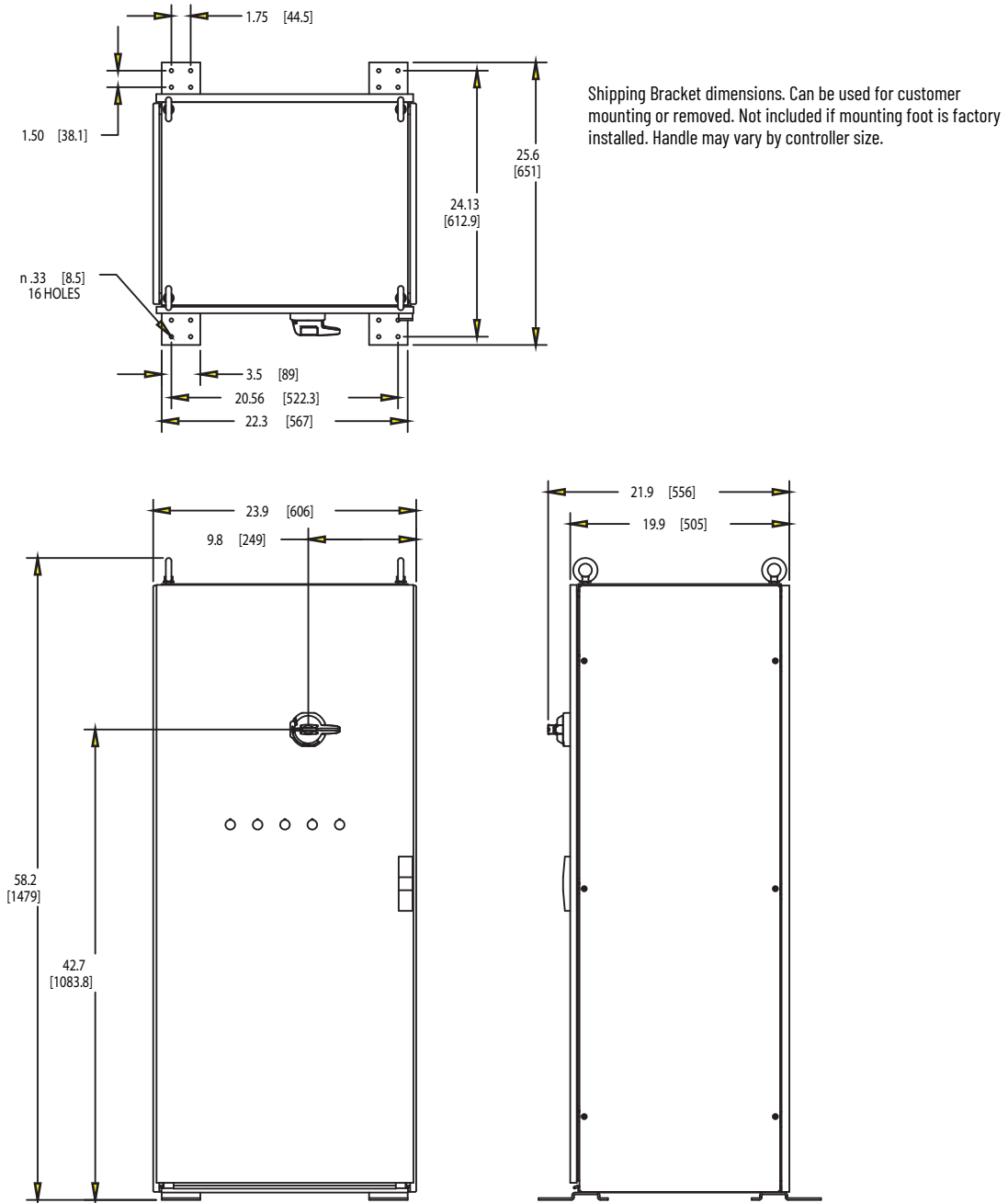
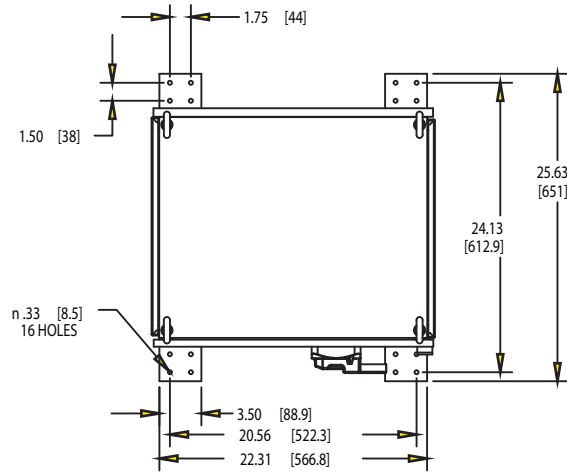

Figure 48 - Enclosure for SMC Controllers—1600 mm x 600 mm x 500 mm



Shipping Bracket dimensions. Can be used for customer mounting or removed. Not included if mounting foot is factory installed. Handle may vary by controller size.

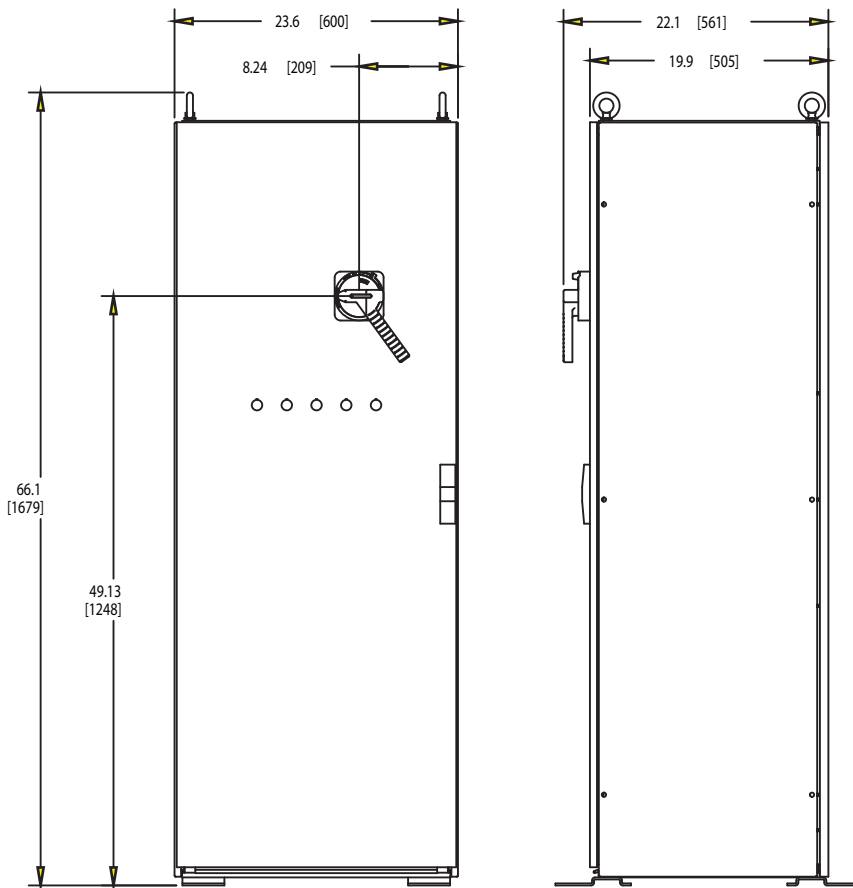
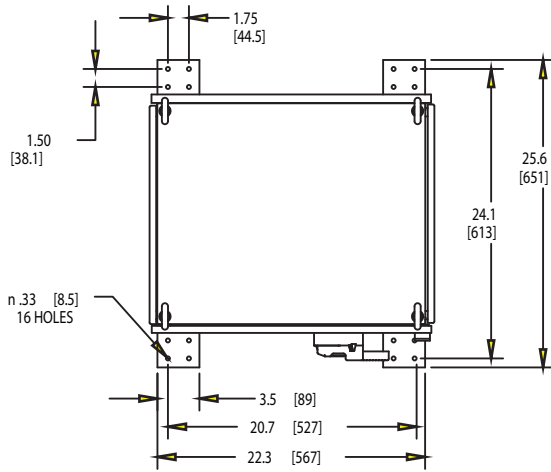

Figure 49 - Enclosure for SMC Controllers—2000 mm x 600 mm x 500 mm



Shipping Bracket dimensions. Can be used for customer mounting or removed. Not included if mounting foot is factory installed. Handle may vary by controller size.

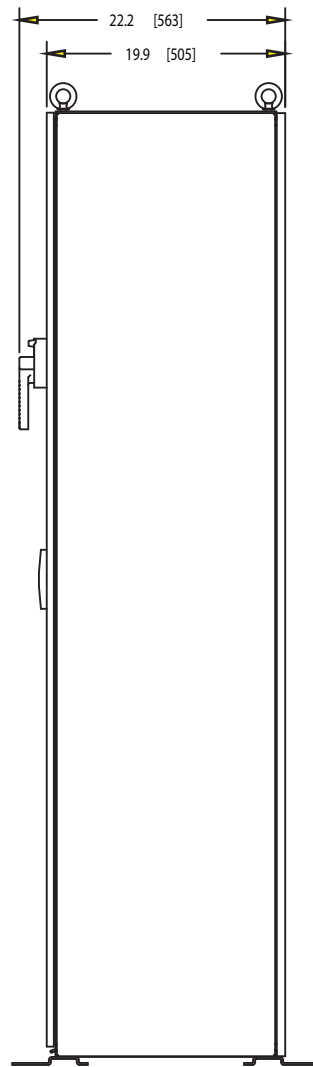
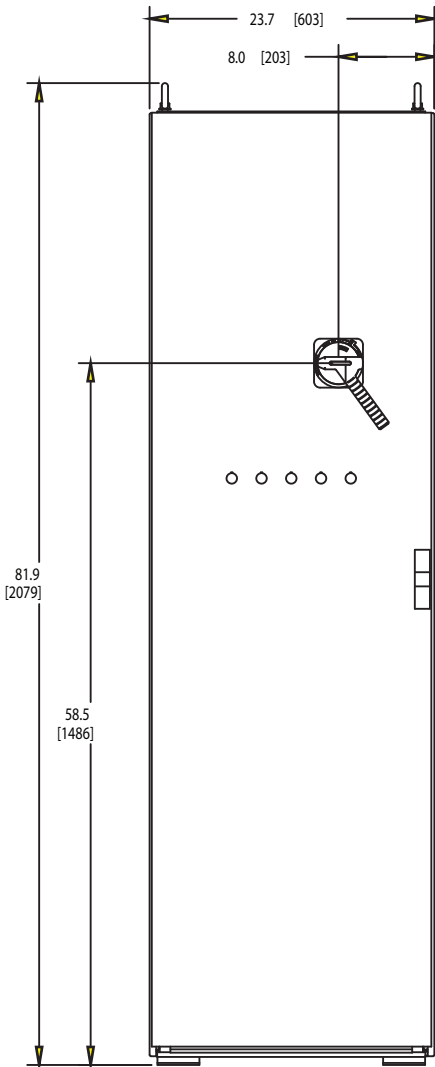

Figure 50 - Enclosure for SMC Controllers—2000 mm x 1000 mm x 500 mm

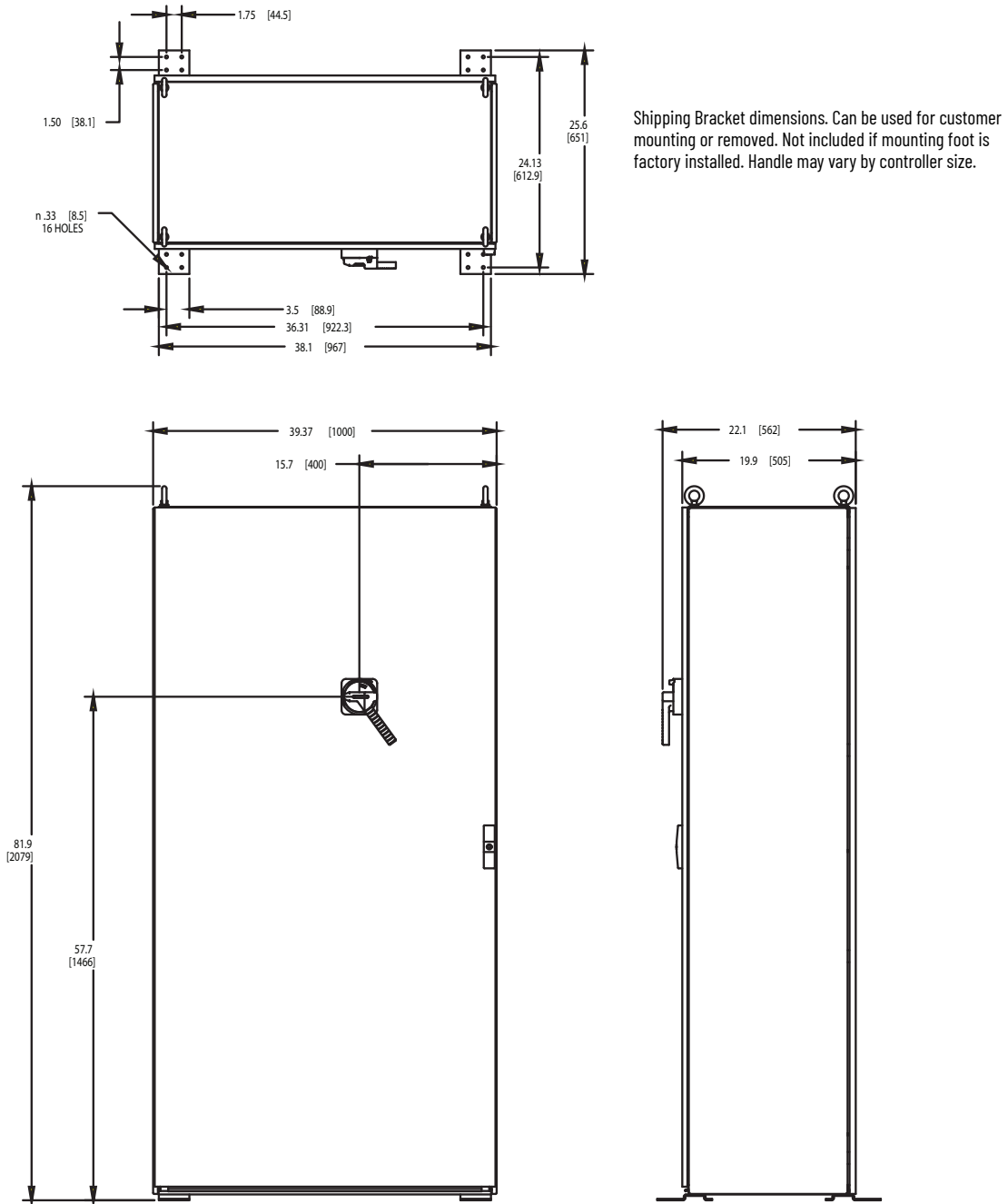
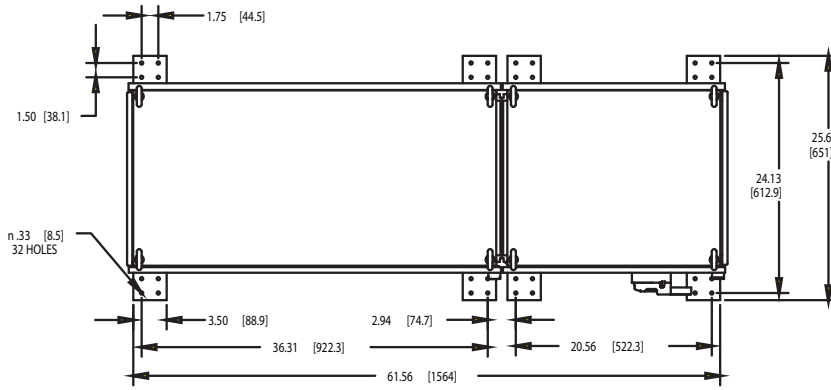

Figure 51 - Enclosure for SMC Controllers—2000 mm x 1600 mm x 500 mm



Shipping Bracket dimensions. Can be used for customer mounting or removed. Not included if mounting foot is factory installed. Handle may vary by controller size.

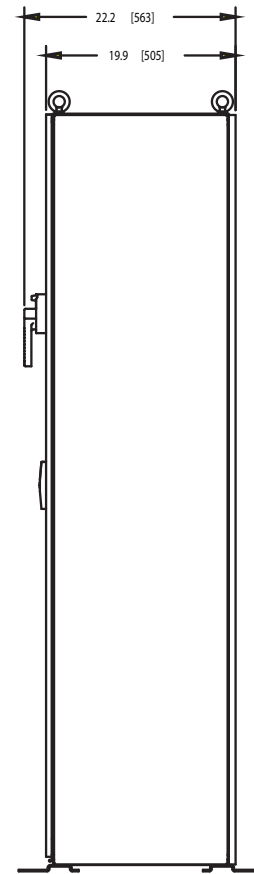
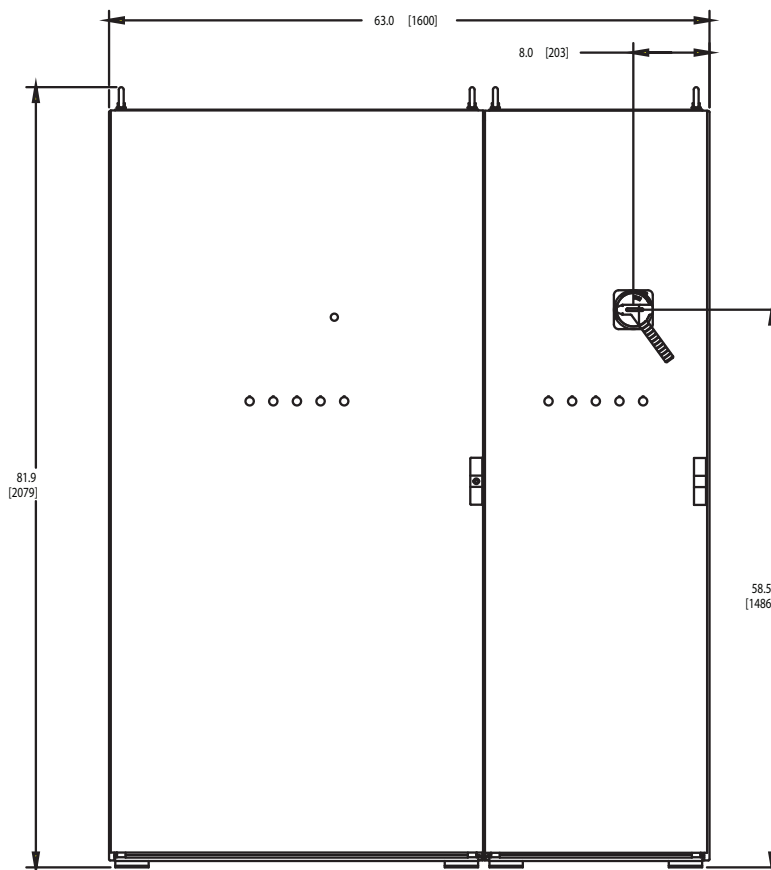

Table 65 - SMC-50 Controller with External Bypass Enclosure Dimensions

Non-combination Controllers		Combination Controllers			
		With Fusible Disconnect Switch		With Circuit Breaker	
Cat. No.	Dimensions (H x W x D)	Cat. No.	Dimensions (H x W x D)	Cat. No.	Dimensions (H x W x D)
150S-C90J...	1400 x 600 x 500 (55.1 x 23.6 x 19.7) see Figure 47	152S-C90J...	1400 x 600 x 500 (55.1 x 23.6 x 19.7) see Figure 47	153S-C90J...	1400 x 600 x 500 (55.1 x 23.6 x 19.7) see Figure 47
150S-D11J...		152S-D11J...		153S-D11J...	
150S-D14J...		152S-D14J...		153S-D14J...	
150S-D18J...		152S-D18J...		153S-D18J...	
150S-D21J...		152S-D21J...	153S-D21J...	1600 x 600 x 500 (63.0 x 23.6 x 19.7) see Figure 48	
150S-D26J...		152S-D26J...	153S-D26J...		
150S-D32J...		152S-D32J...	153S-D32J...		
150S-D36J...	2000 x 1000 x 500 (78.7 x 39.4 x 19.7) see Figure 50	152S-D36J...	2000 x 1000 x 500 (78.7 x 39.4 x 19.7) see Figure 50	153S-D36J...	2000 x 1000 x 500 (78.7 x 39.4 x 19.7) see Figure 50
150S-D42J...		152S-D42J...		153S-D42J...	
150S-D52J...		152S-D52J...		153S-D52J...	

Table 66 - SMC-50 Controller with Internal Bypass Enclosure Dimensions

Non-combination Controllers		Combination Controllers			
		With Fusible Disconnect Switch		With Circuit Breaker	
Cat. No.	Dimensions (H x W x D)	Cat. No.	Dimensions (H x W x D)	Cat. No.	Dimensions (H x W x D)
150S-D10J...	1400 x 400 x 500 (55.1 x 15.7 x 19.7) see Figure 46	152S-D10J...	1400 x 400 x 500 (55.1 x 15.7 x 19.7) see Figure 46	153S-D10J...	1400 x 400 x 500 (55.1 x 15.7 x 19.7) see Figure 46
150S-D13J...		152S-D13J...		153S-D13J...	
150S-D20J...		152S-D20J...	153S-D20J...		
150S-D25J...		152S-D25J...	153S-D25J...		
150S-D31J...		152S-D31J...	153S-D31J...	2000 x 600 x 500 (78.7 x 23.6 x 19.7) see Figure 49	
150S-D36J...		152S-D36J...	153S-D36J...		
150S-D48J...		152S-D48J...	153S-D48J...		
150S-D62J...	2000 x 1000 x 500 (78.7 x 39.4 x 19.7) see Figure 50	152S-D62J...	2000 x 1600 x 500 (78.7 x 63 x 19.7) see Figure 51	153S-D62J...	2000 x 1600 x 500 (78.7 x 63 x 19.7) see Figure 51
150S-D78J...		152S-D78J...		153S-D78J...	

Circuit Breakers and Accessories

For complete molded case circuit breaker and accessory specifications, see Molded Case Circuit Breaker Specifications, publication [140G-TD101](#).

Table 67 - Molded Case Circuit Breakers

	Description	Controller Rating [A]	Circuit Breaker Rating [A]	SCCR	Cat. No.
	Molded Case Circuit Breaker	3, 5, 9	15	Standard SCCR	140G-G2C3-C15
				High SCCR	140G-G6C3-C15
		16	20	Standard SCCR	140G-G2C3-C20
				High SCCR	140G-G6C3-C20
		25	30	Standard SCCR	140G-G2C3-C30
				High SCCR	140G-G6C3-C30
		37	60	Standard SCCR	140G-G2C3-C60
				High SCCR	140G-G6C3-C60
		43, 60	80	Standard SCCR	140G-G2C3-C80
				High SCCR	140G-G6C3-C80
		85, 90	125	Standard SCCR	140G-G2C3-C80
				High SCCR	140G-G6C3-C80
		108, 110, 135, 140, 180, 210	250	Standard SCCR	140G-J2F3-D25
				High SCCR	140G-J6F3-D25
		251, 260, 317, 320	400	Standard SCCR	140G-K3F3-D40
				High SCCR	140G-K6F3-D40
		361, 420, 480, 520, 625	800	Standard SCCR	140G-M5F3-D80
				High SCCR	140G-M6F3-D80
780	1200	Standard SCCR	140G-N5H3-E12		
		High SCCR	140G-N6H3-E12		

Table 68 - Terminal Lugs

	Description	Controller Rating [A]	Circuit Breaker Rating [A]	Cat. No.
	Terminal lugs	3, 5, 9	15	140G-G-TLC13
		16	20	
		25	30	
		37	60	
		43, 60	80	
		85, 90	125	
		108, 110, 135, 140, 180, 210	250	140G-J-TLC13
		251, 260, 317, 320	400	140G-K-TLC13
		361, 420, 480, 520, 625	800	140G-M-TLC13
		780	1200	140G-N-TLC13

Table 69 - Auxiliary Contacts





	Description	Controller Rating [A]	Circuit Breaker Rating [A]	Components	Cat. No.
	Auxiliary contact for circuit breakers	All	All	1 N.O. contact	1495-N85
				1 N.C. contact	1495-N85

Table 70 - Rotary Handles and Operating Mechanisms

	Description	Controller Rating [A]	Circuit Breaker Rating [A]	Components	Cat. No.
	Circuit breaker rotary handles	3...210	15...250	Black/grey handle	140U-PB
		351...780	400...1200		140U-HM4
	Circuit breaker operating shaft	3...210	15...250	305 mm (12 in.)	194R-S1
		351...780	400...1200		194R-R7
	Rotary Variable Depth Operating Mechanism <ul style="list-style-type: none"> • Direct molded case circuit breaker mount • G and H frame uses 194R-S1 or 194R-S2 shafts (140G-N1 or 140G-N2 NFPA) • K, M, and N frames use 194R-R7 or 194R-R8 shafts (140G-R7 or 140G-R8 NFPA) • Shaft is secured with set screw or cotter pin 	3...90	15...125	-	140G-G-RMX
		108...210	175...250		140G-H-RMX
		251...320	400		140G-K-RMX
		361...625	800		140G-M-RMX
		780	1200		140G-N-RMX

Disconnect Switches and Accessories

For complete disconnect switch and accessory specifications, see Rotary Disconnect Switch Specifications, publication [194R-TD001](#).

Table 71 - Disconnect Switches





	Controller Current [A]	Disconnect Switch Type	Cat. No.
 <p>Cat. No. 194R-J30-1753</p>	3, 5, 9, 16, 25	UL Class J, CSA Type HRCI-J	194R-J30-1753
		DIN	194R-D32-1753
	37, 43	UL Class J, CSA Type HRCI-J	194R-J60-1753
		DIN	194R-D63-1753
	60	UL Class J, CSA Type HRCI-J	194R-J100-1753
		DIN	194R-D125-1753
85	UL Class J, CSA Type HRCI-J	194R-J200-1753	
	DIN	194R-D125-1753	
90, 108, 110	UL Class J, CSA Type HRCI-J	194R-J200-1753	
	DIN	194R-D160-1753	
135, 140	UL Class J, CSA Type HRCI-J	194R-J200-1753	
	DIN	194R-D250-1753	
180, 201, 210, 251, 260	UL Class J, CSA Type HRCI-J	194R-J400-1753	
	DIN	194R-D400-1753	
317, 320, 361, 420	UL Class J, CSA Type HRCI-J	194R-J600-1753	
	DIN	194R-D630-1753	
480, 520	UL Class J, CSA Type HRCI-J	194R-L800-1753	
	DIN	194R-D800-1753	
625, 780	UL Class J, CSA Type HRCI-J	194R-NU1200-1753	
	DIN	194R-NE1250-1753	
 <p>Cat. No. 194R-D160-1753</p>			

Table 72 - Auxiliary Contact Blocks

	Description	Contact Configuration	For Use With	Pkg. Qty.	Cat. No.
	Contact Block <ul style="list-style-type: none"> Sold only in multiples of 10. Order (quantity of) 10 to receive one package of 10 pieces Latch not included. 	N.O.	194R 30/60 A switches (all) 194R 100...1250 A switches (fused only). Also used for test mode function for 20...63 A switches.	10	800F-X10
		N.C.		10	800F-X01
		N.C.L.B.		10	800F-X01L
	Auxiliary contact <ul style="list-style-type: none"> Form C 		194R 100...1250 A switches (non-fused only)	2	194R-1STNONC ⁽¹⁾

(1) Does not carry UL Certification.

Table 73 - Operating Handles (Accepts 3 Padlocks)



	Description	For Use With	Color	Degree of Protection	Cat. No.
	Padlockable Handle, standard	Bul. 194R disconnect switches up to 60 A	Black	Type 3, 3R, 4, 4X, 12	194R-PB
	Operating Handle • Standard orientation with defeater	<ul style="list-style-type: none"> IEC Non-fused disconnect switches: 125...630 A IEC Fused disconnect switches: 100...400 A UL Disconnect switches: 100...400 A 	Black	IP65 (Type 1, 3R, 12, 4, 4X)	194R-HM4
		<ul style="list-style-type: none"> IEC Non-fused disconnect switches: 800...1250 A IEC Fused disconnect switches: 630...1250 A UL Non-fused disconnect switches: 600...1200 A UL Fused disconnect switches: 600...800 A 	Black with light gray cover		194R-HM4-L

Table 74 - Operating Shafts

	Description	For Use With	Shaft Length	Cat. No.		
	Extension Shaft	Standard length	140U-P*, 194R-P*, and 194R- P*T handles	12 in. (30.48 cm)	194R-S1	
			21 in. (53.34 cm)	194R-S2		
		Standard length	Bul. 194R-HM handles for	<ul style="list-style-type: none"> IEC Non-fused disconnect switches: 125...630 A IEC Fused disconnect switches: 100...400 A UL Disconnect switches: 100...400 A 	12.6 in. (320 mm)	194R-R7
					22.0 in. (560 mm)	194R-R8
		Extended length	Bul. 194R-HM handles for	<ul style="list-style-type: none"> IEC Non-fused disconnect switches: 800...1250 A IEC Fused disconnect switches: 630...1250 A UL Non-fused disconnect switches: 600...1200 A 	12.6 in. (320 mm)	194R-R9
					22.0 in. (560 mm)	194R-R10
		Standard length	Bul. 194R-HM handles for	<ul style="list-style-type: none"> IEC Fused disconnect switches: 630...1250 A UL Fused disconnect switches: 600...800 A 	12.6 in. (320 mm)	194R-R11
					22.0 in. (560 mm)	194R-R12

Table 75 - Lug Kits







	Description	Wire Size	For Use With	Pkg. Qty	Cat. No.
	Multi-Tap Terminal Lugs • Load side only	(3) 14...4 AWG (3) 0.75...25 mm ²	30 A fused disconnect switches	1	194R-30-MTL3
			60 A fused disconnect switches	1	194R-60-MTL3
	Terminal Lug Kits	(1) 300 MCM	UL Non-fused switches: 100...200 A UL Fused switches: 200 A	3	194R-TL1
			UL Non-fused switches: 100...200 A	4	194R-TL2
(1) 600 MCM		UL Fused and non- fused switches: 400 A	3	194R-TL3	
		UL Non-fused switches: 400 A	4	194R-TL4	
		(2) 350 MCM	UL Fused and non- fused switches: 400 A	3	194R-TL5
			4-pole UL Non-fused switches: 400 A	4	194R-TL6
		(2) 600 MCM	UL Non-fused switches: 600 A UL Fused switches: 600...800 A	3	194R-TL7
			UL Non-fused switches: 600 A	4	194R-TL8

Table 76 - Terminal Shields

	Description	Switch Current Rating [A]	No. of Poles	For Use With	Qty. Required per Disconnect Switch	Pkg. Qty	Cat. No.
	Terminal Shroud • three terminals • IP20	30	—	UL Fused switches	2	2	194R-30-C3
		60					194R-60-C3
	IEC Terminal Shield	1250	4	IEC Non-fused switches	2	1	194R-LNC16
	UL Terminal Shield	800...1200	4	UL Non-fused switches	2	1	194R-LNC26
	IEC (BS/DIN) Terminal Shrouds	125, 160	3	IEC Fused switches	2	3	194R-LNC27
		250, 400		IEC Fused switches			194R-LNC28
		600 (UL), 630 (IEC), 800		UL and IEC Fused switches			194R-LNC29
		1250		IEC Fused switches			194R-LNC30
		200		UL Fused switches			194R-LNC31
	UL/IEC (BS/DIN) Terminal Shrouds	400		UL and IEC Fused switches			194R-LNC32

Additional Resources

These documents contain additional information concerning related products from Rockwell Automation. You can view or download publications at rok.auto/literature.

Resource	Description
SMC-3, SMC Flex, and SMC-50 Technical Data, publication 150-TD009	Provides technical information for open SMC-3, SMC Flex, and SMC-50 controllers.
SMC-50 User Manual, publication 150-UM011	Provides complete user information for SMC-50 controllers.
SMC Flex User Manual, publication 150-UM008	Provides complete user information for SMC Flex controllers.
SMC-3 Installation Instructions, publication 150-IN004	Provides installation instructions for SMC-3 controllers.
IEC Contactor Specifications, publication 100-TD013	Provides product selection and specifications for IEC contactors.
E100 Electronic Overload Relay Specifications, publication 193-TD013	Provides product selection and specifications for Bul. 193/592 E100 overload relays.
Molded Case Circuit Breaker Specifications, publication 140G-TD101	Provides product selection and specifications for Bul. 140G molded case circuit breakers and accessories.
Rotary Disconnect Switch Specifications Technical Data, publication 194R-TD001	Provides product selection and specifications for Bul. 194R rotary disconnect switches and accessories.
Short-circuit Current Ratings and Your Industrial Control Panel, publication SCCR-AT002	Provides examples for short-circuit current ratings of panels based on the methods stated in UL 508A Supplement B
ProposalWorks™ configuration software, rok.auto/systemtools	Helps configure complete, valid catalog numbers and build complete quotes based on detailed product information.
Rockwell Automation Global SCCR tool, rok.auto/sccr	Provides coordinated high-fault branch circuit solutions for motor starters, soft starters, and component drives.
EtherNet/IP Network Devices User Manual, ENET-UM006	Describes how to configure and use EtherNet/IP devices to communicate on the EtherNet/IP network.
Ethernet Reference Manual, ENET-RM002	Describes basic Ethernet concepts, infrastructure components, and infrastructure features.
System Security Design Guidelines Reference Manual, SECURE-RM001	Provides guidance on how to conduct security assessments, implement Rockwell Automation products in a secure system, harden the control system, manage user access, and dispose of equipment.
UL Standards Listing for Industrial Control Products, publication CMPNTS-SR002	Assists original equipment manufacturers (OEMs) with construction of panels, to help ensure that they conform to the requirements of Underwriters Laboratories.
American Standards, Configurations, and Ratings: Introduction to Motor Circuit Design, publication IC-AT001	Provides an overview of American motor circuit design based on methods that are outlined in the NEC.
Industrial Components Preventive Maintenance, Enclosures, and Contact Ratings Specifications, publication IC-TD002	Provides a quick reference tool for Allen-Bradley industrial automation controls and assemblies.
Safety Guidelines for the Application, Installation, and Maintenance of Solid-state Control, publication SGI-1.1	Designed to harmonize with NEMA Standards Publication No. ICS 1.1-1987 and provides general guidelines for the application, installation, and maintenance of solid-state control in the form of individual devices or packaged assemblies incorporating solid-state components.
Industrial Automation Wiring and Grounding Guidelines, publication 1770-4.1	Provides general guidelines for installing a Rockwell Automation industrial system.
Product Certifications website, rok.auto/certifications	Provides declarations of conformity, certificates, and other certification details.

Rockwell Automation Support

Use these resources to access support information.

Technical Support Center	Find help with how-to videos, FAQs, chat, user forums, Knowledgebase, and product notification updates.	rok.auto/support
Local Technical Support Phone Numbers	Locate the telephone number for your country.	rok.auto/phonesupport
Technical Documentation Center	Quickly access and download technical specifications, installation instructions, and user manuals.	rok.auto/techdocs
Literature Library	Find installation instructions, manuals, brochures, and technical data publications.	rok.auto/literature
Product Compatibility and Download Center (PCDC)	Download firmware, associated files (such as AOP, EDS, and DTM), and access product release notes.	rok.auto/pcdc

Documentation Feedback

Your comments help us serve your documentation needs better. If you have any suggestions on how to improve our content, complete the form at rok.auto/docfeedback.

Accu-Stop, Allen-Bradley, Connected Components Workbench, DeviceLogix, DPI, DriveExplorer, DriveExecutive, DriveObserver, DriveTools, E100, expanding human possibility, ProposalWorks, Rockwell Automation, SMB, and SMC are trademarks of Rockwell Automation, Inc.

ControlNet, DeviceNet, and EtherNet/IP are trademarks of ODVA, Inc.

Trademarks not belonging to Rockwell Automation are property of their respective companies.

Rockwell Automation maintains current product environmental compliance information on its website at rok.auto/pec.

Rockwell Otomasyon Ticaret A.Ş. Kar Plaza İş Merkezi E Blok Kat:6 34752, İçerenköy, İstanbul, Tel: +90 (216) 5698400 EEE Yönetmeliğine Uygundur

Connect with us.    

rockwellautomation.com ————— expanding **human possibility**[®]

AMERICAS: Rockwell Automation, 1201 South Second Street, Milwaukee, WI 53204-2496 USA, Tel: (1) 414.382.2000, Fax: (1) 414.382.4444

EUROPE/MIDDLE EAST/AFRICA: Rockwell Automation NV, Pegasus Park, De Kleetlaan 12a, 1831 Diegem, Belgium, Tel: (32) 2663 0600, Fax: (32) 2 663 0640

ASIA PACIFIC: Rockwell Automation SEA Pte Ltd, 2 Corporation Road, #04-05, Main Lobby, Corporation Place, Singapore 618494, Tel: (65) 6510 6608, FAX: (65) 6510 6699

UNITED KINGDOM: Rockwell Automation Ltd., Pitfield, Kiln Farm, Milton Keynes, MK11 3DR, United Kingdom, Tel: (44)(1908) 838-800, Fax: (44)(1908) 261-917

Publication 150-TD010B-EN-P - July 2023

Supersedes Publications 150-TD010A-EN-P July 2018 and 150S-IN001B-EN-P June 2017

Copyright © 2023 Rockwell Automation, Inc. All rights reserved. Printed in the U.S.A.