

SM3000 Multipoint Videographic Recorder



The Company

We are an established world force in the design and manufacture of measurement products for industrial process control, flow measurement, gas and liquid analysis and environmental applications.

As a part of ABB, a world leader in process automation technology, we offer customers application expertise, service and support worldwide.

We are committed to teamwork, high quality manufacturing, advanced technology and unrivalled service and support.

The quality, accuracy and performance of the Company's products result from over 100 years experience, combined with a continuous program of innovative design and development to incorporate the latest technology.

EN ISO 9001:2008



Cert. No. Q 05907

EN 29001 (ISO 9001)



Lenno, Italy – Cert. No. 9/90A

Stonehouse, U.K.



Electrical Safety

This equipment complies with the requirements of CEI/IEC 61010-1:2001-2 'Safety Requirements for Electrical Equipment for Measurement, Control and Laboratory Use'. If the equipment is used in a manner NOT specified by the Company, the protection provided by the equipment may be impaired.

Symbols

One or more of the following symbols may appear on the equipment labelling:

	Warning – Refer to the manual for instructions
	Caution – Risk of electric shock
	Protective earth (ground) terminal
	Earth (ground) terminal

	Direct current supply only
	Alternating current supply only
	Both direct and alternating current supply
	The equipment is protected through double insulation

Information in this manual is intended only to assist our customers in the efficient operation of our equipment. Use of this manual for any other purpose is specifically prohibited and its contents are not to be reproduced in full or part without prior approval of the Technical Publications Department.

Health and Safety

To ensure that our products are safe and without risk to health, the following points must be noted:

1. The relevant sections of these instructions must be read carefully before proceeding.
2. Warning labels on containers and packages must be observed.
3. Installation, operation, maintenance and servicing must only be carried out by suitably trained personnel and in accordance with the information given.
4. Normal safety precautions must be taken to avoid the possibility of an accident occurring when operating in conditions of high pressure and/or temperature.
5. Chemicals must be stored away from heat, protected from temperature extremes and powders kept dry. Normal safe handling procedures must be used.
6. When disposing of chemicals ensure that no two chemicals are mixed.

Safety advice concerning the use of the equipment described in this manual or any relevant hazard data sheets (where applicable) may be obtained from the Company address on the back cover, together with servicing and spares information.

Contents

1	Product Identification	3	6	Configuration	51
2	Getting Started	4	6.1	Introduction	51
3	Introduction	6	6.1.1	Configuration Level Security	51
4	Operation	8	6.1.2	Configuration Level Access	51
4.1	Powering up the Instrument	8	6.2	Overview of Configuration	54
4.2	Displays and Controls	8	6.3	Making Changes to Parameters	55
4.3	Chart Views	10	6.4	Common Configuration	61
4.3.1	Electronic Signatures	20	6.4.1	Setup	61
4.4	Bargraph Views	21	6.4.2	Security	65
4.5	Digital Indicator View	24	6.4.3	Logs	67
4.6	Process View	28	6.4.4	Operator Messages	68
4.7	Group Overview	31	6.4.5	Ethernet	69
4.8	Instrument Status / Audit Log View	34	6.4.6	email	70
4.8.1	Instrument Status View	35	6.4.7	Modbus TCP	72
4.8.2	Audit Log View	36	6.5	Process Group Configuration	76
4.9	Alarm Event Log	37	6.5.1	Setting the Recording Parameters	76
4.10	Totalizer Log	39	6.5.2	Configuring the Chart View	78
5	Setup	41	6.5.3	Configuring the Bargraph View	81
5.1	Introduction	41	6.5.4	Configuring the Process View	82
5.2	Accessing the Setup Level	41	6.5.5	Configuring the Digital Indicator View	83
5.3	Password Entry	42	6.5.6	Archiving	85
5.4	Setup Menu	43	6.6	Channel Configuration	86
5.5	Archiving	45	6.6.1	Recording Channel Setup	87
5.5.1	Card Compatibility	45	6.6.2	Analog Input Configuration	89
5.5.2	Media Status	45	6.6.3	Digital Input Configuration	92
5.5.3	Inserting and Removing Media	46	6.6.4	Alarm Configuration	93
5.5.4	Archive File Types	47	6.6.5	Totalizer Configuration	98
5.5.5	Archive Filenames	47	6.7	I/O Module Configuration	101
5.5.6	Channel Data Files	47	6.7.1	Analog Inputs	101
5.5.7	Log files	48	6.7.2	Relay Modules	102
5.5.8	On-line/Off-line	48	6.7.3	Hybrid Modules	103
5.5.9	Data Verification and Integrity	48	6.7.4	RS485 (Modbus™) Serial Communications Module	105
5.5.10	Backing Up Archived Data	48	6.8	Functions	107
5.5.11	Archive Wrap	48	6.8.1	Custom Linearizers	107
5.5.12	File Formats	49	6.8.2	Custom Chart Zones	108
			6.8.3	Real-time Alarms	108

7	Installation	109	Appendix C – Storage Capacity	170	
7.1	Siting	109	C.1	Internal Storage Capacity	170
7.2	Mounting	110	C.2	Archive Storage Capacity	171
7.3	Electrical Connections	112			
7.4	Analog Inputs	114	Appendix D – Default Settings	172	
7.4.1	Current and Voltage	114	D.1	Company Standard	172
7.4.2	Thermocouple	114	D.1.1	Common Configuration	172
7.4.3	Resistance Thermometer (RTD)	114	D.1.2	Process Groups 1 to 6	172
7.4.4	Transmitter Power Supply	114	D.1.3	Recording Channels	173
7.5	RS422/485 Serial Communications	116	D.1.4	I/O Modules	173
7.5.1	Host Computer Serial Communications	116	D.1.5	Functions	174
7.5.2	Two-wire and Four-wire Connection	116	D.2	QuickStart Templates	174
7.5.3	Pull-up and Pull-down Resistors	117	D.2.1	QSMilliAmp	174
7.5.4	Termination Resistor	117	D.2.2	QSFlow	174
7.5.5	Serial Connections	117	D.2.3	QSTHC_C	174
7.6	Mains Power Connections	118	D.2.4	QSTHC_F	174
7.7	Relay Output Board Connections	118	D.2.5	QSRTD_C	175
7.8	Hybrid I/O Module Connections	119	D.2.6	QSRTD_F	175
7.8.1	Digital Output Connections	119	D.2.7	QSDEMO	175
7.8.2	Digital Input Connections	119			
7.8.3	Analog Output Connections	119	Appendix E – Ethernet	176	
7.9	Ethernet Network Connections	120	E.1	Introduction	176
7.9.1	Direct Connection to a Computer	120	E.1.1	Ethernet Communications	176
7.9.2	Connection to a Network Hub	121	E.1.2	Higher Level Protocols	176
7.9.3	Connection to a Dial-Up Router	121	E.2	Testing a Network Connection	177
7.9.4	Connection to an Internet Gateway	121	E.3	Configuring FTP Access	177
			E.3.1	FTP Access via MS-DOS	178
8	Specification	122	E.3.2	FTP Access via Internet Explorer	179
			E.3.3	Using FTP Access with DataManager	180
			E.3.4	Using the Recorder's Web Server	181
			E.3.5	Glossary of Terms	187
Appendix A – Signal Sources	129		Appendix F – Spare Parts and Accessories	188	
Appendix B – Modbus Guide	131		Appendix G – Error & Diagnostics Information	189	
B.1	Introduction	131	Appendix H – Symbols and Icons	190	
B.2	Setting Up	131	Appendix I – End User License Agreement	191	
B.3	Modbus Protocol	131	Index	192	
B.3.1	Modbus Commands Supported	131	Acknowledgements and Trademarks	196	
B.3.2	Modbus Exception Responses	132			
B.4	Operating Mode	132			
B.4.1	Operating Mode Modbus Coils	132			
B.4.2	Operating Mode Modbus Registers	146			
B.4.3	Communications – Analog and Digital Inputs	169			

1 Product Identification

Check the product code on the serial number label to ensure the correct recorder has been received.

Multipoint Videographic Recorder	SM30	XX	X	X	X	X	X	X	X	X	X	X	X	X	X	X	X	X	XXX
Analog Inputs																			
None		00																	
6 inputs		06																	
12 inputs		12																	
18 inputs		18																	
24 inputs		24																	
30 inputs		30																	
36 inputs		36																	
Universal Inputs																			
Standard																		S	
High Specification																		H	
Build Option																			
Standard																			B
cCSAus*																			C
UL*																			U
Archive Media																			
None — (8 Mb internal flash memory only)																			0
Compact flash drive																			2
Software Option																			
None																			0
Advanced Math & Logic																			1
Batch Recording																			4
Advanced Math & Logic & Batch Recording																			5
Option Modules																			
Position A	Reserved for analog inputs																		0
Position B	Reserved for analog inputs																		0
Position C	Reserved for analog inputs																		0
Position D	Reserved for analog inputs																		0
Position E	None (only option available if 30 or more analog inputs or a 24 V DC powered instrument is specified)																		0
	3 relays																		3
	6 relays																		6
	Hybrid																		H
Position F	None (only option available if 36 analog inputs or a 24 V DC powered instrument is specified)																		0
	3 relays																		3
	6 relays																		6
	Hybrid																		H
Position G	None																		0
	3 relays																		3
	6 relays																		6
	Hybrid																		H
	2-wire transmitter power supply																		T
	RS485 serial communications																		S
Position H	None																		0
	3 relays																		3
	6 relays																		6
	Hybrid																		H
	2-wire transmitter power supply																		T
Mechanical Build																			
Without rear terminal cover																			1
With rear terminal cover																			2
Power Supply																			
100 to 240 V AC ±10 % (90 min. to 264 V max.) 50/60 Hz																			2
24 V DC																			3
Language																			
English																			
French																			F
German																			D
Italian																			I
Spanish																			S
Special Features																			
Standard																			STD
Custom configuration (customer to complete and supply SM3000 custom configuration sheet – INF08/035)																			CUS
GAMP validation compatible instrument**																			VAL
Engineered configuration (customer to supply configuration details required)																			ENG

* Not available in conjunction with 24 V DC power supply

** Instrument supplied preconfigured to customer's requirements, together with calibration and conformity certificates. Configuration must be supplied using custom configuration sheet – [INF08/035](#)

2 Getting Started

1. Make connections and power-up the recorder.

Note. For detailed electrical connection information, refer to Section 7.3, page 112.

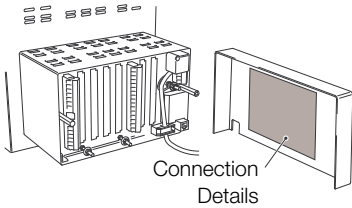

2. Select the configuration level and a quick start template.

Note. For detailed configuration information, refer to Section 6, page 51.

QuickStart Template	Summary Channels 1.1 to 1.6
QSMilliAmp	4 to 20mA inputs, 0 to 100.0 units
QSTHC_C or QSTHC_F	Thermocouple type K 0 to 100°C or 0 to 212°F
QSRTD_C or QSRTD_F	PT100 inputs 0 to 100°C or 0 to 212°F
QSFlow	4 to 20mA, 0 to 2000 l/hr, Totalizer enabled

Main Configuration Menu

3. Set the time and date.

4. Set the sample rate.

Chart Speed	Sample Rate	Internal Storage
10 mm/h	72s	13.2 months
20 mm/h	36s	6.6 months 6
60 mm/h	12s	2.2 months Channels Enabled
120 mm/h	6s	1.1 months
240 mm/h	3s	16.4 days
720 mm/h	1s	5.5 days

5. Select the views required and the operator menu choices.



6. Configure the archive files.

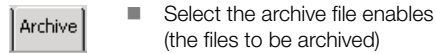

7. Change the channel configurations.

- Select a channel source
Select the input filter type: instantaneous or max. and min. values during the sample interval.
- Select the input type, linearizer, ranges and tag name
Analog I/P A1
- Select the alarm type, set the alarm trip points, the tag and the hysteresis.
Alarm A, B, C, D
- Set the count rate, preset & predetermined count values
Totalizer A, B

8. Set up I/O.

Note. Modules fitted are detected automatically.

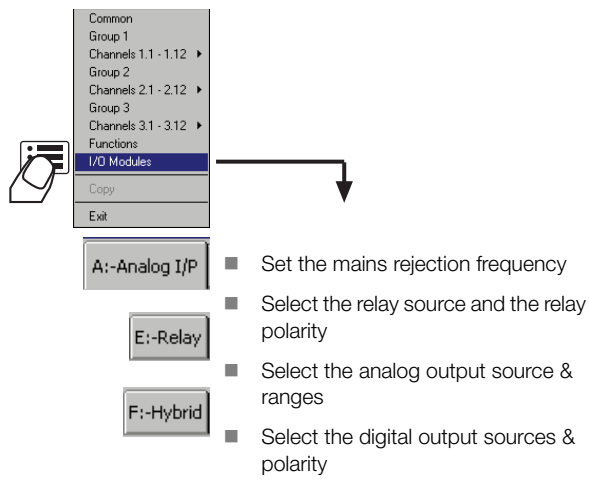

9. Exit configuration and save changes.

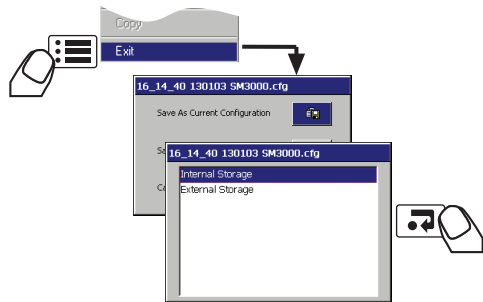

10. Start recording!

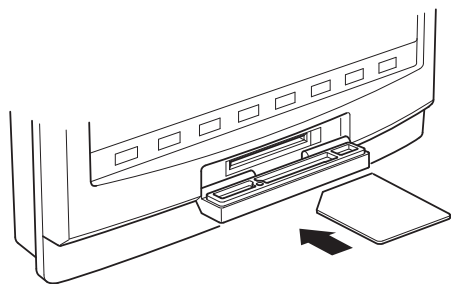

Insert media to start the archiving process automatically.

3 Introduction

Functional Overview

- 36 Recording Channels as standard, equally divided into up to 6 Process Groups, each with up to a maximum of 12 Recording Channels.
- Four Alarms and two Totalizers are assigned to each Recording Channel.
- Signal sources derived from universal analog inputs, the optional Modbus serial link, optional digital inputs or internal analog and digital signals.
- Any source can be assigned to any recording channel.
- Data from assigned sources can be displayed in:
 - Vertical-, Horizontal- or Circular-Chart view format
 - Vertical or Horizontal Bargraph view format
 - Digital Indicator view format
 - Process view format
- Group Overview display – each enabled process group's vertical-chart view can be displayed together on one screen.
- Three instrument logs record alarm events, totalizer values and system/configuration changes.
- Screen Capture facility – Saves an image of any of the operator views to external archive media provided external archive media with sufficient free space is inserted in the instrument. It is not necessary for archiving to be 'online'.

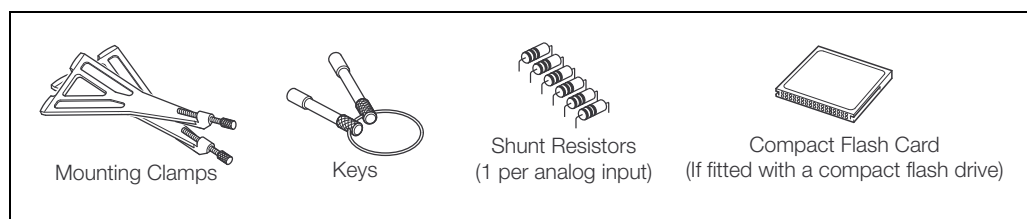

Fig. 3.1 **Standard Accessories**

Note. For optional accessories, refer to Appendix F on page 188.

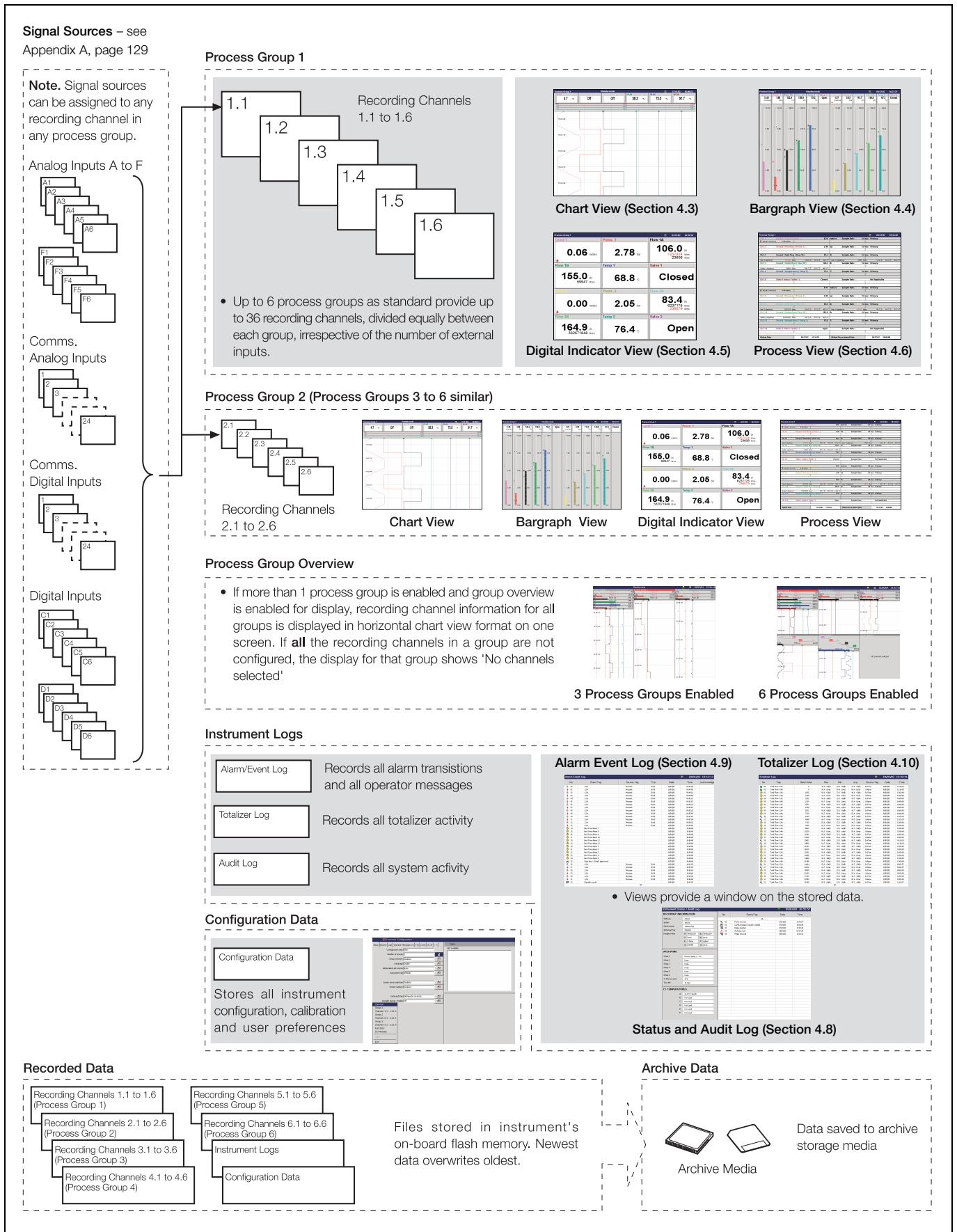

Fig. 3.2 Functional Overview

4 Operation

4.1 Powering up the Instrument

When power is first applied to the instrument, its processor carries out a number of self-tests and displays the start-up screen. At the end of the start up sequence the instrument displays the last Operator View that was displayed when the instrument was powered down.

4.2 Displays and Controls

In normal day-to-day use, the instrument is operated via the Operator Keys located along the bottom of the screen.

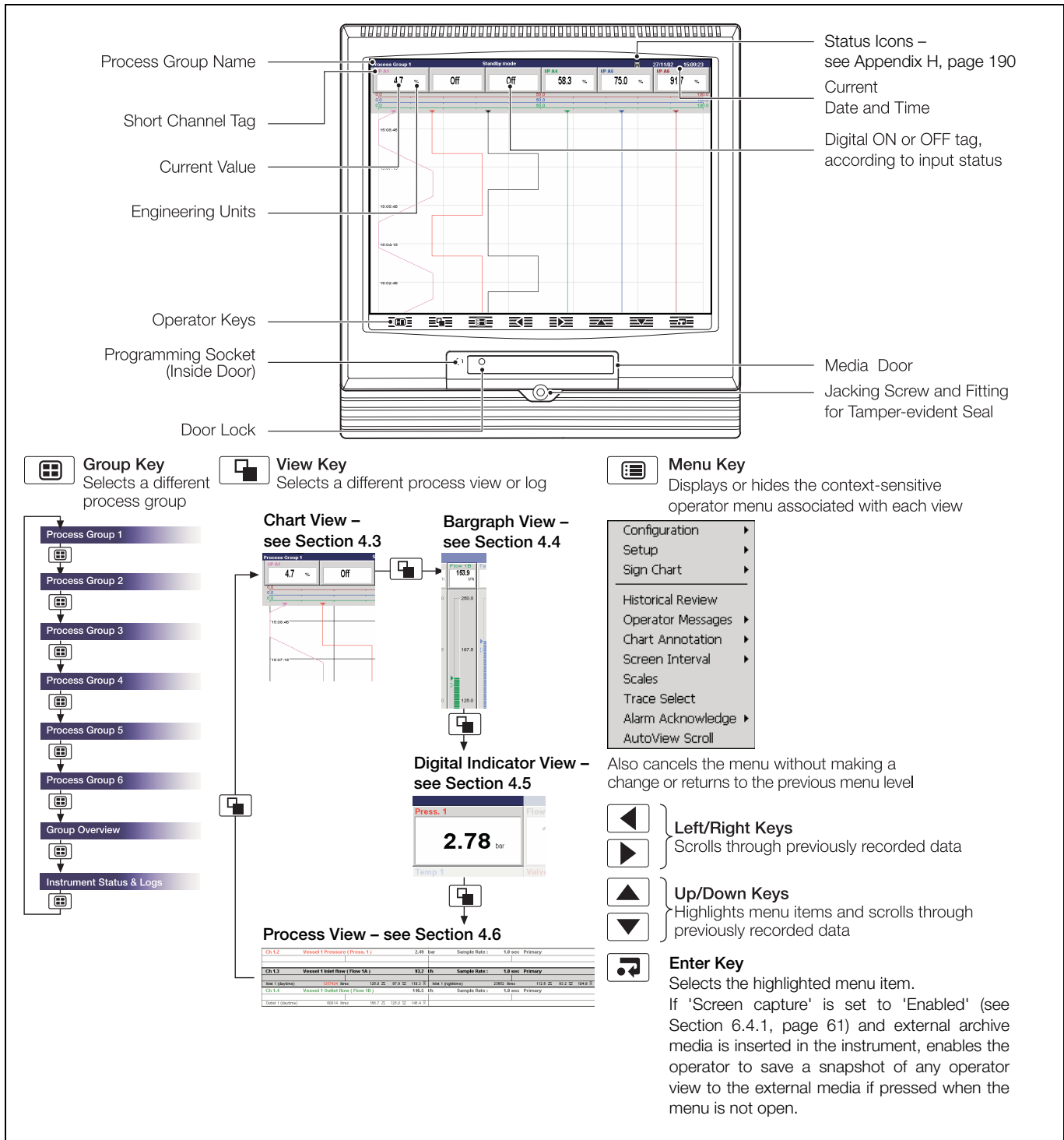

Fig. 4.1 Displays and Controls

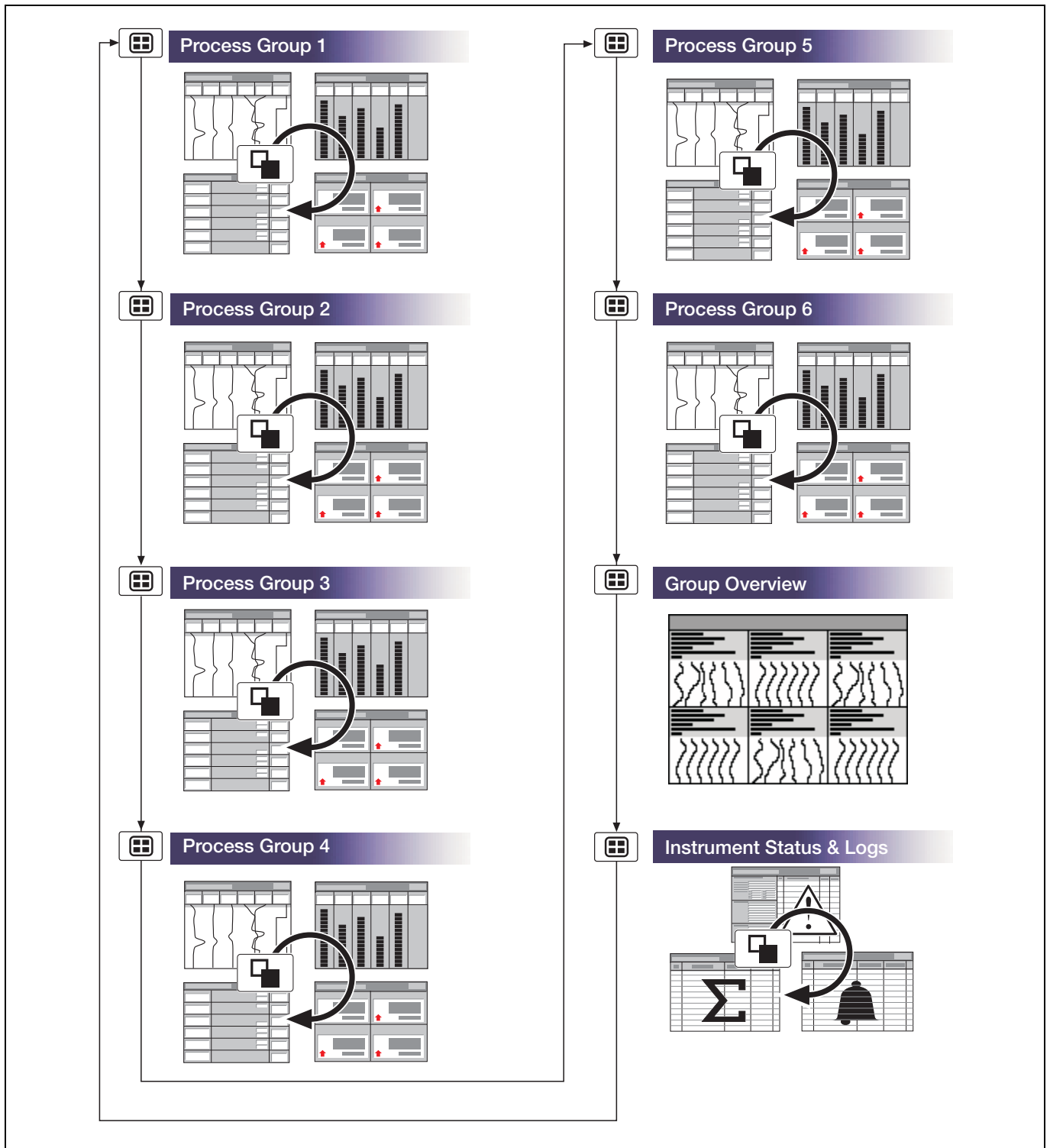

Fig. 4.2 Overview of Operator Displays

Note.

- Only process groups and views that have been enabled are displayed – see Section 6.5, page 76.
- Group Overview is displayed only if more than one process group has been configured and group overview display has been enabled – see Section 6.4.1, page 61.

4.3 Chart Views

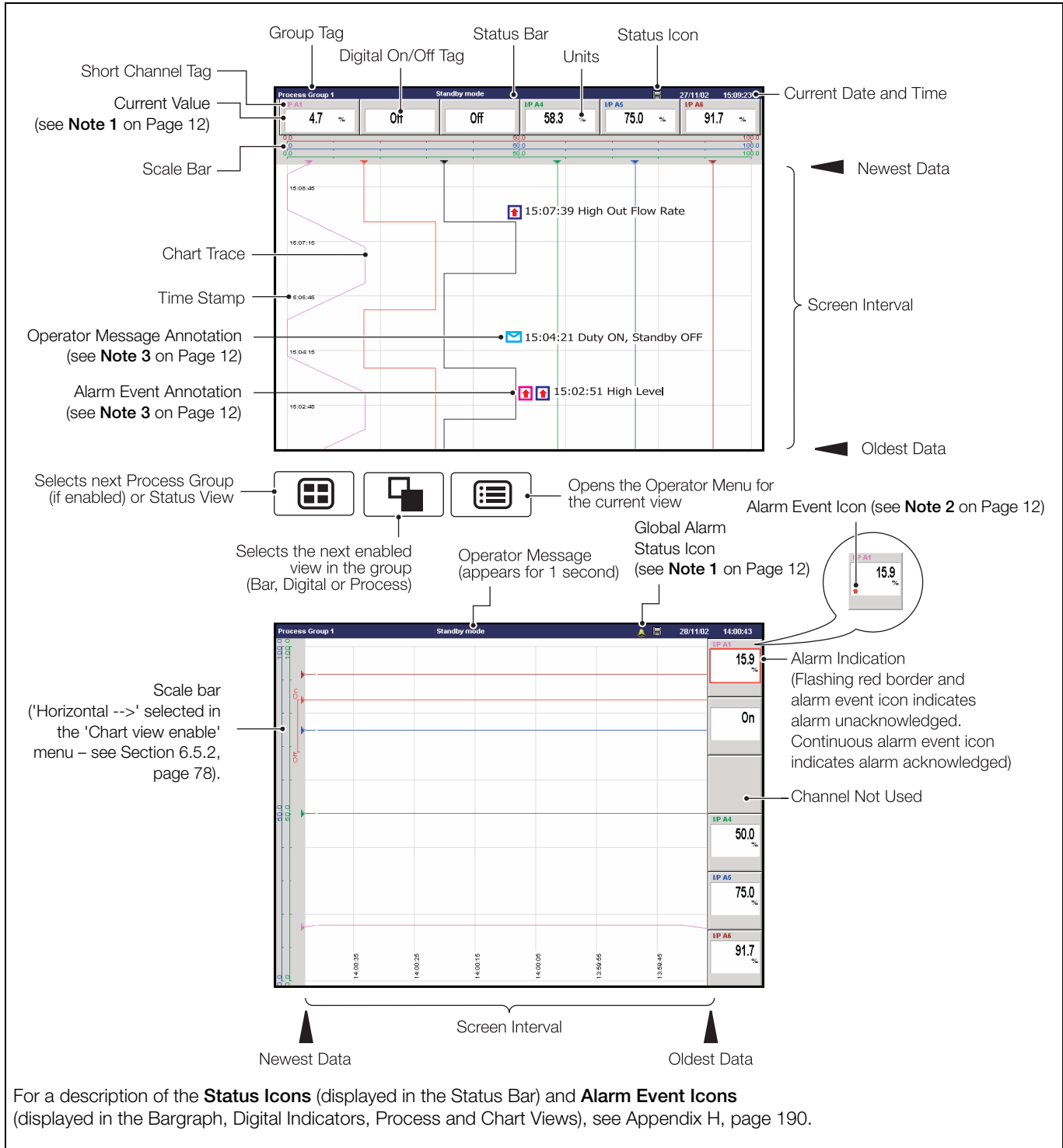

Fig. 4.3 Horizontal and Vertical Chart Views

Note. Do not remove media while either of the media update in progress status icons (🔴 or 🔵) are displayed.

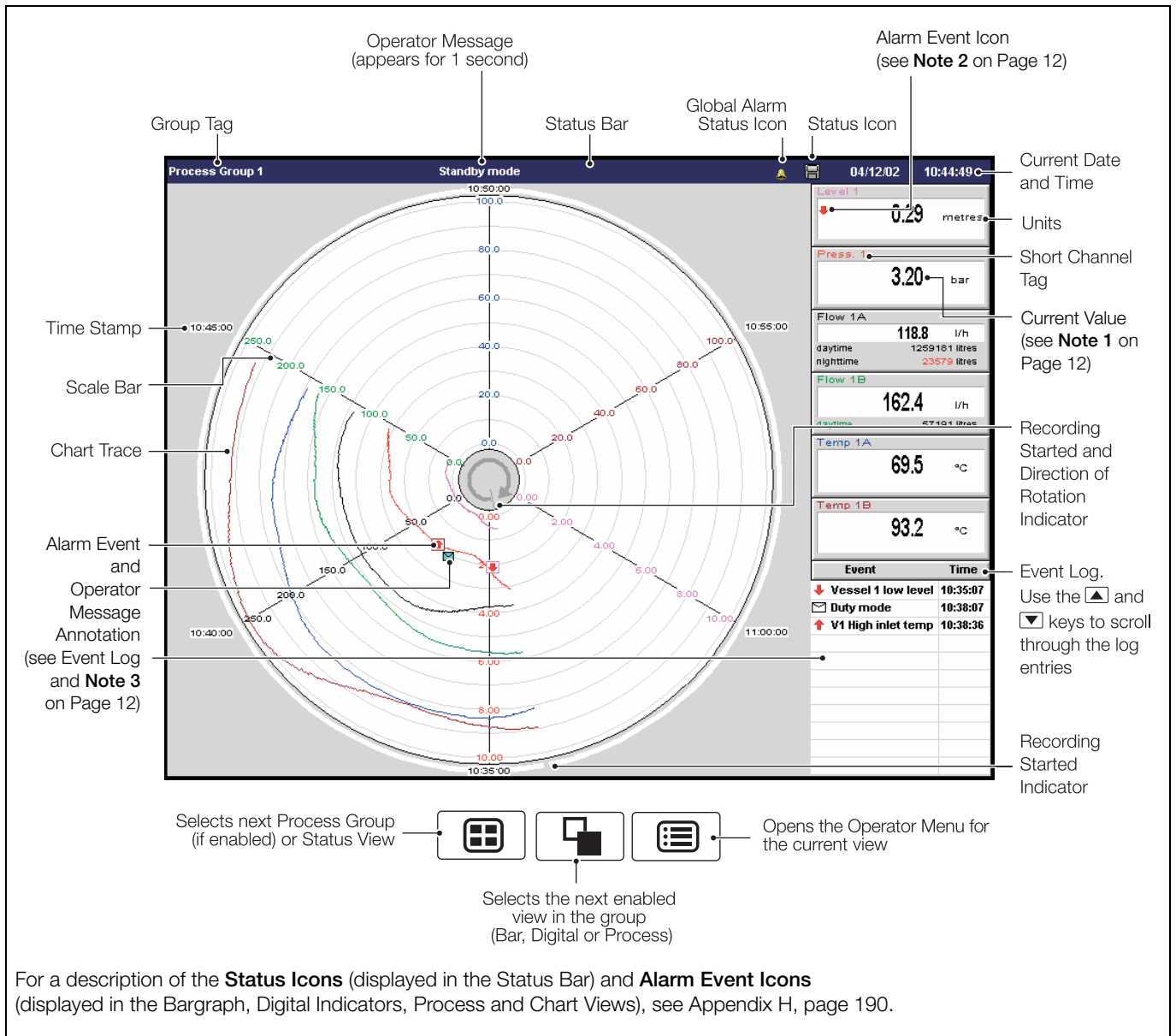

Fig. 4.4 Circular Chart View

Note.

1. Current Values



The Current Value, shown on the digital indicators at either the top (vertical chart view) or right hand side (horizontal chart view) of the screen, is the latest instantaneous value and its update rate is not affected by the recording sample rate.

If the current value in the digital indicator is displayed in red, recording has been stopped for that channel – see Section 5.4, page 43 and see Section 6.6.1, page 87.

Traces are shown only when that particular channel is being recorded. When a channel is set to Stop, its trace continues to be shown for up to one sample period.

2. Alarm Status



- Flashing red border around channel indicator alternating with flashing red alarm event icon – alarm active and unacknowledged
- Continuous red alarm event icon – alarm active and acknowledged

If any alarm in any process group is active, the Global Alarm status icon () is displayed in the status bar – Fig. 4.3. If any active alarm in any process group is unacknowledged, the icon is surrounded by a red flashing border ().

3. Alarm Event and Operator Message Annotations

Alarm Event and Operator Message annotations are not shown on the chart unless enabled – see 'Chart Annotation' on page 16 and see Section 6.5.2, page 78.

If Alarm event annotation is enabled and an alarm becomes active, a red alarm event icon surrounded by a channel colored box is displayed at the point at which the alarm occurred, together with the alarm time and tag, for example:

   11:58:00 1.1A High Level

If more than one alarm occurs in the same sample period:

- and the second alarm on a channel becomes active, its icon is added behind the first.
- and more than one operator message is active (max. six), a second icon is added behind the first.
- the new alarm event icons appear to the left of earlier icons.
- the time and tag of the oldest alarm (right-most icon) only is displayed.

4. Screen Capture

If 'Screen capture' is set to 'Enabled' in Common Configuration (see Section 6.4.1, page 61) and an external archive media card is inserted in the instrument, an image of any Chart, Bargraph, Digital Indicator, Process, Instrument Status/Audit Log, Alarm Log or Totalizer Log view can be saved to the external media by pressing the  key whenever the Operator Menu is not open.



- Configuration ▶
- Setup
- Sign Chart ▶
- Historical Review

Select the Configuration Level – see Section 6, page 51.

Select the Setup Level – see Section 5, page 41.

Sign the chart electronically – see Section 4.3.1, page 20.

Select Historical Review to view previously recorded data stored in the instrument's onboard memory.

Note. Use the ▲ and ▼ keys (Horizontal and Vertical Chart view) or ◀ and ▶ keys (Circular Chart view) to move backwards and forwards through the recorded data.

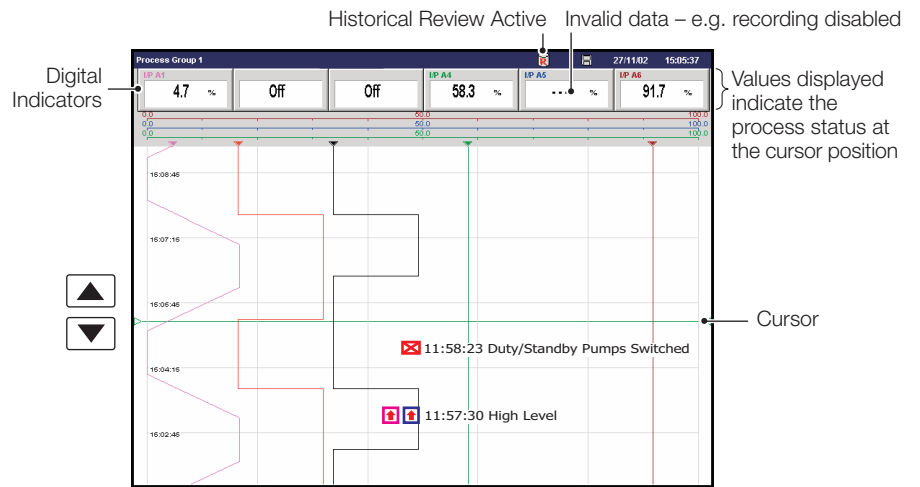

Note.

While in Historical Review mode:

- Recording of new data continues unless stopped from the Setup Menu – see Section 5.4, page 43.
- Invalid historical data (for example, when recording has stopped) is denoted by '---' in the digital indicator.
- Where the trace at the cursor position represents more than one sample, the indicators flash between the maximum and minimum values of those samples.
- Menu options remain active – allowing the screen interval to be changed, different scales and channels to be selected, etc.
- Operator messages generated are added to the alarm event log at the present time, not the time indicated by the cursor.
- All data stored in the instrument's internal memory can be viewed.
- The display can be scrolled back to the start of the oldest data.
- Archiving to removable media does not occur but all data recorded in the internal memory buffer during this time is archived on exiting Historical Review mode.

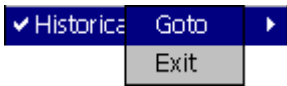

Select 'Goto' to move to data stored in the instrument's onboard memory that was recorded at a specific date and time.

Oldest data in internal memory

Newest data in internal memory

'Goto' target date

'Goto' target time

Selected 'goto' target date/time is within daylight saving period

Daylight Saving

Cancel

Cursor

Goto

Returns to the chart view

Moves cursor between 'goto' target date and time boxes. Use ▲ and ▼ keys to change selected date or time

Goes to the chart view at the selected 'goto' target date and time

Note.

- If daylight saving is enabled (see Section 6.4.1, page 61) and the selected 'Goto' target date/time is within the daylight saving period, 'Daylight Saving' is displayed on the dialog box.
- Once internal memory becomes full, oldest data is overwritten by newest data. If historical review has been selected for some time, the oldest data present may no longer be available.
- The instrument exits Historical Review mode automatically after 15 minutes if no key is pressed.

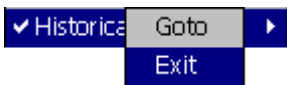

Select Exit to return to the real-time recording display.

Note. Pressing the or key also exits Historical Review mode and displays the next enabled view.

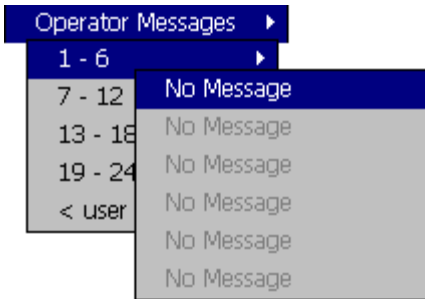

Add one of 24 predefined Operator Messages (see Section 6.4.4, page 68) or one User-Defined Message to the alarm event log.

If '< user defined >' is selected, a data entry keyboard first appears to enable the message to be entered (see Fig. 6.5, page 56).

An 'Assign to group' dialog box then appears to enable the message to be assigned to one or more Process Groups.

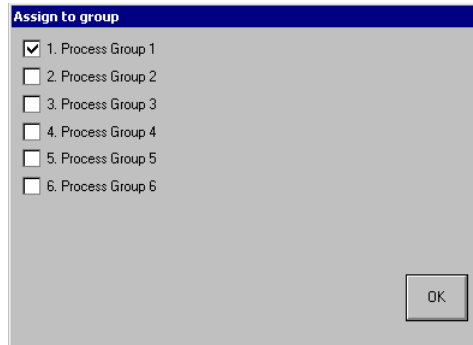

The selected or user-defined message is displayed briefly in the status bar. If Operator Message annotation is selected (see 'Chart Annotation' on page 16) the message is also added to the chart.

Note. When the instrument is in Historical Review mode, Operator Messages generated are added at the current time, not the time indicated by the cursor.

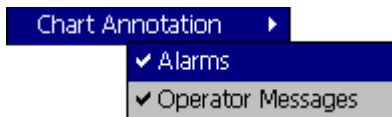

If an alarm or operator message is obscuring part of a chart trace, use the Chart Annotation option to hide or display alarms and messages on the screen. Select the annotation required. ✓ indicates the annotations selected.

The possible combinations are:

- No annotation (Alarms and Operator Messages both disabled)
- Alarm annotation only
- Alarms and Operator Message annotation

Operator Message annotation cannot be enabled unless Alarm annotation is also enabled.

Note.

- If more than 40 icons are present on the screen, chart annotation is disabled automatically.
- When chart annotation is disabled, new operator messages and alarms are still added to the Alarm Event log – see Section 4.9, page 37.

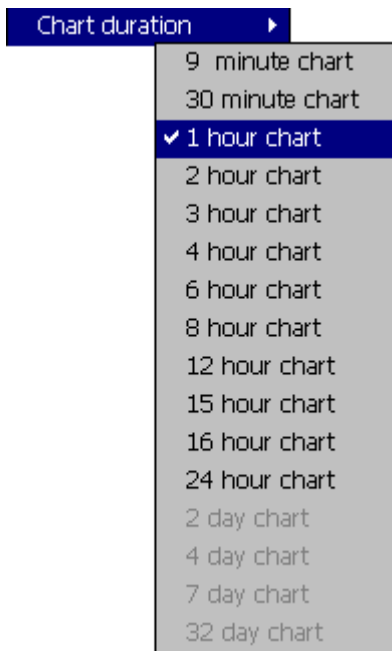

Note. Applicable only to Circular Chart view in Historical Review mode and is greyed-out in the menu until 'Historical review' is selected.

Use 'Chart Duration' to change the amount of data displayed on the screen in historical review mode. A longer chart duration displays more data, a shorter chart duration displays data over a shorter time period, but in more detail. In both cases, the full trace is preserved by plotting the maximum and minimum samples for each display point. Unavailable chart durations are greyed-out.

The chart durations available in the menu are determined by the faster of the primary and secondary sample rates set for the process group during configuration – see Section 6.5.1, page 76. Unavailable chart durations are greyed-out.

Table 4.1 on page 17 shows the relationship between sample rate and chart duration for the Circular Chart view.

Note.

- A 'Please Wait' message appears in the status bar while the instrument retrieves data from storage.
- Selecting a different chart duration does not affect the rate at which data is sampled.
- Changing the chart duration causes the time at the cursor position to change.
- If the chart duration is changed when in historical review mode, it reverts to that set during configuration (see Section 6.5.1, page 76) upon exiting historical review mode.

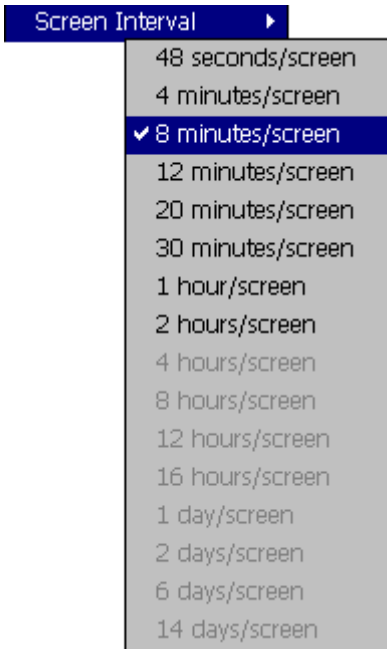

Note. Applicable only to Vertical and Horizontal Chart views.

Use the 'Screen Interval' to change the amount of data displayed on the screen. A longer screen interval displays more data, a shorter screen interval displays data over a shorter time period, but in more detail. In both cases, the full trace is preserved by plotting the maximum and minimum samples for each display point.

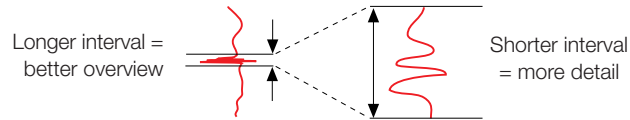

The screen intervals available in the menu are determined by the faster of the primary and secondary sample rates set for the process group during configuration – see Section 6.5.1, page 76. Unavailable screen intervals are greyed-out.

Table 4.1 shows the relationship between sample rate and screen interval for the Vertical and Horizontal Chart views.

Note.

- A 'Please Wait' message appears in the status bar while the instrument retrieves data from storage.
- Selecting a different screen interval does not affect the rate at which data is sampled.
- When in historical review mode, changing the screen interval causes the time at the cursor position to change.

Circular Chart View		Vertical Chart View		Horizontal Chart View	
Chart Duration	Fastest Sample Rate	Screen Interval	Fastest Sample Rate	Screen Interval	Fastest Sample Rate
9 minutes	0.1 seconds	48 seconds	0.1 seconds	70 seconds	0.1 seconds
30 minutes	0.1 seconds	4 minutes	0.1 seconds	6 minutes	0.1 seconds
1 hour	1 second	8 minutes	0.1 seconds	12 minutes	0.1 seconds
2 hours	1 second	12 minutes	0.1 seconds	17 minutes	0.1 seconds
3 hours	1 second	20 minutes	0.1 seconds	30 minutes	0.1 seconds
4 hours	1 second	30 minutes	1 second	45 minutes	1 second
6 hours	1 second	1 hour	1 second	1.5 hours	1 second
8 hours	1 second	2 hours	1 second	3 hours	1 second
12 hours	1 second	4 hours	10 seconds	6 hours	10 seconds
15 hours	1 second	8 hours	10 seconds	12 hours	10 seconds
16 hours	1 second	12 hours	10 seconds	18 hours	10 seconds
1 day	1 second	16 hours	10 seconds	1 day	10 seconds
2 days	10 seconds	1 day	20 seconds	1.5 days	20 seconds
4 days	20 seconds	2 days	40 seconds	3 days	40 seconds
8 days	40 seconds	6 days	60 seconds	9 days	60 seconds
32 days	140 seconds	14 days	140 seconds	21 days	140 seconds

Table 4.1 Sample Rates and Screen Intervals

Scales

Note. Applicable only to Vertical and Horizontal Chart views.

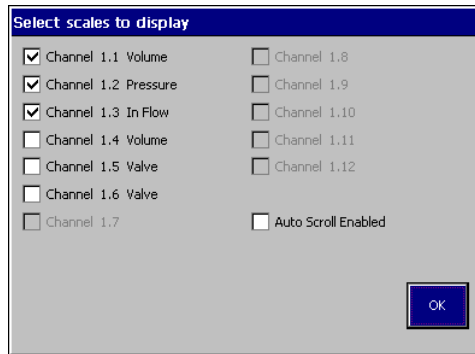

Select the scale(s) to be displayed in the scale bar at the top of the chart window. For digital channels, the On and Off tags are displayed at the corresponding position on the scale bar. A maximum of 3 scales can be selected for display at any one time.

Select 'Auto Scroll Enabled' to display the scale for each enabled channel in turn for 36 seconds in groups of 3.

Trace Select

Hide individual channel traces to improve chart clarity.

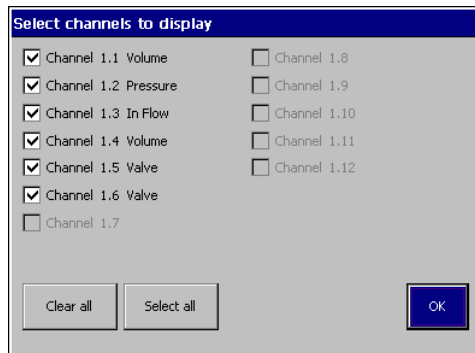

Select the channel trace(s) to be displayed in the chart view:

Select...

- 'Clear All' to clear all check boxes and hide all channel traces
- 'Select All' to select all configured channel traces for viewing
- individual check boxes to select that channel trace for viewing

Select 'OK' to exit.

Note. The recording of a channel's data is not affected by this operation and the instantaneous channel values are still shown on the indicators at the top of the screen.

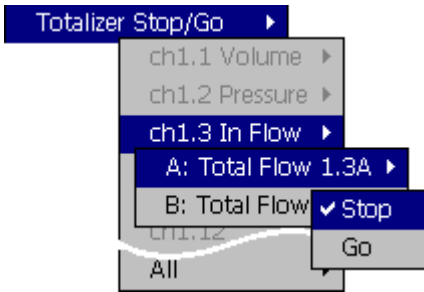

Note. Applicable only to Circular Chart view.

Stop and start individual totalizers.

Channel totalizers that have not been enabled in the Configuration level are greyed-out.

Note. When a totalizer is not running (i.e. 'Stop' is selected), the corresponding totalizer value is shown in red.

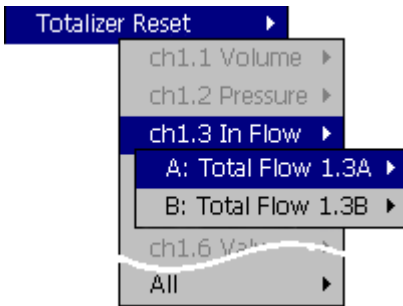

Note. Applicable only to Circular Chart view.

Reset the totalizer value to the totalizer preset value.

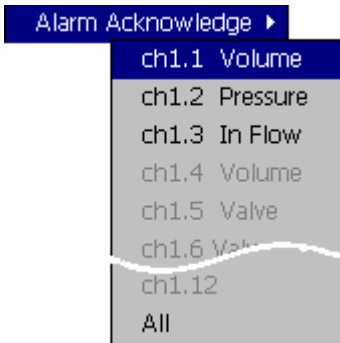

Channel totalizers that have not been enabled in the Configuration level are greyed-out.



To acknowledge a particular alarm, use the ▲ and ▼ keys to highlight it in the menu and press the  key.

Note. Active unacknowledged alarms in the current process group are identified by a red border around the value in the associated channel indicator, alternating with a red Alarm Event icon in the bottom left hand corner of the same indicator. Active acknowledged alarms are identified by a continuous red Alarm Event icon in the bottom left hand corner of the indicator – see Fig. 4.3, page 10.

To acknowledge all active alarms in the current process group simultaneously, select 'All' and press the  key.

Note. If an alarm in another process group is active, the Global Alarm status icon  continues to be displayed in the status bar. If an active alarm in another process group is unacknowledged, the icon is surrounded by a red flashing border .

The short channel tags of individual alarms that have not been configured are greyed-out in the menu.



Select 'AutoView Scroll' to display the enabled chart view for each configured process group in turn for 40 seconds. The AutoView Scroll status icon  is displayed in the status bar when AutoView Scroll is active. Press any key to cancel AutoView Scroll.

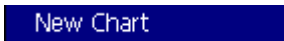

Note. Applicable only to Circular Chart view.

Select to start a new circular chart.

4.3.1 Electronic Signatures

Entering an electronic signature is the equivalent to signing the chart of a conventional paper recorder. Local procedures may require the approval of a record by an authorized signatory; for this reason, an electronic signature is password protected.

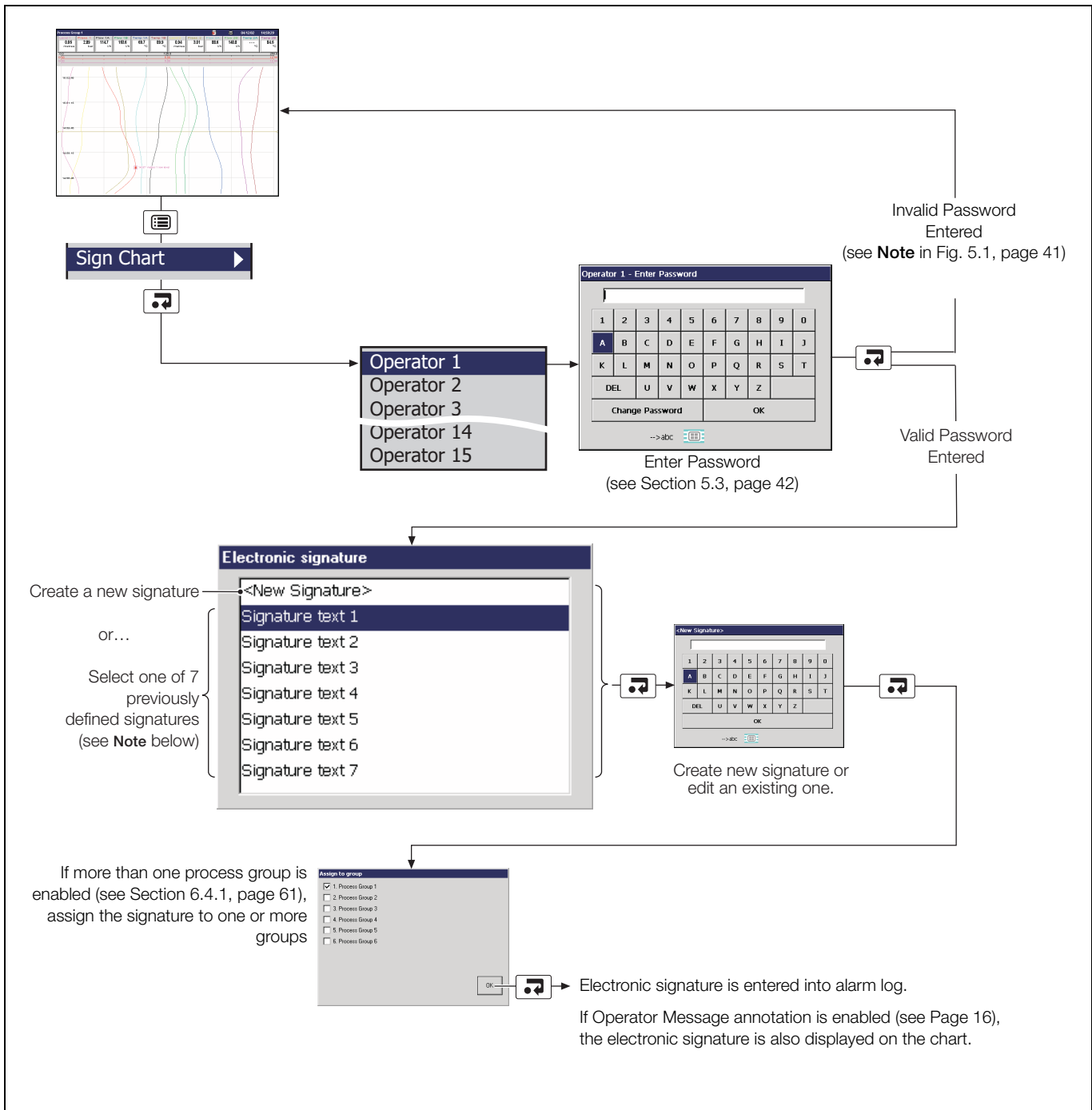

Fig. 4.5 Entering an Electronic Signature

Note. Up to 7 electronic signatures can be stored in the instrument's memory. If 7 signatures exist and a new one is created, the oldest is overwritten.

4.4 Bargraph Views

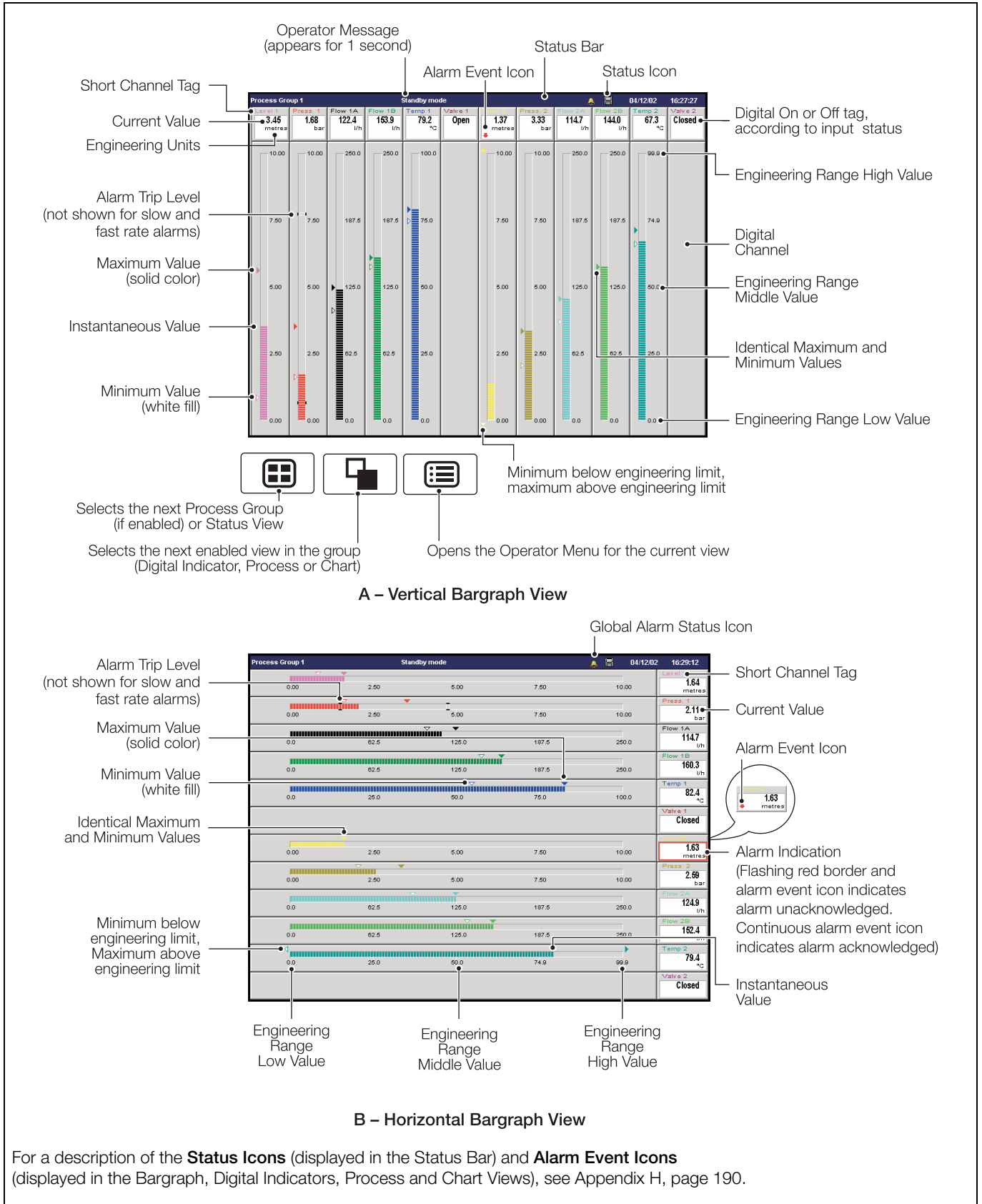

Fig. 4.6 Bargraph Views



Configuration ▶

Setup

Operator Messages ▶

1 - 6 ▶

- 7 - 12 No Message
- 13 - 18 No Message
- 19 - 24 No Message
- < user No Message
- No Message
- No Message

Select the Configuration Level – see Section 6, page 51.

Select the Setup Level – see Section 5, page 41.

Add one of 24 predefined Operator Messages (see Section 6.4.4, page 68) or one User-Defined Message to the alarm event log.

If '< user defined >' is selected, a data entry keyboard first appears to enable the message to be entered (see Fig. 6.5, page 56).

An 'Assign to group' dialog box then appears to enable the message to be assigned to one or more Process Groups.

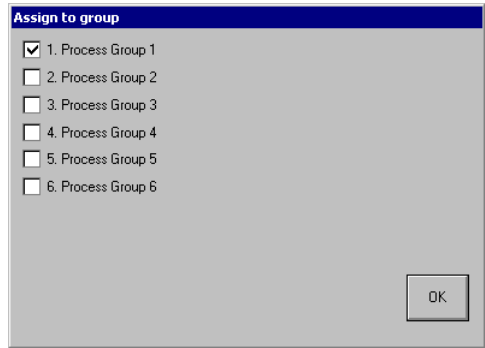

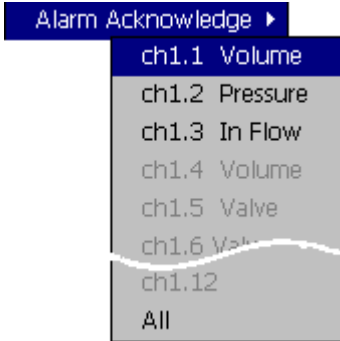
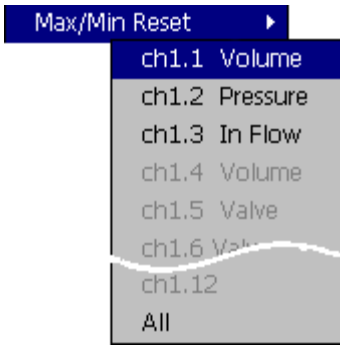

Reset the Maximum and Minimum value markers on one or all channels to the current value.

Notes.

- These Maximum and Minimum values are for display purposes only. They are not saved or archived and are not connected to the Totalizer Maximum and Minimum Values displayed in the Process View.
- These Maximum and Minimum values are reset whenever the current configuration has been changed or is re-saved.

To acknowledge a particular alarm, use the and keys to highlight it in the menu and press the key.

Note. Active unacknowledged alarms in the current process group are identified by a red border around the value in the associated channel indicator, alternating with a red Alarm Event icon in the bottom left hand corner of the same indicator. Active acknowledged alarms are identified by a continuous red Alarm Event icon in the bottom left hand corner of the indicator – see Fig. 4.6, page 21.

To acknowledge all active alarms in the current process group simultaneously, select 'All' and press the key.

Note. If an alarm in another process group is active, the Global Alarm status icon () continues to be displayed in the status bar. If an active alarm in another process group is unacknowledged, the icon is surrounded by a red flashing border ()

The short channel tags of individual alarms that have not been configured are greyed-out in the menu.

Select 'AutoView Scroll' to display the enabled bargraph for each configured process group in turn for 40 seconds. The AutoView Scroll status icon () is displayed in the status bar when AutoView Scroll is active. Press any key to cancel AutoView Scroll.

4.5 Digital Indicator View

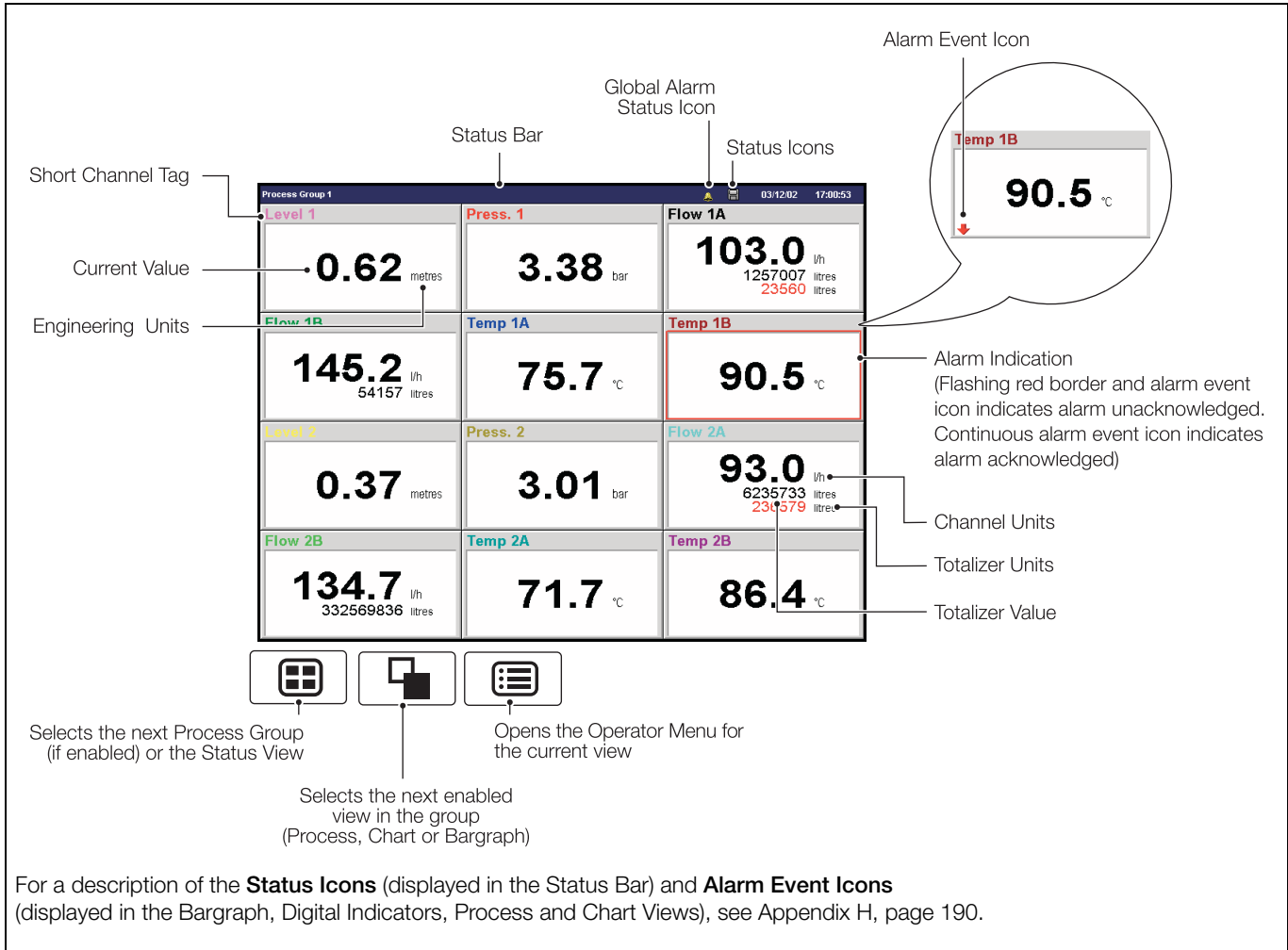

Fig. 4.7 Digital Indicator View

Note.

- Digital indicators resize automatically according to the number of channels displayed.
- Totalizers must be configured and enabled before they are displayed – see Section 6.6.5, page 98.
- When a totalizer is not running (i.e. 'Stop' is selected), the corresponding totalizer value is shown in red.



Configuration ▶

Setup

Operator Messages ▶

- 1 - 6 ▶
- 7 - 12 No Message
- 13 - 18 No Message
- 19 - 24 No Message
- < user No Message
- No Message
- No Message

Select the Configuration Level – see Section 6, page 51.

Select the Setup Level – see Section 5, page 41.

Add one of 24 predefined Operator Messages (see Section 6.4.4, page 68) or one User-Defined Message to the alarm event log.

If '< user defined >' is selected, a data entry keyboard first appears to enable the message to be entered (see Fig. 6.5, page 56).

An 'Assign to group' dialog box then appears to enable the message to be assigned to one or more Process Groups.

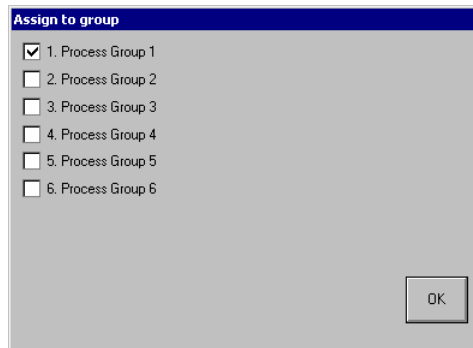

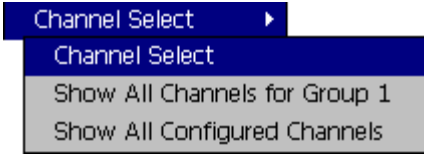

Hide or display individual channel indicators for the process group currently displayed.

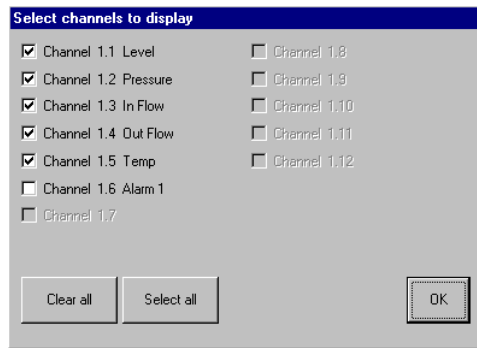

Select the channel digital indicator(s) to be displayed in the digital indicator view:

Select...

- 'Clear All' to clear all check boxes and hide all channels
- 'Select All' to select all configured channels for viewing
- individual check boxes to select that channel for viewing

Select 'OK' to exit.

Notes.

- The digital indicators displayed are sized equally depending on the number of channels selected. This has no effect on the recording of the channel.
- The number of channels available for display depends on the number of Process Groups enabled, for example, if 5 Process Groups are enabled, each group has up to 7 channels available for display.
- Channels that have not been configured are greyed-out in the menu.

Level 1 0.62 mm	Press 1 3.38 bar	Flow 1B 103.0 m ³ /h 23564 litres
Flow 1B 145.2 m ³ /h 32856 litres	Temp 1A 75.7 °C	Temp 1B 90.5 °C
Press 2 0.37 bar	Press 2A 3.01 bar	Temp 2A 93.0 °C 20512 litres
Temp 1B 134.7 °C 300558 litres	Temp 2A 71.7 °C	Temp 1B 86.4 °C

Twelve Channels Selected

Level 1 0.66 metres	Press 1 2.27 bar
Flow 1A 112.0 m ³ /h 23564 litres	Flow 1B 166.7 m ³ /h 36883 litres
Temp 1 82.2 °C	Valve 1 Closed

Six Channels Selected

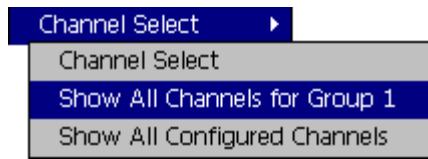

Display all configured channel indicators for the process group currently selected for display.



Display all configured channel indicators for all process groups.

Note. Selecting this option enables up to 36 channels to be displayed if all 36 channels are configured.

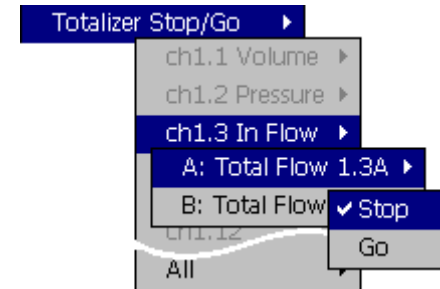

Stop and start individual totalizers.

Channel totalizers that have not been enabled in the Configuration level are greyed-out.

Note.

- When a totalizer is not running (i.e. 'Stop' is selected), the corresponding totalizer value is shown in red.
- When 'Show All Configured Channels' is selected above, this menu changes to show Group followed by Channel followed by Totalizer.

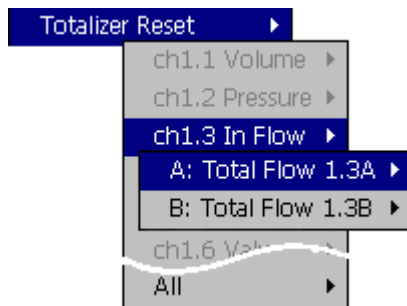

Reset the totalizer value to the totalizer preset value.

Channel totalizers that have not been enabled in the Configuration level are greyed-out.

Note. When 'Show All Configured Channels' is selected above, this menu changes to show Group followed by Channel followed by Totalizer.

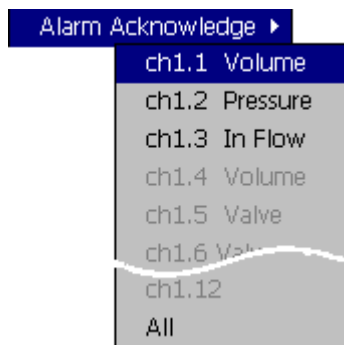



To acknowledge a particular alarm, use the ▲ and ▼ keys to highlight it in the menu and press the  key.

Note.

- Active unacknowledged alarms in the current process group are identified by a red border around the value in the associated channel indicator, alternating with a red Alarm Event icon in the bottom left hand corner of the same indicator. Active acknowledged alarms are identified by a continuous red Alarm Event icon in the bottom left hand corner of the indicator – see Fig. 4.7, page 24.
- When 'Show All Configured Channels' is selected above, this menu changes to show Group followed by Channel.

To acknowledge all active alarms in the current process group simultaneously, select 'All' and press the  key.

Note. If an alarm in another process group is active, the Global Alarm status icon  continues to be displayed in the status bar. If an active alarm in another process group is unacknowledged, the icon is surrounded by a red flashing border .

The short channel tags of individual alarms that have not been configured are greyed-out in the menu.



Select 'AutoView Scroll' to display the enabled digital indicator for each configured process group in turn for 40 seconds. The AutoView Scroll status icon  is displayed in the status bar when AutoView Scroll is active. Press any key to cancel AutoView Scroll.

4.6 Process View

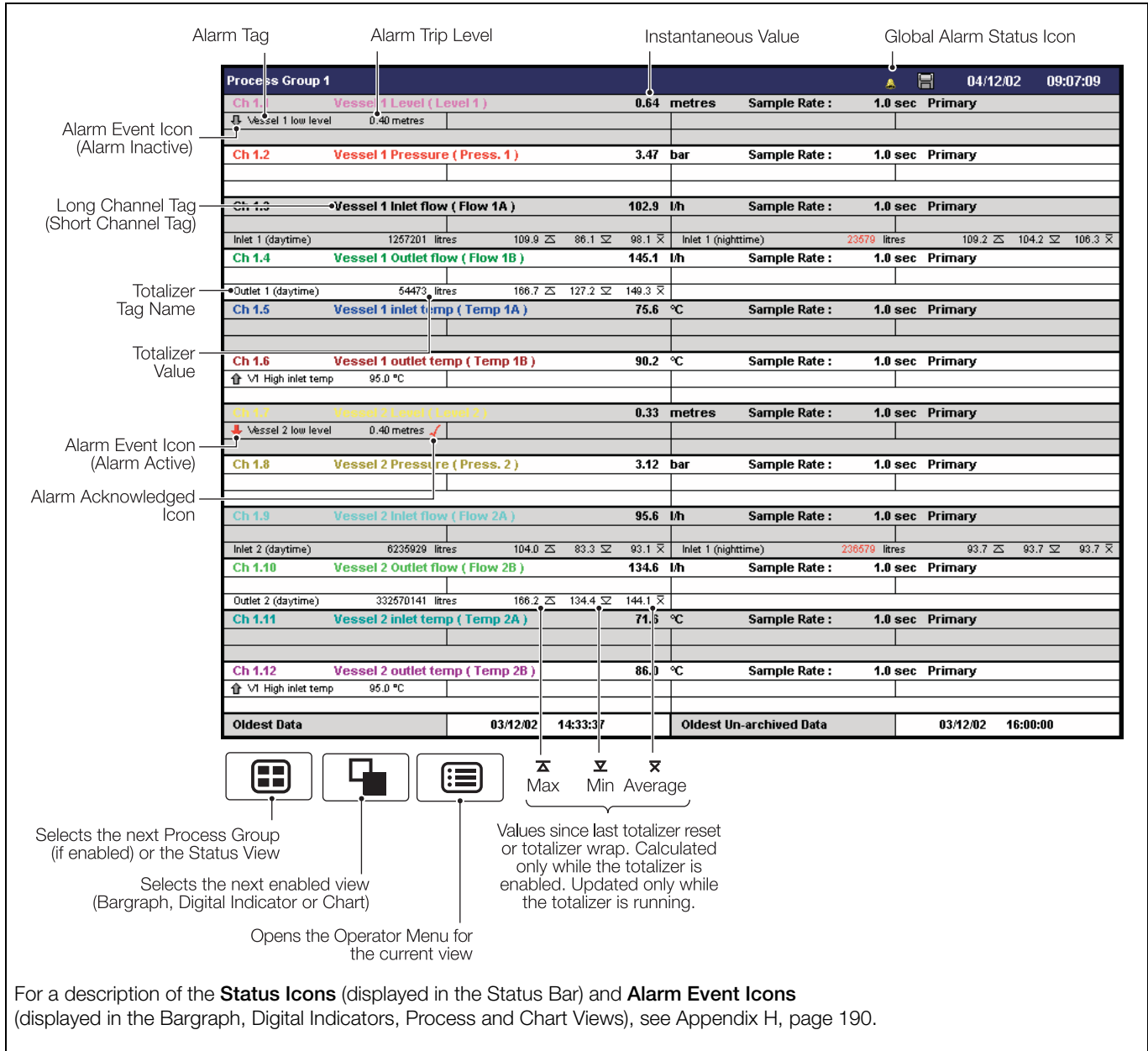

For a description of the **Status Icons** (displayed in the Status Bar) and **Alarm Event Icons** (displayed in the Bargraph, Digital Indicators, Process and Chart Views), see Appendix H, page 190.

Fig. 4.8 Process View

Note.

- Only totalizers that have been enabled in the Configuration level are displayed.
- When a totalizer is not running (i.e. 'Stop' is selected), the corresponding totalizer value is shown in red.



Configuration ▶

Setup

Operator Messages ▶

- 1 - 6 ▶
- 7 - 12 No Message
- 13 - 18 No Message
- 19 - 24 No Message
- < user No Message
- No Message
- No Message

Select the Configuration Level – see Section 6, page 51.

Select the Setup Level – see Section 5, page 41.

Add one of 24 predefined Operator Messages (see Section 6.4.4, page 68) or one User-Defined Message to the alarm event log.

If '< user defined >' is selected, a data entry keyboard first appears to enable the message to be entered (see Fig. 6.5, page 56).

An 'Assign to group' dialog box then appears to enable the message to be assigned to one or more Process Groups.

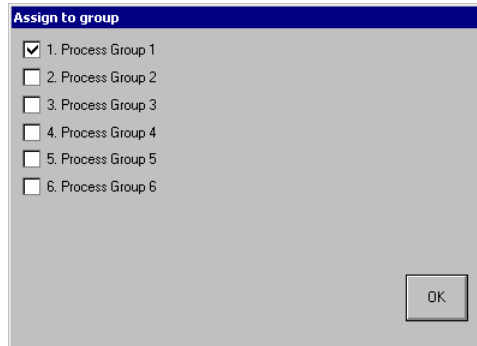

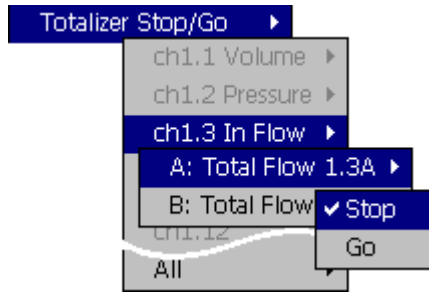

Stop and start individual totalizers.

Channel totalizers that have not been enabled in the Configuration level are greyed-out.

Note. When a totalizer is not running (i.e. 'Stop' is selected), the corresponding totalizer value is shown in red.

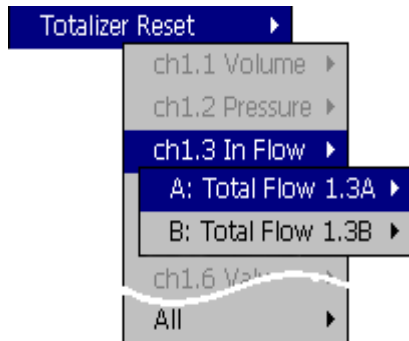

Reset the totalizer value to the totalizer preset value.

Channel totalizers that have not been enabled in the Configuration level are greyed-out.

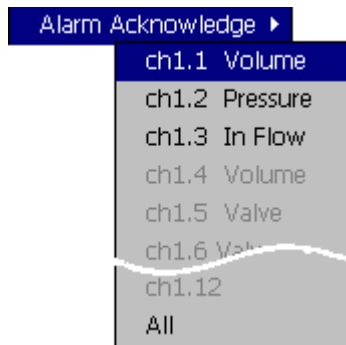

To acknowledge a particular alarm, use the and keys to highlight it in the menu and press the key.

Note. In Process View, inactive alarms in the current process group are indicated by a grey Alarm Event icon next to the Alarm Tag. Active alarms are identified by a red Alarm Event icon next to the Alarm Tag. Acknowledged alarms are identified by a red Alarm Acknowledged icon next to the Alarm Trip Level – see Fig. 4.8, page 28.

To acknowledge all active alarms in the current process group simultaneously, select 'All' and press the key.

Note. If an alarm in another process group is active, the Global Alarm status icon continues to be displayed in the status bar. If an active alarm in another process group is unacknowledged, the icon is surrounded by a red flashing border .

The short channel tags of individual alarms that have not been configured are greyed-out in the menu.

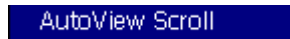

Select 'AutoView Scroll' to display the enabled process view for each configured process group in turn for 40 seconds. The AutoView Scroll status icon is displayed in the status bar when AutoView Scroll is active. Press any key to cancel AutoView Scroll.

4.7 Group Overview

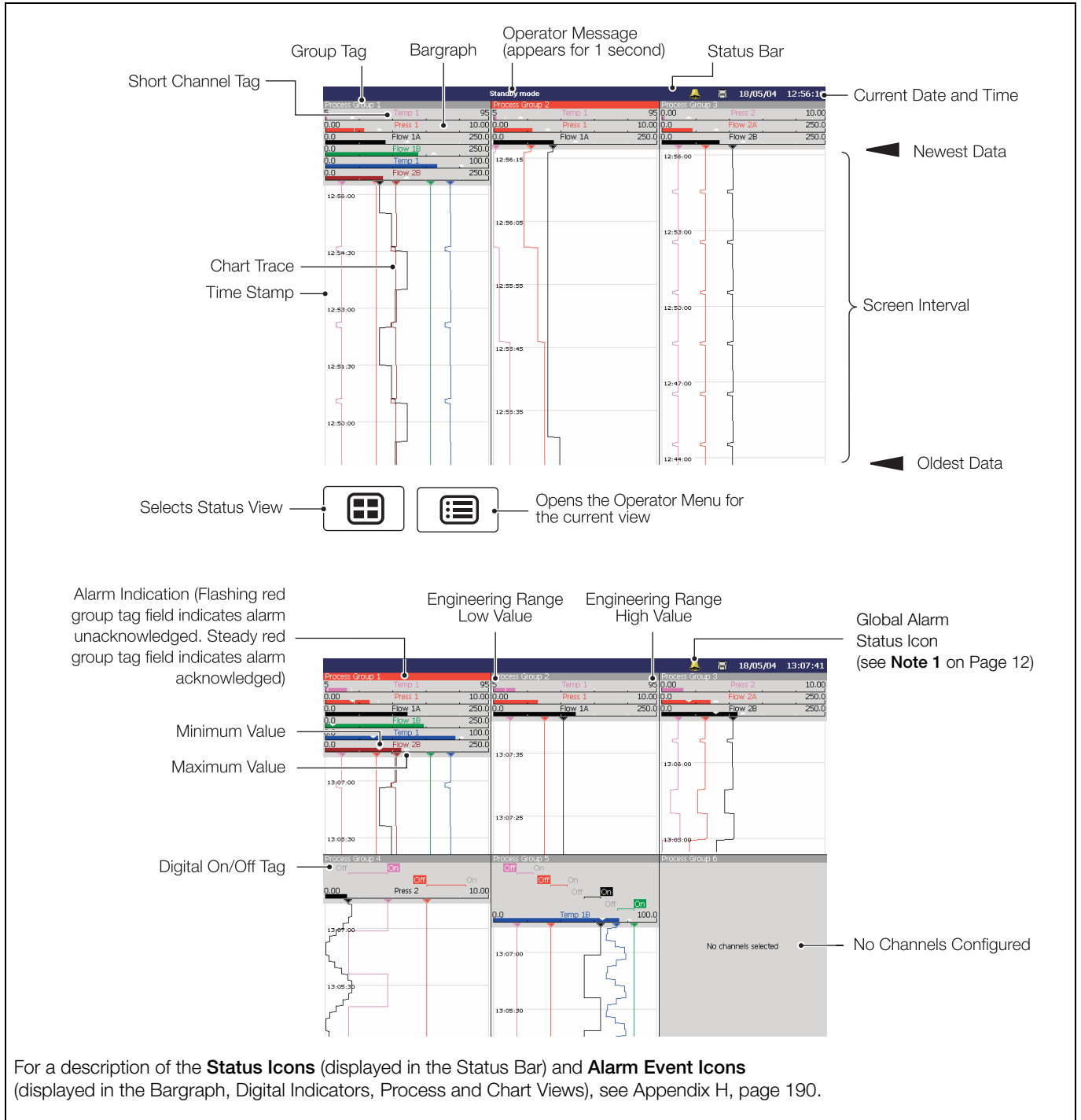

Fig. 4.9 Group Overview



- Configuration ▶
- Setup
- Sign Chart ▶

Operator Messages ▶

- 1 - 6 ▶
- 7 - 12 No Message
- 13 - 18 No Message
- 19 - 24 No Message
- < user No Message
- No Message
- No Message

Select the Configuration Level – see Section 6, page 51.

Select the Setup Level – see Section 5, page 41.

Sign the chart electronically – see Section 4.3.1, page 20.

Add one of 24 predefined Operator Messages (see Section 6.4.4, page 68) or one User-Defined Message to the alarm event log.

If '< user defined >' is selected, a data entry keyboard first appears to enable the message to be entered (see Fig. 6.5, page 56).

An 'Assign to group' dialog box then appears to enable the message to be assigned to one or more Process Groups.

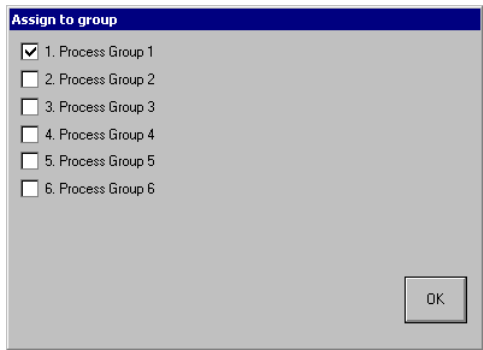

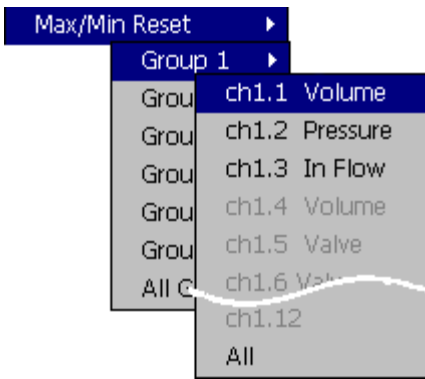



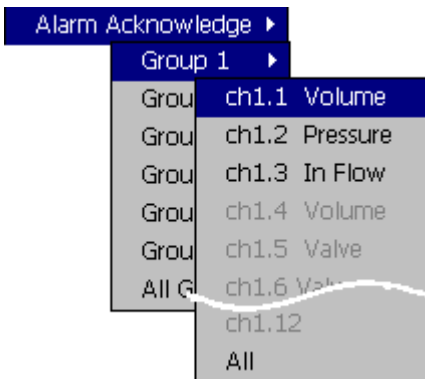

Reset the Maximum and Minimum value markers on one or all channels to the current value.

Notes.

- These Maximum and Minimum values are for display purposes only. They are not saved or archived and are not connected to the Totalizer Maximum and Minimum Values displayed in the Process View.
- These Maximum and Minimum values are reset whenever the current configuration has been changed or is re-saved.





Group Overview is not group specific therefore to acknowledge a particular alarm, use the ,  and  keys to select the group, highlight the alarm in the sub-sub-menu and press the  key.

Note. In Group Overview, active alarms are identified by a flashing red group tag field. Acknowledged alarms are identified by a steady red group tag field – see Fig. 4.9, page 31.

To acknowledge all active alarms in all process groups simultaneously, select 'All' and press the  key.

To acknowledge all active alarms in the selected process group simultaneously, select 'All' and press the  key.

Note. If an alarm in another process group is active, the Global Alarm status icon () continues to be displayed in the status bar. If an active alarm in another process group is unacknowledged, the icon is surrounded by a red flashing border (.

The short channel tags of individual alarms that have not been configured are greyed-out in the menu.

4.8 Instrument Status / Audit Log View

Note.

- The combined Instrument Status and Audit log view provides an overview of the instrument's status together with an historical log of system activity.
- The two views are described separately in Sections 4.8.1 and 4.8.2.

Instrument Status – see Fig. 4.11, page 35.

Audit Log – See Fig. 4.12.

Fig. 4.10 Instrument Status / Audit Log



Configuration ▶

Select the Configuration Level – see Section 6, page 51.

Setup

Select the Setup Level – see Section 5, page 41.

4.8.1 Instrument Status View

Note. The Instrument Status view provides an overview of the instrument's status.

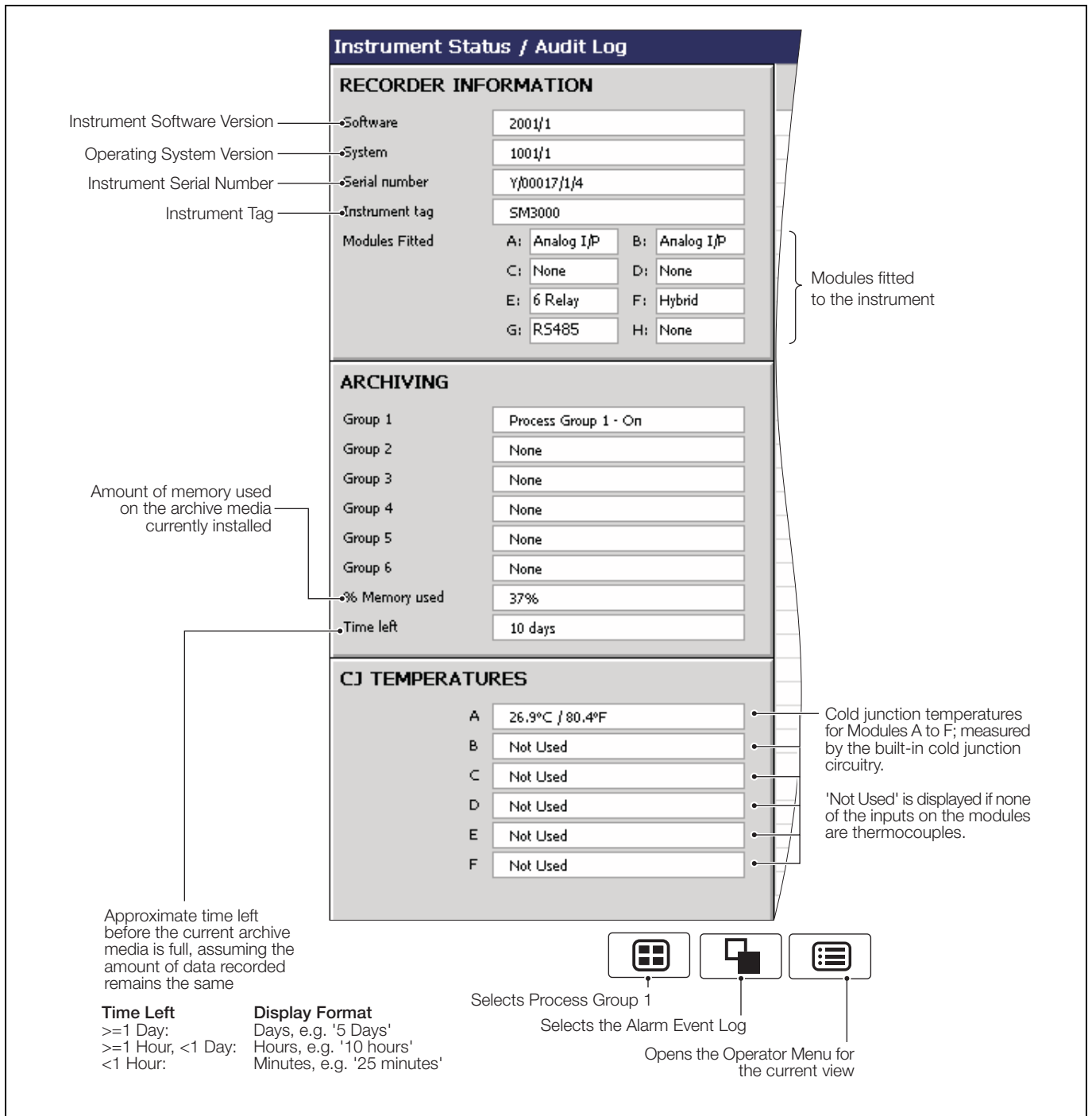

Fig. 4.11 Instrument Status

4.8.2 Audit Log View

Note.

- The Audit log view provides an historical log of system activity.
- When the number of entries in the Audit log has reached that defined in 'Audit log size' (see Section 6.4.3, page 67), the oldest data is overwritten by the newest. Entries are renumbered so that the number of the oldest entry is always 00.

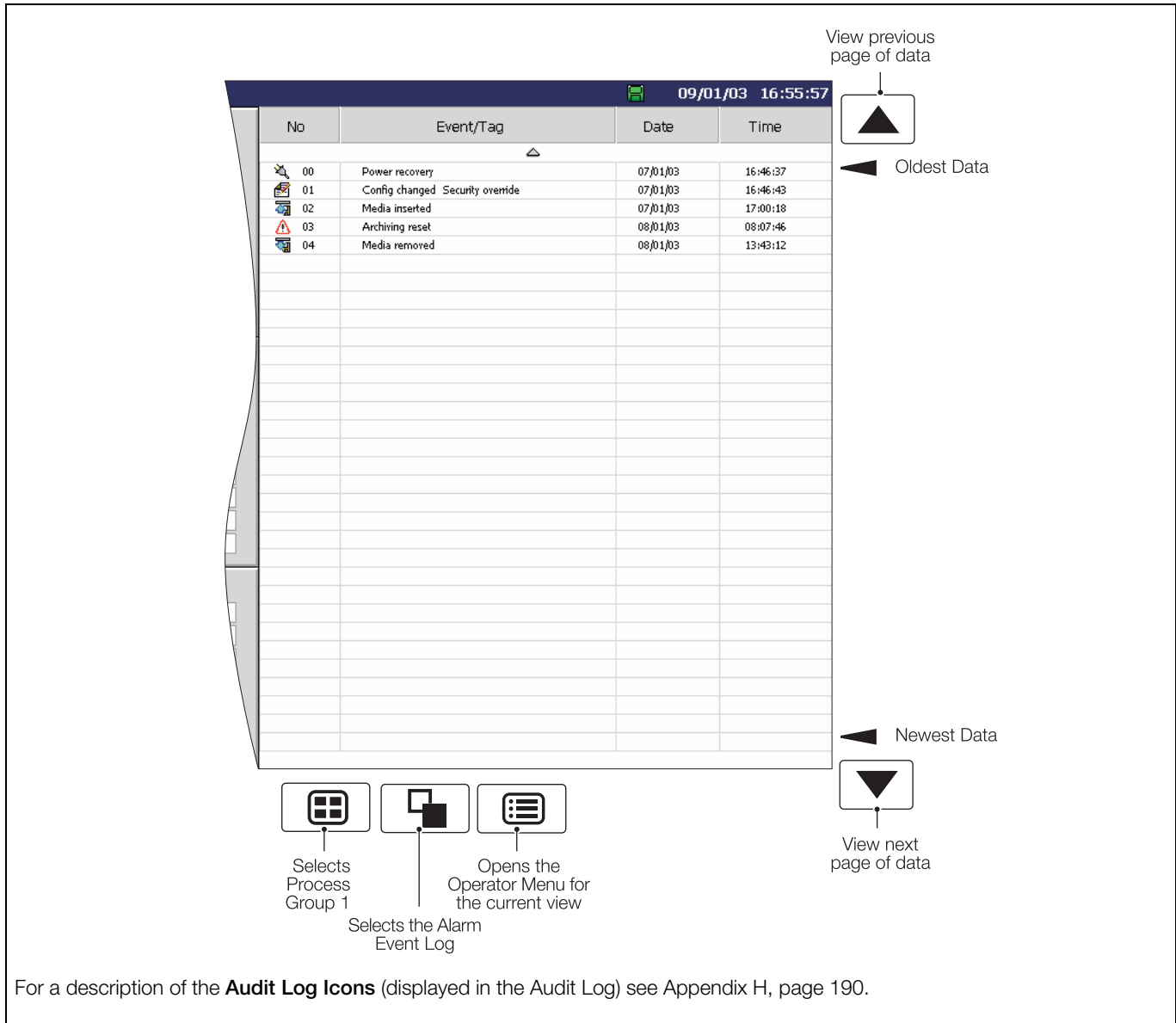

Fig. 4.12 Audit Log

4.9 Alarm Event Log

Note. The Alarm Event log view provides an historical log of all alarm events in the sequence in which they occurred. To view the current status of all alarms, choose the Process View – see Section 4.6, page 28.

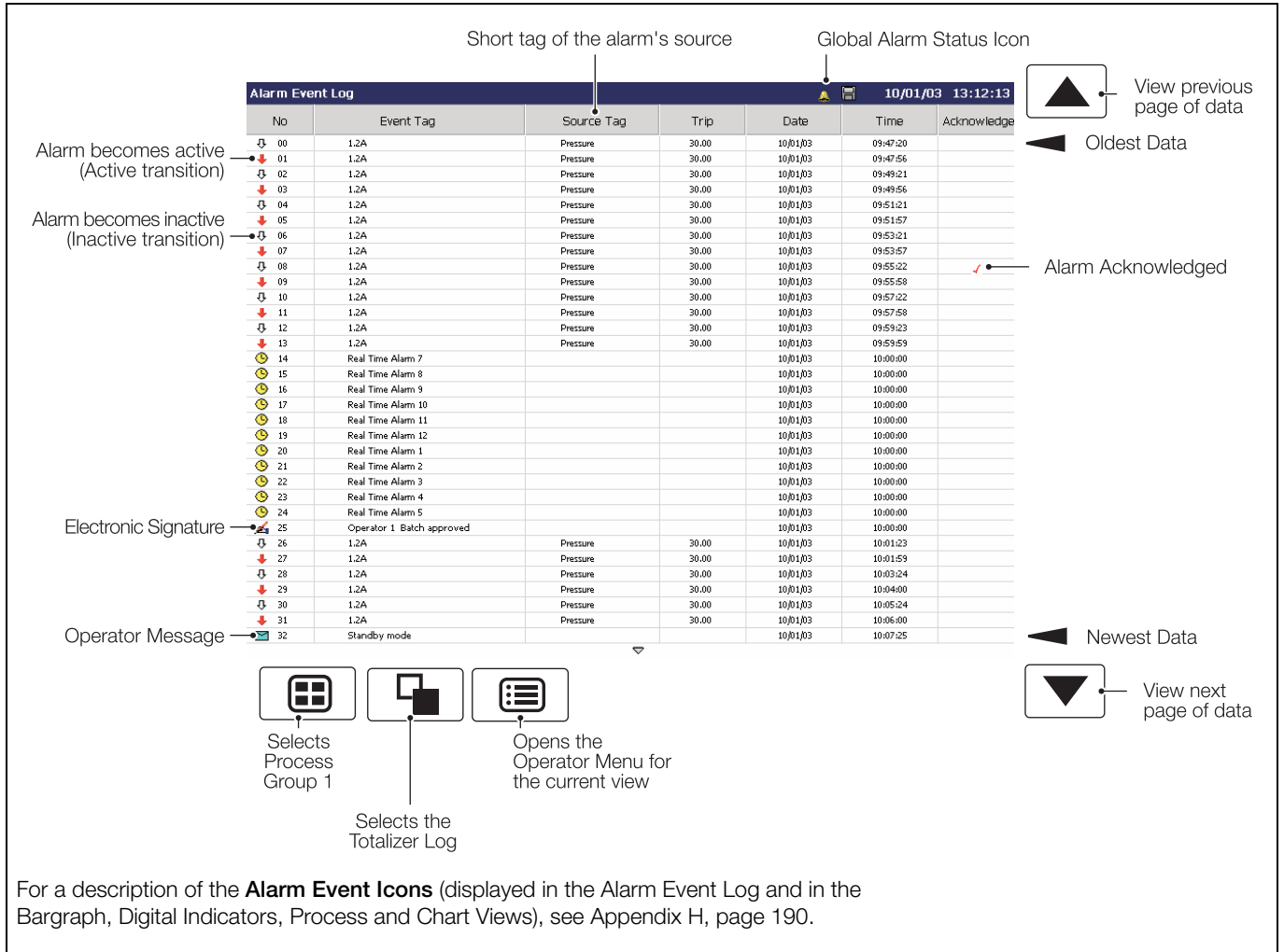

Fig. 4.13 Alarm Event Log

Note. When the number of entries in the Alarm Event log has reached that defined in 'Alarm log size' (see Section 6.4.3, page 67), the oldest data is overwritten by the newest. Entries are renumbered so that the number of the oldest entry is always 00.



Configuration ▶

Setup

Filter ▶

- ✓ Group 1 Alarms
- Group 2 Alarms
- Group 3 Alarms
- Group 4 Alarms
- Group 5 Alarms
- Group 6 Alarms
- ✓ Operator Messages
- All Data

- Active Transitions Only

Alarm Acknowledge ▶

- Group 1 Alarms ▶
- Group ch1.1 Volume
- Group ch1.2 Pressure
- Group ch1.3 In Flow
- Group ch1.4 Volume
- Group ch1.5 Valve
- All Groups ch1.6 Valve
- ch1.12
- All

Select the Configuration Level – see Section 6, page 51.

Select the Setup Level – see Section 5, page 41.

Select the entries to be displayed in the log. ✓ Indicates entries currently displayed.

Note.

- Hiding and displaying log entries does not affect the recording of events in the log.
- All selected alarm event transitions (from inactive to active, from active to acknowledged, from acknowledged to inactive, from active to inactive) appear in the sequence in which they occurred.
- Selecting 'All Data' displays entries for all enabled group alarms and operator messages.
- Selecting 'Active Transitions Only' displays entries for alarms when made active and hides all acknowledged & inactive transitions.

The Alarm Event log is not group specific therefore to acknowledge a particular alarm, use the ▲, ▼ and ⏏ keys to select the relevant process group, followed by the alarm to be acknowledged from the sub-sub-menu.

To acknowledge all active alarms in all process groups simultaneously, select 'All Groups' and press the ⏏ key.

To acknowledge all active alarms in the selected process group simultaneously, select 'All' and press the ⏏ key.

Note. If an alarm in another process group is active, the Global Alarm status icon (🔔) continues to be displayed in the status bar. If an active alarm in another process group is unacknowledged, the icon is surrounded by a red flashing border (🔔).

The short channel tags of individual alarms that have not been configured are greyed-out in the menu.

4.10 Totalizer Log

Note.

- The Totalizer log view provides an historical log of totalizer activity. To view the current totalizer status, choose the Process or Digital View.
- When the number of entries in the Totalizer log has reached that defined in 'Totalizer log size' (see Section 6.4.3, page 67), the oldest data is overwritten by the newest. Entries are renumbered so that the number of the oldest entry is always 00.
- The logging of totalizer values can be triggered at pre-determined intervals and/or by digital signal – see 'Log update time' and 'Log update source' on page 99.

No	Tag	Batch total	Max	Min	Avg	Source Tag	Date	Time
00	Total Flow 1.3A	0	33.8 Gal/h	33.8 Gal/h	33.8 Gal/h	In Flow	08/01/03	12:18:28
01	Total Flow 1.4A	0	50.4 Litres	50.4 Litres	50.4 Litres	Volume	08/01/03	12:18:55
02	Total Flow 1.3A	1036	50.0 Gal/h	33.3 Gal/h	41.6 Gal/h	In Flow	08/01/03	13:00:00
03	Total Flow 1.4A	1438	66.7 Litres	50.0 Litres	58.4 Litres	Volume	08/01/03	13:00:00
04	Total Flow 1.3A	2252	50.0 Gal/h	33.3 Gal/h	41.7 Gal/h	In Flow	08/01/03	14:00:00
05	Total Flow 1.4A	3139	66.7 Litres	50.0 Litres	58.4 Litres	Volume	08/01/03	14:00:00
06	Total Flow 1.3A	3751	50.0 Gal/h	33.3 Gal/h	41.7 Gal/h	In Flow	08/01/03	15:00:00
07	Total Flow 1.4A	5238	66.7 Litres	50.0 Litres	58.4 Litres	Volume	08/01/03	15:00:00
08	Total Flow 1.3A	5231	50.0 Gal/h	33.3 Gal/h	41.7 Gal/h	In Flow	08/01/03	16:00:00
09	Total Flow 1.4A	7310	66.7 Litres	50.0 Litres	58.4 Litres	Volume	08/01/03	16:00:00
10	Total Flow 1.3A	6329	50.0 Gal/h	33.3 Gal/h	41.7 Gal/h	In Flow	09/01/03	11:22:38
11	Total Flow 1.4A	8848	66.7 Litres	50.0 Litres	58.3 Litres	Volume	09/01/03	11:22:38
12	Total Flow 1.3A	7103	50.0 Gal/h	33.3 Gal/h	41.7 Gal/h	In Flow	09/01/03	12:00:00
13	Total Flow 1.4A	9930	66.7 Litres	50.0 Litres	58.4 Litres	Volume	09/01/03	12:00:00
14	Total Flow 1.3A	8602	50.0 Gal/h	33.3 Gal/h	41.7 Gal/h	In Flow	09/01/03	13:00:00
15	Total Flow 1.4A	12029	66.7 Litres	50.0 Litres	58.4 Litres	Volume	09/01/03	13:00:00
16	Total Flow 1.3A	10101	50.0 Gal/h	33.3 Gal/h	41.7 Gal/h	In Flow	09/01/03	14:00:00
17	Total Flow 1.4A	14128	66.7 Litres	50.0 Litres	58.4 Litres	Volume	09/01/03	14:00:00
18	Total Flow 1.3A	10431	50.0 Gal/h	33.3 Gal/h	41.7 Gal/h	In Flow	09/01/03	14:15:30
19	Total Flow 1.4A	14589	66.7 Litres	50.0 Litres	58.4 Litres	Volume	09/01/03	14:15:30
20	Total Flow 1.3A	11453	50.0 Gal/h	33.3 Gal/h	41.7 Gal/h	In Flow	09/01/03	15:00:00
21	Total Flow 1.4A	16020	66.7 Litres	50.0 Litres	58.4 Litres	Volume	09/01/03	15:00:00
22	Total Flow 1.3A	12901	50.0 Gal/h	33.3 Gal/h	41.7 Gal/h	In Flow	09/01/03	16:00:00
23	Total Flow 1.4A	18046	66.7 Litres	50.0 Litres	58.4 Litres	Volume	09/01/03	16:00:00
24	Total Flow 1.3A	14400	50.0 Gal/h	33.3 Gal/h	41.7 Gal/h	In Flow	09/01/03	17:00:00
25	Total Flow 1.4A	20145	66.7 Litres	50.0 Litres	58.4 Litres	Volume	09/01/03	17:00:00
26	Total Flow 1.3A	14464	50.0 Gal/h	33.3 Gal/h	41.7 Gal/h	In Flow	10/01/03	08:06:57
27	Total Flow 1.4A	20235	66.7 Litres	50.0 Litres	58.4 Litres	Volume	10/01/03	08:06:57
28	Total Flow 1.3A	15649	50.0 Gal/h	33.3 Gal/h	41.7 Gal/h	In Flow	10/01/03	09:00:00
29	Total Flow 1.4A	21893	66.7 Litres	50.0 Litres	58.4 Litres	Volume	10/01/03	09:00:00
30	Total Flow 1.3A	17149	50.0 Gal/h	33.3 Gal/h	41.7 Gal/h	In Flow	10/01/03	10:00:00
31	Total Flow 1.4A	23993	66.7 Litres	50.0 Litres	58.4 Litres	Volume	10/01/03	10:00:00
32	Total Flow 1.3A	18150	50.0 Gal/h	33.3 Gal/h	41.7 Gal/h	In Flow	10/01/03	11:26:27

Fig. 4.14 Totalizer Log



Configuration ▶

Setup

Filter ▶

- ✓ Group 1 Totalizers
 - Group 2 Totalizers
 - Group 3 Totalizers
 - Group 4 Totalizers
 - Group 5 Totalizers
 - Group 6 Totalizers
 - All Data
-
- Max / Min Details

Select the Configuration Level – see Section 6, page 51.

Select the Setup Level – see Section 5, page 41.

Select the entries to be displayed in the log. ✓ Indicates entries currently displayed.

Note.

- This selection does not affect which events are recorded in the log.
- Totalizer groups that have not been configured are greyed-out in the menu.

Select 'All Data' to select all enabled totalizers for display.

Selecting 'Max / Min Details' changes the totalizer log view to show the dates and times at which the maximum and minimum values occurred:

Totalizer Log										07/02/03 12:19:57	
No	Tag	Max Value	Max Date	Max Time	Min Value	Min Date	Min Time	Avg	Date	Time	
146	Total Flow 1.3A	50.0 Gal/h	08/01/03	15:29:51	-0.0 Gal/h	13/01/03	15:29:51	41.7 Gal/h	30/01/03	14:00:00	
147	Total Flow 1.4A	66.7 Litres	08/01/03	12:20:47	50.0 Litres	08/01/03	12:20:47	58.4 Litres	30/01/03	14:00:00	
148	Total Flow 1.3A	50.0 Gal/h	08/01/03	15:29:51	-0.0 Gal/h	13/01/03	15:29:51	41.7 Gal/h	30/01/03	15:00:00	
149	Total Flow 1.4A	66.7 Litres	08/01/03	12:20:47	50.0 Litres	08/01/03	12:20:47	58.4 Litres	30/01/03	15:00:00	
150	Total Flow 1.3A	50.0 Gal/h	08/01/03	15:29:51	-0.0 Gal/h	13/01/03	15:29:51	41.7 Gal/h	30/01/03	16:00:00	
151	Total Flow 1.4A	66.7 Litres	08/01/03	12:20:47	50.0 Litres	08/01/03	12:20:47	58.4 Litres	30/01/03	16:00:00	
152	Total Flow 1.3A	50.0 Gal/h	08/01/03	15:29:51	-0.0 Gal/h	13/01/03	15:29:51	41.7 Gal/h	05/02/03	11:56:29	
153	Total Flow 1.4A	66.7 Litres	08/01/03	12:20:47	50.0 Litres	08/01/03	12:20:47	58.4 Litres	05/02/03	11:56:29	
154	Total Flow 1.3A	50.0 Gal/h	08/01/03	15:29:51	-0.0 Gal/h	13/01/03	15:29:51	41.7 Gal/h	05/02/03	12:00:00	
155	Total Flow 1.4A	66.7 Litres	08/01/03	12:20:47	50.0 Litres	08/01/03	12:20:47	58.4 Litres	05/02/03	12:00:00	
156	Total Flow 1.3A	50.0 Gal/h	08/01/03	15:29:51	-0.0 Gal/h	13/01/03	15:29:51	41.7 Gal/h	05/02/03	13:00:00	
157	Total Flow 1.4A	66.7 Litres	08/01/03	12:20:47	50.0 Litres	08/01/03	12:20:47	58.4 Litres	05/02/03	13:00:00	
158	Total Flow 1.4A	66.7 Litres	08/01/03	12:20:47	50.0 Litres	08/01/03	12:20:47	58.4 Litres	05/02/03	14:00:00	
159	Total Flow 1.3A	50.0 Gal/h	08/01/03	15:29:51	-0.0 Gal/h	13/01/03	15:29:51	41.7 Gal/h	05/02/03	14:00:00	
160	Total Flow 1.3A	50.0 Gal/h	08/01/03	15:29:51	-0.0 Gal/h	13/01/03	15:29:51	41.7 Gal/h	06/02/03	11:23:14	
161	Total Flow 1.4A	66.7 Litres	08/01/03	12:20:47	50.0 Litres	08/01/03	12:20:47	58.4 Litres	06/02/03	11:23:14	
162	Total Flow 1.3A	50.0 Gal/h	08/01/03	15:29:51	-0.0 Gal/h	13/01/03	15:29:51	41.7 Gal/h	06/02/03	13:03:41	
163	Total Flow 1.4A	66.7 Litres	08/01/03	12:20:47	50.0 Litres	08/01/03	12:20:47	58.4 Litres	06/02/03	13:03:41	
164	Total Flow 1.3A	50.0 Gal/h	08/01/03	15:29:51	-0.0 Gal/h	13/01/03	15:29:51	41.7 Gal/h	06/02/03	15:51:37	
165	Total Flow 1.4A	66.7 Litres	08/01/03	12:20:47	50.0 Litres	08/01/03	12:20:47	58.4 Litres	06/02/03	15:51:37	
166	Total Flow 1.3A	50.0 Gal/h	08/01/03	15:29:51	-0.0 Gal/h	13/01/03	15:29:51	41.7 Gal/h	06/02/03	16:00:00	
167	Total Flow 1.4A	66.7 Litres	08/01/03	12:20:47	50.0 Litres	08/01/03	12:20:47	58.4 Litres	06/02/03	16:00:00	
168	Total Flow 1.3A	50.0 Gal/h	08/01/03	15:29:51	-0.0 Gal/h	13/01/03	15:29:51	41.7 Gal/h	06/02/03	16:24:08	
169	Total Flow 1.4A	66.7 Litres	08/01/03	12:20:47	50.0 Litres	08/01/03	12:20:47	58.4 Litres	06/02/03	16:24:08	
170	Total Flow 1.3A	50.0 Gal/h	08/01/03	15:29:51	-0.0 Gal/h	13/01/03	15:29:51	41.7 Gal/h	07/02/03	08:07:31	
171	Total Flow 1.4A	66.7 Litres	08/01/03	12:20:47	50.0 Litres	08/01/03	12:20:47	58.4 Litres	07/02/03	08:07:31	
172	Total Flow 1.3A	50.0 Gal/h	08/01/03	15:29:51	-0.0 Gal/h	13/01/03	15:29:51	41.7 Gal/h	07/02/03	09:55:54	
173	Total Flow 1.4A	66.7 Litres	08/01/03	08:21:16	-99.9 Litres	07/02/03	08:21:16	58.3 Litres	07/02/03	09:55:54	
174	Total Flow 1.3A	50.0 Gal/h	08/01/03	15:29:51	-0.0 Gal/h	13/01/03	15:29:51	41.7 Gal/h	07/02/03	11:00:00	
175	Total Flow 1.4A	66.7 Litres	08/01/03	08:21:16	-99.9 Litres	07/02/03	08:21:16	58.3 Litres	07/02/03	11:00:00	
176	Total Flow 1.3A	50.0 Gal/h	08/01/03	15:29:51	-0.0 Gal/h	13/01/03	15:29:51	41.7 Gal/h	07/02/03	12:00:00	
177	Total Flow 1.4A	66.7 Litres	08/01/03	08:21:16	-99.9 Litres	07/02/03	08:21:16	58.3 Litres	07/02/03	12:00:00	

5 Setup

5.1 Introduction

Note. Users with Setup access can:

- Start/Stop recording.
- Switch between primary and secondary recording rates.
- Set archiving 'on-line' and 'off-line'.
- View internal and external archive media file directories and delete external archive media files.

5.2 Accessing the Setup Level

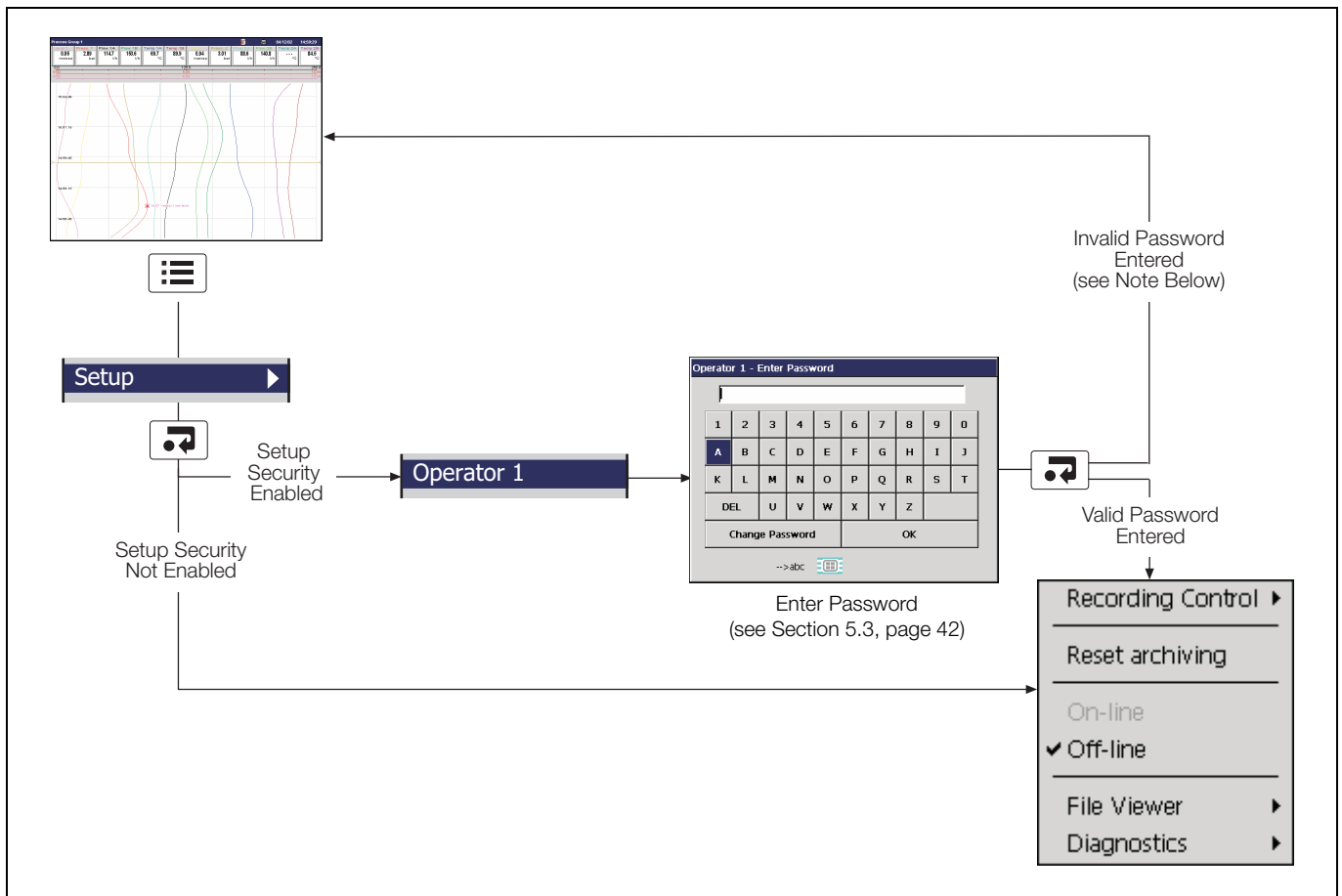

Fig. 5.1 Accessing the Setup Level

Note. If an incorrect password is entered the display returns to the Operating view. However, if the maximum number of consecutive incorrect password entries is exceeded, the user's access privileges are removed and the following message is displayed:



If this occurs, access privileges can be reinstated only by the system administrator (User 1). If the system administrator's access privileges have been removed, the security system must be disabled using the configuration security switch (Yellow switch) to gain access to the configuration – see Section 6.1.2, page 51.

5.3 Password Entry

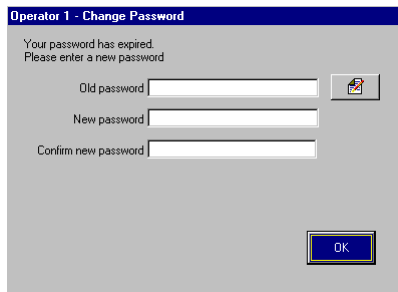
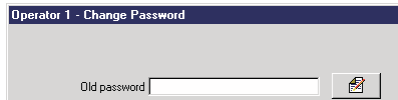
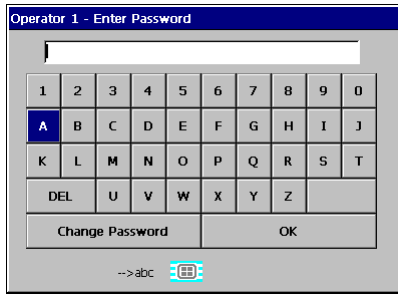

Enter Password

1. Select the required character using the , , , and keys.
2. Add the selected character to the password string using the key.
Note. For security, all characters are displayed as '*'.
3. Repeat 1 and 2 until all characters have been entered.
4. Highlight the 'OK' button using the , , , and keys and press .

Change Password

Select 'Change Password' using the , , , and keys and press .

1. Highlight the Edit Button () using the and keys and press to display the character entry box.
2. Enter the old password using the , , , and keys. Highlight the 'OK' button and press .
3. Enter the new password using the same procedure as for the old password.
4. Enter the new password again to confirm it.
5. Highlight the 'OK' button and press .

Password change successful.

Note. If the key is pressed at any stage or 'OK' is selected before the new password is confirmed, the password change operation is cancelled and the following message is displayed:

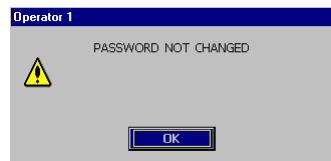

Password Expired

Passwords can be configured to expire at pre-determined intervals. If a password is time expired, this screen is displayed automatically. Enter a new password as described above.

5.4 Setup Menu



Use this menu to stop and start recording or change the sample rate for the channels in the current Process Group.

The Primary sample rate is set typically to a relatively slow rate (depending upon process recording requirements) and is active during normal process operating conditions in order to maximize internal memory and external archive media.

The Secondary sample rate is set typically to a faster rate than the Primary sample rate and may be selected manually in order to record the maximum amount of detail during, for example, an alarm condition.

The rates are set during configuration – see Section 6.5.1, page 76.

Note.

- Switching between the primary and secondary sample rates does not affect the screen interval in the Vertical and Horizontal Chart views or the screen duration in the Circular Chart view.
- When the channels are set to 'Stop' the instantaneous values in the associated indicator are displayed in red and, after the end of the next sample period, no further samples are plotted on the associated traces.
- Digital recording channels can only be set to 'Stop' or 'Go'.
- Recording control can also be implemented using digital sources – see Section 6.5.1, page 76.

Reset archiving

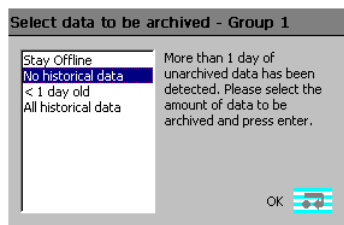

If selected, the date of the oldest unarchived data is set to that of the oldest data in the internal flash memory. This allows all data in the internal memory to be re-archived to external media.

Note. Ideally, a blank media storage card should be inserted prior to selecting this function.

To re-archive data:

1. Insert archive media, with sufficient free space, into the instrument.
2. Select 'Stay Offline' from the 'Select data to be archived' box that appears.
3. Select 'Reset archiving' in the Setup Menu.
4. Select 'On-line' in the Setup Menu.
5. Select data to be archived (if >1 day of data in internal memory) and press .

On-line

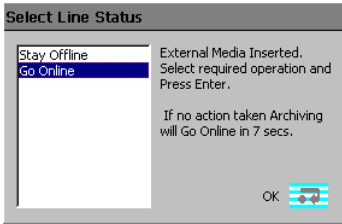

Places the archive media on-line, starting the archiving process.

Note.

- The On-line function is disabled (greyed-out in the Setup Menu) if no archive media card is inserted or the instrument has been placed in Historical Review mode.
- When an archive media card is inserted and there is <1 day of data in internal memory, the 'Select Line Status' dialog box (left) is displayed, giving the user the choice of placing archiving on-line or remaining off-line. Archiving is placed automatically on-line in 10 seconds unless 'Stay Offline' is selected.
- When an archive media card is inserted and there is >1 day of data in internal memory, the 'Select data to be archived' dialog box (above left) is displayed. Select data to be archived and press .

Once selected, all data within the selected time frame is archived. Older unarchived data remains in the internal memory buffer until overwritten by newer data but is not available for archiving unless 'Reset archiving' is selected.

Off-line

Places the archive media off-line. Recording of channel data into internal memory continues uninterrupted but archiving to the removable media is suspended until it is put on-line again.

Note.

- Always set the external media Off-line before removing it.
- The Off-line function is disabled (greyed-out in the Setup Menu) when in Historical Review mode.

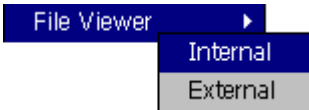

Use the file viewer to view a list of the files stored in internal memory and on external archive media.

Note. Files stored in internal memory cannot be deleted.

Internal file view		
Name	Size	Date
Company_standard.cfg	79536	01/06/2002 12:01
QSDairy.cfg	79536	01/06/2002 12:01
QSDemo.cfg	79536	01/06/2002 12:01
QSFLOW.cfg	79536	01/06/2002 12:01
QSMillamp.cfg	79536	01/06/2002 12:01
QSRTD_C.cfg	79536	01/06/2002 12:01
QSRTD_F.cfg	79536	01/06/2002 12:01
QSTHC_C.cfg	79536	01/06/2002 12:01
QSTHC_F.cfg	79536	01/06/2002 12:01
SavedDataSM3000	11984	09/01/2003 16:35
SM3000.cfg	79536	09/01/2003 15:54
TotalizerCode.ts	80	07/01/2003 10:40
TotLog.lgf	13072	09/01/2003 16:00

Exit 

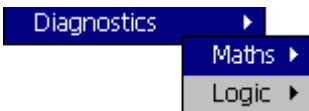

The diagnostics features are available only on instruments with the Advanced Software option enabled. To use the diagnostics features, refer to the *Advanced Software Options User Guide Supplement, IM/SM3000ADV*.

5.5 Archiving

Recorded data, logs and configuration files stored on the instrument's internal memory can be archived to files created on removable media. Parameters for archiving each process groups' data are configured independently.

Note. To configure Archiving, refer to Section 6.5.6, page 85.

5.5.1 Card Compatibility

Our recorders comply with approved industry standards for memory cards. SanDisk Standard Grade memory cards have been fully tested and are recommended for use with our recorders. Other brands may not be fully compatible with this device and therefore may not function correctly.

5.5.2 Media Status

Process Group 1 04/12/02 13:53:24

Instrument Status / Audit Log

RECORDER INFORMATION

Software: 2001/1
System: 1001/1
Serial number: Y/00017/1/4
Instrument tag: SM3000
Modules Fitted:
A: Analog I/P B: Analog I/P
C: None D: None
E: 6 Relay F: Hybrid
G: R5485 H: None

ARCHIVING

Group 1: Process Group 1 - On
Group 2: None
Group 3: None
Group 4: None
Group 5: None
Group 6: None
% Memory used: 37%
Time left: 10 days

Media Status Icons:

- External archive media not inserted (yellow flashing exclamation mark)
- External archive media on-line (green icon, shaded area indicates % used)
- External archive media off-line (grey icon, shaded area indicates % used)
- External archive media update in progress (see **Note** below)
- External media 100% full, archiving stopped (green/red icon, flashing white cross)
- Warning! Too many files (green icon – media online, grey icon – media offline)
- Too many files, archiving stopped (red icon, flashing yellow cross)

Time Left
31 Day:
-1 Hour, <1 Day:
<1 Hour:

Display Format
Days, e.g. '5 days'
Hours, e.g. '10 hours'
Minutes, e.g. '25 minutes'

Amount of memory used on the external archive media currently installed

Approximate time left before the current external archive media is full, assuming the amount of data recorded remains the same.

Fig. 5.2 Media Status Icons

Note. Do not remove media while either of the media update in progress status icons ( or ) are displayed.

5.5.3 Inserting and Removing Media

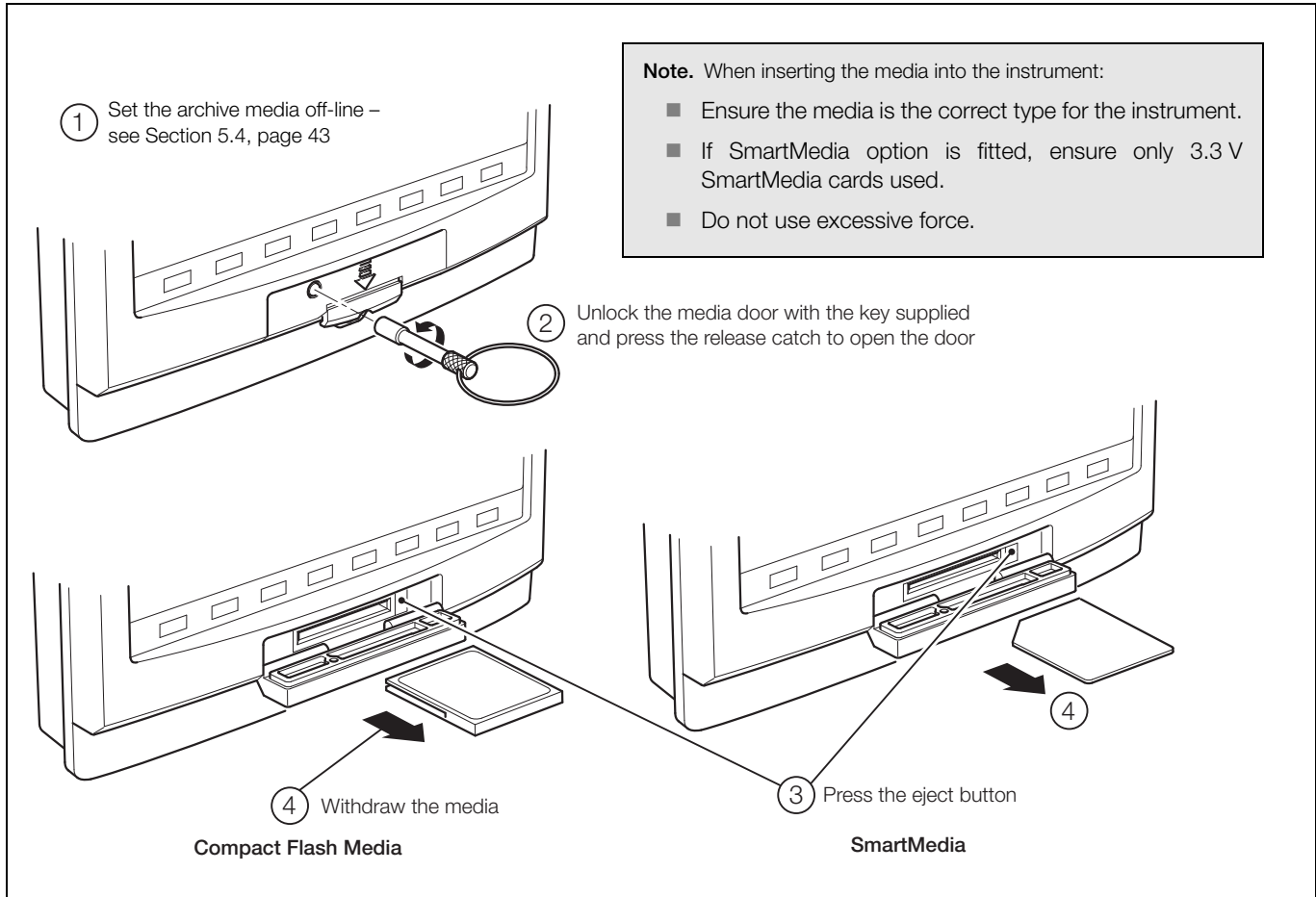

Fig. 5.3 Inserting and Removing External Media

5.5.4 Archive File Types

Archive files created by the instrument are given filenames automatically. Each type of archived file is given a different filename extension as shown in Table 5.1.

Type	Extension	No. of Files	Contents
Channel data files	*.B00	One per channel	Analog or digital recording channel data
Alarm event log files	*.EEO	One per process group	The historical record of the alarm events related to a particular process group's channels plus the history of any operator messages, electronic signatures or real time alarms.
Totalizer log files	*.TE0	One per process group	The historical record of all totalizer and associated statistical values relating to a particular group's recording channels.
Audit log files	*.AE0	One per instrument	The historical entries from the audit log.
Batch data files	*.V**	One per process group	Analog or digital recording channels in the current process group when the batch function is active
Batch log files	*.X**	One per instrument	Historical record of the batches recorded.

Table 5.1 Archive File Types

5.5.5 Archive Filenames

Archive filenames are formatted as shown in Table 5.2.

Type	Format
Channel data files	<Start Time HHMMSS><Start Date DDMMYY><Ch<Group>_<Channel><Instrument tag> for example, 14322719Dec03Ch1_2Boiler room3
Alarm event log files	<Start Time HH_MM><Start Date DDMMYY><Process Group Tag> for example, 14_3219Dec03Boiler5
Totalizer log files	<Start Time HH_MM><Start Date DDMMYY><Process Group Tag> for example, 14_3219Dec03Boiler5
Audit log files	<Start Time HH_MM><Start Date DDMMYY><Instrument Tag> for example, 14_3219Dec03Boiler room 3

Table 5.2 Archive Filenames

5.5.6 Channel Data Files

A new channel data file is created under the following conditions:

- On power up.
- When the current file for a channel does not exist on the media card.
- When the maximum size (5Mb) of the existing data file is exceeded.
- When the recording channel's configuration is changed.
- When the daylight saving period starts or ends.

Note. The instrument's internal clock can be configured to adjust automatically at the start and end of Daylight Saving Time (Summertime) periods – see Section 6.4.1, page 61.

Files containing channel data generated during the daylight saving period have “~DS” appended to the filename.

Example 1 – Start of daylight saving period:

Archiving is started at 01:45:00 on 30th March 2003 – filename: 01450030Mar03Ch1_1AnlgSM3000.B00.

Summertime starts at 2:00am on 30th March 2003.

The clock changes automatically to 3:00am. The existing file is closed and a new file is created – filename: 03000030Mar03Ch1_1AnlgSM3000~DS.B00.

The file '01450330Mar03Ch1_1AnlgSM3000.B00' contains data generated from 01:45:00 to 01:59:59 (before summertime starts).

The file '03000030Mar03Ch1_1AnlgSM3000~DS.B00' contains data generated from 03:00:00 (after summertime starts).

Example 2 – End of daylight saving period:

Archiving is started at 00:15:00 on 26th October 2003 – filename: 00150026Oct03Ch1_1AnlgSM3000~DS.B00.

Summertime ends at 3:00am on 26th October 2003.

The clock changes automatically to 2:00am. The existing file is closed and a new file is created – filename: 02000026Oct03Ch1_1AnlgSM3000.B00.

The file '00150026Oct03Ch1_1AnlgSM3000~DS.B00' contains data generated from 00:15:00 to 02:59:59 (before summertime ends).

The file '02000026Oct03Ch1_1AnlgSM3000.B00' contains data generated from 02:00:00 (after summertime ends).

5.5.7 Log files

A new log file is created under the following conditions:

- When an existing valid log file does not exist on an external archive media card inserted in the instrument.
- When the maximum size (64,000 entries) is exceeded.
- When the daylight saving period starts or ends.

Files containing log data generated during the daylight saving period (summertime) have “-DS” appended to the filename.

5.5.8 On-line/Off-line

Before data can be archived to external media, the external media must be placed on-line and one or more archive file enables set.

- When an external archive media card is inserted and there is <1 day of data in internal memory, a dialog box is displayed giving the user the choice of putting the media on-line or remaining off-line. If no selection is made within 10 seconds, the media card is placed on-line automatically:

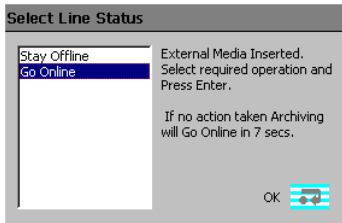

- When an external archive media card is inserted and there is >1 day of data in internal memory, a dialog box is displayed prompting the user to select either the data to be archived or remain off-line:

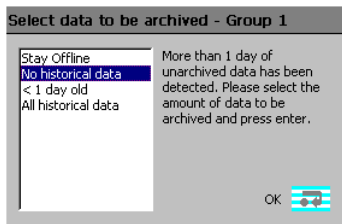

- External archive media can be set on-line (if a media card is inserted) or off-line in the setup menu.
- Set archiving off-line before removing external media to prevent loss of data and possible damage to the media card.
- When external archive media contains approximately 250 files, its read/write performance begins to degrade and either of the 'Warning – Too Many Files' icons (⚠ or ⚠) are displayed. Change the media as soon as possible.
- When external archive media contains approximately 300 files, its read/write performance becomes too slow, Archiving is stopped automatically and the 'Too Many Files – Archiving Stopped' icons (⛔ alternating with ⛔) are displayed. Change the media immediately to prevent loss of data.

5.5.9 Data Verification and Integrity

When data is saved to the archive media it is checked automatically to verify that the data stored on the media matches exactly what is stored in the internal memory.

Each block of data in the channel data files has its own data integrity check. This enables the integrity of the data stored on the external media card to be verified when it is viewed using the DataManager software package.

The log files also contain built-in integrity checks enabling the integrity of the data to be verified by the DataManager software.

5.5.10 Backing Up Archived Data

It is advisable to back-up critical data stored on SmartMedia or Compact Flash cards on a regular basis. The instrument's internal memory provides a buffer for the most recent data so if data stored on archive media is lost, it can be re-archived – see 'Reset archiving' on page 43.

To ensure that all required data is available for re-archiving, it is recommended that data archived on archive media is removed and backed-up before the instrument's internal buffer overwrites that data. The length of time for which data remains in the instrument's internal memory depends on the sample rate and the number of channels selected – see Table C.1 on page 170 for details.

5.5.11 Archive Wrap

Archiving can be configured to delete the oldest archived data file from the external media automatically when the media approaches its maximum capacity – see 'Wrap' on page 85.

5.5.12 File Formats

The archived data is stored in a secure binary encoded format. A separate file is created for each recording channel. The log data is stored in an encrypted text format. The files can be read on a PC using the Company's DataManager data analysis software package.

Note. Archive files created during the daylight saving period (summertime) are compatible with the database feature of Version 5.8 (or later) only of the Company's DataManager data analysis software package.

	A	B	C	D	E	F	G	H	I	J	K	L	M	N
2	Instrument:	SM3000(Y00017/6/1)												
3	Group tag	Boiler Rooms 1 & 2												
4														
5				CH1.1				Boiler 1 Temperature				-50.0..1300.0 °C		
6				CH1.2				Boiler 1 Pressure				0.0..100.0 bar		
7				CH1.3				Inlet 1 Flow Rate				0.0..100.0 Gal/h		
8				CH1.4				Tank 1 Level				0.0..200.0 Litres		
9				CH1.5				Ambient Temperature 1				10.0..120.0 °F		
10				CH1.6				Valve 1 status				Close..Open		
11				CH1.7				Boiler 2 Temperature				-50.0..1300.0 °C		
12				CH1.8				Boiler 2 Pressure				0.0..100.0 bar		
13				CH1.9				Inlet 2 Flow Rate				0.0..100.0 Gal/h		
14				CH1.10				Tank 2 Level				0.0..200.0 Litres		
15				CH1.11				Ambient Temperature 2				10.0..120.0 °F		
16				CH1.12				Valve 2 status				Close..Open		
17														
18	SM3000(Y00017/6/1) Process Group 1													
19	Date	Time	Temp 1	Press 1	InFlow 1	Tank 1	Room 1	Valve 1	Temp 2	Press 2	InFlow 2	Tank 2	Room 2	Valve 2
20			CH1.1	CH1.2	CH1.3	CH1.4	CH1.5	CH1.6	CH1.7	CH1.8	CH1.9	CH1.10	CH1.11	CH1.12
21			°C	bar	Gal/h	Litres	°F	0= Close	°C	bar	Gal/h	Litres	°F	0= Close
22			instant	instant	instant	instant	instant	1= Open	instant	instant	instant	instant	instant	1= Open
23	25/Jan/03	18:03:37	1.2	20.1	0.0	50.3	67.0	0	42.2	17.0	0.0	100.2	67.0	0
24	25/Jan/03	18:03:38	2.1	22.3	0.0	50.3	67.0	0	48.3	17.0	0.0	100.2	67.0	0
25	25/Jan/03	18:03:39	3.0	24.5	0.0	50.3	67.1	0	49.9	17.1	0.0	100.2	67.1	0
26	25/Jan/03	18:03:40	3.9	26.7	0.0	50.3	67.2	0	51.2	17.2	0.0	100.2	67.2	0
27	25/Jan/03	18:03:41	4.8	28.9	0.0	50.3	67.4	0	53.4	17.4	0.0	100.2	67.4	0
28	25/Jan/03	18:03:42	5.7	31.1	0.0	50.3	67.6	0	55.9	17.6	0.0	100.2	67.6	0
29	25/Jan/03	18:03:43	6.6	33.3	0.0	50.3	67.8	0	56.9	17.8	10.2	101.4	67.8	1
30	25/Jan/03	18:03:44	7.5	35.5	34.7	51.4	68.0	1	58.2	18.0	20.5	105.3	68.0	1
31	25/Jan/03	18:03:45	8.4	37.7	35.0	51.6	68.3	1	60.2	18.3	35.2	106.7	68.3	1
32	25/Jan/03	18:03:46	9.3	39.9	35.2	51.9	68.6	1	65.3	18.6	35.2	108.3	68.6	1
33	25/Jan/03	18:03:47	10.2	42.1	35.5	52.2	68.8	1	68.7	18.8	35.5	112.5	68.8	1
34	25/Jan/03	18:03:48	11.1	44.3	35.8	52.5	69.1	1	70.1	19.1	35.8	115.7	69.1	1
35	25/Jan/03	18:03:49	12.0	46.5	36.1	52.8	69.5	1	72.8	19.5	36.1	120.6	69.5	1
36	25/Jan/03	18:03:50	12.9	48.7	36.5	53.1	69.8	0	74.5	19.8	20.1	122.7	69.8	0
37	25/Jan/03	18:03:51	13.8	50.9	0.0	53.1	70.1	0	76.2	20.1	0.0	122.7	70.1	0
38	25/Jan/03	18:03:52	14.7	53.1	0.0	53.1	70.5	0	77.9	20.5	0.0	122.7	70.5	0
39	25/Jan/03	18:03:53	15.6	55.3	0.0	53.1	70.9	0	79.7	20.9	0.0	122.7	70.9	0
40	25/Jan/03	18:03:54	16.5	57.5	0.0	53.1	71.3	0	81.5	21.3	0.0	122.7	71.3	0
41	25/Jan/03	18:03:55	17.4	59.7	0.0	53.1	71.7	0	83.4	21.7	0.0	122.7	71.7	0
42	25/Jan/03	18:03:56	18.3	61.9	0.0	53.1	72.1	0	85.2	22.1	0.0	55.4	72.1	0
43	25/Jan/03	18:03:57	19.2	64.1	0.0	53.1	72.5	0	87.1	22.5	0.0	55.8	72.5	0
44	25/Jan/03	18:03:58	20.1	66.3	0.0	53.1	72.9	0	88.9	22.9	0.0	56.2	72.9	0
45	25/Jan/03	18:03:59	21.0	68.5	0.0	53.1	73.3	0	91.7	23.3	0.0	56.6	73.3	0
46	25/Jan/03	18:04:00	21.9	70.7	0.0	53.1	73.7	0	93.4	23.7	0.0	57.1	73.7	0

Fig. 5.4 Channel Data File Sample

	A	B	C	D	E	F	G	H	I
4	SM3000(Y/00017/6/1) Process Group 1								
5	Date	Time	Type	Event tag	Source tag	Trip Value	Units	State	Ack
6									
7									
8									
9	25-Jan-03	18:04:06	High process	Boiler 1 too high	Boiler 1	800	°C	Active	Yes
10	25-Jan-03	18:04:58	Low process	Flow 1 below limit	Flow 1	5.2	Gal/h	Inactive	No
11	25-Jan-03	18:06:06	High process	Flow 2 above Limit	Flow 2	12.3	Gal/h	Active	No
12	25-Jan-03	18:06:37	Low process	Boiler 2 too low	Boiler 2	-20	°C	Active	Yes
13	25-Jan-03	18:06:37	Real time alarm	Start Boiler 2				Active	No
14	25-Jan-03	18:06:37	High Rate	In Flow 1 too high	In Flow 1	5	Gal/h	Active	No
15	25-Jan-03	18:06:37	Low process	Amb Temp 2 too Low	A Temp 2	20	°F	Active	No
16	25-Jan-03	18:06:37	Op Message	Batch 1 Started					
17	25-Jan-03	18:06:37	Low process	Open Inlet Valve 2	Tank 2	20	Litres	Active	Yes
18	25-Jan-03	18:06:37	Real time alarm	Start Boiler 1				Active	No
19	25-Jan-03	18:06:37	High process	Pressure 1 too high	Pressure 1	80	Bar	Active	No
20	25-Jan-03	18:06:37	Real time alarm	Real Time Alarm 12				Active	No

Fig. 5.5 Alarm Event Log Sample

	A	B	C	D	E	F	G	H	I	J	K	L	M	N	O	P
2	Group tag Boilers 1 and 2															
3																
4																
5	CHI.1		Boiler 1 Temperature				-50.0, 1300.0 °C									
6	CHI.2		Boiler 1 Pressure				0.0, 100.0 bar									
7	CHI.3		Inlet 1 Flow Rate				0.0, 100.0 Gal/h									
8	CHI.4		Tank 1 Level				0.0, 200.0 Litres									
9	CHI.5		Ambient Temperature 1				10.0, 120.0 °F									
10	CHI.6		Valve 1 status				Close, Open									
11																
12																
13	SM3000(Y/00017/6/1) Process Group 1															
14	Date	Time	Totalizer Tag	Source tag	Batch Total	Total units	Max value	Max date	Max time	Min value	Min date	Min time	Average	Units	Secure Total	Events
15																
16																
17	25/Jan/03	18:00:00	Total Flow 1	Flow 1	267895	Gal	63	9-Jan-03	18:03:37	24	21-Jan-03	6:03:37	39	Gal/h	8932103233	Started
18	25/Jan/03	18:00:00	Total Tank 1	Tank 1	653214	Litres	170	20-Jan-03	18:03:37	53	24-Jan-03	18:03:37	117	Litres	7320123534	Started
19	25/Jan/03	18:10:00	Total Flow 1	Flow 1	267956	Gal	64	25-Jan-70	18:06:32	24	21-Jan-03	6:03:37	40	Gal/h	8932103415	Timed
20	25/Jan/03	18:10:00	Total Tank 1	Tank 1	653254	Litres	170	20-Jan-03	18:03:37	52	25-Jan-03	18:09:24	117	Litres	7320123689	Timed
21	25/Jan/03	18:20:00	Total Flow 1	Flow 1	268024	Gal	64	25-Jan-70	18:06:32	24	21-Jan-03	6:03:37	40	Gal/h	7857450368	Timed
22	25/Jan/03	18:20:00	Total Tank 1	Tank 1	653295	Litres	170	20-Jan-03	18:03:37	51	25-Jan-03	18:09:24	116	Litres	7857450445	Timed
23	25/Jan/03	18:30:00	Total Flow 1	Flow 1	268320	Gal	64	25-Jan-70	18:06:32	24	21-Jan-03	6:03:37	39	Gal/h	7857450523	Timed
24	25/Jan/03	18:30:00	Total Tank 1	Tank 1	653320	Litres	170	20-Jan-03	18:03:37	51	25-Jan-03	18:09:24	116	Litres	7857450600	Timed
25	25/Jan/03	18:40:00	Total Flow 1	Flow 1	268450	Gal	64	25-Jan-70	18:06:32	24	21-Jan-03	6:03:37	39	Gal/h	7857450678	Timed
26	25/Jan/03	18:40:00	Total Tank 1	Tank 1	653421	Litres	170	20-Jan-03	18:03:37	51	25-Jan-03	18:09:24	116	Litres	7857450755	Timed
27	25/Jan/03	18:50:00	Total Flow 1	Flow 1	268976	Gal	64	25-Jan-70	18:06:32	24	21-Jan-03	6:03:37	39	Gal/h	7857450833	Timed
28	25/Jan/03	18:50:00	Total Tank 1	Tank 1	653520	Litres	170	20-Jan-03	18:03:37	51	25-Jan-03	18:09:24	115	Litres	7857450910	Timed
29	25/Jan/03	19:00:00	Total Flow 1	Flow 1	268677	Gal	64	25-Jan-70	18:06:32	24	21-Jan-03	6:03:37	38	Gal/h	7857450988	Timed
30	25/Jan/03	19:00:00	Total Tank 1	Tank 1	653587	Litres	170	20-Jan-70	18:03:37	51	25-Jan-03	18:09:24	115	Litres	7857451065	Timed
31	25/Jan/03	19:10:00	Total Flow 1	Flow 1	268662	Gal	64	25-Jan-70	18:06:32	24	21-Jan-03	6:03:37	38	Gal/h	7857451143	Timed
32	25/Jan/03	19:10:00	Total Tank 1	Tank 1	653985	Litres	170	20-Jan-03	18:03:37	51	25-Jan-03	18:09:24	115	Litres	7857451220	Timed
33	25/Jan/03	18:07:01	Total Flow 1.A	Temp 1	268999	Litres	0.3	7-Jan-03	18:03:37	0.3	7-Jan-03	18:03:37	0.3	°C	0	Reset
34	25/Jan/03	18:07:01	Total Flow 1.B	Temp 1	0	Litres	0.3	7-Jan-03	18:03:37	0.3	7-Jan-03	18:03:37	0.3	°C	0	Reset

Fig. 5.6 Totalizer Log Sample

	A	B	C	D	E
3	SM3000(Y/00017/6/1)				
4	Date	Time	Type of event	Description	Op id
5					
6					
7	7-Jan-03	18:06:34	Power failure		
8	7-Jan-03	18:07:19	Power recovery		
9	7-Jan-03	18:09:28	Analog I/p Calibration	Module A	Joe Smith
10	7-Jan-03	18:10:02	Analog I/p Calibration	Module B	Joe Smith
11	7-Jan-03	18:11:30	Configuration change		Paul Brown
12	7-Jan-03	18:11:33	Media inserted		
13	07/Jan/03	18:11:39	Online	Archiving data in group:1, 2, 3	
14	07/Jan/03	18:11:43	Offline		Peter Jones
15	07/Jan/03	18:12:03	Media removed		
16					

Fig. 5.7 Audit Log Sample

6 Configuration

6.1 Introduction

This section details the configuration of the instrument locally using the front panel membrane switches. A configuration file can also be created on a PC and transferred to the instrument via one of the archive media options.

In addition, up to 5 different configurations can be stored in internal memory and restored when required.

6.1.1 Configuration Level Security

Two methods of configuration access protection are available:

1. **Password protection** (Factory Default).
The Configuration level cannot be accessed until the correct password has been entered – see Fig. 6.1, page 52.
2. **Internal switch protection.**
The Configuration level cannot be accessed until the instrument is withdrawn from its case and the internal switch set to the 'Configuration Level Not Protected' position – see Fig. 6.2, page 53.

	'Configuration security type' Parameter Setting (see Section 6.4.2, page 65)	
Internal Security Switch Setting (see Fig. 6.2, page 53)	'Password protected' (Factory Default)	'Internal switch protected' (Alternative)
Configuration Level Protected (Factory Default)	Password Access	No Access
Configuration Level Not Protected	Free Access	Free Access

6.1.2 Configuration Level Access

To configure an instrument when 'Configuration security type' is set to the factory default setting of 'Password protected':

- Access the Configuration Level – see Fig. 6.1, page 52.
- Make changes to parameters as detailed in Figs. 6.1 and 6.3.

To configure an instrument when 'Configuration security type' is set to 'Internal switch protected':

- Set the internal security switch to the 'Configuration Level Not Protected' position – see Fig. 6.2, page 53.
- Access the Configuration Level – see Fig. 6.1, page 52.
- Make changes to parameters as detailed in Figs. 6.1 and 6.3.

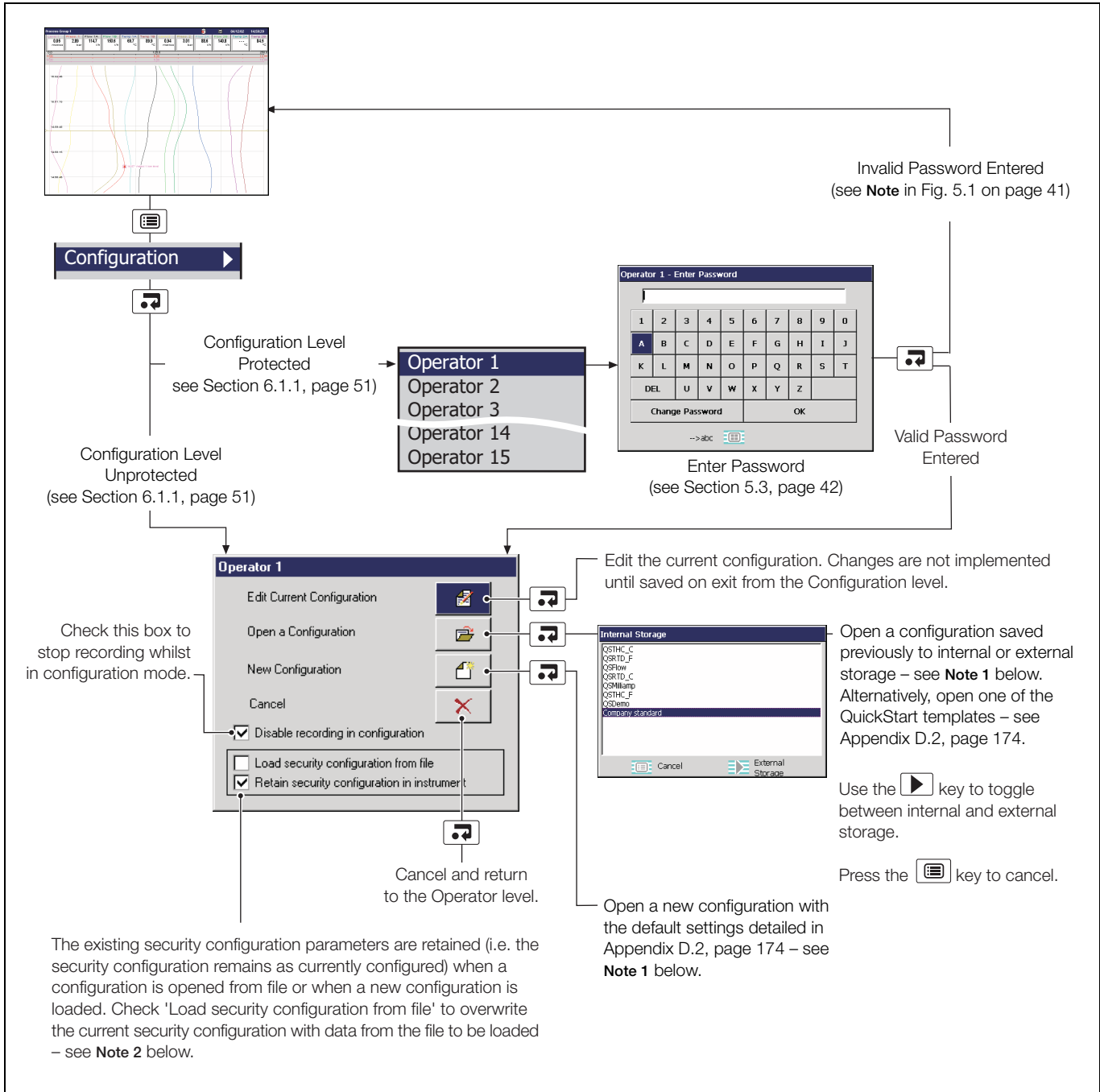

Fig. 6.1 Accessing the Configuration Level

Note.

1. If 'New Configuration' or 'Open a Configuration' is selected and the modified configuration file is saved later as the current configuration, new internal data files for all enabled recording channels are created and any unarchived data is lost.
2. The option to load or retain the security configuration is available only to the System Administrator (User 1). If a new or existing configuration file is opened by a user other than the System Administrator, the instrument's existing security settings are retained.

Note. The Internal Security Switch is used to access the Configuration level when 'Configuration security type' is set to 'Internal switch protected' – see Section 6.4.2, page 65. Do Not use the switch to access the Configuration level when 'Configuration security type' is set to 'Password protected' (default setting) unless the Password has been forgotten. The switch overrides Password protection, enabling free access to the Configuration level.

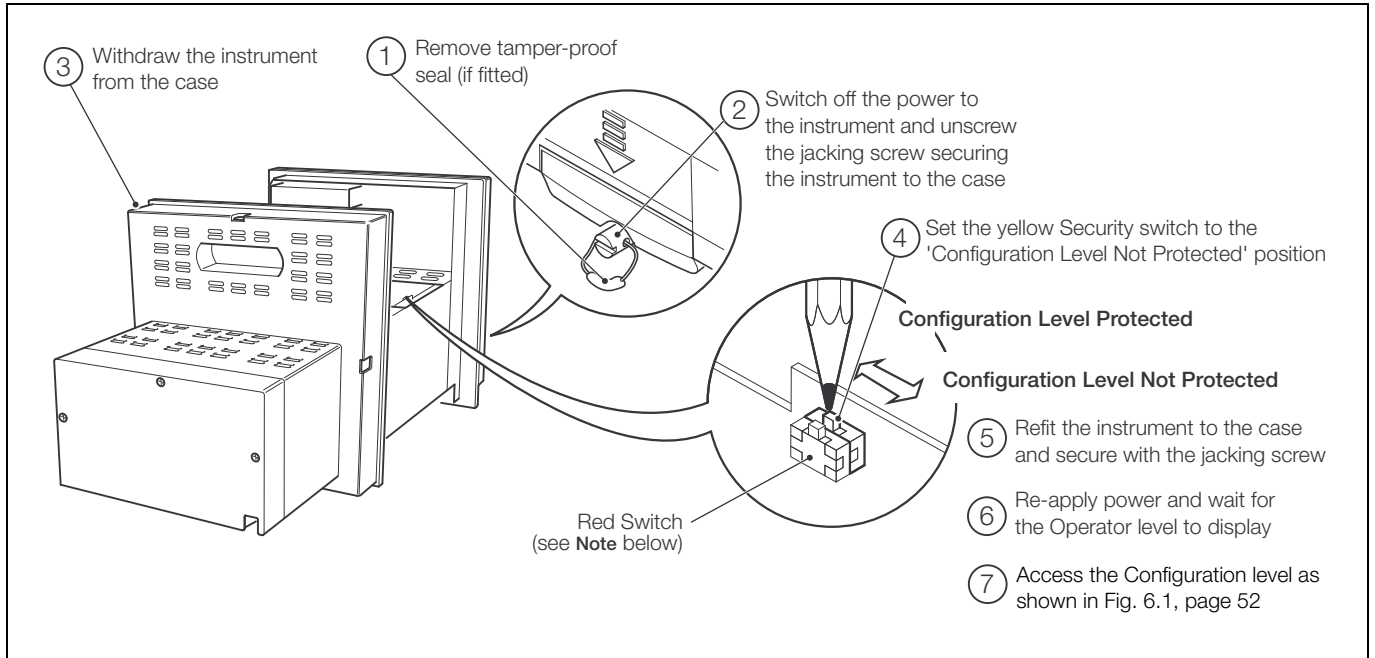

Fig. 6.2 Setting the Security Switch

Note. The red switch is for factory use only. Ensure it remains in the position closest to the rear of the instrument.

6.2 Overview of Configuration

The diagram illustrates the navigation steps for the SM3000 Common Configuration menu. It consists of two screenshots of the configuration interface.

Step 1: Select 'Common' from the Configuration menu. The first screenshot shows the 'Common' option highlighted in the left-hand menu.

Step 2: Select the required parameter using the ▲ and ▼ keys. The second screenshot shows the 'Number of groups' parameter selected, with a callout indicating that the up and down arrow keys are used for selection.

Step 3: Press the [F4] key to edit selected parameter. A callout points to the edit icon (a document with a pencil) next to the 'Number of groups' field.

Step 4: Use the ◀ and ▶ keys to select the next required tab. A callout points to the left and right arrow keys, indicating navigation between tabs like 'Setup', 'Security', 'Logs', etc.

Step 5: Press the [F5] key to display the menu. Select the next item required and activate using the [F4] key. A callout points to the menu icon (a document with a list) next to the 'Group 1' option in the left-hand menu.

Step 6: When all configuration changes are complete, select Exit to save or cancel changes. A callout points to the 'Exit' option at the bottom of the left-hand menu.

Fig. 6.3 Overview of Configuration Steps

Note. Only enabled Process Groups (and their associated Channel Options) are visible in the menu.

6.3 Making Changes to Parameters

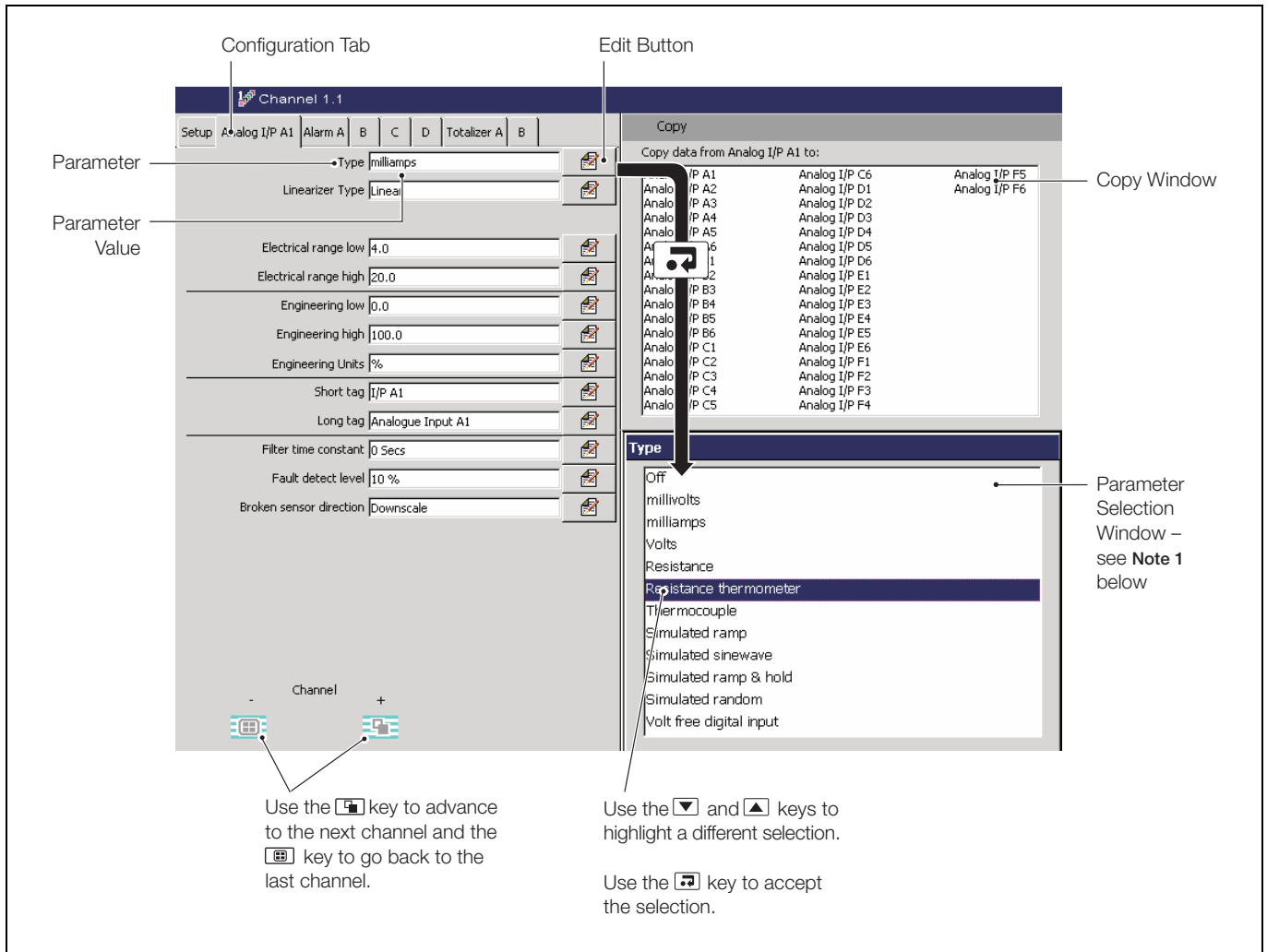
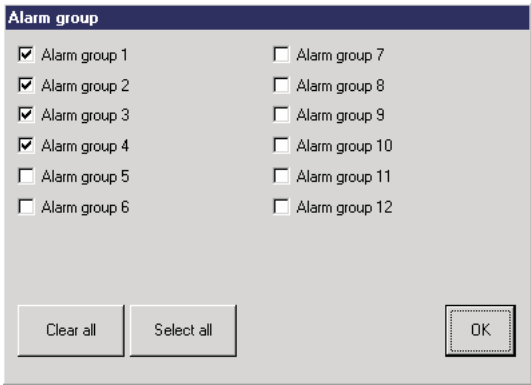

Fig. 6.4 Locating Parameter Settings

Note.

1. The appropriate parameter selection window or data entry dialog box is displayed automatically – see Fig. 6.5, page 56.
2. Use the key to open the Configuration menu in order to select a different channel – see Fig. 6.13, page 86.



Alarm group

<input checked="" type="checkbox"/> Alarm group 1	<input type="checkbox"/> Alarm group 7
<input checked="" type="checkbox"/> Alarm group 2	<input type="checkbox"/> Alarm group 8
<input checked="" type="checkbox"/> Alarm group 3	<input type="checkbox"/> Alarm group 9
<input checked="" type="checkbox"/> Alarm group 4	<input type="checkbox"/> Alarm group 10
<input type="checkbox"/> Alarm group 5	<input type="checkbox"/> Alarm group 11
<input type="checkbox"/> Alarm group 6	<input type="checkbox"/> Alarm group 12

Clear all Select all OK

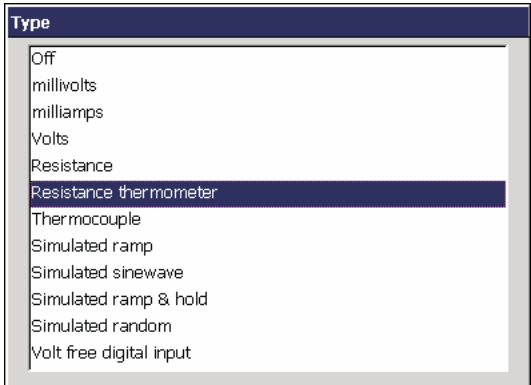

Type

- Off
- millivolts
- milliamps
- Volts
- Resistance
- Resistance thermometer
- Thermocouple
- Simulated ramp
- Simulated sinewave
- Simulated ramp & hold
- Simulated random
- Volt free digital input

Use ▲ and ▼ keys to highlight an item and press  to select it.

Note. Items not selected are indicated by an X in the parameter value window.

1 2 3 4 X X X X X X X X

Parameter Limits



Eng. low (-200-600 Deg C)

250.5

7	8	9	.
4	5	6	
1	2	3	C
.	0	Del	OK

Highlight text box and use ◀ and ▶ keys to position cursor to edit text as required.

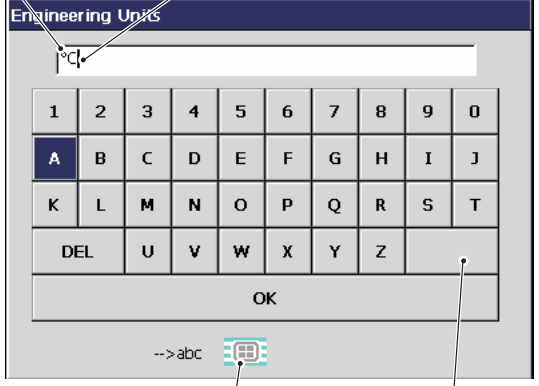



Engineering Units

°C

1	2	3	4	5	6	7	8	9	0
A	B	C	D	E	F	G	H	I	J
K	L	M	N	O	P	Q	R	S	T
DEL	U	V	W	X	Y	Z			

OK

--> abc  Spacebar

Use ◀, ▶, ▲ and ▼ keys to highlight a character and press  to select it.

Note. Values outside the preset parameter limits or with too many decimal places are highlighted when the OK button is selected.

623.45

Fig. 6.5 Parameter Selection Windows/Data Entry Dialog Boxes

Note. Tags with a high percentage of capital letters and wide characters such as 'W' or 'M' may appear truncated in some Operator Views. In such cases, use lower case letters or fewer characters.

Select the tab appropriate to the data to be copied. ①

Press the key to open the menu and use the , and keys to select the copy facility. ②

Source of copied data

Use the , , , and keys to select copy destinations. ③

Copy to selected items

Clear all selections

Exit copy

④ Press the key to open the menu and use the , and keys to copy the source settings to the selected destinations.

Copy to selected items

Clear all selections

Exit copy

⑤ Press the key to open the menu and use the , and keys to exit the copy facility.

Fig. 6.6 Copy Facility

Note. The copy facility enables the settings from a feature configured previously to be copied to other, identical features; for example, from one analog input to another, one operator message to another, etc.

Parameter	Copy?
Common Configuration	
Operator Messages	
Message tag	✓
Source ID	✓
Group Configuration	
Recording	
Tag	✗
Recording enable source	✓
Primary sample rate	✓
Secondary sample rate	✓
Sample rate select source	✓
Chart View	
Chart view enable	✓
Chart annotation	✓
Major chart divisions/Chart divisions	✓
Minor chart divisions	✓
Screen interval/Chart duration	✓
Menu enables (All)	✓
Bargraph View	
Bargraph view enable	✓
Bargraph markers	✓
Menu enables (All)	✓
Process View	
Process view enable	✓
Menu enables (All)	✓
Digital Indicator View	
Digital view enable	✓
Totalizer display enable	✓
Menu enables (All)	✓
Channel select enable (All)	✓
Archive	
Archive file format (binary)	✓
Archive file enables:	
Channel data file enable	✓
Alarm event log file enable	✓
Totalizer log file enable	✓
Audit log file enable	✗

Table 6.1 Copy Facility

Parameter	Copy?
Channel Configuration	
Setup	
Source ID	✓
Trace color	✗
Zone	✓
Filter type	✓
Analog Input	
Type	✓
Linearizer type	✓
Linearizer units	✓
Electrical range low	✓
Electrical range high	✓
Engineering low	✓
Engineering high	✓
Engineering units	✓
Short tag	✗
Long tag	✗
Filter time constant	✓
Fault detect level	✓
Broken sensor direction	✓
Analog Communications	
Engineering low	✓
Engineering high	✓
Engineering units	✓
Short tag	✗
Long tag	✗
Digital Input	
Digital on tag	✓
Digital off tag	✓
Short tag	✗
Long tag	✗

Table 6.1 Copy Facility (Continued)

Parameter	Copy?
Alarms	
Alarm type	✓
Alarm tag	✗
Trip	✓
Hysteresis	✓
Time hysteresis	✓
Delay time	✓
Deviation	✓
Period	✓
Rate filter	✓
Enable source	✓
Log enable	✓
Alarm group	✓
Totalizers	
Count enable	✓
Wrap enable	✓
Tag	✗
Units	✓
Stop/Go recovery	✓
Stop/Go source	✓
Preset count	✓
Predetermined count	✓
Intermediate count	✓
Reset source	✓
Log update time	✓
Log update source	✓
Count rate	✓
Cut-off	✓
Functions	
Custom Linearizers	
All breakpoints	✓
Custom Chart Zones	
Upper and lower zone margins	✓

Table 6.1 Copy Facility (Continued)

Parameter	Copy?
Real Time Alarms	
Alarm tag	✗
Daily enables	✓
1st of the month enable	✓
On time – Every hour	✓
On time – Hours	✓
On time – Minutes	✓
Duration – Hours	✓
Duration – Minutes	✓
Duration – Seconds	✓
Log enable	✓

Note. The following functions are available only with Advanced Software Option.

Logic Equations	
Equation tag	✗
Log enable	✓
All operands	✓
All operand invert states	✓
All operators	✓
Math Functions	
Equation	✓
Reset source	✓
Digital sources 1, 2 & 3	✓
Engineering low	✓
Engineering high	✓
Engineering units	✓
Short tag	✗
Long tag	✗

Table 6.1 Copy Facility (Continued)

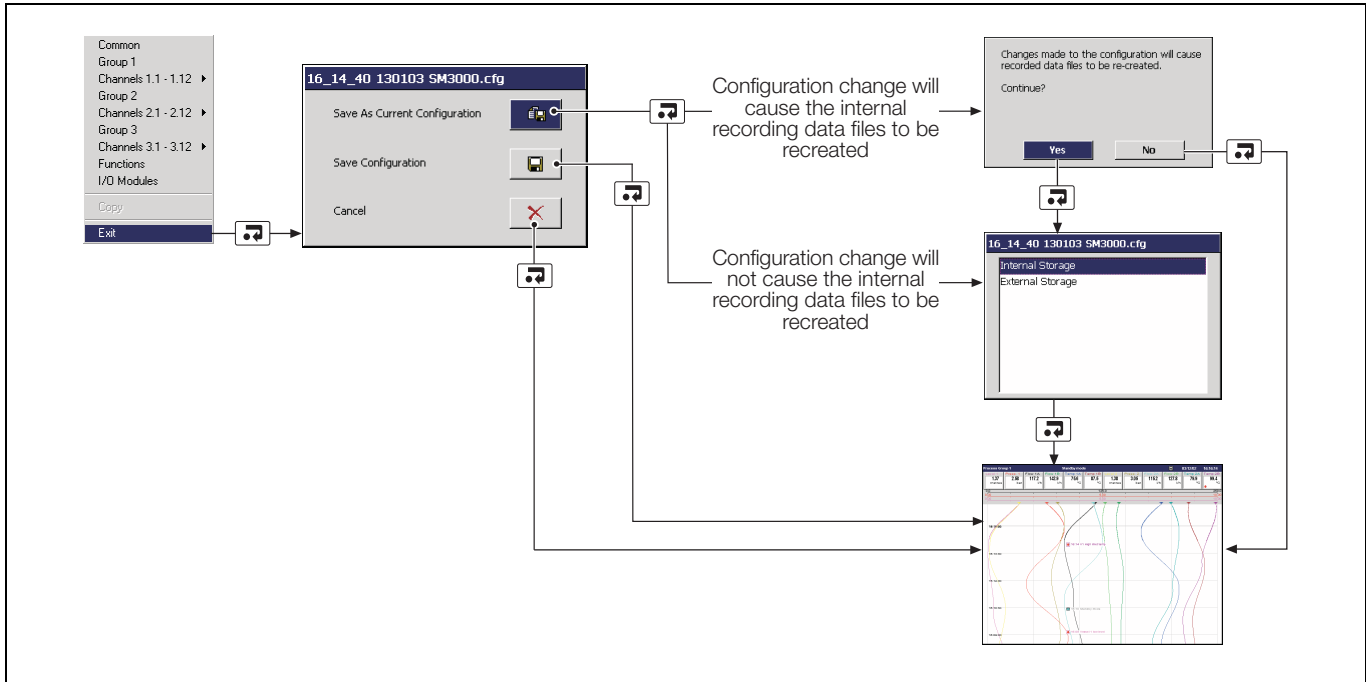

Fig. 6.7 Exiting Configuration Mode

Note.

- Selecting 'Save as Current Configuration' suspends recording for a short time while the new configuration is implemented.
- When saving the current configuration to internal storage, it is saved twice, once with the filename 'SM3000.cfg' and again with the filename '<time><date><instrument tag>.cfg'.
- When saving the current configuration to external storage, it is saved with the filename '<time><date><instrument tag>.cfg'. It is also saved automatically to internal storage with the filename 'SM3000.cfg'.
- When 'Save Configuration' is selected, the configuration file is saved with the filename '<time><date><instrument tag>.cfg' to either selected location, internal or external.
- Changes are saved to non-volatile memory only when one of the save options above has been selected. Any powerdown before this results in lost configuration changes.
- Selecting 'Cancel' discards unsaved changes and returns the instrument to the Operating level.
- New internal data files for enabled recording channels are created if any of the following configuration parameters are changed:
 - Recording channel source
 - Primary/secondary sample rate
 - Primary/secondary sample rate source
 - Input filter type
 - Engineering range
 - Channel tag
- New internal data files for all enabled recording channels are created if the instrument tag or the number of groups is changed, or any previously disabled channel is enabled. Any unarchived data is lost.
- A warning is displayed if a configuration change will result in new internal data files for enabled recording channels being created. Select 'Yes' to accept the configuration change. Select 'No' to cancel the configuration change.

6.4 Common Configuration

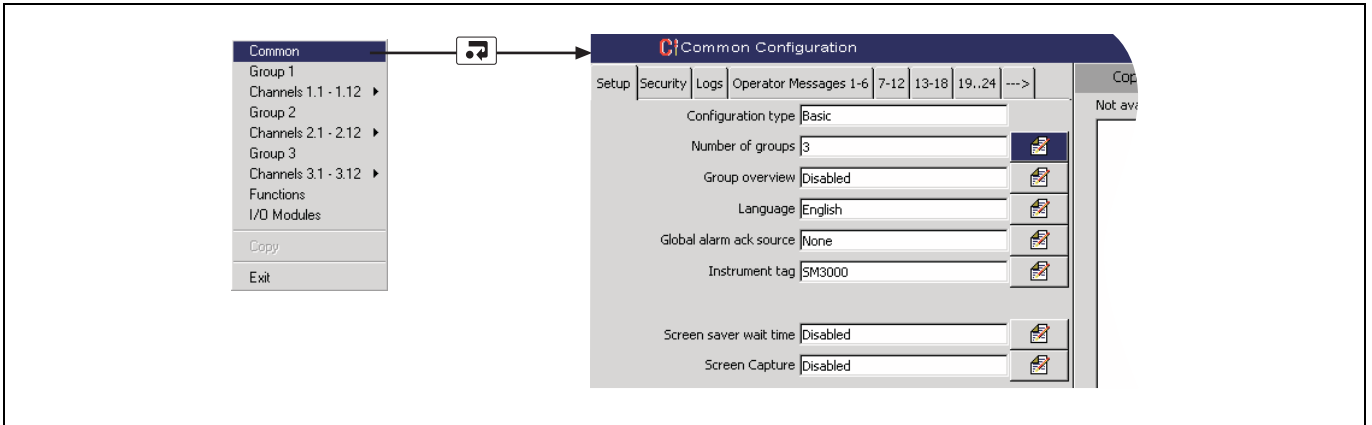
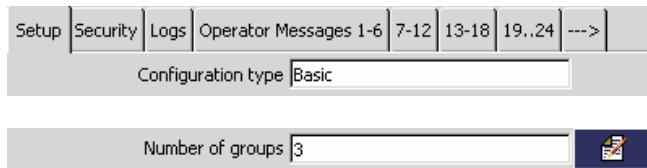

Fig. 6.8 Selecting Common Configuration

6.4.1 Setup



Configuration type is fixed as 'Basic'.

Enter the number of process groups required.

The number of channels assigned to each process group is dependent upon the number of groups selected – see Table 6.2 below.

Note. If the 'Number of groups' setting is increased, the channel source IDs of all new channels are set to 'None' and their alarms and totalizers are set to 'Off'.

No. of Groups	No. of Channels per Group	Channel IDs	Total No. of Channels
1	12	Ch1.1 to Ch1.12	12
2	12	Ch1.1 to Ch1.12 Ch2.1 to Ch2.12	24
3	12	Ch1.1 to Ch1.12 Ch2.1 to Ch2.12 Ch3.1 to Ch3.12	36
4	9	Ch1.1 to Ch1.9 Ch2.1 to Ch2.9 Ch3.1 to Ch3.9 Ch4.1 to Ch4.9	36

No. of Groups	No. of Channels per Group	Channel IDs	Total No. of Channels
5	7	Ch1.1 to Ch1.7 Ch2.1 to Ch2.7 Ch3.1 to Ch3.7 Ch4.1 to Ch4.7 Ch5.1 to Ch5.7	35
6	6	Ch1.1 to Ch1.6 Ch2.1 to Ch2.6 Ch3.1 to Ch3.6 Ch4.1 to Ch4.6 Ch5.1 to Ch5.6 Ch6.1 to Ch6.6	36

Table 6.2 Channels and Groups

Group overview Disabled 

Enable or disable the process group overview display.

Note. If 'Number of groups' is set to 1, group overview is not available.

Select 'Enable' to enable group overview.

Select 'Max and Min' and 'Alarms' to enable maximum and minimum markers and alarms for display as required.

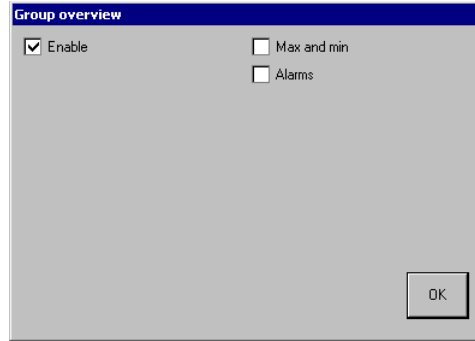

Language English 

Select the language to be used to display standard user prompts and menu items.

Global alarm ack source None 

A digital signal source can be used to acknowledge active alarms in all Process Groups simultaneously. Refer to Appendix A on page 129 for a full list of sources available.

Instrument tag SM3000 

Enter the tag to be used to identify the instrument on configuration and audit log files.

Note. When reviewing data, the instrument tag is used to identify the source of the data, therefore it is important to ensure that the instrument tag is unique to each recorder.

Screen saver wait time Disabled 

Select the waiting time between the last key press and activation of the screen saver.

Screen Capture Disabled 

When set to 'Enabled', the user can save an image of any Operator screen to external archive media by pressing the  key when an Operator Menu is not open.

Note.

- All images are saved to a folder on the archive media named 'BMP'.
- The images are saved even if archiving is set to 'Offline'.
- If external archive media is not inserted, or is full, the screen capture facility is disabled automatically.

•1 A new internal data file for all the recording channels in this group is created if this parameter is changed. All historical data stored internally for these channels is lost.

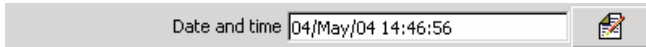

Set the current date and time.

Note. If daylight saving is required, enter the settings (see next page) before setting the time and date as the operation of the internal clock is affected by the daylight saving settings.

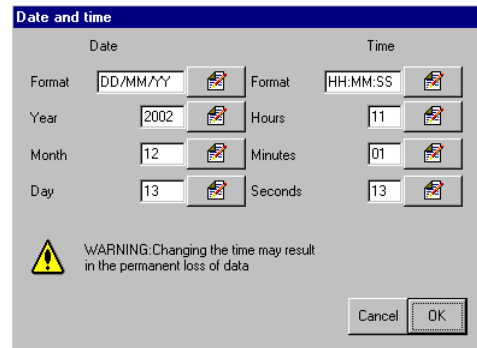

Note.

- The date and time cannot be adjusted if recording is enabled during configuration, i.e the 'Disable recording in configuration' check box is not ticked on entry to the Configuration level – see Fig. 6.1, page 52.
- Changes to the date and time are effective immediately upon selecting 'OK' in the dialog box above. Selecting 'Cancel' upon exiting Configuration Mode (see Fig. 6.7, page 60) does not reset the clock to its previous setting. Select 'Cancel' in the dialog box above to exit date and time setup without saving changes.
- Setting an earlier date or time results in the loss of all data currently in the internal buffer memory past that date. Data archived to external media is unaffected. If an earlier time must be set, change the Instrument Tag (see page 62). This causes new archive files to be created and the duplicated hour of data is then saved to the new files.
- Time changes due to automatic daylight saving do not affect the recorded data.
- Archive files created during the daylight saving period (see Section 6.5.6, page 85) are compatible with the database feature of Version 5.8 (or later) only of the Company's DataManager data analysis software package.

Daylight Saving - Enable 

Select the daylight saving method.

Note. Changes to daylight saving are effective immediately a method is selected. However, if 'Cancel' is selected upon exiting Configuration Mode (see Fig. 6.7, page 60), the last saved daylight saving settings are restored.



Off	Daylight saving is disabled.
Auto - USA	The start and end of the daylight saving period in the USA is calculated automatically. The clock is incremented automatically by 1 hour at 2:00am on the first Sunday in April and decremented automatically by 1 hour at 2:00am on the last Sunday in October.
Auto - Europe	The start and end of the daylight saving period in Central Europe is calculated automatically. The clock is incremented automatically by 1 hour at 2:00am on the last Sunday in March and decremented automatically by 1 hour at 2:00am on the last Sunday in October.
Auto - Custom	The start and end of the daylight saving period can be configured manually for regions that do not follow either the USA or Europe conventions. The clock is incremented automatically by 1 hour at the manually selected start time and decremented automatically by 1 hour at the manually selected end time.

Daylight Saving - Start
Daylight Saving - End

Note. Displayed only if 'Daylight Saving - Enable' is set to 'Auto - USA'.

Daylight Saving - Start
Daylight Saving - End

Note. Displayed only if 'Daylight Saving - Enable' is set to 'Auto - Europe'.

Daylight Saving - Start 
Daylight Saving - End 

Note. Displayed only if 'Daylight Saving - Enable' is set to 'Auto - Custom'.

Set the start and end of the daylight saving period.

Daylight Saving - Start

Time 

Occurrence 

Day 

Month 

6.4.2 Security

Change user names, access privileges and passwords.

Note.

- User 1 is the System Administrator and is able to change user names/access privileges and enter initial passwords for all users. Other users cannot change their user names and access privileges once set by User 1. All users may change their own passwords.
- All other parameters can be changed only by the System Administrator (User 1).

The screenshot shows a configuration interface with a menu bar at the top containing 'Setup', 'Security', 'Logs', and 'Operator Messages 1-6', '7-12', '13-18', '19..24', and '--->'. Below the menu, there are four configuration rows, each with a label, a text input field, and a small icon on the right:

- User 1 Name: Operator 1
- User 1 Access: Config (Full) , Setup, e-Sign
- User 1 Password: *****
- Configuration security type: Password protected

Set the method of access to the Configuration level. If 'Password protected' is selected, access is by means of the password set above.

Note. If 'Internal switch protected' is selected, access to the Configuration level for all users is prohibited once the changes have been saved and made active. Access to the configuration level is then achieved only by setting the internal security switch to the 'Configuration Level Not Protected' position – see Fig. 6.2, page 53.

The screenshot shows a single configuration row with the label 'Setup level security' and a dropdown menu set to 'Off'. A small icon is visible on the right side of the dropdown.

When set to 'On', access to the Setup level is password protected and restricted to users with setup access privileges. Each user must enter their own unique password.

The screenshot shows a single configuration row with the label 'Reconfigure preset passwords' and a dropdown menu set to 'No'. A small icon is visible on the right side of the dropdown.

Passwords are entered initially by the System Administrator but, subsequently, any user can change their own password. When this parameter is set to 'Yes', each user must change their password after it is used for the first time following initial configuration – see also 'User 2 Password' on page 66.

The screenshot shows a single configuration row with the label 'Password expiry' and a dropdown menu set to 'Disabled'. A small icon is visible on the right side of the dropdown.

Enter the time period after which all passwords will expire. After this period of time, all users have to change their passwords.

The screenshot shows a single configuration row with the label 'Inactive user de-activation' and a dropdown menu set to 'Disabled'. A small icon is visible on the right side of the dropdown.

Enter the time period after which an inactive user's access privileges are de-activated. A user is considered inactive if their password has not been used. A user is de-activated by removal of their access privileges and can be re-activated only by the System Administrator (User 1).

Password failure limit 

Enter the number of consecutive incorrect password entries allowed by a user. If the number of incorrect entries exceeds this limit, the user's access privileges are de-activated and can be reinstated only by the System Administrator (User 1).

Minimum password length 

Passwords have a maximum length of 20 characters. Enter the minimum length required for all new passwords.

View/Edit other users 

The System Administrator (User 1) can view and/or change the user name, access privileges and password for any other user. Select the user to be viewed/edited.

User 2 Name 

Enter a name for the selected user.

User 2 Access 

Set access privileges for selected user.

Access

<input checked="" type="checkbox"/> Electronic signature	<input type="checkbox"/> Configuration (No access)
<input checked="" type="checkbox"/> Setup	<input type="checkbox"/> Configuration (Load)
	<input type="checkbox"/> Configuration (Limited)
	<input checked="" type="checkbox"/> Configuration (Full)

OK

Disabled – The selected user is unable to access the Configuration and Setup levels or enter electronic signatures.

Setup – The selected user is able to access the Setup level.

e-Sign – The selected user is able to enter an electronic signature.

Config (Full) – The selected user is allowed full configuration access with the exception of access to the Audit Log size setting and the Security Settings.

Note. The System Administrator (User 1) only is able to change the Audit Log size and the Security Settings.

Config (Ltd) – The selected user is able to:

- Change alarm trip points, hysteresis and time hysteresis settings.
- Make input adjustments for analog input boards.
- Load configurations from external media only.

Config (Load) – The selected user is unable to make any configuration changes but can load configurations from external media.

User 2 Password 

Enter an initial password for the selected user.

Note. The user may subsequently change this password.

6.4.3 Logs

Setup	Security	Logs	Operator Messages 1-6	7-12	13-18	19..24	--->
		Alarm log size	100				
		Totalizer log size	200				
		Audit log size	100				

Set the maximum number of entries in each instrument log.

Note. Changing the log size deletes the current log entries.

The Alarm Event log records all process alarm transitions (inactive to active, unacknowledged to acknowledged or active to inactive), real-time events and Operator Messages – see Section 4.9, page 37.

The Totalizer log records all activity associated with the totalizers: start, stop, reset, wrap, current total and intermediate totals – see Section 4.10, page 39.

The Audit log records all system changes and events – see Section 4.8.2, page 36.

Note. The size of the Audit log can be changed only by the System Administrator (User 1).

Log sizes must be set in the range 10 to 200. The size of the logs has no effect on the amount of memory available for storing channel data.

6.4.4 Operator Messages

Setup	Security	Logs	Operator Messages 1-6	7-12	13-18	19..24	--->	
			Message tag 1	Boiler Temp High				
			Group	1 2 3 X X X				
			Source ID	Comms digital I/P 1				
			Message tag 2	Boiler Temp High				
			Group	X X X 4 5 6				
			Source ID	Comms digital I/P 2				
			Message tag 3	Boiler Press High				
			Group	1 2 3 X X X				
			Source ID	Comms digital I/P 3				
			Message tag 4	Boiler Press High				
			Group	X X X 4 5 6				
			Source ID	Comms digital I/P 4				
			Message tag 5	Fuel Press Low				
			Group	1 2 3 4 5 6				
			Source ID	Comms digital I/P 5				
			Message tag 6	Oil Press Low				
			Group	1 2 3 4 5 6				
			Source ID	Comms digital I/P 6				

Operator messages can be triggered via the Operator Menu or a digital signal.

Message Tag

Enter the message text – 20 characters maximum.

Group

Select the group(s) to which the message is to apply.

Source ID

Select the internal or external signal source used to add the tag to the Alarm Event log. Refer to Appendix A on page 129 for a full list of sources available.

6.4.5 Ethernet

The Ethernet module fitted to the instrument contains an embedded web server enabling the instrument's data and status to be viewed remotely using an internet browser on a PC. The web server supports up to eight independent connections.

Note.

- To connect the instrument to an Ethernet network, see Section 7.9, page 120.
- For an overview of Ethernet Communications and information on testing, FTP access and a operation of the instrument's embedded web server – see Appendix E, page 176.
- Changes to the IP address, subnet mask and default gateway are implemented only after the instrument has been restarted. Change the addressing parameters, exit and save the configuration, wait until the 'Please Wait' message disappears then power down and restart the instrument.

Navigation: <--- Ethernet | email 1 | email 2 | Modbus TCP

IP-address: 192.168.1.1

Set the IP address to be assigned to the instrument. The IP address is used by the TCP/IP protocol to distinguish between different devices. The address is a 32 bit value expressed with four values (0 to 255), each separated by a period (.).

Subnet mask: 255.255.255.0

The subnet mask is used to indicate which part of the IP address is for the network ID and which is for the host ID. Set as '1's each bit that is part of the network ID, for example, 255.255.255.0 indicates first 24 bits are for the network ID.

Default Gateway: 0.0.0.0

Set the IP address for the gateway (router, switch etc.) required to communicate with other networks. This setting may not be required. The default setting is 0.0.0.0

FTP Users

The FTP user name and password are used during logon to enable the FTP server. Access for up to 11 different users is provided. These passwords can also be used to allow access to some functionality provided by the web server.

Enter the name of the user granted FTP access.

Enter the password of the user granted FTP access.

Select whether this FTP user has full access (i.e. the ability to read, write and delete files) or read-only access.

User name: []

Password: []

Access Level: Full

Remote operation Access: Configuration

OK

Note. If a user is given full access via FTP, that user is able to delete both data and configuration files. This could result in erroneous operation of the instrument.

Select the level of remote operation access granted to this user:

- None – the user is unable to log on to the instrument remotely using a web browser
- Operator – the user can acknowledge alarms and start/stop totalizers using a web browser
- Configuration – in addition to operator functions, the user can load configurations and change the instrument's internal clock using a web browser

6.4.6 email

The instrument can be configured to send emails to a maximum of 6 recipients in response to certain events. The addressees can all subscribe to the same SMTP server or the instrument can be configured to send emails via 2 different SMTP servers to a maximum of 3 addressees per server.

Up to 10, independently configurable triggers can be enabled to generate an email when the selected source becomes active.

When a trigger source becomes active, an internal 1 minute delay timer is started. At the end of that minute, an email is generated that includes, not only the event that initiated the delay timer, but every other event that occurred during the delay period together with any enabled reports. The data returned in the email therefore reflects the real-time alarm state at the time the email was generated, not the state when the first trigger source became active.

Each email includes a link to the instrument's embedded web server enabling the instrument's data and status to be viewed remotely using an internet browser on a PC – see Section 6.4.5, page 69 and see Appendix E, page 176.

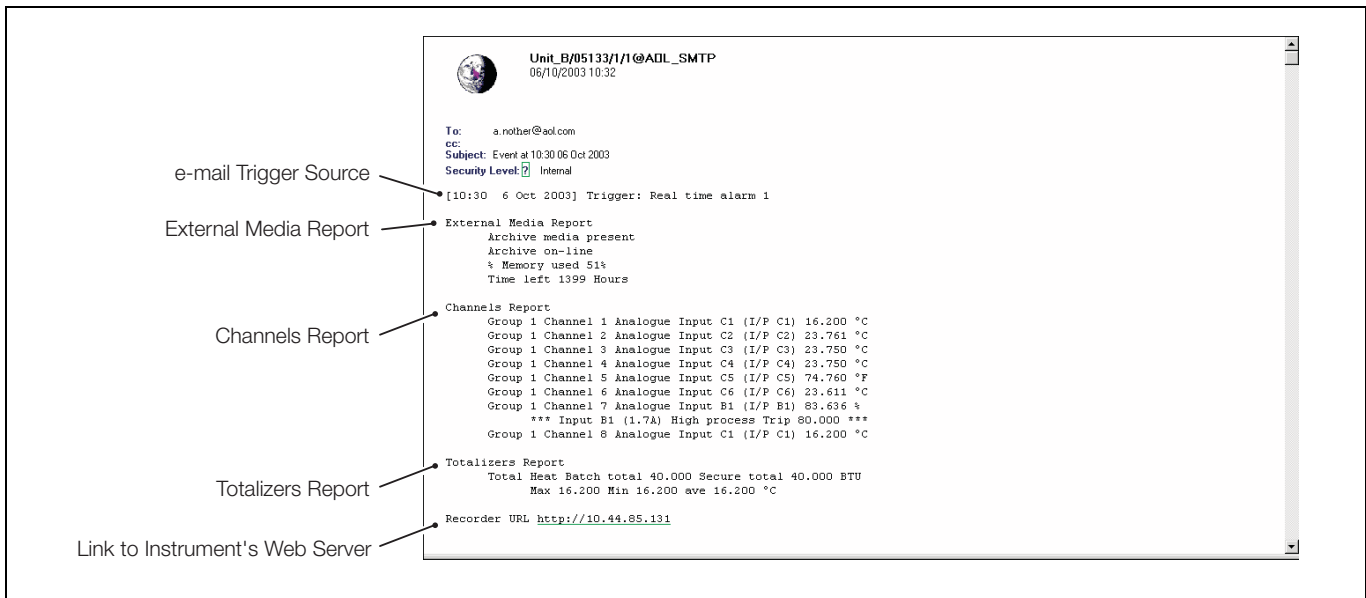

Fig. 6.9 Reports email Example



Fig. 6.10 Event Trigger email Example

Ethernet email 1 email 2 Modbus TCP

SMTP Server IP address:

Recipient 1:

Recipient 2:

Recipient 3:

Options enabled:

Options enabled

<input checked="" type="checkbox"/> Channels Report	<input type="checkbox"/> Trigger 6 Inverted
<input checked="" type="checkbox"/> Totalizers Report	<input type="checkbox"/> Trigger 7 Inverted
<input checked="" type="checkbox"/> External Media Report	<input type="checkbox"/> Trigger 8 Inverted
<input type="checkbox"/> Reports in ALL emails	<input type="checkbox"/> Trigger 9 Inverted
	<input type="checkbox"/> Trigger 10 Inverted

Enter the IP address of the SMTP server through which emails are to be routed.

Enter the address(es) of the email recipient(s).

Select the options to enable:

Channels Report

A summary of all enabled channels is included in the email, together with their instantaneous values.

Totalizers Report

A summary of all enabled totalizers is included in the email, together with their instantaneous values.

External Media Report

A summary of the condition of the external media (if any) and archiving status is included in the email. Fig. 6.9 on page 70 is an example of a reports email.

Notes.

- Reports, when enabled, are included only on an email generated as a result of a real-time alarm event unless the 'Reports in ALL emails' box is ticked, in which case enabled reports are included on every email generated.
- Triggers 6 to 10, if enabled ('Source Type' set to anything other than 'None' – see below), may be 'inverted', i.e. an email is generated when the trigger source becomes inactive instead of active. Event trigger source types that cannot be inverted are: Alarm acknowledge, Any alarm and New alarm.

Trigger 1	<input type="text" value="None"/>	<input type="button" value="ⓘ"/>
Trigger 2	<input type="text" value="None"/>	<input type="button" value="ⓘ"/>
Trigger 3	<input type="text" value="None"/>	<input type="button" value="ⓘ"/>
Trigger 4	<input type="text" value="None"/>	<input type="button" value="ⓘ"/>
Trigger 5	<input type="text" value="None"/>	<input type="button" value="ⓘ"/>
Trigger 6	<input type="text" value="None"/>	<input type="button" value="ⓘ"/>
Trigger 7	<input type="text" value="None"/>	<input type="button" value="ⓘ"/>
Trigger 8	<input type="text" value="None"/>	<input type="button" value="ⓘ"/>
Trigger 9	<input type="text" value="None"/>	<input type="button" value="ⓘ"/>
Trigger 10	<input type="text" value="None"/>	<input type="button" value="ⓘ"/>

Select up to 10 event source types to generate an e-mail. Fig. 6.10 on page 70 is an example of an event-triggered e-mail.

Source Type

- Any alarm
- Digital I/P
- Logic equation
- Real time alarm
- Comms digital I/P
- Analog I/P fail
- Comms analog I/P fail**
- Totalizer run state
- Totalizer wrap pulse
- Totalizer 1st stage o/p
- Stats fail
- Archive state

6.4.7 Modbus TCP

Modbus TCP enables Modbus TCP devices to communicate via an ethernet network transferring Modbus messages via TCP/IP. Communication with standard, serially connected, Modbus RTU devices is also possible through a Modbus TCP Gateway.

The instrument can be configured to act as either a Modbus TCP Server (Slave) or a Modbus TCP Client (Master) device on a Modbus TCP network.

If configured as a Server, the recorder responds to Modbus queries transferred via the Modbus TCP protocol for the registers described in Appendix B, page 131. The recorder can be configured for unrestricted access or access can be restricted to a maximum of 6 Modbus TCP Clients, from defined IP addresses.

If configured as a Client, the recorder collects data from Modbus TCP Servers (or RTUs via a gateway) into its 36 Comms Analog and 36 Comms Digital Channels. Each analog and digital input can be individually configured to any register within any slave device. The configuration allows for receipt of data in most commonly used data formats

Select the required Modbus TCP configuration.

Disabled – Modbus TCP disabled.

Modbus TCP Server – instrument acts as a Modbus Slave

Modbus TCP Client – instrument acts as a Modbus Master

Note. Displayed only if 'Implementation' is not set to 'Disabled'.

Set the TCP/IP port-through used by the Modbus TCP network – normally port 502.

Note. The remaining parameters on this page are displayed only if 'Implementation' (above) is set to 'Modbus TCP Server', i.e. the instrument is configured to act as a Modbus slave on a Modbus TCP network.

Select the maximum number of simultaneous TCP/IP connections permitted:

Unrestricted – any Modbus TCP Client device is permitted to poll the instrument.

1 (to 6) – only the Modbus TCP client device(s) whose IP address(es) is(are) entered in the 'Authorized IP 1' (to 'Authorized IP 6') parameter(s) (below) is(are) permitted to poll the instrument.

Note. Displayed only if 'TCP Client Access' is not set to 'Unrestricted'.

Enter the IP address(es) of the Modbus TCP Client (Modbus Master) device(s) that is(are) permitted to poll the instrument for data.

All analog data is read from the instrument in IEEE format contained in adjacent registers representing the data in high word, low word order.

Select 'Yes' to reverse the IEEE data, otherwise select 'No'.

Note. The parameters on this and the next two pages are displayed only if 'Implementation' (see page 72) is set to 'Modbus TCP Client', i.e. the instrument is configured to act as a Modbus master on a Modbus TCP network.

Connections Allowed 

Select the maximum number of simultaneous TCP/IP connections permitted, min. 1, max. 9.

Poll Rate 

Set the poll rate in milliseconds – min. 0, max. 3600000.

Poll fail limit 

Set the number of successive polls permitted to fail before the data is marked as a failed input – min. 0, max. 4.

Response Timeout 

Set the timeout time in milliseconds for a single poll – min. 0, max. 60000.

Note. If any RTU devices connected through a gateway are polled, set a response time that is long enough to allow for the normal turn around time from these devices. The configuration allows for only one setting for all devices connected to the network.

Comms analog I/P 

Select the comms analog input to hold the data from the nominated slave device.

Protocol 

Select the communications protocol to be used by the instrument to communicate with the nominated slave device:

- None – comms analog channel unused
- TCP – Modbus Transmission Control Protocol
- RTU – access a Remote Terminal Unit (RTU) via Modbus TCP gateway

RTU Address 

Note. Displayed only if 'Protocol' is set to 'RTU'.

Enter the RTU address assigned to the remote unit (1 to 247).

Gateway 

Notes.

- Displayed only if 'Protocol' is set to 'RTU'.
- This setting is always required to access a RTU via Ethernet.

Set the IP address for the Modbus TCP gateway required to communicate with the RTU.

IP-address 0.0.0.0 

Note. Displayed only if 'Protocol' is set to 'TCP'.
Enter the IP address assigned to the slave device.

Register Number 0 

Note. Displayed only if 'Protocol' is set to 'TCP' or 'RTU'.
Enter the register number to be read in the slave device.

Type Input Register 

Note. Displayed only if 'Protocol' is set to 'TCP' or 'RTU'.
Select the register type, 'Holding Register' or 'Input Register'.

Format Sint16 

Note. Displayed only if 'Protocol' is set to 'TCP' or 'RTU'.
Select the format of the data to be read from the slave device:

- Sint16 – signed, 16 bit integer
- Sint32 – signed, 32 bit integer, transmitted in high/low order
- rev. Sint32 – signed, 32 bit integer, transmitted in low/high order
- IEEE – 32 bit floating point number, transmitted in high/low order
- Rev. IEEE – 32 bit floating point number, transmitted in low/high order

Comms digital I/P Comms digital I/P 1 

Select the comms digital input to hold the data from the nominated slave device.

Protocol RTU 

Select the communications protocol to be used by the instrument to communicate with the nominated slave device:

- None – comms digital channel unused
- TCP – Modbus Transmission Control Protocol
- RTU – access a Remote Terminal Unit (RTU) via Modbus TCP gateway

RTU Address 

Note. Displayed only if 'Protocol' is set to 'RTU'.
Enter the RTU address assigned to the remote unit (1 to 247).

Gateway 

Notes.

- Displayed only if 'Protocol' is set to 'RTU'.
- This setting is always required to access a RTU via Ethernet.

Set the IP address for the Modbus TCP gateway required to communicate with the RTU.

IP-address 

Note. Displayed only if 'Protocol' is set to 'TCP'.
Enter the IP address assigned to the slave device.

Register Number 

Note. Displayed only if 'Protocol' is set to 'TCP' or 'RTU'.
Enter the register number to be read or written to in the slave device.

Type 

Note. Displayed only if 'Protocol' is set to 'TCP' or 'RTU'.
Select the register type, 'Input Status' or 'Coil Status'.

6.5 Process Group Configuration

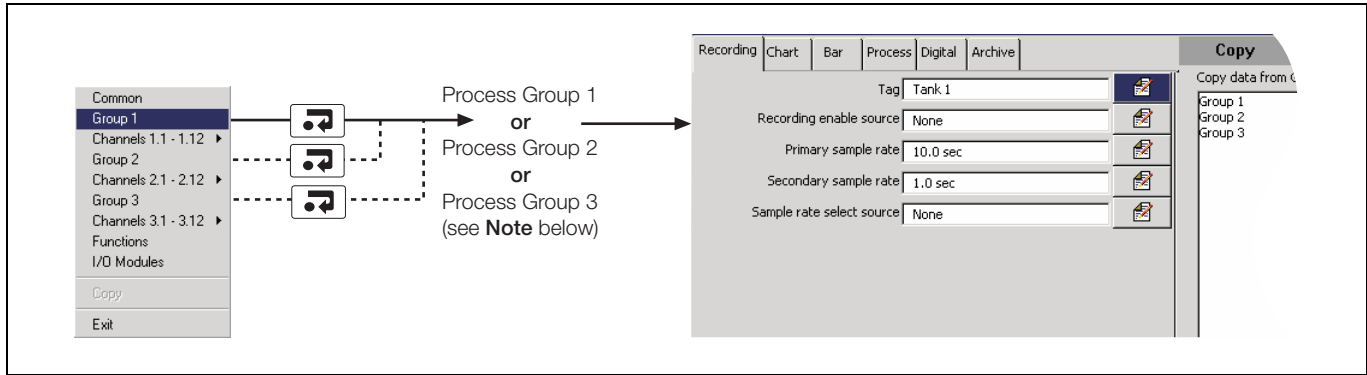

Fig. 6.11 Selecting Process Group Configuration

Note. The number of Process Groups and associated channel options displayed depend on the number of Process Groups selected during common configuration setup – see Section 6.4.1, page 61.

6.5.1 Setting the Recording Parameters



Enter the process group tag (maximum 20 characters) that appears in the title bar when any operator views from that group are displayed.

Note. Each process group tag must be unique.

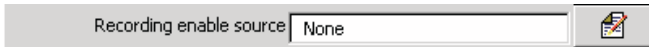

Select a signal source to enable/disable recording of all channels in the current Process Group. Refer to Appendix A on page 129 for a description of the available sources.

Note. This signal is edge-triggered. A rising edge (inactive to active) enables recording. A falling edge (active to inactive) disables recording.



The instrument can be configured to sample all recording channels in the group and store the data in internal memory and external archive media (if archiving is enabled) at two rates, Primary and Secondary.

The Primary sample rate is active during normal process operating conditions and is set typically to a relatively slow rate (depending upon process recording requirements) in order to maximize internal memory and external archive media capacity.

The instrument can be configured to switch to a faster, Secondary sample rate when a selected digital source becomes active in order to record the maximum amount of detail for the period in which that source is active, or may be switched manually – see Section 5.4, page 43.

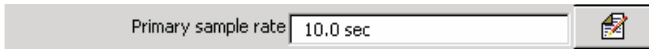

•1 Set the Primary sample rate to between 0.1 seconds and 720 minutes (12 hours). The table below compares example sample rates with the equivalent chart speeds of a traditional chart recorder together with the storage capacity of internal memory. Refer to Appendix C on page 170 for full details of internal memory and external archive media storage capacity.

Sample Rate	Equivalent Chart Speed	On-board Storage Time (6 Channels)
1 second	720mm/h	5.5 days
3 seconds	240mm/h	16.4 days
6 seconds	120mm/h	1.1 months
12 seconds	60mm/h	2.2 months
36 seconds	20mm/h	6.6 months
72 seconds	10mm/h	13.2 months

Notes.

- Sample rates are set using one of the following combinations of units:
 - Minutes or minutes and seconds
 - Seconds
 - Tenths of seconds (minutes and seconds must first be set to zero).
- The rate at which data is displayed in the Chart View (screen interval [Horizontal and Vertical Chart View] or chart duration [Circular Chart View]) is set separately – see Section 6.5.2, page 78.
- The sample rate determines the maximum screen interval/ chart duration that can be selected – see Table 4.1 on page 17.

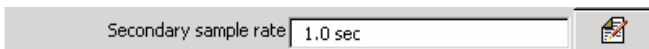

•1 Set the Secondary sample rate to between 0.1 seconds and 720 minutes (12 hours).

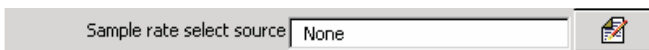

•1 Select a signal source to enable switching between the primary and secondary sample rates. Refer to Appendix A on page 129 for a description of the available sources.

Note. This signal is edge-triggered. A rising edge (inactive to active) switches to the secondary sampling rate. A falling edge (active to inactive) switches to the primary sampling rate.



- 1 A new internal data file for all the recording channels in this group is created if this parameter is changed. All historical data stored internally for these channels is lost.

6.5.2 Configuring the Chart View

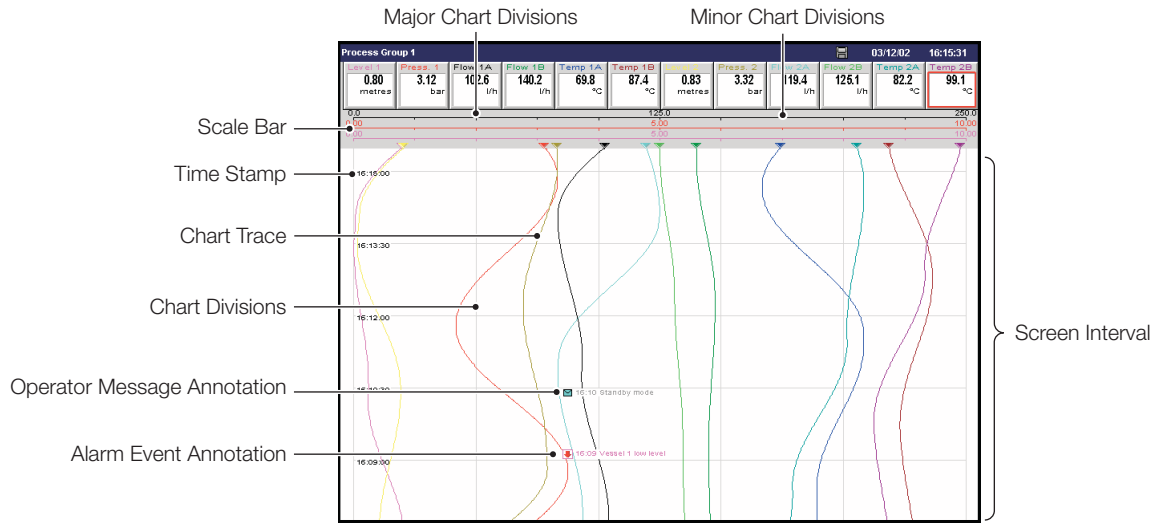

Vertical Chart

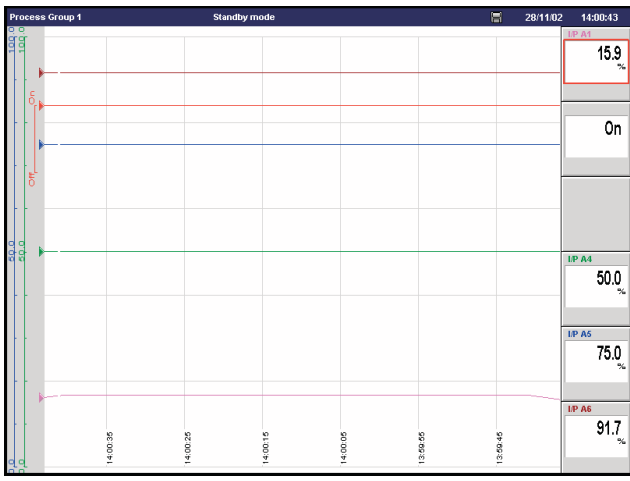

Horizontal --> Chart

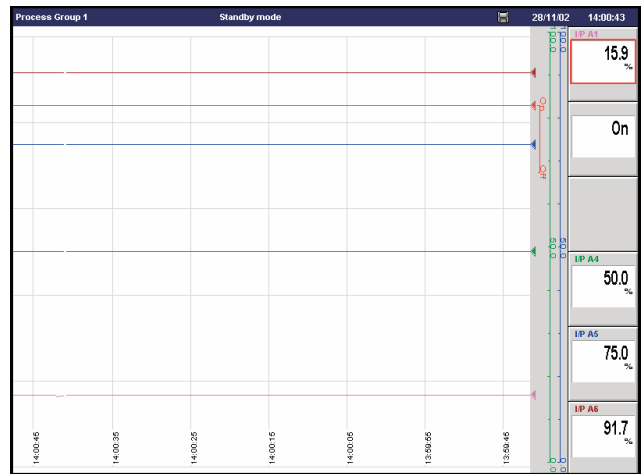

Horizontal <-- Chart

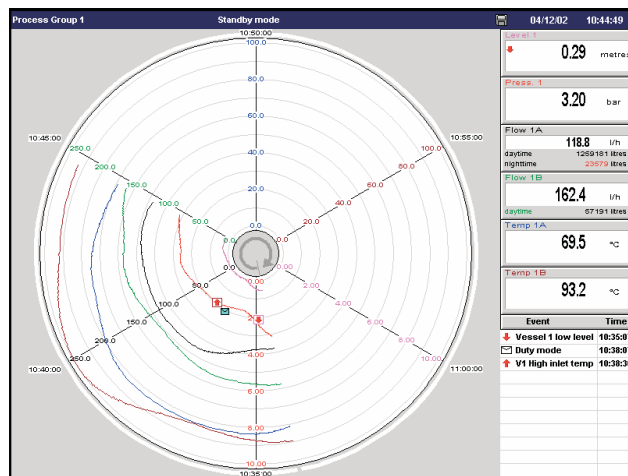

Circular Chart

Recording Chart Bar Process Digital Archive
Chart view enable Vertical 

Select Horizontal --> (Chart runs left to right with scale bar on left), Horizontal <-- (chart runs right to left with scale bar on right), Vertical or Circular chart view.

Chart annotation Alarms & Op. Messages 

Select the annotations to be displayed on the chart. Alarm events and operator messages are displayed on the chart adjacent to the point at which the alarm occurred – see Section 4.3, page 10.

This initial setting can be changed by the operator if 'Chart annotation select enable' is enabled in the Chart view menu enables – see 'Menu Enables' on page 80.

Major chart divisions 5 

Set the number of major vertical divisions to be displayed on the scale bar and the chart.

Minor chart divisions 2 

Set the number of minor vertical divisions to appear between the major chart divisions on the scale bar.

Vertical and Horizontal Chart Views only

OR

Chart divisions 5 

Set the number of divisions to appear on the chart.

Circular Chart View only

Screen interval 8 minutes/screen 

Vertical and Horizontal Chart Views only

OR

Chart duration 1 hour chart 

Circular Chart View only

Trace width 1 

Menu enables 1 2 3 4 5 6 7 X X 

Chart menu enables

<input checked="" type="checkbox"/> 1. Message select enable	<input type="checkbox"/> 8. Totalizer reset enable
<input checked="" type="checkbox"/> 2. Alarm acknowledge enable	<input type="checkbox"/> 9. Totalizer stop/go enable
<input checked="" type="checkbox"/> 3. Scale select enable	
<input checked="" type="checkbox"/> 4. Trace select enable	
<input checked="" type="checkbox"/> 5. Screen interval select enable	
<input checked="" type="checkbox"/> 6. Historical review enable	
<input checked="" type="checkbox"/> 7. Chart annotation select enable	

Select the amount of historical data to be displayed on the screen. Available selections are limited by the sample rate selected – see 'Primary sample rate' and 'Secondary sample rate' on page 77 and Table 4.1 on page 17.

Select the required trace width in pixels (Vertical and Horizontal Chart views only).

Select the menu items to be accessible from the Chart View.

Message select enable

Enables the operator to activate one of 24 pre-configured messages or a user-defined message.

Alarm acknowledge enable

Enables the Operator to acknowledge any alarms associated with the current group.

Scale select enable (Vertical and Horizontal Chart views only)

Enables the operator to select which scales are displayed on the scale bar at the top of the screen.

Trace select enable

Enables individual chart traces to be displayed or hidden.

Screen interval select enable

Enables the Operator to change the amount of data displayed on the screen at one time.

Historical review enable

Enables the Operator to scroll back through data recorded previously that is no longer visible on screen.

Chart annotation select enable

Enables the display of Alarm events and Operator messages on the chart to be enabled or disabled by the operator.

Totalizer reset enable (Circular Chart view only)

Enables the Operator to reset the totalizers on any or all channels.

Totalizer stop/go enable (Circular Chart view only)

Enables the Operator to stop and start totalizers on any or all channels.

Note. Menu items that are not enabled are greyed-out in the relevant Chart View menu.

6.5.3 Configuring the Bargraph View

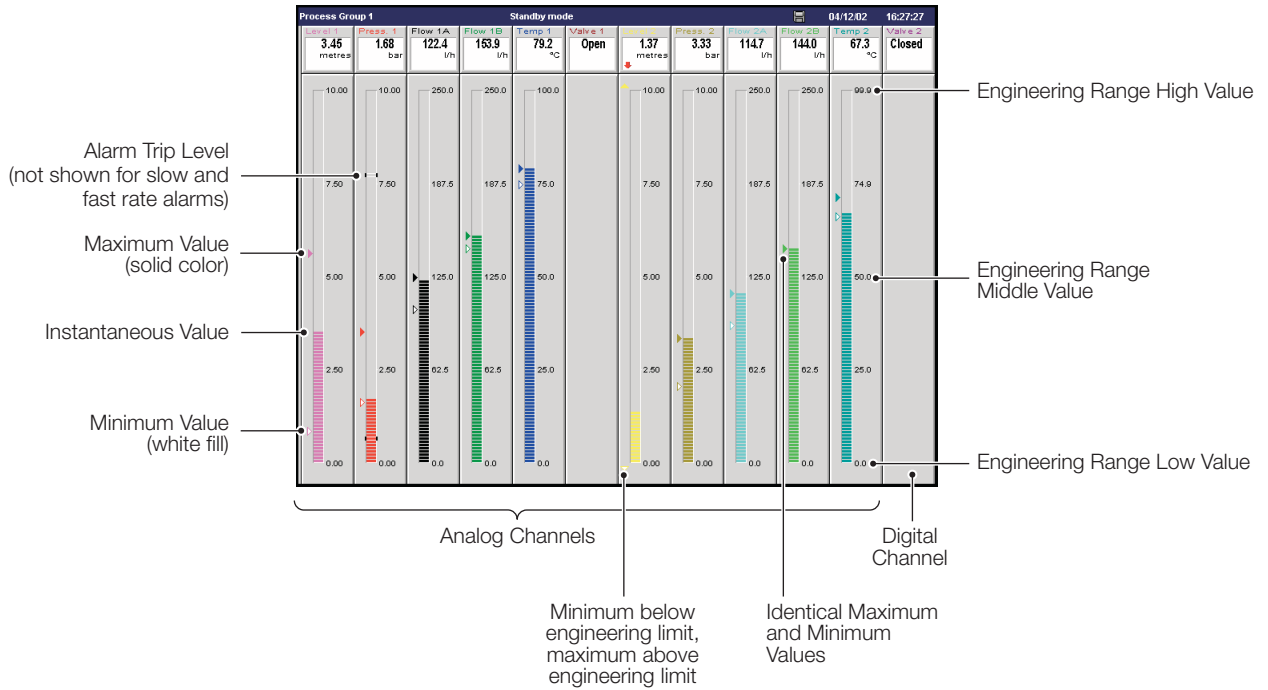

Recording | Chart | Bar | Process | Digital | Archive

Bar graph view enable: Horizontal and vertical

Bar graph markers: Max, min and alarm trips

Menu enables: 1 2 3

Bar graph menu enables

- 1. Message select enable
- 2. Alarm acknowledge enable
- 3. Max/min reset enable

Buttons: Clear all, Select all, OK

Select the Bargraph views to be displayed in the current Process Group.

Select the markers (channel-colored max./min. indicators and alarm trip points) to be displayed on the bargraph.

Select the menu items to be accessible from the Bargraph views.

Message select enable

Enables the operator to activate one of 24 pre-configured messages or a user-defined message.

Alarm acknowledge enable

Enables the Operator to acknowledge any alarms associated with the current group.

Max/min reset enable

Enables the operator to reset the maximum and minimum values of one or more channels to the current value.

Note. Menu items that are not enabled are greyed-out in the Bargraph menu.

6.5.4 Configuring the Process View

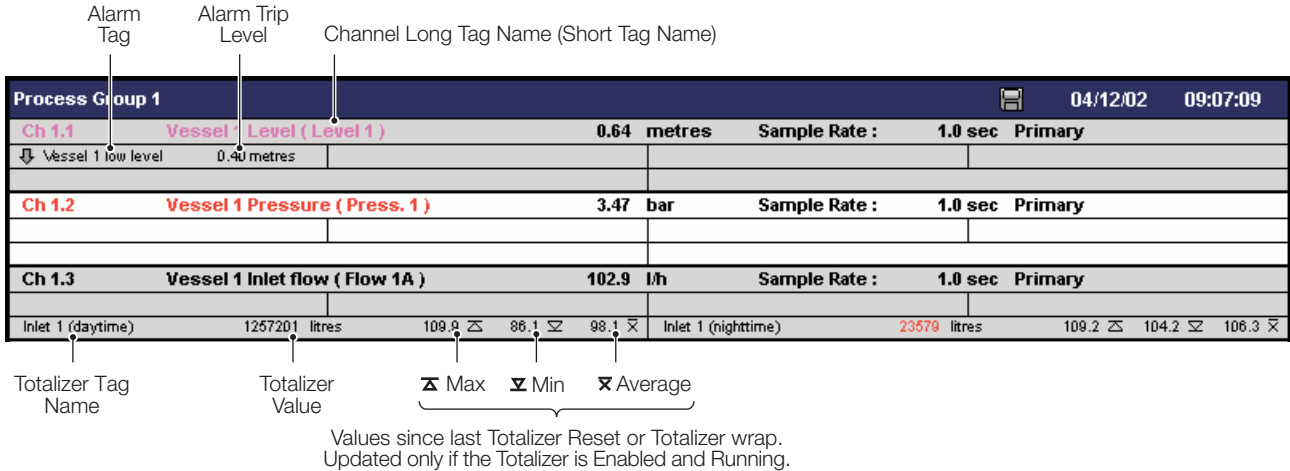

Recording | Chart | Bar | Process | Digital | Archive

Process view enable: On

Menu enables: 1 2 3 4

Process menu enables

- 1. Message select enable
- 2. Alarm acknowledge enable
- 3. Totalizer reset enable
- 4. Totalizer stop/go enable

Clear all Select all OK

Set to 'On' to enable the operator to display the Process view.

Select the menu items to be accessible from the Process view.

Message select enable

Enables the operator to activate one of 24 pre-configured messages or a user-defined message.

Alarm acknowledge enable

Enables the Operator to acknowledge any alarms associated with the current group.

Totalizer reset enable

Enables the Operator to reset the totalizers on any or all channels.

Totalizer stop/go enable

Enables the Operator to stop and start totalizers on any or all channels.

Note. Menu items that are not enabled are greyed-out in the Process view menu.

6.5.5 Configuring the Digital Indicator View

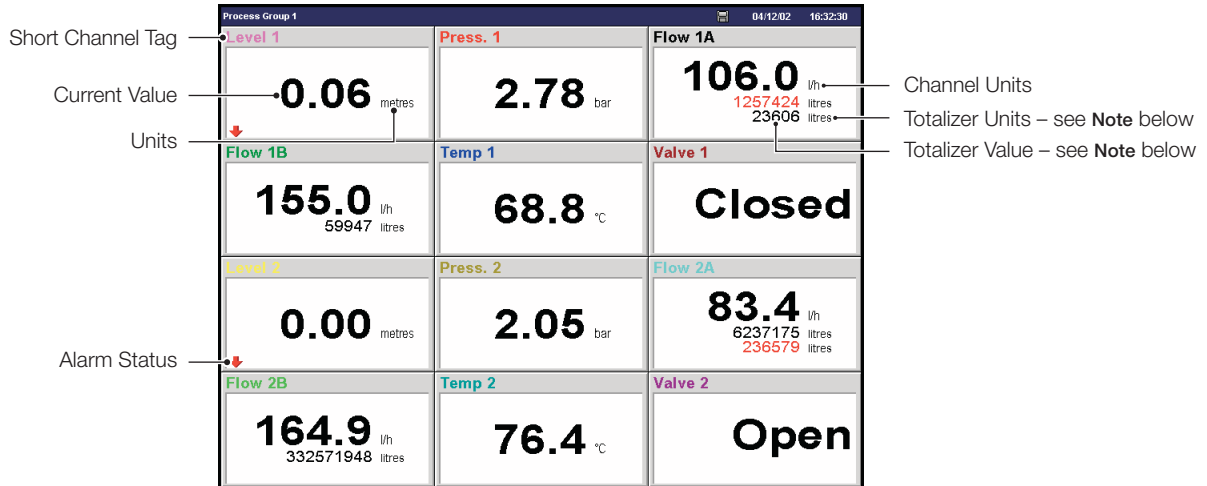

Note. Displayed only if the totalizer is enabled for that channel (see Section 6.6.5, page 98) and for display (see below).

Recording | Chart | Bar | Process | Digital | Archive

Digital view enable

Totalizer display enable

Menu enables

Digital menu enables

- 1. Message select enable
- 2. Alarm acknowledge enable
- 3. Totalizer reset enable
- 4. Totalizer stop/go enable
- 5. Channel select enable

Clear all Select all OK

Set to 'On' to enable the operator to display the Digital Indicator view.

Set to 'On' to add the channel totalizer value and units to the indicator displays (if the totalizer for that channel is enabled – see Section 6.6.5, page 98).

Select the menu items to be accessible from the Digital Indicator view.

Message select enable

Enables the Operator to activate one of 24 pre-configured messages or a user-defined message.

Alarm acknowledge enable

Enables the Operator to acknowledge any alarms associated with the current group.

Totalizer reset enable

Enables the Operator to reset the totalizer value to the preset totalizer value on any or all channels.

Totalizer stop/go enable

Enables the Operator to start and stop the totalizer.

Channel select enable

Enables the Operator to display or hide individual channels.

Note. Menu items that are not enabled are greyed-out in the Digital Indicator View menu.

Channel select enable 1 2 3 4 5 6 X X X X X X X X 

Select channels to display

<input checked="" type="checkbox"/> Channel 1.1	<input type="checkbox"/> Channel 1.8
<input checked="" type="checkbox"/> Channel 1.2	<input type="checkbox"/> Channel 1.9
<input checked="" type="checkbox"/> Channel 1.3	<input type="checkbox"/> Channel 1.10
<input checked="" type="checkbox"/> Channel 1.4	<input type="checkbox"/> Channel 1.11
<input checked="" type="checkbox"/> Channel 1.5	<input type="checkbox"/> Channel 1.12
<input checked="" type="checkbox"/> Channel 1.6	
<input type="checkbox"/> Channel 1.7	<input type="checkbox"/> All configured channels

Select the channels to be accessible from the Digital Indicator view.

Note. Channels that are not enabled are greyed-out in the Digital Indicator view menu.

6.5.6 Archiving Introduction

Recorded data, logs and configuration files stored in the instrument's internal memory can be archived to files created in removable media. Parameters for archiving data in each process group are set up independently.

For a full description of archiving and archive file formats, see Section 5.5, page 45.

Sample Rates – Fig. 6.12

Data is saved to the archive file at the same rate as it is saved to internal memory, i.e. at either the group's primary or secondary recording sample rate.

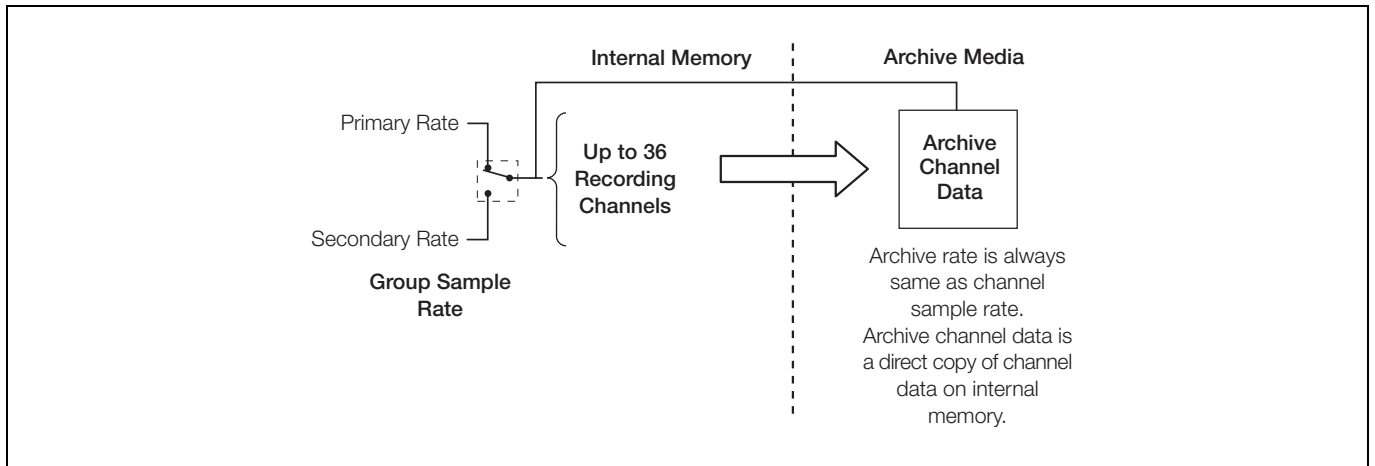
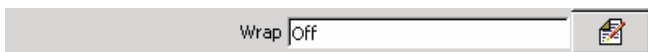
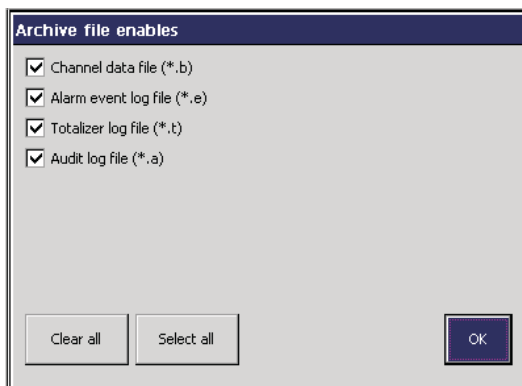
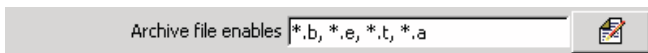
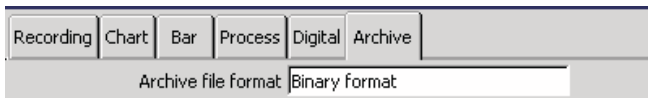

Fig. 6.12 Archiving Sample Rates



Archive file format is fixed as 'Binary format'

Select the data types that are to be archived to the storage media: Channel Data; Alarm Event log; Totalizer log; Audit log.

Note. The Audit log is archived only with Process Group 1 files.

File Type	Contents	Extension
Channel data files	Analog or digital recording channel data	*.BO0
Alarm event log files	The historical record of the alarm events related to the group's channels plus the history of any operator messages, electronic signatures or real time alarms.	*.EE0
Totalizer log files	The historical record of all totalizer and associated statistical values relating to the group's recording channels.	*.TE0
Audit log files	The historical entries in the audit log.	*.AE0

When set to 'On', archive wrap deletes the oldest archived data file from external archive media automatically when the media approaches its maximum capacity.

When set to 'Off', archiving stops automatically when external archive media is full. No files are deleted.

6.6 Channel Configuration

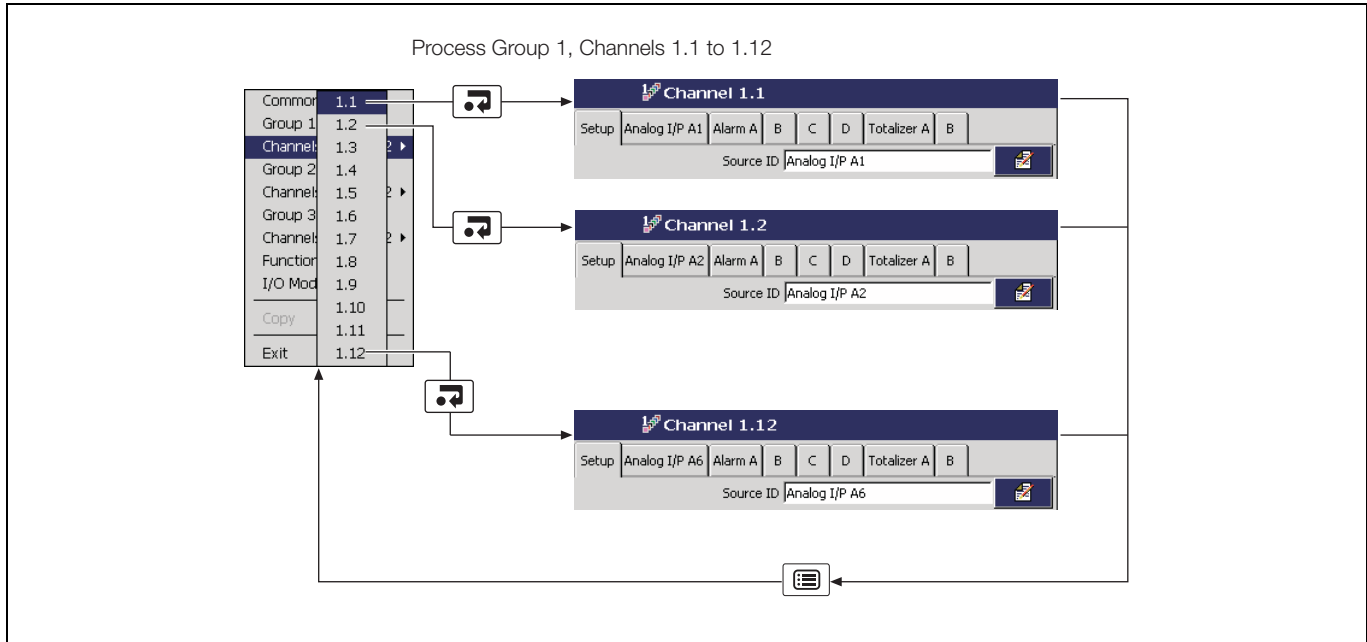
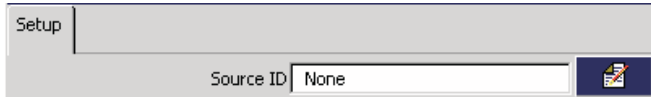

Fig. 6.13 Recording Channel Configuration

Note. The number of Process Groups and associated channel options displayed depend on the number of Process Groups selected during common configuration setup – see Section 6.4.1, page 61.

6.6.1 Recording Channel Setup



•1

Select the signal source for the selected channel. This can be any external analog or digital signal – Refer to Appendix A, page 129 for full list.

Note.

- The input source for Channel 1 in any process group **must** be an analog input to ensure correct operation of the recorder.
- The tabs change according to the selection made.

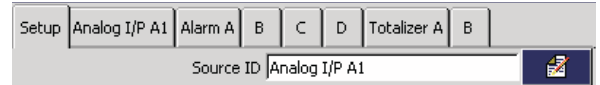

Analog Source

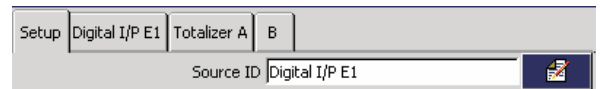

Digital Source

- Setting a channel source to 'None' does not switch off the analog input to which the channel was assigned previously – i.e. the analog input continues to be monitored. To switch off an analog input, set Analog I/P 'Type' for the required channel to 'Off' – see Section 6.6.2, page 89.



The trace color cannot be changed. The trace colors are:

1st	2nd	3rd	4th	5th	6th
Magenta	Red	Black	Green	Blue	Brown
7th	8th	9th	10th	11th	12th
Yellow	Dark Yellow	Cyan	Light Green	Dark Cyan	Dark Magenta

- 1 If this parameter is changed from any previous setting other than 'None', a new internal data file for this recording channel is created. All historical data stored internally for this channel is lost. If this parameter is changed from a previous setting of 'None' new internal data files for all enabled recording channels are created. Any unarchived data is lost.

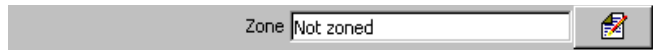

'Chart view enable' set to 'Vertical', 'Horizontal -->' or 'Horizontal <--'

OR

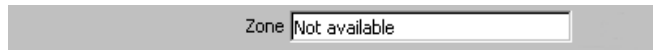

'Chart view enable' set to 'Circular'

Each recording channel can be configured to position its trace in a specific zone in the vertical or horizontal chart views in order to separate traces that would otherwise be very close to each other.

Select one of the 15 pre-defined or 10 custom zones available – see Section 6.8.2, page 108 for custom zone configuration details.

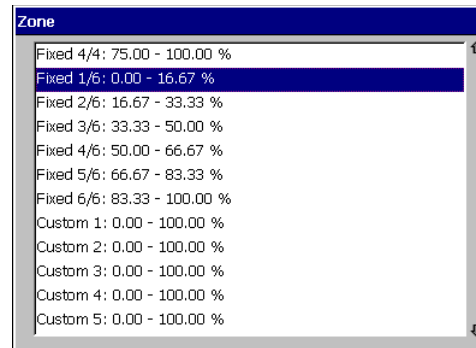

•1

Select the filter to be applied to the electrical input prior to sampling.

Notes.

- Applicable to analog sources only.
- Filters are applied to the recorded values shown on the chart view only, not to instantaneous values displayed on the channel indicators or bargraphs.

Instantaneous – A single value based on process conditions at the time of sampling.

Average – The average value of the analog signal since the previous sample.

Minimum – The minimum value of the analog signal since the previous sample.

Maximum – The maximum value of the analog signal since the previous sample.

Max & min – Two values are recorded to capture the maximum & minimum signal values since the previous sample. This allows the memory use to be extended by permitting a slower sample rate to be selected without losing the transient behavior of the signal.

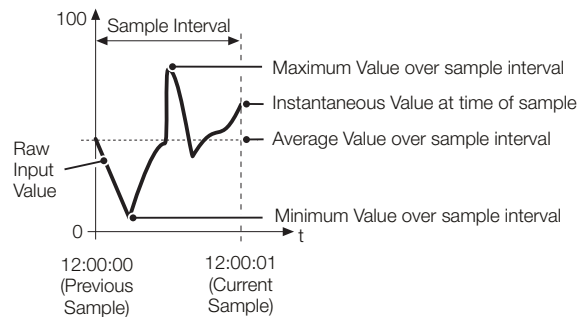

•1 If this parameter is changed, a new internal data file for this recording channel is created. All historical data stored internally for this channel is lost.

6.6.2 Analog Input Configuration

Note.

- The 'Analog I/P' tab is displayed only if 'Source ID' for the Recording Channel is set to an analog signal source – see Section 6.6.1, page 87.
- If an analog input is assigned to more than one recording channel, changes to any of its parameters and tags are applied to each channel the input is assigned to.
- If an analog input is already assigned to another channel, the edit keys () are not available.



Select the electrical characteristics of the input.

Note.

- Simulated input types are available for evaluating instrument features without the need for process connections.
- If 'Volt free digital input' is selected, the input channel becomes a digital input channel – see Section 6.6.3, page 92.
- Select 'Off' to disable an analog input.

Warning.

- Ensure that the appropriate electrical connections have been made – see Section 7.4, page 114.
- When 'Type' is set to 'Volts', input signals with voltages greater than 2 V (standard inputs) or 1 V (high specification inputs) must be connected through an external voltage divider (part no. GR2000/0375) – see Section 7.4.1, page 114.
- Input signals with voltages up to 2 V (2000 mV – standard inputs) or 1 V (1000 mV – high specification inputs) may be measured without the need for the voltage divider by setting 'Type' to 'millivolts'.
- An external 10 Ω shunt resistor is required for current ranges – see Section 7.4.1, page 114.

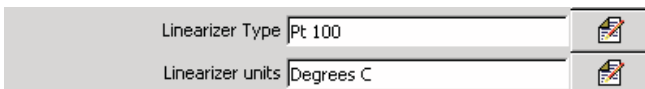

Select the linearizer type and the units used to condition the input signal before it is sampled.

Note.

- For thermocouple applications using an external fixed cold junction, set 'Type' to 'millivolts' and select the appropriate linearizer type.
- Linearizer units are displayed only if a temperature linearizer type (Thermocouple or RTD) is selected.

Electrical range low	4.0	
Electrical range high	20.0	

Set the required electrical range.

Notes.

- Applicable only to mA, mV, V and Resistance input types.
- When an input is connected through an external voltage divider (see Warnings on page 89), set the electrical range low and high values to the actual voltage applied to the divider, not the voltage after it has been divided down. The range of the electrical input signal is determined by the input type – see Table 6.3:

Input Type	Standard Inputs				High Specification Inputs			
	mV	V	mA	Ω	mV	V	mA	Ω
Min.	0	0	0	0	-1000	-50	-100	0
Max.	2000	20	50	5000	1000	50	100	2000

Table 6.3 Limits of Electrical Ranges

Engineering low	0.00		•1
Engineering high	10.00		•1
Engineering Units	°C		•1

Specify the display range and units of the engineering value corresponding to the electrical high and low values, within the limits defined in Table 6.4:

THC/RTD Type	°C		°F	
	Min.	Max.	Min.	Max.
Type B	-18	1800	0	3270
Type E	-100	900	-140	1650
Type J	-100	900	-140	1650
Type K	-100	1300	-140	2350
Type L	-100	900	-140	1650
Type N	-200	1300	-325	2350
Type R & S	-18	1700	0	3090
Type T	-250	300	-400	570
Pt100	-200	600	-325	1100
Power 5/2 Power 3/2 Square Root Custom Linearizer 1 Custom Linearizer 2 Custom Linearizer 3 Custom Linearizer 4 Linear	-999 to +9999			

Table 6.4 Limits of Engineering Ranges

Example – for an electrical input range of 4.0 to 20.0 mA, representing a pressure range of 50 to 250 bar, set the 'Engineering low' value to 50.0 and the 'Engineering high' value to 250.0.

- 1 If this parameter is changed, a new internal data file for this recording channel is created. All historical data stored internally for this channel is lost.

Short tag 

•1 Enter the tag name to be displayed on channel indicators and used to identify the channel in archive files (8 characters max.).

Note. Tags with a high percentage of capital letters and wide characters such as 'W' or 'M' may appear truncated in some Operator Views. In such cases, use lower case letters or fewer characters.

Long tag 

•1 Enter the tag name to be displayed in the Process view and used in the archive files (20 characters max.).

Filter time constant 

Set the time period over which the process variable is to be filtered prior to being sampled (0 to 60 seconds).

Fault detect level 

Set a tolerance level (between 0 and 100 % of the engineering range) to allow for deviation of the input signal above or below the input span before an input failure is detected.

Example – setting the fault detection level to 10 % on an input range of 50 to 250 bar causes an 'Analog Input Failure' fault to be detected below 30 bar and above 270 bar.

Broken sensor direction 

In the event of an input failure, recorder channels can be set to drive upscale, downscale or in the direction of failure.

- Upscale – channel value driven beyond full scale.
- None – driven in direction of failure.
- Downscale – channel value driven below zero.

•1 If this parameter is changed, a new internal data file for this recording channel is created. All historical data stored internally for this channel is lost.

6.6.3 Digital Input Configuration

Note. The 'Digital I/P' tab is displayed only if 'Source ID' for the Recording Channel is set to a digital signal source – see Section 6.6.1, page 87.

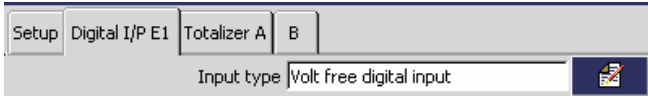

Setup Digital I/P E1 Totalizer A B
Input type Volt free digital input

Note. This parameter is displayed only if 'Input type' on the 'Analog I/P' tab is set to 'Volt free digital input'. If this parameter is changed to anything other than 'Volt free digital input', the input channel reverts to an analog input channel – see Section 6.6.2, page 89.

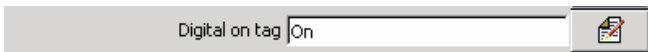

Digital on tag On

Enter the tag to be displayed on channel indicators when the digital signal is active (6 characters max.).

Note. Tags with a high percentage of capital letters and wide characters such as 'W' or 'M' may appear truncated in some Operator views. In such cases, use lower case letters or fewer characters.

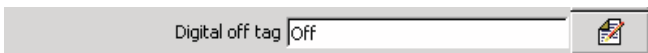

Digital off tag Off

Enter the tag to be displayed on channel indicators when the digital signal is inactive (6 characters max.).



Short tag

Enter the tag name to be displayed on channel indicators and used to identify the channel in archive files (8 characters max.).

Note. Tags with a high percentage of capital letters and wide characters such as 'W' or 'M' may appear truncated in some Operator views. In such cases, use lower case letters or fewer characters.



Long tag

Enter the tag name to be displayed in the Process view and used in the archive files (20 characters max.).

•1 If this parameter is changed, a new internal data file for this recording channel is created. All historical data stored internally for this channel is lost.

6.6.4 Alarm Configuration

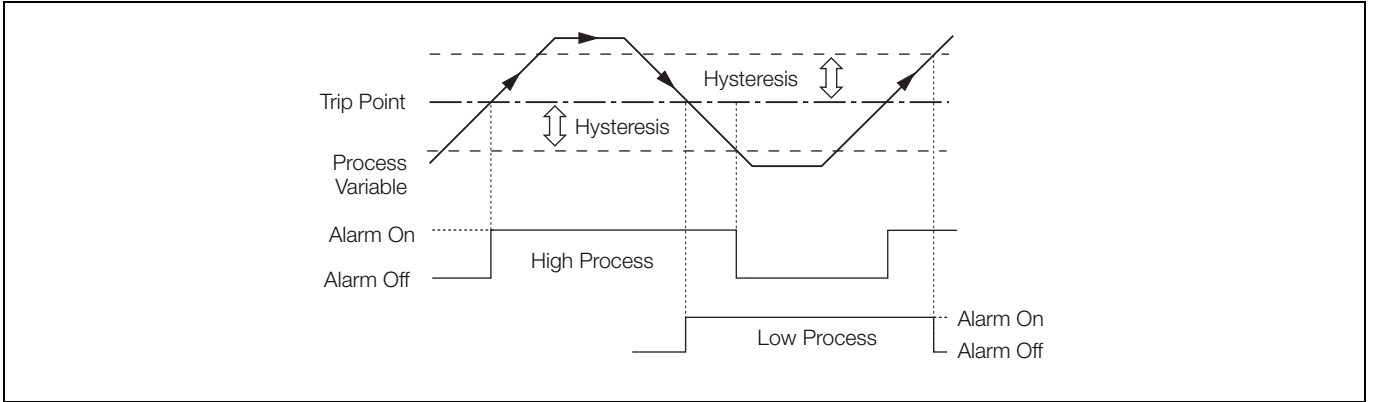

Fig. 6.14 High/Low Process Alarms

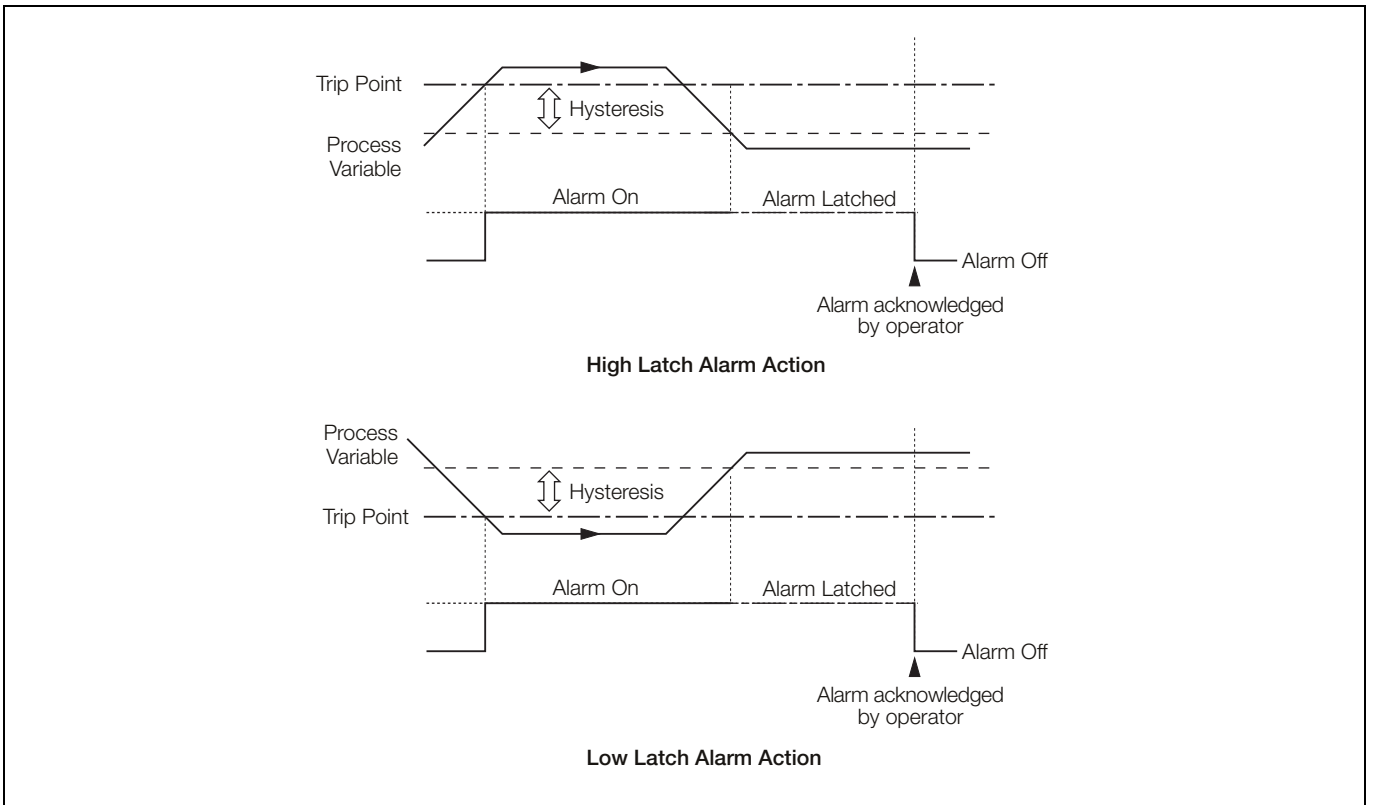

Fig. 6.15 High/Low Latch Alarms

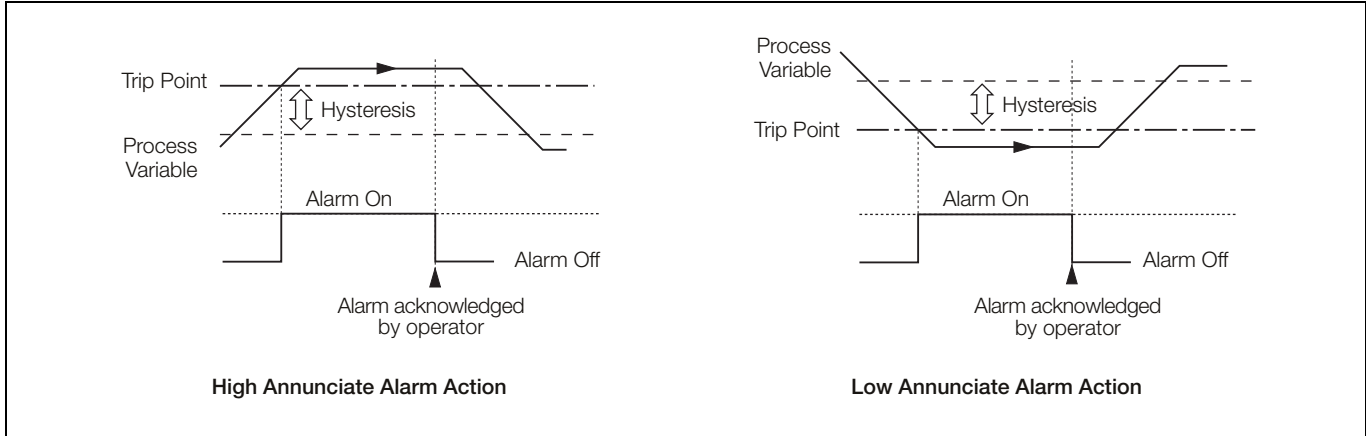

Fig. 6.16 High/Low Annunciate Alarms

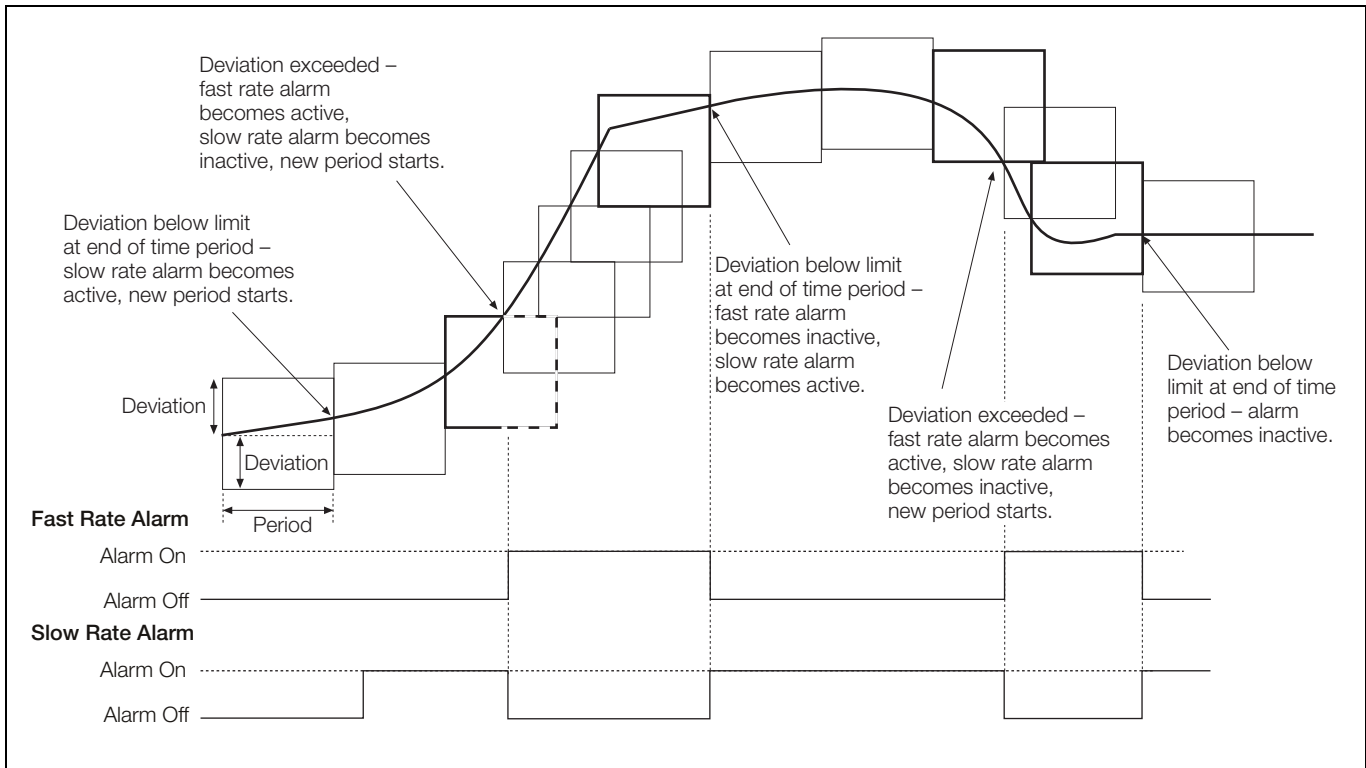

Fig. 6.17 Fast-/Slow-Rate Alarms

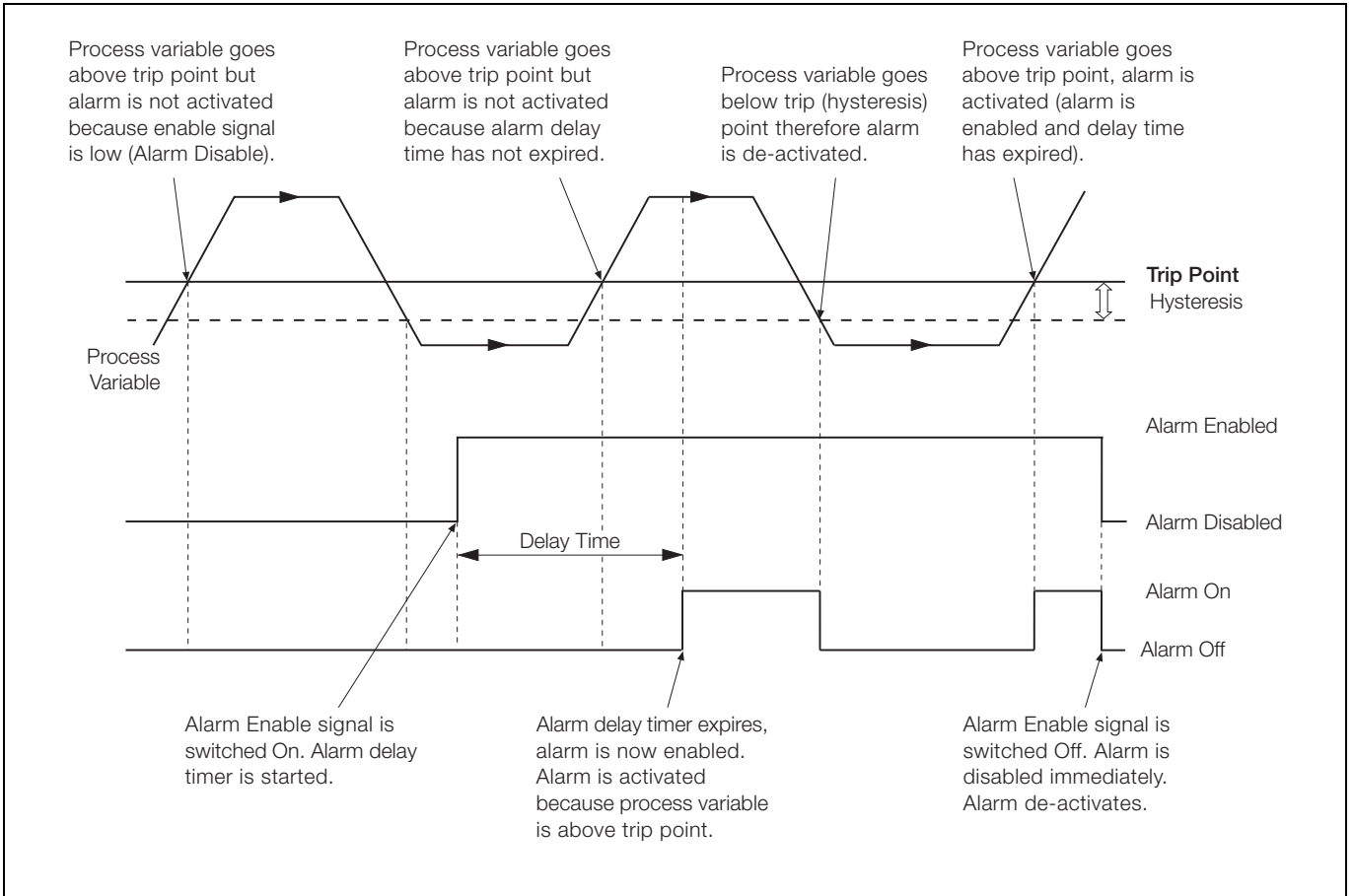

Fig. 6.18 Delayed High/Low Process Alarms

Note. The Alarm Configuration tabs are displayed only if 'Source ID' for the Recording Channel is set to an analog signal source – see Section 6.6.1, page 87.

Setup Analog I/P A1 Alarm A B C D Totalizer A B

Alarm type Off

Set the alarm type:

- High/Low process – see Fig. 6.14, page 93
- High/Low latch – see Fig. 6.15, page 93
- High/Low annunciate – see Fig. 6.16, page 94
- Fast/Slow rate – see Fig. 6.17, page 94
- Delayed high/low process – see Fig. 6.18, page 95

Alarm tag Tank 1 High Temp

Enter an Alarm Tag to identify the alarm when it is displayed in the Chart, Process and Alarm Event views (20 characters max.).

Trip 95 °C

Set the value, in engineering units, at which the alarm is to activate.

Note. Process, Delayed process, Latch and Annunciate alarms only.

Hysteresis 5 °C

Set the hysteresis value, in engineering units.

Note. Process, Delayed process, Latch and Annunciate alarms only.

Time hysteresis 2 Secs

Set the time hysteresis value, in seconds. When an alarm trip value is exceeded, the alarm does not become active until the time hysteresis value has expired. If the signal goes out of the alarm condition before the time hysteresis has expired, the hysteresis value is reset.

Note. Process, Latch and Annunciate alarms only.

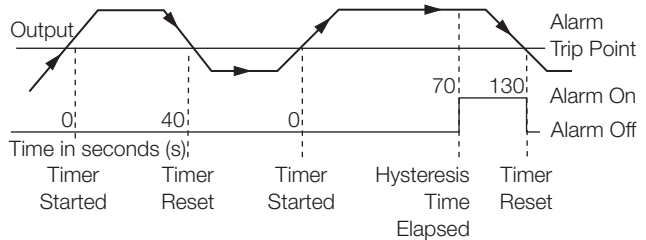
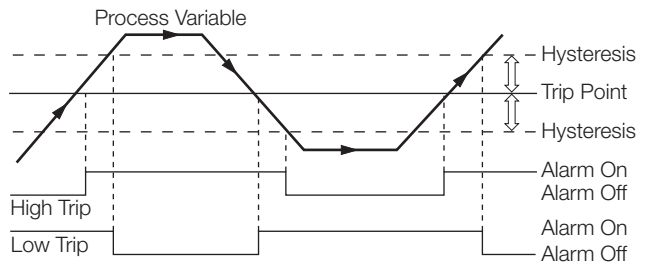

Delay time 0 Secs 

Set the period of time for which to delay alarm activation after the enable signal is switched on. Once the delay time has expired, the alarm operates in the same way as a standard process alarm.

Note. Delayed process alarms only.

Deviation 20 °C 

Set the minimum or maximum amount of deviation allowed within the alarm 'Period' (see below) before the alarm is activated.

Note. Rate alarms only – see Fig. 6.17, page 94.

Period 15 Secs 

Set the time period over which the deviation is measured. For fast rate alarms, the alarm becomes active if the value changes by more than the deviation value within the alarm period. For slow rate alarms, the alarm becomes active if the channel value changes by less than the deviation within the alarm period.

Note.

- Rate alarms only – see Fig. 6.17, page 94.
- A rate alarm remains active until the rate has been within limits for at least one complete alarm 'Period'.

Rate filter 10 Secs 

Set the filter time to be used to reduce the number of spurious alarm trips. The source signal is averaged over the filter period prior to the rate alarm being determined.

Note. Rate alarms only – see Fig. 6.17, page 94.

Enable source None 

Select an alarm Enable source. When the 'Enable source' is active, the alarm is enabled. When the source is inactive the alarm is disabled. If set to 'None' the alarm is always enabled.

Note. For Delayed Process alarm operation, see Fig. 6.18, page 95.

Log enable On 

Set to 'On' to record all changes in the alarm state in the Alarm event log – see Section 4.8, page 34.

Alarm group 1 2 3 4 5 6 X X X X X X 

Assign the alarm to one or more of 12 groups. The alarm states assigned to each group are 'ORed' together to create an internal digital signal that may be assigned to relays, digital outputs or internal digital controls.

6.6.5 Totalizer Configuration

Note.

- Current totalizer values are displayed in the Circular Chart, Digital Indicator and Process Views – see Sections 4.3, 4.5 and 4.6 (Operation), and Sections 6.5.2, 6.5.5 and 6.5.4 (Configuration) respectively.
- For analog sources, the total value of a signal is calculated by counting pulses produced at a rate proportional to the input. For digital sources, off/on transitions are counted and scaled to produce a batch total.

Setup	Analog I/P A1	Alarm A	B	C	D	Totalizer A	B	
Count enable		Count up						
Wrap enable		Wrap on						

Select the totalizer Count direction and Wrap action.

When the count direction is set to 'Up', the totalizer counts up from the 'Preset count' value to the 'Predetermined count' value – see next page.

If 'Wrap enable' is set to 'On', the total is reset automatically to the 'Preset count' value once the 'Predetermined count' value is reached.

If 'Wrap enable' is set to 'Off', the count stops when the 'Predetermined count' value is reached.

Note. A wrap pulse, with a duration of 2s, occurs if the total reaches the 'Predetermined count' value and 'Wrap enable' is set to 'On'. If 'Wrap enable' is set to 'Off', the wrap pulse becomes active when the 'Predetermined count' value is reached and remains active until the totalizer is reset. The pulse can be assigned to a relay, digital output or digital counter.

Tag	Total Flow 1.1A	
-----	-----------------	--

Enter the totalizer tag to be displayed in the Process view and the Totalizer log (20 characters max).

Units	Gals	
-------	------	--

Enter the totalizer units to be displayed in Operator views.

Stop/Go recovery	Last	
------------------	------	--

Select the totalizer action following a power failure:

Last – On power recovery, the totalizer continues in the same state as before the failure, i.e. stopped or running.

Stop – Totalizer stops counting.

Go – Totalizer starts counting from the last recorded value.

Stop/Go source	None	
----------------	------	--

Select a signal source to stop and start the totalizer. Refer to Appendix A on page 129 for a description of the available sources.

Note. This signal is edge-triggered. A rising edge (inactive to active) starts the totalizer. A falling edge (active to inactive) stops the totalizer.





Preset count 

Predetermined count 

Intermediate count 

Reset source 

Log update time 

Log update source 

Set the value the totalizer counts from and the value applied when the totalizer is reset.

Set the value at which the totalizer stops or wraps.

Note. A counter configured to count up must have a 'Preset count' value lower than the 'Predetermined count' value. A counter configured to count down must have a 'Preset count' value greater than the 'Predetermined count' value.

Set the required number of decimal places on the higher of the 'Preset count' value or 'Predetermined count' value.

Set the value at which a digital source is activated. This can be used as an alarm threshold to indicate when the 'Predetermined count' value is about to be reached.

Select a signal source to reset the totalizer on a rising edge. Refer to Appendix A on page 129 for a description of the available sources.

Select the frequency with which totalizer values are added to the Totalizer log.

Log update time	Log updated every...
5 minutes	0, 5, 10, 15... etc. minutes past the hour
10 minutes	0, 10, 20, 30,...etc. minutes past the hour
15 minutes	0, 15, 30, 45 minutes past the hour
20 minutes	0, 20, 40 minutes past the hour
30 minutes	0, 30 minutes past the hour
60 minutes	On the hour
2 hours	Midnight, 2am, 4am, etc.
3 hours	Midnight, 3am, 6am, etc.
4 hours	Midnight, 4am, 8am, etc.
8 hours	Midnight, 8am, 4pm, etc.
12 hours	Midnight, 12am
24 hours	Midnight

Select a signal source to trigger the addition of the current totalizer values to the Totalizer log on a rising edge. Refer to Appendix A on page 129 for a description of the available sources.

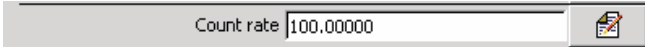

Analog Input Sources only – see Section 6.6.1, page 87.

Set the required totalizer count rate.

The count rate is determined by the maximum number of engineering units (or pulses) per second and the smallest totalizer increment:

$$\frac{\text{engineering full scale value (rate)}}{\text{engineering units (in seconds)}}$$

Example – to totalize a flow with a maximum rate of 2500 liters/minute (= 2.5 m³/minute) to the nearest 0.1 m³, the calculation is as follows:

$$\frac{150 \text{ m}^3/\text{hour}}{3600 \text{ seconds}} = 0.04167 \text{ pulses/second}$$

The resulting value must be within the range 0.00001 to 99.99999. The totalizer increment is determined by the number of decimal places in the 'Predetermined count' value – see page 99.



Analog Input Sources only – see Section 6.6.1, page 87.

Set the required totalizer cut off value.

The totalizer cut off value is the lowest input value (in engineering units) at which the totalizer is to stop counting.

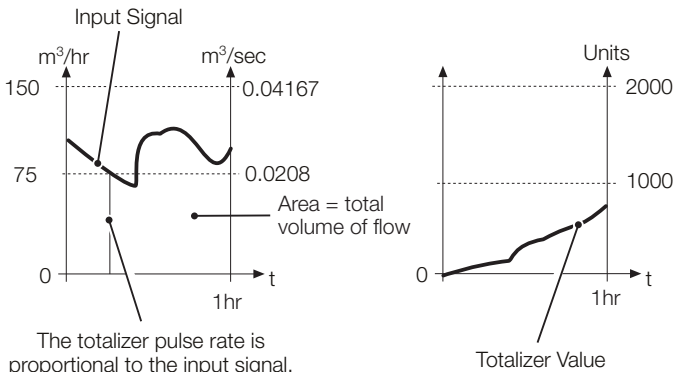

The totalizer pulse rate is proportional to the input signal. At this point it is 0.0208 pulses per second

OR

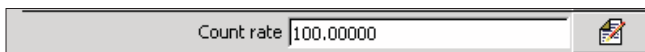

Digital Input Sources only – see Section 6.6.1, page 87

Set the required totalizer count rate.

A digital totalizer pulse can be scaled to represent a value of between 0.00001 and 1000.00000. The totalizer is then incremented by this amount each time there is an off/on transition.

Example – a count of 5 digital pulses with 'Count rate' set to 100 increments the totalizer from 0 to 500 in 100 unit steps.

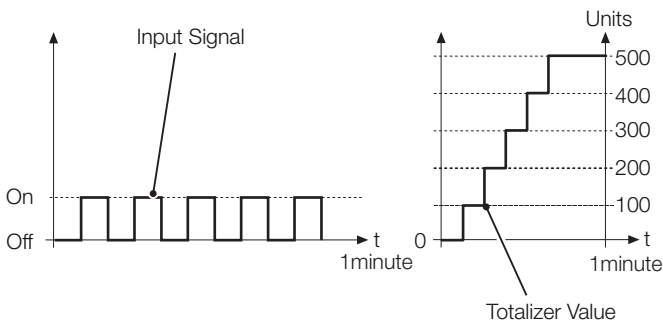

6.7 I/O Module Configuration

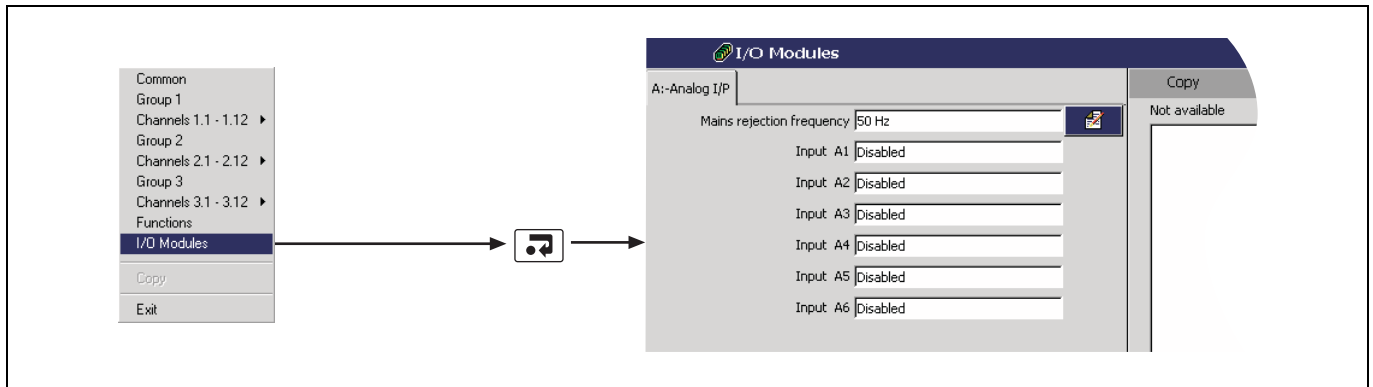
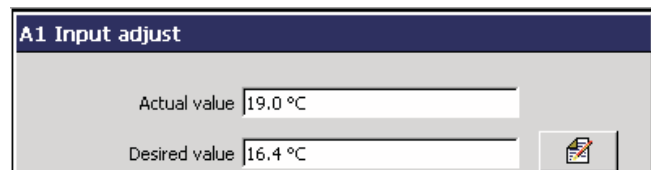
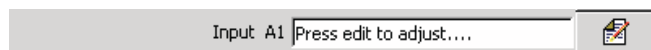
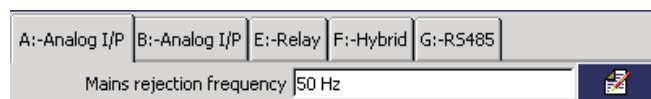

Fig. 6.19 I/O Module Configuration

Note. The instrument detects the type of module fitted in each position automatically.

6.7.1 Analog Inputs



Set the mains rejection frequency used to electrical noise induced on the signal lines by power supply cables.

Input Adjustment

Manually fine-tune inputs to remove process offset errors or system scale errors.

Note.

- Input adjustment frames appear only if recording is enabled during configuration, i.e. the 'Disable recording in configuration' check box is not ticked on entry to the Configuration level – see Fig. 6.1, page 52.
- Changes to the Analog Input Type (see Section 6.6.2, page 89) must be saved to the current configuration before commencing input adjustment.

Actual value / Desired value

1. Adjust the process or simulated input signal to a known value below 50 % of the engineering range.
2. If 'Actual value' (in engineering units) is different from expected, set 'Desired value' to the correct value ('Offset adjust' and 'Span adjust' values are calculated automatically).
3. Repeat steps 1 and 2 for a value above 50 % of the engineering range.
4. Repeat steps 1 to 3 for each input.

Reset adjustment

Select to reset 'Offset adjust' and 'Span adjust' (see next page) to zero and to 1 respectively.

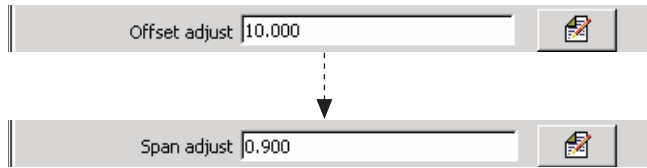

Offset adjust / Span adjust

Manually fine-tune the offset adjust and span adjust values to remove process errors. These are calculated values applied to the raw input signal.

Note. If simulating thermocouple inputs, connect the millivolt source using appropriate compensating cable – see Section 7.4.2, page 114. For 2-lead resistance thermometers, either connect the resistance box at the sensor end of the leads or add the lead resistance to the calibration values.

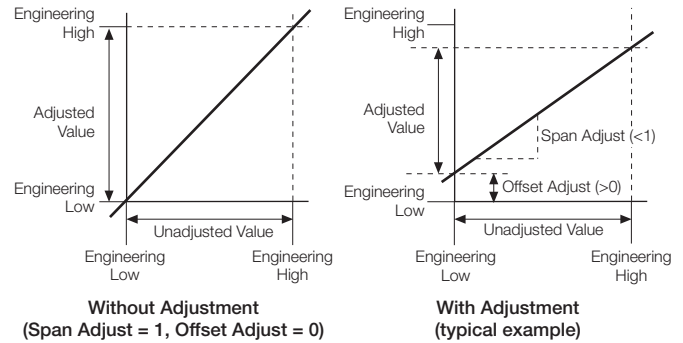

6.7.2 Relay Modules

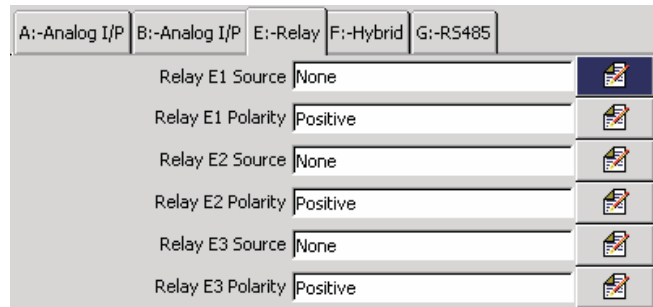

Select the relay source (a digital source) to be used to energize/de-energize the relay.

Note. If the relay is used to provide a totalizer count pulse, the maximum pulse frequency is 5 Hz. Consideration must also be given to the mechanical life of the relay.

Select the relay source polarity.

Note. When polarity is set to 'Positive', the relay is energized when the digital source is active (On).

6.7.3 Hybrid Modules

A:-Analog I/P	B:-Analog I/P	E:-Relay	F:-Hybrid	G:-RS485
Digital o/p F1 Source	None			
Digital o/p F1 Polarity	Positive			
Digital o/p F2 Source	None			
Digital o/p F2 Polarity	Positive			
Digital o/p F3 Source	None			
Digital o/p F3 Polarity	Positive			
Digital o/p F4 Source	None			
Digital o/p F4 Polarity	Positive			
Digital o/p F5 Source	None			
Digital o/p F5 Polarity	Positive			
Digital o/p F6 Source	None			
Digital o/p F6 Polarity	Positive			
Analog o/p F1 Source	Analog I/P A1			

Select a digital output source.

Note.

- A digital output source is the internal digital source used to activate/de-activate a digital output.
- If a digital output is used to provide a totalizer count pulse, the maximum pulse frequency is 5 Hz.

Select the digital output source polarity.

Note. When the polarity is set to 'Positive', the digital output is energized when the digital source is active (On).

The six digital inputs from any hybrid module produce six independent digital states that can be used as digital sources for recording channels, relay outputs, alarm acknowledgement etc., for example:

Digital I/P F1, Digital I/P F2

Additionally, digital inputs from a hybrid module in position F (see Fig. 7.5, page 113) can be used to produce up to 32 Binary Encoded (BCD) digital states, for example:

BCD digital I/P F0 to BCD digital I/P F31

BCD digital inputs can be used as digital sources in the same way as standard digital inputs.

Inputs F1, F2, F3, F4 and F5 have 'weightings' of 1, 2, 4, 8, and 16 respectively. A rising edge on input F6 is used as the update trigger.

Following an inactive to active transition on input F6, inputs F1 to F5 are evaluated, the weighted values of any active inputs are added together and the BCD digital input corresponding to the total is activated. All other BCD digital inputs are deactivated.

Example.

If digital inputs F1 (weighting = 1), F2 (weighting = 2) and F4 (weighting = 8) are active when digital input F6 (update trigger) is activated, BCD digital input F11 (1 + 2 + 8) is activated. BCD digital inputs F0 to F10 and BCD digital inputs F12 to F31 are deactivated.

If digital inputs F1 to F5 are all inactive when digital input F6 (update trigger) is activated then BCD digital input F0 is activated. BCD digital inputs F1 to F31 are deactivated.

Analog o/p F1 Source 

Select the analog output source.

Note. The analog output source can be any internal or external analog signal.

Analog o/p F1 Engineering range 

Set the required analog output engineering range.

Note. The 'Engineering low' and 'Engineering high' settings are the engineering values corresponding to the 'Electrical low' and 'Electrical high' values below.

Analog output F1 range

Engineering low 

Engineering high 

Analog o/p F1 Electrical range 

Set the required analog output electrical range.

The 'Electrical low' and 'Electrical high' values are the minimum and maximum values of the current output, in Electrical units – range 0 to 23 mA.

Analog output F1 range

Electrical low 

Electrical high 

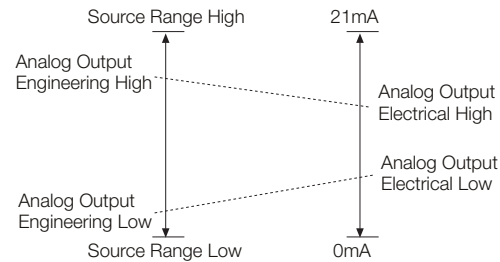

6.7.4 RS485 (Modbus™) Serial Communications Module

Refer to Appendix B, page 131 for further information on using the optional Modbus link.

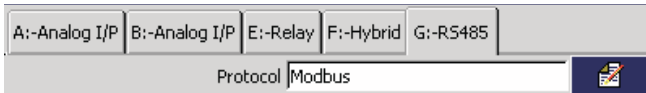

A horizontal menu with five tabs: 'A:-Analog I/P', 'B:-Analog I/P', 'E:-Relay', 'F:-Hybrid', and 'G:-RS485'. Below the tabs is a dropdown menu labeled 'Protocol' with 'Modbus' selected. A small icon is visible on the right side of the dropdown.

Select the Modbus protocol required.

- Modbus – instrument acts as a Modbus Slave
- Modbus Master – instrument acts as a Modbus Master

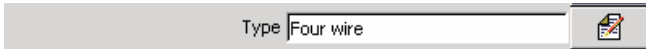

A horizontal menu with a dropdown labeled 'Type' and 'Four wire' selected. A small icon is visible on the right side of the dropdown.

Set according to the number of transmission wires connected to the instrument: 4-wire, 2-wire.

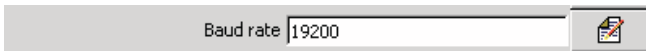

An input field labeled 'Baud rate' with the value '19200' entered. A small icon is visible on the right side of the field.

Set the Baud rate used by the host system: 1200, 2400, 4800, 9600, 19200, 38400, 115200.

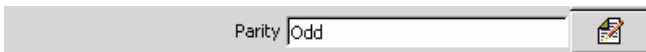

A horizontal menu with a dropdown labeled 'Parity' and 'Odd' selected. A small icon is visible on the right side of the dropdown.

Set the Parity used by the host system: None, Odd, Even.

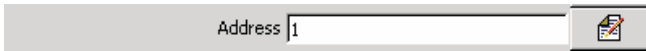

An input field labeled 'Address' with the value '1' entered. A small icon is visible on the right side of the field.

Note. Displayed only if 'Protocol' is set to 'Modbus'.

Set a unique Modbus Address that allows the host system to identify the instrument on a Modbus link.

Note. Maximum 31 slaves per loop

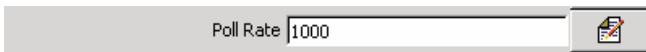

An input field labeled 'Poll Rate' with the value '1000' entered. A small icon is visible on the right side of the field.

Note. Displayed only if 'Protocol' is set to 'Modbus Master'.

Set the poll rate in milliseconds – min. 0, max. 3600000.



An input field labeled 'Poll fail limit' with the value '1' entered. A small icon is visible on the right side of the field.

Note. Displayed only if 'Protocol' is set to 'Modbus Master'.

Set the number of successive polls permitted to fail before the data is marked as a failed input – min. 0, max. 4.

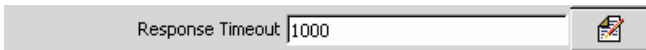

An input field labeled 'Response Timeout' with the value '1000' entered. A small icon is visible on the right side of the field.

Note. Displayed only if 'Protocol' is set to 'Modbus Master'.

Set the timeout time in milliseconds for a single poll – min. 0, max. 60000.

Note. If any RTU devices are polled, set a response time that is long enough to allow for the normal turn around time from these devices. The configuration allows for only one setting for all devices connected to the network.

Note. The following parameters are displayed only if 'Protocol' (previous page) is set to 'Modbus Master'.

Comms analog I/P Comms analog I/P 1



Select the comms analog input to hold the data from the nominated slave device.

RTU Address 1



Enter the RTU address assigned to the remote unit (1 to 247).

Register Number 0



Note. Displayed only if 'RTU Address' is not set to 'None'.

Enter the register number to be read in the slave device.

Type Input Register



Note. Displayed only if 'RTU Address' is not set to 'None'.

Select the register type, 'Holding Register' or 'Input Register'.

Format Sint16



Note. Displayed only if 'RTU Address' is not set to 'None'.

Select the format of the data to be read from the slave device:

- Sint16 – signed, 16 bit integer
- Sint32 – signed, 32 bit integer, transmitted in high/low order
- rev. Sint32 – signed, 32 bit integer, transmitted in low/high order
- IEEE – 32 bit floating point number, transmitted in high/low order
- Rev. IEEE – 32 bit floating point number, transmitted in low/high order
- Sint16 X 10 – signed, 16 bit integer, multiplied by a factor of 10
- Sint16 X 100 – signed, 16 bit integer, multiplied by a factor of 100
- Sint16 X 1000 – signed, 16 bit integer, multiplied by a factor of 1000

Comms digital I/P Comms digital I/P 1



Select the comms digital input to hold the data from the nominated slave device.

Register Number 0



Enter the RTU address assigned to the remote unit (1 to 247).

Register Number 0



Note. Displayed only if 'RTU Address' is not set to 'None'.

Enter the register number to be read or written to in the slave device.

Type Input Status



Note. Displayed only if 'RTU Address' is not set to 'None'.

Select the register type, 'Input Status' or 'Coil Status'.

6.8 Functions

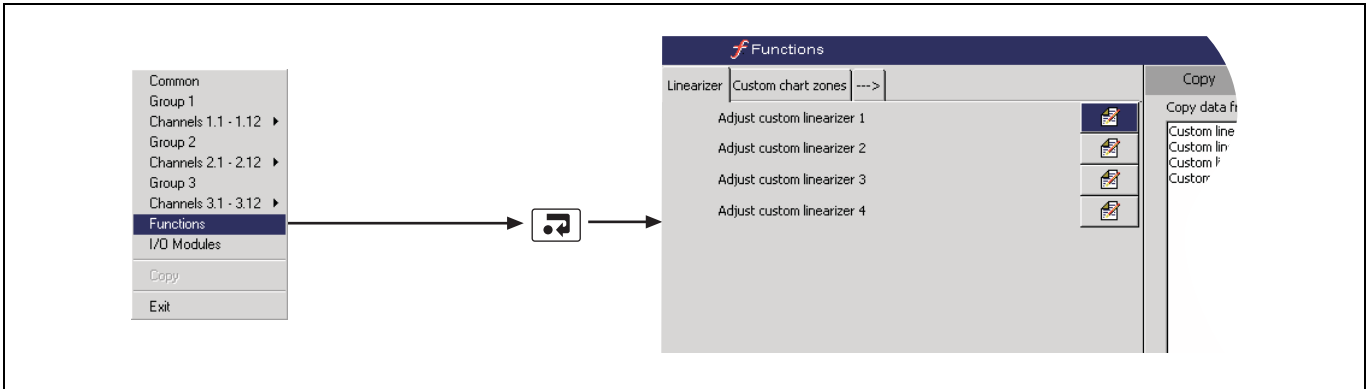
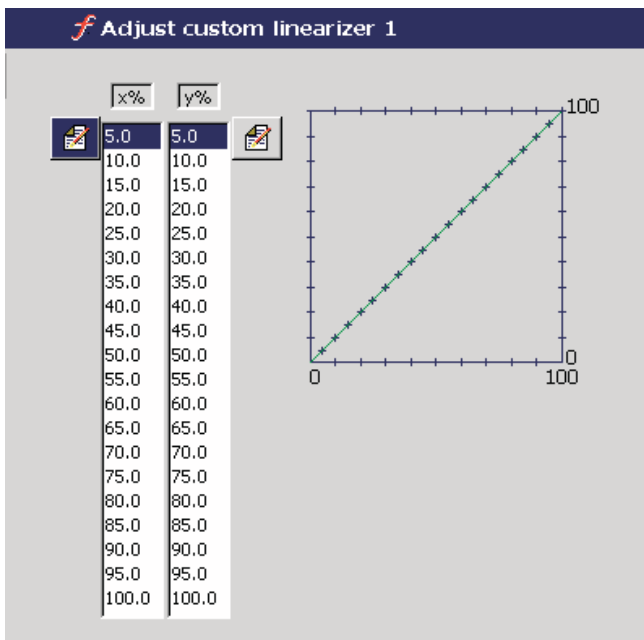
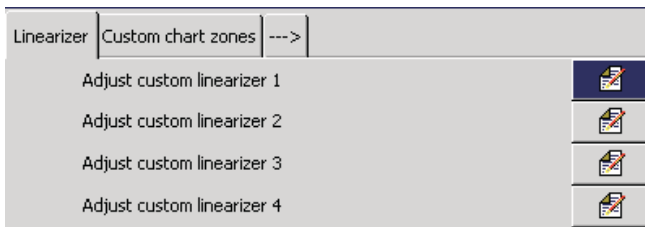

Fig. 6.20 Functions Configuration

6.8.1 Custom Linearizers



Use the and keys to highlight the linearizer to be adjusted.

Use the key to open the 'Adjust custom linearizer' screen.

Use the , , , and keys to highlight the point to be modified.

Press the key to open the digipad to change the position of the point.

Press the key to return to the Functions screen. Each linearizer has 20 breakpoints. Both X and Y values are set as percentages.

Custom linearizers can be applied to any analog input by selecting them as the linearizer type for that input – see Section 6.6.2, page 89.

Note.

X is input to the linearizer expressed as a percentage of the electrical range.

Y is output expressed as a percentage of the engineering range.

6.8.2 Custom Chart Zones

Linearizer	Custom chart zones	---	>
Custom zone 1:	Lower margin	0.00	
	Upper margin	100.00	
Custom zone 2:	Lower margin	0.00	
	Upper margin	100.00	

For each custom chart zone, set the lower and upper margins of the zone, between 0.00 and 100.00 %.

Example. If the lower and upper margins for Custom zone 1 are set to 10 and 25 % respectively, the trace for a recording channel assigned to 'Custom 1' (see Section 6.6.1, page 87) is confined to that area of the chart that lies between 10 and 25 % of:

- a vertical chart's width from the left hand edge
- a horizontal chart's height from the bottom

6.8.3 Real-time Alarms

<---	RTA 1	2	3	4	5	6	7	8	9	10	11	12	
Alarm tag												Real Time Alarm 1	

Enter the tag to be used in the Alarm Event log – see Section 4.9, page 37.

Daily enables	Su,Mo,Tu,We,Th,Fr,Sa	
---------------	----------------------	--

Set the day(s) on which the alarm is activated.

Daily enables	
<input checked="" type="checkbox"/>	Sunday
<input checked="" type="checkbox"/>	Monday
<input checked="" type="checkbox"/>	Tuesday
<input checked="" type="checkbox"/>	Wednesday
<input checked="" type="checkbox"/>	Thursday
<input checked="" type="checkbox"/>	Friday
<input checked="" type="checkbox"/>	Saturday
<input type="button" value="Clear all"/> <input type="button" value="Select all"/> <input type="button" value="OK"/>	

1st of the month enable	Off	
-------------------------	-----	--

Set to 'On' to activate the real-time alarm on the first day of each month.

On time -	Every hour	Off	
	Hours	10	
	Minutes	30	

Set the time at which the alarm becomes active.

If 'Every hour' is set to 'On', the 'Hours' setting cannot be adjusted and the alarm is activated at the same time every hour (determined by the 'Minutes' setting) or on the hour (if 'Minutes' is set to 'Off').

Duration -	Hours	0	
	Minutes	0	
	Seconds	30	

Set the duration for the alarm to remain active.

Log enable	Off	
------------	-----	--

Set to 'On' to add an entry to the Alarm event log each time the real-time alarm becomes active.

7 Installation

EC Directive 89/336/EEC

In order to meet the requirements of EC Directive 89/336/EEC for EMC regulations, this product must not be used in a non-industrial environment.

End of Life Disposal

- The instrument contains a small lithium battery which should be removed and disposed of responsibly in accordance with local environmental regulations.
- The remainder of the instrument does not contain any substance that will cause undue harm to the environment and must be disposed of in accordance with the Directive on Waste Electrical and Electronic Equipment (WEEE). It must not be disposed of in Municipal Waste Collection.

Cleaning

Clean only the front panel, using warm water and a mild detergent.

7.1 Siting

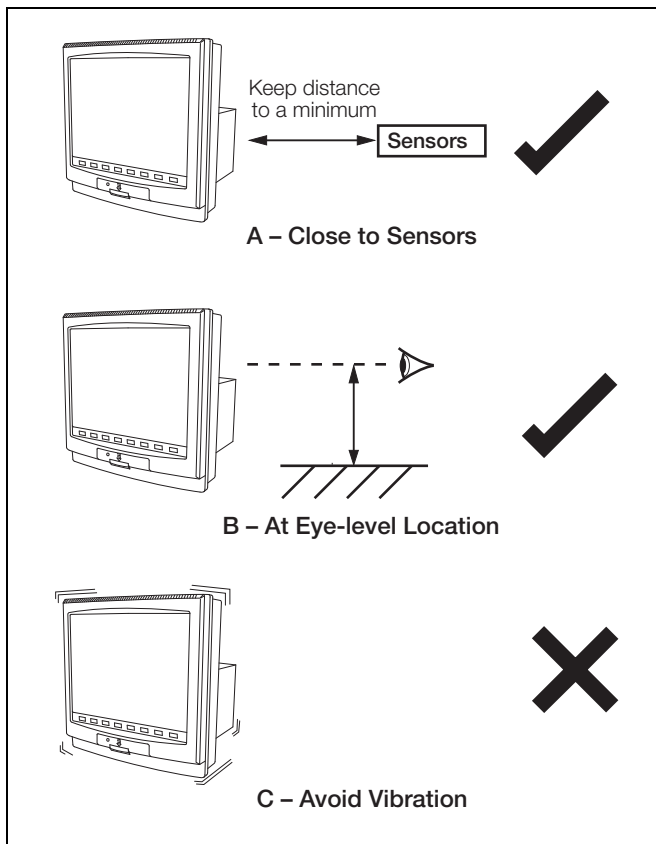

Fig. 7.1 General Requirements

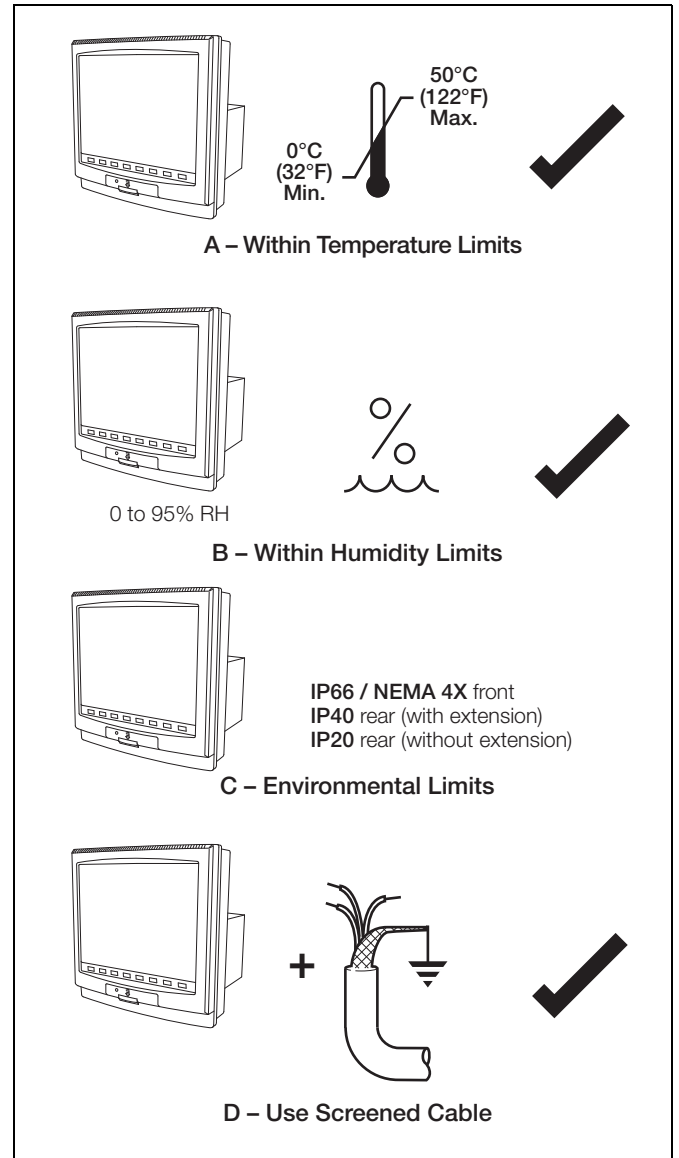

Fig. 7.2 Environmental Limits

Warning. Select a location away from strong electrical and magnetic fields. If this is not possible, particularly in applications where mobile communications equipment is expected to be used, screened cables within earthed metal conduit must be used.

7.2 Mounting

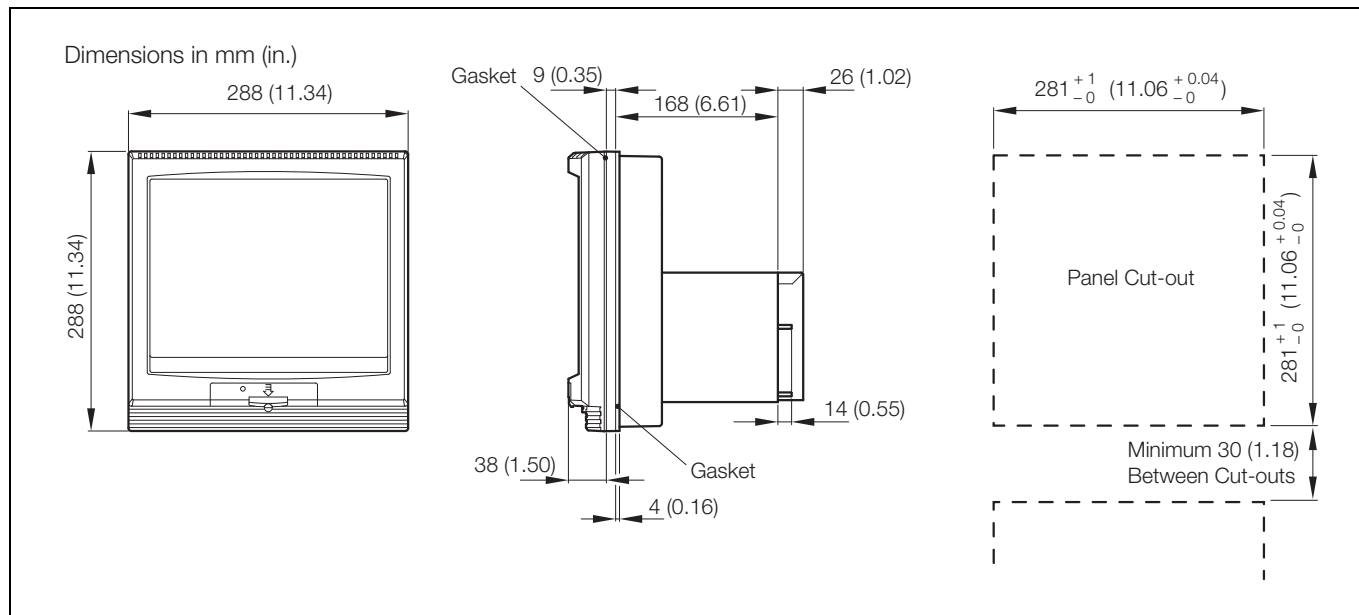

Fig. 7.3 Mounting Dimensions

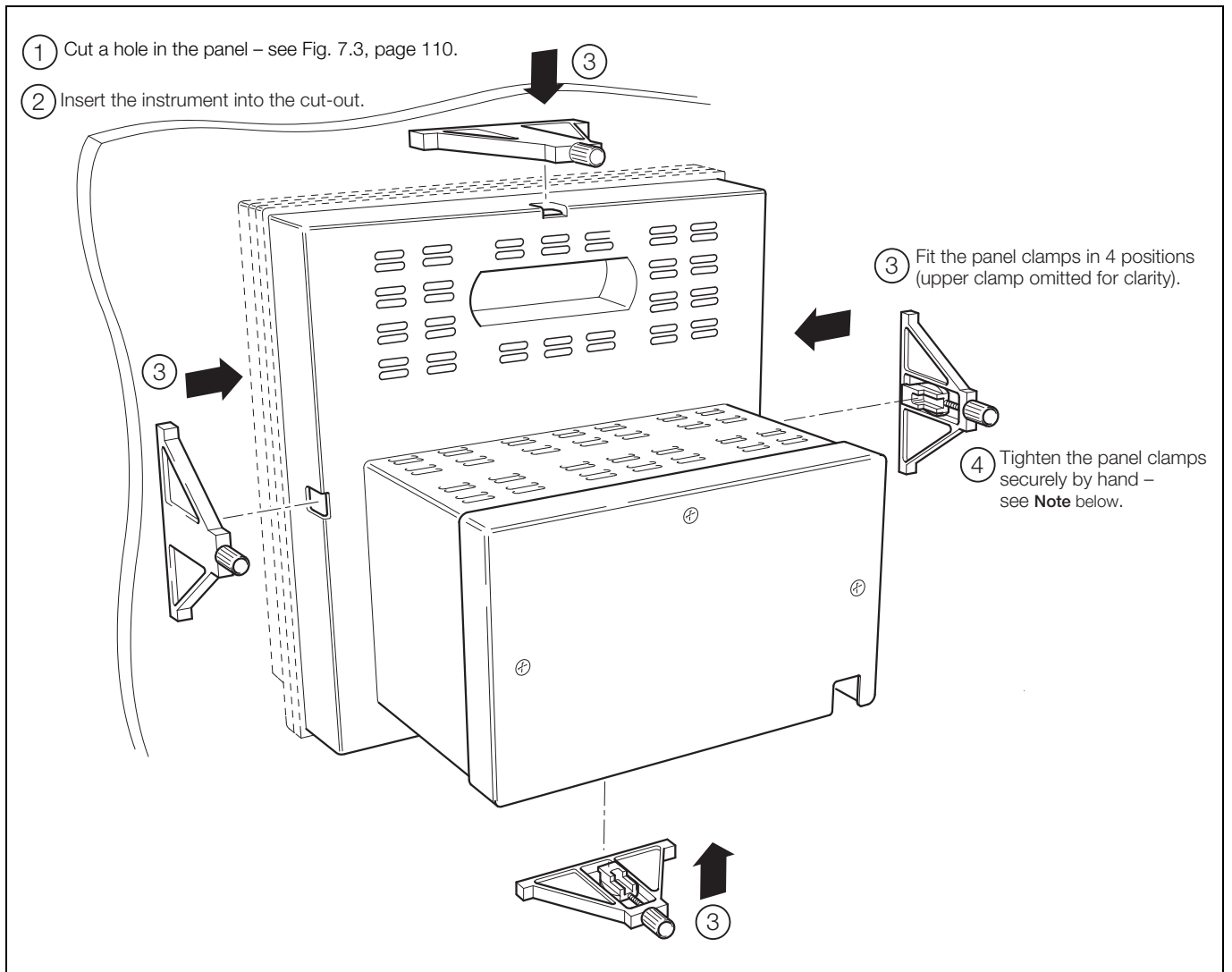



Fig. 7.4 Fitting the Instrument into the Panel

Note. This is critical in order to ensure proper compression of the panel seal and achieve the NEMA 4X hosedown rating.

7.3 Electrical Connections

Warning.

- The instrument is not fitted with a switch therefore a disconnecting device such as a switch or circuit breaker conforming to local safety standards must be fitted to the final installation. It must be fitted in close proximity to the instrument within easy reach of the operator and must be marked clearly as the disconnection device for the instrument.
- The AC power supply earth (ground) cable must be connected to the earth (ground) stud .
- Remove all power from supply, relay and any powered control circuits and high common mode voltages before accessing or making any connections.
- Use cable appropriate for the load currents. The terminals accept cables up to 14AWG (2.5mm²).
- The instrument conforms to Mains Power Input Insulation Category III. All other inputs and outputs conform to Category II.
- All connections to secondary circuits must have basic insulation.
- After installation, there must be no access to live parts, for example, terminals.
- Terminals for external circuits are for use only with equipment with no accessible live parts.
- If the instrument is used in a manner not specified by the Company, the protection provided by the equipment may be impaired.
- All equipment connected to the instrument's terminals must comply with local safety standards (IEC 60950, EN601010-1).

Note.

- Always route signal leads and power cables separately, preferably in earthed (grounded) metal conduit.
- It is strongly recommended that screened cable is used for signal inputs and relay connections. Connect the screen to the earth (ground stud) – see Fig. 7.5, page 113.
- Replacement of the internal battery (types Duracell DL2450 or Renata CR2450N 3 V lithium cell) must be carried out by an approved technician only.

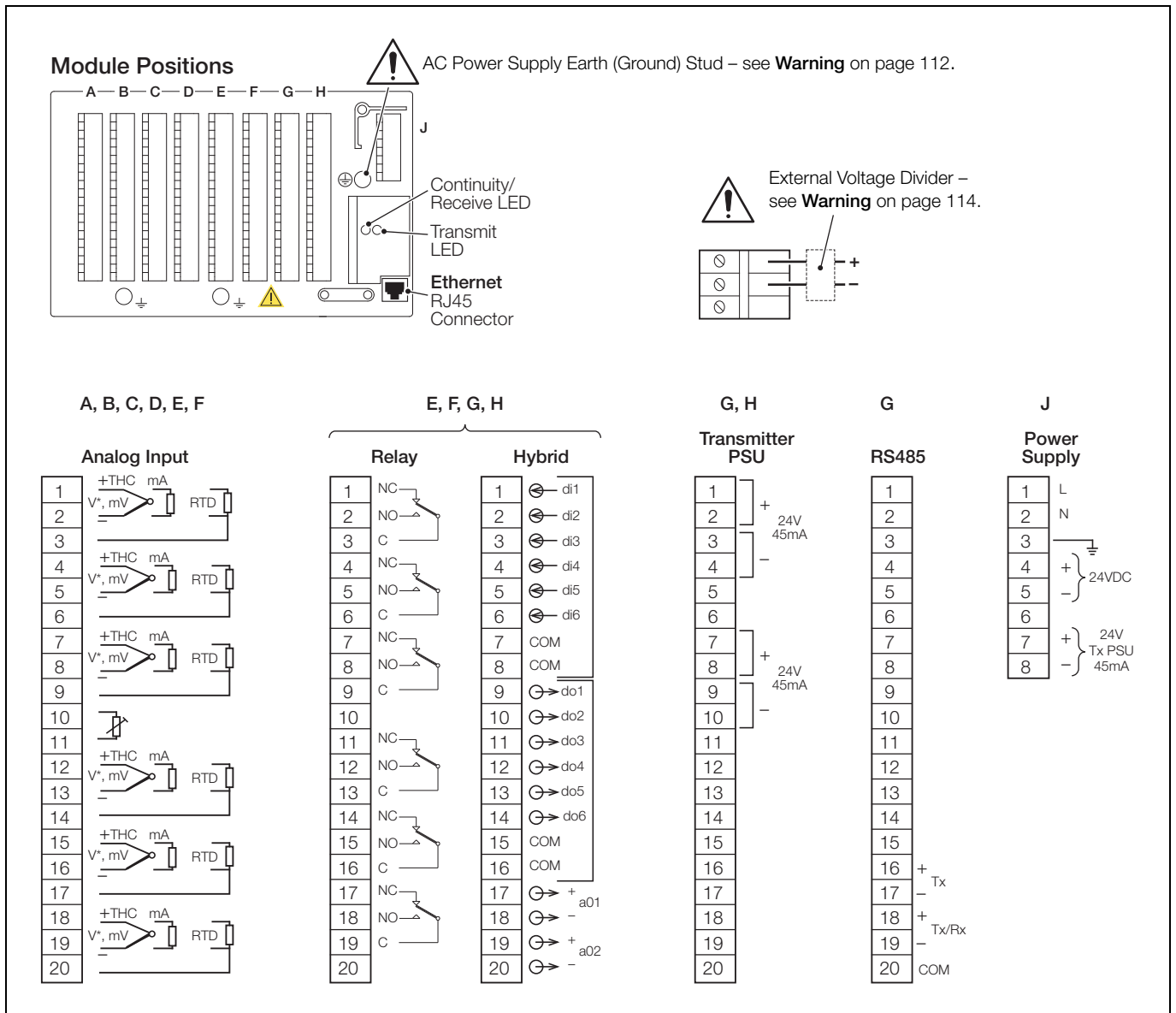

Fig. 7.5 Electrical Connections

Note. Terminal screws must be tightened to a torque of 2.5 lbf.in (0.28 Nm).

7.4 Analog Inputs

7.4.1 Current and Voltage

Warning.

- When input 'Type' is set to 'Volts' (see Section 6.6.2, page 89), input signals with voltages greater than 2 V (standard inputs) or 1 V (high specification inputs) must be connected through an external voltage divider (part no. GR2000/0375).
- Input signals with voltages up to 2 V (2000 mV – standard inputs) or 1 V (1000 mV – high specification inputs) may be measured without the need for the voltage divider by setting 'Type' to 'millivolts' – see Section 6.6.2, page 89.
- An external 10 Ω shunt resistor is required for current ranges.
- To avoid damage to multi-channel instruments, high common mode voltages up to 500 V r.m.s. max. must be present on all channels, or not at all.
- For the standard input card the maximum channel-to-channel voltage (between any two channels) must not exceed 35 V or permanent damage to the instrument's input circuitry may occur. For applications requiring higher levels of isolation refer to the high specification card.

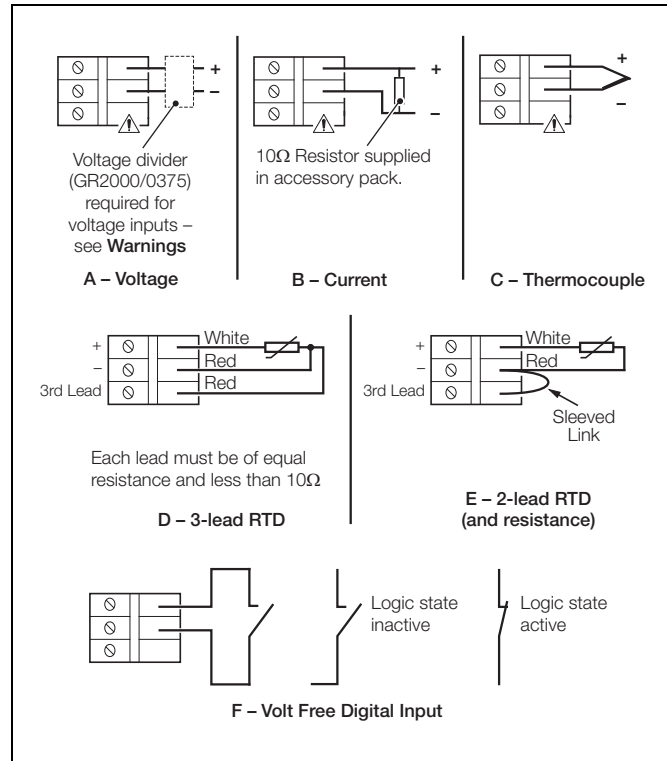

Fig. 7.6 Analog Input Connections

7.4.2 Thermocouple

Use the correct compensating cable between the thermocouple and the terminals – see Table 7.1 on page 115.

Automatic cold junction compensation (ACJC) is incorporated but an independent cold (reference) junction may be used.

7.4.3 Resistance Thermometer (RTD)

On applications requiring long leads it is preferable to use a 3-lead resistance thermometer.

If 2-lead resistance thermometers are used, each input must be calibrated to take account of the lead resistance.

7.4.4 Transmitter Power Supply

Note. The power supply board provides a 24 V supply capable of driving two 2-wire transmitters. Two additional 24 V power supplies are provided on the transmitter power supply module boards, each of which is capable of driving two 2-wire transmitters.

Warning. Under no circumstances must the spare input terminal be linked to the negative.

Note. Refer also to Fig. 7.5 for terminal numbers.

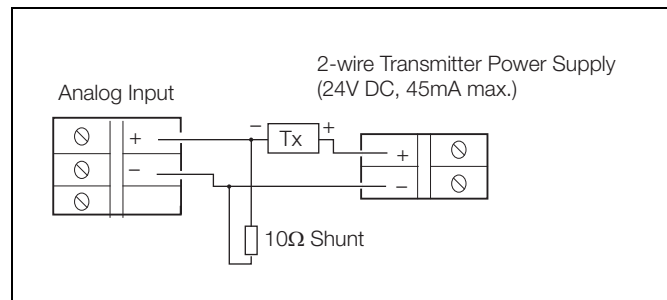

Fig. 7.7 Transmitter Power Supply

Type of Thermocouple	Compensating Cable												
	BS1843			ANSI MC 96.1			DIN 43714			BS4937 Part No.30			
	+	-	Case	+	-	Case	+	-	Case	+	-	Case	
Ni-Cr/Ni-Al (K)	Brown	Blue	Red	Yellow	Red	Yellow	Red	Green	Green	Green	White	Green	*
Ni-Cr/Cu-Ni (E)	—			—			—			Violet	White	Violet	*
Nicrisil/Nisil (N)	Orange	Blue	Orange	Orange	Red	Orange	—			Pink	White	Pink	*
Pt/Pt-Rh (R and S)	White	Blue	Green	Black	Red	Green	Red	White	White	Orange	White	Orange	*
Pt-Rh/Pt-Rh (B)	—			—			—			Grey	White	Grey	*
Cu/Cu-Ni (T)	White	Blue	Blue	Blue	Red	Blue	Red	Brown	Brown	Brown	White	Brown	*
Fe/Con (J)	Yellow	Blue	Black	White	Red	Black	Red	Blue	Blue	Black	White	Black	*
* Case Blue for intrinsically safe circuits													
Fe/Con (DIN 43710)	—			—			DIN 43710			—			
							Blue/Red	Blue	Blue				

Table 7.1 Thermocouple Compensating Cable

7.5 RS422/485 Serial Communications

This section describes the connection of serial data cables between the master (host computer) and slave instrument on a Modbus serial link.

7.5.1 Host Computer Serial Communications

The optional serial interface module has been designed to operate using the Modbus Remote Terminal Unit (RTU) Master/Slave protocol.

An appropriate RS422/485 communications driver must be fitted to the host (Master) computer. It is strongly recommended that the interface has galvanic isolation to protect the computer from lightning damage and to increase signal immunity to noise pick-up.

7.5.2 Two-wire and Four-wire Connection

Modbus serial communications must be configured as either two-wire or four-wire serial links – see Fig. 7.8. Two-/four-wire operation must also be selected in the instrument's Configuration Level – see Section 6.7.4, page 105.

The instrument must be added to the link configuration on the host system – refer to information supplied with the host system.

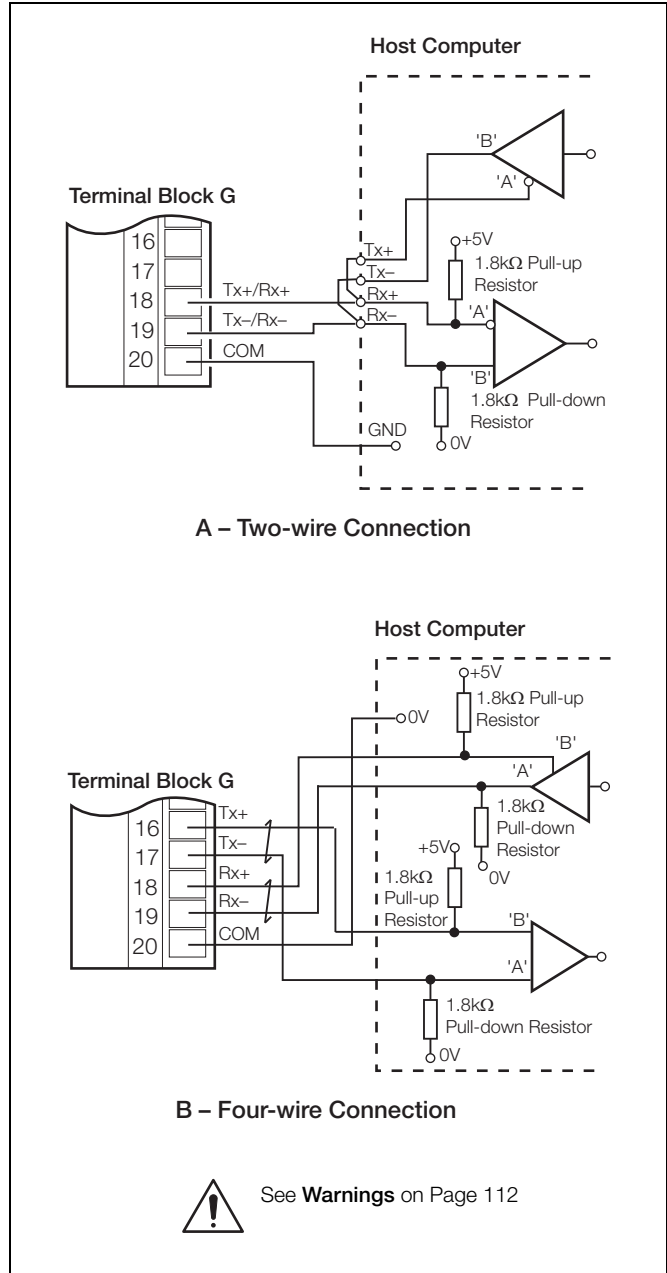

Fig. 7.8 Two-wire and Four-wire Connection

7.5.3 Pull-up and Pull-down Resistors

To prevent false triggering of slaves when the master (host computer) is inactive, pull-up and pull-down resistors must be fitted to the RS422/485 interface in the host computer.

Resistors are normally connected to the interface by means of hard-wired links or switches – refer to the manufacturer's instructions

7.5.4 Termination Resistor

For long transmission lines, a 120 Ω termination resistor must be fitted to the last slave in the chain – see Fig. 7.9.

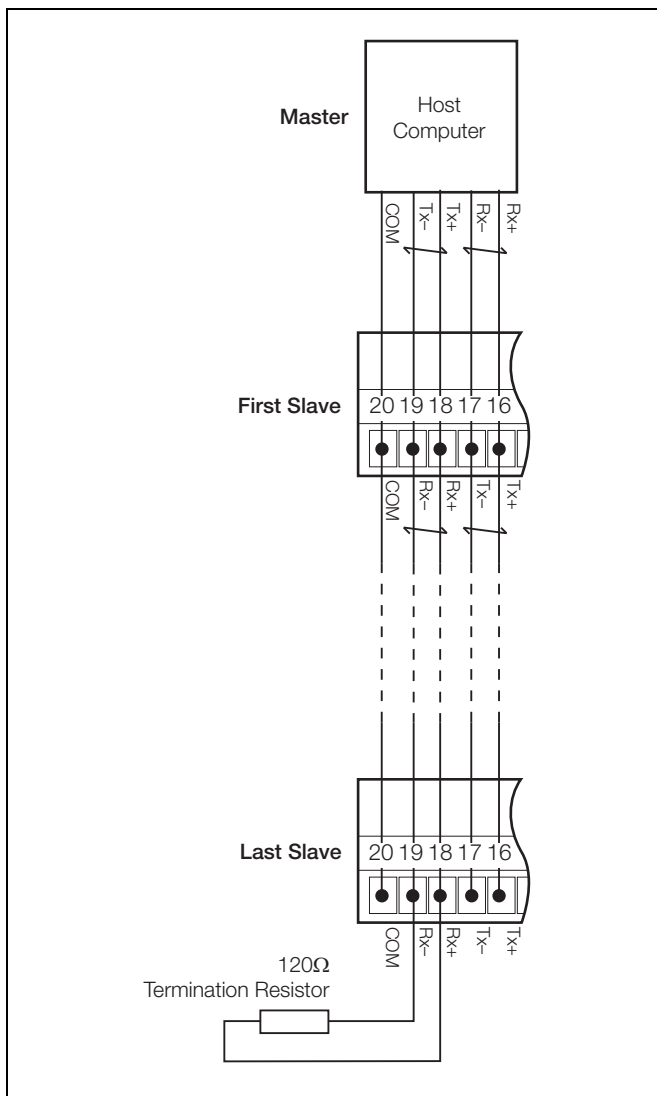

Fig. 7.9 Connecting Multiple Slaves

7.5.5 Serial Connections

Connections to the Modbus serial board must be made as shown in Fig. 7.8. Connections to two-wire or four-wire link configurations on systems with multiple slaves must be made in parallel as shown in Fig. 7.9. When connecting cable screens, ensure that 'ground loops' are not introduced.

The maximum serial data transmission line length for both RS422 and RS485 systems is 1200 m. The types of cable that can be used are determined by the total line length:

- Up to 6 m** – standard screened or twisted pair cable.
- Up to 300 m** – twin twisted pair with overall foil screen and an integral drain wire.
- Up to 1.2 km** – twin twisted pair with separate foil screens and integral drain wires.

7.6 Mains Power Connections

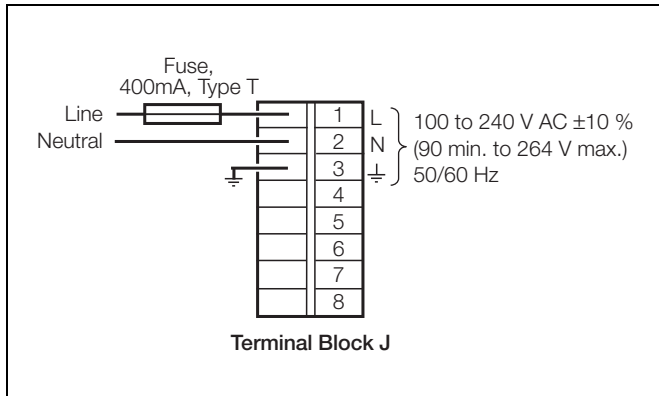

Fig. 7.10 AC Power Supply

Warning. Use fuse rating – 400 mA (max.) type T.

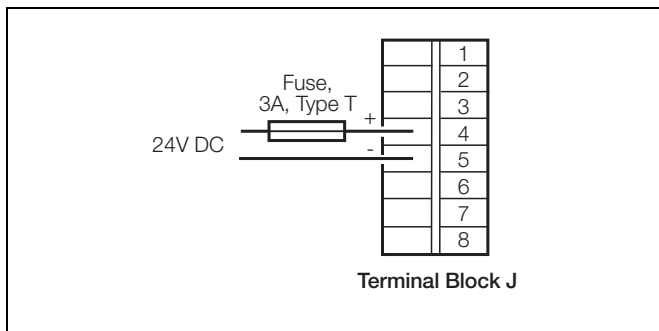

Fig. 7.11 DC Power Supply

Warning. Use fuse rating – 3 A (max.) type T.

7.7 Relay Output Board Connections

Note.

- The maximum total combined current flowing through the relays is 36 A. The maximum individual relay current is 5 A.
- The polarity is selected during I/O module configuration – see Section 6.7.2, page 102.

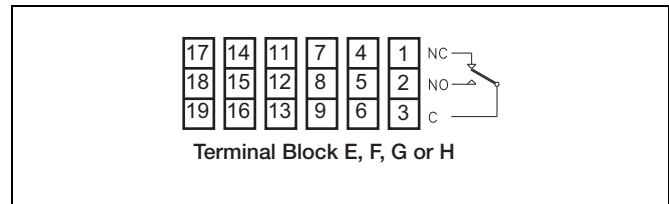

Fig. 7.12 Relay Connections

Note. Relay contacts are fitted with arc suppression components as standard.

7.8 Hybrid I/O Module Connections

7.8.1 Digital Output Connections

Six digital outputs are provided on the Hybrid option board.

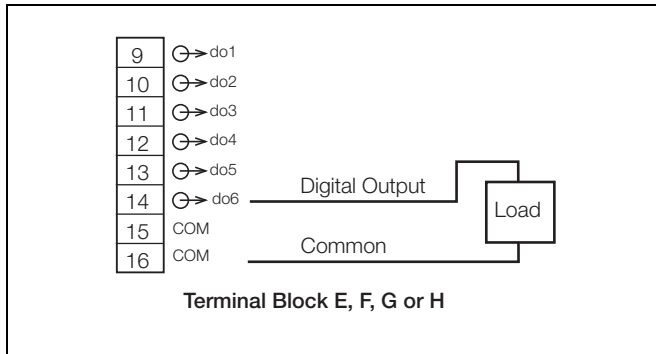

Fig. 7.13 Digital Output Connections

Note. Voltage level: 5 V.
Load: 450 Ω min. 15 kΩ max.

7.8.2 Digital Input Connections

Six digital inputs are provided on Hybrid option boards.

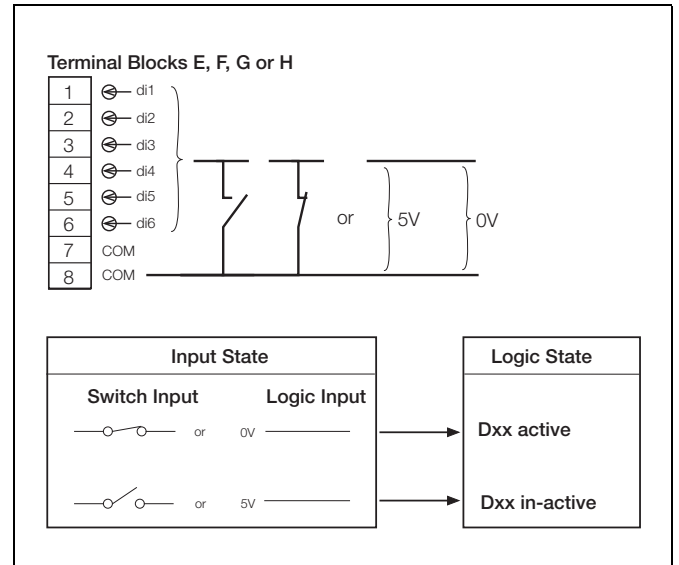

Fig. 7.14 Digital Input Connections

7.8.3 Analog Output Connections

Two analog outputs are provided on the Hybrid option board.

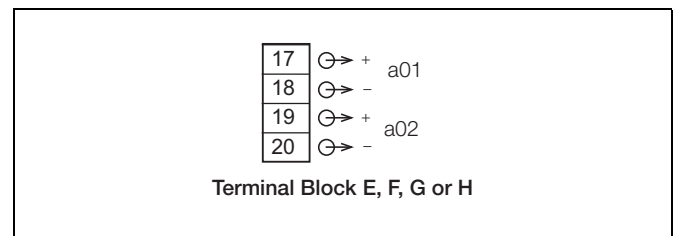

Fig. 7.15 Analog Output Connections

7.9 Ethernet Network Connections

Note. Ensure that permission has been granted for installation of new devices on the network. If in doubt, consult the System Administrator before connecting the instrument.

To connect the instrument into an Ethernet network, use a single network cable to link it to the network hub. The connection is made using a standard RJ45 connector at the rear of the unit – see Fig. 7.5, page 113.

Table 7.2 shows the signals carried by each pin of the connector:

Pin Number	Signal
1	TD+
2	TD-
3	RD+
4	Unused
5	Unused
6	RD-
7	Unused
8	Unused

TD = Transmit Data

RD = Receive Data

Table 7.2 Ethernet Connector Signals

Note. To prevent signal degradation, the maximum cable length between 10BaseT network devices is limited to 100 m. If longer cable runs are required between devices, repeaters or gateways must be used to boost signal strengths.

The instrument uses standard Ethernet and web standards and can be connected in a number of network configurations including:

- Direct connection to a computer – see Fig. 7.16
- Connection to a network hub – see Fig. 7.18
- Connection to a dial-up router – see Fig. 7.19
- Connection to an internet gateway – see Fig. 7.20

7.9.1 Direct Connection to a Computer

Note. A crossover cable is required for this configuration. See Fig. 7.17 for connection details.

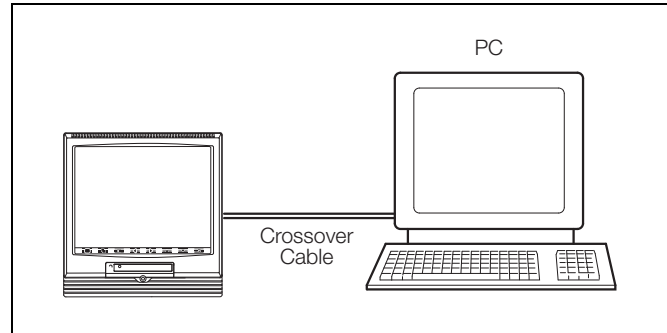

Fig. 7.16 One-to-One Connection

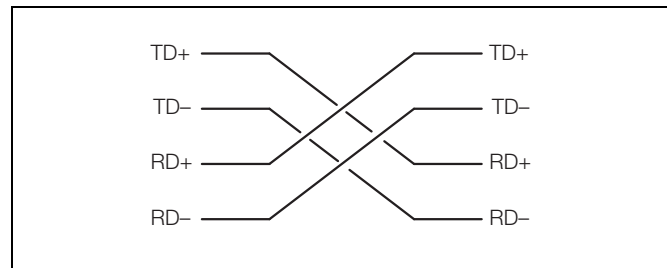

Fig. 7.17 Crossover Cable Connections

7.9.2 Connection to a Network Hub

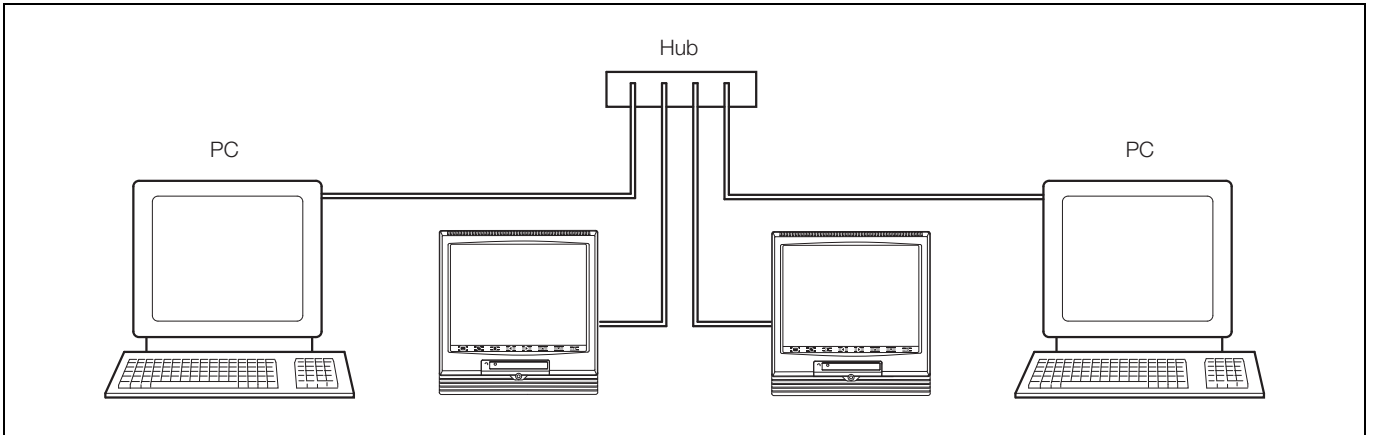

Fig. 7.18 Connection to a Network Hub

7.9.3 Connection to a Dial-Up Router

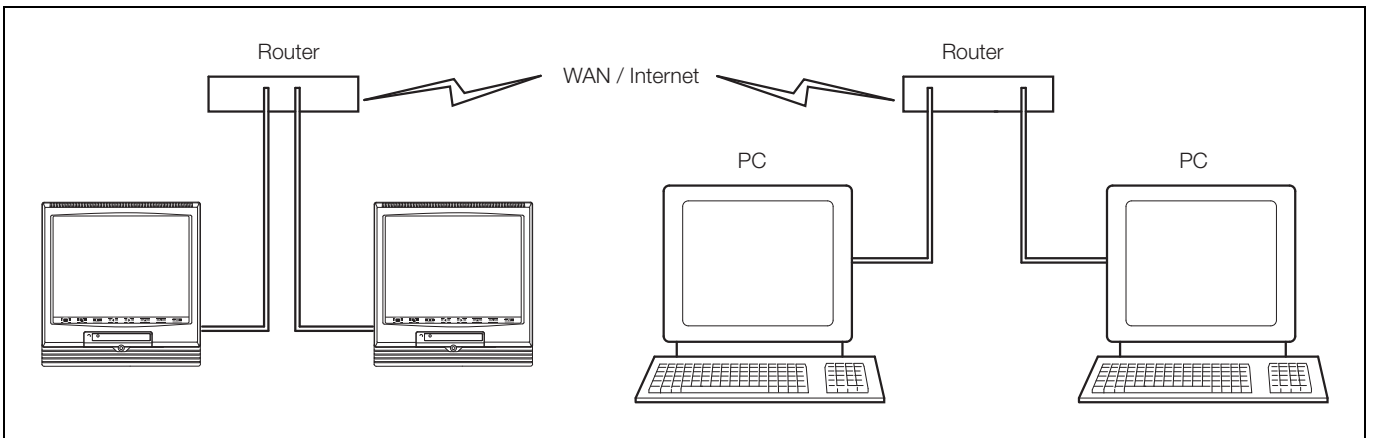

Fig. 7.19 Connection to a Dial-Up Router

7.9.4 Connection to an Internet Gateway

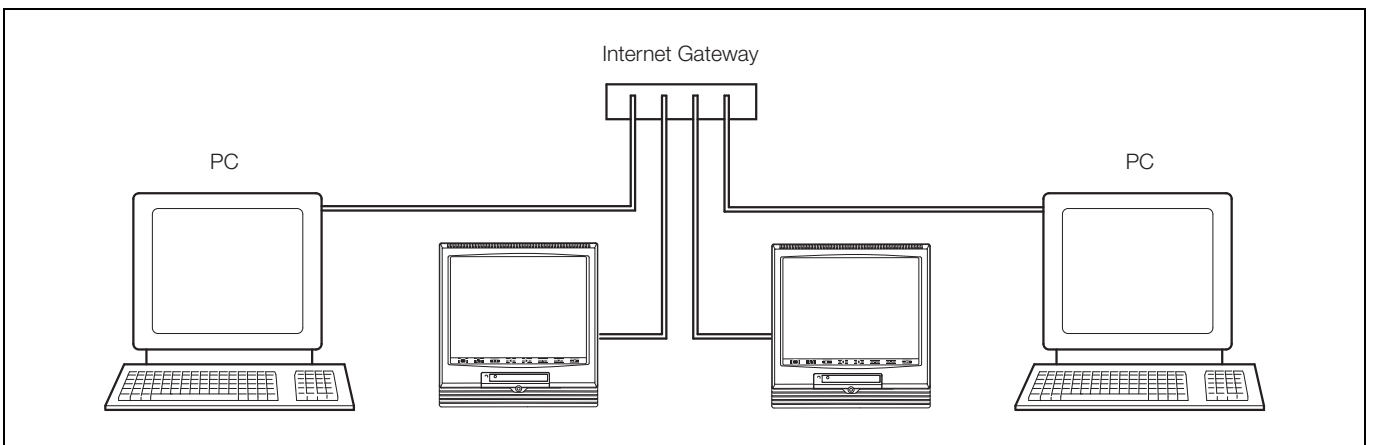

Fig. 7.20 Connection to an Internet Gateway

8 Specification

Operation and Configuration

Configuration

Via tactile membrane keys on front panel or
PC Configuration using removable media card

Multiple configuration files can be stored in internal (up to 5 files) or
external memory (with removable media option fitted)

Display

Thin film transistor (TFT), active-matrix, color, liquid crystal display
(LCD) with built-in backlight

Low-reflective, 31 cm (12.1 in.) diagonal display area,
480,000 pixel display*

Viewing angle — Horizontal 55 ° typ. (left side, right side)
Vertical 50 ° from below, 40 ° from above

***Note.** A small percentage of the display pixels may be either
constantly active or inactive. Max. percentage of inoperative pixels <
0.01 %.

Screensaver

Can be programmed to dim the backlight if operator keys are not
pressed for a selected period of time

Languages

English, German, French, Italian and Spanish

Dedicated operator keys

- Group select
- View select
- Menu key
- Left cursor
- Right cursor
- Up/Increment key
- Down/Decrement key
- Enter key

Vertical chart screen intervals

Selectable from 48 s to 14 days

Horizontal chart screen intervals

Selectable from 70 s to 20 days

Circular chart duration

Selectable from 9 minutes to 32 days

Chart scales

Independent primary and secondary ranges for each channel

Vertical/horizontal chart divisions

Programmable for up to 10 major and 10 minor divisions

Circular chart divisions

Programmable up to 10 divisions

Chart annotation

Alarm and operator messages may be annotated on the chart

Icons to identify the type of event, time of occurrence and tag are
displayed

Operator Views

Contents	Views Available			
	Chart	Bargraph	Digital Indicator	Process
Instantaneous values/states	✓	✓	✓	✓
Units of measure	✓	✓	✓	✓
Short tags	✓	✓	✓	✓
Long tags	—	—	—	✓
Alarm status	✓	✓	✓	✓
Alarm trip markers	—	✓	—	—
Alarm trip values	—	—	—	✓
Max./Min. markers	—	✓	—	—
Analog bargraphs	—	✓	—	—
Totalizer values & units of measure	—	—	✓	✓
Totalizer tags	—	—	—	✓
Max., min. and average batch values	—	—	—	✓
Graphical view of historical data	✓	—	—	—

Security

Configuration security

Password protection	Access to configuration is allowed only after the user has entered a password
Internal switch protection	Access to configuration is allowed only after a hardware switch has been set. This switch is situated behind a tamper evident seal

Setup security

Configuration	Can be configured for password protection or free access to setup levels
---------------	--

Users

Number of users	Up to 15
Usernames	Up to 20 characters, Usernames are unique, i.e. names cannot be repeated
Access privileges	Setup access — Yes/No Electronic signature access — Yes/No Configuration access — None/load file only/limited/full
Passwords	Up to 20 characters A minimum required password length of 4 to 20 characters can be configured and a password expiry time can be applied to eliminate password ageing
Password failure limit	Configurable for 1 to 10 consecutive occasions or 'infinite' A user is deactivated if a wrong password is entered repeatedly
Deactivation of inactive users	Can be disabled or configured for 7, 14, 30, 60, 90, 180 or 360 days of inactivity Users are deactivated (by removal of access privileges) after a period of inactivity

Electronic signature

Protection	Only accessible to users with electronic signature access privileges Access requires a valid username and password
Function	Provides an electronic equivalent to the signing of a conventional paper chart Enables operator to securely approve recorded data
Content	Date/Time, operator ID and operator defined 20-character message are stored in the alarm/event log and can be displayed on the chart

Standard Functionality

Operator Messages

Number	24 configurable messages of up to 20 characters each 1 operator defined message of up to 20 characters
---------------	---

Trigger

Via front panel or digital signals

Recording in alarm/event log

Can be enabled or disabled on configuration

Process Alarms

Number	144 (4 per recording channel)
Update rate	Up to 12 alarms processed every 100 ms, e.g. with 36 alarms enabled each alarm is updated once every 300 ms.

Types

High/low: process, latch & annunciator, delayed process
Rate: fast/slow

Tag

20-characters tag for each alarm

Hysteresis

Programmable value and time hysteresis 1 to 9999 s

Alarm enable

Allows alarm to be enabled/disabled via a digital input

Alarm log enable

Recording of alarm state changes in the alarm/event log can be enabled/disabled for each alarm

Acknowledgement

Via front panel or digital signals

Real-time Alarms

Number	12
Programmable	Day of the week, 1st of month, start and duration times

Totalizer

Number

72 (2 per recording channel) 10-digit totals

Type

Analog or digital, batch and secure totals

Statistical calculations

Average, maximum, minimum (for analog signals)

Date and time of max. and min. values

Update rate

Up to 4 totalizers processed every 100 ms, e.g. with 12 totalizers enabled each total is updated once every 300 ms.

Custom Linearization

Number

4

Number of breakpoints

20 per linearizer

Number of Channels v. Number of Groups

Groups	Channels per Group
1, 2, 3	Up to 12
4	Up to 9
5	Up to 7
6	Up to 6

Recording — to Internal Memory

Data Channels

Internal buffer memory

8 Mb Flash memory provides storage for 2.9 million samples

Oldest data is automatically overwritten by new data when memory is full

Data integrity checks

Checksum for each block of data samples

48-bit code for error detection/correction built-in

Independent process groups

6

No. of recording channels

36

Sources

Analog inputs, Modbus input, any digital signal

Filters

Programmable for each channel to allow recording of instantaneous values, average, max., min. and max. & min. value over sample time

Primary/secondary sample rates

Programmable from 0.1 s to 12 hours for each process group

Primary/secondary sample rate selection

Via any digital signal or from password protected menu

Recording start/stop control

Via any digital signal or from password protected menu

Recording Duration

Approximate duration calculated for continuous recording of 12 channels of analog data (for 24 channels divide by 2, for 6 channels multiply by 2 etc.)

Sample Rate	1 s	10 s	40 s	60 s	120 s	480 s
Internal Flash buffer memory	1½ days	27½ days	3½ months	5½ months	11 months	3½ years

Sample Rate	1 s	10 s	40 s	60 s	120 s	480 s
512 Mb Compact Flash	8 months	6 years	26 years	40 years	79 years	319 years
1 Gb Compact Flash	1 year	13 years	52 years	77 years	155 years	623 years

Historical Logs

Types

Alarm/Event, Totalizer and Audit logs

No. of records in each historical log

Up to 200 in internal memory

Oldest data is automatically overwritten by new data when log is full

Historical Logs

Log Type	Alarm/Event Log		Totalizer Log		Audit Log	
Information Recorded in Logs Log Entry Events	<ul style="list-style-type: none"> Alarm state changes Operator messages Electronic signatures 		<ul style="list-style-type: none"> User defined logging intervals Totalizer stop/start, reset, wrap Power up/down 		<ul style="list-style-type: none"> Configuration/calibration changes System events Errors, operator actions 	
	In Log	On Screen	In Log	On Screen	In Log	On Screen
Date & time of event	✓	✓	✓	✓	✓	✓
Type of event	✓	✓	✓	✓	✓	✓
Tag	✓	✓	✓	✓	—	—
Source tag	✓	—	✓	—	—	—
Alarm trip value & units of measure	✓	—	—	—	—	—
Alarm trip	✓	✓	—	—	—	—
Alarm acknowledgement state	✓	✓	—	—	—	—
Operator ID	✓	—	—	—	✓	✓
Description	—	—	—	—	✓	✓
Batch total and units of measurement	—	—	✓	✓	—	—
Max., Min. and average values plus units	—	—	✓	✓	—	—
Secure total	—	—	✓	—	—	—
Time & date of min./max. values	—	—	✓	✓	—	—

Archiving – To Memory Card

File types that can be saved to removable media

Recorded data for each channel

Alarm event log for each group

Totalizer log for each group

Audit log

Configuration

File Structure

Binary encoded with built-in data integrity checks

Automatic updating of archive files

At regular time intervals according to the sample rate

When a media card is inserted

Data verification

Carried out automatically on all writes to removable-media files

Card compatibility

ABB recorders comply with approved industry standards for memory cards and ABB has fully tested and recommend the use of SanDisk Standard Grade or Ultra II memory cards. Other brands may not be fully compatible with this device and therefore may not function correctly

Card size

Cards up to 4 Gb capacity may be used

Analog Input Modules

General

Number of inputs

6 per board, max. of 36 inputs

Input types

Milliamps, millivolts, voltage, resistance, THC, RTD, digital input

Digital input types

TypeVolt-free contact

Minimum pulse duration 1 s

Thermocouple types

B, E, J, K, L, N, R, S, T

Resistance thermometer

PT100

Other linearizations

\sqrt{x} , $x^{3/2}$, $x^{5/2}$, custom linearization

Digital filter

Programmable 0 to 60 s

Display range

–999 to 9999

Common mode noise rejection

> 120 dB at 50/60 Hz with 300 Ω imbalance resistance

Normal (series) mode noise rejection

> 60 dB at 50/60 Hz

CJC rejection ratio

0.05 $^{\circ}\text{C}/^{\circ}\text{C}$

Sensor break protection

Programmable as upscale or downscale

Temperature stability

0.02 $\%/^{\circ}\text{C}$ or 2 $\mu\text{V}/^{\circ}\text{C}$

Long term drift

< 0.2 % of reading or 20 μV annually

Input impedance

> 10 M Ω (millivolts inputs)

500 k Ω (voltage inputs) externally mounted divider

10 Ω (mA inputs) externally mounted on terminals*

* Hart transmitters require a minimum 250 Ω loop impedance. A 250 Ω shunt resistor can be used together with the voltage divider board (GR2000/0375) to meet this requirement. In such cases the input should be programmed for 1 to 5 V.

Standard/High Specification Analog Input Modules

Linear Inputs	Standard Analog Input	High Specification Analog Input	Accuracy (% of reading)
Millivolts	0 to 2000 mV	–1000 to +1000 mV	0.1 % or $\pm 10 \mu\text{V}$
Milliamps	0 to 50 mA	–100 to +100 mA	0.2 % or $\pm 2 \mu\text{A}$
Volts	0 to +20 V*	–50 to +50 V*	0.2 % or $\pm 10 \text{mV}$
Resistance Ω	0 to 5000 Ω	0 to 2000 Ω	0.2 % or $\pm 0.08 \Omega$
Sample Interval	100 ms per sample (2 modules are processed in parallel) gives worst case update times as follows: 600 ms for 6 or 12 channels — mV, mA, voltage 800 ms for 6 or 12 channels — THC 1100 ms for 6 or 12 channels — resistance, RTD	100 ms per sample (2 modules are processed in parallel) gives worst case update times as follows: 100 ms for 6 or 12 channels — all input types	
Input Isolation	35 V DC channel-to-channel	500 V DC channel-to-channel	
Isolation from Rest of Instrument	Galvanically isolated to 500 V DC	Galvanically isolated to 500 V DC	

*Requires external voltage divider board Part No. GR2000/0375

Analog Input Types

Thermocouple	Maximum Range °C	Maximum Range °F	Accuracy (% of reading)
B	−18 to 1800	0 to 3270	0.1 % or ± 2 °C (3.6 °F) (above 200 °C [392 °F])
E	−100 to 900	−140 to 1650	0.1 % or ± 0.5 °C (0.9 °F)
J	−100 to 900	−140 to 1650	0.1 % or ± 0.5 °C (0.9 °F)
K	−100 to 1300	−140 to 2350	0.1 % or ± 0.5 °C (0.9 °F)
L	−100 to 900	−140 to 1650	0.1 % or ± 1.5 °C (2.7 °F)
N	−200 to 1300	−325 to 2350	0.1 % or ± 0.5 °C (0.9 °F)
R	−18 to 1700	0 to 3000	0.1 % or ± 1 °C (1.8 °F) (above 300 °C [540 °F])
S	−18 to 1700	0 to 3000	0.1 % or ± 1 °C (1.8 °F) (above 200 °C [392 °F])
T	−250 to 300	−400 to 550	0.1 % or ± 0.5 °C (0.9 °F)

RTD	Maximum Range °C	Maximum Range °F	Accuracy (% of reading)
PT100	−200 to 600	−325 to 1100	0.1 % or ± 0.5 °C (0.9 °F)

2-wire Transmitter Power Supply

Number

1 fitted as standard

Voltage

24 V DC

Drive

Up to 45 mA, i.e. can drive 2 loops

Ethernet

Physical medium

10BaseT

Protocols

TCP/IP, ARP, ICMP, FTP (server), HTTP, MODBUS TCP (client + server)

FTP server functions

Directory selection and listing

File upload/download

12 configurable users with full or read-only access

Web server functions

Operator screen monitoring/selection. Remote monitoring of recording channels, analog/digital signals, alarms, totalizers and archiving

Advanced Math

Math Blocks

Type

12 equations provide ability to perform general arithmetic calculations including F_0 , mass flow (of ideal gases), relative humidity and emissions calculations

Size

40-character equation

Functions —

+, −, /, log, Ln., Exp, X^n , $\sqrt{\quad}$, Sin, Cos, Tan, mean, rolling average, standard deviation, high/median/low select, multiplexer, absolute, relative humidity

Tags

8- and 20-character tags for each block

Update rate

1 enabled block every 100 ms

Logic Equations

Number

12

Size

11 elements each

Functions

AND, OR, NAND, NOR, XOR, NOT

Tags

20-character tag for each equation

Update rate

300 ms

Modules

3- or 6-Relay Output Modules (max. of 4 Modules)

Number of relays

3 or 6 per module, max. of 4 modules (24 relays)

Type and rating

Relay type single-pole changeover

Voltage	250 V AC	30V DC
Current	5 A AC	5 A DC
Loading (non-inductive)	1250VA	150 Ω

Note. The total load for all relays within the instrument must not exceed 36 A.

Hybrid Module (max. of 4 Modules)

Digital I/O

Number	6 inputs and 6 outputs per card
Type	Volt-free switching inputs
Polarity	Negative, i.e. closed switch contact or 0 V = active signal
Digital input min. pulse	125 ms
Digital output voltage	5 V
Isolation	500 V from any other I/O

Analog output

Number	2 isolated
Configurable current range	0 to 20 mA
Max. load	750 Ω
Isolation	500 V DC from any other I/O
Accuracy	0.25 %

2-Wire Transmitter Power Supply Module (max. of 2 Modules)

Number

2 isolated supplies per module

Voltage

24 V DC nominal

Drive

45 mA per supply, i.e. each module can drive 2 x 2 = 4 loops

RS485 Serial Communications Module (Max. of 1 Module)

Number of ports

1

Connections

RS485, 2- or 4-wire

Protocol

Modbus RTU slave + master

EMC

Emissions & Immunity

Meets requirements of:

EN50081-2

EN50082-2

EN61326 for an industrial environment

Electrical

Power supply

100 to 240 V AC ± 10 % (90 min. to 264 V max.) 50/60 Hz

24 V DC ± 2.4 V (optional)

Power consumption

35 VA max.

Power interruption protection

No effect for interruptions of up to 20 ms

Maximum accepted cable size

Instrument terminal block 14 AWG (1.63 mm OD)

GR2000/0375, GR2000/0377 15 AWG (1.45 mm OD)

Safety

General safety

EN61010-1

cULus

cCSAus

Overvoltage Class III on mains, Class II on inputs and outputs

Pollution category 2

Isolation

500 V DC to earth (ground)

Environmental

Operating temperature range

0 to 50 °C (32 to 122 °F) with SmartMedia/Compact Flash

Operating humidity range

5 to 95 % RH (non-condensing)

Storage temperature range

-20 to 60 °C (-4 to 140 °F)

Front panel sealing

IP66 and NEMA4X

Rear panel sealing

(with rear cover) IP40

(without rear cover) IP20

Physical

Size

288 mm (11.34 in.) x 288 mm (11.34 in.) x 195 mm (7.68 in.) (depth behind panel)

Weight

8 kg (17.4 lb) approx. (unpacked)

Panel cutout

281 mm (11.06 in.) x 281 mm (11.06 in.)

Case material

20 % glass-filled polyester/stainless steel (grade 304)

Display housing material

25 % glass-filled polyester

Screen

Double layer polyester coated toughened glass

DS/SM3000-EN Rev. X

Appendix A – Signal Sources

Source Name	Description
Analog Sources	
Analog I/P A1 to Analog I/P F6	Analog input values (from Analog input module). Available only if an analog input module is fitted in the relevant position.
Comms AIN 1 to 36	Analog input values. Received via the Modbus/Modbus TCP serial communications link – see Sections 6.7.4 (page 105) and 6.4.7 (page 72) respectively.
Stats 1.1A max to Stats 6.6B max	Maximum Statistics Input Value. Value since the totalizer on a given channel last wrapped or reset. Available only on analog channels and if the relevant totalizer is enabled in the Configuration level.
Stats 1.1A min to Stats 6.6B min	Minimum Statistics Input Value. Value since the totalizer on a given channel last wrapped or reset. Available only on analog channels and only if the relevant totalizer is enabled in the Configuration level.
Stats 1.1A avg to Stats 6.6B avg	Average Statistics Input Value. Value since the totalizer on a given channel last wrapped or reset. Available only on analog channels and only if the relevant totalizer is enabled in the Configuration level.
Error States	
AIN A1 fail to AIN F6 fail	Analog Input Failure. Active when the signal detected at the analog input is outside the 'Fault Detect Level' specified in Section 6.6.2, page 91.
Comms AIN 1 fail to Comms AIN 36 fail	
Stats 1.1A fail to Stats 6.6B fail	Totalizer Input Value Failure. Activated when the totalizer fails, cleared when the totalizer wraps or is reset. Available only for analog channels if the relevant totalizer is enabled in the Configuration level.
Archive media not present	Active when the removable archive media is not present.
Too many files on archive media	Active when there are approximately 300 files on the removable archive media.
Archive 100 % full	Active when the removable archive media is 100 % full.
Archive 80 % full	Active when the removable archive media is 80 % full.
Archive media present	Active when the removable archive media is present.
Digital Input States	
Digital I/P A1 to Digital I/P H6	Digital Input States. From optional hybrid I/O boards fitted at module positions E, F, G or H or from analog input modules fitted at module positions A, B, C, D, E or F if input 'Type' is set to 'Volt free digital input' – see Section 6.6.2, page 89. Available only if the module is fitted.
BCD digital I/P H0 to BCD digital I/P H31	BCD (Binary Coded Decimal) Digital Input States. Digital states derived from digital inputs H1 to H6. Available only if optional hybrid I/O board is fitted in module position H.

Table A.1 Signal Sources

Source Name	Description
Comms Dig I/P 1 to Comms Dig I/P 36	Digital Input States. Digital signals received via Modbus/Modbus TCP serial link – see Sections 6.7.4 (page 105) and 6.4.7 (page 72) respectively.
Alarm state 1.1A to Alarm state 6.6D	Alarm States. Available only if the relevant alarm is enabled in the Configuration level.
Alarm ack 1.1A to Alarm ack 6.6D	Alarm Acknowledge States. Available only if the relevant alarm is enabled in the Configuration level. Acknowledged alarm = 0; Unacknowledged alarm = 1. Applicable to Process, Latch and Annunciator alarms only.
Alarm group 1 to Alarm group 12	Alarm Groups. Available only if any alarms are enabled in the configuration level. Active only if any of the alarms assigned to a group are active.
Any alarm	Available only if there is at least one alarm enabled in the configuration level. Active only if any of the enabled alarms are active.
New alarm	Available only as a source for e-mail triggers. Causes an e-mail to be generated if any alarm becomes active.
Real time alarm 1 to Real time alarm 12	Real Time Alarm States. Available only if the relevant alarm is enabled in the Configuration level.
Run state 1.1A to Run state 6.6B	Totalizer Run States. Active while totalizer is running. Available only if the relevant totalizer is enabled in the Configuration level.
Wrap pulse 1.1A to Wrap pulse 6.6B	Totalizer Wrap Pulse. Available only if the relevant totalizer is enabled in the Configuration level – see Section 6.6.5, page 98. If 'Wrap Enable' set to 'On': Active for 2 seconds when the predetermined count has been reached. If 'Wrap Enable' set to 'Off': Active when the predetermined count has been reached and remains active until the totalizer is reset.
1st stage o/p 1.1A to 1st stage o/p 6.6B	Totalizer First Stage Output (Intermediate Count). Activated when the intermediate count is reached, de-activated when reset or wrapped – see Section 6.6.5, page 98. Available only if the relevant totalizer is enabled in the Configuration level.
Count pulse 1.1 A to Count pulse 6.6B	Totalizer Count Pulse. Active for 100 ms each time the totalizer updates by one whole count. For example, if two decimal places are set, a pulse is generated when the totalizer value increments from 0.99 to 1.00 or 1.99 to 2.00.

Table A.1 Signal Sources (Continued)

Appendix B – Modbus Guide

B.1 Introduction

A Modbus/RS485 serial communications link is available as an option.

Note. The Modbus option provides the following facilities:

- n Standard RS422/485 communications.
- n Modbus RTU protocol – for master (host computer) to slave (Multipoint Videographic Recorder) system.
- n Modbus protocol – for master (Multipoint Videographic Recorder) to slave (RTU) system.
- n 500 V DC isolation from external connections to the instrument.
- n Two-wire or four-wire communication.
- n 1200, 2400, 4800, 9600, 19200, 38400, or 115200 baud transmission rate.
- n Parity-checking – odd, even or none.

The instrument can be configured to act as either a Remote Terminal Unit (RTU) slave when communicating with a master (host) system, or as a Modbus master device, enabling it to collect data from RTU slaves into its 36 Comms Analog and 36 Comms Digital Channels.

B.2 Setting Up

To set up the instrument on a Modbus network:

1. Connect the instrument to a Modbus link – see Section 7.5, page 116.
2. Set the RS485 configuration parameters – see Section 6.7.4, page 105.
3. Add the instrument to the link configuration on the host system – refer to information supplied with the host system.

B.3 Modbus Protocol

B.3.1 Modbus Commands Supported

The following Modbus commands are supported:

- 01 **Read Coil Status** – reads the on/off status of up to 120 consecutive digital states, starting at a specified address. The instrument returns zeros for points that do not contain defined data.
- 03 **Read Holding Registers** – reads up to 120 consecutive analog values, starting from a specified address. The instrument returns zeros for registers that do not contain defined data.
- 05 **Force Single Coil** – sets the value of a single coil (digital signal) at the specified address. The data value must be FF00Hex to set the signal ON and zero to turn it OFF. The instrument returns an exception response if the register is not currently writable.
- 06 **Preset Single Register** – sets the value of a single register (analog value) at the specified address. The instrument returns an exception response if the register is not currently writable. Limits defined in configuration are applied to the value before storage.
- 08 **Loopback Diagnostic Test** – used to test the integrity of Modbus transmissions. The instrument returns the message received.
- 15 **Force Multiple Coils** – the instrument carries out updates that are valid and returns an exception response if any of the coils are not currently writable.
- 16 **Preset Multiple Registers** – the instrument carries out updates that are valid and generates an exception response if any of the registers are not currently writable.

Note.

- n Negative numbers are represented in '2's complement' format, e.g 1000 = 03E8 (Hex), -1000 = FC18 (Hex).
- n The instrument cannot accept a new message until the current message has been processed and a reply sent to the master (maximum response time 50 ms).
- n The instrument monitors the elapsed time between receipt of characters from the host. If the elapsed time between two characters is 3.5 character times, the slave assumes the second character received is the start of a new message.

B.3.2 Modbus Exception Responses

If the instrument detects one of the errors listed in Table B.1 while receiving a message from the host system, it replies with a response message consisting of the instrument's Modbus address, the function code, the error code and error check fields.

Code	Name	Definition
01	Illegal Function	The message function received is not an allowable action
02	Illegal Data Address	The address reference in the data field is not an allowable address
03	Illegal Data Value	The value referenced in the data field is not allowable in the addressed slave
07	Negative Acknowledgment	Received message error
08	Memory Parity Error	Parity check indicates an error in one or more of the characters received

Table B.1 Modbus Exception Responses

B.4 Operating Mode

B.4.1 Operating Mode Modbus Coils

Tables B.2 to B.17 detail the contents of each Modbus coil. Each coil is assigned a register that can have one of two values: 0000 or 0001.

Analog Input	Modbus Coil (Read Only) 0 = Input OK 1 = Input failed	Analog Input	Modbus Coil (Read Only) 0 = Input OK 1 = Input failed
A1	0001	D1	0019
A2	0002	D2	0020
A3	0003	D3	0021
A4	0004	D4	0022
A5	0005	D5	0023
A6	0006	D6	0024
B1	0007	E1	0025
B2	0008	E2	0026
B3	0009	E3	0027
B4	0010	E4	0028
B5	0011	E5	0029
B6	0012	E6	0030
C1	0013	F1	0031
C2	0014	F2	0032
C3	0015	F3	0033
C4	0016	F4	0034
C5	0017	F5	0035
C6	0018	F6	0036

Table B.2 Analog Input Fail States

Read Access 0 = Alarm inactive 1 = Alarm active		Write Access None					
Title	Modbus Coil	Title	Modbus Coil	Title	Modbus Coil	Title	Modbus Coil
Alarm 1.1A	0051	Alarm 1.10A	0087	Alarm 2.7A	0123	Alarm 3.4A	0159
Alarm 1.1B	0052	Alarm 1.10B	0088	Alarm 2.7B	0124	Alarm 3.4B	0160
Alarm 1.1C	0053	Alarm 1.10C	0089	Alarm 2.7C	0125	Alarm 3.4C	0161
Alarm 1.1D	0054	Alarm 1.10D	0090	Alarm 2.7D	0126	Alarm 3.4D	0162
Alarm 1.2A	0055	Alarm 1.11A	0091	Alarm 2.8A	0127	Alarm 3.5A	0163
Alarm 1.2B	0056	Alarm 1.11B	0092	Alarm 2.8B	0128	Alarm 3.5B	0164
Alarm 1.2C	0057	Alarm 1.11C	0093	Alarm 2.8C	0129	Alarm 3.5C	0165
Alarm 1.2D	0058	Alarm 1.11D	0094	Alarm 2.8D	0130	Alarm 3.5D	0166
Alarm 1.3A	0059	Alarm 1.12A	0095	Alarm 2.9A	0131	Alarm 3.6A	0167
Alarm 1.3B	0060	Alarm 1.12B	0096	Alarm 2.9B	0132	Alarm 3.6B	0168
Alarm 1.3C	0061	Alarm 1.12C	0097	Alarm 2.9C	0133	Alarm 3.6C	0169
Alarm 1.3D	0062	Alarm 1.12D	0098	Alarm 2.9D	0134	Alarm 3.6D	0170
Alarm 1.4A	0063	Alarm 2.1A	0099	Alarm 2.10A	0135	Alarm 3.7A	0171
Alarm 1.4B	0064	Alarm 2.1B	0100	Alarm 2.10B	0136	Alarm 3.7B	0172
Alarm 1.4C	0065	Alarm 2.1C	0101	Alarm 2.10C	0137	Alarm 3.7C	0173
Alarm 1.4D	0066	Alarm 2.1D	0102	Alarm 2.10D	0138	Alarm 3.7D	0174
Alarm 1.5A	0067	Alarm 2.2A	0103	Alarm 2.11A	0139	Alarm 3.8A	0175
Alarm 1.5B	0068	Alarm 2.2B	0104	Alarm 2.11B	0140	Alarm 3.8B	0176
Alarm 1.5C	0069	Alarm 2.2C	0105	Alarm 2.11C	0141	Alarm 3.8C	0177
Alarm 1.5D	0070	Alarm 2.2D	0106	Alarm 2.11D	0142	Alarm 3.8D	0178
Alarm 1.6A	0071	Alarm 2.3A	0107	Alarm 2.12A	0143	Alarm 3.9A	0179
Alarm 1.6B	0072	Alarm 2.3B	0108	Alarm 2.12B	0144	Alarm 3.9B	0180
Alarm 1.6C	0073	Alarm 2.3C	0109	Alarm 2.12C	0145	Alarm 3.9C	0181
Alarm 1.6D	0074	Alarm 2.3D	0110	Alarm 2.12D	0146	Alarm 3.9D	0182
Alarm 1.7A	0075	Alarm 2.4A	0111	Alarm 3.1A	0147	Alarm 3.10A	0183
Alarm 1.7B	0076	Alarm 2.4B	0112	Alarm 3.1B	0148	Alarm 3.10B	0184
Alarm 1.7C	0077	Alarm 2.4C	0113	Alarm 3.1C	0149	Alarm 3.10C	0185
Alarm 1.7D	0078	Alarm 2.4D	0114	Alarm 3.1D	0150	Alarm 3.10D	0186
Alarm 1.8A	0079	Alarm 2.5A	0115	Alarm 3.2A	0151	Alarm 3.11A	0187
Alarm 1.8B	0080	Alarm 2.5B	0116	Alarm 3.2B	0152	Alarm 3.11B	0188
Alarm 1.8C	0081	Alarm 2.5C	0117	Alarm 3.2C	0153	Alarm 3.11C	0189
Alarm 1.8D	0082	Alarm 2.5D	0118	Alarm 3.2D	0154	Alarm 3.11D	0190
Alarm 1.9A	0083	Alarm 2.6A	0119	Alarm 3.3A	0155	Alarm 3.12A	0191
Alarm 1.9B	0084	Alarm 2.6B	0120	Alarm 3.3B	0156	Alarm 3.12B	0192
Alarm 1.9C	0085	Alarm 2.6C	0121	Alarm 3.3C	0157	Alarm 3.12C	0193
Alarm 1.9D	0086	Alarm 2.6D	0122	Alarm 3.3D	0158	Alarm 3.12D	0194

Table B.3 Alarm Active/Inactive States

Read Access		0 = Alarm inactive		Write Access		None	
		1 = Alarm active					
Title	Modbus Coil	Title	Modbus Coil	Title	Modbus Coil	Title	Modbus Coil
Alarm 4.1A	0195	Alarm 4.10A	0231	Alarm 5.7A	0267	Alarm 6.4A	0303
Alarm 4.1B	0196	Alarm 4.10B	0232	Alarm 5.7B	0268	Alarm 6.4B	0304
Alarm 4.1C	0197	Alarm 4.10C	0233	Alarm 5.7C	0269	Alarm 6.4C	0305
Alarm 4.1D	0198	Alarm 4.10D	0234	Alarm 5.7D	0270	Alarm 6.4D	0306
Alarm 4.2A	0199	Alarm 4.11A	0235	Alarm 5.8A	0271	Alarm 6.5A	0307
Alarm 4.2B	0200	Alarm 4.11B	0236	Alarm 5.8B	0272	Alarm 6.5B	0308
Alarm 4.2C	0201	Alarm 4.11C	0237	Alarm 5.8C	0273	Alarm 6.5C	0309
Alarm 4.2D	0202	Alarm 4.11D	0238	Alarm 5.8D	0274	Alarm 6.5D	0310
Alarm 4.3A	0203	Alarm 4.12A	0239	Alarm 5.9A	0275	Alarm 6.6A	0311
Alarm 4.3B	0204	Alarm 4.12B	0240	Alarm 5.9B	0276	Alarm 6.6B	0312
Alarm 4.3C	0205	Alarm 4.12C	0241	Alarm 5.9C	0277	Alarm 6.6C	0313
Alarm 4.3D	0206	Alarm 4.12D	0242	Alarm 5.9D	0278	Alarm 6.6D	0314
Alarm 4.4A	0207	Alarm 5.1A	0243	Alarm 5.10A	0279	Alarm 6.7A	0315
Alarm 4.4B	0208	Alarm 5.1B	0244	Alarm 5.10B	0280	Alarm 6.7B	0316
Alarm 4.4C	0209	Alarm 5.1C	0245	Alarm 5.10C	0281	Alarm 6.7C	0317
Alarm 4.4D	0210	Alarm 5.1D	0246	Alarm 5.10D	0282	Alarm 6.7D	0318
Alarm 4.5A	0211	Alarm 5.2A	0247	Alarm 5.11A	0283	Alarm 6.8A	0319
Alarm 4.5B	0212	Alarm 5.2B	0248	Alarm 5.11B	0284	Alarm 6.8B	0320
Alarm 4.5C	0213	Alarm 5.2C	0249	Alarm 5.11C	0285	Alarm 6.8C	0321
Alarm 4.5D	0214	Alarm 5.2D	0250	Alarm 5.11D	0286	Alarm 6.8D	0322
Alarm 4.6A	0215	Alarm 5.3A	0251	Alarm 5.12A	0287	Alarm 6.9A	0323
Alarm 4.6B	0216	Alarm 5.3B	0252	Alarm 5.12B	0288	Alarm 6.9B	0324
Alarm 4.6C	0217	Alarm 5.3C	0253	Alarm 5.12C	0289	Alarm 6.9C	0325
Alarm 4.6D	0218	Alarm 5.3D	0254	Alarm 5.12D	0290	Alarm 6.9D	0326
Alarm 4.7A	0219	Alarm 5.4A	0255	Alarm 6.1A	0291	Alarm 6.10A	0327
Alarm 4.7B	0220	Alarm 5.4B	0256	Alarm 6.1B	0292	Alarm 6.10B	0328
Alarm 4.7C	0221	Alarm 5.4C	0257	Alarm 6.1C	0293	Alarm 6.10C	0329
Alarm 4.7D	0222	Alarm 5.4D	0258	Alarm 6.1D	0294	Alarm 6.10D	0330
Alarm 4.8A	0223	Alarm 5.5A	0259	Alarm 6.2A	0295	Alarm 6.11A	0331
Alarm 4.8B	0224	Alarm 5.5B	0260	Alarm 6.2B	0296	Alarm 6.11B	0332
Alarm 4.8C	0225	Alarm 5.5C	0261	Alarm 6.2C	0297	Alarm 6.11C	0333
Alarm 4.8D	0226	Alarm 5.5D	0262	Alarm 6.2D	0298	Alarm 6.11D	0334
Alarm 4.9A	0227	Alarm 5.6A	0263	Alarm 6.3A	0299	Alarm 6.12A	0335
Alarm 4.9B	0228	Alarm 5.6B	0264	Alarm 6.3B	0300	Alarm 6.12B	0336
Alarm 4.9C	0229	Alarm 5.6C	0265	Alarm 6.3C	0301	Alarm 6.12C	0337
Alarm 4.9D	0230	Alarm 5.6D	0266	Alarm 6.3D	0302	Alarm 6.12D	0338

Table B.3 Alarm Active/Inactive States (Continued)

Read Access				Write Access			
0 = Alarm acknowledged or inactive				0 = No affect			
1 = Alarm active and unacknowledged				1 = Acknowledge			
Title	Modbus Coil	Title	Modbus Coil	Title	Modbus Coil	Title	Modbus Coil
Alarm 1.1A	0351	Alarm 1.10A	0387	Alarm 2.7A	0423	Alarm 3.4A	0459
Alarm 1.1B	0352	Alarm 1.10B	0388	Alarm 2.7B	0424	Alarm 3.4B	0460
Alarm 1.1C	0353	Alarm 1.10C	0389	Alarm 2.7C	0425	Alarm 3.4C	0461
Alarm 1.1D	0354	Alarm 1.10D	0390	Alarm 2.7D	0426	Alarm 3.4D	0462
Alarm 1.2A	0355	Alarm 1.11A	0391	Alarm 2.8A	0427	Alarm 3.5A	0463
Alarm 1.2B	0356	Alarm 1.11B	0392	Alarm 2.8B	0428	Alarm 3.5B	0464
Alarm 1.2C	0357	Alarm 1.11C	0393	Alarm 2.8C	0429	Alarm 3.5C	0465
Alarm 1.2D	0358	Alarm 1.11D	0394	Alarm 2.8D	0430	Alarm 3.5D	0466
Alarm 1.3A	0359	Alarm 1.12A	0395	Alarm 2.9A	0431	Alarm 3.6A	0467
Alarm 1.3B	0360	Alarm 1.12B	0396	Alarm 2.9B	0432	Alarm 3.6B	0468
Alarm 1.3C	0361	Alarm 1.12C	0397	Alarm 2.9C	0433	Alarm 3.6C	0469
Alarm 1.3D	0362	Alarm 1.12D	0398	Alarm 2.9D	0434	Alarm 3.6D	0470
Alarm 1.4A	0363	Alarm 2.1A	0399	Alarm 2.10A	0435	Alarm 3.7A	0471
Alarm 1.4B	0364	Alarm 2.1B	0400	Alarm 2.10B	0436	Alarm 3.7B	0472
Alarm 1.4C	0365	Alarm 2.1C	0401	Alarm 2.10C	0437	Alarm 3.7C	0473
Alarm 1.4D	0366	Alarm 2.1D	0402	Alarm 2.10D	0438	Alarm 3.7D	0474
Alarm 1.5A	0367	Alarm 2.2A	0403	Alarm 2.11A	0439	Alarm 3.8A	0475
Alarm 1.5B	0368	Alarm 2.2B	0404	Alarm 2.11B	0440	Alarm 3.8B	0476
Alarm 1.5C	0369	Alarm 2.2C	0405	Alarm 2.11C	0441	Alarm 3.8C	0477
Alarm 1.5D	0370	Alarm 2.2D	0406	Alarm 2.11D	0442	Alarm 3.8D	0478
Alarm 1.6A	0371	Alarm 2.3A	0407	Alarm 2.12A	0443	Alarm 3.9A	0479
Alarm 1.6B	0372	Alarm 2.3B	0408	Alarm 2.12B	0444	Alarm 3.9B	0480
Alarm 1.6C	0373	Alarm 2.3C	0409	Alarm 2.12C	0445	Alarm 3.9C	0481
Alarm 1.6D	0374	Alarm 2.3D	0410	Alarm 2.12D	0446	Alarm 3.9D	0482
Alarm 1.7A	0375	Alarm 2.4A	0411	Alarm 3.1A	0447	Alarm 3.10A	0483
Alarm 1.7B	0376	Alarm 2.4B	0412	Alarm 3.1B	0448	Alarm 3.10B	0484
Alarm 1.7C	0377	Alarm 2.4C	0413	Alarm 3.1C	0449	Alarm 3.10C	0485
Alarm 1.7D	0378	Alarm 2.4D	0414	Alarm 3.1D	0450	Alarm 3.10D	0486
Alarm 1.8A	0379	Alarm 2.5A	0415	Alarm 3.2A	0451	Alarm 3.11A	0487
Alarm 1.8B	0380	Alarm 2.5B	0416	Alarm 3.2B	0452	Alarm 3.11B	0488
Alarm 1.8C	0381	Alarm 2.5C	0417	Alarm 3.2C	0453	Alarm 3.11C	0489
Alarm 1.8D	0382	Alarm 2.5D	0418	Alarm 3.2D	0454	Alarm 3.11D	0490
Alarm 1.9A	0383	Alarm 2.6A	0419	Alarm 3.3A	0455	Alarm 3.12A	0491
Alarm 1.9B	0384	Alarm 2.6B	0420	Alarm 3.3B	0456	Alarm 3.12B	0492
Alarm 1.9C	0385	Alarm 2.6C	0421	Alarm 3.3C	0457	Alarm 3.12C	0493
Alarm 1.9D	0386	Alarm 2.6D	0422	Alarm 3.3D	0458	Alarm 3.12D	0494

Table B.4 Alarm Acknowledge States

Read Access 0 = Alarm acknowledged or inactive 1 = Alarm active and unacknowledged		Write Access 0 = No affect 1 = Acknowledge					
Title	Modbus Coil	Title	Modbus Coil	Title	Modbus Coil	Title	Modbus Coil
Alarm 4.1A	0495	Alarm 4.10A	0531	Alarm 5.7A	0567	Alarm 6.4A	0603
Alarm 4.1B	0496	Alarm 4.10B	0532	Alarm 5.7B	0568	Alarm 6.4B	0604
Alarm 4.1C	0497	Alarm 4.10C	0533	Alarm 5.7C	0569	Alarm 6.4C	0605
Alarm 4.1D	0498	Alarm 4.10D	0534	Alarm 5.7D	0570	Alarm 6.4D	0606
Alarm 4.2A	0499	Alarm 4.11A	0535	Alarm 5.8A	0571	Alarm 6.5A	0607
Alarm 4.2B	0500	Alarm 4.11B	0536	Alarm 5.8B	0572	Alarm 6.5B	0608
Alarm 4.2C	0501	Alarm 4.11C	0537	Alarm 5.8C	0573	Alarm 6.5C	0609
Alarm 4.2D	0502	Alarm 4.11D	0538	Alarm 5.8D	0574	Alarm 6.5D	0610
Alarm 4.3A	0503	Alarm 4.12A	0539	Alarm 5.9A	0575	Alarm 6.6A	0611
Alarm 4.3B	0504	Alarm 4.12B	0540	Alarm 5.9B	0576	Alarm 6.6B	0612
Alarm 4.3C	0505	Alarm 4.12C	0541	Alarm 5.9C	0577	Alarm 6.6C	0613
Alarm 4.3D	0506	Alarm 4.12D	0542	Alarm 5.9D	0578	Alarm 6.6D	0614
Alarm 4.4A	0507	Alarm 5.1A	0543	Alarm 5.10A	0579	Alarm 6.7A	0615
Alarm 4.4B	0508	Alarm 5.1B	0544	Alarm 5.10B	0580	Alarm 6.7B	0616
Alarm 4.4C	0509	Alarm 5.1C	0545	Alarm 5.10C	0581	Alarm 6.7C	0617
Alarm 4.4D	0510	Alarm 5.1D	0546	Alarm 5.10D	0582	Alarm 6.7D	0618
Alarm 4.5A	0511	Alarm 5.2A	0547	Alarm 5.11A	0583	Alarm 6.8A	0619
Alarm 4.5B	0512	Alarm 5.2B	0548	Alarm 5.11B	0584	Alarm 6.8B	0620
Alarm 4.5C	0513	Alarm 5.2C	0549	Alarm 5.11C	0585	Alarm 6.8C	0621
Alarm 4.5D	0514	Alarm 5.2D	0550	Alarm 5.11D	0586	Alarm 6.8D	0622
Alarm 4.6A	0515	Alarm 5.3A	0551	Alarm 5.12A	0587	Alarm 6.9A	0623
Alarm 4.6B	0516	Alarm 5.3B	0552	Alarm 5.12B	0588	Alarm 6.9B	0624
Alarm 4.6C	0517	Alarm 5.3C	0553	Alarm 5.12C	0589	Alarm 6.9C	0625
Alarm 4.6D	0518	Alarm 5.3D	0554	Alarm 5.12D	0590	Alarm 6.9D	0626
Alarm 4.7A	0519	Alarm 5.4A	0555	Alarm 6.1A	0591	Alarm 6.10A	0627
Alarm 4.7B	0520	Alarm 5.4B	0556	Alarm 6.1B	0592	Alarm 6.10B	0628
Alarm 4.7C	0521	Alarm 5.4C	0557	Alarm 6.1C	0593	Alarm 6.10C	0629
Alarm 4.7D	0522	Alarm 5.4D	0558	Alarm 6.1D	0594	Alarm 6.10D	0630
Alarm 4.8A	0523	Alarm 5.5A	0559	Alarm 6.2A	0595	Alarm 6.11A	0631
Alarm 4.8B	0524	Alarm 5.5B	0560	Alarm 6.2B	0596	Alarm 6.11B	0632
Alarm 4.8C	0525	Alarm 5.5C	0561	Alarm 6.2C	0597	Alarm 6.11C	0633
Alarm 4.8D	0526	Alarm 5.5D	0562	Alarm 6.2D	0598	Alarm 6.11D	0634
Alarm 4.9A	0527	Alarm 5.6A	0563	Alarm 6.3A	0599	Alarm 6.12A	0635
Alarm 4.9B	0528	Alarm 5.6B	0564	Alarm 6.3B	0600	Alarm 6.12B	0636
Alarm 4.9C	0529	Alarm 5.6C	0565	Alarm 6.3C	0601	Alarm 6.12C	0637
Alarm 4.9D	0530	Alarm 5.6D	0566	Alarm 6.3D	0602	Alarm 6.12D	0638

Table B.4 Alarm Acknowledge States (Continued)

Read Access: Always reads '0'		Write Access: 0 = No effect 1 = Activate	
Title	Modbus Coil	Title	Modbus Coil
Operator Message 1	0651	Operator Message 13	0663
Operator Message 2	0652	Operator Message 14	0664
Operator Message 3	0653	Operator Message 15	0665
Operator Message 4	0654	Operator Message 16	0666
Operator Message 5	0655	Operator Message 17	0667
Operator Message 6	0656	Operator Message 18	0668
Operator Message 7	0657	Operator Message 19	0669
Operator Message 8	0658	Operator Message 20	0670
Operator Message 9	0659	Operator Message 21	0671
Operator Message 10	0660	Operator Message 22	0672
Operator Message 11	0661	Operator Message 23	0673
Operator Message 12	0662	Operator Message 24	0674

Table B.5 Operator Messages

Read Only 0 = Output or Input Inactive 1 = Output or Input Active							
Modbus Coil Numbers							
Channel	Digital Inputs	Digital Outputs	Relay Outputs	Channel	Digital Inputs	Digital Outputs	Relay Outputs
A1	0701	0751	0801	E1	0725	0775	0825
A2	0702	0752	0802	E2	0726	0776	0826
A3	0703	0753	0803	E3	0727	0777	0827
A4	0704	0754	0804	E4	0728	0778	0828
A5	0705	0755	0805	E5	0729	0779	0829
A6	0706	0756	0806	E6	0730	0780	0830
B1	0707	0757	0807	F1	0731	0781	0831
B2	0708	0758	0808	F2	0732	0782	0832
B3	0709	0759	0809	F3	0733	0783	0833
B4	0710	0760	0810	F4	0734	0784	0834
B5	0711	0761	0811	F5	0735	0785	0835
B6	0712	0762	0812	F6	0736	0786	0836
C1	0713	0763	0813	G1	0737	0787	0837
C2	0714	0764	0814	G2	0738	0788	0838
C3	0715	0765	0815	G3	0739	0789	0839
C4	0716	0766	0816	G4	0740	0790	0840
C5	0717	0767	0817	G5	0741	0791	0841
C6	0718	0768	0818	G6	0742	0792	0842
D1	0719	0769	0819	H1	0743	0793	0843
D2	0720	0770	0820	H2	0744	0794	0844
D3	0721	0771	0821	H3	0745	0795	0845
D4	0722	0772	0822	H4	0746	0796	0846
D5	0723	0773	0823	H5	0747	0797	0847
D6	0724	0774	0824	H6	0748	0798	0848

Table B.6 Digital I/O States

Read Access				Write Access			
0 = Stopped				0 = Stop			
1 = Running				1 = Go			
Title	Modbus Coil	Title	Modbus Coil	Title	Modbus Coil	Title	Modbus Coil
Totalizer 1.1A	0851	Totalizer 2.7A	0887	Totalizer 4.1A	0923	Totalizer 5.7A	0959
Totalizer 1.1B	0852	Totalizer 2.7B	0888	Totalizer 4.1B	0924	Totalizer 5.7B	0960
Totalizer 1.2A	0853	Totalizer 2.8A	0889	Totalizer 4.2A	0925	Totalizer 5.8A	0961
Totalizer 1.2B	0854	Totalizer 2.8B	0890	Totalizer 4.2B	0926	Totalizer 5.8B	0962
Totalizer 1.3A	0855	Totalizer 2.9A	0891	Totalizer 4.3A	0927	Totalizer 5.9A	0963
Totalizer 1.3B	0856	Totalizer 2.9B	0892	Totalizer 4.3B	0928	Totalizer 5.9B	0964
Totalizer 1.4A	0857	Totalizer 2.10A	0893	Totalizer 4.4A	0929	Totalizer 5.10A	0965
Totalizer 1.4B	0858	Totalizer 2.10B	0894	Totalizer 4.4B	0930	Totalizer 5.10B	0966
Totalizer 1.5A	0859	Totalizer 2.11A	0895	Totalizer 4.5A	0931	Totalizer 5.11A	0967
Totalizer 1.5B	0860	Totalizer 2.11B	0896	Totalizer 4.5B	0932	Totalizer 5.11B	0968
Totalizer 1.6A	0861	Totalizer 2.12A	0897	Totalizer 4.6A	0933	Totalizer 5.12A	0969
Totalizer 1.6B	0862	Totalizer 2.12B	0898	Totalizer 4.6B	0934	Totalizer 5.12B	0970
Totalizer 1.7A	0863	Totalizer 3.1A	0899	Totalizer 4.7A	0935	Totalizer 6.1A	0971
Totalizer 1.7B	0864	Totalizer 3.1B	0900	Totalizer 4.7B	0936	Totalizer 6.1B	0972
Totalizer 1.8A	0865	Totalizer 3.2A	0901	Totalizer 4.8A	0937	Totalizer 6.2A	0973
Totalizer 1.8B	0866	Totalizer 3.2B	0902	Totalizer 4.8B	0938	Totalizer 6.2B	0974
Totalizer 1.9A	0867	Totalizer 3.3A	0903	Totalizer 4.9A	0939	Totalizer 6.3A	0975
Totalizer 1.9B	0868	Totalizer 3.3B	0904	Totalizer 4.9B	0940	Totalizer 6.3B	0976
Totalizer 1.10A	0869	Totalizer 3.4A	0905	Totalizer 4.10A	0941	Totalizer 6.4A	0977
Totalizer 1.10B	0870	Totalizer 3.4B	0906	Totalizer 4.10B	0942	Totalizer 6.4B	0978
Totalizer 1.11A	0871	Totalizer 3.5A	0907	Totalizer 4.11A	0943	Totalizer 6.5A	0979
Totalizer 1.11B	0872	Totalizer 3.5B	0908	Totalizer 4.11B	0944	Totalizer 6.5B	0980
Totalizer 1.12A	0873	Totalizer 3.6A	0909	Totalizer 4.12A	0945	Totalizer 6.6A	0981
Totalizer 1.12B	0874	Totalizer 3.6B	0910	Totalizer 4.12B	0946	Totalizer 6.6B	0982
Totalizer 2.1A	0875	Totalizer 3.7A	0911	Totalizer 5.1A	0947	Totalizer 6.7A	0983
Totalizer 2.1B	0876	Totalizer 3.7B	0912	Totalizer 5.1B	0948	Totalizer 6.7B	0984
Totalizer 2.2A	0877	Totalizer 3.8A	0913	Totalizer 5.2A	0949	Totalizer 6.8A	0985
Totalizer 2.2B	0878	Totalizer 3.8B	0914	Totalizer 5.2B	0950	Totalizer 6.8B	0986
Totalizer 2.3A	0879	Totalizer 3.9A	0915	Totalizer 5.3A	0951	Totalizer 6.9A	0987
Totalizer 2.3B	0880	Totalizer 3.9B	0916	Totalizer 5.3B	0952	Totalizer 6.9B	0988
Totalizer 2.4A	0881	Totalizer 3.10A	0917	Totalizer 5.4A	0953	Totalizer 6.10A	0989
Totalizer 2.4B	0882	Totalizer 3.10B	0918	Totalizer 5.4B	0954	Totalizer 6.10B	0990
Totalizer 2.5A	0883	Totalizer 3.11A	0919	Totalizer 5.5A	0955	Totalizer 6.11A	0991
Totalizer 2.5B	0884	Totalizer 3.11B	0920	Totalizer 5.5B	0956	Totalizer 6.11B	0992
Totalizer 2.6A	0885	Totalizer 3.12A	0921	Totalizer 5.6A	0957	Totalizer 6.12A	0993
Totalizer 2.6B	0886	Totalizer 3.12B	0922	Totalizer 5.6B	0958	Totalizer 6.12B	0994

Table B.7 Totalizer Stop/Go

Read Access				Write Access			
0 = > 2s since last reset				0 = No effect			
1 = < 2s since last reset				1 = Reset			
Title	Modbus Coil	Title	Modbus Coil	Title	Modbus Coil	Title	Modbus Coil
Totalizer 1.1A	1001	Totalizer 2.7A	1037	Totalizer 4.1A	1073	Totalizer 5.7A	1109
Totalizer 1.1B	1002	Totalizer 2.7B	1038	Totalizer 4.1B	1074	Totalizer 5.7B	1110
Totalizer 1.2A	1003	Totalizer 2.8A	1039	Totalizer 4.2A	1075	Totalizer 5.8A	1111
Totalizer 1.2B	1004	Totalizer 2.8B	1040	Totalizer 4.2B	1076	Totalizer 5.8B	1112
Totalizer 1.3A	1005	Totalizer 2.9A	1041	Totalizer 4.3A	1077	Totalizer 5.9A	1113
Totalizer 1.3B	1006	Totalizer 2.9B	1042	Totalizer 4.3B	1078	Totalizer 5.9B	1114
Totalizer 1.4A	1007	Totalizer 2.10A	1043	Totalizer 4.4A	1079	Totalizer 5.10A	1115
Totalizer 1.4B	1008	Totalizer 2.10B	1044	Totalizer 4.4B	1080	Totalizer 5.10B	1116
Totalizer 1.5A	1009	Totalizer 2.11A	1045	Totalizer 4.5A	1081	Totalizer 5.11A	1117
Totalizer 1.5B	1010	Totalizer 2.11B	1046	Totalizer 4.5B	1082	Totalizer 5.11B	1118
Totalizer 1.6A	1011	Totalizer 2.12A	1047	Totalizer 4.6A	1083	Totalizer 5.12A	1119
Totalizer 1.6B	1012	Totalizer 2.12B	1048	Totalizer 4.6B	1084	Totalizer 5.12B	1120
Totalizer 1.7A	1013	Totalizer 3.1A	1049	Totalizer 4.7A	1085	Totalizer 6.1A	1121
Totalizer 1.7B	1014	Totalizer 3.1B	1050	Totalizer 4.7B	1086	Totalizer 6.1B	1122
Totalizer 1.8A	1015	Totalizer 3.2A	1051	Totalizer 4.8A	1087	Totalizer 6.2A	1123
Totalizer 1.8B	1016	Totalizer 3.2B	1052	Totalizer 4.8B	1088	Totalizer 6.2B	1124
Totalizer 1.9A	1017	Totalizer 3.3A	1053	Totalizer 4.9A	1089	Totalizer 6.3A	1125
Totalizer 1.9B	1018	Totalizer 3.3B	1054	Totalizer 4.9B	1090	Totalizer 6.3B	1126
Totalizer 1.10A	1019	Totalizer 3.4A	1055	Totalizer 4.10A	1091	Totalizer 6.4A	1127
Totalizer 1.10B	1020	Totalizer 3.4B	1056	Totalizer 4.10B	1092	Totalizer 6.4B	1128
Totalizer 1.11A	1021	Totalizer 3.5A	1057	Totalizer 4.11A	1093	Totalizer 6.5A	1129
Totalizer 1.11B	1022	Totalizer 3.5B	1058	Totalizer 4.11B	1094	Totalizer 6.5B	1130
Totalizer 1.12A	1023	Totalizer 3.6A	1059	Totalizer 4.12A	1095	Totalizer 6.6A	1131
Totalizer 1.12B	1024	Totalizer 3.6B	1060	Totalizer 4.12B	1096	Totalizer 6.6B	1132
Totalizer 2.1A	1025	Totalizer 3.7A	1061	Totalizer 5.1A	1097	Totalizer 6.7A	1133
Totalizer 2.1B	1026	Totalizer 3.7B	1062	Totalizer 5.1B	1098	Totalizer 6.7B	1134
Totalizer 2.2A	1027	Totalizer 3.8A	1063	Totalizer 5.2A	1099	Totalizer 6.8A	1135
Totalizer 2.2B	1028	Totalizer 3.8B	1064	Totalizer 5.2B	1100	Totalizer 6.8B	1136
Totalizer 2.3A	1029	Totalizer 3.9A	1065	Totalizer 5.3A	1101	Totalizer 6.9A	1137
Totalizer 2.3B	1030	Totalizer 3.9B	1066	Totalizer 5.3B	1102	Totalizer 6.9B	1138
Totalizer 2.4A	1031	Totalizer 3.10A	1067	Totalizer 5.4A	1103	Totalizer 6.10A	1139
Totalizer 2.4B	1032	Totalizer 3.10B	1068	Totalizer 5.4B	1104	Totalizer 6.10B	1140
Totalizer 2.5A	1033	Totalizer 3.11A	1069	Totalizer 5.5A	1105	Totalizer 6.11A	1141
Totalizer 2.5B	1034	Totalizer 3.11B	1070	Totalizer 5.5B	1106	Totalizer 6.11B	1142
Totalizer 2.6A	1035	Totalizer 3.12A	1071	Totalizer 5.6A	1107	Totalizer 6.12A	1143
Totalizer 2.6B	1036	Totalizer 3.12B	1072	Totalizer 5.6B	1108	Totalizer 6.12B	1144

Table B.8 Totalizer Reset

Read Access				Write Access		Read only	
0 = Inactive							
1 = Active							
Title	Modbus Coil	Title	Modbus Coil	Title	Modbus Coil	Title	Modbus Coil
Totalizer 1.1A	1151	Totalizer 2.7A	1187	Totalizer 4.1A	1223	Totalizer 5.7A	1259
Totalizer 1.1B	1152	Totalizer 2.7B	1188	Totalizer 4.1B	1224	Totalizer 5.7B	1260
Totalizer 1.2A	1153	Totalizer 2.8A	1189	Totalizer 4.2A	1225	Totalizer 5.8A	1261
Totalizer 1.2B	1154	Totalizer 2.8B	1190	Totalizer 4.2B	1226	Totalizer 5.8B	1262
Totalizer 1.3A	1155	Totalizer 2.9A	1191	Totalizer 4.3A	1227	Totalizer 5.9A	1263
Totalizer 1.3B	1156	Totalizer 2.9B	1192	Totalizer 4.3B	1228	Totalizer 5.9B	1264
Totalizer 1.4A	1157	Totalizer 2.10A	1193	Totalizer 4.4A	1229	Totalizer 5.10A	1265
Totalizer 1.4B	1158	Totalizer 2.10B	1194	Totalizer 4.4B	1230	Totalizer 5.10B	1266
Totalizer 1.5A	1159	Totalizer 2.11A	1195	Totalizer 4.5A	1231	Totalizer 5.11A	1267
Totalizer 1.5B	1160	Totalizer 2.11B	1196	Totalizer 4.5B	1232	Totalizer 5.11B	1268
Totalizer 1.6A	1161	Totalizer 2.12A	1197	Totalizer 4.6A	1233	Totalizer 5.12A	1269
Totalizer 1.6B	1162	Totalizer 2.12B	1198	Totalizer 4.6B	1234	Totalizer 5.12B	1270
Totalizer 1.7A	1163	Totalizer 3.1A	1199	Totalizer 4.7A	1235	Totalizer 6.1A	1271
Totalizer 1.7B	1164	Totalizer 3.1B	1200	Totalizer 4.7B	1236	Totalizer 6.1B	1272
Totalizer 1.8A	1165	Totalizer 3.2A	1201	Totalizer 4.8A	1237	Totalizer 6.2A	1273
Totalizer 1.8B	1166	Totalizer 3.2B	1202	Totalizer 4.8B	1238	Totalizer 6.2B	1274
Totalizer 1.9A	1167	Totalizer 3.3A	1203	Totalizer 4.9A	1239	Totalizer 6.3A	1275
Totalizer 1.9B	1168	Totalizer 3.3B	1204	Totalizer 4.9B	1240	Totalizer 6.3B	1276
Totalizer 1.10A	1169	Totalizer 3.4A	1205	Totalizer 4.10A	1241	Totalizer 6.4A	1277
Totalizer 1.10B	1170	Totalizer 3.4B	1206	Totalizer 4.10B	1242	Totalizer 6.4B	1278
Totalizer 1.11A	1171	Totalizer 3.5A	1207	Totalizer 4.11A	1243	Totalizer 6.5A	1279
Totalizer 1.11B	1172	Totalizer 3.5B	1208	Totalizer 4.11B	1244	Totalizer 6.5B	1280
Totalizer 1.12A	1173	Totalizer 3.6A	1209	Totalizer 4.12A	1245	Totalizer 6.6A	1281
Totalizer 1.12B	1174	Totalizer 3.6B	1210	Totalizer 4.12B	1246	Totalizer 6.6B	1282
Totalizer 2.1A	1175	Totalizer 3.7A	1211	Totalizer 5.1A	1247	Totalizer 6.7A	1283
Totalizer 2.1B	1176	Totalizer 3.7B	1212	Totalizer 5.1B	1248	Totalizer 6.7B	1284
Totalizer 2.2A	1177	Totalizer 3.8A	1213	Totalizer 5.2A	1249	Totalizer 6.8A	1285
Totalizer 2.2B	1178	Totalizer 3.8B	1214	Totalizer 5.2B	1250	Totalizer 6.8B	1286
Totalizer 2.3A	1179	Totalizer 3.9A	1215	Totalizer 5.3A	1251	Totalizer 6.9A	1287
Totalizer 2.3B	1180	Totalizer 3.9B	1216	Totalizer 5.3B	1252	Totalizer 6.9B	1288
Totalizer 2.4A	1181	Totalizer 3.10A	1217	Totalizer 5.4A	1253	Totalizer 6.10A	1289
Totalizer 2.4B	1182	Totalizer 3.10B	1218	Totalizer 5.4B	1254	Totalizer 6.10B	1290
Totalizer 2.5A	1183	Totalizer 3.11A	1219	Totalizer 5.5A	1255	Totalizer 6.11A	1291
Totalizer 2.5B	1184	Totalizer 3.11B	1220	Totalizer 5.5B	1256	Totalizer 6.11B	1292
Totalizer 2.6A	1185	Totalizer 3.12A	1221	Totalizer 5.6A	1257	Totalizer 6.12A	1293
Totalizer 2.6B	1186	Totalizer 3.12B	1222	Totalizer 5.6B	1258	Totalizer 6.12B	1294

Table B.9 Totalizer Wrap

Read Access				Write Access		Read only	
0 = Inactive							
1 = Active							
Title	Modbus Coil	Title	Modbus Coil	Title	Modbus Coil	Title	Modbus Coil
Totalizer 1.1A	1301	Totalizer 2.7A	1337	Totalizer 4.1A	1373	Totalizer 5.7A	1409
Totalizer 1.1B	1302	Totalizer 2.7B	1338	Totalizer 4.1B	1374	Totalizer 5.7B	1410
Totalizer 1.2A	1303	Totalizer 2.8A	1339	Totalizer 4.2A	1375	Totalizer 5.8A	1411
Totalizer 1.2B	1304	Totalizer 2.8B	1340	Totalizer 4.2B	1376	Totalizer 5.8B	1412
Totalizer 1.3A	1305	Totalizer 2.9A	1341	Totalizer 4.3A	1377	Totalizer 5.9A	1413
Totalizer 1.3B	1306	Totalizer 2.9B	1342	Totalizer 4.3B	1378	Totalizer 5.9B	1414
Totalizer 1.4A	1307	Totalizer 2.10A	1343	Totalizer 4.4A	1379	Totalizer 5.10A	1415
Totalizer 1.4B	1308	Totalizer 2.10B	1344	Totalizer 4.4B	1380	Totalizer 5.10B	1416
Totalizer 1.5A	1309	Totalizer 2.11A	1345	Totalizer 4.5A	1381	Totalizer 5.11A	1417
Totalizer 1.5B	1310	Totalizer 2.11B	1346	Totalizer 4.5B	1382	Totalizer 5.11B	1418
Totalizer 1.6A	1311	Totalizer 2.12A	1347	Totalizer 4.6A	1383	Totalizer 5.12A	1419
Totalizer 1.6B	1312	Totalizer 2.12B	1348	Totalizer 4.6B	1384	Totalizer 5.12B	1420
Totalizer 1.7A	1313	Totalizer 3.1A	1349	Totalizer 4.7A	1385	Totalizer 6.1A	1421
Totalizer 1.7B	1314	Totalizer 3.1B	1350	Totalizer 4.7B	1386	Totalizer 6.1B	1422
Totalizer 1.8A	1315	Totalizer 3.2A	1351	Totalizer 4.8A	1387	Totalizer 6.2A	1423
Totalizer 1.8B	1316	Totalizer 3.2B	1352	Totalizer 4.8B	1388	Totalizer 6.2B	1424
Totalizer 1.9A	1317	Totalizer 3.3A	1353	Totalizer 4.9A	1389	Totalizer 6.3A	1425
Totalizer 1.9B	1318	Totalizer 3.3B	1354	Totalizer 4.9B	1390	Totalizer 6.3B	1426
Totalizer 1.10A	1319	Totalizer 3.4A	1355	Totalizer 4.10A	1391	Totalizer 6.4A	1427
Totalizer 1.10B	1320	Totalizer 3.4B	1356	Totalizer 4.10B	1392	Totalizer 6.4B	1428
Totalizer 1.11A	1321	Totalizer 3.5A	1357	Totalizer 4.11A	1393	Totalizer 6.5A	1429
Totalizer 1.11B	1322	Totalizer 3.5B	1358	Totalizer 4.11B	1394	Totalizer 6.5B	1430
Totalizer 1.12A	1323	Totalizer 3.6A	1359	Totalizer 4.12A	1395	Totalizer 6.6A	1431
Totalizer 1.12B	1324	Totalizer 3.6B	1360	Totalizer 4.12B	1396	Totalizer 6.6B	1432
Totalizer 2.1A	1325	Totalizer 3.7A	1361	Totalizer 5.1A	1397	Totalizer 6.7A	1433
Totalizer 2.1B	1326	Totalizer 3.7B	1362	Totalizer 5.1B	1398	Totalizer 6.7B	1434
Totalizer 2.2A	1327	Totalizer 3.8A	1363	Totalizer 5.2A	1399	Totalizer 6.8A	1435
Totalizer 2.2B	1328	Totalizer 3.8B	1364	Totalizer 5.2B	1400	Totalizer 6.8B	1436
Totalizer 2.3A	1329	Totalizer 3.9A	1365	Totalizer 5.3A	1401	Totalizer 6.9A	1437
Totalizer 2.3B	1330	Totalizer 3.9B	1366	Totalizer 5.3B	1402	Totalizer 6.9B	1438
Totalizer 2.4A	1331	Totalizer 3.10A	1367	Totalizer 5.4A	1403	Totalizer 6.10A	1439
Totalizer 2.4B	1332	Totalizer 3.10B	1368	Totalizer 5.4B	1404	Totalizer 6.10B	1440
Totalizer 2.5A	1333	Totalizer 3.11A	1369	Totalizer 5.5A	1405	Totalizer 6.11A	1441
Totalizer 2.5B	1334	Totalizer 3.11B	1370	Totalizer 5.5B	1406	Totalizer 6.11B	1442
Totalizer 2.6A	1335	Totalizer 3.12A	1371	Totalizer 5.6A	1407	Totalizer 6.12A	1443
Totalizer 2.6B	1336	Totalizer 3.12B	1372	Totalizer 5.6B	1408	Totalizer 6.12B	1444

Table B.10 Totalizer First Stage Output

Read Access				Write Access		Read only	
0 = OK							
1 = Failed							
Title	Modbus Coil	Title	Modbus Coil	Title	Modbus Coil	Title	Modbus Coil
Totalizer 1.1A	1451	Totalizer 2.7A	1487	Totalizer 4.1A	1523	Totalizer 5.7A	1559
Totalizer 1.1B	1452	Totalizer 2.7B	1488	Totalizer 4.1B	1524	Totalizer 5.7B	1560
Totalizer 1.2A	1453	Totalizer 2.8A	1489	Totalizer 4.2A	1525	Totalizer 5.8A	1561
Totalizer 1.2B	1454	Totalizer 2.8B	1490	Totalizer 4.2B	1526	Totalizer 5.8B	1562
Totalizer 1.3A	1455	Totalizer 2.9A	1491	Totalizer 4.3A	1527	Totalizer 5.9A	1563
Totalizer 1.3B	1456	Totalizer 2.9B	1492	Totalizer 4.3B	1528	Totalizer 5.9B	1564
Totalizer 1.4A	1457	Totalizer 2.10A	1493	Totalizer 4.4A	1529	Totalizer 5.10A	1565
Totalizer 1.4B	1458	Totalizer 2.10B	1494	Totalizer 4.4B	1530	Totalizer 5.10B	1566
Totalizer 1.5A	1459	Totalizer 2.11A	1495	Totalizer 4.5A	1531	Totalizer 5.11A	1567
Totalizer 1.5B	1460	Totalizer 2.11B	1496	Totalizer 4.5B	1532	Totalizer 5.11B	1568
Totalizer 1.6A	1461	Totalizer 2.12A	1497	Totalizer 4.6A	1533	Totalizer 5.12A	1569
Totalizer 1.6B	1462	Totalizer 2.12B	1498	Totalizer 4.6B	1534	Totalizer 5.12B	1570
Totalizer 1.7A	1463	Totalizer 3.1A	1499	Totalizer 4.7A	1535	Totalizer 6.1A	1571
Totalizer 1.7B	1464	Totalizer 3.1B	1500	Totalizer 4.7B	1536	Totalizer 6.1B	1572
Totalizer 1.8A	1465	Totalizer 3.2A	1501	Totalizer 4.8A	1537	Totalizer 6.2A	1573
Totalizer 1.8B	1466	Totalizer 3.2B	1502	Totalizer 4.8B	1538	Totalizer 6.2B	1574
Totalizer 1.9A	1467	Totalizer 3.3A	1503	Totalizer 4.9A	1539	Totalizer 6.3A	1575
Totalizer 1.9B	1468	Totalizer 3.3B	1504	Totalizer 4.9B	1540	Totalizer 6.3B	1576
Totalizer 1.10A	1469	Totalizer 3.4A	1505	Totalizer 4.10A	1541	Totalizer 6.4A	1577
Totalizer 1.10B	1470	Totalizer 3.4B	1506	Totalizer 4.10B	1542	Totalizer 6.4B	1578
Totalizer 1.11A	1471	Totalizer 3.5A	1507	Totalizer 4.11A	1543	Totalizer 6.5A	1579
Totalizer 1.11B	1472	Totalizer 3.5B	1508	Totalizer 4.11B	1544	Totalizer 6.5B	1580
Totalizer 1.12A	1473	Totalizer 3.6A	1509	Totalizer 4.12A	1545	Totalizer 6.6A	1581
Totalizer 1.12B	1474	Totalizer 3.6B	1510	Totalizer 4.12B	1546	Totalizer 6.6B	1582
Totalizer 2.1A	1475	Totalizer 3.7A	1511	Totalizer 5.1A	1547	Totalizer 6.7A	1583
Totalizer 2.1B	1476	Totalizer 3.7B	1512	Totalizer 5.1B	1548	Totalizer 6.7B	1584
Totalizer 2.2A	1477	Totalizer 3.8A	1513	Totalizer 5.2A	1549	Totalizer 6.8A	1585
Totalizer 2.2B	1478	Totalizer 3.8B	1514	Totalizer 5.2B	1550	Totalizer 6.8B	1586
Totalizer 2.3A	1479	Totalizer 3.9A	1515	Totalizer 5.3A	1551	Totalizer 6.9A	1587
Totalizer 2.3B	1480	Totalizer 3.9B	1516	Totalizer 5.3B	1552	Totalizer 6.9B	1588
Totalizer 2.4A	1481	Totalizer 3.10A	1517	Totalizer 5.4A	1553	Totalizer 6.10A	1589
Totalizer 2.4B	1482	Totalizer 3.10B	1518	Totalizer 5.4B	1554	Totalizer 6.10B	1590
Totalizer 2.5A	1483	Totalizer 3.11A	1519	Totalizer 5.5A	1555	Totalizer 6.11A	1591
Totalizer 2.5B	1484	Totalizer 3.11B	1520	Totalizer 5.5B	1556	Totalizer 6.11B	1592
Totalizer 2.6A	1485	Totalizer 3.12A	1521	Totalizer 5.6A	1557	Totalizer 6.12A	1593
Totalizer 2.6B	1486	Totalizer 3.12B	1522	Totalizer 5.6B	1558	Totalizer 6.12B	1594

Table B.11 Totalizer Flowrate Fail State

Signal		Channel Number											
		1.1	1.2	1.3	1.4	1.5	1.6	1.7	1.8	1.9	1.10	1.11	1.12
Analog i/p failure state	R	2001	2021	2041	2061	2081	2101	2121	2141	2161	2181	2201	2221
Alarm A state	R	2002	2022	2042	2062	2082	2102	2122	2142	2162	2182	2202	2222
Alarm B state	R	2003	2023	2043	2063	2083	2103	2123	2143	2163	2183	2203	2223
Alarm C state	R	2004	2024	2044	2064	2084	2104	2124	2144	2164	2184	2204	2224
Alarm D state	R	2005	2025	2045	2065	2085	2105	2125	2145	2165	2185	2205	2225
Alarm A acknowledge	R/W	2006	2026	2046	2066	2086	2106	2126	2146	2166	2186	2206	2226
Alarm B acknowledge	R/W	2007	2027	2047	2067	2087	2107	2127	2147	2167	2187	2207	2227
Alarm C acknowledge	R/W	2008	2028	2048	2068	2088	2108	2128	2148	2168	2188	2208	2228
Alarm D acknowledge	R/W	2009	2029	2049	2069	2089	2109	2129	2149	2169	2189	2209	2229
Totalizer A stop/go	R/W	2010	2030	2050	2070	2090	2110	2130	2150	2170	2190	2210	2230
Totalizer B stop/go	R/W	2011	2031	2051	2071	2091	2111	2131	2151	2171	2191	2211	2231
Totalizer A reset	R/W	2012	2032	2052	2072	2092	2112	2132	2152	2172	2192	2212	2232
Totalizer B reset	R/W	2013	2033	2053	2073	2093	2113	2133	2153	2173	2193	2213	2233
Totalizer A wrap	R	2014	2034	2054	2074	2094	2114	2134	2154	2174	2194	2214	2234
Totalizer B wrap	R	2015	2035	2055	2075	2095	2115	2135	2155	2175	2195	2215	2235
Totalizer A 1st stage	R	2016	2036	2056	2076	2096	2116	2136	2156	2176	2196	2216	2236
Totalizer B 1st stage	R	2017	2037	2057	2077	2097	2117	2137	2157	2177	2197	2217	2237
Totalizer A flowrate failure	R	2018	2038	2058	2078	2098	2118	2138	2158	2178	2198	2218	2238
Totalizer B flowrate failure	R	2019	2039	2059	2079	2099	2119	2139	2159	2179	2199	2219	2239

Table B.12 Channel Digital Signals (Process Group 1)

Signal		Channel Number											
		2.1	2.2	2.3	2.4	2.5	2.6	2.7	2.8	2.9	2.10	2.11	2.12
Analog i/p failure state	R	2241	2261	2281	2301	2321	2341	2361	2381	2401	2421	2441	2461
Alarm A state	R	2242	2262	2282	2302	2322	2342	2362	2382	2402	2422	2442	2462
Alarm B state	R	2243	2263	2283	2303	2323	2343	2363	2383	2403	2423	2443	2463
Alarm C state	R	2244	2264	2284	2304	2324	2344	2364	2384	2404	2424	2444	2464
Alarm D state	R	2245	2265	2285	2305	2325	2345	2365	2385	2405	2425	2445	2465
Alarm A acknowledge	R/W	2246	2266	2286	2306	2326	2346	2366	2386	2406	2426	2446	2466
Alarm B acknowledge	R/W	2247	2267	2287	2307	2327	2347	2367	2387	2407	2427	2447	2467
Alarm C acknowledge	R/W	2248	2268	2288	2308	2328	2348	2368	2388	2408	2428	2448	2468
Alarm D acknowledge	R/W	2249	2269	2289	2309	2329	2349	2369	2389	2409	2429	2449	2469
Totalizer A stop/go	R/W	2250	2270	2290	2310	2330	2350	2370	2390	2410	2430	2450	2470
Totalizer B stop/go	R/W	2251	2271	2291	2311	2331	2351	2371	2391	2411	2431	2451	2471
Totalizer A reset	R/W	2252	2272	2292	2312	2332	2352	2372	2392	2412	2432	2452	2472
Totalizer B reset	R/W	2253	2273	2293	2313	2333	2353	2373	2393	2413	2433	2453	2473
Totalizer A wrap	R	2254	2274	2294	2314	2334	2354	2374	2394	2414	2434	2454	2474
Totalizer B wrap	R	2255	2275	2295	2315	2335	2355	2375	2395	2415	2435	2455	2475
Totalizer A 1st stage	R	2256	2276	2296	2316	2336	2356	2376	2396	2416	2436	2456	2476
Totalizer B 1st stage	R	2257	2277	2297	2317	2337	2357	2377	2397	2417	2437	2457	2477
Totalizer A flowrate failure	R	2258	2278	2298	2318	2338	2358	2378	2398	2418	2438	2458	2478
Totalizer B flowrate failure	R	2259	2279	2299	2319	2339	2359	2379	2399	2419	2439	2459	2479

Table B.13 Channel Digital Signals (Process Group 2)

Signal		Channel Number											
		3.1	3.2	3.3	3.4	3.5	3.6	3.7	3.8	3.9	3.10	3.11	3.12
Analog i/p failure state	R	2481	2501	2521	2541	2561	2581	2601	2621	2641	2661	2681	2701
Alarm A state	R	2482	2502	2522	2542	2562	2582	2602	2622	2642	2662	2682	2702
Alarm B state	R	2483	2503	2523	2543	2563	2583	2603	2623	2643	2663	2683	2703
Alarm C state	R	2484	2504	2524	2544	2564	2584	2604	2624	2644	2664	2684	2704
Alarm D state	R	2485	2505	2525	2545	2565	2585	2605	2625	2645	2665	2685	2705
Alarm A acknowledge	R/W	2486	2506	2526	2546	2566	2586	2606	2626	2646	2666	2686	2706
Alarm B acknowledge	R/W	2487	2507	2527	2547	2567	2587	2607	2627	2647	2667	2687	2707
Alarm C acknowledge	R/W	2488	2508	2528	2548	2568	2588	2608	2628	2648	2668	2688	2708
Alarm D acknowledge	R/W	2489	2509	2529	2549	2569	2589	2609	2629	2649	2669	2689	2709
Totalizer A stop/go	R/W	2490	2510	2530	2550	2570	2590	2610	2630	2650	2670	2690	2710
Totalizer B stop/go	R/W	2491	2511	2531	2551	2571	2591	2611	2631	2651	2671	2691	2711
Totalizer A reset	R/W	2492	2512	2532	2552	2572	2592	2612	2632	2652	2672	2692	2712
Totalizer B reset	R/W	2493	2513	2533	2553	2573	2593	2613	2633	2653	2673	2693	2713
Totalizer A wrap	R	2494	2514	2534	2554	2574	2594	2614	2634	2654	2674	2694	2714
Totalizer B wrap	R	2495	2515	2535	2555	2575	2595	2615	2635	2655	2675	2695	2715
Totalizer A 1st stage	R	2496	2516	2536	2556	2576	2596	2616	2636	2656	2676	2696	2716
Totalizer B 1st stage	R	2497	2517	2537	2557	2577	2597	2617	2637	2657	2677	2697	2717
Totalizer A flowrate failure	R	2498	2518	2538	2558	2578	2598	2618	2638	2658	2678	2698	2718
Totalizer B flowrate failure	R	2499	2519	2539	2559	2579	2599	2619	2639	2659	2679	2699	2719

Table B.14 Channel Digital Signals (Process Group 3)

Signal		Channel Number											
		4.1	4.2	4.3	4.4	4.5	4.6	4.7	4.8	4.9	4.10	4.11	4.12
Analog i/p failure state	R	2721	2741	2761	2781	2801	2821	2841	2861	2881	2901	2921	2941
Alarm A state	R	2722	2742	2762	2782	2802	2822	2842	2862	2882	2902	2922	2942
Alarm B state	R	2723	2743	2763	2783	2803	2823	2843	2863	2883	2903	2923	2943
Alarm C state	R	2724	2744	2764	2784	2804	2824	2844	2864	2884	2904	2924	2944
Alarm D state	R	2725	2745	2765	2785	2805	2825	2845	2865	2885	2905	2925	2945
Alarm A acknowledge	R/W	2726	2746	2766	2786	2806	2826	2846	2866	2886	2906	2926	2946
Alarm B acknowledge	R/W	2727	2747	2767	2787	2807	2827	2847	2867	2887	2907	2927	2947
Alarm C acknowledge	R/W	2728	2748	2768	2788	2808	2828	2848	2868	2888	2908	2928	2948
Alarm D acknowledge	R/W	2729	2749	2769	2789	2809	2829	2849	2869	2889	2909	2929	2949
Totalizer A stop/go	R/W	2730	2750	2770	2790	2810	2830	2850	2870	2890	2910	2930	2950
Totalizer B stop/go	R/W	2731	2751	2771	2791	2811	2831	2851	2871	2891	2911	2931	2951
Totalizer A reset	R/W	2732	2752	2772	2792	2812	2832	2852	2872	2892	2912	2932	2952
Totalizer B reset	R/W	2733	2753	2773	2793	2813	2833	2853	2873	2893	2913	2933	2953
Totalizer A wrap	R	2734	2754	2774	2794	2814	2834	2854	2874	2894	2914	2934	2954
Totalizer B wrap	R	2735	2755	2775	2795	2815	2835	2855	2875	2895	2915	2935	2955
Totalizer A 1st stage	R	2736	2756	2776	2796	2816	2836	2856	2876	2896	2916	2936	2956
Totalizer B 1st stage	R	2737	2757	2777	2797	2817	2837	2857	2877	2897	2917	2937	2957
Totalizer A flowrate failure	R	2738	2758	2778	2798	2818	2838	2858	2878	2898	2918	2938	2958
Totalizer B flowrate failure	R	2739	2759	2779	2799	2819	2839	2859	2879	2899	2919	2939	2959

Table B.15 Channel Digital Signals (Process Group 4)

Signal		Channel Number											
		5.1	5.2	5.3	5.4	5.5	5.6	5.7	5.8	5.9	5.10	5.11	5.12
Analog i/p failure state	R	2961	2981	3001	3021	3041	3061	3081	3101	3121	3141	3161	3181
Alarm A state	R	2962	2982	3002	3022	3042	3062	3082	3102	3122	3142	3162	3182
Alarm B state	R	2963	2983	3003	3023	3043	3063	3083	3103	3123	3143	3163	3183
Alarm C state	R	2964	2984	3004	3024	3044	3064	3084	3104	3124	3144	3164	3184
Alarm D state	R	2965	2985	3005	3025	3045	3065	3085	3105	3125	3145	3165	3185
Alarm A acknowledge	R/W	2966	2986	3006	3026	3046	3066	3086	3106	3126	3146	3166	3186
Alarm B acknowledge	R/W	2967	2987	3007	3027	3047	3067	3087	3107	3127	3147	3167	3187
Alarm C acknowledge	R/W	2968	2988	3008	3028	3048	3068	3088	3108	3128	3148	3168	3188
Alarm D acknowledge	R/W	2969	2989	3009	3029	3049	3069	3089	3109	3129	3149	3169	3189
Totalizer A stop/go	R/W	2970	2990	3010	3030	3050	3070	3090	3110	3130	3150	3170	3190
Totalizer B stop/go	R/W	2971	2991	3011	3031	3051	3071	3091	3111	3131	3151	3171	3191
Totalizer A reset	R/W	2972	2992	3012	3032	3052	3072	3092	3112	3132	3152	3172	3192
Totalizer B reset	R/W	2973	2993	3013	3033	3053	3073	3093	3113	3133	3153	3173	3193
Totalizer A wrap	R	2974	2994	3014	3034	3054	3074	3094	3114	3134	3154	3174	3194
Totalizer B wrap	R	2975	2995	3015	3035	3055	3075	3095	3115	3135	3155	3175	3195
Totalizer A 1st stage	R	2976	2996	3016	3036	3056	3076	3096	3116	3136	3156	3176	3196
Totalizer B 1st stage	R	2977	2997	3017	3037	3057	3077	3097	3117	3137	3157	3177	3197
Totalizer A flowrate failure	R	2978	2998	3018	3038	3058	3078	3098	3118	3138	3158	3178	3198
Totalizer B flowrate failure	R	2979	2999	3019	3039	3059	3079	3099	3119	3139	3159	3179	3199

Table B.16 Channel Digital Signals (Process Group 5)

Signal		Channel Number											
		6.1	6.2	6.3	6.4	6.5	6.6	6.7	6.8	6.9	6.10	6.11	6.12
Analog i/p failure state	R	3201	3221	3241	3261	3281	3301	3321	3341	3361	3381	3401	3421
Alarm A state	R	3202	3222	3242	3262	3282	3302	3322	3342	3362	3382	3402	3422
Alarm B state	R	3203	3223	3243	3263	3283	3303	3323	3343	3363	3383	3403	3423
Alarm C state	R	3204	3224	3244	3264	3284	3304	3324	3344	3364	3384	3404	3424
Alarm D state	R	3205	3225	3245	3265	3285	3305	3325	3345	3365	3385	3405	3425
Alarm A acknowledge	R/W	3206	3226	3246	3266	3286	3306	3326	3346	3366	3386	3406	3426
Alarm B acknowledge	R/W	3207	3227	3247	3267	3287	3307	3327	3347	3367	3387	3407	3427
Alarm C acknowledge	R/W	3208	3228	3248	3268	3288	3308	3328	3348	3368	3388	3408	3428
Alarm D acknowledge	R/W	3209	3229	3249	3269	3289	3309	3329	3349	3369	3389	3409	3429
Totalizer A stop/go	R/W	3210	3230	3250	3270	3290	3310	3330	3350	3370	3390	3410	3430
Totalizer B stop/go	R/W	3211	3231	3251	3271	3291	3311	3331	3351	3371	3391	3411	3431
Totalizer A reset	R/W	3212	3232	3252	3272	3292	3312	3332	3352	3372	3392	3412	3432
Totalizer B reset	R/W	3213	3233	3253	3273	3293	3313	3333	3353	3373	3393	3413	3433
Totalizer A wrap	R	3214	3234	3254	3274	3294	3314	3334	3354	3374	3394	3414	3434
Totalizer B wrap	R	3215	3235	3255	3275	3295	3315	3335	3355	3375	3395	3415	3435
Totalizer A 1st stage	R	3216	3236	3256	3276	3296	3316	3336	3356	3376	3396	3416	3436
Totalizer B 1st stage	R	3217	3237	3257	3277	3297	3317	3337	3357	3377	3397	3417	3437
Totalizer A flowrate failure	R	3218	3238	3258	3278	3298	3318	3338	3358	3378	3398	3418	3438
Totalizer B flowrate failure	R	3219	3239	3259	3279	3299	3319	3339	3359	3379	3399	3419	3439

Table B.17 Channel Digital Signals (Process Group 6)

B.4.2 Operating Mode Modbus Registers

Tables B.18 to B.39 detail the contents of the Modbus registers accessible while the instrument is in the operating mode.

Two data types are used:

- n 32-bit single precision floating point data in IEEE format
- n 64-bit double precision floating point data in IEEE format

Note. When writing to a parameter that occupies more than one register position then all registers relating to that parameter **MUST** be written to as part of a multiple register write. If this is not achieved a NAK exception response is issued. Individual registers can be read without causing an exception response.

When accessing a parameter that occupies more than one register position, the lowest numbered register contains the most significant data.

Analog Inputs	Modbus Registers
	Read only, 32-bit single precision floating point
A1	0001 and 0002
A2	0003 and 0004
A3	0005 and 0006
A4	0007 and 0008
A5	0009 and 0010
A6	0011 and 0012
B1	0013 and 0014
B2	0015 and 0016
B3	0017 and 0018
B4	0019 and 0020
B5	0021 and 0022
B6	0023 and 0024
C1	0025 and 0026
C2	0027 and 0028
C3	0029 and 0030
C4	0031 and 0032
C5	0033 and 0034
C6	0035 and 0036
D1	0037 and 0038
D2	0039 and 0040
D3	0041 and 0042
D4	0043 and 0044
D5	0045 and 0046
D6	0047 and 0048
E1	0049 and 0050
E2	0051 and 0052
E3	0053 and 0054
E4	0055 and 0056
E5	0057 and 0058
E6	0059 and 0060
F1	0061 and 0062
F2	0063 and 0064
F3	0065 and 0066
F4	0067 and 0068
F5	0069 and 0070
F6	0071 and 0072

Table B.18 Analog Inputs

32-bit single precision floating point				Read: -999 to 9999			
				Write: -999 to 9999			
Alarm Name	Trip Point Registers	Alarm Name	Trip Point Registers	Alarm Name	Trip Point Registers	Alarm Name	Trip Point Registers
Alarm 1.1A	0101 and 0102	Alarm 1.10A	0173 and 0174	Alarm 2.7A	0245 and 0246	Alarm 3.4A	0317 and 0318
Alarm 1.1B	0103 and 0104	Alarm 1.10B	0175 and 0176	Alarm 2.7B	0247 and 0248	Alarm 3.4B	0319 and 0320
Alarm 1.1C	0105 and 0106	Alarm 1.10C	0177 and 0178	Alarm 2.7C	0249 and 0250	Alarm 3.4C	0321 and 0322
Alarm 1.1D	0107 and 0108	Alarm 1.10D	0179 and 0180	Alarm 2.7D	0251 and 0252	Alarm 3.4D	0323 and 0324
Alarm 1.2A	0109 and 0110	Alarm 1.11A	0181 and 0182	Alarm 2.8A	0253 and 0254	Alarm 3.5A	0325 and 0326
Alarm 1.2B	0111 and 0112	Alarm 1.11B	0183 and 0184	Alarm 2.8B	0255 and 0256	Alarm 3.5B	0327 and 0328
Alarm 1.2C	0113 and 0114	Alarm 1.11C	0185 and 0186	Alarm 2.8C	0257 and 0258	Alarm 3.5C	0329 and 0330
Alarm 1.2D	0115 and 0116	Alarm 1.11D	0187 and 0188	Alarm 2.8D	0259 and 0260	Alarm 3.5D	0331 and 0332
Alarm 1.3A	0117 and 0118	Alarm 1.12A	0189 and 0190	Alarm 2.9A	0261 and 0262	Alarm 3.6A	0333 and 0334
Alarm 1.3B	0119 and 0120	Alarm 1.12B	0191 and 0192	Alarm 2.9B	0263 and 0264	Alarm 3.6B	0335 and 0336
Alarm 1.3C	0121 and 0122	Alarm 1.12C	0193 and 0194	Alarm 2.9C	0265 and 0266	Alarm 3.6C	0337 and 0338
Alarm 1.3D	0123 and 0124	Alarm 1.12D	0195 and 0196	Alarm 2.9D	0267 and 0268	Alarm 3.6D	0339 and 0340
Alarm 1.4A	0125 and 0126	Alarm 2.1A	0197 and 0198	Alarm 2.10A	0269 and 0270	Alarm 3.7A	0341 and 0342
Alarm 1.4B	0127 and 0128	Alarm 2.1B	0199 and 0200	Alarm 2.10B	0271 and 0272	Alarm 3.7B	0343 and 0344
Alarm 1.4C	0129 and 0130	Alarm 2.1C	0201 and 0202	Alarm 2.10C	0273 and 0274	Alarm 3.7C	0345 and 0346
Alarm 1.4D	0131 and 0132	Alarm 2.1D	0203 and 0204	Alarm 2.10D	0275 and 0276	Alarm 3.7D	0347 and 0348
Alarm 1.5A	0133 and 0134	Alarm 2.2A	0205 and 0206	Alarm 2.11A	0277 and 0278	Alarm 3.8A	0349 and 0350
Alarm 1.5B	0135 and 0136	Alarm 2.2B	0207 and 0208	Alarm 2.11B	0279 and 0280	Alarm 3.8B	0351 and 0352
Alarm 1.5C	0137 and 0138	Alarm 2.2C	0209 and 0210	Alarm 2.11C	0281 and 0282	Alarm 3.8C	0353 and 0354
Alarm 1.5D	0139 and 0140	Alarm 2.2D	0211 and 0212	Alarm 2.11D	0283 and 0284	Alarm 3.8D	0355 and 0356
Alarm 1.6A	0141 and 0142	Alarm 2.3A	0213 and 0214	Alarm 2.12A	0285 and 0286	Alarm 3.9A	0357 and 0358
Alarm 1.6B	0143 and 0144	Alarm 2.3B	0215 and 0216	Alarm 2.12B	0287 and 0288	Alarm 3.9B	0359 and 0360
Alarm 1.6C	0145 and 0146	Alarm 2.3C	0217 and 0218	Alarm 2.12C	0289 and 0290	Alarm 3.9C	0361 and 0362
Alarm 1.6D	0147 and 0148	Alarm 2.3D	0219 and 0220	Alarm 2.12D	0291 and 0292	Alarm 3.9D	0363 and 0364
Alarm 1.7A	0149 and 0150	Alarm 2.4A	0221 and 0222	Alarm 3.1A	0293 and 0294	Alarm 3.10A	0365 and 0366
Alarm 1.7B	0151 and 0152	Alarm 2.4B	0223 and 0224	Alarm 3.1B	0295 and 0296	Alarm 3.10B	0367 and 0368
Alarm 1.7C	0153 and 0154	Alarm 2.4C	0225 and 0226	Alarm 3.1C	0297 and 0298	Alarm 3.10C	0369 and 0370
Alarm 1.7D	0155 and 0156	Alarm 2.4D	0227 and 0228	Alarm 3.1D	0299 and 0300	Alarm 3.10D	0371 and 0372
Alarm 1.8A	0157 and 0158	Alarm 2.5A	0229 and 0230	Alarm 3.2A	0301 and 0302	Alarm 3.11A	0373 and 0374
Alarm 1.8B	0159 and 0160	Alarm 2.5B	0231 and 0232	Alarm 3.2B	0303 and 0304	Alarm 3.11B	0375 and 0376
Alarm 1.8C	0161 and 0162	Alarm 2.5C	0233 and 0234	Alarm 3.2C	0305 and 0306	Alarm 3.11C	0377 and 0378
Alarm 1.8D	0163 and 0164	Alarm 2.5D	0235 and 0236	Alarm 3.2D	0307 and 0308	Alarm 3.11D	0379 and 0380
Alarm 1.9A	0165 and 0166	Alarm 2.6A	0237 and 0238	Alarm 3.3A	0309 and 0310	Alarm 3.12A	0381 and 0382
Alarm 1.9B	0167 and 0168	Alarm 2.6B	0239 and 0240	Alarm 3.3B	0311 and 0312	Alarm 3.12B	0383 and 0384
Alarm 1.9C	0169 and 0170	Alarm 2.6C	0241 and 0242	Alarm 3.3C	0313 and 0314	Alarm 3.12C	0385 and 0386
Alarm 1.9D	0171 and 0172	Alarm 2.6D	0243 and 0244	Alarm 3.3D	0315 and 0316	Alarm 3.12D	0387 and 0388

Table B.19 Alarm Trip Levels

32-bit single precision floating point				Read: –999 to 9999			
				Write: –999 to 9999			
Alarm Name	Trip Point Registers	Alarm Name	Trip Point Registers	Alarm Name	Trip Point Registers	Alarm Name	Trip Point Registers
Alarm 4.1A	0389 and 0390	Alarm 4.10A	0461 and 0462	Alarm 5.7A	0533 and 0534	Alarm 6.4A	0605 and 0606
Alarm 4.1B	0391 and 0392	Alarm 4.10B	0463 and 0464	Alarm 5.7B	0535 and 0536	Alarm 6.4B	0607 and 0608
Alarm 4.1C	0393 and 0394	Alarm 4.10C	0465 and 0466	Alarm 5.7C	0537 and 0538	Alarm 6.4C	0609 and 0610
Alarm 4.1D	0395 and 0396	Alarm 4.10D	0467 and 0468	Alarm 5.7D	0539 and 0540	Alarm 6.4D	0611 and 0612
Alarm 4.2A	0397 and 0398	Alarm 4.11A	0469 and 0470	Alarm 5.8A	0541 and 0542	Alarm 6.5A	0613 and 0614
Alarm 4.2B	0399 and 0400	Alarm 4.11B	0471 and 0472	Alarm 5.8B	0543 and 0544	Alarm 6.5B	0615 and 0616
Alarm 4.2C	0401 and 0402	Alarm 4.11C	0473 and 0474	Alarm 5.8C	0545 and 0546	Alarm 6.5C	0617 and 0618
Alarm 4.2D	0403 and 0404	Alarm 4.11D	0475 and 0476	Alarm 5.8D	0547 and 0548	Alarm 6.5D	0619 and 0620
Alarm 4.3A	0405 and 0406	Alarm 4.12A	0477 and 0478	Alarm 5.9A	0549 and 0550	Alarm 6.6A	0621 and 0622
Alarm 4.3B	0407 and 0408	Alarm 4.12B	0479 and 0480	Alarm 5.9B	0551 and 0552	Alarm 6.6B	0623 and 0624
Alarm 4.3C	0409 and 0410	Alarm 4.12C	0481 and 0482	Alarm 5.9C	0553 and 0554	Alarm 6.6C	0625 and 0626
Alarm 4.3D	0411 and 0412	Alarm 4.12D	0483 and 0484	Alarm 5.9D	0555 and 0556	Alarm 6.6D	0627 and 0628
Alarm 4.4A	0413 and 0414	Alarm 5.1A	0485 and 0486	Alarm 5.10A	0557 and 0558	Alarm 6.7A	0629 and 0630
Alarm 4.4B	0415 and 0416	Alarm 5.1B	0487 and 0488	Alarm 5.10B	0559 and 0560	Alarm 6.7B	0631 and 0632
Alarm 4.4C	0417 and 0418	Alarm 5.1C	0489 and 0490	Alarm 5.10C	0561 and 0562	Alarm 6.7C	0633 and 0634
Alarm 4.4D	0419 and 0420	Alarm 5.1D	0491 and 0492	Alarm 5.10D	0563 and 0564	Alarm 6.7D	0635 and 0636
Alarm 4.5A	0421 and 0422	Alarm 5.2A	0493 and 0494	Alarm 5.11A	0565 and 0566	Alarm 6.8A	0637 and 0638
Alarm 4.5B	0423 and 0424	Alarm 5.2B	0495 and 0496	Alarm 5.11B	0567 and 0568	Alarm 6.8B	0639 and 0640
Alarm 4.5C	0425 and 0426	Alarm 5.2C	0497 and 0498	Alarm 5.11C	0569 and 0570	Alarm 6.8C	0641 and 0642
Alarm 4.5D	0427 and 0428	Alarm 5.2D	0499 and 0500	Alarm 5.11D	0571 and 0572	Alarm 6.8D	0643 and 0644
Alarm 4.6A	0429 and 0430	Alarm 5.3A	0501 and 0502	Alarm 5.12A	0573 and 0574	Alarm 6.9A	0645 and 0646
Alarm 4.6B	0431 and 0432	Alarm 5.3B	0503 and 0504	Alarm 5.12B	0575 and 0576	Alarm 6.9B	0647 and 0648
Alarm 4.6C	0433 and 0434	Alarm 5.3C	0505 and 0506	Alarm 5.12C	0577 and 0578	Alarm 6.9C	0649 and 0650
Alarm 4.6D	0435 and 0436	Alarm 5.3D	0507 and 0508	Alarm 5.12D	0579 and 0580	Alarm 6.9D	0651 and 0652
Alarm 4.7A	0437 and 0438	Alarm 5.4A	0509 and 0510	Alarm 6.1A	0581 and 0582	Alarm 6.10A	0653 and 0654
Alarm 4.7B	0439 and 0440	Alarm 5.4B	0511 and 0512	Alarm 6.1B	0583 and 0584	Alarm 6.10B	0655 and 0656
Alarm 4.7C	0441 and 0442	Alarm 5.4C	0513 and 0514	Alarm 6.1C	0585 and 0586	Alarm 6.10C	0657 and 0658
Alarm 4.7D	0443 and 0444	Alarm 5.4D	0515 and 0516	Alarm 6.1D	0587 and 0588	Alarm 6.10D	0659 and 0660
Alarm 4.8A	0445 and 0446	Alarm 5.5A	0517 and 0518	Alarm 6.2A	0589 and 0590	Alarm 6.11A	0661 and 0662
Alarm 4.8B	0447 and 0448	Alarm 5.5B	0519 and 0520	Alarm 6.2B	0591 and 0592	Alarm 6.11B	0663 and 0664
Alarm 4.8C	0449 and 0450	Alarm 5.5C	0521 and 0522	Alarm 6.2C	0593 and 0594	Alarm 6.11C	0665 and 0666
Alarm 4.8D	0451 and 0452	Alarm 5.5D	0523 and 0524	Alarm 6.2D	0595 and 0596	Alarm 6.11D	0667 and 0668
Alarm 4.9A	0453 and 0454	Alarm 5.6A	0525 and 0526	Alarm 6.3A	0597 and 0598	Alarm 6.12A	0669 and 0670
Alarm 4.9B	0455 and 0456	Alarm 5.6B	0527 and 0528	Alarm 6.3B	0599 and 0600	Alarm 6.12B	0671 and 0672
Alarm 4.9C	0457 and 0458	Alarm 5.6C	0529 and 0530	Alarm 6.3C	0601 and 0602	Alarm 6.12C	0673 and 0674
Alarm 4.9D	0459 and 0460	Alarm 5.6D	0531 and 0532	Alarm 6.3D	0603 and 0604	Alarm 6.12D	0675 and 0676

Table B.19 Alarm Trip Levels (Continued)

Write Access: Read only		32-bit single precision floating point, -999 to 9999					
Totalizer Name	Modbus Registers	Totalizer Name	Modbus Registers	Totalizer Name	Modbus Registers	Totalizer Name	Modbus Registers
Totalizer 1.1A	0701 and 0702	Totalizer 2.7A	0773 and 0774	Totalizer 4.1A	0845 and 0846	Totalizer 5.7A	0917 and 0918
Totalizer 1.1B	0703 and 0704	Totalizer 2.7B	0775 and 0776	Totalizer 4.1B	0847 and 0848	Totalizer 5.7B	0919 and 0920
Totalizer 1.2A	0705 and 0706	Totalizer 2.8A	0777 and 0778	Totalizer 4.2A	0849 and 0850	Totalizer 5.8A	0921 and 0922
Totalizer 1.2B	0707 and 0708	Totalizer 2.8B	0779 and 0780	Totalizer 4.2B	0851 and 0852	Totalizer 5.8B	0923 and 0924
Totalizer 1.3A	0709 and 0710	Totalizer 2.9A	0781 and 0782	Totalizer 4.3A	0853 and 0854	Totalizer 5.9A	0925 and 0926
Totalizer 1.3B	0711 and 0712	Totalizer 2.9B	0783 and 0784	Totalizer 4.3B	0855 and 0856	Totalizer 5.9B	0927 and 0928
Totalizer 1.4A	0713 and 0714	Totalizer 2.10A	0785 and 0786	Totalizer 4.4A	0857 and 0858	Totalizer 5.10A	0929 and 0930
Totalizer 1.4B	0715 and 0716	Totalizer 2.10B	0787 and 0788	Totalizer 4.4B	0859 and 0860	Totalizer 5.10B	0931 and 0932
Totalizer 1.5A	0717 and 0718	Totalizer 2.11A	0789 and 0790	Totalizer 4.5A	0861 and 0862	Totalizer 5.11A	0933 and 0934
Totalizer 1.5B	0719 and 0720	Totalizer 2.11B	0791 and 0792	Totalizer 4.5B	0863 and 0864	Totalizer 5.11B	0935 and 0936
Totalizer 1.6A	0721 and 0722	Totalizer 2.12A	0793 and 0794	Totalizer 4.6A	0865 and 0866	Totalizer 5.12A	0937 and 0938
Totalizer 1.6B	0723 and 0724	Totalizer 2.12B	0795 and 0796	Totalizer 4.6B	0867 and 0868	Totalizer 5.12B	0939 and 0940
Totalizer 1.7A	0725 and 0726	Totalizer 3.1A	0797 and 0798	Totalizer 4.7A	0869 and 0870	Totalizer 6.1A	0941 and 0942
Totalizer 1.7B	0727 and 0728	Totalizer 3.1B	0799 and 0800	Totalizer 4.7B	0871 and 0872	Totalizer 6.1B	0943 and 0944
Totalizer 1.8A	0729 and 0730	Totalizer 3.2A	0801 and 0802	Totalizer 4.8A	0873 and 0874	Totalizer 6.2A	0945 and 0946
Totalizer 1.8B	0731 and 0732	Totalizer 3.2B	0803 and 0804	Totalizer 4.8B	0875 and 0876	Totalizer 6.2B	0947 and 0948
Totalizer 1.9A	0733 and 0734	Totalizer 3.3A	0805 and 0806	Totalizer 4.9A	0877 and 0878	Totalizer 6.3A	0949 and 0950
Totalizer 1.9B	0735 and 0736	Totalizer 3.3B	0807 and 0808	Totalizer 4.9B	0879 and 0880	Totalizer 6.3B	0951 and 0952
Totalizer 1.10A	0737 and 0738	Totalizer 3.4A	0809 and 0810	Totalizer 4.10A	0881 and 0882	Totalizer 6.4A	0953 and 0954
Totalizer 1.10B	0739 and 0740	Totalizer 3.4B	0811 and 0812	Totalizer 4.10B	0883 and 0884	Totalizer 6.4B	0955 and 0956
Totalizer 1.11A	0741 and 0742	Totalizer 3.5A	0813 and 0814	Totalizer 4.11A	0885 and 0886	Totalizer 6.5A	0957 and 0958
Totalizer 1.11B	0743 and 0744	Totalizer 3.5B	0815 and 0816	Totalizer 4.11B	0887 and 0888	Totalizer 6.5B	0959 and 0960
Totalizer 1.12A	0745 and 0746	Totalizer 3.6A	0817 and 0818	Totalizer 4.12A	0889 and 0890	Totalizer 6.6A	0961 and 0962
Totalizer 1.12B	0747 and 0748	Totalizer 3.6B	0819 and 0820	Totalizer 4.12B	0891 and 0892	Totalizer 6.6B	0963 and 0964
Totalizer 2.1A	0749 and 0750	Totalizer 3.7A	0821 and 0822	Totalizer 5.1A	0893 and 0894	Totalizer 6.7A	0965 and 0966
Totalizer 2.1B	0751 and 0752	Totalizer 3.7B	0823 and 0824	Totalizer 5.1B	0895 and 0896	Totalizer 6.7B	0967 and 0968
Totalizer 2.2A	0753 and 0754	Totalizer 3.8A	0825 and 0826	Totalizer 5.2A	0897 and 0898	Totalizer 6.8A	0969 and 0970
Totalizer 2.2B	0755 and 0756	Totalizer 3.8B	0827 and 0828	Totalizer 5.2B	0899 and 0900	Totalizer 6.8B	0971 and 0972
Totalizer 2.3A	0757 and 0758	Totalizer 3.9A	0829 and 0830	Totalizer 5.3A	0901 and 0902	Totalizer 6.9A	0973 and 0974
Totalizer 2.3B	0759 and 0760	Totalizer 3.9B	0831 and 0832	Totalizer 5.3B	0903 and 0904	Totalizer 6.9B	0975 and 0976
Totalizer 2.4A	0761 and 0762	Totalizer 3.10A	0833 and 0834	Totalizer 5.4A	0905 and 0906	Totalizer 6.10A	0977 and 0978
Totalizer 2.4B	0763 and 0764	Totalizer 3.10B	0835 and 0836	Totalizer 5.4B	0907 and 0908	Totalizer 6.10B	0979 and 0980
Totalizer 2.5A	0765 and 0766	Totalizer 3.11A	0837 and 0838	Totalizer 5.5A	0909 and 0910	Totalizer 6.11A	0981 and 0982
Totalizer 2.5B	0767 and 0768	Totalizer 3.11B	0839 and 0840	Totalizer 5.5B	0911 and 0912	Totalizer 6.11B	0983 and 0984
Totalizer 2.6A	0769 and 0770	Totalizer 3.12A	0841 and 0842	Totalizer 5.6A	0913 and 0914	Totalizer 6.12A	0985 and 0986
Totalizer 2.6B	0771 and 0772	Totalizer 3.12B	0843 and 0844	Totalizer 5.6B	0915 and 0916	Totalizer 6.12B	0987 and 0988

Table B.20 Totalizer Maximum Flowrate – Current Batch

Write Access: Read only		32-bit single precision floating point, -999 to 9999					
Totalizer Name	Modbus Registers	Totalizer Name	Modbus Registers	Totalizer Name	Modbus Registers	Totalizer Name	Modbus Registers
Totalizer 1.1A	1001 and 1002	Totalizer 2.7A	1073 and 1074	Totalizer 4.1A	1145 and 1146	Totalizer 5.7A	1217 and 1218
Totalizer 1.1B	1003 and 1004	Totalizer 2.7B	1075 and 1076	Totalizer 4.1B	1147 and 1148	Totalizer 5.7B	1219 and 1220
Totalizer 1.2A	1005 and 1006	Totalizer 2.8A	1077 and 1078	Totalizer 4.2A	1149 and 1150	Totalizer 5.8A	1221 and 1222
Totalizer 1.2B	1007 and 1008	Totalizer 2.8B	1079 and 1080	Totalizer 4.2B	1151 and 1152	Totalizer 5.8B	1223 and 1224
Totalizer 1.3A	1009 and 1010	Totalizer 2.9A	1081 and 1082	Totalizer 4.3A	1153 and 1154	Totalizer 5.9A	1225 and 1226
Totalizer 1.3B	1011 and 1012	Totalizer 2.9B	1083 and 1084	Totalizer 4.3B	1155 and 1156	Totalizer 5.9B	1227 and 1228
Totalizer 1.4A	1013 and 1014	Totalizer 2.10A	1085 and 1086	Totalizer 4.4A	1157 and 1158	Totalizer 5.10A	1229 and 1230
Totalizer 1.4B	1015 and 1016	Totalizer 2.10B	1087 and 1088	Totalizer 4.4B	1159 and 1160	Totalizer 5.10B	1231 and 1232
Totalizer 1.5A	1017 and 1018	Totalizer 2.11A	1089 and 1090	Totalizer 4.5A	1161 and 1162	Totalizer 5.11A	1233 and 1234
Totalizer 1.5B	1019 and 1020	Totalizer 2.11B	1091 and 1092	Totalizer 4.5B	1163 and 1164	Totalizer 5.11B	1235 and 1236
Totalizer 1.6A	1021 and 1022	Totalizer 2.12A	1093 and 1094	Totalizer 4.6A	1165 and 1166	Totalizer 5.12A	1237 and 1238
Totalizer 1.6B	1023 and 1024	Totalizer 2.12B	1095 and 1096	Totalizer 4.6B	1167 and 1168	Totalizer 5.12B	1239 and 1240
Totalizer 1.7A	1025 and 1026	Totalizer 3.1A	1097 and 1098	Totalizer 4.7A	1169 and 1170	Totalizer 6.1A	1241 and 1242
Totalizer 1.7B	1027 and 1028	Totalizer 3.1B	1099 and 1100	Totalizer 4.7B	1171 and 1172	Totalizer 6.1B	1243 and 1244
Totalizer 1.8A	1029 and 1030	Totalizer 3.2A	1101 and 1102	Totalizer 4.8A	1173 and 1174	Totalizer 6.2A	1245 and 1246
Totalizer 1.8B	1031 and 1032	Totalizer 3.2B	1103 and 1104	Totalizer 4.8B	1175 and 1176	Totalizer 6.2B	1247 and 1248
Totalizer 1.9A	1033 and 1034	Totalizer 3.3A	1105 and 1106	Totalizer 4.9A	1177 and 1178	Totalizer 6.3A	1249 and 1250
Totalizer 1.9B	1035 and 1036	Totalizer 3.3B	1107 and 1108	Totalizer 4.9B	1179 and 1180	Totalizer 6.3B	1251 and 1252
Totalizer 1.10A	1037 and 1038	Totalizer 3.4A	1109 and 1110	Totalizer 4.10A	1181 and 1182	Totalizer 6.4A	1253 and 1254
Totalizer 1.10B	1039 and 1040	Totalizer 3.4B	1111 and 1112	Totalizer 4.10B	1183 and 1184	Totalizer 6.4B	1255 and 1256
Totalizer 1.11A	1041 and 1042	Totalizer 3.5A	1113 and 1114	Totalizer 4.11A	1185 and 1186	Totalizer 6.5A	1257 and 1258
Totalizer 1.11B	1043 and 1044	Totalizer 3.5B	1115 and 1116	Totalizer 4.11B	1187 and 1188	Totalizer 6.5B	1259 and 1260
Totalizer 1.12A	1045 and 1046	Totalizer 3.6A	1117 and 1118	Totalizer 4.12A	1189 and 1190	Totalizer 6.6A	1261 and 1262
Totalizer 1.12B	1047 and 1048	Totalizer 3.6B	1119 and 1120	Totalizer 4.12B	1191 and 1192	Totalizer 6.6B	1263 and 1264
Totalizer 2.1A	1049 and 1050	Totalizer 3.7A	1121 and 1122	Totalizer 5.1A	1193 and 1194	Totalizer 6.7A	1265 and 1266
Totalizer 2.1B	1051 and 1052	Totalizer 3.7B	1123 and 1124	Totalizer 5.1B	1195 and 1196	Totalizer 6.7B	1267 and 1268
Totalizer 2.2A	1053 and 1054	Totalizer 3.8A	1125 and 1126	Totalizer 5.2A	1197 and 1198	Totalizer 6.8A	1269 and 1270
Totalizer 2.2B	1055 and 1056	Totalizer 3.8B	1127 and 1128	Totalizer 5.2B	1199 and 1200	Totalizer 6.8B	1271 and 1272
Totalizer 2.3A	1057 and 1058	Totalizer 3.9A	1129 and 1130	Totalizer 5.3A	1201 and 1202	Totalizer 6.9A	1273 and 1274
Totalizer 2.3B	1059 and 1060	Totalizer 3.9B	1131 and 1132	Totalizer 5.3B	1203 and 1204	Totalizer 6.9B	1275 and 1276
Totalizer 2.4A	1061 and 1062	Totalizer 3.10A	1133 and 1134	Totalizer 5.4A	1205 and 1206	Totalizer 6.10A	1277 and 1278
Totalizer 2.4B	1063 and 1064	Totalizer 3.10B	1135 and 1136	Totalizer 5.4B	1207 and 1208	Totalizer 6.10B	1279 and 1280
Totalizer 2.5A	1065 and 1066	Totalizer 3.11A	1137 and 1138	Totalizer 5.5A	1209 and 1210	Totalizer 6.11A	1281 and 1282
Totalizer 2.5B	1067 and 1068	Totalizer 3.11B	1139 and 1140	Totalizer 5.5B	1211 and 1212	Totalizer 6.11B	1283 and 1284
Totalizer 2.6A	1069 and 1070	Totalizer 3.12A	1141 and 1142	Totalizer 5.6A	1213 and 1214	Totalizer 6.12A	1285 and 1286
Totalizer 2.6B	1071 and 1072	Totalizer 3.12B	1143 and 1144	Totalizer 5.6B	1215 and 1216	Totalizer 6.12B	1287 and 1288

Table B.21 Totalizer Minimum Flowrate – Current Batch

Write Access: Read only		32-bit single precision floating point, -999 to 9999					
Totalizer Name	Modbus Registers	Totalizer Name	Modbus Registers	Totalizer Name	Modbus Registers	Totalizer Name	Modbus Registers
Totalizer 1.1A	1301 and 1302	Totalizer 2.7A	1373 and 1374	Totalizer 4.1A	1445 and 1446	Totalizer 5.7A	1517 and 1518
Totalizer 1.1B	1303 and 1304	Totalizer 2.7B	1375 and 1376	Totalizer 4.1B	1447 and 1448	Totalizer 5.7B	1519 and 1520
Totalizer 1.2A	1305 and 1306	Totalizer 2.8A	1377 and 1378	Totalizer 4.2A	1449 and 1450	Totalizer 5.8A	1521 and 1522
Totalizer 1.2B	1307 and 1308	Totalizer 2.8B	1379 and 1380	Totalizer 4.2B	1451 and 1452	Totalizer 5.8B	1523 and 1524
Totalizer 1.3A	1309 and 1310	Totalizer 2.9A	1381 and 1382	Totalizer 4.3A	1453 and 1454	Totalizer 5.9A	1525 and 1526
Totalizer 1.3B	1311 and 1312	Totalizer 2.9B	1383 and 1384	Totalizer 4.3B	1455 and 1456	Totalizer 5.9B	1527 and 1528
Totalizer 1.4A	1313 and 1314	Totalizer 2.10A	1385 and 1386	Totalizer 4.4A	1457 and 1458	Totalizer 5.10A	1529 and 1530
Totalizer 1.4B	1315 and 1316	Totalizer 2.10B	1387 and 1388	Totalizer 4.4B	1459 and 1460	Totalizer 5.10B	1531 and 1532
Totalizer 1.5A	1317 and 1318	Totalizer 2.11A	1389 and 1390	Totalizer 4.5A	1461 and 1462	Totalizer 5.11A	1533 and 1534
Totalizer 1.5B	1319 and 1320	Totalizer 2.11B	1391 and 1392	Totalizer 4.5B	1463 and 1464	Totalizer 5.11B	1535 and 1536
Totalizer 1.6A	1321 and 1322	Totalizer 2.12A	1393 and 1394	Totalizer 4.6A	1465 and 1466	Totalizer 5.12A	1537 and 1538
Totalizer 1.6B	1323 and 1324	Totalizer 2.12B	1395 and 1396	Totalizer 4.6B	1467 and 1468	Totalizer 5.12B	1539 and 1540
Totalizer 1.7A	1325 and 1326	Totalizer 3.1A	1397 and 1398	Totalizer 4.7A	1469 and 1470	Totalizer 6.1A	1541 and 1542
Totalizer 1.7B	1327 and 1328	Totalizer 3.1B	1399 and 1400	Totalizer 4.7B	1471 and 1472	Totalizer 6.1B	1543 and 1544
Totalizer 1.8A	1329 and 1330	Totalizer 3.2A	1401 and 1402	Totalizer 4.8A	1473 and 1474	Totalizer 6.2A	1545 and 1546
Totalizer 1.8B	1331 and 1332	Totalizer 3.2B	1403 and 1404	Totalizer 4.8B	1475 and 1476	Totalizer 6.2B	1547 and 1548
Totalizer 1.9A	1333 and 1334	Totalizer 3.3A	1405 and 1406	Totalizer 4.9A	1477 and 1478	Totalizer 6.3A	1549 and 1550
Totalizer 1.9B	1335 and 1336	Totalizer 3.3B	1407 and 1408	Totalizer 4.9B	1479 and 1480	Totalizer 6.3B	1551 and 1552
Totalizer 1.10A	1337 and 1338	Totalizer 3.4A	1409 and 1410	Totalizer 4.10A	1481 and 1482	Totalizer 6.4A	1553 and 1554
Totalizer 1.10B	1339 and 1340	Totalizer 3.4B	1411 and 1412	Totalizer 4.10B	1483 and 1484	Totalizer 6.4B	1555 and 1556
Totalizer 1.11A	1341 and 1342	Totalizer 3.5A	1413 and 1414	Totalizer 4.11A	1485 and 1486	Totalizer 6.5A	1557 and 1558
Totalizer 1.11B	1343 and 1344	Totalizer 3.5B	1415 and 1416	Totalizer 4.11B	1487 and 1488	Totalizer 6.5B	1559 and 1560
Totalizer 1.12A	1345 and 1346	Totalizer 3.6A	1417 and 1418	Totalizer 4.12A	1489 and 1490	Totalizer 6.6A	1561 and 1562
Totalizer 1.12B	1347 and 1348	Totalizer 3.6B	1419 and 1420	Totalizer 4.12B	1491 and 1492	Totalizer 6.6B	1563 and 1564
Totalizer 2.1A	1349 and 1350	Totalizer 3.7A	1421 and 1422	Totalizer 5.1A	1493 and 1494	Totalizer 6.7A	1565 and 1566
Totalizer 2.1B	1351 and 1352	Totalizer 3.7B	1423 and 1424	Totalizer 5.1B	1495 and 1496	Totalizer 6.7B	1567 and 1568
Totalizer 2.2A	1353 and 1354	Totalizer 3.8A	1425 and 1426	Totalizer 5.2A	1497 and 1498	Totalizer 6.8A	1569 and 1570
Totalizer 2.2B	1355 and 1356	Totalizer 3.8B	1427 and 1428	Totalizer 5.2B	1499 and 1500	Totalizer 6.8B	1571 and 1572
Totalizer 2.3A	1357 and 1358	Totalizer 3.9A	1429 and 1430	Totalizer 5.3A	1501 and 1502	Totalizer 6.9A	1573 and 1574
Totalizer 2.3B	1359 and 1360	Totalizer 3.9B	1431 and 1432	Totalizer 5.3B	1503 and 1504	Totalizer 6.9B	1575 and 1576
Totalizer 2.4A	1361 and 1362	Totalizer 3.10A	1433 and 1434	Totalizer 5.4A	1505 and 1506	Totalizer 6.10A	1577 and 1578
Totalizer 2.4B	1363 and 1364	Totalizer 3.10B	1435 and 1436	Totalizer 5.4B	1507 and 1508	Totalizer 6.10B	1579 and 1580
Totalizer 2.5A	1365 and 1366	Totalizer 3.11A	1437 and 1438	Totalizer 5.5A	1509 and 1510	Totalizer 6.11A	1581 and 1582
Totalizer 2.5B	1367 and 1368	Totalizer 3.11B	1439 and 1440	Totalizer 5.5B	1511 and 1512	Totalizer 6.11B	1583 and 1584
Totalizer 2.6A	1369 and 1370	Totalizer 3.12A	1441 and 1442	Totalizer 5.6A	1513 and 1514	Totalizer 6.12A	1585 and 1586
Totalizer 2.6B	1371 and 1372	Totalizer 3.12B	1443 and 1444	Totalizer 5.6B	1515 and 1516	Totalizer 6.12B	1587 and 1588

Table B.22 Totalizer Average Flowrate – Current Batch

Write Access: Read only		64-bit double precision floating point, 0 to 9999999999					
Totalizer Name	Modbus Registers	Totalizer Name	Modbus Registers	Totalizer Name	Modbus Registers	Totalizer Name	Modbus Registers
Totalizer 1.1A	1601 to 1604	Totalizer 2.7A	1745 to 1748	Totalizer 4.1A	1889 to 1892	Totalizer 5.7A	2033 to 2036
Totalizer 1.1B	1605 to 1608	Totalizer 2.7B	1749 to 1752	Totalizer 4.1B	1893 to 1896	Totalizer 5.7B	2037 to 2040
Totalizer 1.2A	1609 to 1612	Totalizer 2.8A	1753 to 1756	Totalizer 4.2A	1897 to 1900	Totalizer 5.8A	2041 to 2044
Totalizer 1.2B	1613 to 1616	Totalizer 2.8B	1757 to 1760	Totalizer 4.2B	1901 to 1904	Totalizer 5.8B	2045 to 2048
Totalizer 1.3A	1617 to 1620	Totalizer 2.9A	1761 to 1764	Totalizer 4.3A	1905 to 1908	Totalizer 5.9A	2049 to 2052
Totalizer 1.3B	1621 to 1624	Totalizer 2.9B	1765 to 1768	Totalizer 4.3B	1909 to 1912	Totalizer 5.9B	2053 to 2056
Totalizer 1.4A	1625 to 1628	Totalizer 2.10A	1769 to 1772	Totalizer 4.4A	1913 to 1916	Totalizer 5.10A	2057 to 2060
Totalizer 1.4B	1629 to 1632	Totalizer 2.10B	1773 to 1776	Totalizer 4.4B	1917 to 1920	Totalizer 5.10B	2061 to 2064
Totalizer 1.5A	1633 to 1636	Totalizer 2.11A	1777 to 1780	Totalizer 4.5A	1921 to 1924	Totalizer 5.11A	2065 to 2068
Totalizer 1.5B	1637 to 1640	Totalizer 2.11B	1781 to 1784	Totalizer 4.5B	1925 to 1928	Totalizer 5.11B	2069 to 2072
Totalizer 1.6A	1641 to 1644	Totalizer 2.12A	1785 to 1788	Totalizer 4.6A	1929 to 1932	Totalizer 5.12A	2073 to 2076
Totalizer 1.6B	1645 to 1648	Totalizer 2.12B	1789 to 1792	Totalizer 4.6B	1933 to 1936	Totalizer 5.12B	2077 to 2080
Totalizer 1.7A	1649 to 1652	Totalizer 3.1A	1793 to 1796	Totalizer 4.7A	1937 to 1940	Totalizer 6.1A	2081 to 2084
Totalizer 1.7B	1653 to 1656	Totalizer 3.1B	1797 to 1800	Totalizer 4.7B	1941 to 1944	Totalizer 6.1B	2085 to 2088
Totalizer 1.8A	1657 to 1660	Totalizer 3.2A	1801 to 1804	Totalizer 4.8A	1945 to 1948	Totalizer 6.2A	2089 to 2092
Totalizer 1.8B	1661 to 1664	Totalizer 3.2B	1805 to 1808	Totalizer 4.8B	1949 to 1952	Totalizer 6.2B	2093 to 2096
Totalizer 1.9A	1665 to 1668	Totalizer 3.3A	1809 to 1812	Totalizer 4.9A	1953 to 1956	Totalizer 6.3A	2097 to 2100
Totalizer 1.9B	1669 to 1672	Totalizer 3.3B	1813 to 1816	Totalizer 4.9B	1957 to 1960	Totalizer 6.3B	2101 to 2104
Totalizer 1.10A	1673 to 1676	Totalizer 3.4A	1817 to 1820	Totalizer 4.10A	1961 to 1964	Totalizer 6.4A	2105 to 2108
Totalizer 1.10B	1677 to 1680	Totalizer 3.4B	1821 to 1824	Totalizer 4.10B	1965 to 1968	Totalizer 6.4B	2109 to 2112
Totalizer 1.11A	1681 to 1684	Totalizer 3.5A	1825 to 1828	Totalizer 4.11A	1969 to 1972	Totalizer 6.5A	2113 to 2116
Totalizer 1.11B	1685 to 1688	Totalizer 3.5B	1829 to 1832	Totalizer 4.11B	1973 to 1976	Totalizer 6.5B	2117 to 2120
Totalizer 1.12A	1689 to 1692	Totalizer 3.6A	1833 to 1836	Totalizer 4.12A	1977 to 1980	Totalizer 6.6A	2121 to 2124
Totalizer 1.12B	1693 to 1696	Totalizer 3.6B	1837 to 1840	Totalizer 4.12B	1981 to 1984	Totalizer 6.6B	2125 to 2128
Totalizer 2.1A	1697 to 1700	Totalizer 3.7A	1841 to 1844	Totalizer 5.1A	1985 to 1988	Totalizer 6.7A	2129 to 2132
Totalizer 2.1B	1701 to 1704	Totalizer 3.7B	1845 to 1848	Totalizer 5.1B	1989 to 1992	Totalizer 6.7B	2133 to 2136
Totalizer 2.2A	1705 to 1708	Totalizer 3.8A	1849 to 1852	Totalizer 5.2A	1993 to 1996	Totalizer 6.8A	2137 to 2140
Totalizer 2.2B	1709 to 1712	Totalizer 3.8B	1853 to 1856	Totalizer 5.2B	1997 to 2000	Totalizer 6.8B	2141 to 2144
Totalizer 2.3A	1713 to 1716	Totalizer 3.9A	1857 to 1860	Totalizer 5.3A	2001 to 2004	Totalizer 6.9A	2145 to 2148
Totalizer 2.3B	1717 to 1720	Totalizer 3.9B	1861 to 1864	Totalizer 5.3B	2005 to 2008	Totalizer 6.9B	2149 to 2152
Totalizer 2.4A	1721 to 1724	Totalizer 3.10A	1865 to 1868	Totalizer 5.4A	2009 to 2012	Totalizer 6.10A	2153 to 2156
Totalizer 2.4B	1725 to 1728	Totalizer 3.10B	1869 to 1872	Totalizer 5.4B	2013 to 2016	Totalizer 6.10B	2157 to 2160
Totalizer 2.5A	1729 to 1732	Totalizer 3.11A	1873 to 1876	Totalizer 5.5A	2017 to 2020	Totalizer 6.11A	2161 to 2164
Totalizer 2.5B	1733 to 1736	Totalizer 3.11B	1877 to 1880	Totalizer 5.5B	2021 to 2024	Totalizer 6.11B	2165 to 2168
Totalizer 2.6A	1737 to 1740	Totalizer 3.12A	1881 to 1884	Totalizer 5.6A	2025 to 2028	Totalizer 6.12A	2169 to 2172
Totalizer 2.6B	1741 to 1744	Totalizer 3.12B	1885 to 1888	Totalizer 5.6B	2029 to 2032	Totalizer 6.12B	2173 to 2176

Table B.23 Totalizer Batch Total – Current Batch

Write Access: Read only		32-bit single precision floating point, -999 to 9999					
Totalizer Name	Modbus Registers	Totalizer Name	Modbus Registers	Totalizer Name	Modbus Registers	Totalizer Name	Modbus Registers
Totalizer 1.1A	2201 and 2202	Totalizer 2.7A	2273 and 2274	Totalizer 4.1A	2345 and 2346	Totalizer 5.7A	2417 and 2418
Totalizer 1.1B	2203 and 2204	Totalizer 2.7B	2275 and 2276	Totalizer 4.1B	2347 and 2348	Totalizer 5.7B	2419 and 2420
Totalizer 1.2A	2205 and 2206	Totalizer 2.8A	2277 and 2278	Totalizer 4.2A	2349 and 2350	Totalizer 5.8A	2421 and 2422
Totalizer 1.2B	2207 and 2208	Totalizer 2.8B	2279 and 2280	Totalizer 4.2B	2351 and 2352	Totalizer 5.8B	2423 and 2424
Totalizer 1.3A	2209 and 2210	Totalizer 2.9A	2281 and 2282	Totalizer 4.3A	2353 and 2354	Totalizer 5.9A	2425 and 2426
Totalizer 1.3B	2211 and 2212	Totalizer 2.9B	2283 and 2284	Totalizer 4.3B	2355 and 2356	Totalizer 5.9B	2427 and 2428
Totalizer 1.4A	2213 and 2214	Totalizer 2.10A	2285 and 2286	Totalizer 4.4A	2357 and 2358	Totalizer 5.10A	2429 and 2430
Totalizer 1.4B	2215 and 2216	Totalizer 2.10B	2287 and 2288	Totalizer 4.4B	2359 and 2360	Totalizer 5.10B	2431 and 2432
Totalizer 1.5A	2217 and 2218	Totalizer 2.11A	2289 and 2290	Totalizer 4.5A	2361 and 2362	Totalizer 5.11A	2433 and 2434
Totalizer 1.5B	2219 and 2220	Totalizer 2.11B	2291 and 2292	Totalizer 4.5B	2363 and 2364	Totalizer 5.11B	2435 and 2436
Totalizer 1.6A	2221 and 2222	Totalizer 2.12A	2293 and 2294	Totalizer 4.6A	2365 and 2366	Totalizer 5.12A	2437 and 2438
Totalizer 1.6B	2223 and 2224	Totalizer 2.12B	2295 and 2296	Totalizer 4.6B	2367 and 2368	Totalizer 5.12B	2439 and 2440
Totalizer 1.7A	2225 and 2226	Totalizer 3.1A	2297 and 2298	Totalizer 4.7A	2369 and 2370	Totalizer 6.1A	2441 and 2442
Totalizer 1.7B	2227 and 2228	Totalizer 3.1B	2299 and 2300	Totalizer 4.7B	2371 and 2372	Totalizer 6.1B	2443 and 2444
Totalizer 1.8A	2229 and 2230	Totalizer 3.2A	2301 and 2302	Totalizer 4.8A	2373 and 2374	Totalizer 6.2A	2445 and 2446
Totalizer 1.8B	2231 and 2232	Totalizer 3.2B	2303 and 2304	Totalizer 4.8B	2375 and 2376	Totalizer 6.2B	2447 and 2448
Totalizer 1.9A	2233 and 2234	Totalizer 3.3A	2305 and 2306	Totalizer 4.9A	2377 and 2378	Totalizer 6.3A	2449 and 2450
Totalizer 1.9B	2235 and 2236	Totalizer 3.3B	2307 and 2308	Totalizer 4.9B	2379 and 2380	Totalizer 6.3B	2451 and 2452
Totalizer 1.10A	2237 and 2238	Totalizer 3.4A	2309 and 2310	Totalizer 4.10A	2381 and 2382	Totalizer 6.4A	2453 and 2454
Totalizer 1.10B	2239 and 2240	Totalizer 3.4B	2311 and 2312	Totalizer 4.10B	2383 and 2384	Totalizer 6.4B	2455 and 2456
Totalizer 1.11A	2241 and 2242	Totalizer 3.5A	2313 and 2314	Totalizer 4.11A	2385 and 2386	Totalizer 6.5A	2457 and 2458
Totalizer 1.11B	2243 and 2244	Totalizer 3.5B	2315 and 2316	Totalizer 4.11B	2387 and 2388	Totalizer 6.5B	2459 and 2460
Totalizer 1.12A	2245 and 2246	Totalizer 3.6A	2317 and 2318	Totalizer 4.12A	2389 and 2390	Totalizer 6.6A	2461 and 2462
Totalizer 1.12B	2247 and 2248	Totalizer 3.6B	2319 and 2320	Totalizer 4.12B	2391 and 2392	Totalizer 6.6B	2463 and 2464
Totalizer 2.1A	2249 and 2250	Totalizer 3.7A	2321 and 2322	Totalizer 5.1A	2393 and 2394	Totalizer 6.7A	2465 and 2466
Totalizer 2.1B	2251 and 2252	Totalizer 3.7B	2323 and 2324	Totalizer 5.1B	2395 and 2396	Totalizer 6.7B	2467 and 2468
Totalizer 2.2A	2253 and 2254	Totalizer 3.8A	2325 and 2326	Totalizer 5.2A	2397 and 2398	Totalizer 6.8A	2469 and 2470
Totalizer 2.2B	2255 and 2256	Totalizer 3.8B	2327 and 2328	Totalizer 5.2B	2399 and 2400	Totalizer 6.8B	2471 and 2472
Totalizer 2.3A	2257 and 2258	Totalizer 3.9A	2329 and 2330	Totalizer 5.3A	2401 and 2402	Totalizer 6.9A	2473 and 2474
Totalizer 2.3B	2259 and 2260	Totalizer 3.9B	2331 and 2332	Totalizer 5.3B	2403 and 2404	Totalizer 6.9B	2475 and 2476
Totalizer 2.4A	2261 and 2262	Totalizer 3.10A	2333 and 2334	Totalizer 5.4A	2405 and 2406	Totalizer 6.10A	2477 and 2478
Totalizer 2.4B	2263 and 2264	Totalizer 3.10B	2335 and 2336	Totalizer 5.4B	2407 and 2408	Totalizer 6.10B	2479 and 2480
Totalizer 2.5A	2265 and 2266	Totalizer 3.11A	2337 and 2338	Totalizer 5.5A	2409 and 2410	Totalizer 6.11A	2481 and 2482
Totalizer 2.5B	2267 and 2268	Totalizer 3.11B	2339 and 2340	Totalizer 5.5B	2411 and 2412	Totalizer 6.11B	2483 and 2484
Totalizer 2.6A	2269 and 2270	Totalizer 3.12A	2341 and 2342	Totalizer 5.6A	2413 and 2414	Totalizer 6.12A	2485 and 2486
Totalizer 2.6B	2271 and 2272	Totalizer 3.12B	2343 and 2344	Totalizer 5.6B	2415 and 2416	Totalizer 6.12B	2487 and 2488

Table B.24 Totalizer Maximum Flowrate – Previous Batch

Write Access: Read only		32-bit single precision floating point, -999 to 9999					
Totalizer Name	Modbus Registers	Totalizer Name	Modbus Registers	Totalizer Name	Modbus Registers	Totalizer Name	Modbus Registers
Totalizer 1.1A	2501 and 2502	Totalizer 2.7A	2573 and 2574	Totalizer 4.1A	2645 and 2646	Totalizer 5.7A	2717 and 2718
Totalizer 1.1B	2503 and 2504	Totalizer 2.7B	2575 and 2576	Totalizer 4.1B	2647 and 2648	Totalizer 5.7B	2719 and 2720
Totalizer 1.2A	2505 and 2506	Totalizer 2.8A	2577 and 2578	Totalizer 4.2A	2649 and 2650	Totalizer 5.8A	2721 and 2722
Totalizer 1.2B	2507 and 2508	Totalizer 2.8B	2579 and 2580	Totalizer 4.2B	2651 and 2652	Totalizer 5.8B	2723 and 2724
Totalizer 1.3A	2509 and 2510	Totalizer 2.9A	2581 and 2582	Totalizer 4.3A	2653 and 2654	Totalizer 5.9A	2725 and 2726
Totalizer 1.3B	2511 and 2512	Totalizer 2.9B	2583 and 2584	Totalizer 4.3B	2655 and 2656	Totalizer 5.9B	2727 and 2728
Totalizer 1.4A	2513 and 2514	Totalizer 2.10A	2585 and 2586	Totalizer 4.4A	2657 and 2658	Totalizer 5.10A	2729 and 2730
Totalizer 1.4B	2515 and 2516	Totalizer 2.10B	2587 and 2588	Totalizer 4.4B	2659 and 2660	Totalizer 5.10B	2731 and 2732
Totalizer 1.5A	2517 and 2518	Totalizer 2.11A	2589 and 2590	Totalizer 4.5A	2661 and 2662	Totalizer 5.11A	2733 and 2734
Totalizer 1.5B	2519 and 2520	Totalizer 2.11B	2591 and 2592	Totalizer 4.5B	2663 and 2664	Totalizer 5.11B	2735 and 2736
Totalizer 1.6A	2521 and 2522	Totalizer 2.12A	2593 and 2594	Totalizer 4.6A	2665 and 2666	Totalizer 5.12A	2737 and 2738
Totalizer 1.6B	2523 and 2524	Totalizer 2.12B	2595 and 2596	Totalizer 4.6B	2667 and 2668	Totalizer 5.12B	2739 and 2740
Totalizer 1.7A	2525 and 2526	Totalizer 3.1A	2597 and 2598	Totalizer 4.7A	2669 and 2670	Totalizer 6.1A	2741 and 2742
Totalizer 1.7B	2527 and 2528	Totalizer 3.1B	2599 and 2600	Totalizer 4.7B	2671 and 2672	Totalizer 6.1B	2743 and 2744
Totalizer 1.8A	2529 and 2530	Totalizer 3.2A	2601 and 2602	Totalizer 4.8A	2673 and 2674	Totalizer 6.2A	2745 and 2746
Totalizer 1.8B	2531 and 2532	Totalizer 3.2B	2603 and 2604	Totalizer 4.8B	2675 and 2676	Totalizer 6.2B	2747 and 2748
Totalizer 1.9A	2533 and 2534	Totalizer 3.3A	2605 and 2606	Totalizer 4.9A	2677 and 2678	Totalizer 6.3A	2749 and 2750
Totalizer 1.9B	2535 and 2536	Totalizer 3.3B	2607 and 2608	Totalizer 4.9B	2679 and 2680	Totalizer 6.3B	2751 and 2752
Totalizer 1.10A	2537 and 2538	Totalizer 3.4A	2609 and 2610	Totalizer 4.10A	2681 and 2682	Totalizer 6.4A	2753 and 2754
Totalizer 1.10B	2539 and 2540	Totalizer 3.4B	2611 and 2612	Totalizer 4.10B	2683 and 2684	Totalizer 6.4B	2755 and 2756
Totalizer 1.11A	2541 and 2542	Totalizer 3.5A	2613 and 2614	Totalizer 4.11A	2685 and 2686	Totalizer 6.5A	2757 and 2758
Totalizer 1.11B	2543 and 2544	Totalizer 3.5B	2615 and 2616	Totalizer 4.11B	2687 and 2688	Totalizer 6.5B	2759 and 2760
Totalizer 1.12A	2545 and 2546	Totalizer 3.6A	2617 and 2618	Totalizer 4.12A	2689 and 2690	Totalizer 6.6A	2761 and 2762
Totalizer 1.12B	2547 and 2548	Totalizer 3.6B	2619 and 2620	Totalizer 4.12B	2691 and 2692	Totalizer 6.6B	2763 and 2764
Totalizer 2.1A	2549 and 2550	Totalizer 3.7A	2621 and 2622	Totalizer 5.1A	2693 and 2694	Totalizer 6.7A	2765 and 2766
Totalizer 2.1B	2551 and 2552	Totalizer 3.7B	2623 and 2624	Totalizer 5.1B	2695 and 2696	Totalizer 6.7B	2767 and 2768
Totalizer 2.2A	2553 and 2554	Totalizer 3.8A	2625 and 2626	Totalizer 5.2A	2697 and 2698	Totalizer 6.8A	2769 and 2770
Totalizer 2.2B	2555 and 2556	Totalizer 3.8B	2627 and 2628	Totalizer 5.2B	2699 and 2700	Totalizer 6.8B	2771 and 2772
Totalizer 2.3A	2557 and 2558	Totalizer 3.9A	2629 and 2630	Totalizer 5.3A	2701 and 2702	Totalizer 6.9A	2773 and 2774
Totalizer 2.3B	2559 and 2560	Totalizer 3.9B	2631 and 2632	Totalizer 5.3B	2703 and 2704	Totalizer 6.9B	2775 and 2776
Totalizer 2.4A	2561 and 2562	Totalizer 3.10A	2633 and 2634	Totalizer 5.4A	2705 and 2706	Totalizer 6.10A	2777 and 2778
Totalizer 2.4B	2563 and 2564	Totalizer 3.10B	2635 and 2636	Totalizer 5.4B	2707 and 2708	Totalizer 6.10B	2779 and 2780
Totalizer 2.5A	2565 and 2566	Totalizer 3.11A	2637 and 2638	Totalizer 5.5A	2709 and 2710	Totalizer 6.11A	2781 and 2782
Totalizer 2.5B	2567 and 2568	Totalizer 3.11B	2639 and 2640	Totalizer 5.5B	2711 and 2712	Totalizer 6.11B	2783 and 2784
Totalizer 2.6A	2569 and 2570	Totalizer 3.12A	2641 and 2642	Totalizer 5.6A	2713 and 2714	Totalizer 6.12A	2785 and 2786
Totalizer 2.6B	2571 and 2572	Totalizer 3.12B	2643 and 2644	Totalizer 5.6B	2715 and 2716	Totalizer 6.12B	2787 and 2788

Table B.25 Totalizer Minimum Flowrate – Previous Batch

Write Access: Read only		32-bit single precision floating point, -999 to 9999					
Totalizer Name	Modbus Registers	Totalizer Name	Modbus Registers	Totalizer Name	Modbus Registers	Totalizer Name	Modbus Registers
Totalizer 1.1A	2801 and 2802	Totalizer 2.7A	2873 and 2874	Totalizer 4.1A	2945 and 2946	Totalizer 5.7A	3017 and 3018
Totalizer 1.1B	2803 and 2804	Totalizer 2.7B	2875 and 2876	Totalizer 4.1B	2947 and 2948	Totalizer 5.7B	3019 and 3020
Totalizer 1.2A	2805 and 2806	Totalizer 2.8A	2877 and 2878	Totalizer 4.2A	2949 and 2950	Totalizer 5.8A	3021 and 3022
Totalizer 1.2B	2807 and 2808	Totalizer 2.8B	2879 and 2880	Totalizer 4.2B	2951 and 2952	Totalizer 5.8B	3023 and 3024
Totalizer 1.3A	2809 and 2810	Totalizer 2.9A	2881 and 2882	Totalizer 4.3A	2953 and 2954	Totalizer 5.9A	3025 and 3026
Totalizer 1.3B	2811 and 2812	Totalizer 2.9B	2883 and 2884	Totalizer 4.3B	2955 and 2956	Totalizer 5.9B	3027 and 3028
Totalizer 1.4A	2813 and 2814	Totalizer 2.10A	2885 and 2886	Totalizer 4.4A	2957 and 2958	Totalizer 5.10A	3029 and 3030
Totalizer 1.4B	2815 and 2816	Totalizer 2.10B	2887 and 2888	Totalizer 4.4B	2959 and 2960	Totalizer 5.10B	3031 and 3032
Totalizer 1.5A	2817 and 2818	Totalizer 2.11A	2889 and 2890	Totalizer 4.5A	2961 and 2962	Totalizer 5.11A	3033 and 3034
Totalizer 1.5B	2819 and 2820	Totalizer 2.11B	2891 and 2892	Totalizer 4.5B	2963 and 2964	Totalizer 5.11B	3035 and 3036
Totalizer 1.6A	2821 and 2822	Totalizer 2.12A	2893 and 2894	Totalizer 4.6A	2965 and 2966	Totalizer 5.12A	3037 and 3038
Totalizer 1.6B	2823 and 2824	Totalizer 2.12B	2895 and 2896	Totalizer 4.6B	2967 and 2968	Totalizer 5.12B	3039 and 3040
Totalizer 1.7A	2825 and 2826	Totalizer 3.1A	2897 and 2898	Totalizer 4.7A	2969 and 2970	Totalizer 6.1A	3041 and 3042
Totalizer 1.7B	2827 and 2828	Totalizer 3.1B	2899 and 2900	Totalizer 4.7B	2971 and 2972	Totalizer 6.1B	3043 and 3044
Totalizer 1.8A	2829 and 2830	Totalizer 3.2A	2901 and 2902	Totalizer 4.8A	2973 and 2974	Totalizer 6.2A	3045 and 3046
Totalizer 1.8B	2831 and 2832	Totalizer 3.2B	2903 and 2904	Totalizer 4.8B	2975 and 2976	Totalizer 6.2B	3047 and 3048
Totalizer 1.9A	2833 and 2834	Totalizer 3.3A	2905 and 2906	Totalizer 4.9A	2977 and 2978	Totalizer 6.3A	3049 and 3050
Totalizer 1.9B	2835 and 2836	Totalizer 3.3B	2907 and 2908	Totalizer 4.9B	2979 and 2980	Totalizer 6.3B	3051 and 3052
Totalizer 1.10A	2837 and 2838	Totalizer 3.4A	2909 and 2910	Totalizer 4.10A	2981 and 2982	Totalizer 6.4A	3053 and 3054
Totalizer 1.10B	2839 and 2840	Totalizer 3.4B	2911 and 2912	Totalizer 4.10B	2983 and 2984	Totalizer 6.4B	3055 and 3056
Totalizer 1.11A	2841 and 2842	Totalizer 3.5A	2913 and 2914	Totalizer 4.11A	2985 and 2986	Totalizer 6.5A	3057 and 3058
Totalizer 1.11B	2843 and 2844	Totalizer 3.5B	2915 and 2916	Totalizer 4.11B	2987 and 2988	Totalizer 6.5B	3059 and 3060
Totalizer 1.12A	2845 and 2846	Totalizer 3.6A	2917 and 2918	Totalizer 4.12A	2989 and 2990	Totalizer 6.6A	3061 and 3062
Totalizer 1.12B	2847 and 2848	Totalizer 3.6B	2919 and 2920	Totalizer 4.12B	2991 and 2992	Totalizer 6.6B	3063 and 3064
Totalizer 2.1A	2849 and 2850	Totalizer 3.7A	2921 and 2922	Totalizer 5.1A	2993 and 2994	Totalizer 6.7A	3065 and 3066
Totalizer 2.1B	2851 and 2852	Totalizer 3.7B	2923 and 2924	Totalizer 5.1B	2995 and 2996	Totalizer 6.7B	3067 and 3068
Totalizer 2.2A	2853 and 2854	Totalizer 3.8A	2925 and 2926	Totalizer 5.2A	2997 and 2998	Totalizer 6.8A	3069 and 3070
Totalizer 2.2B	2855 and 2856	Totalizer 3.8B	2927 and 2928	Totalizer 5.2B	2999 and 3000	Totalizer 6.8B	3071 and 3072
Totalizer 2.3A	2857 and 2858	Totalizer 3.9A	2929 and 2930	Totalizer 5.3A	3001 and 3002	Totalizer 6.9A	3073 and 3074
Totalizer 2.3B	2859 and 2860	Totalizer 3.9B	2931 and 2932	Totalizer 5.3B	3003 and 3004	Totalizer 6.9B	3075 and 3076
Totalizer 2.4A	2861 and 2862	Totalizer 3.10A	2933 and 2934	Totalizer 5.4A	3005 and 3006	Totalizer 6.10A	3077 and 3078
Totalizer 2.4B	2863 and 2864	Totalizer 3.10B	2935 and 2936	Totalizer 5.4B	3007 and 3008	Totalizer 6.10B	3079 and 3080
Totalizer 2.5A	2865 and 2866	Totalizer 3.11A	2937 and 2938	Totalizer 5.5A	3009 and 3010	Totalizer 6.11A	3081 and 3082
Totalizer 2.5B	2867 and 2868	Totalizer 3.11B	2939 and 2940	Totalizer 5.5B	3011 and 3012	Totalizer 6.11B	3083 and 3084
Totalizer 2.6A	2869 and 2870	Totalizer 3.12A	2941 and 2942	Totalizer 5.6A	3013 and 3014	Totalizer 6.12A	3085 and 3086
Totalizer 2.6B	2871 and 2872	Totalizer 3.12B	2943 and 2944	Totalizer 5.6B	3015 and 3016	Totalizer 6.12B	3087 and 3088

Table B.26 Totalizer Average Flowrate – Previous Batch

Write Access: Read only		64-bit double precision floating point, 0 to 9999999999					
Totalizer Name	Modbus Registers	Totalizer Name	Modbus Registers	Totalizer Name	Modbus Registers	Totalizer Name	Modbus Registers
Totalizer 1.1A	3101 to 3104	Totalizer 2.7A	3245 to 3248	Totalizer 4.1A	3389 to 3392	Totalizer 5.7A	3533 to 3536
Totalizer 1.1B	3105 to 3108	Totalizer 2.7B	3249 to 3252	Totalizer 4.1B	3393 to 3396	Totalizer 5.7B	3537 to 3540
Totalizer 1.2A	3109 to 3112	Totalizer 2.8A	3253 to 3256	Totalizer 4.2A	3397 to 3400	Totalizer 5.8A	3541 to 3544
Totalizer 1.2B	3113 to 3116	Totalizer 2.8B	3257 to 3260	Totalizer 4.2B	3401 to 3404	Totalizer 5.8B	3545 to 3548
Totalizer 1.3A	3117 to 3120	Totalizer 2.9A	3261 to 3264	Totalizer 4.3A	3405 to 3408	Totalizer 5.9A	3549 to 3552
Totalizer 1.3B	3121 to 3124	Totalizer 2.9B	3265 to 3268	Totalizer 4.3B	3409 to 3412	Totalizer 5.9B	3553 to 3556
Totalizer 1.4A	3125 to 3128	Totalizer 2.10A	3269 to 3272	Totalizer 4.4A	3413 to 3416	Totalizer 5.10A	3557 to 3560
Totalizer 1.4B	3129 to 3132	Totalizer 2.10B	3273 to 3276	Totalizer 4.4B	3417 to 3420	Totalizer 5.10B	3561 to 3564
Totalizer 1.5A	3133 to 3136	Totalizer 2.11A	3277 to 3280	Totalizer 4.5A	3421 to 3424	Totalizer 5.11A	3565 to 3568
Totalizer 1.5B	3137 to 3140	Totalizer 2.11B	3281 to 3284	Totalizer 4.5B	3425 to 3428	Totalizer 5.11B	3569 to 3572
Totalizer 1.6A	3141 to 3144	Totalizer 2.12A	3285 to 3288	Totalizer 4.6A	3429 to 3432	Totalizer 5.12A	3573 to 3576
Totalizer 1.6B	3145 to 3148	Totalizer 2.12B	3289 to 3292	Totalizer 4.6B	3433 to 3436	Totalizer 5.12B	3577 to 3580
Totalizer 1.7A	3149 to 3152	Totalizer 3.1A	3293 to 3296	Totalizer 4.7A	3437 to 3440	Totalizer 6.1A	3581 to 3584
Totalizer 1.7B	3153 to 3156	Totalizer 3.1B	3297 to 3300	Totalizer 4.7B	3441 to 3444	Totalizer 6.1B	3585 to 3588
Totalizer 1.8A	3157 to 3160	Totalizer 3.2A	3301 to 3304	Totalizer 4.8A	3445 to 3448	Totalizer 6.2A	3589 to 3592
Totalizer 1.8B	3161 to 3164	Totalizer 3.2B	3305 to 3308	Totalizer 4.8B	3449 to 3452	Totalizer 6.2B	3593 to 3596
Totalizer 1.9A	3165 to 3168	Totalizer 3.3A	3309 to 3312	Totalizer 4.9A	3453 to 3456	Totalizer 6.3A	3597 to 3600
Totalizer 1.9B	3169 to 3172	Totalizer 3.3B	3313 to 3316	Totalizer 4.9B	3457 to 3460	Totalizer 6.3B	3601 to 3604
Totalizer 1.10A	3173 to 3176	Totalizer 3.4A	3317 to 3320	Totalizer 4.10A	3461 to 3464	Totalizer 6.4A	3605 to 3608
Totalizer 1.10B	3177 to 3180	Totalizer 3.4B	3321 to 3324	Totalizer 4.10B	3465 to 3468	Totalizer 6.4B	3609 to 3612
Totalizer 1.11A	3181 to 3184	Totalizer 3.5A	3325 to 3328	Totalizer 4.11A	3469 to 3472	Totalizer 6.5A	3613 to 3616
Totalizer 1.11B	3185 to 3188	Totalizer 3.5B	3329 to 3332	Totalizer 4.11B	3473 to 3476	Totalizer 6.5B	3617 to 3620
Totalizer 1.12A	3189 to 3192	Totalizer 3.6A	3333 to 3336	Totalizer 4.12A	3477 to 3480	Totalizer 6.6A	3621 to 3624
Totalizer 1.12B	3193 to 3196	Totalizer 3.6B	3337 to 3340	Totalizer 4.12B	3481 to 3484	Totalizer 6.6B	3625 to 3628
Totalizer 2.1A	3197 to 3200	Totalizer 3.7A	3341 to 3344	Totalizer 5.1A	3485 to 3488	Totalizer 6.7A	3629 to 3632
Totalizer 2.1B	3201 to 3204	Totalizer 3.7B	3345 to 3348	Totalizer 5.1B	3489 to 3492	Totalizer 6.7B	3633 to 3636
Totalizer 2.2A	3205 to 3208	Totalizer 3.8A	3349 to 3352	Totalizer 5.2A	3493 to 3496	Totalizer 6.8A	3637 to 3640
Totalizer 2.2B	3209 to 3212	Totalizer 3.8B	3353 to 3356	Totalizer 5.2B	3497 to 3500	Totalizer 6.8B	3641 to 3644
Totalizer 2.3A	3213 to 3216	Totalizer 3.9A	3357 to 3360	Totalizer 5.3A	3501 to 3504	Totalizer 6.9A	3645 to 3648
Totalizer 2.3B	3217 to 3220	Totalizer 3.9B	3361 to 3364	Totalizer 5.3B	3505 to 3508	Totalizer 6.9B	3649 to 3652
Totalizer 2.4A	3221 to 3224	Totalizer 3.10A	3365 to 3368	Totalizer 5.4A	3509 to 3512	Totalizer 6.10A	3653 to 3656
Totalizer 2.4B	3225 to 3228	Totalizer 3.10B	3369 to 3372	Totalizer 5.4B	3513 to 3516	Totalizer 6.10B	3657 to 3660
Totalizer 2.5A	3229 to 3232	Totalizer 3.11A	3373 to 3376	Totalizer 5.5A	3517 to 3520	Totalizer 6.11A	3661 to 3664
Totalizer 2.5B	3233 to 3236	Totalizer 3.11B	3377 to 3380	Totalizer 5.5B	3521 to 3524	Totalizer 6.11B	3665 to 3668
Totalizer 2.6A	3237 to 3240	Totalizer 3.12A	3381 to 3384	Totalizer 5.6A	3525 to 3528	Totalizer 6.12A	3669 to 3672
Totalizer 2.6B	3241 to 3244	Totalizer 3.12B	3385 to 3388	Totalizer 5.6B	3529 to 3532	Totalizer 6.12B	3673 to 3676

Table B.27 Totalizer Batch Total – Previous Batch

Signal		Channel Number					
		1.1	1.2	1.3	1.4	1.5	1.6
Analog input value	R	4001 and 4002	4051 and 4052	4101 and 4102	4151 and 4152	4201 and 4202	4251 and 4252
Alarm A trip	R/W	4003 and 4004	4053 and 4054	4103 and 4104	4153 and 4154	4203 and 4204	4253 and 4254
Alarm B trip	R/W	4005 and 4006	4055 and 4056	4105 and 4106	4155 and 4156	4205 and 4206	4255 and 4256
Alarm C trip	R/W	4007 and 4008	4057 and 4058	4107 and 4108	4157 and 4158	4207 and 4208	4257 and 4258
Alarm D trip	R/W	4009 and 4010	4059 and 4060	4109 and 4110	4159 and 4160	4209 and 4210	4259 and 4260
Totalizer A max. flowrate	R	4011 and 4012	4061 and 4062	4111 and 4112	4161 and 4162	4211 and 4212	4261 and 4262
Totalizer B max. flowrate	R	4013 and 4014	4063 and 4064	4113 and 4114	4163 and 4164	4213 and 4214	4263 and 4264
Totalizer A min. flowrate	R	4015 and 4016	4065 and 4066	4115 and 4116	4165 and 4166	4215 and 4216	4265 and 4266
Totalizer B min. flowrate	R	4017 and 4018	4067 and 4068	4117 and 4118	4167 and 4168	4217 and 4218	4267 and 4268
Totalizer A average flowrate	R	4019 and 4020	4069 and 4070	4119 and 4120	4169 and 4170	4219 and 4220	4269 and 4270
Totalizer B average flowrate	R	4021 and 4022	4071 and 4072	4121 and 4122	4171 and 4172	4221 and 4222	4271 and 4272
Totalizer A batch total	R	4023 to 4026	4073 to 4076	4123 to 4126	4173 to 4176	4223 to 4226	4273 to 4276
Totalizer B batch total	R	4027 to 4030	4077 to 4080	4127 to 4130	4177 to 4180	4227 to 4230	4277 to 4280
Totalizer A max. flowrate (previous batch)	R	4031 and 4032	4081 and 4082	4131 and 4132	4181 and 4182	4231 and 4232	4281 and 4282
Totalizer B max. flowrate (previous batch)	R	4033 and 4034	4083 and 4084	4133 and 4134	4183 and 4184	4233 and 4234	4283 and 4284
Totalizer A min. flowrate (previous batch)	R	4035 and 4036	4085 and 4086	4135 and 4136	4185 and 4186	4235 and 4236	4285 and 4286
Totalizer B min. flowrate (previous batch)	R	4037 and 4038	4087 and 4088	4137 and 4138	4187 and 4188	4237 and 4238	4287 and 4288
Totalizer A average flowrate (previous batch)	R	4039 and 4040	4089 and 4090	4139 and 4140	4189 and 4190	4239 and 4240	4289 and 4290
Totalizer B average flowrate (previous batch)	R	4041 and 4042	4091 and 4092	4141 and 4142	4191 and 4192	4241 and 4242	4291 and 4292
Totalizer A batch total (previous batch)	R	4043 to 4046	4093 to 4096	4143 to 4146	4193 to 4196	4243 to 4246	4293 to 4296
Totalizer B batch total (previous batch)	R	4047 to 4050	4097 to 4100	4147 to 4150	4197 to 4200	4247 to 4250	4297 to 4300

Table B.28 Registers by Channel – Process Group 1, Channels 1 to 6

Signal		Channel Number					
		1.7	1.8	1.9	1.10	1.11	1.12
Analog input value	R	4301 and 4302	4351 and 4352	4401 and 4402	4451 and 4452	4501 and 4502	4551 and 4552
Alarm A trip	R/W	4303 and 4304	4353 and 4354	4403 and 4404	4453 and 4454	4503 and 4504	4553 and 4554
Alarm B trip	R/W	4305 and 4306	4355 and 4356	4405 and 4406	4455 and 4456	4505 and 4506	4555 and 4556
Alarm C trip	R/W	4307 and 4308	4357 and 4358	4407 and 4408	4457 and 4458	4507 and 4508	4557 and 4558
Alarm D trip	R/W	4309 and 4310	4359 and 4360	4409 and 4410	4459 and 4460	4509 and 4510	4559 and 4560
Totalizer A max. flowrate	R	4311 and 4312	4361 and 4362	4411 and 4412	4461 and 4462	4511 and 4512	4561 and 4562
Totalizer B max. flowrate	R	4313 and 4314	4363 and 4364	4413 and 4414	4463 and 4464	4513 and 4514	4563 and 4564
Totalizer A min. flowrate	R	4315 and 4316	4365 and 4366	4415 and 4416	4465 and 4466	4515 and 4516	4565 and 4566
Totalizer B min. flowrate	R	4317 and 4318	4367 and 4368	4417 and 4418	4467 and 4468	4517 and 4518	4567 and 4568
Totalizer A average flowrate	R	4319 and 4320	4369 and 4370	4419 and 4420	4469 and 4470	4519 and 4520	4569 and 4570
Totalizer B average flowrate	R	4321 and 4322	4371 and 4372	4421 and 4422	4471 and 4472	4521 and 4522	4571 and 4572
Totalizer A batch total	R	4323 to 4326	4373 to 4376	4423 to 4426	4473 to 4476	4523 to 4526	4573 to 4576
Totalizer B batch total	R	4327 to 4330	4377 to 4380	4427 to 4430	4477 to 4480	4527 to 4530	4577 to 4580
Totalizer A max. flowrate (previous batch)	R	4331 and 4332	4381 and 4382	4431 and 4432	4481 and 4482	4531 and 4532	4581 and 4582
Totalizer B max. flowrate (previous batch)	R	4333 and 4334	4383 and 4384	4433 and 4434	4483 and 4484	4533 and 4534	4583 and 4584
Totalizer A min. flowrate (previous batch)	R	4335 and 4336	4385 and 4386	4435 and 4436	4485 and 4486	4535 and 4536	4585 and 4586
Totalizer B min. flowrate (previous batch)	R	4337 and 4338	4387 and 4388	4437 and 4438	4487 and 4488	4537 and 4538	4587 and 4588
Totalizer A average flowrate (previous batch)	R	4339 and 4340	4389 and 4390	4439 and 4440	4489 and 4490	4539 and 4540	4589 and 4590
Totalizer B average flowrate (previous batch)	R	4341 and 4342	4391 and 4392	4441 and 4442	4491 and 4492	4541 and 4542	4591 and 4592
Totalizer A batch total (previous batch)	R	4343 to 4346	4393 to 4396	4443 to 4446	4493 to 4496	4543 to 4546	4593 to 4596
Totalizer B batch total (previous batch)	R	4347 to 4350	4397 to 4400	4447 to 4450	4497 to 4500	4547 to 4550	4597 to 4600

Table B.29 Registers by Channel – Process Group 1, Channels 7 to 12

Signal		Channel Number					
		2.1	2.2	2.3	2.4	2.5	2.6
Analog input value	R	4601 and 4602	4651 and 4652	4701 and 4702	4751 and 4752	4801 and 4802	4851 and 4852
Alarm A trip	R/W	4603 and 4604	4653 and 4654	4703 and 4704	4753 and 4754	4803 and 4804	4853 and 4854
Alarm B trip	R/W	4605 and 4606	4655 and 4656	4705 and 4706	4755 and 4756	4805 and 4806	4855 and 4856
Alarm C trip	R/W	4607 and 4608	4657 and 4658	4707 and 4708	4757 and 4758	4807 and 4808	4857 and 4858
Alarm D trip	R/W	4609 and 4610	4659 and 4660	4709 and 4710	4759 and 4760	4809 and 4810	4859 and 4860
Totalizer A max. flowrate	R	4611 and 4612	4661 and 4662	4711 and 4712	4761 and 4762	4811 and 4812	4861 and 4862
Totalizer B max. flowrate	R	4613 and 4614	4663 and 4664	4713 and 4714	4763 and 4764	4813 and 4814	4863 and 4864
Totalizer A min. flowrate	R	4615 and 4616	4665 and 4666	4715 and 4716	4765 and 4766	4815 and 4816	4865 and 4866
Totalizer B min. flowrate	R	4617 and 4618	4667 and 4668	4717 and 4718	4767 and 4768	4817 and 4818	4867 and 4868
Totalizer A average flowrate	R	4619 and 4620	4669 and 4670	4719 and 4720	4769 and 4770	4819 and 4820	4869 and 4870
Totalizer B average flowrate	R	4621 and 4622	4671 and 4672	4721 and 4722	4771 and 4772	4821 and 4822	4871 and 4872
Totalizer A batch total	R	4623 to 4626	4673 to 4676	4723 to 4726	4773 to 4776	4823 to 4826	4873 to 4876
Totalizer B batch total	R	4627 to 4630	4677 to 4680	4727 to 4730	4777 to 4780	4827 to 4830	4877 to 4880
Totalizer A max. flowrate (previous batch)	R	4631 and 4632	4681 and 4682	4731 and 4732	4781 and 4782	4831 and 4832	4881 and 4882
Totalizer B max. flowrate (previous batch)	R	4633 and 4634	4683 and 4684	4733 and 4734	4783 and 4784	4833 and 4834	4883 and 4884
Totalizer A min. flowrate (previous batch)	R	4635 and 4636	4685 and 4686	4735 and 4736	4785 and 4786	4835 and 4836	4885 and 4886
Totalizer B min. flowrate (previous batch)	R	4637 and 4638	4687 and 4688	4737 and 4738	4787 and 4788	4837 and 4838	4887 and 4888
Totalizer A average flowrate (previous batch)	R	4639 and 4640	4689 and 4690	4739 and 4740	4789 and 4790	4839 and 4840	4889 and 4890
Totalizer B average flowrate (previous batch)	R	4641 and 4642	4691 and 4692	4741 and 4742	4791 and 4792	4841 and 4842	4891 and 4892
Totalizer A batch total (previous batch)	R	4643 to 4646	4693 to 4696	4743 to 4746	4793 to 4796	4843 to 4846	4893 to 4896
Totalizer B batch total (previous batch)	R	4647 to 4650	4697 to 4700	4747 to 4750	4797 to 4800	4847 to 4850	4897 to 4900

Table B.30 Registers by Channel – Process Group 2, Channels 1 to 6

Signal		Channel Number					
		2.7	2.8	2.9	2.10	2.11	2.12
Analog input value	R	4901 and 4902	4951 and 4952	5001 and 5002	5051 and 5052	5101 and 5102	5151 and 5152
Alarm A trip	R/W	4903 and 4904	4953 and 4954	5003 and 5004	5053 and 5054	5103 and 5104	5153 and 5154
Alarm B trip	R/W	4905 and 4906	4955 and 4956	5005 and 5006	5055 and 5056	5105 and 5106	5155 and 5156
Alarm C trip	R/W	4907 and 4908	4957 and 4958	5007 and 5008	5057 and 5058	5107 and 5108	5157 and 5158
Alarm D trip	R/W	4909 and 4910	4959 and 4960	5009 and 5010	5059 and 5060	5109 and 5110	5159 and 5160
Totalizer A max. flowrate	R	4911 and 4912	4961 and 4962	5011 and 5012	5061 and 5062	5111 and 5112	5161 and 5162
Totalizer B max. flowrate	R	4913 and 4914	4963 and 4964	5013 and 5014	5063 and 5064	5113 and 5114	5163 and 5164
Totalizer A min. flowrate	R	4915 and 4916	4965 and 4966	5015 and 5016	5065 and 5066	5115 and 5116	5165 and 5166
Totalizer B min. flowrate	R	4917 and 4918	4967 and 4968	5017 and 5018	5067 and 5068	5117 and 5118	5167 and 5168
Totalizer A average flowrate	R	4919 and 4920	4969 and 4970	5019 and 5020	5069 and 5070	5119 and 5120	5169 and 5170
Totalizer B average flowrate	R	4921 and 4922	4971 and 4972	5021 and 5022	5071 and 5072	5121 and 5122	5171 and 5172
Totalizer A batch total	R	4923 to 4926	4973 to 4976	5024 and 5025	5073 to 5076	5123 to 5126	5173 to 5176
Totalizer B batch total	R	4927 to 4930	4977 to 4980	5028 and 5029	5077 to 5080	5127 to 5130	5177 to 5180
Totalizer A max. flowrate (previous batch)	R	4931 and 4932	4981 and 4982	5031 and 5032	5081 and 5082	5131 and 5132	5181 and 5182
Totalizer B max. flowrate (previous batch)	R	4933 and 4934	4983 and 4984	5033 and 5034	5083 and 5084	5133 and 5134	5183 and 5184
Totalizer A min. flowrate (previous batch)	R	4935 and 4936	4985 and 4986	5035 and 5036	5085 and 5086	5135 and 5136	5185 and 5186
Totalizer B min. flowrate (previous batch)	R	4937 and 4938	4987 and 4988	5037 and 5038	5087 and 5088	5137 and 5138	5187 and 5188
Totalizer A average flowrate (previous batch)	R	4939 and 4940	4989 and 4990	5039 and 5040	5089 and 5090	5139 and 5140	5189 and 5190
Totalizer B average flowrate (previous batch)	R	4941 and 4942	4391 and 4392	5041 and 5042	5091 and 5092	5141 and 5142	5191 and 5192
Totalizer A batch total (previous batch)	R	4943 to 4946	4993 to 4996	5043 to 5046	5093 to 5096	5143 to 5146	5193 to 5196
Totalizer B batch total (previous batch)	R	4947 to 4950	4997 to 5000	5047 to 5050	5097 to 5100	5147 to 5150	5197 to 5200

Table B.31 Registers by Channel – Process Group 2, Channels 7 to 12

Signal		Channel Number					
		3.1	3.2	3.3	3.4	3.5	3.6
Analog input value	R	5201 and 5202	5251 and 5252	5301 and 5302	5351 and 5352	5401 and 5402	5451 and 5452
Alarm A trip	R/W	5203 and 5204	5253 and 5254	5303 and 5304	5353 and 5354	5403 and 5404	5453 and 5454
Alarm B trip	R/W	5205 and 5206	5255 and 5256	5305 and 5306	5355 and 5356	5405 and 5406	5455 and 5456
Alarm C trip	R/W	5207 and 5208	5257 and 5258	5307 and 5308	5357 and 5358	5407 and 5408	5457 and 5458
Alarm D trip	R/W	5209 and 5210	5259 and 5260	5309 and 5310	5359 and 5360	5409 and 5410	5459 and 5460
Totalizer A max. flowrate	R	5211 and 5212	5261 and 5262	5311 and 5312	5361 and 5362	5411 and 5412	5461 and 5462
Totalizer B max. flowrate	R	5213 and 5214	5263 and 5264	5313 and 5314	5363 and 5364	5413 and 5414	5463 and 5464
Totalizer A min. flowrate	R	5215 and 5216	5265 and 5266	5315 and 5316	5365 and 5366	5415 and 5416	5465 and 5466
Totalizer B min. flowrate	R	5217 and 5218	5267 and 5268	5317 and 5318	5367 and 5368	5417 and 5418	5467 and 5468
Totalizer A average flowrate	R	5219 and 5220	5269 and 5270	5319 and 5320	5369 and 5370	5419 and 5420	5469 and 5470
Totalizer B average flowrate	R	5221 and 5222	5271 and 5272	5321 and 5322	5371 and 5372	5421 and 5422	5471 and 5472
Totalizer A batch total	R	5223 to 5226	5273 to 5276	5323 to 5326	5373 to 5376	5423 to 5426	5473 to 5476
Totalizer B batch total	R	5227 to 5230	5277 to 5280	5327 to 5330	5377 to 5380	5427 to 5430	5477 to 5480
Totalizer A max. flowrate (previous batch)	R	5231 and 5232	5281 and 5282	5331 and 5332	5381 and 5382	5431 and 5432	5481 and 5482
Totalizer B max. flowrate (previous batch)	R	5233 and 5234	5283 and 5284	5333 and 5334	5383 and 5384	5433 and 5434	5483 and 5484
Totalizer A min. flowrate (previous batch)	R	5235 and 5236	5285 and 5286	5335 and 5336	5385 and 5386	5435 and 5436	5485 and 5486
Totalizer B min. flowrate (previous batch)	R	5237 and 5238	5287 and 5288	5337 and 5338	5387 and 5388	5437 and 5438	5487 and 5488
Totalizer A average flowrate (previous batch)	R	5239 and 5240	5289 and 5290	5339 and 5340	5389 and 5390	5439 and 5440	5489 and 5490
Totalizer B average flowrate (previous batch)	R	5241 and 5242	5291 and 5292	5341 and 5342	5391 and 5392	5441 and 5442	5491 and 5492
Totalizer A batch total (previous batch)	R	5243 to 5246	5293 to 5296	5343 to 5346	5393 to 5396	5443 to 5446	5493 to 5496
Totalizer B batch total (previous batch)	R	5247 to 5250	5297 to 5300	5347 to 5350	5397 to 5400	5447 to 5450	5497 to 5500

Table B.32 Registers by Channel – Process Group 3, Channels 1 to 6

Signal		Channel Number					
		3.7	3.8	3.9	3.10	3.11	3.12
Analog input value	R	5501 and 5502	5551 and 5552	5601 and 5602	5651 and 5652	5701 and 5702	5751 and 5752
Alarm A trip	R/W	5503 and 5504	5553 and 5554	5603 and 5604	5653 and 5654	5703 and 5704	5753 and 5754
Alarm B trip	R/W	5505 and 5506	5555 and 5556	5605 and 5606	5655 and 5656	5705 and 5706	5755 and 5756
Alarm C trip	R/W	5507 and 5508	5557 and 5558	5607 and 5608	5657 and 5658	5707 and 5708	5757 and 5758
Alarm D trip	R/W	5509 and 5510	5559 and 5560	5609 and 5610	5659 and 5660	5709 and 5710	5759 and 5760
Totalizer A max. flowrate	R	5511 and 5512	5561 and 5562	5611 and 5612	5661 and 5662	5711 and 5712	5761 and 5762
Totalizer B max. flowrate	R	5513 and 5514	5563 and 5564	5613 and 5614	5663 and 5664	5713 and 5714	5763 and 5764
Totalizer A min. flowrate	R	5515 and 5516	5565 and 5566	5615 and 5616	5665 and 5666	5715 and 5716	5765 and 5766
Totalizer B min. flowrate	R	5517 and 5518	5567 and 5568	5617 and 5618	5667 and 5668	5717 and 5718	5767 and 5768
Totalizer A average flowrate	R	5519 and 5520	5569 and 5570	5619 and 5620	5669 and 5670	5719 and 5720	5769 and 5770
Totalizer B average flowrate	R	5521 and 5522	5571 and 5572	5621 and 5622	5671 and 5672	5721 and 5722	5771 and 5772
Totalizer A batch total	R	5523 to 5526	5573 to 5576	5623 to 5626	5673 to 5676	5723 to 5726	5773 to 5776
Totalizer B batch total	R	5527 to 5530	5577 to 5580	5627 to 5630	5677 to 5680	5727 to 5730	5777 to 5780
Totalizer A max. flowrate (previous batch)	R	5531 and 5532	5581 and 5582	5631 and 5632	5681 and 5682	5731 and 5732	5781 and 5782
Totalizer B max. flowrate (previous batch)	R	5533 and 5534	5583 and 5584	5633 and 5634	5683 and 5684	5733 and 5734	5783 and 5784
Totalizer A min. flowrate (previous batch)	R	5535 and 5536	5585 and 5586	5635 and 5636	5685 and 5686	5735 and 5736	5785 and 5786
Totalizer B min. flowrate (previous batch)	R	5537 and 5538	5587 and 5588	5637 and 5638	5687 and 5688	5737 and 5738	5787 and 5788
Totalizer A average flowrate (previous batch)	R	5539 and 5540	5589 and 5590	5639 and 5640	5689 and 5690	5739 and 5740	5789 and 5790
Totalizer B average flowrate (previous batch)	R	5541 and 5542	5591 and 5592	5641 and 5642	5691 and 5692	5741 and 5742	5791 and 5792
Totalizer A batch total (previous batch)	R	5543 to 5546	5593 to 5596	5643 to 5646	5693 to 5696	5743 to 5746	5793 to 5796
Totalizer B batch total (previous batch)	R	5547 to 5550	5597 to 5600	5647 to 5650	5697 to 5700	5747 to 5750	5797 to 5800

Table B.33 Registers by Channel – Process Group 3, Channels 7 to 12

Signal		Channel Number					
		4.1	4.2	4.3	4.4	4.5	4.6
Analog input value	R	5801 and 5802	5851 and 5852	5901 and 5902	5951 and 5952	6001 and 6002	6051 and 6052
Alarm A trip	R/W	5803 and 5804	5853 and 5854	5903 and 5904	5953 and 5954	6003 and 6004	6053 and 6054
Alarm B trip	R/W	5805 and 5806	5855 and 5856	5905 and 5906	5955 and 5956	6005 and 6006	6055 and 6056
Alarm C trip	R/W	5807 and 5808	5857 and 5858	5907 and 5908	5957 and 5958	6007 and 6008	6057 and 6058
Alarm D trip	R/W	5809 and 5810	5859 and 5860	5909 and 5910	5959 and 5960	6009 and 6010	6059 and 6060
Totalizer A max. flowrate	R	5811 and 5812	5861 and 5862	5911 and 5912	5961 and 5962	6011 and 6012	6061 and 6062
Totalizer B max. flowrate	R	5813 and 5814	5863 and 5864	5913 and 5914	5963 and 5964	6013 and 6014	6063 and 6064
Totalizer A min. flowrate	R	5815 and 5816	5865 and 5866	5915 and 5916	5965 and 5966	6015 and 6016	6065 and 6066
Totalizer B min. flowrate	R	5817 and 5818	5867 and 5868	5917 and 5918	5967 and 5968	6017 and 6018	6067 and 6068
Totalizer A average flowrate	R	5819 and 5820	5869 and 5870	5919 and 5920	5969 and 5970	6019 and 6020	6069 and 6070
Totalizer B average flowrate	R	5821 and 5822	5871 and 5872	5921 and 5922	5971 and 5972	6021 and 6022	6071 and 6072
Totalizer A batch total	R	5823 to 5826	5873 to 5876	5943 to 5946	5973 to 5976	6023 to 6026	6073 to 6076
Totalizer B batch total	R	5827 to 5830	5877 to 5880	5947 to 5950	5977 to 5980	6027 to 6030	6077 to 6080
Totalizer A max. flowrate (previous batch)	R	5831 and 5832	5881 and 5882	5931 and 5932	5981 and 5982	6031 and 6032	6081 and 6082
Totalizer B max. flowrate (previous batch)	R	5833 and 5834	5883 and 5884	5933 and 5934	5983 and 5984	6033 and 6034	6083 and 6084
Totalizer A min. flowrate (previous batch)	R	5835 and 5836	5885 and 5886	5935 and 5936	5985 and 5986	6035 and 6036	6085 and 6086
Totalizer B min. flowrate (previous batch)	R	5837 and 5838	5887 and 5888	5937 and 5938	5987 and 5988	6037 and 6038	6087 and 6088
Totalizer A average flowrate (previous batch)	R	5839 and 5840	5889 and 5890	5939 and 5940	5989 and 5990	6039 and 6040	6089 and 6090
Totalizer B average flowrate (previous batch)	R	5841 and 5842	5891 and 5892	5941 and 5942	5991 and 5992	6041 and 6042	6091 and 6092
Totalizer A batch total (previous batch)	R	5843 to 5846	5893 to 5896	5943 to 5946	5993 to 5996	6043 to 6046	6093 to 6096
Totalizer B batch total (previous batch)	R	5847 to 5850	5897 to 5900	5947 to 5950	5997 to 6000	6047 to 6050	6097 to 6100

Table B.34 Registers by Channel – Process Group 4, Channels 1 to 6

Signal		Channel Number					
		4.7	4.8	4.9	4.10	4.11	4.12
Analog input value	R	6101 and 6102	6151 and 6152	6201 and 6202	6251 and 6252	6301 and 6302	6351 and 6352
Alarm A trip	R/W	6103 and 6104	6153 and 6154	6203 and 6204	6253 and 6254	6303 and 6304	6353 and 6354
Alarm B trip	R/W	6105 and 6106	6155 and 6156	6205 and 6206	6255 and 6256	6305 and 6306	6355 and 6356
Alarm C trip	R/W	6107 and 6108	6157 and 6158	6207 and 6208	6257 and 6258	6307 and 6308	6357 and 6358
Alarm D trip	R/W	6109 and 6110	6159 and 6160	6209 and 6210	6259 and 6260	6309 and 6310	6359 and 6360
Totalizer A max. flowrate	R	6111 and 6112	6161 and 6162	6211 and 6212	6261 and 6262	6311 and 6312	6361 and 6362
Totalizer B max. flowrate	R	6113 and 6114	6163 and 6164	6213 and 6214	6263 and 6264	6313 and 6314	6363 and 6364
Totalizer A min. flowrate	R	6115 and 6116	6165 and 6166	6215 and 6216	6265 and 6266	6315 and 6316	6365 and 6366
Totalizer B min. flowrate	R	6117 and 6118	6167 and 6168	6217 and 6218	6267 and 6268	6317 and 6318	6367 and 6368
Totalizer A average flowrate	R	6119 and 6120	6169 and 6170	6219 and 6220	6269 and 6270	6319 and 6320	6369 and 6370
Totalizer B average flowrate	R	6121 and 6122	6171 and 6172	6221 and 6222	6271 and 6272	6321 and 6322	6371 and 6372
Totalizer A batch total	R	6123 to 6126	6173 to 6176	6223 to 6226	6273 to 6276	6323 to 6326	6373 to 6376
Totalizer B batch total	R	6127 to 6130	6177 to 6180	6227 to 6230	6277 to 6280	6327 to 6330	6377 to 6380
Totalizer A max. flowrate (previous batch)	R	6131 and 6132	6181 and 6182	6231 and 6232	6281 and 6282	6331 and 6332	6381 and 6382
Totalizer B max. flowrate (previous batch)	R	6133 and 6134	6183 and 6184	6233 and 6234	6283 and 6284	6333 and 6334	6383 and 6384
Totalizer A min. flowrate (previous batch)	R	6135 and 6136	6185 and 6186	6235 and 6236	6285 and 6286	6335 and 6336	6385 and 6386
Totalizer B min. flowrate (previous batch)	R	6137 and 6138	6187 and 6188	6237 and 6238	6287 and 6288	6337 and 6338	6387 and 6388
Totalizer A average flowrate (previous batch)	R	6139 and 6140	6189 and 6190	6239 and 6240	6289 and 6290	6339 and 6340	6389 and 6390
Totalizer B average flowrate (previous batch)	R	6141 and 6142	6191 and 6192	6241 and 6242	6291 and 6292	6341 and 6342	6391 and 6392
Totalizer A batch total (previous batch)	R	6143 to 6146	6193 to 6196	6243 to 6246	6293 to 6296	6343 to 6346	6393 to 6396
Totalizer B batch total (previous batch)	R	6147 to 6150	6197 to 6200	6247 to 6250	6297 to 6300	6347 to 6350	6397 to 6400

Table B.35 Registers by Channel – Process Group 4, Channels 7 to 12

Signal		Channel Number					
		5.1	5.2	5.3	5.4	5.5	5.6
Analog input value	R	6401 and 6402	6451 and 6452	6501 and 6502	6551 and 6552	6601 and 6602	6651 and 6652
Alarm A trip	R/W	6403 and 6404	6453 and 6454	6503 and 6504	6553 and 6554	6603 and 6604	6653 and 6654
Alarm B trip	R/W	6405 and 6406	6455 and 6456	6505 and 6506	6555 and 6556	6605 and 6606	6655 and 6656
Alarm C trip	R/W	6407 and 6408	6457 and 6458	6507 and 6508	6557 and 6558	6607 and 6608	6657 and 6658
Alarm D trip	R/W	6409 and 6410	6459 and 6460	6509 and 6510	6559 and 6560	6609 and 6610	6659 and 6660
Totalizer A max. flowrate	R	6411 and 6412	6461 and 6462	6511 and 6512	6561 and 6562	6611 and 6612	6661 and 6662
Totalizer B max. flowrate	R	6413 and 6414	6463 and 6464	6513 and 6514	6563 and 6564	6613 and 6614	6663 and 6664
Totalizer A min. flowrate	R	6415 and 6416	6465 and 6466	6515 and 6516	6565 and 6566	6615 and 6616	6665 and 6666
Totalizer B min. flowrate	R	6417 and 6418	6467 and 6468	6517 and 6518	6567 and 6568	6617 and 6618	6667 and 6668
Totalizer A average flowrate	R	6419 and 6420	6469 and 6470	6519 and 6520	6569 and 6570	6619 and 6620	6669 and 6670
Totalizer B average flowrate	R	6421 and 6422	6471 and 6472	6521 and 6522	6571 and 6572	6621 and 6622	6671 and 6672
Totalizer A batch total	R	6423 to 6426	6473 to 6476	6523 to 6526	6573 to 6576	6623 to 6626	6673 to 6676
Totalizer B batch total	R	6427 to 6430	6477 to 6480	6527 to 6530	6577 to 6580	6627 to 6630	6677 to 6680
Totalizer A max. flowrate (previous batch)	R	6431 and 6432	6481 and 6482	6531 and 6532	6581 and 6582	6631 and 6632	6681 and 6682
Totalizer B max. flowrate (previous batch)	R	6433 and 6434	6483 and 6484	6533 and 6534	6583 and 6584	6633 and 6634	6683 and 6684
Totalizer A min. flowrate (previous batch)	R	6435 and 6436	6485 and 6486	6535 and 6536	6585 and 6586	6635 and 6636	6685 and 6686
Totalizer B min. flowrate (previous batch)	R	6437 and 6438	6487 and 6488	6537 and 6538	6587 and 6588	6637 and 6638	6687 and 6688
Totalizer A average flowrate (previous batch)	R	6439 and 6440	6489 and 6490	6539 and 6540	6589 and 6590	6639 and 6640	6689 and 6690
Totalizer B average flowrate (previous batch)	R	6441 and 6442	6491 and 6492	6541 and 6542	6591 and 6592	6641 and 6642	6691 and 6692
Totalizer A batch total (previous batch)	R	6443 to 6446	6493 to 6496	6543 to 6546	6593 to 6596	6643 to 6646	6693 to 6696
Totalizer B batch total (previous batch)	R	6447 to 6450	6497 to 6500	6547 to 6550	6597 to 6600	6647 to 6650	6697 to 6700

Table B.36 Registers by Channel – Process Group 5, Channels 1 to 6

Signal		Channel Number					
		5.7	5.8	5.9	5.10	5.11	5.12
Analog input value	R	6701 and 6702	6751 and 6752	6801 and 6802	6851 and 6852	6901 and 6902	6951 and 6952
Alarm A trip	R/W	6703 and 6704	6753 and 6754	6803 and 6804	6853 and 6854	6903 and 6904	6953 and 6954
Alarm B trip	R/W	6705 and 6706	6755 and 6756	6805 and 6806	6855 and 6856	6905 and 6906	6955 and 6956
Alarm C trip	R/W	6707 and 6708	6757 and 6758	6807 and 6808	6857 and 6858	6907 and 6908	6957 and 6958
Alarm D trip	R/W	6709 and 6710	6759 and 6760	6809 and 6810	6859 and 6860	6909 and 6910	6959 and 6960
Totalizer A max. flowrate	R	6711 and 6712	6761 and 6762	6811 and 6812	6861 and 6862	6911 and 6912	6961 and 6962
Totalizer B max. flowrate	R	6713 and 6714	6763 and 6764	6813 and 6814	6863 and 6864	6913 and 6914	6963 and 6964
Totalizer A min. flowrate	R	6715 and 6716	6765 and 6766	6815 and 6816	6865 and 6866	6915 and 6916	6965 and 6966
Totalizer B min. flowrate	R	6717 and 6718	6767 and 6768	6817 and 6818	6867 and 6868	6917 and 6918	6967 and 6968
Totalizer A average flowrate	R	6719 and 6720	6769 and 6770	6819 and 6820	6869 and 6870	6919 and 6920	6969 and 6970
Totalizer B average flowrate	R	6721 and 6722	6771 and 6772	6821 and 6822	6871 and 6872	6921 and 6922	6971 and 6972
Totalizer A batch total	R	6723 to 6726	6773 to 6776	6823 to 6826	6873 to 6876	6923 to 6926	6973 to 6976
Totalizer B batch total	R	6727 to 6730	6777 to 6780	6827 to 6830	6877 to 6880	6927 to 6930	6977 to 6980
Totalizer A max. flowrate (previous batch)	R	6731 and 6732	6781 and 6782	6831 and 6832	6881 and 6882	6931 and 6932	6981 and 6982
Totalizer B max. flowrate (previous batch)	R	6733 and 6734	6783 and 6784	6833 and 6834	6883 and 6884	6933 and 6934	6983 and 6984
Totalizer A min. flowrate (previous batch)	R	6735 and 6736	6785 and 6786	6835 and 6836	6885 and 6886	6935 and 6936	6985 and 6986
Totalizer B min. flowrate (previous batch)	R	6737 and 6738	6787 and 6788	6837 and 6838	6887 and 6888	6937 and 6938	6987 and 6988
Totalizer A average flowrate (previous batch)	R	6739 and 6740	6789 and 6790	6839 and 6840	6889 and 6890	6939 and 6940	6989 and 6990
Totalizer B average flowrate (previous batch)	R	6741 and 6742	6791 and 6792	6841 and 6842	6891 and 6892	6941 and 6942	6991 and 6992
Totalizer A batch total (previous batch)	R	6743 to 6746	6793 to 6796	6843 to 6846	6893 to 6896	6943 to 6946	6993 to 6996
Totalizer B batch total (previous batch)	R	6747 to 6750	6797 to 6800	6847 to 6850	6897 to 6900	6947 to 6950	6997 to 7000

Table B.37 Registers by Channel – Process Group 5, Channels 7 to 12

Signal		Channel Number					
		6.1	6.2	6.3	6.4	6.6	6.6
Analog input value	R	7001 and 7002	7051 and 7052	7101 and 7102	7151 and 7152	7201 and 7202	7251 and 7252
Alarm A trip	R/W	7003 and 7004	7053 and 7054	7103 and 7104	7153 and 7154	7203 and 7204	7253 and 7254
Alarm B trip	R/W	7005 and 7006	7055 and 7056	7105 and 7106	7155 and 7156	7205 and 7206	7255 and 7256
Alarm C trip	R/W	7007 and 7008	7057 and 7058	7107 and 7108	7157 and 7158	7207 and 7208	7257 and 7258
Alarm D trip	R/W	7009 and 7010	7059 and 7060	7109 and 7110	7159 and 7160	7209 and 7210	7259 and 7260
Totalizer A max. flowrate	R	7011 and 7012	7061 and 7062	7111 and 7112	7161 and 7162	7211 and 7212	7261 and 7262
Totalizer B max. flowrate	R	7013 and 7014	7063 and 7064	7113 and 7114	7163 and 7164	7213 and 7214	7263 and 7264
Totalizer A min. flowrate	R	7015 and 7016	7065 and 7066	7115 and 7116	7165 and 7166	7215 and 7216	7265 and 7266
Totalizer B min. flowrate	R	7017 and 7018	7067 and 7068	7117 and 7118	7167 and 7168	7217 and 7218	7267 and 7268
Totalizer A average flowrate	R	7019 and 7020	7069 and 7070	7119 and 7120	7169 and 7170	7219 and 7220	7269 and 7270
Totalizer B average flowrate	R	7021 and 7022	7071 and 7072	7121 and 7122	7171 and 7172	7221 and 7222	7271 and 7272
Totalizer A batch total	R	7023 to 7026	7073 to 7076	7123 to 7126	7173 to 7176	7223 to 7226	7273 to 7276
Totalizer B batch total	R	7027 to 7030	7077 to 7080	7127 to 7130	7177 to 7180	7227 to 7230	7277 to 7280
Totalizer A max. flowrate (previous batch)	R	7031 and 7032	7081 and 7082	7131 and 7132	7181 and 7182	7231 and 7232	7281 and 7282
Totalizer B max. flowrate (previous batch)	R	7033 and 7034	7083 and 7084	7133 and 7134	7183 and 7184	7233 and 7234	7283 and 7284
Totalizer A min. flowrate (previous batch)	R	7035 and 7036	7085 and 7086	7135 and 7136	7185 and 7186	7235 and 7236	7285 and 7286
Totalizer B min. flowrate (previous batch)	R	7037 and 7038	7087 and 7088	7137 and 7138	7187 and 7188	7237 and 7238	7287 and 7288
Totalizer A average flowrate (previous batch)	R	7039 and 7040	7089 and 7090	7139 and 7140	7189 and 7190	7239 and 7240	7289 and 7290
Totalizer B average flowrate (previous batch)	R	5241 and 5242	7091 and 7092	7141 and 7142	7191 and 7192	7241 and 7242	7291 and 7292
Totalizer A batch total (previous batch)	R	7043 to 7046	7093 to 7096	7143 to 7146	7193 to 7196	7243 to 7246	7293 to 7296
Totalizer B batch total (previous batch)	R	7047 to 7050	7097 to 7100	7147 to 7150	7197 to 7200	7247 to 7250	7297 to 7300

Table B.38 Registers by Channel – Process Group 6, Channels 1 to 6

Signal		Channel Number					
		6.7	6.8	6.9	6.10	6.11	6.12
Analog input value	R	7301 and 7302	7351 and 7352	7401 and 7402	7451 and 7452	7501 and 7502	7551 and 7552
Alarm A trip	R/W	7303 and 7304	7353 and 7354	7403 and 7404	7453 and 7454	7503 and 7504	7553 and 7554
Alarm B trip	R/W	7305 and 7306	7355 and 7356	7405 and 7406	7455 and 7456	7505 and 7506	7555 and 7556
Alarm C trip	R/W	7307 and 7308	7357 and 7358	7407 and 7408	7457 and 7458	7507 and 7508	7557 and 7558
Alarm D trip	R/W	7309 and 7310	7359 and 7360	7409 and 7410	7459 and 7460	7509 and 7510	7559 and 7560
Totalizer A max. flowrate	R	7311 and 7312	7361 and 7362	7411 and 7412	7461 and 7462	7511 and 7512	7561 and 7562
Totalizer B max. flowrate	R	7313 and 7314	7363 and 7364	7413 and 7414	7463 and 7464	7513 and 7514	7563 and 7564
Totalizer A min. flowrate	R	7315 and 7316	7365 and 7366	7415 and 7416	7465 and 7466	7515 and 7516	7565 and 7566
Totalizer B min. flowrate	R	7317 and 7318	7367 and 7368	7417 and 7418	7467 and 7468	7517 and 7518	7567 and 7568
Totalizer A average flowrate	R	7319 and 7320	7369 and 7370	7419 and 7420	7469 and 7470	7519 and 7520	7569 and 7570
Totalizer B average flowrate	R	7321 and 7322	7371 and 7372	7421 and 7422	7471 and 7472	7521 and 7522	7571 and 7572
Totalizer A batch total	R	7323 to 7326	7373 to 7376	7423 to 7426	7473 to 7476	7523 to 7526	7573 to 7576
Totalizer B batch total	R	7327 to 7330	7377 to 7380	7427 to 7430	7477 to 7480	7527 to 7530	7577 to 7580
Totalizer A max. flowrate (previous batch)	R	7331 and 7332	7381 and 7382	7431 and 7432	7481 and 7482	7531 and 7532	7581 and 7582
Totalizer B max. flowrate (previous batch)	R	7333 and 7334	7383 and 7384	7433 and 7434	7483 and 7484	7533 and 7534	7583 and 7584
Totalizer A min. flowrate (previous batch)	R	7335 and 7336	7385 and 7386	7435 and 7436	7485 and 7486	7535 and 7536	7585 and 7586
Totalizer B min. flowrate (previous batch)	R	7337 and 7338	7387 and 7388	7437 and 7438	7487 and 7488	7537 and 7538	7587 and 7588
Totalizer A average flowrate (previous batch)	R	7339 and 7340	7389 and 7390	7439 and 7440	7489 and 7490	7539 and 7540	7589 and 7590
Totalizer B average flowrate (previous batch)	R	7341 and 7342	7391 and 7392	7441 and 7442	7491 and 7492	7541 and 7542	7591 and 7592
Totalizer A batch total (previous batch)	R	7343 to 7346	7393 to 7396	7443 to 7446	7493 to 7496	7543 to 7546	7593 to 7596
Totalizer B batch total (previous batch)	R	7347 to 7350	7397 to 7400	7447 to 7450	7497 to 7500	7547 to 7550	7597 to 7600

Table B.39 Registers by Channel – Process Group 6, Channels 7 to 12

B.4.3 Communications – Analog and Digital Inputs

<table border="1" style="width: 100%; border-collapse: collapse;"> <tr> <td style="width: 25%;">Communications – Digital Inputs</td> <td style="width: 25%;">Communications – Analog Inputs Failure</td> <td colspan="2" style="width: 50%;">Communications – Analog Inputs</td> </tr> <tr> <td>Read Access 0 = Inactive 1 = Active</td> <td></td> <td colspan="2" rowspan="2" style="text-align: center; vertical-align: middle;">32-bit single precision floating point (–999 to 9999)</td> </tr> <tr> <td>Write Access 0 = De-activate 1 = Activate</td> <td>Write Access Read Only</td> </tr> </table>				Communications – Digital Inputs	Communications – Analog Inputs Failure	Communications – Analog Inputs		Read Access 0 = Inactive 1 = Active		32-bit single precision floating point (–999 to 9999)		Write Access 0 = De-activate 1 = Activate	Write Access Read Only
Communications – Digital Inputs	Communications – Analog Inputs Failure	Communications – Analog Inputs											
Read Access 0 = Inactive 1 = Active		32-bit single precision floating point (–999 to 9999)											
Write Access 0 = De-activate 1 = Activate	Write Access Read Only												
Input Number	Coil Number	Coil Number	Registers										
1	1601	1651	3701 and 3702										
2	1602	1652	3703 and 3704										
3	1603	1653	3705 and 3706										
4	1604	1654	3707 and 3708										
5	1605	1655	3709 and 3710										
6	1606	1656	3711 and 3712										
7	1607	1657	3713 and 3714										
8	1608	1658	3715 and 3716										
9	1609	1659	3717 and 3718										
10	1610	1660	3719 and 3720										
11	1611	1661	3721 and 3722										
12	1612	1662	3723 and 3724										
13	1613	1663	3725 and 3726										
14	1614	1664	3727 and 3728										
15	1615	1665	3729 and 3730										
16	1616	1666	3731 and 3732										
17	1617	1667	3733 and 3734										
18	1618	1668	3735 and 3736										
19	1619	1669	3737 and 3738										
20	1620	1670	3739 and 3740										
21	1621	1671	3741 and 3742										
22	1622	1672	3743 and 3744										
23	1623	1673	3745 and 3746										
24	1624	1674	3747 and 3748										
25	1625	1675	3749 and 3750										
26	1626	1676	3751 and 3752										
27	1627	1677	3753 and 3754										
28	1628	1678	3755 and 3756										
29	1629	1679	3757 and 3758										
30	1630	1680	3759 and 3760										
31	1631	1681	3761 and 3762										
32	1632	1682	3763 and 3764										
33	1633	1683	3765 and 3766										
34	1634	1684	3767 and 3768										
35	1635	1685	3769 and 3770										
36	1636	1686	3771 and 3772										

Table B.40 Modbus Inputs

Appendix C – Storage Capacity

C.1 Internal Storage Capacity

Sample Rate	Number of Channels					
	6	12	18	24	30	36
0.1 seconds	13.1 hours	6.6 hours	4.4 hours	3.3 hours	2.6 hours	2.2 hours
0.2 seconds	1.1 days	13.1 hours	8.8 hours	6.6 hours	5.3 hours	4.4 hours
0.3 seconds	1.6 days	19.7 hours	13.1 hours	9.9 hours	7.9 hours	6.6 hours
0.4 seconds	2.2 days	1.1 days	17.5 hours	13.1 hours	10.5 hours	8.8 hours
0.5 seconds	2.7 days	1.4 days	21.9 hours	16.4 hours	13.1 hours	10.9 hours
0.6 seconds	3.3 days	1.6 days	1.1 days	19.7 hours	15.8 hours	13.1 hours
0.7 seconds	3.8 days	1.9 days	1.3 days	23.0 hours	18.4 hours	15.3 hours
0.8 seconds	4.4 days	2.2 days	1.5 days	1.1 days	21.0 hours	17.5 hours
0.9 seconds	4.9 days	2.5 days	1.6 days	1.2 days	23.6 hours	19.7 hours
1.0 second	5.5 days	2.7 days	1.8 days	1.4 days	1.1 days	21.9 hours
2.0 seconds	10.9 days	5.5 days	3.6 days	2.7 days	2.2 days	1.8 days
3.0 seconds	16.4 days	8.2 days	5.5 days	4.1 days	3.3 days	2.7 days
4.0 seconds	21.9 days	10.9 days	7.3 days	5.5 days	4.4 days	3.6 days
5.0 seconds	27.4 days	13.7 days	9.1 days	6.8 days	5.5 days	4.6 days
6.0 seconds	1.1 months	16.4 days	10.9 days	8.2 days	6.6 days	5.5 days
7.0 seconds	1.3 months	19.2 days	12.8 days	9.6 days	7.7 days	6.4 days
8.0 seconds	1.4 months	21.9 days	14.6 days	10.9 days	8.8 days	7.3 days
9.0 seconds	1.6 months	24.6 days	16.4 days	12.3 days	9.9 days	8.2 days
10.0 seconds	1.8 months	27.4 days	18.2 days	13.7 days	10.9 days	9.1 days
1.0 minute	10.8 months	5.4 months	3.6 months	2.7 months	2.2 months	1.8 months
10.0 minutes	108.0 months	54.0 months	36.0 months	27.0 months	21.6 months	18.0 months
1.0 hour	54.0 years	27.0 years	18.0 years	13.5 years	10.8 years	9.0 years
12.0 hours	647.9 years	323.9 years	216.0 years	162.0 years	129.6 years	108.0 years

Table C.1 Internal Storage Capacity

C.2 Archive Storage Capacity

Note. The storage capacity times shown are for archiving of 12 channels. If more or less channels are enabled, divide or multiply the times accordingly, for example, if 24 channels are enabled, halve the given times; if 6 channels are enabled, double the given times.

Sample Rate	Media Size			
	128 Mb	256 Mb	512 Mb	1 Gb
0.1 seconds	6.1 days	1.7 weeks	3.5 weeks	1.6 months
0.2 seconds	1.7 weeks	3.5 weeks	1.6 months	3.2 months
0.3 seconds	2.6 weeks	1.2 months	2.4 months	4.7 months
0.4 seconds	3.5 weeks	1.6 months	3.2 months	6.3 months
0.5 seconds	1 month	2 months	4 months	7.9 months
0.6 seconds	1.2 months	2.4 months	4.9 months	9.5 months
0.7 seconds	1.4 months	2.8 months	5.7 months	11.1 months
0.8 seconds	1.6 months	3.2 months	6.5 months	12.6 months
0.9 seconds	1.8 months	3.6 months	7.3 months	1.2 years
1.0 second	2 months	4 months	8.1 months	1.3 years
2.0 seconds	4 months	8.1 months	1.3 years	2.6 years
3.0 seconds	6.1 months	12.1 months	2 years	3.9 years
4.0 seconds	8.1 months	16.2 months	2.7 years	5.2 years
5.0 seconds	10.1 months	20.2 months	3.3 years	6.5 years
6.0 seconds	12.1 months	2 years	4 years	7.8 years
7.0 seconds	14.2 months	2.3 years	4.7 years	9.1 years
8.0 seconds	16.2 months	2.7 years	5.3 years	10.4 years
9.0 seconds	18.2 months	3 years	6 years	11.7 years
10.0 seconds	20.2 months	3.3 years	6.7 years	13 years
1.0 minute	10 years	20 years	39.9 years	77.9 years
10.0 minutes	99.8 years	199.5 years	399 years	779.3 years

Table C.2 External (Archive) Storage Capacity

Appendix D – Default Settings

D.1 Company Standard

D.1.1 Common Configuration

Setup

Configuration type	Basic
Number of groups	1
Group overview	Not available
Global alarm	
ack source	None
Instrument tag	SM3000
Screen saver wait time	Disabled
Screen capture	Disabled
Date format	DD/MM/YY
Time format	HH:MM:SS
Daylight Saving – Enable	Off

Security

User names	Operator 1, 2 etc.
User access	
User 1	Config (Full), Setup, e-Sign
All other users	Access disabled
Passwords	
User 1	Blank
All other users	4 spaces

Logs

Alarm log size	200
Totalizer log size	200
Audit log size	200

Operator messages (all)

Message tag	Blank
Group	1
Source ID	None

D.1.2 Process Groups 1 to 6

Recording

Group 1 tag	Process group 1
Group 2 tag	Process group 2
Group 3 tag	Process group 3
Group 4 tag	Process group 4
Group 5 tag	Process group 5
Group 6 tag	Process group 6
Recording enable source	None
Primary sample rate	10s
Secondary sample rate	1s
Sample rate select source	None

Chart view

Chart view enable	Vertical
Chart annotation	None
Major chart divisions	5
Minor chart divisions	2
Screen interval	8 minutes/screen
Trace width	1
Menu enables	
Message select	False
Alarm acknowledge	True
Scale select	False
Trace select	False
Screen interval select	True
Historical review	True
Chart annotation select	False

Bargraph view

Bar graph view enable	Off
Bar graph markers	No markers
Menu enables	
Message select	False
Alarm acknowledge	True
Max/min reset	False

Process view

Process view enable	Off
Menu enables	
Message select	False
Alarm acknowledge	True
Totalizer reset	False
Totalizer stop/go	False

Digital indicator view

Digital view enable	Off
Totalizer display enable	Off
Menu enables	
Message select	False
Alarm acknowledge	True
Totalizer reset	False
Totalizer stop/go	False
Channel select	False
Channel select enables	
Channels x.1 to x.6	True
Channels x.7 to x.12	False

Archiving

Archive file enables	
Channel data file	False
Alarm event log file	False
Totalizer log file	False
Audit log file	False
Wrap	Off

D.1.3 Recording Channels**Setup**

Source identifiers	
Channels 1.1 to 1.6	Analog I/P A1 to A6
All other channels	None
Trace color	
x.1	Magenta
x.2	Red
x.3	Black
x.4	Green
x.5	Blue
x.6	Brown
x.7	Yellow
x.8	Dark yellow
x.9	Cyan
x.10	Light green
x.11	Dark cyan
x.12	Dark magenta
Zone (all channels)	Not zoned
Filter type (all channels)	Instantaneous

Analog inputs

Type	milliamps
Linearizer type	Linear
Electrical range low	4.0
Electrical range high	20.0
Engineering range low	0.0
Engineering range high	100.0
Engineering units	%
Short tag	I/P xx
Long tag	Analog input xx
Filter time constant	0
Fault detect level	10 %
Broken sensor direction	Downscale
Linearizer units	Deg C
ACJC ref	2700
ACJC beta	3977
Mains frequency	50 Hz

Digital recording channels

Long tag	Blank
Short tag	Blank
On tag	On
Off tag	Off

Process alarms (all channels)

Alarm type	Off
Alarm tags (only for channels 1.1A to 1.6D)	
Alarm A tag	1.xA
Alarm B tag	1.xB
Alarm C tag	1.xC
Alarm D tag	1.xD
Trip	0.0 %
Hysteresis	0.0 %
Time hysteresis	0 Secs
Enable source	None
Log enable	On
Alarm groups	All False

Totalizers

Count enable	Off
Wrap enable	Wrap on
Channel x.xA totalizer tag	Total flow x.xA
Channel x.xB totalizer tag	Total flow x.xB
	(for totalizers 1.1A to 1.6B, all others = Blank)
Units	Blank
Stop/Go recovery	Last
Stop/Go source	None
Preset count	0
Predetermined count	1000000000
Intermediate count	900000000
Reset source	None
Log update time	Off
Log update source	None
Count rate	1.00000
Cut off	0.0

D.1.4 I/O Modules**Relay modules (all sources)**

Source	None
Polarity	Positive

Hybrid modules

Digital outputs	
Source	None
Polarity	Positive
Analog outputs	
Analog output source	None
Engineering range low	0.0
Engineering range high	100.0
Electrical range low	4.0 mA
Electrical range high	20.0 mA

RS485 module

Protocol	Modbus
Type	4-wire
Baud rate	19200
Parity	Odd
Address	1

D.1.5 Functions**Custom Linearizers 1, 2, 3 and 4**

X co-ordinates	0.0, 5.0, 10.0, 15.0, 20.0, 25.0, 30.0, 35.0, 40.0, 45.0, 50.0, 55.0, 60.0, 65.0, 70.0, 75.0, 80.0, 85.0, 90.0, 95.0, 100.0
Y co-ordinates	As X co-ordinates

Custom chart zones

All custom chart zones	
Lower margin	0.00 %
Upper margin	100.00 %

Real-time alarms 1 to 12

Alarm tag	Real time alarm x
Daily enables	
(Sun, Mon, Tues etc.)	All false
1st of the month enable	Off
On time –	
Every hour	Off
Hours	0
Minutes	0
Duration –	
Hours	0
Minutes	0
Seconds	0
Log enable	Off

D.2 QuickStart Templates**D.2.1 QSMilliAmp****Bargraph view**

Bar graph view enable	Vertical
Bar graph markers	Max and min
Menu enables	
Alarm acknowledge	True
Max/min reset	True

Process view

Process view enable	Off
Menu enables	
Alarm acknowledge	True
Totalizer reset	True
Totalizer stop/go	True

Digital indicator view

Digital view enable	On
Totalizer display enable	Off
Menu enables	
Alarm acknowledge	True
Channel select enables	
Channels x.1 to x.6	True

Archiving

Archive file enables	
Channel data file	True

D.2.2 QSFlow

As D.2.1 QSMilliAmp, except:

Analog inputs

Engineering range high	2000
Engineering units	l/h

Totalizers

Count enable	Up
Preset count	0.0
Predetermined count	10000000.0
Intermediate count	9000000.0
Count rate	0.55556

I/O Modules

Analog outputs	
Engineering range high	2000

D.2.3 QSTHC_C

As D.2.1 QSMilliAmp, except:

Analog inputs

Type	Thermocouple
Linearizer type	K
Linearizer units	Degrees C
Engineering units	°C

D.2.4 QSTHC_F

As D.2.3 QSTHC_C, except:

Analog inputs

Linearizer units	Degrees F
Engineering units	°F

D.2.5 QSRTD_C

As D.2.3 QSTHC_C, except:

Analog inputs

Type	Resistance thermometer
Linearizer type	Pt100

D.2.6 QSRTD_F

As D.2.4 QSTHC_F, except:

Analog inputs

Type	Resistance thermometer
Linearizer type	Pt100

D.2.7 QSDEMO

As D.1 Company Standard, except:

Operator messages

Message 1	Start of batch
Message 2	End of batch
Message 3	Standby mode active
Message 4	Cleaning in progress

Chart view

Menu enables	
Message select	True
Scale select	True
Trace select	True
Chart annotation select	True

Bargraph view

Bar graph view enable	Horizontal and vertical
Bar graph markers	Max, min and alarm trips
Menu enables	
Message select	True
Max/min reset	True

Process view

Process view enable	On
Menu enables	
Message select	True
Alarm acknowledge	True
Totalizer reset	True
Totalizer stop/go	True

Archiving

Archive file enables	
Channel data file	True
Alarm event log file	True
Totalizer log file	True
Audit log file	True

Recording channels

Source identifiers	
Channels 1.1 to 1.5	Analog I/P A.1 to A.5
Channel 1.6	Alarm state 1.1A

Analog inputs

Type	Simulated sinewave
Engineering range low	0.0
Engineering range high	10.0
Engineering units	%
Ch1.1	°C
Ch1.2	bar
Ch1.3	Gal/h
Ch1.4	Liters
Ch1.5	°F
Analog input short tags	
A.1	Temp 1
A.2	Pressure
A.3	In Flow
A.4	Volume
A.5	Temp 2

Digital channel 1.6

Digital on tag	Open
Digital off tag	Close
Short tag	Valve
Long tag	Valve status

Alarms

Alarm 1.1A	
Type	High process
Trip	10.0°C
Alarm 1.5A	
Type	Low process
Trip	75.0°F

Totalizers

Count enable	Count up
Log update time	60 min

Real-time alarms

Daily enables	Mo,Tu,We,Th,Fr
On time –	
Every hour	On
Duration –	
Minutes	10
Log enable	On

Appendix E – Ethernet

E.1 Introduction

E.1.1 Ethernet Communications

Ethernet is a form of electronic communication that has been adopted as a worldwide networking standard. Each device on an Ethernet acts independently from other stations on the network, that has no central controller.

There are a number of media that can be used for Ethernet interconnections, for example, coaxial cable, unshielded twisted pair (UTP) cable and air transmission. The Ethernet module fitted to the recorder supports the 10BaseT standard that uses UTP cable to connect nodes. UTP cable comprises four pairs of wires twisted together into a single cable. Ethernet signals are transmitted serially, one bit at a time, over a shared signal channel to every station attached to the network.

When a station has data to transmit, it listens to the channel to wait until the channel is idle then transmits its data as an Ethernet frame or packet. After each frame transmission, all stations must contend equally for the next frame transmission opportunity. This ensures that no station can lock out the other stations on the network.

Access to the network channel is determined by the Medium Access Control (MAC) mechanism embedded in the Ethernet interface of each station. This mechanism is based on a Carrier Sense Multiple Access with Collision Detection (CSMA/CD) system.

Each Ethernet frame contains the source and destination addresses for the frame, a variable size data field and an error checking field that checks the integrity of the frame content to ensure that it has been delivered intact. The address fields, called physical or MAC addresses, are each 48-bits long. Every station on the network has a unique, pre-assigned MAC address programmed into its Ethernet board.

E.1.2 Higher Level Protocols

Data can be transmitted over an Ethernet network using higher level protocols that overlay the Ethernet infrastructure. The higher level protocol packets are contained within the data field of Ethernet packets. The recorder uses the Transmission Control Protocol/Internet Protocol (TCP/IP); this is a worldwide standard that was used to create the Internet.

The Internet Protocol (IP) routes the packets of information to their destination devices. The routing is performed using an IP address embedded in the header attached to each packet. The IP address is a 32-bit number divided into four sections (called octets) that are shown as decimal values. A typical example is 192.168.1.1.

The Transmission Control Protocol (TCP) establishes a connection between the two devices before any data is transmitted; this enables confirmation of receipt of all transmitted packets, so that any lost packets can be retransmitted.

Other protocols that operate at the same level are the Address Resolution Protocol (ARP) and the Internet Control Message Protocol (ICMP).

Above the TCP and IP layers there are a number of application protocols that perform a range of tasks. Typical examples are File Transfer Protocol (FTP) and HyperText Transfer Protocol (HTTP).

These layers fit together to provide a full data transfer system:

Application Protocols	File Transfer Protocol (FTP)	HyperText Transfer Protocol (HTTP)	
Low Level Network Protocols	Transmission Control Protocol (TCP)		
	Internet Protocol (IP)	Address Resolution Protocol (ARP)	Internet Control Message Protocol (ICMP)
Data Link	Ethernet		
Physical Media	Twisted Pair		

Table E.1 Protocol Layers

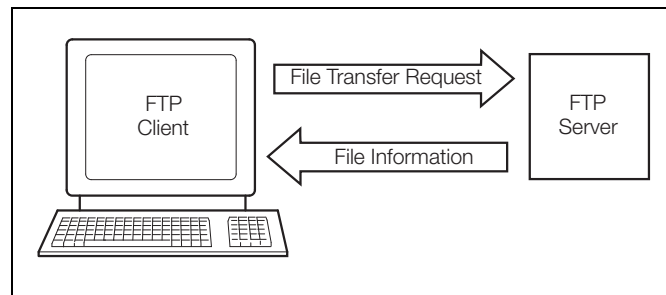

Fig. E.1 Typical FTP Transfer

FTP provides a reliable mechanism for the transfer of files between a client and a server – see Fig. E.1.

HTTP enables the transfer of hypertext files such as web pages and allows a web browser to access pages within a web server – see Fig. E.2.

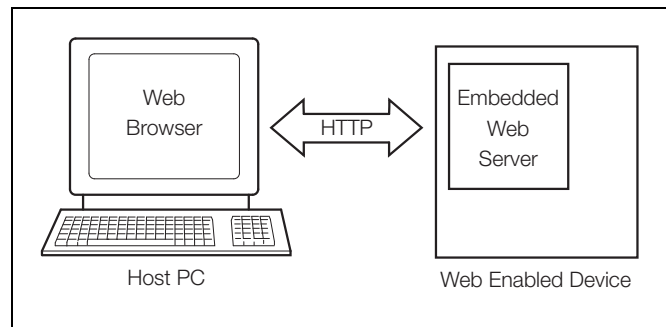
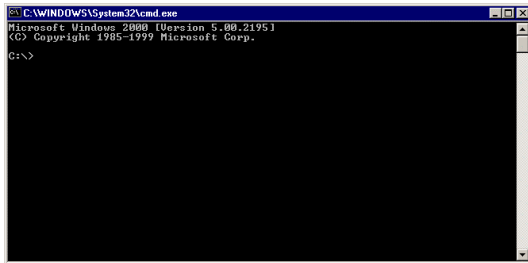

Fig. E.2 Typical HTTP Transfer

E.2 Testing a Network Connection

With the recorder connected to an Ethernet network (see Section 7.9, page 120) and configured for use (see Section 6.4.5, page 69), use the MS-DOS® 'ping' command to test its operation:

1. On the PC, click the 'Start' button on the task bar and select 'Run'.
2. In the 'Open:' field, type 'cmd' and click the 'OK' button. This displays a DOS window with the cursor at the default drive prompt:



3. Type 'ping' followed by the IP address assigned to the recorder and press Enter. A message is displayed in the window indicating that a ping operation is sending 32 bytes of data to the specified address. If the connection and address are correct, four replies are received, for example:

Pinging 192.168.1.1 with 32 bytes of data:

```
Reply from 192.168.1.1: bytes = 32 time<10ms TTL=128
Reply from 192.168.1.1: bytes = 32 time<10ms TTL=128
Reply from 192.168.1.1: bytes = 32 time<10ms TTL=128
Reply from 192.168.1.1: bytes = 32 time<10ms TTL=128
```

4. If a valid response is not received, check that the correct IP address was entered and that the host PC has an IP address with the same network ID as defined by the subnet mask. If the addressing is correct, check the connecting cable and confirm that the green continuity LED on recorder's Ethernet module is lit, indicating that a connection has been made.

E.3 Configuring FTP Access

The FTP server in the recorder is used to access its file system from a remote station on the network. This requires an FTP client on the host PC. Both MS-DOS® and Microsoft® Internet Explorer version 5.5 or later can be used as an FTP client.

A File Transfer Scheduler Program (FTSP) is available that enables archive and configuration files to be transferred automatically to a PC using FTP. The transferred files can be stored either on the local drive of the PC or on a network drive for easy access and secure back-up.

To obtain the FTSP (FTS.exe), enter the following (without spaces) in a web browser's address bar:

<http://search.abb.com/library/ABBLibrary.asp?DocumentID=FTS.exe&LanguageCode=en&DocumentPartId=&Action=Launch>

To obtain the FTSP User Guide (IM/SMFTS), enter the following (without spaces) in a web browser's address bar:

<http://search.abb.com/library/ABBLibrary.asp?DocumentID=IM/SMFTS&LanguageCode=en&DocumentPartId=&Action=Launch>

E.3.1 FTP Access via MS-DOS

To use FTP access:

1. If the DOS window is not open, click the 'Start' button on the task bar and select 'Run'.
2. Type 'ftp' and press Enter. The 'ftp>' prompt is displayed.
3. In the 'Open:' field, type 'cmd' and click the 'OK' button. A DOS window is displayed with the cursor at the default drive prompt.
4. Type 'open' followed by the IP address assigned to the recorder and press Enter. If connection is successful, a confirmation message is displayed, for example, the following is displayed for a device with IP address 192.168.1.1:

```
Connected to 192.168.1.1
220 WinCE GkWare FTP Service (Version 1.3 May 6
2003)
User (192.168.1.1: (none)):
```

5. Enter the FTP User name for the recorder (see Section 6.4.5, page 69) and press Enter. The following is displayed:

```
331 OK, password required
Password:
```

6. Type the device password and press Enter. If the user has full access, the following is displayed:

```
230 OK
ftp>
```

If the user has read-only access, the following is displayed:

```
230 OK, Read-only access granted
ftp>
```

Note.

- n When typing the password, the cursor does not move and nothing appears in the DOS window.
- n An audit log entry is created for each FTP logon giving details of the logon user name and type of access (full or read-only), e.g:



The link is now open.

The following FTP commands are used to communicate with the recorder:

Cd	Change directory on the server
Close	Terminate the data connection
Del	Delete a file on the server
Dir	Display the server directory
Get	Get a file from the server
Help	Display help
Ls	Lists contents of the remote directory
Mget	Get several files from the server
Mput	Send several files to the server
Open	Connect to the server
Put	Send a file to the server
Pwd	Display the current server directory
Quote	Supply an internal FTP command directly
Quit	Terminate the FTP session

For example, to view the contents of the root directory, type 'dir' at the ftp prompt and press Enter. A list of folders is displayed:

```
ftp> dir
200 PORT command successful.
150 Opening ASCII mode data connection for /bin/ls.
01-01-1998 12:00PM <DIR> Flash_Disk
01-01-1998 12:00PM <DIR> Storage_Card
10-03-2003 12:59PM <DIR> www
10-03-2003 12:59PM <DIR> My Documents
10-03-2003 12:59PM <DIR> Program Files
10-03-2003 12:59PM <DIR> Temp
10-03-2003 12:59PM <DIR> Windows
226 Transfer complete.
ftp: 348 bytes received in 1.03Seconds 0.34Kbytes/sec.
```

To view the contents of a folder, type 'cd [Folder Name]' and press Enter, then type 'dir' and press Enter. A similar list is displayed showing the contents of the folder.

Note. The contents of the Storage_Card folder are accessible only if archiving is set to 'On-line' in the recorder's Setup menu – see Section 5.4, page 43.

To copy a file from the recorder to the PC's local or network drive, type:

```
get '[File name]'
```

...at the ftp prompt and press Enter. A confirmation such as the following is displayed:

```
ftp> get'14083218Sep03Ch1_4AnlgSM3000.B00'
200 PORT command successful.
150 Opening ASCII mode data connection for
14083218Sep03Ch1_4AnlgSM3000.B00
226 RETR command successful.
ftp: 75912 bytes received in 1.38 Seconds 55.21
Kbytes/sec.
ftp>
```

E.3.2 FTP Access via Internet Explorer

Note. Internet Explorer version 5.5 or later is required for FTP access via Internet Explorer.

Before data can be accessed via FTP, Internet Explorer must be configured with the appropriate options.

To ensure that the latest data file is copied, Internet Explorer must be set to check for newer versions of stored pages on every visit to a page. If this check is not performed, the browser may use data stored in the cache of the local PC rather than retrieve the current data over the network from the remote device.

1. Start Internet Explorer, select 'Tools' from the menu bar and select 'Internet Options'.



2. In the 'General' tab of the displayed dialog box, click the Settings button in the 'Temporary Internet Files' grouping.
3. From the options for 'Check for newer versions of stored pages:', select 'Every visit to the page' and click 'OK'.
4. To enable FTP access, select the 'Advanced' tab of the 'Internet Options' dialog box, ensure that the 'Enable folder view for FTP sites option' under the 'Browsing' heading is selected and click 'OK'.

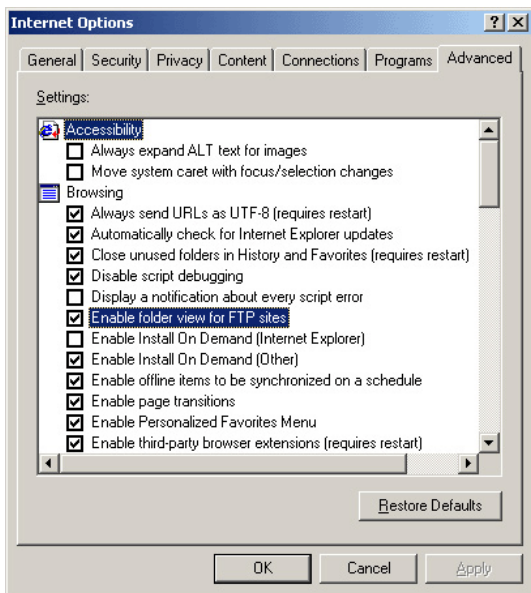

Note. Step 5 is applicable only to PCs equipped with Windows XP Service Pack 2.

5. On the 'Advanced' tab of the 'Internet Options' dialog box, scroll down and ensure that 'Use Passive FTP' (for firewall and DSL modem compatibility) is NOT ticked.

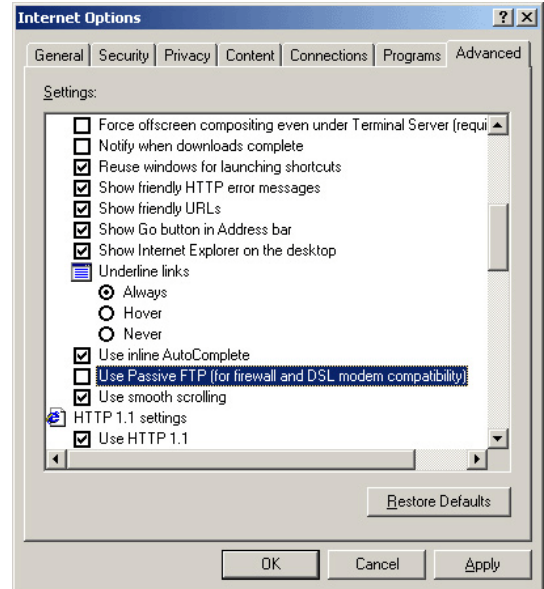

Accessing Data via FTP

To access data:

1. Start Internet Explorer.
2. In the 'Address' bar, enter 'ftp://' followed by the IP address of the recorder from which the files are to be copied. The following is displayed:

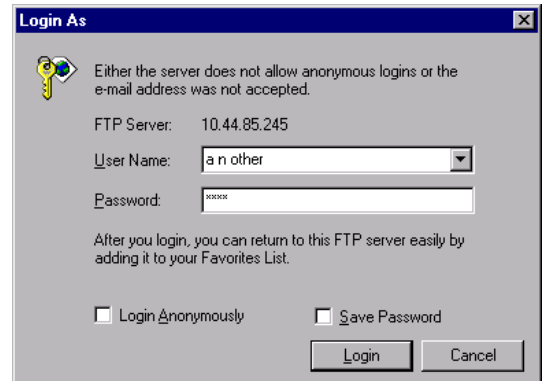

- Enter the 'User Name:' and 'Password:' for the recorder (see Section 6.4.5, page 69), and click on 'Login'. The contents of the recorder, that looks similar to the following, is displayed:

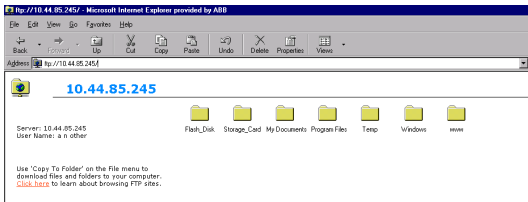

- Open the folder containing the file to be displayed. The files within the folder can be displayed in any standard format (small icon, large icon, list or details) by selecting the appropriate option from the 'View' menu.

Note. The contents of the Storage_Card folder are accessible only if archiving is set to 'On-line' in the recorder's Setup menu – see Section 5.4, page 43.

- Select the file or files to be copied. The 'Shift' and 'Ctrl' keys can be used to select more than one file.
- Click the right mouse button to display the following option menu:

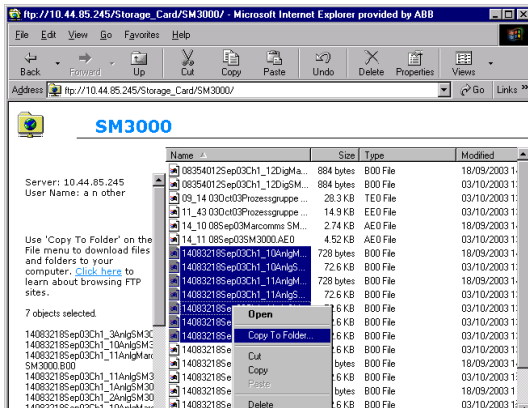

- Select the 'Copy To Folder' option. The 'Browse for Folder' window is displayed:

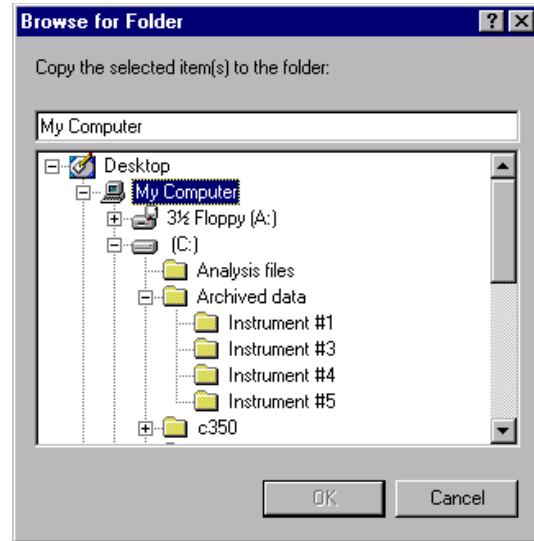

- Select the drive and folder to which the file is to be copied.
- Click on OK. The file is copied into the selected folder.

Note.

- n An audit log entry is created for each FTP logon giving details of the logon user name and type of access (full or read-only) e.g:

28	User Operator 1 full FTP Logon	07/10/03	09:05:15
----	--------------------------------	----------	----------

- n When Internet Explorer is used as the FTP client, two logons are performed at the start of each session resulting in two log entries.

E.3.3 Using FTP Access with DataManager

The Company's DataManager software can be used with FTP to access data files that have been saved to the archive media (SmartMedia or Compact Flash card) inserted in the recorder. For full details of how to configure DataManager for use with FTP access, refer to the DataManager User Guide, IM/DATMGR.

Note. The content of the archive media is accessible only if archiving is set to 'On-line' in the recorder's Setup menu – see Section 5.4, page 43.

E.3.4 Using the Recorder's Web Server

Figs. E.3 to E.13 are examples of the page views available from the recorder's web server.

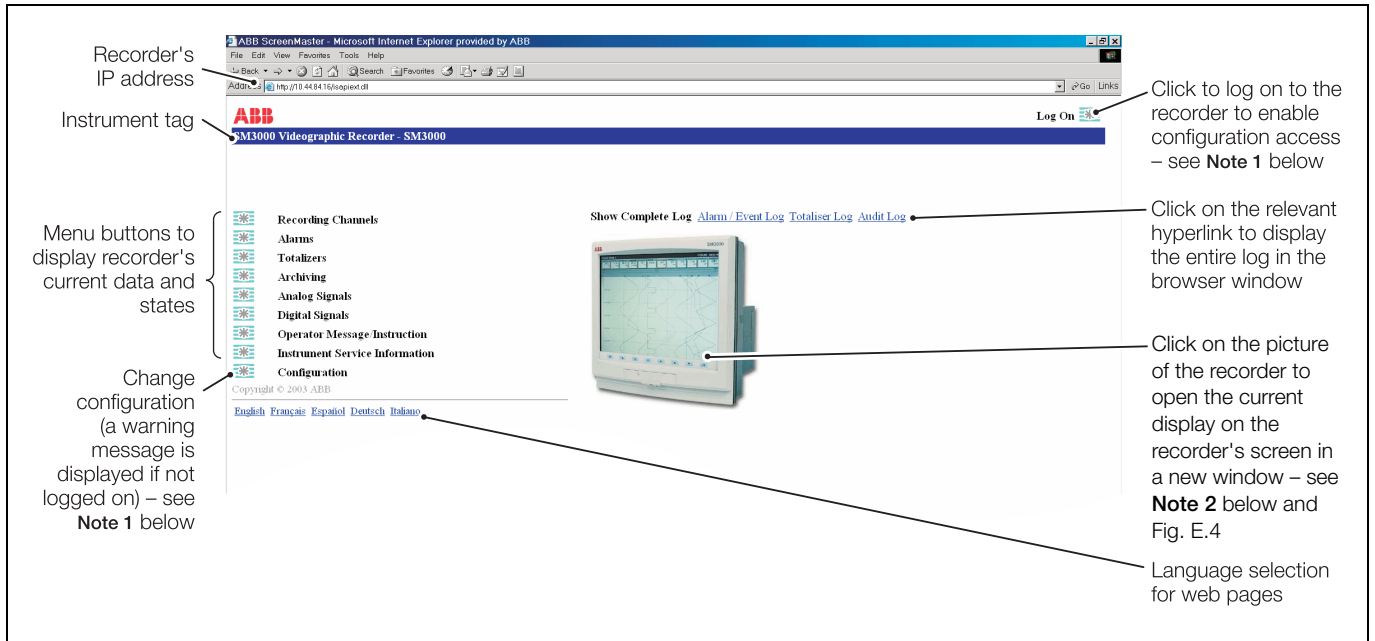

Fig. E.3 Home Page

Note.

1. The 'Log On' and 'Configuration' buttons are displayed only if a user has been configured for remote operation access – see Section 6.4.5, page 69.
2. The Current Display view is not available if the recorder is in historical review or configuration mode.

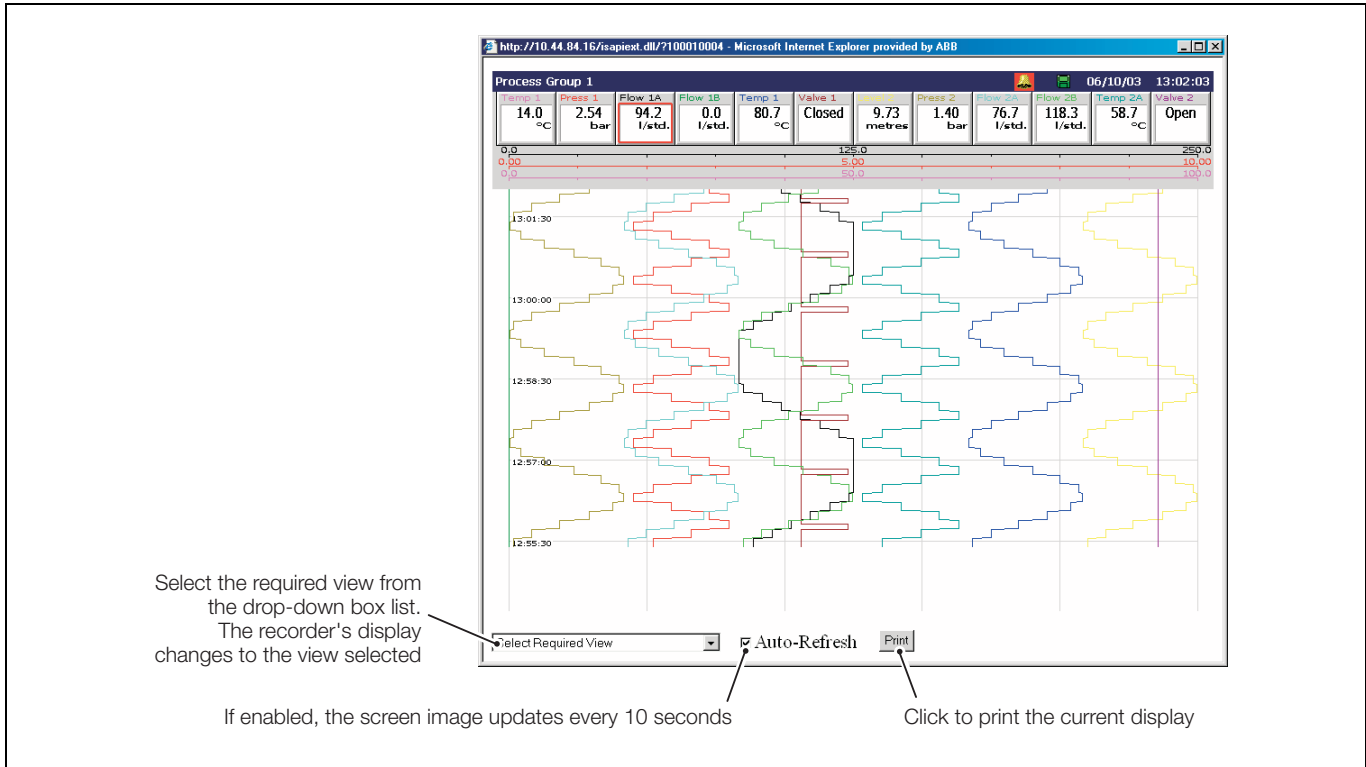

Fig. E.4 Current Display

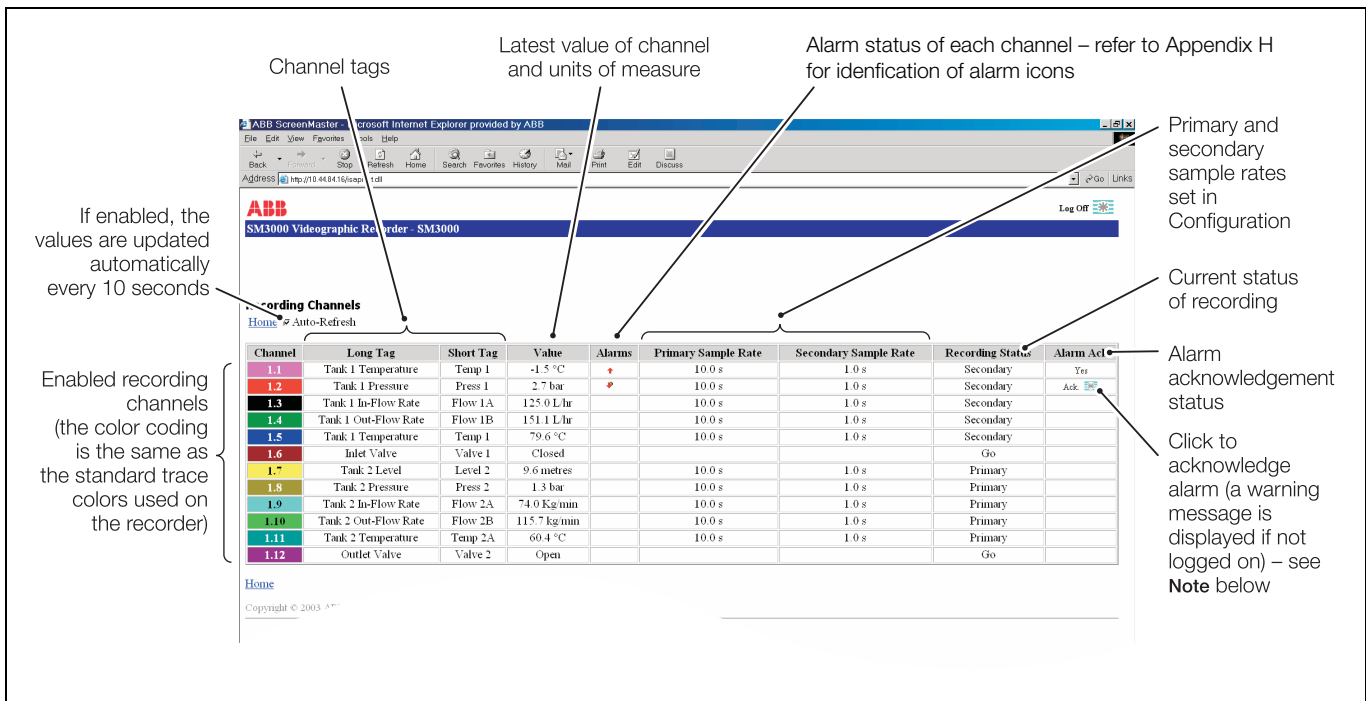

Fig. E.5 Recording Channels Page

Note. Alarm acknowledgement is enabled only if a user has been configured for remote operation access – see Section 6.4.5, page 69.

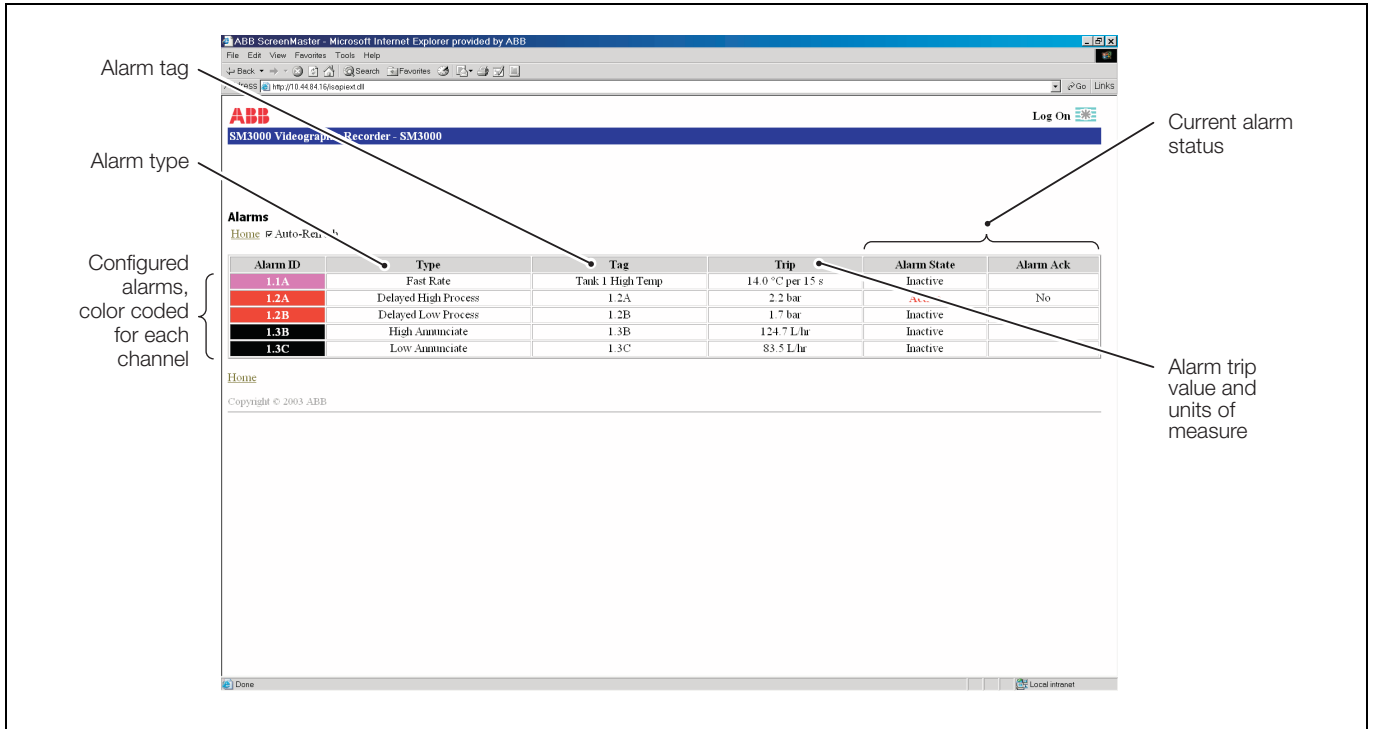

Fig. E.6 Alarms Page

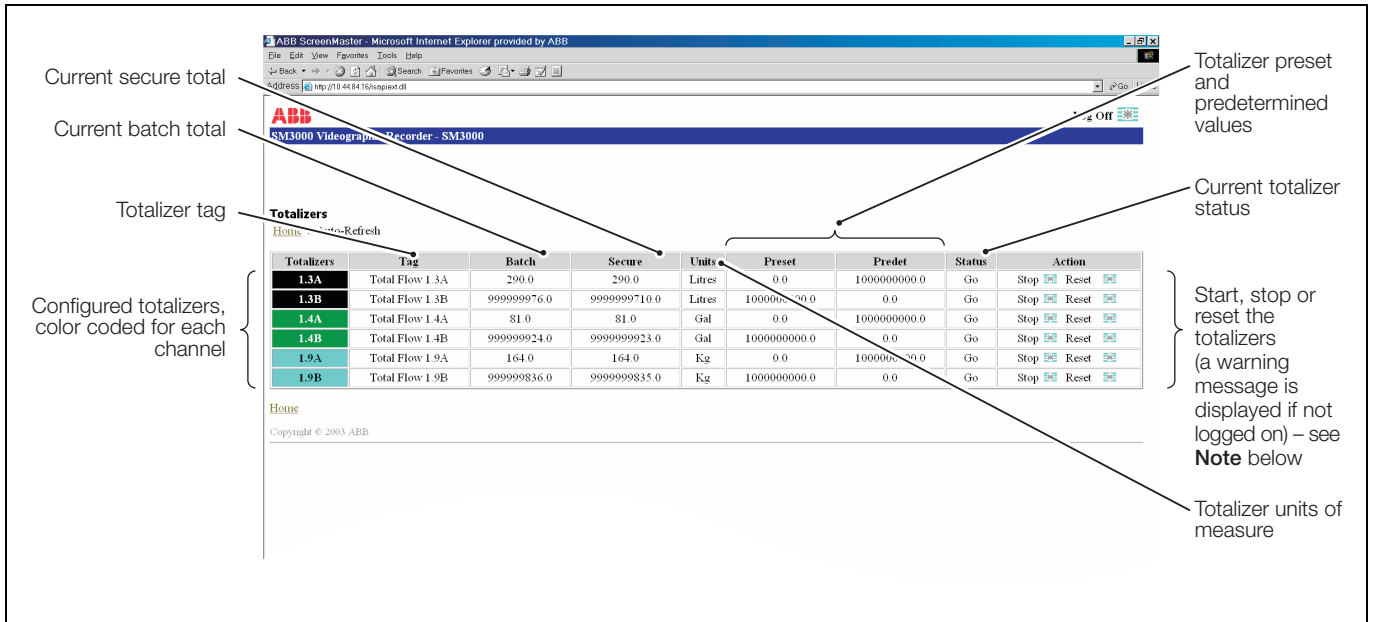

Fig. E.7 Totalizers Page

Note. Totalizer control is enabled only if a user has been configured for remote operation access – see Section 6.4.5, page 69.

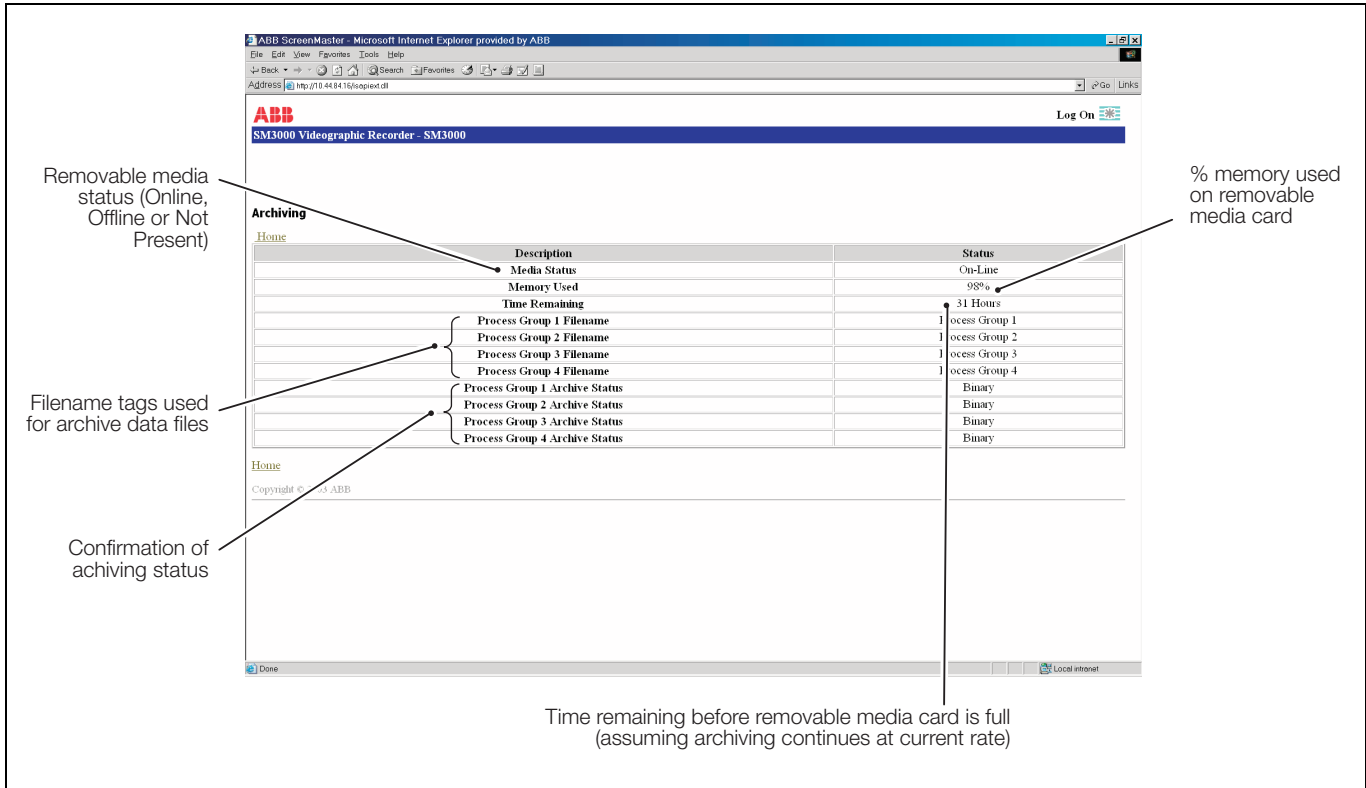

Fig. E.8 Archiving Page

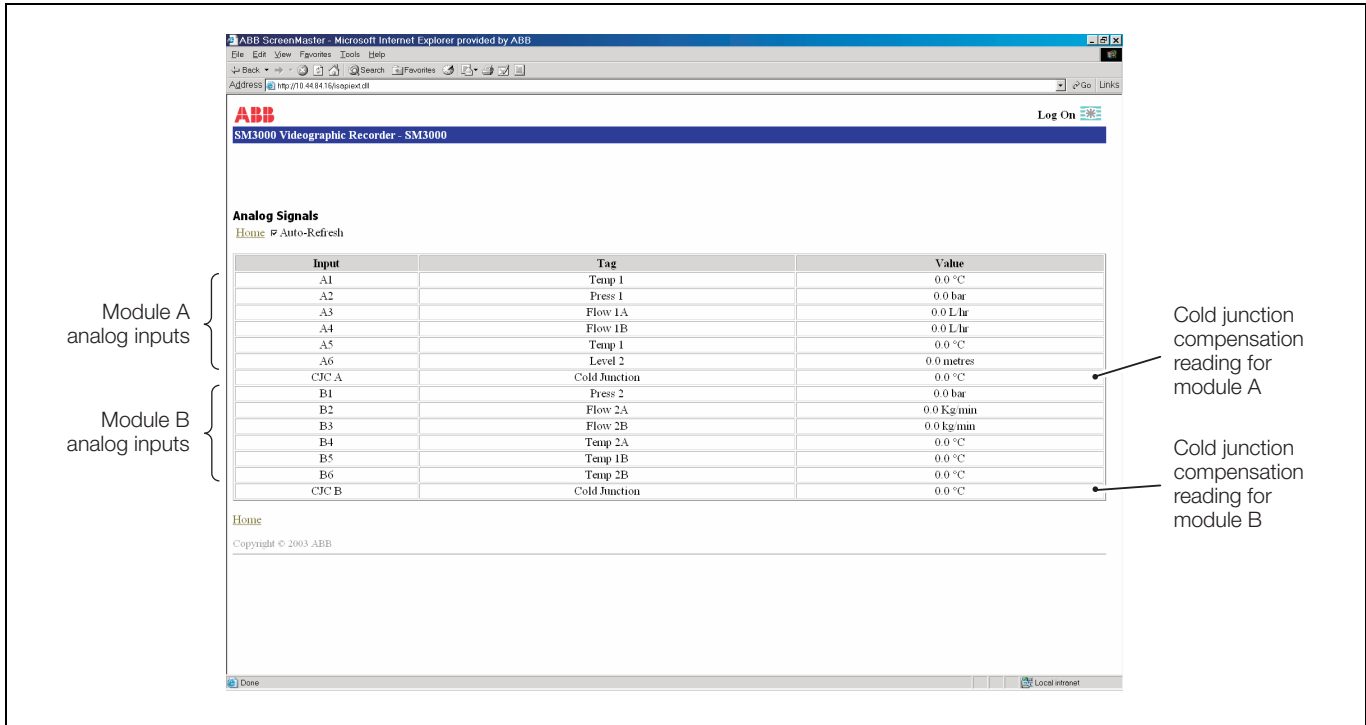

Fig. E.9 Analog Signals Page

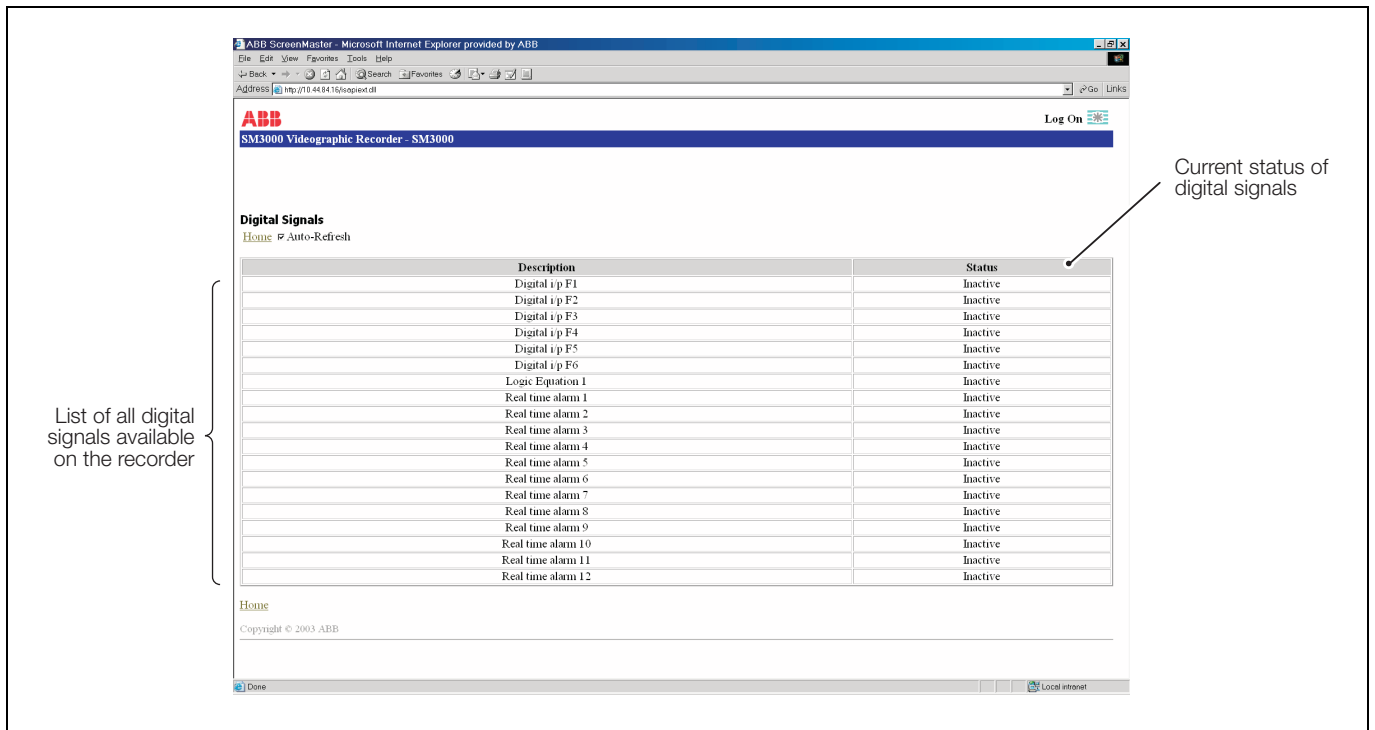

Fig. E.10 Digital Signals Page

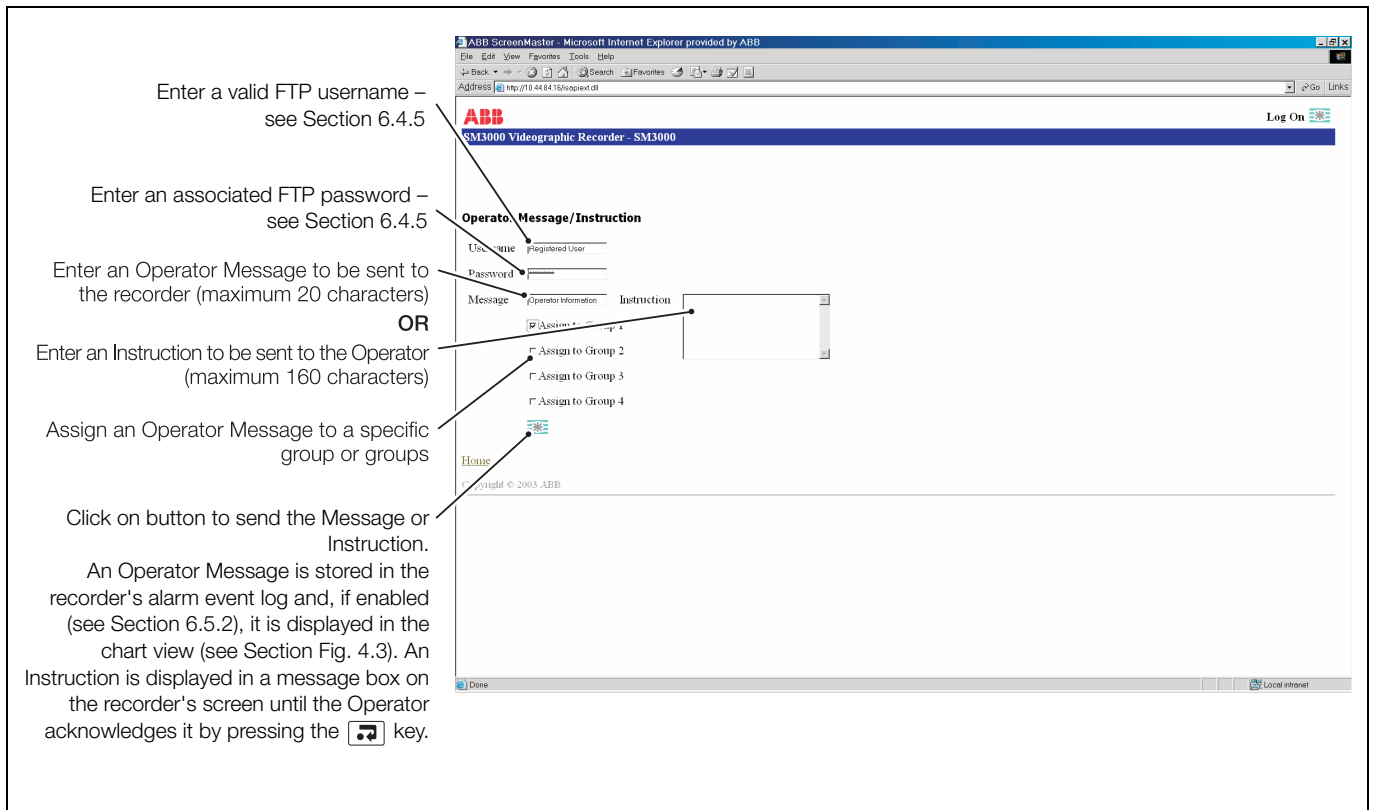

Fig. E.11 Operator Message Page

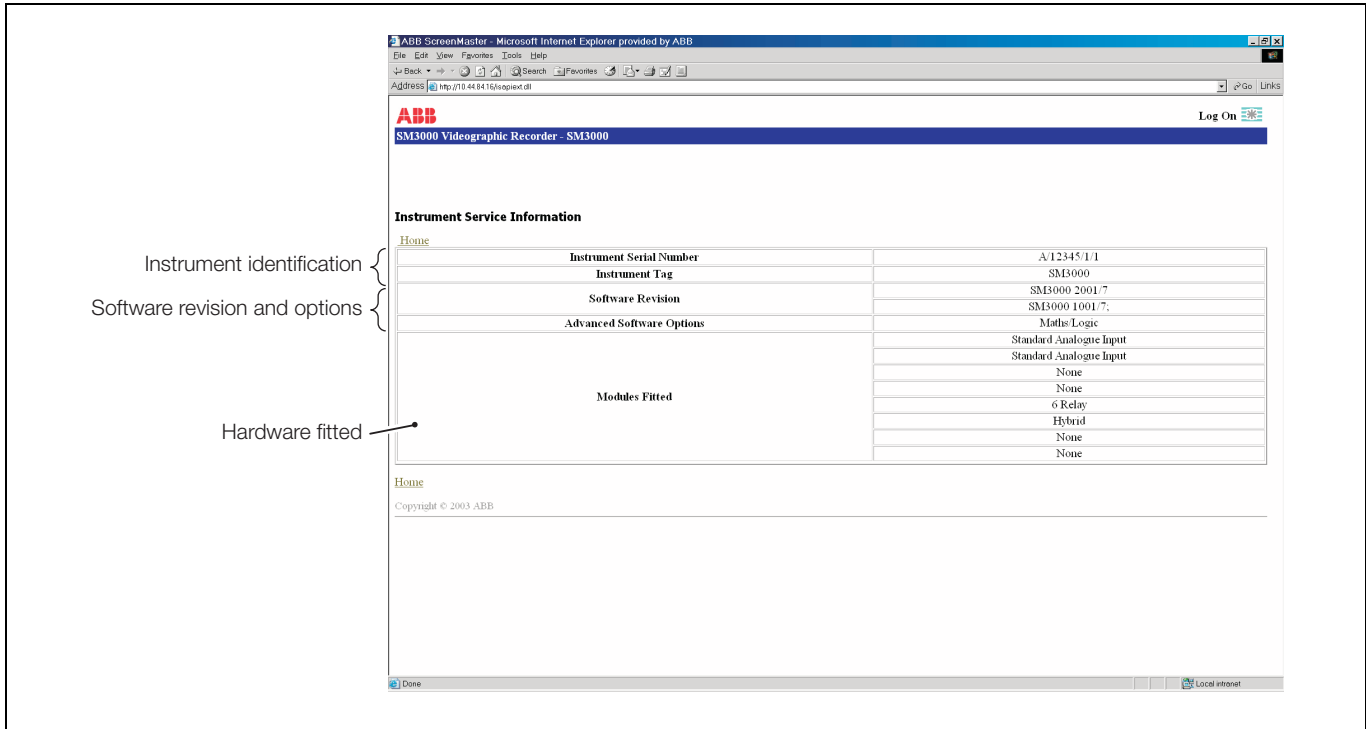

Fig. E.12 Service Information Page

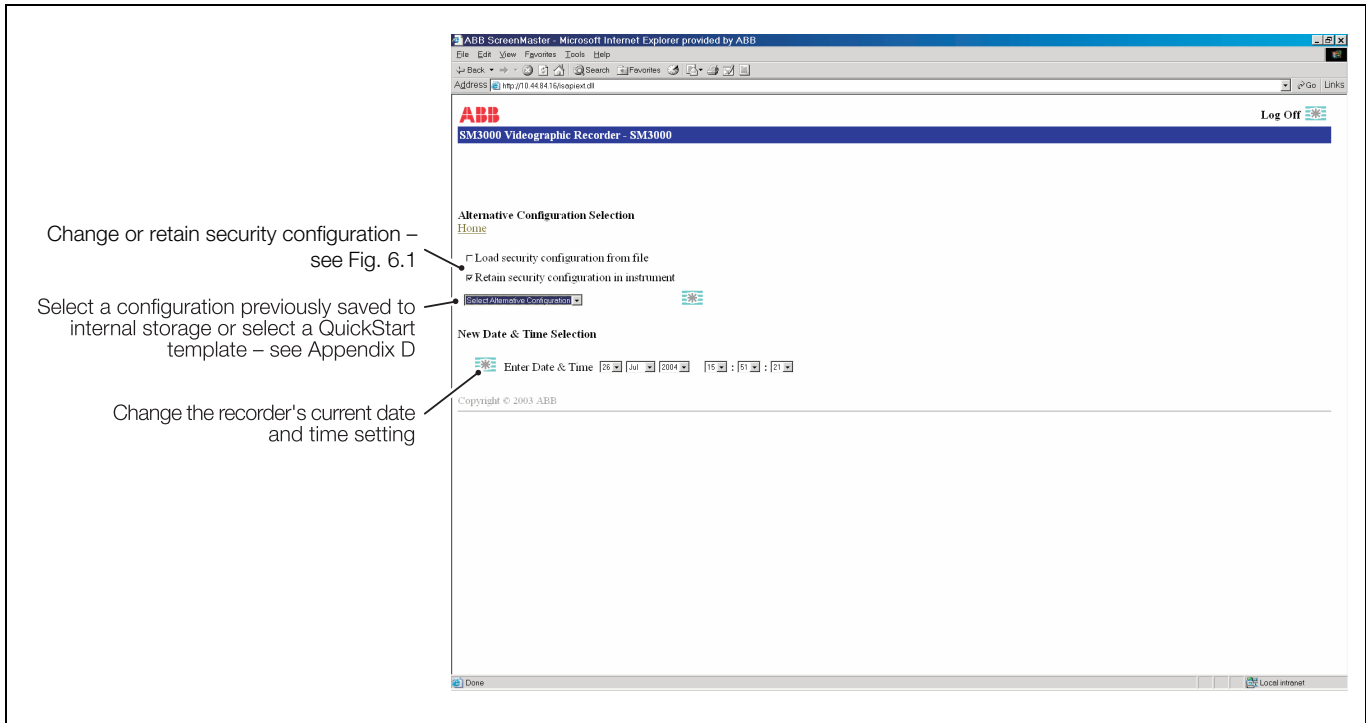

Fig. E.13 Alternative Configuration Selection

Note. Alternative Configuration Selection is available only if a user has been configured for remote operation access with Configuration access rights – see Section 6.4.5, page 69.

E.3.5 Glossary of Terms

The following terms have specific meanings within the Ethernet environment:

10BaseT

A definition of the cable type and transmission rate of the network. The '10' represents a transmission rate of 10Mbps and the 'T' for unshielded twisted pair cable.

100BaseT

A higher speed version of 10BaseT with a transmission rate of 100Mbps.

ARP

Address Resolution Protocol. Converts between IP addresses and MAC (hardware) addresses on the network.

Default gateway

The IP address of the gateway (router, switch etc.) that is used to communicate with other networks.

FTP

File Transfer Protocol. A TCP/IP suite application that provides an efficient and reliable means of transferring files between a remote server and a client.

HTTP

HyperText Transfer Protocol. Used for the transfer of web pages.

ICMP

Internet Control Message Protocol. An Internet protocol sent in response to errors in TCP/IP messages. It is an error reporting protocol between a host and a gateway.

IP address

Internet Protocol address. This is the unique address given to each computer on a TCP/IP network (including the Internet).

LAN

Local Area Network. A group of computers and associated devices that share a common communications line or wireless link and, typically, the resources of a single processor or server within a small geographic area (for example, within an office building). Usually, the server has applications and data storage that are shared in common by multiple computer users. A LAN may serve as few as two or three users (for example, in a home network) or as many as thousands of users (for example, in a large office).

MAC address

Media Access Control address, also called the hardware or physical address. This is a unique address given to each Ethernet interface that is used in an Ethernet packet to identify the source and destination of the data being sent.

Open system

A system conforming to specifications and guidelines that are 'open' to all. This allows any manufacturers' equipment that comply with these standards to be used interchangeably on the standard network.

Router

Links a local network to a remote network. For example, your company's network probably uses a router to connect to the Internet. Can be used to connect a LAN to a LAN, a WAN to a WAN, or a LAN to the Internet.

Subnet mask (or Sub-Network Mask)

A mask used to determine what subnet an IP address belongs to (an IP address has two components, the network address and the host address).

TCP/IP

Transmission Control Protocol/Internet Protocol. The language all computers on the Internet, LANs and WANs use to communicate with each other.

UTP

Unshielded Twisted Pair. The type of wire that is used in 10BaseT Ethernet communications.

WAN

Wide Area Network. A geographically dispersed telecommunications network. The term distinguishes a broader telecommunication structure from a local area network (LAN). A WAN may be privately owned or rented, but the term usually implies the inclusion of public (shared user) networks.

Appendix F – Spare Parts and Accessories

Media Door Keys
GR2000/0725



20-way Terminal Block
for analog input modules:
GR2000/0726
for other modules:
GR2000/0727



Panel Clamp
GR2000/3723

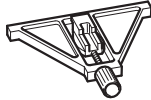

8-way Terminal Block
GR2000/0728



Voltage Divider Board
GR2000/0375
(inc. 250 Ω shunt GR2000/0377)



Instrument to Panel Seal
GR100/3102

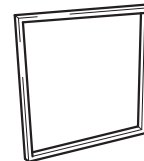

Compact Flash Card
512 Mb B12156
1 Gb B12567
2 GB B12568



Terminal Compartment
GR2000/3716

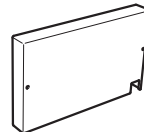

USB Universal Card Reader
B12028



Documentation Pack
This manual
IM/SM3000
Quick reference guide
IM/SM3000-Q
End User Licence Agreement
IM/SM2000-L
Data Sheet
SS/SM3000

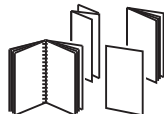

Removable Media Options
(in place of existing option, if fitted)
Compact Flash upgrade pack
GR2000/3700
SmartMedia upgrade pack
GR2000/3702

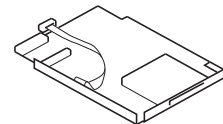

Optional I/O Boards
(Max. 6, including factory-fitted option boards – see Fig. 7.5, page 113 for possible combinations)
3-Relay board upgrade pack
GR2000/0703
6-Relay board upgrade pack
GR2000/0704
Hybrid I/O board upgrade pack
GR2000/0705
Transmitter PSU board upgrade pack
GR2000/0706
6-Channel standard analog I/P board upgrade pack
GR2000/0708
6-Channel high specification analog I/P board upgrade pack
GR2000/0714
RS485 serial communications board upgrade pack
GR2000/1722

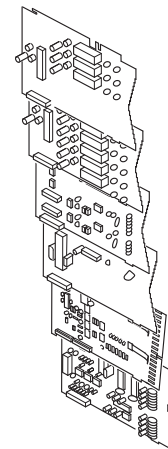

Appendix G – Error & Diagnostics Information

Error Message	Action
"The system has not finished updating the files in the storage card folder. Please re-insert the storage card now. WARNING: Failure to do so may result in lost data on the storage card."	Re-insert the storage card immediately and press the  key to clear the error message.
"Would you like the system to format the storage card folder so that the system can use it? WARNING: If you select Yes, all files on the storage card folder will be erased!"	Remove the card from the recorder and format the card on a PC before reinserting.
"Disk removed before signature sign" message appears in audit log.	Caused by static damage to media card. Format or replace current card. Observe anti-static precautions when handling.

Appendix H – Symbols and Icons

Process Group Name

Process Group 1

03/12/02 16:16:14

Status Icons

Process Group 1 Configuration to Process Group 6 Configuration

Channel 1.1 to 1.6 Configuration to Channel 6.1 to 6.6 Configuration

Common Configuration

Functions Configuration

I/O Module Configuration

- Historical Review Active
- External archive media on-line (green icon, shaded area indicates % used)
- External archive media off-line (grey icon, shaded area indicates % used)
- Media update in progress. *Do not remove media while this symbol is displayed*
- External media 100% full, archiving stopped (green/red icon, flashing white cross)
- Warning! Too many files (green icon – media online, grey icon – media offline)
- Too many files, archiving stopped (red icon, flashing yellow cross)
- Alarm(s) active. Red flashing border indicates unacknowledged alarm(s) active
- AutoView scroll active
- Clock battery needs replacing – refer to instructions in INF05/90

Alarm Event Icons	Totalizer Icons	Audit Log Icons																																																																																																							
<table border="0" style="width: 100%;"> <tr> <td style="width: 15%;">Inactive</td> <td></td> <td></td> <td></td> <td>Totalizer Started</td> <td></td> <td>Power Failed</td> </tr> <tr> <td></td> <td></td> <td></td> <td></td> <td>Totalizer Stopped</td> <td></td> <td>Power Restored</td> </tr> <tr> <td></td> <td></td> <td></td> <td></td> <td>Totalizer Wrapped</td> <td></td> <td>Calibration Change</td> </tr> <tr> <td></td> <td></td> <td></td> <td></td> <td>Totalizer Reset</td> <td></td> <td>Configuration Change</td> </tr> <tr> <td></td> <td></td> <td></td> <td></td> <td>Intermediate Value Reached</td> <td></td> <td>File Deleted</td> </tr> <tr> <td></td> <td></td> <td></td> <td></td> <td>Timed Event</td> <td></td> <td>Archive Media Inserted</td> </tr> <tr> <td></td> <td></td> <td></td> <td></td> <td>Triggered Event</td> <td></td> <td>Archive Media Removed</td> </tr> <tr> <td></td> <td></td> <td></td> <td></td> <td>Power Failed</td> <td></td> <td>Archive Media Off-line</td> </tr> <tr> <td></td> <td></td> <td></td> <td></td> <td>Power Restored</td> <td></td> <td>Archive Media On-line</td> </tr> <tr> <td></td> <td></td> <td></td> <td></td> <td>Batch Total</td> <td></td> <td>Archive Media Full</td> </tr> <tr> <td></td> <td></td> <td></td> <td></td> <td>Maximum Value</td> <td></td> <td>System Error/Reset Archiving</td> </tr> <tr> <td></td> <td></td> <td></td> <td></td> <td>Minimum Value</td> <td></td> <td>Date/Time or Daylight Saving Start/End Changed</td> </tr> <tr> <td></td> <td></td> <td></td> <td></td> <td>Average Value</td> <td></td> <td>FTP Logon</td> </tr> <tr> <td></td> <td></td> <td></td> <td></td> <td>Daylight Saving Start/End Changed</td> <td></td> <td>Electronic Signature</td> </tr> <tr> <td></td> <td></td> <td></td> <td></td> <td></td> <td></td> <td>Security Change</td> </tr> </table>	Inactive				Totalizer Started		Power Failed					Totalizer Stopped		Power Restored					Totalizer Wrapped		Calibration Change					Totalizer Reset		Configuration Change					Intermediate Value Reached		File Deleted					Timed Event		Archive Media Inserted					Triggered Event		Archive Media Removed					Power Failed		Archive Media Off-line					Power Restored		Archive Media On-line					Batch Total		Archive Media Full					Maximum Value		System Error/Reset Archiving					Minimum Value		Date/Time or Daylight Saving Start/End Changed					Average Value		FTP Logon					Daylight Saving Start/End Changed		Electronic Signature							Security Change
Inactive				Totalizer Started		Power Failed																																																																																																			
				Totalizer Stopped		Power Restored																																																																																																			
				Totalizer Wrapped		Calibration Change																																																																																																			
				Totalizer Reset		Configuration Change																																																																																																			
				Intermediate Value Reached		File Deleted																																																																																																			
				Timed Event		Archive Media Inserted																																																																																																			
				Triggered Event		Archive Media Removed																																																																																																			
				Power Failed		Archive Media Off-line																																																																																																			
				Power Restored		Archive Media On-line																																																																																																			
				Batch Total		Archive Media Full																																																																																																			
				Maximum Value		System Error/Reset Archiving																																																																																																			
				Minimum Value		Date/Time or Daylight Saving Start/End Changed																																																																																																			
				Average Value		FTP Logon																																																																																																			
				Daylight Saving Start/End Changed		Electronic Signature																																																																																																			
						Security Change																																																																																																			

Fig. H.1 Symbols and Icons

Appendix I – End User License Agreement

You have acquired a ScreenMaster graphical recorder ('ScreenMaster') that includes software licensed by ABB from Microsoft Licensing Inc. or its affiliates ('MS'). Those installed software products of MS origin, as well as associated media, printed materials, and 'online' or electronic documentation ('software') are protected by copyright laws and international copyright treaties, as well as other intellectual property laws and treaties. The software is licensed, not sold.

If you do not agree to this end user license agreement ('EULA'), do not use the ScreenMaster or copy the software. Instead, promptly contact ABB for instructions on return of the unused ScreenMaster for a refund. Any use of the software, including but not limited to use on the ScreenMaster, will constitute your agreement to this EULA (or ratification of any previous consent).

Grant of license. The software is licensed, not sold. This EULA grants you the following rights to the software:

1. **You may use the software only on the ScreenMaster.**
2. **Not fault tolerant.** The software is not fault tolerant. ABB has independently determined how to use the software in the ScreenMaster, and MS has relied upon ABB to conduct sufficient testing to determine that the software is suitable for such use.
3. **No warranties for the software.** The software is provided 'as is' and with all faults. The entire risk as to satisfactory quality, performance, accuracy, and effort (including lack of negligence) is with you. Also, there is no warranty against interference with your enjoyment of the software or against infringement. If you have received any warranties regarding the ScreenMaster or the software, those warranties do not originate from, and are not binding on, MS.
4. **Note on Java support.** The software may contain support for programs written in Java. Java technology is not fault tolerant and is not designed, manufactured, or intended for use or resale as online control equipment in hazardous environments requiring fail-safe performance, such as in the operation of nuclear facilities, aircraft navigation or communication systems, air traffic control, direct life support machines, or weapons systems, in which the failure of Java technology could lead directly to death, personal injury, or severe physical or environmental damage.

Sun Microsystems, Inc. Has contractually obligated MS to make this disclaimer.

ABB informs users that the ScreenMaster does not contain programs written in Java.

5. **No liability for certain damages.** Except as prohibited by law, MS shall have no liability for any indirect, special, consequential or incidental damages arising from or in connection with the use or performance of the software. This limitation shall apply even if any remedy fails of its essential purpose. In no event shall MS be liable for any amount in excess of U.S. two hundred and fifty dollars (U.S.\$250.00).
6. **Limitations on reverse engineering, decompilation, and disassembly.** You may not reverse engineer, decompile, or disassemble the software, except and only to the extent that such activity is expressly permitted by applicable law notwithstanding this limitation.
7. **Software transfer allowed but with restrictions.** You may permanently transfer rights under this EULA only as part of a permanent sale or transfer of the ScreenMaster, and only if the recipient agrees to this EULA. If the software is an upgrade, any transfer must also include all prior versions of the software.
8. **Export restrictions.** You acknowledge that software is of US-origin. You agree to comply with all applicable international and national laws that apply to the software, including the U.S. export administrations, as well as end-user, end-use and country destination restrictions issued by U.S. and other governments. For additional information on exporting the software, see <http://www.microsoft.com/exporting/>.

Index

A

Alarm event log	37, 38, 67
Filter	38
Alarms	12
Acknowledging	19, 23, 27, 30, 33, 38,
62,	69, 80, 81, 82, 83, 103
Event	12
Groups	97, 130
Hysteresis	66, 96
New Alarm	12, 71, 130
State Recording	97
Tag	96
Type	96
Analog Inputs	
Connections	114
High Specification Inputs	89, 90, 114
Volt Free Digital Input	89, 92
Analog Outputs	
Connections	119
Archiving	
Archive File Format	85
Archive Wrap	48, 85
Channel Data Files	44, 47, 85
Data Verification and Integrity	48
File Names	47
File Types	47
Log Files	48
Media Off-line	41, 48
Media On-line	41, 48
Off-line	44
On-line	44
Reset	43
Sample Rates	85
Too Many Files – Archiving Stopped	48
Warning – Too Many Files	48
Assign to Group	
Electronic Signatures	20
Operator Messages	15, 22, 25, 29, 32
Audit Log	34, 36, 47, 67, 85
AutoView Scroll – See Chart : AutoView Scroll	

B

Bargraph	6, 21, 58
Configuration	81
Markers	81
Max./Min. Reset	23
Views	
Enabling Menu Items	81
BCD (Binary Encoded) Digital Inputs	103, 129

C

Channel Indicator	
Tags	91, 92
Chart	
Annotation	16, 79
AutoView Scroll	19, 23, 27, 30
Duration	16, 43, 77, 80
Electronic Signature	20, 66
New Chart	19
Scales	14, 18, 80
Totalizer Reset	19, 80
Totalizer Stop/Go	19, 80
Traces	12, 18, 80, 88
Views	
Circular	11
Horizontal	10
Vertical	10
Zoning	88
Custom Zones	108

...C

Configuration	
Access	51, 52
Alarms	93 to 97
Analog Input	89 to 91
Electrical Range	90
Engineering Range	90
Input Adjustment	101
Input Failure	91
Bargraph View	81
Channel	86 to 100
Chart View	78 to 80
Common	61 to 71
Company Standard	172
Copy Facility	57 to 59
Custom Chart Zones	108
Custom Linearizers	107
Data Entry	56
Digital Indicator View	83
Digital Input	92
Disabling Recording During Configuration	52
email	70 to 71
Ethernet	69
Exiting Configuration Mode	60
I/O Modules	101 to 106
Analog Inputs	101
Hybrid Modules	103
Relay Modules	102
RS485(Modbus) Modules	105
Internal Switch Protection	51
Logs	67
Number of Groups	61
Operator Messages	68
Overview	54
Password Protection	51
Process Group	76 to 85
Process View	82
Real Time Alarms	108
Recording Parameters	76 to 77
Sample Rates	77
Security	51, 65 to 66
Access Privileges	66
Inactive user De-activation	65
Internal Switch	51, 53
Passwords	66
Type	51, 65
View/Edit Other Users	66
Totalizers	98 to 100
Type	61

D

Date and Time	63 to 64
Daylight Saving	14, 47, 48, 49, 64
Diagnostics (Math and Logic)	44
See also Advanced Software Options	
User Guide Supplement, IM/SM3000ADV	
Digital Indicator View	24
Channel Select	26
Channel Select Enable	84
Menu Items Enabling	83
Totalizer Reset	27
Totalizer Stop/Go	27
Digital Inputs	
Connections	119
Volt Free Digital Input	89, 92
Digital Outputs	
Connections	119

E

Electrical Connections	112 to 119
Electronic Signature – See Chart: Electronic Signature	
Email	70
Address	71
Reports	71
Triggers	71
Environmental Limits	109
Error Messages	189
Ethernet	
Configuration	69
Configuring FTP Access	177
FTP User Name	69
Glossary of Terms	187
Higher Level Protocols	176
Introduction	176
IP Address	69
Testing a Network Connection	177
Using FTP Access with DataManager	180
Using the Recorder's Web Server	181 to 186

- F**
- File Viewer44
 - Filter
 - Mains Rejection Frequency101
 - Rate Alarm97
 - Recording Channel Input88
 - Filter Time91
 - FTP Logon69
 - Functions 107 to 108
- G**
- Getting started4
 - Group Overview6, 9, 31
 - Alarm Acknowledgement33
 - Enable62
- H**
- Historical Review13, 15, 16, 17, 44, 181
 - Enable80
 - Exit14
 - Goto14
 - Hybrid I/O Modules103
 - Connections119
- I**
- Input Adjustment66, 101
 - Installation 109 to 121
 - Electrical Connections 112 to 119
 - Ethernet Network Connections 120 to 121
 - Fitting the Instrument111
 - Mounting Dimensions110
 - Instrument Status 34 to 35
 - Instrument Tag62
- L**
- Language62
 - Linearizer Type89
 - Linearizer Units89
 - Log Sizes67
 - Logic Equations44
 - See also Advanced Software Options
 - User Guide Supplement, IM/SM3000ADV
- M**
- Mains Power Connections 118
 - Mains Rejection Frequency 101
 - Math Blocks 44
 - See also Advanced Software Options
 - User Guide Supplement, IM/SM3000ADV
 - Modbus (RS485) 105 to 106
 - Master
 - Poll limit 105
 - Poll rate 105
 - Response timeout 105
 - RTU address 106
 - Modbus TCP 72 to 75
 - Client (Modbus master) 73 to 75
 - Reverse IEEE Data 72
 - Server (Modbus slave) 72
 - TCP Client Access 72
 - TCP/IP Port 72
 - Module Positions 113
- O**
- Offset Adjust 102
 - Operator Messages
 - Alarm Event Log 38, 67
 - Bargraph View 22
 - Chart View 15, 16, 79, 80
 - Digital Indicator View 25
 - Group Overview 32
 - Message Tag 68
 - Process View 29
 - Source ID 68
 - User Defined 15, 22, 25, 29, 32
- P**
- Passwords
 - Entering 42
 - Entry Failure Limit 66
 - Expiry 42, 65
 - Length 66
 - Primary and Secondary Sample Rates 16, 17, 41, 43, 60, 77, 85
 - Process Group Tag 76
 - Process View 28 to 30
 - Menu Items Enabling 82
 - Totalizer Reset 30
 - Totalizer Stop/Go 30
 - Product code 3

Q

QuickStart Templates 174 to 175

R

Real-time Alarms 108
 Relay Connections 118
 Reset Archiving – See Archiving: Reset
 Resistance Thermometer (RTD) 89, 90, 114

S

Sample Rates – See Primary and Secondary Sample Rates
 Scales – See Chart: Scales
 Screen Capture 6, 12, 62
 Screen Interval 17, 43, 77
 Select Enable 80
 Screen Saver 62
 Setup Level
 Accessing 41
 Passwords 42
 Menu 43
 Recording Control 43
 Signal Sources 129
 Simulated Inputs 89
 Siting 109
 Span Adjust 102
 Spare Parts and Accessories 188
 Specification 122
 Storage Capacity
 External Media 171
 Internal Memory 170
 Symbols & icons 190
 System Administrator 41, 52, 65, 66, 67

T

Thermocouple Compensating Cable 102, 114, 115
 Totalizer Log 39 to 40
 Configuration 67
 Filter 40
 Max/Min Details 40
 Update Frequency 99
 Totalizers
 Count Direction 98
 Count Rate 100
 Intermediate Count 99
 Predetermined Count 99
 Preset Count 99
 Tag 98
 Units 98
 Wrap 98, 99
 Trace
 Color 87
 Width 80
 Transmitter Power Supply 114

Acknowledgements and Trademarks

Modbus is a registered trademark of the Modbus-IDA organization

Microsoft is a registered trademark of Microsoft Corporation in the United States and/or other countries

Products and customer support

Automation Systems

For the following industries:

- Chemical & Pharmaceutical
- Food & Beverage
- Manufacturing
- Metals and Minerals
- Oil, Gas & Petrochemical
- Pulp and Paper

Drives and Motors

- AC and DC Drives, AC and DC Machines, AC Motors to 1kV
- Drive Systems
- Force Measurement
- Servo Drives

Controllers & Recorders

- Single and Multi-loop Controllers
- Circular Chart and Strip Chart Recorders
- Paperless Recorders
- Process Indicators

Flexible Automation

- Industrial Robots and Robot Systems

Flow Measurement

- Electromagnetic Flowmeters
- Mass Flowmeters
- Turbine Flowmeters
- Wedge Flow Elements

Marine Systems & Turbochargers

- Electrical Systems
- Marine Equipment
- Offshore Retrofit and Refurbishment

Process Analytics

- Process Gas Analysis
- Systems Integration

Transmitters

- Pressure
- Temperature
- Level
- Interface Modules

Valves, Actuators and Positioners

- Control Valves
- Actuators
- Positioners

Water, Gas & Industrial Analytics Instrumentation

- pH, Conductivity and Dissolved Oxygen Transmitters and Sensors
- Ammonia, Nitrate, Phosphate, Silica, Sodium, Chloride, Fluoride, Dissolved Oxygen and Hydrazine Analyzers
- Zirconia Oxygen Analyzers, Katharometers, Hydrogen Purity and Purge-gas Monitors, Thermal Conductivity

Customer support

We provide a comprehensive after sales service via a Worldwide Service Organization. Contact one of the following offices for details on your nearest Service and Repair Centre.

UK

ABB Limited

Tel: +44 (0)1480 475321

Fax: +44 (0)1480 217948

USA

ABB Inc.

Tel: +1 215 674 6000

Fax: +1 215 674 7183

Client Warranty

Prior to installation, the equipment referred to in this manual must be stored in a clean, dry environment, in accordance with the Company's published specification. Periodic checks must be made on the equipment's condition. In the event of a failure under warranty, the following documentation must be provided as substantiation:

- A listing evidencing process operation and alarm logs at time of failure.
- Copies of all storage, installation, operating and maintenance records relating to the alleged faulty unit.

Contact us

ABB Limited

Process Automation

Howard Road

St. Neots

Cambridgeshire PE19 8EU

UK

Tel: +44 (0)1480 475321

Fax: +44 (0)1480 217948

ABB Inc.

Process Automation

125 E. County Line Road

Warminster

PA 18974

USA

Tel: +1 215 674 6000

Fax: +1 215 674 7183

www.abb.com/recorders

Note

We reserve the right to make technical changes or modify the contents of this document without prior notice. With regard to purchase orders, the agreed particulars shall prevail. ABB does not accept any responsibility whatsoever for potential errors or possible lack of information in this document.

We reserve all rights in this document and in the subject matter and illustrations contained therein. Any reproduction, disclosure to third parties or utilization of its contents in whole or in parts – is forbidden without prior written consent of ABB.

Copyright© 2013 ABB

All rights reserved



Sales



Service



Software