SELECTION GUIDE

Merchandise ReliaGear™ Lighting and neXT SuperBox Power Panelboards

A panelboard offer ready to go for projects
with quick turnaround



Merchandise ReliaGear™ lighting and neXT SuperBox power panelboards are engineered for projects with quick turnaround — such as those that come in an emergency situation or when natural disaster hits a customer's property. They're also a great option for small projects with standard technical requirements.

Table of contents

ReliaGear™ lighting panelboards

04	Product overview
05	Interior product number structure
06	Step-by-step selection
12	Configuration examples

ReliaGear™ neXT SuperBox power panelboards

15	Product overview
18	Step-by-step selection
26	Configuration examples
29	Resources

ReliaGear™ lighting panelboards

A smart investment when operational downtime can't be afforded

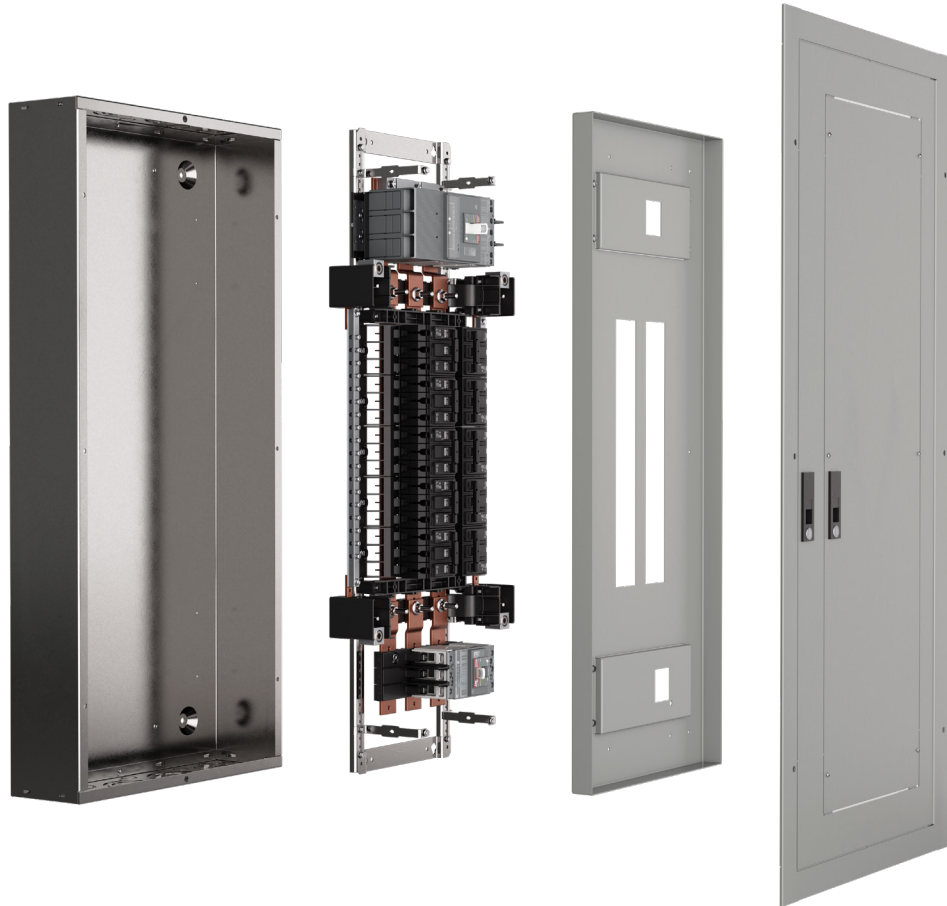

Projects with quick turnaround

Emergency situations, property damage, strip malls, subways, small business or buildings



+1K configurations

XTreme flexibility to meet your application requirements with fewer SKUs to stock



XTra value at every level

A smart investment when operational downtime can't be afforded



No lead time

Available immediately on the distributors' shelves



Unassembled

Assemble and install on site in about 30 minutes



Standard parts

7 steps to complete your selection

ReliaGear™ lighting panelboards

Interior product number structure

ReliaGear™ lighting panelboards are engineered for projects with short turnaround like those that come in an emergency situation or when natural disaster hits our customers' property. They are also a great option for small projects with standard technical requirements.

Lighting panelboards come unassembled, providing the flexibility to select interior, enclosure type, front, main and sub-breaker kit to meet most application requirements immediately.

Applications

- Emergency situations
- Natural disasters
- Property damage
- Storage units
- Strip malls
- Subways
- Small businesses
- Small buildings and more

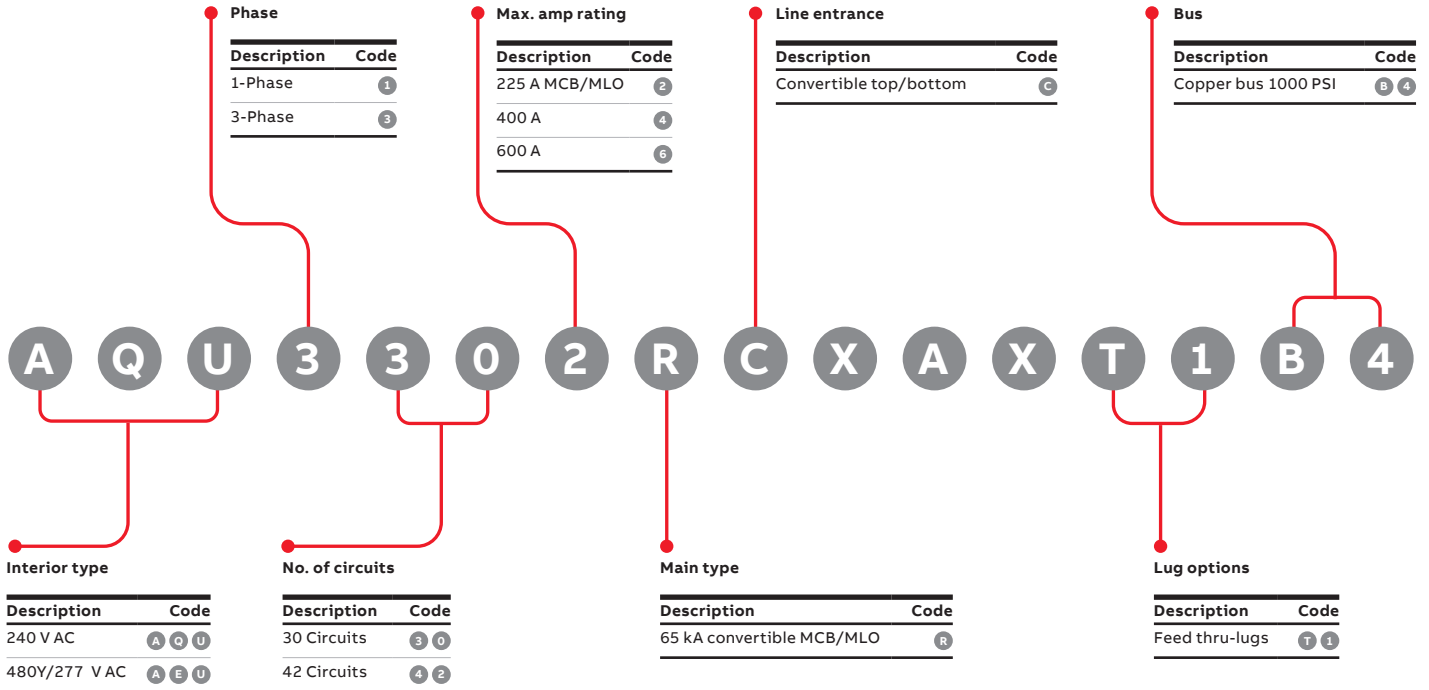

ReliaGear™ lighting panelboards

Step 1: Select interior

Select the interior by voltage, number of circuits and ampacity. Identify the box/front height for interior selected.

Feed-thru copper bus

Voltage	Rating (amps)	No. of circuits	Ordering code ¹	Box/front height (in.)	No. of TGL2 ground bars required ²
240 V AC, 1-Phase	100–225	30	AQU1302RCXAXT1B4	43.5	3
		42	AQU1422RCXAXT1B4	49.5	4
	400	42	AQU1424RCXAXT1B4	76.5	4
	600	42	AQU1426RCXAXT1B4	76.5	4
208Y/120 V AC, 3-Phase	100–225	30	AQU3302RCXAXT1B4	43.5	3
		42	AQU3422RCXAXT1B4	49.5	4
	400	42	AQU3424RCXAXT1B4	76.5	4
	600 ³	42	AQU3426RCXAXT1B4	76.5	4
480Y/277 V AC, 3-Phase	100–225	30	AEU3302RCXAXT1B4	43.5	3
		42	AEU3422RCXAXT1B4	49.5	4
	400	42	AEU3424RCXAXT1B4	76.5	4
	600 ³	42	AEU3426RCXAXT1B4	76.5	4

¹ See table below for TGL20 ground lug quantities.

² For isolated ground, use EGS12. When using the EGS12, 5 and 7 ground lugs (TGL20s) are required for 30 and 42 circuit panels respectively.

³ 600 A available as main lug only.

TGL20 ground lugs required by panel type

Interior type	100–225 A	400 A	600 A
Main lug only	1	1	2
Main lug and sub-feed	2	2	4
Main lug and feed-thru	2	2	4
Main breaker only	1	1	–
Main breaker and sub-feed	2	2	–
Main breaker and feed-thru	2	2	–

ReliaGear™ lighting panelboards

Steps 2–3: Select box and front



NEMA 1



NEMA 3R

Select a 20" wide box of correct height based on interior selected in Step 1.

- Boxes come with blank endwalls.

Box height (in.)	NEMA 1 ordering code	NEMA 3R ordering code
43.5	AB43B	AB433
49.5	AB49B	AB493
76.5	AB76B	AB763



Standard



Door within door



Standard with quarter-turn lock

For NEMA 1 enclosures only, select a 20" wide front of correct height based on interior selected in Step 1 and box selected above.

- Standard fronts are equipped with concealed hinges and trim adjusting screws hinges, trim adjusting screws and quarter-turn locks.
- Door within door fronts are convenient for easy access to equipment from the front of the panel because they allow access to the gutters without removing the front.
- Front hinged to box fronts are similar to door within door fronts for convenient access to gutters, but four screws must be removed to access the outer door.

Front height (in.)	Standard		Door within door		Front hinged to box	
	Flush ordering code	Surface ordering code	Surface ordering code	Surface ordering code	Surface ordering code	Surface ordering code
43.5	AF43F	AF43S	AF43S	AF43SP	AF43SD	AF43SD
49.5	AF49F	AF49S	AF49S	AF49SP	AF49SD	AF49SD
76.5 ¹	AF76FT	AF76ST	AF76ST	AF76SPT	AF76SDT	AF76SDT

¹ 76.5" fronts include quarter-turn lock, enabling applications with XT5 circuit breakers.

ReliaGear™ lighting panelboards

Step 4: Select main and/or sub-feed breaker kit(s)

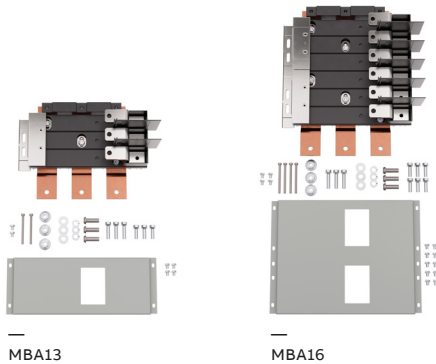

Select the main breaker kit appropriate for your interior type, amp rating and kAIC rating. If a sub-feed breaker is required, repeat the selection process.

Interior type	Ordering code ¹	Rating (amps)	No. of poles	Breaker short circuit rating (kAIC)						
				10	14	22	25	35	50	65
AQU1: 240 V AC, 1-Phase	MB612	100	2	THQB	-	THHQB	-	-	-	-
	MB614	100	4	(x2) THQB	-	(x2) THHQB	-	-	-	-
	MBA12	225	2	A2A	-	A2N2	-	-	-	-
	MBM324	400	2	-	-	-	-	-	-	XT5N
AQU3: 208Y/120 V AC, 3-Phase	MB613	100	3	THQB	-	THHQB	-	-	-	-
	MB616 ²	100	6	(x2) THQB	-	(x2) THHQB	-	-	-	-
	MBA13	225	3	A2A	-	A2N ²	-	-	-	-
	MBA16	400	6	(x2) A2A	-	(x2) A2N ²	-	-	-	-
	MBB33	150	3	-	-	-	-	-	-	XT4N
	MBB33	225	3	-	-	-	-	-	-	XT4N
	MBB36 ³	400	6 ³	-	-	-	-	-	-	(x2) XT4N
MBM334	400	3	-	-	-	-	-	-	XT5N	
AEU3: 480Y/277 V AC, 3-Phase	MB423	100	3	-	TEY	-	-	-	-	-
	MB426	100	6	-	(x2) TEY	-	-	-	-	-
	MBC33	125	3	-	-	-	XT1N	XT1S	-	XT1H
	MBB33	150	3	-	-	-	XT4N	XT4S	-	XT4H
	MBB33	225	3	-	-	-	XT4N	XT4S	-	XT4H
	MBB36 ³	400	6 ³	-	-	-	(x2) XT4N	(x2) XT4S	-	(x2) XT4H
	MBM334	400	3	-	-	-	-	XT5N	XT5S	XT5H

¹ Breaker not included

² Actual breaker short circuit rating is 25 kAIC

³ 6 poles of sub-feed applies only to 400 A and 600 A interiors

⁴ Can use (2) 3-pole devices only, no 2-pole allowed

ReliaGear™ lighting panelboards

Step 5: Select main and/or sub-feed circuit breaker(s)

To correlate breaker types with the kAIC rating in specific panelboards, see the table for Step 4. For THQB and TEY main breakers, see branch breakers tables in Step 7.

Tmax® XT breakers (3-pole) for use with appropriate main breaker or sub-feed breaker kit.

240 V kAIC	480 V kAIC	Breaker description	Ordering code	Wire range (Cu/Al)	Cables per lug
65	65	XT1H 125 TMF 30 amps 3P	XT1HU3030AFD000XXX	Cu Al 1x14-2/0 AWG	1
65	65	XT1H 125 TMF 60 amps 3P	XT1HU3060AFD000XXX	Cu Al 1x14-2/0 AWG	1
65	65	XT1H 125 TMF 100 amps 3P	XT1HU3100AFD000XXX	Cu Al 1x14-2/0 AWG	1
65	65	XT1H 125 TMF 125 amps 3P	XT1HU3125AFD000XXX	Cu Al 1x14-2/0 AWG	1
65	35	XT1S 125 TMF 100 amps 3P	XT1SU3100AFD000XXX	Cu Al 1x14-2/0 AWG	1
65	65	XT4H 250 TMF 150 amps 3P	XT4HU3150AFJ000XXX	Cu Al 1x4 AWG-300 kcmil	1
65	65	XT4H 250 TMF 200 amps 3P	XT4HU3200AFJ000XXX	Cu Al 1x4 AWG-300 kcmil	1
65	65	XT4H 250 TMF 225 amps 3P	XT4HU3225AFJ000XXX	Cu Al 1x4 AWG-300 kcmil	1
65	35	XT4S 250 TMF 175 amps 3P	XT4SU3175AFJ000XXX	Cu Al 1x4 AWG-300 kcmil	1
65	35	XT4S 250 TMF 200 amps 3P	XT4SU3200AFJ000XXX	Cu Al 1x4 AWG-300 kcmil	1
65	35	XT4S 250 TMF 225 amps 3P	XT4SU3225AFJ000XXX	Cu Al 1x4 AWG-300 kcmil	1
65	25	XT4N 250 Ekip DIP 60-150 amps 3P	XT4NU3150FFJ000XXX	Cu Al 1x4 AWG-300 kcmil	1
65	35	XT4S 250 Ekip DIP 100-250 amps 3P	XT4SU3250FFL000XXX	Cu Al 1x4 AWG-300 kcmil	1
65	65	XT4H 250 Ekip DIP 100-250 amps 3P	XT4HU3250FFL000XXX	Cu Al 1x4 AWG-300 kcmil	1
65	65	XT5H 400 TMA 400 amps 3P	XT5HU340ABFN000XXX	Cu Al 2x2/0 AWG-500 kcmi	2
65	50	XT5S 400 TMA 300 amps 3P	XT5SU330ABFN000XXX	Cu Al 2x2/0 AWG-500 kcmi	2
65	50	XT5S 400 TMA 400 amps 3P	XT5SU340ABFN000XXX	Cu Al 2x2/0 AWG-500 kcmi	2
65	35	XT5N 400 Ekip DIP 16-400 amps 3P	XT5NU340AFFN000XXX	Cu Al 2x2/0 AWG-500 kcmi	2
65	65	XT5H 400 Ekip DIP 16-400 amps 3P	XT5HU340AFFN000XXX	Cu Al 2x2/0 AWG-500 kcmi	2

Main or sub-feed breakers for use with RQ panels (208Y/120 V AC 3-phase or 240 V AC 1-phase).

Amp rating	2-pole		3-pole	
	10 kAIC	22 kAIC	10 kAIC	22 kAIC
	Ordering code	Ordering code	Ordering code	Ordering code
125	A2A125TL-2	A2N125TL-2	A2A125TT	A2N125TT
150	A2A150TL-2	A2N150TL-2	A2A150TT	A2N150TT
175	A2A175TL-2	A2N175TL-2	A2A175TT	A2N175TT
200	A2A200TL-2	A2N200TL-2	A2A200TT	A2N200TT
225	A2A225TL-2	A2N225TL-2	A2A225TT	A2N225TT

ReliaGear™ lighting panelboards

Step 6: Select main and/or feed-thru lug kit(s) and accessories

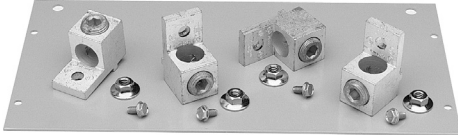

Select lug kit(s) for main lug and/or feed-thru applications, if required.

Main lug kits

Lug type	Amp rating	Ordering code	Standard		Oversized		200% Neutral	
			Wire range	Ordering code	Wire range	Ordering code		
Mechanical	225	MLA1	6–350 kcmil	MLA2	1–600 kcmil or (2) 1/0–250 kcmil	NKA		
	400	MLA41	2–600 kcmil or (2) 1/0–250 kcmil	MLA62	3/0–800 kcmil	NKA4 ¹		
	600	MLA61	(2) 2/0–500 kcmil	MLA62	3/0–800 kcmil	–		

¹ For 200% neutral feed-thru, order NKA4FT, (GO-101P). Wire range (2) 2/0–600 kcmil or (4) 4–250 kcmil.

ReliaGear™ lighting panelboards

Step 7: Select bolt-on branch circuit breakers

Select branch circuit breakers from the tables below.

- THQB and THHQB breakers are only compatible with RQ panels.
- TEY and TEYF breakers are only compatible with RE panels.

Branch circuit breakers for use with RQ panels (208Y/120 V AC 3-phase or 240 V AC 1-phase)

Amp rating	10 kAIC			22 kAIC		
	1-pole	2-pole	3-pole	1-pole	2-pole	3-pole
	Product number	Product number	Product number	Product number	Product number	Product number
15	THQB1115 ^{1,2,3,4}	THQB2115 ^{1,4}	THQB32015	THHQB1115 ^{1,2,3,4}	THHQB2115 ^{1,4}	THHQB32015
20	THQB1120 ^{1,2,3,4}	THQB2120 ^{1,4}	THQB32020	THHQB1120 ^{1,2,3,4}	THHQB2120 ^{1,4}	THHQB32020
25	THQB1125 ¹	THQB2125 ¹	THQB32025	THHQB1125 ¹	THHQB2125 ¹	THHQB32025
30	THQB1130 ^{1,4}	THQB2130 ^{1,4}	THQB32030	THHQB1130 ^{1,4}	THHQB2130 ^{1,4}	THHQB32030
35	THQB1135	THQB2135	THQB32035	THHQB1135	THHQB2135	THHQB32035
40	THQB1140	THQB2140 ⁴	THQB32040	THHQB1140	THHQB2140	THHQB32040
45	THQB1145	THQB2145	THQB32045	THHQB1145	THHQB2145	THHQB32045
50	THQB1150	THQB2150	THQB32050	THHQB1150	THHQB2150	THHQB32050
60	THQB1160	THQB2160	THQB32060	THHQB1160	THHQB2160	THHQB32060
70	THQB1170	THQB2170	THQB32070	THHQB1170	THHQB2170	THHQB32070
80	-	THQB2180	THQB32080	-	THHQB2180	THHQB32080
90	-	THQB2190	THQB32090	-	THHQB2190	THHQB32090
100	-	THQB21100	THQB32100	-	THHQB21100	THHQB32100

¹ For ground fault, add 'GFT' suffix to breaker SKU

² For AFCI, add 'AF2' suffix to breaker SKU

³ For AFCI/GFCI, add 'DF' suffix to breaker SKU

⁴ For equipment ground fault, add 'GFEP' suffix to breaker SKU

Branch circuit breakers for use with RE panels (480Y/277 V AC 3-phase)

Amp rating	14 kAIC			18 KAIC		
	1-pole	2-pole	3-pole	1-pole	2-pole	3-pole
	Product number	Product number	Product number	Product number	Product number	Product number
15	TEY115	TEY215	TEY315	TEYF115	TEYF215	TEYF315
20	TEY120	TEY220	TEY320	TEYF120	TEYF220	TEYF320
25	TEY125	TEY225	TEY325	TEYF125	TEYF225	TEYF325
30	TEY130	TEY230	TEY330	TEYF130	TEYF230	TEYF330
35	TEY135	TEY235	TEY335	TEYF135	TEYF235	TEYF335
40	TEY140	TEY240	TEY340	TEYF140	TEYF240	TEYF340
45	TEY145	TEY245	TEY345	TEYF145	TEYF245	TEYF345
50	TEY150	TEY250	TEY350	TEYF150	TEYF250	TEYF350
60	TEY160	TEY260	TEY360	TEYF160	TEYF260	TEYF360
70	TEY170	TEY270	TEY370	-	TEYF270	TEYF370
80	TEY180	TEY280	TEY380	-	TEYF280	TEYF380
90	TEY190	TEY290	TEY390	-	TEYF290	TEYF390
100	TEY1100	TEY2100	TEY3100	-	TEYF2100	TEYF3100

ReliaGear™ lighting panelboards

Configuration example 1

Panel: RQ with (2) 200 A sub-feeds
 Number of circuits: 42
 Mounting: Bolt-on

Volts: 208Y/120 V AC
 Phase: 3
 Wires: 4
 AIC rating: 10 kA

Main type: Main breaker
 Mains rating: 400 A
 Enclosure: NEMA 1
 Front: Standard

Circuit	Circuit description	Trip (A)	Poles	A	B	C	Poles	Trip (A)	Circuit description	Circuit
1	Circuit 1	20	1				1	20	Circuit 2	2
3	Circuit 3	20	1				1	20	Circuit 4	4
5	Circuit 5	20	1				1	20	Circuit 6	6
7	Circuit 7	20	1				1	20	Circuit 8	8
9	Circuit 9	20	1				1	20	Circuit 10	10
11	Circuit 11	20	1				1	20	Circuit 12	12
13	Circuit 13	20	1				1	20	Circuit 14	14
15	Circuit 15	20	1				1	20	Circuit 16	16
17	Circuit 17	20	1				1	20	Circuit 18	18
19	Circuit 19	20	1				1	20	Circuit 20	20
21	Circuit 21	20	1				1	20	Circuit 22	22
23	Circuit 23	20	1				1	20	Circuit 24	24
25	Circuit 25	20	1				1	20	Circuit 26	26
27	Circuit 27	20	1				1	20	Circuit 28	28
29	Circuit 29	20	1				1	20	Circuit 30	30
31	Circuit 31	20	1				1	20	Circuit 32	32
33	Circuit 33	20	1				1	20	Circuit 34	34
35	Circuit 35	20	1				1	20	Circuit 36	36
37	Circuit 37	20	1				1	20	Circuit 38	38
39	Circuit 39	20	1				1	20	Circuit 40	40
41	Circuit 41	20	1				1	20	Circuit 42	42

Selection example:

Step 1: Select interior

Select the interior SKU for a 42-circuit lighting panelboard for 400 A with a 208/120 voltage. Take note that the interior box/front height is 76.5". Ground bars and ground lugs are also selected in this step based on requirements.

- Qty (1) AQU3424RCXAXT1B4
- Qty (4) TGL2
- Qty (2) TGL20

Step 2: Select box

The interior selected in Step 1 requires a 76.5" box height. There is a single option for a NEMA 1 with this height.

- Qty (1) AB76B

Step 3: Select front

NEMA 1 enclosures require a front. The interior selected in Step 1 requires a 76.5" front, aligning with the box height in Step 2. Since flush mounting was not specifically identified, select a surface-mount front.

- Qty (1) AF76ST

Step 4: Select main and/or sub-feed breaker kit(s)

In this example, we need a 400 A main breaker kit as well as sub-feed breakers kits for 2 200 A breakers. We will use a Tmax® XT5 for the main breaker and Formula A2 breakers for the sub-feed breakers.

- Qty (1) MBM334
- Qty (1) MBA16

Step 5: Select main and/or sub-feed breaker(s)

In this example, we will use a Tmax XT5 as the main and Formula A2 breakers as sub-feed breakers.

- Qty (1) XT5NU340AFFN000XXX
- Qty (2) A2A200TT

Step 6: Select main and/or feed-thru lug kit(s) and accessories

Not required for this example.

Step 7: Select bolt-on branch circuit breakers

In this example, we need 42 20 A branch breakers with a 10 kAIC rating.

- Qty (42) THQB1120

ReliaGear™ lighting panelboards

Configuration example 2

Panel: RE with (2) 200 A sub-feeds
 Number of circuits: 42
 Mounting: Bolt-on

Volts: 480Y/277 V AC
 Phase: 3
 Wires: 4
 AIC rating: 18 kA

Main type: Main lug
 Mains rating: 600 A
 Enclosure: NEMA 3R
 Front: Standard

Circuit	Circuit description	Trip (A)	Poles	A	B	C	Poles	Trip (A)	Circuit description	Circuit
1	Circuit 1	20	1				1	20	Circuit 2	2
3	Circuit 3	20	1				1	20	Circuit 4	4
5	Circuit 5	20	1				1	20	Circuit 6	6
7	Circuit 7	20	1				1	20	Circuit 8	8
9	Circuit 9	20	1				1	20	Circuit 10	10
11	Circuit 11	20	1				1	20	Circuit 12	12
13	Circuit 13	20	1				1	20	Circuit 14	14
15	Circuit 15	20	1				1	20	Circuit 16	16
17	Circuit 17	20	1				1	20	Circuit 18	18
19	Circuit 19	20	1				1	20	Circuit 20	20
21	Circuit 21	20	1				1	20	Circuit 22	22
23	Circuit 23	20	1				1	20	Circuit 24	24
25	Circuit 25	20	1				1	20	Circuit 26	26
27	Circuit 27	20	1				1	20	Circuit 28	28
29	Circuit 29	20	1				1	20	Circuit 30	30
31	Circuit 31	20	1				1	20	Circuit 32	32
33	Circuit 33	20	1				1	20	Circuit 34	34
35	Circuit 35	20	1				1	20	Circuit 36	36
37	Circuit 37	20	1				1	20	Circuit 38	38
39	Circuit 39	20	1				1	20	Circuit 40	40
41	Circuit 41	20	1				1	20	Circuit 42	42

Selection example:

Step 1: Select interior

Select the interior SKU for a 42-circuit lighting panelboard for 600 A with a 480Y/277 voltage. Take note that the interior box/front height is 76.5". Ground bars and ground lugs are also selected in this step based on requirements.

- Qty (1) AEU3426RCXAXT1B4
- Qty (4) TGL2
- Qty (2) TGL20

Step 2: Select box

The interior selected in Step 1 requires a 76.5" box height. There is a single option for a NEMA 3R with this height.

- Qty (1) AB763

Step 3: Select front

Not required for this example as front selection is only required with NEMA 1 enclosures.

Step 4: Select main and/or sub-feed breaker kit(s)

In this example, we need sub-feed breaker kits for two 200 A breakers. We will use Tmax® XT4 breakers for the sub-feed breakers.

- Qty (1) MBB36

Step 5: Select main and/or sub-feed breaker(s)

In this example, we will use Tmax XT4 as sub-feed breakers.

- Qty (2) XT4NU3200AFJ000XXX

Step 6: Select main and/or feed-thru lug kit(s) and accessories

In this example, we need a 600 A main lug kit.

- Qty (1) MLA61

Step 7: Select bolt-on branch circuit breakers

In this example, we need 42 20 A branch breakers with an 18 kAIC rating.

- Qty (42) TEYF120

ReliaGear™ lighting panelboards

Configuration example 3

Panel: RE feed-thru
Number of circuits: 30
Mounting: Bolt-on

Volts: 480Y/277 V AC
Phase: 3
Wires: 4
AIC rating: 14 kA

Main type: Main breaker
Mains rating: 225 A
Enclosure: NEMA 1
Front: Door within door

Circuit	Circuit description	Trip (A)	Poles	A	B	C	Poles	Trip (A)	Circuit description	Circuit
1	Circuit 1	15	2				2	15	Circuit 2	2
3										4
5	Circuit 3	15	2				2	15	Circuit 4	6
7										8
9	Circuit 5	15	2				2	15	Circuit 6	10
11										12
13	Circuit 7	15	2				2	15	Circuit 8	14
15										16
17	Circuit 9	15	2				2	15	Circuit 10	18
19										20
21	Circuit 11	15	2				2	15	Circuit 12	22
23										24
25	Circuit 13	15	2				2	15	Circuit 14	26
27										28
29										30

Selection example:

Step 1: Select interior

Select the interior SKU for a 30-circuit lighting panelboard for 225 A with a 480Y/277 voltage. Take note that the interior box/front height is 43.5". Ground bars and ground lugs are also selected in this step based on requirements.

- Qty (1) AEU3302RCXAXT1B4
- Qty (3) TGL2
- Qty (2) TGL20

Step 2: Select box

The interior selected in Step 1 requires a 43.5" box height. There is a single option for a NEMA 1 with this height.

- Qty (1) AB43B

Step 3: Select front

NEMA 1 enclosures require a front. The interior selected in Step 1 requires a 43.5" front and for this example, door within door is required.

- Qty (1) AF43SP

Step 4: Select main and/or sub-feed breaker kit(s)

In this example, we need a main breaker kit for a 225 A breaker. We will use a Tmax® XT4 breaker for the main breaker.

- Qty (1) MBB33

Step 5: Select main and/or sub-feed breaker(s)

In this example, we will use a Tmax XT4 as the main breaker.

- Qty (1) XT4NU3225AFJ000XXX

Step 6: Select main and/or feed-thru lug kit(s) and accessories

In this example, we need a feed-thru lug kit for 225 A.

- Qty (1) MLA41

Step 7: Select bolt-on branch circuit breakers

In this example, we need 14 20 A 2-pole branch breakers with a 14 kAIC rating.

- Qty (14) TEY215

ReliaGear™ neXT power panelboards

Plug in and break out

Take power panel innovations to the neXT level with modular, field-modifiable panel design and groundbreaking Tmax® XT plug-in circuit breakers.

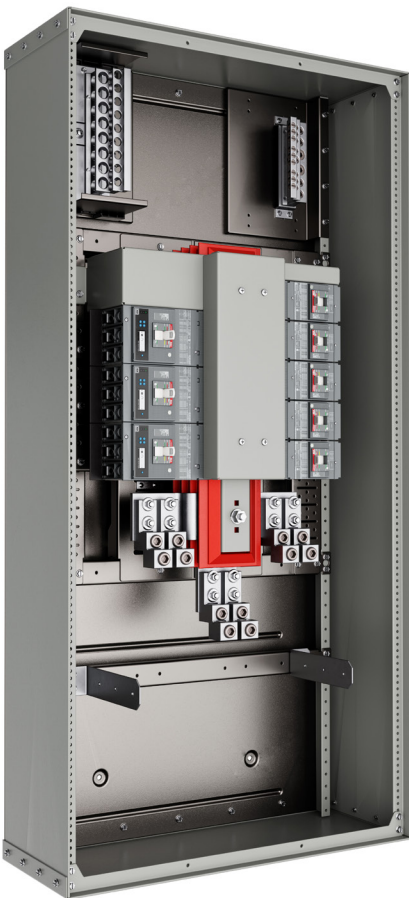

Plug into the advantages of ReliaGear neXT

- IP20 finger-safe bus stack design on main breaker applications
- Easy and fast top/bottom feed changes in the field
- Ground and neutral locations easily moved
- Single-tool component installation
- Plug-in circuit breakers allow for quick location flexibility
- Easy gutter access with hinged trims as standard

ReliaGear™ neXT SuperBox power panelboards

Product overview

ReliaGear™ neXT power panelboards, featuring ABB's Tmax® XT plug-in circuit breakers, are now ready to go!



The SuperBox offer is a preassembled combination of enclosures, interiors, ground, neutral, fronts and fillers available from inventory for immediate installation. One SKU includes everything needed for the power panelboard selection. Simply fill with Tmax XT plug-in circuit breakers and accessories required for the project, and you're ready to go.¹

¹ Other ReliaGear neXT configurations are available as factory-assembled, made-to-order items. Contact your local ABB sales team for more information.



ReliaGear™ neXT SuperBox power panelboards

General characteristics

System voltages

- 240 V AC; 3-phase, 3-wire
- 480 V AC; 3-phase, 3-wire
- 600 V AC; 3-phase, 3-wire
- 208Y/120 V AC; 3-phase, 4-wire
- 480Y/277 V AC; 3-phase, 4-wire
- 600Y/347 V AC; 3-phase, 4-wire

Short circuit rating

Equal to 200 kAIC at 240 V, 100 kAIC at 480 V or 65 kAIC at 600 V, or the lowest current interruption rating of any device installed, except as noted in the series rating listed with an integral or remote main breaker or fusible switch installed ahead of the power panel.

Enclosures

- NEMA 1 — For indoor use to provide a degree of protection to personnel against access to hazardous parts and to provide a degree of protection against ingress of solid foreign objects (falling dirt).
- NEMA 3R — For either indoor or outdoor use to provide a degree of protection to personnel against access to hazardous parts, falling dirt and harmful effects on the equipment due to the ingress of water (rain, sleet and snow); and that will be undamaged by the external formation of ice and snow with no damage to the external enclosure.

Bussing

Silver-plated copper

Certifications

- ANSI/NEMA PB 1, panelboards
- ANSI/NFPA 70, National Electrical Code
- Federal specification W-C-375, rev. B, amend. 1, circuit breakers, molded case; branch circuit and service
- Federal specification W-P 115, rev. C, panel, power distribution
- UL 489, molded case circuit breakers
- CSA 22.2 No. 5-13, molded case circuit breakers
- UL 50, enclosures for electrical equipment
- UL 67, panelboards
- cUL listed, low-voltage modular power panels
- Seismic certification according to ICC-ES AC15

ReliaGear™ neXT SuperBox power panelboards

Selection

1

Select main and branch feeder circuit breakers

2

Select the required accessories

3

Determine the X-space required to meet main and branch feeder circuit breaker selection

4

Select the SuperBox required based on maximum ampacity, main type, enclosure type and bus X-space required



ReliaGear™ neXT SuperBox power panelboards

Step 1: Select main and branch feeder circuit breakers (XT1–XT4)^{1,2}

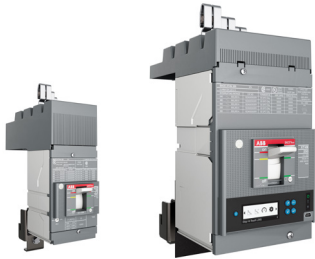

Ordering code	Frame	Int. rating at 480 V AC	Trip unit	Poles	Amps	Load side lugs (AWG or kcmil)
XT1NU3015AYD000XXX	XT1 ³	N (25 kA)	TMF	3	15	1x #10–2/0
XT1NU3020AYD000XXX	XT1 ³	N (25 kA)	TMF	3	20	1x #10–2/0
XT1NU3030AYD000XXX	XT1 ³	N (25 kA)	TMF	3	30	1x #10–2/0
XT1NU3040AYD000XXX	XT1 ³	N (25 kA)	TMF	3	40	1x #10–2/0
XT1NU3050AYD000XXX	XT1 ³	N (25 kA)	TMF	3	50	1x #10–2/0
XT1NU3060AYD000XXX	XT1 ³	N (25 kA)	TMF	3	60	1x #10–2/0
XT1NU3070AYD000XXX	XT1 ³	N (25 kA)	TMF	3	70	1x #10–2/0
XT1NU3100AYD000XXX	XT1 ³	N (25 kA)	TMF	3	100	1x #10–2/0
XT1NU3125AYD000XXX	XT1 ³	N (25 kA)	TMF	3	125	1x #10–2/0
XT1SU3015AYD000XXX	XT1 ³	S (35 kA)	TMF	3	15	1x #10–2/0
XT1SU3020AYD000XXX	XT1 ³	S (35 kA)	TMF	3	20	1x #10–2/0
XT1SU3030AYD000XXX	XT1 ³	S (35 kA)	TMF	3	30	1x #10–2/0
XT1SU3040AYD000XXX	XT1 ³	S (35 kA)	TMF	3	40	1x #10–2/0
XT1SU3050AYD000XXX	XT1 ³	S (35 kA)	TMF	3	50	1x #10–2/0
XT1SU3060AYD000XXX	XT1 ³	S (35 kA)	TMF	3	60	1x #10–2/0
XT1SU3070AYD000XXX	XT1 ³	S (35 kA)	TMF	3	70	1x #10–2/0
XT1SU3100AYD000XXX	XT1 ³	S (35 kA)	TMF	3	100	1x #10–2/0
XT1SU3125AYD000XXX	XT1 ³	S (35 kA)	TMF	3	125	1x #10–2/0
XT1HU3015AYD000XXX	XT1 ³	H (65 kA)	TMF	3	15	1x #10–2/0
XT1HU3020AYD000XXX	XT1 ³	H (65 kA)	TMF	3	20	1x #10–2/0
XT1HU3030AYD000XXX	XT1 ³	H (65 kA)	TMF	3	30	1x #10–2/0
XT1HU3040AYD000XXX	XT1 ³	H (65 kA)	TMF	3	40	1x #10–2/0
XT1HU3050AYD000XXX	XT1 ³	H (65 kA)	TMF	3	50	1x #10–2/0
XT1HU3060AYD000XXX	XT1 ³	H (65 kA)	TMF	3	60	1x #10–2/0
XT1HU3070AYD000XXX	XT1 ³	H (65 kA)	TMF	3	70	1x #10–2/0
XT1HU3100AYD000XXX	XT1 ³	H (65 kA)	TMF	3	100	1x #10–2/0
XT1HU3125AYD000XXX	XT1 ³	H (65 kA)	TMF	3	125	1x #10–2/0
XT4NU3150AY8000XXX	XT4	N (25 kA)	TMF	3	150	1x 3/0–350
XT4NU3175AY8000XXX	XT4	N (25 kA)	TMF	3	175	1x 3/0–350
XT4NU3200AY8000XXX	XT4	N (25 kA)	TMF	3	200	1x 3/0–350
XT4NU3225AY8000XXX	XT4	N (25 kA)	TMF	3	225	1x 3/0–350
XT4NU3250AY8000XXX	XT4	N (25 kA)	TMF	3	250	1x 3/0–350
XT4SU3150AY8000XXX	XT4	S (35 kA)	TMF	3	150	1x 3/0–350
XT4SU3175AY8000XXX	XT4	S (35 kA)	TMF	3	175	1x 3/0–350
XT4SU3200AY8000XXX	XT4	S (35 kA)	TMF	3	200	1x 3/0–350
XT4SU3225AY8000XXX	XT4	S (35 kA)	TMF	3	225	1x 3/0–350
XT4SU3250AY8000XXX	XT4	S (35 kA)	TMF	3	250	1x 3/0–350
XT4HU3150AY8000XXX	XT4	H (65 kA)	TMF	3	150	1x 3/0–350
XT4HU3175AY8000XXX	XT4	H (65 kA)	TMF	3	175	1x 3/0–350
XT4HU3200AY8000XXX	XT4	H (65 kA)	TMF	3	200	1x 3/0–350
XT4HU3225AY8000XXX	XT4	H (65 kA)	TMF	3	225	1x 3/0–350
XT4HU3250AY8000XXX	XT4	H (65 kA)	TMF	3	250	1x 3/0–350

¹Additional Tmax® XT plug-in circuit breakers and accessories are available. Contact your local ABB sales team for more information.

²All breakers are standard rated (standard circuit breakers design considers 80% of the rated load). In case a 100% rated breaker is needed, a factory assembled ReliaGear neXT configuration will be required.

³Separate mounting rail required. See details in accessories table.

ReliaGear™ neXT SuperBox power panelboards

Step 1: Select main and branch feeder circuit breakers (XT5–XT7)^{1,2,3}

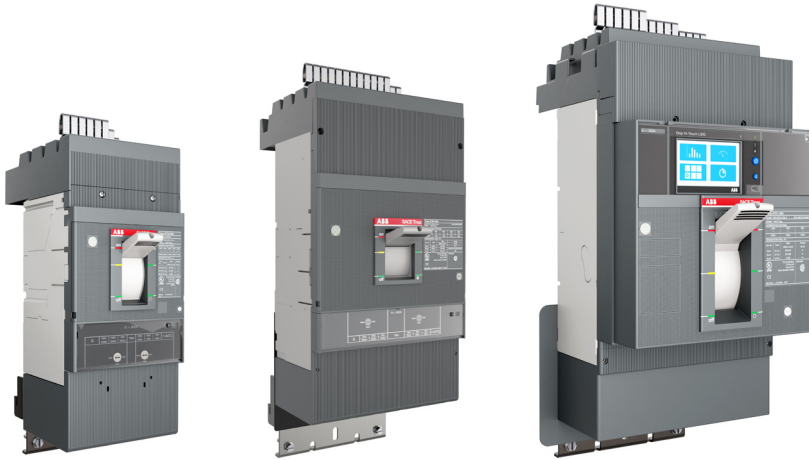

Ordering code	Frame	Int. rating at 480 V	Trip unit	Poles	Amps	Load side lugs (AWG or kcmil)
XT5NU330ABYN000XXX	XT5	N (35 kA)	TMA	3	300	2x 3/0–350
XT5NU340ABYN000XXX	XT5	N (35 kA)	TMA	3	400	2x 3/0–350
XT5NU360BBYN000XXX	XT5	N (35 kA)	TMA	3	600	2x 3/0–350
XT5SU330ABYN000XXX	XT5	S (50 kA)	TMA	3	300	2x 3/0–350
XT5SU340ABYN000XXX	XT5	S (50 kA)	TMA	3	400	2x 3/0–350
XT5SU360BBYN000XXX	XT5	S (50 kA)	TMA	3	600	2x 3/0–350
XT5HU330ABYN000XXX	XT5	H (65 kA)	TMA	3	300	2x 3/0–350
XT5HU340ABYN000XXX	XT5	H (65 kA)	TMA	3	400	2x 3/0–350
XT5HU360BBYN000XXX	XT5	H (65 kA)	TMA	3	600	2x 3/0–350
XT6NU3800BYU000XXX	XT6	N (35 kA)	TMA	3	800	3x 3/0–350
XT6SU3800BYU000XXX	XT6	S (50 kA)	TMA	3	800	3x 3/0–350
XT6HU3800BYU000XXX	XT6	H (65 kA)	TMA	3	800	3x 3/0–350
XT7SU310EEYW000XXX	XT7	S (50 kA)	DIP LS/I	3	1000	4x 4/0–500
XT7SU312EEYW000XXX	XT7	S (50 kA)	DIP LS/I	3	1200	4x 4/0–500
XT7HU310EEYW000XXX	XT7	H (65 kA)	DIP LS/I	3	1000	4x 4/0–500
XT7HU312EEYW000XXX	XT7	H (65 kA)	DIP LS/I	3	1200	4x 4/0–500
XT7SU310EPYW000XXR	XT7	S (50 kA)	Touch LSI	3	1000	4x 4/0–500
XT7SU312EPYW000XXR	XT7	S (50 kA)	Touch LSI	3	1200	4x 4/0–500
XT7HU310EPYW000XXR	XT7	H (65 kA)	Touch LSI	3	1000	4x 4/0–500
XT7HU312EPYW000XXR	XT7	H (65 kA)	Touch LSI	3	1200	4x 4/0–500

¹Additional Tmax® XT plug-in circuit breakers and accessories are available. Contact your local ABB sales team for more information.

²All breakers are standard rated (standard circuit breakers design considers 80% of the rated load). In case a 100% rated breaker is needed, a factory assembled ReliaGear neXT configuration will be required.

³If 750 kcmil lugs are needed, a factory assembled ReliaGear neXT configuration will be required.

ReliaGear™ neXT SuperBox power panelboards

Step 1: Select main and branch feeder circuit breakers (TEY–FB)^{1,2}



1-pole FB



2-pole FB



1-pole TEY

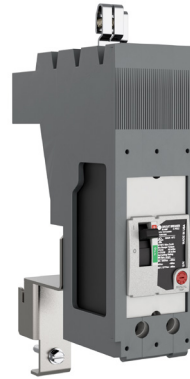

2-pole TEY

Ordering code	Frame	Int. rating at 480 V	Trip unit	Poles	Amps	Phase	Load side lugs (AWG or kcmil)
TEYADED0AAXXXXXX	TEY	D (25 kA)	TMF	1	20	A	1x #14–10
TEYADED0BAXXXXXX	TEY	D (25 kA)	TMF	1	20	B	1x #14–10
TEYADED0CAXXXXXX	TEY	D (25 kA)	TMF	1	20	C	1x #14–10
TEYAHED0AAXXXXXX	TEY	H (35 kA)	TMF	1	20	A	1x #14–10
TEYAHED0BAXXXXXX	TEY	H (35 kA)	TMF	1	20	B	1x #14–10
TEYAHED0CAXXXXXX	TEY	H (35 kA)	TMF	1	20	C	1x #14–10
TEYALEDOAAXXXXXX	TEY	L (65 kA)	TMF	1	20	A	1x #14–10
TEYALEDOBAXXXXXX	TEY	L (65 kA)	TMF	1	20	B	1x #14–10
TEYALEDOCAXXXXXX	TEY	L (65 kA)	TMF	1	20	C	1x #14–10
TEYADFDABAXXXXXX	TEY	D (25 kA)	TMF	2	20	AB	1x #14–10
TEYADFHABXXXXXX	TEY	D (25 kA)	TMF	2	40	AB	1x #10–4
TEYADFQABDXXXXXX	TEY	D (25 kA)	TMF	2	100	AB	1x #14–2/0
TEYADFSABDXXXXXX	TEY	D (25 kA)	TMF	2	125	AB	1x #4–2/0
TEYADFDBCAXXXXXX	TEY	D (25 kA)	TMF	2	20	BC	1x #14–10
TEYADFHBCBXXXXXX	TEY	D (25 kA)	TMF	2	40	BC	1x #10–4
TEYADFQBDCXXXXXX	TEY	D (25 kA)	TMF	2	100	BC	1x #4–2/0
TEYADFSBCDXXXXXX	TEY	D (25 kA)	TMF	2	125	BC	1x #4–2/0
TEYADFDACAXXXXXX	TEY	D (25 kA)	TMF	2	20	AC	1x #14–10
TEYADFHACBXXXXXX	TEY	D (25 kA)	TMF	2	40	AC	1x #10–4
TEYADFQACDXXXXXX	TEY	D (25 kA)	TMF	2	100	AC	1x #4–2/0
TEYADFSACDXXXXXX	TEY	D (25 kA)	TMF	2	125	AC	1x #4–2/0
NEFBV16TE020R2A	FB	V (35 kA) ³	TMF	1	20	A	1x #14–10
NEFBV16TE020R2B	FB	V (35 kA) ³	TMF	1	20	B	1x #14–10
NEFBV16TE020R2C	FB	V (35 kA) ³	TMF	1	20	C	1x #14–10
NEFBN16TE020R2A	FB	N (65 kA) ³	TMF	1	20	A	1x #14–10
NEFBN16TE020R2B	FB	N (65 kA) ³	TMF	1	20	B	1x #14–10
NEFBN16TE020R2C	FB	N (65 kA) ³	TMF	1	20	C	1x #14–10
NEFBH16TE020R2A	FB	H (100 kA) ³	TMF	1	20	A	1x #14–10
NEFBH16TE020R2B	FB	H (100 kA) ³	TMF	1	20	B	1x #14–10
NEFBH16TE020R2C	FB	H (100 kA) ³	TMF	1	20	C	1x #14–10
NEFBV26TE100R2AB	FB	V (35 kA)	TMF	2	100	AB	1x #1–1/0
NEFBV26TE100R2AC	FB	V (35 kA)	TMF	2	100	AC	1x #1–1/0
NEFBV26TE100R2BC	FB	V (35 kA)	TMF	2	100	BC	1x #1–1/0

¹Additional TEY and FB plug-in circuit breakers and accessories are available. Contact your local ABB sales team for more information.

²All breakers are standard rated (standard circuit breakers design considers 80% of the rated load). In case a 100% rated breaker is needed, a factory assembled ReliaGear neXT configuration will be required.

³Interrupt rating at 240 V AC.

ReliaGear™ neXT SuperBox power panelboards

Step 1: Select main and branch feeder circuit breakers (Formula A2)^{1,2,3}



2-pole Formula A2

Ordering code	Frame	Int. rating at 240 V	Trip unit	Poles	Amps	Phase	Cu load side lugs (AWG or kcmil)	Al load side lugs (AWG or kcmil)
A2A2125ABDXXXX	A2	A (10 kA)	TMF	2	125	AB	1x 1-250	1x 2/0-300
A2A2125ACDXXXX	A2	A (10 kA)	TMF	2	125	AC	1x 1-250	1x 2/0-300
A2A2150ABDXXXX	A2	A (10 kA)	TMF	2	150	AB	1x 1-250	1x 2/0-300
A2A2150ACDXXXX	A2	A (10 kA)	TMF	2	150	AC	1x 1-250	1x 2/0-300
A2A2200ABDXXXX	A2	A (10 kA)	TMF	2	200	AB	1x 1-250	1x 2/0-300
A2A2200ACDXXXX	A2	A (10 kA)	TMF	2	200	AC	1x 1-250	1x 2/0-300
A2N2125ABDXXXX	A2	A (10 kA)	TMF	2	125	AB	1x 1-250	1x 2/0-300
A2N2125ACDXXXX	A2	N (25 kA)	TMF	2	125	AC	1x 1-250	1x 2/0-300
A2N2150ABDXXXX	A2	N (25 kA)	TMF	2	150	AB	1x 1-250	1x 2/0-300
A2N2150ACDXXXX	A2	N (25 kA)	TMF	2	150	AC	1x 1-250	1x 2/0-300
A2N2200ABDXXXX	A2	N (25 kA)	TMF	2	200	AB	1x 1-250	1x 2/0-300
A2N2200ACDXXXX	A2	N (25 kA)	TMF	2	200	AC	1x 1-250	1x 2/0-300
A2N2250ABDXXXX	A2	N (25 kA)	TMF	2	250	AB	1x 1-250	—

¹ Additional Formula A2 plug-in circuit breakers are available. Contact your local ABB sales team for more information.

² All breakers are standard rated (standard circuit breakers design considers 80% of the rated load). In case a 100% rated breaker is needed, a factory-assembled ReliaGear neXT configuration will be required.

³ 250 A Formula A2 plug-in breakers with 350 kcmil Al load side lugs available. Contact your local ABB sales team for more information.

ReliaGear™ neXT SuperBox power panelboards

Step 2: Determine the **X-space** required

Each circuit breaker frame has specific requirements for the number of mounting positions (**X-spaces**). Thanks to the optimized dimensions of the XT1, the mounting positions required are lower when two or five breakers are mounted

close to one another. RELTs also require **X-space**, since they are plug-in modules. Refer to the table below and add up the number of **X-spaces** required for each breaker frame.

Frame	Max. ampacity (A)	Poles	X-spaces
Single XT1	125	3	3
Two XT1	125	3	5
Five XT1	125	3	11
XT2	125	3	3
XT4	250	3	3
XT5 ¹	600	3	4
XT6	800	3	6
XT7	1200	3	6
FB	100	1	1
FB	100	2	2
TEY	70	1	1
TEY	125	2	2
A2	250	2	2
RELT	-	-	3

¹Tmax® XT5 with electrical accessories requires 1 (one) additional X-space.

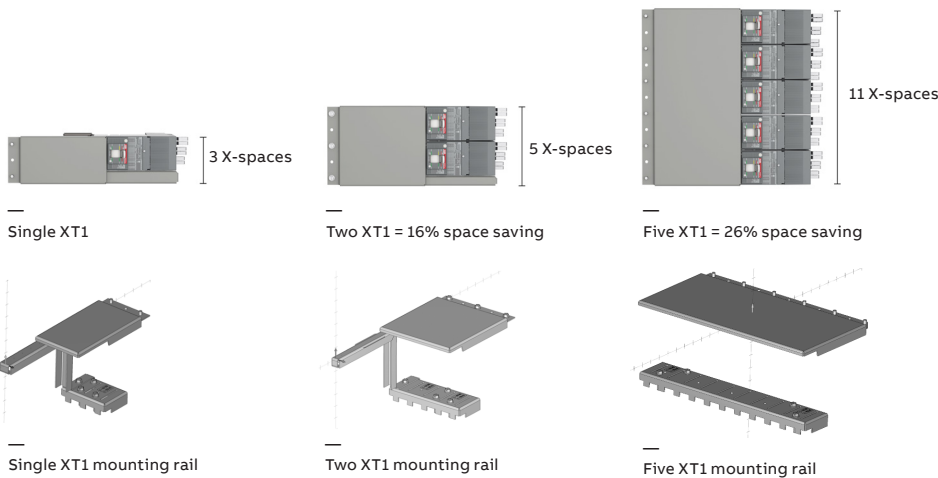

The small footprint of the XT1 allows this panel to offer multiple options to improve circuit breaker density. As you configure and order ReliaGear neXT panelboards, you'll notice that XT1 are grouped in quantities of one, two or five. As part of this feature, unique mounting brackets are required when adding XT1 breaker assemblies. See above for X-space and mounting brackets required. These additional rails are not included with SuperBox configurations and must be ordered as accessories.

Order codes for XT1 mounting rails

- SR1XBF for 1 single XT1 breaker
- SR2XBF for 2 adjacent XT1 breakers
- SR5XBF for 5 adjacent XT1 breakers

ReliaGear™ neXT SuperBox power panelboards

Step 3: Select the SuperBox required

Ordering code	Description	Amps	Enclosure type	Main	Dimensions (H x W x D inches)	X-space left	X-space right
RNSB06L6040A	600A MLO NEMA 1 60 x 40 16X no breakers	600 A	NEMA 1	Main lugs (2x #2-600 kcmil)	60.3 x 40.7 x 11	12	12
RNSB06B6040A	600A MCB NEMA 1 60 x 40 16X no breakers	600 A	NEMA 1	Main breaker ¹	60.3 x 40.7 x 11	16	16
RNSB06L6040R	600A MLO NEMA 3R 60 x 40 16X no breakers	600 A	NEMA 3R	Main lugs (2x #2-600 kcmil)	61 x 43.5 x 16.7 ²	12	12
RNSB06B6040R	600A MCB NEMA 3R 60 x 40 16X no breakers	600 A	NEMA 3R	Main breaker ¹	61 x 43.5 x 16.7 ²	16	16
RNSB08L7245A	800A MLO NEMA 1 72 x 45 24X no breakers	800 A	NEMA 1	Main lugs (4x #2-600 kcmil)	72.3 x 45.7 x 11	20	20
RNSB08B7245A	800A MCB NEMA 1 72 x 45 24X no breakers	800 A	NEMA 1	Main breaker ¹	72.3 x 45.7 x 11	24	24
RNSB08L7245R	800A MLO NEMA 3R 72 x 45 24X no breakers	800 A	NEMA 3R	Main lugs (4x #2-600 kcmil)	73 x 48.5 x 16.7 ²	20	20
RNSB08B7245R	800A MCB NEMA 3R 72 x 45 24X no breakers	800 A	NEMA 3R	Main breaker ¹	73 x 48.5 x 16.7 ²	24	24
RNSB12L8445A	1200A MLO NEMA 1 84 x 45 32X no breakers	1200 A	NEMA 1	Main lugs (4x #2-600 kcmil)	84.3 x 45.7 x 11	28	28
RNSB12B8445A	1200A MCB NEMA 1 84 x 45 32X no breakers	1200 A	NEMA 1	Main breaker ¹	84.3 x 45.7 x 11	32	32
RNSB12L8445R	1200A MLO NEMA 3R 84 x 45 32X no breakers	1200 A	NEMA 3R	Main lugs (4x #2-600 kcmil)	85 x 48.5 x 16.7 ²	28	28
RNSB12B8445R	1200A MCB NEMA 3R 84 x 45 32X no breakers	1200 A	NEMA 3R	Main breaker ¹	85 x 48.5 x 16.7 ²	32	32

¹ X-space required for main breaker must be accounted for based on specific breaker selected.

² Depth includes 0.9" of hanger bracket.

Available configurations and wire bend space

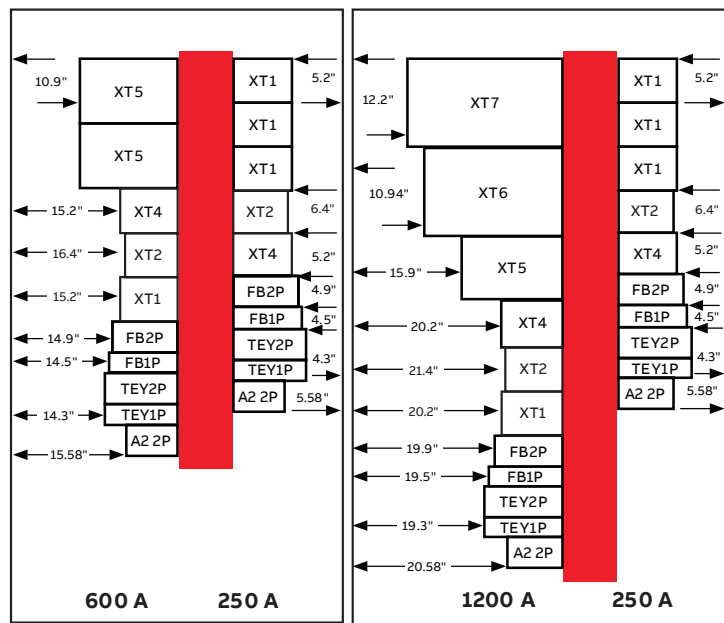

40" offset box

45" offset box

All ReliaGear neXT panelboards are double sided. Wire bending space requirements restrict XT5-XT7 mounting to the left side of the interior.

Wire bend space

Breaker	Left mount space (in)	Right mount space (in)
40" offset enclosure		
XT5	10.9	-
XT4	15.2	5.2
XT2	16.4	6.4
XT1	15.2	5.2
FB 1-pole	14.5	4.5
FB 2-pole	14.9	4.9
TEY 1-pole	14.3	4.3
TEY 2-pole	14.3	4.3
A2 2-pole	15.58	5.58
45" offset enclosure		
XT7	12.2	-
XT6	10.94	-
XT5	15.9	-
XT4	20.2	5.2
XT2	21.4	6.4
XT1	20.2	5.2
FB 1-pole	19.5	4.5
FB 2-pole	19.9	4.9
TEY 1-pole	19.3	4.3
TEY 2-pole	19.3	4.3
A2 2-pole	20.58	5.58

ReliaGear™ neXT SuperBox power panelboards

Step 4: Select the required accessories³



Auxiliary contacts



Shunt trip



Fixed padlock



RELT



Mounting rail

Group	Type	Volts AC	XT1	XT2	XT4	XT5 ²	XT6	XT7	TEY	FB	A2
Auxiliary contacts Q = Indication of the status of the circuit breaker SY = Bell alarm	AUX-C 1 Q + 1 SY	250					KXTAAXCQSYFP	-	-	-	-
	AUX-C 2 Q + 1 SY	250					KXTAAXC2QSYFP	-	-	-	-
	AUX-C 1 Q + 1 SY	24					KXTAAXCDQSYFP	-	-	-	-
	AUX-C 3 Q + 1 SY	24	-				KXTDAXCD3QSYFP	-	-	-	-
	AUX 4Q	24					-	ZE1AUX4D	-	-	-
	AUX 4Q	400					-	ZE1AUX4	-	-	-
	AUX 1 SY	24					-	ZE1BAD	-	-	-
	AUX 1 SY	250					-	ZE1BA	-	-	-
Shunt trip	Pre-cabled (except for XT7)	24		KXTASORCFPB			KXTFYOCFPD	ZEZSZ	-	-	-
	Pre-cabled (except for XT7)	110		KXTASORCFPD			KXTFYOCFPD	ZEASE	-	-	-
	Pre-cabled (except for XT7)	220		KXTASORCFPE				ZEASG	-	-	-
Undervoltage release	Pre-cabled (except for XT7)	24		KXTAUVRCFP1			KXTFYUC1	ZEUAU	-	-	-
	Pre-cabled (except for XT7)	110		KXTAUVRCFP4			KXTFYUC4	ZEUAU	-	-	-
	Pre-cabled (except for XT7)	220		KXTAUVRCFP5			KXTFYUC5	ZEUAU	-	-	-
Fixed padlock ¹	Open position	-	KXTBPLOP	KXTCPLLOP	KXT5PLOP	KXT6PLOP	KXT7PLOP				
	Open/closed position	-	KXTBLOPL	KXTCPLLOPL	KXT5PLOPLC	KXT6PLOPLC		TEYPLD1	FB1PF		
Removable padlock	Open position: KA2LD	-									KA2LDOR
RELT	RELT kit ⁴	120/240						RT04A			
	RELT kit ⁴	480						RT04B			
	RELT kit ⁴	600						RT04C			
	RELT wire connector							CN003			
Mounting rail	1 single Tmax® XT1	-	SR1XBF								
	2 adjacent Tmax® XT1	-	SR2XBF								
	5 adjacent Tmax® XT1	-	SR5XBF								
Blank and fillers	1X blank + filler	-									SR01BF
	1X blank only	-									SR01BB
	2X blank + filler	-									SR02BF
	2X blank only	-									SR02BB
	3X blank + filler	-									SR03BF
	3X blank only	-									SR03BB
	XT1 blank only	-	SRT1BB								

¹ Padlocks are not included in the kit.

² Tmax XT5 electrical accessories require 1 (one) extra X-space for installation.

³ Additional Tmax XT accessories are available. Contact your local ABB sales team for more information.

⁴ Requires XT7 equipped with Ekip Touch or above trip unit, 3 X-space factor required.

ReliaGear™ neXT SuperBox power panelboards

Configuration example 1

Panel:	Volts: 480Y/277 V AC	Main type: Main breaker
Location:	Phase: 3	Mains rating: 800 A
Mounting: Plug-on	Wires: 4	
Enclosure: NEMA 1	AIC rating: 35 kA	

Circuit	Circuit description	Trip (A)	Poles	A	B	C	Poles	Trip	Circuit description	Circuit
1	Circuit 1	400	3				3	100	Circuit 2	2
3	(110 V — shunt trip)	400	3				3	100		4
5		400	3				3	100		6
7	Circuit 3	200	3				3	100	Circuit 4	8
9		200	3				3	100		10
11		200	3				3	100		12
13	Circuit 5	200	3				3	100	Prepared space	14
15		200	3				3	100		16
17		200	3				3	100		18
19	Prepared space	200	3				3	100	Prepared space	20
21		200	3				3	100		22
23		200	3				3	100		24
25	—	—	—				—	—	—	26
27	—	—	—				—	—	—	28
29	—	—	—				—	—	—	30

Selection example:

Step 1: Select main and branch feeder circuit breakers

Main breakers are not included in the SuperBox and must be ordered separately. XT1 mounting rails are not included with breakers and must be selected to accommodate one, two or five XT1 circuit breakers. In this step, you must also take note of any prepared space requirements.

- Qty (1) XT6NU3800BYU000XXX
- Qty (1) XT5NU360BBYN000XXX
- Qty (2) XT4SU3200AY8000XXX
- Qty (1) XT4 prepared space
- Qty (2) XT1SU3100AYD000XXX
- Qty (2) XT1 prepared space

Step 2: Select the required accessories

In this case, we see that the XT5 requires a shunt trip. As indicated in the footnote, all XT5 electrical accessories require one additional X-space. Accessories listed are ordered separately and are UL certified for field installation.

- Qty (1) KXTFYOCFPD

Step 3: Determine the X-space required to meet main and branch feeder circuit breaker selection

In this example, we need X-space for (1) XT6, (1) XT5, (3) XT4 and (4) XT1.

Each XT6 requires 6 X-spaces; each XT5 requires 4 X-spaces plus 1 X-space for the shunt trip; each XT4 requires 3 X-spaces;

a single XT1 requires 3 X-spaces; two XT1s require 5 X-spaces; five XT1s require 11 X-spaces depending on the mounting rail(s) selected.

For the XT1s, we can use a five-unit mounting rail, which will require 11 X-spaces and will leave an additional future space, or we could use (2) two-unit mounting rails, which will require 10 X-spaces, or we could use four single-unit mounting rails, which will require 12 X-spaces. For this exercise, we will use (2) two-unit mounting rails requiring 10 X-spaces.

Total X space required = XT6 (6 spaces) + XT5 (4 spaces + 1 space) + XT4 (9 spaces) + XT1 (10 spaces) = 30 spaces in total.

Note that XT6s and XT5s can only be mounted on the left side of the bus stack. In this example, we need to ensure we have 11 X-spaces available on the left side.

- Qty (2) SR2XBF

Step 4: Select the SuperBox required based on maximum ampacity, main type, enclosure type and bus X-space required

In this example, we need an 800 A main breaker interior, in a NEMA 1 enclosure. Using the SuperBox selection table, we find that the 800 A main breaker panel has a total of 48 X-spaces available, with 24 X-spaces on the left side and 24 X-spaces available on the right side. Blanks and filler plates are included in the SuperBox so all future spaces will be covered. No additional items required.

- Qty (1) RNSB08B7245A

ReliaGear™ neXT SuperBox power panelboards

Configuration example 2

Panel:
Location:
Mounting: Plug-on
Enclosure: NEMA 3R

Volts: 240 V AC
Phase: 3
Wires: 3
AIC rating: 65 kA

Main type: Main lugs
Mains rating: 1200 A

Circuit	Circuit description	Trip (A)	Poles	A	B	C	Poles	Trip (A)	Circuit description	Circuit
1	Circuit 1 (240 V	1000	3				3	200	Circuit 2	2
3	REL T + shunt	1000	3				3	200		4
5	trip)	1000	3				3	200		6
7	Circuit 3	600	3				3	100	Circuit 4	8
9		600	3				3	100		10
11		600	3				3	100		12
13	Circuit 5	400	3				3	100	Circuit 6	14
15		400	3				3	100		16
17		400	3				3	100		18
19	Circuit 7	400	3				3	100	Circuit 8	20
21		400	3				3	100		22
23		400	3				3	100		24
25	Circuit 9	70	3				3	125	Prepared	26
27		70	3				3	125	space	28
29		70	3				3	125		30

Selection example:

Step 1: Select main and branch feeder circuit breakers

Main breakers are not included in the SuperBox and must be ordered separately. XT1 mounting rails are not included with breakers and must be selected to accommodate one, two or five XT1 circuit breakers. In this step, you must also take note of any prepared space requirements.

- Qty (1) XT7HU310EPYW000XXX
- Qty (1) XT5HU360BBYN000XXX
- Qty (2) XT5HU340ABYN000XXX
- Qty (1) XT4HU3200AY8000XXX
- Qty (3) XT1HU3100AYD000XXX
- Qty (1) XT1HU3070AYD000XXX
- Qty (1) XT1 prepared space

Step 2: Select the required accessories

In this case, we see that the XT7 requires RELT and a shunt trip. As indicated in the footnote, RELT requires an XT7 equipped with Ekip Touch or above trip unit, and requires 3 additional X-spaces.

- Qty (1) RT04A
- Qty (1) CN003

Step 3: Determine the X-space required to meet main and branch feeder circuit breaker selection

In this example, we need X-space for (1) XT7, (2) XT5, (1) XT4 and (5) XT1.

Each XT7 requires 6 X-spaces plus 3 X-spaces for RELT; each XT5 requires 4 X-spaces; each XT4 requires 3 X-spaces; a single XT1 requires 3 X-spaces; two XT1s require 5 X-spaces; five XT1s require 11 X-spaces depending on the mounting rail(s) selected.

For this exercise, we will use (1) five-unit mounting rail for the XT1s, which requires 11 X-spaces.

Total X-space required = XT7 (6 spaces + 3 spaces) + XT5 (12 spaces) + XT4 (3 spaces) + XT1 (11 spaces) = 35 spaces in total. Note that XT7s and XT5s can only be mounted on the left side of the bus stack. In this example, we need to ensure we have 21 X-spaces available on the left side.

- Qty (1) SR5XBF

Step 4: Select the SuperBox required based on maximum ampacity, main type, enclosure type and bus X-space required

In this example, we need a 1200 A main lug interior, in a NEMA 3R enclosure. Using the SuperBox selection table, we find that the 1200 A main lug panel has a total of 56 X-spaces available, with 28 X-spaces on the left side and 28 X-spaces available on the right side. Blanks and filler plates are included in the SuperBox so all future spaces will be covered. No additional items required.

- Qty (1) RNSB12L8445R

ReliaGear™ neXT SuperBox power panelboards

Configuration example 3

Panel:	Volts: 480Y/277 V AC	Main type: Main breaker
Location:	Phase: 3	Mains rating: 800 A
Mounting: Plug-on	Wires: 4	
Enclosure: NEMA 1	AIC rating: 35 kA	

Circuit	Circuit description	Trip (A)	Poles	A	B	C	Poles	Trip (A)	Circuit description	Circuit
1	Circuit 1 (110 V	400	3				3	100	Circuit 2	2
3	shunt trip)	400	3				3	100		4
5		400	3				3	100		6
7	Circuit 3 (110 V	300	3				3	100	Circuit 4	8
9	shunt trip)	300	3				3	100		10
11		300	3				3	100		12
13	Circuit 5 (110 V	300	3				2	100	Circuit 6	14
15	shunt trip)	300	3				2	100		16
17		300	3				2	100	Circuit 8	18
19	Circuit 7 (110 V	300	3				2	100		20
21	shunt trip)	300	3							22
22		300	3							24

Selection example:

Step 1: Select main and branch feeder circuit breakers

Main breakers are not included in the SuperBox and must be ordered separately. XT1 mounting rails are not included with breakers and must be selected to accommodate one, two or five XT1 circuit breakers. In this step, you must also take note of any prepared space requirements.

- Qty (1) XT6NU3800BYU000XXX
- Qty (1) XT5NU340ABYN000XXX
- Qty (3) XT5NU330ABYN000XXX
- Qty (2) XT1SU3100AYD000XXX
- Qty (1) NEFBV26TE100R2AB
- Qty (1) NEFBV26TE100R2AC

Step 2: Select the required accessories

In this case, we see that four XT5s require a 110 V shunt trip. As indicated in the footnote, electrical accessories for XT5 breakers require 1 additional X-space.

- Qty (4) KXTFYOCFPD

Step 3: Determine the X-space required to meet main and branch feeder circuit breaker selection

In this example, we need X-space for (1) XT6, (4) XT5, (2) XT1 and (2) FB.

Each XT6 requires 6 X-spaces; each XT5 requires 4 X-spaces plus 1 X-space for a shunt trip; a single XT1 requires 3 X-spaces; two XT1s require 5 X-spaces; five XT1s require 11 X-spaces depending on the mounting rail(s) selected.

For this exercise, we will use (1) two-unit mounting rail for the XT1s, which requires 5 X-spaces.

Total X-space required = XT6 (6 X-spaces) + XT5 (16 spaces + 4 spaces) + XT1 (5 spaces) + FB (4 spaces) = 35 spaces in total. Note that XT6s and XT5s can only be mounted on the left side of the bus stack. In this example, we need to ensure we have 26 X-spaces available on the left side.

- Qty (1) SR2XBF

Step 4: Select the SuperBox required based on maximum ampacity, main type, enclosure type and bus X-space required

In this example, we need an 800 A main breaker interior, in a NEMA 1 enclosure. Using the SuperBox selection table, we find that the 800 A main breaker panel has a total of 48 X-spaces available, with 24 X-spaces on the left side and 28 X-spaces available on the right side.

In this example, the 24 X-spaces available on the left side of the 800 A main breaker panel is insufficient for the breakers required. Moving to the next larger SuperBox, the 1200 A main breaker interior in a NEMA 1 enclosure has 64 X-spaces available, with 32 X-spaces on each side. This larger SuperBox must be used. Blanks and filler plates are included in the SuperBox so all future spaces will be covered. No additional items required.

- Qty (1) RNSB08B7245R

ReliaGear™ neXT SuperBox power panelboards

Resources for easy installation

Installation videos and documents

Product installation videos

ReliaGear neXT — Bus stack installation

ReliaGear neXT — Fronts and gutter doors installation

ReliaGear neXT — Branch circuit breaker installation

ReliaGear neXT — Ground and neutral installation

ReliaGear neXT — Interior frame installation

ReliaGear neXT — Field modification — top feed to bottom

ReliaGear neXT — Lug wire post installation

Resource documents

Brochure — 1SQC900001B0201

Catalog — 1SQC900001C0201

Typicals brochure — 1SXU900300G0201

White paper — 1SQC900001G0201

Instruction sheet — RELT — 1SQC900005M0201

Instruction sheet — Grounds and neutral — 1SQC900007M0201

Instruction sheet — ReliaGear™ neXT SuperBox panelboard — 1SQC900014M0201





ABB Inc.

305 Gregson Drive
Cary, NC 27511

electrification.us.abb.com

Customer Service

Phone: +1 800 431 7867

Distributors

E-mail: us-el.distributorsales@abb.com

All other customers

E-mail: us-el.oemsales@abb.com

Monday - Friday,

7:00 A.M. - 5:30 P.M., Central Time

Tech Support: + 1 888-437-3765

Monday - Friday

7:00 A.M. - 5:00 P.M., Central Time

We reserve the right to make technical changes or modify the contents of this document without prior notice. With regard to purchase orders, the agreed particulars shall prevail. ABB Inc. does not accept any responsibility whatsoever for potential errors or possible lack of information in this document. We reserve all rights in this document and in the subject matter and illustrations contained therein. Any reproduction, disclosure to third parties or utilization of its contents – in whole or in parts – is forbidden without prior written consent of ABB Inc.