

DOBBINSALES LIMITED

Lawler Manufacturing 2009 List Price Sheet

(valid in SK, MB, ON and QC only)

Effective Date: January 1, 2009

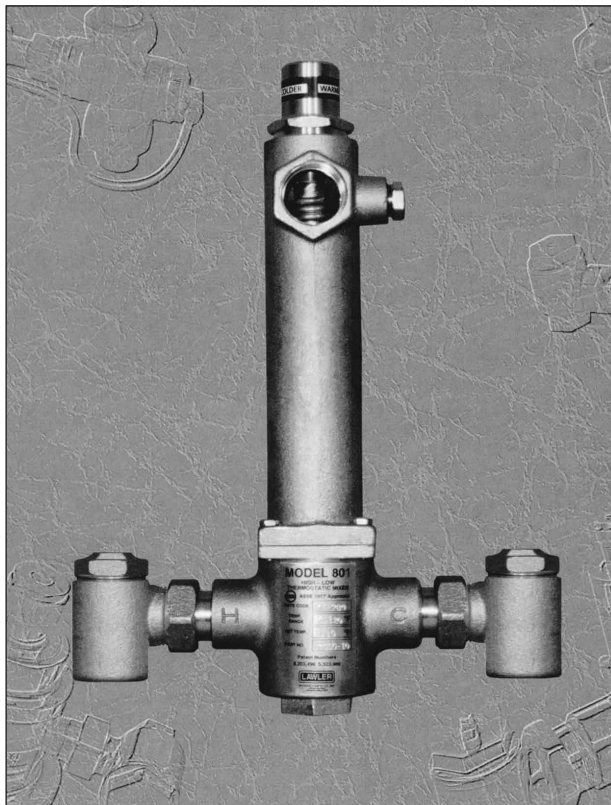

For more information contact www.dobbinsales.com



MANUFACTURING CO., INC.

Go to www.lawlervalve.com to find the most current data sheets and technical information

PRICE LIST

EFFECTIVE January 1, 2009

Prices subject to change without notice.

Plumbing Products Price List 2009

Table of Contents

Product

Master Controllers 1—17

Series 800 Hi-Lo Mixing Valves	1-2
Series 61 and 800 Special Applications	3
AVAS	4
Series 66 Thermostatic Mixing Valves	5-7
Series 66 & Series 800 Repair Kits	8-9
Series 61 Thermostatic Mixing Valves	10
Series 67 Thermostatic Pressure Balanced Valves	11
Series 61 & Series 67 Repair Kits	12-13
Series 310 Under-The-Counter Valves	14
Series 410 Under-The-Counter Valves	15
Series 310 & 410 Repair Kits	16
Model 570	17
Model 570 Cabinet	18

Point of Use 18—25

Model TMM-1000	18
Series 4000 Exposed Shower Valves	19
Series 4000 Accessories	20
Series 3000 & Series 7000 Concealed Shower Valves	21
Series 3000 & Series 7000 Accessories	22
Shower Heads & Fixtures	23
Shower Covers & Face Plates	24
Shower Valve Repair Kits	25

Safety Valves 26—30

Safety Systems (ETS)	26
Model 911 Emergency Drench Showers	27
Model 911 E Emergency Combination Units	28
Model 911 E/F Eye/Face Wash Units	29
ETS, Model 911, 911E & 911E/F Repair Kits	30

Type S Regulator 31

Index 32—36



Distributed in Canada by R.G. Dobbin Sales Limited
230 Wildcat Road, Toronto, Ontario M3J 2N5
Telephone: 416-663-5465 • Toll Free: 1-800-565-8515 • Fax: 416-663-0897
www.dobbinsales.com • Email: info@dobbinsales.com

Suffixes

bwe	Baked white enamel
cp	Chrome plated/Rough Chrome/ White Chrome
evb	Elevated vacuum breaker
exp/sur	Standard exposed, also called surface mounted cabinet
nc	Nickel coating
pc	Polished chrome
rb	Rough bronze/brass
rec	Standard recessed cabinet
semi	This is a standard semi recessed cabinet
ss	Stainless steel
th	Thermometer
vr	Vandal resistant handle screw

Valve Finishes

Chrome Finish	Rough Chrome
Chrome Plated	Rough Chrome
Satin Spray Finish	Rough Chrome
White Chrome	Rough Chrome
Nickel Coating	Nickel plated inside and outside
Polished Chrome	High gloss

Note: Parts breakdown for each kit found in valve's installation and maintenance manual.

Note: Unless otherwise indicated part numbers are for standard temperature range for that class of valve. Please contact our representative or the factory for alternate ranges and set temperatures.

Note: All drawings are for pricing information only. Go to www.lawlervalve.com to find the most current data sheets and technical information. Specifications and pricing subject to change without notice.



MANUFACTURING CO., INC.



Master Controllers



ASSE 1017 Approved

PAT. NO. 5,203,496. PAT. NO. 5,323,960.

PRICE LIST

EFFECTIVE January 1, 2009

Series 801/802/804/805 High-Low Mixing Valves

Drawing No. 72999 (801) 73000 (802) 73005 (804) 73100 (805)

Valve	GPM @ 45 psi	Inlet	Outlet	Ship Wght.	Rough Part Number	Bronze Price
801	50	3/4"	1"	20	72999-10	\$ 2478.45
802	80	1"	1 1/4"	21	73000-10	3024.05
804	150	1 1/2"	2"	44	73005-10	3566.55
805	200	2"	2"	45	73100-10	3771.45

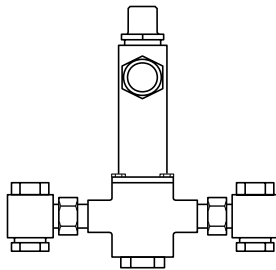

Valve	GPM @ 45 psi	Inlet	Outlet	Ship Wght.	Rough Part Number	Chrome Price
801	50	3/4"	1"	20	72999-11	\$ 2765.20
802	80	1"	1 1/4"	21	73000-11	3420.85
804	150	1 1/2"	2"	44	73005-11	3876.55
805	200	2"	2"	45	73100-11	4169.50

Drawing No. 86208 (801) 86008 (802) 86308 (804) 86108 (805)

Valve	GPM @ 45 psi	Inlet	Outlet	Ship Wght.	Rough Part Number	Bronze Price
801	50	3/4"	1"	22	86208-05	\$ 2856.65
802	80	1"	1 1/4"	23	86008-05	3554.15
804	150	1 1/2"	2"	48	86308-05	4116.80
805	200	2"	2"	49	86108-05	4332.25

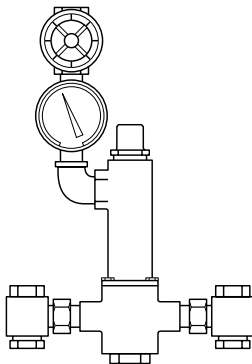

Valve	GPM @ 45 psi	Inlet	Outlet	Ship Wght.	Rough Part Number	Chrome Price
801	50	3/4"	1"	22	86208-06	\$ 3194.55
802	80	1"	1 1/4"	23	86008-06	3805.25
804	150	1 1/2"	2"	48	86308-06	4425.25
805	200	2"	2"	49	86108-06	4634.50

Specifications subject to change without notice.

Series 801/802/804/805 High-Low Mixing Valves

*Cabinet Unit Drawing No. 86506 (801) 86006 (802) 86306 (804) 86106 (805)

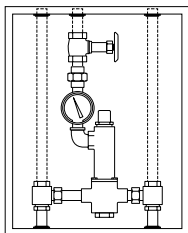

Valve	Pipe Size	Ship Wght.	Cabinet Carbon Steel		Cabinet Stainless Steel	
			Rough Brass	Rough Chrome	Rough Brass	Rough Chrome
801	3/4" x 1"	95	\$ 4774.00	\$ 5017.35	\$ 5097.95	\$ 5339.75
802	1" x 1 1/4"	99	5032.85	5274.65	5356.80	5907.05
804	1 1/2" x 2"	128	5629.60	5862.10	5938.05	6186.05
805	2" x 2"	130	5983.00	6224.80	6306.95	6550.30

*Cabinet Unit Drawing No. 86579 (801) 86379 (802) 86318 (804) 86380 (805)

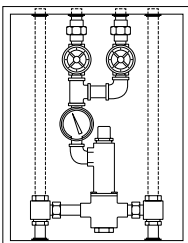

Valve	Pipe Size	Ship Wght.	Cabinet Carbon Steel		Cabinet Stainless Steel	
			Rough Brass	Rough Chrome	Rough Brass	Rough Chrome
801	3/4" x 1"	95	\$ 5226.90	\$ 5542.80	\$ 5631.15	\$ 5899.30
802	1" x 1 1/4"	99	5525.75	5801.65	5888.45	6156.60
804	1 1/2" x 2"	128	6496.05	6765.75	6837.05	7120.70
805	2" x 2"	130	6579.75	6849.45	6934.70	7202.85

*Cabinet Unit Drawing No. 86504 (801) 86004 (802) 86304 (804) 86104 (805)

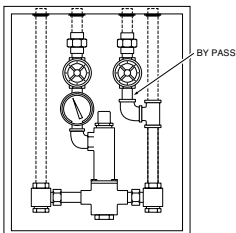

Valve	Pipe Size	Ship Wght.	Cabinet Carbon Steel		Cabinet Stainless Steel	
			Rough Brass	Rough Chrome	Rough Brass	Rough Chrome
801	3/4" x 1"	95	\$ 5266.90	\$ 5542.80	\$ 5631.15	\$ 5899.30
802	1" x 1 1/4"	99	5525.75	5801.65	5888.45	6156.60
804	1 1/2" x 2"	151	6496.05	6765.75	6837.05	7120.70
805	2" x 2"	155	6579.75	6849.45	6934.70	7202.85

Note: Part numbers shown are for standard temperature range of 90-120°F.
For alternate ranges contact the factory.

* Must specify recessed, exposed, or semi-recessed cabinets for each order placed.
If semi recessed, add \$200 to list price.

**800 Series Test Connection

Includes garden hose connect, shut-off and thermometer

Size	Rough Bronze		Rough Chrome	
	Part Number	Price	Part Number	Price
1/2"	87100-01	\$ 162.75	87100-02	\$ 196.85

**Note: Cannot be used with cabinet assembly.

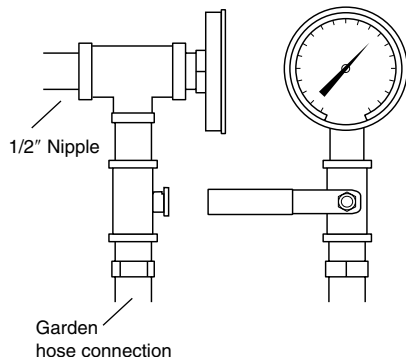

Specification subject to change without notice.



MANUFACTURING CO., INC.

Master Controllers

PRICE LIST

EFFECTIVE January 1, 2009



ASSE 1017 Approved

Special Applications

Manifold Systems Series 61 and 800

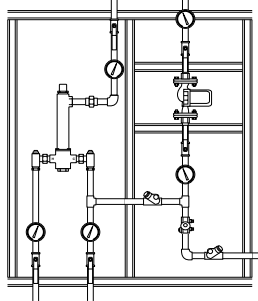

Model	Price	Model	Price
801 MS	\$13,886.60	61-10 MS	\$10,686.20
802 MS	\$15,236.20	61-15 MS	\$10,686.20
804 MS	\$15,759.80	61-25 MS	\$10,743.60
805 MS	\$15,969.80		

Pricing subject to recirculating pump specifications and other accessories. Above price includes \$400 recirculating pump allowance. Add \$800 to list price for optional aquastat, circulator switch and test connection.

Manifold Recirculation Systems

Recirculation units are factory preassembled and include: recirculation pump, mounting strut, thermometers on inlets and outlets, check valves on inlets, circuit setting balancing valve, return piping, ball valves, and all other necessary piping.

Contact factory with questions concerning recirculation pump allowance or other options.

Parallel Installation Series 800

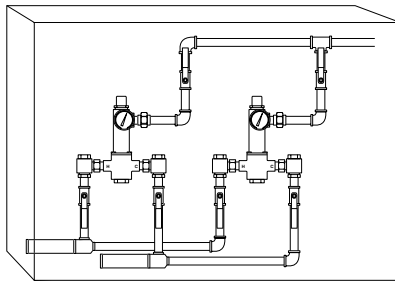

Model	Piped
801 PI	\$16,664.20
802 PI	\$16,634.80
804 PI	\$18,207.00
805 PI	\$18,515.00

Parallel Installation

Parallel installation doubles the flow rate for use in large commercial and industrial applications where high flow rates are needed. Units include all necessary piping. Exposed cabinet assemblies available. For optional test connection see page 2.

Contact factory for pricing with cabinet.

Tri Parallel Installation Series 800

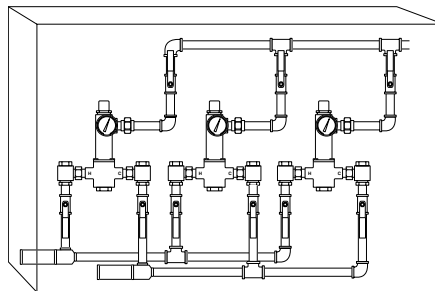

Tri Parallel Installation

Tri Parallel installation triples the flow rate for use in large commercial and industrial applications where high flow rates are needed. Units include all necessary piping. Exposed cabinet assemblies available.

Contact factory for pricing of tri parallel units and cabinets.

Specification subject to change without notice.



MANUFACTURING CO., INC.

Alarm System

PRICE LIST

EFFECTIVE January 1, 2009

High Temp Audio-Visual Alarm System AVAS

Lawler Model AVAS High Temperature Audio-Visual Alarm System is designed to monitor and provide audible and visible alert in the event of hot water temperatures exceeding set point thresholds. Programmable electronic module features three operational modes: normal valve operation, caution (alert), and alarm (shutdown) default setting at 120°F (49°C). Set point range is 40°F - 149°F (4.5°C - 65°C).

When specified with optional solenoid valve, the system, when in alarm mode, will provide complete emergency shutdown of water flow. System to include key access programmable electronic module, stainless steel panel, 6" x 6" electrical mounting box, 120V AC - 12V DC/1.5A UL Listed/CSA Certified Class 2 transformer, solid state temperature probe with 5' of cable and (2) system operation keys.

Options:

Solenoid Valves - 12V DC N.C. 10 watts max

1/2" NPT

3/4" NPT

1" NPT

1-1/4" NPT

1-1/2" NPT

2" NPT

1/2" NPT Water Hammer Arrestor

3/4" NPT Water Hammer Arrestor

1" NPT Water Hammer Arrestor

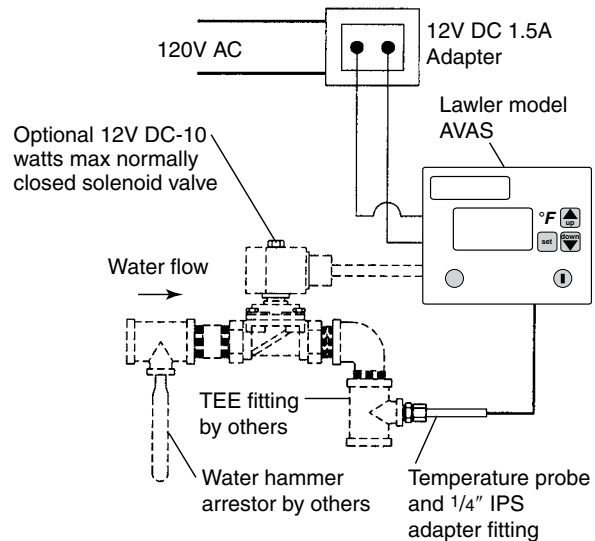

Model No.	Part No.	List Price
AVAS	8647-00	\$1534.50

Specification subject to change without notice.



MANUFACTURING CO., INC.

Master Controllers

PRICE LIST

EFFECTIVE January 1, 2009



ASSE 1017 Approved

Series 66

Thermostatic Mixing Valves

Series 66 Thermostatic Water Controller

Combination stops, checks and strainers. Standard finishes: brass and chrome plated.

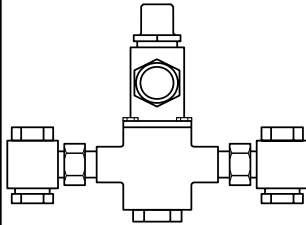

Valve	GPM @ 45 psi	Inlet	Outlet	Ship Wght.	Rough Bronze Part Number	Bronze Price
66-25	25	3/4"	3/4"	17	71762-06	\$ 907.70
66-50	50	3/4"	1"	17	71762-11	907.70
66-80	80	1"	1 1/4"	19	71762-16	1052.70
66-125	125	1 1/4"	1 1/2"	25	71762-21	1242.65
66-150	150	1 1/2"	2"	28	71762-26	1505.10
66-200	200	2"	2"	35	71762-31	1568.90

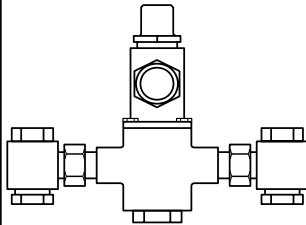

Valve	GPM @ 45 psi	Inlet	Outlet	Ship Wght.	Rough Chrome Part Number	Chrome Price
66-25	25	3/4"	3/4"	17	71762-36	\$ 971.50
66-50	50	3/4"	1"	17	71762-41	971.50
66-80	80	1"	1 1/4"	19	71762-46	1126.65
66-125	125	1 1/4"	1 1/2"	25	71762-51	1328.20
66-150	150	1 1/2"	2"	28	71762-56	1609.50
66-200	200	2"	2"	35	71762-61	1676.20

Note: For polished chrome finish, use the rough brass price shown on this page and add 25%. Part numbers above are for controllers with a 85-135°F temperature range with a maximum setting of 110°F. For alternate ranges and set temperatures, please contact our representative in your area or the factory.

Series 66 Without Stop & Checks

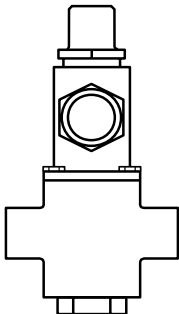

Valve	GPM @ 45 psi	Inlet	Outlet	Ship Wght.	Rough Bronze Part Number	Bronze Price
66-25	25	3/4"	3/4"	17	73050-06	\$ 646.70
66-50	50	3/4"	1"	17	73050-11	646.70
66-80	80	1"	1 1/4"	19	73050-16	971.50
66-125	125	1 1/4"	1 1/2"	25	73050-21	1200.60
66-150	150	1 1/2"	2"	28	73050-26	1241.20
66-200	200	2"	2"	35	73050-31	1249.90

Specifications subject to change without notice.



ASSE 1017 Approved

Series 66

Thermostatic Mixing Valves

Assembly Unit No. 83007

Refer to ENG. 83007 for all details.

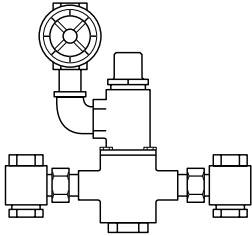

Valve	Pipe Size	Ship Wght.	Rough Bronze Part Number	Rough Bronze Price	Rough Chrome Part Number	Rough Chrome Price
66-25	3/4" x 3/4"	25	83007-01	\$ 1293.40	83007-02	\$ 1386.20
66-50	3/4" x 1"	26	83007-03	1344.15	83007-04	1438.40
66-80	1" x 1 1/4"	29	83007-05	1602.25	83007-06	1712.45
66-125	1 1/4" x 1 1/2"	37	83007-07	1845.85	83007-08	1973.45
66-150	1 1/2" x 2"	43	83007-09	2125.70	83007-10	2273.60
66-200	2" x 2"	50	83007-11	2285.20	83007-12	2446.15

Assembly Unit No. 83008

Refer to ENG. 83008 for all details.

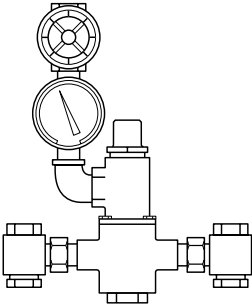

Valve	Pipe Size	Ship Wght.	Rough Bronze Part Number	Rough Bronze Price	Rough Chrome Part Number	Rough Chrome Price
66-25	3/4" x 3/4"	27	83008-01	\$ 1471.75	83008-02	\$ 1574.70
66-50	3/4" x 1"	28	83008-03	1570.35	83008-04	1680.55
66-80	1" x 1 1/4"	31	83008-05	1840.05	83008-06	1966.20
66-125	1 1/4" x 1 1/2"	40	83008-07	2077.85	83008-08	2221.40
66-150	1 1/2" x 2"	48	83008-09	2389.60	83008-10	2553.45
66-200	2" x 2"	55	83008-11	2549.10	83008-12	2724.55

Assembly Unit No. 83009

Refer to ENG. 83009 for all details.

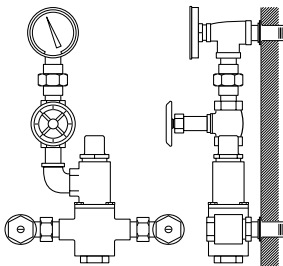

Valve	Pipe Size	Ship Wght.	Rough Bronze Part Number	Rough Bronze Price	Rough Chrome Part Number	Rough Chrome Price
66-25	3/4" x 3/4"	30	83009-01	\$ 1532.65	83009-02	\$ 1574.70
66-50	3/4" x 1"	31	83009-03	1638.50	83009-04	1751.60
66-80	1" x 1 1/4"	34	83009-05	1840.05	83009-06	2053.20
66-125	1 1/4" x 1 1/2"	44	83009-07	1919.80	83009-08	2337.40
66-150	1 1/2" x 2"	54	83009-09	2499.80	83009-10	2672.35
66-200	2" x 2"	61	83009-11	2549.10	83009-12	2888.40

Assembly Unit No. 83010

Refer to ENG. 83010 for all details.

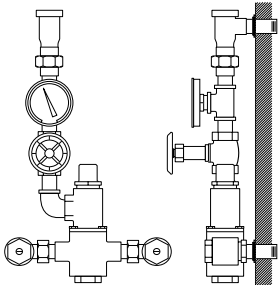

Valve	Pipe Size	Ship Wght.	Rough Bronze Part Number	Rough Bronze Price	Rough Chrome Part Number	Rough Chrome Price
66-25	3/4" x 3/4"	32	83010-01	\$ 1737.10	83010-02	\$ 1857.45
66-50	3/4" x 1"	33	83010-03	1856.00	83010-04	1985.05
66-80	1" x 1 1/4"	36	83010-05	2153.25	83010-06	2302.60
66-125	1 1/4" x 1 1/2"	49	83010-07	2494.00	83010-08	2665.10
66-150	1 1/2" x 2"	61	83010-09	2863.75	83010-10	3065.30
66-200	2" x 2"	66	83010-11	3130.55	83010-12	3348.05

Specifications subject to change without notice.



MANUFACTURING CO., INC.

Master Controllers

PRICE LIST

EFFECTIVE January 1, 2009



ASSE ASSE 1017 Approved

Series 66

Thermostatic Mixing Valves

Cabinet Unit Drawing No. 83004 rec/83314 sur** Refer to ENG. 83004 for all details.

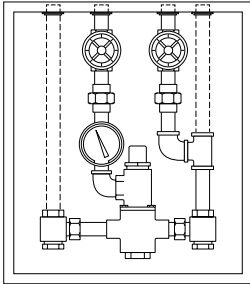

Valve	Pipe Size	Ship Wght.	Cabinet Carbon Steel		Cabinet Stainless Steel	
			Rough Brass	Rough Chrome*	Rough Brass	Rough Chrome*
66-25	3/4" x 3/4"	139	\$ 2717.30	\$ 2905.80	\$ 3036.30	\$ 3248.00
66-50	3/4" x 1"	144	3155.20	3374.15	3598.90	3848.30
66-80	1" x 1 1/4"	162	3755.50	4015.05	4194.85	4484.85
66-125	1 1/4" x 1 1/2"	195	3916.45	4187.60	4403.65	4706.70
66-150	1 1/2" x 2"	247	4194.85	4484.85	4753.10	5082.25
66-200	2" x 2"	272	4674.80	4999.60	5172.15	5533.20

Cabinet Unit Drawing No. 83006 rec/83014 sur** Refer to ENG. 83006 for all details.

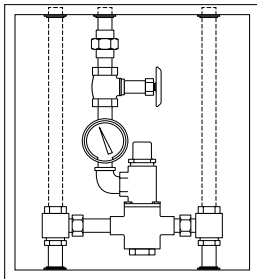

Valve	Pipe Size	Ship Wght.	Cabinet Carbon Steel		Cabinet Stainless Steel	
			Rough Brass	Rough Chrome*	Rough Brass	Rough Chrome*
66-25	3/4" x 3/4"	99	\$ 2118.45	\$ 2219.95	\$ 2565.05	\$ 2666.55
66-50	3/4" x 1"	104	2349.00	2457.75	2799.95	2908.70
66-80	1" x 1 1/4"	117	2765.15	2889.85	3279.90	3406.05
66-125	1 1/4" x 1 1/2"	150	3078.35	3220.45	3395.90	3539.45
66-150	1 1/2" x 2"	197	3300.20	3464.05	3875.85	4039.70
66-200	2" x 2"	232	3475.65	3652.55	4194.85	4370.30

*Note: For polished chrome finish, use the rough brass price shown on this page and add 25%.

** For semi recessed cabinet, transmit description as separate line item on purchase order to Lawler and add \$181.25 to list price for 66-25 through 66-80 and \$200 to list price for 66-125 through 66-200.

- **LOCK AND PIANO STYLE HINGE INCLUDED • FINISH:** Carbon Steel Cabinet (baked white enamel) or Stainless Steel Cabinet
- **Wall Brackets** — For use on exposed assemblies only.
66-25,66-50,66-80, 801 and 802 use P/N 7511-00 \$ 156.75
66-125,66-150,66-200, 804 and 805 use P/N 7510-00 \$ 156.75

Specifications subject to change without notice.

Series 66 & Series 800

Repair Kits

Parts breakdown for each kit found in valve's Installation and Maintenance Manual.

Replacement kits contain all O-rings, gaskets and springs that are needed for repair.

All kits weigh 3 pounds or less.

Series 66

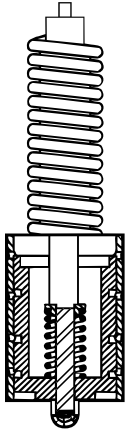

Series 800

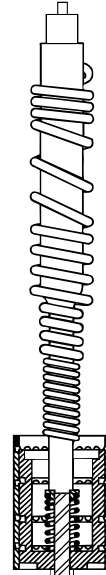

Complete Controller Repair Kits and Thermostats

Kit # 1

Size	50°-100° Part Number	85°-135° Part Number	100°-150° Part Number	Kit Price
66-25 & 66-50	79776-06	79776-01	79776-11	\$ 883.00
66-80	79776-07	79776-02	79776-12	883.00
66-125	79776-08	79776-03	79776-13	1020.25
66-150	79776-09	79776-04	79776-14	1020.25
66-200	79776-10	79776-05	79776-15	1020.25
Size	70°-100° Part Number	90°-120° Part Number	110°-140° Part Number	Kit Price
Model 801	79981-01	79981-00	79981-02	\$1146.25
Model 802	79978-04	79978-01	79978-07	1146.25
Model 804	79978-06	79978-03	79978-09	1396.50
Model 805	79978-05	79978-02	79978-08	1396.50

Kits contain all necessary O-rings, gaskets and springs.

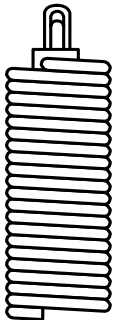

Series 66 Thermostats Kit # 4

Series 66 Replacement Thermostats and Gaskets		
Part No.	Range	Price
79956-00	85° - 135°	\$ 376.25
79956-01	50° - 100°	376.25
79956-02	100° - 150°	376.25
79956-79 nickel plated	85° - 135°	546.00

Model 800 Thermostats Kit # 4

Series 800 Replacement Thermostats and Gaskets		
Part No.	Range	Price
72911-11	90° - 120°	\$ 441.00
72911-10	70° - 100°	441.00
72911-12	110° - 140°	441.00
72911-79 nickel plated	90° - 120°	612.50



Piston and Liner Replacement

Kit # 2

Size	Part Number	Kit Price
66-25 & 66-50	71945-01	\$ 511.00
66-80	71945-01	511.00
66-125	71946-01	689.50
66-150	71946-01	689.50
66-200	71946-01	689.50
Model 801 & 802	71945-16	703.50
Model 804 & 805	71946-16	703.50

Only sold as a complete assembly.

Specifications subject to change without notice.

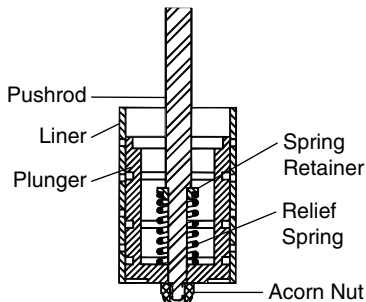

Figure C

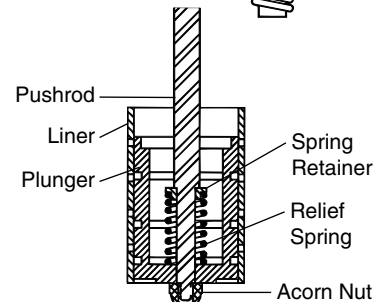

Figure C



MANUFACTURING CO., INC.

Master Controllers

PRICE LIST

EFFECTIVE January 1, 2009

Series 66 & Series 800

Repair Kits

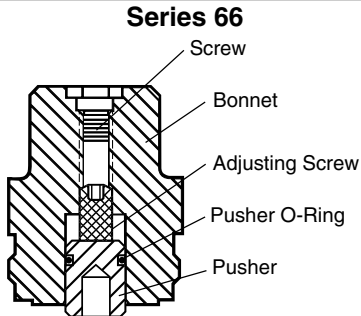

Figure B

Bonnet Assembly Kit # 5

Size	Part Number	Price
All 66, 801, 802	71965-10	\$ 161
Model 804 & 805	71965-11	161

Only sold as a complete assembly.

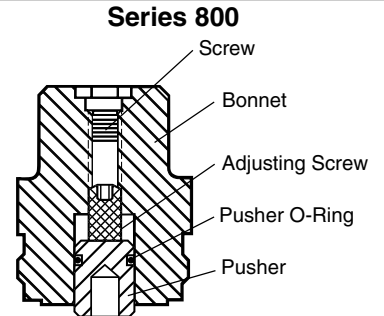

Figure B

O-Ring & Gasket

Kit # 6 O-Ring & Gasket

Kit # 6

Size	Part Number	Kit Price	Size	Part Number	Kit Price
66-25 & 66-50	79830-01	\$78.75	Model 801	79830-01	\$78.75
66-80	79830-02	\$78.75	Model 802	79830-02	\$78.75
66-125	79830-03	\$78.75	Model 804	79830-04	\$78.75
66-150	79830-04	\$78.75	Model 805	79830-05	\$78.75
66-200	79830-05	\$78.75			

Stop & Check

Repair Kits (Pair) #3

Repair Kit	Price
79907-02	\$ 190.75
79908-02	255.50
79909-02	322.00
79910-02	365.75
79911-02	388.50
79907-02	190.75
79908-02	255.50
79910-02	365.75
79911-02	388.50

Replacement Stop & Checks (Pair)*

Size	S & C Rough Brass	Price *	S & C Rough Chrome	Price*
66-25 & 66-50	71828-00	\$ 491.75	71828-05	\$ 612.50
66-80	71828-01	626.50	71828-06	775.25
66-125	71828-02	773.50	71828-07	934.50
66-150	71828-03	862.75	71828-08	1050.00
66-200	71828-04	950.25	71828-09	1181.25
Model 801	71828-00	491.75	71828-05	612.50
Model 802	71828-01	626.50	71828-06	775.25
Model 804	71828-03	862.75	71828-08	1050.00
Model 805	71828-04	950.25	71828-09	1181.25

*Includes union nuts and tailpieces.

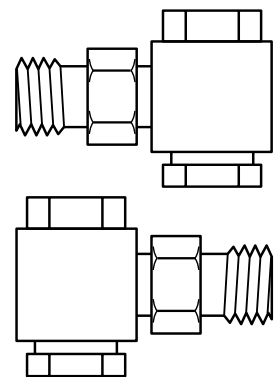

Thermometer and Tee



Thermometer only

Thermometer Part No.	Price
6679-02	\$143.50

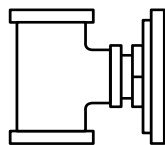

Size	Rough Bronze Part Number	Rough Bronze Price	Rough Chrome Part Number	Rough Chrome Price
1/2"	8225-01	\$ 190.75	8225-11	\$ 248.50
3/4"	8225-02	194.25	8225-12	252.00
1"	8225-03	267.75	8225-13	343.00
1 1/4"	8225-04	276.50	8225-14	388.50
1 1/2"	8225-05	302.75	8225-15	400.75
2"	8225-06	327.25	8225-16	423.50



Series 61

Thermostatic Mixing Valves

Assembly Unit No. 72906 / 72907

Refer to ENG. 72906 / 72907 for all details.

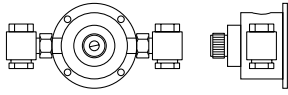

Valve	Pipe Size	Ship Wght.	Rough Part Number	Bronze Price	Polished Part Number	Chrome Price
6110	1/2"	9	72906-10	\$ 652.50	72906-11	\$ 752.55
6115	1/2"	9	72906-20	652.50	72906-21	752.55
6125	3/4"	12	72907-10	691.65	72907-11	790.25

Assembly Unit No. 84008 Exposed

Refer to ENG. 84008 for all details.

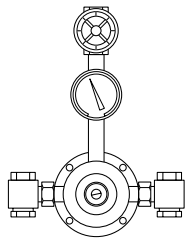

Valve	Pipe Size	Ship Wght.	Rough Part Number	Bronze Price	Polished Part Number	Chrome Price
6110	1/2"	15	84008-03	\$ 930.90	84008-04	\$ 1096.20
6115	1/2"	15	84008-05	930.90	84008-06	1096.20
6125	3/4"	18	84008-09	1152.75	84008-10	1355.75

Assembly Unit No. 84010 Exposed

Refer to ENG. 84010 for all details.

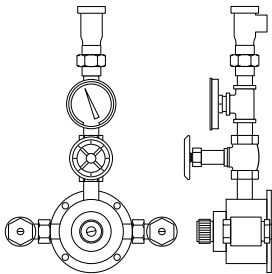

Valve	Pipe Size	Ship Wght.	Rough Part Number	Bronze Price	Polished Part Number	Chrome Price
6110	1/2"	16	84010-03	\$ 1083.15	84010-04	\$ 1190.45
6115	1/2"	16	84010-05	1083.15	84010-06	1190.45
6125	3/4"	19	84010-09	1349.95	84010-10	1444.20

Assembly Unit No. 84011 Exposed

Refer to ENG. 84011 for all details.

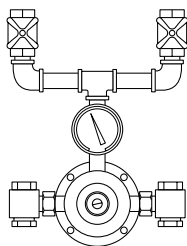

Valve	Pipe Size	Ship Wght.	Rough Part Number	Bronze Price	Polished Part Number	Chrome Price
6110	1/2"	17	84011-03	\$ 1003.40	84011-04	\$ 1103.45
6115	1/2"	17	84011-05	1003.40	84011-06	1103.45
6125	3/4"	20	84011-09	1249.90	84011-10	1103.45

Vandal Resistant Handle Screw available on all above, Suffix VR.

For 61 Cabinet Assemblies, add the price of the valve to the cabinet price.

Material	Ship Wght.	Recessed	Exposed	Semi Recessed
304 S.S. #4 Finish	35	\$ 1104.90	\$ 1104.90	\$ 1305.00
Carbon Steel Baked White Enamel	35	\$ 803.30	\$ 803.30	\$ 1006.30

Note: Unless otherwise indicated part numbers are for standard temperature range for that class of valve. Please contact our representative or the factory for alternate ranges and set temperatures.

Specifications subject to change without notice.

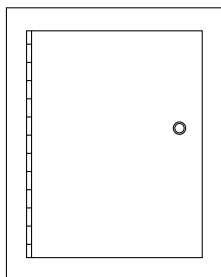

Eng. No. 8221



MANUFACTURING CO., INC.

Master Controllers

PRICE LIST

EFFECTIVE January 1, 2009

PAT. NO. 5,011,074.

Series 67 Thermostatic & Pressure Balanced

Assembly Unit No. 72956 / 72957 Exposed Refer to ENG. 72956/ 72957 for all details.

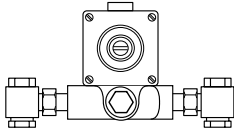

Valve	Pipe Size	Ship Wght.	Rough Bronze Part Number	Rough Bronze Price	Rough Chrome Part Number	Rough Chrome Price
6710	1/2"	9	72956-00	\$ 1441.30	72956-01	\$ 1663.15
6725	3/4"	9	72957-10	1537.00	72957-11	1757.40

Assembly Unit No. 84508 Exposed Refer to ENG. 84508 for all details.

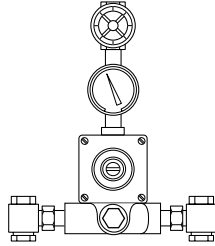

Valve	Pipe Size	Ship Wght.	Rough Bronze Part Number	Rough Bronze Price	Rough Chrome Part Number	Rough Chrome Price
6710	1/2"	15	84508-01	\$ 1925.60	84508-02	\$ 2140.20
6725	3/4"	15	84508-09	2219.95	84508-10	2457.75

Assembly Unit No. 84510 Exposed Refer to ENG. 84510 for all details.

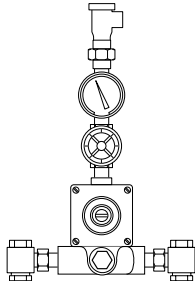

Valve	Pipe Size	Ship Wght.	Rough Bronze Part Number	Rough Bronze Price	Rough Chrome Part Number	Rough Chrome Price
6710	1/2"	16	84510-01	\$ 2243.15	84510-02	\$ 2460.65
6725	3/4"	16	84510-09	2599.85	84510-10	2781.10

Assembly Unit No. 84511 Exposed Refer to ENG. 84511 for all details.

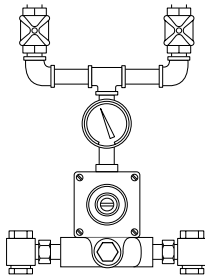

Valve	Pipe Size	Ship Wght.	Rough Bronze Part Number	Rough Bronze Price	Rough Chrome Part Number	Rough Chrome Price
6710	1/2"	17	84511-01	\$ 2076.40	84511-02	\$ 2283.75
6725	3/4"	17	84511-09	2407.00	84511-10	2644.80

Assembly Unit No. 84509 Exposed Refer to ENG. 84509 for all details.

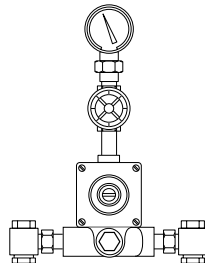

Valve	Pipe Size	Ship Wght.	Rough Bronze Part Number	Rough Bronze Price	Rough Chrome Part Number	Rough Chrome Price
6710	1/2"	17	84509-01	\$ 2076.40	84509-02	\$ 2283.75
6725	3/4"	17	84509-09	2407.00	84509-10	2644.80

Vandal Resistant Handle Screw available on all above, Suffix VR.

For 67 Cabinet Assemblies, add the price of the valve to the cabinet price.

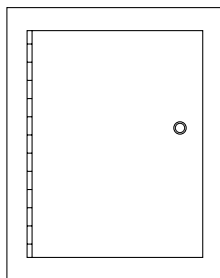

Eng. No. 8221

Material	Ship Wght.	Recessed	Exposed	Semi Recessed
304 S.S. #4 Finish	35	\$ 1104.90	\$ 1104.90	\$ 1305.00
Carbon Steel Baked White Enamel	35	\$ 803.30	\$ 803.30	\$ 1006.30

Note: Unless otherwise indicated part numbers are for standard temperature range for that class of valve. Please contact our representative or the factory for alternate ranges and set temperatures.

Specifications subject to change without notice.

Series 61 & Series 67

Repair Kits

Series 61

Complete Controller Repair Kits and Thermostats

Kit A

Series 67

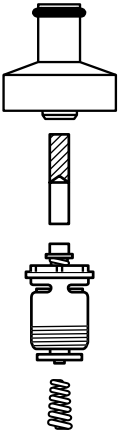

Size	50°-100° Part Number	85°-135° Part Number	100°-150° Part Number	Kit Price
61-05 1/2"	78001-03	78001-00	78001-06	\$439.25
61-10 1/2"	78001-04	78001-01	78001-07	439.25
61-15 1/2"	78001-05	78001-02	78001-08	439.25
61-20 3/4"	78002-02	78002-00	78002-04	535.50
61-25 3/4"	78002-03	78002-01	78002-05	535.50
67-10 1/2"	78005-03	78005-00	78005-06	551.25
67-25 3/4"	78006-03	78006-00	78006-06	822.50

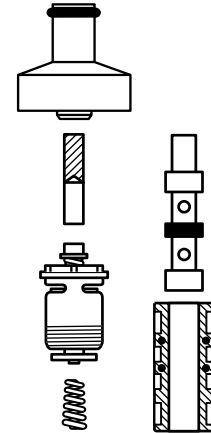

Piston and Liner Replacement

Kit C



Size	Part Number	Kit Price
61-05 1/2"	72904-10	\$343.00
61-10 1/2"	72904-11	343.00
61-15 1/2"	72904-12	343.00
61-20 3/4"	72905-10	439.25
61-25 3/4"	72905-11	439.25
67-10 1/2"	72904-11	343.00
67-25 3/4"	72905-11	439.25

O-Ring & Gasket Replacement

Kit B

Size	Part Number	Kit Price
61-05 1/2"	79959-00	\$ 64.75
61-10 1/2"	79959-00	64.75
61-15 1/2"	79959-00	64.75
61-20 3/4"	79960-00	91.00
61-25 3/4"	79960-00	91.00
67-10 1/2"	79959-00	64.75
67-25 3/4"	79960-00	91.00

Thermostat Kits

Kit D

Series 61/67 Replacement Thermostats and Gaskets		
Part No.	Range	Price
72903-11	85°-135°	\$204.75
72903-12	50°-100°	204.75
72903-13	100°-150°	204.75
72903-79 nickel plated	85°-135°	362.25

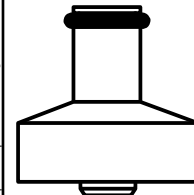

Pressure Balancers

Kit F

Model No.	Part No.	Price
67-10	71823-02	\$ 178.50
67-25	71824-01	379.75

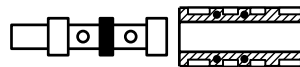

*Replacement kits contain all O-rings, gaskets and springs that are needed for repair.
Parts breakdown for each kit found in valve's Installation and Maintenance Manual.
All kits weigh 3 pounds or less.*

Specifications subject to change without notice.



MANUFACTURING CO., INC.

Master Controllers

PRICE LIST

EFFECTIVE January 1, 2009

Series 61 & Series 67

Repair Kits

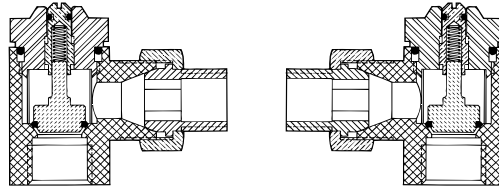

Replacement Stop & Checks (Pair)*

Size	Rough Brass	Price	Polished Chrome	Price
All 61-67 1/2"	72323-03	\$ 274.75	72323-06	\$320.25
All 61 67 3/4"	71828-00	491.75	71828-05	612.50

Stop & Check Repair Kits (Pair)

Size	Part No.	Price
61-67 1/2"	79902-03	\$71.75
61-67 3/4"	79907-12	183.75

*Includes union nuts and tailpieces.

Square Cover Series 67

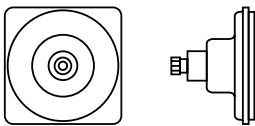

Round Cover Series 61

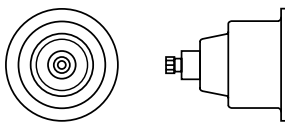

Cover and Spindle Replacement

Kit E

Size	Rough Brass	Price	Polished Chrome	Price
All 67 1/2"	72945-00	\$ 204.75	72945-01	\$ 245.00
All 67 3/4"	72946-00	280.00	72946-01	301.00
	Rough Brass		Polished Chrome	
All 61 1/2"	72940-00	218.75	72940-01	302.75
All 61 3/4"	72941-00	245.00	72941-01	309.75

Replacement kits contain all O-rings, gaskets and springs that are needed for repair.
Parts breakdown for each kit found in valve's Installation and Maintenance Manual.

Specifications subject to change without notice.

Series 310

Under-The-Counter Valves

Assembly Unit No. 72046

Refer to ENG. 72046/72049 for all details.

Valve	GPM @ 45 psi	Inlet	Outlet	Ship Wght.	Rough Part Number	Bronze Price
310-SC1	8	1/2"	1/2"	5	72046-00	\$ 295.80
310-SC1	12	1/2"	3/4"	5	72049-00	\$ 362.50

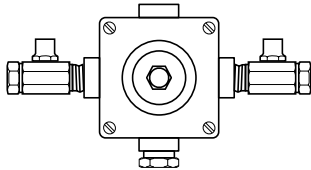

Valve	GPM @ 45 psi	Inlet	Outlet	Ship Wght.	Rough Part Number	Chrome Price
310-SC1	8	1/2"	1/2"	5	72046-61	\$ 345.10
310-SC1	12	1/2"	3/4"	5	72049-61	\$ 411.80

Assembly Unit No. 73046

Refer to ENG. 73046/73049 for all details.

Valve	GPM @ 45 psi	Inlet	Outlet	Ship Wght.	Rough Part Number	Bronze Price
310-TH	8	1/2"	1/2"	6	73046-00	\$ 452.40
310-TH	12	1/2"	3/4"	6	73049-00	\$ 519.10

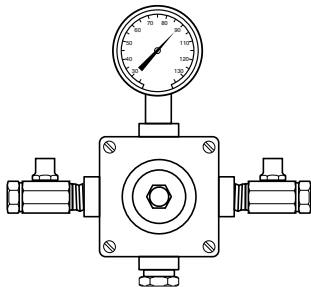

Valve	GPM @ 45 psi	Inlet	Outlet	Ship Wght.	Rough Part Number	Chrome Price
310-TH	8	1/2"	1/2"	6	73046-61	\$ 551.00
310-TH	12	1/2"	3/4"	6	73049-61	\$ 616.25

Cabinet Unit Drawing No. 86401*

Refer to ENG. 86401/86411 for all details.

Valve	Pipe Size	Ship Wght.	Cabinet Carbon Steel		Cabinet Stainless Steel	
			Part Number	Rough Brass	Part Number	Rough Brass
310 exp	1/2" x 1/2"	18	86401-06	\$ 1068.65	86401-04	\$ 1149.85
310 rec	1/2" x 1/2"	18	86401-14	1068.65	86401-12	1149.85
310 exp	1/2" x 3/4"	18	86411-06	1133.90	86411-04	1215.10
310 rec	1/2" x 3/4"	18	86411-14	1133.90	86411-12	1215.10

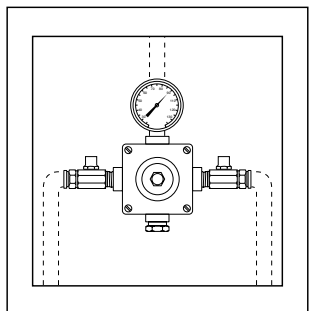

Valve	Pipe Size	Ship Wght.	Cabinet Carbon Steel		Cabinet Stainless Steel	
			Part Number	Rough Chrome	Part Number	Rough Chrome
310 exp	1/2" x 1/2"	18	86401-07	\$ 1149.85	86401-05	\$ 1232.50
310 rec	1/2" x 1/2"	18	86401-15	1149.85	86401-13	1232.50
310 exp	1/2" x 3/4"	18	86411-07	1215.10	86411-05	1297.75
310 rec	1/2" x 3/4"	18	86411-15	1215.10	86411-13	1297.75

exp = exposed/surface mounted **rec** = recessed

* For semi recessed cabinet, transmit description as separate line item on purchase order to Lawler and add \$181.25 to list price.

Note: Unless otherwise indicated part numbers are for standard temperature range for that class of valve. Please contact our representative or the factory for alternate ranges and set temperatures.

Specifications subject to change without notice.



MANUFACTURING CO., INC.

Master Controllers

PRICE LIST

EFFECTIVE January 1, 2009

Series 410

Under-The-Counter Valves

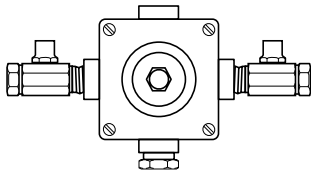

Assembly Unit No. 72146

Refer to ENG. 72146 for all details.

Valve	GPM @ 45 psi	Inlet	Outlet	Ship Wght.	Rough Part Number	Bronze Price
410-SC1	20	3/4"	3/4"	10	72146-00	\$ 591.60

Valve	GPM @ 45 psi	Inlet	Outlet	Ship Wght.	Rough Part Number	Chrome Price
410-SC1	20	3/4"	3/4"	10	72146-01	\$ 656.85

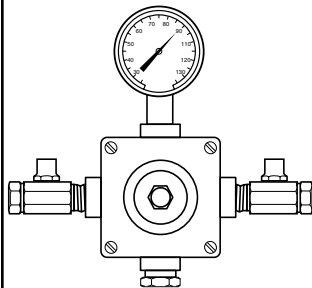

Assembly Unit No. 74146

Refer to ENG. 74146 for all details.

Valve	GPM @ 45 psi	Inlet	Outlet	Ship Wght.	Rough Part Number	Bronze Price
410-TH	20	3/4"	3/4"	12	74146-00	\$ 764.15

Valve	GPM @ 45 psi	Inlet	Outlet	Ship Wght.	Rough Part Number	Chrome Price
410-TH	20	3/4"	3/4"	12	74146-61	\$ 880.15

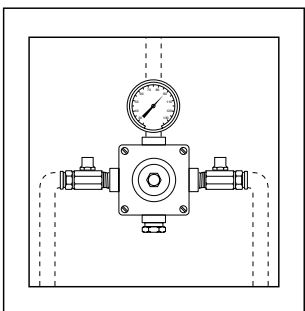

Cabinet Unit Drawing No. 86501

Refer to ENG. 86501 for all details.

Valve	Pipe Size	Ship Wght.	Cabinet Carbon Steel		Cabinet Stainless Steel	
			Part Number	Rough Brass	Part Number	Rough Brass
410 exp	3/4" x 3/4"	18	86501-06	\$ 1421.00	86501-04	\$ 1584.85
410 rec	3/4" x 3/4"	18	86501-14	1421.00	86501-12	1584.85

Valve	Pipe Size	Ship Wght.	Cabinet Carbon Steel		Cabinet Stainless Steel	
			Part Number	Rough Chrome	Part Number	Rough Chrome
410 exp	3/4" x 3/4"	18	86501-07	\$ 1537.00	86501-05	\$ 1702.30
410 rec	3/4" x 3/4"	18	86501-15	1537.00	86501-13	1702.30

exp = exposed/surface mounted **rec** = recessed

* For semi recessed cabinet, transmit description as separate line item on purchase order to Lawler and add \$181.25 to list price.

Note: Unless otherwise indicated part numbers are for standard temperature range for that class of valve. Please contact our representative or the factory for alternate ranges and set temperatures.

Specifications subject to change without notice.

Series 310 & 410

Repair Kits

Parts breakdown for each kit found in valve's Installation and Maintenance Manual.

Replacement kits contain all O-rings, gaskets and springs that are needed for repair.

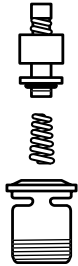

Piston and Liner Replacement Kit D

Size	Part Number	Price
Series 310	79855-00	\$227.55
Series 410	72014-15	402.50

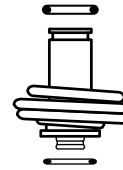

Thermostat Replacement Kit E

Size	Part Number	Price
Series 310	71870-21	\$183.75
Series 410	71036-21	213.50

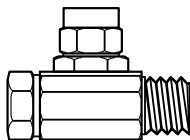

Replacement Stop & Checks (Pair)

Size	Rough Brass	Price	Rough Chrome	Price
Series 310	6839-01	\$ 63.00	6839-66	\$ 68.25
Series 410	71182-14	217.00	71182-15	257.25

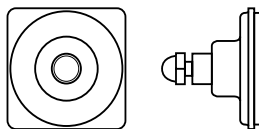

Replacement Cover

Kit C

Size	Rough Brass	Price	Chrome Plate	Price
Series 310	78271-03	\$ 89.25	78271-04	\$129.50
Series 410	79271-01	\$ 110.25	79271-02	\$148.75

O-Ring & Gasket Replacement Kit B

Size	Part Number	Price
Series 310	79961-00	\$ 63
Series 410	79962-00	91

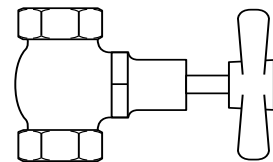

1/2" Shut-Off Valve Series 310

Part Number	Price
72561-00	\$ 84.00

Available in chrome only.

Thermometer and Tee

Size	Rough Brass	Price	Chrome Plate	Price
Series 310	8225-01	\$ 190.75	8225-11	\$248.50
Series 410	8225-02	194.25	8225-12	252.00

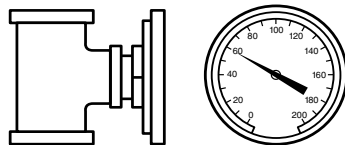

Thermometer (only)

Part Number	Price
6679-02	\$ 147.00

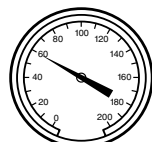

3/4" Ball Valve Series 410

Rough Bronze		Chrome Plate	
Part Number	Price	Part Number	Price
8150-04	\$ 36.75	8150-05	\$ 56.00

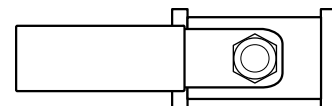



MANUFACTURING CO., INC.

Master Controllers

PRICE LIST

EFFECTIVE September 1, 2008

ASSE ASSE 1017 Approved

ASSE ASSE 1070 Approved

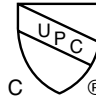

Certified to
CSA B125.3

Model 570

Thermostatic Mixing Valve

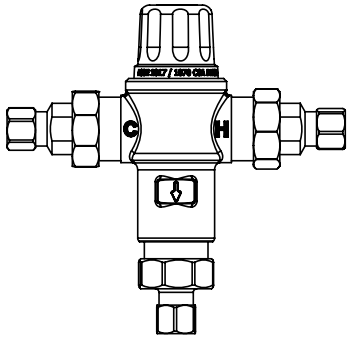

Valve	Pipe Size	Ship Wght.	Rough Bronze	Price
Model 570	3/8"	2	86820-00	\$ 175

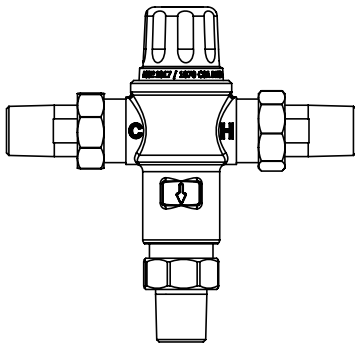

Valve	Pipe Size	Ship Wght.	Rough Bronze	Price
Model 570	1/2"	2	86821-00	\$ 168

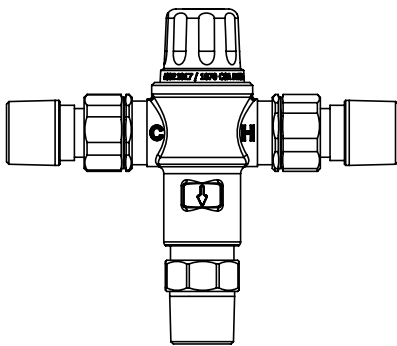

Valve	Pipe Size	Ship Wght.	Rough Bronze	Price
Model 570	3/4"	2	86822-00	\$ 210

Specifications subject to change without notice.



MANUFACTURING CO., INC.

Point of Use

PRICE LIST

EFFECTIVE January 1, 2009

 ASSE 1016 Approved

PAT. NO. 6,042,015. PAT. NO. 6,508,406.

Model TMM-1000
Model 570 Cabinet

Under the Counter Valves

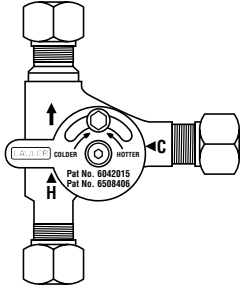

Valve	Pipe Size	Ship Wght.	Rough Bronze	Price
TMM-1000	$\frac{3}{8}$ "	.5	86800-00	\$ 119

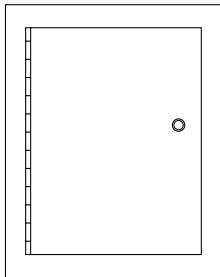

Model 570 Cabinet, add the price of the valve to the cabinet price.

Material	Ship Wght.	Recessed	Exposed
570 S.S. #4 Finish	13	\$ 770.00	\$ 770.00
Carbon Steel Baked White Enamel	15	\$ 623.00	\$ 623.00

Specifications subject to change without notice.



MANUFACTURING CO., INC.

Point of Use

PRICE LIST

EFFECTIVE January 1, 2009

Series 4000

Exposed Shower Valves



Assembly Unit No. 72306 / 72395 / 72316

Refer to ENG. 72306 / 72395 and 72316 for all details.

Valve	Pipe Size	Ship Wght.	Rough Bronze Part Number	Rough Bronze Price	Polished Chrome Part Number	Polished Chrome Price
4205	1/2"	13	72306-01	\$ 493.00	72306-02	\$ 558.25
4210	1/2"	13	72395-01	493.00	72395-02	558.25
4220	3/4"	17	72316-01	623.50	72316-02	701.80

Without Stop and Checks

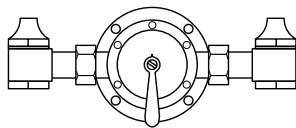

Assembly Unit No. 82306 / 82304

Refer to ENG. 82306 / 82304 for all details.

Valve	Pipe Size	Ship Wght.	Rough Bronze Part Number	Rough Bronze Price	Polished Chrome Part Number	Polished Chrome Price
4205	1/2"	16	82306-10	\$ 719.20	82306-11	\$ 823.60
4210	1/2"	16	82306-01	719.20	82306-00	823.60
4220	3/4"	21	82304-01	865.65	82304-00	1026.60

With Stop and Checks

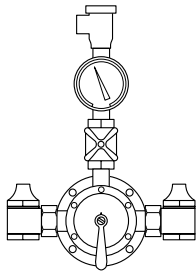

Assembly Unit No. 85002 Exposed

Refer to ENG. 85002 for all details.

Pipe Size	Shipping Weight	Rough Bronze Part Number	Rough Bronze Price	Polished Chrome Part Number	Polished Chrome Price
1/2"	11	85002-03	\$ 1436.95	85002-04	\$ 1580.50
3/4"	15	85002-07	1664.60	85002-08	1784.95

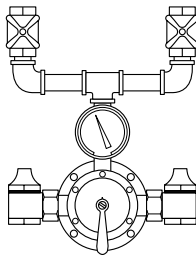

Assembly Unit No. 85004 Exposed

Refer to ENG. 85004 for all details.

Pipe Size	Shipping Weight	Rough Bronze Part Number	Rough Bronze Price	Polished Chrome Part Number	Polished Chrome Price
1/2"	16	85004-03	\$ 1332.55	85004-04	\$ 1464.50
3/4"	18	85004-07	1542.80	85004-08	1784.95

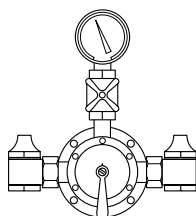

Assembly Unit No. 85005 Exposed

Refer to ENG. 85005 for all details.

Pipe Size	Shipping Weight	Rough Bronze Part Number	Rough Bronze Price	Polished Chrome Part Number	Polished Chrome Price
1/2"	14	85005-03	\$ 1236.85	85005-04	\$ 1371.70
3/4"	17	85005-07	1425.35	85005-08	1577.60

Vandal Resistant Handle Screw available on all above, Suffix VR.

Specifications subject to change without notice.



MANUFACTURING CO., INC.

Point of Use

PRICE LIST

EFFECTIVE January 1, 2009

Series 4000

Accessories

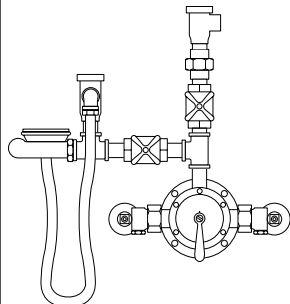

Assembly Unit No. 85003 Exposed

Pipe Size	Ship Wght.	Polished Chrome Part Number	Chrome Price
1/2"	15	85003-04	\$ 2311.75
3/4"	19	85003-08	2506.00

Vandal Resistant Handle Screw available, Suffix VR.

Replacement Stop & Checks (Pair)

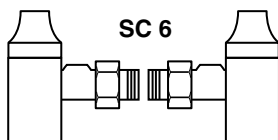

Series 4000	Pipe Size	Ship Wght.	Rough Bronze Part Number	Bronze Price	Polished Chrome Part Number	Chrome Price
4000 SC6	1/2"	3	72323-03	\$ 274.75	72323-06	\$ 320.25
4000 SC6	3/4"	4	70412-25	318.50	70412-26	392.00

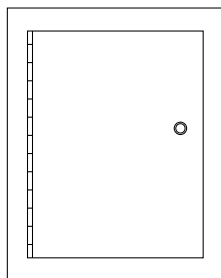

For 4000 Cabinet Assemblies, add the price of the valve to the cabinet price.

Material	Ship Wght.	Recessed	Exposed	Semi Recessed
304 S.S. #4 Finish	35	\$ 1333.50	\$ 1333.50	\$ 1575.00
Carbon Steel Baked White Enamel	35	\$ 969.50	\$ 969.50	\$ 1214.50

Does not apply to unit No. 85003, contact factory for pricing.

Eng. No. 8221

Thermometer and Tee

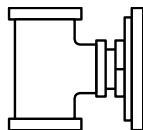

Size	Rough Bronze Part Number	Bronze Price	Chrome Plate Part Number	Chrome Plate Price
1/2"	8225-01	\$ 190.75	8225-11	\$ 248.50
3/4"	8225-02	194.25	8225-12	252.00

Thermometer only

Thermometer Part No.	Price
6679-02	\$143.50

Specifications subject to change without notice.



MANUFACTURING CO., INC.

Point of Use

ASSE ASSE 1016 Approved

PRICE LIST

EFFECTIVE January 1, 2009

Series 3000 & 7000 Concealed Shower Valves

Single Stage Thermostatic Control Valves

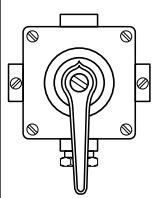

Model # 3000 1/2"
Part # 72047-05
Price \$ 426.30
Rough Bronze

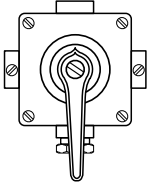

Model # 3000 1/2"
Part # 72047-11
Price \$ 497.35
Rough Chrome

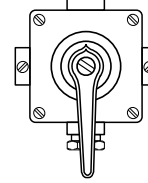

Model # 3000 3/4"
Part # 72047-15
Price \$ 746.75
Rough Bronze

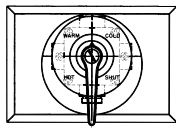

Model # 3500 1/2"
Part # 72047-01
Price \$ 536.50

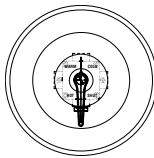

Model # 3800 1/2"
Part # 73047-01
Price \$ 478.50

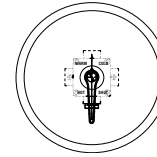

Model # 3900 1/2"
Part # 74147-01
Price \$ 484.30

RECESSED

Type T/P - Dual Stage Combination Pressure Balanced and Thermostatic Control Valves

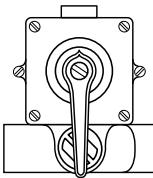

Model # 7000 1/2"
Part # 81697-00
Price \$ 606.10
Rough Bronze

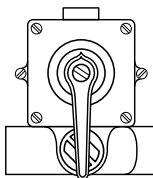

Model # 7000 1/2"
Part # 81697-10
Price \$ 710.50
Rough Chrome

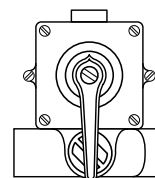

Model # 7000 3/4"
Part # 72913-00
Price \$ 1273.10
Rough Bronze

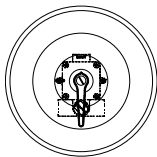

Model # 7800 1/2"
Part # 73914-00
Price \$ 687.30

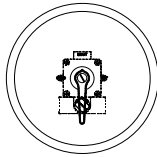

Model # 7900 1/2"
Part # 75147-01
Price \$ 694.55

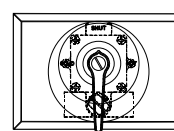

Model # 7500 1/2"
Part # 72914-00
Price \$ 765.60

RECESSED

Flow Rates*: 1/2-2 1/2 Low – Prefix L
 1-4 Medium – Prefix M
 4-10 High – Prefix H

* Valves ordered without a prefix will be medium flow measured at 1-4 gpm.
 All valves are available with 3/4" inlets and 3/4" outlets, contact factory for pricing.

Specifications subject to change without notice.



MANUFACTURING CO., INC.

Point of Use

PRICE LIST

EFFECTIVE January 1, 2009

Series 3000 & 7000

Shower Accessories

Inlet Stop and Checks

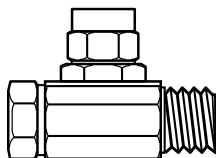

Straight

Part #	6839-01
Size	1/2"
Price	\$ 63.00 pair
	Rough Brass
Suffix	SC1-RB

Part #	6839-66
Size	1/2"
Price	\$ 68.25 pair
	Chrome Plated
Suffix	SC1-CP

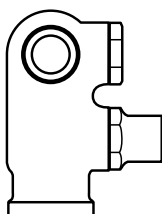

Angled

Part #	70484-00
Size	1/2"
Price	\$ 253.75 pair
	Brass
Suffix	SC5-RB

Part #	70484-65
Size	1/2"
Price	\$ 327.25 pair
	Chrome Plated
Suffix	SC5-CP

Outlet Accessories

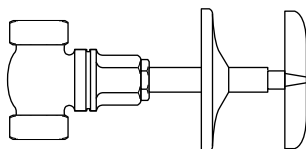

Sweat Fittings

Concealed Volume Controls

Part #	6750-01
Size	1/2"
Price	\$ 276.50
Suffix	VC3

Part #	6751-01
Size	3/4"
Price	\$ 311.50
Suffix	VC4

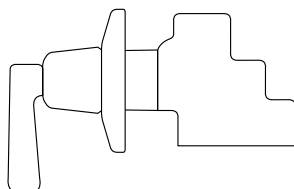

Concealed Diverter Valve

Part #	8331-00
Size	1/2"
Price	\$ 423.50
Suffix	DV1

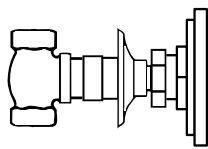
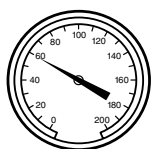

Sweat Fittings

Concealed In-Line Thermometer Assembly

Part #	72502-00
Size	1/2"
Price	\$ 346.50
Suffix	TH4

Part #	72503-00
Size	1/2"
Price	\$ 336.00
Suffix	TH5

To be used with Series 3900 and Series 7900 shower valves.

To be used with Series 3500, 3800, 7500 and 7800 shower valves.

Specifications subject to change without notice.

Shower Heads & Fixtures

Shower Heads

Part #	72167-00*
Price	\$ 92.80
Suffix	SH1

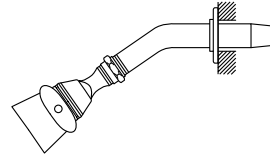
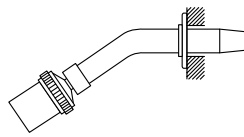

Part #	72168-00*
Price	\$ 71.05
Suffix	SH2 Small

Part #	72094-00*
Price	\$ 107.30
Suffix	SH4 Large

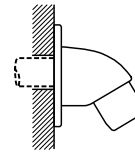
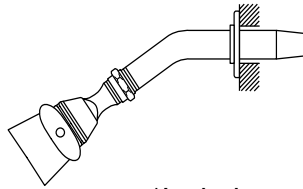

Part #	4577-60
Price	\$ 329.15
Suffix	SH6

*Includes arm and wall flange

Hand Held Shower Heads

Type: Hand shower with 60" hose, vacuum breaker and wall mount only

Part #	72142-00
Price	\$ 320.45
Suffix	HS1

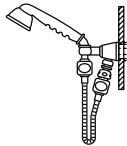

Type: Standard hand shower with 60" hose, and 24" slide bar only

Part #	73147-00
Price	\$ 237.80
Suffix	HS5

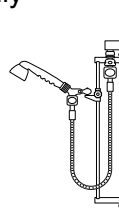

Type: Deluxe hand shower with 60" hose, 24" bar, vacuum breaker and supply elbow only

Part #	72147-00
Price	\$ 417.60
Suffix	HS3

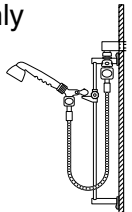

Tub Diverters and Fillers

Type: Tub Filler

Part #	4085-00
Price	\$ 50.75
Suffix	TF1



Optional: Twin El

Part #	4955-00
Price	\$ 21.75

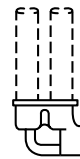

Type: Tub Filler Diverter

Part #	72171-00
Price	\$ 417.60
Suffix	TF2

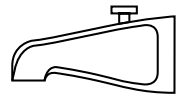

Shut-off Valves

Type: Elevated Vacuum Breaker

Part #	72606-10
Size	1/2"
Price	\$ 307.40
Suffix	EVB

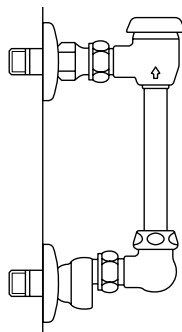

BALL VALVES

Size	Rough Bronze		Rough Chrome	
	Part Number	Price	Part Number	Price
1/2"	8150-01	24.65	8150-02	30.45
3/4"	8150-04	30.45	8150-05	46.40
1"	8150-07	46.40	8150-08	60.90
1 1/4"	8150-10	69.60	8150-11	87.00
1 1/2"	8150-13	97.15	8150-14	110.20
2"	8150-16	136.30	8150-17	191.40

Specifications subject to change without notice.







MANUFACTURING CO., INC.

Point of Use

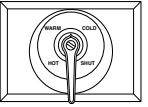
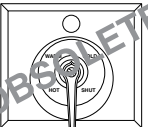

PRICE LIST

EFFECTIVE January 1, 2009

Shower Covers & Face Plates

Kit H			Kit E	
Face Plate	Face Plate Assembly Number	Price	Cover and Spindle	Price
 Series 3500 and 7500	71985-00	\$234.90	71983-11	\$ 139.20
 Series 3501 and 7501	Not Applicable	N/A	71983-11	\$ 139.20
 Series 3800 and 7800	71985-04	\$201.55	71983-11	\$ 139.20
 RECESSED Series 3900 and 7900	74985-00	\$217.50	71982-41	\$ 127.60
1/2" - 4000 Kit D	Not Applicable	N/A	Brass 72327-10	\$ 176.90
			Chrome 72327-11	\$ 221.85
3/4" - 4000 Kit D	Not Applicable	N/A	Brass 72392-11	\$ 226.20
			Chrome 72392-12	\$ 226.20
 Recesso	72910-10 Conversion kit to Model 3800, Includes Cover & Spindle	\$261.00	71982-11	\$ 117.45
 Echelon	71978-00 Conversion kit to Model 7800, Includes Cover & Spindle	\$333.50	71981-11	\$ 127.60

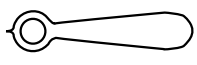
Replacement Handles (All interchangeable)

Handle	Finish	Part Number	Price
	Chrome	4076-60	\$ 73.95
	Chrome	1819-60	49.30
	Brass	8062-00	46.40
	Chrome	8062-60	110.20

Replacement Handle Screw

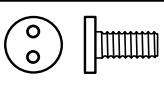
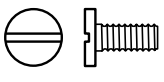
Handle Screw	Finish	Part Number	Price
	Brass	8180-00	\$ 10.15
	Chrome	8180-60	14.50
	Brass	7628-00	10.15
	Chrome	7628-60	14.50

Specifications subject to change without notice.



MANUFACTURING CO., INC.

Point of Use

PRICE LIST

EFFECTIVE January 1, 2009

Shower Valve Repair Kits

Universal Complete Repair Kits - For Valves Manufactured After 1953 Kit A

Valve Name	Serial Number Prefix	Size and Flow GPM	Part Number	Price
BE-RI	1 & 2	1/2" Low 1/2-2 1/2 Med 1-5 High 4-10	79850-01	\$ 402.50
BC-RI	1 & 2		79850-00	
BCA	1 & 2		79850-02	
Recesso	3	3/4" Low 4-10 Med 7-14 High 15-20	79851-01	603.75
3500	3		79851-00	
4000	5		79851-02	
Echelon	4-7000 and Up	1/2" Low 1/2-2 1/2 Med 1-5 High 4-10	79805-02	507.50
			79805-00	
			79805-03	
		3/4" Low 4-10 Med 7-14 High 15-20	79805-04	782.25
			79805-01	
			79805-05	
Echelon II	4-7000 and Up	1/2" Low 1/2-2 1/2 Med 1-5 High 4-10	79866-01	614.25
			79866-00	
			79866-02	

Low-flow kit should be selected for valve used with shower head and tub spout combination.

Partial Repair Kits for Mixing Valves

Thermostat Assemblies (includes thermostat, cold seat, O-Rings and cover gasket)

Kit F

Valve Series	Serial Prefix	Size	Number	Price
BE-RI	1 or 2	1/2"	79809-00	\$ 213.50
BC-RI	1 or 2	3/4"	79810-01	246.75
BCA	1 or 2			
Recesso	3	1/2"	71870-11	183.75
	3			
Echelon	4	3/4"	71036-10	213.50
4000	5			

O-Ring Kit - USK Kit B

All Valve Series After 1953		
Size	Number	Price
1/2"	79959-00	\$64.75
3/4"	79960-00	91.00

(Universal seal kits include all O-rings, gaskets and seals.)

Piston and Liner Assemblies (includes gaskets)

Kit C

Valve Series	Size and Flow GPM	Number	Price
All After 1953	1/2" Low 1/2-2 1/2 Med 1-5 High 4-10	71672-12	\$ 320.25
		72014-11	
		72014-13	
	3/4" Low 4-10 Med 7-14 High 15-20	72014-19	\$ 402.50
		72014-15	
		72014-16	
		72014-16	

Pressure Balancers

Kit D

Valve Series	Size	Number	Price
Echelon & 7000	1/2"	71823-02	\$178.50
	3/4"	71824-01	379.75

(includes O-Rings, shuttle and cylinder)

Stop and Check Repair Kits

Strainer, O-Ring & Spring Kit

Kit H&J

Valve Style	Size	Number	Price
ALL	1/2"	79965-00	\$ 59.50
	3/4"	79966-00	59.50

Stem and Disc Holder	Size	Number	Price
ALL	1/2"	79969-00	\$ 71.75
	3/4"	79970-00	94.50

Stop & Check Repair Kit

Valve Style	Size	Number	Price
Angle	1/2"	79922-02	\$ 71.75
Union Angle	1/2"	79902-03	71.75
Straight	1/2" 	79905-02	71.75
ALL		3/4"	79894-02

Emergency Tempering System (ETS)

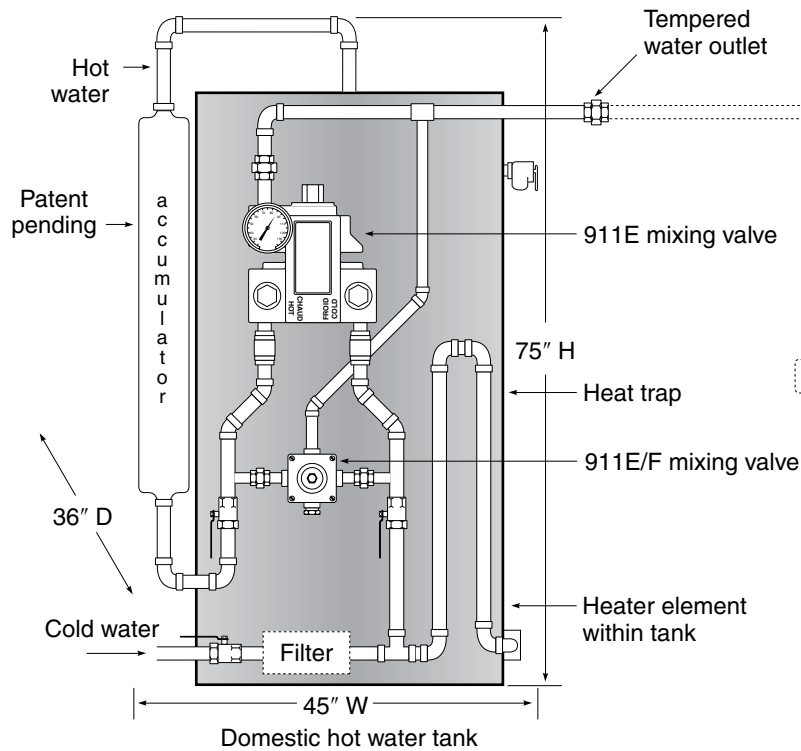

Model 911E ETS

Part Number	Price
87200-00	\$ 25,844.00

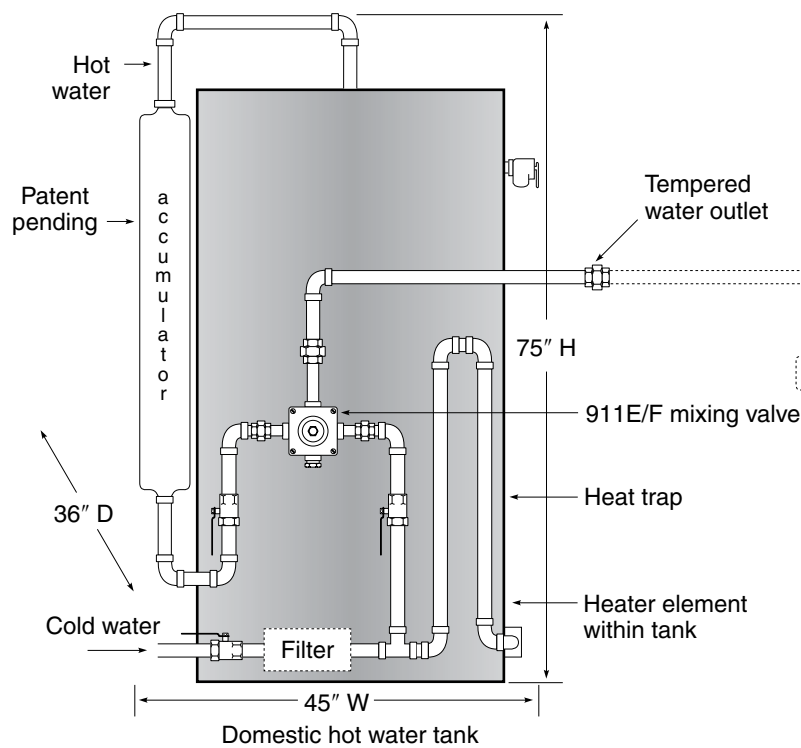
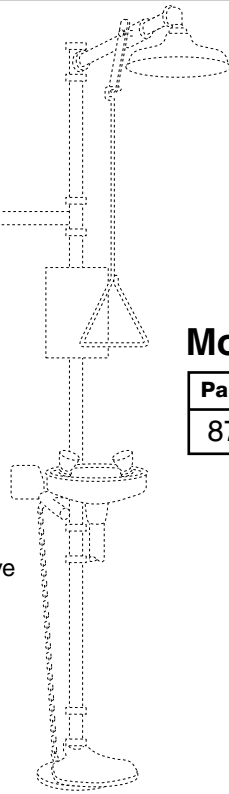

Model 911E/F ETS

Part Number	Price
87300-00	\$ 23,808.75

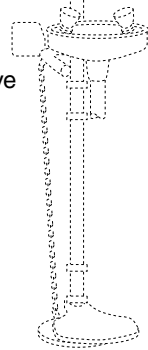

Specifications subject to change without notice.



MANUFACTURING CO., INC.

Safety Valves

PRICE LIST

EFFECTIVE January 1, 2009

PAT. NOS. 5,647,531, 5,379,936, 5,011,074.

Model 911™

Multiple Showers

Emergency Shower Valves

Assembly Unit No. 8334 (911)

Refer to ENG. 8334 for all details.

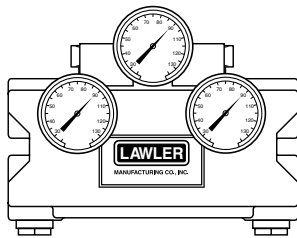

Valve No.	GPM @ 30 psi	Inlet	Outlet	Ship Wght.	Rough Bronze Part Number	Rough Bronze Price
911	60	1 1/4"	1 1/4"	31	8334-36	\$ 3346.00

Valve No.	GPM @ 30 psi	Inlet	Outlet	Ship Wght.	Rough Chrome Part Number	Rough Chrome Price
911	60	1 1/4"	1 1/4"	31	8334-58	\$ 3419.50

Assembly Unit No. 8334 Must be installed with inlet check valves

Assembly Unit No. 84708 (911)

Refer to ENG. 84708 for all details.

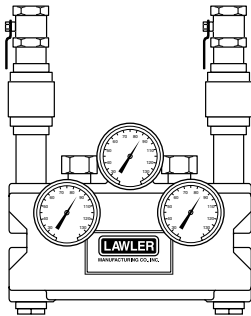

Valve No.	GPM @ 30 psi	Inlet	Outlet	Ship Wght.	Rough Bronze Part Number	Rough Bronze Price
911	60	1 1/4"	1 1/4"	56	84708-01	\$ 3855.25

Valve No.	GPM @ 30 psi	Inlet	Outlet	Ship Wght.	Rough Chrome Part Number	Rough Chrome Price
911	60	1 1/4"	1 1/4"	56	84708-02	\$ 4117.75

Cabinet Unit Drawing No. 84701 (911)

Refer to ENG. 84701 for all details.

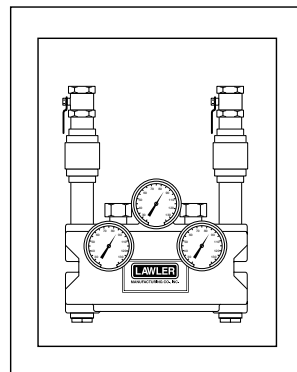

Valve No.	Pipe Size	Ship Wght.	Cabinet Part Number	Carbon Steel Rough Brass	Cabinet Part Number	Stainless Steel Rough Brass
911/rec	1 1/4" x 1 1/4"	78	84701-23	\$ 5188.75	84701-21	\$ 5374.25
911/sur	1 1/4" x 1 1/4"	78	84701-11	\$ 5188.75	84701-09	\$ 5374.25

Valve No.	Pipe Size	Ship Wght.	Cabinet Part Number	Carbon Steel Rough Chrome	Cabinet Part Number	Stainless Steel Rough Chrome
911/rec	1 1/4" x 1 1/4"	78	84701-24	\$ 5467.00	84701-22	\$ 5652.50
911/sur	1 1/4" x 1 1/4"	78	84701-12	\$ 5467.00	84701-10	\$ 5652.50

exp = exposed/surface mounted rec = recessed

* For semi recessed cabinet, transmit description as separate line item on purchase order to Lawler and add \$130 to list price.

Bottom out available.
For more information see the corresponding data sheet.

Specifications subject to change without notice.



MANUFACTURING CO., INC.

Safety Valves

PRICE LIST

EFFECTIVE January 1, 2009

PAT. NOs. 5,379,936, 5,011,074.

Model 911E™

Single Shower & Eye Wash

Emergency Shower & Eye/Face Valves

Assembly Unit No. 8429 (911E)

Refer to ENG. 8429 for all details.

Valve No.	GPM @ 30 psi	Inlet	Outlet	Ship Wght.	Rough Bronze Part Number	Rough Bronze Price
911E	25	1 1/4"	1 1/4"	14	8429-10	\$ 1744.00

Valve No.	GPM @ 30 psi	Inlet	Outlet	Ship Wght.	Rough Chrome Part Number	Rough Chrome Price
911E	25	1 1/4"	1 1/4"	14	8429-60	\$ 1839.25

Assembly Unit No. 8429 Must be installed with inlet check valves

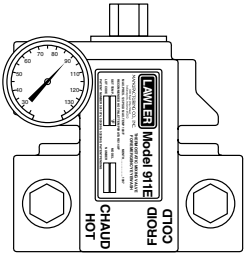

Assembly Unit No. 85808 (911E)

Refer to ENG. 85808 for all details.

Valve No.	GPM @ 30 psi	Inlet	Outlet	Ship Wght.	Rough Bronze Part Number	Rough Bronze Price
911E	25	1 1/4"	1 1/4"	21	85808-01	\$ 1839.25

Valve No.	GPM @ 30 psi	Inlet	Outlet	Ship Wght.	Rough Chrome Part Number	Rough Chrome Price
911E	25	1 1/4"	1 1/4"	21	85808-02	\$ 2115.75

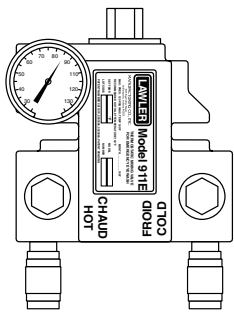

Cabinet Unit Drawing No. 85801 (911E)

Refer to ENG. 85801 for all details.

Valve No.	Pipe Size	Ship Wght.	Cabinet Part Number	Carbon Steel Rough Brass	Cabinet Part Number	Stainless Steel Rough Brass
911E/rec	1 1/4" x 1 1/4"	40	85801-23	\$ 2952.25	85801-21	\$ 3137.75
911E/sur	1 1/4" x 1 1/4"	40	85801-11	\$ 2952.25	85801-09	\$ 3137.75

Valve No.	Pipe Size	Ship Wght.	Cabinet Part Number	Carbon Steel Rough Chrome	Cabinet Part Number	Stainless Steel Rough Chrome
911E/rec	1 1/4" x 1 1/4"	40	85801-24	\$ 3230.50	85801-22	\$ 3416.00
911E/sur	1 1/4" x 1 1/4"	40	85801-12	\$ 3230.50	85801-10	\$ 3416.00

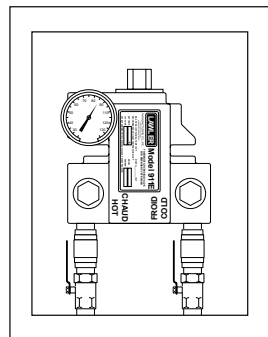

For more information see the corresponding data sheet.

exp = exposed/surface mounted **rec** = recessed

* For semi recessed cabinet, transmit description as separate line item on purchase order to Lawler and add \$227.50 to list price.

Specifications subject to change without notice.



MANUFACTURING CO., INC.

Safety Valves

PRICE LIST

EFFECTIVE January 1, 2009

PAT. NOS. 5,379,936, 5,011,074.

Model 911E/F™

Eye/Face Wash

Emergency Eye/Face Wash Valves

Assembly Unit No. 84907 (911E/F)

Refer to ENG. 84907 for all details.

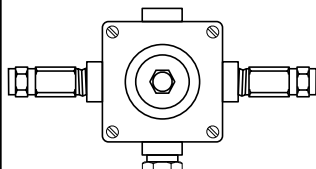

Valve No.	GPM @ 30 psi	Inlet	Outlet	Ship Wght.	Rough Bronze Part Number	Bronze Price
911E/F	7	1/2"	1/2"	5	84907-00	\$ 992.25

Valve No.	GPM @ 30 psi	Inlet	Outlet	Ship Wght.	Rough Chrome Part Number	Chrome Price
911E/F	7	1/2"	1/2"	5	84907-60	\$ 1085.00

Assembly Unit No. 84908 (911E/F)

Refer to ENG. 84908 for all details.

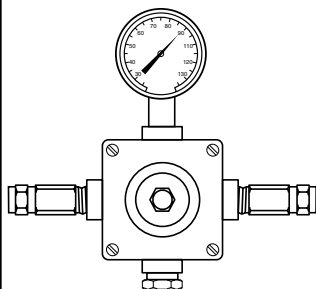

Valve No.	GPM @ 30 psi	Inlet	Outlet	Ship Wght.	Rough Bronze Part Number	Bronze Price
911E/F	7	1/2"	1/2"	6	84908-01	\$ 1268.00

Valve No.	GPM @ 30 psi	Inlet	Outlet	Ship Wght.	Rough Chrome Part Number	Chrome Price
911E/F	7	1/2"	1/2"	6	84908-02	\$ 1286.25

Cabinet Unit Drawing No. 84909 (911E/F)

Refer to ENG. 84909 for all details.

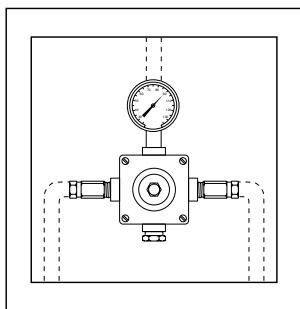

Valve No.	Pipe Size	Ship Wght.	Cabinet Part Number	Carbon Steel Rough Brass	Cabinet Part Number	Stainless Steel Rough Brass
911E/Frec	1/2" x 1/2"	18	84909-23	\$ 1884.75	84909-21	\$ 2115.75
911E/Fsur	1/2" x 1/2"	18	84909-11	1884.75	84909-09	2115.75

Valve No.	Pipe Size	Ship Wght.	Cabinet Part Number	Carbon Steel Rough Chrome	Cabinet Part Number	Stainless Steel Rough Chrome
911E/Frec	1/2" x 1/2"	18	84909-24	\$ 1975.75	84909-22	\$ 2206.75
911E/Fsur	1/2" x 1/2"	18	84909-12	1975.75	84909-10	2206.75

Bottom out available.

For more information see the corresponding data sheet.

exp = exposed/surface mounted **rec** = recessed

* For semi recessed cabinet, transmit description as separate line item on purchase order to Lawler and add \$218.75 to list price.

Specifications subject to change without notice.



MANUFACTURING CO., INC.

Safety Valves

PRICE LIST

EFFECTIVE January 1, 2009

Repair Kits

Model 911/911E Repair Kits

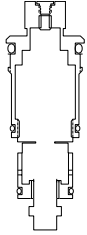

Complete Thermostatic Cartridge Assembly

Part Number	Price
8334-50	\$ 661.50

For 911 and 911E



Check Valve 1 1/4"

Part Number	Price
8334-64	\$178.50 ea

For 911 and 911E

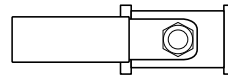

Locking Union Ball Valve 1 1/4"

Part Number	Price
8334-20	\$ 234.50

For 911 and 911E

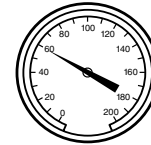

Thermometer

Part Number	Price
6679-02	\$ 147.00

For 911, 911E, 911E/F

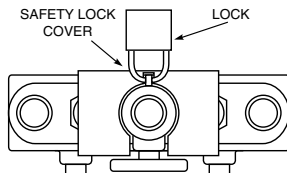

Cover/Lock Set

Part Number	Price
8334-19	\$ 318.50

(2) Keys included

For 911 only

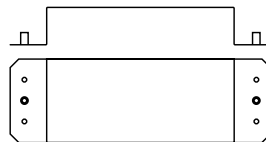

Mounting Bracket

Part Number	Price
8334-73	\$ 171.50

(2) Bolts, (2) Washers included

For 911 only

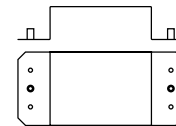

Mounting Bracket

Part Number	Price
8429-73	\$ 150.50

(2) Bolts, (2) Washers included

For 911E only

Model 911E/F Repair Kits

Complete Valve Kit

Includes replacement thermostat, piston and liner.

Part Number	Price
79854-00	\$ 402.50

Kit A

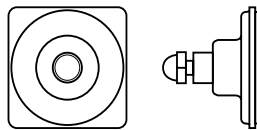

O-Ring & Gasket

Part Number	Price
79961-00	\$ 63.00

Kit B

Replacement Cover Kit

Rough Bronze		Chrome Plated	
Part Number	Price	Part Number	Price
78271-00	\$ 89.25	78271-01	\$ 129.50

Piston & Liner

Part Number	Price
72904-60	\$ 320.25

Kit D

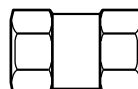

Thermostat

Part Number	Price
78490-00	\$ 213.50

Kit E

Replacement Check Valves (Pair)

Rough Bronze		Chrome Plated	
Part Number	Price	Part Number	Price
8445-01	\$ 91.00	8445-66	\$ 112.00

Replacement kits contain all O-rings, gaskets and springs that are needed for repair.

Specifications subject to change without notice.



MANUFACTURING CO., INC.

PRICE LIST

EFFECTIVE January 1, 2009

Type S Regulators

Thermostatic Actuators: Standard actuators have copper bulb and 10 ft capillary. Tank bushing, gasket, and screws included.

Thermostatic Actuator

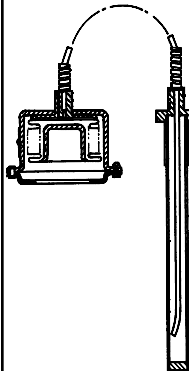

Copper Bulb

Type & Size	Temp. Range° F	Part Number	Price	Type & Size	Part Number	Price
S 1/2 thru 2"	80°-120°	70714-15 (B)	\$ 822.50	S 2 1/2 thru 4"	70715-16 (E)	\$ 1690.50
	100°-140°	70714-20 (B)			70715-21 (E)	
	120°-160°	70709-25 (A)			70708-26 (B)	
	140°-180°	70709-40 (A)			70708-41 (B)	
	160°-200°	70709-45 (A)			70708-46 (B)	
	180°-220°	70709-55 (A)			70708-56 (B)	

SFS 1/2 thru 2"	80°-110°	70718-35 (D)	\$ 1032.50	SFS 2 1/2 thru 4"	70719-36 (E)	\$ 1968.75
	110°-140°	70718-50 (D)			70719-51 (E)	
	125°-155°	70713-55 (C)			70726-56 (D)	
	140°-170°	70713-60 (C)			70726-61 (D)	
	165°-195°	70713-75 (C)			70726-76 (D)	
	180°-210°	70713-85 (C)			70726-86 (D)	

Standard bulb sizes: (A) 5/8 by 11" (B) 7/8 by 18" (C) 3/4 by 12" (D) 1 by 15" (E) 1 1/8 by 36"

Type S Regulator BODY CODE

Complete regulator includes body, bracket, and actuator.

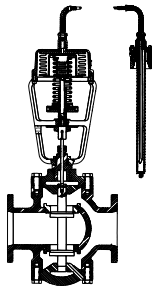

Type S Regulators

Pipe Size	01	02 & 02R	03	05 & 05R	3-way 06
1/2"	\$ 2600.50	\$ 2770.25	N/A	N/A	\$ 2735.25
3/4"	2660.00	2829.75	\$ 3533.25	\$ 3543.75	2899.75
1"	2978.50	3200.75	3720.50	4088.00	3015.25
1 1/4"	3265.50	3508.75	4315.50	4287.50	3286.50
1 1/2"	3592.75	3881.50	4779.25	4851.00	3598.00
2"	4158.00	4452.75	6002.50	5367.25	4422.25

Pipe Size	01	02 & 02R	03	05 & 05R	3-way 06
2 1/2"	N/A	N/A	N/A	\$ 7658.00	\$ 8774.50
3"	N/A	N/A	N/A	8153.25	9418.50
4"	N/A	N/A	N/A	9660.00	10,918.25

NOTES: Capacity charts and roughing in dimensions - Contact factory

1. Direct Acting (DA) - A rise in temperature causes the valve to close.
2. Reverse Acting (RA) - A rise in temperature causes the valve to open.
3. SFS - Valve remains closed on a DA and open on a RA valve upon thermostatic failure.
4. Union ends - 1/2" thru 2"; Bronze body.
5. Flange Ends - 2 1/2" thru 4"; Cast iron body.
6. Three Way Mixing Valve - Body code 06; will fail "HOT"; not for domestic water purposes.
7. Bulb Sizes - See actuator chart above; "Well" sizes & pricing: contact factory.
8. Lead Time - 4 to 6 weeks after receipt of order.
9. SFS List Price - add \$700.00 for 1/2" through 2"; \$ 2012.50 for 2.5" through 4".



MANUFACTURING CO., INC.

All Part Numbers in Ascending Order

PRICE LIST

EFFECTIVE January 1, 2009

Part #	Page	Part #	Page	Part #	Page	Part #	Page
1819-60	24	71762-56	5	72316-02	19	73005-11	1
4076-60	24	71762-61	5	72323-03	13, 20	73046-00	14
4085-00	23	71823-02	12, 25	72323-06	13, 20	73046-61	14
4577-60	23	71824-01	12, 25	72327-10	24	73047-01	21
4955-00	23	71828-00	9, 13	72327-11	24	73049-00	14
6679-02	9, 16, 20, 30	71828-01	9	72392-11	24	73049-61	14
6750-01	22	71828-02	9	72392-12	24	73050-06	5
6751-01	22	71828-03	9	72395-01	19	73050-11	5
6839-01	16, 22	71828-04	9	72395-02	19	73050-16	5
6839-66	16, 22	71828-05	9	72406-00	24	73050-21	5
8647-00	4	71828-05	9, 13	72502-00	22	73050-26	5
70412-25	20	71828-06	9	72503-00	22	73050-31	5
70412-26	20	71828-07	9	72561-00	16, 23	73100-10	1
70484-00	22	71828-08	9	72606-10	23	73100-11	1
70484-65	22	71828-09	9	72903-11	12	73147-00	23
70708-26	31	71870-11	25	72903-12	12	73914-00	21
70708-41	31	71870-21	16	72903-13	12	74146-00	15
70708-46	31	71945-01	8	72903-79	12	74146-61	15
70708-56	31	71945-16	8	72904-10	12	74147-01	21
70709-25	31	71946-01	8	72904-11	12	74985-00	24
70709-40	31	71946-16	8	72904-12	12	75147-01	21
70709-45	31	71965-10	9	72904-60	30	7628-00	24
70709-55	31	71965-11	9	72905-10	12	7628-60	24
70713-55	31	71978-00	24	72905-11	12	78001-00	12
70713-60	31	71981-11	24	72906-10	10	78001-01	12
70713-75	31	71982-11	24	72906-11	10	78001-02	12
70713-85	31	71982-41	24	72906-20	10	78001-03	12
70714-15	31	71983-11	24	72906-21	10	78001-04	12
70714-20	31	71985-00	24	72907-10	10	78001-05	12
70715-16	31	71985-04	24	72907-11	10	78001-06	12
70715-21	31	72014-11	25	72910-10	24	78001-07	12
70718-35	31	72014-13	25	72911-10	8	78001-08	12
70718-50	31	72014-15	25	72911-11	8	78002-00	12
70719-36	31	72014-16	25	72911-12	8	78002-01	12
70719-51	31	72014-19	25	72911-79	8	78002-02	12
70726-56	31	72046-00	14	72913-00	21	78002-03	12
70726-61	31	72046-61	14	72914-00	21	78002-04	12
70726-76	31	72047-01	21	72940-00	13	78002-05	12
70726-86	31	72047-05	21	72940-01	13	78005-00	12
71036-10	25	72047-11	21	72941-00	13	78005-03	12
71036-21	16	72047-15	21	72941-01	13	78005-06	12
71182-14	16	72049-00	14	72945-00	13	78006-00	12
71182-15	16	72049-61	14	72945-01	13	78006-03	12
71672-12	25	72094-00	23	72946-00	13	78006-06	12
71762-06	5	72142-00	23	72946-01	13	78271-00	30
71762-11	5	72146-00	15	72956-00	11	78271-01	30
71762-16	5	72146-01	15	72956-01	11	78271-03	16
71762-21	5	72147-00	23	72957-10	11	78271-04	16
71762-26	5	72167-00	23	72957-11	11	78490-00	30
71762-31	5	72168-00	23	72999-10	1	79271-01	16
71762-36	5	72171-00	23	72999-11	1	79271-02	16
71762-41	5	72306-01	19	73000-10	1	79776-01	8
71762-46	5	72306-02	19	73000-11	1	79776-02	8
71762-51	5	72316-01	19	73005-10	1	79776-03	8



MANUFACTURING CO., INC.

All Part Numbers in Ascending Order

PRICE LIST

EFFECTIVE January 1, 2009

Part # Page

79776-04 8
 79776-05 8
 79776-06 8
 79776-07 8
 79776-08 8
 79776-09 8
 79776-10 8
 79776-11 8
 79776-12 8
 79776-13 8
 79776-14 8
 79776-15 8
 79805-00 25
 79805-01 25
 79805-02 25
 79805-03 25
 79805-04 25
 79805-05 25
 79809-00 25
 79810-01 25
 79830-01 9
 79830-02 9
 79830-03 9
 79830-04 9
 79830-05 9
 79850-00 25
 79850-01 25
 79850-02 25
 79851-00 25
 79851-01 25
 79851-02 25
 79854-00 30
 79855-00 16
 79866-00 25
 79866-01 25
 79866-02 25
 79894-02 25
 79902-03 13, 25
 79905-02 25
 79907-02 9
 79907-12 13
 79908-02 9
 79909-02 9
 79910-02 9
 79911-02 9
 79922-02 25
 79956-00 8
 79956-01 8
 79956-02 8
 79956-79 8
 79959-00 12, 25
 79960-00 12, 25
 79961-00 16, 30

Part # Page

79962-00 16
 79965-00 25
 79966-00 25
 79969-00 25
 79970-00 25
 79978-01 8
 79978-02 8
 79978-03 8
 79978-04 8
 79978-05 8
 79978-06 8
 79978-07 8
 79978-08 8
 79978-09 8
 79981-00 8
 79981-01 8
 79981-02 8
 8062-00 24
 8062-60 24
 8150-01 23
 8150-02 23
 8150-04 16, 23
 8150-05 16, 23
 8150-07 23
 8150-08 23
 8150-10 23
 8150-11 23
 8150-13 23
 8150-14 23
 8150-16 23
 8150-17 23
 81697-00 21
 81697-10 21
 8180-00 24
 8180-60 24
 8221 10, 11, 20
 8225-01 9, 16, 20
 8225-02 9, 16, 20
 8225-03 9
 8225-04 9
 8225-05 9
 8225-06 9
 8225-11 9, 16, 20
 8225-12 9, 16, 20
 8225-13 9
 8225-14 9
 8225-15 9
 8225-16 9
 82304-00 19
 82304-01 19
 82306-00 19
 82306-01 19
 82306-10 19

Part # Page

82306-11 19
 83004 7
 83006 7
 83007-01 6
 83007-02 6
 83007-03 6
 83007-04 6
 83007-05 6
 83007-06 6
 83007-07 6
 83007-08 6
 83007-09 6
 83007-10 6
 83007-11 6
 83007-12 6
 83008-01 6
 83008-02 6
 83008-03 6
 83008-04 6
 83008-05 6
 83008-06 6
 83008-07 6
 83008-08 6
 83008-09 6
 83008-10 6
 83008-11 6
 83008-12 6
 83009-01 6
 83009-02 6
 83009-03 6
 83009-04 6
 83009-05 6
 83009-06 6
 83009-07 6
 83009-08 6
 83009-09 6
 83009-10 6
 83009-11 6
 83009-12 6
 83010-01 6
 83010-02 6
 83010-03 6
 83010-04 6
 83010-05 6
 83010-06 6
 83010-07 6
 83010-08 6
 83010-09 6
 83010-10 6
 83010-11 6
 83010-12 6
 8331-00 22
 8334-19 30

Part # Page

8334-36 27
 8334-50 30
 8334-58 27
 8334-64 30
 8334-73 30
 84008-03 10
 84008-04 10
 84008-05 10
 84008-06 10
 84008-09 10
 84008-10 10
 84010-03 10
 84010-04 10
 84010-05 10
 84010-06 10
 84010-09 10
 84010-10 10
 84011-03 10
 84011-04 10
 84011-05 10
 84011-06 10
 84011-09 10
 84011-10 10
 8429-10 28
 8429-60 28
 8429-73 30
 8445-01 30
 8445-66 30
 84508-01 11
 84508-02 11
 84508-09 11
 84508-10 11
 84509-01 11
 84509-02 11
 84509-09 11
 84509-10 11
 84510-01 11
 84510-02 11
 84510-09 11
 84510-10 11
 84511-01 11
 84511-02 11
 84511-09 11
 84511-10 11
 84701-09 27
 84701-10 27
 84701-11 27
 84701-12 27
 84701-21 27
 84701-22 27
 84701-23 27
 84701-24 27
 84708-01 27



MANUFACTURING CO., INC.

All Part Numbers in Ascending Order

PRICE LIST

EFFECTIVE January 1, 2009

Part # Page

Part # Page

84708-02	27
84907-00	29
84907-60	29
84908-01	29
84908-02	29
84909-09	29
84909-10	29
84909-11	29
84909-12	29
84909-21	29
84909-22	29
84909-23	29
84909-24	29
85002-03	19
85002-04	19
85002-07	19
85002-08	19
85003-04	20
85003-08	20
85004-03	19
85004-04	19
85004-07	19
85004-08	19
85005-03	19
85005-04	19
85005-07	19
85005-08	19
85801-09	28
85801-10	28
85801-11	28
85801-12	28
85801-21	28
85801-22	28
85801-23	28
85801-24	28
85808-01	28
85808-02	28
86004	2
86006	2
86008-05	1
86008-06	1
86104	2
86106	2
86108-05	1
86108-06	1
86208-05	1
86208-06	1
86304	2
86306	2
86308-05	1
86308-06	1
86378	2
86379	2
86380	2

Part # Page

86401-04	14
86401-05	14
86401-06	14
86401-07	14
86401-12	14
86401-13	14
86401-14	14
86401-15	14
86411-04	14
86411-05	14
86411-06	14
86411-07	14
86411-12	14
86411-13	14
86411-14	14
86411-15	14
86501-04	15
86501-05	15
86501-06	15
86501-07	15
86501-12	15
86501-13	15
86501-14	15
86501-15	15
86504	2
86506	2
86579	2
86600	3
86601	3
86602	3
86608	3
86610	3
86611	3
86612	3
86613	3
86800-00	18
86820-00	17
86821-00	17
86822-00	17
87100-01	2
87100-02	2
8720-00	26

These Parts are only available in the Universal Seal Kit

Part #	Size
00111-00	
00142-00	3/4"
00143-00	1/2"
00145-00	
00148-00	1/2"
00149-00	3/4"
00150-00	1/2"
00151-00	3/4"
00157-00	1/2"
01826-00	
02631-00	1/2"
02762-00	1/2"
02973-00	1/2"
03141-00	3/4"
03145-00	3/4"
03150-00	3/4"
03762-00	1/2"
04799-00	1/2"
07900-00	1/2"
07979-00	
79838-01	1/2"
79838-02	3/4"
79839-01	1/2"
79839-02	3/4"
79840-01	1/2"
79840-02	3/4"

These Parts are only available in the Piston and Liner Kit

Part #	Size
03271-00	1/2"
03272-00	
03991-00	
79939-00	1/2"
79940-00	3/4"

These Parts are only available in the Pressure Balancer Kit

Part #	Size
02781-00	1/2"
06764-00	1/2"

Terms and Conditions

PRICES ALL TAXES AND EXTRA

These prices are subject to change without notice and supersede those in all previous price sheets and quotations. Orders will be shipped at prices in effect at time of shipment, except that firm orders for specific projects will be accepted at prices in effect the date the order is received if delivery of such orders is taken within 60 days from the date of any price advance. Extended delivery beyond 60 days will be subject to our written acceptance. Minimum charge pm all orders \$10.00 net.

TERMS

2% cash discount, 15th proximo, net 30 days. Orders do not become an obligation of R.G. Dobbin Sales Limited until accepted by our written acknowledgement, and delivery on these orders is subject to accidents, strikes and other causes beyond our control. Orders for special units, i.e. requiring special modification or fabrication for particular job conditions, may be changed (with price adjustment if necessary) before our going into production. Cancellation prior to production will be subject to engineering charges. Once these orders are in production, we will not accept cancellation.

RETURN GOODS

AUTHORIZATION REQUIRED FROM FACTORY BEFORE ANY MERCHANDISE IS ACCEPTED FOR RETURN. WHEN AUTHORIZATION IS GIVEN, ALL MERCHANDISE MUST BE LABELED WITH A RETURN GOODS MATERIAL NUMBER. Transportation charges to be paid by shipper and returned material is subject to 25% Handling Charge plus a repacking charge if necessary. Merchandise should be returned within Ninety (90) Days **OF ITS SHIPMENT FROM FACTORY** to qualify for **MERCHANDISE** credit. Amount of **MERCHANDISE** credit will be determined upon receipt and inspection at factory.

FREIGHT

All shipments from factory are F.O.B. Downsview, Ontario with full freight allowance on shipments of \$2500.00 NET or more. This freight allowance does not apply to partial shipments requested by the customer unless the shipment exceeds \$2500.00 NET.

WARRANTY AND LIMITATION OF LIABILITY

Lawler warrants for a period of eighteen (18) months from date of shipment from its factory or one (1) year from date of installation, whichever occurs first, that all Products furnished by it are free from defects in materials and workmanship. Lawler's liability for any breach of this Warranty shall be limited solely to replacement or repair, at the sole option of Lawler, of any part or parts found to be defective during the Warranty period providing the product is properly installed and is being used as originally intended. Buyer must notify Lawler of any breach of this Warranty within the aforementioned warranty period; defective parts must be shipped by Buyer to Lawler, transportation charges prepaid.

IT IS EXPRESSLY AGREED THAT THIS SHALL BE THE SOLE AND EXCLUSIVE REMEDY OF THE BUYER. UNDER NO CIRCUMSTANCES SHALL LAWLER BE LIABLE FOR ANY COSTS, LOSS, EXPENSE, DAMAGES, INCIDENTAL DAMAGES OR CONSEQUENTIAL DAMAGES ARISING DIRECTLY OR INDIRECTLY FROM THE DESIGN, MANUFACTURE, SALE, USE OR REPAIR OF THE PRODUCT WHETHER BASED UPON WARRANTY, CONTRACT NEGLIGENCE OR STRICT LIABILITY. IN NO EVENT WILL LIABILITY EXCEED THE PURCHASE PRICE OF THE PRODUCT. THE WARRANTY AND LIMITS OF LIABILITY CONTAINED HEREIN ARE IN LIEU OF ALL OTHER WARRANTIES AND LIABILITIES, EXPRESSED OR IMPLIED. ALL IMPLIED WARRANTIES OF MERCHANTABILITY AND FITNESS FOR A PARTICULAR PURPOSE ARE HEREBY DISCLAIMED BY LAWLER AND EXCLUDED FROM THIS WARRANTY.

Lawler neither assumes nor authorizes any person to assume for it, any other Warranty obligation in connection with the sale of the Product. This Warranty shall not apply to any Product or parts of Products which (a) have been repaired or altered outside of Lawler's facilities; or (b) have been subject to misuse, negligence or accident; or (c) have been used in manner contrary to Lawler instructions. In the case of Products not manufactured by Lawler there is no Warranty from Lawler, but Lawler will extend to the Buyers any Warranty of Lawler supplier of such products.

FORCE MAJEURE

Lawler shall have no liability in respect of failure to deliver or perform, or delay in delivering or performing any obligations due to causes such as acts or omissions of Buyer; acts of God, fire, flood, war and civil disturbances; riot, acts of governments, currency restrictions, labor shortages or disputes, unavailability of materials, fuel, power, energy or transportation facilities, failures of suppliers or subcontractors to deliver on time and every other circumstance outside the reasonable control of Lawler.

Customer Service Contact Information:

www.dobbinsales.com • info@dobbinsales.com • 1-800-565-8515