

3400 PCA

# Illustrated Parts List

210/4

Revision: March 2022



## Contact Information

<https://itwgse.com/service-and-support/>

### Europe, Middle East & Asia Pacific

ITW GSE ApS. Denmark  
Tel: (+45) 63 18 60 00  
Mail: [support@itwgse.com](mailto:support@itwgse.com)

### Americas

ITW GSE Inc. USA  
Tel: (+1) 941 721 1000  
Mail: [support@itwgse.us](mailto:support@itwgse.us)

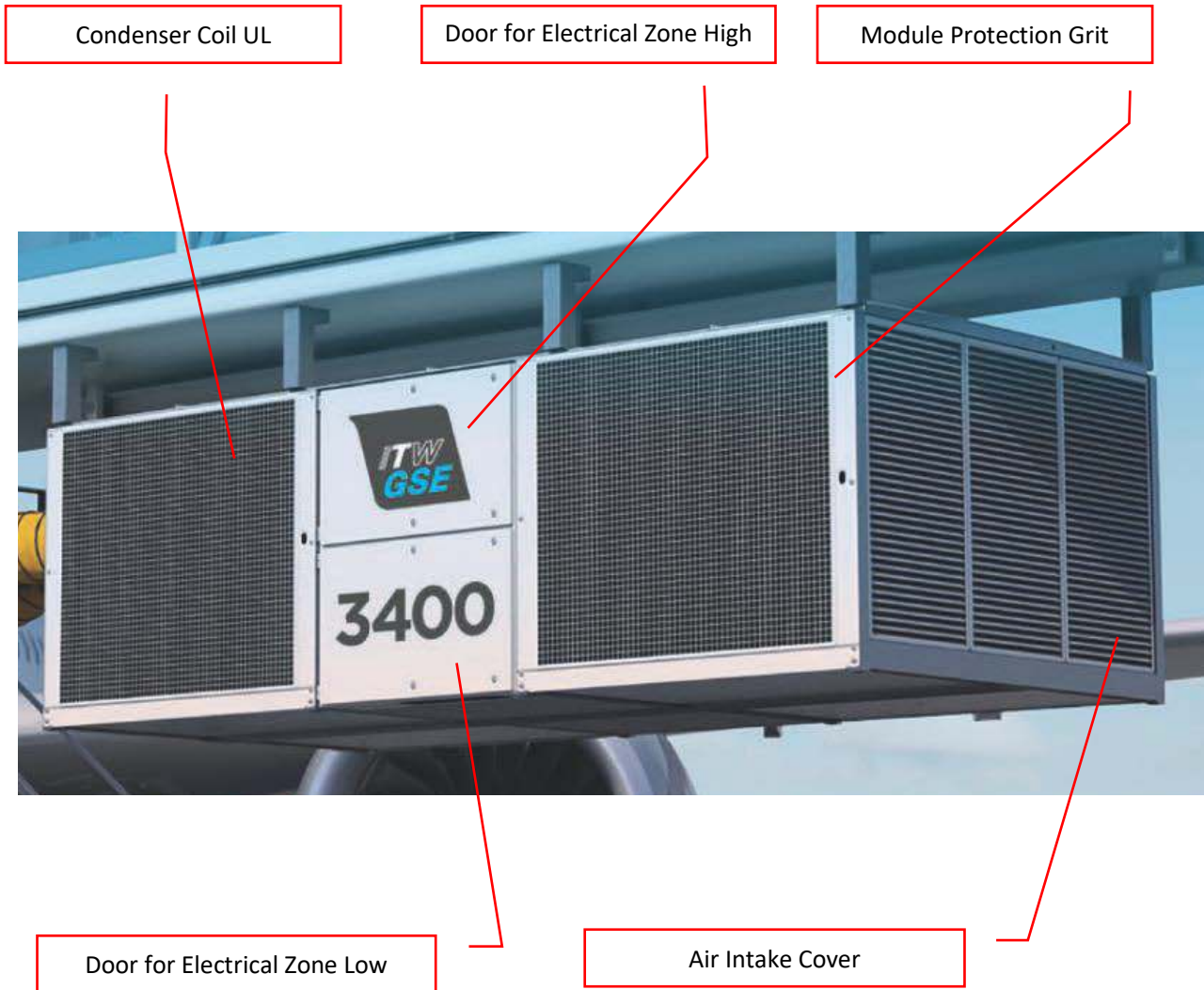

Figure 1: PCA 210

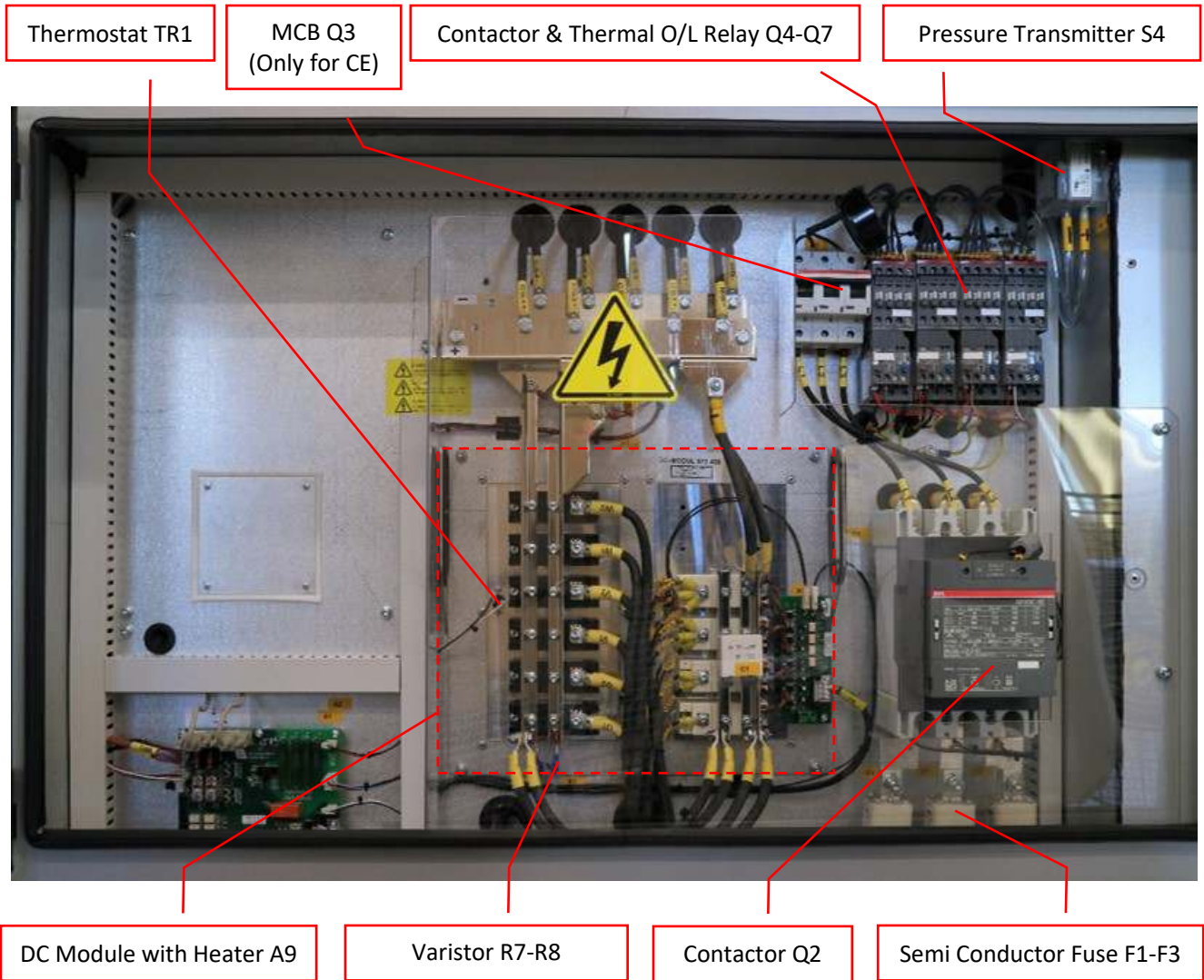

Figure 2: Electronic zone High 1 of 2

\*Note: This part number differ for UL and CE configuration, check manual or contact ITW GSE support  
 Note: Please refer to last pages for part numbers

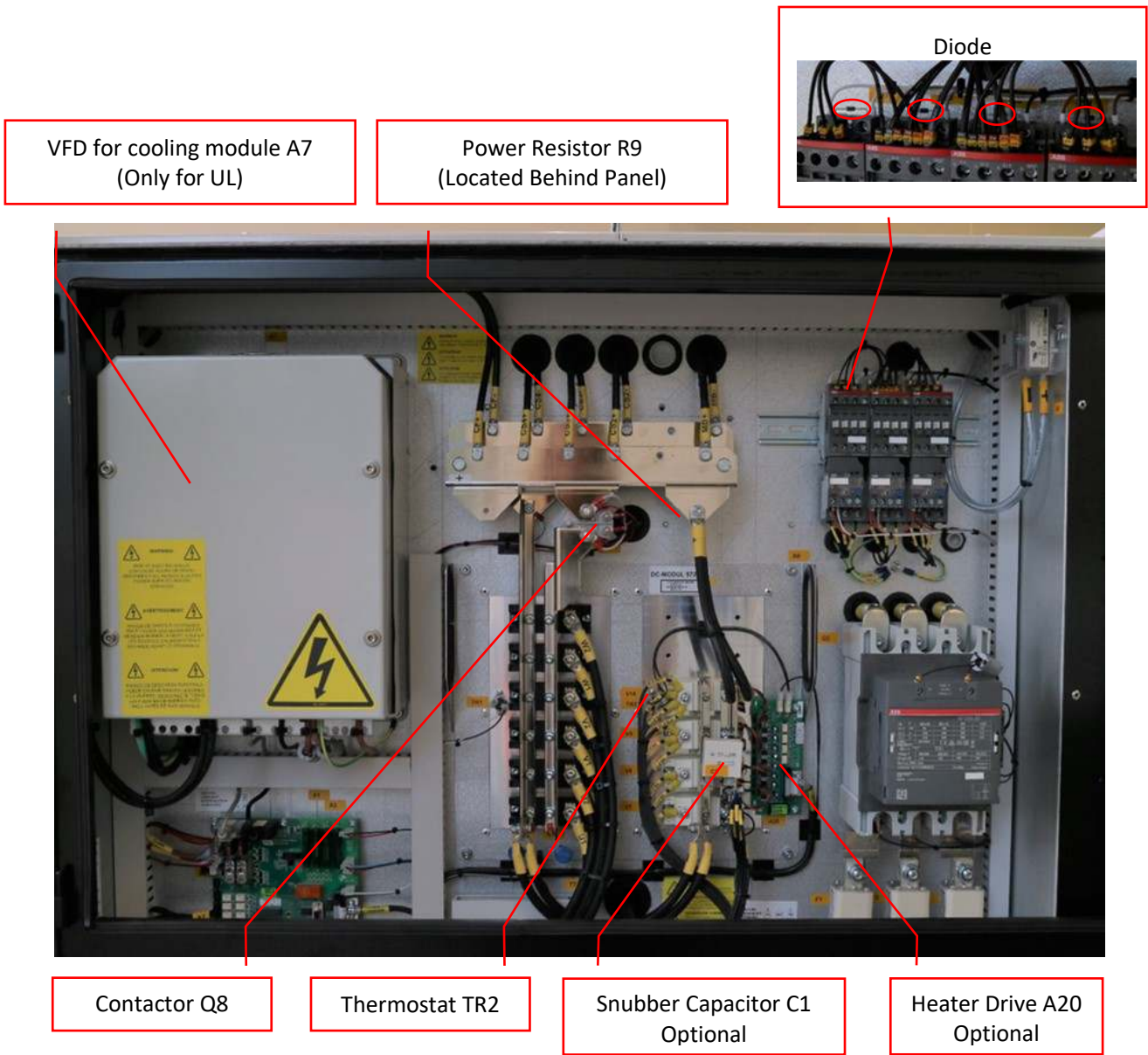

Figure 3: Electronic zone High 2 of 2

\*Note: This part number differ for UL and CE configuration, check manual or contact ITW GSE support  
 Note: Please refer to last pages for part numbers

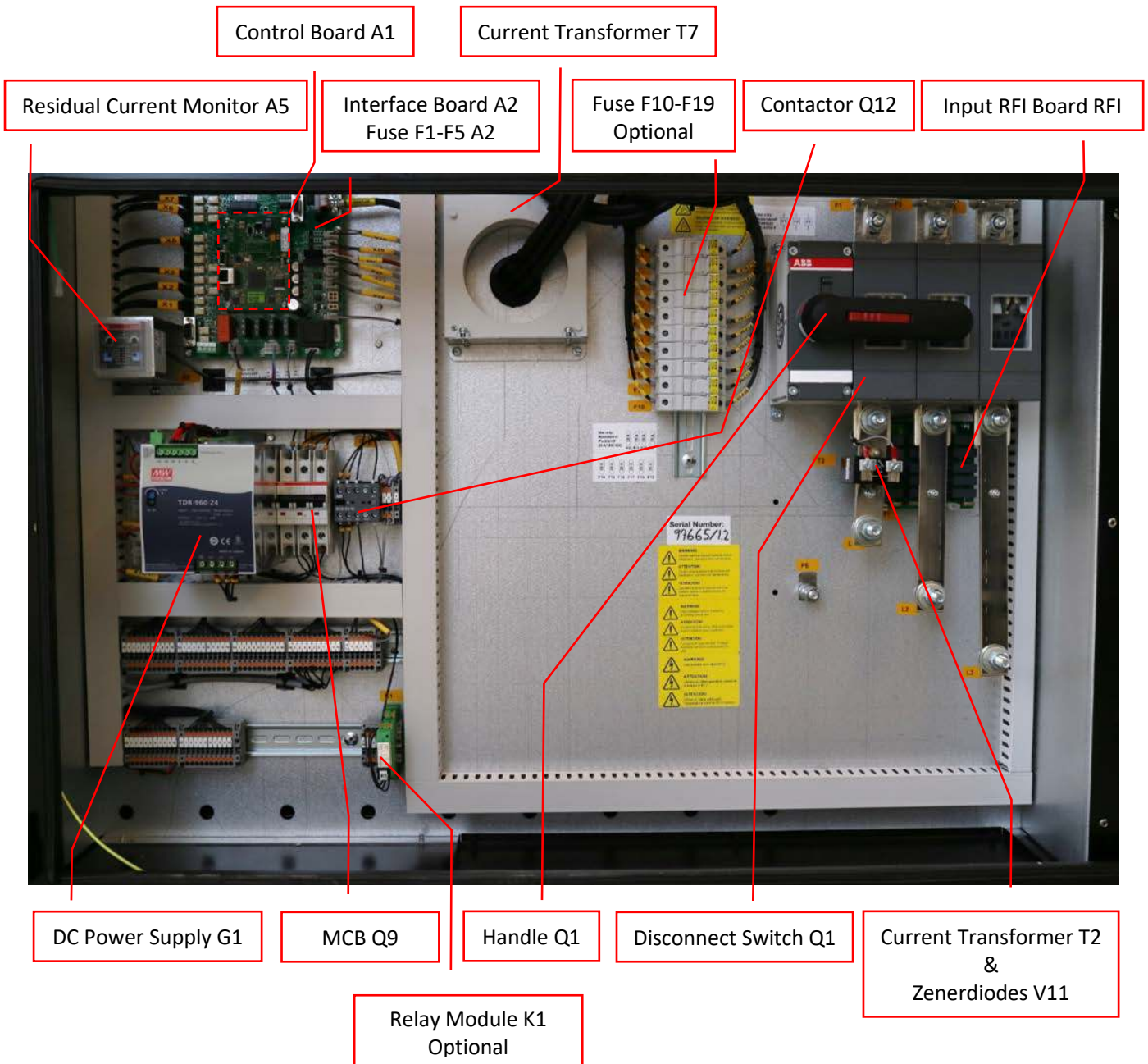
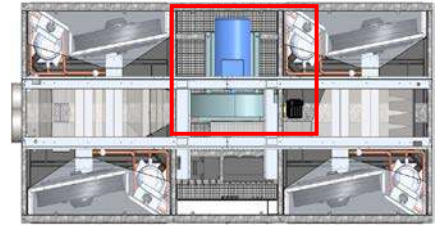

Figure 4: Electronic zone Low

\*Note: This part number differ for UL and CE configuration, check manual or contact ITW GSE support  
 Note: Please refer to last pages for part numbers



VFD With Fan A8

Centrifugal Fan M2

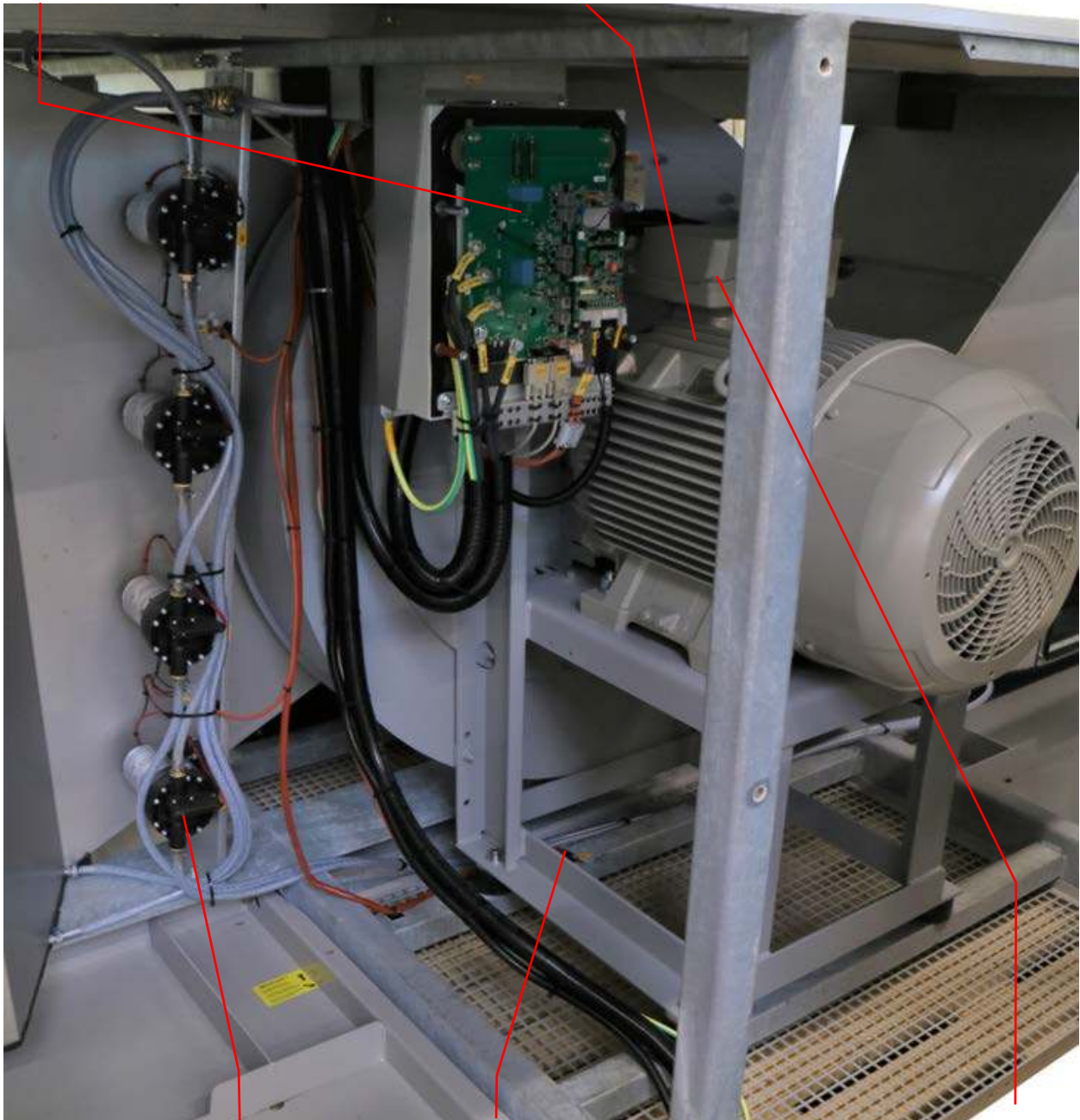

Water Pump M5-M8

PT100 sensor S1

\*Current Transformer T6  
(Located Inside)

Figure 5: Main Blower zone

\*Note: This part number differ for UL and CE configuration, check manual or contact ITW GSE support  
Note: Please refer to last pages for part numbers

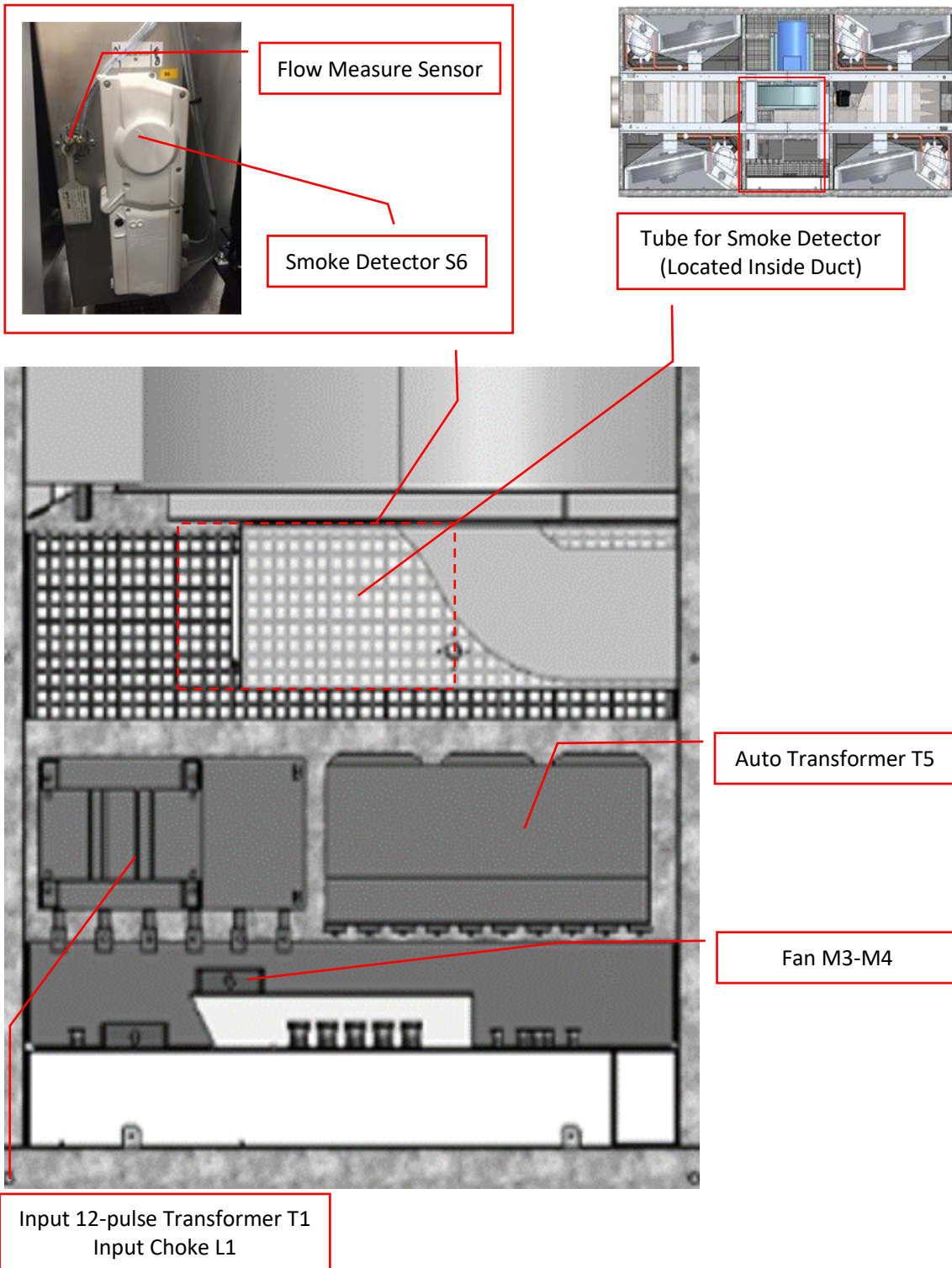

Figure 6: Internal Electrical zone

\*Note: This part number differ for UL and CE configuration, check manual or contact ITW GSE support  
 Note: Please refer to last pages for part numbers

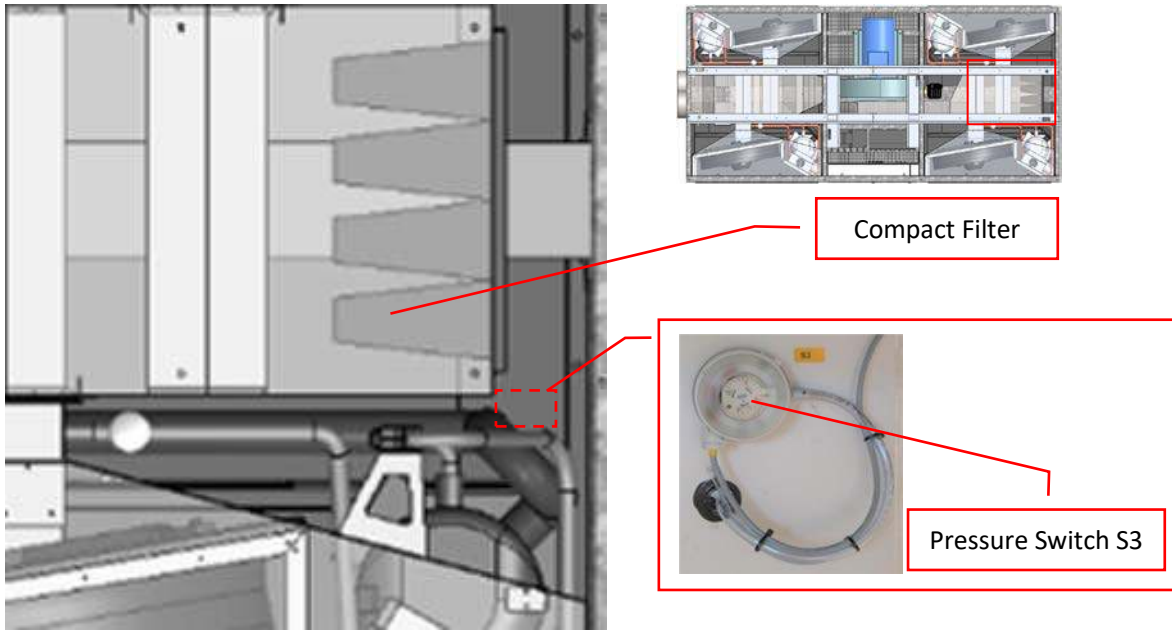

Figure 8: Air Inlet

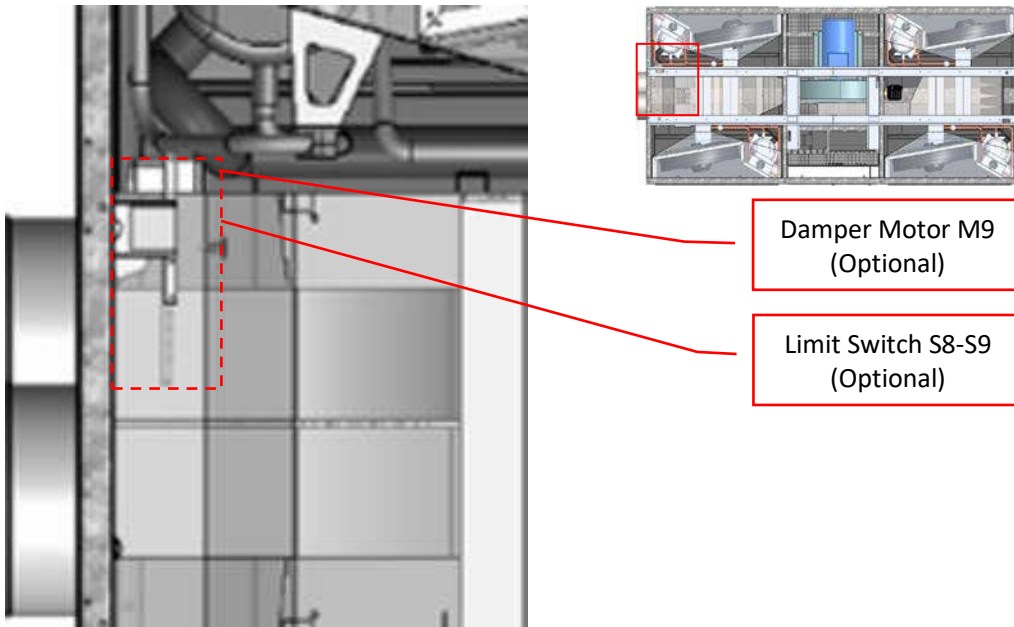
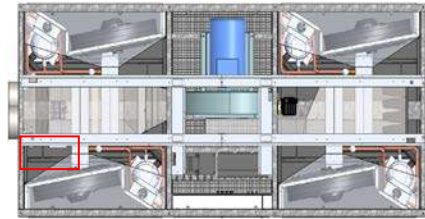
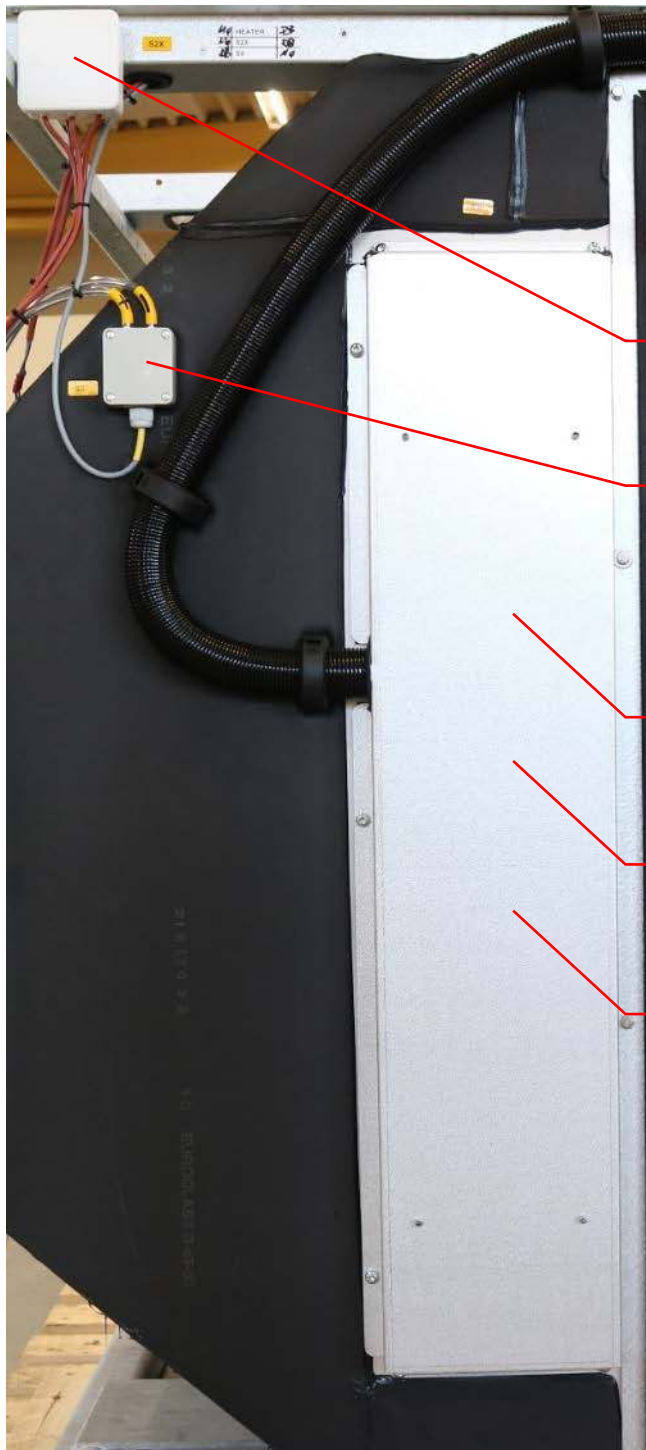

Figure 7: Air Outlet





PT100 sensor S2a-d (S2x)

Pressure Transmitter S5

Heating Unit A10  
(Located Behind Panel)

PT100 sensor S10  
(Located Inside Duct)

Thermostat TR3  
(Located Inside Duct)

Figure 9: Air Outlet and Heater zone

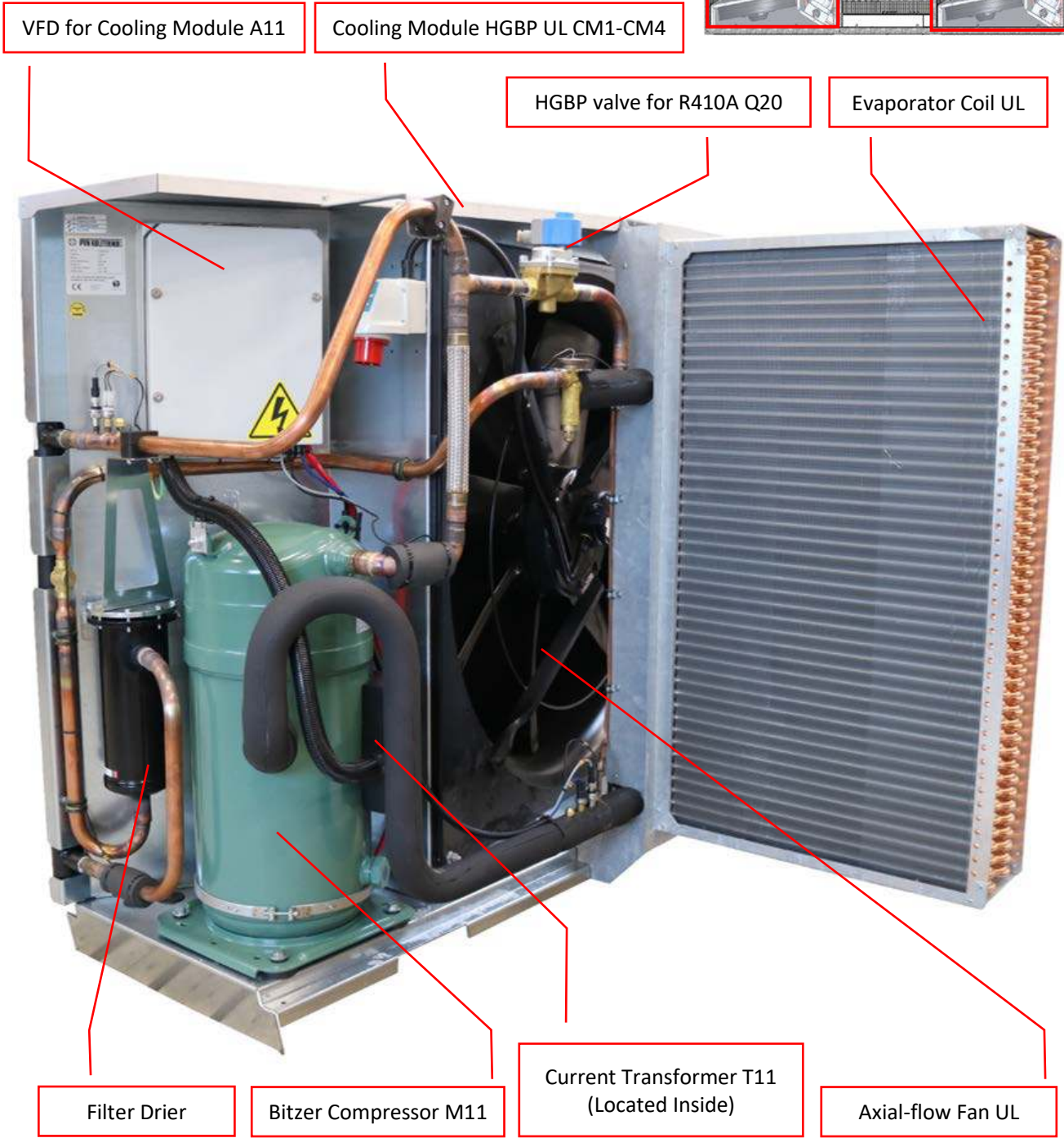
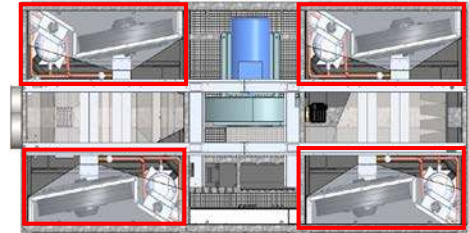

Figure 10: Cooling Module 1 of 2

\*Note: This part number differ for UL and CE configuration, check manual or contact ITW GSE support  
 Note: Please refer to last pages for part numbers

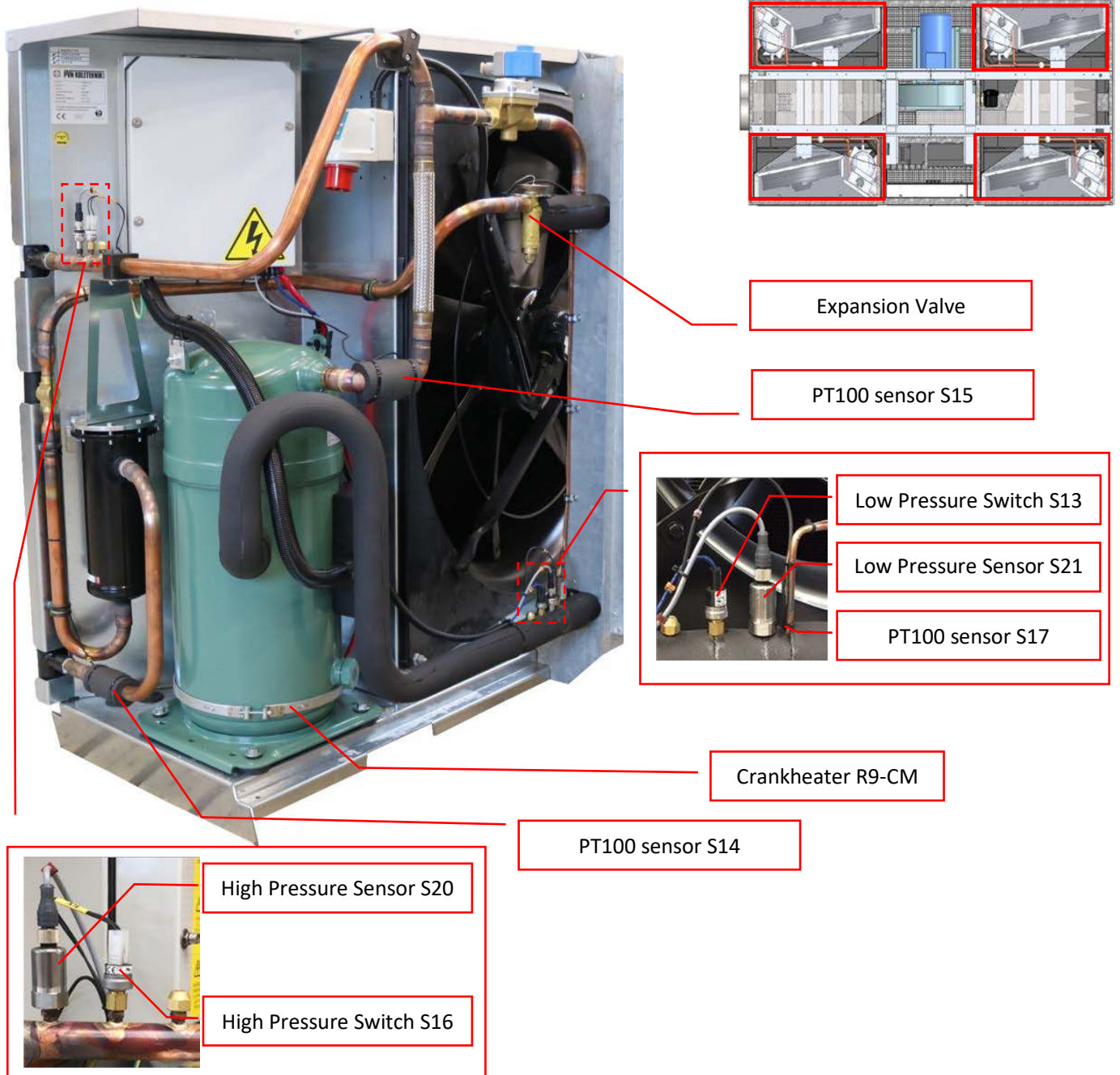

Figure 11: Cooling Module 2 of 2

\*Note: This part number differ for UL and CE configuration, check manual or contact ITW GSE support  
 Note: Please refer to last pages for part numbers

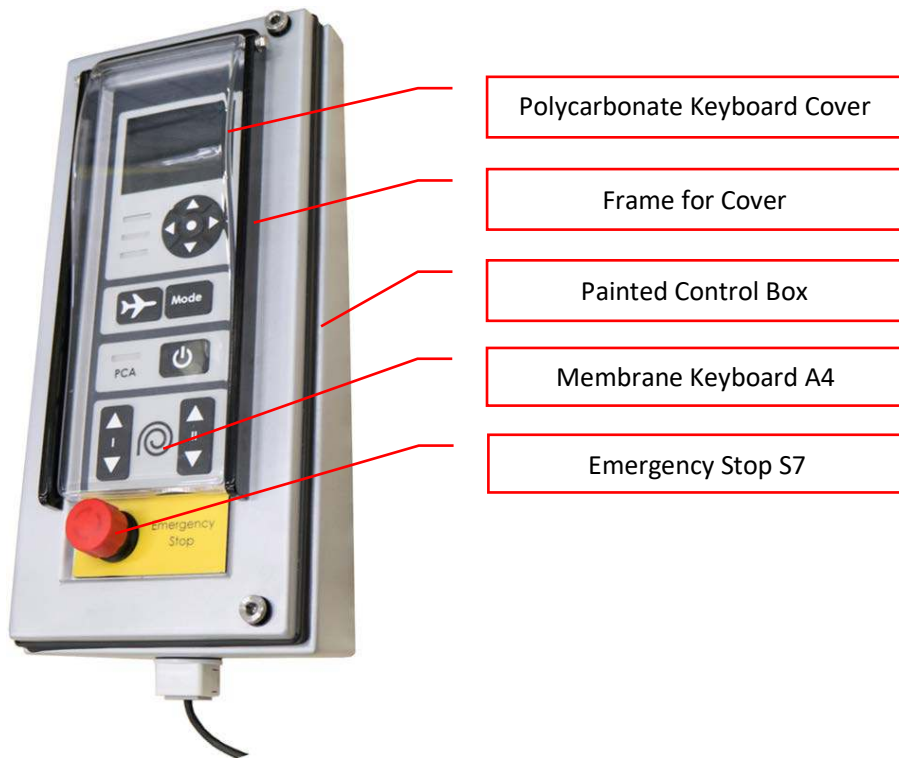

Figure 12: Remote Control Box Front

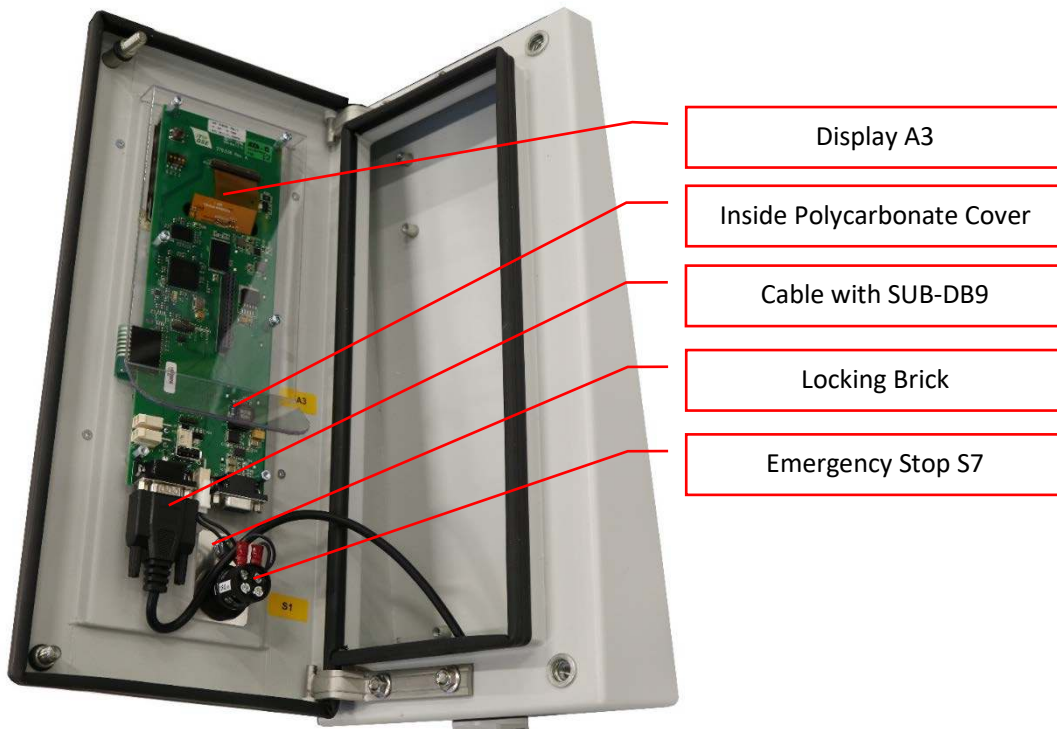

Figure 13: Remote Control Box Internal

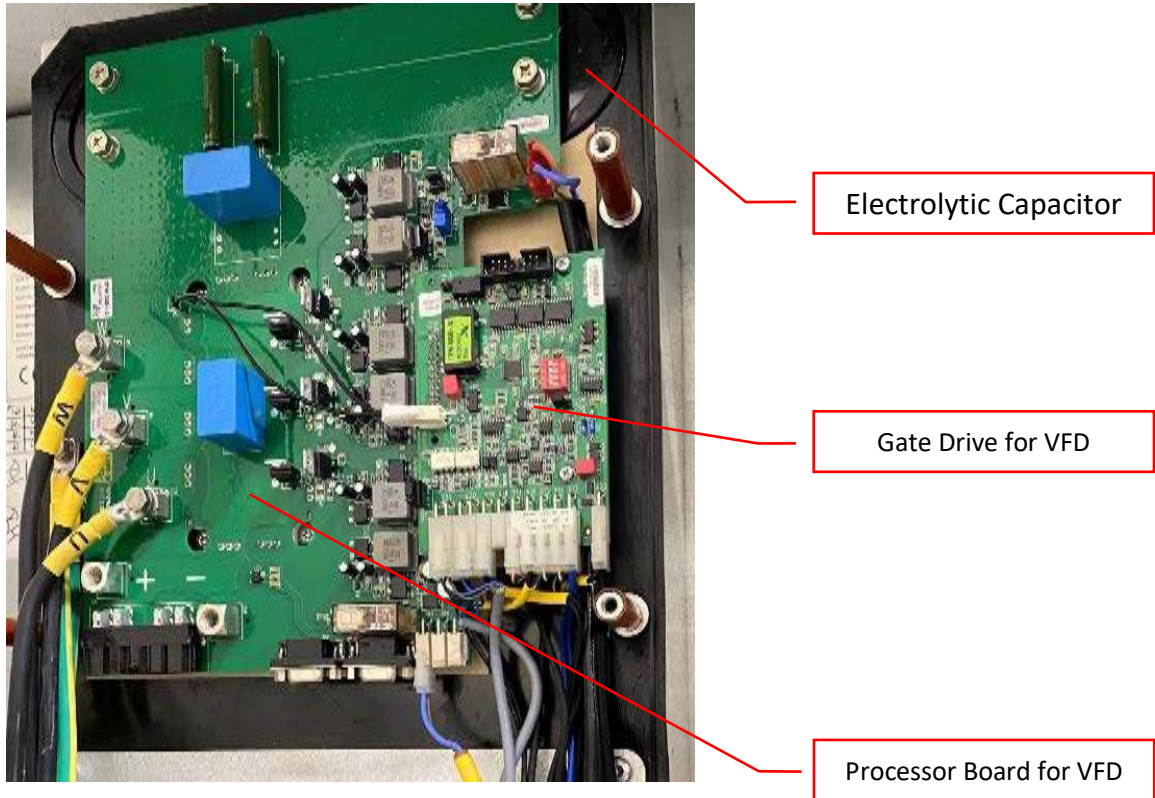

Figure 14: VFD Inside

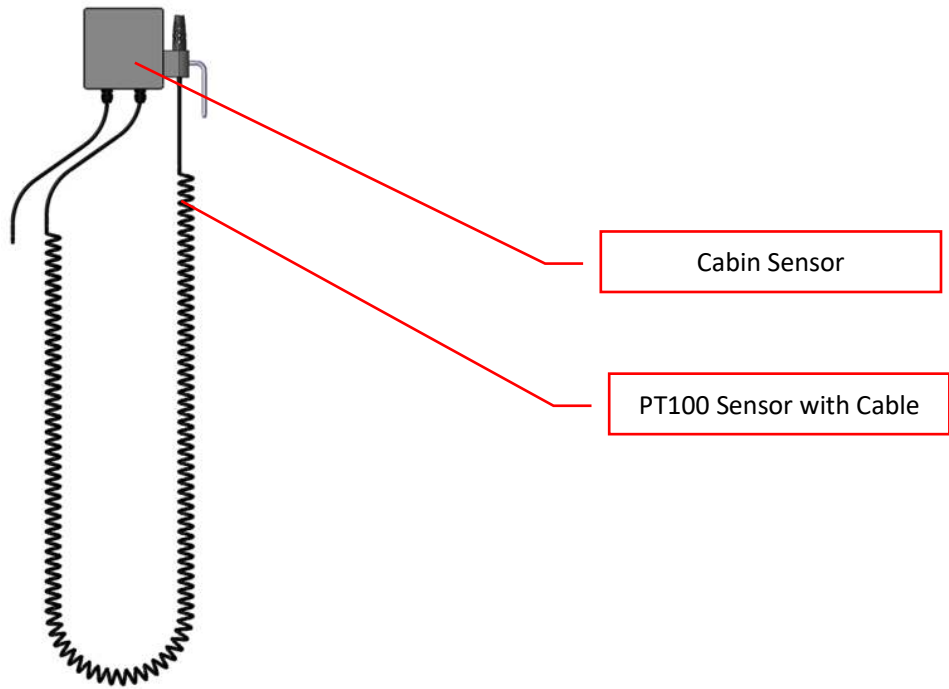

Figure 15: Cabin Sensor Optional

\*Note: This part number differ for UL and CE configuration, check manual or contact ITW GSE support  
Note: Please refer to last pages for part numbers

Comp. No.	Part No.	Description	Data
A1	579526	GSE Control Board	
A2	579555	Interfaceboard	
A3	579536	Display board	
A4	DV3026	Operator membrane keyboard	PCA Dual Hose
A5	RE2000	Residual Current Monitor	0.03-30 A, 50-60 Hz
A7	572315	VFD for cooling module	100 A
A8	572317	VFD with fan	100 A
A9	572409	DC Module w/o Heater Control	PCA210
A9	572408	DC Module with Heater Control	PCA210
A10	NA	Heating Unit	
A11	572315	VFD for cooling module	100 A
A20	579546	Heater Drive	
C1	KP0490	Snubber Capacitor	1 $\mu$ F 1000VDC 10%
CM1-CM4	572507	Cooling Module HGBP UL	R410A og HGBP
F1-F3	SI4931	Semi conductor fuse	630A/690V
F10-F19	SI1220	Fuse	20A, 1000VDC (10x38)
F1-F4 A2	SI2076	ATO fuse	2A
F5-F6 A2	SI2066	ATO fuse	10A
G1	PS0040	DC Power Supply	24-28 Vdc / 40 A
K1	RE4424	Relay Module	250 V AC/DC, NC/NO
L1	DR0020	Input Choke	175 $\mu$ H, 250 A
M11	AM4009	Bitzer GSD80295 compressor	380V/3ph/60Hz
*M2	VN0309	Centrifugal Fan CE	3x400V 50Hz 45 kW 2P
*M2	VN0307	Centrifugal Fan UL	3x400V 50Hz 45 kW 2P
M3-M4	VN0018	Fan	24 VDC (16-30 VDC)
M5-M8	AE2030	Water pump	24 VDC
M9	GM0012	Damper Motor	5 Nm, 24 VDC, 35 sec
Q1	AF0272	Disconnect Switch	3 pol. / 630 A
Q1	AF0273	Handle for direct mounting	Operating angle 90°
Q2	KO4355	Contactora	250-500V 50-60Hz
Q3	DP1231	MCB	63 A, 690 Vac, 3-pol
Q4-Q7	KO4378	Contactora	24 Vdc Coil Voltage
Q4-Q7	KO4379	Thermal O/L Relay	10-14 A adjust.
Q8	KO4376	Contactora	Coil: 24 VDC
Q9	DP1234	MCB	10 A, 480 Vac, 3-pol
Q12	KO4006	Contactora	24 VDC Coil
Q20	AM4044	HGBP valve for R410A	45 bar CU - UL

R7-R8	VR7510	Varistor	S20K510
R9 - CM	AM4011	Crankheater	24VDC 140W ø305x20
R9	MO0595	Power Resistor	22 Ohm, cURus
RFI	579504	Input RFI board	300V (Phase-Neutral)
S1	AE2004	PT100 sensor, fast	2,5m kabel
S3	AE2009	Pressure Switch	100-1000 Pa
S4	AE2024	Pressure Transmitter	0-500 Pa, 0-1000 Pa
S5	AE2013	Pressure Transmitter	0-12000 Pa / 0-10 V
S6	AE2020	Smoke Detector	-
S7	AF0403	Emergency stop, compact	
S8-S9	AF0501	Proximity sensor	NO, 4.0 mm distance
S10	AE2004	PT100 sensor, fast	2,5m kabel
S13	AM4024	Low Pressure Switch	O: 35 Cl.: 60 psig
S14-S15	AE2000	PT100 sensor	5 m cable
S16	AM4025	High Pressure Switch	O: 665 Cl.: 565 psig
S17	AE2000	PT100 sensor	5 m cable
S20	AM4028	High Pressure Sensor	0-60 bar
S21	AM4027	Low Pressure Sensor	0-16 bar
S2X	AE2004	PT100 sensor, fast	2,5m kabel
T1	IT0803	Input 12-pulse Transformer	Input 3x550, 240 A
T2	IT0401	Current Transformer	400/0.2A 3,5VA Cl.1
T5	IT0804	Auto Transformer	3x400-480/550V, 240A
*T6	IT7005	Current Transformer (CE)	(1):1000 - 100 Arms
*T6	IT7006	Current Transformer (UL)	V3 1000/1A(100/0.1A)
T7	IT0300	Current Transformer	ø110 mm, 100mA-1250A
T11	IT7006	Current Transformer	V3 1000/1A(100/0.1A)
TR1	TR7010	Thermostat	110±3 °C, NC
TR2	TR7007	Thermostat	90±3 °C, NC
TR3	TR7014	Thermostat	NC, 100.000 cycles
V11	DI0068	Zenerdiode	TVS, 12V, 600W
VFD	579513	Gate Drive for VFD	A7 – A8 – A11
VFD	579522	Processorboard for VFD	A7 – A8 – A11
VFD	EL3414	Electrolytic Capacitor	A7 – A8 – A11
Figure 1	272452	Condenser Coil UL	HWD: 1295x1617x38
Figure 1	272419	Door for electrical zone High	
Figure 1	272420	Door for electrical zone Low	
Figure 1	272427	Module protection grit	
Figure 1	272407	Air intake cover	
Figure 3	DI2600	Diode	1A 1000V

Figure 6	AE2014	Flow Measure Sensor	Length 400 mm
**Figure 6	AE2021	Tube for Smoke Detector	Up to 1 ft.
Figure 7	AM5012	Compact Filter - Standard	M6 / ePM10/ MERV 11
Figure 7	EMEA AM5013	Compact Filter – Optional	F8 / ePM1 / MERV 14
Figure 7	Americas FA11838	Compact Filter – Optional	F8 / ePM1 / MERV 14
Figure 10	AM4036	Filter Drier, Core	48-DM
Figure 10	VN0308	Axial-flow fan UL	3 x 230/400 V, 50 Hz
Figure 10	272451	Evaporator Coil UL	HWD: 1143x193x764
Figure 11	AM4026	Expansion Valve	R410A
Figure 12	543172	Painted Control Box	RAL 7035
Figure 12	278164	Polycarbonate Keyboard Cover	2,2mm godstykkelse
Figure 12	278165	Frame for Cover	RAL 9005 Black
Figure 13	KB4103	Serial Cable	30m, DB9-M/F, Øy=5mm
Figure 13	278116	Inside Polycarbonate Cover	Polycarbonat plade
Figure 13	278124	Lock brick for emergency stop	1,5mm AluZink
Figure 15	272904	PT100 sensor with cable	Spiral cable L=6000mm
Figure 15	572810	Cabin Sensor	4-20 mA / 0-50 °C

\*Note: This part numbers differ for UL and CE configuration, check manual or contact ITW GSE support

\*\* Note: Parts not illustrated.